



PLANNING DIVISION

17575 Peak Avenue Morgan Hill CA 95037 (408) 778-6480 Fax (408) 779-7236
Website Address: www.morgan-hill.ca.gov

MITIGATED NEGATIVE DECLARATION

I. DESCRIPTION OF PROJECT:

Date: August 30, 2019

Application #s: UP2018-0015

APN: 767-17-047

Project Title: Voices Charter School

Project Location: North of Cosmo Avenue, west of Monterey Road, Morgan Hill, California

Project Proponent: Pacific West Communities, Inc.
430 E. State Street, Suite 100
Eagle, ID 83616
(949) 599-6069

Project Description: The proposed project consists of development of a kindergarten through eighth grade (K-8) public charter school, to be developed in two phases. The proposed public charter school would replace an existing charter school within the City (Voices Morgan Hill), located at 610 Jarvis Drive. Phase I would include development of a 27,825-square foot (sf) school building, an uncovered parking lot, a playground and turf play area, a lunch shelter, a 405-sf trash enclosure, and associated improvements. Phase II would replace the lunch shelter with a 7,326-sf multi-purpose building. Public access to the project site would be provided by a new driveway at Cosmo Avenue, with turn movements limited to right-in and right-out only. In addition, the project would include a separate emergency vehicle only access off Monterey Road, at the northeast portion of the site.

At full buildout (2023/2024 school year), the project would serve up to 504 students. Office hours at the proposed school would be limited to 7:30 AM to 4:30 PM, Monday through Friday. Staff would typically be on-site between 7:00 AM and 6:00 PM. In addition to typical daily operations, the proposed school would host a range of school events including, but not limited to, an annual winter celebration, one to two Kermes/Carnival celebrations per year, a kinder graduation, parent workshops, and parent fundraisers. Furthermore, an afterschool program would be provided for a limited number of students.

Water and sewer service for the proposed school would be provided by the City through connections to existing infrastructure located in the site vicinity. The site would be served by an existing fire hydrant located at the southeast portion of the site adjacent to Monterey Road and Cosmo Avenue, as well as a new hydrant to be located within the proposed parking lot. Stormwater runoff from impervious surfaces within the site would be captured by a series of drain inlets and routed, by way of new underground storm drain piping, to a series of four bio-retention basins located within the eastern portion of the site. The bio-retention basins

would treat and detain all on-site runoff prior to discharging to the City's existing stormwater drain located in Cosmo Avenue.

In order to develop the proposed public charter school within the Mixed Use Flex (MU-F) zoning district, the project would require approval of a Conditional Use Permit (CUP). The project would be consistent with the site's current General Plan land use and zoning designations. The project requires the City's approval of the following entitlements:

- Adoption of an IS/MND and Mitigation Monitoring and Reporting Program; and
- Approval of a Conditional Use Permit.

In addition, subsequent to approval of the above entitlements, the project applicant would be required to obtain a Design Review Permit for approval of a site plan, building elevations, and landscape plans.

II. DETERMINATION

In accordance with the City of Morgan Hill procedures for compliance with the California Environmental Quality Act (CEQA), the City has completed an Initial Study to determine whether the proposed project may have a significant adverse effect on the environment. On the basis of that study, the City makes the following determination:

- Although the project, as proposed, could have had a significant effect on the environment, there will not be a significant effect in this case because mitigation measures will be included in the project, and, therefore, this **MITIGATED NEGATIVE DECLARATION** has been prepared.

III. MITIGATION AND AVOIDANCE MEASURES

A. Biological Resources

- IV-1. A pre-construction survey shall be conducted by a qualified Burrowing Owl biologist no more than 30 days prior to initiation of any ground disturbing (construction) activity to assure take avoidance of burrowing owls. The survey shall consist of a habitat assessment, burrow survey, owl survey, and completion of a written report. The written report shall be submitted to the City of Morgan Hill Development Services Department. If owls are not determined to be present on-site, further mitigation is not required. If owls are observed during the preconstruction survey, no impacts to the owls or their habitat will be allowed during the nesting season (February 1 to August 31), and Mitigation Measures IV-2 and IV-3 shall be implemented.*
- IV-2. Should burrowing owls be found on the site during the breeding season (February 1 through August 31), exclusion zones, with a 250-foot radius from occupied burrows, shall be established. All development-related activities shall occur outside of the exclusion area until the young have fledged. Establishment of the exclusion area shall be determined by a qualified biologist to the satisfaction of the City of Morgan Hill Development Services Department.*
- IV-3. If pre-construction surveys are conducted during the non-breeding season (September 1 through January 31) and burrowing owls are observed on the site, the project proponent shall establish a 250-foot non-disturbance buffer around occupied burrows as determined by a qualified biologist. Construction activities outside of the 250-foot buffer shall be allowed. Construction activities within the non-disturbance*

buffer shall be allowed if the following criteria are met in order to prevent owls from abandoning important overwintering sites:

- *A qualified biologist monitors the owls for at least three days prior to construction to determine baseline foraging behavior (i.e., behavior without construction).*
- *The same qualified biologist monitors the owls during construction and finds no change in owl foraging behavior in response to construction activities.*
- *If any change in owl foraging behavior occurs as a result of construction activities, such activities shall cease within the 250-foot buffer.*
- *If the owls are gone for at least one week, the project proponent may request approval from the Habitat Agency that a qualified biologist excavate usable burrows to prevent owls from reoccupying the site. After all usable burrows are excavated, the buffer zone shall be removed, and construction may continue. Monitoring shall continue as described above for the non-breeding season as long as the burrow remains active.*

Passive relocation of owls shall not be permitted unless the positive growth trend described in Section 5.4.6 of the SCVHP is achieved and all passive relocation measures identified in the SCVHP are implemented. The project applicant may choose to obtain an exception that would allow for passive relocation, in which case an application shall be submitted to the Habitat Agency along with a passive relocation plan in accordance with Section 6.6.1, Condition 15, Exceptions to Passive Relocation Prohibition, of the SCVHP. The Habitat Agency shall have the final authority to grant or deny the requested exception.

- IV-4. *If construction is proposed during breeding season (February 1 to August 31), a pre-construction nesting survey for raptors and other protected migratory birds shall be conducted by a qualified biologist and submitted to the City of Morgan Hill Development Services Department for review no more than 14 days prior to the start of construction. Pre-construction surveys during the non-breeding season (September 1 to January 31) are not necessary for birds, including roosting raptors, as they are expected to abandon their roosts during construction. If these species are deemed absent from the area, construction may occur within 14 days following the survey during the early nesting season (February to May) and within 30 days following the survey during the late nesting season (June to August).*

If nesting raptors are detected on or adjacent to the site during the survey, a suitable construction-free buffer shall be established around all active nests. The precise dimension of the buffer (250-foot minimum for certain raptors) shall be determined by the qualified biologist at that time and may vary depending on location, topography, type of construction activity, and species. The buffer areas shall be enclosed with temporary fencing, and construction equipment and workers shall not enter the enclosed setback areas. Buffers shall remain in place for the duration of the breeding season or until it has been confirmed by a qualified biologist that all chicks have fledged and are independent of their parents.

- IV-5. *The project applicant shall mitigate for the removal of the Ordinance Sized Tree located at the eastern portion of the site along Monterey Road, as identified in the tree survey prepared for the proposed project, by providing an on-site replacement planting at a minimum 1:1 ratio with 15-gallon minimum size trees.*

For the Ordinance Sized Trees within the southwestern corner of the site, which are to be preserved as part of the project, the project applicant shall retain a certified arborist to prepare a tree protection plan, subject to review and approval by the Development Services Department. The plan shall demonstrate how any retained trees are to be protected during and after construction. The tree protection plan may include, but not be limited to, the following:

- *Locate structures, grade changes, etc. as far as feasible from the 'dripline' area of the tree.*
- *Avoid root damage through grading, trenching, compaction, etc., at least within an area 1.5 times the 'dripline' area of trees. Where root damage cannot be avoided, roots encountered (over one inch in diameter) should be exposed approximately 12 inches beyond the area to be disturbed (towards tree stem), by hand excavation, or with specialized hydraulic or pneumatic equipment, cut cleanly with hand pruners or power saw, and immediately back-filled with soil. Tearing, or otherwise disturbing the portion of the root(s) to remain, shall be avoided.*
- *A temporary fence shall be constructed as far from the tree stem (trunk) as possible, completely surrounding the tree, and six to eight feet in height. 'No parking or storage' signs shall be posted outside/on the fencing. Postings shall not be attached to the main stem of the tree.*
- *Vehicles, equipment, pedestrian traffic, building materials, debris storage, and/or disposal of toxic or other materials shall not be permitted inside of the fenced off area.*
- *The project applicant shall avoid pruning immediately before, during, or immediately after construction impact. Perform only that pruning which is unavoidable due to conflicts with proposed development. Aesthetic pruning should not be performed for at least one to two years following completion of construction.*
- *Trees that will be impacted by construction may benefit from fertilization, ideally performed in the fall, and preferably prior to any construction activities, with not more than six pounds of actual nitrogen per 1,000 square feet of accessible 'drip line' area or beyond.*
- *The 'rooting' area shall be mulched with an acidic, organic compost or mulch.*
- *The project applicant shall arrange for periodic (Biannual/Quarterly) inspection of tree's condition, and treatment of damaging conditions (insects, diseases, nutrient deficiencies, etc.) as such conditions occur, or as appropriate.*
- *Subject to the discretion of the Development Services Department, individual trees likely to suffer significant impacts may require specific, more extensive efforts and/or a more detailed specification than those contained within the above general guidelines.*

IV-6. No later than submittal of the first construction or grading permit for the proposed project the owner or designee shall pay the Santa Clara Valley Habitat Plan per-acre fee in effect for the appropriate fee zone of the project site, as determined by the Santa Clara Valley Habitat Agency, in compliance with Section 18.132.050 of the Morgan Hill Municipal Code.

IV-7. Implement Mitigation Measures IV-1 through IV-5.

B. Hydrology and Water Quality

X-1. Prior to submittal to the RWQCB, the Storm Water Pollution Prevention Plan (SWPPP) prepared for the proposed project shall include, to the satisfaction of the City Engineer, Best Management Practices (BMPs) designed to limit the discharge of sediment or other pollutants to West Little Llagas Creek. Such BMPs shall include, but not necessarily be limited to, the installation of silt fencing at the limit of the proposed grading activities.

C. Noise

XIII-1. Noise-generating construction activities associated with the proposed project shall not occur within the hours identified in Municipal Code Section 8.28.040(D). The above language shall be included on final project improvement plans prior to approval by the City of Morgan Hill Development Services Department.

XIII-2. To the maximum extent practical, the following measures should be implemented during project construction:

- All noise-producing project equipment and vehicles using internal-combustion engines shall be equipped with manufacturers-recommended mufflers and be maintained in good working condition;*
- All mobile or fixed noise-producing equipment used on the project site that are regulated for noise output by a federal, State, or local agency shall comply with such regulations while in the course of project construction;*
- Electrically powered equipment shall be used instead of pneumatic or internal-combustion-powered equipment, where feasible;*
- Material stockpiles and mobile equipment staging, parking, and maintenance areas shall be located as far as practicable from noise-sensitive receptors;*
- Project area and site access road speed limits shall be established and enforced during the construction period; and*
- Nearby residences shall be notified of construction schedules so that arrangements can be made, if desired, to limit their exposure to short-term increases in ambient noise levels.*

The above requirements shall be included via notation on project grading plans, subject to review and approval by the Development Services Department.

D. Transportation

XVII-1. Prior to submittal of the improvement plans for the project, the project plans shall show the construction of a raised median along Monterey Road at San Pedro Avenue, restricting left-turns out of San Pedro Avenue to southbound Monterey Road. With the left-turn restriction, only right-turns in and out at both San Pedro Avenue (east leg of the intersection) and the existing driveway (west leg of the intersection), as well as southbound left-turns, shall be allowed. The design of the median shall be to the satisfaction of the Engineering and Utilities Division.

XVII-2. Final project improvement plans prepared for the proposed project shall include, to the satisfaction of the City Engineer, installation of a crosswalk at the northern leg of the Monterey Road/Cosmo Avenue intersection and protected phasing on all

approaches of the intersection, including modifying the traffic signal to include protected left-turn phasing on the northbound and southbound approaches and split phasing on the eastbound and westbound approaches.

XVII-3. *The following conditions shall be noted on project construction drawings, to the satisfaction of the City Engineer, prior to issuance of a building permit or approval of improvement plan:*

- *During morning drop-off times at the proposed project, school staff or parent volunteers shall be stationed along the drop-off area to assist students in and out of vehicles and improve drop-off procedures efficiency. Additionally, in order to speed up student pick-up, parents picking up students shall place a name card on the passenger side visor showing the last name and grade level of the child being picked-up so that school staff, positioned at the project driveway, can radio ahead to staff at the drop-off area the name of the student being picked up to ensure the student is ready for pick-up by the time the parent reaches the drop-off area.*
- *Measures shall be taken to ensure efficient utilization of the available queue storage space within the project site and the efficient and safe loading/unloading of the students. The drop-off/pick-up area shall be well-defined with implementation of appropriate signage and pavement markings clearly showing the student loading zone and each vehicle position. The loading lane shall be designed to provide the maximum loading area possible. During drop-off times, school staff shall be positioned along the drive aisle to ensure that students do not unload outside of the designated loading zone.*
- *On-street parking along the southern project site frontage on Cosmo Avenue shall be prohibited. The on-street parking restriction may be permanent (red curb) or time-restricted to the school peak hours only.*
- *The proposed charter school shall implement 30-minute staggered start times; specifically, a start time of 8:00 AM for upper grade levels (sixth through eighth grades) and 8:30 AM for lower grade levels (kindergarten through fifth grades).*

XVII-4. *Final project improvement plans prepared for the proposed project shall demonstrate that double solid striping shall be installed on Cosmo Avenue, along the project frontage to the intersection of Monterey Road/Cosmo Avenue, to prohibit left-turn movements from eastbound and westbound Cosmo Avenue into and out of the project site driveway. The plans shall be reviewed and approved by the City Engineer.*

III. FINDING

The City of Morgan Hill hereby finds that the proposed project could have a significant effect on the environment; however, there would not be a significant effect in this case because mitigation measures summarized above and described in the initial study will reduce the impacts to a less-than-significant level.



Jennifer Carman, Development Services Director

8-22-19

Date

INITIAL STUDY

VOICES CHARTER SCHOOL PROJECT MORGAN HILL, CALIFORNIA

PREPARED FOR
CITY OF MORGAN HILL
DEVELOPMENT SERVICES DEPARTMENT
17575 PEAK AVENUE
MORGAN HILL, CA 95037

AUGUST 2019

PREPARED BY



1501 Sports Drive, Suite A, Sacramento, CA 95834

TABLE OF CONTENTS

SECTION 1. PROJECT INFORMATION	1
SECTION 2. PROJECT DESCRIPTION	1
SECTION 3. SOURCES	14
SECTION 4. EVALUATION OF ENVIRONMENTAL IMPACTS	16
<i>I. AESTHETICS</i>	20
<i>II. AGRICULTURE AND FOREST RESOURCES</i>	23
<i>III. AIR QUALITY</i>	24
<i>IV. BIOLOGICAL RESOURCES</i>	33
<i>V. CULTURAL RESOURCES</i>	42
<i>VI. ENERGY</i>	45
<i>VII. GEOLOGY AND SOILS</i>	49
<i>VIII. GREENHOUSE GAS EMISSIONS</i>	53
<i>IX. HAZARDS AND HAZARDOUS MATERIALS</i>	55
<i>X. HYDROLOGY AND WATER QUALITY</i>	58
<i>XI. LAND USE AND PLANNING</i>	71
<i>XII. MINERAL RESOURCES</i>	72
<i>XIII. NOISE</i>	73
<i>XIV. POPULATION AND HOUSING</i>	90
<i>XV. PUBLIC SERVICES</i>	91
<i>XVI. RECREATION</i>	93
<i>XVII. TRANSPORTATION</i>	94
<i>XVIII. TRIBAL CULTURAL RESOURCES</i>	119
<i>XIX. UTILITIES AND SERVICE SYSTEMS</i>	120
<i>XX. WILDFIRE</i>	124
<i>XXI. MANDATORY FINDINGS OF SIGNIFICANCE</i>	126

FIGURES

Figure 1: Regional Project Location	2
Figure 2: Project Vicinity Map	3
Figure 3: Site Plan – Phase I.....	5
Figure 4: Building Elevations – Phase I	6
Figure 5: Site Plan – Phase II.....	7
Figure 6: Building Elevations – Phase II	8
Figure 7: Proposed School Building – First and Second Floors	9
Figure 8: Proposed Multi-Purpose Building – Phase II	10
Figure 9: Landscape Schematic Master Plan – Phase I	12
Figure 10: Landscape Schematic Master Plan – Phase II.....	13
Figure 11: Stormwater Control Plan	61
Figure 12: Pre-Project 100-Year Flood Conditions	67
Figure 13: Post-Project 100-Year Flood Conditions	69

Figure 14: Noise Measurement Locations	74
Figure 15: Study Intersection Locations	95

TABLES

Table 1: BAAQMD Thresholds of Significance	25
Table 2: Maximum Construction Emissions (lbs/day)	26
Table 3: Unmitigated Maximum Operational Emissions	27
Table 4: Soil Properties.....	51
Table 5: Summary of Modeled Base Flood Elevations at the Project Site.....	65
Table 6: Long-Term Ambient Noise Level Measurement Results	75
Table 7: Noise Level Performance Standards.....	78
Table 8: Significance of Changes in Cumulative Noise Exposure	79
Table 9: Typical Construction Equipment Noise.....	80
Table 10: Off-Site Traffic Noise: Existing Plus Project	82
Table 11: Off-Site Traffic Noise: Year 2025 Plus Project.....	83
Table 12: Proposed Playground Noise Levels at Nearest Sensitive Receptors	85
Table 13: Proposed Special Event Noise Levels at Nearest Sensitive Receptors.....	86
Table 14: Groundborne Vibration Impact Criteria	88
Table 15: Vibration Source Levels for Construction Equipment	89
Table 16: Trip Generation Estimates	100
Table 17: Existing and Existing Plus Project Conditions Intersection LOS.....	101
Table 18: Cumulative and Cumulative Plus Project Conditions Intersection LOS	104
Table 19: Roadway Segment Analysis Summary.....	107
Table 20: Monterey Road and Cosmo Avenue Intersection LOS	111
Table 21: Staggered School Start Times Summary	115

APPENDICES

- Appendix A: CalEEMod Modeling Results
- Appendix B: Biological Report and Tree Survey Report
- Appendix C: Phase I Environmental Site Assessment
- Appendix D: Hydraulic Modeling and Floodplain Impacts
- Appendix E: Environmental Noise and Vibration Analysis
- Appendix F: Traffic Impact Analysis

SECTION 1. PROJECT INFORMATION

- 1.1 Project Title:** Voices Charter School
- 1.2 Lead Agency Contact:** Joey Dinh
Associate Planner
Morgan Hill, CA
17575 Peak Avenue
Morgan Hill, CA 95037
- 1.3 Project Location:** North of Cosmo Avenue,
West of Monterey Road
Morgan Hill, CA
APN 767-17-047
- 1.4 Project Applicant:** Pacific West Communities, Inc.
430 E. State Street, Suite 100
Eagle, ID 83616
(949) 599-6069
- 1.5 Existing Zoning:** Mixed Use Flex (MU-F)
- 1.6 Existing General Plan Designation:** MU-F (7 to 24 du/ac)
- 1.7 Required Approvals from Other Public Agencies:** None

SECTION 2. PROJECT DESCRIPTION

2.1 Project Location and Setting

The Voices Charter School Project (proposed project) site consists of approximately 2.02 acres located northwest of the intersection of Cosmo Avenue and Monterey Road in the City of Morgan Hill, California (see Figure 1 and Figure 2). The site is identified by Assessor's Parcel Number (APN) 767-17-047. The City's General Plan land use and zoning designation for the site is Mixed Use Flex (MU-F).

The project site is vacant and consists primarily of ruderal grasses that are regularly mowed. A narrow, channelized creek – West Little Llagas Creek – runs through the project site along the western site boundary. A temporary construction easement for the Upper Llagas Creek Flood Protection Project has been executed between the Santa Clara Valley Water District and the property owner along the western boundary of the site, contiguous with the creek. A total of two trees are located at the southwestern corner of the site, where West Little Llagas Creek flows under Cosmo Avenue through a concrete box culvert. A third tree is located along the site's eastern boundary along the Monterey Road frontage. The site is situated at approximately 350 feet above mean sea level (msl).

**Figure 1
Regional Project Location**

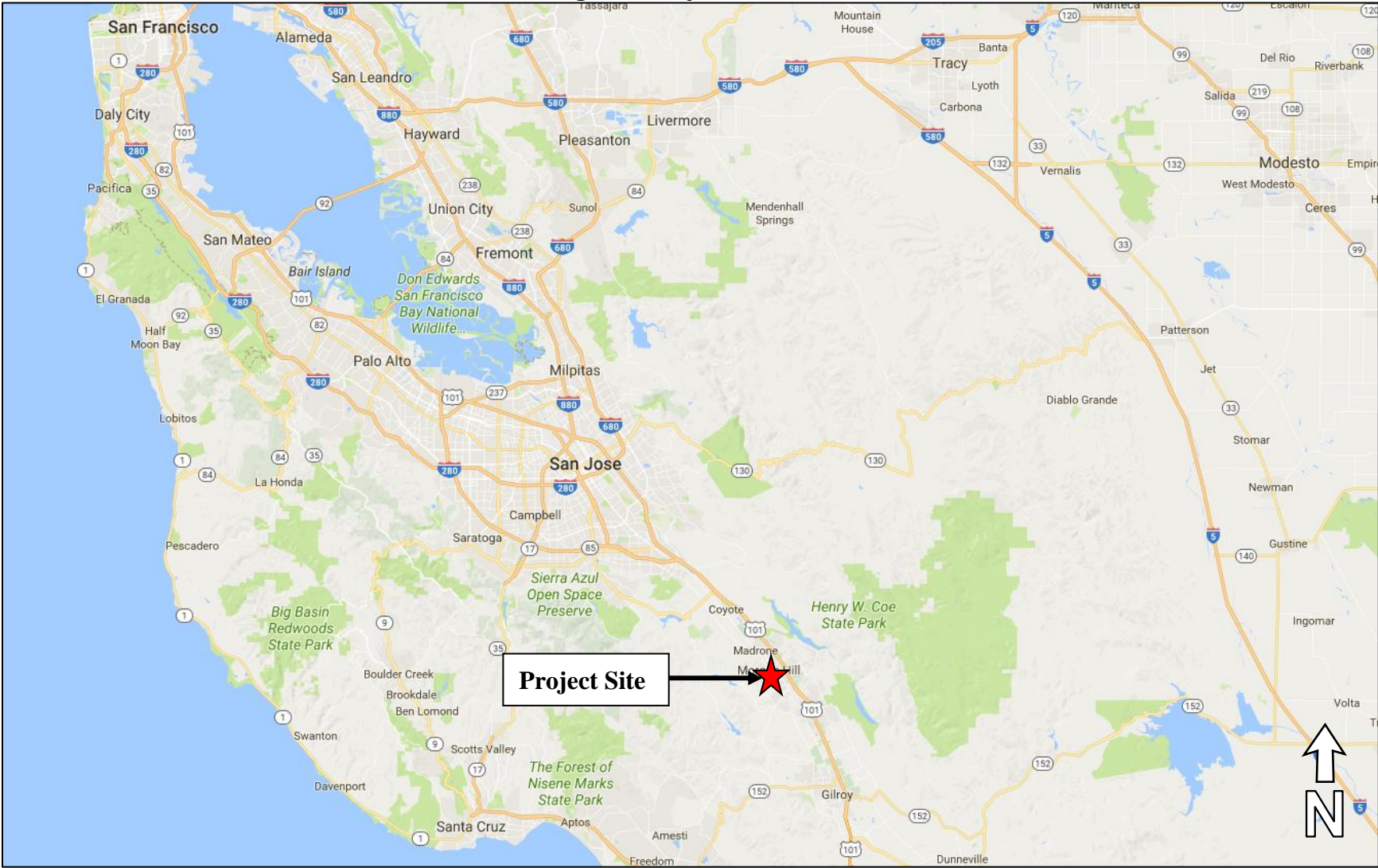
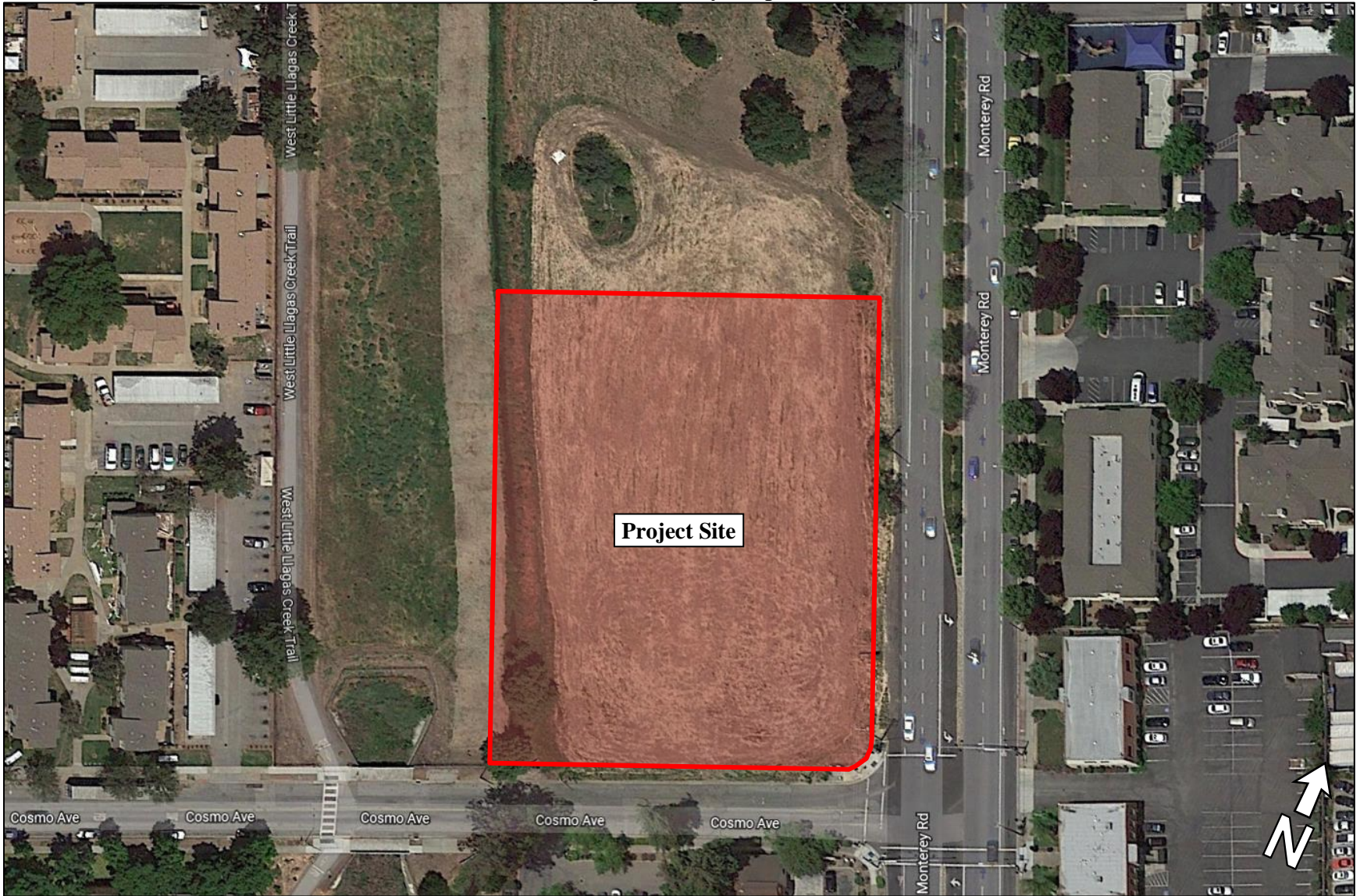

Figure 2
Project Vicinity Map



Surrounding development in the project area includes multi-family residential homes to the west, single-family homes to the northwest, commercial development to the south across Cosmo Avenue, and additional commercial development to the east across Monterey Road. The property to the north of the site is vacant and undeveloped, with scattered trees located along Monterey Road. Similar to the project site, the property to the north is designated and zoned MU-F.

A narrow strip of land designated Open Space in the City's General Plan, separates the project site from the existing residential development to the west of the site. The open space parcel contains a bicycle/pedestrian trail (West Little Llagas Creek Trail) that extends northward from Cosmo Avenue, ultimately connecting to Spring Avenue approximately 0.18-miles to the northwest of the project site.

2.2 Project Components

The proposed project consists of development of a kindergarten through eighth grade (K-8) public charter school, to be developed in two phases. The proposed public charter school would replace an existing charter school within the City (Voices Morgan Hill), located at 610 Jarvis Drive. Phase I would include development of a school building, an uncovered parking lot, a playground and turf play area, a lunch shelter, a 405-square foot trash enclosure, and associated improvements (see Figure 3 and Figure 4). Phase II would replace the lunch shelter with a multi-purpose building (see Figure 5 and Figure 6). In order to develop the proposed public charter school within the MU-F zoning district, the project would require approval of a Conditional Use Permit (CUP).

Proposed Buildings

Within the northern portion of the site, the project would include development of a 27,825-square foot two-story school building with 18 classrooms (see Figure 7). The building would include a total height of approximately 31 feet, not including mechanical equipment screening to be included on the rooftop. The ground floor of the building would include office/administrative space, an 884 square foot food servery, restrooms, and eight classrooms. The second floor would include a teacher's room, additional restrooms, and ten classrooms. Each of the classrooms would be accessed by exterior walkways/balconies.

Phase I of the proposed project would include construction of two covered lunch shelters in the southeast portion of the project site. As part of Phase II, the lunch shelters would be replaced with a 7,326 square foot multi-purpose building (see Figure 8). The building would include a multi-purpose room, a reading room, a special education room, storage space, and two bathrooms.

Parking, Access, and Circulation

Parking for the proposed project would be provided by an uncovered parking area located at the northwestern portion of the site adjacent to the proposed school building. The proposed parking lot would include a total of 35 parking spaces and include two Americans with Disabilities Act (ADA)-compliant spaces, oriented around a circular drive aisle. The eastern portion of the parking lot would include a designated student drop-off area adjacent to the proposed school building.

**Figure 3
Site Plan – Phase I**

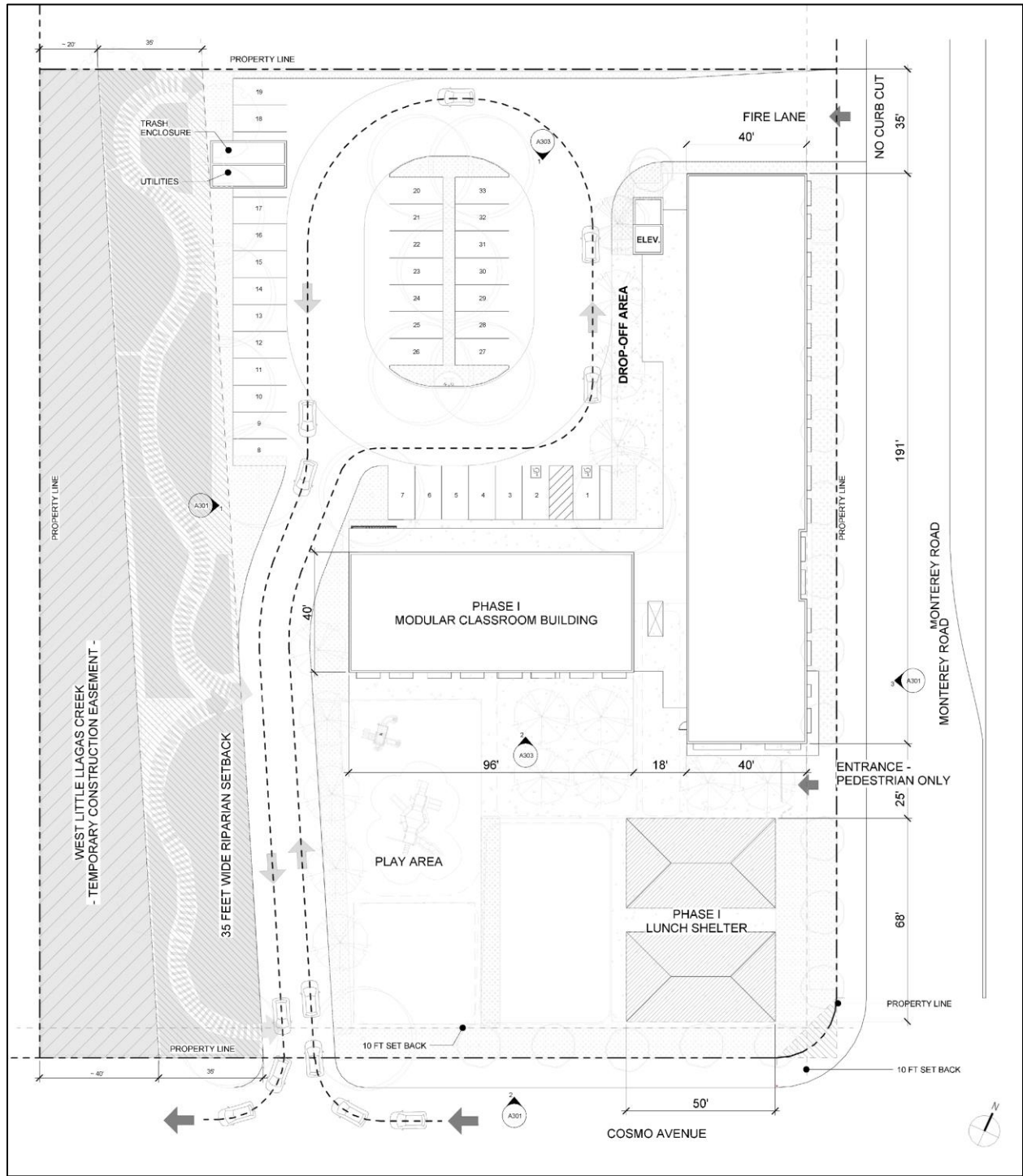

Figure 4
Building Elevations – Phase I

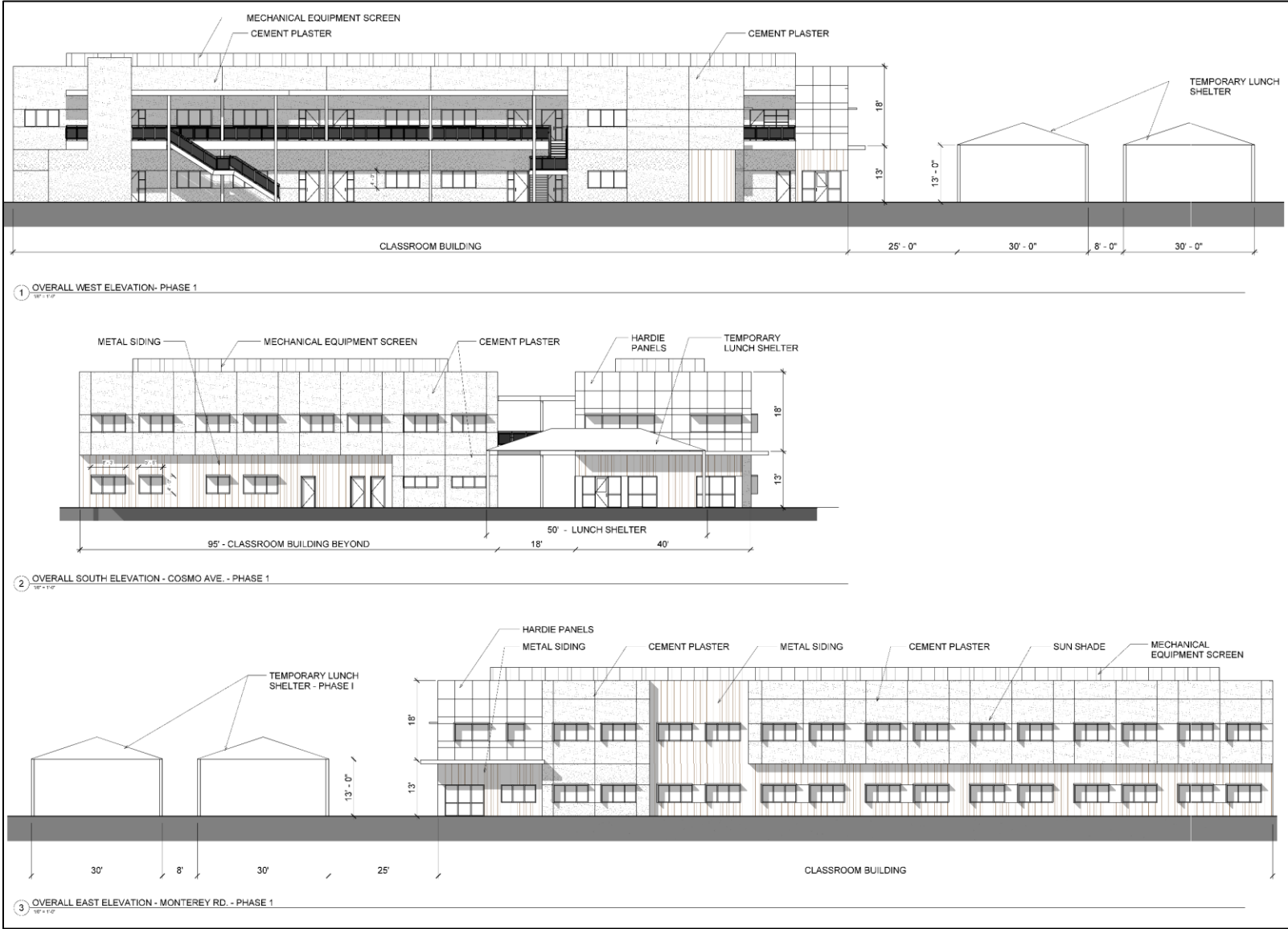

Figure 5
Site Plan – Phase II

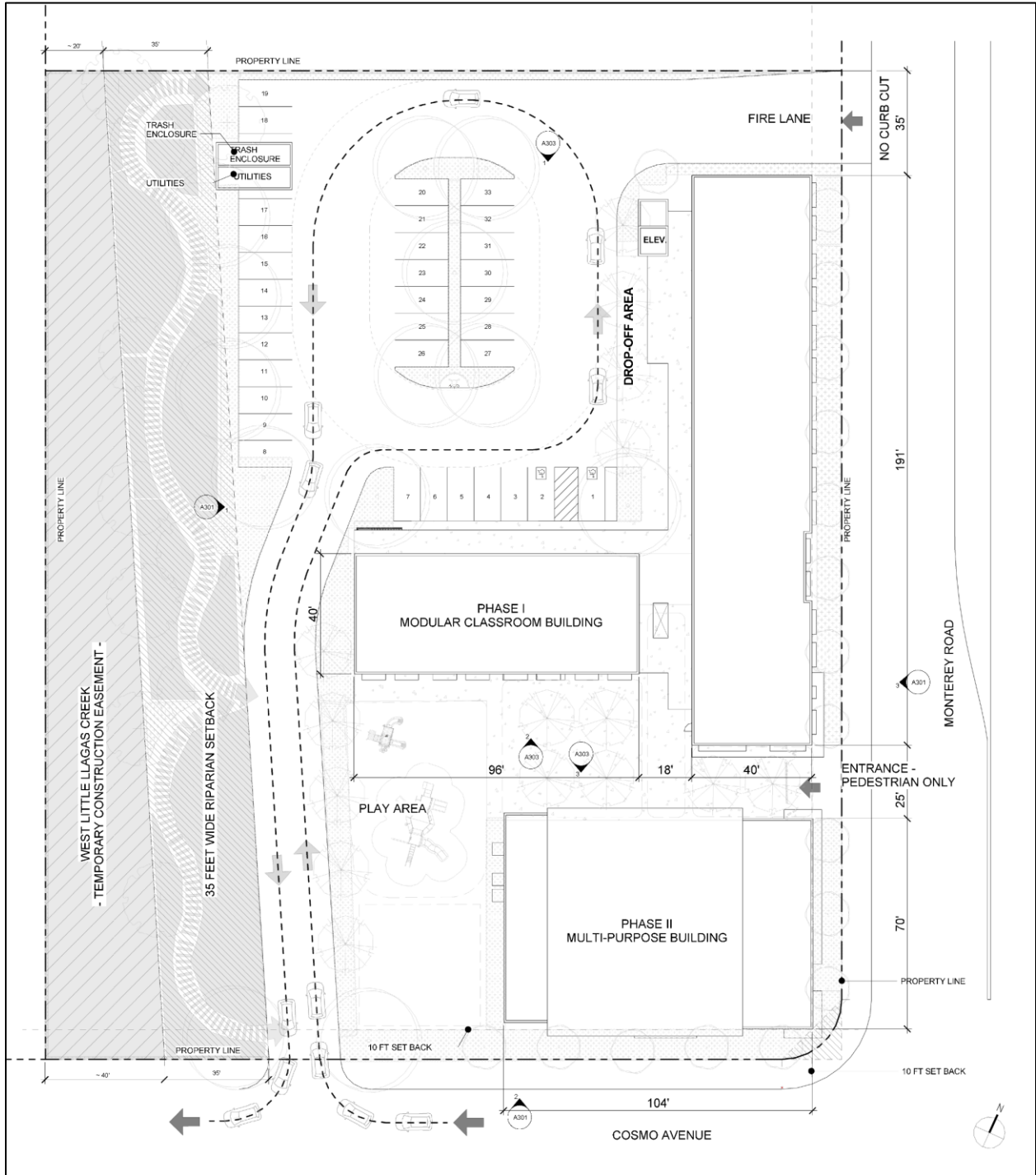

Figure 6
Building Elevations – Phase II

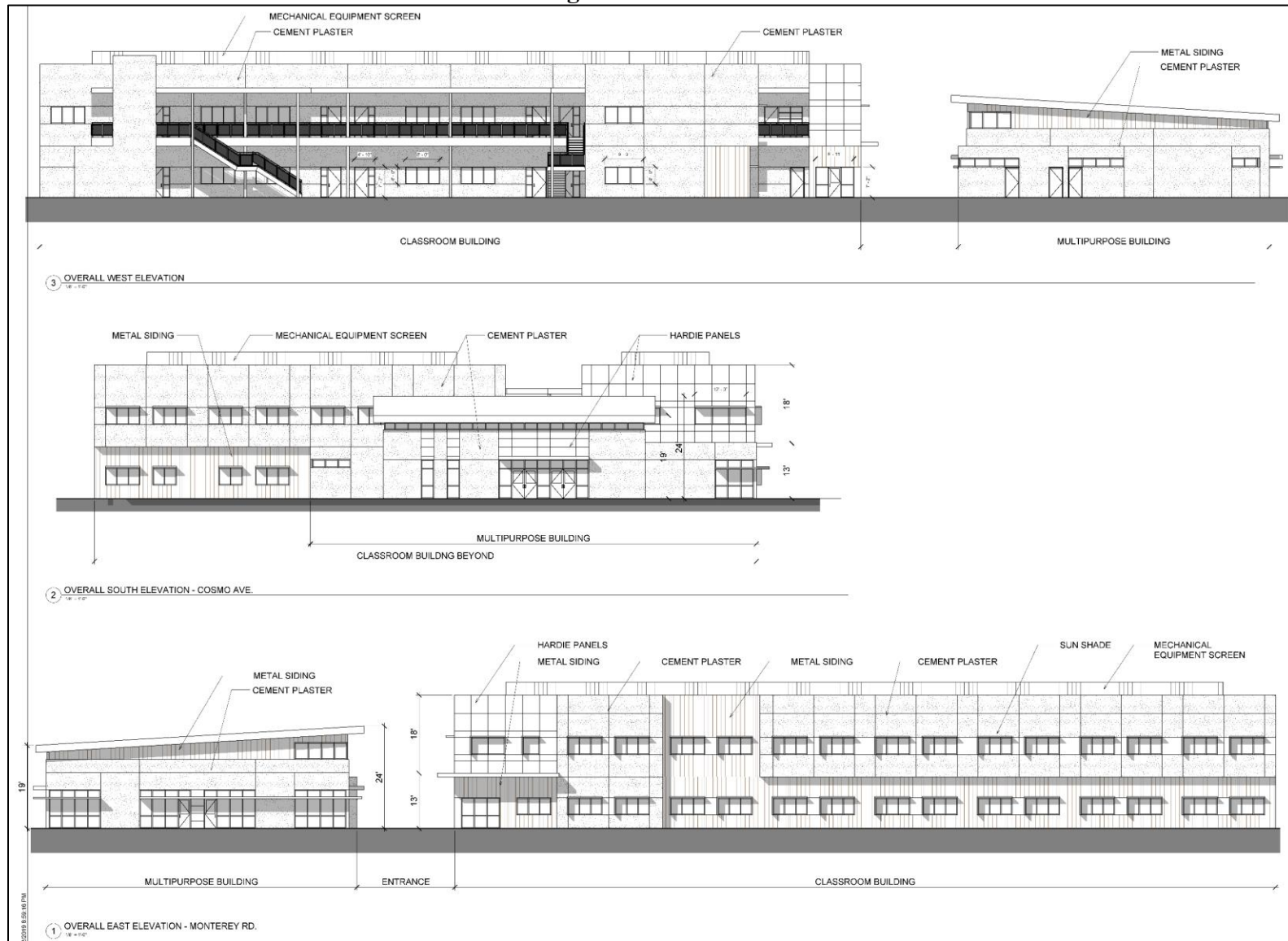
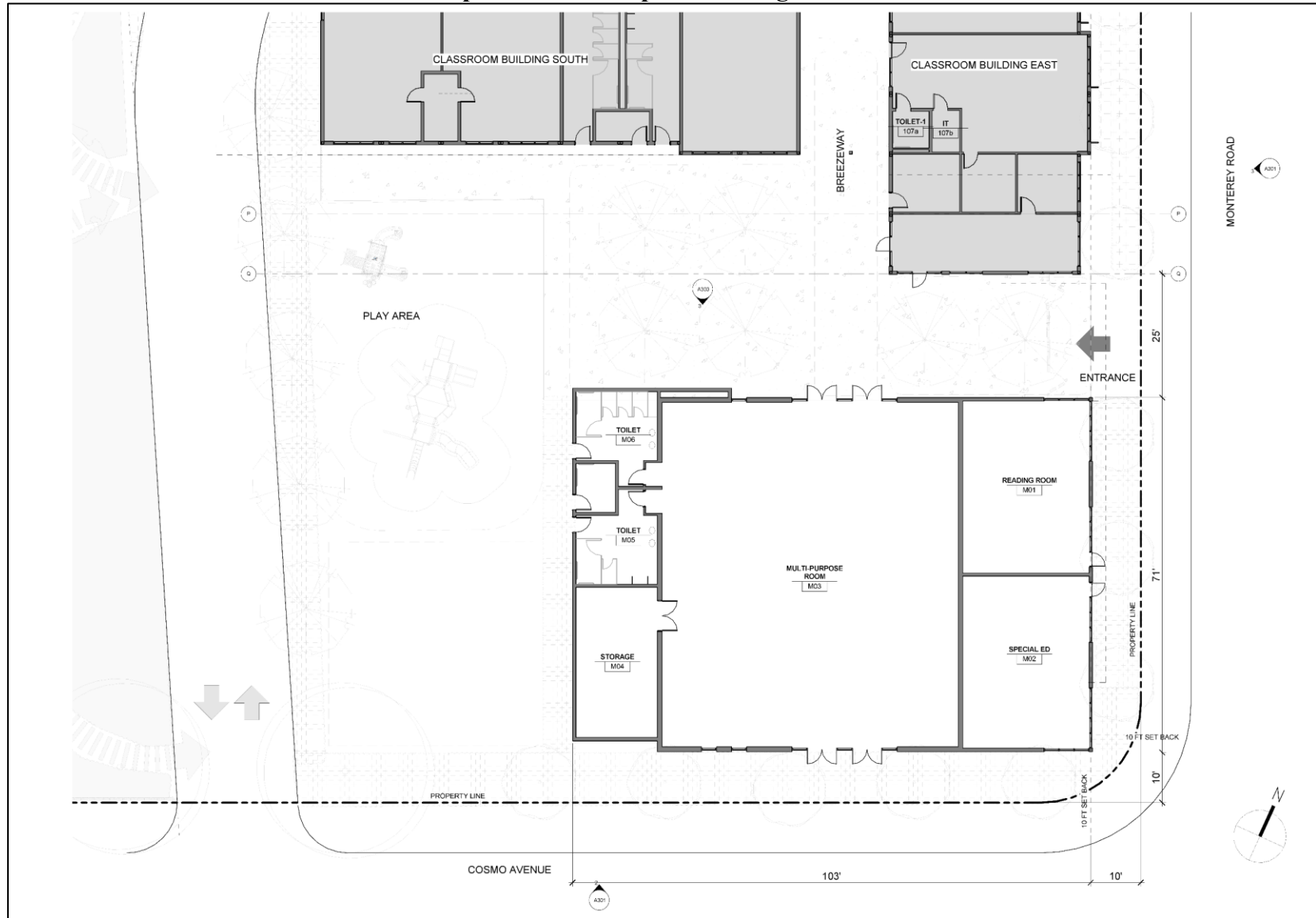

Figure 7
Proposed School Building – First and Second Floors



Figure 8
Proposed Multi-Purpose Building – Phase II



A total of three alternative site access scenarios were initially considered for the proposed project. Based on the results of a Traffic Impact Analysis prepared for the project by Hexagon Transportation Consultants, Inc., and input from the City, one preferred alternative has been evaluated in this Initial Study.

Access to the project site would be provided by a new 24-foot-wide driveway off Cosmo Avenue connecting to the proposed parking lot. Vehicles would enter the project site from the driveway at Cosmo Avenue, circle through the parking lot to the drop-off area, and exit the site by way of the same driveway. The Cosmo Avenue driveway would be limited to right-in, right-out turning movements only. Thus, all outbound project traffic would head westbound on Cosmo Avenue to Del Monte Avenue or Olympic Drive, away from the Monterey Road/Cosmo Avenue intersection. In addition, the project would include a separate fire lane access off Monterey Road at the northeast portion of the site. Sidewalks would be provided along the project frontages at Cosmo Avenue and Monterey Road.

Landscaping and Open Space

Consistent with Section 18.64.050 of the City's Municipal Code, landscaping would be provided throughout the site in accordance with the City's minimum landscape requirements for non-residential zones. For example, the project would include planting of drought-tolerant native plant species along the project frontages at Cosmo Avenue and Monterey Road (see Figure 9). The western portion of the site within the existing temporary construction easement, as well as a 35-foot-wide buffer east of the easement required by the Santa Clara Valley Habitat Plan (SCVHP), would be planted with native riparian vegetation and retained as open space. A meandering five-foot-wide interpretive trail consisting of decomposed granite would extend southward from the parking lot, through the proposed open space area, and curving eastward at the southern site boundary. A perimeter fence or wall would be provided along the length of the northern and western site boundaries.

In addition, Phase I of the project would include a playground area and turf play area to the west of the proposed lunch shelters. As part of Phase II, a portion of the turf play area would be removed to accommodate the proposed multi-purpose building (see Figure 10).

Utilities

Water and sewer service for the proposed school would be provided by the City through connections to existing infrastructure located in the site vicinity. The site would be served by an existing fire hydrant located at the southeast portion of the site adjacent to Monterey Road and Cosmo Avenue, as well as a new hydrant to be located within the proposed parking lot.

Stormwater runoff from impervious surfaces within the site would be captured by a series of drain inlets and routed, by way of new underground storm drain piping, to a series of four bio-retention basins located within the eastern portion of the site. The bio-retention basins would treat and detain all on-site runoff prior to discharging to the City's existing stormwater drain located in Cosmo Avenue.

Figure 9
Landscape Schematic Master Plan – Phase I

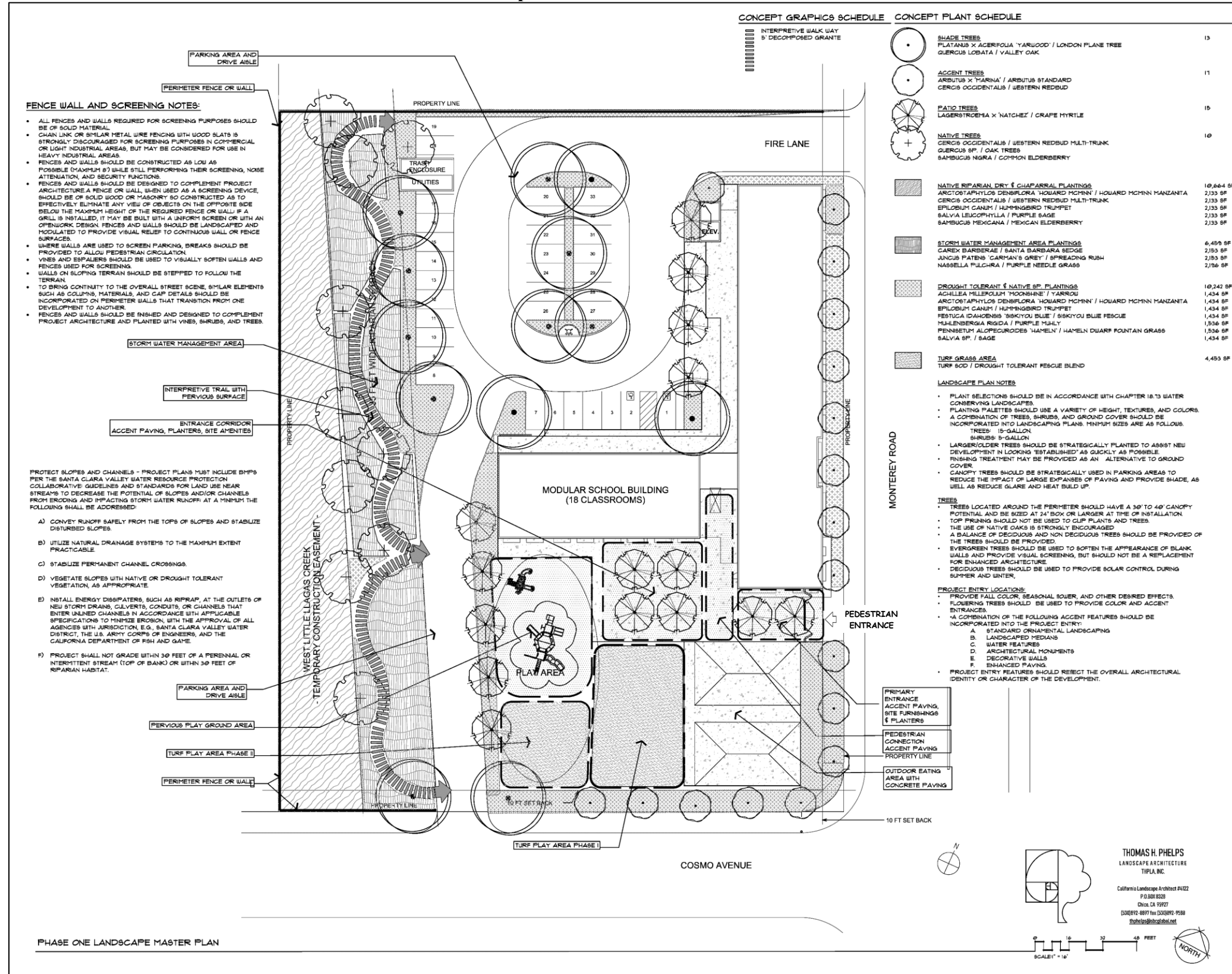
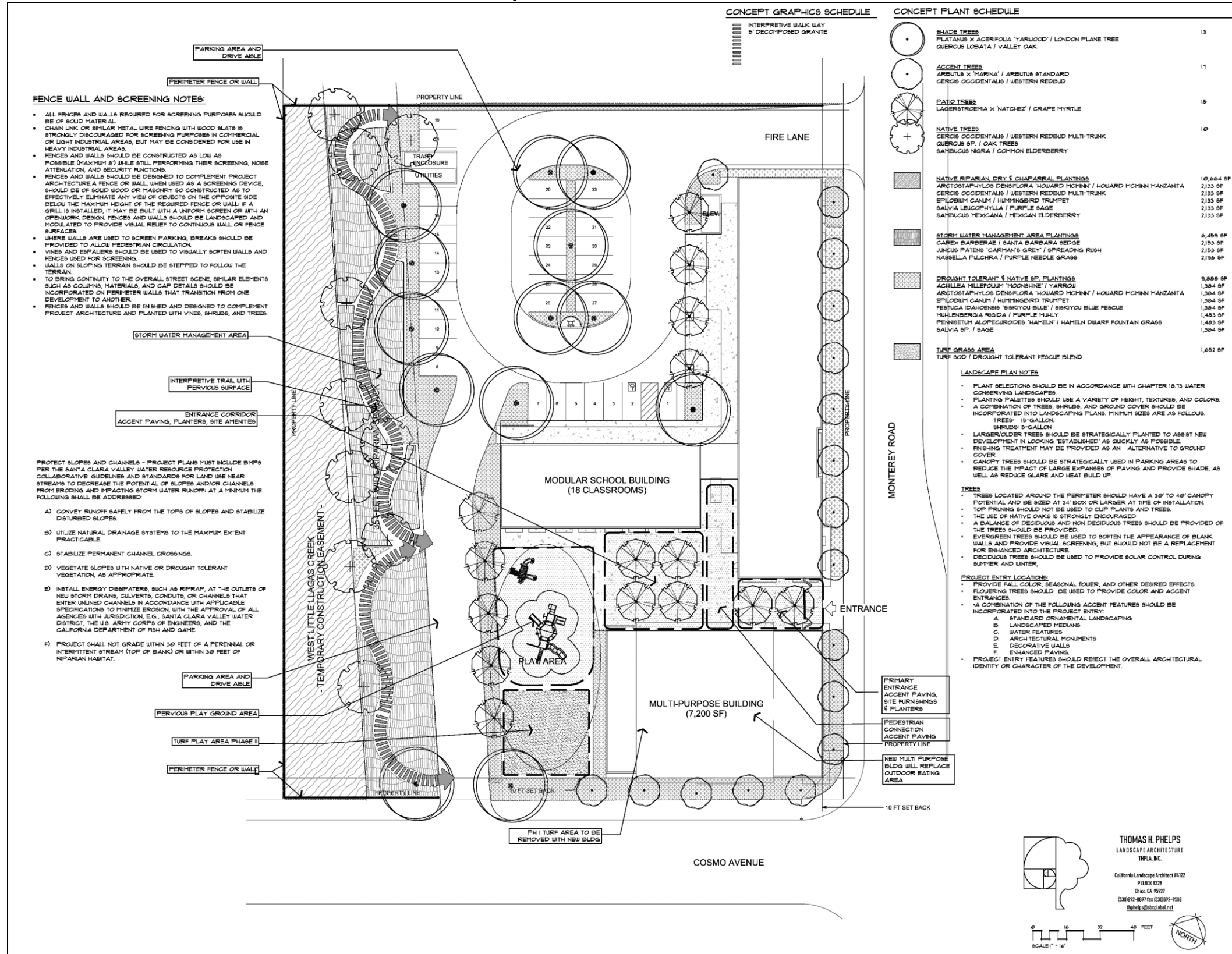

Figure 10
Landscape Schematic Master Plan – Phase II



Operations

For the first full year of operation, the proposed school would serve approximately 360 students and include approximately 46 employees. At full buildout (2023/2024 school year), the project would serve up to 504 students and include 63 employees. Approximately 70 to 75 percent of the project employees would be instructional staff.

Office hours at the proposed school would be limited to 7:30 AM to 4:30 PM, Monday through Friday. Staff would typically be on-site between 7:00 AM and 6:00 PM. In addition to typical daily operations, the proposed school would host a range of school events including, but not limited to, an annual winter celebration, one to two Kermes/Carnival celebrations per year, a kinder graduation, parent workshops, and parent fundraisers. Furthermore, an afterschool program would be provided for a limited number of students.

Requested/Required Entitlements

The proposed project would require the City's approval of the following entitlements:

- Adoption of the Initial Study/Mitigated Negative Declaration (IS/MND) and Mitigation Monitoring and Reporting Program; and
- Approval of a CUP to allow for a new public school within the MU-F zoning district.

Subsequent to the approval of the above entitlements, the applicant would be required to obtain a Design Review Permit for approval of a site plan, building elevations, and landscape plans.

2.3 Surrounding Land Uses

The immediate existing surrounding land uses and developments are as follows:

North - Vacant.
West - Vacant, multi-family residential uses.
East - Commercial uses.
South - Commercial uses.

SECTION 3. SOURCES

The following documents are referenced information sources utilized by this analysis:

1. Association of Bay Area Governments. *Dam Failure Inundation Hazard Map for Morgan Hill*. 1995. Available at: http://www.mhcert.com/prepare/dam_failure.shtml. Accessed May 2019.
2. Association of Bay Area Governments. *Resilience Program*. Available at: <http://gis.abag.ca.gov/website/Hazards/?hlyr=liqSusceptibility>. Accessed February 2019.
3. Balance Hydrologics, Inc. *Summary of Hydraulic Modeling and Floodplain Impacts for the Proposed Voices School Site, City of Morgan Hill*. May 10, 2019.

4. Bay Area Air Quality Management District. *California Environmental Quality Act Air Quality Guidelines*. May 2017.
5. Bollard Acoustical Consultants, Inc. *Environmental Noise & Vibration Analysis, Voices Charter School, Morgan Hill, California*. May 31, 2019.
6. California Air Resources Board. *The 2017 Climate Change Scoping Plan Update*. January 20, 2017.
7. California Department of Conservation. *Santa Clara County Important Farmland Map 2014*. October 2016.
8. California Department of Resources Recycling and Recovery (CalRecycle). *Facility/Site Summary Details: Johnson Canyon Sanitary Landfill (27-AA-0005)*. Available at: <http://www.calrecycle.ca.gov/SWFacilities/Directory/27-AA-0005/Detail/>. Accessed July 2018.
9. California Energy Commission. *Title 24 2019 Building Energy Efficiency Standards FAQ*. November 2018.
10. California Historical Resources Information System. *Record search results for the proposed Voices Charter School Project*. March 28, 2019.
11. City of Morgan Hill. *2015 Urban Water Management Plan*. 2016.
12. City of Morgan Hill. *2035 General Plan Draft EIR*. January 2016.
13. City of Morgan Hill. *2035 General Plan, City of Morgan Hill*. Adopted July 2016.
14. City of Morgan Hill. *City Council Staff Report 2163, Accept Report Regarding Wastewater System Needs and Rate Study Schedule*. February 6, 2019.
15. City of Morgan Hill. *City of Morgan Hill Wildland Urban Interface Map*. March 2009.
16. City of Morgan Hill. *Emergency Operations Plan*. January 11, 2018.
17. City of Morgan Hill. *Morgan Hill 2035 Final Environmental Impact Report*. Adopted July 2016.
18. Department of Conservation. *State of California, Special Studies Zones, Mt. Madonna Quadrangle, Revised Official Map*. Effective January 1, 1976.
19. Federal Emergency Management Agency. *National Flood Hazard Layer FIRMette*. Accessed May 2019.
20. Hexagon Transportation Consultants, Inc. *Voices School Morgan Hill, Traffic Impact Analysis*. August 20, 2019.

21. Live Oak Associates, Inc. *Tree letter for the proposed Voices Charter School project at the intersection of Monterey Road and Cosmo Avenue in Morgan Hill, Santa Clara County, California (PN 2344-01)*. July 2, 2019.
22. Live Oak Associates, Inc. *Voices Charter School Technical Biological Report, Morgan Hill, Santa Clara County, California*. March 11, 2019.
23. Native American Heritage Commission. *Voices Charter School Project, City of Morgan Hill, Mount Madonna USGS Quadrangle, Santa Clara County, California*. March 7, 2019.
24. Natural Resources Conservation Service. *Calculated Coefficients of Linear Extensibility*. Available at: https://www.nrcs.usda.gov/wps/portal/nrcs/detail/soils/survey/office/ssr10/tr/?cid=nrcs144p2_074840. Accessed July 2018.
25. Natural Resources Conservation Service. *Web Soil Survey*. Available at: <https://websoilsurvey.sc.egov.usda.gov/App/HomePage.htm>. Accessed February 2019.
26. RNC Environmental, LLC. *Phase I Environmental Site Assessment, Voices Charter School, APN 767-17-047, NW Corner Monterey Rd., Cosmo Ave., Morgan Hill, Santa Clara County, California 95037*. August 6, 2018.
27. Salinas Valley Solid Waste Authority. *2016-17 Annual Report*. 2018.
28. Santa Clara County. *Comprehensive Land Use Plan, Santa Clara County, South County Airport*. Amended November 16, 2016.
29. Santa Clara Valley Transportation Authority. *2015 Congestion Management Plan*. October 2015.
30. Santa Clara Valley Water District. *2016 Groundwater Management Plan, Santa Clara and Llagas Subbasins*. November 2016.
31. Santa Clara Valley Water District. *C1: Anderson Dam Seismic Retrofit**. Available at: <https://www.valleywater.org/anderson-dam-project>. Updated November 2018.
32. Santa Clara Valley Water District. *E6: Upper Llagas Creek Flood Protection*. Available at: <https://www.valleywater.org/project-updates/e6-upper-llagas-creek-flood-protection>. Updated April 2019.
33. Santa Clara Valley Water District. *Upper Llagas Creek Project Environmental Impact Report*. January 2014.

SECTION 4. EVALUATION OF ENVIRONMENTAL IMPACTS

4.1 Background and Introduction

The mitigation measures prescribed for environmental effects described in this IS/MND would be

implemented in conjunction with the project, as required by CEQA. The mitigation measures would be incorporated into the project through project Conditions of Approval. The City would adopt findings and a Mitigation Monitoring/Reporting Program for the project in conjunction with approval of the project.

In July 2016, the City of Morgan Hill adopted the 2035 General Plan,¹ as well as an associated Environmental Impact Report (EIR) for the updated General Plan.² The General Plan EIR is a program EIR, prepared pursuant to Section 15168 of the CEQA Guidelines (Title 14, California Code of Regulations, Sections 15000 *et seq.*). The General Plan EIR analyzed full implementation of the General Plan and identified measures to mitigate the significant adverse impacts associated with the General Plan. The City of Morgan Hill 2035 General Plan designates the site as Mixed Use Flex (MU-F) (7 to 24 du/ac), which permits residential, commercial, and office uses with a maximum floor area ratio (FAR) of 0.5. The project site includes a total of 2.02 acres, or 87,991 square feet. The project would include a total of 35,151 square feet of building area, resulting in a FAR of approximately 0.40. Thus, the proposed project would be consistent with the General Plan.

Pursuant to Section 15152 of the CEQA Guidelines, a project which is consistent with the General Plan and zoning of the City may tier from the analysis contained in the General Plan EIR, incorporating by reference the general discussions from the broader EIR. Given that the proposed project would be consistent with the site’s current General Plan land use designation of MU-F, the environmental analysis contained in this IS/MND tiers, where applicable, from the General Plan EIR in accordance with CEQA Guidelines Section 15152.

ENVIRONMENTAL FACTORS POTENTIALLY AFFECTED:

The environmental factors checked below would be potentially affected by this project, involving at least one impact that is “Less Than Significant with Mitigation Incorporated” as indicated by the checklist on the following pages.

- | | | |
|---|---|--|
| <input type="checkbox"/> Aesthetics | <input type="checkbox"/> Agriculture and Forest Resources | <input type="checkbox"/> Air Quality |
| <input checked="" type="checkbox"/> Biological Resources | <input type="checkbox"/> Cultural Resources | <input type="checkbox"/> Energy |
| <input type="checkbox"/> Geology and Soils | <input type="checkbox"/> Greenhouse Gas Emissions | <input type="checkbox"/> Hazards and Hazardous Materials |
| <input checked="" type="checkbox"/> Hydrology and Water Quality | <input type="checkbox"/> Land Use and Planning | <input type="checkbox"/> Mineral Resources |
| <input checked="" type="checkbox"/> Noise | <input type="checkbox"/> Population and Housing | <input type="checkbox"/> Public Services |
| <input type="checkbox"/> Recreation | <input checked="" type="checkbox"/> Transportation | <input type="checkbox"/> Tribal Cultural Resources |
| <input type="checkbox"/> Utilities and Service Systems | <input type="checkbox"/> Wildfire | <input checked="" type="checkbox"/> Mandatory Findings of Significance |

¹ City of Morgan Hill. *2035 General Plan, City of Morgan Hill*. Adopted July 2016.

² City of Morgan Hill. *Morgan Hill 2035 Final Environmental Impact Report*. Adopted July 2016.

DETERMINATION:

On the basis of this initial study:

- I find that the Proposed Project COULD NOT have a significant effect on the environment, and a NEGATIVE DECLARATION will be prepared.
- I find that although the Proposed Project could have a significant effect on the environment, there will not be a significant effect in this case because revisions in the project have been made by or agreed to by the applicant. A MITIGATED NEGATIVE DECLARATION will be prepared.
- I find that the Proposed Project MAY have a significant effect on the environment, and an ENVIRONMENTAL IMPACT REPORT is required.
- I find that the proposed project MAY have a “potentially significant impact” or “potentially significant unless mitigated” on the environment, but at least one effect 1) has been adequately analyzed in an earlier document pursuant to applicable legal standards, and 2) has been addressed by mitigation measures based on the earlier analysis as described on attached sheets. An ENVIRONMENTAL IMPACT REPORT is required, but it must analyze only the effects that remain to be addressed.
- I find that although the proposed project could have a significant effect on the environment, because all potentially significant effects (a) have been analyzed adequately in an earlier EIR pursuant to applicable standards, and (b) have been avoided or mitigated pursuant to that earlier EIR, including revisions or mitigation measures that are imposed upon the proposed project, nothing further is required.



Signature

8.22.19

Date

Jennifer Carman, Development Services Director
Printed Name

City of Morgan Hill
For

ENVIRONMENTAL CHECKLIST:

The following Checklist contains the environmental checklist form presented in Appendix G of the CEQA Guidelines. The checklist form is used to describe the impacts of the proposed project. A discussion follows each environmental issue identified in the checklist. Included in each discussion are project-specific mitigation measures recommended, as appropriate, as part of the proposed project.

For this checklist, the following designations are used:

Potentially Significant Impact: An impact that could be significant, and for which no mitigation has been identified. If any potentially significant impacts are identified, an EIR must be prepared.

Less Than Significant with Mitigation Incorporated: An impact that requires mitigation to reduce the impact to a less-than-significant level.

Less-Than-Significant Impact: Any impact that would not be considered significant under CEQA relative to existing standards.

No Impact: The project would not have any impact.

I. AESTHETICS. <i>Would the project:</i>	Potentially Significant Impact	Less Than Significant with Mitigation Incorporated	Less-Than-Significant Impact	No Impact
a. Have a substantial adverse effect on a scenic vista?	<input type="checkbox"/>	<input type="checkbox"/>	✘	<input type="checkbox"/>
b. Substantially damage scenic resources, including, but not limited to, trees, rock outcroppings, and historic buildings within a State scenic highway?	<input type="checkbox"/>	<input type="checkbox"/>	<input type="checkbox"/>	✘
c. In non-urbanized areas, substantially degrade the existing visual character or quality of public views of the site and its surroundings? (Public views are those that are experienced from publicly accessible vantage point). If the project is in an urbanized area, would the project conflict with applicable zoning and other regulations governing scenic quality?	<input type="checkbox"/>	<input type="checkbox"/>	✘	<input type="checkbox"/>
d. Create a new source of substantial light or glare which would adversely affect day or nighttime views in the area?	<input type="checkbox"/>	<input type="checkbox"/>	✘	<input type="checkbox"/>

a,c. The Morgan Hill General Plan does not designate official scenic view corridors or vistas. However, according to the General Plan, the hillsides that surround the City to the east and west are considered scenic. The project site is surrounded by existing development and is not located on a hillside or in the vicinity of a hillside. While distant views of the hills to the west of the City are visible across the project site from motorists, bicyclists, and pedestrians travelling along Monterey Road, Monterey Road is not considered a scenic vista.³ In addition, such views are partially obscured by existing vegetation within the residential neighborhood to the west of the site.

The project site is undeveloped. Surrounding development in the project area includes multi-family residential homes to the west, commercial development to the south across Cosmo Avenue, and additional commercial development to the east across Monterey Road. The property to the north of the site is vacant and undeveloped, with scattered trees located along Monterey Road. Similar to the project site, the property to the north is designated and zoned MU-F. Generally, the site is located within an urbanized area.

³ It is important to distinguish between public and private views. Private views are views seen from privately-owned land and are typically viewed by individual viewers, including views from private residences. Public views are experienced by the collective public. These include views of significant landscape features and along scenic roads. California Environmental Quality Act (CEQA) (Pub. Resources Code, § 21000 et seq.) case law has established that only public views, not private views, are protected under CEQA. For example, in *Association for Protection etc. Values v. City of Ukiah* (1991) 2 Cal.App.4th 720 [3 Cal. Rptr.2d 488] the court determined that “we must differentiate between adverse impacts upon particular persons and adverse impacts upon the environment of persons in general. As recognized by the court in *Topanga Beach Renters Assn. v. Department of General Services* (1976) 58 Cal.App.3d 188 [129 Cal.Rptr. 739]: ‘[A]ll government activity has some direct or indirect adverse effect on some persons. The issue is not whether [the project] will adversely affect particular persons but whether [the project] will adversely affect the environment of persons in general.’” Therefore, it is appropriate to focus the aesthetic impact analysis on potential impacts to public views.

The proposed project is subject to Design Review in accordance with Morgan Hill Municipal Code Section 18.108.040, which would ensure that the proposed project is consistent with applicable design standards and guidelines in the City's Architectural Review Handbook for Commercial/Industrial/Public Facility development. The Handbook is intended to create usable and attractive streetscapes, achieve higher design quality, protect natural features through sensitive site planning, create attractive pedestrian-friendly developments, and enhance public safety.

Furthermore, given that the proposed project is consistent with the site's current land use and zoning designations, the City has anticipated buildout of the project site and associated impacts to scenic vistas and other aesthetic resources in the General Plan EIR.⁴ The City's General Plan EIR concluded that buildout of the General Plan, including the project site, would result in a less-than-significant impact related to visual character and quality. Thus, pursuant to CEQA Guidelines Section 15152(d), the analysis presented herein is limited to the effects of the proposed project that were not previously evaluated in the General Plan EIR. The project would not result in any additional environmental effects beyond those which were previously evaluated.

Based on the above, the General Plan does not designate any official scenic vistas within the City of Morgan Hill. The project site is in an urbanized area and the proposed project would be consistent with the site's current zoning designation. In addition, the design review process would ensure that all project elements are consistent with the City's Architectural Review Handbook. Thus, the proposed project would not have a substantial adverse effect on a scenic vista or conflict with applicable zoning and other regulations governing scenic quality, and a *less-than-significant* impact would occur.

- b. Scenic gateways to the City include the Coyote greenbelt area north of Morgan Hill. According to the California Department of Transportation (Caltrans) map of Santa Clara County prepared for the Scenic Highway Mapping System, officially designated State or County scenic highways do not occur in the project vicinity. Because the project site is not located in the vicinity of any State scenic highway or scenic gateway identified by the City, the proposed project would not damage any scenic resources within a State scenic highway. Therefore, *no impact* related to damaging scenic resources within a State scenic highway would occur.
- d. The proposed project site does not contain any existing sources of light or glare. As such, development of the proposed project would increase the amount of light including, but not limited to, headlights on cars using the on-site drive aisle, exterior light fixtures, and interior light spilling through windows. However, the existing commercial development to the north, east, and south of the site currently generates light and glare in the area.

In addition, new sources of lighting would be required to comply with the standards set forth in Section G of the City's Architectural Review Handbook, Section 18.76.060 (Glare), and Section 15.40.310 (Open parking lots) of the Morgan Hill Municipal Code,

⁴ City of Morgan Hill. *Morgan Hill 2035 Final Environmental Impact Report* [pg. 4.1-10]. Adopted July 2016.

which includes such requirements as cut-off lenses to direct light downward and minimum maintained lighting on parking surfaces. Compliance with such would help to ensure that the light and glare created by the proposed project would be consistent with the levels of light and glare currently emitted in the surrounding developed environment. Therefore, the proposed project would not introduce new sources of substantial light or glare to the site which would adversely affect day or nighttime views in the area, and a *less-than-significant* impact would occur.

II. AGRICULTURE AND FOREST RESOURCES. <i>Would the project:</i>	Potentially Significant Impact	Less Than Significant with Mitigation Incorporated	Less-Than-Significant Impact	No Impact
a. Convert Prime Farmland, Unique Farmland, or Farmland of Statewide Importance (Farmland), as shown on the maps prepared pursuant to the Farmland Mapping and Monitoring Program of the California Resources Agency, to non-agricultural use?	<input type="checkbox"/>	<input type="checkbox"/>	<input type="checkbox"/>	✘
b. Conflict with existing zoning for agricultural use, or a Williamson Act contract?	<input type="checkbox"/>	<input type="checkbox"/>	<input type="checkbox"/>	✘
c. Conflict with existing zoning for, or cause rezoning of, forest land (as defined in Public Resources Code section 12220(g)), timberland (as defined by Public Resources Code section 4526), or timberland zoned Timberland Production (as defined by Government Code section 51104(g))?	<input type="checkbox"/>	<input type="checkbox"/>	<input type="checkbox"/>	✘
d. Result in the loss of forest land or conversion of forest land to non-forest use?	<input type="checkbox"/>	<input type="checkbox"/>	<input type="checkbox"/>	✘
e. Involve other changes in the existing environment which, due to their location or nature, could result in conversion of Farmland, to non-agricultural use or conversion of forest land to non-forest use?	<input type="checkbox"/>	<input type="checkbox"/>	<input type="checkbox"/>	✘
a,e. A Phase I Environmental Site Assessment (ESA) has been prepared for the project site, which indicates that a vineyard had previously been developed from at least the 1940s through the 1960s, which was the point of time the vineyard was removed from the site. The site continued to be used for other agricultural uses up to the 1990s. ⁵ While the project site historically contained a vineyard, the site has not been used recently for agricultural production and is designated as “Urban and Built-Up Land” on the Santa Clara County Important Farmland map. ⁶ Given the designation of the site as Urban and Built-Up Land, development of the proposed project would not convert Prime Farmland, Unique Farmland, or Farmland of Statewide Importance to a non-agricultural use, or otherwise result in the loss of Farmland to non-agricultural use. Therefore, no impact would occur as a result of the proposed project.				
b. The project site is not under a Williamson Act contract and is not zoned for agricultural uses. Therefore, buildout of the proposed project would not conflict with an agricultural use or a Williamson Act contract, and no impact would occur.				
c,d. The project site is not considered forest land (as defined in Public Resources Code Section 12220[g]), timberland (as defined by Public Resources Code Section 4526), and is not zoned Timberland Production (as defined by Government Code Section 51104[g]). Therefore, the proposed project would have no impact with regard to conversion of forest land or any potential conflict with forest land, timberland, or Timberland Production zoning.				

⁵ RNC Environmental, LLC. *Phase I Environmental Site Assessment, Voices Charter School, APN 767-17-047, NW Corner Monterey Rd. Cosmo Ave., Morgan Hill, Santa Clara County, California 95037.* August 6, 2018.

⁶ California Department of Conservation. *Santa Clara County Important Farmland Map 2014.* October 2016.

III. AIR QUALITY.

Would the project:

	Potentially Significant Impact	Less Than Significant with Mitigation Incorporated	Less-Than-Significant Impact	No Impact
a. Conflict with or obstruct implementation of the applicable air quality plan?	<input type="checkbox"/>	<input type="checkbox"/>	<input checked="" type="checkbox"/>	<input type="checkbox"/>
b. Result in a cumulatively considerable net increase of any criteria pollutant for which the project region is non-attainment under an applicable federal or state ambient air quality standard?	<input type="checkbox"/>	<input type="checkbox"/>	<input checked="" type="checkbox"/>	<input type="checkbox"/>
c. Expose sensitive receptors to substantial pollutant concentrations?	<input type="checkbox"/>	<input type="checkbox"/>	<input checked="" type="checkbox"/>	<input type="checkbox"/>
d. Result in other emissions (such as those leading to odors) adversely affecting a substantial number of people?	<input type="checkbox"/>	<input type="checkbox"/>	<input checked="" type="checkbox"/>	<input type="checkbox"/>

a,b. The City of Morgan Hill is located in the San Francisco Bay Area Air Basin (SFBAAB), which is under the jurisdiction of the Bay Area Air Quality Management District (BAAQMD). The SFBAAB area is currently designated as a nonattainment area for State and federal ozone, State and federal fine particulate matter 2.5 microns in diameter (PM_{2.5}), and State respirable particulate matter 10 microns in diameter (PM₁₀) ambient air quality standards (AAQS). The SFBAAB is designated attainment or unclassified for all other AAQS. It should be noted that on January 9, 2013, the U.S. Environmental Protection Agency (USEPA) issued a final rule to determine that the Bay Area has attained the 24-hour PM_{2.5} federal AAQS. Nonetheless, the Bay Area must continue to be designated as nonattainment for the federal PM_{2.5} AAQS until such time as the BAAQMD submits a redesignation request and a maintenance plan to the USEPA, and the USEPA approves the proposed redesignation. The USEPA has not yet approved a request for redesignation of the SFBAAB; therefore, the SFBAAB remains in nonattainment for 24-hour PM_{2.5}.

In compliance with regulations, due to the nonattainment designations of the area, the BAAQMD periodically prepares and updates air quality plans that provide emission reduction strategies to achieve attainment of the AAQS, including control strategies to reduce air pollutant emissions through regulations, incentive programs, public education, and partnerships with other agencies. The current air quality plans are prepared in cooperation with the Metropolitan Transportation Commission (MTC) and the Association of Bay Area Governments (ABAG).

The most recent federal ozone plan is the 2001 Ozone Attainment Plan, which was adopted on October 24, 2001 and approved by the California Air Resources Board (CARB) on November 1, 2001. The plan was submitted to the USEPA on November 30, 2001 for review and approval. The most recent State ozone plan is the 2017 Clean Air Plan (CAP), adopted on April 19, 2017. The 2017 CAP was developed as a multi-pollutant plan that provides an integrated control strategy to reduce ozone, PM, toxic air contaminants (TACs), and greenhouse gases (GHGs). Although a plan for achieving the State PM₁₀ standard is not required, the BAAQMD has prioritized measures to reduce PM in developing the control strategy for the 2017 CAP. The control strategy serves as the backbone of the BAAQMD’s current PM control program.

The aforementioned air quality plans contain mobile source controls, stationary source controls, and transportation control measures to be implemented in the region to attain the State and federal AAQS within the SFBAAB. Adopted BAAQMD rules and regulations, as well as the thresholds of significance, have been developed with the intent to ensure continued attainment of AAQS, or to work towards attainment of AAQS for which the area is currently designated nonattainment, consistent with applicable air quality plans. For development projects, BAAQMD establishes significance thresholds for emissions of the ozone precursors reactive organic gases (ROG) and oxides of nitrogen (NO_x), as well as for PM₁₀, and PM_{2.5}, expressed in pounds per day (lbs/day) and tons per year (tons/yr). The thresholds are listed in Table 1. Thus, by exceeding the BAAQMD's mass emission thresholds for operational emissions of ROG, NO_x, or PM₁₀, a project would be considered to conflict with or obstruct implementation of the BAAQMD's air quality planning efforts.

Pollutant	Construction	Operational	
	Average Daily Emissions (lbs/day)	Average Daily Emissions (lbs/day)	Maximum Annual Emissions (tons/year)
ROG	54	54	10
NO _x	54	54	10
PM ₁₀ (exhaust)	82	82	15
PM _{2.5} (exhaust)	54	54	10

Source: BAAQMD, CEQA Guidelines, May 2017.

The proposed project's construction and operational emissions were quantified using the California Emissions Estimator Model (CalEEMod) software version 2016.3.2 - a Statewide model designed to provide a uniform platform for government agencies, land use planners, and environmental professionals to quantify air quality emissions, including GHG emissions, from land use projects. The model applies inherent default values for various land uses, including construction data, vehicle mix, trip length, average speed, etc. Where project-specific information is available, such information is applied in the model. The proposed project's modeling assumed the following:

- Construction would commence in January of 2020 and occur over an approximately 11-month period;
- Approximately 50 cubic yards of soil material would be exported during grading activities; and,
- The weekday average daily trip rate was adjusted in accordance with the Traffic Impact Analysis prepared for the project by Hexagon Transportation Consultants, Inc.

It should be noted that in order to provide a worst-case analysis, the modeling assumed buildout of the proposed project in a single phase, with full operations commencing in 2021. Actual full buildout of the project, including Phase II, would likely occur at a later date, at which point improvements in energy efficiency standards will have improved relative to 2021 standards. Thus, this Initial Study presents a conservative analysis.

The proposed project’s estimated emissions associated with construction and operations and the project’s contribution to cumulative air quality conditions are provided below. All CalEEMod results are included as Appendix A to this IS/MND.

Construction Emissions

According to the CalEEMod results, the proposed project would result in maximum construction criteria air pollutant emissions as shown in Table 2. The proposed project’s construction emissions would be below the applicable thresholds of significance.

Table 2			
Maximum Construction Emissions (lbs/day)			
Pollutant	Proposed Project Emissions	Threshold of Significance	Exceeds Threshold?
ROG	4.39	54	NO
NO _x	21.66	54	NO
PM ₁₀ (exhaust)	1.07	82	NO
PM ₁₀ (fugitive)	6.48	None	N/A
PM _{2.5} (exhaust)	1.03	54	NO
PM _{2.5} (fugitive)	3.38	None	N/A

Source: CalEEMod, May 2019 (see Appendix A).

Although thresholds of significance for mass emissions of fugitive dust PM₁₀ and PM_{2.5} have not been identified by the City of Morgan Hill or BAAQMD, the proposed project’s estimated fugitive dust emissions have been included for informational purposes. All projects within the jurisdiction of the BAAQMD are required to implement all of the BAAQMD’s Basic Construction Mitigation Measures, which would be included in the project approval as Conditions of Approval:

1. All haul trucks transporting soil, sand, or other loose material off-site shall be covered.
2. All visible mud or dirt track-out onto adjacent public roads shall be removed using wet power vacuum street sweepers at least once per day. The use of dry power sweeping is prohibited.
3. All vehicle speeds on unpaved roads shall be limited to 15 mph.
4. All roadways, driveways, and sidewalks to be paved shall be completed as soon as possible. Building pads shall be laid as soon as possible after grading unless seeding or soil binders are used.
5. Idling times shall be minimized either by shutting equipment off when not in use or reducing the maximum idling time to five minutes (as required by the California airborne toxics control measure Title 13, Section 2485 of California Code of Regulations [CCR]). Clear signage shall be provided for construction workers at all access points.
6. All construction equipment shall be maintained and properly tuned in accordance with manufacturer’s specifications. All equipment shall be checked by a certified visible emissions evaluator.

7. Post a publicly visible sign with the telephone number and person to contact at the lead agency regarding dust complaints. This person shall respond and take corrective action within 48 hours. The Air District’s phone number shall also be visible to ensure compliance with applicable regulations.

The proposed project’s required implementation of the BAAQMD’s Basic Construction Mitigation Measures listed above for the project’s construction activities, would help to further minimize construction-related emissions.

Because the proposed project would be below the applicable thresholds of significance for construction emissions, project construction would not result in a significant air quality impact.

Operational Emissions

According to the CalEEMod results, the proposed project would result in maximum operational criteria air pollutant emissions as shown in Table 3. The proposed project’s operational emissions would be below the applicable thresholds of significance. As such, the proposed project would not result in a significant air quality impact during operations.

Table 3 Unmitigated Maximum Operational Emissions					
Pollutant	Proposed Project Emissions		Threshold of Significance		Exceeds Threshold?
	lbs/day	tons/yr	lbs/day	tons/yr	
ROG	2.26	0.34	54	10	NO
NO _x	6.95	0.90	54	10	NO
PM ₁₀ (exhaust)	0.06	0.01	82	15	NO
PM ₁₀ (fugitive)	4.5	0.56	None	None	N/A
PM _{2.5} (exhaust)	0.06	0.01	54	10	NO
PM _{2.5} (fugitive)	1.21	0.15	None	None	N/A

Source: CalEEMod, May 2019 (see Appendix A).

Cumulative Emissions

Past, present and future development projects contribute to the region’s adverse air quality impacts on a cumulative basis. By nature, air pollution is largely a cumulative impact. A single project is not sufficient in size to, by itself, result in nonattainment of AAQS. Instead, a project’s individual emissions contribute to existing cumulatively significant adverse air quality impacts. If a project’s contribution to the cumulative impact is considerable, then the project’s impact on air quality would be considered significant. In developing thresholds of significance for air pollutants, BAAQMD considered the emission levels for which a project’s individual emissions would be cumulatively considerable. The thresholds of significance presented in Table 1 represent the levels at which a project’s individual emissions of criteria air pollutants or precursors would result in a cumulatively considerable contribution to the SFBAAB’s existing air quality conditions. If a project exceeds the significance thresholds presented in Table 1, the proposed project’s emissions would be cumulatively considerable, resulting in significant adverse cumulative air quality

impacts to the region's existing air quality conditions. Because the proposed project would result in emissions below the applicable thresholds of significance, the project would not be expected to result in a cumulatively considerable contribution to the region's existing air quality conditions.

Conclusion

As stated previously, the applicable regional air quality plans include the 2001 Ozone Attainment Plan and the 2017 CAP. According to BAAQMD, if a project would not result in significant and unavoidable air quality impacts, after the application of all feasible mitigation, the project may be considered consistent with the air quality plans. Because the proposed project would result in emissions below the applicable thresholds of significance, the project would not be considered to conflict with or obstruct implementation of regional air quality plans.

Because the proposed project would not conflict with or obstruct implementation of the applicable air quality plans, violate any air quality standards or contribute substantially to an existing or projected air quality violation, or result in a cumulatively considerable net increase in any criteria air pollutant, impacts would be considered *less than significant*.

- c. Some land uses are considered more sensitive to air pollution than others, due to the types of population groups or activities involved. Heightened sensitivity may be caused by health problems, proximity to the emissions source, and/or duration of exposure to air pollutants. Children, pregnant women, the elderly, and those with existing health problems are especially vulnerable to the effects of air pollution. Accordingly, land uses that are typically considered to be sensitive receptors include residences, schools, childcare centers, playgrounds, retirement homes, convalescent homes, hospitals, and medical clinics. The nearest existing sensitive receptor to the project site would be the multi-family residential development located approximately 200 feet to the west of the site.

The major pollutant concentrations of concern are localized carbon monoxide (CO) emissions and Toxic Air Contaminants (TAC) emissions, which are addressed in further detail below.

Localized CO Emissions

Localized concentrations of CO are related to the levels of traffic and congestion along streets and at intersections. High levels of localized CO concentrations are only expected where background levels are high, and traffic volumes and congestion levels are high. Emissions of CO are of potential concern, as the pollutant is a toxic gas that results from the incomplete combustion of carbon-containing fuels such as gasoline or wood. CO emissions are particularly related to traffic levels.

In order to provide a conservative indication of whether a project would result in localized CO emissions that would exceed the applicable threshold of significance, the BAAQMD has established screening criteria for localized CO emissions. According to BAAQMD, a

proposed project would result in a less-than-significant impact related to localized CO emission concentrations if all of the following conditions are true for the project:

- The project is consistent with an applicable congestion management program established by the county congestion management agency for designated roads or highways, regional transportation plan, and local congestion management agency plans;
- The project traffic would not increase traffic volumes at affected intersections to more than 44,000 vehicles per hour; and
- The project traffic would not increase traffic volumes at affected intersections to more than 24,000 vehicles per hour where vertical and/or horizontal mixing is substantially limited (e.g., tunnel, parking garage, underpass, etc.).

The project would not conflict with the Santa Clara Valley Transportation Authority (VTA) Congestion Management Program (CMP).⁷ Additionally, existing traffic volumes calculated at study intersections in the project area as part of the Traffic Impact Analysis prepared for the project by Hexagon Transportation Consultants, Inc. show that all of the intersections in the project area experience traffic levels far below 44,000 vehicles during AM and PM peak hour periods,⁸ and traffic associated with the proposed development would not increase traffic volumes at an affected intersection to more than 44,000 vehicles per hour. Furthermore, areas where vertical and/or horizontal mixing is limited due to tunnels, underpasses, or similar features do not exist in the project area. Therefore, based on the BAAQMD's screening criteria for localized CO emissions, the proposed project would not be expected to result in substantial levels of localized CO at surrounding intersections or generate localized concentrations of CO that would exceed standards or cause health hazards.

TAC Emissions

Another category of environmental concern is TACs. The CARB's *Air Quality and Land Use Handbook: A Community Health Perspective* (Handbook) provides recommended setback distances for sensitive land uses from major sources of TACs, including, but not limited to, freeways and high traffic roads, distribution centers, and rail yards. The CARB has identified diesel particulate matter (DPM) from diesel-fueled engines as a TAC; thus, high volume freeways, stationary diesel engines, and facilities attracting heavy and constant diesel vehicle traffic are identified as having the highest associated health risks from DPM. Health risks associated with TACs are a function of both the concentration of emissions and the duration of exposure, where the higher the concentration and/or the longer the period of time that a sensitive receptor is exposed to pollutant concentrations would correlate to a higher health risk.

The proposed project would not involve any land uses or operations that would be considered major sources of TACs, including DPM. As such, the proposed project would

⁷ Santa Clara Valley Transportation Authority. *2015 Congestion Management Plan*. October 2015.

⁸ Hexagon Transportation Consultants, Inc. *Voices School Morgan Hill, Traffic Impact Analysis* [Figure 6]. August, 2019.

not generate any substantial pollutant concentrations during operations. However, short-term, construction-related activities could result in the generation of TACs, specifically DPM, from on-road haul trucks and off-road equipment exhaust emissions. Construction is temporary and occurs over a relatively short duration in comparison to the operational lifetime of the proposed project. Specifically, as noted above, construction would occur over an approximately 11-month period. Mass grading of the project site, when emissions would be most intensive, is estimated to occur over a period of approximately six days. The exposure period typically analyzed in health risk assessments is 30 years or greater, which is substantially longer than the estimated 11-month construction period associated with the proposed project.

All construction equipment and operation thereof would be regulated by the In-Use Off-Road Diesel Vehicle Regulation, which is intended to help reduce emissions associated with off-road diesel vehicles and equipment, including DPM. In addition, the project applicant would be required to prepare, and include on all site development and grading plans, a management plan detailing strategies for control of noise, dust and vibration, and storage of hazardous materials during construction of the project. Pursuant to Section 18.76.040 (Air contaminants) of the City's Municipal Code, the management plan must include all applicable BAAQMD rules and regulations, as well as the City's standard conditions for construction activity, listed below:

1. All exposed surfaces (e.g., parking areas, staging areas, soil piles, graded areas, and unpaved access roads) shall be watered two times per day.
2. All haul trucks transporting soil, sand, or other loose material off-site shall be covered.
3. All visible mud or dirt track-out onto adjacent public roads shall be removed using wet power vacuum street sweepers at least once per day. The use of dry power sweeping is prohibited.
4. All vehicle speeds on unpaved roads shall be limited to 15 mph.
5. All roadways, driveways, and sidewalks to be paved shall be completed as soon as possible. Building pads shall be laid as soon as possible after grading unless seeding or soil binders are used.
6. Idling times shall be minimized either by shutting equipment off when not in use or reducing the maximum idling time to 5 minutes (as required by the California airborne toxics control measure Title 13, Section 2485 of California Code of Regulations [CCR]). Clear signage shall be provided for construction workers at all access points.
7. All construction equipment shall be maintained and properly tuned in accordance with manufacturer's specifications. All equipment shall be checked by a certified visible emissions evaluator.
8. Post a publicly visible sign with the telephone number and person to contact at the lead agency regarding dust complaints. This person shall respond and take corrective action within 48 hours. The Air District's phone number shall also be visible to ensure compliance with applicable regulations.

The City of Morgan Hill Development Services Department would ensure that the conditions listed above would be noted on project construction drawings prior to issuance of a building permit or approval of improvement plans.

During construction, only portions of the project site would be disturbed at a time. Operation of construction equipment would occur on such portions of the site intermittently throughout the course of a day over the overall construction period. Because construction equipment on-site would not operate for any long periods of time and would be used at varying locations within the site, associated emissions of DPM would not occur at the same location (or be evenly spread throughout the entire project site) for long periods of time. Due to the temporary nature of construction and the relatively short duration of potential exposure to associated emissions, sensitive receptors in the area would not be exposed to pollutants for a permanent or substantially extended period of time. Furthermore, any one nearby sensitive receptor would be exposed to varying concentrations of DPM emissions throughout the construction period. According to BAAQMD, research conducted by CARB indicates that DPM is highly dispersive in the atmosphere. Thus, emissions at the project site would be substantially dispersed at the nearest sensitive receptor.

Considering the short-term nature of construction activities, the regulated and intermittent nature of the operation of construction equipment, and the highly dispersive nature of DPM, the likelihood that any one sensitive receptor would be exposed to high concentrations of DPM for any extended period of time would be low. For the aforementioned reasons, project construction would not be expected to expose sensitive receptors to substantial pollutant concentrations.

Conclusion

Based on the above discussion, the proposed project would not expose any sensitive receptors to substantial concentrations of localized CO or TACs from construction or operation. Therefore, the proposed project would result in a *less-than-significant* impact related to the exposure of sensitive receptors to substantial pollutant concentrations.

- d. Emissions such as those leading to odors have the potential to adversely affect sensitive receptors within the project area. Pollutants of principal concern include emissions leading to odors, emission of dust, or emissions considered to constitute air pollutants. Air pollutants have been discussed in section “a” through “c” above. Therefore, the following discussion focuses on emissions of odors and dust.

Pursuant to the BAAQMD CEQA Guidelines, odors are generally regarded as an annoyance rather than a health hazard.⁹ Manifestations of a person’s reaction to odors can range from psychological (e.g., irritation, anger, or anxiety) to physiological (e.g., circulatory and respiratory effects, nausea, vomiting, and headache). The presence of an odor impact is dependent on several variables including: the nature of the odor source; the

⁹ Bay Area Air Quality Management District. *California Environmental Quality Act Air Quality Guidelines* [pg. 7-1]. May 2017.

frequency of odor generation; the intensity of odor; the distance of odor source to sensitive receptors; wind direction; and sensitivity of the receptor.

Due to the subjective nature of odor impacts, the number of variables that can influence the potential for an odor impact, and the variety of odor sources, quantification of significant odor impacts is relatively difficult. Typical odor-generating land uses include, but are not limited to, wastewater treatment plants, landfills, and composting facilities. The proposed project would not introduce any such land uses and is not located in the vicinity of any such existing or planned land uses.

Construction activities often include diesel-fueled equipment and heavy-duty diesel trucks, which can create odors associated with diesel fumes, which could be found to be objectionable. However, as discussed above, construction activities would be temporary, and operation of construction equipment would be regulated and intermittent. Project construction would also be required to comply with all applicable BAAQMD rules and regulations, particularly associated with permitting of air pollutant sources. The aforementioned regulations would help to minimize air pollutant emissions as well as any associated odors. Accordingly, substantial objectionable odors would not occur during construction activities or affect a substantial number of people. In addition, the BAAQMD rules and regulations would act to reduce construction related dust, which would ensure that construction of the proposed project does not result in substantial emissions of dust. Following project construction, the project site would not include any exposed topsoil. Thus, project operations would not include any substantial sources of dust.

For the aforementioned reasons, construction and operation of the proposed project would not result in emissions (such as those leading to odors) adversely affecting a substantial number of people, and a *less-than-significant* impact would result.

IV. BIOLOGICAL RESOURCES.

Would the project:

	Potentially Significant Impact	Less Than Significant with Mitigation Incorporated	Less-Than-Significant Impact	No Impact
a. Have a substantial adverse effect, either directly or through habitat modifications, on any species identified as a candidate, sensitive, or special status species in local or regional plans, policies, or regulations, or by the California Department of Fish and Wildlife or U.S. Fish and Wildlife Service?	<input type="checkbox"/>	<input checked="" type="checkbox"/>	<input type="checkbox"/>	<input type="checkbox"/>
b. Have a substantial adverse effect on any riparian habitat or other sensitive natural community identified in local or regional plans, policies, and regulations or by the California Department of Fish and Wildlife or US Fish and Wildlife Service?	<input type="checkbox"/>	<input type="checkbox"/>	<input checked="" type="checkbox"/>	<input type="checkbox"/>
c. Have a substantial adverse effect on state or federally protected wetlands (including, but not limited to, marsh, vernal pool, coastal, etc.) through direct removal, filling, hydrological interruption, or other means?	<input type="checkbox"/>	<input type="checkbox"/>	<input checked="" type="checkbox"/>	<input type="checkbox"/>
d. Interfere substantially with the movement of any resident or migratory fish or wildlife species or with established resident or migratory wildlife corridors, or impede the use of wildlife nursery sites?	<input type="checkbox"/>	<input type="checkbox"/>	<input checked="" type="checkbox"/>	<input type="checkbox"/>
e. Conflict with any local policies or ordinances protecting biological resources, such as a tree preservation policy or ordinance?	<input type="checkbox"/>	<input checked="" type="checkbox"/>	<input type="checkbox"/>	<input type="checkbox"/>
f. Conflict with the provisions of an adopted Habitat Conservation Plan, Natural Conservation Community Plan, or other approved local, regional, or state habitat conservation plan?	<input type="checkbox"/>	<input checked="" type="checkbox"/>	<input type="checkbox"/>	<input type="checkbox"/>

The following is based primarily on the Biological Report prepared for the proposed project by Live Oak Associates, Inc. (LOA) (see Appendix B).¹⁰

- a. As noted in the Biological Report, a sizable number of native plants and animals have been formally designated as threatened or endangered under State and federal endangered species legislation. Others have been designated as “candidates” for such listing or designated as “species of special concern” by the California Department of Fish and Wildlife (CDFW). The California Native Plant Society (CNPS) has developed its own set of lists of native plants considered rare, threatened, or endangered. Collectively, such plant and wildlife species are referred to as “special status species.” For the purpose of this analysis, special-status species are defined to include the following:

¹⁰ Live Oak Associates, Inc. *Voices Charter School Technical Biological Report, Morgan Hill, Santa Clara County, California*. March 11, 2019.

- Plant and wildlife species that have been formally listed, are proposed as endangered or threatened, or are candidates for such listing under the State and federal Endangered Species Acts;
- CDFW species of special concern;
- U.S. Fish and Wildlife Service (USFWS) Birds of Conservation Concern; and
- Plant species on CNPS Lists 1 and 2.

In addition, nesting birds and raptors are protected under the Federal Migratory Bird Treaty Act (MBTA), which prohibits killing, possessing, or trading of migratory birds, except in accordance with regulations prescribed by the Secretary of the Interior. The MBTA covers take of whole birds, parts of birds, and bird nests and eggs.

The project site is located within the boundaries of the SCVHP, which provides take authorization for 18 listed and non-listed species (i.e. covered species). In addition, the SCVHP includes conservation measures to protect the species covered by the SCVHP, as well as a conservation strategy designed to mitigate impacts on covered species and contribute to the recovery of the species in the study area. Compliance with the SCVHP is discussed under question ‘f’ below.

As part of the Biological Report, various databases were reviewed to evaluate the potential for special-status species to occur within the project area. In addition, a field survey of the project site was conducted by LOA on March 1, 2019. Sources of information reviewed by LOA included California Natural Diversity Database (CNDDDB), USFWS’s *Listed Plants and Listed Animals*, CDFW’s *State and Federally Listed Endangered and Threatened Animals of California*, *California Bird Species of Special Concern*, and *California Amphibian and Reptile Species of Special Concern*, and the CNPS’s *Inventory of Rare and Endangered Vascular Plants of California*. Based on such sources, LOA determined that a total of 10 special-status plant species and 24 special-status wildlife species have been documented within the project region.

Special-Status Plant Species

For each of the 10 special-status plant species known to occur, or that once occurred, within the project region, LOA evaluated the potential for the species to occur on the project site based on habitat requirements and other considerations. Pursuant to the Biological Report, habitat in the form of serpentine and/or alkaline soils, woodlands nor vernal pools occur on the project site. As such, many of the plant species that occur on such soils or in such habitat types are considered absent from the site. In addition, special-status plant species that occur in grassland habitats are absent due to the highly disturbed nature of the grasslands on the site and the overwhelming dominance of non-native annual grasses on the site. As such, development of the proposed project would not result in substantial adverse effects to special-status plant species.

Special-Status Wildlife Species

Of the 24 special-status wildlife species with documented occurrences in the project region, 15 species are absent or unlikely to occur on the project site due to a lack of suitable habitat on the site, such as streams, vernal pools, woodland, chaparral, and forest habitat. While individual Townsend's big-eared bats and pallid bats may forage within the site from time to time, evidence of bats was not observed during reconnaissance surveys, and the on-site trees do not support suitable roosting habitat for bats. The remaining seven species have the potential to occur as potential foragers, transients, or residents to the site, or may occur within areas adjacent to the site. Such species include burrowing owl and nesting migratory birds and raptors protected by the MBTA, including Swainson's hawk, northern harrier, white-tailed kite, golden eagle, loggerhead shrike, and grasshopper sparrow.

Burrowing Owl

Burrowing owls do not require a specific vegetation cover or soil type and typically use vacated burrows dug by small mammals as nesting habitat; however, burrowing owls are also known to use artificial burrows including pipes, culverts, and piles of concrete pieces in urban areas.

The project site is located outside of the SCVHP burrowing owl fee area. However, the site provides overwintering habitat for burrowing owls in the form of California ground squirrel burrows and foraging land. As such, should site grading occur during the nesting season for the species (February 1 through August 31), nests and nestlings potentially present on the site could be adversely affected by the proposed development, and a potentially significant impact could occur.

Nesting Migratory Birds and Raptors

Existing trees and shrubs on and near the project site provide potential nesting habitat for nesting migratory birds and raptors. Therefore, project construction activities, including initial site grading, soil excavation, and/or tree and vegetation removal occurring during the nesting period for migratory birds (typically between February 1 to August 31) could have the potential to result in nest abandonment or death of any live eggs or young, should migratory birds or their nests be present within or near the project site. In such an event, the proposed project could result in a potentially significant impact.

Conclusion

Based on the above, development of the proposed project would not result in any substantial adverse effects to special-status plants, as the disturbed nature of the site and the lack of suitable habitat precludes the likely occurrence of such species on the site. However, the site provides potential habitat for burrowing owls and nesting migratory birds and raptors protected by the MBTA, including Swainson's hawk, northern harrier, white-tailed kite, golden eagle, loggerhead shrike, and grasshopper sparrow. Such species could occur on the project site during construction activities associated with the proposed project.

As such, the project could have a substantial adverse effect, either directly or through habitat modifications, on species identified as candidate, sensitive, or special status-species in local or regional plans, policies, or regulations, or by the CDFW or USFWS, and a *potentially significant* impact could occur.

Mitigation Measure(s)

Implementation of the following mitigation measures would reduce the above identified potential impact to a *less-than-significant* level.

- IV-1. *A pre-construction survey shall be conducted by a qualified Burrowing Owl biologist no more than 30 days prior to initiation of any ground disturbing (construction) activity to assure take avoidance of burrowing owls. The survey shall consist of a habitat assessment, burrow survey, owl survey, and completion of a written report. The written report shall be submitted to the City of Morgan Hill Development Services Department. If owls are not determined to be present on-site, further mitigation is not required. If owls are observed during the preconstruction survey, no impacts to the owls or their habitat will be allowed during the nesting season (February 1 to August 31), and Mitigation Measures IV-2 and IV-3 shall be implemented.*
- IV-2. *Should burrowing owls be found on the site during the breeding season (February 1 through August 31), exclusion zones, with a 250-foot radius from occupied burrows, shall be established. All development-related activities shall occur outside of the exclusion area until the young have fledged. Establishment of the exclusion area shall be determined by a qualified biologist to the satisfaction of the City of Morgan Hill Development Services Department.*
- IV-3. *If pre-construction surveys are conducted during the non-breeding season (September 1 through January 31) and burrowing owls are observed on the site, the project proponent shall establish a 250-foot non-disturbance buffer around occupied burrows as determined by a qualified biologist. Construction activities outside of the 250-foot buffer shall be allowed. Construction activities within the non-disturbance buffer shall be allowed if the following criteria are met in order to prevent owls from abandoning important overwintering sites:*
- *A qualified biologist monitors the owls for at least three days prior to construction to determine baseline foraging behavior (i.e., behavior without construction).*
 - *The same qualified biologist monitors the owls during construction and finds no change in owl foraging behavior in response to construction activities.*
 - *If any change in owl foraging behavior occurs as a result of construction activities, such activities shall cease within the 250-foot buffer.*

- *If the owls are gone for at least one week, the project proponent may request approval from the Habitat Agency that a qualified biologist excavate usable burrows to prevent owls from reoccupying the site. After all usable burrows are excavated, the buffer zone shall be removed, and construction may continue. Monitoring shall continue as described above for the non-breeding season as long as the burrow remains active.*

Passive relocation of owls shall not be permitted unless the positive growth trend described in Section 5.4.6 of the SCVHP is achieved and all passive relocation measures identified in the SCVHP are implemented. The project applicant may choose to obtain an exception that would allow for passive relocation, in which case an application shall be submitted to the Habitat Agency along with a passive relocation plan in accordance with Section 6.6.1, Condition 15, Exceptions to Passive Relocation Prohibition, of the SCVHP. The Habitat Agency shall have the final authority to grant or deny the requested exception.

IV-4. If construction is proposed during breeding season (February 1 to August 31), a pre-construction nesting survey for raptors and other protected migratory birds shall be conducted by a qualified biologist and submitted to the City of Morgan Hill Development Services Department for review no more than 14 days prior to the start of construction. Pre-construction surveys during the non-breeding season (September 1 to January 31) are not necessary for birds, including roosting raptors, as they are expected to abandon their roosts during construction. If these species are deemed absent from the area, construction may occur within 14 days following the survey during the early nesting season (February to May) and within 30 days following the survey during the late nesting season (June to August).

If nesting raptors are detected on or adjacent to the site during the survey, a suitable construction-free buffer shall be established around all active nests. The precise dimension of the buffer (250-foot minimum for certain raptors) shall be determined by the qualified biologist at that time and may vary depending on location, topography, type of construction activity, and species. The buffer areas shall be enclosed with temporary fencing, and construction equipment and workers shall not enter the enclosed setback areas. Buffers shall remain in place for the duration of the breeding season or until it has been confirmed by a qualified biologist that all chicks have fledged and are independent of their parents.

b,c. The project site consists primarily of disturbed ruderal vegetation and is bordered by paved roadways to the east and south. West Little Llagas Creek, which is considered a Category 2 Stream pursuant to the SCVHP, is located along the western portion of the site. The project would adhere to a 35-foot setback from the creek and riparian habitat as required by the SCVHP, with the exception of the proposed interpretive trail which, pursuant to the

SCVHP, is allowed within the 35-foot setback. The project would not include construction of any new stormwater outfalls to the creek. Limited grading within the 35-foot riparian setback required by SCVHP could result in potential water quality impacts to the creek; however, as discussed in Section X, Hydrology and Water Quality, of this IS/MND, the proposed project would be required to prepare a Stormwater Pollution Prevention Plan (SWPPP) incorporating Best Management Practices (BMPs) to control sedimentation, erosion, and hazardous materials contamination of runoff during project construction.

Based on the above, the project would not have a substantial adverse effect on any riparian habitat or other sensitive natural community identified in local or regional plans, policies, and regulations or by the CDFW or USFWS or have a substantial adverse effect on State or federally protected wetlands through direct removal, filling, hydrological interruption, or other means. Thus, a *less-than-significant* impact would occur.

- d. Movement corridors or landscape linkages are usually linear habitats that connect two or more habitat patches, providing assumed benefits to the species by reducing inbreeding depression and increasing the potential for recolonization of habitat patches. Although the reach of West Little Llagas Creek within the project site may support local wildlife movement, the project site does not fall within any regional corridor defined by the SCVHP. Movements on and across the site consist of normal movements associated with an individual animal's home range or territory, or animals dispersing from their natal range.

Given that the project site and the properties within the project area are already developed and do not support any major wildlife movement corridors, buildout of the proposed project would not constrain native wildlife movement. As noted in the Biological Report, any wildlife currently using West Little Llagas Creek as a local movement corridor would continue to do so upon development of the project. As such, the project would not interfere substantially with the movement of any resident or migratory fish or wildlife species or with established resident or migratory wildlife corridors, or impede the use of wildlife nursery sites. Thus, a *less-than-significant* impact would occur.

- e. Section 12.32.030 (Permit-Required) of the City of Morgan Hill's Municipal Code requires the approval of a tree removal permit before the removal of any Ordinance Sized Trees, defined as a non-indigenous tree with a circumference greater than 40 inches or any indigenous tree with circumference greater than 18 inches. Indigenous tree means any tree native to the Morgan Hill region, such as oaks (all types), Sycamore, California Bay, Madrone, or Alder.

A tree survey was prepared for the project site by Live Oak Associates, Inc. (see Appendix B).¹¹ Based on the results of the tree survey, the project site contains three Ordinance Sized Trees, all of which are walnut trees and are considered to be in fair or good condition. Two of the trees are located at the southwestern corner of the site, adjacent to Cosmo Avenue, and would be retained as part of the project. However, the remaining Ordinance Sized Tree, located along the eastern portion of the site, fronting Monterey Road, would require

¹¹ Live Oak Associates, Inc. *Tree letter for the proposed Voices Charter School project at the intersection of Monterey Road and Cosmo Avenue in Morgan Hill, Santa Clara County, California (PN 2344-01)*. July 2, 2019.

removal to accommodate the proposed project. Removal of the one Ordinance Sized Tree would require replacement plantings. The two Ordinance Sized Trees to be preserved would require preservation and/or protection measures.

Therefore, the proposed project could have a *potentially significant* impact related to conflicting with local policies or ordinances protecting biological resources, particularly related to Chapter 12.32 (Restrictions on Removal of Significant Trees) of the City's Municipal Code.

Mitigation Measure(s)

Implementation of the following mitigation measure would reduce the above potential impact to a *less-than-significant* level.

IV-5. *The project applicant shall mitigate for the removal of the Ordinance Sized Tree located at the eastern portion of the site along Monterey Road, as identified in the tree survey prepared for the proposed project, by providing an on-site replacement planting at a minimum 1:1 ratio with 15-gallon minimum size trees.*

For the Ordinance Sized Trees within the southwestern corner of the site, which are to be preserved as part of the project, the project applicant shall retain a certified arborist to prepare a tree protection plan, subject to review and approval by the Development Services Department. The plan shall demonstrate how any retained trees are to be protected during and after construction. The tree protection plan may include, but not be limited to, the following:

- *Locate structures, grade changes, etc. as far as feasible from the 'dripline' area of the tree.*
- *Avoid root damage through grading, trenching, compaction, etc., at least within an area 1.5 times the 'dripline' area of trees. Where root damage cannot be avoided, roots encountered (over one inch in diameter) should be exposed approximately 12 inches beyond the area to be disturbed (towards tree stem), by hand excavation, or with specialized hydraulic or pneumatic equipment, cut cleanly with hand pruners or power saw, and immediately back-filled with soil. Tearing, or otherwise disturbing the portion of the root(s) to remain, shall be avoided.*
- *A temporary fence shall be constructed as far from the tree stem (trunk) as possible, completely surrounding the tree, and six to eight feet in height. 'No parking or storage' signs shall be posted outside/on the fencing. Postings shall not be attached to the main stem of the tree.*
- *Vehicles, equipment, pedestrian traffic, building materials, debris storage, and/or disposal of toxic or other materials shall not be permitted inside of the fenced off area.*

- *The project applicant shall avoid pruning immediately before, during, or immediately after construction impact. Perform only that pruning which is unavoidable due to conflicts with proposed development. Aesthetic pruning should not be performed for at least one to two years following completion of construction.*
- *Trees that will be impacted by construction may benefit from fertilization, ideally performed in the fall, and preferably prior to any construction activities, with not more than six pounds of actual nitrogen per 1,000 square feet of accessible 'drip line' area or beyond.*
- *The 'rooting' area shall be mulched with an acidic, organic compost or mulch.*
- *The project applicant shall arrange for periodic (Biannual/Quarterly) inspection of tree's condition, and treatment of damaging conditions (insects, diseases, nutrient deficiencies, etc.) as such conditions occur, or as appropriate.*
- *Subject to the discretion of the Development Services Department, individual trees likely to suffer significant impacts may require specific, more extensive efforts and/or a more detailed specification than those contained within the above general guidelines.*

f. As noted above, the project site is located within the boundaries of the SCVHP permit area. The SCVHP was developed through a partnership between Santa Clara County, the cities of San José, Morgan Hill, and Gilroy, the Santa Clara Valley Water District (SCVWD), the Santa Clara VTA, the USFWS, and the CDFW. The SCVHP is intended to promote the recovery of endangered species and enhance ecological diversity and function, while accommodating planned growth in approximately 500,000 acres of southern Santa Clara County. The SCVHP provides take authorization for 18 covered species and includes conservation measures to protect the species covered by the SCVHP, as well as a conservation strategy designed to mitigate impacts on covered species and contribute to the recovery of the species in the study area. Per the SCVHP, the project site is designated as a "Golf Course/Urban Parks" land cover type.

Compliance with the SCVHP requires payment of fees according to the Fee Zone designation of the property, payment of nitrogen deposition fees related to the number of anticipated car trips resulting from the development, and any surcharge fees that are required based on site-specific impacts to sensitive habitats or sensitive species. The project site is within Fee Zone B (Agricultural and Valley Floor Lands). As such, the proposed project would be subject to Zone B fees, which are currently \$14,725 per acre (2018/2019 rates) and would be applied to the western edge of the interpretive trail eastward throughout the remainder of the project site. Fees would not be required for the area west of the trail, which would not be developed as part of the project. In addition, the project would be subject to nitrogen deposition fees, which, as of 2019, are \$4.96 for each new vehicle trip. For any temporary impacts, all the same fees are applied, but at a fraction of the total cost, depending on how long the project expects the temporary impact to last. Potential on-site

temporary fees include irrigation to proposed native tree plantings on the western side of the interpretive trail.

As discussed under question ‘b,c’ above, the SCVHP requires a 35-foot setback from all Category 2 Streams, including the reach of West Little Llagas Creek within the project site. The project would adhere to a 35-foot setback from the creek and riparian habitat as required by the SCVHP, with the exception of the proposed interpretive trail which, per the SCVHP, is allowed within the 35-foot setback. Therefore, the project would comply with Condition 11 of the SCVHP related to stream and riparian setbacks.

In addition to fees, the proposed project would be required to comply with applicable conditions of the SCVHP. Compliance with such conditions would be ensured with implementation of Mitigation Measures IV-1 through IV-5 above. However, should the proposed project not comply with the mitigation requirements of the SCVHP for covered species during construction or fulfill payment of necessary fees, the project could conflict with the SCVHP. Thus, a *potentially significant* impact could occur.

IV-6. No later than submittal of the first construction or grading permit for the proposed project the owner or designee shall pay the Santa Clara Valley Habitat Plan per-acre fee in effect for the appropriate fee zone of the project site, as determined by the Santa Clara Valley Habitat Agency, in compliance with Section 18.132.050 of the Morgan Hill Municipal Code.

IV-7. Implement Mitigation Measures IV-1 through IV-5.

V. CULTURAL RESOURCES.

Would the project:

	Potentially Significant Impact	Less Than Significant with Mitigation Incorporated	Less-Than-Significant Impact	No Impact
a. Cause a substantial adverse change in the significance of a historical resource pursuant to Section 15064.5?	<input type="checkbox"/>	<input type="checkbox"/>	✘	<input type="checkbox"/>
b. Cause a substantial adverse change in the significance of a unique archaeological resource pursuant to Section 15064.5?	<input type="checkbox"/>	<input type="checkbox"/>	✘	<input type="checkbox"/>
c. Disturb any human remains, including those interred outside of dedicated cemeteries.	<input type="checkbox"/>	<input type="checkbox"/>	✘	<input type="checkbox"/>
<p>a. A records search of the California Historic Resources Information System (CHRIS) was performed by the North Central Information Center (NWIC) for cultural resource site records and survey reports within the proposed project area. Based on the results of the CHRIS search, the State Office of Historic Preservation Directory (which includes listings of the California Register of Historical Resources, California State Historical Landmarks, California State Points of Historical Interest, and the National Register of Historic Places) there are no listed recorded buildings or structures in or adjacent to the project site.¹² Furthermore, the site is currently vacant and undeveloped. Therefore, the proposed project would not cause any adverse change in the significance of a historical resource, and a <i>less-than-significant</i> impact would occur.</p>				
<p>b,c. According to the CHRIS search, the project site has been subject to a prior archaeological study that covered the entirety of the site. The site does not contain any recorded archaeological resources. However, as noted in the General Plan EIR, archaeological surveys conducted in Morgan Hill have identified numerous prehistoric sites with shell midden components, including human burials. Based on such findings, the potential exists for additional undiscovered archeological resources in the City. As such, while unlikely, the possibility exists for previously unknown resources to be found on-site during grading and excavation associated with development of the proposed project. In the event that such resources are unearthed, the following City standard Condition of Approval related to the protection of archaeological resources would be implemented:</p> <ol style="list-style-type: none"> 1. An archaeologist shall be present on-site to monitor all ground-disturbing activities. Where historical or archaeological artifacts are found, work in areas where remains or artifacts are found will be restricted or stopped until proper protocols are met, as described below: <ol style="list-style-type: none"> a. Work at the location of the find will halt immediately within thirty feet of the find. If an archaeologist is not present at the time of the discovery, the applicant shall contact an archaeologist for evaluation of the find to determine whether it qualifies as a unique archaeological resource as defined by this chapter; 				

¹² California Historical Resources Information System. *Record search results for the proposed Voices Charter School Project*. March 28, 2019.

- b. If the find is determined not to be a Unique Archaeological Resource, construction can continue. The archaeologist will prepare a brief informal memo/letter that describes and assesses the significance of the resource, including a discussion of the methods used to determine significance for the find;
 - c. If the find appears significant and to qualify as a unique archaeological resource, the archaeologist will determine if the resource can be avoided and will detail avoidance procedures in a formal memo/letter; and
 - d. If the resource cannot be avoided, the archaeologist shall develop within forty-eight hours an action plan to avoid or minimize impacts. The field crew shall not proceed until the action plan is approved by the Development Services Director. The action plan shall be in conformance with California Public Resources Code 21083.2.
- 2. The following policies and procedures for treatment and disposition of inadvertently discovered human remains or archaeological materials shall apply. If human remains are discovered, it is probable they are the remains of Native Americans,
 - a. If human remains are encountered, they shall be treated with dignity and respect as due to them. Discovery of Native American remains is a very sensitive issue and serious concern. Information about such a discovery shall be held in confidence by all project personnel on a need to know basis. The rights of Native Americans to practice ceremonial observances on sites, in labs and around artifacts shall be upheld.
 - b. Remains should not be held by human hands. Surgical gloves should be worn if remains need to be handled.
 - c. Surgical mask should also be worn to prevent exposure to pathogens that may be associated with the remains.
- 3. In the event that known or suspected Native American remains are encountered, or significant historic or archaeological materials are discovered, ground-disturbing activities shall be immediately stopped. Examples of significant historic or archaeological materials include, but are not limited to, concentrations of historic artifacts (e.g., bottles, ceramics) or prehistoric artifacts (chipped chert or obsidian, arrow points, groundstone mortars and pestles), culturally altered ash-stained midden soils associated with pre-contact Native American habitation sites, concentrations of fire-altered rock and/or burned or charred organic materials and historic structure remains such as stone-lined building foundations, wells or privy pits. Ground-disturbing project activities may continue in other areas that are outside the exclusion zone as defined below.
- 4. An "exclusion zone" where unauthorized equipment and personnel are not permitted shall be established (e.g., taped off) around the discovery area plus a reasonable buffer zone by the contractor foreman or authorized representative, or party who made the discovery and initiated these protocols, or if on-site at the time of discovery, by the monitoring archaeologist (typically twenty-five to fifty feet for single burial or archaeological find).

5. The exclusion zone shall be secured (e.g., twenty-four-hour surveillance) as directed by the city or county if considered prudent to avoid further disturbances.
6. The contractor foreman or authorized representative, or party who made the discovery and initiated these protocols shall be responsible for immediately contacting by telephone the parties listed below to report the find and initiate the consultation process for treatment and disposition:
 - a. The City of Morgan Hill Development Services Director,
 - b. The contractor's point(s) of contact,
 - c. The coroner of the county of Santa Clara (if human remains found),
and
 - d. The Native American Heritage Commission (NAHC) in Sacramento.
7. The coroner has two working days to examine the remains after being notified of the discovery. If the remains are Native American, the Coroner has twenty-four hours to notify the NAHC.
8. The NAHC is responsible for identifying and immediately notifying the Most Likely Descendant (MLD). (Note: NAHC policy holds that the Native American Monitor will not be designated the MLD.).
9. Within twenty-hour hours of their notification by the NAHC, the MLD will be granted permission to inspect the discovery site if they so choose,
10. Within twenty-four hours of their notification by the NAHC, the MLD may recommend to the City's Development Services Director the recommended means for treating or disposing, with appropriate dignity, the human remains and any associated grave goods. The recommendation may include the scientific removal and non-destructive or destructive analysis of human remains and items associated with Native American burials. Only those osteological analyses or DNA analyses recommended by the appropriate tribe may be considered and carried out.
11. If the MLD recommendation is rejected by the City of Morgan Hill, the parties will attempt to mediate the disagreement with the NAHC. If mediation fails, then the remains and all associated grave offerings shall be reburied with appropriate dignity on the property in a location not subject to further subsurface disturbance.

Compliance with the above standard Conditions of Approval would ensure that construction of the proposed project would have a *less-than-significant* impact related to unique archeological, paleontological, and geological resources, as well as the disturbance of human remains.

VI. ENERGY.

Would the project:

	Potentially Significant Impact	Less-Than-Significant with Mitigation Incorporated	Less-Than-Significant Impact	No Impact
a. Result in potentially significant environmental impact due to wasteful, inefficient, or unnecessary consumption of energy resources, during project construction or operation?	<input type="checkbox"/>	<input type="checkbox"/>	<input checked="" type="checkbox"/>	<input type="checkbox"/>
b. Conflict with or obstruct a state or local plan for renewable energy or energy efficiency?	<input type="checkbox"/>	<input type="checkbox"/>	<input checked="" type="checkbox"/>	<input type="checkbox"/>
a,b. The main forms of available energy supply are electricity, natural gas, and oil. A description of the California Green Building Standards Code and the Building Energy Efficiency Standards, with which the proposed project would be required to comply, as well as discussions regarding the proposed project’s potential effects related to energy demand during construction and operations are provided below.				

California Green Building Standards Code

The California Green Building Standards Code, otherwise known as the CALGreen Code (CCR Title 24, Part 11), is a portion of the California Building Standards Code (CBSC), which became effective with the rest of the CBSC on January 1, 2017. The purpose of the CALGreen Code is to improve public health, safety, and general welfare by enhancing the design and construction of buildings through the use of building concepts having a reduced negative impact or positive environmental impact and encouraging sustainable construction practices. The provisions of the code apply to the planning, design, operation, construction, use, and occupancy of every newly constructed building or structure throughout California. Requirements of the CALGreen Code include, but are not limited to, the following measures:

- Compliance with relevant regulations related to future installation of Electric Vehicle charging infrastructure in residential and non-residential structures;
- Indoor water use consumption is reduced through the establishment of maximum fixture water use rates;
- Outdoor landscaping must comply with the California Department of Water Resources’ Model Water Efficient Landscape Ordinance (MWEL0), or a local ordinance, whichever is more stringent, to reduce outdoor water use;
- Diversion of 65 percent of construction and demolition waste from landfills;
- Mandatory periodic inspections of energy systems (i.e., heat furnace, air conditioner, mechanical equipment) for nonresidential buildings over 10,000 square feet to ensure that all are working at their maximum capacity according to their design efficiencies; and
- Mandatory use of low-pollutant emitting interior finish materials such as paints, carpet, vinyl flooring, and particle board.

Building Energy Efficiency Standards

The 2016 Building Energy Efficiency Standards is a portion of the CBSC, which expands upon energy-efficiency measures from the 2013 Building Energy Efficiency Standards resulting in a five percent reduction in energy consumption from the 2013 standards for commercial structures. Energy reductions relative to previous Building Energy Efficiency Standards are achieved through various regulations including requirements for the use of high efficacy lighting, improved water heating system efficiency, and high-performance attics and walls.

It should be noted that the 2019 Building Energy Efficiency Standards will go into effect for building permit applications submitted on or after January 1, 2020. The 2019 standards will provide for additional efficiency improvements beyond the current 2016 standards. Non-residential buildings built in compliance with the 2019 standards are anticipated to use approximately 30 percent less energy compared to the 2016 standards, primarily due to lighting upgrades.¹³

Construction Energy Use

Construction of the proposed project would involve on-site energy demand and consumption related to use of oil in the form of gasoline and diesel fuel for construction worker vehicle trips, hauling and materials delivery truck trips, and operation of off-road construction equipment. In addition, diesel-fueled portable generators may be necessary to provide additional electricity demands for temporary on-site lighting, welding, and for supplying energy to areas of the site where energy supply cannot be met via a hookup to the existing electricity grid. Project construction would not involve the use of natural gas appliances or equipment.

Even during the most intense period of construction, due to the different types of construction activities (e.g., site preparation, grading, building construction), only portions of the project site would be disturbed at a time, with operation of construction equipment occurring at different locations on the project site, rather than a single location. In addition, all construction equipment and operation thereof would be regulated by the CARB In-Use Off-Road Diesel Vehicle Regulation. The In-Use Off-Road Diesel Vehicle Regulation is intended to reduce emissions from in-use, off-road, heavy-duty diesel vehicles in California by imposing limits on idling, requiring all vehicles to be reported to CARB, restricting the addition of older vehicles into fleets, and requiring fleets to reduce emissions by retiring, replacing, or repowering older engines, or installing exhaust retrofits. The In-Use Off-Road Diesel Vehicle Regulation would subsequently help to improve fuel efficiency and reduce GHG emissions. Technological innovations and more stringent standards are being researched, such as multi-function equipment, hybrid equipment, or other design changes, which could help to reduce demand on oil and emissions associated with construction.

¹³ California Energy Commission. *Title 24 2019 Building Energy Efficiency Standards FAQ*. November 2018.

The CARB has recently prepared the *2017 Climate Change Scoping Plan Update* (2017 Scoping Plan),¹⁴ which builds upon previous efforts to reduce GHG emissions and is designed to continue to shift the California economy away from dependence on fossil fuels. Appendix B of the 2017 Scoping Plan includes examples of local actions (municipal code changes, zoning changes, policy directions, and mitigation measures) that would support the State's climate goals. The examples provided include, but are not limited to, enforcing idling time restrictions for construction vehicles, utilizing existing grid power for electric energy rather than operating temporary gasoline/diesel-powered generators, and increasing use of electric and renewable fuel-powered construction equipment. The In-Use Off-Road Diesel Vehicle Regulation described above, with which the proposed project must comply, would be consistent with the intention of the 2017 Scoping Plan and the recommended actions included in Appendix B of the 2017 Scoping Plan.

Based on the above, the temporary increase in energy use occurring during construction of the proposed project would not result in a significant increase in peak or base demands or require additional capacity from local or regional energy supplies. In addition, the proposed project would be required to comply with all applicable regulations related to energy conservation and fuel efficiency, which would help to reduce the temporary increase in demand.

Operational Energy Use

Following implementation of the proposed project, PG&E would provide electricity and natural gas to the project site. Energy use associated with operation of the proposed project would be typical of school uses, requiring electricity and natural gas for interior and exterior building lighting, heating, ventilation, and air conditioning (HVAC), electronic equipment, appliances, security systems, and more. Maintenance activities during operations, such as landscape maintenance, would involve the use of electric or gas-powered equipment. In addition to on-site energy use, the proposed project would result in transportation energy use associated with vehicle trips generated by employee commutes and student drop-offs and pick-ups.

The proposed project would be subject to all relevant provisions of the most recent update of the CBSC, including the Building Energy Efficiency Standards. Adherence to the most recent CALGreen Code and the Building Energy Efficiency Standards would ensure that the proposed structure would consume energy efficiently through the incorporation of such features as door and window interlocks, direct digital controls for HVAC systems, and high efficiency outdoor lighting. Required compliance with the CBSC would ensure that the building energy use associated with the proposed project would not be wasteful, inefficient, or unnecessary. In addition, electricity supplied to the project by PG&E would comply with the State's Renewable Portfolio Standard (RPS), which requires investor-owned utilities, electric service providers, and community choice aggregators to increase procurement from eligible renewable energy resources to 33 percent of total procurement by 2020 and to 60 percent by 2030. Thus, a portion of the energy consumed during project operations would originate from renewable sources.

¹⁴ California Air Resources Board. *The 2017 Climate Change Scoping Plan Update*. January 20, 2017.

With regard to transportation energy use, the proposed project would comply with all applicable regulations associated with vehicle efficiency and fuel economy. In addition, as discussed in Section XVII, Transportation, of this Initial Study, the project site is located within close proximity to existing residential neighborhoods, bicycle infrastructure, and transit infrastructure. The site's proximity to existing residences and alternative transportation infrastructure could reduce vehicle miles travelled (VMT) by allowing school staff and students to live in close proximity to the project site and use alternative means of transportation to travel to and from the site. The use of alternative means of transportation and associated reduction of VMT would reduce fuel consumption.

Conclusion

Based on the context above, construction and operation of the proposed project would not result in wasteful, inefficient, or unnecessary consumption of energy resources or conflict with or obstruct a State or local plan for renewable energy or energy efficiency. Thus, a *less-than-significant* impact would occur.

VII. GEOLOGY AND SOILS.

Would the project:

	Potentially Significant Impact	Less Than Significant with Mitigation Incorporated	Less-Than-Significant Impact	No Impact
a. Directly or indirectly cause potential substantial adverse effects, including the risk of loss, injury, or death involving:				
i. Rupture of a known earthquake fault, as delineated on the most recent Alquist-Priolo Earthquake Fault Zoning Map issued by the State Geologist for the area based on other substantial evidence of a known fault? Refer to Division of Mines and Geology Special Publication 42.	<input type="checkbox"/>	<input type="checkbox"/>	<input checked="" type="checkbox"/>	<input type="checkbox"/>
ii. Strong seismic ground shaking?	<input type="checkbox"/>	<input type="checkbox"/>	<input checked="" type="checkbox"/>	<input type="checkbox"/>
iii. Seismic-related ground failure, including liquefaction?	<input type="checkbox"/>	<input type="checkbox"/>	<input checked="" type="checkbox"/>	<input type="checkbox"/>
iv. Landslides?	<input type="checkbox"/>	<input type="checkbox"/>	<input checked="" type="checkbox"/>	<input type="checkbox"/>
b. Result in substantial soil erosion or the loss of topsoil?	<input type="checkbox"/>	<input type="checkbox"/>	<input checked="" type="checkbox"/>	<input type="checkbox"/>
c. Be located on a geologic unit or soil that is unstable, or that would become unstable as a result of the project, and potentially result in on- or off-site landslide, lateral spreading, subsidence, liquefaction or collapse?	<input type="checkbox"/>	<input type="checkbox"/>	<input checked="" type="checkbox"/>	<input type="checkbox"/>
d. Be located on expansive soil, as defined in Table 18-1B of the Uniform Building Code (1994), creating substantial direct or indirect risks to life or property?	<input type="checkbox"/>	<input type="checkbox"/>	<input checked="" type="checkbox"/>	<input type="checkbox"/>
e. Have soils incapable of adequately supporting the use of septic tanks or alternative wastewater disposal systems where sewers are not available for the disposal of wastewater?	<input type="checkbox"/>	<input type="checkbox"/>	<input type="checkbox"/>	<input checked="" type="checkbox"/>
f. Directly or indirectly destroy a unique paleontological resource or site or unique geologic feature?	<input type="checkbox"/>	<input type="checkbox"/>	<input checked="" type="checkbox"/>	<input type="checkbox"/>
ai-iv. Active faults do not cross the site, and the site is not mapped within an Alquist-Priolo Earthquake Fault Zone. ¹⁵ Therefore, the proposed project would not be subject to risks related to fault rupture. Furthermore, the site is not located within the vicinity of any steep slopes that would be subject to landslide risk, nor within an area requiring special investigation for landslides or liquefaction hazards. According to the Association of Bay Area Governments (ABAG) Resilience Program’s interactive Hazards Map, the project site is located in an area of relatively low to moderate liquefaction susceptibility. ¹⁶				

¹⁵ Department of Conservation. *State of California, Special Studies Zones, Mt. Madonna Quadrangle, Revised Official Map*. Effective January 1, 1976.

¹⁶ Association of Bay Area Governments. *Resilience Program*. Available at: <http://gis.abag.ca.gov/website/Hazards/?hlyr=liqSusceptibility>. Accessed February 2019.

Due to the proximity of the site area to nearby active faults, including but not limited to the Hayward, Calaveras, and the San Andreas fault zones, strong ground shaking could occur at the site as a result of an earthquake on any one of the faults. However, the proposed school would be subject to all applicable regulations within the CBSC and Chapter 15.08 (Building Code) of the City's Municipal Code, which provide standards to protect property and public safety by regulating the design and construction of foundations, building frames, and other building elements. Therefore, a *less-than-significant* impact would occur related to exposure of people or structures to potential substantial adverse effects, including the risk of loss, injury, or death involving rupture of a known earthquake fault, strong seismic ground shaking, seismic-related ground failure, or landslides.

- b. Development of the proposed project site would cause ground disturbance of mostly topsoil related to construction activity. The ground disturbance would be limited to the areas proposed for grading and excavation, including the school building pads; curb, gutter, and sidewalk improvement areas; and drainage, sewer, and water infrastructure alignments. After grading and excavation and prior to overlaying the disturbed ground surfaces with impervious surfaces and structures, the potential exists for wind and water erosion to occur, which could adversely affect downstream storm drainage facilities.

New development within the City that disturbs one or more acres of land is required to comply with the National Pollutant Discharge Elimination System (NPDES) General Construction Permit and prepare a SWPPP incorporating BMPs to control sedimentation, erosion, and hazardous materials contamination of runoff during construction. The proposed project would disturb approximately two acres and, thus, would be subject to such requirements. In addition, pursuant to Chapter 13.30 (Urban Storm Water Quality Management and Discharge Control) of the City's Municipal Code, the project applicant would be required to submit a sediment and erosion control plan to the City of Morgan Hill, Public Works Department, prior to the approval of improvement plans and issuance of building permits. The plan(s) shall be acceptable and conform to City standards to prevent significant sediment and soil erosion during construction and include the standards and guidelines found in the California Stormwater Quality Association, Stormwater Best Management Practice Handbook. Based on the above, the proposed project would not result in substantial soil erosion or the loss of topsoil. Thus, a *less-than-significant* impact would occur.

- c,d. As noted previously, the project site would not be subject to substantial landslide or liquefaction hazards. In addition, as noted in the General Plan EIR, the CBSC and Chapter 15.08 (Building Code) of the City's Municipal Code provide standards to protect property and public safety by regulating the design and construction of excavations, foundations, building frames, and other building elements.

In order to determine the expansive potential of the on-site soils, the project site was evaluated using the Department of Agriculture (USDA) Natural Resources Conservation Service (NRCS) Web Soil Survey program.¹⁷ According to the NRCS, soils with a linear

¹⁷ Natural Resources Conservation Service. *Web Soil Survey*. Available at: <https://websoilsurvey.sc.egov.usda.gov/App/HomePage.htm>. Accessed February 2019.

extensibility rating of between three and six percent and a clay content of 25 to 35 percent are characterized by a moderate shrink-swell class (i.e., moderate expansive potential).¹⁸ Soils with a linear extensibility rating of between six and nine percent with a clay content of 35 to 45 percent are characterized by a high shrink-swell class.

The Web Soil Survey program indicates that mapped soils within the project site consist of Cropley clay, zero to two percent slopes, and San Ysidro loam, zero to two percent slopes. Table 4 below provides a summary of the extensibility and clay content of the on-site soils, along with the corresponding shrink-swell class. As shown in the table, based on the NRCS calculated coefficients of linear extensibility, the project site contains soil that may be considered expansive.

Table 4 Soil Properties				
Soil Type	% of Project Site	Linear Extensibility Rating	% Clay Content	Shrink-Swell Class
Cropley clay	61	7.2	36.4	High
San Ysidro loam	39	3.3	25.5	Moderate

Source: Natural Resources Conservation Service, Web Soil Survey, 2019.

To avoid damage due to soil expansion and shrinkage, Section 15.08.090 (Section 1907A.1 amended-Minimum slab provisions) of the City’s Municipal Code includes requirements for minimum thickness of concrete floor slabs, as well as required reinforcement with wire mesh or an approved alternate. In addition, Section 15.08.100 (Section 1808A.1 amended-Foundations) requires footing reinforcement for new foundations to help prevent damage due to shrinking and swelling. Given required compliance with the slab and foundation construction standards provided in the Municipal Code, the proposed project would not be subject to substantial risks related to expansive soils.

Based on the above, the proposed project would not create substantial direct or indirect risks to life or property related to being located on expansive soil, as defined in Table 18-1B of the Uniform Building Code (1994), creating substantial direct or indirect risks to life or property. Thus, a *less-than-significant* impact would occur.

- e. The proposed development would connect to existing City-maintained sewer infrastructure and would not include the use of septic tanks. Accordingly, *no impact* would occur related to soils incapable of adequately supporting the use of septic tanks.
- f. Paleontological resources or fossils are the remains of prehistoric plant and animal life. As noted in the General Plan EIR, based on a review of the University of California’s Museum of Paleontology’s (UCMP) fossil locality database conducted for all of Santa Clara County,

¹⁸ Natural Resources Conservation Service. *Calculated Coefficients of Linear Extensibility*. Available at: https://www.nrcs.usda.gov/wps/portal/nrcs/detail/soils/survey/office/ssr10/tr/?cid=nrcs144p2_074840. Accessed July 2018.

paleontological resources have not been explicitly identified as being found within Morgan Hill.¹⁹

As noted in the City's General Plan, occurrences of fossil resources are closely tied to the geologic units. As indicated in the USDA NRCS Web Soil Survey, soils within the project site consist of Cropley clay and San Ysidro Loam. Such soil types are not considered unique geologic features and are common within the geographic area of the City. As such, development of the proposed project would not destroy a unique geologic feature. Furthermore, the project would be subject to the City's standard measures listed in Chapter V, Cultural Resources, of this IS/MND. As noted in the General Plan EIR, such measures would further lessen potential impacts to paleontological resources. Therefore, the proposed project would not result in the direct or indirect destruction of a unique paleontological resource, and a *less-than-significant* impact could occur.

¹⁹ City of Morgan Hill. *2035 General Plan, City of Morgan Hill* [pg. 4.5-17]. Adopted July 2016.

VIII. GREENHOUSE GAS EMISSIONS.

Would the project:

	Potentially Significant Impact	Less Than Significant with Mitigation Incorporated	Less-Than-Significant Impact	No Impact
a. Generate greenhouse gas emissions, either directly or indirectly, that may have a significant impact on the environment?	<input type="checkbox"/>	<input type="checkbox"/>	<input checked="" type="checkbox"/>	<input type="checkbox"/>
b. Conflict with an applicable plan, policy or regulation adopted for the purpose of reducing the emissions of greenhouse gasses?	<input type="checkbox"/>	<input type="checkbox"/>	<input checked="" type="checkbox"/>	<input type="checkbox"/>

a,b. Emissions of Greenhouse Gases (GHGs) contributing to global climate change are attributable in large part to human activities associated with the industrial/manufacturing, utility, transportation, residential, and agricultural sectors. Therefore, the cumulative global emissions of GHGs contributing to global climate change can be attributed to every nation, region, and city, and virtually every individual on earth. An individual project’s GHG emissions are at a micro-scale level relative to global emissions and effects to global climate change; however, an individual project could result in a cumulatively considerable incremental contribution to a significant cumulative macro-scale impact. As such, impacts related to emissions of GHG are inherently considered cumulative impacts.

Implementation of the proposed project would cumulatively contribute to increases of GHG emissions. Estimated GHG emissions attributable to future development would be primarily associated with increases of carbon dioxide (CO₂) and, to a lesser extent, other GHG pollutants, such as methane (CH₄) and nitrous oxide (N₂O) associated with area sources, mobile sources or vehicles, utilities (electricity and natural gas), water usage, wastewater generation, and the generation of solid waste. The primary source of GHG emissions for the project would be mobile source emissions. The common unit of measurement for GHG is expressed in terms of annual metric tons of CO₂ equivalents (MTCO_{2e}/yr).

The proposed project is located within the jurisdictional boundaries of BAAQMD. The BAAQMD threshold of significance for project-level operational GHG emissions is 1,100 MTCO_{2e}/yr. BAAQMD’s approach to developing a threshold of significance for GHG emissions is to identify the emissions level for which a project would not be expected to substantially conflict with existing California legislation adopted to reduce statewide GHG emissions needed to move towards climate stabilization. If a project would generate GHG emissions above the threshold level, the project would be considered to generate significant GHG emissions and conflict with applicable GHG regulations.

The proposed project’s GHG emissions were quantified with CalEEMod using the same assumptions as presented in the Air Quality section of this IS/MND, and compared to the 1,100 MTCO_{2e}/yr threshold of significance. The proposed project’s required compliance with the current California Building Energy Efficiency Standards Code was assumed in the modeling. In addition, the CO₂ intensity factor within the model was adjusted to reflect the Pacific Gas & Electric Company’s anticipated CO₂ emissions factor for 2021. All CalEEMod results are included in the appendix to this IS/MND.

According to the CalEEMod results, the proposed project would result in unmitigated operational GHG emissions of 704.96 MTCO_{2e}/yr, which is below the 1,100 MTCO_{2e}/yr threshold of significance. Construction GHG emissions are a one-time release and are, therefore, not typically expected to generate a significant contribution to global climate change. Neither the City of Morgan Hill nor BAAQMD has adopted a threshold of significance for construction-related GHG emissions. Nevertheless, to provide a conservative estimate of emissions, the proposed project's total construction GHG emissions have been added to annual operational emissions. Construction would occur over approximately 11 months and result in total GHG emissions of 326.99 MTCO_{2e}. If the total construction emissions are added to the annual operational emissions, the project's total GHG emissions would equal 1,031.95 MTCO_{2e}/yr, which remains below BAAQMD's threshold of significance for operational emissions. Accordingly, the proposed project would not be expected to have a significant impact related to GHG emissions during construction.

Based on the above, the proposed project would not be considered to generate GHG emissions, either directly or indirectly, that may have a significant impact on the environment, or conflict with any applicable plan, policy, or regulation adopted for the purpose of reducing the emissions of GHGs; and impacts would be considered *less than significant*.

IX. HAZARDS AND HAZARDOUS MATERIALS.

Would the project:

	Potentially Significant Impact	Less Than Significant with Mitigation Incorporated	Less-Than-Significant Impact	No Impact
a. Create a significant hazard to the public or the environment through the routine transport, use, or disposal of hazardous materials?	<input type="checkbox"/>	<input type="checkbox"/>	<input checked="" type="checkbox"/>	<input type="checkbox"/>
b. Create a significant hazard to the public or the environment through reasonably foreseeable upset and accident conditions involving the likely release of hazardous materials into the environment?	<input type="checkbox"/>	<input type="checkbox"/>	<input checked="" type="checkbox"/>	<input type="checkbox"/>
c. Emit hazardous emissions or handle hazardous or acutely hazardous materials, substances, or waste within one-quarter mile of an existing or proposed school?	<input type="checkbox"/>	<input type="checkbox"/>	<input type="checkbox"/>	<input checked="" type="checkbox"/>
d. Be located on a site which is included on a list of hazardous materials sites compiled pursuant to Government Code Section 65962.5 and, as a result, would it create a significant hazard to the public or the environment?	<input type="checkbox"/>	<input type="checkbox"/>	<input type="checkbox"/>	<input checked="" type="checkbox"/>
e. For a project located within an airport land use plan or, where such a plan has not been adopted, within two miles of a public airport or public use airport, would the project result in a safety hazard or excessive noise for people residing or working in the project area?	<input type="checkbox"/>	<input type="checkbox"/>	<input type="checkbox"/>	<input checked="" type="checkbox"/>
f. Impair implementation of or physically interfere with an adopted emergency response plan or emergency evacuation plan?	<input type="checkbox"/>	<input type="checkbox"/>	<input checked="" type="checkbox"/>	<input type="checkbox"/>
g. Expose people or structures, either directly or indirectly, to the risk of loss, injury or death involving wildland fires?	<input type="checkbox"/>	<input type="checkbox"/>	<input checked="" type="checkbox"/>	<input type="checkbox"/>
a. Schools are not typically associated with the routine transport, use, disposal, or generation of hazardous materials. Operations would likely involve use of common commercial cleaning products, fertilizers, and herbicides on-site, any of which could contain potentially hazardous chemicals; however, such products would be expected to be used in accordance with label instructions. Due to the regulations governing use of such products and the amount utilized on the site, occasional use of such products would not represent a substantial risk to public health or the environment. Therefore, the project would not create a significant hazard to the public or the environment through the routine transport, use, or disposal of hazardous materials, and a <i>less-than-significant</i> impact would occur.				
b. Construction activities associated with the proposed project would involve the use of various products such as concrete, paints, and adhesives. In addition, heavy-duty construction equipment operating on the project site would contain hydraulic fluid, diesel fuel, and other petroleum products. Small quantities of such potentially toxic substances				

would be used at the project site and transported to and from the site during construction. However, the project contractor would be required to comply with all California Health and Safety Codes and local County ordinances regulating the handling, storage, and transportation of hazardous and toxic materials.

A Phase I ESA was prepared for the proposed project site by RNC Environmental, LLC (see Appendix C).²⁰ The ESA included a survey of the site and a review of historical documentation, aerial photography, regulatory agency files, and environmental sites radius reports. According to the Phase I ESA, the project site was previously developed with a vineyard from at least the 1940s through the 1960s, at which point the vineyard was removed from the site. The site continued to be used for other agricultural uses up to the 1990s. The site was never developed with any permanent structures.

Hazardous materials or hazardous wastes were not identified on the project site or adjacent to the site. In addition, evidence of underground storage tanks (USTs) or aboveground storage tanks (ASTs) was not observed at the site. Two Leaking UST cleanup sites and one hazardous waste cleanup site were identified within a half-mile radius of the site; however, RCN Environmental, LLC concluded that none of the cleanup sites have the potential to adversely affect groundwater conditions at the project site. Results of a Vapor Encroachment Screening (VES) conducted as part of the Phase I ESA indicate that there is no Vapor Encroachment Condition at the project site.

While the Phase I ESA did not note any evidence of hazardous materials or hazardous wastes on the site, due to the historical use of the site as a vineyard, the potential exists that persistent pesticides, such as arsenic compounds and organochlorines such as DDT, may have been applied to the site. In order to further evaluate this potential concern, soil sampling for arsenic and chlorinated hydrocarbon pesticides was conducted at the same time as the Phase I site visit on July 26, 2018.

The soil sampling conducted included collection of samples from four representative locations on the site. At each sample location, one soil sample was collected from the top six inches of the soil and subsequently submitted to laboratory analysis for organochlorine pesticides and arsenic. Organochlorine pesticides were not detected in any of the collected samples. Arsenic was detected at concentrations ranging from 4.2 to 5.0 milligrams per kilogram (mg/kg); however, the Department of Toxic Substances Control (DTSC) has determined that arsenic concentrations below 12 mg/kg can generally be considered to be natural background arsenic levels and do not need further evaluation. Given that the detected concentrations of arsenic are below background levels, arsenic contamination would not pose a risk to future students or workers at the project site.

Based on the above, the project site is not associated with any historical recognized environmental conditions, including contaminated soils, that would pose a risk to the proposed project. Therefore, development of the proposed project would result in a *less-than-significant* impact related to the creation of a significant hazard to the public or the

²⁰ RNC Environmental, LLC. *Phase I Environmental Site Assessment, Voices Charter School, APN 767-17-047, NW Corner Monterey Rd., Cosmo Ave., Morgan Hill, Santa Clara County, California 95037*. August 6, 2018.

environment through reasonably foreseeable upset and accident conditions involving the likely release of hazardous materials into the environment.

- c. The nearest school relative to the project site is the Barrett Elementary School, located approximately 0.85-mile to the north of the site. Development of the proposed project would not create a significant hazard to the public or the environment through the routine transport, use, or disposal of hazardous materials. Thus, ***no impact*** would result relating to the emission or handling of hazardous materials, substances, or waste within one-quarter mile of an existing or proposed school.
- d. The Phase I ESA indicates that the project site is not included on the list of hazardous materials sites compiled pursuant to Government Code Section 65962.5. Therefore, ***no impact*** would result from implementation of the proposed project.
- e. The public airport nearest to the project site is the San Martin Airport, which is located approximately 3.5 miles south of the project site at 13030 Murphy Avenue. The project site is located well outside of the Airport Influence Area (AIA) identified in the South County Airport Comprehensive Land Use Plan.²¹ In addition, the project site is not located within the vicinity of a private airstrip. Therefore, the proposed project would not result in an airport-related safety hazard for people residing or working in the project area, and ***no impact*** would occur.
- f. Implementation of the proposed project would not result in any substantial modifications to the City's existing roadway system and would not interfere with potential evacuation or response routes used by emergency response teams. In addition, the project would not conflict with the City's Emergency Operations Plan.²² The proposed project is consistent with the site's current General Plan land use and zoning designations; thus, development of the site and associated effects on emergency evacuation routes has been anticipated per the General Plan and analyzed in the General Plan EIR. Therefore, the project would not impair implementation of or physically interfere with an adopted emergency response plan or emergency evacuation plan, and a ***less-than-significant*** impact would occur.
- g. The City's Wildland Urban Interface map indicates that the proposed project site is not located in a High or Very High Fire Hazard Severity Zone (FHSZ).²³ While the residential area to the west of the site is located within a Very High FHSZ, the area was classified as such in 2008, prior to buildout of the area with residential uses. In addition, buildout of the site has been previously considered by the City, and the site is situated within a developed area. Therefore, the proposed project would not expose people or structures to the risk of loss, injury or death involving wildland fires, including where wildlands are adjacent to urbanized areas or where residences are intermixed with wildlands, and a ***less-than-significant*** impact would occur.

²¹ Santa Clara County. *Comprehensive Land Use Plan, Santa Clara County, South County Airport*. Amended November 16, 2016.

²² City of Morgan Hill. *Emergency Operations Plan*. January 11, 2018.

²³ City of Morgan Hill. *City of Morgan Hill Wildland Urban Interface Map*. March 2009.

X. HYDROLOGY AND WATER QUALITY.

Would the project:

	Potentially Significant Impact	Less Than Significant with Mitigation Incorporated	Less-Than-Significant Impact	No Impact
a. Violate any water quality standards or waste discharge requirements or otherwise substantially degrade surface or ground water quality?	<input type="checkbox"/>	<input checked="" type="checkbox"/>	<input type="checkbox"/>	<input type="checkbox"/>
b. Substantially decrease groundwater supplies or interfere substantially with groundwater recharge such that the project may impede sustainable groundwater management of the basin?	<input type="checkbox"/>	<input type="checkbox"/>	<input checked="" type="checkbox"/>	<input type="checkbox"/>
c. Substantially alter the existing drainage pattern of the site or area, including through the alteration of the course of a stream or river or through the addition of impervious surfaces, in a manner which would:				
i. Result in substantial erosion or siltation on- or off-site;	<input type="checkbox"/>	<input type="checkbox"/>	<input checked="" type="checkbox"/>	<input type="checkbox"/>
ii. Substantially increase the rate or amount of surface runoff in a manner which would result in flooding on- or offsite;	<input type="checkbox"/>	<input type="checkbox"/>	<input checked="" type="checkbox"/>	<input type="checkbox"/>
iii. Create or contribute runoff water which would exceed the capacity of existing or planned stormwater drainage systems or provide substantial additional sources of polluted runoff; or	<input type="checkbox"/>	<input type="checkbox"/>	<input checked="" type="checkbox"/>	<input type="checkbox"/>
iv. Impede or redirect flood flows?	<input type="checkbox"/>	<input type="checkbox"/>	<input checked="" type="checkbox"/>	<input type="checkbox"/>
d. In flood hazard, tsunami, or seiche zones, risk release of pollutants due to project inundation?	<input type="checkbox"/>	<input type="checkbox"/>	<input checked="" type="checkbox"/>	<input type="checkbox"/>
e. Conflict with or obstruct implementation of a water quality control plan or sustainable groundwater management plan?	<input type="checkbox"/>	<input type="checkbox"/>	<input checked="" type="checkbox"/>	<input type="checkbox"/>

- a. The proposed project’s potential to result in water quality impacts during construction and operations is discussed in further detail separately below.

Construction

Project construction activities such as grading, excavation, and trenching for site improvements would result in the disturbance of on-site soils. The exposed soils have the potential to affect water quality in two ways: 1) suspended soil particles and sediments transported through runoff; or 2) sediments transported as dust that eventually reach local water bodies. Spills or leaks from heavy equipment and machinery, staging areas, or building sites also have the potential to enter runoff. Typical pollutants include, but are not limited to, petroleum and heavy metals from equipment and products such as paints, solvents, and cleaning agents, which could contain hazardous constituents. Sediment from erosion of graded or excavated surface materials, leaks or spills from equipment, or

inadvertent releases of building products could result in water quality degradation if runoff containing the sediment or contaminants should enter receiving waters in sufficient quantities. Impacts from construction-related activities would generally be short-term and of limited duration.

Water quality degradation is regulated by the federal NPDES Program, established by the Clean Water Act, which controls and reduces pollutants to water bodies from point and non-point discharges. In California, the NPDES permitting program is administered by the State Water Resources Control Board (SWRCB) through nine Regional Water Quality Control Boards (RWQCBs). As discussed in Section VII, Geology and Soils, of this IS/MND, new development within the City that disturbs one or more acres of land is required to comply with the NPDES General Construction Permit and prepare a SWPPP incorporating BMPs to control sedimentation, erosion, and hazardous materials contamination of runoff during construction. The proposed project would disturb approximately two acres, and, thus, would be subject to the State NPDES General Permit conditions.

The proposed project would also be subject to all regional and local water quality regulations. In order to meet water quality objectives for the region, the City of Morgan Hill, City of Gilroy, and County of Santa Clara have prepared and are implementing a Revised Regional Storm Water Management Plan (SWMP). The SWMP incorporates the efforts of the City of Morgan Hill, the City of Gilroy, and the unincorporated portion of Santa Clara County, within the watershed of the Pajaro River and Monterey Bay, to meet the Phase II Storm Water Permit requirements for small municipal separate storm sewer systems (MS4s). The Upper Pajaro River Watershed is located within the jurisdiction of the Central Coast Regional Water Quality Control Board (CCRWQCB). The City of Morgan Hill implements the SWMP through an extensive program that entails: 1) the establishment of SWMP goals for the City; 2) public education and outreach; 3) public involvement and participation; 4) illicit discharge control; 5) construction site storm water runoff control; 6) post-construction storm water management in development; and 7) pollution prevention. For construction activities, the SWMP presents BMPs that are required for the control of storm water runoff quality during construction.

West Little Llagas Creek, which is considered a Category 2 Stream is located along the western portion of the site. The project would adhere to a 35-foot setback from the creek and riparian habitat as required by the SCVHP, with the exception of the proposed interpretive trail. Project ground-disturbing activities within the 35-foot setback would be limited to construction of the trail and planting of native vegetation, as well as potential encroachment of construction equipment for parking lot and drive aisle construction purposes. The project's required compliance with the SWMP and NPDES regulations discussed above would help to ensure that construction activities would not result in degradation of downstream water quality. Inclusion of specific BMPs related to creek protection would ensure that adverse effects to water quality of the creek would not occur.

It should be noted that a temporary construction easement has been executed between the Santa Clara Valley Water District and the property owner along the western boundary of

the site, contiguous with West Little Llagas Creek. The easement is necessary for the purpose of implementing the Upper Llagas Creek Flood Protection Project, with associated construction activities anticipated to begin between May 1, 2020 and October 31, 2021. Environmental effects associated with construction, including potential impacts to water quality, have been analyzed in the Upper Llagas Creek Flood Protection Project EIR.²⁴ Such construction activities are not part of the proposed project.

Operation

After project completion, impervious surfaces on the project site could contribute incrementally to the degradation of downstream water quality during storm events. During the dry season, vehicles and other urban activities may release contaminants onto the impervious surfaces, where they would accumulate until the first storm event. During the initial storm event, or first flush, the concentrated pollutants would be transported via stormwater runoff from the site to the stormwater drainage system and eventually a downstream waterway. Typical urban pollutants that would likely be associated with the proposed project include sediment, pesticides, oil and grease, nutrients, metals, bacteria, and trash. In addition, stormwater runoff could cause soil erosion if not properly addressed and provide a more lucrative means of transport for pollutants to enter the waterways.

The proposed project would be managed in accordance with Resolution R3-2013-0032 issued by the California Regional Water Quality Control Board, Central Coast Region. This resolution formally adopts post-construction stormwater management requirements for development projects in the Central Coast Region. The requirements identify 10 Watershed Management Zones (WMZs) in the covered area, and specify stormwater management requirements for each zone, depending on the size of the development project. Because the proposed project site is located in an area classified as WMZ-2, stormwater management at the project site must include site design and runoff features to limit the amount of runoff from the project site as well as on-site water quality treatment to reduce pollutant loads in the stormwater runoff using a Low Impact Development (LID) treatment system such as biofiltration. In WMZ-2, the treatment system must retain 95 percent of the runoff from the project site and also maintain peak runoff flows such that they do not exceed pre-project flows.

A preliminary Stormwater Control Plan (SWCP) has been prepared for the proposed project. On-site stormwater runoff from impervious surfaces would be collected by a series of drain inlets along the internal parking areas, drive aisles, and paved walkways and transported, by way of underground storm drains, to a series of four bio-retention basins located within the western portion of the site (see Figure 11). The bio-retention basins would treat and detain all runoff from on-site impervious areas, with treated runoff discharging to the City's existing storm drain in Cosmo Avenue during large storm events. The proposed storage volume would exceed the 95th percentile first flush treatment volume requirement.

²⁴ Santa Clara Valley Water District. *Upper Llagas Creek Project Environmental Impact Report*. January 2014.

**Figure 11
Stormwater Control Plan**

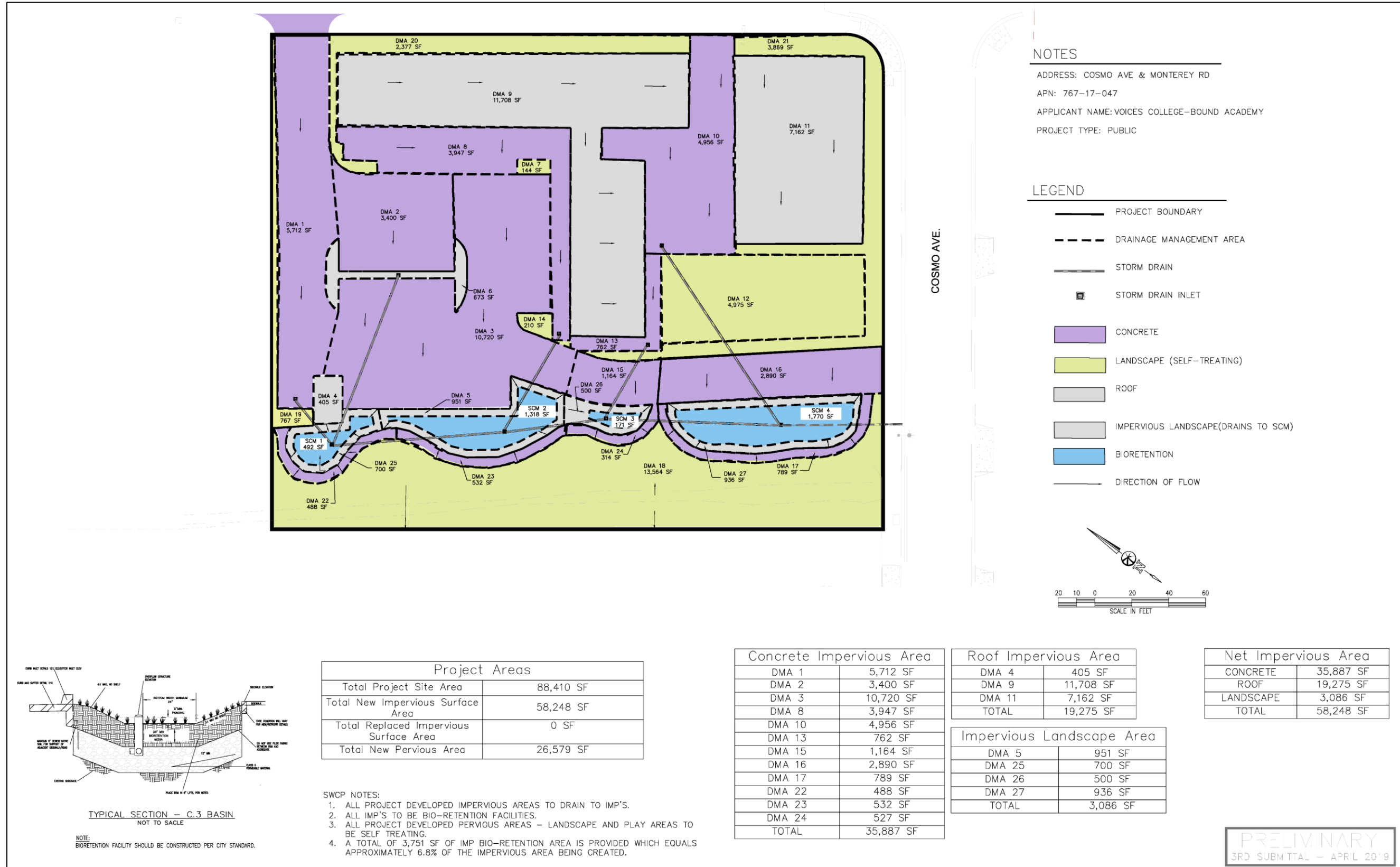

The design, construction, operation, and maintenance of the proposed bio-retention system would be addressed in a final SWCP to be submitted to the City of Morgan Hill in accordance with the stormwater management requirements adopted by Resolution R3-2013-0032. The final SWCP would demonstrate how the bio-retention basins would meet the specified water quality, runoff retention, and peak flow management requirements. Prior to occupancy of the project, the stormwater controls would be field verified by the City of Morgan Hill to confirm design of the controls in accordance with the specified standards, and the controls would be subject to later operation and maintenance inspections by the City.

Pursuant to Chapter 18.140 (Post Construction Stormwater Pollution Prevention) of the City's Municipal Code, the proposed project would be subject to permanent storm water pollution prevention measures. As such, the proposed project would be required to comply with the design standards set forth in Section 18.140.040 (Design standards and selection of best management practices), and select and implement BMPs to the satisfaction of the City in accordance with the requirements contained in the most recent versions of the following documents:

1. City of Morgan Hill Stormwater Post Construction Best Management Practices Development Standards for new development and redevelopment;
2. California Storm Water Quality Association Best Management Practice Handbooks;
3. City of Gilroy, City of Morgan Hill and County of Santa Clara Regional Stormwater Management Plan (SWMP), as approved by the Central Coast Regional Water Quality Control Board; and
4. City of Morgan Hill Hydro-modification Management Plan, as approved by the Central Coast Regional Water Quality Control Board.

The final design of the proposed drainage system would be reviewed and approved by the City of Morgan Hill Engineering Land Development Division, which would ensure that the proposed drainage system complies with the City's Post Construction Stormwater Pollution Prevention Ordinance with respect to incorporating sufficient permanent stormwater treatment control BMPs. Therefore, water quality standards or waste discharge requirements would not be violated, and water quality would not be degraded as a result of the proposed project operations.

Conclusion

Based on the above discussions, the proposed project would not violate any water quality standards or waste discharge requirements or otherwise substantially degrade surface or ground water quality during operations. However, inclusion of project-specific BMPs in the SWPPP prepared for the proposed project would be necessary to ensure that discharge of pollutants to West Little Llagas Creek does not occur during construction activities. Therefore, a *potentially significant* impact could occur.

Mitigation Measure(s)

Implementation of the following mitigation measure would reduce the above potential impact to a *less-than-significant* level.

X-1. *Prior to submittal to the RWQCB, the Storm Water Pollution Prevention Plan (SWPPP) prepared for the proposed project shall include, to the satisfaction of the City Engineer, Best Management Practices (BMPs) designed to limit the discharge of sediment or other pollutants to West Little Llagas Creek. Such BMPs shall include, but not necessarily be limited to, the installation of silt fencing at the limit of the proposed grading activities.*

b,e. The City's water supplies currently consist entirely of groundwater. Approximately 25 percent of the City's supply is extracted from the Coyote Valley subarea of the Santa Clara Subbasin, and approximately 75 percent is extracted from the Llagas Subbasin. The project site is located within the Llagas Subbasin. Neither of the subbasins are in a condition of overdraft, and groundwater levels are not expected to drop.²⁵ It should be noted that water supply is discussed in Section XIX, Utilities and Service Systems, of this IS/MND.

Groundwater within the Llagas Subbasin is managed by the SCVWD. The 2016 Groundwater Management Plan (GWMP), prepared pursuant to the Sustainable Groundwater Management Act of 2014 (SGMA), describes the SCVWD's comprehensive groundwater management framework, including existing and potential actions to achieve basin sustainability goals and ensure continued sustainable groundwater management. The GWMP covers the Santa Clara and Llagas subbasins, located entirely in Santa Clara County and identified by the Department of Water Resources (DWR) as Basins 2-9.02 and 3-3.01, respectively. Pursuant to the DWR, the Llagas Subbasin is designated as a high-priority basin.²⁶

Major recharge facilities within the Llagas Subbasin include the Uvas and Chesbro Reservoirs, in-stream recharge in Llagas and Uvas Creeks, the Madrone Channel, the San Pedro and Main Avenue groundwater recharge ponds, and the Uvas-Llagas pipeline, which is capable of diverting water from Uvas Reservoir to Llagas Creek. The western portion of the project site includes a reach of West Little Llagas Creek. However, as part of the proposed project, the western portion of the site nearest to the channel would be planted with native riparian vegetation and retained as open space. In addition, the proposed bio-retention basins would allow for captured runoff to infiltrate underlying soils in a manner similar to what currently occurs on-site.

Given that groundwater levels within the subbasin underlying the project site are currently stable, and that the proposed project would provide for substantial opportunities for on-site recharge, the project would not substantially decrease groundwater supplies or interfere substantially with groundwater recharge such that the project may impede sustainable groundwater management of the Llagas Subbasin. In addition, the project would not

²⁵ City of Morgan Hill. *Morgan Hill 2035 Final Environmental Impact Report* [pg. 4.9-18]. Adopted July 2016.

²⁶ Santa Clara Valley Water District. *2016 Groundwater Management Plan, Santa Clara and Llagas Subbasins* [pg. ES-1]. November 2016.

Conflict with or obstruct implementation of a water quality control plan or sustainable groundwater management plan. Thus, a *less-than-significant* impact would occur.

- ci-iii. As previously mentioned, the proposed project site consists primarily of vacant, undeveloped land with ruderal vegetation. Development of the proposed project would add approximately 58,248 square feet of impervious surfaces to the project site, which would alter the existing drainage pattern of the site. However, as discussed above, on-site stormwater runoff would be collected by a series of drain inlets and transported, by way of underground storm drains, to a series of four bio-retention basins. The bio-retention basins would allow runoff to infiltrate underlying soils in a manner similar to what currently occurs on-site. During large storm events, excess runoff would be discharged to the City's public storm drain system located in Cosmo Avenue. The bio-retention basins would treat and retain 95 percent of the runoff from the project site and also maintain peak runoff flows such that they do not exceed pre-project flows in accordance with the stormwater management requirements adopted by Resolution R3-2013-0032. The project would not directly discharge runoff to West Little Llagas Creek.

Furthermore, stormwater runoff associated with the site would be required to comply with the City's SWMP standards. As such, the project would not significantly increase stormwater flows into the existing system. The final drainage system design for the project will be subject to review and approval by the City of Morgan Hill Engineering Land Development Division, who will confirm that the proposed drainage system for the project is consistent with the City's Storm Drainage Master Plan and standard stormwater-related conditions of approval. Therefore, the proposed project would not substantially alter the existing drainage pattern of the site or area in a manner that would result in substantial erosion, siltation, or flooding on- or off-site, create or contribute runoff water which would exceed the capacity of existing or planned stormwater drainage systems, or provide substantial additional sources of polluted runoff. Thus, a *less-than-significant* impact would occur.

- civ. The following discussion is based primarily on a technical memorandum (Flood Hazard Study) prepared for the project by Balance Hydrologics, Inc. (see Appendix D).²⁷

According to FEMA Flood Insurance Rate Map (FIRM) number 06085C0607H, the central and western portions of the project site, including portions of the proposed development area, are located within a Special Flood Hazard Area (SFHA) (Zone AE) subject to a one percent (100-year) annual chance flood.²⁸ The mapped FEMA base flood elevation (BFE) for the site is approximately 334 feet. The proposed project would include placement of fill and construction of structures within the mapped SFHA.

As discussed previously, a temporary construction easement has been executed between the SCVWD and the property owner along the western boundary of the site for the purpose of implementing the Upper Llagas Creek Flood Protection Project, with associated

²⁷ Balance Hydrologics, Inc. *Summary of Hydraulic Modeling and Floodplain Impacts for the Proposed Voices School Site, City of Morgan Hill*. May 10, 2019.

²⁸ Federal Emergency Management Agency. *National Flood Hazard Layer FIRMette*. Accessed May 2019.

construction activities anticipated to begin between May 1, 2020 and October 31, 2021. The Upper Llagas Creek Flood Protection Project would relocate the existing West Little Llagas channel (Reach 7B) approximately 100 feet to the west, further from the project site, and is anticipated to protect the urban areas of the City, including the project site, from 100-year flood risks.²⁹ Thus, with completion of the planned improvements, the project site would be removed from the 100-year floodplain. Environmental effects associated with the Upper Llagas Creek Flood Protection Project have been analyzed in the Upper Llagas Creek Flood Protection Project EIR.³⁰ However, completion of the Upper Llagas Creek Flood Protection Project is anticipated to occur after development of the proposed project. As such, in order to provide a worst-case analysis, this IS/MND does not assume completion of the Upper Llagas Creek Flood Protection Project improvements within the project vicinity.

As part of the Flood Hazard Study prepared for the proposed project, the extent of the 100-year floodplain on the project site was modeled under both pre-project and post-project conditions using the U.S. Army Corps of Engineers HEC-RAS software platform (version 5.0.7). All modeling was conducted consistent with FEMA modeling protocols.

Pre-Project Conditions

Based on the results of the modeling, pre-project conditions were determined to be generally consistent with the flood profile included in the published FIRM database. However, base (i.e., pre-project) flood conditions from the updated model are lower downstream from Cosmo Avenue and on the order of 0.10 feet lower upstream of Cosmo Avenue. The pre-project model predicts overtopping of Cosmo Avenue, with the road grade acting as a weir that largely dictates base flood elevations at the project site. Overall, based on the updated pre-project modeling, a smaller portion of the site is included within the Zone AE SFHA compared to the published FIRM for the site (see Figure 12).

Post-Project Conditions

The post-project modeling conducted for the Flood Hazard Study included updated cross-sections to reflect the placement of fill on the project site as part of the proposed development. As shown in Table 5 below, such fill placement would result in relatively minor increases in base flood elevations at the site (up to approximately one inch).

HEC-RAS Cross-Section	Modeled Base Flood Elevation (feet, North American Vertical Datum)		
	Pre-Project	Post-Project	Change
363	334.48	334.57	0.09
362.5	334.33	334.33	0.00
362	334.08	334.15	0.07

²⁹ Santa Clara Valley Water District. *E6: Upper Llagas Creek Flood Protection*. Available at: <https://www.valleywater.org/project-updates/e6-upper-llagas-creek-flood-protection>. Updated April 2019.

³⁰ Santa Clara Valley Water District. *Upper Llagas Creek Project Environmental Impact Report*. January 2014.

361	334.10	334.09	-0.01
360	334.03	334.04	0.01
<i>Source: Balance Hydrologics, Inc., 2019.</i>			

Figure 12
Pre-Project 100-Year Flood Conditions

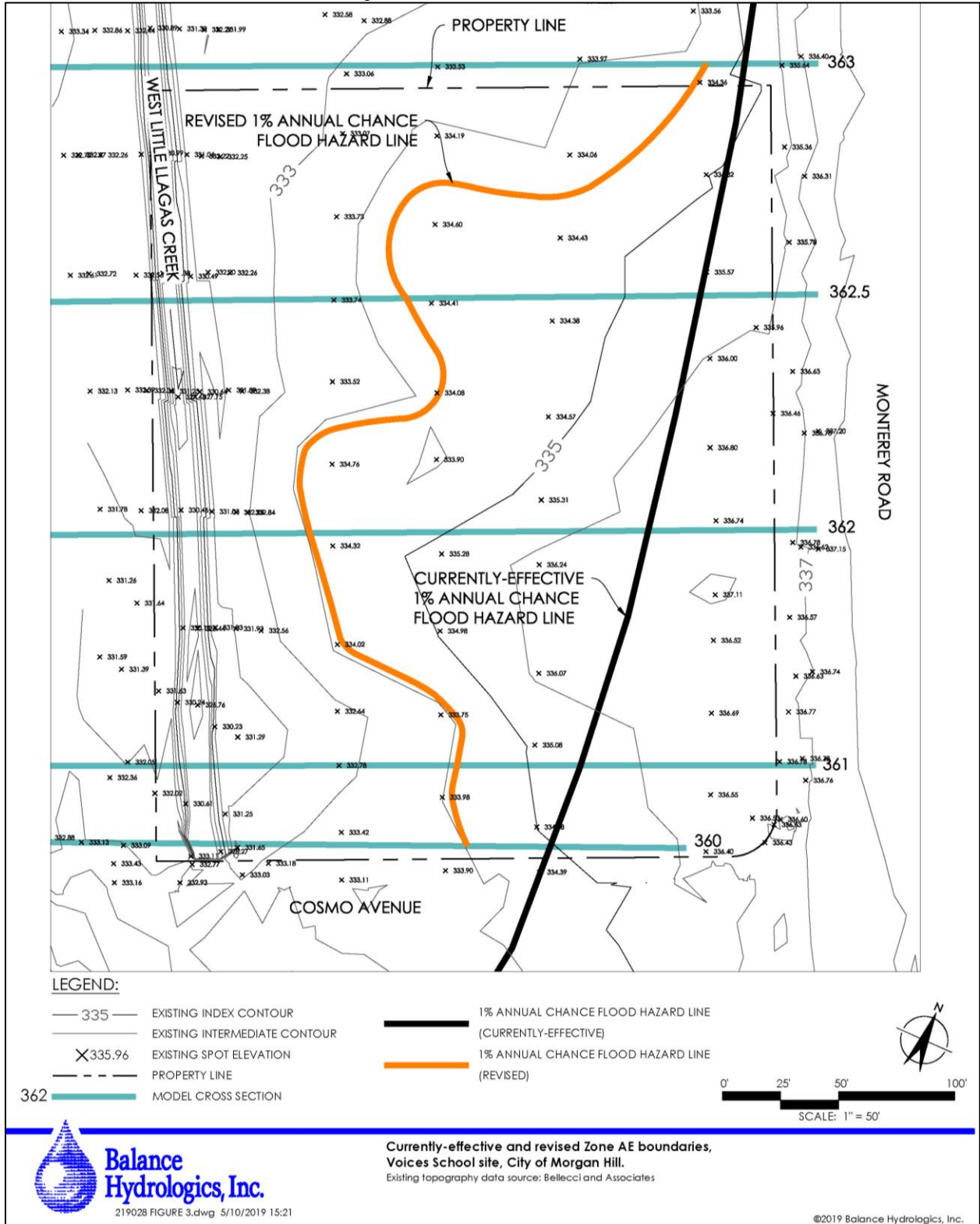

Figure 13 shows the updated post-project flood elevations at the project site relative to the proposed buildings. As shown in the figure, the proposed finished floor elevations would be above the modeled post-project base flood elevations.

Conclusion

Based on the above, the actual extents of the 100-year floodplain at the project site are less than depicted at the scale of the published FEMA FIRM panel. In addition, placement of fill within the floodplain as part of the proposed project would result in relatively minor increases in base flood elevations relative to modeled pre-project conditions. The finished floor elevations of the proposed school buildings would not be located within the 100-year floodplain. Given that the project would not substantially increase base flood elevations, a FEMA Conditional Letter of Map Revision (CLOMR) would not be required. It should be noted that prior to approval of the proposed project, the Flood Hazard Study would be reviewed and approved by SCVWD at the expense of the project applicant.

For any improvements occurring within the modeled post-project 100-year floodplain, the project would implement all necessary policies and regulations set forth by the City regarding development in a flood zone, including Chapter 15.80 (Flood Damage Prevention) of the City's Municipal Code. Section 15.80.160 (Standards of construction) specifies standards related to anchoring, construction materials and methods, and elevation and floodproofing for all new development within SFHAs. Therefore, a *less-than-significant* impact would occur regarding alteration of the existing drainage pattern of a site or area such that flood flows would be impeded or redirected.

- d. A seiche is defined as a wave generated by rapid displacement of water within a reservoir or lake, due to an earthquake that triggers land movement within the water body or land sliding into or beneath the water body. The project site is not located near a water body that is susceptible to seiche hazard. In addition, the distance to the nearest coastline does not subject the site to tsunami hazards. However, as noted above, the site is located within a Special Flood Hazard Area associated with West Little Llagas Creek. The project site is within the dam failure inundation hazard zone for Anderson Reservoir as indicated within the dam failure inundation hazard maps.³¹

The dams in Santa Clara County are managed by the SCVWD. The dams are inspected twice each year and are continuously monitored for seepage and settling and inspected immediately following significant earthquakes. A seismic stability evaluation performed in 2007 for Anderson Dam indicated that the downstream and upstream embankments could become unstable during a very large magnitude earthquake and the rupture of faults underlying the dam may have adverse impact on the outlet pipes and intake structure.

³¹ Association of Bay Area Governments. *Dam Failure Inundation Hazard Map for Morgan Hill*. 1995. Available at: http://www.mhcert.com/prepare/dam_failure.shtml. Accessed May 2019.

Figure 13
Post-Project 100-Year Flood Conditions

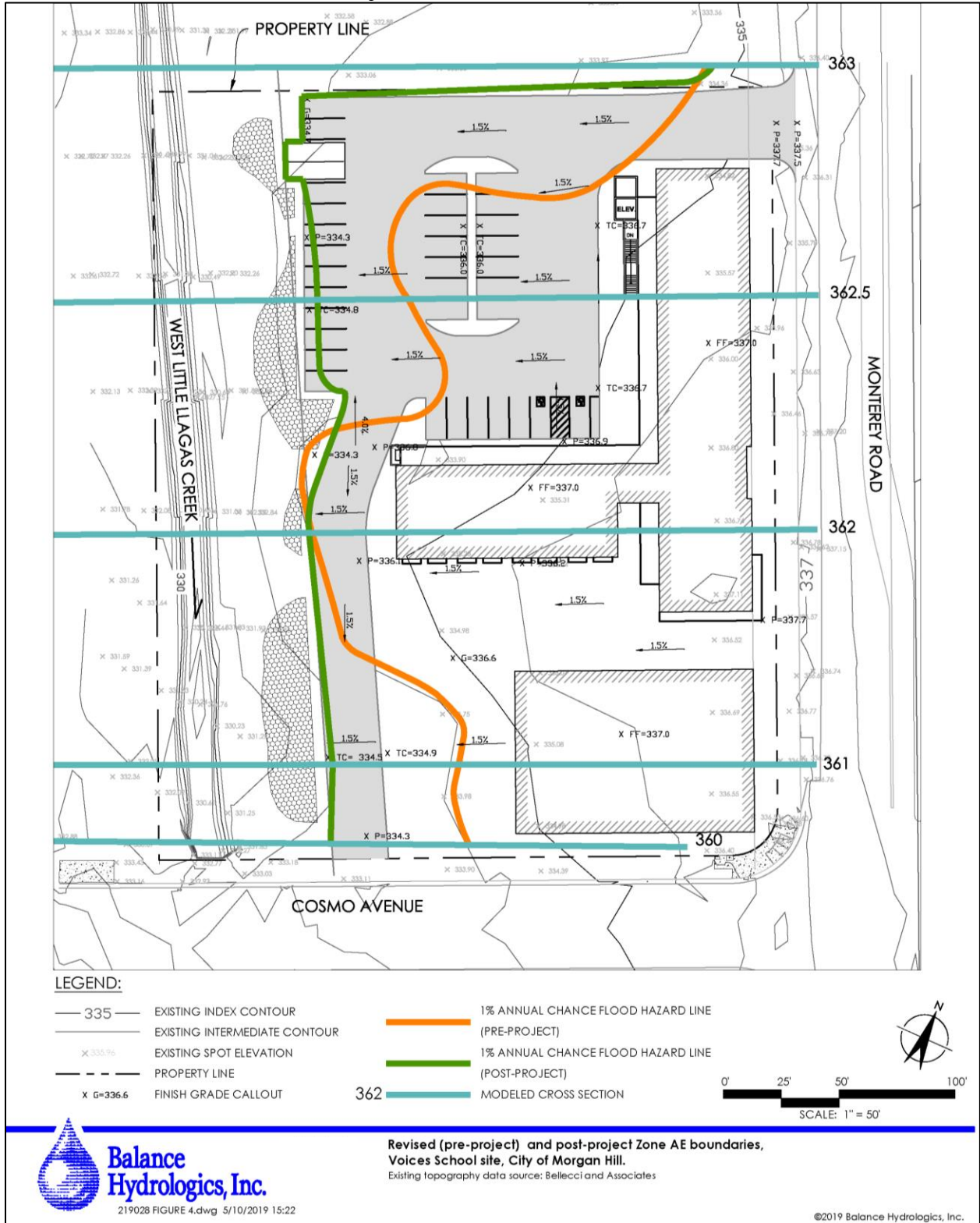

The SCVWD has initiated a capital project, the Anderson Dam Seismic Retrofit Project (ADSRP), to complete the planning, design, and construction of the seismic retrofit of the dam. Construction work for the ADSRP is planned to start in 2021.³²

In order to protect the public from potential effects until the ADSRP is complete, a storage restriction of approximately 45 feet below the dam crest has been put in place, with a reduced storage capacity of 61,810 acre-feet. The SCVWD and regulatory agencies (California Division of Safety of Dams and the Federal Energy Regulatory Commission) have approved the restriction and believe that the restriction would be sufficient to prevent the uncontrolled release of water in case of dam failure after a major earthquake.

Based on the above, the proposed project would not be exposed to substantial risks related to flooding as a result of the failure of a dam, tsunamis, or seiches. In addition, given compliance with Chapter 15.80 (Flood Damage Prevention) of the City's Municipal Code, potential flooding events at the project site associated with West Little Llagas Creek would not result in the release of pollutants due to project inundation. Therefore, a *less-than-significant* impact would occur.

³² Santa Clara Valley Water District. *CI: Anderson Dam Seismic Retrofit**. Available at: <https://www.valleywater.org/anderson-dam-project>. Updated November 2018.

XI. LAND USE AND PLANNING.

Would the project:

	Potentially Significant Impact	Less Than Significant with Mitigation Incorporated	Less-Than-Significant Impact	No Impact
a. Physically divide an established community?	<input type="checkbox"/>	<input type="checkbox"/>	<input checked="" type="checkbox"/>	<input type="checkbox"/>
b. Cause a significant environmental impact due to a conflict with any land use plan, policy, or regulation adopted for the purpose of avoiding or mitigating an environmental effect?	<input type="checkbox"/>	<input type="checkbox"/>	<input checked="" type="checkbox"/>	<input type="checkbox"/>
a. Currently, the project site is vacant and undeveloped. Construction and operation of the proposed charter school would provide infill development between the existing residential uses to the west of the site and the commercial uses to the east and south of the site across Monterey Road and Cosmo Avenue, respectively. In addition, the project would provide school facilities to serve existing and planned residential uses in the project region. As such, the project would not physically divide an established community. Thus, a less-than-significant impact would occur.				
b. Pursuant to Section 18.22.020 (Land use regulations) of the Morgan Hill Municipal Code, public schools are considered a conditionally allowed use within the MU-F zone district. In addition, as discussed previously, the proposed project would develop the project site at a FAR of 0.41, which is below the 0.5 FAR maximum development standard established for the MU-F zone district. . Thus, with approval of a Conditional Use Permit, the proposed project would be consistent with the site’s current MU-F General Plan land use and zoning designations. As such, the type and intensity of growth that would be induced by the proposed project has been anticipated per the General Plan and associated environmental effects have been analyzed in the General Plan EIR. As discussed throughout this IS/MND, the proposed project would not result in any significant environmental effects that would not be mitigated to a less-than-significant level.				

The proposed project would generally be consistent with General Plan policies, as well as other applicable policies and regulations adopted for the purpose of avoiding or mitigating environmental effects. For example, with implementation of Mitigation Measures IV-1 through IV-5 (b), the project would not conflict with any applicable policies, regulations, or ordinances related to the protection of biological resources. As discussed under Section XIII, Noise, of this IS/MND, the project would comply with the noise level thresholds established in the City’s General Plan and the Municipal Code during construction or operation with implementation of Mitigation Measure XII-2. In addition, as noted previously, the project would comply with Condition 11 of the SCVHP related to provision of a 35-foot buffer along West Little Llagas Creek.

Based on the above, the proposed project would not cause a substantial adverse environmental impact due to a conflict with any land use plan, policy, or regulation adopted for the purpose of avoiding or mitigating an environmental effect, and a **less-than-significant** impact would result.

XII. MINERAL RESOURCES.

Would the project:

	Potentially Significant Impact	Less Than Significant with Mitigation Incorporated	Less-Than-Significant Impact	No Impact
a. Result in the loss of availability of a known mineral resource that would be of value to the region and the residents of the state?	<input type="checkbox"/>	<input type="checkbox"/>	<input type="checkbox"/>	✘
b. Result in the loss of availability of a locally-important mineral resource recovery site delineated on a local general plan, specific plan or other land use plan?	<input type="checkbox"/>	<input type="checkbox"/>	<input type="checkbox"/>	✘
<p>a,b. The City’s General Plan does not identify any regionally or locally important mineral resources within the City of Morgan Hill. The <i>Santa Clara County General Plan</i> does identify mineral resources of importance; however, the project site is not in proximity to the quarries currently in operation. Consequently, the proposed project would not result in the loss of a known mineral resource that would be of value to the region nor would the project result in the loss of a locally important mineral resource recovery site delineated on a local general plan, specific plan, or other land use plan. Therefore, <i>no impact</i> to mineral resources would occur as a result of the proposed project.</p>				

XIII. NOISE. <i>Would the project result in:</i>	Potentially Significant Impact	Less Than Significant with Mitigation Incorporated	Less-Than-Significant Impact	No Impact
a. Generation of a substantial temporary or permanent increase in ambient noise levels in the vicinity of the project in excess of standards established in the local general plan or noise ordinance, or applicable standards of other agencies?	<input type="checkbox"/>	<input checked="" type="checkbox"/>	<input type="checkbox"/>	<input type="checkbox"/>
b. Generation of excessive groundborne vibration or groundborne noise levels?	<input type="checkbox"/>	<input type="checkbox"/>	<input checked="" type="checkbox"/>	<input type="checkbox"/>
c. For a project located within the vicinity of a private airstrip or an airport land use plan or, where such a plan has not been adopted, within two miles of a public airport or public use airport, would the project expose people residing or working in the project area to excessive noise levels?	<input type="checkbox"/>	<input type="checkbox"/>	<input type="checkbox"/>	<input checked="" type="checkbox"/>

The discussion presented below is based primarily on an Environmental Noise & Vibration Analysis prepared for the proposed project by Bollard Acoustical Consultants, Inc. (BAC) (see Appendix E).³³

- a. The following section includes a discussion of noise standards and criteria applicable to various land uses, as well as potential traffic noise and non-transportation noise sources associated with the proposed project.

Sensitive Receptors

Noise-sensitive land uses are generally defined as locations where people reside or where the presence of unwanted sound could adversely affect the primary intended use of the land. Places where people live, sleep, recreate, worship, and study are considered to be sensitive to noise because intrusive noise can be disruptive to such activities. Within the project vicinity, the nearest sensitive receptors are the multi-family residential land uses to the west of the site (see Figure 14, Receivers 2, 3, and 4). In addition, single-family residences are located to the northwest of the site, the nearest of which is identified as Receiver 1 on Figure 14.

Existing Noise Environment

The ambient noise environment in the immediate project vicinity is defined by traffic on Cosmo Avenue and Monterey Road. To quantify the existing noise environment on the project site, two long-term (24-hour) ambient noise surveys were performed on the project site (see Figure 14, LT-1 and LT-2).

³³ Bollard Acoustical Consultants, Inc. *Environmental Noise & Vibration Analysis, Voices Charter School, Morgan Hill, California*. May 31, 2019.

**Figure 14
Noise Measurement Locations**



The long-term measurement sites were selected to be representative of the ambient noise exposure at the nearest potentially affected existing residential land uses to the project site. The results of the noise level measurement surveys are shown in Table 6 below.

Table 6 Long-Term Ambient Noise Level Measurement Results						
Site	Measured Hourly Averages, L_{eq} (dB)			Measured Hourly Maximums, L_{max} (dB)		
	Minimum	Maximum	Average	Minimum	Maximum	Average
LT-1	51	56	53	64	78	69
LT-2	52	55	53	68	79	72

Source: Bollard Acoustical Consultants, Inc., 2019.

As indicated in Table 6, measured hourly average noise levels in the project vicinity during the timeframe when school would typically be in session were 53 dB L_{eq} at both measurement sites. Measured hourly maximum noise levels ranged from 64 dB to 78 dB L_{max} at site LT-1 and 68 dB to 79 dB L_{max} at site LT-2.

City Noise Standards and Criteria

Chapter 9, Safety, Service, and Infrastructure, of the City’s General Plan contains the following policies that would be applicable to the proposed project:

SSI-8.1 Exterior Noise Level Standards. Require new development projects to be designed and constructed to meet acceptable exterior noise level standards (see Table SSI-1 [of the General Plan]), as follows:

- Apply a maximum exterior noise level of 60 dBA L_{dn} in residential areas where outdoor use is a major consideration (e.g., backyards in single-family housing developments and recreation areas in multi-family housing projects). Where the City determines that providing an L_{dn} of 60 dBA or lower cannot be achieved after the application of reasonable and feasible mitigation, an L_{dn} of 65 dBA may be permitted.
- Indoor noise levels should not exceed an L_{dn} of 45 dBA in new residential housing units.
- Noise levels in new residential development exposed to an exterior L_{dn} 60 dBA or greater should be limited to a maximum instantaneous noise level (e.g., trucks on busy streets, train warning whistles) in bedrooms of 50 dBA. Maximum instantaneous noise levels in all other habitable rooms should not exceed 55 dBA. The maximum outdoor noise level for new residences near the railroad shall be 70 dBA L_{dn} , recognizing that train noise is characterized by relatively few loud events.

SSI-8.2 Impact Evaluation. The impact of a proposed development project on existing land uses should be evaluated in terms of the potential for adverse community response based on significant increase in existing noise levels, regardless of compatibility guidelines.

- SSI-8.5 Traffic Noise Level Standards. Consider noise level increases resulting from traffic associated with new projects significant if: a) the noise level increase is 5 dBA L_{dn} or greater, with a future noise level of less than 60 dBA L_{dn} , or b) the noise level increase is 3 dBA L_{dn} or greater, with a future noise level of 60 dBA L_{dn} or greater.
- SSI-8.6 Stationary Noise Level Standards. Consider noise levels produced by stationary noise sources associated with new projects significant if they substantially exceed existing ambient noise levels.
- SSI-8.7 Other Noise Sources. Consider noise levels produced by other noise sources (such as ballfields) significant if an acoustical study demonstrates they would substantially exceed ambient noise levels.
- SSI-8.9 Site Planning and Design. Require attention to site planning and design techniques other than sound walls to reduce noise impacts, including: a) installing earth berms, b) increasing the distance between the noise source and the receiver, c) using non-sensitive structures such as parking lots, utility areas, and garages to shield noise-sensitive areas, d) orienting buildings to shield outdoor spaces from the noise source, and e) minimizing the noise at its source.

In addition to the policies listed above, Section 18.76.090 (Noise) of the City's Municipal Code contains maximum noise levels for non-transportation noise sources. Section 8.28.040.D of the Morgan Hill Municipal Code, limits construction activity noise as follows:

"Construction activities" are defined as including but not limited to excavation, grading, paving, demolition, construction, alteration or repair of any building, site, street or highway, delivery or removal of construction material to a site, or movement of construction materials on a site. Construction activities are prohibited other than between the hours of seven a.m. and eight p.m., Monday through Friday and between the hours of nine a.m. to six p.m. on Saturday. Construction activities may not occur on Sundays or federal holidays. No third person, including but not limited to landowners, construction company owners, contractors, subcontractors, or employers, shall permit or allow any person working on construction activities which are under their ownership, control or direction to violate this provision.

Construction activities may occur in the following cases without violation of this provision:

- a. In the event of urgent necessity in the interests of the public health and safety, and then only with a permit from the Chief Building Official, which permit may be granted for a period of not to exceed three days or less while the emergency continues and which permit may be renewed for periods of three days or less while the emergency continues.

- b. If the chief building official determines that the public health and safety will not be impaired by the construction activities between the hours of eight p.m. and seven a.m., and that loss or inconvenience would result to any party in interest, the chief building official may grant permission for such work to be done between the hours of eight p.m. and seven a.m. upon an application being made at the time the permit for the work is issued or during the progress of the work.
- c. The city council finds that construction by the resident of a single residence does not have the same magnitude or frequency of noise impacts as a larger construction project. Therefore, the resident of a single residence may perform construction activities on that home during the hours in this subsection, as well as on Sundays and federal holidays from nine a.m. to six p.m., provided that such activities are limited to the improvement or maintenance undertaken by the resident on a personal basis.
- d. Public work projects are exempt from this section and the public works director shall determine the hours of construction for public works projects.
- e. Until November 30, 1998, construction activities shall be permitted between the hours of ten a.m. to six p.m. on Sundays, subject to the following conditions. No power-driven vehicles, equipment or tools may be used during construction activities, except on the interior of a building or other structure which is enclosed by exterior siding (including windows and doors) and roofing, and which windows and doors are closed during construction activities. Construction activities must be situated at least one hundred fifty feet from the nearest occupied dwelling. No delivery or removal of construction material to a site, or movement of construction materials on a site, is permitted. No activity, including but not limited to the playing of radios, tape players, compact disc players or other devices, which creates a loud or unusual noise which offends, disturbs or harasses the peace and quiet of the persons of ordinary sensibilities beyond the confines of the property from which the sound emanates is allowed.

The City's quantitative exterior noise standards are reproduced below in Table 7. According to City staff, such standards are interpreted as being hourly average noise level standards (L_{eq}).

Table 7	
Noise Level Performance Standards	
Receiving Land Use	Maximum Noise Level at Lot Line of Receiving Use
Industrial and Wholesale	70 dBA
Commercial	65 dBA
Residential or Public/Quasi Public	60 dBA
Notes: <ul style="list-style-type: none"> • The planning commission may allow an additional 5 dBA noise level at the lot line if the maximum noise level shown above cannot be achieved with reasonable and feasible mitigation. • Noise standards shown above do not apply to noise generated by vehicle traffic in the public right-of-way or from temporary construction, demolition, and vehicles that enter or leave the site of the noise-generating use (e.g., construction equipment, trains, trucks). 	
<i>Source: City of Morgan Hill Municipal Code</i>	

Impact Analysis

For noise generated by on-site activities, the Municipal Code establishes a maximum noise level standard of 60 dB L_{eq} assessed at the property line of the receiving residential land use. In addition, General Plan Policy SSI-8.6 considers noise levels produced by stationary noise sources associated with new projects significant if they substantially exceed existing ambient noise levels. Because project activities would take place primarily during weekdays from 7:30 AM to 4:30 PM, the ambient noise level data presented in Table 6 would serve as the baseline ambient noise level environment in the project vicinity. The General Plan, however, does not provide guidelines for determining a substantial noise increase relative to ambient conditions.

For noise generated by on-site activities and the determination of a substantial noise increase relative to ambient conditions, the following discussion is provided: CEQA Guidelines require the identification of significant noise impacts if the project would result in substantial permanent or temporary increases in noise. However, the CEQA guidelines do not specify the numeric noise level increase which is considered substantial. An increase of at least 3 dB for similar noise sources is usually required before most people will perceive a change in noise levels, and an increase of 6 dB is required before the change will be clearly noticeable.

The Federal Interagency Commission on Noise (FICON) has developed a graduated scale for use in the assessment of project related noise level increases. Table 8 was developed by FICON as a means of developing thresholds for impact identification for project related noise level increases. The FICON standards have been used extensively in recent years in the preparation of noise sections of EIRs that have been certified in many California cities and counties.

The rationale for the graduated scale used in the FICON standards is that test subjects' reactions to increases in noise levels varied depending on the starting level of noise. Specifically, with lower ambient noise environments, such as those below 60 dB L_{dn} , a larger increase in noise levels was required to achieve a negative reaction than was necessary in more elevated noise environments.

Table 8 Significance of Changes in Cumulative Noise Exposure	
Ambient Noise Level Without Project, L_{dn}	Increase Required for Significant Impact
<60 dB	+5.0 dB or more
60-65 dB	+3.0 dB or more
>65 dB	+1.5 dB or more
<i>Source: Bollard Acoustical Consultants, Inc., 2019.</i>	

The use of the FICON standards are considered conservative relative to thresholds used by other agencies in the State of California. For example, Caltrans requires a project related traffic noise level increase of 12 dB for a finding of significance, and the California Energy Commission (CEC) considers project related noise level increases between 5 and 10 dB significant, depending on local factors. Therefore, the use of the FICON standards, which set the threshold for finding of significant noise impacts as low as 1.5 dB, provides a conservative approach to impact assessment.

Based on the FICON research, as shown in Table 8, a 5 dB increase in noise levels due to a project is required for a finding of significant noise impact where ambient noise levels without the project are less than 60 dB L_{dn} . Where pre-project ambient conditions are between 60 and 65 dB L_{dn} , a 3 dB increase is applied as the standard of significance. Furthermore, in areas already exposed to higher noise levels, specifically pre-project noise levels in excess of 65 dB L_{dn} , a 1.5 dB increase is considered by FICON as the threshold of significance.

The graduated FICON scale indicates that in quieter noise environments, test subjects tolerated a higher increase in noise levels due to a project before the onset of adverse noise impacts than did test subjects in louder environments. According to the FICON study, if screening analysis shows that noise-sensitive areas will be at or above 65 dB L_{dn} and will have an increase of 1.5 dB L_{dn} or more, further analysis should be conducted. The FICON study also reported the following: Every change in the noise environment does not necessarily impact public health and welfare.

For this project, measured ambient hourly average noise levels in the project vicinity during the timeframe when on-site activities would take place on the project site were 53 dB L_{eq} . Hourly maximum noise levels ranged from 64 dB to 79 dB L_{max} with an overall arithmetic average of 71 dB L_{max} . Therefore, a significant noise impact would be identified if predicted hourly average or maximum noise levels due to the project would exceed 58 dB L_{eq} or 76 dB L_{max} , respectively (i.e. 5 dB above ambient).

Project Construction Noise

During the construction phases of the proposed project, noise from construction activities would add to the noise environment in the immediate project vicinity. Activities involved in typical construction would generate maximum noise levels, as indicated in Table 9, ranging from 55 to 90 dB at a distance of 50 feet.

Equipment Description	Maximum Noise Level at 50 feet, dBA
Auger drill rig	85
Backhoe	80
Bar bender	80
Boring jack power unit	80
Chain saw	85
Compactor (ground)	80
Compressor (air)	80
Concrete batch plant	83
Concrete mixer truck	85
Concrete pump truck	82
Concrete saw	90
Crane (mobile or stationary)	85
Dozer	85
Dump truck	84
Excavator	85
Flatbed truck	84
Front end loader	80
Generator (25 kilovolt-amperes [kVA] or less)	70
Generator (more than 25 kVA)	82
Grader	85
Hydra break ram	90
Jackhammer	85
Mounted impact hammer (hoe ram)	90
Paver	85
Pickup truck	55
Pneumatic tools	85
Pumps	77
Rock drill	85
Scraper	85
Soil mix drill rig	80
Tractor	84
Vacuum street sweeper	80
Vibratory concrete mixer	80

Source: Bollard Acoustical Consultants, Inc., 2019.

The proposed buildings would be located approximately 230 feet from the nearest residential property lines to the west. The Environmental Noise and Vibration Analysis indicates that the maximum noise levels at such a distance would be expected to be approximately 42 dB to 77 dB L_{max} , which is within the range of measured existing maximum noise levels in the project vicinity.

As noted above, Chapter 8.28 (Noise) of the Morgan Hill Municipal Code prohibits construction activities between 8:00 PM and 7:00 AM, Monday through Friday, and between 6:00 PM and 9:00 AM on Saturdays. Construction activities may not occur on Sundays or federal holidays. The Morgan Hill Municipal Code does not specify any short-

term construction noise level limits. Provided project construction activities do not occur during such hours, and that noise-generating equipment is equipped with sound-dampening features such as mufflers, air-inlet silencers, shrouds, shields, or other noise-reducing features where appropriate, construction noise associated with the project would be exempt from the City's applicable standards.

Project Operational Noise

Operations associated with the proposed charter school would generate noise associated with vehicle traffic on local roadways, on-site circulation of vehicles throughout the proposed drive aisles and parking area, playground activity, and occasional special events. Such potential noise sources are discussed in the sections below.

Off-Site Traffic Noise

To assess noise impacts due to project-related traffic increases on the local roadway network, traffic noise levels were predicted at a representative distance for Existing, Existing plus Project, Year 2025 Cumulative, and Year 2025 Plus Project conditions. Noise impacts are identified at existing noise-sensitive areas if the noise level increases which result from the project exceed the significance thresholds established in General Plan Policy SSI-8.5.

To describe existing and projected traffic noise levels, the Federal Highway Administration Highway Traffic Noise Prediction Model (FHWA RD-77-108) was used. The model is based upon the Calveno reference noise factors for automobiles, medium trucks and heavy trucks, with consideration given to vehicle volume, speed, roadway configuration, distance to the receiver, and the acoustical characteristics of the site. The FHWA model was developed to predict hourly L_{eq} values for free-flowing traffic conditions. To predict traffic noise levels in terms of L_{dn} , the input volume was adjusted to account for the day/night distribution of traffic. Traffic volumes for each traffic scenario evaluated were obtained from the Traffic Impact Analysis prepared for the proposed project by Hexagon Transportation Consultants, Inc.³⁴

Table 10 summarizes traffic noise levels along each study roadway segment in the project vicinity for Existing and Existing plus Project conditions. Year 2025 Cumulative and Year 2025 Plus Project conditions are summarized in Table 11. Traffic noise levels are presented in terms of L_{dn} at a standard distance of 100 feet from the centerlines of each roadway segment.

³⁴ Hexagon Transportation Consultants, Inc. *Voices School Morgan Hill, Traffic Impact Analysis*. August 20, 2019.

Table 10
Off-Site Traffic Noise: Existing Plus Project

Segment	Roadway	Segment Description	Traffic Noise Level at 100 feet, dB L _{dn}			Substantial Increase?
			Existing	Existing plus Project	Increase	
1	Monterey Road	North of Main Ave	62.4	62.5	0.1	No
2		Main Ave to Dunne Ave	62.2	62.3	0.1	No
3		Dunne Ave to Spring Ave	62.4	62.6	0.2	No
4		Spring Ave to San Pedro Ave	62.6	62.8	0.2	No
5		San Pedro Ave to Cosmo Ave	62.1	62.3	0.2	No
6		Cosmo Ave to Edmundson Ave	62.4	62.5	0.1	No
7		Edmundson Ave to Vineyard Blvd	62.2	62.3	0.1	No
8		Vineyard Blvd to Watsonville Rd	61.5	61.5	0.0	No
9		South of Watsonville Rd	62.9	62.9	0.0	No
10	Butterfield Blvd	North of Main Ave	65.8	65.8	0.0	No
11		Main Ave to Dunne Ave	66.8	66.8	0.0	No
12		Dunne Ave to San Pedro Ave	65.4	65.4	0.0	No
13		San Pedro Ave to Tennant Ave	64.6	64.6	0.0	No
14		South of Tennant Ave	65.2	65.2	0.0	No
15	Del Monte Ave	North of Cosmo Ave	48.1	48.2	0.1	No
16	Dunne Ave	West of Main Ave	59.9	59.9	0.0	No
17		Main Ave to Butterfield Blvd	62.4	62.6	0.2	No
18		Butterfield Blvd to US 101 SB Ramps	64.1	64.2	0.1	No
19	Edmundson Ave	West of Olympic Drive	59.0	59.1	0.1	No
20		Olympic Drive to Monterey Rd	58.5	58.5	0.0	No
21	Tennant Ave	East of Monterey Rd	58.9	58.9	0.0	No
22	Spring Ave	West of Del Monte Ave	52.1	52.1	0.0	No
23		Del Monte Ave to Monterey Rd	53.0	53.1	0.1	No
24	Cosmo Ave	West of Del Monte Ave	47.6	47.6	0.0	No
25		Del Monte Ave to Project Entrance	49.2	49.3	0.1	No
26		Project Entrance to Monterey Rd	50.7	53.2	2.5	No

Source: Bollard Acoustical Consultants, Inc., 2019.

**Table 11
Off-Site Traffic Noise: Year 2025 Plus Project**

Segment	Roadway	Segment Description	Traffic Noise Level at 100 feet, dB L _{dn}			Substantial Increase?
			Year 2025 Cumulative	Year 2025 plus Project	Increase	
1	Monterey Road	North of Main Ave	64.2	64.3	0.1	No
2		Main Ave to Dunne Ave	62.6	62.7	0.1	No
3		Dunne Ave to Spring Ave	63.1	63.3	0.2	No
4		Spring Ave to San Pedro Ave	63.4	63.5	0.1	No
5		San Pedro Ave to Cosmo Ave	62.9	63.1	0.2	No
6		Cosmo Ave to Edmundson Ave	63.1	63.1	0.0	No
7		Edmundson Ave to Vineyard Blvd	63.0	63.0	0.0	No
8		Vineyard Blvd to Watsonville Rd	62.4	62.5	0.1	No
9		South of Watsonville Rd	63.6	63.7	0.1	No
10	Butterfield Blvd	North of Main Ave	66.6	66.6	0.0	No
11		Main Ave to Dunne Ave	67.4	67.5	0.1	No
12		Dunne Ave to San Pedro Ave	65.9	65.9	0.0	No
13		San Pedro Ave to Tennant Ave	65.1	65.1	0.0	No
14		South of Tennant Ave	66.2	66.2	0.0	No
15	Del Monte Ave	North of Cosmo Ave	48.4	48.5	0.1	No
16	Dunne Ave	West of Main Ave	60.8	60.8	0.0	No
17		Main Ave to Butterfield Blvd	63.0	63.1	0.1	No
18		Butterfield Blvd to US 101 SB Ramps	64.4	64.5	0.1	No
19	Edmundson Ave	West of Olympic Drive	60.5	60.5	0.0	No
20		Olympic Drive to Monterey Rd	59.4	59.4	0.0	No
21	Tennant Ave	East of Monterey Rd	59.4	59.5	0.1	No
22	Spring Ave	West of Del Monte Ave	52.9	53.0	0.1	No
23		Del Monte Ave to Monterey Rd	53.1	53.2	0.1	No
24	Cosmo Ave	West of Del Monte Ave	48.0	48.0	0.0	No
25		Del Monte Ave to Project Entrance	49.2	49.3	0.1	No
26		Project Entrance to Monterey Rd	50.7	53.2	2.5	No

Source: Bollard Acoustical Consultants, Inc., 2019.

Pursuant to General Plan Policy SSI-8.5, noise level increases resulting from traffic associated with new projects are considered significant if: a) the noise level increase is 5 dBA L_{dn} or greater, with a future noise level of less than 60 dBA L_{dn} , or b) the noise level increase is 3 dBA L_{dn} or greater, with a future noise level of 60 dBA L_{dn} or greater.

As shown in Table 10, under Existing plus Project conditions, traffic generated by the proposed project would result in traffic noise level increases ranging from 0.0 to 2.5 dB L_{dn} relative to existing conditions. Table 11 indicates that project traffic noise increases occurring under Year 2025 plus Project conditions would be similar. Given that such increases would be below the significance criteria identified in General Plan Policy SSI-8.5, off-site traffic noise increases associated with the project would not be considered substantial under either Existing plus Project or Year 2025 plus Project conditions.

On-Site Vehicle Circulation Noise

The FHWA Model was used to calculate the project's on-site circulation traffic noise at the existing noise-sensitive residential land uses nearest to the project site. The project is expected to generate 265 vehicle passbys on the proposed circulation route during the AM peak hour.

The nearest existing noise-sensitive residential land uses to the on-site circulation route are apartments located approximately 200 feet to the west. Conservatively assuming a vehicle speed of 25 mph, 265 vehicle passbys during a worst-case hour (AM peak hour), and a distance of 200 feet from the centerline of the circulation route, the FHWA Model predicts an hourly average traffic noise level of 44 dB L_{eq} at the property line of the nearest existing residences to the west. Predicted maximum noise levels due to on-site circulation are conservatively estimated to be 10 dB higher than predicted hourly average noise levels (54 dB L_{max}).

Based on the above, predicted average noise levels due to on-site vehicle circulation would comply with the City's Municipal Code noise level standard of 60 dB L_{eq} . Furthermore, hourly average noise levels due to on-site circulation would be below measured ambient noise levels in the project vicinity. As a result, on-site circulation noise impacts associated with the project would be less than significant.

Playground Noise

The proposed project would include a playground area in the southern portion of the project site. During operations, the morning recess during which the playground would be occupied would occur from approximately 9:25 AM to 10:15 AM. The tentative recess schedule for the various grades at the school is as follows:

- 9:25 to 9:40 AM: Third Grade – 56 Students;
- 9:45 to 10:00 AM: First Grade, Fourth Grade, and Fifth Grade – 168 Students; and
- 10:00 to 10:15 AM: Kindergarten and Second Grade – 112 Students.

To quantify the noise emissions of elementary school children playing outside during recess, BAC utilized reference noise level data collected on October 29, 2013 at Woodland Christian School site located at 1616 West Street in the City of Woodland. The results of the playground noise level measurements indicate that a group of approximately 100 children spread out over the various playground locations generated average and maximum noise levels of approximately 60 dB L_{eq} and 75 dB L_{max} at a distance of approximately 100 feet from the effective noise center of the playground activities. As part of the Environmental Noise and Vibration Analysis, the data was extrapolated to the worst-case proposed condition of 168 students playing outside at the proposed charter school using standard acoustical algorithms. Table 12 below summarizes the predicted playground noise levels at the nearest noise-sensitive receptors.

Receiver	Land Use	Distance to Playground Area (feet)	Predicted Playground Noise Levels (dB)	
			L_{eq}	L_{max}
1	Single-Family Residential	600	47	59
2	Multi-Family Residential	300	53	65
3	Multi-Family Residential	250	54	67
4	Multi-Family Residential	500	38	51

Notes:

- Predicted noise levels based on BAC file data for playground generated noise, 62 dB L_{eq} and 75 dB L_{max} at a reference distance of 100 feet from the approximate center of activity.
- An offset of -10 dB was applied to predicted noise levels at receiver 4 to account for the screening provided by intervening buildings.

Source: Bollard Acoustical Consultants, Inc., 2019.

For noise generated by on-site activities, the Municipal Code establishes a noise level standard of 60 dB L_{eq} assessed at the property line of the receiving residential land use. As indicated above in Table 12, playground activity noise levels at the nearest residential receivers are predicted to be 54 dB L_{eq} or less. In addition, predicted hourly average and maximum noise levels due to playground activity at all the nearest residential receivers would be below measured ambient noise levels in the project vicinity. As discussed previously, a noise impact relative to ambient conditions would be identified if project-related noise levels exceed hourly average and hourly maximum noise levels of 58 dB L_{eq} and 76 dB L_{max} . Because the predicted noise levels shown in Table 12 would be well below such criteria, the project would not result in a significant noise increase in the community. In

addition, the duration of the day during which playground activities are proposed is limited. As a result, noise impacts associated with playground activities are identified as being less than significant.

Special Event Noise

In addition to typical daily operations, the proposed school would host a range of school events including, but not limited to, an annual winter celebration, Kermes/Carnival (outdoor fair) celebrations, a kinder graduation, parent workshops, and parent fundraisers. Furthermore, an afterschool program would be provided for a limited number of students.

Of such special events, the highest noise generation would likely be due to Kermes related activities. The Kermes events would typically take place once or twice per year, on Thursday or Friday afternoons, for a two-hour block sometime between 2:00 and 6:00 PM. The events would be held outdoors on the project site and includes carnival games such as bean bag toss, ring toss, etc. Approximately 75 to 150 adults and children would attend the Kermes events.

To quantify the noise emissions of the Kermes events, BAC utilized reference noise level data for special events in combination with published sound level data for persons conversing at various levels. Such data indicate that for a gathering of 200 people, the typical noise level at a reference distance of 50 feet from the effective noise center would be approximately 70 dB L_{eq} . Table 13 below provides predicted special event noise levels at the nearest noise-sensitive receptors.

Receiver	Land Use	Distance to Playground Area (feet)	Predicted Playground Noise Levels (dB)	
			L_{eq}	L_{max}
1	Single-Family Residential	600	48	58
2	Multi-Family Residential	300	54	64
3	Multi-Family Residential	250	56	66
4	Multi-Family Residential	500	40	50

Notes:

- Predicted noise levels based on BAC file data for special event noise, 70 dB L_{eq} and 80 dB L_{max} at a reference distance of 50 feet from the approximate center of activity.
- An offset of -10 dB was applied to predicted noise levels at receiver 4 to account for the screening provided by intervening buildings.

Source: Bollard Acoustical Consultants, Inc., 2019.

For noise generated by on-site activities, the Municipal Code establishes an average noise level standard of 60 dB L_{eq} assessed at the property line of the receiving residential land use. As indicated above in Table 13, average special event noise levels at the nearest residential receivers are predicted to be 56 dB L_{eq} or less. In

addition, predicted hourly average and maximum noise levels due to special event activities at all the nearest residential receivers would be below measured ambient noise levels in the project vicinity. A noise impact relative to ambient conditions would be identified if project-related noise levels exceed hourly average and hourly maximum noise levels of 58 dB L_{eq} and 76 dB L_{max} . Because the predicted noise levels shown in Table 13 would be below such criteria, the project would not result in a significant noise increase in the community. As a result, noise impacts associated with special event activities are identified as being less than significant.

Conclusion

Based on the above, operation of the proposed project would not result in the generation of a substantial permanent increase in ambient noise levels in the vicinity of the project in excess of standards established in the City's General Plan and the Municipal Code. However, considering the potential for construction activities to conflict with standards established by Section 8.28.040 (Enumeration of unlawful noises) of the City's Municipal Code, the proposed project could result in a *potentially significant* impact related to temporary increases in ambient noise levels in the project area.

Mitigation Measure(s)

Implementation of the following mitigation measure would reduce the above impact to a *less-than-significant* level.

XIII-1. Noise-generating construction activities associated with the proposed project shall not occur within the hours identified in Municipal Code Section 8.28.040(D). The above language shall be included on final project improvement plans prior to approval by the City of Morgan Hill Development Services Department.

XIII-2. To the maximum extent practical, the following measures should be implemented during project construction:

- *All noise-producing project equipment and vehicles using internal-combustion engines shall be equipped with manufacturers-recommended mufflers and be maintained in good working condition;*
- *All mobile or fixed noise-producing equipment used on the project site that are regulated for noise output by a federal, State, or local agency shall comply with such regulations while in the course of project construction;*
- *Electrically powered equipment shall be used instead of pneumatic or internal-combustion-powered equipment, where feasible;*
- *Material stockpiles and mobile equipment staging, parking, and maintenance areas shall be located as far as practicable from noise-sensitive receptors;*

- *Project area and site access road speed limits shall be established and enforced during the construction period; and*
- *Nearby residences shall be notified of construction schedules so that arrangements can be made, if desired, to limit their exposure to short-term increases in ambient noise levels.*

The above requirements shall be included via notation on project grading plans, subject to review and approval by the Development Services Department.

- b. Similar to noise, vibration involves a source, a transmission path, and a receiver. However, noise is generally considered to be pressure waves transmitted through air, whereas vibration usually consists of the excitation of a structure or surface. As with noise, vibration consists of an amplitude and frequency. A person’s perception to the vibration depends on their individual sensitivity to vibration, as well as the amplitude and frequency of the source and the response of the system which is vibrating. A common practice is to monitor vibration measures in terms of velocity in inches per second peak particle velocity (IPS, PPV) or root-mean-square (VdB, RMS).

Human and structural response to different vibration levels is influenced by a number of factors, including ground type, distance between source and receptor, duration, and the number of perceived vibration events. Table 14, which was developed by the U.S. Department of Transportation’s Federal Transit Administration (FTA), provides vibration assessment criteria based on the maximum overall levels for a single event, such as vehicle passby on roadways and heavy equipment operations.

Table 14			
Groundborne Vibration Impact Criteria			
Land Use Category	Groundborne Vibration Impact Levels (VdB re 1 μinch/sec, RMS)		
	Frequent Events¹	Occasional Events²	Infrequent Events³
Category 1 – Buildings where vibration would interfere with interior operations	65 ⁴	65 ⁴	65 ⁴
Category 2 – Residences and buildings where people normally sleep	72	75	80
Category 3 – Institutional land uses with primarily daytime use	75	78	83
¹ “Frequent Events” is defined as more than 70 vibration events of the same source per day. ² “Occasional Events” is defined as between 30 and 70 vibration events of the same source per day. ³ “Infrequent Events” is defined as fewer than 30 vibration events of the same kind per day. ⁴ This criterion limit is based on levels that are acceptable for most moderately sensitive equipment such as optical microscopes. For equipment that is more sensitive, a detailed vibration analysis must be performed.			
<i>Source: Bollard Acoustical Consultants, Inc., 2019.</i>			

During a site visit conducted by BAC on March 18, 2019, vibration levels were below the threshold of perception. Nonetheless, to quantify existing vibration levels at the project site, BAC conducted short-term (five-minute) vibration measurements at two on-site locations (see Figure 14, V-1 and V-2). Based on the results of the vibration measurements, the average vibration levels in the project vicinity ranged from 34 to 36 VdB RMS.

During project construction, heavy equipment would be used for grading excavation, paving, and building construction. Use of such equipment would generate localized vibration in the immediate vicinity of the project site. The range of vibration source levels for construction equipment commonly used in similar projects is summarized in Table 15 below. The vibration levels depicted in the table are representative of measurements at a distance of 25 feet from the equipment source. As noted previously, the nearest existing residences are located approximately 230 feet from the proposed school buildings.

Equipment Type	Approximate Vibration Level at 25 Feet (VdB re 1 μinch/sec, RMS)
Vibratory roller	94
Large bulldozer	87
Loaded trucks	86
Jackhammer	79
Small bulldozer	58

Source: Bollard Acoustical Consultants, Inc., 2019.

Because vibration levels dissipate very rapidly from the type of construction equipment required for this project, vibration levels at the nearest residences are expected to be below 70 VdB RMS during project construction. Construction-generated vibration levels of less than the 70 VdB RMS at nearby existing receptors would satisfy the strictest FTA groundborne vibration impact criteria of 72 VdB RMS shown in Table 14 (regardless of number of vibration events from a source). Therefore, project construction would not result in the generation of excessive groundborne vibration or groundborne noise levels, and a *less-than-significant* impact would occur.

- c. The public airport nearest to the project site is the San Martin Airport, which is located approximately 3.5 miles south of the project site at 13030 Murphy Avenue. The project site is located well outside of the AIA identified in the South County Airport Comprehensive Land Use Plan.³⁵ In addition, the project site is not located within the vicinity of a private airstrip. Therefore, the proposed project would not expose people residing or working in the project area to excessive noise levels associated with air traffic, and *no impact* would occur.

³⁵ Santa Clara County. *Comprehensive Land Use Plan, Santa Clara County, South County Airport*. Amended November 16, 2016.

XIV. POPULATION AND HOUSING.

Would the project:

	Potentially Significant Impact	Less Than Significant with Mitigation Incorporated	Less-Than-Significant Impact	No Impact
a. Induce substantial unplanned population growth in an area, either directly (for example, by proposing new homes and businesses) or indirectly (e.g., through projects in an undeveloped area or extension of major infrastructure)?	<input type="checkbox"/>	<input type="checkbox"/>	<input checked="" type="checkbox"/>	<input type="checkbox"/>
b. Displace substantial numbers of existing people or housing, necessitating the construction of replacement housing elsewhere?	<input type="checkbox"/>	<input type="checkbox"/>	<input type="checkbox"/>	<input checked="" type="checkbox"/>

- a. The proposed project would consist of a public K-8 charter school that would serve the existing student population within the project area. The project would not include the development of new residential uses.

Based on the above, the proposed project would not induce substantial unplanned population growth in an area, either directly (for example, by proposing new homes and businesses) or indirectly (e.g., through projects in an undeveloped area or extension of major infrastructure), and a *less-than-significant* impact would occur.

- b. The proposed project site does not contain any existing residences. As such, the proposed project would not displace a substantial number of existing housing or people and would not necessitate the construction of replacement housing elsewhere. Therefore, *no impact* would occur.

XV. PUBLIC SERVICES.

Would the project result in substantial adverse physical impacts associated with the provision of new or physically altered governmental facilities, need for new or physically altered governmental facilities, the construction of which could cause significant environmental impacts, in order to maintain acceptable service ratios, response times or other performance objectives for any of the public services:

	Potentially Significant Impact	Less Than Significant with Mitigation Incorporated	Less-Than-Significant Impact	No Impact
a. Fire protection?	<input type="checkbox"/>	<input type="checkbox"/>	<input checked="" type="checkbox"/>	<input type="checkbox"/>
b. Police protection?	<input type="checkbox"/>	<input type="checkbox"/>	<input checked="" type="checkbox"/>	<input type="checkbox"/>
c. Schools?	<input type="checkbox"/>	<input type="checkbox"/>	<input checked="" type="checkbox"/>	<input type="checkbox"/>
d. Parks?	<input type="checkbox"/>	<input type="checkbox"/>	<input checked="" type="checkbox"/>	<input type="checkbox"/>
e. Other Public Facilities?	<input type="checkbox"/>	<input type="checkbox"/>	<input checked="" type="checkbox"/>	<input type="checkbox"/>

a-c,e. The City of Morgan Hill contracts with CAL FIRE (California Department of Forestry and Fire Protection) for fire protection services. Three fire stations are located within the City boundaries: El Toro Station, located at 18300 Old Monterey Road; Dunne-Hill Station, located at 2100 Dunne Avenue; and the CAL FIRE station at 15670 Monterey Road. The nearest fire station (CAL FIRE station) is located approximately 0.8-mile to the south of the site. The incremental increase in demand associated with the proposed project would not necessitate new or physically altered facilities and would not be substantial enough that the current response times could not be maintained. Accordingly, the response time from the CAL FIRE station would be anticipated to be within the City’s preferred response time of five minutes or less. The project site is also located within the Morgan Hill Police Department’s normal patrol routes, and, thus, police response times would be comparable to nearby existing developments. Furthermore, given that the project is consistent with the site’s current General Plan land use and zoning designations, impacts related to provision of new or physically altered fire and police protection facilities has been previously analyzed in the General Plan EIR. The General Plan EIR concluded that buildout of the City would have a less-than-significant impact related to the provision of such public services.

The proposed project would consist of a public charter school that would provide school services to existing residents in the project area, therefore, the project would not increase demand for school services. With regard to other public facilities, such as libraries, the project would not introduce new residents to the project area and, thus, would not be anticipated to result in a substantial increase in demand for library services, or other public facilities, such that expanded facilities would be required. In addition, the proposed project would include on-site reading room to serve future students at the charter school. The General Plan EIR concluded that buildout of the City, including the project site, would have a less-than-significant impact related to libraries.

Based on the above, the project would have a *less-than-significant* impact with respect to creating adverse physical environmental impacts associated with the provision of new or physically altered governmental facilities in order to maintain acceptable service ratios,

response times or other performance objectives for fire protection, police protection, and schools.

- d. The proposed project would not introduce new residents to the project area and, thus, would not increase demand on existing park facilities within the City of Morgan Hill. In addition, the project would include an on-site playground area for future students of the proposed school. Therefore, the project would have a *less-than-significant* impact with respect to creating adverse physical environmental impacts associated with the provision of new or physically altered governmental facilities in order to maintain acceptable service ratios, response times or other performance objectives for parks.

XVI. RECREATION.

Would the project:

	Potentially Significant Impact	Less Than Significant with Mitigation Incorporated	Less-Than-Significant Impact	No Impact
a. Would the project increase the use of existing neighborhood and regional parks or other recreational facilities such that substantial physical deterioration of the facility would occur or be accelerated?	<input type="checkbox"/>	<input type="checkbox"/>	<input checked="" type="checkbox"/>	<input type="checkbox"/>
b. Does the project include recreational facilities or require the construction or expansion of recreational facilities which might have an adverse physical effect on the environment?	<input type="checkbox"/>	<input type="checkbox"/>	<input checked="" type="checkbox"/>	<input type="checkbox"/>
a,b. As noted previously, the proposed project would not introduce new residents to the project area and, thus, would not increase demand on existing parks and recreation facilities within the City of Morgan Hill. In addition, the project would include an on-site playground area for future students of the proposed school. Physical environmental effects associated with construction of the on-site recreation facilities are analyzed throughout this IS/MND. Given that the project would not introduce new residents to the area such that increased use of neighborhood and regional recreational parks and recreational facilities would occur, a <i>less-than-significant</i> impact would occur with regard to recreational resources.				

XVII. TRANSPORTATION.

Would the project:

	Potentially Significant Impact	Less Than Significant with Mitigation Incorporated	Less-Than-Significant Impact	No Impact
a. Conflict with a program, plan, ordinance, or policy addressing the circulation system, including transit, roadway, bicycle, and pedestrian facilities?	<input type="checkbox"/>	<input checked="" type="checkbox"/>	<input type="checkbox"/>	<input type="checkbox"/>
b. Conflict or be inconsistent with CEQA Guidelines section 15064.3, subdivision (b)?	<input type="checkbox"/>	<input type="checkbox"/>	<input checked="" type="checkbox"/>	<input type="checkbox"/>
c. Substantially increase hazards due to a geometric design feature (e.g., sharp curves or dangerous intersections) or incompatible uses (e.g., farm equipment)?	<input type="checkbox"/>	<input checked="" type="checkbox"/>	<input type="checkbox"/>	<input type="checkbox"/>
d. Result in inadequate emergency access?	<input type="checkbox"/>	<input checked="" type="checkbox"/>	<input type="checkbox"/>	<input type="checkbox"/>

The following discussion is based on the Traffic Impact Analysis prepared for the proposed project by Hexagon Transportation Consultants, Inc. (see Appendix F).³⁶

a. The Traffic Impact Analysis evaluated the following study intersections within the project vicinity (see Figure 15):

1. Monterey Road and Main Avenue;
2. Monterey Road and Dunne Avenue;
3. Monterey Road and Spring Avenue;
4. Monterey Road and San Pedro Avenue (unsignalized);
5. Monterey Road and Cosmo Avenue;
6. Monterey Road and Tennant Avenue/Edmundson Ave;
7. Monterey Road and Vineyard Boulevard;
8. Monterey Road and Watsonville Road/Butterfield Boulevard;
9. Butterfield Boulevard and Main Avenue;
10. Butterfield Boulevard and Dunne Avenue;
11. Butterfield Boulevard and San Pedro Avenue;
12. Butterfield Boulevard and Tennant Avenue;
13. US 101 SB Ramps and Dunne Avenue;
14. US 101 NB Ramps and Dunne Avenue;
15. Church Street and Dunne Avenue;
16. Olympic Drive and Edmundson Avenue (unsignalized);
17. Del Monte Avenue and Cosmo Avenue (unsignalized); and
18. Del Monte Avenue and Spring Avenue (unsignalized).

It should be noted that according to Congestion Management Program (CMP) Traffic Impact Analysis Guidelines, dated March 2009, a freeway level of service (LOS) analysis is required if the number of project trips added to any freeway segment equals or exceeds one percent of the capacity of the segment.

³⁶ Hexagon Transportation Consultants, Inc. *Voices School Morgan Hill, Traffic Impact Analysis*. August 20, 2019

Figure 15
Study Intersection Locations

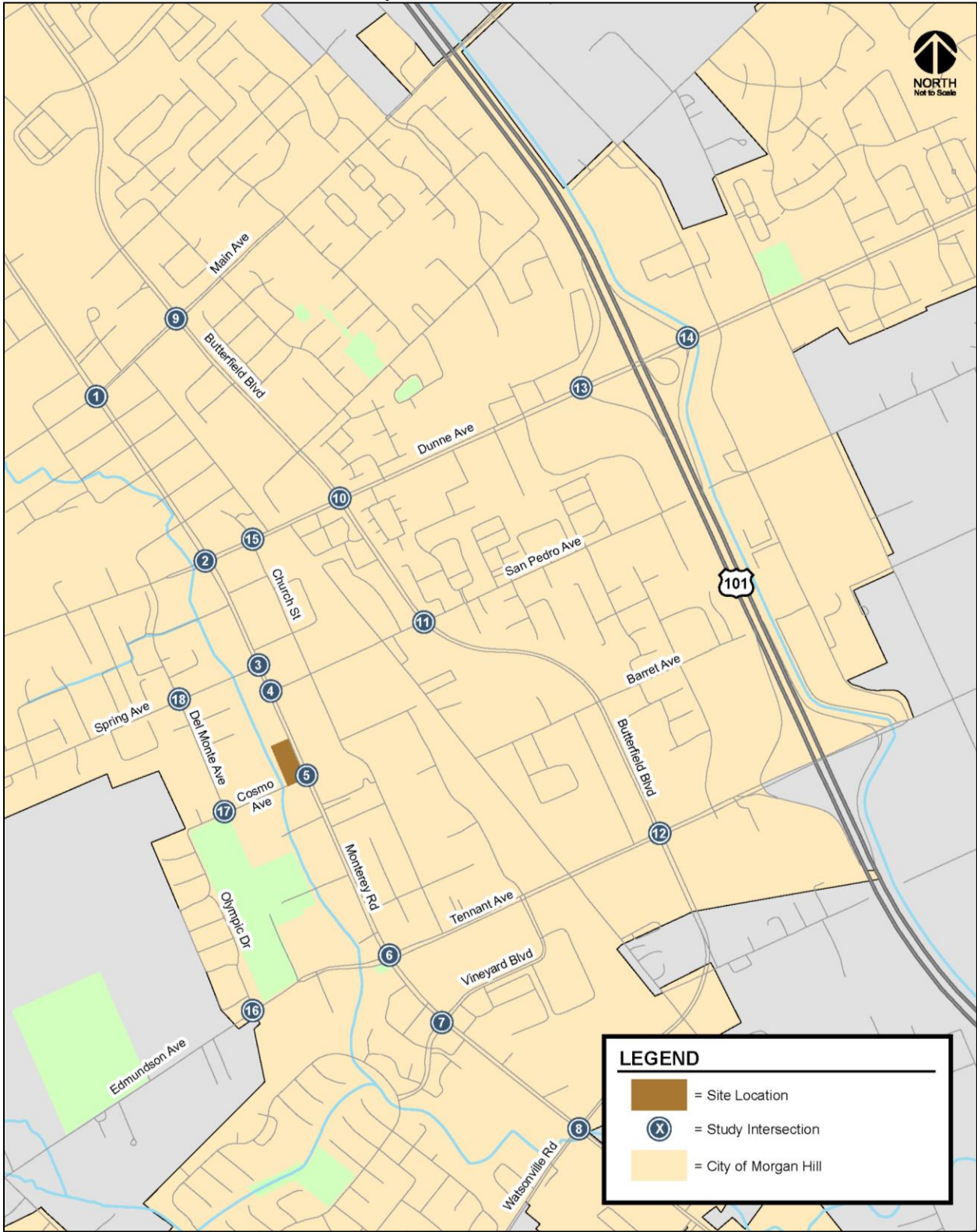

Source: Hexagon Transportation Consultants, Inc.

The key freeway segments in the study area were evaluated to determine if the project traffic on each segment would exceed this threshold.

In the vicinity of the project site, US 101 includes three mixed-flow lanes in each direction of travel south of Cochrane Road and three mixed-flow lanes plus one high occupancy vehicle (HOV) lane north of Cochrane Road. The three mixed-flow lanes on US 101 near the project site have a capacity of 6,900 vehicles per hour (vph) plus 1,650 vph for the segments with HOV lanes. Using the CMP's one-percent threshold, a freeway LOS analysis for US 101 would be needed if the project adds 69 or more trips to the freeway segments (mixed-flow lanes) near the site. A review of the project trip assignment indicates that the highest number of project trips in any direction on the subject freeway segments would be 32 trips or less (US 101, between East Dunne Avenue and SR 85) during both the AM and PM peak hours. Given that the number of project trips added to the freeway segments within the vicinity of the project site would not equal or exceed one percent of the capacity of such segments, a freeway LOS analysis is not required.

Study Time Periods

The instructional school day would begin at 8:00 AM and end at 4:00 PM for all grades, with some students arriving at the site as early as 7:00 AM for before school care. Some students also are anticipated to remain on-site for after school care/activities and leave the site as late as 6:00 PM. The peak hour of school traffic in the morning would coincide with the AM peak-hour of commute traffic (generally between 7:00 and 9:00 AM). After school traffic also would be generated during the PM peak-hour (typically between 4:00 and 6:00 PM), consisting of both traffic associated with the end of the school day dismissal and after school programming. Thus, traffic conditions at the study intersections were analyzed for the standard weekday AM and PM peak hours of traffic. During such peak commute periods, traffic is busiest and the impact on the roadway system by traffic from the proposed school would be greatest.

Study Scenarios

The operations of the study intersections were evaluated for the following four scenarios:

- **Scenario 1: *Existing Conditions.*** Existing conditions represent existing peak-hour traffic volumes on the existing roadway network. Existing peak-hour traffic volumes were obtained from turning-movement traffic counts conducted in May 2018 and March 2019.
- **Scenario 2: *Existing plus Project Conditions.*** Project-generated traffic volumes at full capacity of the proposed school were added to existing traffic volumes to estimate existing plus project conditions. Existing plus project conditions were evaluated relative to existing conditions in order to determine potential project impacts.
- **Scenario 3: *Year 2025 Cumulative Conditions.*** Year 2025 Cumulative conditions represent future traffic volumes on the future transportation network. Year 2025

Cumulative conditions include traffic growth projected to occur in the Year 2025 without the proposed project.

- **Scenario 4:** *Year 2025 Cumulative plus Project Conditions.* Year 2025 Cumulative with project consists of Year 2025 Cumulative traffic conditions with the addition of project traffic. Cumulative plus project conditions were evaluated relative to cumulative conditions in order to determine potential cumulative project impacts.

The following section describes the analysis methodology, thresholds of significance, and each of the scenarios evaluated for the proposed project.

Thresholds of Significance

The City of Morgan Hill's 2010 *Guidelines for Preparation of Transportation Impact Studies* requires signalized intersection operations and impacts to be evaluated based on the jurisdiction's LOS standards (i.e., minimum threshold for acceptable operations). The LOS standard for City of Morgan Hill intersections is LOS D, except for the following:

- **LOS F** for Downtown intersections and segments including at Main Avenue/Monterey Road, along Monterey Road between Main Avenue and Fifth Street, and along Depot Street at First Street through Fifth Street;
- **LOS E** for the following intersections and freeway zones:
 - Main Avenue and Del Monte Avenue;
 - Main Avenue and Depot Street;
 - Dunne Avenue and Del Monte Avenue;
 - Dunne Avenue and Monterey Avenue;
 - Dunne Avenue and Church Street;
 - Dunne Avenue and Depot Street;
 - Cochrane Road and Monterey Road;
 - Tennant Avenue and Monterey Road;
 - Tennant Avenue and Butterfield Boulevard;
 - Cochrane Road Freeway Zone: from Madrone Parkway/Cochrane Plaza to Cochrane Road/DePaul Drive;
 - Dunne Avenue Freeway Zone: from Walnut Grove Drive/East Dunne Avenue to Condit Road/East Dunne Avenue; and
 - Tennant Avenue Freeway Zone: from Butterfield Boulevard/Tennant Avenue to Condit Road/Tennant Avenue.

Seven of the study intersections are subject to LOS E or LOS F standards, while the remaining eleven study intersections are subject to a LOS D standard.

Signalized Intersections

According to the City of Morgan Hill LOS guidelines, a development would create a significant adverse impact on traffic conditions at a signalized intersection if the following occurs for either peak hour:

1. The LOS at the intersection degrades from an acceptable level under existing conditions to an unacceptable level under project conditions, or
2. The LOS at the intersection is an unacceptable level under existing conditions and the addition of project trips causes the average critical delay to increase by four or more seconds *and* the volume-to-capacity ratio (V/C) to increase by 0.01 or more.

An exception to the above applies when the addition of project traffic reduces the amount of average delay for critical movements (i.e., the change in average delay for critical movements is negative). In such a case, the threshold of significance is an increase in the critical V/C value by 0.01 or more.

Unsignalized Intersections

Unsignalized intersections within the City of Morgan Hill have a minimum operating level of LOS D, with the exception of unsignalized intersections located within the Downtown area and freeway zones, as identified above, which have a LOS E or F standard. All four of the unsignalized study intersections have a LOS standard of LOS D.

A development would have a significant adverse impact on traffic conditions at an unsignalized intersection if, for either peak hour, the worst approach (for one- and two-way stop control) or the overall intersection (for all-way stop control) delay corresponds to an unacceptable LOS E or F and the traffic volumes at the intersection are sufficiently high to satisfy the peak-hour signal warrant.

Trip Generation

Trip generation resulting from new development proposed within the City of Morgan Hill typically is estimated by multiplying the Institute of Transportation Engineers (ITE) recommended trip generation rates by the size of the development. However, because the project consists of the expansion and permanent site of an existing school, the trips generated by the proposed school were estimated based on trip generation rates derived for the existing Voices School site.

The project trip generation rates were derived based on trip generation counts conducted at the existing Voices School site on April 3, 2019 by Hexagon Transportation Consultants, Inc. Based on the trip generation counts, at the beginning of the school day (AM peak hour) the trip generation rate for the existing Voices School was calculated to be 1.18 trips per student. At the end of the school day (PM peak hour), the trip generation rates were calculated to be 0.67 trips per student.

The magnitude of traffic added to the roadway system by the proposed project was estimated by multiplying the surveyed trip generation rates by the proposed student enrollment at buildout (504 students). Based on such information, the proposed school would generate approximately 593 AM peak-hour trips and 340 PM peak-hour trips. For comparison purpose, the trip generation for the proposed school was estimated using ITE trip generation rates for charter elementary schools (land use code #537), contained in the

ITE Trip Generation Manual, 10th Edition. Based on ITE rates, the proposed school would generate approximately 575 AM peak-hour trips (305 inbound and 270 outbound) and 348 PM peak-hour trips (160 inbound and 188 outbound). Such projections are shown to be nearly identical to the trip generation rate estimated based on the trip generation counts. Table 16 below provides a summary of the proposed project's estimated vehicle trip generation.

Trip Distribution and Assignment

The trip distribution pattern for the proposed project was estimated based on project information, existing travel patterns on the surrounding roadway system, and the locations of complementary land uses. Hexagon Transportation Consultants, Inc. estimated that approximately 60 percent of parents would drop-off students at the project site on their way to work, while the remaining 40 percent of parents would drop-off students and return home. Based on the different types of trips anticipated to be generated by the project, four separate trip distributions were evaluated in the Traffic Impact Analysis: (1) staff and visitors; (2) non-working parents; (3) incoming trips for working parents; and (4) outgoing trips for working parents.

The peak hour trips generated by the proposed development were assigned to the roadway system in accordance with the trip distribution patterns discussed above. While the project would replace trips currently occurring at the existing Voices School, this analysis conservatively assumes that all project traffic represents new trips at all study intersections. Additional details regarding vehicle trip assumptions are included in the Traffic Impact Analysis.

Existing Plus Project

Project trips, as represented in the project trip assignment discussed above, were added to the existing traffic volumes to obtain Existing Plus Project traffic volumes. The results of the intersection LOS analysis under existing plus project conditions are summarized in Table 17. All of the study intersections, with the exception of Monterey Road and San Pedro Avenue, are projected to operate at acceptable levels of service under Existing Plus Project conditions during both the AM and PM peak hours.

The unsignalized intersection of Monterey Road and San Pedro Avenue is projected to degrade from LOS D to LOS E during the AM peak hour, and to continue to operate at an unacceptable LOS F during the PM peak hour under Existing Plus Project conditions. In addition, the traffic volumes at the intersection would meet signal warrants during the PM peak hour under both Existing and Existing Plus Project conditions. Therefore, the proposed project would result in a potentially significant impact to the intersection of Monterey Road and San Pedro Avenue under the Existing Plus Project condition.

**Table 16
Trip Generation Estimates**

Land Use	Size	Daily ²		AM Peak Hour			PM Peak Hour ³				
		Rate	Trips	Rate	In	Out	Total	Rate	In	Out	Total
Trip Generation Counts¹											
Existing Voices School	248 Students			1.18	157	135	292	0.67	69	98	167
Estimates of Project Traffic Based on Driveway Counts¹											
Charter School (K-8 th grade)	504 Students										
<i>Staff/Faculty and Visitor Trips</i>					63	0	63		0	33	33
<i>Parent/Student Trips</i>					265	265	530		138	169	307
Total Trips		1.91	962	1.18	328	265	593	0.67	138	202	340
Estimates of Project Traffic Based on ITE Rates											
Charter Elementary School ⁴		1.85	932	1.14	305	270	575	0.69	160	188	348

Notes:

- ¹ Trip rates (per student) based on trip generation counts conducted at Voices Academy in Morgan Hill on April 3, 2019. All staff/faculty members were assumed to arrive at the school site during the AM peak-hour and approximately half of the staff/faculty members would leave the school during the PM peak-hour.
- ² Daily trip rate was derived by multiplying the AM peak-hour rate (1.18) by the ratio between the daily trip rate to the AM trip rate (1.85/1.14) contained in the ITE Trip Generation Manual, 10th Edition 2017, for Charter Elementary School (ITE Land Use #537).
- ³ PM peak-hour trip generation reflects 4:00 to 5:00 PM traffic conditions, which is when peak project traffic and peak background traffic overlap.
- ⁴ For comparison purposes, proposed project traffic was estimated utilizing ITE trip generation rates for Charter Elementary School (Land Use #537). Trip rates are expressed in trips per student and based on the ITE Trip Generation Manual, 10th Edition 2017.

Source: Hexagon Transportation Consultants, Inc., 2019.

**Table 17
Existing and Existing Plus Project Conditions Intersection LOS**

Intersection	LOS Standard	Peak Hour	Existing			Existing Plus Project				
			Warrant Met? ¹	Average Critical Delay ²	LOS	Warrant Met? ¹	Average Critical Delay ²	LOS	Average Critical Delay Change	Critical Change V/C
1. Monterey Rd. and Main Ave.	F	AM	--	44.2	D		44.5	D	0.9	0.033
		PM	--	45.1	D		45.5	D	0.4	0.011
2. Monterey Rd. and Dunne Ave.	E	AM	--	28.9	C		30.6	C	1.8	0.028
		PM	--	31.4	C		33	C	2.4	0.04
3. Monterey Rd. and Spring Ave.	D	AM	--	5.1	A		5.5	A	0.6	0.008
		PM	--	11.3	B		11.6	B	0.2	0.035
4. Monterey Rd. and San Pedro Ave. ³	D	AM	No	26.7	D	No	38.6	E	N/A	N/A
		PM	Yes	71.1	F	Yes	97.1	F	N/A	N/A
5. Monterey Rd. and Cosmo Ave.	E	AM	--	3.8	A		3.5	A	0	0
		PM	--	3.9	A		3.8	A	0	0
6. Monterey Rd. and Tennant Ave./Edmundson Ave.	D	AM	--	23.7	C		24.2	C	0.5	0.037
		PM	--	36.4	D		37.3	D	1.2	0.015
7. Monterey Rd. and Vineyard Blvd.	D	AM	--	20.3	C		20.2	C	-0.3	0.014
		PM	--	27.8	C		27.6	C	-0.2	0.008
8. Monterey Rd. and Watsonville Rd./Butterfield Blvd.	D	AM	--	30.1	C		30.4	C	0.4	0.006
		PM	--	46.6	D		47.5	D	1.4	0.007
9. Butterfield Blvd. and Main Ave.	D	AM	--	27.6	C		27.9	C	0.2	0.007
		PM	--	29.8	C		30	C	0.3	0.005
10. Butterfield Blvd. and Dunne Ave.	D	AM	--	38.3	D		39.6	D	1.8	0.029
		PM	--	35.3	D		36.2	D	1.5	0.031
11. Butterfield Blvd. and San Pedro Ave.	D	AM	--	13	B		13.3	B	0.4	0.009
		PM	--	13.2	B		13.3	B	0.2	0.005
12. Butterfield Blvd. and Tennant Ave.	E	AM	--	23.9	C		24	C	0	0.007
		PM	--	37.4	D		37.4	D	0	0.003
13. US 101 SB Ramps and Dunne Ave.	E	AM	--	20.9	C		21.4	C	-0.2	0.033
		PM	--	18.8	B		20.1	C	0.2	0.037
14. US 101 NB Ramps and Dunne Ave.	E	AM	--	5.3	A		5.2	A	-0.1	0.009
		PM	--	11.8	B		11.7	B	0.3	0.003

(Continued on next page)

**Table 17
Existing and Existing Plus Project Conditions Intersection LOS**

Intersection	LOS Standard	Peak Hour	Existing			Existing Plus Project				
			Warrant Met? ¹	Average Critical Delay ²	LOS	Warrant Met? ¹	Average Critical Delay ²	LOS	Average Critical Delay Change	Critical Change V/C
15. Church St. and Dunne Ave.	E	AM	--	17.8	B		18	B	0	0.047
		PM	--	19.9	B		19.2	B	-0.5	0.021
16. Olympic Drive and Edmundson Ave.	D	AM	No	9.8	A	No	11.2	B	N/A	N/A
		PM	No	10.9	B	No	12.3	B	N/A	N/A
17. Del Monte Ave. and Cosmo Ave.	D	AM	No	7.2	A	No	8.1	A	0.9	0.243
		PM	No	7.4	A	No	8.3	A	0.8	0.189
18. Del Monte Ave. and Spring Ave.	D	AM	No	7.8	A	No	9.3	A	1.4	0.255
		PM	No	7.9	A	No	8.7	A	0.8	0.148

Notes:

- ¹ Signal warrant analysis based on the Peak Hour Signal Warrant #3, Figure 4C Caltrans MUTCD, 2014. Signal warrant analysis is not applicable to signalized intersections.
- ² The reported delay and corresponding LOS for signalized and all-way stop-controlled intersections represents the average delay for all approaches at the intersection. The reported delay and corresponding LOS for one- and two-way stop-controlled intersections are based on the stop-controlled approach with the highest delay.
- ³ **Bold** indicates unacceptable LOS.

Source: Hexagon Transportation Consultants, Inc., 2019.

Cumulative Plus Project

Traffic volumes for the Year 2025 Cumulative condition were developed based on traffic forecasts produced for the City of Morgan Hill 2035 General Plan using the City's Traffic Demand Forecasting (TDF) model. The Year 2035 General Plan traffic forecasts include land use growth and transportation improvements associated with buildout of the City's General Plan. The Year 2025 Cumulative traffic volumes were developed using a growth method that involved adding a proportion (10 years, or 50 percent) of the 2035 projected growth, developed from forecasted turn-movements, to existing traffic counts at each of the study intersections. The projected growth was calculated by taking the difference between Base Year 2015 and Year 2025 forecasted turn movements. The Traffic Impact Study did not account for any future roadway improvements under the cumulative conditions.

Traffic associated with buildout of the project site was included in the City's General Plan forecasts and the developed Year 2025 Cumulative traffic volumes. However, the land uses assumed for the project site as part of the General Plan were general in nature (16 multi-family residential units, 800 square feet of shopping center, and 800 square feet of office space). Given that the proposed project includes a site-specific development plan with a defined land use, the cumulative traffic volumes included in the General Plan were updated to reflect the current development proposal.

The LOS results under Cumulative and Cumulative Plus Project conditions are summarized in Table 18. The following study intersections are projected to operate at unacceptable levels of service during at least one of the peak hours analyzed under 2025 Cumulative Plus Project conditions:

4. Monterey Road and San Pedro Avenue (AM and PM peak hours); and
8. Monterey Road and Watsonville Road/Butterfield Boulevard (PM peak hour).

The unsignalized intersection of Monterey Road and San Pedro Avenue is projected to operate at an unacceptable LOS E or F during both the AM and PM peak hours under both Cumulative and Cumulative Plus Project conditions. In addition, the peak-hour traffic signal warrant checks indicate that the traffic volumes at the intersection would continue to meet signal warrants during both peak hours under Cumulative Plus Project. Therefore, the proposed project could result in a potentially significant cumulative impact to the intersection of Monterey Road and San Pedro Avenue.

The signalized intersection of Monterey Road and Watsonville Road/Butterfield Boulevard is projected to operate at unacceptable LOS E during the PM peak hour under both Cumulative and Cumulative Plus Project conditions. However, the addition of project trips would not cause the average critical delay to increase by more than four seconds, nor the V/C to increase by 0.01 or more. Therefore, the proposed project would not result in a significant cumulative impact at the intersection.

Table 18
Cumulative and Cumulative Plus Project Conditions Intersection LOS

Intersection	LOS Standard	Peak Hour	Cumulative			Cumulative Plus Project				
			Warrant Met? ¹	Average Critical Delay ²	LOS	Warrant Met? ¹	Average Critical Delay ²	LOS	Average Critical Delay Change	Critical Change V/C
1. Monterey Rd. and Main Ave.	F	AM	--	55.8	E	--	56.9	E	1.4	0.013
		PM	--	48.2	D	--	48.9	D	0.5	0.011
2. Monterey Rd. and Dunne Ave.	E	AM	--	29.8	C	--	31.6	C	2.0	0.028
		PM	--	34.7	C	--	36.1	D	1.6	0.034
3. Monterey Rd. and Spring Ave.	D	AM	--	4.7	A	--	5.1	A	0.5	0.008
		PM	--	11.8	B	--	12.1	B	0.2	0.034
4. Monterey Rd. and San Pedro Ave. ³	D	AM	No	42.9	E	Yes	75.6	F	N/A	N/A
		PM	Yes	148.8	F	Yes	209.0	F	N/A	N/A
5. Monterey Rd. and Cosmo Ave.	E	AM	--	3.7	A	--	3.5	A	0.0	0.000
		PM	--	3.9	A	--	3.8	A	0.0	0.000
6. Monterey Rd. and Tennant Ave./Edmundson Ave.	D	AM	--	23.9	C	--	24.4	C	0.5	0.036
		PM	--	36.1	D	--	36.9	D	1.2	0.014
7. Monterey Rd. and Vineyard Blvd.	D	AM	--	19.8	B	--	19.9	B	-0.1	0.014
		PM	--	27.3	C	--	27.2	C	-0.1	0.008
8. Monterey Rd. and Watsonville Rd./Butterfield Blvd.	D	AM	--	34.8	C	--	35.3	D	0.8	0.006
		PM	--	61.1	E	--	62.1	E	1.8	0.007
9. Butterfield Blvd. and Main Ave.	D	AM	--	30.6	C	--	31.0	C	0.8	0.015
		PM	--	33.2	C	--	33.4	C	0.4	0.005
10. Butterfield Blvd. and Dunne Ave.	D	AM	--	42.6	D	--	44.5	D	2.6	0.026
		PM	--	37.7	D	--	38.9	D	1.7	0.029
11. Butterfield Blvd. and San Pedro Ave.	D	AM	--	13.7	B	--	13.9	B	0.4	0.009
		PM	--	13.8	B	--	14.0	B	0.2	0.005
12. Butterfield Blvd. and Tennant Ave.	E	AM	--	26.3	C	--	26.6	C	0.5	0.008
		PM	--	40.9	D	--	40.9	D	0.1	0.003
13. US 101 SB Ramps and Dunne Ave.	E	AM	--	21.0	C	--	22.1	C	-0.1	0.014
		PM	--	20.1	C	--	21.3	C	0.7	0.035

(Continued on next page)

**Table 18
Cumulative and Cumulative Plus Project Conditions Intersection LOS**

Intersection	LOS Standard	Peak Hour	Cumulative			Cumulative Plus Project				
			Warrant Met? ¹	Average Critical Delay ²	LOS	Warrant Met? ¹	Average Critical Delay ²	LOS	Average Critical Delay Change	Critical Change V/C
14. US 101 NB Ramps and Dunne Ave.	E	AM	--	6.3	A	--	6.2	A	-0.1	0.009
		PM	--	11.2	B	--	11.2	B	0.0	0.001
15. Church St. and Dunne Ave.	E	AM	--	18.1	B	--	18.5	B	0.1	0.046
		PM	--	19.5	B	--	18.9	B	-0.4	0.020
16. Olympic Drive and Edmundson Ave.	D	AM	No	10.4	B	No	12.4	B	N/A	N/A
		PM	No	11.4	B	No	13.1	B	N/A	N/A
17. Del Monte Ave. and Cosmo Ave.	D	AM	No	7.2	A	No	8.1	A	0.8	0.236
		PM	No	7.5	A	No	8.3	A	0.8	0.182
18. Del Monte Ave. and Spring Ave.	D	AM	No	8.1	A	No	9.6	A	1.5	0.243
		PM	No	8.1	A	No	8.8	A	0.8	0.145

Notes:

- ¹ Signal warrant analysis based on the Peak Hour Signal Warrant #3, Figure 4C Caltrans MUTCD, 2014. Signal warrant analysis is not applicable to signalized intersections.
- ² The reported delay and corresponding LOS for signalized and all-way stop-controlled intersections represents the average delay for all approaches at the intersection. The reported delay and corresponding LOS for one- and two-way stop-controlled intersections are based on the stop-controlled approach with the highest delay.
- ³ **Bold** indicates unacceptable LOS.

Source: Hexagon Transportation Consultants, Inc., 2019.

The remaining study intersections are projected to operate at acceptable levels of service, and would not meet signal warrants, under Cumulative and Cumulative Plus Project conditions during each of the peak hours analyzed.

Roadway Segments

As part of the Traffic Impact Analysis, an evaluation of the effects of project traffic along the following key roadway segments was completed:

1. Cosmo Avenue
2. Del Monte Avenue
3. Olympic Drive
4. Spring Avenue

For the evaluation, the Existing and Existing Plus Project peak-hour traffic volumes along the above roadway segments were compared to acceptable volume thresholds for each segment to determine if the projected change in traffic volume would be considered significant. Unlike the intersection LOS analysis methodology, which has established impact thresholds, the analyses contained in this section are based on professional judgment in accordance with the standards and methods employed by the traffic engineering community.

The roadway segments evaluated all consist of two -lane, undivided roadways that provide access to residential areas and connect to arterials. All of the evaluated roadways are classified as collector roadways in the City of Morgan Hill 2035 General Plan, Transportation section. All roadways are approximately 35 to 40 feet wide, curb-to-curb, with on-street parking on both sides of the street and no striped bike lanes.

Speed and count data were collected on April 3, 2019 along the study roadway segments. The traffic count data revealed that the study roadway segments currently carry between 550 (along Olympic Drive) to 2,400 (along Spring Avenue) daily vehicles (both directions combined) near the project site. Based on the typical traffic volume ranges associated with collector streets, all of the study roadway segments currently serve the recommended traffic volumes associated with their street classification.

Under the proposed site access configuration (right-in/right-out only on Cosmo Avenue), all outbound project traffic would utilize westbound Cosmo Avenue after exiting the project driveway. This equates to approximately 482 daily trips being added by the project to westbound Cosmo Avenue, between the project driveway and Del Monte Avenue, the most project traffic added to a single roadway segment, (representing a 30 percent increase in daily traffic volumes from Existing conditions). At Del Monte Avenue, project traffic traveling on Cosmo Avenue would continue northbound to Del Monte Avenue (354 daily trips) or westbound/southbound to Olympic Drive (128 daily trips). The increase in daily traffic volumes along Del Monte Avenue and Olympic Drive would be approximately 20 percent and 23 percent, respectively, from Existing conditions. Spring Avenue would

experience the smallest increase in daily traffic volumes with an increase of 24 daily trips, or a one percent increase in daily traffic volumes.

Even with the additional traffic added to the adjacent roadway network, all study roadway segments would continue to carry the recommended average daily traffic volumes associated with collector streets (see Table 19).

Roadway Segment	Count Date	Direction	Speed		Average Daily Trips			
			Limit	85 th Percentile	Existing	Project Trips	Existing Plus Project	% Change
1. Cosmo Ave, east of Del Monte Ave	4/3/19	EB	25	30	901	0	901	0%
		WB	25	29	724	482	1,206	67%
		Total			1,625	482	2,107	30%
2. Del Monte Ave, north of Cosmo Ave	4/3/19	NB	25	30	889	354	1,243	40%
		SB	25	32	909	0	909	0%
		Total			1,798	354	2,152	20%
3. Olympic Dr, south of Cosmo Ave	4/3/19	NB	25	32	285	0	285	0%
		SB	25	33	262	128	390	49%
		Total			547	128	675	23%
4. Spring Ave, east of Del Monte Ave	4/3/19	EB	25	34	1,110	24	1,134	2%
		WB	25	32	1,249	0	1,249	0%
		Total			2,359	24	2,383	1%

Source: Hexagon Transportation Consultants, Inc., 2019.

The following conclusions can be drawn from the evaluation of the study roadways:

- Traffic volumes at all study roadways are and would continue to be within the local street volume range characteristic for collector streets.
- With the proposed site access configuration, traffic volumes along Cosmo Avenue are projected to increase by approximately 30 percent from existing conditions as a result of the proposed project, an increase which could be considered measurable and would be perceptible to residents of the adjacent neighborhood, but would not be considered a significant impact under CEQA.
- Most of the traffic increases along the study roadway segments would occur during the peak hours, with little to no change in traffic during the off-peak hours.

Pedestrian, Bicycle, and Transit Facilities

The proposed project’s potential impacts related to transit, bicycle, and pedestrian facilities is discussed below.

Transit Facilities

In the City of Morgan Hill, transit service is operated by the VTA, the Monterey-Salinas Transit (MST), and Caltrain. The nearest bus stops to the project site are located on

Monterey Road just north and south of Cosmo Avenue, approximately 175 feet from the project site. The bus stops are served by Local Route 68. Additionally, the Morgan Hill Caltrain Station, located on the east side of Depot Street, is less than one mile north of the project site and provides a connection to most transit lines serving Morgan Hill in addition to Caltrain and the MST 55 line. The study area is served by one local bus (Local Bus Route 68) and three express buses (Express Route 121, 168, and 185).

The proposed project would not conflict with any existing or planned transit facilities. In addition, due to the relatively small size of the proposed project, the project would generate a relatively small number of transit trips, and, thus, would not substantially increase demand for transit services in the project area.

Furthermore, because trips generated by the proposed project would not substantially increase the delay at nearby intersections, the project would not substantially affect transit vehicle delay for area bus routes. Overall, the proposed project would not have a substantial adverse effect on transit facilities in the project area.

Bicycle Facilities

Currently, numerous bike lanes and bike paths are provided in the vicinity of the project site, including the West Llagas Creek Trail and the Class II bike lanes along Monterey Road, which serve the project site directly and provide connections to other bicycle facilities in the area.

The proposed project could result in increased use of bicycle facilities in the vicinity of the project site. Assuming bicycle trips would comprise up to one percent of the total project-generated trips, the project could generate up to six new bicycle trips during the AM and PM peak hours. However, per the Traffic Impact Study, the potential demand could be easily served by the various bicycle facilities available in the immediate vicinity of the project site. Therefore, the potential increase in bicycle trips by the proposed project would not have an adverse effect on the existing bicycle facilities in the study area, and would not require new off-site bicycle facilities. In addition, the project would not create inconsistencies or conflict with policies in the City's Bikeways, Trails, Parks, and Recreation Master Plan.

Pedestrian Access

Pedestrian facilities in the study area consist primarily of sidewalks, crosswalks, and pedestrian signals at signalized intersections. The adjacent intersection of Monterey Road and Cosmo Avenue has marked crosswalks and pedestrian signal heads along the south and west legs of the intersection. However, sidewalks are currently missing along the entire project site frontages on both Monterey Road and Cosmo Avenue. Additionally, sidewalks are missing along the west side of Monterey Road, between the project site and just south of San Pedro Avenue.

The proposed project would include installation of new sidewalks along the entire project frontage. While the lack of sidewalks along the west side of Monterey Road to the north of the project site would result in a discontinuous pedestrian facility network in the immediate project area for potential pedestrian traffic originating from the north, pedestrian traffic from the north could instead utilize Del Monte Avenue and the existing trail that runs along the west side of the school site, between Spring Avenue to Cosmo Avenue. Pedestrian traffic from the north and east of Monterey Road could use the sidewalks along the east side of Monterey Road to access the project site. Thus, the proposed project would not disrupt existing pedestrian facilities, eliminate existing pedestrian facilities, interfere with planned pedestrian facilities, increase conflicts between drivers and pedestrians, or create inconsistencies or conflicts with policies in the City's Bikeways, Trails, Parks, and Recreation Master Plan. Nonetheless, given that a crosswalk is not currently provided across the north leg of the Monterey Road/Cosmo Avenue intersection, and the existing traffic signal operates with permitted phasing on all approaches, pedestrian connectivity between the project site and the areas east of the site across Monterey Road would be limited. Given the deficiency in pedestrian facilities available to serve future students of the proposed project, a potentially significant impact could occur.

Conclusion

Based on the above, with the exception of the Monterey Road/San Pedro Avenue intersection, the study intersections would operate acceptably with the addition of project traffic and would not conflict with any applicable City standards. In addition, the proposed project would not conflict with adopted policies supporting transit and bicycle transportation.

However, under both Existing Plus Project and Cumulative Plus Project conditions, the proposed project would conflict with applicable City LOS standards at the Monterey Road/San Pedro Avenue intersection. In addition, the existing signal at the Monterey Road/Cosmo Avenue intersection does not include pedestrian phasing necessary to allow for connectivity between the project site and the surrounding area. Therefore, a ***potentially significant*** impact would occur related to conflicting with a program, plan, ordinance, or policy addressing the circulation system, including transit, roadway, bicycle, and pedestrian facilities.

Mitigation Measure(s)

Mitigation measures for the Monterey Road/San Pedro Avenue and Monterey Road/Cosmo Avenue intersections are described below.

Monterey Road/San Pedro Avenue Intersection

The potential impact at the Monterey Road/San Pedro Avenue intersection could be mitigated by installing a raised median along Monterey Road at San Pedro Avenue, restricting left-turns out of San Pedro Avenue to southbound Monterey Road. With the left-turn restriction, only right-turns in and out at both San Pedro Avenue (east leg of the

intersection) and the existing driveway (west leg of the intersection) as well as southbound left-turns would be allowed, reducing the amount of conflicting traffic at the intersection. The southbound left-turn movement from Monterey Road to eastbound San Pedro Avenue could be maintained without having an adverse effect on operations at the intersection, because the movement would only be in conflict with the northbound approach. With the restriction of the westbound left-turn movement, the intersection of Monterey Road and San Pedro Avenue is projected to operate at an acceptable LOS C or better during the AM and PM peak hours under Existing Plus Project conditions, which would reduce the impact to a *less-than-significant level*.

The left-turn restriction at San Pedro Avenue would result in the displacement of traffic bound for southbound Monterey Road from westbound San Pedro Avenue (34 and 28 AM and PM peak hour trips, respectively, under Existing Plus Project conditions, with 7 and 1 of those trips being AM and PM peak hour project trips, respectively) to utilize alternative routes, such as Barrett Avenue, Edmundson Avenue, or Tennant Avenue. Left-turns in and out of the existing west-leg driveway (approximately 15 trips during the PM peak hour) would be required to complete a U-turn north and south of the intersection. Project traffic along westbound San Pedro Avenue would travel southbound on Church Street to Barrett Avenue, to northbound Monterey Road and complete a northbound left-turn at Cosmo Avenue. The minimal amount of displaced traffic represents an average of one trip every two minutes added to two to three other roadways, and is not anticipated to have an adverse effect on traffic conditions at the surrounding intersections. The additional northbound left-turn project trips at the intersection of Monterey Road/Cosmo Avenue as a result of the left-turn restriction are not projected to have an adverse effect on intersection operations at this location.

Monterey Road/Cosmo Avenue Intersection

All school traffic, as well as potential pedestrian traffic along Monterey Road, would utilize this intersection to access the school site. This intersection is currently signalized with crosswalks along the south and west legs only and permitted signal phasing on all approaches of the intersection. The intersection level of service analysis (see Tables 17 and 18) shows the intersection to currently operate at acceptable LOS A during both the AM and PM peak hours and is projected to continue to operate at LOS A with the addition of project traffic. The intersection's projected operating conditions and low delays are due to the majority of the intersection traffic traveling through Monterey Road, with relatively low traffic volumes from/to Cosmo Avenue, resulting in very little conflicting movements and intersection delay. Although the project would add traffic to this intersection, all project traffic under the proposed site access alternative would be added to a non-critical movement (the northbound left-turn movement), resulting in a slight improvement to the overall intersection average delay.

As discussed previously, however, although the intersection is projected to operate adequately with the implementation of the proposed school project, the missing crosswalk along the north leg of the intersection and permitted signal phasing is less than ideal for an intersection that would serve as the main access intersection for the school. Thus, it is

recommended that protected pedestrian phasing be installed on all approaches of the intersection to accommodate pedestrian school traffic. Implementing pedestrian phasing on all approaches of the intersection would require the installation of the north crosswalk as well as modification of the traffic signal to include protected left-turn phasing on the northbound and southbound approaches and split phasing on the eastbound and westbound approaches. Signal timing also would have to be modified to accommodate the additional pedestrian phases.

With the implementation of the recommended signal phasing improvements to improve safe pedestrian circulation, the intersection is projected to continue to operate at an acceptable LOS C or better during the AM and PM peak-hours with the project (see Table 20).

Table 20					
Monterey Road and Cosmo Avenue Intersection LOS					
Scenario	Peak Hour	Existing Conditions		Existing Plus Project Conditions	
		Delay (sec)	LOS	Delay (sec)	LOS
Existing					
Permitted NB/SB Left Turns, Permitted NB/WB Left Turns	AM	3.8	A	3.5	A
	PM	3.9	A	3.8	A
With Mitigation Measure XVII-2					
Protected NB/SB Left Turns, Split EB/WB Left Turns	AM	15.6	B	18.4	B
	PM	19.2	B	26.2	C
<i>Source: Hexagon Transportation Consultants, Inc., 2019.</i>					

XVII-1. Prior to submittal of the improvement plans for the project, the project plans shall show the construction of a raised median along Monterey Road at San Pedro Avenue, restricting left-turns out of San Pedro Avenue to southbound Monterey Road. With the left-turn restriction, only right-turns in and out at both San Pedro Avenue (east leg of the intersection) and the existing driveway (west leg of the intersection), as well as southbound left-turns, shall be allowed. The design of the median shall be to the satisfaction of the Engineering and Utilities Division.

XVII-2. Final project improvement plans prepared for the proposed project shall include, to the satisfaction of the City Engineer, installation of a crosswalk at the northern leg of the Monterey Road/Cosmo Avenue intersection and protected phasing on all approaches of the intersection, including modifying the traffic signal to include protected left-turn phasing on the northbound and southbound approaches and split phasing on the eastbound and westbound approaches.

- b. Section 15064.3 of the CEQA Guidelines provides specific considerations for evaluating a project’s transportation impacts. Pursuant to Section 15064.3, analysis of vehicle miles traveled (VMT) attributable to a project is the most appropriate measure of transportation impacts. Other relevant considerations may include the effects of the project on transit and

non-motorized travel. It should be noted that currently, the provisions of Section 15064.3 apply only prospectively; determination of impacts based on VMT is not required Statewide until July 1, 2020.

The proposed project would include features to reduce overall VMT. Pursuant to Section 15064.3(b)(3), a lead agency may analyze a project's VMT qualitatively based on the availability of transit, proximity to destinations, etc. Bus service is currently provided in the project vicinity by the VTA, and the site is located approximately 150 feet from the nearest bus stop. As noted previously, numerous bike lanes and bike paths are provided in the vicinity of the project site, including the West Llagas Creek Trail and the Class II bike lanes along Monterey Road, which serve the project site directly and provide connections to other bicycle facilities in the area. The proposed project would include installation of new sidewalks along the entire project frontage. The availability of such transit, bicycle, and pedestrian infrastructure in the site vicinity would help to reduce VMT associated with staff and students travelling to and from the project site. Furthermore, the site is located adjacent to existing residential neighborhoods to the west and northwest. The site's proximity to such uses would be anticipated to reduce VMT associated with the proposed charter school.

Based on the above, the proposed project would not conflict or be inconsistent with CEQA Guidelines Section 15064.3(b), and a *less-than-significant* impact would occur.

- c,d. Primary access to the proposed project would be by way of a right-in, right-out access at the project driveway at Cosmo Avenue. The Monterey Road project driveway, located approximately 350 feet north of Cosmo Avenue, would be limited to emergency vehicle access only. The project site driveway on Cosmo Avenue would connect to the proposed on-site parking area by way of a long (approximately 200 feet) two-way drive aisle. The parking area would be located along the northern project site boundary, northwest of the modular school building, and would consist of a total of 35, 90-degree parking spaces with a centrally located row of parking spaces. The center row of parking spaces would allow for a circular counter clock-wise one-way circulation within the parking area. A designated drop-off/pick-up area is proposed along the east side of the circular drive aisle, adjacent to the school building. The proposed internal circulation system and driveways would be designed to be consistent with all applicable City roadway engineering standards.

Emergency Access

Emergency vehicles entering the site from Monterey Road most likely would enter the site, circulate the site in a counter-clockwise direction, and exit the site at either the Cosmo Avenue driveway or the Monterey Road driveway. Thus, the parking lot, including driveway and drive aisle widths and on-site turn radii, would be designed to ensure emergency vehicles can maneuver through the site without encountering obstructions. Given compliance with required roadway design standards, adequate emergency vehicle access would be provided at the project site.

Site Distance

The sight distance from the proposed Cosmo Avenue driveway to the east extends to the Monterey Road/Cosmo Avenue intersections, approximately 175 feet. According to the Caltrans Highway Design Manual, the minimum required stopping sight distance for a roadway with a posted speed limit of 25 mph is 150 feet. Based on field observations and Caltrans requirements, the available sight distance at the Cosmo Avenue driveway would be adequate.

Student Pick-Up and Drop-Off

During student drop-off and pick-up times, inbound vehicles would enter the site via the Cosmo Avenue driveway, access the drop-off/pick-up area, circulate the parking lot back to the Cosmo Avenue driveway, and exit the site. The one-way circulation pattern would allow for efficient movement of traffic in and out of the project site by minimizing conflict between vehicles on-site. All inbound project traffic would utilize the Monterey Road/Cosmo Avenue intersection to access the project driveway. All outbound project traffic would head westbound on Cosmo Avenue to Del Monte Avenue or Olympic Drive, away from the Monterey Road/Cosmo Avenue intersection. The right-in/right-out operations of the project driveway would eliminate conflict between inbound and outbound traffic and reduce the amount of traffic that would be added to the intersection of Monterey Road/Cosmo Avenue.

The proposed drop-off/pick-up area would be located adjacent to the proposed school building, on the east side of the circular parking lot drive aisle. The distance between the project driveway and the first position at the drop-off area is approximately 260 feet. Assuming an average vehicle length of 25 feet, approximately 10 to 11 vehicles could be stored within the inbound drive aisle prior to reaching the drop-off area. Based on the length of the drop-off area, an additional three to four vehicles could be stored within the drop-off area, representing a total queue storage capacity of approximately 13 to 14 vehicles within the school site.

Based on the length of the proposed drop-off area, approximately three to four vehicles could be loaded/unloaded at one time. Conservatively assuming that dropping-off/picking-up a student and driving away would take up one minute per vehicle, and assuming four vehicles are continuously served at once, approximately four drop-offs/pick-ups would occur per minute.

Based on the project trip generation estimates, approximately 265 vehicles would enter the drop-off area during the AM peak-hour (highest peak hour). In addition, the trip generation counts conducted at the existing Voices School site show that school traffic arriving at the school site during the peak 15-minute period represent approximately 55 percent of the total peak-hour school traffic. Assuming the same arrival pattern would be observed at the proposed school site, approximately 146 vehicles would arrive at the school site within the peak 15-minute period, an average of 10 vehicles per minute. With an unloading time of one minute or less per vehicle and the ability to serve four vehicles

at once, the average queue length at the drop-off area would be approximately six vehicles.

Following the same methodology noted above, a maximum of approximately 12 vehicles would queue up beyond the drop-off area during the peak 15-minute period (the maximum queue is approximately twice the average queue). However, such an estimate assumes all 146 vehicles would arrive at the site evenly during the peak 15-minute period. Traffic patterns, however, are seldom uniform. Random vehicle arrivals result in short periods of time experiencing longer queues than estimated and other short times not experiencing any queues whatsoever. Nevertheless, the proposed queue storage capacity within the inbound drive aisle would be approximately one to two vehicles short of meeting the estimated maximum vehicle queue during the school's peak 15-minute period, resulting in one to two vehicles from the queue spilling onto Cosmo Avenue. During the rest of the peak-hour, the queue storage capacity within the site would be adequate to serve the estimated drop-off queue length.

In order to avoid or minimize the possibility of the inbound queue length extending onto Cosmo Avenue, additional drop-off positions could be added (without reducing the inbound queue storage capacity) or the drop-off area could be operated more efficiently (shortening the time each vehicle spends in the drop-off area). Such changes would result in more vehicles being served than the four vehicles per minute assumed in the above queue length estimates. Additionally, the school may implement staggered start times spreading the arrival times and reducing the amount of inbound traffic during the peak 15-minute period. Staggered start times are discussed below.

Staggered School Start Times Evaluation

To spread the amount of traffic accessing the project site over the peak hour, rather than the 15-minute period that is typical of school start times, and reduce potential issues associated with peak period vehicular access, the school could implement staggered start times. Implementing staggered start times would reduce the amount of traffic accessing the school site during the peak 15-minute period, resulting in shorter queue lengths at the drop-off area. Staggered start times a minimum of 30 minutes apart would have the greatest effect on inbound queue lengths, as traffic associated with the first start time would no longer be on site by the time the second start time traffic begins to arrive at the site.

Table 21 shows estimates of the number of students that would arrive at the school site during the peak hour, peak 15 minutes, and peak minute if the school implemented a start time of 8:00 AM for the upper grades (sixth through eighth grades) and an 8:30 AM start time for the lower grades (kindergarten through fifth grades). Such estimates are based on the following assumptions:

- All student traffic would arrive to the site within 30-minutes prior to their respective school start time. Based on this assumption, approximately 168 and 336 students would arrive to the site between 7:30 and 8:00 AM and 8:00 and 8:30 AM, respectively.

**Table 21
Staggered School Start Times Summary**

Potential school start times: (Between 8:00 and 8:30 AM)		TIME												9:00					
		7:15 AM		7:30			8:00			8:30									
8:30	Lower Grades (K-5) arrival						336												
8:00	Upper Grades (6-8) arrival			168															
	15-min arrivals	0	0	76	92	151	185			0			504						
	5-min arrivals	0	0	25	25	25	31	31	31	50	50	50	62	62	62	0	0	0	504
	1-min arrivals	0	0	5	5	5	6	6	6	10	10	10	12	12	12	0	0	0	101
	Hourly Student Arrivals:																		
	Between 7:30-8:30	504																	
	Between 8:00-9:00	428																	
	Between 8:00-9:00	336																	
<p>Assumptions: All students would arrive to the school within 30 minutes prior to their respective school start time. Fifty-five percent (55%) of the students would arrive to the school within 15 minutes prior to their respective school start time, as was observed at the existing Voices School Site. Within each 15-minute period, traffic was assumed to arrive at the site evenly.</p>																			

Source: Hexagon Transportation Consultants, Inc., 2019.

- 55 percent of the students would arrive at the school site during the peak 15-minute period (based on the count data collected at the existing Voices School site), equating to approximately 185 student arrivals during this period.
- Based on the applicable trip generation rates, student arrivals during the peak 15-minute period are estimated to generate 98 inbound trips, or approximately seven inbound trips per minute.

With 30-minute staggered start times, student arrivals would be spread out more evenly during the entire peak hour, also reducing the amount of inbound trips arriving to the site just prior to the school start time (peak 15-minute period). Based on the estimated number of inbound trips and assuming loading/unloading time of no more than one minute per vehicle and the ability to serve four vehicles at once, the average queue length at the drop-off area would be approximately three vehicles during the peak period, or a maximum of approximately six vehicles.

Access Driveway Operations

As noted above, all non-emergency access to the project site would be provided by the single driveway on Cosmo Avenue. A total of approximately 328 inbound and 265 outbound project trips would access the Cosmo Avenue driveway during the AM peak hour (138 inbound and 202 outbound project trips during the PM peak- hour). The existing traffic volumes on Cosmo Avenue at the project site driveway (both directions combined) are 122 and 164 vehicles during the AM and PM peak hours, respectively.

Because the inbound traffic would be restricted to making right-turns into the site only, minimal conflict with existing traffic would occur at the project driveway. The estimated queue length of inbound traffic would mostly be able to store within the project site, with a maximum of two vehicles potentially spilling onto Cosmo Avenue during the school's peak 15-minute period (not accounting for 30-minute staggered start times required in Mitigation Measure XVII-2 below). The two-vehicle queue along westbound Cosmo Avenue could potentially block access to westbound through traffic on Cosmo Avenue. However, the existing 44 westbound AM peak-hour vehicles on Cosmo Avenue represent less than one vehicle per minute. Therefore, because of the low traffic volumes on Cosmo Avenue, the westbound queue length at the project driveway would not be anticipated to extend to or affect the operations at the intersection of Monterey Road and Cosmo Avenue. Further, implementation of Mitigation Measure XVII-2 would ensure that the inbound queue does not spill back onto Cosmo Avenue.

Outbound project traffic would be in conflict with existing westbound traffic along Cosmo Avenue. However, due to the relatively low traffic volumes along westbound Cosmo Avenue, adequate gaps would be available in the westbound direction to allow outbound project traffic to exit the site, having minimal effect on traffic operations at the project driveway and along Cosmo Avenue.

Cosmo Avenue consists of a 40-foot wide (curb-to-curb) two-lane undivided roadway with on-street parking. Within 100 feet of the proposed site driveway location, two trees on the

south side of the street partially encroach onto Cosmo Avenue, reducing the eastbound width of the street by six to eight feet near the project site driveway. Because vehicles would not access the site from eastbound Cosmo Avenue, the reduced street width in the eastbound direction would not affect traffic operations at the project site driveway. Consequently, allowing left-turns into the site from Cosmo Avenue would result in inbound queues along the reduced 12- to 14-foot right-of-way blocking eastbound through-traffic. Thus, prohibition of left-turn inbound access at the project site would be necessary to ensure that a significant impact would not occur.

Conclusion

Based on the above, the proposed project driveway at Monterey Road would provide adequate emergency vehicle access to the project site. In addition, adequate site distance would be available for vehicles exiting the Cosmo Avenue driveway. However, in the absence of measures to improve efficiency of student pick-up and drop-off on-site, as well as staggered start times, vehicle queues could potentially extend onto Cosmo Avenue. In addition, prohibition of left-turn inbound access to the project site would be necessary in order to ensure that the project would not result in excessive queuing at Cosmo Avenue during peak hours. Therefore, a *potentially significant* impact could occur related to substantially increasing hazards due to design features or introduction of incompatible uses.

Mitigation Measure(s)

Implementation of the following mitigation measures would reduce the above potential impact to a *less-than-significant* level.

XVII-3. *The following conditions shall be noted on project construction drawings, to the satisfaction of the City Engineer, prior to issuance of a building permit or approval of improvement plan:*

- *During morning drop-off times at the proposed project, school staff or parent volunteers shall be stationed along the drop-off area to assist students in and out of vehicles and improve drop-off procedures efficiency. Additionally, in order to speed up student pick-up, parents picking up students shall place a name card on the passenger side visor showing the last name and grade level of the child being picked-up so that school staff, positioned at the project driveway, can radio ahead to staff at the drop-off area the name of the student being picked up to ensure the student is ready for pick-up by the time the parent reaches the drop-off area.*
- *Measures shall be taken to ensure efficient utilization of the available queue storage space within the project site and the efficient and safe loading/unloading of the students. The drop-off/pick-up area shall be well-defined with implementation of appropriate signage and pavement markings clearly showing the*

student loading zone and each vehicle position. The loading lane shall be designed to provide the maximum loading area possible. During drop-off times, school staff shall be positioned along the drive aisle to ensure that students do not unload outside of the designated loading zone.

- *On-street parking along the southern project site frontage on Cosmo Avenue shall be prohibited. The on-street parking restriction may be permanent (red curb) or time-restricted to the school peak hours only.*
- *The proposed charter school shall implement 30-minute staggered start times; specifically, a start time of 8:00 AM for upper grade levels (sixth through eighth grades) and 8:30 AM for lower grade levels (kindergarten through fifth grades).*

XVII-4. Final project improvement plans prepared for the proposed project shall demonstrate that double solid striping shall be installed on Cosmo Avenue, along the project frontage to the intersection of Monterey Road/Cosmo Avenue, to prohibit left-turn movements from eastbound and westbound Cosmo Avenue into and out of the project site driveway. The plans shall be reviewed and approved by the City Engineer.

XVIII. TRIBAL CULTURAL RESOURCES.

Would the project cause a substantial adverse change in the significance of a tribal cultural resource, defined in Public Resources Code section 21074 as either a site, feature, place, cultural landscape that is geographically defined in terms of the size and scope of the landscape, sacred place, or object with cultural value to a California Native American Tribe, and that is:

	Potentially Significant Impact	Less-Than-Significant with Mitigation Incorporated	Less-Than-Significant Impact	No Impact
a. Listed or eligible for listing in the California Register of Historical Resources, or in a local register of historical resources as defined in Public Resources Code section 5020.1(k).	<input type="checkbox"/>	<input type="checkbox"/>	<input checked="" type="checkbox"/>	<input type="checkbox"/>
b. A resource determined by the lead agency, in its discretion and supported by substantial evidence, to be significant pursuant to criteria set forth in subdivision (c) of Public Resources Code Section 5024.1. In applying the criteria set forth in subdivision (c) of Public Resources Code Section 5024.1, the lead agency shall consider the significance of the resource to a California Native American tribe.	<input type="checkbox"/>	<input type="checkbox"/>	<input checked="" type="checkbox"/>	<input type="checkbox"/>
a,b. As discussed in Section V, Cultural Resources, of this IS/MND, the proposed project site does not contain any existing permanent structures or any other known resources listed or eligible for listing in the California Register of Historical Resources, or in a local register of historical resources as defined in Public Resources Code Section 5020.1(k), and does not contain known resources that could be considered historic pursuant to the criteria set forth in subdivision (c) of Public Resources Code Section 5024.1. Furthermore, based on a search of the NAHC Sacred Lands File, the project site does not contain known tribal cultural resources. ³⁷ The records search of the CHRIS database for cultural resource site records and survey reports within the project area indicated that a moderate potential exists for unrecorded tribal cultural resources to occur within the project site. ³⁸ However, ethnographic literature does not reference any Native American resources in or adjacent to the project area.				

Based on the above, the proposed project is not expected to adversely impact tribal cultural resources. In addition, the project applicant would be required to comply with the City’s standard conditions of approval related to cultural resource discovery. Therefore, a **less-than-significant** impact to tribal cultural resources would occur.

³⁷ Native American Heritage Commission. *Voices Charter School Project, City of Morgan Hill, Mount Madonna USGS Quadrangle, Santa Clara County, California*. March 7, 2019.

³⁸ California Historical Resources Information System. *Record search results for the proposed Voices Charter School Project*. March 28, 2019.

XIX. UTILITIES AND SERVICE SYSTEMS.

Would the project:

	Potentially Significant Impact	Less Than Significant with Mitigation Incorporated	Less-Than-Significant Impact	No Impact
a. Require or result in the relocation or construction of new or expanded water, wastewater treatment, or storm water drainage, electric power, natural gas, or telecommunications facilities, the construction or relocation of which could cause significant environmental effects?	<input type="checkbox"/>	<input type="checkbox"/>	<input checked="" type="checkbox"/>	<input type="checkbox"/>
b. Have sufficient water supplies available to serve the project and reasonably foreseeable future development during normal, dry, and multiple dry years?	<input type="checkbox"/>	<input type="checkbox"/>	<input checked="" type="checkbox"/>	<input type="checkbox"/>
c. Result in a determination by the wastewater treatment provider which serves or may serve the project that it has adequate capacity to serve the project’s projected demand in addition to the provider’s existing commitments?	<input type="checkbox"/>	<input type="checkbox"/>	<input checked="" type="checkbox"/>	<input type="checkbox"/>
d. Generate solid waste in excess of State or local standards, or in excess of the capacity of local infrastructure, or otherwise impair the attainment of solid waste reduction goals?	<input type="checkbox"/>	<input type="checkbox"/>	<input checked="" type="checkbox"/>	<input type="checkbox"/>
e. Comply with federal, state, and local management and reduction statutes and regulations related to solid waste?	<input type="checkbox"/>	<input type="checkbox"/>	<input checked="" type="checkbox"/>	<input type="checkbox"/>
a-c. Brief discussions of the water, wastewater, stormwater drainage, electrical, natural gas, and telecommunications facilities that would serve the proposed project are included below.				

Water

The City of Morgan Hill provides potable water service to its residential, commercial, industrial, and institutional customers within the City limits. The City’s water system facilities include 14 groundwater wells, 10 potable water storage tanks, 10 booster stations, and over 160 miles of pressured pipes ranging from two to 14 inches in diameter. The City’s water distribution system meets the needs of existing customers. The City has planned and constructed water projects in conjunction with new street construction in anticipation of future growth and water needs.

According to the City’s Urban Water Management Plan, the City’s projected water supply far exceeds the water demand for normal, single-dry, and multiple-dry years until at least 2040.³⁹ For example, during a normal year in 2020, the anticipated supply exceeds the anticipated demand by 55,351 acre-feet per year. Given that the proposed project is consistent with the site’s current land use and zoning designations, the type and intensity

³⁹ City of Morgan Hill. *2015 Urban Water Management Plan* [pg. 7-4 to 7-7]. 2016.

of growth that would be induced by the proposed project was generally considered in the 2035 General Plan and associated water use has been analyzed in the General Plan EIR. Therefore, the proposed project would not require or result in the construction of new water treatment facilities or expansion of existing facilities, and sufficient water supplies would be available to serve the project from existing entitlements and resources.

Wastewater

The City of Morgan Hill sewer collection system consists of approximately 160 miles of gravity sewers, over 3,000 manholes, nearly 3 miles of force mains, and 14 lift stations. The sewer lines range in size from four inches to 30 inches in diameter and the piping system includes 26 siphons. The City's collection system moves the City's wastewater south to the South County Regional Wastewater Authority (SCRWA) Wastewater Treatment Facility (WWTF) located in southern Gilroy. SCRWA is a joint powers authority formed by the cities of Morgan Hill and Gilroy to collectively treat the wastewater of both cities.⁴⁰ The City of Morgan Hill has an allocation of 3.56 million gallons per day (MGD) from the WWTF. The average dry weather flow from the City of Morgan Hill was approximately 2.7 MGD in 2015.⁴¹

The proposed project would connect to existing sewer lines located within the site vicinity. Based on the current and projected sewage flows associated with the WWTF, the incremental increase in wastewater generation associated with the development of the proposed private charter school would not require the construction of new or expansion of existing wastewater treatment facilities, as adequate capacity is already sufficient to serve the proposed project. Furthermore, given that the project is consistent with the site's current General Plan land use and zoning designations, the type and intensity of growth that would be induced by the proposed project has been generally considered in the 2035 General Plan and associated wastewater generation has been analyzed in the General Plan EIR. The General Plan EIR determined that impacts related to wastewater treatment capacity would be less than significant.

Stormwater

Issues related to stormwater infrastructure are discussed in Section X, Hydrology and Water Quality, of this IS/MND. As noted therein, the proposed project would not significantly increase stormwater flows into the City's existing system. The final drainage system design for the project will be subject to review and approval by the City of Morgan Hill Public Works Department to confirm that the proposed drainage system for the project is consistent with the City's Storm Drainage Master Plan and standard stormwater-related conditions of approval. Therefore, the proposed project would not require or result in the construction of new stormwater drainage facilities or expansion of existing facilities, the construction of which could cause significant environmental effects.

⁴⁰ City of Morgan Hill. *City Council Staff Report 2163, Accept Report Regarding Wastewater System Needs and Rate Study Schedule*. February 6, 2019.

⁴¹ City of Morgan Hill. *2035 General Plan Draft EIR*. January 2016.

Electricity, Natural Gas, and Telecommunications

Electricity and natural gas service for the proposed project would be provided by PG&E by way of existing electrical and gas infrastructure in the project vicinity. Internet and telephone services would be provided by Frontier Communications, AT&T, Charter Communications, or a similar service provider operating within the City. The project would not require major upgrades to, or extension of, existing infrastructure. Thus, impacts to electricity, natural gas, and telecommunications infrastructure would be less than significant.

Conclusion

Based on the above, the type and intensity of growth that would be induced by the proposed project was generally considered in the 2035 General Plan and associated wastewater generation and water use has been analyzed in the General Plan EIR. Thus, the increase in water demand and wastewater generation associated with the proposed project would not be considered substantial. In addition, the project is located within a developed urban area and would not require major expansion or extension of existing water, wastewater, electrical, natural gas, or telecommunications facilities in the project area.

Therefore, the proposed project would not require or result in the relocation or construction of new or expanded water, wastewater treatment, stormwater, electric power, natural gas, or telecommunications facilities, the construction or relocation of which could cause significant environmental effects. Sufficient water supplies would be available to serve the project and reasonably foreseeable future development during normal, dry, and multiple dry years. Furthermore, adequate wastewater capacity would be available to serve the project's projected demand in addition to the SCRWA's existing commitments. Thus, a *less-than-significant* impact would occur.

- d,e. Recology South Valley provides solid waste and recycling services to the businesses and residents of the cities of Morgan Hill and Gilroy. Recology South Valley has contracted with the Salinas Valley Solid Waste Authority to dispose of municipal solid waste at Johnson Canyon Sanitary Landfill. Per the Landfill's proposed 2018 Solid Waste Facility (SWF) Permit, the Landfill has a maximum permitted tonnage limit of 1,574 tons per day, a design capacity of 13,834,328 cubic yards, and an estimated closure date of 2055.⁴² For fiscal year 2016/2017, 198,388 tons of waste were disposed of at the Landfill.⁴³ The proposed project would not produce enough solid waste for the landfill to exceed capacity. Therefore, sufficient permitted capacity exists at the Johnson Canyon Sanitary Landfill to accommodate the proposed project's incremental increase in solid waste disposal needs.

The proposed school facility would involve the generation of typical solid waste types and would not require specialized solid waste disposal needs. Furthermore, per CBC Section

⁴² California Department of Resources Recycling and Recovery (CalRecycle). *Facility/Site Summary Details: Johnson Canyon Sanitary Landfill (27-AA-0005)*. Available at: <http://www.calrecycle.ca.gov/SWFacilities/Directory/27-AA-0005/Detail/>. Accessed July 2018.

⁴³ Salinas Valley Solid Waste Authority. *2016-17 Annual Report*. 2018.

4.408, the proposed project would be required to submit a Waste Management Plan to the City detailing on-site sorting of construction debris. Implementation of the Waste Management Plan would ensure that the proposed project meets established diversion requirements for reused or recycled construction waste. As such, the proposed project would comply with applicable federal, State, and local statutes and regulations related to solid waste. Therefore, the proposed project would have a *less-than-significant* impact related to solid waste.

XX. WILDFIRE.

If located in or near state responsibility areas or lands classified as very high fire hazard severity zones, would the project:

	Potentially Significant Impact	Less-Than-Significant with Mitigation Incorporated	Less-Than-Significant Impact	No Impact
a. Substantially impair an adopted emergency response plan or emergency evacuation plan?	<input type="checkbox"/>	<input type="checkbox"/>	✘	<input type="checkbox"/>
b. Due to slope, prevailing winds, and other factors, exacerbate wildfire risks, and thereby expose project occupants to, pollutant concentrations from a wildfire or the uncontrolled spread of a wildfire?	<input type="checkbox"/>	<input type="checkbox"/>	✘	<input type="checkbox"/>
c. Require the installation or maintenance of associated infrastructure (such as roads, fuel breaks, emergency water sources, power lines or other utilities) that may exacerbate fire risk or that may result in temporary or ongoing impacts to the environment?	<input type="checkbox"/>	<input type="checkbox"/>	✘	<input type="checkbox"/>
d. Expose people or structures to significant risks, including downslope or downstream flooding or landslides, as a result of runoff, post-fire slope instability, or drainage changes?	<input type="checkbox"/>	<input type="checkbox"/>	✘	<input type="checkbox"/>

a-d. As discussed in Section IX, Hazards and Hazardous Materials, of this IS/MND, the City’s Wildland Urban Interface map indicates that the proposed project site is not located in a High or Very High FHSZ.⁴⁴ While the residential area to the west of the site is located within a Very High FHSZ, the area was classified as such in 2008, prior to buildout of the area with residential uses. The project would be required to comply with all applicable requirements of the California Fire Code, as adopted by Chapter 15.44 of the City’s Municipal Code, including installation of fire sprinkler systems.

As noted in Section IX, implementation of the proposed project would not result in any substantial modifications to the City’s existing roadway system and would not interfere with potential evacuation or response routes used by emergency response teams. The project would not conflict with the City’s Emergency Operations Plan.⁴⁵ In addition, the project is not located on a substantial slope, and the project area does not include any existing features that would substantially increase fire risk for future staff and students at the proposed school. Given that the project site is located within a developed urban area and is situated adjacent to existing roads, water lines, and other utilities, the project would not result in substantial fire risks related to installation or maintenance of such infrastructure. Lastly, as discussed in Section VII, Geology and Soils, and Section X, Hydrology and Water Quality, of this IS/MND, development of the proposed project would not expose people or structures to significant risks related to flooding or landslides.

⁴⁴ City of Morgan Hill. *City of Morgan Hill Wildland Urban Interface Map*. March 2009.

⁴⁵ City of Morgan Hill. *Emergency Operations Plan*. January 11, 2018.

Based on the above, the proposed project would not expose people or structures to the risk of loss, injury or death involving wildland fires, including where wildlands are adjacent to urbanized areas or where residences are intermixed with wildlands, and ***no impact*** would occur.

XXI. MANDATORY FINDINGS OF SIGNIFICANCE.

	Potentially Significant Impact	Less Than Significant with Mitigation Incorporated	Less-Than-Significant Impact	No Impact
a. Does the project have the potential to substantially degrade the quality of the environment, substantially reduce the habitat of a fish or wildlife species, cause a fish or wildlife population to drop below self-sustaining levels, threaten to eliminate a plant or animal community, substantially reduce the number or restrict the range of a rare or endangered plant or animal or eliminate important examples of the major periods of California history or prehistory?	<input type="checkbox"/>	<input checked="" type="checkbox"/>	<input type="checkbox"/>	<input type="checkbox"/>
b. Does the project have impacts that are individually limited, but cumulatively considerable? ("Cumulatively considerable" means that the incremental effects of a project are considerable when viewed in connection with the effects of past projects, the effects of other current projects, and the effects of probable future projects)?	<input type="checkbox"/>	<input checked="" type="checkbox"/>	<input type="checkbox"/>	<input type="checkbox"/>
c. Does the project have environmental effects which will cause substantial adverse effects on human beings, either directly or indirectly?	<input type="checkbox"/>	<input type="checkbox"/>	<input checked="" type="checkbox"/>	<input type="checkbox"/>
a. As discussed in Section IV, Biological Resources, of this IS/MND, the proposed project would be required to implement mitigation measures to minimize impacts to burrowing owls and nesting migratory birds and raptors protected by the MBTA. In addition, the site does not contain known historical or cultural resources. Although unlikely, the possibility exists that subsurface excavation of the site during grading and other construction activities could unearth deposits of cultural significance. However, this IS/MND explains how the City's Municipal Code requires standard measures for development projects that would ensure any impacts to archaeological resources would be less than significant. Therefore, the proposed project's impact related to degradation of the quality of the environment, substantial reduction of habitat or plant and wildlife species, and elimination of important examples of the major periods of California history or prehistory would be <i>less than significant with mitigation incorporated</i> .				
b. As discussed in Section XI, Land Use and Planning, of this IS/MND, with approval of a Conditional Use Permit, the proposed project would be consistent with the site's current MU-F General Plan land use and zoning designations. As such, the type and intensity of growth that would be induced by the proposed project has been generally anticipated per the General Plan and associated cumulative environmental effects have been analyzed in the General Plan EIR. Furthermore, as demonstrated in this IS/MND, all potential environmental impacts that could occur as a result of project implementation would be reduced to a less-than-significant level with implementation of project-specific mitigation measures and compliance with applicable General Plan policies. When viewed in conjunction with other closely related past, present, or reasonably foreseeable future				

projects, development of the proposed project would not contribute to cumulative impacts in the City of Morgan Hill, and the project's cumulative impact would be *less than significant with mitigation incorporated*.

- c. The proposed project site would be developed in a generally urbanized and built-up area of the City of Morgan Hill. Development of the proposed project would not be expected to result in substantial adverse impacts to human beings, either directly or indirectly. The potential for substantial environmental effects on human beings is addressed within this IS/MND and all impacts have been identified as less-than-significant or less than significant with the incorporation of mitigation measures. As such, a *less-than-significant* impact would result.

Appendix A

CalEEMod Modeling Results

Voices Charter School - Bay Area AQMD Air District, Annual

Voices Charter School
Bay Area AQMD Air District, Annual

1.0 Project Characteristics

1.1 Land Usage

Land Uses	Size	Metric	Lot Acreage	Floor Surface Area	Population
Elementary School	35.15	1000sqft	1.47	35,151.00	0
Parking Lot	23.89	1000sqft	0.55	23,886.00	0

1.2 Other Project Characteristics

Urbanization	Urban	Wind Speed (m/s)	2.2	Precipitation Freq (Days)	64
Climate Zone	4			Operational Year	2021
Utility Company	Pacific Gas & Electric Company				
CO2 Intensity (lb/MWhr)	281.31	CH4 Intensity (lb/MWhr)	0.029	N2O Intensity (lb/MWhr)	0.006

1.3 User Entered Comments & Non-Default Data

Project Characteristics - Intensity factor for CO2 adjusted based on PG&E's RPS reductions

Land Use - Applicant provided

Construction Phase - Applicant provided

Grading - Applicant provided

Vehicle Trips - Per Hexagon traffic report

Voices Charter School - Bay Area AQMD Air District, Annual

Table Name	Column Name	Default Value	New Value
tblConstructionPhase	NumDays	10.00	220.00
tblGrading	AcresOfGrading	3.00	2.02
tblGrading	AcresOfGrading	4.50	0.00
tblGrading	MaterialExported	0.00	50.00
tblLandUse	LandUseSquareFeet	35,150.00	35,151.00
tblLandUse	LandUseSquareFeet	23,890.00	23,886.00
tblLandUse	LotAcreage	0.81	1.47
tblProjectCharacteristics	CO2IntensityFactor	641.35	281.31
tblVehicleTrips	WD_TR	15.43	27.37

2.0 Emissions Summary

Voices Charter School - Bay Area AQMD Air District, Annual

Quarter	Start Date	End Date	Maximum Unmitigated ROG + NOX (tons/quarter)	Maximum Mitigated ROG + NOX (tons/quarter)
1	1-1-2020	3-31-2020	0.7196	0.7196
2	4-1-2020	6-30-2020	0.8029	0.8029
3	7-1-2020	9-30-2020	0.8117	0.8117
		Highest	0.8117	0.8117

2.2 Overall Operational

Unmitigated Operational

	ROG	NOx	CO	SO2	Fugitive PM10	Exhaust PM10	PM10 Total	Fugitive PM2.5	Exhaust PM2.5	PM2.5 Total	Bio- CO2	NBio- CO2	Total CO2	CH4	N2O	CO2e
Category	tons/yr										MT/yr					
Area	0.1577	0.0000	5.4000e-004	0.0000		0.0000	0.0000		0.0000	0.0000	0.0000	1.0500e-003	1.0500e-003	0.0000	0.0000	1.1300e-003
Energy	3.5000e-003	0.0318	0.0267	1.9000e-004		2.4100e-003	2.4100e-003		2.4100e-003	2.4100e-003	0.0000	59.8320	59.8320	3.2700e-003	1.1700e-003	60.2630
Mobile	0.1806	0.8650	2.0033	6.7400e-003	0.5640	6.3000e-003	0.5703	0.1514	5.9000e-003	0.1573	0.0000	617.8422	617.8422	0.0238	0.0000	618.4367
Waste						0.0000	0.0000		0.0000	0.0000	9.2767	0.0000	9.2767	0.5482	0.0000	22.9826
Water						0.0000	0.0000		0.0000	0.0000	0.3234	1.8742	2.1976	0.0334	8.2000e-004	3.2783
Total	0.3418	0.8968	2.0305	6.9300e-003	0.5640	8.7100e-003	0.5727	0.1514	8.3100e-003	0.1597	9.6001	679.5494	689.1494	0.6087	1.9900e-003	704.9617

Voices Charter School - Bay Area AQMD Air District, Annual

2.2 Overall Operational

Mitigated Operational

	ROG	NOx	CO	SO2	Fugitive PM10	Exhaust PM10	PM10 Total	Fugitive PM2.5	Exhaust PM2.5	PM2.5 Total	Bio- CO2	NBio- CO2	Total CO2	CH4	N2O	CO2e
Category	tons/yr										MT/yr					
Area	0.1577	0.0000	5.4000e-004	0.0000		0.0000	0.0000		0.0000	0.0000	0.0000	1.0500e-003	1.0500e-003	0.0000	0.0000	1.1300e-003
Energy	3.5000e-003	0.0318	0.0267	1.9000e-004		2.4100e-003	2.4100e-003		2.4100e-003	2.4100e-003	0.0000	59.8320	59.8320	3.2700e-003	1.1700e-003	60.2630
Mobile	0.1806	0.8650	2.0033	6.7400e-003	0.5640	6.3000e-003	0.5703	0.1514	5.9000e-003	0.1573	0.0000	617.8422	617.8422	0.0238	0.0000	618.4367
Waste						0.0000	0.0000		0.0000	0.0000	9.2767	0.0000	9.2767	0.5482	0.0000	22.9826
Water						0.0000	0.0000		0.0000	0.0000	0.3234	1.8742	2.1976	0.0334	8.2000e-004	3.2783
Total	0.3418	0.8968	2.0305	6.9300e-003	0.5640	8.7100e-003	0.5727	0.1514	8.3100e-003	0.1597	9.6001	679.5494	689.1494	0.6087	1.9900e-003	704.9617

	ROG	NOx	CO	SO2	Fugitive PM10	Exhaust PM10	PM10 Total	Fugitive PM2.5	Exhaust PM2.5	PM2.5 Total	Bio- CO2	NBio- CO2	Total CO2	CH4	N2O	CO2e
Percent Reduction	0.00	0.00	0.00	0.00	0.00	0.00	0.00	0.00	0.00	0.00	0.00	0.00	0.00	0.00	0.00	0.00

3.0 Construction Detail

Construction Phase

Voices Charter School - Bay Area AQMD Air District, Annual

Phase Number	Phase Name	Phase Type	Start Date	End Date	Num Days Week	Num Days	Phase Description
1	Site Preparation	Site Preparation	1/1/2020	1/3/2020	5	3	
2	Grading	Grading	1/4/2020	1/13/2020	5	6	
3	Building Construction	Building Construction	1/28/2020	11/30/2020	5	220	
4	Paving	Paving	1/14/2020	1/27/2020	5	10	
5	Architectural Coating	Architectural Coating	2/11/2020	12/14/2020	5	220	

Acres of Grading (Site Preparation Phase): 0

Acres of Grading (Grading Phase): 2.02

Acres of Paving: 0.55

Residential Indoor: 0; Residential Outdoor: 0; Non-Residential Indoor: 52,727; Non-Residential Outdoor: 17,576; Striped Parking Area: 1,433 (Architectural Coating – sqft)

OffRoad Equipment

Voices Charter School - Bay Area AQMD Air District, Annual

Phase Name	Offroad Equipment Type	Amount	Usage Hours	Horse Power	Load Factor
Site Preparation	Graders	1	8.00	187	0.41
Site Preparation	Scrapers	1	8.00	367	0.48
Site Preparation	Tractors/Loaders/Backhoes	1	7.00	97	0.37
Grading	Graders	1	8.00	187	0.41
Grading	Rubber Tired Dozers	1	8.00	247	0.40
Grading	Tractors/Loaders/Backhoes	2	7.00	97	0.37
Building Construction	Cranes	1	8.00	231	0.29
Building Construction	Forklifts	2	7.00	89	0.20
Building Construction	Generator Sets	1	8.00	84	0.74
Building Construction	Tractors/Loaders/Backhoes	1	6.00	97	0.37
Building Construction	Welders	3	8.00	46	0.45
Paving	Cement and Mortar Mixers	1	8.00	9	0.56
Paving	Pavers	1	8.00	130	0.42
Paving	Paving Equipment	1	8.00	132	0.36
Paving	Rollers	2	8.00	80	0.38
Paving	Tractors/Loaders/Backhoes	1	8.00	97	0.37
Architectural Coating	Air Compressors	1	6.00	78	0.48

Trips and VMT

Phase Name	Offroad Equipment Count	Worker Trip Number	Vendor Trip Number	Hauling Trip Number	Worker Trip Length	Vendor Trip Length	Hauling Trip Length	Worker Vehicle Class	Vendor Vehicle Class	Hauling Vehicle Class
Site Preparation	3	8.00	0.00	0.00	10.80	7.30	20.00	LD_Mix	HDT_Mix	HHDT
Grading	4	10.00	0.00	6.00	10.80	7.30	20.00	LD_Mix	HDT_Mix	HHDT
Building Construction	8	25.00	10.00	0.00	10.80	7.30	20.00	LD_Mix	HDT_Mix	HHDT
Paving	6	15.00	0.00	0.00	10.80	7.30	20.00	LD_Mix	HDT_Mix	HHDT
Architectural Coating	1	5.00	0.00	0.00	10.80	7.30	20.00	LD_Mix	HDT_Mix	HHDT

Voices Charter School - Bay Area AQMD Air District, Annual

3.1 Mitigation Measures Construction

3.2 Site Preparation - 2020

Unmitigated Construction On-Site

	ROG	NOx	CO	SO2	Fugitive PM10	Exhaust PM10	PM10 Total	Fugitive PM2.5	Exhaust PM2.5	PM2.5 Total	Bio- CO2	NBio- CO2	Total CO2	CH4	N2O	CO2e
Category	tons/yr										MT/yr					
Fugitive Dust					0.0000	0.0000	0.0000	0.0000	0.0000	0.0000	0.0000	0.0000	0.0000	0.0000	0.0000	0.0000
Off-Road	2.4800e-003	0.0299	0.0169	4.0000e-005		1.1700e-003	1.1700e-003		1.0700e-003	1.0700e-003	0.0000	3.2290	3.2290	1.0400e-003	0.0000	3.2551
Total	2.4800e-003	0.0299	0.0169	4.0000e-005	0.0000	1.1700e-003	1.1700e-003	0.0000	1.0700e-003	1.0700e-003	0.0000	3.2290	3.2290	1.0400e-003	0.0000	3.2551

Voices Charter School - Bay Area AQMD Air District, Annual

3.2 Site Preparation - 2020

Unmitigated Construction Off-Site

	ROG	NOx	CO	SO2	Fugitive PM10	Exhaust PM10	PM10 Total	Fugitive PM2.5	Exhaust PM2.5	PM2.5 Total	Bio- CO2	NBio- CO2	Total CO2	CH4	N2O	CO2e
Category	tons/yr										MT/yr					
Hauling	0.0000	0.0000	0.0000	0.0000	0.0000	0.0000	0.0000	0.0000	0.0000	0.0000	0.0000	0.0000	0.0000	0.0000	0.0000	0.0000
Vendor	0.0000	0.0000	0.0000	0.0000	0.0000	0.0000	0.0000	0.0000	0.0000	0.0000	0.0000	0.0000	0.0000	0.0000	0.0000	0.0000
Worker	4.0000e-005	3.0000e-005	2.9000e-004	0.0000	9.0000e-005	0.0000	1.0000e-004	3.0000e-005	0.0000	3.0000e-005	0.0000	0.0831	0.0831	0.0000	0.0000	0.0831
Total	4.0000e-005	3.0000e-005	2.9000e-004	0.0000	9.0000e-005	0.0000	1.0000e-004	3.0000e-005	0.0000	3.0000e-005	0.0000	0.0831	0.0831	0.0000	0.0000	0.0831

Mitigated Construction On-Site

	ROG	NOx	CO	SO2	Fugitive PM10	Exhaust PM10	PM10 Total	Fugitive PM2.5	Exhaust PM2.5	PM2.5 Total	Bio- CO2	NBio- CO2	Total CO2	CH4	N2O	CO2e
Category	tons/yr										MT/yr					
Fugitive Dust					0.0000	0.0000	0.0000	0.0000	0.0000	0.0000	0.0000	0.0000	0.0000	0.0000	0.0000	0.0000
Off-Road	2.4800e-003	0.0299	0.0169	4.0000e-005		1.1700e-003	1.1700e-003		1.0700e-003	1.0700e-003	0.0000	3.2290	3.2290	1.0400e-003	0.0000	3.2551
Total	2.4800e-003	0.0299	0.0169	4.0000e-005	0.0000	1.1700e-003	1.1700e-003	0.0000	1.0700e-003	1.0700e-003	0.0000	3.2290	3.2290	1.0400e-003	0.0000	3.2551

Voices Charter School - Bay Area AQMD Air District, Annual

3.2 Site Preparation - 2020

Mitigated Construction Off-Site

	ROG	NOx	CO	SO2	Fugitive PM10	Exhaust PM10	PM10 Total	Fugitive PM2.5	Exhaust PM2.5	PM2.5 Total	Bio- CO2	NBio- CO2	Total CO2	CH4	N2O	CO2e
Category	tons/yr										MT/yr					
Hauling	0.0000	0.0000	0.0000	0.0000	0.0000	0.0000	0.0000	0.0000	0.0000	0.0000	0.0000	0.0000	0.0000	0.0000	0.0000	0.0000
Vendor	0.0000	0.0000	0.0000	0.0000	0.0000	0.0000	0.0000	0.0000	0.0000	0.0000	0.0000	0.0000	0.0000	0.0000	0.0000	0.0000
Worker	4.0000e-005	3.0000e-005	2.9000e-004	0.0000	9.0000e-005	0.0000	1.0000e-004	3.0000e-005	0.0000	3.0000e-005	0.0000	0.0831	0.0831	0.0000	0.0000	0.0831
Total	4.0000e-005	3.0000e-005	2.9000e-004	0.0000	9.0000e-005	0.0000	1.0000e-004	3.0000e-005	0.0000	3.0000e-005	0.0000	0.0831	0.0831	0.0000	0.0000	0.0831

3.3 Grading - 2020

Unmitigated Construction On-Site

	ROG	NOx	CO	SO2	Fugitive PM10	Exhaust PM10	PM10 Total	Fugitive PM2.5	Exhaust PM2.5	PM2.5 Total	Bio- CO2	NBio- CO2	Total CO2	CH4	N2O	CO2e
Category	tons/yr										MT/yr					
Fugitive Dust					0.0191	0.0000	0.0191	0.0101	0.0000	0.0101	0.0000	0.0000	0.0000	0.0000	0.0000	0.0000
Off-Road	5.7700e-003	0.0640	0.0298	6.0000e-005		2.9700e-003	2.9700e-003		2.7300e-003	2.7300e-003	0.0000	5.4333	5.4333	1.7600e-003	0.0000	5.4773
Total	5.7700e-003	0.0640	0.0298	6.0000e-005	0.0191	2.9700e-003	0.0221	0.0101	2.7300e-003	0.0128	0.0000	5.4333	5.4333	1.7600e-003	0.0000	5.4773

Voices Charter School - Bay Area AQMD Air District, Annual

3.3 Grading - 2020

Unmitigated Construction Off-Site

	ROG	NOx	CO	SO2	Fugitive PM10	Exhaust PM10	PM10 Total	Fugitive PM2.5	Exhaust PM2.5	PM2.5 Total	Bio- CO2	NBio- CO2	Total CO2	CH4	N2O	CO2e
Category	tons/yr										MT/yr					
Hauling	3.0000e-005	8.8000e-004	1.8000e-004	0.0000	5.0000e-005	0.0000	5.0000e-005	1.0000e-005	0.0000	2.0000e-005	0.0000	0.2299	0.2299	1.0000e-005	0.0000	0.2302
Vendor	0.0000	0.0000	0.0000	0.0000	0.0000	0.0000	0.0000	0.0000	0.0000	0.0000	0.0000	0.0000	0.0000	0.0000	0.0000	0.0000
Worker	1.0000e-004	7.0000e-005	7.4000e-004	0.0000	2.4000e-004	0.0000	2.4000e-004	6.0000e-005	0.0000	6.0000e-005	0.0000	0.2077	0.2077	1.0000e-005	0.0000	0.2078
Total	1.3000e-004	9.5000e-004	9.2000e-004	0.0000	2.9000e-004	0.0000	2.9000e-004	7.0000e-005	0.0000	8.0000e-005	0.0000	0.4376	0.4376	2.0000e-005	0.0000	0.4380

Mitigated Construction On-Site

	ROG	NOx	CO	SO2	Fugitive PM10	Exhaust PM10	PM10 Total	Fugitive PM2.5	Exhaust PM2.5	PM2.5 Total	Bio- CO2	NBio- CO2	Total CO2	CH4	N2O	CO2e
Category	tons/yr										MT/yr					
Fugitive Dust					0.0191	0.0000	0.0191	0.0101	0.0000	0.0101	0.0000	0.0000	0.0000	0.0000	0.0000	0.0000
Off-Road	5.7700e-003	0.0640	0.0298	6.0000e-005		2.9700e-003	2.9700e-003		2.7300e-003	2.7300e-003	0.0000	5.4333	5.4333	1.7600e-003	0.0000	5.4773
Total	5.7700e-003	0.0640	0.0298	6.0000e-005	0.0191	2.9700e-003	0.0221	0.0101	2.7300e-003	0.0128	0.0000	5.4333	5.4333	1.7600e-003	0.0000	5.4773

Voices Charter School - Bay Area AQMD Air District, Annual

3.3 Grading - 2020

Mitigated Construction Off-Site

	ROG	NOx	CO	SO2	Fugitive PM10	Exhaust PM10	PM10 Total	Fugitive PM2.5	Exhaust PM2.5	PM2.5 Total	Bio- CO2	NBio- CO2	Total CO2	CH4	N2O	CO2e
Category	tons/yr										MT/yr					
Hauling	3.0000e-005	8.8000e-004	1.8000e-004	0.0000	5.0000e-005	0.0000	5.0000e-005	1.0000e-005	0.0000	2.0000e-005	0.0000	0.2299	0.2299	1.0000e-005	0.0000	0.2302
Vendor	0.0000	0.0000	0.0000	0.0000	0.0000	0.0000	0.0000	0.0000	0.0000	0.0000	0.0000	0.0000	0.0000	0.0000	0.0000	0.0000
Worker	1.0000e-004	7.0000e-005	7.4000e-004	0.0000	2.4000e-004	0.0000	2.4000e-004	6.0000e-005	0.0000	6.0000e-005	0.0000	0.2077	0.2077	1.0000e-005	0.0000	0.2078
Total	1.3000e-004	9.5000e-004	9.2000e-004	0.0000	2.9000e-004	0.0000	2.9000e-004	7.0000e-005	0.0000	8.0000e-005	0.0000	0.4376	0.4376	2.0000e-005	0.0000	0.4380

3.4 Building Construction - 2020

Unmitigated Construction On-Site

	ROG	NOx	CO	SO2	Fugitive PM10	Exhaust PM10	PM10 Total	Fugitive PM2.5	Exhaust PM2.5	PM2.5 Total	Bio- CO2	NBio- CO2	Total CO2	CH4	N2O	CO2e
Category	tons/yr										MT/yr					
Off-Road	0.2517	1.9177	1.6387	2.7500e-003		0.1043	0.1043		0.1000	0.1000	0.0000	228.4088	228.4088	0.0464	0.0000	229.5678
Total	0.2517	1.9177	1.6387	2.7500e-003		0.1043	0.1043		0.1000	0.1000	0.0000	228.4088	228.4088	0.0464	0.0000	229.5678

Voices Charter School - Bay Area AQMD Air District, Annual

3.4 Building Construction - 2020

Unmitigated Construction Off-Site

	ROG	NOx	CO	SO2	Fugitive PM10	Exhaust PM10	PM10 Total	Fugitive PM2.5	Exhaust PM2.5	PM2.5 Total	Bio- CO2	NBio- CO2	Total CO2	CH4	N2O	CO2e
Category	tons/yr										MT/yr					
Hauling	0.0000	0.0000	0.0000	0.0000	0.0000	0.0000	0.0000	0.0000	0.0000	0.0000	0.0000	0.0000	0.0000	0.0000	0.0000	0.0000
Vendor	4.2600e-003	0.1269	0.0319	3.0000e-004	7.2100e-003	6.2000e-004	7.8300e-003	2.0900e-003	5.9000e-004	2.6800e-003	0.0000	28.8001	28.8001	1.4900e-003	0.0000	28.8373
Worker	9.1100e-003	6.5200e-003	0.0675	2.1000e-004	0.0217	1.5000e-004	0.0219	5.7800e-003	1.3000e-004	5.9200e-003	0.0000	19.0377	19.0377	4.6000e-004	0.0000	19.0492
Total	0.0134	0.1334	0.0995	5.1000e-004	0.0289	7.7000e-004	0.0297	7.8700e-003	7.2000e-004	8.6000e-003	0.0000	47.8379	47.8379	1.9500e-003	0.0000	47.8865

Mitigated Construction On-Site

	ROG	NOx	CO	SO2	Fugitive PM10	Exhaust PM10	PM10 Total	Fugitive PM2.5	Exhaust PM2.5	PM2.5 Total	Bio- CO2	NBio- CO2	Total CO2	CH4	N2O	CO2e
Category	tons/yr										MT/yr					
Off-Road	0.2517	1.9177	1.6387	2.7500e-003		0.1043	0.1043		0.1000	0.1000	0.0000	228.4086	228.4086	0.0464	0.0000	229.5675
Total	0.2517	1.9177	1.6387	2.7500e-003		0.1043	0.1043		0.1000	0.1000	0.0000	228.4086	228.4086	0.0464	0.0000	229.5675

Voices Charter School - Bay Area AQMD Air District, Annual

3.4 Building Construction - 2020

Mitigated Construction Off-Site

	ROG	NOx	CO	SO2	Fugitive PM10	Exhaust PM10	PM10 Total	Fugitive PM2.5	Exhaust PM2.5	PM2.5 Total	Bio- CO2	NBio- CO2	Total CO2	CH4	N2O	CO2e
Category	tons/yr										MT/yr					
Hauling	0.0000	0.0000	0.0000	0.0000	0.0000	0.0000	0.0000	0.0000	0.0000	0.0000	0.0000	0.0000	0.0000	0.0000	0.0000	0.0000
Vendor	4.2600e-003	0.1269	0.0319	3.0000e-004	7.2100e-003	6.2000e-004	7.8300e-003	2.0900e-003	5.9000e-004	2.6800e-003	0.0000	28.8001	28.8001	1.4900e-003	0.0000	28.8373
Worker	9.1100e-003	6.5200e-003	0.0675	2.1000e-004	0.0217	1.5000e-004	0.0219	5.7800e-003	1.3000e-004	5.9200e-003	0.0000	19.0377	19.0377	4.6000e-004	0.0000	19.0492
Total	0.0134	0.1334	0.0995	5.1000e-004	0.0289	7.7000e-004	0.0297	7.8700e-003	7.2000e-004	8.6000e-003	0.0000	47.8379	47.8379	1.9500e-003	0.0000	47.8865

3.5 Paving - 2020

Unmitigated Construction On-Site

	ROG	NOx	CO	SO2	Fugitive PM10	Exhaust PM10	PM10 Total	Fugitive PM2.5	Exhaust PM2.5	PM2.5 Total	Bio- CO2	NBio- CO2	Total CO2	CH4	N2O	CO2e
Category	tons/yr										MT/yr					
Off-Road	5.7700e-003	0.0579	0.0590	9.0000e-005		3.2800e-003	3.2800e-003		3.0300e-003	3.0300e-003	0.0000	7.7529	7.7529	2.4600e-003	0.0000	7.8143
Paving	7.2000e-004					0.0000	0.0000		0.0000	0.0000	0.0000	0.0000	0.0000	0.0000	0.0000	0.0000
Total	6.4900e-003	0.0579	0.0590	9.0000e-005		3.2800e-003	3.2800e-003		3.0300e-003	3.0300e-003	0.0000	7.7529	7.7529	2.4600e-003	0.0000	7.8143

Voices Charter School - Bay Area AQMD Air District, Annual

3.5 Paving - 2020

Unmitigated Construction Off-Site

	ROG	NOx	CO	SO2	Fugitive PM10	Exhaust PM10	PM10 Total	Fugitive PM2.5	Exhaust PM2.5	PM2.5 Total	Bio- CO2	NBio- CO2	Total CO2	CH4	N2O	CO2e
Category	tons/yr										MT/yr					
Hauling	0.0000	0.0000	0.0000	0.0000	0.0000	0.0000	0.0000	0.0000	0.0000	0.0000	0.0000	0.0000	0.0000	0.0000	0.0000	0.0000
Vendor	0.0000	0.0000	0.0000	0.0000	0.0000	0.0000	0.0000	0.0000	0.0000	0.0000	0.0000	0.0000	0.0000	0.0000	0.0000	0.0000
Worker	2.5000e-004	1.8000e-004	1.8400e-003	1.0000e-005	5.9000e-004	0.0000	6.0000e-004	1.6000e-004	0.0000	1.6000e-004	0.0000	0.5192	0.5192	1.0000e-005	0.0000	0.5195
Total	2.5000e-004	1.8000e-004	1.8400e-003	1.0000e-005	5.9000e-004	0.0000	6.0000e-004	1.6000e-004	0.0000	1.6000e-004	0.0000	0.5192	0.5192	1.0000e-005	0.0000	0.5195

Mitigated Construction On-Site

	ROG	NOx	CO	SO2	Fugitive PM10	Exhaust PM10	PM10 Total	Fugitive PM2.5	Exhaust PM2.5	PM2.5 Total	Bio- CO2	NBio- CO2	Total CO2	CH4	N2O	CO2e
Category	tons/yr										MT/yr					
Off-Road	5.7700e-003	0.0579	0.0590	9.0000e-005		3.2800e-003	3.2800e-003		3.0300e-003	3.0300e-003	0.0000	7.7529	7.7529	2.4600e-003	0.0000	7.8143
Paving	7.2000e-004					0.0000	0.0000		0.0000	0.0000	0.0000	0.0000	0.0000	0.0000	0.0000	0.0000
Total	6.4900e-003	0.0579	0.0590	9.0000e-005		3.2800e-003	3.2800e-003		3.0300e-003	3.0300e-003	0.0000	7.7529	7.7529	2.4600e-003	0.0000	7.8143

Voices Charter School - Bay Area AQMD Air District, Annual

3.5 Paving - 2020

Mitigated Construction Off-Site

	ROG	NOx	CO	SO2	Fugitive PM10	Exhaust PM10	PM10 Total	Fugitive PM2.5	Exhaust PM2.5	PM2.5 Total	Bio- CO2	NBio- CO2	Total CO2	CH4	N2O	CO2e
Category	tons/yr										MT/yr					
Hauling	0.0000	0.0000	0.0000	0.0000	0.0000	0.0000	0.0000	0.0000	0.0000	0.0000	0.0000	0.0000	0.0000	0.0000	0.0000	0.0000
Vendor	0.0000	0.0000	0.0000	0.0000	0.0000	0.0000	0.0000	0.0000	0.0000	0.0000	0.0000	0.0000	0.0000	0.0000	0.0000	0.0000
Worker	2.5000e-004	1.8000e-004	1.8400e-003	1.0000e-005	5.9000e-004	0.0000	6.0000e-004	1.6000e-004	0.0000	1.6000e-004	0.0000	0.5192	0.5192	1.0000e-005	0.0000	0.5195
Total	2.5000e-004	1.8000e-004	1.8400e-003	1.0000e-005	5.9000e-004	0.0000	6.0000e-004	1.6000e-004	0.0000	1.6000e-004	0.0000	0.5192	0.5192	1.0000e-005	0.0000	0.5195

3.6 Architectural Coating - 2020

Unmitigated Construction On-Site

	ROG	NOx	CO	SO2	Fugitive PM10	Exhaust PM10	PM10 Total	Fugitive PM2.5	Exhaust PM2.5	PM2.5 Total	Bio- CO2	NBio- CO2	Total CO2	CH4	N2O	CO2e
Category	tons/yr										MT/yr					
Archit. Coating	0.1883					0.0000	0.0000		0.0000	0.0000	0.0000	0.0000	0.0000	0.0000	0.0000	0.0000
Off-Road	0.0266	0.1852	0.2015	3.3000e-004		0.0122	0.0122		0.0122	0.0122	0.0000	28.0858	28.0858	2.1700e-003	0.0000	28.1402
Total	0.2149	0.1852	0.2015	3.3000e-004		0.0122	0.0122		0.0122	0.0122	0.0000	28.0858	28.0858	2.1700e-003	0.0000	28.1402

Voices Charter School - Bay Area AQMD Air District, Annual

3.6 Architectural Coating - 2020

Unmitigated Construction Off-Site

	ROG	NOx	CO	SO2	Fugitive PM10	Exhaust PM10	PM10 Total	Fugitive PM2.5	Exhaust PM2.5	PM2.5 Total	Bio- CO2	NBio- CO2	Total CO2	CH4	N2O	CO2e
Category	tons/yr										MT/yr					
Hauling	0.0000	0.0000	0.0000	0.0000	0.0000	0.0000	0.0000	0.0000	0.0000	0.0000	0.0000	0.0000	0.0000	0.0000	0.0000	0.0000
Vendor	0.0000	0.0000	0.0000	0.0000	0.0000	0.0000	0.0000	0.0000	0.0000	0.0000	0.0000	0.0000	0.0000	0.0000	0.0000	0.0000
Worker	1.8200e-003	1.3000e-003	0.0135	4.0000e-005	4.3500e-003	3.0000e-005	4.3800e-003	1.1600e-003	3.0000e-005	1.1800e-003	0.0000	3.8075	3.8075	9.0000e-005	0.0000	3.8099
Total	1.8200e-003	1.3000e-003	0.0135	4.0000e-005	4.3500e-003	3.0000e-005	4.3800e-003	1.1600e-003	3.0000e-005	1.1800e-003	0.0000	3.8075	3.8075	9.0000e-005	0.0000	3.8099

Mitigated Construction On-Site

	ROG	NOx	CO	SO2	Fugitive PM10	Exhaust PM10	PM10 Total	Fugitive PM2.5	Exhaust PM2.5	PM2.5 Total	Bio- CO2	NBio- CO2	Total CO2	CH4	N2O	CO2e
Category	tons/yr										MT/yr					
Archit. Coating	0.1883					0.0000	0.0000		0.0000	0.0000	0.0000	0.0000	0.0000	0.0000	0.0000	0.0000
Off-Road	0.0266	0.1852	0.2015	3.3000e-004		0.0122	0.0122		0.0122	0.0122	0.0000	28.0858	28.0858	2.1700e-003	0.0000	28.1401
Total	0.2149	0.1852	0.2015	3.3000e-004		0.0122	0.0122		0.0122	0.0122	0.0000	28.0858	28.0858	2.1700e-003	0.0000	28.1401

Voices Charter School - Bay Area AQMD Air District, Annual

3.6 Architectural Coating - 2020

Mitigated Construction Off-Site

	ROG	NOx	CO	SO2	Fugitive PM10	Exhaust PM10	PM10 Total	Fugitive PM2.5	Exhaust PM2.5	PM2.5 Total	Bio- CO2	NBio- CO2	Total CO2	CH4	N2O	CO2e
Category	tons/yr										MT/yr					
Hauling	0.0000	0.0000	0.0000	0.0000	0.0000	0.0000	0.0000	0.0000	0.0000	0.0000	0.0000	0.0000	0.0000	0.0000	0.0000	0.0000
Vendor	0.0000	0.0000	0.0000	0.0000	0.0000	0.0000	0.0000	0.0000	0.0000	0.0000	0.0000	0.0000	0.0000	0.0000	0.0000	0.0000
Worker	1.8200e-003	1.3000e-003	0.0135	4.0000e-005	4.3500e-003	3.0000e-005	4.3800e-003	1.1600e-003	3.0000e-005	1.1800e-003	0.0000	3.8075	3.8075	9.0000e-005	0.0000	3.8099
Total	1.8200e-003	1.3000e-003	0.0135	4.0000e-005	4.3500e-003	3.0000e-005	4.3800e-003	1.1600e-003	3.0000e-005	1.1800e-003	0.0000	3.8075	3.8075	9.0000e-005	0.0000	3.8099

4.0 Operational Detail - Mobile

4.1 Mitigation Measures Mobile

Voices Charter School - Bay Area AQMD Air District, Annual

	ROG	NOx	CO	SO2	Fugitive PM10	Exhaust PM10	PM10 Total	Fugitive PM2.5	Exhaust PM2.5	PM2.5 Total	Bio- CO2	NBio- CO2	Total CO2	CH4	N2O	CO2e
Category	tons/yr										MT/yr					
Mitigated	0.1806	0.8650	2.0033	6.7400e-003	0.5640	6.3000e-003	0.5703	0.1514	5.9000e-003	0.1573	0.0000	617.8422	617.8422	0.0238	0.0000	618.4367
Unmitigated	0.1806	0.8650	2.0033	6.7400e-003	0.5640	6.3000e-003	0.5703	0.1514	5.9000e-003	0.1573	0.0000	617.8422	617.8422	0.0238	0.0000	618.4367

4.2 Trip Summary Information

Land Use	Average Daily Trip Rate			Unmitigated	Mitigated
	Weekday	Saturday	Sunday	Annual VMT	Annual VMT
Elementary School	962.06	0.00	0.00	1,515,196	1,515,196
Parking Lot	0.00	0.00	0.00		
Total	962.06	0.00	0.00	1,515,196	1,515,196

4.3 Trip Type Information

Land Use	Miles			Trip %			Trip Purpose %		
	H-W or C-W	H-S or C-C	H-O or C-NW	H-W or C-W	H-S or C-C	H-O or C-NW	Primary	Diverted	Pass-by
Elementary School	9.50	7.30	7.30	65.00	30.00	5.00	63	25	12
Parking Lot	9.50	7.30	7.30	0.00	0.00	0.00	0	0	0

4.4 Fleet Mix

Land Use	LDA	LDT1	LDT2	MDV	LHD1	LHD2	MHD	HHD	OBUS	UBUS	MCY	SBUS	MH
Elementary School	0.575198	0.040076	0.193827	0.113296	0.016988	0.005361	0.017552	0.025197	0.002581	0.002349	0.005904	0.000881	0.000789
Parking Lot	0.575198	0.040076	0.193827	0.113296	0.016988	0.005361	0.017552	0.025197	0.002581	0.002349	0.005904	0.000881	0.000789

Voices Charter School - Bay Area AQMD Air District, Annual

5.0 Energy Detail

Historical Energy Use: N

5.1 Mitigation Measures Energy

	ROG	NOx	CO	SO2	Fugitive PM10	Exhaust PM10	PM10 Total	Fugitive PM2.5	Exhaust PM2.5	PM2.5 Total	Bio- CO2	NBio- CO2	Total CO2	CH4	N2O	CO2e
Category	tons/yr										MT/yr					
Electricity Mitigated						0.0000	0.0000		0.0000	0.0000	0.0000	25.2424	25.2424	2.6000e-003	5.4000e-004	25.4679
Electricity Unmitigated						0.0000	0.0000		0.0000	0.0000	0.0000	25.2424	25.2424	2.6000e-003	5.4000e-004	25.4679
NaturalGas Mitigated	3.5000e-003	0.0318	0.0267	1.9000e-004		2.4100e-003	2.4100e-003		2.4100e-003	2.4100e-003	0.0000	34.5896	34.5896	6.6000e-004	6.3000e-004	34.7951
NaturalGas Unmitigated	3.5000e-003	0.0318	0.0267	1.9000e-004		2.4100e-003	2.4100e-003		2.4100e-003	2.4100e-003	0.0000	34.5896	34.5896	6.6000e-004	6.3000e-004	34.7951

Voices Charter School - Bay Area AQMD Air District, Annual

5.2 Energy by Land Use - NaturalGas

Unmitigated

	NaturalGas Use	ROG	NOx	CO	SO2	Fugitive PM10	Exhaust PM10	PM10 Total	Fugitive PM2.5	Exhaust PM2.5	PM2.5 Total	Bio- CO2	NBio- CO2	Total CO2	CH4	N2O	CO2e
Land Use	kBTU/yr	tons/yr										MT/yr					
Elementary School	648184	3.5000e-003	0.0318	0.0267	1.9000e-004		2.4100e-003	2.4100e-003		2.4100e-003	2.4100e-003	0.0000	34.5896	34.5896	6.6000e-004	6.3000e-004	34.7951
Parking Lot	0	0.0000	0.0000	0.0000	0.0000		0.0000	0.0000		0.0000	0.0000	0.0000	0.0000	0.0000	0.0000	0.0000	0.0000
Total		3.5000e-003	0.0318	0.0267	1.9000e-004		2.4100e-003	2.4100e-003		2.4100e-003	2.4100e-003	0.0000	34.5896	34.5896	6.6000e-004	6.3000e-004	34.7951

Mitigated

	NaturalGas Use	ROG	NOx	CO	SO2	Fugitive PM10	Exhaust PM10	PM10 Total	Fugitive PM2.5	Exhaust PM2.5	PM2.5 Total	Bio- CO2	NBio- CO2	Total CO2	CH4	N2O	CO2e
Land Use	kBTU/yr	tons/yr										MT/yr					
Elementary School	648184	3.5000e-003	0.0318	0.0267	1.9000e-004		2.4100e-003	2.4100e-003		2.4100e-003	2.4100e-003	0.0000	34.5896	34.5896	6.6000e-004	6.3000e-004	34.7951
Parking Lot	0	0.0000	0.0000	0.0000	0.0000		0.0000	0.0000		0.0000	0.0000	0.0000	0.0000	0.0000	0.0000	0.0000	0.0000
Total		3.5000e-003	0.0318	0.0267	1.9000e-004		2.4100e-003	2.4100e-003		2.4100e-003	2.4100e-003	0.0000	34.5896	34.5896	6.6000e-004	6.3000e-004	34.7951

Voices Charter School - Bay Area AQMD Air District, Annual

5.3 Energy by Land Use - Electricity

Unmitigated

	Electricity Use	Total CO2	CH4	N2O	CO2e
Land Use	kWh/yr	MT/yr			
Elementary School	189464	24.1756	2.4900e-003	5.2000e-004	24.3916
Parking Lot	8360.1	1.0668	1.1000e-004	2.0000e-005	1.0763
Total		25.2424	2.6000e-003	5.4000e-004	25.4679

Mitigated

	Electricity Use	Total CO2	CH4	N2O	CO2e
Land Use	kWh/yr	MT/yr			
Elementary School	189464	24.1756	2.4900e-003	5.2000e-004	24.3916
Parking Lot	8360.1	1.0668	1.1000e-004	2.0000e-005	1.0763
Total		25.2424	2.6000e-003	5.4000e-004	25.4679

6.0 Area Detail

6.1 Mitigation Measures Area

Voices Charter School - Bay Area AQMD Air District, Annual

	ROG	NOx	CO	SO2	Fugitive PM10	Exhaust PM10	PM10 Total	Fugitive PM2.5	Exhaust PM2.5	PM2.5 Total	Bio- CO2	NBio- CO2	Total CO2	CH4	N2O	CO2e
Category	tons/yr										MT/yr					
Mitigated	0.1577	0.0000	5.4000e-004	0.0000		0.0000	0.0000		0.0000	0.0000	0.0000	1.0500e-003	1.0500e-003	0.0000	0.0000	1.1300e-003
Unmitigated	0.1577	0.0000	5.4000e-004	0.0000		0.0000	0.0000		0.0000	0.0000	0.0000	1.0500e-003	1.0500e-003	0.0000	0.0000	1.1300e-003

6.2 Area by SubCategory

Unmitigated

	ROG	NOx	CO	SO2	Fugitive PM10	Exhaust PM10	PM10 Total	Fugitive PM2.5	Exhaust PM2.5	PM2.5 Total	Bio- CO2	NBio- CO2	Total CO2	CH4	N2O	CO2e
SubCategory	tons/yr										MT/yr					
Architectural Coating	0.0188					0.0000	0.0000		0.0000	0.0000	0.0000	0.0000	0.0000	0.0000	0.0000	0.0000
Consumer Products	0.1388					0.0000	0.0000		0.0000	0.0000	0.0000	0.0000	0.0000	0.0000	0.0000	0.0000
Landscaping	5.0000e-005	0.0000	5.4000e-004	0.0000		0.0000	0.0000		0.0000	0.0000	0.0000	1.0500e-003	1.0500e-003	0.0000	0.0000	1.1300e-003
Total	0.1577	0.0000	5.4000e-004	0.0000		0.0000	0.0000		0.0000	0.0000	0.0000	1.0500e-003	1.0500e-003	0.0000	0.0000	1.1300e-003

Voices Charter School - Bay Area AQMD Air District, Annual

6.2 Area by SubCategory

Mitigated

	ROG	NOx	CO	SO2	Fugitive PM10	Exhaust PM10	PM10 Total	Fugitive PM2.5	Exhaust PM2.5	PM2.5 Total	Bio- CO2	NBio- CO2	Total CO2	CH4	N2O	CO2e
SubCategory	tons/yr										MT/yr					
Architectural Coating	0.0188					0.0000	0.0000		0.0000	0.0000	0.0000	0.0000	0.0000	0.0000	0.0000	0.0000
Consumer Products	0.1388					0.0000	0.0000		0.0000	0.0000	0.0000	0.0000	0.0000	0.0000	0.0000	0.0000
Landscaping	5.0000e-005	0.0000	5.4000e-004	0.0000		0.0000	0.0000		0.0000	0.0000	0.0000	1.0500e-003	1.0500e-003	0.0000	0.0000	1.1300e-003
Total	0.1577	0.0000	5.4000e-004	0.0000		0.0000	0.0000		0.0000	0.0000	0.0000	1.0500e-003	1.0500e-003	0.0000	0.0000	1.1300e-003

7.0 Water Detail

7.1 Mitigation Measures Water

Voices Charter School - Bay Area AQMD Air District, Annual

	Total CO2	CH4	N2O	CO2e
Category	MT/yr			
Mitigated	2.1976	0.0334	8.2000e-004	3.2783
Unmitigated	2.1976	0.0334	8.2000e-004	3.2783

7.2 Water by Land Use

Unmitigated

	Indoor/Outdoor Use	Total CO2	CH4	N2O	CO2e
Land Use	Mgal	MT/yr			
Elementary School	1.01924 / 2.62091	2.1976	0.0334	8.2000e-004	3.2783
Parking Lot	0 / 0	0.0000	0.0000	0.0000	0.0000
Total		2.1976	0.0334	8.2000e-004	3.2783

Voices Charter School - Bay Area AQMD Air District, Annual

7.2 Water by Land Use

Mitigated

	Indoor/Outdoor Use	Total CO2	CH4	N2O	CO2e
Land Use	Mgal	MT/yr			
Elementary School	1.01924 / 2.62091	2.1976	0.0334	8.2000e-004	3.2783
Parking Lot	0 / 0	0.0000	0.0000	0.0000	0.0000
Total		2.1976	0.0334	8.2000e-004	3.2783

8.0 Waste Detail

8.1 Mitigation Measures Waste

Category/Year

	Total CO2	CH4	N2O	CO2e
	MT/yr			
Mitigated	9.2767	0.5482	0.0000	22.9826
Unmitigated	9.2767	0.5482	0.0000	22.9826

Voices Charter School - Bay Area AQMD Air District, Annual

8.2 Waste by Land Use

Unmitigated

	Waste Disposed	Total CO2	CH4	N2O	CO2e
Land Use	tons	MT/yr			
Elementary School	45.7	9.2767	0.5482	0.0000	22.9826
Parking Lot	0	0.0000	0.0000	0.0000	0.0000
Total		9.2767	0.5482	0.0000	22.9826

Mitigated

	Waste Disposed	Total CO2	CH4	N2O	CO2e
Land Use	tons	MT/yr			
Elementary School	45.7	9.2767	0.5482	0.0000	22.9826
Parking Lot	0	0.0000	0.0000	0.0000	0.0000
Total		9.2767	0.5482	0.0000	22.9826

9.0 Operational Offroad

Equipment Type	Number	Hours/Day	Days/Year	Horse Power	Load Factor	Fuel Type
----------------	--------	-----------	-----------	-------------	-------------	-----------

Voices Charter School - Bay Area AQMD Air District, Annual

10.0 Stationary Equipment

Fire Pumps and Emergency Generators

Equipment Type	Number	Hours/Day	Hours/Year	Horse Power	Load Factor	Fuel Type
----------------	--------	-----------	------------	-------------	-------------	-----------

Boilers

Equipment Type	Number	Heat Input/Day	Heat Input/Year	Boiler Rating	Fuel Type
----------------	--------	----------------	-----------------	---------------	-----------

User Defined Equipment

Equipment Type	Number
----------------	--------

11.0 Vegetation

Voices Charter School - Bay Area AQMD Air District, Summer

Voices Charter School
Bay Area AQMD Air District, Summer

1.0 Project Characteristics

1.1 Land Usage

Land Uses	Size	Metric	Lot Acreage	Floor Surface Area	Population
Elementary School	35.15	1000sqft	1.47	35,151.00	0
Parking Lot	23.89	1000sqft	0.55	23,886.00	0

1.2 Other Project Characteristics

Urbanization	Urban	Wind Speed (m/s)	2.2	Precipitation Freq (Days)	64
Climate Zone	4			Operational Year	2021
Utility Company	Pacific Gas & Electric Company				
CO2 Intensity (lb/MW hr)	281.31	CH4 Intensity (lb/MW hr)	0.029	N2O Intensity (lb/MW hr)	0.006

1.3 User Entered Comments & Non-Default Data

Project Characteristics - Intensity factor for CO2 adjusted based on PG&E's RPS reductions

Land Use - Applicant provided

Construction Phase - Applicant provided

Grading - Applicant provided

Vehicle Trips - Per Hexagon traffic report

Voices Charter School - Bay Area AQMD Air District, Summer

Table Name	Column Name	Default Value	New Value
tblConstructionPhase	NumDays	10.00	220.00
tblGrading	AcresOfGrading	3.00	2.02
tblGrading	AcresOfGrading	4.50	0.00
tblGrading	MaterialExported	0.00	50.00
tblLandUse	LandUseSquareFeet	35,150.00	35,151.00
tblLandUse	LandUseSquareFeet	23,890.00	23,886.00
tblLandUse	LotAcreage	0.81	1.47
tblProjectCharacteristics	CO2IntensityFactor	641.35	281.31
tblVehicleTrips	WD_TR	15.43	27.37

2.0 Emissions Summary

Voices Charter School - Bay Area AQMD Air District, Summer

2.2 Overall Operational

Unmitigated Operational

	ROG	NOx	CO	SO2	Fugitive PM10	Exhaust PM10	PM10 Total	Fugitive PM2.5	Exhaust PM2.5	PM2.5 Total	Bio- CO2	NBio- CO2	Total CO2	CH4	N2O	CO2e
Category	lb/day										lb/day					
Area	0.8644	6.0000e-005	6.0500e-003	0.0000		2.0000e-005	2.0000e-005		2.0000e-005	2.0000e-005		0.0129	0.0129	3.0000e-005		0.0138
Energy	0.0192	0.1741	0.1463	1.0400e-003		0.0132	0.0132		0.0132	0.0132		208.9233	208.9233	4.0000e-003	3.8300e-003	210.1648
Mobile	1.5920	6.4494	15.9333	0.0549	4.5070	0.0483	4.5553	1.2059	0.0453	1.2512		5,545.4685	5,545.4685	0.2026		5,550.5322
Total	2.4756	6.6235	16.0856	0.0559	4.5070	0.0616	4.5685	1.2059	0.0585	1.2644		5,754.4047	5,754.4047	0.2066	3.8300e-003	5,760.7107

Mitigated Operational

	ROG	NOx	CO	SO2	Fugitive PM10	Exhaust PM10	PM10 Total	Fugitive PM2.5	Exhaust PM2.5	PM2.5 Total	Bio- CO2	NBio- CO2	Total CO2	CH4	N2O	CO2e
Category	lb/day										lb/day					
Area	0.8644	6.0000e-005	6.0500e-003	0.0000		2.0000e-005	2.0000e-005		2.0000e-005	2.0000e-005		0.0129	0.0129	3.0000e-005		0.0138
Energy	0.0192	0.1741	0.1463	1.0400e-003		0.0132	0.0132		0.0132	0.0132		208.9233	208.9233	4.0000e-003	3.8300e-003	210.1648
Mobile	1.5920	6.4494	15.9333	0.0549	4.5070	0.0483	4.5553	1.2059	0.0453	1.2512		5,545.4685	5,545.4685	0.2026		5,550.5322
Total	2.4756	6.6235	16.0856	0.0559	4.5070	0.0616	4.5685	1.2059	0.0585	1.2644		5,754.4047	5,754.4047	0.2066	3.8300e-003	5,760.7107

Voices Charter School - Bay Area AQMD Air District, Summer

	ROG	NOx	CO	SO2	Fugitive PM10	Exhaust PM10	PM10 Total	Fugitive PM2.5	Exhaust PM2.5	PM2.5 Total	Bio- CO2	NBio-CO2	Total CO2	CH4	N2O	CO2e
Percent Reduction	0.00	0.00	0.00	0.00	0.00	0.00	0.00	0.00	0.00	0.00	0.00	0.00	0.00	0.00	0.00	0.00

3.0 Construction Detail

Construction Phase

Phase Number	Phase Name	Phase Type	Start Date	End Date	Num Days Week	Num Days	Phase Description
1	Site Preparation	Site Preparation	1/1/2020	1/3/2020	5	3	
2	Grading	Grading	1/4/2020	1/13/2020	5	6	
3	Building Construction	Building Construction	1/28/2020	11/30/2020	5	220	
4	Paving	Paving	1/14/2020	1/27/2020	5	10	
5	Architectural Coating	Architectural Coating	2/11/2020	12/14/2020	5	220	

Acres of Grading (Site Preparation Phase): 0

Acres of Grading (Grading Phase): 2.02

Acres of Paving: 0.55

Residential Indoor: 0; Residential Outdoor: 0; Non-Residential Indoor: 52,727; Non-Residential Outdoor: 17,576; Striped Parking Area: 1,433 (Architectural Coating – sqft)

OffRoad Equipment

Voices Charter School - Bay Area AQMD Air District, Summer

Phase Name	Offroad Equipment Type	Amount	Usage Hours	Horse Power	Load Factor
Site Preparation	Graders	1	8.00	187	0.41
Site Preparation	Scrapers	1	8.00	367	0.48
Site Preparation	Tractors/Loaders/Backhoes	1	7.00	97	0.37
Grading	Graders	1	8.00	187	0.41
Grading	Rubber Tired Dozers	1	8.00	247	0.40
Grading	Tractors/Loaders/Backhoes	2	7.00	97	0.37
Building Construction	Cranes	1	8.00	231	0.29
Building Construction	Forklifts	2	7.00	89	0.20
Building Construction	Generator Sets	1	8.00	84	0.74
Building Construction	Tractors/Loaders/Backhoes	1	6.00	97	0.37
Building Construction	Welders	3	8.00	46	0.45
Paving	Cement and Mortar Mixers	1	8.00	9	0.56
Paving	Pavers	1	8.00	130	0.42
Paving	Paving Equipment	1	8.00	132	0.36
Paving	Rollers	2	8.00	80	0.38
Paving	Tractors/Loaders/Backhoes	1	8.00	97	0.37
Architectural Coating	Air Compressors	1	6.00	78	0.48

Trips and VMT

Phase Name	Offroad Equipment Count	Worker Trip Number	Vendor Trip Number	Hauling Trip Number	Worker Trip Length	Vendor Trip Length	Hauling Trip Length	Worker Vehicle Class	Vendor Vehicle Class	Hauling Vehicle Class
Site Preparation	3	8.00	0.00	0.00	10.80	7.30	20.00	LD_Mix	HDT_Mix	HHDT
Grading	4	10.00	0.00	6.00	10.80	7.30	20.00	LD_Mix	HDT_Mix	HHDT
Building Construction	8	25.00	10.00	0.00	10.80	7.30	20.00	LD_Mix	HDT_Mix	HHDT
Paving	6	15.00	0.00	0.00	10.80	7.30	20.00	LD_Mix	HDT_Mix	HHDT
Architectural Coating	1	5.00	0.00	0.00	10.80	7.30	20.00	LD_Mix	HDT_Mix	HHDT

Voices Charter School - Bay Area AQMD Air District, Summer

3.1 Mitigation Measures Construction

3.2 Site Preparation - 2020

Unmitigated Construction On-Site

	ROG	NOx	CO	SO2	Fugitive PM10	Exhaust PM10	PM10 Total	Fugitive PM2.5	Exhaust PM2.5	PM2.5 Total	Bio- CO2	NBio- CO2	Total CO2	CH4	N2O	CO2e
Category	lb/day										lb/day					
Fugitive Dust					0.0000	0.0000	0.0000	0.0000	0.0000	0.0000			0.0000			0.0000
Off-Road	1.6521	19.9196	11.2678	0.0245		0.7771	0.7771		0.7149	0.7149		2,372.906 2	2,372.906 2	0.7675		2,392.092 4
Total	1.6521	19.9196	11.2678	0.0245	0.0000	0.7771	0.7771	0.0000	0.7149	0.7149		2,372.906 2	2,372.906 2	0.7675		2,392.092 4

Voices Charter School - Bay Area AQMD Air District, Summer

3.2 Site Preparation - 2020

Unmitigated Construction Off-Site

	ROG	NOx	CO	SO2	Fugitive PM10	Exhaust PM10	PM10 Total	Fugitive PM2.5	Exhaust PM2.5	PM2.5 Total	Bio- CO2	NBio- CO2	Total CO2	CH4	N2O	CO2e
Category	lb/day										lb/day					
Hauling	0.0000	0.0000	0.0000	0.0000	0.0000	0.0000	0.0000	0.0000	0.0000	0.0000		0.0000	0.0000	0.0000		0.0000
Vendor	0.0000	0.0000	0.0000	0.0000	0.0000	0.0000	0.0000	0.0000	0.0000	0.0000		0.0000	0.0000	0.0000		0.0000
Worker	0.0278	0.0168	0.2146	6.6000e-004	0.0657	4.3000e-004	0.0661	0.0174	3.9000e-004	0.0178		65.6621	65.6621	1.5800e-003		65.7017
Total	0.0278	0.0168	0.2146	6.6000e-004	0.0657	4.3000e-004	0.0661	0.0174	3.9000e-004	0.0178		65.6621	65.6621	1.5800e-003		65.7017

Mitigated Construction On-Site

	ROG	NOx	CO	SO2	Fugitive PM10	Exhaust PM10	PM10 Total	Fugitive PM2.5	Exhaust PM2.5	PM2.5 Total	Bio- CO2	NBio- CO2	Total CO2	CH4	N2O	CO2e
Category	lb/day										lb/day					
Fugitive Dust					0.0000	0.0000	0.0000	0.0000	0.0000	0.0000			0.0000			0.0000
Off-Road	1.6521	19.9196	11.2678	0.0245		0.7771	0.7771		0.7149	0.7149	0.0000	2,372.9062	2,372.9062	0.7675		2,392.0924
Total	1.6521	19.9196	11.2678	0.0245	0.0000	0.7771	0.7771	0.0000	0.7149	0.7149	0.0000	2,372.9062	2,372.9062	0.7675		2,392.0924

Voices Charter School - Bay Area AQMD Air District, Summer

3.2 Site Preparation - 2020

Mitigated Construction Off-Site

	ROG	NOx	CO	SO2	Fugitive PM10	Exhaust PM10	PM10 Total	Fugitive PM2.5	Exhaust PM2.5	PM2.5 Total	Bio- CO2	NBio- CO2	Total CO2	CH4	N2O	CO2e
Category	lb/day										lb/day					
Hauling	0.0000	0.0000	0.0000	0.0000	0.0000	0.0000	0.0000	0.0000	0.0000	0.0000		0.0000	0.0000	0.0000		0.0000
Vendor	0.0000	0.0000	0.0000	0.0000	0.0000	0.0000	0.0000	0.0000	0.0000	0.0000		0.0000	0.0000	0.0000		0.0000
Worker	0.0278	0.0168	0.2146	6.6000e-004	0.0657	4.3000e-004	0.0661	0.0174	3.9000e-004	0.0178		65.6621	65.6621	1.5800e-003		65.7017
Total	0.0278	0.0168	0.2146	6.6000e-004	0.0657	4.3000e-004	0.0661	0.0174	3.9000e-004	0.0178		65.6621	65.6621	1.5800e-003		65.7017

3.3 Grading - 2020

Unmitigated Construction On-Site

	ROG	NOx	CO	SO2	Fugitive PM10	Exhaust PM10	PM10 Total	Fugitive PM2.5	Exhaust PM2.5	PM2.5 Total	Bio- CO2	NBio- CO2	Total CO2	CH4	N2O	CO2e
Category	lb/day										lb/day					
Fugitive Dust					6.3801	0.0000	6.3801	3.3489	0.0000	3.3489			0.0000			0.0000
Off-Road	1.9219	21.3418	9.9355	0.0206		0.9902	0.9902		0.9110	0.9110		1,996.4061	1,996.4061	0.6457		2,012.5480
Total	1.9219	21.3418	9.9355	0.0206	6.3801	0.9902	7.3702	3.3489	0.9110	4.2599		1,996.4061	1,996.4061	0.6457		2,012.5480

Voices Charter School - Bay Area AQMD Air District, Summer

3.3 Grading - 2020

Unmitigated Construction Off-Site

	ROG	NOx	CO	SO2	Fugitive PM10	Exhaust PM10	PM10 Total	Fugitive PM2.5	Exhaust PM2.5	PM2.5 Total	Bio- CO2	NBio- CO2	Total CO2	CH4	N2O	CO2e
Category	lb/day										lb/day					
Hauling	8.2500e-003	0.2864	0.0569	8.0000e-004	0.0175	9.4000e-004	0.0184	4.7900e-003	9.0000e-004	5.6800e-003		85.0784	85.0784	4.2600e-003		85.1848
Vendor	0.0000	0.0000	0.0000	0.0000	0.0000	0.0000	0.0000	0.0000	0.0000	0.0000		0.0000	0.0000	0.0000		0.0000
Worker	0.0348	0.0210	0.2683	8.2000e-004	0.0822	5.3000e-004	0.0827	0.0218	4.9000e-004	0.0223		82.0777	82.0777	1.9800e-003		82.1271
Total	0.0430	0.3075	0.3252	1.6200e-003	0.0996	1.4700e-003	0.1011	0.0266	1.3900e-003	0.0280		167.1560	167.1560	6.2400e-003		167.3119

Mitigated Construction On-Site

	ROG	NOx	CO	SO2	Fugitive PM10	Exhaust PM10	PM10 Total	Fugitive PM2.5	Exhaust PM2.5	PM2.5 Total	Bio- CO2	NBio- CO2	Total CO2	CH4	N2O	CO2e
Category	lb/day										lb/day					
Fugitive Dust					6.3801	0.0000	6.3801	3.3489	0.0000	3.3489			0.0000			0.0000
Off-Road	1.9219	21.3418	9.9355	0.0206		0.9902	0.9902		0.9110	0.9110	0.0000	1,996.4061	1,996.4061	0.6457		2,012.5480
Total	1.9219	21.3418	9.9355	0.0206	6.3801	0.9902	7.3702	3.3489	0.9110	4.2599	0.0000	1,996.4061	1,996.4061	0.6457		2,012.5480

Voices Charter School - Bay Area AQMD Air District, Summer

3.3 Grading - 2020

Mitigated Construction Off-Site

	ROG	NOx	CO	SO2	Fugitive PM10	Exhaust PM10	PM10 Total	Fugitive PM2.5	Exhaust PM2.5	PM2.5 Total	Bio- CO2	NBio- CO2	Total CO2	CH4	N2O	CO2e
Category	lb/day										lb/day					
Hauling	8.2500e-003	0.2864	0.0569	8.0000e-004	0.0175	9.4000e-004	0.0184	4.7900e-003	9.0000e-004	5.6800e-003		85.0784	85.0784	4.2600e-003		85.1848
Vendor	0.0000	0.0000	0.0000	0.0000	0.0000	0.0000	0.0000	0.0000	0.0000	0.0000		0.0000	0.0000	0.0000		0.0000
Worker	0.0348	0.0210	0.2683	8.2000e-004	0.0822	5.3000e-004	0.0827	0.0218	4.9000e-004	0.0223		82.0777	82.0777	1.9800e-003		82.1271
Total	0.0430	0.3075	0.3252	1.6200e-003	0.0996	1.4700e-003	0.1011	0.0266	1.3900e-003	0.0280		167.1560	167.1560	6.2400e-003		167.3119

3.4 Building Construction - 2020

Unmitigated Construction On-Site

	ROG	NOx	CO	SO2	Fugitive PM10	Exhaust PM10	PM10 Total	Fugitive PM2.5	Exhaust PM2.5	PM2.5 Total	Bio- CO2	NBio- CO2	Total CO2	CH4	N2O	CO2e
Category	lb/day										lb/day					
Off-Road	2.2879	17.4336	14.8972	0.0250		0.9482	0.9482		0.9089	0.9089		2,288.8877	2,288.8877	0.4646		2,300.5014
Total	2.2879	17.4336	14.8972	0.0250		0.9482	0.9482		0.9089	0.9089		2,288.8877	2,288.8877	0.4646		2,300.5014

Voices Charter School - Bay Area AQMD Air District, Summer

3.4 Building Construction - 2020

Unmitigated Construction Off-Site

	ROG	NOx	CO	SO2	Fugitive PM10	Exhaust PM10	PM10 Total	Fugitive PM2.5	Exhaust PM2.5	PM2.5 Total	Bio- CO2	NBio- CO2	Total CO2	CH4	N2O	CO2e
Category	lb/day										lb/day					
Hauling	0.0000	0.0000	0.0000	0.0000	0.0000	0.0000	0.0000	0.0000	0.0000	0.0000		0.0000	0.0000	0.0000		0.0000
Vendor	0.0379	1.1396	0.2718	2.7500e-003	0.0677	5.5900e-003	0.0733	0.0195	5.3400e-003	0.0248		291.7081	291.7081	0.0144		292.0672
Worker	0.0869	0.0526	0.6708	2.0600e-003	0.2054	1.3300e-003	0.2067	0.0545	1.2300e-003	0.0557		205.1941	205.1941	4.9400e-003		205.3178
Total	0.1248	1.1922	0.9426	4.8100e-003	0.2731	6.9200e-003	0.2800	0.0740	6.5700e-003	0.0805		496.9022	496.9022	0.0193		497.3849

Mitigated Construction On-Site

	ROG	NOx	CO	SO2	Fugitive PM10	Exhaust PM10	PM10 Total	Fugitive PM2.5	Exhaust PM2.5	PM2.5 Total	Bio- CO2	NBio- CO2	Total CO2	CH4	N2O	CO2e
Category	lb/day										lb/day					
Off-Road	2.2879	17.4336	14.8972	0.0250		0.9482	0.9482		0.9089	0.9089	0.0000	2,288.8877	2,288.8877	0.4646		2,300.5014
Total	2.2879	17.4336	14.8972	0.0250		0.9482	0.9482		0.9089	0.9089	0.0000	2,288.8877	2,288.8877	0.4646		2,300.5014

Voices Charter School - Bay Area AQMD Air District, Summer

3.4 Building Construction - 2020

Mitigated Construction Off-Site

	ROG	NOx	CO	SO2	Fugitive PM10	Exhaust PM10	PM10 Total	Fugitive PM2.5	Exhaust PM2.5	PM2.5 Total	Bio- CO2	NBio- CO2	Total CO2	CH4	N2O	CO2e
Category	lb/day										lb/day					
Hauling	0.0000	0.0000	0.0000	0.0000	0.0000	0.0000	0.0000	0.0000	0.0000	0.0000		0.0000	0.0000	0.0000		0.0000
Vendor	0.0379	1.1396	0.2718	2.7500e-003	0.0677	5.5900e-003	0.0733	0.0195	5.3400e-003	0.0248		291.7081	291.7081	0.0144		292.0672
Worker	0.0869	0.0526	0.6708	2.0600e-003	0.2054	1.3300e-003	0.2067	0.0545	1.2300e-003	0.0557		205.1941	205.1941	4.9400e-003		205.3178
Total	0.1248	1.1922	0.9426	4.8100e-003	0.2731	6.9200e-003	0.2800	0.0740	6.5700e-003	0.0805		496.9022	496.9022	0.0193		497.3849

3.5 Paving - 2020

Unmitigated Construction On-Site

	ROG	NOx	CO	SO2	Fugitive PM10	Exhaust PM10	PM10 Total	Fugitive PM2.5	Exhaust PM2.5	PM2.5 Total	Bio- CO2	NBio- CO2	Total CO2	CH4	N2O	CO2e
Category	lb/day										lb/day					
Off-Road	1.1547	11.5873	11.8076	0.0178		0.6565	0.6565		0.6051	0.6051		1,709.2180	1,709.2180	0.5417		1,722.7605
Paving	0.1441					0.0000	0.0000		0.0000	0.0000			0.0000			0.0000
Total	1.2988	11.5873	11.8076	0.0178		0.6565	0.6565		0.6051	0.6051		1,709.2180	1,709.2180	0.5417		1,722.7605

Voices Charter School - Bay Area AQMD Air District, Summer

3.5 Paving - 2020

Unmitigated Construction Off-Site

	ROG	NOx	CO	SO2	Fugitive PM10	Exhaust PM10	PM10 Total	Fugitive PM2.5	Exhaust PM2.5	PM2.5 Total	Bio- CO2	NBio- CO2	Total CO2	CH4	N2O	CO2e
Category	lb/day										lb/day					
Hauling	0.0000	0.0000	0.0000	0.0000	0.0000	0.0000	0.0000	0.0000	0.0000	0.0000		0.0000	0.0000	0.0000		0.0000
Vendor	0.0000	0.0000	0.0000	0.0000	0.0000	0.0000	0.0000	0.0000	0.0000	0.0000		0.0000	0.0000	0.0000		0.0000
Worker	0.0521	0.0316	0.4025	1.2400e-003	0.1232	8.0000e-004	0.1240	0.0327	7.4000e-004	0.0334		123.1165	123.1165	2.9700e-003		123.1907
Total	0.0521	0.0316	0.4025	1.2400e-003	0.1232	8.0000e-004	0.1240	0.0327	7.4000e-004	0.0334		123.1165	123.1165	2.9700e-003		123.1907

Mitigated Construction On-Site

	ROG	NOx	CO	SO2	Fugitive PM10	Exhaust PM10	PM10 Total	Fugitive PM2.5	Exhaust PM2.5	PM2.5 Total	Bio- CO2	NBio- CO2	Total CO2	CH4	N2O	CO2e
Category	lb/day										lb/day					
Off-Road	1.1547	11.5873	11.8076	0.0178		0.6565	0.6565		0.6051	0.6051	0.0000	1,709.2180	1,709.2180	0.5417		1,722.7605
Paving	0.1441					0.0000	0.0000		0.0000	0.0000			0.0000			0.0000
Total	1.2988	11.5873	11.8076	0.0178		0.6565	0.6565		0.6051	0.6051	0.0000	1,709.2180	1,709.2180	0.5417		1,722.7605

Voices Charter School - Bay Area AQMD Air District, Summer

3.5 Paving - 2020

Mitigated Construction Off-Site

	ROG	NOx	CO	SO2	Fugitive PM10	Exhaust PM10	PM10 Total	Fugitive PM2.5	Exhaust PM2.5	PM2.5 Total	Bio- CO2	NBio- CO2	Total CO2	CH4	N2O	CO2e
Category	lb/day										lb/day					
Hauling	0.0000	0.0000	0.0000	0.0000	0.0000	0.0000	0.0000	0.0000	0.0000	0.0000		0.0000	0.0000	0.0000		0.0000
Vendor	0.0000	0.0000	0.0000	0.0000	0.0000	0.0000	0.0000	0.0000	0.0000	0.0000		0.0000	0.0000	0.0000		0.0000
Worker	0.0521	0.0316	0.4025	1.2400e-003	0.1232	8.0000e-004	0.1240	0.0327	7.4000e-004	0.0334		123.1165	123.1165	2.9700e-003		123.1907
Total	0.0521	0.0316	0.4025	1.2400e-003	0.1232	8.0000e-004	0.1240	0.0327	7.4000e-004	0.0334		123.1165	123.1165	2.9700e-003		123.1907

3.6 Architectural Coating - 2020

Unmitigated Construction On-Site

	ROG	NOx	CO	SO2	Fugitive PM10	Exhaust PM10	PM10 Total	Fugitive PM2.5	Exhaust PM2.5	PM2.5 Total	Bio- CO2	NBio- CO2	Total CO2	CH4	N2O	CO2e
Category	lb/day										lb/day					
Archit. Coating	1.7116					0.0000	0.0000		0.0000	0.0000			0.0000			0.0000
Off-Road	0.2422	1.6838	1.8314	2.9700e-003		0.1109	0.1109		0.1109	0.1109		281.4481	281.4481	0.0218		281.9928
Total	1.9538	1.6838	1.8314	2.9700e-003		0.1109	0.1109		0.1109	0.1109		281.4481	281.4481	0.0218		281.9928

Voices Charter School - Bay Area AQMD Air District, Summer

3.6 Architectural Coating - 2020

Unmitigated Construction Off-Site

	ROG	NOx	CO	SO2	Fugitive PM10	Exhaust PM10	PM10 Total	Fugitive PM2.5	Exhaust PM2.5	PM2.5 Total	Bio- CO2	NBio- CO2	Total CO2	CH4	N2O	CO2e
Category	lb/day										lb/day					
Hauling	0.0000	0.0000	0.0000	0.0000	0.0000	0.0000	0.0000	0.0000	0.0000	0.0000		0.0000	0.0000	0.0000		0.0000
Vendor	0.0000	0.0000	0.0000	0.0000	0.0000	0.0000	0.0000	0.0000	0.0000	0.0000		0.0000	0.0000	0.0000		0.0000
Worker	0.0174	0.0105	0.1342	4.1000e-004	0.0411	2.7000e-004	0.0413	0.0109	2.5000e-004	0.0111		41.0388	41.0388	9.9000e-004		41.0636
Total	0.0174	0.0105	0.1342	4.1000e-004	0.0411	2.7000e-004	0.0413	0.0109	2.5000e-004	0.0111		41.0388	41.0388	9.9000e-004		41.0636

Mitigated Construction On-Site

	ROG	NOx	CO	SO2	Fugitive PM10	Exhaust PM10	PM10 Total	Fugitive PM2.5	Exhaust PM2.5	PM2.5 Total	Bio- CO2	NBio- CO2	Total CO2	CH4	N2O	CO2e
Category	lb/day										lb/day					
Archit. Coating	1.7116					0.0000	0.0000		0.0000	0.0000			0.0000			0.0000
Off-Road	0.2422	1.6838	1.8314	2.9700e-003		0.1109	0.1109		0.1109	0.1109	0.0000	281.4481	281.4481	0.0218		281.9928
Total	1.9538	1.6838	1.8314	2.9700e-003		0.1109	0.1109		0.1109	0.1109	0.0000	281.4481	281.4481	0.0218		281.9928

Voices Charter School - Bay Area AQMD Air District, Summer

3.6 Architectural Coating - 2020

Mitigated Construction Off-Site

	ROG	NOx	CO	SO2	Fugitive PM10	Exhaust PM10	PM10 Total	Fugitive PM2.5	Exhaust PM2.5	PM2.5 Total	Bio- CO2	NBio- CO2	Total CO2	CH4	N2O	CO2e
Category	lb/day										lb/day					
Hauling	0.0000	0.0000	0.0000	0.0000	0.0000	0.0000	0.0000	0.0000	0.0000	0.0000		0.0000	0.0000	0.0000		0.0000
Vendor	0.0000	0.0000	0.0000	0.0000	0.0000	0.0000	0.0000	0.0000	0.0000	0.0000		0.0000	0.0000	0.0000		0.0000
Worker	0.0174	0.0105	0.1342	4.1000e-004	0.0411	2.7000e-004	0.0413	0.0109	2.5000e-004	0.0111		41.0388	41.0388	9.9000e-004		41.0636
Total	0.0174	0.0105	0.1342	4.1000e-004	0.0411	2.7000e-004	0.0413	0.0109	2.5000e-004	0.0111		41.0388	41.0388	9.9000e-004		41.0636

4.0 Operational Detail - Mobile

4.1 Mitigation Measures Mobile

Voices Charter School - Bay Area AQMD Air District, Summer

	ROG	NOx	CO	SO2	Fugitive PM10	Exhaust PM10	PM10 Total	Fugitive PM2.5	Exhaust PM2.5	PM2.5 Total	Bio- CO2	NBio- CO2	Total CO2	CH4	N2O	CO2e
Category	lb/day										lb/day					
Mitigated	1.5920	6.4494	15.9333	0.0549	4.5070	0.0483	4.5553	1.2059	0.0453	1.2512		5,545.4685	5,545.4685	0.2026		5,550.5322
Unmitigated	1.5920	6.4494	15.9333	0.0549	4.5070	0.0483	4.5553	1.2059	0.0453	1.2512		5,545.4685	5,545.4685	0.2026		5,550.5322

4.2 Trip Summary Information

Land Use	Average Daily Trip Rate			Unmitigated	Mitigated
	Weekday	Saturday	Sunday	Annual VMT	Annual VMT
Elementary School	962.06	0.00	0.00	1,515,196	1,515,196
Parking Lot	0.00	0.00	0.00		
Total	962.06	0.00	0.00	1,515,196	1,515,196

4.3 Trip Type Information

Land Use	Miles			Trip %			Trip Purpose %		
	H-W or C-W	H-S or C-C	H-O or C-NW	H-W or C-W	H-S or C-C	H-O or C-NW	Primary	Diverted	Pass-by
Elementary School	9.50	7.30	7.30	65.00	30.00	5.00	63	25	12
Parking Lot	9.50	7.30	7.30	0.00	0.00	0.00	0	0	0

4.4 Fleet Mix

Land Use	LDA	LDT1	LDT2	MDV	LHD1	LHD2	MHD	HHD	OBUS	UBUS	MCY	SBUS	MH
Elementary School	0.575198	0.040076	0.193827	0.113296	0.016988	0.005361	0.017552	0.025197	0.002581	0.002349	0.005904	0.000881	0.000789
Parking Lot	0.575198	0.040076	0.193827	0.113296	0.016988	0.005361	0.017552	0.025197	0.002581	0.002349	0.005904	0.000881	0.000789

Voices Charter School - Bay Area AQMD Air District, Summer

5.0 Energy Detail

Historical Energy Use: N

5.1 Mitigation Measures Energy

	ROG	NOx	CO	SO2	Fugitive PM10	Exhaust PM10	PM10 Total	Fugitive PM2.5	Exhaust PM2.5	PM2.5 Total	Bio- CO2	NBio- CO2	Total CO2	CH4	N2O	CO2e
Category	lb/day										lb/day					
NaturalGas Mitigated	0.0192	0.1741	0.1463	1.0400e-003		0.0132	0.0132		0.0132	0.0132		208.9233	208.9233	4.0000e-003	3.8300e-003	210.1648
NaturalGas Unmitigated	0.0192	0.1741	0.1463	1.0400e-003		0.0132	0.0132		0.0132	0.0132		208.9233	208.9233	4.0000e-003	3.8300e-003	210.1648

Voices Charter School - Bay Area AQMD Air District, Summer

5.2 Energy by Land Use - NaturalGas

Unmitigated

	NaturalGas Use	ROG	NOx	CO	SO2	Fugitive PM10	Exhaust PM10	PM10 Total	Fugitive PM2.5	Exhaust PM2.5	PM2.5 Total	Bio- CO2	NBio- CO2	Total CO2	CH4	N2O	CO2e
Land Use	kBTU/yr	lb/day										lb/day					
Elementary School	1775.85	0.0192	0.1741	0.1463	1.0400e-003		0.0132	0.0132		0.0132	0.0132		208.9233	208.9233	4.0000e-003	3.8300e-003	210.1648
Parking Lot	0	0.0000	0.0000	0.0000	0.0000		0.0000	0.0000		0.0000	0.0000		0.0000	0.0000	0.0000	0.0000	0.0000
Total		0.0192	0.1741	0.1463	1.0400e-003		0.0132	0.0132		0.0132	0.0132		208.9233	208.9233	4.0000e-003	3.8300e-003	210.1648

Mitigated

	NaturalGas Use	ROG	NOx	CO	SO2	Fugitive PM10	Exhaust PM10	PM10 Total	Fugitive PM2.5	Exhaust PM2.5	PM2.5 Total	Bio- CO2	NBio- CO2	Total CO2	CH4	N2O	CO2e
Land Use	kBTU/yr	lb/day										lb/day					
Elementary School	1.77585	0.0192	0.1741	0.1463	1.0400e-003		0.0132	0.0132		0.0132	0.0132		208.9233	208.9233	4.0000e-003	3.8300e-003	210.1648
Parking Lot	0	0.0000	0.0000	0.0000	0.0000		0.0000	0.0000		0.0000	0.0000		0.0000	0.0000	0.0000	0.0000	0.0000
Total		0.0192	0.1741	0.1463	1.0400e-003		0.0132	0.0132		0.0132	0.0132		208.9233	208.9233	4.0000e-003	3.8300e-003	210.1648

6.0 Area Detail

6.1 Mitigation Measures Area

Voices Charter School - Bay Area AQMD Air District, Summer

	ROG	NOx	CO	SO2	Fugitive PM10	Exhaust PM10	PM10 Total	Fugitive PM2.5	Exhaust PM2.5	PM2.5 Total	Bio- CO2	NBio- CO2	Total CO2	CH4	N2O	CO2e
Category	lb/day										lb/day					
Mitigated	0.8644	6.0000e-005	6.0500e-003	0.0000		2.0000e-005	2.0000e-005		2.0000e-005	2.0000e-005		0.0129	0.0129	3.0000e-005		0.0138
Unmitigated	0.8644	6.0000e-005	6.0500e-003	0.0000		2.0000e-005	2.0000e-005		2.0000e-005	2.0000e-005		0.0129	0.0129	3.0000e-005		0.0138

6.2 Area by SubCategory

Unmitigated

	ROG	NOx	CO	SO2	Fugitive PM10	Exhaust PM10	PM10 Total	Fugitive PM2.5	Exhaust PM2.5	PM2.5 Total	Bio- CO2	NBio- CO2	Total CO2	CH4	N2O	CO2e
SubCategory	lb/day										lb/day					
Architectural Coating	0.1032					0.0000	0.0000		0.0000	0.0000			0.0000			0.0000
Consumer Products	0.7607					0.0000	0.0000		0.0000	0.0000			0.0000			0.0000
Landscaping	5.7000e-004	6.0000e-005	6.0500e-003	0.0000		2.0000e-005	2.0000e-005		2.0000e-005	2.0000e-005		0.0129	0.0129	3.0000e-005		0.0138
Total	0.8644	6.0000e-005	6.0500e-003	0.0000		2.0000e-005	2.0000e-005		2.0000e-005	2.0000e-005		0.0129	0.0129	3.0000e-005		0.0138

Voices Charter School - Bay Area AQMD Air District, Summer

6.2 Area by SubCategory

Mitigated

	ROG	NOx	CO	SO2	Fugitive PM10	Exhaust PM10	PM10 Total	Fugitive PM2.5	Exhaust PM2.5	PM2.5 Total	Bio- CO2	NBio- CO2	Total CO2	CH4	N2O	CO2e
SubCategory	lb/day										lb/day					
Architectural Coating	0.1032					0.0000	0.0000		0.0000	0.0000			0.0000			0.0000
Consumer Products	0.7607					0.0000	0.0000		0.0000	0.0000			0.0000			0.0000
Landscaping	5.7000e-004	6.0000e-005	6.0500e-003	0.0000		2.0000e-005	2.0000e-005		2.0000e-005	2.0000e-005		0.0129	0.0129	3.0000e-005		0.0138
Total	0.8644	6.0000e-005	6.0500e-003	0.0000		2.0000e-005	2.0000e-005		2.0000e-005	2.0000e-005		0.0129	0.0129	3.0000e-005		0.0138

7.0 Water Detail

7.1 Mitigation Measures Water

8.0 Waste Detail

8.1 Mitigation Measures Waste

9.0 Operational Offroad

Equipment Type	Number	Hours/Day	Days/Year	Horse Power	Load Factor	Fuel Type
----------------	--------	-----------	-----------	-------------	-------------	-----------

10.0 Stationary Equipment

Fire Pumps and Emergency Generators

Voices Charter School - Bay Area AQMD Air District, Summer

Equipment Type	Number	Hours/Day	Hours/Year	Horse Power	Load Factor	Fuel Type
----------------	--------	-----------	------------	-------------	-------------	-----------

Boilers

Equipment Type	Number	Heat Input/Day	Heat Input/Year	Boiler Rating	Fuel Type
----------------	--------	----------------	-----------------	---------------	-----------

User Defined Equipment

Equipment Type	Number
----------------	--------

11.0 Vegetation

Voices Charter School - Bay Area AQMD Air District, Winter

Voices Charter School
Bay Area AQMD Air District, Winter

1.0 Project Characteristics

1.1 Land Usage

Land Uses	Size	Metric	Lot Acreage	Floor Surface Area	Population
Elementary School	35.15	1000sqft	1.47	35,151.00	0
Parking Lot	23.89	1000sqft	0.55	23,886.00	0

1.2 Other Project Characteristics

Urbanization	Urban	Wind Speed (m/s)	2.2	Precipitation Freq (Days)	64
Climate Zone	4			Operational Year	2021
Utility Company	Pacific Gas & Electric Company				
CO2 Intensity (lb/MWhr)	281.31	CH4 Intensity (lb/MWhr)	0.029	N2O Intensity (lb/MWhr)	0.006

1.3 User Entered Comments & Non-Default Data

Project Characteristics - Intensity factor for CO2 adjusted based on PG&E's RPS reductions

Land Use - Applicant provided

Construction Phase - Applicant provided

Grading - Applicant provided

Vehicle Trips - Per Hexagon traffic report

Voices Charter School - Bay Area AQMD Air District, Winter

Table Name	Column Name	Default Value	New Value
tblConstructionPhase	NumDays	10.00	220.00
tblGrading	AcresOfGrading	3.00	2.02
tblGrading	AcresOfGrading	4.50	0.00
tblGrading	MaterialExported	0.00	50.00
tblLandUse	LandUseSquareFeet	35,150.00	35,151.00
tblLandUse	LandUseSquareFeet	23,890.00	23,886.00
tblLandUse	LotAcreage	0.81	1.47
tblProjectCharacteristics	CO2IntensityFactor	641.35	281.31
tblVehicleTrips	WD_TR	15.43	27.37

2.0 Emissions Summary

Voices Charter School - Bay Area AQMD Air District, Winter

2.2 Overall Operational

Unmitigated Operational

	ROG	NOx	CO	SO2	Fugitive PM10	Exhaust PM10	PM10 Total	Fugitive PM2.5	Exhaust PM2.5	PM2.5 Total	Bio- CO2	NBio- CO2	Total CO2	CH4	N2O	CO2e
Category	lb/day										lb/day					
Area	0.8644	6.0000e-005	6.0500e-003	0.0000		2.0000e-005	2.0000e-005		2.0000e-005	2.0000e-005		0.0129	0.0129	3.0000e-005		0.0138
Energy	0.0192	0.1741	0.1463	1.0400e-003		0.0132	0.0132		0.0132	0.0132		208.9233	208.9233	4.0000e-003	3.8300e-003	210.1648
Mobile	1.3802	6.7755	16.1961	0.0513	4.5070	0.0487	4.5557	1.2059	0.0457	1.2516		5,189.3826	5,189.3826	0.2073		5,194.5649
Total	2.2638	6.9497	16.3484	0.0524	4.5070	0.0620	4.5689	1.2059	0.0589	1.2648		5,398.3188	5,398.3188	0.2113	3.8300e-003	5,404.7435

Mitigated Operational

	ROG	NOx	CO	SO2	Fugitive PM10	Exhaust PM10	PM10 Total	Fugitive PM2.5	Exhaust PM2.5	PM2.5 Total	Bio- CO2	NBio- CO2	Total CO2	CH4	N2O	CO2e
Category	lb/day										lb/day					
Area	0.8644	6.0000e-005	6.0500e-003	0.0000		2.0000e-005	2.0000e-005		2.0000e-005	2.0000e-005		0.0129	0.0129	3.0000e-005		0.0138
Energy	0.0192	0.1741	0.1463	1.0400e-003		0.0132	0.0132		0.0132	0.0132		208.9233	208.9233	4.0000e-003	3.8300e-003	210.1648
Mobile	1.3802	6.7755	16.1961	0.0513	4.5070	0.0487	4.5557	1.2059	0.0457	1.2516		5,189.3826	5,189.3826	0.2073		5,194.5649
Total	2.2638	6.9497	16.3484	0.0524	4.5070	0.0620	4.5689	1.2059	0.0589	1.2648		5,398.3188	5,398.3188	0.2113	3.8300e-003	5,404.7435

Voices Charter School - Bay Area AQMD Air District, Winter

	ROG	NOx	CO	SO2	Fugitive PM10	Exhaust PM10	PM10 Total	Fugitive PM2.5	Exhaust PM2.5	PM2.5 Total	Bio- CO2	NBio-CO2	Total CO2	CH4	N2O	CO2e
Percent Reduction	0.00	0.00	0.00	0.00	0.00	0.00	0.00	0.00	0.00	0.00	0.00	0.00	0.00	0.00	0.00	0.00

3.0 Construction Detail

Construction Phase

Phase Number	Phase Name	Phase Type	Start Date	End Date	Num Days Week	Num Days	Phase Description
1	Site Preparation	Site Preparation	1/1/2020	1/3/2020	5	3	
2	Grading	Grading	1/4/2020	1/13/2020	5	6	
3	Building Construction	Building Construction	1/28/2020	11/30/2020	5	220	
4	Paving	Paving	1/14/2020	1/27/2020	5	10	
5	Architectural Coating	Architectural Coating	2/11/2020	12/14/2020	5	220	

Acres of Grading (Site Preparation Phase): 0

Acres of Grading (Grading Phase): 2.02

Acres of Paving: 0.55

Residential Indoor: 0; Residential Outdoor: 0; Non-Residential Indoor: 52,727; Non-Residential Outdoor: 17,576; Striped Parking Area: 1,433 (Architectural Coating – sqft)

OffRoad Equipment

Voices Charter School - Bay Area AQMD Air District, Winter

Phase Name	Offroad Equipment Type	Amount	Usage Hours	Horse Power	Load Factor
Site Preparation	Graders	1	8.00	187	0.41
Site Preparation	Scrapers	1	8.00	367	0.48
Site Preparation	Tractors/Loaders/Backhoes	1	7.00	97	0.37
Grading	Graders	1	8.00	187	0.41
Grading	Rubber Tired Dozers	1	8.00	247	0.40
Grading	Tractors/Loaders/Backhoes	2	7.00	97	0.37
Building Construction	Cranes	1	8.00	231	0.29
Building Construction	Forklifts	2	7.00	89	0.20
Building Construction	Generator Sets	1	8.00	84	0.74
Building Construction	Tractors/Loaders/Backhoes	1	6.00	97	0.37
Building Construction	Welders	3	8.00	46	0.45
Paving	Cement and Mortar Mixers	1	8.00	9	0.56
Paving	Pavers	1	8.00	130	0.42
Paving	Paving Equipment	1	8.00	132	0.36
Paving	Rollers	2	8.00	80	0.38
Paving	Tractors/Loaders/Backhoes	1	8.00	97	0.37
Architectural Coating	Air Compressors	1	6.00	78	0.48

Trips and VMT

Phase Name	Offroad Equipment Count	Worker Trip Number	Vendor Trip Number	Hauling Trip Number	Worker Trip Length	Vendor Trip Length	Hauling Trip Length	Worker Vehicle Class	Vendor Vehicle Class	Hauling Vehicle Class
Site Preparation	3	8.00	0.00	0.00	10.80	7.30	20.00	LD_Mix	HDT_Mix	HHDT
Grading	4	10.00	0.00	6.00	10.80	7.30	20.00	LD_Mix	HDT_Mix	HHDT
Building Construction	8	25.00	10.00	0.00	10.80	7.30	20.00	LD_Mix	HDT_Mix	HHDT
Paving	6	15.00	0.00	0.00	10.80	7.30	20.00	LD_Mix	HDT_Mix	HHDT
Architectural Coating	1	5.00	0.00	0.00	10.80	7.30	20.00	LD_Mix	HDT_Mix	HHDT

Voices Charter School - Bay Area AQMD Air District, Winter

3.1 Mitigation Measures Construction

3.2 Site Preparation - 2020

Unmitigated Construction On-Site

	ROG	NOx	CO	SO2	Fugitive PM10	Exhaust PM10	PM10 Total	Fugitive PM2.5	Exhaust PM2.5	PM2.5 Total	Bio- CO2	NBio- CO2	Total CO2	CH4	N2O	CO2e
Category	lb/day										lb/day					
Fugitive Dust					0.0000	0.0000	0.0000	0.0000	0.0000	0.0000			0.0000			0.0000
Off-Road	1.6521	19.9196	11.2678	0.0245		0.7771	0.7771		0.7149	0.7149		2,372.906 2	2,372.906 2	0.7675		2,392.092 4
Total	1.6521	19.9196	11.2678	0.0245	0.0000	0.7771	0.7771	0.0000	0.7149	0.7149		2,372.906 2	2,372.906 2	0.7675		2,392.092 4

Voices Charter School - Bay Area AQMD Air District, Winter

3.2 Site Preparation - 2020

Unmitigated Construction Off-Site

	ROG	NOx	CO	SO2	Fugitive PM10	Exhaust PM10	PM10 Total	Fugitive PM2.5	Exhaust PM2.5	PM2.5 Total	Bio- CO2	NBio- CO2	Total CO2	CH4	N2O	CO2e
Category	lb/day										lb/day					
Hauling	0.0000	0.0000	0.0000	0.0000	0.0000	0.0000	0.0000	0.0000	0.0000	0.0000		0.0000	0.0000	0.0000		0.0000
Vendor	0.0000	0.0000	0.0000	0.0000	0.0000	0.0000	0.0000	0.0000	0.0000	0.0000		0.0000	0.0000	0.0000		0.0000
Worker	0.0294	0.0208	0.2016	6.1000e-004	0.0657	4.3000e-004	0.0661	0.0174	3.9000e-004	0.0178		60.4852	60.4852	1.4800e-003		60.5222
Total	0.0294	0.0208	0.2016	6.1000e-004	0.0657	4.3000e-004	0.0661	0.0174	3.9000e-004	0.0178		60.4852	60.4852	1.4800e-003		60.5222

Mitigated Construction On-Site

	ROG	NOx	CO	SO2	Fugitive PM10	Exhaust PM10	PM10 Total	Fugitive PM2.5	Exhaust PM2.5	PM2.5 Total	Bio- CO2	NBio- CO2	Total CO2	CH4	N2O	CO2e
Category	lb/day										lb/day					
Fugitive Dust					0.0000	0.0000	0.0000	0.0000	0.0000	0.0000			0.0000			0.0000
Off-Road	1.6521	19.9196	11.2678	0.0245		0.7771	0.7771		0.7149	0.7149	0.0000	2,372.9062	2,372.9062	0.7675		2,392.0924
Total	1.6521	19.9196	11.2678	0.0245	0.0000	0.7771	0.7771	0.0000	0.7149	0.7149	0.0000	2,372.9062	2,372.9062	0.7675		2,392.0924

Voices Charter School - Bay Area AQMD Air District, Winter

3.2 Site Preparation - 2020

Mitigated Construction Off-Site

	ROG	NOx	CO	SO2	Fugitive PM10	Exhaust PM10	PM10 Total	Fugitive PM2.5	Exhaust PM2.5	PM2.5 Total	Bio- CO2	NBio- CO2	Total CO2	CH4	N2O	CO2e
Category	lb/day										lb/day					
Hauling	0.0000	0.0000	0.0000	0.0000	0.0000	0.0000	0.0000	0.0000	0.0000	0.0000		0.0000	0.0000	0.0000		0.0000
Vendor	0.0000	0.0000	0.0000	0.0000	0.0000	0.0000	0.0000	0.0000	0.0000	0.0000		0.0000	0.0000	0.0000		0.0000
Worker	0.0294	0.0208	0.2016	6.1000e-004	0.0657	4.3000e-004	0.0661	0.0174	3.9000e-004	0.0178		60.4852	60.4852	1.4800e-003		60.5222
Total	0.0294	0.0208	0.2016	6.1000e-004	0.0657	4.3000e-004	0.0661	0.0174	3.9000e-004	0.0178		60.4852	60.4852	1.4800e-003		60.5222

3.3 Grading - 2020

Unmitigated Construction On-Site

	ROG	NOx	CO	SO2	Fugitive PM10	Exhaust PM10	PM10 Total	Fugitive PM2.5	Exhaust PM2.5	PM2.5 Total	Bio- CO2	NBio- CO2	Total CO2	CH4	N2O	CO2e
Category	lb/day										lb/day					
Fugitive Dust					6.3801	0.0000	6.3801	3.3489	0.0000	3.3489			0.0000			0.0000
Off-Road	1.9219	21.3418	9.9355	0.0206		0.9902	0.9902		0.9110	0.9110		1,996.4061	1,996.4061	0.6457		2,012.5480
Total	1.9219	21.3418	9.9355	0.0206	6.3801	0.9902	7.3702	3.3489	0.9110	4.2599		1,996.4061	1,996.4061	0.6457		2,012.5480

Voices Charter School - Bay Area AQMD Air District, Winter

3.3 Grading - 2020

Unmitigated Construction Off-Site

	ROG	NOx	CO	SO2	Fugitive PM10	Exhaust PM10	PM10 Total	Fugitive PM2.5	Exhaust PM2.5	PM2.5 Total	Bio- CO2	NBio- CO2	Total CO2	CH4	N2O	CO2e
Category	lb/day										lb/day					
Hauling	8.4800e-003	0.2935	0.0613	7.8000e-004	0.0175	9.5000e-004	0.0184	4.7900e-003	9.1000e-004	5.7000e-003		83.6494	83.6494	4.4700e-003		83.7611
Vendor	0.0000	0.0000	0.0000	0.0000	0.0000	0.0000	0.0000	0.0000	0.0000	0.0000		0.0000	0.0000	0.0000		0.0000
Worker	0.0368	0.0260	0.2520	7.6000e-004	0.0822	5.3000e-004	0.0827	0.0218	4.9000e-004	0.0223		75.6065	75.6065	1.8500e-003		75.6528
Total	0.0452	0.3195	0.3133	1.5400e-003	0.0996	1.4800e-003	0.1011	0.0266	1.4000e-003	0.0280		159.2559	159.2559	6.3200e-003		159.4139

Mitigated Construction On-Site

	ROG	NOx	CO	SO2	Fugitive PM10	Exhaust PM10	PM10 Total	Fugitive PM2.5	Exhaust PM2.5	PM2.5 Total	Bio- CO2	NBio- CO2	Total CO2	CH4	N2O	CO2e
Category	lb/day										lb/day					
Fugitive Dust					6.3801	0.0000	6.3801	3.3489	0.0000	3.3489			0.0000			0.0000
Off-Road	1.9219	21.3418	9.9355	0.0206		0.9902	0.9902		0.9110	0.9110	0.0000	1,996.4061	1,996.4061	0.6457		2,012.5480
Total	1.9219	21.3418	9.9355	0.0206	6.3801	0.9902	7.3702	3.3489	0.9110	4.2599	0.0000	1,996.4061	1,996.4061	0.6457		2,012.5480

Voices Charter School - Bay Area AQMD Air District, Winter

3.3 Grading - 2020

Mitigated Construction Off-Site

	ROG	NOx	CO	SO2	Fugitive PM10	Exhaust PM10	PM10 Total	Fugitive PM2.5	Exhaust PM2.5	PM2.5 Total	Bio- CO2	NBio- CO2	Total CO2	CH4	N2O	CO2e
Category	lb/day										lb/day					
Hauling	8.4800e-003	0.2935	0.0613	7.8000e-004	0.0175	9.5000e-004	0.0184	4.7900e-003	9.1000e-004	5.7000e-003		83.6494	83.6494	4.4700e-003		83.7611
Vendor	0.0000	0.0000	0.0000	0.0000	0.0000	0.0000	0.0000	0.0000	0.0000	0.0000		0.0000	0.0000	0.0000		0.0000
Worker	0.0368	0.0260	0.2520	7.6000e-004	0.0822	5.3000e-004	0.0827	0.0218	4.9000e-004	0.0223		75.6065	75.6065	1.8500e-003		75.6528
Total	0.0452	0.3195	0.3133	1.5400e-003	0.0996	1.4800e-003	0.1011	0.0266	1.4000e-003	0.0280		159.2559	159.2559	6.3200e-003		159.4139

3.4 Building Construction - 2020

Unmitigated Construction On-Site

	ROG	NOx	CO	SO2	Fugitive PM10	Exhaust PM10	PM10 Total	Fugitive PM2.5	Exhaust PM2.5	PM2.5 Total	Bio- CO2	NBio- CO2	Total CO2	CH4	N2O	CO2e
Category	lb/day										lb/day					
Off-Road	2.2879	17.4336	14.8972	0.0250		0.9482	0.9482		0.9089	0.9089		2,288.8877	2,288.8877	0.4646		2,300.5014
Total	2.2879	17.4336	14.8972	0.0250		0.9482	0.9482		0.9089	0.9089		2,288.8877	2,288.8877	0.4646		2,300.5014

Voices Charter School - Bay Area AQMD Air District, Winter

3.4 Building Construction - 2020

Unmitigated Construction Off-Site

	ROG	NOx	CO	SO2	Fugitive PM10	Exhaust PM10	PM10 Total	Fugitive PM2.5	Exhaust PM2.5	PM2.5 Total	Bio- CO2	NBio- CO2	Total CO2	CH4	N2O	CO2e
Category	lb/day										lb/day					
Hauling	0.0000	0.0000	0.0000	0.0000	0.0000	0.0000	0.0000	0.0000	0.0000	0.0000		0.0000	0.0000	0.0000		0.0000
Vendor	0.0399	1.1524	0.3110	2.6900e-003	0.0677	5.6800e-003	0.0734	0.0195	5.4300e-003	0.0249		284.3272	284.3272	0.0155		284.7157
Worker	0.0919	0.0650	0.6300	1.9000e-003	0.2054	1.3300e-003	0.2067	0.0545	1.2300e-003	0.0557		189.0164	189.0164	4.6200e-003		189.1319
Total	0.1318	1.2174	0.9410	4.5900e-003	0.2731	7.0100e-003	0.2801	0.0740	6.6600e-003	0.0806		473.3436	473.3436	0.0202		473.8476

Mitigated Construction On-Site

	ROG	NOx	CO	SO2	Fugitive PM10	Exhaust PM10	PM10 Total	Fugitive PM2.5	Exhaust PM2.5	PM2.5 Total	Bio- CO2	NBio- CO2	Total CO2	CH4	N2O	CO2e
Category	lb/day										lb/day					
Off-Road	2.2879	17.4336	14.8972	0.0250		0.9482	0.9482		0.9089	0.9089	0.0000	2,288.8877	2,288.8877	0.4646		2,300.5014
Total	2.2879	17.4336	14.8972	0.0250		0.9482	0.9482		0.9089	0.9089	0.0000	2,288.8877	2,288.8877	0.4646		2,300.5014

Voices Charter School - Bay Area AQMD Air District, Winter

3.4 Building Construction - 2020

Mitigated Construction Off-Site

	ROG	NOx	CO	SO2	Fugitive PM10	Exhaust PM10	PM10 Total	Fugitive PM2.5	Exhaust PM2.5	PM2.5 Total	Bio- CO2	NBio- CO2	Total CO2	CH4	N2O	CO2e
Category	lb/day										lb/day					
Hauling	0.0000	0.0000	0.0000	0.0000	0.0000	0.0000	0.0000	0.0000	0.0000	0.0000		0.0000	0.0000	0.0000		0.0000
Vendor	0.0399	1.1524	0.3110	2.6900e-003	0.0677	5.6800e-003	0.0734	0.0195	5.4300e-003	0.0249		284.3272	284.3272	0.0155		284.7157
Worker	0.0919	0.0650	0.6300	1.9000e-003	0.2054	1.3300e-003	0.2067	0.0545	1.2300e-003	0.0557		189.0164	189.0164	4.6200e-003		189.1319
Total	0.1318	1.2174	0.9410	4.5900e-003	0.2731	7.0100e-003	0.2801	0.0740	6.6600e-003	0.0806		473.3436	473.3436	0.0202		473.8476

3.5 Paving - 2020

Unmitigated Construction On-Site

	ROG	NOx	CO	SO2	Fugitive PM10	Exhaust PM10	PM10 Total	Fugitive PM2.5	Exhaust PM2.5	PM2.5 Total	Bio- CO2	NBio- CO2	Total CO2	CH4	N2O	CO2e
Category	lb/day										lb/day					
Off-Road	1.1547	11.5873	11.8076	0.0178		0.6565	0.6565		0.6051	0.6051		1,709.2180	1,709.2180	0.5417		1,722.7605
Paving	0.1441					0.0000	0.0000		0.0000	0.0000			0.0000			0.0000
Total	1.2988	11.5873	11.8076	0.0178		0.6565	0.6565		0.6051	0.6051		1,709.2180	1,709.2180	0.5417		1,722.7605

Voices Charter School - Bay Area AQMD Air District, Winter

3.5 Paving - 2020

Unmitigated Construction Off-Site

	ROG	NOx	CO	SO2	Fugitive PM10	Exhaust PM10	PM10 Total	Fugitive PM2.5	Exhaust PM2.5	PM2.5 Total	Bio- CO2	NBio- CO2	Total CO2	CH4	N2O	CO2e
Category	lb/day										lb/day					
Hauling	0.0000	0.0000	0.0000	0.0000	0.0000	0.0000	0.0000	0.0000	0.0000	0.0000		0.0000	0.0000	0.0000		0.0000
Vendor	0.0000	0.0000	0.0000	0.0000	0.0000	0.0000	0.0000	0.0000	0.0000	0.0000		0.0000	0.0000	0.0000		0.0000
Worker	0.0552	0.0390	0.3780	1.1400e-003	0.1232	8.0000e-004	0.1240	0.0327	7.4000e-004	0.0334		113.4098	113.4098	2.7700e-003		113.4792
Total	0.0552	0.0390	0.3780	1.1400e-003	0.1232	8.0000e-004	0.1240	0.0327	7.4000e-004	0.0334		113.4098	113.4098	2.7700e-003		113.4792

Mitigated Construction On-Site

	ROG	NOx	CO	SO2	Fugitive PM10	Exhaust PM10	PM10 Total	Fugitive PM2.5	Exhaust PM2.5	PM2.5 Total	Bio- CO2	NBio- CO2	Total CO2	CH4	N2O	CO2e
Category	lb/day										lb/day					
Off-Road	1.1547	11.5873	11.8076	0.0178		0.6565	0.6565		0.6051	0.6051	0.0000	1,709.2180	1,709.2180	0.5417		1,722.7605
Paving	0.1441					0.0000	0.0000		0.0000	0.0000			0.0000			0.0000
Total	1.2988	11.5873	11.8076	0.0178		0.6565	0.6565		0.6051	0.6051	0.0000	1,709.2180	1,709.2180	0.5417		1,722.7605

Voices Charter School - Bay Area AQMD Air District, Winter

3.5 Paving - 2020

Mitigated Construction Off-Site

	ROG	NOx	CO	SO2	Fugitive PM10	Exhaust PM10	PM10 Total	Fugitive PM2.5	Exhaust PM2.5	PM2.5 Total	Bio- CO2	NBio- CO2	Total CO2	CH4	N2O	CO2e
Category	lb/day										lb/day					
Hauling	0.0000	0.0000	0.0000	0.0000	0.0000	0.0000	0.0000	0.0000	0.0000	0.0000		0.0000	0.0000	0.0000		0.0000
Vendor	0.0000	0.0000	0.0000	0.0000	0.0000	0.0000	0.0000	0.0000	0.0000	0.0000		0.0000	0.0000	0.0000		0.0000
Worker	0.0552	0.0390	0.3780	1.1400e-003	0.1232	8.0000e-004	0.1240	0.0327	7.4000e-004	0.0334		113.4098	113.4098	2.7700e-003		113.4792
Total	0.0552	0.0390	0.3780	1.1400e-003	0.1232	8.0000e-004	0.1240	0.0327	7.4000e-004	0.0334		113.4098	113.4098	2.7700e-003		113.4792

3.6 Architectural Coating - 2020

Unmitigated Construction On-Site

	ROG	NOx	CO	SO2	Fugitive PM10	Exhaust PM10	PM10 Total	Fugitive PM2.5	Exhaust PM2.5	PM2.5 Total	Bio- CO2	NBio- CO2	Total CO2	CH4	N2O	CO2e
Category	lb/day										lb/day					
Archit. Coating	1.7116					0.0000	0.0000		0.0000	0.0000			0.0000			0.0000
Off-Road	0.2422	1.6838	1.8314	2.9700e-003		0.1109	0.1109		0.1109	0.1109		281.4481	281.4481	0.0218		281.9928
Total	1.9538	1.6838	1.8314	2.9700e-003		0.1109	0.1109		0.1109	0.1109		281.4481	281.4481	0.0218		281.9928

Voices Charter School - Bay Area AQMD Air District, Winter

3.6 Architectural Coating - 2020

Unmitigated Construction Off-Site

	ROG	NOx	CO	SO2	Fugitive PM10	Exhaust PM10	PM10 Total	Fugitive PM2.5	Exhaust PM2.5	PM2.5 Total	Bio- CO2	NBio- CO2	Total CO2	CH4	N2O	CO2e
Category	lb/day										lb/day					
Hauling	0.0000	0.0000	0.0000	0.0000	0.0000	0.0000	0.0000	0.0000	0.0000	0.0000		0.0000	0.0000	0.0000		0.0000
Vendor	0.0000	0.0000	0.0000	0.0000	0.0000	0.0000	0.0000	0.0000	0.0000	0.0000		0.0000	0.0000	0.0000		0.0000
Worker	0.0184	0.0130	0.1260	3.8000e-004	0.0411	2.7000e-004	0.0413	0.0109	2.5000e-004	0.0111		37.8033	37.8033	9.2000e-004		37.8264
Total	0.0184	0.0130	0.1260	3.8000e-004	0.0411	2.7000e-004	0.0413	0.0109	2.5000e-004	0.0111		37.8033	37.8033	9.2000e-004		37.8264

Mitigated Construction On-Site

	ROG	NOx	CO	SO2	Fugitive PM10	Exhaust PM10	PM10 Total	Fugitive PM2.5	Exhaust PM2.5	PM2.5 Total	Bio- CO2	NBio- CO2	Total CO2	CH4	N2O	CO2e
Category	lb/day										lb/day					
Archit. Coating	1.7116					0.0000	0.0000		0.0000	0.0000			0.0000			0.0000
Off-Road	0.2422	1.6838	1.8314	2.9700e-003		0.1109	0.1109		0.1109	0.1109	0.0000	281.4481	281.4481	0.0218		281.9928
Total	1.9538	1.6838	1.8314	2.9700e-003		0.1109	0.1109		0.1109	0.1109	0.0000	281.4481	281.4481	0.0218		281.9928

Voices Charter School - Bay Area AQMD Air District, Winter

3.6 Architectural Coating - 2020

Mitigated Construction Off-Site

	ROG	NOx	CO	SO2	Fugitive PM10	Exhaust PM10	PM10 Total	Fugitive PM2.5	Exhaust PM2.5	PM2.5 Total	Bio- CO2	NBio- CO2	Total CO2	CH4	N2O	CO2e
Category	lb/day										lb/day					
Hauling	0.0000	0.0000	0.0000	0.0000	0.0000	0.0000	0.0000	0.0000	0.0000	0.0000		0.0000	0.0000	0.0000		0.0000
Vendor	0.0000	0.0000	0.0000	0.0000	0.0000	0.0000	0.0000	0.0000	0.0000	0.0000		0.0000	0.0000	0.0000		0.0000
Worker	0.0184	0.0130	0.1260	3.8000e-004	0.0411	2.7000e-004	0.0413	0.0109	2.5000e-004	0.0111		37.8033	37.8033	9.2000e-004		37.8264
Total	0.0184	0.0130	0.1260	3.8000e-004	0.0411	2.7000e-004	0.0413	0.0109	2.5000e-004	0.0111		37.8033	37.8033	9.2000e-004		37.8264

4.0 Operational Detail - Mobile

4.1 Mitigation Measures Mobile

Voices Charter School - Bay Area AQMD Air District, Winter

	ROG	NOx	CO	SO2	Fugitive PM10	Exhaust PM10	PM10 Total	Fugitive PM2.5	Exhaust PM2.5	PM2.5 Total	Bio- CO2	NBio- CO2	Total CO2	CH4	N2O	CO2e
Category	lb/day										lb/day					
Mitigated	1.3802	6.7755	16.1961	0.0513	4.5070	0.0487	4.5557	1.2059	0.0457	1.2516		5,189.3826	5,189.3826	0.2073		5,194.5649
Unmitigated	1.3802	6.7755	16.1961	0.0513	4.5070	0.0487	4.5557	1.2059	0.0457	1.2516		5,189.3826	5,189.3826	0.2073		5,194.5649

4.2 Trip Summary Information

Land Use	Average Daily Trip Rate			Unmitigated	Mitigated
	Weekday	Saturday	Sunday	Annual VMT	Annual VMT
Elementary School	962.06	0.00	0.00	1,515,196	1,515,196
Parking Lot	0.00	0.00	0.00		
Total	962.06	0.00	0.00	1,515,196	1,515,196

4.3 Trip Type Information

Land Use	Miles			Trip %			Trip Purpose %		
	H-W or C-W	H-S or C-C	H-O or C-NW	H-W or C-W	H-S or C-C	H-O or C-NW	Primary	Diverted	Pass-by
Elementary School	9.50	7.30	7.30	65.00	30.00	5.00	63	25	12
Parking Lot	9.50	7.30	7.30	0.00	0.00	0.00	0	0	0

4.4 Fleet Mix

Land Use	LDA	LDT1	LDT2	MDV	LHD1	LHD2	MHD	HHD	OBUS	UBUS	MCY	SBUS	MH
Elementary School	0.575198	0.040076	0.193827	0.113296	0.016988	0.005361	0.017552	0.025197	0.002581	0.002349	0.005904	0.000881	0.000789
Parking Lot	0.575198	0.040076	0.193827	0.113296	0.016988	0.005361	0.017552	0.025197	0.002581	0.002349	0.005904	0.000881	0.000789

Voices Charter School - Bay Area AQMD Air District, Winter

5.0 Energy Detail

Historical Energy Use: N

5.1 Mitigation Measures Energy

	ROG	NOx	CO	SO2	Fugitive PM10	Exhaust PM10	PM10 Total	Fugitive PM2.5	Exhaust PM2.5	PM2.5 Total	Bio- CO2	NBio- CO2	Total CO2	CH4	N2O	CO2e
Category	lb/day										lb/day					
NaturalGas Mitigated	0.0192	0.1741	0.1463	1.0400e-003		0.0132	0.0132		0.0132	0.0132		208.9233	208.9233	4.0000e-003	3.8300e-003	210.1648
NaturalGas Unmitigated	0.0192	0.1741	0.1463	1.0400e-003		0.0132	0.0132		0.0132	0.0132		208.9233	208.9233	4.0000e-003	3.8300e-003	210.1648

Voices Charter School - Bay Area AQMD Air District, Winter

5.2 Energy by Land Use - NaturalGas

Unmitigated

	NaturalGas Use	ROG	NOx	CO	SO2	Fugitive PM10	Exhaust PM10	PM10 Total	Fugitive PM2.5	Exhaust PM2.5	PM2.5 Total	Bio- CO2	NBio- CO2	Total CO2	CH4	N2O	CO2e
Land Use	kBTU/yr	lb/day										lb/day					
Elementary School	1775.85	0.0192	0.1741	0.1463	1.0400e-003		0.0132	0.0132		0.0132	0.0132		208.9233	208.9233	4.0000e-003	3.8300e-003	210.1648
Parking Lot	0	0.0000	0.0000	0.0000	0.0000		0.0000	0.0000		0.0000	0.0000		0.0000	0.0000	0.0000	0.0000	0.0000
Total		0.0192	0.1741	0.1463	1.0400e-003		0.0132	0.0132		0.0132	0.0132		208.9233	208.9233	4.0000e-003	3.8300e-003	210.1648

Mitigated

	NaturalGas Use	ROG	NOx	CO	SO2	Fugitive PM10	Exhaust PM10	PM10 Total	Fugitive PM2.5	Exhaust PM2.5	PM2.5 Total	Bio- CO2	NBio- CO2	Total CO2	CH4	N2O	CO2e
Land Use	kBTU/yr	lb/day										lb/day					
Elementary School	1.77585	0.0192	0.1741	0.1463	1.0400e-003		0.0132	0.0132		0.0132	0.0132		208.9233	208.9233	4.0000e-003	3.8300e-003	210.1648
Parking Lot	0	0.0000	0.0000	0.0000	0.0000		0.0000	0.0000		0.0000	0.0000		0.0000	0.0000	0.0000	0.0000	0.0000
Total		0.0192	0.1741	0.1463	1.0400e-003		0.0132	0.0132		0.0132	0.0132		208.9233	208.9233	4.0000e-003	3.8300e-003	210.1648

6.0 Area Detail

6.1 Mitigation Measures Area

Voices Charter School - Bay Area AQMD Air District, Winter

	ROG	NOx	CO	SO2	Fugitive PM10	Exhaust PM10	PM10 Total	Fugitive PM2.5	Exhaust PM2.5	PM2.5 Total	Bio- CO2	NBio- CO2	Total CO2	CH4	N2O	CO2e
Category	lb/day										lb/day					
Mitigated	0.8644	6.0000e-005	6.0500e-003	0.0000		2.0000e-005	2.0000e-005		2.0000e-005	2.0000e-005		0.0129	0.0129	3.0000e-005		0.0138
Unmitigated	0.8644	6.0000e-005	6.0500e-003	0.0000		2.0000e-005	2.0000e-005		2.0000e-005	2.0000e-005		0.0129	0.0129	3.0000e-005		0.0138

6.2 Area by SubCategory

Unmitigated

	ROG	NOx	CO	SO2	Fugitive PM10	Exhaust PM10	PM10 Total	Fugitive PM2.5	Exhaust PM2.5	PM2.5 Total	Bio- CO2	NBio- CO2	Total CO2	CH4	N2O	CO2e
SubCategory	lb/day										lb/day					
Architectural Coating	0.1032					0.0000	0.0000		0.0000	0.0000			0.0000			0.0000
Consumer Products	0.7607					0.0000	0.0000		0.0000	0.0000			0.0000			0.0000
Landscaping	5.7000e-004	6.0000e-005	6.0500e-003	0.0000		2.0000e-005	2.0000e-005		2.0000e-005	2.0000e-005		0.0129	0.0129	3.0000e-005		0.0138
Total	0.8644	6.0000e-005	6.0500e-003	0.0000		2.0000e-005	2.0000e-005		2.0000e-005	2.0000e-005		0.0129	0.0129	3.0000e-005		0.0138

Voices Charter School - Bay Area AQMD Air District, Winter

6.2 Area by SubCategory

Mitigated

	ROG	NOx	CO	SO2	Fugitive PM10	Exhaust PM10	PM10 Total	Fugitive PM2.5	Exhaust PM2.5	PM2.5 Total	Bio- CO2	NBio- CO2	Total CO2	CH4	N2O	CO2e
SubCategory	lb/day										lb/day					
Architectural Coating	0.1032					0.0000	0.0000		0.0000	0.0000			0.0000			0.0000
Consumer Products	0.7607					0.0000	0.0000		0.0000	0.0000			0.0000			0.0000
Landscaping	5.7000e-004	6.0000e-005	6.0500e-003	0.0000		2.0000e-005	2.0000e-005		2.0000e-005	2.0000e-005		0.0129	0.0129	3.0000e-005		0.0138
Total	0.8644	6.0000e-005	6.0500e-003	0.0000		2.0000e-005	2.0000e-005		2.0000e-005	2.0000e-005		0.0129	0.0129	3.0000e-005		0.0138

7.0 Water Detail

7.1 Mitigation Measures Water

8.0 Waste Detail

8.1 Mitigation Measures Waste

9.0 Operational Offroad

Equipment Type	Number	Hours/Day	Days/Year	Horse Power	Load Factor	Fuel Type
----------------	--------	-----------	-----------	-------------	-------------	-----------

10.0 Stationary Equipment

Fire Pumps and Emergency Generators

Voices Charter School - Bay Area AQMD Air District, Winter

Equipment Type	Number	Hours/Day	Hours/Year	Horse Power	Load Factor	Fuel Type
----------------	--------	-----------	------------	-------------	-------------	-----------

Boilers

Equipment Type	Number	Heat Input/Day	Heat Input/Year	Boiler Rating	Fuel Type
----------------	--------	----------------	-----------------	---------------	-----------

User Defined Equipment

Equipment Type	Number
----------------	--------

11.0 Vegetation

Voices Charter School
Bay Area AQMD Air District, Mitigation Report

Construction Mitigation Summary

Phase	ROG	NOx	CO	SO2	Exhaust PM10	Exhaust PM2.5	Bio- CO2	NBio- CO2	Total CO2	CH4	N2O	CO2e
Percent Reduction												
Architectural Coating	0.00	0.00	0.00	0.00	0.00	0.00	0.00	0.00	0.00	0.00	0.00	0.00
Building Construction	0.00	0.00	0.00	0.00	0.00	0.00	0.00	0.00	0.00	0.00	0.00	0.00
Grading	0.00	0.00	0.00	0.00	0.00	0.00	0.00	0.00	0.00	0.00	0.00	0.00
Paving	0.00	0.00	0.00	0.00	0.00	0.00	0.00	0.00	0.00	0.00	0.00	0.00
Site Preparation	0.00	0.00	0.00	0.00	0.00	0.00	0.00	0.00	0.00	0.00	0.00	0.00

OFFROAD Equipment Mitigation

Equipment Type	Fuel Type	Tier	Number Mitigated	Total Number of Equipment	DPF	Oxidation Catalyst
Air Compressors	Diesel	No Change	0	1	No Change	0.00
Cement and Mortar Mixers	Diesel	No Change	0	1	No Change	0.00
Cranes	Diesel	No Change	0	1	No Change	0.00
Forklifts	Diesel	No Change	0	2	No Change	0.00
Generator Sets	Diesel	No Change	0	1	No Change	0.00
Graders	Diesel	No Change	0	2	No Change	0.00
Pavers	Diesel	No Change	0	1	No Change	0.00
Paving Equipment	Diesel	No Change	0	1	No Change	0.00
Rollers	Diesel	No Change	0	2	No Change	0.00
Rubber Tired Dozers	Diesel	No Change	0	1	No Change	0.00
Scrapers	Diesel	No Change	0	1	No Change	0.00
Tractors/Loaders/Backhoes	Diesel	No Change	0	5	No Change	0.00
Welders	Diesel	No Change	0	3	No Change	0.00

Equipment Type	ROG	NOx	CO	SO2	Exhaust PM10	Exhaust PM2.5	Bio- CO2	NBio- CO2	Total CO2	CH4	N2O	CO2e
	Unmitigated tons/yr						Unmitigated mt/yr					
Air Compressors	2.66400E-002	1.85220E-001	2.01460E-001	3.30000E-004	1.22000E-002	1.22000E-002	0.00000E+000	2.80858E+001	2.80858E+001	2.17000E-003	0.00000E+000	2.81402E+001
Cement and Mortar Mixers	2.90000E-004	1.84000E-003	1.54000E-003	0.00000E+000	7.00000E-005	7.00000E-005	0.00000E+000	2.29140E-001	2.29140E-001	2.00000E-005	0.00000E+000	2.29730E-001
Cranes	4.98700E-002	5.93070E-001	2.32690E-001	6.30000E-004	2.44500E-002	2.24900E-002	0.00000E+000	5.57618E+001	5.57618E+001	1.80300E-002	0.00000E+000	5.62127E+001
Forklifts	2.77200E-002	2.49770E-001	2.27200E-001	2.90000E-004	1.86100E-002	1.71200E-002	0.00000E+000	2.58511E+001	2.58511E+001	8.36000E-003	0.00000E+000	2.60601E+001
Generator Sets	4.39000E-002	3.82650E-001	4.07610E-001	7.20000E-004	2.15900E-002	2.15900E-002	0.00000E+000	6.21728E+001	6.21728E+001	3.50000E-003	0.00000E+000	6.22603E+001
Graders	2.14000E-003	2.84600E-002	8.17000E-003	3.00000E-005	9.10000E-004	8.40000E-004	0.00000E+000	2.62379E+000	2.62379E+000	8.50000E-004	0.00000E+000	2.64501E+000
Pavers	1.31000E-003	1.40500E-002	1.44900E-002	2.00000E-005	6.80000E-004	6.30000E-004	0.00000E+000	2.06508E+000	2.06508E+000	6.70000E-004	0.00000E+000	2.08178E+000
Paving Equipment	1.04000E-003	1.07100E-002	1.26700E-002	2.00000E-005	5.40000E-004	4.90000E-004	0.00000E+000	1.78955E+000	1.78955E+000	5.80000E-004	0.00000E+000	1.80402E+000
Rollers	2.08000E-003	2.08100E-002	1.89300E-002	3.00000E-005	1.33000E-003	1.22000E-003	0.00000E+000	2.30485E+000	2.30485E+000	7.50000E-004	0.00000E+000	2.32349E+000
Rubber Tired Dozers	3.24000E-003	3.40000E-002	1.23900E-002	3.00000E-005	1.66000E-003	1.53000E-003	0.00000E+000	2.25166E+000	2.25166E+000	7.30000E-004	0.00000E+000	2.26986E+000
Scrapers	1.49000E-003	1.76300E-002	1.11900E-002	2.00000E-005	6.90000E-004	6.30000E-004	0.00000E+000	1.99628E+000	1.99628E+000	6.50000E-004	0.00000E+000	2.01242E+000
Tractors/Loaders/Backhoes	1.97100E-002	1.98020E-001	2.14430E-001	2.90000E-004	1.25200E-002	1.15200E-002	0.00000E+000	2.56652E+001	2.56652E+001	8.30000E-003	0.00000E+000	2.58727E+001
Welders	1.12890E-001	5.18540E-001	5.83110E-001	8.40000E-004	2.86700E-002	2.86700E-002	0.00000E+000	6.21128E+001	6.21128E+001	9.18000E-003	0.00000E+000	6.23423E+001

Equipment Type	ROG	NOx	CO	SO2	Exhaust PM10	Exhaust PM2.5	Bio- CO2	NBio- CO2	Total CO2	CH4	N2O	CO2e
	Mitigated tons/yr						Mitigated mt/yr					
Air Compressors	2.66400E-002	1.85220E-001	2.01460E-001	3.30000E-004	1.22000E-002	1.22000E-002	0.00000E+000	2.80858E+001	2.80858E+001	2.17000E-003	0.00000E+000	2.81401E+001
Cement and Mortar Mixers	2.90000E-004	1.84000E-003	1.54000E-003	0.00000E+000	7.00000E-005	7.00000E-005	0.00000E+000	2.29140E-001	2.29140E-001	2.00000E-005	0.00000E+000	2.29730E-001
Cranes	4.98700E-002	5.93070E-001	2.32690E-001	6.30000E-004	2.44500E-002	2.24900E-002	0.00000E+000	5.57617E+001	5.57617E+001	1.80300E-002	0.00000E+000	5.62126E+001
Forklifts	2.77200E-002	2.49770E-001	2.27200E-001	2.90000E-004	1.86100E-002	1.71200E-002	0.00000E+000	2.58511E+001	2.58511E+001	8.36000E-003	0.00000E+000	2.60601E+001
Generator Sets	4.39000E-002	3.82650E-001	4.07610E-001	7.20000E-004	2.15900E-002	2.15900E-002	0.00000E+000	6.21728E+001	6.21728E+001	3.50000E-003	0.00000E+000	6.22603E+001
Graders	2.14000E-003	2.84600E-002	8.17000E-003	3.00000E-005	9.10000E-004	8.40000E-004	0.00000E+000	2.62379E+000	2.62379E+000	8.50000E-004	0.00000E+000	2.64500E+000
Pavers	1.31000E-003	1.40500E-002	1.44900E-002	2.00000E-005	6.80000E-004	6.30000E-004	0.00000E+000	2.06508E+000	2.06508E+000	6.70000E-004	0.00000E+000	2.08177E+000
Paving Equipment	1.04000E-003	1.07100E-002	1.26700E-002	2.00000E-005	5.40000E-004	4.90000E-004	0.00000E+000	1.78955E+000	1.78955E+000	5.80000E-004	0.00000E+000	1.80402E+000
Rollers	2.08000E-003	2.08100E-002	1.89300E-002	3.00000E-005	1.33000E-003	1.22000E-003	0.00000E+000	2.30485E+000	2.30485E+000	7.50000E-004	0.00000E+000	2.32349E+000
Rubber Tired Dozers	3.24000E-003	3.40000E-002	1.23900E-002	3.00000E-005	1.66000E-003	1.53000E-003	0.00000E+000	2.25165E+000	2.25165E+000	7.30000E-004	0.00000E+000	2.26986E+000
Scrapers	1.49000E-003	1.76300E-002	1.11900E-002	2.00000E-005	6.90000E-004	6.30000E-004	0.00000E+000	1.99628E+000	1.99628E+000	6.50000E-004	0.00000E+000	2.01242E+000
Tractors/Loaders/Balckhoes	1.97100E-002	1.98020E-001	2.14430E-001	2.90000E-004	1.25200E-002	1.15200E-002	0.00000E+000	2.56652E+001	2.56652E+001	8.30000E-003	0.00000E+000	2.58727E+001
Welders	1.12890E-001	5.18540E-001	5.83110E-001	8.40000E-004	2.86700E-002	2.86700E-002	0.00000E+000	6.21127E+001	6.21127E+001	9.18000E-003	0.00000E+000	6.23423E+001

Equipment Type	ROG	NOx	CO	SO2	Exhaust PM10	Exhaust PM2.5	Bio- CO2	NBio- CO2	Total CO2	CH4	N2O	CO2e
Percent Reduction												
Air Compressors	0.00000E+000	0.00000E+000	0.00000E+000	0.00000E+000	0.00000E+000	0.00000E+000	0.00000E+000	1.06816E-006	1.06816E-006	0.00000E+000	0.00000E+000	1.06609E-006
Cement and Mortar Mixers	0.00000E+000	0.00000E+000	0.00000E+000	0.00000E+000	0.00000E+000	0.00000E+000	0.00000E+000	0.00000E+000	0.00000E+000	0.00000E+000	0.00000E+000	0.00000E+000
Cranes	0.00000E+000	0.00000E+000	0.00000E+000	0.00000E+000	0.00000E+000	0.00000E+000	0.00000E+000	1.25534E-006	1.25534E-006	0.00000E+000	0.00000E+000	1.24527E-006
Forklifts	0.00000E+000	0.00000E+000	0.00000E+000	0.00000E+000	0.00000E+000	0.00000E+000	0.00000E+000	1.16049E-006	1.16049E-006	0.00000E+000	0.00000E+000	1.15119E-006
Generator Sets	0.00000E+000	0.00000E+000	0.00000E+000	0.00000E+000	0.00000E+000	0.00000E+000	0.00000E+000	1.12589E-006	1.12589E-006	0.00000E+000	0.00000E+000	1.12431E-006
Graders	0.00000E+000	0.00000E+000	0.00000E+000	0.00000E+000	0.00000E+000	0.00000E+000	0.00000E+000	0.00000E+000	0.00000E+000	0.00000E+000	0.00000E+000	3.78070E-006
Pavers	0.00000E+000	0.00000E+000	0.00000E+000	0.00000E+000	0.00000E+000	0.00000E+000	0.00000E+000	0.00000E+000	0.00000E+000	0.00000E+000	0.00000E+000	4.80358E-006
Paving Equipment	0.00000E+000	0.00000E+000	0.00000E+000	0.00000E+000	0.00000E+000	0.00000E+000	0.00000E+000	0.00000E+000	0.00000E+000	0.00000E+000	0.00000E+000	0.00000E+000
Rollers	0.00000E+000	0.00000E+000	0.00000E+000	0.00000E+000	0.00000E+000	0.00000E+000	0.00000E+000	0.00000E+000	0.00000E+000	0.00000E+000	0.00000E+000	0.00000E+000
Rubber Tired Dozers	0.00000E+000	0.00000E+000	0.00000E+000	0.00000E+000	0.00000E+000	0.00000E+000	0.00000E+000	4.44117E-006	4.44117E-006	0.00000E+000	0.00000E+000	0.00000E+000
Scrapers	0.00000E+000	0.00000E+000	0.00000E+000	0.00000E+000	0.00000E+000	0.00000E+000	0.00000E+000	0.00000E+000	0.00000E+000	0.00000E+000	0.00000E+000	0.00000E+000
Tractors/Loaders/Balckhoes	0.00000E+000	0.00000E+000	0.00000E+000	0.00000E+000	0.00000E+000	0.00000E+000	0.00000E+000	1.16890E-006	1.16890E-006	0.00000E+000	0.00000E+000	1.15952E-006
Welders	0.00000E+000	0.00000E+000	0.00000E+000	0.00000E+000	0.00000E+000	0.00000E+000	0.00000E+000	1.28798E-006	1.28798E-006	0.00000E+000	0.00000E+000	1.28324E-006

Fugitive Dust Mitigation

Yes/No Mitigation Measure Mitigation Input Mitigation Input Mitigation Input

No	Soil Stabilizer for unpaved Roads	PM10 Reduction	PM2.5 Reduction	
No	Replace Ground Cover of Area Disturbed	PM10 Reduction	PM2.5 Reduction	
No	Water Exposed Area	PM10 Reduction	PM2.5 Reduction	Frequency (per day)

No	Unpaved Road Mitigation	Moisture Content %		Vehicle Speed (mph)	0.00		
No	Clean Paved Road	% PM Reduction	0.00				

Phase	Source	Unmitigated		Mitigated		Percent Reduction	
		PM10	PM2.5	PM10	PM2.5	PM10	PM2.5
Architectural Coating	Fugitive Dust	0.00	0.00	0.00	0.00	0.00	0.00
Architectural Coating	Roads	0.00	0.00	0.00	0.00	0.00	0.00
Building Construction	Fugitive Dust	0.00	0.00	0.00	0.00	0.00	0.00
Building Construction	Roads	0.03	0.01	0.03	0.01	0.00	0.00
Grading	Fugitive Dust	0.02	0.01	0.02	0.01	0.00	0.00
Grading	Roads	0.00	0.00	0.00	0.00	0.00	0.00
Paving	Fugitive Dust	0.00	0.00	0.00	0.00	0.00	0.00
Paving	Roads	0.00	0.00	0.00	0.00	0.00	0.00
Site Preparation	Fugitive Dust	0.00	0.00	0.00	0.00	0.00	0.00
Site Preparation	Roads	0.00	0.00	0.00	0.00	0.00	0.00

Operational Percent Reduction Summary

Category	ROG	NOx	CO	SO2	Exhaust PM10	Exhaust PM2.5	Bio- CO2	NBio- CO2	Total CO2	CH4	N2O	CO2e
Percent Reduction												
Architectural Coating	0.00	0.00	0.00	0.00	0.00	0.00	0.00	0.00	0.00	0.00	0.00	0.00
Consumer Products	0.00	0.00	0.00	0.00	0.00	0.00	0.00	0.00	0.00	0.00	0.00	0.00
Electricity	0.00	0.00	0.00	0.00	0.00	0.00	0.00	0.00	0.00	0.00	0.00	0.00
Hearth	0.00	0.00	0.00	0.00	0.00	0.00	0.00	0.00	0.00	0.00	0.00	0.00
Landscaping	0.00	0.00	0.00	0.00	0.00	0.00	0.00	0.00	0.00	0.00	0.00	0.00
Mobile	0.00	0.00	0.00	0.00	0.00	0.00	0.00	0.00	0.00	0.00	0.00	0.00
Natural Gas	0.00	0.00	0.00	0.00	0.00	0.00	0.00	0.00	0.00	0.00	0.00	0.00
Water Indoor	0.00	0.00	0.00	0.00	0.00	0.00	0.00	0.00	0.00	0.00	0.00	0.00
Water Outdoor	0.00	0.00	0.00	0.00	0.00	0.00	0.00	0.00	0.00	0.00	0.00	0.00

Operational Mobile Mitigation

Project Setting:

Mitigation	Category	Measure	% Reduction	Input Value 1	Input Value 2	Input Value
No	Land Use	Increase Density	0.00			
No	Land Use	Increase Diversity	0.09	0.30		
No	Land Use	Improve Walkability Design	0.00			
No	Land Use	Improve Destination Accessibility	0.00			
No	Land Use	Increase Transit Accessibility	0.25			
No	Land Use	Integrate Below Market Rate Housing	0.00			
	Land Use	Land Use SubTotal	0.00			

No	Neighborhood Enhancements	Improve Pedestrian Network			
No	Neighborhood Enhancements	Provide Traffic Calming Measures			
No	Neighborhood Enhancements	Implement NEV Network	0.00		
	Neighborhood Enhancements	Neighborhood Enhancements Subtotal	0.00		
No	Parking Policy Pricing	Limit Parking Supply	0.00		
No	Parking Policy Pricing	Unbundle Parking Costs	0.00		
No	Parking Policy Pricing	On-street Market Pricing	0.00		
	Parking Policy Pricing	Parking Policy Pricing Subtotal	0.00		
No	Transit Improvements	Provide BRT System	0.00		
No	Transit Improvements	Expand Transit Network	0.00		
No	Transit Improvements	Increase Transit Frequency	0.00		
	Transit Improvements	Transit Improvements Subtotal	0.00		
		Land Use and Site Enhancement Subtotal	0.00		
No	Commute	Implement Trip Reduction Program			
No	Commute	Transit Subsidy			
No	Commute	Implement Employee Parking "Cash Out"			
No	Commute	Workplace Parking Charge			
No	Commute	Encourage Telecommuting and Alternative Work Schedules	0.00		
No	Commute	Market Commute Trip Reduction Option	0.00		
No	Commute	Employee Vanpool/Shuttle	0.00		2.00
No	Commute	Provide Ride Sharing Program			
	Commute	Commute Subtotal	0.00		

No	School Trip	Implement School Bus Program	0.00		
		Total VMT Reduction	0.00		

Area Mitigation

Measure Implemented	Mitigation Measure	Input Value
No	Only Natural Gas Hearth	
No	No Hearth	
No	Use Low VOC Cleaning Supplies	
No	Use Low VOC Paint (Residential Interior)	100.00
No	Use Low VOC Paint (Residential Exterior)	150.00
No	Use Low VOC Paint (Non-residential Interior)	100.00
No	Use Low VOC Paint (Non-residential Exterior)	150.00
No	Use Low VOC Paint (Parking)	150.00
No	% Electric Lawnmower	
No	% Electric Leafblower	
No	% Electric Chainsaw	

Energy Mitigation Measures

Measure Implemented	Mitigation Measure	Input Value 1	Input Value 2
No	Exceed Title 24		
No	Install High Efficiency Lighting		
No	On-site Renewable		

Appliance Type	Land Use Subtype	% Improvement
ClothWasher		30.00
DishWasher		15.00
Fan		50.00
Refrigerator		15.00

Water Mitigation Measures

Measure Implemented	Mitigation Measure	Input Value 1	Input Value 2
No	Apply Water Conservation on Strategy		
No	Use Reclaimed Water		
No	Use Grey Water		
No	Install low-flow bathroom faucet	32.00	
No	Install low-flow Kitchen faucet	18.00	
No	Install low-flow Toilet	20.00	
No	Install low-flow Shower	20.00	
No	Turf Reduction		
No	Use Water Efficient Irrigation Systems	6.10	
No	Water Efficient Landscape		

Solid Waste Mitigation

Mitigation Measures	Input Value
---------------------	-------------

Institute Recycling and Composting Services Percent Reduction in Waste Disposed	
--	--

Appendix B

Biological Report and Tree Survey Report



LIVE OAK ASSOCIATES, INC.

an Ecological Consulting Firm

VOICES CHARTER SCHOOL TECHNICAL BIOLOGICAL REPORT MORGAN HILL, SANTA CLARA COUNTY, CALIFORNIA

Prepared by

LIVE OAK ASSOCIATES, INC.

Rick Hopkins, Ph.D., Principal/Senior Wildlife Ecologist
Katrina Krakow, M.S., Project Manager/Staff Ecologist

Prepared for

Raney Planning and Management, Inc.
ATTN: Nick Pappani
1501 Sports Drive
Sacramento, CA 95834

March 11, 2019

PN 2344-01

Oakhurst: P.O. Box 2697 • 39930 Sierra Way, Suite B • Oakhurst, CA 93644 • Phone: (559) 642-4880 • Fax: (559) 642-4883
San Jose: 6840 Via Del Oro, Suite 220 • San Jose, CA 95119 • Phone: (408) 224-8300 • Fax: (408) 224-1411
Truckee: P.O. Box 8810 • Truckee, CA 96161 • Phone: (530) 214-8947

www.loainc.com

TABLE OF CONTENTS

1 INTRODUCTION.....1
 1.1 PROJECT DESCRIPTION.....3

2 EXISTING CONDITIONS.....5
 2.1 BIOTIC HABITATS6
 2.1.1 California Annual Grassland6
 2.1.2 Mixed Riparian Woodland and Forest6
 2.1.3 Channel (West Little Llagas Creek).....7
 2.1.4 Developed/Hardscape.....7
 2.2 MOVEMENT CORRIDORS9
 2.3 SPECIAL STATUS PLANTS AND ANIMALS11
 2.4 JURISDICTIONAL WATERS.....22

3 IMPACTS AND MITIGATIONS.....23
 3.1 SIGNIFICANCE CRITERIA23
 3.2 RELEVANT GOALS, POLICIES, AND LAWS24
 3.2.1 Threatened and Endangered Species24
 3.2.2 Migratory Birds25
 3.2.3 Birds of Prey.....25
 3.2.4 Bats.....25
 3.2.5 Wetlands and Other “Jurisdictional Waters”.....26
 3.2.6 Ordinance Sized Trees.....28
 3.2.7 2035 General Plan31
 3.2.8 Santa Clara Valley Habitat Plan.....37
 3.3 IMPACTS SPECIFIC TO THE PROJECT.....41
 3.3.1 Loss of Habitat for Special Status Plants41
 3.3.2 Loss of Habitat for Special Status Animals.....41
 3.3.3 Loss of Habitat for Native Wildlife.....42
 3.3.4 Interference with the Movement of Native Wildlife42
 3.3.5 Impacts to Nesting Migratory Bird Including Nesting Raptors and other
 Protected Birds43
 3.3.6 Impacts to Western Burrowing Owls43
 3.3.7 Potential Impacts to Riparian Habitat and Other Sensitive Natural Communities,
 Including Federally and State Protected Wetlands.....46
 3.3.8 Degradation of Water Quality in Seasonal Drainages, Stock Ponds and
 Downstream Waters46
 3.3.9 Conflict with Local Policies and Ordinances: City of Morgan Hill Tree
 Ordinance.....47
 3.3.10 Conflict with Local Policies and Ordinances: 2035 General Plan47
 3.3.11 Conflict with Local Policies and Ordinances: Santa Clara Valley Habitat
 Conservation Plan.....47

4 LITERATURE CITED.....52

1 INTRODUCTION

This site was evaluated by Live Oak Associates, Inc. (LOA) to ascertain whether or not build-out of the proposed project would have a significant impact (as defined by CEQA) on the biological resources of the site and region. This report describes the biotic resources of the Voices Charter School Property (hereafter referred to as the “study area” or “site”), in Morgan Hill, California and evaluates possible impacts to these resources resulting from the proposed land use changes upon these resources. The site is bordered by Monterey Road to the east, Cosmo Avenue to the south, apartment complexes to the east, and vacant land to the north, and includes a portion of Little Llagas Creek on the eastern side of the site, and is located in the City of Morgan Hill, Santa Clara County, California (Figure 1). The site can be found on the Mt. Madonna U.S.G.S. 7.5’ quadrangle in Section 31 of Township 6 South, Range 2 East. The site is comprised of pasture with a residence, barns, stables, and outbuildings.

In general, the development of parcels can damage or modify biotic habitats used by sensitive plant and wildlife species. In such cases, site development may be regulated by state or federal agencies, subject to provisions of the California Environmental Quality Act (CEQA), and/or covered by policies and ordinances of the City of Morgan Hill. Therefore, this report addresses issues related to: 1) sensitive biotic resources occurring in the study area; 2) the federal, state, and local laws regulating such resources, 3) evaluate whether or not the project results in any significant impacts to these resources; and if so, 4) includes mitigation measures to reduce these impacts to less-than-significant (as defined by CEQA).

The analysis of impacts, as discussed in Section 3.0 of this report, was based on the known and potential biotic resources of the study area discussed in Section 2.0. Sources of information used in the preparation of this analysis included: 1) the *California Natural Diversity Data Base* (RareFind5, 2019); 2) the *California Rare Plant Rank* (CNPS 2019); 3) manuals and references related to plants and animals of the Santa Clara Valley region; 4) the City of San Jose policies and ordinances; and 5) the Santa Clara Valley Habitat Plan (SCVHP; 2012).

A field survey of the study area was conducted on March 1, 2019 by LOA ecologist Katrina Krakow.

Site Location Map

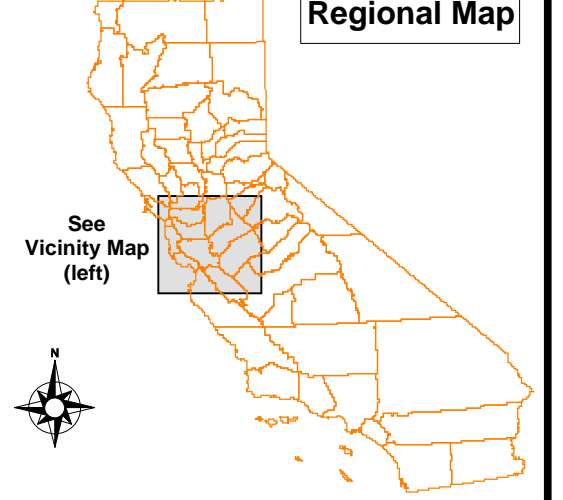
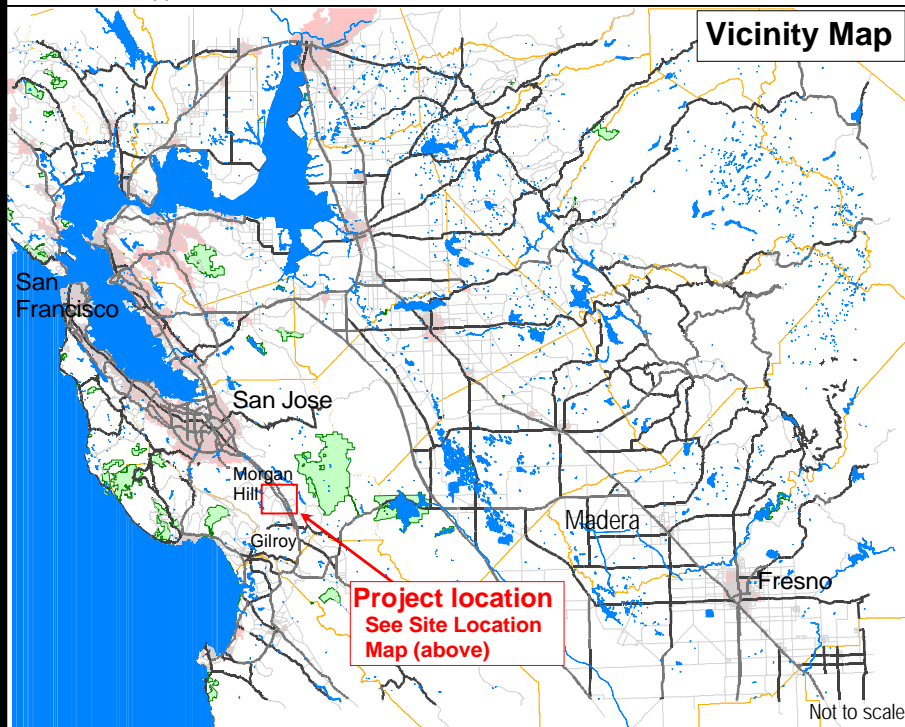
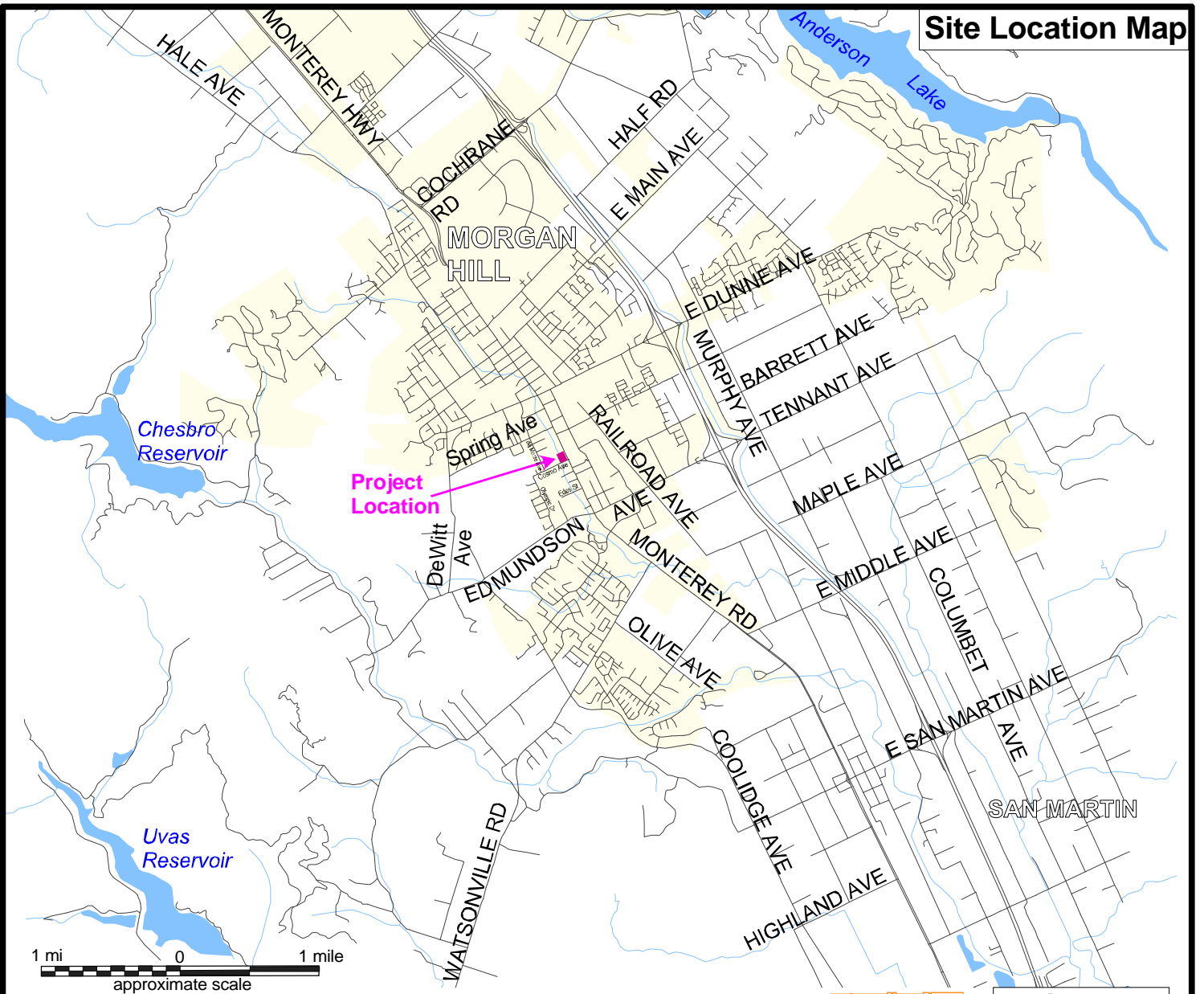

 Live Oak Associates, Inc.		
Voices Charter School Site / Vicinity Map		
Date	Project #	Figure #
2/26/2019	2344-01	1

1.1 PROJECT DESCRIPTION

The project, as proposed, would develop the site into a charter school with associated playground, parking lot, landscaping, and interpretive trail along the east side of West Little Llagas Creek. See Figure 2 for the Site Plan.



Date	Project #	Figure #
2/26/2019	2344-01	2

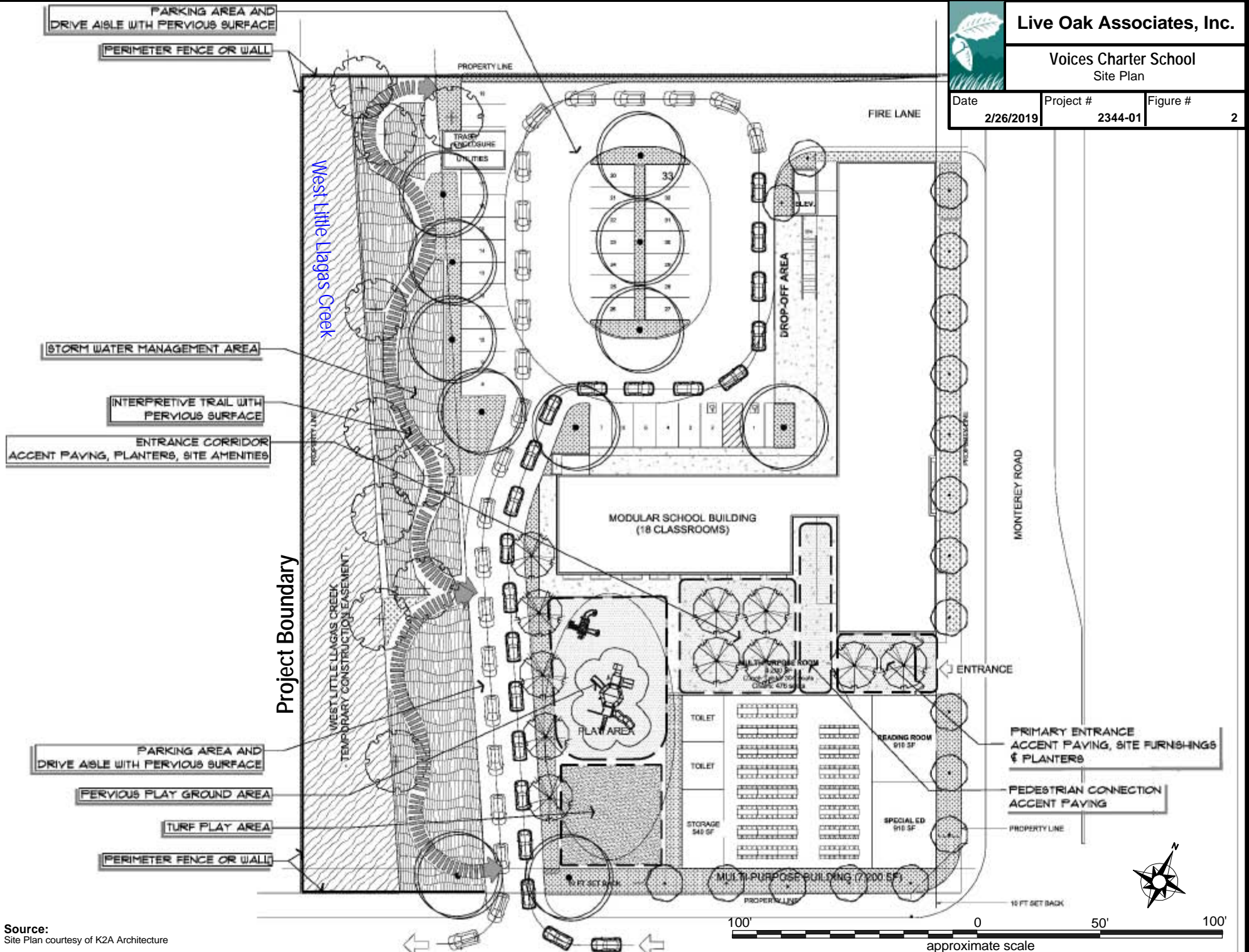

Source:
Site Plan courtesy of K2A Architecture

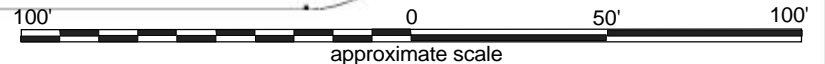

2 EXISTING CONDITIONS

The project site is located at the northwest corner of Monterey Road and Cosmo Avenue in Morgan Hill, Santa Clara County, California. The site is bordered by Monterey Road to the east, Cosmo Avenue to the south, apartment complexes to the east, and vacant land to the north, and includes a portion of Little Llagas Creek on the eastern side of the site. The site has a relatively flat topography with the elevation increasing as the site progresses to the northeast and is approximately 330 feet (100 meters) National Geodetic Vertical Datum (NGVD).

Annual precipitation in the general vicinity of the study area is about 15-20 inches, almost 85% of which falls between the months of October and March. Virtually all precipitation falls in the form of rain.

Two soil map units occur onsite: Cropley clay to 2 percent slopes (very deep, moderately well and well drained soils, slow permeability); MLRA 14 and San Ysidro loam, 0 to 2 percent slopes, MLRA 14 (very deep, moderately well drained soils with very slow permeability, and mildly alkaline). Both of the soils onsite are considered to be hydric.

2.1 BIOTIC HABITATS

Three land cover types are present on the Voices Charter School and these have been named consistent with nomenclature for land cover types contained in the Santa Clara Valley Habitat Plan (SCVHP). These three land cover types include California Annual Grassland; Mixed Riparian Woodland and Forest; and Category 2 Stream (West Little Llagas Creek). These land cover types are described in greater detail below.

2.1.1 California Annual Grassland

This is the most prevalent land cover type present on the property. This land cover type is comprised of California annual grassland habitat dominated by non-native species. A few puddles existed on the project site on the side of Monterey Road at the time of the March survey which occurred after significant rain; these puddles are not classified as wetlands and did not support wetland vegetation. Constituent grass species observed in this habitat included grasses including wild oat (*Avena* sp.), and ripgut brome (*Bromus diandrus*), farmer's foxtail (*Hordeum murinum*), and annual bluegrass (*Poa annua*). In addition to the grasses, several forb species were also observed including fiddleneck (*Amsinckia* sp.), common mustard (*Brassica rapa*), Italian thistle (*Carduus pycnocephalus*), chicory (*Cichorium intybus*), Bermuda grass (*Cynodon dactylon*), filaree (*Erodium* sp.), bedstraw (*Galium aparine*), dissected geranium (*Geranium dissectum*), mallow (*Malva* sp.), burclover (*Medicago polymorpha*), English plantain (*Plantago lanceolata*), wild radish (*Raphanus raphanistrum*), curly dock (*Rumex crispus*), corn spurry (*Spergula arvensis*) and vetch (*Vicia* sp.). Woody vegetation was limited to included grape (*Vitis vinifera*) and walnut (*Juglans* sp.).

Wildlife observed within or flying over the grasslands of the site during the March survey included the American crow (*Corvus brachyrhynchos*), northern mockingbird (*Mimus polyglottos*), black phoebe (*Sayornis nigricans*), and house finch (*Haemorhous mexicanus*). Additionally, Botta's pocket gopher (*Thomomys bottae*) sign and a few California ground squirrel (*Otospermophilus beecheyi*) burrows were observed onsite.

2.1.2 Mixed Riparian Woodland and Forest

The next most prevalent land cover type on the parcel is comprised of two walnut trees growing on the banks of West Little Llagas Creek; one tree is on the western bank and the other tree is on

the eastern bank. This habitat is classified as “Mixed Riparian Woodland and Forest” within the SCVHP. The project is not expected to impact these two trees.

Wildlife occurring in adjacent habitats are likely to occur within this habitat as well.

2.1.3 Channel (West Little Llagas Creek)

West Little Llagas Creek runs along the western boundary of the property. This creek has been channelized and has steep banks. Stream width is steady at approximately 10 feet, moving to approximately 14 feet wide at Cosmo Avenue, under which exist two four-foot culverts. West Little Llagas Creek is considered to be a “Category 2 Stream” under the SCVHP. This land cover also supports grasses found in the adjacent habitat, with the addition of canary grass (*Phalaris sp.*) on the banks.

Wildlife occurring in adjacent habitats are likely to occur within this habitat as well.

2.1.4 Developed/Hardscape

A small section of sidewalk apron exists in the southeastern corner of the site.

LEGEND

-  Project Boundary
-  Top of Bank / Edge of Riparian
-  California Annual Grassland
-  West Little Llagas Crk
-  Mixed Riparian Woodland & Forest
-  Developed / Hardscape

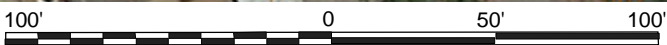

Source: approximate scale
 Topographic Contours courtesy of Santa Clara Valley Water District
 Aerial Photograph courtesy of Google Earth, 2018



Live Oak Associates, Inc.

Voices Charter School
 Biotic Habitats

Date	Project #	Figure #
2/26/2019	2344-01	3

2.2 MOVEMENT CORRIDORS

Ecologists and conservation biologists have expended a great deal of energy since the early 1980's advocating the protection and restoration of landscape linkages among suitable habitat patches. Movement corridors or landscape linkages are usually linear habitats that connect two or more habitat patches (Harris and Gallager 1989), providing assumed benefits to the species by reducing inbreeding depression, and increasing the potential for recolonization of habitat patches. Some researchers have even demonstrated that poor quality corridors can still provide some benefit to the species that use them (Beier 1996).

Beier and Noss (1998) evaluated the claims of the efficacy of wildlife corridors of 32 scientific papers. In general, these authors believed that the utility of corridors was demonstrated in fewer than half of the reviewed papers, and they believed that study design played a role in whether or not given corridors were successful. Examples of well-designed studies supported the value of corridors. They believed, however, that connectivity questions make sense only in terms "of a particular focal species and landscape." For example, volant (flying) species are less affected by barriers than small, slow moving species such as frogs or snakes (Beier and Noss 1998). In addition, large mammals such as carnivores that can move long distances in a single night (e.g., cougars) are more capable of making use of poor quality or inhospitable terrain than species that move more slowly and can easily fall prey to various predators or that are less able to avoid traffic or other anthropogenic effects (Beier 1996). Therefore, it is reasonable to conclude that landscape linkages, even poor ones, can be and are useful, especially for terrestrial species.

Therefore, while the importance of landscape linkages is well demonstrated in the scientific literature, the cautionary note of Beier and Noss (1998) that consideration of context and ecological scale are also of critical importance in evaluating linkages.

Habitat corridors are vital to terrestrial animals for connectivity between core habitat areas (i.e., larger intact habitat areas where species make their living). Connections between two or more core habitat areas help ensure that genetic diversity is maintained, thereby diminishing the probability of inbreeding depression and geographic extinctions.

The quality of habitat within the corridors is important: "better" habitat consists of an area with a minimum of human interference (e.g., roads, homes, etc.) and is more desirable to more species

than areas with sparse vegetation and high-density roads. Movement corridors in California are typically associated with valleys, rivers and creeks supporting riparian vegetation, and ridgelines. With increasing encroachment of humans on wildlife habitats, it has become important to establish and maintain linkages, or movement corridors, for animals to be able to access locations containing different biotic resources that are essential to maintaining their life cycles.

Healthy riparian areas (supporting structural diversity, i.e., understory species to saplings to mature riparian trees) have a high biological value as they not only support a rich and diverse wildlife community but have also been shown to facilitate regional wildlife movement. Riparian areas can vary from tributaries winding through scrubland to densely vegetated riparian forests.

A riparian zone can be defined as an area that has a source of fresh water (e.g., rill, stream, river), a defined bank, and upland areas consisting of moist soils (e.g., wetter than would be expected simply due to seasonal precipitation). These areas support a characteristic suite of vegetative species, many of which are woody, that are adapted to moister soils. Such vegetation in hills surrounding San Jose include California buckeye (*Aesculus californica*), dogwood (*Cornus* sp.), California hazelnut (*Corylus cornuta* var. *californica*), elderberry (*Sambucus* sp.), Oregon ash (*Fraxinus latifolia*), walnut (*Juglans* sp.), California laurel (*Umbellularia californica*), toyon (*Heteromeles arbutifolia*), oaks (*Quercus* sp.), and willow (*Salix* sp.).

Beier and Loe (1992) noted five functions of corridors (rather than physical traits) that are relevant when conducting an analysis regarding the value of linkages. The following five functions should be used to evaluate the suitability of a given tract of land for use as a habitat corridor:

1. Wide ranging mammals can migrate and find mates;
2. Plants can propagate within the corridor and beyond;
3. Genetic integrity can be maintained;
4. Animals can use the corridor in response to environmental changes or a catastrophic event;
5. Individuals can recolonize areas where local extinctions have occurred.

A corridor is “wide enough” when it meets these functions for the suite of animals in the area. It is important to note that landscape linkages are used differently by different species. For instance, medium to large mammals (or some bird species) may traverse a corridor in a matter of minutes

or hours, while smaller mammals or other species may take a longer period of time to move through the same corridor (e.g., measured in days, weeks and even years). For example, an individual cougar may traverse the entire length of a long narrow corridor in an hour while travel of smaller species (such as rodent or rabbit species) may best be measured as gene flow within regional populations. These examples demonstrate that landscape linkages are not simply highways that animals use to move back and forth. While linkages may serve this purpose, they also allow for slower or more infrequent movement. Width and length must be considered in evaluating the value of a landscape linkage. A long narrow corridor would most likely only be useful to wide ranging animals such as cougars and coyotes when moving between core habitat areas.

To the extent practicable, conservation of linkages should address the needs of “passage species” (those species that typically use a corridor for the express purpose of moving from one intact area to another) *and* “corridor dwellers” (slow moving species such as plants and some amphibians and reptiles that require days or generations to move through the corridor).

Although the reach of West Little Llagas Creek onsite may support local wildlife movement, the project site does not fall within any regional corridor defined by the SCVHP. Movements on and across the site consists of normal movements associated with an individual animal’s home range or territory, or animals dispersing from their natal range.

2.3 SPECIAL STATUS PLANTS AND ANIMALS

Several species of plants and animals within the state of California have low populations, limited distributions, or both. Such species may be considered “rare” and are vulnerable to extirpation as the state’s human population grows and the habitats these species occupy are converted to agricultural and urban uses. As described more fully in Section 3.2, state and federal laws have provided the California Department of Fish and Wildlife (CDFW) and the U.S. Fish and Wildlife Service (USFWS) with a mechanism for conserving and protecting the diversity of plant and animal species native to the state. A sizable number of native plants and animals have been formally designated as threatened or endangered under state and federal endangered species legislation. Others have been designated as “candidates” for such listing. Still others have been designated as “species of special concern” by the CDFW. The California Native Plant Society

(CNPS) has developed its own set of lists of native plants considered rare, threatened, or endangered (CNPS 2001). Collectively, these plants and animals are referred to as “special status species.”

A number of special status plants and animals occur in the vicinity of the study area. These species, and their potential to occur in the study area, are listed in Table 1. Sources of information for this table included *California Natural Diversity Data Base* (CDFW 2019), *Listed Plants and Listed Animals* (USFWS 2019), *State and Federally Listed Endangered and Threatened Animals of California* (CDFW 2019), *The California Native Plant Society’s Inventory of Rare and Endangered Vascular Plants of California* (CNPS 2019), *California Bird Species of Special Concern* (Shuford and Gardall 2008), and *California Amphibian and Reptile Species of Special Concern* (Thompson et al. 2016). This information was used to evaluate the potential for special status plant and animal species that occur on the site. Figures 4a and 4b depict the location of special status species found by the California Natural Diversity Data Base (CNDDDB).

A search of published accounts for all of the relevant special status plant and animal species was conducted for the Mt. Madonna USGS 7.5 minute quadrangle in which the project site occurs, and for the eight surrounding quadrangles (Santa Teresa Hills, Morgan Hill, Mt. Sizer, Loma Prieta, Gilroy, Watsonville West, Watsonville East, Chittenden) using the California Natural Diversity Data Base (CNDDDB) Rarefind5. All species listed as occurring in these quadrangles on CNPS Lists 1A, 1B, 2, or 4 were also reviewed (See Figures 4a and 4b).

Serpentine soils are absent from the site; as such, those species that are uniquely adapted to serpentine conditions in the project’s vicinity are considered absent from the site. These species include the Bay checkerspot butterfly (*Euphydryas editha bayensis*), big-scale balsamroot (*Balsamorhiza macrolepis* var. *macrolepis*), Tiburon Indian paintbrush (*Castilleja affinis* ssp. *neglecta*), pink creamsacs (*Castilleja rubicundula* ssp. *rubicundula*), coyote ceanothus (*Ceanothus ferrisae*), dwarf soaproot (*Chlorogalum pomeridianum* var. *minus*), Mt. Hamilton fountain thistle (*Cirsium fontinale* var. *campylon*), San Francisco collinsia (*Collinsia multicolor*), Santa Clara Valley dudleya (*Dudleya abramsii* ssp. *setchellii*), smooth lessingia (*Lessingia micradenia* ssp. *glabrata*), woodland woollythreads (*Monolopia gracilens*), Metcalf Canyon jewel-flower (*Streptanthus albidus* ssp. *albidus*), and most beautiful jewel-flower (*Streptanthus albidus* ssp. *peramoenus*).

Several other special status plant species have been ruled out on the site as they occur in habitats not present in the study area (e.g., vernal pool, chaparral, broadleafed forest, coastal prairie, coastal scrub, etc.) or at elevations significantly below or above elevations of the site (approximately 100 meters NGVD) and, therefore, are also considered absent from the site. These species include the Anderson's manzanita (*Arctostaphylos andersonii*), Hooker's manzanita (*Arctostaphylos hookeri* ssp. *hookeri*), Pajaro manzanita (*Arctostaphylos pajaroensis*), Santa Cruz Mountains pussypaws (*Calyptridium parryi* var. *hesseae*), Monterey spineflower (*Chorizanthe pungens* var. *pungens*), robust spineflower (*Chorizanthe robusta* var. *robusta*), Santa Clara red ribbons (*Clarkia concinna* ssp. *automixa*), Hoover's button-celery (*Eryngium aristulatum* var. *hooveri*), Sand-loving wallflower (*Erysimum ammophilum*), Monterey gilia (*Gilia tenuiflora* ssp. *arenaria*), Kellogg's horkelia (*Horkelia cuneata* var. *sericea*), arcuate bush-mallow (*Malacothamnus arcuatus*), Hall's bush-mallow (*Malacothamnus hallii*), Santa Cruz Mountains beardtongue (*Penstemon rattanii* var. *kleei*), Choris' popcorn-flower (*Plagiobothrys chorisianus* var. *chorisianus*), and Santa Cruz clover (*Trifolium buckwestiorum*).

Other species having potential to occur on the project site or immediate vicinity because suitable habitats are present are discussed further below.

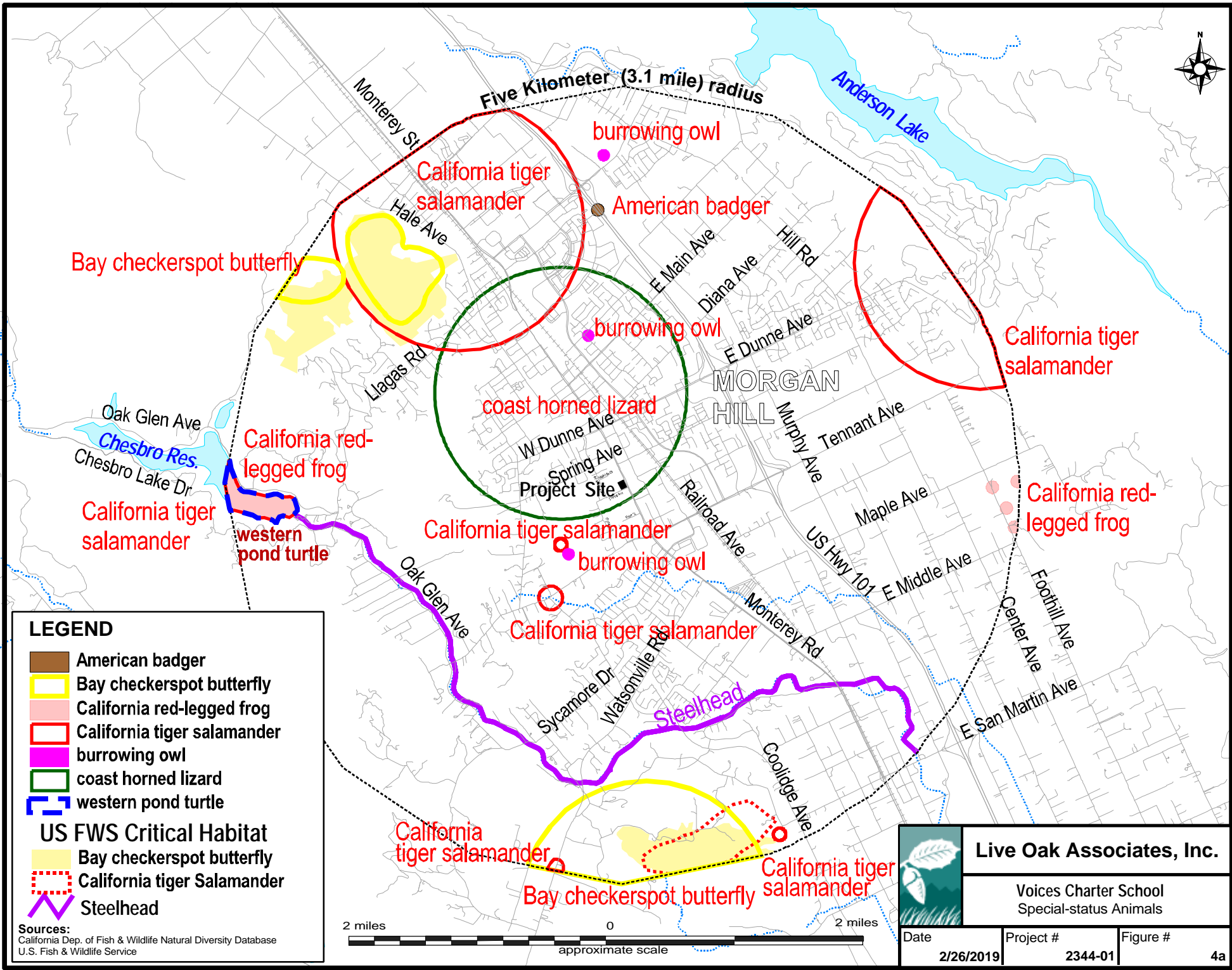

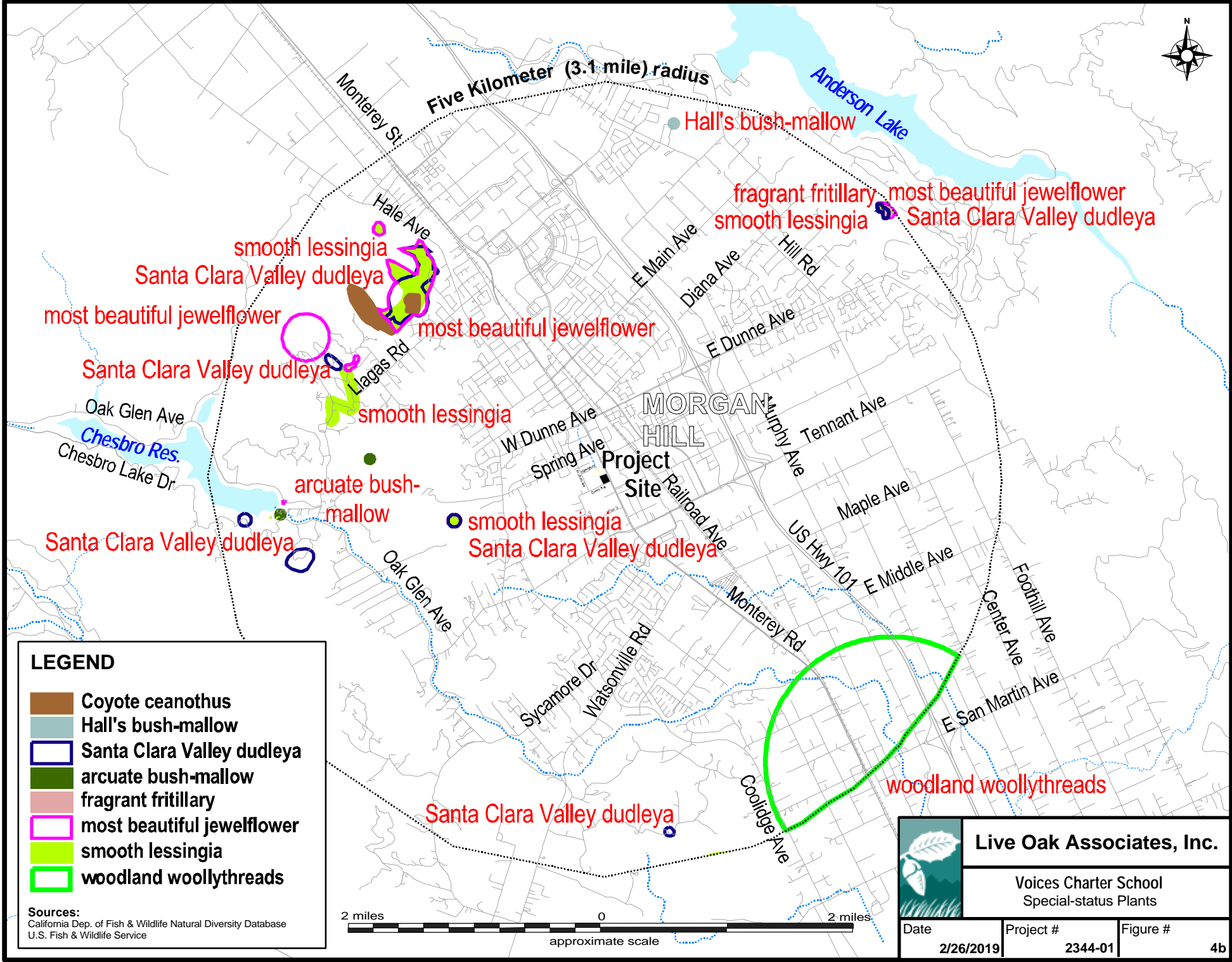

LEGEND

- Coyote ceanothus
- Hall's bush-mallow
- Santa Clara Valley dudleya
- arcuate bush-mallow
- fragrant fritillary
- most beautiful jewelflower
- smooth lessingia
- woodland woollythreads

Sources:
California Dep. of Fish & Wildlife Natural Diversity Database
U.S. Fish & Wildlife Service

	Live Oak Associates, Inc.		
	Voices Charter School Special-status Plants		
Date	Project #	Figure #	
2/26/2019	2344-01	4b	

TABLE 1. LIST OF SPECIAL STATUS SPECIES THAT COULD OCCUR IN THE PROJECT VICINITY

PLANTS (adapted from CDFW 2019 and CNPS 2019)

Species Listed as Threatened or Endangered under the State and/or Federal Endangered Species Act

Species	Status	Habitat	Occurrence in the Study Area
Santa Cruz tarplant (<i>Holocarpha macradenia</i>)	FT, CE, CNPS 1B	<u>Habitat:</u> Occurs coastal prairie, coastal scrub, and valley and foothill grasslands, often in clay or sandy soils. <u>Elevation:</u> 10-220 meters. <u>Blooms:</u> Annual herb; June-October.	Absent. Although species is known to occur in grassland habitats, the grasslands of the site are heavily disturbed and heavily dominated by annual grasses, and therefore do not provide suitable habitat for this species. Also, this species is only known from Alameda, Contra Costa and Santa Cruz Counties (CNDDDB 2019).
San Francisco popcornflower (<i>Plagiobothrys diffusus</i>)	CE, CNPS 1B	<u>Habitat:</u> Occurs in coastal prairie and valley and foothill grassland. <u>Elevation:</u> 60-360 meters. <u>Blooms:</u> March-June.	Absent. Although species is known to occur in grassland habitats, the grasslands of the site are heavily disturbed and heavily dominated by annual grasses, and therefore do not provide suitable habitat for this species. Additionally, there are no known occurrences of this species within a three-mile radius of the site (CNDDDB 2019).

PLANTS (adapted from CDFW 2019 and CNPS 2019)

Other special status plants listed by CNPS

Species	Status	Habitat	Occurrence in the Study Area
Congdon's tarplant (<i>Centromadia parryi</i> ssp. <i>congdonii</i>)	CNPS 1B	<u>Habitat:</u> Occurs chaparral and cismontane woodlands. <u>Elevation:</u> 90-1500 meters. <u>Blooms:</u> Annual herb; April-May.	Absent. Although species is known to occur in disturbed grasslands, soils are only mildly alkaline soils on the study area for this species. Additionally, there are no known occurrences of this species within a three-mile radius of the site (CNDDDB 2019).
Fragrant fritillary (<i>Fritillaria liliacea</i>)	CNPS 1B	<u>Habitat:</u> Occurs in grassland, chaparral, cismontane woodland, riparian woodland, often on serpentine. <u>Elevation:</u> 30-860 meters. <u>Blooms:</u> Perennial herb; May-October.	Absent. Although species is known to occur in grassland habitats and on clay soils, which are present on the site, the grasslands of the site are heavily disturbed and heavily dominated by annual grasses, and therefore do not provide suitable habitat for this species. Additionally, this species is now found primarily on serpentine soils which are absent from the site and the closest known occurrence of this species is nearly three miles to the east of the site in the Mt. Hamilton Range (CNDDDB 2019).
Loma Prieta hoita (<i>Hoita strobilina</i>)	CNPS 1B	<u>Habitat:</u> Occurs in chaparral, cismontane woodland, coastal prairie, and valley and foothill grassland. <u>Elevation:</u> 55-1500 meters. <u>Blooms:</u> Annual herb; April-July.	Absent. Although species is known to occur in grassland habitats, the grasslands of the site are heavily disturbed and heavily dominated by annual grasses, and therefore do not provide suitable habitat for this species. Additionally, this species is generally found on serpentine soils which are absent from the site and there are no known occurrences within a 3-mile radius of the site (CNDDDB 2019).

TABLE 1. LIST OF SPECIAL STATUS SPECIES THAT COULD OCCUR IN THE PROJECT VICINITY

PLANTS (Continued adapted from CDFW 2019 and CNPS 2019)
 Other special status plants listed by CNPS

Species	Status	Habitat	Occurrence in the Study Area
Legenere (<i>Legenere limosa</i>)	CNPS 1B	<u>Habitat</u> : Occurs in vernal pools. <u>Elevation</u> : 1-880 meters. <u>Blooms</u> : April-June.	Absent. Vernal pools are absent from the site.
Dudley’s lousewort (<i>Pedicularis dudleyi</i>)	CNPS 1B	<u>Habitat</u> : Occurs in chaparral, cismontane woodland, north coast coniferous forest, and valley and foothill grassland. <u>Elevation</u> : 60-900 meters. <u>Blooms</u> : April-June.	Absent. Suitable habitat is absent from the site.
California alkali grass (<i>Puccinellia simplex</i>)	CNPS 1B	<u>Habitat</u> : Occurs in mesic areas within cismontane woodland, north coast coniferous forest, valley and foothill grasslands, and vernal pools. <u>Elevation</u> : 15-470 meters. <u>Blooms</u> : Annual herb; February-May	Absent. Suitable habitat is absent on the site for this species.
Rock sanicle (<i>Sanicula saxatilis</i>)	CR, CNPS 1B	<u>Habitat</u> : Occurs in broadleaved upland forests, coastal prairie, coastal scrub, North Coast coniferous forests, and riparian woodland, often in disturbed areas. <u>Elevation</u> : 0-730 meters. <u>Blooms</u> : March-August.	Absent. Although species is known to occur in grassland habitats, the grasslands of the site are heavily disturbed and heavily dominated by annual grasses, and therefore do not provide suitable habitat for this species. Additionally, there are no known occurrences within a three-mile radius (CNDDDB 2019).
Saline clover (<i>Trifolium hydrophilum</i>)	CNPS 1B	<u>Habitat</u> : Marshes and swamps, mesic and alkaline areas of valley and foothill grasslands, and vernal pools. <u>Elevation</u> : 0-300 meters. <u>Blooms</u> : Annual herb; April-June.	Absent. Suitable habitat is absent on the site for this species.

ANIMALS (adapted from CDFW 2019 and USFWS 2019)**Species Listed as Threatened or Endangered under the State and/or Federal Endangered Species Act**

Species	Status	Habitat	Occurrence in the Study Area
Steelhead - Central California Coast ESU / South-Central Calif Coast ESU (<i>Oncorhynchus mykiss irideus</i>)	FT/ FT, CSC	Spawn in freshwater rivers or streams in the spring and spend the remainder of their life in the ocean.	Unlikely. Although steelhead are known from Little Llagas Creek, which is designated as Critical Habitat for Steelhead downstream of Chesbro Reservoir (CNDDDB 2019), West Little Llagas Creek is a branch which flows into Little Llags Creek and does not provide a permanent year-round water source for the Steelhead, therefore, it would not support inland populations. The site also lacks suitable spawning habitat for the steelhead, although this species could swim upstream during seasonal high flows.
California Tiger Salamander (<i>Ambystoma californiense</i>)	FT, CT	Breeds in vernal pools and stock ponds of central California; adults aestivate in grassland habitats adjacent to the breeding sites.	Absent. Suitable breeding habitat for this species in the form of stagnant pools with continuous inundation for a minimum of three months is absent from the site and the immediate vicinity. The nearest recorded observation of CTS is more than a half-mile to the southwest of the site (CNDDDB 2019) between which development exists which would act as a barrier for the CTS to get to the site.
Foothill yellow-legged frog (<i>Rana boylei</i>)	CSC CCT	Occurs in swiftly flowing streams and rivers with rocky substrate with open, sunny banks in forest, chaparral, and woodland habitats, and can sometimes be found in isolated pools.	Absent. Although FYLF are known from Little Llagas Creek above Chesbro Reservoir, they are not known from the onsite branch of Llagas Creek (West Little Llagas Creek), which then flows into Llagas Creek. The nearest documented observation of this species is more than three miles from the site (CNDDDB 2019).
California Red-legged Frog (<i>Rana aurora draytonii</i>)	FT, CSC	Rivers, creeks and stock ponds of the Sierra foothills and Bay Area, preferring pools with overhanging vegetation.	Absent. Although CRLF are known from to occur in Chesbro Reservoir (CNDDDB 2019), they are not known from the onsite branch of Llagas Creek (West Little Llagas Creek), which then flows into Llagas Creek.
Tricolored Blackbird (<i>Agelaius tricolor</i>)	CSC, CCE	Breeds near fresh water in dense emergent vegetation.	Absent. Suitable nesting habitat is absent from the site. The nearest documented observation of this species is more than three miles from the site (CNDDDB 2019).
Swainson's hawk (nesting) (<i>Buteo swainsoni</i>)	CT	Breeds in stands with few trees in juniper-sage flats, riparian areas, and in oak savannah. Requires adjacent suitable foraging areas such as grasslands or alfalfa fields supporting rodent populations.	Possible. The SWHA is only known in the region from one pair which breeds each year in Coyote Valley. Therefore, Swainson's hawks are not expected to nest onsite, but may be expected to forage over the site from time to time (CNDDDB 2019).

TABLE 1. LIST OF SPECIAL STATUS SPECIES THAT COULD OCCUR IN THE PROJECT VICINITY

ANIMALS (Continued adapted from CDFW 2019 and USFWS 2019)

Species Listed as Threatened or Endangered under the State and/or Federal Endangered Species Act

Species	Status	Habitat	Occurrence in the Study Area
Least Bell's vireo (<i>Vireo bellii pusillus</i>)	FE, CE	Occurs in southern California and southern Santa Clara County during the breeding season March, migrates out of the state July through September. Early successional riparian vegetation including dense brush, mesquite, or cottonwood-willow forests in riparian areas.	Absent. This branch of West Little Llagas Creek is not identified as primary habitat for the LBV within the Santa Clara Valley Habitat Conservation Plan (SCVHP), early successional riparian vegetation preferred by this species for breeding habitat is absent from the site. Additionally, the nearest documented observation of this species is more than three miles from the site (CNDDDB 2019).

TABLE 1. LIST OF SPECIAL STATUS SPECIES THAT COULD OCCUR IN THE PROJECT VICINITY

ANIMALS (adapted from CDFG 2019 and USFWS 2019)

State Species of Special Concern and Protected Species

Species	Status	Habitat	Occurrence in the Study Area
Monterey roach (<i>Lavinia symmetricus subditus</i>)	CSC	Occurs in the Pajaro, Salinas, and San Lorenzo River and their tributaries.	Unlikely. West Little Llagas Creek does not provide a permanent year-round water source for the Monterey Roach. Additionally, this reach is further up into the watershed, therefore, it is not expected to support Monterey Roach, although this species could swim upstream during seasonal high flows. The nearest documented observation of this species is more than three miles from the site (CNDDDB 2019).
Santa Cruz black salamander (<i>Aneides niger</i>)	CSC	Occurs in deciduous woodland, coniferous forests, and coastal grasslands around the Santa Cruz Mountains and foothills. This species is also known to occur on the developed flats in pockets within older developments. They can be found under rocks near streams, in talus, under damp logs, rotting wood, and other objects.	Absent. Suitable habitat for the Santa Cruz black salamander is absent from the project site. Additionally, the nearest documented observation of this species is more than three miles from the site (CNDDDB 2019).

TABLE 1. LIST OF SPECIAL STATUS SPECIES THAT COULD OCCUR IN THE PROJECT VICINITY

ANIMALS (Continued adapted from CDFG 2019 and USFWS 2019)

State Species of Special Concern and Protected Species

Species	Status	Habitat	Occurrence in the Study Area
Northern California legless lizard (<i>Anniella pulchra</i>)	CSC	The NCLL (previously called black legless lizard) occurs mostly underground in warm moist areas with loose soil and substrate. The NCLL occurs in habitats including sparsely vegetated areas of beach dunes, chaparral, pine-oak woodlands, desert scrub, sandy washes, and stream terraces with sycamores, cottonwoods, or oaks.	Unlikely. Habitats required by northern California legless lizards are moderately suitable, as the site lacks sandy soils. Additionally, the nearest documented observation of this species is more than three miles from the site (CNDDDB 2019).
Coast horned lizard (<i>Phrynosoma blainvillii</i>)	CSC	Occur in grasslands, scrublands, oak woodlands, etc. of central California. Common in sandy washes with scattered shrubs.	Unlikely. Habitats required by coast horned lizards are moderately suitable, as the site lacks sandy soils. The center of the radius of the nearest documented observation of this species is less than one mile to the north of the site (CNDDDB 2019).
Western pond turtle (<i>Actinemys marmorata</i>)	CSC	Intermittent and permanent waterways including streams, marshes, rivers, ponds and lakes. Open slow-moving water of rivers and creeks of central California with rocks and logs for basking.	Absent. Although WPT are known from to occur in Chesbro Reservoir (CNDDDB 2019), they are not known from the onsite branch of Llagas Creek (West Little Llagas Creek), which then flows into Llagas Creek. Additionally, the banks of the creek onsite are not suitable for WPT basking.
Northern harrier (nesting) (<i>Circus cyaneus</i>)	CSC	Frequents meadows, grasslands, open rangelands, freshwater emergent wetlands; uncommon in wooded habitats.	Possible. Although the nearest documented observation of this species is more than 3 miles from the site (CNDDDB 2019), the site provides suitable foraging habitat for this species.
White-tailed Kite (nesting) (<i>Elanus leucurus</i>)	CP	Open grasslands and agricultural areas throughout central California.	Possible. Although the nearest documented observation of this species is more than 3 miles from the site (CNDDDB 2019), suitable breeding habitat exists onsite for this species and the site supports foraging habitat onsite and in the vicinity of the site.
Golden Eagle (nesting & nonbreeding/wintering) (<i>Aquila chrysaetos</i>)	CP	Typically frequents rolling foothills, mountain areas, sage-juniper flats and desert.	Possible. Although suitable breeding habitat for the golden eagle is absent from the site, foraging habitat exists onsite. The nearest documented occurrence of the GE is more than 3 miles from the site (CNDDDB 2019).
Burrowing Owl (<i>Athene cunicularia</i>)	CSC	Found in open, dry grasslands, deserts and ruderal areas. Requires suitable burrows. This species is often associated with California ground squirrels.	Possible. Suitable overwintering habitat is present onsite. The nearest documented occurrence of BUOW is less than one mile to the southwest of the site (CNDDDB 2019).

TABLE 1. LIST OF SPECIAL STATUS SPECIES THAT COULD OCCUR IN THE PROJECT VICINITY

ANIMALS (Continued adapted from CDFW 2019 and USFWS 2019)

State Species of Special Concern and Protected Species

Species	Status	Habitat	Occurrence in the Study Area
Loggerhead Shrike (nesting) <i>(Lanius ludovicianus)</i>	CSC	Frequents open habitats with sparse shrubs and trees, other suitable perches, bare ground, and low herbaceous cover. Nests in tall shrubs and dense trees. Forages in grasslands, marshes, and ruderal habitats. Can often be found in cropland.	Possible. Suitable breeding and foraging habitat exist onsite and they are known to occur in the area.
Yellow-breasted chat <i>(Icteria virens)</i>	CSC	Frequently breeds in dense shrubs and blackberry thickets and uses areas of dense vegetation during migration.	Unlikely. Potential nesting habitat of dense vegetation is generally absent from the site. The YBC may be expected to fly over or forage on the site from time to time.
Grasshopper sparrow <i>(Ammodramus savannarum)</i>	CSC	Occurs in California during spring and summer in open grasslands with scattered shrubs.	Possible. Suitable breeding habitat exists onsite. The nearest documented occurrence is more than 3 miles from the site (CNDDDB 2019).
Townsend’s Big-eared bat <i>(Corynorhinus townsendii)</i>	CSC	Primarily a cave-dwelling bat that may also roost in buildings. Occurs in a variety of habitats.	Possible. Although suitable foraging habitat occurs onsite, suitable roosting habitat is absent from the site. The nearest documented occurrence is more than 3 miles from the site (CNDDDB 2019).
Pallid Bat <i>(Antrozous pallidus)</i>	CSC	Grasslands, chaparral, woodlands, and forests; most common in dry rocky open areas providing roosting opportunities.	Possible. Although suitable foraging habitat occurs onsite, suitable roosting habitat is absent from the site. The nearest documented occurrence is more than 3 miles from the site (CNDDDB 2019).
San Francisco Dusky-Footed Woodrat <i>(Neotoma fuscipes annectens)</i>	CSC	Found in hardwood forests, oak riparian and shrub habitats.	Absent. Suitable habitat is absent from the site; additionally, woodrat nests would have been observed during the site visit if they occurred onsite. The nearest documented occurrence is more than 3 miles from the site (CNDDDB 2019).
American Badger <i>(Taxidea taxus)</i>	CSC	Found in drier open stages of most shrub, forest and herbaceous habitats with friable soils, specifically grassland environments. Natal dens occur on slopes.	Unlikely. Suitable habitat is present onsite, however, development separates the site from suitable contiguous habitat to the west, and it is unlikely badgers would find their way to the site. The nearest documented occurrence is approximately 2.5 miles to the north of the site (CNDDDB 2019).

***Explanation of Occurrence Designations and Status Codes**

Present: Species observed on the sites at time of field surveys or during recent past.

Likely: Species not observed on the site, but it may reasonably be expected to occur there on a regular basis.

Possible: Species not observed on the sites, but it could occur there from time to time.

Unlikely: Species not observed on the sites, and would not be expected to occur there except, perhaps, as a transient.

Absent: Species not observed on the sites, and precluded from occurring there because habitat requirements not met.

STATUS CODES

FE Federally Endangered

FT Federally Threatened

FPE Federally Endangered (Proposed)

CE California Endangered

CT California Threatened

CR California Rare

FC	Federal Candidate	CP	California Protected
CSC	California Species of Special Concern		
CNPS	California Native Plant Society Listing	CCE	California Candidate Endangered
1A	Plants Presumed Extinct in California	3	Plants about which we need more information – a review list
1B	Plants Rare, Threatened, or Endangered in California and elsewhere	4	Plants of limited distribution – a watch list
2	Plants Rare, Threatened, or Endangered in California, but more common elsewhere		

2.4 JURISDICTIONAL WATERS

Jurisdictional waters include rivers, creeks, and drainages that have a defined bed and bank and which, at the very least, carry ephemeral flows. Jurisdictional waters also include lakes, ponds, reservoirs, and wetlands. Such waters may be subject to the regulatory authority of the U.S. Army Corps of Engineers (USACE), the California Department of Fish and Wildlife (CDFW), and the California Regional Water Quality Control Board (RWQCB). See Section 3.2.4 of this report for additional information. West Little Llagas Creek onsite is considered to be a jurisdictional water.

3 IMPACTS AND MITIGATIONS

3.1 SIGNIFICANCE CRITERIA

General plans, area plans, and specific projects are subject to the provisions of the California Environmental Quality Act (CEQA). The purpose of CEQA is to assess the impacts of proposed projects on the environment before they are constructed. For example, site development may require the removal of some or all of its existing vegetation. Animals associated with this vegetation could be destroyed or displaced. Animals adapted to humans, roads, buildings, pets, etc., may replace those species formerly occurring on a site. Plants and animals that are state and/or federally listed as threatened or endangered may be destroyed or displaced. Sensitive habitats such as wetlands and riparian woodlands may be altered or destroyed. These impacts may be considered significant. According to *Guide to the California Environmental Quality Act* (Remy et al. 1996), “Significant effect on the environment” means a substantial, or potentially substantial, adverse change in any of the physical conditions within the area affected by the project including land, air, water, minerals, flora, fauna, ambient noise, and objects of historic or aesthetic interest. Specific project impacts to biological resources may be considered “significant” if they will:

- Have a substantial adverse effect, either directly or through habitat modifications, on any species identified as a candidate, sensitive, or special status species in local or regional plans, policies, or regulations, or by the California Department of Fish and Game or U.S. Fish and Wildlife Service;
- Have a substantial adverse effect on any riparian habitat or other sensitive natural community identified in local or regional plans, policies, regulations or by the California Department of Fish and Game or U.S. Fish and Wildlife Service;
- Have a substantial adverse effect on federally protected wetlands as defined by Section 404 of the Clean Water Act (including, but not limited to, marsh, vernal pool, coastal, etc.) through direct removal, filling, hydrological interruption, or other means;
- Interfere substantially with the movement of any native resident or migratory fish or wildlife species or with established native resident or migratory wildlife corridors, or impede the use of native wildlife nursery sites.

- Reduce substantially the habitat of a fish or wildlife species, including causing a fish or wildlife population to drop below self-sustaining levels or threaten to eliminate an animal community.
- Conflict with any local policies or ordinances protecting biological resources, such as a tree preservation policy or ordinance.
- Conflict with the provisions of an adopted Habitat Conservation Plan, Natural Community Conservation Plan, or other approved local, regional, or state habitat conservation plan.

For the purposes of this report, it is assumed that impacts will be buildout of the entire property outside of the proposed riparian setbacks.

3.2 RELEVANT GOALS, POLICIES, AND LAWS

3.2.1 Threatened and Endangered Species

State and federal “endangered species” legislation has provided the California Department of Fish and Wildlife (CDFW) and the U.S. Fish and Wildlife Service (USFWS) with a mechanism for conserving and protecting plant and animal species of limited distribution and/or low or declining populations. Species listed as threatened or endangered under provisions of the state and federal Endangered Species Acts, candidate species for such listing, state species of special concern, and some plants listed as endangered by the California Native Plant Society are collectively referred to as “species of special status.” Permits may be required from both the CDFW and USFWS if activities associated with a proposed project will result in the take of a listed species. To “take” a listed species, as defined by the state of California, is “to hunt, pursue, catch, capture, or kill, or attempt to hunt, pursue, catch, capture or kill” said species (California Fish and Game Code, Section 86). “Take” is more broadly defined by the federal Endangered Species Act to include “harm” of a listed species (16 USC, Section 1532(19), 50 CFR, Section 17.3). Furthermore, the CDFW and the USFWS are responding agencies under the California Environmental Quality Act (CEQA). Both agencies review CEQA documents in order to determine the adequacy of their treatment of endangered species issues and to make project-specific recommendations for their conservation.

3.2.2 Migratory Birds

State and federal laws also protect most bird species. The Federal Migratory Bird Treaty Act (FMBTA: 16 U.S.C., sec. 703, Supp. I, 1989) prohibits killing, possessing, or trading in migratory birds, except in accordance with regulations prescribed by the Secretary of the Interior. This act encompasses whole birds, parts of birds, and bird nests and eggs.

3.2.3 Birds of Prey

Birds of prey are protected in California under provisions of the State Fish and Game Code, Section 3503.5, which states that it is “unlawful to take, possess, or destroy any birds in the order *Falconiformes* or *Strigiformes* (birds of prey) or to take, possess, or destroy the nest or eggs of any such bird except as otherwise provided by this code or any regulation adopted pursuant thereto”. Construction disturbance during the breeding season could result in the incidental loss of fertile eggs or nestlings, or otherwise lead to nest abandonment. Disturbance that causes nest abandonment and/or loss of reproductive effort is considered “taking” by the CDFW.

Additionally, the Bald and Golden Eagle Protection Act (16 U.S.C., sec. 668-668c) prohibits anyone from taking bald or golden eagles, including their parts, nests, or eggs, unless authorized under a federal permit. The act prohibits any disturbance that directly affects an eagle or an active eagle nest as well as any disturbance caused by humans around a previously used nest site during a time when eagles are not present such that it agitates or bothers an eagle to a degree that interferes with or interrupts normal breeding, feeding, or sheltering habits, and causes injury, death or nest abandonment.

3.2.4 Bats

Section 2000 and 4150 of the California Fish and Game Code states that it is unlawful to take or possess a number of species, including bats, without a license or permit, as required by Section 3007. Additionally, Title 14 of the California Code of Regulations states it is unlawful to harass, herd, or drive a number of species, including bats. To harass is defined as “an intentional act which disrupts an animal's normal behavior patterns, which includes, but is not limited to, breeding, feeding or sheltering.” For these reasons, bat colonies in particular are considered to be sensitive and therefore, disturbances that cause harm to bat colonies are unlawful.

3.2.5 Wetlands and Other “Jurisdictional Waters”

The USACE regulates the filling or grading of Waters of the U.S. under the authority of Section 404 of the Clean Water Act. Natural drainage channels and adjacent wetlands may be considered “Waters of the United States” or “jurisdictional waters” subject to the jurisdiction of the USACE. The extent of jurisdiction has been defined in the Code of Federal Regulations and clarified in federal courts.

On June 29, 2015, the Environmental Protection Agency and USACE jointly issued the Clean Water Rule as a synthesis of statute, science, and U.S. Supreme Court decisions. The Clean Water Rule defines Waters of the U.S. to include the following:

1. All waters used in interstate or foreign commerce (also known as traditional navigable waters), including all waters subject to the ebb and flow of the tide;
2. All interstate waters including interstate wetlands;
3. The territorial seas;
4. All impoundments of Waters of the U.S.;
5. All tributaries of waters defined in Nos. 1 through 4 above, where “tributary” refers to a water (natural or constructed) that contributes flow to another water and is characterized by the physical indicators of a bed and bank and an ordinary high water (OHW) mark;
6. Adjacent waters, defined as either (a) located in whole or in part within 100 feet of the OHW mark of waters defined in Nos. 1 through 5 above, or (b) located in whole or in part within the 100-year floodplain and within 1,500 feet of the OHW mark of waters defined in Nos. 1 through 5 above;
7. Western vernal pools, prairie potholes, Carolina bays and Delmarva bays, pocosins, and Texas coastal prairie wetlands, if determined on a case-specific basis to have a significant nexus to waters defined in Nos. 1 through 3 above;
8. Waters that do not meet the definition of adjacency, but are determined on a case-specific basis to have a significant nexus to waters defined in Nos. 1 through 3 above, and are either (a) located in whole or in part within the 100-year floodplain of waters defined in Nos. 1 through 3 above, or (b) located within 4,000 feet of the OHW mark of waters defined in Nos. 1 through 5 above.

The 2015 rule also redefines exclusions from jurisdiction, which include:

1. Waste treatment systems;
2. Prior converted cropland;
3. Artificially irrigated areas that would revert to dry land should application of irrigation water to the area cease;
4. Groundwater;
5. Stormwater control features constructed to convey treat or store stormwater created in dry land; and
6. Three types of ditches: (a) ditches with ephemeral flow that are not a relocated or excavated tributary, (b) ditches with intermittent flow that are not a relocated or excavated tributary or that do not drain wetlands, and (c) ditches that do not flow, either directly or through another water, to a traditional navigable water.

A ditch may be a water of the U.S. only if it meets the definition of “tributary” and is not otherwise excluded under the provision.

All activities that involve the discharge of dredge or fill material into Waters of the U.S. are subject to the permit requirements of the USACE. Such permits are typically issued on the condition that the applicant agrees to provide mitigation that result in no net loss of wetland functions or values. No permit can be issued until the RWQCB issues a Section 401 Water Quality Certification (or waiver of such certification) verifying that the proposed activity will meet state water quality standards.

Under the Porter-Cologne Water Quality Control Act of 1969, the State Water Resources Control Board has regulatory authority to protect the water quality of all surface water and groundwater in the State of California (“Waters of the State”). Nine RWQCBs oversee water quality at the local and regional level. The RWQCB for a given region regulates discharges of fill or pollutants into Waters of the State through the issuance of various permits and orders. Discharges into Waters of the State that are also Waters of the U.S. require a Section 401 Water Quality Certification from the RWQCB as a prerequisite to obtaining certain federal permits, such as a Section 404 Clean Water Act permit. Discharges into all Waters of the State, even those that are not also Waters of

the U.S., require Waste Discharge Requirements (WDRs), or waivers of WDRs, from the RWQCB.

The RWQCB also administers the Construction Stormwater Program and the federal National Pollution Discharge Elimination System (NPDES) program. Projects that disturb one or more acres of soil must obtain a Construction General Permit under the Construction Stormwater Program. A prerequisite for this permit is the development of a Stormwater Pollution Prevention Plan (SWPPP) by a certified Qualified SWPPP Developer. Projects that discharge wastewater, stormwater, or other pollutants into a Water of the U.S. may require a NPDES permit.

CDFW has jurisdiction over the bed and bank of natural drainages and lakes according to provisions of Section 1601 and 1602 of the California Fish and Game Code. Activities that may substantially modify such waters through the diversion or obstruction of their natural flow, change or use of any material from their bed or bank, or the deposition of debris require a Notification of Lake or Streambed Alteration. If CDFW determines that the activity may adversely affect fish and wildlife resources, a Lake or Streambed Alteration Agreement will be prepared. Such an agreement typically stipulates that certain measures will be implemented to protect the habitat values of the lake or drainage in question.

3.2.6 Ordinance Sized Trees

City of Morgan Hill's Municipal Code Chapter 12.32-Restrictions on Removal of Significant Trees.

The following are excerpts from the City of Morgan Hill's Restrictions on Removal of Significant Trees Ordinance.

"12.32.020 - Definitions.

- C. "Community of trees" means a group of trees of any size which are ecologically or aesthetically related to each other such that loss of several of them would cause a significant ecological, aesthetic, or environmental impact in the immediate area.
- G. "Ordinance Sized Tree" means any live woody plant rising above the ground with a single stem or trunk of a circumference of forty inches (12.7 inch diameter) or more for nonindigenous species and eighteen inches (5.7 inch diameter) or more for indigenous species measured at four and one-half feet vertically above the ground or immediately below the lowest branch, whichever is lower, and having the inherent capacity of naturally producing

one main axis continuing to grow more vigorously than the lateral axes. All commercial tree farms, nonindigenous tree species in residential zones and orchards (including individual fruit trees) are exempted from the definition of tree for the purpose of this chapter.

- H. "Street Tree" is a tree, of any size, situated within the public street right-of-way or publicly accessible private street (e.g., trees within a landscape park strip), or within five feet of a publicly accessible sidewalk adjacent to a public or private street in the case of a street without a landscape park strip.
- I. "Indigenous tree" means any tree which is native to the Morgan Hill region. Such trees include, oaks (all types), California Bays, Madrones, Sycamore, and Alder.

12.32.030 - Permit—Required.

It is unlawful for any person to cut down, remove, poison, or otherwise kill or destroy, or cause to be removed, any ordinance sized tree, street tree, or a community of trees on any city or private property without first securing a permit as provided in this chapter; provided, however, that a permit shall not be required for the following:

- A. Developments which have been reviewed and approved by the planning commission or community development director and the tree removal conforms with the landscape plans of those developments.
- B. Commercial tree farms.
- C. Non-indigenous trees within a single-family residential zoning district that do not qualify as street trees.

A permit shall otherwise be required for the removal of or pruning of which would reduce the canopy area by more than twenty-five percent of any trees as defined in subsection G. of Section 12.32.020 of this chapter.

12.32.040 - Permit—Application.

Any person desiring to cut down, remove, destroy, or cause to be removed any tree regulated in this chapter shall apply to the community development department for a tree cutting permit on forms provided by the department. The application shall be accompanied by such drawings, written material, photographs, and other information as are necessary to provide necessary data concerning trees within the affected area and which shall include:

- A. The diameter and height of the tree;
- B. The type of trees (e.g. coniferous, evergreen hardwood and deciduous hardwood);
- C. A map or accurate sketch of location and trees proposed to be cut (showing other significant trees, shrubs, buildings or proposed buildings; photographs may be used to show the area);
- D. Method for marking the tree proposed to be cut down, removed, or destroyed;
- E. Description of method to be used in removing the tree;
- F. Description of tree planting or replacement program;
- G. Reasons for proposing removal of the tree;
- H. Address where tree is located;
- I. General health of tree to be cut down or removed; and
- J. Other pertinent information which the community development director may require.

12.32.070 - Permit—Approval—Criteria.

The community development director or any other person or body charged with determining whether to grant, conditionally grant, or deny a tree cutting permit may approve a permit only if one or more of the following findings are made:

- A. Removal of the tree is warranted because the tree meets one of the following conditions:
 - 1. Is diseased as demonstrated in a report provided by a qualified arborist or tree surgeon documenting the extent and nature of the disease and how the diseased conditions warrants the trees removal,
 - 2. Could adversely affect the general public health and safety,
 - 3. Could cause substantial damage,
 - 4. Is a public nuisance,
 - 5. Is in danger of falling,
 - 6. Is too closely located to existing structures,
 - 7. All practical design alternatives for site layout have been exhausted without being able to design around the tree(s), etc.
 - 8. Interferes with utility service,
 - 9. Acts as a host for a plant which is parasitic to another species of tree which is in danger of being infested or exterminated by the parasite,
 - 10. Is a substantial fire hazard,
 - 11. Is necessary for the continuing agricultural use of the property, or
 - 12. Is a street tree that is not identified on a list of suitable street trees maintained by the community development director.

- B. The required action is necessary:
 - 1. To utilize the property in a manner which is of greater public value than any environmental degradation caused by the action, or
 - 2. To allow reasonable economic or other enjoyment of the property.
- C. The tree will be replaced by plantings approved by the community development director, unless special conditions indicate otherwise.

12.32.080 - Permit—Approval—Conditions.

In granting any permit as provided in this chapter, the community development director, planning commission, or city council may attach reasonable conditions to insure compliance with the intent and purpose of this chapter including, but not limited to,:

- A. Replacement of trees removed with plantings of trees acceptable to the community development director. In all cases, native trees shall be planted to replace native trees removed unless practical reasons preclude this option;
- B. Use of measures to effect erosion control, soil and water retention and diversion or control of increased flow of surface waters;
- C. Use of measures to insure that the contemplated action will not have adverse environmental effects relating to shade, noise buffers, protection from wind, air pollution and historic features; and/or
- D. Posting of a bond to insure maintenance of substitute landscaping pursuant to the requirements of Chapter 18.74 of this code.”

3.2.7 2035 General Plan

The Natural Resources and Environment Element of the 2035 General Plan (General Plan) aims to “preserve open space, agricultural sites, hillsides, riparian areas, wildlife habitat, and other natural features”. The General Plan includes several goals and policies relevant to biological protections including, but are not limited to, the following:

GOAL NRE-1 Preservation of open space areas and natural features.

- Policy NRE-1.1 Natural Features. Preserve outstanding natural features, such as the skyline of a prominent hill and rock outcroppings.
- Policy NRE-1.2 Large Open Space Areas. Work with the County, the Open Space Authority, appropriate conservancy organizations and land trusts, and property owners to

preserve large open space areas, such as agricultural lands and outdoor recreation areas, to conserve natural resources and retain the City's unique identity.

- Policy NRE-1.3 Designated Open Space. Maintain land designated as “Open Space” on the Morgan Hill General Plan Land Use Map (Figure CNF-3).
- Policy NRE-1.4 South County Open Space. Preserve and maintain the wide variety of open spaces in the South County; including greenbelt areas, parks, and agricultural uses. (South County Joint Area Plan 16.00)
- Policy NRE-1.5 Coordinated Action. Continue to coordinate with Gilroy and Santa Clara County to implement South County open space goals and objectives and participate in the development of regional open space preservation programs. (South County Joint Area Plan 16.19 & 16.20)
- Policy NRE-1.6 Open Space Preservation Tools. Use a variety of open space preservation tools to protect open space, including public acquisition, land use regulation, urban development policy, economic incentives to landowners, open space easements, transfer of development rights, planned cluster development, assessment districts, and dedication of additional lands upon development. (South County Joint Area Plan 16.17)
- Policy NRE-1.7 Priority Areas for Preservation. The South County includes a variety of open space areas, including the valley floor, stream corridors, lands around reservoirs, foothills, inter-mountain valleys, and mountain areas beyond the foothills. Of these geographic areas, stream corridors, lands around the reservoirs, lands which provide greenbelts, and significant hillside features should receive highest priority for preservation as open space and future regional park location. (South County Joint Area Plan 16.01 & 16.02)
- Policy NRE-1.8 County Parks and Open Space Programs. Support County programs to: a) acquire and develop regional parks in the South County, providing just compensation for the taking of private lands; b) protect open space resources by prohibiting the introduction of uses incompatible with open space resource preservation, and preserve open space through planning, regulation, acquisition and/or development rights transfer programs; c) plan and regulate land use to avoid hazardous areas and protect critical natural resources; and d) continue to provide property tax relief via the Williamson Act to land owners who agree to maintain their lands in open space uses. (South County Joint Area Plan 16.21)

- Policy NRE-1.9 Poppy Jasper. Preserve Poppy Jasper as a natural resource unique to Morgan Hill.
- Policy NRE-1.10 Wetland Delineation and Mitigation. Require wetland delineation and mitigation as part of the environmental review of future development.
- Policy NRE-1.11 Wetlands Enhancement. Encourage enhancement of sensitive wetlands as part of future development.
- Action NRE-1.A Identification of Lands to Preserve. Identify appropriate lands to preserve as open space.
- Action NRE-1.B Open Space Acquisition and Maintenance. Formulate a program for open space acquisition and maintenance that could involve a variety of funding sources and stewardship agencies.
- Action NRE-1.C Orderly Development. Retain important open space lands through planning for orderly, staged urban development. (South County Joint Area Plan 16.20)
- Action NRE-1.D Prohibition of Poppy Jasper Mining. Work cooperatively with the County to ensure that County regulations prohibit the mining of Poppy Jasper.

GOAL NRE-2 Preservation of hillside areas as open space and scenic features.

- Policy NRE-2.1 Hillside and Ridgeline Views. Protect views of hillsides, ridgelines, and prominent natural features surrounding the City. These features help define the City's historic rural character, sense of place, image and identity.
- Policy NRE-2.2 El Toro Mountain as Landmark Feature. Retain the City's unique identity by preserving its landmark natural feature, El Toro Mountain.
- Policy NRE-2.3 Scenic Hillside Preservation. Preserve scenic hillsides around the City in an undeveloped state, wherever feasible. Provide for retention of hillside areas as open space through the dedication and/or purchase of scenic easements and/or open space easements, transfer of development rights and other appropriate measures.
- Policy NRE-2.4 Building Distance below Ridgelines. Limit all building pads located within the hillside areas to an elevation at or below the 80-foot vertical drop from the ridgeline.
- Action NRE-2.A Rural Hillsides. Limit the hillside/mountain areas to the east and west to low-intensity rural uses compatible with open space in order to maintain their integrity as

the South County's major scenic and natural resources. (South County Joint Area Plan 16.08)

- Action NRE-2.B El Toro Mountain Preservation. Preserve El Toro Mountain in open space above the 500-foot contour line on all sides, with the exception of the Llagas and Paradise Valleys (where all land above the 600-foot contour elevation should be preserved).
- Action NRE-2.C Purchase of Easements. Purchase lands and/or open space easements on El Toro Mountain through funds provided by a general bond election and/or grants from State, federal, and private sources.
- Action NRE-2.D El Toro Mountain and Santa Clara County Parks. Work with Santa Clara County Parks and Recreation Department and/or the Open Space Authority of Santa Clara Valley (OSA) to incorporate a portion of El Toro Mountain into the County park system or into the OSA managed system of open space.
- Action NRE-2.E Hillside Ordinance. All hillside areas with an average slope of 10 percent or greater shall be regulated by the Hillside Ordinance.

GOAL NRE-5 Preservation and reclamation of streams and riparian areas as open space.

- Policy NRE-5.1 Reclamation of Streams and Riparian Areas. Encourage reclamation of degraded streams and riparian areas.
- Policy NRE-5.2 Other Agencies and Environmental Review. Coordinate with jurisdictional agencies, as required, as part of the environmental review process for development projects.
- Policy NRE-5.3 Natural State of Streamside and Riparian Areas. Retain natural streamside and riparian areas in their natural state in order to preserve their value as percolation and recharge areas, natural habitat, scenic resources, and recreation corridors, and to stabilize banks. (South County Joint Area Plan 15.08)
- Policy NRE-5.4 Development Impacts in Riparian Areas. Consider development impacts upon wildlife in riparian areas and mitigate those environmental impacts.
- Policy NRE-5.5 Flood Control Projects. Where flood control projects are needed to protect existing development, minimize disruption of streams and riparian systems, maintaining slow flow and stable banks through design and other appropriate mitigation measures. (South County Joint Area Plan 15.08)

- Policy NRE-5.6 Stream Channel Protection. Protect existing stream channels and riparian vegetation by requiring buffering or landscaped setbacks and storm runoff interception as specified in Table NRE-1 and consistent with the Santa Clara Valley Habitat Plan.
- Policy NRE-5.7 Creek Visibility. Require creek areas in new developments to be visible from the public right of-way to ensure safety, maintenance, access, and integration into the neighborhood.
- Policy NRE-5.8 Creeks Access. Access to creeks should be of sufficient width to accommodate trails, flood control access, and protection of riparian habitat. (South County Joint Area Plan 16.11)
- Action NRE-5.A West Little Llagas Creek. A proposed streamside park along West Little Llagas Creek should be actively implemented and connected to the County trail system. (South County Joint Area Plan 16.10 & 16.12)
- Action NRE-5.B Design Guidelines for Riparian Features. Develop Design Guidelines for preserving, reclaiming and incorporating riparian features into development.
- Action NRE-5.C Riparian Preservation and Reclamation Programs. Develop programs for the preservation and reclamation of degraded riparian areas.

GOAL NRE-6 Protection of native plants, animals, and sensitive habitats.

- Policy NRE-6.1 Natural State of Habitat. Preserve all fish and wildlife habitats in their natural state whenever possible. Consider development impacts upon wildlife and utilize actions to mitigate those environmental impacts.
- Policy NRE-6.2 Habitat Conservation Plan. Support the implementation of the Santa Clara Valley Habitat Plan to protect wildlife, rare and endangered plants and animals, and sensitive habitats from loss and destruction.
- Policy NRE-6.3 Urban Expansion Impacts. Minimize impacts upon wildlife when considering annexations, urban service area extensions, and other governmental actions that permit urban development of previously undeveloped property.
- Policy NRE-6.4 Tree Preservation and Protection. Preserve and protect mature, healthy trees whenever feasible, particularly native trees, historically significant trees, and other trees which are of significant size or of significant aesthetic value to the immediate vicinity or to the community as a whole.

- Policy NRE-6.5 Soil and Erosion. Require development to be designed to conserve soil and avoid erosion. (South County Joint Area Plan 13.06)
- Policy NRE-6.6 Use of Native Plants. Encourage use of native plants, especially drought-resistant species, in landscaping.
- Policy NRE-6.7 Habitat Protection and Enhancement. Encourage the protection, restoration, and enhancement of remaining native grasslands, oak woodlands, marshlands, and riparian habitat.
- Action NRE-6.A Standard Measures for Construction Activities. Develop a set of standard measures requiring construction activities to avoid disturbance to natural features to the extent feasible.

Additional policies which may apply include:

- Policy HC-3.11 Conservation Coordination. Coordinate location and development of parks with the Natural Resources and Environment Element of the General Plan to maximize opportunities for resource protection, greenbelt creation, environmental education, and passive recreational use of open space.
- Policy HC-3.14 Streamside Trails. Work in partnership with the Santa Clara Valley Water District to establish easements and develop trails and linear parks along creeks and drainage channels, connecting parks, regional trails, schools, library, and other community facilities and ensuring that natural resources are protected and restored.
- Policy HC-3.24 Parkland Acquisition. Actively pursue acquisition of appropriate parkland for recommended parks, trails and facilities, and to meet existing and future recreation needs.
- Action HC-3.G Parkland Dedication. Consider adoption of a Citywide Parkland Dedication Ordinance to achieve more development of public park space.
- Action HC-3.N El Toro Trails. Continue the development of hiking trails on the open space/greenbelt areas of El Toro.
- Policy TR-9.1: Private Development Connections. Ensure adequate pedestrian access in all developments, with special emphasis on pedestrian connections in the downtown area, in shopping areas, and major work centers, including sidewalks in industrial areas in accordance with the Trails and Natural Resources Master Plan.

Projects must be consistent with all measures (Goals and Policies) of the General Plan.

3.2.8 Santa Clara Valley Habitat Plan

Six local partners (i.e., County of Santa Clara, Santa Clara Valley Transportation Authority; Santa Clara Valley Water District; and the Cities of San Jose, Gilroy, and Morgan Hill) and two wildlife agencies (the California Department of Fish and Wildlife and the U.S. Fish and Wildlife Service) prepared and adopted this multi-species habitat conservation plan, which primarily covers southern Santa Clara County, as well as the City of San Jose with the exception of the bayland areas. The SCVHP addresses listed species and species that are likely to become listed during the plan's 50-year permit term. The eighteen covered species include nine plants and nine animals. The animal species covered include, but are not limited to, the California tiger salamander, California red-legged frog, western pond turtle, and western burrowing owl. The SCVHP requires that the agencies comment on reportable interim projects and recommend mitigation measures or project alternatives that would help achieve the preliminary conservation objectives and not preclude important conservation planning options or connectivity between areas of high habitat value. Funding sources for the SCVHP include development fees based on land cover types (natural, agricultural or small vacant sites surrounded by urban development). Additional fees are charged based on the occurrence of certain sensitive habitat types such as serpentine and wetlands.

The project is considered a covered project under the SCVHP. As a result, the project would be subject to conditions and fees of the SCVHP.

3.2.8.1 SCVHP Fees

Chapter 9 of the SCVHP identifies fees that would be required by this project. The following describes fees that are based on the 2018-2019 fee schedule; however, fees are calculated at the time the project submits the SCVHP application, which corresponds to application timing of grading and/or building permits. Thus, the following numbers are provided for a sense of magnitude and should be considered approximate.

The site is within Fee Zone B “Mostly Cultivated Agricultural Lands”. The 2018-2019 SCVHP fees for development of Zone B lands are \$14,725 per acre. In addition, a Nitrogen Deposition

Fee would also be required at \$4.96 per new vehicle trip. Temporary impact fees, such as for utility trenching, are assessed at a fraction of these fees.

3.2.8.2 Conditions on Covered Activities

The SCVHP provides several conditions for covered activities under the SCVHP. These conditions can be found in Chapter 6 of the SCVHP and are summarized below.

- **Condition 1 (page 6-7). Avoid Direct Impacts on Legally Protected Plant and Wildlife Species-** Condition 1 instructs developers to avoid direct impacts on legally protected plant and wildlife species, including federally endangered Contra Costa goldfields and fully protected wildlife species including the golden eagle, bald eagle, American peregrine falcon, southern bald eagle, white-tailed kite, California condor, and ring-tailed cat. Several of these species are likely to occur on or forage over the site (golden eagle, bald eagle, white-tailed kite, and ringtail). Condition 1 also protects bird species and their nests that are protected under the Migratory Bird Treaty Act (MBTA); additionally, golden eagles and bald eagles are protected under the Bald and Golden Eagle Protection Act. Additionally, page 6-94 and Table 6-8 identify required surveys for breeding habitat of select covered wildlife species.
- **Condition 2 (page 6-9). Incorporate Urban-Reserve System Interface Design Requirements-** Condition 2 provides design requirements for the urban-reserve system interface. Some of the design requirements included in Condition 2 are installing non-permeable fences between urban and reserve areas, fencing public roads that run adjacent to reserve areas, minimizing the length of shared boundaries between urban and reserve areas, outdoor lighting limitations, and landscaping requirements.
- **Condition 3 (page 6-12). Maintain Hydrologic Conditions and Protect Water Quality- (Condition applies to project)-** Condition 3 is for all projects due to the fact that implementation of projects could result in impacts on watershed health, including impacts to aquatic habitat for species, through changes in hydrology and water quality. This condition incorporates all of the most important measures for water quality protection of the National Pollutant Discharge Elimination System (NPDES) Program of the Clean Water Act. Required measures of Condition 3 are located in Table 6-2 of the SCVHP; these measures relate to water quality and habitat protection during and after project

construction. They include measures typically included in a Storm Water Pollution Prevention Plan (SWPPP) but may include measures that are in addition to such plans.

- **Condition 4 (page 6-14). Avoidance and Minimization for In-Stream Projects-** Condition 4 minimizes impacts on riparian and aquatic habitat through appropriate design requirements and construction practices and provides avoidance and minimization measures for in-stream projects that may impact stream morphology, aquatic and riparian habitat, flow conditions, covered species, natural communities, and wildlife movement.
- **Condition 5 (page 6-18). Avoidance and Minimization Measures for In-Stream Operations and Maintenance-** Condition 5 provides avoidance and minimization measures for in-stream operations and maintenance activities, which includes, but is not limited to trail, bridge, road, and culvert maintenance, bank stabilization, removal of debris, and vegetation management.
- **Condition 6 (Page 6-21). Design and Construction Requirements for Covered Transportation Projects-** Condition 6 provides requirements for rural development design, construction, and post-construction. Types of projects that Condition 6 includes highway projects, mass transit projects, roadway projects and interchange upgrades, road safety and operational improvements, and dirt road construction.
- **Condition 7 (page 6-28). Rural Development Design and Construction Requirements-** Condition 7 provides requirements for development design and construction of new development outside of the urban service area including requirements relating to site hydrology, vineyards, private rural roads, vegetation management, soils, and lighting.
- **Condition 8 (page 6-35). Implement Avoidance and Minimization Measures for Rural Road Maintenance-** Condition 8 provides requirements for rural roads, road median, and barrier maintenance including requirements regarding riparian setbacks, erosion measures, herbicide and pesticide use, seasonal restrictions, mower cleaning, revegetation, ground-disturbing road maintenance, and flow lines.
- **Condition 9 (page 6-37). Prepare and Implement a Recreation Plan-** Condition 9 requires providing public access to all reserve lands owned by a public entity; each reserve land must provide a recreation plan.
- **Condition 10 (page 6-42). Fuel Buffer-** Condition 10 provides requirements for fuel buffers between 30 and 100 feet of structures. Requirements include measures relating to

fuel buffers near structures and on reserve lands; the most notable measure is the requirement for nesting bird surveys prior to any fuel buffer maintenance during the nesting season.

- **Condition 11 (page 6-44). Stream and Riparian Setbacks-** Condition 11 provides requirements for stream and riparian setbacks; as the development area is within the Urban Service Area, stream setbacks measured from the top of the stream bank should be 35 to 150 feet depending on the category rating of the stream and the slope class. Setbacks for Category 1 streams with 0-30% slopes should be at least 100 feet, and with >30% slopes should be at least 150 feet. Category 2 streams should have a setback of 35 feet.
- **Condition 12 (page 6-56). Wetland and Pond Avoidance and Minimization-** Condition 12 provides measures to protect wetlands and ponds, including planning actions, design, and construction actions.
- **Condition 13 (page 6-58). Serpentine and Associated Covered Species Avoidance and Minimization-** Condition 13 requires surveys for special status plants and the Bay checkerspot butterfly as well as its larval host plant in areas that support serpentine bunchgrass grassland, serpentine rock outcrops, serpentine seeps, and serpentine chaparral. Fees apply for impacts to serpentine habitat.
- **Condition 14 (page 6-60). Valley Oak and Blue Oak Woodland Avoidance and Minimization-** Condition 14 provides requirements for project planning and project construction, including avoidance of large oaks, guidance on irrigation near oak trees, and a buffer around the root protection zone, roads and pathways within 25 feet of the dripline of an oak tree, trenching, and pruning activities.
- **Condition 15 (page 6-62). Western Burrowing Owl-** Condition 15 requires preconstruction surveys for burrowing owls in appropriate habitat prior to construction activities, provides avoidance measures for owls and nests in the breeding season and owls in the non-breeding season, and requirements for construction monitoring.
- **Condition 16 (page 6-68) Least Bell's Vireo-** Condition 16 requires preconstruction surveys in appropriate habitat for the least Bell's vireo prior to construction activities, and provides avoidance and construction monitoring measures.

- **Condition 17 (page 6-69) Tricolored Blackbird-** Condition 17 requires preconstruction surveys in appropriate habitat for the tricolored blackbird prior to construction activities, and provides avoidance and construction monitoring measures.
- **Condition 18 (page 6-71) San Joaquin Kit Fox-** Condition 18 requires preconstruction surveys in appropriate habitat for the San Joaquin kit fox prior to construction activities, and provides avoidance and construction monitoring measures.
- **Condition 19 (page 6-74). Plant Salvage when Impacts are Unavoidable-** Condition 19 provides salvage guidance and requirements for covered plants.
- **Condition 20 (page 6-76). Avoid and Minimize Impacts to Covered Plant Occurrences-** Condition 20 provides requirements for preconstruction surveys for appropriate covered plants (per habitat).

3.3 IMPACTS SPECIFIC TO THE PROJECT

The project, as proposed, would develop the site into a charter school with associated playground, parking lot, landscaping, and interpretive trail along West Little Llagas Creek. As discussed above, activities resulting in impacts to biotic resources may be regulated by local, state, and federal laws. The natural resource issues specific to this project are discussed in detail below.

3.3.1 Loss of Habitat for Special Status Plants

Potential Impact. Of the 10 special status plant species that occur, or that once occurred, regionally, habitat in the form of serpentine and/or alkaline soils, woodlands, vernal pools, etc., are absent from the site and therefore most of these plant species that occur on those soils or in those habitat types are considered absent from the site. Additionally, special status plant species that occur in grassland habitats are considered absent due to the highly disturbed nature of the grasslands on the site and their overwhelming dominance by non-native annual grasses.

Mitigation. None warranted.

3.3.2 Loss of Habitat for Special Status Animals

Potential Impact. Twenty-four (24) special status animal species occur, or once occurred, regionally. Of these, fifteen species would be absent or unlikely to occur on the site due to a lack of suitable habitat for these species. The species that would be absent or unlikely to occur include the Monterey roach, steelhead, California tiger salamander, Foothill yellow-legged frog,

California red-legged frog, Santa Cruz black salamander, northern California legless lizard, Coast horned lizard, western pond turtle, yellow-breasted chat, least Bell's vireo, tricolored blackbird, western snowy plover, San Francisco dusky-footed woodrat, and American badger.

The remaining nine special status animal species from Table 1 potentially occur more frequently as potential foragers, transients, may be resident to the site, or they may occur within areas adjacent to the site. These include Swainson's hawk, northern harrier, white-tailed kite, golden eagle, burrowing owl, loggerhead shrike, grasshopper sparrow, Townsend's big-eared bat, and pallid bat.

No evidence of bats was observed during reconnaissance surveys, and onsite trees do not support suitable roosting habitat for bats however, individual Townsend's big-eared bats and pallid bats may forage within the site from time to time.

Potential impacts to specific species are discussed further below.

Mitigation. No mitigation warranted.

3.3.3 Loss of Habitat for Native Wildlife

Potential Impact. The habitats of the site comprise only a small portion of the regionally available habitat for plant and animal species that are expected to use the habitat. The proposed project would result in the loss of California annual grassland habitat. This is not expected to result in a significant effect on local wildlife. Therefore, impacts due to the loss of habitats for native wildlife resulting from the proposed project are considered less-than-significant.

Mitigation. No mitigation would be warranted for the loss of habitat for native wildlife.

3.3.4 Interference with the Movement of Native Wildlife

Potential Impact. Buildout of the site would not constrain native wildlife movement, as the site and the properties surrounding the site are already developed and do not support a major wildlife movement corridor. Any wildlife using the West Little Llagas Creek as a local movement corridor would continue to use it in the same manner after site development.

Mitigation. No mitigation would be warranted for interference with the movement of native wildlife.

3.3.5 Impacts to Nesting Migratory Bird Including Nesting Raptors and other Protected Birds

Potential Impacts. Trees and shrubs of landscaped areas onsite may support nesting birds and raptors. Buildout of the project during the nesting period for migratory birds (i.e., typically between February 1 to August 31), including initial site grading, soil excavation, and/or tree and vegetation removal, poses a risk of nest abandonment and death of any live eggs or young that may be present within the nest within or near the site. Such an effect would be considered a significant impact. To ensure that any active nests will not be disturbed and individual birds will not be harmed by construction activities, the following measures should be followed.

Mitigation. The following measures will ensure that active migratory bird and raptor nests will not be disturbed and individual birds will not be harmed by construction activities, especially including tree removal. Completion of the following measures, including Mitigation Measure 3.3.5a, will reduce the potential impacts to nesting migratory birds to a less-than-significant level.

Mitigation Measure 3.3.5a. If initial site disturbance activities, including tree, shrub, or vegetation removal, are to occur during the breeding season (typically February 1 to August 31), a qualified biologist would conduct pre-construction surveys for nesting migratory birds onsite and within 250 feet (for raptors) of the site, where accessible. The survey should occur within 14-days prior to the onset of ground disturbance. If a nesting migratory bird were to be detected, an appropriate construction-free buffer would be established. Actual size of buffer, which would be determined by the project biologist, would depend on species, topography, and type of activity that would occur in the vicinity of the nest. The project buffer would be monitored periodically by the project biologist to ensure compliance. After the nesting is completed, as determined by the biologist, the buffer would no longer be required.

3.3.6 Impacts to Western Burrowing Owls

Potential Impacts. The site outside of the burrowing owl fee area for the SCVHP, however, the site provides overwintering habitat for burrowing owls in the form of California ground squirrel burrows and foraging land. As burrowing owls are protected under Condition 1 of the SCVHP, following measures within Condition 15 of the SCVHP is required, and the project shall conduct pre-construction surveys in accordance with the Condition 15 of the SCVHP. Measures to ensure compliance with this condition are included below as Mitigation Measure 3.3.6.

Should site grading occur during the nesting season for this species (February 1 through August 31), nests and nestlings that may be present would likely be destroyed. Overwintering burrowing owls may also be buried in their roost burrows outside of the nesting season (September 1 through January 31). Any actions related to site development that result in the mortality of burrowing owls would constitute a violation of the federal Migratory Bird Treaty Act and provisions of the California Fish and Game Code. Therefore, the mortality of burrowing owls would constitute a significant impact under CEQA.

Mitigation. The following measures will ensure that burrowing owls will not be harmed by construction activities. Completion of the following measures will reduce the potential impacts to burrowing owls to a less-than-significant level.

Mitigation Measure 3.3.6a: Preconstruction surveys are required to ascertain whether or not burrowing owls occupy burrows on the site and off-site elements prior to construction. These surveys consist of a minimum of two surveys, with the first survey no more than 14 days prior to initial construction activities (i.e. vegetation removal, grading, excavation, etc.) and the second survey conducted no more than 2 days prior to initial construction activities. If no burrowing owls or fresh sign of burrowing owls are observed during pre-construction surveys, construction may continue; however, if a burrowing owl is observed during these surveys, occupied burrows will be identified by the monitoring biologist and a buffer, as described in Mitigation Measure 3.3.6b, will be established.

- If an active nest is found onsite, a 250-foot non-disturbance buffer will be established around all nest sites as identified and defined by a qualified biologist. If the biologist determines that the nest is vacant, the non-disturbance buffer zone may be removed. The SCVHP specifies that a vacation from the site for a week or more by a burrowing owl, as determined by a qualified biologist, would constitute a voluntary relocation by the owl, and the qualified biologist could then take measures to collapse suitable burrows of the site to discourage reoccupation. The biologist will supervise hand excavation of the burrow to prevent reoccupation only after receiving approval from the wildlife agencies (SCVHP, Chapter 6, Condition 15)

For permission to encroach within 250 feet of such burrows during the nesting season (February 1 through August 31), an Avoidance, Minimization, and Monitoring Plan would need to be prepared and approved by the Implementing Entity and the Wildlife Agencies prior to such encroachment (review Chapter 6, pp. 6-64 & 6-65, of the SCVHP for further detail).

- Should a burrowing owl be located onsite in the non-breeding season (September through January), construction activities would not be allowed within this 250-foot buffer of the active burrow(s) used by any burrowing owl unless the following avoidance measures are adhered to:
 - A qualified biologist monitors the owls for at least 3 days prior to construction to determine baseline foraging behavior (i.e., behavior without construction).
 - The same qualified biologist monitors the owls during construction and finds no change in owl foraging behavior in response to construction activities.
 - If there is any change in owl nesting and foraging behavior as a result of construction activities, these activities will cease within the 250-foot buffer.
 - If the owls are gone for at least one week, the project proponent may request approval from the Implementing Entity that a qualified biologist excavates usable burrows to prevent owls from reoccupying the site. After all usable burrows are excavated, the buffer zone will be removed and construction may continue;

Mitigation Measure 3.3.6b: The SCVHP stipulates that passive relocation or exclusion of burrowing owls would not be allowed until a positive regional growth trend is achieved as defined in Section 5.4.6 of the SCVHP; however, a project may qualify for an exception to this prohibition. In the event that voluntary relocation of site burrowing owls does not occur (defined as owls of the site having vacated the site for 10 or more consecutive days), permission to engage in passive relocation during the non-breeding season would need to be requested through the standard application process (Section 6.8 of the SCVHP). Application for an exception would need additional information including a relocation plan/schedule and documentation by a qualified biologist that owls have occupied the site for the full year without vacating the site for 10 or more consecutive days. The application would need to be submitted to the Implementing Entity, and the Wildlife Agencies would then evaluate the application and make a determination for granting the exception. If passive relocation is granted, additional measures may be required by the Implementing Entity.

However, if the owls voluntarily vacate the site for 10 or more consecutive days, as documented by a qualified biologist, the applicant could seek permission to have the qualified biologist take measures to collapse vacated and other suitable burrows to ensure that owls do not recolonize the site.

3.3.7 Potential Impacts to Riparian Habitat and Other Sensitive Natural Communities, Including Federally and State Protected Wetlands

Potential Impacts. As West Little Llagas Creek is considered to be a Category 2 Stream under the SCVHP, the site will adhere to the 35-foot setback from the creek and riparian habitat as required by the SCVHP, with the exception of the interpretive trail, which, per the SCVHP, is allowed within the 35-foot setback. Impact fees will be up to the western edge of the trail. No SCVHP fees will be due for the area between the western edge of the interpretive trail and the western edge of the property. Native trees are expected to be planted along the interpretive trail. These trees will eventually shade parts of the creek. Irrigation for these plantings should be via drip irrigation as to not spray water into the creek or create erosion into the creek.

Mitigation. Impacts to riparian habitat and other sensitive natural communities is not a part of this project. Additionally, native trees planted within the 35-foot setback will have appropriate irrigation, such as drip irrigation, that does not spray water into the creek or create erosion into the creek. No mitigation is warranted.

3.3.8 Degradation of Water Quality in Seasonal Drainages, Stock Ponds and Downstream Waters

Potential Impact. Eventual site development and construction may require grading that leaves the soil of construction zones barren of vegetation and, therefore, vulnerable to sheet, rill, or gully erosion. Eroded soil is generally carried as sediment in surface runoff to be deposited in natural creek beds, canals, and adjacent wetlands. Furthermore, urban runoff is often polluted with grease, oil, pesticide and herbicide residues, heavy metals, etc. These pollutants may eventually be carried to sensitive wetland habitats used by a diversity of native wildlife species. The deposition of pollutants and sediments in sensitive riparian and wetland habitats would be considered a potentially significant adverse environmental impact. The project would comply with the City's grading requirements. Therefore, the project buildout would result in a less-than-significant impact to water quality.

Mitigation. No mitigation is warranted.

3.3.9 Conflict with Local Policies and Ordinances: City of Morgan Hill Tree Ordinance

Potential Impacts. A tree survey was not conducted as a part of this project. A tree survey should be conducted should any trees onsite in order to confirm whether ordinance-sized trees occur onsite. At least one ordinance-sized tree (a walnut) occurs onsite which is likely to be removed during construction. A permit from the City would be required to remove ordinance-sized trees onsite.

Mitigation. Should protected trees occurring onsite require removal a permit must be obtained from the City and compensatory mitigation for loss of trees should occur. The current landscaping plan of planting 10 native trees as a part of the site plan would likely appropriately mitigate for loss of one ordinance-sized tree, although all measures of the permit must also be followed.

3.3.10 Conflict with Local Policies and Ordinances: 2035 General Plan

The 2035 General Plan includes policies adopted by the City of Morgan Hill that aim to protect biological resources during implementation of new projects. Failure to comply with the General Plan policies (Section 3.2.7) could constitute a significant impact under CEQA. However, the proposed project would ensure compliance with the General Plan which would ensure there is no project conflict with the General Plan.

Mitigation. No mitigation is warranted.

3.3.11 Conflict with Local Policies and Ordinances: Santa Clara Valley Habitat Conservation Plan

Proposed development of the approximately 2.03-acre site would be considered a covered project under the SCVHP and, as such, would be subject to conditions and fees of the SCVHP. Failure to comply with the SCVHP would constitute a significant impact under CEQA.

Compliance with the SCVHP includes payment of fees according to the “Fee Zone” designation of the property, payment of nitrogen deposition fees related to the number of residential units and/or anticipated car trips (for non-residential projects) resulting from the development, and any surcharge fees that are required based on site-specific impacts to sensitive habitats or sensitive species. The onsite portion of the proposed project would be subject to Zone B fees, which are

currently \$14,725 per acre (2018-2019 rates) which would be applied to the western edge of the interpretive trail eastward throughout the remainder of the project, leaving no permanent impact fees to the west of the interpretive trail, and nitrogen deposition fees, which are currently \$4.96 for each new vehicle trip. For any temporary impacts, all the same fees are applied, but at a fraction of the total cost depending on how long the project expects the temporary impact to last. Potential onsite temporary fees include irrigation to proposed native tree plantings on the western side of the interpretive trail. The project is not expected to impact the Mixed Riparian Woodland and Forest onsite, which consists of two walnut trees on the southern side of the site within the banks of West Little Llagas Creek.

In addition to fees, the project would be required to comply with applicable conditions of the SCVHP. Conditions of the SCVHP, summarized above (Section 3.2.8.2), that would apply to the project include Conditions 1, 3, 11 and 15 (Table 3). Condition 11 requires a setback on 35 feet for Category 2 streams, however, trails are allowed within the setback, and permanent fees would be assessed based on the western edge of the trail east to include the remainder of the project site, with no fees due west of the interpretive trail with the exception of any irrigation for native tree planting, which would be considered a temporary impact, and should consist of drip irrigation as to avoid spraying water into the creek or causing erosion; these fees would be based on the amount of time the impact is to occur (fraction of 1 year).

TABLE 3. APPLICABLE SANTA CLARA VALLEY HABITAT PLAN (SCVHP) CONDITIONS OF THE PROPOSED VOICES CHARTER SCHOOL PROJECT, LOCATED IN THE CITY OF MORGAN HILL, CALIFORNIA		
Condition (page references ICF International 2012)	Applicable to project	Comments/Requirements
Condition 1 (page 6-7). Avoid Direct Impacts on Legally Protected Plant and Wildlife Species	Applies	This condition requires actions conducted under the SCVHP to comply with existing laws protecting plant and wildlife species including those species not covered as part of the SCVHP. This requires compliance with Migratory Bird Treaty Act, which prohibits killing or possessing covered migratory birds, their young, nests, feathers, or eggs. Several species of nesting bird that could use the project site are protected by the MBTA. Project mitigations for pre-construction surveys for migratory birds, including for burrowing owls, ensures compliance with this condition.
Condition 2 (page 6-9). Incorporate Urban-Reserve System Interface Design Requirements	N/A	The project is not interfacing with the reserve system.
Condition 3 (page 6-12). Maintain Hydrologic Conditions and Protect Water Quality	Applies	This condition requires all projects to incorporate appropriate measures itemized in the SCVHP’s Table 6-2 (refer to ICF International 2012) to minimize indirect and direct effects to covered species and their aquatic habitat. This condition also requires the local jurisdiction (i.e. the City of San Jose) to verify that all appropriate measures from Table 6-2 are implemented. Measures from Table 6-2 should be incorporated into project engineering and SWPPP plans.
Condition 4 (page 6-14). Avoidance and Minimization for In-Stream Projects	N/A	The project is not impacting streams.
Condition 5 (page 6-18). Avoidance and Minimization Measures for In-Stream Operations and Maintenance	N/A	The project is not impacting streams.
Condition 6 (Page 6-21). Design and Construction Requirements for Covered Transportation Projects	N/A	Project is not a transportation project.
Condition 7 (page 6-28). Rural Development Design and Construction Requirements	N/A	The project is within the urban service area and is not a rural development.
Condition 8 (page 6-35). Implement Avoidance and Minimization Measures for Rural Road Maintenance	N/A	No rural road maintenance.
Condition 9 (page 6-37). Prepare and Implement a Recreation Plan	N/A	Project is not part of the Reserve System.
Condition 10 (page 6-42). Fuel Buffer	N/A	A fuel buffer is not required for this project.

TABLE 3. APPLICABLE SANTA CLARA VALLEY HABITAT PLAN (SCVHP) CONDITIONS OF THE PROPOSED VOICES CHARTER SCHOOL PROJECT, LOCATED IN THE CITY OF MORGAN HILL, CALIFORNIA		
Condition (page references ICF International 2012)	Applicable to project	Comments/Requirements
Condition 11 (page 6-44). Stream and Riparian Setbacks	Applies	The project is not impacting streams, however, the project will be encroaching on the 35-foot setback from West Little Llagas Creek with an interpretive trail and tree plantings.
Condition 12 (page 6-56). Wetland and Pond Avoidance and Minimization	N/A	The project is not impacting wetlands or ponds.
Condition 13 (page 6-58). Serpentine and Associated Covered Species Avoidance and Minimization	N/A	Serpentine habitat and species are absent.
Condition 14 (page 6-60). Valley Oak and Blue Oak Woodland Avoidance and Minimization	N/A	Valley and blue oak woodlands are absent.
Condition 15 (page 6-62). Western Burrowing Owl	Applies	Although the site is outside the burrowing owl fee zone, overwintering burrowing owls may occur onsite, and therefore, in order to comply with Condition 1, this project must also comply with Condition 15, including preconstruction surveys and avoidance measures for owls and nests, and requirements for construction monitoring. Measure 3.3.6 (above) defines the required actions for compliance with this condition.
Condition 16 (page 6-68) Least Bell’s Vireo	N/A	Although the project occurs within the Pajaro Watershed—the only watershed currently associated with this species in the SCVHP coverage area, this species is not known within the watershed from this far north, additionally, suitable habitat is absent from the site.
Condition 17 (page 6-69) Tricolored Blackbird	N/A	Suitable habitat for the tricolored blackbird is absent from the site, additionally, the project does not occur within 250 feet of SCVHP-mapped tricolored blackbird habitat.
Condition 18 (page 6-71) San Joaquin Kit Fox	N/A	Project outside of modeled habitat for the San Joaquin kit fox.
Condition 19 (page 6-74). Plant Salvage when Impacts are Unavoidable	N/A	Covered plants are absent.
Condition 20 (page 6-76). Avoid and Minimize Impacts to Covered Plant Occurrences	N/A	Covered plants are absent.

Implementation of the measures listed and described above, including payment of Land Zone B, and nitrogen deposition fees and compliance with Conditions 1, 3, 11, and 15, the project would be in compliance with the SCVHP. The project would follow the required measures of the SCVHP; therefore, the project would not conflict with this local policy. To ensure compliance, it

is recommended that the project proponent thoroughly review the identified sections of the SCVHP, including Table 6-2.

Mitigation. No mitigation is warranted.

4 LITERATURE CITED

- Beier, P 1996 Dispersal of juvenile cougars in fragmented habitat. [Abstract]. Fifth Mountain Lion Workshop. Organized by the California Department of Fish and Game and the Southern California Chapter of the Wildlife Society, San Diego, California, February 27 - March 1, 1996.
- Beier, P. and S. Loe. 1992. A Checklist for Evaluating Impacts to Wildlife Movement Corridors. *Wildlife Society Bulletin* 20(4):434-440.
- Beier, P. and R.F. Noss. 1998. Do Habitat Corridors Provide Connectivity? *Conservation Biology* 12(6):1241-1252. December.
- California Department of Fish and Wildlife. 2019. Annual Report on the Status of California State Listed Threatened and Endangered Animals and Plants. The Resources Agency, Sacramento, CA.
- California Department of Fish and Game. 2002. California Fish and Game code. Gould Publications. Binghamton, N.Y.
- California Department of Fish and Wildlife. 2019. California Natural Diversity Database, Rarefind5. The Resources Agency, Sacramento, CA.
- California Native Plant Society (CNPS). 2019. Inventory of Rare and Endangered Plants (online edition, v6-05c). California Native Plant Society. Sacramento, CA.
<http://www.cnps.org/inventory>.
- 2035 General Plan. 2016. City of Morgan Hill.
- City of Morgan Hill Municipal Code.
- Harris, L.D., Gallagher, P.B., 1989. New initiatives for wildlife conservation: the need for movement corridors. In: Mackintosh, G. (Ed.), *Preserving Communities and Corridors*. Defenders of Wildlife, Washington DC, pp. 11–34.
- Holland, R.F. 1986. Preliminary Description of the Terrestrial Natural Communities of California. Resources Agency, Sacramento, CA. 156 pp.
- Mayer, K. E., and W. F. Laudenslayer, Jr. Ed. 1988. A guide to wildlife habitats of California. California Department of Forestry and Fire Protection. Sacramento, CA. 166 pp.
- Natural Resource Conservation Service. 2019. Web Soil Survey. USDA.
- Remy, M. H., T. A. Thomas, J. G. Moose, and W. F. Manley. 1996. Guide to the California Environmental Quality Act.
- Shuford, W. David and Thomas Gardall eds. 2008. California Bird Species of Special Concern. Western Field Ornithologists and California Department of Fish and Game.

Thomson, Robert C., Amber N. Wright, and H. Bradley Shaffer. 2016. California Amphibian and Reptile Species of Special Concern. California Department of Wildlife. University of California Press.

USACE. 1987. Corps of Engineers Wetlands Delineation Manual. Department of the Army.

U.S. Fish and Wildlife Service. 2018. Endangered and threatened wildlife and plants.

Wetland Training Institute, Inc. 1990. Federal Wetland Regulation Reference Manual. B.N. Goode and R.J. Pierce (eds.) WTI 90-1. 281pp.



LIVE OAK ASSOCIATES, INC.

an Ecological Consulting Firm

July 2, 2019

Nick Pappani
Vice President
Raney Planning and Management, Inc.
1501 Sports Drive
Sacramento, CA 95834

SUBJECT: Tree letter for the proposed Voices Charter School project at the intersection of Monterey Road and Cosmo Avenue in Morgan Hill, Santa Clara County, California (PN 2344-01).

Dear Mr. Pappani:

At your request, Live Oak Associates, Inc. (LOA) conducted a site visit to measure the three trees onsite in order to assess which trees may be covered as an ordinance-sized tree under the City of Morgan Hill's qualifications.

The City defines an Ordinance-sized tree as "any live woody plant rising above the ground with a single stem or trunk of a circumference of forty inches (12.7 inch diameter) or more for nonindigenous species and eighteen inches (5.7 inch diameter) or more for indigenous species measured at four and one-half feet vertically above the ground or immediately below the lowest branch, whichever is lower, and having the inherent capacity of naturally producing one main axis continuing to grow more vigorously than the lateral axes."

LOA ecologist Katrina Krakow measured the three trees on the approximately 2.03-acre site located at the northwestern corner of Monterey Road and Cosmo Avenue (APN 767-17-047) in Morgan Hill, Santa Clara County, California. All three trees are walnuts (*Juglans sp.*). The two walnuts along the creek were previously tagged as Tree # 31 on the western bank and Tree # 30 on the eastern bank and will remain onsite. The one remaining walnut tree onsite is along Monterey Road and was tagged as Tree #1 during the site visit; this tree is planned to be removed as a part of the project. Ms. Krakow took measurements and then photos of the trees; the photos were evaluated by ISA Certified Arborist Wendy Fisher. Below are the measurements and health ratings:

Tree ID#	Species	Circumference (inches)	Condition	Ordinance-sized Tree?	To be Removed?
1	Walnut	72	Fair	Yes	Yes
30	Walnut	76	Good	Yes	No
31	Walnut	58.5	Good	Yes	No

* Condition: **Good** = 80-100% healthy foliage and no significant defects; **Fair** = 50-79% healthy foliage and/or minor defects; **Poor** = 5-49% healthy foliage and/or other significant defects; **Dead** = less than 5% healthy foliage







If you have any questions or concerns regarding this letter, please contact me at (408) 281-5889, at your convenience.

Sincerely,



Katrina Krakow
 Project Manager
 Staff Ecologist

LEGEND

-  Project Boundary
-  Top of Bank / Edge of Riparian
-  California Annual Grassland
-  West Little Llagas Crk
-  Mixed Riparian Woodland & Forest
-  Developed / Hardscape
-  Walnut Tree Location & Number

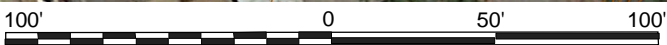
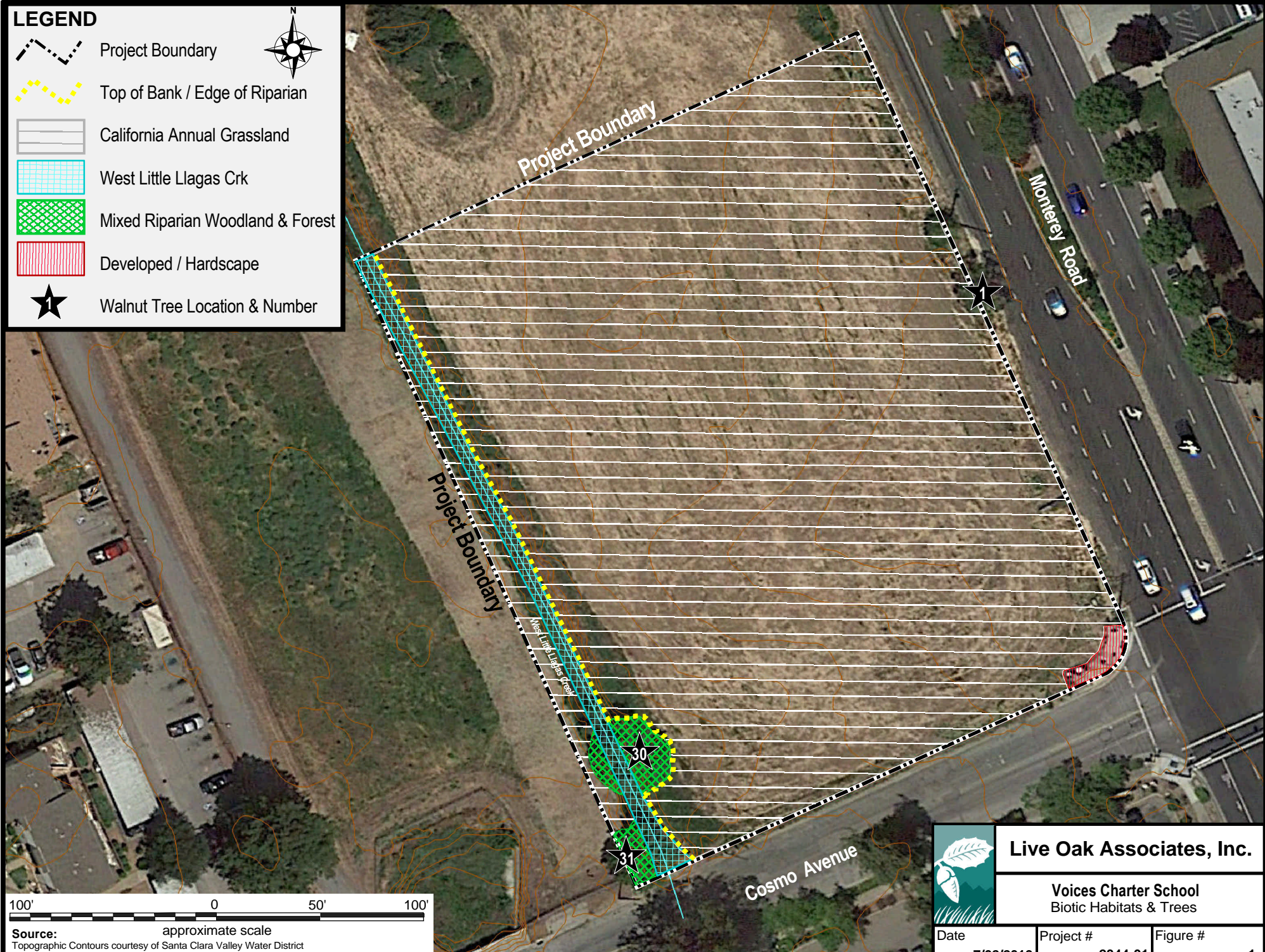

Source: approximate scale
 Topographic Contours courtesy of Santa Clara Valley Water District
 Aerial Photograph courtesy of Google Earth, 2018



Live Oak Associates, Inc.

Voices Charter School
 Biotic Habitats & Trees

Date	Project #	Figure #
7/02/2019	2344-01	1

Tree photos:



Figure 1. Tree # 1 along Monterey Road.



Figure 2. Tree # 1 along Monterey Road.



Figure 3. Tree # 30.



Figure 4. Tree # 31.



Figure 5. Trees #31 (left) and #30 (right).

Appendix C

Phase I Environmental Site Assessment

Phase I
Environmental Site Assessment
(ASTM E1527-13)

Voices Charter School
APN 767-17-047
NW Corner Monterey Rd./Cosmo Ave.
Morgan Hill, Santa Clara County, California 95037



Prepared For:

Pacific West Communities, Inc
430 East State Street, Suite 100
Eagle, ID 83616

August 6, 2018
RNC Project Number 1811A

RNC Environmental, LLC

151 Nursery Street • Ashland, OR 97520
(888) 485-3330 • rnc-enviro.com

RNC Environmental, LLC

151 Nursery Street • Ashland, OR 97520

(888) 485-3330 • rnc-enviro.com

Phase I Environmental Site Assessment Voices Charter School APN 767-17-047 NW Corner Monterey Rd./Cosmo Ave. Morgan Hill, California

Table of Contents

1.	Summary.....	1
2.	Introduction.....	2
2.1.	Location and Legal Description of Subject Property	
2.2.	Purpose	
2.3.	Scope of Work	
2.4.	Limitations and Exceptions	
2.5.	User Reliance	
2.6.	Validity of Report	
3.	User Provided Information	4
3.1.	Title Records	
3.2.	Environmental Liens or Activity and Use Limitations	
3.3.	Owner, Property Manager, and Occupant Information	
3.4.	User Questionnaire	
3.4.1.	Specialized Knowledge	
3.4.2.	Commonly Known or Reasonably Ascertainable Information	
3.4.3.	Valuation Reduction for Environmental Issues	
3.5.	Additional Documents	
4.	Records Review.....	5
4.1.	Physical Setting	
4.1.1.	Topography	
4.1.2.	Geology and Soils	
4.1.3.	Groundwater	
4.1.4.	Radon	
4.2.	Environmental Records Sources	
4.2.1.	Fuel Storage and Waste Management Activities	
4.2.2.	Liens and Use Restrictions	
4.2.3.	Accidental Spills and Releases	
4.2.4.	Leaking Underground Fuel Tanks	
4.2.5.	Waste Management Activities in Surrounding Area	
4.2.6.	Hazardous Waste Cleanup Sites	
4.2.7.	Previously Regulated Hazardous Waste Sites	
4.2.8.	Cortese List	
4.3.	Historical Use Information	
4.3.1.	Recorded Land Title Records	
4.3.2.	Aerial Photographs	
4.3.3.	USGS Topographic Maps	
4.3.4.	Sanborn Insurance Company Maps	
4.3.5.	Property Tax Files	
4.3.6.	Planning and Zoning Records	
4.3.7.	Other Public Information	
5.	Site Reconnaissance.....	12
5.1.	Site and Vicinity General Characteristics	

RNC Environmental, LLC

151 Nursery Street • Ashland, OR 97520

(888) 485-3330 • rnc-enviro.com

5.2.	Current Use of the Property	
5.2.1.	Descriptions of Structures, Roads, Other Improvements on the Site	
5.2.2.	Potable Water Supply	
5.2.3.	Sewage Disposal System	
5.2.4.	Observations on Subject Property	
5.3.	Current Uses of the Adjoining Properties	
5.3.1.	Observed Conditions on Adjoining Properties	
6.	Interviews	15
6.1.	Owners and Occupants	
6.2.	Government Officials	
6.2.1.	Santa Clara County Environmental Health Department	
7.	Phase II Assessment	16
7.1.	Background	
7.2.	Methodology	
7.3.	Results of Analysis	
8.	Vapor Encroachment Screening	16
8.1.	Tier 1	
8.2.	Tier 2	
8.3.	Conclusions	
9.	Evaluation	17
9.1.	Findings	
9.2.	Data Gaps	
9.3.	Opinions	
9.4.	Conclusions	
10.	Signature of Environmental Professional	18
11.	Statement of Qualifications	19

Appendices

- A. Location Maps
- B. Photographs
- C. Site Assessment Checklist
- D. Historical Photos and Maps
- E. Government Records Search
- F. Title Records
- G. Questionnaires
- H. Phase II Soil Sampling

**Phase I Environmental Site Assessment
Voices Charter School
APN 767-17-047
NW Corner Monterey Rd./Cosmo Ave.
Morgan Hill, California**

1. SUMMARY

RNC Environmental, LLC (RNC) has been retained by Pacific West Communities, Inc., to conduct a Phase I Environmental Site Assessment for the property identified as Assessor's Parcel Number 767-17-047, located at NW Corner Monterey Rd./Cosmo Ave. in the City of Morgan Hill, Santa Clara County, California. This site is proposed for development as the "Voices Charter School." The primary investigator for the assessment was Neil O'Hara, Environmental Professional.

The standards and practices implemented in this assessment are intended to result in the identification of conditions indicative of releases and threatened releases of hazardous substances on, at, in, or to the subject property. The assessment seeks to identify current and past property uses of the property, uses of hazardous substances on the property, and activities that could have caused releases or threatened releases of hazardous substances. The assessment also seeks to identify and evaluate adjoining and nearby properties where environmental conditions may exist that could have resulted the migration of hazardous substances onto the subject property.

Sources of this information include interviews with present and (as necessary) past owners and operators of the property; a review of historical sources such as aerial photographs, maps, and building records; a search for environmental cleanup liens on the property; a review of government records of hazardous material storage facilities, known or threatened releases, waste generation, cleanup sites, etc., for the subject and surrounding properties; a visual inspection of the subject and adjacent properties, and a review of various information provided by the client.

This assessment has found that the subject property consists of a single 2.0± acre vacant parcel. The property appears to have been vacant since the 1970s. Previously, it was agricultural, and had been developed as a vineyard from at least the 1940s through 1960s. The property is located in a newer, mixed-use residential/commercial neighborhood.

Ten leaking UST sites and one State cleanup site were identified within the surrounding area. There is no evidence that any of them have any potential to impact the subject property. No other regulated hazardous materials sites or facilities were identified in the surrounding area. The presence of a Vapor Encroachment Condition (VEC) at the subject property can be ruled out. No potential source of Chemicals of Concern which could affect the property have been identified.

Soil testing was conducted to evaluate the potential presence of persistent pesticides. The result indicate that no residual persistent pesticides are present on the property.

This assessment has revealed no evidence of recognized environmental conditions in connection with the subject property.

2. INTRODUCTION

2.1. LOCATION AND LEGAL DESCRIPTION OF SUBJECT PROPERTY

The subject property consists of a 2.0± acre parcel, located at the northwest corner of Monterey Road and Cosmo Avenue in the City of Morgan Hill, Santa Clara County, California. No street address has been assigned.

The property includes Assessor's Parcel 767-17-047. The full legal description of the property is provided in the preliminary title report, Appendix F.

Location maps and site maps of the subject property are attached to this report as Appendix A. Photographs of the subject property are attached to this report as Appendix B.

2.2. PURPOSE

This report is intended to constitute an "inquiry by an environmental professional" for All Appropriate Inquiry under the Comprehensive Environmental Response, Compensation, and Liability Act (CERCLA). As such, it presents the results of an effort to identify whether *recognized environmental conditions* may exist on the property.

The term *recognized environmental conditions* means the presence or likely presence of any hazardous substances or petroleum products in, on, or at a property: (1) due to any release to the environment; (2) under conditions indicative of a release to the environment; or (3) under conditions that pose a material threat of a future release to the environment. De minimis conditions are not recognized environmental conditions.

This report was commissioned in association with the potential acquisition of the site for development of the property as a charter school.

2.3. SCOPE OF WORK

RNC Environmental, LLC, has contractually agreed to conduct a Phase I Environmental Site Assessment, utilizing methods and procedures consistent with the nationally recognized standard, ASTM E1527-13, and with EPA All Appropriate Inquiry regulations.

The definition of *recognized environmental conditions* includes the encroachment of hazardous vapors onto the property. Where not otherwise specified, this assessment uses the guidelines defined by ASTM E2600-10 to determine whether a vapor encroachment condition is potentially present.

No special terms or conditions were specified by the user. Should there be a need to conduct an investigation into a specific question not addressed in this report, contact our office immediately regarding your concerns.

2.4. LIMITATIONS AND EXCEPTIONS

This report was compiled as a Phase I Environmental Site Assessment for the subject project. This report contains information and data provided to RNC by several sources. RNC in no way warrants the accuracy or completeness of the information provided by those sources.

No environmental site assessment can wholly eliminate uncertainty regarding the potential for recognized environmental conditions in connection with a property. A Phase I Environmental Site Assessment is intended to reduce, but not eliminate, uncertainty regarding the potential for recognized environmental conditions in connection with a property, and this practice recognizes reasonable limits of time and cost. All appropriate inquiries does not mean an exhaustive assessment of a property. This assessment represents a balance between the competing goals of limiting the costs and time demands and the reduction of uncertainty about unknown conditions resulting from additional information.

For this assessment, no additional project-specific limitations arose, and no exceptions were made to the assessment process as defined by ASTM E1527-13.

2.5. USER RELIANCE

This report was prepared for the exclusive use of Pacific West Communities, Inc, and its successors and/or assigns. It also may be relied upon by lenders, investors, government agencies (including, but not limited to, the California Department of Housing and Community Development, the USDA Rural Development Program, and the California Tax Credit Allocation Committee) and/or nonprofit entities which may provide financial assistance for the proposed development of the subject property. No other person or entity is entitled to rely upon this report without the specific written authorization of RNC. Any such reliance is subject to the same limitations, terms, and conditions as the original contract with the client. RNC specifically disclaims any responsibility for any unauthorized use of this report.

All users of this report, whether identified in this section, provided authorization in a separate reliance letter, or for any reason using this report without specific authorization, should be aware that Landowner Liability Protection under CERCLA is also contingent upon the user's compliance with certain additional responsibilities, as specified in ASTM E1527-13, §6. This includes recording your own knowledge (or lack thereof) regarding the property; we have provided a blank user questionnaire in Appendix G for this purpose. RNC cannot be responsible for any user's failure to comply with these responsibilities.

2.6. VALIDITY OF REPORT

This report may be presumed to be valid for one year from its cover date, excepting that if acquisition of the property occurs more than 180 days after the cover date of this report, certain information in the report must be updated in accordance with ASTM E1527-13, §4.6.

3. USER PROVIDED INFORMATION

3.1. TITLE RECORDS

A Preliminary Title Report regarding the subject property, prepared by Chicago Title Company and dated April 12, 2018 was provided.

3.2. ENVIRONMENTAL LIENS OR ACTIVITY AND USE LIMITATIONS

Based on a review of the title documents, no Environmental Liens and/or Activity Use Limitations, which indicate a past or present release of a hazardous substance or petroleum products, were recorded. No other knowledge of environmental liens was identified by the user.

3.3. OWNER, PROPERTY MANAGER, AND OCCUPANT INFORMATION

According to the Preliminary Title Report, the property is owned by "PEPPER LANE-COSMO, LLC., a California Limited Liability Company."

3.4. USER QUESTIONNAIRE

A User Questionnaire was completed by Darren Berberian on behalf of Pacific West Communities, Inc.

3.4.1. SPECIALIZED KNOWLEDGE

The user reported no specialized knowledge of the property.

3.4.2. COMMONLY KNOWN OR REASONABLY ASCERTAINABLE INFORMATION

The user reported no commonly known or reasonably ascertainable information of environmental significance with regard to the property.

3.4.3. VALUATION REDUCTION FOR ENVIRONMENTAL ISSUES

The user reported that the purchase price of the property is consistent with current market value.

3.5. ADDITIONAL DOCUMENTS

No previous environmental documents were provided.

4. RECORDS REVIEW

4.1. PHYSICAL SETTING

4.1.1. TOPOGRAPHY

According to the USGS topographic map¹ covering the subject property and vicinity, the subject property is located at an elevation of approximately 350 feet above mean sea level, on the floor of a northwest-to-southeast trending valley.

Local surface water drains toward the south; a small channelized creek, Little Llagas Creek, runs southward along the west boundary of the property. The creek is tributary to the Pajaro River, which flow into the Pacific Ocean 20 miles to the southwest.

4.1.2. GEOLOGY AND SOILS

The subject property is located in the Coast Ranges geomorphic province. The Coast Ranges are northwest-trending mountain ranges (2,000 to 4,000, occasionally 6,000 feet elevation above sea level), and valleys. The ranges and valleys trend northwest, subparallel to the San Andreas Fault. Strata dip beneath alluvium of the Great Valley. To the west is the Pacific Ocean. The Coast Ranges are composed of thick Mesozoic and Cenozoic sedimentary strata. The northern Coast Ranges are dominated by irregular, knobby, landslide-topography of the Franciscan Complex.

The Geologic Map of California indicates that the property is located on “older alluvium.”

According to the Natural Resources Conservation Service, Web Soil Survey, the property is underlain by Cropley clay, and San Ysidro loam.

The Cropley soil is on terraces, alluvial fans, hills. The parent material consists of alluvium derived from calcareous shale. Depth to a root restrictive layer is greater than 60 inches. The natural drainage class is moderately well drained. Water movement in the most restrictive layer is moderately low. Available water to a depth of 60 inches (or restricted depth) is high. Shrink-swell potential is high. This soil is not flooded. It is not ponded. There is no zone of water saturation within a depth of 72 inches. Organic matter content in the surface horizon is

¹ Mount Madonna, California 7.5' quadrangle; 2015.

about 2 percent. This component is in the R014XD001CA Clayey ecological site. Nonirrigated land capability classification is 3s. Irrigated land capability classification is 2s. This soil does not meet hydric criteria. The calcium carbonate equivalent within 40 inches, typically, does not exceed 10 percent. There are no saline horizons within 30 inches of the soil surface. The soil has a maximum sodium adsorption ratio of 1 within 30 inches of the soil surface.

The San Ysidro soil is on terraces, alluvial plains. The parent material consists of alluvium derived from sedimentary rock. Depth to a root restrictive layer, abrupt textural change, is 16 to 24 inches. The natural drainage class is moderately well drained. Water movement in the most restrictive layer is moderately low. Available water to a depth of 60 inches (or restricted depth) is high. Shrink-swell potential is moderate. This soil is not flooded. It is not ponded. There is no zone of water saturation within a depth of 72 inches. Organic matter content in the surface horizon is about 1 percent. This component is in the R014XE029CA Loamy Claypan ecological site. Nonirrigated land capability classification is 4e. Irrigated land capability classification is 3e. This soil does not meet hydric criteria. There are no saline horizons within 30 inches of the soil surface.

4.1.3. GROUNDWATER

Based on monitoring reports for nearby sites obtained through the State Water Resources Control Board, groundwater appears to be at a depth of 15 to 25 feet below ground surface. The groundwater gradient is variable.

4.1.4. RADON

The National Radon Database has been developed by the U.S. Environmental Protection Agency and is a compilation of the EPA/State Residential Radon Survey and the National Residential Radon Survey.

The US EPA has designated Santa Clara County as Radon Zone 2, where average radon level in the area is between 2.0 and 4.0 pCi/L (pico curies per liter of air) for the first floor living area. This is only a general estimation of the radon levels for the area in which the subject property is located. Actual indoor radon concentrations may vary.

4.2. ENVIRONMENTAL RECORDS SOURCES

On July 24, 2018, RNC conducted a review of data files obtained from various local, state and federal regulatory agencies, to determine whether there are publicly available records regarding hazardous materials for the subject and surrounding properties. All sources and minimum search distances specified by ASTM E1527-13 were utilized.

A full report of the findings, including a detailed description of the agencies contacted and sources reviewed is provided in **Appendix E**.

4.2.1. FUEL STORAGE AND WASTE MANAGEMENT ACTIVITIES

- The California State Water Resources Control Board GeoTracker² system was reviewed to identify registered underground storage tanks on the subject and adjacent properties.
- The California State Water Resources Control Board historical database was reviewed to identify historical registered underground storage tanks on the subject and adjacent properties.
- The US Environmental Protection Agency EnviroMapper³ system was reviewed to identify hazardous waste generators on the subject and adjacent properties.
- The California Department of Toxic Substances Control Hazardous Waste Tracking System was reviewed to identify any hazardous waste manifests associated with the subject property.
- The California Division of Oil, Gas and Geothermal Resources Well Finder⁴ was reviewed for active and historic oil and gas wells on the site or adjacent properties.

Neither the subject property nor any adjacent property is listed as a hazardous waste generator or registered UST site. No oil or gas wells were identified.

4.2.2. LIENS AND USE RESTRICTIONS

- As noted above, no lien or land use restriction appears on the Preliminary Title Report for the property.
- The California State Water Resources Control Board GeoTracker⁵ system was reviewed to identify whether the subject property is subject to a deed restriction, land use restriction, or covenants.
- The US Environmental Protection Agency EnviroMapper system was reviewed to identify hazardous waste generators on the subject and adjacent properties.
- The US Environmental Protection Agency's EnviroMapper and Cleanups in My Community⁶ systems were reviewed to identify any liens and land use restrictions listed for the subject property.

The subject property is not listed in any of these sources as having a deed restriction or land use restriction.

² <http://geotracker.waterboards.ca.gov>

³ <https://www.epa.gov/emefdata/em4ef.home>

⁴ <http://www.conservation.ca.gov/dog/Pages/WellFinder.aspx>

⁵ <http://geotracker.waterboards.ca.gov>

⁶ <https://www.epa.gov/cleanups/cleanups-my-community>

4.2.3. ACCIDENTAL SPILLS AND RELEASES

- The US Coast Guard National Response Center⁷ (formerly the Emergency Response Notification System) was reviewed for records of accidental spills and releases of hazardous material on the subject property.

No accidental spills or releases were identified.

4.2.4. LEAKING UNDERGROUND FUEL TANKS

- The California State Water Resources Control Board GeoTracker system was reviewed to identify Leaking Underground Fuel Tank records within one-half mile of the subject property.

Ten leaking UST sites were identified:

SITE NAME	SITE_TYPE	STATUS	ADDRESS
BP FACILITY #11224	LUST CLEANUP SITE	OPEN - SITE ASSESSMENT	16995 MONTEREY
DON LOVE EXXON	LUST CLEANUP SITE	COMPLETED - CASE CLOSED	16990 MONTEREY RD
MORGAN HILL CORPORATION YARD	LUST CLEANUP SITE	COMPLETED - CASE CLOSED	105 EDES COURT
NEMATOLLAH GHASSEMKHAMI	LUST CLEANUP SITE	COMPLETED - CASE CLOSED	16380 MONTEREY HWY
REDTREE PROPERTIES	LUST CLEANUP SITE	COMPLETED - CASE CLOSED	140 SAN PEDRO AVE
SABEK GAS STATION	LUST CLEANUP SITE	OPEN - VERIFICATION MONITORING	16270 MONTEREY ROAD
UNOCAL #6169	LUST CLEANUP SITE	COMPLETED - CASE CLOSED	17015 MONTEREY ST
UNOCAL #6169	LUST CLEANUP SITE	COMPLETED - CASE CLOSED	17015 MONTEREY
VILLA CIOLINO	LUST CLEANUP SITE	COMPLETED - CASE CLOSED	16873 MONTEREY ROAD

⁷ <http://nrc.uscg.mil>

WORLD OIL #52	LUST CLEANUP SITE	COMPLETED - CASE CLOSED	16720 MONTEREY
---------------	-------------------	-------------------------	----------------

Agency file information for these sites were obtained through the Geotracker system. All but two of the sites are closed. Of the remaining sites, **BP Facility # 11224** is located almost a half mile north of the subject property; the groundwater gradient is toward the northeast, away from the subject property. **Sabek Gas Station** is located about 1,000 feet southeast of the subject property. The most recent monitoring report for this site⁸ shows that groundwater contamination has not migrated beyond the immediate vicinity of the leak.

There is no evidence that any of these leaks have resulted in groundwater contamination under the subject property.

4.2.5. WASTE MANAGEMENT ACTIVITIES IN SURROUNDING AREA

- The US EPA's Enforcement and Compliance History Online (ECHO) system was reviewed to identify RCRA Treatment, Storage and Disposal Facilities within one-half mile of the subject property.
- The California Department of Resources Recycling and Recovery Facility Information Toolbox (FacIT) was reviewed to identify solid waste facilities within one-half mile of the subject property.

No hazardous waste facilities or landfills were identified.

4.2.6. HAZARDOUS WASTE CLEANUP SITES

- The US Environmental Protection Agency's EnviroMapper and Enforcement and Compliance History Online systems were reviewed to identify RCRA Corrective Action (CORRACTS) sites within one mile of the subject property.
- The US Environmental Protection Agency's EnviroMapper and Cleanups in My Community systems were reviewed to identify "Superfund" National Priority List (NPL) sites within one mile of the subject property, and non-NPL CERCLIS sites within one-half mile of the subject property.
- The California Department of Toxic Substances Control EnviroStor⁹ System was reviewed to identify State Superfund-equivalent ("State Response") sites and Voluntary Cleanup sites.
- The California State Water Resources Control Board GeoTracker system was reviewed to identify Spills, Leaks, Investigations and Cleanups (SLIC), overseen by the various Regional Water Quality Control Boards, within one-half mile of the subject property.

One cleanup sites was identified within the specified search distances:

⁸ http://geotracker.waterboards.ca.gov/esi/uploads/geo_report/2849807977/T0608578682.PDF

⁹ <http://www.envirostor.dtsc.ca.gov/public/>

SITE NAME	SITE_TYPE	STATUS	ADDRESS
CASTLE VEGTECH	CLEANUP PROGRAM SITE	OPEN - ASSESSMENT & INTERIM REMEDIAL ACTION	16470 VINEYARD BLVD

Castle Vegtech is located about 1500 feet east of the subject property. According to RWQCB files, Castle Vegtech, Inc., operated a pesticide formulation, sales, and application business at 16470 Vineyard Boulevard from 1958 to 1986. In the course doing business, Castle Vegtech allowed pesticide related wastes to leak or spill into or onto the ground, which have contaminated soils and groundwater beneath the site and the surrounding area.

The most recent groundwater monitoring report¹⁰ indicates that contaminated groundwater has migrated about 200 feet to the southeast from the Castle Vegtech property, and has no potential to impact the subject property.

4.2.7. PREVIOUSLY REGULATED HAZARDOUS WASTE SITES

- The US Environmental Protection Agency’s EnviroMapper system was reviewed to identify Delisted NPL Sites, CERCLIS "No Further Action" sites, and Brownfield sites within one-half mile of the subject property.

No former cleanup or remediation sites were identified within one-half mile of the subject property.

4.2.8. CORTESE LIST

The California Environmental Protection Agency is responsible for compiling a list of known contaminated sites, generally referred to as the “Cortese List.” The list is used for planning, rather than regulatory purposes, and is compiled from the following sources:

- Contaminated or potentially contaminated hazardous waste sites listed in the CAL Sites database by DTSC;
- Leaking Underground Storage Tanks with known groundwater contamination, listed by the California State Water Resources Control Board;
- Landfills which have evidence of groundwater contamination or known migration of hazardous materials, listed by the California Integrated Waste Management Board.

Each of these sources is separately referenced in this report. The subject property is not reported on the Cortese List.

¹⁰ http://geotracker.waterboards.ca.gov/esi/uploads/geo_report/1612500131/SL0608727312.PDF

4.3. HISTORICAL USE INFORMATION

4.3.1. RECORDED LAND TITLE RECORDS

A chain of title report was not provided by the client for RNC's use in preparing this report. The Preliminary Title Report indicates that the subject parcel was created by a map filed in 1978. A development plan which included the subject property was approved in 1981, restated in 1991, and rescinded in 1992.

4.3.2. AERIAL PHOTOGRAPHS

Aerial photographs of the subject property were obtained from the U. S. Geological Survey, via EarthExplorer¹¹ and/or Google Earth. Copies of the aerial photos are included in Appendix D of this report.

1948: The subject property appears to be planted as a vineyard. The adjacent land to the north is part of the same vineyard; a house is present at the northwest corner of the vineyard, on the adjacent property. Surrounding properties are predominantly orchards and vineyards, with some homes and outbuildings along Monterey Road. An unpaved lane marks the present location of Cosmo Avenue.

1953: No significant changes are apparent.

1971: The subject property appears vacant. Most of the orchards and vineyards have been removed from the area. Several small residential subdivisions are visible to the northwest of the property. The creek along the west side of the property has been channelized.

1974: The subject property is vacant. The apartments to the west have been constructed; Cosmo Avenue has been constructed to provide access to the apartments.

1981: The subject property remains vacant. The office building to the south across Cosmo Avenue has been constructed; office buildings directly across Monterey Road from the end of Cosmo Avenue have also been constructed.

1993: The Cosmo Avenue bridge for the eventual drainage realignment has been constructed.

1998: No significant changes apparent.

2004: The subject property remains vacant. The office buildings across Monterey Road from the subject property are under construction.

2008, 2012, 2018: No significant changes apparent.

4.3.3. USGS TOPOGRAPHIC MAPS

Historic U. S. Geologic Survey topographic maps were reviewed. Copies of the maps are included in Appendix D of this report.

¹¹ <http://earthexplorer.usgs.gov/>

1917: Monterey Road and Little Llagas Creek are mapped. No development is shown on the subject property; the house at the north end of the vineyard is mapped.

1939: The subject property is mapped as vineyard. Monterey Road is designated as US Highway 101. Additional houses are shown along Monterey Road.

1955: No development is shown on the subject property. An unimproved lane is shown at the location of Cosmo Avenue. Monterey Road / Hwy 101 is noted as 3 lanes.

1968: Urban development is noted in portions of the surrounding area.

1973: The urban development area now includes the apartments to the west of the property.

1980, 1994, 1996: Urban infill continues to increase; no development is shown on the subject property.

2015: The surrounding area is generally urbanized; new map format does not show buildings.

4.3.4. SANBORN INSURANCE COMPANY MAPS

The Sanborn Map Company produced a series of large-scale maps, dating from 1867 to the present and depicting the commercial, industrial, and residential sections of some twelve thousand cities and towns in North America. The maps show significant detail regarding dwellings, commercial buildings, and factories. Where available, Sanborn maps are a valuable source of information about past land uses.

No Sanborn maps were identified which cover the subject property.

4.3.5. PROPERTY TAX FILES

County Assessor records indicate that the property is undeveloped.

4.3.6. PLANNING AND ZONING RECORDS

The City of Morgan Hill General Plan indicates the property is designated for "Mixed Use Flex"; this designation "is primarily applied to properties along the Monterey Road corridor north and south of downtown, allows for a mix of residential, commercial, and office uses applied either vertically (i.e., one structure with multiple uses) or horizontally (i.e., structures with different land uses located adjacent to one another)." This City of Morgan Hill zoning map indicates the property is zoned for Light Commercial/Residential District (CL-R).

4.3.7. OTHER PUBLIC INFORMATION

An internet search identified no significant additional information.

5. SITE RECONNAISSANCE

A visual and physical reconnaissance of the subject property was conducted on July 26, 2018, by Neil O'Hara. The reconnaissance was conducted by walking around the entire perimeter

of the property, and crossing the property as needed to assure that the entire site was observed. A site map and photographs of the subject property are attached to this report in Appendices A and B. A site visit/assessment checklist is attached to this report as Appendix C.

5.1. SITE AND VICINITY GENERAL CHARACTERISTICS

The property is located in a mixed use area the City of Morgan Hill. Properties along Monterey Road are mostly commercial; farther east is a light industrial/business park area. Farther west of Monterey Road is predominantly residential. Grape vine sprouts on portions of the property are an indicator of its historic use as a vineyard.

5.2. CURRENT USE OF THE PROPERTY

The property is currently vacant.

5.2.1. DESCRIPTIONS OF STRUCTURES, ROADS, OTHER IMPROVEMENTS ON THE SITE

No structures, roads or other improvements exist on the property, other than a curb along Cosmo Avenue.

5.2.2. POTABLE WATER SUPPLY

No potable water service is active on the property.

5.2.3. SEWAGE DISPOSAL SYSTEM

No sewer service is present on the property.

5.2.4. OBSERVATIONS ON SUBJECT PROPERTY

Observation	YES	NO	Comments
Hazardous Substances Associated with Identified Uses		X	
Storage Tanks		X	
Drums		X	
Hazardous Materials Containers		X	
Unidentified Containers		X	
Pits, Ponds or Lagoons		X	
Drains or Sumps		X	
Pools of Liquid		X	

Observation	YES	NO	Comments
Wells (supply or monitoring)		X	
Odors		X	
Fill soil and debris		X	
Soil Stains, Stressed Vegetation		X	
Stains or Corrosion		X	
Potential Asbestos-Containing Materials		X	
Potential lead-based paint		X	

5.3. CURRENT USES OF THE ADJOINING PROPERTIES

The adjacent property to the north is vacant. Across Monterey Road to the east and Cosmo Avenue to the south are one- and two-story office/commercial buildings. To the west is an easement owned by the Santa Clara Valley Water District, which is reportedly intended to provide future drainage improvements in the vicinity. West of the easement is an apartment complex.

5.3.1. OBSERVED CONDITIONS ON ADJOINING PROPERTIES

Observation	YES	NO	Comments
Hazardous Substances Associated with Identified Uses		X	
Storage Tanks		X	
Drums		X	
Hazardous Materials Containers		X	
Unidentified Containers		X	
Pits, Ponds or Lagoons		X	
Drains or Sumps		X	
Pools of Liquid		X	

Observation	YES	NO	Comments
Wells (supply or monitoring)		X	
Odors		X	
Fill soil and debris		X	
Soil Stains, Stressed Vegetation		X	
Stains or Corrosion		X	

6. INTERVIEWS

6.1. OWNERS AND OCCUPANTS

An environmental questionnaire was completed by Myra Reinhard, President of Pepper Lane Properties, as manager of Pepper Lane - Cosmo LLC. Ms. Reinhard states that the property is vacant. She provided a copy of a Phase I report dated August 22, 2000, which stated that the property was farmland until the 1990s, and has been vacant since. The report found no evidence of recognized environmental conditions on the property (See text portion of report, Appendix G). Ms. Reinhard is unaware of the presence of any hazardous materials on the property and is unaware of any lawsuits, liens or regulator actions against the property, either past, present, or pending.

6.2. GOVERNMENT OFFICIALS

6.2.1. SANTA CLARA COUNTY ENVIRONMENTAL HEALTH DEPARTMENT

The Santa Clara County Environmental Health Department is the Certified Unified Program Agency (“CUPA”) responsible for all oversight of hazardous materials storage, releases or spills, underground storage tanks, above ground storage tanks, and leaking underground storage tanks in Santa Clara County.

According to the Department’s web site, all files from its Local Oversight Program have been uploaded to GeoTracker. County files were reviewed using that system, and are included with the Records Search information discussed above.

7. PHASE II ASSESSMENT

7.1. BACKGROUND

Because of the historical use of the property as an orchard, there is a potential that extremely persistent pesticides, such as arsenic compounds and organochlorines such as DDT, may have been applied to the property. There is a potential for residual concentrations of these chemicals to remain present in the soil for many years at levels considered unacceptable for residential use by regulatory agencies. In order to further evaluate this potential concern, soil sampling for arsenic and chlorinated hydrocarbon pesticides was conducted. The sampling was conducted at the same time as the Phase I site visit on July 26, 2018.

7.2. METHODOLOGY

This assessment was conducted accordance with ASTM E1903-11, Standard Guide for Environmental Site Assessments: Phase II Environmental Site Assessment Process. The scope of the sampling and analysis protocol was based in part on the Interim Guidance for Sampling Agricultural Fields for School Sites (Third Revision), published by the California Department of Toxic Substances Control, California Environmental Protection Agency, August 7, 2008.

Four representative sample locations were established on the property. At each sample location, one soil sample was collected from the top 6 inches of the soil. All samples were submitted to a California certified analytical laboratory. Each sample was individually analyzed for organochlorine pesticides by EPA Method 8081A, and for arsenic.

A map of the sample locations and the laboratory analysis report are attached in **Appendix H**.

7.3. RESULTS OF ANALYSIS

No organochlorine pesticides were detected in any of the samples. Arsenic was detected in concentrations ranging from 4.2 to 5.0 mg/kg.

Although arsenic is present in excess of the California Human Health Screening Level of 0.07 mg/kg, arsenic commonly occurs in natural background concentrations that exceed the CHHSL. DTSC has determined that arsenic concentrations below 12 mg/kg can generally be considered to be natural background levels and do not need further evaluation as a Chemical of Potential Concern. The detected arsenic concentrations on this site meet this criteria, so no further evaluation of arsenic is required.

8. VAPOR ENCROACHMENT SCREENING

A Vapor Encroachment Screening, in accordance with ASTM Standard E2600-10, was conducted for this property, utilizing the information and sources discussed throughout this Phase I report.

8.1. TIER 1

Our review of the history of the site and vicinity identified no potential Chemicals of Concern associated with past uses of the property.

ASTM 2600-10 defines the Area of Concern to include petroleum hydrocarbon releases within one-tenth mile of the subject property, and other chemical releases within one-third mile. Based on the information sources utilized in this Phase I assessment, the following sites meet this criteria:

- Castle Vegtech

8.2. TIER 2

Sufficient data is available from agency files to make a critical distance determination regarding the proximity of known contamination plumes from Castle Vegtech to the subject property. For non-hydrocarbons, ASTM E2600 defines the critical distance as 100 feet from the subject property boundary. According to monitoring data discussed above, the plume from the Castle Vegtech site is at least 1,500 feet from the nearest boundary of the subject property.

8.3. CONCLUSIONS

The presence of a Vapor Encroachment Condition (VEC) at the subject property can be ruled out. No potential source of Chemicals of Concern which could affect the property have been identified.

9. EVALUATION

9.1. FINDINGS

This assessment has found that:

- The subject property consists of a single 2.0± acre vacant parcel.
- The property appears to have been vacant since the 1970s. Previously, it was agricultural, and had been developed as a vineyard from at least the 1940s through 1960s.
- The property is located in a newer, mixed-use residential/commercial neighborhood.
- Ten leaking UST sites and one State cleanup site were identified within the surrounding area. There is no evidence that any of them have any potential to impact the subject property.
- No other regulated hazardous materials sites or facilities were identified in the surrounding area.

- The presence of a Vapor Encroachment Condition (VEC) at the subject property can be ruled out. No potential source of Chemicals of Concern which could affect the property have been identified.
- Soil testing was conducted to evaluate the potential presence of persistent pesticides. The result indicate that no residual persistent pesticides are present on the property.

9.2. DATA GAPS

None of the limitations of this assessment has result in a data gap of any significance.

9.3. OPINIONS

No evidence suggestive of the potential presence of recognized environmental conditions has been identified.

No historic or controlled recognized environmental conditions associated with the subject property were identified.

9.4. CONCLUSIONS

We have performed a Phase I Environmental Site Assessment in conformance with the scope and limitations of ASTM Practice E1527-13, of NW Corner Monterey Rd./Cosmo Ave. (APN 767-17-047), located in the city of Morgan Hill, Santa Clara County, California, "the property". Any exceptions to, or deletions from, this practice are described in the Limitations Section of this report. This assessment has revealed no evidence of recognized environmental conditions in connection with the subject property.

10. SIGNATURE OF ENVIRONMENTAL PROFESSIONAL

"I declare that, to the best of my professional knowledge and belief, I meet the definition of Environmental Professional as defined in the §312.10 of 40 CFR part 312. I have the specific qualifications based on education, training, and experience to assess a property of the nature, history, and setting of the subject property. I have developed and performed the all appropriate inquiries in conformance with the standards and practices set forth in 40 CFR part 312."



8/6/18

Neil O'Hara
Environmental Professional

11. STATEMENT OF QUALIFICATIONS

The US EPA All Appropriate Inquiry rule defines an environmental professional as someone who “possesses sufficient specific education, training, and experience necessary to exercise professional judgment to develop opinions and conclusions regarding conditions indicative of releases or threatened releases of hazardous substances on, at, in, or to a property, sufficient to meet the objectives and performance factors of the rule. In addition, an environmental professional must have either a state or tribal issued certification or license and three years of relevant full-time work experience; a Baccalaureate degree or higher in science or engineering and five years of relevant full-time work experience; or ten years of relevant full-time work experience.”

Neil O’Hara meets and exceeds this requirement based on the following qualifications:

- Bachelor of Science, Environmental Planning & Management; University of California, Davis, 1974.
- 25+ years professional full-time experience, including:
 - RNC Environmental, LLC. Founding partner, 2004; sole proprietor since 2007.
 - Neil O. Anderson & Associates, Lodi, CA. Senior Environmental Specialist, 1998-2004.
 - O’Hara Environmental, Volcano, CA. Independent consultant, 1995-1998.
 - Sugnet & Associates, Roseville, CA. Water Quality Specialist, 1992-1995.
 - Limnion Corp., Concord, CA. Senior Biologist, 1989-1992.

Mr. O’Hara was a California Registered Environmental Assessor (REA) from 1993 until the REA program was cancelled in 2012.

Mr. O’Hara’s career in the environmental sciences includes 25+ years as a consultant and 15 years as an educator. His areas of expertise include environmental site assessment and due diligence, biological resources evaluation and wetlands assessment, CEQA compliance and regulatory compliance. He has conducted environmental assessments, trained and supported others in conducting such work, and provided third-party review services for a real estate investment fund. He has conducted over 200 Phase I Environmental Site Assessments, and provided third-party reviews for hundreds more.

A. Location Maps

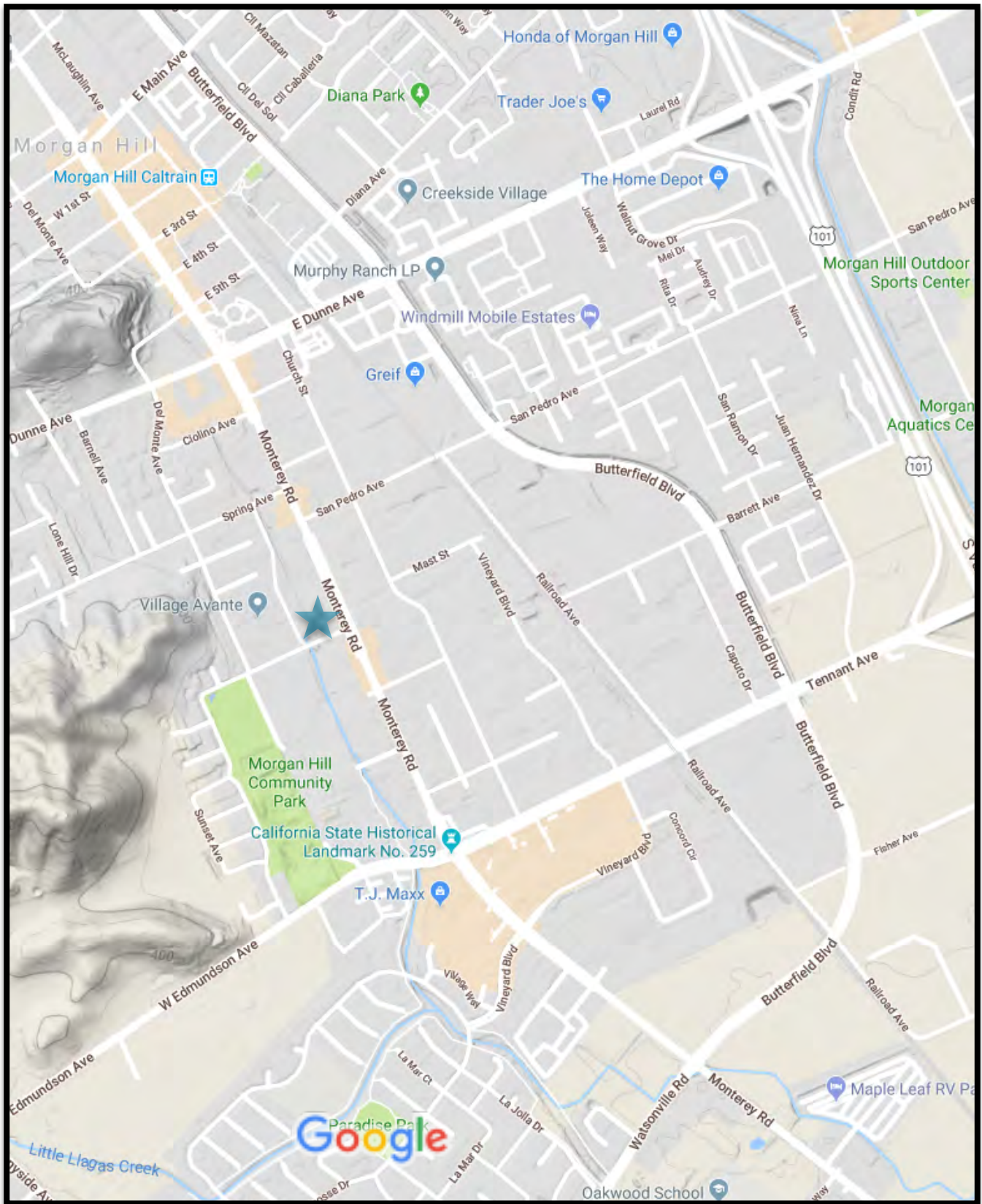

Location Map

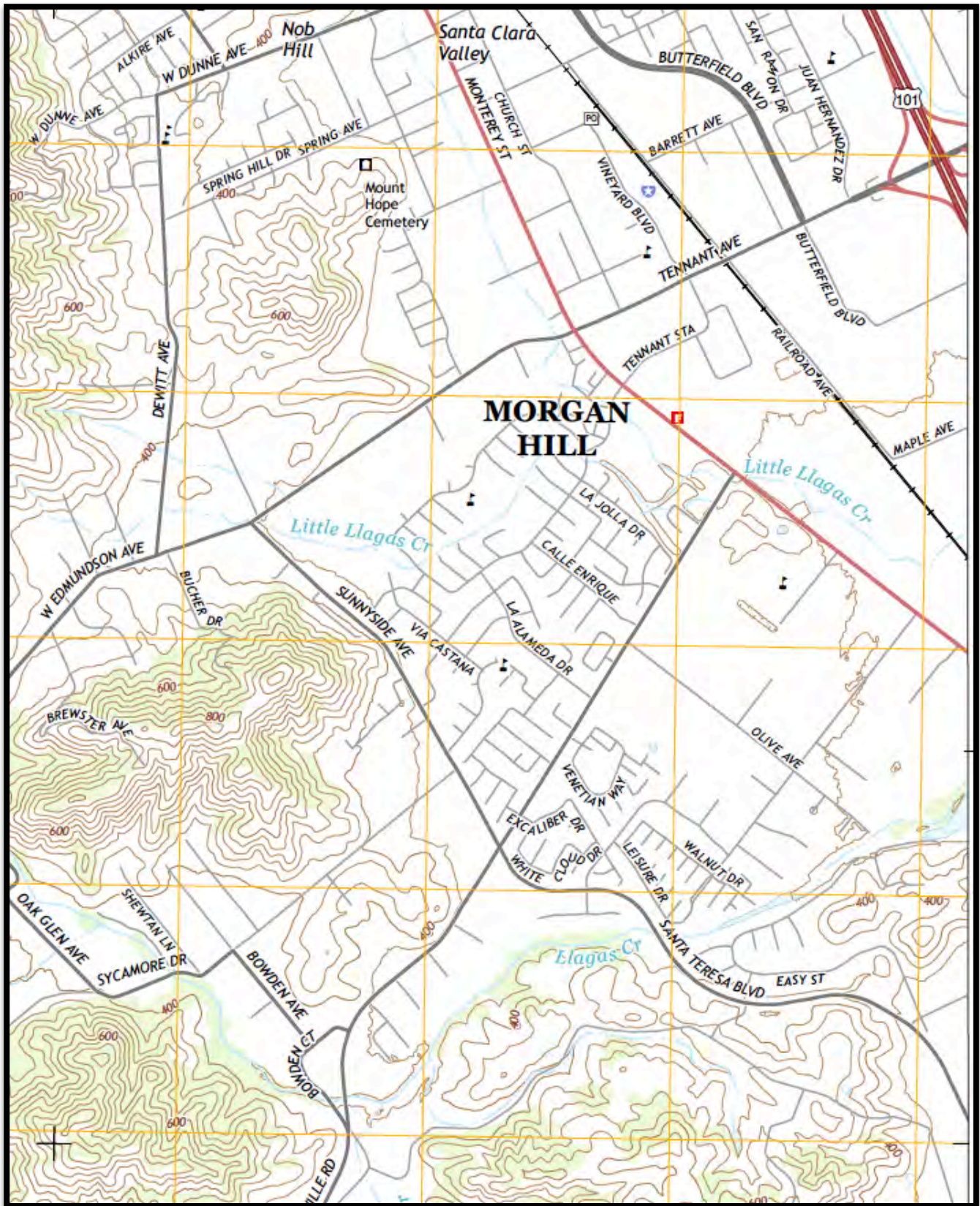

USGS Topographic Map, Mount Madonna quad, 2015

OFFICE OF COUNTY ASSESSOR — SANTA CLARA COUNTY, CALIFORNIA

MONTEREY ROAD

CATHERINE DUNNE RANCH MAP N° 3

BK 817

MONTEREY

AVENUE

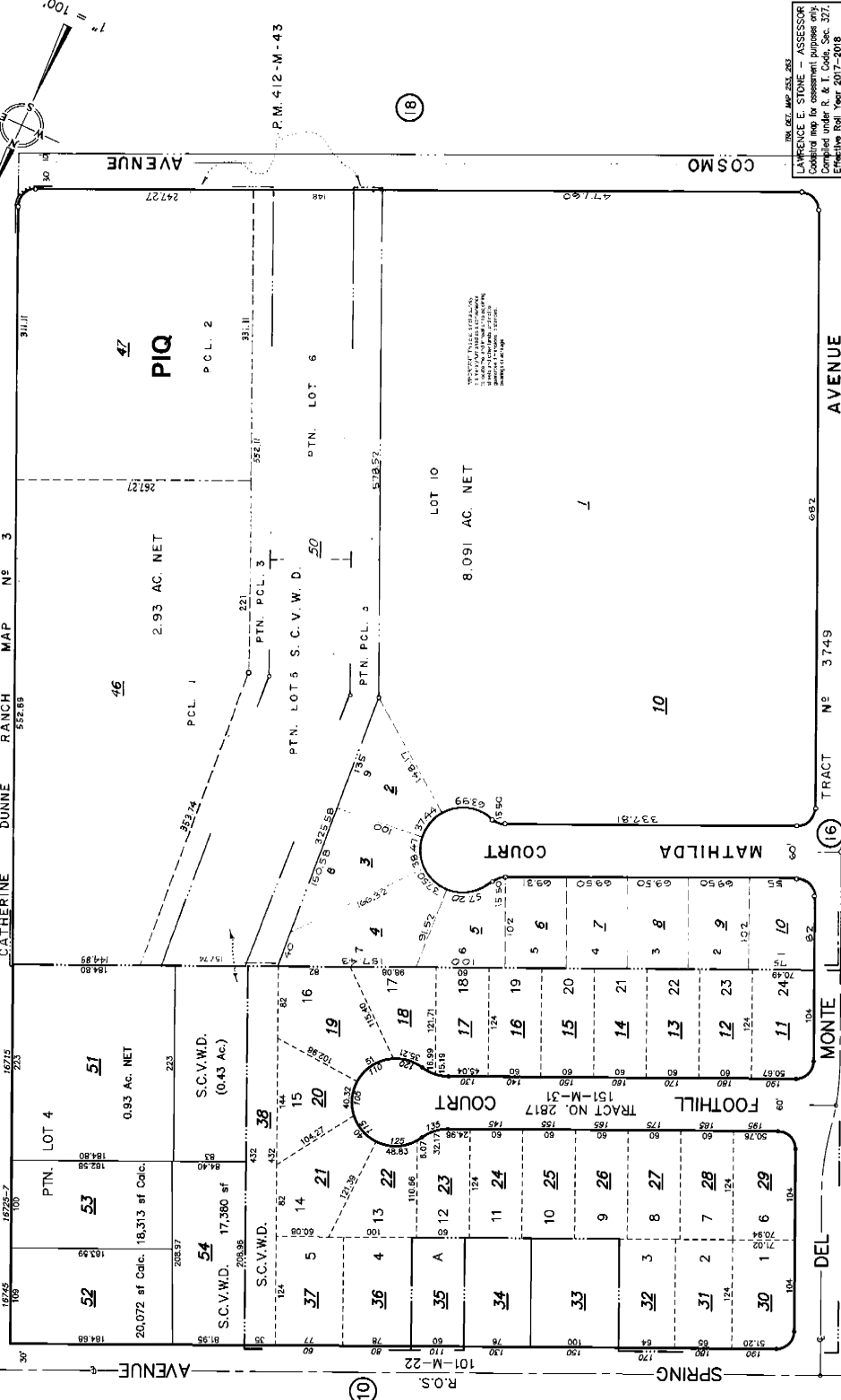

Assessor's Parcel Map



Aerial Photo, 2018

B. Photographs



Looking north across property



Looking south across property



Monterey Road: subject property on right



Cosmo Avenue: subject property on right



Creek channel along west boundary



Adjacent drainage easement to west (future channel)



Offices across Cosmo Avenue to south



Offices across Monterey Road to east



Vacant land to north



Apartments beyond drainage easement to west

C. Site Assessment Checklist

RNC Environmental, LLC
Phase I Site Reconnaissance Checklist

Project #	Site location	Date	By
1811A	SWC Monterey Rd/Cosmo Ave Morgan Hill, CA	7/26/18	Neil O'Hara
General Description of Property			
<i>Level, vacant lot</i>			
General Description of Buildings			
<i>No buildings. Curb and gutter on Cosmo Ave. frontage</i>			

	Observed Land Uses
Subject Property	<i>Vacant</i>
North	<i>Vacant</i>
East	<i>Monterey Road; office buildings</i>
South	<i>Cosmo Avenue; office buildings</i>
West	<i>Drainage easement; apartments</i>

RNC Environmental, LLC
Phase I Site Reconnaissance Checklist

SWC Monterey Rd/Cosmo Ave
Morgan Hill, CA

Observed Hazardous Materials		
	Subject Property	Adjacent Properties
<i>Any business typically associated with waste treatment, storage, disposal, processing, or recycling</i>	<input type="checkbox"/> Yes <input checked="" type="checkbox"/> No	<input type="checkbox"/> Yes <input checked="" type="checkbox"/> No
<i>Pesticides, batteries, paints, or other chemicals</i>	<input type="checkbox"/> Yes <input checked="" type="checkbox"/> No	<input type="checkbox"/> Yes <input checked="" type="checkbox"/> No
<i>Industrial drums or sacks of chemicals</i>	<input type="checkbox"/> Yes <input checked="" type="checkbox"/> No	<input type="checkbox"/> Yes <input checked="" type="checkbox"/> No
<i>Unidentified open or damaged containers</i>	<input type="checkbox"/> Yes <input checked="" type="checkbox"/> No	<input type="checkbox"/> Yes <input checked="" type="checkbox"/> No
<i>Evidence of underground/aboveground storage tanks</i>	<input type="checkbox"/> Yes <input checked="" type="checkbox"/> No	<input type="checkbox"/> Yes <input checked="" type="checkbox"/> No
<i>Old or leaking electrical transformers</i>	<input type="checkbox"/> Yes <input checked="" type="checkbox"/> No	<input type="checkbox"/> Yes <input checked="" type="checkbox"/> No
<i>Comments</i>		

RNC Environmental, LLC
Phase I Site Reconnaissance Checklist

SWC Monterey Rd/Cosmo Ave
Morgan Hill, CA

Physical Observations		
	Subject Property	Adjacent
<i>Stained Soil</i>	<input type="checkbox"/> Yes <input checked="" type="checkbox"/> No	<input type="checkbox"/> Yes <input checked="" type="checkbox"/> No
<i>Stressed/dead vegetation?(other than seasonal)</i>	<input type="checkbox"/> Yes <input checked="" type="checkbox"/> No	<input type="checkbox"/> Yes <input checked="" type="checkbox"/> No
<i>Odors</i>	<input type="checkbox"/> Yes <input checked="" type="checkbox"/> No	<input type="checkbox"/> Yes <input checked="" type="checkbox"/> No
<i>Trash and debris</i>	<input type="checkbox"/> Yes <input checked="" type="checkbox"/> No	<input type="checkbox"/> Yes <input checked="" type="checkbox"/> No
<i>Fill soil</i>	<input type="checkbox"/> Yes <input checked="" type="checkbox"/> No	<input type="checkbox"/> Yes <input checked="" type="checkbox"/> No
<i>Wastewater discharges</i>	<input type="checkbox"/> Yes <input checked="" type="checkbox"/> No	<input type="checkbox"/> Yes <input checked="" type="checkbox"/> No
<i>Pits/ponds/lagoons</i>	<input type="checkbox"/> Yes <input checked="" type="checkbox"/> No	<input type="checkbox"/> Yes <input checked="" type="checkbox"/> No
<i>Monitoring wells</i>	<input type="checkbox"/> Yes <input checked="" type="checkbox"/> No	<input type="checkbox"/> Yes <input checked="" type="checkbox"/> No
<i>Comments</i>		

RNC Environmental, LLC
Phase I Site Reconnaissance Checklist

SWC Monterey Rd/Cosmo Ave
Morgan Hill, CA

Water and Wastewater	
<i>Potable water supply</i>	<input type="checkbox"/> Public <input type="checkbox"/> Private well <input type="checkbox"/> Other <input checked="" type="checkbox"/> None
<i>Sewage disposal</i>	<input type="checkbox"/> Public <input type="checkbox"/> Private septic <input type="checkbox"/> Other <input checked="" type="checkbox"/> None
<i>Discharges to surface or pond</i>	<input type="checkbox"/> Yes <input checked="" type="checkbox"/> No
<i>Wetlands or surface waters</i>	<input checked="" type="checkbox"/> Yes <input type="checkbox"/> No <i>Channelized creek runs along the east side of property</i>

D. Historical Photos and Maps



1948



1953



1971



1974

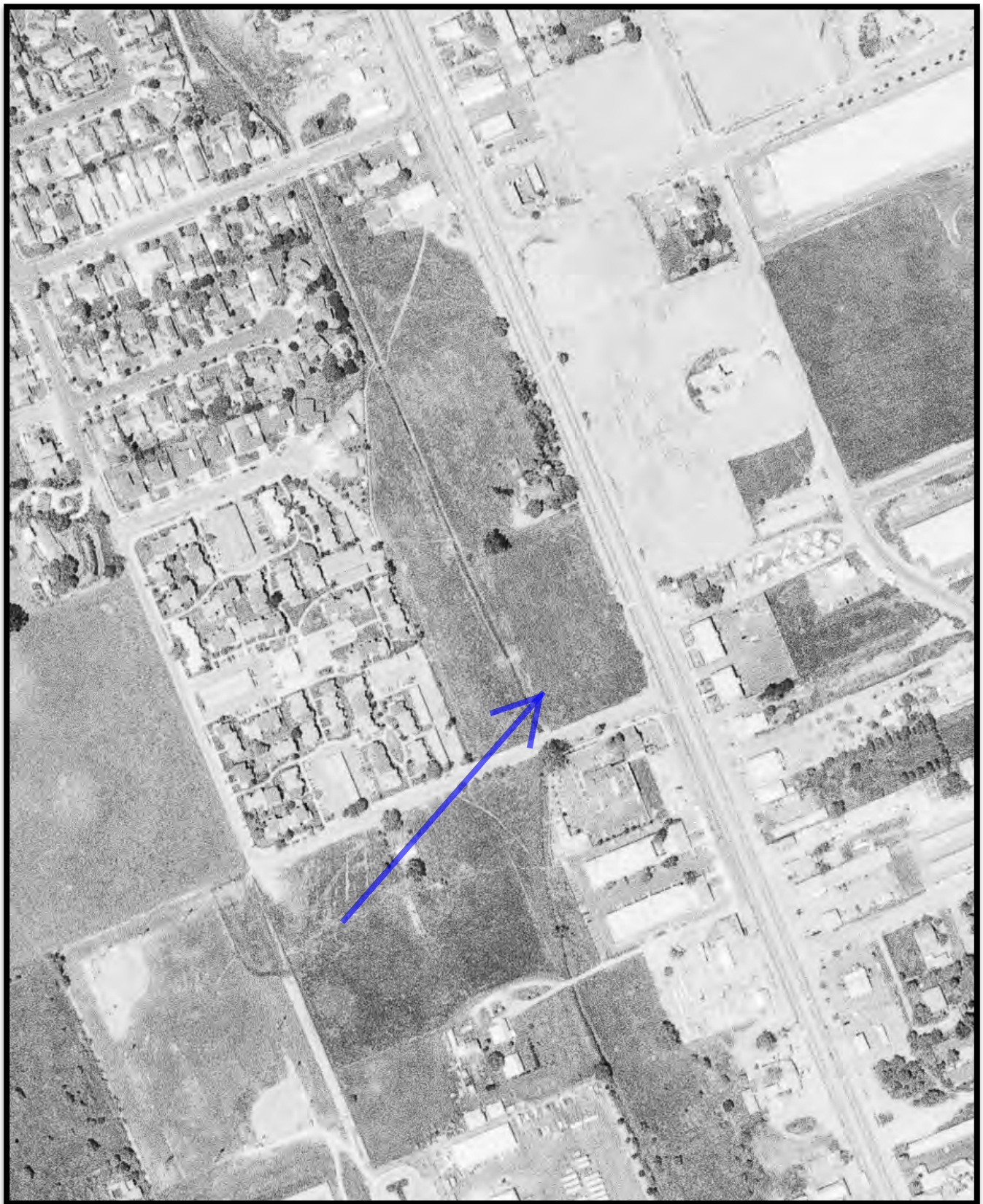

1981

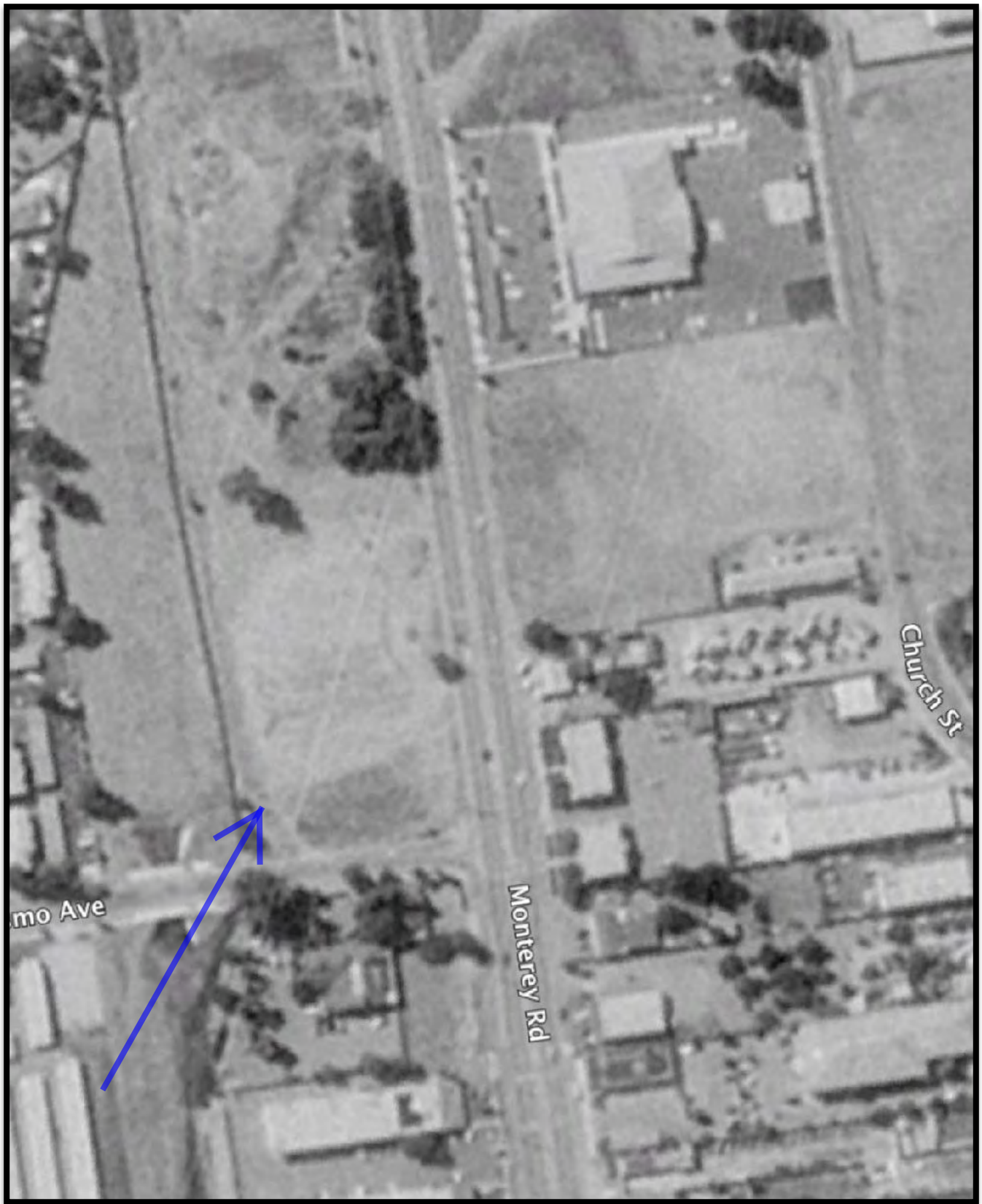

1993

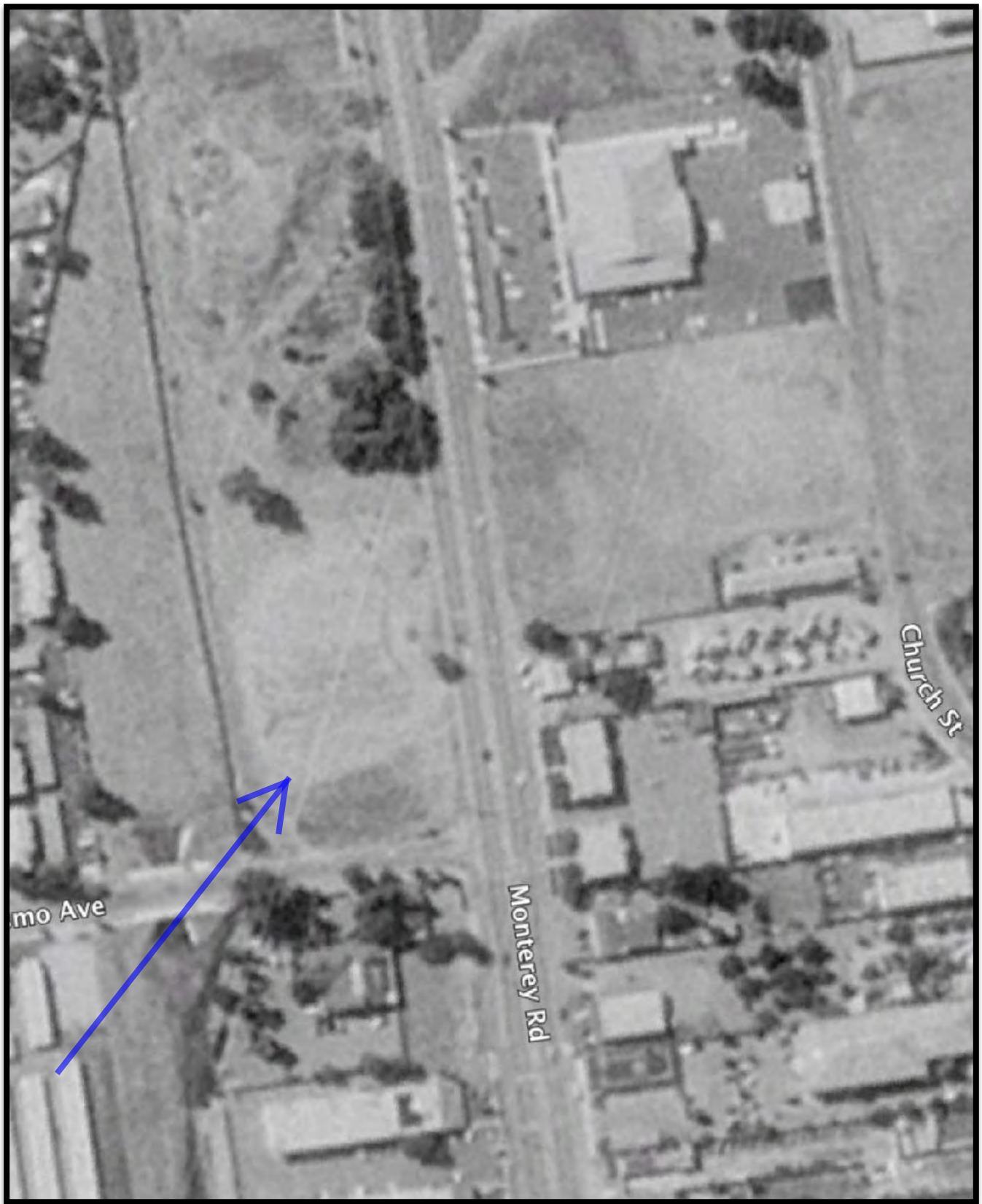

1998



2004



2008

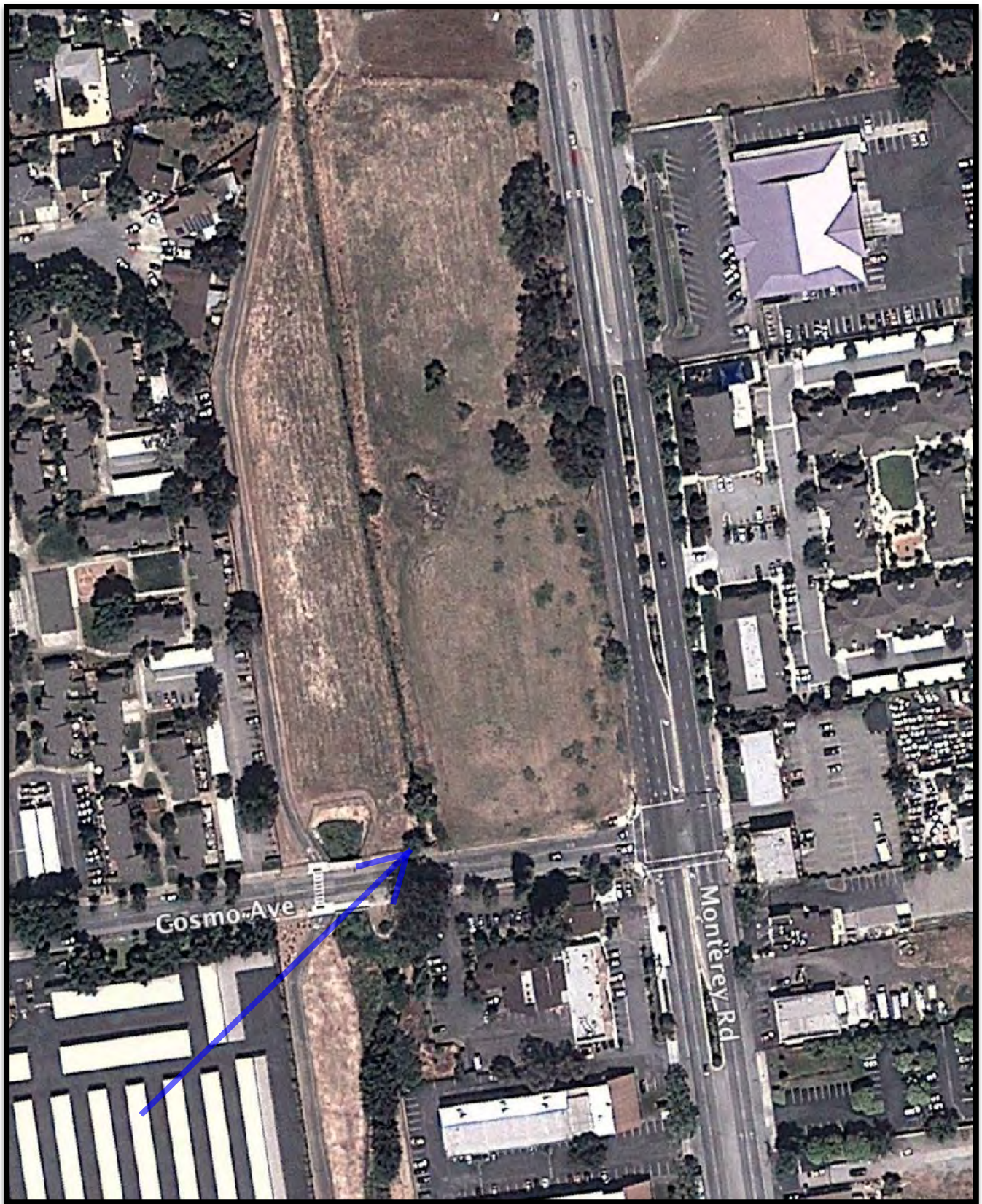

2012

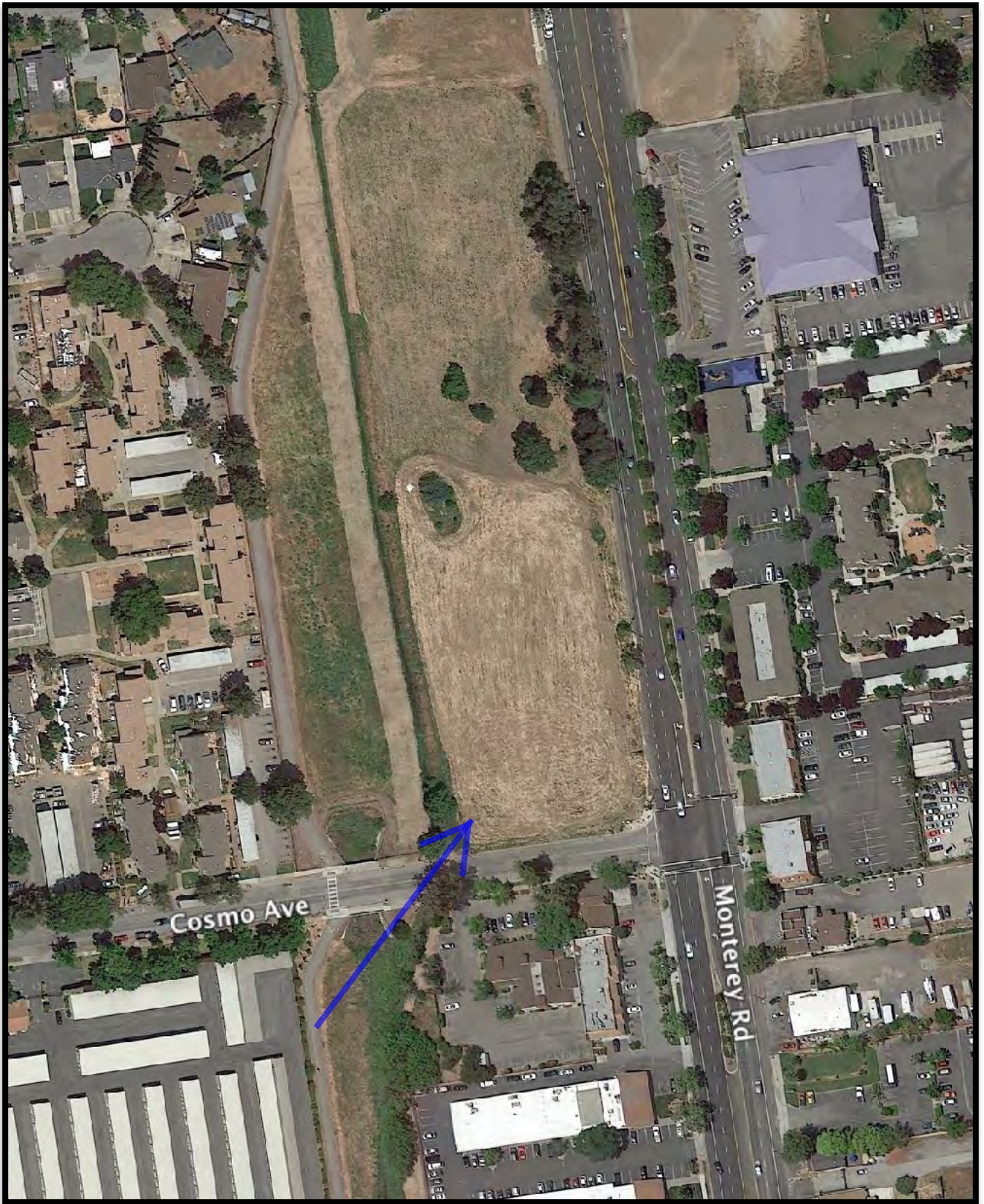

2018

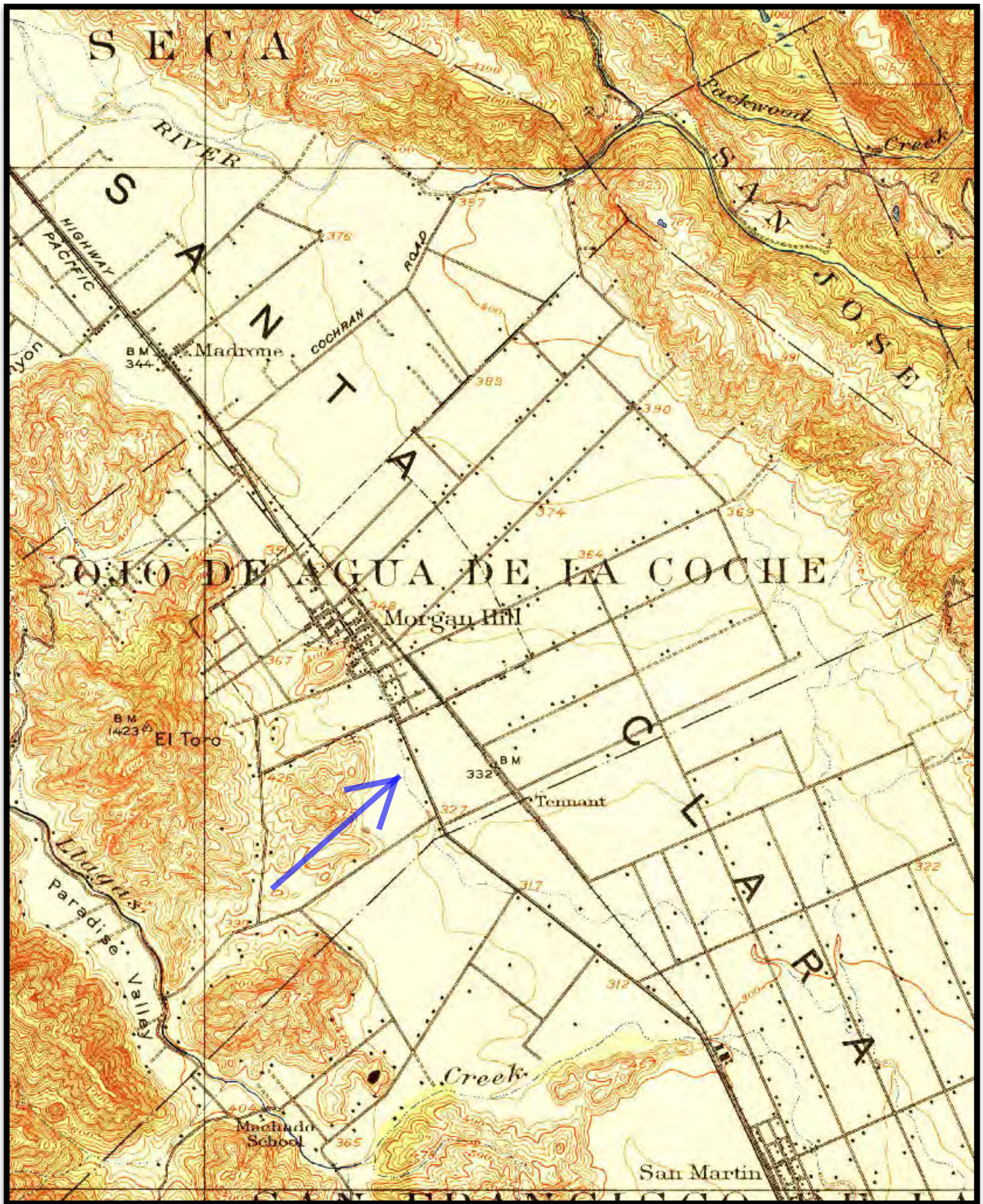

1917

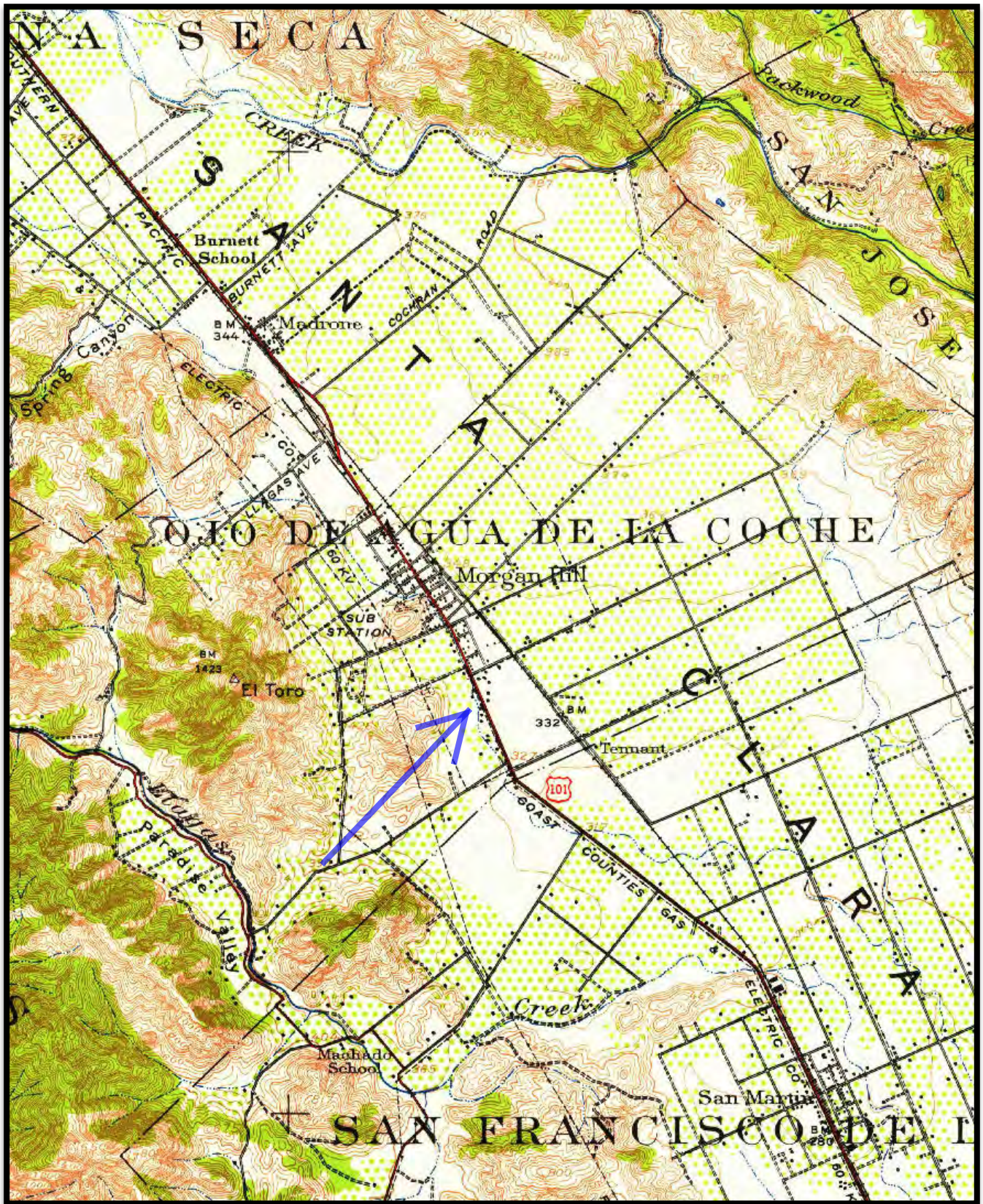

1939

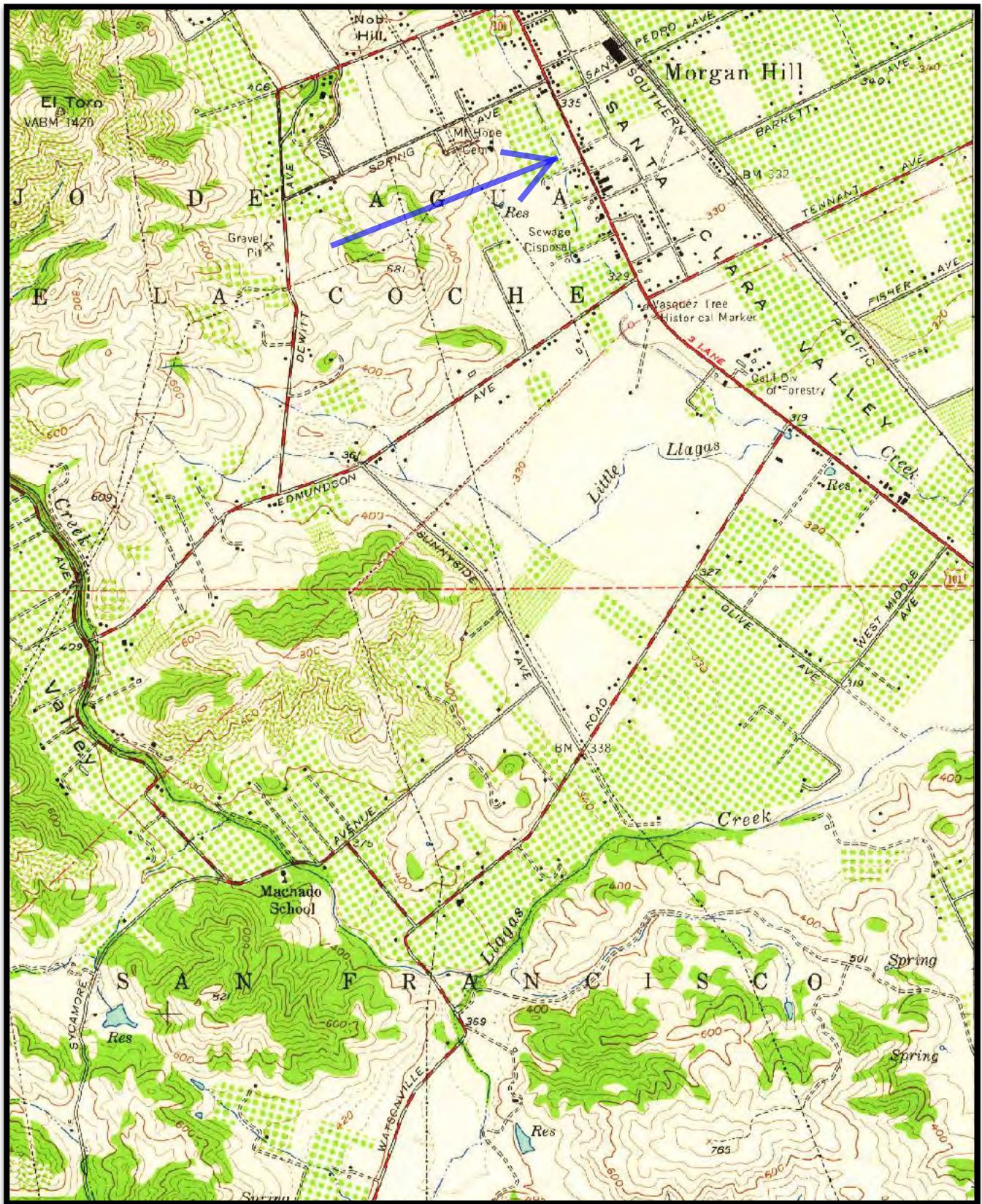

1955

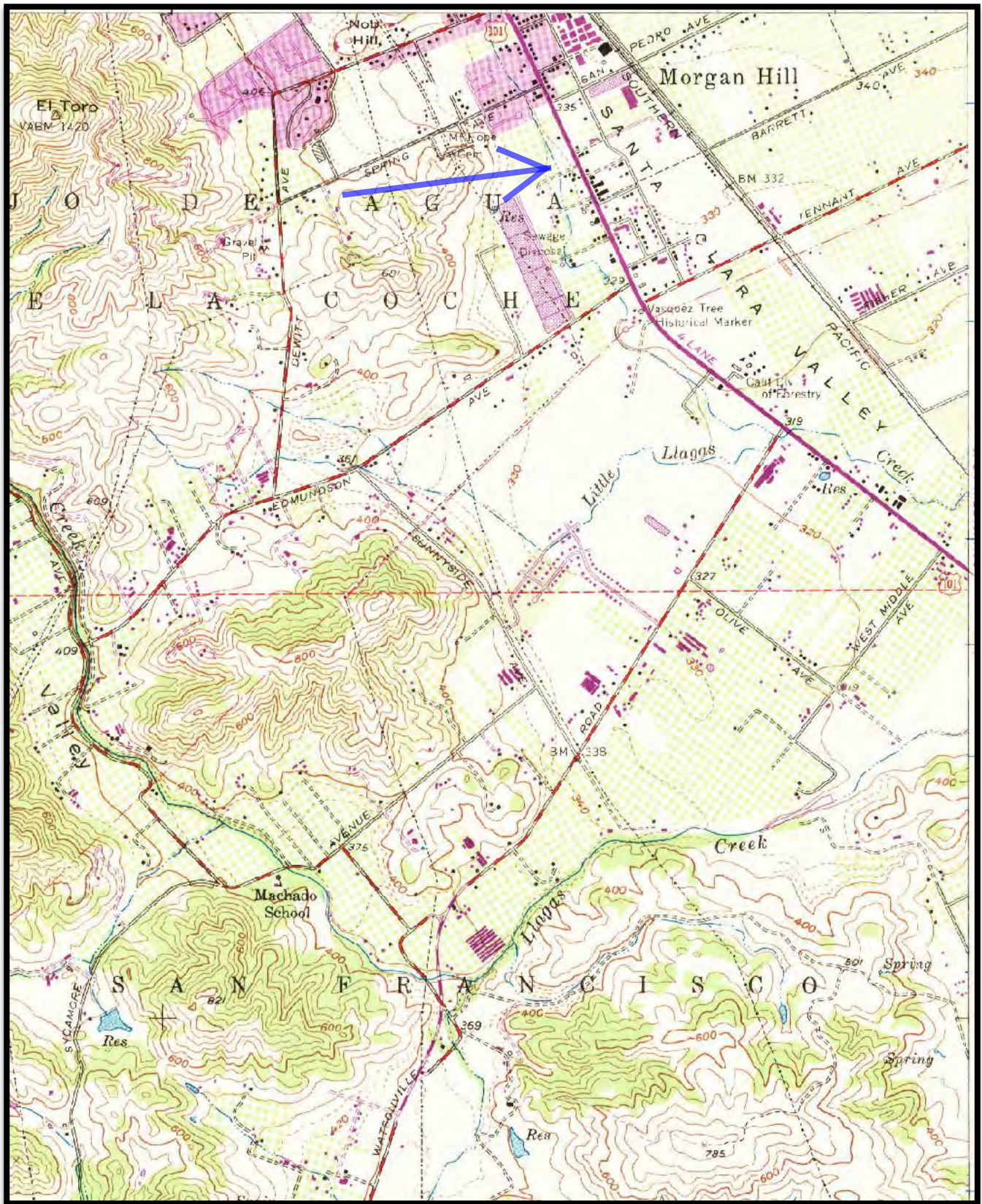

1968

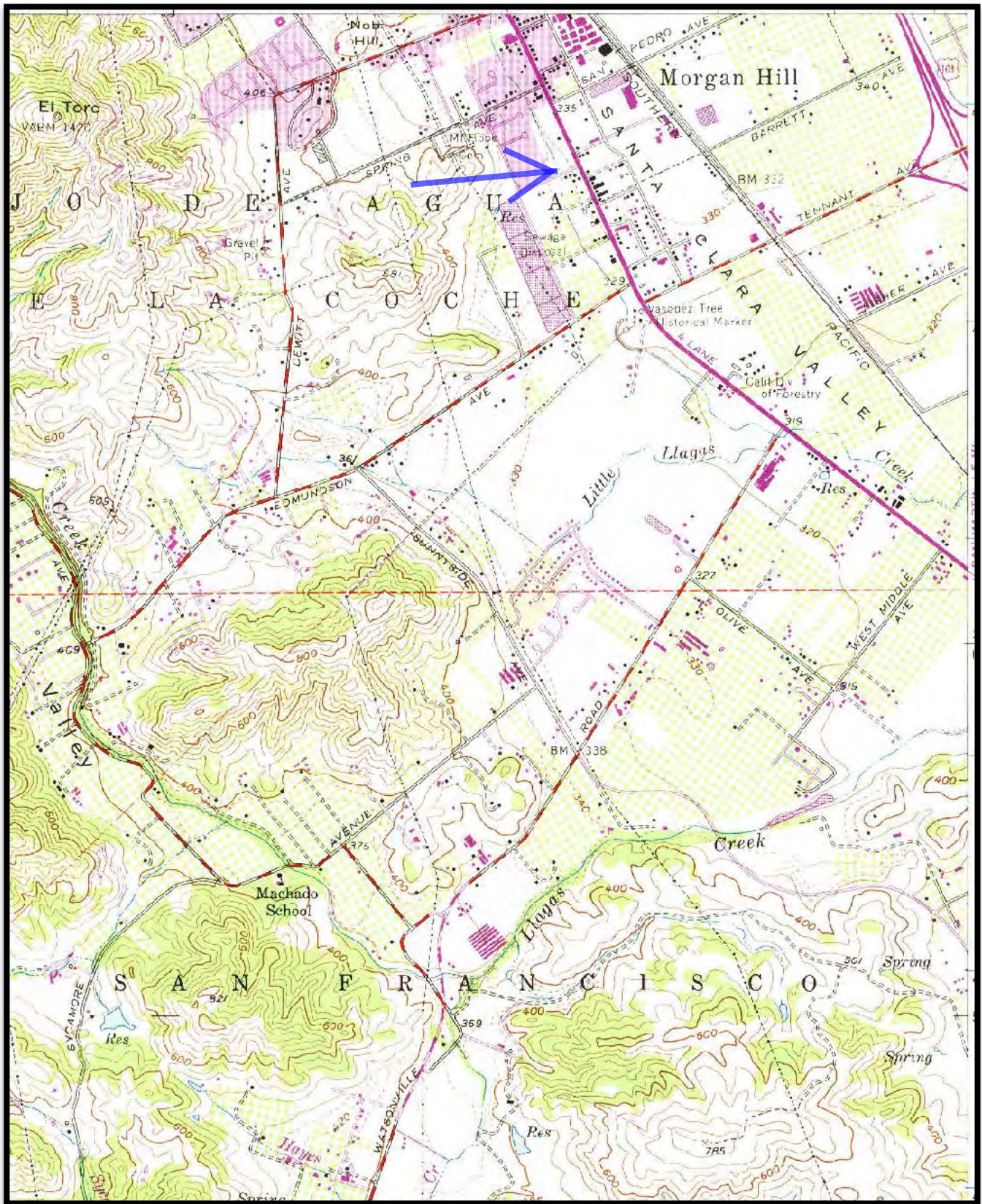

1973

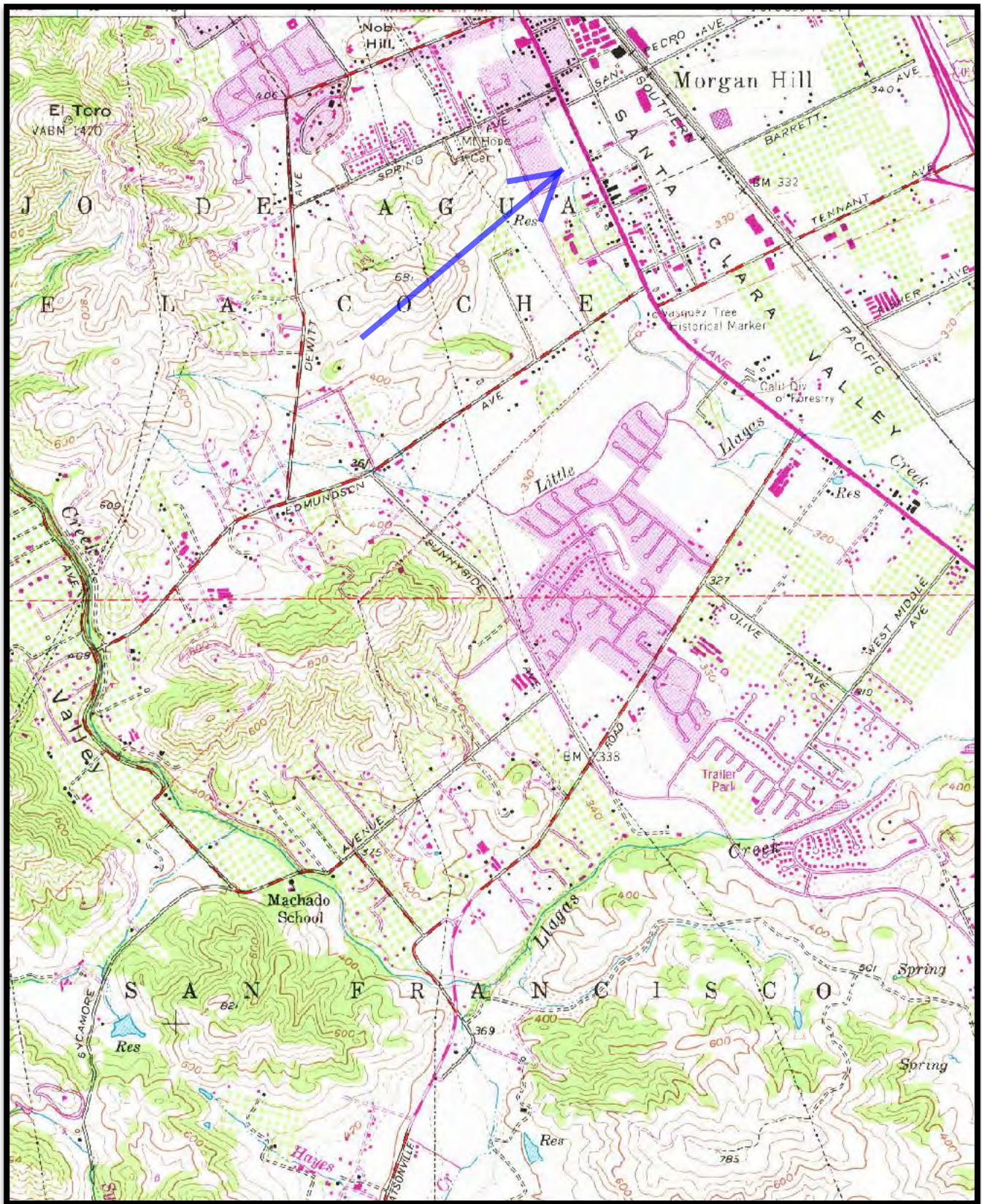

1980

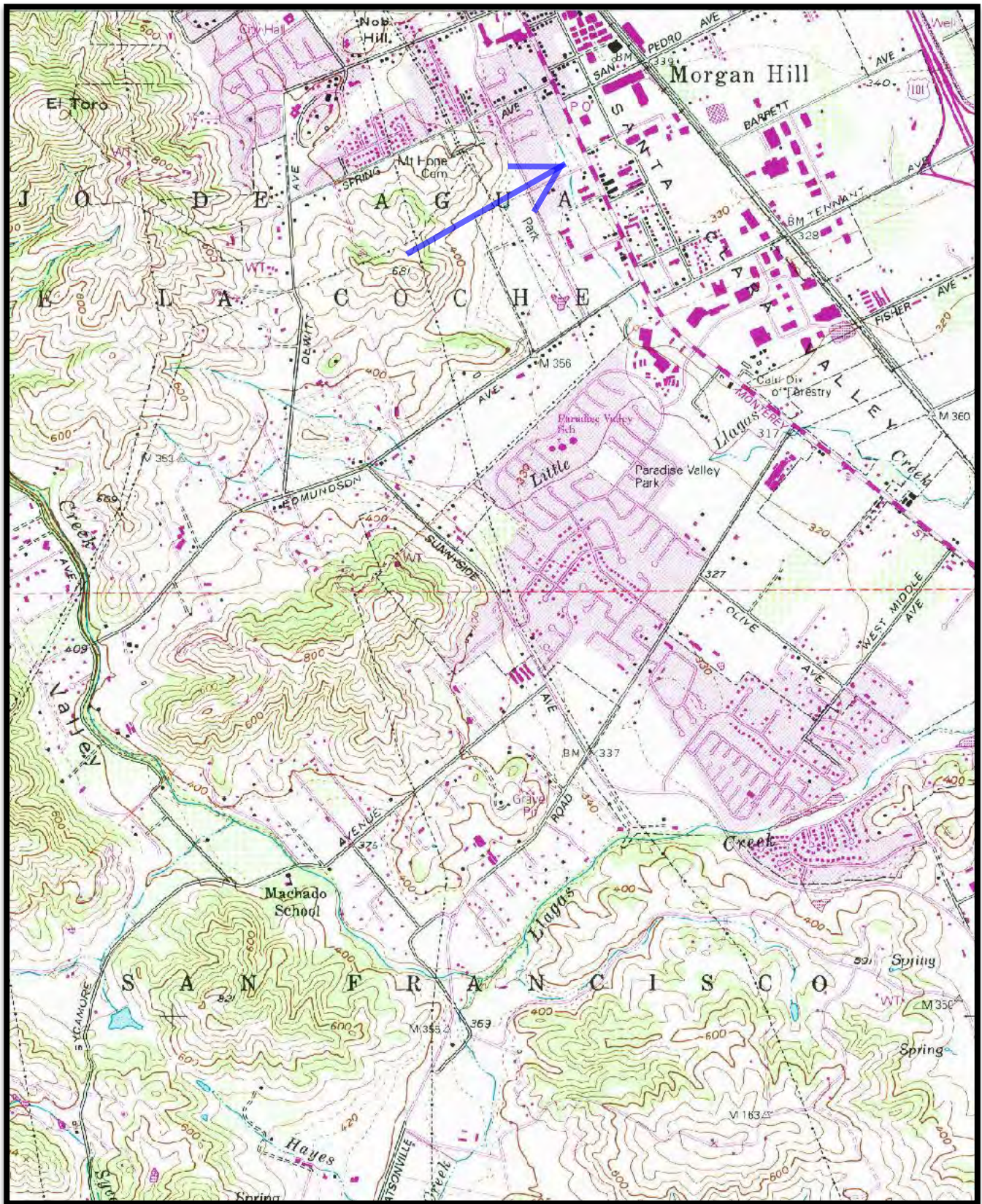

1994

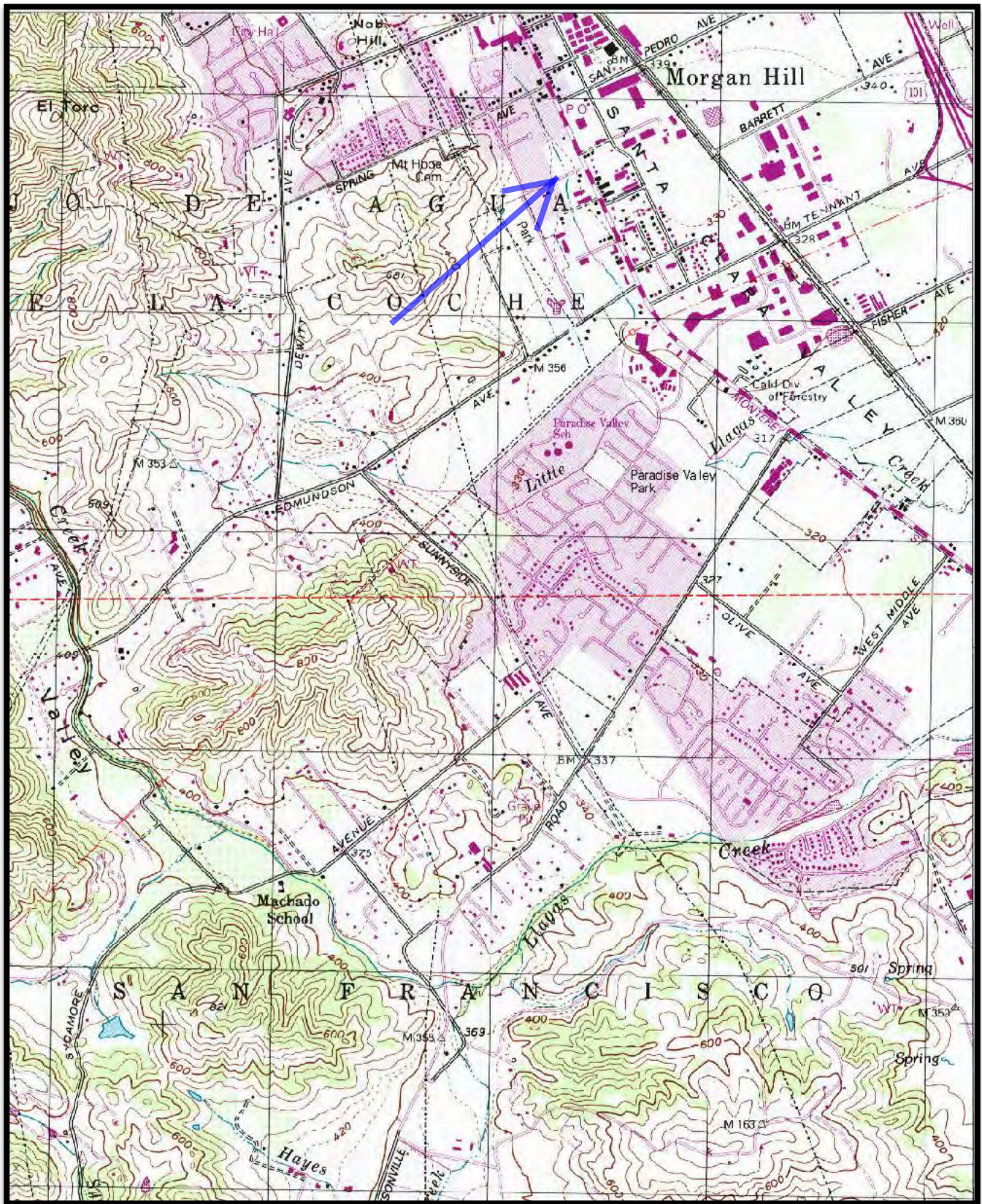

1996

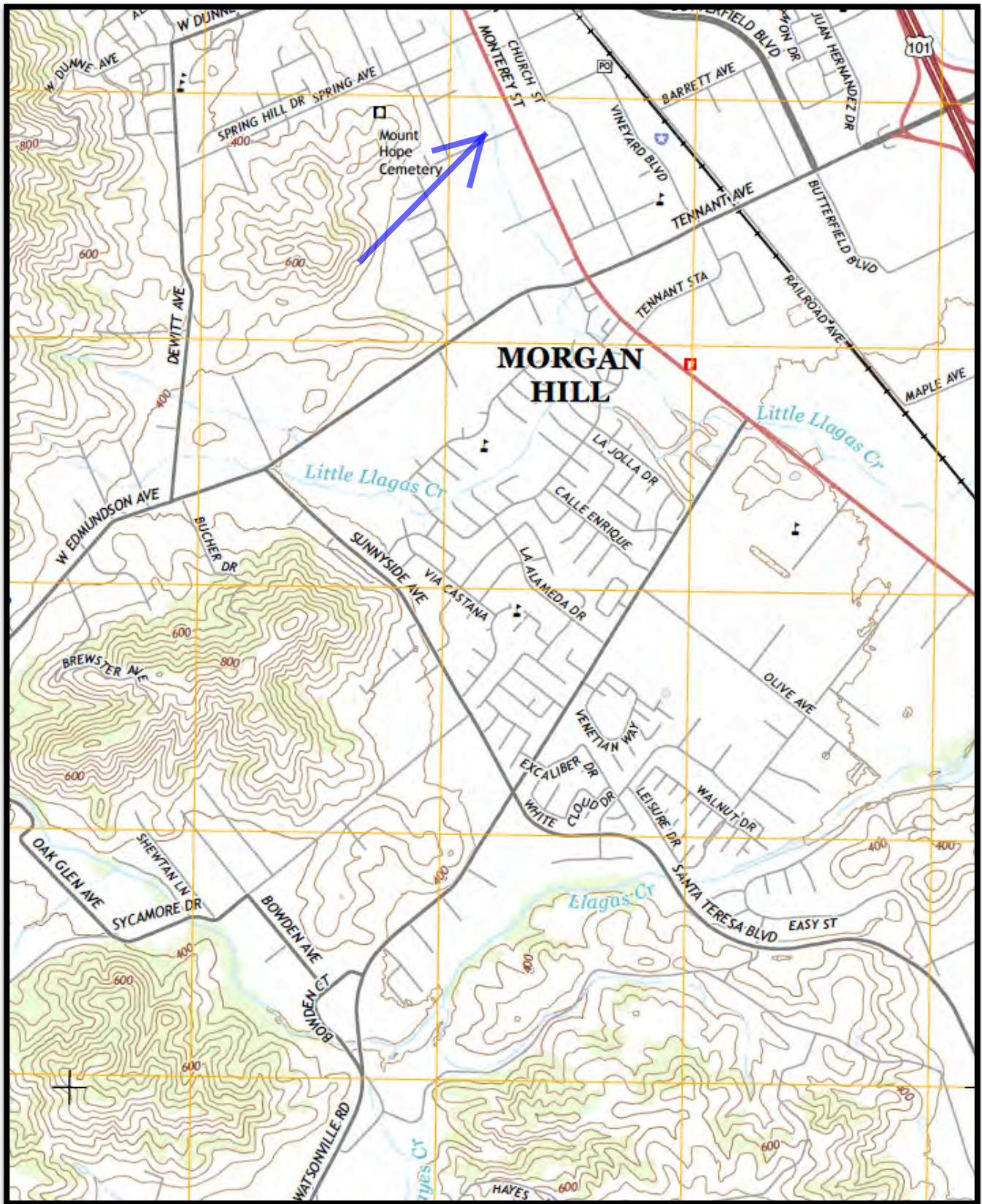

2015

E. Government Records Search

Regulatory Records Review

Voices Charter School
NWC Monterey Rd./Cosmo Ave.
Morgan Hill, California 95037



July 24, 2018

HAZARDOUS WASTE CLEANUPS

Sites	Source	Search	Found
“Superfund” National Priority List (N P L)	U S Environmental Protection Agency: <ul style="list-style-type: none"> • Enviromapper • Cleanups In My Community 	1 Mi.	0
Non-N P L Federal Cleanup Sites	U S Environmental Protection Agency: <ul style="list-style-type: none"> • Enviromapper • Cleanups In My Community 	0.5 Mi.	0
R C R A Corrective Action (Corracts)	U S Environmental Protection Agency: <ul style="list-style-type: none"> • Enviromapper • Enforcement And Compliance History Online (E C H O) 	1 Mi.	0
State-Response Cleanup Sites	California Department Of Toxic Substances Control: <ul style="list-style-type: none"> • Envirostor 	1 Mi.	0
Regional/Local Oversight	California State Water Resources Control Board: <ul style="list-style-type: none"> • Geotracker 	0.5 Mi.	1
Voluntary Cleanup	California State Water Resources Control Board: <ul style="list-style-type: none"> • Geotracker 	0.5 Mi.	0
Previously Regulated Sites			
Delisted N P L	U S Environmental Protection Agency: <ul style="list-style-type: none"> • Cleanups In My Community 	0.5 Mi.	0
No Further Action	U S Environmental Protection Agency: <ul style="list-style-type: none"> • Cleanups In My Community 	0.5 Mi.	0
Brownfields	U S Environmental Protection Agency: <ul style="list-style-type: none"> • Cleanups In My Community 	0.5 Mi.	0

Hazardous Waste Cleanup Site Findings

SITE NAME	SITE_TYPE	STATUS	ADDRESS
CASTLE VEGTECH	CLEANUP PROGRAM SITE	OPEN - ASSESSMENT & INTERIM REMEDIAL ACTION	16470 VINEYARD BLVD

MAP 1: HAZARDOUS WASTE CLEANUP SITES

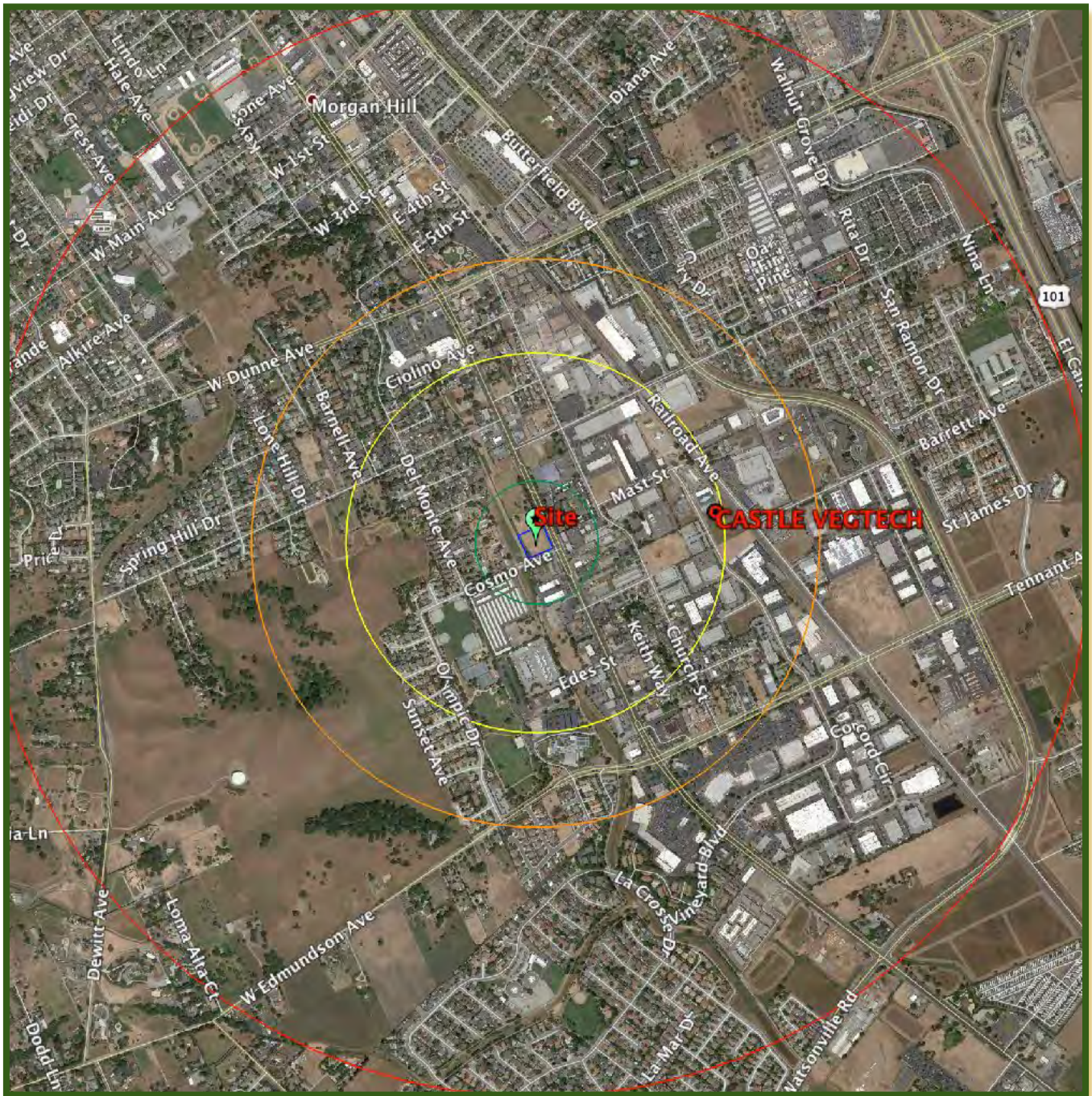

- Subject Property
- 0.1 mile
- 0.33 mile
- 0.5 mile
- 1.0 mile

LEAKING UNDERGROUND FUEL TANKS AND WASTE MANAGEMENT ACTIVITIES

Sites	Source	Search	Found
Leaking Underground Fuel Tanks (L U F T)	California State Water Resources Control Board: <ul style="list-style-type: none"> • Geotracker 	0.5 Mi.	10
R C R A Treatment, Storage And Disposal Facilities (T S D)	U S Environmental Protection Agency: <ul style="list-style-type: none"> • Enforcement And Compliance History Online (E C H O) 	0.5 Mi.	0
Solid Waste Sites (Landfills)	California Department Of Resources Recycling And Recovery: <ul style="list-style-type: none"> • Solid Waste Information System (S W I S) 	0.5 Mi.	0

LEAKING UNDERGROUND FUEL TANKS AND WASTE MANAGEMENT FINDINGS

SITE NAME	SITE_TYPE	STATUS	ADDRESS
BP FACILITY #11224	LUST CLEANUP SITE	OPEN - SITE ASSESSMENT	16995 MONTEREY
DON LOVE EXXON	LUST CLEANUP SITE	COMPLETED - CASE CLOSED	16990 MONTEREY RD
MORGAN HILL CORPORATION YARD	LUST CLEANUP SITE	COMPLETED - CASE CLOSED	105 EDES COURT
NEMATOLLAH GHASSEMKHAMI	LUST CLEANUP SITE	COMPLETED - CASE CLOSED	16380 MONTEREY HWY
REDTREE PROPERTIES	LUST CLEANUP SITE	COMPLETED - CASE CLOSED	140 SAN PEDRO AVE
SABEK GAS STATION	LUST CLEANUP SITE	OPEN - VERIFICATION MONITORING	16270 MONTEREY ROAD
UNOCAL #6169	LUST CLEANUP SITE	COMPLETED - CASE CLOSED	17015 MONTEREY ST
UNOCAL #6169	LUST CLEANUP SITE	COMPLETED - CASE CLOSED	17015 MONTEREY
VILLA CIOLINO	LUST CLEANUP SITE	COMPLETED - CASE CLOSED	16873 MONTEREY ROAD
WORLD OIL #52	LUST CLEANUP SITE	COMPLETED - CASE CLOSED	16720 MONTEREY

MAP 2: LEAKING UNDERGROUND FUEL TANKS AND WASTE MANAGEMENT

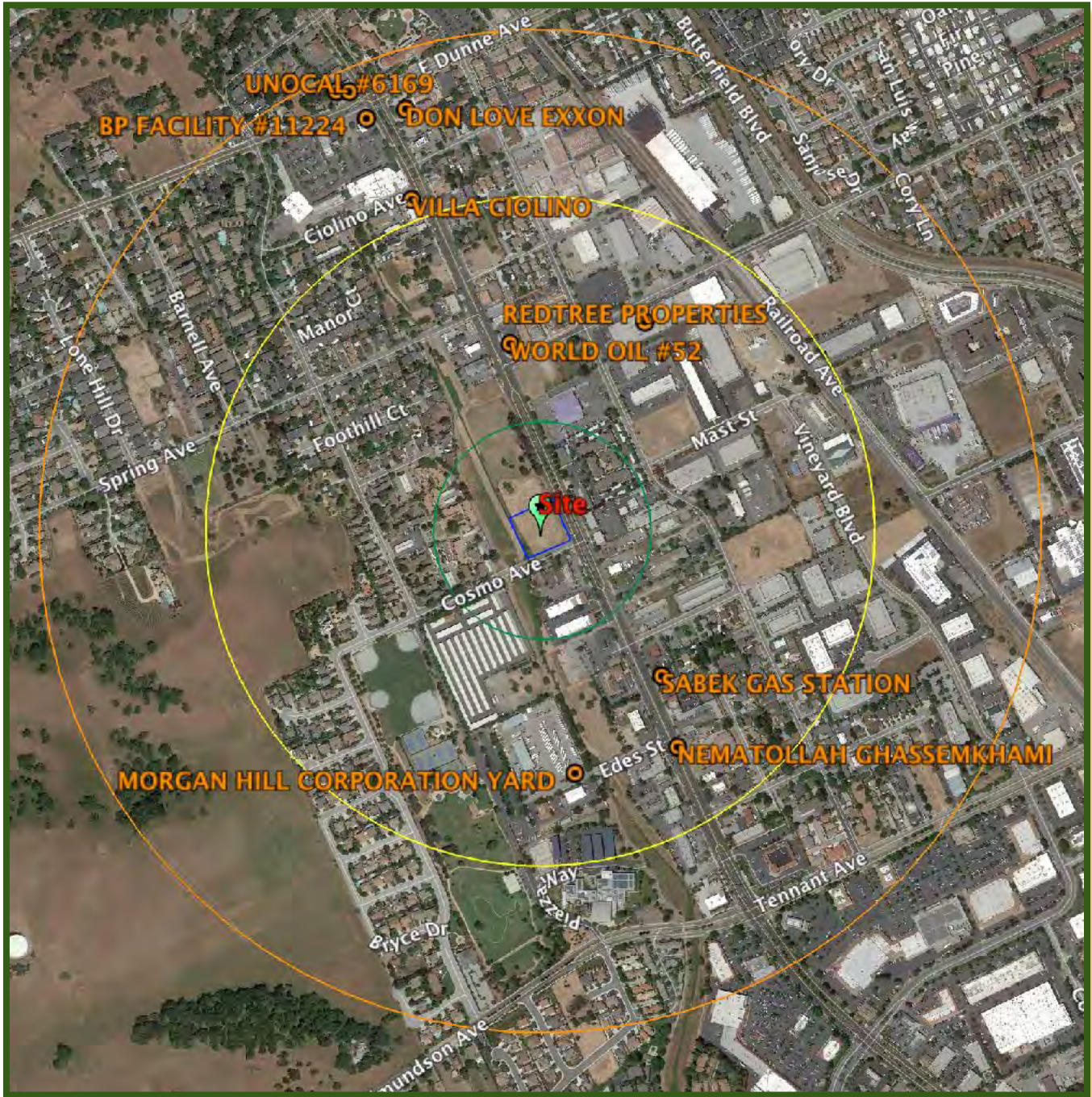

- Subject Property
- 0.1 mile
- 0.33 mile
- 0.5 mile
- 1.0 mile

FUEL STORAGE, HAZARDOUS WASTE AND SPILLS¹

Sites	Source	Search	Found
Registered Underground Storage Tanks	California State Water Resources Control Board: • Geotracker	Site And Adjacent	0
Historical Underground Storage Tanks	California State Water Resources Control Board: • Geotracker	Site And Adjacent	0
Hazardous Waste Generators (R C R A)	U S Environmental Protection Agency: • Enviromapper	Site And Adjacent	0
Waste Generator Manifests	CA Department Of Toxic Substances Control: • Hazardous Waste Tracking System (H W T S)	Site	0
Oil And Gas Wells	California Division Of Oil, Gas And Geothermal Resources: • Well Finder	Site	0
Spills	U S Coast Guard: • National Response Center (Formerly The Emergency Response Notification System)	Site	0

LIENS AND USE RESTRICTIONS

Liens And Use Restrictions	U S Environmental Protection Agency: • Enviromapper	Site	0
	California State Water Resources Control Board: • Geotracker	Site	0

¹ HWTS: http://hwts.dtsc.ca.gov/report_list.cfm

Well Finder: <http://www.conservation.ca.gov/dog/Pages/WellFinder.aspx>

National Response Center (formerly the Emergency Response Notification System): <http://www.nrc.uscg.mil> (data downloaded to local file for database search)

Fuel Storage, Waste and Spills Findings

Site	Address	Source	Status
None			

Liens and Use Restrictions

Site	Address	Source	Status
None			

MAP3: SITE AND ADJACENT PROPERTIES

FUEL STORAGE AND WASTE MANAGEMENT
LIENS AND USE RESTRICTIONS
ACCIDENTAL SPILLS AND RELEASES



Subject Property
0.1 mile

CSM REPORT FOR PUBLIC NOTICING

PROJECT INFORMATION (DATA PULLED FROM GEOTRACKER) - [MAP THIS SITE](#)

<u>SITE NAME / ADDRESS</u>	<u>STATUS</u>	<u>STATUS DATE</u>	<u>RELEASE REPORT DATE</u>	<u>AGE OF CASE</u>	<u>CLEANUP OVERSIGHT AGENCIES</u>
CASTLE VEGTECH (Global ID: SL0608727312) 16470 Vineyard Blvd MORGAN HILL, CA 95037-5497	Open - Assessment & Interim Remedial Action	3/17/2017	1/2/1965	54	CENTRAL COAST RWQCB (REGION 3) (LEAD) - CASE #: s296 CASEWORKER: DEAN THOMAS - SUPERVISOR: GREG BISHOP

SITE HISTORY

From 1958 to 1986, Castle Vegtech, Inc., owned or controlled by Tom Castle, operated a pesticide formulation, sales, and application business at 16470 Vineyard Boulevard (formerly 190 Mast Street), Morgan Hill. In the course doing business, Castle Vegtech allowed pesticide related wastes to leak or spill into or onto the ground, which have contaminated soils and groundwater beneath the site and the surrounding area.

Regional Board opened this case in 1987. Castle Vegtech (CV) was initially identified and named as the responsible party. In October 1988, during a public hearing for an ACL imposed to CV, Regional Board staff learned that Jamina Investments, a General Partnership of Tom Castle's three children, acquired the CV property on April 4, 1986. Since then, both CV and Jamina Investments (Jamina) had been identified and named as the responsible parties until 2001, when CV property was sold to Alan Hui. After CV and Jamina sold the property in 2001, all correspondences from the Regional Board to the RP's have been directed to Michael Mangano, who was Alan Hui's initial representative and apparently later became the current owner of the CV property.

Since opening this case, the Regional Board has issued several Cleanup or Abatement Orders (CAO) as well as several ACLs to CV and Jamina. After the public hearing for the first ACL in October 1988, the Regional Board raised the staff recommended ACL amount of \$6,000 to \$25,000. On February 7, 1989, the Regional Board issued the first CAO, No. 89-66, to CV and Jamina, requiring delineation and remediation of soil and groundwater at the site. To date, three CAOs (No.'s 92-104, 93-111, and 96-63), one Settlement Agreement between the Regional Board and CV responsible parties, including CV, Jamina, James A. Castle, Michael C. Castle, and Nancy Buchanan (Tom Castle's daughter), a General NPDES Permit Order, and a groundwater Monitoring and Reporting Program Order are in effect (see attached Active Orders for CV). All of these existing orders from the Regional Board were issued to CV and Jamina.

In 1997, a Settlement Agreement was reached between the RPs and the Regional Board to resolve a total of \$85,000 outstanding balance of two previous ACL orders (No. 92-78 and 92-83) adopted by the Regional Board in June 1992. The Settlement Agreement requires Castle Vegtech, Jamina Investments, James A. Castle, Michael C. Castle, and Nancy Buchanan to pay \$85,000 plus 10% interest from May 8, 1997, if the Executive Officer notifies the Castle Family that he has found that the cleanup of the property is not proceeding in accordance with the requirements and time schedules in Cleanup or Abatement Order No. 96-63, or any then current cleanup order(s) issued by the Regional Board, or is not proceeding to the Executive Officer's satisfaction. During the following years until early 2001, the Castle Family generally complied with the Regional Board's orders and requirements.

In a letter dated March 22, 2001, Michael Castle informed the staff that CV property was sold to Mr. Alan Hui. Since then, although staff who worked on this case did not, either verbally or in writing, release the CV and Jamina's responsibility for this site, all discussions and requests have been directed to Michael Mangano who was initially acting as Alan Hui's representative and at some unknown later time became the owner.

CLEANUP ACTION INFO

NO CLEANUP ACTIONS HAVE BEEN REPORTED

RISK INFORMATION

[VIEW CASE REVIEWS](#)

<u>CONTAMINANTS OF CONCERN</u>	<u>CURRENT LAND USE</u>	<u>BENEFICIAL USE</u>	<u>DISCHARGE SOURCE</u>	<u>DATE REPORTED</u>	<u>STOP METHOD</u>	<u>NEARBY / IMPACTED WELLS</u>
1,1,1-Trichloroethane (TCA), 1,2,3-Trichloropropane (TCP), Other Chlorinated Hydrocarbons, DDD / DDE / DDT, Endrin, Other Insecticides / Pesticide / Fumigants / Herbicides, Toxaphene	Commercial, Industrial, Vacant	GW - Municipal and Domestic Supply		1/2/1965		0

<u>FREE PRODUCT</u>	<u>OTHER CONSTITUENTS</u>	<u>NAME OF WATER SYSTEM</u>	<u>LAST REGULATORY ACTIVITY</u>	<u>LAST ESI UPLOAD</u>	<u>LAST EDF UPLOAD</u>	<u>EXPECTED CLOSURE DATE</u>	<u>MOST RECENT CLOSURE REQUEST</u>
			7/24/2017	6/25/2018	6/25/2018		

CDPH WELLS WITHIN 1500 FEET OF THIS SITE

NONE

CALCULATED FIELDS (BASED ON LATITUDE / LONGITUDE)

<u>APN</u>	<u>GW BASIN NAME</u>	<u>WATERSHED NAME</u>
81702044	Gilroy-Hollister Valley - Llagas Area (3-003.01)	Pajaro River - South Santa Clara Valley (305.30)
<u>COUNTY</u>	<u>PUBLIC WATER SYSTEM(S)</u>	
Santa Clara	<ul style="list-style-type: none"> CITY OF MORGAN HILL - RAY DELLANINI, MORGAN HILL, CA 95037 SANTA CLARA VALLEY WATER DISTRICT - 5750 ALMADEN EXPRESSWAY, SAN JOSE, CA 95118 	

MOST RECENT CONCENTRATIONS OF PETROLEUM CONSTITUENTS IN GROUNDWATER

[VIEW ESI SUBMITTALS](#)

<u>FIELD PT NAME</u>	<u>DATE</u>	<u>TPHg</u>	<u>BENZENE</u>	<u>TOLUENE</u>	<u>ETHYL-BENZENE</u>	<u>XYLENES</u>	<u>MTBE</u>	<u>TBA</u>
MW-1	4/27/2015					ND		
MW-10	4/29/2015					ND		
MW-11R	4/28/2015					ND		
MW-12	4/28/2015					ND		
MW-14	4/27/2015					ND		
MW-14B	4/27/2015					ND		
MW-2	4/28/2015					ND		
MW-4	4/27/2015					ND		
MW-7	4/28/2015					ND		
MW-8	4/27/2015					ND		
OH-MW-1RD	4/28/2015					ND		
OH-MW-2RD	4/28/2015					ND		
OH-MW-3RD	4/28/2015					ND		
OL-MW-1	4/27/2015					ND		
ON-MW-3	4/27/2015					ND		
ON-MW-3B	4/27/2015					ND		

OP-MW-1 4/27/2015
RW-1 4/28/2015

[ND](#)
[ND](#)

MOST RECENT CONCENTRATIONS OF PETROLEUM CONSTITUENTS IN SOIL

[VIEW ESI SUBMITTALS](#)

NO SOIL DATA HAS BEEN SUBMITTED TO GEOTRACKER ESI FOR THIS SITE

MOST RECENT GEO_WELL DATA

[VIEW ESI SUBMITTALS](#)

<u>FIELD PT NAME</u>	<u>DATE</u>	<u>DEPTH TO WATER (FT)</u>	<u>SHEEN</u>	<u>DEPTH TO FREE PRODUCT (FT)</u>
MW-1	9/8/2017			
MW-10	9/8/2017	36.98	N	
MW-11	9/20/2012		U	
MW-11R	9/8/2017	29.25	N	
MW-12	9/8/2017	25.26	N	
MW-13	9/20/2012		U	
MW-14	9/8/2017	24.77	N	
MW-14B	9/8/2017	34.08	N	
MW-15	9/20/2012		U	
MW-16	9/20/2012		U	
MW-18	9/20/2012		U	
MW-2	9/8/2017	28.6	N	
MW-3	9/20/2012		U	
MW-4	9/8/2017	35.07	N	
MW-5	9/20/2012		U	
MW-6	9/20/2012		U	
MW-7	9/8/2017	27.92	N	
MW-8	9/8/2017	31.98	N	
MW-9	9/20/2012		U	
OH-MW-1RD	9/8/2017	23.46	N	
OH-MW-2RD	9/8/2017	22.92	N	
OH-MW-3RD	9/8/2017	22.88	N	
OHMW-1R	9/20/2012		U	
OHMW-2R	9/20/2012		U	
OHMW-3R	9/20/2012		U	
OHMW1RD	9/20/2012	31.99	U	
OHMW2RD	9/20/2012	31.59	U	
OHMW3RD	9/20/2012	31.55	U	
OL-MW-1	9/8/2017	23.77	N	
OLMW-1	9/20/2012	30.03	U	
ON-MW-3	9/8/2017	25.17	N	
ON-MW-3B	9/8/2017	34.31	N	
ONMW-2	9/20/2012		U	
ONMW-3	9/20/2012	33.85	U	
ONMW-3B	9/20/2012	40.91	U	
OP-MW-1	9/8/2017	23.9	N	
OPMW-1	9/20/2012	32.43	U	
RW-1	9/8/2017	29.31	N	

CSM REPORT FOR PUBLIC NOTICING

PROJECT INFORMATION (DATA PULLED FROM GEOTRACKER) - [MAP THIS SITE](#)

SITE NAME / ADDRESS	STATUS	STATUS DATE	RELEASE REPORT DATE	AGE OF CASE	CLEANUP OVERSIGHT AGENCIES
BP FACILITY #11224 (Global ID: T0608519223) 16995 MONTEREY MORGAN HILL, CA 95037	Open - Site Assessment	9/28/2016	5/4/1987	31	SANTA CLARA COUNTY LOP (LEAD) - CASE #: 09S3E28F01f CASEWORKER: TRAVIS L. FLORA - SUPERVISOR: JENNIFER KAAHAAINA CENTRAL COAST RWQCB (REGION 3) - CASE #: 3378 CASEWORKER: WEI LIU - SUPERVISOR: JENNIFER EPP

SITE HISTORY

The Site is a former Beacon-branded gasoline retail outlet located at the intersection of Monterey Road and West Dunne Avenue in Morgan Hill, California. BP acquired the property from Mobil Oil Corporation in 1989. In 1994, BP transferred the property to others and has not operated the facility since then. The Site is located in a mixed commercial and residential area. A former Beacon station is located north of the Site across Dunne Avenue, and a former Exxon station was previously located east of the Site across Monterey Road. Two 6,000-gallon and one 8,000-gallon underground storage tanks were removed and replaced in April 1987. Nineteen groundwater monitoring wells (ten on-site wells and nine off-site wells) and two groundwater extraction wells (MW-7 and SW-1) are active at and in the vicinity of the Site. Additionally, seven wells have been decommissioned at and in the vicinity of the Site. Soil boring and well construction details are summarized in Table 1 of the groundwater monitoring report.

A groundwater extraction and treatment system (GWETS) operated at the Site from October 2001 to June 2005, in accordance with the National Pollutant Discharge Elimination System (NPDES) Permit No. CAG993002, Order No. R3-2006-0067. The GWETS extracted groundwater from two extraction wells (MW-7 and SW-1), which was treated with granular activated carbon before discharging to the storm drain. The system has not routinely operated since June 2005. The GWETS was briefly restarted on March 22, 2007 to collect effluent samples required by the NPDES permit. Because the dissolved hydrocarbon plume has been relatively stable, the GWETS has remained shut down. In the event that the GWETS is restarted, the Regional Water Quality Control Board will be notified in accordance with the NPDES permit requirements.

An analytical data summary as of April 30, 2012, are follows:

GRO was detected above analytical method detection limits in groundwater samples collected from nine wells at concentrations ranging from 78 micrograms per liter (µg/L; MW-1) to 11,000 µg/L (SW-1). The highest concentrations of GRO were detected in four wells located in the vicinity of the dispenser islands (MW-2, MW-7, SW-1, and VP-2). GRO concentrations at these wells exhibit stable to decreasing concentration trends.

Benzene was detected in groundwater samples collected from six wells at concentrations ranging from 0.62 µg/L (MW-8) to 1,200 µg/L (SW-1). These six wells are located near the dispenser islands (MW-2, MW-7, MW-8, MW-12, SW-1, and VP-2). Benzene concentrations at these wells continue to exhibit decreasing or stable concentration trends.

MTBE was detected in groundwater samples collected from six monitoring wells at concentrations ranging from 2.6 µg/L (MW-10B) to 80 µg/L (SW-1). Similar to GRO and benzene, these wells are located near and downgradient from the dispenser islands. MTBE concentrations at these wells exhibit stable to decreasing concentration trends.

Based on the observed groundwater concentration trends, ARCADIS recommends continued semi-annual groundwater monitoring. In the Conceptual Site Model Report (CSM) submitted on September 28, 2011, ARCADIS recommended destroying monitoring wells MW-15 and MW-18 through MW-21. We have yet to receive a response from the County and are therefore requesting again that these wells be destroyed for the reasons stated in the September 28, 2011 CSM.

CLEANUP ACTION INFO

ACTION TYPE	BEGIN DATE	END DATE	PHASE	CONTAMINANT MASS REMOVED	DESCRIPTION
PUMP & TREAT (P&T) GROUNDWATER	7/12/2004	9/9/9999			
PUMP & TREAT (P&T) GROUNDWATER	10/31/2001	9/9/9999			
SOIL VAPOR EXTRACTION (SVE)	11/1/1993	12/1/1993			

RISK INFORMATION

[VIEW LTCP CHECKLIST](#)

[VIEW PATH TO CLOSURE PLAN](#)

[VIEW CASE REVIEWS](#)

CONTAMINANTS OF CONCERN	CURRENT LAND USE	BENEFICIAL USE	DISCHARGE SOURCE	DATE REPORTED	STOP METHOD	NEARBY / IMPACTED WELLS
Benzene, Toluene, Xylene, MTBE / TBA / Other Fuel Oxygenates, Gasoline	Commercial	GW - Groundwater Recharge, GW - Municipal and Domestic Supply	Piping	5/4/1987	Close and Remove Tank, Replace product piping	0

FREE PRODUCT	OTHER CONSTITUENTS	NAME OF WATER SYSTEM	LAST REGULATORY ACTIVITY	LAST ESI UPLOAD	LAST EDF UPLOAD	EXPECTED CLOSURE DATE	MOST RECENT CLOSURE REQUEST
NO	NO	City of Morgan Hill	4/30/2018	6/11/2018	5/21/2018		

CDPH WELLS WITHIN 1500 FEET OF THIS SITE

WELL NAME	STATE WELL #	STATUS	SOURCE	# TIMES SAMPLED	DIST TO WELL
DIANA WELL 01	4310006-007	Active Raw	G	1204	1183 feet

CALCULATED FIELDS (BASED ON LATITUDE / LONGITUDE)

APN	GW BASIN NAME	WATERSHED NAME
76709009	Gilroy-Hollister Valley - Llagas Area (3-003.01)	Pajaro River - South Santa Clara Valley (305.30)
COUNTY	PUBLIC WATER SYSTEM(S)	
Santa Clara	<ul style="list-style-type: none"> CITY OF MORGAN HILL - RAY DELLANINI, MORGAN HILL, CA 95037 SANTA CLARA VALLEY WATER DISTRICT - 5750 ALMADEN EXPRESSWAY, SAN JOSE, CA 95118 	

MOST RECENT CONCENTRATIONS OF PETROLEUM CONSTITUENTS IN GROUNDWATER

[VIEW ESI SUBMITTALS](#)

FIELD PT NAME	DATE	TPHg	BENZENE	TOLUENE	ETHYL-BENZENE	XYLENES	MTBE	TBA
CS								
EFF	1/25/2007	OTHER	ND	ND	ND	ND	0.85 UG/L	ND
INF	1/25/2007	OTHER	960 UG/L	87 UG/L	430 UG/L	630 UG/L	99 UG/L	130 UG/L
MID-1	1/25/2007	OTHER	ND	ND	ND	ND	ND	ND
MID-2	1/25/2007	OTHER	ND	1.8 UG/L	ND	ND	ND	5.5 UG/L
MW-1	3/29/2018	OTHER	ND	ND	ND	ND	1.4 UG/L	30.1 UG/L
MW-10	6/10/2002	OTHER	25.6 UG/L	ND	27.9 UG/L	27.9 UG/L	ND	ND
MW-10B	3/30/2018	OTHER	ND	ND	ND	ND	ND	ND
MW-11	6/10/2002	OTHER	ND	ND	ND	ND	4.1 UG/L	ND
MW-11B	3/29/2018	OTHER	ND	ND	5.52 UG/L	4.51 UG/L	ND	ND
MW-11C	3/29/2018	OTHER	ND	ND	ND	ND	ND	ND
MW-12	3/30/2018	OTHER	182 UG/L	4.92 UG/L	8.19 UG/L	20.9 UG/L	17.6 UG/L	ND

MW-13	3/29/2018	OTHER	ND	ND	ND	ND	ND	ND
MW-14	3/29/2018	OTHER	ND	ND	ND	ND	ND	ND
MW-15	3/29/2018	OTHER	ND	ND	ND	ND	ND	ND
MW-16	3/29/2018	OTHER	ND	ND	ND	ND	ND	ND
MW-17	3/29/2018	OTHER	ND	ND	ND	ND	ND	ND
MW-18	3/29/2018	OTHER	ND	ND	ND	ND	ND	ND
MW-19	3/29/2018	OTHER	ND	ND	ND	ND	ND	ND
MW-2	3/30/2018	OTHER	213 UG/L	ND	7.07 UG/L	ND	11.6 UG/L	51.1 UG/L
MW-20	3/29/2018	OTHER	ND	ND	ND	ND	ND	ND
MW-21	3/29/2018	OTHER	ND	ND	ND	ND	ND	ND
MW-22	3/30/2018	OTHER	266 UG/L	121 UG/L	1160 UG/L	776 UG/L	ND	ND
MW-23	3/29/2018	OTHER	ND	ND	ND	ND	0.387 UG/L	ND
MW-24A	5/7/2018	OTHER	1.6 UG/L	ND	ND	ND	ND	ND
MW-24B	5/7/2018	OTHER	0.699 UG/L	ND	ND	ND	ND	ND
MW-7	3/29/2018	OTHER	264 UG/L	4.93 UG/L	52.2 UG/L	ND	9.53 UG/L	37 UG/L
MW-8	3/29/2018	OTHER	ND	ND	ND	ND	ND	ND
MW-9	3/29/2018	OTHER	ND	ND	ND	ND	ND	ND
SW-1	1/17/2012	OTHER	1200 UG/L	45 UG/L	170 UG/L	120 UG/L	80 UG/L	ND
TRIP BLANK	8/13/2015		00 UG/L	00 UG/L	00 UG/L	00 UG/L	00 UG/L	00 UG/L
VP-1	3/30/2018	OTHER	ND	ND	ND	ND	ND	ND
VP-2	3/30/2018	OTHER	158 UG/L	ND	11.9 UG/L	ND	ND	ND

MOST RECENT CONCENTRATIONS OF PETROLEUM CONSTITUENTS IN SOIL

[VIEW ESI SUBMITTALS](#)

FIELD PT NAME	DATE	TPHg	BENZENE	TOLUENE	ETHYL-BENZENE	XYLENES	MTBE	TBA
MW-22-S-46	8/19/2015		0.0267 MG/KG	0.025 MG/KG	0.419 MG/KG	0.385 MG/KG	00 MG/KG	
MW-22-S-50	8/19/2015		0.0274 MG/KG	0.0329 MG/KG	0.279 MG/KG	1.31 MG/KG	00 MG/KG	
MW-23-S-25.5	8/18/2015		00 MG/KG	00 MG/KG	00 MG/KG	00 MG/KG	00 MG/KG	
MW-23-S-35.5	8/18/2015		00 MG/KG	00 MG/KG	00 MG/KG	00 MG/KG	00 MG/KG	
MW-24	3/20/2018		ND	ND	ND	ND	ND	
SB-3-S-4	8/13/2015		00 MG/KG	00 MG/KG	00 MG/KG	00 MG/KG	00 MG/KG	
SB-3-S-9.5	8/13/2015		00 MG/KG	00 MG/KG	00 MG/KG	00 MG/KG	00 MG/KG	
SB-4-S-4	8/13/2015		00 MG/KG	00 MG/KG	00 MG/KG	00 MG/KG	00 MG/KG	
SB-4-S-7	8/13/2015		00 MG/KG	00 MG/KG	00 MG/KG	0.00235 MG/KG	00 MG/KG	
SB-5-S-1	8/13/2015		00 MG/KG	00 MG/KG	00 MG/KG	00 MG/KG	0.00128 MG/KG	
SB-5-S-6	8/13/2015		00 MG/KG	00 MG/KG	00 MG/KG	00 MG/KG	00 MG/KG	

MOST RECENT GEO_WELL DATA

[VIEW ESI SUBMITTALS](#)

FIELD PT NAME	DATE	DEPTH TO WATER (FT)	SHEEN	DEPTH TO FREE PRODUCT (FT)
MW-1	3/29/2018	12.52	N	
MW-10B	3/29/2018	20.3	N	
MW-11B	3/29/2018	11.7	N	
MW-11C	3/29/2018	19.46	N	
MW-12	3/29/2018	20.64	N	
MW-13	3/29/2018	26.95	N	
MW-14	3/29/2018	26.81	N	
MW-15	3/29/2018	26.47	N	
MW-16	3/29/2018	22.2	N	
MW-17	3/29/2018	13.89	N	
MW-18	3/29/2018	11.14	N	
MW-19	3/29/2018	16.48	N	
MW-2	3/29/2018	11.4	N	
MW-20	3/29/2018	24.57	N	
MW-21	3/29/2018	24.53	N	
MW-22	3/29/2018	19.12	N	
MW-23	3/29/2018	22.86	N	
MW-24A	5/7/2018	15.61	N	
MW-24B	5/7/2018	21.49	N	
MW-7	3/29/2018	25.41	N	
MW-8	3/29/2018	25.73	N	
MW-9	3/29/2018	25.76	N	
SW-1	3/29/2018	11.58	N	
VP-1	3/29/2018	11.75	N	
VP-2	3/29/2018	11.68	N	

CSM REPORT FOR PUBLIC NOTICING

PROJECT INFORMATION (DATA PULLED FROM GEOTRACKER) - [MAP THIS SITE](#)

<u>SITE NAME / ADDRESS</u>	<u>STATUS</u>	<u>STATUS DATE</u>	<u>RELEASE REPORT DATE</u>	<u>AGE OF CASE</u>	<u>CLEANUP OVERSIGHT AGENCIES</u>
Don Love Exxon (Global ID: T0608569527) 16990 Monterey Rd MORGAN HILL, CA 95037	Completed - Case Closed	4/29/1994	8/7/1987	31	SANTA CLARA COUNTY LOP (LEAD) CASEWORKER: UST CASE WORKER - SUPERVISOR: JENNIFER KAAHAAINA CENTRAL COAST RWQCB (REGION 3) - CASE #: 3383 SANTA CLARA VALLEY WATER DISTRICT - CASE #: 09S3E28F04f

SITE HISTORY

<NO SITE HISTORY ENTERED>

CLEANUP ACTION INFO

<u>ACTION TYPE</u>	<u>BEGIN DATE</u>	<u>END DATE</u>	<u>PHASE</u>	<u>CONTAMINANT MASS REMOVED</u>	<u>DESCRIPTION</u>
EXCAVATION	9/12/1989	2/17/1994			
EXCAVATION	9/12/1989	2/17/1994			

RISK INFORMATION

[VIEW CASE REVIEWS](#)

<u>CONTAMINANTS OF CONCERN</u>	<u>CURRENT LAND USE</u>	<u>BENEFICIAL USE</u>	<u>DISCHARGE SOURCE</u>	<u>DATE REPORTED</u>	<u>STOP METHOD</u>	<u>NEARBY / IMPACTED WELLS</u>
Gasoline		SW - Municipal and Domestic Supply		8/7/1987		0

<u>FREE PRODUCT</u>	<u>OTHER CONSTITUENTS</u>	<u>NAME OF WATER SYSTEM</u>	<u>LAST REGULATORY ACTIVITY</u>	<u>LAST ESI UPLOAD</u>	<u>LAST EDF UPLOAD</u>	<u>EXPECTED CLOSURE DATE</u>	<u>MOST RECENT CLOSURE REQUEST</u>
			4/29/1994				

CDPH WELLS WITHIN 1500 FEET OF THIS SITE

<u>WELL NAME</u>	<u>STATE WELL #</u>	<u>STATUS</u>	<u>SOURCE</u>	<u># TIMES SAMPLED</u>	<u>DIST TO WELL</u>
DIANA WELL 01	4310006-007	Active Raw	G	1204	1019 feet

CALCULATED FIELDS (BASED ON LATITUDE / LONGITUDE)

<u>APN</u>	<u>GW BASIN NAME</u>	<u>WATERSHED NAME</u>
81701059	Gilroy-Hollister Valley - Llagas Area (3-003.01)	Pajaro River - South Santa Clara Valley (305.30)

<u>COUNTY</u>	<u>PUBLIC WATER SYSTEM(S)</u>
Santa Clara	<ul style="list-style-type: none"> CITY OF MORGAN HILL - RAY DELLANINI, MORGAN HILL, CA 95037 SANTA CLARA VALLEY WATER DISTRICT - 5750 ALMADEN EXPRESSWAY, SAN JOSE, CA 95118

MOST RECENT CONCENTRATIONS OF PETROLEUM CONSTITUENTS IN GROUNDWATER

[VIEW ESI SUBMITTALS](#)

NO GROUNDWATER DATA HAS BEEN SUBMITTED TO GEOTRACKER ESI FOR THIS SITE

MOST RECENT CONCENTRATIONS OF PETROLEUM CONSTITUENTS IN SOIL

[VIEW ESI SUBMITTALS](#)

NO SOIL DATA HAS BEEN SUBMITTED TO GEOTRACKER ESI FOR THIS SITE

MOST RECENT GEO_WELL DATA

[VIEW ESI SUBMITTALS](#)

NO GEO_WELL DATA HAS BEEN SUBMITTED TO GEOTRACKER ESI FOR THIS SITE

CSM REPORT FOR PUBLIC NOTICING

PROJECT INFORMATION (DATA PULLED FROM GEOTRACKER) - [MAP THIS SITE](#)

SITE NAME / ADDRESS	STATUS	STATUS DATE	RELEASE REPORT DATE	AGE OF CASE	CLEANUP OVERSIGHT AGENCIES
MORGAN HILL CORPORATION YARD (Global ID: T0608500041) 105 EDES Court MORGAN HILL, CA 95037	Completed - Case Closed	4/13/2015	7/13/1995	23	SANTA CLARA COUNTY LOP (LEAD) - CASE #: 09S3E33B01f CASEWORKER: Gerald O'Regan - SUPERVISOR: JENNIFER KAAHAAINA CENTRAL COAST RWQCB (REGION 3) - CASE #: 2827 CASEWORKER: WEI LIU - SUPERVISOR: JENNIFER EPP

SITE HISTORY

The project has been ongoing since 1995 and has involved evaluating, remediating, and monitoring Site soils and groundwater impacted with gasoline related constituents of concern (COCs) including total petroleum hydrocarbons as gasoline (TPH-g), benzene, toluene, ethylbenzene, and xylenes (BTEX), and methyl tert butyl ether (MTBE) from an underground storage tank (UST) fuel leak that occurred in the mid 1990s.

On March 23, 2012, SCS Engineers performed the First Semester 2012 groundwater monitoring episode at the Morgan Hill Corporation Yard. Water levels were measured and groundwater samples were collected and analyzed from 12 of the project groundwater monitoring wells. The following are concentrations in the monitoring wells:

- * TPH-g was only detected in well P-3 at a concentration of 9,500 ug/L.;
- * Benzene was only detected in well P-3 at a concentration of 1,100 ug/L;
- * MTBE was detected in three wells at concentrations ranging from 9.6; to 1,700 ug/L, and the maximum concentration was detected in well ATC-1;
- * Toluene, ethylbenzene, and xylenes were only detected in well P-3;
- * Based on current and previous data, the down-gradient extent of MTBE-impacted groundwater in the "A-Zone" appears to be over 800 feet southeast of the source area (north of groundwater monitoring well API2-4). The down-gradient extent of MTBE impacted groundwater in the "B-Zone" appears to be approximately 950 feet southeast of the source area (north of the Edmundson Avenue cul-de-sac. This takes into consideration that the plum appears to be reducing in length.

Based on information and data presented in the Corrective Action Review and Case Closure Evaluation report dated July 10, 2012, the Site satisfies all but two criteria of the new Low-Threat UST Closure Policy adopted by the SWRCB on May 1, 2012.

CLEANUP ACTION INFO

ACTION TYPE	BEGIN DATE	END DATE	PHASE	CONTAMINANT MASS REMOVED	DESCRIPTION
PUMP & TREAT (P&T) GROUNDWATER	3/27/2002	9/9/9999			

RISK INFORMATION

[VIEW LTCP CHECKLIST](#)

[VIEW PATH TO CLOSURE PLAN](#)

[VIEW CASE REVIEWS](#)

CONTAMINANTS OF CONCERN	CURRENT LAND USE	BENEFICIAL USE	DISCHARGE SOURCE	DATE REPORTED	STOP METHOD	NEARBY / IMPACTED WELLS
Benzene, Toluene, Xylene, MTBE / TBA / Other Fuel Oxygenates, Gasoline	Commercial	GW - Freshwater Replenishment, GW - Groundwater Recharge, GW - Municipal and Domestic Supply	Piping	7/13/1995	Remove Contents	0

FREE PRODUCT	OTHER CONSTITUENTS	NAME OF WATER SYSTEM	LAST REGULATORY ACTIVITY	LAST ESI UPLOAD	LAST EDF UPLOAD	EXPECTED CLOSURE DATE	MOST RECENT CLOSURE REQUEST
NO	NO	City of Morgan Hill	4/13/2015	3/31/2015	4/30/2013		3/31/2015

CDPH WELLS WITHIN 1500 FEET OF THIS SITE

NONE

CALCULATED FIELDS (BASED ON LATITUDE / LONGITUDE)

APN	GW BASIN NAME	WATERSHED NAME
76718048	Gilroy-Hollister Valley - Llagas Area (3-003.01)	Pajaro River - South Santa Clara Valley (305.30)
COUNTY	PUBLIC WATER SYSTEM(S)	
Santa Clara	<ul style="list-style-type: none"> CITY OF MORGAN HILL - RAY DELLANINI, MORGAN HILL, CA 95037 SANTA CLARA VALLEY WATER DISTRICT - 5750 ALMADEN EXPRESSWAY, SAN JOSE, CA 95118 	

MOST RECENT CONCENTRATIONS OF PETROLEUM CONSTITUENTS IN GROUNDWATER

[VIEW ESI SUBMITTALS](#)

FIELD PT NAME	DATE	TPHg	BENZENE	TOLUENE	ETHYL-BENZENE	XYLENES	MTBE	TBA
API2-2	3/13/2013	OTHER	ND	ND	ND	ND	ND	ND
API2-3	3/13/2013	OTHER	ND	ND	ND	ND	ND	ND
API2-4	3/13/2013	OTHER	ND	ND	ND	ND	ND	ND
API2-5	3/13/2013	OTHER	ND	ND	ND	ND	ND	ND
API2-6	3/13/2013	OTHER	ND	ND	ND	ND	ND	ND
API2-7	3/13/2013	OTHER	ND	ND	ND	ND	110 UG/L	ND
ATC-1	3/15/2013	OTHER	ND	ND	ND	ND	360 UG/L	ND
ATC-1 DUP	9/29/2009	OTHER	ND	ND	ND	ND	140 UG/L	ND
ATC-2	3/15/2013	OTHER	ND	ND	ND	ND	100 UG/L	ND
ATC-2 DUP	6/20/2002	OTHER	ND	ND	ND	ND	8500 UG/L	ND
ATC-3	3/15/2013	OTHER	ND	ND	ND	ND	ND	ND
ATC-3 DUP	5/13/2003	OTHER	ND	ND	ND	ND	28 UG/L	ND
DUP	3/15/2013	OTHER	ND	ND	ND	ND	360 UG/L	ND
MW-1	3/12/2009	OTHER	ND	ND	ND	ND	ND	ND
MW-2	3/15/2013	OTHER	ND	ND	ND	ND	ND	ND
MW-2 DUP	3/12/2003	OTHER	12 UG/L	8.2 UG/L	77 UG/L	43 UG/L	ND	ND
MW-3	3/14/2013	OTHER	ND	ND	ND	ND	ND	ND
P-1	3/15/2013	OTHER	ND	2 UG/L	ND	ND	6.8 UG/L	ND
P-10B	3/14/2013	OTHER	ND	ND	ND	ND	630 UG/L	ND
P-11B	3/14/2013	OTHER	ND	ND	ND	ND	990 UG/L	ND
P-2	3/15/2013	OTHER	ND	ND	ND	ND	7.7 UG/L	ND
P-2 DUP	9/21/2004	OTHER	ND	1.1 UG/L	0.92 UG/L	1 UG/L	40 UG/L	ND

P-3	3/15/2013	OTHER	70 UG/L	12 UG/L	62 UG/L	180 UG/L	ND
P-3 DUP	9/26/2011	OTHER	510 UG/L	7.6 UG/L	100 UG/L	590 UG/L	ND
P10B	12/11/2012	OTHER	ND	ND	ND	ND	880 UG/L
P11B	12/11/2012	OTHER	ND	ND	ND	ND	170 UG/L
QC TB	12/11/2002	OTHER	ND		ND	ND	ND
QCTB	3/13/2013	OTHER	ND	ND	ND	ND	ND
SCS-1E	3/15/2013	OTHER	ND	ND	ND	ND	ND
SCS-1E DUP	12/20/2001	OTHER	ND	ND	ND	ND	ND
SCS-2B	3/14/2013	OTHER	ND	ND	ND	ND	ND
SCS-2B DUP	9/8/2003	OTHER	ND	ND	ND	ND	380 UG/L
SCS-2C	3/14/2013	OTHER	ND	ND	ND	ND	ND
SCS-2E	3/14/2013	OTHER	ND	ND	ND	ND	ND
SCS-2E DUP	12/18/2001	OTHER	ND	ND	ND	ND	ND
SCS-3B	3/14/2013	OTHER	ND	ND	ND	ND	ND
SCS-3D	3/14/2013	OTHER	ND	ND	ND	ND	ND
SCS-3D DUP	3/20/2002		ND	ND	ND	ND	ND
SCS-3E	3/14/2013	OTHER	ND	ND	ND	ND	ND
SCS-4A	3/14/2013	OTHER	ND	ND	ND	ND	ND
SCS-4B	3/14/2013	OTHER	ND	ND	ND	ND	ND
SCS-4B DUP	5/12/2003	OTHER	ND	ND	ND	ND	ND
SCS-5D	3/16/2011	OTHER	ND	ND	ND	ND	ND
SCS-5D DUP	3/11/2003	OTHER	ND	ND	ND	ND	ND
TB	12/11/2012	OTHER	ND	ND	ND	ND	ND

MOST RECENT CONCENTRATIONS OF PETROLEUM CONSTITUENTS IN SOIL

[VIEW ESI SUBMITTALS](#)

NO SOIL DATA HAS BEEN SUBMITTED TO GEOTRACKER ESI FOR THIS SITE

MOST RECENT GEO_WELL DATA

[VIEW ESI SUBMITTALS](#)

FIELD PT NAME	DATE	DEPTH TO WATER (FT)	SHEEN	DEPTH TO FREE PRODUCT (FT)
API2-1	3/14/2006			
API2-2	3/14/2006	10.65	N	
API2-3	3/14/2006	10.65	N	
API2-4	3/14/2006	9.18	N	
API2-5	3/14/2006	9.24	N	
API2-6	3/14/2006	9.17	N	
API2-7	3/14/2006			
ATC-1	3/13/2006	12.85	N	
ATC-2	3/13/2006	9.25	N	
ATC-3	3/13/2006	7.55	N	
EMW-1	3/13/2006			
GW-1	3/13/2006			
MW-1	3/13/2006	13.36	N	
MW-2	3/13/2006	10.11	N	
MW-3	3/13/2006	9.56	N	
P-1	3/13/2006	10.98	N	
P-10B	3/13/2006			
P-11B	3/13/2006			
P-13A	3/13/2006			
P-14A	3/13/2006			
P-15A	3/13/2006			
P-2	3/13/2006	10.33	N	
P-2A	3/13/2006			
P-3	3/13/2006	8.49	N	
P-3A	3/13/2006			
P-4A	3/13/2006			
P-5A	3/13/2006			
P-6A	3/13/2006			
P-7A	3/13/2006			
P-8A	3/13/2006			
P-9B	3/13/2006			
POW-1	3/13/2006	11.46	N	
POW-2	3/13/2006	10.27	N	
POW-3	3/13/2006	8.51	N	
POW-4	3/13/2006	11.18	N	
PZ-1	3/13/2006	9.95	N	
PZ-2	3/13/2006	10.21	N	
SCS-1E	3/13/2006	12.97	N	
SCS-2B	3/13/2006	11.24	N	
SCS-2C	3/13/2006	11.26	N	
SCS-2E	3/13/2006	11.44	N	
SCS-3B	3/13/2006	15.77	N	
SCS-3D	3/13/2006	15.75	N	
SCS-3E	3/13/2006	16.45	N	
SCS-4A	3/13/2006	12.3	N	
SCS-4B	3/13/2006	12.38	N	
SCS-5D	3/13/2006	11.92	N	

CSM REPORT FOR PUBLIC NOTICING

PROJECT INFORMATION (DATA PULLED FROM GEOTRACKER) - [MAP THIS SITE](#)

<u>SITE NAME / ADDRESS</u>	<u>STATUS</u>	<u>STATUS DATE</u>	<u>RELEASE REPORT DATE</u>	<u>AGE OF CASE</u>	<u>CLEANUP OVERSIGHT AGENCIES</u>
NEMATOLLAH GHASSEMKHAMI (Global ID: T0608502163) 16380 MONTEREY HWY MORGAN HILL, CA 95037	Completed - Case Closed	10/7/1988	4/3/1987	31	CENTRAL COAST RWQCB (REGION 3) (LEAD) - CASE #: 449 CASEWORKER: RB3 STAFF - SUPERVISOR: THEA TRYON SANTA CLARA COUNTY LOP CASEWORKER: UST CASE WORKER - SUPERVISOR: JENNIFER KAAHAAINA SANTA CLARA VALLEY WATER DISTRICT

SITE HISTORY

<NO SITE HISTORY ENTERED>

CLEANUP ACTION INFO

<u>ACTION TYPE</u>	<u>BEGIN DATE</u>	<u>END DATE</u>	<u>PHASE</u>	<u>CONTAMINANT MASS REMOVED</u>	<u>DESCRIPTION</u>
EXCAVATION			Soil		

RISK INFORMATION

[VIEW CASE REVIEWS](#)

<u>CONTAMINANTS OF CONCERN</u>		<u>CURRENT LAND USE</u>	<u>BENEFICIAL USE</u>	<u>DISCHARGE SOURCE</u>	<u>DATE REPORTED</u>	<u>STOP METHOD</u>	<u>NEARBY / IMPACTED WELLS</u>
Waste Oil / Motor / Hydraulic / Lubricating				Other	4/3/1987		0
<u>FREE PRODUCT</u>	<u>OTHER CONSTITUENTS</u>	<u>NAME OF WATER SYSTEM</u>	<u>LAST REGULATORY ACTIVITY</u>	<u>LAST ESI UPLOAD</u>	<u>LAST EDF UPLOAD</u>	<u>EXPECTED CLOSURE DATE</u>	<u>MOST RECENT CLOSURE REQUEST</u>
			1/1/1950				

CDPH WELLS WITHIN 1500 FEET OF THIS SITE

NONE

CALCULATED FIELDS (BASED ON LATITUDE / LONGITUDE)

<u>APN</u>	<u>GW BASIN NAME</u>	<u>WATERSHED NAME</u>
No APN Found	Gilroy-Hollister Valley - Llagas Area (3-003.01)	Pajaro River - South Santa Clara Valley (305.30)
<u>COUNTY</u>	<u>PUBLIC WATER SYSTEM(S)</u>	
Santa Clara	<ul style="list-style-type: none"> CITY OF MORGAN HILL - RAY DELLANINI, MORGAN HILL, CA 95037 SANTA CLARA VALLEY WATER DISTRICT - 5750 ALMADEN EXPRESSWAY, SAN JOSE, CA 95118 	

MOST RECENT CONCENTRATIONS OF PETROLEUM CONSTITUENTS IN GROUNDWATER

[VIEW ESI SUBMITTALS](#)

NO GROUNDWATER DATA HAS BEEN SUBMITTED TO GEOTRACKER ESI FOR THIS SITE

MOST RECENT CONCENTRATIONS OF PETROLEUM CONSTITUENTS IN SOIL

[VIEW ESI SUBMITTALS](#)

NO SOIL DATA HAS BEEN SUBMITTED TO GEOTRACKER ESI FOR THIS SITE

MOST RECENT GEO_WELL DATA

[VIEW ESI SUBMITTALS](#)

NO GEO_WELL DATA HAS BEEN SUBMITTED TO GEOTRACKER ESI FOR THIS SITE

CSM REPORT FOR PUBLIC NOTICING

PROJECT INFORMATION (DATA PULLED FROM GEOTRACKER) - [MAP THIS SITE](#)

<u>SITE NAME / ADDRESS</u>	<u>STATUS</u>	<u>STATUS DATE</u>	<u>RELEASE REPORT DATE</u>	<u>AGE OF CASE</u>	<u>CLEANUP OVERSIGHT AGENCIES</u>
Redtree Properties (Global ID: T0608526086) 140 San Pedro Ave MORGAN HILL, CA 95037	Completed - Case Closed	11/12/1993	1/1/1991	28	SANTA CLARA COUNTY LOP (LEAD) CASEWORKER: UST CASE WORKER - SUPERVISOR: JENNIFER KAAHAAINA CENTRAL COAST RWQCB (REGION 3) - CASE #: 3396 SANTA CLARA VALLEY WATER DISTRICT - CASE #: 09S3E28K01f

SITE HISTORY
<NO SITE HISTORY ENTERED>

CLEANUP ACTION INFO
NO CLEANUP ACTIONS HAVE BEEN REPORTED

RISK INFORMATION [VIEW CASE REVIEWS](#)

<u>CONTAMINANTS OF CONCERN</u>	<u>CURRENT LAND USE</u>	<u>BENEFICIAL USE</u>	<u>DISCHARGE SOURCE</u>	<u>DATE REPORTED</u>	<u>STOP METHOD</u>	<u>NEARBY / IMPACTED WELLS</u>	
		SW - Municipal and Domestic Supply		1/1/1991		0	
<u>FREE PRODUCT</u>	<u>OTHER CONSTITUENTS</u>	<u>NAME OF WATER SYSTEM</u>	<u>LAST REGULATORY ACTIVITY</u>	<u>LAST ESI UPLOAD</u>	<u>LAST EDF UPLOAD</u>	<u>EXPECTED CLOSURE DATE</u>	<u>MOST RECENT CLOSURE REQUEST</u>
			3/28/1994				

CDPH WELLS WITHIN 1500 FEET OF THIS SITE
NONE

CALCULATED FIELDS (BASED ON LATITUDE / LONGITUDE)

<u>APN</u>	<u>GW BASIN NAME</u>	<u>WATERSHED NAME</u>
81702026	Gilroy-Hollister Valley - Llagas Area (3-003.01)	Pajaro River - South Santa Clara Valley (305.30)
<u>COUNTY</u>	<u>PUBLIC WATER SYSTEM(S)</u>	
Santa Clara	<ul style="list-style-type: none"> CITY OF MORGAN HILL - RAY DELLANINI, MORGAN HILL, CA 95037 SANTA CLARA VALLEY WATER DISTRICT - 5750 ALMADEN EXPRESSWAY, SAN JOSE, CA 95118 	

MOST RECENT CONCENTRATIONS OF PETROLEUM CONSTITUENTS IN GROUNDWATER [VIEW ESI SUBMITTALS](#)
NO GROUNDWATER DATA HAS BEEN SUBMITTED TO GEOTRACKER ESI FOR THIS SITE

MOST RECENT CONCENTRATIONS OF PETROLEUM CONSTITUENTS IN SOIL [VIEW ESI SUBMITTALS](#)
NO SOIL DATA HAS BEEN SUBMITTED TO GEOTRACKER ESI FOR THIS SITE

MOST RECENT GEO_WELL DATA [VIEW ESI SUBMITTALS](#)
NO GEO_WELL DATA HAS BEEN SUBMITTED TO GEOTRACKER ESI FOR THIS SITE

CSM REPORT FOR PUBLIC NOTICING

PROJECT INFORMATION (DATA PULLED FROM GEOTRACKER) - [MAP THIS SITE](#)

SITE NAME / ADDRESS	STATUS	STATUS DATE	RELEASE REPORT DATE	AGE OF CASE	CLEANUP OVERSIGHT AGENCIES
SABEK GAS STATION (Global ID: T0608578682) 16270 MONTEREY ROAD MORGAN HILL, CA 95037	Open - Verification Monitoring	9/28/2016	1/25/1988	31	SANTA CLARA COUNTY LOP (LEAD) - CASE #: 09S3E28Q01f CASEWORKER: Gerald O'Regan - SUPERVISOR: JENNIFER KAAHAAINA CENTRAL COAST RWQCB (REGION 3) - CASE #: 3399 CASEWORKER: WEI LIU - SUPERVISOR: JENNIFER EPP

SITE HISTORY

1987 - during installation of an aspirating UST monitoring system, gas a(2,400 ppm) nd diesel (395 ppm) were reported at 12 ft in soil near the file lines. 3 wells were installed and confirmed soil contamination and groundwater contamination. 8/29/88 Cleanup and Abatement Order No. 89-112 was issued for the site. 5/91 the USTs were removed from the site and gasoline station demolished. Approximately 440 cubic yards of soil were removed from the site at this time.

1995 - CAP prepared and recommended air-sparge, soil vapor extraction and groundwater extraction to remediate the site, but was not implemented.

By 1987, groundwater at the site had risen to 20 ft bgs. 1998 approximately 120 pounds of Oxygen Releasing Compound (ORC) was added to well EW1 and 10 pounds to well MW5.

March 2003, approximately 274 tons of soil were removed in the area of the former USTs. In December 2007 an ozone sparge system was started onsite.

There are currently 13 active groundwater monitoring wells, 6 ozone sparge wells, and 15 destroyed monitoring wells. The site is occupied by the Sno-White Drive In restaurant and a commercial building.

In 12/10, additional soil borings were advanced on the Sno-White Drive In property to evaluate conditions between the former UST location and well MW5. Found soil and groundwater contamination between the source area and well MW5 concentrated from 40-47 ft bgs, which is below the depths of shallow borings and wells previously drilled onsite.

CLEANUP ACTION INFO

ACTION TYPE	BEGIN DATE	END DATE	PHASE	CONTAMINANT MASS REMOVED	DESCRIPTION
SOIL VAPOR EXTRACTION (SVE)	10/30/2014	1/19/2015	Soil	1,410 Pounds	Shut off due to financial concerns.
IN SITU PHYSICAL/CHEMICAL TREATMENT (OTHER THAN SVE)	9/8/2006	3/28/2011	Water		ozone sparge
EXCAVATION	3/1/2003	3/10/2003	Soil		volume unknown
IN SITU PHYSICAL/CHEMICAL TREATMENT (OTHER THAN SVE)	1/1/1998	6/5/1998	Water		120 lbs of ORC added to EW-1; 10 lbs in MW-5
IN SITU PHYSICAL/CHEMICAL TREATMENT (OTHER THAN SVE)	9/1/1995	9/10/1995	Other (See Description)		2.1 lbs of hydrocarbons; DPE test
EXCAVATION	5/1/1991	5/1/1991	Soil		during UST removal

RISK INFORMATION

[VIEW LTCP CHECKLIST](#)

[VIEW PATH TO CLOSURE PLAN](#)

[VIEW CASE REVIEWS](#)

CONTAMINANTS OF CONCERN	CURRENT LAND USE	BENEFICIAL USE	DISCHARGE SOURCE	DATE REPORTED	STOP METHOD	NEARBY / IMPACTED WELLS
Benzene, Gasoline, MTBE / TBA / Other Fuel Oxygenates	Commercial	GW - Municipal and Domestic Supply	Tank	1/25/1988	Close and Remove Tank	0

FREE PRODUCT	OTHER CONSTITUENTS	NAME OF WATER SYSTEM	LAST REGULATORY ACTIVITY	LAST ESI UPLOAD	LAST EDF UPLOAD	EXPECTED CLOSURE DATE	MOST RECENT CLOSURE REQUEST
NO	NO	City of Morgan Hill Public Works Dept.	5/8/2018	7/24/2018	3/5/2018		3/21/2013

CDPH WELLS WITHIN 1500 FEET OF THIS SITE

NONE

CALCULATED FIELDS (BASED ON LATITUDE / LONGITUDE)

APN	GW BASIN NAME	WATERSHED NAME
81703009	Gilroy-Hollister Valley - Llagas Area (3-003.01)	Pajaro River - South Santa Clara Valley (305.30)

COUNTY	PUBLIC WATER SYSTEM(S)
Santa Clara	<ul style="list-style-type: none"> CITY OF MORGAN HILL - RAY DELLANINI, MORGAN HILL, CA 95037 SANTA CLARA VALLEY WATER DISTRICT - 5750 ALMADEN EXPRESSWAY, SAN JOSE, CA 95118

MOST RECENT CONCENTRATIONS OF PETROLEUM CONSTITUENTS IN GROUNDWATER

[VIEW ESI SUBMITTALS](#)

FIELD PT NAME	DATE	TPHg	BENZENE	TOLUENE	ETHYL-BENZENE	XYLENES	MTBE	TBA
AEI-1	12/15/2010	OTHER	920 UG/L	1300 UG/L	160 UG/L	3200 UG/L	ND	ND
AEI-10	12/16/2010	OTHER	ND	ND	ND	ND	0.92 UG/L	ND
AEI-2	12/14/2010	OTHER	3900 UG/L	1700 UG/L	350 UG/L	5800 UG/L	ND	ND
AEI-3	12/15/2010	OTHER	6200 UG/L	3200 UG/L	470 UG/L	11000 UG/L	ND	ND
AEI-4	12/16/2010	OTHER	5200 UG/L	17000 UG/L	4000 UG/L	34000 UG/L	ND	ND
AEI-5	12/15/2010	OTHER	46 UG/L	56 UG/L	39 UG/L	150 UG/L	ND	ND
AEI-6	12/16/2010	OTHER	ND	ND	ND	ND	1.9 UG/L	200 UG/L
AEI-7	12/14/2010	OTHER	ND	ND	ND	ND	ND	ND
AEI-8	12/16/2010	OTHER	ND	ND	ND	ND	1 UG/L	ND
AEI-9	12/14/2010	OTHER	9.6 UG/L	4.2 UG/L	10 UG/L	110 UG/L	ND	ND
MW - 14	5/25/2004		11 UG/L	ND	1.8 UG/L	2.3 UG/L	1.3 UG/L	5.5 UG/L
MW - 15	5/25/2004		320 UG/L	15 UG/L	340 UG/L	1100 UG/L	5.9 UG/L	ND
MW - 16	5/25/2004		ND	ND	ND	ND	ND	ND
MW-10	6/5/2017	OTHER	ND	ND	ND	ND	ND	ND
MW-14	12/22/2014	OTHER	0.82 UG/L	2.1 UG/L	2.4 UG/L	15 UG/L	ND	ND
MW-15	3/27/2013	OTHER	ND	ND	ND	ND	ND	ND
MW-16	3/14/2012	OTHER	ND	ND	ND	ND	ND	ND
MW-17	6/7/2017	OTHER	3.2 UG/L	ND	ND	2.1 UG/L	ND	ND
MW-18	6/7/2017	OTHER	3.9 UG/L	ND	ND	1.3 UG/L	ND	ND
MW-19	6/7/2017	OTHER	ND	ND	ND	ND	0.8 UG/L	ND
MW-2	3/25/2009	OTHER	250 UG/L	380 UG/L	33 UG/L	570 UG/L	ND	220 UG/L
MW-20	6/7/2017	OTHER	2200 UG/L	6900 UG/L	1300 UG/L	17000 UG/L	ND	ND
MW-21	6/7/2017	OTHER	67 UG/L	270 UG/L	270 UG/L	510 UG/L	ND	ND
MW-22	6/5/2017	OTHER	ND	ND	ND	ND	ND	ND

MW-23	6/5/2017	OTHER	ND	ND	ND	ND	ND	ND
MW-24	6/5/2017	OTHER	ND	ND	ND	ND	ND	ND
MW-2R	6/7/2017	OTHER	2.2 UG/L	ND	0.57 UG/L	ND	1.6 UG/L	29 UG/L
MW-3	6/7/2017	OTHER	ND	ND	ND	ND	ND	ND
MW-5	9/16/2016	OTHER	36 UG/L	ND	15 UG/L	ND	ND	
MW-6	3/13/2012	OTHER	ND	ND	ND	ND	ND	
MW-7	9/16/2016	OTHER	ND	ND	ND	ND	ND	
MW-8	3/13/2012	OTHER	ND	ND	ND	ND	ND	
MW-T6	6/5/2017	OTHER	ND	ND	ND	ND	ND	ND
MW-T8	6/5/2017	OTHER	ND	ND	ND	ND	ND	ND
MW-T9	9/15/2016	OTHER	ND	ND	ND	ND	ND	
OS1	1/9/2006	OTHER	ND	ND	ND	ND	ND	ND
OS2	1/10/2006	OTHER	ND	ND	ND	ND	ND	ND
OS3	1/10/2006	OTHER	ND	ND	ND	ND	ND	ND

MOST RECENT CONCENTRATIONS OF PETROLEUM CONSTITUENTS IN SOIL

[VIEW ESI SUBMITTALS](#)

FIELD PT NAME	DATE	TPHg	BENZENE	TOLUENE	ETHYL-BENZENE	XYLENES	MTBE	TBA
AEI-1	12/15/2010		0.66 MG/KG	1.5 MG/KG	1.2 MG/KG	17 MG/KG	ND	ND
AEI-10	12/16/2010		ND	ND	ND	ND	ND	ND
AEI-11	8/17/2015		1.2 MG/KG	1.1 MG/KG	0.56 MG/KG	1.7 MG/KG	ND	ND
AEI-12	8/17/2015		1.1 MG/KG	2.2 MG/KG	0.48 MG/KG	2.8 MG/KG	ND	ND
AEI-13	8/17/2015		0.42 MG/KG	4.8 MG/KG	8.4 MG/KG	34 MG/KG	ND	ND
AEI-14	8/17/2015		14 MG/KG	260 MG/KG	95 MG/KG	550 MG/KG	ND	ND
AEI-2	12/14/2010		ND	ND	ND	ND	ND	ND
AEI-3	12/15/2010		4.2 MG/KG	26 MG/KG	22 MG/KG	160 MG/KG	ND	ND
AEI-4	12/16/2010		3.1 MG/KG	13 MG/KG	5.5 MG/KG	32 MG/KG	ND	ND
AEI-5	12/15/2010		73 MG/KG	750 MG/KG	250 MG/KG	1400 MG/KG	ND	ND
AEI-6	12/16/2010		ND	ND	ND	ND	ND	ND
AEI-7	12/14/2010		1.1 MG/KG	2.7 MG/KG	26 MG/KG	67 MG/KG	ND	ND
AEI-8	12/16/2010		ND	ND	ND	ND	ND	ND
AEI-9	12/14/2010		0.16 MG/KG	360 MG/KG	79 MG/KG	840 MG/KG	ND	ND
MW-17	4/16/2009		17 MG/KG	120 MG/KG	71 MG/KG	410 MG/KG	ND	
MW-18	4/16/2009		3.3 MG/KG	12 MG/KG	6.4 MG/KG	46 MG/KG	ND	
MW-19	10/10/2011		ND	0.11 MG/KG	0.52 MG/KG	0.93 MG/KG	ND	
MW-20	10/11/2011		58 MG/KG	530 MG/KG	130 MG/KG	730 MG/KG	ND	
MW-21	10/10/2011		20 MG/KG	170 MG/KG	58 MG/KG	320 MG/KG	ND	
MW-22	10/12/2011		ND	ND	ND	ND	ND	
MW-23	10/11/2011		ND	ND	ND	ND	ND	
MW-24	10/11/2011		ND	ND	ND	0.0086 MG/KG	ND	
MW-2R	4/15/2009		8.8 MG/KG	97 MG/KG	42 MG/KG	230 MG/KG	ND	
MW14	5/3/2004		ND	ND	ND	ND	ND	ND
MW15	5/3/2004		ND	ND	ND	ND	ND	ND
MW16	5/3/2004		ND	ND	ND	ND	ND	ND
OS-6	11/29/2007		1 MG/KG	0.16 MG/KG	0.46 MG/KG	0.28 MG/KG	ND	

MOST RECENT GEO_WELL DATA

[VIEW ESI SUBMITTALS](#)

FIELD PT NAME	DATE	DEPTH TO WATER (FT)	SHEEN	DEPTH TO FREE PRODUCT (FT)
MW-10	4/2/2015	51.49	N	
MW-14	4/2/2015	34.02	N	
MW-15	4/2/2015	33.91	N	
MW-16	4/2/2015	34.32	N	
MW-17	4/2/2015	33.28	N	
MW-18	4/2/2015	39.89	N	
MW-19	4/2/2015	47.63	N	
MW-2	3/25/2009	19.33	N	
MW-20	4/2/2015	47.67	N	
MW-21	4/2/2015	46.11	N	
MW-22	4/2/2015	47.87	N	
MW-23	4/2/2015	47.57	N	
MW-24	4/2/2015	47.83	N	
MW-2R	4/2/2015	52.24	N	
MW-3	4/2/2015	51.58	N	
MW-5	4/2/2015	34.38	N	
MW-6	4/2/2015	34.22	N	
MW-7	4/2/2015	30.76	N	
MW-8	4/2/2015	31.63	N	
MW-T6	4/2/2015	52.12	N	
MW-T8	4/2/2015	52.1	N	
MW-T9	4/2/2015	51.03	N	

CSM REPORT FOR PUBLIC NOTICING

PROJECT INFORMATION (DATA PULLED FROM GEOTRACKER) - [MAP THIS SITE](#)

<u>SITE NAME / ADDRESS</u>	<u>STATUS</u>	<u>STATUS DATE</u>	<u>RELEASE REPORT DATE</u>	<u>AGE OF CASE</u>	<u>CLEANUP OVERSIGHT AGENCIES</u>
Unocal #6169 (Global ID: T0608500036) 17015 Monterey St MORGAN HILL, CA 95037	Completed - Case Closed	6/27/1996	1/1/1989	30	SANTA CLARA COUNTY LOP (LEAD) CASEWORKER: UST CASE WORKER - SUPERVISOR: JENNIFER KAAHAAINA CENTRAL COAST RWQCB (REGION 3) - CASE #: 2717 CASEWORKER: RB3 STAFF - SUPERVISOR: THEA TRYON SANTA CLARA VALLEY WATER DISTRICT - CASE #: 09S3E28F02f

SITE HISTORY

<NO SITE HISTORY ENTERED>

CLEANUP ACTION INFO

NO CLEANUP ACTIONS HAVE BEEN REPORTED

RISK INFORMATION

[VIEW CASE REVIEWS](#)

<u>CONTAMINANTS OF CONCERN</u>	<u>CURRENT LAND USE</u>	<u>BENEFICIAL USE</u>	<u>DISCHARGE SOURCE</u>	<u>DATE REPORTED</u>	<u>STOP METHOD</u>	<u>NEARBY / IMPACTED WELLS</u>
Gasoline		SW - Municipal and Domestic Supply		1/1/1989		0

<u>FREE PRODUCT</u>	<u>OTHER CONSTITUENTS</u>	<u>NAME OF WATER SYSTEM</u>	<u>LAST REGULATORY ACTIVITY</u>	<u>LAST ESI UPLOAD</u>	<u>LAST EDF UPLOAD</u>	<u>EXPECTED CLOSURE DATE</u>	<u>MOST RECENT CLOSURE REQUEST</u>
			6/27/1996	10/24/2001			

CDPH WELLS WITHIN 1500 FEET OF THIS SITE

<u>WELL NAME</u>	<u>STATE WELL #</u>	<u>STATUS</u>	<u>SOURCE</u>	<u># TIMES SAMPLED</u>	<u>DIST TO WELL</u>
DIANA WELL 01	4310006-007	Active Raw	G	1204	1140 feet

CALCULATED FIELDS (BASED ON LATITUDE / LONGITUDE)

<u>APN</u>	<u>GW BASIN NAME</u>	<u>WATERSHED NAME</u>
76708034	Gilroy-Hollister Valley - Llagas Area (3-003.01)	Pajaro River - South Santa Clara Valley (305.30)

<u>COUNTY</u>	<u>PUBLIC WATER SYSTEM(S)</u>
Santa Clara	<ul style="list-style-type: none"> CITY OF MORGAN HILL - RAY DELLANINI, MORGAN HILL, CA 95037 SANTA CLARA VALLEY WATER DISTRICT - 5750 ALMADEN EXPRESSWAY, SAN JOSE, CA 95118

MOST RECENT CONCENTRATIONS OF PETROLEUM CONSTITUENTS IN GROUNDWATER

[VIEW ESI SUBMITTALS](#)

NO GROUNDWATER DATA HAS BEEN SUBMITTED TO GEOTRACKER ESI FOR THIS SITE

MOST RECENT CONCENTRATIONS OF PETROLEUM CONSTITUENTS IN SOIL

[VIEW ESI SUBMITTALS](#)

NO SOIL DATA HAS BEEN SUBMITTED TO GEOTRACKER ESI FOR THIS SITE

MOST RECENT GEO_WELL DATA

[VIEW ESI SUBMITTALS](#)

NO GEO_WELL DATA HAS BEEN SUBMITTED TO GEOTRACKER ESI FOR THIS SITE

CSM REPORT FOR PUBLIC NOTICING

PROJECT INFORMATION (DATA PULLED FROM GEOTRACKER) - [MAP THIS SITE](#)

SITE NAME / ADDRESS	STATUS	STATUS DATE	RELEASE REPORT DATE	AGE OF CASE	CLEANUP OVERSIGHT AGENCIES
UNOCAL #6169 (Global ID: T0608543406) 17015 MONTEREY MORGAN HILL, CA 95037	Completed - Case Closed	6/19/2006	2/5/2003	15	SANTA CLARA COUNTY LOP (<i>LEAD</i>) - CASE #: 09S3E28C03f CENTRAL COAST RWQCB (REGION 3) - CASE #: 2717

SITE HISTORY

<NO SITE HISTORY ENTERED>

CLEANUP ACTION INFO

ACTION TYPE	BEGIN DATE	END DATE	PHASE	CONTAMINANT MASS REMOVED	DESCRIPTION
MONITORED NATURAL ATTENUATION	4/20/2004	10/28/2005	Water		

RISK INFORMATION

[VIEW CASE REVIEWS](#)

CONTAMINANTS OF CONCERN	CURRENT LAND USE	BENEFICIAL USE	DISCHARGE SOURCE	DATE REPORTED	STOP METHOD	NEARBY / IMPACTED WELLS
Gasoline		GW - Municipal and Domestic Supply		2/5/2003		0

FREE PRODUCT	OTHER CONSTITUENTS	NAME OF WATER SYSTEM	LAST REGULATORY ACTIVITY	LAST ESI UPLOAD	LAST EDF UPLOAD	EXPECTED CLOSURE DATE	MOST RECENT CLOSURE REQUEST
			6/19/2006	6/15/2006	3/21/2006		

CDPH WELLS WITHIN 1500 FEET OF THIS SITE

WELL NAME	STATE WELL #	STATUS	SOURCE	# TIMES SAMPLED	DIST TO WELL
DIANA WELL 01	4310006-007	Active Raw	G	1204	1191 feet

CALCULATED FIELDS (BASED ON LATITUDE / LONGITUDE)

APN	GW BASIN NAME	WATERSHED NAME
76708034	Gilroy-Hollister Valley - Llagas Area (3-003.01)	Pajaro River - South Santa Clara Valley (305.30)

COUNTY	PUBLIC WATER SYSTEM(S)
Santa Clara	<ul style="list-style-type: none"> CITY OF MORGAN HILL - RAY DELLANINI, MORGAN HILL, CA 95037 SANTA CLARA VALLEY WATER DISTRICT - 5750 ALMADEN EXPRESSWAY, SAN JOSE, CA 95118

MOST RECENT CONCENTRATIONS OF PETROLEUM CONSTITUENTS IN GROUNDWATER

[VIEW ESI SUBMITTALS](#)

FIELD PT NAME	DATE	TPHg	BENZENE	TOLUENE	ETHYL-BENZENE	XYLENES	MTBE	TBA
MW-1	1/18/2006	ND	ND	ND	ND	ND	ND	ND
MW-2	1/18/2006	ND	ND	ND	ND	ND	ND	ND
MW-3	1/18/2006	ND	ND	ND	ND	ND	ND	ND
MW-4	1/18/2006	ND	ND	ND	ND	ND	ND	ND

MOST RECENT CONCENTRATIONS OF PETROLEUM CONSTITUENTS IN SOIL

[VIEW ESI SUBMITTALS](#)

NO SOIL DATA HAS BEEN SUBMITTED TO GEOTRACKER ESI FOR THIS SITE

MOST RECENT GEO_WELL DATA

[VIEW ESI SUBMITTALS](#)

FIELD PT NAME	DATE	DEPTH TO WATER (FT)	SHEEN	DEPTH TO FREE PRODUCT (FT)
MW-1	1/18/2006	8.83	N	
MW-2	1/18/2006	9.44	N	
MW-3	1/18/2006	8.85	N	
MW-4	1/18/2006	8.35	N	

CSM REPORT FOR PUBLIC NOTICING

PROJECT INFORMATION (DATA PULLED FROM GEOTRACKER) - [MAP THIS SITE](#)

SITE NAME / ADDRESS	STATUS	STATUS DATE	RELEASE REPORT DATE	AGE OF CASE	CLEANUP OVERSIGHT AGENCIES
VILLA CIOLINO (Global ID: T0608566519) 16873 MONTEREY ROAD MORGAN HILL, CA 95037	Completed - Case Closed	11/23/2011	8/5/2006	12	SANTA CLARA COUNTY LOP (LEAD) - CASE #: 09S3E28F05f CENTRAL COAST RWQCB (REGION 3) - CASE #: 14-768 CASEWORKER: WEI LIU - SUPERVISOR: JENNIFER EPP

SITE HISTORY

2/06 - 2 suspect underground storage tanks (USTs) and fill pipes were discovered while demolishing a former restaurant building. Additional suspect USTs were found during a geophysical survey and it was reported the site was occupied by a gasoline station between the 1950-1960s. 8/06 - 5 USTs filled with concrete were removed. Soil excavation was conducted and contaminated soil appeared to extend east under the sidewalk. Soil samples were reported to have maximum concentrations of 9,330 ppm TPHg, 2,160 ppm TOG, 1.9 ppm Benzene, 111 ppm Toluene, 145 ppm Ethylbenzene, and 825 ppm Xylenes. Approximately 494 tons of soil were removed from the site. 3 groundwater monitoring wells were installed and initially sampled in 3/07. Maximum concentrations are reported for well MW3 (downgradient well) of 7,020 ppb TPHg, 126 ppb Benzene, 132 ppb Ethylbenzene, and 153 ppb Xylenes. 7/07 4 Geoprobe borings (B3 through B6) were advanced offsite and downgradient of the site. The investigation concluded that the "analytical data show that the concentrations of petroleum hydrocarbons in the soil and groundwater attenuate rapidly with distance from the site." Grab groundwater samples collected downgradient were reported to have detectable concentrations of Constituents of Concern. Groundwater monitoring commenced.

CLEANUP ACTION INFO

ACTION TYPE	BEGIN DATE	END DATE	PHASE	CONTAMINANT MASS REMOVED	DESCRIPTION
EXCAVATION	8/14/2006	11/9/2006	Soil		Marina Landfill, Monterey, CA

RISK INFORMATION

[VIEW CASE REVIEWS](#)

CONTAMINANTS OF CONCERN	CURRENT LAND USE	BENEFICIAL USE	DISCHARGE SOURCE	DATE REPORTED	STOP METHOD	NEARBY / IMPACTED WELLS
Gasoline	Commercial	GW - Municipal and Domestic Supply		8/5/2006	Close and Remove Tank	0

FREE PRODUCT	OTHER CONSTITUENTS	NAME OF WATER SYSTEM	LAST REGULATORY ACTIVITY	LAST ESI UPLOAD	LAST EDF UPLOAD	EXPECTED CLOSURE DATE	MOST RECENT CLOSURE REQUEST
			1/2/2018	12/16/2011	6/10/2011		2/28/2011

CDPH WELLS WITHIN 1500 FEET OF THIS SITE

WELL NAME	STATE WELL #	STATUS	SOURCE	# TIMES SAMPLED	DIST TO WELL
DIANA WELL 01	4310006-007	Active Raw	G	1204	1456 feet

CALCULATED FIELDS (BASED ON LATITUDE / LONGITUDE)

APN	GW BASIN NAME	WATERSHED NAME
76709029	Gilroy-Hollister Valley - Llagas Area (3-003.01)	Pajaro River - South Santa Clara Valley (305.30)
COUNTY	PUBLIC WATER SYSTEM(S)	
Santa Clara	<ul style="list-style-type: none"> CITY OF MORGAN HILL - RAY DELLANINI, MORGAN HILL, CA 95037 SANTA CLARA VALLEY WATER DISTRICT - 5750 ALMADEN EXPRESSWAY, SAN JOSE, CA 95118 	

MOST RECENT CONCENTRATIONS OF PETROLEUM CONSTITUENTS IN GROUNDWATER

[VIEW ESI SUBMITTALS](#)

FIELD PT NAME	DATE	TPHg	BENZENE	TOLUENE	ETHYL-BENZENE	XYLENES	MTBE	TBA
B-3	7/26/2007	OTHER	ND	ND	ND	OTHER	ND	
B-4	7/26/2007	OTHER	6.2 UG/L	6.7 UG/L	36.3 UG/L	OTHER	ND	
B-5	7/26/2007	OTHER	1.1 UG/L	ND	ND	OTHER	ND	
B-6	7/26/2007	OTHER	ND	ND	ND	OTHER	ND	
EB	5/13/2008	OTHER	ND	ND	ND	ND	ND	
GW-NW1	11/10/2006	OTHER	ND	ND	ND	OTHER	ND	ND
MW-1	5/16/2011	OTHER	ND	ND	ND	OTHER	ND	
MW-2	5/16/2011	OTHER	ND	ND	ND	OTHER	ND	
MW-3	5/16/2011	OTHER	56 UG/L	1.9 UG/L	10 UG/L	OTHER	ND	
MW-4	5/13/2008	OTHER	70 UG/L	ND	22 UG/L	18 UG/L	ND	
QCTB	5/13/2008	OTHER	ND	ND	ND	ND	ND	

MOST RECENT CONCENTRATIONS OF PETROLEUM CONSTITUENTS IN SOIL

[VIEW ESI SUBMITTALS](#)

FIELD PT NAME	DATE	TPHg	BENZENE	TOLUENE	ETHYL-BENZENE	XYLENES	MTBE	TBA
B-1	1/24/2007		ND	ND	ND		ND	ND
B-2	1/24/2007		ND	ND	ND		ND	ND
B-3	7/26/2007		ND	ND	ND		ND	
B-4	7/26/2007		4 UG/KG	ND	ND		ND	
MW-1	1/23/2007		ND	ND	ND		ND	ND
MW-2	1/23/2007		ND	ND	ND		ND	ND
MW-3	2/15/2007		64 UG/KG	48 UG/KG	7100 UG/KG		ND	ND
PS-1	8/14/2006		ND	ND	29 UG/KG		ND	ND
PS-10	8/14/2006		265 UG/KG	ND	2000 UG/KG		ND	ND
PS-11	8/14/2006		ND	ND	ND		ND	ND
PS-12	8/14/2006		ND	ND	4610 UG/KG		ND	ND
PS-13	8/14/2006		ND	ND	ND		ND	ND
PS-14	8/14/2006		ND	ND	116 UG/KG		ND	ND
PS-15	8/14/2006		ND	ND	2060 UG/KG		ND	ND
PS-16	8/14/2006		ND	ND	ND		ND	ND
PS-17	8/14/2006		ND	ND	2350 UG/KG		ND	ND
PS-18	8/14/2006		ND	ND	15100 UG/KG		ND	ND
PS-19	11/8/2006		ND	ND	1400 UG/KG		ND	ND
PS-2	8/14/2006		ND	ND	1160 UG/KG		ND	ND

PS-20	11/8/2006	ND	46 UG/KG	1720 UG/KG	ND	ND
PS-21	11/8/2006	ND	ND	ND	ND	ND
PS-22	11/8/2006	ND	ND	64 UG/KG	ND	ND
PS-23	11/8/2006	ND	ND	ND	ND	ND
PS-24	11/9/2006	ND	ND	ND	ND	ND
PS-25	11/9/2006	ND	ND	ND	ND	ND
PS-26	11/9/2006	ND	ND	ND	ND	ND
PS-27	11/9/2006	ND	ND	ND	ND	ND
PS-28	11/9/2006	ND	ND	ND	ND	ND
PS-29	11/9/2006	ND	ND	ND	ND	ND
PS-3	8/14/2006	1900 UG/KG	111000 UG/KG	145000 UG/KG	ND	ND
PS-30	11/10/2006	ND	ND	ND	ND	ND
PS-31	11/10/2006	ND	ND	ND	ND	ND
PS-32	11/9/2006	ND	ND	ND	ND	ND
PS-33	11/9/2006	ND	4520 UG/KG	35900 UG/KG	ND	ND
PS-34	11/9/2006	64 UG/KG	72 UG/KG	8200 UG/KG	ND	ND
PS-35	11/9/2006	ND	ND	ND	ND	ND
PS-36	11/10/2006	ND	2980 UG/KG	8340 UG/KG	ND	ND
PS-4	8/14/2006	ND	ND	95000 UG/KG	ND	ND
PS-5	8/14/2006	ND	128 UG/KG	5000 UG/KG	ND	ND
PS-6	8/14/2006	ND	ND	17800 UG/KG	ND	ND
PS-7	8/14/2006	1120 UG/KG	460 UG/KG	7500 UG/KG	ND	ND
PS-8	8/14/2006	440 UG/KG	420 UG/KG	35200 UG/KG	ND	ND
PS-9	8/14/2006	ND	ND	7060 UG/KG	ND	ND

MOST RECENT GEO_WELL DATA

[VIEW ESI SUBMITTALS](#)

FIELD PT NAME	DATE	DEPTH TO WATER (FT)	SHEEN	DEPTH TO FREE PRODUCT (FT)
MW-1	5/16/2011	3.26	N	
MW-2	5/16/2011	3.61	N	
MW-3	5/16/2011	4.64	N	

CSM REPORT FOR PUBLIC NOTICING

PROJECT INFORMATION (DATA PULLED FROM GEOTRACKER) - [MAP THIS SITE](#)

SITE NAME / ADDRESS	STATUS	STATUS DATE	RELEASE REPORT DATE	AGE OF CASE	CLEANUP OVERSIGHT AGENCIES
WORLD OIL #52 (Global ID: T0608502184) 16720 MONTEREY MORGAN HILL, CA 95037	Completed - Case Closed	9/10/2015	3/25/1988	30	SANTA CLARA COUNTY LOP (LEAD) - CASE #: 09S3E28L01f CASEWORKER: AARON COSTA - SUPERVISOR: JENNIFER KAAHAAINA CENTRAL COAST RWQCB (REGION 3) - CASE #: 3411

SITE HISTORY
As of August 2102, DEH has required additional soil and groundwater investigation (for soil and groundwater data gaps) , and the preparation of a SCM for this site.

CLEANUP ACTION INFO						
ACTION TYPE	BEGIN DATE	END DATE	PHASE	CONTAMINANT MASS REMOVED	DESCRIPTION	
PUMP & TREAT (P&T) GROUNDWATER	8/23/2000	9/9/9999				
EXCAVATION	9/30/1988	9/9/9999				

RISK INFORMATION		VIEW LTCP CHECKLIST	VIEW PATH TO CLOSURE PLAN	VIEW CASE REVIEWS			
CONTAMINANTS OF CONCERN	CURRENT LAND USE	BENEFICIAL USE	DISCHARGE SOURCE	DATE REPORTED	STOP METHOD	NEARBY / IMPACTED WELLS	
Gasoline	Commercial	GW - Municipal and Domestic Supply	Piping, Other	3/25/1988	Repair Product Piping, Replace Vapor Recovery Piping	0	
FREE PRODUCT	OTHER CONSTITUENTS	NAME OF WATER SYSTEM	LAST REGULATORY ACTIVITY	LAST ESI UPLOAD	LAST EDF UPLOAD	EXPECTED CLOSURE DATE	MOST RECENT CLOSURE REQUEST
NO	NO	Santa Clara Valley Water District (according to Geotracker)	9/10/2015	9/3/2015	1/31/2013		

CDPH WELLS WITHIN 1500 FEET OF THIS SITE
NONE

CALCULATED FIELDS (BASED ON LATITUDE / LONGITUDE)		
APN	GW BASIN NAME	WATERSHED NAME
81701002	Gilroy-Hollister Valley - Llagas Area (3-003.01)	Pajaro River - South Santa Clara Valley (305.30)
COUNTY	PUBLIC WATER SYSTEM(S)	
Santa Clara	<ul style="list-style-type: none"> CITY OF MORGAN HILL - RAY DELLANINI, MORGAN HILL, CA 95037 SANTA CLARA VALLEY WATER DISTRICT - 5750 ALMADEN EXPRESSWAY, SAN JOSE, CA 95118 	

MOST RECENT CONCENTRATIONS OF PETROLEUM CONSTITUENTS IN GROUNDWATER [VIEW ESI SUBMITTALS](#)

FIELD PT NAME	DATE	TPHg	BENZENE	TOLUENE	ETHYL-BENZENE	XYLENES	MTBE	TBA
E-1	2/10/2011	OTHER	1.3 UG/L	ND	0.63 UG/L	OTHER	ND	ND
E-2	2/10/2011	OTHER	4.6 UG/L	ND	2.7 UG/L	OTHER	ND	ND
EFFLUENT	8/4/2005	OTHER	ND	ND	ND	ND		
ET-MW-30A	2/10/2011	OTHER	ND	ND	ND	OTHER	ND	ND
ET-MW-30B	2/10/2011	OTHER	ND	ND	ND	OTHER	ND	ND
ET-MW-30C	2/10/2011	OTHER	ND	ND	ND	OTHER	ND	ND
ET-MW-30D	2/10/2011	OTHER	ND	ND	ND	OTHER	ND	ND
ET-MW-31A	2/10/2011	OTHER	ND	ND	ND	OTHER	ND	ND
ET-MW-31B	2/10/2011	OTHER	ND	ND	ND	OTHER	ND	ND
ET-MW-31C	2/10/2011	OTHER	ND	ND	ND	OTHER	ND	ND
ET-MW-31D	2/10/2011	OTHER	ND	ND	ND	OTHER	2.4 UG/L	ND
ET-MW-32B	2/9/2011	OTHER	ND	ND	ND	OTHER	ND	ND
ET-MW-32C	2/9/2011	OTHER	ND	ND	ND	OTHER	ND	ND
ET-MW-32D	2/9/2011	OTHER	ND	ND	ND	OTHER	5 UG/L	ND
ET-MW-33B	2/9/2011	OTHER	ND	ND	ND	OTHER	ND	ND
ET-MW-33C	2/9/2011	OTHER	ND	ND	ND	OTHER	ND	ND
ET-MW-33D	2/9/2011	OTHER	ND	ND	ND	OTHER	ND	ND
MW-100	11/9/2001	OTHER	<00 UG/L	<00 UG/L	<00 UG/L	<00 UG/L	<00 UG/L	
MW-11	2/11/2011	OTHER	ND	ND	ND	OTHER	ND	ND
MW-13	2/10/2011	OTHER	ND	ND	ND	OTHER	ND	ND
MW-14	2/10/2011	OTHER	ND	ND	ND	OTHER	ND	ND
MW-15	11/20/2012	OTHER	83 UG/L	5.2 UG/L	14 UG/L	OTHER	ND	ND
MW-16	2/10/2011	OTHER	3.7 UG/L	0.97 UG/L	2.6 UG/L	OTHER	ND	ND
MW-18	2/26/2008	OTHER	0.86 UG/L	ND	ND	OTHER	ND	ND
MW-19	2/9/2011	OTHER	ND	ND	ND	OTHER	ND	ND
MW-20	2/26/2008	OTHER	ND	ND	ND	OTHER	ND	ND
MW-21	2/9/2011	OTHER	ND	ND	ND	OTHER	ND	ND
MW-22	2/10/2011	OTHER	ND	ND	0.85 UG/L	OTHER	ND	ND
MW-23	2/10/2011	OTHER	ND	ND	ND	OTHER	ND	ND
MW-24	2/11/2011	OTHER	ND	ND	ND	OTHER	ND	ND
MW-3	2/10/2011	OTHER	ND	ND	ND	OTHER	ND	ND
MW-7	3/23/2010	OTHER	ND	ND	ND	OTHER	ND	ND
MW-9	2/9/2011	OTHER	ND	ND	ND	OTHER	ND	ND
QCTB	2/11/2011	OTHER	ND	ND	ND	OTHER	ND	ND
TSG-MW-25A	11/20/2012	OTHER	ND	ND	ND	OTHER	ND	ND
TSG-MW-25B	2/10/2011	OTHER	ND	ND	ND	OTHER	ND	ND
TSG-MW-25C	2/10/2011	OTHER	ND	ND	ND	OTHER	ND	ND
TSG-MW-26A	2/10/2011	OTHER	ND	ND	ND	OTHER	ND	ND
TSG-MW-26B	2/10/2011	OTHER	ND	ND	ND	OTHER	ND	ND
TSG-MW-26C	2/10/2011	OTHER	ND	0.86 UG/L	ND	OTHER	2.1 UG/L	ND

TSG-MW-27A	2/10/2011	OTHER	ND	ND	ND	OTHER	ND	ND
TSG-MW-27B	2/10/2011	OTHER	ND	ND	ND	OTHER	ND	ND
TSG-MW-27C	2/10/2011	OTHER	ND	ND	ND	OTHER	ND	ND
TSG-MW-28A	2/10/2011	OTHER	ND	ND	ND	OTHER	ND	ND
TSG-MW-28B	2/10/2011	OTHER	16 UG/L	0.58 UG/L	1.3 UG/L	OTHER	6 UG/L	ND
TSG-MW-28C	2/10/2011	OTHER	3.3 UG/L	ND	ND	OTHER	ND	ND
TSG-MW-29B	9/22/2010	OTHER	ND	ND	ND	OTHER	ND	ND
TSG-MW-29C	2/11/2011	OTHER	ND	ND	ND	OTHER	ND	ND
TSG-OW-1A	2/11/2011	OTHER	ND	ND	ND	OTHER	ND	ND
TSG-OW-1B	2/11/2011	OTHER	ND	ND	ND	OTHER	ND	ND
TSG-OW-2A	2/11/2011	OTHER	ND	ND	ND	OTHER	ND	ND
TSG-OW-2B	2/11/2011	OTHER	ND	ND	ND	OTHER	ND	ND

MOST RECENT CONCENTRATIONS OF PETROLEUM CONSTITUENTS IN SOIL

[VIEW ESI SUBMITTALS](#)

FIELD PT NAME	DATE	TPHg	BENZENE	TOLUENE	ETHYL-BENZENE	XYLENES	MTBE	TBA
CB-1	11/5/2012		ND	ND	ND		ND	0.08 MG/KG
CB-2	11/6/2012		ND	ND	0.024 MG/KG		ND	ND
CB-3	11/5/2012		ND	ND	ND		ND	ND
CB-4	11/5/2012		0.0079 MG/KG	0.0033 MG/KG	4 MG/KG		ND	0.11 MG/KG
CB-5	11/6/2012		ND	ND	ND		ND	0.03 MG/KG
CB-6	11/6/2012		ND	ND	ND		ND	ND
CB-7	11/7/2012		ND	ND	ND		ND	ND
ET-MW-30D	8/14/2002		ND	ND	ND		ND	
ET-MW-31D	8/12/2002		ND	ND	ND		ND	ND
ET-MW-32D	8/16/2002		ND	ND	ND		ND	
ET-MW-33D	8/19/2002		ND	ND	ND		ND	ND

MOST RECENT GEO_WELL DATA

[VIEW ESI SUBMITTALS](#)

FIELD PT NAME	DATE	DEPTH TO WATER (FT)	SHEEN	DEPTH TO FREE PRODUCT (FT)
E-1	2/10/2011	6.68	N	
E-2	2/10/2011	6.61	N	
ET-MW-30A	2/10/2011	14.61	N	
ET-MW-30B	2/10/2011	19.47	N	
ET-MW-30C	2/10/2011	24.38	N	
ET-MW-30D	2/10/2011	25.25	N	
ET-MW-31A	2/10/2011	16.05	N	
ET-MW-31B	2/10/2011	21.34	N	
ET-MW-31C	2/10/2011	22.2	N	
ET-MW-31D	2/10/2011	26.34	N	
ET-MW-32B	2/9/2011	19.1	N	
ET-MW-32C	2/9/2011	21.22	N	
ET-MW-32D	2/9/2011	20.31	N	
ET-MW-33B	2/9/2011	19.83	N	
ET-MW-33C	2/9/2011	21.11	N	
ET-MW-33D	2/9/2011	18.7	N	
MW-11	2/11/2011	12.71	N	
MW-13	2/10/2011	10.01	N	
MW-14	2/10/2011	13.93	N	
MW-15	2/10/2011	7	N	
MW-16	2/10/2011	8.07	N	
MW-18	3/24/2009		N	
MW-19	2/9/2011	15.11	N	
MW-20	3/24/2009		N	
MW-21	2/9/2011	7.9	N	
MW-22	2/10/2011	7.81	N	
MW-23	2/10/2011	15.64	N	
MW-24	2/11/2011	18.04	N	
MW-3	2/10/2011	7.6	N	
MW-7	9/22/2010		N	
MW-9	2/9/2011	6.72	N	
TSG-MW-25A	2/10/2011	6.7	N	
TSG-MW-25B	2/10/2011	17.35	N	
TSG-MW-25C	2/10/2011	17.44	N	
TSG-MW-26A	2/10/2011	7.03	N	
TSG-MW-26B	2/10/2011	15.98	N	
TSG-MW-26C	2/10/2011	23.71	N	
TSG-MW-27A	2/10/2011	12.87	N	
TSG-MW-27B	2/10/2011	18.66	N	
TSG-MW-27C	2/10/2011	23.61	N	
TSG-MW-28A	2/10/2011	9.34	N	
TSG-MW-28B	2/10/2011	17.77	N	
TSG-MW-28C	2/10/2011	16.66	N	
TSG-MW-29B	2/9/2011	22.91	N	
TSG-MW-29C	2/11/2011	21.96	N	
TSG-OW-1A	2/11/2011	13.57	N	
TSG-OW-1B	2/11/2011	14.78	N	
TSG-OW-2A	2/11/2011	13	N	
TSG-OW-2B	2/11/2011	13.9	N	

F. Title Records



Issuing Policies of **Chicago Title Insurance Company**

Order No.: 98201364-982-EA-KC

Title Officer: **Kenneth Connaker**

TO:

Kidder Mathews
10 Almaden Blvd, suite 550
San Jose, CA 95113

Escrow Officer: **Eilbra Abbasteh**
675 N. First St, Suite 300
San Jose, CA 95112
(408) 292-4212
(408) 282-1404

ATTN: **.Rodney Moreschini**
YOUR REFERENCE:

PROPERTY ADDRESS: APN: 767-17-047, Morgan Hill, CA

PRELIMINARY REPORT

*In response to the application for a policy of title insurance referenced herein, **Chicago Title Company** hereby reports that it is prepared to issue, or cause to be issued, as of the date hereof, a policy or policies of title insurance describing the land and the estate or interest therein hereinafter set forth, insuring against loss which may be sustained by reason of any defect, lien or encumbrance not shown or referred to as an exception herein or not excluded from coverage pursuant to the printed Schedules, Conditions and Stipulations or Conditions of said policy forms.*

The printed Exceptions and Exclusions from the coverage and Limitations on Covered Risks of said policy or policies are set forth in Attachment One. The policy to be issued may contain an arbitration clause. When the Amount of Insurance is less than that set forth in the arbitration clause, all arbitrable matters shall be arbitrated at the option of either the Company or the Insured as the exclusive remedy of the parties. Limitations on Covered Risks applicable to the CLTA and ALTA Homeowner's Policies of Title Insurance which establish a Deductible Amount and a Maximum Dollar Limit of Liability for certain coverages are also set forth in Attachment One. Copies of the policy forms should be read. They are available from the office which issued this report.

This report (and any supplements or amendments hereto) is issued solely for the purpose of facilitating the issuance of a policy of title insurance and no liability is assumed hereby. If it is desired that liability be assumed prior to the issuance of a policy of title insurance, a Binder or Commitment should be requested.

*The policy(s) of title insurance to be issued hereunder will be policy(s) of **Chicago Title Insurance Company**, a Florida corporation.*

Please read the exceptions shown or referred to herein and the exceptions and exclusions set forth in Attachment One of this report carefully. The exceptions and exclusions are meant to provide you with notice of matters which are not covered under the terms of the title insurance policy and should be carefully considered.

It is important to note that this preliminary report is not a written representation as to the condition of title and may not list all liens, defects and encumbrances affecting title to the land.

Chicago Title Company

By: 
Authorized Signature



By: 
Randy Quirk, President
Attest: 
Michael Gravelle, Secretary



PRELIMINARY REPORT

EFFECTIVE DATE: **April 12, 2018 at 7:30 a.m.**

ORDER NO.: **98201364-982-EA-KC**

The form of policy or policies of title insurance contemplated by this report is:

ALTA Extended Loan Policy (6-17-06)
ALTA Extended Owners Policy (6-17-06)

1. THE ESTATE OR INTEREST IN THE LAND HEREINAFTER DESCRIBED OR REFERRED TO COVERED BY THIS REPORT IS:

A FEE

2. TITLE TO SAID ESTATE OR INTEREST AT THE DATE HEREOF IS VESTED IN:

PEPPER LANE-COSMO, LLC., a California Limited Liability Company

3. THE LAND REFERRED TO IN THIS REPORT IS DESCRIBED AS FOLLOWS:

See Exhibit A attached hereto and made a part hereof.

EXHIBIT A
LEGAL DESCRIPTION

THE LAND REFERRED TO HEREIN BELOW IS SITUATED **IN THE CITY OF MORGAN HILL**, IN THE COUNTY OF **SANTA CLARA**, STATE OF **CALIFORNIA**, AND IS DESCRIBED AS FOLLOWS:

Parcel 2, as delineated upon that certain Map entitled "Parcel Map", filed for record in the Office of the Recorder of the County of Santa Clara, State of California, on February 10th, 1978 in Book 412 of Maps, at Page 43.

APN: **767-17-047**

EXCEPTIONS

AT THE DATE HEREOF, ITEMS TO BE CONSIDERED AND EXCEPTIONS TO COVERAGE IN ADDITION TO THE PRINTED EXCEPTIONS AND EXCLUSIONS IN SAID POLICY FORM WOULD BE AS FOLLOWS:

1. Property taxes, which are a lien not yet due and payable, including any assessments collected with taxes to be levied for the fiscal year 2018-2019.
2. Prior to close of escrow, please contact the Tax Collector's Office to confirm all amounts owing, including current fiscal year taxes, supplemental taxes, escaped assessments and any delinquencies.
3. The lien of supplemental or escaped assessments of property taxes, if any, made pursuant to the provisions of Chapter 3.5 (commencing with Section 75) or Part 2, Chapter 3, Articles 3 and 4, respectively, of the Revenue and Taxation Code of the State of California as a result of the transfer of title to the vestee named in Schedule A or as a result of changes in ownership or new construction occurring prior to Date of Policy.

4. The herein described property lies within the boundaries of a Mello-Roos Community Facilities District (CFD) as follows:
For: Library JPA CFD 2013-1 Mello Roos

This property, along with all other parcels in the CFD, is liable for an annual special tax. This special tax is included with and payable with the general property taxes of the City of Morgan Hill, County of Santa Clara. The tax may not be prepaid.

5. Easement(s) for the purpose(s) shown below and rights incidental thereto, as granted in a document:

Granted to: Santa Clara County Water District, a public corporation
Purpose: Temporary Maintenance
Recording Date: December 16, 1977
Recording No: Book D345, Page 135, of Official Records
Affects: Southwesterly 40 feet of said land

6. Easement(s) for the purpose(s) shown below and rights incidental thereto as delineated or as offered for dedication, on the map of said tract/plat;

Purpose: Access for Parcel One
Affects: The Southwesterly 25 feet of said land

7. Matters contained in that certain document

Entitled: Improvement Agreement
Dated: January 6, 1978
Executed by: City of Morgan Hill, a Municipal corporation and Cosmo D. and Ernesta I. Perrotta
Recording Date: February 27, 1978
Recording No: Book D488, Page 664, of Official Records

Reference is hereby made to said document for full particulars.

EXCEPTIONS (Continued)

8. The Community Development Plan of the Ojo de Agua Project Area in the City of Morgan Hill, recorded on June 23, 1981 in Book G169, Page 270, Official Records of Santa Clara County, as Instrument Number 7092982.

An Ordinance of the City Council of the City of Morgan Hill (Ordinance No. 552, New Series) Approving and Adopting the Ojo De Agua Community Development Plan and Making Certain Findings Pursuant to the Community Redevelopment Law of the State of California, recorded June 23, 1981 in Book G169 Page 327, Official Records, as Instrument Number 7092983.

Statement of Institution of Redevelopment Proceedings, pursuant to the California Community Redevelopment Law, Health & Safety Code Sections 33000, et seq., recorded June 23, 1981 in Book G169, Page 340, Official Records, as Instrument Number 7092984.

An Ordinance of the City of Morgan Hill (Ordinance No. 1057, N.S.) Adopting the Amended and Restated Ojo De Agua Community Development Project Area Plan Pursuant to the Community Redevelopment Law of the State of California (Health & Safety Code Sections 33000, et seq.), recorded November 7, 1991 in Book L923, Page 1101, Official Records, as Instrument Number 11126298.

Statement of Institution of Amended Redevelopment Plan pursuant to the California Redevelopment Law, Health & Safety Code Sections 33000, et seq., recorded November 7, 1991 in Book L923, Page 1109, Official Records, as Instrument Number 11126299.

Notice of Non-effectiveness of Amended and Restated Redevelopment Plan recorded December 15, 1992 in Book M541, Page 803, Official Records, as Instrument Number 11692063.

An Ordinance of the City Council of the City of Morgan Hill, (Ordinance No. 1204, New Series) Adopting an Amendment to the Ojo De Agua Community Development Plan Pursuant to Health and Safety Code Section 33333.6 and Amending a Related Ordinance in Connection therewith, recorded January 9, 1995 in Book N724, Page 1384, Official Records, as Instrument No. 12769934.

EXCEPTIONS (Continued)

9. The Company will require the following documents for review prior to the issuance of any title insurance predicated upon a conveyance or encumbrance from the entity named below:

Limited Liability Company: PEPPER LANE-COSMO, LLC., a California Limited Liability Company

- a) A copy of its operating agreement, if any, and all amendments, supplements and/or modifications thereto, certified by the appropriate manager or member.
- b) If a domestic Limited Liability Company, a copy of its Articles of Organization and all amendments thereto with the appropriate filing stamps.
- c) If the Limited Liability Company is member-managed, a full and complete current list of members certified by the appropriate manager or member.
- d) A current dated certificate of good standing from the proper governmental authority of the state in which the entity is currently domiciled.
- e) If less than all members, or managers, as appropriate, will be executing the closing documents, furnish evidence of the authority of those signing.
- f) If Limited Liability Company is a Single Member Entity, a Statement of Information for the Single Member will be required.
- g) Each member and manager of the LLC without an Operating Agreement must execute in the presence of a notary public the Certificate of California LLC (Without an Operating Agreement) Status and Authority form.

10. The Company will require that an Owner's Affidavit be completed by the party(s) named below before the issuance of any policy of title insurance.

Party(s): PEPPER LANE-COSMO, LLC., a California Limited Liability Company

The Company reserves the right to add additional items or make further requirements after review of the requested Affidavit.

11. Any rights of the parties in possession of a portion of, or all of, said Land, which rights are not disclosed by the public records.

The Company will require, for review, a full and complete copy of any unrecorded agreement, contract, license and/or lease, together with all supplements, assignments and amendments thereto, before issuing any policy of title insurance without excepting this item from coverage.

The Company reserves the right to except additional items and/or make additional requirements after reviewing said documents.

**EXCEPTIONS
(Continued)**

12. The transaction contemplated in connection with this Report is subject to the review and approval of the Company's Corporate Underwriting Department. The Company reserves the right to add additional items or make further requirements after such review.

END OF EXCEPTIONS

NOTES

1. None of the items shown in this report will cause the Company to decline to attach CLTA Endorsement Form 100 to an Extended Coverage Loan Policy, when issued.
2. Note: The name(s) of the proposed insured(s) furnished with this application for title insurance is/are:

No names were furnished with the application. Please provide the name(s) of the buyers as soon as possible.
3. Note: Property taxes for the fiscal year shown below are PAID. For proration purposes the amounts were:

Tax Identification No.:	767-17-047
Fiscal Year:	2017-2018
1st Installment:	\$6,620.76
2nd Installment:	\$6,620.76
Exemption:	\$0.00
Land:	\$1,081,957.00
Improvements:	\$0.00
Personal Property:	\$0.00
Code Area:	004-002
Bill No.:	767-17-047-00
4. Note: There are NO conveyances affecting said Land recorded within 24 months of the date of this report.
5. Note: The charge for a policy of title insurance, when issued through this title order, will be based on the Basic Title Insurance Rate.
6. Your application for title insurance was placed by reference to only a street address or tax identification number. Based on our records, we believe that the legal description in this report covers the parcel(s) of Land that you requested. If the legal description is incorrect, the seller/borrower must notify the Company and/or the settlement company in order to prevent errors and to be certain that the correct parcel(s) of Land will appear on any documents to be recorded in connection with this transaction and on the policy of title insurance.
7. Note: If a county recorder, title insurance company, escrow company, real estate broker, real estate agent or association provides a copy of a declaration, governing document or deed to any person, California law requires that the document provided shall include a statement regarding any unlawful restrictions. Said statement is to be in at least 14-point bold face type and may be stamped on the first page of any document provided or included as a cover page attached to the requested document. Should a party to this transaction request a copy of any document reported herein that fits this category, the statement is to be included in the manner described.
8. Note: Any documents being executed in conjunction with this transaction must be signed in the presence of an authorized Company employee, an authorized employee of an agent, an authorized employee of the insured lender, or by using Bancserv or other approved third-party service. If the above requirement cannot be met, please call the Company at the number provided in this report.
9. Note: The policy of title insurance will include an arbitration provision. The Company or the insured may demand arbitration. Arbitrable matters may include, but are not limited to, any controversy or claim between the Company and the insured arising out of or relating to this policy, any service of the Company in connection with its issuance or the breach of a policy provision or other obligation. Please ask your escrow or title officer for a sample copy of the policy to be issued if you wish to review the arbitration provisions and any other provisions pertaining to your Title Insurance coverage.

**NOTES
(Continued)**

10. Notice: Please be aware that due to the conflict between federal and state laws concerning the cultivation, distribution, manufacture or sale of marijuana, the Company is not able to close or insure any transaction involving Land that is associated with these activities.
11. Pursuant to Government Code Section 27388.1, as amended and effective as of 1-1-2018, a Documentary Transfer Tax (DTT) Affidavit may be required to be completed and submitted with each document when DTT is being paid or when an exemption is being claimed from paying the tax. If a governmental agency is a party to the document, the form will not be required. DTT Affidavits may be available at a Tax Assessor-County Clerk-Recorder.

END OF NOTES

Kenneth Connaker/ad

BK 817

MONTEREY ROAD

CATHERINE DUNNE RANCH MAP N^o 3

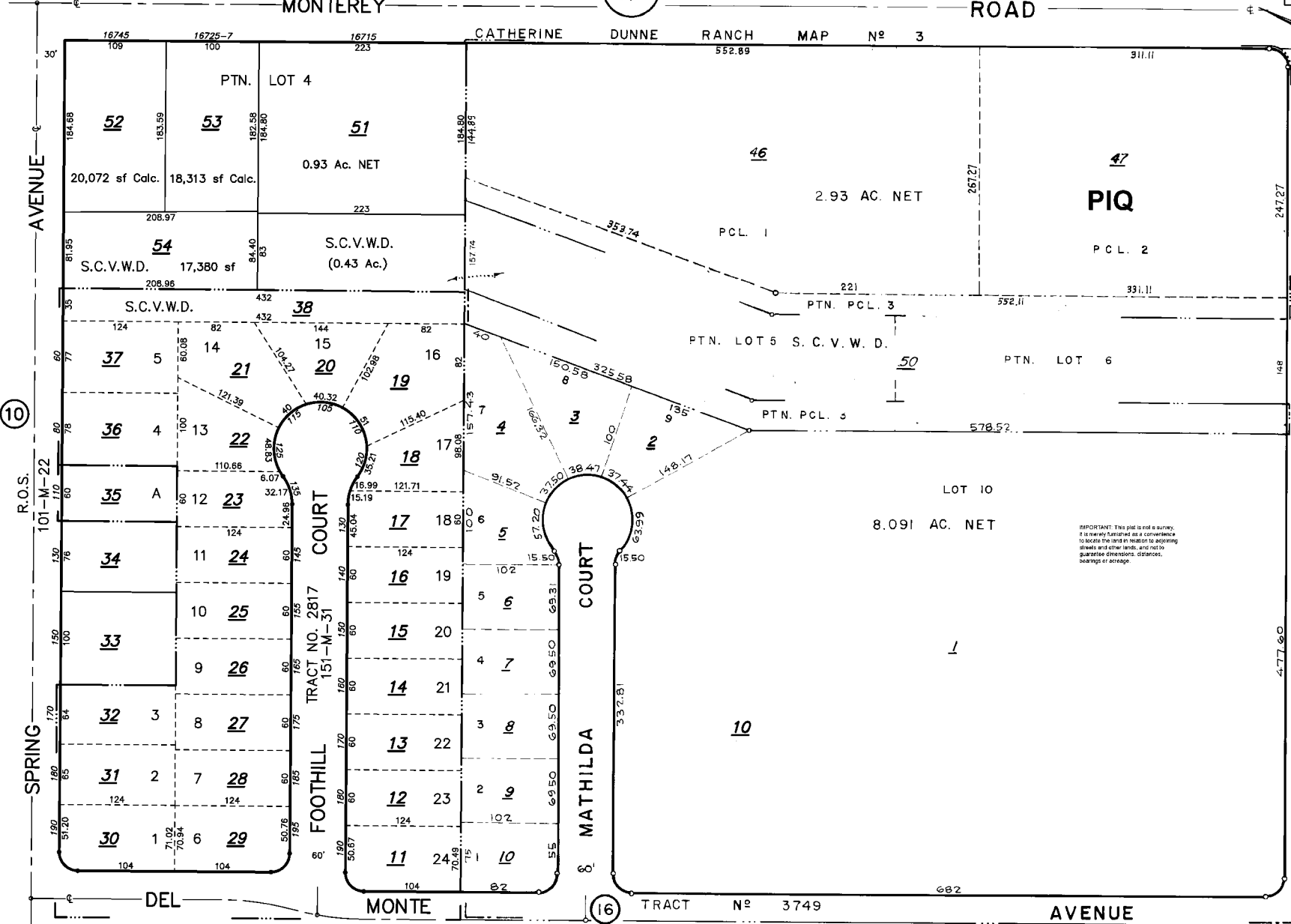
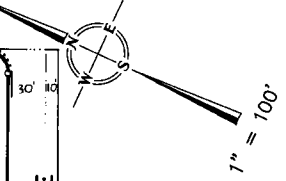

P.M. 412-M-43

IMPORTANT: This plat is not a survey. It is merely furnished as a convenience to locate the land in relation to adjoining streets and other lands, and not to guarantee dimensions, distances, bearings or acreage.

LAWRENCE E. STONE — ASSESSOR
Cadastral map for assessment purposes only.
Compiled under R. & T. Code, Sec. 327.
Effective Roll Year 2017-2018

Property Information (APN: 767-17-047)**Situs Address (es) :** COSMO AV MORGAN HILL 95037-0000**Mailing Address:** 15729 LOS GATOS BL #200 LOS GATOS CA 95032-2539**Current Information Assessed Value**

PROPERTY INFORMATION			
Document No:	16133487	Document Type:	GRANT DEED
Transfer Date:	3/1/2002	Tax Default Date:	N/A

TAX RATE AREA INFORMATION 004-002	
City:	Morgan Hill
Unified School:	Morgan Hill
Comm. College:	Gavilan Jt(35,43)
Resource Conserv.:	Loma Prieta Soil
Air Quality Mgmt.:	Bay Area Jt(1,7,21,28,38,41,43,48,49)
Redevelopment:	Morgan Hill-ojo De Agua Community
County Service:	Area No. 01 (library Services), Benefit Assessment
County Service:	Area No. 01 (library Services)
County Water:	Santa Clara Valley
County Water:	Santa Clara Valley-zone S-1
County Water:	Santa Clara Valley-zone W-3
Water-misc.:	Santa Clara County Importation

VALUE INFORMATION (Assessed Information as of 6/30/2018)						
Real Property		Business		Exemptions		Net Assessed Value
Land:	\$1,103,596	Fixtures:	\$0	Homeowner:	\$0	
Improvements:	\$0	Structure:	\$0	Other:	\$0	
		Personal Property:	\$0			
Total:	\$1,103,596	Total:	\$0	Total:	\$0	\$1,103,596

DISCLAIMER: This service has been provided to allow easy access and a visual display of County information. A reasonable effort has been made to ensure the accuracy of the data provided; nevertheless, some information may be out of date or may not be accurate. The County of Santa Clara assumes no responsibility arising from use of this information. ASSOCIATED DATA ARE PROVIDED WITHOUT WARRANTY OF ANY KIND, either expressed or implied, including but not limited to, the implied warranties of merchantability and fitness for a particular purpose. Do not make any business decisions based on this data before validating the data. [Revenue and Taxation Code Section 408.3(c)]

2018 Assessed Value

PROPERTY INFORMATION			
Document No:	16133487	Document Type:	GRANT DEED
Transfer Date:	3/1/2002	Tax Default Date:	N/A

TAX RATE AREA INFORMATION 004-002	
City:	Morgan Hill
Unified School:	Morgan Hill
Comm. College:	Gavilan Jt(35,43)
Resource Conserv.:	Loma Prieta Soil
Air Quality Mgmt.:	Bay Area Jt(1,7,21,28,38,41,43,48,49)
Redevelopment:	Morgan Hill-ojo De Agua Community
County Service:	Area No. 01 (library Services), Benefit Assessment
County Service:	Area No. 01 (library Services)
County Water:	Santa Clara Valley
County Water:	Santa Clara Valley-zone S-1
County Water:	Santa Clara Valley-zone W-3
Water-misc.:	Santa Clara County Importation

VALUE INFORMATION (Assessed Information as of 6/30/2018)						
Real Property		Business		Exemptions		Net Assessed Value
Land:	\$1,103,596	Fixtures:	\$0	Homeowner:	\$0	
Improvements:	\$0	Structure:	\$0	Other:	\$0	
		Personal Property:	\$0			
Total:	\$1,103,596	Total:	\$0	Total:	\$0	\$1,103,596

DISCLAIMER: This service has been provided to allow easy access and a visual display of County information. A reasonable effort has been made to ensure the accuracy of the data provided; nevertheless, some information may be out of date or may not be accurate. The County of Santa Clara assumes no responsibility arising from use of this information. ASSOCIATED DATA ARE PROVIDED WITHOUT WARRANTY OF ANY KIND, either expressed or implied, including but not limited to, the implied warranties of merchantability and fitness for a particular purpose. Do not make any business decisions based on this data before validating the data. [Revenue and Taxation Code Section 408.3(c)]

2017 Assessed Value

PROPERTY INFORMATION			
Document No:	16133487	Document Type:	GRANT DEED
Transfer Date:	3/1/2002	Tax Default Date:	N/A

TAX RATE AREA INFORMATION 004-002	
City:	Morgan Hill
City:	Morgan Hill
Unified School:	Morgan Hill
Unified School:	Morgan Hill
Comm. College:	Gavilan Jt(35,43)
Comm. College:	Gavilan Jt(35,43)
Resource Consv.:	Loma Prieta Soil
Resource Consv.:	Loma Prieta Soil
Air Quality Mgmt.:	Bay Area Jt(1,7,21,28,38,41,43,48,49)
Air Quality Mgmt.:	Bay Area Jt(1,7,21,28,38,41,43,48,49)
Redevelopment:	Morgan Hill-ojo De Agua Community
Redevelopment:	Morgan Hill-ojo De Agua Community
County Service:	Area No. 01 (library Services), Benefit Assessment
County Service:	Area No. 01 (library Services), Benefit Assessment
County Service:	Area No. 01 (library Services)
County Service:	Area No. 01 (library Services)
County Water:	Santa Clara Valley
County Water:	Santa Clara Valley
County Water:	Santa Clara Valley-zone S-1
County Water:	Santa Clara Valley-zone S-1
County Water:	Santa Clara Valley-zone W-3
County Water:	Santa Clara Valley-zone W-3
Water-misc.:	Santa Clara County Importation
Water-misc.:	Santa Clara County Importation

VALUE INFORMATION (Assessed Information as of 6/30/2017)						
Real Property		Business		Exemptions		Net Assessed Value
Land:	\$1,081,957	Fixtures:	\$0	Homeowner:	\$0	
Improvements:	\$0	Structure:	\$0	Other:	\$0	
		Personal Property:	\$0			
Total:	\$1,081,957	Total:	\$0	Total:	\$0	\$1,081,957

DISCLAIMER: This service has been provided to allow easy access and a visual display of County information. A reasonable effort has been made to ensure the accuracy of the data provided; nevertheless, some information may be out of date or may not be accurate. The County of Santa Clara assumes no responsibility arising from use of this information. ASSOCIATED DATA ARE PROVIDED WITHOUT WARRANTY OF ANY KIND, either expressed or implied, including but not limited to, the implied warranties of merchantability and fitness for a particular purpose. Do not make any business decisions based on this data before validating the data. [Revenue and Taxation Code Section 408.3(c)]

2016 Assessed Value

PROPERTY INFORMATION			
Document No:	16133487	Document Type:	GRANT DEED
Transfer Date:	3/1/2002	Tax Default Date:	N/A

TAX RATE AREA INFORMATION 004-002	
City:	Morgan Hill
City:	Morgan Hill
City:	Morgan Hill
Unified School:	Morgan Hill
Unified School:	Morgan Hill
Unified School:	Morgan Hill
Comm. College:	Gavilan Jt(35,43)
Comm. College:	Gavilan Jt(35,43)
Comm. College:	Gavilan Jt(35,43)
Resource Consv.:	Loma Prieta Soil
Resource Consv.:	Loma Prieta Soil
Resource Consv.:	Loma Prieta Soil
Air Quality Mgmt.:	Bay Area Jt(1,7,21,28,38,41,43,48,49)
Air Quality Mgmt.:	Bay Area Jt(1,7,21,28,38,41,43,48,49)
Air Quality Mgmt.:	Bay Area Jt(1,7,21,28,38,41,43,48,49)
Redevelopment:	Morgan Hill-ojo De Agua Community
Redevelopment:	Morgan Hill-ojo De Agua Community
Redevelopment:	Morgan Hill-ojo De Agua Community
County Service:	Area No. 01 (library Services), Benefit Assessment
County Service:	Area No. 01 (library Services), Benefit Assessment
County Service:	Area No. 01 (library Services), Benefit Assessment
County Service:	Area No. 01 (library Services)
County Service:	Area No. 01 (library Services)
County Service:	Area No. 01 (library Services)
County Water:	Santa Clara Valley
County Water:	Santa Clara Valley
County Water:	Santa Clara Valley
County Water:	Santa Clara Valley-zone S-1
County Water:	Santa Clara Valley-zone S-1
County Water:	Santa Clara Valley-zone S-1
County Water:	Santa Clara Valley-zone W-3
County Water:	Santa Clara Valley-zone W-3
County Water:	Santa Clara Valley-zone W-3
Water-misc.:	Santa Clara County Importation
Water-misc.:	Santa Clara County Importation

Water-misc.:	Santa Clara County Importation
--------------	--------------------------------

VALUE INFORMATION (Assessed Information as of 6/30/2016)						
Real Property		Business		Exemptions		Net Assessed Value
Land:	\$1,060,743	Fixtures:	\$0	Homeowner:	\$0	
Improvements:	\$0	Structure:	\$0	Other:	\$0	
		Personal Property:	\$0			
Total:	\$1,060,743	Total:	\$0	Total:	\$0	\$1,060,743

DISCLAIMER: This service has been provided to allow easy access and a visual display of County information. A reasonable effort has been made to ensure the accuracy of the data provided; nevertheless, some information may be out of date or may not be accurate. The County of Santa Clara assumes no responsibility arising from use of this information. ASSOCIATED DATA ARE PROVIDED WITHOUT WARRANTY OF ANY KIND, either expressed or implied, including but not limited to, the implied warranties of merchantability and fitness for a particular purpose. Do not make any business decisions based on this data before validating the data. [Revenue and Taxation Code Section 408.3(c)]

G. Questionnaires

RNC ENVIRONMENTAL, LLC

151 Nursery Street, Ashland, OR 97520
(888)485-3330 • www.rnc-enviro.com

Phase I Environmental Site Assessment (ASTM E1527-13) Questionnaire

In order to qualify for one of the Landowner Liability Protections offered by the Small Business Liability Relief and Brownfields Revitalization Act of 2001 (the "Brownfields Amendments"), the user must provide the following information (if available) to the environmental professional. Failure to provide this information could result in a determination that "all appropriate inquiry" is not complete.

Project Name: N/A Address: NWC Monterey Rd/Cosmo Ave
Morgan Hill, CA

Questionnaire completed by:

Name: Darren Berberian Date: 7/30/18
Title: President

	Yes	No
(1.) Are you aware of any environmental cleanup liens against the property that are filed or recorded under federal, tribal, state or local law?	<input type="checkbox"/>	<input checked="" type="checkbox"/>
(2.) Are you aware of any activity and land use limitations, such as engineering controls, land use restrictions or institutional controls that are in place at the site and/or have been filed or recorded in a registry under federal, tribal, state or local law?	<input type="checkbox"/>	<input checked="" type="checkbox"/>
(3.) Do you have any specialized knowledge or experience related to the property or nearby properties? For example, are you involved in the same line of business as the current or former occupants of the property or an adjoining property so that you would have specialized knowledge of the chemicals and processes used by this type of business?	<input type="checkbox"/>	<input checked="" type="checkbox"/>
(4.) (a.) Is the purchase price being paid for this property significantly less than the fair market value of the property? (b.) If you conclude that there is a difference, is there any concern that the lower purchase price may be because contamination is known or believed to be present at the property?	<input type="checkbox"/>	<input checked="" type="checkbox"/>
(5.) Are you aware of commonly known or reasonably ascertainable information about the property that would help the environmental professional to identify conditions indicative of releases or threatened releases? For example, do you know the past uses of the property? Do you know of specific chemicals that are present or once were present at the property? Do you know of spills or other chemical releases that have taken place at the property? Do you know of any environmental cleanups that have taken place at the property?	<input type="checkbox"/>	<input checked="" type="checkbox"/>
(6.) Based on your knowledge and experience related to the property are there any obvious indicators that point to the presence or likely presence of contamination at the property?	<input type="checkbox"/>	<input checked="" type="checkbox"/>

Phase I Environmental Site Assessment (ASTM E1527-13) Questionnaire

Project Name: Monterey Rd./Cosmo Ave. Property Address: NWC Monterey Rd./Cosmo Ave.
Morgan Hill, CA

To whom it may concern:

RNC Environmental has been retained to complete a Phase I Environmental Site Assessment of the above-specified property. Your assistance in sharing your knowledge of present and past uses of the property, and of any known or suspected environmental conditions relating to it, is much appreciated. Please respond to the questions below "to the best of your knowledge"; no additional investigation on your part is required. Thank you!

Questionnaire completed by: _____ Date: August 6, 2018

Name: Pepper Lane - Cosmo, LLC Title: Myra Reinhard, President of Pepper Lane Properties, as manager of Pepper Lane - Cosmo LLC

Please provide a telephone number or email address, in case we have any additional questions: myra@pepperlaneproperties.com

This person's association with the subject property:

Current Owner Previous Owner Property Manager Occupant Other : _____

1. What is the current use of the property?

Commercial Industrial Single-family Residential Multi-family Agriculture

Vacant Land Other: _____

2. How long has the property been used for this purpose? Since prior to Pepper Lane - Cosmo LLC's acquisition of the property.

3. Are you aware of any other past uses of the property? Pepper Lane - Cosmo LLC has no knowledge of past uses other than as stated in the Phase I Environmental Site Assessment for the property dated August 22, 2000 and prepared by Sierra Environmental, Inc.

4. Are you aware of any pending, threatened, or past litigation relevant to hazardous substances or petroleum products in, on, or from the property? Yes No

5. Are you aware of any pending, threatened, or past administrative proceedings relevant to hazardous substances or petroleum products in, on or from the property? Yes No

6. Are you aware of any notices from any governmental entity regarding any possible violation of environmental laws or possible liability relating to hazardous substances or petroleum products? Yes No

7. Are you aware of any other present or past any environmental problems at the property? Yes No

If yes, please describe Pepper Lane - Cosmo LLC has no knowledge regarding past uses other than as stated in the Phase I Environmental Site Assessment for the property dated August 22, 2000 and prepared by Sierra Environmental, Inc.

8. Are there currently, or to the best of your knowledge have there been previously, any gasoline, diesel, fuel oil or other chemical storage tanks (above or underground) located on the property? Yes No

9. Are there currently, or to the best of your knowledge have there been previously, are any pesticides, paints, or other chemicals stored or used on the property in drums, sacks or other containers greater than 5 gallons each or 50 gallons in the aggregate? Yes No

10. Are there currently, or to the best of your knowledge have there been previously a type of business located on the property which uses hazardous chemicals, such as a gas station or dry cleaner? Yes No

11. Are you aware of any previous environmental reports (Phase I, Phase II, Geotechnical, etc.) for the property? Please provide copies, if available. Yes No

12. Are there, or to the best of your knowledge have there been previously, any buildings/structures on the property? If so, please complete the building survey on the next page. Yes No

13. Please attach any additional information, clarification, and/or comments on a separate sheet, or by email.

Please email the completed form to neil@rnc-enviro.com, or fax to (888) 485-3330. Thank you!

Building Survey -- Please complete one copy of this form for each building that currently exists, or formerly existed, on the property.

Building number/ID: _____

Building use and type of construction: _____

Approximate year of construction: _____

Is this building still standing? Yes No If not, approximate year of demolition: _____

Type of level below grade? Full Basement Crawl Space Slab on Grade Parking Garage

Are there any sump pumps, floor drains, or trenches? Yes No Unknown

Heating system type? (CHECK ALL THAT APPLY)

- Unheated
 Natural Gas Electric Propane Fuel Oil Kerosene
 Wood Coal Solar Other _____

**PHASE I
ENVIRONMENTAL
SITE ASSESSMENT**

**Property with APN 767-17-047
Northwest Corner of Monterey Road
and Cosmo Avenue
Morgan Hill, California**

**Prepared for
Mr. Ravi Sahni
5979 central Avenue
Fremont, California 94560**

**Prepared by
Sierra Environmental, Inc.**

*** ORIGINAL REPORT
August 22, 2000
Project 00-150.01**

* ORIGINAL RETURN

TABLE OF CONTENT

	Page
1.0 EXECUTIVE SUMMARY	2
2.0 OBJECTIVES.....	3
2.1 Purpose and Scope of Work.....	3
2.2 Limitations and Exception of Assessment.....	3
3.0 SITE OVERVIEW	4
3.1 Site Name.....	4
3.2 Site Address	4
3.3 Legal Description of the Site.....	4
3.4 Description of Existing on-Site Structures and Improvements	4
4.0 SITE BACKGROUND/OPERATION HISTORY.....	4
4.1 Current Ownership.....	4
4.2 Prior Ownership	5
4.3 Review of Aerial Photographs.....	5
4.4 Historical City Directories/Fire Insurance Maps	5
5.0 ENVIRONMENTAL SETTING.....	6
5.1 Surface Water Characteristics	6
5.2 Subsurface Geological Characteristics.....	6
5.3 Groundwater Characteristics	6
5.4 Drinking Water Quality	6
6.0 SITE INSPECTION.....	6
6.1 Site Observations and Inquiries.....	6
6.2 AST/UST systems and Pipelines.....	7
6.3 Transformers and PCB Equipment	7
6.4 On-Site Regulated Substance Identification/Inventory.....	7
6.5 Area Reconnaissance	8
6.6 Site Plan Drawings	8
6.7 Asbestos Containing Material.....	8
6.8 Lead based Paint	8
6.9 Radon Testing.....	9
7.0 ENVIRONMENTAL/REGULATORY AGENCY INQUIRIES	9
8.0 CONCLUSIONS AND RECOMMENDATIONS	12
8.1 Conclusions.....	12
8.2 Recommendations.....	12
9.0 REFERENCES	13

ATTACHMENTS:

- Appendix A - Figure 1, 2, and 3, (Aerial Photograph 1988 and 1996, and Site's neighboring Properties, Respectively)
- Appendix B - Site's Photographs
- Appendix C - VISTA Report
- Appendix D - Relevant Documents for the Investigated Properties
- Appendix E - Certification of Credential

1.0 EXECUTIVE SUMMARY

Sierra Environmental, Inc. (Sierra) performed a Phase I environmental site assessment (ESA) for the property located at the northwest corner of Cosmo Avenue and Monterey Road, Morgan Hill, California (Site), to identify the potential for impact to the structure, soil, or groundwater of the Site from the on-site or off-site sources of hazardous substances or petroleum hydrocarbon products.

Review of historical aerial photographs taken since 1960s indicated that the general area in the vicinity of the Site was developed with residential and light commercial buildings in 1980s and 1990s. The Site was a farmland until 1990s and has remained an undeveloped vacant land since then.

A Santa Clara valley Water District (SCVW) easement exists west of the Site.

No hazardous substances or petroleum hydrocarbon products were observed at the Site. The Site was not identified in VISTA site assessment report (under any Federal or State agency lists). No records were found in the SCVWD or Santa Clara County Fire Department (SCCFD) files for the Site.

During his visit, Sierra's representative did not observe evidence of existence of UST, release or spill of hazardous substances or petroleum products, or evidence of any area with distressed, discolored, stained, or dead vegetation at the Site. Sierra's representative did not observe any asbestos, lead-based paint, polychlorinated biphenyls (PCBs), or Radon concerns at the Site, during his Site visit.

Several off-site sources of petroleum hydrocarbon and hazardous substances contamination were identified within 1 mile radius of the Site. Case closures have been issued to few of these properties indicating that they have completed necessary investigation and cleanup works required by SCVWD. The remaining active properties appear to be cross or down-gradient of the Site, therefore, their pollutant migration to the Site is unlikely.

Based on the above information, in our professional opinion, the risk of environmental impact to soil and/or groundwater of the Site from the identified off-site sources of hazardous substances and petroleum products is low.

2.0 OBJECTIVE

The objective of the ESA is to identify existing or potential conditions that may pose an environmental liability on the owner or the operator of the Site.

2.1 Purpose and Scope of Work

The purpose of the ESA is to identify the potential for impact to the structure, soil, or groundwater of the Site from on-site or off-site sources of hazardous substances or petroleum products.

The ESA was performed in accordance with American Society for Testing and Materials (ASTM) guidelines for Phase I Environmental Site Assessments (ASTM E 1527-97), and included the following activities:

- Interview the property owner/agent to obtain general information and Site history.
- Site visit to observe current conditions, hazardous chemical usage, and storage practices.
- Site vicinity drive-by and reconnaissance of the neighborhood within a 1-mile radius of the Site, to identify any potential off-site sources of contamination based on the nature of activities in the area.
- Review historical aerial photographs of the Site and properties within its vicinity to identify land use practices in the area to evaluate any potential for impact to the soil and groundwater at the Site.
- Review the appropriate federal and state lists of contaminated sites to determine if any property within a 1-mile radius of the Site is under federal or state investigation for soil or groundwater contamination that could impact or contribute to the environmental impairment of the Site.
- Review available records at Santa Clara Valley Water District (SCVWD) and Santa Clara County Fire Department (SCCFD).
- Summarize the findings in this report.

2.2 Limitations and Exceptions of Assessment

This report was prepared solely for the use of Mr. Ravi Sahni, its agents, lenders, and representatives. The content and conclusion provided by Sierra in this report are based

on the available information, procedures and practices which are generally accepted in the environmental consulting field in California, and our professional judgment by reviewing the available data.

This assessment was based primarily on the information gathered from other individuals and entities such as the regulatory agencies, government databases, and various professionals related to ownership or activities of the Site. Regulatory agency files and lists may be incomplete, incorrect, or missing. Sierra is not responsible for the accuracy of information provided by others that is in this report. No warranty, either expressed or implied, is made.

3.0 SITE OVERVIEW

3.1 Site Name

The Site has no name.

3.2 Site Address

The Site is located at the northwestern corner of Monterey Road and Cosmo Avenue, Morgan Hill, Santa Clara County, California. Presently, there is no street address for the Site. Site location is shown in Map of Sites of VISTA report in Appendix C.

3.3 Legal Description of the Site

The Site is identified with assessor parcel number 767-17-047

3.4 Description of Existing On-Site Structures and Improvement

Sierra's representative, Mr. Mitch Hajiaghai, visited the Site on August 13, 2000. At the time of his Site visits, the weather was sunny and mild. The Site consisted of approximately 2 acres of vacant land. No structure or improvement was observed at the Site.

4.0 SITE BACKGROUND/OPERATION HISTORY

4.1 Current Ownership

The current Site owner is Mr. Shang-Chiai Kung and partners. They owned the Site since June 3, 1988.

4.2 Prior Ownership

The documents supplied to Sierra by the Site owner representative, Mr. Ed Mattos, indicated that Cosmo D., and Ernesta I. Perrota were the former owners of the Site since February 27 1978.

4.3 Aerial Photograph Review

To better understand the land use practices at the Site and its vicinity, Sierra reviewed available historical aerial photographs at Pacific Aerial Surveys in Oakland, California on April 26, 2000. Sierra observed photographs dated 1966, 1978, 1988 and 1996.

3-22-1966: This photograph showed that the Site and its neighboring properties were farmlands. No structure was observed at the Site. A farm house was observed at the adjacent property north of the Site.

5-8-1978: This photograph was similar to the previous one, except for few residential developments being observed west of the Site. The general area in the vicinity of the Site was developed with several residential buildings. Few light commercial buildings were observed along Monterey Road.

4-7-1988: This Photograph was similar to the previous one. The Site appeared to have been plowed. Still few parcel of lands, near the Site, were used for farming.

8-9-1996: More residential developments were observed in the general area. The Site appeared to be vacant.

The historical aerial photographs indicated that the Site and its neighboring properties were farm lands until 1980s and 1990s when they were developed with residential and light commercial buildings. The Site was used for farming until 1980s, and it appeared vacant since then. Sierra's representative did not observe any on-site land use practices at the Site which could have caused impact to soil and groundwater beneath the Site in the photographs.

A photocopy of the 1988 and 1996 aerial photographs are presented as Figures 1 and 2 of Appendix A, respectively.

4.4 Historical Fire Insurance Maps

Sierra requested VISTA Environmental Solution, Inc. (VISTA) to provide historical map for the Site. No historic maps were available for the Site.

5.0 ENVIRONMENTAL SETTING

5.1 Surface Water Characteristics

Little Llagas Creek runs adjacent and west of the Site. Coyote Lake is located approximately 10 miles east of the Site. Chesbro Reservoir is located approximately 5 miles west of the Site. The Site is approximately 100 feet above mean sea level (San Jose Quadrangle map, 1978).

5.2 Subsurface Geological and Soil Characteristics

The Site is located in the southern part of Santa Clara Valley along the eastern margin of Little Llagas Creek. It is located on the northern portion of the Llagas Basin, south of Santa Clara and Coyote Valley Basin. The Llagas basin is filled with alluvial materials derived from Diablo Range to the east and Santa Cruz Mountains to the West. This alluvial material overlies the Santa Clara Formation which overlies bedrock. Subsurface investigations for a property near the Site, World Oil Station, has shown clay from 5 to 8 feet below ground surface (bgs). The clay is underlain by a mixture of clay-and silt-rich sand and gravel to depths ranging approximately 30 to 50 feet bgs. ✓

5.3 Groundwater Characteristics

First groundwater beneath the World Oil Property was encountered ranging 15 to 31 feet bgs with a easterly flow direction.

5.4 Drinking Water Quality

No drinking water supply is presently connected to the Site, City of Morgan Hill, however, provides drinking water to the properties in the general area.

6.0 SITE INSPECTION

6.1 Site Observations and Inquiries

Sierra's representative, Mr. Mitch Hajiaghai, interviewed Mr. Ed Mattos of Prudential Real Estate, Site's owner representative, on August 17, 2000, to obtain information regarding the Site's ownership and land use practices. Mr. Mattos indicated that the Site was a farmland and has been vacant for last 6 years. According to Mr. Mattos, to the best of Mr. Kung's knowledge, Site's present owner, he was not aware of any existence of USTs or release or spill of hazardous materials or petroleum products at the Site. No document suggesting existence of USTs or release of hazardous substances or petroleum products were sighted in the SCVWD, SCCFD files or VISTA assessment report for the Site. Appendix B presents photographs taken at the Site.

During its Site visit, Sierra's representative observed no sign of UST or release of hazardous substances or petroleum hydrocarbon products at the Site.

A SCVWD easement exists at southwestern part of the Site.

6.2 AST/UST System and Pipelines

Sierra's representative did not observe any sign of existence of above ground or underground storage tanks (AST/UST) or pipelines at the Site.

6.3 Transformers and PCB Equipment

Fluorescent light ballast's which contain polychlorinated biphenyls (PCBs) are considered hazardous waste if discarded. Ballast manufactured after January 1, 1978, do not contain PCBs and should be labeled as such on the ballast. Ballast without non-PCB labels, therefore, shall be assumed to contain PCBs. The California Department of Toxic Substances Control (DTSC) does not have the authority to regulate the use of PCBs. Therefore, there are no DTSC regulations that would require removal of an item that contains PCBs such as transformers and fluorescent light ballast. DTSC hazardous waste regulations apply only when and if materials which contain PCBs becomes a waste. Fluorescent light fixtures were used in the buildings at the Site. However, Sierra's representative observed no discarded or defective ballast at the Site. Additionally, considering that the Site was recently renovated, it is unlikely that PCB ballasts have been used in the lights.

Transformers containing more than 50 parts per million (ppm) PCB are considered PCB transformers. Pacific Gas & Electric Company (PG&E) is responsible for overseeing operation and maintenance of transformers. Through a conversation with one of PG&E representatives, Sierra was told that presently more than 90 percent of transformers are non-PCB transformers in California. If a property owner wishes to determine whether the transformer at his property is a PCB transformer, he shall contact PG&E for inspection, sampling, and analysis. If the transformer is a PCB transformer, PG&E will replace PCB with mineral oil at no cost. But if the transformer is non-PCB transformer, the owner has to pay for the inspection and chemical analysis. Sierra's representative observed one above-ground pad mounted transformer in a landscaping area in front of the building at the Site. No transformers or ballasts were observed at the Site.

6.4 On-Site Regulated Substance Identification/Inventory

Sierra's representative observed no chemicals at the Site.

6.5 Area Reconnaissance

Sierra's representative surveyed the properties within 1 mile radius of the Site. The Site was situated in an area developed with residential and light commercial buildings, and it was bounded by Monterey Road to the east, A vacant farmland to the north, Cosmo Avenue to the South, and Residential Development (Villa Avante Apartments) and a creek to the west.

6.6 Site Plan Drawing(s)

Figure 3 of Appendix B shows Site's neighboring properties. A copy of the assessor parcel map is also provided in Appendix B

6.7 Asbestos Containing Material

The Department of Toxic Substances Control (DTSC) has classified friable, finely divided, and powdered wastes containing greater than one percent (1.0%) asbestos as hazardous waste. Asbestos includes all mineralogical forms of chrysotile, amosite, crocidolite, tremolite, antophyllite, and actinolite. A friable material is one which can be reduced to powder or dust under hand pressure when dry.

The federal government has banned production of friable asbestos-containing materials (ACMs) since 1979. Asbestos generally becomes a health hazard when the individual fibers become airborne and inhaled by the public. ACMs, therefore, are not considered health hazard if they are properly maintained, and not disturbed. No regulation requires property owners to remove ACMs as long as they are maintained properly. ACMs must be removed prior to demolition or renovations where its disturbance becomes imminent.

Section 25915, Division 20 of the California Health and Safety Code dated 1988 indicated that owners of public and commercial buildings constructed prior to 1979 must disclose the presence of asbestos to their tenants and workers doing business or work in areas where they could be exposed to asbestos. Additionally, section 25915 also requires that knowledge of ACMs be disclosed during real estate transactions.

No structure exists at the Site, therefore, there is no asbestos concern at the Site.

6.8 Lead-Based Paint

Lead-based paint (LBP) or other surface coatings are considered material that contain an amount of lead equal to, or in excess of, one milligram per square centimeter (1.0 mg/cm²), more than 5,000 parts per million (ppm), or more than half of one percent (0.5%) by weight. Engineering controls and air monitoring shall be implemented during

disturbance of chipping or deteriorated LBP to eliminate the risk of public and workers exposure.

Abatement projects producing hazardous lead waste must meet land disposal restrictions under Resource Conservation and Recovery Act (RCRA).

Cal-OSHA requires that worker's safety protection shall be implemented to prevent lead exposure above Permissible Exposure Level (PEL) during construction activities. PEL for lead is 50 $\mu\text{g}/\text{m}^3$.

There is no lead-based paint concern at the Site.

6.9 Radon Issues

Radon is a colorless, odorless, radioactive gas. It is generated from the natural decay of uranium that is found in almost all soils. It typically moves through the ground to the air above and into buildings through cracks and openings in the foundation.

The United States Environmental Protection Agency (EPA) considers 4 picocuries per liter (pCi/l) Radon as the threshold of concern. A document, EPA's Map of Radon Zones for California dated September 1993, identified Santa Clara County as Zone 2. Zone 2 areas are predicted to have an average indoor radon screening potential between 2 pCi/l and 4 pCi/l. Table 1 of the same document shows 1.4 pCi/l as a mean radon level surveyed in Santa Clara County during 1989 to 1990.

A California Statewide Radon Survey Screening Results prepared by Department of Health Services in 1990 show survey screening results of <1.0 pCi/l for the area with the same zip code as for the Site.

7.0 ENVIRONMENTAL REGULATORY AGENCY INQUIRIES

Sierra reviewed the following federal and state lists of properties known for soil or groundwater contamination within a mile radius of the Site, through an automated database search, VISTA Environmental Information, Inc. (VISTA). This information is presented in a report by VISTA (Appendix C). A map produced by VISTA (VISTA map) in Appendix C shows the identified properties in relation to the Site. Please note that some of the lists are extended to a mile while the others cover listed properties located within 1/2-mile radius of the Site.

DATABASE	TYPE OF RECORDS	AGENCY
CERCLIS/ NFRAP	Contaminated Sites Under CERCLA	US EPA
NPL	National Priority List	US EPA
TSD	Facilities that treat, store and/or dispose of hazardous waste	US EPA
CORRACTS	Facilities under RCRA corrective action	US EPA
SPL	Sites prioritized by the State for cleanup State	
SCL	Sites under review by the State	State
SWLF	Sites permitted as solid waste landfills Incinerators, or transfer stations	State
LUST	Leaking Underground Storage Tanks	State
UST	Registered Underground Storage Tanks State	
AST	Registered Aboveground Storage Tanks State	
ERNS	Emergency Response Notification System of Spills	US EPA
SM GEN LG GEN	RCRA Registered Small or Large Generator of Hazardous Waste	US EPA
DEED RSTR	Sites with Deed Restrictions	State
SOUTH BAY	Sites on South Bay Toxic List	Regional
CORTESE	State Index for Properties with Hazardous Waste	State
TOXIC PITS	Toxic Pits Cleanup Facilities	State
RCRA VIOL	RCRA Violations/Enforcement Actions	US EPA
TRIS	Toxic Release Inventory Database	US EPA

The Site was not identified in the above list. No file was found for the Site at SCVWD or SCCFD.

Several properties with soil and groundwater contamination were identified within 1 mile radius of the Site. Case closures have been issued to few of these properties indicating that they have completed necessary investigation and cleanup works required by SCVWD. Other active properties were sighted which are still performing investigation and cleanup activities. The followings are among the noteworthy cases reviewed:

World Oil Marketing Company: This property is located at 16720 Monterey, north of the Site, and identified as property #4A on the VISTA map. According to a groundwater feasibility test report prepared by The Source Group, Inc. (SGI) dated April 11, 2000, soil and groundwater investigation and cleanup started at this property in 1986. The environmental cleanup work resulted due to release of petroleum hydrocarbon products in soil and groundwater beneath this property.

A quarterly monitoring and status report, second quarter 2000, prepared by SGI dated July 25, 2000, indicated that several on-site and off-site groundwater monitoring wells have been sampled during the second quarter of 2000. The groundwater monitoring results showed no detectable concentrations of total petroleum hydrocarbons as gasoline (TPHG), benzene, or methyl tertiary butyl ether (MTBE) in the off-site groundwater monitoring wells suggesting that the pollutants have remained within the property boundaries.

Shallow groundwater was encountered beneath this property ranging 8 to 16 feet bgs with a easterly flow direction during this monitoring event. Therefore, this property appears to be down-gradient of the Site. A copy of the relevant most updated document for this property is provided in Appendix D.

City of Morgan Hill Corporation yard: This property is located at 105 Edes Court, southwest of the Site, and is identified as property # 5 on the VISTA map. According to a groundwater monitoring report, second quarter 2000, prepared by SCS Engineers (SCS) dated July 17, 2000, In June 1995, gasoline constituents were detected in the sanitary sewer system at this property. A groundwater extraction and treatment system was constructed at this property, and it has been operating since then. Up to 160,000 parts per billion (ppb) TPHG, 22,000 ppb benzene, and 41,000 ppb MTBE were detected in groundwater samples collected beneath this property in May 2000. According to SCS, the bulk of the hydrocarbon plume remains limited to the Corporation Yard's boundaries. Shallow groundwater levels have been recorded ranging from approximately 4 to 24 feet bgs with a easterly flow direction.

Based on the easterly groundwater flow direction measured for this property, this property appears to be cross-gradient of the Site. Copies of relevant data for this property is provided in Appendix D.

8.0 CONCLUSIONS AND RECOMMENDATIONS

8.1 Conclusion

Sierra performed a Phase I ESA to identify the potential for impact to the structure, soil, or groundwater of the Site from the on-site or off-site sources of hazardous substances or petroleum products.

Review of historical aerial photographs taken since 1960s indicated that the general area in the vicinity of the Site was developed with residential and light commercial buildings in 1980s and 1990s. The Site was a farmland until 1990s and has remained an undeveloped vacant land since then.

A SCVWD easement exists southwest of the Site.

No hazardous substances or petroleum hydrocarbon products were observed at the Site. The Site was not identified in VISTA site assessment report (under any Federal or State agency lists). No records were found in the SCVWD or SCCFD files for the Site.

During his visit, Sierra's representative did not observe evidence of existence of UST, release or spill of hazardous substances or petroleum products, or evidence of any area with distressed, discolored, stained, or dead vegetation at the Site. Sierra's representative did not observe any asbestos, lead-based paint, polychlorinated biphenyls (PCBs), or Radon issues at the Site, during his Site visit.

Several off-site sources of petroleum hydrocarbon and hazardous substances contamination were identified within 1 mile radius of the Site. Case closures have been issued to few of these properties indicating that they have completed necessary investigation and cleanup works required by SCVWD. The remaining active properties appear to be cross or down-gradient of the Site, therefore, their pollutant migration to the Site is unlikely.

Based on the above information, in our professional opinion, the risk of environmental impact to soil and/or groundwater of the Site from the identified off-site sources of hazardous substances and petroleum products is low.

8.2 Recommendations

Sierra recommends no further environmental investigation for the Site.

9.0 REFERENCES

9.1 Records of Communication and Previous ESA Review

August 17, 2000, Mr. Ed Mattos, Site Owner's Agent

August 17, 2000, Relevant document and Assessor Parcel Map, Old Republic Title Company

9.2 Regulatory Records and Public Documents

July 25, 2000, Quarterly Monitoring and Status Report for World Oil Marketing Company, SCVWD Files

July 17, 2000, Quarterly Monitoring Report for City of Morgan Hill, Corporation Yard, SCVWD Files

March 28, 1994, Case Closure Letter by City of Morgan Hill for 140 San Pedro Avenue, Morgan Hill, SCVWD Files

April 12, 2000, Partial Preliminary report for the Site, Old Republic Title Company San Jose, California

9.3 Published References

VISTA Site Assessment Report, VISTA Information Solution, Inc,
August 15, 2000

Aerial Photographs, Pacific Aerial Photo, Oakland, California, August 15, 2000

Sanborn Fire Insurance Map Search, Environmental Risk Information & Imaging Services, August 15, 2000

EPA's Map of Radon Zones, California, September 1993

Department of Health Services, California Statewide Radon Survey Screen Results

**PHASE I
ENVIRONMENTAL
SITE ASSESSMENT UPDATE**

**Property with APN 767-17-047
Northwest Corner of Monterey Road
and Cosmo Avenue
Morgan Hill, California**

Prepared for

**Ms. Pushpa Sahni
5979 Central Avenue
Newark, California 94560**

Prepared by

Sierra Environmental, Inc.

**October 22, 2001
Project 01-150.02**



TABLE OF CONTENT

	Page
1.0 EXECUTIVE SUMMARY	2
2.0 OBJECTIVES	2
2.1 Purpose and Scope of Work	3
2.2 Limitations and Exception of Assessment	3
3.0 SITE OVERVIEW.....	4
3.1 Site Name.....	4
3.2 Site Address.....	4
3.3 Legal Description of the Site	4
3.4 Description of Existing on-Site Structures and Improvements.....	4
4.0 SITE BACKGROUND/OPERATION HISTORY	4
4.1 Current Ownership.....	4
4.2 Prior Ownership.....	4
4.3 Review of Aerial Photographs	4
4.4 Historical Fire Insurance Maps.....	4
5.0 ENVIRONMENTAL SETTING	5
5.1 Surface Water Characteristics.....	5
5.2 Subsurface Geological Characteristics.....	5
5.3 Groundwater Characteristics.....	5
5.4 Drinking Water Quality.....	5
6.0 SITE INSPECTION	5
6.1 Site Observations and Inquiries.....	5
6.2 AST/UST systems and Pipelines	6
6.3 Transformers and PCB Equipment.....	6
6.4 On-Site Regulated Substance Identification/Inventory	6
6.5 Area Reconnaissance.....	6
6.6 Site Plan Drawings.....	7
6.7 Asbestos Containing Material.....	7
6.8 Lead based Paint.....	7
6.9 Radon Testing.....	8
7.0 ENVIRONMENTAL/REGULATORY AGENCY INQUIRIES.....	8
8.0 CONCLUSIONS AND RECOMMENDATIONS.....	10
8.1 Conclusions.....	10
8.2 Recommendations	10
9.0 REFERENCES.....	11

ATTACHMENTS: August 22, 2000, Phase I ESA Report

- Appendix A - Figure 1, 2, and 3, (Aerial Photograph 1988 and 1996, and Site's neighboring Properties, Respectively)
- Appendix B - Site's Photographs
- Appendix C - VISTA Reports
- Appendix D - Relevant Documents for the Investigated Properties
- Appendix E - Certification of Credential

1.0 EXECUTIVE SUMMARY

On August 22, 2000, Sierra Environmental, Inc. (Sierra) prepared a phase I environmental site assessment (ESA) report for the property located at the northwest corner of Cosmo Avenue and Monterey Road, Morgan Hill, California (Site). The report concluded that the risk of identified environmental conditions to soil and groundwater of the Site was low.

Sierra updated the phase I ESA for the Site in October 2001, to determine whether environmental conditions at the Site have remained unchanged since August 2000. The site inspection was performed by Sierra's representative, Mr. Mitch Hajiaghai, a California registered environmental assessor II (REA II), a certified asbestos consultant, and a DHS certified lead inspector/assessor on October 18, 2001.

The Site consists of approximately 2 acres of vacant land. No structure or improvement was observed at the Site. No debris, stains, or suspect environmental conditions were observed at the Site. The Site appeared to be in the similar condition as it was observed in August 2000.

The same tenants identified in the August 22, 2000, ESA report are occupying the site-neighborhood properties. No activities that may have adversely impacted soil and groundwater of the Site were observed at the neighboring properties.

Sierra obtained lists of properties known for soil or groundwater contamination within 1-mile radius of the Site through an automated database search, VISTA Environmental Information, Inc. (VISTA) dated October 16, 2001. The Site and its neighboring properties were not identified in the VISTA list. The listed off-site sources of petroleum hydrocarbon and hazardous substance contamination were similar to those identified in the August 2000 ESA report. Case closures have been issued to few of these properties indicating that they have completed necessary investigation and cleanup works. The remaining active properties appear to be cross or down-gradient of the Site, therefore, their pollutant migration to the Site is unlikely.

Based on the above information, in our professional opinion, the risk of environmental impact to soil and/or groundwater of the Site from the identified off-site sources of hazardous substances and petroleum products remains to be low.

2.0 OBJECTIVE

The objective of the ESA update is to identify existing or potential conditions that may pose an environmental liability on the owner or the operator of the Site.

2.1 Purpose and Scope of Work

The purpose of the ESA update is to identify the potential for impact to soil or groundwater of the Site from possible on-site or off-site sources of hazardous substances or petroleum products that may have occurred since August 2000.

The ESA update included the following activities:

- Interview the property owner/agent to obtain updated general information for the Site.
- Visit the Site and observe its current conditions.
- Site vicinity drive-by and reconnaissance of the neighborhood within a 1-mile radius of the Site, to identify any potential off-site sources of contamination based on the nature of activities in the area.
- Review the appropriate federal and state lists of contaminated sites to determine if any property within a 1-mile radius of the Site is under federal or state investigation for soil or groundwater contamination that could impact or contribute to the environmental impairment of the Site.
- Summarize the findings in this report.

2.2 Limitations and Exceptions of Assessment

This report was prepared solely for the use of Ms. Pushpa Sahni, its agents, lenders, and representatives. The content and conclusion provided by Sierra in this report are based on the available information, procedures and practices which are generally accepted in the environmental consulting field in California, and our professional judgment by reviewing the available data.

This assessment was based primarily on the information gathered from other individuals and entities such as the regulatory agencies, government databases, and various professionals related to ownership or activities of the Site. Regulatory agency files and lists may be incomplete, incorrect, or missing. Sierra is not responsible for the accuracy of information provided by others that is in this report. No warranty, either expressed or implied, is made.

3.0 SITE OVERVIEW

3.1 Site Name

The Site has no name.

3.2 Site Address

The Site is located at the northwestern corner of Monterey Road and Cosmo Avenue, Morgan Hill, Santa Clara County, California. Presently, there is no street address for the Site. Site location is shown in Map of Sites of VISTA report in Appendix C of the enclosed August 22, 2000, ESA report.

3.3 Legal Description of the Site

The Site is identified with assessor parcel number 767-17-047

3.4 Description of Existing On-Site Structures and Improvement

Sierra's representative, Mr. Mitch Hajiaghai, visited the Site on October 18, 2001. At the time of his Site visit, the weather was sunny and mild. The Site consisted of approximately 2 acres of vacant and undeveloped land. The Site condition remains the same as August 2000.

4.0 SITE BACKGROUND/OPERATION HISTORY

4.1 Current Ownership

The current Site owner is Ms. Pushpa Sahni.

4.2 Prior Ownership

See section 4.2 of the enclosed August 22, 2000, ESA report.

4.3 Aerial Photograph Review

See section 4.3 of the enclosed August 22, 2000, ESA report.

4.4 Historical Fire Insurance Maps

See section 4.4 of the enclosed August 22, 2000, ESA report.

5.0 ENVIRONMENTAL SETTING

5.1 Surface Water Characteristics

Little Llagas Creek runs adjacent and west of the Site. Coyote Lake is located approximately 10 miles east of the Site. Chesbro Reservoir is located approximately 5 miles west of the Site. The Site is approximately 100 feet above mean sea level (San Jose Quadrangle map, 1978).

5.2 Subsurface Geological and Soil Characteristics

The Site is located in the southern part of Santa Clara Valley along the eastern margin of Little Llagas Creek. It is located on the northern portion of the Llagas Basin, south of Santa Clara and Coyote Valley Basin. The Llagas basin is filled with alluvial materials derived from Diablo Range to the east and Santa Cruz Mountains to the West. This alluvial material overlies the Santa Clara Formation that overlies bedrock. Subsurface investigations for a property near the Site, World Oil Station, has shown clay from 5 to 8 feet below ground surface (bgs). The clay is underlain by a mixture of clay-and silt-rich sand and gravel to depths ranging approximately 30 to 50 feet bgs.

5.3 Groundwater Characteristics

First groundwater beneath the World Oil Property, northeast of the Site, was encountered ranging 15 to 31 feet bgs with an easterly flow direction.

5.4 Drinking Water Quality

No drinking water supply is presently connected to the Site, City of Morgan Hill, however, provides drinking water to the properties in the general area.

6.0 SITE INSPECTION

6.1 Site Observations and Inquiries

Sierra's representative, Mr. Mitch Hajiaghai, interviewed Mr. Ed Mattos of Prudential Real Estate, Site's owner representative, on October 17, 2001, to obtain information regarding the present Site's ownership, and whether there has been any changes in the land use practices at the Site. Mr. Mattos indicated that the Site has remained vacant since August 2000. According to Mr. Mattos, the Site is planned to be developed with a two-story administrative building, with approximately 42,000 square feet of space.

During its Site visit, Sierra's representative observed no sign of UST or release of hazardous substances or petroleum hydrocarbon products at the Site. The site

condition remained the same as August 2000 (see section 6.1 of the enclosed August 22, 2000, ESA report)

6.2 AST/UST System and Pipelines

Sierra's representative did not observe any sign of existence of above ground or underground storage tanks (AST/UST) or pipelines at the Site.

6.3 Transformers and PCB Equipment

Fluorescent light ballast's which contain polychlorinated biphenyls (PCBs) are considered hazardous waste if discarded. Ballast manufactured after January 1, 1978, do not contain PCBs and should be labeled as such on the ballast. Ballast without non-PCB labels, therefore, shall be assumed to contain PCBs. The California Department of Toxic Substances Control (DTSC) does not have the authority to regulate the use of PCBs. Therefore, there are no DTSC regulations that would require removal of an item that contains PCBs such as transformers and fluorescent light ballast. DTSC hazardous waste regulations apply only when and if materials that contain PCBs becomes a waste. Fluorescent light fixtures were used in the buildings at the Site.

Transformers containing more than 50 parts per million (ppm) PCB are considered PCB transformers. Pacific Gas & Electric Company (PG&E) is responsible for overseeing operation and maintenance of transformers. Through a conversation with one of PG&E representatives, Sierra was told that presently more than 90 percent of transformers are non-PCB transformers in California. If a property owner wishes to determine whether the transformer at his property is a PCB transformer, he shall contact PG&E for inspection, sampling, and analysis. If the transformer is a PCB transformer, PG&E will replace PCB with mineral oil at no cost. But if the transformer is non-PCB transformer, the owner has to pay for the inspection and chemical analysis. No transformers or ballasts were observed at the Site.

6.4 On-Site Regulated Substance Identification/Inventory

Sierra's representative observed no chemicals at the Site.

6.5 Area Reconnaissance

Sierra's representative surveyed the properties within 1 mile radius of the Site. The Site was situated in an area developed with residential and light commercial buildings, and it was bounded by Monterey Road to the east, A vacant farmland to the north, Cosmo Avenue to the South, and Residential Development (Villa Avante Apartments) and a creek to the west.

6.6 Site Plan Drawing(s)

See section 6.6 of the enclosed August 22, 2000, ESA report.

6.7 Asbestos Containing Material

The Department of Toxic Substances Control (DTSC) has classified friable, finely divided, and powdered wastes containing greater than one percent (1.0%) asbestos as hazardous waste. Asbestos includes all mineralogical forms of chrysotile, amosite, crocidolite, tremolite, antophyllite, and actinolite. A friable material is one that can be reduced to powder or dust under hand pressure when dry.

The federal government has banned production of friable asbestos-containing materials (ACMs) since 1979. Asbestos generally becomes a health hazard when the individual fibers become airborne and inhaled by the public. ACMs, therefore, are not considered health hazard if they are properly maintained, and not disturbed. No regulation requires property owners to remove ACMs as long as they are maintained properly. ACMs must be removed prior to demolition or renovations where its disturbance becomes imminent.

Section 25915, Division 20 of the California Health and Safety Code dated 1988 indicated that owners of public and commercial buildings constructed prior to 1979 must disclose the presence of asbestos to their tenants and workers doing business or work in areas where they could be exposed to asbestos. Additionally, section 25915 also requires that knowledge of ACMs be disclosed during real estate transactions.

No structure exists at the Site, therefore, there is no asbestos concern at the Site.

6.8 Lead-Based Paint

Lead-based paint (LBP) or other surface coatings are considered material that contain an amount of lead equal to, or in excess of, one milligram per square centimeter (1.0 mg/cm²), more than 5,000 parts per million (ppm), or more than half of one percent (0.5%) by weight. Engineering controls and air monitoring shall be implemented during disturbance of chipping or deteriorated LBP to eliminate the risk of public and workers exposure.

Abatement projects producing hazardous lead waste must meet land disposal restrictions under Resource Conservation and Recovery Act (RCRA).

Cal-OSHA requires that worker's safety protection shall be implemented to prevent lead exposure above Permissible Exposure Level (PEL) during construction activities. PEL for lead is 50 µg/m³.

No structure exists at the Site, therefore, there is no lead-based paint concern at the Site. No debris was observed at the Site.

6.9 Radon Issues

Radon is a colorless, odorless, radioactive gas. It is generated from the natural decay of uranium that is found in almost all soils. It typically moves through the ground to the air above and into buildings through cracks and openings in the foundation.

The United States Environmental Protection Agency (EPA) considers 4 picocuries per liter (pCi/l) Radon as the threshold of concern. A document, EPA's Map of Radon Zones for California dated September 1993, identified Santa Clara County as Zone 2. Zone 2 areas are predicted to have an average indoor radon screening potential between 2 pCi/l and 4 pCi/l. Table 1 of the same document shows 1.4 pCi/l as a mean radon level surveyed in Santa Clara County during 1989 to 1990.

A California Statewide Radon Survey Screening Results prepared by Department of Health Services in 1990 show survey screening results of <1.0 pCi/l for the area with the same zip code as for the Site.

7.0 ENVIRONMENTAL REGULATORY AGENCY INQUIRIES

On October 16, 2001 Sierra reviewed the following federal and state lists of properties known for soil or groundwater contamination within a mile radius of the Site, through an automated database search, VISTA Environmental Information, Inc. (VISTA). VISTA (Appendix C of the enclosed August 22, 2000, ESA report) presents this information in a report. A map produced by VISTA (VISTA map) shows the identified properties in relation to the Site. Please note that some of the lists are extended to a mile while the others cover listed properties located within 1/2-mile radius of the Site.

DATABASE	TYPE OF RECORDS	AGENCY
CERCLIS/ NFRAP	Contaminated Sites Under CERCLA	US EPA
NPL	National Priority List	US EPA
TSD	Facilities that treat, store and/or dispose	

	of hazardous waste	US EPA
CORRACTS	Facilities under RCRA corrective action	US EPA
SPL	Sites prioritized by the State for cleanup	State
SCL	Sites under review by the State	State
SWLF	Sites permitted as solid waste landfills Incinerators, or transfer stations	State
LUST	Leaking Underground Storage Tanks	State
UST	Registered Underground Storage Tanks	State
AST	Registered Aboveground Storage Tanks	State
ERNS	Emergency Response Notification System of Spills	US EPA
SM GEN LG GEN	RCRA Registered Small or Large Generator of Hazardous Waste	US EPA
DEED RSTR	Sites with Deed Restrictions	State
SOUTH BAY	Sites on South Bay Toxic List	Regional
CORTESE	State Index for Properties with Hazardous Waste	State
TOXIC PITS	Toxic Pits Cleanup Facilities	State
RCRA VIOL	RCRA Violations/Enforcement Actions	US EPA
TRIS	Toxic Release Inventory Database	US EPA

The Site and its neighboring properties were not identified in the above list.

Several properties with soil and groundwater contamination were identified within 1-mile radius of the Site. These properties were identical to those discussed in the August 22, 2000, ESA report. Case closures have been issued to several of these properties indicating that they have completed necessary investigation and cleanup. Other active properties were sighted which are still performing investigation and cleanup activities.

Appendix D of the enclosed August 22, 2000, contains relevant documents for the noteworthy sighted properties.

8.0 CONCLUSIONS AND RECOMMENDATIONS

8.1 Conclusion

Sierra performed a Phase I ESA update to determine whether environmental conditions has remained the same at the Site and its neighboring properties since August 2000.

Sierra interviewed the Site/agent to obtain the most updated information about land use practices and ownership of the Site, visited the Site to observe its present condition, reviewed VISTA report for State and Federal listed properties within 1-mile radius of the Site, and performed a Site vicinity drive-by and reconnaissance of the neighborhood within a 1-mile radius of the Site to identify any potential off-site sources of contamination based on the nature of activities in the area.

The Site has remained a vault and undeveloped land. No suspect condition that may have adversely impacted soil or groundwater was observed at the Site. Environmental conditions at the Site have remained the same as August 2000.

No new off-site sources of soil and groundwater contamination were identified in the updated VISTA report, therefore, off-site environmental conditions remain the same or has improved since August 2000.

Based on the above information, in our professional opinion, the risk of environmental impact to soil and/or groundwater of the Site from the identified off-site sources of hazardous substances and petroleum products remain to be low.

8.2 Recommendations

Sierra recommends no further environmental investigation for the Site.



USER QUESTIONNAIRE

IMPORTANT: In order to qualify for the Landowner Liability Protections offered by the Small Business Liability Relief and Brownfields Revitalization Act of 2001 (the “Brownfields Amendments”), any additional user of this report should complete a copy of this questionnaire in order to document their own knowledge of the property. This blank questionnaire is provided for your use. See Section 2.5 of this report for additional information.

	Yes	No
(1.) Are you aware of any environmental cleanup liens against the property that are filed or recorded under federal, tribal, state or local law?		
(2.) Are you aware of any activity and land use limitations, such as engineering controls, land use restrictions or institutional controls that are in place at the site and / or have been filed or recorded in a registry under federal, tribal, state or local law?		
(3.) Do you have any specialized knowledge or experience related to the property or nearby properties? For example, are you involved in the same line of business as the current or former occupants of the property or an adjoining property so that you would have specialized knowledge of the chemicals and processes used by this type of business?		
(4.) (a.) Is the purchase price being paid for this property significantly less than the fair market value of the property? (b.) If you conclude that there is a difference, have you considered whether the lower purchase price is because contamination is known or believed to be present at the property?		
(5.) Are you aware of commonly known or reasonably ascertainable information about the property that would help the environmental professional to identify conditions indicative of releases or threatened releases? For example, do you know the past uses of the property? Do you know of specific chemicals that are present or once were present at the property? Do you know of spills or other chemical releases that have taken place at the property? Do you know of any environmental cleanups that have taken place at the property?		
(6.) Based on your knowledge and experience related to the property are there any obvious indicators that point to the presence or likely presence of contamination at the property?		

For each “Yes” answer, please attach a description or supporting documentation as appropriate, for your files.

Completed by (please print): _____

Signed _____

Date _____

H. Phase II Soil Sampling

Soil Sample Points

Legend

- Sample point
- ▭ Subject Property





CALIFORNIA LABORATORY SERVICES

Committed. Responsive. Flexible.

August 03, 2018

CLS Work Order #: 18G1536

COC #:

Neil O'Hara
RNC Environmental
151 Nursery St
Ashland, OR 97520

Project Name: Voices Charter School

Enclosed are the results of analyses for samples received by the laboratory on 07/27/18 14:00. Samples were analyzed pursuant to client request utilizing EPA or other ELAP approved methodologies. I certify that the results are in compliance both technically and for completeness.

Analytical results are attached to this letter. Please call if we can provide additional assistance.

Sincerely,

James Liang, Ph.D.
Laboratory Director

CA SWRCB ELAP Accreditation/Registration number 1233

CLS - Labs

1851536

CHAIN OF CUSTODY

CLS ID No.:

LOG NO. WEB FORM

REPORT TO:
 RNC Environmental, LLC
 151 Nursery St
 Ashland OR 97520

CONTACT PERSON: Neil O'Hara (888)485-3330

CLIENT: Voices Charter School

CONTACT: Neil O'Hara

CLIENT JOB NUMBER: 1811A

LABORATORY:
 CLS (916) 638-7301
 3249 E. ZEPHYRUS RD
 HANCOCK CORDOVA, CA 95742

OTHER:

ANALYSIS REQUESTED:

GEOTRACKER:
 EDF REPORT YES NO
 GLOBAL ID:

LOCATION: Morgan Hill CA

DATE	TIME	SAMPLE IDENTIFICATION
7/26/18		1811A 1
7/26/18		1811A 2
7/26/18		1811A 3
7/26/18		1811A 4

MATRIX	CONTAINER	
	NO.	TYPE

PRESERVATIVES

OCPs - 8081
 Arsenic

COMPOSITE:

FIELD CONDITIONS:

TURN AROUND TIME:

SPECIAL INSTRUCTIONS:

RELINQUISHED BY (SIGN):

PRINT NAME COMPANY: Neil O'Hara RNC Environmental, LLC

DATE - TIME: 7/26/18 noon

RECEIVED BY (SIGN):
PRINT NAME - COMPANY:

SHIPPED BY:

DATE - TIME: 7/27/18
 UPS OTHER

RECEIVED BY: 372

CLS LABS
SAMPLE RECEIVING EXCEPTION REPORTS

CLS Labs Job # 18G1536

Problem discovered by: MT

Date: 7/27/19

Nature of problem

NO SAMPLE TIME DOCUMENTED

Client contacted? Yes No Spoke With: _____

By whom: _____ Date: ___/___/___ Time: _____ HRS

Client instructions:

Resolution of problem:

LOGGED IN REGARDLESS @ 00:00



RNC Environmental 151 Nursery St Ashland, OR 97520	Project: Voices Charter School Project Number: 1811A Project Manager: Neil O'Hara	CLS Work Order #: 18G1536 COC #:
--	---	-------------------------------------

Metals by EPA 6000/7000 Series Methods

Analyte	Result	Reporting Limit	Units	Dilution	Batch	Prepared	Analyzed	Method	Notes
1811A 1 (18G1536-01) Soil Sampled: 07/26/18 00:00 Received: 07/27/18 14:00									
Arsenic	4.2	2.0	mg/kg	10	1806286	07/31/18	08/02/18	EPA 6020	
1811A 2 (18G1536-02) Soil Sampled: 07/26/18 00:00 Received: 07/27/18 14:00									
Arsenic	4.4	2.0	mg/kg	10	1806286	07/31/18	08/02/18	EPA 6020	
1811A 3 (18G1536-03) Soil Sampled: 07/26/18 00:00 Received: 07/27/18 14:00									
Arsenic	5.0	2.0	mg/kg	10	1806286	07/31/18	08/02/18	EPA 6020	
1811A 4 (18G1536-04) Soil Sampled: 07/26/18 00:00 Received: 07/27/18 14:00									
Arsenic	5.0	2.0	mg/kg	10	1806286	07/31/18	08/02/18	EPA 6020	



RNC Environmental 151 Nursery St Ashland, OR 97520	Project: Voices Charter School Project Number: 1811A Project Manager: Neil O'Hara	CLS Work Order #: 18G1536 COC #:
--	---	-------------------------------------

Organochlorine Pesticides by EPA Method 8081A

Analyte	Result	Reporting Limit	Units	Dilution	Batch	Prepared	Analyzed	Method	Notes
1811A 1 (18G1536-01) Soil Sampled: 07/26/18 00:00 Received: 07/27/18 14:00									
4,4'-DDD	ND	33	µg/kg	10	1806308	07/31/18	08/01/18	EPA 8081A	
4,4'-DDE	ND	33	"	"	"	"	"	"	
4,4'-DDT	ND	33	"	"	"	"	"	"	
Aldrin	ND	10	"	"	"	"	"	"	
alpha-BHC	ND	17	"	"	"	"	"	"	
beta-BHC	ND	17	"	"	"	"	"	"	
Chlordane-technical	ND	33	"	"	"	"	"	"	
delta-BHC	ND	17	"	"	"	"	"	"	
Dieldrin	ND	10	"	"	"	"	"	"	
Endosulfan I	ND	17	"	"	"	"	"	"	
Endosulfan II	ND	33	"	"	"	"	"	"	
Endosulfan sulfate	ND	33	"	"	"	"	"	"	
Endrin	ND	33	"	"	"	"	"	"	
Endrin aldehyde	ND	33	"	"	"	"	"	"	
gamma-BHC (Lindane)	ND	17	"	"	"	"	"	"	
Heptachlor	ND	17	"	"	"	"	"	"	
Heptachlor epoxide	ND	17	"	"	"	"	"	"	
Methoxychlor	ND	170	"	"	"	"	"	"	
Mirex	ND	33	"	"	"	"	"	"	
Toxaphene	ND	200	"	"	"	"	"	"	

QRL-8

Surrogate: Decachlorobiphenyl 80 % 52-141 " " " "

Surrogate: Tetrachloro-meta-xylene 101 % 46-139 " " " "

1811A 2 (18G1536-02) Soil Sampled: 07/26/18 00:00 Received: 07/27/18 14:00									
4,4'-DDD	ND	33	µg/kg	10	1806308	07/31/18	08/01/18	EPA 8081A	
4,4'-DDE	ND	33	"	"	"	"	"	"	
4,4'-DDT	ND	33	"	"	"	"	"	"	
Aldrin	ND	10	"	"	"	"	"	"	
alpha-BHC	ND	17	"	"	"	"	"	"	
beta-BHC	ND	17	"	"	"	"	"	"	

QRL-8



CALIFORNIA LABORATORY SERVICES

Committed. Responsive. Flexible.

RNC Environmental 151 Nursery St Ashland, OR 97520	Project: Voices Charter School Project Number: 1811A Project Manager: Neil O'Hara	CLS Work Order #: 18G1536 COC #:
--	---	-------------------------------------

Organochlorine Pesticides by EPA Method 8081A

Analyte	Result	Reporting Limit	Units	Dilution	Batch	Prepared	Analyzed	Method	Notes
1811A 2 (18G1536-02) Soil Sampled: 07/26/18 00:00 Received: 07/27/18 14:00									
Chlordane-technical	ND	33	µg/kg	10	1806308	"	08/01/18	EPA 8081A	
delta-BHC	ND	17	"	"	"	"	"	"	
Dieldrin	ND	10	"	"	"	"	"	"	
Endosulfan I	ND	17	"	"	"	"	"	"	
Endosulfan II	ND	33	"	"	"	"	"	"	
Endosulfan sulfate	ND	33	"	"	"	"	"	"	
Endrin	ND	33	"	"	"	"	"	"	
Endrin aldehyde	ND	33	"	"	"	"	"	"	
gamma-BHC (Lindane)	ND	17	"	"	"	"	"	"	
Heptachlor	ND	17	"	"	"	"	"	"	
Heptachlor epoxide	ND	17	"	"	"	"	"	"	
Methoxychlor	ND	170	"	"	"	"	"	"	
Mirex	ND	33	"	"	"	"	"	"	
Toxaphene	ND	200	"	"	"	"	"	"	

QRL-8

Surrogate: Decachlorobiphenyl 110 % 52-141 " " " "

Surrogate: Tetrachloro-meta-xylene 114 % 46-139 " " " "

1811A 3 (18G1536-03) Soil Sampled: 07/26/18 00:00 Received: 07/27/18 14:00									
4,4'-DDD	ND	33	µg/kg	10	1806308	07/31/18	08/01/18	EPA 8081A	
4,4'-DDE	ND	33	"	"	"	"	"	"	
4,4'-DDT	ND	33	"	"	"	"	"	"	
Aldrin	ND	10	"	"	"	"	"	"	
alpha-BHC	ND	17	"	"	"	"	"	"	
beta-BHC	ND	17	"	"	"	"	"	"	
Chlordane-technical	ND	33	"	"	"	"	"	"	
delta-BHC	ND	17	"	"	"	"	"	"	
Dieldrin	ND	10	"	"	"	"	"	"	
Endosulfan I	ND	17	"	"	"	"	"	"	
Endosulfan II	ND	33	"	"	"	"	"	"	
Endosulfan sulfate	ND	33	"	"	"	"	"	"	

QRL-8



RNC Environmental 151 Nursery St Ashland, OR 97520	Project: Voices Charter School Project Number: 1811A Project Manager: Neil O'Hara	CLS Work Order #: 18G1536 COC #:
--	---	-------------------------------------

Organochlorine Pesticides by EPA Method 8081A

Analyte	Result	Reporting Limit	Units	Dilution	Batch	Prepared	Analyzed	Method	Notes
1811A 4 (18G1536-04) Soil Sampled: 07/26/18 00:00 Received: 07/27/18 14:00									
Mirex	ND	33	µg/kg	10	1806308	"	08/01/18	EPA 8081A	
Toxaphene	ND	200	"	"	"	"	"	"	
<i>Surrogate: Decachlorobiphenyl</i>		125 %		52-141		"	"	"	"
<i>Surrogate: Tetrachloro-meta-xylene</i>		122 %		46-139		"	"	"	"

QRL-8



CALIFORNIA LABORATORY SERVICES

Committed. Responsive. Flexible.

RNC Environmental 151 Nursery St Ashland, OR 97520	Project: Voices Charter School Project Number: 1811A Project Manager: Neil O'Hara	CLS Work Order #: 18G1536 COC #:
--	---	-------------------------------------

Metals by EPA 6000/7000 Series Methods - Quality Control

Analyte	Result	Reporting Limit	Units	Spike Level	Source Result	%REC	%REC Limits	RPD	RPD Limit	Notes
Batch 1806286 - EPA 3050B										
Blank (1806286-BLK1)										
					Prepared: 07/31/18 Analyzed: 08/02/18					
Arsenic	ND	0.20	mg/kg							
LCS (1806286-BS1)										
					Prepared: 07/31/18 Analyzed: 08/02/18					
Arsenic	8.88	0.20	mg/kg	10.0	7.92	73	75-125			
Matrix Spike (1806286-MS1)										
					Source: 18G1543-03 Prepared: 07/31/18 Analyzed: 08/02/18					
Arsenic	15.2	2.0	mg/kg	10.0	7.92	73	75-125			QM-5
Matrix Spike Dup (1806286-MSD1)										
					Source: 18G1543-03 Prepared: 07/31/18 Analyzed: 08/02/18					
Arsenic	16.0	2.0	mg/kg	10.0	7.92	81	75-125	5	30	



RNC Environmental 151 Nursery St Ashland, OR 97520	Project: Voices Charter School Project Number: 1811A Project Manager: Neil O'Hara	CLS Work Order #: 18G1536 COC #:
--	---	-------------------------------------

Organochlorine Pesticides by EPA Method 8081A - Quality Control

Analyte	Result	Reporting Limit	Units	Spike Level	Source Result	%REC	%REC Limits	RPD	RPD Limit	Notes
---------	--------	-----------------	-------	-------------	---------------	------	-------------	-----	-----------	-------

Batch 1806308 - LUFT-DHS GCNV

Blank (1806308-BLK1)

Prepared: 07/31/18 Analyzed: 08/01/18

Aldrin	ND	1.0	µg/kg							
alpha-BHC	ND	1.7	"							
beta-BHC	ND	1.7	"							
gamma-BHC (Lindane)	ND	1.7	"							
delta-BHC	ND	1.7	"							
Chlordane-technical	ND	3.3	"							
4,4'-DDD	ND	3.3	"							
4,4'-DDE	ND	3.3	"							
4,4'-DDT	ND	3.3	"							
Dieldrin	ND	1.0	"							
Endosulfan I	ND	1.7	"							
Endosulfan II	ND	3.3	"							
Endosulfan sulfate	ND	3.3	"							
Endrin	ND	3.3	"							
Endrin aldehyde	ND	3.3	"							
Heptachlor	ND	1.7	"							
Heptachlor epoxide	ND	1.7	"							
Methoxychlor	ND	17	"							
Mirex	ND	3.3	"							
Toxaphene	ND	20	"							
Surrogate: Tetrachloro-meta-xylene	7.55		"	8.33		91	46-139			
Surrogate: Decachlorobiphenyl	7.81		"	8.33		94	52-141			

LCS (1806308-BS1)

Prepared: 07/31/18 Analyzed: 08/01/18

Aldrin	16.3	1.0	µg/kg	16.7		98	47-132			
gamma-BHC (Lindane)	15.2	1.7	"	16.7		91	56-133			
4,4'-DDT	14.3	3.3	"	16.7		86	46-137			
Dieldrin	16.4	1.0	"	16.7		98	44-143			
Endrin	15.8	3.3	"	16.7		95	30-147			
Heptachlor	14.5	1.7	"	16.7		87	33-148			
Surrogate: Tetrachloro-meta-xylene	7.71		"	8.33		92	46-139			



RNC Environmental 151 Nursery St Ashland, OR 97520	Project: Voices Charter School Project Number: 1811A Project Manager: Neil O'Hara	CLS Work Order #: 18G1536 COC #:
--	---	-------------------------------------

Organochlorine Pesticides by EPA Method 8081A - Quality Control

Analyte	Result	Reporting Limit	Units	Spike Level	Source Result	%REC	%REC Limits	RPD	RPD Limit	Notes
---------	--------	-----------------	-------	-------------	---------------	------	-------------	-----	-----------	-------

Batch 1806308 - LUFT-DHS GCNV

LCS (1806308-BS1)

Prepared: 07/31/18 Analyzed: 08/01/18

Surrogate: Decachlorobiphenyl	7.89		µg/kg	8.33		95	52-141			
-------------------------------	------	--	-------	------	--	----	--------	--	--	--

LCS Dup (1806308-BSD1)

Prepared: 07/31/18 Analyzed: 08/01/18

Aldrin	15.8	1.0	µg/kg	16.7		95	47-132	4	30	
gamma-BHC (Lindane)	14.6	1.7	"	16.7		88	56-133	4	30	
4,4'-DDT	13.0	3.3	"	16.7		78	46-137	9	30	
Dieldrin	15.7	1.0	"	16.7		94	44-143	4	30	
Endrin	14.8	3.3	"	16.7		89	30-147	6	30	
Heptachlor	13.9	1.7	"	16.7		84	33-148	4	30	

Surrogate: Tetrachloro-meta-xylene	7.61		"	8.33		91	46-139			
------------------------------------	------	--	---	------	--	----	--------	--	--	--

Surrogate: Decachlorobiphenyl	7.69		"	8.33		92	52-141			
-------------------------------	------	--	---	------	--	----	--------	--	--	--

Matrix Spike (1806308-MS1)

Source: 18G1536-01

Prepared: 07/31/18 Analyzed: 08/01/18

QRL-8

Aldrin	14.4	10	µg/kg	16.7	ND	87	47-138			
gamma-BHC (Lindane)	15.5	17	"	16.7	ND	93	38-144			
4,4'-DDT	14.3	33	"	16.7	ND	86	41-157			
Dieldrin	14.6	10	"	16.7	ND	88	46-155			
Endrin	14.2	33	"	16.7	ND	85	34-149			
Heptachlor	13.0	17	"	16.7	ND	78	36-155			

Surrogate: Tetrachloro-meta-xylene	19.8		"	20.8		95	46-139			
------------------------------------	------	--	---	------	--	----	--------	--	--	--

Surrogate: Decachlorobiphenyl	15.9		"	20.8		76	52-141			
-------------------------------	------	--	---	------	--	----	--------	--	--	--

Matrix Spike Dup (1806308-MSD1)

Source: 18G1536-01

Prepared: 07/31/18 Analyzed: 08/01/18

QRL-8

Aldrin	15.3	10	µg/kg	16.7	ND	92	47-138	6	35	
gamma-BHC (Lindane)	16.4	17	"	16.7	ND	98	38-144	5	35	
4,4'-DDT	13.4	33	"	16.7	ND	80	41-157	7	35	
Dieldrin	15.2	10	"	16.7	ND	91	46-155	4	35	
Endrin	14.3	33	"	16.7	ND	86	34-149	0.9	35	
Heptachlor	13.6	17	"	16.7	ND	81	36-155	4	35	

Surrogate: Tetrachloro-meta-xylene	20.7		"	20.8		99	46-139			
------------------------------------	------	--	---	------	--	----	--------	--	--	--

Surrogate: Decachlorobiphenyl	21.1		"	20.8		101	52-141			
-------------------------------	------	--	---	------	--	-----	--------	--	--	--



RNC Environmental 151 Nursery St Ashland, OR 97520	Project: Voices Charter School Project Number: 1811A Project Manager: Neil O'Hara	CLS Work Order #: 18G1536 COC #:
--	---	--

Notes and Definitions

- QRL-8 The extract of this sample was dark and/or oily. Therefore, the sample was analyzed with a dilution and the reporting limit was raised for all target compounds.
- QM-5 The spike recovery was outside acceptance limits for the MS and/or MSD due to matrix interference. The LCS and/or LCSD were within acceptance limits showing that the laboratory is in control and the data is acceptable.
- DET Analyte DETECTED
- ND Analyte NOT DETECTED at or above the reporting limit (or method detection limit when specified)
- NR Not Reported
- dry Sample results reported on a dry weight basis
- RPD Relative Percent Difference

Appendix D

Hydraulic Modeling and Floodplain Analysis

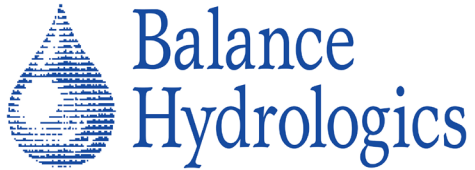

800 Bancroft Way • Suite 101 • Berkeley, CA 94710 • (510) 704-1000
224 Walnut Avenue • Suite E • Santa Cruz, CA 95060 • (831) 457-9900
PO Box 1077 • Truckee, CA 96160 • (530) 550-9776
www.balancehydro.com • email: office@balancehydro.com

May 10, 2019

Mr. Caleb Roope
Pacific West Communities, Inc.
430 East State Street, Suite 100
Eagle, Idaho 83616

**RE: Summary of Hydraulic Modeling and Floodplain Impacts for
the Proposed Voices School Site, City of Morgan Hill**

Dear Mr. Roope,

I'd like to begin by again thanking you for contacting Balance Hydrologics for technical support related to assessing potential floodplain impacts related to the proposed Voices School site in the City of Morgan Hill, California. As you are aware, Balance staff regularly work on such assignments throughout the region, and we welcome the opportunity to apply our experience to this project.

We have completed a number of tasks in this regard including a preliminary site reconnaissance, meeting with Valley Water staff, supplemental survey work, and hydraulic modeling per FEMA protocols and standards. This letter report summarizes the work completed, with a focus on the findings as they pertain to protecting the site and adjacent lands from flood hazards originating in West Little Llagas Creek.

Project Background

The project site is located in the City of Morgan Hill at the intersection of Monterey Road and Cosmo Avenue. The westerly side of the site is bounded by West Little Llagas Creek, which has been mapped by the Federal Emergency Management Agency (FEMA) at a detailed study level, with the Zone AE Special Flood Hazard Area (SFHA, colloquially known as the "100-year floodplain") illustrated on Flood Insurance Rate Map Panel No. 06085C0607H having an effective date of May 18, 2009. An excerpt of the FIRM panel is shown as the attached Figure 1.

Mr. Caleb Roope
May 10, 2019
Page 2

The Voices School project proposes to make site improvements that include the placement of fill and construction of structures within the mapped SFHA. Therefore, the City has requested a flood study to evaluate how the site development will account for the flood hazard associated with the creek.

Modeling Approach and Assumptions

The study work plan is based on preparing hydraulic modeling of this reach of the creek to represent both the pre- and post-project (e.g. proposed) conditions at the site. All modeling is completed consistent with FEMA modeling protocols so that the model output can be used to guide the selection of finish grade and lowest floor elevations such that the project complies with local ordinances and National Flood Insurance Program requirements. Modeling the pre- and post-project conditions also generates base flood elevations (e.g. those associated with the 1-percent chance flood event) to quantify the anticipated changes due to the placement of fill in the floodplain.

The baseline modeling used for the study was provided by Valley Water staff as that used for the currently-effective flood hazard mapping. The model file was in U.S. Army Corps of Engineers HEC-2 format consistent with the date of preparation, which is noted as June of 1992. The model files were imported into the U.S. Army Corps of Engineers HEC-RAS software platform (version 5.0.7, the successor to HEC-2). The model files cover the entire length of West Little Llagas Creek of which the local reach is only a small portion. Nonetheless, the model was not truncated, but was converted from the former NGVD 29 elevation datum to the current FEMA-standard NAVD 88 datum using an elevation correction of +2.85 feet as directed by Valley Water.

The file conversion to HEC-RAS worked quite well, though a number of issues were addressed to create the revised historical (or pre-project model). These include:

- *Update of channel crossing information.* For unknown reasons, the model file provided did not include culvert data for the existing twin 54-inch CMP culverts and triple 7-foot by 10-foot box culverts that cross under Cosmo Avenue immediately downstream of the site. Additionally, the depiction of an existing wooden bridge and the triple 7-foot by 10-foot box culverts under Edes Street downstream were clearly inaccurate based on the preliminary site reconnaissance. Therefore, crossing elevations and dimensions were confirmed through supplemental survey completed by Balance staff in April and May 2019.

Mr. Caleb Roope
May 10, 2019
Page 3

- *Update of channel cross-section geometries.* As with the noted channel crossings, the channel cross-section geometries in the model were found to be quite coarse, almost certainly reflective of the topographic mapping data available in 1992 when the modeling was first compiled. Therefore, supplemental survey information for all cross-sections from just downstream of Edes Street to just upstream of the Voices site was also collected and used to refine the model. For increase resolution, this included the addition of several cross-sections in the immediate vicinity of the site.¹ The location of the revised channel cross-sections is provided in the attached Figure 2.
- *Manning's n values.* The original HEC-2 file included assigned Manning's n (roughness) values that field reconnaissance showed were not representative of present-day conditions. Thus, n values were updated as appropriate, generally using 0.03 for the main channel, and either 0.04 or 0.045 for the overbank areas. The latter may well be conservative with respect to flood elevations as the main overbank flow path is presently open space reserved for the future flood control channel project. These areas were found to be covered primarily in annual grasses, with most areas clearly subject to mowing. Additionally, a low roughness recreational trail runs along the right (west) bank of the creek in the study area.

Except for the changes noted above, the parameters in the HEC-2 model files were maintained. This includes the 1-percent flood discharge values which transition from 1,094 cfs above the site to 1,296 cfs just upstream of the Cosmo Avenue crossing (at Section 362).

Modeling Results

The full HEC-RAS model output tables are presented in Appendix A, noting that the project site is located adjacent to Sections 360 to 362.5, with Sections 363 located upstream of the site.

The revised historical or pre-project model results are generally consistent with the with flood profile published in the Flood Insurance Study for Santa Clara County (Flood Profile 162P). Base flood elevations from the updated model are lower downstream from Cosmo Avenue and on the order of 0.10 feet lower upstream of Cosmo Avenue. The modeling indicates that even though the new triple box culverts are in place under Cosmo, the fact that they are not directly connected with an improved channel to their actual bottom elevations limits their conveyance capacity. Therefore, the modeling predicts overtopping of Cosmo Avenue, with the road grade acting as a weir that largely dictates base flood elevations adjacent to the Voices site. That said, the slightly lower flood elevations coupled with more

¹ The refined model reach has a total length of approximately 1,740 feet measured along the channel centerline. Model runs were carried out to verify that refinement of the model further downstream did not impact the results at for the run of channel immediately upstream of Cosmo Avenue. Model results outside the refined channel reach should only be referenced or used with an understanding of the limitations in the original HEC-2 model file that was provided.

Mr. Caleb Roope
 May 10, 2019
 Page 4

detailed site topography result in a revised pre-project floodplain boundary at the site that shows less of the property within the Zone AE area (see Figure 3).

The post-project modeling included adjustments to the pertinent cross-sections based on the proposed grading configuration provided by Bellecci & Associates, lead civil engineers for the project. The modeling indicates that the proposed fill placement would result in only minor increases in base flood elevations in the vicinity of the site. Those elevations range from 334.04 feet just upstream of Cosmo Avenue to approximately 334.45 feet at the northwest corner of the site (between Sections 362.5 and 363). Pre- and post-project base flood elevations are summarized in Table 1 and show that the largest predicted increase is at Section 363 where the BFE increases by 0.09 feet from 334.48 to 334.57 feet NAVD. The resulting revised floodplain boundary at the project property is illustrated on the attached Figure 4.

Table 1. Summary of modeled base flood elevations adjacent to the Voices site.

RAS Cross-section	Modeled Base Flood Elevation (ft, NAVD)		
	Pre-project	Post-project	Difference
363	334.48	334.57	0.09
362.5	334.33	334.33	0
362	334.08	334.15	0.07
361	334.10	334.09	-0.01
360	334.03	334.04	0.01

Mr. Caleb Roope
May 10, 2019
Page 5

Closing

The results of the modeling show that the actual extents of the floodplain at the project property in the pre-project condition are less than depicted at the scale of the published floodplain map. This implies that the encroachment into the floodplain due to the limited proposed fill can be expected to have only a minor impact on base flood elevations. Indeed, the modeling results confirm this and indicate that flood elevations would increase by just over an inch at most. Furthermore, the proposed finished floor elevations are well above the pertinent base flood elevations, especially in light of the fact that significant flood control channel improvements are planned for the near future that will lower the base flood elevation by roughly four feet in this reach of the creek (Upper Llagas Creek Flood Protection Project Phase 2, Sheet PP-12 as provided by Valley Water).

Thank you again for the opportunity to assist with this matter. Do not hesitate to contact Balance Hydrologics if you have any questions or comments related to the work conducted.

Sincerely,

BALANCE HYDROLOGICS, Inc.



Edward D. Ballman, P.E., CFM
Principal Engineer



Enclosures: Figures 1 through 4
Appendix A. HEC-RAS Output Report

National Flood Hazard Layer FIRMette



Legend

SEE FIS REPORT FOR DETAILED LEGEND AND INDEX MAP FOR FIRM PANEL LAYOUT

SPECIAL FLOOD HAZARD AREAS		Without Base Flood Elevation (BFE) Zone A, V, XDS	
		With BFE or Depth Zone AE, AD, AH, VE, AP	
		Regulatory Floodway	
OTHER AREAS OF FLOOD HAZARD		0.2% Annual Chance Flood Hazard, Areas of 1% annual chance flood with average depth less than one foot or with drainage areas of less than one square mile Zone X	
		Future Conditions 1% Annual Chance Flood Hazard Zone X	
		Area with Reduced Flood Risk due to Levee. See Notes. Zone X	
		Area with Flood Risk due to Levee Zone D	
OTHER AREAS		Area of Minimal Flood Hazard Zone X	
		Effective LOMRs	
GENERAL STRUCTURES		Channel, Culvert, or Storm Sewer	
		Levee, Dike, or Floodwall	
OTHER FEATURES		Cross Sections with 1% Annual Chance Water Surface Elevation	
		Coastal Transect	
		Base Flood Elevation Line (BFE)	
		Limit of Study	
		Jurisdiction Boundary	
		Coastal Transect Baseline	
		Profile Baseline	
		Hydrographic Feature	
	MAP PANELS		Digital Data Available
			No Digital Data Available
		Unmapped	

The pin displayed on the map is an approximate point selected by the user and does not represent an authoritative property location.

This map complies with FEMA's standards for the use of digital flood maps if it is not void as described below. The basemap shown complies with FEMA's basemap accuracy standards.

The flood hazard information is derived directly from the authoritative NFHL web services provided by FEMA. This map was exported on 3/20/2019 at 1:15:24 PM and does not reflect changes or amendments subsequent to this date and time. The NFHL and effective information may change or become superseded by new data over time.

This map image is void if the one or more of the following map elements do not appear: basemap imagery, flood zone labels, legend, scale bar, map creation date, community identifiers, FIRM panel number, and FIRM effective date. Map images for unmapped and unmodernized areas cannot be used for regulatory purposes.

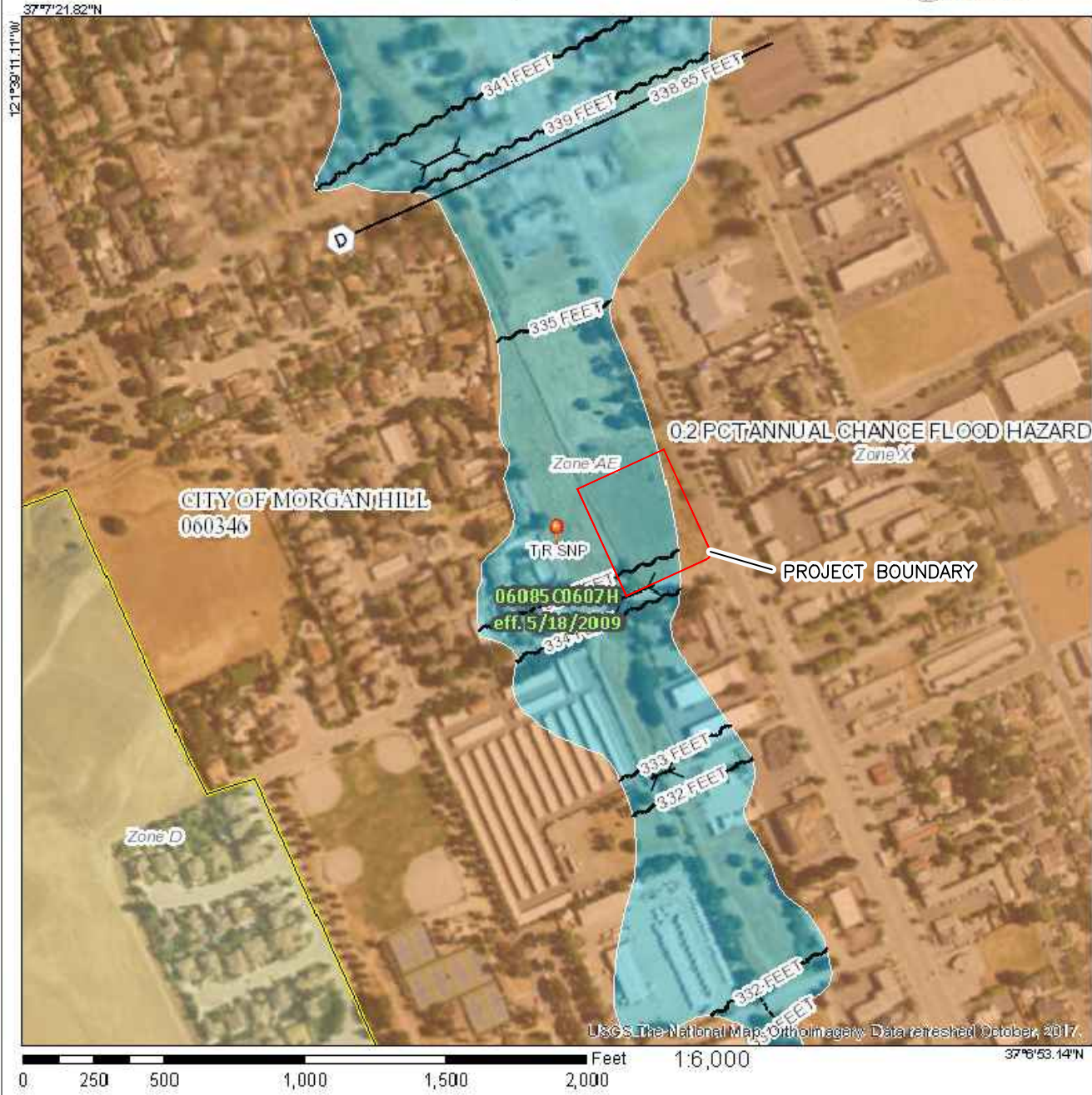

Figure 1. FEMA FIRMette with Voices School project boundary, West Little Llagas Creek at Voices School site, City of Morgan Hill.

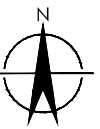
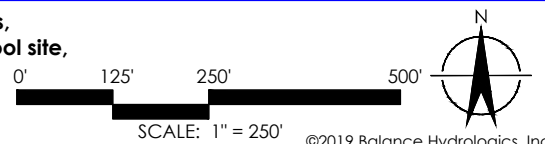
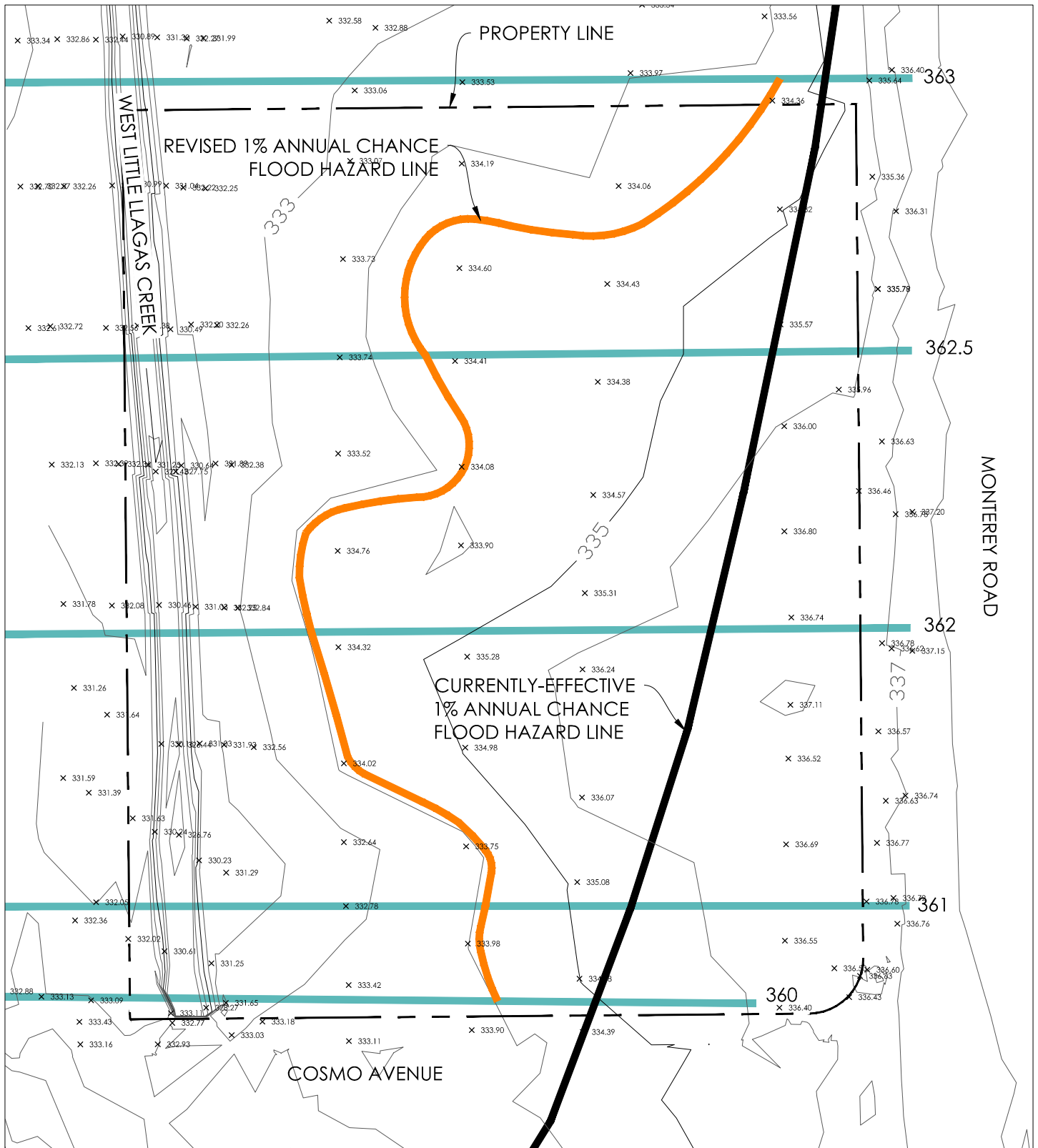



Figure 2. Revised hydraulic model cross sections, West Little Llagas Creek at Voices School site, City of Morgan Hill.





LEGEND:

- 335 — EXISTING INDEX CONTOUR
- — — EXISTING INTERMEDIATE CONTOUR
- × 335.96 EXISTING SPOT ELEVATION
- - - - - PROPERTY LINE
- 362 MODEL CROSS SECTION
- 1% ANNUAL CHANCE FLOOD HAZARD LINE (CURRENTLY-EFFECTIVE)
- 1% ANNUAL CHANCE FLOOD HAZARD LINE (REVISED)

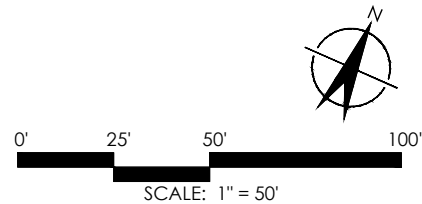
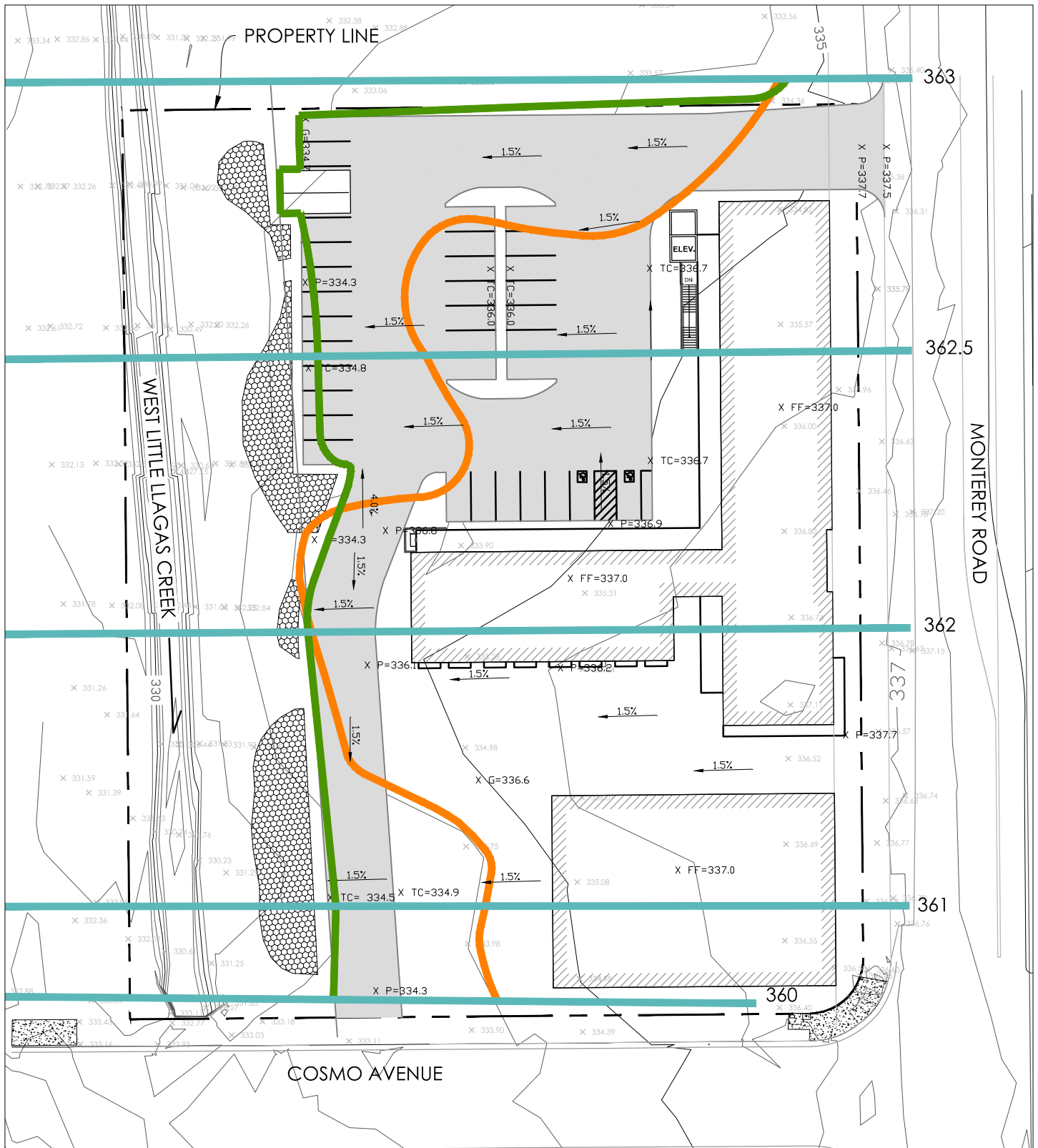

Figure 3. Currently-effective and revised Zone AE boundaries, Voices School site, City of Morgan Hill.

Existing topography data source: Bellecci and Associates



LEGEND:

- 335 — EXISTING INDEX CONTOUR
- EXISTING INTERMEDIATE CONTOUR
- × 335.96 EXISTING SPOT ELEVATION
- - - PROPERTY LINE
- × G=336.6 FINISH GRADE CALLOUT
- 1% ANNUAL CHANCE FLOOD HAZARD LINE (PRE-PROJECT)
- 1% ANNUAL CHANCE FLOOD HAZARD LINE (POST-PROJECT)
- 362 — MODELED CROSS SECTION

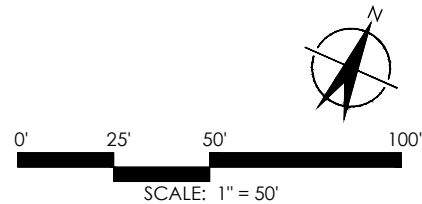

Figure 4. Revised (pre-project) and post-project Zone AE boundaries, Voices School site, City of Morgan Hill.

Existing topography data source: Bellecci and Associates

HEC-RAS River: RIVER-1 Reach: Reach-1 Profile: PF 1 (Continued)

Reach	River Sta	Profile	Plan	Q Total	Min Ch El	W.S. Elev	Crit W.S.	E.G. Elev	E.G. Slope	Vel Chnl	Flow Area	Top Width	Froude # Chl
				(cfs)	(ft)	(ft)	(ft)	(ft)	(ft/ft)	(ft/s)	(sq ft)	(ft)	
Reach-1	478	PF 1	Rev Hist	100.00	361.15	364.93	362.88	365.11	0.003489	3.40	29.41	7.86	0.31
Reach-1	478	PF 1	Post Proj	100.00	361.15	364.93	362.88	365.11	0.003489	3.40	29.41	7.86	0.31
Reach-1	476	PF 1	Rev Hist	100.00	360.85	364.25	363.12	364.44	0.003172	3.50	28.59	14.11	0.43
Reach-1	476	PF 1	Post Proj	100.00	360.85	364.25	363.12	364.44	0.003172	3.50	28.59	14.11	0.43
Reach-1	474	PF 1	Rev Hist	100.00	357.45	359.57	359.57	360.26	0.018485	6.66	15.01	10.94	1.00
Reach-1	474	PF 1	Post Proj	100.00	357.45	359.57	359.57	360.26	0.018485	6.66	15.01	10.94	1.00
Reach-1	472	PF 1	Rev Hist	400.00	353.15	358.70		358.72	0.000199	1.26	411.49	132.96	0.13
Reach-1	472	PF 1	Post Proj	400.00	353.15	358.70		358.72	0.000199	1.26	411.49	132.96	0.13
Reach-1	470	PF 1	Rev Hist	400.00	352.85	358.57	355.03	358.63	0.000500	2.35	222.72	67.00	0.17
Reach-1	470	PF 1	Post Proj	400.00	352.85	358.57	355.03	358.63	0.000500	2.35	222.72	67.00	0.17
Reach-1	467			Bridge									
Reach-1	464	PF 1	Rev Hist	400.00	352.85	356.69	355.02	357.03	0.003057	4.72	84.70	22.15	0.43
Reach-1	464	PF 1	Post Proj	400.00	352.85	356.69	355.02	357.03	0.003057	4.72	84.70	22.15	0.43
Reach-1	462	PF 1	Rev Hist	400.00	352.05	355.94	355.94	356.28	0.005990	5.73	123.94	173.99	0.63
Reach-1	462	PF 1	Post Proj	400.00	352.05	355.94	355.94	356.28	0.005990	5.73	123.94	173.99	0.63
Reach-1	461	PF 1	Rev Hist	400.00	349.35	354.24		354.24	0.000015	0.24	2519.85	2050.23	0.03
Reach-1	461	PF 1	Post Proj	400.00	349.35	354.24		354.24	0.000015	0.24	2519.85	2050.23	0.03
Reach-1	460	PF 1	Rev Hist	400.00	349.35	354.24	353.11	354.24	0.000161	1.16	2051.06	1972.60	0.09
Reach-1	460	PF 1	Post Proj	400.00	349.35	354.24	353.11	354.24	0.000161	1.16	2051.06	1972.60	0.09
Reach-1	455			Bridge									
Reach-1	450	PF 1	Rev Hist	400.00	346.15	351.68	351.32	353.89	0.023422	11.91	33.58	6.14	0.90
Reach-1	450	PF 1	Post Proj	400.00	346.15	351.68	351.32	353.89	0.023422	11.91	33.58	6.14	0.90
Reach-1	449	PF 1	Rev Hist	500.00	346.15	353.10	348.78	353.24	0.000502	3.05	163.79	26.00	0.21
Reach-1	449	PF 1	Post Proj	500.00	346.15	353.10	348.78	353.24	0.000502	3.05	163.79	26.00	0.21
Reach-1	448	PF 1	Rev Hist	500.00	345.75	352.37	350.44	352.76	0.002189	5.08	139.01	156.00	0.46
Reach-1	448	PF 1	Post Proj	500.00	345.75	352.37	350.44	352.76	0.002189	5.08	139.01	156.00	0.46
Reach-1	446	PF 1	Rev Hist	500.00	345.05	351.27	349.62	351.68	0.002346	5.41	211.99	311.53	0.48
Reach-1	446	PF 1	Post Proj	500.00	345.05	351.27	349.62	351.68	0.002346	5.41	211.99	311.53	0.48

HEC-RAS River: RIVER-1 Reach: Reach-1 Profile: PF 1 (Continued)

Reach	River Sta	Profile	Plan	Q Total	Min Ch El	W.S. Elev	Crit W.S.	E.G. Elev	E.G. Slope	Vel Chnl	Flow Area	Top Width	Froude # Chl
				(cfs)	(ft)	(ft)	(ft)	(ft)	(ft/ft)	(ft/s)	(sq ft)	(ft)	
Reach-1	444	PF 1	Rev Hist	500.00	344.65	351.13	348.81	351.19	0.000461	2.65	548.65	495.00	0.22
Reach-1	444	PF 1	Post Proj	500.00	344.65	351.13	348.81	351.19	0.000461	2.65	548.65	495.00	0.22
Reach-1	442	PF 1	Rev Hist	500.00	344.15	351.10	348.30	351.11	0.000084	1.24	2760.37	1855.93	0.10
Reach-1	442	PF 1	Post Proj	500.00	344.15	351.10	348.30	351.11	0.000084	1.24	2760.37	1855.93	0.10
Reach-1	440.2	PF 1	Rev Hist	500.00	344.05	351.04	348.61	351.08	0.000437	2.79	693.69	348.70	0.19
Reach-1	440.2	PF 1	Post Proj	500.00	344.05	351.04	348.61	351.08	0.000437	2.79	693.69	348.70	0.19
Reach-1	440	PF 1	Rev Hist	500.00	344.05	350.24	348.61	350.90	0.010777	7.51	197.35	297.64	0.46
Reach-1	440	PF 1	Post Proj	500.00	344.05	350.24	348.61	350.90	0.010777	7.51	197.35	297.64	0.46
Reach-1	436	PF 1	Rev Hist	500.00	343.95	350.00	348.51	350.46	0.002807	6.41	222.59	242.61	0.46
Reach-1	436	PF 1	Post Proj	500.00	343.95	350.00	348.51	350.46	0.002807	6.41	222.59	242.61	0.46
Reach-1	434	PF 1	Rev Hist	500.00	343.55	350.01	347.11	350.19	0.001646	3.58	246.93	204.27	0.29
Reach-1	434	PF 1	Post Proj	500.00	343.55	350.01	347.11	350.19	0.001646	3.58	246.93	204.27	0.29
Reach-1	430.2	PF 1	Rev Hist	650.00	342.65	348.66	347.80	348.75	0.002478	3.68	532.41	305.70	0.27
Reach-1	430.2	PF 1	Post Proj	650.00	342.65	348.66	347.80	348.75	0.002478	3.68	532.41	305.70	0.27
Reach-1	430	PF 1	Rev Hist	650.00	342.65	348.67	347.97	348.74	0.006316	3.33	432.38	284.25	0.15
Reach-1	430	PF 1	Post Proj	650.00	342.65	348.67	347.97	348.74	0.006316	3.33	432.38	284.25	0.15
Reach-1	422	PF 1	Rev Hist	650.00	342.55	348.63	347.44	348.65	0.000689	1.94	1325.37	865.10	0.14
Reach-1	422	PF 1	Post Proj	650.00	342.55	348.63	347.44	348.65	0.000689	1.94	1325.37	865.10	0.14
Reach-1	420.2	PF 1	Rev Hist	700.00	341.85	348.35	347.46	348.39	0.001522	2.85	803.77	471.00	0.20
Reach-1	420.2	PF 1	Post Proj	700.00	341.85	348.35	347.46	348.39	0.001522	2.85	803.77	471.00	0.20
Reach-1	420	PF 1	Rev Hist	700.00	341.85	348.11	348.06	348.33	0.022288	5.77	343.28	404.89	0.26
Reach-1	420	PF 1	Post Proj	700.00	341.85	348.11	348.06	348.33	0.022288	5.77	343.28	404.89	0.26
Reach-1	412	PF 1	Rev Hist	700.00	340.45	348.19	346.67	348.23	0.001263	2.92	901.09	731.79	0.19
Reach-1	412	PF 1	Post Proj	700.00	340.45	348.19	346.67	348.23	0.001263	2.92	901.09	731.79	0.19
Reach-1	411	PF 1	Rev Hist	840.00	340.35	348.10	342.88	348.13	0.000226	1.65	1213.63	545.68	0.11
Reach-1	411	PF 1	Post Proj	840.00	340.35	348.10	342.88	348.13	0.000226	1.65	1213.63	545.68	0.11
Reach-1	410	PF 1	Rev Hist	840.00	339.85	348.01	346.36	348.07	0.001129	2.98	1008.82	711.98	0.18
Reach-1	410	PF 1	Post Proj	840.00	339.85	348.01	346.36	348.07	0.001129	2.98	1008.82	711.98	0.18

HEC-RAS River: RIVER-1 Reach: Reach-1 Profile: PF 1 (Continued)

Reach	River Sta	Profile	Plan	Q Total	Min Ch El	W.S. Elev	Crit W.S.	E.G. Elev	E.G. Slope	Vel Chnl	Flow Area	Top Width	Froude # Chl
				(cfs)	(ft)	(ft)	(ft)	(ft)	(ft/ft)	(ft/s)	(sq ft)	(ft)	
Reach-1	402	PF 1	Rev Hist	840.00	339.85	347.10	344.46	347.82	0.027980	8.30	277.41	360.70	0.45
Reach-1	402	PF 1	Post Proj	840.00	339.85	347.10	344.46	347.82	0.027980	8.30	277.41	360.70	0.45
Reach-1	394	PF 1	Rev Hist	900.00	338.65	345.76	344.48	345.83	0.001981	3.51	878.29	430.23	0.23
Reach-1	394	PF 1	Post Proj	900.00	338.65	345.76	344.48	345.83	0.001981	3.51	878.29	430.23	0.23
Reach-1	393		Culvert										
Reach-1	392	PF 1	Rev Hist	900.00	337.95	345.83	343.18	345.83	0.000210	0.50	1639.48	1032.49	0.08
Reach-1	392	PF 1	Post Proj	900.00	337.95	345.83	343.18	345.83	0.000210	0.50	1639.48	1032.49	0.08
Reach-1	390.2	PF 1	Rev Hist	980.00	337.35	345.74	344.65	345.76	0.000873	2.67	1979.43	1080.37	0.16
Reach-1	390.2	PF 1	Post Proj	980.00	337.35	345.74	344.65	345.76	0.000873	2.67	1979.43	1080.37	0.16
Reach-1	390	PF 1	Rev Hist	980.00	337.35	345.74	344.70	345.76	0.001641	2.20	1889.89	1061.63	0.06
Reach-1	390	PF 1	Post Proj	980.00	337.35	345.74	344.70	345.76	0.001641	2.20	1889.89	1061.63	0.06
Reach-1	384	PF 1	Rev Hist	980.00	337.15	345.05	344.61	345.46	0.007048	7.18	549.14	436.59	0.45
Reach-1	384	PF 1	Post Proj	980.00	337.15	345.05	344.61	345.46	0.007048	7.18	549.14	436.59	0.45
Reach-1	382	PF 1	Rev Hist	1094.00	336.95	343.74	342.87	344.03	0.003261	5.78	443.88	390.93	0.43
Reach-1	382	PF 1	Post Proj	1094.00	336.95	343.74	342.87	344.03	0.003261	5.78	443.88	390.93	0.43
Reach-1	380	PF 1	Rev Hist	1094.00	336.75	343.37	342.99	343.55	0.007137	5.84	579.19	475.38	0.40
Reach-1	380	PF 1	Post Proj	1094.00	336.75	343.37	342.99	343.55	0.007137	5.84	579.19	475.38	0.40
Reach-1	378		Culvert										
Reach-1	376	PF 1	Rev Hist	1094.00	333.65	341.17	339.86	341.20	0.001160	2.53	983.13	519.52	0.16
Reach-1	376	PF 1	Post Proj	1094.00	333.65	341.17	339.86	341.20	0.001160	2.53	983.13	519.52	0.16
Reach-1	374	PF 1	Rev Hist	1094.00	333.65	340.90	340.18	341.09	0.002465	4.86	431.92	298.20	0.37
Reach-1	374	PF 1	Post Proj	1094.00	333.65	340.90	340.18	341.09	0.002465	4.86	431.92	298.20	0.37
Reach-1	372	PF 1	Rev Hist	1094.00	331.75	341.01	337.72	341.01	0.000011	0.41	5004.56	1713.93	0.03
Reach-1	372	PF 1	Post Proj	1094.00	331.75	341.01	337.72	341.01	0.000011	0.41	5004.56	1713.93	0.03
Reach-1	370.2	PF 1	Rev Hist	1094.00	331.15	341.01	338.02	341.01	0.000030	0.52	3529.51	1389.36	0.03
Reach-1	370.2	PF 1	Post Proj	1094.00	331.15	341.01	338.02	341.01	0.000030	0.52	3529.51	1389.36	0.03
Reach-1	370	PF 1	Rev Hist	1094.00	331.15	340.10	340.10	340.93	0.016897	9.52	319.94	160.00	0.43

HEC-RAS River: RIVER-1 Reach: Reach-1 Profile: PF 1 (Continued)

Reach	River Sta	Profile	Plan	Q Total (cfs)	Min Ch El (ft)	W.S. Elev (ft)	Crit W.S. (ft)	E.G. Elev (ft)	E.G. Slope (ft/ft)	Vel Chnl (ft/s)	Flow Area (sq ft)	Top Width (ft)	Froude # Chl
Reach-1	348	PF 1	Rev Hist	1296.00	323.91	331.81		332.00	0.001402	4.58	551.83	376.15	0.39
Reach-1	348	PF 1	Post Proj	1296.00	323.91	331.81		332.00	0.001402	4.58	551.83	376.15	0.39
Reach-1	346	PF 1	Rev Hist	1296.00	323.16	331.44		331.85	0.001960	6.53	430.98	294.95	0.47
Reach-1	346	PF 1	Post Proj	1296.00	323.16	331.44		331.85	0.001960	6.53	430.98	294.95	0.47
Reach-1	344	PF 1	Rev Hist	1296.00	322.37	330.86		331.20	0.002113	5.78	392.81	245.68	0.47
Reach-1	344	PF 1	Post Proj	1296.00	322.37	330.86		331.20	0.002113	5.78	392.81	245.68	0.47
Reach-1	342	PF 1	Rev Hist	1296.00	322.94	330.67		330.85	0.000955	4.29	513.56	252.07	0.34
Reach-1	342	PF 1	Post Proj	1296.00	322.94	330.67		330.85	0.000955	4.29	513.56	252.07	0.34
Reach-1	340	PF 1	Rev Hist	1296.00	321.74	330.62	325.77	330.76	0.000451	3.33	568.37	204.87	0.22
Reach-1	340	PF 1	Post Proj	1296.00	321.74	330.62	325.77	330.76	0.000451	3.33	568.37	204.87	0.22
Reach-1	339			Culvert									
Reach-1	338	PF 1	Rev Hist	1296.00	321.59	330.30		330.56	0.000646	4.15	350.53	148.42	0.27
Reach-1	338	PF 1	Post Proj	1296.00	321.59	330.30		330.56	0.000646	4.15	350.53	148.42	0.27
Reach-1	336	PF 1	Rev Hist	1296.00	321.92	329.86	328.64	330.34	0.002413	5.83	300.85	198.62	0.52
Reach-1	336	PF 1	Post Proj	1296.00	321.92	329.86	328.64	330.34	0.002413	5.83	300.85	198.62	0.52
Reach-1	334	PF 1	Rev Hist	1296.00	322.55	328.55	328.55	329.36	0.003602	8.26	316.77	203.52	0.65
Reach-1	334	PF 1	Post Proj	1296.00	322.55	328.55	328.55	329.36	0.003602	8.26	316.77	203.52	0.65
Reach-1	332	PF 1	Rev Hist	1296.00	320.75	326.90		327.25	0.001365	4.75	291.35	110.65	0.41
Reach-1	332	PF 1	Post Proj	1296.00	320.75	326.90		327.25	0.001365	4.75	291.35	110.65	0.41
Reach-1	330	PF 1	Rev Hist	1296.00	320.75	326.81	323.75	327.17	0.001201	4.85	266.99	44.16	0.35
Reach-1	330	PF 1	Post Proj	1296.00	320.75	326.81	323.75	327.17	0.001201	4.85	266.99	44.16	0.35
Reach-1	329			Culvert									
Reach-1	328	PF 1	Rev Hist	1296.00	318.15	326.54		326.67	0.000326	3.11	621.02	310.95	0.19
Reach-1	328	PF 1	Post Proj	1296.00	318.15	326.54		326.67	0.000326	3.11	621.02	310.95	0.19
Reach-1	326	PF 1	Rev Hist	1296.00	319.45	326.24		326.57	0.001386	4.58	282.95	69.97	0.40
Reach-1	326	PF 1	Post Proj	1296.00	319.45	326.24		326.57	0.001386	4.58	282.95	69.97	0.40
Reach-1	324	PF 1	Rev Hist	1444.00	319.45	326.16		326.29	0.000629	3.03	533.08	156.21	0.27
Reach-1	324	PF 1	Post Proj	1444.00	319.45	326.16		326.29	0.000629	3.03	533.08	156.21	0.27

HEC-RAS River: RIVER-1 Reach: Reach-1 Profile: PF 1 (Continued)

Reach	River Sta	Profile	Plan	Q Total (cfs)	Min Ch El (ft)	W.S. Elev (ft)	Crit W.S. (ft)	E.G. Elev (ft)	E.G. Slope (ft/ft)	Vel Chnl (ft/s)	Flow Area (sq ft)	Top Width (ft)	Froude # Chl
Reach-1	322	PF 1	Rev Hist	1444.00	318.65	325.76	321.89	325.97	0.000572	3.62	398.46	71.46	0.27
Reach-1	322	PF 1	Post Proj	1444.00	318.65	325.76	321.89	325.97	0.000572	3.62	398.46	71.46	0.27
Reach-1	320	PF 1	Rev Hist	1444.00	318.45	325.61	321.54	325.90	0.000778	4.30	335.80	46.95	0.28
Reach-1	320	PF 1	Post Proj	1444.00	318.45	325.61	321.54	325.90	0.000778	4.30	335.80	46.95	0.28
Reach-1	319		Culvert										
Reach-1	318	PF 1	Rev Hist	1444.00	318.25	325.45	321.35	325.73	0.000765	4.28	337.53	46.97	0.28
Reach-1	318	PF 1	Post Proj	1444.00	318.25	325.45	321.35	325.73	0.000765	4.28	337.53	46.97	0.28
Reach-1	316	PF 1	Rev Hist	1444.00	318.15	325.34		325.67	0.001032	4.65	310.43	58.92	0.36
Reach-1	316	PF 1	Post Proj	1444.00	318.15	325.34		325.67	0.001032	4.65	310.43	58.92	0.36
Reach-1	314	PF 1	Rev Hist	1936.00	317.75	324.22		324.95	0.002871	7.99	352.92	117.34	0.60
Reach-1	314	PF 1	Post Proj	1936.00	317.75	324.22		324.95	0.002871	7.99	352.92	117.34	0.60
Reach-1	312	PF 1	Rev Hist	1936.00	316.55	324.24		324.51	0.000693	4.18	463.45	76.88	0.30
Reach-1	312	PF 1	Post Proj	1936.00	316.55	324.24		324.51	0.000693	4.18	463.45	76.88	0.30
Reach-1	310	PF 1	Rev Hist	1936.00	316.55	324.19	319.81	324.48	0.000698	4.35	445.13	58.38	0.28
Reach-1	310	PF 1	Post Proj	1936.00	316.55	324.19	319.81	324.48	0.000698	4.35	445.13	58.38	0.28
Reach-1	307		Culvert										
Reach-1	304	PF 1	Rev Hist	1936.00	315.95	324.11	319.20	324.37	0.000565	4.07	481.64	128.59	0.25
Reach-1	304	PF 1	Post Proj	1936.00	315.95	324.11	319.20	324.37	0.000565	4.07	481.64	128.59	0.25
Reach-1	302	PF 1	Rev Hist	1936.00	315.75	324.15	319.25	324.28	0.000595	3.02	836.72	518.48	0.21
Reach-1	302	PF 1	Post Proj	1936.00	315.75	324.15	319.25	324.28	0.000595	3.02	836.72	518.48	0.21
Reach-1	300	PF 1	Rev Hist	1936.00	315.35	324.16	320.51	324.17	0.000094	1.15	3326.94	1733.88	0.08
Reach-1	300	PF 1	Post Proj	1936.00	315.35	324.16	320.51	324.17	0.000094	1.15	3326.94	1733.88	0.08
Reach-1	298	PF 1	Rev Hist	1936.00	314.35	324.15	318.04	324.15	0.000036	0.87	4653.61	2134.79	0.05
Reach-1	298	PF 1	Post Proj	1936.00	314.35	324.15	318.04	324.15	0.000036	0.87	4653.61	2134.79	0.05
Reach-1	296	PF 1	Rev Hist	1936.00	314.25	324.12	321.06	324.13	0.000089	1.18	3584.23	2274.15	0.08
Reach-1	296	PF 1	Post Proj	1936.00	314.25	324.12	321.06	324.13	0.000089	1.18	3584.23	2274.15	0.08
Reach-1	294	PF 1	Rev Hist	1936.00	314.05	324.10	321.04	324.10	0.000033	0.76	5586.86	2951.03	0.05

HEC-RAS River: RIVER-1 Reach: Reach-1 Profile: PF 1 (Continued)

Reach	River Sta	Profile	Plan	Q Total	Min Ch El	W.S. Elev	Crit W.S.	E.G. Elev	E.G. Slope	Vel Chnl	Flow Area	Top Width	Froude # Chl
				(cfs)	(ft)	(ft)	(ft)	(ft)	(ft/ft)	(ft/s)	(sq ft)	(ft)	
Reach-1	294	PF 1	Post Proj	1936.00	314.05	324.10	321.04	324.10	0.000033	0.76	5586.86	2951.03	0.05
Reach-1	292	PF 1	Rev Hist	1936.00	314.05	324.10	319.39	324.10	0.000007	0.33	10071.37	2981.06	0.02
Reach-1	292	PF 1	Post Proj	1936.00	314.05	324.10	319.39	324.10	0.000007	0.33	10071.37	2981.06	0.02
Reach-1	290	PF 1	Rev Hist	1936.00	314.05	324.08	320.84	324.09	0.000131	1.87	3480.94	1136.28	0.10
Reach-1	290	PF 1	Post Proj	1936.00	314.05	324.08	320.84	324.09	0.000131	1.87	3480.94	1136.28	0.10
Reach-1	287			Bridge									
Reach-1	284	PF 1	Rev Hist	1936.00	314.05	324.06		324.07	0.000137	1.91	3427.30	1134.75	0.11
Reach-1	284	PF 1	Post Proj	1936.00	314.05	324.06		324.07	0.000137	1.91	3427.30	1134.75	0.11
Reach-1	282	PF 1	Rev Hist	1936.00	314.05	324.01	321.56	324.04	0.000382	2.14	1918.99	682.37	0.14
Reach-1	282	PF 1	Post Proj	1936.00	314.05	324.01	321.56	324.04	0.000382	2.14	1918.99	682.37	0.14
Reach-1	280	PF 1	Rev Hist	1936.00	314.05	323.96	320.49	324.01	0.000390	2.76	1600.70	792.40	0.15
Reach-1	280	PF 1	Post Proj	1936.00	314.05	323.96	320.49	324.01	0.000390	2.76	1600.70	792.40	0.15
Reach-1	279			Culvert									
Reach-1	278	PF 1	Rev Hist	1936.00	313.85	320.54	320.54	321.87	0.009313	10.33	253.28	96.70	0.70
Reach-1	278	PF 1	Post Proj	1936.00	313.85	320.54	320.54	321.87	0.009313	10.33	253.28	96.70	0.70
Reach-1	276	PF 1	Rev Hist	1936.00	313.75	319.87	319.87	320.18	0.005226	6.67	729.74	919.35	0.57
Reach-1	276	PF 1	Post Proj	1936.00	313.75	319.87	319.87	320.18	0.005226	6.67	729.74	919.35	0.57
Reach-1	274	PF 1	Rev Hist	1936.00	313.55	319.45	318.51	319.47	0.000502	2.07	1999.35	1424.06	0.18
Reach-1	274	PF 1	Post Proj	1936.00	313.55	319.45	318.51	319.47	0.000502	2.07	1999.35	1424.06	0.18
Reach-1	272	PF 1	Rev Hist	1936.00	313.05	319.37	317.63	319.38	0.000091	0.97	3634.07	1789.38	0.08
Reach-1	272	PF 1	Post Proj	1936.00	313.05	319.37	317.63	319.38	0.000091	0.97	3634.07	1789.38	0.08
Reach-1	270	PF 1	Rev Hist	1936.00	312.85	319.33	317.12	319.33	0.000091	1.04	3102.91	1176.65	0.08
Reach-1	270	PF 1	Post Proj	1936.00	312.85	319.33	317.12	319.33	0.000091	1.04	3102.91	1176.65	0.08
Reach-1	268	PF 1	Rev Hist	1936.00	312.55	319.30		319.31	0.000022	0.54	4640.42	1144.23	0.04
Reach-1	268	PF 1	Post Proj	1936.00	312.55	319.30		319.31	0.000022	0.54	4640.42	1144.23	0.04
Reach-1	266	PF 1	Rev Hist	1936.00	312.25	319.29	314.66	319.30	0.000020	0.48	5472.54	1926.64	0.03
Reach-1	266	PF 1	Post Proj	1936.00	312.25	319.29	314.66	319.30	0.000020	0.48	5472.54	1926.64	0.03

HEC-RAS River: RIVER-1 Reach: Reach-1 Profile: PF 1 (Continued)

Reach	River Sta	Profile	Plan	Q Total	Min Ch El	W.S. Elev	Crit W.S.	E.G. Elev	E.G. Slope	Vel Chnl	Flow Area	Top Width	Froude # Chl
				(cfs)	(ft)	(ft)	(ft)	(ft)	(ft/ft)	(ft/s)	(sq ft)	(ft)	
Reach-1	264	PF 1	Rev Hist	1936.00	311.45	319.29		319.29	0.000013	0.43	6334.32	1570.59	0.03
Reach-1	264	PF 1	Post Proj	1936.00	311.45	319.29		319.29	0.000013	0.43	6334.32	1570.59	0.03
Reach-1	262	PF 1	Rev Hist	1936.00	310.95	319.29		319.29	0.000002	0.17	15757.66	3468.10	0.01
Reach-1	262	PF 1	Post Proj	1936.00	310.95	319.29		319.29	0.000002	0.17	15757.66	3468.10	0.01
Reach-1	260	PF 1	Rev Hist	1936.00	310.75	319.23	318.56	319.28	0.000552	3.26	1830.12	2009.70	0.20
Reach-1	260	PF 1	Post Proj	1936.00	310.75	319.23	318.56	319.28	0.000552	3.26	1830.12	2009.70	0.20
Reach-1	259			Culvert									
Reach-1	258	PF 1	Rev Hist	1936.00	310.55	318.92	318.92	319.23	0.003375	6.89	943.71	2114.60	0.42
Reach-1	258	PF 1	Post Proj	1936.00	310.55	318.92	318.92	319.23	0.003375	6.89	943.71	2114.60	0.42
Reach-1	256	PF 1	Rev Hist	1936.00	310.55	315.15		315.16	0.000495	2.05	2260.61	1889.42	0.19
Reach-1	256	PF 1	Post Proj	1936.00	310.55	315.15		315.16	0.000495	2.05	2260.61	1889.42	0.19
Reach-1	254	PF 1	Rev Hist	3246.00	309.95	314.42		314.50	0.002322	4.30	1622.98	1292.57	0.42
Reach-1	254	PF 1	Post Proj	3246.00	309.95	314.42		314.50	0.002322	4.30	1622.98	1292.57	0.42
Reach-1	252	PF 1	Rev Hist	3246.00	308.65	312.93		313.07	0.004181	6.27	1427.71	1497.18	0.59
Reach-1	252	PF 1	Post Proj	3246.00	308.65	312.93		313.07	0.004181	6.27	1427.71	1497.18	0.59
Reach-1	250	PF 1	Rev Hist	3246.00	307.75	312.92	311.85	312.93	0.000512	2.49	3442.80	2505.06	0.19
Reach-1	250	PF 1	Post Proj	3246.00	307.75	312.92	311.85	312.93	0.000512	2.49	3442.80	2505.06	0.19
Reach-1	249			Bridge									
Reach-1	248	PF 1	Rev Hist	3246.00	307.75	312.80		312.84	0.001986	4.23	3157.49	2471.85	0.33
Reach-1	248	PF 1	Post Proj	3246.00	307.75	312.80		312.84	0.001986	4.23	3157.49	2471.85	0.33
Reach-1	246	PF 1	Rev Hist	3246.00	307.35	312.71	312.05	312.74	0.001427	3.10	3357.96	2346.00	0.30
Reach-1	246	PF 1	Post Proj	3246.00	307.35	312.71	312.05	312.74	0.001427	3.10	3357.96	2346.00	0.30
Reach-1	244	PF 1	Rev Hist	3246.00	306.45	312.38	311.13	312.41	0.000579	2.98	2695.62	1624.47	0.23
Reach-1	244	PF 1	Post Proj	3246.00	306.45	312.38	311.13	312.41	0.000579	2.98	2695.62	1624.47	0.23
Reach-1	242	PF 1	Rev Hist	3246.00	305.95	312.28	310.29	312.29	0.000254	2.11	3559.20	1696.84	0.16
Reach-1	242	PF 1	Post Proj	3246.00	305.95	312.28	310.29	312.29	0.000254	2.11	3559.20	1696.84	0.16
Reach-1	240	PF 1	Rev Hist	3246.00	305.35	312.21	310.04	312.22	0.000183	1.80	4831.35	2367.19	0.13
Reach-1	240	PF 1	Post Proj	3246.00	305.35	312.21	310.04	312.22	0.000183	1.80	4831.35	2367.19	0.13

HEC-RAS River: RIVER-1 Reach: Reach-1 Profile: PF 1 (Continued)

Reach	River Sta	Profile	Plan	Q Total	Min Ch El	W.S. Elev	Crit W.S.	E.G. Elev	E.G. Slope	Vel Chnl	Flow Area	Top Width	Froude # Chl
				(cfs)	(ft)	(ft)	(ft)	(ft)	(ft/ft)	(ft/s)	(sq ft)	(ft)	
Reach-1	235			Bridge									
Reach-1	230	PF 1	Rev Hist	3246.00	304.95	312.19	309.86	312.19	0.000089	0.90	6416.36	2700.00	0.08
Reach-1	230	PF 1	Post Proj	3246.00	304.95	312.19	309.86	312.19	0.000089	0.90	6416.36	2700.00	0.08
Reach-1	222	PF 1	Rev Hist	3246.00	304.45	312.15	309.68	312.16	0.000081	1.33	5747.32	1991.00	0.09
Reach-1	222	PF 1	Post Proj	3246.00	304.45	312.15	309.68	312.16	0.000081	1.33	5747.32	1991.00	0.09
Reach-1	220.2	PF 1	Rev Hist	3246.00	303.95	312.15	308.46	312.15	0.000032	0.62	8053.85	2285.59	0.04
Reach-1	220.2	PF 1	Post Proj	3246.00	303.95	312.15	308.46	312.15	0.000032	0.62	8053.85	2285.59	0.04
Reach-1	220.1			Bridge									
Reach-1	220	PF 1	Rev Hist	3246.00	303.95	312.15	308.46	312.15	0.000033	0.62	8048.69	2285.28	0.04
Reach-1	220	PF 1	Post Proj	3246.00	303.95	312.15	308.46	312.15	0.000033	0.62	8048.69	2285.28	0.04
Reach-1	214	PF 1	Rev Hist	3246.00	304.05	312.15	308.71	312.15	0.000030	0.61	8276.13	2246.50	0.04
Reach-1	214	PF 1	Post Proj	3246.00	304.05	312.15	308.71	312.15	0.000030	0.61	8276.13	2246.50	0.04
Reach-1	212	PF 1	Rev Hist	3246.00	303.75	312.15	308.57	312.15	0.000019	0.63	8221.70	2170.09	0.04
Reach-1	212	PF 1	Post Proj	3246.00	303.75	312.15	308.57	312.15	0.000019	0.63	8221.70	2170.09	0.04
Reach-1	210	PF 1	Rev Hist	3246.00	303.75	312.14	308.25	312.15	0.000015	0.55	8560.99	2065.55	0.03
Reach-1	210	PF 1	Post Proj	3246.00	303.75	312.14	308.25	312.15	0.000015	0.55	8560.99	2065.55	0.03
Reach-1	209			Bridge									
Reach-1	208	PF 1	Rev Hist	3246.00	303.75	312.14	308.25	312.14	0.000015	0.55	8560.67	2065.55	0.03
Reach-1	208	PF 1	Post Proj	3246.00	303.75	312.14	308.25	312.14	0.000015	0.55	8560.67	2065.55	0.03
Reach-1	206	PF 1	Rev Hist	3246.00	302.35	312.14	306.84	312.14	0.000009	0.46	9400.79	1737.37	0.03
Reach-1	206	PF 1	Post Proj	3246.00	302.35	312.14	306.84	312.14	0.000009	0.46	9400.79	1737.37	0.03
Reach-1	204	PF 1	Rev Hist	3246.00	301.65	312.14	305.52	312.14	0.000008	0.52	8623.49	1276.70	0.03
Reach-1	204	PF 1	Post Proj	3246.00	301.65	312.14	305.52	312.14	0.000008	0.52	8623.49	1276.70	0.03
Reach-1	202	PF 1	Rev Hist	3246.00	300.15	312.13	305.25	312.14	0.000011	0.65	6775.85	886.06	0.04
Reach-1	202	PF 1	Post Proj	3246.00	300.15	312.13	305.25	312.14	0.000011	0.65	6775.85	886.06	0.04
Reach-1	200	PF 1	Rev Hist	3246.00	299.75	310.58	306.30	311.77	0.002517	8.78	369.69	34.20	0.47
Reach-1	200	PF 1	Post Proj	3246.00	299.75	310.58	306.30	311.77	0.002517	8.78	369.69	34.20	0.47

HEC-RAS River: RIVER-1 Reach: Reach-1 Profile: PF 1 (Continued)

Reach	River Sta	Profile	Plan	Q Total	Min Ch El	W.S. Elev	Crit W.S.	E.G. Elev	E.G. Slope	Vel Chnl	Flow Area	Top Width	Froude # Chl
				(cfs)	(ft)	(ft)	(ft)	(ft)	(ft/ft)	(ft/s)	(sq ft)	(ft)	
Reach-1	199			Culvert									
Reach-1	198	PF 1	Rev Hist	3246.00	298.95	305.92	305.92	306.51	0.002803	7.88	868.18	573.70	0.53
Reach-1	198	PF 1	Post Proj	3246.00	298.95	305.92	305.92	306.51	0.002803	7.88	868.18	573.70	0.53

Appendix E

Environmental Noise and Vibration Analysis

Environmental Noise & Vibration Analysis

Voices Charter School

Morgan Hill, California

BAC Job # 2019-045

Prepared For:

Raney Planning & Management, Inc.

Attn: Mr. Nick Pappani
1501 Sports Drive, Suite A
Sacramento, CA 95834

Prepared By:

Bollard Acoustical Consultants, Inc.



Paul Bollard, President

May 31, 2019



CEQA Checklist

NOISE AND VIBRATION – Would the Project Result in:	NA – Not Applicable	Potentially Significant Impact	Less than Significant with Mitigation Incorporated	Less Than Significant Impact	No Impact
a) Generation of substantial temporary or permanent increase in ambient noise levels in the vicinity of the project in excess of standards established in the local general plan or noise ordinance, or in other applicable local, state, or federal standards?			X		
b) Generation of excessive groundborne vibration or groundborne noise levels?				X	
c) For a project located within the vicinity of a private airstrip or an airport land use plan or, where such a plan has not been adopted, within two miles of a public airport or public use airport, would the project expose people residing or working in the project area to excessive noise levels?					X

Introduction

The Voices Charter School project proposes the development of a public charter elementary school at the northwest corner of Cosmo Avenue and Monterey Road in Morgan Hill, California. The school will serve approximately 594 students in transitional kindergarten through eighth grade. Existing land uses in the immediate project vicinity consist of multi-family residential, single-family residential, and commercial uses. The project site area and site plan are shown on Figures 1 and 2, respectively.

Due to the proximity of the proposed development to existing residential uses, the City of Morgan Hill has requested an environmental noise and vibration assessment to ensure that the applicable noise standards are satisfied. In response to this request, Raney Planning and Management, Inc. has retained Bollard Acoustical Consultants, Inc. (BAC) to prepare this noise and vibration assessment. Specifically, this assessment focuses on the quantification of off-site traffic noise generation, on-site traffic circulation noise, playground activity noise, special events noise, and project-generated construction noise and vibration levels.

Noise and Vibration Fundamentals

Noise

Noise is often described as unwanted sound. Sound is defined as any pressure variation in air that the human ear can detect. If the pressure variations occur frequently enough (at least 20 times per second), they can be heard and are designated as sound. The number of pressure variations per second is called the frequency of sound and is expressed as cycles per second, or Hertz (Hz). Definitions of acoustical terminology are provided in Appendix A.

Measuring sound directly in terms of pressure would require a very large and awkward range of numbers. To avoid this, the decibel scale was devised. The decibel scale uses the hearing threshold (20 micropascals of pressure) as a point of reference, defined as 0 dB. Other sound pressures are then compared to the reference pressure, and the logarithm is taken to keep the numbers in a practical range. The decibel scale allows a million-fold increase in pressure to be expressed as 120 dB. Another useful aspect of the decibel scale is that changes in decibel levels correspond closely to human perception of relative loudness.

The perceived loudness of sounds is dependent upon many factors, including sound pressure level and frequency content. However, within the usual range of environmental noise levels, perception of loudness is relatively predictable and can be approximated by filtering the frequency response of a sound level meter by means of the standardized A-weighting network. There is a strong correlation between A-weighted sound levels (expressed as dBA) and community response to noise. For this reason, the A-weighted sound level has become the standard tool of environmental noise assessment. All noise levels reported in this section are in terms of A-weighted levels.

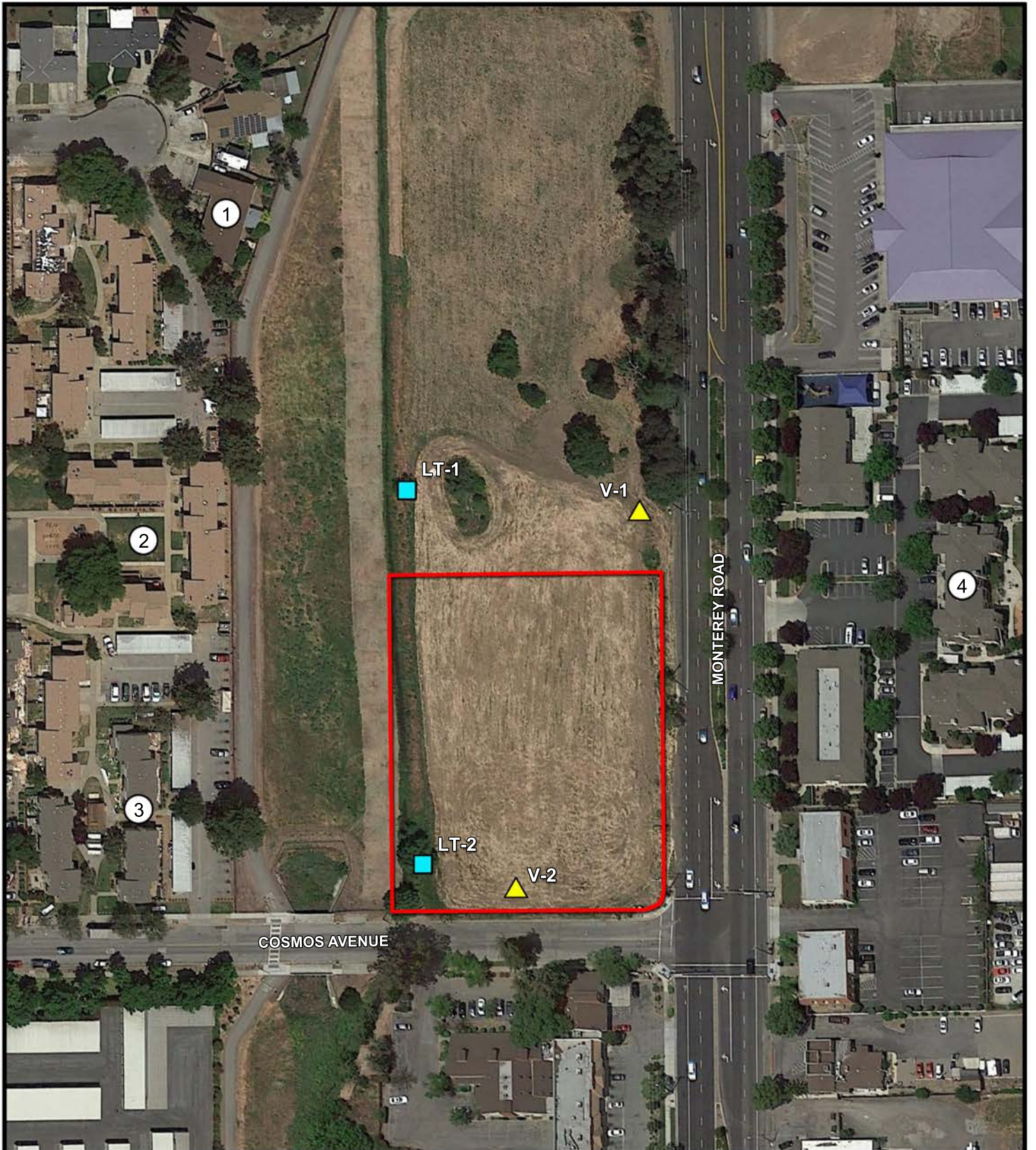

Legend

- Project Boundary (Approximate)
- Ambient Noise Measurement Locations
- ▲ Ambient Vibration Measurement Locations
- Ⓝ Noise-Sensitive Receivers

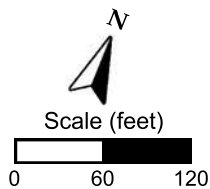

Voices Charter School
Morgan Hill, California

Project Area

Figure 1



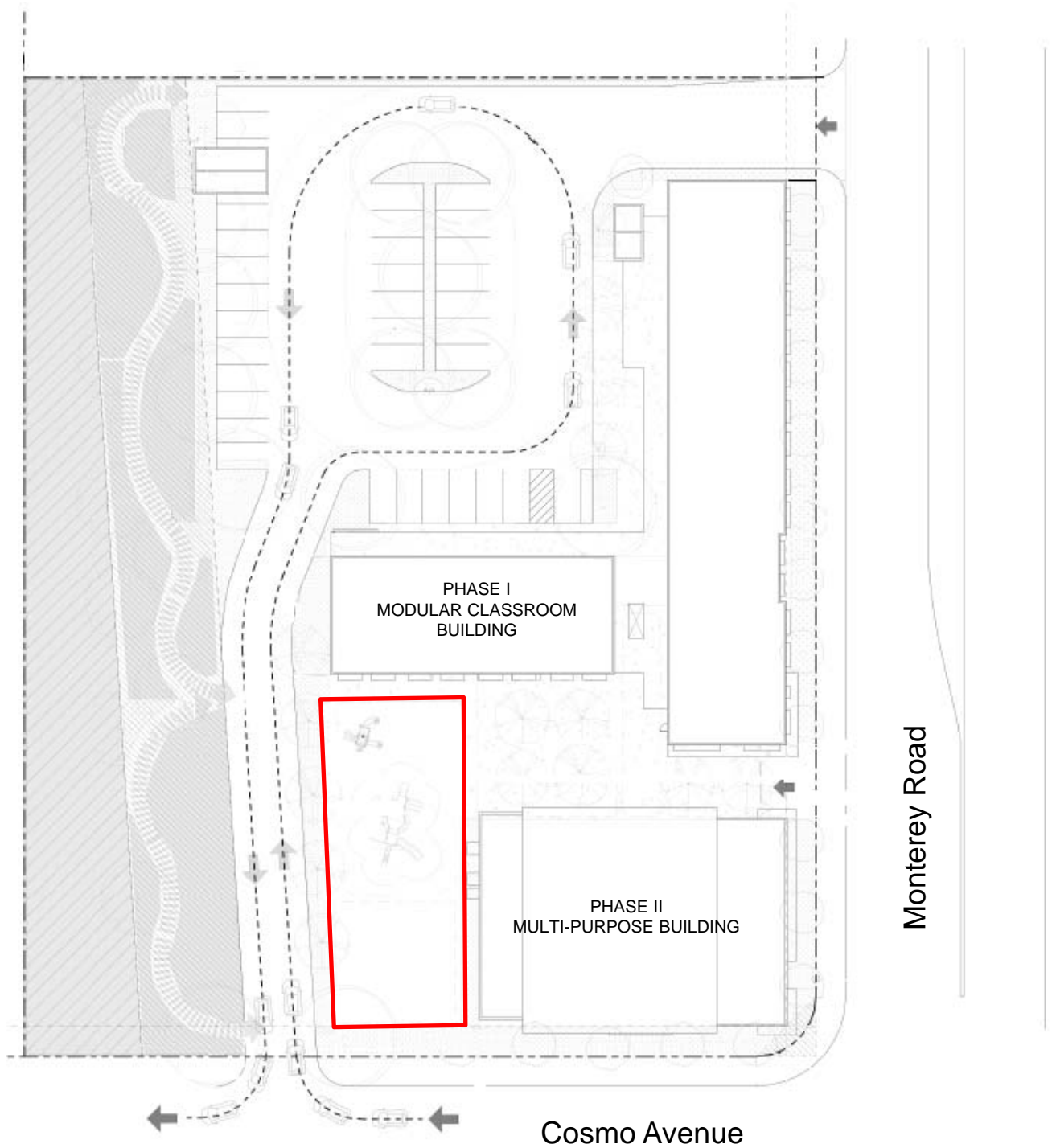

Legend

 Playground Area



Scale (Feet)

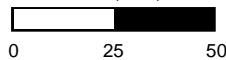

Voices Charter School

Morgan Hill, California

Project Site Plan

Figure 2



Community noise is commonly described in terms of the ambient noise level, which is defined as the all-encompassing noise level associated with a given noise environment. A common statistical tool to measure the ambient noise level is the average, or equivalent, sound level (L_{eq}). The L_{eq} is the foundation of the day/night average noise descriptor, L_{dn} , and shows very good correlation with community response to noise. The day/night average sound level (L_{dn}) is based on the average noise level over a 24-hour day, with a +10 decibel weighting applied to noise occurring during nighttime (10:00 PM to 7:00 AM) hours. The nighttime penalty is based on the assumption that people react to nighttime noise exposures as though they were twice as loud as daytime exposures. Because L_{dn} represents a 24-hour average, it tends to disguise short-term variations in the noise environment. For this reason, the City of Morgan Hill utilizes performance standards for non-transportation noise sources. Specifically, performance standards in terms of instantaneous maximum levels (L_{max}) are used to assess noise generated on the project site.

Vibration

Vibration is like noise in that it involves a source, a transmission path, and a receiver. While vibration is related to noise, it differs in that noise is generally considered to be pressure waves transmitted through air, while vibration is usually associated with transmission through the ground or structures. As with noise, vibration consists of an amplitude and frequency. A person's response to vibration will depend on their individual sensitivity as well as the amplitude and frequency of the source.

Vibration can be described in terms of acceleration, velocity, or displacement. A common practice is to monitor vibration in terms of velocity in inches per second peak particle velocity (IPS, PPV) or root-mean-square (VdB, RMS). Standards pertaining to perception as well as damage to structures have been developed for vibration in terms of peak particle velocity as well as RMS velocities.

As vibrations travel outward from the source, they excite the particles of rock and soil through which they pass and cause them to oscillate. Differences in subsurface geologic conditions and distance from the source of vibration will result in different vibration levels characterized by different frequencies and intensities. In all cases, vibration amplitudes will decrease with increasing distance. The maximum rate, or velocity of particle movement, is the commonly accepted descriptor of the vibration "strength".

Human response to vibration is difficult to quantify. Vibration can be felt or heard well below the levels that produce any damage to structures. The duration of the event has an effect on human response, as does frequency. Generally, as the duration and vibration frequency increase, the potential for adverse human response increases.

According to the Transportation and Construction-Induced Vibration Guidance Manual (Caltrans, June 2004), operation of construction equipment and construction techniques generate ground vibration. Traffic traveling on roadways can also be a source of such vibration. At high enough amplitudes, ground vibration has the potential to damage structures and/or cause cosmetic damage. Ground vibration can also be a source of annoyance to individuals who live or work

close to vibration-generating activities. However, traffic, rarely generates vibration amplitudes high enough to cause structural or cosmetic damage.

**Figure 3
Noise Levels Associated with Common Noise Sources**

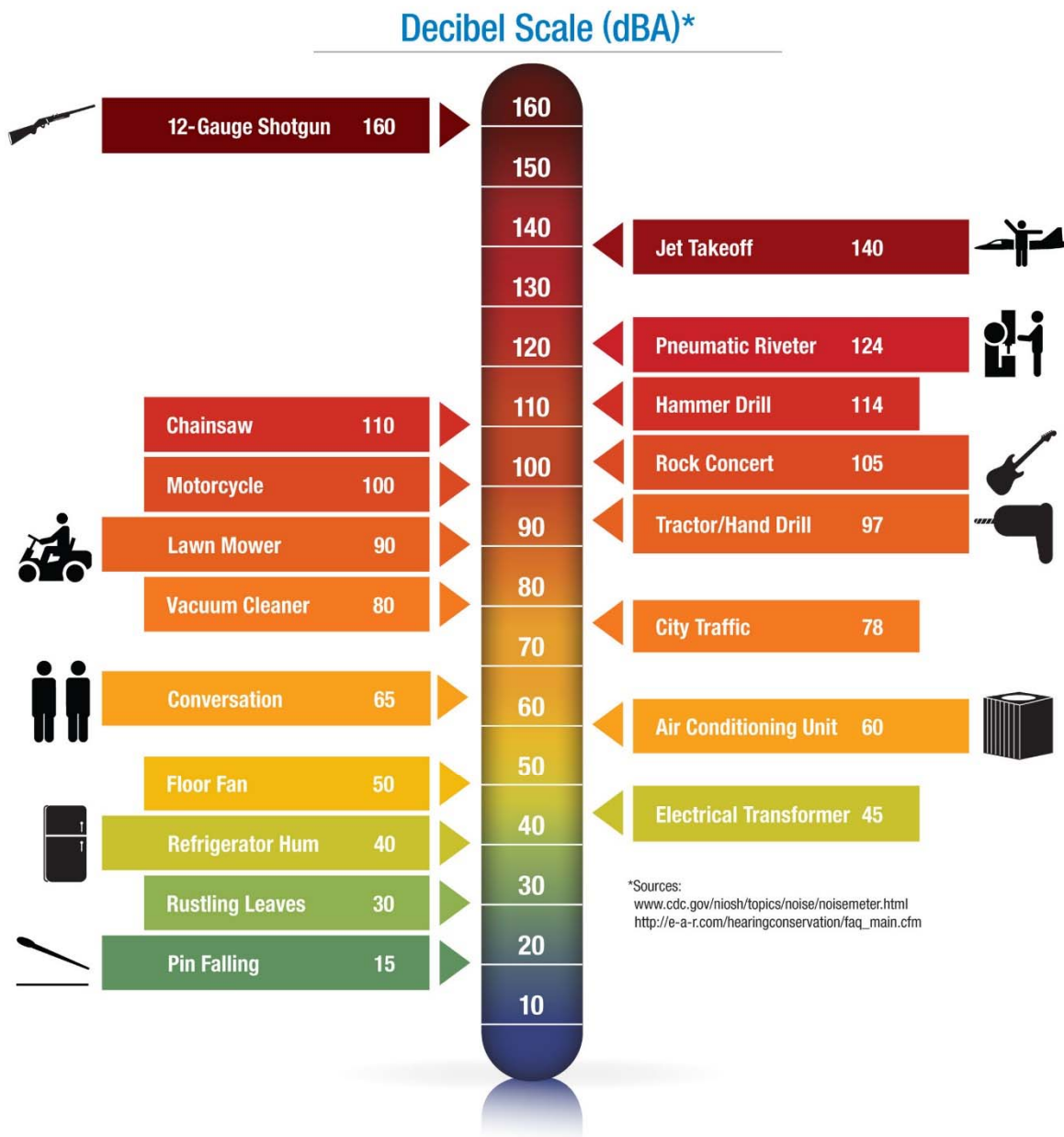

Environmental Setting - Existing Ambient Noise and Vibration Environment

Noise Sensitive Land Uses in the Project Vicinity

Noise-sensitive land uses are generally defined as locations where people reside or where the presence of unwanted sound could adversely affect the primary intended use of the land. Places where people live, sleep, recreate, worship, and study are generally considered to be sensitive to noise because intrusive noise can be disruptive to these activities.

The noise-sensitive land uses which would potentially be affected by the project consist primarily of residential uses. Specifically, the nearest multi-family residential land uses to the project site are identified on Figure 1 as Receivers 2-4. The nearest single-family residential land uses to the project site are identified as Receiver 1 on Figure 1.

Existing Traffic Noise Levels along Project Area Roadway Network

The FHWA Traffic Noise Model (FHWA-RD-77-108) was used to develop existing noise contours expressed in terms of L_{dn} for major roadways within the project study area. The FHWA model predicts hourly L_{eq} values for free-flowing traffic conditions. Estimates of the hourly distribution of traffic for a typical 24-hour period were used to develop L_{dn} values from L_{eq} values.

Traffic data in the form of AM and PM peak hour movements for existing conditions were obtained from Hexagon Transportation Consultants, Inc. (HTC - the project traffic engineers). Average daily traffic volumes were conservatively estimated by applying a factor of 10 to AM peak hour conditions. Using these data and the FHWA model, traffic noise levels were calculated. The traffic noise level at 100 feet from the roadway centerline and distances from the centerlines of selected roadways to the 60 dB, 65 dB, and 70 dB L_{dn} contours are summarized in Table 1.

In many cases, the actual distances to noise level contours may vary from the distances predicted by the FHWA model. Factors such as roadway curvature, roadway grade, shielding from local topography or structures, elevated roadways, or elevated receivers may affect actual sound propagation. The distances reported in Table 1 are considered to be conservative estimates of noise exposure along roadways in the project study area.

It is also recognized that existing sensitive land uses within the project vicinity are located varying distances from the centerlines of the local roadway network. The 100 foot reference distance is utilized in this analysis to provide a reference position at which changes in existing and future traffic noise levels resulting from the project can be evaluated. Appendix B contains the FHWA model inputs for existing conditions.

**Table 1
Existing Traffic Noise Modeling Results**

Segment	Roadway	Segment Description	L _{dn} 100 feet from roadway	Distance to Contour (feet)		
				70 dB L _{dn}	65 dB L _{dn}	60 dB L _{dn}
1	Monterey Road	North of Main Ave	62	31	67	145
2		Main Ave to Dunne Ave	62	30	66	141
3		Dunne Ave to Spring Ave	62	31	67	145
4		Spring Ave to San Pedro Ave	63	32	69	149
5		San Pedro Ave to Cosmo Ave	62	30	64	139
6		Cosmo Ave to Edmundson Ave	62	31	67	144
7		Edmundson Ave to Vineyard Blvd	62	30	65	141
8		Vineyard Blvd to Watsonville Rd	61	27	58	125
9		South of Watsonville Rd	63	34	73	156
10	Butterfield Blvd	North of Main Ave	66	52	112	242
11		Main Ave to Dunne Ave	67	62	133	286
12		Dunne Ave to San Pedro Ave	65	49	106	229
13		San Pedro Ave to Tennant Ave	65	44	95	204
14		South of Tennant Ave	65	48	103	222
15	Del Monte Ave	North of Cosmo Ave	48	3	7	16
16	Dunne Ave	West of Main Ave	60	21	45	98
17		Main Ave to Butterfield Blvd	62	31	68	146
18		Butterfield Blvd to US 101 SB Ramps	64	41	88	189
19	Edmundson Ave	West of Olympic Drive	59	19	40	86
20		Olympic Drive to Monterey Rd	58	17	37	79
21	Tennant Ave	East of Monterey Rd	59	18	39	84
22	Spring Ave	West of Del Monte Ave	52	6	14	30
23		Del Monte Ave to Monterey Rd	53	7	16	34
24	Cosmo Ave	West of Del Monte Ave	48	3	7	15
25		Del Monte Ave to Project Entrance	49	4	9	19
26		Project Entrance to Monterey Rd	51	5	11	24

Source: FHWA-RD-77-108 with inputs from HTC and BAC file data. A complete listing of traffic model inputs is provided in Appendix B.

Existing Ambient Noise Environment in Immediate Project Vicinity

The ambient noise environment in the immediate project vicinity is defined primarily by noise from Cosmos Boulevard and Monterey Road traffic. During evening hours, it was noted that noise generated by insects significantly contributed to the project area noise environment. To generally quantify existing ambient noise levels in the project vicinity, two long-term (24-hour) ambient noise surveys were conducted on February 6, 2019. The long-term measurement sites were selected to be representative of the ambient noise exposure at the nearest potentially affected existing residential land uses to the project site.

Larson Davis Laboratories (LDL) Model 820 precision integrating sound level meters were used for the noise level measurement surveys. The meters were calibrated before use with an LDL Model CA200 acoustical calibrator to ensure the accuracy of the measurements. The equipment used meets all specifications of the American National Standards Institute requirements for Type 1 sound level meters (ANSI S1.4). A summary of the measurement results is provided below in Table 2. Detailed noise level measurement results are contained in Appendices C and D.

**Table 2
Long-Term Ambient Noise Monitoring Results**

Site	Date	L _{dn}	Average Measured Hourly Noise Levels, dB			
			Daytime (7 AM-10 PM)		Nighttime (10 PM-7 AM)	
			L _{eq}	L _{max}	L _{eq}	L _{max}
LT-1	Thursday, March 14, 2019	65	64	64-79	56	57-79
	Friday, March 15, 2019	70	65	64-80	64	64-80
	Saturday, March 16, 2019	70	64	62-81	63	67-77
	Sunday, March 17, 2019	66	61	62-82	60	57-79
LT-2	Thursday, March 14, 2019	76	69	68-88	70	62-81
	Friday, March 15, 2019	79	72	68-83	72	74-83
	Saturday, March 16, 2019	77	70	69-82	70	62-81
	Sunday, March 17, 2019	77	72	69-84	70	61-81

Source: Bollard Acoustical Consultants, Inc. (2019)

The Table 2 data indicate measured day/night average noise levels at LT-1 ranged from 65 dB to 70 dB L_{dn}. At site LT-2, measured day/night average noise levels ranged from 76 dB to 79 dB L_{dn}. However, after close inspection of the collected ambient noise level data (Appendix C), it appears that the measured noise levels were significantly influenced by noise sources present between the 7 PM and 3 AM hours. The elevated noise levels during this time frame are believed to be attributable to insect activity within Llagas Creek to the immediate west of the noise monitoring locations. Because the proposed school would not be operating during the hours during which the increased ambient noise levels were registered, they had no bearing on this study.

Noise generated by project-related on-site activities would occur during normal school hours. According to the project applicant, school hours would be weekdays from 8 AM to 4 PM. To more accurately establish baseline ambient conditions in the project vicinity during this time frame, a more detailed analysis was conducted for the data collected during Thursday, March 14 and Friday, March 15, 2019. The results of that analysis are presented below in Table 3.

**Table 3
Long-Term Ambient Noise Monitoring Results
8 AM to 4PM on Weekdays, March 14-15, 2019**

Site	Measured Hourly Averages, L_{eq} (dB)			Measured Hourly Maximums, L_{max} (dB)		
	Minimum	Maximum	Average	Minimum	Maximum	Average
LT-1	51	56	53	64	78	69
LT-2	52	55	53	68	79	72

Source: Bollard Acoustical Consultants, Inc. (2019)

As indicated in Table 3, measured hourly average noise levels in the project vicinity during the timeframe when school would be typically be in session were 53 dB Hourly L_{eq} at both measurement sites. Measured hourly maximum noise levels ranged from 64 dB to 78 dB at site LT-1 and 68 dB to 79 dB at site LT-2.

Vibration Environment

During the site visit on the morning of March 18, 2019, vibration levels were below the threshold of perception at the project site. Nonetheless, to quantify existing vibration levels at the project site, BAC conducted short-term (5-minute) vibration measurements at the two locations shown on Figure 1.

A Larson-Davis Laboratories Model LxT precision integrating sound level meter equipped with a vibration transducer was used to complete the measurements. The results are summarized in Table 4. The Table 4 data indicate that measured average vibration levels in the project vicinity ranged from 34 VdB to 36 VdB RMS.

**Table 4
Ambient Vibration Monitoring Results – March 18, 2019**

Site	Description	Time of Day	Average Vibration Level, VdB RMS ¹
V-1	Just north project site, 90' from Monterey Road centerline	10:28 AM	34
V-2	South side of project site, 60' from Cosmos Avenue centerline	10:06 AM	36

Source: Bollard Acoustical Consultants, Inc.

1. VdB RMS refers to root-mean-square measurements of vibration velocity, reported in decibels.

The low measured vibration levels reported in Table 4 support BAC staff observations that baseline vibration levels were below the threshold of perception at the project site.

Regulatory Setting: Criteria for Acceptable Noise and Vibration Exposure

Federal

There are no federal noise or vibration criteria which would be directly applicable to this project.

State of California

California Environmental Quality Act (CEQA)

The State of California has established regulatory criteria that are applicable to this assessment. Specifically, Appendix G of the State of California Environmental Quality Act (CEQA) Guidelines are used to assess the potential significance of impacts pursuant to local General Plan policies, Municipal Code standards, or the applicable standards of other agencies. According to Appendix G of the CEQA guidelines, the project would result in a significant noise or vibration impact if the following occur:

- A. Generation of substantial temporary or permanent increase in ambient noise levels in the vicinity of the project in excess of standards established in the local general plan or noise ordinance, or in other applicable local, state, or federal standards?
- B. Generation of excessive groundborne vibration or groundborne noise levels?
- C. For a project located within the vicinity of a private airstrip or an airport land use plan or, where such a plan has not been adopted, within two miles of a public airport or public use airport, would the project expose people residing or working in the project area to excessive noise levels?

It should be noted that audibility is not a test of significance according to CEQA. If this were the case, any project which added any audible amount of noise to the environment would be considered unacceptable according to CEQA. Because every physical process creates noise, the use of audibility alone as significance criteria would be unworkable. CEQA requires a substantial increase in noise levels before noise impacts are identified, not simply an audible change.

Federal Transit Administration (FTA)

The City of Morgan Hill does not currently have adopted standards for groundborne vibration. As a result, vibration impact assessment criteria established by the U.S. Department of Transportation's Federal Transit Administration (FTA) criteria was applied to the project. The FTA vibration impact criteria is based on maximum overall levels for a single event, such as vehicle passbys on roadways and heavy equipment operations. This vibration impact criteria, identified in Table 6-3 of the FTA's Transit Noise and Vibration Impact Assessment Manual (September 2018), has been reproduced in Table 5.

**Table 5
Groundborne Vibration Impact Criteria**

Land Use Category	Groundborne Vibration Impact Levels (VdB re 1 μ inch/sec, RMS)		
	Frequent Events ¹	Occasional Events ²	Infrequent Events ³
Category 1 – Buildings where vibration would interfere with interior operations	65 ⁴	65 ⁴	65 ⁴
Category 2 – Residences and buildings where people normally sleep	72	75	80
Category 3 – Institutional land uses with primarily daytime use	75	78	83
Notes: ¹ “Frequent Events” is defined as more than 70 vibration events of the same source per day. ² “Occasional Events” is defined as between 30 and 70 vibration events of the same source per day. ³ “Infrequent Events” is defined as fewer than 30 vibration events of the same kind per day. ⁴ This criterion limit is based on levels that are acceptable for most moderately sensitive equipment such as optical microscopes. For equipment that is more sensitive, a Detailed Vibration Analysis must be performed. Source: Federal Transit Administration (FTA), Transit Noise and Vibration Impact Assessment Manual (Sep. 2018), Table 6-3			

Local

Morgan Hill General Plan

The City of Morgan Hill General Plan Safety, Services, and Infrastructure Element provides goals and policies to ensure that city residents are not subjected to noise beyond acceptable levels. The General Plan includes land use compatibility guidelines for community noise environments (Table 6). The General Plan noise policies pertaining to various land uses are reproduced below.

Policies

SSI-8.1 Exterior Noise Level Standards. Require new development projects to be designed and constructed to meet acceptable exterior noise level standards (see Table 6), as follows:

- Apply a maximum exterior noise level of 60 dBA L_{dn} in residential areas where outdoor use is a major consideration (e.g., backyards in single-family housing developments and recreation areas in multi-family housing projects). Where the City determines that providing an L_{dn} of 60 dBA or lower cannot be achieved after the application of reasonable and feasible mitigation, an L_{dn} of 65 dBA may be permitted.
- Indoor noise levels should not exceed an L_{dn} of 45 dBA in new residential housing units.

- Noise levels in new residential development exposed to an exterior L_{dn} of 60 dBA or greater should be limited to a maximum instantaneous noise level (e.g., trucks on busy streets, train warning whistles) in bedrooms of 50 dBA. Maximum instantaneous noise levels in all other habitable rooms should not exceed 55 dBA. The maximum outdoor noise level for new residences near the railroad shall be 70 dBA L_{dn} , recognizing that train noise is characterized by relatively few loud events.

SSI-8.2 **Impact Evaluation.** The impact of a proposed development project on existing land uses should be evaluated in terms of the potential for adverse community response based on significant increase in existing noise levels, regardless of compatibility guidelines.

SSI-8.3 **Commercial and Industrial Noise Level Standards.** Evaluate interior noise levels in commercial and industrial structures on a case-by-case basis based on the use of the space.

SSI-8.4 **Office Noise Level Standards.** Interior noise levels in office buildings should be maintained at 45 dBA L_{eq} (hourly average) or less, rather than 45 dB L_{dn} (daily average).

Table 6
State of California Land Use Compatibility Guidelines for Community Noise Environments

Land Uses	CNEL (dBA)					
	55	60	65	70	75	80
Residential – Low Density Single-Family, Duplex, Mobile Homes	Normally Acceptable	Normally Acceptable	Normally Acceptable	Normally Acceptable	Normally Unacceptable	Clearly Unacceptable
Residential – Multiple-Family	Normally Acceptable	Normally Acceptable	Normally Acceptable	Normally Unacceptable	Clearly Unacceptable	Clearly Unacceptable
Transient Lodging, Motels, Hotels	Normally Acceptable	Normally Acceptable	Normally Acceptable	Normally Unacceptable	Clearly Unacceptable	Clearly Unacceptable
Schools, Libraries, Churches, Hospitals, Nursing Homes	Normally Acceptable	Normally Acceptable	Normally Acceptable	Normally Unacceptable	Clearly Unacceptable	Clearly Unacceptable
Auditoriums, Concert Halls, Amphitheaters	Normally Acceptable	Normally Acceptable	Normally Acceptable	Conditionally Acceptable	Clearly Unacceptable	Clearly Unacceptable
Sports Arena, Outdoor Spectator Sports	Normally Acceptable	Normally Acceptable	Normally Acceptable	Conditionally Acceptable	Clearly Unacceptable	Clearly Unacceptable
Playgrounds, Neighborhood Parks	Normally Acceptable	Normally Acceptable	Normally Acceptable	Conditionally Acceptable	Clearly Unacceptable	Clearly Unacceptable
Golf Courses, Riding Stables, Water Recreation, Cemeteries	Normally Acceptable	Normally Acceptable	Normally Acceptable	Normally Acceptable	Normally Acceptable	Clearly Unacceptable
Office Buildings, Businesses, Commercial and Professional	Normally Acceptable	Normally Acceptable	Normally Acceptable	Conditionally Acceptable	Normally Unacceptable	Clearly Unacceptable
Industrial, Manufacturing, Utilities, Agricultural	Normally Acceptable	Normally Acceptable	Normally Acceptable	Conditionally Acceptable	Normally Unacceptable	Clearly Unacceptable

 **Normally Acceptable:**
 Specified land use is satisfactory based upon the assumption that any buildings involved are of normal conventional construction, without any special noise insulation requirements.

 **Normally Unacceptable:**
 New construction or development should generally be discouraged. If new construction does proceed, a detailed analysis of the noise reduction requirements must be made and needed noise insulation features included in the design.

 **Conditionally Acceptable:**
 New construction or development should be undertaken only after a detailed analysis of the noise reduction requirements is made and the needed noise insulation features included in the design. Conventional construction, but with closed windows and fresh air supply systems or air conditioning will normally suffice.

 **Clearly Unacceptable:**
 New construction or development generally should not be undertaken.

Source: Governor's Office of Planning and Research, General Plan Guidelines 2003.

- SSI-8.5 **Traffic Noise Level Standards.** Consider noise level increases resulting from traffic associated with new projects significant if: a) the noise level increase is 5 dBA L_{dn} or greater, with a future noise level of less than 60 dBA L_{dn}, or b) the noise level increase is 3 dBA L_{dn} or greater, with a future noise level of 60 dBA L_{dn} or greater.
- SSI-8.6 **Stationary Noise Level Standards.** Consider noise levels produced by stationary noise sources associated with new projects significant if they substantially exceed existing ambient noise levels.
- SSI-8.7 **Other Noise Sources.** Consider noise levels produced by other noise sources (such as ballfields) significant if an acoustical study demonstrates they would substantially exceed ambient noise levels.
- SSI-8.9 **Site Planning and Design.** Require attention to site planning and design techniques other than sound walls to reduce noise impacts, including: a) installing earth berms, b) increasing the distance between the noise source and the receiver, c) using non-sensitive structures such as parking lots, utility areas, and garages to shield noise-sensitive areas, d) orienting buildings to shield outdoor spaces from the noise source, and e) minimizing the noise at its source.

Technically, the proposed school use is the only use which would be subject to the City's General Plan standards shown in Table 6 because it is the only proposed new use. As a result, the project site would be considered acceptable for school uses provided exterior noise levels do not exceed the 70 dB standard identified in Table 6. However, Policies SS1-8.6 and SSI-8.7 would be applicable to assessing impacts related to the increase in ambient noise levels resulting from the operations at the proposed school at the nearest sensitive receptors.

Morgan Hill Municipal Code

The provisions of the City of Morgan Hill Municipal Code which would be most applicable to this project are reproduced below. The complete text of the municipal code sections pertaining to noise are provided in Appendix E.

Chapter 8.28 of the municipal code provides an enumeration of unlawful noise sources (i.e., animals, birds, auto body repairs, blowers, fans, combustion engines, construction activities, exhausts, loudspeakers). Chapter 8.28 does not, however, provide quantitative performance standards. Section 8.28.040(D) exempts construction noise provided the activities are limited to a specific time frame. Section 8.28.040(D) is reproduced below:

"Construction activities" are defined as including but not limited to excavation, grading, paving, demolition, construction, alteration or repair of any building, site, street or highway, delivery or removal of construction material to a site, or movement of construction materials on a site. Construction activities are prohibited other than between the hours of seven a.m. and eight p.m., Monday through Friday and between the hours of nine a.m. to six p.m. on Saturday. Construction activities may not occur on Sundays or federal holidays. No third person, including but not limited to landowners, construction company

owners, contractors, subcontractors, or employers, shall permit or allow any person working on construction activities which are under their ownership, control or direction to violate this provision.

Section 18.46.090 of the municipal code establishes acceptable noise level criteria for non-transportation noise sources, which would include all sources of noise occurring within the project site such as on-site circulation traffic noise, playground noise, and special events noise. The City’s quantitative exterior noise standards are provided below in Table 7. According to City Staff, the Table 7 standards are interpreted as being hourly average noise level standards (L_{eq}).

**Table 7
Noise Level Performance Standards
City of Morgan Hill Municipal Code**

Receiving Land Use	Maximum Noise Level at Lot Line of Receiving Use ^{1,2}
Industrial and Wholesale	70 dBA
Commercial	65 dBA
Residential or Public/Quasi Public	60 dBA
Notes	
¹ The planning commission may allow an additional 5 dBA noise level at the lot line if the maximum noise level shown above cannot be achieved with reasonable and feasible mitigation. ² Noise standards shown above do not apply to noise generated by vehicle traffic in the public right-of-way or from temporary construction, demolition, and vehicles that enter or leave the site of the noise-generating use (e.g., construction equipment, trains, trucks). Source: City of Morgan Hill Municipal Code	

Impacts and Mitigation Measures

Significance Criteria

The following criteria have been established to quantify the level of significance of an adverse effect to noise and vibration evaluated pursuant to the California Environmental Quality Act Criteria (CEQA). According to the CEQA guidelines, a project would result in significant noise or vibration impacts if the project would result in any of the following:

- A. Generation of substantial temporary or permanent increase in ambient noise levels in the vicinity of the project in excess of standards established in the local general plan or noise ordinance, or in other applicable local, state, or federal standards?

For this project, compliance with the applicable provisions of the General Plan and Municipal Code is required. For increases in off-site traffic noise, General Plan Policy SSI-8.5 considers noise level increases resulting from traffic associated with new projects significant if: a) the noise level increase is 5 dBA L_{dn} or greater, with a future noise level of less than 60 dBA L_{dn} , or b) the noise level increase is 3 dBA L_{dn} or greater, with a future noise level of 60 dBA L_{dn} or greater.

For noise generated by on-site activities, the Municipal Code establishes a maximum noise level standard of 60 dB L_{eq} assessed at the property line of the receiving residential land use. In addition, General Plan Policy SSI-8.6 considers noise levels produced by stationary noise sources associated with new projects significant if they substantially exceed existing ambient noise levels. Because project activities would take place during weekdays from 8 AM to 4 PM, the ambient noise level data presented in Table 3 would serve as the baseline ambient noise level environment in the project vicinity. The General Plan, however, does not provide guidelines for determining a substantial noise increase relative to ambient conditions.

For noise generated by on-site activities and the determination of a substantial noise increase relative to ambient conditions, the following discussion is provided:

CEQA guideline A requires the identification of significant noise impacts if the project would result in substantial permanent or temporary increases in noise. However, the CEQA guidelines do not specify the numeric noise level increase which is considered substantial.

It is generally recognized that an increase of at least 3 dB for similar noise sources is usually required before most people will perceive a change in noise levels, and an increase of 6 dB is required before the change will be clearly noticeable.

The Federal Interagency Commission on Noise (FICON) has developed a graduated scale for use in the assessment of project related noise level increases. Table 8 was developed by FICON as a means of developing thresholds for impact identification for project related noise level increases. The FICON standards have been used extensively in recent years in the preparation of noise sections of Environmental Impact Reports that have been certified in many California Cities and Counties.

The rationale for the graduated scale used in the FICON standards is that test subjects' reactions to increases in noise levels varied depending on the starting level of noise. Specifically, with lower ambient noise environments, such as those below 60 dB L_{dn} , a larger increase in noise levels was required to achieve a negative reaction than was necessary in more elevated noise environments.

The use of the FICON standards are considered conservative relative to thresholds used by other agencies in the State of California. For example, the California Department of Transportation (Caltrans) requires a project related traffic noise level increase of 12 dB for a finding of significance, and the California Energy Commission (CEC) considers project related noise level increases between 5-10 dB significant, depending on local factors. Therefore, the use of the FICON standards, which set the threshold for finding of significant noise impacts as low as 1.5 dB, provides a conservative approach to impact assessment.

Table 8
Significance of Changes in Cumulative Noise Exposure

Ambient Noise Level Without Project, L_{dn}	Increase Required for Significant Impact
<60 dB	+5.0 dB or more
60-65 dB	+3.0 dB or more
>65 dB	+1.5 dB or more
Source: Federal Interagency Committee on Noise (FICON)	

Based on the FICON research, as shown in Table 8, a 5 dB increase in noise levels due to a project is required for a finding of significant noise impact where ambient noise levels without the project are less than 60 dB L_{dn} . Where pre-project ambient conditions are between 60 and 65 dB L_{dn} , a 3 dB increase is applied as the standard of significance. Finally, in areas already exposed to higher noise levels, specifically pre-project noise levels in excess of 65 dB L_{dn} , a 1.5 dB increase is considered by FICON as the threshold of significance.

This graduated scale indicates that in quieter noise environments, test subjects tolerated a higher increase in noise levels due to a project before the onset of adverse noise impacts than did test subjects in louder environments.

According to the FICON study, if screening analysis shows that noise-sensitive areas will be at or above DNL 65 dB and will have an increase of DNL 1.5 or more, further analysis should be conducted. The FICON study also reported the following: Every change in the noise environment does not necessarily impact public health and welfare.

For this project, measured ambient hourly average noise levels in the project vicinity during the timeframe when on-site activities would take place on the project site were 53 dB L_{eq} . Hourly maximum noise levels ranged from 64 dB to 79 dB L_{max} with an overall arithmetic average of 71 dB L_{max} . Therefore, a significant noise impact would be identified if predicted hourly average or maximum noise levels due to the project would exceed 58 dB L_{eq} or 76 dB L_{max} , respectively (i.e. 5 dB above ambient).

B. Generation of excessive groundborne vibration or groundborne noise levels?

The existing ambient vibration environment in the project vicinity was evaluated as being imperceptible. In addition, the project does not propose the introduction of any perceptible vibration sources. However, due to the potential for elevated vibration levels during typical construction activities, a construction vibration analysis would be warranted. Vibration levels due to construction activities were assessed relative to the FTA Groundborne Vibration Impact Criteria provided in Table 5.

C. For a project located within the vicinity of a private airstrip or an airport land use plan or, where such a plan has not been adopted, within two miles of a public airport or public use airport, would the project expose people residing or working in the project area to excessive noise levels?

Because the project site is not located within 2 miles of a public use airport or in the vicinity of private airstrips, consideration of noise impacts relative to CEQA criteria C would not be warranted for this evaluation.

Analysis Methodology

Noise impacts are identified if the proposed project would result in a substantial increase in off-site traffic noise levels, or if noise generated by on-site activities would either exceed the applicable City noise standards or result in a substantial increase in ambient noise levels. Vibration impacts are identified if project-related construction activities would result in an exceedance of the FTA Table 5 criteria.

Off-Site Traffic Noise Impacts

Impact 1: Project-Related Changes in Off-Site Traffic Noise Levels

To assess noise impacts due to project-related traffic increases on the local roadway network, traffic noise levels are predicted at a representative distance for both existing and future (Year 2025 cumulative), project and no-project condition. Noise impacts are identified at existing noise-sensitive areas if the noise level increases which result from the project exceed the significance thresholds established in General Plan policy SSI-8.5.

To describe existing and projected noise levels due to traffic, the Federal Highway Administration Highway Traffic Noise Prediction Model (FHWA RD-77-108) was used. The model is based upon the Calveno reference noise factors for automobiles, medium trucks and heavy trucks, with consideration given to vehicle volume, speed, roadway configuration, distance to the receiver, and the acoustical characteristics of the site. The FHWA model was developed to predict hourly Leq values for free-flowing traffic conditions. To predict traffic noise levels in terms of L_{dn} , it is necessary to adjust the input volume to account for the day/night distribution of traffic.

Traffic volumes for the existing, project and no-project conditions, were obtained from the Hexagon Transportation Consultants, Inc. traffic study. It is important to note that the traffic study considered three (3) site access alternatives. However, because the traffic distribution into the local roadway network for the varying site access alternatives was determined to not vary significantly, the results of Alternative 1 are utilized in this report. Table 9 shows the predicted changes in existing traffic noise levels resulting from the project. The Table 9 data are provided in terms of L_{dn} at a standard distance of 100 feet from the centerlines of the project-area roadways. Appendix D contains the FHWA model inputs for both existing and cumulative conditions.

**Table 9
Traffic Noise Modeling Results and Project-Related Traffic Noise Increases
Existing Conditions**

Segment	Roadway	Segment Description	Traffic Noise Level at 100 feet, dB L _{dn}			Substantial Increase?
			Existing	Existing + Project	Increase	
1	Monterey Road	North of Main Ave	62.4	62.5	0.1	No
2		Main Ave to Dunne Ave	62.2	62.3	0.1	No
3		Dunne Ave to Spring Ave	62.4	62.6	0.2	No
4		Spring Ave to San Pedro Ave	62.6	62.8	0.2	No
5		San Pedro Ave to Cosmo Ave	62.1	62.3	0.2	No
6		Cosmo Ave to Edmundson Ave	62.4	62.5	0.1	No
7		Edmundson Ave to Vineyard Blvd	62.2	62.3	0.1	No
8		Vineyard Blvd to Watsonville Rd	61.5	61.5	0.0	No
9		South of Watsonville Rd	62.9	62.9	0.0	No
10	Butterfield Blvd	North of Main Ave	65.8	65.8	0.0	No
11		Main Ave to Dunne Ave	66.8	66.8	0.0	No
12		Dunne Ave to San Pedro Ave	65.4	65.4	0.0	No
13		San Pedro Ave to Tennant Ave	64.6	64.6	0.0	No
14		South of Tennant Ave	65.2	65.2	0.0	No
15	Del Monte Ave	North of Cosmo Ave	48.1	48.2	0.1	No
16	Dunne Ave	West of Main Ave	59.9	59.9	0.0	No
17		Main Ave to Butterfield Blvd	62.4	62.6	0.2	No
18		Butterfield Blvd to US 101 SB Ramps	64.1	64.2	0.1	No
19	Edmundson Ave	West of Olympic Drive	59.0	59.1	0.1	No
20		Olympic Drive to Monterey Rd	58.5	58.5	0.0	No
21	Tennant Ave	East of Monterey Rd	58.9	58.9	0.0	No
22	Spring Ave	West of Del Monte Ave	52.1	52.1	0.0	No
23		Del Monte Ave to Monterey Rd	53.0	53.1	0.1	No
24	Cosmo Ave	West of Del Monte Ave	47.6	47.6	0.0	No
25		Del Monte Ave to Project Entrance	49.2	49.3	0.1	No
26		Project Entrance to Monterey Rd	50.7	53.2	2.5	No

Source: FHWA-RD-77-108 with inputs from HTC and BAC file data. A complete listing of traffic model inputs is provided in Appendix B.

The data in Table 9 indicate that traffic generated by the project would result in traffic noise level increases ranging from 0.0 to 2.5 dB L_{dn}. Relative to the significance criteria identified in General Plan Policy SSI-8.5, these increases would not be considered substantial. As a result, off-site traffic noise impacts related to increases in traffic resulting from the implementation of the project are identified as being **less than significant**.

Noise Impacts Associated with On-Site Circulation

Impact 2: Noise Generated by On-Site Circulation

The FHWA Model, discussed in previous sections of this report, was utilized to determine the on-site circulation traffic noise generated by the project upon the existing noise-sensitive residential land uses nearest to the project site. The drop off queue study conducted for the project indicates access to the project site would occur at Cosmo Avenue. According to the traffic study completed for the project by Hexagon Transportation Consultants, Inc., the project is expected to generate 265 vehicle passbys on the proposed circulation route during the AM peak hour.

The nearest existing noise-sensitive residential land uses to the circulation route are apartments located approximately 200 feet to the west. Conservatively assuming a vehicle speed of 25 mph, 265 vehicle passbys during a worst-case hour (AM peak hour), and a distance of 200 feet from the centerline of the circulation route, the FHWA Model predicts an hourly average traffic noise level of 44 dB L_{eq} at the property line of the nearest existing residences to the west. Predicted maximum noise levels due to on-site circulation are conservatively estimated to be 10 dB higher than predicted hourly average noise levels (54 dB L_{max}).

Predicted average noise levels due to on-site circulation are expected to be in compliance with the City of Morgan Hill Municipal Code noise level standard of 60 dB L_{eq} . Furthermore, predicted hourly average noise levels due to on-site circulation are well below measured ambient hourly average noise levels in the project vicinity. As a result, on-site circulation noise impacts due to the project are identified as being *less than significant*.

Noise Impacts Associated with Playground Activity

Impact 3: Noise Generated by Playground Activity

As indicated in Figure 2, the project proposes a playground area in the southwestern area of the project site. According to the bell schedule provided by the project applicant, the morning recess will occur from approximately 9:25 AM to 10:15 AM. The tentative recess schedule for the various grades is as follows:

- 9:25 AM - 9:40 AM: Third Grade – 56 Students
- 9:45 AM -10:00 AM: First Grade, Fourth Grade, Fifth Grade – 168 Students
- 10:00-10:15: TK/Kinder, Second Grade – 112 Students

To quantify the noise emissions of elementary school children playing outside during recess, BAC utilized reference noise level data collected at Woodland Christian School site located at 1616 West Street in the City of Woodland on October 29, 2013. The results of the playground noise level measurements indicate that a group of approximately 100 children spread out over the various playground locations generated average and maximum noise levels of approximately 60 dB L_{eq} and 75 dB L_{max} at the distance of approximately 100 feet from the effective noise center of the playground activities. The data applicable to 100 students was extrapolated to the worst-

case proposed condition of 168 students playing outside at the proposed voices charter school using standard acoustical algorithms. Table 10 below provides predicted playground noise levels at the nearest noise-sensitive receiver locations.

**Table 10
Predicted Playground Noise Levels at Nearest Residential Receivers**

Receiver	Land Use	Distance to Playground Area (feet)	Predicted Playground Noise Levels (dB) ^{1,2}	
			Hourly Average, Leq	Hourly Maximum, Lmax
1	Single-Family Residential	600	47	59
2	Multi-Family Residential	300	53	65
3	Multi-Family Residential	250	54	67
4	Multi-Family Residential	500	38	51

Notes:

¹ Predicted noise levels based on BAC file data for playground generated noise, 62 dB Leq and 75 dB Lmax at a reference distance of 100 feet from the approximate center of activity.

² An offset of -10 dB was applied to predicted noise levels at receiver 4 to account for the screening provided by intervening buildings.

For noise generated by on-site activities, the Municipal Code establishes a noise level standard of 60 dB Leq assessed at the property line of the receiving residential land use. As indicated above in Table 10, playground activity noise levels at the nearest residential receivers are predicted to be 54 dB Leq or less. In addition, predicted hourly average and maximum noise levels due to playground activity at all the nearest residential receivers would be below measured ambient noise levels in the project vicinity. As discussed previously, a noise impact relative to ambient conditions would be identified if project-related noise levels exceed hourly average and hourly maximum noise levels of 58 dB Leq and 76 dB Lmax. Because the predicted noise levels shown in Table 10 would be well below those criteria, the project would not result in a significant noise increase in the community. In addition, the duration of the day during which playground activities are proposed is limited. As a result, noise impacts associated with playground activities are identified as being **less than significant**.

Noise Impacts Associated with Special Events

Impact 4: Noise Generated by Special Events

According to the project applicant, the school proposes to host various special events each year. Examples of potential special events include, Winter Celebration, Kermes, Kinder Graduation, parent workshops, and parent fundraisers. Of these special events, the highest noise generation would likely be due to Kermes related activities. The Kermes events typically take place once or twice per year, on Thursday or Friday afternoons for a 2-hour block ranging anywhere from 2 PM to 6 PM. The event is held outdoors on the project site and includes carnival games such as bean bag toss, ring toss, etc. Anywhere between 75-150 adults and children are reported to attend the Kermes events.

To quantify the noise emissions of the Kermes events, BAC utilized reference noise level data for special events in combination with published sound level data for persons conversing at various

levels (*Handbook of Acoustical Measurements and Noise Control, Harris, McGraw Hill, 1998*). Those data indicate that for a gathering of 200 people, the typical noise level at a reference distance of 50 feet from the effective noise center would be approximately 70 dB Hourly L_{eq} . Table 11 below provides predicted special event noise levels at the nearest noise-sensitive receiver locations.

**Table 11
Predicted Special Event Noise Levels at Nearest Residential Receivers**

Receiver	Land Use	Distance to Special Event Area (feet)	Predicted Special Event Noise Levels (dB) ^{1,2}	
			Hourly Average, L_{eq}	Hourly Maximum, L_{max}
1	Single-Family Residential	600	48	58
2	Multi-Family Residential	300	54	64
3	Multi-Family Residential	250	56	66
4	Multi-Family Residential	500	40	50

Notes:

¹ Predicted noise levels based on BAC file data for special event noise, 70 dB L_{eq} and 80 dB L_{max} at a reference distance of 50 feet from the approximate center of activity.

² An offset of -10 dB was applied to predicted noise levels at receiver 4 to account for the screening provided by intervening buildings.

For noise generated by on-site activities, the Municipal Code establishes an average noise level standard of 60 dB L_{eq} assessed at the property line of the receiving residential land use. As indicated above in Table 11, average special event noise levels at the nearest residential receivers are predicted to be 56 dB L_{eq} or less. In addition, predicted hourly average and maximum noise levels due to special event activities at all the nearest residential receivers would be below measured ambient noise levels in the project vicinity. As discussed previously, a noise impact relative to ambient conditions would be identified if project-related noise levels exceed hourly average and hourly maximum noise levels of 58 dB L_{eq} and 76 dB L_{max} . Because the predicted noise levels shown in Table 11 would be well below those criteria, the project would not result in a significant noise increase in the community. As a result, noise impacts associated with special event activities are identified as being **less than significant**.

Noise Impacts Associated with Construction Activities

Impact 5: Noise Generated by Construction Activities

During the construction phases of the proposed project, noise from construction activities would add to the noise environment in the immediate project vicinity. Activities involved in typical construction would generate maximum noise levels, as indicated in Table 12, ranging from 55 to 90 dB at a distance of 50 feet.

**Table 12
Typical Construction Equipment Noise**

Equipment Description	Maximum Noise Level at 50 feet, dBA
Auger drill rig	85
Backhoe	80
Bar bender	80
Boring jack power unit	80
Chain saw	85
Compactor (ground)	80
Compressor (air)	80
Concrete batch plant	83
Concrete mixer truck	85
Concrete pump truck	82
Concrete saw	90
Crane (mobile or stationary)	85
Dozer	85
Dump truck	84
Excavator	85
Flatbed truck	84
Front end loader	80
Generator (25 kilovolt-amperes [kVA] or less)	70
Generator (more than 25 kVA)	82
Grader	85
Hydra break ram	90
Jackhammer	85
Mounted impact hammer (hoe ram)	90
Paver	85
Pickup truck	55
Pneumatic tools	85
Pumps	77
Rock drill	85
Scraper	85
Soil mix drill rig	80
Tractor	84
Vacuum street sweeper	80
Vibratory concrete mixer	80

Source: Federal Highway Administration 2006

The proposed project buildings are located approximately 230 feet from the nearest residential property lines to the west. At this distance, maximum noise levels would be expected to be approximately 42 dB to 77 dB L_{max}. Noise levels in this range would fall within the range of measured maximum noise levels in the project vicinity. The predicted noise levels, however, would exceed the Municipal Code noise level standard of 60 dB L_{max}. As noted in the Regulatory Setting section of this report, Section 8.28.040(D) exempts construction noise provided the activities do not occur during set hours. Construction activities are prohibited other than between the hours of seven a.m. and eight p.m., Monday through Friday and between the hours of nine a.m. to six p.m. on Saturday. Construction activities may not occur on Sundays or federal holidays. Provided project construction activities do not occur during these hours, construction activities would be exempt and this impact would be considered less than significant.

However, if construction activities are proposed during the hours not exempted by Municipal Code Section 8.28.040(D), noise levels generated by construction activities would likely exceed the Municipal Code noise level standard of 60 dB L_{max} at the nearest residences. As a result, noise impacts associated with construction activities are identified as being **potentially significant**.

Mitigation for Impact 5: Construction Noise Control Measures

MM-5: To the maximum extent practical, the following measures should be incorporated into the project construction operations:

- Noise-generating construction activities shall not occur within the hours identified in Municipal Code Section 8.28.040(D).
- All noise-producing project equipment and vehicles using internal-combustion engines shall be equipped with manufacturers-recommended mufflers and be maintained in good working condition.
- All mobile or fixed noise-producing equipment used on the project site that are regulated for noise output by a federal, state, or local agency shall comply with such regulations while in the course of project activity.
- Electrically powered equipment shall be used instead of pneumatic or internal-combustion-powered equipment, where feasible.
- Material stockpiles and mobile equipment staging, parking, and maintenance areas shall be located as far as practicable from noise-sensitive receptors.
- Project area and site access road speed limits shall be established and enforced during the construction period.
- Nearby residences shall be notified of construction schedules so that arrangements can be made, if desired, to limit their exposure to short-term increases in ambient noise levels.

Significance of Impact 5 following Mitigation: *Less than Significant*

Vibration Impacts Associated with Construction Activities

Impact 6: Vibration Generated by Construction Activities

During project construction heavy equipment would be used for grading excavation, paving, and building construction, which would generate localized vibration in the immediate vicinity of the construction. As mentioned previously, the nearest residences are located approximately 230 feet from construction activities which would occur on the project site.

The range of vibration source levels for construction equipment commonly used in similar projects are shown in Table 13. The vibration levels depicted in Table 13 are representative of measurements at a distance of 25 feet from the equipment source.

Table 13
Vibration Source Levels for Construction Equipment

Equipment	Approximate RMS L _v ¹ at 25 feet
Vibratory roller	94
Large bulldozer	87
Loaded trucks	86
Jackhammer	79
Small bulldozer	58
Notes:	
¹ RMS velocity in decibels (VdB) re 1 micro-inch/second	
Source: Federal Transit Administration, Transit Noise and Vibration Impact Assessment Manual (2018)	

Because vibration levels generated by the type of construction equipment which will be required for this project dissipates very rapidly with distance, vibration levels at the nearest residences are expected to be below 70 VdB over the course of project construction activities. Construction-generated vibration levels of less than the 70 VdB RMS at nearby existing receptors would satisfy the strictest Federal Transportation Authority (FTA) groundborne vibration impact criteria of 72 VdB shown in Table 5 (regardless of number of vibration events from a source). Therefore, project construction would not result in the exposure of persons to excessive groundborne vibration levels.

As indicated in Table 4, the measured average vibration levels at the project site were well below the strictest FTA groundborne vibration impact criteria (ranged from 34-36 VdB RMS). Therefore, the project would not result in the exposure of persons to excessive groundborne vibration levels at the project site.

It is our understanding that the development is not proposing equipment that would generate significant vibration levels. Therefore, it is not expected that the proposed uses of the development will experience excessive groundborne vibration.

Because vibration levels due to and upon the proposed project will satisfy the applicable FTA groundborne impact vibration criteria, this impact is considered to be ***less than significant***.

Impact 7: Cumulative Changes in Traffic Noise Levels

Table 14 shows the predicted changes in future (cumulative) traffic noise levels resulting from the project. Traffic volumes for the cumulative conditions were obtained from Hexagon Transportation Consultants, Inc. The Table 14 data indicate that traffic generated by the project would result in traffic noise level increases ranging from 0.0 to 2.5 dB L_{dn}. Relative to the significance criteria identified in General Plan Policy SSI-8.5, these increases would not be considered substantial. As a result, the project's cumulative contribution to off-site traffic noise levels would be ***less than significant***.

**Table 14
Traffic Noise Modeling Results and Project-Related Traffic Noise Increases
Year 2025 Cumulative Conditions**

Segment	Roadway	Segment Description	Traffic Noise Level at 100 feet, dB L _{dn}			Substantial Increase?
			2025	2025 + Project	Increase	
1	Monterey Road	North of Main Ave	64.2	64.3	0.1	No
2		Main Ave to Dunne Ave	62.6	62.7	0.1	No
3		Dunne Ave to Spring Ave	63.1	63.3	0.2	No
4		Spring Ave to San Pedro Ave	63.4	63.5	0.1	No
5		San Pedro Ave to Cosmo Ave	62.9	63.1	0.2	No
6		Cosmo Ave to Edmundson Ave	63.1	63.1	0.0	No
7		Edmundson Ave to Vineyard Blvd	63.0	63.0	0.0	No
8		Vineyard Blvd to Watsonville Rd	62.4	62.5	0.1	No
9		South of Watsonville Rd	63.6	63.7	0.1	No
10	Butterfield Blvd	North of Main Ave	66.6	66.6	0.0	No
11		Main Ave to Dunne Ave	67.4	67.5	0.1	No
12		Dunne Ave to San Pedro Ave	65.9	65.9	0.0	No
13		San Pedro Ave to Tennant Ave	65.1	65.1	0.0	No
14		South of Tennant Ave	66.2	66.2	0.0	No
15	Del Monte Ave	North of Cosmo Ave	48.4	48.5	0.1	No
16	Dunne Ave	West of Main Ave	60.8	60.8	0.0	No
17		Main Ave to Butterfield Blvd	63.0	63.1	0.1	No
18		Butterfield Blvd to US 101 SB Ramps	64.4	64.5	0.1	No
19	Edmundson Ave	West of Olympic Drive	60.5	60.5	0.0	No
20		Olympic Drive to Monterey Rd	59.4	59.4	0.0	No
21	Tennant Ave	East of Monterey Rd	59.4	59.5	0.1	No
22	Spring Ave	West of Del Monte Ave	52.9	53.0	0.1	No
23		Del Monte Ave to Monterey Rd	53.1	53.2	0.1	No
24	Cosmo Ave	West of Del Monte Ave	48.0	48.0	0.0	No
25		Del Monte Ave to Project Entrance	49.2	49.3	0.1	No
26		Project Entrance to Monterey Rd	50.7	53.2	2.5	No
Source: FHWA-RD-77-108 with inputs from HTC and BAC file data. A complete listing of traffic model inputs is provided in Appendix B.						

This concludes BAC's noise and vibration assessment of the Voices Charter School project. Please contact BAC at (916) 663-0500 or Paulb@bacnoise.com if you have any comments or questions regarding this report.

Appendix A Acoustical Terminology

Acoustics	The science of sound.
Ambient Noise	The distinctive acoustical characteristics of a given space consisting of all noise sources audible at that location. In many cases, the term ambient is used to describe an existing or pre-project condition such as the setting in an environmental noise study.
Attenuation	The reduction of an acoustic signal.
A-Weighting	A frequency-response adjustment of a sound level meter that conditions the output signal to approximate human response.
Decibel or dB	Fundamental unit of sound, A Bell is defined as the logarithm of the ratio of the sound pressure squared over the reference pressure squared. A Decibel is one-tenth of a Bell.
CNEL	Community Noise Equivalent Level. Defined as the 24-hour average noise level with noise occurring during evening hours (7 - 10 p.m.) weighted by a factor of three and nighttime hours weighted by a factor of 10 prior to averaging.
Frequency	The measure of the rapidity of alterations of a periodic signal, expressed in cycles per second or hertz.
L_{dn}	Day/Night Average Sound Level. Similar to CNEL but with no evening weighting.
Leq	Equivalent or energy-averaged sound level.
L_{max}	The highest root-mean-square (RMS) sound level measured over a given period of time.
Loudness	A subjective term for the sensation of the magnitude of sound.
Masking	The amount (or the process) by which the threshold of audibility is for one sound is raised by the presence of another (masking) sound.
Noise	Unwanted sound.
Peak Noise	The level corresponding to the highest (not RMS) sound pressure measured over a given period of time. This term is often confused with the Maximum level, which is the highest RMS level.
RT₆₀	The time it takes reverberant sound to decay by 60 dB once the source has been removed.
Sabin	The unit of sound absorption. One square foot of material absorbing 100% of incident sound has an absorption of 1 sabin.
SEL	A rating, in decibels, of a discrete event, such as an aircraft flyover or train passby, that compresses the total sound energy of the event into a 1-s time period.
Threshold of Hearing	The lowest sound that can be perceived by the human auditory system, generally considered to be 0 dB for persons with perfect hearing.
Threshold of Pain	Approximately 120 dB above the threshold of hearing.

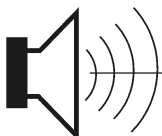

B O L L A R D

Acoustical Consultants

Appendix B-1
FHWA-RD-77-108 Highway Traffic Noise Prediction Model
Data Input Sheet

Project #: 2019-045 Voices Charter School - Morgan Hill
Description: Existing
Ldn/CNEL: Ldn
Hard/Soft: Soft

Segment	Roadway Name	Segment Description	ADT	Day %	Eve %	Night %	% Med. Trucks	% Hvy. Trucks	Speed	Distance	Offset (dB)
1	Monterey Road	North of Main Ave	14,260	80		20	2	1	35	100	
2		Main Ave to Dunne Ave	13,680	80		20	2	1	35	100	
3		Dunne Ave to Spring Ave	14,290	80		20	2	1	35	100	
4		Spring Ave to San Pedro Ave	14,800	80		20	2	1	35	100	
5		San Pedro Ave to Cosmo Ave	13,300	80		20	2	1	35	100	
6		Cosmo Ave to Edmundson Ave	14,120	80		20	2	1	35	100	
7		Edmundson Ave to Vineyard Blvd	13,580	80		20	2	1	35	100	
8		Vineyard Blvd to Watsonville Rd	11,450	80		20	2	1	35	100	
9		South of Watsonville Rd	15,940	80		20	2	1	35	100	
10	Butterfield Blvd	North of Main Ave	16,890	80		20	2	1	45	100	
11		Main Ave to Dunne Ave	21,650	80		20	2	1	45	100	
12		Dunne Ave to San Pedro Ave	15,550	80		20	2	1	45	100	
13		San Pedro Ave to Tennant Ave	13,030	80		20	2	1	45	100	
14	South of Tennant Ave	14,790	80		20	2	1	45	100		
15	Del Monte Ave	North of Cosmo Ave	970	80		20	2	1	25	100	
16	Dunne Ave	West of Main Ave	7,880	80		20	2	1	35	100	
17		Main Ave to Butterfield Blvd	10,480	80		20	2	1	40	100	
18		Butterfield Blvd to US 101 SB Ramps	15,440	80		20	2	1	40	100	
19	Edmundson Ave	West of Olympic Drive	3,580	80		20	2	1	45	100	
20		Olympic Drive to Monterey Rd	5,740	80		20	2	1	35	100	
21	Tennant Ave	East of Monterey Rd	6,260	80		20	2	1	35	100	
22	Spring Ave	West of Del Monte Ave	1,680	80		20	2	1	30	100	
23		Del Monte Ave to Monterey Rd	2,100	80		20	2	1	30	100	
24	Cosmo Ave	West of Del Monte Ave	600	80		20	2	1	30	100	
25		Del Monte Ave to Project Entrance	860	80		20	2	1	30	100	
26		Project Entrance to Monterey Rd	1,220	80		20	2	1	30	100	

Appendix B-2

FHWA-RD-77-108 Highway Traffic Noise Prediction Model

Data Input Sheet

Project #: 2019-045 Voices Charter School - Morgan Hill

Description: Existing Plus Project

Ldn/CNEL: Ldn

Hard/Soft: Soft

Segment	Roadway Name	Segment Description	ADT	Day %	Eve %	Night %	% Med. Trucks	% Hvy. Trucks	Speed	Distance	Offset (dB)
1	Monterey Road	North of Main Ave	14,427	80		20	2	1	35	100	
2		Main Ave to Dunne Ave	13,935	80		20	2	1	35	100	
3		Dunne Ave to Spring Ave	14,929	80		20	2	1	35	100	
4		Spring Ave to San Pedro Ave	15,452	80		20	2	1	35	100	
5		San Pedro Ave to Cosmo Ave	13,970	80		20	2	1	35	100	
6		Cosmo Ave to Edmundson Ave	14,375	80		20	2	1	35	100	
7		Edmundson Ave to Vineyard Blvd	13,729	80		20	2	1	35	100	
8		Vineyard Blvd to Watsonville Rd	11,562	80		20	2	1	35	100	
9		South of Watsonville Rd	16,019	80		20	2	1	35	100	
10	Butterfield Blvd	North of Main Ave	16,965	80		20	2	1	45	100	
11		Main Ave to Dunne Ave	21,687	80		20	2	1	45	100	
12		Dunne Ave to San Pedro Ave	15,550	80		20	2	1	45	100	
13		San Pedro Ave to Tennant Ave	13,030	80		20	2	1	45	100	
14	South of Tennant Ave	14,790	80		20	2	1	45	100		
15	Del Monte Ave	North of Cosmo Ave	989	80		20	2	1	25	100	
16	Dunne Ave	West of Main Ave	7,932	80		20	2	1	35	100	
17		Main Ave to Butterfield Blvd	10,814	80		20	2	1	40	100	
18		Butterfield Blvd to US 101 SB Ramps	15,737	80		20	2	1	40	100	
19	Edmundson Ave	West of Olympic Drive	3,614	80		20	2	1	45	100	
20		Olympic Drive to Monterey Rd	5,768	80		20	2	1	35	100	
21	Tennant Ave	East of Monterey Rd	6,338	80		20	2	1	35	100	
22	Spring Ave	West of Del Monte Ave	1,698	80		20	2	1	30	100	
23		Del Monte Ave to Monterey Rd	2,113	80		20	2	1	30	100	
24	Cosmo Ave	West of Del Monte Ave	606	80		20	2	1	30	100	
25		Del Monte Ave to Project Entrance	886	80		20	2	1	30	100	
26		Project Entrance to Monterey Rd	2,156	80		20	2	1	30	100	

Appendix B-3

FHWA-RD-77-108 Highway Traffic Noise Prediction Model

Data Input Sheet

Project #: 2019-045 Voices Charter School - Morgan Hill

Description: Year 2025 Cumulative

Ldn/CNEL: Ldn

Hard/Soft: Soft

Segment	Roadway Name	Segment Description	ADT	Day %	Eve %	Night %	% Med. Trucks	% Hvy. Trucks	Speed	Distance	Offset (dB)
1	Monterey Road	North of Main Ave	21,600	80		20	2	1	35	100	
2		Main Ave to Dunne Ave	14,940	80		20	2	1	35	100	
3		Dunne Ave to Spring Ave	16,690	80		20	2	1	35	100	
4		Spring Ave to San Pedro Ave	17,700	80		20	2	1	35	100	
5		San Pedro Ave to Cosmo Ave	15,800	80		20	2	1	35	100	
6		Cosmo Ave to Edmundson Ave	16,570	80		20	2	1	35	100	
7		Edmundson Ave to Vineyard Blvd	16,130	80		20	2	1	35	100	
8		Vineyard Blvd to Watsonville Rd	14,280	80		20	2	1	35	100	
9		South of Watsonville Rd	18,870	80		20	2	1	35	100	
10	Butterfield Blvd	North of Main Ave	20,300	80		20	2	1	45	100	
11		Main Ave to Dunne Ave	24,890	80		20	2	1	45	100	
12		Dunne Ave to San Pedro Ave	17,450	80		20	2	1	45	100	
13		San Pedro Ave to Tennant Ave	14,410	80		20	2	1	45	100	
14	South of Tennant Ave	18,700	80		20	2	1	45	100		
15	Del Monte Ave	North of Cosmo Ave	1,030	80		20	2	1	25	100	
16	Dunne Ave	West of Main Ave	9,840	80		20	2	1	35	100	
17		Main Ave to Butterfield Blvd	11,810	80		20	2	1	40	100	
18		Butterfield Blvd to US 101 SB Ramps	16,550	80		20	2	1	40	100	
19	Edmundson Ave	West of Olympic Drive	4,990	80		20	2	1	45	100	
20		Olympic Drive to Monterey Rd	7,060	80		20	2	1	35	100	
21	Tennant Ave	East of Monterey Rd	7,120	80		20	2	1	35	100	
22	Spring Ave	West of Del Monte Ave	2,050	80		20	2	1	30	100	
23	Cosmo Ave	Del Monte Ave to Monterey Rd	2,140	80		20	2	1	30	100	
24		West of Del Monte Ave	650	80		20	2	1	30	100	
25		Del Monte Ave to Project Entrance	870	80		20	2	1	30	100	
26		Project Entrance to Monterey Rd	1,220	80		20	2	1	30	100	

Appendix B-4

FHWA-RD-77-108 Highway Traffic Noise Prediction Model

Data Input Sheet

Project #: 2019-045 Voices Charter School - Morgan Hill

Description: Year 2025 Cumulative Plus Project

Ldn/CNEL: Ldn

Hard/Soft: Soft

Segment	Roadway Name	Segment Description	ADT	Day %	Eve %	Night %	% Med. Trucks	% Hvy. Trucks	Speed	Distance	Offset (dB)
1	Monterey Road	North of Main Ave	21,767	80		20	2	1	35	100	
2		Main Ave to Dunne Ave	15,195	80		20	2	1	35	100	
3		Dunne Ave to Spring Ave	17,329	80		20	2	1	35	100	
4		Spring Ave to San Pedro Ave	18,352	80		20	2	1	35	100	
5		San Pedro Ave to Cosmo Ave	16,470	80		20	2	1	35	100	
6		Cosmo Ave to Edmundson Ave	16,825	80		20	2	1	35	100	
7		Edmundson Ave to Vineyard Blvd	16,279	80		20	2	1	35	100	
8		Vineyard Blvd to Watsonville Rd	14,392	80		20	2	1	35	100	
9		South of Watsonville Rd	18,949	80		20	2	1	35	100	
10	Butterfield Blvd	North of Main Ave	20,375	80		20	2	1	45	100	
11		Main Ave to Dunne Ave	24,927	80		20	2	1	45	100	
12		Dunne Ave to San Pedro Ave	17,450	80		20	2	1	45	100	
13		San Pedro Ave to Tennant Ave	14,410	80		20	2	1	45	100	
14	South of Tennant Ave	18,700	80		20	2	1	45	100		
15	Del Monte Ave	North of Cosmo Ave	1,049	80		20	2	1	25	100	
16	Dunne Ave	West of Main Ave	9,892	80		20	2	1	35	100	
17		Main Ave to Butterfield Blvd	12,144	80		20	2	1	40	100	
18		Butterfield Blvd to US 101 SB Ramps	16,847	80		20	2	1	40	100	
19	Edmundson Ave	West of Olympic Drive	5,024	80		20	2	1	45	100	
20		Olympic Drive to Monterey Rd	7,088	80		20	2	1	35	100	
21	Tennant Ave	East of Monterey Rd	7,198	80		20	2	1	35	100	
22	Spring Ave	West of Del Monte Ave	2,068	80		20	2	1	30	100	
23	Cosmo Ave	Del Monte Ave to Monterey Rd	2,153	80		20	2	1	30	100	
24		West of Del Monte Ave	656	80		20	2	1	30	100	
25		Del Monte Ave to Project Entrance	896	80		20	2	1	30	100	
26		Project Entrance to Monterey Rd	2,156	80		20	2	1	30	100	

Appendix C-1
Ambient Noise Monitoring Results
Voices Charter School - Morgan Hill - Site 1
Thursday, March 14, 2019

Hour	Leq	Lmax	L50	L90
12:00 AM	52	75	44	39
1:00 AM	55	71	42	38
2:00 AM	52	69	45	42
3:00 AM	53	79	44	42
4:00 AM	51	57	50	48
5:00 AM	54	64	53	50
6:00 AM	55	67	55	52
7:00 AM	56	65	55	53
8:00 AM	55	64	55	52
9:00 AM	55	78	52	49
10:00 AM	51	70	49	46
11:00 AM	52	70	51	47
12:00 PM	51	65	50	47
1:00 PM	51	66	49	46
2:00 PM	51	67	50	46
3:00 PM	54	73	51	47
4:00 PM	52	67	51	48
5:00 PM	55	79	51	47
6:00 PM	52	65	51	47
7:00 PM	64	75	53	48
8:00 PM	73	76	74	57
9:00 PM	70	76	62	52
10:00 PM	61	75	52	46
11:00 PM	61	77	50	43

Statistical Summary						
Daytime (7 a.m. - 10 p.m.)				Nighttime (10 p.m. - 7 a.m.)		
	High	Low	Average	High	Low	Average
Leq (Average)	73	51	64	61	51	56
Lmax (Maximum)	79	64	71	79	57	70
L50 (Median)	74	49	54	55	42	48
L90 (Background)	57	46	49	52	38	44

Leq (Average)
Lmax (Maximum)
L50 (Median)
L90 (Background)

Computed Ldn, dB	65
% Daytime Energy	90%
% Nighttime Energy	10%

GPS Coordinates	37°7'9.50"N
	121°38'51.92"W

Appendix C-2
Ambient Noise Monitoring Results
Voices Charter School - Morgan Hill - Site 1
Friday, March 15, 2019

Hour	Leq	Lmax	L50	L90
12:00 AM	57	72	46	41
1:00 AM	61	73	49	44
2:00 AM	56	73	48	45
3:00 AM	56	72	49	45
4:00 AM	55	69	51	47
5:00 AM	53	64	52	50
6:00 AM	57	80	55	52
7:00 AM	56	67	56	53
8:00 AM	54	71	53	50
9:00 AM	53	71	52	48
10:00 AM	52	67	50	46
11:00 AM	53	67	50	45
12:00 PM	56	70	53	47
1:00 PM	54	70	51	46
2:00 PM	53	69	51	47
3:00 PM	53	75	51	47
4:00 PM	53	64	52	48
5:00 PM	54	72	53	48
6:00 PM	55	80	52	48
7:00 PM	72	78	64	50
8:00 PM	73	78	72	58
9:00 PM	71	77	68	57
10:00 PM	71	78	68	56
11:00 PM	67	76	61	48

Statistical Summary						
Daytime (7 a.m. - 10 p.m.)				Nighttime (10 p.m. - 7 a.m.)		
	High	Low	Average	High	Low	Average
Leq (Average)	73	52	65	71	53	64
Lmax (Maximum)	80	64	72	80	64	73
L50 (Median)	72	50	55	68	46	53
L90 (Background)	58	45	49	56	41	48

Leq (Average)
Lmax (Maximum)
L50 (Median)
L90 (Background)

Computed Ldn, dB	70
% Daytime Energy	72%
% Nighttime Energy	28%

GPS Coordinates	37°7'9.50"N
	121°38'51.92"W

Appendix C-3
Ambient Noise Monitoring Results
Voices Charter School - Morgan Hill - Site 1
Saturday, March 16, 2019

Hour	Leq	Lmax	L50	L90
12:00 AM	67	76	55	46
1:00 AM	64	77	50	45
2:00 AM	63	76	48	43
3:00 AM	58	75	45	41
4:00 AM	53	73	47	43
5:00 AM	54	73	48	44
6:00 AM	51	67	50	48
7:00 AM	54	65	53	51
8:00 AM	54	62	54	52
9:00 AM	55	81	51	47
10:00 AM	55	76	52	47
11:00 AM	52	69	50	46
12:00 PM	57	71	51	47
1:00 PM	52	63	51	47
2:00 PM	55	80	51	47
3:00 PM	55	80	51	47
4:00 PM	57	81	52	48
5:00 PM	54	76	51	47
6:00 PM	54	75	51	47
7:00 PM	71	77	66	49
8:00 PM	73	78	71	57
9:00 PM	67	76	61	55
10:00 PM	65	75	63	55
11:00 PM	67	75	62	52

Statistical Summary						
Daytime (7 a.m. - 10 p.m.)				Nighttime (10 p.m. - 7 a.m.)		
	High	Low	Average	High	Low	Average
Leq (Average)	73	52	64	67	51	63
Lmax (Maximum)	81	62	74	77	67	74
L50 (Median)	71	50	54	63	45	52
L90 (Background)	57	46	49	55	41	47

Leq (Average)
Lmax (Maximum)
L50 (Median)
L90 (Background)

Computed Ldn, dB	70
% Daytime Energy	69%
% Nighttime Energy	31%

GPS Coordinates	37°7'9.50"N
	121°38'51.92"W

Appendix C-4
Ambient Noise Monitoring Results
Voices Charter School - Morgan Hill - Site 1
Sunday, March 17, 2019

Hour	Leq	Lmax	L50	L90
12:00 AM	59	74	52	47
1:00 AM	57	71	49	45
2:00 AM	52	68	45	40
3:00 AM	50	67	45	42
4:00 AM	47	59	45	42
5:00 AM	53	79	45	43
6:00 AM	50	57	50	46
7:00 AM	53	62	51	49
8:00 AM	54	74	52	48
9:00 AM	53	65	52	48
10:00 AM	56	72	53	47
11:00 AM	58	71	57	54
12:00 PM	60	70	59	53
1:00 PM	59	70	56	51
2:00 PM	58	68	57	53
3:00 PM	55	67	54	50
4:00 PM	58	82	54	50
5:00 PM	57	82	53	50
6:00 PM	52	67	51	47
7:00 PM	67	75	59	48
8:00 PM	68	75	64	55
9:00 PM	65	75	60	55
10:00 PM	64	74	60	52
11:00 PM	65	75	60	52

Statistical Summary						
Daytime (7 a.m. - 10 p.m.)			Nighttime (10 p.m. - 7 a.m.)			
	High	Low	Average	High	Low	Average
Leq (Average)	68	52	61	65	47	60
Lmax (Maximum)	82	62	72	79	57	69
L50 (Median)	64	51	55	60	45	50
L90 (Background)	55	47	51	52	40	45

Leq (Average)
Lmax (Maximum)
L50 (Median)
L90 (Background)

Computed Ldn, dB	66
% Daytime Energy	71%
% Nighttime Energy	29%

GPS Coordinates	37°7'9.50"N
	121°38'51.92"W

Appendix C-5
Ambient Noise Monitoring Results
Voices Charter School - Morgan Hill - Site 2
Thursday, March 14, 2019

Hour	Leq	Lmax	L50	L90
12:00 AM	64	77	50	41
1:00 AM	59	72	47	39
2:00 AM	60	72	49	44
3:00 AM	52	76	46	42
4:00 AM	52	65	51	49
5:00 AM	53	62	52	50
6:00 AM	55	70	55	52
7:00 AM	56	70	55	52
8:00 AM	55	71	54	50
9:00 AM	54	69	52	49
10:00 AM	52	72	50	46
11:00 AM	53	71	51	48
12:00 PM	52	69	51	47
1:00 PM	52	68	50	46
2:00 PM	53	72	51	47
3:00 PM	55	79	51	48
4:00 PM	54	71	53	49
5:00 PM	59	88	53	48
6:00 PM	55	76	53	49
7:00 PM	63	77	54	49
8:00 PM	79	82	79	72
9:00 PM	77	82	77	59
10:00 PM	76	81	77	58
11:00 PM	75	81	75	53

Statistical Summary						
Daytime (7 a.m. - 10 p.m.)			Nighttime (10 p.m. - 7 a.m.)			
	High	Low	Average	High	Low	Average
Leq (Average)	79	52	69	76	52	70
Lmax (Maximum)	88	68	74	81	62	73
L50 (Median)	79	50	56	77	46	56
L90 (Background)	72	46	51	58	39	47

Leq (Average)
Lmax (Maximum)
L50 (Median)
L90 (Background)

Computed Ldn, dB	76
% Daytime Energy	61%
% Nighttime Energy	39%

GPS Coordinates	37°7'6.34"N
	121°38'49.99"W

Appendix C-6
Ambient Noise Monitoring Results
Voices Charter School - Morgan Hill - Site 2
Friday, March 15, 2019

Hour	Leq	Lmax	L50	L90
12:00 AM	69	79	54	43
1:00 AM	68	79	53	45
2:00 AM	68	78	53	47
3:00 AM	65	77	51	47
4:00 AM	57	74	52	46
5:00 AM	57	74	52	49
6:00 AM	56	78	54	51
7:00 AM	57	71	56	53
8:00 AM	54	75	52	48
9:00 AM	53	69	50	47
10:00 AM	52	70	49	45
11:00 AM	53	74	49	45
12:00 PM	52	76	49	44
1:00 PM	53	76	48	44
2:00 PM	53	70	50	46
3:00 PM	53	68	51	47
4:00 PM	55	74	53	49
5:00 PM	55	75	53	49
6:00 PM	55	75	53	49
7:00 PM	74	81	57	50
8:00 PM	79	83	80	66
9:00 PM	80	83	81	77
10:00 PM	80	83	81	77
11:00 PM	74	83	69	58

Statistical Summary						
Daytime (7 a.m. - 10 p.m.)			Nighttime (10 p.m. - 7 a.m.)			
	High	Low	Average	High	Low	Average
Leq (Average)	80	52	72	80	56	72
Lmax (Maximum)	83	68	75	83	74	78
L50 (Median)	81	48	56	81	51	57
L90 (Background)	77	44	51	77	43	52

Leq (Average)
Lmax (Maximum)
L50 (Median)
L90 (Background)

Computed Ldn, dB	79
% Daytime Energy	59%
% Nighttime Energy	41%

GPS Coordinates	37°7'6.34"N
	121°38'49.99"W

Appendix C-7
Ambient Noise Monitoring Results
Voices Charter School - Morgan Hill - Site 2
Saturday, March 16, 2019

Hour	Leq	Lmax	L50	L90
12:00 AM	68	78	59	55
1:00 AM	69	77	57	52
2:00 AM	65	77	53	44
3:00 AM	61	74	50	42
4:00 AM	56	72	47	44
5:00 AM	49	62	48	44
6:00 AM	54	72	50	47
7:00 AM	54	69	53	51
8:00 AM	55	74	53	50
9:00 AM	53	76	50	45
10:00 AM	52	71	49	44
11:00 AM	53	75	50	45
12:00 PM	53	70	50	46
1:00 PM	54	74	52	47
2:00 PM	56	79	51	46
3:00 PM	55	76	51	47
4:00 PM	56	79	52	47
5:00 PM	55	73	52	48
6:00 PM	55	75	53	48
7:00 PM	69	80	56	49
8:00 PM	78	82	78	62
9:00 PM	80	82	80	78
10:00 PM	76	81	76	65
11:00 PM	75	80	76	63

Statistical Summary						
Daytime (7 a.m. - 10 p.m.)				Nighttime (10 p.m. - 7 a.m.)		
	High	Low	Average	High	Low	Average
Leq (Average)	80	52	70	76	49	70
Lmax (Maximum)	82	69	76	81	62	75
L50 (Median)	80	49	55	76	47	57
L90 (Background)	78	44	50	65	42	51

Leq (Average)
Lmax (Maximum)
L50 (Median)
L90 (Background)

Computed Ldn, dB	77
% Daytime Energy	63%
% Nighttime Energy	37%

GPS Coordinates	37°7'6.34"N
	121°38'49.99"W

Appendix C-8
Ambient Noise Monitoring Results
Voices Charter School - Morgan Hill - Site 2
Sunday, March 17, 2019

Hour	Leq	Lmax	L50	L90
12:00 AM	70	78	59	51
1:00 AM	56	70	52	46
2:00 AM	58	73	48	40
3:00 AM	60	73	46	42
4:00 AM	47	61	46	42
5:00 AM	50	69	45	42
6:00 AM	54	67	52	48
7:00 AM	53	70	51	49
8:00 AM	52	69	50	46
9:00 AM	53	81	50	45
10:00 AM	59	76	50	45
11:00 AM	65	69	64	63
12:00 PM	64	70	64	63
1:00 PM	64	73	64	62
2:00 PM	64	74	64	62
3:00 PM	63	72	63	62
4:00 PM	64	75	64	62
5:00 PM	65	84	64	62
6:00 PM	58	70	52	48
7:00 PM	69	78	56	49
8:00 PM	79	82	79	76
9:00 PM	80	83	80	79
10:00 PM	78	81	78	69
11:00 PM	74	79	71	61

Statistical Summary						
Daytime (7 a.m. - 10 p.m.)				Nighttime (10 p.m. - 7 a.m.)		
	High	Low	Average	High	Low	Average
Leq (Average)	80	52	72	78	47	70
Lmax (Maximum)	84	69	75	81	61	72
L50 (Median)	80	50	61	78	45	55
L90 (Background)	79	45	58	69	40	49

Leq (Average)
Lmax (Maximum)
L50 (Median)
L90 (Background)

Computed Ldn, dB	77
% Daytime Energy	69%
% Nighttime Energy	31%

GPS Coordinates	37°7'6.34"N
	121°38'49.99"W

Appendix D-1
Ambient Noise Monitoring Results
Voices Charter School - Morgan Hill - Site 1
Thursday, March 14, 2019

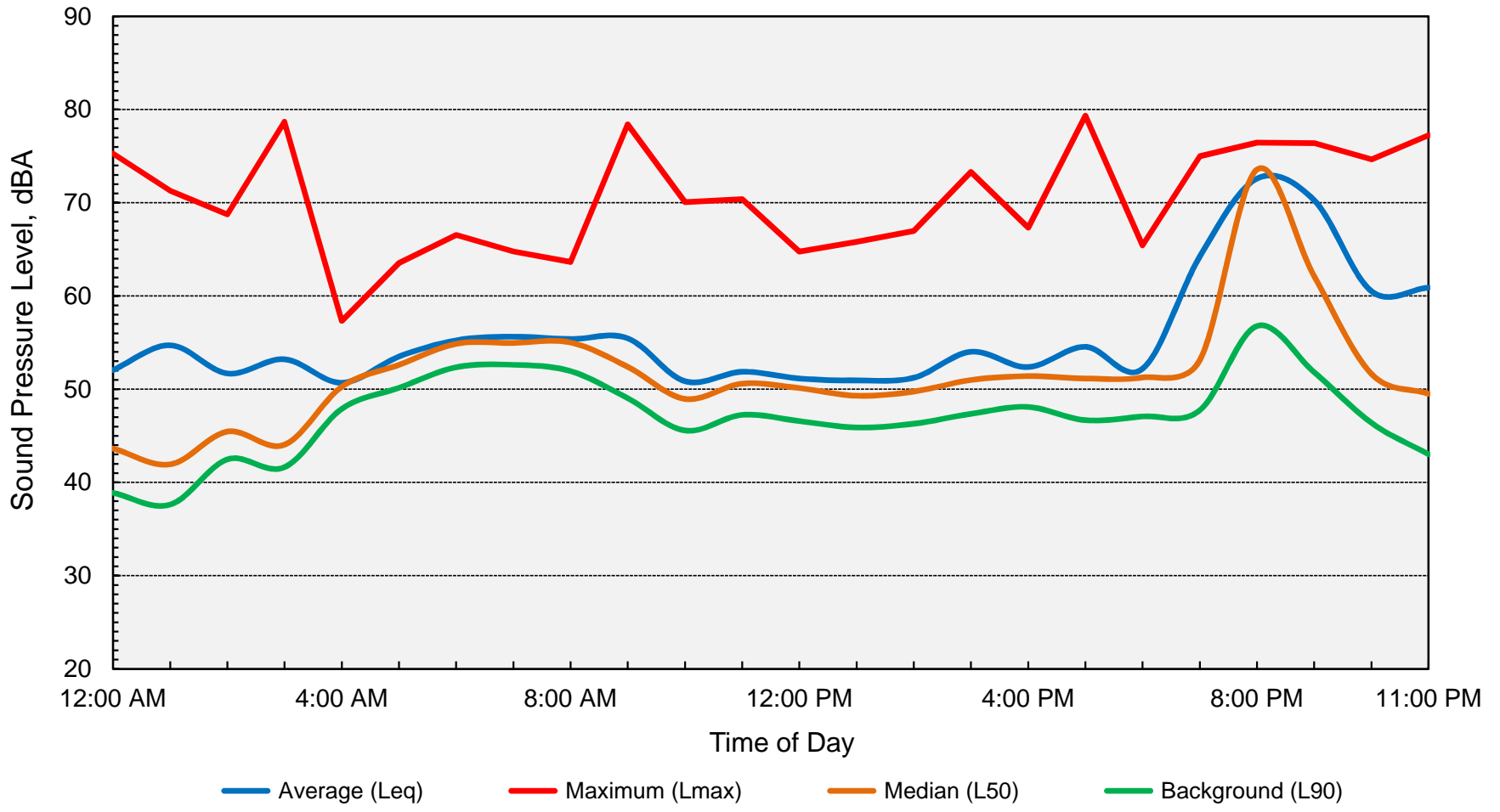

Computed Ldn = 65 dB

Appendix D-2
Ambient Noise Monitoring Results
Voices Charter School - Morgan Hill - Site 1
Friday, March 15, 2019

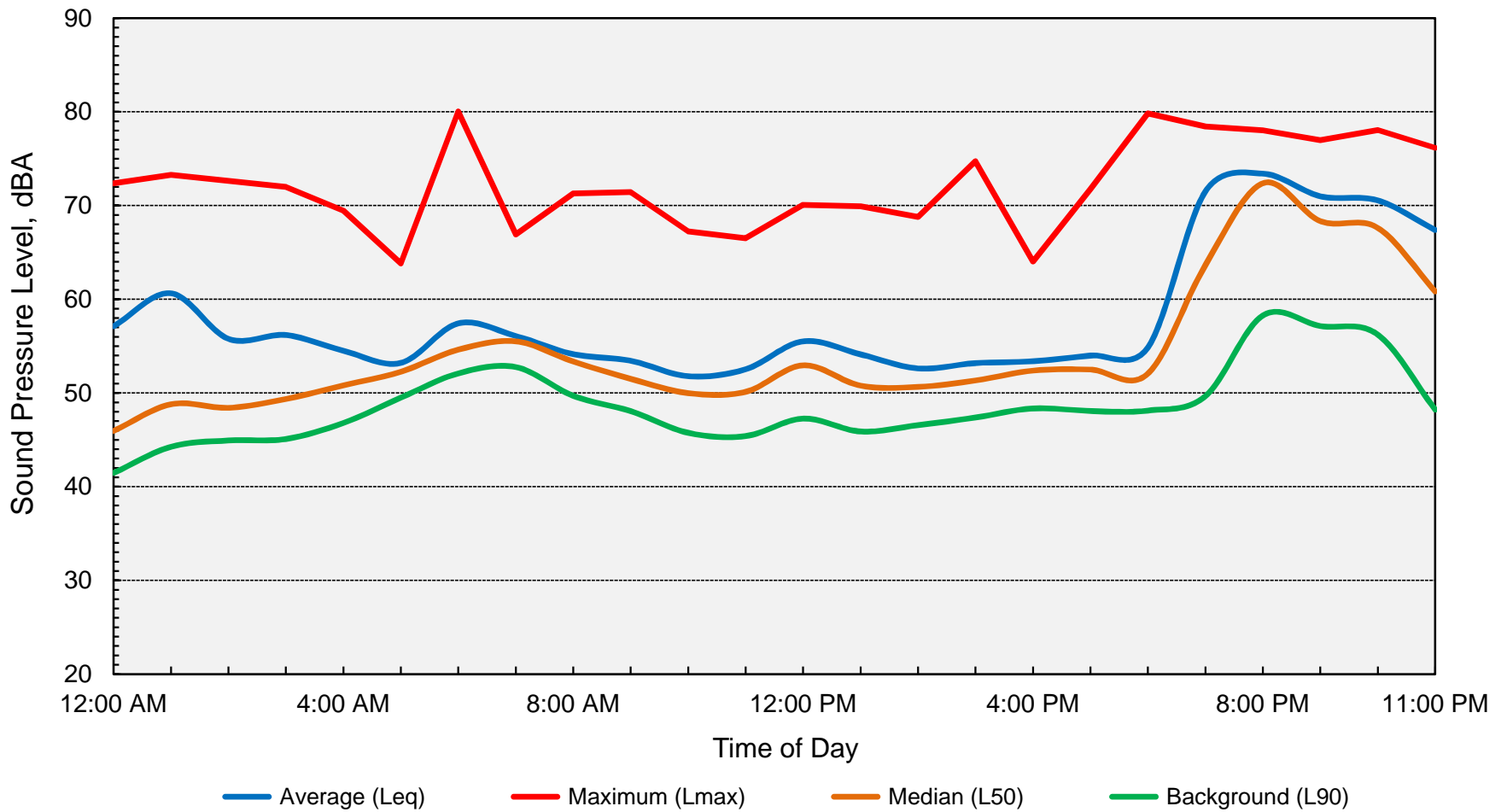

Computed Ldn = 70 dB

Appendix D-3
Ambient Noise Monitoring Results
Voices Charter School - Morgan Hill - Site 1
Saturday, March 16, 2019

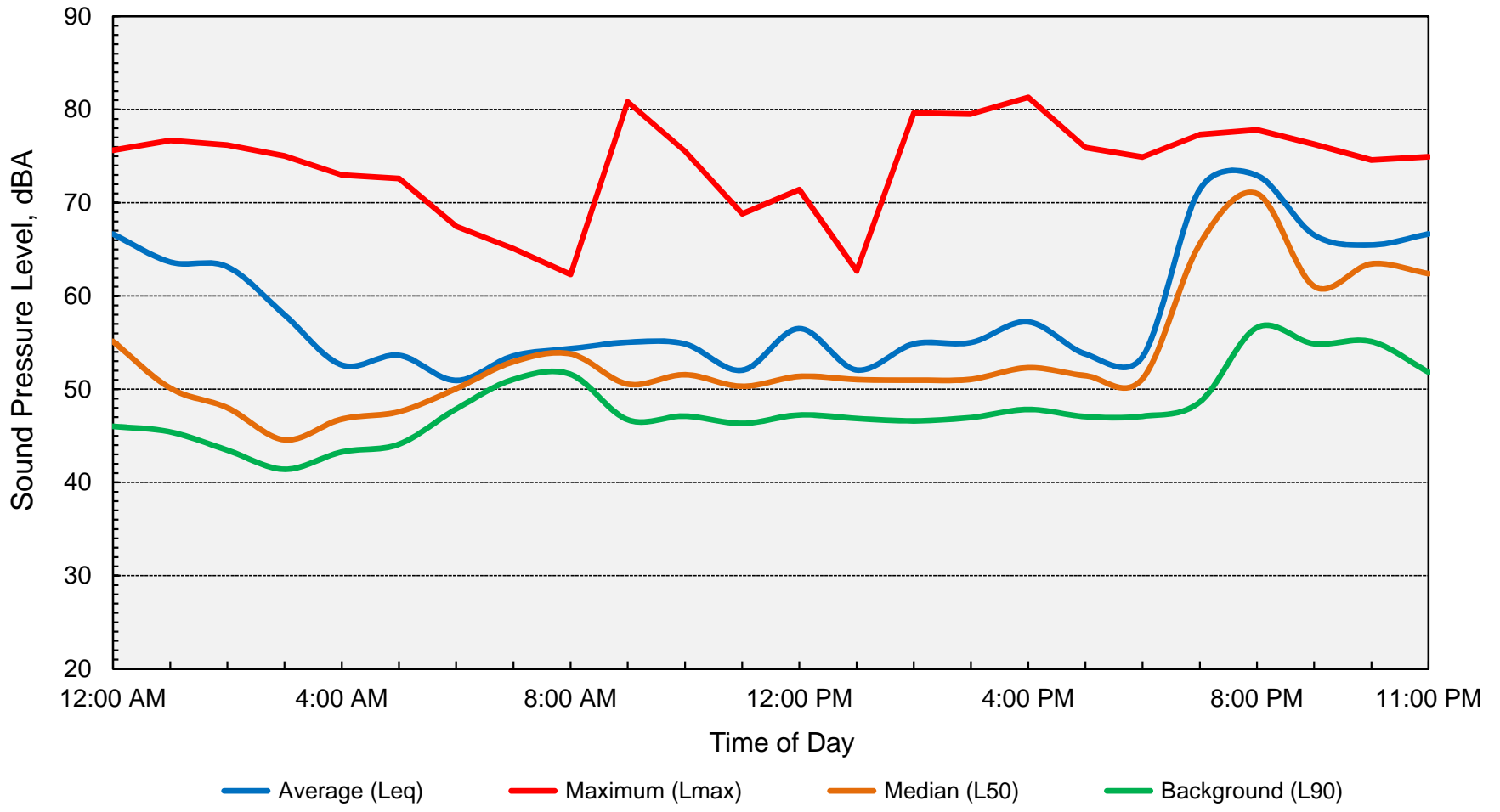

Computed Ldn = 70 dB

**Appendix D-4
Ambient Noise Monitoring Results
Voices Charter School - Morgan Hill - Site 1
Sunday, March 17, 2019**

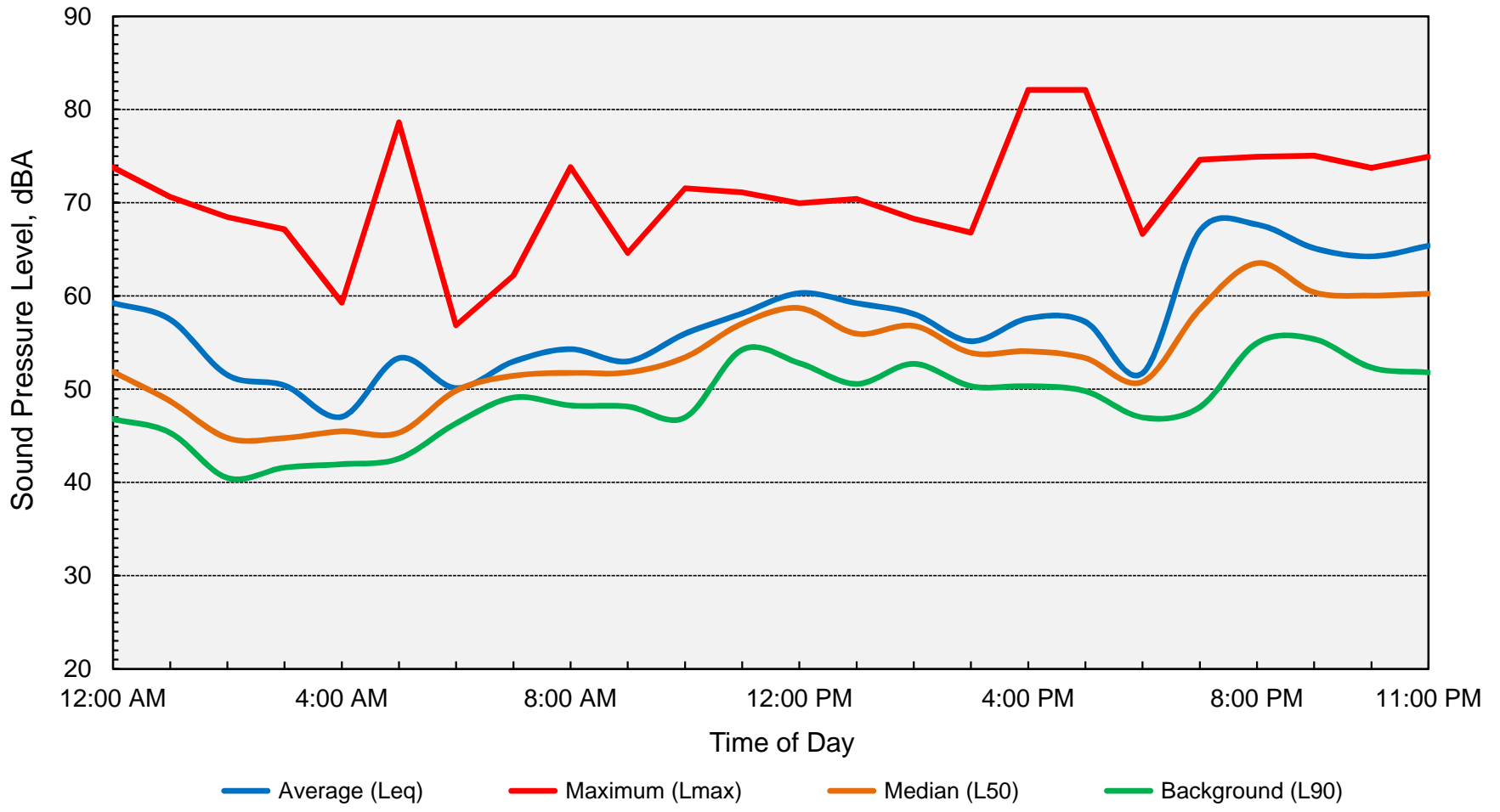

Computed Ldn = 66 dB

Appendix D-5
Ambient Noise Monitoring Results
Voices Charter School - Morgan Hill - Site 2
Thursday, March 14, 2019

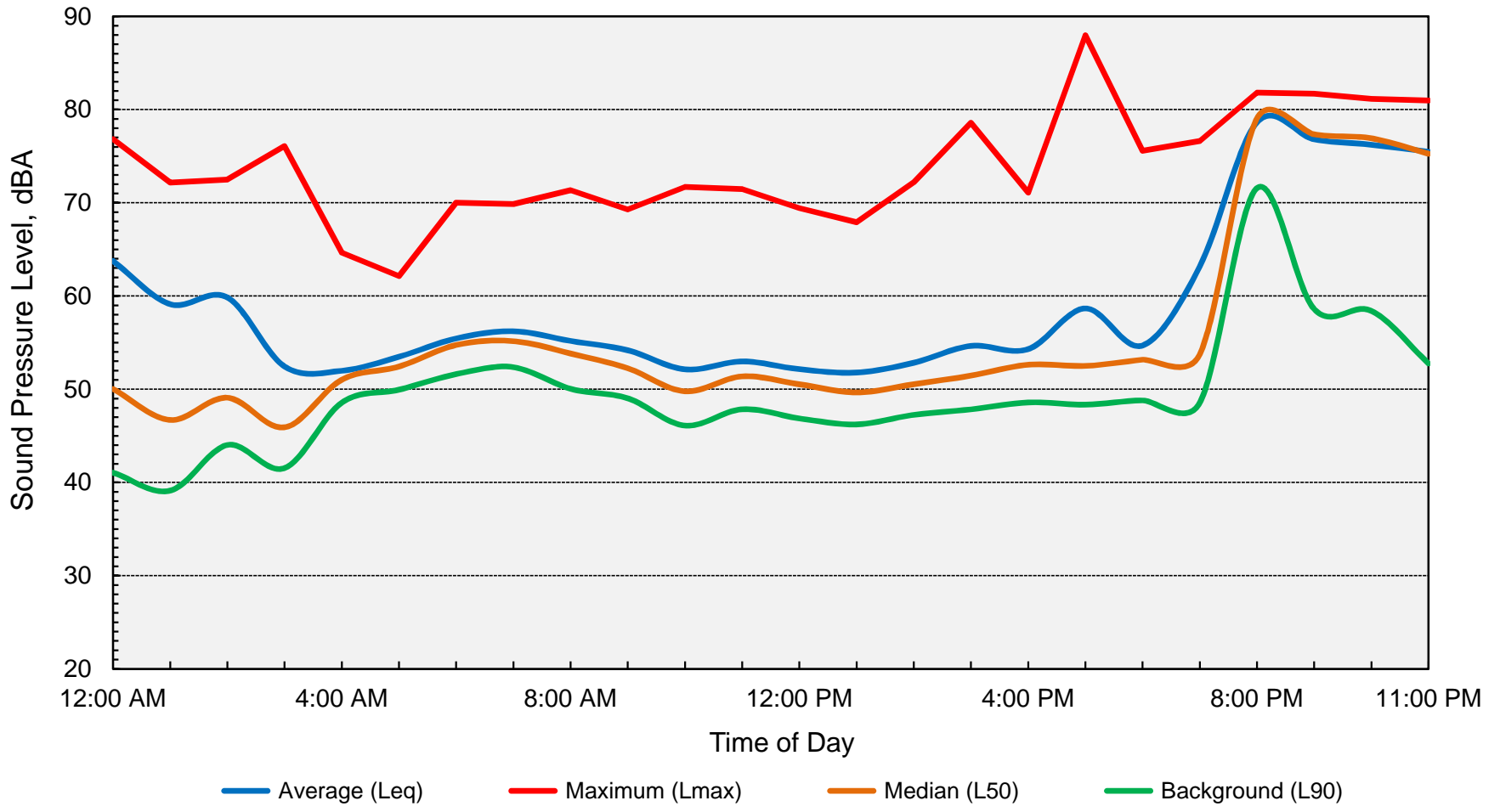

Computed Ldn = 76 dB

Appendix D-6
Ambient Noise Monitoring Results
Voices Charter School - Morgan Hill - Site 2
Friday, March 15, 2019

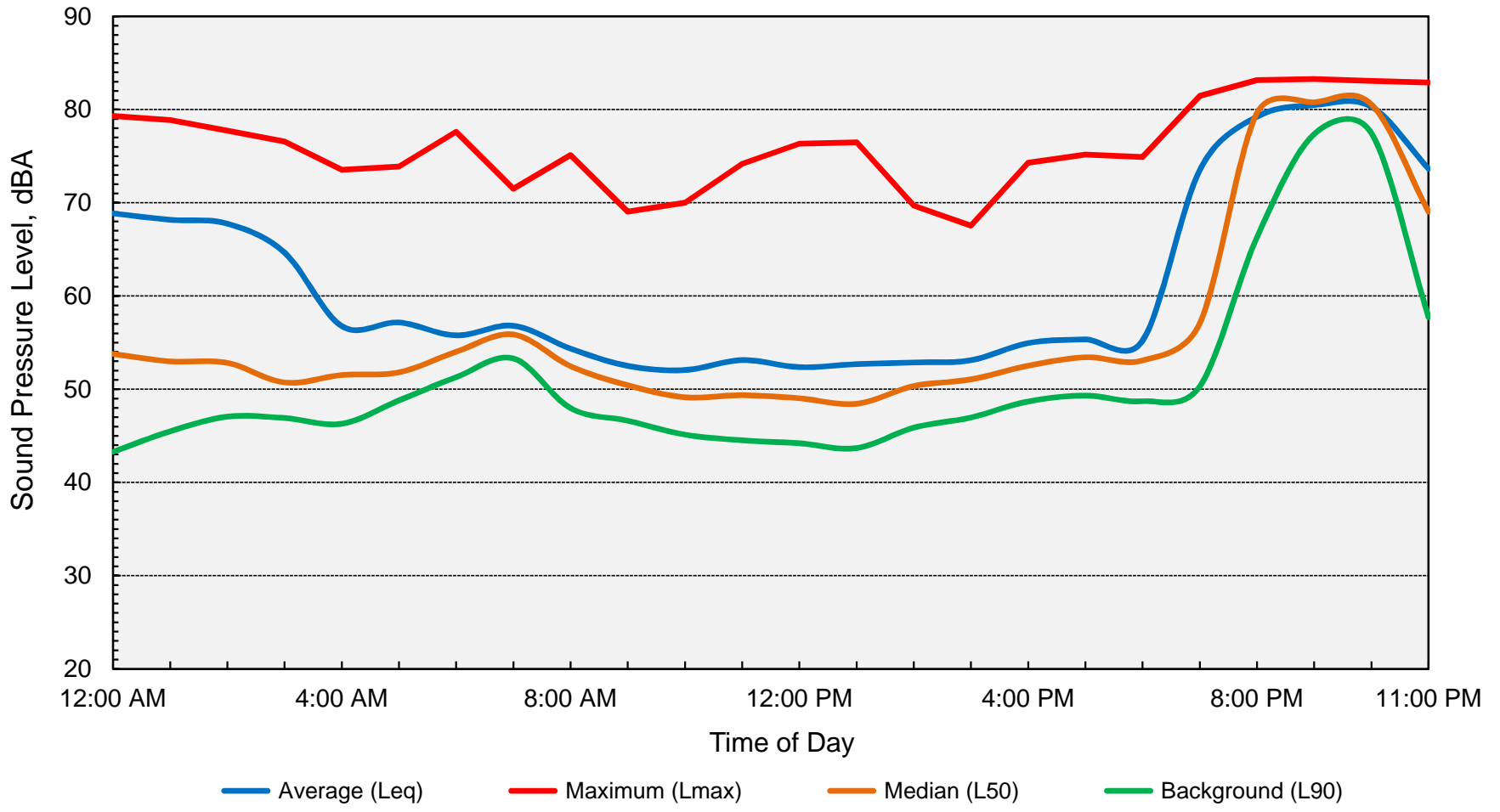

Computed Ldn = 79 dB

Appendix D-7
Ambient Noise Monitoring Results
Voices Charter School - Morgan Hill - Site 2
Saturday, March 16, 2019

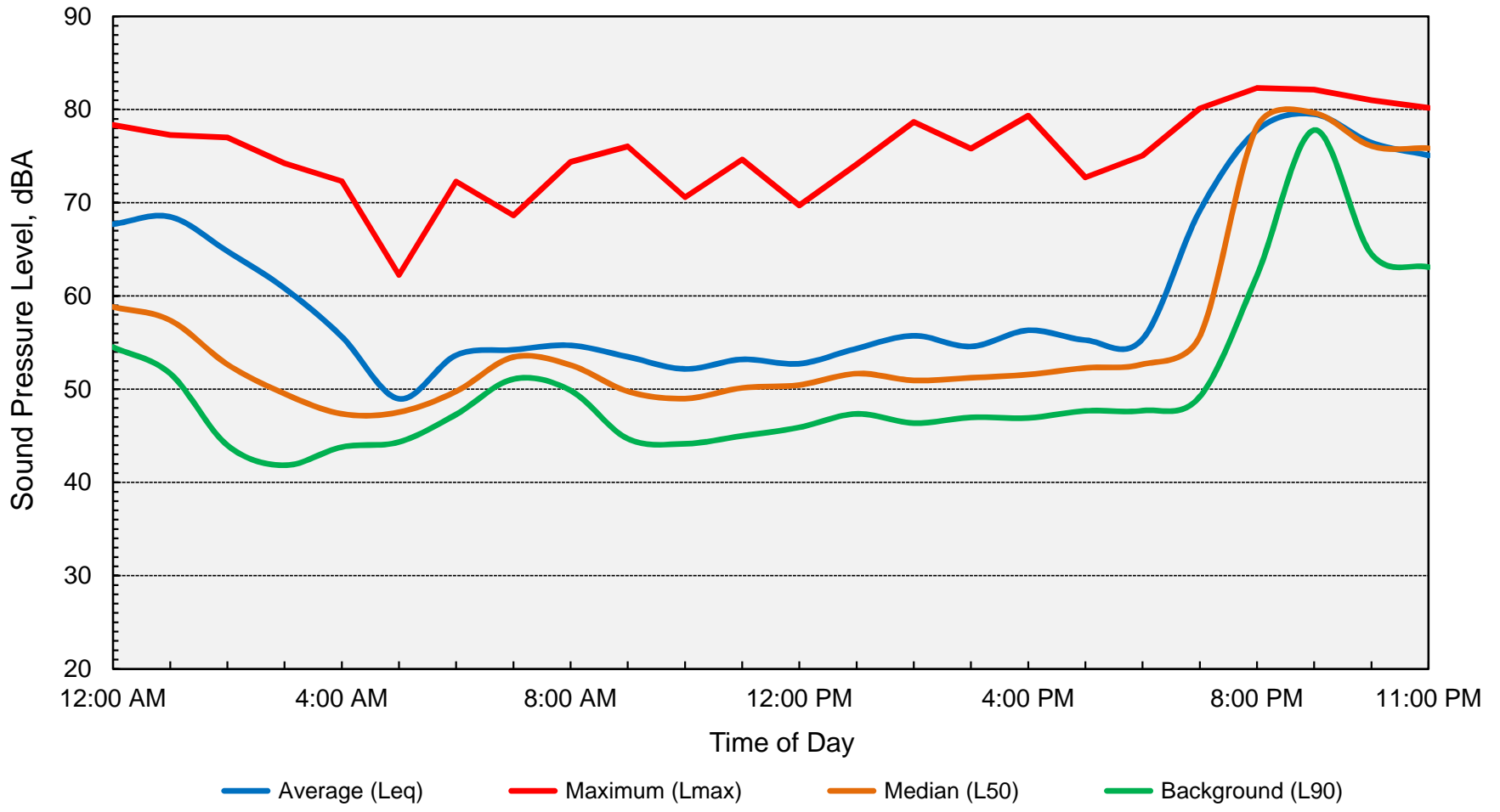

Computed Ldn = 77 dB

Appendix D-8
Ambient Noise Monitoring Results
Voices Charter School - Morgan Hill - Site 2
Sunday, March 17, 2019

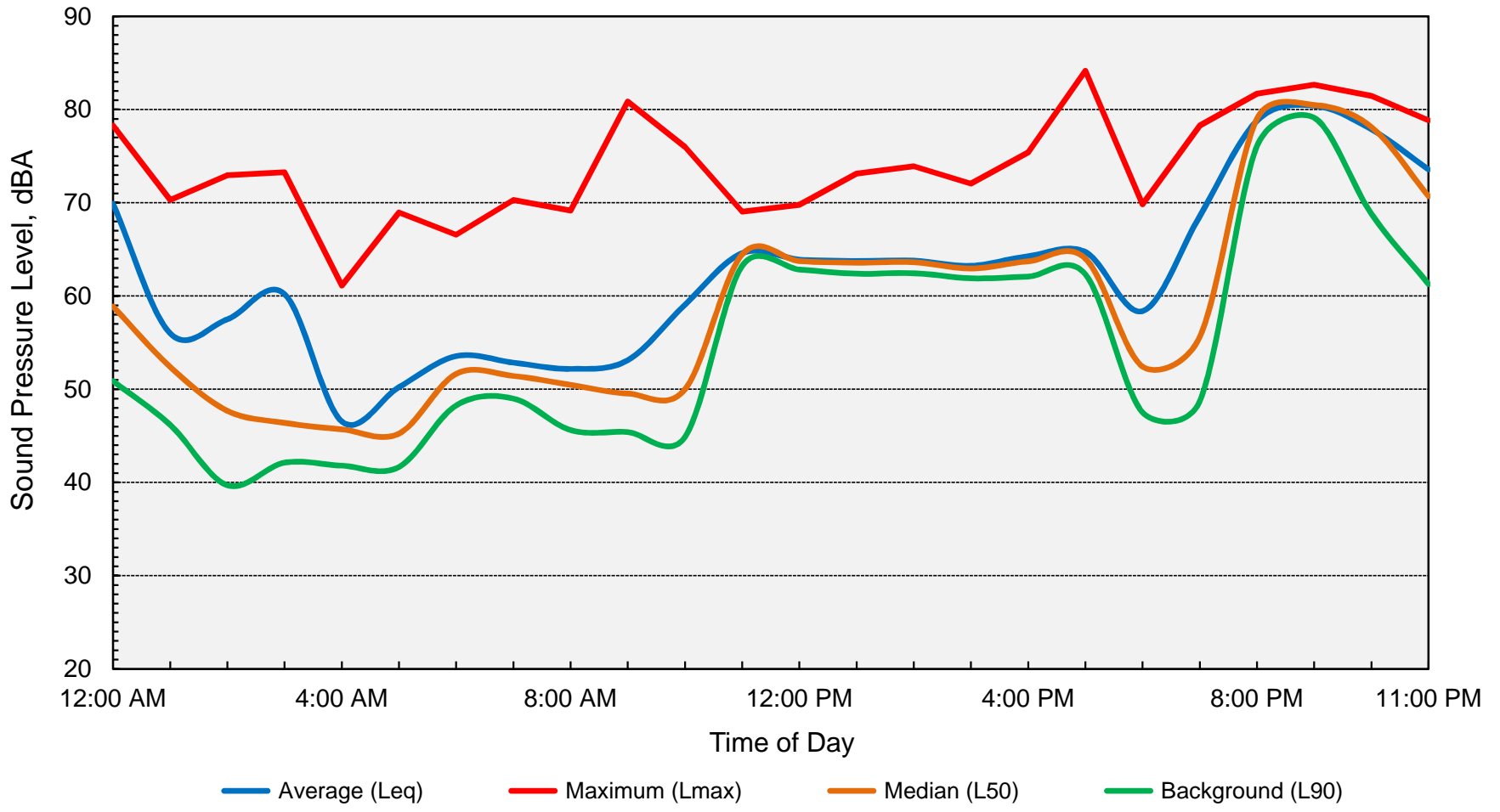

Computed Ldn = 77 dB

Appendix E – Morgan Hill Municipal Code – Noise

Chapter 8.28 - NOISE

8.28.010 - Council findings and declarations.

The city council finds and declares as follows:

- A. That the making, creation or maintenance of loud, unnecessary, unnatural or unusual noises which are prolonged, unusual and unnatural in their time, place and use affect and are a detriment to the public health, comfort, convenience, safety, welfare and prosperity of the residents of the city; and
- B. That the necessity in the public interest for the provisions and prohibitions set forth in this chapter is declared as a matter of legislative determination and public policy, and it is further declared that the provisions of this chapter are in pursuance of, and for the purpose of, securing and promoting the public health, comfort, convenience, safety, welfare and prosperity and the peace and quiet of the city and its inhabitants.

(Ord. 328 N.S. § A (part), 1972)

8.28.020 - Unlawful behavior defined.

It is unlawful for any person to make or continue, or cause to be made or continued, any loud, disturbing, unnecessary or unusual noise or any noise which annoys, disturbs, injures, or endangers the comfort, health, repose, peace, or safety of another person within the city.

(Ord. 328 N.S. § A (part), 1972)

(Ord. No. 2276 N.S., § 29, 5-2-2018)

8.28.030 - Police and fire sirens exempted from chapter provisions.

Nothing in this chapter shall be construed to prevent the proper use of a siren or other alarm by a police, fire or authorized emergency vehicle as defined in the California Vehicle Code. Likewise, any stationary fire alarm operated by the fire department of the city is exempt from the provisions of this chapter.

(Ord. 328 N.S. § A (part), 1972)

8.28.040 - Enumeration of unlawful noises.

Unlawful noises include:

- A. Animals and Birds. The keeping of any animal or bird which, by causing frequent or long-continued noise, disturbs the comfort or repose of any person in the vicinity;
- B. Auto Body Repairs.
 - 1. The repairing of any auto body, or part thereof, except within a completely enclosed building and the noises therefrom are reasonably confined to such building, and
 - 2. The repairing of any auto body, or part thereof, between the hours of eight p.m. and seven a.m., which shall be deemed a violation of the provisions of this section;
- C. Blowers, Fans, and Combustion Engines. The operation of any noise-creating blower, power fan or internal combustion engine, the operation of which causes noise due to the explosion of operating gases or fluids, unless the noise from such blower or fan is muffled and such engine is equipped with a muffler device to deaden such noise;

- D. 1. Construction activities as limited below. "Construction activities" are defined as including but not limited to excavation, grading, paving, demolition, construction, alteration or repair of any building, site, street or highway, delivery or removal of construction material to a site, or movement of construction materials on a site. Construction activities are prohibited other than between the hours of seven a.m. and eight p.m., Monday through Friday and between the hours of nine a.m. to six p.m. on Saturday. Construction activities may not occur on Sundays or federal holidays. No third person, including but not limited to landowners, construction company owners, contractors, subcontractors, or employers, shall permit or allow any person working on construction activities which are under their ownership, control or direction to violate this provision. Construction activities may occur in the following cases without violation of this provision:
- a. In the event of urgent necessity in the interests of the public health and safety, and then only with a permit from the chief building official, which permit may be granted for a period of not to exceed three days or less while the emergency continues and which permit may be renewed for periods of three days or less while the emergency continues.
 - b. If the chief building official determines that the public health and safety will not be impaired by the construction activities between the hours of eight p.m. and seven a.m., and that loss or inconvenience would result to any party in interest, the chief building official may grant permission for such work to be done between the hours of eight p.m. and seven a.m. upon an application being made at the time the permit for the work is issued or during the progress of the work.
 - c. The city council finds that construction by the resident of a single residence does not have the same magnitude or frequency of noise impacts as a larger construction project. Therefore, the resident of a single residence may perform construction activities on that home during the hours in this subsection, as well as on Sundays and federal holidays from nine a.m. to six p.m., provided that such activities are limited to the improvement or maintenance undertaken by the resident on a personal basis.
 - d. Public work projects are exempt from this section and the public works director shall determine the hours of construction for public works projects.
 - e. Until November 30, 1998, construction activities shall be permitted between the hours of ten a.m. to six p.m. on Sundays, subject to the following conditions. No power-driven vehicles, equipment or tools may be used during construction activities, except on the interior of a building or other structure which is enclosed by exterior siding (including windows and doors) and roofing, and which windows and doors are closed during construction activities. Construction activities must be situated at least one hundred fifty feet from the nearest occupied dwelling. No delivery or removal of construction material to a site, or movement of construction materials on a site, is permitted. No activity, including but not limited to the playing of radios, tape players, compact disc players or other devices, which creates a loud or unusual noise which offends, disturbs or harasses the peace and quiet of the persons of ordinary sensibilities beyond the confines of the property from which the sound emanates is allowed.
2. If it is determined necessary in order to ensure compliance with this section, the chief building official may require fences, gates or other barriers prohibiting access to a construction site by construction crews during hours in which construction is prohibited by this subsection. The project manager of each project shall be responsible for ensuring the fences, gates or barriers are locked and/or in place during hours in which no construction is allowed. This subsection shall apply to construction sites other than public works projects or single dwelling units which are not a part of larger projects.
- E. Defective or Loaded Vehicles. The use of any automobile, motorcycle or vehicle so out of repair, so loaded, or in such manner as to create loud and unnecessary grating, grinding, rattling or other noise;

- F. Exhausts. The discharge into the open air of the exhaust of any steam engine, stationary internal combustion engine, motorboat or motor vehicle except through a muffler or other device which will effectively prevent loud or explosive noises therefrom;
- G. Loading or Unloading Vehicles and Opening Boxes. The creation of loud and excessive noise in connection with loading or unloading any vehicle or the opening and destruction of bales, boxes, crates and containers;
- H. Loudspeakers, Amplifiers and Similar Advertising Devices. The using or operating or permitting to be played, used or operated, of any radio receiving set, musical instrument, phonograph, loudspeaker, sound amplifier or other machine or device for the producing or reproducing of sound which is cast upon the public streets for the purpose of commercial advertising or attracting the attention of the public to any building or structure;
- I. Noises Adjacent to Schools, Courts, Churches and Hospitals. The creation of any excessive noise on any street adjacent to any school, institution of learning, church or court while the same is in use or adjacent to any hospital, which noise unreasonably interferes with the workings of such institution or which disturbs or unduly annoys patients in the hospital; provided, conspicuous signs are displayed in such streets indicating that the street is adjacent to a school, hospital or court;
- J. Pile Drivers, Hammers and Similar Equipment. The operation, between the hours of eight p.m. and seven a.m. of any pile driver, steam shovel, pneumatic hammer, derrick, steam or electric hoist or other appliance, the use of which is attended by loud or unusual noise;
- K. Radios, Phonographs, Musical Instruments and Similar Devices.
 - 1. The using or operating, or permitting to be played, used or operated, of any radio receiving set, musical instrument, phonograph or other machine or device for the producing or reproducing of sound in such manner as to disturb the peace, quiet and comfort of the neighborhood inhabitants or at any time with louder volume than is necessary for convenient hearing for the persons who are in the room, vehicle or chamber in which such machine or device is operated and who are voluntary listeners thereto, and
 - 2. The operation of any such set, instrument, phonograph, machine or device between the hours of eleven p.m. and seven a.m. in such manner as to be plainly audible at a distance of fifty feet from the building, structure or vehicle in which such device is located which shall be prima facie evidence of a violation of the provisions of this section;
- L. Shouting by Hawkers and Peddlers. The shouting and crying of peddlers, hawkers and vendors which disturb the peace and quiet of the neighborhood;
- M. Steam Whistles. The blowing of any locomotive steam whistle or steam whistle attached to any stationary boiler except to give notice of the time to begin or stop work, or as a warning of fire or danger, or upon the request of proper city authorities;
- N. Vehicle Horns and Signaling Devices.
 - 1. The sounding of any horn or signaling device on any automobile, motorcycle, streetcar or other vehicle on any street or public place of the city except as a danger warning,
 - 2. The creation, by means of any such signaling device of any unreasonably loud or harsh sound,
 - 3. The sounding of any such device for an unnecessary and unreasonable period of time,
 - 4. The use of any signaling device except one operated by hand or electricity,
 - 5. The use of any horn, whistle or other device operated by engine exhaust, and
 - 6. The use of any such signaling device when traffic is delayed for any reason.

(Ord. 1405 N.S. § 1, 1998; Ord. 1196 N.S. § 4 Exh. A, 1994; Ord. 328 N.S. § A (part), 1972)

(Ord. No. 2276 N.S., § 29, 5-2-2018)

8.28.050 - Violation.

It is unlawful for any person to violate any of the provisions of this chapter.

(Ord. No. 2276 N.S., § 29, 5-2-2018)

Editor's note— Ord. No. 2276 N.S., § 29, adopted May 2, 2018, amended § 8.28.050 in its entirety to read as herein set out. Former § 8.28.050 pertained to violation—penalty and derived from Ord. 328 N.S., § A(part), adopted in 1972; Ord. 1192 N.S., § 13, adopted in 1994; and Ord. 1320 N.S., § 8, adopted in 1997.

Chapter 18.76 - PERFORMANCE STANDARDS

18.76.010 - Purpose. This chapter establishes performance standards for uses and activities to protect the community from nuisances, hazards, and objectionable conditions; promote compatibility of different land uses; and to protect environmental resources.

18.76.090 - Noise.

A. No land use or activity may produce a noise level in excess of the standards in Table 18.76-1.

Table 18.76-1: Maximum Noise Levels

Receiving Land Use	Maximum Noise Level at Lot Line of Receiving Use [1]
Industrial and Wholesale	70 dBA
Commercial	65 dBA
Residential or Public/Quasi Public	60 dBA

Notes:

[1] The planning commission may allow an additional 5 dBA noise level at the lot line if the maximum noise level shown in Table 18.76-1 cannot be achieved with reasonable and feasible mitigation.

B. Noise standards in Table 18.76-1 do not apply to noise generated by vehicle traffic in the public right-of-way or from temporary construction, demolition, and vehicles that enter and leave the site of the noise-generating use (e.g., construction equipment, trains, trucks).

C. All uses and activities shall comply with Municipal Code Chapter 8.28 (Noise).

(Ord. No. 2277 N.S., § 5(Exh. A), 6-6-2018)

Appendix F
Traffic Impact Analysis



HEXAGON TRANSPORTATION CONSULTANTS, INC.



Voices School Morgan Hill

Traffic Impact Analysis



Prepared for:

Raney Planning and Management, Inc.



August 20, 2019



Hexagon Transportation Consultants, Inc.

Hexagon Office: 8070 Santa Teresa Boulevard, Suite 230

Gilroy, CA 95020

Hexagon Job Number: 19RD07

Phone: 408.846.7410

Client Name: Raney Planning and Management, Inc.

Staff: RD, GD, LD



San Jose · Gilroy · Pleasanton · Phoenix

www.hextrans.com



Areawide Circulation Plans Corridor Studies Pavement Delineation Plans Traffic Handling Plans Impact Fees Interchange Analysis Parking Transportation Planning Traffic Calming Traffic Control Plans Traffic Simulation Traffic Impact Analysis Traffic Signal Design Travel Demand Forecasting

Table of Contents

Executive Summary	iv
1. Introduction	1
2. Existing Conditions	9
3. Existing Plus Project Conditions	20
4. Other Transportation Issues	36
5. Year 2025 Cumulative Conditions	74
6. Conclusions	87

Appendices

Appendix A	Traffic Counts
Appendix B	Volume Summary Tables
Appendix C	Level of Service Calculations
Appendix D	Signal Warrants
Appendix E	Poisson Probability Calculations
Appendix F	Site Access Alternatives Evaluation Memo

List of Tables

Table ES 1	Intersection Level of Service Summary	xiii
Table ES 2	Intersection Queuing Analysis Summary	xiv
Table 1	Signalized Intersection Level of Service Definitions Based on Control Delay	6
Table 2	Unsignalized Intersection Level of Service Definitions Based on Control Delay	7
Table 3	Freeway Segment Capacity Evaluation	8
Table 4	Existing Conditions Intersection Levels of Service	19
Table 5	Project Trip Generation Estimates	24
Table 6	Existing Plus Project Conditions Intersection Levels of Service	34
Table 7	Roadway Segment Analysis Summary	45
Table 8	Monterey Road and Cosmo Avenue Intersection Levels of Service	47
Table 9	Roadway Segment Analysis Summary	61
Table 10	Intersection Queuing Analysis Summary	66
Table 11	General Plan 2035 Trip Generation Estimates	78
Table 12	Cumulative Conditions Intersection Levels of Service	83

List of Figures

Figure 1	Site Location and Study Intersections	1
Figure 2	Project Site Plan	2
Figure 3	Existing Bicycle Facilities	11
Figure 4	Existing Transit Services	13
Figure 5	Existing Lane Configurations	15
Figure 6	Existing Traffic Volumes	17
Figure 7	Project Trip Distribution – Non-Working Parents	25
Figure 8	Project Trip Distribution – Working Parents (Inbound)	26
Figure 9	Project Trip Distribution – Working Parents (Outbound)	27

Figure 10	Project Trip Distribution – Staff.....	28
Figure 11	Project Trip Assignment.....	29
Figure 12	Existing Plus Project Traffic Volumes.....	31
Figure 13	Proposed Site Plan and Site Access.....	37
Figure 14	Proposed Emergency Vehicle Access.....	40
Figure 15	Recommended Pedestrian Improvements.....	42
Figure 16	Year 2025 Cumulative No Project Traffic Volumes.....	75
Figure 17	Year 2025 Cumulative Plus Project Traffic Volumes.....	81

Executive Summary

This report presents the results of the traffic impact analysis conducted for the proposed Voices School in Morgan Hill, California. Voices School is an existing Transitional Kinder (TK) through 4th grade public charter school currently located at a temporary site on Jarvis Drive in the northern part of Morgan Hill. The project as proposed consists of the construction of a new permanent site for the charter school that will house a TK through 8th grade school. A total of 33 parking spaces would be provided on site. Access to the project site would be provided via a driveway on Cosmo Avenue. A second driveway along Monterey Road would provide emergency access only to the site.

Scope of Study

The potential impacts related to the proposed school project were evaluated following the standards and methodologies set forth by the City of Morgan Hill and the Santa Clara Valley Transportation Authority (VTA). The VTA administers the County Congestion Management Program (CMP).

The study includes an analysis of AM and PM peak-hour traffic conditions for fourteen signalized intersections and four unsignalized intersections. The study also includes a site access and on-site circulation analysis, which includes levels of service analysis, sight distance analysis, and vehicle-storage requirements. The site access and circulation analyses were based on professional judgment in accordance with the standards and methods employed by the traffic engineering community.

Project Trip Generation

The magnitude of traffic produced by a new development is typically estimated by applying the size of the project to the applicable trip generation rates contained in the Institute of Transportation Engineers (ITE) *Trip Generation Manual*, latest edition. However, because the project consists of the expansion and permanent site of an existing school, the trips generated by the proposed school were estimated based on trip generation rates derived for the existing Voices School site.

The magnitude of traffic added to the roadway system by the proposed project was estimated by multiplying the surveyed trip generation rates by the proposed student enrollment at buildout (504 students). Based on this information, it is estimated that the proposed school would generate approximately 593 AM peak-hour trips, with 328 of these trips in the inbound direction and 265 trips in the outbound direction, and 340 PM peak-hour trips, with 138 inbound and 202 outbound trips.

Existing Plus Project Intersection Level of Service Analysis

The intersection level of service is summarized in Table ES1. The results show that, measured against the City of Morgan Hill level of service standards, the intersection of **Monterey Road and San Pedro Avenue** is projected to operate at an unacceptable LOS F during the PM peak-hour under existing plus project conditions. In addition, the peak-hour traffic signal warrant checks indicate that the traffic volumes at this intersection would meet the threshold that warrants signalization during the PM peak-hour under existing and existing plus project conditions. Therefore, the intersection of Monterey Road and San Pedro Avenue is projected to be impacted by the proposed project during the PM peak-hour.

Intersection Mitigations under Existing Plus Project Conditions

4. Monterey Road and San Pedro Avenue

Mitigation: The project impact at this intersection could be mitigated with the installation of a raised median along Monterey Road at San Pedro Avenue, thus restricting left-turns out of San Pedro Avenue to southbound Monterey Road. With the left-turn restriction, only right-turns in and out at both San Pedro Avenue (east leg of the intersection) and the existing driveway (west leg of the intersection) as well as southbound left-turns would be allowed, reducing the amount of conflicting traffic at the intersection. The southbound left-turn movement from Monterey Road to eastbound San Pedro Avenue could be maintained without having an adverse effect on operations at the intersection since this movement would only be in conflict with the northbound approach. With the restriction of the westbound left-turn movement, the intersection of Monterey Road and San Pedro Avenue is projected to operate at an acceptable LOS C or better during the AM and PM peak hours under existing plus project conditions. The left-turn restriction at San Pedro Avenue would result in the displacement of traffic bound for southbound Monterey Road from westbound San Pedro Avenue (34 and 28 AM and PM peak hour trips, respectively, under existing plus project conditions, with 7 and 1 of those trips being AM and PM peak hour project trips, respectively) to utilize alternative routes, such as Barrett Avenue, Edmundson Avenue, or Tennant Avenue. Left-turns in and out of the existing west-leg driveway (approximately 15 trips total during the PM peak-hour) would have to complete a U-turn north and south of this intersection. Project traffic along westbound San Pedro Avenue would travel southbound on Church Street to Barrett Avenue, to northbound Monterey Road and complete a northbound left-turn at Cosmo Avenue. The minimal amount of displaced traffic represents an average of one trip every two minutes added to two to three other roadways and is not anticipated to have an adverse affect on traffic conditions at the surrounding intersections. The additional northbound left-turn project trips at the intersection of Monterey Road/Cosmo Avenue as a result of the left-turn restriction are not projected to have an adverse affect on intersection operations at this location either.

Freeway Segment Analysis

A freeway level of service analysis was not conducted since the number of project trips added to the freeway segments near the site does not equal or exceed one percent of the capacity of those segments. Based on CMP Traffic Impact Analysis Guidelines, a freeway level of service analysis is not required.

Cumulative Plus Project Intersection Level of Service Analysis

The intersection level of service is summarized in Table ES1. The results show that, measured against the City of Morgan Hill level of service standards, the following study intersections are projected to operate at unacceptable levels of service during at least one of the peak hours analyzed under 2025 cumulative plus project conditions:

4. Monterey Road and San Pedro Avenue – **Impact:** AM and PM peak hours
8. Monterey Road and Watsonville Road/Butterfield Boulevard

The unsignalized intersection of Monterey Road and San Pedro Avenue is projected to operate at an unacceptable LOS E or F during both the AM and PM peak hours under both cumulative and cumulative plus project conditions. In addition, the peak-hour traffic signal warrant checks indicate that the traffic volumes at this intersection would continue to meet the threshold that warrants signalization during both peak hours under cumulative plus project conditions. Therefore, the intersection of Monterey Road and San Pedro Avenue is projected to be impacted by the proposed project during both peak hours under cumulative plus project conditions.

Intersection Mitigations under Cumulative Conditions

4. Monterey Road and San Pedro Avenue

Mitigation: Same as described under existing plus project conditions.

Other Transportation Issues

Project Site Access Evaluation

This review is based on the proposed project site plan, which assumes all access to the school site would be provided via a single right-in and right-out access only driveway along Cosmo Avenue, and a second access point along Monterey Road would provide access to emergency vehicles only..

Site Access

The proposed right-in/right-out operations of the project driveway would eliminate conflict between inbound and outbound traffic and reduce the amount of traffic that would be added to the intersection of Monterey Road/Cosmo Avenue.

Recommendation: The design of the project access driveways must adhere to City of Morgan Hill design guidelines.

On-Site Circulation

The one-way circulation pattern allows for efficient movement of traffic in and out of the school site by minimizing conflict between vehicles on site.

Recommendation: The design of the parking lot, including drive aisle widths, parking stall dimensions, and turn radii, must adhere to City of Morgan Hill design guidelines.

Recommendation: To prohibit left-turn movements from eastbound Cosmo Avenue into the Cosmo Avenue driveway, City staff recommends the installation of double solid striping on Cosmo Avenue, along the project site frontage. In addition, it is recommended that school staff monitor the school driveway during the school peak hours to ensure the left-turn in and out restriction is implemented.

Sight Distance

Based on field observations and Caltrans requirements, the available sight distance at the Cosmo Avenue driveway would be adequate.

Recommendation: The site plan shows trees surrounding the project site. The design of the school campus should ensure design features, in particular the landscaping and signage along the school frontage, will not interfere with the sight distance at the proposed site driveway.

Emergency Vehicle and Truck Access

With implementation of an adequate parking lot design, emergency vehicles and trash collector trucks would be able to circulate in and out of the site without a problem.

Pedestrian Access and Circulation

With the existing and proposed pedestrian facilities in the vicinity of the project site, adequate pedestrian access to and from the project site would be provided.

Recommendation: Since the proposed school is located at the intersection of Monterey Road and Cosmo Avenue, it is recommended that protected pedestrian phasing be installed on all approaches of the intersection. Currently, no crosswalk is located along the north leg of the intersection and the traffic signal operates with permitted phasing on all approaches. Pedestrians crossing Monterey Street at this intersection must use the south crosswalk. Implementing protected pedestrian phasing on all approaches of the intersection would require modifying the traffic signal to include protected left-turn phasing on the northbound and southbound approaches and split phasing on the eastbound and westbound approaches, in addition to the required ADA-compatible wheelchair ramps at both ends of the new crosswalk.

Recommendation: In order to enhance pedestrian safety at the Little Llagas Creek Trail access and crosswalk on Cosmo Avenue, it is recommended that post-mounted rectangular rapid flashing LED beacons be installed on the adjacent bike/pedestrian crossing warning signs to further enhance the visibility of pedestrians within this mid-block crosswalk for motorists.

Recommendation: It is recommended that Voices School work with the City of Morgan Hill to develop a safe routes to school program that will define the safest routes for pedestrians between the adjacent residential areas and the project site.

Recommendation: Crossing of the entry drive aisle from the on-site pedestrian pathway should be discouraged by eliminating any possible pedestrian access to the school campus along the entry drive aisle. If a connection between the on-site pedestrian pathway and the school campus must be provided, however, it is recommended that a clear marked pedestrian connection be provided along the entry drive aisle. A marked connection would encourage crossing of the entry drive aisle from the trail at a single point as well as provide the benefit of a marked crossing that is clearly visible to drivers entering/exiting the site.

Drop-off/Pick-up Estimated Queue Length

It is estimated that a maximum of approximately 12 vehicles would queue up beyond the drop-off area during the peak 15-minute period. However, this estimate assumes all 146 vehicles would arrive at the site evenly during the peak 15-minute period. Traffic patterns, however, are seldom uniform. Random vehicle arrivals result in short periods of time experiencing longer queues than estimated and other short times experiencing no queues at all. Nevertheless, the proposed queue storage capacity within the inbound drive aisle would be approximately one to two vehicles short of meeting the estimated maximum vehicle queue during the school's peak 15-minute period, resulting in one to two vehicles

from the queue spilling onto Cosmo Avenue. During the rest of the peak-hour, the queue storage capacity within the site would be adequate to serve the estimated drop-off queue length.

Additionally, the school may implement staggered start times spreading the arrival times and reducing the amount of inbound traffic during the peak 15-minute period.

Recommendation: It is recommended that school staff or parent volunteers be stationed along the drop-off area to assist students in and out of vehicles and improve drop-off procedures efficiency.

Additionally, in order to speed up student pick up, it is recommended that parents place a name card on the passenger side visor showing the last name and grade level of the child being picked-up so that school staff, positioned at the project driveway, could radio ahead to staff at the drop-off area the name of the student being picked up to ensure the student is ready for pick-up by the time the parent reaches the drop-off area. This would result in a continuous flow of traffic through the site, expediting the pick-up process and limiting inbound vehicle queue lengths.

Recommendation: Measures should be taken to ensure efficient utilization of the available queue storage space within the site and the efficient and safe loading/unloading of the students. It is recommended that the drop-off/pick-up area be well defined with implementation of appropriate signage and pavement markings clearly showing the student loading zone and each vehicle position. The loading lane should be designed to provide the maximum loading area possible. School staff should be positioned along the drive aisle to ensure that students do not unload outside of the designated loading zone.

Recommendation: It is recommended that on-street parking along the southern project site frontage on Cosmo Avenue be prohibited. This would allow potential vehicular queues from the drop-off area to store within this space and avoid blocking access to westbound through traffic. The on-street parking restriction could be permanent (red curb) or time restricted to be implemented during the school peak hours only.

Staggered School Start Times Evaluation

To spread the amount of traffic accessing the project site over the peak-hour, rather than the 15-minute period that is typical of school start times, and reduce potential issues associated with peak-period vehicular access, the school could implement staggered start times. Implementing staggered start times would reduce the amount of traffic accessing the school site during the peak 15-minute period, resulting in shorter queue lengths at the drop-off area.

It is estimated that with 30-minute staggered start times, the average queue length at the drop-off area would be approximately 3 vehicles during the peak period, or a maximum of approximately 6 vehicles. The projected inbound queue length at the drop-off area would be able to accommodate within the site.

Access Driveway Operations

Since the inbound traffic would be restricted to making right-turns into the site only, minimal conflict with existing traffic would occur at the project driveway. It is not anticipated that the westbound queue length at the project driveway would extend to or affect the operations at the intersection of Monterey Road and Cosmo Avenue.

Outbound project traffic would be in conflict with existing westbound traffic along Cosmo Avenue. However, due to the relatively low traffic volumes along westbound Cosmo Avenue, there would be adequate gaps in the westbound direction to allow outbound project traffic to exit the site, having minimal effect on traffic operations at the project driveway and along Cosmo Avenue.

Recommendation: In order to avoid vehicular queues along the eastbound direction on Cosmo Avenue that would result in the blockage of through traffic, left-turn inbound and outbound access should be prohibited. Double solid striping, as recommended by City staff, should be installed along the project site frontage on Cosmo Avenue to indicate no left-turn access is allowed at the project driveway.

Monterey Road and Cosmo Avenue Intersection Operations

The intersection level of service analysis shows the intersection of Monterey Road and Cosmo Avenue to currently operate at acceptable LOS A during both the AM and PM peak hours and is projected to continue to operate at LOS A with the addition of project traffic.

Although the intersection is projected to operate adequately with the implementation of the proposed school project, the missing crosswalk along the north leg of the intersection and permitted signal phasing is less than ideal for an intersection that would serve as the main access intersection for the school. Thus, it was previously recommended that protected pedestrian phasing be installed on all approaches of the intersection to accommodate pedestrian school traffic. With the implementation of the recommended signal phasing improvements, the intersection is projected to continue to operate at an acceptable LOS C or better during the AM and PM peak-hours with the project.

Roadway Segment Analysis

The purpose of the roadway segment analysis is to quantify the potential change in traffic volumes along key roadway segments in the vicinity of the project site as a result of the proposed project.

Findings of the Roadway Segment Analysis

The following conclusions can be drawn from the evaluation of the study roadways:

- Traffic volumes at all study roadways are and would continue to be within the volume range characteristic for collector streets.
- Speeds along three of the four study roadway segments currently exceed the posted speed limit by more than 5 mph. Speeding is occurring under existing conditions and not caused by the project.
- With the proposed site access configuration, traffic volumes along Cosmo Avenue are projected to increase by approximately 30% from existing conditions as a result of the proposed project, an increase which could be considered measurable and would be perceptible to residents of the adjacent neighborhood.
- Most of the traffic increases along the study roadway segments would occur during the peak hours, with little to no change in traffic during the off-peak hours.

Parking

The project is proposing to provide a total of 33 on-site parking spaces, which would include two accessible parking spaces.

Section 18.72.030 of the Morgan Hill City Code specifies the required number of on-site parking spaces for different types of land uses. Per Table 18.72-2, elementary and middle schools are required to provide one parking space per classroom, plus one parking space per 250 square feet (s.f.) of office area. According to the site plan, the school would consist of an 18-classroom modular school building and would include less than 2,000 s.f. of administration office space. Based on this information and the City's parking requirements, the proposed school would be required to provide a total of 26 parking spaces.

Recommendation: Some of the school traffic could park on the street. There are currently no on-street parking restrictions along the extent of Cosmo Avenue. However, it is recommended that on-street

parking be prohibited along the school frontage on Cosmo Avenue, at a minimum during the school peak hours. This would eliminate parking activity near the project site driveway and thus conflict between school traffic entering/exiting the site and those parking on the street. In addition, as mentioned previously, prohibiting on-street parking along the southern site frontage on Cosmo Avenue would provide additional space for potential inbound queues to store next to the curb and avoid blocking westbound through traffic flow.

Recommendation: There are no parking restrictions along Monterey Road, with the exception of red curbing next to bus stops and fire hydrants. For this reason, the school should encourage all student drop-offs/pick-ups to occur within the site at the drop-off area. Should student drop-offs/pick-ups along Monterey Road become an issue, on-street parking along the Monterey Road school frontage should be prohibited during the school peak hours. Ultimately, the City of Morgan Hill will determine if on-street parking would be allowed along Cosmo Avenue and Monterey Road in the vicinity of the proposed school.

Intersection Operations Analysis

The intersection queuing analysis is summarized in Table ES2. Intersections projected to have left-turn queue storage deficiencies are discussed below.

2. Monterey Road and Dunne Avenue

Eastbound Left-Turn

The addition of project traffic to this intersection would increase the 95th percentile vehicle queues for this movement by 5 and 6 vehicles (to 10 and 11 vehicles) during the AM and PM peak hours, respectively, exceeding the existing queue storage capacity by 6 to 7 vehicles.

It is possible to extend the existing eastbound left-turn lane the additional 150 feet needed by removing the adjacent two-way left-turn (TWLT) lane. Removing the adjacent TWLT lane would affect left-turn access at the adjacent shopping center driveway (south side of Dunne Avenue). However, a second driveway to the shopping center located approximately 150 feet west of the affected driveway would continue to provide full access to the shopping center. Alternatively, the projected maximum queue length, which is projected to occur during the school's peak 15-minute period, could accommodate within the existing TWLT lane.

5. Monterey Road and Cosmo Avenue

Northbound Left-Turn

The addition of project traffic to this intersection would increase the 95th percentile vehicle queues for this movement by 7 vehicles (to 8 vehicles) during the AM peak hour, exceeding the existing queue storage capacity by 3 vehicles.

It is possible to extend the existing northbound left-turn lane the additional 75 feet needed by removing/modifying the existing landscape median, which would include the removal of 3 to 4 trees within the median.

Additionally, the projected queue length for this movement also was evaluated assuming the implementation of the recommended pedestrian phasing on all approaches of the intersection. With the recommended signal phasing improvements, the northbound left-turn queue length is projected to increase by 10 vehicles (to 11 vehicles) during the AM peak-hour, exceeding the future queue storage capacity by as many as 6 vehicles. Extending the existing left-turn pocket an additional 150 feet to accommodate 6 additional vehicles would require removal/modification of the existing landscape median and part of the two-way left-turn to provide a 275-foot left-turn lane.

6. Monterey Road and Tennant Avenue

Southbound Left-Turn

The queuing analysis indicates that the maximum vehicle queue for this movement is projected to exceed the existing vehicle storage capacity during the PM peak-hour. The addition of project traffic to this intersection, however, is not projected to have an effect in the 95th percentile vehicle queue length for this movement.

9. Butterfield Boulevard and Main Avenue

Eastbound Left-Turn

The addition of project traffic to this intersection would increase the 95th percentile vehicle queues for this movement by 1 vehicle (to 8 vehicles) during the AM peak-hour, exceeding the existing queue storage capacity by 3 vehicles.

It is not possible to extend the existing eastbound left-turn lane at this intersection due to the adjacent eastbound left-turn lane providing access to the office complex located at the northwest corner of the Butterfield Boulevard/Main Avenue intersection. In order to extend the existing left-turn pocket the additional 75 feet needed, the adjacent left-turn pocket would need to be removed. Alternatively, a second eastbound left-turn lane could be provided.

10. Butterfield Boulevard and Dunne Avenue

Eastbound Left-Turn

The addition of project traffic to this intersection would increase the 95th percentile vehicle queues for this movement by 2 vehicles (to 11 vehicles) during both peak hours exceeding the existing queue storage capacity by 1 vehicle.

It is not possible to extend the existing eastbound left-turn lane at this intersection due to the adjacent back-to-back left-turn pocket. In order to extend the existing left-turn pocket at the intersection of Butterfield Boulevard/Dunne Avenue, the adjacent left-turn pocket would need to be reduced. Alternatively, a second eastbound left-turn lane could be provided. In addition, the maximum queue length is projected to occur during the school's peak 15-minute periods. Outside of the peak 15-minute periods, the existing queue storage capacity for this movement would be adequate.

Potential Impacts on Pedestrians, Bicycles, and Transit

Project's Effect on Pedestrian Facilities

New pedestrian traffic potentially could be generated by the proposed project. The school site is surrounded by residential communities. Additionally, bus stops are located along both side of Monterey Road, adjacent to the project site.

With the existing and proposed pedestrian facilities within and in the vicinity of the project site, adequate pedestrian access to and from the project site to nearby pedestrian destinations, such as the bus stops along Monterey Road and residential areas near the project site, would be provided. Therefore, pedestrian access to and from the project site would be adequate.

Project's Effect on Bicycle Facilities

The proposed project could increase the demand on bicycle facilities in the vicinity of the project site. Assuming bicycle trips would comprise no more than one percent of the total project-generated trips, the project could generate up to 6 new bicycle trips during the peak hours. The potential demand could

be easily served by the various bicycle facilities available in the immediate vicinity of the project site. Therefore, the potential increase in bicycle trips by the proposed project would not have an adverse effect on the existing bicycle facilities in the study area, and would not require new off-site bicycle facilities.

Project's Effect on Bicycle Facilities

Due to the nature of the project, it is not anticipated that transit demand by the project would be significant to justify the enhancement of the existing transit facilities.

**Table ES 1
Intersection Level of Service Summary**

Int. #	Intersection	Existing Control	LOS Standard	Peak Hour	Count Date	Existing			Existing + Project				2025 Cumulative			2025 Cumulative + Project				
						Warrant Met? ¹	Avg. Delay ²	LOS	Warrant Met? ¹	Avg. Delay ²	LOS	Incr. In Crit. Delay	Incr. In Crit. V/C	Warrant Met? ¹	Avg. Delay ²	LOS	Warrant Met? ¹	Avg. Delay ²	LOS	Incr. In Crit. Delay
1	Monterey Road and Main Avenue	Signal	F	AM 05/08/18	--	44.2	D	--	44.5	D	0.9	0.033	--	55.8	E	--	56.9	E	1.4	0.013
				PM 05/08/18	--	45.1	D	--	45.5	D	0.4	0.011	--	48.2	D	--	48.9	D	0.5	0.011
2	Monterey Road and Dunne Avenue	Signal	E	AM 05/08/18	--	28.9	C	--	30.6	C	1.8	0.028	--	29.8	C	--	31.6	C	2.0	0.028
				PM 05/08/18	--	31.4	C	--	33.0	C	2.4	0.040	--	34.7	C	--	36.1	D	1.6	0.034
3	Monterey Road and Spring Avenue	Signal	D	AM 03/14/19	--	5.1	A	--	5.5	A	0.6	0.008	--	4.7	A	--	5.1	A	0.5	0.008
				PM 03/21/19	--	11.3	B	--	11.6	B	0.2	0.035	--	11.8	B	--	12.1	B	0.2	0.034
4	Monterey Road and San Pedro Avenue	TWSC	D	AM 03/14/19	No	26.7	D	No	38.6	E	N/A	N/A	No	42.9	E	Yes	75.6	F	N/A	N/A
				PM 03/14/19	Yes	71.1	F	Yes	97.1	F	N/A	N/A	Yes	148.8	F	Yes	209.0	F	N/A	N/A
5	Monterey Road and Cosmo Avenue	Signal	D	AM 03/14/19	--	3.8	A	--	3.5	A	0.0	0.000	--	3.7	A	--	3.5	A	0.0	0.000
				PM 03/14/19	--	3.9	A	--	3.8	A	0.0	0.000	--	3.9	A	--	3.8	A	0.0	0.000
6	Monterey Road and Tennant Avenue/Edmundson Avenue	Signal	E	AM 03/14/19	--	23.7	C	--	24.2	C	0.5	0.037	--	23.9	C	--	24.4	C	0.5	0.036
				PM 03/14/19	--	36.4	D	--	37.3	D	1.2	0.015	--	36.1	D	--	36.9	D	1.2	0.014
7	Monterey Road and Vineyard Boulevard	Signal	D	AM 03/14/19	--	20.3	C	--	20.2	C	-0.3	0.014	--	19.8	B	--	19.9	B	-0.1	0.014
				PM 03/14/19	--	27.8	C	--	27.6	C	-0.2	0.008	--	27.3	C	--	27.2	C	-0.1	0.008
8	Monterey Road and Watsonville Road/Butterfield Boulevard	Signal	D	AM 03/14/19	--	30.1	C	--	30.4	C	0.4	0.006	--	34.8	C	--	35.3	D	0.8	0.006
				PM 03/14/19	--	46.6	D	--	47.5	D	1.4	0.007	--	61.1	E	--	62.1	E	1.8	0.007
9	Butterfield Boulevard and Main Avenue	Signal	D	AM 05/08/18	--	27.6	C	--	27.9	C	0.2	0.007	--	30.6	C	--	31.0	C	0.8	0.015
				PM 05/08/18	--	29.8	C	--	30.0	C	0.3	0.005	--	33.2	C	--	33.4	C	0.4	0.005
10	Butterfield Boulevard and Dunne Avenue	Signal	D	AM 05/18/18	--	38.3	D	--	39.6	D	1.8	0.029	--	42.6	D	--	44.5	D	2.6	0.026
				PM 05/18/18	--	35.3	D	--	36.2	D	1.5	0.031	--	37.7	D	--	38.9	D	1.7	0.029
11	Butterfield Boulevard and San Pedro Avenue	Signal	D	AM 03/14/19	--	13.0	B	--	13.3	B	0.4	0.009	--	13.7	B	--	13.9	B	0.4	0.009
				PM 03/14/19	--	13.2	B	--	13.3	B	0.2	0.005	--	13.8	B	--	14.0	B	0.2	0.005
12	Butterfield Boulevard and Tennant Avenue	Signal	E	AM 01/23/18	--	23.9	C	--	24.0	C	0.0	0.007	--	26.3	C	--	26.6	C	0.5	0.008
				PM 01/23/18	--	37.4	D	--	37.4	D	0.0	0.003	--	40.9	D	--	40.9	D	0.1	0.003
13	US 101 SB Ramps and Dunne Avenue	Signal	E	AM 05/08/18	--	20.9	C	--	21.4	C	-0.2	0.033	--	21.0	C	--	22.1	C	-0.1	0.014
				PM 05/08/18	--	18.8	B	--	20.1	C	0.2	0.037	--	20.1	C	--	21.3	C	0.7	0.035
14	US 101 NB Ramps and Dunne Avenue	Signal	E	AM 05/08/18	--	5.3	A	--	5.2	A	-0.1	0.009	--	6.3	A	--	6.2	A	-0.1	0.009
				PM 05/08/18	--	11.8	B	--	11.7	B	0.3	0.003	--	11.2	B	--	11.2	B	0.0	0.001
15	Church Street and Dunne Avenue	Signal	E	AM 06/06/18	--	17.8	B	--	18.0	B	0.0	0.047	--	18.1	B	--	18.5	B	0.1	0.046
				PM 06/06/18	--	19.9	B	--	19.2	B	-0.5	0.021	--	19.5	B	--	18.9	B	-0.4	0.020
16	Olympic Drive and Edmundson Avenue	OWSC	D	AM 03/14/19	No	9.8	A	No	11.2	B	N/A	N/A	No	10.4	B	No	12.4	B	N/A	N/A
				PM 03/14/19	No	10.9	B	No	12.3	B	N/A	N/A	No	11.4	B	No	13.1	B	N/A	N/A
17	Del Monte Avenue and Cosmo Avenue	AWSC	D	AM 03/14/19	No	7.2	A	No	8.1	A	0.9	0.243	No	7.2	A	No	8.1	A	0.8	0.236
				PM 03/14/19	No	7.4	A	No	8.3	A	0.8	0.189	No	7.5	A	No	8.3	A	0.8	0.182
18	Del Monte Avenue and Spring Avenue	AWSC	D	AM 03/14/19	No	7.8	A	No	9.3	A	1.4	0.255	No	8.1	A	No	9.6	A	1.5	0.243
				PM 03/14/19	No	7.9	A	No	8.7	A	0.8	0.148	No	8.1	A	No	8.8	A	0.8	0.145

¹ Signal warrant analysis based on the Peak Hour Signal Warrant #3, Figure 4C Caltrans MUTCD, 2014. Signal warrant analysis is not applicable to signalized intersections.
² The reported delay and corresponding level of service for signalized and all-way stop-controlled intersections represents the average delay for all approaches at the intersection.
 The reported delay and corresponding level of service for one- and two-way stop-controlled intersections are based on the stop-controlled approach with the highest delay.
Bold indicates unacceptable level of service.
Bold and boxed indicate significant impact.

**Table ES 2
Intersection Queuing Analysis Summary**

Measurement	2. Monterey/ Dunne				5. Monterey/ Cosmo		6. Monterey/ Tennant		8. Monterey/ Watsonville		9. Butterfield/ Main		10. Butterfield/ Dunne	
	EBL AM	EBL PM	WBL AM	WBL PM	NBL AM	NBL PM	SBL AM	SBL PM	EBL AM	EBL PM	EBL AM	EBL PM	EBL AM	EBL AM
Existing Conditions														
Cycle/Delay ¹ (sec)	105	105	105	105	60	60	90	135	85	140	100	110	120	120
Lanes	1	1	2	2	1	1	2	2	1	1	1	1	1	1
Volume (vph)	85	77	144	329	17	45	92	213	58	43	134	87	153	153
Volume (vphpl)	85	77	72	165	17	45	46	107	58	43	134	87	153	153
Avg. Queue (veh./ln.)	2	2	2	5	0	1	1	4	1	2	4	3	5	5
Avg. Queue ² (ft./ln)	62	56	53	120	7	19	29	100	34	42	93	66	128	128
95th % Queue (veh./ln.)	5	5	5	9	1	2	3	8	4	4	7	6	9	9
95th % Queue (ft./ln)	125	125	125	225	25	50	75	200	100	100	175	150	225	225
Storage (ft./ ln.)	100	100	350	350	125	125	175	175	200	200	125	125	250	250
Adequate (Y/N)	NO	NO	YES	YES	YES	YES	YES	NO	YES	YES	NO	NO	YES	YES
Existing Plus Project Conditions with Proposed Site Access (Right-in/Right-out at Cosmo Driveway)														
Cycle/Delay ¹ (sec)	105	105	105	105	60	60	90	135	85	140	100	110	120	120
Lanes	1	1	2	2	1	1	2	2	1	1	1	1	1	1
Volume (vph)	193	227	312	494	251	128	92	213	92	50	145	98	195	195
Volume (vphpl)	193	227	156	247	251	128	46	107	92	50	145	98	195	195
Avg. Queue (veh./ln.)	6	7	5	7	4	2	1	4	2	2	4	3	7	7
Avg. Queue ² (ft./ln)	141	166	114	180	105	53	29	100	54	49	101	75	163	163
95th % Queue (veh./ln.)	10	11	8	12	8	5	3	8	5	4	8	6	11	11
95th % Queue (ft./ln)	250	275	200	300	200	125	75	200	125	100	200	150	275	275
Storage (ft./ ln.)	100	100	350	350	125	125	175	175	200	200	125	125	250	250
Adequate (Y/N)	NO	NO	YES	YES	NO	YES	YES	NO	YES	YES	NO	NO	NO	NO

¹ Vehicle queue calculations based on cycle length for signalized intersections and control delay for unsignalized intersections.
² Assumes 25 feet per vehicle in the queue.
 NB = Northbound, SB = Southbound, EB = Eastbound, WB = Westbound, R = Right, T = Through, L = Left.

1. Introduction

This report presents the results of the traffic impact analysis conducted for the proposed Voices School in Morgan Hill, California. Voices School is an existing Transitional Kinder (TK) through 4th grade public charter school currently located at a temporary site on Jarvis Drive in the northern part of Morgan Hill. The project as proposed consists of the construction of a new permanent site for the charter school that will house a TK through 8th grade school. The project site is located at the northwest corner of the intersection of Monterey Road and Cosmo Avenue and consists of an undeveloped lot. As proposed, the new school site would consist of a two-story school campus that would include 18 classrooms, administrative offices, teacher's workroom, storage, restrooms, and a multipurpose building/cafeteria. At full buildout (School Year 2023-2024), the school is proposing to serve up to 504 students with 63 staff/faculty members. The school's hours of operation would be from 7:00 AM and 6:00 PM Monday through Friday, which includes office hours between 7:30 AM and 4:30 PM and before and after school care/activities. School instructional hours would be from 8:00 AM to 4:00 PM Monday through Friday (with the exception of minimum days when school would be out at 12:30 PM) and it would follow a traditional school year calendar (from September to June). A total of 33 parking spaces would be provided on site. Access to the project site would be provided via a driveway on Cosmo Avenue. A second driveway along Monterey Road would provide emergency access only to the site.

The project site location and the surrounding study area are shown on Figure 1. The project site plan is shown on Figure 2.

Scope of Study

The potential impacts related to the proposed school project were evaluated following the standards and methodologies set forth by the City of Morgan Hill and the Santa Clara Valley Transportation Authority (VTA). The VTA administers the County Congestion Management Program (CMP).

The study includes an analysis of AM and PM peak-hour traffic conditions for fourteen signalized intersections and four unsignalized intersections. Additionally, per CMP guidelines, an evaluation to determine whether a freeway level of service analysis is required was conducted and is included within the following sections. The study also includes a site access and on-site circulation analysis, which includes levels of service analysis, sight distance analysis, and vehicle-storage requirements. The site access and circulation analyses were based on professional judgment in accordance with the standards and methods employed by the traffic engineering community.

The study intersections and freeway segments are listed below and shown on Figure 1.

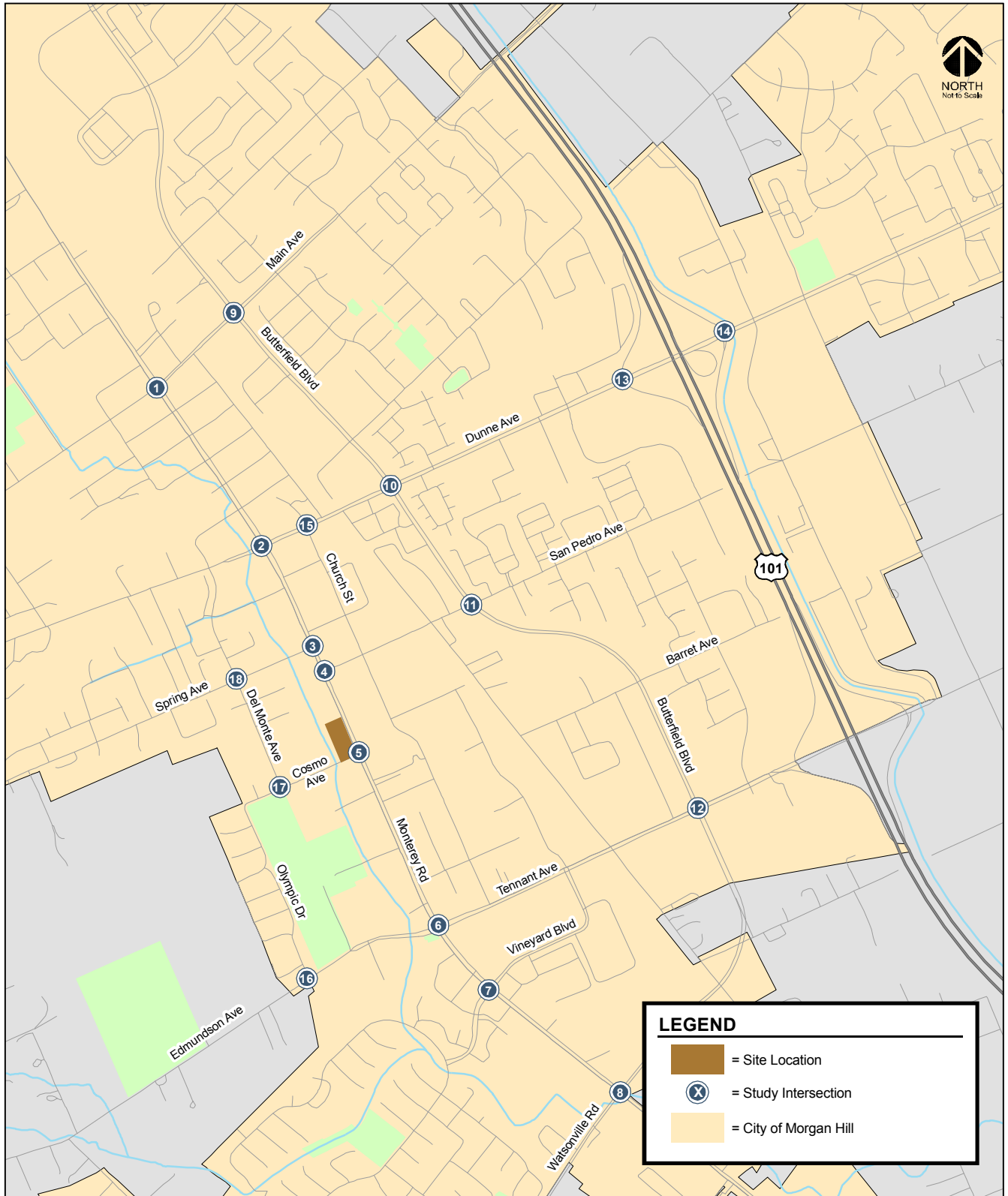
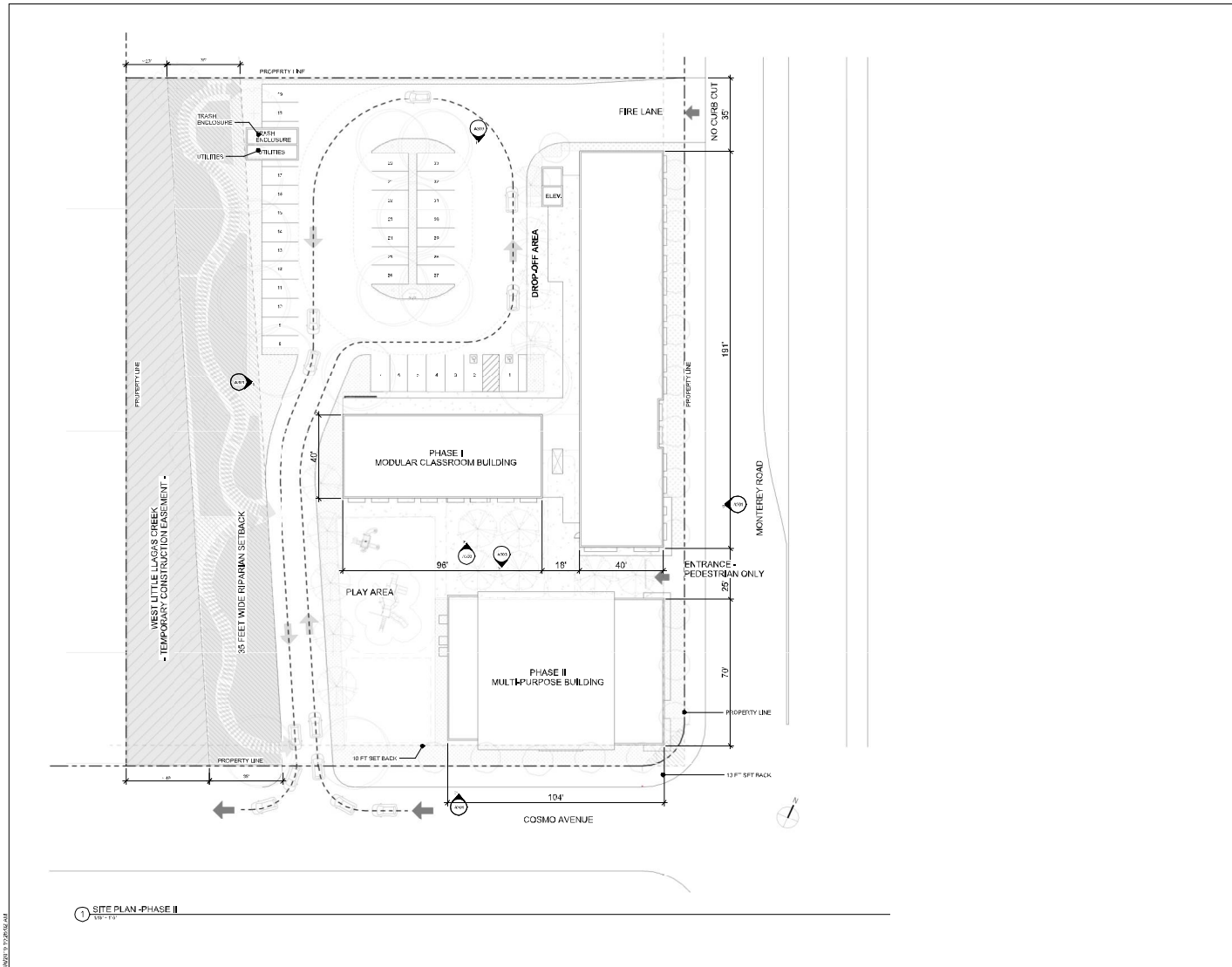

Figure 1
Site Location and Study Intersections



K2A
ARCHITECTURE
• INTERIORS
555 De Haro Street, Suite 380
San Francisco, CA 94107
T: 415.487.6900
F: 415.487.0909

ARCHITECT
NO. 01556
200 00
STATE OF CALIFORNIA

Client
Voices College Bound
Language Academies

Project Name
Voices Morgan Hill

1000 Ave. S. Monterey Rd.
Morgan Hill, CA 95037

Sheaf Name
SITE PLAN - PHASE II

Approval Stamp

Revisions

Show Information
Drawing Scale: 1/8" = 1'-0"
Drawn By: A.B.C.

Project Information
Date: 04/20/19
Status: PLANNING PERM.
Project Number: 1017

Show

A101b

Figure 2
Project Site Plan

Study Intersections

The study includes the evaluation of traffic conditions at the following fourteen signalized intersections and four unsignalized intersection:

1. Monterey Road and Main Avenue
2. Monterey Road and Dunne Avenue
3. Monterey Road and Spring Avenue
4. Monterey Road and San Pedro Avenue (unsignalized)
5. Monterey Road and Cosmo Avenue
6. Monterey Road and Tennant Avenue/Edmundson Ave
7. Monterey Road and Vineyard Boulevard
8. Monterey Road and Watsonville Road/Butterfield Boulevard
9. Butterfield Boulevard and Main Avenue
10. Butterfield Boulevard and Dunne Avenue
11. Butterfield Boulevard and San Pedro Avenue
12. Butterfield Boulevard and Tennant Avenue
13. US 101 SB Ramps and Dunne Avenue
14. US 101 NB Ramps and Dunne Avenue
15. Church Street and Dunne Avenue
16. Olympic Drive and Edmundson Avenue (unsignalized)
17. Del Monte Avenue and Cosmo Avenue (unsignalized)
18. Del Monte Avenue and Spring Avenue (unsignalized)

Study Freeway Segments

The study includes the evaluation of the following freeway segments:

1. US 101 between Masten Avenue and San Martin Avenue
2. US 101 between San Martin Avenue and Tennant Avenue
3. US 101 between Tennant Avenue and Dunne Avenue
4. US 101 between Dunne Avenue and Cochrane Road
5. US 101 between Cochrane Road and Burnett Avenue (Lane Drop)

Study Time Periods

The instructional school day would begin at 8:00 AM and end at 4:00 PM for all grades, with some students arriving at the site as early as 7:00 AM for before school care. Some students also are anticipated to remain on-site for after school care/activities and leave the site as late as 6:00 PM. The peak hour of school traffic in the morning would coincide with the AM peak-hour of commute traffic (generally between 7:00 and 9:00 AM). After school traffic also would be generated during the PM peak-hour (typically between 4:00 and 6:00 PM), consisting of both traffic associated with the end of the school day dismissal and after school programming. Thus, traffic conditions at the study intersections were analyzed for the standard weekday AM and PM peak hours of traffic. It is during these peak commute periods that traffic is busiest and the impact on the roadway system by traffic from the school would be greatest.

Study Scenarios

Traffic conditions were evaluated for the following scenarios:

Scenario 1: Existing Conditions. Existing conditions represent existing peak-hour traffic volumes on the existing roadway network. Existing peak-hour traffic volumes were obtained from turning-movement traffic counts conducted in May 2018 and March 2019.

Scenario 2: *Existing plus Project Conditions.* Project-generated traffic volumes at full capacity of the proposed school were added to existing traffic volumes to estimate existing plus project conditions. Existing plus project conditions were evaluated relative to existing conditions in order to determine potential project impacts.

Scenario 3: *Year 2025 Cumulative Conditions.* Year 2025 Cumulative conditions represent future traffic volumes on the future transportation network. Year 2025 Cumulative conditions include traffic growth projected to occur in the Year 2025 without the proposed project.

Scenario 4: *Year 2025 Cumulative plus Project Conditions.* Year 2025 Cumulative with project consists of Year 2025 Cumulative traffic conditions with the addition of project traffic. Cumulative plus project conditions were evaluated relative to cumulative conditions in order to determine potential cumulative project impacts.

Methodology

This section presents the methods used to determine the traffic conditions for each scenario described above. It includes descriptions of the data requirements, the analysis methodologies, and the applicable level of service standards.

Data Requirements

The data required for the analysis were obtained from new peak-hour intersection turn-movement counts, previous traffic studies, the City of Morgan Hill, and field observations. The following data were collected from these sources:

- Existing traffic volumes
- Existing lane configurations
- Signal timing and phasing
- Year 2025 traffic volume forecasts

Analysis Methodologies and Level of Service Standards

Traffic conditions at the study intersections were evaluated using level of service (LOS). *Level of Service* is a qualitative description of operating conditions ranging from LOS A, or free-flow conditions with little or no delay, to LOS F, or jammed conditions with excessive delays. The various analysis methods are described below.

Signalized Intersections

Signalized study intersections are subject to the City of Morgan Hill level of service standards. The City of Morgan Hill level of service methodology is TRAFFIX, which is based on the 2000 *Highway Capacity Manual* (HCM) method for signalized intersections. TRAFFIX evaluates signalized intersection operations on the basis of average control delay time for all vehicles at the intersection. Since TRAFFIX is also the CMP-designated intersections level of service methodology, the City of Morgan Hill methodology employs the CMP defaults values for the analysis parameters, which include adjusted saturation flow rates to reflect conditions in Santa Clara County.

In accordance with the adopted threshold of significance described in the City of Morgan Hill's Guidelines for Preparation of Transportation Impact Reports, , dated February 2010, all intersections within the City of Morgan Hill are required to meet the City's LOS standard of LOS D, with the exception of the following:

- **LOS F** for Downtown intersections and segments including at Main Avenue/Monterey Road, along Monterey Road between Main Avenue and Fifth Street, and along Depot Street at First Street through Fifth Street;
- **LOS E** for the following intersections and freeway zones:
 - Main Avenue and Del Monte Avenue
 - Main Avenue and Depot Street
 - Dunne Avenue and Del Monte Avenue
 - Dunne Avenue and Monterey Avenue
 - Dunne Avenue and Church Street
 - Dunne Avenue and Depot Street
 - Cochrane Road and Monterey Road
 - Tennant Avenue and Monterey Road
 - Tennant Avenue and Butterfield Boulevard
 - Cochrane Road Freeway Zone: from Madrone Parkway/Cochrane Plaza to Cochrane Road/DePaul Drive
 - Dunne Avenue Freeway Zone: from Walnut Grove Drive/East Dunne Avenue to Condit Road/East Dunne Avenue
 - Tennant Avenue Freeway Zone: from Butterfield Boulevard/Tennant Avenue to Condit Road/Tennant Avenue

Seven of the study intersections are located within the Downtown Core area (LOS F standard) or LOS E standard areas. The remaining eleven study intersections have a LOS D standard.

The correlation between average delay and level of service for signalized intersections is shown in Table 1.

Unsignalized Intersections

The methodology used to determine the level of service for unsignalized intersections is also TRAFFIX and the 2000 HCM methodology for unsignalized intersection analysis. This method is applicable for both two-way and all-way stop-controlled intersections. For the analysis of stop-controlled intersections, the 2000 HCM methodology evaluates intersection operations on the basis of average control delay time for all vehicles on the stop-controlled approaches. For the purpose of reporting level of service for one- and two-way stop-controlled intersections, the delay and corresponding level of service for the stop-controlled minor street approach with the highest delay is reported. For all-way stop-controlled intersections, the reported average delay and corresponding level of service is the average for all approaches at the intersection.

The City of Morgan Hill uses a minimum acceptable level of service standard of LOS D for unsignalized intersections (with the exception of unsignalized intersections located within the Downtown area and freeway zones, as described above), in accordance with its adopted threshold of significance in its Guidelines for Preparation of Transportation Impact Reports. All four of the unsignalized intersections have a level of service standard of LOS D. The correlation between average delay and level of service for unsignalized intersections is shown in Table 2.

Signal Warrants

The level of service analysis at unsignalized intersections is supplemented with an assessment of the need for signalization of the intersection. The need for signalization of unsignalized intersections is assessed based on the Peak Hour Volume Warrant (Warrant 3) described in the *California Manual on Uniform Traffic Control Devices for Streets and Highways (CA MUTCD)*, Part 4, Highway Traffic

Table 1
Signalized Intersection Level of Service Definitions Based on Control Delay

Level of Service	Description	Average Control Delay Per Vehicle (Sec.)
A	Operations with very low delay occurring with favorable progression and/or short cycle lengths.	Up to 10.0
B	Operations with low delay occurring with good progression and/or short cycle lengths.	10.1 to 20.0
C	Operations with average delays resulting from fair progression and/or longer cycle lengths. Individual cycle failures begin to appear.	20.1 to 35.0
D	Operations with longer delays due to a combination of unfavorable progression, long cycle lengths, or high V/C ratios. Many vehicles stop and individual cycle failures are noticeable.	35.1 to 55.0
E	Operations with high delay values indicating poor progression, long cycle lengths, and high V/C ratios. Individual cycle failures are frequent occurrences. This is considered to be the limit of acceptable delay.	55.1 to 80.0
F	Operation with delays unacceptable to most drivers occurring due to over saturation, poor progression, or very long cycle lengths.	Greater than 80.0

Source: Transportation Research Board, 2000 Highway Capacity Manual. (Washington, D.C., 2000)

Signals, 2014. This method makes no evaluation of intersection level of service, but simply provides an indication whether vehicular peak-hour traffic volumes are, or would be, sufficient to justify installation of a traffic signal. The decision to install a traffic signal should not be based purely on the warrants alone. Instead, the installation of a signal should be considered and further analysis performed when one or more of the warrants are met. Additionally, engineering judgment is exercised on a case-by-case basis to evaluate the effect a traffic signal will have on certain types of accidents and traffic conditions at the subject intersection as well as at adjacent intersections. Intersections that meet the peak-hour warrant are subject to further analysis before determining that a traffic signal is necessary. Other options such as traffic control devices, signage, or geometric changes may be preferable based on existing field conditions.

Freeway Segments

According to CMP Traffic Impact Analysis Guidelines, dated March 2009, a freeway level of service analysis is required if the number of project trips added to any freeway segment equals or exceeds one percent of the capacity of the segment. The key freeway segments in the study area were evaluated to determine if the project traffic on each segment would exceed this threshold. In the vicinity of the project site, US 101 has three mixed-flow lanes in each direction of travel south of Cochrane Road, and three mixed-flow lanes plus one high occupancy vehicle (HOV) lane north of Cochrane Road. The CMP specifies that a capacity of 2,300 vehicles per hour per lane (vphpl) be used for mixed-flow lane segments that are three lanes or wider in one direction, and a capacity of 2,200 vphpl be used for mixed-flow lane segments that are two lanes wide in one direction. A capacity of 1,650 vphpl was used

Table 2
Unsignalized Intersection Level of Service Definitions Based on Control Delay

Level of Service	Description	Average Control Delay per Vehicle (sec.)
A	Operations with very low delays occurring with favorable progression.	up to 10.0
B	Operations with low delays occurring with good progression.	10.1 to 15.0
C	Operations with average delays resulting from fair progression.	15.1 to 25.0
D	Operation with longer delays due to a combination of unfavorable progression of high V/C ratios.	25.1 to 35.0
E	Operation with high delay values indicating poor progression and high V/C ratios. This is considered to be the limited of acceptable delay.	35.1 to 50.0
F	Operation with delays unacceptable to most drivers occurring due to oversaturation and poor progression.	Greater than 50.0

Source: Transportation Research Board, 2000 Highway Capacity Manual, (Washington, D.C., 2000).

for high occupancy vehicle (HOV) lanes. Thus, the three mixed-flow lanes on US 101 near the project site have a capacity of 6,900 vph plus 1,650 vph for the segments with HOV lanes. Using the CMP's one-percent threshold, a freeway level of service analysis for US 101 would be needed if the project adds 69 or more trips to the freeway segments (mixed-flow lanes) near the site.

A review of the project trip assignment indicates that the highest number of project trips in any direction on the subject freeway segments would be no more than 32 trips (US 101, between East Dunne Avenue and SR 85) during both the AM and PM peak hours. Since the number of project trips on the freeway falls below the one-percent threshold, the project would not cause a significant increase in traffic on the freeway segments in the study area, and a freeway level of service analysis is not required. The freeway capacity analysis is summarized on Table 3.

Report Organization

The remainder of this report is divided into five chapters. Chapter 2 describes existing conditions in terms of the existing roadway network, transit service, and existing bicycle and pedestrian facilities. Chapter 3 presents the project impact on the transportation system and describes the recommended mitigation measures under existing plus project conditions. Chapter 4 presents the analysis of other transportation related issues, including site access and on-site circulation. Chapter 5 presents the traffic conditions in the study area under Year 2025 Cumulative conditions without and with the addition of project traffic. Chapter 6 presents the conclusions of the traffic impact analysis.

**Table 3
Freeway Segment Capacity Evaluation**

#	Freeway Segment	Direction	Peak Hour	Existing Plus Project				Project Trip				
				Mixed-Flow Lane		HOV Lane		Total Volume	Mixed-Flow Lane		HOV Lane	
				# of Lanes ¹	Capacity (vph)	# of Lanes ¹	Capacity (vph)		% of Volume	% of Capacity	% of Volume	% of Capacity
1	US 101 from Masten Avenue to San Martin Avenue	NB	AM	3	6,900	--	--	13	13	0.19	--	--
		NB	PM	3	6,900	--	--	0	0	0.00	--	--
2	US 101 from San Martin Avenue to Tennant Avenue	NB	AM	3	6,900	--	--	13	13	0.19	--	--
		NB	PM	3	6,900	--	--	0	0	0.00	--	--
3	US 101 from Tennant Avenue to East Dunne Avenue	NB	AM	3	6,900	--	--	0	0	0.00	--	--
		NB	PM	3	6,900	--	--	0	0	0.00	--	--
4	US 101 from East Dunne Avenue to Cochrane Road	NB	AM	3	6,900	--	--	0	0	0.00	--	--
		NB	PM	3	6,900	--	--	17	17	0.25	--	--
5	US 101 from Cochrane Road to Burnett Avenue (Lane Drop)	NB	AM	3	6,900	1	1,650	0	0	0.00	0	0.00
		NB	PM	3	6,900	1	1,650	17	14	0.20	3	0.18
6	US 101 from Burnett Avenue (Lane Drop) to Sheller Avenue	NB	AM	3	6,900	1	1,650	0	0	0.00	0	0.00
		NB	PM	3	6,900	1	1,650	17	15	0.22	2	0.12
7	US 101 from Sheller Avenue to Lane Drop (SB)	NB	AM	3	6,900	1	1,650	0	0	0.00	0	0.00
		NB	PM	3	6,900	1	1,650	17	13	0.19	4	0.24
8	US 101 from Lane Drop (SB) to SR 85	NB	AM	3	6,900	1	1,650	0	0	0.00	0	0.00
		NB	PM	3	6,900	1	1,650	17	15	0.22	2	0.12
9	US 101 from SR 85 to Lane Drop (SB)	SB	AM	4	9,200	1	1,650	32	28	0.30	4	0.24
		SB	PM	4	9,200	1	1,650	0	0	0.00	0	0.00
10	US 101 from Lane Drop (SB) to Sheller Avenue	SB	AM	3	6,900	1	1,650	32	26	0.38	6	0.36
		SB	PM	3	6,900	1	1,650	0	0	0.00	0	0.00
11	US 101 from Sheller Avenue to Burnett Avenue (Lane Drop)	SB	AM	3	6,900	1	1,650	32	27	0.39	5	0.30
		SB	PM	3	6,900	1	1,650	0	0	0.00	0	0.00
12	US 101 from Burnett Avenue (Lane Drop) to Cochrane Road	SB	AM	3	6,900	--	--	32	32	0.46	--	--
		SB	PM	3	6,900	--	--	0	0	0.00	--	--
13	US 101 from Cochrane Road to East Dunne Avenue	SB	AM	3	6,900	--	--	32	32	0.46	--	--
		SB	PM	3	6,900	--	--	0	0	0.00	--	--
14	US 101 from East Dunne Avenue to Tennant Avenue	SB	AM	3	6,900	--	--	0	0	0.00	--	--
		SB	PM	3	6,900	--	--	0	0	0.00	--	--
15	US 101 from Tennant Avenue to San Martin Avenue	SB	AM	3	6,900	--	--	0	0	0.00	--	--
		SB	PM	3	6,900	--	--	7	7	0.10	--	--
16	US 101 from San Martin Avenue to Masten Avenue	SB	AM	3	6,900	--	--	0	0	0.00	--	--
		SB	PM	3	6,900	--	--	7	7	0.10	--	--

¹ Source: Santa Clara Valley Transportation Authority Congestion Management Program Monitoring Study, 2016.

2. Existing Conditions

This chapter describes the existing conditions for transportation facilities in the vicinity of the site, including the roadway network, transit service, pedestrian and bicycle facilities.

Existing Roadway Network

Regional access to the project site is provided via US 101. Local access to the site is provided by Monterey Road, Dunne Avenue, Tennant Avenue, Butterfield Boulevard, Del Monte Avenue, Olympic Drive, and Cosmo Avenue. These facilities are described below.

US 101 is a north-south freeway extending northward to San Francisco and southward through Gilroy. US 101 is an eight-lane freeway (three mixed-flow lanes and one high-occupancy vehicle (HOV) lane in each direction) north of Cochrane Road. South of Cochrane Road, it is a six-lane freeway with no HOV lanes. Access to the project site would be provided via full interchanges at Dunne Avenue and Tennant Avenue.

Monterey Road is classified in the City of Morgan Hill General Plan as a four-lane major arterial that runs directly through Morgan Hill. Monterey Road extends from Market Street, in downtown San Jose, to US 101 south of the City of Gilroy. Monterey Road has a posted speed limit of 45 miles per hour (mph) and sidewalks along both sides of the street (with the exception of the eastern project site boundary) in the vicinity of the project site. The segment of Monterey Road between Main Avenue and Dunne Avenue is designated as a bike route (Class III facility), while the segments of Monterey Road north of Main Avenue and south of Dunne Avenue currently provide bike lanes (Class II) along both sides of the street. Monterey Road is the eastern project site frontage which includes the main entrance to the school campus and an emergency access driveway.

Dunne Avenue is classified in the City of Morgan Hill General Plan as a four-lane major arterial, with the exception of the two-lane arterial segment between Del Monte Avenue and Peak Avenue. Dunne Avenue transverses the City extending from the east part of town to the west with a posted speed limit of 35 to 40 mph and sidewalks along both sides of the street. Bike lanes are found along both side of Dunne Avenue between Peak Avenue and Gallop Drive (east of US 101). With a full interchange at US 101, Dunne Avenue provides regional access to the project site.

Tennant Avenue is classified in the City of Morgan Hill General Plan as a 4- to 6-lane major arterial. Tennant Avenue extends from Monterey Road eastward to Carey Avenue where it terminates. West of Monterey Road, Tennant Avenue changes designation to Edmundson Avenue. With a full interchange at US 101, Tennant Avenue provides regional access to the project site.

Butterfield Boulevard is a north-south four-lane divided arterial roadway that begins in the north part of town at its intersection with Cochrane Road and extends southward to its intersection with Monterey Road where it changes designation to Watsonville Road. Butterfield Boulevard has a posted speed limit of 45 mph. Along with Monterey Road, Butterfield Boulevard serves as a primary north-south route within the City of Morgan Hill. Butterfield Boulevard is planned to be extended north of Cochrane Road as a two-lane arterial to connect to Madrone Parkway. Bike lanes are currently provided along the entire length of Butterfield Boulevard. Butterfield Boulevard would provide access to the project site via Dunne Avenue and Main Avenue.

Del Monte Avenue is a two-lane undivided roadway that runs north/south and west of Monterey Road, extending between Fifth Street and Cosmo Avenue. It has a posted speed limit of 25 mph and sidewalks along both sides of the street along its entire length. Del Monte Avenue would provide access to the project site via Cosmo Avenue.

Olympic Drive is a two-lane undivided roadway that runs north/south and west of Monterey Road, between Edmundson Avenue and Cosmo Avenue. It has a posted speed limit of 25 mph and sidewalks along both sides of the street, with the exception of the segment between Cosmo Avenue and Denali Drive, where no sidewalks are found along the east side of the street. Olympic Drive would provide access to the project site via Cosmo Avenue.

Cosmo Avenue is a two-lane undivided roadway that extends from Monterey Road westward to Olympic Drive. Cosmo Avenue is the southern project site frontage. It has a posted speed limit of 25 mph with sidewalks along both sides of the street, with the exception of the project site frontage, and on-street parking along most of the street. The school's access driveway is proposed to be located along Cosmo Avenue.

Existing Bicycle and Pedestrian Facilities

There are numerous bike lanes and bike paths in the vicinity of the project site. The existing bicycle facilities within the study area are described below and shown on Figure 3.

Class I Trail or Path is an off-street path with exclusive right-of-way for non-motorized transportation used for commuting as well as recreation. There is an existing Class I bike path along the west bank of Little Llagas Creek that extends from Watsonville Road and La Crosse Drive north to Spring Avenue, with access via Cosmo Avenue, approximately 150 feet west of the project site. A high visibility crosswalk (marked crosswalk with longitudinal striping) is located along Cosmo Avenue at the trail access points. A Class I bike path also is provided along the east side of Butterfield Boulevard, between San Pedro Avenue and Central Avenue.

Class II Bike Lanes are on street striped bike lanes. Within the project vicinity, Class II bikeways are present along the following roadways:

- Monterey Road, nearly its entire length within City of Morgan Hill limits, with the exception of the segment that runs through downtown between Dunne Avenue and Main Avenue;
- Butterfield Boulevard, along its entire length;
- Main Avenue, from Peak Avenue to east of US 101;
- Dunne Avenue, from Peak Avenue to east of Hill Road;
- Tennant Avenue, from Olympic Drive to east of US 101.

Class III Bike Routes are signed bike routes that provide a connection through residential, downtown, and rural/hillside areas to Class I and Class II facilities. Bike routes serve as transportation routes within neighborhoods to parks, schools, and other community amenities. The segment of Monterey Road between Main Avenue and Dunne Avenue is designated as a bike route.

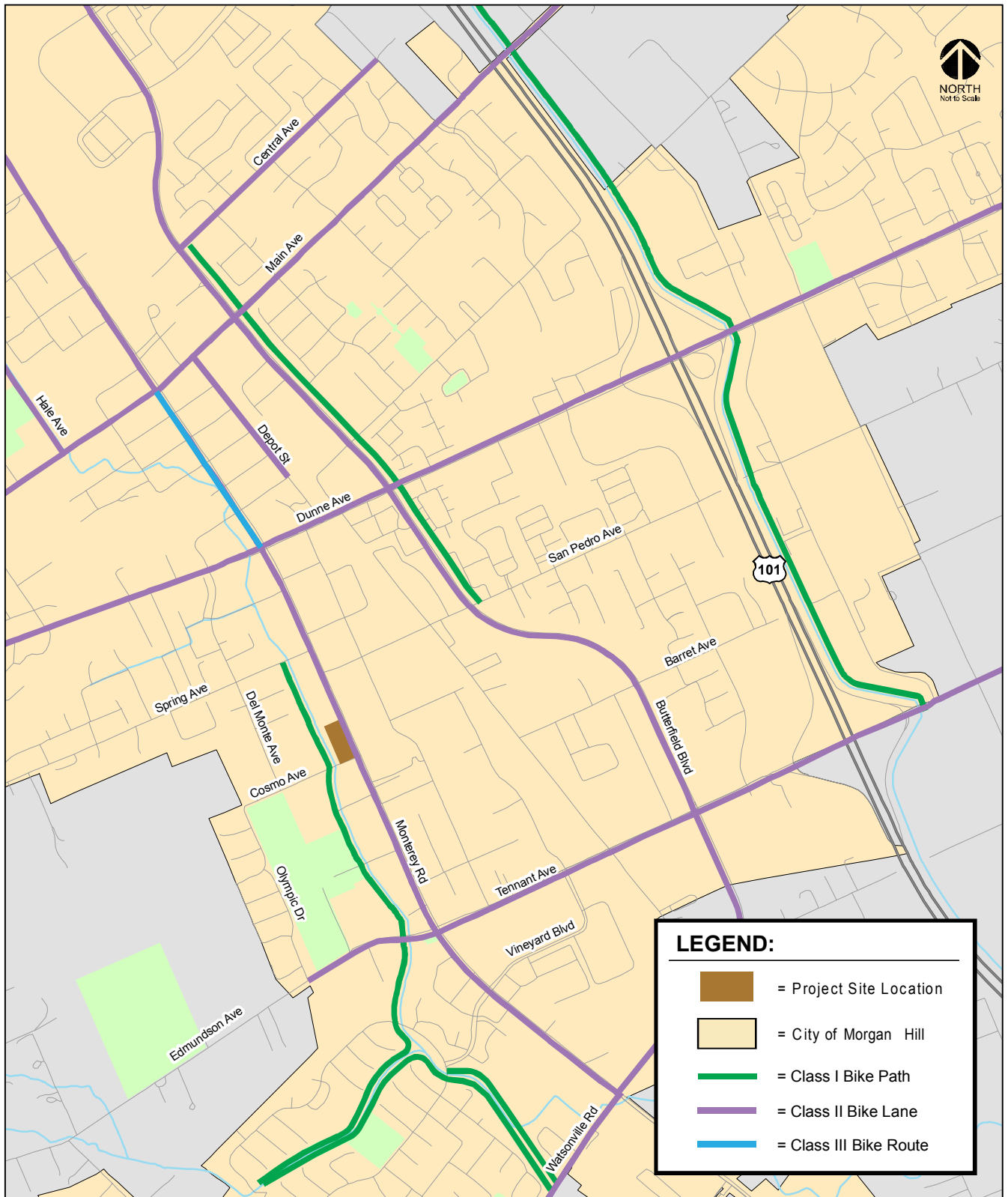

Figure 3
Existing Bicycle Facilities

Pedestrian facilities in the study area consist primarily of sidewalks, crosswalks, and pedestrian signals at signalized intersections. All of the signalized intersections in the vicinity of the project site have marked crosswalks and pedestrian push buttons and signal heads along at least two of the legs of the intersection. Crosswalks with pedestrian signal heads and push buttons are provided on the west and south legs of the Monterey Road and Cosmo Avenue intersection. Americans with Disabilities Act (ADA)-compatible wheelchair ramps are installed at the northwest, southwest, and southeast corners of the intersection, connecting the marked crosswalks.

Sidewalks also are provided along most roadways in the vicinity of the project site, with the exception of a few roadway segments in the immediate project area where sidewalks are missing along one side of the street:

Cosmo Avenue – Sidewalks are found along both sides of Cosmo Avenue, with the exception of the southern project site frontage. Although no sidewalks are currently found along the project site frontage, as described above, the northwest corner of the Monterey Road/Cosmo Avenue intersection includes an ADA-compatible ramp, connected to the west crosswalk of the intersection.

Monterey Road – No sidewalks are present along the west side of Monterey Road between Cosmo Avenue and approximately 125 feet south of San Pedro Avenue. This includes the entire eastern project site boundary.

Existing Transit Service

Existing transit service to the study area is provided by the VTA, the Monterey-Salinas Transit (MST), and Caltrain. The nearest bus stops to the project site are located on Monterey Road just north and south of Cosmo Avenue, approximately 175 feet from the project site. These bus stops are served by Local Route 68 (described below). Additionally, the Morgan Hill Caltrain Station, located on the east side of Depot Street, is less than one mile north of the project site and provides a connection to most transit lines serving Morgan Hill in addition to Caltrain and the MST 55 line. The existing transit services are described below and shown on Figure 4.

The study area is served by one local bus (Local Bus Route 68) and three express buses (Express Route 121, 168, and 185).

Local Bus Route 68 operates on Monterey Road on its route between the Gilroy Transit Center and the San Jose Diridon Transit Center with 15 to 20-minute headways on weekdays in the AM and PM peak hours. Route 68 operates between 4:00 AM and 1:30 AM. The nearest Route 68 stop to the project site is located at the intersection of Monterey Road and Cosmo Avenue.

Express Route 121 operates on Monterey Road on its route between the Gilroy Transit Center and the Lockheed Martin Transit Center. It operates northbound with 15 to 30-minute headways during the AM peak hour and southbound with 15 to 30-minute headways during the PM peak hour. The nearest Route 121 stop to the project site is located at the intersection of Monterey Road and Tennant Avenue, less than ½ mile south of the project site.

Express Route 168 operates on Monterey Road on its route between the Gilroy Transit Center and the San Jose Diridon Transit Center. It operates northbound with 30-minute headways during the AM peak hour and southbound with 30-minute headways during the PM peak hour. The nearest Route 168 stop to the project site is located at the intersection of Monterey Road and Tennant Avenue, less than ½ mile south of the project site.

Express Route 185 operates on Monterey on its route between the Gilroy Transit Center and Mountain View. It operates northbound with 45-minute headways during the AM peak hour and southbound with

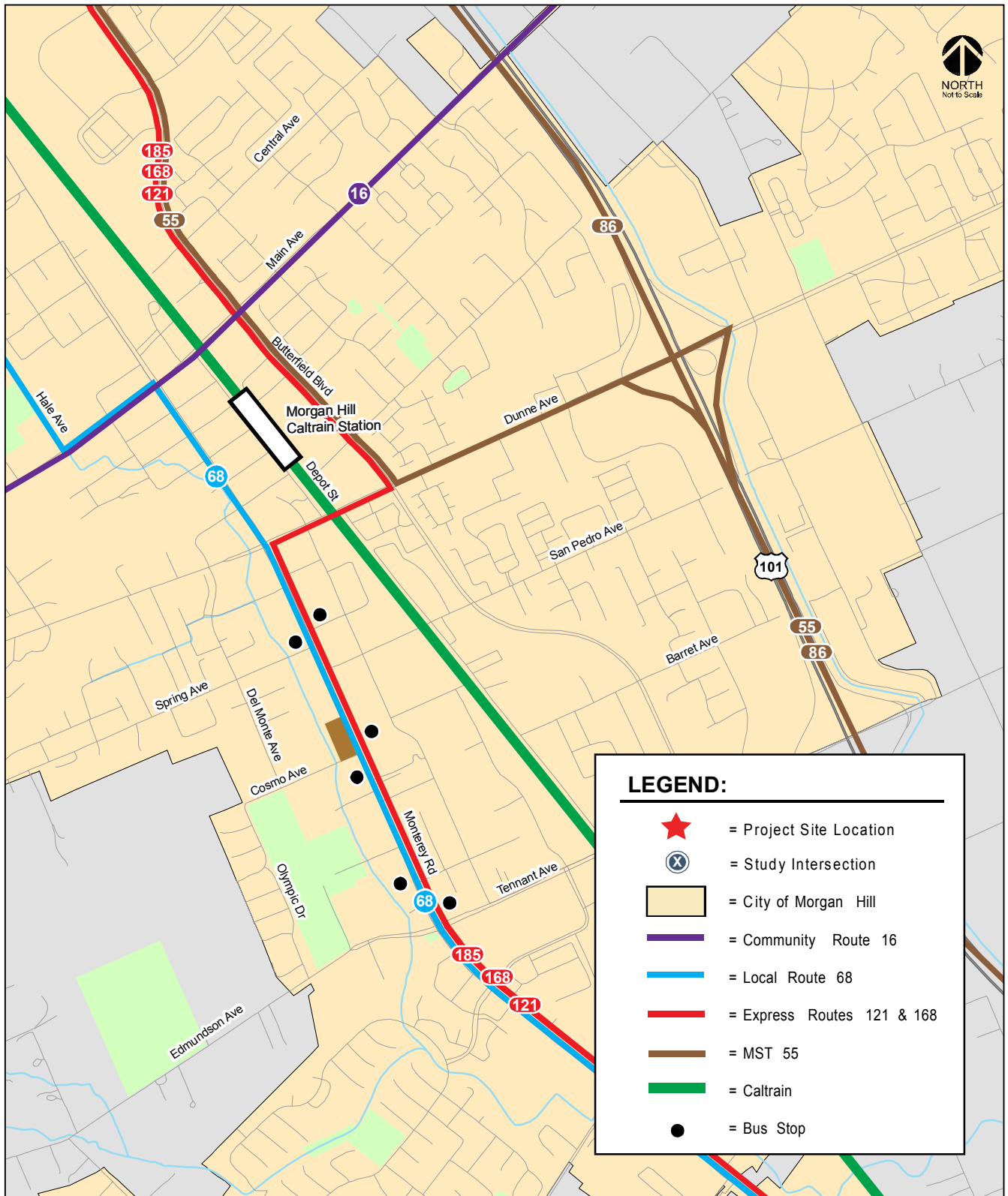

Figure 4
Existing Transit Services

45-minute headways during the PM peak hour. The 185 line has scheduled stops at the Morgan Hill Caltrain Station.

The Monterey Salinas Transit (**MST 55**) provides service between Monterey and the San Jose Diridon Station with three daily trips (one during the morning, one midday, and one in the evening). The MST 55 line has scheduled stops at the Morgan Hill Caltrain Station.

Commuter rail service between San Francisco and Gilroy is provided by Caltrain. The Morgan Hill Caltrain Station is located north of the project site, with main access and parking off of Butterfield Boulevard. At the Morgan Hill Station, Caltrain provides service with approximately 30- to 40-minute headways during commute hours.

Existing Intersection Lane Configurations

The existing lane configurations at the study intersections were determined by observations in the field and are shown on Figure 5.

Existing Traffic Volumes

Existing peak-hour traffic volumes were obtained from other recently conducted traffic studies in the project area (May and June 2018 counts) and new intersection turn-movement counts conducted in March 2019. The existing peak-hour intersection volumes are shown on Figure 6. The existing traffic count data is included in Appendix A and peak-hour intersection turning movement volumes for all intersections and study scenarios are tabulated in Appendix B.

Existing Intersection Levels of Service

The results of the intersection level of service analysis under existing conditions are summarized in Table 4. The results show that, measured against the City of Morgan Hill level of service standards, the following unsignalized study intersection currently operates at an unacceptable level of service under existing conditions:

4. Monterey Road and San Pedro Avenue – LOS F, PM peak-hour

Additionally, based on the Peak-Hour Volume Signal Warrant, (Warrant #3 – Part B) described in the *California Manual on Uniform Traffic Control Devices (MUTCD)*, 2014 Edition, the existing traffic volumes at the Monterey Road/San Pedro Avenue intersection are sufficient to warrant installation of a traffic signal during the PM peak hour under existing conditions.

All other study intersections currently operate at an acceptable level of service. Additionally, all other unsignalized study intersections currently have traffic conditions that fall below the thresholds that warrant signalization. The level of service calculation sheets are included in Appendix C. The peak-hour signal warrant sheets are contained in Appendix D.

Existing Freeway Levels of Service

As discussed in Chapter 1 of this report, a freeway level of service analysis was not conducted since the number of new trips added to the freeway segments by the proposed project do not equal or exceed one percent of the capacity of the freeway segments near the project site. Based on CMP Traffic Impact Analysis Guidelines, a freeway level of service analysis is not required.

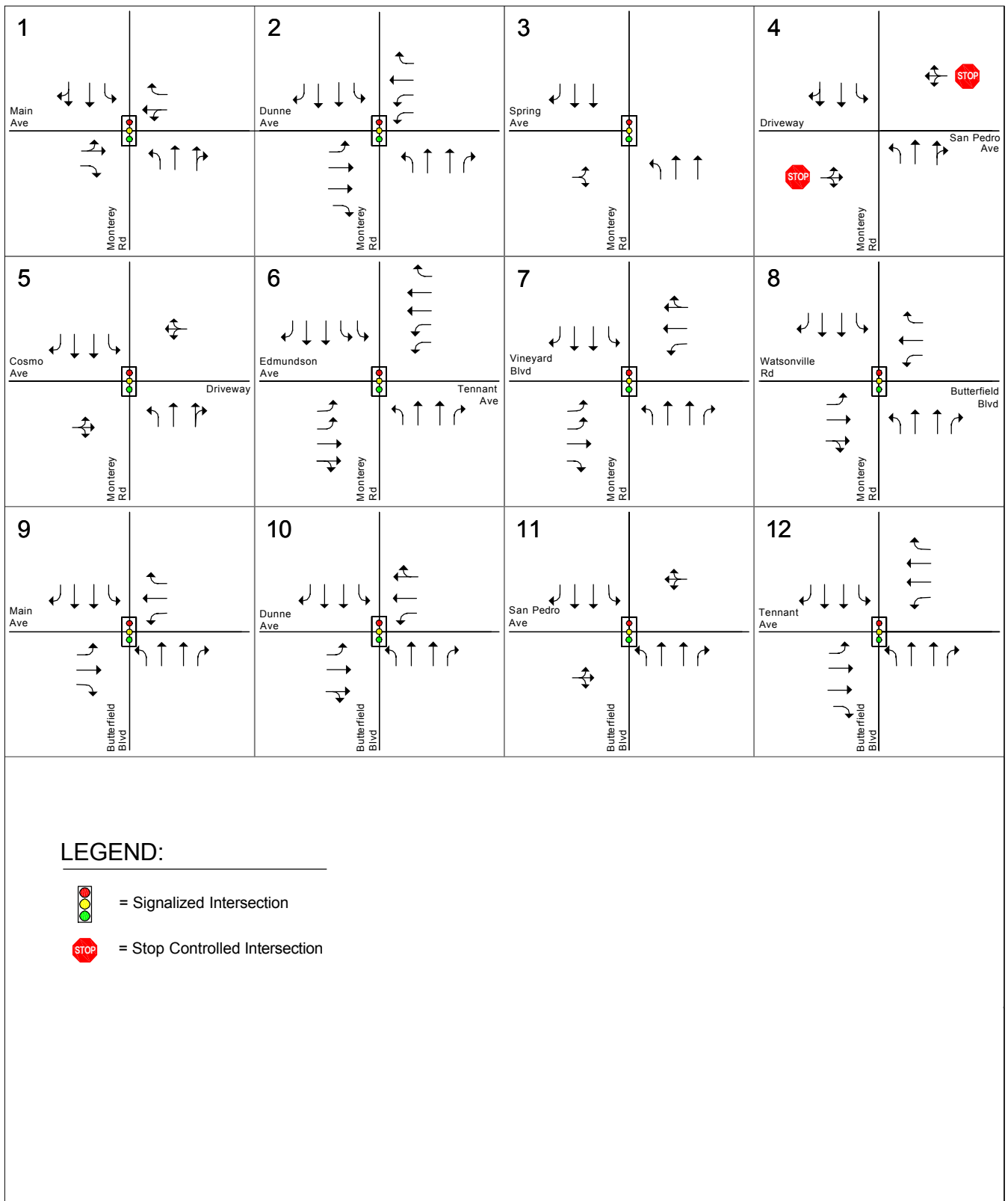
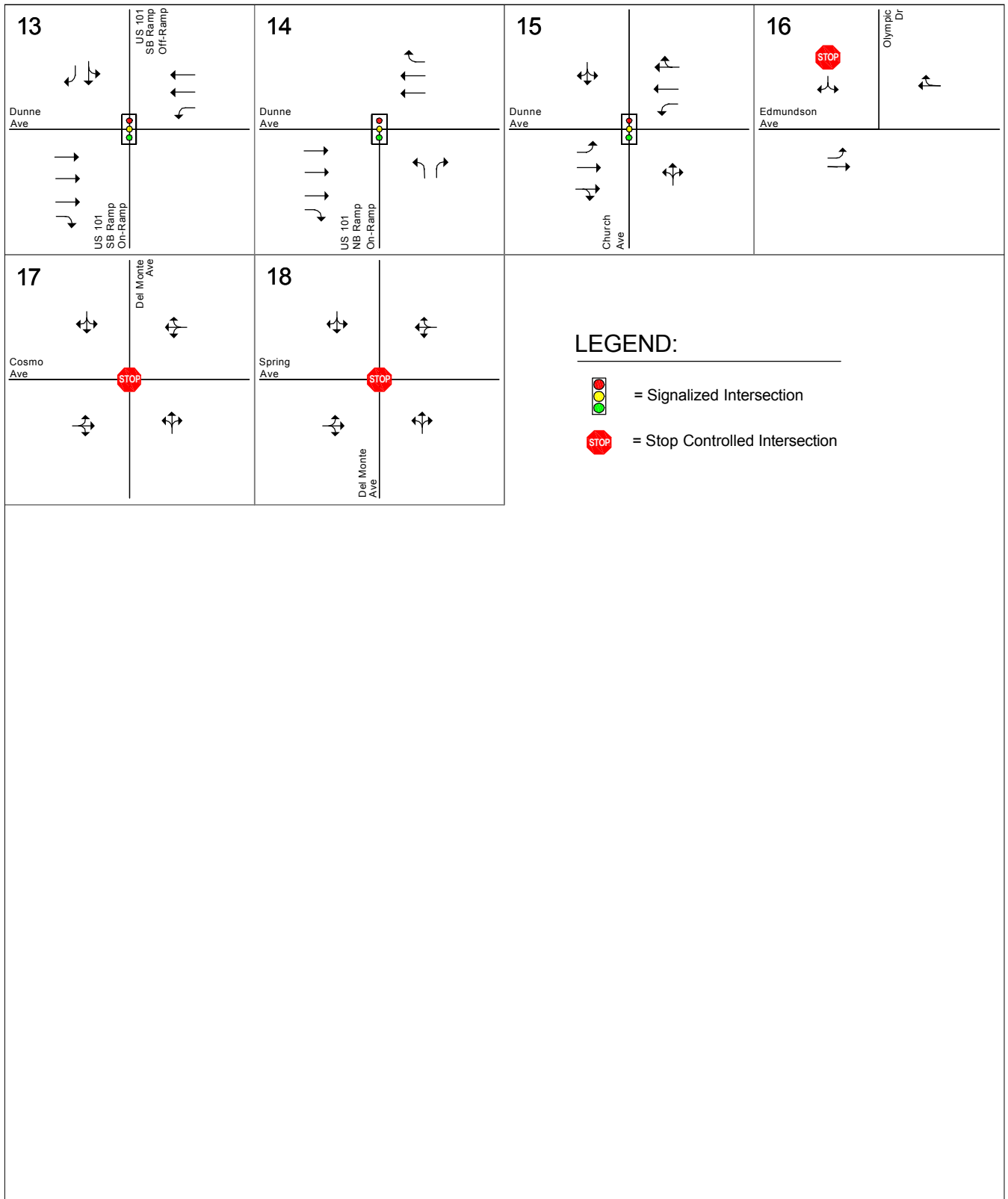

Figure 5
Existing Lane Configurations



**Figure 5 (Continued)
Existing Lane Configurations**

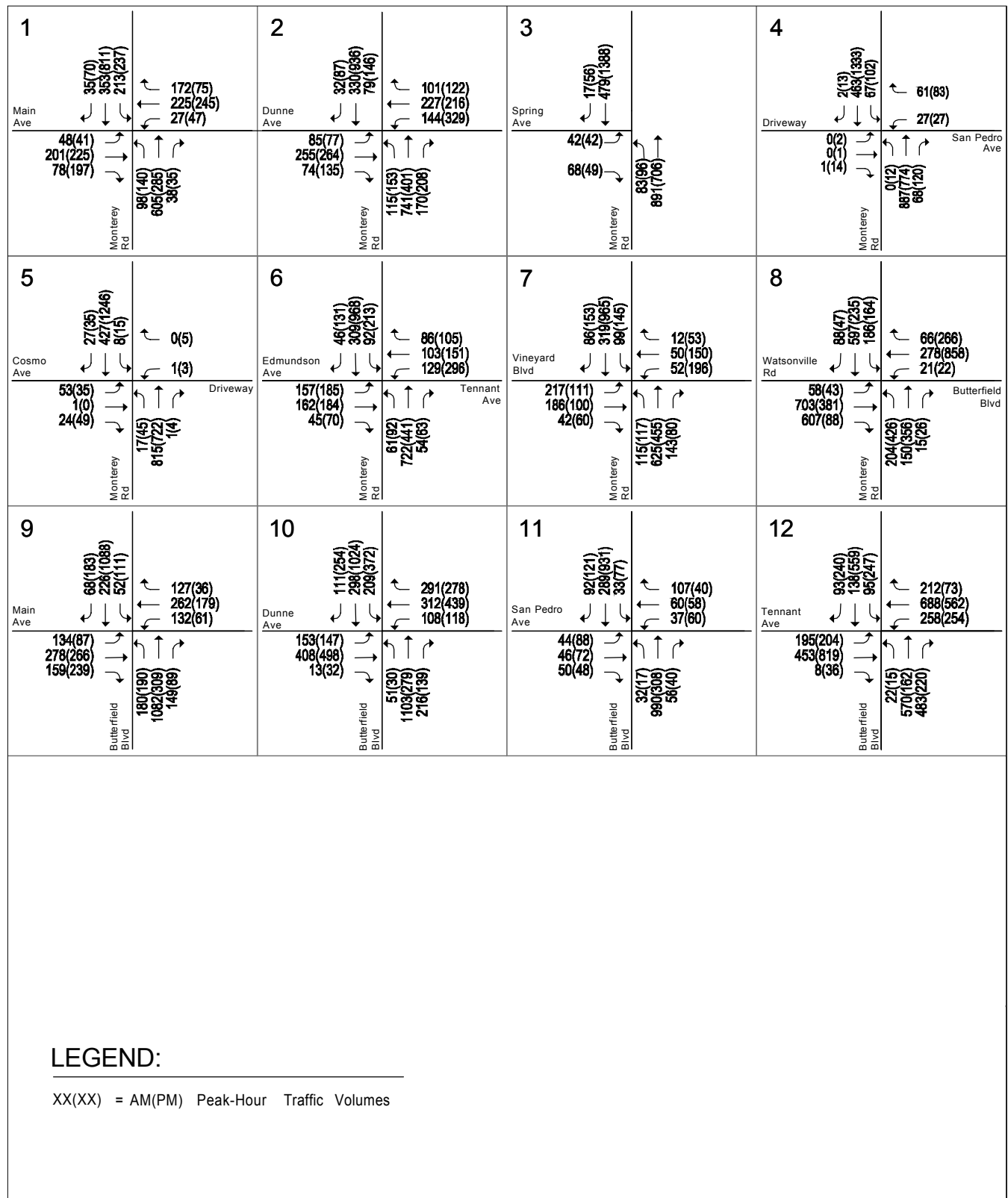
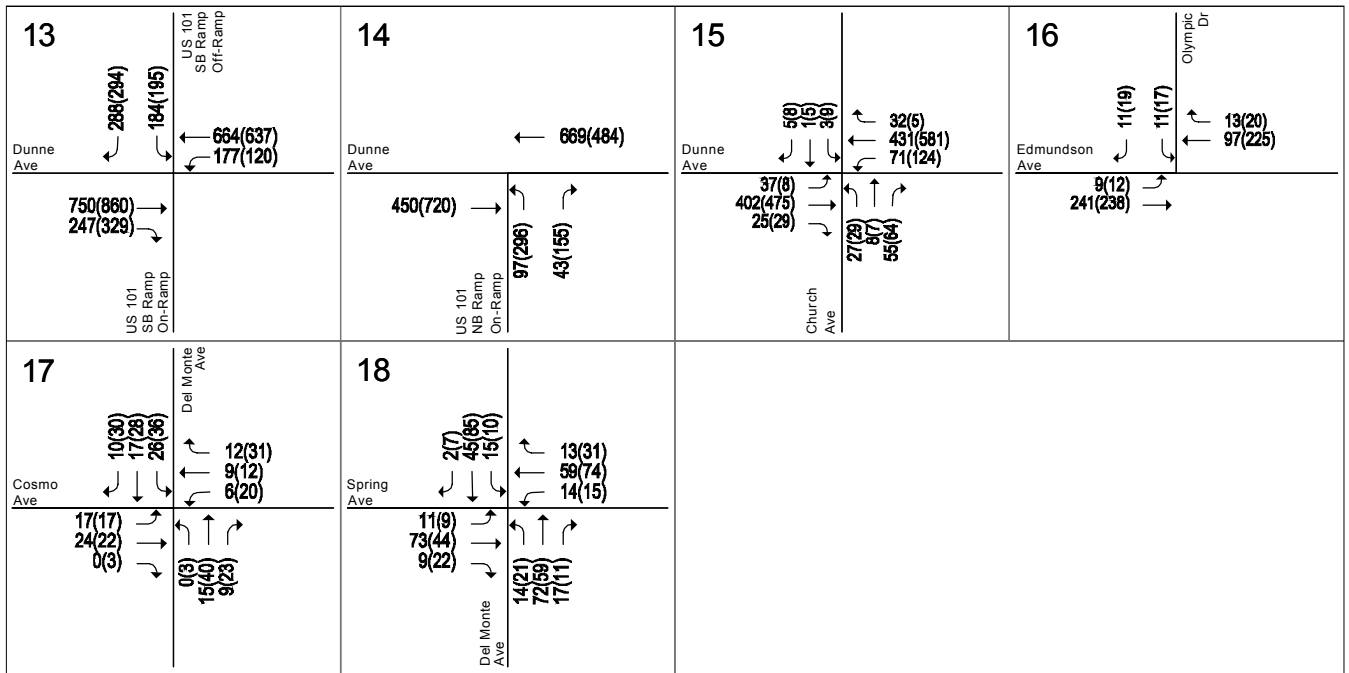

Figure 6
Existing Traffic Volumes



LEGEND:

XX(XX) = AM(PM) Peak-Hour Traffic Volumes

**Figure 6 (continued)
 Existing Traffic Volumes**

Table 4
Existing Conditions Intersection Levels of Service

Int. #	Intersection	Existing Control	LOS Standard	Peak Hour	Count Date	Warrant Met? ¹	Avg. Delay ²	LOS
1	Monterey Road and Main Avenue	Signal	F	AM	05/08/18	--	44.2	D
				PM	05/08/18	--	45.1	D
2	Monterey Road and Dunne Avenue	Signal	E	AM	05/08/18	--	28.9	C
				PM	05/08/18	--	31.4	C
3	Monterey Road and Spring Avenue	Signal	D	AM	03/14/19	--	5.1	A
				PM	03/21/19	--	11.3	B
4	Monterey Road and San Pedro Avenue	TWSC	D	AM	03/14/19	No	26.7	D
				PM	03/14/19	Yes	71.1	F
5	Monterey Road and Cosmo Avenue	Signal	D	AM	03/14/19	--	3.8	A
				PM	03/14/19	--	3.9	A
6	Monterey Road and Tennant Avenue/Edmundson Avenue	Signal	E	AM	03/14/19	--	23.7	C
				PM	03/14/19	--	36.4	D
7	Monterey Road and Vineyard Boulevard	Signal	D	AM	03/14/19	--	20.3	C
				PM	03/14/19	--	27.8	C
8	Monterey Road and Watsonville Road/Butterfield Boulevard	Signal	D	AM	03/14/19	--	30.1	C
				PM	03/14/19	--	46.6	D
9	Butterfield Boulevard and Main Avenue	Signal	D	AM	05/08/18	--	27.6	C
				PM	05/08/18	--	29.8	C
10	Butterfield Boulevard and Dunne Avenue	Signal	D	AM	05/18/18	--	38.3	D
				PM	05/18/18	--	35.3	D
11	Butterfield Boulevard and San Pedro Avenue	Signal	D	AM	03/14/19	--	13.0	B
				PM	03/14/19	--	13.2	B
12	Butterfield Boulevard and Tennant Avenue	Signal	E	AM	01/23/18	--	23.9	C
				PM	01/23/18	--	37.4	D
13	US 101 SB Ramps and Dunne Avenue	Signal	E	AM	05/08/18	--	20.9	C
				PM	05/08/18	--	18.8	B
14	US 101 NB Ramps and Dunne Avenue	Signal	E	AM	05/08/18	--	5.3	A
				PM	05/08/18	--	11.8	B
15	Church Street and Dunne Avenue	Signal	E	AM	06/06/18	--	17.8	B
				PM	06/06/18	--	19.9	B
16	Olympic Drive and Edmundson Avenue	OWSC	D	AM	03/14/19	No	9.8	A
				PM	03/14/19	No	10.9	B
17	Del Monte Avenue and Cosmo Avenue	AWSC	D	AM	03/14/19	No	7.2	A
				PM	03/14/19	No	7.4	A
18	Del Monte Avenue and Spring Avenue	AWSC	D	AM	03/14/19	No	7.8	A
				PM	03/14/19	No	7.9	A

¹ Signal warrant analysis based on the Peak Hour Signal Warrant #3, Figure 4C Caltrans MUTCD, 2014.

Signal warrant analysis is not applicable to signalized intersections.

² The reported delay and corresponding level of service for signalized and all-way stop-controlled intersections represents the average delay for all approaches at the intersection.

The reported delay and corresponding level of service for one- and two-way stop-controlled intersections are based on the stop-controlled approach with the highest delay.

Bold indicates unacceptable level of service.

3.

Existing Plus Project Conditions

This chapter describes existing plus project traffic conditions, significant project impacts, and measures that are recommended to mitigate project impacts. Included are descriptions of the significance criteria that define an impact, estimates of project-generated traffic, identification of the impacts, and descriptions of the mitigation measures. Existing plus project conditions are represented by existing traffic conditions with the addition of traffic generated by the proposed project.

Significant Impact Criteria

Significance criteria are used to establish what constitutes an impact. Significance criteria for impacts on intersections for this analysis are based on the City of Morgan Hill and CMP Level of Service standards.

Definition of Significant Signalized Intersection Impacts

All intersections within the City of Morgan Hill are required to meet the City's LOS standard of LOS D, with the exception of the following:

- **LOS F** for Downtown intersections and segments including at Main Avenue/Monterey Road, along Monterey Road between Main Avenue and Fifth Street, and along Depot Street at First through Fifth Streets;
- **LOS E** for the following intersections and freeway zones:
 - Main Avenue and Del Monte Avenue
 - Main Avenue and Depot Street
 - Dunne Avenue and Del Monte Avenue
 - Dunne Avenue and Monterey Avenue
 - Dunne Avenue and Church Street;
 - Dunne Avenue and Depot Street
 - Cochrane Road and Monterey Road
 - Tennant Avenue and Monterey Road
 - Tennant Avenue and Butterfield Boulevard
 - Cochrane Road Freeway Zone: from Madrone Parkway/Cochrane Plaza to Cochrane Road/DePaul Drive
 - Dunne Avenue Freeway Zone: from Walnut Grove Drive/East Dunne Avenue to Condit Road/East Dunne Avenue

- Tennant Avenue Freeway Zone: from Butterfield Boulevard/Tennant Avenue to Condit Road/Tennant Avenue

Seven of the study intersections are located within the Downtown Core area (LOS F standard) or LOS E standard areas. The remaining eleven study intersections have a LOS D standard.

According to the City of Morgan Hill level of service guidelines, a development is said to create a significant adverse impact on traffic conditions at a signalized intersection if for either peak hour:

1. The level of service at the intersection degrades from an acceptable level (LOS D or LOS E as identified above) under existing conditions to an unacceptable level (LOS E or F) under project conditions, or
2. The level of service at the intersection is an unacceptable level (LOS E or F as identified above) under existing conditions and the addition of project trips causes the average critical delay to increase by four (4) or more seconds *and* the volume-to-capacity ratio (V/C) to increase by 0.01.

An exception to this rule applies when the addition of project traffic reduces the amount of average delay for critical movements (i.e., the change in average delay for critical movements is negative). In this case, the threshold of significance is an increase in the critical V/C value by 0.01 or more.

Definition of Significant Unsignalized Intersection Impacts

Unsignalized intersections within the City of Morgan Hill have a minimum operating level of LOS D, with the exception of unsignalized intersections located within the Downtown area and freeway zones, as identified above, which have a LOS E or F standard. All four of the unsignalized study intersections have a level of service standard of LOS D.

According to the City of Morgan Hill level of service significant impact thresholds, a development is said to have a significant adverse impact on traffic conditions at an unsignalized intersection if for either peak hour the worst approach (for one- and two-way stop control) or the intersection (for all-way stop control) delay corresponds to an unacceptable LOS E or F *and* the traffic volumes at the intersection are sufficiently high to satisfy the peak-hour signal warrant.

Transportation Network under Existing Plus Project Conditions

No off-site transportation improvements are planned by the project. Therefore, it is assumed that the transportation network under existing plus project conditions would be the same as that described under existing conditions.

Project Description

Voices School is an existing public charter school currently offering Transitional Kinder (TK) through 4th grades at their temporary site at 610 Jarvis Drive, in the northern part of Morgan Hill. The project as proposed consists of the construction of a new permanent site for the charter school that will house a TK through 8th grade school. The project site is located at the northwest corner of the intersection of Monterey Road and Cosmo Avenue and consists of an undeveloped lot. The existing school hours, programs, and events that currently take place at the existing site would remain at the proposed new site (described below).

As proposed, the new school site would consist of a two-story school campus that would include 18 classrooms, administrative offices, teacher's workroom, storage, restrooms, and a multipurpose building/cafeteria. Each year, the school is adding a new grade as students in the top grade move up to the next grade. At full buildout (School Year 2023-2024), the school is proposing to serve up to 504

students in TK through 8th grade with 63 staff/faculty members. The school's hours of operation would be from 7:00 AM and 6:00 PM Monday through Friday, which includes office hours between 7:30 AM and 4:30 PM. School instructional hours would be from 8:00 AM to 4:00 PM Monday through Friday (with the exception of minimum days when students would be dismissed at 12:30 PM) and it would follow a traditional school year calendar (from September to June). Before and after school care and programs would be offered, as it is currently done, as early as 7:00 AM and until 6:00 PM. Other school related events that are anticipated to be hosted at the school site include the Winter Celebration, 1-2 annual Kermes/Carnival per year, Kindergarten graduation, parent workshops, and parent fundraisers. These events are anticipated to occur during the off-peak hours of traffic or on the weekend.

A total of 33 parking spaces would be provided on site. All vehicular access to the project site would be provided via a right-in and right-out access only driveway on Cosmo Avenue. A second driveway along Monterey Road would provide emergency vehicle access only to the site.

Project Trip Estimates

The magnitude of traffic produced by a new development and the locations where that traffic would appear are estimated using a three-step process: (1) trip generation, (2) trip distribution, and (3) trip assignment. In determining project trip generation, the magnitude of traffic entering and exiting the site is estimated for the AM and PM peak hours. As part of the project trip distribution step, an estimate is made of the directions to and from which the project trips would travel. In the project trip assignment step, the project trips are assigned to specific streets and intersections in the study area. These procedures are described further in the following sections.

Trip Generation

Trip generation resulting from new development proposed within the City of Morgan Hill typically is estimated by multiplying the Institute of Transportation Engineers (ITE) recommended trip generation rates by the size of the development. The recommended ITE trip generation rates are detailed in their manual entitled *Trip Generation* (latest edition). However, because the project consists of the expansion and permanent site of an existing school, the trips generated by the proposed school were estimated based on trip generation rates derived for the existing Voices School site.

Trip Generation Counts

The trip generation rates were derived based on trip generation counts conducted at the existing Voices School site on April 3, 2019 by Hexagon. Based on the trip generation counts, at the beginning of the school day (AM peak-hour) the trip generation rate for the existing Voices School was calculated to be 1.18 trips per student. At the end of the school day (PM peak-hour), the trip generation rates were calculated to be 0.67 trips per student.

Proposed School Project

The magnitude of traffic added to the roadway system by the proposed project was estimated by multiplying the surveyed trip generation rates by the proposed student enrollment at buildout (504 students). Based on this information, it is estimated that the proposed school would generate approximately 593 AM peak-hour trips, with 328 of these trips in the inbound direction and 265 trips in the outbound direction, and 340 PM peak-hour trips, with 138 inbound and 202 outbound trips.

For comparison purpose, the trip generation for the proposed school was estimated using ITE trip generation rates for charter elementary schools (land use code #537), contained in the ITE *Trip Generation Manual*, 10th Edition. Based on ITE rates, it is estimated that the proposed school would generate approximately 575 AM peak-hour trips (305 inbound and 270 outbound) and 348 PM peak-

hour trips (160 inbound and 188 outbound). These projections are shown to be almost identical to those estimated based on the trip generation counts.

Trip generation counts information as well as the trip generation estimates for the proposed project are presented in Table 5.

Trip Distribution

The trip distribution pattern for the proposed project was estimated based on project information, existing travel patterns on the surrounding roadway system, and the locations of complementary land uses. The traffic generated by the school would comprise trips by staff/faculty, visitors, non-working parents, and working parents. It is anticipated that there would be approximately 63 staff/faculty members at the site every day, approximately 55 of whom would be full-time employees. It was also assumed in this process that the majority of student trips would originate from within Morgan Hill, and that the majority of staff/faculty trips would originate from outside Morgan Hill. In addition, based on previous school studies, Hexagon estimates that approximately 60% of parents would drop-off students on their way to work, while the remaining 40% of parents would drop-off students and return home.

Based on the different types of trips anticipated to be generated by the project, four separate trip distributions were used in this analysis: (1) staff and visitors, (2) non-working parents, (3) incoming trips for working parents, and (4) outgoing trips for working parents. The trip distribution patterns are illustrated on Figures 7, 8, 9, and 10.

Trip Assignment

The peak hour trips generated by the proposed development were assigned to the roadway system in accordance with the trip distribution patterns discussed above.

The assignment assumes that all project traffic represents new trips on the roadway network. However, because of the nature of the project (an existing TK-4th grade school that would expand up to 8th grade), presumably some of the estimated project trips are currently accessing the existing school site and others would consist of new students whom, without the proposed project, would attend school elsewhere. Assuming all school trips are new trips may result in double counting existing trips already on the roadway network (and included in the existing traffic counts). Additionally, it is assumed that some of the students would be dropped-off by a parent/family member on their way to work. These trips are not new trips but rather existing trips on the roadway network that would detour to the school site and proceed back to their normal direction of travel and on to their final destination. Detoured trips would show up as new trips only at intersections off their normal direction of travel, most likely intersections in the immediate vicinity of the project site.

Since there is not sufficient information available to determine the current travel path of the anticipated student population, it is not possible to estimate the amount of existing traffic and complete a reassignment to account for the change in travel path to avoid double counting of trips. Furthermore, unless the existing trip origin or destination is in the vicinity of the project site, all estimated project traffic would represent new trips at all study intersections in the vicinity of the project site. For this reason, it is conservatively assumed in the analysis of the project that all project traffic represents new trips at all study intersections.

Project traffic on the freeway would mainly represent working parents and school staff/faculty trips. It is assumed that project traffic on the freeway associated with working parents does not represent new trips on the freeway since presumably they are already on the freeway, regardless of the proposed project. Therefore, the only new project trips on the freeway would be those associated with out of town school staff/faculty. These travel patterns are reflected in the project trip assignment. As discussed

Table 5
Project Trip Generation Estimates

Land Use	Size	Daily Rate ²	Daily Trips	AM Peak-Hour			PM Peak-Hour ³				
				Rate	In	Out	Total	Rate	In	Out	Total
Trip Generation Counts¹											
Voices School (Morgan Hill)	248 Students			1.18	157	135	292	0.67	69	98	167
Estimates of Project Traffic Based on Driveway Counts¹											
Charter School (K-8)	504 Students										
Staff/Faculty and Visitors Trips					63	0	63		0	33	33
Parent/Student Trips					265	265	530		138	169	307
Total Project Trips		1.91	962	1.18	328	265	593	0.67	138	202	340
Estimates of Project Traffic Based on ITE Rates											
Charter Elementary School ⁴		1.85	932	1.14	305	270	575	0.69	160	188	348
<p>¹ Trip rates (per student) based on Hexagon Transportation Consultants trip generation counts conducted at Voices Academy in Morgan Hill on April 3, 2019. It was assumed that all staff/faculty members would arrive at the school site during the AM peak-hour and approximately half of the staff/faculty members would leave the school during the PM peak-hour.</p> <p>² Daily trip rate was derived by multiplying the AM peak-hour rate (1.18) by the ratio between the daily trip rate to the AM trip rate (1.85/1.14) contained in the Institute of Transportation Engineers (ITE) <i>Trip Generation Manual</i>, 10th Edition 2017, for Charter Elementary School (ITE Land Use #537).</p> <p>³ PM peak-hour trip generation reflects 4:00-5:00 PM traffic conditions, which is when peak project traffic and peak background traffic overlap.</p> <p>⁴ For comparison purposes, proposed project traffic was estimated utilizing ITE trip generation rates for Charter Elementary School (Land Use #537). Trip rates are expressed in trips per student and based on the Institute of Transportation Engineers (ITE) <i>Trip Generation Manual</i>, 10th Edition 2017.</p>											

above, all project traffic was assumed to be new trips at all study intersections, including the freeway ramp intersections.

The project trip assignment at the study intersections is shown graphically on Figure 11.

Existing Plus Project Traffic Volumes

Project trips, as represented in the project trip assignment discussed above, were added to the existing traffic volumes to obtain existing plus project traffic volumes. Existing plus project traffic volumes are shown on Figure 12. Traffic volumes for all components of traffic are tabulated in Appendix B.

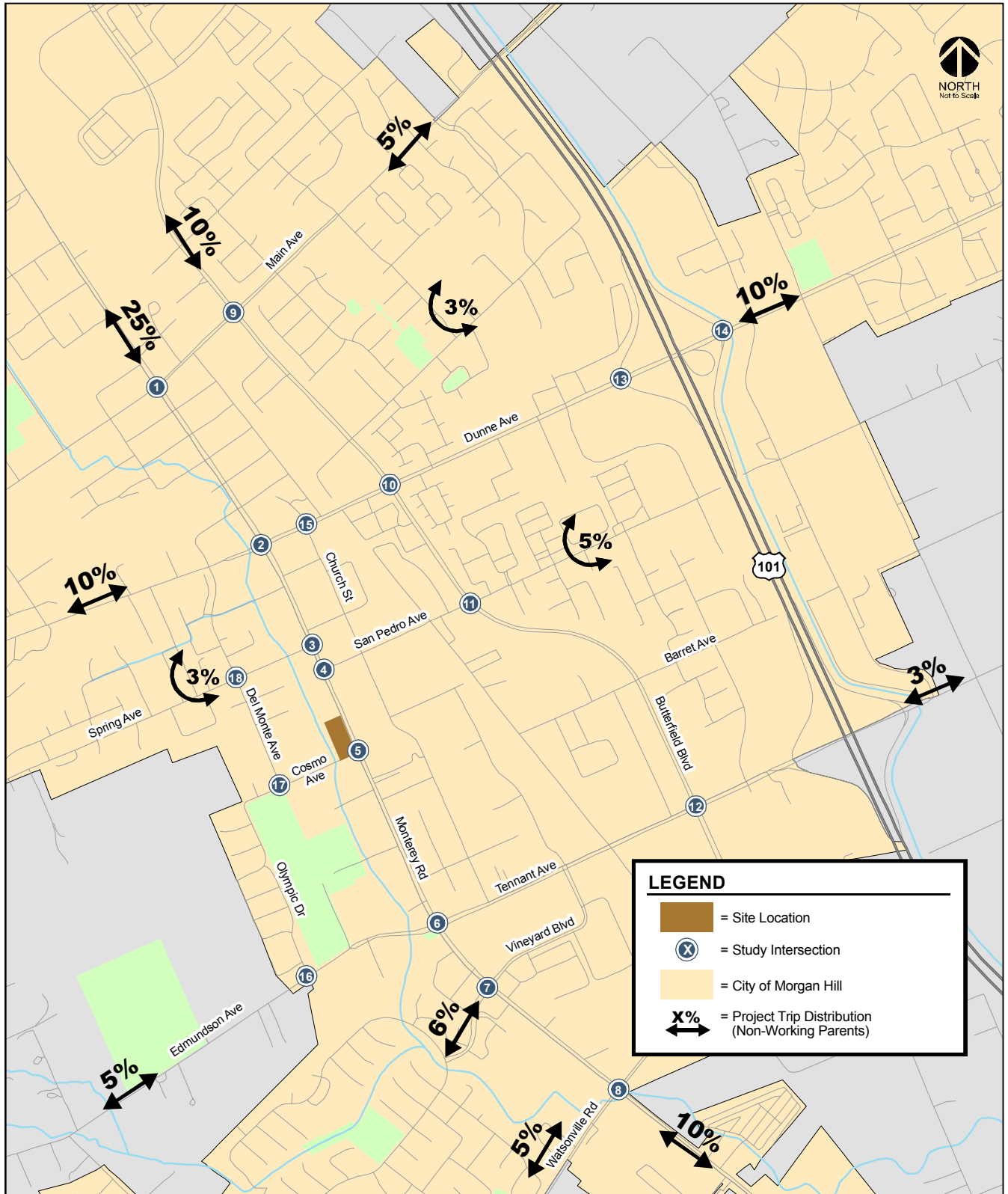

Figure 7
Project Trip Distribution – Non-Working Parents

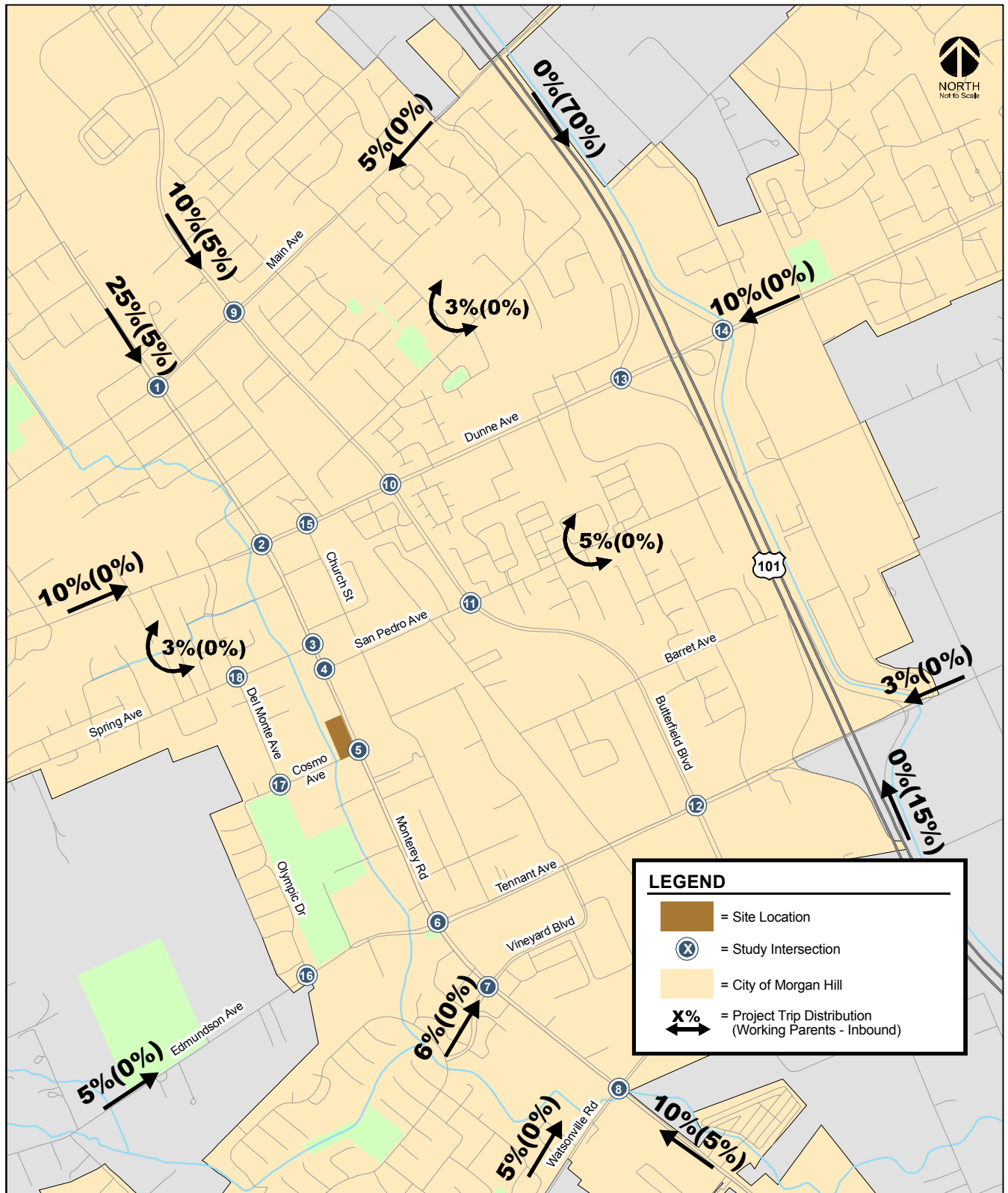

Figure 8
Project Trip Distribution – Working Parents (Inbound)

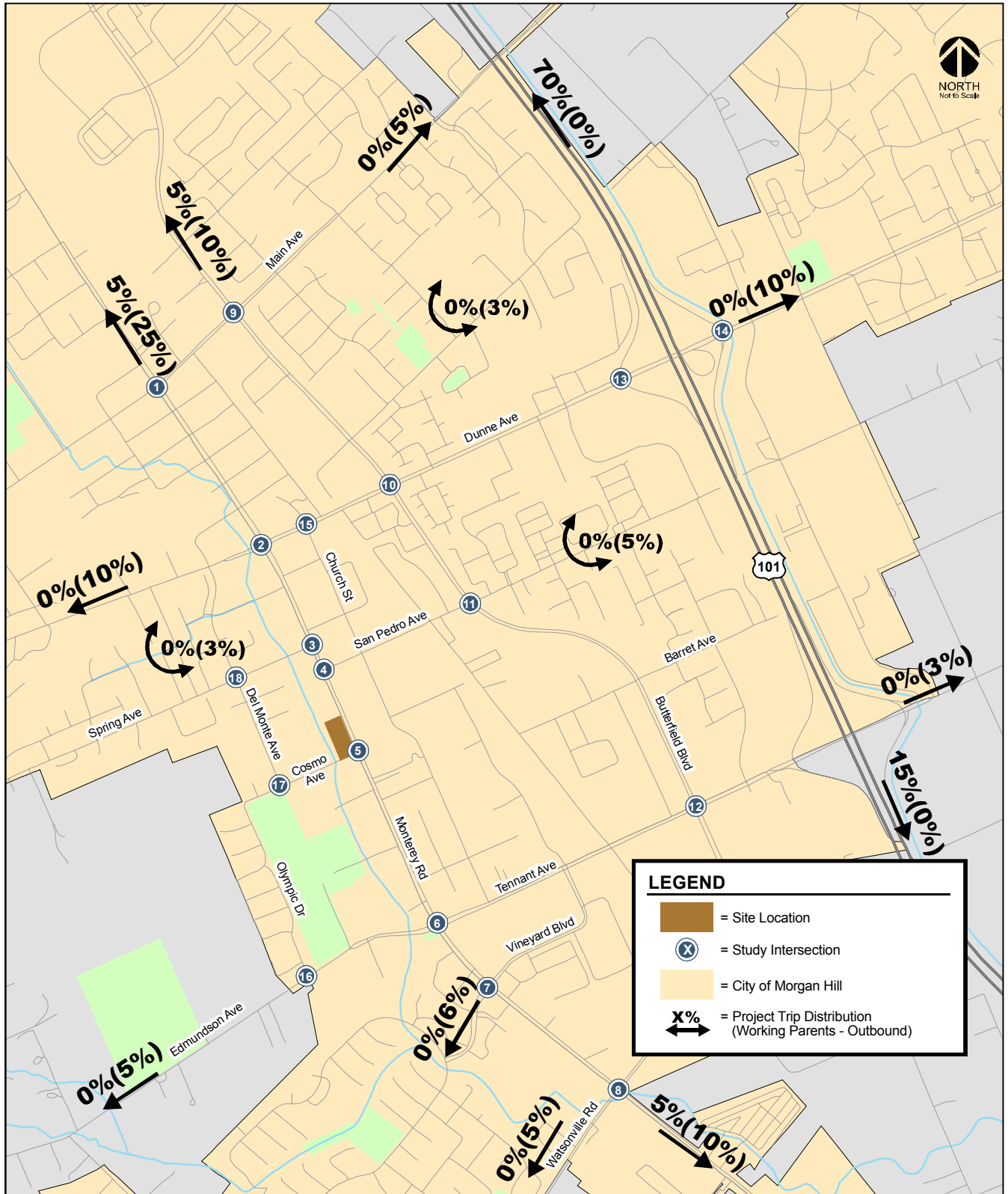

Figure 9
Project Trip Distribution – Working Parents (Outbound)

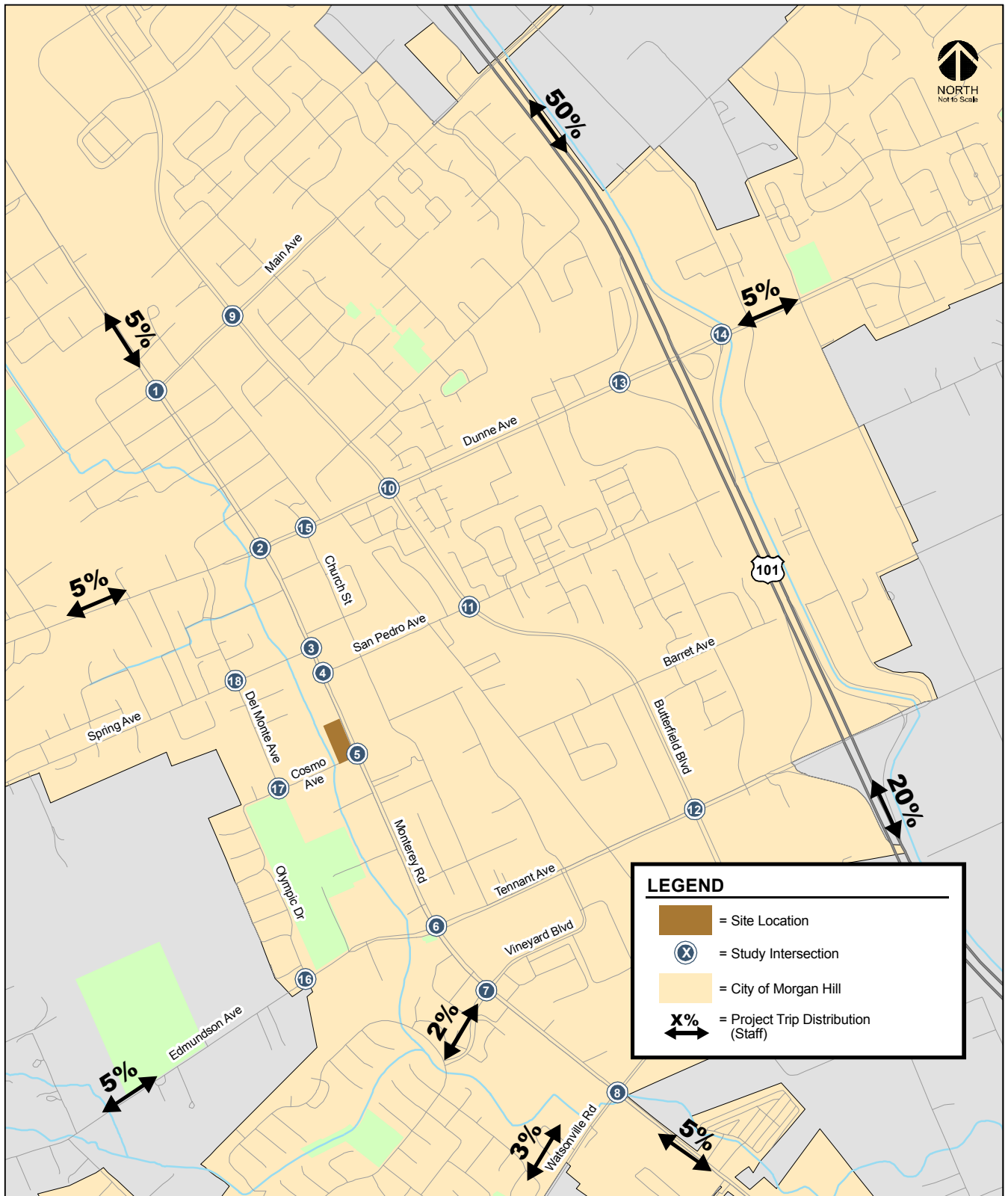

Figure 10
Project Trip Distribution – Staff

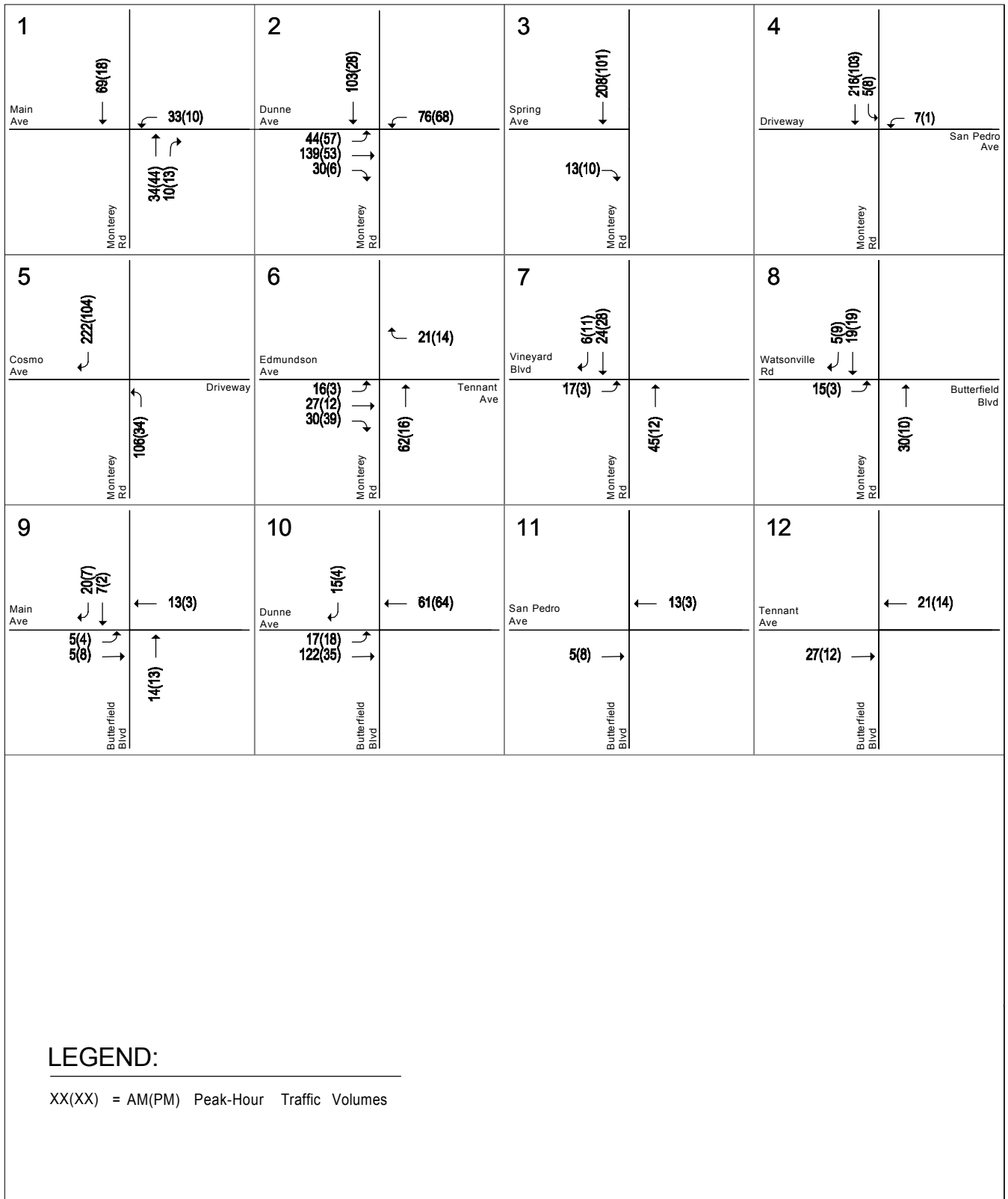
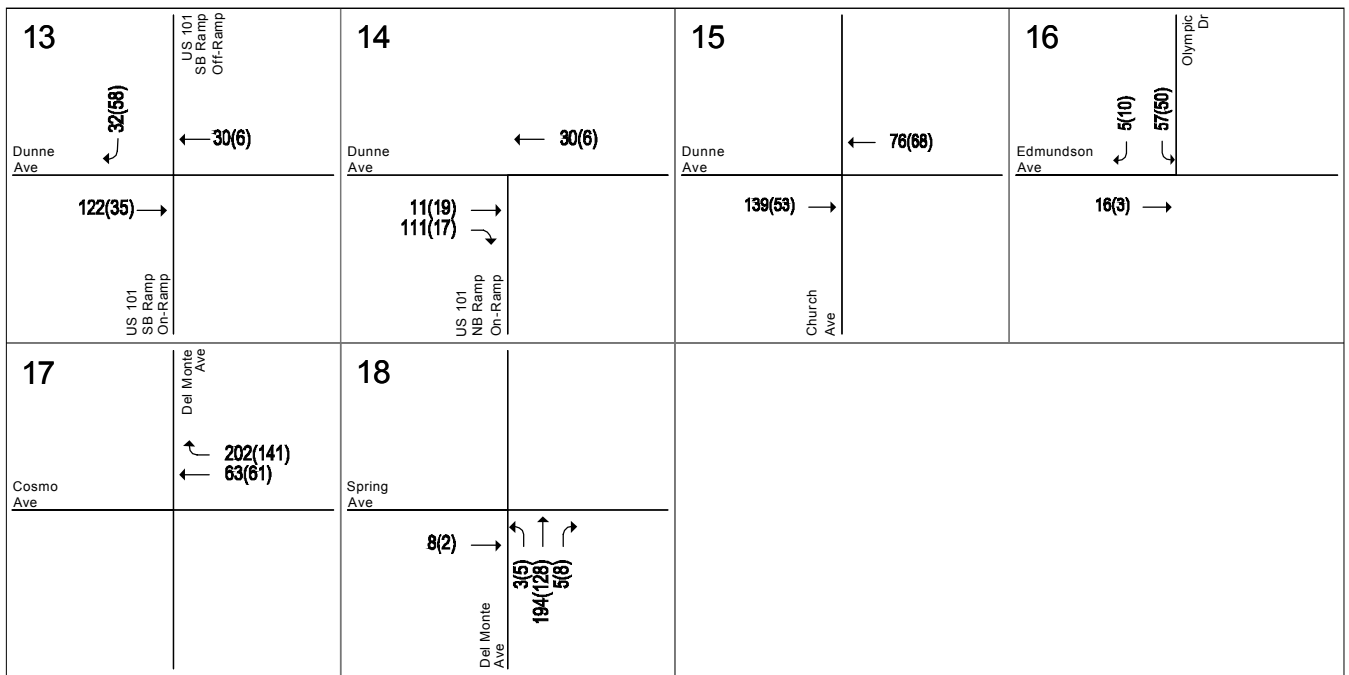

Figure 11
Project Trip Assignment



LEGEND:

XX(XX) = AM(PM) Peak-Hour Traffic Volumes

**Figure 11 (continued)
Project Trip Assignment**

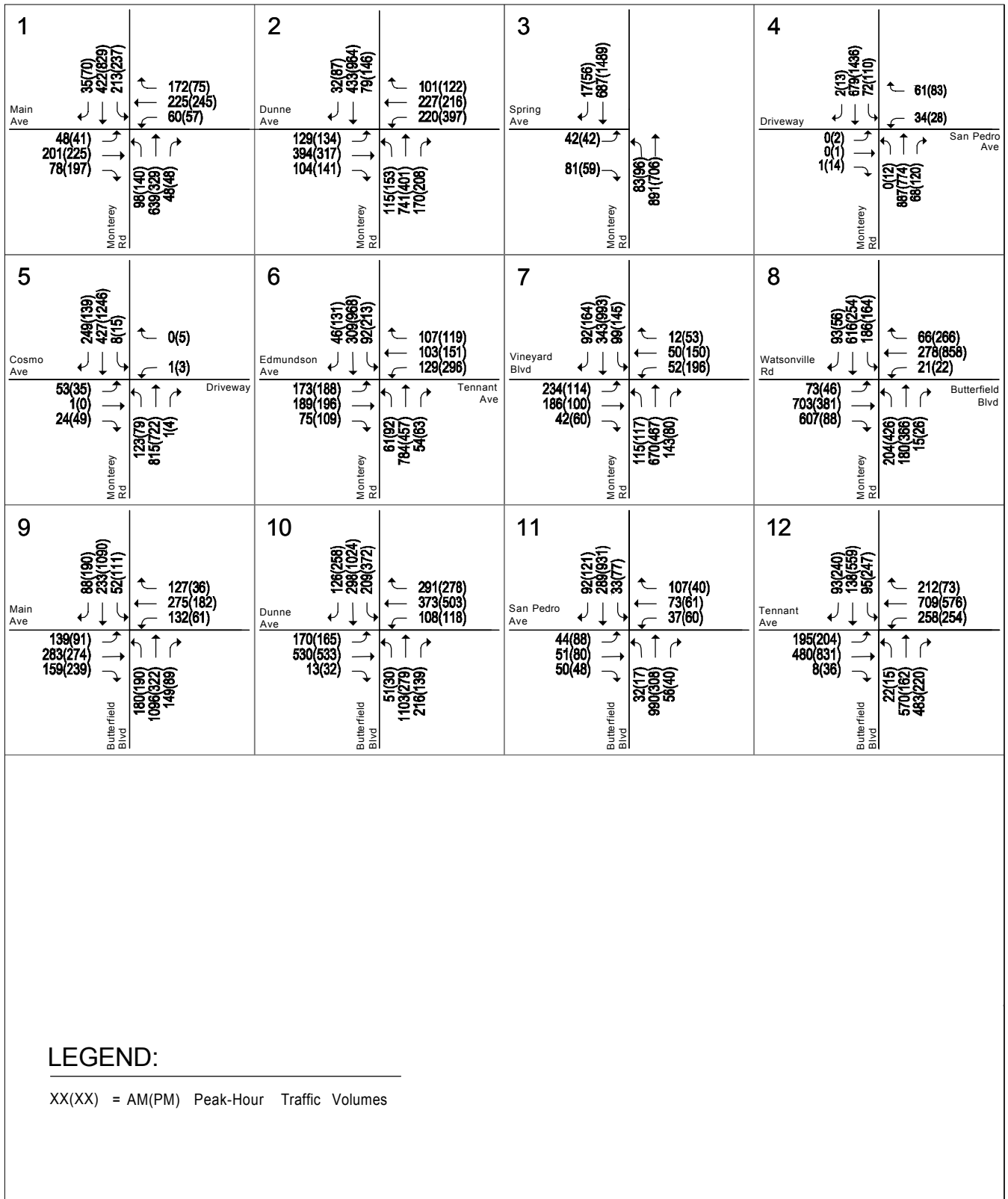
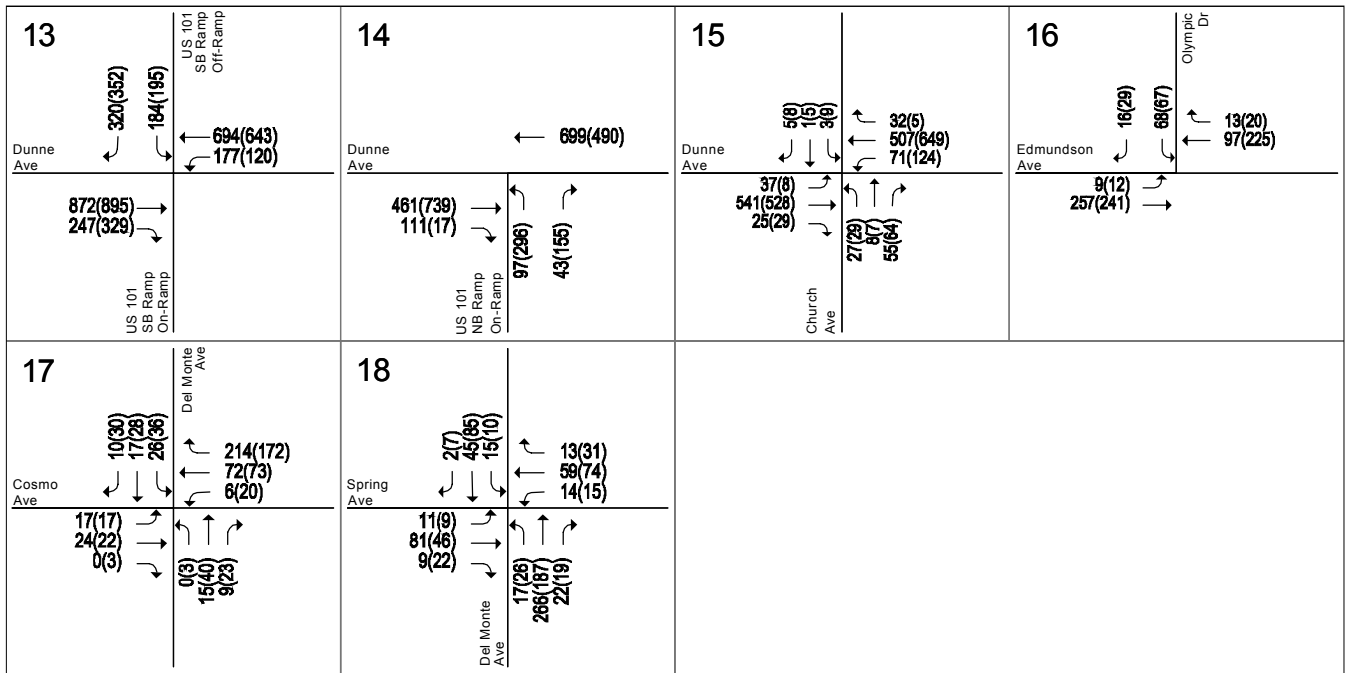

Figure 12
Existing Plus Project Traffic Volumes



LEGEND:

XX(X) = AM(PM) Peak-Hour Traffic Volumes

**Figure 12 (continued)
 Existing Plus Project Traffic Volumes**

Existing Plus Project Intersection Levels of Service

The results of the intersection level of service analysis under existing plus project conditions are summarized in Table 6. The results show that, measured against the City of Morgan Hill level of service standards, all of the study intersections, with the exception of Monterey Road and San Pedro Avenue, are projected to operate at acceptable levels of service under existing plus project conditions during both the AM and PM peak hours. The intersection of Monterey Road and San Pedro Avenue is projected to degrade from LOS D to LOS E during the AM peak-hour, and to continue to operate at an unacceptable LOS F during the PM peak-hour under existing plus project conditions.

The intersection of Monterey Road and San Pedro Avenue is currently unsignalized. According to the City of Morgan Hill level of service significant impact thresholds, the project will have an impact at this intersection if, in addition to the intersection operating at unacceptable conditions (LOS E or F), the peak-hour signal warrant is met during the same peak-hour. Based on the Peak-Hour Volume Signal Warrant, (Warrant #3 – Part B) described in the *California Manual on Uniform Traffic Control Devices* (CA MUTCD), 2014 Edition, this intersection would warrant installation of a traffic signal during the PM peak-hour under both existing and existing plus project conditions.

Therefore, the intersection of Monterey Road and San Pedro Avenue is projected to be impacted by the proposed project during the PM peak-hour.

The level of service calculation sheets are included in Appendix C, and the signal warrant checks are included in Appendix D.

Freeway Segment Analysis

As discussed in Chapter 1 of this report, a freeway level of service analysis was not conducted since the number of project trips added to the freeway segments near the project site does not equal or exceed one percent of the capacity of those segments. Based on CMP Traffic Impact Analysis Guidelines, a freeway level of service analysis is not required.

Intersection Mitigations under Existing Plus Project Conditions

4. Monterey Road and San Pedro Avenue

- Impact:** This intersection is projected to operate at an unacceptable LOS F during the PM peak-hour under existing plus project conditions. In addition, the CA MUTCD Peak-Hour Volume Signal Warrant (Warrant #3 – Part B) would be met during the PM peak-hour under existing plus project conditions. Based on City of Morgan Hill unsignalized intersection level of service impact criteria, this constitutes a significant project impact.
- Mitigation:** The project impact at this intersection could be mitigated with the installation of a raised median along Monterey Road at San Pedro Avenue, thus restricting left-turns out of San Pedro Avenue to southbound Monterey Road. With the left-turn restriction, only right-turns in and out at both San Pedro Avenue (east leg of the intersection) and the existing driveway (west leg of the intersection) as well as southbound left-turns would be allowed, reducing the amount of conflicting traffic at the intersection. The southbound left-turn movement from Monterey Road to eastbound San Pedro Avenue could be maintained without having an adverse effect on operations at the intersection since this movement would only be in conflict with the northbound approach. With the restriction of the westbound left-turn movement, the intersection of Monterey Road and San Pedro Avenue is projected to operate at an acceptable LOS C or better during the AM and PM peak hours under existing plus project conditions. The left-turn restriction at San Pedro

**Table 6
Existing Plus Project Conditions Intersection Levels of Service**

Int. #	Intersection	LOS Standard	Peak Hour	Existing			Existing + Project				
				Warrant Met? ¹	Avg. Delay ²	LOS	Warrant Met? ¹	Avg. Delay ²	LOS	Incr. In Crit. Delay	Incr. In Crit. V/C
1	Monterey Road and Main Avenue	F	AM	--	44.2	D	--	44.5	D	0.9	0.033
			PM	--	45.1	D	--	45.5	D	0.4	0.011
2	Monterey Road and Dunne Avenue	E	AM	--	28.9	C	--	30.6	C	1.8	0.028
			PM	--	31.4	C	--	33.0	C	2.4	0.040
3	Monterey Road and Spring Avenue	D	AM	--	5.1	A	--	5.5	A	0.6	0.008
			PM	--	11.3	B	--	11.6	B	0.2	0.035
4	Monterey Road and San Pedro Avenue	D	AM	No	26.7	D	No	38.6	E	N/A	N/A
			PM	Yes	71.1	F	Yes	97.1	F	N/A	N/A
5	Monterey Road and Cosmo Avenue	D	AM	--	3.8	A	--	3.5	A	0.0	0.000
			PM	--	3.9	A	--	3.8	A	0.0	0.000
6	Monterey Road and Tennant Avenue/Edmundson Avenue	E	AM	--	23.7	C	--	24.2	C	0.5	0.037
			PM	--	36.4	D	--	37.3	D	1.2	0.015
7	Monterey Road and Vineyard Boulevard	D	AM	--	20.3	C	--	20.2	C	-0.3	0.014
			PM	--	27.8	C	--	27.6	C	-0.2	0.008
8	Monterey Road and Watsonville Road/Butterfield Boulevard	D	AM	--	30.1	C	--	30.4	C	0.4	0.006
			PM	--	46.6	D	--	47.5	D	1.4	0.007
9	Butterfield Boulevard and Main Avenue	D	AM	--	27.6	C	--	27.9	C	0.2	0.007
			PM	--	29.8	C	--	30.0	C	0.3	0.005
10	Butterfield Boulevard and Dunne Avenue	D	AM	--	38.3	D	--	39.6	D	1.8	0.029
			PM	--	35.3	D	--	36.2	D	1.5	0.031
11	Butterfield Boulevard and San Pedro Avenue	D	AM	--	13.0	B	--	13.3	B	0.4	0.009
			PM	--	13.2	B	--	13.3	B	0.2	0.005
12	Butterfield Boulevard and Tennant Avenue	E	AM	--	23.9	C	--	24.0	C	0.0	0.007
			PM	--	37.4	D	--	37.4	D	0.0	0.003
13	US 101 SB Ramps and Dunne Avenue	E	AM	--	20.9	C	--	21.4	C	-0.2	0.033
			PM	--	18.8	B	--	20.1	C	0.2	0.037
14	US 101 NB Ramps and Dunne Avenue	E	AM	--	5.3	A	--	5.2	A	-0.1	0.009
			PM	--	11.8	B	--	11.7	B	0.3	0.003
15	Church Street and Dunne Avenue	E	AM	--	17.8	B	--	18.0	B	0.0	0.047
			PM	--	19.9	B	--	19.2	B	-0.5	0.021
16	Olympic Drive and Edmundson Avenue	D	AM	No	9.8	A	No	11.2	B	N/A	N/A
			PM	No	10.9	B	No	12.3	B	N/A	N/A
17	Del Monte Avenue and Cosmo Avenue	D	AM	No	7.2	A	No	8.1	A	0.9	0.243
			PM	No	7.4	A	No	8.3	A	0.8	0.189
18	Del Monte Avenue and Spring Avenue	D	AM	No	7.8	A	No	9.3	A	1.4	0.255
			PM	No	7.9	A	No	8.7	A	0.8	0.148

¹ Signal warrant analysis based on the Peak Hour Signal Warrant #3, Figure 4C Caltrans MUTCD, 2014.

Signal warrant analysis is not applicable to signalized intersections.

² The reported delay and corresponding level of service for signalized and all-way stop-controlled intersections represents the average delay for all approaches at the intersection.

The reported delay and corresponding level of service for one- and two-way stop-controlled intersections are based on the stop-controlled approach with the highest delay.

Bold indicates unacceptable level of service.

Bold and boxed indicate significant impact.

Avenue would result in the displacement of traffic bound for southbound Monterey Road from westbound San Pedro Avenue (34 and 28 AM and PM peak hour trips, respectively, under existing plus project conditions, with 7 and 1 of those trips being AM and PM peak hour project trips, respectively) to utilize alternative routes, such as Barrett Avenue, Edmundson Avenue, or Tennant Avenue. Left-turns in and out of the existing west-leg driveway (approximately 15 trips total during the PM peak-hour) would have to complete a U-turn north and south of this intersection. Project traffic along westbound San Pedro Avenue would travel southbound on Church Street to Barrett Avenue, to northbound Monterey Road and complete a northbound left-turn at Cosmo Avenue. The minimal amount of displaced traffic represents an average of one trip every two minutes added to two to three other roadways and is not anticipated to have an adverse affect on traffic conditions at the surrounding intersections. The additional northbound left-turn project trips at the intersection of Monterey Road/Cosmo Avenue as a result of the left-turn restriction are not projected to have an adverse affect on intersection operations at this location either (discussed in the following chapter).

4. Other Transportation Issues

This chapter presents an analysis of other transportation issues associated with the project site. In particular, this chapter evaluates the effect of the project in the immediate project site area, including at the project site driveway, adjacent intersection, and surrounding roadways. The other transportation issues evaluated include the following:

- Site access and on-site circulation
- Parking
- Drop-off and pick-up activities
- Intersection operations analysis – vehicle queuing and left-turn pocket storage at intersections
- Roadway segment analysis
- Potential impacts on pedestrian, bicycle, and transit facilities

Unlike the level of service impact methodology, which is adopted by the City Council, the analyses in this chapter are based on professional judgment in accordance with the standards and methods employed by the traffic engineering community.

Project Site Access Evaluation

The analysis of the proposed project presented in the previous chapters assumes all access to the school site would be provided via a single right-in and right-out access only driveway along Cosmo Avenue. A second access point to the project site along Monterey Road would provide access to emergency vehicles only.

Two other site access alternatives are being investigated by the school:

- Alternative 1 – Right-in only and right-and-left-out access at the Cosmo Avenue driveway. Emergency access only at the Monterey Road driveway.
- Alternative 2 – Right-in access only at Cosmo Avenue driveway. Right-out (and emergency) access at the Monterey Road driveway.

The two site access alternatives include the same on-site layout as the proposed site access; the only difference would be how school traffic would enter/exit the site. Based on City of Morgan Hill comments on the project, however, all access to the school site must be provided via the proposed right-in and right-out access only driveway on Cosmo Avenue, as evaluated within this report and illustrated on the project site plan prepared by K2A Architecture, dated April 29, 2019, presented on Figure 13 below.

For information purposes, the effect the two site access alternatives would have at the project site driveways and adjacent intersection were evaluated and the results are included in Appendix F.

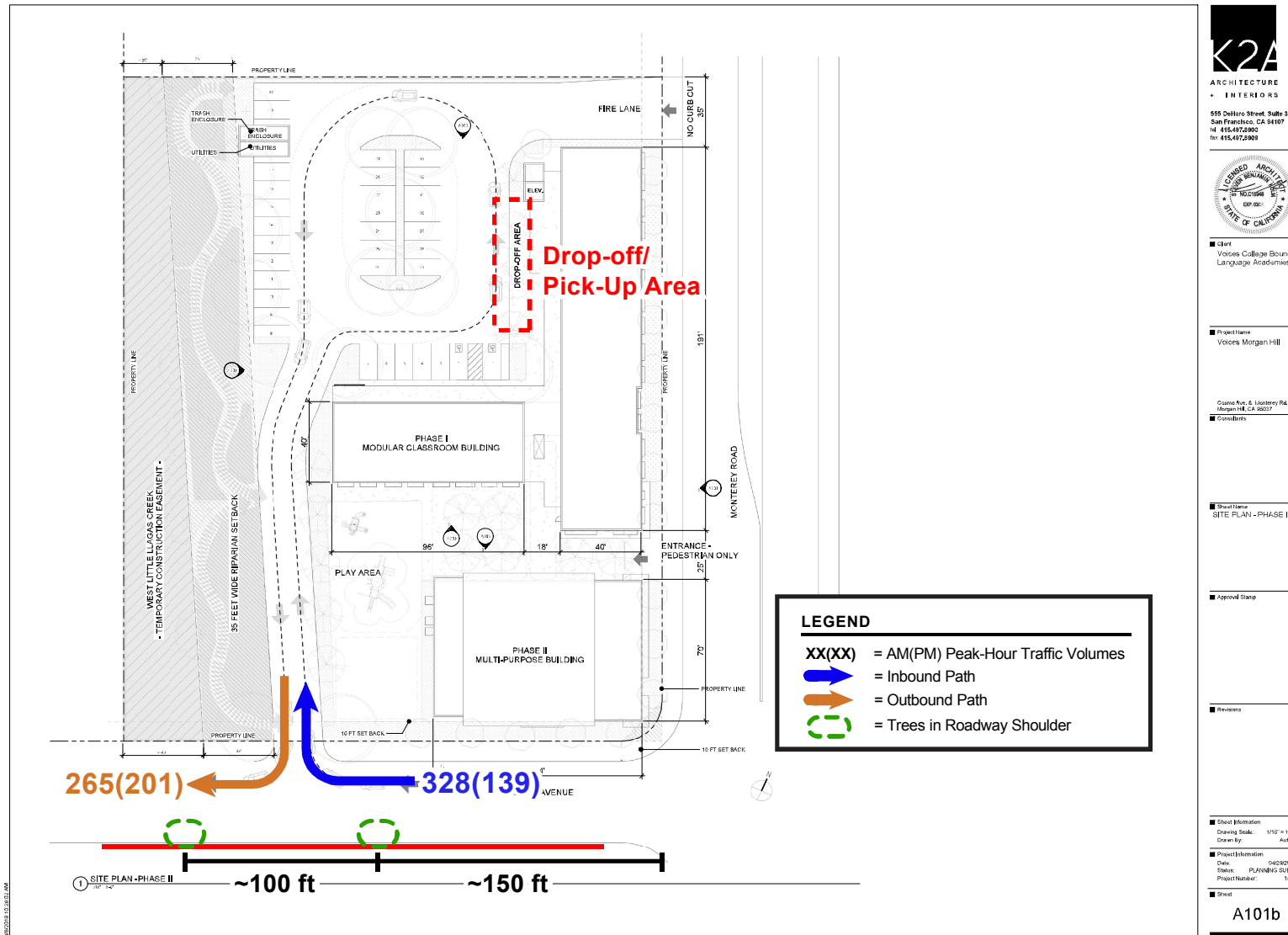

Figure 13
Proposed Site Plan and Site Access

Site Access

As illustrated on Figure 13, all vehicular access to the project site would be provided via the Cosmo Avenue driveway. The project driveway on Cosmo Avenue, located approximately 175 feet west of Monterey Road, would provide right-in and right-out access only. The Monterey Road project driveway, located approximately 350 feet north of Cosmo Avenue, would provide emergency vehicle access only.

With the proposed access, all peak-hour site access activity would occur along Cosmo Avenue, a roadway with relatively low traffic volumes. All inbound project traffic would utilize the Monterey Road/Cosmo Avenue intersection to access the project driveway. All outbound project traffic would head westbound on Cosmo Avenue to Del Monte Avenue or Olympic Drive, away from the Monterey Road/Cosmo Avenue intersection. The effect of project traffic along the adjacent roadways is discussed below. The right-in/right-out operations of the project driveway would eliminate conflict between inbound and outbound traffic and reduce the amount of traffic that would be added to the intersection of Monterey Road/Cosmo Avenue.

Recommendation: The design of the project access driveways must adhere to City of Morgan Hill design guidelines.

On-Site Circulation

The project site driveway on Cosmo Avenue would connect to the proposed on-site parking area via a long (approximately 200 feet) two-way drive aisle. The parking area would be located along the northern project site boundary, northwest of the modular school building, and it would consist of a total of 33 90-degree parking spaces with a centrally located row of parking spaces. The center row of parking spaces would allow for a circular counter clock-wise one-way circulation within the parking area. A designated drop-off/pick-up area is proposed east of the circular drive aisle, adjacent to the school building.

During student drop-off and pick-up times, inbound vehicles would enter the site via the Cosmo Avenue driveway, access the drop-off/pick-up area, circulate the parking lot back to the Cosmo Avenue driveway, and exit the site. The one-way circulation pattern allows for efficient movement of traffic in and out of the school site by minimizing conflict between vehicles on site.

Recommendation: The design of the parking lot, including drive aisle widths, parking stall dimensions, and turn radii, must adhere to City of Morgan Hill design guidelines.

Recommendation: To prohibit left-turn movements from eastbound Cosmo Avenue into the Cosmo Avenue driveway, City staff recommends the installation of double solid striping on Cosmo Avenue, along the project site frontage. In addition, it is recommended that school staff monitor the school driveway during the school peak hours to ensure the left-turn in and out restriction is implemented.

Sight Distance

Adequate sight distance should be provided at the project driveway. The project driveway along Cosmo Avenue is located along a straight roadway segment with minimal visual obstruction. Outbound traffic at the driveway must be able to see opposing traffic in order to safely complete a turn out of the site. Since only right-turn out of the driveway would be allowed, outbound traffic must be able to see westbound traffic along Cosmo Avenue.

The sight distance from the project driveway to the east extends to the Monterey Road/Cosmo Avenue intersections, approximately 175 feet. According to the Caltrans Highway Design Manual, the minimum required stopping sight distance for a roadway with a posted speed limit of 25 mph is 150 feet. Based

on field observations and Caltrans requirements, the available sight distance at the Cosmo Avenue driveway would be adequate.

Recommendation: The site plan shows trees surrounding the project site. The design of the school campus should ensure design features, in particular the landscaping and signage along the school frontage, will not interfere with the sight distance at the proposed site driveway.

Emergency Vehicle and Truck Access

Emergency vehicles would enter the site via Monterey Road. Based on the Fire Department Access site plan dated April 29, 2019 by K2A Architecture (see Figure 14), emergency vehicles would have access to the project site via both the Cosmo Avenue and the Monterey Road driveway. Thus, the design of the parking lot, including driveway and drive aisle widths and on-site turn radii, must be adequate to ensure emergency vehicles can maneuver through the site without a problem.

The site plan shows the trash enclosures to be located near the northwest corner of the project site. Trash collection vehicles would enter, circulate, and exit the site in the same manner as all other school traffic via the Cosmo Avenue driveway. With implementation of an adequate parking lot design, trash collector trucks would be able to access the trash enclosures and circulate in and out of the site without a problem.

Pedestrian Access and Circulation

Some of the students may walk or ride their bike to school. Pedestrian facilities in the study areas consist primarily of sidewalks, bike lanes, and pedestrian push buttons and signal heads at intersections. Bike lanes are provided along both sides of Monterey Road. The adjacent intersection of Monterey Road and Cosmo Avenue has marked crosswalks and pedestrian signal heads along the south and west legs of the intersection. However, sidewalks are currently missing along the entire project site frontages on both Monterey Road and Cosmo Avenue and no marked crosswalk currently exists along the north leg of the Monterey Road/Cosmo Avenue intersection. Additionally, sidewalks are missing along the west side of Monterey Road, between the project site and just south of San Pedro Avenue. Although the project is proposing to install sidewalks along its entire frontage, there would continue to be missing sidewalks along the west side of Monterey Road, north of the project site, resulting in a discontinuous pedestrian facility along Monterey Road for potential pedestrian traffic originating from the north. However, pedestrian traffic from the neighborhoods immediately north of the project site would most likely utilize Del Monte Avenue and the existing off-street trail that runs along the west side of the project site (Little Llagas Creek Trail). Little Llagas Creek Trail extends between Ciolino Avenue (north of Spring Avenue) and Watsonville Road with access from Cosmo Avenue, approximately 200 feet west of the project site. The existing trail access along Cosmo Avenue includes a high-visibility crosswalk (ladder-style crosswalk), connecting the trail entry points on both sides of Cosmo Avenue, Americans with Disabilities Act (ADA) –compliance curb ramps, and bike/pedestrian crossing warning signs. Pedestrian traffic from the north and east of Monterey Road could utilize the sidewalks along the east side of Monterey Road to access the project site. Therefore, it can be concluded that adequate pedestrian access from the surrounding neighborhoods would be provided.

The main school entrance would be located along the Monterey Road frontage and would provide direct access to the entrance corridor, which would connect to all proposed buildings and outdoor areas of the school. The school campus also would be accessible via the parking lot. The site plan does not show a direct pedestrian connection from Cosmo Avenue to the school campus. Presumably, pedestrians on Cosmo Avenue would access the site via the Monterey Road entrance. Additionally, a new pedestrian pathway along the western project site boundary would connect the sidewalks on Cosmo Avenue to the school parking lot, allowing for pedestrian movement between Cosmo Avenue

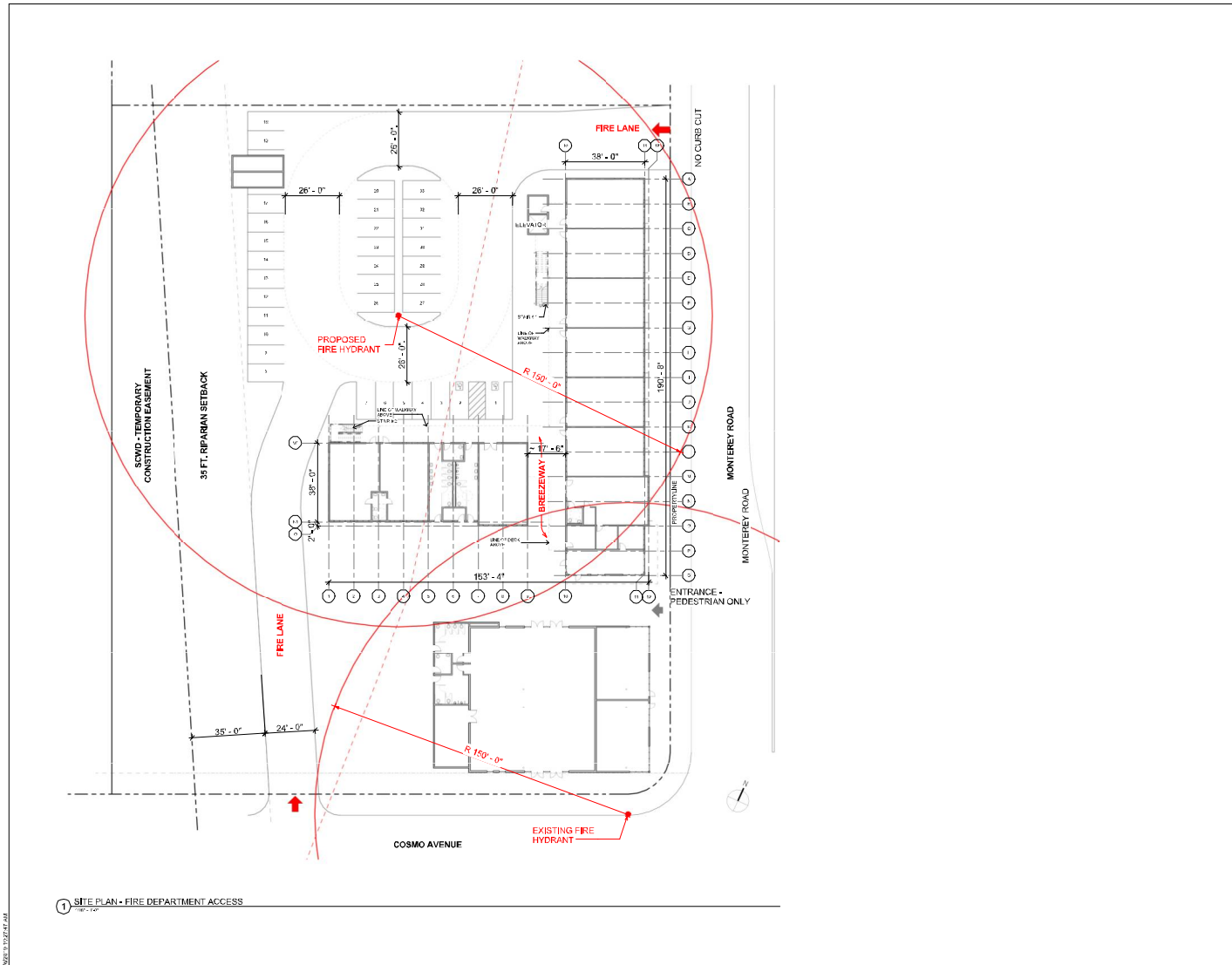

K2A
 ARCHITECTURE
 • INTERIORS
 555 De Haro Street, Suite 380
 San Francisco, CA 94107
 Tel: 415.487.6900
 Fax: 415.487.0909

REGISTERED ARCHITECT
 No. 01556
 200 C.E.
 STATE OF CALIFORNIA

Client
 Voices College Board
 Language Academies

Project Name
 Voices Morgan Hill

1000 Ave. S. Monterey Rd.
 Morgan Hill, CA 95037

Sheaf Name
 SITE PLAN - FIRE
 DEPARTMENT ACCESS

Approved Stamp

Revisions

Sheet Information
 Drawing Scale: 1/8" = 1'-0"
 Drawn By: A.B.C.

Project Information
 Date: 04/20/19
 Status: PLANNING PERM.
 Project Number: 1017

Sheet
A103

Figure 14
Proposed Emergency Vehicle Access

and the parking lot away from the parking lot and entry drive aisle. The pedestrian pathway is not shown to connect directly to the school campus, which would require crossing of the entry drive aisle.

The proposed location of the on-site drop-off area would allow direct pedestrian access to the school campus without the need to cross drive aisles. On-site pedestrian walkways would allow for adequate pedestrian circulation within the school campus, including the main entrance on Monterey Road, the drop-off area, and parking lot.

With the existing and proposed pedestrian facilities in the vicinity of the project site, adequate pedestrian access to and from the project site would be provided.

The Circulation Element of the City of Morgan Hill General Plan states that safe pedestrian and bicycle routes to all new schools (public and private) be defined during the planning and design process so that these routes can be developed and in place prior to opening the school.

Recommendation: Since the proposed school is located at the intersection of Monterey Road and Cosmo Avenue, it is recommended that protected pedestrian phasing be installed on all approaches of the intersection. Currently, no crosswalk is located along the north leg of the intersection and the traffic signal operates with permitted phasing on all approaches. Pedestrians crossing Monterey Street at this intersection must use the south crosswalk. Implementing protected pedestrian phasing on all approaches of the intersection would require modifying the traffic signal to include protected left-turn phasing on the northbound and southbound approaches and split phasing on the eastbound and westbound approaches, in addition to the required ADA-compatible wheelchair ramps at both ends of the new crosswalk. This is further discussed in a following section.

Recommendation: In order to enhance pedestrian safety at the Little Llagas Creek Trail access and crosswalk on Cosmo Avenue, it is recommended that post-mounted rectangular rapid flashing LED beacons be installed on the adjacent bike/pedestrian crossing warning signs to further enhance the visibility of pedestrians within this mid-block crosswalk for motorists.

Recommendation: It is recommended that Voices School work with the City of Morgan Hill to develop a safe routes to school program that will define the safest routes for pedestrians between the adjacent residential areas and the project site.

Recommendation: Crossing of the entry drive aisle from the on-site pedestrian pathway should be discouraged by eliminating any possible pedestrian access to the school campus along the entry drive aisle. If a connection between the on-site pedestrian pathway and the school campus must be provided, however, it is recommended that a clear marked pedestrian connection be provided along the entry drive aisle. A marked connection would encourage crossing of the entry drive aisle from the trail at a single point as well as provide the benefit of a marked crossing that is clearly visible to drivers entering/exiting the site.

The recommended physical improvements to enhance pedestrian access and safety are illustrated on Figure 15.

Drop-Off and Pick-Up Activities

The drop-off/pick-up area is proposed to be located adjacent to the modular school building, on the east side of the circular parking lot drive aisle.

The distance between the project driveway and the first position at the drop-off area is approximately 260 feet. Assuming an average vehicle length of 25 feet, approximately 10-11 vehicles could be stored within the inbound drive aisle prior to reaching the drop-off area. Based on the length of the drop-off area shown on the site plan, an additional 3-4 vehicles could be stored within the drop-off area. This represents a total queue storage capacity of approximately 13-14 vehicles within the school site.

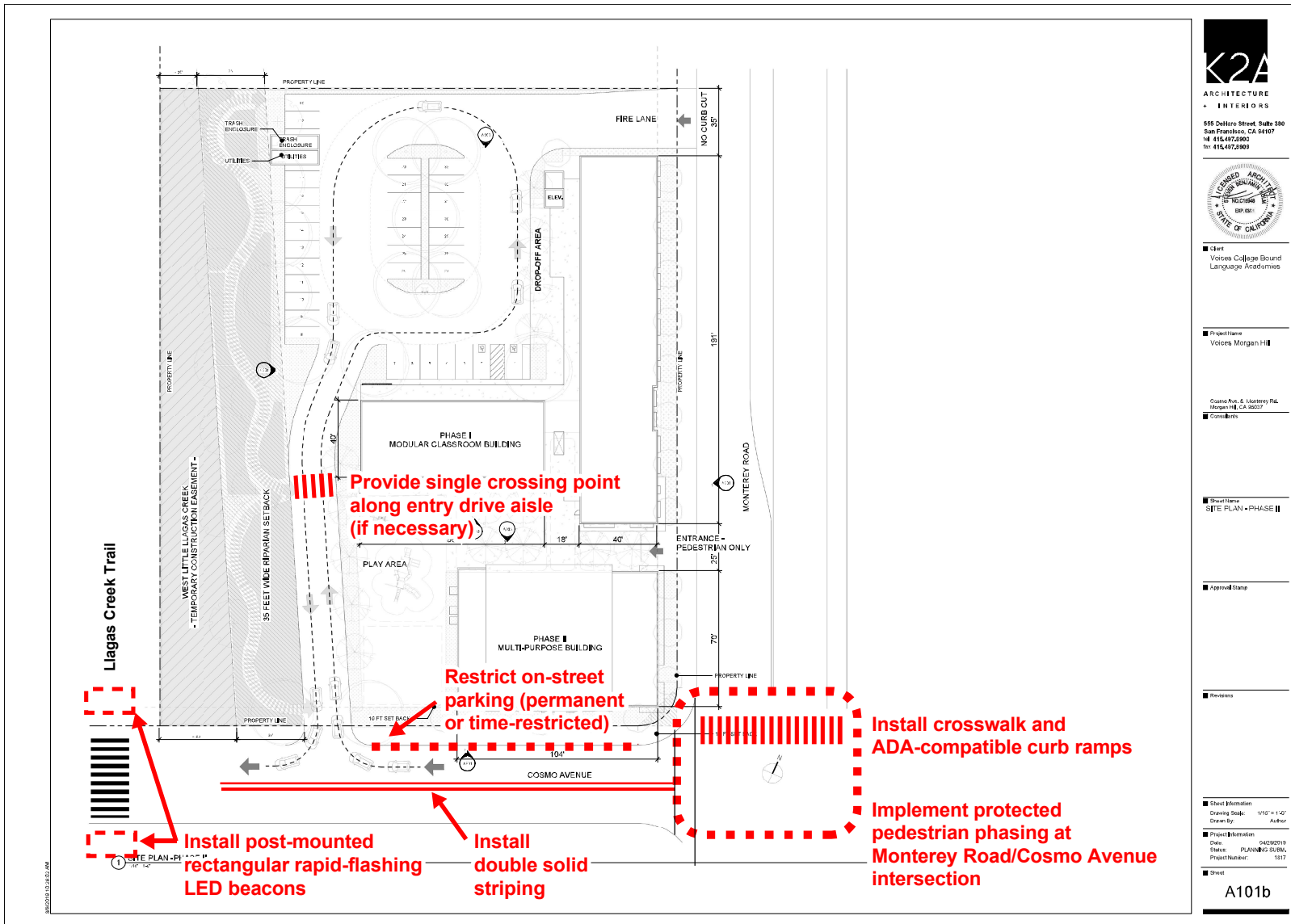

Figure 15
Recommended Pedestrian Improvements

Drop-off/Pick-up Estimated Queue Length

Based on the length of the drop-off area, approximately 3 to 4 vehicles could be loaded/unloaded at once. Conservatively assuming that dropping-off/picking-up a student and driving away would take up one minute per vehicle (assumed time includes maneuvering into and out of the drop-off area and loading/unloading student) and assuming four vehicles are continuously served at once, this calculates to 4 drop-offs/pick-ups per minute.

Based on the project trip generation estimates, it is estimated that approximately 265 vehicles would enter the drop-off area during the AM peak-hour (highest peak hour). In addition, the trip generation counts conducted at the existing Voices School site show that school traffic arriving at the school site during the peak 15-minute period represent approximately 55 percent (%) of the total peak-hour school traffic. Assuming the same arrival pattern would be observed at the proposed school site, approximately 146 vehicles would arrive at the school site within the peak 15-minute period, an average of 10 vehicles per minute. With an unloading time of no more than one minute per vehicle and the ability to serve 4 vehicles at once, the average queue length at the drop-off area would be approximately 6 vehicles. Following the same method, it is estimated that a maximum of approximately 12 vehicles would queue up beyond the drop-off area during the peak 15-minute period (the maximum queue is approximately twice the average queue). However, this estimate assumes all 146 vehicles would arrive at the site evenly during the peak 15-minute period. Traffic patterns, however, are seldom uniform. Random vehicle arrivals result in short periods of time experiencing longer queues than estimated and other short times experiencing no queues at all. Nevertheless, the proposed queue storage capacity within the inbound drive aisle would be approximately one to two vehicles short of meeting the estimated maximum vehicle queue during the school's peak 15-minute period, resulting in one to two vehicles from the queue spilling onto Cosmo Avenue. During the rest of the peak-hour, the queue storage capacity within the site would be adequate to serve the estimated drop-off queue length.

In order to avoid or minimize the possibility of the inbound queue length extending onto Cosmo Avenue, additional drop-off positions could be added (without reducing the inbound queue storage capacity) or the drop-off area could be operated more efficiently (shortening the time each vehicle spends in the drop-off area). This would result in more vehicles being served than the 4 vehicles per minute assumed in the above queue length estimates. Additionally, the school may implement staggered start times spreading the arrival times and reducing the amount of inbound traffic during the peak 15-minute period. Staggered start times are discussed below.

Recommendation: It is recommended that school staff or parent volunteers be stationed along the drop-off area to assist students in and out of vehicles and improve drop-off procedures efficiency.

Additionally, in order to speed up student pick up, it is recommended that parents place a name card on the passenger side visor showing the last name and grade level of the child being picked-up so that school staff, positioned at the project driveway, could radio ahead to staff at the drop-off area the name of the student being picked up to ensure the student is ready for pick-up by the time the parent reaches the drop-off area. This would result in a continuous flow of traffic through the site, expediting the pick-up process and limiting inbound vehicle queue lengths.

Recommendation: Measures should be taken to ensure efficient utilization of the available queue storage space within the site and the efficient and safe loading/unloading of the students. It is recommended that the drop-off/pick-up area be well defined with implementation of appropriate signage and pavement markings clearly showing the student loading zone and each vehicle position. The loading lane should be designed to provide the maximum loading area possible. School staff should be positioned along the drive aisle to ensure that students do not unload outside of the designated loading zone.

Recommendation: It is recommended that on-street parking along the southern project site frontage on Cosmo Avenue be prohibited. This would allow potential vehicular queues from the drop-off area to store within this space and avoid blocking access to westbound through traffic. The on-street parking restriction could be permanent (red curb) or time restricted to be implemented during the school peak hours only.

Staggered School Start Times Evaluation

To spread the amount of traffic accessing the project site over the peak-hour, rather than the 15-minute period that is typical of school start times, and reduce potential issues associated with peak-period vehicular access, the school could implement staggered start times. Implementing staggered start times would reduce the amount of traffic accessing the school site during the peak 15-minute period, resulting in shorter queue lengths at the drop-off area. Staggered start times a minimum of 30 minutes apart would have the greatest effect on inbound queue lengths since traffic associated with the first start time would no longer be on site by the time the second start time traffic begins to arrive at the site.

Table 7 shows estimates of the number of students that would arrive at the school site during the peak hour, peak 15 minutes, and peak minute if the school implemented a start time of 8:00 AM for the upper grades (6-8 grades) and an 8:30 AM start time for the lower grades (K-5 grades). These estimates are based on the following assumptions:

- All student traffic would arrive to the site within 30-minute prior to their respective school start time. Based on this assumption, approximately 168 and 336 students would arrive to the site between 7:30-8:00 AM and 8:00-8:30 AM, respectively.
- Fifty-five percent (55%) of the students would arrive at the school site during the peak 15-minute period (based on the count data collected at the existing Voices School site), equating to a maximum of approximately 185 student arrivals during this period.
- Based on the applicable trip generation rates, student arrivals during the peak 15-minute period are estimated to generate 98 inbound trips, or approximately 7 inbound trips per minute.

As shown on Table 7, with 30-minute staggered start times, student arrivals would be spread out more evenly during the entire peak hour, also reducing the amount of inbound trips arriving to the site just prior to the school start time (peak 15-minute period). Based on the estimated number of inbound trips and assuming a loading/unloading time of no more than one minute per vehicle and the ability to serve 4 vehicles at once, the average queue length at the drop-off area would be approximately 3 vehicles during the peak period, or a maximum of approximately 6 vehicles. The projected inbound queue length at the drop-off area would be able to accommodate within the site.

Access Driveway Operations

All access to the project site would be provided via the single driveway on Cosmo Avenue. It is estimated that a total of 328 inbound and 265 outbound project trips would access the Cosmo Avenue driveway during the AM peak hour (138 inbound and 202 outbound project trips during the PM peak-hour). The existing traffic volumes on Cosmo Avenue at the project site driveway (both directions combined) are 122 and 164 vehicles during the AM and PM peak hours, respectively.

Since the inbound traffic would be restricted to making right-turns into the site only, minimal conflict with existing traffic would occur at the project driveway. Additionally, as it was shown in the previous section, with the successful implementation of the proposed pick-up/drop-off plan, the estimated queue length of inbound traffic would mostly be able to store within the project site, with a maximum of two vehicles potentially spilling onto Cosmo Avenue during the school's peak 15-minute period (assuming no staggered times are implemented). The two-vehicle queue along westbound Cosmo Avenue could potentially block access to westbound through traffic on Cosmo Avenue. However, the existing 44

**Table 7
Roadway Segment Analysis Summary**

Potential school start times: (Between 8:00 and 8:30 AM)		TIME																	
		7:15 AM			7:30			8:00			8:30			9:00					
8:30: Lower Grades (K-5) arrival		336																	
8:00: Upper Grades (6-8) arrival		168																	
15-min arrivals		0	76			92			151			185			0	504			
5-min arrivals		0	0	25	25	25	31	31	31	50	50	50	62	62	62	0	0	0	504
1-min arrivals		0	0	5	5	5	6	6	6	10	10	10	12	12	12	0	0	0	101
Hourly Student Arrivals:																			
Between 7:30-8:30		504																	
Between 8:00-9:00		428																	
Between 8:00-9:00		336																	
<p>Assumptions:</p> <p>All students would arrive to the school within 30 minutes prior to their respective school start time.</p> <p>Fifty-five percent (55%) of the students would arrive to the school within 15 minutes prior to their respective school start time, as was observed at the existing Voices School Site.</p> <p>Within each 15-minute period, traffic was assumed to arrive at the site evenly.</p>																			

westbound AM peak-hour vehicles on Cosmo Avenue represent less than one vehicle per minute. Therefore, because of the low traffic volumes on Cosmo Avenue, it is not anticipated that the westbound queue length at the project driveway would extend to or affect the operations at the intersection of Monterey Road and Cosmo Avenue.

Outbound project traffic would be in conflict with existing westbound traffic along Cosmo Avenue. However, due to the relatively low traffic volumes along westbound Cosmo Avenue, there would be adequate gaps in the westbound direction to allow outbound project traffic to exit the site, having minimal effect on traffic operations at the project driveway and along Cosmo Avenue.

Cosmo Avenue consists of a 40-foot wide (curb-to-curb) two-lane undivided roadway with on-street parking. Within 100 feet of the proposed site driveway location, two trees on the south side of the street (one on each side of the driveway) partially encroach onto Cosmo Avenue, reducing the eastbound width of the street by 6 to 8 feet near the project site driveway. Since no project traffic is proposed to access the site from/to eastbound Cosmo Avenue, the reduced street width in the eastbound direction would not affect traffic operations at the site driveway. Consequently, allowing left-turns in and out of the site would result in vehicular queues along eastbound Cosmo Avenue within the reduced 12-14-foot right-of-way blocking eastbound through traffic. Thus, left-turn inbound and outbound access should be prohibited.

Recommendation: In order to avoid vehicular queues along the eastbound direction on Cosmo Avenue that would result in the blockage of through traffic, left-turn inbound and outbound access should be prohibited. Double solid striping, as recommended by City staff, should be installed along the project site frontage on Cosmo Avenue to indicate no left-turn access is allowed at the project driveway.

Monterey Road and Cosmo Avenue Intersection Operations

The proposed school site is located in the northwest quadrant of the Monterey Road and Cosmo Avenue intersection. All school traffic, as well as potential pedestrian traffic along Monterey Road, would utilize this intersection to access the school site. This intersection is currently signalized with crosswalks along the south and west legs only and permitted signal phasing on all approaches of the intersection. The intersection level of service analysis (presented in the previous chapter) shows the intersection to currently operate at acceptable LOS A during both the AM and PM peak hours and is projected to continue to operate at LOS A with the addition of project traffic. The intersection's projected operating conditions and low delays are due to the majority of the intersection traffic traveling through Monterey Road, with relatively low traffic volumes from/to Cosmo Avenue, resulting in very little conflicting movements and intersection delay. Although the project would add traffic to this intersection, all project traffic would be added to a non-critical movement (the northbound left-turn movement), resulting in a slight improvement to the overall intersection average delay.

As discussed previously in the site access section, however, although the intersection is projected to operate adequately with the implementation of the proposed school project, the missing crosswalk along the north leg of the intersection and permitted signal phasing is less than ideal for an intersection that would serve as the main access intersection for the school. Thus, it was previously recommended that protected pedestrian phasing be installed on all approaches of the intersection to accommodate pedestrian school traffic. Implementing protected pedestrian phasing on all approaches of the intersection would modification of the traffic signal to include protected left-turn phasing on the northbound and southbound approaches and split phasing on the eastbound and westbound approaches, in addition to the installation of the north crosswalk and ADA-compatible curb ramps. Signal timing also would have to be modified to accommodate the additional pedestrian phases.

With the implementation of the recommended signal phasing improvements, the intersection is projected to continue to operate at an acceptable LOS C or better during the AM and PM peak-hours with the project (see Table 8).

Table 8
Monterey Road and Cosmo Avenue Intersection Levels of Service

Scenario	Peak Hour	Existing Conditions		Existing+Project (Proposed)	
		Avg. Delay	LOS	Avg. Delay	LOS
Existing					
Permitted NB/SB Left Turns,	AM	3.8	A	3.5	A
Permitted EB/WB Left Turns	PM	3.9	A	3.8	A
Recommended					
Protected NB/SB Left Turns,	AM	15.6	B	18.4	B
Split EB/WB Left Turns	PM	19.2	B	26.2	C
Note: Operating conditions at the intersection of Monterey Road and Cosmo Avenue under the existing and recommended signal phasing. Avg. Delay = Average intersection delay, expressed in seconds.					

Roadway Segment Analysis

The purpose of the roadway segment analysis is to quantify the potential change in traffic volumes along key roadway segments in the vicinity of the project site as a result of the proposed project. As proposed, project traffic would be added to roadway segments west of the project site as they leave the project area. Thus, an evaluation of the effects of project traffic along the following roadway segments was completed:

1. Cosmo Avenue
2. Del Monte Avenue
3. Olympic Drive
4. Spring Avenue

For the evaluation, the existing and existing plus project peak-hour traffic volumes along the above roadway segments were compared to acceptable volume thresholds for each segment to determine if the projected change in traffic volume would be considered significant.

Unlike the intersection level of service analysis methodology, which has established impact thresholds, the analyses contained in this section are based on professional judgment in accordance with the standards and methods employed by the traffic engineering community.

Roadway Characteristics

The roadway segments evaluated all consist of two-lane, undivided roadways that provide access to residential areas and connect to arterials. All of the evaluated roadways are classified as collector roadways in the City of Morgan Hill 3025 General Plan, Transportation section. All roadways are approximately 35 to 40 feet wide, curb-to-curb, with on-street parking on both sides of the street and no striped bike lanes.

Collector streets are typically defined as roadways that provide a connection between local/residential roads and arterial roads, providing a balance between access and mobility. The typical design speed for collector streets is usually between 25 and 45 miles per hour (depending on the area), and, according to the U.S. Department of Transportation – Federal Highway Administration, can carry average daily traffic (ADT) volumes typically ranging from 300 to 2,600 (rural collectors) up to 6,000 vehicles (urban collectors).

Existing Conditions

Speed and count (twenty-four hour tube counts) data were collected on April 3, 2019 along the study roadway segments. The traffic count data revealed that the study roadway segments currently carry between 550 (along Olympic Drive) to 2,400 (along Spring Avenue) daily vehicles (both directions combined) near the project site. Based on the typical traffic volume ranges associated with collector streets, all of the study roadway segments currently serve the recommended traffic volumes associated with their classification.

All of the study roadways have a posted speed limit of 25 mph. The speed surveys revealed that the 85th percentile speeds along three of the four roadway segments studied were measured to exceed the posted speed limit by 7 to 9 mph. The speeds along Cosmo Avenue were measured to be within 5 mph of the posted speed limit. Speeds within 5 mph of the posted speed limits are considered reasonable. Therefore, based on the speed surveys, vehicular speeds along three of the study roadway segments would be considered excessive.

Table 9 summarizes the existing traffic volumes and 85th percentile speeds collected along each of the studied roadway segments.

Project's Effect on Study Roadway Segments

All outbound project traffic during the peak hours would utilize westbound Cosmo Avenue after exiting the project driveway. This equates to approximately 482 daily trips being added by the project to westbound Cosmo Avenue, between the project driveway and Del Monte Avenue, the most project traffic added to a single roadway segment (representing a 30% increase in daily traffic volumes along Cosmo Avenue compared to existing conditions). At Del Monte Avenue, project traffic traveling on Cosmo Avenue would continue northbound to Del Monte Avenue (354 daily trips) or westbound/southbound to Olympic Drive (128 daily trips). The increase in daily traffic volumes along Del Monte Avenue and Olympic Drive would be approximately 20% and 23%, respectively, from existing conditions. Spring Avenue would experience the smallest increase in daily traffic volumes with an increase of 24 daily trips, or 1% increase in daily traffic volumes. Even with the additional traffic added to the adjacent roadway network, all study roadway segments would continue to carry the recommended average daily traffic volumes associated with collector streets (see Table 9).

Although the projected average daily trips along the study roadway segments are within acceptable ranges, the added project trips to Cosmo Avenue constitute an increase in traffic of approximately 30% from the existing daily traffic volumes, which could be considered a measurable increase in traffic volumes.

**Table 9
Roadway Segment Analysis Summary**

#	Roadway Segment	Count Date	Direction	Speed		ADT			
				Limit	85th Percentile	Existing	Proposed Site Access		
						Project Trips	Existing + Project	% Change	
1	Cosmo Avenue, east of Del Monte Avenue	04/03/19	EB	25	30	901	0	901	0%
			WB	25	29	724	482	1,206	67%
			Total			1,625	482	2,107	30%
2	Del Monte Avenue, north of Cosmo Avenue	04/03/19	NB	25	30	889	354	1,243	40%
			SB	25	32	909	0	909	0%
			Total			1,798	354	2,152	20%
3	Olympic Drive, south of Cosmo Avenue	04/03/19	NB	25	32	285	0	285	0%
			SB	25	33	262	128	390	49%
			Total			547	128	675	23%
4	Spring Avenue east of Del Monte Avenue	04/03/19	EB	25	34	1,110	24	1,134	2%
			WB	25	32	1,249	0	1,249	0%
			Total			2,359	24	2,383	1%

Notes:
ADT = Average Daily Traffic

Findings of the Roadway Segment Analysis

The following conclusions can be drawn from the evaluation of the study roadways:

- Traffic volumes at all study roadways are and would continue to be within the volume range characteristic for collector streets.
- Speeds along three of the four study roadway segments currently exceed the posted speed limit by more than 5 mph. Speeding is occurring under existing conditions and not caused by the project.
- With the proposed site access configuration, traffic volumes along Cosmo Avenue are projected to increase by approximately 30% from existing conditions as a result of the proposed project, an increase which could be considered measurable and would be perceptible to residents of the adjacent neighborhood.
- Most of the traffic increases along the study roadway segments would occur during the peak hours, with little to no change in traffic during the off-peak hours.

Parking

The project is proposing to provide a total of 33 on-site parking spaces, which would include two accessible parking spaces.

Section 18.72.030 of the Morgan Hill City Code specifies the required number of on-site parking spaces for different types of land uses. Per Table 18.72-2, elementary and middle schools are required to provide one parking space per classroom, plus one parking space per 250 square feet (s.f.) of office area. The project is proposing classrooms and administrative offices, in addition to teacher's workroom, storage, restrooms, and a multipurpose building/cafeteria. According to the site plan, the school would consist of an 18-classroom modular school building and would include less than 2,000 s.f. of administration office space. Based on this information and the City's parking requirements, the proposed school would be required to provide a total of 26 parking spaces.

Recommendation: The school anticipates a total of 63 staff/faculty members at full buildout. Although some of the school employees would be part-time staff, potentially, up to 63 parking spaces could be needed to serve all school employees. Additionally, it is also likely that some parents would choose to park and walk in their children, in particular those in the lower grades. Some of this school traffic could park on the street. There are currently no on-street parking restrictions along the extent of Cosmo Avenue. However, it is recommended that on-street parking be prohibited along the school frontage on Cosmo Avenue, at a minimum during the school peak hours. This would eliminate parking activity near the project site driveway and thus conflict between school traffic entering/exiting the site and those parking on the street. In addition, as mentioned previously, prohibiting on-street parking along the southern site frontage on Cosmo Avenue would provide additional space for potential inbound queues to store next to the curb and avoid blocking westbound through traffic flow.

Recommendation: There are no parking restrictions along Monterey Road, with the exception of red curbing next to bus stops and fire hydrants. Providing on-site parking along the east project frontage would not interfere with site access operations along Cosmo Avenue. However, it could be utilized by parents dropping-off/picking-up students trying to avoid entering the school site. For this reason, the school should encourage all student drop-offs/pick-ups to occur within the site at the drop-off area. Should student drop-offs/pick-ups along Monterey Road become an issue, on-street parking along the Monterey Road school frontage should be prohibited during the school peak hours. Ultimately, the City of Morgan Hill will determine if on-street parking would be allowed along Cosmo Avenue and Monterey Road in the vicinity of the proposed school.

Intersection Operations Analysis

The intersection operations analysis consists of an evaluation of vehicular queues at locations where the project would add a significant number of left-turns to the intersection (typically 10 or more peak-hour trips per lane; less than 10 peak-hour trips would not affect the length of the queue). The intersection operations analysis includes the following study intersections:

2. Monterey Road and Dunne Avenue
5. Monterey Road and Cosmo Avenue
6. Monterey Road and Tennant Avenue/Edmundson Avenue
8. Monterey Road and Watsonville Road
9. Butterfield Boulevard and Main Avenue
10. Butterfield Boulevard and Dunne Avenue

Vehicle queues were estimated using a Poisson probability distribution, which estimates the probability of “n” vehicles for a vehicle movement using the following formula:

$$P(x=n) = \frac{\lambda^n e^{-\lambda}}{n!}$$

Where:

$P(x=n)$ = probability of “n” vehicles in queue per lane

n = number of vehicles in the queue per lane

λ = average number of vehicles in the queue per lane (vehicles per hour per lane/signal cycles per hour)

The basis of the analysis is as follows: (1) the Poisson probability distribution is used to estimate the 95th percentile maximum number of queued vehicles per signal cycle for a particular movement; (2) the estimated maximum number of vehicles in the queue is translated into a queue length, assuming 25 feet per vehicle; and (3) the estimated maximum queue length is compared to the existing or planned available storage capacity for the movement. This analysis thus provides a basis for estimating future left-turn storage requirements at intersections. The 95th percentile queue length value indicates that during the peak hour, a queue of this length or less would occur on 95 percent of the signal cycles. Likewise, a queue length larger than the 95th percentile queue would only occur on 5 percent of the signal cycles (about 3 cycles during the peak hour for a signal with a 60-second cycle length). Therefore, left-turn storage pocket designs based on the 95th percentile queue length would ensure that storage space would be exceeded only 5 percent of the time. The 95th percentile queue length is also known as the “design queue length”.

Site observations at the existing Voices School in Morgan Hill indicate that the heaviest project activity at the school occurs during a 15-minute period within each peak hour. Based on the trip generation counts conducted at the existing school site, approximately 55% to 60% of the total peak-hour traffic occurs within the peak 15-minute period. Since the calculation of queue lengths is based on peak-hour volumes, as a conservative approach, in order to reflect queue lengths that would occur during the peak 15-minute period of school traffic, queue lengths were calculated based on the peak 15-minute period volumes multiplied by four (to represent hour volumes). By doing this, the maximum queue length during the peak 15-minute traffic conditions are calculated. Queue lengths during the remaining peak-hour would be less than those presented here.

The intersection queuing analysis is summarized in Table 10. The vehicular queuing analysis (Poisson probability calculations) is included in Appendix E. Intersections projected to have left-turn queue storage deficiencies are discussed below.

**Table 10
Intersection Queuing Analysis Summary**

Measurement	2. Monterey/ Dunne				5. Monterey/ Cosmo		6. Monterey/ Tennant		8. Monterey/ Watsonville		9. Butterfield/ Main		10. Butterfield/ Dunne	
	EBL AM	EBL PM	WBL AM	WBL PM	NBL AM	NBL PM	SBL AM	SBL PM	EBL AM	EBL PM	EBL AM	EBL PM	EBL AM	EBL AM
Existing Conditions														
Cycle/Delay ¹ (sec)	105	105	105	105	60	60	90	135	85	140	100	110	120	120
Lanes	1	1	2	2	1	1	2	2	1	1	1	1	1	1
Volume (vph)	85	77	144	329	17	45	92	213	58	43	134	87	153	153
Volume (vphpl)	85	77	72	165	17	45	46	107	58	43	134	87	153	153
Avg. Queue (veh/ln.)	2	2	2	5	0	1	1	4	1	2	4	3	5	5
Avg. Queue ² (ft./ln)	62	56	53	120	7	19	29	100	34	42	93	66	128	128
95th % . Queue (veh/ln.)	5	5	5	9	1	2	3	8	4	4	7	6	9	9
95th % . Queue (ft./ln)	125	125	125	225	25	50	75	200	100	100	175	150	225	225
Storage (ft./ ln.)	100	100	350	350	125	125	175	175	200	200	125	125	250	250
Adequate (Y/N)	NO	NO	YES	YES	YES	YES	YES	NO	YES	YES	NO	NO	YES	YES
Existing Plus Project Conditions with Proposed Site Access (Right-in/Right-out at Cosmo Driveway)														
Cycle/Delay ¹ (sec)	105	105	105	105	60	60	90	135	85	140	100	110	120	120
Lanes	1	1	2	2	1	1	2	2	1	1	1	1	1	1
Volume (vph)	193	227	312	494	251	128	92	213	92	50	145	98	195	195
Volume (vphpl)	193	227	156	247	251	128	46	107	92	50	145	98	195	195
Avg. Queue (veh/ln.)	6	7	5	7	4	2	1	4	2	2	4	3	7	7
Avg. Queue ² (ft./ln)	141	166	114	180	105	53	29	100	54	49	101	75	163	163
95th % . Queue (veh/ln.)	10	11	8	12	8	5	3	8	5	4	8	6	11	11
95th % . Queue (ft./ln)	250	275	200	300	200	125	75	200	125	100	200	150	275	275
Storage (ft./ ln.)	100	100	350	350	125	125	175	175	200	200	125	125	250	250
Adequate (Y/N)	NO	NO	YES	YES	NO	YES	YES	NO	YES	YES	NO	NO	NO	NO
¹ Vehicle queue calculations based on cycle length for signalized intersections and control delay for unsignalized intersections. ² Assumes 25 feet per vehicle in the queue. NB = Northbound, SB = Southbound, EB = Eastbound, WB = Westbound, R = Right, T = Through, L = Left.														

Queuing Analysis Results

2. Monterey Road and Dunne Avenue

Eastbound Left-Turn

The queuing analysis indicates that the maximum vehicle queue for the eastbound left-turn pocket at the Monterey Road and Dunne Avenue intersection currently exceeds the existing vehicle storage capacity during the AM and PM peak hours, and would continue to do so with the addition of project traffic.

The *eastbound left-turn* pocket currently provides 100 feet of vehicle storage (or approximately 4 vehicles). The estimated 95th percentile vehicle queue for this movement under existing conditions is 5 vehicles during the AM and PM peak hours, exceeding the left-turn pocket storage capacity by 1 vehicle during both peak hours.

The addition of project traffic to this intersection would increase the 95th percentile vehicle queues for this movement by 5 and 6 vehicles (to 10 and 11 vehicles) during the AM and PM peak hours, respectively, exceeding the existing queue storage capacity by 6 to 7 vehicles.

It is possible to extend the existing eastbound left-turn lane the additional 150 feet needed by removing the adjacent two-way left-turn (TWLT) lane. Removing the adjacent TWLT lane would affect left-turn access at the adjacent shopping center driveway (south side of Dunne Avenue). However, a second driveway to the shopping center located approximately 150 feet west of the affected driveway would continue to provide full access to the shopping center. Alternatively, the projected maximum queue length, which is projected to occur during the school's peak 15-minute period, could accommodate within the existing TWLT lane.

5. Monterey Road and Cosmo Avenue

Northbound Left-Turn

The queuing analysis indicates that the maximum vehicle queue for the northbound left-turn pocket at the Monterey Road and Cosmo Avenue intersection would exceed the existing vehicle storage capacity during the AM peak-hour with the addition of project traffic.

The *northbound left-turn* pocket currently provides 125 feet of vehicle storage (or approximately 5 vehicles). The estimated 95th percentile vehicle queue for this movement under existing conditions is 1 vehicle during the AM peak-hour.

The addition of project traffic to this intersection would increase the 95th percentile vehicle queues for this movement by 7 vehicles (to 8 vehicles) during the AM peak hour, exceeding the existing queue storage capacity by 3 vehicles.

It is possible to extend the existing northbound left-turn lane the additional 75 feet needed by removing/modifying the existing landscape median, which would include the removal of 3 to 4 trees within the median.

Additionally, the projected queue length for this movement also was evaluated assuming the implementation of the recommended pedestrian phasing on all approaches of the intersection. With the recommended signal phasing improvements, the northbound left-turn queue length is projected to increase by 10 vehicles (to 11 vehicles) during the AM peak-hour, exceeding the future queue storage capacity by as many as 6 vehicles.

Extending the existing left-turn pocket an additional 150 feet to accommodate 6 additional vehicles would require removal/modification of the existing landscape median and part of the two-way left-turn to provide a 275-foot left-turn lane.

6. Monterey Road and Tennant Avenue

Southbound Left-Turn

The queuing analysis indicates that the maximum vehicle queue for the southbound left-turn pocket at the Monterey Road and Tennant Avenue intersection currently exceeds the existing vehicle storage capacity during the PM peak-hour, and would continue to do so with the addition of project traffic.

The *southbound left-turn* pocket currently provides 175 feet of vehicle storage (or approximately 7 vehicles). The estimated 95th percentile vehicle queue for this movement under existing conditions is 8 vehicles during the PM peak-hour, exceeding the left-turn pocket storage capacity by 1 vehicle during the PM peak-hour.

The addition of project traffic to this intersection is not projected to have an effect in the 95th percentile vehicle queue length for this movement.

9. Butterfield Boulevard and Main Avenue

Eastbound Left-Turn

The queuing analysis indicates that the maximum vehicle queue for the eastbound left-turn pocket at the Butterfield Boulevard and Main Avenue intersection currently exceeds the existing vehicle storage capacity during the AM and PM peak hours, and would continue to do so with the addition of project traffic.

The *eastbound left-turn* pocket currently provides 125 feet of vehicle storage (or approximately 5 vehicles). The estimated 95th percentile vehicle queue for this movement under existing conditions is 7 and 6 vehicles during the AM and PM peak hours, respectively, exceeding the left-turn pocket storage capacity by up to 2 vehicles during the peak hours.

The addition of project traffic to this intersection would increase the 95th percentile vehicle queues for this movement by 1 vehicle (to 8 vehicles) during the AM peak-hour, exceeding the existing queue storage capacity by 3 vehicles.

It is not possible to extend the existing eastbound left-turn lane at this intersection due to the adjacent eastbound left-turn lane providing access to the office complex located at the northwest corner of the Butterfield Boulevard/Main Avenue intersection. In order to extend the existing left-turn pocket the additional 75 feet needed, the adjacent left-turn pocket would need to be removed. Alternatively, a second eastbound left-turn lane could be provided.

10. Butterfield Boulevard and Dunne Avenue

Eastbound Left-Turn

The queuing analysis indicates that the maximum vehicle queue for the eastbound left-turn pocket at the Butterfield Boulevard and Dunne Avenue intersection would exceed the existing vehicle storage capacity during both peak hours with the addition of project traffic.

The *eastbound left-turn* pocket currently provides 250 feet of vehicle storage (or approximately 10 vehicles). The estimated 95th percentile vehicle queue for this movement under existing conditions is 9 vehicles during both the AM and PM peak hours.

The addition of project traffic to this intersection would increase the 95th percentile vehicle queues for this movement by 2 vehicles (to 11 vehicles) during both peak hours exceeding the existing queue storage capacity by 1 vehicle.

It is not possible to extend the existing eastbound left-turn lane at this intersection due to the adjacent back-to-back left-turn pocket. In order to extend the existing left-turn pocket at the intersection of Butterfield Boulevard/Dunne Avenue, the adjacent left-turn pocket would need to be reduced. Alternatively, a second eastbound left-turn lane could be provided. In addition, the maximum queue length is projected to occur during the school's peak 15-minute periods. Outside of the peak 15-minute periods, the existing queue storage capacity for this movement would be adequate.

Potential Impacts on Pedestrians, Bicycles, and Transit

Pedestrian Access

As discussed previously, pedestrian facilities in the study areas consist primarily of sidewalks, crosswalks, and pedestrian signals at signalized intersections. The adjacent intersection of Monterey Road and Cosmo Avenue has marked crosswalks and pedestrian signal heads along the south and west legs of the intersection. However, sidewalks are currently missing along the entire project site frontages on both Monterey Road and Cosmo Avenue. Additionally, sidewalks are missing along the west side of Monterey Road, between the project site and just south of San Pedro Avenue.

Although the project is proposing to install sidewalks along its entire frontage, the missing sidewalks along Monterey Road, north of the project site, would result in a discontinuous pedestrian facility network in the immediate project area for potential pedestrian traffic originating from the north. Alternatively, pedestrian traffic from the north could utilize the existing trail that runs along the west side of the school site, between Spring Avenue to Cosmo Avenue.

Project's Effect on Pedestrian Facilities

New pedestrian traffic potentially could be generated by the proposed project. The school site is surrounded by residential communities. Additionally, bus stops are located along both side of Monterey Road, adjacent to the project site.

With the existing and proposed pedestrian facilities within and in the vicinity of the project site, adequate pedestrian access to and from the project site to nearby pedestrian destinations, such as the bus stops along Monterey Road and residential areas near the project site, would be provided. Therefore, pedestrian access to and from the project site would be adequate.

Bicycle Facilities

There are numerous bike lanes and bike paths in the vicinity of the project site, including the West Llagas Creek Trail and the Class II bike lanes along Monterey Road, which serve the project site directly and provide connections to other bicycle facilities in the area.

Project's Effect on Bicycle Facilities

The proposed project could increase the demand on bicycle facilities in the vicinity of the project site. Assuming bicycle trips would comprise no more than one percent of the total project-generated trips, the project could generate up to 6 new bicycle trips during the peak hours. The potential demand could be easily served by the various bicycle facilities available in the immediate vicinity of the project site. Therefore, the potential increase in bicycle trips by the proposed project would not have an adverse effect on the existing bicycle facilities in the study area, and would not require new off-site bicycle facilities.

Transit Facilities

Transit in the study area is provided by VTA. The project site area is served directly by one bus line (local Route 68).

Project's Effect on Bicycle Facilities

Due to the nature of the project, it is not anticipated that transit demand by the project would be significant to justify the enhancement of the existing transit facilities.

5. Year 2025 Cumulative Conditions

This chapter describes Year 2025 Cumulative traffic conditions with and without the proposed project. Cumulative conditions are comprised of forecasted traffic volumes and reflect estimated traffic growth in the City of Morgan Hill for the Year 2025. This chapter describes the procedure used to determine Year 2025 Cumulative traffic volumes and the resulting traffic conditions.

Year 2025 Cumulative Land Use and Traffic Forecasts

Year 2025 Cumulative traffic volumes were developed based on traffic forecasts produced for the City of Morgan Hill 2035 General Plan using the City's Traffic Demand Forecasting (TDF) model. The Year 2035 General Plan traffic forecasts include land use growth and transportation improvements associated with buildout of the City's General Plan. The Year 2025 Cumulative traffic volumes were developed using a growth method that involved adding a proportion (10 Years or 50%) of the 2035 projected growth, developed from forecasted turn-movements, to existing traffic counts at each of the study intersections. The projected growth was calculated by taking the difference between Base Year 2015 and Year 2025 forecasted turn movements. Figure 16 shows the Year 2025 Cumulative No Project traffic volumes. Appendix B lists each of the components used to tabulate cumulative traffic volumes at each study intersection.

Transportation Network Under year 2025 Cumulative Conditions

It is assumed in this analysis that the transportation network under cumulative conditions would be the same as described under existing conditions.

Year 2025 Project Trip Generation Estimates

Peak hour project trips associated with the adopted General Plan land uses for the project site are included within the 2035 General Plan forecasts and the developed Year 2025 Cumulative traffic volumes. However, the land uses assumed for the project site as part of the General Plan are general in nature (16 multi-family residential units, 800 s.f. of shopping center and 800 s.f. of office space). The proposed project now provides for a site-specific development plan with a defined land use. Therefore, the development of Year 2025 with Project Cumulative traffic volumes involved adjusting the Year 2025 cumulative traffic volumes to reflect the proposed development plan.

Hexagon prepared trip estimates for the project site land uses included in the City's traffic model and the proposed development plan. The land uses of the proposed development plan are of greater intensity than those assumed in the General Plan. When compared with the land uses included in the

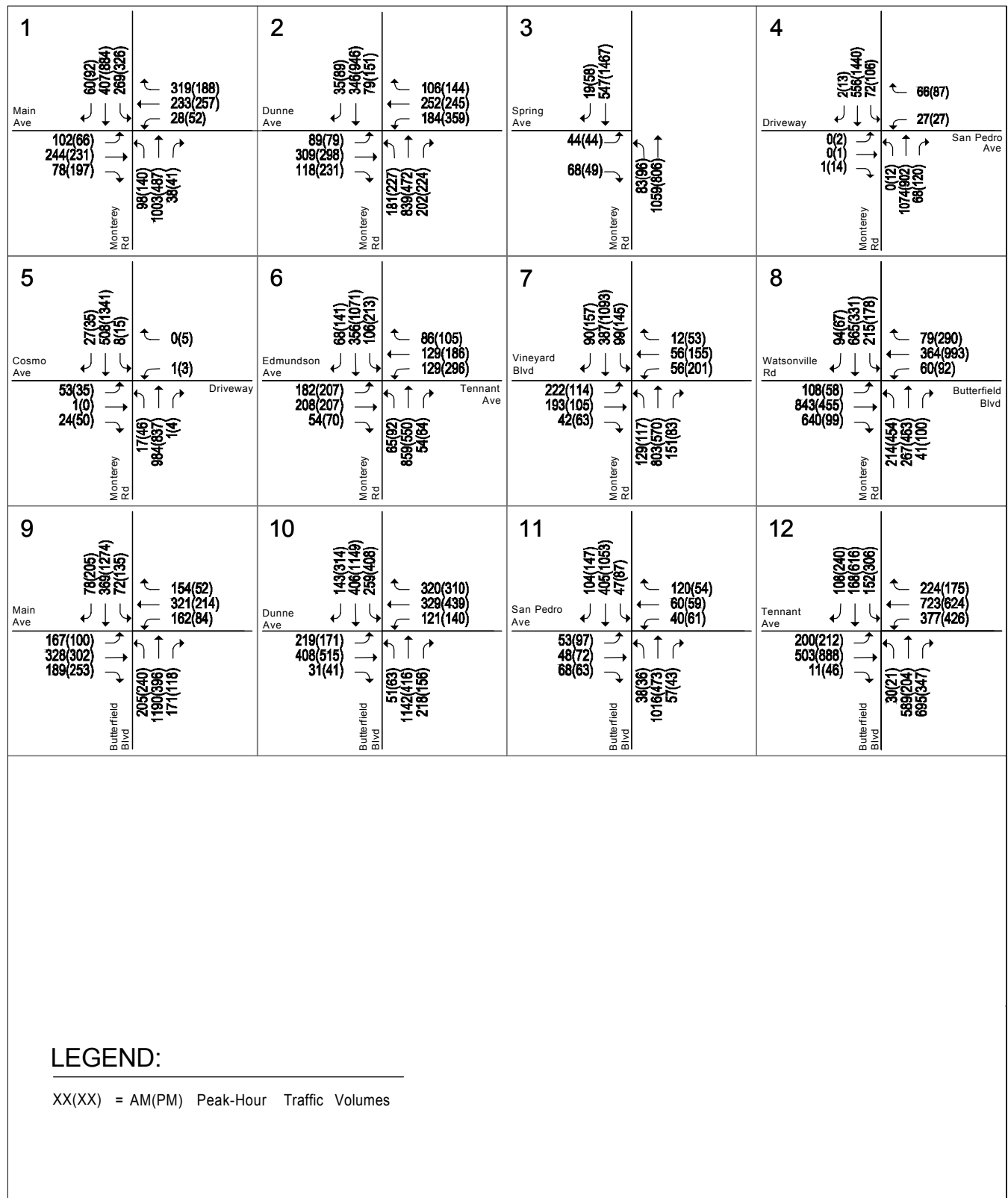
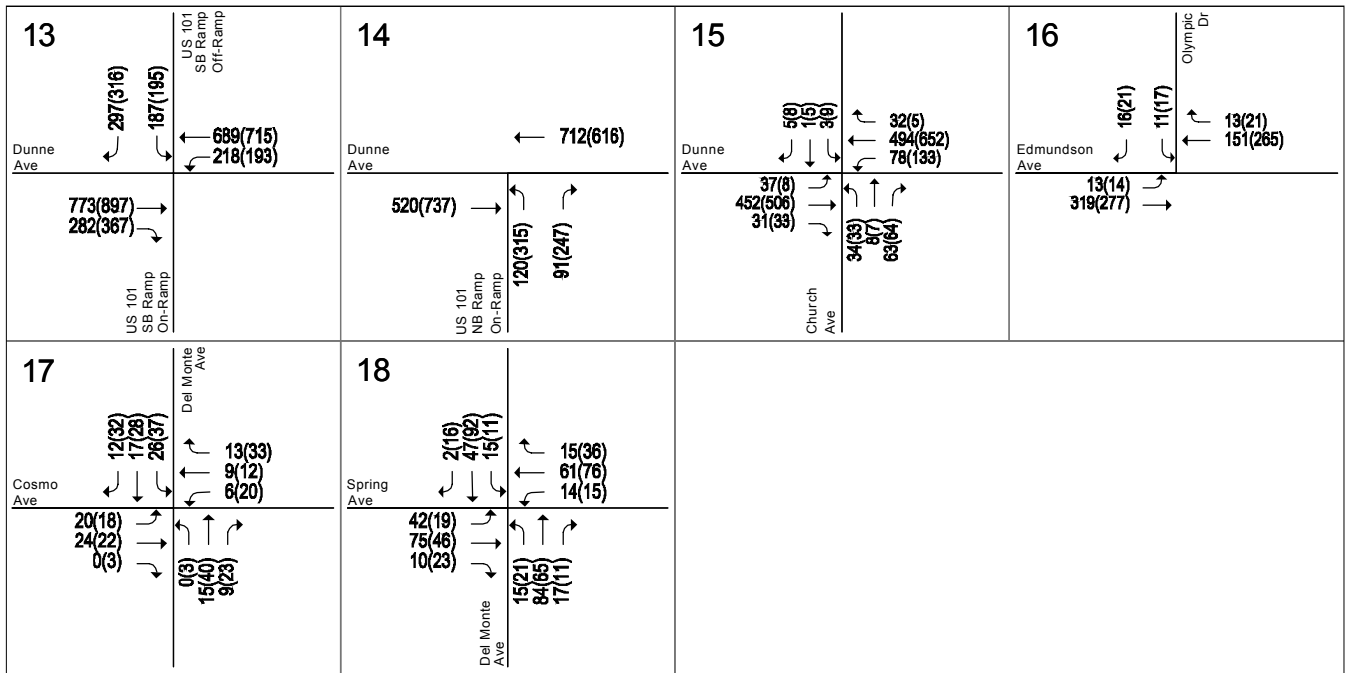

Figure 16
Year 2025 Cumulative No Project Traffic Volumes



LEGEND:

XX(X) = AM(PM) Peak-Hour Traffic Volumes

Figure 16 (Continued)
Year 2025 Cumulative No Project Traffic Volumes

City's current General Plan, the proposed development plan would result in an additional 583 AM peak-hour trips and 327 PM peak-hour trips at the project site. The net new project trip generation under Year 2035 General Plan conditions are presented in Table 11.

The net project trips for the proposed development plan were added to Year 2025 Cumulative traffic volumes to represent Year 2025 Cumulative with project conditions. Figure 17 shows the Year 2025 Cumulative with project traffic volumes. Appendix B lists each of the components used to tabulate cumulative traffic volumes at each study intersection.

Intersection Levels of Service under Cumulative Conditions

The level of service results under Year 2025 Cumulative, both without and with the addition of project traffic, are summarized in Table 12. The results show that, measured against the City of Morgan Hill level of service standards, the following study intersections are projected to operate at unacceptable levels of service during at least one of the peak hours analyzed under 2025 cumulative plus project conditions:

4. Monterey Road and San Pedro Avenue – **Impact:** AM and PM peak hours
8. Monterey Road and Watsonville Road/Butterfield Boulevard

The unsignalized intersection of Monterey Road and San Pedro Avenue is projected to operate at an unacceptable LOS E or F during both the AM and PM peak hours under both cumulative and cumulative plus project conditions. In addition, the peak-hour traffic signal warrant checks indicate that the traffic volumes at this intersection would continue to meet the threshold that warrants signalization during both peak hours under cumulative plus project conditions. Therefore, the intersection of Monterey Road and San Pedro Avenue is projected to be impacted by the proposed project during both peak hours under cumulative plus project conditions.

The intersection of Monterey Road and Watsonville Road/Butterfield Boulevard is projected to operate at unacceptable LOS E during the PM peak-hour under both cumulative and cumulative plus project conditions. However, the addition of project trips would not cause the average critical delay to increase by more than four seconds nor the volume-to-capacity ratio to increase by 0.01 or more. Therefore, the proposed project would not have a significant cumulative project impact at this intersection.

The remaining study intersections are projected to operate at acceptable levels of service under Year 2025 cumulative and cumulative plus project conditions during each of the peak hours analyzed. Additionally, the remaining unsignalized study intersections are projected to have traffic conditions that fall below the thresholds that warrant signalization under Year 2025 cumulative and cumulative plus project conditions. The level of service calculation sheets are included in Appendix C. The peak-hour signal warrant sheets are contained in Appendix D.

Intersection Mitigations under Cumulative Conditions

4. Monterey Road and San Pedro Avenue

Impact: This intersection is projected to operate at an unacceptable LOS F during the AM and PM peak hours under cumulative plus project conditions. In addition, the CA MUTCD Peak-Hour Volume Signal Warrant (Warrant #3 – Part B) would be met during both peak hours under cumulative plus project conditions. Based on City of Morgan Hill unsignalized intersection level of service impact criteria, this constitutes a significant cumulative project impact.

**Table 11
General Plan 2035 Trip Generation Estimates**

Land Use	ITE Land Use		Daily Rate ²	Daily Trips	AM Peak-Hour			PM Peak-Hour ³				
	Code	Size			Rate	In	Out	Total	Rate	In	Out	Total
Proposed Project												
Charter School (K-8) ¹		504 Students	1.91	962	1.18	328	265	593	0.67	138	202	340
Adopted Project Site Uses ⁴												
Multifamily Housing (Low-Rise) ⁵	220	16 Dwelling Units	7.32	117	0.46	2	6	8	0.56	6	3	9
Shopping Center ⁵	820	800 Square Feet	37.75	30	0.94	1	0	1	3.81	1	2	3
General Office Building ⁵	710	800 Square Feet	9.74	8	1.16	1	0	1	1.15	0	1	1
Total Project Trips				155		4	6	10		7	6	13
Net Project Trips (Proposed - Adopted)				807		324	259	583		131	196	327
<p>¹ Trip rates (per student) based on Hexagon Transportation Consultants trip generation counts conducted at Voices Academy in Morgan Hill on April 3, 2019.</p> <p>² Daily trip rate was derived by multiplying the AM peak-hour rate (1.18) by the ratio between the daily trip rate to the AM trip rate (1.85/1.14) contained in the Institute of Transportation Engineers (ITE) <i>Trip Generation Manual</i>, 10th Edition 2017, for Charter Elementary School (ITE Land Use #537).</p> <p>³ PM peak-hour trip generation reflects 4:00-5:00 PM traffic conditions, which is when peak project traffic and peak background traffic overlap.</p> <p>⁴ Source: 2035 General Plan Traffic Demand Forecasting (TDF) model.</p> <p>⁵ Source: ITE Trip Generation Manual, 10th Edition 2017.</p>												

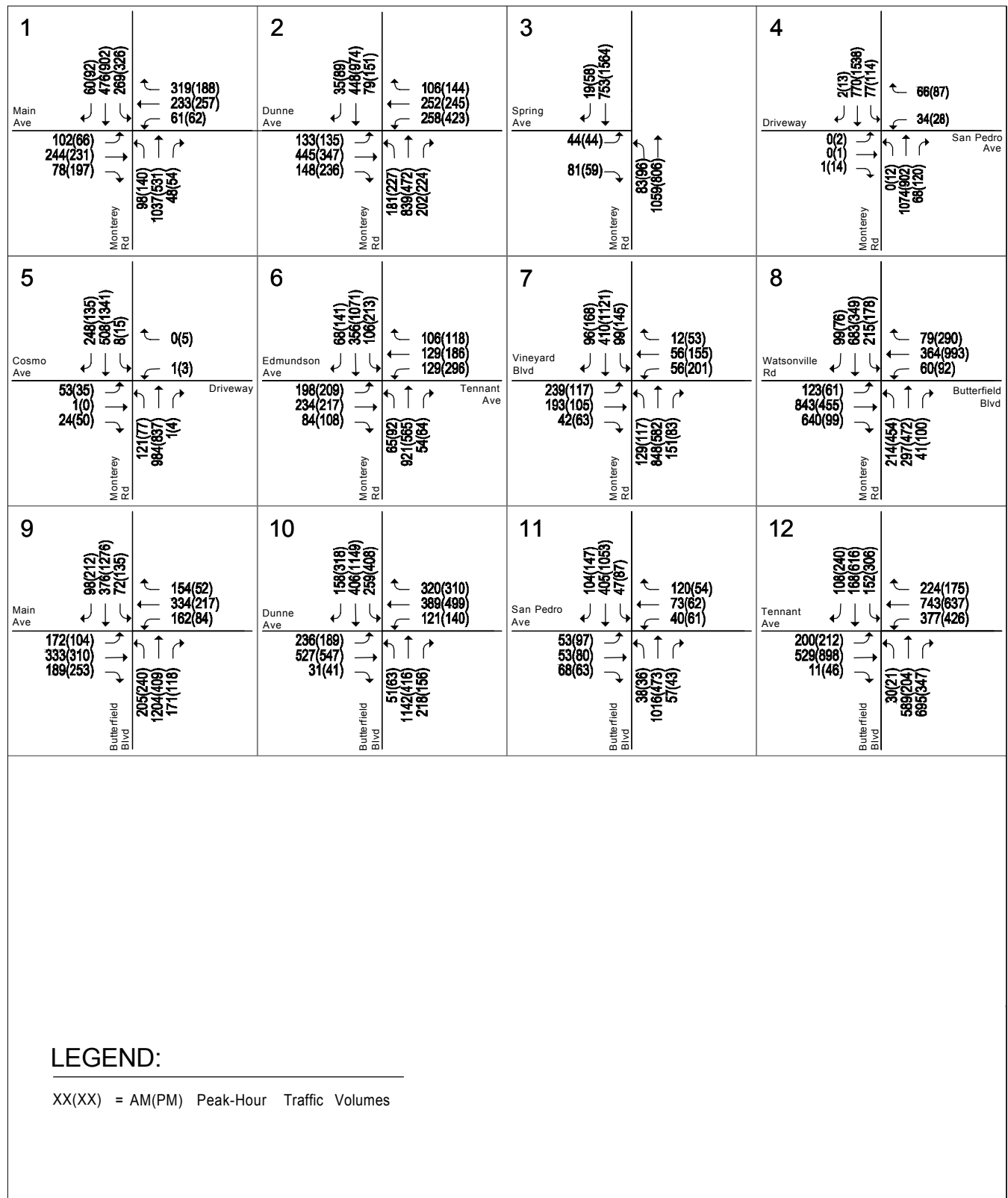
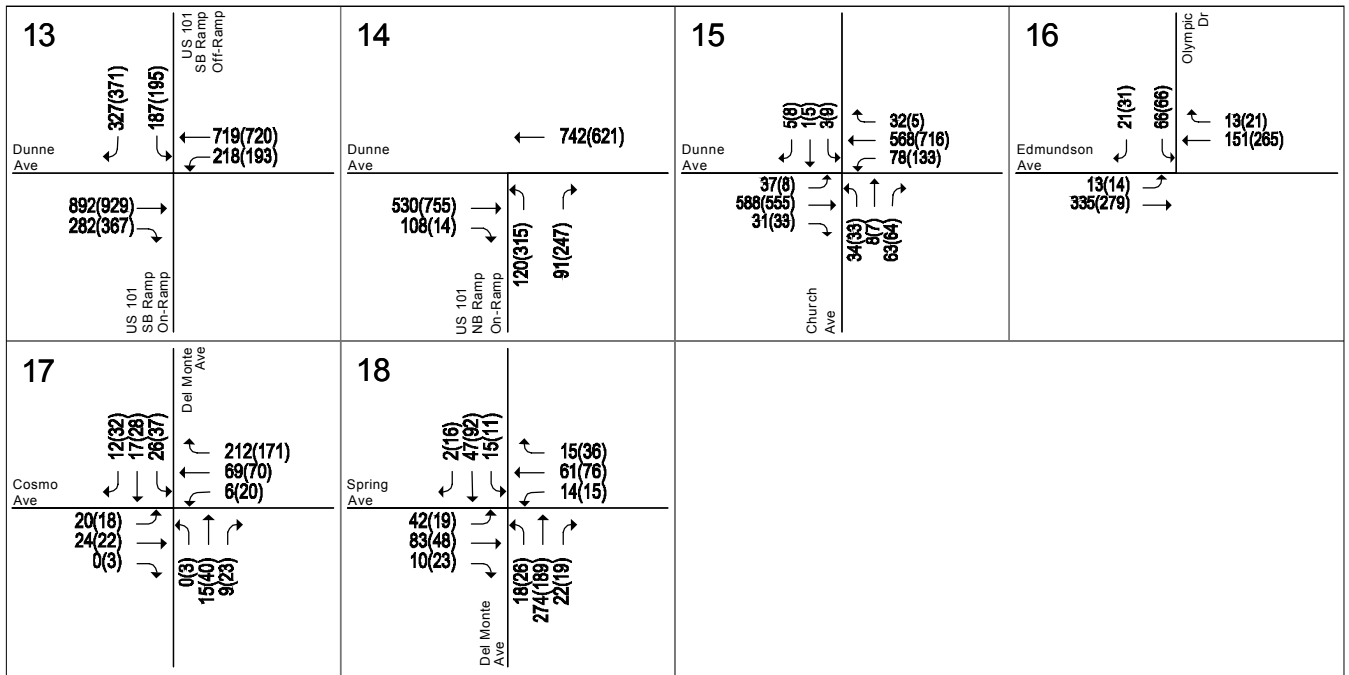

Figure 17
Year 2025 Cumulative Plus Project Traffic Volumes



LEGEND:

XX(X) = AM(PM) Peak-Hour Traffic Volumes

**Figure 17 (Continued)
 Year 2025 Cumulative Plus Project Traffic Volumes**

Table 12
Cumulative Conditions Intersection Levels of Service

Int. #	Intersection	LOS Standard	Peak Hour	2025 Cumulative			2025 Cumulative + Project				
				Warrant Met? ¹	Avg. Delay ²	LOS	Warrant Met? ¹	Avg. Delay ²	LOS	Incr. In Crit. Delay	Incr. In Crit. V/C
1	Monterey Road and Main Avenue	F	AM	--	55.8	E	--	56.9	E	1.4	0.013
			PM	--	48.2	D	--	48.9	D	0.5	0.011
2	Monterey Road and Dunne Avenue	E	AM	--	29.8	C	--	31.6	C	2.0	0.028
			PM	--	34.7	C	--	36.1	D	1.6	0.034
3	Monterey Road and Spring Avenue	D	AM	--	4.7	A	--	5.1	A	0.5	0.008
			PM	--	11.8	B	--	12.1	B	0.2	0.034
4	Monterey Road and San Pedro Avenue	D	AM	No	42.9	E	Yes	75.6	F	N/A	N/A
			PM	Yes	148.8	F	Yes	209.0	F	N/A	N/A
5	Monterey Road and Cosmo Avenue	D	AM	--	3.7	A	--	3.5	A	0.0	0.000
			PM	--	3.9	A	--	3.8	A	0.0	0.000
6	Monterey Road and Tennant Avenue/Edmundson Avenue	E	AM	--	23.9	C	--	24.4	C	0.5	0.036
			PM	--	36.1	D	--	36.9	D	1.2	0.014
7	Monterey Road and Vineyard Boulevard	D	AM	--	19.8	B	--	19.9	B	-0.1	0.014
			PM	--	27.3	C	--	27.2	C	-0.1	0.008
8	Monterey Road and Watsonville Road/Butterfield Boulevard	D	AM	--	34.8	C	--	35.3	D	0.8	0.006
			PM	--	61.1	E	--	62.1	E	1.8	0.007
9	Butterfield Boulevard and Main Avenue	D	AM	--	30.6	C	--	31.0	C	0.8	0.015
			PM	--	33.2	C	--	33.4	C	0.4	0.005
10	Butterfield Boulevard and Dunne Avenue	D	AM	--	42.6	D	--	44.5	D	2.6	0.026
			PM	--	37.7	D	--	38.9	D	1.7	0.029
11	Butterfield Boulevard and San Pedro Avenue	D	AM	--	13.7	B	--	13.9	B	0.4	0.009
			PM	--	13.8	B	--	14.0	B	0.2	0.005
12	Butterfield Boulevard and Tennant Avenue	E	AM	--	26.3	C	--	26.6	C	0.5	0.008
			PM	--	40.9	D	--	40.9	D	0.1	0.003
13	US 101 SB Ramps and Dunne Avenue	E	AM	--	21.0	C	--	22.1	C	-0.1	0.014
			PM	--	20.1	C	--	21.3	C	0.7	0.035
14	US 101 NB Ramps and Dunne Avenue	E	AM	--	6.3	A	--	6.2	A	-0.1	0.009
			PM	--	11.2	B	--	11.2	B	0.0	0.001
15	Church Street and Dunne Avenue	E	AM	--	18.1	B	--	18.5	B	0.1	0.046
			PM	--	19.5	B	--	18.9	B	-0.4	0.020
16	Olympic Drive and Edmundson Avenue	D	AM	No	10.4	B	No	12.4	B	N/A	N/A
			PM	No	11.4	B	No	13.1	B	N/A	N/A
17	Del Monte Avenue and Cosmo Avenue	D	AM	No	7.2	A	No	8.1	A	0.8	0.236
			PM	No	7.5	A	No	8.3	A	0.8	0.182
18	Del Monte Avenue and Spring Avenue	D	AM	No	8.1	A	No	9.6	A	1.5	0.243
			PM	No	8.1	A	No	8.8	A	0.8	0.145

¹ Signal warrant analysis based on the Peak Hour Signal Warrant #3, Figure 4C Caltrans MUTCD, 2014.

Signal warrant analysis is not applicable to signalized intersections.

² The reported delay and corresponding level of service for signalized and all-way stop-controlled intersections represents the average delay for all approaches at the intersection.

The reported delay and corresponding level of service for one- and two-way stop-controlled intersections are based on the stop-controlled approach with the highest delay.

Bold indicates unacceptable level of service.

Bold and boxed indicate significant impact.

Mitigation: The project impact at this intersection could be mitigated with the installation of a raised median along Monterey Road at San Pedro Avenue, thus restricting left-turns out of San Pedro Avenue to southbound Monterey Road. With the left-turn restriction, only right-turns in and out at both San Pedro Avenue (east leg of the intersection) and the existing driveway (west leg of the intersection) as well as southbound left-turns would be allowed, reducing the amount of conflicting traffic at the intersection. The southbound left-turn movement from Monterey Road to eastbound San Pedro Avenue could be maintained without having an adverse effect on operations at the intersection since this movement would only be in conflict with the northbound approach. With the restriction of the westbound left-turn movement, the intersection of Monterey Road and San Pedro Avenue is projected to operate at an acceptable LOS C or better during the AM and PM peak hours under cumulative plus project conditions. The left-turn restriction at San Pedro Avenue would result in the displacement of traffic bound for southbound Monterey Road from westbound San Pedro Avenue (34 and 28 AM and PM peak hour trips, respectively, under cumulative plus project conditions, with 7 and 1 of those trips being AM and PM peak hour project trips, respectively) to utilize alternative routes, such as Barrett Avenue, Edmundson Avenue, or Tennant Avenue. Left-turns in and out of the existing west-leg driveway (approximately 15 trips during the PM peak-hour) would have to complete a U-turn north and south of this intersection. Project traffic along westbound San Pedro Avenue would travel southbound on Church Street to Barrett Avenue, to northbound Monterey Road and complete a northbound left-turn at Cosmo Avenue. The minimal amount of displaced traffic represents an average of one trip every two minutes added to two to three other roadways and is not anticipated to have an adverse affect on traffic conditions at the surrounding intersections. The additional northbound left-turn project trips at the intersection of Monterey Road/Cosmo Avenue as a result of the left-turn restriction are not projected to have an adverse affect on intersection operations at this location either.

6. Conclusions

The potential impacts related to the proposed school project were evaluated following the standards and methodologies set forth by the City of Morgan Hill and the Santa Clara Valley Transportation Authority (VTA). The VTA administers the County Congestion Management Program (CMP). The study includes an analysis of AM and PM peak-hour traffic conditions for fourteen signalized intersections and four unsignalized intersections. The study also includes a site access and on-site circulation analysis, which includes levels of service analysis, sight distance analysis, and vehicle-storage requirements.

Existing Plus Project Intersection Level of Service Analysis

The results show that, measured against the City of Morgan Hill level of service standards, the intersection of **Monterey Road and San Pedro Avenue** is projected to be impacted by the proposed project during the PM peak-hour under existing plus project conditions.

Intersection Mitigations under Existing Plus Project Conditions

4. Monterey Road and San Pedro Avenue

Mitigation: The project impact at this intersection could be mitigated with the installation of a raised median along Monterey Road at San Pedro Avenue, thus restricting left-turns out of San Pedro Avenue to southbound Monterey Road. With the left-turn restriction, only right-turns in and out at both San Pedro Avenue (east leg of the intersection) and the existing driveway (west leg of the intersection) as well as southbound left-turns would be allowed, reducing the amount of conflicting traffic at the intersection. The southbound left-turn movement from Monterey Road to eastbound San Pedro Avenue could be maintained without having an adverse effect on operations at the intersection since this movement would only be in conflict with the northbound approach. With the restriction of the westbound left-turn movement, the intersection of Monterey Road and San Pedro Avenue is projected to operate at an acceptable LOS C or better during the AM and PM peak hours under existing plus project conditions. The left-turn restriction at San Pedro Avenue would result in the displacement of traffic bound for southbound Monterey Road from westbound San Pedro Avenue (34 and 28 AM and PM peak hour trips, respectively, under existing plus project conditions, with 7 and 1 of those trips being AM and PM peak hour project trips, respectively) to utilize alternative routes, such as Barrett Avenue, Edmundson Avenue, or Tennant Avenue. Left-turns in and out of the existing west-leg driveway (approximately 15 trips total during the PM peak-hour) would have to complete a U-turn north and south of this intersection. Project traffic along westbound

San Pedro Avenue would travel southbound on Church Street to Barrett Avenue, to northbound Monterey Road and complete a northbound left-turn at Cosmo Avenue. The minimal amount of displaced traffic represents an average of one trip every two minutes added to two to three other roadways and is not anticipated to have an adverse affect on traffic conditions at the surrounding intersections. The additional northbound left-turn project trips at the intersection of Monterey Road/Cosmo Avenue as a result of the left-turn restriction are not projected to have an adverse affect on intersection operations at this location either.

Cumulative Plus Project Intersection Level of Service Analysis

The results show that, measured against the City of Morgan Hill level of service standards, the intersection of **Monterey Road and San Pedro Avenue** is projected to be impacted by the proposed project during both peak hours under cumulative plus project conditions.

Intersection Mitigations under Cumulative Conditions

4. Monterey Road and San Pedro Avenue

Mitigation: Same as described under existing plus project conditions.

Other Transportation Issues

Project Site Access Evaluation

Site Access

Recommendation: The design of the project access driveways must adhere to City of Morgan Hill design guidelines.

On-Site Circulation

Recommendation: The design of the parking lot, including drive aisle widths, parking stall dimensions, and turn radii, must adhere to City of Morgan Hill design guidelines.

Recommendation: To prohibit left-turn movements from eastbound Cosmo Avenue into the Cosmo Avenue driveway, City staff recommends the installation of double solid striping on Cosmo Avenue, along the project site frontage. In addition, it is recommended that school staff monitor the school driveway during the school peak hours to ensure the left-turn in and out restriction is implemented.

Sight Distance

Recommendation: The site plan shows trees surrounding the project site. The design of the school campus should ensure design features, in particular the landscaping and signage along the school frontage, will not interfere with the sight distance at the proposed site driveway.

Pedestrian Access and Circulation

Recommendation: Since the proposed school is located at the intersection of Monterey Road and Cosmo Avenue, it is recommended that protected pedestrian phasing be installed on all approaches of the intersection. Currently, no crosswalk is located along the north leg of the intersection and the traffic signal operates with permitted phasing on all approaches. Pedestrians crossing Monterey Street at this intersection must use the south crosswalk. Implementing protected pedestrian phasing on all approaches of the intersection would require modifying the traffic signal to include protected left-turn phasing on the northbound and southbound approaches and split phasing on the eastbound and

westbound approaches, in addition to the required ADA-compatible wheelchair ramps at both ends of the new crosswalk.

Recommendation: In order to enhance pedestrian safety at the Little Llagas Creek Trail access and crosswalk on Cosmo Avenue, it is recommended that post-mounted rectangular rapid flashing LED beacons be installed on the adjacent bike/pedestrian crossing warning signs to further enhance the visibility of pedestrians within this mid-block crosswalk for motorists.

Recommendation: It is recommended that Voices School work with the City of Morgan Hill to develop a safe routes to school program that will define the safest routes for pedestrians between the adjacent residential areas and the project site.

Recommendation: Crossing of the entry drive aisle from the on-site pedestrian pathway should be discouraged by eliminating any possible pedestrian access to the school campus along the entry drive aisle. If a connection between the on-site pedestrian pathway and the school campus must be provided, however, it is recommended that a clear marked pedestrian connection be provided along the entry drive aisle. A marked connection would encourage crossing of the entry drive aisle from the trail at a single point as well as provide the benefit of a marked crossing that is clearly visible to drivers entering/exiting the site.

Drop-off/Pick-up Estimated Queue Length

Recommendation: It is recommended that school staff or parent volunteers be stationed along the drop-off area to assist students in and out of vehicles and improve drop-off procedures efficiency.

Additionally, in order to speed up student pick up, it is recommended that parents place a name card on the passenger side visor showing the last name and grade level of the child being picked-up so that school staff, positioned at the project driveway, could radio ahead to staff at the drop-off area the name of the student being picked up to ensure the student is ready for pick-up by the time the parent reaches the drop-off area. This would result in a continuous flow of traffic through the site, expediting the pick-up process and limiting inbound vehicle queue lengths.

Recommendation: Measures should be taken to ensure efficient utilization of the available queue storage space within the site and the efficient and safe loading/unloading of the students. It is recommended that the drop-off/pick-up area be well defined with implementation of appropriate signage and pavement markings clearly showing the student loading zone and each vehicle position. The loading lane should be designed to provide the maximum loading area possible. School staff should be positioned along the drive aisle to ensure that students do not unload outside of the designated loading zone.

Recommendation: It is recommended that on-street parking along the southern project site frontage on Cosmo Avenue be prohibited. This would allow potential vehicular queues from the drop-off area to store within this space and avoid blocking access to westbound through traffic. The on-street parking restriction could be permanent (red curb) or time restricted to be implemented during the school peak hours only.

Staggered School Start Times Evaluation

It is estimated that with 30-minute staggered start times, the average queue length at the drop-off area would be approximately 3 vehicles during the peak period, or a maximum of approximately 6 vehicles. The projected inbound queue length at the drop-off area would be able to accommodate with the site.

Access Driveway Operations

Recommendation: In order to avoid vehicular queues along the eastbound direction on Cosmo Avenue that would result in the blockage of through traffic, left-turn inbound and outbound access should be prohibited. Double solid striping, as recommended by City staff, should be installed along the project site frontage on Cosmo Avenue to indicate no left-turn access is allowed at the project driveway.

Monterey Road and Cosmo Avenue Intersection Operations

The intersection level of service analysis shows the intersection of Monterey Road and Cosmo Avenue to currently operate at acceptable LOS A during both the AM and PM peak hours and is projected to continue to operate at LOS A with the addition of project traffic.

With the implementation of the recommended signal phasing improvements, the intersection is projected to continue to operate at an acceptable LOS C or better during the AM and PM peak-hours with the project.

Findings of the Roadway Segment Analysis

The following conclusions can be drawn from the evaluation of the study roadways:

- Traffic volumes at all study roadways are and would continue to be within the volume range characteristic for collector streets.
- Speeds along three of the four study roadway segments currently exceed the posted speed limit by more than 5 mph. Speeding is occurring under existing conditions and not caused by the project.
- With the proposed site access configuration, traffic volumes along Cosmo Avenue are projected to increase by approximately 30% from existing conditions as a result of the proposed project, an increase which could be considered measurable and would be perceptible to residents of the adjacent neighborhood.
- Most of the traffic increases along the study roadway segments would occur during the peak hours, with little to no change in traffic during the off-peak hours.

Parking

Recommendation: It is recommended that on-street parking be prohibited along the school frontage on Cosmo Avenue, at a minimum during the school peak hours.

Recommendation: Should student drop-offs/pick-ups along Monterey Road become an issue, on-street parking along the Monterey Road school frontage should be prohibited during the school peak hours. Ultimately, the City of Morgan Hill will determine if on-street parking would be allowed along Cosmo Avenue and Monterey Road in the vicinity of the proposed school.

Intersection Operations Analysis

2. Monterey Road and Dunne Avenue

Eastbound Left-Turn

The addition of project traffic to this intersection would increase the 95th percentile vehicle queues for this movement by 5 and 6 vehicles (to 10 and 11 vehicles) during the AM and PM peak hours, respectively, exceeding the existing queue storage capacity by 6 to 7 vehicles.

It is possible to extend the existing eastbound left-turn lane the additional 150 feet needed by removing the adjacent two-way left-turn (TWLT) lane. Removing the adjacent TWLT lane would affect left-turn access at the adjacent shopping center driveway (south side of Dunne Avenue). However, a second

driveway to the shopping center located approximately 150 feet west of the affected driveway would continue to provide full access to the shopping center. Alternatively, the projected maximum queue length, which is projected to occur during the school's peak 15-minute period, could accommodate within the existing TWLT lane.

5. Monterey Road and Cosmo Avenue

Northbound Left-Turn

The addition of project traffic to this intersection would increase the 95th percentile vehicle queues for this movement by 7 vehicles (to 8 vehicles) during the AM peak hour, exceeding the existing queue storage capacity by 3 vehicles.

It is possible to extend the existing northbound left-turn lane the additional 75 feet needed by removing/modifying the existing landscape median, which would include the removal of 3 to 4 trees within the median.

Additionally, the projected queue length for this movement also was evaluated assuming the implementation of the recommended pedestrian phasing on all approaches of the intersection. With the recommended signal phasing improvements, the northbound left-turn queue length is projected to increase by 10 vehicles (to 11 vehicles) during the AM peak-hour, exceeding the future queue storage capacity by as many as 6 vehicles. Extending the existing left-turn pocket an additional 150 feet to accommodate 6 additional vehicles would require removal/modification of the existing landscape median and part of the two-way left-turn to provide a 275-foot left-turn lane.

6. Monterey Road and Tennant Avenue

Southbound Left-Turn

The queuing analysis indicates that the maximum vehicle queue for this movement is projected to exceed the existing vehicle storage capacity during the PM peak-hour. The addition of project traffic to this intersection, however, is not projected to have an effect in the 95th percentile vehicle queue length for this movement.

9. Butterfield Boulevard and Main Avenue

Eastbound Left-Turn

The addition of project traffic to this intersection would increase the 95th percentile vehicle queues for this movement by 1 vehicle (to 8 vehicles) during the AM peak-hour, exceeding the existing queue storage capacity by 3 vehicles.

It is not possible to extend the existing eastbound left-turn lane at this intersection due to the adjacent eastbound left-turn lane providing access to the office complex located at the northwest corner of the Butterfield Boulevard/Main Avenue intersection. In order to extend the existing left-turn pocket the additional 75 feet needed, the adjacent left-turn pocket would need to be removed. Alternatively, a second eastbound left-turn lane could be provided.

10. Butterfield Boulevard and Dunne Avenue

Eastbound Left-Turn

The addition of project traffic to this intersection would increase the 95th percentile vehicle queues for this movement by 2 vehicles (to 11 vehicles) during both peak hours exceeding the existing queue storage capacity by 1 vehicle.

It is not possible to extend the existing eastbound left-turn lane at this intersection due to the adjacent back-to-back left-turn pocket. In order to extend the existing left-turn pocket at the intersection of Butterfield Boulevard/Dunne Avenue, the adjacent left-turn pocket would need to be reduced. Alternatively, a second eastbound left-turn lane could be provided. In addition, the maximum queue length is projected to occur during the school's peak 15-minute periods. Outside of the peak 15-minute periods, the existing queue storage capacity for this movement would be adequate.

Potential Impacts on Pedestrians, Bicycles, and Transit

Project's Effect on Pedestrian Facilities

New pedestrian traffic potentially could be generated by the proposed project. The school site is surrounded by residential communities. Additionally, bus stops are located along both side of Monterey Road, adjacent to the project site.

With the existing and proposed pedestrian facilities within and in the vicinity of the project site, adequate pedestrian access to and from the project site to nearby pedestrian destinations, such as the bus stops along Monterey Road and residential areas near the project site, would be provided. Therefore, pedestrian access to and from the project site would be adequate.

Project's Effect on Bicycle Facilities

The proposed project could increase the demand on bicycle facilities in the vicinity of the project site. Assuming bicycle trips would comprise no more than one percent of the total project-generated trips, the project could generate up to 6 new bicycle trips during the peak hours. The potential demand could be easily served by the various bicycle facilities available in the immediate vicinity of the project site. Therefore, the potential increase in bicycle trips by the proposed project would not have an adverse effect on the existing bicycle facilities in the study area, and would not require new off-site bicycle facilities.

Project's Effect on Bicycle Facilities

Due to the nature of the project, it is not anticipated that transit demand by the project would be significant to justify the enhancement of the existing transit facilities.

Voices School Morgan Hill TIA
Technical Appendices

August 20, 2019

Appendix A
Traffic Counts



(303) 216-2439
www.alltrafficdata.net

Location: 18 MONTEREY RD & MAIN AVE AM
Date and Start Time: Tuesday, May 8, 2018
Peak Hour: 07:45 AM - 08:45 AM
Peak 15-Minutes: 08:00 AM - 08:15 AM

Peak Hour - All Vehicles

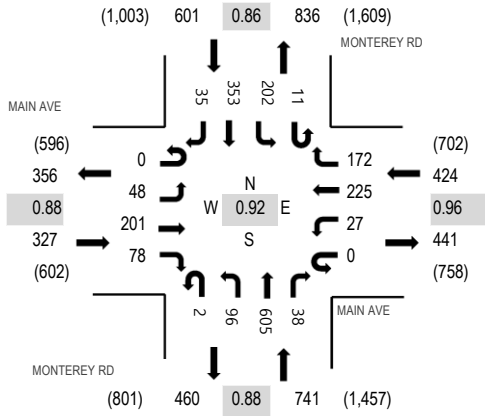

Peak Hour - Pedestrians/Bicycles in Crosswalk

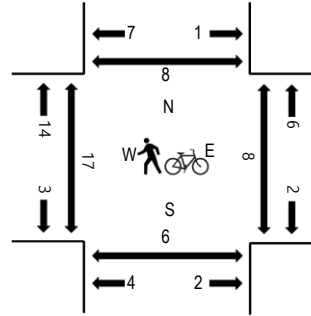

Note: Total study counts contained in parentheses.

Traffic Counts

Interval Start Time	MAIN AVE Eastbound				MAIN AVE Westbound				MONTEREY RD Northbound				MONTEREY RD Southbound				Total	Rolling Hour	Pedestrian Crossings			
	U-Turn	Left	Thru	Right	U-Turn	Left	Thru	Right	U-Turn	Left	Thru	Right	U-Turn	Left	Thru	Right			West	East	South	North
7:00 AM	0	8	22	18	0	4	28	25	1	19	153	7	1	15	34	3	338	1,760	1	0	1	0
7:15 AM	0	17	26	24	0	4	24	25	2	24	148	9	1	31	37	2	374	1,989	2	0	3	1
7:30 AM	0	13	42	22	0	6	49	33	2	20	207	14	0	44	44	5	501	2,067	0	1	0	1
7:45 AM	0	14	60	19	0	9	63	32	0	19	175	9	3	60	78	6	547	2,093	0	0	2	0
8:00 AM	0	12	59	19	0	7	57	38	1	28	181	13	2	51	90	9	567	2,004	2	3	0	1
8:15 AM	0	7	45	17	0	7	53	48	1	26	119	9	3	38	70	9	452		5	2	3	3
8:30 AM	0	15	37	23	0	4	52	54	0	23	130	7	3	53	115	11	527		8	3	1	2
8:45 AM	0	12	49	22	0	9	28	43	4	16	81	9	6	49	108	22	458		8	1	1	1

Peak Rolling Hour Flow Rates

Vehicle Type	Eastbound				Westbound				Northbound				Southbound				Total
	U-Turn	Left	Thru	Right	U-Turn	Left	Thru	Right	U-Turn	Left	Thru	Right	U-Turn	Left	Thru	Right	
Articulated Trucks	0	0	0	0	0	0	0	0	0	1	2	0	0	1	1	0	5
Lights	0	48	198	74	0	27	222	168	2	91	595	38	11	200	346	35	2,055
Mediums	0	0	3	4	0	0	3	4	0	4	8	0	0	1	6	0	33
Total	0	48	201	78	0	27	225	172	2	96	605	38	11	202	353	35	2,093



(303) 216-2439
www.alltrafficdata.net

Location: 18 MONTEREY RD & MAIN AVE PM
Date and Start Time: Tuesday, May 8, 2018
Peak Hour: 04:00 PM - 05:00 PM
Peak 15-Minutes: 04:15 PM - 04:30 PM

Peak Hour - All Vehicles

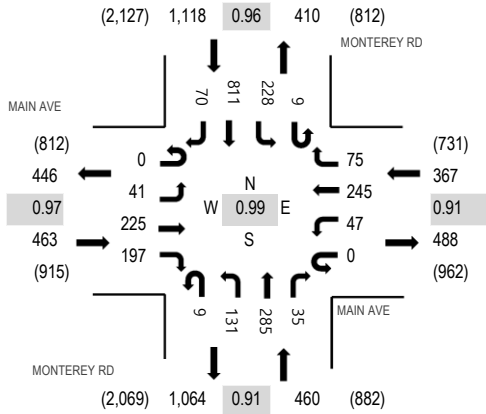

Peak Hour - Pedestrians/Bicycles in Crosswalk

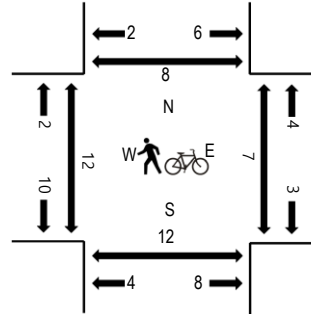

Note: Total study counts contained in parentheses.

Traffic Counts

Interval Start Time	MAIN AVE Eastbound				MAIN AVE Westbound				MONTEREY RD Northbound				MONTEREY RD Southbound				Total	Rolling Hour	Pedestrian Crossings			
	U-Turn	Left	Thru	Right	U-Turn	Left	Thru	Right	U-Turn	Left	Thru	Right	U-Turn	Left	Thru	Right			West	East	South	North
4:00 PM	0	10	54	42	0	12	57	24	6	27	76	8	2	54	204	23	599	2,408	3	0	3	0
4:15 PM	0	11	56	49	0	10	63	15	0	40	78	7	4	59	200	17	609	2,369	5	1	2	1
4:30 PM	0	9	59	51	0	10	59	16	2	45	70	9	2	61	185	16	594	2,336	4	3	4	2
4:45 PM	0	11	56	55	0	15	66	20	1	19	61	11	1	54	222	14	606	2,303	0	3	2	2
5:00 PM	0	7	63	45	0	12	59	24	1	13	71	13	2	49	185	16	560	2,247	2	3	1	2
5:15 PM	0	10	50	39	0	14	49	21	1	26	63	8	1	58	221	15	576		4	1	0	3
5:30 PM	0	11	65	45	0	12	54	19	4	27	82	12	0	44	176	10	561		3	0	2	0
5:45 PM	0	4	56	57	0	15	65	20	5	20	66	10	1	46	173	12	550		1	2	0	0

Peak Rolling Hour Flow Rates

Vehicle Type	Eastbound				Westbound				Northbound				Southbound				Total
	U-Turn	Left	Thru	Right	U-Turn	Left	Thru	Right	U-Turn	Left	Thru	Right	U-Turn	Left	Thru	Right	
Articulated Trucks	0	0	0	0	0	0	0	0	0	0	0	0	0	1	0	0	1
Lights	0	41	222	191	0	46	243	75	9	127	283	35	9	223	801	70	2,375
Mediums	0	0	3	6	0	1	2	0	0	4	2	0	0	4	10	0	32
Total	0	41	225	197	0	47	245	75	9	131	285	35	9	228	811	70	2,408



(303) 216-2439
www.alltrafficdata.net

Location: 22 MONTEREY RD & DUNNE AVE AM
Date and Start Time: Tuesday, May 8, 2018
Peak Hour: 07:30 AM - 08:30 AM
Peak 15-Minutes: 07:45 AM - 08:00 AM

Peak Hour - All Vehicles

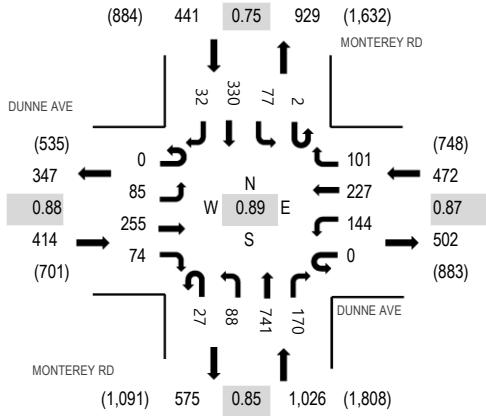

Peak Hour - Pedestrians/Bicycles in Crosswalk

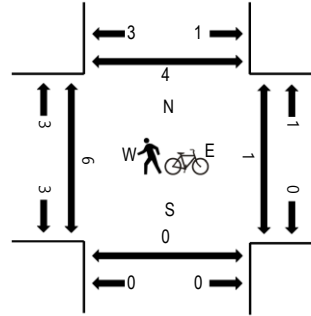

Note: Total study counts contained in parentheses.

Traffic Counts

Interval Start Time	DUNNE AVE Eastbound				DUNNE AVE Westbound				MONTEREY RD Northbound				MONTEREY RD Southbound				Total	Rolling Hour	Pedestrian Crossings			
	U-Turn	Left	Thru	Right	U-Turn	Left	Thru	Right	U-Turn	Left	Thru	Right	U-Turn	Left	Thru	Right			West	East	South	North
7:00 AM	0	14	37	8	0	13	24	10	5	12	170	36	4	14	43	1	391	2,008	0	1	0	0
7:15 AM	0	17	43	14	0	10	13	12	1	14	165	32	0	13	56	1	391	2,229	1	0	3	0
7:30 AM	0	32	69	16	0	31	36	18	3	16	208	48	0	13	69	3	562	2,353	1	0	0	0
7:45 AM	0	23	61	12	0	36	78	27	12	27	219	48	1	19	91	10	664	2,279	1	0	0	0
8:00 AM	0	17	64	25	0	49	61	30	10	21	173	43	0	23	85	11	612	2,133	1	0	0	0
8:15 AM	0	13	61	21	0	28	52	26	2	24	141	31	1	22	85	8	515		2	1	0	3
8:30 AM	0	14	43	12	0	39	36	26	7	16	138	27	3	27	95	5	488		1	4	1	0
8:45 AM	0	13	44	28	0	38	35	20	6	19	93	41	4	24	141	12	518		2	0	0	1

Peak Rolling Hour Flow Rates

Vehicle Type	Eastbound				Westbound				Northbound				Southbound				Total
	U-Turn	Left	Thru	Right	U-Turn	Left	Thru	Right	U-Turn	Left	Thru	Right	U-Turn	Left	Thru	Right	
Articulated Trucks	0	0	0	0	0	0	1	0	0	0	3	2	0	1	0	0	7
Lights	0	85	253	73	0	142	224	99	27	88	727	164	2	74	324	32	2,314
Mediums	0	0	2	1	0	2	2	2	0	0	11	4	0	2	6	0	32
Total	0	85	255	74	0	144	227	101	27	88	741	170	2	77	330	32	2,353



(303) 216-2439
www.alltrafficdata.net

Location: 22 MONTEREY RD & DUNNE AVE PM
Date and Start Time: Tuesday, May 8, 2018
Peak Hour: 04:00 PM - 05:00 PM
Peak 15-Minutes: 04:00 PM - 04:15 PM

Peak Hour - All Vehicles

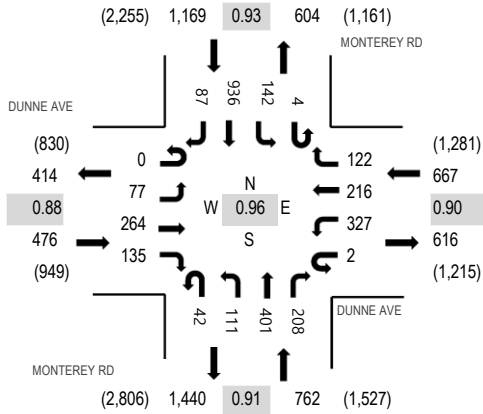

Peak Hour - Pedestrians/Bicycles in Crosswalk

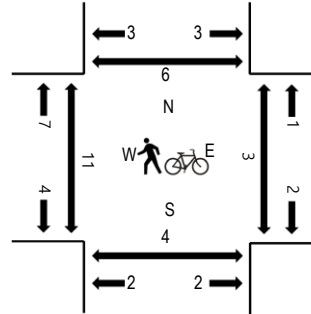

Note: Total study counts contained in parentheses.

Traffic Counts

Interval Start Time	DUNNE AVE Eastbound				DUNNE AVE Westbound				MONTEREY RD Northbound				MONTEREY RD Southbound				Total	Rolling Hour	Pedestrian Crossings			
	U-Turn	Left	Thru	Right	U-Turn	Left	Thru	Right	U-Turn	Left	Thru	Right	U-Turn	Left	Thru	Right			West	East	South	North
4:00 PM	0	17	78	26	1	77	65	34	15	35	108	64	1	38	213	27	799	3,074	1	0	1	2
4:15 PM	0	21	57	36	0	78	46	34	9	31	110	52	1	41	251	22	789	3,029	2	0	0	0
4:30 PM	0	17	66	36	1	79	51	29	8	20	103	39	2	32	233	16	732	2,978	5	2	1	2
4:45 PM	0	22	63	37	0	93	54	25	10	25	80	53	0	31	239	22	754	3,039	3	1	1	2
5:00 PM	0	21	70	35	1	85	53	15	10	31	94	57	0	24	240	18	754	2,938	3	1	3	1
5:15 PM	0	17	52	35	2	73	80	31	13	26	94	52	0	32	213	18	738		3	3	4	3
5:30 PM	0	18	88	33	0	80	50	26	14	28	116	53	2	20	241	24	793		1	3	6	1
5:45 PM	0	16	61	27	0	53	46	19	12	29	88	48	0	39	202	13	653		3	3	1	0

Peak Rolling Hour Flow Rates

Vehicle Type	Eastbound				Westbound				Northbound				Southbound				Total
	U-Turn	Left	Thru	Right	U-Turn	Left	Thru	Right	U-Turn	Left	Thru	Right	U-Turn	Left	Thru	Right	
Articulated Trucks	0	0	0	0	0	1	0	0	0	0	0	0	0	0	0	0	1
Lights	0	77	259	135	2	316	215	121	42	111	395	207	4	138	922	87	3,031
Mediums	0	0	5	0	0	10	1	1	0	0	6	1	0	4	14	0	42
Total	0	77	264	135	2	327	216	122	42	111	401	208	4	142	936	87	3,074

Traffic Data Service

San Jose, CA
 (408) 622-4787
 tdsbay@cs.com

File Name : 1AM FINAL
 Site Code : 00000001
 Start Date : 3/14/2019
 Page No : 1

Groups Printed- Vehicles

Start Time	MONTEREY RD Southbound					Westbound					MONTEREY RD Northbound					SPRING AVE Eastbound					Int. Total
	Right	Thru	Left	Peds	App. Total	Right	Thru	Left	Peds	App. Total	Right	Thru	Left	Peds	App. Total	Right	Thru	Left	Peds	App. Total	
07:00 AM	4	55	0	1	60	0	0	0	0	0	0	227	3	0	230	11	0	12	1	24	314
07:15 AM	3	66	0	2	71	0	0	0	0	0	0	196	5	0	201	17	0	15	0	32	304
07:30 AM	1	101	0	1	103	0	0	0	0	0	0	260	24	0	284	27	0	11	0	38	425
07:45 AM	6	118	0	1	125	0	0	0	0	0	0	258	17	0	275	21	0	9	0	30	430
Total	14	340	0	5	359	0	0	0	0	0	0	941	49	0	990	76	0	47	1	124	1473
08:00 AM	7	115	0	1	123	0	0	0	0	0	0	187	24	0	211	12	0	9	0	21	355
08:15 AM	3	145	0	0	148	0	0	0	0	0	0	186	18	0	204	8	0	13	0	21	373
08:30 AM	3	133	0	2	138	0	0	0	0	0	0	202	10	0	212	10	0	3	0	13	363
08:45 AM	8	155	0	1	164	0	0	0	0	0	0	161	11	0	172	9	0	4	0	13	349
Total	21	548	0	4	573	0	0	0	0	0	0	736	63	0	799	39	0	29	0	68	1440
Grand Total	35	888	0	9	932	0	0	0	0	0	0	1677	112	0	1789	115	0	76	1	192	2913
Apprch %	3.8	95.3	0	1		0	0	0	0		0	93.7	6.3	0		59.9	0	39.6	0.5		
Total %	1.2	30.5	0	0.3	32	0	0	0	0		0	57.6	3.8	0	61.4	3.9	0	2.6	0	6.6	

Start Time	MONTEREY RD Southbound					Westbound					MONTEREY RD Northbound					SPRING AVE Eastbound					Int. Total
	Right	Thru	Left	Peds	App. Total	Right	Thru	Left	Peds	App. Total	Right	Thru	Left	Peds	App. Total	Right	Thru	Left	Peds	App. Total	
07:30 AM	1	101	0		102	0	0	0	0	0	0	260	24	284	27	0	11		38	424	
07:45 AM	6	118	0		124	0	0	0	0	0	0	258	17	275	21	0	9		30	429	
08:00 AM	7	115	0		122	0	0	0	0	0	0	187	24	211	12	0	9		21	354	
08:15 AM	3	145	0		148	0	0	0	0	0	0	186	18	204	8	0	13		21	373	
Total Volume	17	479	0		496	0	0	0	0	0	0	891	83	974	68	0	42		110	1580	
% App. Total	3.4	96.6	0			0	0	0	0		0	91.5	8.5		61.8	0	38.2				
PHF	.607	.826	.000		.838	.000	.000	.000	.000	.000	.000	.857	.865	.857	.630	.000	.808		.724	.921	

Peak Hour Analysis From 07:00 AM to 08:45 AM - Peak 1 of 1

Peak Hour for Entire Intersection Begins at 07:30 AM

Traffic Data Service

San Jose, CA
 (408) 622-4787
 tdsbay@cs.com

File Name : 1AM FINAL
 Site Code : 00000001
 Start Date : 3/14/2019
 Page No : 2

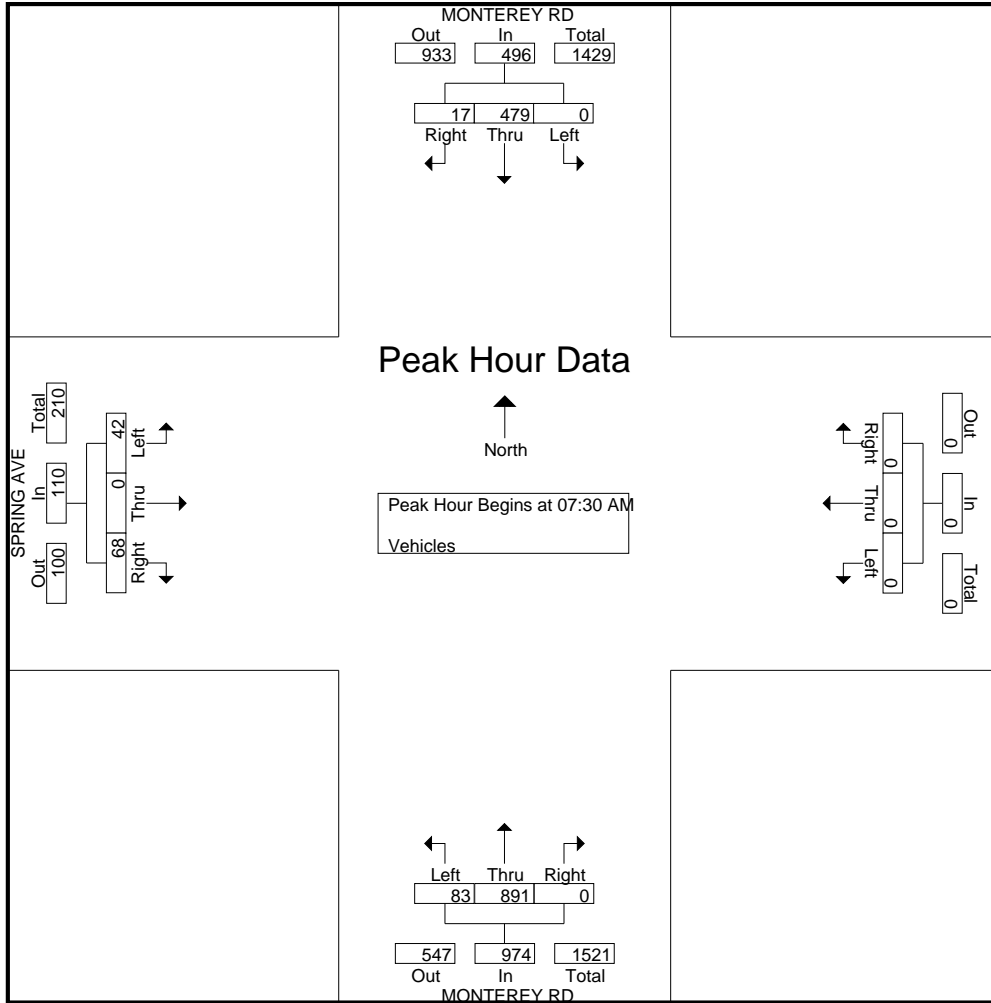

Traffic Data Service

San Jose, CA
 (408) 622-4787
 tdsbay@cs.com

File Name : 1PM FINAL
 Site Code : 00000001
 Start Date : 3/14/2019
 Page No : 1

Groups Printed- Vehicles

Start Time	MONTEREY RD Southbound					Westbound					MONTEREY RD Northbound					SPRING AVE Eastbound					Int. Total
	Right	Thru	Left	Peds	App. Total	Right	Thru	Left	Peds	App. Total	Right	Thru	Left	Peds	App. Total	Right	Thru	Left	Peds	App. Total	
04:00 PM	8	317	0	2	327	0	0	0	0	0	0	187	20	0	207	10	0	13	5	28	562
04:15 PM	17	379	0	5	401	0	0	0	0	0	0	185	18	0	203	18	0	7	2	27	631
04:30 PM	18	312	0	7	337	0	0	0	0	0	0	194	28	0	222	15	0	6	5	26	585
04:45 PM	13	348	0	3	364	0	0	0	0	0	0	204	32	0	236	9	0	10	5	24	624
Total	56	1356	0	17	1429	0	0	0	0	0	0	770	98	0	868	52	0	36	17	105	2402
05:00 PM	13	363	0	0	376	0	0	0	0	0	0	222	29	0	251	12	0	8	3	23	650
05:15 PM	21	442	0	4	467	0	0	0	0	0	0	251	37	0	288	19	0	10	0	29	784
05:30 PM	20	411	0	6	437	0	0	0	0	0	0	218	26	0	244	17	0	23	3	43	724
Grand Total	110	2572	0	27	2709	0	0	0	0	0	0	1461	190	0	1651	100	0	77	23	200	4560
Apprch %	4.1	94.9	0	1		0	0	0	0		0	88.5	11.5	0		50	0	38.5	11.5		
Total %	2.4	56.4	0	0.6	59.4	0	0	0	0	0	0	32	4.2	0	36.2	2.2	0	1.7	0.5	4.4	

Start Time	MONTEREY RD Southbound				Westbound				MONTEREY RD Northbound				SPRING AVE Eastbound				Int. Total	
	Right	Thru	Left	App. Total	Right	Thru	Left	App. Total	Right	Thru	Left	App. Total	Right	Thru	Left	App. Total		
Peak Hour Analysis From 04:00 PM to 05:30 PM - Peak 1 of 1																		
Peak Hour for Entire Intersection Begins at 04:45 PM																		
04:45 PM	13	348	0	361	0	0	0	0	0	0	204	32	236	9	0	10	19	616
05:00 PM	13	363	0	376	0	0	0	0	0	0	222	29	251	12	0	8	20	647
05:15 PM	21	442	0	463	0	0	0	0	0	0	251	37	288	19	0	10	29	780
05:30 PM	20	411	0	431	0	0	0	0	0	0	218	26	244	17	0	23	40	715
Total Volume	67	1564	0	1631	0	0	0	0	0	0	895	124	1019	57	0	51	108	2758
% App. Total	4.1	95.9	0		0	0	0		0	0	87.8	12.2		52.8	0	47.2		
PHF	.798	.885	.000	.881	.000	.000	.000	.000	.000	.000	.891	.838	.885	.750	.000	.554	.675	.884

Traffic Data Service

San Jose, CA
 (408) 622-4787
 tdsbay@cs.com

File Name : 1PM FINAL
 Site Code : 00000001
 Start Date : 3/14/2019
 Page No : 2

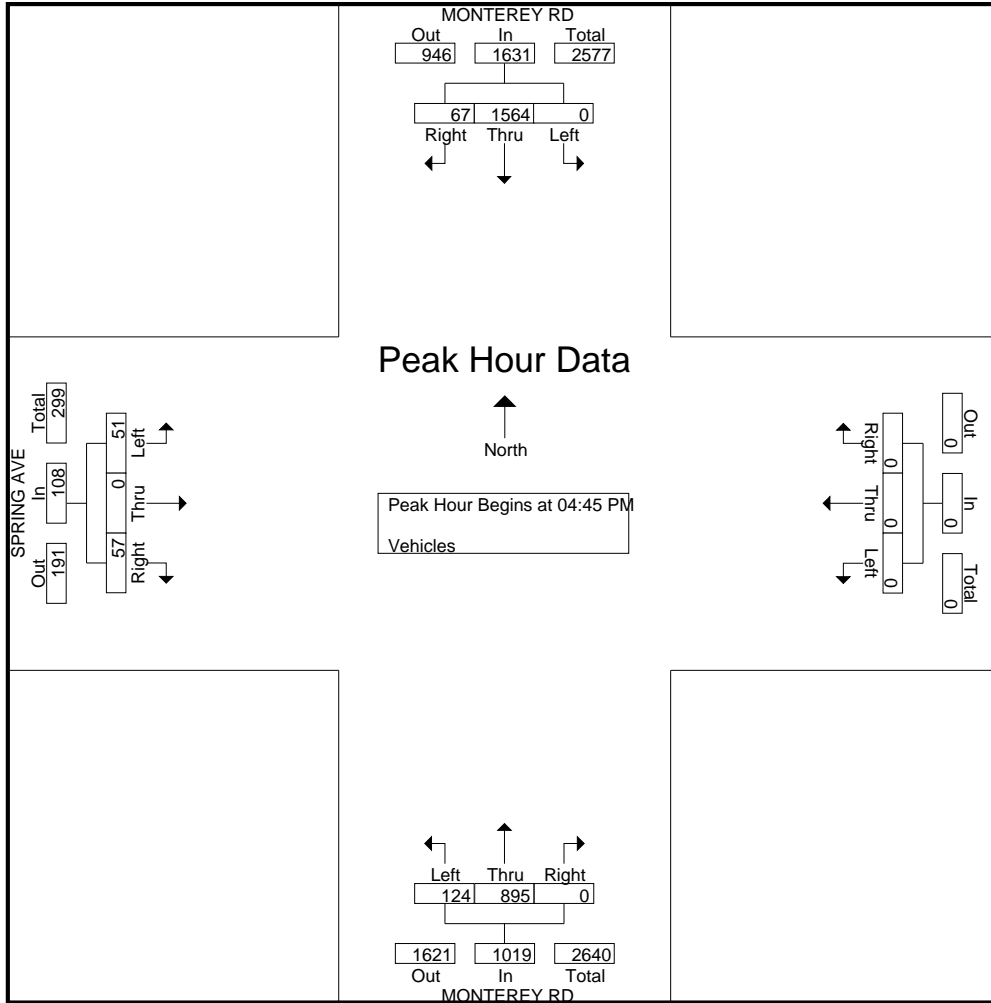

Traffic Data Service

San Jose, CA
 (408) 622-4787
 tdsbay@cs.com

File Name : 2AM FINAL
 Site Code : 00000002
 Start Date : 3/14/2019
 Page No : 1

Groups Printed- Vehicles

Start Time	MONTEREY RD Southbound					SAN PEDRO AVE Westbound					MONTEREY RD Northbound					DRIVEWAY Eastbound					Int. Total
	Right	Thru	Left	Peds	App. Total	Right	Thru	Left	Peds	App. Total	Right	Thru	Left	Peds	App. Total	Right	Thru	Left	Peds	App. Total	
07:00 AM	0	55	8	0	63	6	0	2	1	9	9	214	0	0	223	0	0	0	1	1	296
07:15 AM	1	72	4	0	77	8	0	2	0	10	12	194	0	0	206	0	0	1	0	1	294
07:30 AM	0	107	18	0	125	11	0	4	0	15	16	259	0	0	275	0	0	0	0	0	415
07:45 AM	2	97	23	0	122	21	0	6	0	27	20	247	0	0	267	0	0	0	0	0	416
Total	3	331	53	0	387	46	0	14	1	61	57	914	0	0	971	0	0	1	1	2	1421
08:00 AM	0	123	9	1	133	16	0	8	0	24	12	192	0	0	204	1	0	0	0	1	362
08:15 AM	0	136	17	0	153	13	0	9	1	23	20	189	0	0	209	0	0	0	0	0	385
08:30 AM	2	128	15	0	145	8	0	6	1	15	16	197	0	0	213	0	0	0	2	2	375
08:45 AM	0	149	15	1	165	9	0	5	1	15	11	162	1	0	174	0	0	1	3	4	358
Total	2	536	56	2	596	46	0	28	3	77	59	740	1	0	800	1	0	1	5	7	1480
Grand Total	5	867	109	2	983	92	0	42	4	138	116	1654	1	0	1771	1	0	2	6	9	2901
Apprch %	0.5	88.2	11.1	0.2		66.7	0	30.4	2.9		6.5	93.4	0.1	0		11.1	0	22.2	66.7		
Total %	0.2	29.9	3.8	0.1	33.9	3.2	0	1.4	0.1	4.8	4	57	0	0	61	0	0	0.1	0.2	0.3	

Start Time	MONTEREY RD Southbound					SAN PEDRO AVE Westbound					MONTEREY RD Northbound					DRIVEWAY Eastbound					Int. Total
	Right	Thru	Left	Peds	App. Total	Right	Thru	Left	Peds	App. Total	Right	Thru	Left	Peds	App. Total	Right	Thru	Left	Peds	App. Total	
Peak Hour Analysis From 07:00 AM to 08:45 AM - Peak 1 of 1																					
Peak Hour for Entire Intersection Begins at 07:30 AM																					
07:30 AM	0	107	18		125	11	0	4		15	16	259	0	275	0	0	0		0		415
07:45 AM	2	97	23		122	21	0	6		27	20	247	0	267	0	0	0		0		416
08:00 AM	0	123	9		132	16	0	8		24	12	192	0	204	1	0	0		1		361
08:15 AM	0	136	17		153	13	0	9		22	20	189	0	209	0	0	0		0		384
Total Volume	2	463	67		532	61	0	27		88	68	887	0	955	1	0	0		1		1576
% App. Total	0.4	87	12.6			69.3	0	30.7			7.1	92.9	0		100	0	0				
PHF	.250	.851	.728		.869	.726	.000	.750		.815	.850	.856	.000	.868	.250	.000	.000		.250		.947

Traffic Data Service

San Jose, CA
 (408) 622-4787
 tdsbay@cs.com

File Name : 2AM FINAL
 Site Code : 00000002
 Start Date : 3/14/2019
 Page No : 2

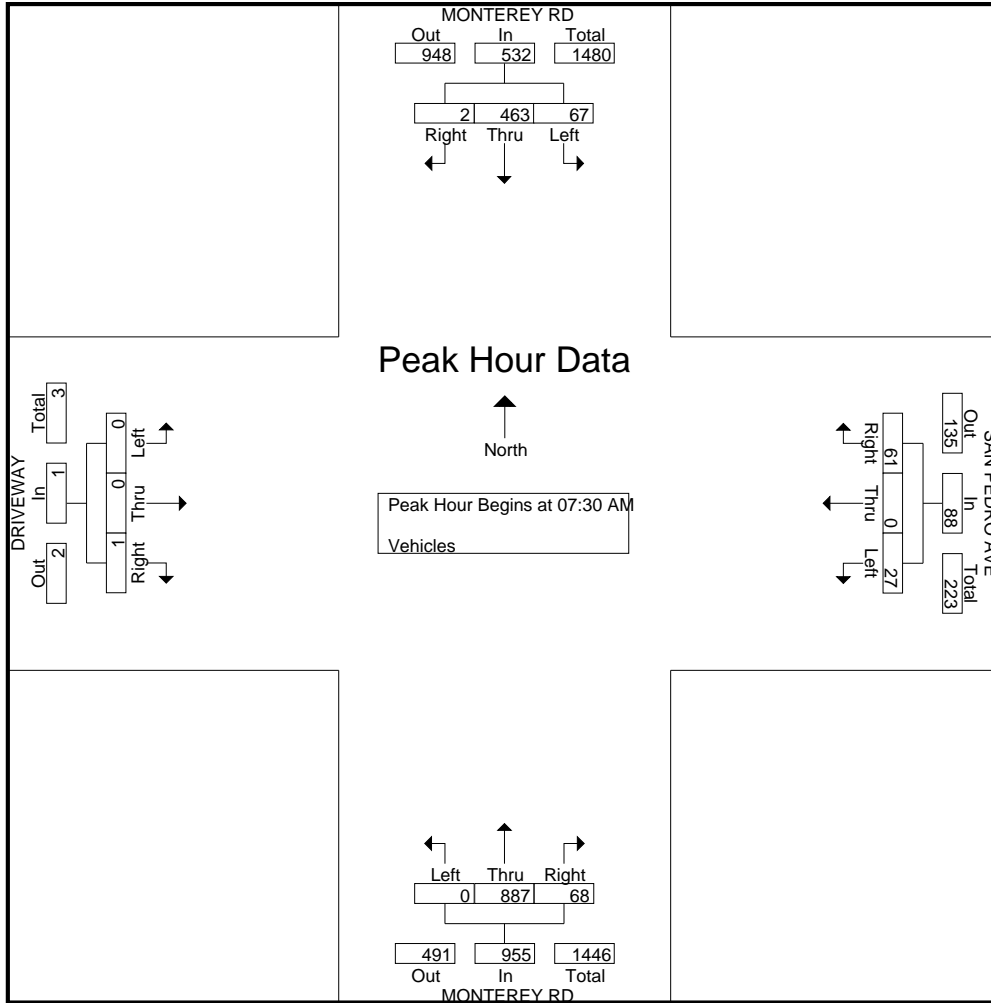

Traffic Data Service

San Jose, CA
(408) 622-4787
tdsbay@cs.com

File Name : 2PM FINAL
 Site Code : 00000002
 Start Date : 3/14/2019
 Page No : 1

Groups Printed- Vehicles

Start Time	MONTEREY RD Southbound					SAN PEDRO AVE Westbound					MONTEREY RD Northbound					DRIVEWAY Eastbound					Int. Total
	Right	Thru	Left	Peds	App. Total	Right	Thru	Left	Peds	App. Total	Right	Thru	Left	Peds	App. Total	Right	Thru	Left	Peds	App. Total	
04:00 PM	2	296	25	0	323	15	0	7	0	22	34	178	4	0	216	5	0	2	6	13	574
04:15 PM	4	369	28	0	401	20	0	10	2	32	33	180	3	0	216	2	1	0	0	3	652
04:30 PM	1	322	20	0	343	22	0	6	6	34	27	197	3	0	227	6	0	0	4	10	614
04:45 PM	5	320	30	0	355	16	0	9	3	28	28	208	4	0	240	4	0	1	7	12	635
Total	12	1307	103	0	1422	73	0	32	11	116	122	763	14	0	899	17	1	3	17	38	2475
05:00 PM	3	322	24	0	349	25	0	2	0	27	32	189	2	0	223	2	0	1	4	7	606
05:15 PM	1	319	28	1	349	21	1	4	1	27	20	191	0	0	211	2	0	0	1	3	590
05:30 PM	4	346	28	0	378	16	0	10	2	28	15	187	0	0	202	1	1	0	5	7	615
05:45 PM	5	305	29	0	339	13	0	7	2	22	17	182	2	0	201	4	0	0	2	6	568
Total	13	1292	109	1	1415	75	1	23	5	104	84	749	4	0	837	9	1	1	12	23	2379
Grand Total	25	2599	212	1	2837	148	1	55	16	220	206	1512	18	0	1736	26	2	4	29	61	4854
Apprch %	0.9	91.6	7.5	0		67.3	0.5	25	7.3		11.9	87.1	1	0		42.6	3.3	6.6	47.5		
Total %	0.5	53.5	4.4	0	58.4	3	0	1.1	0.3	4.5	4.2	31.1	0.4	0	35.8	0.5	0	0.1	0.6	1.3	

Start Time	MONTEREY RD Southbound					SAN PEDRO AVE Westbound					MONTEREY RD Northbound					DRIVEWAY Eastbound					Int. Total
	Right	Thru	Left	Peds	App. Total	Right	Thru	Left	Peds	App. Total	Right	Thru	Left	Peds	App. Total	Right	Thru	Left	Peds	App. Total	
Peak Hour Analysis From 04:00 PM to 05:45 PM - Peak 1 of 1																					
Peak Hour for Entire Intersection Begins at 04:15 PM																					
04:15 PM	4	369	28		401	20	0	10		30	33	180	3	216	2	1	0		3	650	
04:30 PM	1	322	20		343	22	0	6		28	27	197	3	227	6	0	0		6	604	
04:45 PM	5	320	30		355	16	0	9		25	28	208	4	240	4	0	1		5	625	
05:00 PM	3	322	24		349	25	0	2		27	32	189	2	223	2	0	1		3	602	
Total Volume	13	1333	102		1448	83	0	27		110	120	774	12	906	14	1	2		17	2481	
% App. Total	0.9	92.1	7			75.5	0	24.5			13.2	85.4	1.3		82.4	5.9	11.8				
PHF	.650	.903	.850		.903	.830	.000	.675		.917	.909	.930	.750	.944	.583	.250	.500		.708	.954	

Traffic Data Service

San Jose, CA
 (408) 622-4787
 tdsbay@cs.com

File Name : 2PM FINAL
 Site Code : 00000002
 Start Date : 3/14/2019
 Page No : 2

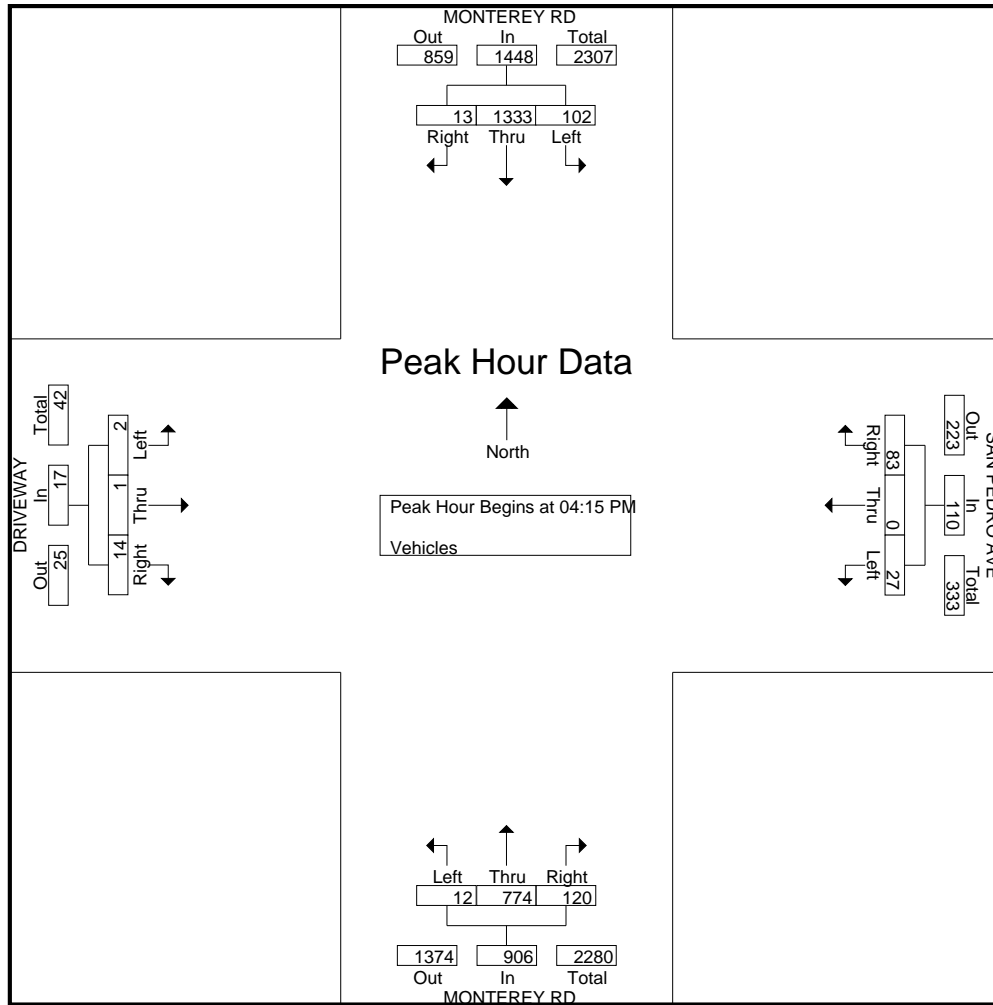

Traffic Data Service

San Jose, CA
 (408) 622-4787
 tdsbay@cs.com

File Name : 3AM FINAL
 Site Code : 00000003
 Start Date : 3/14/2019
 Page No : 1

Groups Printed- Vehicles

Start Time	MONTEREY RD Southbound					DRIVEWAY Westbound					MONTEREY RD Northbound					COSMO AVE Eastbound					Int. Total
	Right	Thru	Left	Peds	App. Total	Right	Thru	Left	Peds	App. Total	Right	Thru	Left	Peds	App. Total	Right	Thru	Left	Peds	App. Total	
07:00 AM	2	56	0	0	58	0	0	0	3	3	0	219	4	0	223	6	0	9	0	15	299
07:15 AM	0	69	0	0	69	0	0	0	0	0	0	183	5	1	189	5	0	14	1	20	278
07:30 AM	3	109	0	0	112	0	0	0	0	0	0	242	1	0	243	12	0	17	0	29	384
07:45 AM	8	88	2	0	98	0	0	0	0	0	0	243	7	0	250	6	0	15	0	21	369
Total	13	322	2	0	337	0	0	0	3	3	0	887	17	1	905	29	0	55	1	85	1330
08:00 AM	7	112	3	0	122	0	0	0	0	0	0	172	7	1	180	3	0	9	0	12	314
08:15 AM	9	118	3	0	130	0	0	1	1	2	1	158	2	0	161	3	1	12	1	17	310
08:30 AM	6	122	5	0	133	0	0	0	3	3	2	163	6	1	172	4	0	9	0	13	321
08:45 AM	9	128	1	0	138	1	0	0	2	3	2	144	5	1	152	1	0	4	0	5	298
Total	31	480	12	0	523	1	0	1	6	8	5	637	20	3	665	11	1	34	1	47	1243
Grand Total	44	802	14	0	860	1	0	1	9	11	5	1524	37	4	1570	40	1	89	2	132	2573
Apprch %	5.1	93.3	1.6	0		9.1	0	9.1	81.8		0.3	97.1	2.4	0.3		30.3	0.8	67.4	1.5		
Total %	1.7	31.2	0.5	0	33.4	0	0	0	0.3	0.4	0.2	59.2	1.4	0.2	61	1.6	0	3.5	0.1	5.1	

Start Time	MONTEREY RD Southbound					DRIVEWAY Westbound					MONTEREY RD Northbound					COSMO AVE Eastbound					Int. Total
	Right	Thru	Left	Peds	App. Total	Right	Thru	Left	Peds	App. Total	Right	Thru	Left	Peds	App. Total	Right	Thru	Left	Peds	App. Total	
Peak Hour Analysis From 07:00 AM to 08:45 AM - Peak 1 of 1																					
Peak Hour for Entire Intersection Begins at 07:30 AM																					
07:30 AM	3	109	0	0	112	0	0	0	0	0	0	242	1	243	12	0	17	0	29	384	
07:45 AM	8	88	2	0	98	0	0	0	0	0	0	243	7	250	6	0	15	0	21	369	
08:00 AM	7	112	3	0	122	0	0	0	0	0	0	172	7	179	3	0	9	0	12	313	
08:15 AM	9	118	3	0	130	0	0	1	1	1	1	158	2	161	3	1	12	0	16	308	
Total Volume	27	427	8	0	462	0	0	1	1	1	1	815	17	833	24	1	53	0	78	1374	
% App. Total	5.8	92.4	1.7	0		0	0	100			0.1	97.8	2		30.8	1.3	67.9				
PHF	.750	.905	.667		.888	.000	.000	.250	.250	.250	.250	.838	.607	.833	.500	.250	.779		.672	.895	

Traffic Data Service

San Jose, CA
 (408) 622-4787
 tdsbay@cs.com

File Name : 3AM FINAL
 Site Code : 00000003
 Start Date : 3/14/2019
 Page No : 2

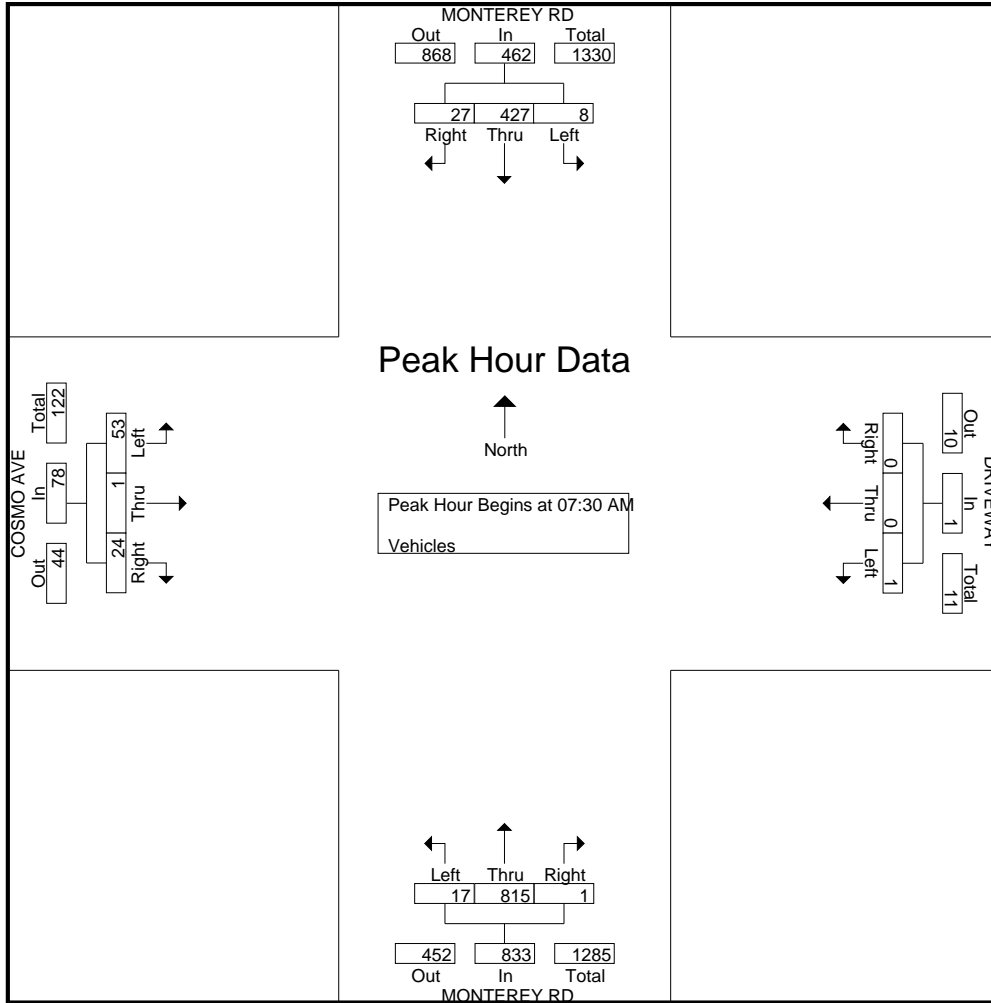

Traffic Data Service

San Jose, CA
 (408) 622-4787
 tdsbay@cs.com

File Name : 3PM FINAL
 Site Code : 00000003
 Start Date : 3/14/2019
 Page No : 1

Groups Printed- Vehicles

Start Time	MONTEREY RD Southbound					DRIVEWAY Westbound					MONTEREY RD Northbound					COSMO AVE Eastbound					Int. Total
	Right	Thru	Left	Peds	App. Total	Right	Thru	Left	Peds	App. Total	Right	Thru	Left	Peds	App. Total	Right	Thru	Left	Peds	App. Total	
04:00 PM	10	269	1	0	280	2	0	2	4	8	0	180	11	4	195	7	1	7	4	19	502
04:15 PM	17	317	4	0	338	2	0	1	4	7	2	172	19	2	195	14	1	9	0	24	564
04:30 PM	6	250	4	0	260	0	0	2	4	6	1	190	13	3	207	13	0	10	0	23	496
04:45 PM	10	281	6	0	297	3	0	0	1	4	0	189	15	0	204	14	0	13	1	28	533
Total	43	1117	15	0	1175	7	0	5	13	25	3	731	58	9	801	48	2	39	5	94	2095
05:00 PM	9	306	5	0	320	0	0	1	4	5	2	166	11	7	186	14	0	11	0	25	536
05:15 PM	6	318	2	0	326	2	0	1	3	6	1	193	12	0	206	14	0	5	1	20	558
05:30 PM	10	341	2	0	353	0	0	1	8	9	1	174	7	2	184	7	0	6	0	13	559
05:45 PM	8	286	0	0	294	3	0	1	3	7	0	169	12	1	182	10	0	9	0	19	502
Total	33	1251	9	0	1293	5	0	4	18	27	4	702	42	10	758	45	0	31	1	77	2155
Grand Total	76	2368	24	0	2468	12	0	9	31	52	7	1433	100	19	1559	93	2	70	6	171	4250
Apprch %	3.1	95.9	1	0		23.1	0	17.3	59.6		0.4	91.9	6.4	1.2		54.4	1.2	40.9	3.5		
Total %	1.8	55.7	0.6	0	58.1	0.3	0	0.2	0.7	1.2	0.2	33.7	2.4	0.4	36.7	2.2	0	1.6	0.1	4	

Start Time	MONTEREY RD Southbound					DRIVEWAY Westbound					MONTEREY RD Northbound					COSMO AVE Eastbound					Int. Total
	Right	Thru	Left	Peds	App. Total	Right	Thru	Left	Peds	App. Total	Right	Thru	Left	Peds	App. Total	Right	Thru	Left	Peds	App. Total	
Peak Hour Analysis From 04:00 PM to 05:45 PM - Peak 1 of 1																					
Peak Hour for Entire Intersection Begins at 04:45 PM																					
04:45 PM	10	281	6	0	297	3	0	0	3	6	0	189	15	0	204	14	0	13	1	28	533
05:00 PM	9	306	5	0	320	0	0	1	4	5	2	166	11	7	186	14	0	11	0	25	536
05:15 PM	6	318	2	0	326	2	0	1	3	6	1	193	12	0	206	14	0	5	1	20	558
05:30 PM	10	341	2	0	353	0	0	1	8	9	1	174	7	2	184	7	0	6	0	13	559
Total Volume	35	1246	15	0	1296	5	0	3	18	27	4	722	45	10	771	49	0	35	1	77	2155
% App. Total	2.7	96.1	1.2	0		62.5	0	37.5			0.5	93.6	5.8			58.3	0	41.7			
PHF	.875	.913	.625	0	.918	.417	.000	.750		.667	.500	.935	.750		.936	.875	.000	.673		.778	.974

Traffic Data Service

San Jose, CA
 (408) 622-4787
 tdsbay@cs.com

File Name : 3PM FINAL
 Site Code : 00000003
 Start Date : 3/14/2019
 Page No : 2

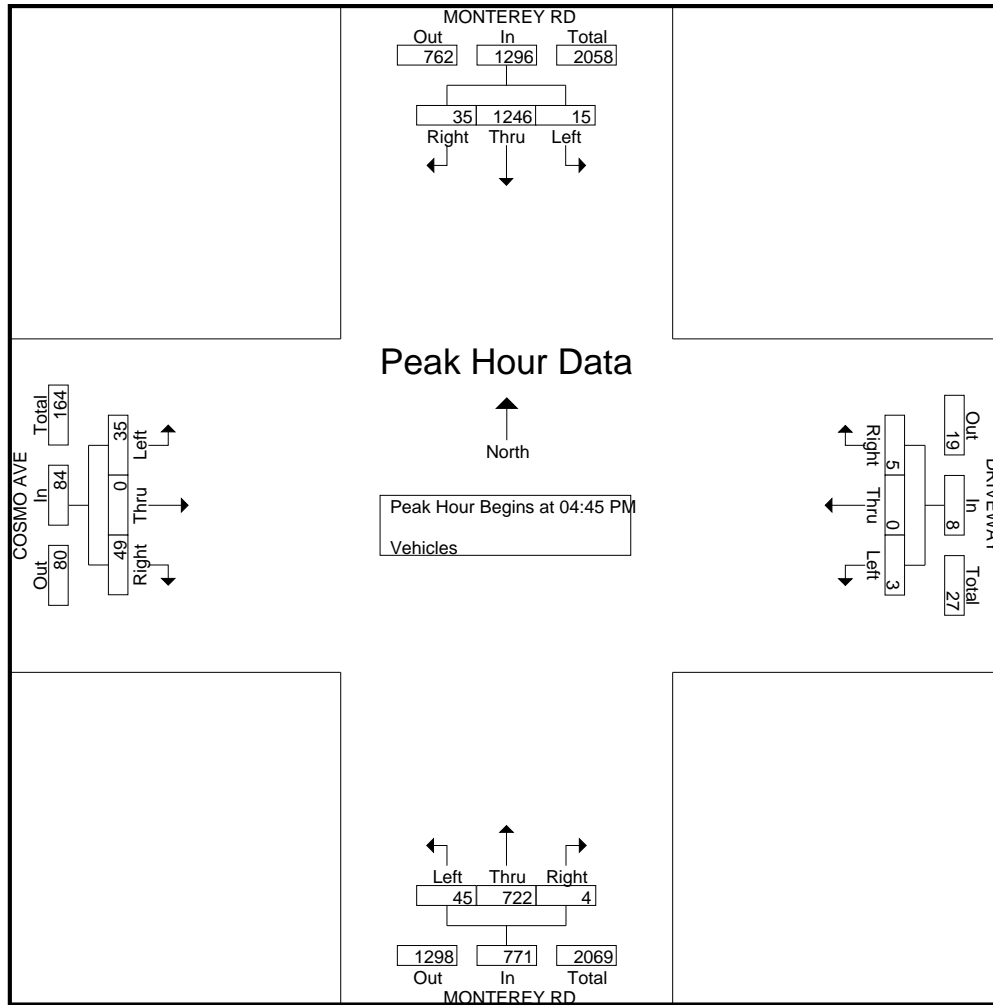

Traffic Data Service

San Jose, CA
(408) 622-4787
tdsbay@cs.com

File Name : 4AM FINAL
Site Code : 00000004
Start Date : 3/14/2019
Page No : 1

Groups Printed- Vehicles

Start Time	MONTEREY RD Southbound					TENNANT AVE Westbound					MONTEREY RD Northbound					W EDMUNDSON AVE Eastbound					Int. Total
	Right	Thru	Left	Peds	App. Total	Right	Thru	Left	Peds	App. Total	Right	Thru	Left	Peds	App. Total	Right	Thru	Left	Peds	App. Total	
07:00 AM	5	41	12	0	58	11	10	18	0	39	10	175	9	0	194	6	30	38	0	74	365
07:15 AM	7	62	7	1	77	15	14	21	0	50	8	158	10	0	176	17	39	28	0	84	387
07:30 AM	5	92	17	1	115	14	17	40	0	71	15	215	11	0	241	10	40	33	0	83	510
07:45 AM	11	59	29	2	101	25	33	24	1	83	15	202	12	1	230	13	52	51	0	116	530
Total	28	254	65	4	351	65	74	103	1	243	48	750	42	1	841	46	161	150	0	357	1792
08:00 AM	10	81	26	3	120	23	23	34	0	80	15	164	20	0	199	6	30	34	2	72	471
08:15 AM	20	77	20	0	117	24	30	31	0	85	9	141	18	0	168	16	40	39	1	96	466
08:30 AM	13	73	25	4	115	19	24	18	1	62	6	143	7	2	158	10	41	42	0	93	428
08:45 AM	13	95	22	0	130	39	21	40	0	100	11	124	6	1	142	12	34	37	1	84	456
Total	56	326	93	7	482	105	98	123	1	327	41	572	51	3	667	44	145	152	4	345	1821
Grand Total	84	580	158	11	833	170	172	226	2	570	89	1322	93	4	1508	90	306	302	4	702	3613
Apprch %	10.1	69.6	19	1.3		29.8	30.2	39.6	0.4		5.9	87.7	6.2	0.3		12.8	43.6	43	0.6		
Total %	2.3	16.1	4.4	0.3	23.1	4.7	4.8	6.3	0.1	15.8	2.5	36.6	2.6	0.1	41.7	2.5	8.5	8.4	0.1	19.4	

Start Time	MONTEREY RD Southbound					TENNANT AVE Westbound					MONTEREY RD Northbound					W EDMUNDSON AVE Eastbound					Int. Total
	Right	Thru	Left	Peds	App. Total	Right	Thru	Left	Peds	App. Total	Right	Thru	Left	Peds	App. Total	Right	Thru	Left	Peds	App. Total	
07:30 AM	5	92	17		114	14	17	40		71	15	215	11		241	10	40	33		83	509
07:45 AM	11	59	29		99	25	33	24		82	15	202	12		229	13	52	51		116	526
08:00 AM	10	81	26		117	23	23	34		80	15	164	20		199	6	30	34		70	466
08:15 AM	20	77	20		117	24	30	31		85	9	141	18		168	16	40	39		95	465
Total Volume	46	309	92		447	86	103	129		318	54	722	61		837	45	162	157		364	1966
% App. Total	10.3	69.1	20.6			27	32.4	40.6			6.5	86.3	7.3			12.4	44.5	43.1			
PHF	.575	.840	.793		.955	.860	.780	.806		.935	.900	.840	.763		.868	.703	.779	.770		.784	.934

Peak Hour Analysis From 07:00 AM to 08:45 AM - Peak 1 of 1
Peak Hour for Entire Intersection Begins at 07:30 AM

Traffic Data Service

San Jose, CA
 (408) 622-4787
 tdsbay@cs.com

File Name : 4AM FINAL
 Site Code : 00000004
 Start Date : 3/14/2019
 Page No : 2

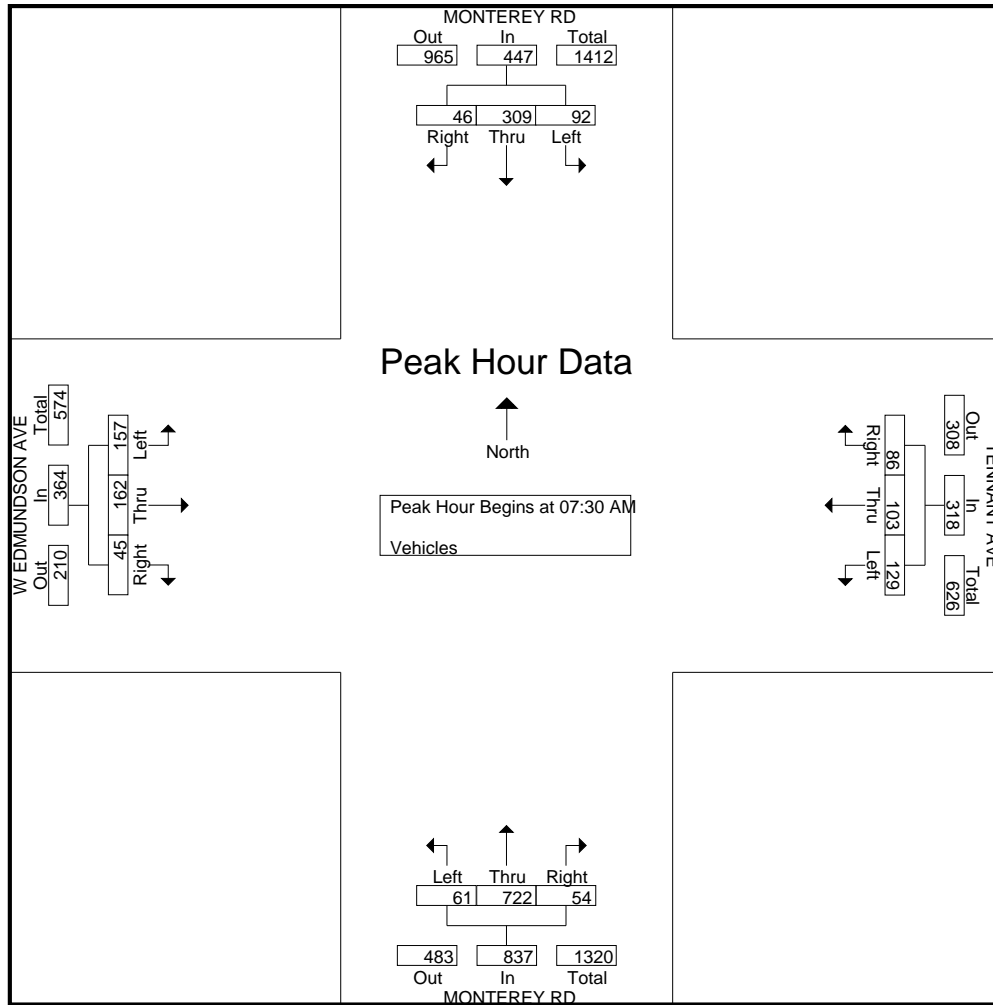

Traffic Data Service

San Jose, CA
 (408) 622-4787
 tdsbay@cs.com

File Name : 4PM FINAL
 Site Code : 00000004
 Start Date : 3/14/2019
 Page No : 1

Groups Printed- Vehicles

Start Time	MONTEREY RD Southbound					TENNANT AVE Westbound					MONTEREY RD Northbound					W EDMUNDSON AVE Eastbound					Int. Total
	Right	Thru	Left	Peds	App. Total	Right	Thru	Left	Peds	App. Total	Right	Thru	Left	Peds	App. Total	Right	Thru	Left	Peds	App. Total	
04:00 PM	30	208	63	2	303	33	31	62	0	126	19	109	10	2	140	25	45	61	8	139	708
04:15 PM	28	235	58	0	321	36	44	71	1	152	18	118	14	1	151	17	60	41	4	122	746
04:30 PM	28	250	54	2	334	31	37	57	2	127	7	129	13	7	156	16	46	43	0	105	722
04:45 PM	32	246	58	1	337	30	37	58	0	125	14	123	39	6	182	17	40	49	4	110	754
Total	118	939	233	5	1295	130	149	248	3	530	58	479	76	16	629	75	191	194	16	476	2930
05:00 PM	35	217	58	5	315	24	34	75	1	134	16	97	20	1	134	21	50	49	2	122	705
05:15 PM	33	239	50	0	322	37	42	83	2	164	19	96	16	5	136	17	46	50	5	118	740
05:30 PM	31	266	47	1	345	14	38	80	2	134	14	125	17	0	156	15	48	37	0	100	735
05:45 PM	25	264	74	1	364	27	24	43	2	96	14	130	21	1	166	21	46	53	0	120	746
Total	124	986	229	7	1346	102	138	281	7	528	63	448	74	7	592	74	190	189	7	460	2926
Grand Total	242	1925	462	12	2641	232	287	529	10	1058	121	927	150	23	1221	149	381	383	23	936	5856
Apprch %	9.2	72.9	17.5	0.5		21.9	27.1	50	0.9		9.9	75.9	12.3	1.9		15.9	40.7	40.9	2.5		
Total %	4.1	32.9	7.9	0.2	45.1	4	4.9	9	0.2	18.1	2.1	15.8	2.6	0.4	20.9	2.5	6.5	6.5	0.4	16	

Start Time	MONTEREY RD Southbound				TENNANT AVE Westbound				MONTEREY RD Northbound				W EDMUNDSON AVE Eastbound				Int. Total
	Right	Thru	Left	App. Total	Right	Thru	Left	App. Total	Right	Thru	Left	App. Total	Right	Thru	Left	App. Total	
Peak Hour Analysis From 04:00 PM to 05:45 PM - Peak 1 of 1																	
Peak Hour for Entire Intersection Begins at 04:45 PM																	
04:45 PM	32	246	58	336	30	37	58	125	14	123	39	176	17	40	49	106	743
05:00 PM	35	217	58	310	24	34	75	133	16	97	20	133	21	50	49	120	696
05:15 PM	33	239	50	322	37	42	83	162	19	96	16	131	17	46	50	113	728
05:30 PM	31	266	47	344	14	38	80	132	14	125	17	156	15	48	37	100	732
Total Volume	131	968	213	1312	105	151	296	552	63	441	92	596	70	184	185	439	2899
% App. Total	10	73.8	16.2		19	27.4	53.6		10.6	74	15.4		15.9	41.9	42.1		
PHF	.936	.910	.918	.953	.709	.899	.892	.852	.829	.882	.590	.847	.833	.920	.925	.915	.975

Traffic Data Service

San Jose, CA
 (408) 622-4787
 tdsbay@cs.com

File Name : 4PM FINAL
 Site Code : 00000004
 Start Date : 3/14/2019
 Page No : 2

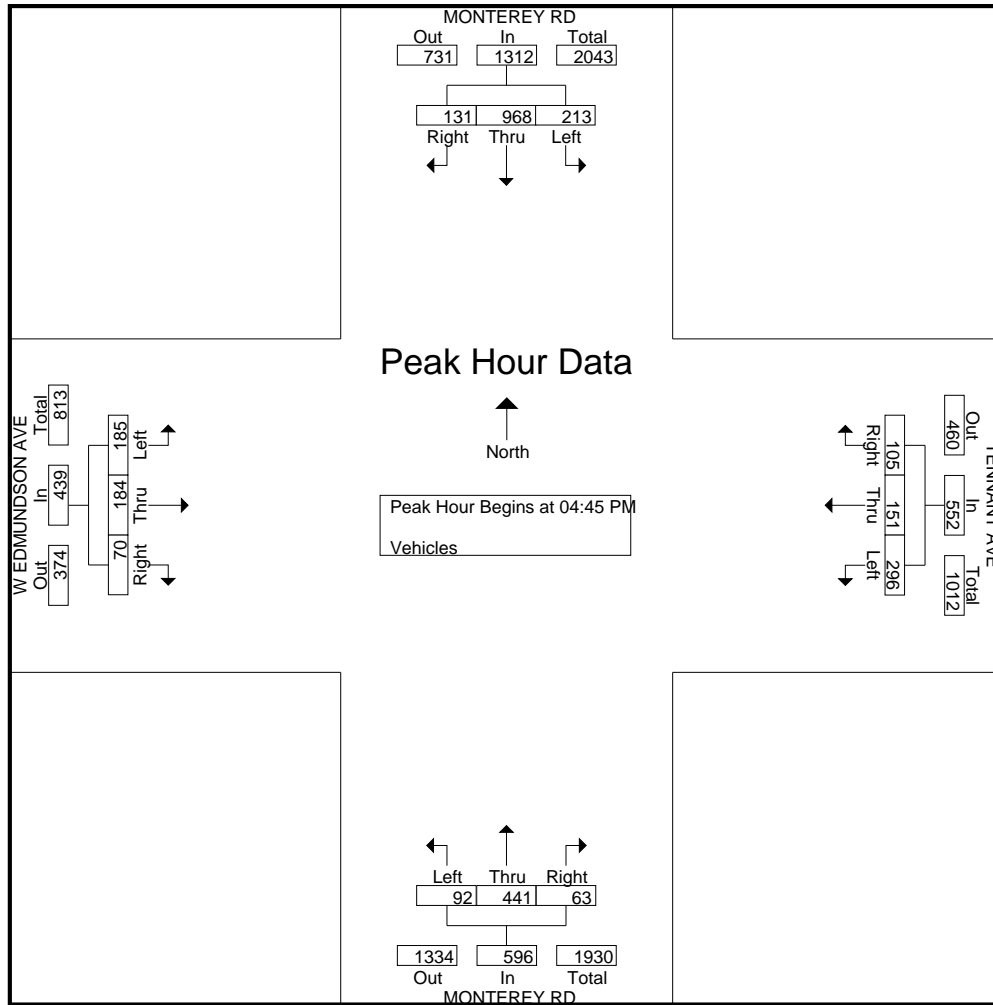

Traffic Data Service

San Jose, CA
 (408) 622-4787
 tdsbay@cs.com

File Name : 5AM FINAL
 Site Code : 00000005
 Start Date : 3/14/2019
 Page No : 1

Groups Printed- Vehicles

Start Time	MONTEREY RD Southbound					VINEYARD BLVD Westbound					MONTEREY RD Northbound					VINEYARD BLVD Eastbound					Int. Total
	Right	Thru	Left	Peds	App. Total	Right	Thru	Left	Peds	App. Total	Right	Thru	Left	Peds	App. Total	Right	Thru	Left	Peds	App. Total	
07:00 AM	10	39	14	1	64	3	8	8	0	19	12	174	23	0	209	1	18	22	1	42	334
07:15 AM	22	51	22	1	96	3	20	3	0	26	28	132	33	0	193	11	29	39	0	79	394
07:30 AM	44	94	15	1	154	3	19	10	0	32	39	164	28	1	232	18	67	87	1	173	591
07:45 AM	17	75	17	0	109	2	12	14	0	28	46	164	32	2	244	12	62	76	0	150	531
Total	93	259	68	3	423	11	59	35	0	105	125	634	116	3	878	42	176	224	2	444	1850
08:00 AM	15	72	36	0	123	3	8	11	0	22	30	163	29	2	224	6	32	27	2	67	436
08:15 AM	10	78	31	1	120	4	11	17	0	32	28	134	26	0	188	6	25	27	0	58	398
08:30 AM	19	64	24	1	108	7	8	13	0	28	28	129	28	0	185	7	22	38	0	67	388
08:45 AM	29	74	33	2	138	0	12	14	0	26	18	100	20	0	138	6	24	24	0	54	356
Total	73	288	124	4	489	14	39	55	0	108	104	526	103	2	735	25	103	116	2	246	1578
Grand Total	166	547	192	7	912	25	98	90	0	213	229	1160	219	5	1613	67	279	340	4	690	3428
Apprch %	18.2	60	21.1	0.8		11.7	46	42.3	0		14.2	71.9	13.6	0.3		9.7	40.4	49.3	0.6		
Total %	4.8	16	5.6	0.2	26.6	0.7	2.9	2.6	0	6.2	6.7	33.8	6.4	0.1	47.1	2	8.1	9.9	0.1	20.1	

Start Time	MONTEREY RD Southbound					VINEYARD BLVD Westbound					MONTEREY RD Northbound					VINEYARD BLVD Eastbound					Int. Total
	Right	Thru	Left	Peds	App. Total	Right	Thru	Left	Peds	App. Total	Right	Thru	Left	Peds	App. Total	Right	Thru	Left	Peds	App. Total	
Peak Hour Analysis From 07:00 AM to 08:45 AM - Peak 1 of 1																					
Peak Hour for Entire Intersection Begins at 07:30 AM																					
07:30 AM	44	94	15		153	3	19	10		32	39	164	28		231	18	67	87		172	588
07:45 AM	17	75	17		109	2	12	14		28	46	164	32		242	12	62	76		150	529
08:00 AM	15	72	36		123	3	8	11		22	30	163	29		222	6	32	27		65	432
08:15 AM	10	78	31		119	4	11	17		32	28	134	26		188	6	25	27		58	397
Total Volume	86	319	99		504	12	50	52		114	143	625	115		883	42	186	217		445	1946
% App. Total	17.1	63.3	19.6			10.5	43.9	45.6			16.2	70.8	13			9.4	41.8	48.8			
PHF	.489	.848	.688		.824	.750	.658	.765		.891	.777	.953	.898		.912	.583	.694	.624		.647	.827

Traffic Data Service

San Jose, CA
 (408) 622-4787
 tdsbay@cs.com

File Name : 5AM FINAL
 Site Code : 00000005
 Start Date : 3/14/2019
 Page No : 2

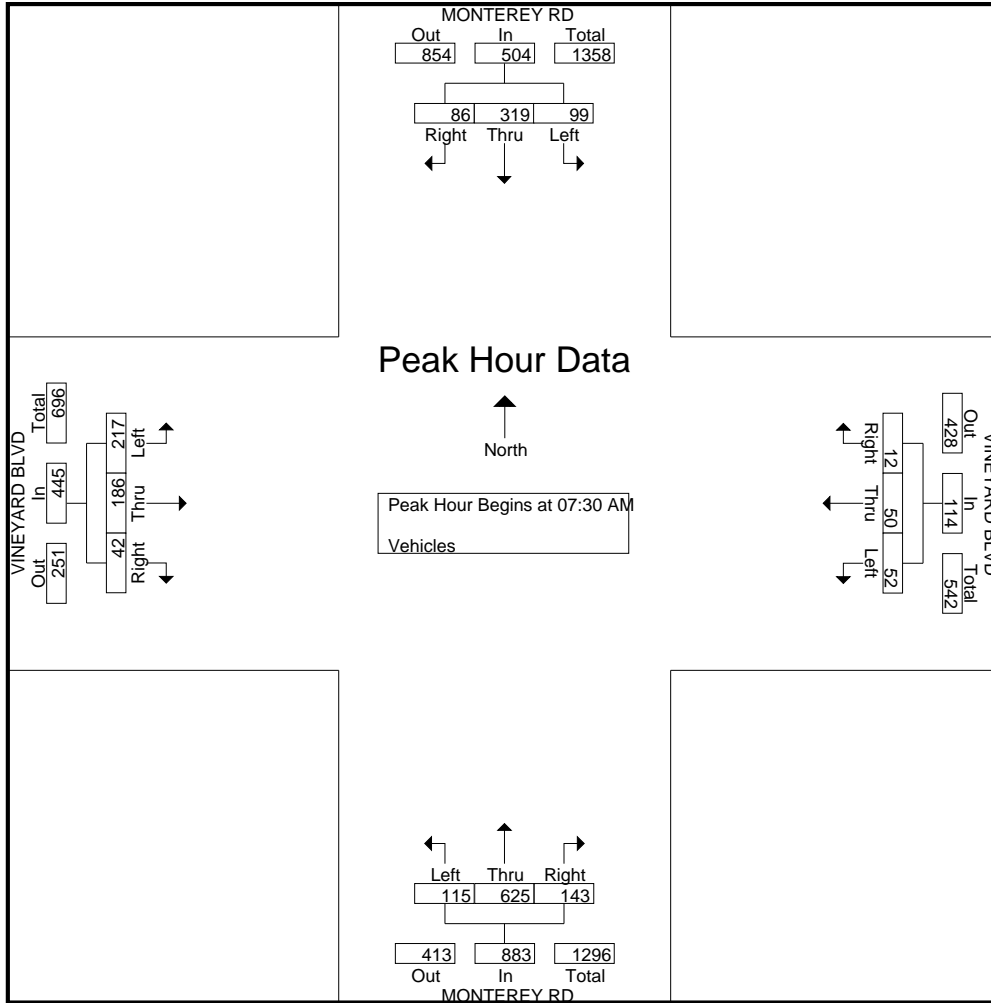

Traffic Data Service

San Jose, CA
 (408) 622-4787
 tdsbay@cs.com

File Name : 5PM FINAL
 Site Code : 00000005
 Start Date : 3/14/2019
 Page No : 1

Groups Printed- Vehicles

Start Time	MONTEREY RD Southbound					VINEYARD BLVD Westbound					MONTEREY RD Northbound					VINEYARD BLVD Eastbound					Int. Total
	Right	Thru	Left	Peds	App. Total	Right	Thru	Left	Peds	App. Total	Right	Thru	Left	Peds	App. Total	Right	Thru	Left	Peds	App. Total	
04:00 PM	34	220	34	0	288	16	32	51	1	100	10	104	26	0	140	10	29	25	4	68	596
04:15 PM	32	231	33	1	297	12	25	51	1	89	15	108	32	1	156	21	24	36	1	82	624
04:30 PM	46	231	46	1	324	12	29	54	0	95	19	107	27	1	154	20	27	22	1	70	643
04:45 PM	37	200	30	2	269	9	25	47	0	81	28	125	34	1	188	13	18	38	2	71	609
Total	149	882	143	4	1178	49	111	203	2	365	72	444	119	3	638	64	98	121	8	291	2472
05:00 PM	39	253	24	2	318	10	37	47	3	97	11	111	26	0	148	14	23	33	1	71	634
05:15 PM	38	248	30	1	317	12	37	45	4	98	22	113	29	0	164	17	25	22	0	64	643
05:30 PM	43	227	48	1	319	14	35	47	1	97	27	115	31	2	175	17	26	30	3	76	667
05:45 PM	33	237	43	2	315	17	41	57	2	117	20	116	31	0	167	12	26	26	1	65	664
Total	153	965	145	6	1269	53	150	196	10	409	80	455	117	2	654	60	100	111	5	276	2608
Grand Total	302	1847	288	10	2447	102	261	399	12	774	152	899	236	5	1292	124	198	232	13	567	5080
Apprch %	12.3	75.5	11.8	0.4		13.2	33.7	51.6	1.6		11.8	69.6	18.3	0.4		21.9	34.9	40.9	2.3		
Total %	5.9	36.4	5.7	0.2	48.2	2	5.1	7.9	0.2	15.2	3	17.7	4.6	0.1	25.4	2.4	3.9	4.6	0.3	11.2	

Start Time	MONTEREY RD Southbound				VINEYARD BLVD Westbound				MONTEREY RD Northbound				VINEYARD BLVD Eastbound				Int. Total
	Right	Thru	Left	App. Total	Right	Thru	Left	App. Total	Right	Thru	Left	App. Total	Right	Thru	Left	App. Total	
Peak Hour Analysis From 04:00 PM to 05:45 PM - Peak 1 of 1																	
Peak Hour for Entire Intersection Begins at 05:00 PM																	
05:00 PM	39	253	24	316	10	37	47	94	11	111	26	148	14	23	33	70	628
05:15 PM	38	248	30	316	12	37	45	94	22	113	29	164	17	25	22	64	638
05:30 PM	43	227	48	318	14	35	47	96	27	115	31	173	17	26	30	73	660
05:45 PM	33	237	43	313	17	41	57	115	20	116	31	167	12	26	26	64	659
Total Volume	153	965	145	1263	53	150	196	399	80	455	117	652	60	100	111	271	2585
% App. Total	12.1	76.4	11.5		13.3	37.6	49.1		12.3	69.8	17.9		22.1	36.9	41		
PHF	.890	.954	.755	.993	.779	.915	.860	.867	.741	.981	.944	.942	.882	.962	.841	.928	.979

Traffic Data Service

San Jose, CA
 (408) 622-4787
 tdsbay@cs.com

File Name : 5PM FINAL
 Site Code : 00000005
 Start Date : 3/14/2019
 Page No : 2

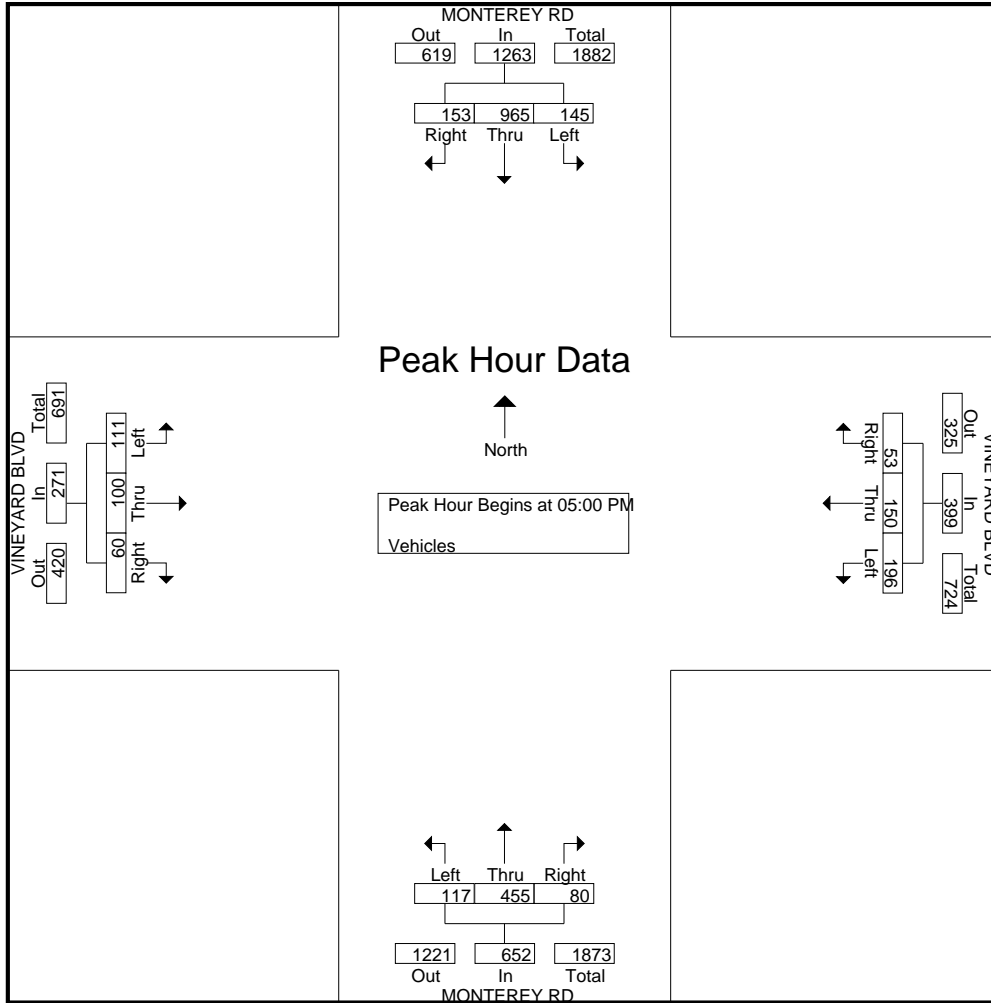

Traffic Data Service

San Jose, CA
(408) 622-4787
tdsbay@cs.com

File Name : 6AM FINAL
Site Code : 00000006
Start Date : 3/14/2019
Page No : 1

Groups Printed- Vehicles

Start Time	MONTEREY RD Southbound					BUTTERFIELD BLVD Westbound					MONTEREY RD Northbound					WATSONVILLE RD Eastbound					Int. Total
	Right	Thru	Left	Peds	App. Total	Right	Thru	Left	Peds	App. Total	Right	Thru	Left	Peds	App. Total	Right	Thru	Left	Peds	App. Total	
07:00 AM	5	138	42	0	185	12	29	2	0	43	5	20	16	0	41	135	161	5	0	301	570
07:15 AM	14	160	43	0	217	13	48	4	0	65	3	24	21	0	48	149	146	5	0	300	630
07:30 AM	24	170	43	0	237	12	88	8	0	108	4	22	60	0	86	167	177	12	0	356	787
07:45 AM	36	150	46	0	232	13	83	6	0	102	4	36	84	0	124	145	223	28	0	396	854
Total	79	618	174	0	871	50	248	20	0	318	16	102	181	0	299	596	707	50	0	1353	2841
08:00 AM	14	117	54	0	185	28	59	3	0	90	4	68	39	0	111	146	157	13	0	316	702
08:15 AM	9	99	43	1	152	23	72	4	0	99	3	51	21	0	75	96	151	11	0	258	584
08:30 AM	14	115	45	0	174	15	61	3	0	79	2	41	32	0	75	72	117	11	0	200	528
08:45 AM	3	86	46	0	135	27	68	6	0	101	1	26	21	0	48	44	107	13	0	164	448
Total	40	417	188	1	646	93	260	16	0	369	10	186	113	0	309	358	532	48	0	938	2262
Grand Total	119	1035	362	1	1517	143	508	36	0	687	26	288	294	0	608	954	1239	98	0	2291	5103
Apprch %	7.8	68.2	23.9	0.1		20.8	73.9	5.2	0		4.3	47.4	48.4	0		41.6	54.1	4.3	0		
Total %	2.3	20.3	7.1	0	29.7	2.8	10	0.7	0	13.5	0.5	5.6	5.8	0	11.9	18.7	24.3	1.9	0	44.9	

Start Time	MONTEREY RD Southbound					BUTTERFIELD BLVD Westbound					MONTEREY RD Northbound					WATSONVILLE RD Eastbound					Int. Total
	Right	Thru	Left	Peds	App. Total	Right	Thru	Left	Peds	App. Total	Right	Thru	Left	Peds	App. Total	Right	Thru	Left	Peds	App. Total	
Peak Hour Analysis From 07:00 AM to 08:45 AM - Peak 1 of 1																					
Peak Hour for Entire Intersection Begins at 07:15 AM																					
07:15 AM	14	160	43		217	13	48	4		65	3	24	21		48	149	146	5		300	630
07:30 AM	24	170	43		237	12	88	8		108	4	22	60		86	167	177	12		356	787
07:45 AM	36	150	46		232	13	83	6		102	4	36	84		124	145	223	28		396	854
08:00 AM	14	117	54		185	28	59	3		90	4	68	39		111	146	157	13		316	702
Total Volume	88	597	186		871	66	278	21		365	15	150	204		369	607	703	58		1368	2973
% App. Total	10.1	68.5	21.4			18.1	76.2	5.8			4.1	40.7	55.3			44.4	51.4	4.2			
PHF	.611	.878	.861		.919	.589	.790	.656		.845	.938	.551	.607		.744	.909	.788	.518		.864	.870

Traffic Data Service

San Jose, CA
 (408) 622-4787
 tdsbay@cs.com

File Name : 6AM FINAL
 Site Code : 00000006
 Start Date : 3/14/2019
 Page No : 2

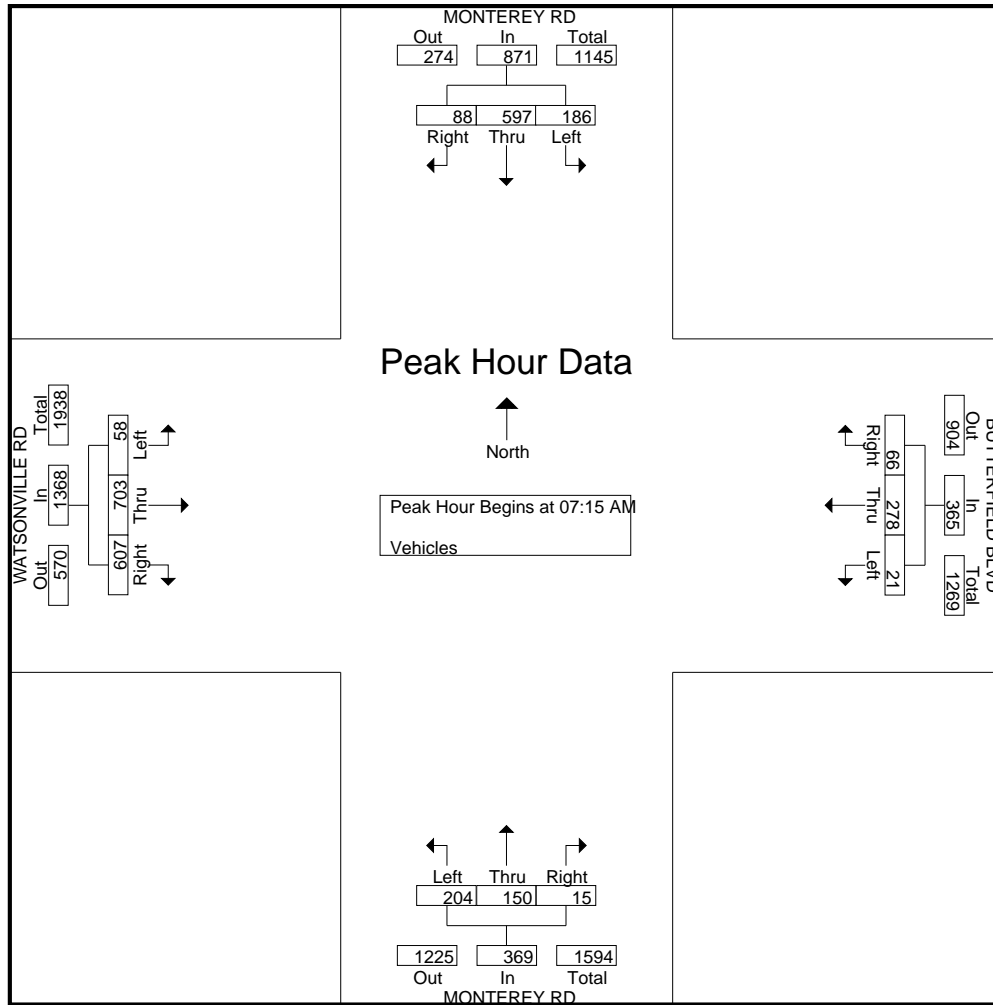

Traffic Data Service

San Jose, CA
 (408) 622-4787
 tdsbay@cs.com

File Name : 6PM FINAL
 Site Code : 00000006
 Start Date : 3/14/2019
 Page No : 1

Groups Printed- Vehicles

Start Time	MONTEREY RD Southbound					BUTTERFIELD BLVD Westbound					MONTEREY RD Northbound					WATSONVILLE RD Eastbound					Int. Total
	Right	Thru	Left	Peds	App. Total	Right	Thru	Left	Peds	App. Total	Right	Thru	Left	Peds	App. Total	Right	Thru	Left	Peds	App. Total	
04:00 PM	8	59	29	0	96	53	178	3	0	234	2	81	82	0	165	42	73	5	0	120	615
04:15 PM	17	53	37	0	107	70	223	5	1	299	7	88	105	0	200	32	110	14	0	156	762
04:30 PM	12	44	39	0	95	73	221	3	0	297	3	93	96	0	192	38	93	13	0	144	728
04:45 PM	13	52	42	0	107	65	200	5	0	270	2	79	102	0	183	28	127	12	0	167	727
Total	50	208	147	0	405	261	822	16	1	1100	14	341	385	0	740	140	403	44	0	587	2832
05:00 PM	7	47	32	0	86	58	236	10	0	304	9	91	97	0	197	19	75	9	0	103	690
05:15 PM	16	62	41	0	119	80	226	3	0	309	10	97	114	1	222	24	79	9	0	112	762
05:30 PM	11	74	49	0	134	63	196	4	0	263	5	89	113	0	207	17	100	13	0	130	734
05:45 PM	6	35	39	0	80	75	224	9	0	308	7	87	88	0	182	17	111	14	0	142	712
Total	40	218	161	0	419	276	882	26	0	1184	31	364	412	1	808	77	365	45	0	487	2898
Grand Total	90	426	308	0	824	537	1704	42	1	2284	45	705	797	1	1548	217	768	89	0	1074	5730
Apprch %	10.9	51.7	37.4	0		23.5	74.6	1.8	0		2.9	45.5	51.5	0.1		20.2	71.5	8.3	0		
Total %	1.6	7.4	5.4	0	14.4	9.4	29.7	0.7	0	39.9	0.8	12.3	13.9	0	27	3.8	13.4	1.6	0	18.7	

Start Time	MONTEREY RD Southbound					BUTTERFIELD BLVD Westbound					MONTEREY RD Northbound					WATSONVILLE RD Eastbound					Int. Total
	Right	Thru	Left	Peds	App. Total	Right	Thru	Left	Peds	App. Total	Right	Thru	Left	Peds	App. Total	Right	Thru	Left	Peds	App. Total	
Peak Hour Analysis From 04:00 PM to 05:45 PM - Peak 1 of 1																					
Peak Hour for Entire Intersection Begins at 04:45 PM																					
04:45 PM	13	52	42		107	65	200	5		270	2	79	102		183	28	127	12		167	727
05:00 PM	7	47	32		86	58	236	10		304	9	91	97		197	19	75	9		103	690
05:15 PM	16	62	41		119	80	226	3		309	10	97	114		221	24	79	9		112	761
05:30 PM	11	74	49		134	63	196	4		263	5	89	113		207	17	100	13		130	734
Total Volume	47	235	164		446	266	858	22		1146	26	356	426		808	88	381	43		512	2912
% App. Total	10.5	52.7	36.8			23.2	74.9	1.9			3.2	44.1	52.7			17.2	74.4	8.4			
PHF	.734	.794	.837		.832	.831	.909	.550		.927	.650	.918	.934		.914	.786	.750	.827		.766	.957

Traffic Data Service

San Jose, CA
 (408) 622-4787
 tdsbay@cs.com

File Name : 6PM FINAL
 Site Code : 00000006
 Start Date : 3/14/2019
 Page No : 2

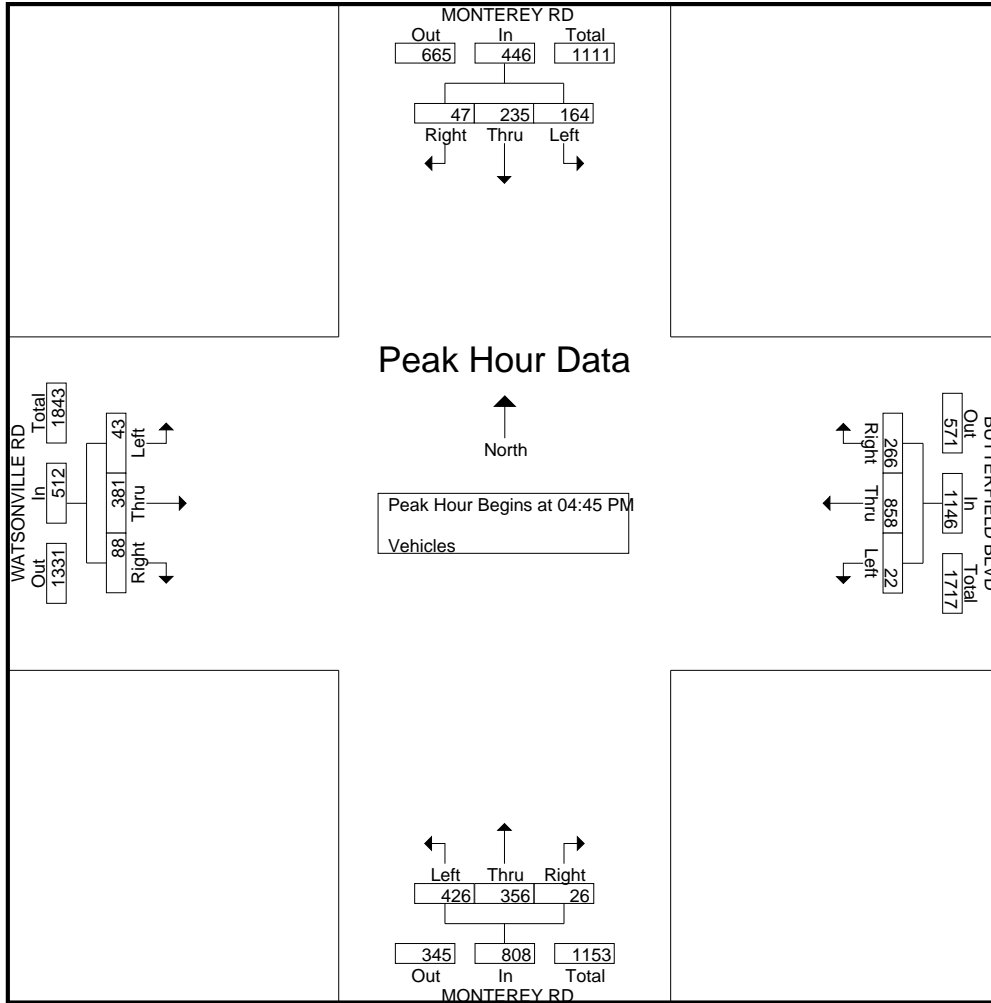



(303) 216-2439
www.alltrafficdata.net

Location: 19 BUTTERFIELD BLVD & MAIN AVE AM

Date and Start Time: Tuesday, May 8, 2018

Peak Hour: 07:15 AM - 08:15 AM

Peak 15-Minutes: 07:45 AM - 08:00 AM

Peak Hour - All Vehicles

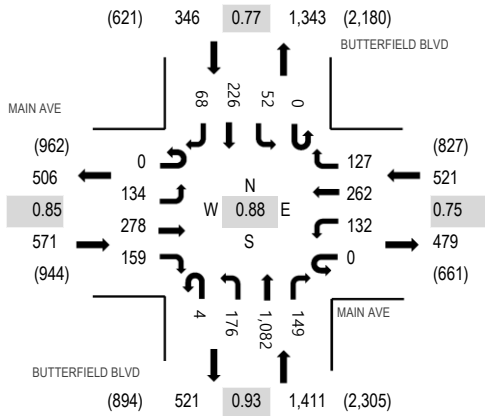

Peak Hour - Pedestrians/Bicycles in Crosswalk

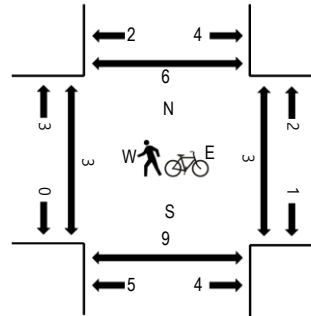

Note: Total study counts contained in parentheses.

Traffic Counts

Interval Start Time	MAIN AVE Eastbound				MAIN AVE Westbound				BUTTERFIELD BLVD Northbound				BUTTERFIELD BLVD Southbound				Total	Rolling Hour	Pedestrian Crossings			
	U-Turn	Left	Thru	Right	U-Turn	Left	Thru	Right	U-Turn	Left	Thru	Right	U-Turn	Left	Thru	Right			West	East	South	North
7:00 AM	0	18	15	23	0	18	29	25	0	16	253	10	0	3	25	7	442	2,524	1	0	3	2
7:15 AM	0	20	42	28	0	20	27	23	0	37	235	31	0	15	32	6	516	2,849	0	0	0	0
7:30 AM	0	34	73	45	0	28	64	43	1	34	296	50	0	10	60	15	753	2,825	2	3	4	3
7:45 AM	0	40	92	39	0	46	96	37	1	39	286	51	0	11	51	24	813	2,557	0	0	2	0
8:00 AM	0	40	71	47	0	38	75	24	2	66	265	17	0	16	83	23	767	2,173	1	0	3	1
8:15 AM	0	33	30	35	0	21	49	14	2	60	163	0	0	6	58	21	492		0	1	1	0
8:30 AM	0	28	46	40	0	10	53	21	0	73	140	9	0	2	39	24	485		0	3	3	0
8:45 AM	0	27	43	35	0	17	42	7	0	53	108	7	0	11	50	29	429		0	2	1	0

Peak Rolling Hour Flow Rates

Vehicle Type	Eastbound				Westbound				Northbound				Southbound				Total
	U-Turn	Left	Thru	Right	U-Turn	Left	Thru	Right	U-Turn	Left	Thru	Right	U-Turn	Left	Thru	Right	
Articulated Trucks	0	0	0	2	0	0	0	0	0	0	2	0	0	1	1	0	6
Lights	0	129	275	153	0	132	259	125	4	176	1,059	147	0	48	219	67	2,793
Mediums	0	5	3	4	0	0	3	2	0	0	21	2	0	3	6	1	50
Total	0	134	278	159	0	132	262	127	4	176	1,082	149	0	52	226	68	2,849



(303) 216-2439
www.alltrafficdata.net

Location: 19 BUTTERFIELD BLVD & MAIN AVE PM
Date and Start Time: Tuesday, May 8, 2018
Peak Hour: 04:15 PM - 05:15 PM
Peak 15-Minutes: 05:00 PM - 05:15 PM

Peak Hour - All Vehicles

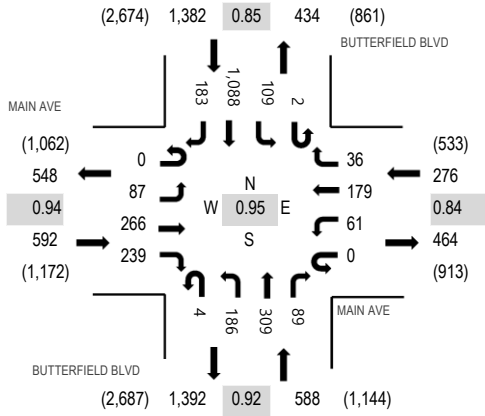

Peak Hour - Pedestrians/Bicycles in Crosswalk

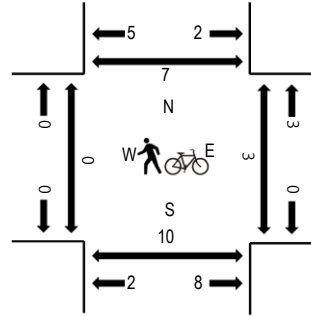

Note: Total study counts contained in parentheses.

Traffic Counts

Interval Start Time	MAIN AVE Eastbound				MAIN AVE Westbound				BUTTERFIELD BLVD Northbound				BUTTERFIELD BLVD Southbound				Total	Rolling Hour	Pedestrian Crossings			
	U-Turn	Left	Thru	Right	U-Turn	Left	Thru	Right	U-Turn	Left	Thru	Right	U-Turn	Left	Thru	Right			West	East	South	North
4:00 PM	0	31	56	57	0	16	41	10	0	45	72	23	0	14	282	48	695	2,785	0	0	2	0
4:15 PM	0	25	79	45	0	17	50	7	1	50	82	24	1	29	271	44	725	2,838	0	0	2	2
4:30 PM	0	18	77	65	0	21	53	10	1	36	70	19	0	24	253	27	674	2,825	0	0	4	2
4:45 PM	0	25	50	66	0	9	42	7	2	61	84	20	1	23	263	38	691	2,808	0	3	0	0
5:00 PM	0	19	60	63	0	14	34	12	0	39	73	26	0	33	301	74	748	2,738	0	0	1	2
5:15 PM	0	34	63	60	0	14	39	10	1	51	81	35	0	28	257	39	712		0	0	1	0
5:30 PM	0	39	59	50	0	19	37	4	2	52	67	25	0	34	234	35	657		1	0	0	1
5:45 PM	0	23	65	43	0	15	44	8	1	38	47	16	1	31	244	45	621		0	2	4	0

Peak Rolling Hour Flow Rates

Vehicle Type	Eastbound				Westbound				Northbound				Southbound				Total
	U-Turn	Left	Thru	Right	U-Turn	Left	Thru	Right	U-Turn	Left	Thru	Right	U-Turn	Left	Thru	Right	
Articulated Trucks	0	0	1	0	0	0	0	1	0	0	1	0	0	0	4	0	7
Lights	0	85	261	237	0	61	177	34	4	186	301	89	2	109	1,066	182	2,794
Mediums	0	2	4	2	0	0	2	1	0	0	7	0	0	0	18	1	37
Total	0	87	266	239	0	61	179	36	4	186	309	89	2	109	1,088	183	2,838



(303) 216-2439
www.alltrafficdata.net

Location: 23 BUTTERFIELD BLVD & DUNNE AVE AM

Date and Start Time: Tuesday, May 8, 2018

Peak Hour: 07:15 AM - 08:15 AM

Peak 15-Minutes: 07:45 AM - 08:00 AM

Peak Hour - All Vehicles

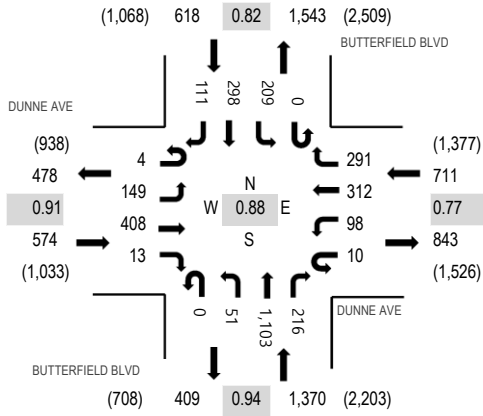

Peak Hour - Pedestrians/Bicycles in Crosswalk

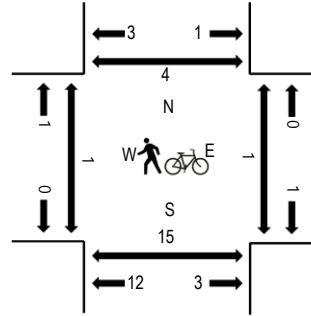

Note: Total study counts contained in parentheses.

Traffic Counts

Interval Start Time	DUNNE AVE Eastbound				DUNNE AVE Westbound				BUTTERFIELD BLVD Northbound				BUTTERFIELD BLVD Southbound				Total	Rolling Hour	Pedestrian Crossings			
	U-Turn	Left	Thru	Right	U-Turn	Left	Thru	Right	U-Turn	Left	Thru	Right	U-Turn	Left	Thru	Right			West	East	South	North
7:00 AM	0	26	76	7	1	9	48	44	0	6	207	65	0	29	37	10	565	3,006	0	0	0	2
7:15 AM	0	34	72	2	2	19	31	59	0	8	269	74	0	50	43	4	667	3,273	0	0	1	1
7:30 AM	1	34	112	5	3	21	66	65	0	14	302	47	0	51	93	25	839	3,246	0	1	13	1
7:45 AM	2	51	110	1	4	36	124	98	0	14	289	50	0	39	81	36	935	3,034	1	0	0	0
8:00 AM	1	30	114	5	1	22	91	69	0	15	243	45	0	69	81	46	832	2,675	0	0	1	2
8:15 AM	2	25	101	4	3	19	85	66	0	6	166	40	0	40	61	22	640		0	0	1	0
8:30 AM	2	23	87	4	2	20	93	75	0	13	163	32	0	45	46	22	627		0	0	1	0
8:45 AM	0	16	81	5	1	22	116	62	0	10	93	32	0	48	65	25	576		0	0	1	0

Peak Rolling Hour Flow Rates

Vehicle Type	Eastbound				Westbound				Northbound				Southbound				Total
	U-Turn	Left	Thru	Right	U-Turn	Left	Thru	Right	U-Turn	Left	Thru	Right	U-Turn	Left	Thru	Right	
Articulated Trucks	0	0	0	1	0	1	4	0	0	0	2	2	0	1	2	0	13
Lights	4	141	400	12	9	94	307	285	0	51	1,089	207	0	204	290	110	3,203
Mediums	0	8	8	0	1	3	1	6	0	0	12	7	0	4	6	1	57
Total	4	149	408	13	10	98	312	291	0	51	1,103	216	0	209	298	111	3,273



(303) 216-2439
www.alltrafficdata.net

Location: 23 BUTTERFIELD BLVD & DUNNE AVE PM

Date and Start Time: Tuesday, May 8, 2018

Peak Hour: 04:30 PM - 05:30 PM

Peak 15-Minutes: 05:00 PM - 05:15 PM

Peak Hour - All Vehicles

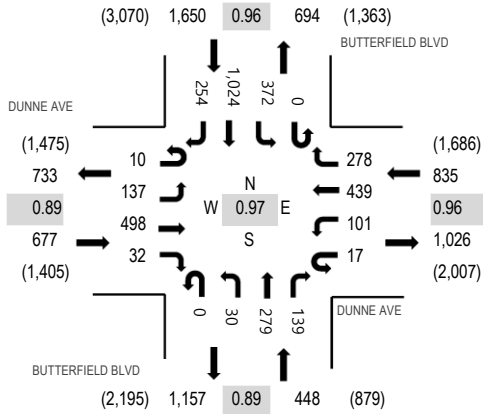

Peak Hour - Pedestrians/Bicycles in Crosswalk

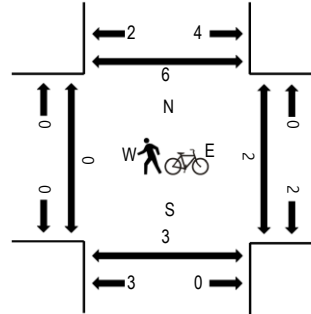

Note: Total study counts contained in parentheses.

Traffic Counts

Interval Start Time	DUNNE AVE Eastbound				DUNNE AVE Westbound				BUTTERFIELD BLVD Northbound				BUTTERFIELD BLVD Southbound				Total	Rolling Hour	Pedestrian Crossings			
	U-Turn	Left	Thru	Right	U-Turn	Left	Thru	Right	U-Turn	Left	Thru	Right	U-Turn	Left	Thru	Right			West	East	South	North
4:00 PM	6	42	123	6	2	31	131	69	0	8	67	34	0	80	236	71	906	3,566	0	0	2	0
4:15 PM	1	47	149	9	2	36	93	62	0	17	70	31	0	86	220	48	871	3,587	0	1	0	0
4:30 PM	1	27	123	10	3	26	96	67	0	8	78	44	0	99	263	67	912	3,610	0	0	0	1
4:45 PM	2	42	124	6	3	24	107	74	0	4	73	31	0	81	238	68	877	3,546	0	0	2	1
5:00 PM	3	44	135	7	4	33	112	76	0	6	51	37	0	86	268	65	927	3,474	0	0	0	1
5:15 PM	4	24	116	9	7	18	124	61	0	12	77	27	0	106	255	54	894		0	2	0	3
5:30 PM	2	46	125	15	2	33	121	62	0	10	71	33	0	74	208	46	848		0	0	0	3
5:45 PM	2	17	125	13	4	23	115	65	0	10	51	29	0	82	208	61	805		1	0	0	1

Peak Rolling Hour Flow Rates

Vehicle Type	Eastbound				Westbound				Northbound				Southbound				Total
	U-Turn	Left	Thru	Right	U-Turn	Left	Thru	Right	U-Turn	Left	Thru	Right	U-Turn	Left	Thru	Right	
Articulated Trucks	0	0	0	0	0	1	0	0	0	0	0	0	0	1	1	1	4
Lights	10	136	490	32	17	100	432	277	0	30	276	138	0	369	1,012	244	3,563
Mediums	0	1	8	0	0	0	7	1	0	0	3	1	0	2	11	9	43
Total	10	137	498	32	17	101	439	278	0	30	279	139	0	372	1,024	254	3,610

Traffic Data Service

San Jose, CA
 (408) 622-4787
 tdsbay@cs.com

File Name : 7AM FINAL
 Site Code : 00000007
 Start Date : 3/14/2019
 Page No : 1

Groups Printed- Vehicles

Start Time	BUTTERFIELD BLVD Southbound					SAN PEDRO AVE Westbound					BUTTERFIELD BLVD Northbound					SAN PEDRO AVE Eastbound					Int. Total
	Right	Thru	Left	Peds	App. Total	Right	Thru	Left	Peds	App. Total	Right	Thru	Left	Peds	App. Total	Right	Thru	Left	Peds	App. Total	
07:00 AM	13	18	4	0	35	10	2	2	0	14	6	279	4	0	289	2	2	6	0	10	348
07:15 AM	14	43	4	1	62	14	9	7	0	30	8	269	3	0	280	0	6	8	0	14	386
07:30 AM	12	76	3	0	91	30	13	15	0	58	8	286	8	0	302	23	14	11	0	48	499
07:45 AM	31	81	12	0	124	44	19	7	3	73	22	269	10	1	302	19	13	9	0	41	540
Total	70	218	23	1	312	98	43	31	3	175	44	1103	25	1	1173	44	35	34	0	113	1773
08:00 AM	17	78	8	1	104	11	17	7	0	35	12	218	7	0	237	4	10	11	1	26	402
08:15 AM	32	54	10	1	97	22	11	8	1	42	14	217	7	0	238	4	9	13	0	26	403
08:30 AM	15	51	6	1	73	25	5	11	1	42	6	149	5	1	161	10	2	7	0	19	295
08:45 AM	15	59	8	0	82	12	6	8	0	26	4	123	13	0	140	8	6	10	0	24	272
Total	79	242	32	3	356	70	39	34	2	145	36	707	32	1	776	26	27	41	1	95	1372
Grand Total	149	460	55	4	668	168	82	65	5	320	80	1810	57	2	1949	70	62	75	1	208	3145
Apprch %	22.3	68.9	8.2	0.6		52.5	25.6	20.3	1.6		4.1	92.9	2.9	0.1		33.7	29.8	36.1	0.5		
Total %	4.7	14.6	1.7	0.1	21.2	5.3	2.6	2.1	0.2	10.2	2.5	57.6	1.8	0.1	62	2.2	2	2.4	0	6.6	

Start Time	BUTTERFIELD BLVD Southbound					SAN PEDRO AVE Westbound					BUTTERFIELD BLVD Northbound					SAN PEDRO AVE Eastbound					Int. Total
	Right	Thru	Left	Peds	App. Total	Right	Thru	Left	Peds	App. Total	Right	Thru	Left	Peds	App. Total	Right	Thru	Left	Peds	App. Total	
Peak Hour Analysis From 07:00 AM to 08:45 AM - Peak 1 of 1																					
Peak Hour for Entire Intersection Begins at 07:30 AM																					
07:30 AM	12	76	3		91	30	13	15		58	8	286	8		302	23	14	11		48	499
07:45 AM	31	81	12		124	44	19	7		70	22	269	10		301	19	13	9		41	536
08:00 AM	17	78	8		103	11	17	7		35	12	218	7		237	4	10	11		25	400
08:15 AM	32	54	10		96	22	11	8		41	14	217	7		238	4	9	13		26	401
Total Volume	92	289	33		414	107	60	37		204	56	990	32		1078	50	46	44		140	1836
% App. Total	22.2	69.8	8			52.5	29.4	18.1			5.2	91.8	3			35.7	32.9	31.4			
PHF	.719	.892	.688		.835	.608	.789	.617		.729	.636	.865	.800		.892	.543	.821	.846		.729	.856

Traffic Data Service

San Jose, CA
 (408) 622-4787
 tdsbay@cs.com

File Name : 7AM FINAL
 Site Code : 00000007
 Start Date : 3/14/2019
 Page No : 2

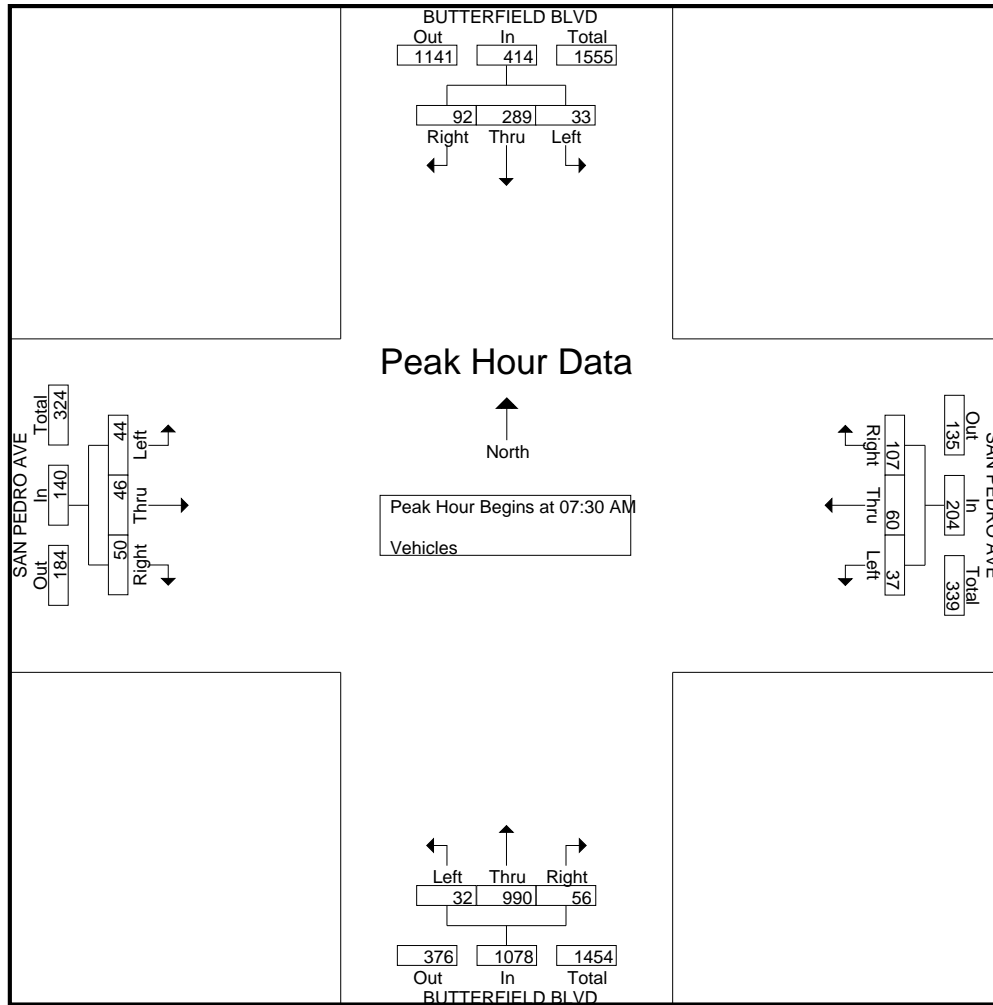

Traffic Data Service

San Jose, CA
(408) 622-4787
tdsbay@cs.com

File Name : 7PM FINAL
Site Code : 00000007
Start Date : 3/14/2019
Page No : 1

Groups Printed- Vehicles

Start Time	BUTTERFIELD BLVD Southbound					SAN PEDRO AVE Westbound					BUTTERFIELD BLVD Northbound					SAN PEDRO AVE Eastbound					Int. Total
	Right	Thru	Left	Peds	App. Total	Right	Thru	Left	Peds	App. Total	Right	Thru	Left	Peds	App. Total	Right	Thru	Left	Peds	App. Total	
04:00 PM	35	203	14	0	252	14	13	8	1	36	16	87	8	1	112	13	21	25	1	60	460
04:15 PM	34	245	22	2	303	10	13	17	1	41	10	90	4	2	106	15	10	16	0	41	491
04:30 PM	25	236	18	0	279	12	17	14	0	43	7	60	4	2	73	15	16	18	2	51	446
04:45 PM	30	224	14	0	268	11	16	15	1	43	12	76	4	0	92	13	22	24	0	59	462
Total	124	908	68	2	1102	47	59	54	3	163	45	313	20	5	383	56	69	83	3	211	1859
05:00 PM	32	226	23	0	281	7	12	14	0	33	11	82	5	0	98	5	24	30	0	59	471
05:15 PM	17	217	17	0	251	6	20	12	0	38	18	73	2	5	98	5	20	15	0	40	427
05:30 PM	26	272	11	0	309	5	11	9	0	25	14	72	8	0	94	8	19	15	0	42	470
05:45 PM	19	209	15	1	244	9	11	12	0	32	8	55	6	1	70	1	11	11	0	23	369
Total	94	924	66	1	1085	27	54	47	0	128	51	282	21	6	360	19	74	71	0	164	1737
Grand Total	218	1832	134	3	2187	74	113	101	3	291	96	595	41	11	743	75	143	154	3	375	3596
Apprch %	10	83.8	6.1	0.1		25.4	38.8	34.7	1		12.9	80.1	5.5	1.5		20	38.1	41.1	0.8		
Total %	6.1	50.9	3.7	0.1	60.8	2.1	3.1	2.8	0.1	8.1	2.7	16.5	1.1	0.3	20.7	2.1	4	4.3	0.1	10.4	

Start Time	BUTTERFIELD BLVD Southbound					SAN PEDRO AVE Westbound					BUTTERFIELD BLVD Northbound					SAN PEDRO AVE Eastbound					Int. Total
	Right	Thru	Left	Peds	App. Total	Right	Thru	Left	Peds	App. Total	Right	Thru	Left	Peds	App. Total	Right	Thru	Left	Peds	App. Total	
Peak Hour Analysis From 04:00 PM to 05:45 PM - Peak 1 of 1																					
Peak Hour for Entire Intersection Begins at 04:15 PM																					
04:15 PM	34	245	22		301	10	13	17		40	10	90	4		104	15	10	16		41	486
04:30 PM	25	236	18		279	12	17	14		43	7	60	4		71	15	16	18		49	442
04:45 PM	30	224	14		268	11	16	15		42	12	76	4		92	13	22	24		59	461
05:00 PM	32	226	23		281	7	12	14		33	11	82	5		98	5	24	30		59	471
Total Volume	121	931	77		1129	40	58	60		158	40	308	17		365	48	72	88		208	1860
% App. Total	10.7	82.5	6.8			25.3	36.7	38			11	84.4	4.7			23.1	34.6	42.3			
PHF	.890	.950	.837		.938	.833	.853	.882		.919	.833	.856	.850		.877	.800	.750	.733		.881	.957

Traffic Data Service

San Jose, CA
 (408) 622-4787
 tdsbay@cs.com

File Name : 7PM FINAL
 Site Code : 00000007
 Start Date : 3/14/2019
 Page No : 2

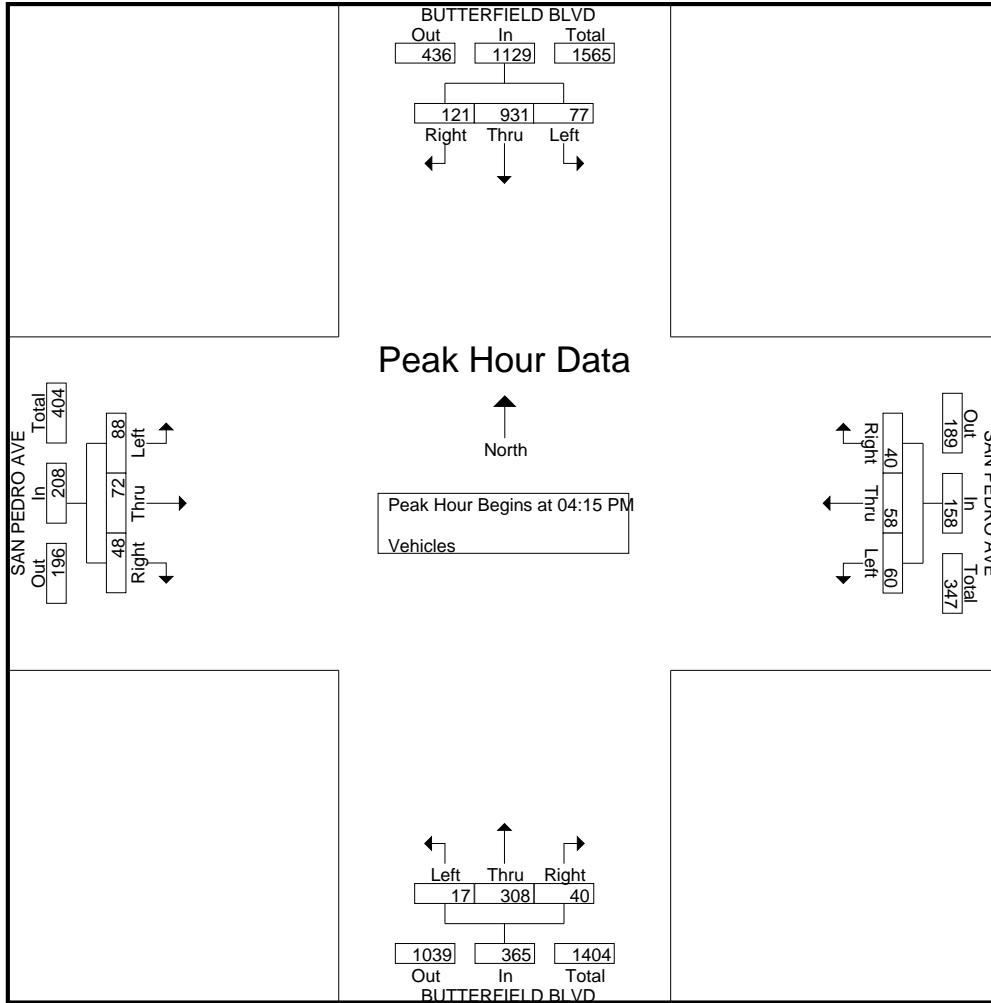



(303) 216-2439
www.alltrafficdata.net

Location: 1 BUTTERFIELD BLVD & TENNANT AVE AM

Date and Start Time: Tuesday, January 23, 2018

Peak Hour: 07:15 AM - 08:15 AM

Peak 15-Minutes: 07:45 AM - 08:00 AM

Peak Hour - All Vehicles

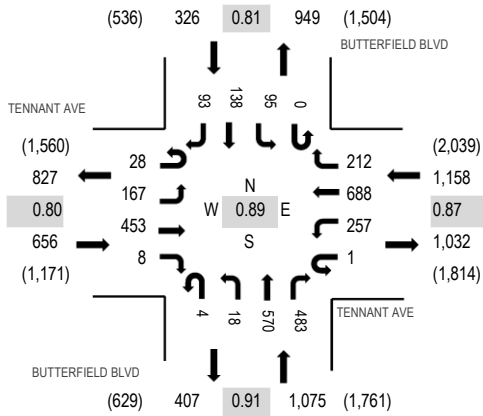

Peak Hour - Pedestrians/Bicycles in Crosswalk

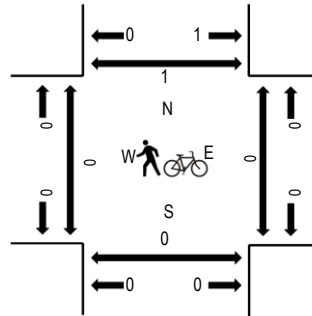

Note: Total study counts contained in parentheses.

Traffic Counts

Interval Start Time	TENNANT AVE Eastbound				TENNANT AVE Westbound				BUTTERFIELD BLVD Northbound				BUTTERFIELD BLVD Southbound				Total	Rolling Hour	Pedestrian Crossings			
	U-Turn	Left	Thru	Right	U-Turn	Left	Thru	Right	U-Turn	Left	Thru	Right	U-Turn	Left	Thru	Right			West	East	South	North
7:00 AM	4	30	77	1	0	22	101	59	2	3	136	95	0	13	12	4	559	3,011	0	0	0	0
7:15 AM	4	36	94	1	0	32	133	58	0	5	169	104	0	22	27	19	704	3,215	0	0	0	1
7:30 AM	2	58	145	1	0	71	140	65	1	0	145	127	0	24	36	30	845	3,117	0	0	0	0
7:45 AM	13	47	116	2	1	90	180	54	1	7	152	139	0	23	52	26	903	2,825	0	0	0	0
8:00 AM	9	26	98	4	0	64	235	35	2	6	104	113	0	26	23	18	763	2,496	0	0	0	0
8:15 AM	4	27	84	1	0	37	172	24	2	4	97	88	0	12	28	26	606		0	0	0	0
8:30 AM	7	19	106	4	0	34	165	26	0	4	55	78	0	17	19	19	553		0	0	1	0
8:45 AM	5	26	120	0	0	34	185	22	2	11	34	75	0	17	24	19	574		0	0	0	0

Peak Rolling Hour Flow Rates

Vehicle Type	Eastbound				Westbound				Northbound				Southbound				Total
	U-Turn	Left	Thru	Right	U-Turn	Left	Thru	Right	U-Turn	Left	Thru	Right	U-Turn	Left	Thru	Right	
Articulated Trucks	0	1	1	1	0	0	9	1	0	0	1	0	0	6	0	0	20
Lights	28	159	446	7	1	252	666	202	4	17	561	476	0	86	136	91	3,132
Mediums	0	7	6	0	0	5	13	9	0	1	8	7	0	3	2	2	63
Total	28	167	453	8	1	257	688	212	4	18	570	483	0	95	138	93	3,215



(303) 216-2439
www.alltrafficdata.net

Location: 1 BUTTERFIELD BLVD & TENNANT AVE PM

Date and Start Time: Tuesday, January 23, 2018

Peak Hour: 04:30 PM - 05:30 PM

Peak 15-Minutes: 05:15 PM - 05:30 PM

Peak Hour - All Vehicles

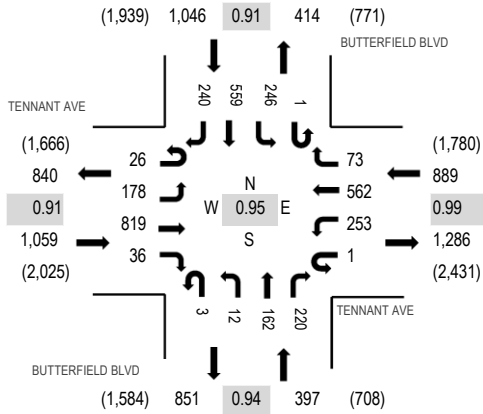

Peak Hour - Pedestrians/Bicycles in Crosswalk

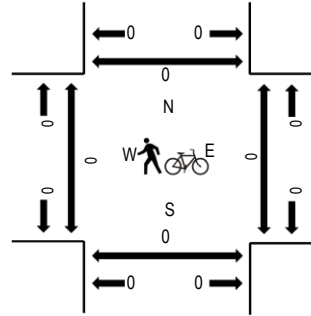

Note: Total study counts contained in parentheses.

Traffic Counts

Interval Start Time	TENNANT AVE Eastbound				TENNANT AVE Westbound				BUTTERFIELD BLVD Northbound				BUTTERFIELD BLVD Southbound				Total	Rolling Hour	Pedestrian Crossings			
	U-Turn	Left	Thru	Right	U-Turn	Left	Thru	Right	U-Turn	Left	Thru	Right	U-Turn	Left	Thru	Right			West	East	South	North
4:00 PM	13	37	184	10	0	54	155	19	0	3	43	31	0	71	121	44	785	3,147	0	0	1	0
4:15 PM	6	34	146	11	1	52	140	23	1	2	24	47	0	60	123	47	717	3,220	0	0	0	0
4:30 PM	6	43	208	11	0	46	154	19	1	4	34	61	0	76	143	64	870	3,391	0	0	0	0
4:45 PM	4	42	199	7	1	68	141	12	1	1	48	46	1	50	118	36	775	3,352	0	0	0	0
5:00 PM	6	45	201	8	0	77	127	18	0	4	42	60	0	55	147	68	858	3,305	0	0	0	0
5:15 PM	10	48	211	10	0	62	140	24	1	3	38	53	0	65	151	72	888		0	0	0	0
5:30 PM	3	51	240	6	0	59	152	12	1	4	21	56	0	48	119	59	831		0	0	1	0
5:45 PM	4	50	165	6	0	69	140	15	2	0	28	48	0	48	99	54	728		0	0	0	0

Peak Rolling Hour Flow Rates

Vehicle Type	Eastbound				Westbound				Northbound				Southbound				Total
	U-Turn	Left	Thru	Right	U-Turn	Left	Thru	Right	U-Turn	Left	Thru	Right	U-Turn	Left	Thru	Right	
Articulated Trucks	0	0	1	0	0	0	1	2	0	0	1	0	0	2	0	0	7
Lights	26	178	816	36	1	252	556	69	3	11	161	220	1	243	553	239	3,365
Mediums	0	0	2	0	0	1	5	2	0	1	0	0	0	1	6	1	19
Total	26	178	819	36	1	253	562	73	3	12	162	220	1	246	559	240	3,391



(303) 216-2439
www.alltrafficdata.net

Location: 24 US101 SB RAMPS & DUNNE AVE
Date and Start Time: Tuesday, May 8, 2018
Peak Hour: 07:30 AM - 08:30 AM
Peak 15-Minutes: 07:45 AM - 08:00 AM

Peak Hour - All Vehicles

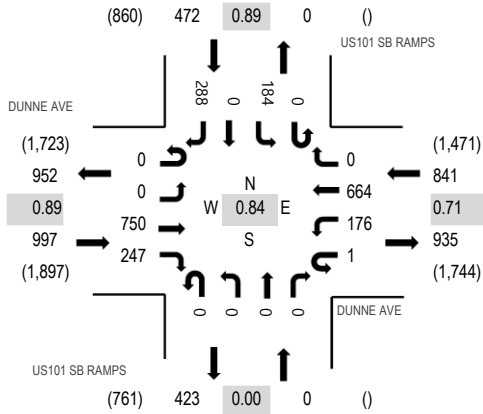

Peak Hour - Pedestrians/Bicycles in Crosswalk

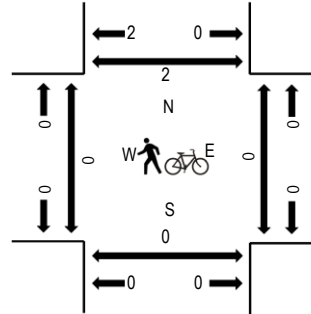

Note: Total study counts contained in parentheses.

Traffic Counts

Interval Start Time	DUNNE AVE Eastbound				DUNNE AVE Westbound				US101 SB RAMPS Northbound				US101 SB RAMPS Southbound				Total	Rolling Hour	Pedestrian Crossings				
	U-Turn	Left	Thru	Right	U-Turn	Left	Thru	Right	U-Turn	Left	Thru	Right	U-Turn	Left	Thru	Right			West	East	South	North	
7:00 AM	0	0	185	49	0	23	116	0	0	0	0	0	0	0	23	0	41	437	2,190	0	0	0	0
7:15 AM	0	0	205	49	0	28	90	0	0	0	0	0	0	0	37	0	59	468	2,297	0	0	0	3
7:30 AM	0	0	226	68	1	42	159	0	0	0	0	0	0	0	45	0	55	596	2,310	0	0	0	0
7:45 AM	0	0	211	48	0	54	241	0	0	0	0	0	0	0	48	0	87	689	2,207	0	0	0	0
8:00 AM	0	0	180	65	0	45	132	0	0	0	0	0	0	0	51	0	71	544	2,038	0	0	0	0
8:15 AM	0	0	133	66	0	35	132	0	0	0	0	0	0	0	40	0	75	481		0	0	0	2
8:30 AM	0	0	148	67	0	24	143	0	0	0	0	0	0	0	39	0	72	493		1	0	0	2
8:45 AM	0	0	138	59	0	39	167	0	0	0	0	0	0	0	34	0	83	520		0	0	0	1

Peak Rolling Hour Flow Rates

Vehicle Type	Eastbound				Westbound				Northbound				Southbound				Total
	U-Turn	Left	Thru	Right	U-Turn	Left	Thru	Right	U-Turn	Left	Thru	Right	U-Turn	Left	Thru	Right	
Articulated Trucks	0	0	4	4	0	1	1	0	0	0	0	0	0	2	0	6	18
Lights	0	0	729	238	1	174	653	0	0	0	0	0	0	175	0	266	2,236
Mediums	0	0	17	5	0	1	10	0	0	0	0	0	0	7	0	16	56
Total	0	0	750	247	1	176	664	0	0	0	0	0	0	184	0	288	2,310



(303) 216-2439
www.alltrafficdata.net

Location: 24 US101 SB RAMPS & DUNNE AVE PM

Date and Start Time: Tuesday, May 8, 2018

Peak Hour: 04:30 PM - 05:30 PM

Peak 15-Minutes: 04:30 PM - 04:45 PM

Peak Hour - All Vehicles

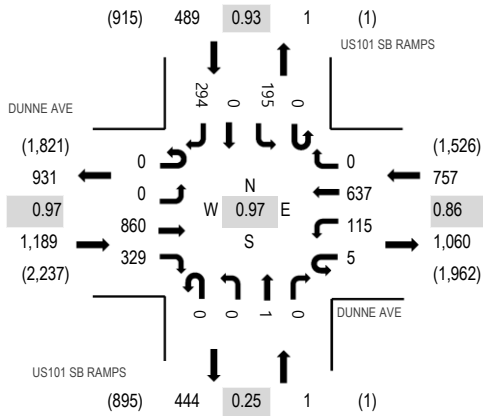

Peak Hour - Pedestrians/Bicycles in Crosswalk

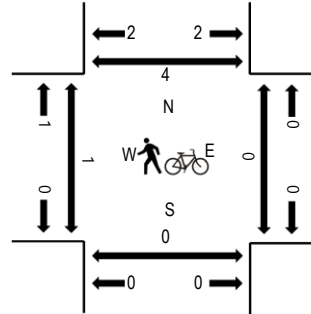

Note: Total study counts contained in parentheses.

Traffic Counts

Interval Start Time	DUNNE AVE Eastbound				DUNNE AVE Westbound				US101 SB RAMPS Northbound				US101 SB RAMPS Southbound				Total	Rolling Hour	Pedestrian Crossings				
	U-Turn	Left	Thru	Right	U-Turn	Left	Thru	Right	U-Turn	Left	Thru	Right	U-Turn	Left	Thru	Right			West	East	South	North	
4:00 PM	0	0	182	88	0	41	147	0	0	0	0	0	0	0	43	0	67	568	2,339	0	0	0	1
4:15 PM	0	0	168	79	0	21	160	0	0	0	0	0	0	0	37	1	68	534	2,365	0	0	0	0
4:30 PM	0	0	211	96	2	40	159	0	0	0	1	0	0	0	45	0	76	630	2,436	1	0	0	2
4:45 PM	0	0	214	84	3	24	150	0	0	0	0	0	0	0	50	0	82	607	2,415	0	0	0	0
5:00 PM	0	0	223	77	0	21	160	0	0	0	0	0	0	0	46	0	67	594	2,340	0	0	0	0
5:15 PM	0	0	212	72	0	30	168	0	0	0	0	0	0	0	54	0	69	605		0	0	0	2
5:30 PM	0	0	196	82	0	41	186	0	0	0	0	0	0	0	48	0	56	609		0	0	0	0
5:45 PM	0	0	184	69	1	29	143	0	0	0	0	0	0	0	43	0	63	532		0	0	0	0

Peak Rolling Hour Flow Rates

Vehicle Type	Eastbound				Westbound				Northbound				Southbound				Total
	U-Turn	Left	Thru	Right	U-Turn	Left	Thru	Right	U-Turn	Left	Thru	Right	U-Turn	Left	Thru	Right	
Articulated Trucks	0	0	1	1	0	2	0	0	0	0	0	0	0	1	0	1	6
Lights	0	0	851	326	5	111	632	0	0	0	1	0	0	193	0	291	2,410
Mediums	0	0	8	2	0	2	5	0	0	0	0	0	0	1	0	2	20
Total	0	0	860	329	5	115	637	0	0	0	1	0	0	195	0	294	2,436



(303) 216-2439
www.alltrafficdata.net

Location: 25 US101 NB RAMPS & DUNNE AVE
Date and Start Time: Tuesday, May 8, 2018
Peak Hour: 07:00 AM - 08:00 AM
Peak 15-Minutes: 07:45 AM - 08:00 AM

Peak Hour - All Vehicles

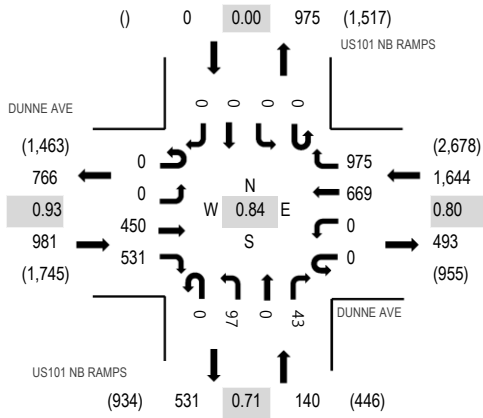

Peak Hour - Pedestrians/Bicycles in Crosswalk

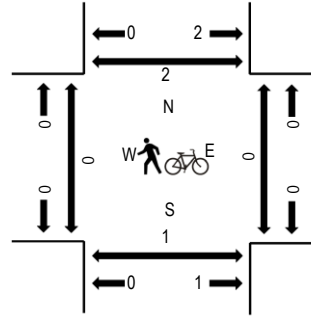

Note: Total study counts contained in parentheses.

Traffic Counts

Interval Start Time	DUNNE AVE Eastbound				DUNNE AVE Westbound				US101 NB RAMPS Northbound				US101 NB RAMPS Southbound				Total	Rolling Hour	Pedestrian Crossings			
	U-Turn	Left	Thru	Right	U-Turn	Left	Thru	Right	U-Turn	Left	Thru	Right	U-Turn	Left	Thru	Right			West	East	South	North
7:00 AM	0	0	61	147	0	0	123	267	0	13	0	9	0	0	0	0	620	2,765	0	0	0	0
7:15 AM	0	0	115	128	0	0	111	220	0	18	0	10	0	0	0	0	602	2,725	0	0	0	2
7:30 AM	0	0	144	127	0	0	160	248	0	32	0	12	0	0	0	0	723	2,621	0	0	1	0
7:45 AM	0	0	130	129	0	0	275	240	0	34	0	12	0	0	0	0	820	2,423	0	0	0	0
8:00 AM	0	0	103	128	0	0	146	160	0	24	0	19	0	0	0	0	580	2,104	0	0	0	1
8:15 AM	0	0	95	78	0	0	113	152	0	42	0	18	0	0	0	0	498		0	0	0	1
8:30 AM	0	0	81	107	0	0	116	125	0	66	0	30	0	0	0	0	525		0	0	0	1
8:45 AM	0	0	82	90	0	0	117	105	0	73	0	34	0	0	0	0	501		0	0	0	2

Peak Rolling Hour Flow Rates

Vehicle Type	Eastbound				Westbound				Northbound				Southbound				Total
	U-Turn	Left	Thru	Right	U-Turn	Left	Thru	Right	U-Turn	Left	Thru	Right	U-Turn	Left	Thru	Right	
Articulated Trucks	0	0	2	2	0	0	4	4	0	1	0	2	0	0	0	0	15
Lights	0	0	436	514	0	0	660	966	0	93	0	39	0	0	0	0	2,708
Mediums	0	0	12	15	0	0	5	5	0	3	0	2	0	0	0	0	42
Total	0	0	450	531	0	0	669	975	0	97	0	43	0	0	0	0	2,765



(303) 216-2439
www.alltrafficdata.net

Location: 25 US101 NB RAMPS & DUNNE AVE PM

Date and Start Time: Tuesday, May 8, 2018

Peak Hour: 04:45 PM - 05:45 PM

Peak 15-Minutes: 05:15 PM - 05:30 PM

Peak Hour - All Vehicles

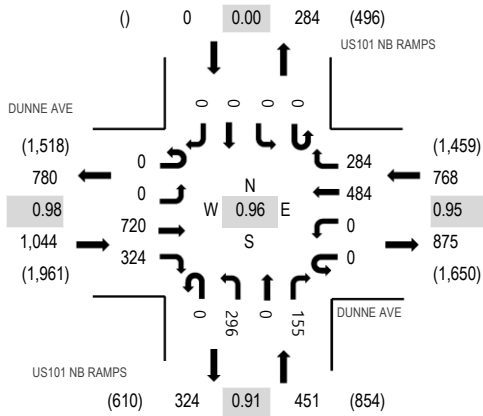

Peak Hour - Pedestrians/Bicycles in Crosswalk

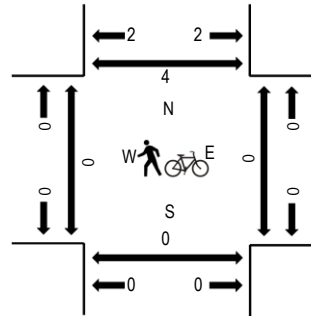

Note: Total study counts contained in parentheses.

Traffic Counts

Interval Start Time	DUNNE AVE Eastbound				DUNNE AVE Westbound				US101 NB RAMPS Northbound				US101 NB RAMPS Southbound				Total	Rolling Hour	Pedestrian Crossings			
	U-Turn	Left	Thru	Right	U-Turn	Left	Thru	Right	U-Turn	Left	Thru	Right	U-Turn	Left	Thru	Right			West	East	South	North
4:00 PM	0	0	165	62	0	0	119	56	0	66	0	26	0	0	0	0	494	2,089	0	0	0	0
4:15 PM	0	0	135	71	0	0	119	51	0	72	0	35	0	0	0	0	483	2,143	0	0	0	1
4:30 PM	0	0	159	98	0	0	133	56	0	57	0	47	0	0	0	0	550	2,249	0	0	0	1
4:45 PM	0	0	194	71	0	0	115	84	0	64	0	34	0	0	0	0	562	2,263	0	0	0	0
5:00 PM	0	0	173	96	0	0	101	69	0	71	0	38	0	0	0	0	548	2,185	0	0	0	1
5:15 PM	0	0	177	89	0	0	129	74	0	81	0	39	0	0	0	0	589		0	0	0	2
5:30 PM	0	0	176	68	0	0	139	57	0	80	0	44	0	0	0	0	564		0	0	0	1
5:45 PM	0	0	172	55	0	0	108	49	0	64	0	36	0	0	0	0	484		0	0	0	0

Peak Rolling Hour Flow Rates

Vehicle Type	Eastbound				Westbound				Northbound				Southbound				Total
	U-Turn	Left	Thru	Right	U-Turn	Left	Thru	Right	U-Turn	Left	Thru	Right	U-Turn	Left	Thru	Right	
Articulated Trucks	0	0	1	1	0	0	1	0	0	0	0	0	0	0	0	0	3
Lights	0	0	715	319	0	0	479	279	0	293	0	153	0	0	0	0	2,238
Mediums	0	0	4	4	0	0	4	5	0	3	0	2	0	0	0	0	22
Total	0	0	720	324	0	0	484	284	0	296	0	155	0	0	0	0	2,263

Traffic Data Service

San Jose, CA
(408) 622-4787
tdsbay@cs.com

File Name : 1AM FINAL
Site Code : 00000001
Start Date : 6/6/2018
Page No : 1

Groups Printed- Vehicles

Start Time	DRIVEWAY Southbound					E DUNNE AVE Westbound					CHURCH ST Northbound					E DUNNE AVE Eastbound					Int. Total
	Right	Thru	Left	Peds	App. Total	Right	Thru	Left	Peds	App. Total	Right	Thru	Left	Peds	App. Total	Right	Thru	Left	Peds	App. Total	
07:00 AM	0	0	0	3	3	1	49	12	0	62	13	3	2	1	19	2	80	3	1	86	170
07:15 AM	0	0	1	1	2	2	40	11	0	53	11	1	3	1	16	5	80	2	1	88	159
07:30 AM	0	0	2	0	2	0	71	19	0	90	30	1	5	3	39	7	112	1	1	121	252
07:45 AM	3	1	1	3	8	1	143	23	1	168	14	2	11	1	28	6	99	4	0	109	313
Total	3	1	4	7	15	4	303	65	1	373	68	7	21	6	102	20	371	10	3	404	894
08:00 AM	1	0	1	1	3	6	113	14	1	134	17	1	9	1	28	5	119	2	0	126	291
08:15 AM	1	0	1	1	3	11	87	17	1	116	11	4	5	0	20	10	87	15	1	113	252
08:30 AM	0	0	0	4	4	14	88	17	0	119	13	1	2	0	16	4	97	16	0	117	256
08:45 AM	0	0	0	3	3	4	91	16	1	112	14	3	4	2	23	4	93	3	0	100	238
Total	2	0	2	9	13	35	379	64	3	481	55	9	20	3	87	23	396	36	1	456	1037
Grand Total	5	1	6	16	28	39	682	129	4	854	123	16	41	9	189	43	767	46	4	860	1931
Apprch %	17.9	3.6	21.4	57.1		4.6	79.9	15.1	0.5		65.1	8.5	21.7	4.8		5	89.2	5.3	0.5		
Total %	0.3	0.1	0.3	0.8	1.5	2	35.3	6.7	0.2	44.2	6.4	0.8	2.1	0.5	9.8	2.2	39.7	2.4	0.2	44.5	

Start Time	DRIVEWAY Southbound					E DUNNE AVE Westbound					CHURCH ST Northbound					E DUNNE AVE Eastbound					Int. Total
	Right	Thru	Left	Peds	App. Total	Right	Thru	Left	Peds	App. Total	Right	Thru	Left	Peds	App. Total	Right	Thru	Left	Peds	App. Total	
Peak Hour Analysis From 07:00 AM to 08:45 AM - Peak 1 of 1																					
Peak Hour for Entire Intersection Begins at 07:45 AM																					
07:45 AM	3	1	1		5	1	143	23		167	14	2	11		27	6	99	4		109	308
08:00 AM	1	0	1		2	6	113	14		133	17	1	9		27	5	119	2		126	288
08:15 AM	1	0	1		2	11	87	17		115	11	4	5		20	10	87	15		112	249
08:30 AM	0	0	0		0	14	88	17		119	13	1	2		16	4	97	16		117	252
Total Volume	5	1	3		9	32	431	71		534	55	8	27		90	25	402	37		464	1097
% App. Total	55.6	11.1	33.3			6	80.7	13.3			61.1	8.9	30			5.4	86.6	8			
PHF	.417	.250	.750		.450	.571	.753	.772		.799	.809	.500	.614		.833	.625	.845	.578		.921	.890

Traffic Data Service

San Jose, CA
 (408) 622-4787
 tdsbay@cs.com

File Name : 1AM FINAL
 Site Code : 00000001
 Start Date : 6/6/2018
 Page No : 2

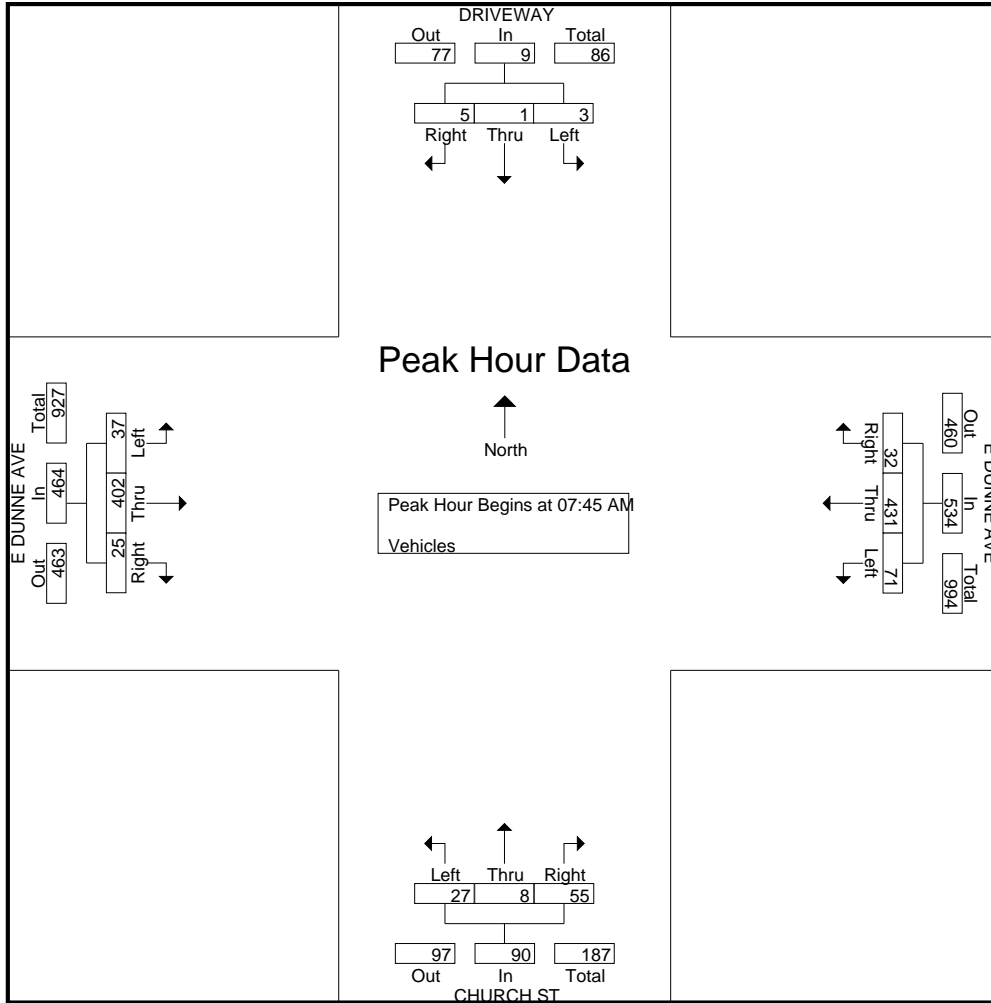

Traffic Data Service

San Jose, CA
 (408) 622-4787
 tdsbay@cs.com

File Name : 1PM FINAL
 Site Code : 00000001
 Start Date : 6/6/2018
 Page No : 1

Groups Printed- Vehicles

Start Time	DRIVEWAY Southbound					E DUNNE AVE Westbound					CHURCH ST Northbound					E DUNNE AVE Eastbound					Int. Total
	Right	Thru	Left	Peds	App. Total	Right	Thru	Left	Peds	App. Total	Right	Thru	Left	Peds	App. Total	Right	Thru	Left	Peds	App. Total	
04:00 PM	0	1	3	1	5	1	97	27	0	125	22	0	6	3	31	5	122	1	0	128	289
04:15 PM	1	0	3	1	5	1	137	27	0	165	14	0	3	1	18	7	119	3	0	129	317
04:30 PM	4	1	3	0	8	1	139	32	1	173	18	1	8	2	29	4	129	4	0	137	347
04:45 PM	1	1	1	7	10	1	155	30	2	188	15	0	6	1	22	11	116	2	0	129	349
Total	6	3	10	9	28	4	528	116	3	651	69	1	23	7	100	27	486	10	0	523	1302
05:00 PM	3	3	3	2	11	1	123	34	1	159	16	4	7	1	28	4	117	1	0	122	320
05:15 PM	0	0	2	4	6	2	164	28	3	197	15	2	8	2	27	10	113	1	1	125	355
05:30 PM	5	3	2	4	14	0	131	31	0	162	19	2	10	2	33	10	104	3	2	119	328
05:45 PM	3	0	0	3	6	0	141	30	0	171	19	0	10	2	31	8	135	5	0	148	356
Total	11	6	7	13	37	3	559	123	4	689	69	8	35	7	119	32	469	10	3	514	1359
Grand Total	17	9	17	22	65	7	1087	239	7	1340	138	9	58	14	219	59	955	20	3	1037	2661
Apprch %	26.2	13.8	26.2	33.8		0.5	81.1	17.8	0.5		63	4.1	26.5	6.4		5.7	92.1	1.9	0.3		
Total %	0.6	0.3	0.6	0.8	2.4	0.3	40.8	9	0.3	50.4	5.2	0.3	2.2	0.5	8.2	2.2	35.9	0.8	0.1	39	

Start Time	DRIVEWAY Southbound					E DUNNE AVE Westbound					CHURCH ST Northbound					E DUNNE AVE Eastbound					Int. Total
	Right	Thru	Left	Peds	App. Total	Right	Thru	Left	Peds	App. Total	Right	Thru	Left	Peds	App. Total	Right	Thru	Left	Peds	App. Total	
Peak Hour Analysis From 04:00 PM to 05:45 PM - Peak 1 of 1																					
Peak Hour for Entire Intersection Begins at 04:30 PM																					
04:30 PM	4	1	3		8	1	139	32		172	18	1	8		27	4	129	4		137	344
04:45 PM	1	1	1		3	1	155	30		186	15	0	6		21	11	116	2		129	339
05:00 PM	3	3	3		9	1	123	34		158	16	4	7		27	4	117	1		122	316
05:15 PM	0	0	2		2	2	164	28		194	15	2	8		25	10	113	1		124	345
Total Volume	8	5	9		22	5	581	124		710	64	7	29		100	29	475	8		512	1344
% App. Total	36.4	22.7	40.9			0.7	81.8	17.5			64	7	29			5.7	92.8	1.6			
PHF	.500	.417	.750		.611	.625	.886	.912		.915	.889	.438	.906		.926	.659	.921	.500		.934	.974

Traffic Data Service

San Jose, CA
 (408) 622-4787
 tdsbay@cs.com

File Name : 1PM FINAL
 Site Code : 00000001
 Start Date : 6/6/2018
 Page No : 2

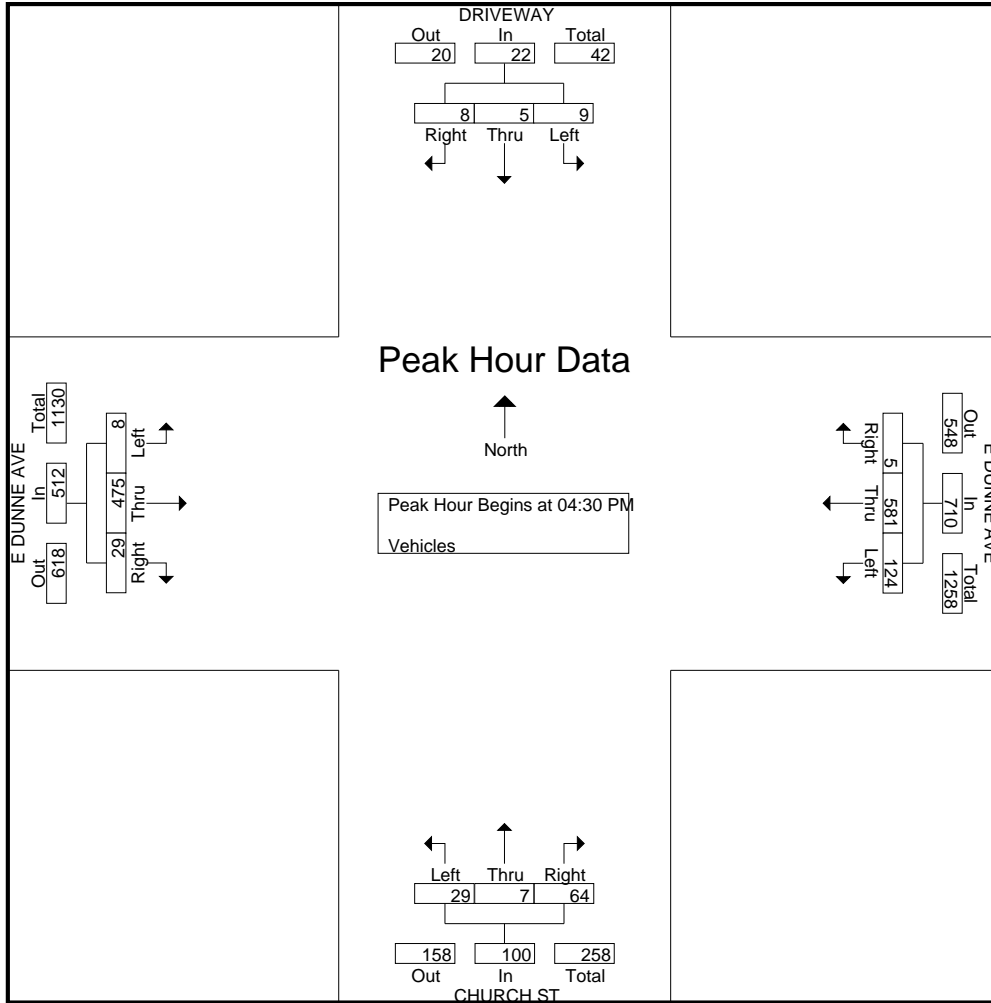

Traffic Data Service

San Jose, CA
 (408) 622-4787
 tdsbay@cs.com

File Name : 8AM FINAL
 Site Code : 00000008
 Start Date : 3/14/2019
 Page No : 1

Groups Printed- Vehicles

Start Time	OLYMPIC DR Southbound					W EDMUNDSON AVE Westbound					Northbound					W EDMUNDSON AVE Eastbound					Int. Total
	Right	Thru	Left	Peds	App. Total	Right	Thru	Left	Peds	App. Total	Right	Thru	Left	Peds	App. Total	Right	Thru	Left	Peds	App. Total	
07:00 AM	0	0	1	0	1	2	19	0	0	21	0	0	0	0	0	0	55	1	0	56	78
07:15 AM	7	0	5	0	12	3	19	0	0	22	0	0	0	0	0	0	47	2	0	49	83
07:30 AM	6	0	4	0	10	5	27	0	0	32	0	0	0	0	0	0	49	0	0	49	91
07:45 AM	0	0	4	2	6	5	21	0	0	26	0	0	0	0	0	0	78	1	0	79	111
Total	13	0	14	2	29	15	86	0	0	101	0	0	0	0	0	0	229	4	0	233	363
08:00 AM	1	0	3	0	4	1	23	0	0	24	0	0	0	0	0	0	47	4	0	51	79
08:15 AM	4	0	0	0	4	2	26	0	0	28	0	0	0	0	0	0	67	4	0	71	103
08:30 AM	1	0	7	0	8	2	21	0	0	23	0	0	0	0	0	0	54	2	0	56	87
08:45 AM	2	0	3	0	5	3	21	0	0	24	0	0	0	0	0	0	59	2	0	61	90
Total	8	0	13	0	21	8	91	0	0	99	0	0	0	0	0	0	227	12	0	239	359
Grand Total	21	0	27	2	50	23	177	0	0	200	0	0	0	0	0	0	456	16	0	472	722
Apprch %	42	0	54	4		11.5	88.5	0	0		0	0	0	0		0	96.6	3.4	0		
Total %	2.9	0	3.7	0.3	6.9	3.2	24.5	0	0	27.7	0	0	0	0		0	63.2	2.2	0	65.4	

Start Time	OLYMPIC DR Southbound					W EDMUNDSON AVE Westbound					Northbound					W EDMUNDSON AVE Eastbound					Int. Total
	Right	Thru	Left	Peds	App. Total	Right	Thru	Left	Peds	App. Total	Right	Thru	Left	Peds	App. Total	Right	Thru	Left	Peds	App. Total	
07:30 AM	6	0	4	0	10	5	27	0	0	32	0	0	0	0	0	0	49	0	0	49	91
07:45 AM	0	0	4	0	4	5	21	0	0	26	0	0	0	0	0	0	78	1	0	79	109
08:00 AM	1	0	3	0	4	1	23	0	0	24	0	0	0	0	0	0	47	4	0	51	79
08:15 AM	4	0	0	0	4	2	26	0	0	28	0	0	0	0	0	0	67	4	0	71	103
Total Volume	11	0	11	0	22	13	97	0	0	110	0	0	0	0	0	0	241	9	0	250	382
% App. Total	50	0	50	0		11.8	88.2	0	0		0	0	0	0		0	96.4	3.6	0		
PHF	.458	.000	.688	.550		.650	.898	.000	.859		.000	.000	.000	.000		.000	.772	.563	.791		.876

Peak Hour Analysis From 07:00 AM to 08:45 AM - Peak 1 of 1

Peak Hour for Entire Intersection Begins at 07:30 AM

Traffic Data Service

San Jose, CA
 (408) 622-4787
 tdsbay@cs.com

File Name : 8AM FINAL
 Site Code : 00000008
 Start Date : 3/14/2019
 Page No : 2

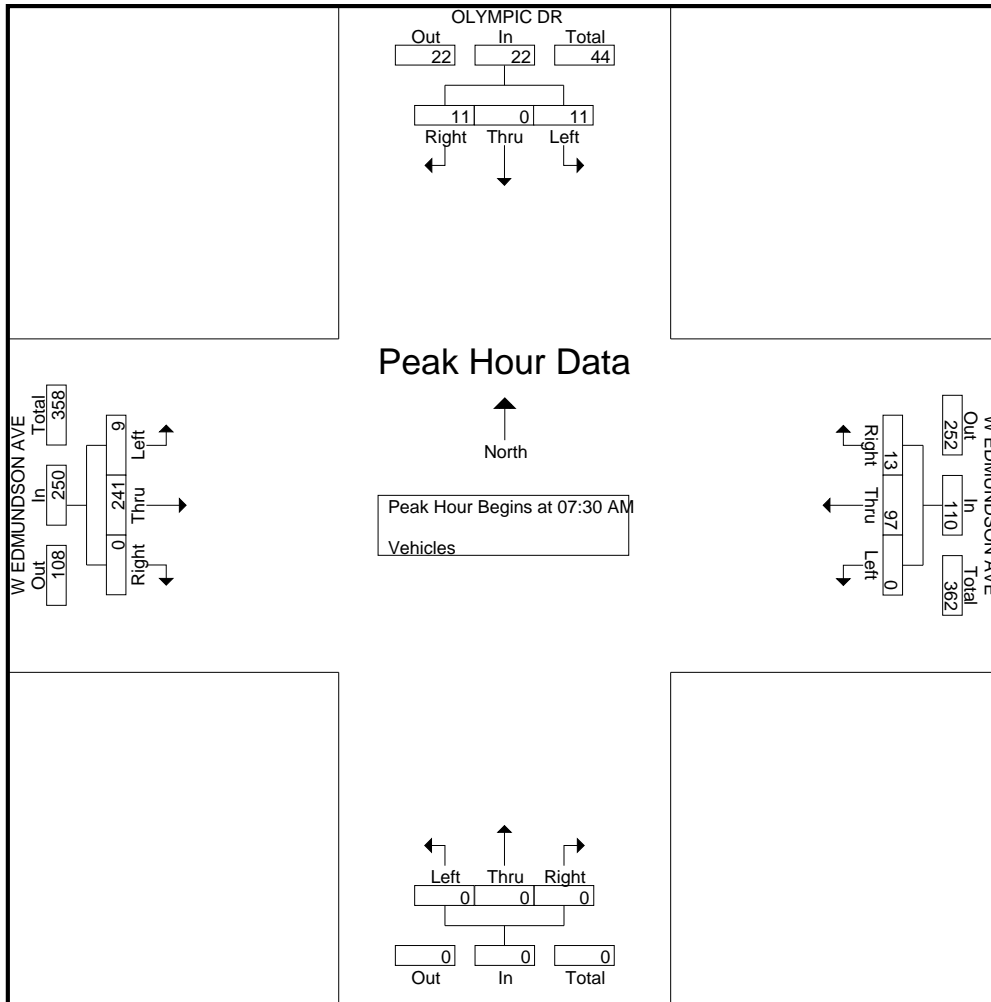

Traffic Data Service

San Jose, CA
(408) 622-4787
tdsbay@cs.com

File Name : 8PM FINAL
Site Code : 00000008
Start Date : 3/14/2019
Page No : 1

Groups Printed- Vehicles

Start Time	OLYMPIC DR Southbound					W EDMUNDSON AVE Westbound					Northbound					W EDMUNDSON AVE Eastbound					Int. Total
	Right	Thru	Left	Peds	App. Total	Right	Thru	Left	Peds	App. Total	Right	Thru	Left	Peds	App. Total	Right	Thru	Left	Peds	App. Total	
04:00 PM	5	0	4	0	9	6	51	0	0	57	0	0	0	0	0	0	72	5	0	77	143
04:15 PM	4	0	6	0	10	8	54	0	0	62	0	0	0	0	0	0	64	5	0	69	141
04:30 PM	3	0	6	0	9	2	50	0	0	52	0	0	0	0	0	0	45	3	0	48	109
04:45 PM	3	0	1	1	5	11	56	0	0	67	0	0	0	0	0	0	54	3	0	57	129
Total	15	0	17	1	33	27	211	0	0	238	0	0	0	0	0	0	235	16	0	251	522
05:00 PM	2	0	1	0	3	6	70	0	0	76	0	0	0	0	0	0	61	1	0	62	141
05:15 PM	4	0	6	0	10	7	45	1	0	53	0	0	0	0	0	0	66	6	0	72	135
05:30 PM	10	0	7	0	17	4	53	0	0	57	0	0	0	0	0	0	49	4	0	53	127
05:45 PM	3	0	3	2	8	3	57	0	0	60	0	0	0	0	0	0	62	1	0	63	131
Total	19	0	17	2	38	20	225	1	0	246	0	0	0	0	0	0	238	12	0	250	534
Grand Total	34	0	34	3	71	47	436	1	0	484	0	0	0	0	0	0	473	28	0	501	1056
Apprch %	47.9	0	47.9	4.2		9.7	90.1	0.2	0		0	0	0	0		0	94.4	5.6	0		
Total %	3.2	0	3.2	0.3	6.7	4.5	41.3	0.1	0	45.8	0	0	0	0		0	44.8	2.7	0	47.4	

Start Time	OLYMPIC DR Southbound					W EDMUNDSON AVE Westbound					Northbound					W EDMUNDSON AVE Eastbound					Int. Total
	Right	Thru	Left	Peds	App. Total	Right	Thru	Left	Peds	App. Total	Right	Thru	Left	Peds	App. Total	Right	Thru	Left	Peds	App. Total	
Peak Hour Analysis From 04:00 PM to 05:45 PM - Peak 1 of 1																					
Peak Hour for Entire Intersection Begins at 05:00 PM																					
05:00 PM	2	0	1	0	3	6	70	0	0	76	0	0	0	0	0	0	61	1	0	62	141
05:15 PM	4	0	6	0	10	7	45	1	0	53	0	0	0	0	0	0	66	6	0	72	135
05:30 PM	10	0	7	0	17	4	53	0	0	57	0	0	0	0	0	0	49	4	0	53	127
05:45 PM	3	0	3	2	6	3	57	0	0	60	0	0	0	0	0	0	62	1	0	63	129
Total Volume	19	0	17	2	36	20	225	1	0	246	0	0	0	0	0	0	238	12	0	250	532
% App. Total	52.8	0	47.2	0.3		8.1	91.5	0.4	0		0	0	0	0		0	95.2	4.8	0		
PHF	.475	.000	.607		.529	.714	.804	.250		.809	.000	.000	.000		.000	.000	.902	.500		.868	.943

Traffic Data Service

San Jose, CA
 (408) 622-4787
 tdsbay@cs.com

File Name : 8PM FINAL
 Site Code : 00000008
 Start Date : 3/14/2019
 Page No : 2

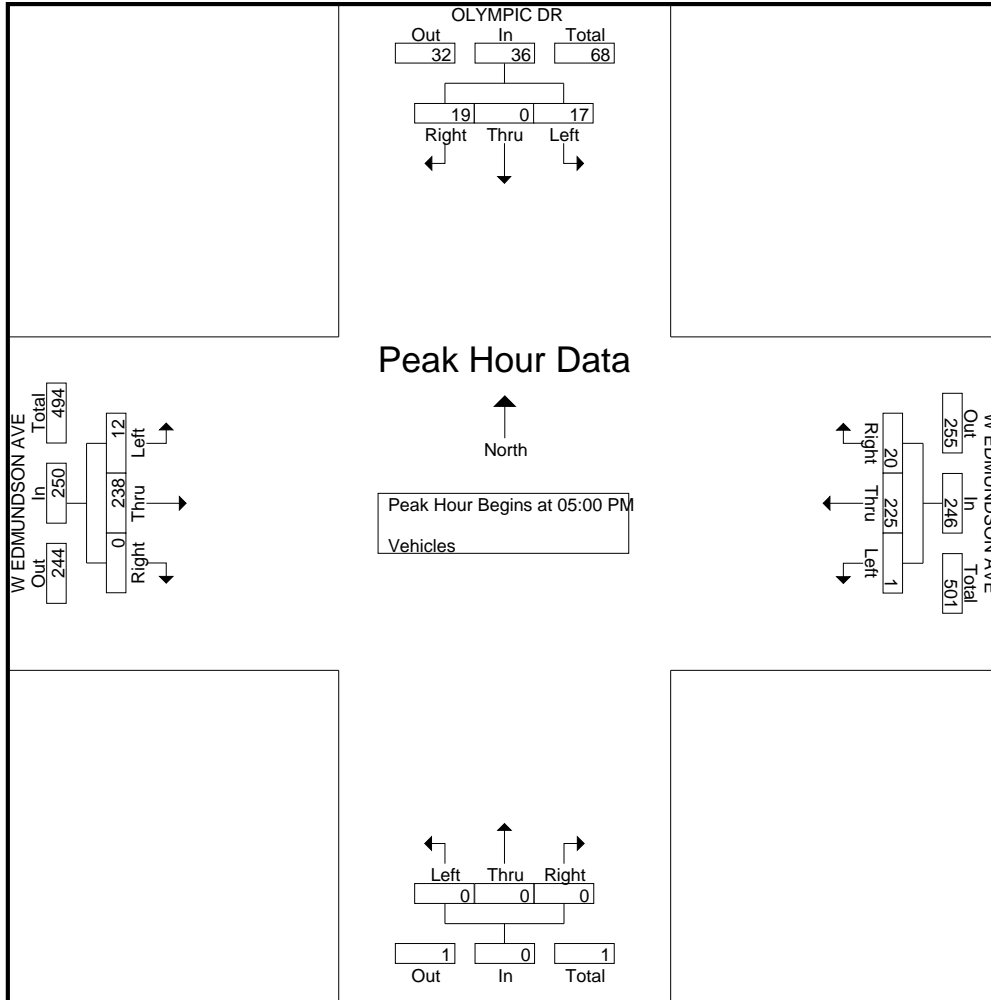

Traffic Data Service

San Jose, CA
 (408) 622-4787
 tdsbay@cs.com

File Name : 9AM FINAL
 Site Code : 00000009
 Start Date : 3/14/2019
 Page No : 1

Groups Printed- Vehicles

Start Time	DEL MONTE AVE Southbound					COSMO AVE Westbound					DRIVEWAY Northbound					COSMO AVE Eastbound					Int. Total
	Right	Thru	Left	Peds	App. Total	Right	Thru	Left	Peds	App. Total	Right	Thru	Left	Peds	App. Total	Right	Thru	Left	Peds	App. Total	
07:00 AM	0	1	5	0	6	2	0	1	1	4	3	1	0	0	4	1	4	2	0	7	21
07:15 AM	2	2	6	0	10	3	4	1	2	10	0	2	0	2	4	1	5	5	0	11	35
07:30 AM	4	4	11	1	20	1	4	1	1	7	3	5	0	1	9	0	7	5	0	12	48
07:45 AM	0	7	5	0	12	3	1	2	0	6	0	3	0	0	3	0	7	3	0	10	31
Total	6	14	27	1	48	9	9	5	4	27	6	11	0	3	20	2	23	15	0	40	135
08:00 AM	4	1	5	0	10	7	2	1	0	10	2	3	0	1	6	0	4	6	0	10	36
08:15 AM	2	5	5	0	12	1	2	2	0	5	4	4	0	0	8	0	6	3	0	9	34
08:30 AM	0	8	4	0	12	4	2	3	0	9	1	3	0	0	4	0	2	3	0	5	30
08:45 AM	3	6	4	2	15	2	2	4	0	8	0	3	0	0	3	0	1	2	0	3	29
Total	9	20	18	2	49	14	8	10	0	32	7	13	0	1	21	0	13	14	0	27	129
Grand Total	15	34	45	3	97	23	17	15	4	59	13	24	0	4	41	2	36	29	0	67	264
Apprch %	15.5	35.1	46.4	3.1		39	28.8	25.4	6.8		31.7	58.5	0	9.8		3	53.7	43.3	0		
Total %	5.7	12.9	17	1.1	36.7	8.7	6.4	5.7	1.5	22.3	4.9	9.1	0	1.5	15.5	0.8	13.6	11	0	25.4	

Start Time	DEL MONTE AVE Southbound					COSMO AVE Westbound					DRIVEWAY Northbound					COSMO AVE Eastbound					Int. Total
	Right	Thru	Left	Peds	App. Total	Right	Thru	Left	Peds	App. Total	Right	Thru	Left	Peds	App. Total	Right	Thru	Left	Peds	App. Total	
Peak Hour Analysis From 07:00 AM to 08:45 AM - Peak 1 of 1																					
Peak Hour for Entire Intersection Begins at 07:30 AM																					
07:30 AM	4	4	11		19	1	4	1		6	3	5	0		8	0	7	5		12	45
07:45 AM	0	7	5		12	3	1	2		6	0	3	0		3	0	7	3		10	31
08:00 AM	4	1	5		10	7	2	1		10	2	3	0		5	0	4	6		10	35
08:15 AM	2	5	5		12	1	2	2		5	4	4	0		8	0	6	3		9	34
Total Volume	10	17	26		53	12	9	6		27	9	15	0		24	0	24	17		41	145
% App. Total	18.9	32.1	49.1			44.4	33.3	22.2			37.5	62.5	0			0	58.5	41.5			
PHF	.625	.607	.591		.697	.429	.563	.750		.675	.563	.750	.000		.750	.000	.857	.708		.854	.806

Traffic Data Service

San Jose, CA
 (408) 622-4787
 tdsbay@cs.com

File Name : 9AM FINAL
 Site Code : 00000009
 Start Date : 3/14/2019
 Page No : 2

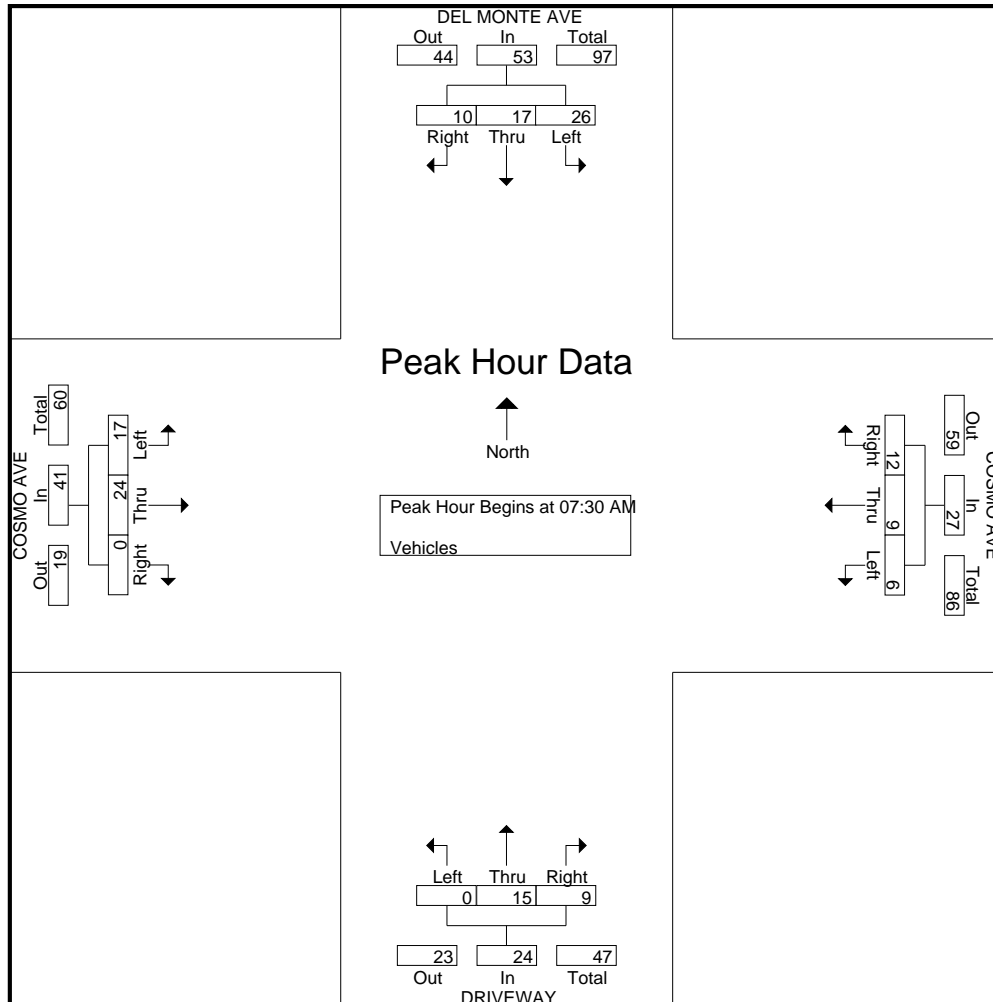

Traffic Data Service

San Jose, CA
 (408) 622-4787
 tdsbay@cs.com

File Name : 9PM FINAL
 Site Code : 00000009
 Start Date : 3/14/2019
 Page No : 1

Groups Printed- Vehicles

Start Time	DEL MONTE AVE Southbound					COSMO AVE Westbound					DRIVEWAY Northbound					COSMO AVE Eastbound					Int. Total
	Right	Thru	Left	Peds	App. Total	Right	Thru	Left	Peds	App. Total	Right	Thru	Left	Peds	App. Total	Right	Thru	Left	Peds	App. Total	
04:00 PM	9	6	6	3	24	6	4	5	6	21	5	12	0	6	23	0	3	5	4	12	80
04:15 PM	8	10	10	0	28	13	5	9	0	27	7	7	3	0	17	2	9	4	0	15	87
04:30 PM	5	6	12	0	23	3	3	2	1	9	1	11	0	0	12	1	5	3	1	10	54
04:45 PM	8	6	8	1	23	9	0	4	1	14	10	10	0	0	20	0	5	5	3	13	70
Total	30	28	36	4	98	31	12	20	8	71	23	40	3	6	72	3	22	17	8	50	291
05:00 PM	4	14	9	0	27	7	2	3	0	12	6	9	1	0	16	0	3	2	0	5	60
05:15 PM	4	11	7	0	22	6	3	1	1	11	3	10	0	0	13	0	5	9	1	15	61
05:30 PM	9	12	6	0	27	5	3	3	1	12	2	6	0	3	11	0	3	4	0	7	57
05:45 PM	5	15	11	0	31	5	4	2	4	15	8	13	2	4	27	2	0	1	3	6	79
Total	22	52	33	0	107	23	12	9	6	50	19	38	3	7	67	2	11	16	4	33	257
Grand Total	52	80	69	4	205	54	24	29	14	121	42	78	6	13	139	5	33	33	12	83	548
Apprch %	25.4	39	33.7	2		44.6	19.8	24	11.6		30.2	56.1	4.3	9.4		6	39.8	39.8	14.5		
Total %	9.5	14.6	12.6	0.7	37.4	9.9	4.4	5.3	2.6	22.1	7.7	14.2	1.1	2.4	25.4	0.9	6	6	2.2	15.1	

Start Time	DEL MONTE AVE Southbound					COSMO AVE Westbound					DRIVEWAY Northbound					COSMO AVE Eastbound					Int. Total
	Right	Thru	Left	Peds	App. Total	Right	Thru	Left	Peds	App. Total	Right	Thru	Left	Peds	App. Total	Right	Thru	Left	Peds	App. Total	
Peak Hour Analysis From 04:00 PM to 05:45 PM - Peak 1 of 1																					
Peak Hour for Entire Intersection Begins at 04:00 PM																					
04:00 PM	9	6	6		21	6	4	5		15	5	12	0		17	0	3	5		8	61
04:15 PM	8	10	10		28	13	5	9		27	7	7	3		17	2	9	4		15	87
04:30 PM	5	6	12		23	3	3	2		8	1	11	0		12	1	5	3		9	52
04:45 PM	8	6	8		22	9	0	4		13	10	10	0		20	0	5	5		10	65
Total Volume	30	28	36		94	31	12	20		63	23	40	3		66	3	22	17		42	265
% App. Total	31.9	29.8	38.3			49.2	19	31.7			34.8	60.6	4.5			7.1	52.4	40.5			
PHF	.833	.700	.750		.839	.596	.600	.556		.583	.575	.833	.250		.825	.375	.611	.850		.700	.761

Traffic Data Service

San Jose, CA
 (408) 622-4787
 tdsbay@cs.com

File Name : 9PM FINAL
 Site Code : 00000009
 Start Date : 3/14/2019
 Page No : 2

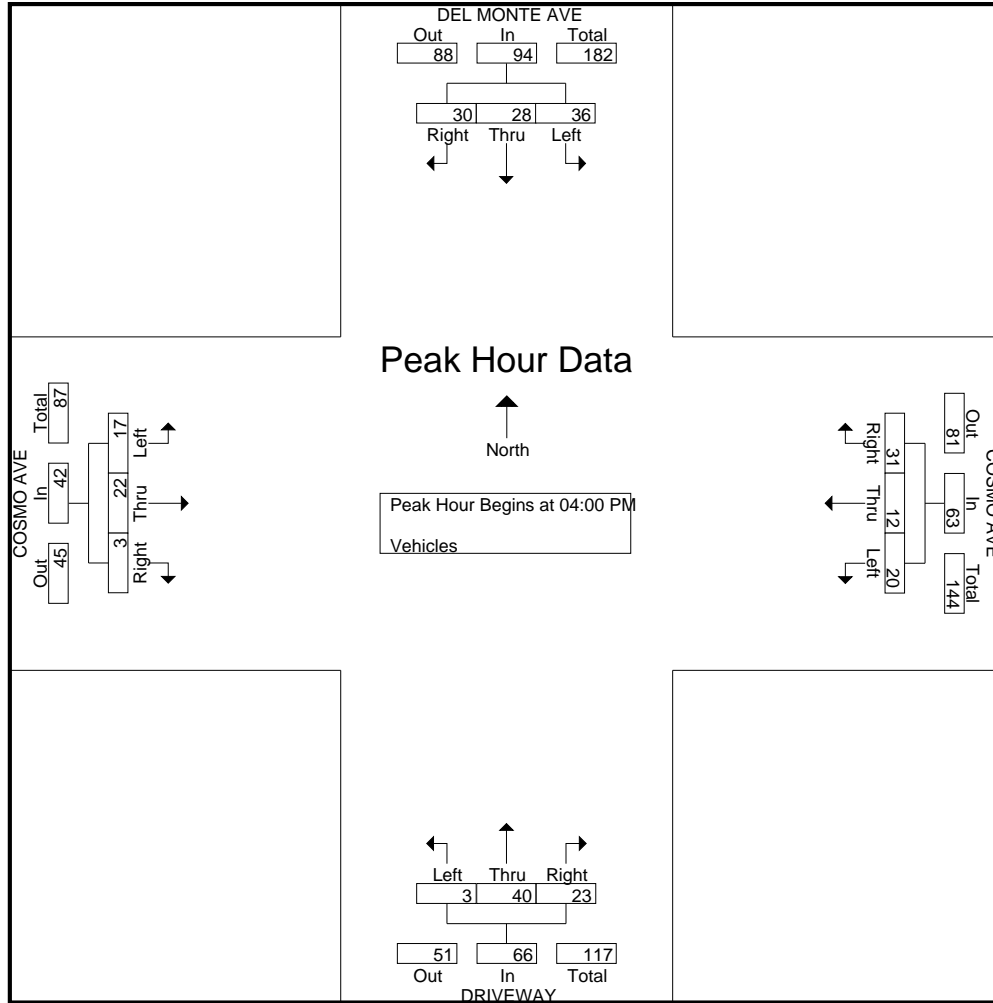

Traffic Data Service

San Jose, CA
 (408) 622-4787
 tdsbay@cs.com

File Name : 10AM FINAL
 Site Code : 00000010
 Start Date : 3/14/2019
 Page No : 1

Groups Printed- Vehicles

Start Time	DEL MONTE AVE Southbound					SPRING AVE Westbound					DEL MONTE AVE Northbound					SPRING AVE Eastbound					Int. Total
	Right	Thru	Left	Peds	App. Total	Right	Thru	Left	Peds	App. Total	Right	Thru	Left	Peds	App. Total	Right	Thru	Left	Peds	App. Total	
07:00 AM	1	5	3	0	9	0	6	1	0	7	2	11	1	1	15	0	17	7	0	24	55
07:15 AM	3	6	7	0	16	1	4	1	2	8	4	13	4	4	25	3	18	2	0	23	72
07:30 AM	0	9	9	0	18	4	15	0	0	19	8	31	4	0	43	4	21	5	0	30	110
07:45 AM	0	9	5	0	14	4	14	4	1	23	3	16	5	0	24	1	19	3	0	23	84
Total	4	29	24	0	57	9	39	6	3	57	17	71	14	5	107	8	75	17	0	100	321
08:00 AM	1	14	1	0	16	3	18	5	0	26	2	15	3	0	20	1	16	1	0	18	80
08:15 AM	1	13	0	2	16	2	12	5	3	22	4	10	2	1	17	3	17	2	0	22	77
08:30 AM	1	13	3	1	18	2	7	2	1	12	4	12	0	2	18	2	6	0	0	8	56
08:45 AM	1	9	1	0	11	4	10	3	0	17	0	11	3	0	14	3	12	3	0	18	60
Total	4	49	5	3	61	11	47	15	4	77	10	48	8	3	69	9	51	6	0	66	273
Grand Total	8	78	29	3	118	20	86	21	7	134	27	119	22	8	176	17	126	23	0	166	594
Apprch %	6.8	66.1	24.6	2.5		14.9	64.2	15.7	5.2		15.3	67.6	12.5	4.5		10.2	75.9	13.9	0		
Total %	1.3	13.1	4.9	0.5	19.9	3.4	14.5	3.5	1.2	22.6	4.5	20	3.7	1.3	29.6	2.9	21.2	3.9	0	27.9	

Start Time	DEL MONTE AVE Southbound					SPRING AVE Westbound					DEL MONTE AVE Northbound					SPRING AVE Eastbound					Int. Total
	Right	Thru	Left	Peds	App. Total	Right	Thru	Left	Peds	App. Total	Right	Thru	Left	Peds	App. Total	Right	Thru	Left	Peds	App. Total	
07:30 AM	0	9	9	0	18	4	15	0	0	19	8	31	4	0	43	4	21	5	0	30	110
07:45 AM	0	9	5	0	14	4	14	4	0	22	3	16	5	0	24	1	19	3	0	23	83
08:00 AM	1	14	1	0	16	3	18	5	0	26	2	15	3	0	20	1	16	1	0	18	80
08:15 AM	1	13	0	2	16	2	12	5	3	22	4	10	2	1	17	3	17	2	0	22	71
Total Volume	2	45	15	0	62	13	59	14	0	86	17	72	14	0	103	9	73	11	0	93	344
% App. Total	3.2	72.6	24.2	0		15.1	68.6	16.3	0		16.5	69.9	13.6	0		9.7	78.5	11.8	0		
PHF	.500	.804	.417	0	.861	.813	.819	.700	0	.827	.531	.581	.700	0	.599	.563	.869	.550	0	.775	.782

Peak Hour Analysis From 07:00 AM to 08:45 AM - Peak 1 of 1

Peak Hour for Entire Intersection Begins at 07:30 AM

Traffic Data Service

San Jose, CA
 (408) 622-4787
 tdsbay@cs.com

File Name : 10AM FINAL
 Site Code : 00000010
 Start Date : 3/14/2019
 Page No : 2

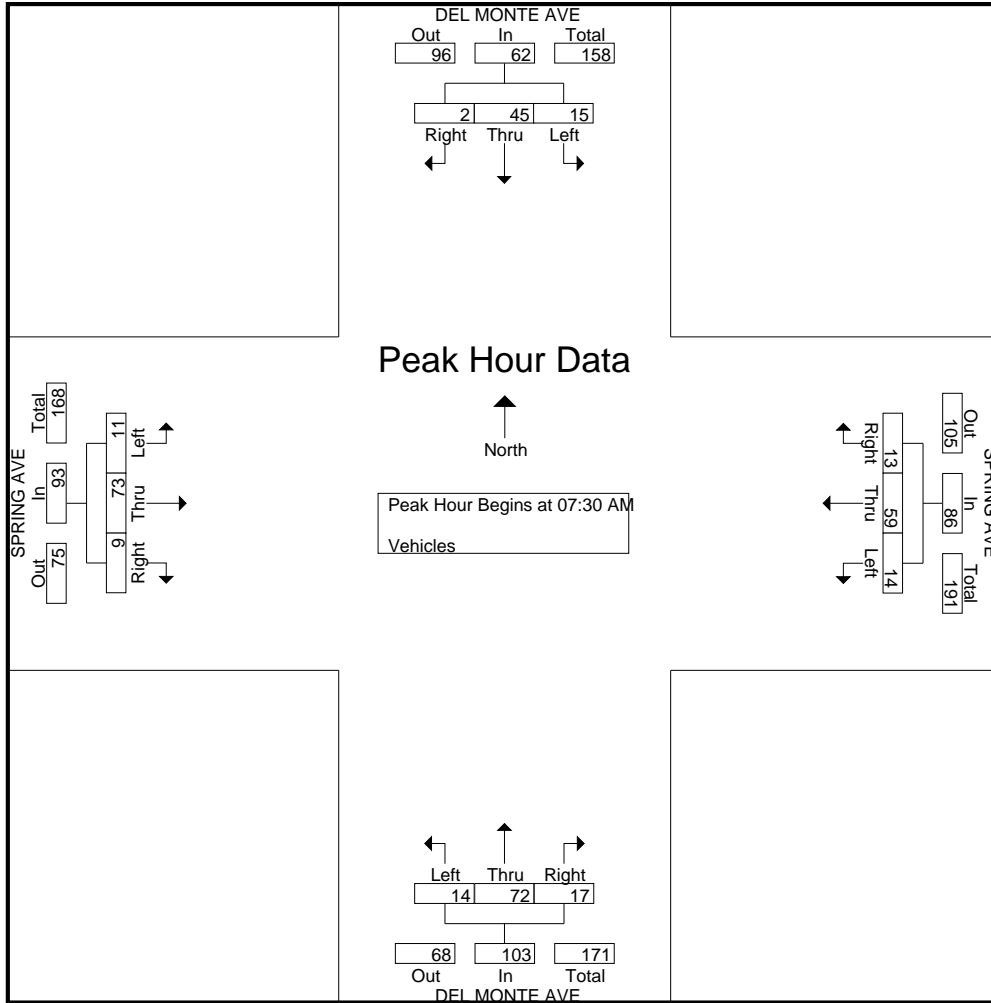

Traffic Data Service

San Jose, CA
 (408) 622-4787
 tdsbay@cs.com

File Name : 10PM FINAL
 Site Code : 00000010
 Start Date : 3/14/2019
 Page No : 1

Groups Printed- Vehicles

Start Time	DEL MONTE AVE Southbound					SPRING AVE Westbound					DEL MONTE AVE Northbound					SPRING AVE Eastbound					Int. Total
	Right	Thru	Left	Peds	App. Total	Right	Thru	Left	Peds	App. Total	Right	Thru	Left	Peds	App. Total	Right	Thru	Left	Peds	App. Total	
04:00 PM	2	19	6	1	28	3	12	4	2	21	5	14	7	0	26	4	12	3	0	19	94
04:15 PM	5	19	3	0	27	2	14	7	0	23	6	13	6	4	29	6	14	5	0	25	104
04:30 PM	2	19	2	3	26	9	15	4	1	29	5	14	3	1	23	4	6	3	0	13	91
04:45 PM	1	24	4	0	29	7	20	1	0	28	1	20	4	2	27	5	11	3	1	20	104
Total	10	81	15	4	110	21	61	16	3	101	17	61	20	7	105	19	43	14	1	77	393
05:00 PM	1	27	4	1	33	2	19	2	2	25	3	11	8	1	23	6	13	1	0	20	101
05:15 PM	3	15	0	1	19	13	20	8	1	42	2	14	6	1	23	7	14	2	1	24	108
05:30 PM	3	20	2	0	25	4	14	3	0	21	1	10	0	0	11	10	13	3	1	27	84
05:45 PM	2	24	7	1	34	3	17	4	4	28	1	17	1	3	22	6	15	5	0	26	110
Total	9	86	13	3	111	22	70	17	7	116	7	52	15	5	79	29	55	11	2	97	403
Grand Total	19	167	28	7	221	43	131	33	10	217	24	113	35	12	184	48	98	25	3	174	796
Apprch %	8.6	75.6	12.7	3.2		19.8	60.4	15.2	4.6		13	61.4	19	6.5		27.6	56.3	14.4	1.7		
Total %	2.4	21	3.5	0.9	27.8	5.4	16.5	4.1	1.3	27.3	3	14.2	4.4	1.5	23.1	6	12.3	3.1	0.4	21.9	

Start Time	DEL MONTE AVE Southbound					SPRING AVE Westbound					DEL MONTE AVE Northbound					SPRING AVE Eastbound					Int. Total
	Right	Thru	Left	Peds	App. Total	Right	Thru	Left	Peds	App. Total	Right	Thru	Left	Peds	App. Total	Right	Thru	Left	Peds	App. Total	
04:30 PM	2	19	2		23	9	15	4		28	5	14	3		22	4	6	3		13	86
04:45 PM	1	24	4		29	7	20	1		28	1	20	4		25	5	11	3		19	101
05:00 PM	1	27	4		32	2	19	2		23	3	11	8		22	6	13	1		20	97
05:15 PM	3	15	0		18	13	20	8		41	2	14	6		22	7	14	2		23	104
Total Volume	7	85	10		102	31	74	15		120	11	59	21		91	22	44	9		75	388
% App. Total	6.9	83.3	9.8			25.8	61.7	12.5			12.1	64.8	23.1			29.3	58.7	12			
PHF	.583	.787	.625		.797	.596	.925	.469		.732	.550	.738	.656		.910	.786	.786	.750		.815	.933

Peak Hour Analysis From 04:00 PM to 05:45 PM - Peak 1 of 1

Peak Hour for Entire Intersection Begins at 04:30 PM

Traffic Data Service

San Jose, CA
 (408) 622-4787
 tdsbay@cs.com

File Name : 10PM FINAL
 Site Code : 00000010
 Start Date : 3/14/2019
 Page No : 2

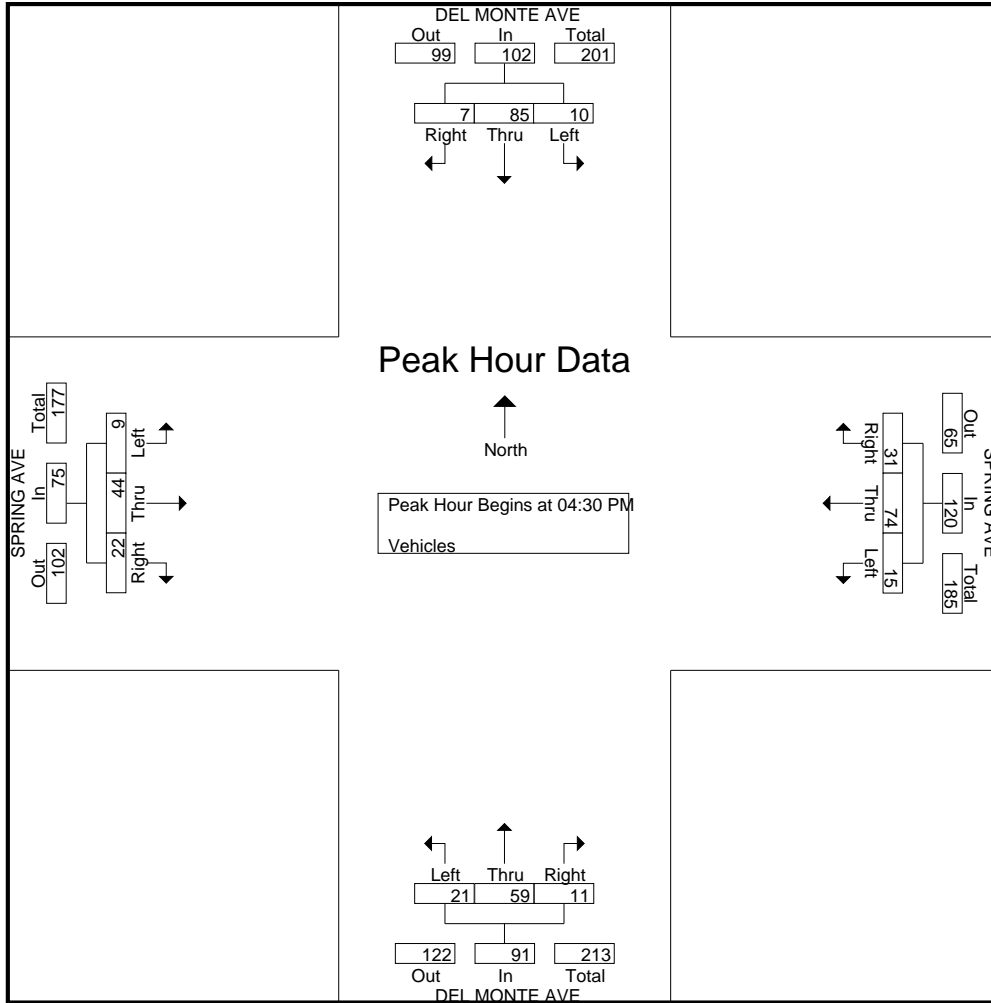

Appendix B
Volume Summary Tables

Intersection Number: 1
 Traffic Node Number: 118
 Intersection Name: Monterey Road and Main Avenue
 Peak Hour: AM
 Count Date: 5/8/18

Scenario:	Movements												Int. Total
	North Approach			East Approach			South Approach			West Approach			
	RT	TH	LT	RT	TH	LT	RT	TH	LT	RT	TH	LT	
Existing Conditions	35	353	213	172	225	27	38	605	98	78	201	48	2093
Project Trips	0	69	0	0	0	33	10	34	0	0	0	0	146
Existing Plus Project Conditions	35	422	213	172	225	60	48	639	98	78	201	48	2239
Year 2025 Cumulative	60	407	269	319	233	28	38	1003	98	78	244	102	2879
Proposed Project Trips	0	69	0	0	0	33	10	34	0	0	0	0	146
Adopted GP Project Trips	0	0	0	0	0	0	0	0	0	0	0	0	0
Net Project Trips	0	69	0	0	0	33	10	34	0	0	0	0	146
Year 2025 Cumulative Plus Project	60	476	269	319	233	61	48	1,037	98	78	244	102	3,025

Intersection Number: 2
 Traffic Node Number: 122
 Intersection Name: Monterey Road and Dunne Avenue
 Peak Hour: AM
 Count Date: 5/8/18

Scenario:	Movements												Int. Total
	North Approach			East Approach			South Approach			West Approach			
	RT	TH	LT	RT	TH	LT	RT	TH	LT	RT	TH	LT	
Existing Conditions	32	330	79	101	227	144	170	741	115	74	255	85	2353
Project Trips	0	103	0	0	0	76	0	0	0	30	139	44	392
Existing Plus Project Conditions	32	433	79	101	227	220	170	741	115	104	394	129	2745
Year 2025 Cumulative	35	346	79	106	252	184	202	839	181	118	309	89	2740
Proposed Project Trips	0	103	0	0	0	76	0	0	0	30	139	44	392
Adopted GP Project Trips	0	0	0	0	0	-2	0	0	0	0	-3	0	-5
Net Project Trips	0	103	0	0	0	74	0	0	0	30	136	44	387
Year 2025 Cumulative Plus Project	35	449	79	106	252	258	202	839	181	148	445	133	3,127

Intersection Number: 3
 Traffic Node Number: 6725
 Intersection Name: Monterey Road and Spring Avenue
 Peak Hour: AM
 Count Date: 3/14/19

Scenario:	Movements												Int. Total
	North Approach			East Approach			South Approach			West Approach			
	RT	TH	LT	RT	TH	LT	RT	TH	LT	RT	TH	LT	
Existing Conditions	17	479	0	0	0	0	0	891	83	68	0	42	1580
Project Trips	0	208	0	0	0	0	0	0	0	13	0	0	221
Existing Plus Project Conditions	17	687	0	0	0	0	0	891	83	81	0	42	1801
Year 2025 Cumulative	19	547	0	0	0	0	0	1059	83	68	0	44	1820
Proposed Project Trips	0	208	0	0	0	0	0	0	0	13	0	0	221
Adopted GP Project Trips	0	-2	0	0	0	0	0	0	0	0	0	0	-2
Net Project Trips	0	206	0	0	0	0	0	0	0	13	0	0	219
Year 2025 Cumulative Plus Project	19	753	0	0	0	0	0	1,059	83	81	0	44	2,039

Intersection Number: 4
 Traffic Node Number: 1112
 Intersection Name: Monterey Road and San Pedro Avenue
 Peak Hour: AM
 Count Date: 3/14/19

Scenario:	Movements												Int. Total
	North Approach			East Approach			South Approach			West Approach			
	RT	TH	LT	RT	TH	LT	RT	TH	LT	RT	TH	LT	
Existing Conditions	2	463	67	61	0	27	68	887	0	1	0	0	1576
Project Trips	0	216	5	0	0	7	0	0	0	0	0	0	228
Existing Plus Project Conditions	2	679	72	61	0	34	68	887	0	1	0	0	1804
Year 2025 Cumulative	2	556	72	66	0	27	68	1074	0	1	0	0	1866
Proposed Project Trips	0	216	5	0	0	7	0	0	0	0	0	0	228
Adopted GP Project Trips	0	-2	0	0	0	0	0	0	0	0	0	0	-2
Net Project Trips	0	214	5	0	0	7	0	0	0	0	0	0	226
Year 2025 Cumulative Plus Project	2	770	77	66	0	34	68	1,074	0	1	0	0	2,092

Intersection Number: 5
 Traffic Node Number: 1200
 Intersection Name: Monterey Road and Cosmo Avenue
 Peak Hour: AM
 Count Date: 3/14/19

Scenario:	Movements												Int. Total
	North Approach			East Approach			South Approach			West Approach			
	RT	TH	LT	RT	TH	LT	RT	TH	LT	RT	TH	LT	
Existing Conditions	27	427	8	0	0	1	1	815	17	24	1	53	1374
Project Trips	222	0	0	0	0	0	0	0	106	0	0	0	328
Existing Plus Project Conditions	249	427	8	0	0	1	1	815	123	24	1	53	1702
Year 2025 Cumulative	27	508	8	0	0	1	1	984	17	24	1	53	1624
Proposed Project Trips	222	0	0	0	0	0	0	0	106	0	0	0	328
Adopted GP Project Trips	-2	0	0	0	0	0	0	0	-1	0	0	0	-3
Net Project Trips	220	0	0	0	0	0	0	0	105	0	0	0	325
Year 2025 Cumulative Plus Project	247	508	8	0	0	1	1	984	122	24	1	53	1,949

Intersection Number: 6
 Traffic Node Number: 6674
 Intersection Name: Monterey Road and Tennant Avenue/Edmundson Avenue
 Peak Hour: AM
 Count Date: 3/14/19

Scenario:	Movements												Int. Total
	North Approach			East Approach			South Approach			West Approach			
	RT	TH	LT	RT	TH	LT	RT	TH	LT	RT	TH	LT	
Existing Conditions	46	309	92	86	103	129	54	722	61	45	162	157	1966
Project Trips	0	0	0	21	0	0	0	62	0	30	27	16	156
Existing Plus Project Conditions	46	309	92	107	103	129	54	784	61	75	189	173	2122
Year 2025 Cumulative	68	356	106	86	129	129	54	859	65	54	208	182	2296
Proposed Project Trips	0	0	0	21	0	0	0	62	0	30	27	16	156
Adopted GP Project Trips	0	0	0	-1	0	0	0	0	0	-1	-1	0	-3
Net Project Trips	0	0	0	20	0	0	0	62	0	29	26	16	153
Year 2025 Cumulative Plus Project	68	356	106	106	129	129	54	921	65	83	234	198	2,449

Intersection Number: 7
 Traffic Node Number: 4111
 Intersection Name: Monterey Road and Vineyard Boulevard
 Peak Hour: AM
 Count Date: 3/14/19

Scenario:	Movements												Int. Total
	North Approach			East Approach			South Approach			West Approach			
	RT	TH	LT	RT	TH	LT	RT	TH	LT	RT	TH	LT	
Existing Conditions	86	319	99	12	50	52	143	625	115	42	186	217	1946
Project Trips	6	24	0	0	0	0	0	45	0	0	0	17	92
Existing Plus Project Conditions	92	343	99	12	50	52	143	670	115	42	186	234	2038
Year 2025 Cumulative	90	387	99	12	56	56	151	803	129	42	193	222	2240
Proposed Project Trips	6	24	0	0	0	0	0	45	0	0	0	17	92
Adopted GP Project Trips	0	0	0	0	0	0	0	0	0	0	0	0	0
Net Project Trips	6	24	0	0	0	0	0	45	0	0	0	17	92
Year 2025 Cumulative Plus Project	96	411	99	12	56	56	151	848	129	42	193	239	2,332

Intersection Number: 8
 Traffic Node Number: 422
 Intersection Name: Monterey Road and Watsonville Road/Butterfield Boulevard
 Peak Hour: AM
 Count Date: 3/14/19

Scenario:	Movements												Int. Total
	North Approach			East Approach			South Approach			West Approach			
	RT	TH	LT	RT	TH	LT	RT	TH	LT	RT	TH	LT	
Existing Conditions	88	597	186	66	278	21	15	150	204	607	703	58	2973
Project Trips	5	19	0	0	0	0	0	30	0	0	0	15	69
Existing Plus Project Conditions	93	616	186	66	278	21	15	180	204	607	703	73	3042
Year 2025 Cumulative	94	665	215	79	364	60	41	267	214	640	843	108	3590
Proposed Project Trips	5	19	0	0	0	0	0	30	0	0	0	15	69
Adopted GP Project Trips	0	0	0	0	0	0	0	0	0	0	0	0	0
Net Project Trips	5	19	0	0	0	0	0	30	0	0	0	15	69
Year 2025 Cumulative Plus Project	99	684	215	79	364	60	41	297	214	640	843	123	3,659

Intersection Number: 9
 Traffic Node Number: 119
 Intersection Name: Butterfield Boulevard and Main Avenue
 Peak Hour: AM
 Count Date: 5/8/18

Scenario:	Movements												Int. Total
	North Approach			East Approach			South Approach			West Approach			
	RT	TH	LT	RT	TH	LT	RT	TH	LT	RT	TH	LT	
Existing Conditions	68	226	52	127	262	132	149	1082	180	159	278	134	2849
Project Trips	20	7	0	0	13	0	0	14	0	0	5	5	64
Existing Plus Project Conditions	88	233	52	127	275	132	149	1096	180	159	283	139	2913
Year 2025 Cumulative	78	369	72	154	321	162	171	1190	205	189	328	167	3406
Proposed Project Trips	20	7	0	0	13	0	0	14	0	0	5	5	64
Adopted GP Project Trips	0	0	0	0	0	0	0	0	0	0	0	0	0
Net Project Trips	20	7	0	0	13	0	0	14	0	0	5	5	64
Year 2025 Cumulative Plus Project	98	376	72	154	334	162	171	1,204	205	189	333	172	3,470

Intersection Number: 10
 Traffic Node Number: 123
 Intersection Name: Butterfield Boulevard and Dunne Avenue
 Peak Hour: AM
 Count Date: 5/18/18

Scenario:	Movements												Int. Total
	North Approach			East Approach			South Approach			West Approach			
	RT	TH	LT	RT	TH	LT	RT	TH	LT	RT	TH	LT	
Existing Conditions	111	298	209	291	312	108	216	1103	51	13	408	153	3273
Project Trips	15	0	0	0	61	0	0	0	0	0	122	17	215
Existing Plus Project Conditions	126	298	209	291	373	108	216	1103	51	13	530	170	3488
Year 2025 Cumulative	143	406	259	320	329	121	218	1142	51	31	408	219	3647
Proposed Project Trips	15	0	0	0	61	0	0	0	0	0	122	17	215
Adopted GP Project Trips	0	0	0	0	-2	0	0	0	0	0	-3	0	-5
Net Project Trips	15	0	0	0	59	0	0	0	0	0	119	17	210
Year 2025 Cumulative Plus Project	158	406	259	320	388	121	218	1,142	51	31	527	236	3,857

Intersection Number: 11
 Traffix Node Number: 1008
 Intersection Name: Butterfield Boulevard and San Pedro Avenue
 Peak Hour: AM
 Count Date: 3/14/19

Scenario:	Movements												Int. Total
	North Approach			East Approach			South Approach			West Approach			
	RT	TH	LT	RT	TH	LT	RT	TH	LT	RT	TH	LT	
Existing Conditions	92	289	33	107	60	37	56	990	32	50	46	44	1836
Project Trips	0	0	0	0	13	0	0	0	0	0	5	0	18
Existing Plus Project Conditions	92	289	33	107	73	37	56	990	32	50	51	44	1854
Year 2025 Cumulative	104	405	47	120	60	40	57	1016	38	68	48	53	2056
Proposed Project Trips	0	0	0	0	13	0	0	0	0	0	5	0	18
Adopted GP Project Trips	0	0	0	0	0	0	0	0	0	0	0	0	0
Net Project Trips	0	0	0	0	13	0	0	0	0	0	5	0	18
Year 2025 Cumulative Plus Project	104	405	47	120	73	40	57	1,016	38	68	53	53	2,074

Intersection Number: 12
 Traffix Node Number: 1111
 Intersection Name: Butterfield Boulevard and Tennant Avenue
 Peak Hour: AM
 Count Date: 1/23/18

Scenario:	Movements												Int. Total
	North Approach			East Approach			South Approach			West Approach			
	RT	TH	LT	RT	TH	LT	RT	TH	LT	RT	TH	LT	
Existing Conditions	93	138	95	212	688	258	483	570	22	8	453	195	3215
Project Trips	0	0	0	0	21	0	0	0	0	0	27	0	48
Existing Plus Project Conditions	93	138	95	212	709	258	483	570	22	8	480	195	3263
Year 2025 Cumulative	108	168	152	224	723	377	695	589	30	11	503	200	3780
Proposed Project Trips	0	0	0	0	21	0	0	0	0	0	27	0	48
Adopted GP Project Trips	0	0	0	0	-1	0	0	0	0	0	-1	0	-2
Net Project Trips	0	0	0	0	20	0	0	0	0	0	26	0	46
Year 2025 Cumulative Plus Project	108	168	152	224	743	377	695	589	30	11	529	200	3,826

Intersection Number: 13
 Traffic Node Number: 124
 Intersection Name: US 101 SB Ramps and Dunne Avenue
 Peak Hour: AM
 Count Date: 5/8/18

Scenario:	Movements												Int. Total
	North Approach			East Approach			South Approach			West Approach			
	RT	TH	LT	RT	TH	LT	RT	TH	LT	RT	TH	LT	
Existing Conditions	288	0	184	0	664	177	0	0	0	247	750	0	2310
Project Trips	32	0	0	0	30	0	0	0	0	0	122	0	184
Existing Plus Project Conditions	320	0	184	0	694	177	0	0	0	247	872	0	2494
Year 2025 Cumulative	297	0	187	0	689	218	0	0	0	282	773	0	2446
Proposed Project Trips	32	0	0	0	30	0	0	0	0	0	122	0	184
Adopted GP Project Trips	-2	0	0	0	0	0	0	0	0	0	-3	0	-5
Net Project Trips	30	0	0	0	30	0	0	0	0	0	119	0	179
Year 2025 Cumulative Plus Project	327	0	187	0	719	218	0	0	0	282	892	0	2,625

Intersection Number: 14
 Traffic Node Number: 125
 Intersection Name: US 101 NB Ramps and Dunne Avenue
 Peak Hour: AM
 Count Date: 5/8/18

Scenario:	Movements												Int. Total
	North Approach			East Approach			South Approach			West Approach			
	RT	TH	LT	RT	TH	LT	RT	TH	LT	RT	TH	LT	
Existing Conditions	0	0	0	0	669	0	43	0	97	0	450	0	1259
Project Trips	0	0	0	0	30	0	0	0	0	111	11	0	152
Existing Plus Project Conditions	0	0	0	0	699	0	43	0	97	111	461	0	1411
Year 2025 Cumulative	0	0	0	0	712	0	91	0	120	0	520	0	1443
Proposed Project Trips	0	0	0	0	30	0	0	0	0	111	11	0	152
Adopted GP Project Trips	0	0	0	0	0	0	0	0	0	-3	0	0	-3
Net Project Trips	0	0	0	0	30	0	0	0	0	108	11	0	149
Year 2025 Cumulative Plus Project	0	0	0	0	742	0	91	0	120	108	531	0	1,592

Intersection Number: 15
 Traffix Node Number: 1004
 Intersection Name: Church Street and Dunne Avenue
 Peak Hour: AM
 Count Date: 6/6/18

Scenario:	Movements												Int. Total
	North Approach			East Approach			South Approach			West Approach			
	RT	TH	LT	RT	TH	LT	RT	TH	LT	RT	TH	LT	
Existing Conditions	5	1	3	32	431	71	55	8	27	25	402	37	1097
Project Trips	0	0	0	0	76	0	0	0	0	0	139	0	215
Existing Plus Project Conditions	5	1	3	32	507	71	55	8	27	25	541	37	1312
Year 2025 Cumulative	5	1	3	32	494	78	63	8	34	31	452	37	1238
Proposed Project Trips	0	0	0	0	76	0	0	0	0	0	139	0	215
Adopted GP Project Trips	0	0	0	0	-2	0	0	0	0	0	-3	0	-5
Net Project Trips	0	0	0	0	74	0	0	0	0	0	136	0	210
Year 2025 Cumulative Plus Project	5	1	3	32	568	78	63	8	34	31	588	37	1,448

Intersection Number: 16
 Traffix Node Number: 1300
 Intersection Name: Olympic Drive and Edmundson Avenue
 Peak Hour: AM
 Count Date: 3/14/19

Scenario:	Movements												Int. Total
	North Approach			East Approach			South Approach			West Approach			
	RT	TH	LT	RT	TH	LT	RT	TH	LT	RT	TH	LT	
Existing Conditions	11	0	11	13	97	0	0	0	0	0	241	9	382
Project Trips	5	0	57	0	0	0	0	0	0	0	16	0	78
Existing Plus Project Conditions	16	0	68	13	97	0	0	0	0	0	257	9	460
Year 2025 Cumulative	16	0	11	13	151	0	0	0	0	0	319	13	523
Proposed Project Trips	5	0	57	0	0	0	0	0	0	0	16	0	78
Adopted GP Project Trips	0	0	-2	0	0	0	0	0	0	0	0	0	-2
Net Project Trips	5	0	55	0	0	0	0	0	0	0	16	0	76
Year 2025 Cumulative Plus Project	21	0	66	13	151	0	0	0	0	0	335	13	599

Intersection Number: 17
 Traffix Node Number: 1400
 Intersection Name: Del Monte Avenue and Cosmo Avenue
 Peak Hour: AM
 Count Date: 3/14/19

Scenario:	Movements												Int. Total
	North Approach			East Approach			South Approach			West Approach			
	RT	TH	LT	RT	TH	LT	RT	TH	LT	RT	TH	LT	
Existing Conditions	10	17	26	12	9	6	9	15	0	0	24	17	145
Project Trips	0	0	0	202	63	0	0	0	0	0	0	0	265
Existing Plus Project Conditions	10	17	26	214	72	6	9	15	0	0	24	17	410
Year 2025 Cumulative	12	17	26	13	9	6	9	15	0	0	24	20	151
Proposed Project Trips	0	0	0	202	63	0	0	0	0	0	0	0	265
Adopted GP Project Trips	0	0	0	-4	-2	0	0	0	0	0	0	0	-6
Net Project Trips	0	0	0	198	61	0	0	0	0	0	0	0	259
Year 2025 Cumulative Plus Project	12	17	26	211	70	6	9	15	0	0	24	20	410

Intersection Number: 18
 Traffix Node Number: 1500
 Intersection Name: Del Monte Avenue and Spring Avenue
 Peak Hour: AM
 Count Date: 3/14/19

Scenario:	Movements												Int. Total
	North Approach			East Approach			South Approach			West Approach			
	RT	TH	LT	RT	TH	LT	RT	TH	LT	RT	TH	LT	
Existing Conditions	2	45	15	13	59	14	17	72	14	9	73	11	344
Project Trips	0	0	0	0	0	0	5	194	3	0	8	0	210
Existing Plus Project Conditions	2	45	15	13	59	14	22	266	17	9	81	11	554
Year 2025 Cumulative	2	47	15	15	61	14	17	84	15	10	75	42	397
Proposed Project Trips	0	0	0	0	0	0	5	194	3	0	8	0	210
Adopted GP Project Trips	0	0	0	0	0	0	0	-4	0	0	0	0	-4
Net Project Trips	0	0	0	0	0	0	5	190	3	0	8	0	206
Year 2025 Cumulative Plus Project	2	47	15	15	61	14	22	274	18	10	83	42	603

Intersection Number: 1
 Traffic Node Number: 118
 Intersection Name: Monterey Road and Main Avenue
 Peak Hour: PM
 Count Date: 5/8/18

Scenario:	Movements												Int. Total
	North Approach			East Approach			South Approach			West Approach			
	RT	TH	LT	RT	TH	LT	RT	TH	LT	RT	TH	LT	
Existing Conditions	70	811	237	75	245	47	35	285	140	197	225	41	2,408
Project Trips	0	18	0	0	0	10	13	44	0	0	0	0	85
Existing Plus Project Conditions	70	829	237	75	245	57	48	329	140	197	225	41	2,493
Year 2025 Cumulative	92	884	326	188	257	52	41	487	140	197	231	66	2,961
Proposed Project Trips	0	18	0	0	0	10	13	44	0	0	0	0	85
Adopted GP Project Trips	0	0	0	0	0	0	0	0	0	0	0	0	0
Net Project Trips	0	18	0	0	0	10	13	44	0	0	0	0	85
Year 2025 Cumulative Plus Project	92	902	326	188	257	62	54	531	140	197	231	66	3,046

Intersection Number: 2
 Traffic Node Number: 122
 Intersection Name: Monterey Road and Dunne Avenue
 Peak Hour: PM
 Count Date: 5/8/18

Scenario:	Movements												Int. Total
	North Approach			East Approach			South Approach			West Approach			
	RT	TH	LT	RT	TH	LT	RT	TH	LT	RT	TH	LT	
Existing Conditions	87	936	146	122	216	329	208	401	153	135	264	77	3,074
Project Trips	0	28	0	0	0	68	0	0	0	6	53	57	212
Existing Plus Project Conditions	87	964	146	122	216	397	208	401	153	141	317	134	3,286
Year 2025 Cumulative	89	946	151	144	245	359	224	472	227	231	298	79	3,465
Proposed Project Trips	0	28	0	0	0	68	0	0	0	6	53	57	212
Adopted GP Project Trips	0	0	0	0	0	-4	0	0	0	0	-3	0	-7
Net Project Trips	0	28	0	0	0	64	0	0	0	6	50	57	205
Year 2025 Cumulative Plus Project	89	974	151	144	245	423	224	472	227	237	348	136	3,670

Intersection Number: 3
 Traffic Node Number: 6725
 Intersection Name: Monterey Road and Spring Avenue
 Peak Hour: PM
 Count Date: 3/21/19

Scenario:	Movements												Int. Total
	North Approach			East Approach			South Approach			West Approach			
	RT	TH	LT	RT	TH	LT	RT	TH	LT	RT	TH	LT	
Existing Conditions	56	1388	0	0	0	0	0	706	96	49	0	42	2,337
Project Trips	0	101	0	0	0	0	0	0	0	10	0	0	111
Existing Plus Project Conditions	56	1,489	0	0	0	0	0	706	96	59	0	42	2,448
Year 2025 Cumulative	58	1,467	0	0	0	0	0	806	96	49	0	44	2,520
Proposed Project Trips	0	101	0	0	0	0	0	0	0	10	0	0	111
Adopted GP Project Trips	0	-5	0	0	0	0	0	0	0	0	0	0	-5
Net Project Trips	0	96	0	0	0	0	0	0	0	10	0	0	106
Year 2025 Cumulative Plus Project	58	1,563	0	0	0	0	0	806	96	59	0	44	2,626

Intersection Number: 4
 Traffic Node Number: 1112
 Intersection Name: Monterey Road and San Pedro Avenue
 Peak Hour: PM
 Count Date: 3/14/19

Scenario:	Movements												Int. Total
	North Approach			East Approach			South Approach			West Approach			
	RT	TH	LT	RT	TH	LT	RT	TH	LT	RT	TH	LT	
Existing Conditions	13	1333	102	83	0	27	120	774	12	14	1	2	2,481
Project Trips	0	103	8	0	0	1	0	0	0	0	0	0	112
Existing Plus Project Conditions	13	1,436	110	83	0	28	120	774	12	14	1	2	2,593
Year 2025 Cumulative	13	1,440	106	87	0	27	120	902	12	14	1	2	2,724
Proposed Project Trips	0	103	8	0	0	1	0	0	0	0	0	0	112
Adopted GP Project Trips	0	-5	0	0	0	0	0	0	0	0	0	0	-5
Net Project Trips	0	98	8	0	0	1	0	0	0	0	0	0	107
Year 2025 Cumulative Plus Project	13	1,538	114	87	0	28	120	902	12	14	1	2	2,831

Intersection Number: 5
 Traffic Node Number: 1200
 Intersection Name: Monterey Road and Cosmo Avenue
 Peak Hour: PM
 Count Date: 3/14/19

Scenario:	Movements												Int. Total
	North Approach			East Approach			South Approach			West Approach			
	RT	TH	LT	RT	TH	LT	RT	TH	LT	RT	TH	LT	
Existing Conditions	35	1246	15	5	0	3	4	722	45	49	0	35	2,159
Project Trips	104	0	0	0	0	0	0	0	34	0	0	0	138
Existing Plus Project Conditions	139	1,246	15	5	0	3	4	722	79	49	0	35	2,297
Year 2025 Cumulative	35	1,341	15	5	0	3	4	837	46	50	0	35	2,371
Proposed Project Trips	104	0	0	0	0	0	0	0	34	0	0	0	138
Adopted GP Project Trips	-5	0	0	0	0	0	0	0	-2	0	0	0	-7
Net Project Trips	99	0	0	0	0	0	0	0	32	0	0	0	131
Year 2025 Cumulative Plus Project	134	1,341	15	5	0	3	4	837	78	50	0	35	2,502

Intersection Number: 6
 Traffic Node Number: 6674
 Intersection Name: Monterey Road and Tennant Avenue/Edmundson Avenue
 Peak Hour: PM
 Count Date: 3/14/19

Scenario:	Movements												Int. Total
	North Approach			East Approach			South Approach			West Approach			
	RT	TH	LT	RT	TH	LT	RT	TH	LT	RT	TH	LT	
Existing Conditions	131	968	213	105	151	296	63	441	92	70	184	185	2,899
Project Trips	0	0	0	14	0	0	0	16	0	39	12	3	84
Existing Plus Project Conditions	131	968	213	119	151	296	63	457	92	109	196	188	2,983
Year 2025 Cumulative	141	1,071	213	105	186	296	64	550	92	70	207	207	3,202
Proposed Project Trips	0	0	0	14	0	0	0	16	0	39	12	3	84
Adopted GP Project Trips	0	0	0	-1	0	0	0	-1	0	-1	-1	0	-4
Net Project Trips	0	0	0	13	0	0	0	15	0	38	11	3	80
Year 2025 Cumulative Plus Project	141	1,071	213	118	186	296	64	565	92	108	218	210	3,282

Intersection Number: 7
 Traffic Node Number: 4111
 Intersection Name: Monterey Road and Vineyard Boulevard
 Peak Hour: PM
 Count Date: 3/14/19

Scenario:	Movements												Int. Total
	North Approach			East Approach			South Approach			West Approach			
	RT	TH	LT	RT	TH	LT	RT	TH	LT	RT	TH	LT	
Existing Conditions	153	965	145	53	150	196	80	455	117	60	100	111	2,585
Project Trips	11	28	0	0	0	0	0	12	0	0	0	3	54
Existing Plus Project Conditions	164	993	145	53	150	196	80	467	117	60	100	114	2,639
Year 2025 Cumulative	157	1,093	145	53	155	201	83	570	117	63	105	114	2,856
Proposed Project Trips	11	28	0	0	0	0	0	12	0	0	0	3	54
Adopted GP Project Trips	0	0	0	0	0	0	0	-1	0	0	0	0	-1
Net Project Trips	11	28	0	0	0	0	0	11	0	0	0	3	53
Year 2025 Cumulative Plus Project	168	1,121	145	53	155	201	83	581	117	63	105	117	2,909

Intersection Number: 8
 Traffic Node Number: 422
 Intersection Name: Monterey Road and Watsonville Road/Butterfield Boulevard
 Peak Hour: PM
 Count Date: 3/14/19

Scenario:	Movements												Int. Total
	North Approach			East Approach			South Approach			West Approach			
	RT	TH	LT	RT	TH	LT	RT	TH	LT	RT	TH	LT	
Existing Conditions	47	235	164	266	858	22	26	356	426	88	381	43	2,912
Project Trips	9	19	0	0	0	0	0	10	0	0	0	3	41
Existing Plus Project Conditions	56	254	164	266	858	22	26	366	426	88	381	46	2,953
Year 2025 Cumulative	67	331	178	290	993	92	100	463	454	99	455	58	3,580
Proposed Project Trips	9	19	0	0	0	0	0	10	0	0	0	3	41
Adopted GP Project Trips	0	0	0	0	0	0	0	0	0	0	0	0	0
Net Project Trips	9	19	0	0	0	0	0	10	0	0	0	3	41
Year 2025 Cumulative Plus Project	76	350	178	290	993	92	100	473	454	99	455	61	3,621

Intersection Number: 9
 Traffic Node Number: 119
 Intersection Name: Butterfield Boulevard and Main Avenue
 Peak Hour: PM
 Count Date: 5/8/18

Scenario:	Movements												Int. Total
	North Approach			East Approach			South Approach			West Approach			
	RT	TH	LT	RT	TH	LT	RT	TH	LT	RT	TH	LT	
Existing Conditions	183	1088	111	36	179	61	89	309	190	239	266	87	2,838
Project Trips	7	2	0	0	3	0	0	13	0	0	8	4	37
Existing Plus Project Conditions	190	1,090	111	36	182	61	89	322	190	239	274	91	2,875
Year 2025 Cumulative	205	1,274	135	52	214	84	118	396	240	253	302	100	3,373
Proposed Project Trips	7	2	0	0	3	0	0	13	0	0	8	4	37
Adopted GP Project Trips	0	0	0	0	0	0	0	0	0	0	0	0	0
Net Project Trips	7	2	0	0	3	0	0	13	0	0	8	4	37
Year 2025 Cumulative Plus Project	212	1,276	135	52	217	84	118	409	240	253	310	104	3,410

Intersection Number: 10
 Traffic Node Number: 123
 Intersection Name: Butterfield Boulevard and Dunne Avenue
 Peak Hour: PM
 Count Date: 5/18/18

Scenario:	Movements												Int. Total
	North Approach			East Approach			South Approach			West Approach			
	RT	TH	LT	RT	TH	LT	RT	TH	LT	RT	TH	LT	
Existing Conditions	254	1024	372	278	439	118	139	279	30	32	498	147	3,610
Project Trips	4	0	0	0	64	0	0	0	0	0	35	18	121
Existing Plus Project Conditions	258	1,024	372	278	503	118	139	279	30	32	533	165	3,731
Year 2025 Cumulative	314	1,149	408	310	439	140	156	416	63	41	515	171	4,122
Proposed Project Trips	4	0	0	0	64	0	0	0	0	0	35	18	121
Adopted GP Project Trips	0	0	0	0	-4	0	0	0	0	0	-3	0	-7
Net Project Trips	4	0	0	0	60	0	0	0	0	0	32	18	114
Year 2025 Cumulative Plus Project	318	1,149	408	310	499	140	156	416	63	41	547	189	4,236

Intersection Number: 11
 Traffic Node Number: 1008
 Intersection Name: Butterfield Boulevard and San Pedro Avenue
 Peak Hour: PM
 Count Date: 3/14/19

Scenario:	Movements												Int. Total
	North Approach			East Approach			South Approach			West Approach			
	RT	TH	LT	RT	TH	LT	RT	TH	LT	RT	TH	LT	
Existing Conditions	121	931	77	40	58	60	40	308	17	48	72	88	1,860
Project Trips	0	0	0	0	3	0	0	0	0	0	8	0	11
Existing Plus Project Conditions	121	931	77	40	61	60	40	308	17	48	80	88	1,871
Year 2025 Cumulative	147	1,053	87	54	59	61	43	473	36	63	72	97	2,245
Proposed Project Trips	0	0	0	0	3	0	0	0	0	0	8	0	11
Adopted GP Project Trips	0	0	0	0	0	0	0	0	0	0	0	0	0
Net Project Trips	0	0	0	0	3	0	0	0	0	0	8	0	11
Year 2025 Cumulative Plus Project	147	1,053	87	54	62	61	43	473	36	63	80	97	2,256

Intersection Number: 12
 Traffic Node Number: 1111
 Intersection Name: Butterfield Boulevard and Tennant Avenue
 Peak Hour: PM
 Count Date: 1/23/18

Scenario:	Movements												Int. Total
	North Approach			East Approach			South Approach			West Approach			
	RT	TH	LT	RT	TH	LT	RT	TH	LT	RT	TH	LT	
Existing Conditions	240	559	247	73	562	254	220	162	15	36	819	204	3,391
Project Trips	0	0	0	0	14	0	0	0	0	0	12	0	26
Existing Plus Project Conditions	240	559	247	73	576	254	220	162	15	36	831	204	3,417
Year 2025 Cumulative	240	616	306	175	624	426	347	204	21	46	888	212	4,105
Proposed Project Trips	0	0	0	0	14	0	0	0	0	0	12	0	26
Adopted GP Project Trips	0	0	0	0	-1	0	0	0	0	0	-1	0	-2
Net Project Trips	0	0	0	0	13	0	0	0	0	0	11	0	24
Year 2025 Cumulative Plus Project	240	616	306	175	637	426	347	204	21	46	899	212	4,129

Intersection Number: 13
 Traffic Node Number: 124
 Intersection Name: US 101 SB Ramps and Dunne Avenue
 Peak Hour: PM
 Count Date: 5/8/18

Scenario:	Movements												Int. Total
	North Approach			East Approach			South Approach			West Approach			
	RT	TH	LT	RT	TH	LT	RT	TH	LT	RT	TH	LT	
Existing Conditions	294	0	195	0	637	120	0	0	0	329	860	0	2,435
Project Trips	58	0	0	0	6	0	0	0	0	0	35	0	99
Existing Plus Project Conditions	352	0	195	0	643	120	0	0	0	329	895	0	2,534
Year 2025 Cumulative	316	0	195	0	715	193	0	0	0	367	897	0	2,683
Proposed Project Trips	58	0	0	0	6	0	0	0	0	0	35	0	99
Adopted GP Project Trips	-4	0	0	0	0	0	0	0	0	0	-3	0	-7
Net Project Trips	54	0	0	0	6	0	0	0	0	0	32	0	92
Year 2025 Cumulative Plus Project	370	0	195	0	721	193	0	0	0	367	929	0	2,775

Intersection Number: 14
 Traffic Node Number: 125
 Intersection Name: US 101 NB Ramps and Dunne Avenue
 Peak Hour: PM
 Count Date: 5/8/18

Scenario:	Movements												Int. Total
	North Approach			East Approach			South Approach			West Approach			
	RT	TH	LT	RT	TH	LT	RT	TH	LT	RT	TH	LT	
Existing Conditions	0	0	0	0	484	0	155	0	296	0	720	0	1,655
Project Trips	0	0	0	0	6	0	0	0	0	17	19	0	42
Existing Plus Project Conditions	0	0	0	0	490	0	155	0	296	17	739	0	1,697
Year 2025 Cumulative	0	0	0	0	616	0	247	0	315	0	737	0	1,915
Proposed Project Trips	0	0	0	0	6	0	0	0	0	17	19	0	42
Adopted GP Project Trips	0	0	0	0	0	0	0	0	0	-3	0	0	-3
Net Project Trips	0	0	0	0	6	0	0	0	0	14	19	0	39
Year 2025 Cumulative Plus Project	0	0	0	0	622	0	247	0	315	14	756	0	1,954

Intersection Number: 15
 Traffix Node Number: 1004
 Intersection Name: Church Street and Dunne Avenue
 Peak Hour: PM
 Count Date: 6/6/18

Scenario:	Movements												Int. Total
	North Approach			East Approach			South Approach			West Approach			
	RT	TH	LT	RT	TH	LT	RT	TH	LT	RT	TH	LT	
Existing Conditions	8	5	9	5	581	124	64	7	29	29	475	8	1,344
Project Trips	0	0	0	0	68	0	0	0	0	0	53	0	121
Existing Plus Project Conditions	8	5	9	5	649	124	64	7	29	29	528	8	1,465
Year 2025 Cumulative	8	5	9	5	652	133	64	7	33	33	506	8	1,463
Proposed Project Trips	0	0	0	0	68	0	0	0	0	0	53	0	121
Adopted GP Project Trips	0	0	0	0	-4	0	0	0	0	0	-3	0	-7
Net Project Trips	0	0	0	0	64	0	0	0	0	0	50	0	114
Year 2025 Cumulative Plus Project	8	5	9	5	716	133	64	7	33	33	556	8	1,577

Intersection Number: 16
 Traffix Node Number: 1300
 Intersection Name: Olympic Drive and Edmundson Avenue
 Peak Hour: PM
 Count Date: 3/14/19

Scenario:	Movements												Int. Total
	North Approach			East Approach			South Approach			West Approach			
	RT	TH	LT	RT	TH	LT	RT	TH	LT	RT	TH	LT	
Existing Conditions	19	0	17	20	225	0	0	0	0	0	238	12	531
Project Trips	10	0	50	0	0	0	0	0	0	0	3	0	63
Existing Plus Project Conditions	29	0	67	20	225	0	0	0	0	0	241	12	594
Year 2025 Cumulative	21	0	17	21	265	0	0	0	0	0	277	14	615
Proposed Project Trips	10	0	50	0	0	0	0	0	0	0	3	0	63
Adopted GP Project Trips	0	0	-2	0	0	0	0	0	0	0	0	0	-2
Net Project Trips	10	0	48	0	0	0	0	0	0	0	3	0	61
Year 2025 Cumulative Plus Project	31	0	65	21	265	0	0	0	0	0	280	14	676

Intersection Number: 17
 Traffic Node Number: 1400
 Intersection Name: Del Monte Avenue and Cosmo Avenue
 Peak Hour: PM
 Count Date: 3/14/19

Scenario:	Movements												Int. Total
	North Approach			East Approach			South Approach			West Approach			
	RT	TH	LT	RT	TH	LT	RT	TH	LT	RT	TH	LT	
Existing Conditions	30	28	36	31	12	20	23	40	3	3	22	17	265
Project Trips	0	0	0	141	61	0	0	0	0	0	0	0	202
Existing Plus Project Conditions	30	28	36	172	73	20	23	40	3	3	22	17	467
Year 2025 Cumulative	32	28	37	33	12	20	23	40	3	3	22	18	271
Proposed Project Trips	0	0	0	141	61	0	0	0	0	0	0	0	202
Adopted GP Project Trips	0	0	0	-4	-2	0	0	0	0	0	0	0	-6
Net Project Trips	0	0	0	137	59	0	0	0	0	0	0	0	196
Year 2025 Cumulative Plus Project	32	28	37	170	71	20	23	40	3	3	22	18	467

Intersection Number: 18
 Traffic Node Number: 1500
 Intersection Name: Del Monte Avenue and Spring Avenue
 Peak Hour: PM
 Count Date: 3/14/19

Scenario:	Movements												Int. Total
	North Approach			East Approach			South Approach			West Approach			
	RT	TH	LT	RT	TH	LT	RT	TH	LT	RT	TH	LT	
Existing Conditions	7	85	10	31	74	15	11	59	21	22	44	9	388
Project Trips	0	0	0	0	0	0	8	128	5	0	2	0	143
Existing Plus Project Conditions	7	85	10	31	74	15	19	187	26	22	46	9	531
Year 2025 Cumulative	16	92	11	36	76	15	11	65	21	23	46	19	431
Proposed Project Trips	0	0	0	0	0	0	8	128	5	0	2	0	143
Adopted GP Project Trips	0	0	0	0	0	0	0	-4	0	0	0	0	-4
Net Project Trips	0	0	0	0	0	0	8	124	5	0	2	0	139
Year 2025 Cumulative Plus Project	16	92	11	36	76	15	19	189	26	23	48	19	570

Appendix C

Level of Service Calculations

Voices School
Morgan Hill, CA
Hexagon Transportation Consultants, Inc.

Level Of Service Computation Report
2000 HCM Operations (Future Volume Alternative)
Existing (AM)

Intersection #118: Monterey Road and Main Avenue

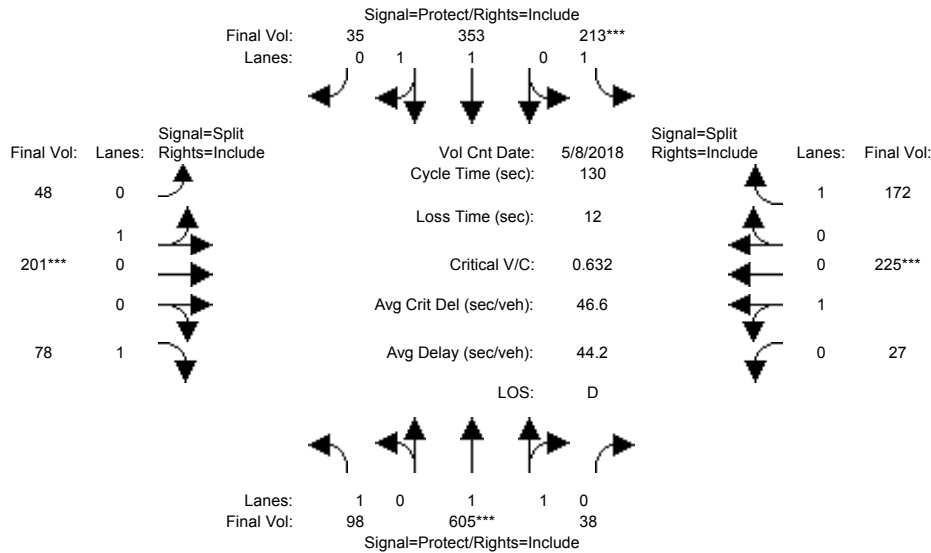

Street Name:	Monterey Road						Main Avenue					
Approach:	North Bound			South Bound			East Bound			West Bound		
Movement:	L	T	R	L	T	R	L	T	R	L	T	R
Min. Green:	7	10	10	7	10	10	10	10	10	10	10	10
Y+R:	4.0	4.0	4.0	4.0	4.0	4.0	4.0	4.0	4.0	4.0	4.0	4.0

Volume Module:	>>	Count	Date:	8 May 2018	<<											
Base Vol:	98	605	38	213	353	35	48	201	78	27	225	172				
Growth Adj:	1.00	1.00	1.00	1.00	1.00	1.00	1.00	1.00	1.00	1.00	1.00	1.00				
Initial Bse:	98	605	38	213	353	35	48	201	78	27	225	172				
Added Vol:	0	0	0	0	0	0	0	0	0	0	0	0				
PasserByVol:	0	0	0	0	0	0	0	0	0	0	0	0				
Initial Fut:	98	605	38	213	353	35	48	201	78	27	225	172				
User Adj:	1.00	1.00	1.00	1.00	1.00	1.00	1.00	1.00	1.00	1.00	1.00	1.00				
PHF Adj:	1.00	1.00	1.00	1.00	1.00	1.00	1.00	1.00	1.00	1.00	1.00	1.00				
PHF Volume:	98	605	38	213	353	35	48	201	78	27	225	172				
Reduct Vol:	0	0	0	0	0	0	0	0	0	0	0	0				
Reduced Vol:	98	605	38	213	353	35	48	201	78	27	225	172				
PCE Adj:	1.00	1.00	1.00	1.00	1.00	1.00	1.00	1.00	1.00	1.00	1.00	1.00				
MLF Adj:	1.00	1.00	1.00	1.00	1.00	1.00	1.00	1.00	1.00	1.00	1.00	1.00				
Final Volume:	98	605	38	213	353	35	48	201	78	27	225	172				

Saturation Flow Module:												
Sat/Lane:	1900	1900	1900	1900	1900	1900	1900	1900	1900	1900	1900	1900
Adjustment:	0.92	0.98	0.95	0.92	0.98	0.95	0.95	0.95	0.92	0.95	0.95	0.92
Lanes:	1.00	1.88	0.12	1.00	1.81	0.19	0.19	0.81	1.00	0.11	0.89	1.00
Final Sat.:	1750	3481	219	1750	3366	334	347	1453	1750	193	1607	1750

Capacity Analysis Module:												
Vol/Sat:	0.06	0.17	0.17	0.12	0.10	0.10	0.14	0.14	0.04	0.14	0.14	0.10
Crit Moves:	****			****			****			****		
Green Time:	21.2	35.7	35.7	25.0	39.6	39.6	28.4	28.4	28.4	28.8	28.8	28.8
Volume/Cap:	0.34	0.63	0.63	0.63	0.34	0.34	0.63	0.63	0.20	0.63	0.63	0.44
Delay/Veh:	49.0	42.7	42.7	52.1	35.3	35.3	49.4	49.4	41.8	49.1	49.1	44.5
User DelAdj:	1.00	1.00	1.00	1.00	1.00	1.00	1.00	1.00	1.00	1.00	1.00	1.00
AdjDel/Veh:	49.0	42.7	42.7	52.1	35.3	35.3	49.4	49.4	41.8	49.1	49.1	44.5
LOS by Move:	D	D	D	D	D	D	D	D	D	D	D	D
HCM2kAvgQ:	4	11	11	9	6	6	10	10	3	9	9	6

Note: Queue reported is the number of cars per lane.

Voices School
Morgan Hill, CA
Hexagon Transportation Consultants, Inc.

Level Of Service Computation Report
2000 HCM Operations (Future Volume Alternative)
Existing (PM)

Intersection #118: Monterey Road and Main Avenue

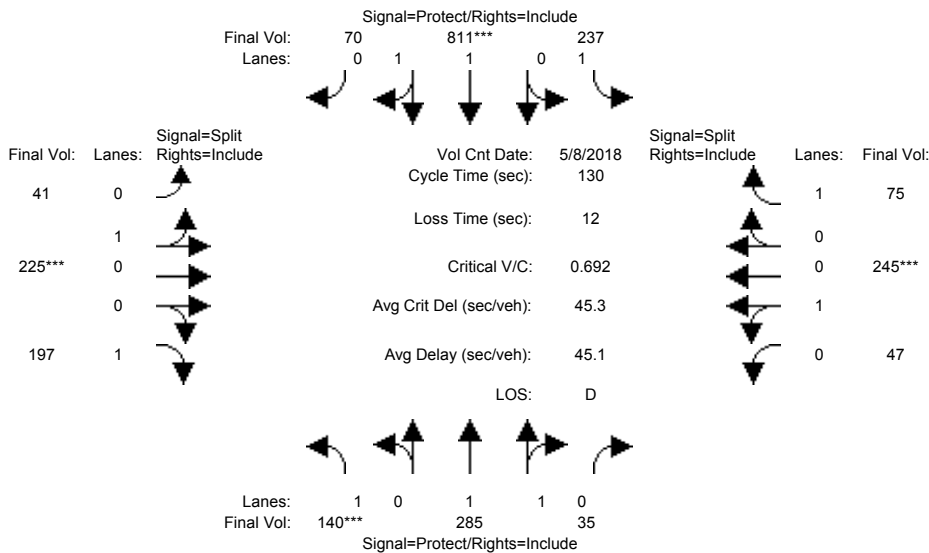

Street Name:	Monterey Road						Main Avenue					
	North Bound			South Bound			East Bound			West Bound		
Approach:	L	T	R	L	T	R	L	T	R	L	T	R
Min. Green:	7	10	10	7	10	10	10	10	10	10	10	10
Y+R:	4.0	4.0	4.0	4.0	4.0	4.0	4.0	4.0	4.0	4.0	4.0	4.0

Volume Module:	>>	Count	Date:	8 May 2018	<<							
Base Vol:	140	285	35	237	811	70	41	225	197	47	245	75
Growth Adj:	1.00	1.00	1.00	1.00	1.00	1.00	1.00	1.00	1.00	1.00	1.00	1.00
Initial Bse:	140	285	35	237	811	70	41	225	197	47	245	75
Added Vol:	0	0	0	0	0	0	0	0	0	0	0	0
PasserByVol:	0	0	0	0	0	0	0	0	0	0	0	0
Initial Fut:	140	285	35	237	811	70	41	225	197	47	245	75
User Adj:	1.00	1.00	1.00	1.00	1.00	1.00	1.00	1.00	1.00	1.00	1.00	1.00
PHF Adj:	1.00	1.00	1.00	1.00	1.00	1.00	1.00	1.00	1.00	1.00	1.00	1.00
PHF Volume:	140	285	35	237	811	70	41	225	197	47	245	75
Reduct Vol:	0	0	0	0	0	0	0	0	0	0	0	0
Reduced Vol:	140	285	35	237	811	70	41	225	197	47	245	75
PCE Adj:	1.00	1.00	1.00	1.00	1.00	1.00	1.00	1.00	1.00	1.00	1.00	1.00
MLF Adj:	1.00	1.00	1.00	1.00	1.00	1.00	1.00	1.00	1.00	1.00	1.00	1.00
FinalVolume:	140	285	35	237	811	70	41	225	197	47	245	75

Saturation Flow Module:												
Sat/Lane:	1900	1900	1900	1900	1900	1900	1900	1900	1900	1900	1900	1900
Adjustment:	0.92	0.98	0.95	0.92	0.98	0.95	0.95	0.95	0.92	0.95	0.95	0.92
Lanes:	1.00	1.78	0.22	1.00	1.84	0.16	0.15	0.85	1.00	0.16	0.84	1.00
Final Sat.:	1750	3295	405	1750	3406	294	277	1523	1750	290	1510	1750

Capacity Analysis Module:												
Vol/Sat:	0.08	0.09	0.09	0.14	0.24	0.24	0.15	0.15	0.11	0.16	0.16	0.04
Crit Moves:	****				****		****			****		
Green Time:	15.0	23.3	23.3	36.5	44.7	44.7	27.8	27.8	27.8	30.5	30.5	30.5
Volume/Cap:	0.69	0.48	0.48	0.48	0.69	0.69	0.69	0.69	0.53	0.69	0.69	0.18
Delay/Veh:	65.1	48.5	48.5	39.7	38.4	38.4	52.5	52.5	46.7	50.4	50.4	40.0
User DelAdj:	1.00	1.00	1.00	1.00	1.00	1.00	1.00	1.00	1.00	1.00	1.00	1.00
AdjDel/Veh:	65.1	48.5	48.5	39.7	38.4	38.4	52.5	52.5	46.7	50.4	50.4	40.0
LOS by Move:	E	D	D	D	D	D	D	D	D	D	D	D
HCM2kAvgQ:	6	6	6	9	16	16	11	11	8	11	11	2

Note: Queue reported is the number of cars per lane.

Voices School
Morgan Hill, CA
Hexagon Transportation Consultants, Inc.

Level Of Service Computation Report
2000 HCM Operations (Future Volume Alternative)
Existing Plus Project (AM) - 2 Cosmo Right out

Intersection #118: Monterey Road and Main Avenue

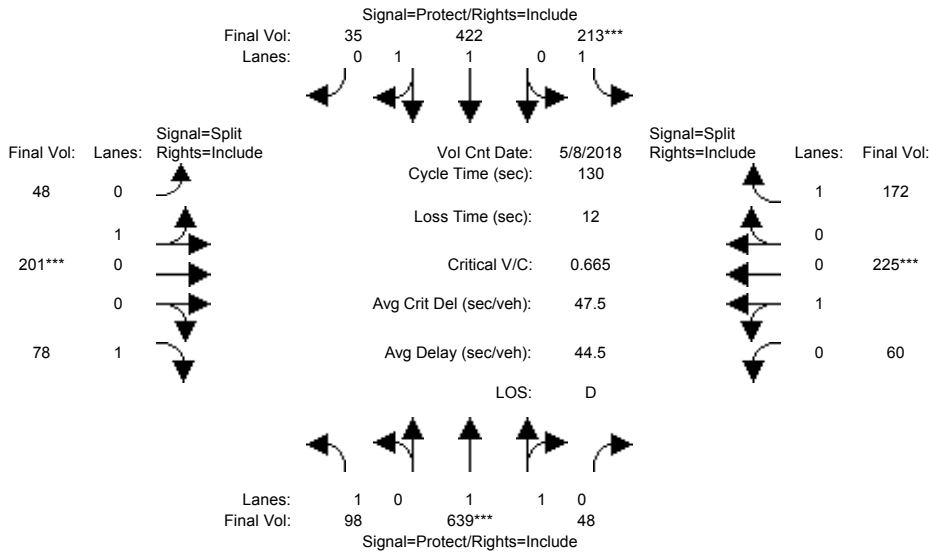

Street Name:	Monterey Road						Main Avenue					
	North Bound			South Bound			East Bound			West Bound		
Approach:	L	T	R	L	T	R	L	T	R	L	T	R
Min. Green:	7	10	10	7	10	10	10	10	10	10	10	10
Y+R:	4.0	4.0	4.0	4.0	4.0	4.0	4.0	4.0	4.0	4.0	4.0	4.0

Volume Module:	>>	Count	Date:	8 May 2018	<<							
Base Vol:	98	605	38	213	353	35	48	201	78	27	225	172
Growth Adj:	1.00	1.00	1.00	1.00	1.00	1.00	1.00	1.00	1.00	1.00	1.00	1.00
Initial Bse:	98	605	38	213	353	35	48	201	78	27	225	172
Added Vol:	0	34	10	0	69	0	0	0	0	33	0	0
PasserByVol:	0	0	0	0	0	0	0	0	0	0	0	0
Initial Fut:	98	639	48	213	422	35	48	201	78	60	225	172
User Adj:	1.00	1.00	1.00	1.00	1.00	1.00	1.00	1.00	1.00	1.00	1.00	1.00
PHF Adj:	1.00	1.00	1.00	1.00	1.00	1.00	1.00	1.00	1.00	1.00	1.00	1.00
PHF Volume:	98	639	48	213	422	35	48	201	78	60	225	172
Reduct Vol:	0	0	0	0	0	0	0	0	0	0	0	0
Reduced Vol:	98	639	48	213	422	35	48	201	78	60	225	172
PCE Adj:	1.00	1.00	1.00	1.00	1.00	1.00	1.00	1.00	1.00	1.00	1.00	1.00
MLF Adj:	1.00	1.00	1.00	1.00	1.00	1.00	1.00	1.00	1.00	1.00	1.00	1.00
FinalVolume:	98	639	48	213	422	35	48	201	78	60	225	172

Saturation Flow Module:												
Sat/Lane:	1900	1900	1900	1900	1900	1900	1900	1900	1900	1900	1900	1900
Adjustment:	0.92	0.98	0.95	0.92	0.98	0.95	0.95	0.95	0.92	0.95	0.95	0.92
Lanes:	1.00	1.86	0.14	1.00	1.84	0.16	0.19	0.81	1.00	0.21	0.79	1.00
Final Sat.:	1750	3441	259	1750	3416	283	347	1453	1750	379	1421	1750

Capacity Analysis Module:												
Vol/Sat:	0.06	0.19	0.19	0.12	0.12	0.12	0.14	0.14	0.04	0.16	0.16	0.10
Crit Moves:	****			****			****			****		
Green Time:	18.7	36.3	36.3	23.8	41.3	41.3	27.0	27.0	27.0	30.9	30.9	30.9
Volume/Cap:	0.39	0.67	0.67	0.67	0.39	0.39	0.67	0.67	0.21	0.67	0.67	0.41
Delay/Veh:	51.4	43.2	43.2	54.7	34.7	34.7	51.8	51.8	43.0	48.8	48.8	42.5
User DelAdj:	1.00	1.00	1.00	1.00	1.00	1.00	1.00	1.00	1.00	1.00	1.00	1.00
AdjDel/Veh:	51.4	43.2	43.2	54.7	34.7	34.7	51.8	51.8	43.0	48.8	48.8	42.5
LOS by Move:	D	D	D	D	C	C	D	D	D	D	D	D
HCM2kAvgQ:	4	12	12	10	7	7	11	11	3	11	11	6

Note: Queue reported is the number of cars per lane.

Voices School
Morgan Hill, CA
Hexagon Transportation Consultants, Inc.

Level Of Service Computation Report
2000 HCM Operations (Future Volume Alternative)
Existing Plus Project (PM) - 2 Cosmo Right out

Intersection #118: Monterey Road and Main Avenue

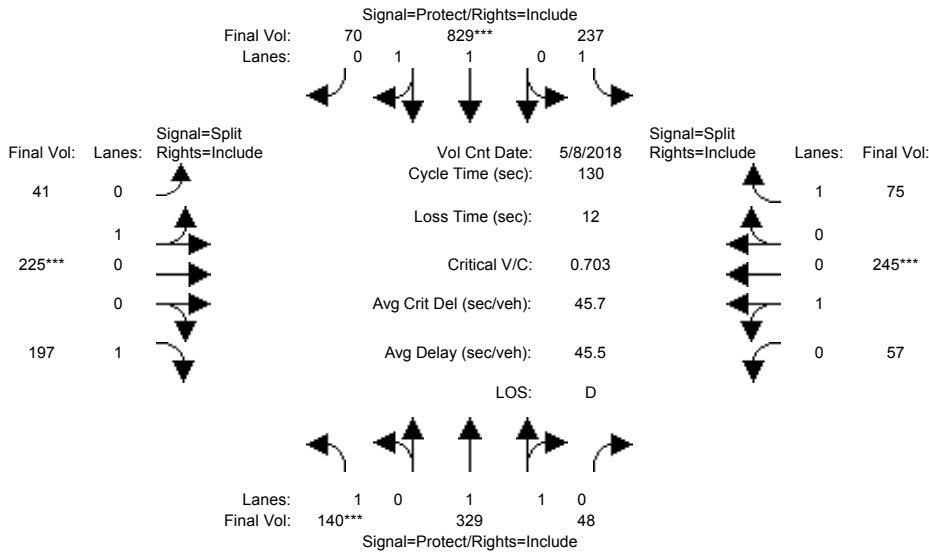

Street Name:	Monterey Road						Main Avenue					
	North Bound			South Bound			East Bound			West Bound		
Approach:	L	T	R	L	T	R	L	T	R	L	T	R
Min. Green:	7	10	10	7	10	10	10	10	10	10	10	10
Y+R:	4.0	4.0	4.0	4.0	4.0	4.0	4.0	4.0	4.0	4.0	4.0	4.0

Volume Module:	>>	Count	Date:	8 May 2018	<<							
Base Vol:	140	285	35	237	811	70	41	225	197	47	245	75
Growth Adj:	1.00	1.00	1.00	1.00	1.00	1.00	1.00	1.00	1.00	1.00	1.00	1.00
Initial Bse:	140	285	35	237	811	70	41	225	197	47	245	75
Added Vol:	0	44	13	0	18	0	0	0	0	10	0	0
PasserByVol:	0	0	0	0	0	0	0	0	0	0	0	0
Initial Fut:	140	329	48	237	829	70	41	225	197	57	245	75
User Adj:	1.00	1.00	1.00	1.00	1.00	1.00	1.00	1.00	1.00	1.00	1.00	1.00
PHF Adj:	1.00	1.00	1.00	1.00	1.00	1.00	1.00	1.00	1.00	1.00	1.00	1.00
PHF Volume:	140	329	48	237	829	70	41	225	197	57	245	75
Reduct Vol:	0	0	0	0	0	0	0	0	0	0	0	0
Reduced Vol:	140	329	48	237	829	70	41	225	197	57	245	75
PCE Adj:	1.00	1.00	1.00	1.00	1.00	1.00	1.00	1.00	1.00	1.00	1.00	1.00
MLF Adj:	1.00	1.00	1.00	1.00	1.00	1.00	1.00	1.00	1.00	1.00	1.00	1.00
FinalVolume:	140	329	48	237	829	70	41	225	197	57	245	75

Saturation Flow Module:												
Sat/Lane:	1900	1900	1900	1900	1900	1900	1900	1900	1900	1900	1900	1900
Adjustment:	0.92	0.98	0.95	0.92	0.98	0.95	0.95	0.95	0.92	0.95	0.95	0.92
Lanes:	1.00	1.74	0.26	1.00	1.84	0.16	0.15	0.85	1.00	0.19	0.81	1.00
Final Sat.:	1750	3229	471	1750	3412	288	277	1523	1750	340	1460	1750

Capacity Analysis Module:												
Vol/Sat:	0.08	0.10	0.10	0.14	0.24	0.24	0.15	0.15	0.11	0.17	0.17	0.04
Crit Moves:	****			****			****			****		
Green Time:	14.8	25.6	25.6	34.1	44.9	44.9	27.3	27.3	27.3	31.0	31.0	31.0
Volume/Cap:	0.70	0.52	0.52	0.52	0.70	0.70	0.70	0.70	0.54	0.70	0.70	0.18
Delay/Veh:	66.3	47.3	47.3	42.0	38.6	38.6	53.5	53.5	47.3	50.5	50.5	39.6
User DelAdj:	1.00	1.00	1.00	1.00	1.00	1.00	1.00	1.00	1.00	1.00	1.00	1.00
AdjDel/Veh:	66.3	47.3	47.3	42.0	38.6	38.6	53.5	53.5	47.3	50.5	50.5	39.6
LOS by Move:	E	D	D	D	D	D	D	D	D	D	D	D
HCM2kAvgQ:	6	7	7	9	17	17	11	11	8	12	12	2

Note: Queue reported is the number of cars per lane.

Voices School
Morgan Hill, CA
Hexagon Transportation Consultants, Inc.

Level Of Service Computation Report
2000 HCM Operations (Future Volume Alternative)
Existing (AM)

Intersection #119: Butterfield Boulevard and Main Avenue

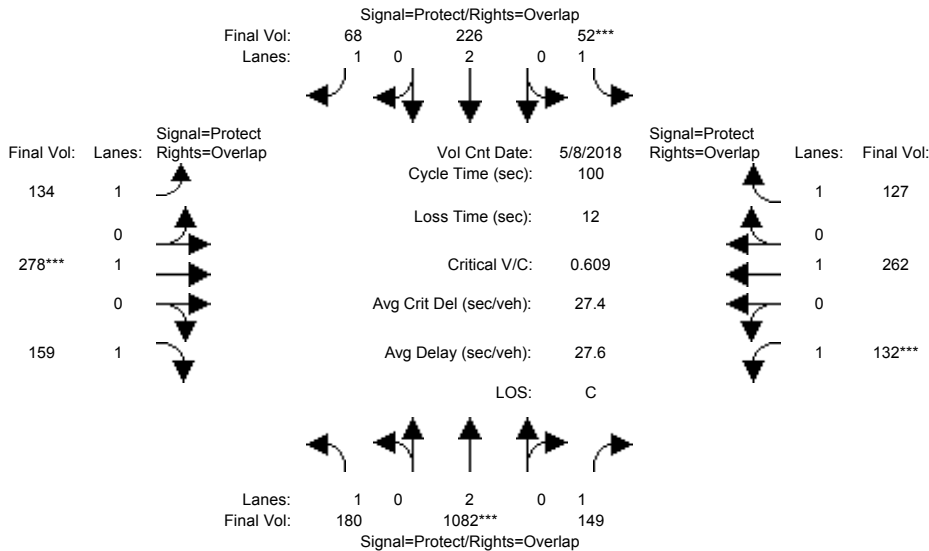

Street Name:	Butterfield Boulevard						Main Avenue					
Approach:	North Bound			South Bound			East Bound			West Bound		
Movement:	L	T	R	L	T	R	L	T	R	L	T	R
Min. Green:	7	10	10	7	10	10	7	10	10	7	10	10
Y+R:	4.0	4.0	4.0	4.0	4.0	4.0	4.0	4.0	4.0	4.0	4.0	4.0
Volume Module: >> Count Date: 8 May 2018 <<												
Base Vol:	180	1082	149	52	226	68	134	278	159	132	262	127
Growth Adj:	1.00	1.00	1.00	1.00	1.00	1.00	1.00	1.00	1.00	1.00	1.00	1.00
Initial Bse:	180	1082	149	52	226	68	134	278	159	132	262	127
Added Vol:	0	0	0	0	0	0	0	0	0	0	0	0
PasserByVol:	0	0	0	0	0	0	0	0	0	0	0	0
Initial Fut:	180	1082	149	52	226	68	134	278	159	132	262	127
User Adj:	1.00	1.00	1.00	1.00	1.00	1.00	1.00	1.00	1.00	1.00	1.00	1.00
PHF Adj:	1.00	1.00	1.00	1.00	1.00	1.00	1.00	1.00	1.00	1.00	1.00	1.00
PHF Volume:	180	1082	149	52	226	68	134	278	159	132	262	127
Reduct Vol:	0	0	0	0	0	0	0	0	0	0	0	0
Reduced Vol:	180	1082	149	52	226	68	134	278	159	132	262	127
PCE Adj:	1.00	1.00	1.00	1.00	1.00	1.00	1.00	1.00	1.00	1.00	1.00	1.00
MLF Adj:	1.00	1.00	1.00	1.00	1.00	1.00	1.00	1.00	1.00	1.00	1.00	1.00
FinalVolume:	180	1082	149	52	226	68	134	278	159	132	262	127
Saturation Flow Module:												
Sat/Lane:	1900	1900	1900	1900	1900	1900	1900	1900	1900	1900	1900	1900
Adjustment:	0.92	1.00	0.92	0.92	1.00	0.92	0.92	1.00	0.92	0.92	1.00	0.92
Lanes:	1.00	2.00	1.00	1.00	2.00	1.00	1.00	1.00	1.00	1.00	1.00	1.00
Final Sat.:	1750	3800	1750	1750	3800	1750	1750	1900	1750	1750	1900	1750
Capacity Analysis Module:												
Vol/Sat:	0.10	0.28	0.09	0.03	0.06	0.04	0.08	0.15	0.09	0.08	0.14	0.07
Crit Moves:	****			****			****			****		
Green Time:	26.6	45.5	57.6	7.0	25.9	38.6	12.7	23.4	50.0	12.1	22.8	29.8
Volume/Cap:	0.39	0.63	0.15	0.42	0.23	0.10	0.60	0.63	0.18	0.63	0.60	0.24
Delay/Veh:	30.5	21.5	9.9	46.9	29.3	19.7	46.0	37.2	13.8	47.6	37.0	26.8
User DelAdj:	1.00	1.00	1.00	1.00	1.00	1.00	1.00	1.00	1.00	1.00	1.00	1.00
AdjDel/Veh:	30.5	21.5	9.9	46.9	29.3	19.7	46.0	37.2	13.8	47.6	37.0	26.8
LOS by Move:	C	C	A	D	C	B	D	D	B	D	D	C
HCM2kAvgQ:	5	13	2	2	3	1	4	7	3	5	8	3

Note: Queue reported is the number of cars per lane.

Voices School
Morgan Hill, CA
Hexagon Transportation Consultants, Inc.

Level Of Service Computation Report
2000 HCM Operations (Future Volume Alternative)
Existing (PM)

Intersection #119: Butterfield Boulevard and Main Avenue

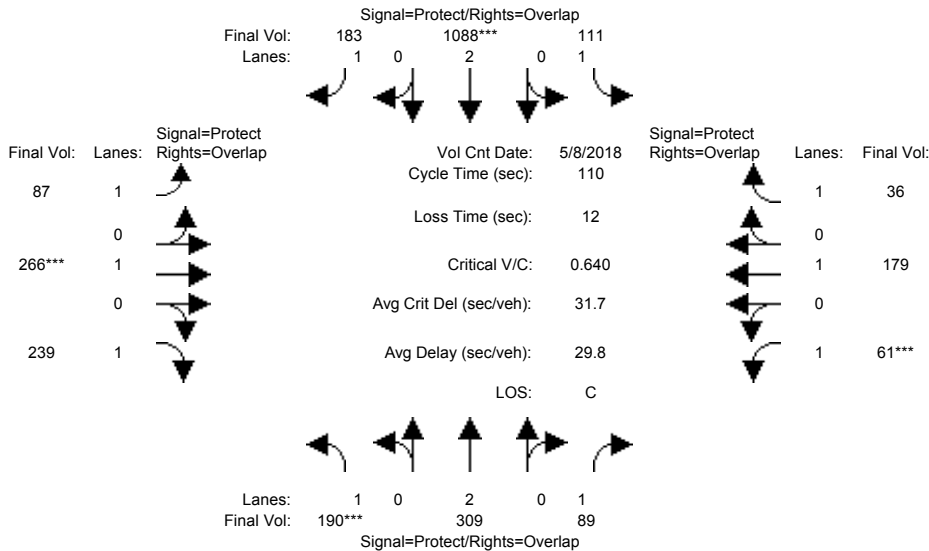

Street Name:	Butterfield Boulevard						Main Avenue					
	North Bound			South Bound			East Bound			West Bound		
Approach:	L	T	R	L	T	R	L	T	R	L	T	R
Min. Green:	7	10	10	7	10	10	7	10	10	7	10	10
Y+R:	4.0	4.0	4.0	4.0	4.0	4.0	4.0	4.0	4.0	4.0	4.0	4.0

Volume Module:	>>	Count	Date:	8 May 2018	<<							
Base Vol:	190	309	89	111	1088	183	87	266	239	61	179	36
Growth Adj:	1.00	1.00	1.00	1.00	1.00	1.00	1.00	1.00	1.00	1.00	1.00	1.00
Initial Bse:	190	309	89	111	1088	183	87	266	239	61	179	36
Added Vol:	0	0	0	0	0	0	0	0	0	0	0	0
PasserByVol:	0	0	0	0	0	0	0	0	0	0	0	0
Initial Fut:	190	309	89	111	1088	183	87	266	239	61	179	36
User Adj:	1.00	1.00	1.00	1.00	1.00	1.00	1.00	1.00	1.00	1.00	1.00	1.00
PHF Adj:	1.00	1.00	1.00	1.00	1.00	1.00	1.00	1.00	1.00	1.00	1.00	1.00
PHF Volume:	190	309	89	111	1088	183	87	266	239	61	179	36
Reduct Vol:	0	0	0	0	0	0	0	0	0	0	0	0
Reduced Vol:	190	309	89	111	1088	183	87	266	239	61	179	36
PCE Adj:	1.00	1.00	1.00	1.00	1.00	1.00	1.00	1.00	1.00	1.00	1.00	1.00
MLF Adj:	1.00	1.00	1.00	1.00	1.00	1.00	1.00	1.00	1.00	1.00	1.00	1.00
FinalVolume:	190	309	89	111	1088	183	87	266	239	61	179	36

Saturation Flow Module:												
Sat/Lane:	1900	1900	1900	1900	1900	1900	1900	1900	1900	1900	1900	1900
Adjustment:	0.92	1.00	0.92	0.92	1.00	0.92	0.92	1.00	0.92	0.92	1.00	0.92
Lanes:	1.00	2.00	1.00	1.00	2.00	1.00	1.00	1.00	1.00	1.00	1.00	1.00
Final Sat.:	1750	3800	1750	1750	3800	1750	1750	1900	1750	1750	1900	1750

Capacity Analysis Module:												
Vol/Sat:	0.11	0.08	0.05	0.06	0.29	0.10	0.05	0.14	0.14	0.03	0.09	0.02
Crit Moves:	***				***			***		***		
Green Time:	18.5	39.5	46.5	27.7	48.7	61.1	12.4	23.8	42.3	7.0	18.4	46.1
Volume/Cap:	0.65	0.23	0.12	0.25	0.65	0.19	0.44	0.65	0.36	0.55	0.56	0.05
Delay/Veh:	47.7	24.7	19.4	33.2	24.8	12.2	47.1	42.8	24.5	55.6	44.4	19.0
User DelAdj:	1.00	1.00	1.00	1.00	1.00	1.00	1.00	1.00	1.00	1.00	1.00	1.00
AdjDel/Veh:	47.7	24.7	19.4	33.2	24.8	12.2	47.1	42.8	24.5	55.6	44.4	19.0
LOS by Move:	D	C	B	C	C	B	D	D	C	E	D	B
HCM2kAvgQ:	8	4	2	3	15	3	3	8	6	3	6	1

Note: Queue reported is the number of cars per lane.

Voices School
Morgan Hill, CA
Hexagon Transportation Consultants, Inc.

Level Of Service Computation Report
2000 HCM Operations (Future Volume Alternative)
Existing Plus Project (AM) - 2 Cosmo Right out

Intersection #119: Butterfield Boulevard and Main Avenue

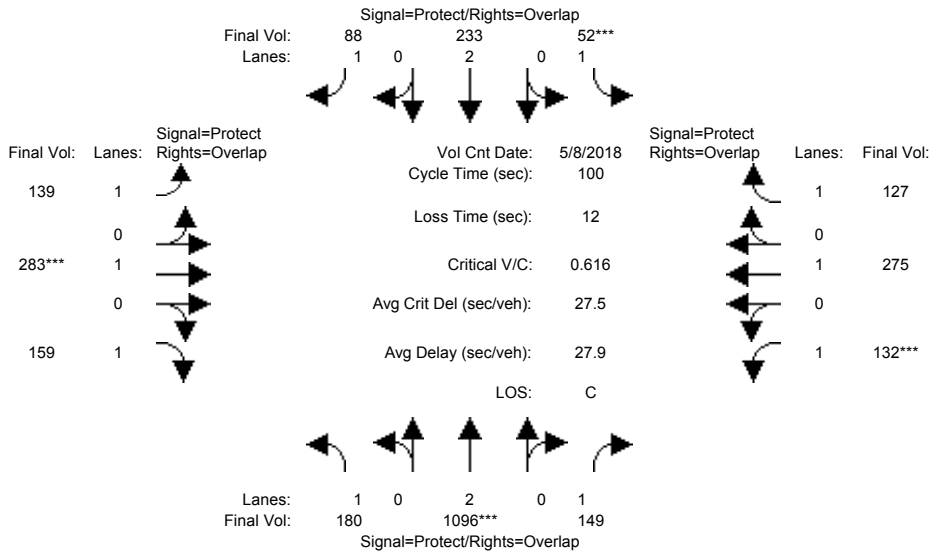

Street Name:	Butterfield Boulevard						Main Avenue					
	North Bound			South Bound			East Bound			West Bound		
Approach:	L	T	R	L	T	R	L	T	R	L	T	R
Min. Green:	7	10	10	7	10	10	7	10	10	7	10	10
Y+R:	4.0	4.0	4.0	4.0	4.0	4.0	4.0	4.0	4.0	4.0	4.0	4.0

Volume Module:	>>	Count	Date:	8 May 2018	<<							
Base Vol:	180	1082	149	52	226	68	134	278	159	132	262	127
Growth Adj:	1.00	1.00	1.00	1.00	1.00	1.00	1.00	1.00	1.00	1.00	1.00	1.00
Initial Bse:	180	1082	149	52	226	68	134	278	159	132	262	127
Added Vol:	0	14	0	0	7	20	5	5	0	0	13	0
PasserByVol:	0	0	0	0	0	0	0	0	0	0	0	0
Initial Fut:	180	1096	149	52	233	88	139	283	159	132	275	127
User Adj:	1.00	1.00	1.00	1.00	1.00	1.00	1.00	1.00	1.00	1.00	1.00	1.00
PHF Adj:	1.00	1.00	1.00	1.00	1.00	1.00	1.00	1.00	1.00	1.00	1.00	1.00
PHF Volume:	180	1096	149	52	233	88	139	283	159	132	275	127
Reduct Vol:	0	0	0	0	0	0	0	0	0	0	0	0
Reduced Vol:	180	1096	149	52	233	88	139	283	159	132	275	127
PCE Adj:	1.00	1.00	1.00	1.00	1.00	1.00	1.00	1.00	1.00	1.00	1.00	1.00
MLF Adj:	1.00	1.00	1.00	1.00	1.00	1.00	1.00	1.00	1.00	1.00	1.00	1.00
FinalVolume:	180	1096	149	52	233	88	139	283	159	132	275	127

Saturation Flow Module:												
Sat/Lane:	1900	1900	1900	1900	1900	1900	1900	1900	1900	1900	1900	1900
Adjustment:	0.92	1.00	0.92	0.92	1.00	0.92	0.92	1.00	0.92	0.92	1.00	0.92
Lanes:	1.00	2.00	1.00	1.00	2.00	1.00	1.00	1.00	1.00	1.00	1.00	1.00
Final Sat.:	1750	3800	1750	1750	3800	1750	1750	1900	1750	1750	1900	1750

Capacity Analysis Module:												
Vol/Sat:	0.10	0.29	0.09	0.03	0.06	0.05	0.08	0.15	0.09	0.08	0.14	0.07
Crit Moves:	****			****			****			****		
Green Time:	26.6	45.6	57.5	7.0	25.9	38.5	12.6	23.5	50.2	11.9	22.9	29.9
Volume/Cap:	0.39	0.63	0.15	0.42	0.24	0.13	0.63	0.63	0.18	0.63	0.63	0.24
Delay/Veh:	30.5	21.6	10.0	46.9	29.4	20.0	47.4	37.3	13.8	48.2	37.8	26.7
User DelAdj:	1.00	1.00	1.00	1.00	1.00	1.00	1.00	1.00	1.00	1.00	1.00	1.00
AdjDel/Veh:	30.5	21.6	10.0	46.9	29.4	20.0	47.4	37.3	13.8	48.2	37.8	26.7
LOS by Move:	C	C	A	D	C	C	D	D	B	D	D	C
HCM2kAvgQ:	5	13	2	2	3	2	4	8	3	5	8	3

Note: Queue reported is the number of cars per lane.

Voices School
Morgan Hill, CA
Hexagon Transportation Consultants, Inc.

Level Of Service Computation Report
2000 HCM Operations (Future Volume Alternative)
Existing Plus Project (PM) - 2 Cosmo Right out

Intersection #119: Butterfield Boulevard and Main Avenue

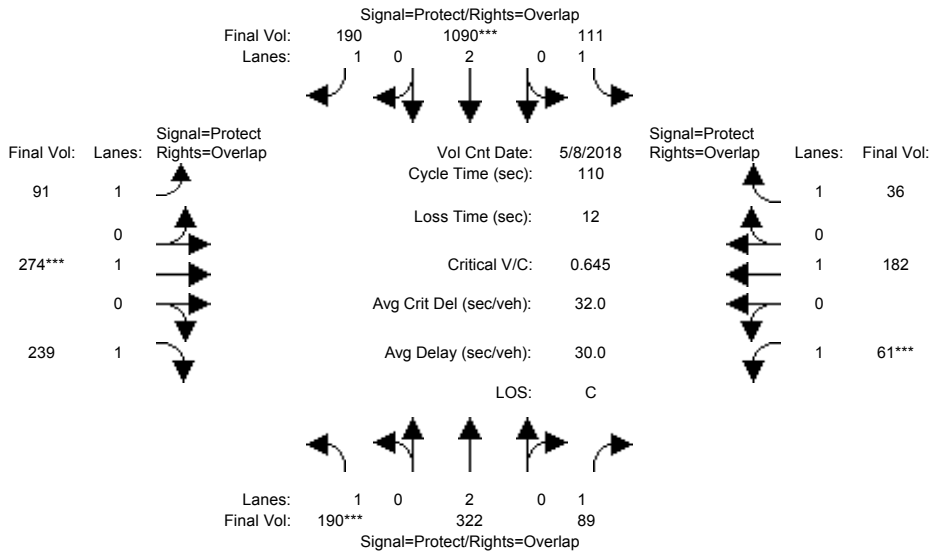

Street Name:	Butterfield Boulevard						Main Avenue					
	North Bound			South Bound			East Bound			West Bound		
Approach:	L	T	R	L	T	R	L	T	R	L	T	R
Min. Green:	7	10	10	7	10	10	7	10	10	7	10	10
Y+R:	4.0	4.0	4.0	4.0	4.0	4.0	4.0	4.0	4.0	4.0	4.0	4.0

Volume Module:	>>	Count	Date:	8 May 2018	<<							
Base Vol:	190	309	89	111	1088	183	87	266	239	61	179	36
Growth Adj:	1.00	1.00	1.00	1.00	1.00	1.00	1.00	1.00	1.00	1.00	1.00	1.00
Initial Bse:	190	309	89	111	1088	183	87	266	239	61	179	36
Added Vol:	0	13	0	0	2	7	4	8	0	0	3	0
PasserByVol:	0	0	0	0	0	0	0	0	0	0	0	0
Initial Fut:	190	322	89	111	1090	190	91	274	239	61	182	36
User Adj:	1.00	1.00	1.00	1.00	1.00	1.00	1.00	1.00	1.00	1.00	1.00	1.00
PHF Adj:	1.00	1.00	1.00	1.00	1.00	1.00	1.00	1.00	1.00	1.00	1.00	1.00
PHF Volume:	190	322	89	111	1090	190	91	274	239	61	182	36
Reduct Vol:	0	0	0	0	0	0	0	0	0	0	0	0
Reduced Vol:	190	322	89	111	1090	190	91	274	239	61	182	36
PCE Adj:	1.00	1.00	1.00	1.00	1.00	1.00	1.00	1.00	1.00	1.00	1.00	1.00
MLF Adj:	1.00	1.00	1.00	1.00	1.00	1.00	1.00	1.00	1.00	1.00	1.00	1.00
FinalVolume:	190	322	89	111	1090	190	91	274	239	61	182	36

Saturation Flow Module:												
Sat/Lane:	1900	1900	1900	1900	1900	1900	1900	1900	1900	1900	1900	1900
Adjustment:	0.92	1.00	0.92	0.92	1.00	0.92	0.92	1.00	0.92	0.92	1.00	0.92
Lanes:	1.00	2.00	1.00	1.00	2.00	1.00	1.00	1.00	1.00	1.00	1.00	1.00
Final Sat.:	1750	3800	1750	1750	3800	1750	1750	1900	1750	1750	1900	1750

Capacity Analysis Module:												
Vol/Sat:	0.11	0.08	0.05	0.06	0.29	0.11	0.05	0.14	0.14	0.03	0.10	0.02
Crit Moves:	****				****			****		****		
Green Time:	18.3	39.2	46.2	27.5	48.4	60.9	12.5	24.3	42.6	7.0	18.8	46.3
Volume/Cap:	0.65	0.24	0.12	0.25	0.65	0.20	0.46	0.65	0.35	0.55	0.56	0.05
Delay/Veh:	48.1	25.0	19.6	33.4	25.1	12.4	47.2	42.6	24.2	55.6	44.0	18.9
User DelAdj:	1.00	1.00	1.00	1.00	1.00	1.00	1.00	1.00	1.00	1.00	1.00	1.00
AdjDel/Veh:	48.1	25.0	19.6	33.4	25.1	12.4	47.2	42.6	24.2	55.6	44.0	18.9
LOS by Move:	D	C	B	C	C	B	D	D	C	E	D	B
HCM2kAvgQ:	8	4	2	3	15	3	3	8	6	3	6	1

Note: Queue reported is the number of cars per lane.

Voices School
Morgan Hill, CA
Hexagon Transportation Consultants, Inc.

Level Of Service Computation Report
2000 HCM Operations (Future Volume Alternative)
Existing (AM)

Intersection #122: Monterey Road and Dunne Avenue

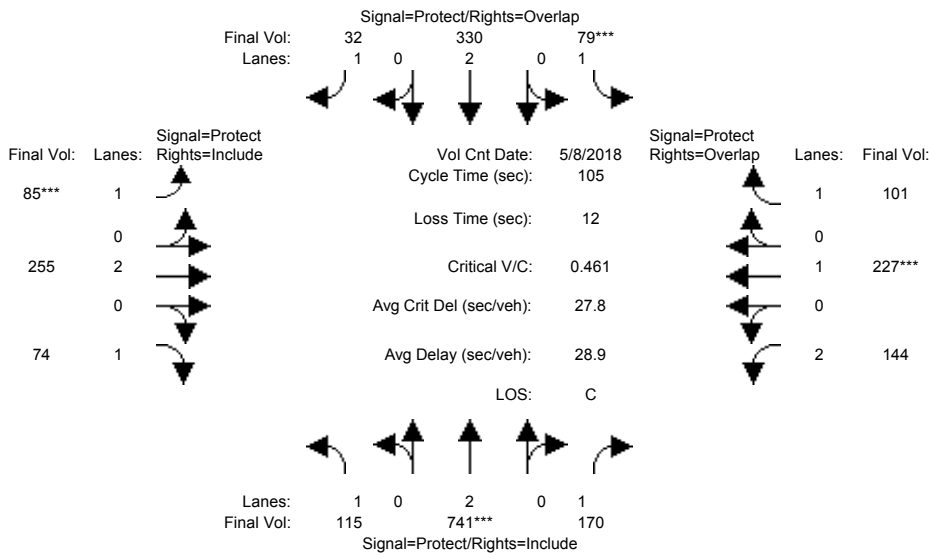

Street Name:	Monterey Road						Dunne Avenue					
	North Bound			South Bound			East Bound			West Bound		
Approach:	L	T	R	L	T	R	L	T	R	L	T	R
Min. Green:	7	10	10	7	10	10	7	10	10	7	10	10
Y+R:	4.0	4.0	4.0	4.0	4.0	4.0	4.0	4.0	4.0	4.0	4.0	4.0
Volume Module: >> Count Date: 8 May 2018 <<												
Base Vol:	115	741	170	79	330	32	85	255	74	144	227	101
Growth Adj:	1.00	1.00	1.00	1.00	1.00	1.00	1.00	1.00	1.00	1.00	1.00	1.00
Initial Bse:	115	741	170	79	330	32	85	255	74	144	227	101
Added Vol:	0	0	0	0	0	0	0	0	0	0	0	0
PasserByVol:	0	0	0	0	0	0	0	0	0	0	0	0
Initial Fut:	115	741	170	79	330	32	85	255	74	144	227	101
User Adj:	1.00	1.00	1.00	1.00	1.00	1.00	1.00	1.00	1.00	1.00	1.00	1.00
PHF Adj:	1.00	1.00	1.00	1.00	1.00	1.00	1.00	1.00	1.00	1.00	1.00	1.00
PHF Volume:	115	741	170	79	330	32	85	255	74	144	227	101
Reduct Vol:	0	0	0	0	0	0	0	0	0	0	0	0
Reduced Vol:	115	741	170	79	330	32	85	255	74	144	227	101
PCE Adj:	1.00	1.00	1.00	1.00	1.00	1.00	1.00	1.00	1.00	1.00	1.00	1.00
MLF Adj:	1.00	1.00	1.00	1.00	1.00	1.00	1.00	1.00	1.00	1.00	1.00	1.00
Final Volume:	115	741	170	79	330	32	85	255	74	144	227	101
Saturation Flow Module:												
Sat/Lane:	1900	1900	1900	1900	1900	1900	1900	1900	1900	1900	1900	1900
Adjustment:	0.92	1.00	0.92	0.92	1.00	0.92	0.92	1.00	0.92	0.83	1.00	0.92
Lanes:	1.00	2.00	1.00	1.00	2.00	1.00	1.00	2.00	1.00	2.00	1.00	1.00
Final Sat.:	1750	3800	1750	1750	3800	1750	1750	3800	1750	3150	1900	1750
Capacity Analysis Module:												
Vol/Sat:	0.07	0.20	0.10	0.05	0.09	0.02	0.05	0.07	0.04	0.05	0.12	0.06
Crit Moves:	****			****			****			****		
Green Time:	22.5	44.4	44.4	10.3	32.2	43.3	11.1	22.5	22.5	15.8	27.2	37.5
Volume/Cap:	0.31	0.46	0.23	0.46	0.28	0.04	0.46	0.31	0.20	0.30	0.46	0.16
Delay/Veh:	35.1	21.9	19.5	46.7	27.8	18.5	46.0	34.9	34.1	40.1	33.4	23.1
User DelAdj:	1.00	1.00	1.00	1.00	1.00	1.00	1.00	1.00	1.00	1.00	1.00	1.00
AdjDel/Veh:	35.1	21.9	19.5	46.7	27.8	18.5	46.0	34.9	34.1	40.1	33.4	23.1
LOS by Move:	D	C	B	D	C	B	D	C	C	D	C	C
HCM2kAvgQ:	3	8	4	3	4	1	3	4	2	2	6	2

Note: Queue reported is the number of cars per lane.

Voices School
Morgan Hill, CA
Hexagon Transportation Consultants, Inc.

Level Of Service Computation Report
2000 HCM Operations (Future Volume Alternative)
Existing (PM)

Intersection #122: Monterey Road and Dunne Avenue

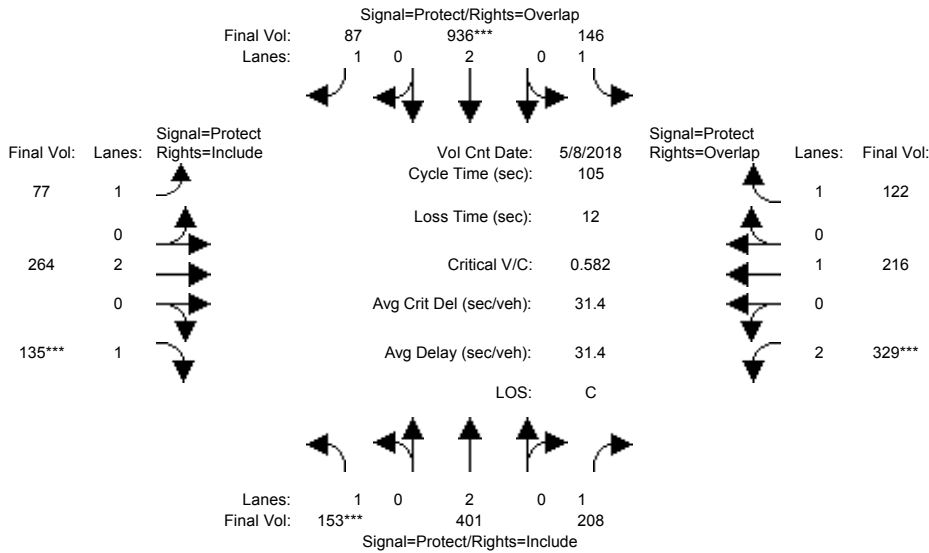

Street Name:	Monterey Road						Dunne Avenue					
	North Bound			South Bound			East Bound			West Bound		
Approach:	L	T	R	L	T	R	L	T	R	L	T	R
Min. Green:	7	10	10	7	10	10	7	10	10	7	10	10
Y+R:	4.0	4.0	4.0	4.0	4.0	4.0	4.0	4.0	4.0	4.0	4.0	4.0

Volume Module:	>>	Count	Date:	8 May 2018	<<							
Base Vol:	153	401	208	146	936	87	77	264	135	329	216	122
Growth Adj:	1.00	1.00	1.00	1.00	1.00	1.00	1.00	1.00	1.00	1.00	1.00	1.00
Initial Bse:	153	401	208	146	936	87	77	264	135	329	216	122
Added Vol:	0	0	0	0	0	0	0	0	0	0	0	0
PasserByVol:	0	0	0	0	0	0	0	0	0	0	0	0
Initial Fut:	153	401	208	146	936	87	77	264	135	329	216	122
User Adj:	1.00	1.00	1.00	1.00	1.00	1.00	1.00	1.00	1.00	1.00	1.00	1.00
PHF Adj:	1.00	1.00	1.00	1.00	1.00	1.00	1.00	1.00	1.00	1.00	1.00	1.00
PHF Volume:	153	401	208	146	936	87	77	264	135	329	216	122
Reduct Vol:	0	0	0	0	0	0	0	0	0	0	0	0
Reduced Vol:	153	401	208	146	936	87	77	264	135	329	216	122
PCE Adj:	1.00	1.00	1.00	1.00	1.00	1.00	1.00	1.00	1.00	1.00	1.00	1.00
MLF Adj:	1.00	1.00	1.00	1.00	1.00	1.00	1.00	1.00	1.00	1.00	1.00	1.00
FinalVolume:	153	401	208	146	936	87	77	264	135	329	216	122

Saturation Flow Module:												
Sat/Lane:	1900	1900	1900	1900	1900	1900	1900	1900	1900	1900	1900	1900
Adjustment:	0.92	1.00	0.92	0.92	1.00	0.92	0.92	1.00	0.92	0.83	1.00	0.92
Lanes:	1.00	2.00	1.00	1.00	2.00	1.00	1.00	2.00	1.00	2.00	1.00	1.00
Final Sat.:	1750	3800	1750	1750	3800	1750	1750	3800	1750	3150	1900	1750

Capacity Analysis Module:												
Vol/Sat:	0.09	0.11	0.12	0.08	0.25	0.05	0.04	0.07	0.08	0.10	0.11	0.07
Crit Moves:	****				****				****	****		
Green Time:	15.8	35.4	35.4	24.8	44.5	56.6	12.1	13.9	13.9	18.8	20.7	45.5
Volume/Cap:	0.58	0.31	0.35	0.35	0.58	0.09	0.38	0.52	0.58	0.58	0.58	0.16
Delay/Veh:	44.8	25.9	26.6	33.9	23.7	11.8	44.2	43.5	46.5	41.0	40.5	18.2
User DelAdj:	1.00	1.00	1.00	1.00	1.00	1.00	1.00	1.00	1.00	1.00	1.00	1.00
AdjDel/Veh:	44.8	25.9	26.6	33.9	23.7	11.8	44.2	43.5	46.5	41.0	40.5	18.2
LOS by Move:	D	C	C	C	C	B	D	D	D	D	D	B
HCM2kAvgQ:	5	5	5	4	11	1	3	5	5	6	6	2

Note: Queue reported is the number of cars per lane.

Voices School
Morgan Hill, CA
Hexagon Transportation Consultants, Inc.

Level Of Service Computation Report
2000 HCM Operations (Future Volume Alternative)
Existing Plus Project (AM) - 2 Cosmo Right out

Intersection #122: Monterey Road and Dunne Avenue

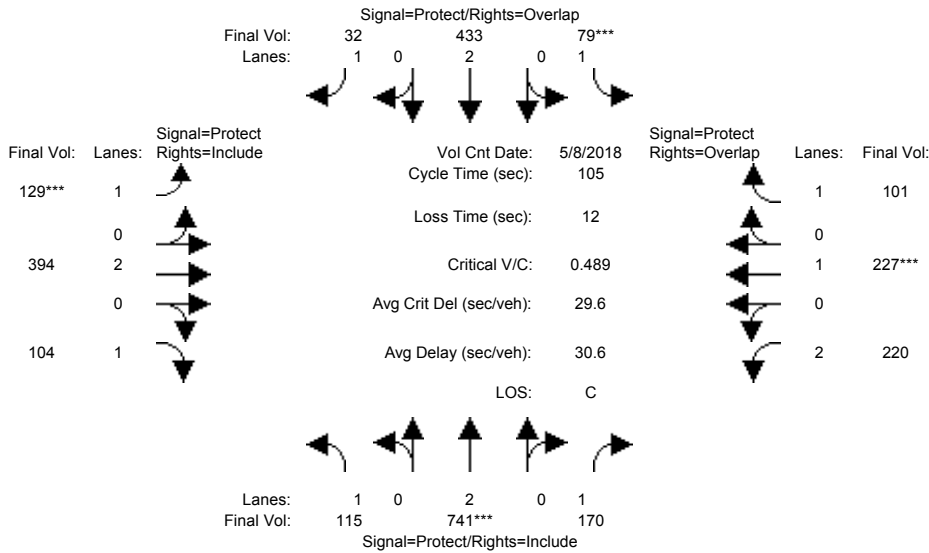

Street Name:	Monterey Road						Dunne Avenue					
	North Bound			South Bound			East Bound			West Bound		
Approach:	L	T	R	L	T	R	L	T	R	L	T	R
Min. Green:	7	10	10	7	10	10	7	10	10	7	10	10
Y+R:	4.0	4.0	4.0	4.0	4.0	4.0	4.0	4.0	4.0	4.0	4.0	4.0

Volume Module:	>>	Count	Date:	8 May 2018	<<							
Base Vol:	115	741	170	79	330	32	85	255	74	144	227	101
Growth Adj:	1.00	1.00	1.00	1.00	1.00	1.00	1.00	1.00	1.00	1.00	1.00	1.00
Initial Bse:	115	741	170	79	330	32	85	255	74	144	227	101
Added Vol:	0	0	0	0	103	0	44	139	30	76	0	0
PasserByVol:	0	0	0	0	0	0	0	0	0	0	0	0
Initial Fut:	115	741	170	79	433	32	129	394	104	220	227	101
User Adj:	1.00	1.00	1.00	1.00	1.00	1.00	1.00	1.00	1.00	1.00	1.00	1.00
PHF Adj:	1.00	1.00	1.00	1.00	1.00	1.00	1.00	1.00	1.00	1.00	1.00	1.00
PHF Volume:	115	741	170	79	433	32	129	394	104	220	227	101
Reduct Vol:	0	0	0	0	0	0	0	0	0	0	0	0
Reduced Vol:	115	741	170	79	433	32	129	394	104	220	227	101
PCE Adj:	1.00	1.00	1.00	1.00	1.00	1.00	1.00	1.00	1.00	1.00	1.00	1.00
MLF Adj:	1.00	1.00	1.00	1.00	1.00	1.00	1.00	1.00	1.00	1.00	1.00	1.00
FinalVolume:	115	741	170	79	433	32	129	394	104	220	227	101

Saturation Flow Module:												
Sat/Lane:	1900	1900	1900	1900	1900	1900	1900	1900	1900	1900	1900	1900
Adjustment:	0.92	1.00	0.92	0.92	1.00	0.92	0.92	1.00	0.92	0.83	1.00	0.92
Lanes:	1.00	2.00	1.00	1.00	2.00	1.00	1.00	2.00	1.00	2.00	1.00	1.00
Final Sat.:	1750	3800	1750	1750	3800	1750	1750	3800	1750	3150	1900	1750

Capacity Analysis Module:												
Vol/Sat:	0.07	0.20	0.10	0.05	0.11	0.02	0.07	0.10	0.06	0.07	0.12	0.06
Crit Moves:	****			****			****			****		
Green Time:	19.0	41.9	41.9	9.7	32.5	48.3	15.8	24.8	24.8	16.7	25.6	35.3
Volume/Cap:	0.36	0.49	0.24	0.49	0.37	0.04	0.49	0.44	0.25	0.44	0.49	0.17
Delay/Veh:	38.4	23.8	21.2	47.6	28.4	15.6	42.3	34.5	32.9	40.5	34.9	24.7
User DelAdj:	1.00	1.00	1.00	1.00	1.00	1.00	1.00	1.00	1.00	1.00	1.00	1.00
AdjDel/Veh:	38.4	23.8	21.2	47.6	28.4	15.6	42.3	34.5	32.9	40.5	34.9	24.7
LOS by Move:	D	C	C	D	C	B	D	C	C	D	C	C
HCM2kAvgQ:	3	9	4	3	5	1	5	6	3	4	6	2

Note: Queue reported is the number of cars per lane.

Voices School
Morgan Hill, CA
Hexagon Transportation Consultants, Inc.

Level Of Service Computation Report
2000 HCM Operations (Future Volume Alternative)
Existing Plus Project (PM) - 2 Cosmo Right out

Intersection #122: Monterey Road and Dunne Avenue

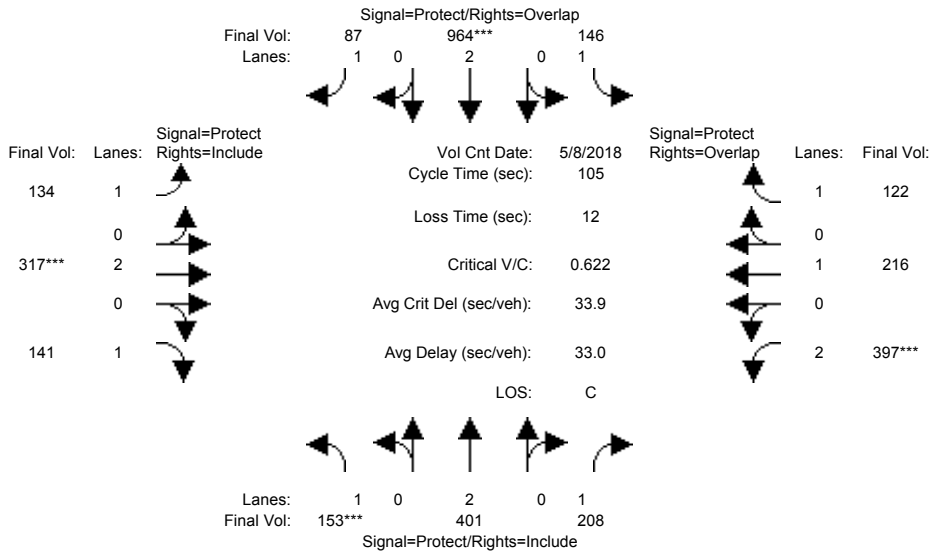

Street Name:	Monterey Road						Dunne Avenue					
	North Bound			South Bound			East Bound			West Bound		
Approach:	L	T	R	L	T	R	L	T	R	L	T	R
Min. Green:	7	10	10	7	10	10	7	10	10	7	10	10
Y+R:	4.0	4.0	4.0	4.0	4.0	4.0	4.0	4.0	4.0	4.0	4.0	4.0

Volume Module:	>>	Count	Date:	8 May 2018	<<							
Base Vol:	153	401	208	146	936	87	77	264	135	329	216	122
Growth Adj:	1.00	1.00	1.00	1.00	1.00	1.00	1.00	1.00	1.00	1.00	1.00	1.00
Initial Bse:	153	401	208	146	936	87	77	264	135	329	216	122
Added Vol:	0	0	0	0	28	0	57	53	6	68	0	0
PasserByVol:	0	0	0	0	0	0	0	0	0	0	0	0
Initial Fut:	153	401	208	146	964	87	134	317	141	397	216	122
User Adj:	1.00	1.00	1.00	1.00	1.00	1.00	1.00	1.00	1.00	1.00	1.00	1.00
PHF Adj:	1.00	1.00	1.00	1.00	1.00	1.00	1.00	1.00	1.00	1.00	1.00	1.00
PHF Volume:	153	401	208	146	964	87	134	317	141	397	216	122
Reduct Vol:	0	0	0	0	0	0	0	0	0	0	0	0
Reduced Vol:	153	401	208	146	964	87	134	317	141	397	216	122
PCE Adj:	1.00	1.00	1.00	1.00	1.00	1.00	1.00	1.00	1.00	1.00	1.00	1.00
MLF Adj:	1.00	1.00	1.00	1.00	1.00	1.00	1.00	1.00	1.00	1.00	1.00	1.00
FinalVolume:	153	401	208	146	964	87	134	317	141	397	216	122

Saturation Flow Module:												
Sat/Lane:	1900	1900	1900	1900	1900	1900	1900	1900	1900	1900	1900	1900
Adjustment:	0.92	1.00	0.92	0.92	1.00	0.92	0.92	1.00	0.92	0.83	1.00	0.92
Lanes:	1.00	2.00	1.00	1.00	2.00	1.00	1.00	2.00	1.00	2.00	1.00	1.00
Final Sat.:	1750	3800	1750	1750	3800	1750	1750	3800	1750	3150	1900	1750

Capacity Analysis Module:												
Vol/Sat:	0.09	0.11	0.12	0.08	0.25	0.05	0.08	0.08	0.08	0.13	0.11	0.07
Crit Moves:	***				***			***		***		
Green Time:	14.8	33.9	33.9	23.8	42.9	57.1	14.2	14.1	14.1	21.3	21.1	44.9
Volume/Cap:	0.62	0.33	0.37	0.37	0.62	0.09	0.56	0.62	0.60	0.62	0.56	0.16
Delay/Veh:	47.3	27.1	27.8	34.9	25.4	11.5	45.6	45.3	47.1	40.1	39.7	18.6
User DelAdj:	1.00	1.00	1.00	1.00	1.00	1.00	1.00	1.00	1.00	1.00	1.00	1.00
AdjDel/Veh:	47.3	27.1	27.8	34.9	25.4	11.5	45.6	45.3	47.1	40.1	39.7	18.6
LOS by Move:	D	C	C	C	C	B	D	D	D	D	D	B
HCM2kAvgQ:	5	5	5	4	12	1	5	6	6	7	6	2

Note: Queue reported is the number of cars per lane.

Voices School
Morgan Hill, CA
Hexagon Transportation Consultants, Inc.

Level Of Service Computation Report
2000 HCM Operations (Future Volume Alternative)
Existing (AM)

Intersection #123: Butterfield Boulevard and Dunne Avenue

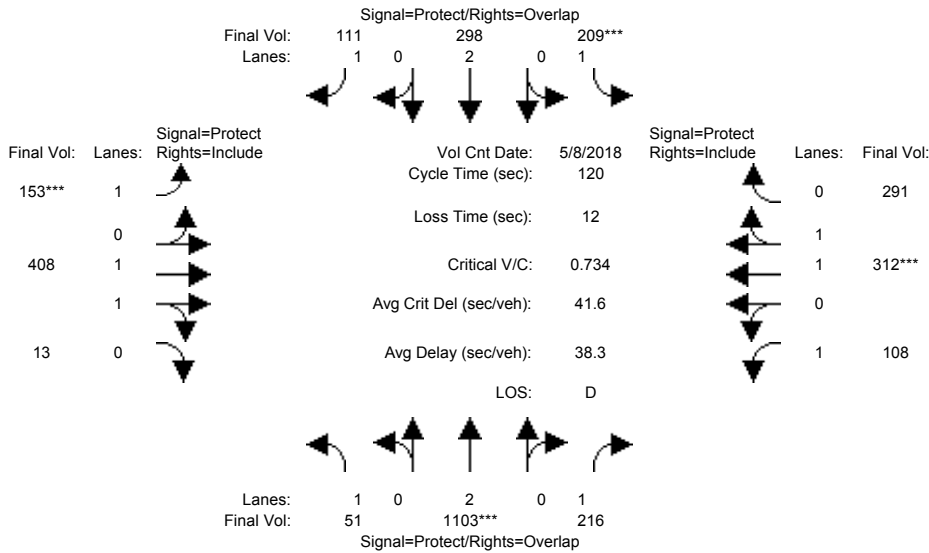

Street Name:	Butterfield Boulevard						Dunne Avenue					
	North Bound			South Bound			East Bound			West Bound		
Approach:	L	T	R	L	T	R	L	T	R	L	T	R
Min. Green:	7	10	10	7	10	10	7	10	10	7	10	10
Y+R:	4.0	4.0	4.0	4.0	4.0	4.0	4.0	4.0	4.0	4.0	4.0	4.0

Volume Module:	>>	Count	Date:	8 May 2018	<<							
Base Vol:	51	1103	216	209	298	111	153	408	13	108	312	291
Growth Adj:	1.00	1.00	1.00	1.00	1.00	1.00	1.00	1.00	1.00	1.00	1.00	1.00
Initial Bse:	51	1103	216	209	298	111	153	408	13	108	312	291
Added Vol:	0	0	0	0	0	0	0	0	0	0	0	0
PasserByVol:	0	0	0	0	0	0	0	0	0	0	0	0
Initial Fut:	51	1103	216	209	298	111	153	408	13	108	312	291
User Adj:	1.00	1.00	1.00	1.00	1.00	1.00	1.00	1.00	1.00	1.00	1.00	1.00
PHF Adj:	1.00	1.00	1.00	1.00	1.00	1.00	1.00	1.00	1.00	1.00	1.00	1.00
PHF Volume:	51	1103	216	209	298	111	153	408	13	108	312	291
Reduct Vol:	0	0	0	0	0	0	0	0	0	0	0	0
Reduced Vol:	51	1103	216	209	298	111	153	408	13	108	312	291
PCE Adj:	1.00	1.00	1.00	1.00	1.00	1.00	1.00	1.00	1.00	1.00	1.00	1.00
MLF Adj:	1.00	1.00	1.00	1.00	1.00	1.00	1.00	1.00	1.00	1.00	1.00	1.00
Final Volume:	51	1103	216	209	298	111	153	408	13	108	312	291

Saturation Flow Module:												
Sat/Lane:	1900	1900	1900	1900	1900	1900	1900	1900	1900	1900	1900	1900
Adjustment:	0.92	1.00	0.92	0.92	1.00	0.92	0.92	0.97	0.95	0.92	1.00	0.95
Lanes:	1.00	2.00	1.00	1.00	2.00	1.00	1.00	1.94	0.06	1.00	1.01	0.99
Final Sat.:	1750	3800	1750	1750	3800	1750	1750	3586	114	1750	1913	1784

Capacity Analysis Module:												
Vol/Sat:	0.03	0.29	0.12	0.12	0.08	0.06	0.09	0.11	0.11	0.06	0.16	0.16
Crit Moves:	****			****			****			****		
Green Time:	27.6	47.5	61.9	19.5	39.4	53.7	14.3	26.6	26.6	14.4	26.7	26.7
Volume/Cap:	0.13	0.73	0.24	0.73	0.24	0.14	0.73	0.51	0.51	0.51	0.73	0.73
Delay/Veh:	36.8	32.8	16.2	57.2	29.5	19.6	63.6	41.6	41.6	51.7	46.8	46.8
User DelAdj:	1.00	1.00	1.00	1.00	1.00	1.00	1.00	1.00	1.00	1.00	1.00	1.00
AdjDel/Veh:	36.8	32.8	16.2	57.2	29.5	19.6	63.6	41.6	41.6	51.7	46.8	46.8
LOS by Move:	D	C	B	E	C	B	E	D	D	D	D	D
HCM2kAvgQ:	2	17	5	9	4	3	6	7	7	4	11	11

Note: Queue reported is the number of cars per lane.

Voices School
Morgan Hill, CA
Hexagon Transportation Consultants, Inc.

Level Of Service Computation Report
2000 HCM Operations (Future Volume Alternative)
Existing (PM)

Intersection #123: Butterfield Boulevard and Dunne Avenue

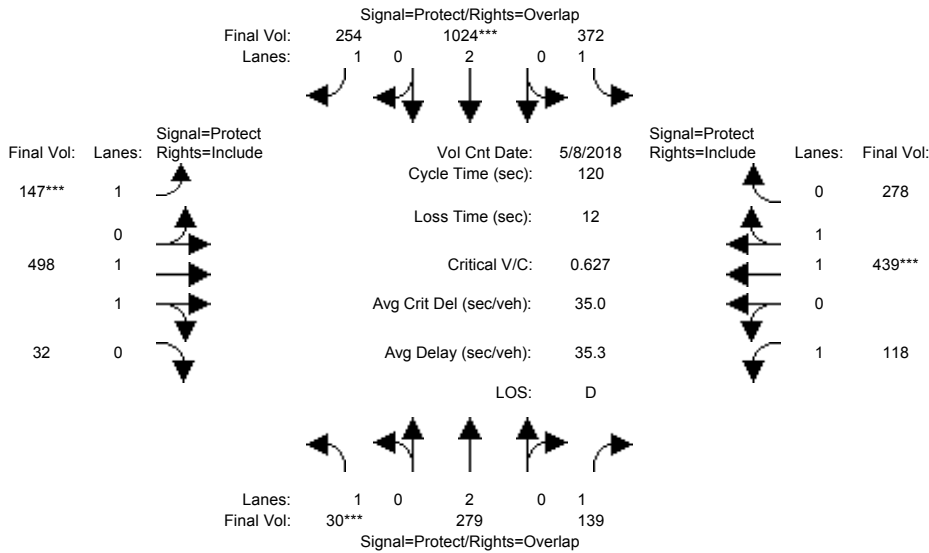

Street Name:	Butterfield Boulevard						Dunne Avenue					
	North Bound			South Bound			East Bound			West Bound		
Approach:	L	T	R	L	T	R	L	T	R	L	T	R
Min. Green:	7	10	10	7	10	10	7	10	10	7	10	10
Y+R:	4.0	4.0	4.0	4.0	4.0	4.0	4.0	4.0	4.0	4.0	4.0	4.0

Volume Module:	>>	Count	Date:	8 May 2018	<<							
Base Vol:	30	279	139	372	1024	254	147	498	32	118	439	278
Growth Adj:	1.00	1.00	1.00	1.00	1.00	1.00	1.00	1.00	1.00	1.00	1.00	1.00
Initial Bse:	30	279	139	372	1024	254	147	498	32	118	439	278
Added Vol:	0	0	0	0	0	0	0	0	0	0	0	0
PasserByVol:	0	0	0	0	0	0	0	0	0	0	0	0
Initial Fut:	30	279	139	372	1024	254	147	498	32	118	439	278
User Adj:	1.00	1.00	1.00	1.00	1.00	1.00	1.00	1.00	1.00	1.00	1.00	1.00
PHF Adj:	1.00	1.00	1.00	1.00	1.00	1.00	1.00	1.00	1.00	1.00	1.00	1.00
PHF Volume:	30	279	139	372	1024	254	147	498	32	118	439	278
Reduct Vol:	0	0	0	0	0	0	0	0	0	0	0	0
Reduced Vol:	30	279	139	372	1024	254	147	498	32	118	439	278
PCE Adj:	1.00	1.00	1.00	1.00	1.00	1.00	1.00	1.00	1.00	1.00	1.00	1.00
MLF Adj:	1.00	1.00	1.00	1.00	1.00	1.00	1.00	1.00	1.00	1.00	1.00	1.00
Final Volume:	30	279	139	372	1024	254	147	498	32	118	439	278

Saturation Flow Module:												
Sat/Lane:	1900	1900	1900	1900	1900	1900	1900	1900	1900	1900	1900	1900
Adjustment:	0.92	1.00	0.92	0.92	1.00	0.92	0.92	0.98	0.95	0.92	0.99	0.95
Lanes:	1.00	2.00	1.00	1.00	2.00	1.00	1.00	1.88	0.12	1.00	1.20	0.80
Final Sat.:	1750	3800	1750	1750	3800	1750	1750	3476	223	1750	2264	1434

Capacity Analysis Module:												
Vol/Sat:	0.02	0.07	0.08	0.21	0.27	0.15	0.08	0.14	0.14	0.07	0.19	0.19
Crit Moves:	****				****		****				****	
Green Time:	7.0	16.0	32.4	40.7	49.7	65.2	15.5	34.9	34.9	16.4	35.8	35.8
Volume/Cap:	0.29	0.55	0.29	0.63	0.65	0.27	0.65	0.49	0.49	0.49	0.65	0.65
Delay/Veh:	55.7	50.0	35.1	35.3	29.1	14.8	56.2	35.6	35.6	49.5	38.1	38.1
User DelAdj:	1.00	1.00	1.00	1.00	1.00	1.00	1.00	1.00	1.00	1.00	1.00	1.00
AdjDel/Veh:	55.7	50.0	35.1	35.3	29.1	14.8	56.2	35.6	35.6	49.5	38.1	38.1
LOS by Move:	E	D	D	D	C	B	E	D	D	D	D	D
HCM2kAvgQ:	1	5	4	13	15	5	6	8	8	4	12	12

Note: Queue reported is the number of cars per lane.

Voices School
Morgan Hill, CA
Hexagon Transportation Consultants, Inc.

Level Of Service Computation Report
2000 HCM Operations (Future Volume Alternative)
Existing Plus Project (AM) - 2 Cosmo Right out

Intersection #123: Butterfield Boulevard and Dunne Avenue

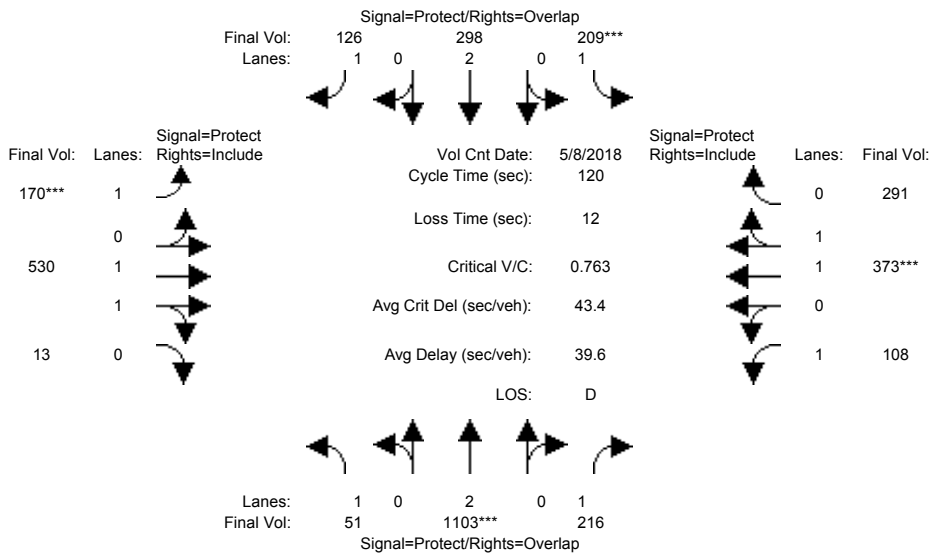

Street Name:	Butterfield Boulevard						Dunne Avenue					
	North Bound			South Bound			East Bound			West Bound		
Approach:	L	T	R	L	T	R	L	T	R	L	T	R
Min. Green:	7	10	10	7	10	10	7	10	10	7	10	10
Y+R:	4.0	4.0	4.0	4.0	4.0	4.0	4.0	4.0	4.0	4.0	4.0	4.0

Volume Module:	>>	Count	Date:	8 May 2018	<<											
Base Vol:	51	1103	216	209	298	111	153	408	13	108	312	291				
Growth Adj:	1.00	1.00	1.00	1.00	1.00	1.00	1.00	1.00	1.00	1.00	1.00	1.00				
Initial Bse:	51	1103	216	209	298	111	153	408	13	108	312	291				
Added Vol:	0	0	0	0	0	15	17	122	0	0	61	0				
PasserByVol:	0	0	0	0	0	0	0	0	0	0	0	0				
Initial Fut:	51	1103	216	209	298	126	170	530	13	108	373	291				
User Adj:	1.00	1.00	1.00	1.00	1.00	1.00	1.00	1.00	1.00	1.00	1.00	1.00				
PHF Adj:	1.00	1.00	1.00	1.00	1.00	1.00	1.00	1.00	1.00	1.00	1.00	1.00				
PHF Volume:	51	1103	216	209	298	126	170	530	13	108	373	291				
Reduct Vol:	0	0	0	0	0	0	0	0	0	0	0	0				
Reduced Vol:	51	1103	216	209	298	126	170	530	13	108	373	291				
PCE Adj:	1.00	1.00	1.00	1.00	1.00	1.00	1.00	1.00	1.00	1.00	1.00	1.00				
MLF Adj:	1.00	1.00	1.00	1.00	1.00	1.00	1.00	1.00	1.00	1.00	1.00	1.00				
FinalVolume:	51	1103	216	209	298	126	170	530	13	108	373	291				

Saturation Flow Module:												
Sat/Lane:	1900	1900	1900	1900	1900	1900	1900	1900	1900	1900	1900	1900
Adjustment:	0.92	1.00	0.92	0.92	1.00	0.92	0.92	0.97	0.95	0.92	0.99	0.95
Lanes:	1.00	2.00	1.00	1.00	2.00	1.00	1.00	1.95	0.05	1.00	1.10	0.90
Final Sat.:	1750	3800	1750	1750	3800	1750	1750	3611	89	1750	2077	1621

Capacity Analysis Module:												
Vol/Sat:	0.03	0.29	0.12	0.12	0.08	0.07	0.10	0.15	0.15	0.06	0.18	0.18
Crit Moves:	****			****			****			****		
Green Time:	26.5	45.7	58.6	18.8	37.9	53.2	15.3	30.6	30.6	12.9	28.3	28.3
Volume/Cap:	0.13	0.76	0.25	0.76	0.25	0.16	0.76	0.57	0.57	0.57	0.76	0.76
Delay/Veh:	37.6	34.9	18.1	60.4	30.6	20.1	65.0	39.9	39.9	55.2	46.8	46.8
User DelAdj:	1.00	1.00	1.00	1.00	1.00	1.00	1.00	1.00	1.00	1.00	1.00	1.00
AdjDel/Veh:	37.6	34.9	18.1	60.4	30.6	20.1	65.0	39.9	39.9	55.2	46.8	46.8
LOS by Move:	D	C	B	E	C	C	E	D	D	E	D	D
HCM2kAvgQ:	2	18	5	10	4	3	7	9	9	4	12	12

Note: Queue reported is the number of cars per lane.

Voices School
Morgan Hill, CA
Hexagon Transportation Consultants, Inc.

Level Of Service Computation Report
2000 HCM Operations (Future Volume Alternative)
Existing Plus Project (PM) - 2 Cosmo Right out

Intersection #123: Butterfield Boulevard and Dunne Avenue

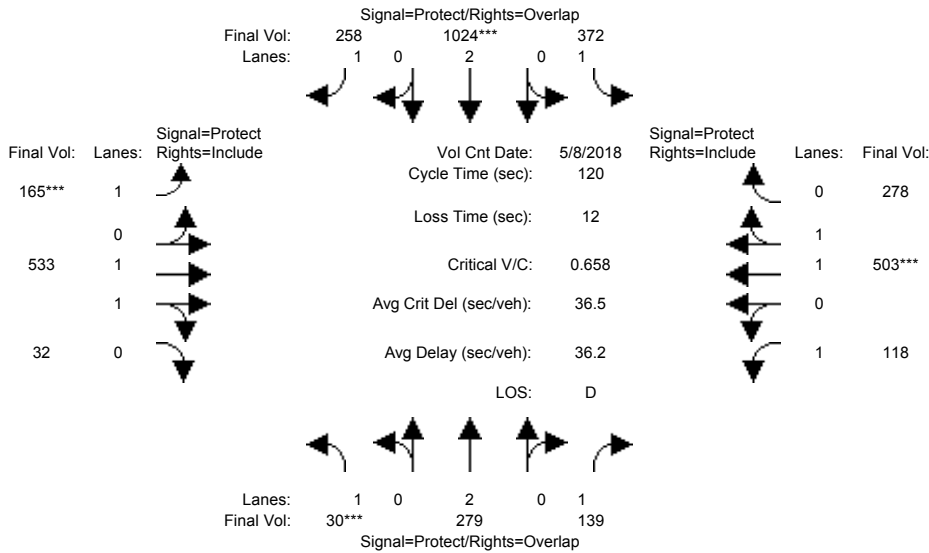

Street Name:	Butterfield Boulevard						Dunne Avenue					
	North Bound			South Bound			East Bound			West Bound		
Approach:	L	T	R	L	T	R	L	T	R	L	T	R
Min. Green:	7	10	10	7	10	10	7	10	10	7	10	10
Y+R:	4.0	4.0	4.0	4.0	4.0	4.0	4.0	4.0	4.0	4.0	4.0	4.0

Volume Module:	>>	Count	Date:	8 May 2018	<<							
Base Vol:	30	279	139	372	1024	254	147	498	32	118	439	278
Growth Adj:	1.00	1.00	1.00	1.00	1.00	1.00	1.00	1.00	1.00	1.00	1.00	1.00
Initial Bse:	30	279	139	372	1024	254	147	498	32	118	439	278
Added Vol:	0	0	0	0	0	4	18	35	0	0	64	0
PasserByVol:	0	0	0	0	0	0	0	0	0	0	0	0
Initial Fut:	30	279	139	372	1024	258	165	533	32	118	503	278
User Adj:	1.00	1.00	1.00	1.00	1.00	1.00	1.00	1.00	1.00	1.00	1.00	1.00
PHF Adj:	1.00	1.00	1.00	1.00	1.00	1.00	1.00	1.00	1.00	1.00	1.00	1.00
PHF Volume:	30	279	139	372	1024	258	165	533	32	118	503	278
Reduct Vol:	0	0	0	0	0	0	0	0	0	0	0	0
Reduced Vol:	30	279	139	372	1024	258	165	533	32	118	503	278
PCE Adj:	1.00	1.00	1.00	1.00	1.00	1.00	1.00	1.00	1.00	1.00	1.00	1.00
MLF Adj:	1.00	1.00	1.00	1.00	1.00	1.00	1.00	1.00	1.00	1.00	1.00	1.00
FinalVolume:	30	279	139	372	1024	258	165	533	32	118	503	278

Saturation Flow Module:												
Sat/Lane:	1900	1900	1900	1900	1900	1900	1900	1900	1900	1900	1900	1900
Adjustment:	0.92	1.00	0.92	0.92	1.00	0.92	0.92	0.98	0.95	0.92	0.99	0.95
Lanes:	1.00	2.00	1.00	1.00	2.00	1.00	1.00	1.88	0.12	1.00	1.27	0.73
Final Sat.:	1750	3800	1750	1750	3800	1750	1750	3490	210	1750	2382	1316

Capacity Analysis Module:												
Vol/Sat:	0.02	0.07	0.08	0.21	0.27	0.15	0.09	0.15	0.15	0.07	0.21	0.21
Crit Moves:	****			****			****			****		
Green Time:	7.0	15.3	31.7	39.0	47.3	63.9	16.6	37.2	37.2	16.4	37.1	37.1
Volume/Cap:	0.29	0.58	0.30	0.65	0.68	0.28	0.68	0.49	0.49	0.49	0.68	0.68
Delay/Veh:	55.7	51.0	35.6	37.4	31.4	15.5	57.0	34.0	34.0	49.5	38.0	38.0
User DelAdj:	1.00	1.00	1.00	1.00	1.00	1.00	1.00	1.00	1.00	1.00	1.00	1.00
AdjDel/Veh:	55.7	51.0	35.6	37.4	31.4	15.5	57.0	34.0	34.0	49.5	38.0	38.0
LOS by Move:	E	D	D	D	C	B	E	C	C	D	D	D
HCM2kAvgQ:	1	5	4	13	16	6	6	8	8	4	13	13

Note: Queue reported is the number of cars per lane.

Voices School
Morgan Hill, CA
Hexagon Transportation Consultants, Inc.

Level Of Service Computation Report
2000 HCM Operations (Future Volume Alternative)
Existing (AM)

Intersection #124: US 101 Southbound Ramps and Dunne Avenue

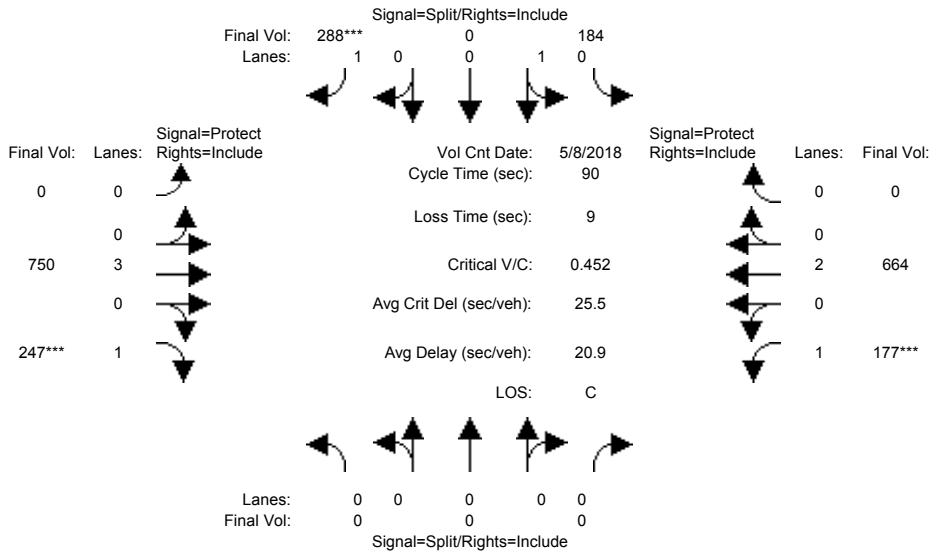

Street Name:	US 101 Southbound Ramps						Dunne Avenue					
Approach:	North Bound			South Bound			East Bound			West Bound		
Movement:	L	T	R	L	T	R	L	T	R	L	T	R
Min. Green:	0	0	0	10	10	10	0	10	10	7	10	0
Y+R:	4.0	4.0	4.0	4.0	4.0	4.0	4.0	4.0	4.0	4.0	4.0	4.0
Volume Module: >> Count Date:	8 May 2018 <<											
Base Vol:	0	0	0	184	0	288	0	750	247	177	664	0
Growth Adj:	1.00	1.00	1.00	1.00	1.00	1.00	1.00	1.00	1.00	1.00	1.00	1.00
Initial Bse:	0	0	0	184	0	288	0	750	247	177	664	0
Added Vol:	0	0	0	0	0	0	0	0	0	0	0	0
PasserByVol:	0	0	0	0	0	0	0	0	0	0	0	0
Initial Fut:	0	0	0	184	0	288	0	750	247	177	664	0
User Adj:	1.00	1.00	1.00	1.00	1.00	1.00	1.00	1.00	1.00	1.00	1.00	1.00
PHF Adj:	1.00	1.00	1.00	1.00	1.00	1.00	1.00	1.00	1.00	1.00	1.00	1.00
PHF Volume:	0	0	0	184	0	288	0	750	247	177	664	0
Reduct Vol:	0	0	0	0	0	0	0	0	0	0	0	0
Reduced Vol:	0	0	0	184	0	288	0	750	247	177	664	0
PCE Adj:	1.00	1.00	1.00	1.00	1.00	1.00	1.00	1.00	1.00	1.00	1.00	1.00
MLF Adj:	1.00	1.00	1.00	1.00	1.00	1.00	1.00	1.00	1.00	1.00	1.00	1.00
FinalVolume:	0	0	0	184	0	288	0	750	247	177	664	0
Saturation Flow Module:												
Sat/Lane:	1900	1900	1900	1900	1900	1900	1900	1900	1900	1900	1900	1900
Adjustment:	0.92	1.00	0.92	0.95	0.95	0.92	0.92	1.00	0.92	0.92	1.00	0.92
Lanes:	0.00	0.00	0.00	1.00	0.00	1.00	0.00	3.00	1.00	1.00	2.00	0.00
Final Sat.:	0	0	0	1800	0	1750	0	5700	1750	1750	3800	0
Capacity Analysis Module:												
Vol/Sat:	0.00	0.00	0.00	0.10	0.00	0.16	0.00	0.13	0.14	0.10	0.17	0.00
Crit Moves:						****			****	****		
Green Time:	0.0	0.0	0.0	32.8	0.0	32.8	0.0	28.1	28.1	20.1	48.2	0.0
Volume/Cap:	0.00	0.00	0.00	0.28	0.00	0.45	0.00	0.42	0.45	0.45	0.33	0.00
Delay/Veh:	0.0	0.0	0.0	20.5	0.0	22.3	0.0	24.7	25.4	31.0	11.8	0.0
User DelAdj:	1.00	1.00	1.00	1.00	1.00	1.00	1.00	1.00	1.00	1.00	1.00	1.00
AdjDel/Veh:	0.0	0.0	0.0	20.5	0.0	22.3	0.0	24.7	25.4	31.0	11.8	0.0
LOS by Move:	A	A	A	C	A	C	A	C	C	C	B	A
HCM2kAvgQ:	0	0	0	4	0	6	0	5	6	5	5	0

Note: Queue reported is the number of cars per lane.

Voices School
Morgan Hill, CA
Hexagon Transportation Consultants, Inc.

Level Of Service Computation Report
2000 HCM Operations (Future Volume Alternative)
Existing (PM)

Intersection #124: US 101 Southbound Ramps and Dunne Avenue

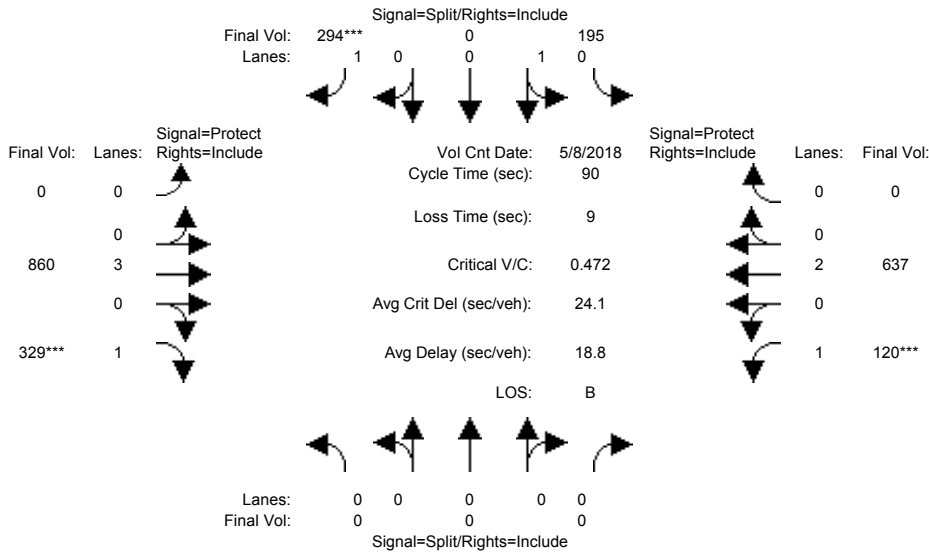

Street Name:	US 101 Southbound Ramps						Dunne Avenue					
Approach:	North Bound			South Bound			East Bound			West Bound		
Movement:	L	T	R	L	T	R	L	T	R	L	T	R
Min. Green:	0	0	0	10	10	10	0	10	10	7	10	0
Y+R:	4.0	4.0	4.0	4.0	4.0	4.0	4.0	4.0	4.0	4.0	4.0	4.0
Volume Module: >> Count Date: 8 May 2018 <<												
Base Vol:	0	0	0	195	0	294	0	860	329	120	637	0
Growth Adj:	1.00	1.00	1.00	1.00	1.00	1.00	1.00	1.00	1.00	1.00	1.00	1.00
Initial Bse:	0	0	0	195	0	294	0	860	329	120	637	0
Added Vol:	0	0	0	0	0	0	0	0	0	0	0	0
PasserByVol:	0	0	0	0	0	0	0	0	0	0	0	0
Initial Fut:	0	0	0	195	0	294	0	860	329	120	637	0
User Adj:	1.00	1.00	1.00	1.00	1.00	1.00	1.00	1.00	1.00	1.00	1.00	1.00
PHF Adj:	1.00	1.00	1.00	1.00	1.00	1.00	1.00	1.00	1.00	1.00	1.00	1.00
PHF Volume:	0	0	0	195	0	294	0	860	329	120	637	0
Reduct Vol:	0	0	0	0	0	0	0	0	0	0	0	0
Reduced Vol:	0	0	0	195	0	294	0	860	329	120	637	0
PCE Adj:	1.00	1.00	1.00	1.00	1.00	1.00	1.00	1.00	1.00	1.00	1.00	1.00
MLF Adj:	1.00	1.00	1.00	1.00	1.00	1.00	1.00	1.00	1.00	1.00	1.00	1.00
FinalVolume:	0	0	0	195	0	294	0	860	329	120	637	0
Saturation Flow Module:												
Sat/Lane:	1900	1900	1900	1900	1900	1900	1900	1900	1900	1900	1900	1900
Adjustment:	0.92	1.00	0.92	0.95	0.95	0.92	0.92	1.00	0.92	0.92	1.00	0.92
Lanes:	0.00	0.00	0.00	1.00	0.00	1.00	0.00	3.00	1.00	1.00	2.00	0.00
Final Sat.:	0	0	0	1800	0	1750	0	5700	1750	1750	3800	0
Capacity Analysis Module:												
Vol/Sat:	0.00	0.00	0.00	0.11	0.00	0.17	0.00	0.15	0.19	0.07	0.17	0.00
Crit Moves:						****			****			****
Green Time:	0.0	0.0	0.0	32.1	0.0	32.1	0.0	35.9	35.9	13.1	48.9	0.0
Volume/Cap:	0.00	0.00	0.00	0.30	0.00	0.47	0.00	0.38	0.47	0.47	0.31	0.00
Delay/Veh:	0.0	0.0	0.0	21.2	0.0	23.0	0.0	19.3	20.6	36.7	11.3	0.0
User DelAdj:	1.00	1.00	1.00	1.00	1.00	1.00	1.00	1.00	1.00	1.00	1.00	1.00
AdjDel/Veh:	0.0	0.0	0.0	21.2	0.0	23.0	0.0	19.3	20.6	36.7	11.3	0.0
LOS by Move:	A	A	A	C	A	C	A	B	C	D	B	A
HCM2kAvgQ:	0	0	0	4	0	7	0	5	7	4	5	0

Note: Queue reported is the number of cars per lane.

Voices School
Morgan Hill, CA
Hexagon Transportation Consultants, Inc.

Level Of Service Computation Report
2000 HCM Operations (Future Volume Alternative)
Existing Plus Project (AM) - 2 Cosmo Right out

Intersection #124: US 101 Southbound Ramps and Dunne Avenue

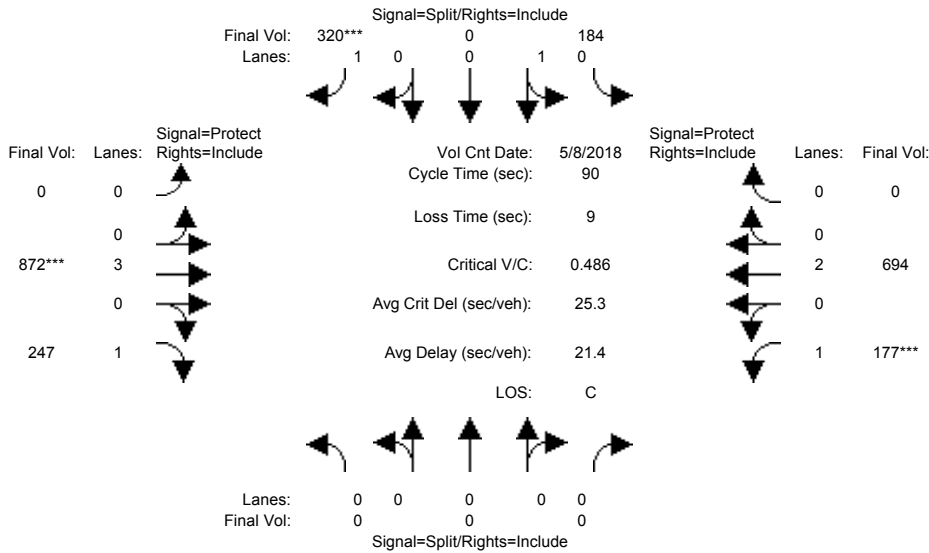

Street Name:	US 101 Southbound Ramps						Dunne Avenue					
Approach:	North Bound			South Bound			East Bound			West Bound		
Movement:	L	T	R	L	T	R	L	T	R	L	T	R
Min. Green:	0	0	0	10	10	10	0	10	10	7	10	0
Y+R:	4.0	4.0	4.0	4.0	4.0	4.0	4.0	4.0	4.0	4.0	4.0	4.0

Volume Module:	>>	Count	Date:	8 May 2018	<<											
Base Vol:	0	0	0	184	0	288	0	750	247	177	664	0				
Growth Adj:	1.00	1.00	1.00	1.00	1.00	1.00	1.00	1.00	1.00	1.00	1.00	1.00				
Initial Bse:	0	0	0	184	0	288	0	750	247	177	664	0				
Added Vol:	0	0	0	0	0	32	0	122	0	0	30	0				
PasserByVol:	0	0	0	0	0	0	0	0	0	0	0	0				
Initial Fut:	0	0	0	184	0	320	0	872	247	177	694	0				
User Adj:	1.00	1.00	1.00	1.00	1.00	1.00	1.00	1.00	1.00	1.00	1.00	1.00				
PHF Adj:	1.00	1.00	1.00	1.00	1.00	1.00	1.00	1.00	1.00	1.00	1.00	1.00				
PHF Volume:	0	0	0	184	0	320	0	872	247	177	694	0				
Reduct Vol:	0	0	0	0	0	0	0	0	0	0	0	0				
Reduced Vol:	0	0	0	184	0	320	0	872	247	177	694	0				
PCE Adj:	1.00	1.00	1.00	1.00	1.00	1.00	1.00	1.00	1.00	1.00	1.00	1.00				
MLF Adj:	1.00	1.00	1.00	1.00	1.00	1.00	1.00	1.00	1.00	1.00	1.00	1.00				
FinalVolume:	0	0	0	184	0	320	0	872	247	177	694	0				

Saturation Flow Module:												
Sat/Lane:	1900	1900	1900	1900	1900	1900	1900	1900	1900	1900	1900	1900
Adjustment:	0.92	1.00	0.92	0.95	0.95	0.92	0.92	1.00	0.92	0.92	1.00	0.92
Lanes:	0.00	0.00	0.00	1.00	0.00	1.00	0.00	3.00	1.00	1.00	2.00	0.00
Final Sat.:	0	0	0	1800	0	1750	0	5700	1750	1750	3800	0

Capacity Analysis Module:												
Vol/Sat:	0.00	0.00	0.00	0.10	0.00	0.18	0.00	0.15	0.14	0.10	0.18	0.00
Crit Moves:						****		****				
Green Time:	0.0	0.0	0.0	33.9	0.0	33.9	0.0	28.4	28.4	18.7	47.1	0.0
Volume/Cap:	0.00	0.00	0.00	0.27	0.00	0.49	0.00	0.49	0.45	0.49	0.35	0.00
Delay/Veh:	0.0	0.0	0.0	19.7	0.0	22.0	0.0	25.1	25.2	32.4	12.6	0.0
User DelAdj:	1.00	1.00	1.00	1.00	1.00	1.00	1.00	1.00	1.00	1.00	1.00	1.00
AdjDel/Veh:	0.0	0.0	0.0	19.7	0.0	22.0	0.0	25.1	25.2	32.4	12.6	0.0
LOS by Move:	A	A	A	B	A	C	A	C	C	C	B	A
HCM2kAvgQ:	0	0	0	4	0	7	0	6	6	5	6	0

Note: Queue reported is the number of cars per lane.

Voices School
Morgan Hill, CA
Hexagon Transportation Consultants, Inc.

Level Of Service Computation Report
2000 HCM Operations (Future Volume Alternative)
Existing Plus Project (PM) - 2 Cosmo Right out

Intersection #124: US 101 Southbound Ramps and Dunne Avenue

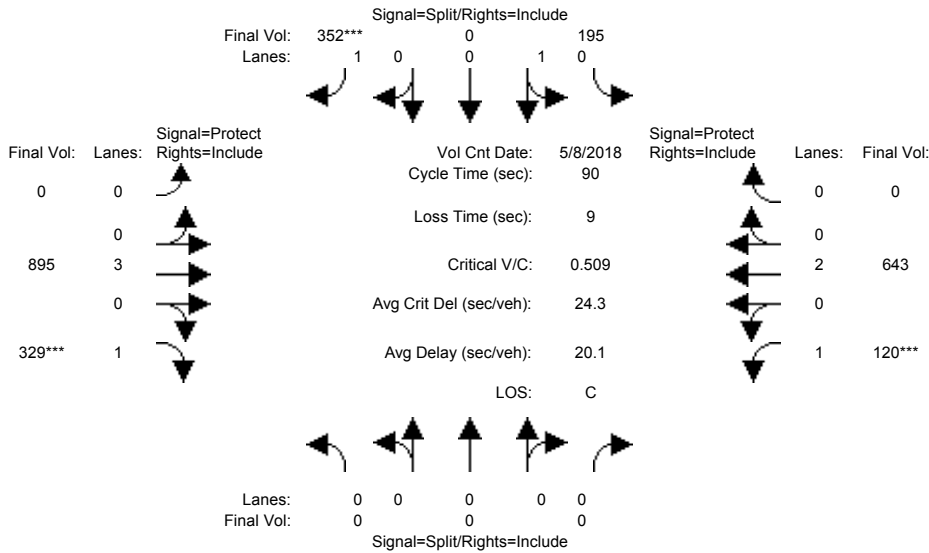

Street Name:	US 101 Southbound Ramps						Dunne Avenue					
	North Bound			South Bound			East Bound			West Bound		
Approach:	L	T	R	L	T	R	L	T	R	L	T	R
Min. Green:	0	0	0	10	10	10	0	10	10	7	10	0
Y+R:	4.0	4.0	4.0	4.0	4.0	4.0	4.0	4.0	4.0	4.0	4.0	4.0

Volume Module:	>>	Count	Date:	8 May 2018	<<							
Base Vol:	0	0	0	195	0	294	0	860	329	120	637	0
Growth Adj:	1.00	1.00	1.00	1.00	1.00	1.00	1.00	1.00	1.00	1.00	1.00	1.00
Initial Bse:	0	0	0	195	0	294	0	860	329	120	637	0
Added Vol:	0	0	0	0	0	58	0	35	0	0	6	0
PasserByVol:	0	0	0	0	0	0	0	0	0	0	0	0
Initial Fut:	0	0	0	195	0	352	0	895	329	120	643	0
User Adj:	1.00	1.00	1.00	1.00	1.00	1.00	1.00	1.00	1.00	1.00	1.00	1.00
PHF Adj:	1.00	1.00	1.00	1.00	1.00	1.00	1.00	1.00	1.00	1.00	1.00	1.00
PHF Volume:	0	0	0	195	0	352	0	895	329	120	643	0
Reduct Vol:	0	0	0	0	0	0	0	0	0	0	0	0
Reduced Vol:	0	0	0	195	0	352	0	895	329	120	643	0
PCE Adj:	1.00	1.00	1.00	1.00	1.00	1.00	1.00	1.00	1.00	1.00	1.00	1.00
MLF Adj:	1.00	1.00	1.00	1.00	1.00	1.00	1.00	1.00	1.00	1.00	1.00	1.00
FinalVolume:	0	0	0	195	0	352	0	895	329	120	643	0

Saturation Flow Module:												
Sat/Lane:	1900	1900	1900	1900	1900	1900	1900	1900	1900	1900	1900	1900
Adjustment:	0.92	1.00	0.92	0.95	0.95	0.92	0.92	1.00	0.92	0.92	1.00	0.92
Lanes:	0.00	0.00	0.00	1.00	0.00	1.00	0.00	3.00	1.00	1.00	2.00	0.00
Final Sat.:	0	0	0	1800	0	1750	0	5700	1750	1750	3800	0

Capacity Analysis Module:												
Vol/Sat:	0.00	0.00	0.00	0.11	0.00	0.20	0.00	0.16	0.19	0.07	0.17	0.00
Crit Moves:						****			****			****
Green Time:	0.0	0.0	0.0	35.6	0.0	35.6	0.0	33.3	33.3	12.1	45.4	0.0
Volume/Cap:	0.00	0.00	0.00	0.27	0.00	0.51	0.00	0.42	0.51	0.51	0.34	0.00
Delay/Veh:	0.0	0.0	0.0	18.7	0.0	21.2	0.0	21.3	22.7	38.0	13.4	0.0
User DelAdj:	1.00	1.00	1.00	1.00	1.00	1.00	1.00	1.00	1.00	1.00	1.00	1.00
AdjDel/Veh:	0.0	0.0	0.0	18.7	0.0	21.2	0.0	21.3	22.7	38.0	13.4	0.0
LOS by Move:	A	A	A	B	A	C	A	C	C	D	B	A
HCM2kAvgQ:	0	0	0	4	0	8	0	6	7	4	5	0

Note: Queue reported is the number of cars per lane.

Voices School
Morgan Hill, CA
Hexagon Transportation Consultants, Inc.

Level Of Service Computation Report
2000 HCM Operations (Future Volume Alternative)
Existing (AM)

Intersection #125: US 101 Northbound Ramps and Dunne Avenue

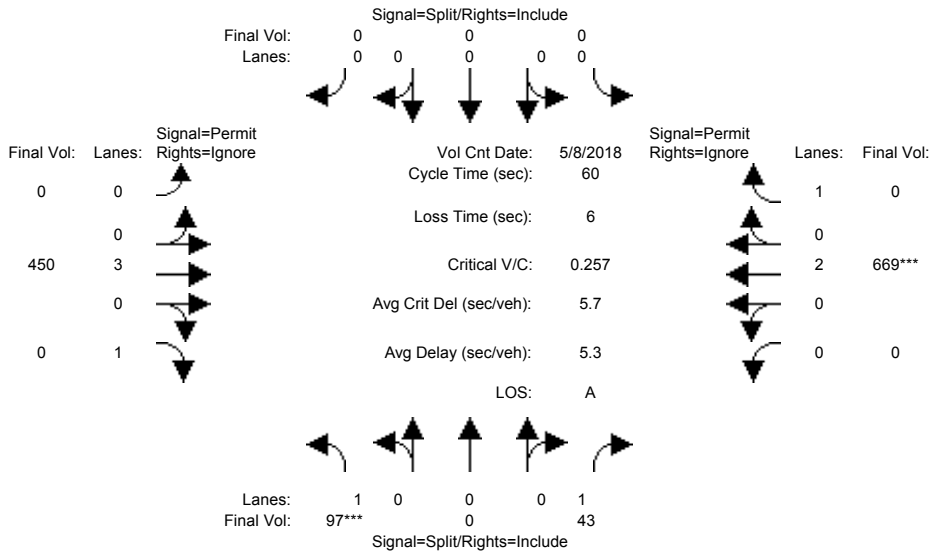

Street Name: US 101 Northbound Ramps Dunne Avenue
Approach: North Bound South Bound East Bound West Bound
Movement: L - T - R L - T - R L - T - R L - T - R

Min. Green:	10	0	10	0	0	0	0	10	10	0	10	10
Y+R:	4.0	4.0	4.0	4.0	4.0	4.0	4.0	4.0	4.0	4.0	4.0	4.0

Volume Module: >> Count Date: 8 May 2018 <<

Base Vol:	97	0	43	0	0	0	0	450	0	0	669	0
Growth Adj:	1.00	1.00	1.00	1.00	1.00	1.00	1.00	1.00	1.00	1.00	1.00	1.00
Initial Bse:	97	0	43	0	0	0	0	450	0	0	669	0
Added Vol:	0	0	0	0	0	0	0	0	0	0	0	0
PasserByVol:	0	0	0	0	0	0	0	0	0	0	0	0
Initial Fut:	97	0	43	0	0	0	0	450	0	0	669	0
User Adj:	1.00	1.00	1.00	1.00	1.00	1.00	1.00	1.00	0.00	1.00	1.00	0.00
PHF Adj:	1.00	1.00	1.00	1.00	1.00	1.00	1.00	1.00	0.00	1.00	1.00	0.00
PHF Volume:	97	0	43	0	0	0	0	450	0	0	669	0
Reduct Vol:	0	0	0	0	0	0	0	0	0	0	0	0
Reduced Vol:	97	0	43	0	0	0	0	450	0	0	669	0
PCE Adj:	1.00	1.00	1.00	1.00	1.00	1.00	1.00	1.00	0.00	1.00	1.00	0.00
MLF Adj:	1.00	1.00	1.00	1.00	1.00	1.00	1.00	1.00	0.00	1.00	1.00	0.00
FinalVolume:	97	0	43	0	0	0	0	450	0	0	669	0

Saturation Flow Module:

Sat/Lane:	1900	1900	1900	1900	1900	1900	1900	1900	1900	1900	1900	1900
Adjustment:	0.92	1.00	0.92	0.92	1.00	0.92	0.92	1.00	0.92	0.92	1.00	0.92
Lanes:	1.00	0.00	1.00	0.00	0.00	0.00	0.00	3.00	1.00	0.00	2.00	1.00
Final Sat.:	1750	0	1750	0	0	0	0	5700	1750	0	3800	1750

Capacity Analysis Module:

Vol/Sat:	0.06	0.00	0.02	0.00	0.00	0.00	0.00	0.08	0.00	0.00	0.18	0.00
Crit Moves:	****										****	
Green Time:	12.9	0.0	12.9	0.0	0.0	0.0	0.0	41.1	0.0	0.0	41.1	0.0
Volume/Cap:	0.26	0.00	0.11	0.00	0.00	0.00	0.00	0.12	0.00	0.00	0.26	0.00
Delay/Veh:	19.9	0.0	19.1	0.0	0.0	0.0	0.0	3.3	0.0	0.0	3.7	0.0
User DelAdj:	1.00	1.00	1.00	1.00	1.00	1.00	1.00	1.00	1.00	1.00	1.00	1.00
AdjDel/Veh:	19.9	0.0	19.1	0.0	0.0	0.0	0.0	3.3	0.0	0.0	3.7	0.0
LOS by Move:	B	A	B	A	A	A	A	A	A	A	A	A
HCM2kAvgQ:	2	0	1	0	0	0	0	1	0	0	2	0

Note: Queue reported is the number of cars per lane.

Voices School
Morgan Hill, CA
Hexagon Transportation Consultants, Inc.

Level Of Service Computation Report
2000 HCM Operations (Future Volume Alternative)
Existing (PM)

Intersection #125: US 101 Northbound Ramps and Dunne Avenue

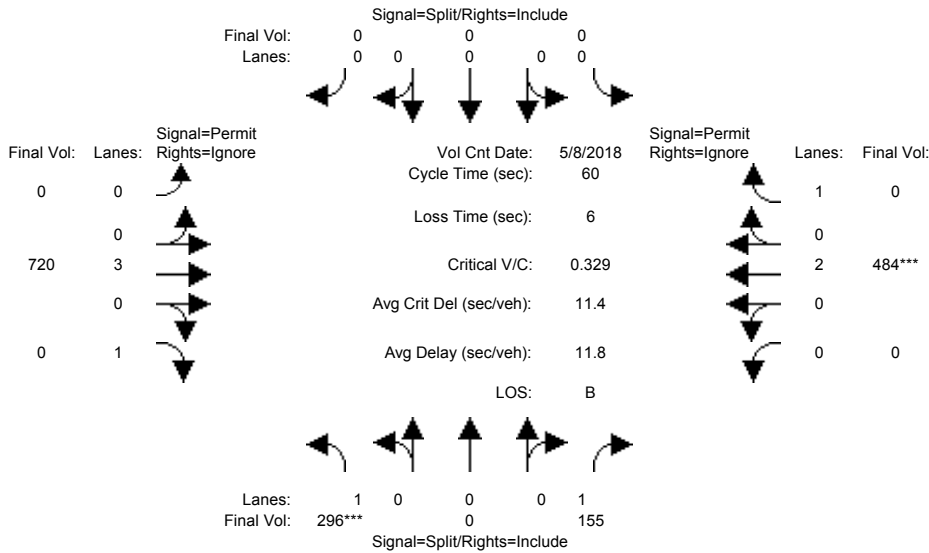

Street Name:	US 101 Northbound Ramps						Dunne Avenue					
	North Bound			South Bound			East Bound			West Bound		
Approach:	L	T	R	L	T	R	L	T	R	L	T	R
Min. Green:	10	0	10	0	0	0	0	10	10	0	10	10
Y+R:	4.0	4.0	4.0	4.0	4.0	4.0	4.0	4.0	4.0	4.0	4.0	4.0

Volume Module:	>>	Count	Date:	8 May 2018	<<							
Base Vol:	296	0	155	0	0	0	0	720	0	0	484	0
Growth Adj:	1.00	1.00	1.00	1.00	1.00	1.00	1.00	1.00	1.00	1.00	1.00	1.00
Initial Bse:	296	0	155	0	0	0	0	720	0	0	484	0
Added Vol:	0	0	0	0	0	0	0	0	0	0	0	0
PasserByVol:	0	0	0	0	0	0	0	0	0	0	0	0
Initial Fut:	296	0	155	0	0	0	0	720	0	0	484	0
User Adj:	1.00	1.00	1.00	1.00	1.00	1.00	1.00	1.00	0.00	1.00	1.00	0.00
PHF Adj:	1.00	1.00	1.00	1.00	1.00	1.00	1.00	1.00	0.00	1.00	1.00	0.00
PHF Volume:	296	0	155	0	0	0	0	720	0	0	484	0
Reduct Vol:	0	0	0	0	0	0	0	0	0	0	0	0
Reduced Vol:	296	0	155	0	0	0	0	720	0	0	484	0
PCE Adj:	1.00	1.00	1.00	1.00	1.00	1.00	1.00	1.00	0.00	1.00	1.00	0.00
MLF Adj:	1.00	1.00	1.00	1.00	1.00	1.00	1.00	1.00	0.00	1.00	1.00	0.00
FinalVolume:	296	0	155	0	0	0	0	720	0	0	484	0

Saturation Flow Module:												
Sat/Lane:	1900	1900	1900	1900	1900	1900	1900	1900	1900	1900	1900	1900
Adjustment:	0.92	1.00	0.92	0.92	1.00	0.92	0.92	1.00	0.92	0.92	1.00	0.92
Lanes:	1.00	0.00	1.00	0.00	0.00	0.00	0.00	3.00	1.00	0.00	2.00	1.00
Final Sat.:	1750	0	1750	0	0	0	0	5700	1750	0	3800	1750

Capacity Analysis Module:															
Vol/Sat:	0.17	0.00	0.09	0.00	0.00	0.00	0.00	0.13	0.00	0.00	0.13	0.00			
Crit Moves:	****												****		
Green Time:	30.8	0.0	30.8	0.0	0.0	0.0	0.0	23.2	0.0	0.0	23.2	0.0			
Volume/Cap:	0.33	0.00	0.17	0.00	0.00	0.00	0.00	0.33	0.00	0.00	0.33	0.00			
Delay/Veh:	8.8	0.0	7.9	0.0	0.0	0.0	0.0	13.0	0.0	0.0	13.1	0.0			
User DelAdj:	1.00	1.00	1.00	1.00	1.00	1.00	1.00	1.00	1.00	1.00	1.00	1.00			
AdjDel/Veh:	8.8	0.0	7.9	0.0	0.0	0.0	0.0	13.0	0.0	0.0	13.1	0.0			
LOS by Move:	A	A	A	A	A	A	A	B	A	A	B	A			
HCM2kAvgQ:	4	0	2	0	0	0	0	3	0	0	3	0			

Note: Queue reported is the number of cars per lane.

Voices School
Morgan Hill, CA
Hexagon Transportation Consultants, Inc.

Level Of Service Computation Report
2000 HCM Operations (Future Volume Alternative)
Existing Plus Project (AM) - 2 Cosmo Right out

Intersection #125: US 101 Northbound Ramps and Dunne Avenue

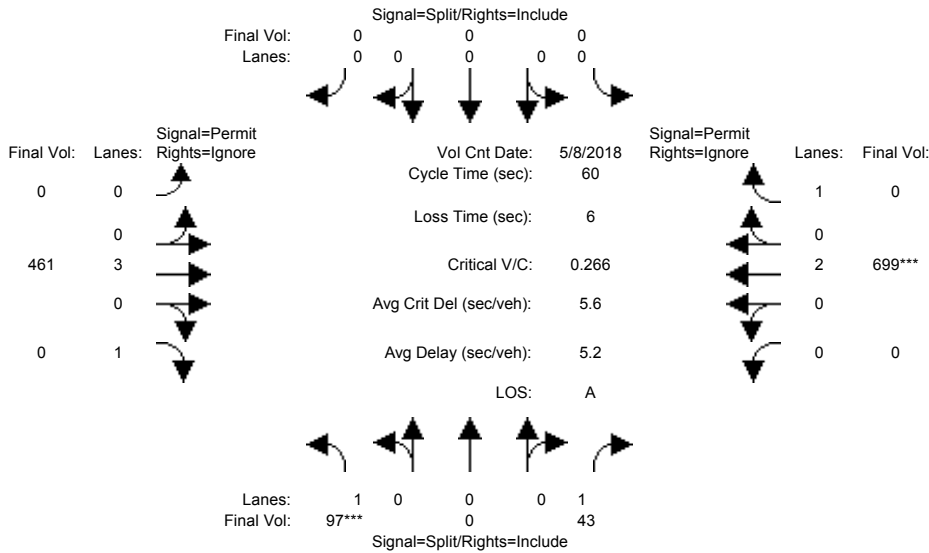

Street Name: US 101 Northbound Ramps Dunne Avenue
Approach: North Bound South Bound East Bound West Bound
Movement: L - T - R L - T - R L - T - R L - T - R

Min. Green: 10 0 10 0 0 0 0 10 10 0 10 10
Y+R: 4.0 4.0 4.0 4.0 4.0 4.0 4.0 4.0 4.0 4.0 4.0 4.0

Volume Module: >> Count Date: 8 May 2018 <<

Base Vol:	97	0	43	0	0	0	0	450	0	0	669	0
Growth Adj:	1.00	1.00	1.00	1.00	1.00	1.00	1.00	1.00	1.00	1.00	1.00	1.00
Initial Bse:	97	0	43	0	0	0	0	450	0	0	669	0
Added Vol:	0	0	0	0	0	0	0	11	111	0	30	0
PasserByVol:	0	0	0	0	0	0	0	0	0	0	0	0
Initial Fut:	97	0	43	0	0	0	0	461	111	0	699	0
User Adj:	1.00	1.00	1.00	1.00	1.00	1.00	1.00	1.00	0.00	1.00	1.00	0.00
PHF Adj:	1.00	1.00	1.00	1.00	1.00	1.00	1.00	1.00	0.00	1.00	1.00	0.00
PHF Volume:	97	0	43	0	0	0	0	461	0	0	699	0
Reduct Vol:	0	0	0	0	0	0	0	0	0	0	0	0
Reduced Vol:	97	0	43	0	0	0	0	461	0	0	699	0
PCE Adj:	1.00	1.00	1.00	1.00	1.00	1.00	1.00	1.00	0.00	1.00	1.00	0.00
MLF Adj:	1.00	1.00	1.00	1.00	1.00	1.00	1.00	1.00	0.00	1.00	1.00	0.00
FinalVolume:	97	0	43	0	0	0	0	461	0	0	699	0

Saturation Flow Module:

Sat/Lane:	1900	1900	1900	1900	1900	1900	1900	1900	1900	1900	1900	1900
Adjustment:	0.92	1.00	0.92	0.92	1.00	0.92	0.92	1.00	0.92	0.92	1.00	0.92
Lanes:	1.00	0.00	1.00	0.00	0.00	0.00	0.00	3.00	1.00	0.00	2.00	1.00
Final Sat.:	1750	0	1750	0	0	0	0	5700	1750	0	3800	1750

Capacity Analysis Module:

Vol/Sat:	0.06	0.00	0.02	0.00	0.00	0.00	0.00	0.08	0.00	0.00	0.18	0.00
Crit Moves:	****										****	
Green Time:	12.5	0.0	12.5	0.0	0.0	0.0	0.0	41.5	0.0	0.0	41.5	0.0
Volume/Cap:	0.27	0.00	0.12	0.00	0.00	0.00	0.00	0.12	0.00	0.00	0.27	0.00
Delay/Veh:	20.3	0.0	19.4	0.0	0.0	0.0	0.0	3.1	0.0	0.0	3.6	0.0
User DelAdj:	1.00	1.00	1.00	1.00	1.00	1.00	1.00	1.00	1.00	1.00	1.00	1.00
AdjDel/Veh:	20.3	0.0	19.4	0.0	0.0	0.0	0.0	3.1	0.0	0.0	3.6	0.0
LOS by Move:	C	A	B	A	A	A	A	A	A	A	A	A
HCM2kAvgQ:	2	0	1	0	0	0	0	1	0	0	3	0

Note: Queue reported is the number of cars per lane.

Voices School
Morgan Hill, CA
Hexagon Transportation Consultants, Inc.

Level Of Service Computation Report
2000 HCM Operations (Future Volume Alternative)
Existing Plus Project (PM) - 2 Cosmo Right out

Intersection #125: US 101 Northbound Ramps and Dunne Avenue

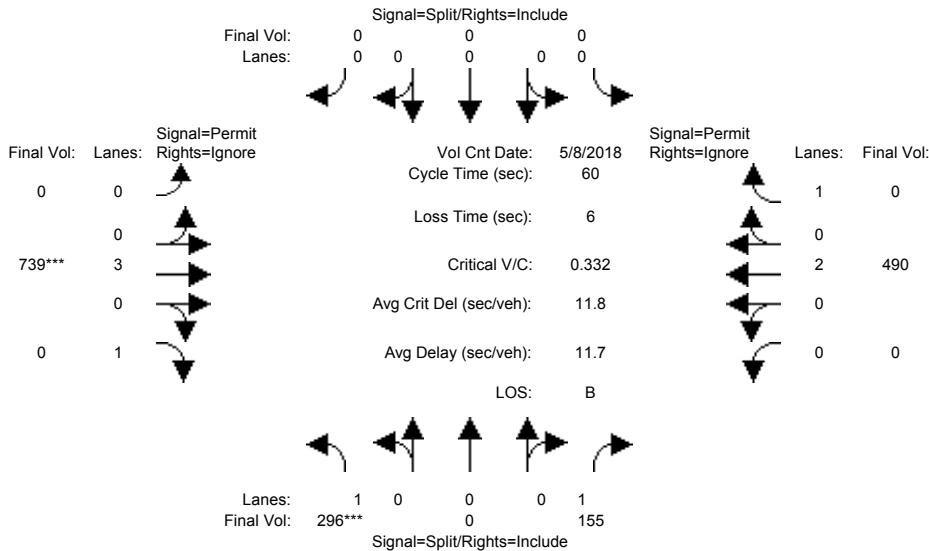

Street Name:	US 101 Northbound Ramps						Dunne Avenue					
Approach:	North Bound			South Bound			East Bound			West Bound		
Movement:	L	T	R	L	T	R	L	T	R	L	T	R
Min. Green:	10	0	10	0	0	0	0	10	10	0	10	10
Y+R:	4.0	4.0	4.0	4.0	4.0	4.0	4.0	4.0	4.0	4.0	4.0	4.0
Volume Module: >> Count Date: 8 May 2018 <<												
Base Vol:	296	0	155	0	0	0	0	720	0	0	484	0
Growth Adj:	1.00	1.00	1.00	1.00	1.00	1.00	1.00	1.00	1.00	1.00	1.00	1.00
Initial Bse:	296	0	155	0	0	0	0	720	0	0	484	0
Added Vol:	0	0	0	0	0	0	0	19	17	0	6	0
PasserByVol:	0	0	0	0	0	0	0	0	0	0	0	0
Initial Fut:	296	0	155	0	0	0	0	739	17	0	490	0
User Adj:	1.00	1.00	1.00	1.00	1.00	1.00	1.00	1.00	0.00	1.00	1.00	0.00
PHF Adj:	1.00	1.00	1.00	1.00	1.00	1.00	1.00	1.00	0.00	1.00	1.00	0.00
PHF Volume:	296	0	155	0	0	0	0	739	0	0	490	0
Reduct Vol:	0	0	0	0	0	0	0	0	0	0	0	0
Reduced Vol:	296	0	155	0	0	0	0	739	0	0	490	0
PCE Adj:	1.00	1.00	1.00	1.00	1.00	1.00	1.00	1.00	0.00	1.00	1.00	0.00
MLF Adj:	1.00	1.00	1.00	1.00	1.00	1.00	1.00	1.00	0.00	1.00	1.00	0.00
FinalVolume:	296	0	155	0	0	0	0	739	0	0	490	0
Saturation Flow Module:												
Sat/Lane:	1900	1900	1900	1900	1900	1900	1900	1900	1900	1900	1900	1900
Adjustment:	0.92	1.00	0.92	0.92	1.00	0.92	0.92	1.00	0.92	0.92	1.00	0.92
Lanes:	1.00	0.00	1.00	0.00	0.00	0.00	0.00	3.00	1.00	0.00	2.00	1.00
Final Sat.:	1750	0	1750	0	0	0	0	5700	1750	0	3800	1750
Capacity Analysis Module:												
Vol/Sat:	0.17	0.00	0.09	0.00	0.00	0.00	0.00	0.13	0.00	0.00	0.13	0.00
Crit Moves:	***						***					
Green Time:	30.6	0.0	30.6	0.0	0.0	0.0	0.0	23.4	0.0	0.0	23.4	0.0
Volume/Cap:	0.33	0.00	0.17	0.00	0.00	0.00	0.00	0.33	0.00	0.00	0.33	0.00
Delay/Veh:	8.9	0.0	8.0	0.0	0.0	0.0	0.0	12.9	0.0	0.0	12.9	0.0
User DelAdj:	1.00	1.00	1.00	1.00	1.00	1.00	1.00	1.00	1.00	1.00	1.00	1.00
AdjDel/Veh:	8.9	0.0	8.0	0.0	0.0	0.0	0.0	12.9	0.0	0.0	12.9	0.0
LOS by Move:	A	A	A	A	A	A	A	B	A	A	B	A
HCM2kAvgQ:	4	0	2	0	0	0	0	3	0	0	3	0

Note: Queue reported is the number of cars per lane.

Voices School
Morgan Hill, CA
Hexagon Transportation Consultants, Inc.

Level Of Service Computation Report
2000 HCM Operations (Future Volume Alternative)
Existing (AM)

Intersection #422: Monterey Road and Butterfield Boulevard/Watsonville Road

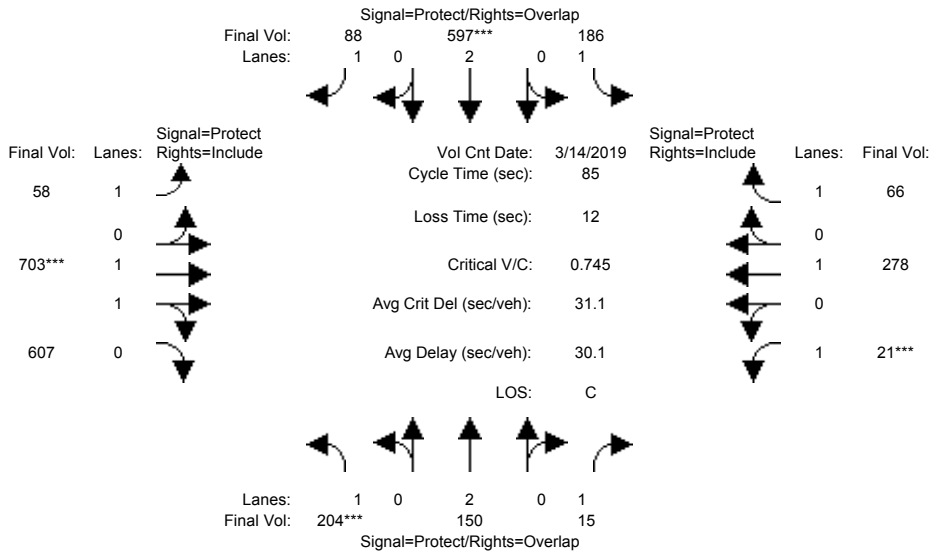

Street Name:	Monterey Rd						Butterfield Blvd/Watsonville Rd					
Approach:	North Bound			South Bound			East Bound			West Bound		
Movement:	L	T	R	L	T	R	L	T	R	L	T	R

Min. Green:	7	10	10	7	10	10	7	10	10	7	10	10
Y+R:	4.0	4.0	4.0	4.0	4.0	4.0	4.0	4.0	4.0	4.0	4.0	4.0

Volume Module: >> Count Date: 14 Mar 2019 <<												
Base Vol:	204	150	15	186	597	88	58	703	607	21	278	66
Growth Adj:	1.00	1.00	1.00	1.00	1.00	1.00	1.00	1.00	1.00	1.00	1.00	1.00
Initial Bse:	204	150	15	186	597	88	58	703	607	21	278	66
Added Vol:	0	0	0	0	0	0	0	0	0	0	0	0
PasserByVol:	0	0	0	0	0	0	0	0	0	0	0	0
Initial Fut:	204	150	15	186	597	88	58	703	607	21	278	66
User Adj:	1.00	1.00	1.00	1.00	1.00	1.00	1.00	1.00	1.00	1.00	1.00	1.00
PHF Adj:	1.00	1.00	1.00	1.00	1.00	1.00	1.00	1.00	1.00	1.00	1.00	1.00
PHF Volume:	204	150	15	186	597	88	58	703	607	21	278	66
Reduct Vol:	0	0	0	0	0	0	0	0	0	0	0	0
Reduced Vol:	204	150	15	186	597	88	58	703	607	21	278	66
PCE Adj:	1.00	1.00	1.00	1.00	1.00	1.00	1.00	1.00	1.00	1.00	1.00	1.00
MLF Adj:	1.00	1.00	1.00	1.00	1.00	1.00	1.00	1.00	1.00	1.00	1.00	1.00
FinalVolume:	204	150	15	186	597	88	58	703	607	21	278	66

Saturation Flow Module:												
Sat/Lane:	1900	1900	1900	1900	1900	1900	1900	1900	1900	1900	1900	1900
Adjustment:	0.92	1.00	0.92	0.92	1.00	0.92	0.92	1.00	0.95	0.92	1.00	0.92
Lanes:	1.00	2.00	1.00	1.00	2.00	1.00	1.00	1.05	0.95	1.00	1.00	1.00
Final Sat.:	1750	3800	1750	1750	3800	1750	1750	1984	1713	1750	1900	1750

Capacity Analysis Module:												
Vol/Sat:	0.12	0.04	0.01	0.11	0.16	0.05	0.03	0.35	0.35	0.01	0.15	0.04
Crit Moves:	***			***			***			***		
Green Time:	12.3	15.1	22.1	13.7	16.5	32.4	15.9	37.2	37.2	7.0	28.3	28.3
Volume/Cap:	0.81	0.22	0.03	0.66	0.81	0.13	0.18	0.81	0.81	0.15	0.44	0.11
Delay/Veh:	52.7	30.1	23.5	39.3	39.4	17.2	29.3	23.9	23.9	36.7	22.6	19.7
User DelAdj:	1.00	1.00	1.00	1.00	1.00	1.00	1.00	1.00	1.00	1.00	1.00	1.00
AdjDel/Veh:	52.7	30.1	23.5	39.3	39.4	17.2	29.3	23.9	23.9	36.7	22.6	19.7
LOS by Move:	D	C	C	D	D	B	C	C	C	D	C	B
HCM2kAvgQ:	8	2	0	5	8	2	1	17	17	1	6	1

Note: Queue reported is the number of cars per lane.

Voices School
Morgan Hill, CA
Hexagon Transportation Consultants, Inc.

Level Of Service Computation Report
2000 HCM Operations (Future Volume Alternative)
Existing (PM)

Intersection #422: Monterey Road and Butterfield Boulevard/Watsonville Road

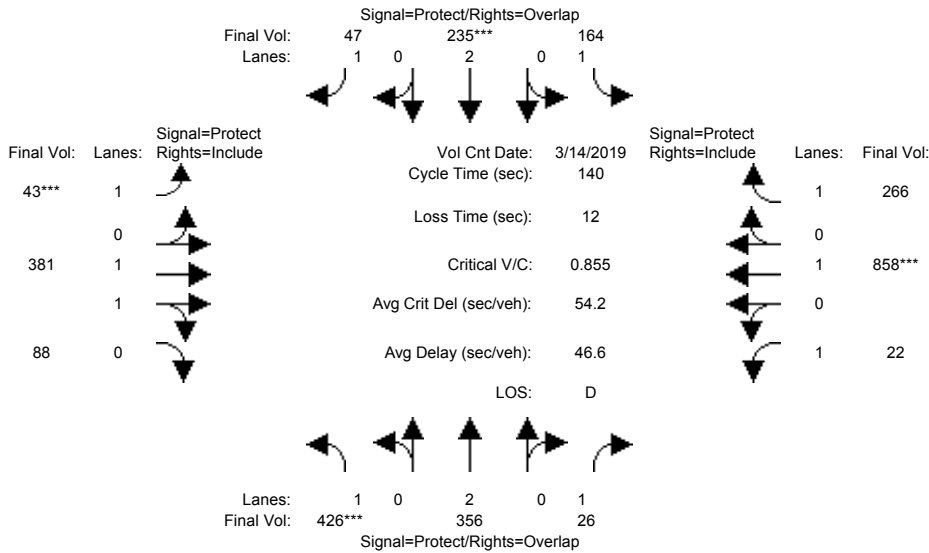

Street Name:	Monterey Rd						Butterfield Blvd/Watsonville Rd					
Approach:	North Bound			South Bound			East Bound			West Bound		
Movement:	L	T	R	L	T	R	L	T	R	L	T	R

Min. Green:	7	10	10	7	10	10	7	10	10	7	10	10
Y+R:	4.0	4.0	4.0	4.0	4.0	4.0	4.0	4.0	4.0	4.0	4.0	4.0

Volume Module:	>>	Count	Date:	14 Mar 2019	<<											
Base Vol:	426	356	26	164	235	47	43	381	88	22	858	266				
Growth Adj:	1.00	1.00	1.00	1.00	1.00	1.00	1.00	1.00	1.00	1.00	1.00	1.00				
Initial Bse:	426	356	26	164	235	47	43	381	88	22	858	266				
Added Vol:	0	0	0	0	0	0	0	0	0	0	0	0				
PasserByVol:	0	0	0	0	0	0	0	0	0	0	0	0				
Initial Fut:	426	356	26	164	235	47	43	381	88	22	858	266				
User Adj:	1.00	1.00	1.00	1.00	1.00	1.00	1.00	1.00	1.00	1.00	1.00	1.00				
PHF Adj:	1.00	1.00	1.00	1.00	1.00	1.00	1.00	1.00	1.00	1.00	1.00	1.00				
PHF Volume:	426	356	26	164	235	47	43	381	88	22	858	266				
Reduct Vol:	0	0	0	0	0	0	0	0	0	0	0	0				
Reduced Vol:	426	356	26	164	235	47	43	381	88	22	858	266				
PCE Adj:	1.00	1.00	1.00	1.00	1.00	1.00	1.00	1.00	1.00	1.00	1.00	1.00				
MLF Adj:	1.00	1.00	1.00	1.00	1.00	1.00	1.00	1.00	1.00	1.00	1.00	1.00				
Final Volume:	426	356	26	164	235	47	43	381	88	22	858	266				

Saturation Flow Module:												
Sat/Lane:	1900	1900	1900	1900	1900	1900	1900	1900	1900	1900	1900	1900
Adjustment:	0.92	1.00	0.92	0.92	1.00	0.92	0.92	0.98	0.95	0.92	1.00	0.92
Lanes:	1.00	2.00	1.00	1.00	2.00	1.00	1.00	1.61	0.39	1.00	1.00	1.00
Final Sat.:	1750	3800	1750	1750	3800	1750	1750	3005	694	1750	1900	1750

Capacity Analysis Module:												
Vol/Sat:	0.24	0.09	0.01	0.09	0.06	0.03	0.02	0.13	0.13	0.01	0.45	0.15
Crit Moves:	***				***		***				***	
Green Time:	38.9	24.4	46.8	24.4	10.0	17.0	7.0	56.7	56.7	22.4	72.1	72.1
Volume/Cap:	0.88	0.54	0.04	0.54	0.87	0.22	0.49	0.31	0.31	0.08	0.88	0.30
Delay/Veh:	64.6	53.5	31.5	54.5	88.4	56.1	69.1	28.5	28.5	50.2	39.0	19.6
User DelAdj:	1.00	1.00	1.00	1.00	1.00	1.00	1.00	1.00	1.00	1.00	1.00	1.00
AdjDel/Veh:	64.6	53.5	31.5	54.5	88.4	56.1	69.1	28.5	28.5	50.2	39.0	19.6
LOS by Move:	E	D	C	D	F	E	E	C	C	D	D	B
HCM2kAvgQ:	22	7	1	7	6	2	3	7	7	1	35	7

Note: Queue reported is the number of cars per lane.

Voices School
Morgan Hill, CA
Hexagon Transportation Consultants, Inc.

Level Of Service Computation Report
2000 HCM Operations (Future Volume Alternative)
Existing Plus Project (AM) - 2 Cosmo Right out

Intersection #422: Monterey Road and Butterfield Boulevard/Watsonville Road

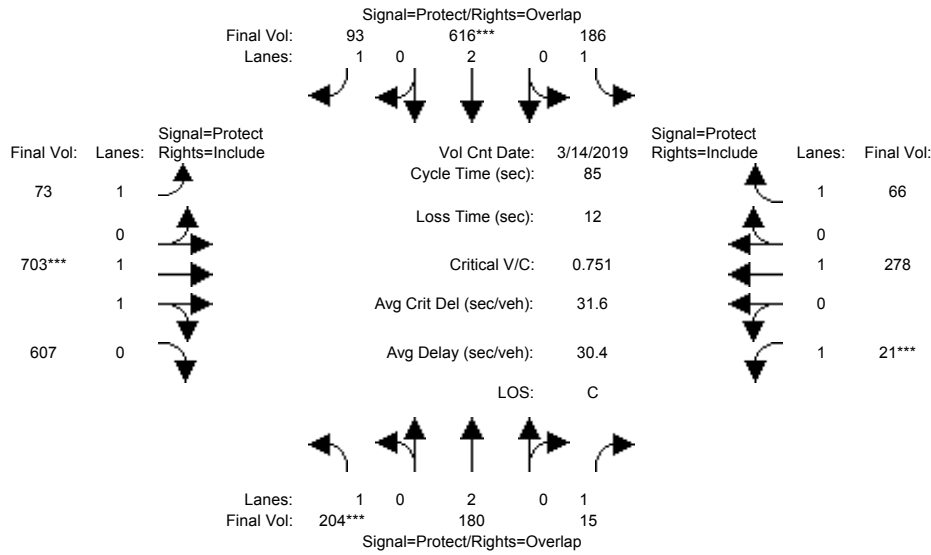

Street Name: Monterey Rd Butterfield Blvd/Watsonville Rd
Approach: North Bound South Bound East Bound West Bound
Movement: L - T - R L - T - R L - T - R L - T - R

Min. Green:	7	10	10	7	10	10	7	10	10	7	10	10
Y+R:	4.0	4.0	4.0	4.0	4.0	4.0	4.0	4.0	4.0	4.0	4.0	4.0

Volume Module: >> Count Date: 14 Mar 2019 <<

Base Vol:	204	150	15	186	597	88	58	703	607	21	278	66
Growth Adj:	1.00	1.00	1.00	1.00	1.00	1.00	1.00	1.00	1.00	1.00	1.00	1.00
Initial Bse:	204	150	15	186	597	88	58	703	607	21	278	66
Added Vol:	0	30	0	0	19	5	15	0	0	0	0	0
PasserByVol:	0	0	0	0	0	0	0	0	0	0	0	0
Initial Fut:	204	180	15	186	616	93	73	703	607	21	278	66
User Adj:	1.00	1.00	1.00	1.00	1.00	1.00	1.00	1.00	1.00	1.00	1.00	1.00
PHF Adj:	1.00	1.00	1.00	1.00	1.00	1.00	1.00	1.00	1.00	1.00	1.00	1.00
PHF Volume:	204	180	15	186	616	93	73	703	607	21	278	66
Reduct Vol:	0	0	0	0	0	0	0	0	0	0	0	0
Reduced Vol:	204	180	15	186	616	93	73	703	607	21	278	66
PCE Adj:	1.00	1.00	1.00	1.00	1.00	1.00	1.00	1.00	1.00	1.00	1.00	1.00
MLF Adj:	1.00	1.00	1.00	1.00	1.00	1.00	1.00	1.00	1.00	1.00	1.00	1.00
FinalVolume:	204	180	15	186	616	93	73	703	607	21	278	66

Saturation Flow Module:

Sat/Lane:	1900	1900	1900	1900	1900	1900	1900	1900	1900	1900	1900	1900
Adjustment:	0.92	1.00	0.92	0.92	1.00	0.92	0.92	1.00	0.95	0.92	1.00	0.92
Lanes:	1.00	2.00	1.00	1.00	2.00	1.00	1.00	1.05	0.95	1.00	1.00	1.00
Final Sat.:	1750	3800	1750	1750	3800	1750	1750	1984	1713	1750	1900	1750

Capacity Analysis Module:

Vol/Sat:	0.12	0.05	0.01	0.11	0.16	0.05	0.04	0.35	0.35	0.01	0.15	0.04
Crit Moves:	***				***			***		***		
Green Time:	12.2	15.3	22.3	13.8	16.9	32.7	15.8	36.9	36.9	7.0	28.1	28.1
Volume/Cap:	0.82	0.26	0.03	0.66	0.82	0.14	0.22	0.82	0.82	0.15	0.44	0.11
Delay/Veh:	53.6	30.2	23.4	38.8	39.4	17.1	29.7	24.4	24.4	36.7	22.8	19.9
User DelAdj:	1.00	1.00	1.00	1.00	1.00	1.00	1.00	1.00	1.00	1.00	1.00	1.00
AdjDel/Veh:	53.6	30.2	23.4	38.8	39.4	17.1	29.7	24.4	24.4	36.7	22.8	19.9
LOS by Move:	D	C	C	D	D	B	C	C	C	D	C	B
HCM2kAvgQ:	8	2	0	5	8	2	2	18	18	1	6	1

Note: Queue reported is the number of cars per lane.

Voices School
Morgan Hill, CA
Hexagon Transportation Consultants, Inc.

Level Of Service Computation Report
2000 HCM Operations (Future Volume Alternative)
Existing Plus Project (PM) - 2 Cosmo Right out

Intersection #422: Monterey Road and Butterfield Boulevard/Watsonville Road

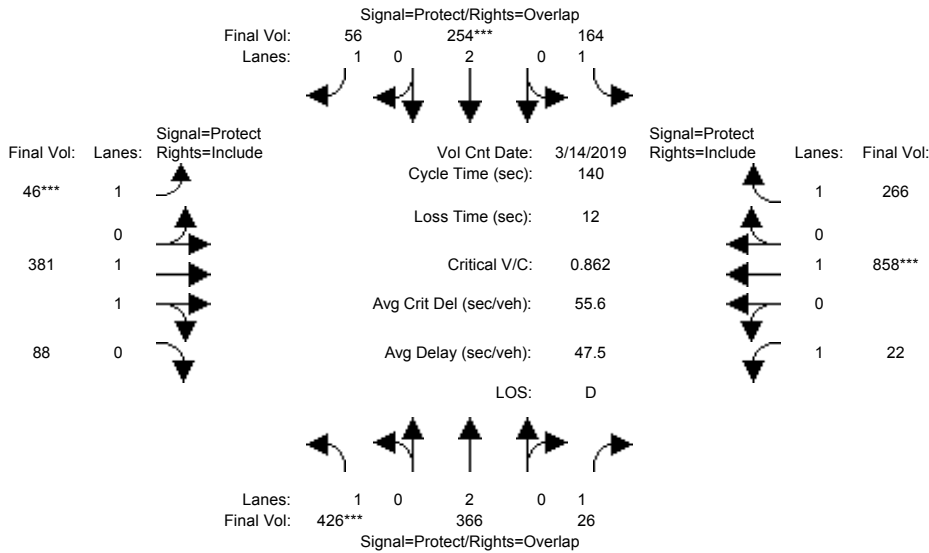

Street Name:	Monterey Rd						Butterfield Blvd/Watsonville Rd					
Approach:	North Bound			South Bound			East Bound			West Bound		
Movement:	L	T	R	L	T	R	L	T	R	L	T	R
Min. Green:	7	10	10	7	10	10	7	10	10	7	10	10
Y+R:	4.0	4.0	4.0	4.0	4.0	4.0	4.0	4.0	4.0	4.0	4.0	4.0

Volume Module:	>>	Count	Date:	14 Mar 2019	<<							
Base Vol:	426	356	26	164	235	47	43	381	88	22	858	266
Growth Adj:	1.00	1.00	1.00	1.00	1.00	1.00	1.00	1.00	1.00	1.00	1.00	1.00
Initial Bse:	426	356	26	164	235	47	43	381	88	22	858	266
Added Vol:	0	10	0	0	19	9	3	0	0	0	0	0
PasserByVol:	0	0	0	0	0	0	0	0	0	0	0	0
Initial Fut:	426	366	26	164	254	56	46	381	88	22	858	266
User Adj:	1.00	1.00	1.00	1.00	1.00	1.00	1.00	1.00	1.00	1.00	1.00	1.00
PHF Adj:	1.00	1.00	1.00	1.00	1.00	1.00	1.00	1.00	1.00	1.00	1.00	1.00
PHF Volume:	426	366	26	164	254	56	46	381	88	22	858	266
Reduct Vol:	0	0	0	0	0	0	0	0	0	0	0	0
Reduced Vol:	426	366	26	164	254	56	46	381	88	22	858	266
PCE Adj:	1.00	1.00	1.00	1.00	1.00	1.00	1.00	1.00	1.00	1.00	1.00	1.00
MLF Adj:	1.00	1.00	1.00	1.00	1.00	1.00	1.00	1.00	1.00	1.00	1.00	1.00
FinalVolume:	426	366	26	164	254	56	46	381	88	22	858	266

Saturation Flow Module:												
Sat/Lane:	1900	1900	1900	1900	1900	1900	1900	1900	1900	1900	1900	1900
Adjustment:	0.92	1.00	0.92	0.92	1.00	0.92	0.92	0.98	0.95	0.92	1.00	0.92
Lanes:	1.00	2.00	1.00	1.00	2.00	1.00	1.00	1.61	0.39	1.00	1.00	1.00
Final Sat.:	1750	3800	1750	1750	3800	1750	1750	3005	694	1750	1900	1750

Capacity Analysis Module:												
Vol/Sat:	0.24	0.10	0.01	0.09	0.07	0.03	0.03	0.13	0.13	0.01	0.45	0.15
Crit Moves:	****				****		****				****	
Green Time:	38.7	25.0	47.2	24.3	10.6	17.6	7.0	56.5	56.5	22.3	71.7	71.7
Volume/Cap:	0.88	0.54	0.04	0.54	0.88	0.25	0.53	0.31	0.31	0.08	0.88	0.30
Delay/Veh:	65.5	53.2	31.2	54.7	89.5	55.9	70.7	28.7	28.7	50.3	39.8	19.8
User DelAdj:	1.00	1.00	1.00	1.00	1.00	1.00	1.00	1.00	1.00	1.00	1.00	1.00
AdjDel/Veh:	65.5	53.2	31.2	54.7	89.5	55.9	70.7	28.7	28.7	50.3	39.8	19.8
LOS by Move:	E	D	C	D	F	E	E	C	C	D	D	B
HCM2kAvgQ:	22	8	1	7	6	2	3	7	7	1	35	7

Note: Queue reported is the number of cars per lane.

Voices School
Morgan Hill, CA
Hexagon Transportation Consultants, Inc.

Level Of Service Computation Report
2000 HCM Operations (Future Volume Alternative)
Existing (AM)

Intersection #1004: Church Street and Dunne Avenue

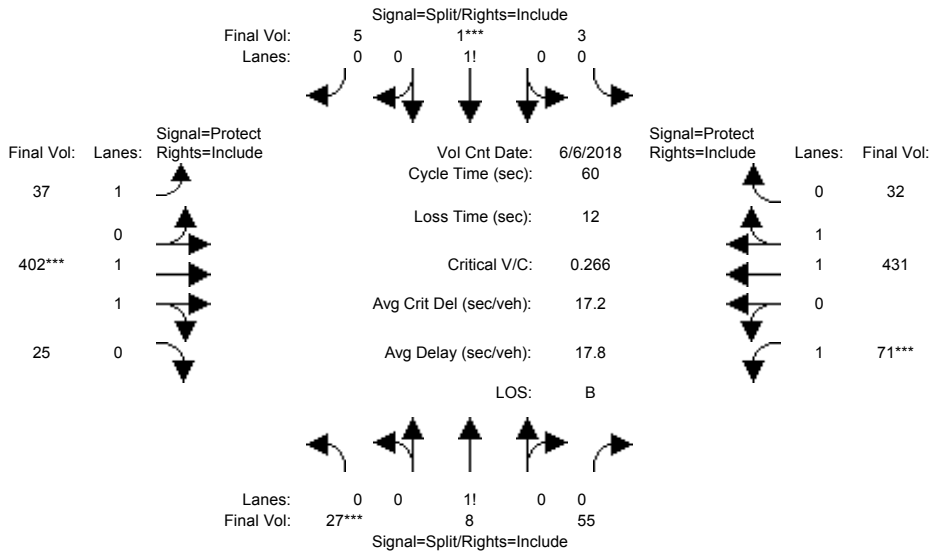

Street Name:	Church Street						Dunne Avenue					
	North Bound			South Bound			East Bound			West Bound		
Approach:	L	T	R	L	T	R	L	T	R	L	T	R
Min. Green:	10	10	10	10	10	10	7	10	10	7	10	10
Y+R:	4.0	4.0	4.0	4.0	4.0	4.0	4.0	4.0	4.0	4.0	4.0	4.0

Volume Module:	>>	Count	Date:	6 Jun 2018	<<							
Base Vol:	27	8	55	3	1	5	37	402	25	71	431	32
Growth Adj:	1.00	1.00	1.00	1.00	1.00	1.00	1.00	1.00	1.00	1.00	1.00	1.00
Initial Bse:	27	8	55	3	1	5	37	402	25	71	431	32
Added Vol:	0	0	0	0	0	0	0	0	0	0	0	0
PasserByVol:	0	0	0	0	0	0	0	0	0	0	0	0
Initial Fut:	27	8	55	3	1	5	37	402	25	71	431	32
User Adj:	1.00	1.00	1.00	1.00	1.00	1.00	1.00	1.00	1.00	1.00	1.00	1.00
PHF Adj:	1.00	1.00	1.00	1.00	1.00	1.00	1.00	1.00	1.00	1.00	1.00	1.00
PHF Volume:	27	8	55	3	1	5	37	402	25	71	431	32
Reduct Vol:	0	0	0	0	0	0	0	0	0	0	0	0
Reduced Vol:	27	8	55	3	1	5	37	402	25	71	431	32
PCE Adj:	1.00	1.00	1.00	1.00	1.00	1.00	1.00	1.00	1.00	1.00	1.00	1.00
MLF Adj:	1.00	1.00	1.00	1.00	1.00	1.00	1.00	1.00	1.00	1.00	1.00	1.00
FinalVolume:	27	8	55	3	1	5	37	402	25	71	431	32

Saturation Flow Module:												
Sat/Lane:	1900	1900	1900	1900	1900	1900	1900	1900	1900	1900	1900	1900
Adjustment:	0.92	0.92	0.92	0.92	0.92	0.92	0.92	0.98	0.95	0.92	0.98	0.95
Lanes:	0.30	0.09	0.61	0.33	0.11	0.56	1.00	1.88	0.12	1.00	1.86	0.14
Final Sat.:	525	156	1069	583	194	972	1750	3483	217	1750	3444	256

Capacity Analysis Module:												
Vol/Sat:	0.05	0.05	0.05	0.01	0.01	0.01	0.02	0.12	0.12	0.04	0.13	0.13
Crit Moves:	***				***			***		***		
Green Time:	10.0	10.0	10.0	10.0	10.0	10.0	11.5	20.7	20.7	7.3	16.5	16.5
Volume/Cap:	0.31	0.31	0.31	0.03	0.03	0.03	0.11	0.33	0.33	0.33	0.46	0.46
Delay/Veh:	22.6	22.6	22.6	21.0	21.0	21.0	20.1	14.7	14.7	25.1	18.4	18.4
User DelAdj:	1.00	1.00	1.00	1.00	1.00	1.00	1.00	1.00	1.00	1.00	1.00	1.00
AdjDel/Veh:	22.6	22.6	22.6	21.0	21.0	21.0	20.1	14.7	14.7	25.1	18.4	18.4
LOS by Move:	C	C	C	C	C	C	C	B	B	C	B	B
HCM2kAvgQ:	2	2	2	0	0	0	1	3	3	1	3	3

Note: Queue reported is the number of cars per lane.

Voices School
Morgan Hill, CA
Hexagon Transportation Consultants, Inc.

Level Of Service Computation Report
2000 HCM Operations (Future Volume Alternative)
Existing (PM)

Intersection #1004: Church Street and Dunne Avenue

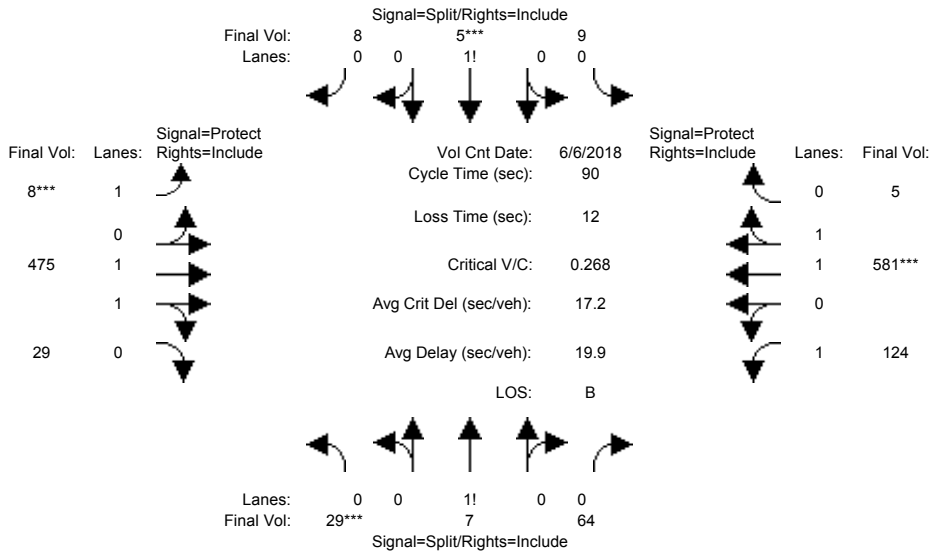

Street Name:	Church Street						Dunne Avenue					
	North Bound			South Bound			East Bound			West Bound		
Approach:	L	T	R	L	T	R	L	T	R	L	T	R
Min. Green:	10	10	10	10	10	10	7	10	10	7	10	10
Y+R:	4.0	4.0	4.0	4.0	4.0	4.0	4.0	4.0	4.0	4.0	4.0	4.0

Volume Module:	>>	Count	Date:	6 Jun 2018	<<							
Base Vol:	29	7	64	9	5	8	8	475	29	124	581	5
Growth Adj:	1.00	1.00	1.00	1.00	1.00	1.00	1.00	1.00	1.00	1.00	1.00	1.00
Initial Bse:	29	7	64	9	5	8	8	475	29	124	581	5
Added Vol:	0	0	0	0	0	0	0	0	0	0	0	0
PasserByVol:	0	0	0	0	0	0	0	0	0	0	0	0
Initial Fut:	29	7	64	9	5	8	8	475	29	124	581	5
User Adj:	1.00	1.00	1.00	1.00	1.00	1.00	1.00	1.00	1.00	1.00	1.00	1.00
PHF Adj:	1.00	1.00	1.00	1.00	1.00	1.00	1.00	1.00	1.00	1.00	1.00	1.00
PHF Volume:	29	7	64	9	5	8	8	475	29	124	581	5
Reduct Vol:	0	0	0	0	0	0	0	0	0	0	0	0
Reduced Vol:	29	7	64	9	5	8	8	475	29	124	581	5
PCE Adj:	1.00	1.00	1.00	1.00	1.00	1.00	1.00	1.00	1.00	1.00	1.00	1.00
MLF Adj:	1.00	1.00	1.00	1.00	1.00	1.00	1.00	1.00	1.00	1.00	1.00	1.00
FinalVolume:	29	7	64	9	5	8	8	475	29	124	581	5

Saturation Flow Module:												
Sat/Lane:	1900	1900	1900	1900	1900	1900	1900	1900	1900	1900	1900	1900
Adjustment:	0.92	0.92	0.92	0.92	0.92	0.92	0.92	0.98	0.95	0.92	0.97	0.95
Lanes:	0.29	0.07	0.64	0.41	0.23	0.36	1.00	1.88	0.12	1.00	1.98	0.02
Final Sat.:	508	123	1120	716	398	636	1750	3487	213	1750	3668	32

Capacity Analysis Module:												
Vol/Sat:	0.06	0.06	0.06	0.01	0.01	0.01	0.00	0.14	0.14	0.07	0.16	0.16
Crit Moves:	***			***			***			***		
Green Time:	16.2	16.2	16.2	10.0	10.0	10.0	7.0	33.0	33.0	18.8	44.8	44.8
Volume/Cap:	0.32	0.32	0.32	0.11	0.11	0.11	0.06	0.37	0.37	0.34	0.32	0.32
Delay/Veh:	32.7	32.7	32.7	36.3	36.3	36.3	38.6	21.1	21.1	30.8	13.6	13.6
User DelAdj:	1.00	1.00	1.00	1.00	1.00	1.00	1.00	1.00	1.00	1.00	1.00	1.00
AdjDel/Veh:	32.7	32.7	32.7	36.3	36.3	36.3	38.6	21.1	21.1	30.8	13.6	13.6
LOS by Move:	C	C	C	D	D	D	D	C	C	C	B	B
HCM2kAvgQ:	3	3	3	1	1	1	0	5	5	3	5	5

Note: Queue reported is the number of cars per lane.

Voices School
Morgan Hill, CA
Hexagon Transportation Consultants, Inc.

Level Of Service Computation Report
2000 HCM Operations (Future Volume Alternative)
Existing Plus Project (AM) - 2 Cosmo Right out

Intersection #1004: Church Street and Dunne Avenue

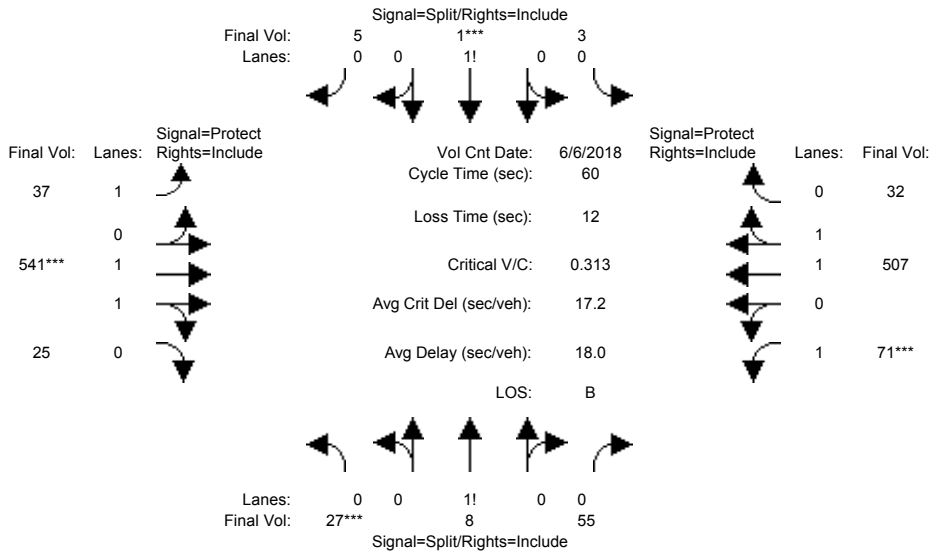

Street Name:	Church Street						Dunne Avenue					
	North Bound			South Bound			East Bound			West Bound		
Approach:	L	T	R	L	T	R	L	T	R	L	T	R
Min. Green:	10	10	10	10	10	10	7	10	10	7	10	10
Y+R:	4.0	4.0	4.0	4.0	4.0	4.0	4.0	4.0	4.0	4.0	4.0	4.0

Volume Module:	>>	Count	Date:	6 Jun 2018	<<							
Base Vol:	27	8	55	3	1	5	37	402	25	71	431	32
Growth Adj:	1.00	1.00	1.00	1.00	1.00	1.00	1.00	1.00	1.00	1.00	1.00	1.00
Initial Bse:	27	8	55	3	1	5	37	402	25	71	431	32
Added Vol:	0	0	0	0	0	0	0	139	0	0	76	0
PasserByVol:	0	0	0	0	0	0	0	0	0	0	0	0
Initial Fut:	27	8	55	3	1	5	37	541	25	71	507	32
User Adj:	1.00	1.00	1.00	1.00	1.00	1.00	1.00	1.00	1.00	1.00	1.00	1.00
PHF Adj:	1.00	1.00	1.00	1.00	1.00	1.00	1.00	1.00	1.00	1.00	1.00	1.00
PHF Volume:	27	8	55	3	1	5	37	541	25	71	507	32
Reduct Vol:	0	0	0	0	0	0	0	0	0	0	0	0
Reduced Vol:	27	8	55	3	1	5	37	541	25	71	507	32
PCE Adj:	1.00	1.00	1.00	1.00	1.00	1.00	1.00	1.00	1.00	1.00	1.00	1.00
MLF Adj:	1.00	1.00	1.00	1.00	1.00	1.00	1.00	1.00	1.00	1.00	1.00	1.00
FinalVolume:	27	8	55	3	1	5	37	541	25	71	507	32

Saturation Flow Module:												
Sat/Lane:	1900	1900	1900	1900	1900	1900	1900	1900	1900	1900	1900	1900
Adjustment:	0.92	0.92	0.92	0.92	0.92	0.92	0.92	0.97	0.95	0.92	0.98	0.95
Lanes:	0.30	0.09	0.61	0.33	0.11	0.56	1.00	1.91	0.09	1.00	1.88	0.12
Final Sat.:	525	156	1069	583	194	972	1750	3536	163	1750	3480	220

Capacity Analysis Module:												
Vol/Sat:	0.05	0.05	0.05	0.01	0.01	0.01	0.02	0.15	0.15	0.04	0.15	0.15
Crit Moves:	***				***			***		***		
Green Time:	10.0	10.0	10.0	10.0	10.0	10.0	11.5	21.0	21.0	7.0	16.5	16.5
Volume/Cap:	0.31	0.31	0.31	0.03	0.03	0.03	0.11	0.44	0.44	0.35	0.53	0.53
Delay/Veh:	22.6	22.6	22.6	21.0	21.0	21.0	20.1	15.2	15.2	25.4	19.0	19.0
User DelAdj:	1.00	1.00	1.00	1.00	1.00	1.00	1.00	1.00	1.00	1.00	1.00	1.00
AdjDel/Veh:	22.6	22.6	22.6	21.0	21.0	21.0	20.1	15.2	15.2	25.4	19.0	19.0
LOS by Move:	C	C	C	C	C	C	C	B	B	C	B	B
HCM2kAvgQ:	2	2	2	0	0	0	1	4	4	1	4	4

Note: Queue reported is the number of cars per lane.

Voices School
Morgan Hill, CA
Hexagon Transportation Consultants, Inc.

Level Of Service Computation Report
2000 HCM Operations (Future Volume Alternative)
Existing Plus Project (PM) - 2 Cosmo Right out

Intersection #1004: Church Street and Dunne Avenue

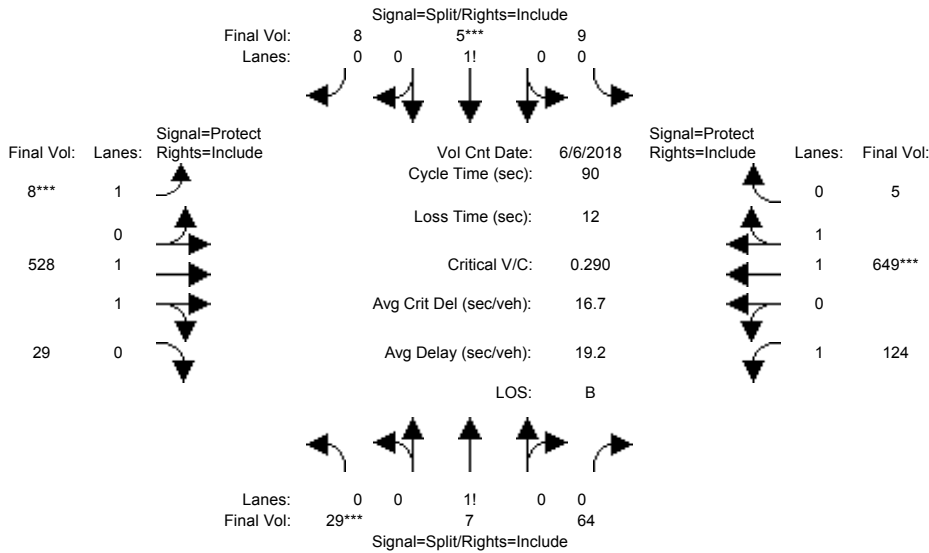

Street Name:	Church Street						Dunne Avenue					
	North Bound			South Bound			East Bound			West Bound		
Approach:	L	T	R	L	T	R	L	T	R	L	T	R
Min. Green:	10	10	10	10	10	10	7	10	10	7	10	10
Y+R:	4.0	4.0	4.0	4.0	4.0	4.0	4.0	4.0	4.0	4.0	4.0	4.0

Volume Module:	>>	Count	Date:	6 Jun 2018	<<							
Base Vol:	29	7	64	9	5	8	8	475	29	124	581	5
Growth Adj:	1.00	1.00	1.00	1.00	1.00	1.00	1.00	1.00	1.00	1.00	1.00	1.00
Initial Bse:	29	7	64	9	5	8	8	475	29	124	581	5
Added Vol:	0	0	0	0	0	0	0	53	0	0	68	0
PasserByVol:	0	0	0	0	0	0	0	0	0	0	0	0
Initial Fut:	29	7	64	9	5	8	8	528	29	124	649	5
User Adj:	1.00	1.00	1.00	1.00	1.00	1.00	1.00	1.00	1.00	1.00	1.00	1.00
PHF Adj:	1.00	1.00	1.00	1.00	1.00	1.00	1.00	1.00	1.00	1.00	1.00	1.00
PHF Volume:	29	7	64	9	5	8	8	528	29	124	649	5
Reduct Vol:	0	0	0	0	0	0	0	0	0	0	0	0
Reduced Vol:	29	7	64	9	5	8	8	528	29	124	649	5
PCE Adj:	1.00	1.00	1.00	1.00	1.00	1.00	1.00	1.00	1.00	1.00	1.00	1.00
MLF Adj:	1.00	1.00	1.00	1.00	1.00	1.00	1.00	1.00	1.00	1.00	1.00	1.00
FinalVolume:	29	7	64	9	5	8	8	528	29	124	649	5

Saturation Flow Module:												
Sat/Lane:	1900	1900	1900	1900	1900	1900	1900	1900	1900	1900	1900	1900
Adjustment:	0.92	0.92	0.92	0.92	0.92	0.92	0.92	0.98	0.95	0.92	0.97	0.95
Lanes:	0.29	0.07	0.64	0.41	0.23	0.36	1.00	1.89	0.11	1.00	1.98	0.02
Final Sat.:	508	123	1120	716	398	636	1750	3507	193	1750	3672	28

Capacity Analysis Module:												
Vol/Sat:	0.06	0.06	0.06	0.01	0.01	0.01	0.00	0.15	0.15	0.07	0.18	0.18
Crit Moves:	****				****		****				****	
Green Time:	14.9	14.9	14.9	10.0	10.0	10.0	7.0	35.0	35.0	18.1	46.1	46.1
Volume/Cap:	0.35	0.35	0.35	0.11	0.11	0.11	0.06	0.39	0.39	0.35	0.35	0.35
Delay/Veh:	33.9	33.9	33.9	36.3	36.3	36.3	38.6	20.0	20.0	31.5	13.1	13.1
User DelAdj:	1.00	1.00	1.00	1.00	1.00	1.00	1.00	1.00	1.00	1.00	1.00	1.00
AdjDel/Veh:	33.9	33.9	33.9	36.3	36.3	36.3	38.6	20.0	20.0	31.5	13.1	13.1
LOS by Move:	C	C	C	D	D	D	D	B	B	C	B	B
HCM2kAvgQ:	3	3	3	1	1	1	0	5	5	3	5	5

Note: Queue reported is the number of cars per lane.

Voices School
Morgan Hill, CA
Hexagon Transportation Consultants, Inc.

Level Of Service Computation Report
2000 HCM Operations (Future Volume Alternative)
Existing (AM)

Intersection #1008: Butterfield Boulevard and San Pedro Avenue

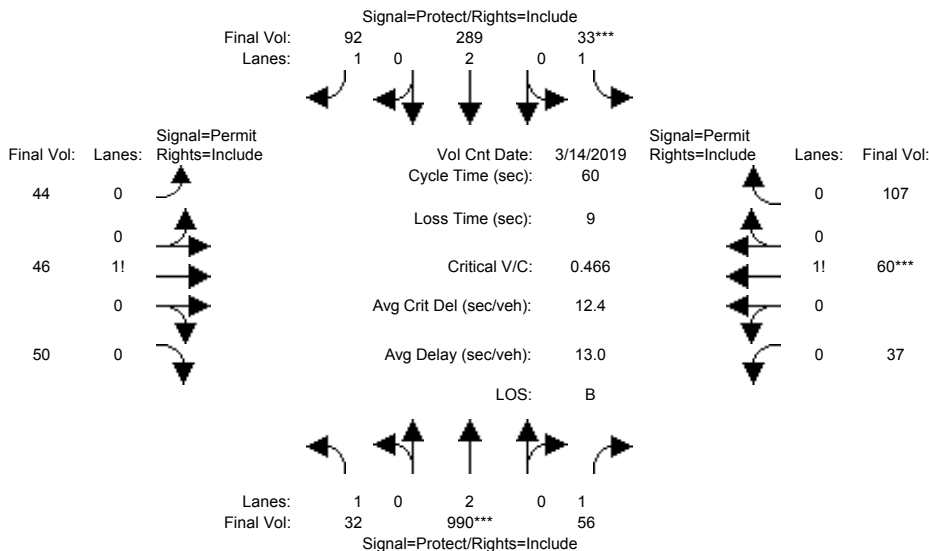

Street Name:	Butterfield Boulevard						San Pedro Avenue					
	North Bound			South Bound			East Bound			West Bound		
Approach:	L	T	R	L	T	R	L	T	R	L	T	R
Min. Green:	7	10	10	7	10	10	10	10	10	10	10	10
Y+R:	4.0	4.0	4.0	4.0	4.0	4.0	4.0	4.0	4.0	4.0	4.0	4.0

Volume Module:	>>	Count	Date:	14 Mar 2019	<<							
Base Vol:	32	990	56	33	289	92	44	46	50	37	60	107
Growth Adj:	1.00	1.00	1.00	1.00	1.00	1.00	1.00	1.00	1.00	1.00	1.00	1.00
Initial Bse:	32	990	56	33	289	92	44	46	50	37	60	107
Added Vol:	0	0	0	0	0	0	0	0	0	0	0	0
PasserByVol:	0	0	0	0	0	0	0	0	0	0	0	0
Initial Fut:	32	990	56	33	289	92	44	46	50	37	60	107
User Adj:	1.00	1.00	1.00	1.00	1.00	1.00	1.00	1.00	1.00	1.00	1.00	1.00
PHF Adj:	1.00	1.00	1.00	1.00	1.00	1.00	1.00	1.00	1.00	1.00	1.00	1.00
PHF Volume:	32	990	56	33	289	92	44	46	50	37	60	107
Reduct Vol:	0	0	0	0	0	0	0	0	0	0	0	0
Reduced Vol:	32	990	56	33	289	92	44	46	50	37	60	107
PCE Adj:	1.00	1.00	1.00	1.00	1.00	1.00	1.00	1.00	1.00	1.00	1.00	1.00
MLF Adj:	1.00	1.00	1.00	1.00	1.00	1.00	1.00	1.00	1.00	1.00	1.00	1.00
FinalVolume:	32	990	56	33	289	92	44	46	50	37	60	107

Saturation Flow Module:												
Sat/Lane:	1900	1900	1900	1900	1900	1900	1900	1900	1900	1900	1900	1900
Adjustment:	0.92	1.00	0.92	0.92	1.00	0.92	0.92	0.92	0.92	0.92	0.92	0.92
Lanes:	1.00	2.00	1.00	1.00	2.00	1.00	0.31	0.33	0.36	0.18	0.29	0.53
Final Sat.:	1750	3800	1750	1750	3800	1750	550	575	625	317	515	918

Capacity Analysis Module:												
Vol/Sat:	0.02	0.26	0.03	0.02	0.08	0.05	0.08	0.08	0.08	0.12	0.12	0.12
Crit Moves:	****			****						****		
Green Time:	15.4	30.4	30.4	7.0	22.0	22.0	13.6	13.6	13.6	13.6	13.6	13.6
Volume/Cap:	0.07	0.51	0.06	0.16	0.21	0.14	0.35	0.35	0.35	0.51	0.51	0.51
Delay/Veh:	17.0	10.1	7.6	24.2	13.1	12.8	20.0	20.0	20.0	21.5	21.5	21.5
User DelAdj:	1.00	1.00	1.00	1.00	1.00	1.00	1.00	1.00	1.00	1.00	1.00	1.00
AdjDel/Veh:	17.0	10.1	7.6	24.2	13.1	12.8	20.0	20.0	20.0	21.5	21.5	21.5
LOS by Move:	B	B	A	C	B	B	C	C	C	C	C	C
HCM2kAvgQ:	0	6	1	1	2	1	3	3	3	4	4	4

Note: Queue reported is the number of cars per lane.

Voices School
Morgan Hill, CA
Hexagon Transportation Consultants, Inc.

Level Of Service Computation Report
2000 HCM Operations (Future Volume Alternative)
Existing (PM)

Intersection #1008: Butterfield Boulevard and San Pedro Avenue

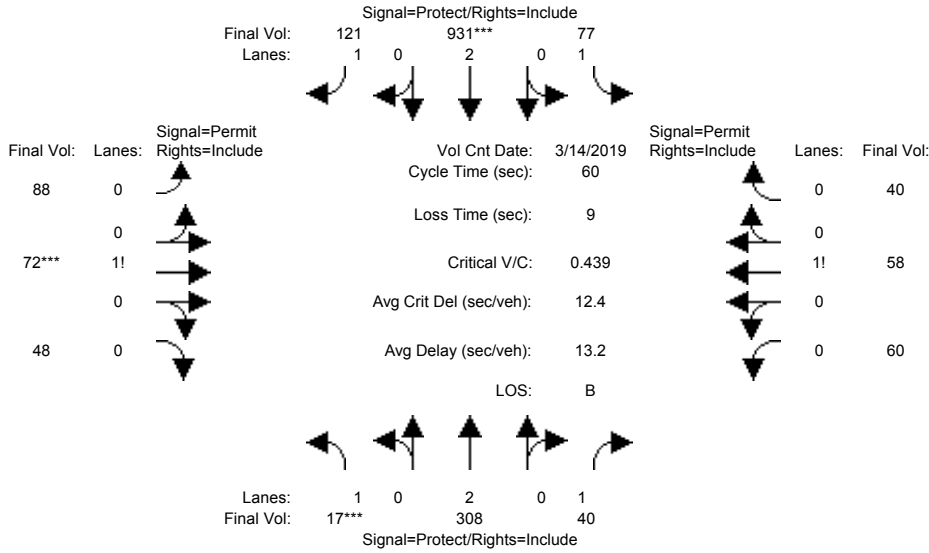

Street Name:	Butterfield Boulevard						San Pedro Avenue					
	North Bound			South Bound			East Bound			West Bound		
Approach:	L	T	R	L	T	R	L	T	R	L	T	R
Min. Green:	7	10	10	7	10	10	10	10	10	10	10	10
Y+R:	4.0	4.0	4.0	4.0	4.0	4.0	4.0	4.0	4.0	4.0	4.0	4.0

Volume Module:	>>	Count	Date:	14 Mar 2019	<<							
Base Vol:	17	308	40	77	931	121	88	72	48	60	58	40
Growth Adj:	1.00	1.00	1.00	1.00	1.00	1.00	1.00	1.00	1.00	1.00	1.00	1.00
Initial Bse:	17	308	40	77	931	121	88	72	48	60	58	40
Added Vol:	0	0	0	0	0	0	0	0	0	0	0	0
PasserByVol:	0	0	0	0	0	0	0	0	0	0	0	0
Initial Fut:	17	308	40	77	931	121	88	72	48	60	58	40
User Adj:	1.00	1.00	1.00	1.00	1.00	1.00	1.00	1.00	1.00	1.00	1.00	1.00
PHF Adj:	1.00	1.00	1.00	1.00	1.00	1.00	1.00	1.00	1.00	1.00	1.00	1.00
PHF Volume:	17	308	40	77	931	121	88	72	48	60	58	40
Reduct Vol:	0	0	0	0	0	0	0	0	0	0	0	0
Reduced Vol:	17	308	40	77	931	121	88	72	48	60	58	40
PCE Adj:	1.00	1.00	1.00	1.00	1.00	1.00	1.00	1.00	1.00	1.00	1.00	1.00
MLF Adj:	1.00	1.00	1.00	1.00	1.00	1.00	1.00	1.00	1.00	1.00	1.00	1.00
Final Volume:	17	308	40	77	931	121	88	72	48	60	58	40

Saturation Flow Module:												
Sat/Lane:	1900	1900	1900	1900	1900	1900	1900	1900	1900	1900	1900	1900
Adjustment:	0.92	1.00	0.92	0.92	1.00	0.92	0.92	0.92	0.92	0.92	0.92	0.92
Lanes:	1.00	2.00	1.00	1.00	2.00	1.00	0.42	0.35	0.23	0.38	0.37	0.25
Final Sat.:	1750	3800	1750	1750	3800	1750	740	606	404	665	642	443

Capacity Analysis Module:												
Vol/Sat:	0.01	0.08	0.02	0.04	0.25	0.07	0.12	0.12	0.12	0.09	0.09	0.09
Crit Moves:	****				****			****				
Green Time:	7.0	21.5	21.5	15.1	29.6	29.6	14.4	14.4	14.4	14.4	14.4	14.4
Volume/Cap:	0.08	0.23	0.06	0.18	0.50	0.14	0.50	0.50	0.50	0.38	0.38	0.38
Delay/Veh:	23.8	13.5	12.7	17.8	10.4	8.3	20.6	20.6	20.6	19.6	19.6	19.6
User DelAdj:	1.00	1.00	1.00	1.00	1.00	1.00	1.00	1.00	1.00	1.00	1.00	1.00
AdjDel/Veh:	23.8	13.5	12.7	17.8	10.4	8.3	20.6	20.6	20.6	19.6	19.6	19.6
LOS by Move:	C	B	B	B	B	A	C	C	C	B	B	B
HCM2kAvgQ:	0	2	0	1	6	1	4	4	4	3	3	3

Note: Queue reported is the number of cars per lane.

Voices School
Morgan Hill, CA
Hexagon Transportation Consultants, Inc.

Level Of Service Computation Report
2000 HCM Operations (Future Volume Alternative)
Existing Plus Project (AM) - 2 Cosmo Right out

Intersection #1008: Butterfield Boulevard and San Pedro Avenue

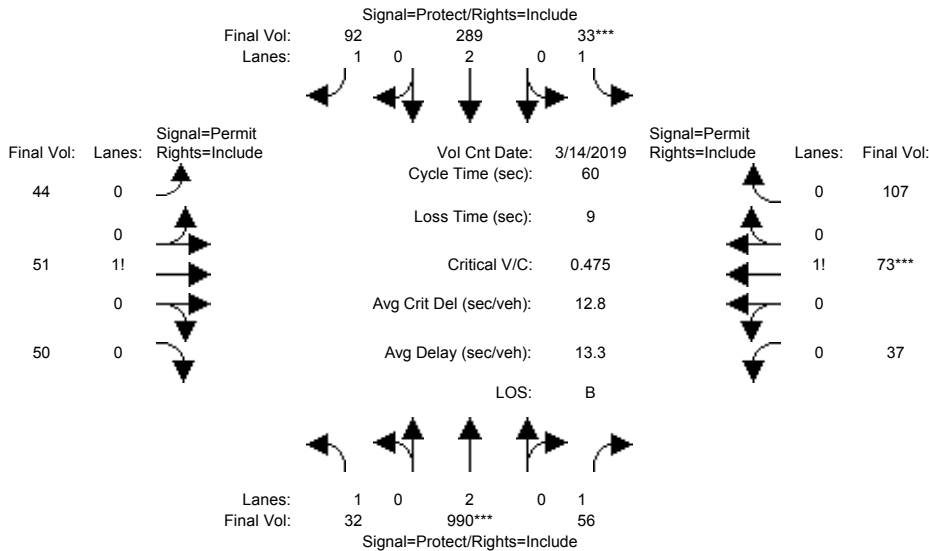

Street Name:	Butterfield Boulevard						San Pedro Avenue					
	North Bound			South Bound			East Bound			West Bound		
Approach:	L	T	R	L	T	R	L	T	R	L	T	R
Min. Green:	7	10	10	7	10	10	10	10	10	10	10	10
Y+R:	4.0	4.0	4.0	4.0	4.0	4.0	4.0	4.0	4.0	4.0	4.0	4.0

Volume Module:	>>	Count	Date:	14 Mar 2019	<<											
Base Vol:	32	990	56	33	289	92	44	46	50	37	60	107				
Growth Adj:	1.00	1.00	1.00	1.00	1.00	1.00	1.00	1.00	1.00	1.00	1.00	1.00				
Initial Bse:	32	990	56	33	289	92	44	46	50	37	60	107				
Added Vol:	0	0	0	0	0	0	0	5	0	0	13	0				
PasserByVol:	0	0	0	0	0	0	0	0	0	0	0	0				
Initial Fut:	32	990	56	33	289	92	44	51	50	37	73	107				
User Adj:	1.00	1.00	1.00	1.00	1.00	1.00	1.00	1.00	1.00	1.00	1.00	1.00				
PHF Adj:	1.00	1.00	1.00	1.00	1.00	1.00	1.00	1.00	1.00	1.00	1.00	1.00				
PHF Volume:	32	990	56	33	289	92	44	51	50	37	73	107				
Reduct Vol:	0	0	0	0	0	0	0	0	0	0	0	0				
Reduced Vol:	32	990	56	33	289	92	44	51	50	37	73	107				
PCE Adj:	1.00	1.00	1.00	1.00	1.00	1.00	1.00	1.00	1.00	1.00	1.00	1.00				
MLF Adj:	1.00	1.00	1.00	1.00	1.00	1.00	1.00	1.00	1.00	1.00	1.00	1.00				
FinalVolume:	32	990	56	33	289	92	44	51	50	37	73	107				

Saturation Flow Module:												
Sat/Lane:	1900	1900	1900	1900	1900	1900	1900	1900	1900	1900	1900	1900
Adjustment:	0.92	1.00	0.92	0.92	1.00	0.92	0.92	0.92	0.92	0.92	0.92	0.92
Lanes:	1.00	2.00	1.00	1.00	2.00	1.00	0.30	0.36	0.34	0.17	0.34	0.49
Final Sat.:	1750	3800	1750	1750	3800	1750	531	616	603	298	589	863

Capacity Analysis Module:												
Vol/Sat:	0.02	0.26	0.03	0.02	0.08	0.05	0.08	0.08	0.08	0.12	0.12	0.12
Crit Moves:	****			****						****		
Green Time:	15.2	29.8	29.8	7.0	21.7	21.7	14.2	14.2	14.2	14.2	14.2	14.2
Volume/Cap:	0.07	0.52	0.06	0.16	0.21	0.15	0.35	0.35	0.35	0.52	0.52	0.52
Delay/Veh:	17.1	10.5	7.9	24.2	13.3	13.0	19.6	19.6	19.6	21.2	21.2	21.2
User DelAdj:	1.00	1.00	1.00	1.00	1.00	1.00	1.00	1.00	1.00	1.00	1.00	1.00
AdjDel/Veh:	17.1	10.5	7.9	24.2	13.3	13.0	19.6	19.6	19.6	21.2	21.2	21.2
LOS by Move:	B	B	A	C	B	B	B	B	B	C	C	C
HCM2kAvgQ:	0	6	1	1	2	1	3	3	3	4	4	4

Note: Queue reported is the number of cars per lane.

Voices School
Morgan Hill, CA
Hexagon Transportation Consultants, Inc.

Level Of Service Computation Report
2000 HCM Operations (Future Volume Alternative)
Existing Plus Project (PM) - 2 Cosmo Right out

Intersection #1008: Butterfield Boulevard and San Pedro Avenue

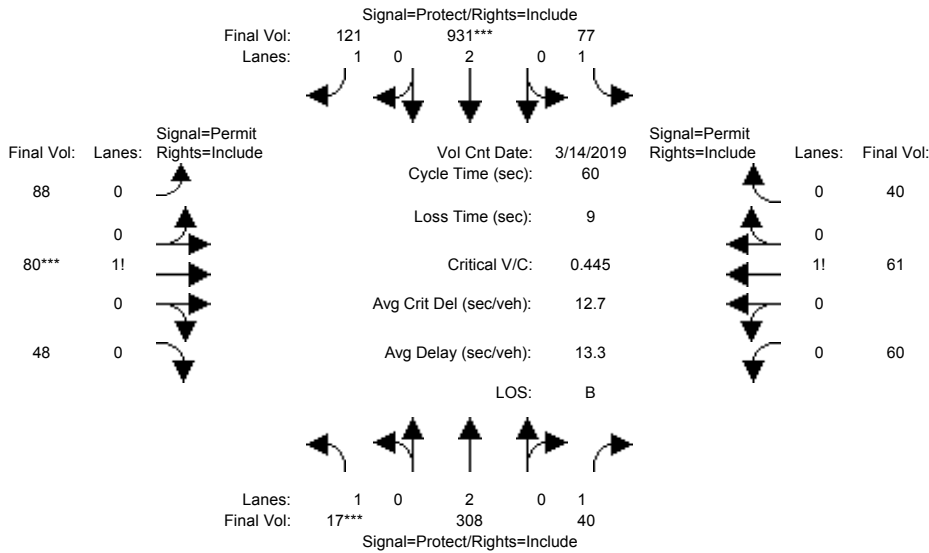

Street Name:	Butterfield Boulevard						San Pedro Avenue					
	North Bound			South Bound			East Bound			West Bound		
Approach:	L	T	R	L	T	R	L	T	R	L	T	R
Min. Green:	7	10	10	7	10	10	10	10	10	10	10	10
Y+R:	4.0	4.0	4.0	4.0	4.0	4.0	4.0	4.0	4.0	4.0	4.0	4.0

Volume Module:	>>	Count	Date:	14 Mar 2019	<<							
Base Vol:	17	308	40	77	931	121	88	72	48	60	58	40
Growth Adj:	1.00	1.00	1.00	1.00	1.00	1.00	1.00	1.00	1.00	1.00	1.00	1.00
Initial Bse:	17	308	40	77	931	121	88	72	48	60	58	40
Added Vol:	0	0	0	0	0	0	0	8	0	0	3	0
PasserByVol:	0	0	0	0	0	0	0	0	0	0	0	0
Initial Fut:	17	308	40	77	931	121	88	80	48	60	61	40
User Adj:	1.00	1.00	1.00	1.00	1.00	1.00	1.00	1.00	1.00	1.00	1.00	1.00
PHF Adj:	1.00	1.00	1.00	1.00	1.00	1.00	1.00	1.00	1.00	1.00	1.00	1.00
PHF Volume:	17	308	40	77	931	121	88	80	48	60	61	40
Reduct Vol:	0	0	0	0	0	0	0	0	0	0	0	0
Reduced Vol:	17	308	40	77	931	121	88	80	48	60	61	40
PCE Adj:	1.00	1.00	1.00	1.00	1.00	1.00	1.00	1.00	1.00	1.00	1.00	1.00
MLF Adj:	1.00	1.00	1.00	1.00	1.00	1.00	1.00	1.00	1.00	1.00	1.00	1.00
FinalVolume:	17	308	40	77	931	121	88	80	48	60	61	40

Saturation Flow Module:												
Sat/Lane:	1900	1900	1900	1900	1900	1900	1900	1900	1900	1900	1900	1900
Adjustment:	0.92	1.00	0.92	0.92	1.00	0.92	0.92	0.92	0.92	0.92	0.92	0.92
Lanes:	1.00	2.00	1.00	1.00	2.00	1.00	0.41	0.37	0.22	0.37	0.38	0.25
Final Sat.:	1750	3800	1750	1750	3800	1750	713	648	389	652	663	435

Capacity Analysis Module:												
Vol/Sat:	0.01	0.08	0.02	0.04	0.25	0.07	0.12	0.12	0.12	0.09	0.09	0.09
Crit Moves:	****				****			****				
Green Time:	7.0	21.3	21.3	14.9	29.3	29.3	14.7	14.7	14.7	14.7	14.7	14.7
Volume/Cap:	0.08	0.23	0.06	0.18	0.50	0.14	0.50	0.50	0.50	0.37	0.37	0.37
Delay/Veh:	23.8	13.6	12.8	17.9	10.6	8.5	20.4	20.4	20.4	19.4	19.4	19.4
User DelAdj:	1.00	1.00	1.00	1.00	1.00	1.00	1.00	1.00	1.00	1.00	1.00	1.00
AdjDel/Veh:	23.8	13.6	12.8	17.9	10.6	8.5	20.4	20.4	20.4	19.4	19.4	19.4
LOS by Move:	C	B	B	B	B	A	C	C	C	B	B	B
HCM2kAvgQ:	0	2	1	1	6	1	4	4	4	3	3	3

Note: Queue reported is the number of cars per lane.

Voices School
Morgan Hill, CA
Hexagon Transportation Consultants, Inc.

Level Of Service Computation Report
2000 HCM Operations (Future Volume Alternative)
Existing (AM)

Intersection #1111: Butterfield Boulevard and Tennant Avenue

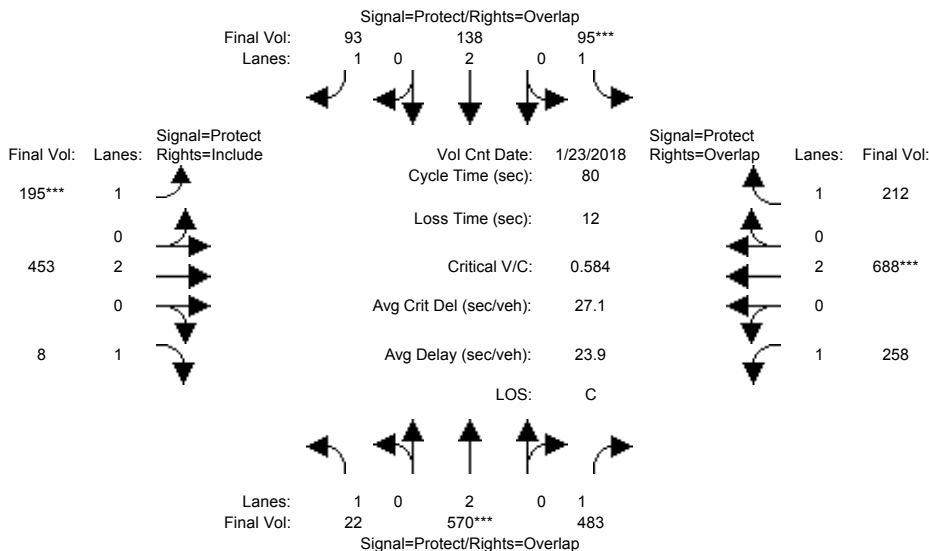

Street Name:	Butterfield Boulevard						Tennant Avenue					
	North Bound			South Bound			East Bound			West Bound		
Approach:	L	T	R	L	T	R	L	T	R	L	T	R
Min. Green:	7	10	10	7	10	10	7	10	10	7	10	10
Y+R:	4.0	4.0	4.0	4.0	4.0	4.0	4.0	4.0	4.0	4.0	4.0	4.0

Volume Module:	>>	Count	Date:	23 Jan 2018	<<											
Base Vol:	22	570	483	95	138	93	195	453	8	258	688	212				
Growth Adj:	1.00	1.00	1.00	1.00	1.00	1.00	1.00	1.00	1.00	1.00	1.00	1.00				
Initial Bse:	22	570	483	95	138	93	195	453	8	258	688	212				
Added Vol:	0	0	0	0	0	0	0	0	0	0	0	0				
PasserByVol:	0	0	0	0	0	0	0	0	0	0	0	0				
Initial Fut:	22	570	483	95	138	93	195	453	8	258	688	212				
User Adj:	1.00	1.00	1.00	1.00	1.00	1.00	1.00	1.00	1.00	1.00	1.00	1.00				
PHF Adj:	1.00	1.00	1.00	1.00	1.00	1.00	1.00	1.00	1.00	1.00	1.00	1.00				
PHF Volume:	22	570	483	95	138	93	195	453	8	258	688	212				
Reduct Vol:	0	0	0	0	0	0	0	0	0	0	0	0				
Reduced Vol:	22	570	483	95	138	93	195	453	8	258	688	212				
PCE Adj:	1.00	1.00	1.00	1.00	1.00	1.00	1.00	1.00	1.00	1.00	1.00	1.00				
MLF Adj:	1.00	1.00	1.00	1.00	1.00	1.00	1.00	1.00	1.00	1.00	1.00	1.00				
Final Volume:	22	570	483	95	138	93	195	453	8	258	688	212				

Saturation Flow Module:												
Sat/Lane:	1900	1900	1900	1900	1900	1900	1900	1900	1900	1900	1900	1900
Adjustment:	0.92	1.00	0.92	0.92	1.00	0.92	0.92	1.00	0.92	0.92	1.00	0.92
Lanes:	1.00	2.00	1.00	1.00	2.00	1.00	1.00	2.00	1.00	1.00	2.00	1.00
Final Sat.:	1750	3800	1750	1750	3800	1750	1750	3800	1750	1750	3800	1750

Capacity Analysis Module:												
Vol/Sat:	0.01	0.15	0.28	0.05	0.04	0.05	0.11	0.12	0.00	0.15	0.18	0.12
Crit Moves:	****			****			****			****		
Green Time:	11.5	20.5	42.2	7.4	16.4	31.7	15.3	18.4	18.4	21.7	24.8	32.2
Volume/Cap:	0.09	0.58	0.52	0.58	0.18	0.13	0.58	0.52	0.02	0.54	0.58	0.30
Delay/Veh:	29.8	26.9	12.9	40.2	26.3	15.5	32.1	27.5	23.9	26.3	24.0	16.5
User DelAdj:	1.00	1.00	1.00	1.00	1.00	1.00	1.00	1.00	1.00	1.00	1.00	1.00
AdjDel/Veh:	29.8	26.9	12.9	40.2	26.3	15.5	32.1	27.5	23.9	26.3	24.0	16.5
LOS by Move:	C	C	B	D	C	B	C	C	C	C	C	B
HCM2kAvgQ:	1	7	9	3	1	2	5	5	0	6	8	4

Note: Queue reported is the number of cars per lane.

Voices School
Morgan Hill, CA
Hexagon Transportation Consultants, Inc.

Level Of Service Computation Report
2000 HCM Operations (Future Volume Alternative)
Existing (PM)

Intersection #1111: Butterfield Boulevard and Tennant Avenue

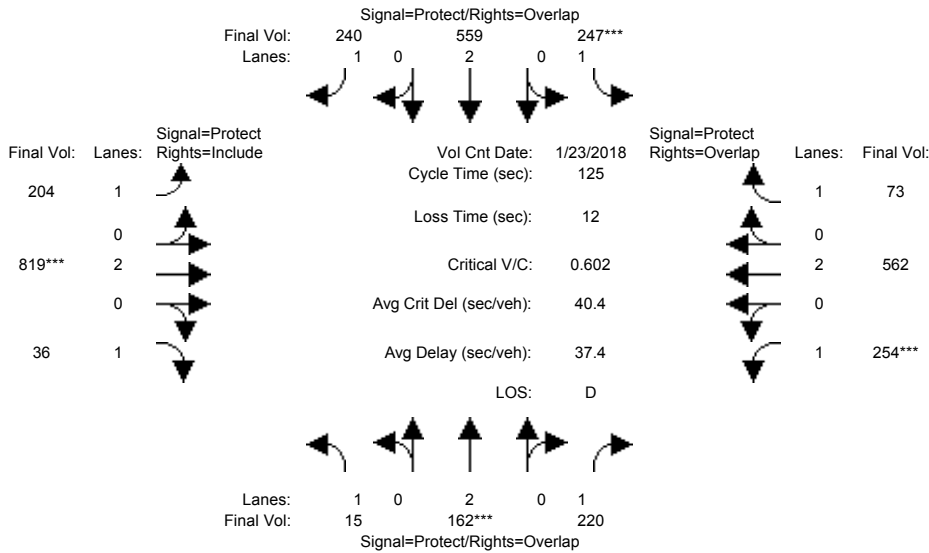

Street Name:	Butterfield Boulevard						Tennant Avenue					
	North Bound			South Bound			East Bound			West Bound		
Approach:	L	T	R	L	T	R	L	T	R	L	T	R
Min. Green:	7	10	10	7	10	10	7	10	10	7	10	10
Y+R:	4.0	4.0	4.0	4.0	4.0	4.0	4.0	4.0	4.0	4.0	4.0	4.0

Volume Module:	>>	Count	Date:	23 Jan 2018	<<							
Base Vol:	15	162	220	247	559	240	204	819	36	254	562	73
Growth Adj:	1.00	1.00	1.00	1.00	1.00	1.00	1.00	1.00	1.00	1.00	1.00	1.00
Initial Bse:	15	162	220	247	559	240	204	819	36	254	562	73
Added Vol:	0	0	0	0	0	0	0	0	0	0	0	0
PasserByVol:	0	0	0	0	0	0	0	0	0	0	0	0
Initial Fut:	15	162	220	247	559	240	204	819	36	254	562	73
User Adj:	1.00	1.00	1.00	1.00	1.00	1.00	1.00	1.00	1.00	1.00	1.00	1.00
PHF Adj:	1.00	1.00	1.00	1.00	1.00	1.00	1.00	1.00	1.00	1.00	1.00	1.00
PHF Volume:	15	162	220	247	559	240	204	819	36	254	562	73
Reduct Vol:	0	0	0	0	0	0	0	0	0	0	0	0
Reduced Vol:	15	162	220	247	559	240	204	819	36	254	562	73
PCE Adj:	1.00	1.00	1.00	1.00	1.00	1.00	1.00	1.00	1.00	1.00	1.00	1.00
MLF Adj:	1.00	1.00	1.00	1.00	1.00	1.00	1.00	1.00	1.00	1.00	1.00	1.00
FinalVolume:	15	162	220	247	559	240	204	819	36	254	562	73

Saturation Flow Module:												
Sat/Lane:	1900	1900	1900	1900	1900	1900	1900	1900	1900	1900	1900	1900
Adjustment:	0.92	1.00	0.92	0.92	1.00	0.92	0.92	1.00	0.92	0.92	1.00	0.92
Lanes:	1.00	2.00	1.00	1.00	2.00	1.00	1.00	2.00	1.00	1.00	2.00	1.00
Final Sat.:	1750	3800	1750	1750	3800	1750	1750	3800	1750	1750	3800	1750

Capacity Analysis Module:												
Vol/Sat:	0.01	0.04	0.13	0.14	0.15	0.14	0.12	0.22	0.02	0.15	0.15	0.04
Crit Moves:	****			****			****			****		
Green Time:	10.7	10.0	39.8	29.0	28.2	60.9	32.6	44.2	44.2	29.8	41.4	70.4
Volume/Cap:	0.10	0.53	0.39	0.61	0.65	0.28	0.45	0.61	0.06	0.61	0.45	0.07
Delay/Veh:	53.0	57.1	33.7	45.6	45.7	19.3	39.3	34.1	26.7	45.0	33.1	12.5
User DelAdj:	1.00	1.00	1.00	1.00	1.00	1.00	1.00	1.00	1.00	1.00	1.00	1.00
AdjDel/Veh:	53.0	57.1	33.7	45.6	45.7	19.3	39.3	34.1	26.7	45.0	33.1	12.5
LOS by Move:	D	E	C	D	D	B	D	C	C	D	C	B
HCM2kAvgQ:	1	4	7	9	10	6	7	13	1	10	8	1

Note: Queue reported is the number of cars per lane.

Voices School
Morgan Hill, CA
Hexagon Transportation Consultants, Inc.

Level Of Service Computation Report
2000 HCM Operations (Future Volume Alternative)
Existing Plus Project (AM) - 2 Cosmo Right out

Intersection #1111: Butterfield Boulevard and Tennant Avenue

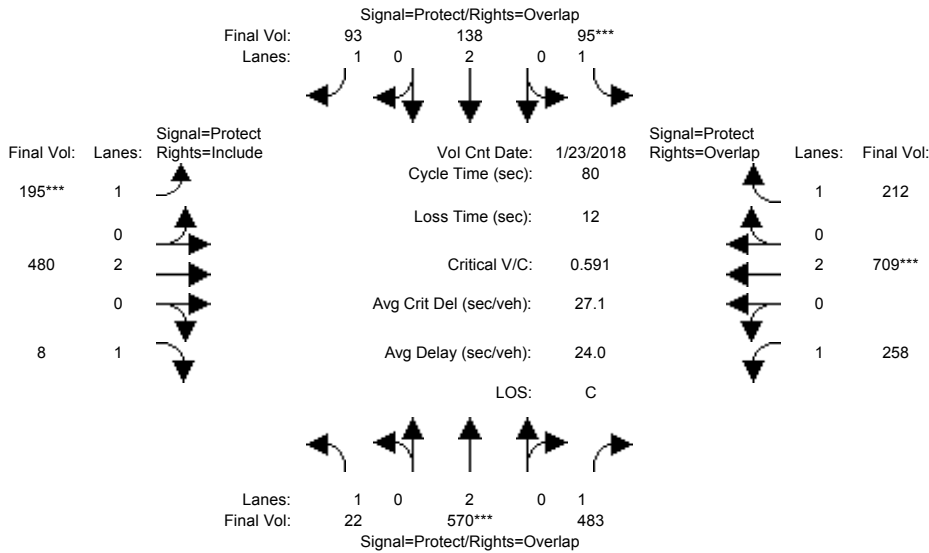

Street Name: Butterfield Boulevard Tennant Avenue
Approach: North Bound South Bound East Bound West Bound
Movement: L - T - R L - T - R L - T - R L - T - R

Min. Green: 7 10 10 7 10 10 7 10 10 7 10 10
Y+R: 4.0 4.0 4.0 4.0 4.0 4.0 4.0 4.0 4.0 4.0 4.0 4.0

Volume Module: >> Count Date: 23 Jan 2018 <<

Base Vol:	22	570	483	95	138	93	195	453	8	258	688	212
Growth Adj:	1.00	1.00	1.00	1.00	1.00	1.00	1.00	1.00	1.00	1.00	1.00	1.00
Initial Bse:	22	570	483	95	138	93	195	453	8	258	688	212
Added Vol:	0	0	0	0	0	0	0	27	0	0	21	0
PasserByVol:	0	0	0	0	0	0	0	0	0	0	0	0
Initial Fut:	22	570	483	95	138	93	195	480	8	258	709	212
User Adj:	1.00	1.00	1.00	1.00	1.00	1.00	1.00	1.00	1.00	1.00	1.00	1.00
PHF Adj:	1.00	1.00	1.00	1.00	1.00	1.00	1.00	1.00	1.00	1.00	1.00	1.00
PHF Volume:	22	570	483	95	138	93	195	480	8	258	709	212
Reduct Vol:	0	0	0	0	0	0	0	0	0	0	0	0
Reduced Vol:	22	570	483	95	138	93	195	480	8	258	709	212
PCE Adj:	1.00	1.00	1.00	1.00	1.00	1.00	1.00	1.00	1.00	1.00	1.00	1.00
MLF Adj:	1.00	1.00	1.00	1.00	1.00	1.00	1.00	1.00	1.00	1.00	1.00	1.00
FinalVolume:	22	570	483	95	138	93	195	480	8	258	709	212

Saturation Flow Module:

Sat/Lane:	1900	1900	1900	1900	1900	1900	1900	1900	1900	1900	1900	1900
Adjustment:	0.92	1.00	0.92	0.92	1.00	0.92	0.92	1.00	0.92	0.92	1.00	0.92
Lanes:	1.00	2.00	1.00	1.00	2.00	1.00	1.00	2.00	1.00	1.00	2.00	1.00
Final Sat.:	1750	3800	1750	1750	3800	1750	1750	3800	1750	1750	3800	1750

Capacity Analysis Module:

Vol/Sat:	0.01	0.15	0.28	0.05	0.04	0.05	0.11	0.13	0.00	0.15	0.19	0.12
Crit Moves:	****			****			****				****	
Green Time:	11.4	20.3	42.0	7.3	16.3	31.4	15.1	18.6	18.6	21.7	25.3	32.6
Volume/Cap:	0.09	0.59	0.53	0.59	0.18	0.14	0.59	0.54	0.02	0.54	0.59	0.30
Delay/Veh:	30.0	27.2	13.0	40.6	26.5	15.7	32.5	27.6	23.7	26.2	23.8	16.2
User DelAdj:	1.00	1.00	1.00	1.00	1.00	1.00	1.00	1.00	1.00	1.00	1.00	1.00
AdjDel/Veh:	30.0	27.2	13.0	40.6	26.5	15.7	32.5	27.6	23.7	26.2	23.8	16.2
LOS by Move:	C	C	B	D	C	B	C	C	C	C	C	B
HCM2kAvgQ:	1	7	9	3	1	2	5	5	0	6	8	4

Note: Queue reported is the number of cars per lane.

Voices School
Morgan Hill, CA
Hexagon Transportation Consultants, Inc.

Level Of Service Computation Report
2000 HCM Operations (Future Volume Alternative)
Existing Plus Project (PM) - 2 Cosmo Right out

Intersection #1111: Butterfield Boulevard and Tennant Avenue

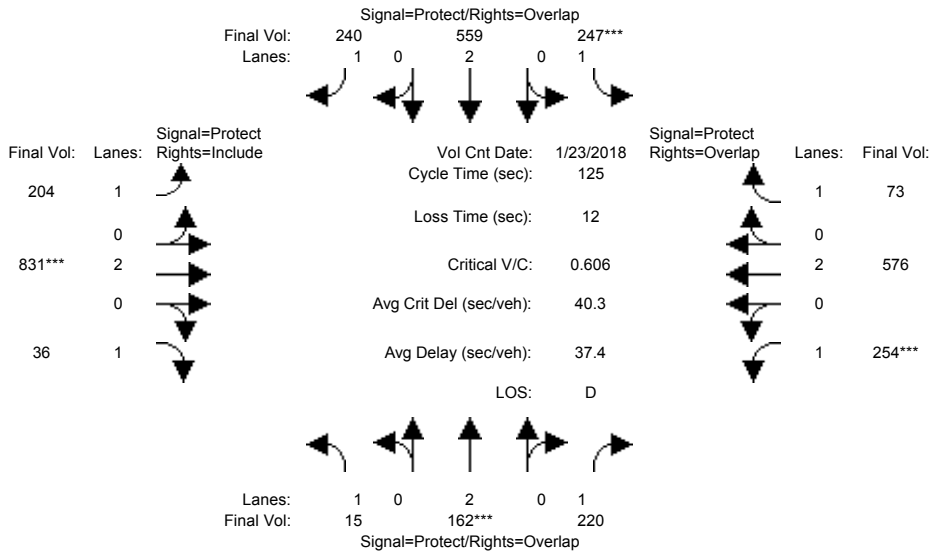

Street Name:	Butterfield Boulevard						Tennant Avenue					
	North Bound			South Bound			East Bound			West Bound		
Approach:	L	T	R	L	T	R	L	T	R	L	T	R
Min. Green:	7	10	10	7	10	10	7	10	10	7	10	10
Y+R:	4.0	4.0	4.0	4.0	4.0	4.0	4.0	4.0	4.0	4.0	4.0	4.0

Volume Module:	>>	Count	Date:	23 Jan 2018	<<							
Base Vol:	15	162	220	247	559	240	204	819	36	254	562	73
Growth Adj:	1.00	1.00	1.00	1.00	1.00	1.00	1.00	1.00	1.00	1.00	1.00	1.00
Initial Bse:	15	162	220	247	559	240	204	819	36	254	562	73
Added Vol:	0	0	0	0	0	0	0	12	0	0	14	0
PasserByVol:	0	0	0	0	0	0	0	0	0	0	0	0
Initial Fut:	15	162	220	247	559	240	204	831	36	254	576	73
User Adj:	1.00	1.00	1.00	1.00	1.00	1.00	1.00	1.00	1.00	1.00	1.00	1.00
PHF Adj:	1.00	1.00	1.00	1.00	1.00	1.00	1.00	1.00	1.00	1.00	1.00	1.00
PHF Volume:	15	162	220	247	559	240	204	831	36	254	576	73
Reduct Vol:	0	0	0	0	0	0	0	0	0	0	0	0
Reduced Vol:	15	162	220	247	559	240	204	831	36	254	576	73
PCE Adj:	1.00	1.00	1.00	1.00	1.00	1.00	1.00	1.00	1.00	1.00	1.00	1.00
MLF Adj:	1.00	1.00	1.00	1.00	1.00	1.00	1.00	1.00	1.00	1.00	1.00	1.00
FinalVolume:	15	162	220	247	559	240	204	831	36	254	576	73

Saturation Flow Module:												
Sat/Lane:	1900	1900	1900	1900	1900	1900	1900	1900	1900	1900	1900	1900
Adjustment:	0.92	1.00	0.92	0.92	1.00	0.92	0.92	1.00	0.92	0.92	1.00	0.92
Lanes:	1.00	2.00	1.00	1.00	2.00	1.00	1.00	2.00	1.00	1.00	2.00	1.00
Final Sat.:	1750	3800	1750	1750	3800	1750	1750	3800	1750	1750	3800	1750

Capacity Analysis Module:												
Vol/Sat:	0.01	0.04	0.13	0.14	0.15	0.14	0.12	0.22	0.02	0.15	0.15	0.04
Crit Moves:	****			****			****			****		
Green Time:	10.7	10.0	39.6	28.8	28.1	60.4	32.3	44.6	44.6	29.6	41.9	70.7
Volume/Cap:	0.10	0.53	0.40	0.61	0.65	0.28	0.45	0.61	0.06	0.61	0.45	0.07
Delay/Veh:	53.0	57.1	33.8	45.9	45.9	19.6	39.7	33.9	26.4	45.3	32.8	12.3
User DelAdj:	1.00	1.00	1.00	1.00	1.00	1.00	1.00	1.00	1.00	1.00	1.00	1.00
AdjDel/Veh:	53.0	57.1	33.8	45.9	45.9	19.6	39.7	33.9	26.4	45.3	32.8	12.3
LOS by Move:	D	E	C	D	D	B	D	C	C	D	C	B
HCM2kAvgQ:	1	4	7	9	10	6	7	13	1	10	9	1

Note: Queue reported is the number of cars per lane.

Voices School
Morgan Hill, CA
Hexagon Transportation Consultants, Inc.

Level Of Service Computation Report
2000 HCM Unsignalized (Future Volume Alternative)
Existing (AM)

Intersection #1112: Monterey Road and San Pedro Avenue

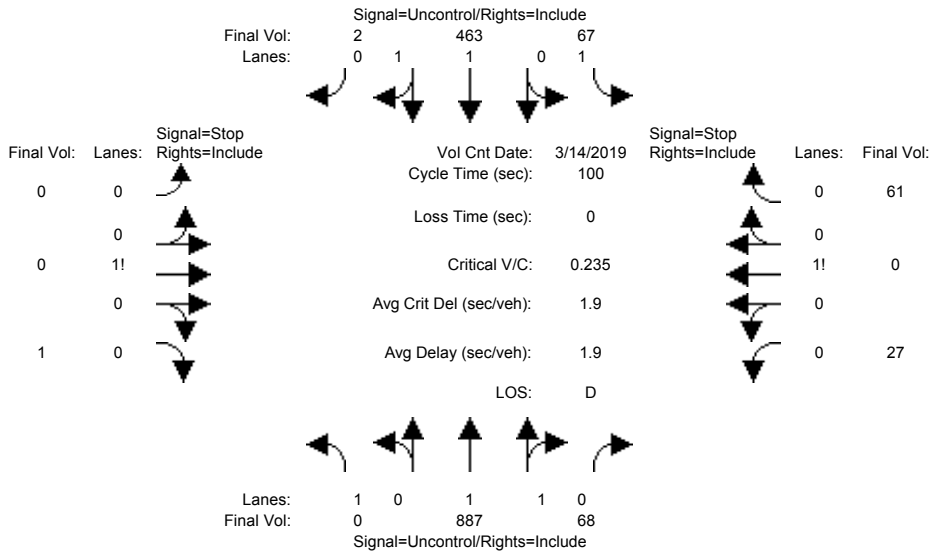

Street Name: Monterey Road San Pedro Avenue
Approach: North Bound South Bound East Bound West Bound
Movement: L - T - R L - T - R L - T - R L - T - R

Volume Module:	>> Count Date: 14 Mar 2019 <<											
Base Vol:	0	887	68	67	463	2	0	0	1	27	0	61
Growth Adj:	1.00	1.00	1.00	1.00	1.00	1.00	1.00	1.00	1.00	1.00	1.00	1.00
Initial Bse:	0	887	68	67	463	2	0	0	1	27	0	61
Added Vol:	0	0	0	0	0	0	0	0	0	0	0	0
PasserByVol:	0	0	0	0	0	0	0	0	0	0	0	0
Initial Fut:	0	887	68	67	463	2	0	0	1	27	0	61
User Adj:	1.00	1.00	1.00	1.00	1.00	1.00	1.00	1.00	1.00	1.00	1.00	1.00
PHF Adj:	1.00	1.00	1.00	1.00	1.00	1.00	1.00	1.00	1.00	1.00	1.00	1.00
PHF Volume:	0	887	68	67	463	2	0	0	1	27	0	61
Reduct Vol:	0	0	0	0	0	0	0	0	0	0	0	0
Final Volume:	0	887	68	67	463	2	0	0	1	27	0	61

Critical Gap Module:

Critical Gp:	xxxxx	xxxx	xxxxx	4.1	xxxx	xxxxx	xxxxx	xxxx	6.9	7.5	6.5	6.9
FollowUpTim:	xxxxx	xxxx	xxxxx	2.2	xxxx	xxxxx	xxxxx	xxxx	3.3	3.5	4.0	3.3

Capacity Module:

Cnflct Vol:	xxxx	xxxx	xxxxx	955	xxxx	xxxxx	xxxx	xxxx	233	1287	1520	478
Potent Cap.:	xxxx	xxxx	xxxxx	728	xxxx	xxxxx	xxxx	xxxx	776	124	120	539
Move Cap.:	xxxx	xxxx	xxxxx	728	xxxx	xxxxx	xxxx	xxxx	776	115	109	539
Volume/Cap:	xxxx	xxxx	xxxx	0.09	xxxx	xxxx	xxxx	xxxx	0.00	0.24	0.00	0.11

Level Of Service Module:

2Way95thQ:	xxxx	xxxx	xxxxx	0.3	xxxx	xxxxx	xxxx	xxxx	0.0	xxxx	xxxx	xxxxx
Control Del:	xxxxx	xxxx	xxxxx	10.4	xxxx	xxxxx	xxxxx	xxxx	9.6	xxxxx	xxxx	xxxxx
LOS by Move:	*	*	*	B	*	*	*	*	A	*	*	*
Movement:	LT - LTR - RT	LT - LTR - RT	LT - LTR - RT	LT - LTR - RT	LT - LTR - RT	LT - LTR - RT	LT - LTR - RT	LT - LTR - RT	LT - LTR - RT	LT - LTR - RT	LT - LTR - RT	LT - LTR - RT
Shared Cap.:	xxxx	xxxx	xxxxx	xxxx	xxxx	xxxxx	xxxx	xxxx	xxxxx	xxxx	253	xxxxx
SharedQueue:	xxxxx	xxxx	xxxxx	xxxxx	xxxx	xxxxx	xxxxx	xxxx	xxxxx	xxxxx	1.5	xxxxx
Shrd ConDel:	xxxxx	xxxx	xxxxx	xxxxx	xxxx	xxxxx	xxxxx	xxxx	xxxxx	xxxxx	26.7	xxxxx
Shared LOS:	*	*	*	*	*	*	*	*	*	*	D	*
ApproachDel:	xxxxxxx	xxxxxxx							9.6		26.7	
ApproachLOS:		*			*				A		D	

Note: Queue reported is the number of cars per lane.

Voices School
Morgan Hill, CA
Hexagon Transportation Consultants, Inc.

Level Of Service Computation Report
2000 HCM Unsignalized (Future Volume Alternative)
Existing (PM)

Intersection #1112: Monterey Road and San Pedro Avenue

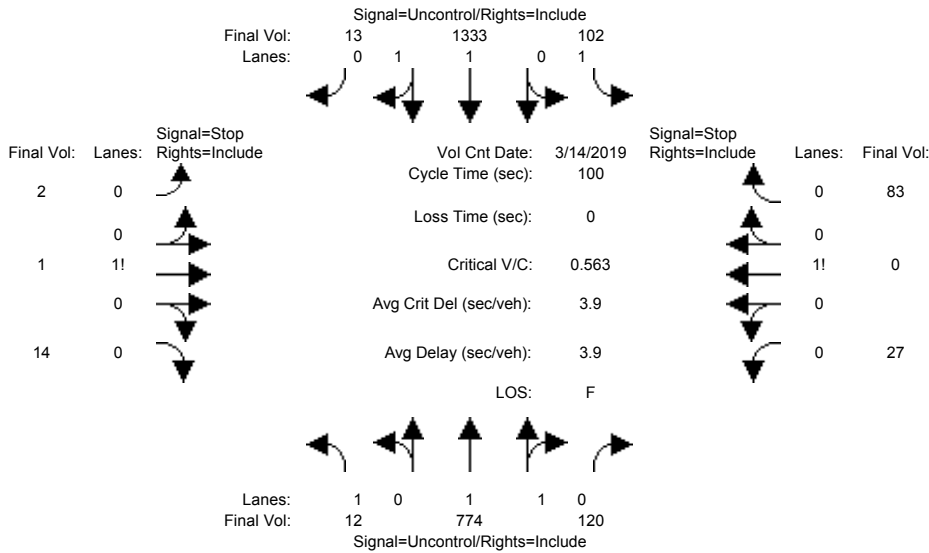

Street Name: Monterey Road San Pedro Avenue
Approach: North Bound South Bound East Bound West Bound
Movement: L - T - R L - T - R L - T - R L - T - R

Volume Module:	>>	Count	Date:	14 Mar 2019	<<							
Base Vol:	12	774	120	102	1333	13	2	1	14	27	0	83
Growth Adj:	1.00	1.00	1.00	1.00	1.00	1.00	1.00	1.00	1.00	1.00	1.00	1.00
Initial Bse:	12	774	120	102	1333	13	2	1	14	27	0	83
Added Vol:	0	0	0	0	0	0	0	0	0	0	0	0
PasserByVol:	0	0	0	0	0	0	0	0	0	0	0	0
Initial Fut:	12	774	120	102	1333	13	2	1	14	27	0	83
User Adj:	1.00	1.00	1.00	1.00	1.00	1.00	1.00	1.00	1.00	1.00	1.00	1.00
PHF Adj:	1.00	1.00	1.00	1.00	1.00	1.00	1.00	1.00	1.00	1.00	1.00	1.00
PHF Volume:	12	774	120	102	1333	13	2	1	14	27	0	83
Reduct Vol:	0	0	0	0	0	0	0	0	0	0	0	0
FinalVolume:	12	774	120	102	1333	13	2	1	14	27	0	83

Critical Gap Module:												
Critical Gp:	4.1	xxxx	xxxxxx	4.1	xxxx	xxxxxx	7.5	6.5	6.9	7.5	6.5	6.9
FollowUpTim:	2.2	xxxx	xxxxxx	2.2	xxxx	xxxxxx	3.5	4.0	3.3	3.5	4.0	3.3

Capacity Module:												
Cnflct Vol:	1346	xxxx	xxxxxx	894	xxxx	xxxxxx	1955	2462	673	1729	2408	447
Potent Cap.:	518	xxxx	xxxxxx	767	xxxx	xxxxxx	39	31	402	58	33	564
Move Cap.:	518	xxxx	xxxxxx	767	xxxx	xxxxxx	29	26	402	48	28	564
Volume/Cap:	0.02	xxxx	xxxx	0.13	xxxx	xxxx	0.07	0.04	0.03	0.56	0.00	0.15

Level Of Service Module:												
2Way95thQ:	0.1	xxxx	xxxxxx	0.5	xxxx	xxxxxx	xxxx	xxxx	xxxxxx	xxxx	xxxx	xxxxxx
Control Del:	12.1	xxxx	xxxxxx	10.4	xxxx	xxxxxx	xxxxxx	xxxx	xxxxxx	xxxxxx	xxxx	xxxxxx
LOS by Move:	B	*	*	B	*	*	*	*	*	*	*	*
Movement:	LT - LTR - RT			LT - LTR - RT			LT - LTR - RT			LT - LTR - RT		
Shared Cap.:	xxxx	xxxx	xxxxxx	xxxx	xxxx	xxxxxx	xxxx	121	xxxxxx	xxxx	155	xxxxxx
SharedQueue:	xxxxxx	xxxx	xxxxxx	xxxxxx	xxxx	xxxxxx	xxxxxx	0.5	xxxxxx	xxxxxx	4.2	xxxxxx
Shrd ConDel:	xxxxxx	xxxx	xxxxxx	xxxxxx	xxxx	xxxxxx	xxxxxx	39.6	xxxxxx	xxxxxx	71.1	xxxxxx
Shared LOS:	*	*	*	*	*	*	*	E	*	*	F	*
ApproachDel:	xxxxxxx			xxxxxxx				39.6			71.1	
ApproachLOS:	*			*				E			F	

Note: Queue reported is the number of cars per lane.

Voices School
Morgan Hill, CA
Hexagon Transportation Consultants, Inc.

Level Of Service Computation Report
2000 HCM Unsignalized (Future Volume Alternative)
Existing Plus Project (AM) - 2 Cosmo Right out

Intersection #1112: Monterey Road and San Pedro Avenue

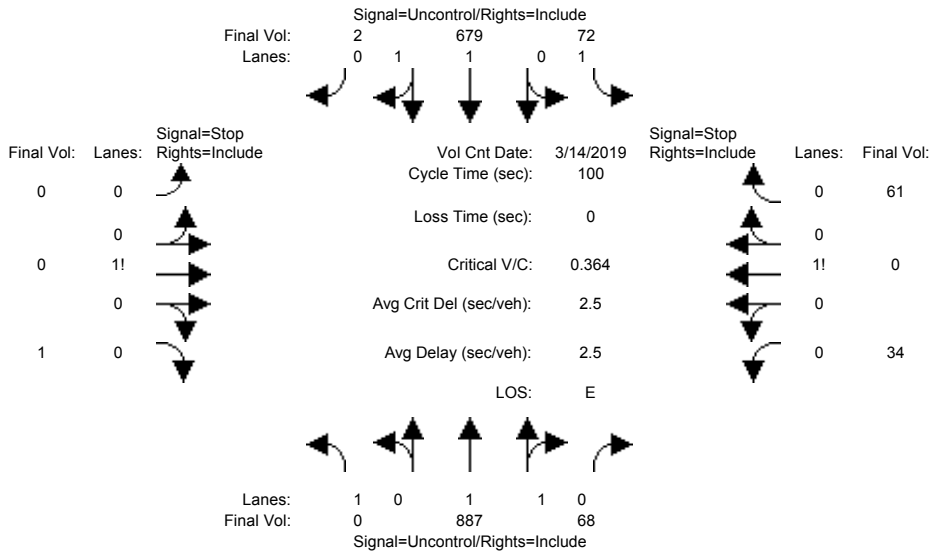

Street Name: Monterey Road San Pedro Avenue
Approach: North Bound South Bound East Bound West Bound
Movement: L - T - R L - T - R L - T - R L - T - R

Volume Module:	>> Count Date: 14 Mar 2019 <<											
Base Vol:	0	887	68	67	463	2	0	0	1	27	0	61
Growth Adj:	1.00	1.00	1.00	1.00	1.00	1.00	1.00	1.00	1.00	1.00	1.00	1.00
Initial Bse:	0	887	68	67	463	2	0	0	1	27	0	61
Added Vol:	0	0	0	5	216	0	0	0	0	7	0	0
PasserByVol:	0	0	0	0	0	0	0	0	0	0	0	0
Initial Fut:	0	887	68	72	679	2	0	0	1	34	0	61
User Adj:	1.00	1.00	1.00	1.00	1.00	1.00	1.00	1.00	1.00	1.00	1.00	1.00
PHF Adj:	1.00	1.00	1.00	1.00	1.00	1.00	1.00	1.00	1.00	1.00	1.00	1.00
PHF Volume:	0	887	68	72	679	2	0	0	1	34	0	61
Reduct Vol:	0	0	0	0	0	0	0	0	0	0	0	0
FinalVolume:	0	887	68	72	679	2	0	0	1	34	0	61

Critical Gap Module:

Critical Gp:	xxxxx	xxxx	xxxxx	4.1	xxxx	xxxxx	xxxxx	xxxx	6.9	7.5	6.5	6.9
FollowUpTim:	xxxxx	xxxx	xxxxx	2.2	xxxx	xxxxx	xxxxx	xxxx	3.3	3.5	4.0	3.3

Capacity Module:

Cnflct Vol:	xxxx	xxxx	xxxxx	955	xxxx	xxxxx	xxxx	xxxx	341	1405	1746	478
Potent Cap.:	xxxx	xxxx	xxxxx	728	xxxx	xxxxx	xxxx	xxxx	661	101	87	539
Move Cap.:	xxxx	xxxx	xxxxx	728	xxxx	xxxxx	xxxx	xxxx	661	93	79	539
Volume/Cap:	xxxx	xxxx	xxxx	0.10	xxxx	xxxx	xxxx	xxxx	0.00	0.36	0.00	0.11

Level Of Service Module:

2Way95thQ:	xxxx	xxxx	xxxxx	0.3	xxxx	xxxxx	xxxx	xxxx	0.0	xxxx	xxxx	xxxxx
Control Del:	xxxxx	xxxx	xxxxx	10.5	xxxx	xxxxx	xxxxx	xxxx	10.5	xxxxx	xxxx	xxxxx
LOS by Move:	*	*	*	B	*	*	*	*	B	*	*	*
Movement:	LT - LTR - RT	LT - LTR - RT	LT - LTR - RT	LT - LTR - RT	LT - LTR - RT	LT - LTR - RT	LT - LTR - RT	LT - LTR - RT	LT - LTR - RT	LT - LTR - RT	LT - LTR - RT	LT - LTR - RT
Shared Cap.:	xxxx	xxxx	xxxxx	xxxx	xxxx	xxxxx	xxxx	xxxx	xxxxx	xxxx	199	xxxxx
SharedQueue:	xxxxx	xxxx	xxxxx	xxxxx	xxxx	xxxxx	xxxxx	xxxx	xxxxx	xxxxx	2.3	xxxxx
Shrd ConDel:	xxxxx	xxxx	xxxxx	xxxxx	xxxx	xxxxx	xxxxx	xxxx	xxxxx	xxxxx	38.6	xxxxx
Shared LOS:	*	*	*	*	*	*	*	*	*	*	E	*
ApproachDel:	xxxxxxx	xxxxxxx					10.5			38.6		
ApproachLOS:	*	*					B			E		

Note: Queue reported is the number of cars per lane.

Voices School
Morgan Hill, CA
Hexagon Transportation Consultants, Inc.

Level Of Service Computation Report
2000 HCM Unsignalized (Future Volume Alternative)
Existing Plus Project (PM) - 2 Cosmo Right out

Intersection #1112: Monterey Road and San Pedro Avenue

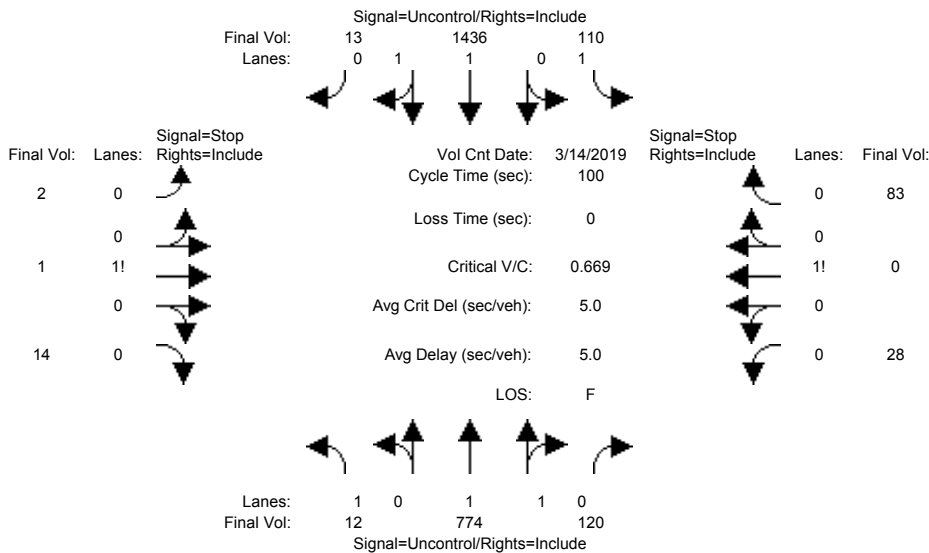

Street Name: Monterey Road San Pedro Avenue
Approach: North Bound South Bound East Bound West Bound
Movement: L - T - R L - T - R L - T - R L - T - R

Volume Module:	>> Count Date: 14 Mar 2019 <<											
Base Vol:	12	774	120	102	1333	13	2	1	14	27	0	83
Growth Adj:	1.00	1.00	1.00	1.00	1.00	1.00	1.00	1.00	1.00	1.00	1.00	1.00
Initial Bse:	12	774	120	102	1333	13	2	1	14	27	0	83
Added Vol:	0	0	0	8	103	0	0	0	0	1	0	0
PasserByVol:	0	0	0	0	0	0	0	0	0	0	0	0
Initial Fut:	12	774	120	110	1436	13	2	1	14	28	0	83
User Adj:	1.00	1.00	1.00	1.00	1.00	1.00	1.00	1.00	1.00	1.00	1.00	1.00
PHF Adj:	1.00	1.00	1.00	1.00	1.00	1.00	1.00	1.00	1.00	1.00	1.00	1.00
PHF Volume:	12	774	120	110	1436	13	2	1	14	28	0	83
Reduct Vol:	0	0	0	0	0	0	0	0	0	0	0	0
FinalVolume:	12	774	120	110	1436	13	2	1	14	28	0	83

Critical Gap Module:

Critical Gp:	4.1	xxxx	xxxxx	4.1	xxxx	xxxxx	7.5	6.5	6.9	7.5	6.5	6.9
FollowUpTim:	2.2	xxxx	xxxxx	2.2	xxxx	xxxxx	3.5	4.0	3.3	3.5	4.0	3.3

Capacity Module:

Cnflct Vol:	1449	xxxx	xxxxx	894	xxxx	xxxxx	2074	2581	725	1797	2527	447
Potent Cap.:	474	xxxx	xxxxx	767	xxxx	xxxxx	32	26	372	52	28	564
Move Cap.:	474	xxxx	xxxxx	767	xxxx	xxxxx	24	22	372	42	23	564
Volume/Cap:	0.03	xxxx	xxxx	0.14	xxxx	xxxx	0.08	0.05	0.04	0.67	0.00	0.15

Level Of Service Module:

2Way95thQ:	0.1	xxxx	xxxxx	0.5	xxxx	xxxxx	xxxx	xxxx	xxxxx	xxxx	xxxx	xxxxx
Control Del:	12.8	xxxx	xxxxx	10.5	xxxx	xxxxx	xxxxx	xxxx	xxxxx	xxxxx	xxxx	xxxxx
LOS by Move:	B	*	*	B	*	*	*	*	*	*	*	*
Movement:	LT - LTR - RT			LT - LTR - RT			LT - LTR - RT			LT - LTR - RT		
Shared Cap.:	xxxx	xxxx	xxxxx	xxxx	xxxx	xxxxx	xxxx	101	xxxxx	xxxx	136	xxxxx
SharedQueue:	xxxxx	xxxx	xxxxx	xxxxx	xxxx	xxxxx	xxxxx	0.6	xxxxx	xxxxx	5.1	xxxxx
Shrd ConDel:	xxxxx	xxxx	xxxxx	xxxxx	xxxx	xxxxx	xxxxx	47.7	xxxxx	xxxxx	97.1	xxxxx
Shared LOS:	*	*	*	*	*	*	*	E	*	*	F	*
ApproachDel:	xxxxxxx			xxxxxxx				47.7			97.1	
ApproachLOS:		*			*			E			F	

Note: Queue reported is the number of cars per lane.

Voices School
Morgan Hill, CA
Hexagon Transportation Consultants, Inc.

Level Of Service Computation Report
2000 HCM Operations (Future Volume Alternative)
Existing (AM)

Intersection #1200: Monterey Road and Cosmo Avenue

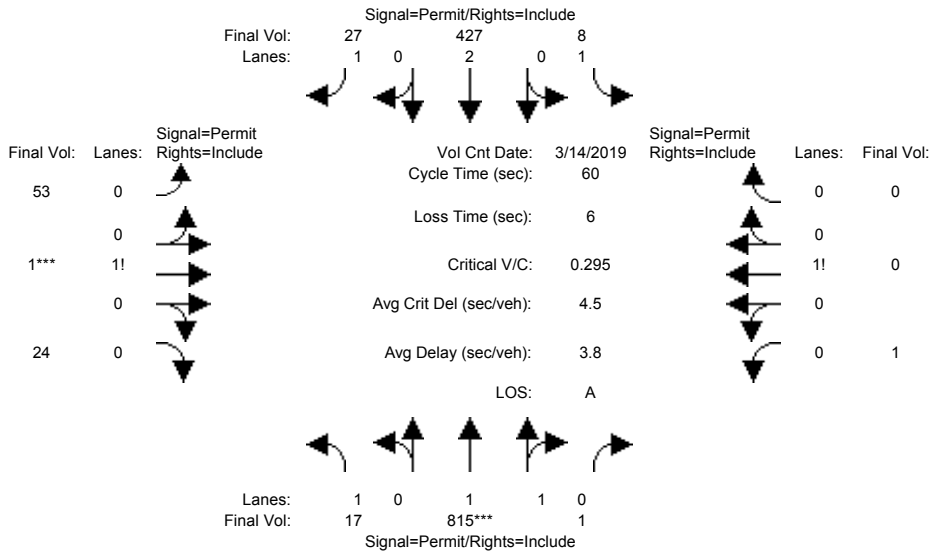

Street Name:	Monterey Rd						Cosmo Ave					
Approach:	North Bound			South Bound			East Bound			West Bound		
Movement:	L	T	R	L	T	R	L	T	R	L	T	R
Min. Green:	10	10	10	10	10	10	10	10	10	10	10	10
Y+R:	4.0	4.0	4.0	4.0	4.0	4.0	4.0	4.0	4.0	4.0	4.0	4.0

Volume Module:	>>	Count	Date:	14 Mar 2019	<<											
Base Vol:	17	815	1	8	427	27	53	1	24	1	0	0				
Growth Adj:	1.00	1.00	1.00	1.00	1.00	1.00	1.00	1.00	1.00	1.00	1.00	1.00				
Initial Bse:	17	815	1	8	427	27	53	1	24	1	0	0				
Added Vol:	0	0	0	0	0	0	0	0	0	0	0	0				
PasserByVol:	0	0	0	0	0	0	0	0	0	0	0	0				
Initial Fut:	17	815	1	8	427	27	53	1	24	1	0	0				
User Adj:	1.00	1.00	1.00	1.00	1.00	1.00	1.00	1.00	1.00	1.00	1.00	1.00				
PHF Adj:	1.00	1.00	1.00	1.00	1.00	1.00	1.00	1.00	1.00	1.00	1.00	1.00				
PHF Volume:	17	815	1	8	427	27	53	1	24	1	0	0				
Reduct Vol:	0	0	0	0	0	0	0	0	0	0	0	0				
Reduced Vol:	17	815	1	8	427	27	53	1	24	1	0	0				
PCE Adj:	1.00	1.00	1.00	1.00	1.00	1.00	1.00	1.00	1.00	1.00	1.00	1.00				
MLF Adj:	1.00	1.00	1.00	1.00	1.00	1.00	1.00	1.00	1.00	1.00	1.00	1.00				
FinalVolume:	17	815	1	8	427	27	53	1	24	1	0	0				

Saturation Flow Module:												
Sat/Lane:	1900	1900	1900	1900	1900	1900	1900	1900	1900	1900	1900	1900
Adjustment:	0.92	0.97	0.95	0.92	1.00	0.92	0.92	0.92	0.92	0.92	1.00	0.92
Lanes:	1.00	1.99	0.01	1.00	2.00	1.00	0.68	0.01	0.31	1.00	0.00	0.00
Final Sat.:	1750	3695	5	1750	3800	1750	1189	22	538	1750	0	0

Capacity Analysis Module:												
Vol/Sat:	0.01	0.22	0.22	0.00	0.11	0.02	0.04	0.04	0.04	0.00	0.00	0.00
Crit Moves:	****									****		
Green Time:	44.0	44.0	44.0	44.0	44.0	44.0	10.0	10.0	10.0	10.0	0.0	0.0
Volume/Cap:	0.01	0.30	0.30	0.01	0.15	0.02	0.27	0.27	0.27	0.00	0.00	0.00
Delay/Veh:	2.2	2.8	2.8	2.1	2.4	2.2	22.3	22.3	22.3	20.8	0.0	0.0
User DelAdj:	1.00	1.00	1.00	1.00	1.00	1.00	1.00	1.00	1.00	1.00	1.00	1.00
AdjDel/Veh:	2.2	2.8	2.8	2.1	2.4	2.2	22.3	22.3	22.3	20.8	0.0	0.0
LOS by Move:	A	A	A	A	A	A	C	C	C	C	A	A
HCM2kAvgQ:	0	3	3	0	1	0	2	2	2	0	0	0

Note: Queue reported is the number of cars per lane.

Voices School
Morgan Hill, CA
Hexagon Transportation Consultants, Inc.

Level Of Service Computation Report
2000 HCM Operations (Future Volume Alternative)
Existing (PM)

Intersection #1200: Monterey Road and Cosmo Avenue

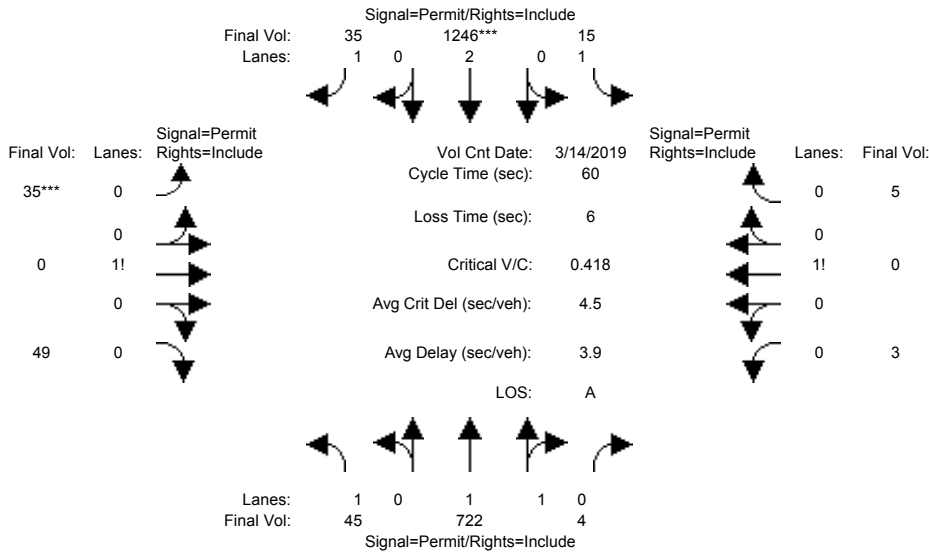

Street Name:	Monterey Rd						Cosmo Ave					
Approach:	North Bound			South Bound			East Bound			West Bound		
Movement:	L	T	R	L	T	R	L	T	R	L	T	R
Min. Green:	10	10	10	10	10	10	10	10	10	10	10	10
Y+R:	4.0	4.0	4.0	4.0	4.0	4.0	4.0	4.0	4.0	4.0	4.0	4.0

Volume Module:	>>	Count	Date:	14 Mar 2019	<<							
Base Vol:	45	722	4	15	1246	35	35	0	49	3	0	5
Growth Adj:	1.00	1.00	1.00	1.00	1.00	1.00	1.00	1.00	1.00	1.00	1.00	1.00
Initial Bse:	45	722	4	15	1246	35	35	0	49	3	0	5
Added Vol:	0	0	0	0	0	0	0	0	0	0	0	0
PasserByVol:	0	0	0	0	0	0	0	0	0	0	0	0
Initial Fut:	45	722	4	15	1246	35	35	0	49	3	0	5
User Adj:	1.00	1.00	1.00	1.00	1.00	1.00	1.00	1.00	1.00	1.00	1.00	1.00
PHF Adj:	1.00	1.00	1.00	1.00	1.00	1.00	1.00	1.00	1.00	1.00	1.00	1.00
PHF Volume:	45	722	4	15	1246	35	35	0	49	3	0	5
Reduct Vol:	0	0	0	0	0	0	0	0	0	0	0	0
Reduced Vol:	45	722	4	15	1246	35	35	0	49	3	0	5
PCE Adj:	1.00	1.00	1.00	1.00	1.00	1.00	1.00	1.00	1.00	1.00	1.00	1.00
MLF Adj:	1.00	1.00	1.00	1.00	1.00	1.00	1.00	1.00	1.00	1.00	1.00	1.00
FinalVolume:	45	722	4	15	1246	35	35	0	49	3	0	5

Saturation Flow Module:	
Sat/Lane:	1900 1900 1900 1900 1900 1900 1900 1900 1900 1900 1900 1900
Adjustment:	0.92 0.97 0.95 0.92 1.00 0.92 0.92 0.92 0.92 0.92 0.92 0.92
Lanes:	1.00 1.99 0.01 1.00 2.00 1.00 0.42 0.00 0.58 0.37 0.00 0.63
Final Sat.:	1750 3680 20 1750 3800 1750 729 0 1021 656 0 1094

Capacity Analysis Module:	
Vol/Sat:	0.03 0.20 0.20 0.01 0.33 0.02 0.05 0.00 0.05 0.00 0.00 0.00
Crit Moves:	****
Green Time:	44.0 44.0 44.0 44.0 44.0 44.0 10.0 0.0 10.0 10.0 0.0 10.0
Volume/Cap:	0.04 0.27 0.27 0.01 0.45 0.03 0.29 0.00 0.29 0.03 0.00 0.03
Delay/Veh:	2.2 2.7 2.7 2.2 3.3 2.2 22.4 0.0 22.4 21.0 0.0 21.0
User DelAdj:	1.00 1.00 1.00 1.00 1.00 1.00 1.00 1.00 1.00 1.00 1.00 1.00
AdjDel/Veh:	2.2 2.7 2.7 2.2 3.3 2.2 22.4 0.0 22.4 21.0 0.0 21.0
LOS by Move:	A A A A A A C A C C A C
HCM2kAvgQ:	0 2 2 0 5 0 2 0 2 0 0 0

Note: Queue reported is the number of cars per lane.

Voices School
Morgan Hill, CA
Hexagon Transportation Consultants, Inc.

Level Of Service Computation Report
2000 HCM Operations (Future Volume Alternative)
Existing Plus Project (AM) - 2 Cosmo Right out

Intersection #1200: Monterey Road and Cosmo Avenue

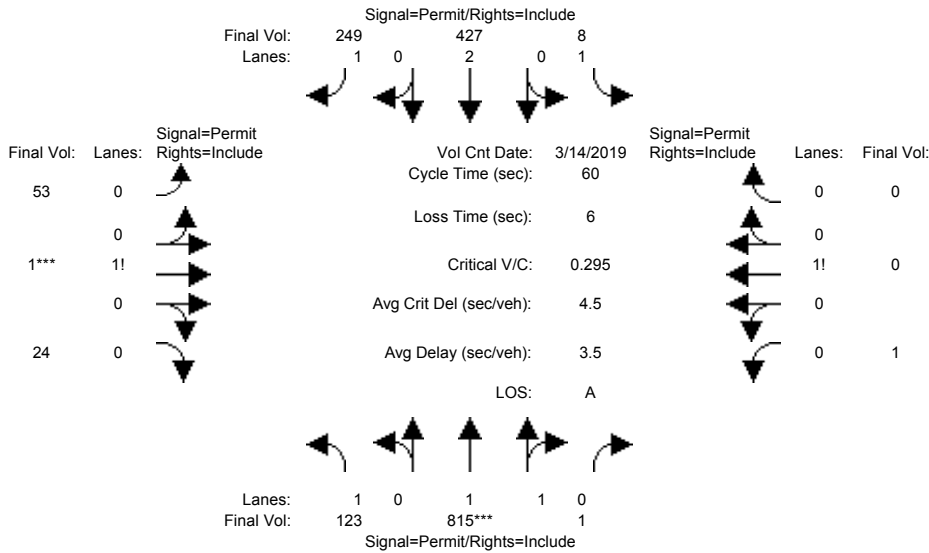

Street Name:	Monterey Rd						Cosmo Ave					
	North Bound			South Bound			East Bound			West Bound		
Approach:	L	T	R	L	T	R	L	T	R	L	T	R
Min. Green:	10	10	10	10	10	10	10	10	10	10	10	10
Y+R:	4.0	4.0	4.0	4.0	4.0	4.0	4.0	4.0	4.0	4.0	4.0	4.0

Volume Module:	>>	Count	Date:	14 Mar 2019	<<											
Base Vol:	17	815	1	8	427	27	53	1	24	1	0	0				
Growth Adj:	1.00	1.00	1.00	1.00	1.00	1.00	1.00	1.00	1.00	1.00	1.00	1.00				
Initial Bse:	17	815	1	8	427	27	53	1	24	1	0	0				
Added Vol:	106	0	0	0	0	222	0	0	0	0	0	0				
PasserByVol:	0	0	0	0	0	0	0	0	0	0	0	0				
Initial Fut:	123	815	1	8	427	249	53	1	24	1	0	0				
User Adj:	1.00	1.00	1.00	1.00	1.00	1.00	1.00	1.00	1.00	1.00	1.00	1.00				
PHF Adj:	1.00	1.00	1.00	1.00	1.00	1.00	1.00	1.00	1.00	1.00	1.00	1.00				
PHF Volume:	123	815	1	8	427	249	53	1	24	1	0	0				
Reduct Vol:	0	0	0	0	0	0	0	0	0	0	0	0				
Reduced Vol:	123	815	1	8	427	249	53	1	24	1	0	0				
PCE Adj:	1.00	1.00	1.00	1.00	1.00	1.00	1.00	1.00	1.00	1.00	1.00	1.00				
MLF Adj:	1.00	1.00	1.00	1.00	1.00	1.00	1.00	1.00	1.00	1.00	1.00	1.00				
FinalVolume:	123	815	1	8	427	249	53	1	24	1	0	0				

Saturation Flow Module:												
Sat/Lane:	1900	1900	1900	1900	1900	1900	1900	1900	1900	1900	1900	1900
Adjustment:	0.92	0.97	0.95	0.92	1.00	0.92	0.92	0.92	0.92	0.92	1.00	0.92
Lanes:	1.00	1.99	0.01	1.00	2.00	1.00	0.68	0.01	0.31	1.00	0.00	0.00
Final Sat.:	1750	3695	5	1750	3800	1750	1189	22	538	1750	0	0

Capacity Analysis Module:												
Vol/Sat:	0.07	0.22	0.22	0.00	0.11	0.14	0.04	0.04	0.04	0.00	0.00	0.00
Crit Moves:	****									****		
Green Time:	44.0	44.0	44.0	44.0	44.0	44.0	10.0	10.0	10.0	10.0	0.0	0.0
Volume/Cap:	0.10	0.30	0.30	0.01	0.15	0.19	0.27	0.27	0.27	0.00	0.00	0.00
Delay/Veh:	2.3	2.8	2.8	2.1	2.4	2.6	22.3	22.3	22.3	20.8	0.0	0.0
User DelAdj:	1.00	1.00	1.00	1.00	1.00	1.00	1.00	1.00	1.00	1.00	1.00	1.00
AdjDel/Veh:	2.3	2.8	2.8	2.1	2.4	2.6	22.3	22.3	22.3	20.8	0.0	0.0
LOS by Move:	A	A	A	A	A	A	C	C	C	C	A	A
HCM2kAvgQ:	1	3	3	0	1	2	2	2	2	0	0	0

Note: Queue reported is the number of cars per lane.

Voices School
Morgan Hill, CA
Hexagon Transportation Consultants, Inc.

Level Of Service Computation Report
2000 HCM Operations (Future Volume Alternative)
Existing Plus Project (PM) - 2 Cosmo Right out

Intersection #1200: Monterey Road and Cosmo Avenue

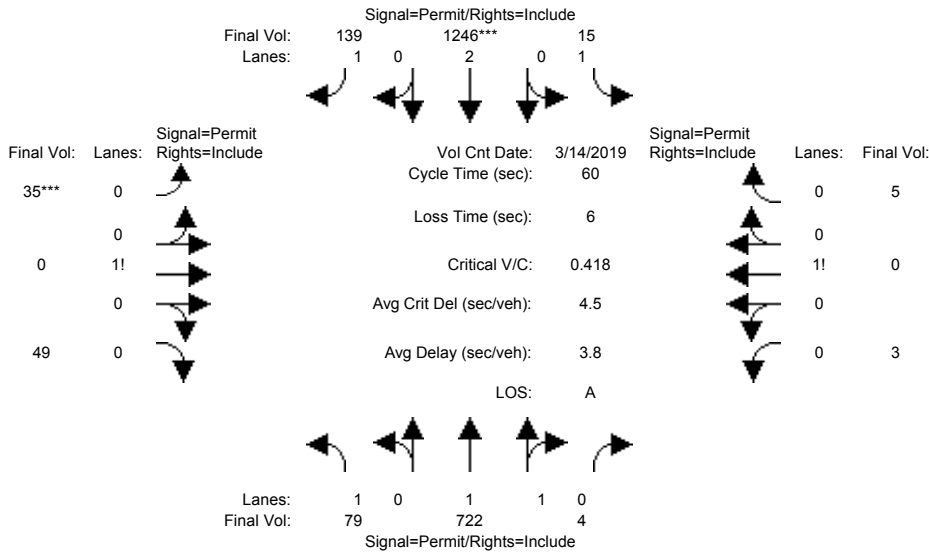

Street Name:	Monterey Rd						Cosmo Ave					
Approach:	North Bound			South Bound			East Bound			West Bound		
Movement:	L	T	R	L	T	R	L	T	R	L	T	R
Min. Green:	10	10	10	10	10	10	10	10	10	10	10	10
Y+R:	4.0	4.0	4.0	4.0	4.0	4.0	4.0	4.0	4.0	4.0	4.0	4.0

Volume Module:	>>	Count	Date:	14 Mar 2019	<<							
Base Vol:	45	722	4	15	1246	35	35	0	49	3	0	5
Growth Adj:	1.00	1.00	1.00	1.00	1.00	1.00	1.00	1.00	1.00	1.00	1.00	1.00
Initial Bse:	45	722	4	15	1246	35	35	0	49	3	0	5
Added Vol:	34	0	0	0	0	104	0	0	0	0	0	0
PasserByVol:	0	0	0	0	0	0	0	0	0	0	0	0
Initial Fut:	79	722	4	15	1246	139	35	0	49	3	0	5
User Adj:	1.00	1.00	1.00	1.00	1.00	1.00	1.00	1.00	1.00	1.00	1.00	1.00
PHF Adj:	1.00	1.00	1.00	1.00	1.00	1.00	1.00	1.00	1.00	1.00	1.00	1.00
PHF Volume:	79	722	4	15	1246	139	35	0	49	3	0	5
Reduct Vol:	0	0	0	0	0	0	0	0	0	0	0	0
Reduced Vol:	79	722	4	15	1246	139	35	0	49	3	0	5
PCE Adj:	1.00	1.00	1.00	1.00	1.00	1.00	1.00	1.00	1.00	1.00	1.00	1.00
MLF Adj:	1.00	1.00	1.00	1.00	1.00	1.00	1.00	1.00	1.00	1.00	1.00	1.00
FinalVolume:	79	722	4	15	1246	139	35	0	49	3	0	5

Saturation Flow Module:	
Sat/Lane:	1900 1900 1900 1900 1900 1900 1900 1900 1900 1900 1900 1900
Adjustment:	0.92 0.97 0.95 0.92 1.00 0.92 0.92 0.92 0.92 0.92 0.92 0.92
Lanes:	1.00 1.99 0.01 1.00 2.00 1.00 0.42 0.00 0.58 0.37 0.00 0.63
Final Sat.:	1750 3680 20 1750 3800 1750 729 0 1021 656 0 1094

Capacity Analysis Module:	
Vol/Sat:	0.05 0.20 0.20 0.01 0.33 0.08 0.05 0.00 0.05 0.00 0.00 0.00
Crit Moves:	****
Green Time:	44.0 44.0 44.0 44.0 44.0 44.0 10.0 0.0 10.0 10.0 0.0 10.0
Volume/Cap:	0.06 0.27 0.27 0.01 0.45 0.11 0.29 0.00 0.29 0.03 0.00 0.03
Delay/Veh:	2.3 2.7 2.7 2.2 3.3 2.4 22.4 0.0 22.4 21.0 0.0 21.0
User DelAdj:	1.00 1.00 1.00 1.00 1.00 1.00 1.00 1.00 1.00 1.00 1.00 1.00
AdjDel/Veh:	2.3 2.7 2.7 2.2 3.3 2.4 22.4 0.0 22.4 21.0 0.0 21.0
LOS by Move:	A A A A A A C A C C A C
HCM2kAvgQ:	0 2 2 0 5 1 2 0 2 0 0 0

Note: Queue reported is the number of cars per lane.

Voices School
Morgan Hill, CA
Hexagon Transportation Consultants, Inc.

Level Of Service Computation Report
2000 HCM Unsignalized (Future Volume Alternative)
Existing (AM)

Intersection #1300: Olympic Drive and Edmundson Avenue

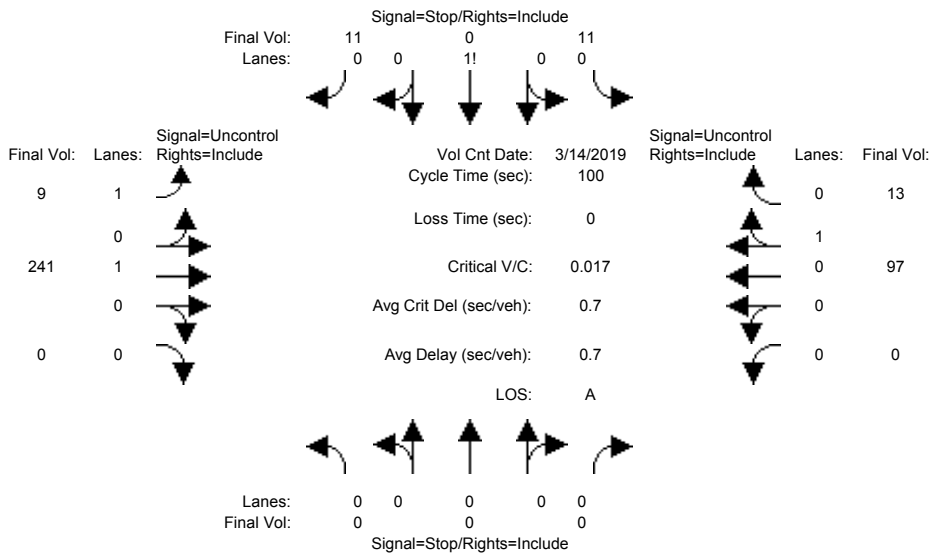

Street Name: Olympic Dr Edmundson Ave
Approach: North Bound South Bound East Bound West Bound
Movement: L - T - R L - T - R L - T - R L - T - R

Volume Module:	>>	Count	Date:	14 Mar 2019	<<							
Base Vol:	0	0	0	11	0	11	9	241	0	0	97	13
Growth Adj:	1.00	1.00	1.00	1.00	1.00	1.00	1.00	1.00	1.00	1.00	1.00	1.00
Initial Bse:	0	0	0	11	0	11	9	241	0	0	97	13
Added Vol:	0	0	0	0	0	0	0	0	0	0	0	0
PasserByVol:	0	0	0	0	0	0	0	0	0	0	0	0
Initial Fut:	0	0	0	11	0	11	9	241	0	0	97	13
User Adj:	1.00	1.00	1.00	1.00	1.00	1.00	1.00	1.00	1.00	1.00	1.00	1.00
PHF Adj:	1.00	1.00	1.00	1.00	1.00	1.00	1.00	1.00	1.00	1.00	1.00	1.00
PHF Volume:	0	0	0	11	0	11	9	241	0	0	97	13
Reduct Vol:	0	0	0	0	0	0	0	0	0	0	0	0
FinalVolume:	0	0	0	11	0	11	9	241	0	0	97	13

Critical Gap Module:

Critical Gp:	xxxxx	xxxx	xxxxx	6.4	6.5	6.2	4.1	xxxx	xxxxx	xxxxx	xxxx	xxxxx
FollowUpTim:	xxxxx	xxxx	xxxxx	3.5	4.0	3.3	2.2	xxxx	xxxxx	xxxxx	xxxx	xxxxx

Capacity Module:

Cnflct Vol:	xxxx	xxxx	xxxxx	363	363	104	110	xxxx	xxxxx	xxxx	xxxx	xxxxx
Potent Cap.:	xxxx	xxxx	xxxxx	641	568	957	1493	xxxx	xxxxx	xxxx	xxxx	xxxxx
Move Cap.:	xxxx	xxxx	xxxxx	638	565	957	1493	xxxx	xxxxx	xxxx	xxxx	xxxxx
Volume/Cap:	xxxx	xxxx	xxxx	0.02	0.00	0.01	0.01	xxxx	xxxx	xxxx	xxxx	xxxx

Level Of Service Module:

2Way95thQ:	xxxx	xxxx	xxxxx	xxxx	xxxx	xxxxx	0.0	xxxx	xxxxx	xxxx	xxxx	xxxxx
Control Del:	xxxxx	xxxx	xxxxx	xxxxx	xxxx	xxxxx	7.4	xxxx	xxxxx	xxxxx	xxxx	xxxxx
LOS by Move:	*	*	*	*	*	*	A	*	*	*	*	*
Movement:	LT - LTR - RT	LT - LTR - RT	LT - LTR - RT	LT - LTR - RT	LT - LTR - RT	LT - LTR - RT	LT - LTR - RT	LT - LTR - RT	LT - LTR - RT	LT - LTR - RT	LT - LTR - RT	LT - LTR - RT
Shared Cap.:	xxxx	xxxx	xxxxx	xxxx	765	xxxxx	xxxx	xxxx	xxxxx	xxxx	xxxx	xxxxx
SharedQueue:	xxxxx	xxxx	xxxxx	xxxxx	0.1	xxxxx	xxxxx	xxxx	xxxxx	xxxxx	xxxx	xxxxx
Shrd ConDel:	xxxxx	xxxx	xxxxx	xxxxx	9.8	xxxxx	xxxxx	xxxx	xxxxx	xxxxx	xxxx	xxxxx
Shared LOS:	*	*	*	*	A	*	*	*	*	*	*	*
ApproachDel:	xxxxxxx			9.8			xxxxxxx			xxxxxxx		
ApproachLOS:	*			A			*			*		*

Note: Queue reported is the number of cars per lane.

Voices School
Morgan Hill, CA
Hexagon Transportation Consultants, Inc.

Level Of Service Computation Report
2000 HCM Unsignalized (Future Volume Alternative)
Existing (PM)

Intersection #1300: Olympic Drive and Edmundson Avenue

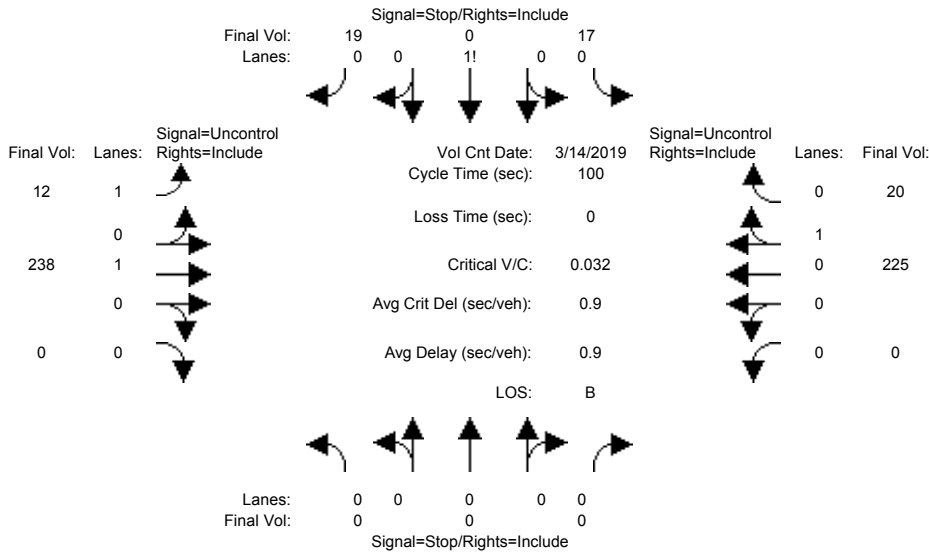

Street Name: Olympic Dr Edmundson Ave
Approach: North Bound South Bound East Bound West Bound
Movement: L - T - R L - T - R L - T - R L - T - R

Volume Module:	>>	Count	Date:	14 Mar 2019	<<							
Base Vol:	0	0	0	17	0	19	12	238	0	0	225	20
Growth Adj:	1.00	1.00	1.00	1.00	1.00	1.00	1.00	1.00	1.00	1.00	1.00	1.00
Initial Bse:	0	0	0	17	0	19	12	238	0	0	225	20
Added Vol:	0	0	0	0	0	0	0	0	0	0	0	0
PasserByVol:	0	0	0	0	0	0	0	0	0	0	0	0
Initial Fut:	0	0	0	17	0	19	12	238	0	0	225	20
User Adj:	1.00	1.00	1.00	1.00	1.00	1.00	1.00	1.00	1.00	1.00	1.00	1.00
PHF Adj:	1.00	1.00	1.00	1.00	1.00	1.00	1.00	1.00	1.00	1.00	1.00	1.00
PHF Volume:	0	0	0	17	0	19	12	238	0	0	225	20
Reduct Vol:	0	0	0	0	0	0	0	0	0	0	0	0
FinalVolume:	0	0	0	17	0	19	12	238	0	0	225	20

Critical Gap Module:

Critical Gp:	xxxxx	xxxx	xxxxx	6.4	6.5	6.2	4.1	xxxx	xxxxx	xxxxx	xxxx	xxxxx
FollowUpTim:	xxxxx	xxxx	xxxxx	3.5	4.0	3.3	2.2	xxxx	xxxxx	xxxxx	xxxx	xxxxx

Capacity Module:

Cnflct Vol:	xxxx	xxxx	xxxxx	497	497	235	245	xxxx	xxxxx	xxxx	xxxx	xxxxx
Potent Cap.:	xxxx	xxxx	xxxxx	536	477	809	1333	xxxx	xxxxx	xxxx	xxxx	xxxxx
Move Cap.:	xxxx	xxxx	xxxxx	532	473	809	1333	xxxx	xxxxx	xxxx	xxxx	xxxxx
Volume/Cap:	xxxx	xxxx	xxxx	0.03	0.00	0.02	0.01	xxxx	xxxx	xxxx	xxxx	xxxx

Level Of Service Module:

2Way95thQ:	xxxx	xxxx	xxxxx	xxxx	xxxx	xxxxx	0.0	xxxx	xxxxx	xxxx	xxxx	xxxxx
Control Del:	xxxxx	xxxx	xxxxx	xxxxx	xxxx	xxxxx	7.7	xxxx	xxxxx	xxxxx	xxxx	xxxxx
LOS by Move:	*	*	*	*	*	*	A	*	*	*	*	*
Movement:	LT - LTR - RT	LT - LTR - RT	LT - LTR - RT	LT - LTR - RT	LT - LTR - RT	LT - LTR - RT	LT - LTR - RT	LT - LTR - RT	LT - LTR - RT	LT - LTR - RT	LT - LTR - RT	LT - LTR - RT
Shared Cap.:	xxxx	xxxx	xxxxx	xxxx	650	xxxxx	xxxx	xxxx	xxxxx	xxxx	xxxx	xxxxx
SharedQueue:	xxxxx	xxxx	xxxxx	xxxxx	0.2	xxxxx	xxxxx	xxxx	xxxxx	xxxxx	xxxx	xxxxx
Shrd ConDel:	xxxxx	xxxx	xxxxx	xxxxx	10.9	xxxxx	xxxxx	xxxx	xxxxx	xxxxx	xxxx	xxxxx
Shared LOS:	*	*	*	*	B	*	*	*	*	*	*	*
ApproachDel:	xxxxxxx			10.9			xxxxxxx			xxxxxxx		
ApproachLOS:	*			B			*			*		*

Note: Queue reported is the number of cars per lane.

Voices School
Morgan Hill, CA
Hexagon Transportation Consultants, Inc.

Level Of Service Computation Report
2000 HCM Unsignalized (Future Volume Alternative)
Existing Plus Project (AM) - 2 Cosmo Right out

Intersection #1300: Olympic Drive and Edmundson Avenue

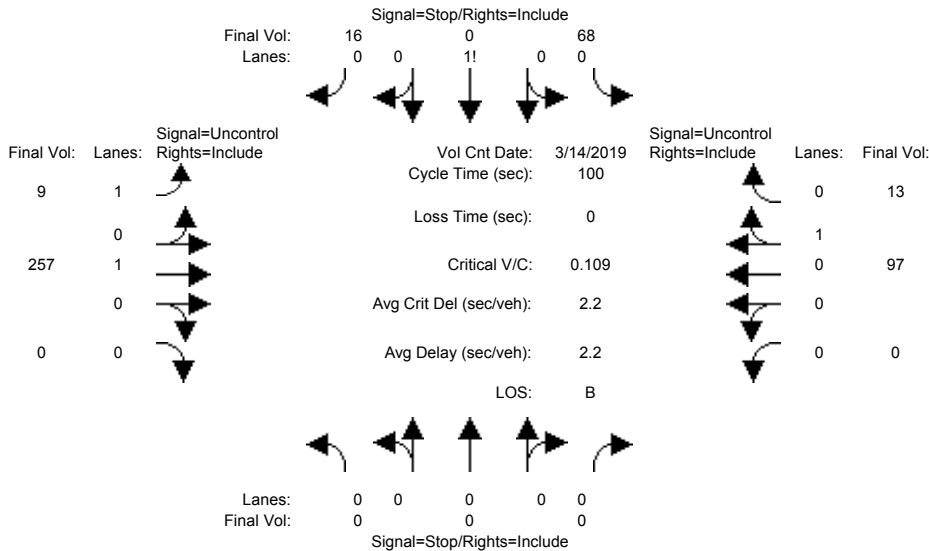

Street Name: Olympic Dr Edmundson Ave
Approach: North Bound South Bound East Bound West Bound
Movement: L - T - R L - T - R L - T - R L - T - R

Volume Module:	>>	Count	Date:	14 Mar 2019	<<							
Base Vol:	0	0	0	11	0	11	9	241	0	0	97	13
Growth Adj:	1.00	1.00	1.00	1.00	1.00	1.00	1.00	1.00	1.00	1.00	1.00	1.00
Initial Bse:	0	0	0	11	0	11	9	241	0	0	97	13
Added Vol:	0	0	0	57	0	5	0	16	0	0	0	0
PasserByVol:	0	0	0	0	0	0	0	0	0	0	0	0
Initial Fut:	0	0	0	68	0	16	9	257	0	0	97	13
User Adj:	1.00	1.00	1.00	1.00	1.00	1.00	1.00	1.00	1.00	1.00	1.00	1.00
PHF Adj:	1.00	1.00	1.00	1.00	1.00	1.00	1.00	1.00	1.00	1.00	1.00	1.00
PHF Volume:	0	0	0	68	0	16	9	257	0	0	97	13
Reduct Vol:	0	0	0	0	0	0	0	0	0	0	0	0
FinalVolume:	0	0	0	68	0	16	9	257	0	0	97	13

Critical Gap Module:

Critical Gp:	xxxxx	xxxx	xxxxx	6.4	6.5	6.2	4.1	xxxx	xxxxx	xxxxx	xxxx	xxxxx
FollowUpTim:	xxxxx	xxxx	xxxxx	3.5	4.0	3.3	2.2	xxxx	xxxxx	xxxxx	xxxx	xxxxx

Capacity Module:

Cnflct Vol:	xxxx	xxxx	xxxxx	379	379	104	110	xxxx	xxxxx	xxxx	xxxx	xxxxx
Potent Cap.:	xxxx	xxxx	xxxxx	627	557	957	1493	xxxx	xxxxx	xxxx	xxxx	xxxxx
Move Cap.:	xxxx	xxxx	xxxxx	624	553	957	1493	xxxx	xxxxx	xxxx	xxxx	xxxxx
Volume/Cap:	xxxx	xxxx	xxxx	0.11	0.00	0.02	0.01	xxxx	xxxx	xxxx	xxxx	xxxx

Level Of Service Module:

2Way95thQ:	xxxx	xxxx	xxxxx	xxxx	xxxx	xxxxx	0.0	xxxx	xxxxx	xxxx	xxxx	xxxxx
Control Del:	xxxxx	xxxx	xxxxx	xxxxx	xxxx	xxxxx	7.4	xxxx	xxxxx	xxxxx	xxxx	xxxxx
LOS by Move:	*	*	*	*	*	*	A	*	*	*	*	*
Movement:	LT - LTR - RT	LT - LTR - RT	LT - LTR - RT	LT - LTR - RT	LT - LTR - RT	LT - LTR - RT	LT - LTR - RT	LT - LTR - RT	LT - LTR - RT	LT - LTR - RT	LT - LTR - RT	LT - LTR - RT
Shared Cap.:	xxxx	xxxx	xxxxx	xxxx	669	xxxxx	xxxx	xxxx	xxxxx	xxxx	xxxx	xxxxx
SharedQueue:	xxxxx	xxxx	xxxxx	xxxxx	0.4	xxxxx	xxxxx	xxxx	xxxxx	xxxxx	xxxx	xxxxx
Shrd ConDel:	xxxxx	xxxx	xxxxx	xxxxx	11.2	xxxxx	xxxxx	xxxx	xxxxx	xxxxx	xxxx	xxxxx
Shared LOS:	*	*	*	*	B	*	*	*	*	*	*	*
ApproachDel:	xxxxxxx			11.2			xxxxxxx			xxxxxxx		
ApproachLOS:	*			B			*			*		*

Note: Queue reported is the number of cars per lane.

Voices School
Morgan Hill, CA
Hexagon Transportation Consultants, Inc.

Level Of Service Computation Report
2000 HCM Unsignalized (Future Volume Alternative)
Existing Plus Project (PM) - 2 Cosmo Right out

Intersection #1300: Olympic Drive and Edmundson Avenue

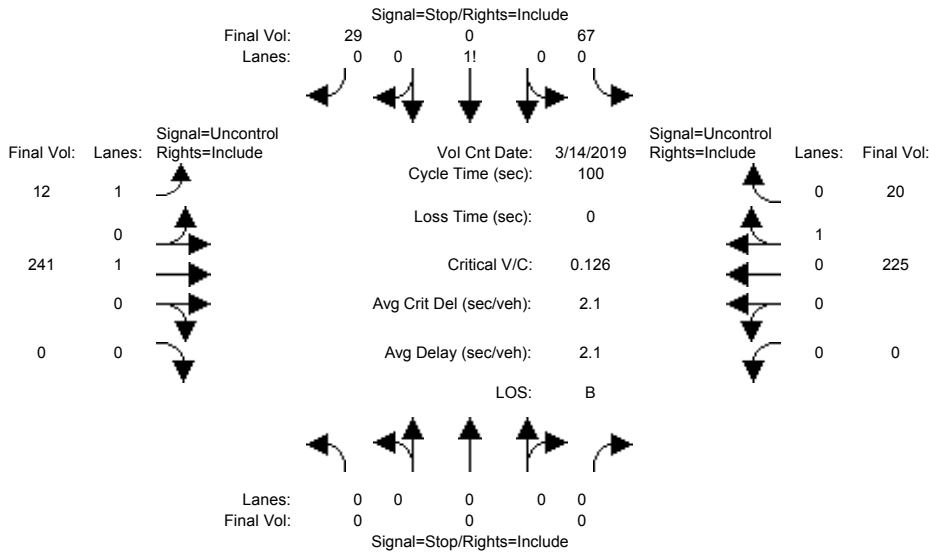

Street Name: Olympic Dr Edmundson Ave

Approach: North Bound South Bound East Bound West Bound

Movement: L - T - R L - T - R L - T - R L - T - R

Volume Module:	>>	Count	Date:	14 Mar 2019	<<							
Base Vol:	0	0	0	17	0	19	12	238	0	0	225	20
Growth Adj:	1.00	1.00	1.00	1.00	1.00	1.00	1.00	1.00	1.00	1.00	1.00	1.00
Initial Bse:	0	0	0	17	0	19	12	238	0	0	225	20
Added Vol:	0	0	0	50	0	10	0	3	0	0	0	0
PasserByVol:	0	0	0	0	0	0	0	0	0	0	0	0
Initial Fut:	0	0	0	67	0	29	12	241	0	0	225	20
User Adj:	1.00	1.00	1.00	1.00	1.00	1.00	1.00	1.00	1.00	1.00	1.00	1.00
PHF Adj:	1.00	1.00	1.00	1.00	1.00	1.00	1.00	1.00	1.00	1.00	1.00	1.00
PHF Volume:	0	0	0	67	0	29	12	241	0	0	225	20
Reduct Vol:	0	0	0	0	0	0	0	0	0	0	0	0
FinalVolume:	0	0	0	67	0	29	12	241	0	0	225	20

Critical Gap Module:

Critical Gp:	xxxxx	xxxx	xxxxx	6.4	6.5	6.2	4.1	xxxx	xxxxx	xxxxx	xxxx	xxxxx
FollowUpTim:	xxxxx	xxxx	xxxxx	3.5	4.0	3.3	2.2	xxxx	xxxxx	xxxxx	xxxx	xxxxx

Capacity Module:

Cnflct Vol:	xxxx	xxxx	xxxxx	500	500	235	245	xxxx	xxxxx	xxxx	xxxx	xxxxx
Potent Cap.:	xxxx	xxxx	xxxxx	534	476	809	1333	xxxx	xxxxx	xxxx	xxxx	xxxxx
Move Cap.:	xxxx	xxxx	xxxxx	530	471	809	1333	xxxx	xxxxx	xxxx	xxxx	xxxxx
Volume/Cap:	xxxx	xxxx	xxxx	0.13	0.00	0.04	0.01	xxxx	xxxx	xxxx	xxxx	xxxx

Level Of Service Module:

2Way95thQ:	xxxx	xxxx	xxxxx	xxxx	xxxx	xxxxx	0.0	xxxx	xxxxx	xxxx	xxxx	xxxxx
Control Del:	xxxxx	xxxx	xxxxx	xxxxx	xxxx	xxxxx	7.7	xxxx	xxxxx	xxxxx	xxxx	xxxxx
LOS by Move:	*	*	*	*	*	*	A	*	*	*	*	*
Movement:	LT - LTR - RT	LT - LTR - RT	LT - LTR - RT	LT - LTR - RT	LT - LTR - RT	LT - LTR - RT	LT - LTR - RT	LT - LTR - RT	LT - LTR - RT	LT - LTR - RT	LT - LTR - RT	LT - LTR - RT
Shared Cap.:	xxxx	xxxx	xxxxx	xxxx	592	xxxxx	xxxx	xxxx	xxxxx	xxxx	xxxx	xxxxx
SharedQueue:	xxxxx	xxxx	xxxxx	xxxxx	0.6	xxxxx	xxxxx	xxxx	xxxxx	xxxxx	xxxx	xxxxx
Shrd ConDel:	xxxxx	xxxx	xxxxx	xxxxx	12.3	xxxxx	xxxxx	xxxx	xxxxx	xxxxx	xxxx	xxxxx
Shared LOS:	*	*	*	*	B	*	*	*	*	*	*	*
ApproachDel:	xxxxxxx			12.3			xxxxxxx			xxxxxxx		
ApproachLOS:	*			B			*			*		*

Note: Queue reported is the number of cars per lane.

Voices School
Morgan Hill, CA
Hexagon Transportation Consultants, Inc.

Level Of Service Computation Report
2000 HCM 4-Way Stop (Future Volume Alternative)
Existing (AM)

Intersection #1400: Del Monte Avenue and Cosmo Avenue

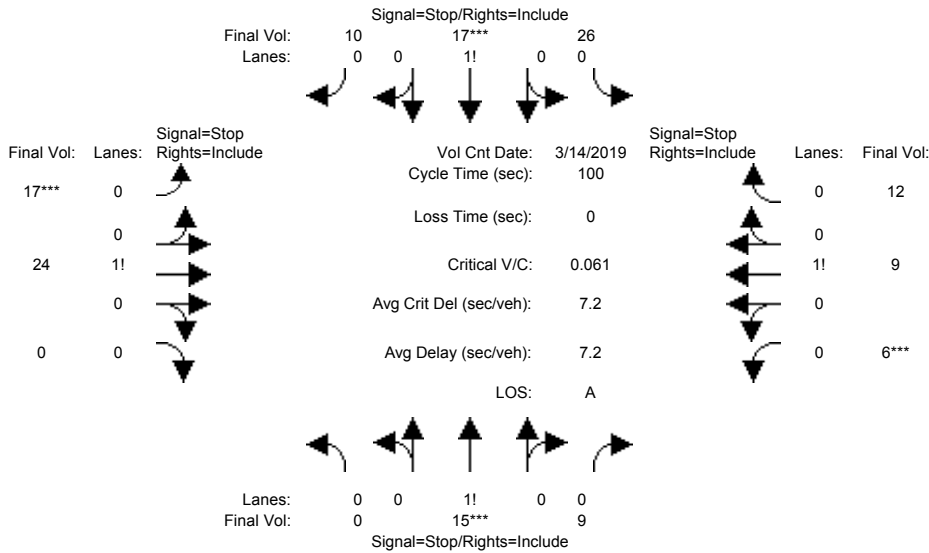

Street Name: Del Monte Ave Cosmo Ave
Approach: North Bound South Bound East Bound West Bound
Movement: L - T - R L - T - R L - T - R L - T - R

Min. Green: 0 0 0 0 0 0 0 0 0 0 0 0

Volume Module: >> Count Date: 14 Mar 2019 <<

Base Vol:	0	15	9	26	17	10	17	24	0	6	9	12
Growth Adj:	1.00	1.00	1.00	1.00	1.00	1.00	1.00	1.00	1.00	1.00	1.00	1.00
Initial Bse:	0	15	9	26	17	10	17	24	0	6	9	12
Added Vol:	0	0	0	0	0	0	0	0	0	0	0	0
PasserByVol:	0	0	0	0	0	0	0	0	0	0	0	0
Initial Fut:	0	15	9	26	17	10	17	24	0	6	9	12
User Adj:	1.00	1.00	1.00	1.00	1.00	1.00	1.00	1.00	1.00	1.00	1.00	1.00
PHF Adj:	1.00	1.00	1.00	1.00	1.00	1.00	1.00	1.00	1.00	1.00	1.00	1.00
PHF Volume:	0	15	9	26	17	10	17	24	0	6	9	12
Reduct Vol:	0	0	0	0	0	0	0	0	0	0	0	0
Reduced Vol:	0	15	9	26	17	10	17	24	0	6	9	12
PCE Adj:	1.00	1.00	1.00	1.00	1.00	1.00	1.00	1.00	1.00	1.00	1.00	1.00
MLF Adj:	1.00	1.00	1.00	1.00	1.00	1.00	1.00	1.00	1.00	1.00	1.00	1.00
FinalVolume:	0	15	9	26	17	10	17	24	0	6	9	12

Saturation Flow Module:

Adjustment:	1.00	1.00	1.00	1.00	1.00	1.00	1.00	1.00	1.00	1.00	1.00	1.00
Lanes:	0.00	0.62	0.38	0.49	0.32	0.19	0.41	0.59	0.00	0.22	0.33	0.45
Final Sat.:	0	571	343	429	281	165	353	498	0	202	303	404

Capacity Analysis Module:

Vol/Sat:	xxxx	0.03	0.03	0.06	0.06	0.06	0.05	0.05	xxxx	0.03	0.03	0.03
Crit Moves:	****			****			****			****		
Delay/Veh:	0.0	7.0	7.0	7.3	7.3	7.3	7.4	7.4	0.0	7.0	7.0	7.0
Delay Adj:	1.00	1.00	1.00	1.00	1.00	1.00	1.00	1.00	1.00	1.00	1.00	1.00
AdjDel/Veh:	0.0	7.0	7.0	7.3	7.3	7.3	7.4	7.4	0.0	7.0	7.0	7.0
LOS by Move:	*	A	A	A	A	A	A	A	*	A	A	A
ApproachDel:		7.0			7.3			7.4			7.0	
Delay Adj:		1.00			1.00			1.00			1.00	
ApprAdjDel:		7.0			7.3			7.4			7.0	
LOS by Appr:		A			A			A			A	
AllWayAvgQ:	0.0	0.0	0.0	0.1	0.1	0.1	0.0	0.0	0.0	0.0	0.0	0.0

Note: Queue reported is the number of cars per lane.

Voices School
Morgan Hill, CA
Hexagon Transportation Consultants, Inc.

Level Of Service Computation Report
2000 HCM 4-Way Stop (Future Volume Alternative)
Existing (PM)

Intersection #1400: Del Monte Avenue and Cosmo Avenue

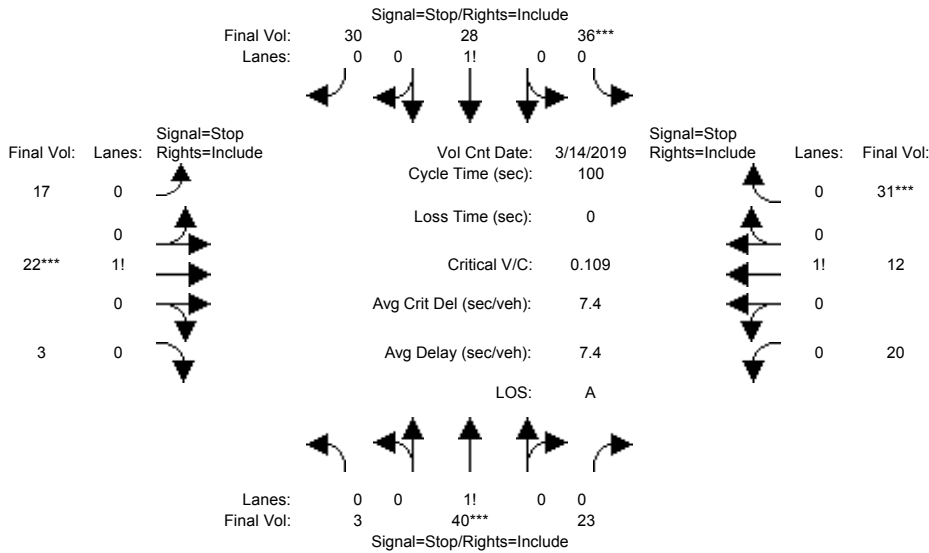

Street Name: Del Monte Ave Cosmo Ave
Approach: North Bound South Bound East Bound West Bound
Movement: L - T - R L - T - R L - T - R L - T - R

Min. Green: 0 0 0 0 0 0 0 0 0 0 0 0

Volume Module: >> Count Date: 14 Mar 2019 <<

Base Vol:	3	40	23	36	28	30	17	22	3	20	12	31
Growth Adj:	1.00	1.00	1.00	1.00	1.00	1.00	1.00	1.00	1.00	1.00	1.00	1.00
Initial Bse:	3	40	23	36	28	30	17	22	3	20	12	31
Added Vol:	0	0	0	0	0	0	0	0	0	0	0	0
PasserByVol:	0	0	0	0	0	0	0	0	0	0	0	0
Initial Fut:	3	40	23	36	28	30	17	22	3	20	12	31
User Adj:	1.00	1.00	1.00	1.00	1.00	1.00	1.00	1.00	1.00	1.00	1.00	1.00
PHF Adj:	1.00	1.00	1.00	1.00	1.00	1.00	1.00	1.00	1.00	1.00	1.00	1.00
PHF Volume:	3	40	23	36	28	30	17	22	3	20	12	31
Reduct Vol:	0	0	0	0	0	0	0	0	0	0	0	0
Reduced Vol:	3	40	23	36	28	30	17	22	3	20	12	31
PCE Adj:	1.00	1.00	1.00	1.00	1.00	1.00	1.00	1.00	1.00	1.00	1.00	1.00
MLF Adj:	1.00	1.00	1.00	1.00	1.00	1.00	1.00	1.00	1.00	1.00	1.00	1.00
FinalVolume:	3	40	23	36	28	30	17	22	3	20	12	31

Saturation Flow Module:

Adjustment:	1.00	1.00	1.00	1.00	1.00	1.00	1.00	1.00	1.00	1.00	1.00	1.00
Lanes:	0.04	0.61	0.35	0.38	0.30	0.32	0.40	0.53	0.07	0.32	0.19	0.49
Final Sat.:	40	529	304	331	257	276	325	421	57	273	164	423

Capacity Analysis Module:

Vol/Sat:	0.08	0.08	0.08	0.11	0.11	0.11	0.05	0.05	0.05	0.07	0.07	0.07
Crit Moves:	****	****	****	****	****	****	****	****	****	****	****	****
Delay/Veh:	7.3	7.3	7.3	7.6	7.6	7.6	7.6	7.6	7.6	7.3	7.3	7.3
Delay Adj:	1.00	1.00	1.00	1.00	1.00	1.00	1.00	1.00	1.00	1.00	1.00	1.00
AdjDel/Veh:	7.3	7.3	7.3	7.6	7.6	7.6	7.6	7.6	7.6	7.3	7.3	7.3
LOS by Move:	A	A	A	A	A	A	A	A	A	A	A	A
ApproachDel:	7.3	7.3	7.3	7.6	7.6	7.6	7.6	7.6	7.6	7.3	7.3	7.3
Delay Adj:	1.00	1.00	1.00	1.00	1.00	1.00	1.00	1.00	1.00	1.00	1.00	1.00
ApprAdjDel:	7.3	7.3	7.3	7.6	7.6	7.6	7.6	7.6	7.6	7.3	7.3	7.3
LOS by Appr:	A	A	A	A	A	A	A	A	A	A	A	A
AllWayAvgQ:	0.1	0.1	0.1	0.1	0.1	0.1	0.1	0.1	0.1	0.1	0.1	0.1

Note: Queue reported is the number of cars per lane.

Voices School
Morgan Hill, CA
Hexagon Transportation Consultants, Inc.

Level Of Service Computation Report
2000 HCM 4-Way Stop (Future Volume Alternative)
Existing Plus Project (AM) - 2 Cosmo Right out

Intersection #1400: Del Monte Avenue and Cosmo Avenue

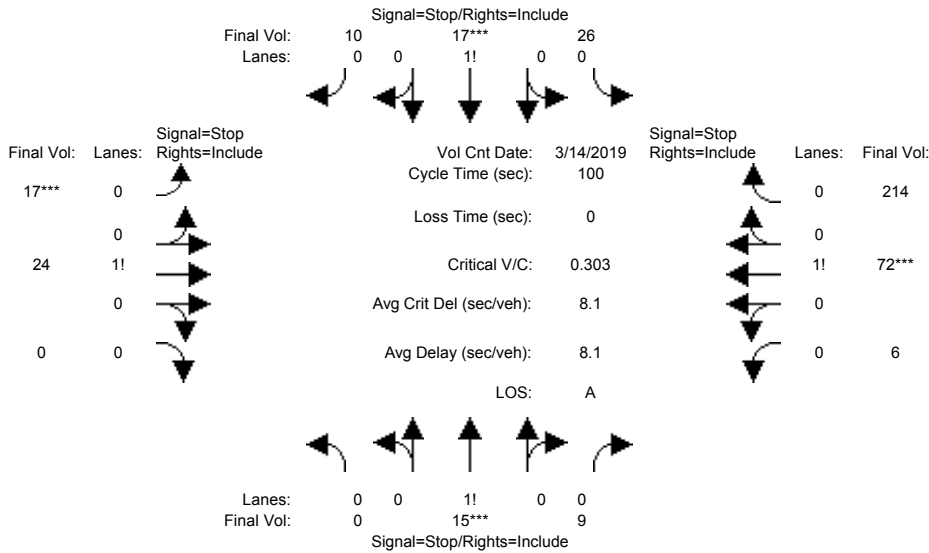

Street Name:	Del Monte Ave						Cosmo Ave					
Approach:	North Bound			South Bound			East Bound			West Bound		
Movement:	L	T	R	L	T	R	L	T	R	L	T	R
Min. Green:	0	0	0	0	0	0	0	0	0	0	0	0
Volume Module: >> Count Date: 14 Mar 2019 <<												
Base Vol:	0	15	9	26	17	10	17	24	0	6	9	12
Growth Adj:	1.00	1.00	1.00	1.00	1.00	1.00	1.00	1.00	1.00	1.00	1.00	1.00
Initial Bse:	0	15	9	26	17	10	17	24	0	6	9	12
Added Vol:	0	0	0	0	0	0	0	0	0	0	63	202
PasserByVol:	0	0	0	0	0	0	0	0	0	0	0	0
Initial Fut:	0	15	9	26	17	10	17	24	0	6	72	214
User Adj:	1.00	1.00	1.00	1.00	1.00	1.00	1.00	1.00	1.00	1.00	1.00	1.00
PHF Adj:	1.00	1.00	1.00	1.00	1.00	1.00	1.00	1.00	1.00	1.00	1.00	1.00
PHF Volume:	0	15	9	26	17	10	17	24	0	6	72	214
Reduct Vol:	0	0	0	0	0	0	0	0	0	0	0	0
Reduced Vol:	0	15	9	26	17	10	17	24	0	6	72	214
PCE Adj:	1.00	1.00	1.00	1.00	1.00	1.00	1.00	1.00	1.00	1.00	1.00	1.00
MLF Adj:	1.00	1.00	1.00	1.00	1.00	1.00	1.00	1.00	1.00	1.00	1.00	1.00
FinalVolume:	0	15	9	26	17	10	17	24	0	6	72	214
Saturation Flow Module:												
Adjustment:	1.00	1.00	1.00	1.00	1.00	1.00	1.00	1.00	1.00	1.00	1.00	1.00
Lanes:	0.00	0.62	0.38	0.49	0.32	0.19	0.41	0.59	0.00	0.02	0.25	0.73
Final Sat.:	0	480	288	364	238	140	329	465	0	20	237	706
Capacity Analysis Module:												
Vol/Sat:	xxxx	0.03	0.03	0.07	0.07	0.07	0.05	0.05	xxxx	0.30	0.30	0.30
Crit Moves:	****			****			****			****		
Delay/Veh:	0.0	7.5	7.5	7.9	7.9	7.9	7.6	7.6	0.0	8.2	8.2	8.2
Delay Adj:	1.00	1.00	1.00	1.00	1.00	1.00	1.00	1.00	1.00	1.00	1.00	1.00
AdjDel/Veh:	0.0	7.5	7.5	7.9	7.9	7.9	7.6	7.6	0.0	8.2	8.2	8.2
LOS by Move:	*	A	A	A	A	A	A	A	*	A	A	A
ApproachDel:		7.5			7.9			7.6			8.2	
Delay Adj:		1.00			1.00			1.00			1.00	
ApprAdjDel:		7.5			7.9			7.6			8.2	
LOS by Appr:		A			A			A			A	
AllWayAvgQ:	0.0	0.0	0.0	0.1	0.1	0.1	0.1	0.1	0.1	0.4	0.4	0.4

Note: Queue reported is the number of cars per lane.

Voices School
Morgan Hill, CA
Hexagon Transportation Consultants, Inc.

Level Of Service Computation Report
2000 HCM 4-Way Stop (Future Volume Alternative)
Existing Plus Project (PM) - 2 Cosmo Right out

Intersection #1400: Del Monte Avenue and Cosmo Avenue

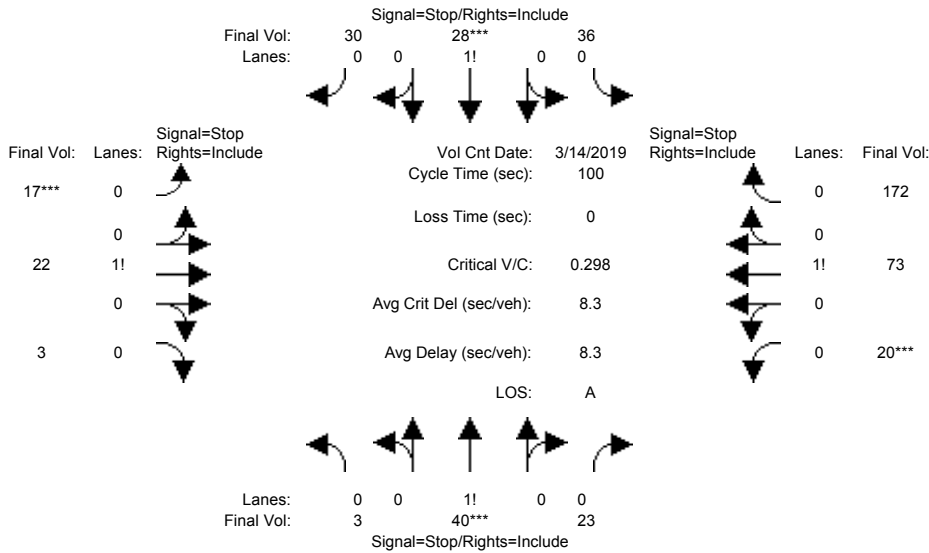

Street Name: Del Monte Ave Cosmo Ave
Approach: North Bound South Bound East Bound West Bound
Movement: L - T - R L - T - R L - T - R L - T - R

Min. Green: 0 0 0 0 0 0 0 0 0 0 0 0

Volume Module: >> Count Date: 14 Mar 2019 <<

Base Vol:	3	40	23	36	28	30	17	22	3	20	12	31
Growth Adj:	1.00	1.00	1.00	1.00	1.00	1.00	1.00	1.00	1.00	1.00	1.00	1.00
Initial Bse:	3	40	23	36	28	30	17	22	3	20	12	31
Added Vol:	0	0	0	0	0	0	0	0	0	0	61	141
PasserByVol:	0	0	0	0	0	0	0	0	0	0	0	0
Initial Fut:	3	40	23	36	28	30	17	22	3	20	73	172
User Adj:	1.00	1.00	1.00	1.00	1.00	1.00	1.00	1.00	1.00	1.00	1.00	1.00
PHF Adj:	1.00	1.00	1.00	1.00	1.00	1.00	1.00	1.00	1.00	1.00	1.00	1.00
PHF Volume:	3	40	23	36	28	30	17	22	3	20	73	172
Reduct Vol:	0	0	0	0	0	0	0	0	0	0	0	0
Reduced Vol:	3	40	23	36	28	30	17	22	3	20	73	172
PCE Adj:	1.00	1.00	1.00	1.00	1.00	1.00	1.00	1.00	1.00	1.00	1.00	1.00
MLF Adj:	1.00	1.00	1.00	1.00	1.00	1.00	1.00	1.00	1.00	1.00	1.00	1.00
FinalVolume:	3	40	23	36	28	30	17	22	3	20	73	172

Saturation Flow Module:

Adjustment:	1.00	1.00	1.00	1.00	1.00	1.00	1.00	1.00	1.00	1.00	1.00	1.00
Lanes:	0.04	0.61	0.35	0.38	0.30	0.32	0.40	0.53	0.07	0.07	0.28	0.65
Final Sat.:	35	462	266	290	225	241	306	396	54	67	245	578

Capacity Analysis Module:

Vol/Sat:	0.09	0.09	0.09	0.12	0.12	0.12	0.06	0.06	0.06	0.30	0.30	0.30
Crit Moves:	****			****			****			****		
Delay/Veh:	7.8	7.8	7.8	8.1	8.1	8.1	7.8	7.8	7.8	8.5	8.5	8.5
Delay Adj:	1.00	1.00	1.00	1.00	1.00	1.00	1.00	1.00	1.00	1.00	1.00	1.00
AdjDel/Veh:	7.8	7.8	7.8	8.1	8.1	8.1	7.8	7.8	7.8	8.5	8.5	8.5
LOS by Move:	A	A	A	A	A	A	A	A	A	A	A	A
ApproachDel:	7.8			8.1			7.8			8.5		
Delay Adj:	1.00			1.00			1.00			1.00		
ApprAdjDel:	7.8			8.1			7.8			8.5		
LOS by Appr:	A			A			A			A		
AllWayAvgQ:	0.1	0.1	0.1	0.1	0.1	0.1	0.1	0.1	0.1	0.4	0.4	0.4

Note: Queue reported is the number of cars per lane.

Voices School
Morgan Hill, CA
Hexagon Transportation Consultants, Inc.

Level Of Service Computation Report
2000 HCM 4-Way Stop (Future Volume Alternative)
Existing (AM)

Intersection #1500: Del Monte Avenue and Spring Avenue

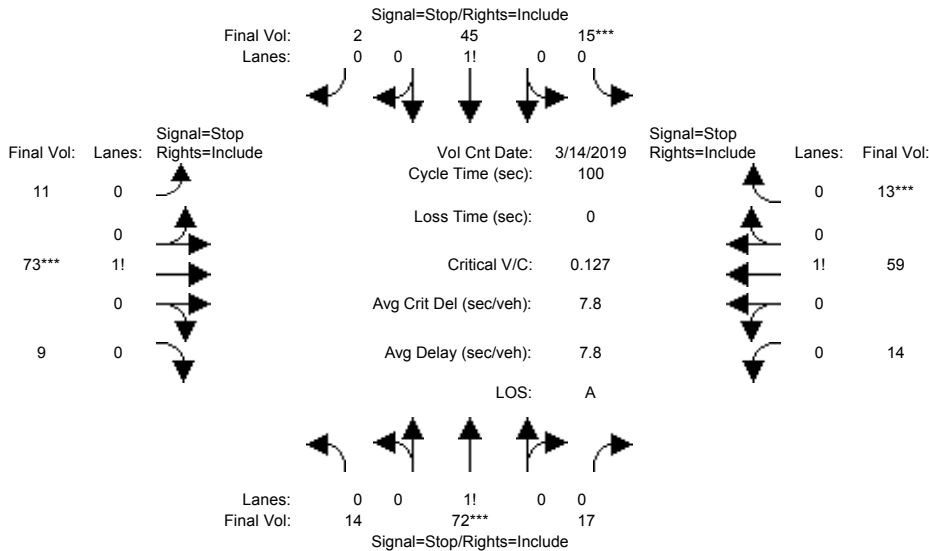

Street Name:	Del Monte Ave						Spring Ave					
Approach:	North Bound			South Bound			East Bound			West Bound		
Movement:	L	T	R	L	T	R	L	T	R	L	T	R

Min. Green:	0	0	0	0	0	0	0	0	0	0	0	0
-------------	---	---	---	---	---	---	---	---	---	---	---	---

Volume Module:	>> Count Date: 14 Mar 2019 <<											
Base Vol:	14	72	17	15	45	2	11	73	9	14	59	13
Growth Adj:	1.00	1.00	1.00	1.00	1.00	1.00	1.00	1.00	1.00	1.00	1.00	1.00
Initial Bse:	14	72	17	15	45	2	11	73	9	14	59	13
Added Vol:	0	0	0	0	0	0	0	0	0	0	0	0
PasserByVol:	0	0	0	0	0	0	0	0	0	0	0	0
Initial Fut:	14	72	17	15	45	2	11	73	9	14	59	13
User Adj:	1.00	1.00	1.00	1.00	1.00	1.00	1.00	1.00	1.00	1.00	1.00	1.00
PHF Adj:	1.00	1.00	1.00	1.00	1.00	1.00	1.00	1.00	1.00	1.00	1.00	1.00
PHF Volume:	14	72	17	15	45	2	11	73	9	14	59	13
Reduct Vol:	0	0	0	0	0	0	0	0	0	0	0	0
Reduced Vol:	14	72	17	15	45	2	11	73	9	14	59	13
PCE Adj:	1.00	1.00	1.00	1.00	1.00	1.00	1.00	1.00	1.00	1.00	1.00	1.00
MLF Adj:	1.00	1.00	1.00	1.00	1.00	1.00	1.00	1.00	1.00	1.00	1.00	1.00
FinalVolume:	14	72	17	15	45	2	11	73	9	14	59	13

Saturation Flow Module:												
Adjustment:	1.00	1.00	1.00	1.00	1.00	1.00	1.00	1.00	1.00	1.00	1.00	1.00
Lanes:	0.14	0.70	0.16	0.24	0.73	0.03	0.12	0.78	0.10	0.16	0.69	0.15
Final Sat.:	110	567	134	189	567	25	95	632	78	131	553	122

Capacity Analysis Module:												
Vol/Sat:	0.13	0.13	0.13	0.08	0.08	0.08	0.12	0.12	0.12	0.11	0.11	0.11
Crit Moves:	****			****			****			****		
Delay/Veh:	7.9	7.9	7.9	7.8	7.8	7.8	7.9	7.9	7.9	7.8	7.8	7.8
Delay Adj:	1.00	1.00	1.00	1.00	1.00	1.00	1.00	1.00	1.00	1.00	1.00	1.00
AdjDel/Veh:	7.9	7.9	7.9	7.8	7.8	7.8	7.9	7.9	7.9	7.8	7.8	7.8
LOS by Move:	A	A	A	A	A	A	A	A	A	A	A	A
ApproachDel:	7.9			7.8			7.9			7.8		
Delay Adj:	1.00			1.00			1.00			1.00		
ApprAdjDel:	7.9			7.8			7.9			7.8		
LOS by Appr:	A			A			A			A		
AllWayAvgQ:	0.1	0.1	0.1	0.1	0.1	0.1	0.1	0.1	0.1	0.1	0.1	0.1

Note: Queue reported is the number of cars per lane.

Voices School
Morgan Hill, CA
Hexagon Transportation Consultants, Inc.

Level Of Service Computation Report
2000 HCM 4-Way Stop (Future Volume Alternative)
Existing (PM)

Intersection #1500: Del Monte Avenue and Spring Avenue

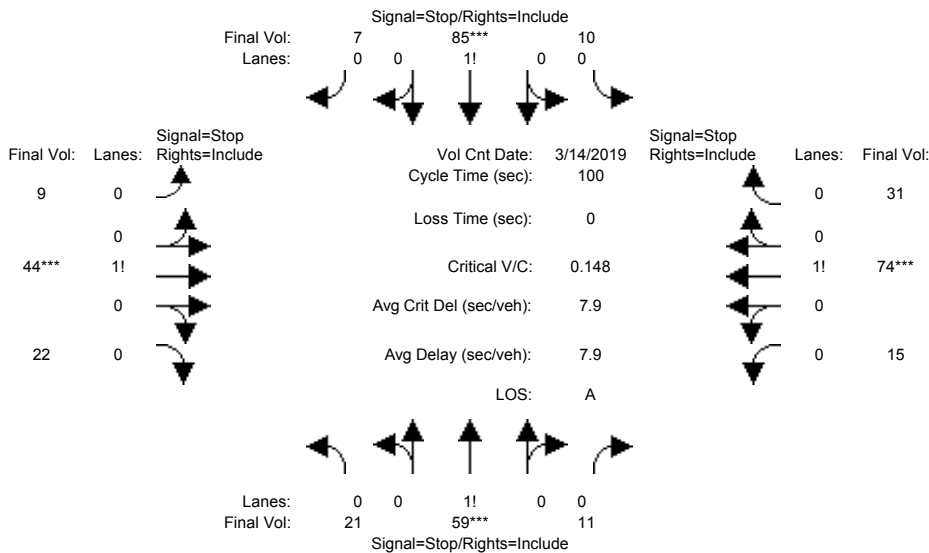

Street Name:	Del Monte Ave						Spring Ave					
Approach:	North Bound			South Bound			East Bound			West Bound		
Movement:	L	T	R	L	T	R	L	T	R	L	T	R

Min. Green:	0	0	0	0	0	0	0	0	0	0	0	0
-------------	---	---	---	---	---	---	---	---	---	---	---	---

Volume Module:	>> Count Date: 14 Mar 2019 <<											
Base Vol:	21	59	11	10	85	7	9	44	22	15	74	31
Growth Adj:	1.00	1.00	1.00	1.00	1.00	1.00	1.00	1.00	1.00	1.00	1.00	1.00
Initial Bse:	21	59	11	10	85	7	9	44	22	15	74	31
Added Vol:	0	0	0	0	0	0	0	0	0	0	0	0
PasserByVol:	0	0	0	0	0	0	0	0	0	0	0	0
Initial Fut:	21	59	11	10	85	7	9	44	22	15	74	31
User Adj:	1.00	1.00	1.00	1.00	1.00	1.00	1.00	1.00	1.00	1.00	1.00	1.00
PHF Adj:	1.00	1.00	1.00	1.00	1.00	1.00	1.00	1.00	1.00	1.00	1.00	1.00
PHF Volume:	21	59	11	10	85	7	9	44	22	15	74	31
Reduct Vol:	0	0	0	0	0	0	0	0	0	0	0	0
Reduced Vol:	21	59	11	10	85	7	9	44	22	15	74	31
PCE Adj:	1.00	1.00	1.00	1.00	1.00	1.00	1.00	1.00	1.00	1.00	1.00	1.00
MLF Adj:	1.00	1.00	1.00	1.00	1.00	1.00	1.00	1.00	1.00	1.00	1.00	1.00
FinalVolume:	21	59	11	10	85	7	9	44	22	15	74	31

Saturation Flow Module:												
Adjustment:	1.00	1.00	1.00	1.00	1.00	1.00	1.00	1.00	1.00	1.00	1.00	1.00
Lanes:	0.23	0.65	0.12	0.10	0.83	0.07	0.12	0.59	0.29	0.12	0.62	0.26
Final Sat.:	181	508	95	77	655	54	96	469	235	101	499	209

Capacity Analysis Module:												
Vol/Sat:	0.12	0.12	0.12	0.13	0.13	0.13	0.09	0.09	0.09	0.15	0.15	0.15
Crit Moves:	****			****			****			****		
Delay/Veh:	8.0	8.0	8.0	8.0	8.0	8.0	7.7	7.7	7.7	8.0	8.0	8.0
Delay Adj:	1.00	1.00	1.00	1.00	1.00	1.00	1.00	1.00	1.00	1.00	1.00	1.00
AdjDel/Veh:	8.0	8.0	8.0	8.0	8.0	8.0	7.7	7.7	7.7	8.0	8.0	8.0
LOS by Move:	A	A	A	A	A	A	A	A	A	A	A	A
ApproachDel:	8.0			8.0			7.7			8.0		
Delay Adj:	1.00			1.00			1.00			1.00		
ApprAdjDel:	8.0			8.0			7.7			8.0		
LOS by Appr:	A			A			A			A		
AllWayAvgQ:	0.1	0.1	0.1	0.1	0.1	0.1	0.1	0.1	0.1	0.2	0.2	0.2

Note: Queue reported is the number of cars per lane.

Voices School
Morgan Hill, CA
Hexagon Transportation Consultants, Inc.

Level Of Service Computation Report
2000 HCM 4-Way Stop (Future Volume Alternative)
Existing Plus Project (AM) - 2 Cosmo Right out

Intersection #1500: Del Monte Avenue and Spring Avenue

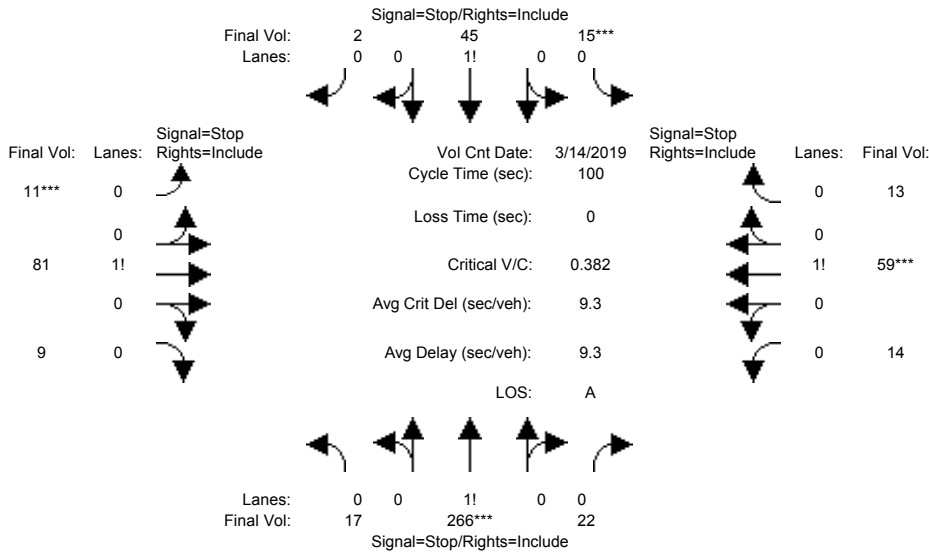

Street Name: Del Monte Ave Spring Ave
Approach: North Bound South Bound East Bound West Bound
Movement: L - T - R L - T - R L - T - R L - T - R

Min. Green: 0 0 0 0 0 0 0 0 0 0 0 0

Volume Module: >> Count Date: 14 Mar 2019 <<

Base Vol:	14	72	17	15	45	2	11	73	9	14	59	13
Growth Adj:	1.00	1.00	1.00	1.00	1.00	1.00	1.00	1.00	1.00	1.00	1.00	1.00
Initial Bse:	14	72	17	15	45	2	11	73	9	14	59	13
Added Vol:	3	194	5	0	0	0	0	8	0	0	0	0
PasserByVol:	0	0	0	0	0	0	0	0	0	0	0	0
Initial Fut:	17	266	22	15	45	2	11	81	9	14	59	13
User Adj:	1.00	1.00	1.00	1.00	1.00	1.00	1.00	1.00	1.00	1.00	1.00	1.00
PHF Adj:	1.00	1.00	1.00	1.00	1.00	1.00	1.00	1.00	1.00	1.00	1.00	1.00
PHF Volume:	17	266	22	15	45	2	11	81	9	14	59	13
Reduct Vol:	0	0	0	0	0	0	0	0	0	0	0	0
Reduced Vol:	17	266	22	15	45	2	11	81	9	14	59	13
PCE Adj:	1.00	1.00	1.00	1.00	1.00	1.00	1.00	1.00	1.00	1.00	1.00	1.00
MLF Adj:	1.00	1.00	1.00	1.00	1.00	1.00	1.00	1.00	1.00	1.00	1.00	1.00
FinalVolume:	17	266	22	15	45	2	11	81	9	14	59	13

Saturation Flow Module:

Adjustment:	1.00	1.00	1.00	1.00	1.00	1.00	1.00	1.00	1.00	1.00	1.00	1.00
Lanes:	0.06	0.87	0.07	0.24	0.73	0.03	0.11	0.80	0.09	0.16	0.69	0.15
Final Sat.:	44	696	58	176	527	23	77	564	63	114	481	106

Capacity Analysis Module:

Vol/Sat:	0.38	0.38	0.38	0.09	0.09	0.09	0.14	0.14	0.14	0.12	0.12	0.12
Crit Moves:	****	****	****	****	****	****	****	****	****	****	****	****
Delay/Veh:	10.0	10.0	10.0	8.1	8.1	8.1	8.5	8.5	8.5	8.4	8.4	8.4
Delay Adj:	1.00	1.00	1.00	1.00	1.00	1.00	1.00	1.00	1.00	1.00	1.00	1.00
AdjDel/Veh:	10.0	10.0	10.0	8.1	8.1	8.1	8.5	8.5	8.5	8.4	8.4	8.4
LOS by Move:	A	A	A	A	A	A	A	A	A	A	A	A
ApproachDel:	10.0			8.1			8.5			8.4		
Delay Adj:	1.00			1.00			1.00			1.00		
ApprAdjDel:	10.0			8.1			8.5			8.4		
LOS by Appr:	A			A			A			A		
AllWayAvgQ:	0.6	0.6	0.6	0.1	0.1	0.1	0.1	0.1	0.1	0.1	0.1	0.1

Note: Queue reported is the number of cars per lane.

Voices School
Morgan Hill, CA
Hexagon Transportation Consultants, Inc.

Level Of Service Computation Report
2000 HCM 4-Way Stop (Future Volume Alternative)
Existing Plus Project (PM) - 2 Cosmo Right out

Intersection #1500: Del Monte Avenue and Spring Avenue

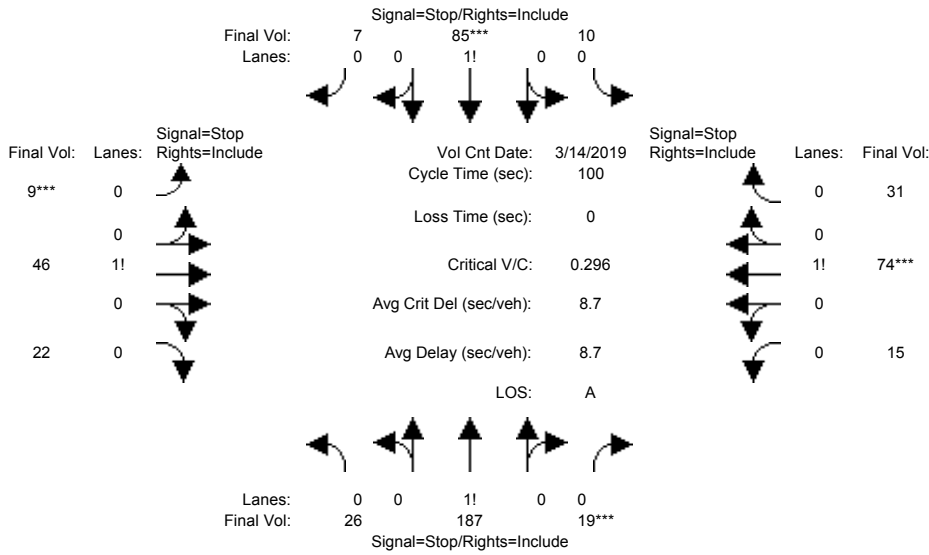

Street Name: Del Monte Ave Spring Ave
Approach: North Bound South Bound East Bound West Bound
Movement: L - T - R L - T - R L - T - R L - T - R

Min. Green: 0 0 0 0 0 0 0 0 0 0 0 0

Volume Module: >> Count Date: 14 Mar 2019 <<

Base Vol:	21	59	11	10	85	7	9	44	22	15	74	31
Growth Adj:	1.00	1.00	1.00	1.00	1.00	1.00	1.00	1.00	1.00	1.00	1.00	1.00
Initial Bse:	21	59	11	10	85	7	9	44	22	15	74	31
Added Vol:	5	128	8	0	0	0	0	2	0	0	0	0
PasserByVol:	0	0	0	0	0	0	0	0	0	0	0	0
Initial Fut:	26	187	19	10	85	7	9	46	22	15	74	31
User Adj:	1.00	1.00	1.00	1.00	1.00	1.00	1.00	1.00	1.00	1.00	1.00	1.00
PHF Adj:	1.00	1.00	1.00	1.00	1.00	1.00	1.00	1.00	1.00	1.00	1.00	1.00
PHF Volume:	26	187	19	10	85	7	9	46	22	15	74	31
Reduct Vol:	0	0	0	0	0	0	0	0	0	0	0	0
Reduced Vol:	26	187	19	10	85	7	9	46	22	15	74	31
PCE Adj:	1.00	1.00	1.00	1.00	1.00	1.00	1.00	1.00	1.00	1.00	1.00	1.00
MLF Adj:	1.00	1.00	1.00	1.00	1.00	1.00	1.00	1.00	1.00	1.00	1.00	1.00
FinalVolume:	26	187	19	10	85	7	9	46	22	15	74	31

Saturation Flow Module:

Adjustment:	1.00	1.00	1.00	1.00	1.00	1.00	1.00	1.00	1.00	1.00	1.00	1.00
Lanes:	0.11	0.81	0.08	0.10	0.83	0.07	0.12	0.60	0.28	0.12	0.62	0.26
Final Sat.:	88	631	64	73	624	51	85	433	207	92	453	190

Capacity Analysis Module:

Vol/Sat:	0.30	0.30	0.30	0.14	0.14	0.14	0.11	0.11	0.11	0.16	0.16	0.16
Crit Moves:			****		****		****				****	
Delay/Veh:	9.2	9.2	9.2	8.3	8.3	8.3	8.2	8.2	8.2	8.4	8.4	8.4
Delay Adj:	1.00	1.00	1.00	1.00	1.00	1.00	1.00	1.00	1.00	1.00	1.00	1.00
AdjDel/Veh:	9.2	9.2	9.2	8.3	8.3	8.3	8.2	8.2	8.2	8.4	8.4	8.4
LOS by Move:	A	A	A	A	A	A	A	A	A	A	A	A
ApproachDel:		9.2			8.3			8.2			8.4	
Delay Adj:		1.00			1.00			1.00			1.00	
ApprAdjDel:		9.2			8.3			8.2			8.4	
LOS by Appr:		A			A			A			A	
AllWayAvgQ:	0.4	0.4	0.4	0.1	0.1	0.1	0.1	0.1	0.1	0.2	0.2	0.2

Note: Queue reported is the number of cars per lane.

Voices School
Morgan Hill, CA
Hexagon Transportation Consultants, Inc.

Level Of Service Computation Report
2000 HCM Operations (Future Volume Alternative)
Existing (AM)

Intersection #4111: Monterey Road and Vineyard Boulevard

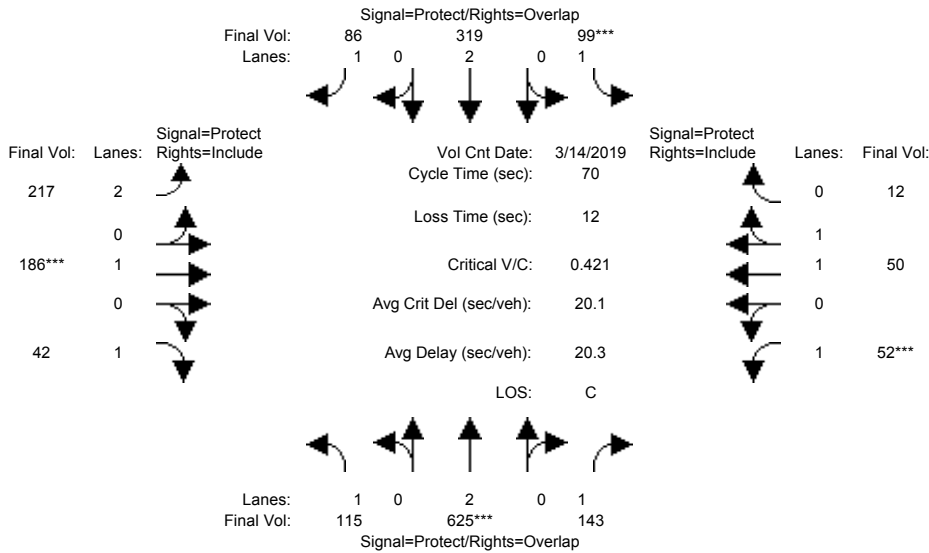

Street Name:	Monterey Road						Vineyard Blvd					
	North Bound			South Bound			East Bound			West Bound		
Approach:	L	T	R	L	T	R	L	T	R	L	T	R
Min. Green:	7	10	10	7	10	10	7	10	10	7	10	10
Y+R:	4.0	4.0	4.0	4.0	4.0	4.0	4.0	4.0	4.0	4.0	4.0	4.0

Volume Module:	>>	Count	Date:	14 Mar 2019	<<												
Base Vol:	115	625	143	99	319	86	217	186	42	52	50	12					
Growth Adj:	1.00	1.00	1.00	1.00	1.00	1.00	1.00	1.00	1.00	1.00	1.00	1.00					
Initial Bse:	115	625	143	99	319	86	217	186	42	52	50	12					
Added Vol:	0	0	0	0	0	0	0	0	0	0	0	0					
PasserByVol:	0	0	0	0	0	0	0	0	0	0	0	0					
Initial Fut:	115	625	143	99	319	86	217	186	42	52	50	12					
User Adj:	1.00	1.00	1.00	1.00	1.00	1.00	1.00	1.00	1.00	1.00	1.00	1.00					
PHF Adj:	1.00	1.00	1.00	1.00	1.00	1.00	1.00	1.00	1.00	1.00	1.00	1.00					
PHF Volume:	115	625	143	99	319	86	217	186	42	52	50	12					
Reduct Vol:	0	0	0	0	0	0	0	0	0	0	0	0					
Reduced Vol:	115	625	143	99	319	86	217	186	42	52	50	12					
PCE Adj:	1.00	1.00	1.00	1.00	1.00	1.00	1.00	1.00	1.00	1.00	1.00	1.00					
MLF Adj:	1.00	1.00	1.00	1.00	1.00	1.00	1.00	1.00	1.00	1.00	1.00	1.00					
FinalVolume:	115	625	143	99	319	86	217	186	42	52	50	12					

Saturation Flow Module:												
Sat/Lane:	1900	1900	1900	1900	1900	1900	1900	1900	1900	1900	1900	1900
Adjustment:	0.92	1.00	0.92	0.92	1.00	0.92	0.83	1.00	0.92	0.92	0.98	0.95
Lanes:	1.00	2.00	1.00	1.00	2.00	1.00	2.00	1.00	1.00	1.00	1.60	0.40
Final Sat.:	1750	3800	1750	1750	3800	1750	3150	1900	1750	1750	2983	716

Capacity Analysis Module:												
Vol/Sat:	0.07	0.16	0.08	0.06	0.08	0.05	0.07	0.10	0.02	0.03	0.02	0.02
Crit Moves:	****			****			****			****		
Green Time:	14.6	26.3	33.3	9.0	20.8	30.1	9.3	15.7	15.7	7.0	13.3	13.3
Volume/Cap:	0.32	0.44	0.17	0.44	0.28	0.11	0.52	0.44	0.11	0.30	0.09	0.09
Delay/Veh:	24.0	16.5	10.6	29.5	19.0	12.0	29.4	24.1	21.7	30.2	23.4	23.4
User DelAdj:	1.00	1.00	1.00	1.00	1.00	1.00	1.00	1.00	1.00	1.00	1.00	1.00
AdjDel/Veh:	24.0	16.5	10.6	29.5	19.0	12.0	29.4	24.1	21.7	30.2	23.4	23.4
LOS by Move:	C	B	B	C	B	B	C	C	C	C	C	C
HCM2kAvgQ:	2	5	2	2	3	1	3	4	1	1	1	1

Note: Queue reported is the number of cars per lane.

Voices School
Morgan Hill, CA
Hexagon Transportation Consultants, Inc.

Level Of Service Computation Report
2000 HCM Operations (Future Volume Alternative)
Existing (PM)

Intersection #4111: Monterey Road and Vineyard Boulevard

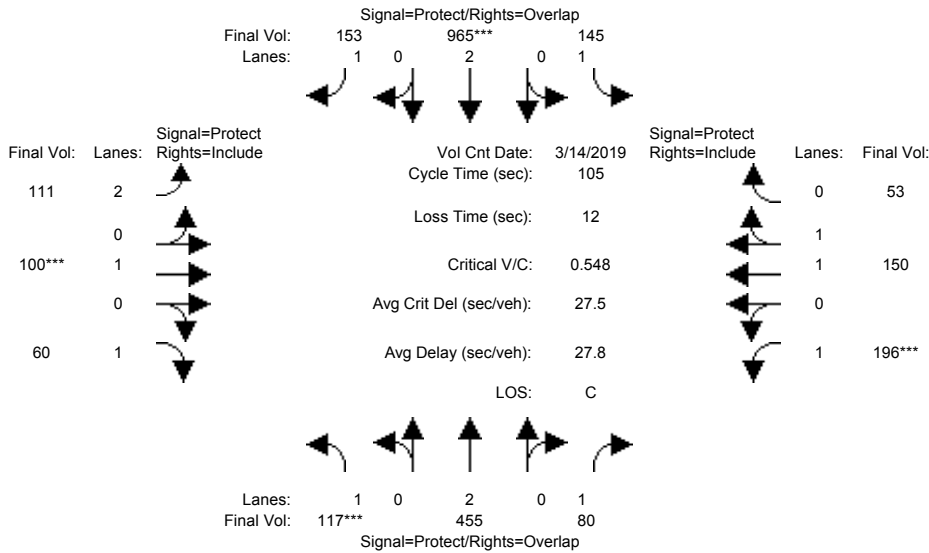

Street Name:	Monterey Road						Vineyard Blvd					
	North Bound			South Bound			East Bound			West Bound		
Approach:	L	T	R	L	T	R	L	T	R	L	T	R
Min. Green:	7	10	10	7	10	10	7	10	10	7	10	10
Y+R:	4.0	4.0	4.0	4.0	4.0	4.0	4.0	4.0	4.0	4.0	4.0	4.0

Volume Module:	>>	Count	Date:	14 Mar 2019	<<							
Base Vol:	117	455	80	145	965	153	111	100	60	196	150	53
Growth Adj:	1.00	1.00	1.00	1.00	1.00	1.00	1.00	1.00	1.00	1.00	1.00	1.00
Initial Bse:	117	455	80	145	965	153	111	100	60	196	150	53
Added Vol:	0	0	0	0	0	0	0	0	0	0	0	0
PasserByVol:	0	0	0	0	0	0	0	0	0	0	0	0
Initial Fut:	117	455	80	145	965	153	111	100	60	196	150	53
User Adj:	1.00	1.00	1.00	1.00	1.00	1.00	1.00	1.00	1.00	1.00	1.00	1.00
PHF Adj:	1.00	1.00	1.00	1.00	1.00	1.00	1.00	1.00	1.00	1.00	1.00	1.00
PHF Volume:	117	455	80	145	965	153	111	100	60	196	150	53
Reduct Vol:	0	0	0	0	0	0	0	0	0	0	0	0
Reduced Vol:	117	455	80	145	965	153	111	100	60	196	150	53
PCE Adj:	1.00	1.00	1.00	1.00	1.00	1.00	1.00	1.00	1.00	1.00	1.00	1.00
MLF Adj:	1.00	1.00	1.00	1.00	1.00	1.00	1.00	1.00	1.00	1.00	1.00	1.00
FinalVolume:	117	455	80	145	965	153	111	100	60	196	150	53

Saturation Flow Module:												
Sat/Lane:	1900	1900	1900	1900	1900	1900	1900	1900	1900	1900	1900	1900
Adjustment:	0.92	1.00	0.92	0.92	1.00	0.92	0.83	1.00	0.92	0.92	0.98	0.95
Lanes:	1.00	2.00	1.00	1.00	2.00	1.00	2.00	1.00	1.00	1.00	1.46	0.54
Final Sat.:	1750	3800	1750	1750	3800	1750	3150	1900	1750	1750	2733	966

Capacity Analysis Module:												
Vol/Sat:	0.07	0.12	0.05	0.08	0.25	0.09	0.04	0.05	0.03	0.11	0.05	0.05
Crit Moves:	****				****			****		****		
Green Time:	12.8	36.3	57.8	25.1	48.7	61.6	13.0	10.1	10.1	21.5	18.6	18.6
Volume/Cap:	0.55	0.35	0.08	0.35	0.55	0.15	0.28	0.55	0.36	0.55	0.31	0.31
Delay/Veh:	46.4	25.7	11.2	33.6	20.6	9.9	42.2	48.8	45.7	39.2	37.9	37.9
User DelAdj:	1.00	1.00	1.00	1.00	1.00	1.00	1.00	1.00	1.00	1.00	1.00	1.00
AdjDel/Veh:	46.4	25.7	11.2	33.6	20.6	9.9	42.2	48.8	45.7	39.2	37.9	37.9
LOS by Move:	D	C	B	C	C	A	D	D	D	D	D	D
HCM2kAvgQ:	4	5	1	4	11	2	2	4	2	7	3	3

Note: Queue reported is the number of cars per lane.

Voices School
Morgan Hill, CA
Hexagon Transportation Consultants, Inc.

Level Of Service Computation Report
2000 HCM Operations (Future Volume Alternative)
Existing Plus Project (AM) - 2 Cosmo Right out

Intersection #4111: Monterey Road and Vineyard Boulevard

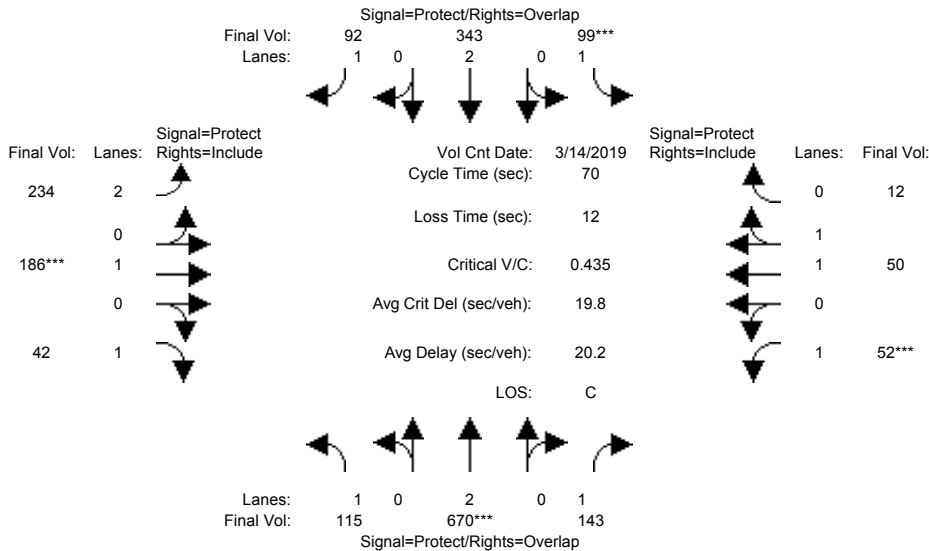

Street Name:	Monterey Road						Vineyard Blvd					
	North Bound			South Bound			East Bound			West Bound		
Approach:	L	T	R	L	T	R	L	T	R	L	T	R
Min. Green:	7	10	10	7	10	10	7	10	10	7	10	10
Y+R:	4.0	4.0	4.0	4.0	4.0	4.0	4.0	4.0	4.0	4.0	4.0	4.0

Volume Module:	>>	Count	Date:	14 Mar 2019	<<							
Base Vol:	115	625	143	99	319	86	217	186	42	52	50	12
Growth Adj:	1.00	1.00	1.00	1.00	1.00	1.00	1.00	1.00	1.00	1.00	1.00	1.00
Initial Bse:	115	625	143	99	319	86	217	186	42	52	50	12
Added Vol:	0	45	0	0	24	6	17	0	0	0	0	0
PasserByVol:	0	0	0	0	0	0	0	0	0	0	0	0
Initial Fut:	115	670	143	99	343	92	234	186	42	52	50	12
User Adj:	1.00	1.00	1.00	1.00	1.00	1.00	1.00	1.00	1.00	1.00	1.00	1.00
PHF Adj:	1.00	1.00	1.00	1.00	1.00	1.00	1.00	1.00	1.00	1.00	1.00	1.00
PHF Volume:	115	670	143	99	343	92	234	186	42	52	50	12
Reduct Vol:	0	0	0	0	0	0	0	0	0	0	0	0
Reduced Vol:	115	670	143	99	343	92	234	186	42	52	50	12
PCE Adj:	1.00	1.00	1.00	1.00	1.00	1.00	1.00	1.00	1.00	1.00	1.00	1.00
MLF Adj:	1.00	1.00	1.00	1.00	1.00	1.00	1.00	1.00	1.00	1.00	1.00	1.00
FinalVolume:	115	670	143	99	343	92	234	186	42	52	50	12

Saturation Flow Module:												
Sat/Lane:	1900	1900	1900	1900	1900	1900	1900	1900	1900	1900	1900	1900
Adjustment:	0.92	1.00	0.92	0.92	1.00	0.92	0.83	1.00	0.92	0.92	0.98	0.95
Lanes:	1.00	2.00	1.00	1.00	2.00	1.00	2.00	1.00	1.00	1.00	1.60	0.40
Final Sat.:	1750	3800	1750	1750	3800	1750	3150	1900	1750	1750	2983	716

Capacity Analysis Module:												
Vol/Sat:	0.07	0.18	0.08	0.06	0.09	0.05	0.07	0.10	0.02	0.03	0.02	0.02
Crit Moves:	****			****			****			****		
Green Time:	14.8	27.2	34.2	8.7	21.1	30.2	9.1	15.1	15.1	7.0	13.0	13.0
Volume/Cap:	0.31	0.45	0.17	0.45	0.30	0.12	0.57	0.45	0.11	0.30	0.09	0.09
Delay/Veh:	23.8	16.1	10.1	29.9	18.9	12.0	30.6	24.7	22.2	30.2	23.7	23.7
User DelAdj:	1.00	1.00	1.00	1.00	1.00	1.00	1.00	1.00	1.00	1.00	1.00	1.00
AdjDel/Veh:	23.8	16.1	10.1	29.9	18.9	12.0	30.6	24.7	22.2	30.2	23.7	23.7
LOS by Move:	C	B	B	C	B	B	C	C	C	C	C	C
HCM2kAvgQ:	2	5	2	2	3	1	4	4	1	1	1	1

Note: Queue reported is the number of cars per lane.

Voices School
Morgan Hill, CA
Hexagon Transportation Consultants, Inc.

Level Of Service Computation Report
2000 HCM Operations (Future Volume Alternative)
Existing Plus Project (PM) - 2 Cosmo Right out

Intersection #4111: Monterey Road and Vineyard Boulevard

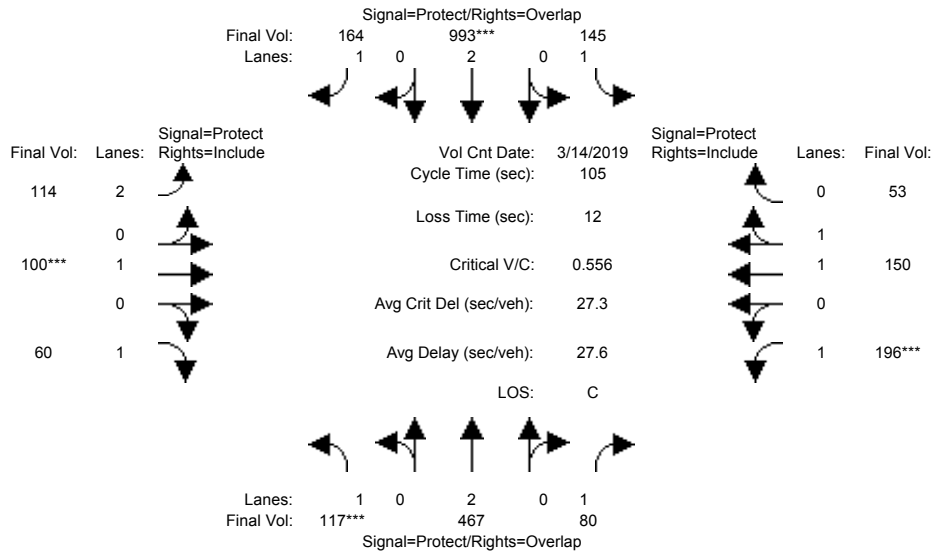

Street Name:	Monterey Road						Vineyard Blvd					
	North Bound			South Bound			East Bound			West Bound		
Approach:	L	T	R	L	T	R	L	T	R	L	T	R
Min. Green:	7	10	10	7	10	10	7	10	10	7	10	10
Y+R:	4.0	4.0	4.0	4.0	4.0	4.0	4.0	4.0	4.0	4.0	4.0	4.0

Volume Module:	>>	Count	Date:	14 Mar 2019	<<							
Base Vol:	117	455	80	145	965	153	111	100	60	196	150	53
Growth Adj:	1.00	1.00	1.00	1.00	1.00	1.00	1.00	1.00	1.00	1.00	1.00	1.00
Initial Bse:	117	455	80	145	965	153	111	100	60	196	150	53
Added Vol:	0	12	0	0	28	11	3	0	0	0	0	0
PasserByVol:	0	0	0	0	0	0	0	0	0	0	0	0
Initial Fut:	117	467	80	145	993	164	114	100	60	196	150	53
User Adj:	1.00	1.00	1.00	1.00	1.00	1.00	1.00	1.00	1.00	1.00	1.00	1.00
PHF Adj:	1.00	1.00	1.00	1.00	1.00	1.00	1.00	1.00	1.00	1.00	1.00	1.00
PHF Volume:	117	467	80	145	993	164	114	100	60	196	150	53
Reduct Vol:	0	0	0	0	0	0	0	0	0	0	0	0
Reduced Vol:	117	467	80	145	993	164	114	100	60	196	150	53
PCE Adj:	1.00	1.00	1.00	1.00	1.00	1.00	1.00	1.00	1.00	1.00	1.00	1.00
MLF Adj:	1.00	1.00	1.00	1.00	1.00	1.00	1.00	1.00	1.00	1.00	1.00	1.00
FinalVolume:	117	467	80	145	993	164	114	100	60	196	150	53

Saturation Flow Module:												
Sat/Lane:	1900	1900	1900	1900	1900	1900	1900	1900	1900	1900	1900	1900
Adjustment:	0.92	1.00	0.92	0.92	1.00	0.92	0.83	1.00	0.92	0.92	0.98	0.95
Lanes:	1.00	2.00	1.00	1.00	2.00	1.00	2.00	1.00	1.00	1.00	1.46	0.54
Final Sat.:	1750	3800	1750	1750	3800	1750	3150	1900	1750	1750	2733	966

Capacity Analysis Module:												
Vol/Sat:	0.07	0.12	0.05	0.08	0.26	0.09	0.04	0.05	0.03	0.11	0.05	0.05
Crit Moves:	****				****			****		****		
Green Time:	12.6	37.0	58.1	24.9	49.3	62.1	12.8	10.0	10.0	21.1	18.3	18.3
Volume/Cap:	0.56	0.35	0.08	0.35	0.56	0.16	0.30	0.55	0.36	0.56	0.31	0.31
Delay/Veh:	46.9	25.3	11.0	33.8	20.4	9.7	42.4	49.0	45.8	39.7	38.2	38.2
User DelAdj:	1.00	1.00	1.00	1.00	1.00	1.00	1.00	1.00	1.00	1.00	1.00	1.00
AdjDel/Veh:	46.9	25.3	11.0	33.8	20.4	9.7	42.4	49.0	45.8	39.7	38.2	38.2
LOS by Move:	D	C	B	C	C	A	D	D	D	D	D	D
HCM2kAvgQ:	4	5	1	4	11	2	2	4	2	7	3	3

Note: Queue reported is the number of cars per lane.

Voices School
Morgan Hill, CA
Hexagon Transportation Consultants, Inc.

Level Of Service Computation Report
2000 HCM Operations (Future Volume Alternative)
Existing (AM)

Intersection #6674: Monterey Road and Tennant Avenue/Edmundson Avenue

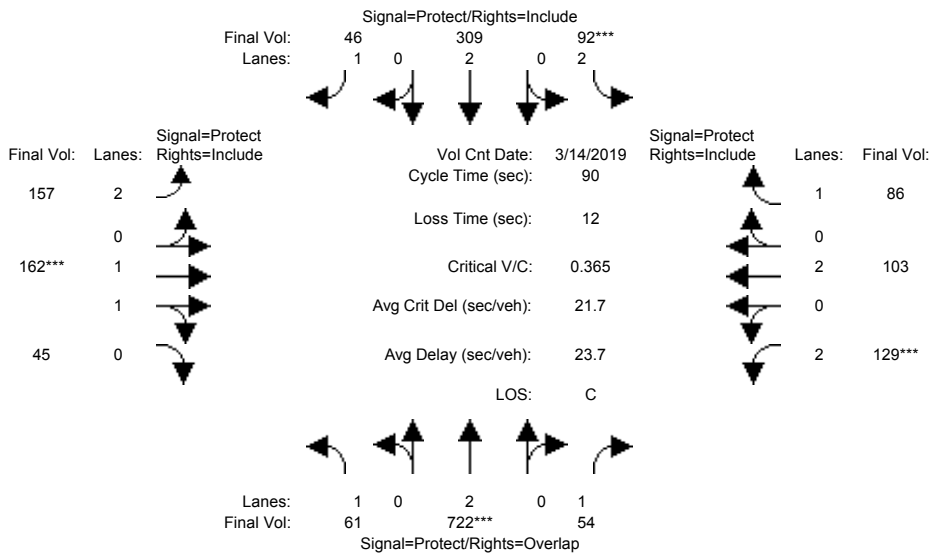

Street Name:	Monterey Rd						Tennant Ave/Edmundson Ave					
	North Bound			South Bound			East Bound			West Bound		
Approach:	L	T	R	L	T	R	L	T	R	L	T	R
Min. Green:	7	10	10	7	10	10	7	10	10	7	10	10
Y+R:	4.0	4.0	4.0	4.0	4.0	4.0	4.0	4.0	4.0	4.0	4.0	4.0

Volume Module:	>>	Count	Date:	14 Mar 2019	<<											
Base Vol:	61	722	54	92	309	46	157	162	45	129	103	86				
Growth Adj:	1.00	1.00	1.00	1.00	1.00	1.00	1.00	1.00	1.00	1.00	1.00	1.00				
Initial Bse:	61	722	54	92	309	46	157	162	45	129	103	86				
Added Vol:	0	0	0	0	0	0	0	0	0	0	0	0				
PasserByVol:	0	0	0	0	0	0	0	0	0	0	0	0				
Initial Fut:	61	722	54	92	309	46	157	162	45	129	103	86				
User Adj:	1.00	1.00	1.00	1.00	1.00	1.00	1.00	1.00	1.00	1.00	1.00	1.00				
PHF Adj:	1.00	1.00	1.00	1.00	1.00	1.00	1.00	1.00	1.00	1.00	1.00	1.00				
PHF Volume:	61	722	54	92	309	46	157	162	45	129	103	86				
Reduct Vol:	0	0	0	0	0	0	0	0	0	0	0	0				
Reduced Vol:	61	722	54	92	309	46	157	162	45	129	103	86				
PCE Adj:	1.00	1.00	1.00	1.00	1.00	1.00	1.00	1.00	1.00	1.00	1.00	1.00				
MLF Adj:	1.00	1.00	1.00	1.00	1.00	1.00	1.00	1.00	1.00	1.00	1.00	1.00				
Final Volume:	61	722	54	92	309	46	157	162	45	129	103	86				

Saturation Flow Module:												
Sat/Lane:	1900	1900	1900	1900	1900	1900	1900	1900	1900	1900	1900	1900
Adjustment:	0.92	1.00	0.92	0.83	1.00	0.92	0.83	0.98	0.95	0.83	1.00	0.92
Lanes:	1.00	2.00	1.00	2.00	2.00	1.00	2.00	1.55	0.45	2.00	2.00	1.00
Final Sat.:	1750	3800	1750	3150	3800	1750	3150	2895	804	3150	3800	1750

Capacity Analysis Module:												
Vol/Sat:	0.03	0.19	0.03	0.03	0.08	0.03	0.05	0.06	0.06	0.04	0.03	0.05
Crit Moves:	****			****			****			****		
Green Time:	22.3	46.9	57.0	7.2	31.8	31.8	9.8	13.8	13.8	10.1	14.1	14.1
Volume/Cap:	0.14	0.36	0.05	0.36	0.23	0.07	0.46	0.36	0.36	0.36	0.17	0.31
Delay/Veh:	26.6	12.9	6.3	40.1	20.6	19.4	38.5	34.6	34.6	37.6	33.1	34.4
User DelAdj:	1.00	1.00	1.00	1.00	1.00	1.00	1.00	1.00	1.00	1.00	1.00	1.00
AdjDel/Veh:	26.6	12.9	6.3	40.1	20.6	19.4	38.5	34.6	34.6	37.6	33.1	34.4
LOS by Move:	C	B	A	D	C	B	D	C	C	D	C	C
HCM2kAvgQ:	1	6	1	2	3	1	3	3	3	2	1	2

Note: Queue reported is the number of cars per lane.

Voices School
Morgan Hill, CA
Hexagon Transportation Consultants, Inc.

Level Of Service Computation Report
2000 HCM Operations (Future Volume Alternative)
Existing (PM)

Intersection #6674: Monterey Road and Tennant Avenue/Edmundson Avenue

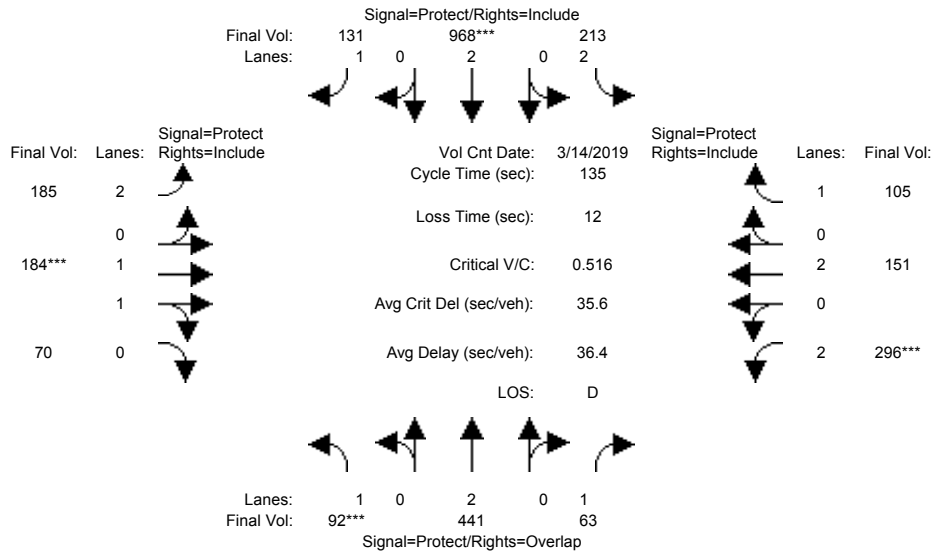

Street Name:	Monterey Rd						Tennant Ave/Edmundson Ave					
	North Bound			South Bound			East Bound			West Bound		
Approach:	L	T	R	L	T	R	L	T	R	L	T	R
Min. Green:	7	10	10	7	10	10	7	10	10	7	10	10
Y+R:	4.0	4.0	4.0	4.0	4.0	4.0	4.0	4.0	4.0	4.0	4.0	4.0

Volume Module:	>>	Count	Date:	14 Mar 2019	<<							
Base Vol:	92	441	63	213	968	131	185	184	70	296	151	105
Growth Adj:	1.00	1.00	1.00	1.00	1.00	1.00	1.00	1.00	1.00	1.00	1.00	1.00
Initial Bse:	92	441	63	213	968	131	185	184	70	296	151	105
Added Vol:	0	0	0	0	0	0	0	0	0	0	0	0
PasserByVol:	0	0	0	0	0	0	0	0	0	0	0	0
Initial Fut:	92	441	63	213	968	131	185	184	70	296	151	105
User Adj:	1.00	1.00	1.00	1.00	1.00	1.00	1.00	1.00	1.00	1.00	1.00	1.00
PHF Adj:	1.00	1.00	1.00	1.00	1.00	1.00	1.00	1.00	1.00	1.00	1.00	1.00
PHF Volume:	92	441	63	213	968	131	185	184	70	296	151	105
Reduct Vol:	0	0	0	0	0	0	0	0	0	0	0	0
Reduced Vol:	92	441	63	213	968	131	185	184	70	296	151	105
PCE Adj:	1.00	1.00	1.00	1.00	1.00	1.00	1.00	1.00	1.00	1.00	1.00	1.00
MLF Adj:	1.00	1.00	1.00	1.00	1.00	1.00	1.00	1.00	1.00	1.00	1.00	1.00
FinalVolume:	92	441	63	213	968	131	185	184	70	296	151	105

Saturation Flow Module:												
Sat/Lane:	1900	1900	1900	1900	1900	1900	1900	1900	1900	1900	1900	1900
Adjustment:	0.92	1.00	0.92	0.83	1.00	0.92	0.83	0.98	0.95	0.83	1.00	0.92
Lanes:	1.00	2.00	1.00	2.00	2.00	1.00	2.00	1.43	0.57	2.00	2.00	1.00
Final Sat.:	1750	3800	1750	3150	3800	1750	3150	2680	1019	3150	3800	1750

Capacity Analysis Module:												
Vol/Sat:	0.05	0.12	0.04	0.07	0.25	0.07	0.06	0.07	0.07	0.09	0.04	0.06
Crit Moves:	***				***			***		***		
Green Time:	13.8	50.8	75.4	29.6	66.7	66.7	18.8	18.0	18.0	24.6	23.7	23.7
Volume/Cap:	0.52	0.31	0.06	0.31	0.52	0.15	0.42	0.52	0.52	0.52	0.23	0.34
Delay/Veh:	60.1	29.8	13.7	44.4	23.5	18.8	53.8	55.4	55.4	50.6	47.9	49.4
User DelAdj:	1.00	1.00	1.00	1.00	1.00	1.00	1.00	1.00	1.00	1.00	1.00	1.00
AdjDel/Veh:	60.1	29.8	13.7	44.4	23.5	18.8	53.8	55.4	55.4	50.6	47.9	49.4
LOS by Move:	E	C	B	D	C	B	D	E	E	D	D	D
HCM2kAvgQ:	4	6	1	4	13	3	5	6	6	6	3	4

Note: Queue reported is the number of cars per lane.

Voices School
Morgan Hill, CA
Hexagon Transportation Consultants, Inc.

Level Of Service Computation Report
2000 HCM Operations (Future Volume Alternative)
Existing Plus Project (AM) - 2 Cosmo Right out

Intersection #6674: Monterey Road and Tennant Avenue/Edmundson Avenue

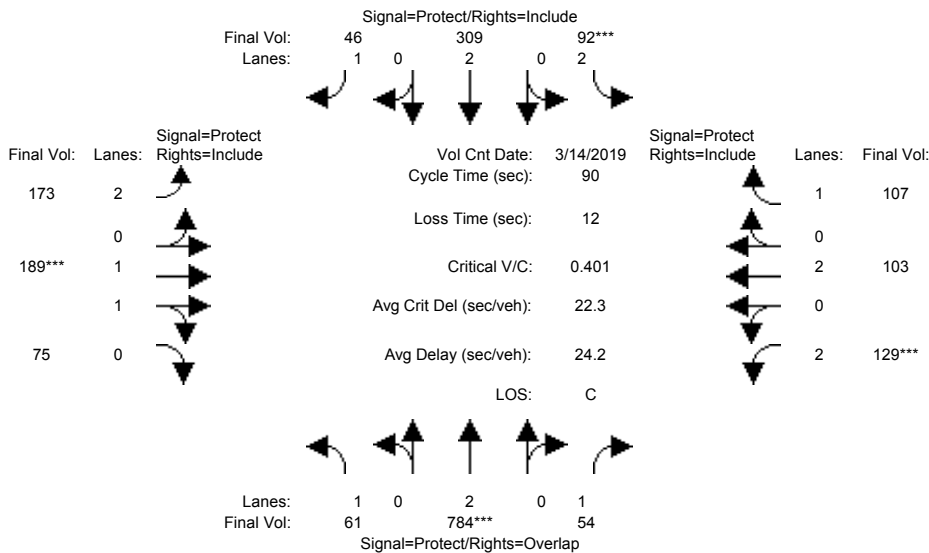

Street Name:	Monterey Rd						Tennant Ave/Edmundson Ave					
	North Bound			South Bound			East Bound			West Bound		
Approach:	L	T	R	L	T	R	L	T	R	L	T	R
Min. Green:	7	10	10	7	10	10	7	10	10	7	10	10
Y+R:	4.0	4.0	4.0	4.0	4.0	4.0	4.0	4.0	4.0	4.0	4.0	4.0

Volume Module: >> Count Date: 14 Mar 2019 <<

Base Vol:	61	722	54	92	309	46	157	162	45	129	103	86
Growth Adj:	1.00	1.00	1.00	1.00	1.00	1.00	1.00	1.00	1.00	1.00	1.00	1.00
Initial Bse:	61	722	54	92	309	46	157	162	45	129	103	86
Added Vol:	0	62	0	0	0	0	16	27	30	0	0	21
PasserByVol:	0	0	0	0	0	0	0	0	0	0	0	0
Initial Fut:	61	784	54	92	309	46	173	189	75	129	103	107
User Adj:	1.00	1.00	1.00	1.00	1.00	1.00	1.00	1.00	1.00	1.00	1.00	1.00
PHF Adj:	1.00	1.00	1.00	1.00	1.00	1.00	1.00	1.00	1.00	1.00	1.00	1.00
PHF Volume:	61	784	54	92	309	46	173	189	75	129	103	107
Reduct Vol:	0	0	0	0	0	0	0	0	0	0	0	0
Reduced Vol:	61	784	54	92	309	46	173	189	75	129	103	107
PCE Adj:	1.00	1.00	1.00	1.00	1.00	1.00	1.00	1.00	1.00	1.00	1.00	1.00
MLF Adj:	1.00	1.00	1.00	1.00	1.00	1.00	1.00	1.00	1.00	1.00	1.00	1.00
Final Volume:	61	784	54	92	309	46	173	189	75	129	103	107

Saturation Flow Module:

Sat/Lane:	1900	1900	1900	1900	1900	1900	1900	1900	1900	1900	1900	1900
Adjustment:	0.92	1.00	0.92	0.83	1.00	0.92	0.83	0.98	0.95	0.83	1.00	0.92
Lanes:	1.00	2.00	1.00	2.00	2.00	1.00	2.00	1.42	0.58	2.00	2.00	1.00
Final Sat.:	1750	3800	1750	3150	3800	1750	3150	2648	1051	3150	3800	1750

Capacity Analysis Module:

Vol/Sat:	0.03	0.21	0.03	0.03	0.08	0.03	0.05	0.07	0.07	0.04	0.03	0.06
Crit Moves:	****			****			****			****		
Green Time:	21.8	46.0	55.1	7.0	31.2	31.2	10.3	15.9	15.9	9.1	14.7	14.7
Volume/Cap:	0.14	0.40	0.05	0.38	0.23	0.08	0.48	0.40	0.40	0.40	0.17	0.37
Delay/Veh:	26.9	13.7	7.0	40.4	21.0	19.8	38.3	33.3	33.3	38.7	32.5	34.4
User DelAdj:	1.00	1.00	1.00	1.00	1.00	1.00	1.00	1.00	1.00	1.00	1.00	1.00
AdjDel/Veh:	26.9	13.7	7.0	40.4	21.0	19.8	38.3	33.3	33.3	38.7	32.5	34.4
LOS by Move:	C	B	A	D	C	B	D	C	C	D	C	C
HCM2kAvgQ:	1	6	1	2	3	1	3	4	4	2	1	3

Note: Queue reported is the number of cars per lane.

Voices School
Morgan Hill, CA
Hexagon Transportation Consultants, Inc.

Level Of Service Computation Report
2000 HCM Operations (Future Volume Alternative)
Existing Plus Project (PM) - 2 Cosmo Right out

Intersection #6674: Monterey Road and Tennant Avenue/Edmundson Avenue

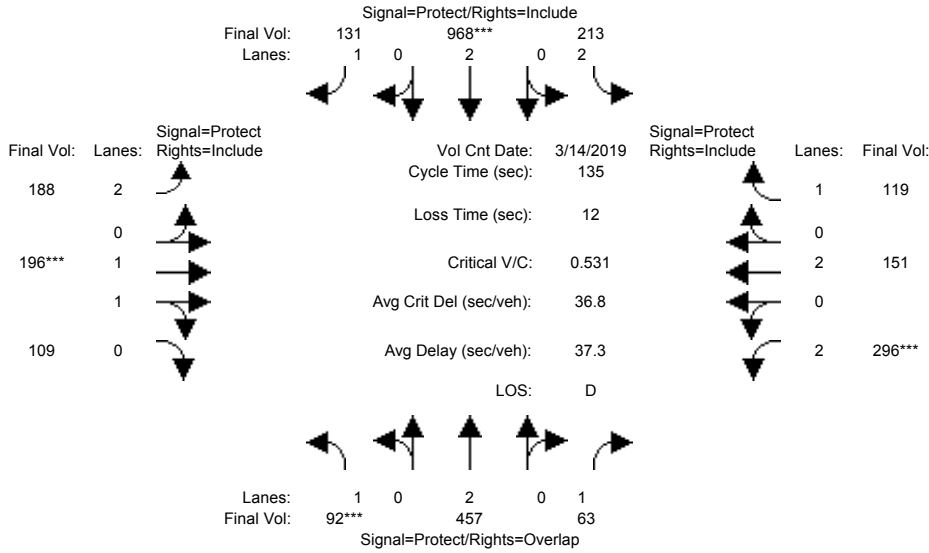

Street Name:	Monterey Rd						Tennant Ave/Edmundson Ave					
	North Bound			South Bound			East Bound			West Bound		
Approach:	L	T	R	L	T	R	L	T	R	L	T	R
Min. Green:	7	10	10	7	10	10	7	10	10	7	10	10
Y+R:	4.0	4.0	4.0	4.0	4.0	4.0	4.0	4.0	4.0	4.0	4.0	4.0

Volume Module:	>>	Count	Date:	14 Mar 2019	<<							
Base Vol:	92	441	63	213	968	131	185	184	70	296	151	105
Growth Adj:	1.00	1.00	1.00	1.00	1.00	1.00	1.00	1.00	1.00	1.00	1.00	1.00
Initial Bse:	92	441	63	213	968	131	185	184	70	296	151	105
Added Vol:	0	16	0	0	0	0	3	12	39	0	0	14
PasserByVol:	0	0	0	0	0	0	0	0	0	0	0	0
Initial Fut:	92	457	63	213	968	131	188	196	109	296	151	119
User Adj:	1.00	1.00	1.00	1.00	1.00	1.00	1.00	1.00	1.00	1.00	1.00	1.00
PHF Adj:	1.00	1.00	1.00	1.00	1.00	1.00	1.00	1.00	1.00	1.00	1.00	1.00
PHF Volume:	92	457	63	213	968	131	188	196	109	296	151	119
Reduct Vol:	0	0	0	0	0	0	0	0	0	0	0	0
Reduced Vol:	92	457	63	213	968	131	188	196	109	296	151	119
PCE Adj:	1.00	1.00	1.00	1.00	1.00	1.00	1.00	1.00	1.00	1.00	1.00	1.00
MLF Adj:	1.00	1.00	1.00	1.00	1.00	1.00	1.00	1.00	1.00	1.00	1.00	1.00
FinalVolume:	92	457	63	213	968	131	188	196	109	296	151	119

Saturation Flow Module:												
Sat/Lane:	1900	1900	1900	1900	1900	1900	1900	1900	1900	1900	1900	1900
Adjustment:	0.92	1.00	0.92	0.83	1.00	0.92	0.83	0.99	0.95	0.83	1.00	0.92
Lanes:	1.00	2.00	1.00	2.00	2.00	1.00	2.00	1.27	0.73	2.00	2.00	1.00
Final Sat.:	1750	3800	1750	3150	3800	1750	3150	2377	1322	3150	3800	1750

Capacity Analysis Module:												
Vol/Sat:	0.05	0.12	0.04	0.07	0.25	0.07	0.06	0.08	0.08	0.09	0.04	0.07
Crit Moves:	***			***			***			***		
Green Time:	13.4	50.0	73.9	28.1	64.8	64.8	20.0	21.0	21.0	23.9	24.8	24.8
Volume/Cap:	0.53	0.32	0.07	0.32	0.53	0.16	0.40	0.53	0.53	0.53	0.22	0.37
Delay/Veh:	61.0	30.5	14.4	45.7	24.8	19.8	52.6	53.4	53.4	51.4	47.0	48.9
User DelAdj:	1.00	1.00	1.00	1.00	1.00	1.00	1.00	1.00	1.00	1.00	1.00	1.00
AdjDel/Veh:	61.0	30.5	14.4	45.7	24.8	19.8	52.6	53.4	53.4	51.4	47.0	48.9
LOS by Move:	E	C	B	D	C	B	D	D	D	D	D	D
HCM2kAvgQ:	4	6	1	5	14	3	5	6	6	7	3	4

Note: Queue reported is the number of cars per lane.

Voices School
Morgan Hill, CA
Hexagon Transportation Consultants, Inc.

Level Of Service Computation Report
2000 HCM Operations (Future Volume Alternative)
Existing (AM)

Intersection #6725: Monterey Road and Spring Avenue

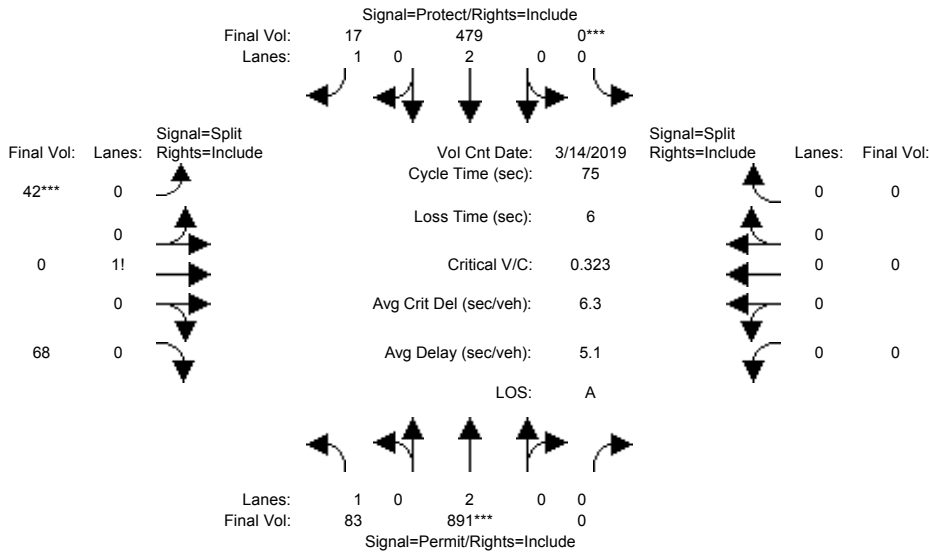

Street Name:	Monterey Road						Spring Avenue					
	North Bound			South Bound			East Bound			West Bound		
Approach:	L	T	R	L	T	R	L	T	R	L	T	R
Min. Green:	10	10	0	0	10	10	10	0	10	0	0	0
Y+R:	4.0	4.0	4.0	4.0	4.0	4.0	4.0	4.0	4.0	4.0	4.0	4.0

Volume Module:	>>	Count	Date:	14 Mar 2019	<<											
Base Vol:	83	891	0	0	479	17	42	0	68	0	0	0	0	0	0	
Growth Adj:	1.00	1.00	1.00	1.00	1.00	1.00	1.00	1.00	1.00	1.00	1.00	1.00	1.00	1.00	1.00	
Initial Bse:	83	891	0	0	479	17	42	0	68	0	0	0	0	0	0	
Added Vol:	0	0	0	0	0	0	0	0	0	0	0	0	0	0	0	
PasserByVol:	0	0	0	0	0	0	0	0	0	0	0	0	0	0	0	
Initial Fut:	83	891	0	0	479	17	42	0	68	0	0	0	0	0	0	
User Adj:	1.00	1.00	1.00	1.00	1.00	1.00	1.00	1.00	1.00	1.00	1.00	1.00	1.00	1.00	1.00	
PHF Adj:	1.00	1.00	1.00	1.00	1.00	1.00	1.00	1.00	1.00	1.00	1.00	1.00	1.00	1.00	1.00	
PHF Volume:	83	891	0	0	479	17	42	0	68	0	0	0	0	0	0	
Reduct Vol:	0	0	0	0	0	0	0	0	0	0	0	0	0	0	0	
Reduced Vol:	83	891	0	0	479	17	42	0	68	0	0	0	0	0	0	
PCE Adj:	1.00	1.00	1.00	1.00	1.00	1.00	1.00	1.00	1.00	1.00	1.00	1.00	1.00	1.00	1.00	
MLF Adj:	1.00	1.00	1.00	1.00	1.00	1.00	1.00	1.00	1.00	1.00	1.00	1.00	1.00	1.00	1.00	
FinalVolume:	83	891	0	0	479	17	42	0	68	0	0	0	0	0	0	

Saturation Flow Module:												
Sat/Lane:	1900	1900	1900	1900	1900	1900	1900	1900	1900	1900	1900	1900
Adjustment:	0.92	1.00	0.92	0.92	1.00	0.92	0.92	0.92	0.92	0.92	1.00	0.92
Lanes:	1.00	2.00	0.00	0.00	2.00	1.00	0.38	0.00	0.62	0.00	0.00	0.00
Final Sat.:	1750	3800	0	0	3800	1750	668	0	1082	0	0	0

Capacity Analysis Module:												
Vol/Sat:	0.05	0.23	0.00	0.00	0.13	0.01	0.06	0.00	0.06	0.00	0.00	0.00
Crit Moves:	****			****			****					
Green Time:	54.4	54.4	0.0	0.0	54.4	54.4	14.6	0.0	14.6	0.0	0.0	0.0
Volume/Cap:	0.07	0.32	0.00	0.00	0.17	0.01	0.32	0.00	0.32	0.00	0.00	0.00
Delay/Veh:	3.0	3.8	0.0	0.0	3.3	2.9	26.5	0.0	26.5	0.0	0.0	0.0
User DelAdj:	1.00	1.00	1.00	1.00	1.00	1.00	1.00	1.00	1.00	1.00	1.00	1.00
AdjDel/Veh:	3.0	3.8	0.0	0.0	3.3	2.9	26.5	0.0	26.5	0.0	0.0	0.0
LOS by Move:	A	A	A	A	A	A	C	A	C	A	A	A
HCM2kAvgQ:	1	4	0	0	2	0	3	0	3	0	0	0

Note: Queue reported is the number of cars per lane.

Voices School
Morgan Hill, CA
Hexagon Transportation Consultants, Inc.

Level Of Service Computation Report
2000 HCM Operations (Future Volume Alternative)
Existing (PM)

Intersection #6725: Monterey Road and Spring Avenue

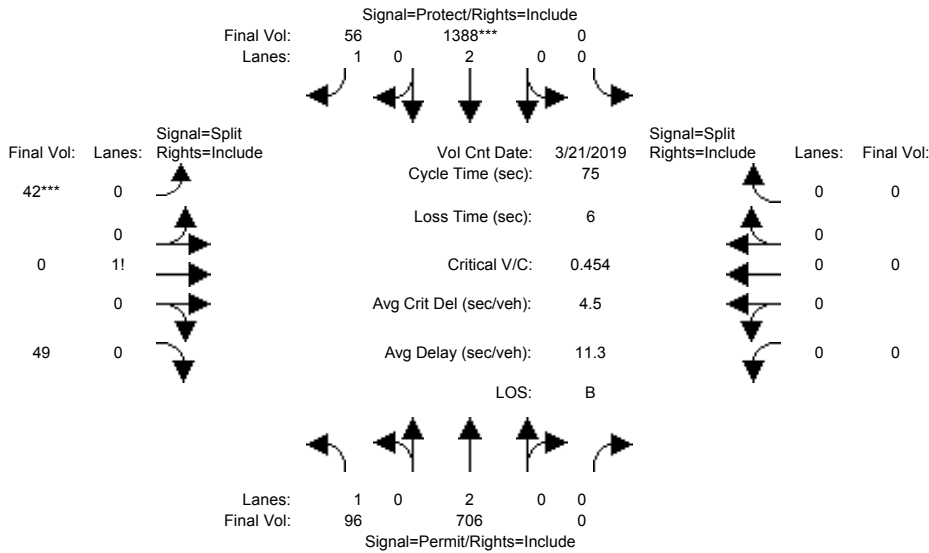

Street Name:	Monterey Road						Spring Avenue					
	North Bound			South Bound			East Bound			West Bound		
Approach:	L	T	R	L	T	R	L	T	R	L	T	R
Min. Green:	10	10	0	0	10	10	10	0	10	0	0	0
Y+R:	4.0	4.0	4.0	4.0	4.0	4.0	4.0	4.0	4.0	4.0	4.0	4.0

Volume Module:	>>	Count	Date:	21 Mar 2019	<<							
Base Vol:	96	706	0	0	1388	56	42	0	49	0	0	0
Growth Adj:	1.00	1.00	1.00	1.00	1.00	1.00	1.00	1.00	1.00	1.00	1.00	1.00
Initial Bse:	96	706	0	0	1388	56	42	0	49	0	0	0
Added Vol:	0	0	0	0	0	0	0	0	0	0	0	0
PasserByVol:	0	0	0	0	0	0	0	0	0	0	0	0
Initial Fut:	96	706	0	0	1388	56	42	0	49	0	0	0
User Adj:	1.00	1.00	1.00	1.00	1.00	1.00	1.00	1.00	1.00	1.00	1.00	1.00
PHF Adj:	1.00	1.00	1.00	1.00	1.00	1.00	1.00	1.00	1.00	1.00	1.00	1.00
PHF Volume:	96	706	0	0	1388	56	42	0	49	0	0	0
Reduct Vol:	0	0	0	0	0	0	0	0	0	0	0	0
Reduced Vol:	96	706	0	0	1388	56	42	0	49	0	0	0
PCE Adj:	1.00	1.00	1.00	1.00	1.00	1.00	1.00	1.00	1.00	1.00	1.00	1.00
MLF Adj:	1.00	1.00	1.00	1.00	1.00	1.00	1.00	1.00	1.00	1.00	1.00	1.00
FinalVolume:	96	706	0	0	1388	56	42	0	49	0	0	0

Saturation Flow Module:												
Sat/Lane:	1900	1900	1900	1900	1900	1900	1900	1900	1900	1900	1900	1900
Adjustment:	0.92	1.00	0.92	0.92	1.00	0.92	0.92	0.92	0.92	0.92	1.00	0.92
Lanes:	1.00	2.00	0.00	0.00	2.00	1.00	0.46	0.00	0.54	0.00	0.00	0.00
Final Sat.:	1750	3800	0	0	3800	1750	808	0	942	0	0	0

Capacity Analysis Module:												
Vol/Sat:	0.05	0.19	0.00	0.00	0.37	0.03	0.05	0.00	0.05	0.00	0.00	0.00
Crit Moves:	****											
Green Time:	21.3	21.3	0.0	0.0	59.0	59.0	10.0	0.0	10.0	0.0	0.0	0.0
Volume/Cap:	0.19	0.66	0.00	0.00	0.46	0.04	0.39	0.00	0.39	0.00	0.00	0.00
Delay/Veh:	20.6	25.1	0.0	0.0	2.8	1.8	30.8	0.0	30.8	0.0	0.0	0.0
User DelAdj:	1.00	1.00	1.00	1.00	1.00	1.00	1.00	1.00	1.00	1.00	1.00	1.00
AdjDel/Veh:	20.6	25.1	0.0	0.0	2.8	1.8	30.8	0.0	30.8	0.0	0.0	0.0
LOS by Move:	C	C	A	A	A	A	C	A	C	A	A	A
HCM2kAvgQ:	2	8	0	0	5	0	3	0	3	0	0	0

Note: Queue reported is the number of cars per lane.

Voices School
Morgan Hill, CA
Hexagon Transportation Consultants, Inc.

Level Of Service Computation Report
2000 HCM Operations (Future Volume Alternative)
Existing Plus Project (AM) - 2 Cosmo Right out

Intersection #6725: Monterey Road and Spring Avenue

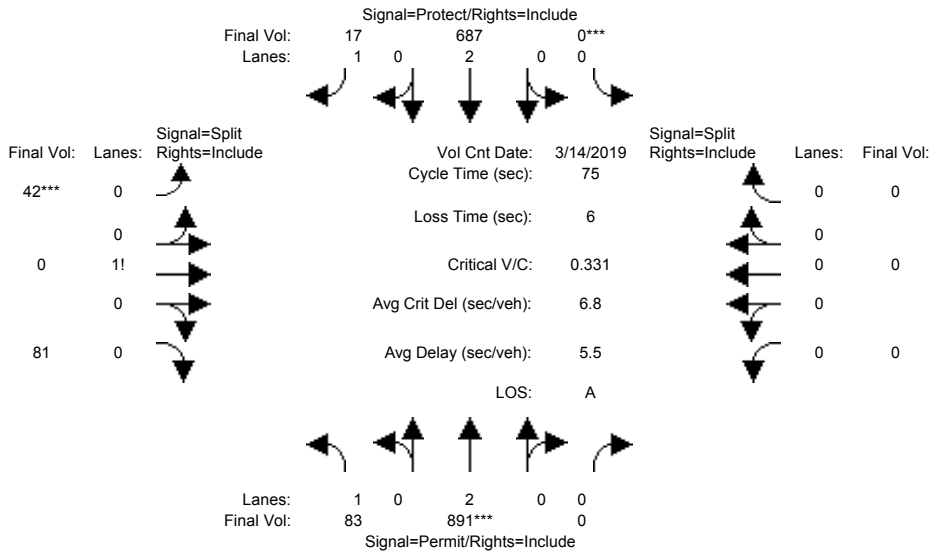

Street Name:	Monterey Road						Spring Avenue					
	North Bound			South Bound			East Bound			West Bound		
Approach:	L	T	R	L	T	R	L	T	R	L	T	R
Min. Green:	10	10	0	0	10	10	10	0	10	0	0	0
Y+R:	4.0	4.0	4.0	4.0	4.0	4.0	4.0	4.0	4.0	4.0	4.0	4.0

Volume Module: >> Count Date: 14 Mar 2019 <<

Base Vol:	83	891	0	0	479	17	42	0	68	0	0	0
Growth Adj:	1.00	1.00	1.00	1.00	1.00	1.00	1.00	1.00	1.00	1.00	1.00	1.00
Initial Bse:	83	891	0	0	479	17	42	0	68	0	0	0
Added Vol:	0	0	0	0	208	0	0	0	13	0	0	0
PasserByVol:	0	0	0	0	0	0	0	0	0	0	0	0
Initial Fut:	83	891	0	0	687	17	42	0	81	0	0	0
User Adj:	1.00	1.00	1.00	1.00	1.00	1.00	1.00	1.00	1.00	1.00	1.00	1.00
PHF Adj:	1.00	1.00	1.00	1.00	1.00	1.00	1.00	1.00	1.00	1.00	1.00	1.00
PHF Volume:	83	891	0	0	687	17	42	0	81	0	0	0
Reduct Vol:	0	0	0	0	0	0	0	0	0	0	0	0
Reduced Vol:	83	891	0	0	687	17	42	0	81	0	0	0
PCE Adj:	1.00	1.00	1.00	1.00	1.00	1.00	1.00	1.00	1.00	1.00	1.00	1.00
MLF Adj:	1.00	1.00	1.00	1.00	1.00	1.00	1.00	1.00	1.00	1.00	1.00	1.00
Final Volume:	83	891	0	0	687	17	42	0	81	0	0	0

Saturation Flow Module:

Sat/Lane:	1900	1900	1900	1900	1900	1900	1900	1900	1900	1900	1900	1900
Adjustment:	0.92	1.00	0.92	0.92	1.00	0.92	0.92	0.92	0.92	0.92	1.00	0.92
Lanes:	1.00	2.00	0.00	0.00	2.00	1.00	0.34	0.00	0.66	0.00	0.00	0.00
Final Sat.:	1750	3800	0	0	3800	1750	598	0	1152	0	0	0

Capacity Analysis Module:

Vol/Sat:	0.05	0.23	0.00	0.00	0.18	0.01	0.07	0.00	0.07	0.00	0.00	0.00
Crit Moves:	****	****	****	****	****	****	****	****	****	****	****	****
Green Time:	53.1	53.1	0.0	0.0	53.1	53.1	15.9	0.0	15.9	0.0	0.0	0.0
Volume/Cap:	0.07	0.33	0.00	0.00	0.26	0.01	0.33	0.00	0.33	0.00	0.00	0.00
Delay/Veh:	3.4	4.3	0.0	0.0	4.0	3.2	25.6	0.0	25.6	0.0	0.0	0.0
User DelAdj:	1.00	1.00	1.00	1.00	1.00	1.00	1.00	1.00	1.00	1.00	1.00	1.00
AdjDel/Veh:	3.4	4.3	0.0	0.0	4.0	3.2	25.6	0.0	25.6	0.0	0.0	0.0
LOS by Move:	A	A	A	A	A	A	C	A	C	A	A	A
HCM2kAvgQ:	1	4	0	0	3	0	3	0	3	0	0	0

Note: Queue reported is the number of cars per lane.

Voices School
Morgan Hill, CA
Hexagon Transportation Consultants, Inc.

Level Of Service Computation Report
2000 HCM Operations (Future Volume Alternative)
Existing Plus Project (PM) - 2 Cosmo Right out

Intersection #6725: Monterey Road and Spring Avenue

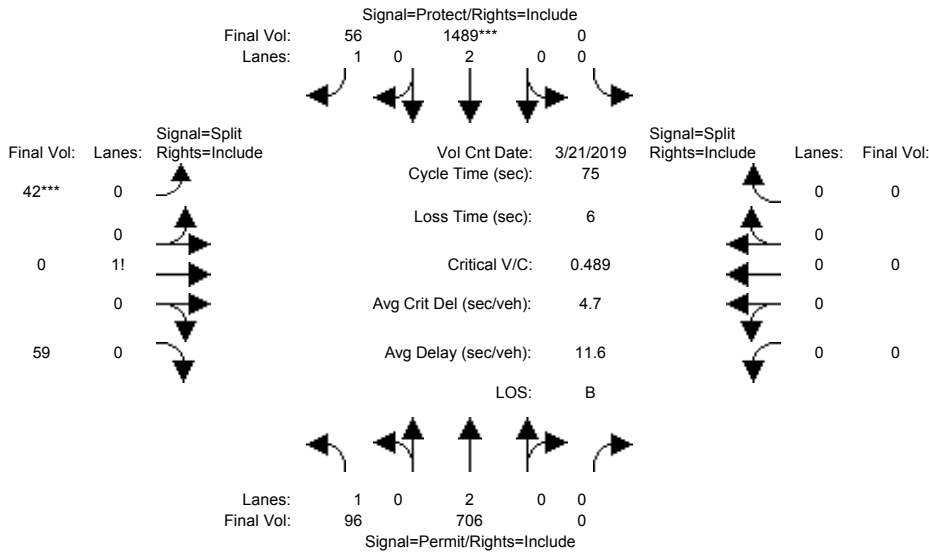

Street Name:	Monterey Road						Spring Avenue					
	North Bound			South Bound			East Bound			West Bound		
Approach:	L	T	R	L	T	R	L	T	R	L	T	R
Min. Green:	10	10	0	0	10	10	10	0	10	0	0	0
Y+R:	4.0	4.0	4.0	4.0	4.0	4.0	4.0	4.0	4.0	4.0	4.0	4.0

Volume Module:	>>	Count	Date:	21 Mar 2019	<<							
Base Vol:	96	706	0	0	1388	56	42	0	49	0	0	0
Growth Adj:	1.00	1.00	1.00	1.00	1.00	1.00	1.00	1.00	1.00	1.00	1.00	1.00
Initial Bse:	96	706	0	0	1388	56	42	0	49	0	0	0
Added Vol:	0	0	0	0	101	0	0	0	10	0	0	0
PasserByVol:	0	0	0	0	0	0	0	0	0	0	0	0
Initial Fut:	96	706	0	0	1489	56	42	0	59	0	0	0
User Adj:	1.00	1.00	1.00	1.00	1.00	1.00	1.00	1.00	1.00	1.00	1.00	1.00
PHF Adj:	1.00	1.00	1.00	1.00	1.00	1.00	1.00	1.00	1.00	1.00	1.00	1.00
PHF Volume:	96	706	0	0	1489	56	42	0	59	0	0	0
Reduct Vol:	0	0	0	0	0	0	0	0	0	0	0	0
Reduced Vol:	96	706	0	0	1489	56	42	0	59	0	0	0
PCE Adj:	1.00	1.00	1.00	1.00	1.00	1.00	1.00	1.00	1.00	1.00	1.00	1.00
MLF Adj:	1.00	1.00	1.00	1.00	1.00	1.00	1.00	1.00	1.00	1.00	1.00	1.00
FinalVolume:	96	706	0	0	1489	56	42	0	59	0	0	0

Saturation Flow Module:												
Sat/Lane:	1900	1900	1900	1900	1900	1900	1900	1900	1900	1900	1900	1900
Adjustment:	0.92	1.00	0.92	0.92	1.00	0.92	0.92	0.92	0.92	0.92	1.00	0.92
Lanes:	1.00	2.00	0.00	0.00	2.00	1.00	0.42	0.00	0.58	0.00	0.00	0.00
Final Sat.:	1750	3800	0	0	3800	1750	728	0	1022	0	0	0

Capacity Analysis Module:												
Vol/Sat:	0.05	0.19	0.00	0.00	0.39	0.03	0.06	0.00	0.06	0.00	0.00	0.00
Crit Moves:	****											
Green Time:	20.2	20.2	0.0	0.0	59.0	59.0	10.0	0.0	10.0	0.0	0.0	0.0
Volume/Cap:	0.20	0.69	0.00	0.00	0.50	0.04	0.43	0.00	0.43	0.00	0.00	0.00
Delay/Veh:	21.4	26.6	0.0	0.0	2.9	1.8	31.2	0.0	31.2	0.0	0.0	0.0
User DelAdj:	1.00	1.00	1.00	1.00	1.00	1.00	1.00	1.00	1.00	1.00	1.00	1.00
AdjDel/Veh:	21.4	26.6	0.0	0.0	2.9	1.8	31.2	0.0	31.2	0.0	0.0	0.0
LOS by Move:	C	C	A	A	A	A	C	A	C	A	A	A
HCM2kAvgQ:	2	9	0	0	6	0	3	0	3	0	0	0

Note: Queue reported is the number of cars per lane.

Voices School
Morgan Hill, CA
Hexagon Transportation Consultants, Inc.

Level Of Service Computation Report
2000 HCM Operations (Future Volume Alternative)
2025 No Project (AM)

Intersection #118: Monterey Road and Main Avenue

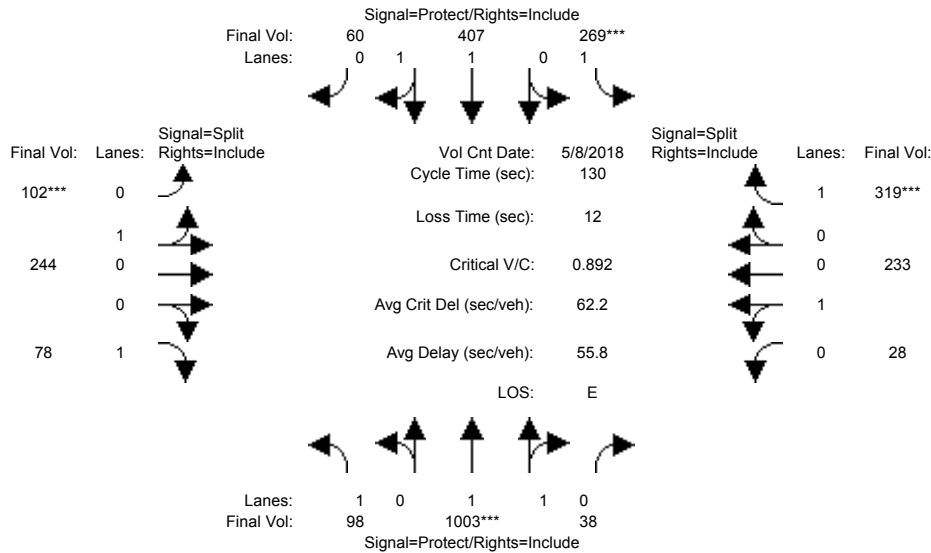

Street Name:	Monterey Road						Main Avenue					
Approach:	North Bound			South Bound			East Bound			West Bound		
Movement:	L	T	R	L	T	R	L	T	R	L	T	R
Min. Green:	7	10	10	7	10	10	10	10	10	10	10	10
Y+R:	4.0	4.0	4.0	4.0	4.0	4.0	4.0	4.0	4.0	4.0	4.0	4.0

Volume Module:	>>	Count	Date:	8 May 2018	<<											
Base Vol:	98	605	38	213	353	35	48	201	78	27	225	172				
Growth Adj:	1.00	1.00	1.00	1.00	1.00	1.00	1.00	1.00	1.00	1.00	1.00	1.00				
Initial Bse:	98	605	38	213	353	35	48	201	78	27	225	172				
Added Vol:	0	0	0	0	0	0	0	0	0	0	0	0				
PasserByVol:	0	398	0	56	54	25	54	43	0	1	8	147				
Initial Fut:	98	1003	38	269	407	60	102	244	78	28	233	319				
User Adj:	1.00	1.00	1.00	1.00	1.00	1.00	1.00	1.00	1.00	1.00	1.00	1.00				
PHF Adj:	1.00	1.00	1.00	1.00	1.00	1.00	1.00	1.00	1.00	1.00	1.00	1.00				
PHF Volume:	98	1003	38	269	407	60	102	244	78	28	233	319				
Reduct Vol:	0	0	0	0	0	0	0	0	0	0	0	0				
Reduced Vol:	98	1003	38	269	407	60	102	244	78	28	233	319				
PCE Adj:	1.00	1.00	1.00	1.00	1.00	1.00	1.00	1.00	1.00	1.00	1.00	1.00				
MLF Adj:	1.00	1.00	1.00	1.00	1.00	1.00	1.00	1.00	1.00	1.00	1.00	1.00				
Final Volume:	98	1003	38	269	407	60	102	244	78	28	233	319				

Saturation Flow Module:												
Sat/Lane:	1900	1900	1900	1900	1900	1900	1900	1900	1900	1900	1900	1900
Adjustment:	0.92	0.97	0.95	0.92	0.98	0.95	0.95	0.95	0.92	0.95	0.95	0.92
Lanes:	1.00	1.92	0.08	1.00	1.74	0.26	0.29	0.71	1.00	0.11	0.89	1.00
Final Sat.:	1750	3565	135	1750	3224	475	531	1269	1750	193	1607	1750

Capacity Analysis Module:												
Vol/Sat:	0.06	0.28	0.28	0.15	0.13	0.13	0.19	0.19	0.04	0.15	0.15	0.18
Crit Moves:	****			****			****			****		
Green Time:	19.5	41.0	41.0	22.4	43.9	43.9	28.0	28.0	28.0	26.6	26.6	26.6
Volume/Cap:	0.37	0.89	0.89	0.89	0.37	0.37	0.89	0.89	0.21	0.71	0.71	0.89
Delay/Veh:	50.7	51.3	51.3	79.0	32.8	32.8	71.4	71.4	42.1	54.4	54.4	73.6
User DelAdj:	1.00	1.00	1.00	1.00	1.00	1.00	1.00	1.00	1.00	1.00	1.00	1.00
AdjDel/Veh:	50.7	51.3	51.3	79.0	32.8	32.8	71.4	71.4	42.1	54.4	54.4	73.6
LOS by Move:	D	D	D	E	C	C	E	E	D	D	D	E
HCM2kAvgQ:	4	22	22	15	7	7	17	17	3	10	10	14

Note: Queue reported is the number of cars per lane.

Voices School
Morgan Hill, CA
Hexagon Transportation Consultants, Inc.

Level Of Service Computation Report
2000 HCM Operations (Future Volume Alternative)
2025 No Project (PM)

Intersection #118: Monterey Road and Main Avenue

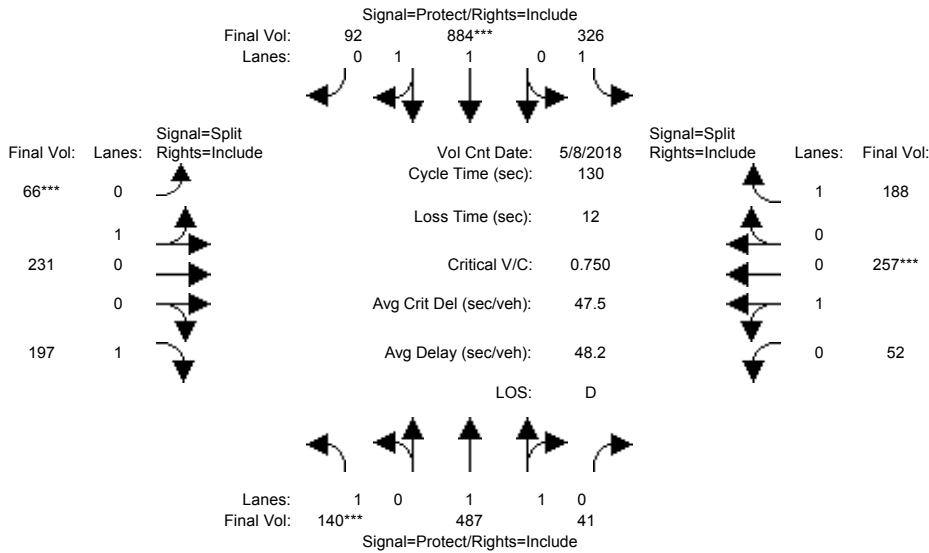

Street Name:	Monterey Road						Main Avenue					
	North Bound			South Bound			East Bound			West Bound		
Approach:	L	T	R	L	T	R	L	T	R	L	T	R
Min. Green:	7	10	10	7	10	10	10	10	10	10	10	10
Y+R:	4.0	4.0	4.0	4.0	4.0	4.0	4.0	4.0	4.0	4.0	4.0	4.0

Volume Module:	>>	Count	Date:	8 May 2018	<<							
Base Vol:	140	285	35	237	811	70	41	225	197	47	245	75
Growth Adj:	1.00	1.00	1.00	1.00	1.00	1.00	1.00	1.00	1.00	1.00	1.00	1.00
Initial Bse:	140	285	35	237	811	70	41	225	197	47	245	75
Added Vol:	0	0	0	0	0	0	0	0	0	0	0	0
PasserByVol:	0	202	6	89	73	22	25	6	0	5	12	113
Initial Fut:	140	487	41	326	884	92	66	231	197	52	257	188
User Adj:	1.00	1.00	1.00	1.00	1.00	1.00	1.00	1.00	1.00	1.00	1.00	1.00
PHF Adj:	1.00	1.00	1.00	1.00	1.00	1.00	1.00	1.00	1.00	1.00	1.00	1.00
PHF Volume:	140	487	41	326	884	92	66	231	197	52	257	188
Reduct Vol:	0	0	0	0	0	0	0	0	0	0	0	0
Reduced Vol:	140	487	41	326	884	92	66	231	197	52	257	188
PCE Adj:	1.00	1.00	1.00	1.00	1.00	1.00	1.00	1.00	1.00	1.00	1.00	1.00
MLF Adj:	1.00	1.00	1.00	1.00	1.00	1.00	1.00	1.00	1.00	1.00	1.00	1.00
FinalVolume:	140	487	41	326	884	92	66	231	197	52	257	188

Saturation Flow Module:												
Sat/Lane:	1900	1900	1900	1900	1900	1900	1900	1900	1900	1900	1900	1900
Adjustment:	0.92	0.98	0.95	0.92	0.98	0.95	0.95	0.95	0.92	0.95	0.95	0.92
Lanes:	1.00	1.84	0.16	1.00	1.81	0.19	0.22	0.78	1.00	0.17	0.83	1.00
Final Sat.:	1750	3412	287	1750	3351	349	400	1400	1750	303	1497	1750

Capacity Analysis Module:												
Vol/Sat:	0.08	0.14	0.14	0.19	0.26	0.26	0.17	0.17	0.11	0.17	0.17	0.11
Crit Moves:	****			****			****			****		
Green Time:	13.9	25.9	25.9	33.8	45.7	45.7	28.6	28.6	28.6	29.8	29.8	29.8
Volume/Cap:	0.75	0.72	0.72	0.72	0.75	0.75	0.75	0.75	0.51	0.75	0.75	0.47
Delay/Veh:	71.8	52.1	52.1	49.2	39.6	39.6	55.1	55.1	45.7	54.1	54.1	44.2
User DelAdj:	1.00	1.00	1.00	1.00	1.00	1.00	1.00	1.00	1.00	1.00	1.00	1.00
AdjDel/Veh:	71.8	52.1	52.1	49.2	39.6	39.6	55.1	55.1	45.7	54.1	54.1	44.2
LOS by Move:	E	D	D	D	D	D	E	E	D	D	D	D
HCM2kAvgQ:	6	10	10	14	19	19	13	13	8	12	12	7

Note: Queue reported is the number of cars per lane.

Voices School
Morgan Hill, CA
Hexagon Transportation Consultants, Inc.

Level Of Service Computation Report
2000 HCM Operations (Future Volume Alternative)
2025 Plus Project (AM) - 2 Cosmo Right out

Intersection #118: Monterey Road and Main Avenue

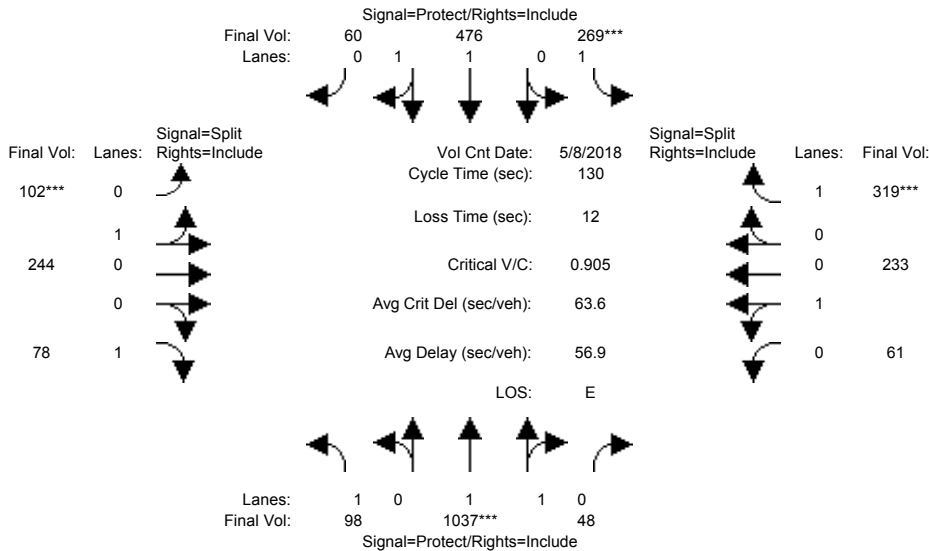

Street Name:	Monterey Road						Main Avenue					
	North Bound			South Bound			East Bound			West Bound		
Approach:	L	T	R	L	T	R	L	T	R	L	T	R
Min. Green:	7	10	10	7	10	10	10	10	10	10	10	10
Y+R:	4.0	4.0	4.0	4.0	4.0	4.0	4.0	4.0	4.0	4.0	4.0	4.0

Volume Module:	>>	Count	Date:	8 May 2018	<<							
Base Vol:	98	605	38	213	353	35	48	201	78	27	225	172
Growth Adj:	1.00	1.00	1.00	1.00	1.00	1.00	1.00	1.00	1.00	1.00	1.00	1.00
Initial Bse:	98	605	38	213	353	35	48	201	78	27	225	172
Added Vol:	0	34	10	0	69	0	0	0	0	33	0	0
PasserByVol:	0	398	0	56	54	25	54	43	0	1	8	147
Initial Fut:	98	1037	48	269	476	60	102	244	78	61	233	319
User Adj:	1.00	1.00	1.00	1.00	1.00	1.00	1.00	1.00	1.00	1.00	1.00	1.00
PHF Adj:	1.00	1.00	1.00	1.00	1.00	1.00	1.00	1.00	1.00	1.00	1.00	1.00
PHF Volume:	98	1037	48	269	476	60	102	244	78	61	233	319
Reduct Vol:	0	0	0	0	0	0	0	0	0	0	0	0
Reduced Vol:	98	1037	48	269	476	60	102	244	78	61	233	319
PCE Adj:	1.00	1.00	1.00	1.00	1.00	1.00	1.00	1.00	1.00	1.00	1.00	1.00
MLF Adj:	1.00	1.00	1.00	1.00	1.00	1.00	1.00	1.00	1.00	1.00	1.00	1.00
Final Volume:	98	1037	48	269	476	60	102	244	78	61	233	319

Saturation Flow Module:												
Sat/Lane:	1900	1900	1900	1900	1900	1900	1900	1900	1900	1900	1900	1900
Adjustment:	0.92	0.97	0.95	0.92	0.98	0.95	0.95	0.95	0.92	0.95	0.95	0.92
Lanes:	1.00	1.91	0.09	1.00	1.77	0.23	0.29	0.71	1.00	0.21	0.79	1.00
Final Sat.:	1750	3536	164	1750	3286	414	531	1269	1750	373	1427	1750

Capacity Analysis Module:												
Vol/Sat:	0.06	0.29	0.29	0.15	0.14	0.14	0.19	0.19	0.04	0.16	0.16	0.18
Crit Moves:	****			****			****			****		
Green Time:	17.9	42.1	42.1	22.1	46.3	46.3	27.6	27.6	27.6	26.2	26.2	26.2
Volume/Cap:	0.41	0.91	0.91	0.91	0.41	0.41	0.91	0.91	0.21	0.81	0.81	0.91
Delay/Veh:	52.3	51.9	51.9	82.0	31.7	31.7	74.2	74.2	42.5	62.4	62.4	76.4
User DelAdj:	1.00	1.00	1.00	1.00	1.00	1.00	1.00	1.00	1.00	1.00	1.00	1.00
AdjDel/Veh:	52.3	51.9	51.9	82.0	31.7	31.7	74.2	74.2	42.5	62.4	62.4	76.4
LOS by Move:	D	D	D	F	C	C	E	E	D	E	E	E
HCM2kAvgQ:	4	23	23	15	8	8	18	18	3	12	12	14

Note: Queue reported is the number of cars per lane.

Voices School
Morgan Hill, CA
Hexagon Transportation Consultants, Inc.

Level Of Service Computation Report
2000 HCM Operations (Future Volume Alternative)
2025 Plus Project (PM) - 2 Cosmo Right out

Intersection #118: Monterey Road and Main Avenue

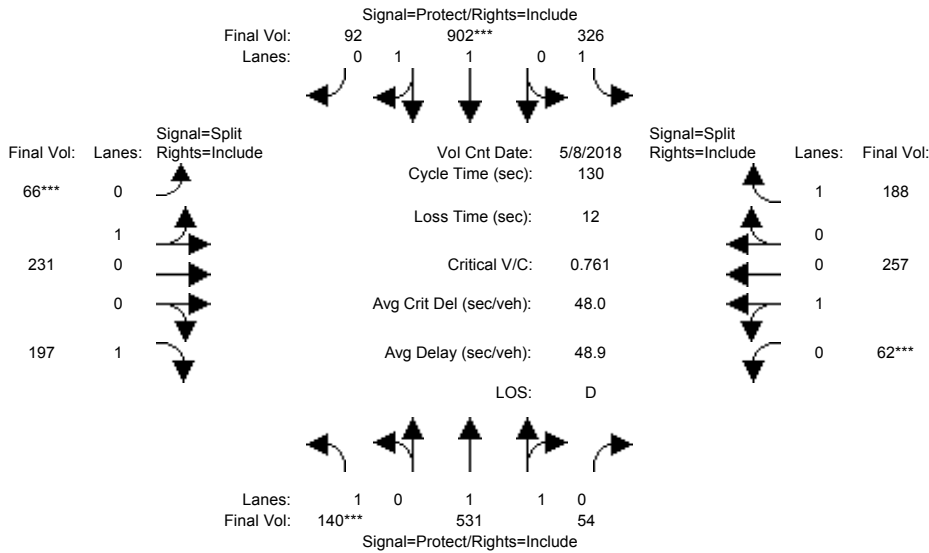

Street Name:	Monterey Road						Main Avenue					
	North Bound			South Bound			East Bound			West Bound		
Approach:	L	T	R	L	T	R	L	T	R	L	T	R
Min. Green:	7	10	10	7	10	10	10	10	10	10	10	10
Y+R:	4.0	4.0	4.0	4.0	4.0	4.0	4.0	4.0	4.0	4.0	4.0	4.0

Volume Module:	>>	Count	Date:	8 May 2018	<<							
Base Vol:	140	285	35	237	811	70	41	225	197	47	245	75
Growth Adj:	1.00	1.00	1.00	1.00	1.00	1.00	1.00	1.00	1.00	1.00	1.00	1.00
Initial Bse:	140	285	35	237	811	70	41	225	197	47	245	75
Added Vol:	0	44	13	0	18	0	0	0	0	10	0	0
PasserByVol:	0	202	6	89	73	22	25	6	0	5	12	113
Initial Fut:	140	531	54	326	902	92	66	231	197	62	257	188
User Adj:	1.00	1.00	1.00	1.00	1.00	1.00	1.00	1.00	1.00	1.00	1.00	1.00
PHF Adj:	1.00	1.00	1.00	1.00	1.00	1.00	1.00	1.00	1.00	1.00	1.00	1.00
PHF Volume:	140	531	54	326	902	92	66	231	197	62	257	188
Reduct Vol:	0	0	0	0	0	0	0	0	0	0	0	0
Reduced Vol:	140	531	54	326	902	92	66	231	197	62	257	188
PCE Adj:	1.00	1.00	1.00	1.00	1.00	1.00	1.00	1.00	1.00	1.00	1.00	1.00
MLF Adj:	1.00	1.00	1.00	1.00	1.00	1.00	1.00	1.00	1.00	1.00	1.00	1.00
Final Volume:	140	531	54	326	902	92	66	231	197	62	257	188

Saturation Flow Module:												
Sat/Lane:	1900	1900	1900	1900	1900	1900	1900	1900	1900	1900	1900	1900
Adjustment:	0.92	0.98	0.95	0.92	0.98	0.95	0.95	0.95	0.92	0.95	0.95	0.92
Lanes:	1.00	1.81	0.19	1.00	1.81	0.19	0.22	0.78	1.00	0.19	0.81	1.00
Final Sat.:	1750	3358	342	1750	3357	342	400	1400	1750	350	1450	1750

Capacity Analysis Module:												
Vol/Sat:	0.08	0.16	0.16	0.19	0.27	0.27	0.17	0.17	0.11	0.18	0.18	0.11
Crit Moves:	***				***		***			***		
Green Time:	13.7	27.3	27.3	32.2	45.9	45.9	28.2	28.2	28.2	30.3	30.3	30.3
Volume/Cap:	0.76	0.75	0.75	0.75	0.76	0.76	0.76	0.76	0.52	0.76	0.76	0.46
Delay/Veh:	73.4	52.3	52.3	52.4	39.9	39.9	56.3	56.3	46.2	54.5	54.5	43.7
User DelAdj:	1.00	1.00	1.00	1.00	1.00	1.00	1.00	1.00	1.00	1.00	1.00	1.00
AdjDel/Veh:	73.4	52.3	52.3	52.4	39.9	39.9	56.3	56.3	46.2	54.5	54.5	43.7
LOS by Move:	E	D	D	D	D	D	E	E	D	D	D	D
HCM2kAvgQ:	6	11	11	14	19	19	13	13	8	12	12	7

Note: Queue reported is the number of cars per lane.

Voices School
Morgan Hill, CA
Hexagon Transportation Consultants, Inc.

Level Of Service Computation Report
2000 HCM Operations (Future Volume Alternative)
2025 No Project (AM)

Intersection #119: Butterfield Boulevard and Main Avenue

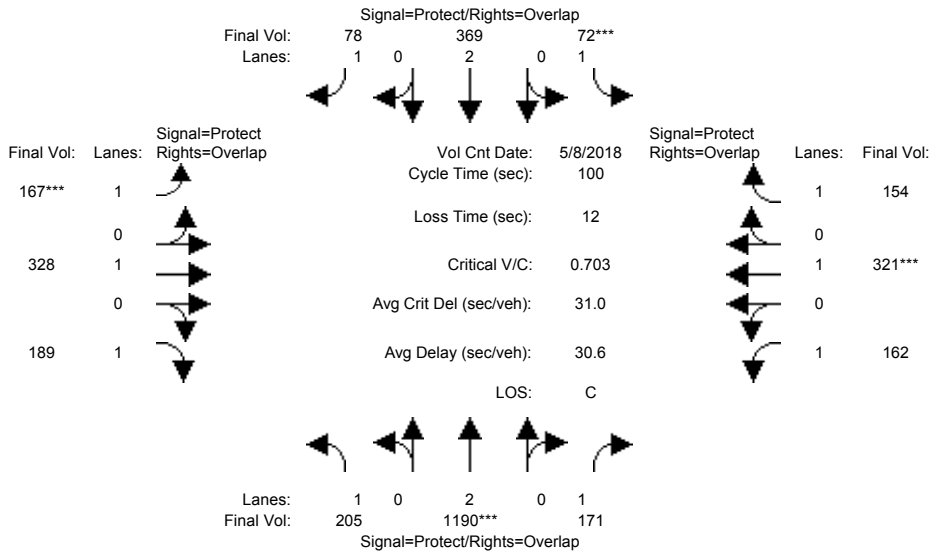

Street Name:	Butterfield Boulevard						Main Avenue					
Approach:	North Bound			South Bound			East Bound			West Bound		
Movement:	L	T	R	L	T	R	L	T	R	L	T	R
Min. Green:	7	10	10	7	10	10	7	10	10	7	10	10
Y+R:	4.0	4.0	4.0	4.0	4.0	4.0	4.0	4.0	4.0	4.0	4.0	4.0
Volume Module: >> Count Date: 8 May 2018 <<												
Base Vol:	180	1082	149	52	226	68	134	278	159	132	262	127
Growth Adj:	1.00	1.00	1.00	1.00	1.00	1.00	1.00	1.00	1.00	1.00	1.00	1.00
Initial Bse:	180	1082	149	52	226	68	134	278	159	132	262	127
Added Vol:	0	0	0	0	0	0	0	0	0	0	0	0
PasserByVol:	25	108	22	20	143	10	33	50	30	30	59	27
Initial Fut:	205	1190	171	72	369	78	167	328	189	162	321	154
User Adj:	1.00	1.00	1.00	1.00	1.00	1.00	1.00	1.00	1.00	1.00	1.00	1.00
PHF Adj:	1.00	1.00	1.00	1.00	1.00	1.00	1.00	1.00	1.00	1.00	1.00	1.00
PHF Volume:	205	1190	171	72	369	78	167	328	189	162	321	154
Reduct Vol:	0	0	0	0	0	0	0	0	0	0	0	0
Reduced Vol:	205	1190	171	72	369	78	167	328	189	162	321	154
PCE Adj:	1.00	1.00	1.00	1.00	1.00	1.00	1.00	1.00	1.00	1.00	1.00	1.00
MLF Adj:	1.00	1.00	1.00	1.00	1.00	1.00	1.00	1.00	1.00	1.00	1.00	1.00
FinalVolume:	205	1190	171	72	369	78	167	328	189	162	321	154
Saturation Flow Module:												
Sat/Lane:	1900	1900	1900	1900	1900	1900	1900	1900	1900	1900	1900	1900
Adjustment:	0.92	1.00	0.92	0.92	1.00	0.92	0.92	1.00	0.92	0.92	1.00	0.92
Lanes:	1.00	2.00	1.00	1.00	2.00	1.00	1.00	1.00	1.00	1.00	1.00	1.00
Final Sat.:	1750	3800	1750	1750	3800	1750	1750	1900	1750	1750	1900	1750
Capacity Analysis Module:												
Vol/Sat:	0.12	0.31	0.10	0.04	0.10	0.04	0.10	0.17	0.11	0.09	0.17	0.09
Crit Moves:	****			****			****			****		
Green Time:	27.5	43.9	56.9	7.0	23.5	36.8	13.4	24.1	51.6	12.9	23.7	30.7
Volume/Cap:	0.43	0.71	0.17	0.59	0.41	0.12	0.71	0.72	0.21	0.72	0.71	0.29
Delay/Veh:	30.4	24.4	10.4	52.4	32.8	21.0	51.4	40.1	13.2	52.1	40.4	26.6
User DelAdj:	1.00	1.00	1.00	1.00	1.00	1.00	1.00	1.00	1.00	1.00	1.00	1.00
AdjDel/Veh:	30.4	24.4	10.4	52.4	32.8	21.0	51.4	40.1	13.2	52.1	40.4	26.6
LOS by Move:	C	C	B	D	C	C	D	D	B	D	D	C
HCM2kAvgQ:	6	16	3	3	5	2	5	9	3	7	10	4

Note: Queue reported is the number of cars per lane.

Voices School
Morgan Hill, CA
Hexagon Transportation Consultants, Inc.

Level Of Service Computation Report
2000 HCM Operations (Future Volume Alternative)
2025 No Project (PM)

Intersection #119: Butterfield Boulevard and Main Avenue

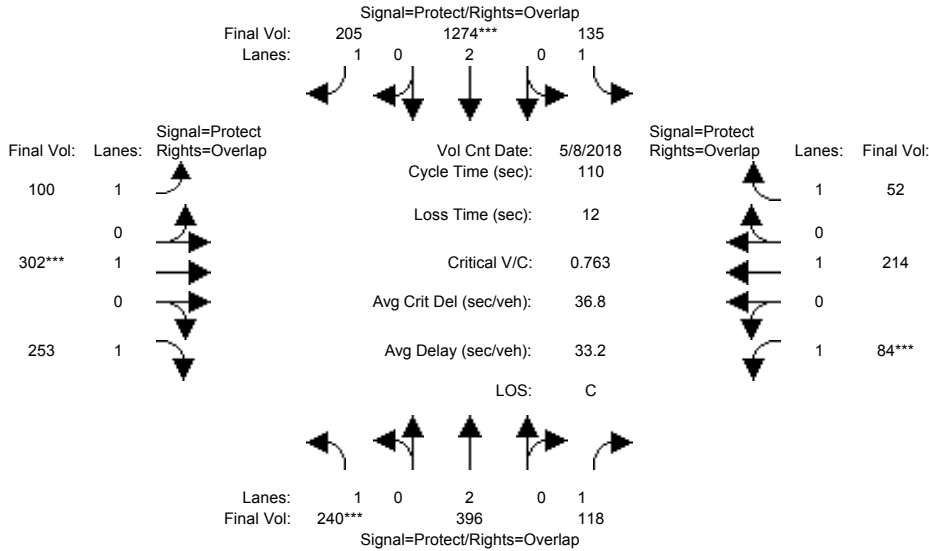

Street Name:	Butterfield Boulevard						Main Avenue					
	North Bound			South Bound			East Bound			West Bound		
Approach:	L	T	R	L	T	R	L	T	R	L	T	R
Min. Green:	7	10	10	7	10	10	7	10	10	7	10	10
Y+R:	4.0	4.0	4.0	4.0	4.0	4.0	4.0	4.0	4.0	4.0	4.0	4.0

Volume Module:	>>	Count	Date:	8 May 2018	<<											
Base Vol:	190	309	89	111	1088	183	87	266	239	61	179	36				
Growth Adj:	1.00	1.00	1.00	1.00	1.00	1.00	1.00	1.00	1.00	1.00	1.00	1.00				
Initial Bse:	190	309	89	111	1088	183	87	266	239	61	179	36				
Added Vol:	0	0	0	0	0	0	0	0	0	0	0	0				
PasserByVol:	50	87	29	24	186	22	13	36	14	23	35	16				
Initial Fut:	240	396	118	135	1274	205	100	302	253	84	214	52				
User Adj:	1.00	1.00	1.00	1.00	1.00	1.00	1.00	1.00	1.00	1.00	1.00	1.00				
PHF Adj:	1.00	1.00	1.00	1.00	1.00	1.00	1.00	1.00	1.00	1.00	1.00	1.00				
PHF Volume:	240	396	118	135	1274	205	100	302	253	84	214	52				
Reduct Vol:	0	0	0	0	0	0	0	0	0	0	0	0				
Reduced Vol:	240	396	118	135	1274	205	100	302	253	84	214	52				
PCE Adj:	1.00	1.00	1.00	1.00	1.00	1.00	1.00	1.00	1.00	1.00	1.00	1.00				
MLF Adj:	1.00	1.00	1.00	1.00	1.00	1.00	1.00	1.00	1.00	1.00	1.00	1.00				
Final Volume:	240	396	118	135	1274	205	100	302	253	84	214	52				

Saturation Flow Module:												
Sat/Lane:	1900	1900	1900	1900	1900	1900	1900	1900	1900	1900	1900	1900
Adjustment:	0.92	1.00	0.92	0.92	1.00	0.92	0.92	1.00	0.92	0.92	1.00	0.92
Lanes:	1.00	2.00	1.00	1.00	2.00	1.00	1.00	1.00	1.00	1.00	1.00	1.00
Final Sat.:	1750	3800	1750	1750	3800	1750	1750	1900	1750	1750	1900	1750

Capacity Analysis Module:												
Vol/Sat:	0.14	0.10	0.07	0.08	0.34	0.12	0.06	0.16	0.14	0.05	0.11	0.03
Crit Moves:	****				****			****		****		
Green Time:	19.8	39.1	46.1	29.0	48.3	59.1	10.8	22.9	42.7	7.0	19.1	48.1
Volume/Cap:	0.76	0.29	0.16	0.29	0.76	0.22	0.58	0.76	0.37	0.75	0.65	0.07
Delay/Veh:	53.4	25.6	20.0	32.7	28.2	13.4	52.4	49.5	24.4	75.6	46.8	18.0
User DelAdj:	1.00	1.00	1.00	1.00	1.00	1.00	1.00	1.00	1.00	1.00	1.00	1.00
AdjDel/Veh:	53.4	25.6	20.0	32.7	28.2	13.4	52.4	49.5	24.4	75.6	46.8	18.0
LOS by Move:	D	C	B	C	C	B	D	D	C	E	D	B
HCM2kAvgQ:	10	5	3	4	19	4	3	9	6	5	8	1

Note: Queue reported is the number of cars per lane.

Voices School
Morgan Hill, CA
Hexagon Transportation Consultants, Inc.

Level Of Service Computation Report
2000 HCM Operations (Future Volume Alternative)
2025 Plus Project (AM) - 2 Cosmo Right out

Intersection #119: Butterfield Boulevard and Main Avenue

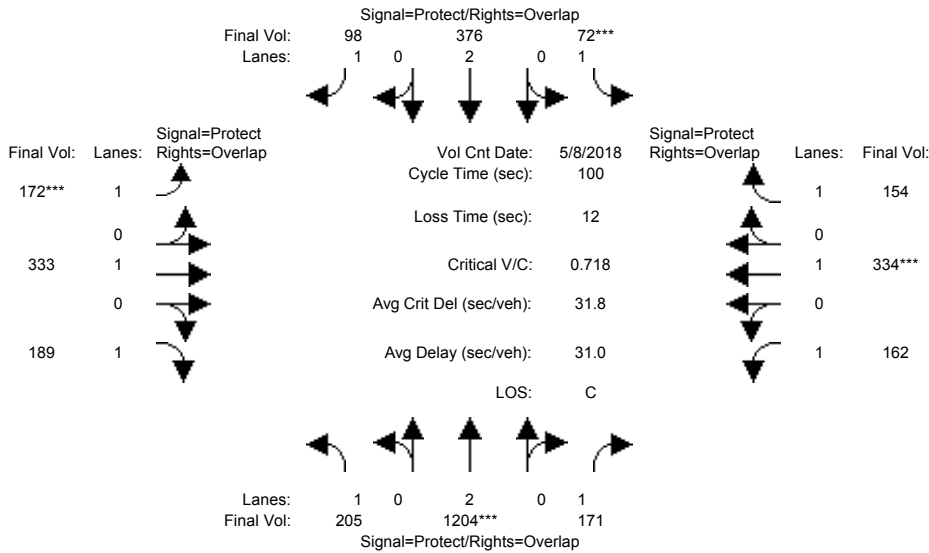

Street Name:	Butterfield Boulevard						Main Avenue					
	North Bound			South Bound			East Bound			West Bound		
Approach:	L	T	R	L	T	R	L	T	R	L	T	R
Min. Green:	7	10	10	7	10	10	7	10	10	7	10	10
Y+R:	4.0	4.0	4.0	4.0	4.0	4.0	4.0	4.0	4.0	4.0	4.0	4.0

Volume Module:	>>	Count	Date:	8 May 2018	<<											
Base Vol:	180	1082	149	52	226	68	134	278	159	132	262	127				
Growth Adj:	1.00	1.00	1.00	1.00	1.00	1.00	1.00	1.00	1.00	1.00	1.00	1.00				
Initial Bse:	180	1082	149	52	226	68	134	278	159	132	262	127				
Added Vol:	0	14	0	0	7	20	5	5	0	0	13	0				
PasserByVol:	25	108	22	20	143	10	33	50	30	30	59	27				
Initial Fut:	205	1204	171	72	376	98	172	333	189	162	334	154				
User Adj:	1.00	1.00	1.00	1.00	1.00	1.00	1.00	1.00	1.00	1.00	1.00	1.00				
PHF Adj:	1.00	1.00	1.00	1.00	1.00	1.00	1.00	1.00	1.00	1.00	1.00	1.00				
PHF Volume:	205	1204	171	72	376	98	172	333	189	162	334	154				
Reduct Vol:	0	0	0	0	0	0	0	0	0	0	0	0				
Reduced Vol:	205	1204	171	72	376	98	172	333	189	162	334	154				
PCE Adj:	1.00	1.00	1.00	1.00	1.00	1.00	1.00	1.00	1.00	1.00	1.00	1.00				
MLF Adj:	1.00	1.00	1.00	1.00	1.00	1.00	1.00	1.00	1.00	1.00	1.00	1.00				
FinalVolume:	205	1204	171	72	376	98	172	333	189	162	334	154				

Saturation Flow Module:												
Sat/Lane:	1900	1900	1900	1900	1900	1900	1900	1900	1900	1900	1900	1900
Adjustment:	0.92	1.00	0.92	0.92	1.00	0.92	0.92	1.00	0.92	0.92	1.00	0.92
Lanes:	1.00	2.00	1.00	1.00	2.00	1.00	1.00	1.00	1.00	1.00	1.00	1.00
Final Sat.:	1750	3800	1750	1750	3800	1750	1750	1900	1750	1750	1900	1750

Capacity Analysis Module:												
Vol/Sat:	0.12	0.32	0.10	0.04	0.10	0.06	0.10	0.18	0.11	0.09	0.18	0.09
Crit Moves:	****			****			****			****		
Green Time:	27.2	43.4	56.4	7.0	23.2	36.7	13.5	24.6	51.8	13.0	24.1	31.1
Volume/Cap:	0.43	0.73	0.17	0.59	0.43	0.15	0.73	0.71	0.21	0.71	0.73	0.28
Delay/Veh:	30.6	25.1	10.6	52.4	33.0	21.3	52.5	39.6	13.1	51.9	40.8	26.3
User DelAdj:	1.00	1.00	1.00	1.00	1.00	1.00	1.00	1.00	1.00	1.00	1.00	1.00
AdjDel/Veh:	30.6	25.1	10.6	52.4	33.0	21.3	52.5	39.6	13.1	51.9	40.8	26.3
LOS by Move:	C	C	B	D	C	C	D	D	B	D	D	C
HCM2kAvgQ:	6	16	3	3	5	2	5	9	3	7	11	4

Note: Queue reported is the number of cars per lane.

Voices School
Morgan Hill, CA
Hexagon Transportation Consultants, Inc.

Level Of Service Computation Report
2000 HCM Operations (Future Volume Alternative)
2025 Plus Project (PM) - 2 Cosmo Right out

Intersection #119: Butterfield Boulevard and Main Avenue

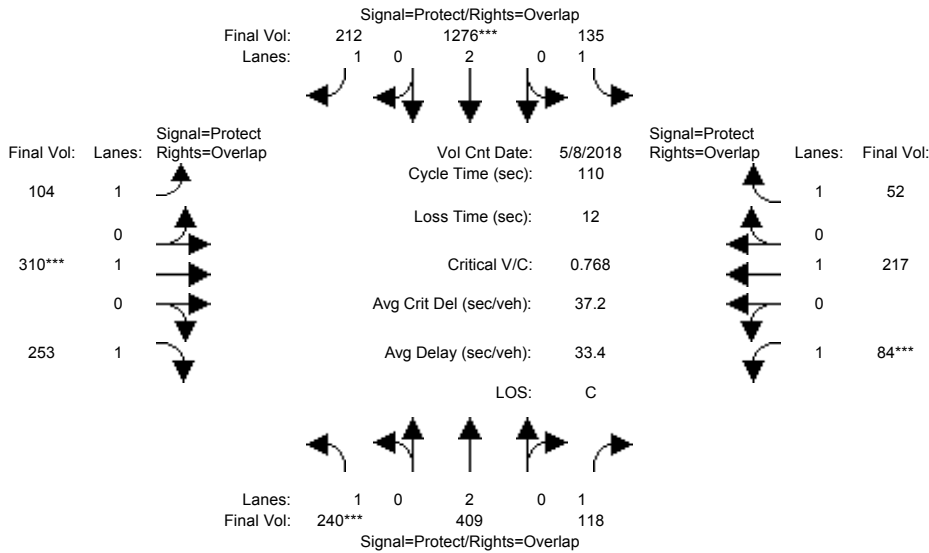

Street Name:	Butterfield Boulevard						Main Avenue					
	North Bound			South Bound			East Bound			West Bound		
Approach:	L	T	R	L	T	R	L	T	R	L	T	R
Min. Green:	7	10	10	7	10	10	7	10	10	7	10	10
Y+R:	4.0	4.0	4.0	4.0	4.0	4.0	4.0	4.0	4.0	4.0	4.0	4.0

Volume Module:	>>	Count	Date:	8 May 2018	<<							
Base Vol:	190	309	89	111	1088	183	87	266	239	61	179	36
Growth Adj:	1.00	1.00	1.00	1.00	1.00	1.00	1.00	1.00	1.00	1.00	1.00	1.00
Initial Bse:	190	309	89	111	1088	183	87	266	239	61	179	36
Added Vol:	0	13	0	0	2	7	4	8	0	0	3	0
PasserByVol:	50	87	29	24	186	22	13	36	14	23	35	16
Initial Fut:	240	409	118	135	1276	212	104	310	253	84	217	52
User Adj:	1.00	1.00	1.00	1.00	1.00	1.00	1.00	1.00	1.00	1.00	1.00	1.00
PHF Adj:	1.00	1.00	1.00	1.00	1.00	1.00	1.00	1.00	1.00	1.00	1.00	1.00
PHF Volume:	240	409	118	135	1276	212	104	310	253	84	217	52
Reduct Vol:	0	0	0	0	0	0	0	0	0	0	0	0
Reduced Vol:	240	409	118	135	1276	212	104	310	253	84	217	52
PCE Adj:	1.00	1.00	1.00	1.00	1.00	1.00	1.00	1.00	1.00	1.00	1.00	1.00
MLF Adj:	1.00	1.00	1.00	1.00	1.00	1.00	1.00	1.00	1.00	1.00	1.00	1.00
FinalVolume:	240	409	118	135	1276	212	104	310	253	84	217	52

Saturation Flow Module:												
Sat/Lane:	1900	1900	1900	1900	1900	1900	1900	1900	1900	1900	1900	1900
Adjustment:	0.92	1.00	0.92	0.92	1.00	0.92	0.92	1.00	0.92	0.92	1.00	0.92
Lanes:	1.00	2.00	1.00	1.00	2.00	1.00	1.00	1.00	1.00	1.00	1.00	1.00
Final Sat.:	1750	3800	1750	1750	3800	1750	1750	1900	1750	1750	1900	1750

Capacity Analysis Module:												
Vol/Sat:	0.14	0.11	0.07	0.08	0.34	0.12	0.06	0.16	0.14	0.05	0.11	0.03
Crit Moves:	****				****			****		****		
Green Time:	19.6	39.4	46.4	28.2	48.0	58.9	10.9	23.3	43.0	7.0	19.5	47.7
Volume/Cap:	0.77	0.30	0.16	0.30	0.77	0.23	0.60	0.77	0.37	0.75	0.64	0.07
Delay/Veh:	54.1	25.5	19.8	33.3	28.5	13.6	53.4	49.5	24.2	75.6	46.3	18.2
User DelAdj:	1.00	1.00	1.00	1.00	1.00	1.00	1.00	1.00	1.00	1.00	1.00	1.00
AdjDel/Veh:	54.1	25.5	19.8	33.3	28.5	13.6	53.4	49.5	24.2	75.6	46.3	18.2
LOS by Move:	D	C	B	C	C	B	D	D	C	E	D	B
HCM2kAvgQ:	10	5	3	4	19	4	4	10	6	5	8	1

Note: Queue reported is the number of cars per lane.

Voices School
Morgan Hill, CA
Hexagon Transportation Consultants, Inc.

Level Of Service Computation Report
2000 HCM Operations (Future Volume Alternative)
2025 No Project (AM)

Intersection #122: Monterey Road and Dunne Avenue

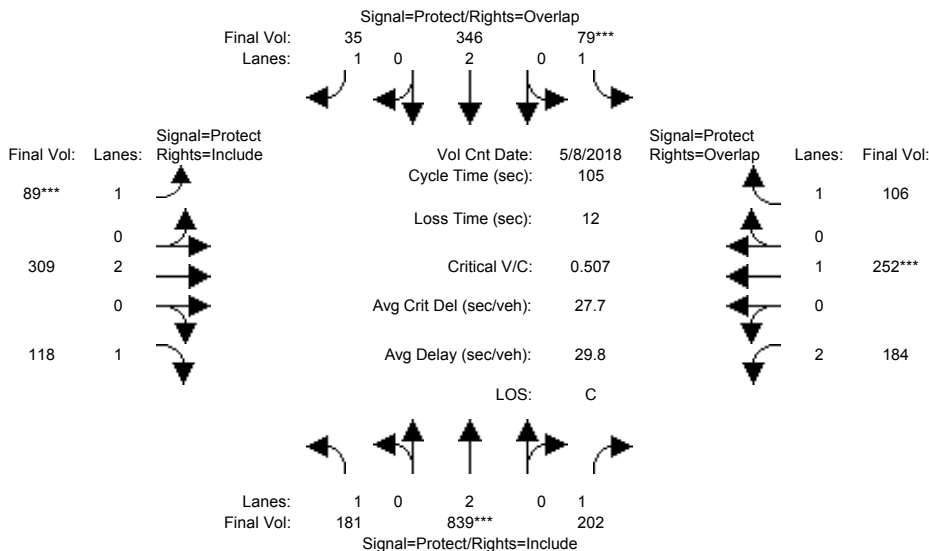

Street Name:	Monterey Road						Dunne Avenue					
	North Bound			South Bound			East Bound			West Bound		
Approach:	L	T	R	L	T	R	L	T	R	L	T	R
Min. Green:	7	10	10	7	10	10	7	10	10	7	10	10
Y+R:	4.0	4.0	4.0	4.0	4.0	4.0	4.0	4.0	4.0	4.0	4.0	4.0
Volume Module: >> Count Date: 8 May 2018 <<												
Base Vol:	115	741	170	79	330	32	85	255	74	144	227	101
Growth Adj:	1.00	1.00	1.00	1.00	1.00	1.00	1.00	1.00	1.00	1.00	1.00	1.00
Initial Bse:	115	741	170	79	330	32	85	255	74	144	227	101
Added Vol:	0	0	0	0	0	0	0	0	0	0	0	0
PasserByVol:	66	98	32	0	16	3	4	54	44	40	25	5
Initial Fut:	181	839	202	79	346	35	89	309	118	184	252	106
User Adj:	1.00	1.00	1.00	1.00	1.00	1.00	1.00	1.00	1.00	1.00	1.00	1.00
PHF Adj:	1.00	1.00	1.00	1.00	1.00	1.00	1.00	1.00	1.00	1.00	1.00	1.00
PHF Volume:	181	839	202	79	346	35	89	309	118	184	252	106
Reduct Vol:	0	0	0	0	0	0	0	0	0	0	0	0
Reduced Vol:	181	839	202	79	346	35	89	309	118	184	252	106
PCE Adj:	1.00	1.00	1.00	1.00	1.00	1.00	1.00	1.00	1.00	1.00	1.00	1.00
MLF Adj:	1.00	1.00	1.00	1.00	1.00	1.00	1.00	1.00	1.00	1.00	1.00	1.00
FinalVolume:	181	839	202	79	346	35	89	309	118	184	252	106
Saturation Flow Module:												
Sat/Lane:	1900	1900	1900	1900	1900	1900	1900	1900	1900	1900	1900	1900
Adjustment:	0.92	1.00	0.92	0.92	1.00	0.92	0.92	1.00	0.92	0.83	1.00	0.92
Lanes:	1.00	2.00	1.00	1.00	2.00	1.00	1.00	2.00	1.00	2.00	1.00	1.00
Final Sat.:	1750	3800	1750	1750	3800	1750	1750	3800	1750	3150	1900	1750
Capacity Analysis Module:												
Vol/Sat:	0.10	0.22	0.12	0.05	0.09	0.02	0.05	0.08	0.07	0.06	0.13	0.06
Crit Moves:	****			****			****			****		
Green Time:	28.6	45.7	45.7	9.3	26.4	36.9	10.5	22.3	22.3	15.6	27.4	36.8
Volume/Cap:	0.38	0.51	0.27	0.51	0.36	0.06	0.51	0.38	0.32	0.39	0.51	0.17
Delay/Veh:	31.5	21.8	19.1	48.4	32.6	22.6	47.2	35.7	35.4	40.9	33.9	23.7
User DelAdj:	1.00	1.00	1.00	1.00	1.00	1.00	1.00	1.00	1.00	1.00	1.00	1.00
AdjDel/Veh:	31.5	21.8	19.1	48.4	32.6	22.6	47.2	35.7	35.4	40.9	33.9	23.7
LOS by Move:	C	C	B	D	C	C	D	D	D	D	C	C
HCM2kAvgQ:	5	10	4	3	4	1	4	4	4	3	7	2

Note: Queue reported is the number of cars per lane.

Voices School
Morgan Hill, CA
Hexagon Transportation Consultants, Inc.

Level Of Service Computation Report
2000 HCM Operations (Future Volume Alternative)
2025 No Project (PM)

Intersection #122: Monterey Road and Dunne Avenue

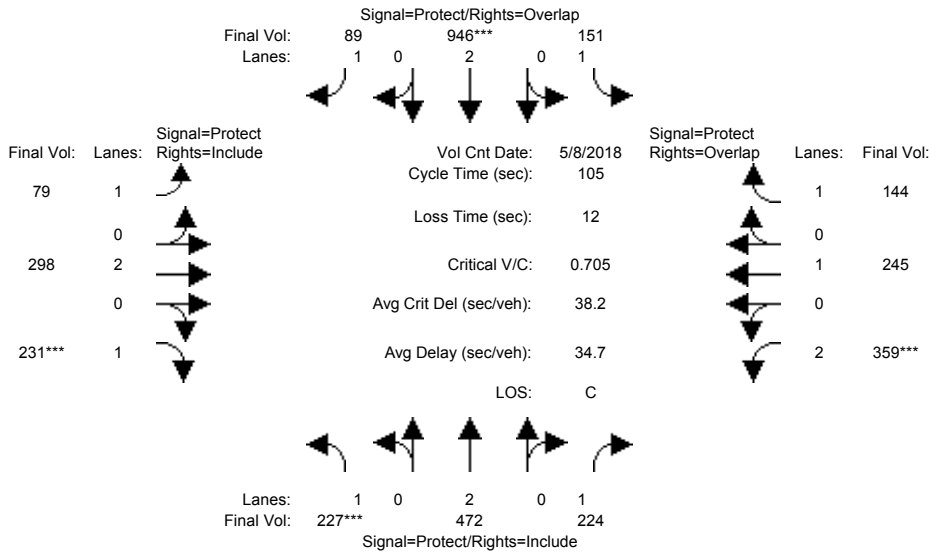

Street Name:	Monterey Road						Dunne Avenue					
	North Bound			South Bound			East Bound			West Bound		
Approach:	L	T	R	L	T	R	L	T	R	L	T	R
Min. Green:	7	10	10	7	10	10	7	10	10	7	10	10
Y+R:	4.0	4.0	4.0	4.0	4.0	4.0	4.0	4.0	4.0	4.0	4.0	4.0

Volume Module:	>>	Count	Date:	8 May 2018	<<							
Base Vol:	153	401	208	146	936	87	77	264	135	329	216	122
Growth Adj:	1.00	1.00	1.00	1.00	1.00	1.00	1.00	1.00	1.00	1.00	1.00	1.00
Initial Bse:	153	401	208	146	936	87	77	264	135	329	216	122
Added Vol:	0	0	0	0	0	0	0	0	0	0	0	0
PasserByVol:	74	71	16	5	10	2	2	34	96	30	29	22
Initial Fut:	227	472	224	151	946	89	79	298	231	359	245	144
User Adj:	1.00	1.00	1.00	1.00	1.00	1.00	1.00	1.00	1.00	1.00	1.00	1.00
PHF Adj:	1.00	1.00	1.00	1.00	1.00	1.00	1.00	1.00	1.00	1.00	1.00	1.00
PHF Volume:	227	472	224	151	946	89	79	298	231	359	245	144
Reduct Vol:	0	0	0	0	0	0	0	0	0	0	0	0
Reduced Vol:	227	472	224	151	946	89	79	298	231	359	245	144
PCE Adj:	1.00	1.00	1.00	1.00	1.00	1.00	1.00	1.00	1.00	1.00	1.00	1.00
MLF Adj:	1.00	1.00	1.00	1.00	1.00	1.00	1.00	1.00	1.00	1.00	1.00	1.00
FinalVolume:	227	472	224	151	946	89	79	298	231	359	245	144

Saturation Flow Module:												
Sat/Lane:	1900	1900	1900	1900	1900	1900	1900	1900	1900	1900	1900	1900
Adjustment:	0.92	1.00	0.92	0.92	1.00	0.92	0.92	1.00	0.92	0.83	1.00	0.92
Lanes:	1.00	2.00	1.00	1.00	2.00	1.00	1.00	2.00	1.00	2.00	1.00	1.00
Final Sat.:	1750	3800	1750	1750	3800	1750	1750	3800	1750	3150	1900	1750

Capacity Analysis Module:												
Vol/Sat:	0.13	0.12	0.13	0.09	0.25	0.05	0.05	0.08	0.13	0.11	0.13	0.08
Crit Moves:	****				****				****	****		
Green Time:	19.3	33.7	33.7	22.7	37.1	49.5	12.5	19.7	19.7	17.0	24.1	46.8
Volume/Cap:	0.71	0.39	0.40	0.40	0.71	0.11	0.38	0.42	0.71	0.71	0.56	0.18
Delay/Veh:	47.1	27.9	28.2	36.0	31.0	15.5	43.8	38.0	46.8	46.1	37.4	17.7
User DelAdj:	1.00	1.00	1.00	1.00	1.00	1.00	1.00	1.00	1.00	1.00	1.00	1.00
AdjDel/Veh:	47.1	27.9	28.2	36.0	31.0	15.5	43.8	38.0	46.8	46.1	37.4	17.7
LOS by Move:	D	C	C	D	C	B	D	D	D	D	D	B
HCM2kAvgQ:	7	6	6	4	13	2	3	5	9	7	7	3

Note: Queue reported is the number of cars per lane.

Voices School
Morgan Hill, CA
Hexagon Transportation Consultants, Inc.

Level Of Service Computation Report
2000 HCM Operations (Future Volume Alternative)
2025 Plus Project (AM) - 2 Cosmo Right out

Intersection #122: Monterey Road and Dunne Avenue

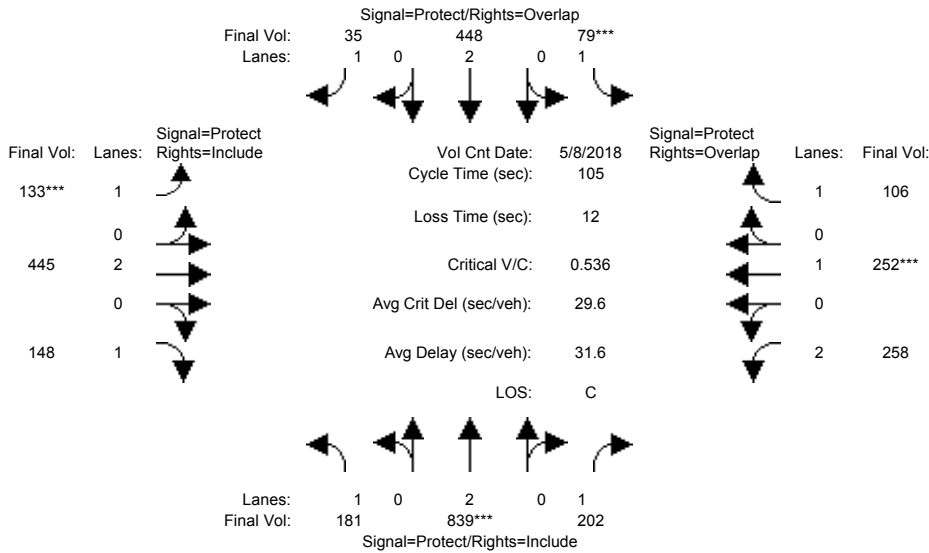

Street Name:	Monterey Road						Dunne Avenue					
	North Bound			South Bound			East Bound			West Bound		
Approach:	L	T	R	L	T	R	L	T	R	L	T	R
Min. Green:	7	10	10	7	10	10	7	10	10	7	10	10
Y+R:	4.0	4.0	4.0	4.0	4.0	4.0	4.0	4.0	4.0	4.0	4.0	4.0
Volume Module: >> Count Date: 8 May 2018 <<												
Base Vol:	115	741	170	79	330	32	85	255	74	144	227	101
Growth Adj:	1.00	1.00	1.00	1.00	1.00	1.00	1.00	1.00	1.00	1.00	1.00	1.00
Initial Bse:	115	741	170	79	330	32	85	255	74	144	227	101
Added Vol:	0	0	0	0	102	0	44	136	30	74	0	0
PasserByVol:	66	98	32	0	16	3	4	54	44	40	25	5
Initial Fut:	181	839	202	79	448	35	133	445	148	258	252	106
User Adj:	1.00	1.00	1.00	1.00	1.00	1.00	1.00	1.00	1.00	1.00	1.00	1.00
PHF Adj:	1.00	1.00	1.00	1.00	1.00	1.00	1.00	1.00	1.00	1.00	1.00	1.00
PHF Volume:	181	839	202	79	448	35	133	445	148	258	252	106
Reduct Vol:	0	0	0	0	0	0	0	0	0	0	0	0
Reduced Vol:	181	839	202	79	448	35	133	445	148	258	252	106
PCE Adj:	1.00	1.00	1.00	1.00	1.00	1.00	1.00	1.00	1.00	1.00	1.00	1.00
MLF Adj:	1.00	1.00	1.00	1.00	1.00	1.00	1.00	1.00	1.00	1.00	1.00	1.00
FinalVolume:	181	839	202	79	448	35	133	445	148	258	252	106
Saturation Flow Module:												
Sat/Lane:	1900	1900	1900	1900	1900	1900	1900	1900	1900	1900	1900	1900
Adjustment:	0.92	1.00	0.92	0.92	1.00	0.92	0.92	1.00	0.92	0.83	1.00	0.92
Lanes:	1.00	2.00	1.00	1.00	2.00	1.00	1.00	2.00	1.00	2.00	1.00	1.00
Final Sat.:	1750	3800	1750	1750	3800	1750	1750	3800	1750	3150	1900	1750
Capacity Analysis Module:												
Vol/Sat:	0.10	0.22	0.12	0.05	0.12	0.02	0.08	0.12	0.08	0.08	0.13	0.06
Crit Moves:	****			****			****			****		
Green Time:	24.4	43.3	43.3	8.8	27.8	42.7	14.9	24.1	24.1	16.8	26.0	34.8
Volume/Cap:	0.45	0.54	0.28	0.54	0.45	0.05	0.54	0.51	0.37	0.51	0.54	0.18
Delay/Veh:	35.3	23.7	20.7	49.9	32.5	18.9	44.1	35.8	34.7	41.2	35.5	25.1
User DelAdj:	1.00	1.00	1.00	1.00	1.00	1.00	1.00	1.00	1.00	1.00	1.00	1.00
AdjDel/Veh:	35.3	23.7	20.7	49.9	32.5	18.9	44.1	35.8	34.7	41.2	35.5	25.1
LOS by Move:	D	C	C	D	C	B	D	D	C	D	D	C
HCM2kAvgQ:	5	10	4	3	6	1	5	7	5	4	7	2

Note: Queue reported is the number of cars per lane.

Voices School
Morgan Hill, CA
Hexagon Transportation Consultants, Inc.

Level Of Service Computation Report
2000 HCM Operations (Future Volume Alternative)
2025 Plus Project (PM) - 2 Cosmo Right out

Intersection #122: Monterey Road and Dunne Avenue

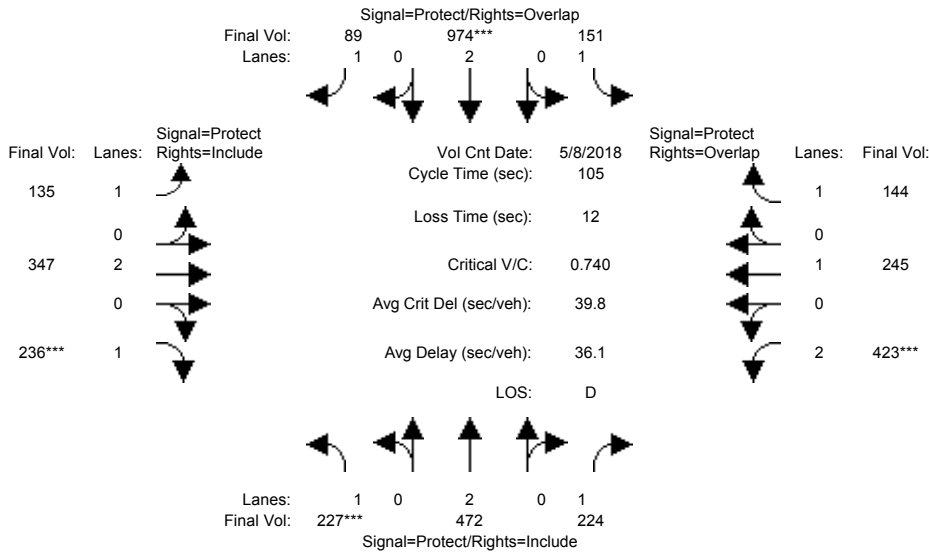

Street Name:	Monterey Road						Dunne Avenue					
	North Bound			South Bound			East Bound			West Bound		
Approach:	L	T	R	L	T	R	L	T	R	L	T	R
Min. Green:	7	10	10	7	10	10	7	10	10	7	10	10
Y+R:	4.0	4.0	4.0	4.0	4.0	4.0	4.0	4.0	4.0	4.0	4.0	4.0

Volume Module:	>>	Count	Date:	8 May 2018	<<							
Base Vol:	153	401	208	146	936	87	77	264	135	329	216	122
Growth Adj:	1.00	1.00	1.00	1.00	1.00	1.00	1.00	1.00	1.00	1.00	1.00	1.00
Initial Bse:	153	401	208	146	936	87	77	264	135	329	216	122
Added Vol:	0	0	0	0	28	0	56	49	5	64	0	0
PasserByVol:	74	71	16	5	10	2	2	34	96	30	29	22
Initial Fut:	227	472	224	151	974	89	135	347	236	423	245	144
User Adj:	1.00	1.00	1.00	1.00	1.00	1.00	1.00	1.00	1.00	1.00	1.00	1.00
PHF Adj:	1.00	1.00	1.00	1.00	1.00	1.00	1.00	1.00	1.00	1.00	1.00	1.00
PHF Volume:	227	472	224	151	974	89	135	347	236	423	245	144
Reduct Vol:	0	0	0	0	0	0	0	0	0	0	0	0
Reduced Vol:	227	472	224	151	974	89	135	347	236	423	245	144
PCE Adj:	1.00	1.00	1.00	1.00	1.00	1.00	1.00	1.00	1.00	1.00	1.00	1.00
MLF Adj:	1.00	1.00	1.00	1.00	1.00	1.00	1.00	1.00	1.00	1.00	1.00	1.00
FinalVolume:	227	472	224	151	974	89	135	347	236	423	245	144

Saturation Flow Module:												
Sat/Lane:	1900	1900	1900	1900	1900	1900	1900	1900	1900	1900	1900	1900
Adjustment:	0.92	1.00	0.92	0.92	1.00	0.92	0.92	1.00	0.92	0.83	1.00	0.92
Lanes:	1.00	2.00	1.00	1.00	2.00	1.00	1.00	2.00	1.00	2.00	1.00	1.00
Final Sat.:	1750	3800	1750	1750	3800	1750	1750	3800	1750	3150	1900	1750

Capacity Analysis Module:												
Vol/Sat:	0.13	0.12	0.13	0.09	0.26	0.05	0.08	0.09	0.13	0.13	0.13	0.08
Crit Moves:	****				****				****	****		
Green Time:	18.4	32.7	32.7	22.1	36.4	50.7	14.3	19.1	19.1	19.1	23.9	46.0
Volume/Cap:	0.74	0.40	0.41	0.41	0.74	0.11	0.57	0.50	0.74	0.74	0.57	0.19
Delay/Veh:	50.2	28.6	29.0	36.6	32.4	14.9	45.6	39.2	49.5	45.7	37.7	18.2
User DelAdj:	1.00	1.00	1.00	1.00	1.00	1.00	1.00	1.00	1.00	1.00	1.00	1.00
AdjDel/Veh:	50.2	28.6	29.0	36.6	32.4	14.9	45.6	39.2	49.5	45.7	37.7	18.2
LOS by Move:	D	C	C	D	C	B	D	D	D	D	D	B
HCM2kAvgQ:	7	6	6	4	13	2	5	6	9	8	7	3

Note: Queue reported is the number of cars per lane.

Voices School
Morgan Hill, CA
Hexagon Transportation Consultants, Inc.

Level Of Service Computation Report
2000 HCM Operations (Future Volume Alternative)
2025 No Project (AM)

Intersection #123: Butterfield Boulevard and Dunne Avenue

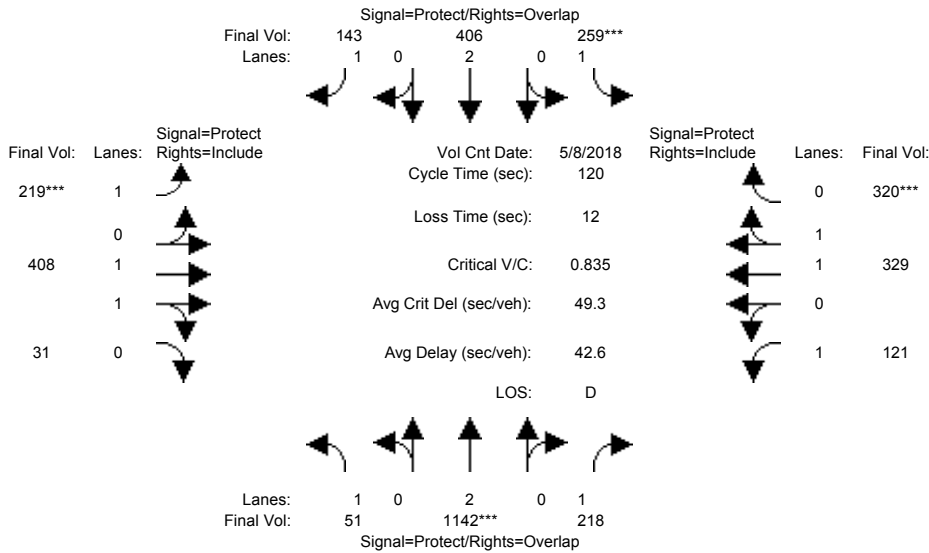

Street Name:	Butterfield Boulevard						Dunne Avenue					
	North Bound			South Bound			East Bound			West Bound		
Approach:	L	T	R	L	T	R	L	T	R	L	T	R
Min. Green:	7	10	10	7	10	10	7	10	10	7	10	10
Y+R:	4.0	4.0	4.0	4.0	4.0	4.0	4.0	4.0	4.0	4.0	4.0	4.0

Volume Module:	>>	Count	Date:	8 May 2018	<<							
Base Vol:	51	1103	216	209	298	111	153	408	13	108	312	291
Growth Adj:	1.00	1.00	1.00	1.00	1.00	1.00	1.00	1.00	1.00	1.00	1.00	1.00
Initial Bse:	51	1103	216	209	298	111	153	408	13	108	312	291
Added Vol:	0	0	0	0	0	0	0	0	0	0	0	0
PasserByVol:	0	39	2	50	108	32	66	0	18	13	17	29
Initial Fut:	51	1142	218	259	406	143	219	408	31	121	329	320
User Adj:	1.00	1.00	1.00	1.00	1.00	1.00	1.00	1.00	1.00	1.00	1.00	1.00
PHF Adj:	1.00	1.00	1.00	1.00	1.00	1.00	1.00	1.00	1.00	1.00	1.00	1.00
PHF Volume:	51	1142	218	259	406	143	219	408	31	121	329	320
Reduct Vol:	0	0	0	0	0	0	0	0	0	0	0	0
Reduced Vol:	51	1142	218	259	406	143	219	408	31	121	329	320
PCE Adj:	1.00	1.00	1.00	1.00	1.00	1.00	1.00	1.00	1.00	1.00	1.00	1.00
MLF Adj:	1.00	1.00	1.00	1.00	1.00	1.00	1.00	1.00	1.00	1.00	1.00	1.00
FinalVolume:	51	1142	218	259	406	143	219	408	31	121	329	320

Saturation Flow Module:												
Sat/Lane:	1900	1900	1900	1900	1900	1900	1900	1900	1900	1900	1900	1900
Adjustment:	0.92	1.00	0.92	0.92	1.00	0.92	0.92	0.98	0.95	0.92	1.00	0.95
Lanes:	1.00	2.00	1.00	1.00	2.00	1.00	1.00	1.85	0.15	1.00	1.00	1.00
Final Sat.:	1750	3800	1750	1750	3800	1750	1750	3439	261	1750	1899	1800

Capacity Analysis Module:												
Vol/Sat:	0.03	0.30	0.12	0.15	0.11	0.08	0.13	0.12	0.12	0.07	0.17	0.18
Crit Moves:	****			****			****			****		
Green Time:	22.8	43.2	59.2	21.3	41.7	59.7	18.0	27.5	27.5	16.0	25.6	25.6
Volume/Cap:	0.15	0.83	0.25	0.83	0.31	0.16	0.83	0.52	0.52	0.52	0.81	0.83
Delay/Veh:	40.8	39.8	17.7	65.2	28.7	16.6	69.7	41.0	41.0	50.4	51.4	53.0
User DelAdj:	1.00	1.00	1.00	1.00	1.00	1.00	1.00	1.00	1.00	1.00	1.00	1.00
AdjDel/Veh:	40.8	39.8	17.7	65.2	28.7	16.6	69.7	41.0	41.0	50.4	51.4	53.0
LOS by Move:	D	D	B	E	C	B	E	D	D	D	D	D
HCM2kAvgQ:	2	20	5	12	5	3	9	7	7	4	12	13

Note: Queue reported is the number of cars per lane.

Voices School
Morgan Hill, CA
Hexagon Transportation Consultants, Inc.

Level Of Service Computation Report
2000 HCM Operations (Future Volume Alternative)
2025 No Project (PM)

Intersection #123: Butterfield Boulevard and Dunne Avenue

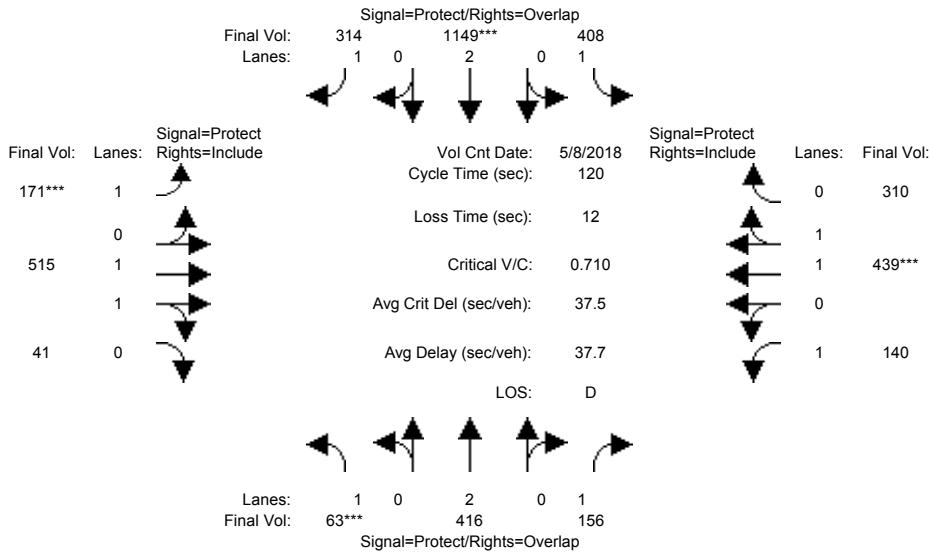

Street Name:	Butterfield Boulevard						Dunne Avenue					
	North Bound			South Bound			East Bound			West Bound		
Approach:	L	T	R	L	T	R	L	T	R	L	T	R
Min. Green:	7	10	10	7	10	10	7	10	10	7	10	10
Y+R:	4.0	4.0	4.0	4.0	4.0	4.0	4.0	4.0	4.0	4.0	4.0	4.0

Volume Module:	>>	Count	Date:	8 May 2018	<<											
Base Vol:	30	279	139	372	1024	254	147	498	32	118	439	278				
Growth Adj:	1.00	1.00	1.00	1.00	1.00	1.00	1.00	1.00	1.00	1.00	1.00	1.00				
Initial Bse:	30	279	139	372	1024	254	147	498	32	118	439	278				
Added Vol:	0	0	0	0	0	0	0	0	0	0	0	0				
PasserByVol:	33	137	17	36	125	60	24	17	9	22	0	32				
Initial Fut:	63	416	156	408	1149	314	171	515	41	140	439	310				
User Adj:	1.00	1.00	1.00	1.00	1.00	1.00	1.00	1.00	1.00	1.00	1.00	1.00				
PHF Adj:	1.00	1.00	1.00	1.00	1.00	1.00	1.00	1.00	1.00	1.00	1.00	1.00				
PHF Volume:	63	416	156	408	1149	314	171	515	41	140	439	310				
Reduct Vol:	0	0	0	0	0	0	0	0	0	0	0	0				
Reduced Vol:	63	416	156	408	1149	314	171	515	41	140	439	310				
PCE Adj:	1.00	1.00	1.00	1.00	1.00	1.00	1.00	1.00	1.00	1.00	1.00	1.00				
MLF Adj:	1.00	1.00	1.00	1.00	1.00	1.00	1.00	1.00	1.00	1.00	1.00	1.00				
Final Volume:	63	416	156	408	1149	314	171	515	41	140	439	310				

Saturation Flow Module:												
Sat/Lane:	1900	1900	1900	1900	1900	1900	1900	1900	1900	1900	1900	1900
Adjustment:	0.92	1.00	0.92	0.92	1.00	0.92	0.92	0.98	0.95	0.92	0.99	0.95
Lanes:	1.00	2.00	1.00	1.00	2.00	1.00	1.00	1.85	0.15	1.00	1.15	0.85
Final Sat.:	1750	3800	1750	1750	3800	1750	1750	3427	273	1750	2167	1531

Capacity Analysis Module:												
Vol/Sat:	0.04	0.11	0.09	0.23	0.30	0.18	0.10	0.15	0.15	0.08	0.20	0.20
Crit Moves:	****				****		****				****	
Green Time:	7.0	18.4	35.9	39.2	50.7	67.1	16.4	32.8	32.8	17.5	33.9	33.9
Volume/Cap:	0.62	0.71	0.30	0.71	0.72	0.32	0.72	0.55	0.55	0.55	0.72	0.72
Delay/Veh:	66.1	52.4	32.7	39.6	30.3	14.4	59.5	37.9	37.9	50.1	41.1	41.1
User DelAdj:	1.00	1.00	1.00	1.00	1.00	1.00	1.00	1.00	1.00	1.00	1.00	1.00
AdjDel/Veh:	66.1	52.4	32.7	39.6	30.3	14.4	59.5	37.9	37.9	50.1	41.1	41.1
LOS by Move:	E	D	C	D	C	B	E	D	D	D	D	D
HCM2kAvgQ:	3	7	5	15	18	7	7	9	9	5	13	13

Note: Queue reported is the number of cars per lane.

Voices School
Morgan Hill, CA
Hexagon Transportation Consultants, Inc.

Level Of Service Computation Report
2000 HCM Operations (Future Volume Alternative)
2025 Plus Project (AM) - 2 Cosmo Right out

Intersection #123: Butterfield Boulevard and Dunne Avenue

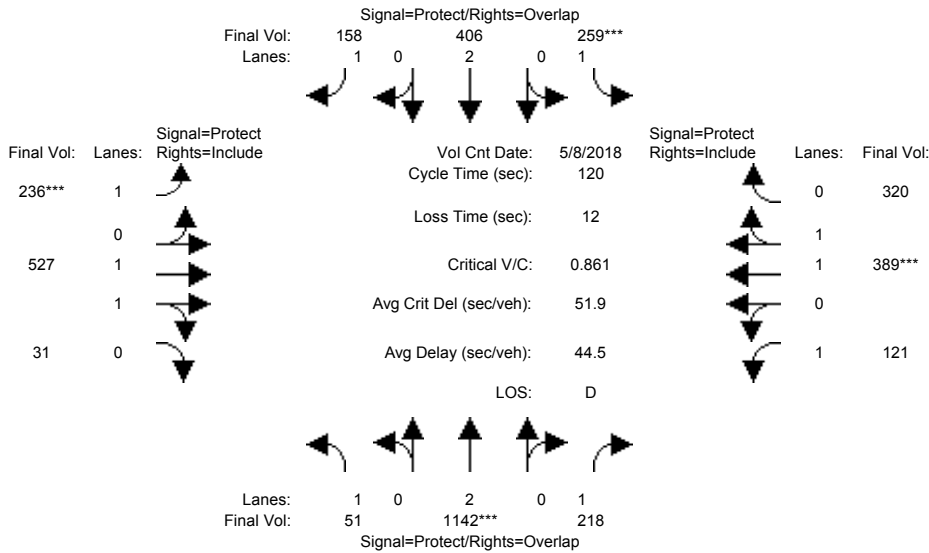

Street Name:	Butterfield Boulevard						Dunne Avenue					
	North Bound			South Bound			East Bound			West Bound		
Approach:	L	T	R	L	T	R	L	T	R	L	T	R
Min. Green:	7	10	10	7	10	10	7	10	10	7	10	10
Y+R:	4.0	4.0	4.0	4.0	4.0	4.0	4.0	4.0	4.0	4.0	4.0	4.0

Volume Module:	>>	Count	Date:	8 May 2018	<<											
Base Vol:	51	1103	216	209	298	111	153	408	13	108	312	291				
Growth Adj:	1.00	1.00	1.00	1.00	1.00	1.00	1.00	1.00	1.00	1.00	1.00	1.00				
Initial Bse:	51	1103	216	209	298	111	153	408	13	108	312	291				
Added Vol:	0	0	0	0	0	15	17	119	0	0	60	0				
PasserByVol:	0	39	2	50	108	32	66	0	18	13	17	29				
Initial Fut:	51	1142	218	259	406	158	236	527	31	121	389	320				
User Adj:	1.00	1.00	1.00	1.00	1.00	1.00	1.00	1.00	1.00	1.00	1.00	1.00				
PHF Adj:	1.00	1.00	1.00	1.00	1.00	1.00	1.00	1.00	1.00	1.00	1.00	1.00				
PHF Volume:	51	1142	218	259	406	158	236	527	31	121	389	320				
Reduct Vol:	0	0	0	0	0	0	0	0	0	0	0	0				
Reduced Vol:	51	1142	218	259	406	158	236	527	31	121	389	320				
PCE Adj:	1.00	1.00	1.00	1.00	1.00	1.00	1.00	1.00	1.00	1.00	1.00	1.00				
MLF Adj:	1.00	1.00	1.00	1.00	1.00	1.00	1.00	1.00	1.00	1.00	1.00	1.00				
FinalVolume:	51	1142	218	259	406	158	236	527	31	121	389	320				

Saturation Flow Module:												
Sat/Lane:	1900	1900	1900	1900	1900	1900	1900	1900	1900	1900	1900	1900
Adjustment:	0.92	1.00	0.92	0.92	1.00	0.92	0.92	0.98	0.95	0.92	1.00	0.95
Lanes:	1.00	2.00	1.00	1.00	2.00	1.00	1.00	1.89	0.11	1.00	1.07	0.93
Final Sat.:	1750	3800	1750	1750	3800	1750	1750	3494	206	1750	2029	1669

Capacity Analysis Module:												
Vol/Sat:	0.03	0.30	0.12	0.15	0.11	0.09	0.13	0.15	0.15	0.07	0.19	0.19
Crit Moves:	****			****			****			****		
Green Time:	22.1	41.9	56.2	20.6	40.4	59.2	18.8	31.2	31.2	14.3	26.7	26.7
Volume/Cap:	0.16	0.86	0.27	0.86	0.32	0.18	0.86	0.58	0.58	0.58	0.86	0.86
Delay/Veh:	41.4	42.3	19.6	69.8	29.7	17.0	72.5	39.6	39.6	54.1	54.1	54.1
User DelAdj:	1.00	1.00	1.00	1.00	1.00	1.00	1.00	1.00	1.00	1.00	1.00	1.00
AdjDel/Veh:	41.4	42.3	19.6	69.8	29.7	17.0	72.5	39.6	39.6	54.1	54.1	54.1
LOS by Move:	D	D	B	E	C	B	E	D	D	D	D	D
HCM2kAvgQ:	2	20	5	13	5	3	10	9	9	5	14	14

Note: Queue reported is the number of cars per lane.

Voices School
Morgan Hill, CA
Hexagon Transportation Consultants, Inc.

Level Of Service Computation Report
2000 HCM Operations (Future Volume Alternative)
2025 Plus Project (PM) - 2 Cosmo Right out

Intersection #123: Butterfield Boulevard and Dunne Avenue

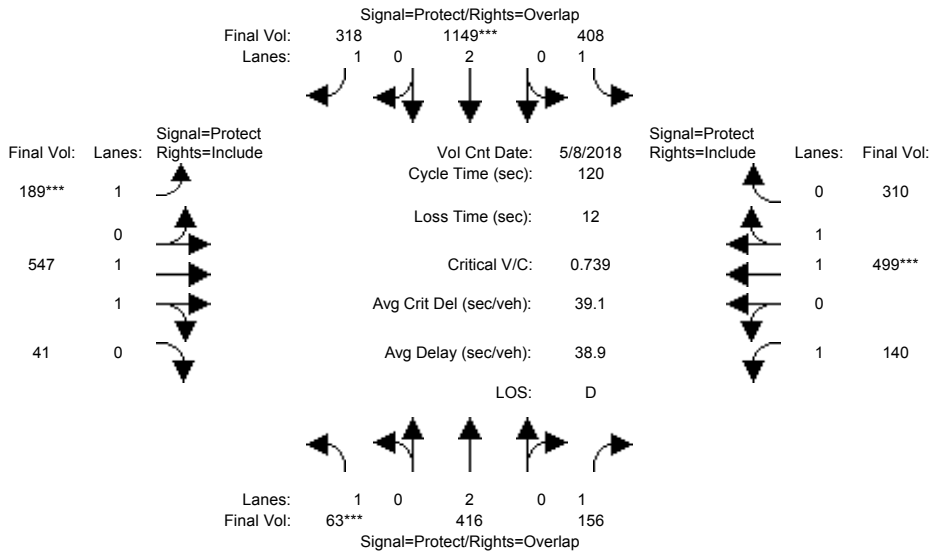

Street Name:	Butterfield Boulevard						Dunne Avenue					
	North Bound			South Bound			East Bound			West Bound		
Approach:	L	T	R	L	T	R	L	T	R	L	T	R
Min. Green:	7	10	10	7	10	10	7	10	10	7	10	10
Y+R:	4.0	4.0	4.0	4.0	4.0	4.0	4.0	4.0	4.0	4.0	4.0	4.0

Volume Module:	>>	Count	Date:	8 May 2018	<<							
Base Vol:	30	279	139	372	1024	254	147	498	32	118	439	278
Growth Adj:	1.00	1.00	1.00	1.00	1.00	1.00	1.00	1.00	1.00	1.00	1.00	1.00
Initial Bse:	30	279	139	372	1024	254	147	498	32	118	439	278
Added Vol:	0	0	0	0	0	4	18	32	0	0	60	0
PasserByVol:	33	137	17	36	125	60	24	17	9	22	0	32
Initial Fut:	63	416	156	408	1149	318	189	547	41	140	499	310
User Adj:	1.00	1.00	1.00	1.00	1.00	1.00	1.00	1.00	1.00	1.00	1.00	1.00
PHF Adj:	1.00	1.00	1.00	1.00	1.00	1.00	1.00	1.00	1.00	1.00	1.00	1.00
PHF Volume:	63	416	156	408	1149	318	189	547	41	140	499	310
Reduct Vol:	0	0	0	0	0	0	0	0	0	0	0	0
Reduced Vol:	63	416	156	408	1149	318	189	547	41	140	499	310
PCE Adj:	1.00	1.00	1.00	1.00	1.00	1.00	1.00	1.00	1.00	1.00	1.00	1.00
MLF Adj:	1.00	1.00	1.00	1.00	1.00	1.00	1.00	1.00	1.00	1.00	1.00	1.00
FinalVolume:	63	416	156	408	1149	318	189	547	41	140	499	310

Saturation Flow Module:												
Sat/Lane:	1900	1900	1900	1900	1900	1900	1900	1900	1900	1900	1900	1900
Adjustment:	0.92	1.00	0.92	0.92	1.00	0.92	0.92	0.98	0.95	0.92	0.99	0.95
Lanes:	1.00	2.00	1.00	1.00	2.00	1.00	1.00	1.86	0.14	1.00	1.21	0.79
Final Sat.:	1750	3800	1750	1750	3800	1750	1750	3442	258	1750	2281	1417

Capacity Analysis Module:												
Vol/Sat:	0.04	0.11	0.09	0.23	0.30	0.18	0.11	0.16	0.16	0.08	0.22	0.22
Crit Moves:	****				****		****				****	
Green Time:	7.0	17.7	35.3	37.8	48.5	65.9	17.3	34.9	34.9	17.6	35.1	35.1
Volume/Cap:	0.62	0.74	0.30	0.74	0.75	0.33	0.75	0.55	0.55	0.55	0.75	0.75
Delay/Veh:	66.1	54.1	33.1	42.0	32.6	15.1	60.8	36.5	36.5	50.0	41.3	41.3
User DelAdj:	1.00	1.00	1.00	1.00	1.00	1.00	1.00	1.00	1.00	1.00	1.00	1.00
AdjDel/Veh:	66.1	54.1	33.1	42.0	32.6	15.1	60.8	36.5	36.5	50.0	41.3	41.3
LOS by Move:	E	D	C	D	C	B	E	D	D	D	D	D
HCM2kAvgQ:	3	8	5	16	19	7	7	9	9	5	14	14

Note: Queue reported is the number of cars per lane.

Voices School
Morgan Hill, CA
Hexagon Transportation Consultants, Inc.

Level Of Service Computation Report
2000 HCM Operations (Future Volume Alternative)
2025 No Project (AM)

Intersection #124: US 101 Southbound Ramps and Dunne Avenue

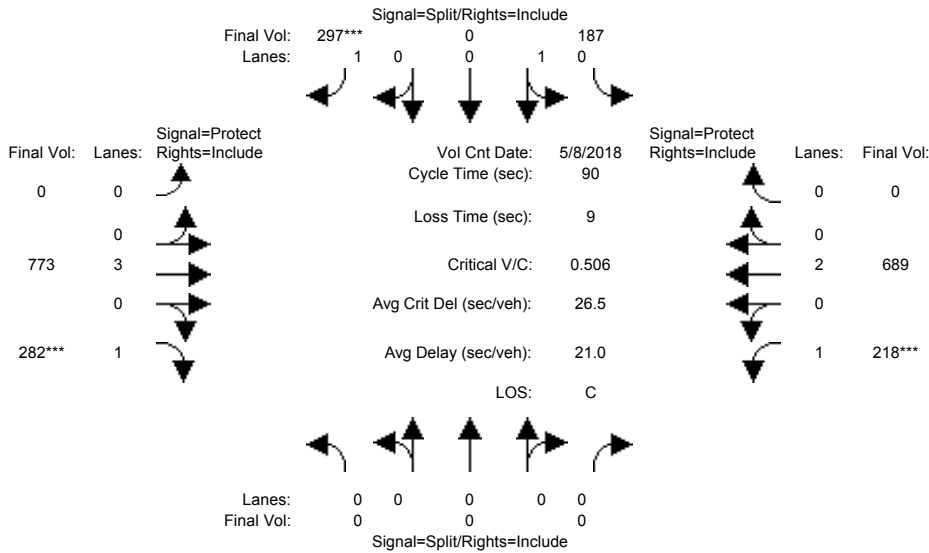

Street Name:	US 101 Southbound Ramps						Dunne Avenue					
	North Bound			South Bound			East Bound			West Bound		
Approach:	L	T	R	L	T	R	L	T	R	L	T	R
Movement:	L	T	R	L	T	R	L	T	R	L	T	R
Min. Green:	0	0	0	10	10	10	0	10	10	7	10	0
Y+R:	4.0	4.0	4.0	4.0	4.0	4.0	4.0	4.0	4.0	4.0	4.0	4.0
Volume Module: >> Count Date: 8 May 2018 <<												
Base Vol:	0	0	0	184	0	288	0	750	247	177	664	0
Growth Adj:	1.00	1.00	1.00	1.00	1.00	1.00	1.00	1.00	1.00	1.00	1.00	1.00
Initial Bse:	0	0	0	184	0	288	0	750	247	177	664	0
Added Vol:	0	0	0	0	0	0	0	0	0	0	0	0
PasserByVol:	0	0	0	3	0	9	0	23	35	41	25	0
Initial Fut:	0	0	0	187	0	297	0	773	282	218	689	0
User Adj:	1.00	1.00	1.00	1.00	1.00	1.00	1.00	1.00	1.00	1.00	1.00	1.00
PHF Adj:	1.00	1.00	1.00	1.00	1.00	1.00	1.00	1.00	1.00	1.00	1.00	1.00
PHF Volume:	0	0	0	187	0	297	0	773	282	218	689	0
Reduct Vol:	0	0	0	0	0	0	0	0	0	0	0	0
Reduced Vol:	0	0	0	187	0	297	0	773	282	218	689	0
PCE Adj:	1.00	1.00	1.00	1.00	1.00	1.00	1.00	1.00	1.00	1.00	1.00	1.00
MLF Adj:	1.00	1.00	1.00	1.00	1.00	1.00	1.00	1.00	1.00	1.00	1.00	1.00
FinalVolume:	0	0	0	187	0	297	0	773	282	218	689	0
Saturation Flow Module:												
Sat/Lane:	1900	1900	1900	1900	1900	1900	1900	1900	1900	1900	1900	1900
Adjustment:	0.92	1.00	0.92	0.95	0.95	0.92	0.92	1.00	0.92	0.92	1.00	0.92
Lanes:	0.00	0.00	0.00	1.00	0.00	1.00	0.00	3.00	1.00	1.00	2.00	0.00
Final Sat.:	0	0	0	1800	0	1750	0	5700	1750	1750	3800	0
Capacity Analysis Module:												
Vol/Sat:	0.00	0.00	0.00	0.10	0.00	0.17	0.00	0.14	0.16	0.12	0.18	0.00
Crit Moves:						****			****	****		
Green Time:	0.0	0.0	0.0	30.2	0.0	30.2	0.0	28.7	28.7	22.2	50.8	0.0
Volume/Cap:	0.00	0.00	0.00	0.31	0.00	0.51	0.00	0.43	0.51	0.51	0.32	0.00
Delay/Veh:	0.0	0.0	0.0	22.5	0.0	24.7	0.0	24.3	25.7	30.2	10.5	0.0
User DelAdj:	1.00	1.00	1.00	1.00	1.00	1.00	1.00	1.00	1.00	1.00	1.00	1.00
AdjDel/Veh:	0.0	0.0	0.0	22.5	0.0	24.7	0.0	24.3	25.7	30.2	10.5	0.0
LOS by Move:	A	A	A	C	A	C	A	C	C	C	B	A
HCM2kAvgQ:	0	0	0	4	0	7	0	5	7	6	5	0

Note: Queue reported is the number of cars per lane.

Voices School
Morgan Hill, CA
Hexagon Transportation Consultants, Inc.

Level Of Service Computation Report
2000 HCM Operations (Future Volume Alternative)
2025 No Project (PM)

Intersection #124: US 101 Southbound Ramps and Dunne Avenue

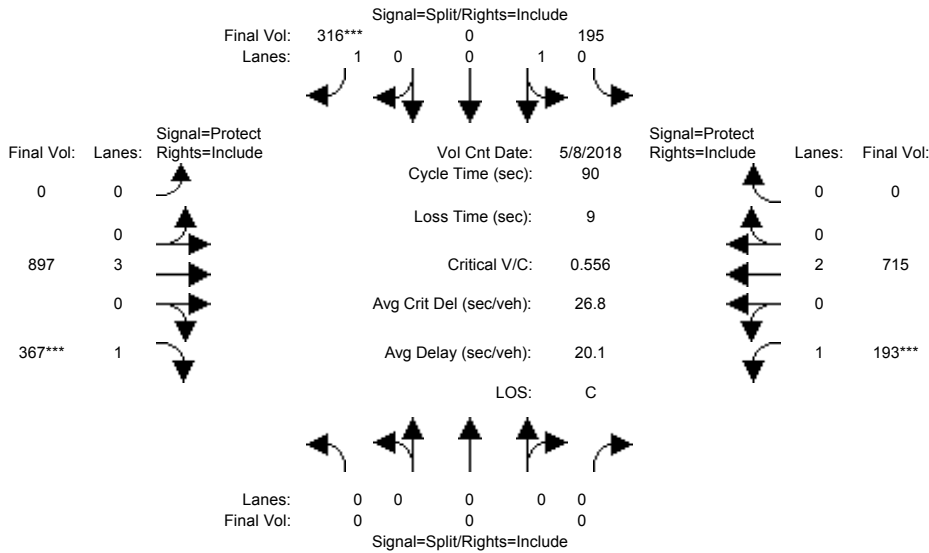

Street Name: US 101 Southbound Ramps Dunne Avenue
Approach: North Bound South Bound East Bound West Bound
Movement: L - T - R L - T - R L - T - R L - T - R

Min. Green:	0	0	0	10	10	10	0	10	10	7	10	0
Y+R:	4.0	4.0	4.0	4.0	4.0	4.0	4.0	4.0	4.0	4.0	4.0	4.0

Volume Module: >> Count Date: 8 May 2018 <<

Base Vol:	0	0	0	195	0	294	0	860	329	120	637	0
Growth Adj:	1.00	1.00	1.00	1.00	1.00	1.00	1.00	1.00	1.00	1.00	1.00	1.00
Initial Bse:	0	0	0	195	0	294	0	860	329	120	637	0
Added Vol:	0	0	0	0	0	0	0	0	0	0	0	0
PasserByVol:	0	0	0	0	0	22	0	37	38	73	78	0
Initial Fut:	0	0	0	195	0	316	0	897	367	193	715	0
User Adj:	1.00	1.00	1.00	1.00	1.00	1.00	1.00	1.00	1.00	1.00	1.00	1.00
PHF Adj:	1.00	1.00	1.00	1.00	1.00	1.00	1.00	1.00	1.00	1.00	1.00	1.00
PHF Volume:	0	0	0	195	0	316	0	897	367	193	715	0
Reduct Vol:	0	0	0	0	0	0	0	0	0	0	0	0
Reduced Vol:	0	0	0	195	0	316	0	897	367	193	715	0
PCE Adj:	1.00	1.00	1.00	1.00	1.00	1.00	1.00	1.00	1.00	1.00	1.00	1.00
MLF Adj:	1.00	1.00	1.00	1.00	1.00	1.00	1.00	1.00	1.00	1.00	1.00	1.00
FinalVolume:	0	0	0	195	0	316	0	897	367	193	715	0

Saturation Flow Module:

Sat/Lane:	1900	1900	1900	1900	1900	1900	1900	1900	1900	1900	1900	1900
Adjustment:	0.92	1.00	0.92	0.95	0.95	0.92	0.92	1.00	0.92	0.92	1.00	0.92
Lanes:	0.00	0.00	0.00	1.00	0.00	1.00	0.00	3.00	1.00	1.00	2.00	0.00
Final Sat.:	0	0	0	1800	0	1750	0	5700	1750	1750	3800	0

Capacity Analysis Module:

Vol/Sat:	0.00	0.00	0.00	0.11	0.00	0.18	0.00	0.16	0.21	0.11	0.19	0.00
Crit Moves:						****			****	****		
Green Time:	0.0	0.0	0.0	29.2	0.0	29.2	0.0	33.9	33.9	17.8	51.8	0.0
Volume/Cap:	0.00	0.00	0.00	0.33	0.00	0.56	0.00	0.42	0.56	0.56	0.33	0.00
Delay/Veh:	0.0	0.0	0.0	23.4	0.0	26.3	0.0	20.9	23.2	34.5	10.1	0.0
User DelAdj:	1.00	1.00	1.00	1.00	1.00	1.00	1.00	1.00	1.00	1.00	1.00	1.00
AdjDel/Veh:	0.0	0.0	0.0	23.4	0.0	26.3	0.0	20.9	23.2	34.5	10.1	0.0
LOS by Move:	A	A	A	C	A	C	A	C	C	C	B	A
HCM2kAvgQ:	0	0	0	4	0	8	0	6	8	6	5	0

Note: Queue reported is the number of cars per lane.

Voices School
Morgan Hill, CA
Hexagon Transportation Consultants, Inc.

Level Of Service Computation Report
2000 HCM Operations (Future Volume Alternative)
2025 Plus Project (AM) - 2 Cosmo Right out

Intersection #124: US 101 Southbound Ramps and Dunne Avenue

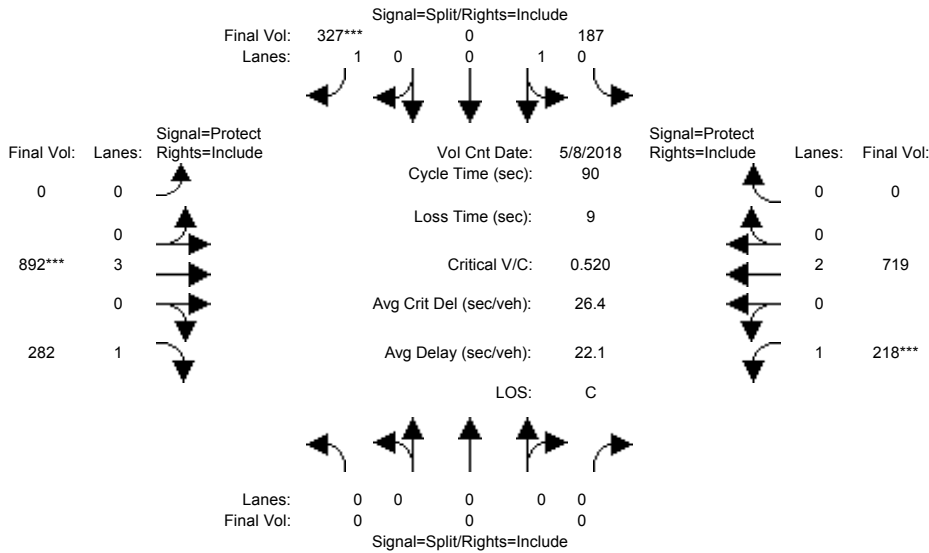

Street Name: US 101 Southbound Ramps Dunne Avenue
Approach: North Bound South Bound East Bound West Bound
Movement: L - T - R L - T - R L - T - R L - T - R

Min. Green:	0	0	0	10	10	10	0	10	10	7	10	0
Y+R:	4.0	4.0	4.0	4.0	4.0	4.0	4.0	4.0	4.0	4.0	4.0	4.0

Volume Module: >> Count Date: 8 May 2018 <<

Base Vol:	0	0	0	184	0	288	0	750	247	177	664	0
Growth Adj:	1.00	1.00	1.00	1.00	1.00	1.00	1.00	1.00	1.00	1.00	1.00	1.00
Initial Bse:	0	0	0	184	0	288	0	750	247	177	664	0
Added Vol:	0	0	0	0	0	30	0	119	0	0	30	0
PasserByVol:	0	0	0	3	0	9	0	23	35	41	25	0
Initial Fut:	0	0	0	187	0	327	0	892	282	218	719	0
User Adj:	1.00	1.00	1.00	1.00	1.00	1.00	1.00	1.00	1.00	1.00	1.00	1.00
PHF Adj:	1.00	1.00	1.00	1.00	1.00	1.00	1.00	1.00	1.00	1.00	1.00	1.00
PHF Volume:	0	0	0	187	0	327	0	892	282	218	719	0
Reduct Vol:	0	0	0	0	0	0	0	0	0	0	0	0
Reduced Vol:	0	0	0	187	0	327	0	892	282	218	719	0
PCE Adj:	1.00	1.00	1.00	1.00	1.00	1.00	1.00	1.00	1.00	1.00	1.00	1.00
MLF Adj:	1.00	1.00	1.00	1.00	1.00	1.00	1.00	1.00	1.00	1.00	1.00	1.00
Final Volume:	0	0	0	187	0	327	0	892	282	218	719	0

Saturation Flow Module:

Sat/Lane:	1900	1900	1900	1900	1900	1900	1900	1900	1900	1900	1900	1900
Adjustment:	0.92	1.00	0.92	0.95	0.95	0.92	0.92	1.00	0.92	0.92	1.00	0.92
Lanes:	0.00	0.00	0.00	1.00	0.00	1.00	0.00	3.00	1.00	1.00	2.00	0.00
Final Sat.:	0	0	0	1800	0	1750	0	5700	1750	1750	3800	0

Capacity Analysis Module:

Vol/Sat:	0.00	0.00	0.00	0.10	0.00	0.19	0.00	0.16	0.16	0.12	0.19	0.00
Crit Moves:						****		****		****		
Green Time:	0.0	0.0	0.0	32.3	0.0	32.3	0.0	27.1	27.1	21.6	48.7	0.0
Volume/Cap:	0.00	0.00	0.00	0.29	0.00	0.52	0.00	0.52	0.54	0.52	0.35	0.00
Delay/Veh:	0.0	0.0	0.0	20.9	0.0	23.5	0.0	26.4	27.3	30.9	11.8	0.0
User DelAdj:	1.00	1.00	1.00	1.00	1.00	1.00	1.00	1.00	1.00	1.00	1.00	1.00
AdjDel/Veh:	0.0	0.0	0.0	20.9	0.0	23.5	0.0	26.4	27.3	30.9	11.8	0.0
LOS by Move:	A	A	A	C	A	C	A	C	C	C	B	A
HCM2kAvgQ:	0	0	0	4	0	8	0	7	7	6	6	0

Note: Queue reported is the number of cars per lane.

Voices School
Morgan Hill, CA
Hexagon Transportation Consultants, Inc.

Level Of Service Computation Report
2000 HCM Operations (Future Volume Alternative)
2025 Plus Project (PM) - 2 Cosmo Right out

Intersection #124: US 101 Southbound Ramps and Dunne Avenue

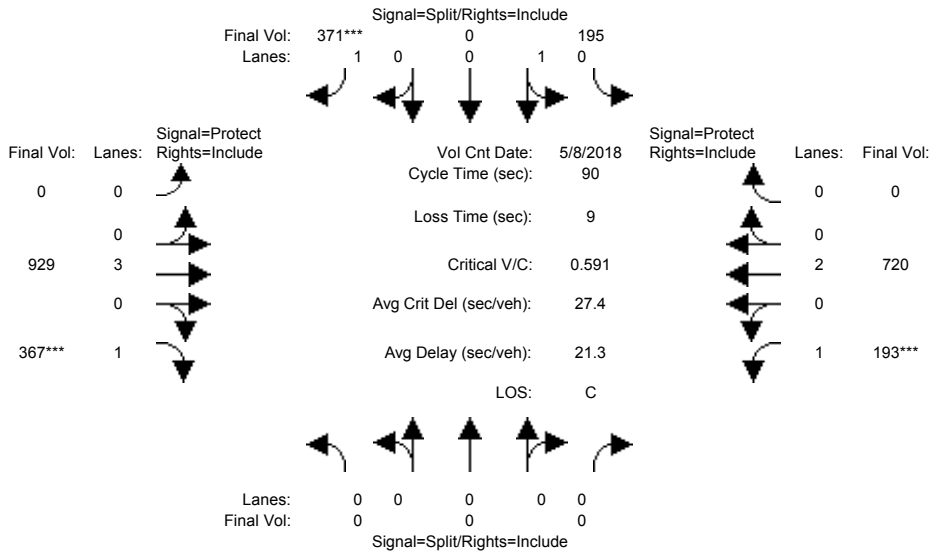

Street Name:	US 101 Southbound Ramps						Dunne Avenue					
	North Bound			South Bound			East Bound			West Bound		
Movement:	L	T	R	L	T	R	L	T	R	L	T	R
Min. Green:	0	0	0	10	10	10	0	10	10	7	10	0
Y+R:	4.0	4.0	4.0	4.0	4.0	4.0	4.0	4.0	4.0	4.0	4.0	4.0

Volume Module:	>>	Count	Date:	8 May 2018	<<							
Base Vol:	0	0	0	195	0	294	0	860	329	120	637	0
Growth Adj:	1.00	1.00	1.00	1.00	1.00	1.00	1.00	1.00	1.00	1.00	1.00	1.00
Initial Bse:	0	0	0	195	0	294	0	860	329	120	637	0
Added Vol:	0	0	0	0	0	55	0	32	0	0	5	0
PasserByVol:	0	0	0	0	0	22	0	37	38	73	78	0
Initial Fut:	0	0	0	195	0	371	0	929	367	193	720	0
User Adj:	1.00	1.00	1.00	1.00	1.00	1.00	1.00	1.00	1.00	1.00	1.00	1.00
PHF Adj:	1.00	1.00	1.00	1.00	1.00	1.00	1.00	1.00	1.00	1.00	1.00	1.00
PHF Volume:	0	0	0	195	0	371	0	929	367	193	720	0
Reduct Vol:	0	0	0	0	0	0	0	0	0	0	0	0
Reduced Vol:	0	0	0	195	0	371	0	929	367	193	720	0
PCE Adj:	1.00	1.00	1.00	1.00	1.00	1.00	1.00	1.00	1.00	1.00	1.00	1.00
MLF Adj:	1.00	1.00	1.00	1.00	1.00	1.00	1.00	1.00	1.00	1.00	1.00	1.00
FinalVolume:	0	0	0	195	0	371	0	929	367	193	720	0

Saturation Flow Module:	
Sat/Lane:	1900 1900 1900 1900 1900 1900 1900 1900 1900 1900 1900 1900
Adjustment:	0.92 1.00 0.92 0.95 0.95 0.92 0.92 1.00 0.92 0.92 1.00 0.92
Lanes:	0.00 0.00 0.00 1.00 0.00 1.00 0.00 3.00 1.00 1.00 2.00 0.00
Final Sat.:	0 0 0 1800 0 1750 0 5700 1750 1750 3800 0

Capacity Analysis Module:	
Vol/Sat:	0.00 0.00 0.00 0.11 0.00 0.21 0.00 0.16 0.21 0.11 0.19 0.00
Crit Moves:	****
Green Time:	0.0 0.0 0.0 32.3 0.0 32.3 0.0 31.9 31.9 16.8 48.7 0.0
Volume/Cap:	0.00 0.00 0.00 0.30 0.00 0.59 0.00 0.46 0.59 0.59 0.35 0.00
Delay/Veh:	0.0 0.0 0.0 21.0 0.0 25.0 0.0 22.5 25.2 36.3 11.8 0.0
User DelAdj:	1.00 1.00 1.00 1.00 1.00 1.00 1.00 1.00 1.00 1.00 1.00 1.00
AdjDel/Veh:	0.0 0.0 0.0 21.0 0.0 25.0 0.0 22.5 25.2 36.3 11.8 0.0
LOS by Move:	A A A C A C A C C D B A
HCM2kAvgQ:	0 0 0 4 0 9 0 6 9 6 6 0

Note: Queue reported is the number of cars per lane.

Voices School
Morgan Hill, CA
Hexagon Transportation Consultants, Inc.

Level Of Service Computation Report
2000 HCM Operations (Future Volume Alternative)
2025 No Project (AM)

Intersection #125: US 101 Northbound Ramps and Dunne Avenue

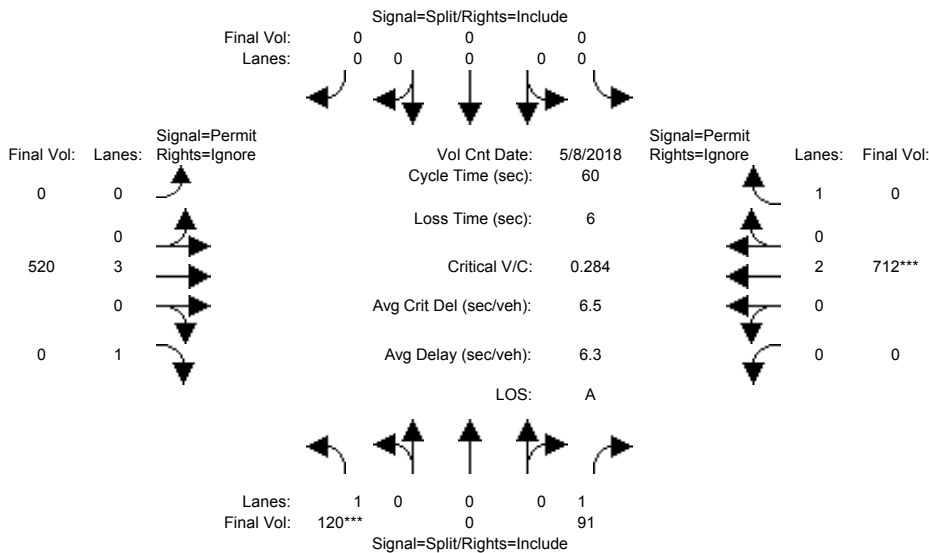

Street Name:	US 101 Northbound Ramps						Dunne Avenue					
	North Bound			South Bound			East Bound			West Bound		
Approach:	L	T	R	L	T	R	L	T	R	L	T	R
Min. Green:	10	0	10	0	0	0	0	10	10	0	10	10
Y+R:	4.0	4.0	4.0	4.0	4.0	4.0	4.0	4.0	4.0	4.0	4.0	4.0

Volume Module:	>>	Count	Date:	8 May 2018	<<							
Base Vol:	97	0	43	0	0	0	0	450	0	0	669	0
Growth Adj:	1.00	1.00	1.00	1.00	1.00	1.00	1.00	1.00	1.00	1.00	1.00	1.00
Initial Bse:	97	0	43	0	0	0	0	450	0	0	669	0
Added Vol:	0	0	0	0	0	0	0	0	0	0	0	0
PasserByVol:	23	0	48	0	0	0	0	70	0	0	43	0
Initial Fut:	120	0	91	0	0	0	0	520	0	0	712	0
User Adj:	1.00	1.00	1.00	1.00	1.00	1.00	1.00	1.00	0.00	1.00	1.00	0.00
PHF Adj:	1.00	1.00	1.00	1.00	1.00	1.00	1.00	1.00	0.00	1.00	1.00	0.00
PHF Volume:	120	0	91	0	0	0	0	520	0	0	712	0
Reduct Vol:	0	0	0	0	0	0	0	0	0	0	0	0
Reduced Vol:	120	0	91	0	0	0	0	520	0	0	712	0
PCE Adj:	1.00	1.00	1.00	1.00	1.00	1.00	1.00	1.00	0.00	1.00	1.00	0.00
MLF Adj:	1.00	1.00	1.00	1.00	1.00	1.00	1.00	1.00	0.00	1.00	1.00	0.00
FinalVolume:	120	0	91	0	0	0	0	520	0	0	712	0

Saturation Flow Module:	
Sat/Lane:	1900 1900 1900 1900 1900 1900 1900 1900 1900 1900 1900 1900
Adjustment:	0.92 1.00 0.92 0.92 1.00 0.92 0.92 1.00 0.92 0.92 1.00 0.92
Lanes:	1.00 0.00 1.00 0.00 0.00 0.00 0.00 3.00 1.00 0.00 2.00 1.00
Final Sat.:	1750 0 1750 0 0 0 0 5700 1750 0 3800 1750

Capacity Analysis Module:	
Vol/Sat:	0.07 0.00 0.05 0.00 0.00 0.00 0.00 0.09 0.00 0.00 0.19 0.00
Crit Moves:	****
Green Time:	14.5 0.0 14.5 0.0 0.0 0.0 0.0 39.5 0.0 0.0 39.5 0.0
Volume/Cap:	0.28 0.00 0.22 0.00 0.00 0.00 0.00 0.14 0.00 0.00 0.28 0.00
Delay/Veh:	18.9 0.0 18.5 0.0 0.0 0.0 0.0 3.9 0.0 0.0 4.4 0.0
User DelAdj:	1.00 1.00 1.00 1.00 1.00 1.00 1.00 1.00 1.00 1.00 1.00 1.00
AdjDel/Veh:	18.9 0.0 18.5 0.0 0.0 0.0 0.0 3.9 0.0 0.0 4.4 0.0
LOS by Move:	B A B A A A A A A A A A
HCM2kAvgQ:	2 0 2 0 0 0 0 1 0 0 3 0

Note: Queue reported is the number of cars per lane.

Voices School
Morgan Hill, CA
Hexagon Transportation Consultants, Inc.

Level Of Service Computation Report
2000 HCM Operations (Future Volume Alternative)
2025 No Project (PM)

Intersection #125: US 101 Northbound Ramps and Dunne Avenue

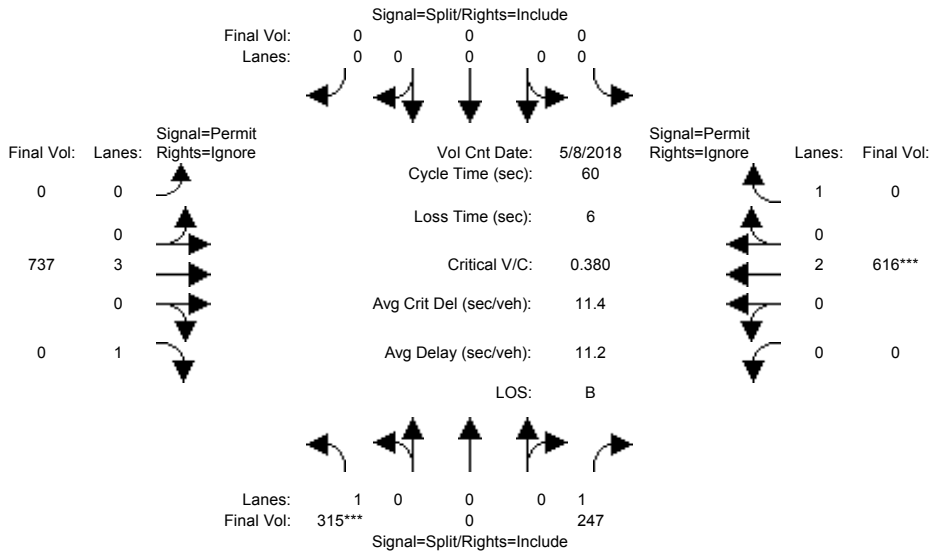

Street Name:	US 101 Northbound Ramps						Dunne Avenue					
	North Bound			South Bound			East Bound			West Bound		
Approach:	L	T	R	L	T	R	L	T	R	L	T	R
Min. Green:	10	0	10	0	0	0	0	10	10	0	10	10
Y+R:	4.0	4.0	4.0	4.0	4.0	4.0	4.0	4.0	4.0	4.0	4.0	4.0

Volume Module:	>>	Count	Date:	8 May 2018	<<							
Base Vol:	296	0	155	0	0	0	0	720	0	0	484	0
Growth Adj:	1.00	1.00	1.00	1.00	1.00	1.00	1.00	1.00	1.00	1.00	1.00	1.00
Initial Bse:	296	0	155	0	0	0	0	720	0	0	484	0
Added Vol:	0	0	0	0	0	0	0	0	0	0	0	0
PasserByVol:	19	0	92	0	0	0	0	17	0	0	132	0
Initial Fut:	315	0	247	0	0	0	0	737	0	0	616	0
User Adj:	1.00	1.00	1.00	1.00	1.00	1.00	1.00	1.00	0.00	1.00	1.00	0.00
PHF Adj:	1.00	1.00	1.00	1.00	1.00	1.00	1.00	1.00	0.00	1.00	1.00	0.00
PHF Volume:	315	0	247	0	0	0	0	737	0	0	616	0
Reduct Vol:	0	0	0	0	0	0	0	0	0	0	0	0
Reduced Vol:	315	0	247	0	0	0	0	737	0	0	616	0
PCE Adj:	1.00	1.00	1.00	1.00	1.00	1.00	1.00	1.00	0.00	1.00	1.00	0.00
MLF Adj:	1.00	1.00	1.00	1.00	1.00	1.00	1.00	1.00	0.00	1.00	1.00	0.00
FinalVolume:	315	0	247	0	0	0	0	737	0	0	616	0

Saturation Flow Module:												
Sat/Lane:	1900	1900	1900	1900	1900	1900	1900	1900	1900	1900	1900	1900
Adjustment:	0.92	1.00	0.92	0.92	1.00	0.92	0.92	1.00	0.92	0.92	1.00	0.92
Lanes:	1.00	0.00	1.00	0.00	0.00	0.00	0.00	3.00	1.00	0.00	2.00	1.00
Final Sat.:	1750	0	1750	0	0	0	0	5700	1750	0	3800	1750

Capacity Analysis Module:															
Vol/Sat:	0.18	0.00	0.14	0.00	0.00	0.00	0.00	0.13	0.00	0.00	0.16	0.00			
Crit Moves:	****												****		
Green Time:	28.4	0.0	28.4	0.0	0.0	0.0	0.0	25.6	0.0	0.0	25.6	0.0			
Volume/Cap:	0.38	0.00	0.30	0.00	0.00	0.00	0.00	0.30	0.00	0.00	0.38	0.00			
Delay/Veh:	10.4	0.0	9.9	0.0	0.0	0.0	0.0	11.4	0.0	0.0	11.9	0.0			
User DelAdj:	1.00	1.00	1.00	1.00	1.00	1.00	1.00	1.00	1.00	1.00	1.00	1.00			
AdjDel/Veh:	10.4	0.0	9.9	0.0	0.0	0.0	0.0	11.4	0.0	0.0	11.9	0.0			
LOS by Move:	B	A	A	A	A	A	A	B	A	A	B	A			
HCM2kAvgQ:	4	0	3	0	0	0	0	3	0	0	4	0			

Note: Queue reported is the number of cars per lane.

Voices School
Morgan Hill, CA
Hexagon Transportation Consultants, Inc.

Level Of Service Computation Report
2000 HCM Operations (Future Volume Alternative)
2025 Plus Project (AM) - 2 Cosmo Right out

Intersection #125: US 101 Northbound Ramps and Dunne Avenue

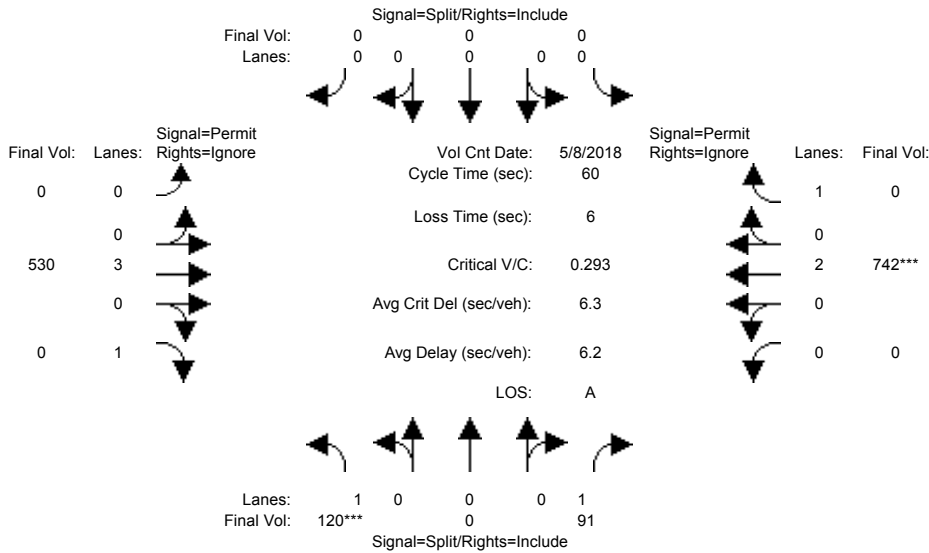

Street Name:	US 101 Northbound Ramps						Dunne Avenue					
	North Bound			South Bound			East Bound			West Bound		
Approach:	L	T	R	L	T	R	L	T	R	L	T	R
Min. Green:	10	0	10	0	0	0	0	10	10	0	10	10
Y+R:	4.0	4.0	4.0	4.0	4.0	4.0	4.0	4.0	4.0	4.0	4.0	4.0

Volume Module:	>>	Count	Date:	8 May 2018	<<							
Base Vol:	97	0	43	0	0	0	0	450	0	0	669	0
Growth Adj:	1.00	1.00	1.00	1.00	1.00	1.00	1.00	1.00	1.00	1.00	1.00	1.00
Initial Bse:	97	0	43	0	0	0	0	450	0	0	669	0
Added Vol:	0	0	0	0	0	0	0	10	108	0	30	0
PasserByVol:	23	0	48	0	0	0	0	70	0	0	43	0
Initial Fut:	120	0	91	0	0	0	0	530	108	0	742	0
User Adj:	1.00	1.00	1.00	1.00	1.00	1.00	1.00	1.00	0.00	1.00	1.00	0.00
PHF Adj:	1.00	1.00	1.00	1.00	1.00	1.00	1.00	1.00	0.00	1.00	1.00	0.00
PHF Volume:	120	0	91	0	0	0	0	530	0	0	742	0
Reduct Vol:	0	0	0	0	0	0	0	0	0	0	0	0
Reduced Vol:	120	0	91	0	0	0	0	530	0	0	742	0
PCE Adj:	1.00	1.00	1.00	1.00	1.00	1.00	1.00	1.00	0.00	1.00	1.00	0.00
MLF Adj:	1.00	1.00	1.00	1.00	1.00	1.00	1.00	1.00	0.00	1.00	1.00	0.00
FinalVolume:	120	0	91	0	0	0	0	530	0	0	742	0

Saturation Flow Module:	
Sat/Lane:	1900 1900 1900 1900 1900 1900 1900 1900 1900 1900 1900 1900
Adjustment:	0.92 1.00 0.92 0.92 1.00 0.92 0.92 1.00 0.92 0.92 1.00 0.92
Lanes:	1.00 0.00 1.00 0.00 0.00 0.00 0.00 3.00 1.00 0.00 2.00 1.00
Final Sat.:	1750 0 1750 0 0 0 0 5700 1750 0 3800 1750

Capacity Analysis Module:	
Vol/Sat:	0.07 0.00 0.05 0.00 0.00 0.00 0.00 0.09 0.00 0.00 0.20 0.00
Crit Moves:	****
Green Time:	14.0 0.0 14.0 0.0 0.0 0.0 0.0 40.0 0.0 0.0 40.0 0.0
Volume/Cap:	0.29 0.00 0.22 0.00 0.00 0.00 0.00 0.14 0.00 0.00 0.29 0.00
Delay/Veh:	19.3 0.0 18.8 0.0 0.0 0.0 0.0 3.7 0.0 0.0 4.2 0.0
User DelAdj:	1.00 1.00 1.00 1.00 1.00 1.00 1.00 1.00 1.00 1.00 1.00 1.00
AdjDel/Veh:	19.3 0.0 18.8 0.0 0.0 0.0 0.0 3.7 0.0 0.0 4.2 0.0
LOS by Move:	B A B A A A A A A A A A
HCM2kAvgQ:	2 0 2 0 0 0 0 1 0 0 3 0

Note: Queue reported is the number of cars per lane.

Voices School
Morgan Hill, CA
Hexagon Transportation Consultants, Inc.

Level Of Service Computation Report
2000 HCM Operations (Future Volume Alternative)
2025 Plus Project (PM) - 2 Cosmo Right out

Intersection #125: US 101 Northbound Ramps and Dunne Avenue

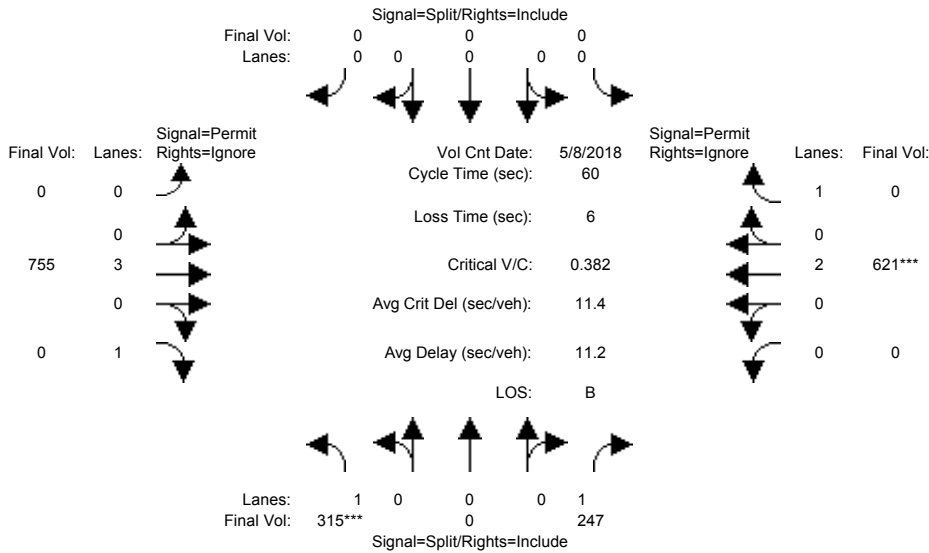

Street Name:	US 101 Northbound Ramps						Dunne Avenue					
	North Bound			South Bound			East Bound			West Bound		
Approach:	L	T	R	L	T	R	L	T	R	L	T	R
Min. Green:	10	0	10	0	0	0	0	10	10	0	10	10
Y+R:	4.0	4.0	4.0	4.0	4.0	4.0	4.0	4.0	4.0	4.0	4.0	4.0

Volume Module:	>>	Count	Date:	8 May 2018	<<							
Base Vol:	296	0	155	0	0	0	0	720	0	0	484	0
Growth Adj:	1.00	1.00	1.00	1.00	1.00	1.00	1.00	1.00	1.00	1.00	1.00	1.00
Initial Bse:	296	0	155	0	0	0	0	720	0	0	484	0
Added Vol:	0	0	0	0	0	0	0	18	14	0	5	0
PasserByVol:	19	0	92	0	0	0	0	17	0	0	132	0
Initial Fut:	315	0	247	0	0	0	0	755	14	0	621	0
User Adj:	1.00	1.00	1.00	1.00	1.00	1.00	1.00	1.00	0.00	1.00	1.00	0.00
PHF Adj:	1.00	1.00	1.00	1.00	1.00	1.00	1.00	1.00	0.00	1.00	1.00	0.00
PHF Volume:	315	0	247	0	0	0	0	755	0	0	621	0
Reduct Vol:	0	0	0	0	0	0	0	0	0	0	0	0
Reduced Vol:	315	0	247	0	0	0	0	755	0	0	621	0
PCE Adj:	1.00	1.00	1.00	1.00	1.00	1.00	1.00	1.00	0.00	1.00	1.00	0.00
MLF Adj:	1.00	1.00	1.00	1.00	1.00	1.00	1.00	1.00	0.00	1.00	1.00	0.00
FinalVolume:	315	0	247	0	0	0	0	755	0	0	621	0

Saturation Flow Module:												
Sat/Lane:	1900	1900	1900	1900	1900	1900	1900	1900	1900	1900	1900	1900
Adjustment:	0.92	1.00	0.92	0.92	1.00	0.92	0.92	1.00	0.92	0.92	1.00	0.92
Lanes:	1.00	0.00	1.00	0.00	0.00	0.00	0.00	3.00	1.00	0.00	2.00	1.00
Final Sat.:	1750	0	1750	0	0	0	0	5700	1750	0	3800	1750

Capacity Analysis Module:												
Vol/Sat:	0.18	0.00	0.14	0.00	0.00	0.00	0.00	0.13	0.00	0.00	0.16	0.00
Crit Moves:	****			****								
Green Time:	28.3	0.0	28.3	0.0	0.0	0.0	0.0	25.7	0.0	0.0	25.7	0.0
Volume/Cap:	0.38	0.00	0.30	0.00	0.00	0.00	0.00	0.31	0.00	0.00	0.38	0.00
Delay/Veh:	10.5	0.0	10.0	0.0	0.0	0.0	0.0	11.4	0.0	0.0	11.9	0.0
User DelAdj:	1.00	1.00	1.00	1.00	1.00	1.00	1.00	1.00	1.00	1.00	1.00	1.00
AdjDel/Veh:	10.5	0.0	10.0	0.0	0.0	0.0	0.0	11.4	0.0	0.0	11.9	0.0
LOS by Move:	B	A	A	A	A	A	A	B	A	A	B	A
HCM2kAvgQ:	4	0	3	0	0	0	0	3	0	0	4	0

Note: Queue reported is the number of cars per lane.

Voices School
Morgan Hill, CA
Hexagon Transportation Consultants, Inc.

Level Of Service Computation Report
2000 HCM Operations (Future Volume Alternative)
2025 No Project (AM)

Intersection #422: Monterey Road and Butterfield Boulevard/Watsonville Road

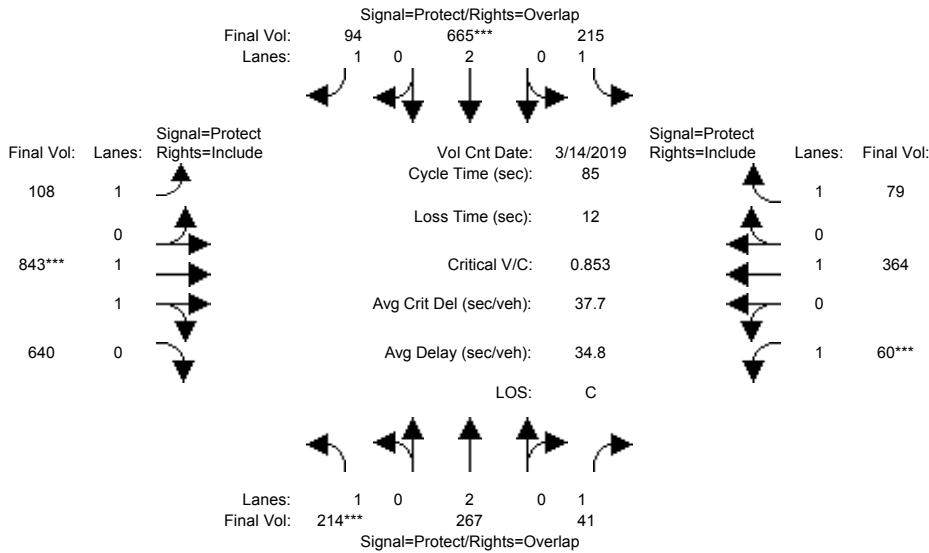

Street Name: Monterey Rd Butterfield Blvd/Watsonville Rd
Approach: North Bound South Bound East Bound West Bound
Movement: L - T - R L - T - R L - T - R L - T - R

Min. Green:	7	10	10	7	10	10	7	10	10	7	10	10
Y+R:	4.0	4.0	4.0	4.0	4.0	4.0	4.0	4.0	4.0	4.0	4.0	4.0

Volume Module: >> Count Date: 14 Mar 2019 <<

Base Vol:	204	150	15	186	597	88	58	703	607	21	278	66
Growth Adj:	1.00	1.00	1.00	1.00	1.00	1.00	1.00	1.00	1.00	1.00	1.00	1.00
Initial Bse:	204	150	15	186	597	88	58	703	607	21	278	66
Added Vol:	0	0	0	0	0	0	0	0	0	0	0	0
PasserByVol:	10	117	26	29	68	6	50	140	33	39	86	13
Initial Fut:	214	267	41	215	665	94	108	843	640	60	364	79
User Adj:	1.00	1.00	1.00	1.00	1.00	1.00	1.00	1.00	1.00	1.00	1.00	1.00
PHF Adj:	1.00	1.00	1.00	1.00	1.00	1.00	1.00	1.00	1.00	1.00	1.00	1.00
PHF Volume:	214	267	41	215	665	94	108	843	640	60	364	79
Reduct Vol:	0	0	0	0	0	0	0	0	0	0	0	0
Reduced Vol:	214	267	41	215	665	94	108	843	640	60	364	79
PCE Adj:	1.00	1.00	1.00	1.00	1.00	1.00	1.00	1.00	1.00	1.00	1.00	1.00
MLF Adj:	1.00	1.00	1.00	1.00	1.00	1.00	1.00	1.00	1.00	1.00	1.00	1.00
FinalVolume:	214	267	41	215	665	94	108	843	640	60	364	79

Saturation Flow Module:

Sat/Lane:	1900	1900	1900	1900	1900	1900	1900	1900	1900	1900	1900	1900
Adjustment:	0.92	1.00	0.92	0.92	1.00	0.92	0.92	0.99	0.95	0.92	1.00	0.92
Lanes:	1.00	2.00	1.00	1.00	2.00	1.00	1.00	1.11	0.89	1.00	1.00	1.00
Final Sat.:	1750	3800	1750	1750	3800	1750	1750	2102	1596	1750	1900	1750

Capacity Analysis Module:

Vol/Sat:	0.12	0.07	0.02	0.12	0.17	0.05	0.06	0.40	0.40	0.03	0.19	0.05
Crit Moves:	***				***			***		***		
Green Time:	11.6	13.7	20.7	14.4	16.5	30.0	13.5	37.9	37.9	7.0	31.4	31.4
Volume/Cap:	0.90	0.43	0.10	0.73	0.90	0.15	0.39	0.90	0.90	0.42	0.52	0.12
Delay/Veh:	69.0	32.6	25.0	42.3	47.4	18.9	33.0	28.9	28.9	39.0	21.6	17.8
User DelAdj:	1.00	1.00	1.00	1.00	1.00	1.00	1.00	1.00	1.00	1.00	1.00	1.00
AdjDel/Veh:	69.0	32.6	25.0	42.3	47.4	18.9	33.0	28.9	28.9	39.0	21.6	17.8
LOS by Move:	E	C	C	D	D	B	C	C	C	D	C	B
HCM2kAvgQ:	9	4	1	6	10	2	3	22	22	2	8	1

Note: Queue reported is the number of cars per lane.

Voices School
Morgan Hill, CA
Hexagon Transportation Consultants, Inc.

Level Of Service Computation Report
2000 HCM Operations (Future Volume Alternative)
2025 No Project (PM)

Intersection #422: Monterey Road and Butterfield Boulevard/Watsonville Road

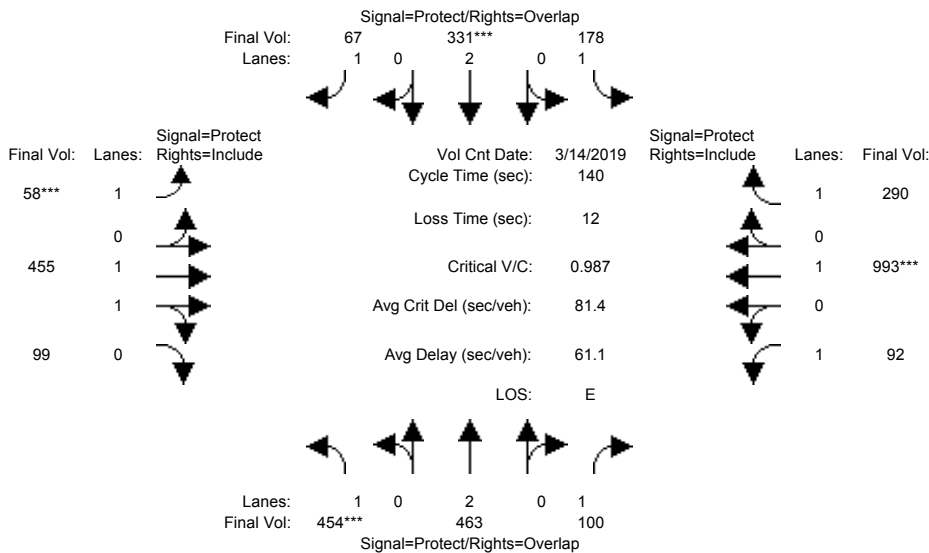

Street Name: Monterey Rd Butterfield Blvd/Watsonville Rd

Approach: North Bound South Bound East Bound West Bound

Movement: L - T - R L - T - R L - T - R L - T - R

Min. Green: 7 10 10 7 10 10 7 10 10 7 10 10

Y+R: 4.0 4.0 4.0 4.0 4.0 4.0 4.0 4.0 4.0 4.0 4.0 4.0

Volume Module: >> Count Date: 14 Mar 2019 <<

Base Vol:	426	356	26	164	235	47	43	381	88	22	858	266
Growth Adj:	1.00	1.00	1.00	1.00	1.00	1.00	1.00	1.00	1.00	1.00	1.00	1.00
Initial Bse:	426	356	26	164	235	47	43	381	88	22	858	266
Added Vol:	0	0	0	0	0	0	0	0	0	0	0	0
PasserByVol:	28	107	74	14	96	20	15	74	11	70	135	24
Initial Fut:	454	463	100	178	331	67	58	455	99	92	993	290
User Adj:	1.00	1.00	1.00	1.00	1.00	1.00	1.00	1.00	1.00	1.00	1.00	1.00
PHF Adj:	1.00	1.00	1.00	1.00	1.00	1.00	1.00	1.00	1.00	1.00	1.00	1.00
PHF Volume:	454	463	100	178	331	67	58	455	99	92	993	290
Reduct Vol:	0	0	0	0	0	0	0	0	0	0	0	0
Reduced Vol:	454	463	100	178	331	67	58	455	99	92	993	290
PCE Adj:	1.00	1.00	1.00	1.00	1.00	1.00	1.00	1.00	1.00	1.00	1.00	1.00
MLF Adj:	1.00	1.00	1.00	1.00	1.00	1.00	1.00	1.00	1.00	1.00	1.00	1.00
FinalVolume:	454	463	100	178	331	67	58	455	99	92	993	290

Saturation Flow Module:

Sat/Lane:	1900	1900	1900	1900	1900	1900	1900	1900	1900	1900	1900	1900
Adjustment:	0.92	1.00	0.92	0.92	1.00	0.92	0.92	0.98	0.95	0.92	1.00	0.92
Lanes:	1.00	2.00	1.00	1.00	2.00	1.00	1.00	1.63	0.37	1.00	1.00	1.00
Final Sat.:	1750	3800	1750	1750	3800	1750	1750	3038	661	1750	1900	1750

Capacity Analysis Module:

Vol/Sat:	0.26	0.12	0.06	0.10	0.09	0.04	0.03	0.15	0.15	0.05	0.52	0.17
Crit Moves:	***				***		***				***	
Green Time:	36.1	26.3	47.0	21.9	12.1	19.1	7.0	59.0	59.0	20.7	72.8	72.8
Volume/Cap:	1.01	0.65	0.17	0.65	1.01	0.28	0.66	0.36	0.36	0.36	1.01	0.32
Delay/Veh:	95.7	54.7	32.9	60.8	115	54.9	82.8	27.7	27.7	54.5	63.6	19.6
User DelAdj:	1.00	1.00	1.00	1.00	1.00	1.00	1.00	1.00	1.00	1.00	1.00	1.00
AdjDel/Veh:	95.7	54.7	32.9	60.8	115	54.9	82.8	27.7	27.7	54.5	63.6	19.6
LOS by Move:	F	D	C	E	F	D	F	C	C	D	E	B
HCM2kAvgQ:	27	10	3	8	9	3	4	8	8	4	50	8

Note: Queue reported is the number of cars per lane.

Voices School
Morgan Hill, CA
Hexagon Transportation Consultants, Inc.

Level Of Service Computation Report
2000 HCM Operations (Future Volume Alternative)
2025 Plus Project (AM) - 2 Cosmo Right out

Intersection #422: Monterey Road and Butterfield Boulevard/Watsonville Road

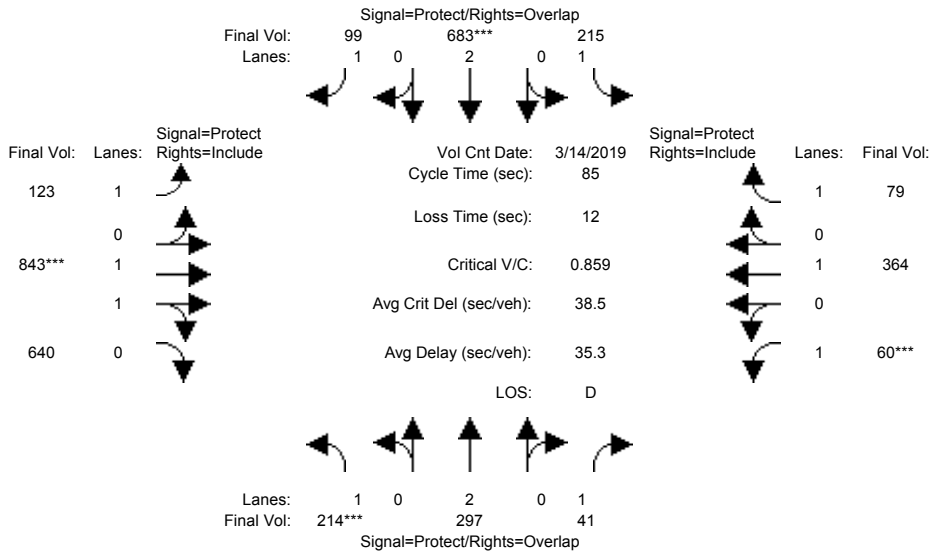

Street Name: Monterey Rd Butterfield Blvd/Watsonville Rd
Approach: North Bound South Bound East Bound West Bound
Movement: L - T - R L - T - R L - T - R L - T - R

Min. Green:	7	10	10	7	10	10	7	10	10	7	10	10
Y+R:	4.0	4.0	4.0	4.0	4.0	4.0	4.0	4.0	4.0	4.0	4.0	4.0

Volume Module: >> Count Date: 14 Mar 2019 <<

Base Vol:	204	150	15	186	597	88	58	703	607	21	278	66
Growth Adj:	1.00	1.00	1.00	1.00	1.00	1.00	1.00	1.00	1.00	1.00	1.00	1.00
Initial Bse:	204	150	15	186	597	88	58	703	607	21	278	66
Added Vol:	0	30	0	0	18	5	15	0	0	0	0	0
PasserByVol:	10	117	26	29	68	6	50	140	33	39	86	13
Initial Fut:	214	297	41	215	683	99	123	843	640	60	364	79
User Adj:	1.00	1.00	1.00	1.00	1.00	1.00	1.00	1.00	1.00	1.00	1.00	1.00
PHF Adj:	1.00	1.00	1.00	1.00	1.00	1.00	1.00	1.00	1.00	1.00	1.00	1.00
PHF Volume:	214	297	41	215	683	99	123	843	640	60	364	79
Reduct Vol:	0	0	0	0	0	0	0	0	0	0	0	0
Reduced Vol:	214	297	41	215	683	99	123	843	640	60	364	79
PCE Adj:	1.00	1.00	1.00	1.00	1.00	1.00	1.00	1.00	1.00	1.00	1.00	1.00
MLF Adj:	1.00	1.00	1.00	1.00	1.00	1.00	1.00	1.00	1.00	1.00	1.00	1.00
FinalVolume:	214	297	41	215	683	99	123	843	640	60	364	79

Saturation Flow Module:

Sat/Lane:	1900	1900	1900	1900	1900	1900	1900	1900	1900	1900	1900	1900
Adjustment:	0.92	1.00	0.92	0.92	1.00	0.92	0.92	0.99	0.95	0.92	1.00	0.92
Lanes:	1.00	2.00	1.00	1.00	2.00	1.00	1.00	1.11	0.89	1.00	1.00	1.00
Final Sat.:	1750	3800	1750	1750	3800	1750	1750	2102	1596	1750	1900	1750

Capacity Analysis Module:

Vol/Sat:	0.12	0.08	0.02	0.12	0.18	0.06	0.07	0.40	0.40	0.03	0.19	0.05
Crit Moves:	***				***			***		***		
Green Time:	11.5	13.9	20.9	14.5	16.9	30.3	13.4	37.6	37.6	7.0	31.2	31.2
Volume/Cap:	0.91	0.48	0.10	0.72	0.91	0.16	0.45	0.91	0.91	0.42	0.52	0.12
Delay/Veh:	70.5	32.9	24.9	41.7	47.8	18.8	33.6	29.6	29.6	39.0	21.8	17.9
User DelAdj:	1.00	1.00	1.00	1.00	1.00	1.00	1.00	1.00	1.00	1.00	1.00	1.00
AdjDel/Veh:	70.5	32.9	24.9	41.7	47.8	18.8	33.6	29.6	29.6	39.0	21.8	17.9
LOS by Move:	E	C	C	D	D	B	C	C	C	D	C	B
HCM2kAvgQ:	9	4	1	6	10	2	4	23	23	2	8	1

Note: Queue reported is the number of cars per lane.

Voices School
Morgan Hill, CA
Hexagon Transportation Consultants, Inc.

Level Of Service Computation Report
2000 HCM Operations (Future Volume Alternative)
2025 Plus Project (PM) - 2 Cosmo Right out

Intersection #422: Monterey Road and Butterfield Boulevard/Watsonville Road

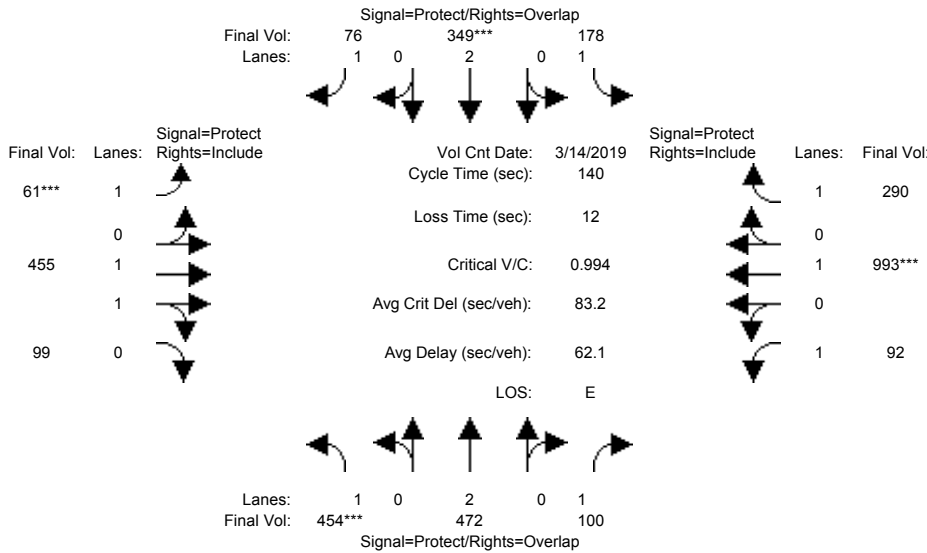

Street Name:	Monterey Rd						Butterfield Blvd/Watsonville Rd					
Approach:	North Bound			South Bound			East Bound			West Bound		
Movement:	L	T	R	L	T	R	L	T	R	L	T	R

Min. Green:	7	10	10	7	10	10	7	10	10	7	10	10
Y+R:	4.0	4.0	4.0	4.0	4.0	4.0	4.0	4.0	4.0	4.0	4.0	4.0

Volume Module:	>>	Count	Date:	14 Mar 2019	<<							
Base Vol:	426	356	26	164	235	47	43	381	88	22	858	266
Growth Adj:	1.00	1.00	1.00	1.00	1.00	1.00	1.00	1.00	1.00	1.00	1.00	1.00
Initial Bse:	426	356	26	164	235	47	43	381	88	22	858	266
Added Vol:	0	9	0	0	18	9	3	0	0	0	0	0
PasserByVol:	28	107	74	14	96	20	15	74	11	70	135	24
Initial Fut:	454	472	100	178	349	76	61	455	99	92	993	290
User Adj:	1.00	1.00	1.00	1.00	1.00	1.00	1.00	1.00	1.00	1.00	1.00	1.00
PHF Adj:	1.00	1.00	1.00	1.00	1.00	1.00	1.00	1.00	1.00	1.00	1.00	1.00
PHF Volume:	454	472	100	178	349	76	61	455	99	92	993	290
Reduct Vol:	0	0	0	0	0	0	0	0	0	0	0	0
Reduced Vol:	454	472	100	178	349	76	61	455	99	92	993	290
PCE Adj:	1.00	1.00	1.00	1.00	1.00	1.00	1.00	1.00	1.00	1.00	1.00	1.00
MLF Adj:	1.00	1.00	1.00	1.00	1.00	1.00	1.00	1.00	1.00	1.00	1.00	1.00
Final Volume:	454	472	100	178	349	76	61	455	99	92	993	290

Saturation Flow Module:												
Sat/Lane:	1900	1900	1900	1900	1900	1900	1900	1900	1900	1900	1900	1900
Adjustment:	0.92	1.00	0.92	0.92	1.00	0.92	0.92	0.98	0.95	0.92	1.00	0.92
Lanes:	1.00	2.00	1.00	1.00	2.00	1.00	1.00	1.63	0.37	1.00	1.00	1.00
Final Sat.:	1750	3800	1750	1750	3800	1750	1750	3038	661	1750	1900	1750

Capacity Analysis Module:												
Vol/Sat:	0.26	0.12	0.06	0.10	0.09	0.04	0.03	0.15	0.15	0.05	0.52	0.17
Crit Moves:	***				***		***				***	
Green Time:	35.9	26.7	47.4	21.9	12.7	19.7	7.0	58.7	58.7	20.6	72.4	72.4
Volume/Cap:	1.01	0.65	0.17	0.65	1.01	0.31	0.70	0.36	0.36	0.36	1.01	0.32
Delay/Veh:	97.3	54.4	32.6	60.9	115	54.7	87.3	27.9	27.9	54.6	65.3	19.8
User DelAdj:	1.00	1.00	1.00	1.00	1.00	1.00	1.00	1.00	1.00	1.00	1.00	1.00
AdjDel/Veh:	97.3	54.4	32.6	60.9	115	54.7	87.3	27.9	27.9	54.6	65.3	19.8
LOS by Move:	F	D	C	E	F	D	F	C	C	D	E	B
HCM2kAvgQ:	27	10	3	8	9	3	4	8	8	4	50	8

Note: Queue reported is the number of cars per lane.

Voices School
Morgan Hill, CA
Hexagon Transportation Consultants, Inc.

Level Of Service Computation Report
2000 HCM Operations (Future Volume Alternative)
2025 No Project (AM)

Intersection #1004: Church Street and Dunne Avenue

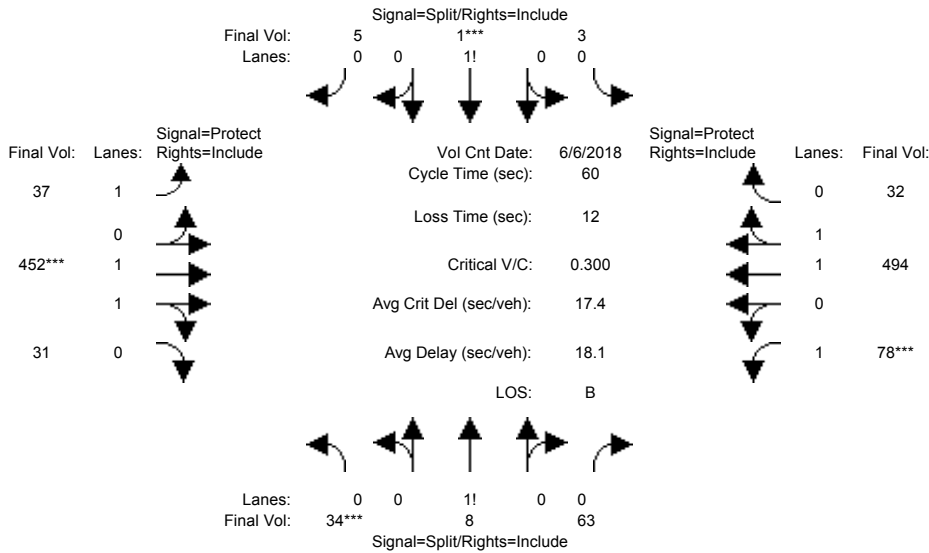

Street Name:	Church Street						Dunne Avenue					
	North Bound			South Bound			East Bound			West Bound		
Approach:	L	T	R	L	T	R	L	T	R	L	T	R
Min. Green:	10	10	10	10	10	10	7	10	10	7	10	10
Y+R:	4.0	4.0	4.0	4.0	4.0	4.0	4.0	4.0	4.0	4.0	4.0	4.0

Volume Module:	>>	Count	Date:	6 Jun 2018	<<							
Base Vol:	27	8	55	3	1	5	37	402	25	71	431	32
Growth Adj:	1.00	1.00	1.00	1.00	1.00	1.00	1.00	1.00	1.00	1.00	1.00	1.00
Initial Bse:	27	8	55	3	1	5	37	402	25	71	431	32
Added Vol:	0	0	0	0	0	0	0	0	0	0	0	0
PasserByVol:	7	0	8	0	0	0	0	50	6	7	63	0
Initial Fut:	34	8	63	3	1	5	37	452	31	78	494	32
User Adj:	1.00	1.00	1.00	1.00	1.00	1.00	1.00	1.00	1.00	1.00	1.00	1.00
PHF Adj:	1.00	1.00	1.00	1.00	1.00	1.00	1.00	1.00	1.00	1.00	1.00	1.00
PHF Volume:	34	8	63	3	1	5	37	452	31	78	494	32
Reduct Vol:	0	0	0	0	0	0	0	0	0	0	0	0
Reduced Vol:	34	8	63	3	1	5	37	452	31	78	494	32
PCE Adj:	1.00	1.00	1.00	1.00	1.00	1.00	1.00	1.00	1.00	1.00	1.00	1.00
MLF Adj:	1.00	1.00	1.00	1.00	1.00	1.00	1.00	1.00	1.00	1.00	1.00	1.00
FinalVolume:	34	8	63	3	1	5	37	452	31	78	494	32

Saturation Flow Module:												
Sat/Lane:	1900	1900	1900	1900	1900	1900	1900	1900	1900	1900	1900	1900
Adjustment:	0.92	0.92	0.92	0.92	0.92	0.92	0.92	0.98	0.95	0.92	0.98	0.95
Lanes:	0.32	0.08	0.60	0.33	0.11	0.56	1.00	1.87	0.13	1.00	1.87	0.13
Final Sat.:	567	133	1050	583	194	972	1750	3462	237	1750	3475	225

Capacity Analysis Module:												
Vol/Sat:	0.06	0.06	0.06	0.01	0.01	0.01	0.02	0.13	0.13	0.04	0.14	0.14
Crit Moves:	***				***			***		***		
Green Time:	10.0	10.0	10.0	10.0	10.0	10.0	11.5	20.9	20.9	7.1	16.5	16.5
Volume/Cap:	0.36	0.36	0.36	0.03	0.03	0.03	0.11	0.38	0.38	0.38	0.52	0.52
Delay/Veh:	22.9	22.9	22.9	21.0	21.0	21.0	20.1	14.9	14.9	25.5	18.9	18.9
User DelAdj:	1.00	1.00	1.00	1.00	1.00	1.00	1.00	1.00	1.00	1.00	1.00	1.00
AdjDel/Veh:	22.9	22.9	22.9	21.0	21.0	21.0	20.1	14.9	14.9	25.5	18.9	18.9
LOS by Move:	C	C	C	C	C	C	C	B	B	C	B	B
HCM2kAvgQ:	2	2	2	0	0	0	1	3	3	1	4	4

Note: Queue reported is the number of cars per lane.

Voices School
Morgan Hill, CA
Hexagon Transportation Consultants, Inc.

Level Of Service Computation Report
2000 HCM Operations (Future Volume Alternative)
2025 No Project (PM)

Intersection #1004: Church Street and Dunne Avenue

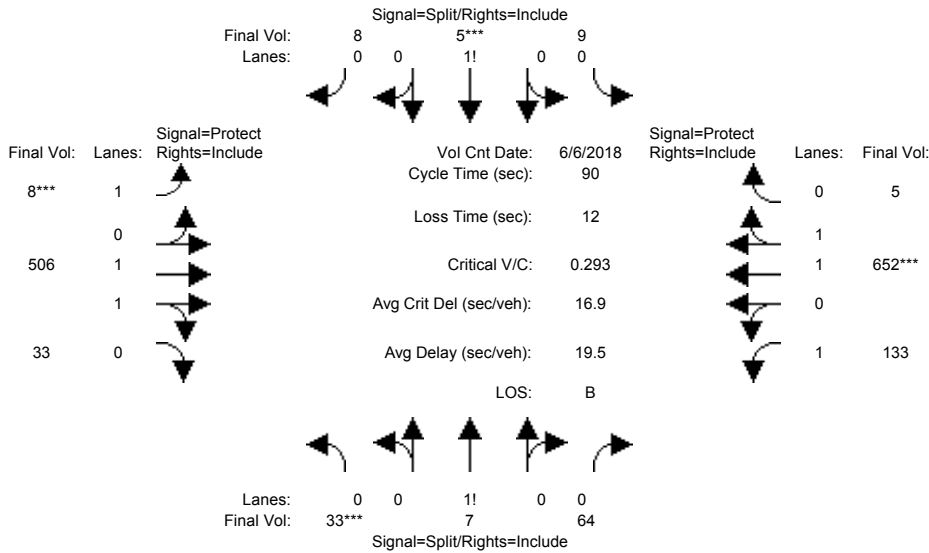

Street Name:	Church Street						Dunne Avenue					
	North Bound			South Bound			East Bound			West Bound		
Approach:	L	T	R	L	T	R	L	T	R	L	T	R
Min. Green:	10	10	10	10	10	10	7	10	10	7	10	10
Y+R:	4.0	4.0	4.0	4.0	4.0	4.0	4.0	4.0	4.0	4.0	4.0	4.0

Volume Module:	>>	Count	Date:	6 Jun 2018	<<							
Base Vol:	29	7	64	9	5	8	8	475	29	124	581	5
Growth Adj:	1.00	1.00	1.00	1.00	1.00	1.00	1.00	1.00	1.00	1.00	1.00	1.00
Initial Bse:	29	7	64	9	5	8	8	475	29	124	581	5
Added Vol:	0	0	0	0	0	0	0	0	0	0	0	0
PasserByVol:	4	0	0	0	0	0	0	31	4	9	71	0
Initial Fut:	33	7	64	9	5	8	8	506	33	133	652	5
User Adj:	1.00	1.00	1.00	1.00	1.00	1.00	1.00	1.00	1.00	1.00	1.00	1.00
PHF Adj:	1.00	1.00	1.00	1.00	1.00	1.00	1.00	1.00	1.00	1.00	1.00	1.00
PHF Volume:	33	7	64	9	5	8	8	506	33	133	652	5
Reduct Vol:	0	0	0	0	0	0	0	0	0	0	0	0
Reduced Vol:	33	7	64	9	5	8	8	506	33	133	652	5
PCE Adj:	1.00	1.00	1.00	1.00	1.00	1.00	1.00	1.00	1.00	1.00	1.00	1.00
MLF Adj:	1.00	1.00	1.00	1.00	1.00	1.00	1.00	1.00	1.00	1.00	1.00	1.00
FinalVolume:	33	7	64	9	5	8	8	506	33	133	652	5

Saturation Flow Module:												
Sat/Lane:	1900	1900	1900	1900	1900	1900	1900	1900	1900	1900	1900	1900
Adjustment:	0.92	0.92	0.92	0.92	0.92	0.92	0.92	0.98	0.95	0.92	0.97	0.95
Lanes:	0.32	0.07	0.61	0.41	0.23	0.36	1.00	1.87	0.13	1.00	1.98	0.02
Final Sat.:	555	118	1077	716	398	636	1750	3473	227	1750	3672	28

Capacity Analysis Module:												
Vol/Sat:	0.06	0.06	0.06	0.01	0.01	0.01	0.00	0.15	0.15	0.08	0.18	0.18
Crit Moves:	***				***		***				***	
Green Time:	15.3	15.3	15.3	10.0	10.0	10.0	7.0	34.4	34.4	18.3	45.7	45.7
Volume/Cap:	0.35	0.35	0.35	0.11	0.11	0.11	0.06	0.38	0.38	0.37	0.35	0.35
Delay/Veh:	33.7	33.7	33.7	36.3	36.3	36.3	38.6	20.3	20.3	31.5	13.4	13.4
User DelAdj:	1.00	1.00	1.00	1.00	1.00	1.00	1.00	1.00	1.00	1.00	1.00	1.00
AdjDel/Veh:	33.7	33.7	33.7	36.3	36.3	36.3	38.6	20.3	20.3	31.5	13.4	13.4
LOS by Move:	C	C	C	D	D	D	D	C	C	C	B	B
HCM2kAvgQ:	3	3	3	1	1	1	0	5	5	3	5	5

Note: Queue reported is the number of cars per lane.

Voices School
Morgan Hill, CA
Hexagon Transportation Consultants, Inc.

Level Of Service Computation Report
2000 HCM Operations (Future Volume Alternative)
2025 Plus Project (AM) - 2 Cosmo Right out

Intersection #1004: Church Street and Dunne Avenue

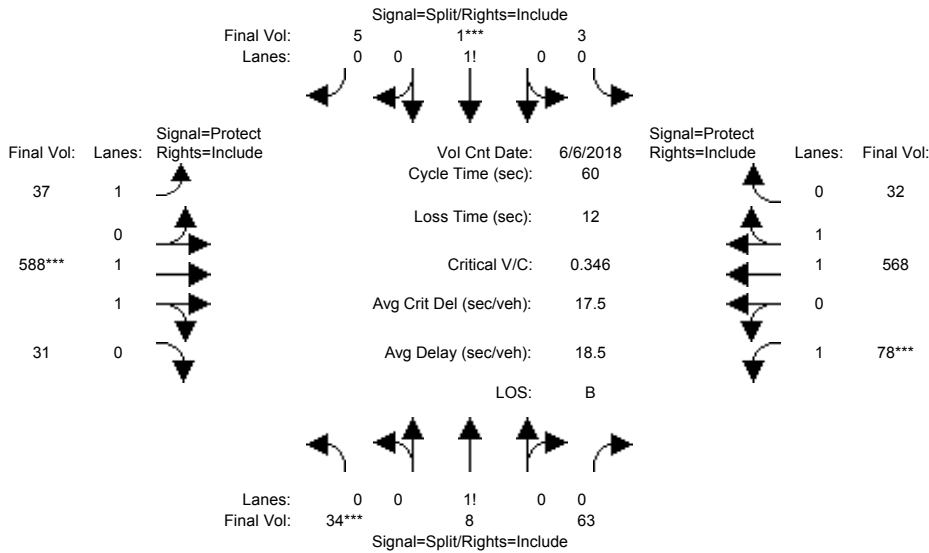

Street Name:	Church Street						Dunne Avenue					
	North Bound			South Bound			East Bound			West Bound		
Approach:	L	T	R	L	T	R	L	T	R	L	T	R
Min. Green:	10	10	10	10	10	10	7	10	10	7	10	10
Y+R:	4.0	4.0	4.0	4.0	4.0	4.0	4.0	4.0	4.0	4.0	4.0	4.0

Volume Module:	>>	Count	Date:	6 Jun 2018	<<							
Base Vol:	27	8	55	3	1	5	37	402	25	71	431	32
Growth Adj:	1.00	1.00	1.00	1.00	1.00	1.00	1.00	1.00	1.00	1.00	1.00	1.00
Initial Bse:	27	8	55	3	1	5	37	402	25	71	431	32
Added Vol:	0	0	0	0	0	0	0	136	0	0	74	0
PasserByVol:	7	0	8	0	0	0	0	50	6	7	63	0
Initial Fut:	34	8	63	3	1	5	37	588	31	78	568	32
User Adj:	1.00	1.00	1.00	1.00	1.00	1.00	1.00	1.00	1.00	1.00	1.00	1.00
PHF Adj:	1.00	1.00	1.00	1.00	1.00	1.00	1.00	1.00	1.00	1.00	1.00	1.00
PHF Volume:	34	8	63	3	1	5	37	588	31	78	568	32
Reduct Vol:	0	0	0	0	0	0	0	0	0	0	0	0
Reduced Vol:	34	8	63	3	1	5	37	588	31	78	568	32
PCE Adj:	1.00	1.00	1.00	1.00	1.00	1.00	1.00	1.00	1.00	1.00	1.00	1.00
MLF Adj:	1.00	1.00	1.00	1.00	1.00	1.00	1.00	1.00	1.00	1.00	1.00	1.00
FinalVolume:	34	8	63	3	1	5	37	588	31	78	568	32

Saturation Flow Module:												
Sat/Lane:	1900	1900	1900	1900	1900	1900	1900	1900	1900	1900	1900	1900
Adjustment:	0.92	0.92	0.92	0.92	0.92	0.92	0.92	0.98	0.95	0.92	0.98	0.95
Lanes:	0.32	0.08	0.60	0.33	0.11	0.56	1.00	1.90	0.10	1.00	1.89	0.11
Final Sat.:	567	133	1050	583	194	972	1750	3515	185	1750	3503	197

Capacity Analysis Module:												
Vol/Sat:	0.06	0.06	0.06	0.01	0.01	0.01	0.02	0.17	0.17	0.04	0.16	0.16
Crit Moves:	***				***			***		***		
Green Time:	10.0	10.0	10.0	10.0	10.0	10.0	11.5	21.0	21.0	7.0	16.5	16.5
Volume/Cap:	0.36	0.36	0.36	0.03	0.03	0.03	0.11	0.48	0.48	0.38	0.59	0.59
Delay/Veh:	22.9	22.9	22.9	21.0	21.0	21.0	20.1	15.5	15.5	25.7	19.8	19.8
User DelAdj:	1.00	1.00	1.00	1.00	1.00	1.00	1.00	1.00	1.00	1.00	1.00	1.00
AdjDel/Veh:	22.9	22.9	22.9	21.0	21.0	21.0	20.1	15.5	15.5	25.7	19.8	19.8
LOS by Move:	C	C	C	C	C	C	C	B	B	C	B	B
HCM2kAvgQ:	2	2	2	0	0	0	1	4	4	1	5	5

Note: Queue reported is the number of cars per lane.

Voices School
Morgan Hill, CA
Hexagon Transportation Consultants, Inc.

Level Of Service Computation Report
2000 HCM Operations (Future Volume Alternative)
2025 Plus Project (PM) - 2 Cosmo Right out

Intersection #1004: Church Street and Dunne Avenue

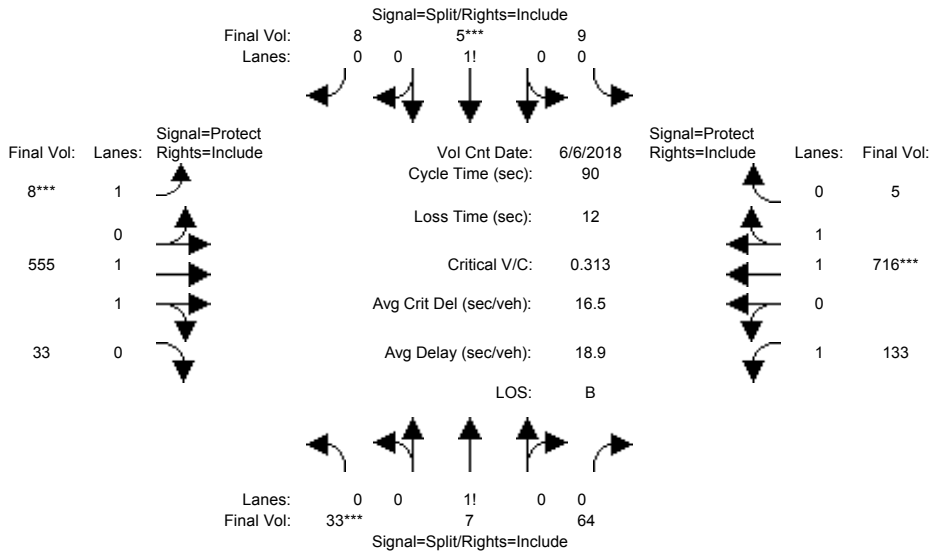

Street Name:	Church Street						Dunne Avenue					
	North Bound			South Bound			East Bound			West Bound		
Approach:	L	T	R	L	T	R	L	T	R	L	T	R
Min. Green:	10	10	10	10	10	10	7	10	10	7	10	10
Y+R:	4.0	4.0	4.0	4.0	4.0	4.0	4.0	4.0	4.0	4.0	4.0	4.0

Volume Module:	>>	Count	Date:	6 Jun 2018	<<							
Base Vol:	29	7	64	9	5	8	8	475	29	124	581	5
Growth Adj:	1.00	1.00	1.00	1.00	1.00	1.00	1.00	1.00	1.00	1.00	1.00	1.00
Initial Bse:	29	7	64	9	5	8	8	475	29	124	581	5
Added Vol:	0	0	0	0	0	0	0	49	0	0	64	0
PasserByVol:	4	0	0	0	0	0	0	31	4	9	71	0
Initial Fut:	33	7	64	9	5	8	8	555	33	133	716	5
User Adj:	1.00	1.00	1.00	1.00	1.00	1.00	1.00	1.00	1.00	1.00	1.00	1.00
PHF Adj:	1.00	1.00	1.00	1.00	1.00	1.00	1.00	1.00	1.00	1.00	1.00	1.00
PHF Volume:	33	7	64	9	5	8	8	555	33	133	716	5
Reduct Vol:	0	0	0	0	0	0	0	0	0	0	0	0
Reduced Vol:	33	7	64	9	5	8	8	555	33	133	716	5
PCE Adj:	1.00	1.00	1.00	1.00	1.00	1.00	1.00	1.00	1.00	1.00	1.00	1.00
MLF Adj:	1.00	1.00	1.00	1.00	1.00	1.00	1.00	1.00	1.00	1.00	1.00	1.00
FinalVolume:	33	7	64	9	5	8	8	555	33	133	716	5

Saturation Flow Module:												
Sat/Lane:	1900	1900	1900	1900	1900	1900	1900	1900	1900	1900	1900	1900
Adjustment:	0.92	0.92	0.92	0.92	0.92	0.92	0.92	0.98	0.95	0.92	0.97	0.95
Lanes:	0.32	0.07	0.61	0.41	0.23	0.36	1.00	1.88	0.12	1.00	1.99	0.01
Final Sat.:	555	118	1077	716	398	636	1750	3492	208	1750	3674	26

Capacity Analysis Module:												
Vol/Sat:	0.06	0.06	0.06	0.01	0.01	0.01	0.00	0.16	0.16	0.08	0.19	0.19
Crit Moves:	***				***		***				***	
Green Time:	14.3	14.3	14.3	10.0	10.0	10.0	7.0	36.1	36.1	17.7	46.7	46.7
Volume/Cap:	0.38	0.38	0.38	0.11	0.11	0.11	0.06	0.40	0.40	0.39	0.38	0.38
Delay/Veh:	34.7	34.7	34.7	36.3	36.3	36.3	38.6	19.4	19.4	32.2	13.0	13.0
User DelAdj:	1.00	1.00	1.00	1.00	1.00	1.00	1.00	1.00	1.00	1.00	1.00	1.00
AdjDel/Veh:	34.7	34.7	34.7	36.3	36.3	36.3	38.6	19.4	19.4	32.2	13.0	13.0
LOS by Move:	C	C	C	D	D	D	D	B	B	C	B	B
HCM2kAvgQ:	3	3	3	1	1	1	0	6	6	3	6	6

Note: Queue reported is the number of cars per lane.

Voices School
Morgan Hill, CA
Hexagon Transportation Consultants, Inc.

Level Of Service Computation Report
2000 HCM Operations (Future Volume Alternative)
2025 No Project (AM)

Intersection #1008: Butterfield Boulevard and San Pedro Avenue

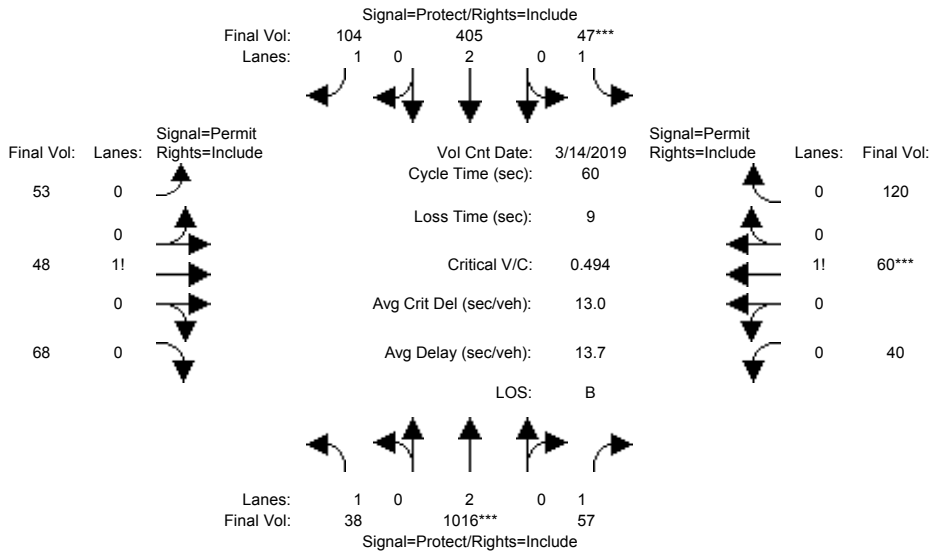

Street Name:	Butterfield Boulevard						San Pedro Avenue					
	North Bound			South Bound			East Bound			West Bound		
Approach:	L	T	R	L	T	R	L	T	R	L	T	R
Min. Green:	7	10	10	7	10	10	10	10	10	10	10	10
Y+R:	4.0	4.0	4.0	4.0	4.0	4.0	4.0	4.0	4.0	4.0	4.0	4.0

Volume Module:	>>	Count	Date:	14 Mar 2019	<<							
Base Vol:	32	990	56	33	289	92	44	46	50	37	60	107
Growth Adj:	1.00	1.00	1.00	1.00	1.00	1.00	1.00	1.00	1.00	1.00	1.00	1.00
Initial Bse:	32	990	56	33	289	92	44	46	50	37	60	107
Added Vol:	0	0	0	0	0	0	0	0	0	0	0	0
PasserByVol:	6	26	1	14	116	12	9	2	18	3	0	13
Initial Fut:	38	1016	57	47	405	104	53	48	68	40	60	120
User Adj:	1.00	1.00	1.00	1.00	1.00	1.00	1.00	1.00	1.00	1.00	1.00	1.00
PHF Adj:	1.00	1.00	1.00	1.00	1.00	1.00	1.00	1.00	1.00	1.00	1.00	1.00
PHF Volume:	38	1016	57	47	405	104	53	48	68	40	60	120
Reduct Vol:	0	0	0	0	0	0	0	0	0	0	0	0
Reduced Vol:	38	1016	57	47	405	104	53	48	68	40	60	120
PCE Adj:	1.00	1.00	1.00	1.00	1.00	1.00	1.00	1.00	1.00	1.00	1.00	1.00
MLF Adj:	1.00	1.00	1.00	1.00	1.00	1.00	1.00	1.00	1.00	1.00	1.00	1.00
FinalVolume:	38	1016	57	47	405	104	53	48	68	40	60	120

Saturation Flow Module:												
Sat/Lane:	1900	1900	1900	1900	1900	1900	1900	1900	1900	1900	1900	1900
Adjustment:	0.92	1.00	0.92	0.92	1.00	0.92	0.92	0.92	0.92	0.92	0.92	0.92
Lanes:	1.00	2.00	1.00	1.00	2.00	1.00	0.31	0.28	0.41	0.18	0.27	0.55
Final Sat.:	1750	3800	1750	1750	3800	1750	549	497	704	318	477	955

Capacity Analysis Module:												
Vol/Sat:	0.02	0.27	0.03	0.03	0.11	0.06	0.10	0.10	0.10	0.13	0.13	0.13
Crit Moves:	****			****						****		
Green Time:	15.2	29.9	29.9	7.0	21.7	21.7	14.1	14.1	14.1	14.1	14.1	14.1
Volume/Cap:	0.09	0.54	0.07	0.23	0.29	0.16	0.41	0.41	0.41	0.54	0.54	0.54
Delay/Veh:	17.2	10.6	7.8	24.6	13.8	13.1	20.1	20.1	20.1	21.5	21.5	21.5
User DelAdj:	1.00	1.00	1.00	1.00	1.00	1.00	1.00	1.00	1.00	1.00	1.00	1.00
AdjDel/Veh:	17.2	10.6	7.8	24.6	13.8	13.1	20.1	20.1	20.1	21.5	21.5	21.5
LOS by Move:	B	B	A	C	B	B	C	C	C	C	C	C
HCM2kAvgQ:	1	6	1	1	3	1	3	3	3	5	5	5

Note: Queue reported is the number of cars per lane.

Voices School
Morgan Hill, CA
Hexagon Transportation Consultants, Inc.

Level Of Service Computation Report
2000 HCM Operations (Future Volume Alternative)
2025 No Project (PM)

Intersection #1008: Butterfield Boulevard and San Pedro Avenue

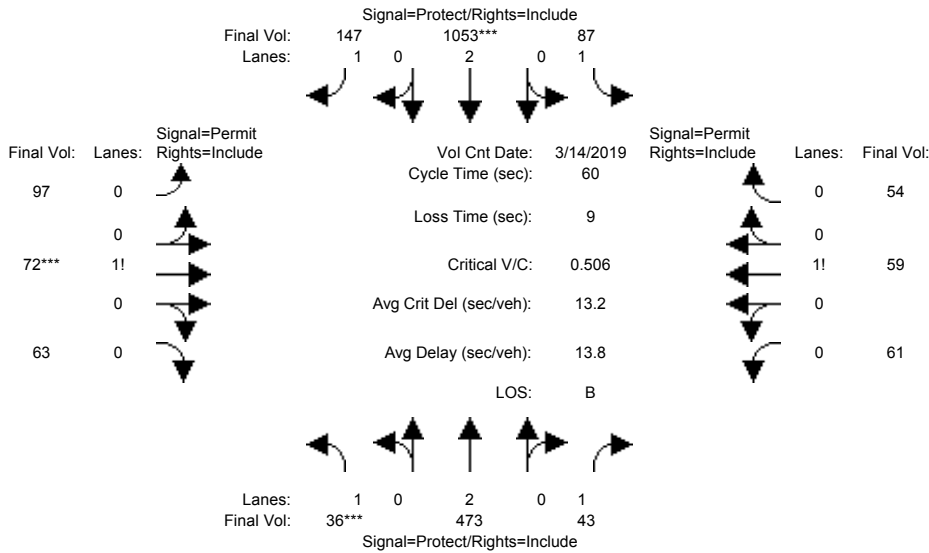

Street Name:	Butterfield Boulevard						San Pedro Avenue					
	North Bound			South Bound			East Bound			West Bound		
Approach:	L	T	R	L	T	R	L	T	R	L	T	R
Min. Green:	7	10	10	7	10	10	10	10	10	10	10	10
Y+R:	4.0	4.0	4.0	4.0	4.0	4.0	4.0	4.0	4.0	4.0	4.0	4.0

Volume Module:	>>	Count	Date:	14 Mar 2019	<<							
Base Vol:	17	308	40	77	931	121	88	72	48	60	58	40
Growth Adj:	1.00	1.00	1.00	1.00	1.00	1.00	1.00	1.00	1.00	1.00	1.00	1.00
Initial Bse:	17	308	40	77	931	121	88	72	48	60	58	40
Added Vol:	0	0	0	0	0	0	0	0	0	0	0	0
PasserByVol:	19	165	3	10	122	26	9	0	15	1	1	14
Initial Fut:	36	473	43	87	1053	147	97	72	63	61	59	54
User Adj:	1.00	1.00	1.00	1.00	1.00	1.00	1.00	1.00	1.00	1.00	1.00	1.00
PHF Adj:	1.00	1.00	1.00	1.00	1.00	1.00	1.00	1.00	1.00	1.00	1.00	1.00
PHF Volume:	36	473	43	87	1053	147	97	72	63	61	59	54
Reduct Vol:	0	0	0	0	0	0	0	0	0	0	0	0
Reduced Vol:	36	473	43	87	1053	147	97	72	63	61	59	54
PCE Adj:	1.00	1.00	1.00	1.00	1.00	1.00	1.00	1.00	1.00	1.00	1.00	1.00
MLF Adj:	1.00	1.00	1.00	1.00	1.00	1.00	1.00	1.00	1.00	1.00	1.00	1.00
FinalVolume:	36	473	43	87	1053	147	97	72	63	61	59	54

Saturation Flow Module:												
Sat/Lane:	1900	1900	1900	1900	1900	1900	1900	1900	1900	1900	1900	1900
Adjustment:	0.92	1.00	0.92	0.92	1.00	0.92	0.92	0.92	0.92	0.92	0.92	0.92
Lanes:	1.00	2.00	1.00	1.00	2.00	1.00	0.42	0.31	0.27	0.35	0.34	0.31
Final Sat.:	1750	3800	1750	1750	3800	1750	732	543	475	614	593	543

Capacity Analysis Module:												
Vol/Sat:	0.02	0.12	0.02	0.05	0.28	0.08	0.13	0.13	0.13	0.10	0.10	0.10
Crit Moves:	****			****			****					
Green Time:	7.0	21.6	21.6	15.1	29.8	29.8	14.2	14.2	14.2	14.2	14.2	14.2
Volume/Cap:	0.18	0.35	0.07	0.20	0.56	0.17	0.56	0.56	0.56	0.42	0.42	0.42
Delay/Veh:	24.3	14.2	12.6	17.9	10.9	8.4	21.8	21.8	21.8	20.1	20.1	20.1
User DelAdj:	1.00	1.00	1.00	1.00	1.00	1.00	1.00	1.00	1.00	1.00	1.00	1.00
AdjDel/Veh:	24.3	14.2	12.6	17.9	10.9	8.4	21.8	21.8	21.8	20.1	20.1	20.1
LOS by Move:	C	B	B	B	B	A	C	C	C	C	C	C
HCM2kAvgQ:	1	3	1	1	7	2	5	5	5	3	3	3

Note: Queue reported is the number of cars per lane.

Voices School
Morgan Hill, CA
Hexagon Transportation Consultants, Inc.

Level Of Service Computation Report
2000 HCM Operations (Future Volume Alternative)
2025 Plus Project (AM) - 2 Cosmo Right out

Intersection #1008: Butterfield Boulevard and San Pedro Avenue

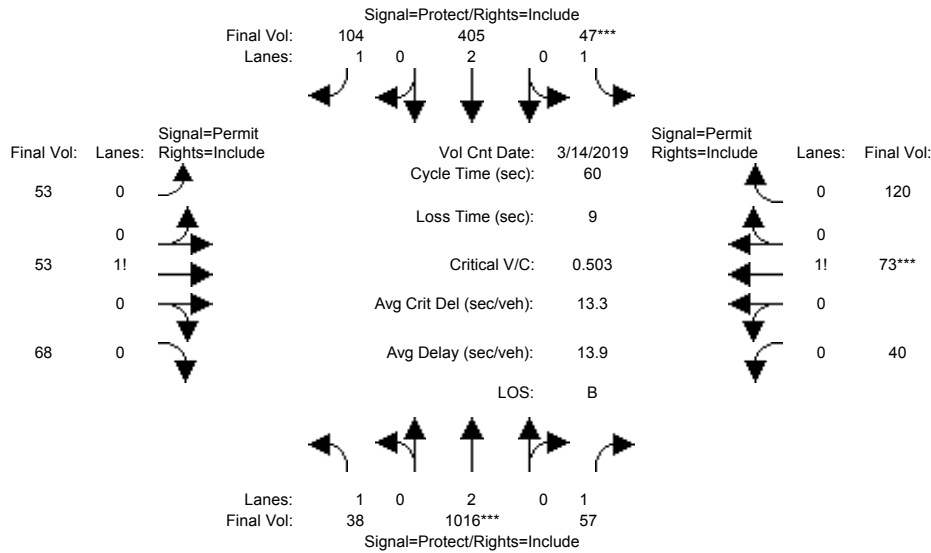

Street Name:	Butterfield Boulevard						San Pedro Avenue					
	North Bound			South Bound			East Bound			West Bound		
Approach:	L	T	R	L	T	R	L	T	R	L	T	R
Min. Green:	7	10	10	7	10	10	10	10	10	10	10	10
Y+R:	4.0	4.0	4.0	4.0	4.0	4.0	4.0	4.0	4.0	4.0	4.0	4.0

Volume Module:	>>	Count	Date:	14 Mar 2019	<<							
Base Vol:	32	990	56	33	289	92	44	46	50	37	60	107
Growth Adj:	1.00	1.00	1.00	1.00	1.00	1.00	1.00	1.00	1.00	1.00	1.00	1.00
Initial Bse:	32	990	56	33	289	92	44	46	50	37	60	107
Added Vol:	0	0	0	0	0	0	0	5	0	0	13	0
PasserByVol:	6	26	1	14	116	12	9	2	18	3	0	13
Initial Fut:	38	1016	57	47	405	104	53	53	68	40	73	120
User Adj:	1.00	1.00	1.00	1.00	1.00	1.00	1.00	1.00	1.00	1.00	1.00	1.00
PHF Adj:	1.00	1.00	1.00	1.00	1.00	1.00	1.00	1.00	1.00	1.00	1.00	1.00
PHF Volume:	38	1016	57	47	405	104	53	53	68	40	73	120
Reduct Vol:	0	0	0	0	0	0	0	0	0	0	0	0
Reduced Vol:	38	1016	57	47	405	104	53	53	68	40	73	120
PCE Adj:	1.00	1.00	1.00	1.00	1.00	1.00	1.00	1.00	1.00	1.00	1.00	1.00
MLF Adj:	1.00	1.00	1.00	1.00	1.00	1.00	1.00	1.00	1.00	1.00	1.00	1.00
Final Volume:	38	1016	57	47	405	104	53	53	68	40	73	120

Saturation Flow Module:												
Sat/Lane:	1900	1900	1900	1900	1900	1900	1900	1900	1900	1900	1900	1900
Adjustment:	0.92	1.00	0.92	0.92	1.00	0.92	0.92	0.92	0.92	0.92	0.92	0.92
Lanes:	1.00	2.00	1.00	1.00	2.00	1.00	0.30	0.30	0.40	0.17	0.31	0.52
Final Sat.:	1750	3800	1750	1750	3800	1750	533	533	684	300	548	901

Capacity Analysis Module:												
Vol/Sat:	0.02	0.27	0.03	0.03	0.11	0.06	0.10	0.10	0.10	0.13	0.13	0.13
Crit Moves:	****			****						****		
Green Time:	15.0	29.4	29.4	7.0	21.4	21.4	14.6	14.6	14.6	14.6	14.6	14.6
Volume/Cap:	0.09	0.55	0.07	0.23	0.30	0.17	0.41	0.41	0.41	0.55	0.55	0.55
Delay/Veh:	17.4	11.0	8.1	24.6	14.0	13.3	19.7	19.7	19.7	21.3	21.3	21.3
User DelAdj:	1.00	1.00	1.00	1.00	1.00	1.00	1.00	1.00	1.00	1.00	1.00	1.00
AdjDel/Veh:	17.4	11.0	8.1	24.6	14.0	13.3	19.7	19.7	19.7	21.3	21.3	21.3
LOS by Move:	B	B	A	C	B	B	B	B	B	C	C	C
HCM2kAvgQ:	1	6	1	1	3	1	3	3	3	5	5	5

Note: Queue reported is the number of cars per lane.

Voices School
Morgan Hill, CA
Hexagon Transportation Consultants, Inc.

Level Of Service Computation Report
2000 HCM Operations (Future Volume Alternative)
2025 Plus Project (PM) - 2 Cosmo Right out

Intersection #1008: Butterfield Boulevard and San Pedro Avenue

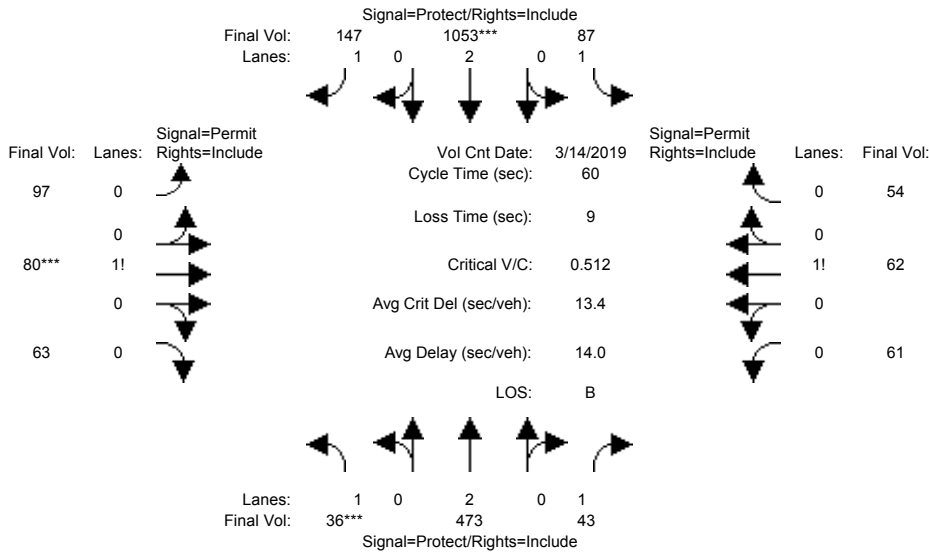

Street Name:	Butterfield Boulevard						San Pedro Avenue					
	North Bound			South Bound			East Bound			West Bound		
Approach:	L	T	R	L	T	R	L	T	R	L	T	R
Min. Green:	7	10	10	7	10	10	10	10	10	10	10	10
Y+R:	4.0	4.0	4.0	4.0	4.0	4.0	4.0	4.0	4.0	4.0	4.0	4.0

Volume Module:	>>	Count	Date:	14 Mar 2019	<<											
Base Vol:	17	308	40	77	931	121	88	72	48	60	58	40				
Growth Adj:	1.00	1.00	1.00	1.00	1.00	1.00	1.00	1.00	1.00	1.00	1.00	1.00				
Initial Bse:	17	308	40	77	931	121	88	72	48	60	58	40				
Added Vol:	0	0	0	0	0	0	0	8	0	0	3	0				
PasserByVol:	19	165	3	10	122	26	9	0	15	1	1	14				
Initial Fut:	36	473	43	87	1053	147	97	80	63	61	62	54				
User Adj:	1.00	1.00	1.00	1.00	1.00	1.00	1.00	1.00	1.00	1.00	1.00	1.00				
PHF Adj:	1.00	1.00	1.00	1.00	1.00	1.00	1.00	1.00	1.00	1.00	1.00	1.00				
PHF Volume:	36	473	43	87	1053	147	97	80	63	61	62	54				
Reduct Vol:	0	0	0	0	0	0	0	0	0	0	0	0				
Reduced Vol:	36	473	43	87	1053	147	97	80	63	61	62	54				
PCE Adj:	1.00	1.00	1.00	1.00	1.00	1.00	1.00	1.00	1.00	1.00	1.00	1.00				
MLF Adj:	1.00	1.00	1.00	1.00	1.00	1.00	1.00	1.00	1.00	1.00	1.00	1.00				
Final Volume:	36	473	43	87	1053	147	97	80	63	61	62	54				

Saturation Flow Module:												
Sat/Lane:	1900	1900	1900	1900	1900	1900	1900	1900	1900	1900	1900	1900
Adjustment:	0.92	1.00	0.92	0.92	1.00	0.92	0.92	0.92	0.92	0.92	0.92	0.92
Lanes:	1.00	2.00	1.00	1.00	2.00	1.00	0.41	0.33	0.26	0.34	0.35	0.31
Final Sat.:	1750	3800	1750	1750	3800	1750	707	583	459	603	613	534

Capacity Analysis Module:												
Vol/Sat:	0.02	0.12	0.02	0.05	0.28	0.08	0.14	0.14	0.14	0.10	0.10	0.10
Crit Moves:	****				****			****				
Green Time:	7.0	21.4	21.4	15.0	29.4	29.4	14.6	14.6	14.6	14.6	14.6	14.6
Volume/Cap:	0.18	0.35	0.07	0.20	0.56	0.17	0.56	0.56	0.56	0.42	0.42	0.42
Delay/Veh:	24.3	14.3	12.8	18.0	11.2	8.6	21.7	21.7	21.7	19.8	19.8	19.8
User DelAdj:	1.00	1.00	1.00	1.00	1.00	1.00	1.00	1.00	1.00	1.00	1.00	1.00
AdjDel/Veh:	24.3	14.3	12.8	18.0	11.2	8.6	21.7	21.7	21.7	19.8	19.8	19.8
LOS by Move:	C	B	B	B	B	A	C	C	C	B	B	B
HCM2kAvgQ:	1	3	1	1	7	2	5	5	5	3	3	3

Note: Queue reported is the number of cars per lane.

Voices School
Morgan Hill, CA
Hexagon Transportation Consultants, Inc.

Level Of Service Computation Report
2000 HCM Operations (Future Volume Alternative)
2025 No Project (AM)

Intersection #1111: Butterfield Boulevard and Tennant Avenue

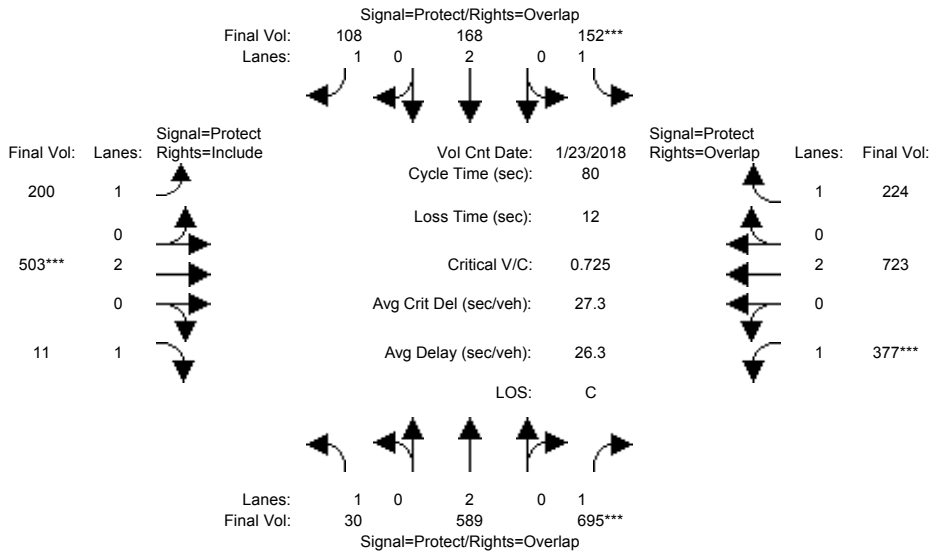

Street Name:	Butterfield Boulevard						Tennant Avenue					
	North Bound			South Bound			East Bound			West Bound		
Approach:	L	T	R	L	T	R	L	T	R	L	T	R
Min. Green:	7	10	10	7	10	10	7	10	10	7	10	10
Y+R:	4.0	4.0	4.0	4.0	4.0	4.0	4.0	4.0	4.0	4.0	4.0	4.0

Volume Module:	>>	Count	Date:	23 Jan 2018	<<							
Base Vol:	22	570	483	95	138	93	195	453	8	258	688	212
Growth Adj:	1.00	1.00	1.00	1.00	1.00	1.00	1.00	1.00	1.00	1.00	1.00	1.00
Initial Bse:	22	570	483	95	138	93	195	453	8	258	688	212
Added Vol:	0	0	0	0	0	0	0	0	0	0	0	0
PasserByVol:	8	19	212	57	30	15	5	50	3	119	35	12
Initial Fut:	30	589	695	152	168	108	200	503	11	377	723	224
User Adj:	1.00	1.00	1.00	1.00	1.00	1.00	1.00	1.00	1.00	1.00	1.00	1.00
PHF Adj:	1.00	1.00	1.00	1.00	1.00	1.00	1.00	1.00	1.00	1.00	1.00	1.00
PHF Volume:	30	589	695	152	168	108	200	503	11	377	723	224
Reduct Vol:	0	0	0	0	0	0	0	0	0	0	0	0
Reduced Vol:	30	589	695	152	168	108	200	503	11	377	723	224
PCE Adj:	1.00	1.00	1.00	1.00	1.00	1.00	1.00	1.00	1.00	1.00	1.00	1.00
MLF Adj:	1.00	1.00	1.00	1.00	1.00	1.00	1.00	1.00	1.00	1.00	1.00	1.00
FinalVolume:	30	589	695	152	168	108	200	503	11	377	723	224

Saturation Flow Module:												
Sat/Lane:	1900	1900	1900	1900	1900	1900	1900	1900	1900	1900	1900	1900
Adjustment:	0.92	1.00	0.92	0.92	1.00	0.92	0.92	1.00	0.92	0.92	1.00	0.92
Lanes:	1.00	2.00	1.00	1.00	2.00	1.00	1.00	2.00	1.00	1.00	2.00	1.00
Final Sat.:	1750	3800	1750	1750	3800	1750	1750	3800	1750	1750	3800	1750

Capacity Analysis Module:												
Vol/Sat:	0.02	0.16	0.40	0.09	0.04	0.06	0.11	0.13	0.01	0.22	0.19	0.13
Crit Moves:			****	****				****		****		
Green Time:	12.2	20.0	43.8	9.6	17.4	31.8	14.4	14.6	14.6	23.8	24.0	33.6
Volume/Cap:	0.11	0.62	0.73	0.73	0.20	0.16	0.63	0.73	0.03	0.73	0.63	0.31
Delay/Veh:	29.4	27.8	16.4	45.8	25.7	15.6	34.6	34.6	26.9	30.2	25.4	15.7
User DelAdj:	1.00	1.00	1.00	1.00	1.00	1.00	1.00	1.00	1.00	1.00	1.00	1.00
AdjDel/Veh:	29.4	27.8	16.4	45.8	25.7	15.6	34.6	34.6	26.9	30.2	25.4	15.7
LOS by Move:	C	C	B	D	C	B	C	C	C	C	C	B
HCM2kAvgQ:	1	7	15	4	2	2	5	6	0	11	9	4

Note: Queue reported is the number of cars per lane.

Voices School
Morgan Hill, CA
Hexagon Transportation Consultants, Inc.

Level Of Service Computation Report
2000 HCM Operations (Future Volume Alternative)
2025 No Project (PM)

Intersection #1111: Butterfield Boulevard and Tennant Avenue

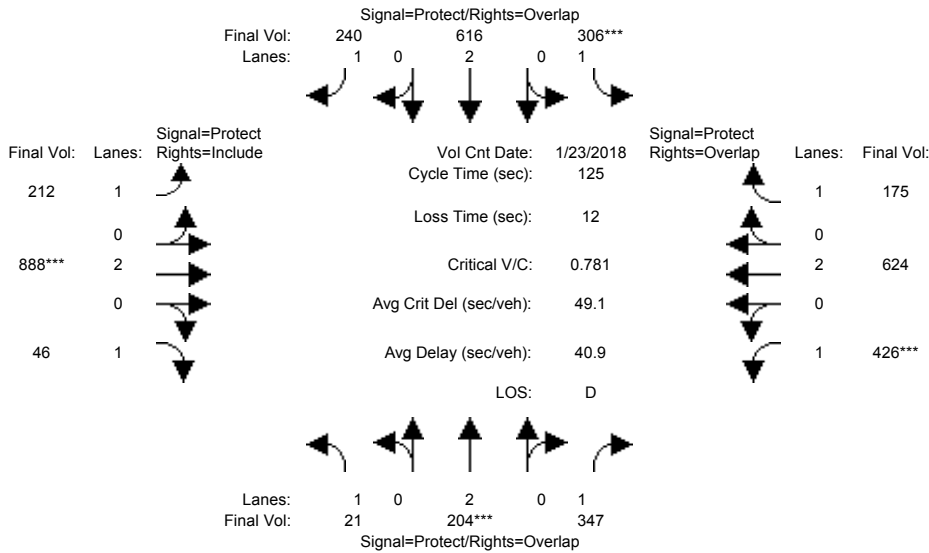

Street Name:	Butterfield Boulevard						Tennant Avenue					
	North Bound			South Bound			East Bound			West Bound		
Approach:	L	T	R	L	T	R	L	T	R	L	T	R
Min. Green:	7	10	10	7	10	10	7	10	10	7	10	10
Y+R:	4.0	4.0	4.0	4.0	4.0	4.0	4.0	4.0	4.0	4.0	4.0	4.0

Volume Module:	>>	Count	Date:	23 Jan 2018	<<							
Base Vol:	15	162	220	247	559	240	204	819	36	254	562	73
Growth Adj:	1.00	1.00	1.00	1.00	1.00	1.00	1.00	1.00	1.00	1.00	1.00	1.00
Initial Bse:	15	162	220	247	559	240	204	819	36	254	562	73
Added Vol:	0	0	0	0	0	0	0	0	0	0	0	0
PasserByVol:	6	42	127	59	57	0	8	69	10	172	62	102
Initial Fut:	21	204	347	306	616	240	212	888	46	426	624	175
User Adj:	1.00	1.00	1.00	1.00	1.00	1.00	1.00	1.00	1.00	1.00	1.00	1.00
PHF Adj:	1.00	1.00	1.00	1.00	1.00	1.00	1.00	1.00	1.00	1.00	1.00	1.00
PHF Volume:	21	204	347	306	616	240	212	888	46	426	624	175
Reduct Vol:	0	0	0	0	0	0	0	0	0	0	0	0
Reduced Vol:	21	204	347	306	616	240	212	888	46	426	624	175
PCE Adj:	1.00	1.00	1.00	1.00	1.00	1.00	1.00	1.00	1.00	1.00	1.00	1.00
MLF Adj:	1.00	1.00	1.00	1.00	1.00	1.00	1.00	1.00	1.00	1.00	1.00	1.00
FinalVolume:	21	204	347	306	616	240	212	888	46	426	624	175

Saturation Flow Module:												
Sat/Lane:	1900	1900	1900	1900	1900	1900	1900	1900	1900	1900	1900	1900
Adjustment:	0.92	1.00	0.92	0.92	1.00	0.92	0.92	1.00	0.92	0.92	1.00	0.92
Lanes:	1.00	2.00	1.00	1.00	2.00	1.00	1.00	2.00	1.00	1.00	2.00	1.00
Final Sat.:	1750	3800	1750	1750	3800	1750	1750	3800	1750	1750	3800	1750

Capacity Analysis Module:												
Vol/Sat:	0.01	0.05	0.20	0.17	0.16	0.14	0.12	0.23	0.03	0.24	0.16	0.10
Crit Moves:	****			****			****			****		
Green Time:	9.7	10.0	48.5	27.6	28.0	60.0	32.0	36.9	36.9	38.5	43.4	71.0
Volume/Cap:	0.16	0.67	0.51	0.79	0.72	0.29	0.47	0.79	0.09	0.79	0.47	0.18
Delay/Veh:	54.4	61.6	29.9	56.6	48.1	19.8	40.2	44.4	31.9	47.4	32.2	13.0
User DelAdj:	1.00	1.00	1.00	1.00	1.00	1.00	1.00	1.00	1.00	1.00	1.00	1.00
AdjDel/Veh:	54.4	61.6	29.9	56.6	48.1	19.8	40.2	44.4	31.9	47.4	32.2	13.0
LOS by Move:	D	E	C	E	D	B	D	D	C	D	C	B
HCM2kAvgQ:	1	5	11	12	11	6	7	16	1	18	9	3

Note: Queue reported is the number of cars per lane.

Voices School
Morgan Hill, CA
Hexagon Transportation Consultants, Inc.

Level Of Service Computation Report
2000 HCM Operations (Future Volume Alternative)
2025 Plus Project (AM) - 2 Cosmo Right out

Intersection #1111: Butterfield Boulevard and Tennant Avenue

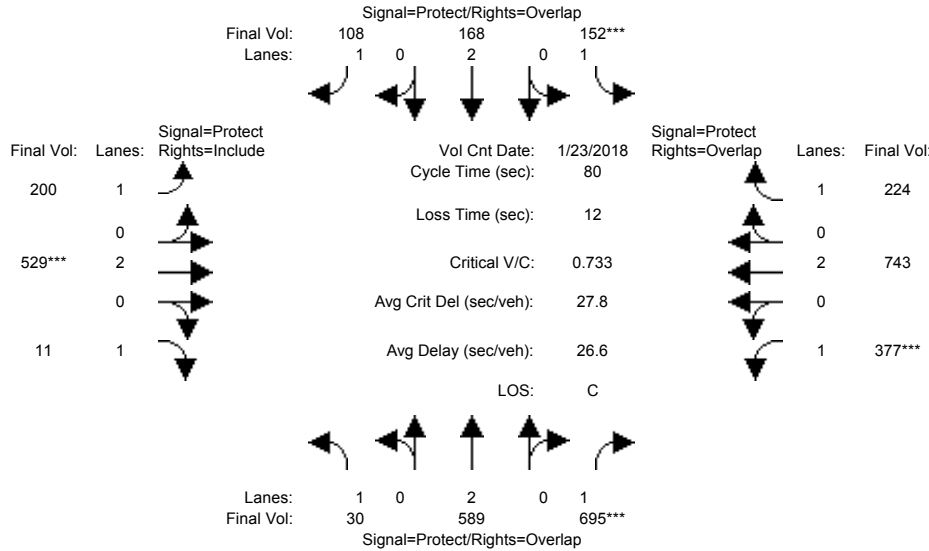

Street Name:	Butterfield Boulevard						Tennant Avenue					
	North Bound			South Bound			East Bound			West Bound		
Approach:	L	T	R	L	T	R	L	T	R	L	T	R
Min. Green:	7	10	10	7	10	10	7	10	10	7	10	10
Y+R:	4.0	4.0	4.0	4.0	4.0	4.0	4.0	4.0	4.0	4.0	4.0	4.0

Volume Module:	>>	Count	Date:	23 Jan 2018	<<							
Base Vol:	22	570	483	95	138	93	195	453	8	258	688	212
Growth Adj:	1.00	1.00	1.00	1.00	1.00	1.00	1.00	1.00	1.00	1.00	1.00	1.00
Initial Bse:	22	570	483	95	138	93	195	453	8	258	688	212
Added Vol:	0	0	0	0	0	0	0	26	0	0	20	0
PasserByVol:	8	19	212	57	30	15	5	50	3	119	35	12
Initial Fut:	30	589	695	152	168	108	200	529	11	377	743	224
User Adj:	1.00	1.00	1.00	1.00	1.00	1.00	1.00	1.00	1.00	1.00	1.00	1.00
PHF Adj:	1.00	1.00	1.00	1.00	1.00	1.00	1.00	1.00	1.00	1.00	1.00	1.00
PHF Volume:	30	589	695	152	168	108	200	529	11	377	743	224
Reduct Vol:	0	0	0	0	0	0	0	0	0	0	0	0
Reduced Vol:	30	589	695	152	168	108	200	529	11	377	743	224
PCE Adj:	1.00	1.00	1.00	1.00	1.00	1.00	1.00	1.00	1.00	1.00	1.00	1.00
MLF Adj:	1.00	1.00	1.00	1.00	1.00	1.00	1.00	1.00	1.00	1.00	1.00	1.00
FinalVolume:	30	589	695	152	168	108	200	529	11	377	743	224

Saturation Flow Module:												
Sat/Lane:	1900	1900	1900	1900	1900	1900	1900	1900	1900	1900	1900	1900
Adjustment:	0.92	1.00	0.92	0.92	1.00	0.92	0.92	1.00	0.92	0.92	1.00	0.92
Lanes:	1.00	2.00	1.00	1.00	2.00	1.00	1.00	2.00	1.00	1.00	2.00	1.00
Final Sat.:	1750	3800	1750	1750	3800	1750	1750	3800	1750	1750	3800	1750

Capacity Analysis Module:												
Vol/Sat:	0.02	0.16	0.40	0.09	0.04	0.06	0.11	0.14	0.01	0.22	0.20	0.13
Crit Moves:			****	****				****		****		
Green Time:	12.1	19.8	43.3	9.5	17.2	31.5	14.3	15.2	15.2	23.5	24.4	33.9
Volume/Cap:	0.11	0.63	0.73	0.73	0.21	0.16	0.64	0.73	0.03	0.73	0.64	0.30
Delay/Veh:	29.5	28.1	16.9	46.7	25.9	15.8	34.9	34.4	26.5	30.8	25.2	15.5
User DelAdj:	1.00	1.00	1.00	1.00	1.00	1.00	1.00	1.00	1.00	1.00	1.00	1.00
AdjDel/Veh:	29.5	28.1	16.9	46.7	25.9	15.8	34.9	34.4	26.5	30.8	25.2	15.5
LOS by Move:	C	C	B	D	C	B	C	C	C	C	C	B
HCM2kAvgQ:	1	7	15	4	2	2	5	6	0	11	9	4

Note: Queue reported is the number of cars per lane.

Voices School
Morgan Hill, CA
Hexagon Transportation Consultants, Inc.

Level Of Service Computation Report
2000 HCM Operations (Future Volume Alternative)
2025 Plus Project (PM) - 2 Cosmo Right out

Intersection #1111: Butterfield Boulevard and Tennant Avenue

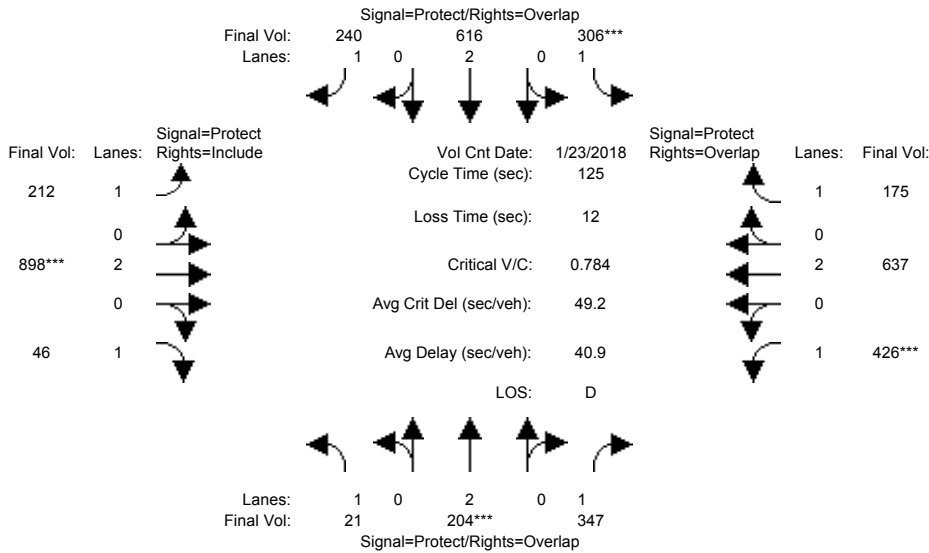

Street Name:	Butterfield Boulevard						Tennant Avenue					
	North Bound			South Bound			East Bound			West Bound		
Approach:	L	T	R	L	T	R	L	T	R	L	T	R
Min. Green:	7	10	10	7	10	10	7	10	10	7	10	10
Y+R:	4.0	4.0	4.0	4.0	4.0	4.0	4.0	4.0	4.0	4.0	4.0	4.0

Volume Module:	>>	Count	Date:	23 Jan 2018	<<							
Base Vol:	15	162	220	247	559	240	204	819	36	254	562	73
Growth Adj:	1.00	1.00	1.00	1.00	1.00	1.00	1.00	1.00	1.00	1.00	1.00	1.00
Initial Bse:	15	162	220	247	559	240	204	819	36	254	562	73
Added Vol:	0	0	0	0	0	0	0	10	0	0	13	0
PasserByVol:	6	42	127	59	57	0	8	69	10	172	62	102
Initial Fut:	21	204	347	306	616	240	212	898	46	426	637	175
User Adj:	1.00	1.00	1.00	1.00	1.00	1.00	1.00	1.00	1.00	1.00	1.00	1.00
PHF Adj:	1.00	1.00	1.00	1.00	1.00	1.00	1.00	1.00	1.00	1.00	1.00	1.00
PHF Volume:	21	204	347	306	616	240	212	898	46	426	637	175
Reduct Vol:	0	0	0	0	0	0	0	0	0	0	0	0
Reduced Vol:	21	204	347	306	616	240	212	898	46	426	637	175
PCE Adj:	1.00	1.00	1.00	1.00	1.00	1.00	1.00	1.00	1.00	1.00	1.00	1.00
MLF Adj:	1.00	1.00	1.00	1.00	1.00	1.00	1.00	1.00	1.00	1.00	1.00	1.00
FinalVolume:	21	204	347	306	616	240	212	898	46	426	637	175

Saturation Flow Module:												
Sat/Lane:	1900	1900	1900	1900	1900	1900	1900	1900	1900	1900	1900	1900
Adjustment:	0.92	1.00	0.92	0.92	1.00	0.92	0.92	1.00	0.92	0.92	1.00	0.92
Lanes:	1.00	2.00	1.00	1.00	2.00	1.00	1.00	2.00	1.00	1.00	2.00	1.00
Final Sat.:	1750	3800	1750	1750	3800	1750	1750	3800	1750	1750	3800	1750

Capacity Analysis Module:												
Vol/Sat:	0.01	0.05	0.20	0.17	0.16	0.14	0.12	0.24	0.03	0.24	0.17	0.10
Crit Moves:	****			****			****			****		
Green Time:	9.6	10.0	48.3	27.5	27.9	59.5	31.7	37.2	37.2	38.3	43.8	71.3
Volume/Cap:	0.16	0.67	0.51	0.79	0.73	0.29	0.48	0.79	0.09	0.79	0.48	0.18
Delay/Veh:	54.4	61.6	30.0	56.9	48.2	20.1	40.5	44.4	31.8	47.8	31.9	12.9
User DelAdj:	1.00	1.00	1.00	1.00	1.00	1.00	1.00	1.00	1.00	1.00	1.00	1.00
AdjDel/Veh:	54.4	61.6	30.0	56.9	48.2	20.1	40.5	44.4	31.8	47.8	31.9	12.9
LOS by Move:	D	E	C	E	D	C	D	D	C	D	C	B
HCM2kAvgQ:	1	5	11	12	11	6	7	16	1	18	10	3

Note: Queue reported is the number of cars per lane.

Voices School
Morgan Hill, CA
Hexagon Transportation Consultants, Inc.

Level Of Service Computation Report
2000 HCM Unsignalized (Future Volume Alternative)
2025 No Project (AM)

Intersection #1112: Monterey Road and San Pedro Avenue

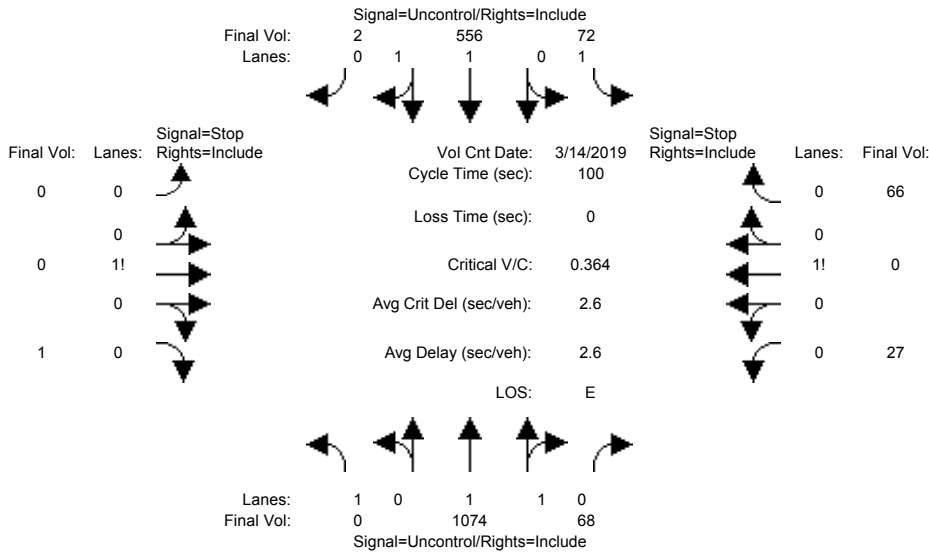

Street Name: Monterey Road San Pedro Avenue
Approach: North Bound South Bound East Bound West Bound
Movement: L - T - R L - T - R L - T - R L - T - R

Volume Module:	>> Count Date: 14 Mar 2019 <<											
Base Vol:	0	887	68	67	463	2	0	0	1	27	0	61
Growth Adj:	1.00	1.00	1.00	1.00	1.00	1.00	1.00	1.00	1.00	1.00	1.00	1.00
Initial Bse:	0	887	68	67	463	2	0	0	1	27	0	61
Added Vol:	0	0	0	0	0	0	0	0	0	0	0	0
PasserByVol:	0	187	0	5	93	0	0	0	0	0	0	5
Initial Fut:	0	1074	68	72	556	2	0	0	1	27	0	66
User Adj:	1.00	1.00	1.00	1.00	1.00	1.00	1.00	1.00	1.00	1.00	1.00	1.00
PHF Adj:	1.00	1.00	1.00	1.00	1.00	1.00	1.00	1.00	1.00	1.00	1.00	1.00
PHF Volume:	0	1074	68	72	556	2	0	0	1	27	0	66
Reduct Vol:	0	0	0	0	0	0	0	0	0	0	0	0
FinalVolume:	0	1074	68	72	556	2	0	0	1	27	0	66

Critical Gap Module:

Critical Gp:	xxxxx	xxxx	xxxxx	4.1	xxxx	xxxxx	xxxxx	xxxx	6.9	7.5	6.5	6.9
FollowUpTim:	xxxxx	xxxx	xxxxx	2.2	xxxx	xxxxx	xxxxx	xxxx	3.3	3.5	4.0	3.3

Capacity Module:

Cnflct Vol:	xxxx	xxxx	xxxxx	1142	xxxx	xxxxx	xxxx	xxxx	279	1530	1810	571
Potent Cap.:	xxxx	xxxx	xxxxx	619	xxxx	xxxxx	xxxx	xxxx	724	82	80	469
Move Cap.:	xxxx	xxxx	xxxxx	619	xxxx	xxxxx	xxxx	xxxx	724	74	70	469
Volume/Cap:	xxxx	xxxx	xxxx	0.12	xxxx	xxxx	xxxx	xxxx	0.00	0.36	0.00	0.14

Level Of Service Module:

2Way95thQ:	xxxx	xxxx	xxxxx	0.4	xxxx	xxxxx	xxxx	xxxx	0.0	xxxx	xxxx	xxxxx
Control Del:	xxxxx	xxxx	xxxxx	11.6	xxxx	xxxxx	xxxxx	xxxx	10.0	xxxxx	xxxx	xxxxx
LOS by Move:	*	*	*	B	*	*	*	*	A	*	*	*
Movement:	LT - LTR - RT	LT - LTR - RT	LT - LTR - RT	LT - LTR - RT	LT - LTR - RT	LT - LTR - RT	LT - LTR - RT	LT - LTR - RT	LT - LTR - RT	LT - LTR - RT	LT - LTR - RT	LT - LTR - RT
Shared Cap.:	xxxx	xxxx	xxxxx	xxxx	xxxx	xxxxx	xxxx	xxxx	xxxxx	xxxx	184	xxxxx
SharedQueue:	xxxxx	xxxx	xxxxx	xxxxx	xxxx	xxxxx	xxxxx	xxxx	xxxxx	xxxxx	2.5	xxxxx
Shrd ConDel:	xxxxx	xxxx	xxxxx	xxxxx	xxxx	xxxxx	xxxxx	xxxx	xxxxx	xxxxx	42.9	xxxxx
Shared LOS:	*	*	*	*	*	*	*	*	*	*	E	*
ApproachDel:	xxxxxxx	xxxxxxx					10.0			42.9		
ApproachLOS:	*	*					A			E		

Note: Queue reported is the number of cars per lane.

Voices School
Morgan Hill, CA
Hexagon Transportation Consultants, Inc.

Level Of Service Computation Report
2000 HCM Unsignalized (Future Volume Alternative)
2025 No Project (PM)

Intersection #1112: Monterey Road and San Pedro Avenue

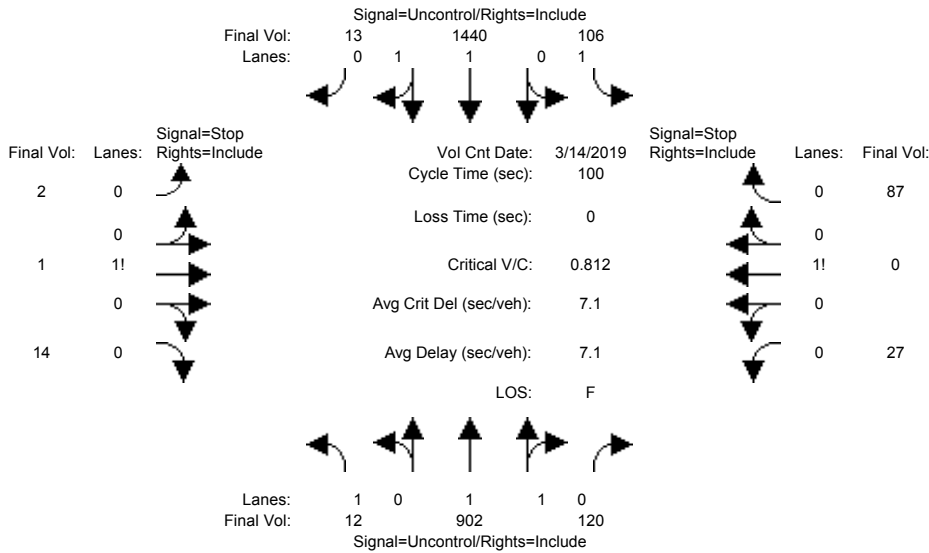

Street Name: Monterey Road San Pedro Avenue
Approach: North Bound South Bound East Bound West Bound
Movement: L - T - R L - T - R L - T - R L - T - R

Volume Module:	>> Count Date: 14 Mar 2019 <<											
Base Vol:	12	774	120	102	1333	13	2	1	14	27	0	83
Growth Adj:	1.00	1.00	1.00	1.00	1.00	1.00	1.00	1.00	1.00	1.00	1.00	1.00
Initial Bse:	12	774	120	102	1333	13	2	1	14	27	0	83
Added Vol:	0	0	0	0	0	0	0	0	0	0	0	0
PasserByVol:	0	128	0	4	107	0	0	0	0	0	0	4
Initial Fut:	12	902	120	106	1440	13	2	1	14	27	0	87
User Adj:	1.00	1.00	1.00	1.00	1.00	1.00	1.00	1.00	1.00	1.00	1.00	1.00
PHF Adj:	1.00	1.00	1.00	1.00	1.00	1.00	1.00	1.00	1.00	1.00	1.00	1.00
PHF Volume:	12	902	120	106	1440	13	2	1	14	27	0	87
Reduct Vol:	0	0	0	0	0	0	0	0	0	0	0	0
FinalVolume:	12	902	120	106	1440	13	2	1	14	27	0	87

Critical Gap Module:												
Critical Gp:	4.1	xxxx	xxxxx	4.1	xxxx	xxxxx	7.5	6.5	6.9	7.5	6.5	6.9
FollowUpTim:	2.2	xxxx	xxxxx	2.2	xxxx	xxxxx	3.5	4.0	3.3	3.5	4.0	3.3

Capacity Module:												
Cnflct Vol:	1453	xxxx	xxxxx	1022	xxxx	xxxxx	2134	2705	727	1919	2651	511
Potent Cap.:	472	xxxx	xxxxx	687	xxxx	xxxxx	29	22	371	42	23	513
Move Cap.:	472	xxxx	xxxxx	687	xxxx	xxxxx	21	18	371	33	19	513
Volume/Cap:	0.03	xxxx	xxxx	0.15	xxxx	xxxx	0.10	0.06	0.04	0.81	0.00	0.17

Level Of Service Module:												
2Way95thQ:	0.1	xxxx	xxxxx	0.5	xxxx	xxxxx	xxxx	xxxx	xxxxx	xxxx	xxxx	xxxxx
Control Del:	12.8	xxxx	xxxxx	11.2	xxxx	xxxxx	xxxxx	xxxx	xxxxx	xxxxx	xxxx	xxxxx
LOS by Move:	B	*	*	B	*	*	*	*	*	*	*	*
Movement:	LT - LTR - RT	LT - LTR - RT	LT - LTR - RT	LT - LTR - RT	LT - LTR - RT	LT - LTR - RT	LT - LTR - RT	LT - LTR - RT	LT - LTR - RT	LT - LTR - RT	LT - LTR - RT	
Shared Cap.:	xxxx	xxxx	xxxxx	xxxx	xxxx	xxxxx	xxxx	89	xxxxx	xxxx	116	xxxxx
SharedQueue:	xxxxx	xxxx	xxxxx	xxxxx	xxxx	xxxxx	xxxxx	0.7	xxxxx	xxxxx	6.4	xxxxx
Shrd ConDel:	xxxxx	xxxx	xxxxx	xxxxx	xxxx	xxxxx	xxxxx	54.8	xxxxx	xxxxx	149	xxxxx
Shared LOS:	*	*	*	*	*	*	*	F	*	*	F	*
ApproachDel:	xxxxxxx	xxxxxxx		xxxxxxx			54.8			148.8		
ApproachLOS:		*			*			F			F	

Note: Queue reported is the number of cars per lane.

Voices School
Morgan Hill, CA
Hexagon Transportation Consultants, Inc.

Level Of Service Computation Report
2000 HCM Unsignalized (Future Volume Alternative)
2025 Plus Project (AM) - 2 Cosmo Right out

Intersection #1112: Monterey Road and San Pedro Avenue

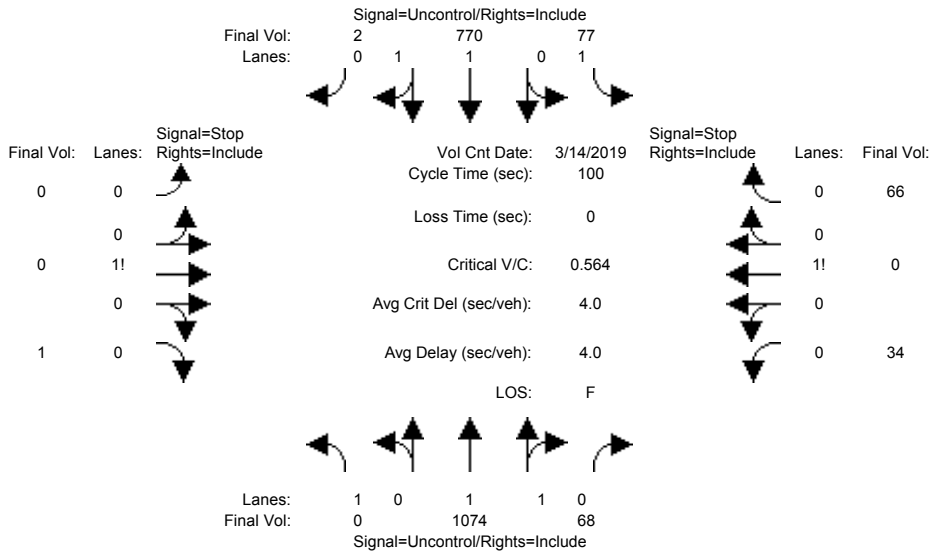

Street Name:	Monterey Road				San Pedro Avenue							
Approach:	North Bound		South Bound		East Bound		West Bound					
Movement:	L	T	R	L	T	R	L	T	R	L	T	R

Volume Module:	>>	Count	Date:	14 Mar 2019	<<							
Base Vol:	0	887	68	67	463	2	0	0	1	27	0	61
Growth Adj:	1.00	1.00	1.00	1.00	1.00	1.00	1.00	1.00	1.00	1.00	1.00	1.00
Initial Bse:	0	887	68	67	463	2	0	0	1	27	0	61
Added Vol:	0	0	0	5	214	0	0	0	0	7	0	0
PasserByVol:	0	187	0	5	93	0	0	0	0	0	0	5
Initial Fut:	0	1074	68	77	770	2	0	0	1	34	0	66
User Adj:	1.00	1.00	1.00	1.00	1.00	1.00	1.00	1.00	1.00	1.00	1.00	1.00
PHF Adj:	1.00	1.00	1.00	1.00	1.00	1.00	1.00	1.00	1.00	1.00	1.00	1.00
PHF Volume:	0	1074	68	77	770	2	0	0	1	34	0	66
Reduct Vol:	0	0	0	0	0	0	0	0	0	0	0	0
FinalVolume:	0	1074	68	77	770	2	0	0	1	34	0	66

Critical Gap Module:												
Critical Gp:	xxxxx	xxxx	xxxxx	4.1	xxxx	xxxxx	xxxxx	xxxx	6.9	7.5	6.5	6.9
FollowUpTim:	xxxxx	xxxx	xxxxx	2.2	xxxx	xxxxx	xxxxx	xxxx	3.3	3.5	4.0	3.3

Capacity Module:												
Cnflct Vol:	xxxx	xxxx	xxxxx	1142	xxxx	xxxxx	xxxx	xxxx	386	1647	2034	571
Potent Cap.:	xxxx	xxxx	xxxxx	619	xxxx	xxxxx	xxxx	xxxx	618	67	58	469
Move Cap.:	xxxx	xxxx	xxxxx	619	xxxx	xxxxx	xxxx	xxxx	618	60	51	469
Volume/Cap:	xxxx	xxxx	xxxx	0.12	xxxx	xxxx	xxxx	xxxx	0.00	0.56	0.00	0.14

Level Of Service Module:												
2Way95thQ:	xxxx	xxxx	xxxxx	0.4	xxxx	xxxxx	xxxx	xxxx	0.0	xxxx	xxxx	xxxxx
Control Del:	xxxxx	xxxx	xxxxx	11.6	xxxx	xxxxx	xxxxx	xxxx	10.8	xxxxx	xxxx	xxxxx
LOS by Move:	*	*	*	B	*	*	*	*	B	*	*	*
Movement:	LT	LTR	RT	LT	LTR	RT	LT	LTR	RT	LT	LTR	RT
Shared Cap.:	xxxx	xxxx	xxxxx	xxxx	xxxx	xxxxx	xxxx	xxxx	xxxxx	xxxx	142	xxxxx
SharedQueue:	xxxxx	xxxx	xxxxx	xxxxx	xxxx	xxxxx	xxxxx	xxxx	xxxxx	xxxxx	4.0	xxxxx
Shrd ConDel:	xxxxx	xxxx	xxxxx	xxxxx	xxxx	xxxxx	xxxxx	xxxx	xxxxx	xxxxx	75.6	xxxxx
Shared LOS:	*	*	*	*	*	*	*	*	*	*	F	*
ApproachDel:	xxxxxxx			xxxxxxx					10.8			75.6
ApproachLOS:									B			F

Note: Queue reported is the number of cars per lane.

Voices School
Morgan Hill, CA
Hexagon Transportation Consultants, Inc.

Level Of Service Computation Report
2000 HCM Unsignalized (Future Volume Alternative)
2025 Plus Project (PM) - 2 Cosmo Right out

Intersection #1112: Monterey Road and San Pedro Avenue

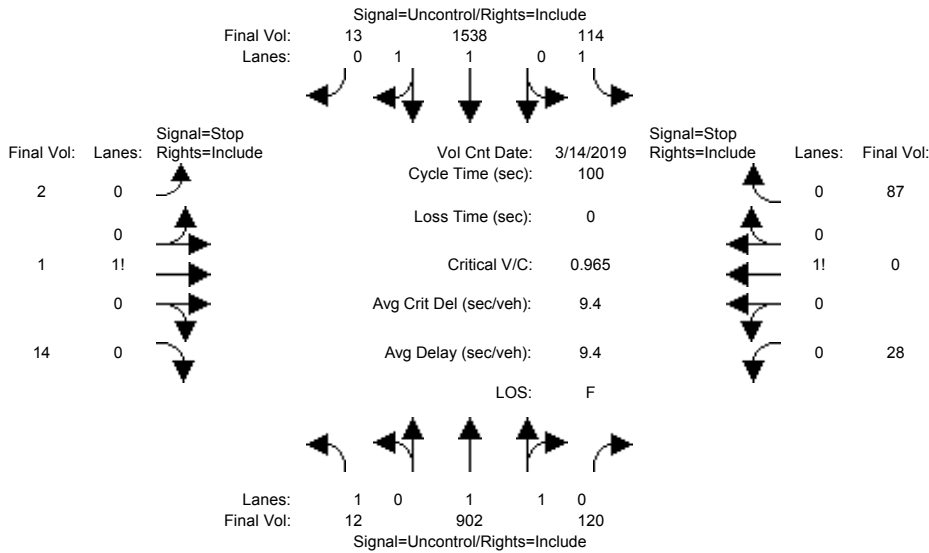

Street Name: Monterey Road San Pedro Avenue
Approach: North Bound South Bound East Bound West Bound
Movement: L - T - R L - T - R L - T - R L - T - R

Volume Module:	>>	Count	Date:	14 Mar 2019	<<							
Base Vol:	12	774	120	102	1333	13	2	1	14	27	0	83
Growth Adj:	1.00	1.00	1.00	1.00	1.00	1.00	1.00	1.00	1.00	1.00	1.00	1.00
Initial Bse:	12	774	120	102	1333	13	2	1	14	27	0	83
Added Vol:	0	0	0	8	98	0	0	0	0	1	0	0
PasserByVol:	0	128	0	4	107	0	0	0	0	0	0	4
Initial Fut:	12	902	120	114	1538	13	2	1	14	28	0	87
User Adj:	1.00	1.00	1.00	1.00	1.00	1.00	1.00	1.00	1.00	1.00	1.00	1.00
PHF Adj:	1.00	1.00	1.00	1.00	1.00	1.00	1.00	1.00	1.00	1.00	1.00	1.00
PHF Volume:	12	902	120	114	1538	13	2	1	14	28	0	87
Reduct Vol:	0	0	0	0	0	0	0	0	0	0	0	0
FinalVolume:	12	902	120	114	1538	13	2	1	14	28	0	87

Critical Gap Module:

Critical Gp:	4.1	xxxx	xxxxxx	4.1	xxxx	xxxxxx	7.5	6.5	6.9	7.5	6.5	6.9
FollowUpTim:	2.2	xxxx	xxxxxx	2.2	xxxx	xxxxxx	3.5	4.0	3.3	3.5	4.0	3.3

Capacity Module:

Cnflct Vol:	1551	xxxx	xxxxxx	1022	xxxx	xxxxxx	2248	2819	776	1984	2765	511
Potent Cap.:	433	xxxx	xxxxxx	687	xxxx	xxxxxx	23	18	345	37	20	513
Move Cap.:	433	xxxx	xxxxxx	687	xxxx	xxxxxx	17	15	345	29	16	513
Volume/Cap:	0.03	xxxx	xxxx	0.17	xxxx	xxxx	0.12	0.07	0.04	0.97	0.00	0.17

Level Of Service Module:

2Way95thQ:	0.1	xxxx	xxxxxx	0.6	xxxx	xxxxxx	xxxx	xxxx	xxxxxx	xxxx	xxxx	xxxxxx
Control Del:	13.6	xxxx	xxxxxx	11.3	xxxx	xxxxxx	xxxxxx	xxxx	xxxxxx	xxxxxx	xxxx	xxxxxx
LOS by Move:	B	*	*	B	*	*	*	*	*	*	*	*
Movement:	LT - LTR - RT			LT - LTR - RT			LT - LTR - RT			LT - LTR - RT		
Shared Cap.:	xxxx	xxxx	xxxxxx	xxxx	xxxx	xxxxxx	xxxx	74	xxxxxx	xxxx	101	xxxxxx
SharedQueue:	xxxxxx	xxxx	xxxxxx	xxxxxx	xxxx	xxxxxx	xxxxxx	0.8	xxxxxx	xxxxxx	7.5	xxxxxx
Shrd ConDel:	xxxxxx	xxxx	xxxxxx	xxxxxx	xxxx	xxxxxx	xxxxxx	67.2	xxxxxx	xxxxxx	209	xxxxxx
Shared LOS:	*	*	*	*	*	*	*	F	*	*	F	*
ApproachDel:	xxxxxxx			xxxxxxx				67.2			209.0	
ApproachLOS:	*			*				F			F	

Note: Queue reported is the number of cars per lane.

Voices School
Morgan Hill, CA
Hexagon Transportation Consultants, Inc.

Level Of Service Computation Report
2000 HCM Operations (Future Volume Alternative)
2025 No Project (AM)

Intersection #1200: Monterey Road and Cosmo Avenue

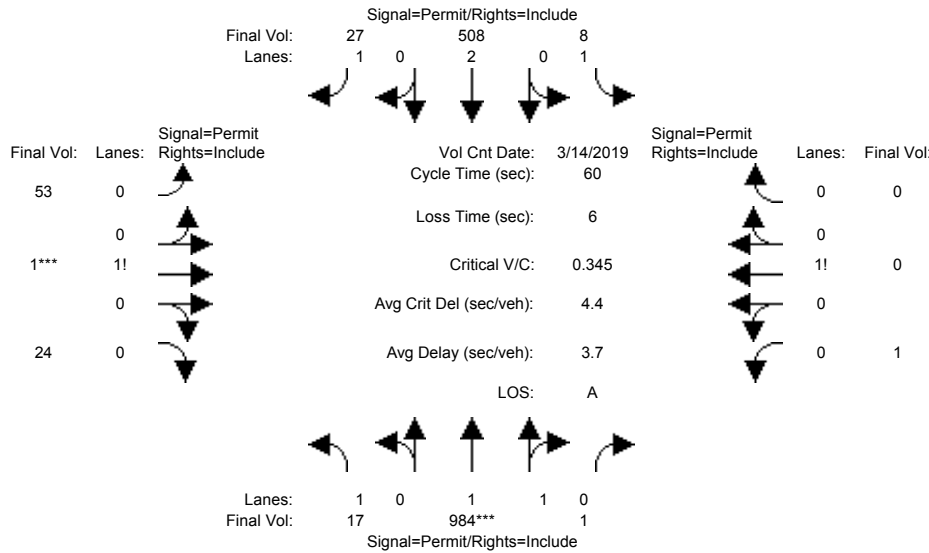

Street Name:	Monterey Rd						Cosmo Ave					
Approach:	North Bound			South Bound			East Bound			West Bound		
Movement:	L	T	R	L	T	R	L	T	R	L	T	R
Min. Green:	10	10	10	10	10	10	10	10	10	10	10	10
Y+R:	4.0	4.0	4.0	4.0	4.0	4.0	4.0	4.0	4.0	4.0	4.0	4.0

Volume Module:	>>	Count	Date:	14 Mar 2019	<<											
Base Vol:	17	815	1	8	427	27	53	1	24	1	0	0				
Growth Adj:	1.00	1.00	1.00	1.00	1.00	1.00	1.00	1.00	1.00	1.00	1.00	1.00				
Initial Bse:	17	815	1	8	427	27	53	1	24	1	0	0				
Added Vol:	0	0	0	0	0	0	0	0	0	0	0	0				
PasserByVol:	0	169	0	0	81	0	0	0	0	0	0	0				
Initial Fut:	17	984	1	8	508	27	53	1	24	1	0	0				
User Adj:	1.00	1.00	1.00	1.00	1.00	1.00	1.00	1.00	1.00	1.00	1.00	1.00				
PHF Adj:	1.00	1.00	1.00	1.00	1.00	1.00	1.00	1.00	1.00	1.00	1.00	1.00				
PHF Volume:	17	984	1	8	508	27	53	1	24	1	0	0				
Reduct Vol:	0	0	0	0	0	0	0	0	0	0	0	0				
Reduced Vol:	17	984	1	8	508	27	53	1	24	1	0	0				
PCE Adj:	1.00	1.00	1.00	1.00	1.00	1.00	1.00	1.00	1.00	1.00	1.00	1.00				
MLF Adj:	1.00	1.00	1.00	1.00	1.00	1.00	1.00	1.00	1.00	1.00	1.00	1.00				
FinalVolume:	17	984	1	8	508	27	53	1	24	1	0	0				

Saturation Flow Module:												
Sat/Lane:	1900	1900	1900	1900	1900	1900	1900	1900	1900	1900	1900	1900
Adjustment:	0.92	0.97	0.95	0.92	1.00	0.92	0.92	0.92	0.92	0.92	1.00	0.92
Lanes:	1.00	1.99	0.01	1.00	2.00	1.00	0.68	0.01	0.31	1.00	0.00	0.00
Final Sat.:	1750	3696	4	1750	3800	1750	1189	22	538	1750	0	0

Capacity Analysis Module:												
Vol/Sat:	0.01	0.27	0.27	0.00	0.13	0.02	0.04	0.04	0.04	0.00	0.00	0.00
Crit Moves:	****									****		
Green Time:	44.0	44.0	44.0	44.0	44.0	44.0	10.0	10.0	10.0	10.0	0.0	0.0
Volume/Cap:	0.01	0.36	0.36	0.01	0.18	0.02	0.27	0.27	0.27	0.00	0.00	0.00
Delay/Veh:	2.2	3.0	3.0	2.1	2.5	2.2	22.3	22.3	22.3	20.8	0.0	0.0
User DelAdj:	1.00	1.00	1.00	1.00	1.00	1.00	1.00	1.00	1.00	1.00	1.00	1.00
AdjDel/Veh:	2.2	3.0	3.0	2.1	2.5	2.2	22.3	22.3	22.3	20.8	0.0	0.0
LOS by Move:	A	A	A	A	A	A	C	C	C	C	A	A
HCM2kAvgQ:	0	4	4	0	2	0	2	2	2	0	0	0

Note: Queue reported is the number of cars per lane.

Voices School
Morgan Hill, CA
Hexagon Transportation Consultants, Inc.

Level Of Service Computation Report
2000 HCM Operations (Future Volume Alternative)
2025 No Project (PM)

Intersection #1200: Monterey Road and Cosmo Avenue

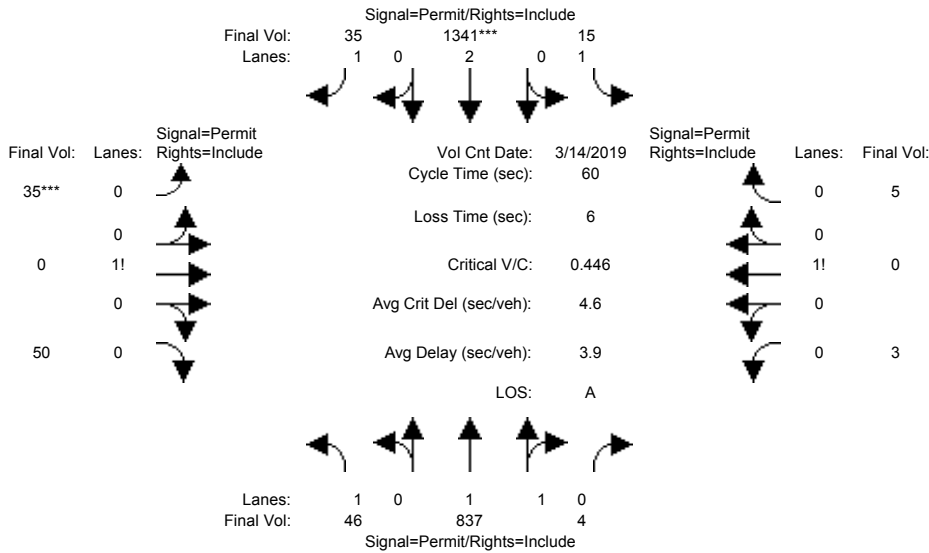

Street Name:	Monterey Rd						Cosmo Ave					
Approach:	North Bound			South Bound			East Bound			West Bound		
Movement:	L	T	R	L	T	R	L	T	R	L	T	R
Min. Green:	10	10	10	10	10	10	10	10	10	10	10	10
Y+R:	4.0	4.0	4.0	4.0	4.0	4.0	4.0	4.0	4.0	4.0	4.0	4.0

Volume Module:	>>	Count	Date:	14 Mar 2019	<<							
Base Vol:	45	722	4	15	1246	35	35	0	49	3	0	5
Growth Adj:	1.00	1.00	1.00	1.00	1.00	1.00	1.00	1.00	1.00	1.00	1.00	1.00
Initial Bse:	45	722	4	15	1246	35	35	0	49	3	0	5
Added Vol:	0	0	0	0	0	0	0	0	0	0	0	0
PasserByVol:	1	115	0	0	95	0	0	0	1	0	0	0
Initial Fut:	46	837	4	15	1341	35	35	0	50	3	0	5
User Adj:	1.00	1.00	1.00	1.00	1.00	1.00	1.00	1.00	1.00	1.00	1.00	1.00
PHF Adj:	1.00	1.00	1.00	1.00	1.00	1.00	1.00	1.00	1.00	1.00	1.00	1.00
PHF Volume:	46	837	4	15	1341	35	35	0	50	3	0	5
Reduct Vol:	0	0	0	0	0	0	0	0	0	0	0	0
Reduced Vol:	46	837	4	15	1341	35	35	0	50	3	0	5
PCE Adj:	1.00	1.00	1.00	1.00	1.00	1.00	1.00	1.00	1.00	1.00	1.00	1.00
MLF Adj:	1.00	1.00	1.00	1.00	1.00	1.00	1.00	1.00	1.00	1.00	1.00	1.00
FinalVolume:	46	837	4	15	1341	35	35	0	50	3	0	5

Saturation Flow Module:	
Sat/Lane:	1900 1900 1900 1900 1900 1900 1900 1900 1900 1900 1900 1900
Adjustment:	0.92 0.97 0.95 0.92 1.00 0.92 0.92 0.92 0.92 0.92 0.92 0.92
Lanes:	1.00 1.99 0.01 1.00 2.00 1.00 0.41 0.00 0.59 0.37 0.00 0.63
Final Sat.:	1750 3682 18 1750 3800 1750 721 0 1029 656 0 1094

Capacity Analysis Module:	
Vol/Sat:	0.03 0.23 0.23 0.01 0.35 0.02 0.05 0.00 0.05 0.00 0.00 0.00
Crit Moves:	****
Green Time:	44.0 44.0 44.0 44.0 44.0 44.0 10.0 0.0 10.0 10.0 0.0 10.0
Volume/Cap:	0.04 0.31 0.31 0.01 0.48 0.03 0.29 0.00 0.29 0.03 0.00 0.03
Delay/Veh:	2.2 2.8 2.8 2.2 3.4 2.2 22.5 0.0 22.5 21.0 0.0 21.0
User DelAdj:	1.00 1.00 1.00 1.00 1.00 1.00 1.00 1.00 1.00 1.00 1.00 1.00
AdjDel/Veh:	2.2 2.8 2.8 2.2 3.4 2.2 22.5 0.0 22.5 21.0 0.0 21.0
LOS by Move:	A A A A A A C A C C A C
HCM2kAvgQ:	0 3 3 0 6 0 2 0 2 0 0 0

Note: Queue reported is the number of cars per lane.

Voices School
Morgan Hill, CA
Hexagon Transportation Consultants, Inc.

Level Of Service Computation Report
2000 HCM Operations (Future Volume Alternative)
2025 Plus Project (AM) - 2 Cosmo Right out

Intersection #1200: Monterey Road and Cosmo Avenue

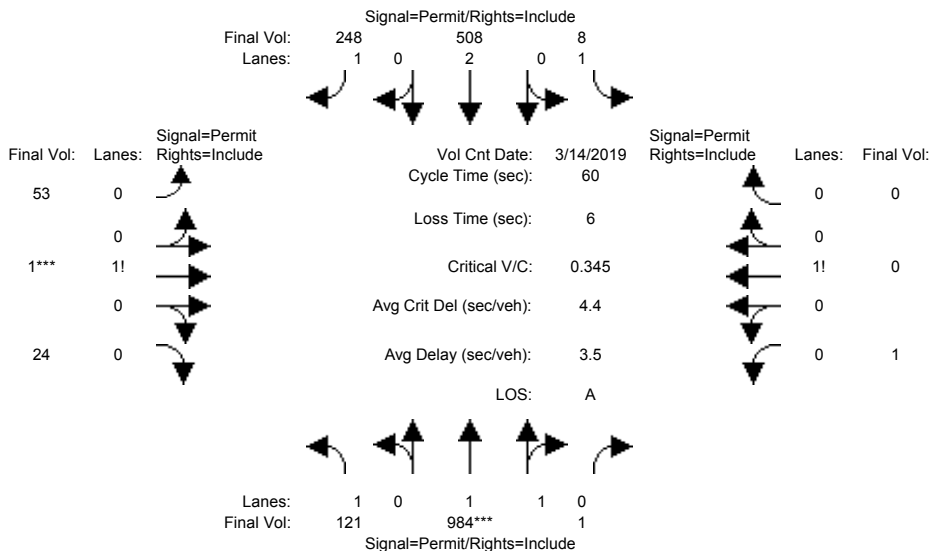

Street Name:	Monterey Rd						Cosmo Ave					
Approach:	North Bound			South Bound			East Bound			West Bound		
Movement:	L	T	R	L	T	R	L	T	R	L	T	R
Min. Green:	10	10	10	10	10	10	10	10	10	10	10	10
Y+R:	4.0	4.0	4.0	4.0	4.0	4.0	4.0	4.0	4.0	4.0	4.0	4.0

Volume Module:	>>	Count	Date:	14 Mar 2019	<<											
Base Vol:	17	815	1	8	427	27	53	1	24	1	0	0				
Growth Adj:	1.00	1.00	1.00	1.00	1.00	1.00	1.00	1.00	1.00	1.00	1.00	1.00				
Initial Bse:	17	815	1	8	427	27	53	1	24	1	0	0				
Added Vol:	104	0	0	0	0	221	0	0	0	0	0	0				
PasserByVol:	0	169	0	0	81	0	0	0	0	0	0	0				
Initial Fut:	121	984	1	8	508	248	53	1	24	1	0	0				
User Adj:	1.00	1.00	1.00	1.00	1.00	1.00	1.00	1.00	1.00	1.00	1.00	1.00				
PHF Adj:	1.00	1.00	1.00	1.00	1.00	1.00	1.00	1.00	1.00	1.00	1.00	1.00				
PHF Volume:	121	984	1	8	508	248	53	1	24	1	0	0				
Reduct Vol:	0	0	0	0	0	0	0	0	0	0	0	0				
Reduced Vol:	121	984	1	8	508	248	53	1	24	1	0	0				
PCE Adj:	1.00	1.00	1.00	1.00	1.00	1.00	1.00	1.00	1.00	1.00	1.00	1.00				
MLF Adj:	1.00	1.00	1.00	1.00	1.00	1.00	1.00	1.00	1.00	1.00	1.00	1.00				
FinalVolume:	121	984	1	8	508	248	53	1	24	1	0	0				

Saturation Flow Module:												
Sat/Lane:	1900	1900	1900	1900	1900	1900	1900	1900	1900	1900	1900	1900
Adjustment:	0.92	0.97	0.95	0.92	1.00	0.92	0.92	0.92	0.92	0.92	1.00	0.92
Lanes:	1.00	1.99	0.01	1.00	2.00	1.00	0.68	0.01	0.31	1.00	0.00	0.00
Final Sat.:	1750	3696	4	1750	3800	1750	1189	22	538	1750	0	0

Capacity Analysis Module:												
Vol/Sat:	0.07	0.27	0.27	0.00	0.13	0.14	0.04	0.04	0.04	0.00	0.00	0.00
Crit Moves:	****									****		
Green Time:	44.0	44.0	44.0	44.0	44.0	44.0	10.0	10.0	10.0	10.0	0.0	0.0
Volume/Cap:	0.09	0.36	0.36	0.01	0.18	0.19	0.27	0.27	0.27	0.00	0.00	0.00
Delay/Veh:	2.3	3.0	3.0	2.1	2.5	2.6	22.3	22.3	22.3	20.8	0.0	0.0
User DelAdj:	1.00	1.00	1.00	1.00	1.00	1.00	1.00	1.00	1.00	1.00	1.00	1.00
AdjDel/Veh:	2.3	3.0	3.0	2.1	2.5	2.6	22.3	22.3	22.3	20.8	0.0	0.0
LOS by Move:	A	A	A	A	A	A	C	C	C	C	A	A
HCM2kAvgQ:	1	4	4	0	2	2	2	2	2	0	0	0

Note: Queue reported is the number of cars per lane.

Voices School
Morgan Hill, CA
Hexagon Transportation Consultants, Inc.

Level Of Service Computation Report
2000 HCM Operations (Future Volume Alternative)
2025 Plus Project (PM) - 2 Cosmo Right out

Intersection #1200: Monterey Road and Cosmo Avenue

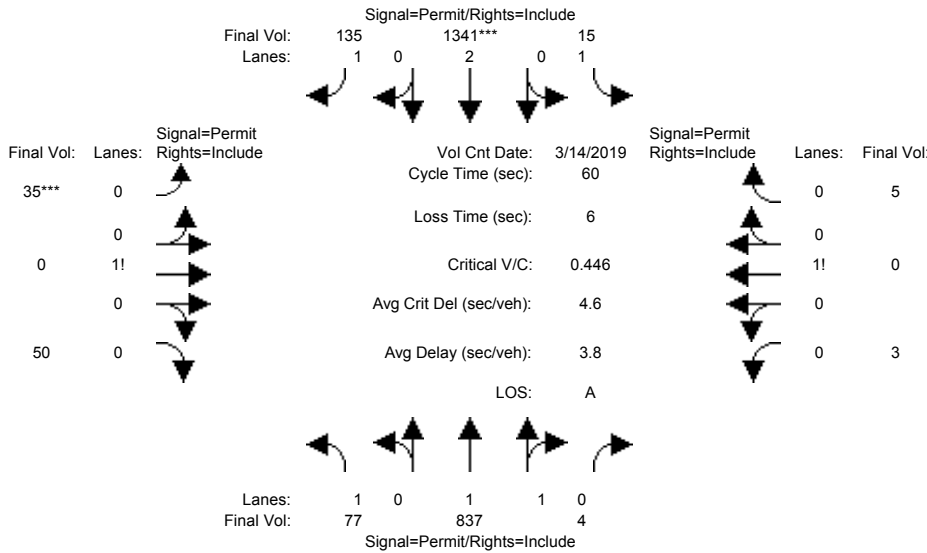

Street Name:	Monterey Rd						Cosmo Ave					
Approach:	North Bound			South Bound			East Bound			West Bound		
Movement:	L	T	R	L	T	R	L	T	R	L	T	R
Min. Green:	10	10	10	10	10	10	10	10	10	10	10	10
Y+R:	4.0	4.0	4.0	4.0	4.0	4.0	4.0	4.0	4.0	4.0	4.0	4.0

Volume Module:	>>	Count	Date:	14 Mar 2019	<<							
Base Vol:	45	722	4	15	1246	35	35	0	49	3	0	5
Growth Adj:	1.00	1.00	1.00	1.00	1.00	1.00	1.00	1.00	1.00	1.00	1.00	1.00
Initial Bse:	45	722	4	15	1246	35	35	0	49	3	0	5
Added Vol:	31	0	0	0	0	100	0	0	0	0	0	0
PasserByVol:	1	115	0	0	95	0	0	0	1	0	0	0
Initial Fut:	77	837	4	15	1341	135	35	0	50	3	0	5
User Adj:	1.00	1.00	1.00	1.00	1.00	1.00	1.00	1.00	1.00	1.00	1.00	1.00
PHF Adj:	1.00	1.00	1.00	1.00	1.00	1.00	1.00	1.00	1.00	1.00	1.00	1.00
PHF Volume:	77	837	4	15	1341	135	35	0	50	3	0	5
Reduct Vol:	0	0	0	0	0	0	0	0	0	0	0	0
Reduced Vol:	77	837	4	15	1341	135	35	0	50	3	0	5
PCE Adj:	1.00	1.00	1.00	1.00	1.00	1.00	1.00	1.00	1.00	1.00	1.00	1.00
MLF Adj:	1.00	1.00	1.00	1.00	1.00	1.00	1.00	1.00	1.00	1.00	1.00	1.00
FinalVolume:	77	837	4	15	1341	135	35	0	50	3	0	5

Saturation Flow Module:												
Sat/Lane:	1900	1900	1900	1900	1900	1900	1900	1900	1900	1900	1900	1900
Adjustment:	0.92	0.97	0.95	0.92	1.00	0.92	0.92	0.92	0.92	0.92	0.92	0.92
Lanes:	1.00	1.99	0.01	1.00	2.00	1.00	0.41	0.00	0.59	0.37	0.00	0.63
Final Sat.:	1750	3682	18	1750	3800	1750	721	0	1029	656	0	1094

Capacity Analysis Module:												
Vol/Sat:	0.04	0.23	0.23	0.01	0.35	0.08	0.05	0.00	0.05	0.00	0.00	0.00
Crit Moves:	****											
Green Time:	44.0	44.0	44.0	44.0	44.0	44.0	10.0	0.0	10.0	10.0	0.0	10.0
Volume/Cap:	0.06	0.31	0.31	0.01	0.48	0.11	0.29	0.00	0.29	0.03	0.00	0.03
Delay/Veh:	2.3	2.8	2.8	2.2	3.4	2.3	22.5	0.0	22.5	21.0	0.0	21.0
User DelAdj:	1.00	1.00	1.00	1.00	1.00	1.00	1.00	1.00	1.00	1.00	1.00	1.00
AdjDel/Veh:	2.3	2.8	2.8	2.2	3.4	2.3	22.5	0.0	22.5	21.0	0.0	21.0
LOS by Move:	A	A	A	A	A	A	C	A	C	C	A	C
HCM2kAvgQ:	0	3	3	0	6	1	2	0	2	0	0	0

Note: Queue reported is the number of cars per lane.

Voices School
Morgan Hill, CA
Hexagon Transportation Consultants, Inc.

Level Of Service Computation Report
2000 HCM Unsignalized (Future Volume Alternative)
2025 No Project (AM)

Intersection #1300: Olympic Drive and Edmundson Avenue

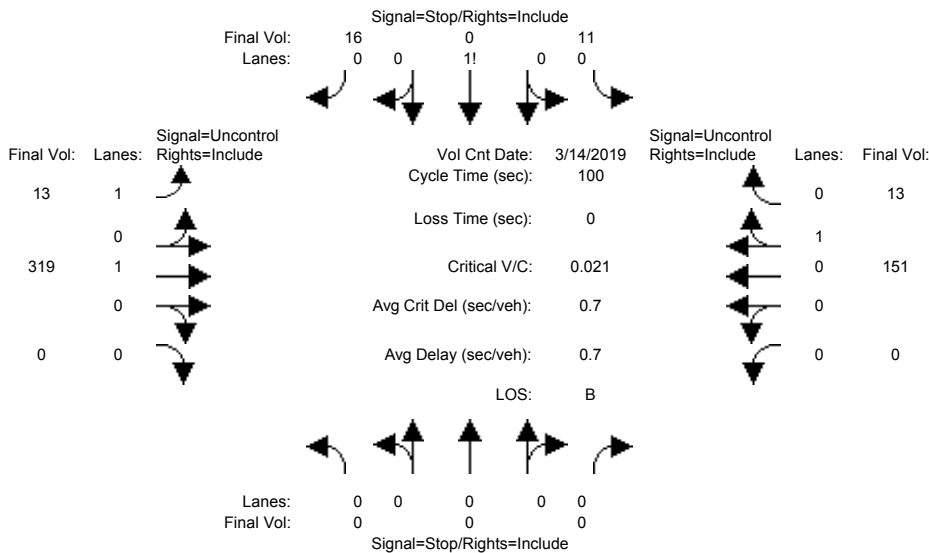

Street Name: Olympic Dr Edmundson Ave
Approach: North Bound South Bound East Bound West Bound
Movement: L - T - R L - T - R L - T - R L - T - R

Volume Module:	>>	Count	Date:	14 Mar 2019	<<							
Base Vol:	0	0	0	11	0	11	9	241	0	0	97	13
Growth Adj:	1.00	1.00	1.00	1.00	1.00	1.00	1.00	1.00	1.00	1.00	1.00	1.00
Initial Bse:	0	0	0	11	0	11	9	241	0	0	97	13
Added Vol:	0	0	0	0	0	0	0	0	0	0	0	0
PasserByVol:	0	0	0	0	0	5	4	78	0	0	54	0
Initial Fut:	0	0	0	11	0	16	13	319	0	0	151	13
User Adj:	1.00	1.00	1.00	1.00	1.00	1.00	1.00	1.00	1.00	1.00	1.00	1.00
PHF Adj:	1.00	1.00	1.00	1.00	1.00	1.00	1.00	1.00	1.00	1.00	1.00	1.00
PHF Volume:	0	0	0	11	0	16	13	319	0	0	151	13
Reduct Vol:	0	0	0	0	0	0	0	0	0	0	0	0
FinalVolume:	0	0	0	11	0	16	13	319	0	0	151	13

Critical Gap Module:

Critical Gp:	xxxxx	xxxx	xxxxx	6.4	6.5	6.2	4.1	xxxx	xxxxx	xxxxx	xxxx	xxxxx
FollowUpTim:	xxxxx	xxxx	xxxxx	3.5	4.0	3.3	2.2	xxxx	xxxxx	xxxxx	xxxx	xxxxx

Capacity Module:

Cnflct Vol:	xxxx	xxxx	xxxxx	503	503	158	164	xxxx	xxxxx	xxxx	xxxx	xxxxx
Potent Cap.:	xxxx	xxxx	xxxxx	532	474	893	1427	xxxx	xxxxx	xxxx	xxxx	xxxxx
Move Cap.:	xxxx	xxxx	xxxxx	528	470	893	1427	xxxx	xxxxx	xxxx	xxxx	xxxxx
Volume/Cap:	xxxx	xxxx	xxxx	0.02	0.00	0.02	0.01	xxxx	xxxx	xxxx	xxxx	xxxx

Level Of Service Module:

2Way95thQ:	xxxx	xxxx	xxxxx	xxxx	xxxx	xxxxx	0.0	xxxx	xxxxx	xxxx	xxxx	xxxxx
Control Del:	xxxxx	xxxx	xxxxx	xxxxx	xxxx	xxxxx	7.5	xxxx	xxxxx	xxxxx	xxxx	xxxxx
LOS by Move:	*	*	*	*	*	*	A	*	*	*	*	*
Movement:	LT - LTR - RT	LT - LTR - RT	LT - LTR - RT	LT - LTR - RT	LT - LTR - RT	LT - LTR - RT	LT - LTR - RT	LT - LTR - RT	LT - LTR - RT	LT - LTR - RT	LT - LTR - RT	LT - LTR - RT
Shared Cap.:	xxxx	xxxx	xxxxx	xxxx	697	xxxxx	xxxx	xxxx	xxxxx	xxxx	xxxx	xxxxx
SharedQueue:	xxxxx	xxxx	xxxxx	xxxxx	0.1	xxxxx	xxxxx	xxxx	xxxxx	xxxxx	xxxx	xxxxx
Shrd ConDel:	xxxxx	xxxx	xxxxx	xxxxx	10.4	xxxxx	xxxxx	xxxx	xxxxx	xxxxx	xxxx	xxxxx
Shared LOS:	*	*	*	*	B	*	*	*	*	*	*	*
ApproachDel:	xxxxxxx			10.4			xxxxxxx			xxxxxxx		
ApproachLOS:	*			B			*			*		*

Note: Queue reported is the number of cars per lane.

Voices School
Morgan Hill, CA
Hexagon Transportation Consultants, Inc.

Level Of Service Computation Report
2000 HCM Unsignalized (Future Volume Alternative)
2025 No Project (PM)

Intersection #1300: Olympic Drive and Edmundson Avenue

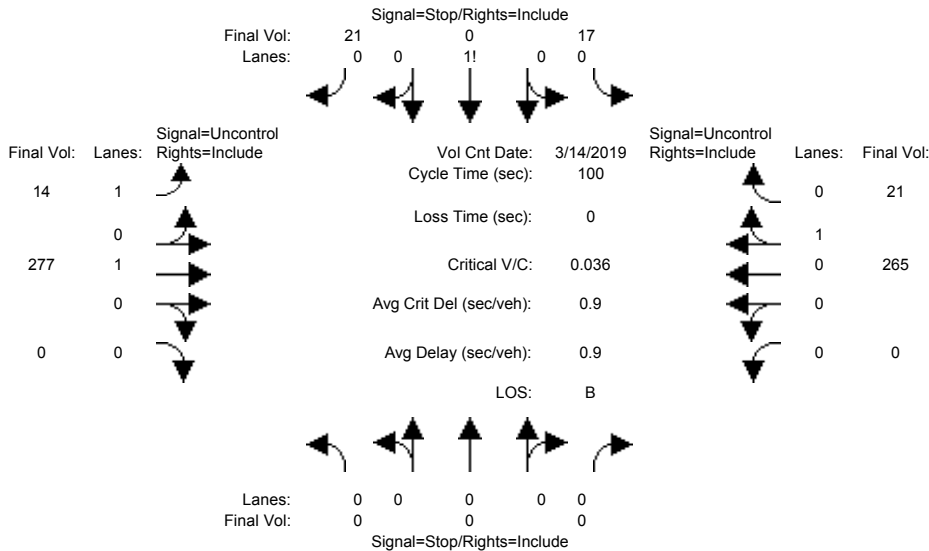

Street Name: Olympic Dr Edmundson Ave
Approach: North Bound South Bound East Bound West Bound
Movement: L - T - R L - T - R L - T - R L - T - R

Volume Module:	>>	Count	Date:	14 Mar 2019	<<							
Base Vol:	0	0	0	17	0	19	12	238	0	0	225	20
Growth Adj:	1.00	1.00	1.00	1.00	1.00	1.00	1.00	1.00	1.00	1.00	1.00	1.00
Initial Bse:	0	0	0	17	0	19	12	238	0	0	225	20
Added Vol:	0	0	0	0	0	0	0	0	0	0	0	0
PasserByVol:	0	0	0	0	0	2	2	39	0	0	40	1
Initial Fut:	0	0	0	17	0	21	14	277	0	0	265	21
User Adj:	1.00	1.00	1.00	1.00	1.00	1.00	1.00	1.00	1.00	1.00	1.00	1.00
PHF Adj:	1.00	1.00	1.00	1.00	1.00	1.00	1.00	1.00	1.00	1.00	1.00	1.00
PHF Volume:	0	0	0	17	0	21	14	277	0	0	265	21
Reduct Vol:	0	0	0	0	0	0	0	0	0	0	0	0
FinalVolume:	0	0	0	17	0	21	14	277	0	0	265	21

Critical Gap Module:

Critical Gp:	xxxxx	xxxx	xxxxx	6.4	6.5	6.2	4.1	xxxx	xxxxx	xxxxx	xxxx	xxxxx
FollowUpTim:	xxxxx	xxxx	xxxxx	3.5	4.0	3.3	2.2	xxxx	xxxxx	xxxxx	xxxx	xxxxx

Capacity Module:

Cnflct Vol:	xxxx	xxxx	xxxxx	581	581	276	286	xxxx	xxxxx	xxxx	xxxx	xxxxx
Potent Cap.:	xxxx	xxxx	xxxxx	480	428	768	1288	xxxx	xxxxx	xxxx	xxxx	xxxxx
Move Cap.:	xxxx	xxxx	xxxxx	476	424	768	1288	xxxx	xxxxx	xxxx	xxxx	xxxxx
Volume/Cap:	xxxx	xxxx	xxxx	0.04	0.00	0.03	0.01	xxxx	xxxx	xxxx	xxxx	xxxx

Level Of Service Module:

2Way95thQ:	xxxx	xxxx	xxxxx	xxxx	xxxx	xxxxx	0.0	xxxx	xxxxx	xxxx	xxxx	xxxxx
Control Del:	xxxxx	xxxx	xxxxx	xxxxx	xxxx	xxxxx	7.8	xxxx	xxxxx	xxxxx	xxxx	xxxxx
LOS by Move:	*	*	*	*	*	*	A	*	*	*	*	*
Movement:	LT - LTR - RT	LT - LTR - RT	LT - LTR - RT	LT - LTR - RT	LT - LTR - RT	LT - LTR - RT	LT - LTR - RT	LT - LTR - RT	LT - LTR - RT	LT - LTR - RT	LT - LTR - RT	LT - LTR - RT
Shared Cap.:	xxxx	xxxx	xxxxx	xxxx	602	xxxxx	xxxx	xxxx	xxxxx	xxxx	xxxx	xxxxx
SharedQueue:	xxxxx	xxxx	xxxxx	xxxxx	0.2	xxxxx	xxxxx	xxxx	xxxxx	xxxxx	xxxx	xxxxx
Shrd ConDel:	xxxxx	xxxx	xxxxx	xxxxx	11.4	xxxxx	xxxxx	xxxx	xxxxx	xxxxx	xxxx	xxxxx
Shared LOS:	*	*	*	*	B	*	*	*	*	*	*	*
ApproachDel:	xxxxxxx			11.4			xxxxxxx			xxxxxxx		
ApproachLOS:	*			B			*			*		*

Note: Queue reported is the number of cars per lane.

Voices School
Morgan Hill, CA
Hexagon Transportation Consultants, Inc.

Level Of Service Computation Report
2000 HCM Unsignalized (Future Volume Alternative)
2025 Plus Project (AM) - 2 Cosmo Right out

Intersection #1300: Olympic Drive and Edmundson Avenue

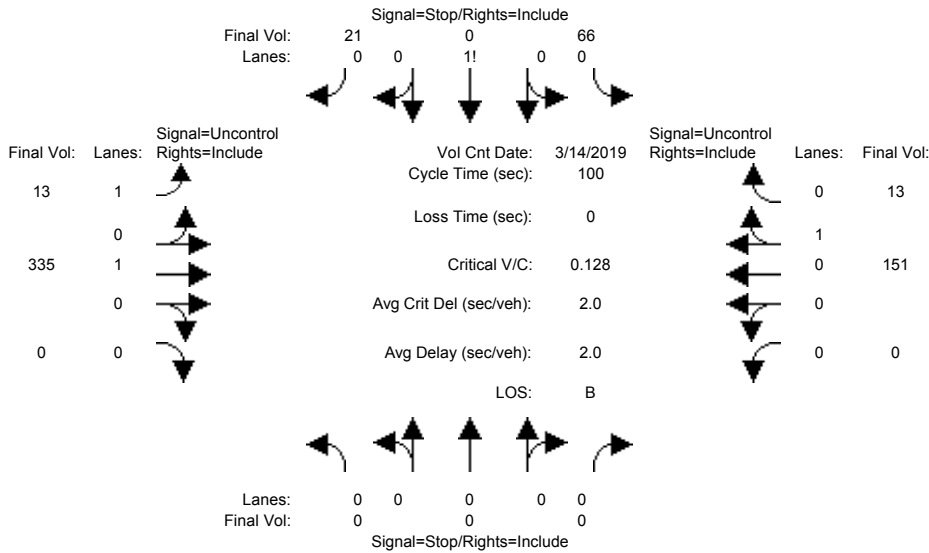

Street Name: Olympic Dr Edmundson Ave

Approach: North Bound South Bound East Bound West Bound

Movement: L - T - R L - T - R L - T - R L - T - R

Volume Module:	>>	Count	Date:	14 Mar 2019	<<							
Base Vol:	0	0	0	11	0	11	9	241	0	0	97	13
Growth Adj:	1.00	1.00	1.00	1.00	1.00	1.00	1.00	1.00	1.00	1.00	1.00	1.00
Initial Bse:	0	0	0	11	0	11	9	241	0	0	97	13
Added Vol:	0	0	0	55	0	5	0	16	0	0	0	0
PasserByVol:	0	0	0	0	0	5	4	78	0	0	54	0
Initial Fut:	0	0	0	66	0	21	13	335	0	0	151	13
User Adj:	1.00	1.00	1.00	1.00	1.00	1.00	1.00	1.00	1.00	1.00	1.00	1.00
PHF Adj:	1.00	1.00	1.00	1.00	1.00	1.00	1.00	1.00	1.00	1.00	1.00	1.00
PHF Volume:	0	0	0	66	0	21	13	335	0	0	151	13
Reduct Vol:	0	0	0	0	0	0	0	0	0	0	0	0
FinalVolume:	0	0	0	66	0	21	13	335	0	0	151	13

Critical Gap Module:

Critical Gp:	xxxxx	xxxx	xxxxx	6.4	6.5	6.2	4.1	xxxx	xxxxx	xxxxx	xxxx	xxxxx
FollowUpTim:	xxxxx	xxxx	xxxxx	3.5	4.0	3.3	2.2	xxxx	xxxxx	xxxxx	xxxx	xxxxx

Capacity Module:

Cnflct Vol:	xxxx	xxxx	xxxxx	519	519	158	164	xxxx	xxxxx	xxxx	xxxx	xxxxx
Potent Cap.:	xxxx	xxxx	xxxxx	521	464	893	1427	xxxx	xxxxx	xxxx	xxxx	xxxxx
Move Cap.:	xxxx	xxxx	xxxxx	517	460	893	1427	xxxx	xxxxx	xxxx	xxxx	xxxxx
Volume/Cap:	xxxx	xxxx	xxxx	0.13	0.00	0.02	0.01	xxxx	xxxx	xxxx	xxxx	xxxx

Level Of Service Module:

2Way95thQ:	xxxx	xxxx	xxxxx	xxxx	xxxx	xxxxx	0.0	xxxx	xxxxx	xxxx	xxxx	xxxxx
Control Del:	xxxxx	xxxx	xxxxx	xxxxx	xxxx	xxxxx	7.5	xxxx	xxxxx	xxxxx	xxxx	xxxxx
LOS by Move:	*	*	*	*	*	*	A	*	*	*	*	*
Movement:	LT - LTR - RT	LT - LTR - RT	LT - LTR - RT	LT - LTR - RT	LT - LTR - RT	LT - LTR - RT	LT - LTR - RT	LT - LTR - RT	LT - LTR - RT	LT - LTR - RT	LT - LTR - RT	LT - LTR - RT
Shared Cap.:	xxxx	xxxx	xxxxx	xxxx	576	xxxxx	xxxx	xxxx	xxxxx	xxxx	xxxx	xxxxx
SharedQueue:	xxxxx	xxxx	xxxxx	xxxxx	0.5	xxxxx	xxxxx	xxxx	xxxxx	xxxxx	xxxx	xxxxx
Shrd ConDel:	xxxxx	xxxx	xxxxx	xxxxx	12.4	xxxxx	xxxxx	xxxx	xxxxx	xxxxx	xxxx	xxxxx
Shared LOS:	*	*	*	*	B	*	*	*	*	*	*	*
ApproachDel:	xxxxxxx			12.4			xxxxxxx			xxxxxxx		
ApproachLOS:	*			B			*			*		*

Note: Queue reported is the number of cars per lane.

Voices School
Morgan Hill, CA
Hexagon Transportation Consultants, Inc.

Level Of Service Computation Report
2000 HCM Unsignalized (Future Volume Alternative)
2025 Plus Project (PM) - 2 Cosmo Right out

Intersection #1300: Olympic Drive and Edmundson Avenue

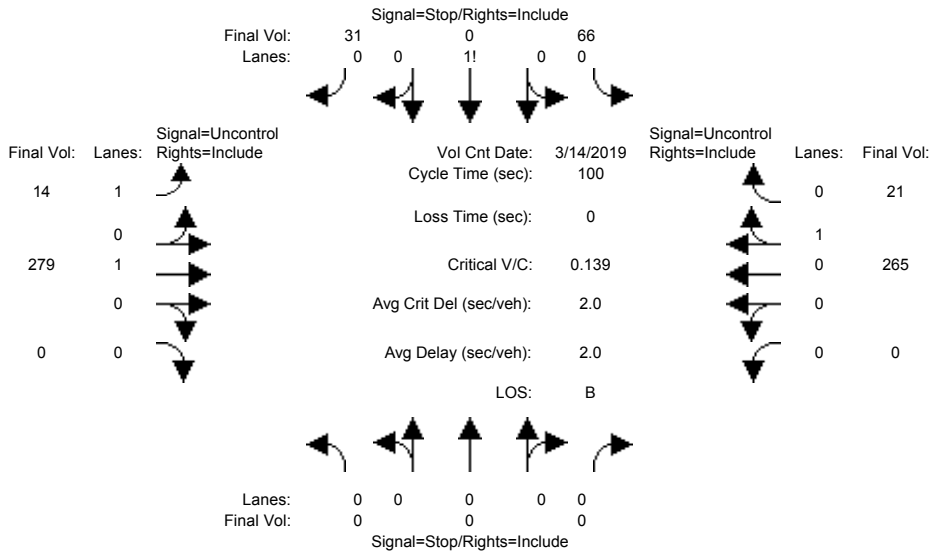

Street Name: Olympic Dr Edmundson Ave
Approach: North Bound South Bound East Bound West Bound
Movement: L - T - R L - T - R L - T - R L - T - R

Volume Module:	>>	Count	Date:	14 Mar 2019	<<							
Base Vol:	0	0	0	17	0	19	12	238	0	0	225	20
Growth Adj:	1.00	1.00	1.00	1.00	1.00	1.00	1.00	1.00	1.00	1.00	1.00	1.00
Initial Bse:	0	0	0	17	0	19	12	238	0	0	225	20
Added Vol:	0	0	0	49	0	10	0	2	0	0	0	0
PasserByVol:	0	0	0	0	0	2	2	39	0	0	40	1
Initial Fut:	0	0	0	66	0	31	14	279	0	0	265	21
User Adj:	1.00	1.00	1.00	1.00	1.00	1.00	1.00	1.00	1.00	1.00	1.00	1.00
PHF Adj:	1.00	1.00	1.00	1.00	1.00	1.00	1.00	1.00	1.00	1.00	1.00	1.00
PHF Volume:	0	0	0	66	0	31	14	279	0	0	265	21
Reduct Vol:	0	0	0	0	0	0	0	0	0	0	0	0
FinalVolume:	0	0	0	66	0	31	14	279	0	0	265	21

Critical Gap Module:

Critical Gp:	xxxxx	xxxx	xxxxx	6.4	6.5	6.2	4.1	xxxx	xxxxx	xxxxx	xxxx	xxxxx
FollowUpTim:	xxxxx	xxxx	xxxxx	3.5	4.0	3.3	2.2	xxxx	xxxxx	xxxxx	xxxx	xxxxx

Capacity Module:

Cnflct Vol:	xxxx	xxxx	xxxxx	583	583	276	286	xxxx	xxxxx	xxxx	xxxx	xxxxx
Potent Cap.:	xxxx	xxxx	xxxxx	478	427	768	1288	xxxx	xxxxx	xxxx	xxxx	xxxxx
Move Cap.:	xxxx	xxxx	xxxxx	474	422	768	1288	xxxx	xxxxx	xxxx	xxxx	xxxxx
Volume/Cap:	xxxx	xxxx	xxxx	0.14	0.00	0.04	0.01	xxxx	xxxx	xxxx	xxxx	xxxx

Level Of Service Module:

2Way95thQ:	xxxx	xxxx	xxxxx	xxxx	xxxx	xxxxx	0.0	xxxx	xxxxx	xxxx	xxxx	xxxxx
Control Del:	xxxxx	xxxx	xxxxx	xxxxx	xxxx	xxxxx	7.8	xxxx	xxxxx	xxxxx	xxxx	xxxxx
LOS by Move:	*	*	*	*	*	*	A	*	*	*	*	*
Movement:	LT - LTR - RT	LT - LTR - RT	LT - LTR - RT	LT - LTR - RT	LT - LTR - RT	LT - LTR - RT	LT - LTR - RT	LT - LTR - RT	LT - LTR - RT	LT - LTR - RT	LT - LTR - RT	LT - LTR - RT
Shared Cap.:	xxxx	xxxx	xxxxx	xxxx	540	xxxxx	xxxx	xxxx	xxxxx	xxxx	xxxx	xxxxx
SharedQueue:	xxxxx	xxxx	xxxxx	xxxxx	0.6	xxxxx	xxxxx	xxxx	xxxxx	xxxxx	xxxx	xxxxx
Shrd ConDel:	xxxxx	xxxx	xxxxx	xxxxx	13.1	xxxxx	xxxxx	xxxx	xxxxx	xxxxx	xxxx	xxxxx
Shared LOS:	*	*	*	*	B	*	*	*	*	*	*	*
ApproachDel:	xxxxxxx			13.1			xxxxxxx			xxxxxxx		
ApproachLOS:	*			B			*			*		*

Note: Queue reported is the number of cars per lane.

Voices School
Morgan Hill, CA
Hexagon Transportation Consultants, Inc.

Level Of Service Computation Report
2000 HCM 4-Way Stop (Future Volume Alternative)
2025 No Project (AM)

Intersection #1400: Del Monte Avenue and Cosmo Avenue

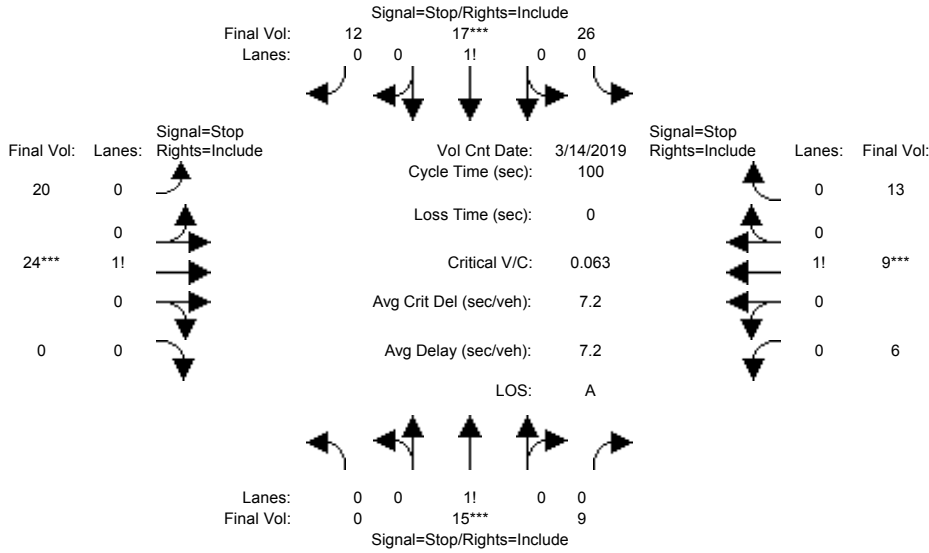

Street Name:	Del Monte Ave						Cosmo Ave					
Approach:	North Bound			South Bound			East Bound			West Bound		
Movement:	L	T	R	L	T	R	L	T	R	L	T	R
Min. Green:	0	0	0	0	0	0	0	0	0	0	0	0
Volume Module: >> Count Date: 14 Mar 2019 <<												
Base Vol:	0	15	9	26	17	10	17	24	0	6	9	12
Growth Adj:	1.00	1.00	1.00	1.00	1.00	1.00	1.00	1.00	1.00	1.00	1.00	1.00
Initial Bse:	0	15	9	26	17	10	17	24	0	6	9	12
Added Vol:	0	0	0	0	0	0	0	0	0	0	0	0
PasserByVol:	0	0	0	0	0	2	3	0	0	0	0	1
Initial Fut:	0	15	9	26	17	12	20	24	0	6	9	13
User Adj:	1.00	1.00	1.00	1.00	1.00	1.00	1.00	1.00	1.00	1.00	1.00	1.00
PHF Adj:	1.00	1.00	1.00	1.00	1.00	1.00	1.00	1.00	1.00	1.00	1.00	1.00
PHF Volume:	0	15	9	26	17	12	20	24	0	6	9	13
Reduct Vol:	0	0	0	0	0	0	0	0	0	0	0	0
Reduced Vol:	0	15	9	26	17	12	20	24	0	6	9	13
PCE Adj:	1.00	1.00	1.00	1.00	1.00	1.00	1.00	1.00	1.00	1.00	1.00	1.00
MLF Adj:	1.00	1.00	1.00	1.00	1.00	1.00	1.00	1.00	1.00	1.00	1.00	1.00
FinalVolume:	0	15	9	26	17	12	20	24	0	6	9	13
Saturation Flow Module:												
Adjustment:	1.00	1.00	1.00	1.00	1.00	1.00	1.00	1.00	1.00	1.00	1.00	1.00
Lanes:	0.00	0.62	0.38	0.47	0.31	0.22	0.45	0.55	0.00	0.21	0.32	0.47
Final Sat.:	0	570	342	415	271	192	385	461	0	195	293	423
Capacity Analysis Module:												
Vol/Sat:	xxxx	0.03	0.03	0.06	0.06	0.06	0.05	0.05	xxxx	0.03	0.03	0.03
Crit Moves:	****			****			****			****		
Delay/Veh:	0.0	7.0	7.0	7.3	7.3	7.3	7.4	7.4	0.0	7.0	7.0	7.0
Delay Adj:	1.00	1.00	1.00	1.00	1.00	1.00	1.00	1.00	1.00	1.00	1.00	1.00
AdjDel/Veh:	0.0	7.0	7.0	7.3	7.3	7.3	7.4	7.4	0.0	7.0	7.0	7.0
LOS by Move:	*	A	A	A	A	A	A	A	*	A	A	A
ApproachDel:		7.0			7.3			7.4			7.0	
Delay Adj:		1.00			1.00			1.00			1.00	
ApprAdjDel:		7.0			7.3			7.4			7.0	
LOS by Appr:		A			A			A			A	
AllWayAvgQ:	0.0	0.0	0.0	0.1	0.1	0.1	0.1	0.1	0.1	0.0	0.0	0.0

Note: Queue reported is the number of cars per lane.

Voices School
Morgan Hill, CA
Hexagon Transportation Consultants, Inc.

Level Of Service Computation Report
2000 HCM 4-Way Stop (Future Volume Alternative)
2025 No Project (PM)

Intersection #1400: Del Monte Avenue and Cosmo Avenue

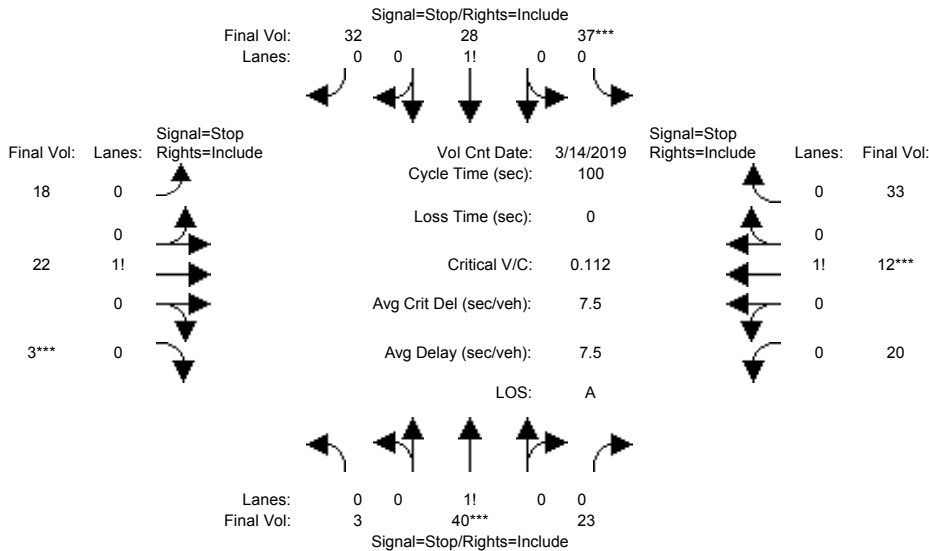

Street Name:	Del Monte Ave						Cosmo Ave					
Approach:	North Bound			South Bound			East Bound			West Bound		
Movement:	L	T	R	L	T	R	L	T	R	L	T	R
Min. Green:	0	0	0	0	0	0	0	0	0	0	0	0
Volume Module: >> Count Date: 14 Mar 2019 <<												
Base Vol:	3	40	23	36	28	30	17	22	3	20	12	31
Growth Adj:	1.00	1.00	1.00	1.00	1.00	1.00	1.00	1.00	1.00	1.00	1.00	1.00
Initial Bse:	3	40	23	36	28	30	17	22	3	20	12	31
Added Vol:	0	0	0	0	0	0	0	0	0	0	0	0
PasserByVol:	0	0	0	1	0	2	1	0	0	0	0	2
Initial Fut:	3	40	23	37	28	32	18	22	3	20	12	33
User Adj:	1.00	1.00	1.00	1.00	1.00	1.00	1.00	1.00	1.00	1.00	1.00	1.00
PHF Adj:	1.00	1.00	1.00	1.00	1.00	1.00	1.00	1.00	1.00	1.00	1.00	1.00
PHF Volume:	3	40	23	37	28	32	18	22	3	20	12	33
Reduct Vol:	0	0	0	0	0	0	0	0	0	0	0	0
Reduced Vol:	3	40	23	37	28	32	18	22	3	20	12	33
PCE Adj:	1.00	1.00	1.00	1.00	1.00	1.00	1.00	1.00	1.00	1.00	1.00	1.00
MLF Adj:	1.00	1.00	1.00	1.00	1.00	1.00	1.00	1.00	1.00	1.00	1.00	1.00
FinalVolume:	3	40	23	37	28	32	18	22	3	20	12	33
Saturation Flow Module:												
Adjustment:	1.00	1.00	1.00	1.00	1.00	1.00	1.00	1.00	1.00	1.00	1.00	1.00
Lanes:	0.04	0.61	0.35	0.38	0.29	0.33	0.42	0.51	0.07	0.31	0.18	0.51
Final Sat.:	40	528	304	329	249	285	335	409	56	265	159	437
Capacity Analysis Module:												
Vol/Sat:	0.08	0.08	0.08	0.11	0.11	0.11	0.05	0.05	0.05	0.08	0.08	0.08
Crit Moves:	****			****			****			****		
Delay/Veh:	7.3	7.3	7.3	7.6	7.6	7.6	7.6	7.6	7.6	7.4	7.4	7.4
Delay Adj:	1.00	1.00	1.00	1.00	1.00	1.00	1.00	1.00	1.00	1.00	1.00	1.00
AdjDel/Veh:	7.3	7.3	7.3	7.6	7.6	7.6	7.6	7.6	7.6	7.4	7.4	7.4
LOS by Move:	A	A	A	A	A	A	A	A	A	A	A	A
ApproachDel:	7.3			7.6			7.6			7.4		
Delay Adj:	1.00			1.00			1.00			1.00		
ApprAdjDel:	7.3			7.6			7.6			7.4		
LOS by Appr:	A			A			A			A		
AllWayAvgQ:	0.1	0.1	0.1	0.1	0.1	0.1	0.1	0.1	0.1	0.1	0.1	0.1

Voices School
Morgan Hill, CA
Hexagon Transportation Consultants, Inc.

Level Of Service Computation Report
2000 HCM 4-Way Stop (Future Volume Alternative)
2025 Plus Project (AM) - 2 Cosmo Right out

Intersection #1400: Del Monte Avenue and Cosmo Avenue

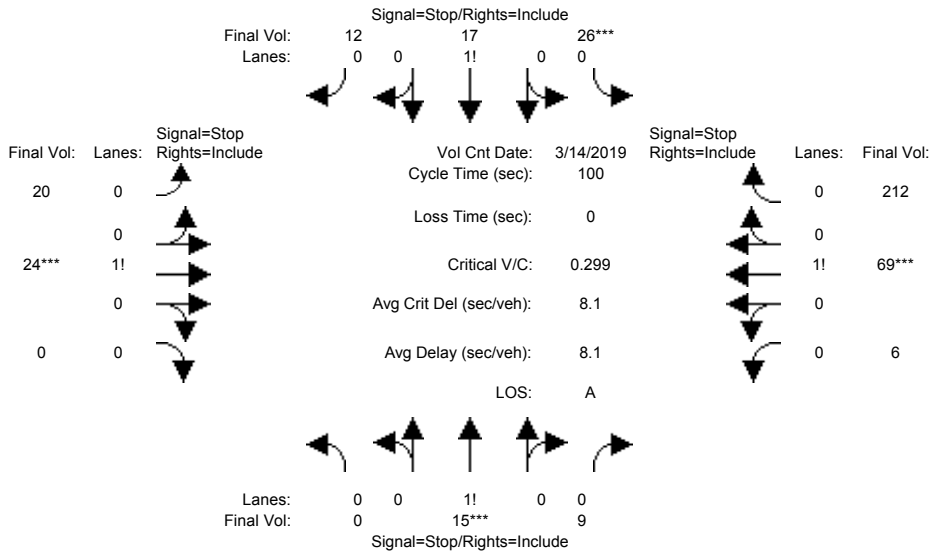

Street Name:	Del Monte Ave						Cosmo Ave					
Approach:	North Bound			South Bound			East Bound			West Bound		
Movement:	L	T	R	L	T	R	L	T	R	L	T	R
Min. Green:	0	0	0	0	0	0	0	0	0	0	0	0
Volume Module: >> Count Date: 14 Mar 2019 <<												
Base Vol:	0	15	9	26	17	10	17	24	0	6	9	12
Growth Adj:	1.00	1.00	1.00	1.00	1.00	1.00	1.00	1.00	1.00	1.00	1.00	1.00
Initial Bse:	0	15	9	26	17	10	17	24	0	6	9	12
Added Vol:	0	0	0	0	0	0	0	0	0	0	60	199
PasserByVol:	0	0	0	0	0	2	3	0	0	0	0	1
Initial Fut:	0	15	9	26	17	12	20	24	0	6	69	212
User Adj:	1.00	1.00	1.00	1.00	1.00	1.00	1.00	1.00	1.00	1.00	1.00	1.00
PHF Adj:	1.00	1.00	1.00	1.00	1.00	1.00	1.00	1.00	1.00	1.00	1.00	1.00
PHF Volume:	0	15	9	26	17	12	20	24	0	6	69	212
Reduct Vol:	0	0	0	0	0	0	0	0	0	0	0	0
Reduced Vol:	0	15	9	26	17	12	20	24	0	6	69	212
PCE Adj:	1.00	1.00	1.00	1.00	1.00	1.00	1.00	1.00	1.00	1.00	1.00	1.00
MLF Adj:	1.00	1.00	1.00	1.00	1.00	1.00	1.00	1.00	1.00	1.00	1.00	1.00
FinalVolume:	0	15	9	26	17	12	20	24	0	6	69	212
Saturation Flow Module:												
Adjustment:	1.00	1.00	1.00	1.00	1.00	1.00	1.00	1.00	1.00	1.00	1.00	1.00
Lanes:	0.00	0.62	0.38	0.47	0.31	0.22	0.45	0.55	0.00	0.02	0.24	0.74
Final Sat.:	0	480	288	353	231	163	361	433	0	20	231	710
Capacity Analysis Module:												
Vol/Sat:	xxxx	0.03	0.03	0.07	0.07	0.07	0.06	0.06	xxxx	0.30	0.30	0.30
Crit Moves:	****			****			****			****		
Delay/Veh:	0.0	7.5	7.5	7.9	7.9	7.9	7.7	7.7	0.0	8.2	8.2	8.2
Delay Adj:	1.00	1.00	1.00	1.00	1.00	1.00	1.00	1.00	1.00	1.00	1.00	1.00
AdjDel/Veh:	0.0	7.5	7.5	7.9	7.9	7.9	7.7	7.7	0.0	8.2	8.2	8.2
LOS by Move:	*	A	A	A	A	A	A	A	*	A	A	A
ApproachDel:		7.5			7.9			7.7			8.2	
Delay Adj:		1.00			1.00			1.00			1.00	
ApprAdjDel:		7.5			7.9			7.7			8.2	
LOS by Appr:		A			A			A			A	
AllWayAvgQ:	0.0	0.0	0.0	0.1	0.1	0.1	0.1	0.1	0.1	0.4	0.4	0.4

Note: Queue reported is the number of cars per lane.

Voices School
Morgan Hill, CA
Hexagon Transportation Consultants, Inc.

Level Of Service Computation Report
2000 HCM 4-Way Stop (Future Volume Alternative)
2025 Plus Project (PM) - 2 Cosmo Right out

Intersection #1400: Del Monte Avenue and Cosmo Avenue

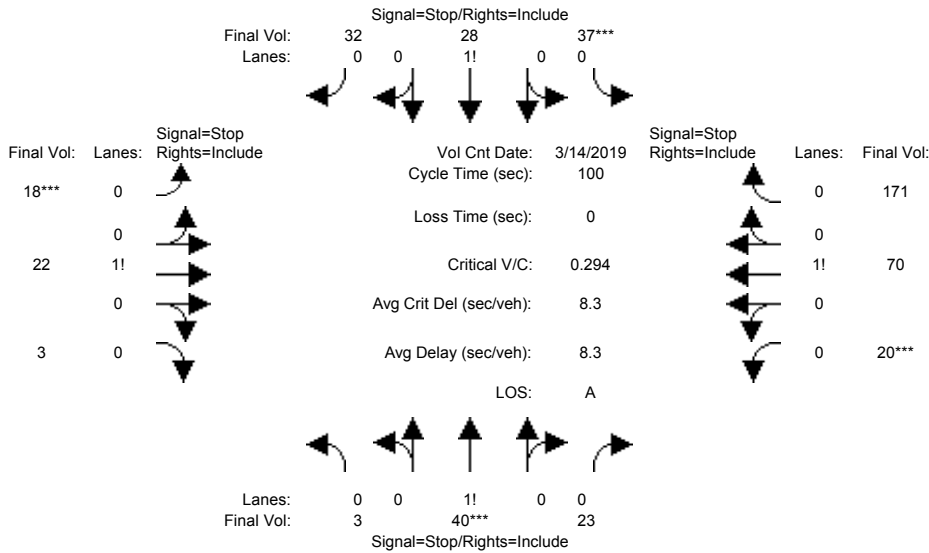

Street Name:	Del Monte Ave						Cosmo Ave					
Approach:	North Bound			South Bound			East Bound			West Bound		
Movement:	L	T	R	L	T	R	L	T	R	L	T	R
Min. Green:	0	0	0	0	0	0	0	0	0	0	0	0
Volume Module: >> Count Date: 14 Mar 2019 <<												
Base Vol:	3	40	23	36	28	30	17	22	3	20	12	31
Growth Adj:	1.00	1.00	1.00	1.00	1.00	1.00	1.00	1.00	1.00	1.00	1.00	1.00
Initial Bse:	3	40	23	36	28	30	17	22	3	20	12	31
Added Vol:	0	0	0	0	0	0	0	0	0	0	58	138
PasserByVol:	0	0	0	1	0	2	1	0	0	0	0	2
Initial Fut:	3	40	23	37	28	32	18	22	3	20	70	171
User Adj:	1.00	1.00	1.00	1.00	1.00	1.00	1.00	1.00	1.00	1.00	1.00	1.00
PHF Adj:	1.00	1.00	1.00	1.00	1.00	1.00	1.00	1.00	1.00	1.00	1.00	1.00
PHF Volume:	3	40	23	37	28	32	18	22	3	20	70	171
Reduct Vol:	0	0	0	0	0	0	0	0	0	0	0	0
Reduced Vol:	3	40	23	37	28	32	18	22	3	20	70	171
PCE Adj:	1.00	1.00	1.00	1.00	1.00	1.00	1.00	1.00	1.00	1.00	1.00	1.00
MLF Adj:	1.00	1.00	1.00	1.00	1.00	1.00	1.00	1.00	1.00	1.00	1.00	1.00
FinalVolume:	3	40	23	37	28	32	18	22	3	20	70	171
Saturation Flow Module:												
Adjustment:	1.00	1.00	1.00	1.00	1.00	1.00	1.00	1.00	1.00	1.00	1.00	1.00
Lanes:	0.04	0.61	0.35	0.38	0.29	0.33	0.42	0.51	0.07	0.08	0.27	0.65
Final Sat.:	35	462	266	289	219	250	316	387	53	68	238	582
Capacity Analysis Module:												
Vol/Sat:	0.09	0.09	0.09	0.13	0.13	0.13	0.06	0.06	0.06	0.29	0.29	0.29
Crit Moves:	****			****			****			****		
Delay/Veh:	7.8	7.8	7.8	8.1	8.1	8.1	7.8	7.8	7.8	8.5	8.5	8.5
Delay Adj:	1.00	1.00	1.00	1.00	1.00	1.00	1.00	1.00	1.00	1.00	1.00	1.00
AdjDel/Veh:	7.8	7.8	7.8	8.1	8.1	8.1	7.8	7.8	7.8	8.5	8.5	8.5
LOS by Move:	A	A	A	A	A	A	A	A	A	A	A	A
ApproachDel:	7.8			8.1			7.8			8.5		
Delay Adj:	1.00			1.00			1.00			1.00		
ApprAdjDel:	7.8			8.1			7.8			8.5		
LOS by Appr:	A			A			A			A		
AllWayAvgQ:	0.1	0.1	0.1	0.1	0.1	0.1	0.1	0.1	0.1	0.4	0.4	0.4

Voices School
Morgan Hill, CA
Hexagon Transportation Consultants, Inc.

Level Of Service Computation Report
2000 HCM 4-Way Stop (Future Volume Alternative)
2025 No Project (AM)

Intersection #1500: Del Monte Avenue and Spring Avenue

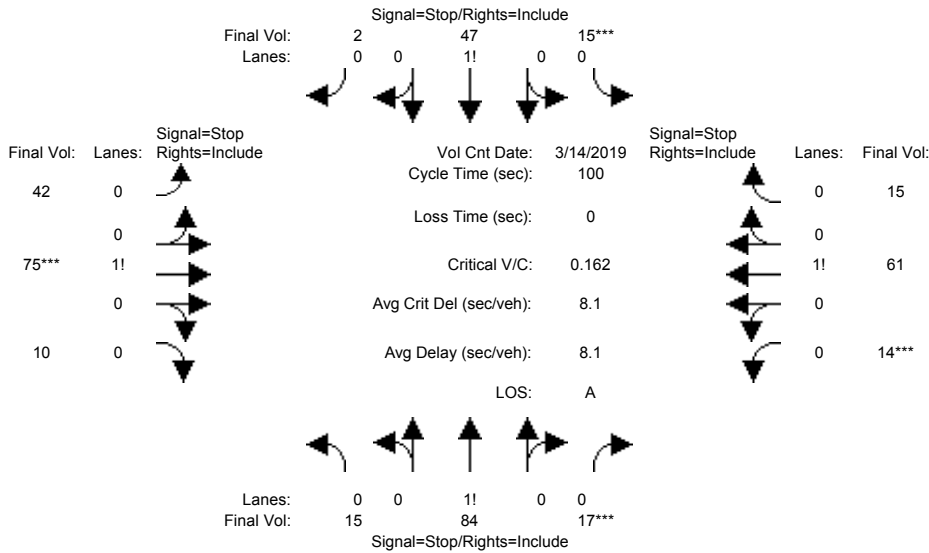

Street Name:	Del Monte Ave						Spring Ave					
Approach:	North Bound			South Bound			East Bound			West Bound		
Movement:	L	T	R	L	T	R	L	T	R	L	T	R
Min. Green:	0	0	0	0	0	0	0	0	0	0	0	0

Volume Module:	>> Count Date: 14 Mar 2019 <<											
Base Vol:	14	72	17	15	45	2	11	73	9	14	59	13
Growth Adj:	1.00	1.00	1.00	1.00	1.00	1.00	1.00	1.00	1.00	1.00	1.00	1.00
Initial Bse:	14	72	17	15	45	2	11	73	9	14	59	13
Added Vol:	0	0	0	0	0	0	0	0	0	0	0	0
PasserByVol:	1	12	0	0	2	0	31	2	1	0	2	2
Initial Fut:	15	84	17	15	47	2	42	75	10	14	61	15
User Adj:	1.00	1.00	1.00	1.00	1.00	1.00	1.00	1.00	1.00	1.00	1.00	1.00
PHF Adj:	1.00	1.00	1.00	1.00	1.00	1.00	1.00	1.00	1.00	1.00	1.00	1.00
PHF Volume:	15	84	17	15	47	2	42	75	10	14	61	15
Reduct Vol:	0	0	0	0	0	0	0	0	0	0	0	0
Reduced Vol:	15	84	17	15	47	2	42	75	10	14	61	15
PCE Adj:	1.00	1.00	1.00	1.00	1.00	1.00	1.00	1.00	1.00	1.00	1.00	1.00
MLF Adj:	1.00	1.00	1.00	1.00	1.00	1.00	1.00	1.00	1.00	1.00	1.00	1.00
FinalVolume:	15	84	17	15	47	2	42	75	10	14	61	15

Saturation Flow Module:												
Adjustment:	1.00	1.00	1.00	1.00	1.00	1.00	1.00	1.00	1.00	1.00	1.00	1.00
Lanes:	0.13	0.72	0.15	0.23	0.74	0.03	0.33	0.59	0.08	0.15	0.68	0.17
Final Sat.:	102	569	115	178	556	24	260	464	62	123	536	132

Capacity Analysis Module:												
Vol/Sat:	0.15	0.15	0.15	0.08	0.08	0.08	0.16	0.16	0.16	0.11	0.11	0.11
Crit Moves:			****	****			****			****		
Delay/Veh:	8.1	8.1	8.1	7.9	7.9	7.9	8.2	8.2	8.2	7.9	7.9	7.9
Delay Adj:	1.00	1.00	1.00	1.00	1.00	1.00	1.00	1.00	1.00	1.00	1.00	1.00
AdjDel/Veh:	8.1	8.1	8.1	7.9	7.9	7.9	8.2	8.2	8.2	7.9	7.9	7.9
LOS by Move:	A	A	A	A	A	A	A	A	A	A	A	A
ApproachDel:		8.1			7.9			8.2			7.9	
Delay Adj:		1.00			1.00			1.00			1.00	
ApprAdjDel:		8.1			7.9			8.2			7.9	
LOS by Appr:		A			A			A			A	
AllWayAvgQ:	0.2	0.2	0.2	0.1	0.1	0.1	0.2	0.2	0.2	0.1	0.1	0.1

Note: Queue reported is the number of cars per lane.

Voices School
Morgan Hill, CA
Hexagon Transportation Consultants, Inc.

Level Of Service Computation Report
2000 HCM 4-Way Stop (Future Volume Alternative)
2025 No Project (PM)

Intersection #1500: Del Monte Avenue and Spring Avenue

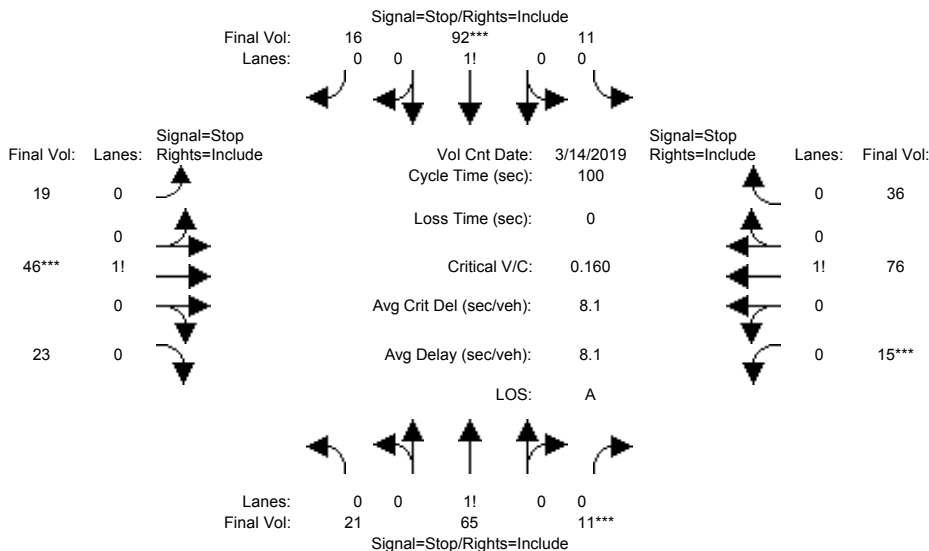

Street Name:	Del Monte Ave						Spring Ave					
	North Bound			South Bound			East Bound			West Bound		
Approach:	L	T	R	L	T	R	L	T	R	L	T	R
Min. Green:	0	0	0	0	0	0	0	0	0	0	0	0

Volume Module:	>> Count Date: 14 Mar 2019 <<											
Base Vol:	21	59	11	10	85	7	9	44	22	15	74	31
Growth Adj:	1.00	1.00	1.00	1.00	1.00	1.00	1.00	1.00	1.00	1.00	1.00	1.00
Initial Bse:	21	59	11	10	85	7	9	44	22	15	74	31
Added Vol:	0	0	0	0	0	0	0	0	0	0	0	0
PasserByVol:	0	6	0	1	7	9	10	2	1	0	2	5
Initial Fut:	21	65	11	11	92	16	19	46	23	15	76	36
User Adj:	1.00	1.00	1.00	1.00	1.00	1.00	1.00	1.00	1.00	1.00	1.00	1.00
PHF Adj:	1.00	1.00	1.00	1.00	1.00	1.00	1.00	1.00	1.00	1.00	1.00	1.00
PHF Volume:	21	65	11	11	92	16	19	46	23	15	76	36
Reduct Vol:	0	0	0	0	0	0	0	0	0	0	0	0
Reduced Vol:	21	65	11	11	92	16	19	46	23	15	76	36
PCE Adj:	1.00	1.00	1.00	1.00	1.00	1.00	1.00	1.00	1.00	1.00	1.00	1.00
MLF Adj:	1.00	1.00	1.00	1.00	1.00	1.00	1.00	1.00	1.00	1.00	1.00	1.00
FinalVolume:	21	65	11	11	92	16	19	46	23	15	76	36

Saturation Flow Module:												
Adjustment:	1.00	1.00	1.00	1.00	1.00	1.00	1.00	1.00	1.00	1.00	1.00	1.00
Lanes:	0.22	0.67	0.11	0.09	0.78	0.13	0.22	0.52	0.26	0.12	0.60	0.28
Final Sat.:	166	515	87	72	603	105	168	407	204	94	476	226

Capacity Analysis Module:												
Vol/Sat:	0.13	0.13	0.13	0.15	0.15	0.15	0.11	0.11	0.11	0.16	0.16	0.16
Crit Moves:			****		****		****			****		
Delay/Veh:	8.1	8.1	8.1	8.2	8.2	8.2	7.9	7.9	7.9	8.1	8.1	8.1
Delay Adj:	1.00	1.00	1.00	1.00	1.00	1.00	1.00	1.00	1.00	1.00	1.00	1.00
AdjDel/Veh:	8.1	8.1	8.1	8.2	8.2	8.2	7.9	7.9	7.9	8.1	8.1	8.1
LOS by Move:	A	A	A	A	A	A	A	A	A	A	A	A
ApproachDel:		8.1			8.2			7.9			8.1	
Delay Adj:		1.00			1.00			1.00			1.00	
ApprAdjDel:		8.1			8.2			7.9			8.1	
LOS by Appr:		A			A			A			A	
AllWayAvgQ:	0.1	0.1	0.1	0.2	0.2	0.2	0.1	0.1	0.1	0.2	0.2	0.2

Note: Queue reported is the number of cars per lane.

Voices School
Morgan Hill, CA
Hexagon Transportation Consultants, Inc.

Level Of Service Computation Report
2000 HCM 4-Way Stop (Future Volume Alternative)
2025 Plus Project (AM) - 2 Cosmo Right out

Intersection #1500: Del Monte Avenue and Spring Avenue

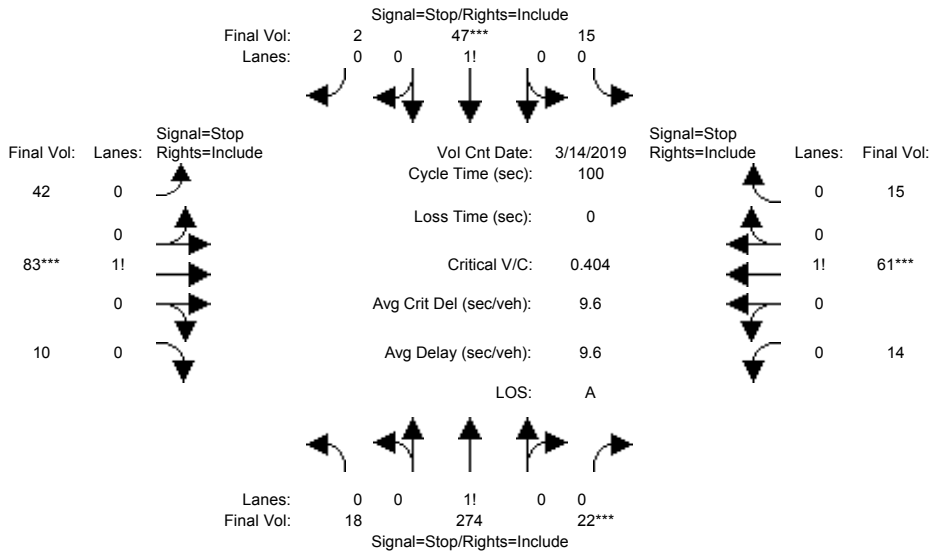

Street Name: Del Monte Ave Spring Ave
Approach: North Bound South Bound East Bound West Bound
Movement: L - T - R L - T - R L - T - R L - T - R

Min. Green: 0 0 0 0 0 0 0 0 0 0 0 0

Volume Module: >> Count Date: 14 Mar 2019 <<

Base Vol:	14	72	17	15	45	2	11	73	9	14	59	13
Growth Adj:	1.00	1.00	1.00	1.00	1.00	1.00	1.00	1.00	1.00	1.00	1.00	1.00
Initial Bse:	14	72	17	15	45	2	11	73	9	14	59	13
Added Vol:	3	190	5	0	0	0	0	8	0	0	0	0
PasserByVol:	1	12	0	0	2	0	31	2	1	0	2	2
Initial Fut:	18	274	22	15	47	2	42	83	10	14	61	15
User Adj:	1.00	1.00	1.00	1.00	1.00	1.00	1.00	1.00	1.00	1.00	1.00	1.00
PHF Adj:	1.00	1.00	1.00	1.00	1.00	1.00	1.00	1.00	1.00	1.00	1.00	1.00
PHF Volume:	18	274	22	15	47	2	42	83	10	14	61	15
Reduct Vol:	0	0	0	0	0	0	0	0	0	0	0	0
Reduced Vol:	18	274	22	15	47	2	42	83	10	14	61	15
PCE Adj:	1.00	1.00	1.00	1.00	1.00	1.00	1.00	1.00	1.00	1.00	1.00	1.00
MLF Adj:	1.00	1.00	1.00	1.00	1.00	1.00	1.00	1.00	1.00	1.00	1.00	1.00
FinalVolume:	18	274	22	15	47	2	42	83	10	14	61	15

Saturation Flow Module:

Adjustment:	1.00	1.00	1.00	1.00	1.00	1.00	1.00	1.00	1.00	1.00	1.00	1.00
Lanes:	0.06	0.87	0.07	0.23	0.74	0.03	0.31	0.62	0.07	0.15	0.68	0.17
Final Sat.:	45	677	54	165	516	22	215	424	51	107	466	115

Capacity Analysis Module:

Vol/Sat:	0.40	0.40	0.40	0.09	0.09	0.09	0.20	0.20	0.20	0.13	0.13	0.13
Crit Moves:			****			****			****			****
Delay/Veh:	10.4	10.4	10.4	8.3	8.3	8.3	9.0	9.0	9.0	8.5	8.5	8.5
Delay Adj:	1.00	1.00	1.00	1.00	1.00	1.00	1.00	1.00	1.00	1.00	1.00	1.00
AdjDel/Veh:	10.4	10.4	10.4	8.3	8.3	8.3	9.0	9.0	9.0	8.5	8.5	8.5
LOS by Move:	B	B	B	A	A	A	A	A	A	A	A	A
ApproachDel:		10.4			8.3			9.0			8.5	
Delay Adj:		1.00			1.00			1.00			1.00	
ApprAdjDel:		10.4			8.3			9.0			8.5	
LOS by Appr:		B			A			A			A	
AllWayAvgQ:	0.6	0.6	0.6	0.1	0.1	0.1	0.2	0.2	0.2	0.1	0.1	0.1

Note: Queue reported is the number of cars per lane.

Voices School
Morgan Hill, CA
Hexagon Transportation Consultants, Inc.

Level Of Service Computation Report
2000 HCM 4-Way Stop (Future Volume Alternative)
2025 Plus Project (PM) - 2 Cosmo Right out

Intersection #1500: Del Monte Avenue and Spring Avenue

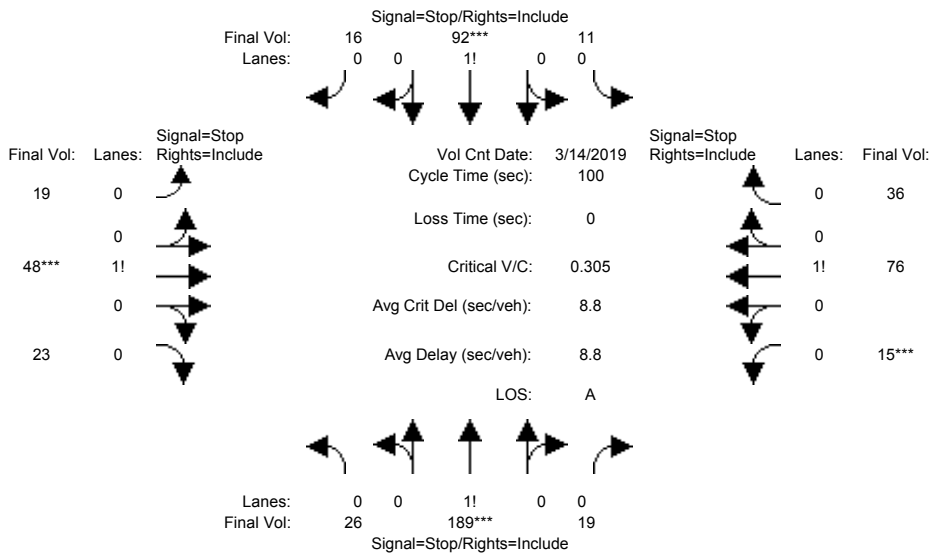

Street Name:	Del Monte Ave						Spring Ave					
Approach:	North Bound			South Bound			East Bound			West Bound		
Movement:	L	T	R	L	T	R	L	T	R	L	T	R

Min. Green:	0	0	0	0	0	0	0	0	0	0	0	0
-------------	---	---	---	---	---	---	---	---	---	---	---	---

Volume Module:	>> Count Date: 14 Mar 2019 <<											
Base Vol:	21	59	11	10	85	7	9	44	22	15	74	31
Growth Adj:	1.00	1.00	1.00	1.00	1.00	1.00	1.00	1.00	1.00	1.00	1.00	1.00
Initial Bse:	21	59	11	10	85	7	9	44	22	15	74	31
Added Vol:	5	124	8	0	0	0	0	2	0	0	0	0
PasserByVol:	0	6	0	1	7	9	10	2	1	0	2	5
Initial Fut:	26	189	19	11	92	16	19	48	23	15	76	36
User Adj:	1.00	1.00	1.00	1.00	1.00	1.00	1.00	1.00	1.00	1.00	1.00	1.00
PHF Adj:	1.00	1.00	1.00	1.00	1.00	1.00	1.00	1.00	1.00	1.00	1.00	1.00
PHF Volume:	26	189	19	11	92	16	19	48	23	15	76	36
Reduct Vol:	0	0	0	0	0	0	0	0	0	0	0	0
Reduced Vol:	26	189	19	11	92	16	19	48	23	15	76	36
PCE Adj:	1.00	1.00	1.00	1.00	1.00	1.00	1.00	1.00	1.00	1.00	1.00	1.00
MLF Adj:	1.00	1.00	1.00	1.00	1.00	1.00	1.00	1.00	1.00	1.00	1.00	1.00
FinalVolume:	26	189	19	11	92	16	19	48	23	15	76	36

Saturation Flow Module:												
Adjustment:	1.00	1.00	1.00	1.00	1.00	1.00	1.00	1.00	1.00	1.00	1.00	1.00
Lanes:	0.11	0.81	0.08	0.09	0.78	0.13	0.21	0.53	0.26	0.12	0.60	0.28
Final Sat.:	85	621	62	69	574	100	149	377	181	85	433	205

Capacity Analysis Module:												
Vol/Sat:	0.30	0.30	0.30	0.16	0.16	0.16	0.13	0.13	0.13	0.18	0.18	0.18
Crit Moves:	****			****			****			****		
Delay/Veh:	9.4	9.4	9.4	8.4	8.4	8.4	8.4	8.4	8.4	8.6	8.6	8.6
Delay Adj:	1.00	1.00	1.00	1.00	1.00	1.00	1.00	1.00	1.00	1.00	1.00	1.00
AdjDel/Veh:	9.4	9.4	9.4	8.4	8.4	8.4	8.4	8.4	8.4	8.6	8.6	8.6
LOS by Move:	A	A	A	A	A	A	A	A	A	A	A	A
ApproachDel:	9.4			8.4			8.4			8.6		
Delay Adj:	1.00			1.00			1.00			1.00		
ApprAdjDel:	9.4			8.4			8.4			8.6		
LOS by Appr:	A			A			A			A		
AllWayAvgQ:	0.4	0.4	0.4	0.2	0.2	0.2	0.1	0.1	0.1	0.2	0.2	0.2

Note: Queue reported is the number of cars per lane.

Voices School
Morgan Hill, CA
Hexagon Transportation Consultants, Inc.

Level Of Service Computation Report
2000 HCM Operations (Future Volume Alternative)
2025 No Project (AM)

Intersection #4111: Monterey Road and Vineyard Boulevard

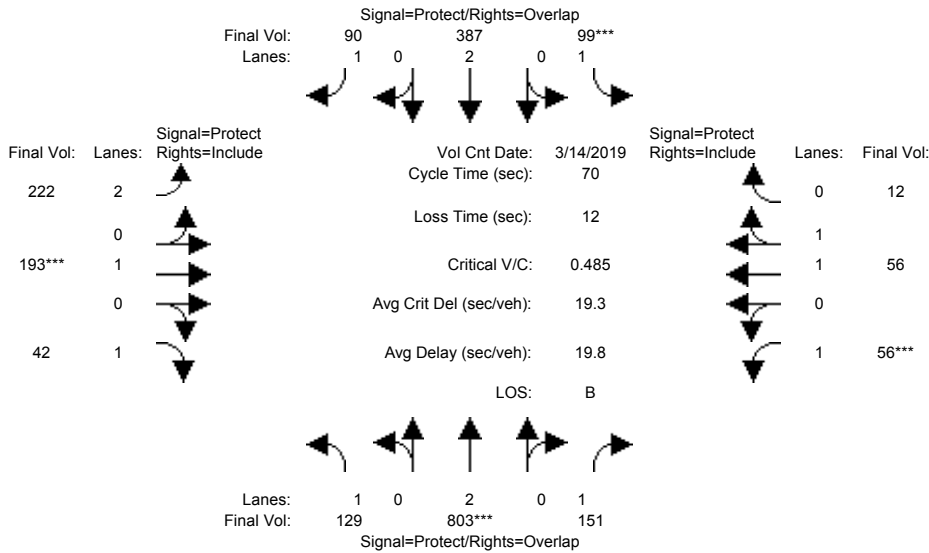

Street Name:	Monterey Road						Vineyard Blvd					
	North Bound			South Bound			East Bound			West Bound		
Approach:	L	T	R	L	T	R	L	T	R	L	T	R
Min. Green:	7	10	10	7	10	10	7	10	10	7	10	10
Y+R:	4.0	4.0	4.0	4.0	4.0	4.0	4.0	4.0	4.0	4.0	4.0	4.0

Volume Module:	>>	Count	Date:	14 Mar 2019	<<							
Base Vol:	115	625	143	99	319	86	217	186	42	52	50	12
Growth Adj:	1.00	1.00	1.00	1.00	1.00	1.00	1.00	1.00	1.00	1.00	1.00	1.00
Initial Bse:	115	625	143	99	319	86	217	186	42	52	50	12
Added Vol:	0	0	0	0	0	0	0	0	0	0	0	0
PasserByVol:	14	178	8	0	68	4	5	7	0	4	6	0
Initial Fut:	129	803	151	99	387	90	222	193	42	56	56	12
User Adj:	1.00	1.00	1.00	1.00	1.00	1.00	1.00	1.00	1.00	1.00	1.00	1.00
PHF Adj:	1.00	1.00	1.00	1.00	1.00	1.00	1.00	1.00	1.00	1.00	1.00	1.00
PHF Volume:	129	803	151	99	387	90	222	193	42	56	56	12
Reduct Vol:	0	0	0	0	0	0	0	0	0	0	0	0
Reduced Vol:	129	803	151	99	387	90	222	193	42	56	56	12
PCE Adj:	1.00	1.00	1.00	1.00	1.00	1.00	1.00	1.00	1.00	1.00	1.00	1.00
MLF Adj:	1.00	1.00	1.00	1.00	1.00	1.00	1.00	1.00	1.00	1.00	1.00	1.00
FinalVolume:	129	803	151	99	387	90	222	193	42	56	56	12

Saturation Flow Module:												
Sat/Lane:	1900	1900	1900	1900	1900	1900	1900	1900	1900	1900	1900	1900
Adjustment:	0.92	1.00	0.92	0.92	1.00	0.92	0.83	1.00	0.92	0.92	0.98	0.95
Lanes:	1.00	2.00	1.00	1.00	2.00	1.00	2.00	1.00	1.00	1.00	1.64	0.36
Final Sat.:	1750	3800	1750	1750	3800	1750	3150	1900	1750	1750	3047	653

Capacity Analysis Module:												
Vol/Sat:	0.07	0.21	0.09	0.06	0.10	0.05	0.07	0.10	0.02	0.03	0.02	0.02
Crit Moves:	****			****			****			****		
Green Time:	15.2	29.2	36.2	7.8	21.8	30.4	8.7	14.0	14.0	7.0	12.4	12.4
Volume/Cap:	0.34	0.51	0.17	0.51	0.33	0.12	0.57	0.51	0.12	0.32	0.10	0.10
Delay/Veh:	23.7	15.4	9.0	31.5	18.7	11.9	30.9	26.0	23.1	30.3	24.2	24.2
User DelAdj:	1.00	1.00	1.00	1.00	1.00	1.00	1.00	1.00	1.00	1.00	1.00	1.00
AdjDel/Veh:	23.7	15.4	9.0	31.5	18.7	11.9	30.9	26.0	23.1	30.3	24.2	24.2
LOS by Move:	C	B	A	C	B	B	C	C	C	C	C	C
HCM2kAvgQ:	2	6	2	2	3	1	4	4	1	2	1	1

Note: Queue reported is the number of cars per lane.

Voices School
Morgan Hill, CA
Hexagon Transportation Consultants, Inc.

Level Of Service Computation Report
2000 HCM Operations (Future Volume Alternative)
2025 No Project (PM)

Intersection #4111: Monterey Road and Vineyard Boulevard

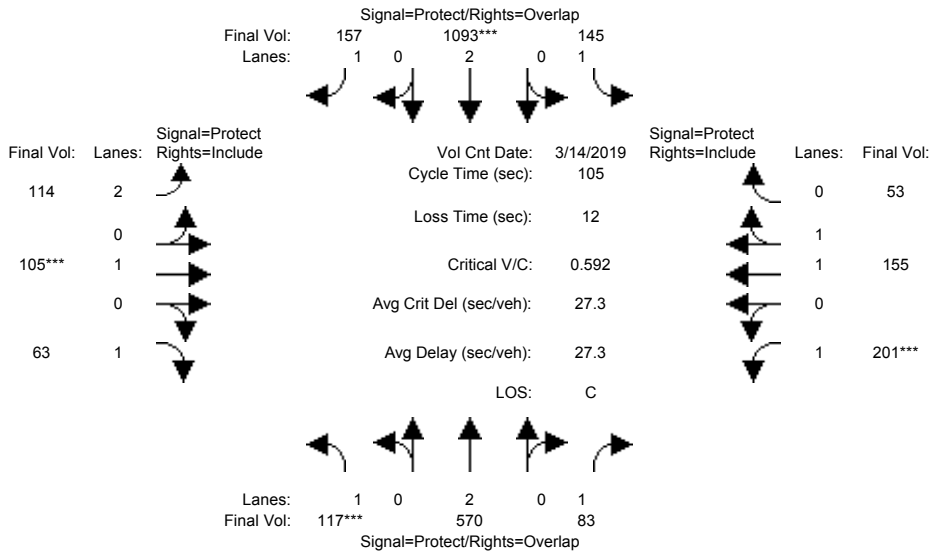

Street Name:	Monterey Road						Vineyard Blvd					
	North Bound			South Bound			East Bound			West Bound		
Approach:	L	T	R	L	T	R	L	T	R	L	T	R
Min. Green:	7	10	10	7	10	10	7	10	10	7	10	10
Y+R:	4.0	4.0	4.0	4.0	4.0	4.0	4.0	4.0	4.0	4.0	4.0	4.0

Volume Module:	>>	Count	Date:	14 Mar 2019	<<							
Base Vol:	117	455	80	145	965	153	111	100	60	196	150	53
Growth Adj:	1.00	1.00	1.00	1.00	1.00	1.00	1.00	1.00	1.00	1.00	1.00	1.00
Initial Bse:	117	455	80	145	965	153	111	100	60	196	150	53
Added Vol:	0	0	0	0	0	0	0	0	0	0	0	0
PasserByVol:	0	115	3	0	128	4	3	5	3	5	5	0
Initial Fut:	117	570	83	145	1093	157	114	105	63	201	155	53
User Adj:	1.00	1.00	1.00	1.00	1.00	1.00	1.00	1.00	1.00	1.00	1.00	1.00
PHF Adj:	1.00	1.00	1.00	1.00	1.00	1.00	1.00	1.00	1.00	1.00	1.00	1.00
PHF Volume:	117	570	83	145	1093	157	114	105	63	201	155	53
Reduct Vol:	0	0	0	0	0	0	0	0	0	0	0	0
Reduced Vol:	117	570	83	145	1093	157	114	105	63	201	155	53
PCE Adj:	1.00	1.00	1.00	1.00	1.00	1.00	1.00	1.00	1.00	1.00	1.00	1.00
MLF Adj:	1.00	1.00	1.00	1.00	1.00	1.00	1.00	1.00	1.00	1.00	1.00	1.00
FinalVolume:	117	570	83	145	1093	157	114	105	63	201	155	53

Saturation Flow Module:												
Sat/Lane:	1900	1900	1900	1900	1900	1900	1900	1900	1900	1900	1900	1900
Adjustment:	0.92	1.00	0.92	0.92	1.00	0.92	0.83	1.00	0.92	0.92	0.98	0.95
Lanes:	1.00	2.00	1.00	1.00	2.00	1.00	2.00	1.00	1.00	1.00	1.48	0.52
Final Sat.:	1750	3800	1750	1750	3800	1750	3150	1900	1750	1750	2757	943

Capacity Analysis Module:												
Vol/Sat:	0.07	0.15	0.05	0.08	0.29	0.09	0.04	0.06	0.04	0.11	0.06	0.06
Crit Moves:	****			****			****			****		
Green Time:	11.8	40.4	60.7	22.3	50.9	63.3	12.5	10.0	10.0	20.3	17.8	17.8
Volume/Cap:	0.59	0.39	0.08	0.39	0.59	0.15	0.30	0.58	0.38	0.59	0.33	0.33
Delay/Veh:	49.1	23.6	9.8	36.2	20.1	9.1	42.8	50.2	46.0	41.4	38.7	38.7
User DelAdj:	1.00	1.00	1.00	1.00	1.00	1.00	1.00	1.00	1.00	1.00	1.00	1.00
AdjDel/Veh:	49.1	23.6	9.8	36.2	20.1	9.1	42.8	50.2	46.0	41.4	38.7	38.7
LOS by Move:	D	C	A	D	C	A	D	D	D	D	D	D
HCM2kAvgQ:	4	6	1	4	12	2	2	4	2	7	3	3

Note: Queue reported is the number of cars per lane.

Voices School
Morgan Hill, CA
Hexagon Transportation Consultants, Inc.

Level Of Service Computation Report
2000 HCM Operations (Future Volume Alternative)
2025 Plus Project (AM) - 2 Cosmo Right out

Intersection #4111: Monterey Road and Vineyard Boulevard

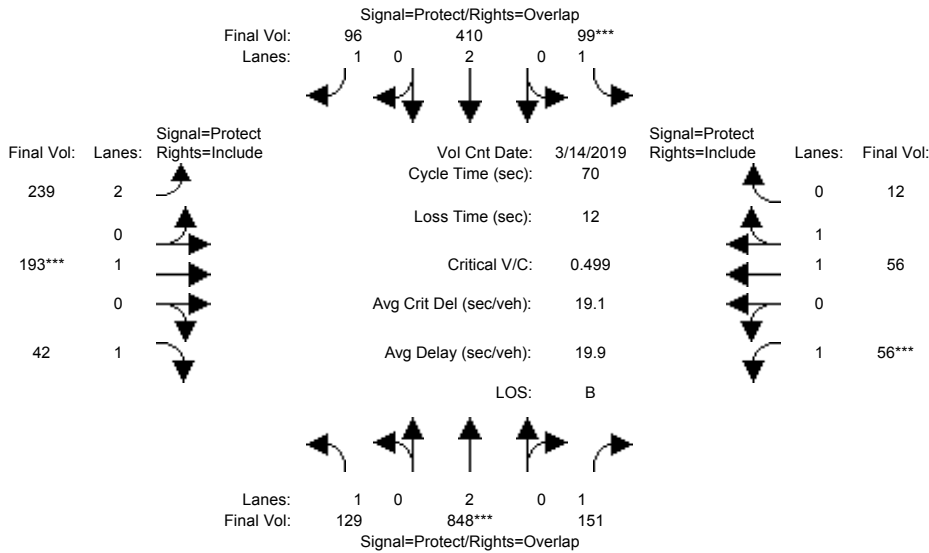

Street Name:	Monterey Road						Vineyard Blvd					
	North Bound			South Bound			East Bound			West Bound		
Approach:	L	T	R	L	T	R	L	T	R	L	T	R
Min. Green:	7	10	10	7	10	10	7	10	10	7	10	10
Y+R:	4.0	4.0	4.0	4.0	4.0	4.0	4.0	4.0	4.0	4.0	4.0	4.0

Volume Module:	>>	Count	Date:	14 Mar 2019	<<											
Base Vol:	115	625	143	99	319	86	217	186	42	52	50	12				
Growth Adj:	1.00	1.00	1.00	1.00	1.00	1.00	1.00	1.00	1.00	1.00	1.00	1.00				
Initial Bse:	115	625	143	99	319	86	217	186	42	52	50	12				
Added Vol:	0	45	0	0	23	6	17	0	0	0	0	0				
PasserByVol:	14	178	8	0	68	4	5	7	0	4	6	0				
Initial Fut:	129	848	151	99	410	96	239	193	42	56	56	12				
User Adj:	1.00	1.00	1.00	1.00	1.00	1.00	1.00	1.00	1.00	1.00	1.00	1.00				
PHF Adj:	1.00	1.00	1.00	1.00	1.00	1.00	1.00	1.00	1.00	1.00	1.00	1.00				
PHF Volume:	129	848	151	99	410	96	239	193	42	56	56	12				
Reduct Vol:	0	0	0	0	0	0	0	0	0	0	0	0				
Reduced Vol:	129	848	151	99	410	96	239	193	42	56	56	12				
PCE Adj:	1.00	1.00	1.00	1.00	1.00	1.00	1.00	1.00	1.00	1.00	1.00	1.00				
MLF Adj:	1.00	1.00	1.00	1.00	1.00	1.00	1.00	1.00	1.00	1.00	1.00	1.00				
FinalVolume:	129	848	151	99	410	96	239	193	42	56	56	12				

Saturation Flow Module:												
Sat/Lane:	1900	1900	1900	1900	1900	1900	1900	1900	1900	1900	1900	1900
Adjustment:	0.92	1.00	0.92	0.92	1.00	0.92	0.83	1.00	0.92	0.92	0.98	0.95
Lanes:	1.00	2.00	1.00	1.00	2.00	1.00	2.00	1.00	1.00	1.00	1.64	0.36
Final Sat.:	1750	3800	1750	1750	3800	1750	3150	1900	1750	1750	3047	653

Capacity Analysis Module:												
Vol/Sat:	0.07	0.22	0.09	0.06	0.11	0.05	0.08	0.10	0.02	0.03	0.02	0.02
Crit Moves:	****			****			****			****		
Green Time:	15.4	29.8	36.8	7.6	22.0	30.5	8.5	13.6	13.6	7.0	12.1	12.1
Volume/Cap:	0.33	0.52	0.16	0.52	0.34	0.13	0.63	0.52	0.12	0.32	0.11	0.11
Delay/Veh:	23.5	15.1	8.7	32.2	18.6	11.9	32.5	26.7	23.5	30.3	24.5	24.5
User DelAdj:	1.00	1.00	1.00	1.00	1.00	1.00	1.00	1.00	1.00	1.00	1.00	1.00
AdjDel/Veh:	23.5	15.1	8.7	32.2	18.6	11.9	32.5	26.7	23.5	30.3	24.5	24.5
LOS by Move:	C	B	A	C	B	B	C	C	C	C	C	C
HCM2kAvgQ:	2	7	2	2	3	1	4	4	1	2	1	1

Note: Queue reported is the number of cars per lane.

Voices School
Morgan Hill, CA
Hexagon Transportation Consultants, Inc.

Level Of Service Computation Report
2000 HCM Operations (Future Volume Alternative)
2025 Plus Project (PM) - 2 Cosmo Right out

Intersection #4111: Monterey Road and Vineyard Boulevard

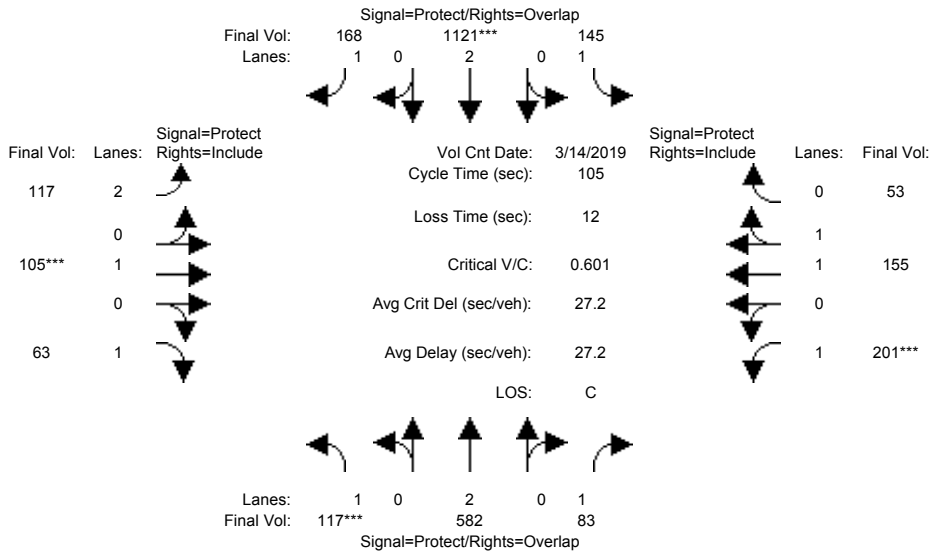

Street Name:	Monterey Road						Vineyard Blvd					
	North Bound			South Bound			East Bound			West Bound		
Approach:	L	T	R	L	T	R	L	T	R	L	T	R
Min. Green:	7	10	10	7	10	10	7	10	10	7	10	10
Y+R:	4.0	4.0	4.0	4.0	4.0	4.0	4.0	4.0	4.0	4.0	4.0	4.0

Volume Module:	>>	Count	Date:	14 Mar 2019	<<							
Base Vol:	117	455	80	145	965	153	111	100	60	196	150	53
Growth Adj:	1.00	1.00	1.00	1.00	1.00	1.00	1.00	1.00	1.00	1.00	1.00	1.00
Initial Bse:	117	455	80	145	965	153	111	100	60	196	150	53
Added Vol:	0	12	0	0	28	11	3	0	0	0	0	0
PasserByVol:	0	115	3	0	128	4	3	5	3	5	5	0
Initial Fut:	117	582	83	145	1121	168	117	105	63	201	155	53
User Adj:	1.00	1.00	1.00	1.00	1.00	1.00	1.00	1.00	1.00	1.00	1.00	1.00
PHF Adj:	1.00	1.00	1.00	1.00	1.00	1.00	1.00	1.00	1.00	1.00	1.00	1.00
PHF Volume:	117	582	83	145	1121	168	117	105	63	201	155	53
Reduct Vol:	0	0	0	0	0	0	0	0	0	0	0	0
Reduced Vol:	117	582	83	145	1121	168	117	105	63	201	155	53
PCE Adj:	1.00	1.00	1.00	1.00	1.00	1.00	1.00	1.00	1.00	1.00	1.00	1.00
MLF Adj:	1.00	1.00	1.00	1.00	1.00	1.00	1.00	1.00	1.00	1.00	1.00	1.00
FinalVolume:	117	582	83	145	1121	168	117	105	63	201	155	53

Saturation Flow Module:												
Sat/Lane:	1900	1900	1900	1900	1900	1900	1900	1900	1900	1900	1900	1900
Adjustment:	0.92	1.00	0.92	0.92	1.00	0.92	0.83	1.00	0.92	0.92	0.98	0.95
Lanes:	1.00	2.00	1.00	1.00	2.00	1.00	2.00	1.00	1.00	1.00	1.48	0.52
Final Sat.:	1750	3800	1750	1750	3800	1750	3150	1900	1750	1750	2757	943

Capacity Analysis Module:												
Vol/Sat:	0.07	0.15	0.05	0.08	0.30	0.10	0.04	0.06	0.04	0.11	0.06	0.06
Crit Moves:	****			****			****			****		
Green Time:	11.6	40.9	60.9	22.1	51.4	63.7	12.4	10.0	10.0	20.0	17.6	17.6
Volume/Cap:	0.60	0.39	0.08	0.39	0.60	0.16	0.32	0.58	0.38	0.60	0.33	0.33
Delay/Veh:	49.7	23.3	9.8	36.4	20.0	9.0	42.9	50.2	46.0	42.0	38.8	38.8
User DelAdj:	1.00	1.00	1.00	1.00	1.00	1.00	1.00	1.00	1.00	1.00	1.00	1.00
AdjDel/Veh:	49.7	23.3	9.8	36.4	20.0	9.0	42.9	50.2	46.0	42.0	38.8	38.8
LOS by Move:	D	C	A	D	B	A	D	D	D	D	D	D
HCM2kAvgQ:	4	6	1	4	13	2	2	4	2	7	3	3

Note: Queue reported is the number of cars per lane.

Voices School
Morgan Hill, CA
Hexagon Transportation Consultants, Inc.

Level Of Service Computation Report
2000 HCM Operations (Future Volume Alternative)
2025 No Project (AM)

Intersection #6674: Monterey Road and Tennant Avenue/Edmundson Avenue

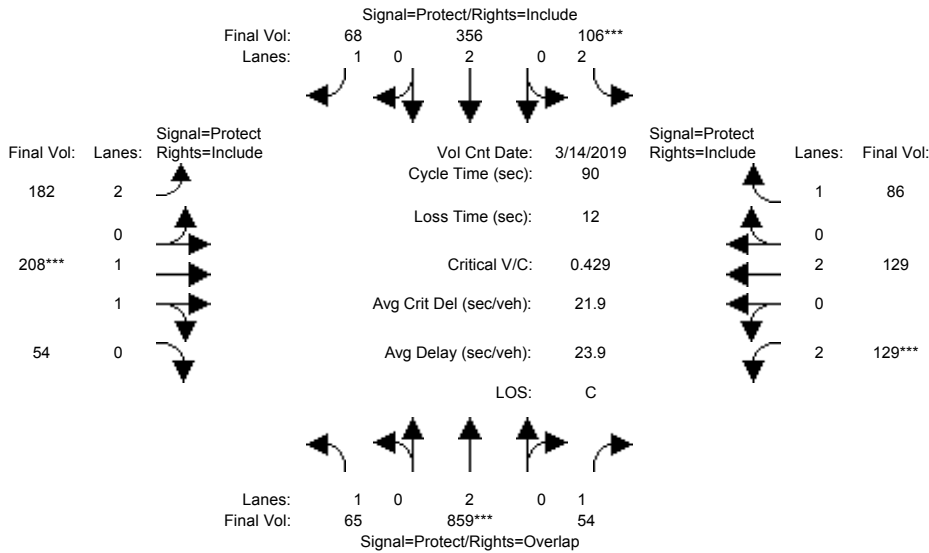

Street Name:	Monterey Rd						Tennant Ave/Edmundson Ave					
	North Bound			South Bound			East Bound			West Bound		
Approach:	L	T	R	L	T	R	L	T	R	L	T	R
Min. Green:	7	10	10	7	10	10	7	10	10	7	10	10
Y+R:	4.0	4.0	4.0	4.0	4.0	4.0	4.0	4.0	4.0	4.0	4.0	4.0

Volume Module:	>>	Count	Date:	14 Mar 2019	<<							
Base Vol:	61	722	54	92	309	46	157	162	45	129	103	86
Growth Adj:	1.00	1.00	1.00	1.00	1.00	1.00	1.00	1.00	1.00	1.00	1.00	1.00
Initial Bse:	61	722	54	92	309	46	157	162	45	129	103	86
Added Vol:	0	0	0	0	0	0	0	0	0	0	0	0
PasserByVol:	4	137	0	14	47	22	25	46	9	0	26	0
Initial Fut:	65	859	54	106	356	68	182	208	54	129	129	86
User Adj:	1.00	1.00	1.00	1.00	1.00	1.00	1.00	1.00	1.00	1.00	1.00	1.00
PHF Adj:	1.00	1.00	1.00	1.00	1.00	1.00	1.00	1.00	1.00	1.00	1.00	1.00
PHF Volume:	65	859	54	106	356	68	182	208	54	129	129	86
Reduct Vol:	0	0	0	0	0	0	0	0	0	0	0	0
Reduced Vol:	65	859	54	106	356	68	182	208	54	129	129	86
PCE Adj:	1.00	1.00	1.00	1.00	1.00	1.00	1.00	1.00	1.00	1.00	1.00	1.00
MLF Adj:	1.00	1.00	1.00	1.00	1.00	1.00	1.00	1.00	1.00	1.00	1.00	1.00
FinalVolume:	65	859	54	106	356	68	182	208	54	129	129	86

Saturation Flow Module:												
Sat/Lane:	1900	1900	1900	1900	1900	1900	1900	1900	1900	1900	1900	1900
Adjustment:	0.92	1.00	0.92	0.83	1.00	0.92	0.83	0.98	0.95	0.83	1.00	0.92
Lanes:	1.00	2.00	1.00	2.00	2.00	1.00	2.00	1.58	0.42	2.00	2.00	1.00
Final Sat.:	1750	3800	1750	3150	3800	1750	3150	2937	762	3150	3800	1750

Capacity Analysis Module:												
Vol/Sat:	0.04	0.23	0.03	0.03	0.09	0.04	0.06	0.07	0.07	0.04	0.03	0.05
Crit Moves:	****			****			****			****		
Green Time:	22.5	47.5	56.1	7.1	32.1	32.1	9.7	14.9	14.9	8.6	13.8	13.8
Volume/Cap:	0.15	0.43	0.05	0.43	0.26	0.11	0.54	0.43	0.43	0.43	0.22	0.32
Delay/Veh:	26.5	13.1	6.6	40.7	20.7	19.5	39.8	34.2	34.2	39.4	33.6	34.6
User DelAdj:	1.00	1.00	1.00	1.00	1.00	1.00	1.00	1.00	1.00	1.00	1.00	1.00
AdjDel/Veh:	26.5	13.1	6.6	40.7	20.7	19.5	39.8	34.2	34.2	39.4	33.6	34.6
LOS by Move:	C	B	A	D	C	B	D	C	C	D	C	C
HCM2kAvgQ:	1	7	1	2	4	1	4	4	4	2	2	2

Note: Queue reported is the number of cars per lane.

Voices School
Morgan Hill, CA
Hexagon Transportation Consultants, Inc.

Level Of Service Computation Report
2000 HCM Operations (Future Volume Alternative)
2025 No Project (PM)

Intersection #6674: Monterey Road and Tennant Avenue/Edmundson Avenue

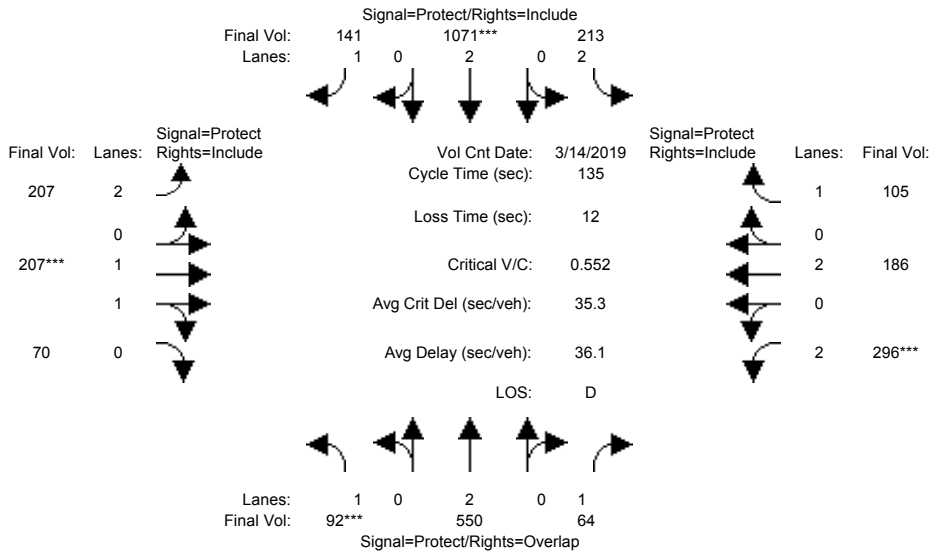

Street Name:	Monterey Rd						Tennant Ave/Edmundson Ave					
Approach:	North Bound			South Bound			East Bound			West Bound		
Movement:	L	T	R	L	T	R	L	T	R	L	T	R
Min. Green:	7	10	10	7	10	10	7	10	10	7	10	10
Y+R:	4.0	4.0	4.0	4.0	4.0	4.0	4.0	4.0	4.0	4.0	4.0	4.0

Volume Module:	>>	Count	Date:	14 Mar 2019	<<											
Base Vol:	92	441	63	213	968	131	185	184	70	296	151	105				
Growth Adj:	1.00	1.00	1.00	1.00	1.00	1.00	1.00	1.00	1.00	1.00	1.00	1.00				
Initial Bse:	92	441	63	213	968	131	185	184	70	296	151	105				
Added Vol:	0	0	0	0	0	0	0	0	0	0	0	0				
PasserByVol:	0	109	1	0	103	10	22	23	0	0	35	0				
Initial Fut:	92	550	64	213	1071	141	207	207	70	296	186	105				
User Adj:	1.00	1.00	1.00	1.00	1.00	1.00	1.00	1.00	1.00	1.00	1.00	1.00				
PHF Adj:	1.00	1.00	1.00	1.00	1.00	1.00	1.00	1.00	1.00	1.00	1.00	1.00				
PHF Volume:	92	550	64	213	1071	141	207	207	70	296	186	105				
Reduct Vol:	0	0	0	0	0	0	0	0	0	0	0	0				
Reduced Vol:	92	550	64	213	1071	141	207	207	70	296	186	105				
PCE Adj:	1.00	1.00	1.00	1.00	1.00	1.00	1.00	1.00	1.00	1.00	1.00	1.00				
MLF Adj:	1.00	1.00	1.00	1.00	1.00	1.00	1.00	1.00	1.00	1.00	1.00	1.00				
FinalVolume:	92	550	64	213	1071	141	207	207	70	296	186	105				

Saturation Flow Module:												
Sat/Lane:	1900	1900	1900	1900	1900	1900	1900	1900	1900	1900	1900	1900
Adjustment:	0.92	1.00	0.92	0.83	1.00	0.92	0.83	0.98	0.95	0.83	1.00	0.92
Lanes:	1.00	2.00	1.00	2.00	2.00	1.00	2.00	1.48	0.52	2.00	2.00	1.00
Final Sat.:	1750	3800	1750	3150	3800	1750	3150	2764	935	3150	3800	1750

Capacity Analysis Module:												
Vol/Sat:	0.05	0.14	0.04	0.07	0.28	0.08	0.07	0.07	0.07	0.09	0.05	0.06
Crit Moves:	****				****			****		****		
Green Time:	12.8	55.7	78.7	26.0	68.9	68.9	19.4	18.3	18.3	23.0	21.9	21.9
Volume/Cap:	0.55	0.35	0.06	0.35	0.55	0.16	0.46	0.55	0.55	0.55	0.30	0.37
Delay/Veh:	62.3	27.4	12.2	47.5	22.9	17.7	53.7	55.9	55.9	52.6	50.1	51.2
User DelAdj:	1.00	1.00	1.00	1.00	1.00	1.00	1.00	1.00	1.00	1.00	1.00	1.00
AdjDel/Veh:	62.3	27.4	12.2	47.5	22.9	17.7	53.7	55.9	55.9	52.6	50.1	51.2
LOS by Move:	E	C	B	D	C	B	D	E	E	D	D	D
HCM2kAvgQ:	4	7	1	5	15	3	5	6	6	7	3	4

Note: Queue reported is the number of cars per lane.

Voices School
Morgan Hill, CA
Hexagon Transportation Consultants, Inc.

Level Of Service Computation Report
2000 HCM Operations (Future Volume Alternative)
2025 Plus Project (AM) - 2 Cosmo Right out

Intersection #6674: Monterey Road and Tennant Avenue/Edmundson Avenue

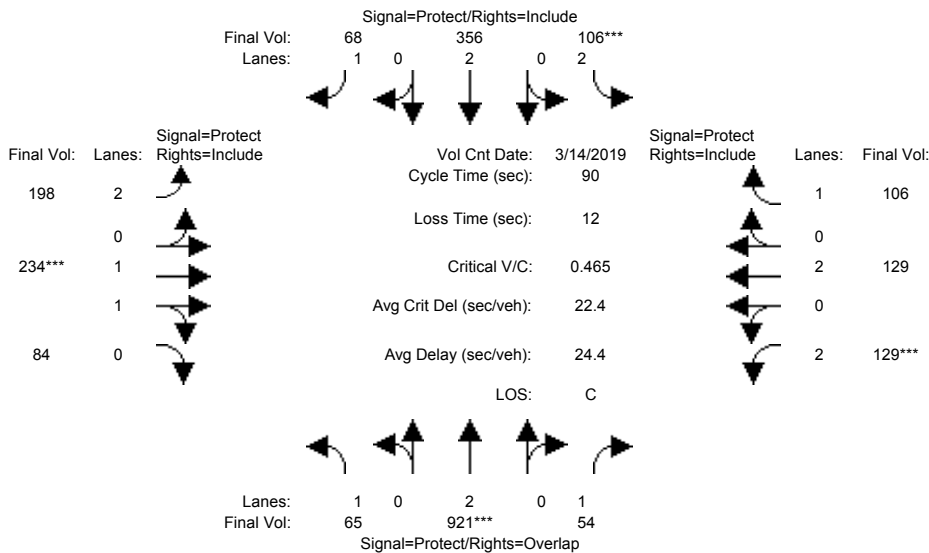

Street Name:	Monterey Rd						Tennant Ave/Edmundson Ave					
	North Bound			South Bound			East Bound			West Bound		
Approach:	L	T	R	L	T	R	L	T	R	L	T	R
Min. Green:	7	10	10	7	10	10	7	10	10	7	10	10
Y+R:	4.0	4.0	4.0	4.0	4.0	4.0	4.0	4.0	4.0	4.0	4.0	4.0

Volume Module:	>>	Count	Date:	14 Mar 2019	<<							
Base Vol:	61	722	54	92	309	46	157	162	45	129	103	86
Growth Adj:	1.00	1.00	1.00	1.00	1.00	1.00	1.00	1.00	1.00	1.00	1.00	1.00
Initial Bse:	61	722	54	92	309	46	157	162	45	129	103	86
Added Vol:	0	62	0	0	0	0	16	26	30	0	0	20
PasserByVol:	4	137	0	14	47	22	25	46	9	0	26	0
Initial Fut:	65	921	54	106	356	68	198	234	84	129	129	106
User Adj:	1.00	1.00	1.00	1.00	1.00	1.00	1.00	1.00	1.00	1.00	1.00	1.00
PHF Adj:	1.00	1.00	1.00	1.00	1.00	1.00	1.00	1.00	1.00	1.00	1.00	1.00
PHF Volume:	65	921	54	106	356	68	198	234	84	129	129	106
Reduct Vol:	0	0	0	0	0	0	0	0	0	0	0	0
Reduced Vol:	65	921	54	106	356	68	198	234	84	129	129	106
PCE Adj:	1.00	1.00	1.00	1.00	1.00	1.00	1.00	1.00	1.00	1.00	1.00	1.00
MLF Adj:	1.00	1.00	1.00	1.00	1.00	1.00	1.00	1.00	1.00	1.00	1.00	1.00
FinalVolume:	65	921	54	106	356	68	198	234	84	129	129	106

Saturation Flow Module:												
Sat/Lane:	1900	1900	1900	1900	1900	1900	1900	1900	1900	1900	1900	1900
Adjustment:	0.92	1.00	0.92	0.83	1.00	0.92	0.83	0.98	0.95	0.83	1.00	0.92
Lanes:	1.00	2.00	1.00	2.00	2.00	1.00	2.00	1.46	0.54	2.00	2.00	1.00
Final Sat.:	1750	3800	1750	3150	3800	1750	3150	2722	977	3150	3800	1750

Capacity Analysis Module:												
Vol/Sat:	0.04	0.24	0.03	0.03	0.09	0.04	0.06	0.09	0.09	0.04	0.03	0.06
Crit Moves:	****			****			****			****		
Green Time:	22.1	46.6	54.5	7.0	31.5	31.5	10.0	16.5	16.5	7.9	14.4	14.4
Volume/Cap:	0.15	0.47	0.05	0.43	0.27	0.11	0.56	0.47	0.47	0.47	0.21	0.38
Delay/Veh:	26.8	14.0	7.3	40.8	21.1	19.8	40.0	33.3	33.3	40.3	33.1	34.7
User DelAdj:	1.00	1.00	1.00	1.00	1.00	1.00	1.00	1.00	1.00	1.00	1.00	1.00
AdjDel/Veh:	26.8	14.0	7.3	40.8	21.1	19.8	40.0	33.3	33.3	40.3	33.1	34.7
LOS by Move:	C	B	A	D	C	B	D	C	C	D	C	C
HCM2kAvgQ:	1	8	1	2	4	1	4	4	4	2	1	3

Note: Queue reported is the number of cars per lane.

Voices School
Morgan Hill, CA
Hexagon Transportation Consultants, Inc.

Level Of Service Computation Report
2000 HCM Operations (Future Volume Alternative)
2025 Plus Project (PM) - 2 Cosmo Right out

Intersection #6674: Monterey Road and Tennant Avenue/Edmundson Avenue

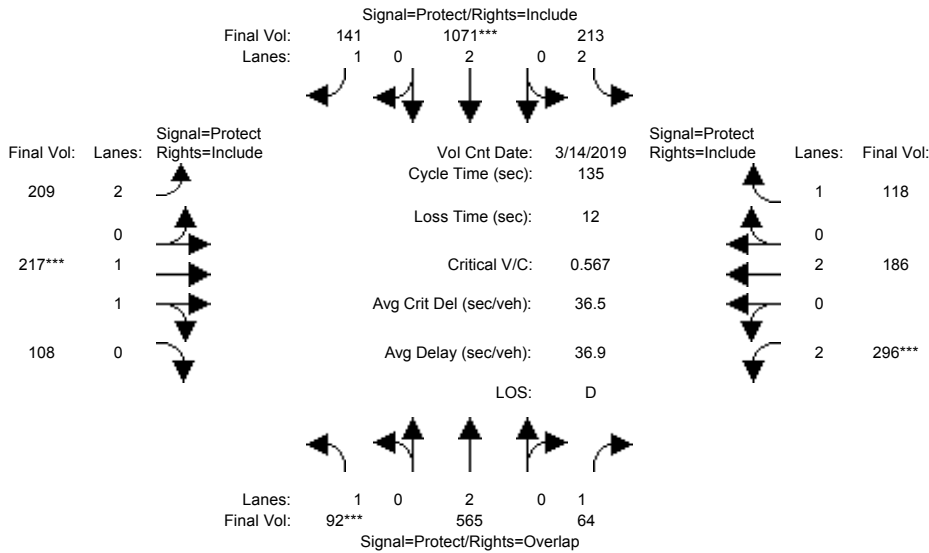

Street Name:	Monterey Rd						Tennant Ave/Edmundson Ave					
	North Bound			South Bound			East Bound			West Bound		
Approach:	L	T	R	L	T	R	L	T	R	L	T	R
Min. Green:	7	10	10	7	10	10	7	10	10	7	10	10
Y+R:	4.0	4.0	4.0	4.0	4.0	4.0	4.0	4.0	4.0	4.0	4.0	4.0

Volume Module:	>>	Count	Date:	14 Mar 2019	<<							
Base Vol:	92	441	63	213	968	131	185	184	70	296	151	105
Growth Adj:	1.00	1.00	1.00	1.00	1.00	1.00	1.00	1.00	1.00	1.00	1.00	1.00
Initial Bse:	92	441	63	213	968	131	185	184	70	296	151	105
Added Vol:	0	15	0	0	0	0	2	10	38	0	0	13
PasserByVol:	0	109	1	0	103	10	22	23	0	0	35	0
Initial Fut:	92	565	64	213	1071	141	209	217	108	296	186	118
User Adj:	1.00	1.00	1.00	1.00	1.00	1.00	1.00	1.00	1.00	1.00	1.00	1.00
PHF Adj:	1.00	1.00	1.00	1.00	1.00	1.00	1.00	1.00	1.00	1.00	1.00	1.00
PHF Volume:	92	565	64	213	1071	141	209	217	108	296	186	118
Reduct Vol:	0	0	0	0	0	0	0	0	0	0	0	0
Reduced Vol:	92	565	64	213	1071	141	209	217	108	296	186	118
PCE Adj:	1.00	1.00	1.00	1.00	1.00	1.00	1.00	1.00	1.00	1.00	1.00	1.00
MLF Adj:	1.00	1.00	1.00	1.00	1.00	1.00	1.00	1.00	1.00	1.00	1.00	1.00
FinalVolume:	92	565	64	213	1071	141	209	217	108	296	186	118

Saturation Flow Module:												
Sat/Lane:	1900	1900	1900	1900	1900	1900	1900	1900	1900	1900	1900	1900
Adjustment:	0.92	1.00	0.92	0.83	1.00	0.92	0.83	0.99	0.95	0.83	1.00	0.92
Lanes:	1.00	2.00	1.00	2.00	2.00	1.00	2.00	1.32	0.68	2.00	2.00	1.00
Final Sat.:	1750	3800	1750	3150	3800	1750	3150	2470	1229	3150	3800	1750

Capacity Analysis Module:												
Vol/Sat:	0.05	0.15	0.04	0.07	0.28	0.08	0.07	0.09	0.09	0.09	0.05	0.07
Crit Moves:	***			***			***			***		
Green Time:	12.5	54.8	77.2	24.9	67.2	67.2	20.5	20.9	20.9	22.4	22.9	22.9
Volume/Cap:	0.57	0.37	0.06	0.37	0.57	0.16	0.44	0.57	0.57	0.57	0.29	0.40
Delay/Veh:	63.3	28.2	12.9	48.5	24.1	18.6	52.7	54.2	54.2	53.3	49.2	50.8
User DelAdj:	1.00	1.00	1.00	1.00	1.00	1.00	1.00	1.00	1.00	1.00	1.00	1.00
AdjDel/Veh:	63.3	28.2	12.9	48.5	24.1	18.6	52.7	54.2	54.2	53.3	49.2	50.8
LOS by Move:	E	C	B	D	C	B	D	D	D	D	D	D
HCM2kAvgQ:	4	8	1	5	15	3	5	7	7	7	3	5

Note: Queue reported is the number of cars per lane.

Voices School
Morgan Hill, CA
Hexagon Transportation Consultants, Inc.

Level Of Service Computation Report
2000 HCM Operations (Future Volume Alternative)
2025 No Project (AM)

Intersection #6725: Monterey Road and Spring Avenue

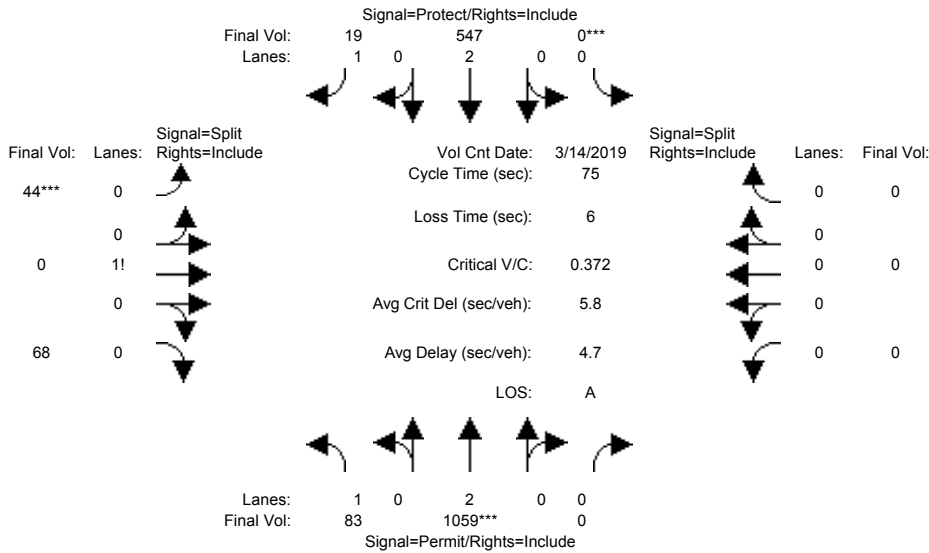

Street Name:	Monterey Road						Spring Avenue					
	North Bound			South Bound			East Bound			West Bound		
Approach:	L	T	R	L	T	R	L	T	R	L	T	R
Min. Green:	10	10	0	0	10	10	10	0	10	0	0	0
Y+R:	4.0	4.0	4.0	4.0	4.0	4.0	4.0	4.0	4.0	4.0	4.0	4.0

Volume Module:	>>	Count	Date:	14 Mar 2019	<<							
Base Vol:	83	891	0	0	479	17	42	0	68	0	0	0
Growth Adj:	1.00	1.00	1.00	1.00	1.00	1.00	1.00	1.00	1.00	1.00	1.00	1.00
Initial Bse:	83	891	0	0	479	17	42	0	68	0	0	0
Added Vol:	0	0	0	0	0	0	0	0	0	0	0	0
PasserByVol:	0	168	0	0	68	2	2	0	0	0	0	0
Initial Fut:	83	1059	0	0	547	19	44	0	68	0	0	0
User Adj:	1.00	1.00	1.00	1.00	1.00	1.00	1.00	1.00	1.00	1.00	1.00	1.00
PHF Adj:	1.00	1.00	1.00	1.00	1.00	1.00	1.00	1.00	1.00	1.00	1.00	1.00
PHF Volume:	83	1059	0	0	547	19	44	0	68	0	0	0
Reduct Vol:	0	0	0	0	0	0	0	0	0	0	0	0
Reduced Vol:	83	1059	0	0	547	19	44	0	68	0	0	0
PCE Adj:	1.00	1.00	1.00	1.00	1.00	1.00	1.00	1.00	1.00	1.00	1.00	1.00
MLF Adj:	1.00	1.00	1.00	1.00	1.00	1.00	1.00	1.00	1.00	1.00	1.00	1.00
FinalVolume:	83	1059	0	0	547	19	44	0	68	0	0	0

Saturation Flow Module:												
Sat/Lane:	1900	1900	1900	1900	1900	1900	1900	1900	1900	1900	1900	1900
Adjustment:	0.92	1.00	0.92	0.92	1.00	0.92	0.92	0.92	0.92	0.92	1.00	0.92
Lanes:	1.00	2.00	0.00	0.00	2.00	1.00	0.39	0.00	0.61	0.00	0.00	0.00
Final Sat.:	1750	3800	0	0	3800	1750	688	0	1063	0	0	0

Capacity Analysis Module:												
Vol/Sat:	0.05	0.28	0.00	0.00	0.14	0.01	0.06	0.00	0.06	0.00	0.00	0.00
Crit Moves:	****			****			****					
Green Time:	56.1	56.1	0.0	0.0	56.1	56.1	12.9	0.0	12.9	0.0	0.0	0.0
Volume/Cap:	0.06	0.37	0.00	0.00	0.19	0.01	0.37	0.00	0.37	0.00	0.00	0.00
Delay/Veh:	2.5	3.4	0.0	0.0	2.8	2.4	28.3	0.0	28.3	0.0	0.0	0.0
User DelAdj:	1.00	1.00	1.00	1.00	1.00	1.00	1.00	1.00	1.00	1.00	1.00	1.00
AdjDel/Veh:	2.5	3.4	0.0	0.0	2.8	2.4	28.3	0.0	28.3	0.0	0.0	0.0
LOS by Move:	A	A	A	A	A	A	C	A	C	A	A	A
HCM2kAvgQ:	1	4	0	0	2	0	3	0	3	0	0	0

Note: Queue reported is the number of cars per lane.

Voices School
Morgan Hill, CA
Hexagon Transportation Consultants, Inc.

Level Of Service Computation Report
2000 HCM Operations (Future Volume Alternative)
2025 No Project (PM)

Intersection #6725: Monterey Road and Spring Avenue

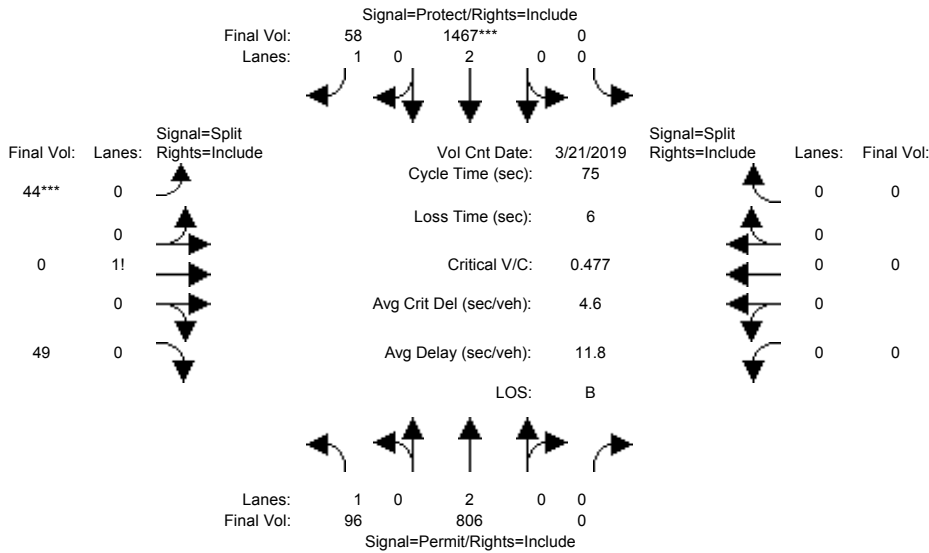

Street Name:	Monterey Road						Spring Avenue					
	North Bound			South Bound			East Bound			West Bound		
Approach:	L	T	R	L	T	R	L	T	R	L	T	R
Min. Green:	10	10	0	0	10	10	10	0	10	0	0	0
Y+R:	4.0	4.0	4.0	4.0	4.0	4.0	4.0	4.0	4.0	4.0	4.0	4.0

Volume Module:	>>	Count	Date:	21 Mar 2019	<<											
Base Vol:	96	706	0	0	1388	56	42	0	49	0	0	0	0	0	0	
Growth Adj:	1.00	1.00	1.00	1.00	1.00	1.00	1.00	1.00	1.00	1.00	1.00	1.00	1.00	1.00	1.00	
Initial Bse:	96	706	0	0	1388	56	42	0	49	0	0	0	0	0	0	
Added Vol:	0	0	0	0	0	0	0	0	0	0	0	0	0	0	0	
PasserByVol:	0	100	0	0	79	2	2	0	0	0	0	0	0	0	0	
Initial Fut:	96	806	0	0	1467	58	44	0	49	0	0	0	0	0	0	
User Adj:	1.00	1.00	1.00	1.00	1.00	1.00	1.00	1.00	1.00	1.00	1.00	1.00	1.00	1.00	1.00	
PHF Adj:	1.00	1.00	1.00	1.00	1.00	1.00	1.00	1.00	1.00	1.00	1.00	1.00	1.00	1.00	1.00	
PHF Volume:	96	806	0	0	1467	58	44	0	49	0	0	0	0	0	0	
Reduct Vol:	0	0	0	0	0	0	0	0	0	0	0	0	0	0	0	
Reduced Vol:	96	806	0	0	1467	58	44	0	49	0	0	0	0	0	0	
PCE Adj:	1.00	1.00	1.00	1.00	1.00	1.00	1.00	1.00	1.00	1.00	1.00	1.00	1.00	1.00	1.00	
MLF Adj:	1.00	1.00	1.00	1.00	1.00	1.00	1.00	1.00	1.00	1.00	1.00	1.00	1.00	1.00	1.00	
FinalVolume:	96	806	0	0	1467	58	44	0	49	0	0	0	0	0	0	

Saturation Flow Module:												
Sat/Lane:	1900	1900	1900	1900	1900	1900	1900	1900	1900	1900	1900	1900
Adjustment:	0.92	1.00	0.92	0.92	1.00	0.92	0.92	0.92	0.92	0.92	1.00	0.92
Lanes:	1.00	2.00	0.00	0.00	2.00	1.00	0.47	0.00	0.53	0.00	0.00	0.00
Final Sat.:	1750	3800	0	0	3800	1750	828	0	922	0	0	0

Capacity Analysis Module:												
Vol/Sat:	0.05	0.21	0.00	0.00	0.39	0.03	0.05	0.00	0.05	0.00	0.00	0.00
Crit Moves:	****											
Green Time:	22.5	22.5	0.0	0.0	59.0	59.0	10.0	0.0	10.0	0.0	0.0	0.0
Volume/Cap:	0.18	0.71	0.00	0.00	0.49	0.04	0.40	0.00	0.40	0.00	0.00	0.00
Delay/Veh:	19.6	25.4	0.0	0.0	2.9	1.8	30.9	0.0	30.9	0.0	0.0	0.0
User DelAdj:	1.00	1.00	1.00	1.00	1.00	1.00	1.00	1.00	1.00	1.00	1.00	1.00
AdjDel/Veh:	19.6	25.4	0.0	0.0	2.9	1.8	30.9	0.0	30.9	0.0	0.0	0.0
LOS by Move:	B	C	A	A	A	A	C	A	C	A	A	A
HCM2kAvgQ:	2	10	0	0	6	0	3	0	3	0	0	0

Note: Queue reported is the number of cars per lane.

Voices School
Morgan Hill, CA
Hexagon Transportation Consultants, Inc.

Level Of Service Computation Report
2000 HCM Operations (Future Volume Alternative)
2025 Plus Project (AM) - 2 Cosmo Right out

Intersection #6725: Monterey Road and Spring Avenue

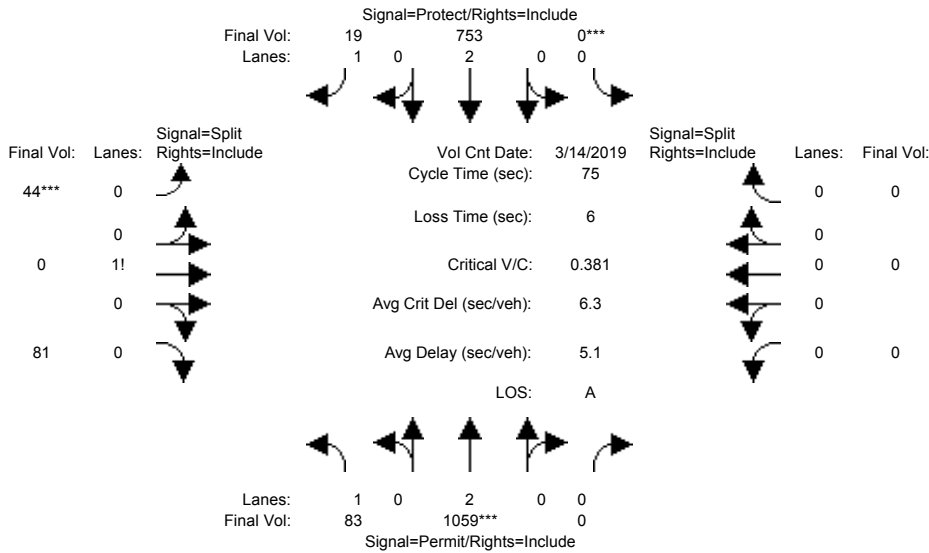

Street Name:	Monterey Road						Spring Avenue					
	North Bound			South Bound			East Bound			West Bound		
Approach:	L	T	R	L	T	R	L	T	R	L	T	R
Min. Green:	10	10	0	0	10	10	10	0	10	0	0	0
Y+R:	4.0	4.0	4.0	4.0	4.0	4.0	4.0	4.0	4.0	4.0	4.0	4.0

Volume Module: >> Count Date: 14 Mar 2019 <<

Base Vol:	83	891	0	0	479	17	42	0	68	0	0	0
Growth Adj:	1.00	1.00	1.00	1.00	1.00	1.00	1.00	1.00	1.00	1.00	1.00	1.00
Initial Bse:	83	891	0	0	479	17	42	0	68	0	0	0
Added Vol:	0	0	0	0	206	0	0	0	13	0	0	0
PasserByVol:	0	168	0	0	68	2	2	0	0	0	0	0
Initial Fut:	83	1059	0	0	753	19	44	0	81	0	0	0
User Adj:	1.00	1.00	1.00	1.00	1.00	1.00	1.00	1.00	1.00	1.00	1.00	1.00
PHF Adj:	1.00	1.00	1.00	1.00	1.00	1.00	1.00	1.00	1.00	1.00	1.00	1.00
PHF Volume:	83	1059	0	0	753	19	44	0	81	0	0	0
Reduct Vol:	0	0	0	0	0	0	0	0	0	0	0	0
Reduced Vol:	83	1059	0	0	753	19	44	0	81	0	0	0
PCE Adj:	1.00	1.00	1.00	1.00	1.00	1.00	1.00	1.00	1.00	1.00	1.00	1.00
MLF Adj:	1.00	1.00	1.00	1.00	1.00	1.00	1.00	1.00	1.00	1.00	1.00	1.00
Final Volume:	83	1059	0	0	753	19	44	0	81	0	0	0

Saturation Flow Module:

Sat/Lane:	1900	1900	1900	1900	1900	1900	1900	1900	1900	1900	1900	1900
Adjustment:	0.92	1.00	0.92	0.92	1.00	0.92	0.92	0.92	0.92	0.92	1.00	0.92
Lanes:	1.00	2.00	0.00	0.00	2.00	1.00	0.35	0.00	0.65	0.00	0.00	0.00
Final Sat.:	1750	3800	0	0	3800	1750	616	0	1134	0	0	0

Capacity Analysis Module:

Vol/Sat:	0.05	0.28	0.00	0.00	0.20	0.01	0.07	0.00	0.07	0.00	0.00	0.00
Crit Moves:	****	****	****	****	****	****	****	****	****	****	****	****
Green Time:	54.9	54.9	0.0	0.0	54.9	54.9	14.1	0.0	14.1	0.0	0.0	0.0
Volume/Cap:	0.06	0.38	0.00	0.00	0.27	0.01	0.38	0.00	0.38	0.00	0.00	0.00
Delay/Veh:	2.8	3.8	0.0	0.0	3.4	2.7	27.4	0.0	27.4	0.0	0.0	0.0
User DelAdj:	1.00	1.00	1.00	1.00	1.00	1.00	1.00	1.00	1.00	1.00	1.00	1.00
AdjDel/Veh:	2.8	3.8	0.0	0.0	3.4	2.7	27.4	0.0	27.4	0.0	0.0	0.0
LOS by Move:	A	A	A	A	A	A	C	A	C	A	A	A
HCM2kAvgQ:	1	5	0	0	3	0	3	0	3	0	0	0

Note: Queue reported is the number of cars per lane.

Voices School
Morgan Hill, CA
Hexagon Transportation Consultants, Inc.

Level Of Service Computation Report
2000 HCM Operations (Future Volume Alternative)
2025 Plus Project (PM) - 2 Cosmo Right out

Intersection #6725: Monterey Road and Spring Avenue

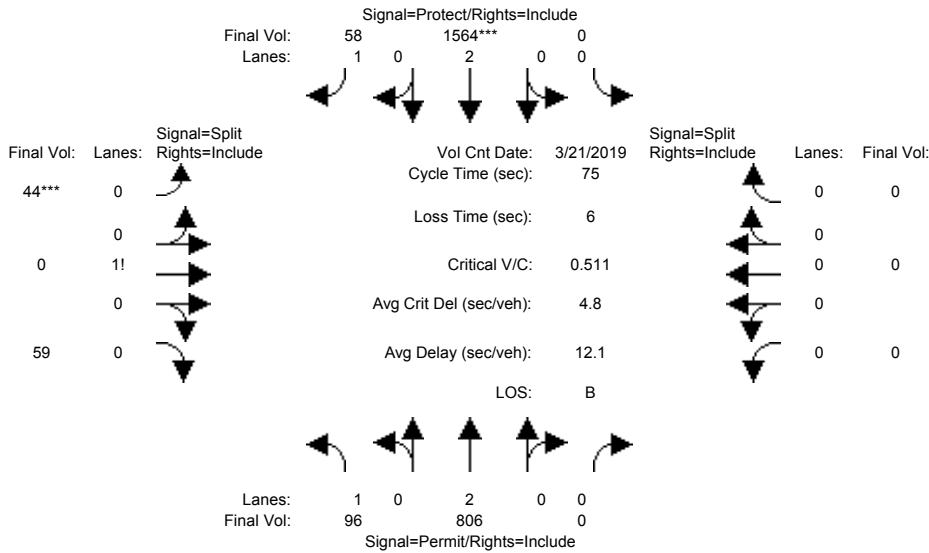

Street Name:	Monterey Road						Spring Avenue					
	North Bound			South Bound			East Bound			West Bound		
Approach:	L	T	R	L	T	R	L	T	R	L	T	R
Min. Green:	10	10	0	0	10	10	10	0	10	0	0	0
Y+R:	4.0	4.0	4.0	4.0	4.0	4.0	4.0	4.0	4.0	4.0	4.0	4.0

Volume Module:	>>	Count	Date:	21 Mar 2019	<<							
Base Vol:	96	706	0	0	1388	56	42	0	49	0	0	0
Growth Adj:	1.00	1.00	1.00	1.00	1.00	1.00	1.00	1.00	1.00	1.00	1.00	1.00
Initial Bse:	96	706	0	0	1388	56	42	0	49	0	0	0
Added Vol:	0	0	0	0	97	0	0	0	10	0	0	0
PasserByVol:	0	100	0	0	79	2	2	0	0	0	0	0
Initial Fut:	96	806	0	0	1564	58	44	0	59	0	0	0
User Adj:	1.00	1.00	1.00	1.00	1.00	1.00	1.00	1.00	1.00	1.00	1.00	1.00
PHF Adj:	1.00	1.00	1.00	1.00	1.00	1.00	1.00	1.00	1.00	1.00	1.00	1.00
PHF Volume:	96	806	0	0	1564	58	44	0	59	0	0	0
Reduct Vol:	0	0	0	0	0	0	0	0	0	0	0	0
Reduced Vol:	96	806	0	0	1564	58	44	0	59	0	0	0
PCE Adj:	1.00	1.00	1.00	1.00	1.00	1.00	1.00	1.00	1.00	1.00	1.00	1.00
MLF Adj:	1.00	1.00	1.00	1.00	1.00	1.00	1.00	1.00	1.00	1.00	1.00	1.00
FinalVolume:	96	806	0	0	1564	58	44	0	59	0	0	0

Saturation Flow Module:												
Sat/Lane:	1900	1900	1900	1900	1900	1900	1900	1900	1900	1900	1900	1900
Adjustment:	0.92	1.00	0.92	0.92	1.00	0.92	0.92	0.92	0.92	0.92	1.00	0.92
Lanes:	1.00	2.00	0.00	0.00	2.00	1.00	0.43	0.00	0.57	0.00	0.00	0.00
Final Sat.:	1750	3800	0	0	3800	1750	748	0	1002	0	0	0

Capacity Analysis Module:												
Vol/Sat:	0.05	0.21	0.00	0.00	0.41	0.03	0.06	0.00	0.06	0.00	0.00	0.00
Crit Moves:	****											
Green Time:	21.4	21.4	0.0	0.0	59.0	59.0	10.0	0.0	10.0	0.0	0.0	0.0
Volume/Cap:	0.19	0.74	0.00	0.00	0.52	0.04	0.44	0.00	0.44	0.00	0.00	0.00
Delay/Veh:	20.4	27.1	0.0	0.0	3.1	1.8	31.3	0.0	31.3	0.0	0.0	0.0
User DelAdj:	1.00	1.00	1.00	1.00	1.00	1.00	1.00	1.00	1.00	1.00	1.00	1.00
AdjDel/Veh:	20.4	27.1	0.0	0.0	3.1	1.8	31.3	0.0	31.3	0.0	0.0	0.0
LOS by Move:	C	C	A	A	A	A	C	A	C	A	A	A
HCM2kAvgQ:	2	10	0	0	6	0	3	0	3	0	0	0

Note: Queue reported is the number of cars per lane.

Appendix D
Signal Warrants

Voices School Morgan Hill

4 . Monterey Road and San Pedro Avenue

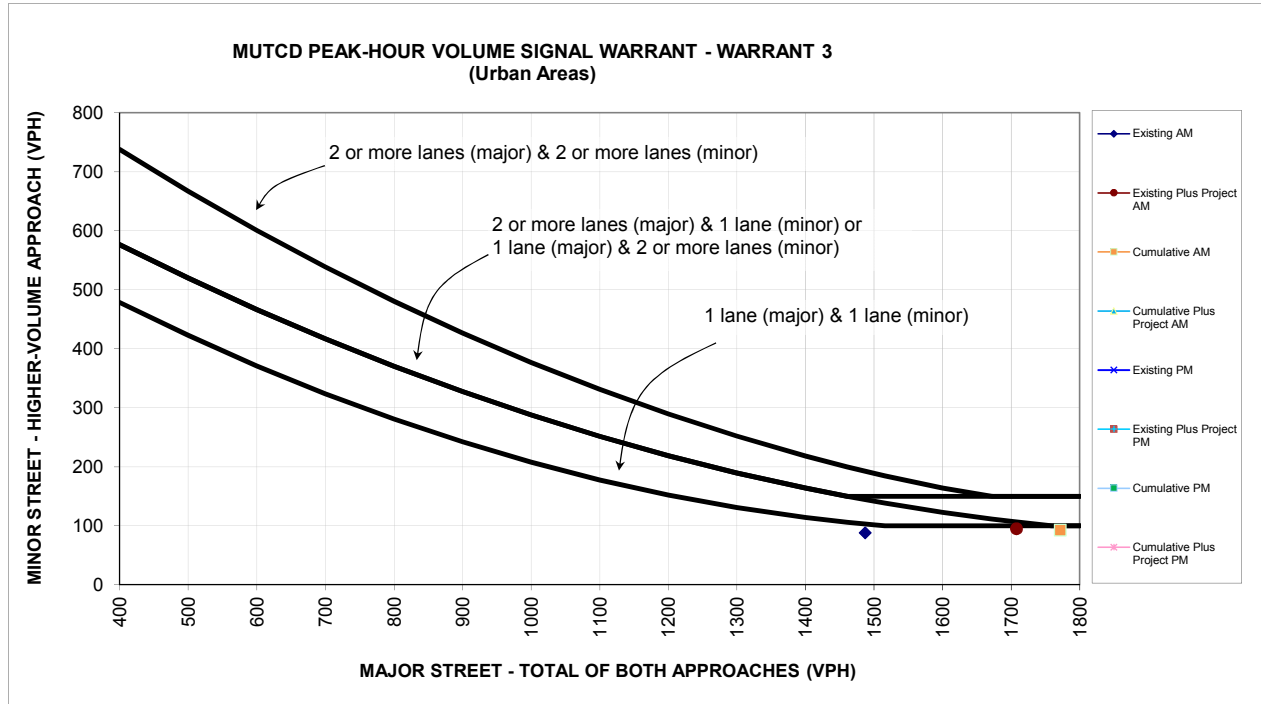

Source: Figure 4C-3 of the Manual on Uniform Traffic Control and Devices (MUTCD) from California Department of Transportation (Caltrans).

* 150 vph applies as the lower threshold volume for a minor-street approach with two or more lanes and 100 vph applies as the lower threshold volume for a minor-street approach with one lane.

		Approach Lanes		Existing AM	Existing Plus Project AM	Cumulative AM	Cumulative Plus Project AM
		2 or One	More				
Major Street - Both Approaches	Monterey Road		X	1487	1708	1772	1991
Minor Street - Highest Approach	San Pedro Avenue	X		88	95	93	100
Maximum warrant threshold for minor street volume				144	106	100	100
Difference between warrant threshold & minor street volume				56	11	7	0
Warrant Met?				No	No	No	Yes

		Approach Lanes		Existing PM	Existing Plus Project PM	Cumulative PM	Cumulative Plus Project PM
		2 or One	More				
Major Street - Both Approaches	Monterey Road		X	2354	2465	2593	2699
Minor Street - Highest Approach	San Pedro Avenue	X		110	111	114	115
Maximum warrant threshold for minor street volume				100	100	100	100
Difference between warrant threshold & minor street volume				10	11	14	15
Warrant Met?				Yes	Yes	Yes	Yes

Voices School Morgan Hill

16 . Olympic Drive and Edmundson Avenue

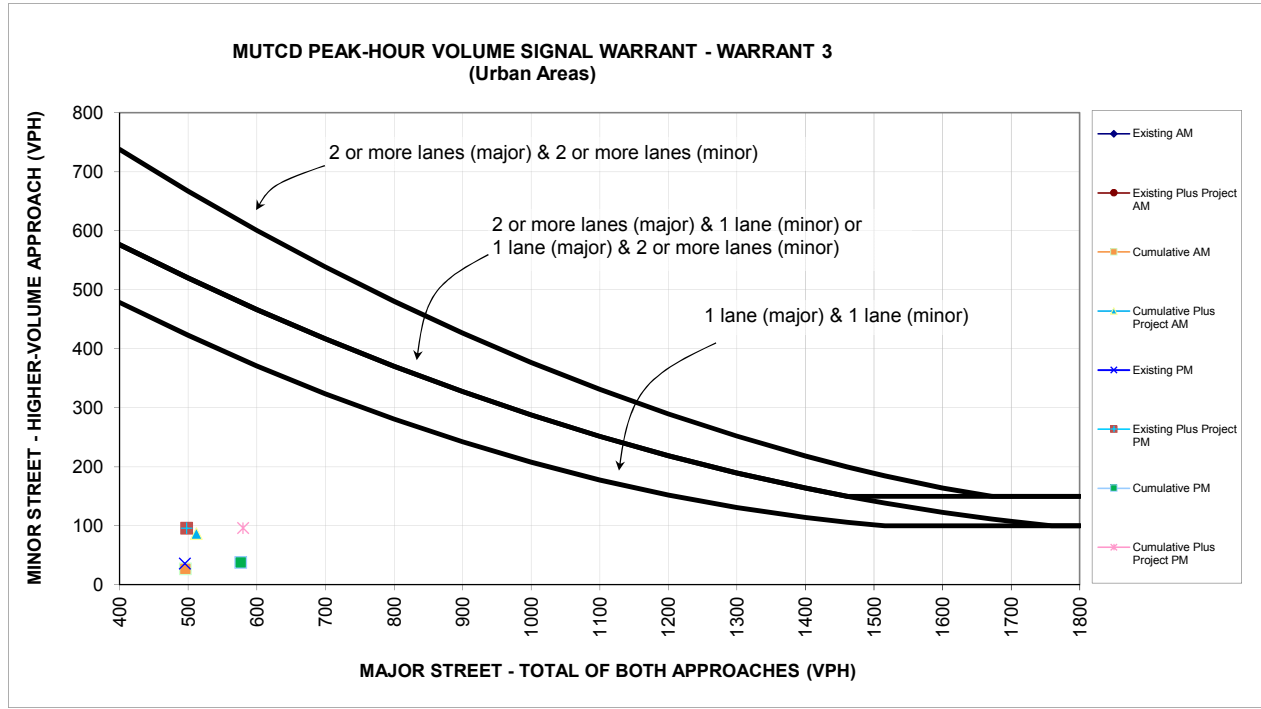

Source: Figure 4C-3 of the Manual on Uniform Traffic Control and Devices (MUTCD) from California Department of Transportation (Caltrans).

* 150 vph applies as the lower threshold volume for a minor-street approach with two or more lanes and 100 vph applies as the lower threshold volume for a minor-street approach with one lane.

		Approach Lanes		Existing AM	Existing Plus Project AM	Cumulative AM	Cumulative Plus Project AM
		2 or One	More				
Major Street - Both Approaches	Edmundson Avenue	X		360	376	496	512
Minor Street - Highest Approach	Olympic Drive	X		22	84	27	87
Maximum warrant threshold for minor street volume				502	492	425	416
Difference between warrant threshold & minor street volume				480	408	398	329
Warrant Met?				No	No	No	No

		Approach Lanes		Existing PM	Existing Plus Project PM	Cumulative PM	Cumulative Plus Project PM
		2 or One	More				
Major Street - Both Approaches	Edmundson Avenue	X		495	498	577	580
Minor Street - Highest Approach	Olympic Drive	X		36	96	38	96
Maximum warrant threshold for minor street volume				425	424	382	381
Difference between warrant threshold & minor street volume				389	328	344	285
Warrant Met?				No	No	No	No

Voices School Morgan Hill

17 . Del Monte Avenue and Cosmo Avenue

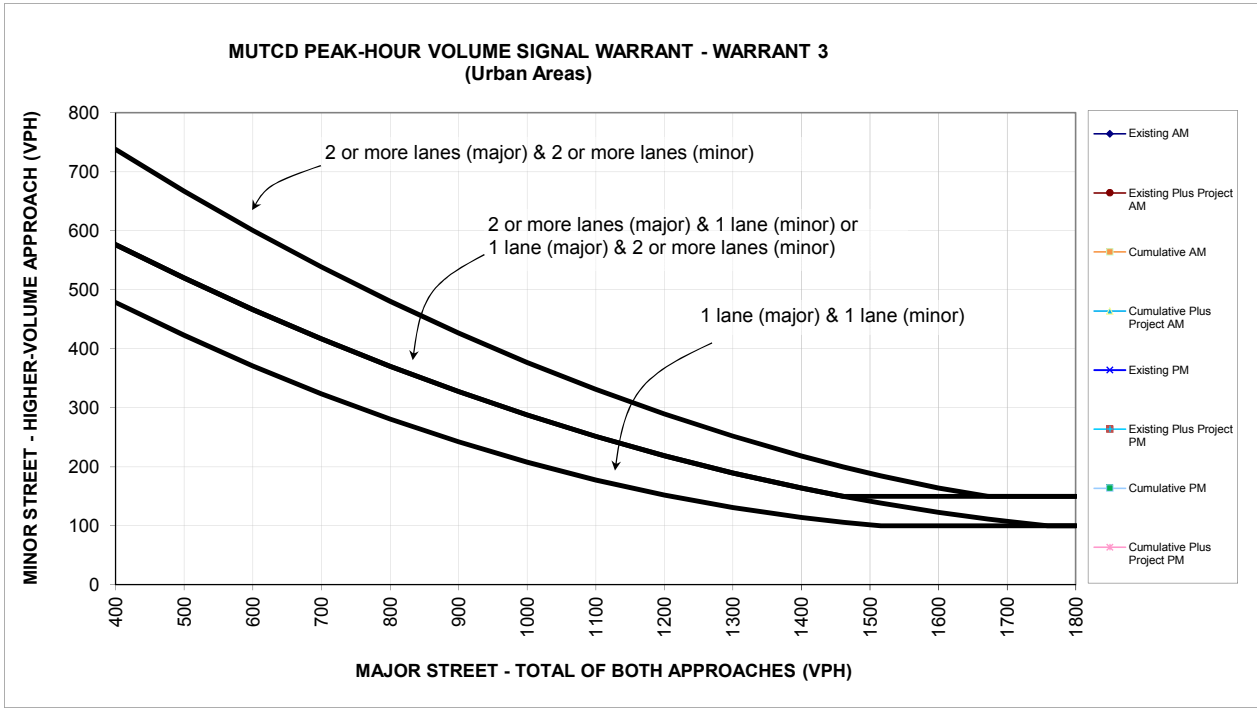

Source: Figure 4C-3 of the Manual on Uniform Traffic Control and Devices (MUTCD) from California Department of Transportation (Caltrans).

* 150 vph applies as the lower threshold volume for a minor-street approach with two or more lanes and 100 vph applies as the lower threshold volume for a minor-street approach with one lane.

		Approach Lanes		Existing AM	Existing Plus Project AM	Cumulative AM	Cumulative Plus Project AM
		2 or One	More				
Major Street - Both Approaches	Del Monte Avenue	X		77	333	79	331
Minor Street - Highest Approach	Cosmo Avenue	X		41	53	44	55
Maximum warrant threshold for minor street volume				689	518	687	520
Difference between warrant threshold & minor street volume				648	465	643	465
Warrant Met?				No	No	No	No

		Approach Lanes		Existing PM	Existing Plus Project PM	Cumulative PM	Cumulative Plus Project PM
		2 or One	More				
Major Street - Both Approaches	Del Monte Avenue	X		160	307	163	304
Minor Street - Highest Approach	Cosmo Avenue	X		63	94	65	97
Maximum warrant threshold for minor street volume				630	534	628	536
Difference between warrant threshold & minor street volume				567	440	563	439
Warrant Met?				No	No	No	No

Voices School Morgan Hill

18 . Del Monte Avenue and Spring Avenue

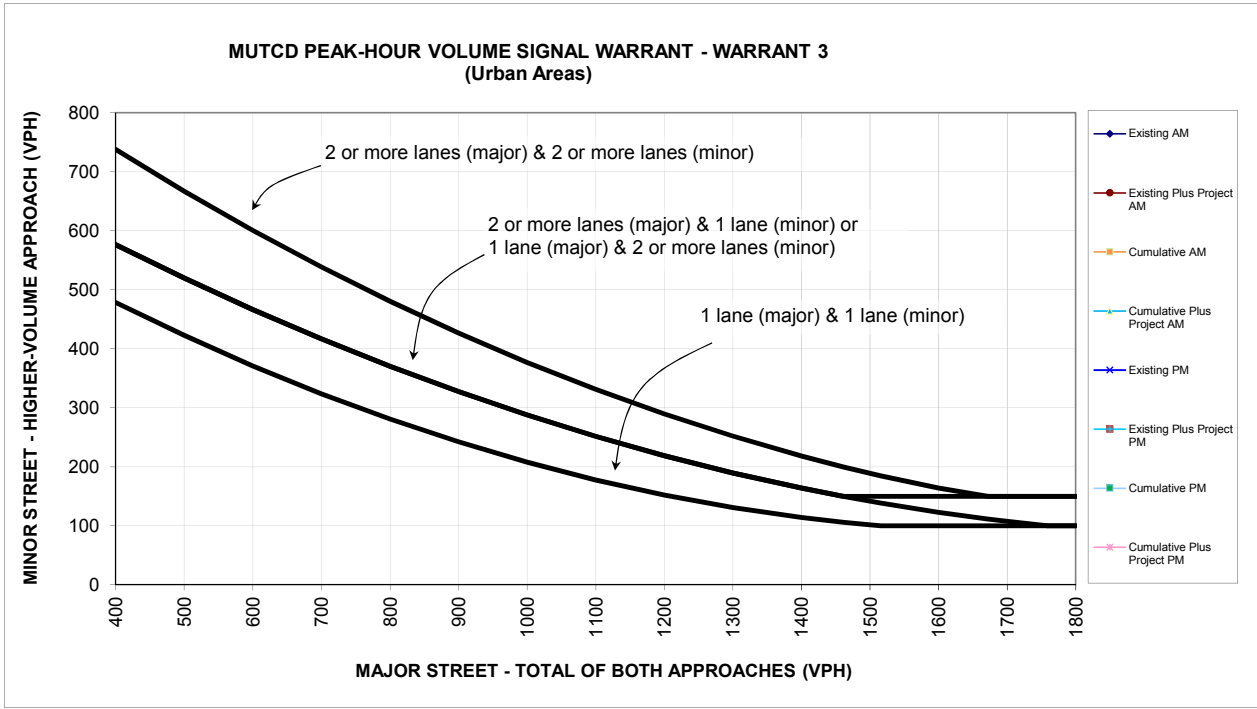

Source: Figure 4C-3 of the Manual on Uniform Traffic Control and Devices (MUTCD) from California Department of Transportation (Caltrans).

* 150 vph applies as the lower threshold volume for a minor-street approach with two or more lanes and 100 vph applies as the lower threshold volume for a minor-street approach with one lane.

		Approach Lanes		Existing AM	Existing Plus Project AM	Cumulative AM	Cumulative Plus Project AM
		2 or One	More				
Major Street - Both Approaches	Spring Avenue	X		179	367	217	378
Minor Street - Highest Approach	Del Monte Avenue	X		103	101	116	135
Maximum warrant threshold for minor street volume				617	498	592	491
Difference between warrant threshold & minor street volume				514	397	476	356
Warrant Met?				No	No	No	No

		Approach Lanes		Existing PM	Existing Plus Project PM	Cumulative PM	Cumulative Plus Project PM
		2 or One	More				
Major Street - Both Approaches	Spring Avenue	X		195	334	216	353
Minor Street - Highest Approach	Del Monte Avenue	X		102	120	127	127
Maximum warrant threshold for minor street volume				607	518	593	506
Difference between warrant threshold & minor street volume				505	398	466	379
Warrant Met?				No	No	No	No

Appendix E

Poisson Probability Calculations

2. Monterey/Dunne

EBL

AM

Existing Conditions

Avg. Queue Per Lane in Veh= 2.5

Percentile = 0.95 5

2. Monterey/Dunne

EBL

AM

Existing Plus Project Conditions with Proposed Site A

Avg. Queue Per Lane in Veh= 5.6

Percentile = 0.95 10

Individual Probability	Cumulative Probability	Number of Queued Vehicles
0.0838	0.0838	0
0.2078	0.2916	1
0.2576	0.5492	2
0.2129	0.7620	3
0.1319	0.8939	4
0.0654	0.9594	5
0.0270	0.9864	6
0.0096	0.9960	7
0.0030	0.9989	8
0.0008	0.9997	9
0.0002	0.9999	10
0.0000	1.0000	11
0.0000	1.0000	12
0.0000	1.0000	13
0.0000	1.0000	14
0.0000	1.0000	15
0.0000	1.0000	16
0.0000	1.0000	17
0.0000	1.0000	18
0.0000	1.0000	19
0.0000	1.0000	20
0.0000	1.0000	21
0.0000	1.0000	22
0.0000	1.0000	23
0.0000	1.0000	24
0.0000	1.0000	25
0.0000	1.0000	26
0.0000	1.0000	27
0.0000	1.0000	28
0.0000	1.0000	29
0.0000	1.0000	30
0.0000	1.0000	31
0.0000	1.0000	32
0.0000	1.0000	33
0.0000	1.0000	34
0.0000	1.0000	35
0.0000	1.0000	36
0.0000	1.0000	37
0.0000	1.0000	38
0.0000	1.0000	39
0.0000	1.0000	40
0.0000	1.0000	41
0.0000	1.0000	42
0.0000	1.0000	43
0.0000	1.0000	44
0.0000	1.0000	45

Individual Probability	Cumulative Probability	Number of Queued Vehicles
0.0036	0.0036	0
0.0202	0.0238	1
0.0569	0.0807	2
0.1068	0.1875	3
0.1503	0.3377	4
0.1692	0.5069	5
0.1587	0.6656	6
0.1276	0.7933	7
0.0898	0.8831	8
0.0562	0.9392	9
0.0316	0.9709	10
0.0162	0.9870	11
0.0076	0.9946	12
0.0033	0.9979	13
0.0013	0.9992	14
0.0005	0.9997	15
0.0002	0.9999	16
0.0001	1.0000	17
0.0000	1.0000	18
0.0000	1.0000	19
0.0000	1.0000	20
0.0000	1.0000	21
0.0000	1.0000	22
0.0000	1.0000	23
0.0000	1.0000	24
0.0000	1.0000	25
0.0000	1.0000	26
0.0000	1.0000	27
0.0000	1.0000	28
0.0000	1.0000	29
0.0000	1.0000	30
0.0000	1.0000	31
0.0000	1.0000	32
0.0000	1.0000	33
0.0000	1.0000	34
0.0000	1.0000	35
0.0000	1.0000	36
0.0000	1.0000	37
0.0000	1.0000	38
0.0000	1.0000	39
0.0000	1.0000	40
0.0000	1.0000	41
0.0000	1.0000	42
0.0000	1.0000	43
0.0000	1.0000	44
0.0000	1.0000	45

2. Monterey/Dunne

EBL

PM

Existing Conditions

Avg. Queue Per Lane in Veh= 2.2

Percentile = 0.95 5

2. Monterey/Dunne

EBL

PM

Existing Plus Project Conditions with Proposed Site A

Avg. Queue Per Lane in Veh= 6.6

Percentile = 0.95 11

Individual Probability	Cumulative Probability	Number of Queued Vehicles
0.1058	0.1058	0
0.2377	0.3435	1
0.2669	0.6105	2
0.1998	0.8103	3
0.1122	0.9225	4
0.0504	0.9728	5
0.0189	0.9917	6
0.0061	0.9978	7
0.0017	0.9995	8
0.0004	0.9999	9
0.0001	1.0000	10
0.0000	1.0000	11
0.0000	1.0000	12
0.0000	1.0000	13
0.0000	1.0000	14
0.0000	1.0000	15
0.0000	1.0000	16
0.0000	1.0000	17
0.0000	1.0000	18
0.0000	1.0000	19
0.0000	1.0000	20
0.0000	1.0000	21
0.0000	1.0000	22
0.0000	1.0000	23
0.0000	1.0000	24
0.0000	1.0000	25
0.0000	1.0000	26
0.0000	1.0000	27
0.0000	1.0000	28
0.0000	1.0000	29
0.0000	1.0000	30
0.0000	1.0000	31
0.0000	1.0000	32
0.0000	1.0000	33
0.0000	1.0000	34
0.0000	1.0000	35
0.0000	1.0000	36
0.0000	1.0000	37
0.0000	1.0000	38
0.0000	1.0000	39
0.0000	1.0000	40
0.0000	1.0000	41
0.0000	1.0000	42
0.0000	1.0000	43
0.0000	1.0000	44
0.0000	1.0000	45

Individual Probability	Cumulative Probability	Number of Queued Vehicles
0.0013	0.0013	0
0.0088	0.0102	1
0.0292	0.0394	2
0.0644	0.1038	3
0.1067	0.2105	4
0.1413	0.3517	5
0.1559	0.5076	6
0.1474	0.6550	7
0.1220	0.7770	8
0.0898	0.8668	9
0.0594	0.9262	10
0.0358	0.9620	11
0.0197	0.9817	12
0.0101	0.9918	13
0.0048	0.9965	14
0.0021	0.9986	15
0.0009	0.9995	16
0.0003	0.9998	17
0.0001	0.9999	18
0.0000	1.0000	19
0.0000	1.0000	20
0.0000	1.0000	21
0.0000	1.0000	22
0.0000	1.0000	23
0.0000	1.0000	24
0.0000	1.0000	25
0.0000	1.0000	26
0.0000	1.0000	27
0.0000	1.0000	28
0.0000	1.0000	29
0.0000	1.0000	30
0.0000	1.0000	31
0.0000	1.0000	32
0.0000	1.0000	33
0.0000	1.0000	34
0.0000	1.0000	35
0.0000	1.0000	36
0.0000	1.0000	37
0.0000	1.0000	38
0.0000	1.0000	39
0.0000	1.0000	40
0.0000	1.0000	41
0.0000	1.0000	42
0.0000	1.0000	43
0.0000	1.0000	44
0.0000	1.0000	45

0

WBL
 AM
 Existing Conditions
 Avg. Queue Per Lane in Veh= 2.1
 Percentile = 0.95 5

0

WBL
 AM
 Existing Plus Project Conditions with Proposed Site A
 Avg. Queue Per Lane in Veh= 4.6
 Percentile = 0.95 8

Individual Probability	Cumulative Probability	Number of Queued Vehicles
0.1225	0.1225	0
0.2572	0.3796	1
0.2700	0.6496	2
0.1890	0.8386	3
0.0992	0.9379	4
0.0417	0.9796	5
0.0146	0.9941	6
0.0044	0.9985	7
0.0011	0.9997	8
0.0003	0.9999	9
0.0001	1.0000	10
0.0000	1.0000	11
0.0000	1.0000	12
0.0000	1.0000	13
0.0000	1.0000	14
0.0000	1.0000	15
0.0000	1.0000	16
0.0000	1.0000	17
0.0000	1.0000	18
0.0000	1.0000	19
0.0000	1.0000	20
0.0000	1.0000	21
0.0000	1.0000	22
0.0000	1.0000	23
0.0000	1.0000	24
0.0000	1.0000	25
0.0000	1.0000	26
0.0000	1.0000	27
0.0000	1.0000	28
0.0000	1.0000	29
0.0000	1.0000	30
0.0000	1.0000	31
0.0000	1.0000	32
0.0000	1.0000	33
0.0000	1.0000	34
0.0000	1.0000	35
0.0000	1.0000	36
0.0000	1.0000	37
0.0000	1.0000	38
0.0000	1.0000	39
0.0000	1.0000	40
0.0000	1.0000	41
0.0000	1.0000	42
0.0000	1.0000	43
0.0000	1.0000	44
0.0000	1.0000	45

Individual Probability	Cumulative Probability	Number of Queued Vehicles
0.0106	0.0106	0
0.0481	0.0586	1
0.1094	0.1680	2
0.1659	0.3339	3
0.1887	0.5226	4
0.1717	0.6944	5
0.1302	0.8246	6
0.0846	0.9092	7
0.0481	0.9574	8
0.0243	0.9817	9
0.0111	0.9928	10
0.0046	0.9974	11
0.0017	0.9991	12
0.0006	0.9997	13
0.0002	0.9999	14
0.0001	1.0000	15
0.0000	1.0000	16
0.0000	1.0000	17
0.0000	1.0000	18
0.0000	1.0000	19
0.0000	1.0000	20
0.0000	1.0000	21
0.0000	1.0000	22
0.0000	1.0000	23
0.0000	1.0000	24
0.0000	1.0000	25
0.0000	1.0000	26
0.0000	1.0000	27
0.0000	1.0000	28
0.0000	1.0000	29
0.0000	1.0000	30
0.0000	1.0000	31
0.0000	1.0000	32
0.0000	1.0000	33
0.0000	1.0000	34
0.0000	1.0000	35
0.0000	1.0000	36
0.0000	1.0000	37
0.0000	1.0000	38
0.0000	1.0000	39
0.0000	1.0000	40
0.0000	1.0000	41
0.0000	1.0000	42
0.0000	1.0000	43
0.0000	1.0000	44
0.0000	1.0000	45

0

WBL
 PM
 Existing Conditions
 Avg. Queue Per Lane in Veh= 4.8
 Percentile = 0.95 9

0

WBL
 PM
 Existing Plus Project Conditions with Proposed Site A
 Avg. Queue Per Lane in Veh= 7.2
 Percentile = 0.95 12

Individual Probability	Cumulative Probability	Number of Queued Vehicles
0.0082	0.0082	0
0.0396	0.0478	1
0.0949	0.1427	2
0.1518	0.2945	3
0.1821	0.4766	4
0.1747	0.6514	5
0.1397	0.7911	6
0.0958	0.8869	7
0.0574	0.9443	8
0.0306	0.9749	9
0.0147	0.9896	10
0.0064	0.9960	11
0.0026	0.9986	12
0.0009	0.9995	13
0.0003	0.9999	14
0.0001	1.0000	15
0.0000	1.0000	16
0.0000	1.0000	17
0.0000	1.0000	18
0.0000	1.0000	19
0.0000	1.0000	20
0.0000	1.0000	21
0.0000	1.0000	22
0.0000	1.0000	23
0.0000	1.0000	24
0.0000	1.0000	25
0.0000	1.0000	26
0.0000	1.0000	27
0.0000	1.0000	28
0.0000	1.0000	29
0.0000	1.0000	30
0.0000	1.0000	31
0.0000	1.0000	32
0.0000	1.0000	33
0.0000	1.0000	34
0.0000	1.0000	35
0.0000	1.0000	36
0.0000	1.0000	37
0.0000	1.0000	38
0.0000	1.0000	39
0.0000	1.0000	40
0.0000	1.0000	41
0.0000	1.0000	42
0.0000	1.0000	43
0.0000	1.0000	44
0.0000	1.0000	45

Individual Probability	Cumulative Probability	Number of Queued Vehicles
0.0007	0.0007	0
0.0054	0.0061	1
0.0193	0.0254	2
0.0463	0.0717	3
0.0834	0.1552	4
0.1202	0.2754	5
0.1444	0.4198	6
0.1486	0.5683	7
0.1338	0.7021	8
0.1071	0.8092	9
0.0772	0.8864	10
0.0505	0.9369	11
0.0303	0.9672	12
0.0168	0.9840	13
0.0087	0.9927	14
0.0042	0.9968	15
0.0019	0.9987	16
0.0008	0.9995	17
0.0003	0.9998	18
0.0001	0.9999	19
0.0000	1.0000	20
0.0000	1.0000	21
0.0000	1.0000	22
0.0000	1.0000	23
0.0000	1.0000	24
0.0000	1.0000	25
0.0000	1.0000	26
0.0000	1.0000	27
0.0000	1.0000	28
0.0000	1.0000	29
0.0000	1.0000	30
0.0000	1.0000	31
0.0000	1.0000	32
0.0000	1.0000	33
0.0000	1.0000	34
0.0000	1.0000	35
0.0000	1.0000	36
0.0000	1.0000	37
0.0000	1.0000	38
0.0000	1.0000	39
0.0000	1.0000	40
0.0000	1.0000	41
0.0000	1.0000	42
0.0000	1.0000	43
0.0000	1.0000	44
0.0000	1.0000	45

5. Monterey/Cosmo

NBL

AM

Existing Conditions

Avg. Queue Per Lane in Veh= 0.3

Percentile = 0.95 1

5. Monterey/Cosmo

NBL

AM

Existing Plus Project Conditions with Proposed Site A

Avg. Queue Per Lane in Veh= 4.2

Percentile = 0.95 8

Individual Probability	Cumulative Probability	Number of Queued Vehicles
0.7533	0.7533	0
0.2134	0.9667	1
0.0302	0.9969	2
0.0029	0.9998	3
0.0002	1.0000	4
0.0000	1.0000	5
0.0000	1.0000	6
0.0000	1.0000	7
0.0000	1.0000	8
0.0000	1.0000	9
0.0000	1.0000	10
0.0000	1.0000	11
0.0000	1.0000	12
0.0000	1.0000	13
0.0000	1.0000	14
0.0000	1.0000	15
0.0000	1.0000	16
0.0000	1.0000	17
0.0000	1.0000	18
0.0000	1.0000	19
0.0000	1.0000	20
0.0000	1.0000	21
0.0000	1.0000	22
0.0000	1.0000	23
0.0000	1.0000	24
0.0000	1.0000	25
0.0000	1.0000	26
0.0000	1.0000	27
0.0000	1.0000	28
0.0000	1.0000	29
0.0000	1.0000	30
0.0000	1.0000	31
0.0000	1.0000	32
0.0000	1.0000	33
0.0000	1.0000	34
0.0000	1.0000	35
0.0000	1.0000	36
0.0000	1.0000	37
0.0000	1.0000	38
0.0000	1.0000	39
0.0000	1.0000	40
0.0000	1.0000	41
0.0000	1.0000	42
0.0000	1.0000	43
0.0000	1.0000	44
0.0000	1.0000	45

Individual Probability	Cumulative Probability	Number of Queued Vehicles
0.0152	0.0152	0
0.0638	0.0790	1
0.1334	0.2125	2
0.1860	0.3985	3
0.1946	0.5931	4
0.1628	0.7559	5
0.1135	0.8694	6
0.0678	0.9372	7
0.0355	0.9727	8
0.0165	0.9892	9
0.0069	0.9960	10
0.0026	0.9987	11
0.0009	0.9996	12
0.0003	0.9999	13
0.0001	1.0000	14
0.0000	1.0000	15
0.0000	1.0000	16
0.0000	1.0000	17
0.0000	1.0000	18
0.0000	1.0000	19
0.0000	1.0000	20
0.0000	1.0000	21
0.0000	1.0000	22
0.0000	1.0000	23
0.0000	1.0000	24
0.0000	1.0000	25
0.0000	1.0000	26
0.0000	1.0000	27
0.0000	1.0000	28
0.0000	1.0000	29
0.0000	1.0000	30
0.0000	1.0000	31
0.0000	1.0000	32
0.0000	1.0000	33
0.0000	1.0000	34
0.0000	1.0000	35
0.0000	1.0000	36
0.0000	1.0000	37
0.0000	1.0000	38
0.0000	1.0000	39
0.0000	1.0000	40
0.0000	1.0000	41
0.0000	1.0000	42
0.0000	1.0000	43
0.0000	1.0000	44
0.0000	1.0000	45

5. Monterey/Cosmo

NBL

PM

Existing Conditions

Avg. Queue Per Lane in Veh= 0.8

Percentile = 0.95 2

5. Monterey/Cosmo

NBL

PM

Existing Plus Project Conditions with Proposed Site A

Avg. Queue Per Lane in Veh= 2.1

Percentile = 0.95 5

Individual Probability	Cumulative Probability	Number of Queued Vehicles
0.4724	0.4724	0
0.3543	0.8266	1
0.1329	0.9595	2
0.0332	0.9927	3
0.0062	0.9989	4
0.0009	0.9999	5
0.0001	1.0000	6
0.0000	1.0000	7
0.0000	1.0000	8
0.0000	1.0000	9
0.0000	1.0000	10
0.0000	1.0000	11
0.0000	1.0000	12
0.0000	1.0000	13
0.0000	1.0000	14
0.0000	1.0000	15
0.0000	1.0000	16
0.0000	1.0000	17
0.0000	1.0000	18
0.0000	1.0000	19
0.0000	1.0000	20
0.0000	1.0000	21
0.0000	1.0000	22
0.0000	1.0000	23
0.0000	1.0000	24
0.0000	1.0000	25
0.0000	1.0000	26
0.0000	1.0000	27
0.0000	1.0000	28
0.0000	1.0000	29
0.0000	1.0000	30
0.0000	1.0000	31
0.0000	1.0000	32
0.0000	1.0000	33
0.0000	1.0000	34
0.0000	1.0000	35
0.0000	1.0000	36
0.0000	1.0000	37
0.0000	1.0000	38
0.0000	1.0000	39
0.0000	1.0000	40
0.0000	1.0000	41
0.0000	1.0000	42
0.0000	1.0000	43
0.0000	1.0000	44
0.0000	1.0000	45

Individual Probability	Cumulative Probability	Number of Queued Vehicles
0.1184	0.1184	0
0.2527	0.3711	1
0.2695	0.6406	2
0.1917	0.8323	3
0.1022	0.9345	4
0.0436	0.9781	5
0.0155	0.9936	6
0.0047	0.9984	7
0.0013	0.9996	8
0.0003	0.9999	9
0.0001	1.0000	10
0.0000	1.0000	11
0.0000	1.0000	12
0.0000	1.0000	13
0.0000	1.0000	14
0.0000	1.0000	15
0.0000	1.0000	16
0.0000	1.0000	17
0.0000	1.0000	18
0.0000	1.0000	19
0.0000	1.0000	20
0.0000	1.0000	21
0.0000	1.0000	22
0.0000	1.0000	23
0.0000	1.0000	24
0.0000	1.0000	25
0.0000	1.0000	26
0.0000	1.0000	27
0.0000	1.0000	28
0.0000	1.0000	29
0.0000	1.0000	30
0.0000	1.0000	31
0.0000	1.0000	32
0.0000	1.0000	33
0.0000	1.0000	34
0.0000	1.0000	35
0.0000	1.0000	36
0.0000	1.0000	37
0.0000	1.0000	38
0.0000	1.0000	39
0.0000	1.0000	40
0.0000	1.0000	41
0.0000	1.0000	42
0.0000	1.0000	43
0.0000	1.0000	44
0.0000	1.0000	45

6. Monterey/Tennant

SBL

AM

Existing Conditions

Avg. Queue Per Lane in Veh= 1.2

Percentile = 0.95 3

6. Monterey/Tennant

SBL

AM

Existing Plus Project Conditions with Proposed Site A

Avg. Queue Per Lane in Veh= 1.2

Percentile = 0.95 3

Individual Probability	Cumulative Probability	Number of Queued Vehicles
0.3166	0.3166	0
0.3641	0.6808	1
0.2094	0.8901	2
0.0803	0.9704	3
0.0231	0.9935	4
0.0053	0.9988	5
0.0010	0.9998	6
0.0002	1.0000	7
0.0000	1.0000	8
0.0000	1.0000	9
0.0000	1.0000	10
0.0000	1.0000	11
0.0000	1.0000	12
0.0000	1.0000	13
0.0000	1.0000	14
0.0000	1.0000	15
0.0000	1.0000	16
0.0000	1.0000	17
0.0000	1.0000	18
0.0000	1.0000	19
0.0000	1.0000	20
0.0000	1.0000	21
0.0000	1.0000	22
0.0000	1.0000	23
0.0000	1.0000	24
0.0000	1.0000	25
0.0000	1.0000	26
0.0000	1.0000	27
0.0000	1.0000	28
0.0000	1.0000	29
0.0000	1.0000	30
0.0000	1.0000	31
0.0000	1.0000	32
0.0000	1.0000	33
0.0000	1.0000	34
0.0000	1.0000	35
0.0000	1.0000	36
0.0000	1.0000	37
0.0000	1.0000	38
0.0000	1.0000	39
0.0000	1.0000	40
0.0000	1.0000	41
0.0000	1.0000	42
0.0000	1.0000	43
0.0000	1.0000	44
0.0000	1.0000	45

Individual Probability	Cumulative Probability	Number of Queued Vehicles
0.3166	0.3166	0
0.3641	0.6808	1
0.2094	0.8901	2
0.0803	0.9704	3
0.0231	0.9935	4
0.0053	0.9988	5
0.0010	0.9998	6
0.0002	1.0000	7
0.0000	1.0000	8
0.0000	1.0000	9
0.0000	1.0000	10
0.0000	1.0000	11
0.0000	1.0000	12
0.0000	1.0000	13
0.0000	1.0000	14
0.0000	1.0000	15
0.0000	1.0000	16
0.0000	1.0000	17
0.0000	1.0000	18
0.0000	1.0000	19
0.0000	1.0000	20
0.0000	1.0000	21
0.0000	1.0000	22
0.0000	1.0000	23
0.0000	1.0000	24
0.0000	1.0000	25
0.0000	1.0000	26
0.0000	1.0000	27
0.0000	1.0000	28
0.0000	1.0000	29
0.0000	1.0000	30
0.0000	1.0000	31
0.0000	1.0000	32
0.0000	1.0000	33
0.0000	1.0000	34
0.0000	1.0000	35
0.0000	1.0000	36
0.0000	1.0000	37
0.0000	1.0000	38
0.0000	1.0000	39
0.0000	1.0000	40
0.0000	1.0000	41
0.0000	1.0000	42
0.0000	1.0000	43
0.0000	1.0000	44
0.0000	1.0000	45

6. Monterey/Tennant

SBL

PM

Existing Conditions

Avg. Queue Per Lane in Veh= 4.0

Percentile = 0.95 8

6. Monterey/Tennant

SBL

PM

Existing Plus Project Conditions with Proposed Site A

Avg. Queue Per Lane in Veh= 4.0

Percentile = 0.95 8

Individual Probability	Cumulative Probability	Number of Queued Vehicles
0.0184	0.0184	0
0.0736	0.0920	1
0.1470	0.2390	2
0.1957	0.4347	3
0.1954	0.6301	4
0.1560	0.7861	5
0.1039	0.8900	6
0.0593	0.9492	7
0.0296	0.9788	8
0.0131	0.9920	9
0.0052	0.9972	10
0.0019	0.9991	11
0.0006	0.9997	12
0.0002	0.9999	13
0.0001	1.0000	14
0.0000	1.0000	15
0.0000	1.0000	16
0.0000	1.0000	17
0.0000	1.0000	18
0.0000	1.0000	19
0.0000	1.0000	20
0.0000	1.0000	21
0.0000	1.0000	22
0.0000	1.0000	23
0.0000	1.0000	24
0.0000	1.0000	25
0.0000	1.0000	26
0.0000	1.0000	27
0.0000	1.0000	28
0.0000	1.0000	29
0.0000	1.0000	30
0.0000	1.0000	31
0.0000	1.0000	32
0.0000	1.0000	33
0.0000	1.0000	34
0.0000	1.0000	35
0.0000	1.0000	36
0.0000	1.0000	37
0.0000	1.0000	38
0.0000	1.0000	39
0.0000	1.0000	40
0.0000	1.0000	41
0.0000	1.0000	42
0.0000	1.0000	43
0.0000	1.0000	44
0.0000	1.0000	45

Individual Probability	Cumulative Probability	Number of Queued Vehicles
0.0184	0.0184	0
0.0736	0.0920	1
0.1470	0.2390	2
0.1957	0.4347	3
0.1954	0.6301	4
0.1560	0.7861	5
0.1039	0.8900	6
0.0593	0.9492	7
0.0296	0.9788	8
0.0131	0.9920	9
0.0052	0.9972	10
0.0019	0.9991	11
0.0006	0.9997	12
0.0002	0.9999	13
0.0001	1.0000	14
0.0000	1.0000	15
0.0000	1.0000	16
0.0000	1.0000	17
0.0000	1.0000	18
0.0000	1.0000	19
0.0000	1.0000	20
0.0000	1.0000	21
0.0000	1.0000	22
0.0000	1.0000	23
0.0000	1.0000	24
0.0000	1.0000	25
0.0000	1.0000	26
0.0000	1.0000	27
0.0000	1.0000	28
0.0000	1.0000	29
0.0000	1.0000	30
0.0000	1.0000	31
0.0000	1.0000	32
0.0000	1.0000	33
0.0000	1.0000	34
0.0000	1.0000	35
0.0000	1.0000	36
0.0000	1.0000	37
0.0000	1.0000	38
0.0000	1.0000	39
0.0000	1.0000	40
0.0000	1.0000	41
0.0000	1.0000	42
0.0000	1.0000	43
0.0000	1.0000	44
0.0000	1.0000	45

9. Butterfield/Main

EBL

AM

Existing Conditions

Avg. Queue Per Lane in Veh= 1.4

Percentile = 0.95 4

9. Butterfield/Main

EBL

AM

Existing Plus Project Conditions with Proposed Site A

Avg. Queue Per Lane in Veh= 2.2

Percentile = 0.95 5

Individual Probability	Cumulative Probability	Number of Queued Vehicles
0.2542	0.2542	0
0.3482	0.6024	1
0.2384	0.8408	2
0.1088	0.9497	3
0.0373	0.9869	4
0.0102	0.9971	5
0.0023	0.9995	6
0.0005	0.9999	7
0.0001	1.0000	8
0.0000	1.0000	9
0.0000	1.0000	10
0.0000	1.0000	11
0.0000	1.0000	12
0.0000	1.0000	13
0.0000	1.0000	14
0.0000	1.0000	15
0.0000	1.0000	16
0.0000	1.0000	17
0.0000	1.0000	18
0.0000	1.0000	19
0.0000	1.0000	20
0.0000	1.0000	21
0.0000	1.0000	22
0.0000	1.0000	23
0.0000	1.0000	24
0.0000	1.0000	25
0.0000	1.0000	26
0.0000	1.0000	27
0.0000	1.0000	28
0.0000	1.0000	29
0.0000	1.0000	30
0.0000	1.0000	31
0.0000	1.0000	32
0.0000	1.0000	33
0.0000	1.0000	34
0.0000	1.0000	35
0.0000	1.0000	36
0.0000	1.0000	37
0.0000	1.0000	38
0.0000	1.0000	39
0.0000	1.0000	40
0.0000	1.0000	41
0.0000	1.0000	42
0.0000	1.0000	43
0.0000	1.0000	44
0.0000	1.0000	45

Individual Probability	Cumulative Probability	Number of Queued Vehicles
0.1139	0.1139	0
0.2475	0.3614	1
0.2688	0.6302	2
0.1946	0.8248	3
0.1057	0.9305	4
0.0459	0.9764	5
0.0166	0.9930	6
0.0052	0.9982	7
0.0014	0.9996	8
0.0003	0.9999	9
0.0001	1.0000	10
0.0000	1.0000	11
0.0000	1.0000	12
0.0000	1.0000	13
0.0000	1.0000	14
0.0000	1.0000	15
0.0000	1.0000	16
0.0000	1.0000	17
0.0000	1.0000	18
0.0000	1.0000	19
0.0000	1.0000	20
0.0000	1.0000	21
0.0000	1.0000	22
0.0000	1.0000	23
0.0000	1.0000	24
0.0000	1.0000	25
0.0000	1.0000	26
0.0000	1.0000	27
0.0000	1.0000	28
0.0000	1.0000	29
0.0000	1.0000	30
0.0000	1.0000	31
0.0000	1.0000	32
0.0000	1.0000	33
0.0000	1.0000	34
0.0000	1.0000	35
0.0000	1.0000	36
0.0000	1.0000	37
0.0000	1.0000	38
0.0000	1.0000	39
0.0000	1.0000	40
0.0000	1.0000	41
0.0000	1.0000	42
0.0000	1.0000	43
0.0000	1.0000	44
0.0000	1.0000	45

9. Butterfield/Main

EBL

PM

Existing Conditions

Avg. Queue Per Lane in Veh= 1.7

Percentile = 0.95 4

9. Butterfield/Main

EBL

PM

Existing Plus Project Conditions with Proposed Site A

Avg. Queue Per Lane in Veh= 1.9

Percentile = 0.95 4

Individual Probability	Cumulative Probability	Number of Queued Vehicles
0.1878	0.1878	0
0.3141	0.5019	1
0.2626	0.7645	2
0.1464	0.9109	3
0.0612	0.9721	4
0.0205	0.9926	5
0.0057	0.9983	6
0.0014	0.9997	7
0.0003	0.9999	8
0.0001	1.0000	9
0.0000	1.0000	10
0.0000	1.0000	11
0.0000	1.0000	12
0.0000	1.0000	13
0.0000	1.0000	14
0.0000	1.0000	15
0.0000	1.0000	16
0.0000	1.0000	17
0.0000	1.0000	18
0.0000	1.0000	19
0.0000	1.0000	20
0.0000	1.0000	21
0.0000	1.0000	22
0.0000	1.0000	23
0.0000	1.0000	24
0.0000	1.0000	25
0.0000	1.0000	26
0.0000	1.0000	27
0.0000	1.0000	28
0.0000	1.0000	29
0.0000	1.0000	30
0.0000	1.0000	31
0.0000	1.0000	32
0.0000	1.0000	33
0.0000	1.0000	34
0.0000	1.0000	35
0.0000	1.0000	36
0.0000	1.0000	37
0.0000	1.0000	38
0.0000	1.0000	39
0.0000	1.0000	40
0.0000	1.0000	41
0.0000	1.0000	42
0.0000	1.0000	43
0.0000	1.0000	44
0.0000	1.0000	45

Individual Probability	Cumulative Probability	Number of Queued Vehicles
0.1431	0.1431	0
0.2782	0.4213	1
0.2705	0.6917	2
0.1753	0.8670	3
0.0852	0.9522	4
0.0331	0.9854	5
0.0107	0.9961	6
0.0030	0.9991	7
0.0007	0.9998	8
0.0002	1.0000	9
0.0000	1.0000	10
0.0000	1.0000	11
0.0000	1.0000	12
0.0000	1.0000	13
0.0000	1.0000	14
0.0000	1.0000	15
0.0000	1.0000	16
0.0000	1.0000	17
0.0000	1.0000	18
0.0000	1.0000	19
0.0000	1.0000	20
0.0000	1.0000	21
0.0000	1.0000	22
0.0000	1.0000	23
0.0000	1.0000	24
0.0000	1.0000	25
0.0000	1.0000	26
0.0000	1.0000	27
0.0000	1.0000	28
0.0000	1.0000	29
0.0000	1.0000	30
0.0000	1.0000	31
0.0000	1.0000	32
0.0000	1.0000	33
0.0000	1.0000	34
0.0000	1.0000	35
0.0000	1.0000	36
0.0000	1.0000	37
0.0000	1.0000	38
0.0000	1.0000	39
0.0000	1.0000	40
0.0000	1.0000	41
0.0000	1.0000	42
0.0000	1.0000	43
0.0000	1.0000	44
0.0000	1.0000	45

9. Butterfield/Main

EBL

AM

Existing Conditions

Avg. Queue Per Lane in Veh= 3.7

Percentile = 0.95 7

9. Butterfield/Main

EBL

AM

Existing Plus Project Conditions with Proposed Site A

Avg. Queue Per Lane in Veh= 4.0

Percentile = 0.95 8

Individual Probability	Cumulative Probability	Number of Queued Vehicles
0.0242	0.0242	0
0.0900	0.1142	1
0.1675	0.2817	2
0.2078	0.4895	3
0.1934	0.6829	4
0.1440	0.8269	5
0.0893	0.9162	6
0.0475	0.9637	7
0.0221	0.9858	8
0.0091	0.9950	9
0.0034	0.9984	10
0.0012	0.9995	11
0.0004	0.9999	12
0.0001	1.0000	13
0.0000	1.0000	14
0.0000	1.0000	15
0.0000	1.0000	16
0.0000	1.0000	17
0.0000	1.0000	18
0.0000	1.0000	19
0.0000	1.0000	20
0.0000	1.0000	21
0.0000	1.0000	22
0.0000	1.0000	23
0.0000	1.0000	24
0.0000	1.0000	25
0.0000	1.0000	26
0.0000	1.0000	27
0.0000	1.0000	28
0.0000	1.0000	29
0.0000	1.0000	30
0.0000	1.0000	31
0.0000	1.0000	32
0.0000	1.0000	33
0.0000	1.0000	34
0.0000	1.0000	35
0.0000	1.0000	36
0.0000	1.0000	37
0.0000	1.0000	38
0.0000	1.0000	39
0.0000	1.0000	40
0.0000	1.0000	41
0.0000	1.0000	42
0.0000	1.0000	43
0.0000	1.0000	44
0.0000	1.0000	45

Individual Probability	Cumulative Probability	Number of Queued Vehicles
0.0178	0.0178	0
0.0718	0.0896	1
0.1445	0.2341	2
0.1940	0.4281	3
0.1953	0.6234	4
0.1574	0.7808	5
0.1056	0.8864	6
0.0608	0.9472	7
0.0306	0.9778	8
0.0137	0.9915	9
0.0055	0.9970	10
0.0020	0.9990	11
0.0007	0.9997	12
0.0002	0.9999	13
0.0001	1.0000	14
0.0000	1.0000	15
0.0000	1.0000	16
0.0000	1.0000	17
0.0000	1.0000	18
0.0000	1.0000	19
0.0000	1.0000	20
0.0000	1.0000	21
0.0000	1.0000	22
0.0000	1.0000	23
0.0000	1.0000	24
0.0000	1.0000	25
0.0000	1.0000	26
0.0000	1.0000	27
0.0000	1.0000	28
0.0000	1.0000	29
0.0000	1.0000	30
0.0000	1.0000	31
0.0000	1.0000	32
0.0000	1.0000	33
0.0000	1.0000	34
0.0000	1.0000	35
0.0000	1.0000	36
0.0000	1.0000	37
0.0000	1.0000	38
0.0000	1.0000	39
0.0000	1.0000	40
0.0000	1.0000	41
0.0000	1.0000	42
0.0000	1.0000	43
0.0000	1.0000	44
0.0000	1.0000	45

9. Butterfield/Main

EBL

PM

Existing Conditions

Avg. Queue Per Lane in Veh= 2.7

Percentile = 0.95 6

9. Butterfield/Main

EBL

PM

Existing Plus Project Conditions with Proposed Site A

Avg. Queue Per Lane in Veh= 3.0

Percentile = 0.95 6

Individual Probability	Cumulative Probability	Number of Queued Vehicles
0.0701	0.0701	0
0.1863	0.2563	1
0.2476	0.5039	2
0.2194	0.7233	3
0.1458	0.8690	4
0.0775	0.9466	5
0.0343	0.9809	6
0.0130	0.9939	7
0.0043	0.9983	8
0.0013	0.9996	9
0.0003	0.9999	10
0.0001	1.0000	11
0.0000	1.0000	12
0.0000	1.0000	13
0.0000	1.0000	14
0.0000	1.0000	15
0.0000	1.0000	16
0.0000	1.0000	17
0.0000	1.0000	18
0.0000	1.0000	19
0.0000	1.0000	20
0.0000	1.0000	21
0.0000	1.0000	22
0.0000	1.0000	23
0.0000	1.0000	24
0.0000	1.0000	25
0.0000	1.0000	26
0.0000	1.0000	27
0.0000	1.0000	28
0.0000	1.0000	29
0.0000	1.0000	30
0.0000	1.0000	31
0.0000	1.0000	32
0.0000	1.0000	33
0.0000	1.0000	34
0.0000	1.0000	35
0.0000	1.0000	36
0.0000	1.0000	37
0.0000	1.0000	38
0.0000	1.0000	39
0.0000	1.0000	40
0.0000	1.0000	41
0.0000	1.0000	42
0.0000	1.0000	43
0.0000	1.0000	44
0.0000	1.0000	45

Individual Probability	Cumulative Probability	Number of Queued Vehicles
0.0501	0.0501	0
0.1499	0.2000	1
0.2245	0.4244	2
0.2240	0.6485	3
0.1677	0.8162	4
0.1004	0.9166	5
0.0501	0.9668	6
0.0214	0.9882	7
0.0080	0.9962	8
0.0027	0.9989	9
0.0008	0.9997	10
0.0002	0.9999	11
0.0001	1.0000	12
0.0000	1.0000	13
0.0000	1.0000	14
0.0000	1.0000	15
0.0000	1.0000	16
0.0000	1.0000	17
0.0000	1.0000	18
0.0000	1.0000	19
0.0000	1.0000	20
0.0000	1.0000	21
0.0000	1.0000	22
0.0000	1.0000	23
0.0000	1.0000	24
0.0000	1.0000	25
0.0000	1.0000	26
0.0000	1.0000	27
0.0000	1.0000	28
0.0000	1.0000	29
0.0000	1.0000	30
0.0000	1.0000	31
0.0000	1.0000	32
0.0000	1.0000	33
0.0000	1.0000	34
0.0000	1.0000	35
0.0000	1.0000	36
0.0000	1.0000	37
0.0000	1.0000	38
0.0000	1.0000	39
0.0000	1.0000	40
0.0000	1.0000	41
0.0000	1.0000	42
0.0000	1.0000	43
0.0000	1.0000	44
0.0000	1.0000	45

10. Butterfield/Dunne

EBL

AM

Existing Conditions

Avg. Queue Per Lane in Veh= 5.1

Percentile = 0.95 9

10. Butterfield/Dunne

EBL

AM

Existing Plus Project Conditions with Proposed Site A

Avg. Queue Per Lane in Veh= 6.5

Percentile = 0.95 11

Individual Probability	Cumulative Probability	Number of Queued Vehicles
0.0061	0.0061	0
0.0311	0.0372	1
0.0793	0.1165	2
0.1348	0.2513	3
0.1719	0.4231	4
0.1753	0.5984	5
0.1490	0.7474	6
0.1086	0.8560	7
0.0692	0.9252	8
0.0392	0.9644	9
0.0200	0.9844	10
0.0093	0.9937	11
0.0039	0.9976	12
0.0015	0.9992	13
0.0006	0.9997	14
0.0002	0.9999	15
0.0001	1.0000	16
0.0000	1.0000	17
0.0000	1.0000	18
0.0000	1.0000	19
0.0000	1.0000	20
0.0000	1.0000	21
0.0000	1.0000	22
0.0000	1.0000	23
0.0000	1.0000	24
0.0000	1.0000	25
0.0000	1.0000	26
0.0000	1.0000	27
0.0000	1.0000	28
0.0000	1.0000	29
0.0000	1.0000	30
0.0000	1.0000	31
0.0000	1.0000	32
0.0000	1.0000	33
0.0000	1.0000	34
0.0000	1.0000	35
0.0000	1.0000	36
0.0000	1.0000	37
0.0000	1.0000	38
0.0000	1.0000	39
0.0000	1.0000	40
0.0000	1.0000	41
0.0000	1.0000	42
0.0000	1.0000	43
0.0000	1.0000	44
0.0000	1.0000	45

Individual Probability	Cumulative Probability	Number of Queued Vehicles
0.0015	0.0015	0
0.0098	0.0113	1
0.0318	0.0430	2
0.0688	0.1118	3
0.1118	0.2237	4
0.1454	0.3690	5
0.1575	0.5265	6
0.1462	0.6728	7
0.1188	0.7916	8
0.0858	0.8774	9
0.0558	0.9332	10
0.0330	0.9661	11
0.0179	0.9840	12
0.0089	0.9929	13
0.0041	0.9970	14
0.0018	0.9988	15
0.0007	0.9996	16
0.0003	0.9998	17
0.0001	0.9999	18
0.0000	1.0000	19
0.0000	1.0000	20
0.0000	1.0000	21
0.0000	1.0000	22
0.0000	1.0000	23
0.0000	1.0000	24
0.0000	1.0000	25
0.0000	1.0000	26
0.0000	1.0000	27
0.0000	1.0000	28
0.0000	1.0000	29
0.0000	1.0000	30
0.0000	1.0000	31
0.0000	1.0000	32
0.0000	1.0000	33
0.0000	1.0000	34
0.0000	1.0000	35
0.0000	1.0000	36
0.0000	1.0000	37
0.0000	1.0000	38
0.0000	1.0000	39
0.0000	1.0000	40
0.0000	1.0000	41
0.0000	1.0000	42
0.0000	1.0000	43
0.0000	1.0000	44
0.0000	1.0000	45

10. Butterfield/Dunne

EBL

AM

Existing Conditions

Avg. Queue Per Lane in Veh= 5.1

Percentile = 0.95 9

Individual Probability	Cumulative Probability	Number of Queued Vehicles
0.0061	0.0061	0
0.0311	0.0372	1
0.0793	0.1165	2
0.1348	0.2513	3
0.1719	0.4231	4
0.1753	0.5984	5
0.1490	0.7474	6
0.1086	0.8560	7
0.0692	0.9252	8
0.0392	0.9644	9
0.0200	0.9844	10
0.0093	0.9937	11
0.0039	0.9976	12
0.0015	0.9992	13
0.0006	0.9997	14
0.0002	0.9999	15
0.0001	1.0000	16
0.0000	1.0000	17
0.0000	1.0000	18
0.0000	1.0000	19
0.0000	1.0000	20
0.0000	1.0000	21
0.0000	1.0000	22
0.0000	1.0000	23
0.0000	1.0000	24
0.0000	1.0000	25
0.0000	1.0000	26
0.0000	1.0000	27
0.0000	1.0000	28
0.0000	1.0000	29
0.0000	1.0000	30
0.0000	1.0000	31
0.0000	1.0000	32
0.0000	1.0000	33
0.0000	1.0000	34
0.0000	1.0000	35
0.0000	1.0000	36
0.0000	1.0000	37
0.0000	1.0000	38
0.0000	1.0000	39
0.0000	1.0000	40
0.0000	1.0000	41
0.0000	1.0000	42
0.0000	1.0000	43
0.0000	1.0000	44
0.0000	1.0000	45

10. Butterfield/Dunne

EBL

AM

Existing Plus Project Conditions with Proposed Site A

Avg. Queue Per Lane in Veh= 6.5

Percentile = 0.95 11

Individual Probability	Cumulative Probability	Number of Queued Vehicles
0.0015	0.0015	0
0.0098	0.0113	1
0.0318	0.0430	2
0.0688	0.1118	3
0.1118	0.2237	4
0.1454	0.3690	5
0.1575	0.5265	6
0.1462	0.6728	7
0.1188	0.7916	8
0.0858	0.8774	9
0.0558	0.9332	10
0.0330	0.9661	11
0.0179	0.9840	12
0.0089	0.9929	13
0.0041	0.9970	14
0.0018	0.9988	15
0.0007	0.9996	16
0.0003	0.9998	17
0.0001	0.9999	18
0.0000	1.0000	19
0.0000	1.0000	20
0.0000	1.0000	21
0.0000	1.0000	22
0.0000	1.0000	23
0.0000	1.0000	24
0.0000	1.0000	25
0.0000	1.0000	26
0.0000	1.0000	27
0.0000	1.0000	28
0.0000	1.0000	29
0.0000	1.0000	30
0.0000	1.0000	31
0.0000	1.0000	32
0.0000	1.0000	33
0.0000	1.0000	34
0.0000	1.0000	35
0.0000	1.0000	36
0.0000	1.0000	37
0.0000	1.0000	38
0.0000	1.0000	39
0.0000	1.0000	40
0.0000	1.0000	41
0.0000	1.0000	42
0.0000	1.0000	43
0.0000	1.0000	44
0.0000	1.0000	45

Appendix F

Site Access Alternatives Evaluation Memo



HEXAGON TRANSPORTATION CONSULTANTS, INC.

Memorandum

Date: August 21, 2019
To: Nick Pappani, Raney Planning and Management, Inc.
From: Gicela Del Rio, T.E.
Subject: Voices School Morgan Hill Site Access Alternatives Evaluation

Hexagon Transportation Consultants, Inc. has completed a traffic impact analysis (hereafter referred to as *traffic study*) for the evaluation of the proposed Voices School project in Morgan Hill, California, dated August 20, 2019. The project consists of the construction of a new permanent site for the existing charter school, currently located at a temporary site in the northern part of town. The project site is located in the northwest corner of the intersection of Monterey Road and Cosmo Avenue. At buildout, the school is proposing to serve up to 504 students (grades TK through 8th) with 63 staff/faculty members. Access to the school site would be provided via a single right-in and right-out access only driveway along Cosmo Avenue, with a second access point along Monterey Road providing access to emergency vehicles only.

In addition to the proposed site access described above, two other site access and on-site circulation alternatives are being investigated by the school. The site access alternatives are described below and illustrated on Figures A and B.

- *Alternative 1* – Right-in only and right-and-left-out access at the Cosmo Avenue driveway. Emergency access only at the Monterey Road driveway. (see Figure A)
- *Alternative 2* – Right-in access only at Cosmo Avenue driveway. Right-out (and emergency) access at the Monterey Road driveway. (see Figure B)

The proposed site layout for the above two project site access alternatives, including parking and drop-off area location, would be the same as the proposed project site layout evaluated in the traffic study. The site access alternatives would only affect the way project traffic enters/exits the site, mainly resulting in different traffic operating conditions than those presented in the project's traffic study at the project driveways and intersection/roadways near the site.

This memo summarizes the results of the evaluation of the effect the two site access alternatives would have at the project site driveways and intersection/roadway near the project site. This memo is a supplement to the analysis and results presented in the project's traffic study and is presented for informational purposes. As such, the results presented in this memo may reference discussions, detailed explanations of analysis methodologies, results, and recommendations presented in the traffic study.

Site Access Alternative 1 Evaluation

Site Access Alternative 1 would allow left-turn outbound access at the Cosmo Avenue project driveway, in addition to the right-in and right-out access. Under this alternative, on-site circulation, emergency vehicular access, and pedestrian access would be the same as described in the project's traffic study, and the same recommendations made in the traffic study also would apply to this alternative.

Site Access

With site access Alternative 1, all inbound project traffic and the majority of outbound project traffic (approximately 90% of all outbound traffic) would utilize the Monterey Road/Cosmo Avenue intersection. This alternative significantly would reduce the amount of outbound project traffic utilizing Cosmo Avenue, Del Monte Avenue, and Olympic Drive.

Sight Distance

Under site access Alternative 1, outbound traffic at the project driveway must be able to see opposing traffic in both the eastbound and westbound directions on Cosmo Avenue in order to safely exit the site.

The sight distance from the project driveway to the east extends to the Monterey Road/Cosmo Avenue intersections, approximately 175 feet. To the west, there is a clear line of sight from the project driveway location to the intersection of Del Monte Avenue/Cosmo Avenue, approximately 750 feet away. According to the Caltrans Highway Design Manual, the minimum required stopping sight distance for a roadway with a posted speed limit of 25 mph is 150 feet. Therefore, the available sight distance at the Cosmo Avenue driveway to both the east and west directions would be adequate.

Access Driveway Operations

Inbound access to the project site would be the same as discussed in the project's traffic study. It is not anticipated that the inbound/westbound queue length at the project driveway would extend to or affect the operations at the intersection of Monterey Road and Cosmo Avenue.

Under site access Alternative 1, however, outbound project traffic also would be allowed to complete a left-turn out of the site. Allowing left-turns out of the Cosmo Avenue driveway could potentially inhibit the flow of on-site outbound traffic during the drop-off/pick-up periods, since left-turning outbound project traffic would need to yield to westbound and eastbound traffic on Cosmo Avenue. Due to the relatively low traffic volumes along Cosmo Avenue, there would be adequate gaps in the traffic to allow outbound project traffic to exit the site. However, due to the close proximity of the Monterey Road/Cosmo Avenue intersection to the project driveway, the ability for project traffic to be able to make a left-turn out of the site also would be dependent of the traffic operations at the Monterey Road/Cosmo Avenue intersection, in particular the queue length along the west leg of the intersection (eastbound queue).

The intersection queuing analysis indicates that the eastbound queue length at the Monterey Road/Cosmo Avenue intersection is projected to extend past the proposed Cosmo Avenue project driveway during the peak 15-minute AM and PM periods under the site access Alternative 1. During the peak 15-minute periods, the outbound queue at the school driveway would be an extension of the eastbound queue at the Monterey Road/Cosmo Avenue intersection. Based on the Poisson probability distribution (described in the traffic study report), the maximum eastbound queue length at the Monterey Road/Cosmo Avenue intersection during the peak 15-minute AM period is estimated to be approximately 17 vehicles (14 during the peak 15-minute PM period), extending into the project site for approximately 250 feet. A 250-foot queue length within the outbound lane would extend back to the parking lot. It is not desirable to have an outbound queue on-site as it could interfere with on-site

operations, including parking and pedestrian movement within the parking lot. Under this alternative, standing queues in the inbound and outbound direction would form along the entry drive aisle. Thus, left-turns out of the Cosmo Avenue driveway (Alternative 1) are not recommended.

Monterey Road and Cosmo Avenue Intersection Operations

Under site access Alternative 1, most of the outbound traffic, in addition to all inbound traffic, would utilize the intersection of Monterey Road and Cosmo Avenue. The additional project traffic added to this intersection under Alternative 1 (eastbound approach) would cause the intersection level of service to deteriorate from a LOS A under existing conditions to LOS B with the project during the AM peak-hour. However, the level of service would continue to be within acceptable levels.

With implementation of the recommended protected pedestrian phasing on all approaches of the intersection to accommodate pedestrian traffic (discussed in the traffic study report), the level of service at the Monterey Road/Cosmo Avenue intersection is projected to be LOS C during both the AM and PM peak hours under site access Alternative 1 (see Table A).

Site Access Alternative 2 Evaluation

Site access Alternative 2 would include inbound (right-in only) access via the Cosmo Avenue project driveway and outbound (right-out only) access via the Monterey Road driveway (see Figure B). Under this alternative, emergency vehicular access, pedestrian access, and drop-off/pick-up procedures would be the same as described in the project's traffic study, and the same recommendations made in the traffic study also would apply to this alternative.

Site Access

With site access Alternative 2, all outbound project traffic would utilize Monterey Road, significantly reducing the amount of outbound project traffic added to Cosmo Avenue, Del Monte Avenue, and Olympic Drive. However, with this alternative, traffic heading north on Monterey Road would have to complete a U-turn at the intersection of Monterey Road/Cosmo Avenue or Monterey Road/Barrett Avenue. Based on the project trip generation estimates and trip distribution, it is estimated that approximately 70% of the outbound project traffic would head north. This represents approximately 200 and 137 vehicles during the AM and PM peak hours, respectively, making a U-turn at an intersection along Monterey Road, south of the project site.

On-Site Circulation

Under site access Alternative 2, inbound access would be the same as evaluated in the project's traffic study. However, rather than circulating the site after accessing the drop-off area to exit via Cosmo Avenue, school traffic would make a right-turn to exit the site via the Monterey Road driveway. With the larger traffic volumes on Monterey Road, outbound traffic at the driveway would have to wait for a gap in traffic to enter Monterey Road, potentially creating on-site queue lengths that could extend to the drop-off area.

Access Driveway Operations

Inbound access to the project site would be the same as discussed in the project's traffic study. It is not anticipated that the inbound/westbound queue length at the project driveway would extend to or affect the operations at the intersection of Monterey Road and Cosmo Avenue.

Under site access Alternative 2, after accessing the drop-off area, outbound traffic would make a right-turn to exit the site via the Monterey Road driveway. The ability for project traffic to be able to exit the site would be dependent of traffic conditions along Monterey Road and at the Monterey Road/Cosmo

Avenue intersection. Additionally, a large amount of project traffic is projected to head northbound after leaving the school site, requiring these drivers to complete a U-turn at the Monterey Road/Cosmo Avenue intersection, or the next available U-turn opportunity. This would create greater delays at the driveway as school traffic would have to merge into the center lane to access the southbound left-turn lane at Cosmo Avenue immediately after exiting the site.

The intersection queuing analysis (discussed in the following section) indicates that, under the site access Alternative 2, the southbound queue length at the Monterey Road/Cosmo Avenue intersection is projected to exceed the existing queue storage capacity by approximately 200 feet during the peak 15-minute AM period. The inability of project traffic to exit the site would result in outbound queues at the Monterey Road driveway. The distance between the Monterey Road driveway and the drop-off area is approximately 80-100 feet, or 3-4 vehicles. Queues greater than 3-4 vehicles would extend into the drop-off area and halt drop-off/pick-up operations. Thus, outbound access from the Monterey Road driveway (Alternative 2) is not recommended.

Monterey Road and Cosmo Avenue Intersection Operations

Under site access Alternative 2, all inbound and outbound traffic would utilize the intersection of Monterey Road and Cosmo Avenue. The additional project traffic added to this intersection under Alternative 2 (southbound approach) is not projected to deteriorate the intersection's level of service conditions from existing conditions, because, as discussed in the traffic study report, all project traffic would be added to non-critical movements (northbound and southbound left-turns), resulting in a slight improvement to the overall intersection average delay. Although the intersection average delay is not projected to increase, however, the southbound queue lengths at this intersection would increase exceeding the existing queue storage capacity (discussed in the following section).

With implementation of the recommended pedestrian phasing on all approaches of the intersection to accommodate pedestrian traffic, the level of service at the Monterey Road/Cosmo Avenue intersection is projected to be LOS C during both the AM and PM peak hours under site access Alternative 2 (see Table A).

Site Access Alternatives Effect on Study Roadway Segments

The proposed project, as proposed and evaluated in the traffic study, would add all outbound traffic to the roadway segments west of the project site. Thus, an evaluation of the project's effect on traffic conditions along roadway segments west of the project site (Cosmo Avenue, Del Monte Avenue, Olympic Drive, and Spring Avenue) was completed for the traffic study.

Under site access Alternatives 1 and 2, however, minimal project traffic would utilize the roadways west of the project site since outbound access would be provided to Monterey Road. It is projected that no more than 45 daily trips (or 3% increase in daily traffic volumes) would utilize the study roadways under site access Alternative 1 and no more than 18 daily trips (1% increase in daily traffic volumes) under site access Alternative 2. Therefore, the projected increases in traffic volumes along the study roadway segments under site access Alternatives 1 and 2 would be minimal.

Queuing Analysis Results

The intersection operations analysis consists of an evaluation of vehicular queues at locations where the project would add a significant number of left-turns to the intersection (typically 10 or more peak-hour trips per lane; less than 10 peak-hour trips would not affect the length of the queue). Vehicle queues were estimated using a Poisson probability distribution.

Intersections projected to have left-turn queue storage deficiencies under site access Alternatives 1 and 2 are discussed below. The intersection queuing analysis under site access Alternatives 1 and 2 is summarized in Table B.

2. Monterey Road and Dunne Avenue

Eastbound Left-Turn

The queuing analysis indicates that the maximum vehicle queue for the eastbound left-turn pocket at the Monterey Road and Dunne Avenue intersection currently exceeds the existing vehicle storage capacity during the AM and PM peak hours, and would continue to do so with the addition of project traffic, under both site access alternatives being evaluated.

Site access Alternatives 1 and 2, however, would not have an effect on the projected queue length (queue length would remain the same as under existing conditions) for this movement.

5. Monterey Road and Cosmo Avenue

Eastbound Approach

The queuing analysis indicates that the maximum vehicle queue for the eastbound approach at the Monterey Road and Cosmo Avenue intersection is currently no more than 100 feet long (or 4 vehicles) during the peak hours and is adequately stored within the entire roadway.

Currently, the *eastbound approach* queue length could be stored along the entire length of Cosmo Avenue. However, with the project, the project site driveway would be located approximately 175 feet west of this intersection, reducing the queue storage capacity to 175 feet, or approximately 7 vehicles.

The addition of project traffic to this intersection, under the site access Alternative 1, would increase the 95th percentile vehicle queues for this movement by 14 and 10 vehicles (to 17 and 14 vehicles) during the AM and PM peak hours, respectively, exceeding the future queue storage capacity by as much as 10 vehicles.

Site access Alternative 2 would have an effect on the projected queue length for this movement since this alternative is not projected to add any traffic to this movement.

Additionally, the projected queue length for this movement also was evaluated assuming the implementation of the recommended signal phasing improvements (installation of pedestrian phasing on all approaches of the intersection discussed in the project's traffic study). With the recommended signal phasing improvements, the eastbound approach queue length is projected to increase by approximately 25 and 21 vehicles during the AM and PM peak hours, respectively, under site access Alternative 1, exceeding the future queue storage capacity by as many as 21 vehicles.

As discussed in the previous section, the projected increase in the queue length would be the result of outbound project traffic making a left-turn out of the site to access the intersection of Monterey Road/Cosmo Avenue. This queue would store within the project site. Nevertheless, it is not recommended that left-turns out of the site be permitted. Without the left-turn out access at the project driveway, the eastbound queue length at this intersection would not be affected. Thus, based on the queue analysis, site access Alternative 1 is not recommended.

Northbound Left-Turn

The queuing analysis indicates that the maximum vehicle queue for the northbound left-turn pocket at the Monterey Road and Cosmo Avenue intersection would exceed the existing vehicle storage capacity

during the AM peak-hour with the addition of project traffic, under both site access alternatives being evaluated.

The *northbound left-turn* pocket currently provides 125 feet of vehicle storage (or approximately 5 vehicles). The estimated 95th percentile vehicle queue for this movement under existing conditions is 1 vehicle during the AM peak-hour.

The addition of project traffic to this intersection, under both site access alternative evaluated, would increase the 95th percentile vehicle queues for this movement by 7 vehicles (to 8 vehicles) during the AM peak hour, exceeding the existing queue storage capacity by 3 vehicles.

It is possible to extend the existing northbound left-turn lane the additional 75 feet needed by removing/modifying the existing landscape median, which would include the removal of 3 to 4 trees within the median.

Additionally, the projected queue length for this movement also was evaluated assuming the implementation of the recommended pedestrian phasing on all approaches of the intersection. With the recommended signal phasing improvements, the northbound left-turn queue length is projected to increase by 10 vehicles (to 11 vehicles) during the AM peak-hour under both site access alternatives evaluated, exceeding the existing queue storage capacity by as many as 6 vehicles.

Extending the existing left-turn pocket an additional 150 feet to accommodate 6 additional vehicles would require removal/modification of the existing landscape median and part of the two-way left-turn to provide a 275-foot left-turn pocket.

Southbound Left-Turn

The queuing analysis indicates that the maximum vehicle queue for the southbound left-turn pocket at the Monterey Road and Cosmo Avenue intersection would exceed the existing vehicle storage capacity during both peak hours with the addition of project traffic under the site access Alternatives 2.

The *southbound left-turn* pocket currently provides 125 feet of vehicle storage (or approximately 5 vehicles). The estimated 95th percentile vehicle queue for this movement under existing conditions is no more than 1 vehicle during the peak hours.

The addition of project traffic to this intersection, under the site access Alternative 2, would increase the 95th percentile vehicle queues for this movement by 12 and 10 vehicles (to 13 and 11 vehicles) during the AM and PM peak hours, respectively, exceeding the existing queue storage capacity by as many as 8 vehicles. The projected increase in this queue length would be the result of outbound project traffic from the Monterey Road driveway making U-turns at this intersection to head north.

Site access Alternative 1 would not have an effect on the projected queue length for this movement since this alternative is not projected to add any traffic to this movement.

It is possible to extend the existing southbound left-turn lane the additional 200 feet needed by partially removing the existing landscape median, which would include the removal of 4 or more trees within the median. However, as mentioned above, the projected increase in this queue length would be the result of U-turns at this intersection by outbound project traffic heading northbound on Monterey Road. Thus, based on the queue analysis, site access Alternative 2 is not recommended.

Additionally, the projected queue length for this movement also was evaluated assuming the implementation of the recommended pedestrian phasing on all approaches of the intersection. With the recommended signal phasing improvements, the southbound left-turn queue length is projected to increase by more than 20 vehicles during both peak hours under site access Alternative 2, exceeding the future queue storage capacity by as many as 25 vehicles. A queue of this length would extend more

than 600 feet, extending beyond the project driveway on Monterey Road. Thus, site access alternative 2 is not recommended.

6. Monterey Road and Tennant Avenue

Southbound Left-Turn

The queuing analysis indicates that the maximum vehicle queue for the southbound left-turn pocket at the Monterey Road and Tennant Avenue intersection currently exceeds the existing vehicle storage capacity during the PM peak-hour, and would continue to do so with the addition of project traffic, under both site access alternatives being evaluated.

The *southbound left-turn* pocket currently provides 175 feet of vehicle storage (or approximately 7 vehicles). The estimated 95th percentile vehicle queue for this movement under existing conditions is 8 vehicles during the PM peak-hour, exceeding the left-turn pocket storage capacity by 1 vehicle during the PM peak-hour.

The addition of project traffic to this intersection, under both site access alternative evaluated, is not projected to have an effect in the 95th percentile vehicle queue length for this movement during the PM peak-hour.

9. Butterfield Boulevard and Main Avenue

Eastbound Left-Turn

The queuing analysis indicates that the maximum vehicle queue for the eastbound left-turn pocket at the Butterfield Boulevard and Main Avenue intersection currently exceeds the existing vehicle storage capacity during the AM and PM peak hours, and would continue to do so with the addition of project traffic, under both site access alternatives being evaluated.

The *eastbound left-turn* pocket currently provides 125 feet of vehicle storage (or approximately 5 vehicles). The estimated 95th percentile vehicle queue for this movement under existing conditions is 7 and 6 vehicles during the AM and PM peak hours, respectively, exceeding the left-turn pocket storage capacity by up to 2 vehicles during the peak hours.

The addition of project traffic to this intersection, under both site access alternative evaluated, would increase the 95th percentile vehicle queues for this movement by 1 vehicle (to 8 vehicles) during the AM peak-hour, exceeding the existing queue storage capacity by 3 vehicles.

It is not possible to extend the existing eastbound left-turn lane at this intersection due to the adjacent eastbound left-turn lane providing access to the office complex located at the northwest corner of the Butterfield Boulevard/Main Avenue intersection. In order to extend the existing left-turn pocket the additional 75 feet needed, the adjacent left-turn pocket would need to be removed. Alternatively, a second eastbound left-turn lane could be provided.

This concludes the evaluation of the site access alternatives being investigated as part of the proposed Voices School Morgan Hill project.

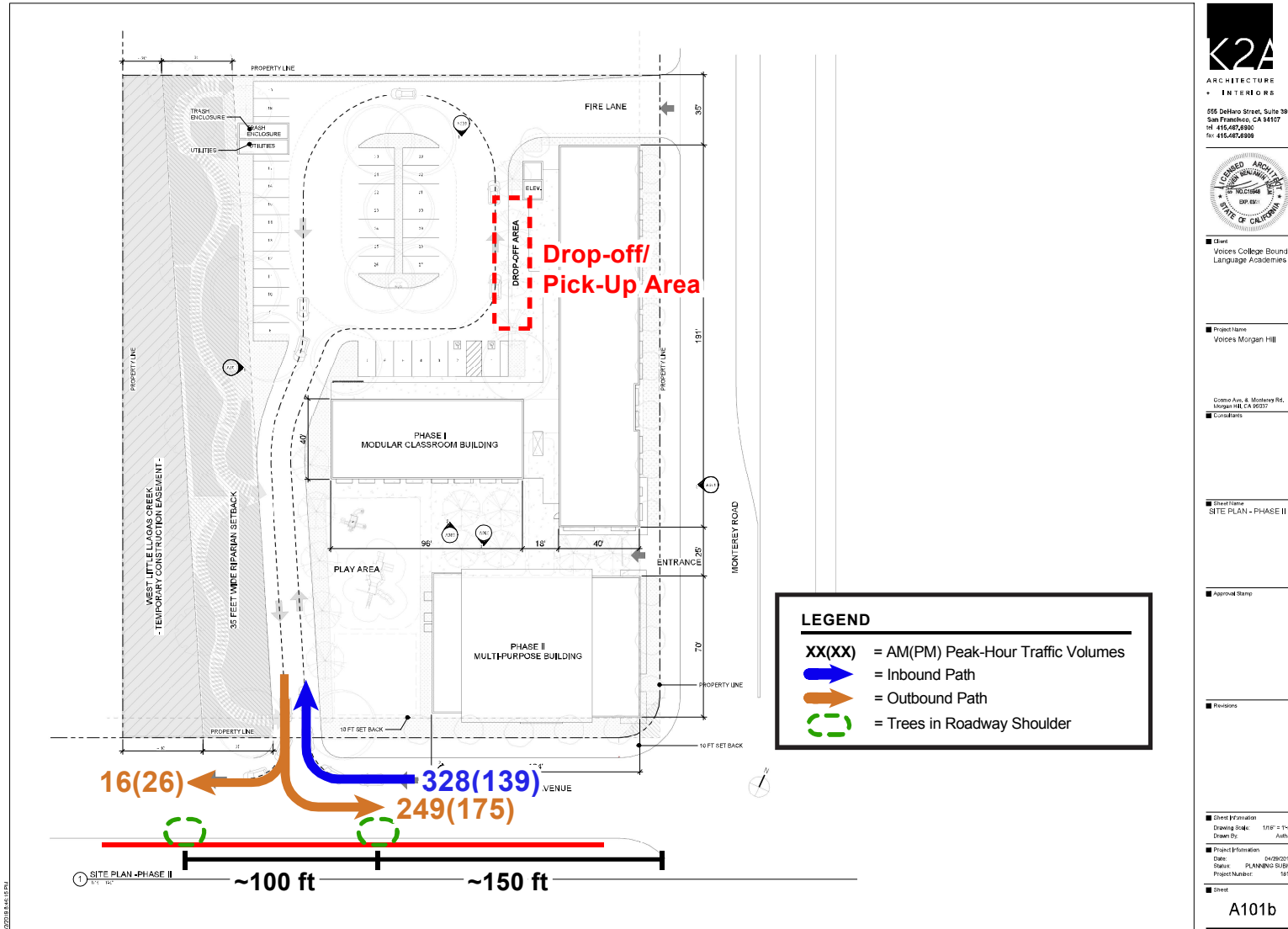
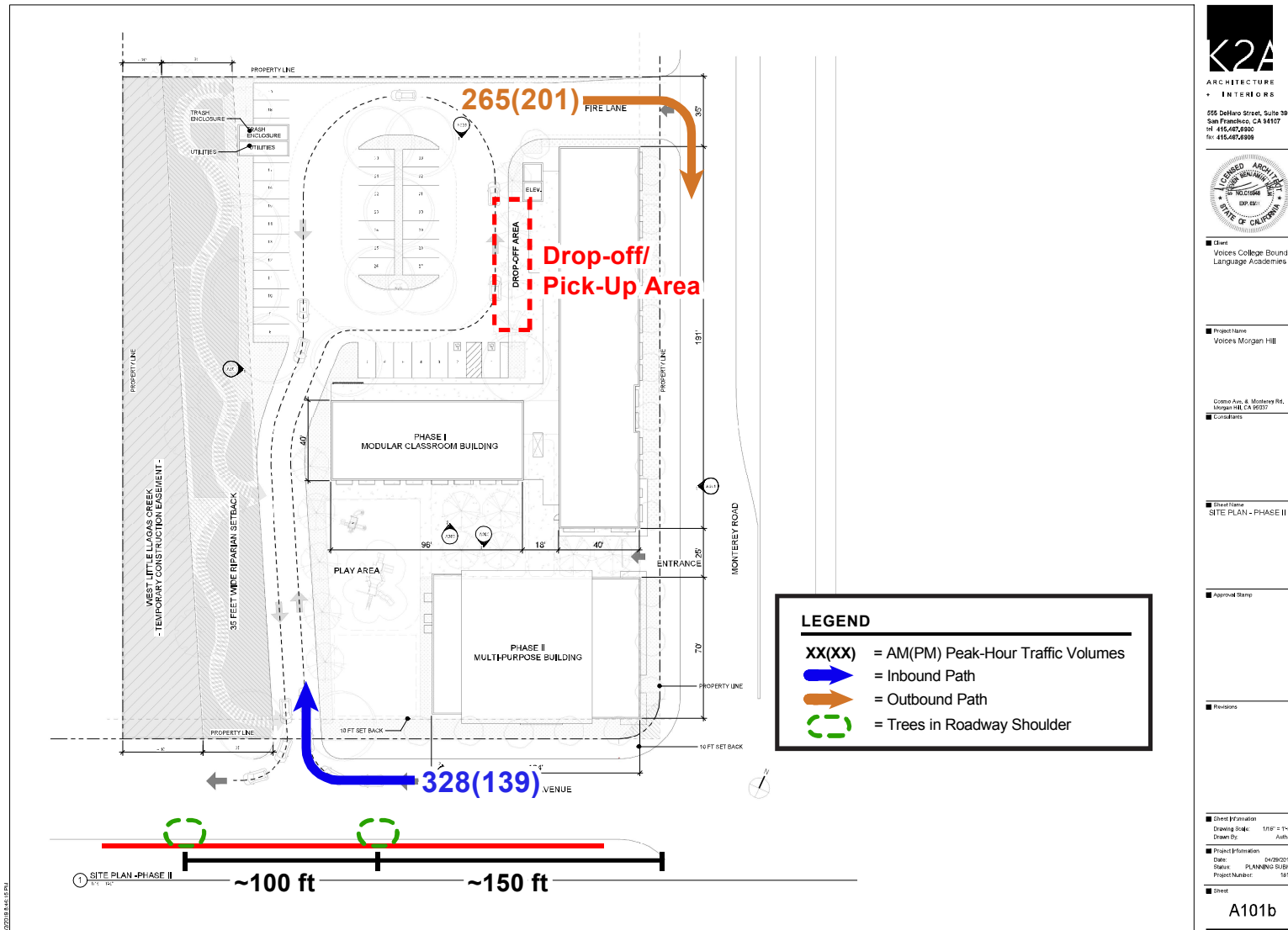

Figure A
Site Access Alternative 1



K2A
 ARCHITECTURE
 • INTERIORS

255 DeHaró Street, Suite 390
 San Francisco, CA 94107
 Tel: 415.487.8900
 Fax: 415.487.8998

Client
 Voices College Bound
 Language Academies

Project Name
 Voices Morgan Hill

College Ave. & Monterey Rd.
 Morgan Hill, CA 95037

Sheet Name
 SITE PLAN - PHASE II

Client Information
 Drawing Scale: 1/8" = 1'-0"
 Author:

Project Information
 Date: 04/26/2019
 Status: PLANNING SUBMITTAL
 Project Number: 1817

Sheet
 A101b

Figure B
Site Access Alternative 2

Table A
Monterey Road and Cosmo Avenue Intersection Operations – Site Access Alternatives 1 and 2

Scenario	Peak Hour	Existing Conditions		Existing+Project (Alt 1)		Existing+Project (Alt 2)	
		Avg. Delay	LOS	Avg. Delay	LOS	Avg. Delay	LOS
Existing							
Permitted NB/SB Left Turns, Permitted EB/WB Left Turns	AM	3.8	A	10.3	B	3.4	A
	PM	3.9	A	7.5	A	3.7	A
Recommended							
Protected NB/SB Left Turns, Split EB/WB Left Turns	AM	15.6	B	24.3	C	21.6	C
	PM	19.2	B	28.8	C	31	C
<p>Note: Operating conditions at the intersection of Monterey Road and Cosmo Avenue under the existing and recommended signal phasing. Avg. Delay = Average intersection delay, expressed in seconds.</p>							

Table B
Intersection Queuing Analysis – Site Access Alternatives 1 and 2

Measurement	2. Monterey/ Dunne				5. Monterey/ Cosmo						6. Monterey/ Tennant		8. Monterey/ Watsonville		9. Butterfield/ Main		10. Butterfield/ Dunne	
	EBL AM	EBL PM	WBL AM	WBL PM	EB AM	EB PM	NBL AM	NBL PM	SBL AM	SBL PM	SBL AM	SBL PM	EBL AM	EBL PM	EBL AM	EBL PM	EBL AM	EBL AM
Existing Conditions																		
Cycle/Delay ¹ (sec)	105	105	105	105	60	60	60	60	60	60	90	135	85	140	100	110	120	120
Lanes	1	1	2	2	1	1	1	1	1	1	2	2	1	1	1	1	1	1
Volume (vph)	85	77	144	329	78	84	17	45	8	15	92	213	58	43	134	87	153	153
Volume (vphpl)	85	77	72	165	78	84	17	45	8	15	46	107	58	43	134	87	153	153
Avg. Queue (veh/ln.)	2	2	2	5	1	1	0	1	0	0	1	4	1	2	4	3	5	5
Avg. Queue ² (ft./ln)	62	56	53	120	33	35	7	19	3	6	29	100	34	42	93	66	128	128
95th % Queue (veh/ln.)	5	5	5	9	3	4	1	2	1	1	3	8	4	4	7	6	9	9
95th % Queue (ft./ln)	125	125	125	225	75	100	25	50	25	25	75	200	100	100	175	150	225	225
Storage (ft./ ln.)	100	100	350	350	900	900	125	125	125	125	175	175	200	200	125	125	250	250
Adequate (Y/N)	NO	NO	YES	YES	YES	YES	YES	YES	YES	YES	YES	NO	YES	YES	NO	NO	YES	YES
Existing Plus Project Conditions Alternative I (Right-in/Full-out at Cosmo Driveway)																		
Cycle/Delay ¹ (sec)	105	105	105	105	60	60	60	60	60	60	90	135	85	140	100	110	120	120
Lanes	1	1	2	2	1	1	1	1	1	1	2	2	1	1	1	1	1	1
Volume (vph)	85	77	312	494	684	545	251	128	8	15	158	244	92	50	168	121	172	172
Volume (vphpl)	85	77	156	247	684	545	251	128	8	15	79	122	92	50	168	121	172	172
Avg. Queue (veh/ln.)	2	2	5	7	11	9	4	2	0	0	2	5	2	2	5	4	6	6
Avg. Queue ² (ft./ln)	62	56	114	180	285	227	105	53	3	6	49	114	54	49	117	92	143	143
95th % Queue (veh/ln.)	5	5	8	12	17	14	8	5	1	1	5	8	5	4	8	7	10	10
95th % Queue (ft./ln)	125	125	200	300	425	350	200	125	25	25	125	200	125	100	200	175	250	250
Storage (ft./ ln.)	100	100	350	350	175	175	125	125	125	125	175	175	200	200	125	125	250	250
Adequate (Y/N)	NO	NO	YES	YES	NO	NO	NO	YES	YES	YES	YES	NO	YES	YES	NO	NO	YES	YES
Existing Plus Project Conditions Alternative II (Right-in at Cosmo Driveway/Right-out at Monterey Driveway)																		
Cycle/Delay ¹ (sec)	105	105	105	105	60	60	60	60	60	60	90	135	85	140	100	110	120	120
Lanes	1	1	2	2	1	1	1	1	1	1	2	2	1	1	1	1	1	1
Volume (vph)	85	77	312	494	78	84	251	128	494	379	158	244	92	50	168	121	172	172
Volume (vphpl)	85	77	156	247	78	84	251	128	494	379	79	122	92	50	168	121	172	172
Avg. Queue (veh/ln.)	2	2	5	7	1	1	4	2	8	6	2	5	2	2	5	4	6	6
Avg. Queue ² (ft./ln)	62	56	114	180	33	35	105	53	206	158	49	114	54	49	117	92	143	143
95th % Queue (veh/ln.)	5	5	8	12	3	4	8	5	13	11	5	8	5	4	8	7	10	10
95th % Queue (ft./ln)	125	125	200	300	75	100	200	125	325	275	125	200	125	100	200	175	250	250
Storage (ft./ ln.)	100	100	350	350	175	175	125	125	125	125	175	175	200	200	125	125	250	250
Adequate (Y/N)	NO	NO	YES	YES	YES	YES	NO	YES	NO	NO	YES	NO	YES	YES	NO	NO	YES	YES
¹ Vehicle queue calculations based on cycle length for signalized intersections and control delay for unsignalized intersections. ² Assumes 25 feet per vehicle in the queue. NB = Northbound, SB = Southbound, EB = Eastbound, WB = Westbound, R = Right, T = Through, L = Left.																		

Voices School
Morgan Hill, CA
Hexagon Transportation Consultants, Inc.

Level Of Service Computation Report
2000 HCM Operations (Future Volume Alternative)
Existing Plus Project (AM) - 1 Cosmo Full out

Intersection #118: Monterey Road and Main Avenue

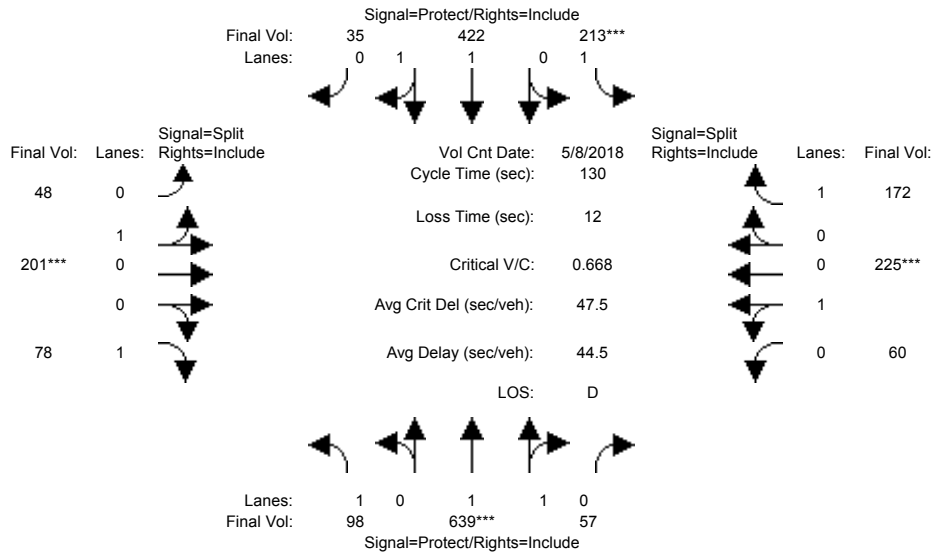

Street Name:	Monterey Road						Main Avenue					
Approach:	North Bound			South Bound			East Bound			West Bound		
Movement:	L	T	R	L	T	R	L	T	R	L	T	R
Min. Green:	7	10	10	7	10	10	10	10	10	10	10	10
Y+R:	4.0	4.0	4.0	4.0	4.0	4.0	4.0	4.0	4.0	4.0	4.0	4.0

Volume Module:	>>	Count	Date:	8 May 2018	<<												
Base Vol:	98	605	38	213	353	35	48	201	78	27	225	172					
Growth Adj:	1.00	1.00	1.00	1.00	1.00	1.00	1.00	1.00	1.00	1.00	1.00	1.00					
Initial Bse:	98	605	38	213	353	35	48	201	78	27	225	172					
Added Vol:	0	34	19	0	69	0	0	0	0	33	0	0					
PasserByVol:	0	0	0	0	0	0	0	0	0	0	0	0					
Initial Fut:	98	639	57	213	422	35	48	201	78	60	225	172					
User Adj:	1.00	1.00	1.00	1.00	1.00	1.00	1.00	1.00	1.00	1.00	1.00	1.00					
PHF Adj:	1.00	1.00	1.00	1.00	1.00	1.00	1.00	1.00	1.00	1.00	1.00	1.00					
PHF Volume:	98	639	57	213	422	35	48	201	78	60	225	172					
Reduct Vol:	0	0	0	0	0	0	0	0	0	0	0	0					
Reduced Vol:	98	639	57	213	422	35	48	201	78	60	225	172					
PCE Adj:	1.00	1.00	1.00	1.00	1.00	1.00	1.00	1.00	1.00	1.00	1.00	1.00					
MLF Adj:	1.00	1.00	1.00	1.00	1.00	1.00	1.00	1.00	1.00	1.00	1.00	1.00					
Final Volume:	98	639	57	213	422	35	48	201	78	60	225	172					

Saturation Flow Module:												
Sat/Lane:	1900	1900	1900	1900	1900	1900	1900	1900	1900	1900	1900	1900
Adjustment:	0.92	0.98	0.95	0.92	0.98	0.95	0.95	0.95	0.92	0.95	0.95	0.92
Lanes:	1.00	1.83	0.17	1.00	1.84	0.16	0.19	0.81	1.00	0.21	0.79	1.00
Final Sat.:	1750	3397	303	1750	3416	283	347	1453	1750	379	1421	1750

Capacity Analysis Module:												
Vol/Sat:	0.06	0.19	0.19	0.12	0.12	0.12	0.14	0.14	0.04	0.16	0.16	0.10
Crit Moves:	****			****			****			****		
Green Time:	18.8	36.6	36.6	23.7	41.5	41.5	26.9	26.9	26.9	30.8	30.8	30.8
Volume/Cap:	0.39	0.67	0.67	0.67	0.39	0.39	0.67	0.67	0.22	0.67	0.67	0.41
Delay/Veh:	51.4	43.0	43.0	54.9	34.6	34.6	52.0	52.0	43.1	49.0	49.0	42.6
User DelAdj:	1.00	1.00	1.00	1.00	1.00	1.00	1.00	1.00	1.00	1.00	1.00	1.00
AdjDel/Veh:	51.4	43.0	43.0	54.9	34.6	34.6	52.0	52.0	43.1	49.0	49.0	42.6
LOS by Move:	D	D	D	D	C	C	D	D	D	D	D	D
HCM2kAvgQ:	4	12	12	10	7	7	11	11	3	11	11	6

Note: Queue reported is the number of cars per lane.

Voices School
Morgan Hill, CA
Hexagon Transportation Consultants, Inc.

Level Of Service Computation Report
2000 HCM Operations (Future Volume Alternative)
Existing Plus Project (PM) - 1 Cosmo Full out

Intersection #118: Monterey Road and Main Avenue

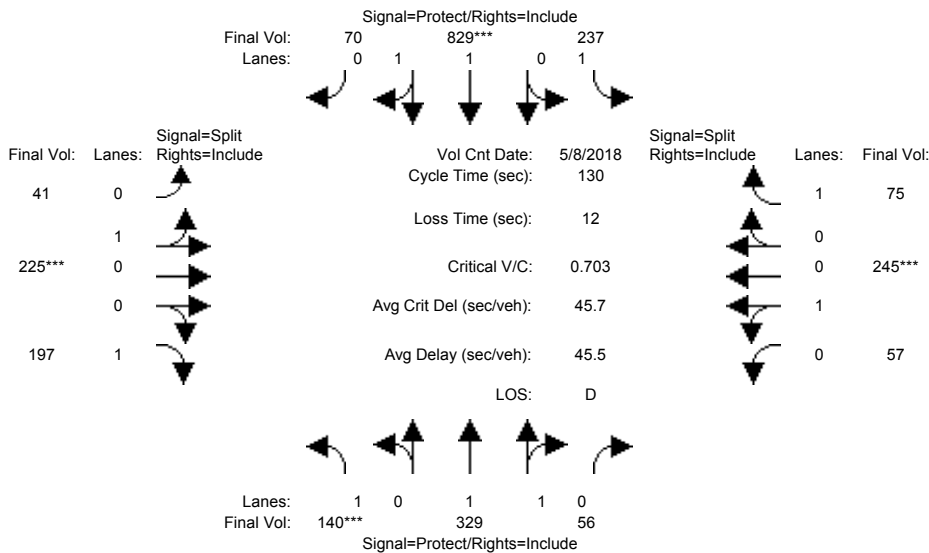

Street Name:	Monterey Road						Main Avenue					
	North Bound			South Bound			East Bound			West Bound		
Approach:	L	T	R	L	T	R	L	T	R	L	T	R
Min. Green:	7	10	10	7	10	10	10	10	10	10	10	10
Y+R:	4.0	4.0	4.0	4.0	4.0	4.0	4.0	4.0	4.0	4.0	4.0	4.0

Volume Module:	>>	Count	Date:	8 May 2018	<<							
Base Vol:	140	285	35	237	811	70	41	225	197	47	245	75
Growth Adj:	1.00	1.00	1.00	1.00	1.00	1.00	1.00	1.00	1.00	1.00	1.00	1.00
Initial Bse:	140	285	35	237	811	70	41	225	197	47	245	75
Added Vol:	0	44	21	0	18	0	0	0	0	10	0	0
PasserByVol:	0	0	0	0	0	0	0	0	0	0	0	0
Initial Fut:	140	329	56	237	829	70	41	225	197	57	245	75
User Adj:	1.00	1.00	1.00	1.00	1.00	1.00	1.00	1.00	1.00	1.00	1.00	1.00
PHF Adj:	1.00	1.00	1.00	1.00	1.00	1.00	1.00	1.00	1.00	1.00	1.00	1.00
PHF Volume:	140	329	56	237	829	70	41	225	197	57	245	75
Reduct Vol:	0	0	0	0	0	0	0	0	0	0	0	0
Reduced Vol:	140	329	56	237	829	70	41	225	197	57	245	75
PCE Adj:	1.00	1.00	1.00	1.00	1.00	1.00	1.00	1.00	1.00	1.00	1.00	1.00
MLF Adj:	1.00	1.00	1.00	1.00	1.00	1.00	1.00	1.00	1.00	1.00	1.00	1.00
FinalVolume:	140	329	56	237	829	70	41	225	197	57	245	75

Saturation Flow Module:												
Sat/Lane:	1900	1900	1900	1900	1900	1900	1900	1900	1900	1900	1900	1900
Adjustment:	0.92	0.98	0.95	0.92	0.98	0.95	0.95	0.95	0.92	0.95	0.95	0.92
Lanes:	1.00	1.70	0.30	1.00	1.84	0.16	0.15	0.85	1.00	0.19	0.81	1.00
Final Sat.:	1750	3161	538	1750	3412	288	277	1523	1750	340	1460	1750

Capacity Analysis Module:												
Vol/Sat:	0.08	0.10	0.10	0.14	0.24	0.24	0.15	0.15	0.11	0.17	0.17	0.04
Crit Moves:	****				****		****			****		
Green Time:	14.8	25.9	25.9	33.8	44.9	44.9	27.3	27.3	27.3	31.0	31.0	31.0
Volume/Cap:	0.70	0.52	0.52	0.52	0.70	0.70	0.70	0.70	0.54	0.70	0.70	0.18
Delay/Veh:	66.3	47.2	47.2	42.3	38.6	38.6	53.5	53.5	47.3	50.5	50.5	39.6
User DelAdj:	1.00	1.00	1.00	1.00	1.00	1.00	1.00	1.00	1.00	1.00	1.00	1.00
AdjDel/Veh:	66.3	47.2	47.2	42.3	38.6	38.6	53.5	53.5	47.3	50.5	50.5	39.6
LOS by Move:	E	D	D	D	D	D	D	D	D	D	D	D
HCM2kAvgQ:	6	7	7	9	17	17	11	11	8	12	12	2

Note: Queue reported is the number of cars per lane.

Voices School
Morgan Hill, CA
Hexagon Transportation Consultants, Inc.

Level Of Service Computation Report
2000 HCM Operations (Future Volume Alternative)
2025 Plus Project (AM) - 1 Cosmo Full out

Intersection #118: Monterey Road and Main Avenue

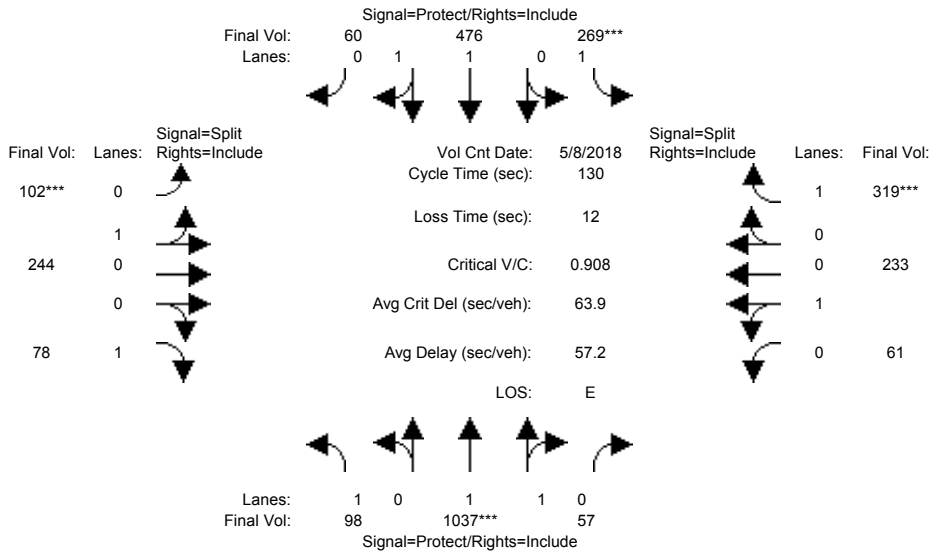

Street Name:	Monterey Road						Main Avenue					
	North Bound			South Bound			East Bound			West Bound		
Approach:	L	T	R	L	T	R	L	T	R	L	T	R
Min. Green:	7	10	10	7	10	10	10	10	10	10	10	10
Y+R:	4.0	4.0	4.0	4.0	4.0	4.0	4.0	4.0	4.0	4.0	4.0	4.0

Volume Module:	>>	Count	Date:	8 May 2018	<<							
Base Vol:	98	605	38	213	353	35	48	201	78	27	225	172
Growth Adj:	1.00	1.00	1.00	1.00	1.00	1.00	1.00	1.00	1.00	1.00	1.00	1.00
Initial Bse:	98	605	38	213	353	35	48	201	78	27	225	172
Added Vol:	0	34	19	0	69	0	0	0	0	33	0	0
PasserByVol:	0	398	0	56	54	25	54	43	0	1	8	147
Initial Fut:	98	1037	57	269	476	60	102	244	78	61	233	319
User Adj:	1.00	1.00	1.00	1.00	1.00	1.00	1.00	1.00	1.00	1.00	1.00	1.00
PHF Adj:	1.00	1.00	1.00	1.00	1.00	1.00	1.00	1.00	1.00	1.00	1.00	1.00
PHF Volume:	98	1037	57	269	476	60	102	244	78	61	233	319
Reduct Vol:	0	0	0	0	0	0	0	0	0	0	0	0
Reduced Vol:	98	1037	57	269	476	60	102	244	78	61	233	319
PCE Adj:	1.00	1.00	1.00	1.00	1.00	1.00	1.00	1.00	1.00	1.00	1.00	1.00
MLF Adj:	1.00	1.00	1.00	1.00	1.00	1.00	1.00	1.00	1.00	1.00	1.00	1.00
FinalVolume:	98	1037	57	269	476	60	102	244	78	61	233	319

Saturation Flow Module:												
Sat/Lane:	1900	1900	1900	1900	1900	1900	1900	1900	1900	1900	1900	1900
Adjustment:	0.92	0.98	0.95	0.92	0.98	0.95	0.95	0.95	0.92	0.95	0.95	0.92
Lanes:	1.00	1.89	0.11	1.00	1.77	0.23	0.29	0.71	1.00	0.21	0.79	1.00
Final Sat.:	1750	3507	193	1750	3286	414	531	1269	1750	373	1427	1750

Capacity Analysis Module:												
Vol/Sat:	0.06	0.30	0.30	0.15	0.14	0.14	0.19	0.19	0.04	0.16	0.16	0.18
Crit Moves:	****	****	****	****	****	****	****	****	****	****	****	****
Green Time:	17.9	42.3	42.3	22.0	46.4	46.4	27.5	27.5	27.5	26.1	26.1	26.1
Volume/Cap:	0.41	0.91	0.91	0.91	0.41	0.41	0.91	0.91	0.21	0.81	0.81	0.91
Delay/Veh:	52.3	52.0	52.0	82.7	31.6	31.6	74.8	74.8	42.6	62.8	62.8	77.1
User DelAdj:	1.00	1.00	1.00	1.00	1.00	1.00	1.00	1.00	1.00	1.00	1.00	1.00
AdjDel/Veh:	52.3	52.0	52.0	82.7	31.6	31.6	74.8	74.8	42.6	62.8	62.8	77.1
LOS by Move:	D	D	D	F	C	C	E	E	D	E	E	E
HCM2kAvgQ:	4	23	23	15	8	8	18	18	3	12	12	14

Note: Queue reported is the number of cars per lane.

Voices School
Morgan Hill, CA
Hexagon Transportation Consultants, Inc.

Level Of Service Computation Report
2000 HCM Operations (Future Volume Alternative)
2025 Plus Project (PM) - 1 Cosmo Full out

Intersection #118: Monterey Road and Main Avenue

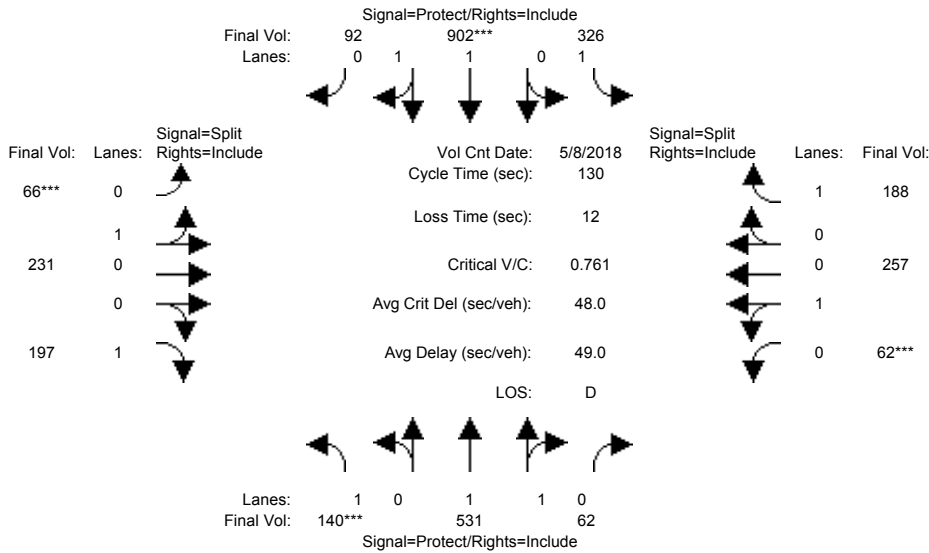

Street Name:	Monterey Road						Main Avenue					
	North Bound			South Bound			East Bound			West Bound		
Approach:	L	T	R	L	T	R	L	T	R	L	T	R
Min. Green:	7	10	10	7	10	10	10	10	10	10	10	10
Y+R:	4.0	4.0	4.0	4.0	4.0	4.0	4.0	4.0	4.0	4.0	4.0	4.0

Volume Module:	>>	Count	Date:	8 May 2018	<<							
Base Vol:	140	285	35	237	811	70	41	225	197	47	245	75
Growth Adj:	1.00	1.00	1.00	1.00	1.00	1.00	1.00	1.00	1.00	1.00	1.00	1.00
Initial Bse:	140	285	35	237	811	70	41	225	197	47	245	75
Added Vol:	0	44	21	0	18	0	0	0	0	10	0	0
PasserByVol:	0	202	6	89	73	22	25	6	0	5	12	113
Initial Fut:	140	531	62	326	902	92	66	231	197	62	257	188
User Adj:	1.00	1.00	1.00	1.00	1.00	1.00	1.00	1.00	1.00	1.00	1.00	1.00
PHF Adj:	1.00	1.00	1.00	1.00	1.00	1.00	1.00	1.00	1.00	1.00	1.00	1.00
PHF Volume:	140	531	62	326	902	92	66	231	197	62	257	188
Reduct Vol:	0	0	0	0	0	0	0	0	0	0	0	0
Reduced Vol:	140	531	62	326	902	92	66	231	197	62	257	188
PCE Adj:	1.00	1.00	1.00	1.00	1.00	1.00	1.00	1.00	1.00	1.00	1.00	1.00
MLF Adj:	1.00	1.00	1.00	1.00	1.00	1.00	1.00	1.00	1.00	1.00	1.00	1.00
FinalVolume:	140	531	62	326	902	92	66	231	197	62	257	188

Saturation Flow Module:												
Sat/Lane:	1900	1900	1900	1900	1900	1900	1900	1900	1900	1900	1900	1900
Adjustment:	0.92	0.98	0.95	0.92	0.98	0.95	0.95	0.95	0.92	0.95	0.95	0.92
Lanes:	1.00	1.79	0.21	1.00	1.81	0.19	0.22	0.78	1.00	0.19	0.81	1.00
Final Sat.:	1750	3313	387	1750	3357	342	400	1400	1750	350	1450	1750

Capacity Analysis Module:												
Vol/Sat:	0.08	0.16	0.16	0.19	0.27	0.27	0.17	0.17	0.11	0.18	0.18	0.11
Crit Moves:	***				***		***			***		
Green Time:	13.7	27.5	27.5	32.0	45.9	45.9	28.2	28.2	28.2	30.3	30.3	30.3
Volume/Cap:	0.76	0.76	0.76	0.76	0.76	0.76	0.76	0.76	0.52	0.76	0.76	0.46
Delay/Veh:	73.4	52.3	52.3	52.9	39.9	39.9	56.3	56.3	46.2	54.5	54.5	43.7
User DelAdj:	1.00	1.00	1.00	1.00	1.00	1.00	1.00	1.00	1.00	1.00	1.00	1.00
AdjDel/Veh:	73.4	52.3	52.3	52.9	39.9	39.9	56.3	56.3	46.2	54.5	54.5	43.7
LOS by Move:	E	D	D	D	D	D	E	E	D	D	D	D
HCM2kAvgQ:	6	12	12	14	19	19	13	13	8	12	12	7

Note: Queue reported is the number of cars per lane.

Voices School
Morgan Hill, CA
Hexagon Transportation Consultants, Inc.

Level Of Service Computation Report
2000 HCM Operations (Future Volume Alternative)
Existing Plus Project (AM) - 1 Cosmo Full out

Intersection #119: Butterfield Boulevard and Main Avenue

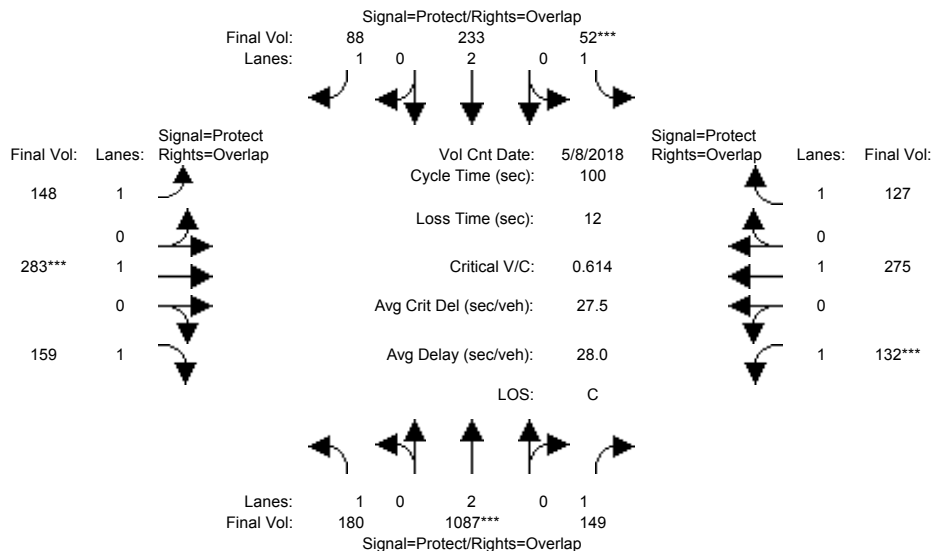

Street Name:	Butterfield Boulevard						Main Avenue					
Approach:	North Bound			South Bound			East Bound			West Bound		
Movement:	L	T	R	L	T	R	L	T	R	L	T	R
Min. Green:	7	10	10	7	10	10	7	10	10	7	10	10
Y+R:	4.0	4.0	4.0	4.0	4.0	4.0	4.0	4.0	4.0	4.0	4.0	4.0

Volume Module:	>>	Count	Date:	8 May 2018	<<											
Base Vol:	180	1082	149	52	226	68	134	278	159	132	262	127				
Growth Adj:	1.00	1.00	1.00	1.00	1.00	1.00	1.00	1.00	1.00	1.00	1.00	1.00				
Initial Bse:	180	1082	149	52	226	68	134	278	159	132	262	127				
Added Vol:	0	5	0	0	7	20	14	5	0	0	13	0				
PasserByVol:	0	0	0	0	0	0	0	0	0	0	0	0				
Initial Fut:	180	1087	149	52	233	88	148	283	159	132	275	127				
User Adj:	1.00	1.00	1.00	1.00	1.00	1.00	1.00	1.00	1.00	1.00	1.00	1.00				
PHF Adj:	1.00	1.00	1.00	1.00	1.00	1.00	1.00	1.00	1.00	1.00	1.00	1.00				
PHF Volume:	180	1087	149	52	233	88	148	283	159	132	275	127				
Reduct Vol:	0	0	0	0	0	0	0	0	0	0	0	0				
Reduced Vol:	180	1087	149	52	233	88	148	283	159	132	275	127				
PCE Adj:	1.00	1.00	1.00	1.00	1.00	1.00	1.00	1.00	1.00	1.00	1.00	1.00				
MLF Adj:	1.00	1.00	1.00	1.00	1.00	1.00	1.00	1.00	1.00	1.00	1.00	1.00				
FinalVolume:	180	1087	149	52	233	88	148	283	159	132	275	127				

Saturation Flow Module:												
Sat/Lane:	1900	1900	1900	1900	1900	1900	1900	1900	1900	1900	1900	1900
Adjustment:	0.92	1.00	0.92	0.92	1.00	0.92	0.92	1.00	0.92	0.92	1.00	0.92
Lanes:	1.00	2.00	1.00	1.00	2.00	1.00	1.00	1.00	1.00	1.00	1.00	1.00
Final Sat.:	1750	3800	1750	1750	3800	1750	1750	1900	1750	1750	1900	1750

Capacity Analysis Module:												
Vol/Sat:	0.10	0.29	0.09	0.03	0.06	0.05	0.08	0.15	0.09	0.08	0.14	0.07
Crit Moves:	****			****			****			****		
Green Time:	26.6	45.4	57.4	7.0	25.8	39.0	13.1	23.6	50.2	12.0	22.5	29.5
Volume/Cap:	0.39	0.63	0.15	0.42	0.24	0.13	0.64	0.63	0.18	0.63	0.64	0.25
Delay/Veh:	30.6	21.6	10.0	46.9	29.4	19.7	47.4	37.1	13.7	48.0	38.5	27.1
User DelAdj:	1.00	1.00	1.00	1.00	1.00	1.00	1.00	1.00	1.00	1.00	1.00	1.00
AdjDel/Veh:	30.6	21.6	10.0	46.9	29.4	19.7	47.4	37.1	13.7	48.0	38.5	27.1
LOS by Move:	C	C	B	D	C	B	D	D	B	D	D	C
HCM2kAvgQ:	5	13	2	2	3	2	5	8	3	5	9	3

Note: Queue reported is the number of cars per lane.

Voices School
Morgan Hill, CA
Hexagon Transportation Consultants, Inc.

Level Of Service Computation Report
2000 HCM Operations (Future Volume Alternative)
Existing Plus Project (PM) - 1 Cosmo Full out

Intersection #119: Butterfield Boulevard and Main Avenue

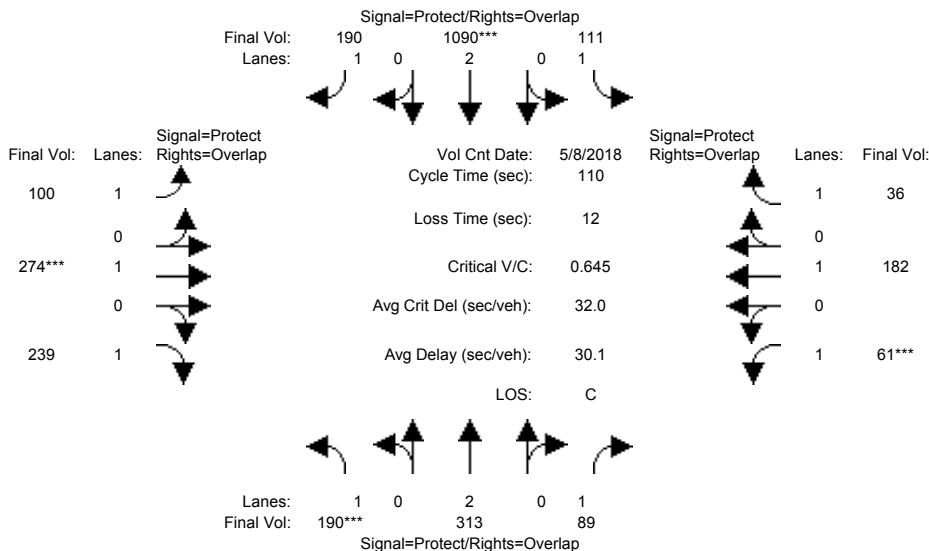

Street Name:	Butterfield Boulevard						Main Avenue					
Approach:	North Bound			South Bound			East Bound			West Bound		
Movement:	L	T	R	L	T	R	L	T	R	L	T	R
Min. Green:	7	10	10	7	10	10	7	10	10	7	10	10
Y+R:	4.0	4.0	4.0	4.0	4.0	4.0	4.0	4.0	4.0	4.0	4.0	4.0

Volume Module:	>>	Count	Date:	8 May 2018	<<							
Base Vol:	190	309	89	111	1088	183	87	266	239	61	179	36
Growth Adj:	1.00	1.00	1.00	1.00	1.00	1.00	1.00	1.00	1.00	1.00	1.00	1.00
Initial Bse:	190	309	89	111	1088	183	87	266	239	61	179	36
Added Vol:	0	4	0	0	2	7	13	8	0	0	3	0
PasserByVol:	0	0	0	0	0	0	0	0	0	0	0	0
Initial Fut:	190	313	89	111	1090	190	100	274	239	61	182	36
User Adj:	1.00	1.00	1.00	1.00	1.00	1.00	1.00	1.00	1.00	1.00	1.00	1.00
PHF Adj:	1.00	1.00	1.00	1.00	1.00	1.00	1.00	1.00	1.00	1.00	1.00	1.00
PHF Volume:	190	313	89	111	1090	190	100	274	239	61	182	36
Reduct Vol:	0	0	0	0	0	0	0	0	0	0	0	0
Reduced Vol:	190	313	89	111	1090	190	100	274	239	61	182	36
PCE Adj:	1.00	1.00	1.00	1.00	1.00	1.00	1.00	1.00	1.00	1.00	1.00	1.00
MLF Adj:	1.00	1.00	1.00	1.00	1.00	1.00	1.00	1.00	1.00	1.00	1.00	1.00
FinalVolume:	190	313	89	111	1090	190	100	274	239	61	182	36

Saturation Flow Module:	
Sat/Lane:	1900 1900 1900 1900 1900 1900 1900 1900 1900 1900 1900 1900
Adjustment:	0.92 1.00 0.92 0.92 1.00 0.92 0.92 1.00 0.92 0.92 1.00 0.92
Lanes:	1.00 2.00 1.00 1.00 2.00 1.00 1.00 1.00 1.00 1.00 1.00 1.00
Final Sat.:	1750 3800 1750 1750 3800 1750 1750 1900 1750 1750 1900 1750

Capacity Analysis Module:	
Vol/Sat:	0.11 0.08 0.05 0.06 0.29 0.11 0.06 0.14 0.14 0.03 0.10 0.02
Crit Moves:	**** ****
Green Time:	18.3 39.2 46.2 27.5 48.4 60.9 12.5 24.3 42.6 7.0 18.8 46.3
Volume/Cap:	0.65 0.23 0.12 0.25 0.65 0.20 0.50 0.65 0.35 0.55 0.56 0.05
Delay/Veh:	48.1 24.9 19.6 33.4 25.1 12.4 47.9 42.6 24.2 55.6 44.0 18.9
User DelAdj:	1.00 1.00 1.00 1.00 1.00 1.00 1.00 1.00 1.00 1.00 1.00 1.00
AdjDel/Veh:	48.1 24.9 19.6 33.4 25.1 12.4 47.9 42.6 24.2 55.6 44.0 18.9
LOS by Move:	D C B C C B D D C E D B
HCM2kAvgQ:	8 4 2 3 15 3 3 8 6 3 6 1

Note: Queue reported is the number of cars per lane.

Voices School
Morgan Hill, CA
Hexagon Transportation Consultants, Inc.

Level Of Service Computation Report
2000 HCM Operations (Future Volume Alternative)
2025 Plus Project (AM) - 1 Cosmo Full out

Intersection #119: Butterfield Boulevard and Main Avenue

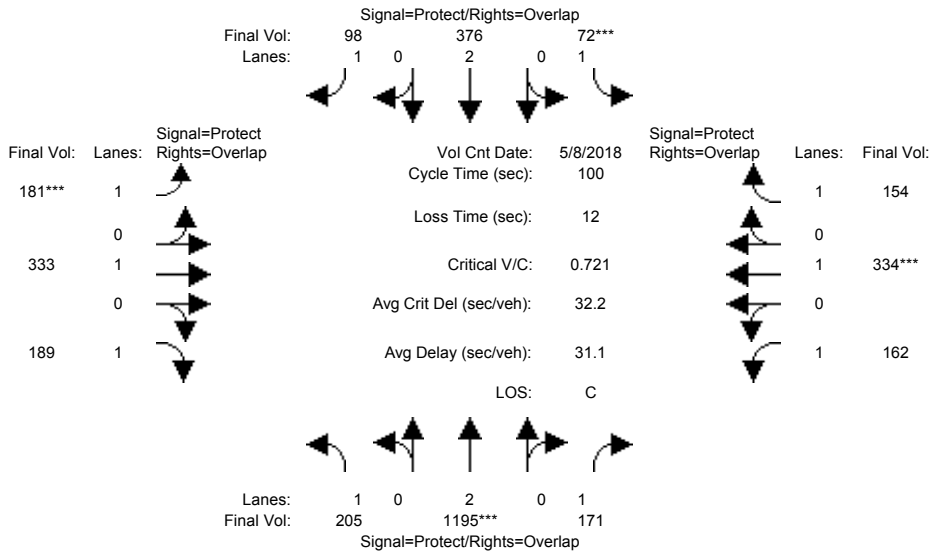

Street Name:	Butterfield Boulevard						Main Avenue					
	North Bound			South Bound			East Bound			West Bound		
Approach:	L	T	R	L	T	R	L	T	R	L	T	R
Min. Green:	7	10	10	7	10	10	7	10	10	7	10	10
Y+R:	4.0	4.0	4.0	4.0	4.0	4.0	4.0	4.0	4.0	4.0	4.0	4.0
Volume Module: >> Count Date: 8 May 2018 <<												
Base Vol:	180	1082	149	52	226	68	134	278	159	132	262	127
Growth Adj:	1.00	1.00	1.00	1.00	1.00	1.00	1.00	1.00	1.00	1.00	1.00	1.00
Initial Bse:	180	1082	149	52	226	68	134	278	159	132	262	127
Added Vol:	0	5	0	0	7	20	14	5	0	0	13	0
PasserByVol:	25	108	22	20	143	10	33	50	30	30	59	27
Initial Fut:	205	1195	171	72	376	98	181	333	189	162	334	154
User Adj:	1.00	1.00	1.00	1.00	1.00	1.00	1.00	1.00	1.00	1.00	1.00	1.00
PHF Adj:	1.00	1.00	1.00	1.00	1.00	1.00	1.00	1.00	1.00	1.00	1.00	1.00
PHF Volume:	205	1195	171	72	376	98	181	333	189	162	334	154
Reduct Vol:	0	0	0	0	0	0	0	0	0	0	0	0
Reduced Vol:	205	1195	171	72	376	98	181	333	189	162	334	154
PCE Adj:	1.00	1.00	1.00	1.00	1.00	1.00	1.00	1.00	1.00	1.00	1.00	1.00
MLF Adj:	1.00	1.00	1.00	1.00	1.00	1.00	1.00	1.00	1.00	1.00	1.00	1.00
FinalVolume:	205	1195	171	72	376	98	181	333	189	162	334	154
Saturation Flow Module:												
Sat/Lane:	1900	1900	1900	1900	1900	1900	1900	1900	1900	1900	1900	1900
Adjustment:	0.92	1.00	0.92	0.92	1.00	0.92	0.92	1.00	0.92	0.92	1.00	0.92
Lanes:	1.00	2.00	1.00	1.00	2.00	1.00	1.00	1.00	1.00	1.00	1.00	1.00
Final Sat.:	1750	3800	1750	1750	3800	1750	1750	1900	1750	1750	1900	1750
Capacity Analysis Module:												
Vol/Sat:	0.12	0.31	0.10	0.04	0.10	0.06	0.10	0.18	0.11	0.09	0.18	0.09
Crit Moves:	****			****			****			****		
Green Time:	26.9	42.9	56.1	7.0	23.0	37.1	14.1	24.9	51.9	13.2	24.0	31.0
Volume/Cap:	0.44	0.73	0.17	0.59	0.43	0.15	0.73	0.70	0.21	0.70	0.73	0.28
Delay/Veh:	30.9	25.5	10.8	52.4	33.3	21.1	51.9	38.9	13.1	51.0	41.1	26.4
User DelAdj:	1.00	1.00	1.00	1.00	1.00	1.00	1.00	1.00	1.00	1.00	1.00	1.00
AdjDel/Veh:	30.9	25.5	10.8	52.4	33.3	21.1	51.9	38.9	13.1	51.0	41.1	26.4
LOS by Move:	C	C	B	D	C	C	D	D	B	D	D	C
HCM2kAvgQ:	6	16	3	3	5	2	5	9	3	7	11	4

Note: Queue reported is the number of cars per lane.

Voices School
Morgan Hill, CA
Hexagon Transportation Consultants, Inc.

Level Of Service Computation Report
2000 HCM Operations (Future Volume Alternative)
2025 Plus Project (PM) - 1 Cosmo Full out

Intersection #119: Butterfield Boulevard and Main Avenue

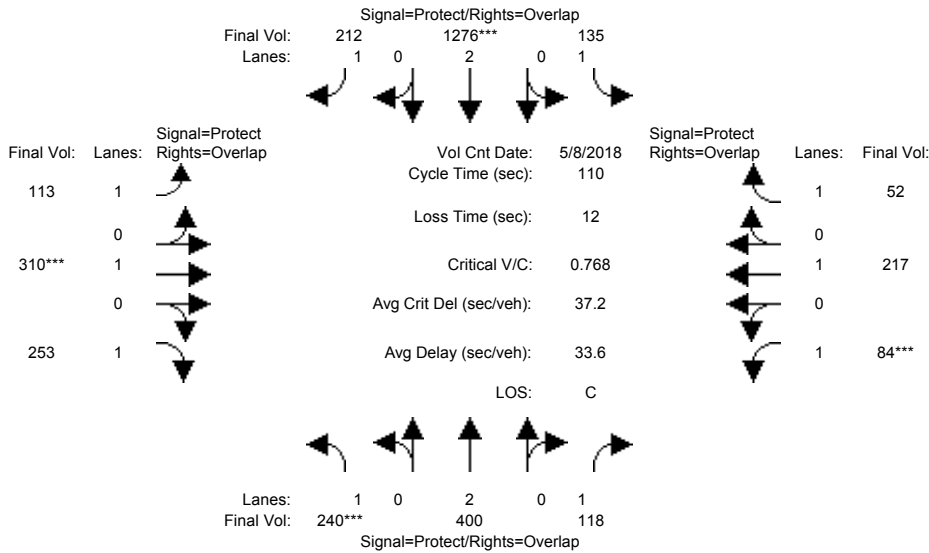

Street Name: Butterfield Boulevard Main Avenue
Approach: North Bound South Bound East Bound West Bound
Movement: L - T - R L - T - R L - T - R L - T - R

Min. Green: 7 10 10 7 10 10 7 10 10 7 10 10
Y+R: 4.0 4.0 4.0 4.0 4.0 4.0 4.0 4.0 4.0 4.0 4.0 4.0

Volume Module: >> Count Date: 8 May 2018 <<

Base Vol:	190	309	89	111	1088	183	87	266	239	61	179	36
Growth Adj:	1.00	1.00	1.00	1.00	1.00	1.00	1.00	1.00	1.00	1.00	1.00	1.00
Initial Bse:	190	309	89	111	1088	183	87	266	239	61	179	36
Added Vol:	0	4	0	0	2	7	13	8	0	0	3	0
PasserByVol:	50	87	29	24	186	22	13	36	14	23	35	16
Initial Fut:	240	400	118	135	1276	212	113	310	253	84	217	52
User Adj:	1.00	1.00	1.00	1.00	1.00	1.00	1.00	1.00	1.00	1.00	1.00	1.00
PHF Adj:	1.00	1.00	1.00	1.00	1.00	1.00	1.00	1.00	1.00	1.00	1.00	1.00
PHF Volume:	240	400	118	135	1276	212	113	310	253	84	217	52
Reduct Vol:	0	0	0	0	0	0	0	0	0	0	0	0
Reduced Vol:	240	400	118	135	1276	212	113	310	253	84	217	52
PCE Adj:	1.00	1.00	1.00	1.00	1.00	1.00	1.00	1.00	1.00	1.00	1.00	1.00
MLF Adj:	1.00	1.00	1.00	1.00	1.00	1.00	1.00	1.00	1.00	1.00	1.00	1.00
FinalVolume:	240	400	118	135	1276	212	113	310	253	84	217	52

Saturation Flow Module:

Sat/Lane:	1900	1900	1900	1900	1900	1900	1900	1900	1900	1900	1900	1900
Adjustment:	0.92	1.00	0.92	0.92	1.00	0.92	0.92	1.00	0.92	0.92	1.00	0.92
Lanes:	1.00	2.00	1.00	1.00	2.00	1.00	1.00	1.00	1.00	1.00	1.00	1.00
Final Sat.:	1750	3800	1750	1750	3800	1750	1750	1900	1750	1750	1900	1750

Capacity Analysis Module:

Vol/Sat:	0.14	0.11	0.07	0.08	0.34	0.12	0.06	0.16	0.14	0.05	0.11	0.03
Crit Moves:	****				****			****		****		
Green Time:	19.6	39.0	46.0	28.6	48.0	59.0	11.0	23.3	43.0	7.0	19.4	48.0
Volume/Cap:	0.77	0.30	0.16	0.30	0.77	0.23	0.65	0.77	0.37	0.75	0.65	0.07
Delay/Veh:	54.1	25.7	20.0	33.0	28.5	13.6	55.9	49.5	24.2	75.6	46.5	18.0
User DelAdj:	1.00	1.00	1.00	1.00	1.00	1.00	1.00	1.00	1.00	1.00	1.00	1.00
AdjDel/Veh:	54.1	25.7	20.0	33.0	28.5	13.6	55.9	49.5	24.2	75.6	46.5	18.0
LOS by Move:	D	C	C	C	C	B	E	D	C	E	D	B
HCM2kAvgQ:	10	5	3	4	19	4	4	10	6	5	8	1

Note: Queue reported is the number of cars per lane.

Voices School
Morgan Hill, CA
Hexagon Transportation Consultants, Inc.

Level Of Service Computation Report
2000 HCM Operations (Future Volume Alternative)
Existing Plus Project (AM) - 1 Cosmo Full out

Intersection #122: Monterey Road and Dunne Avenue

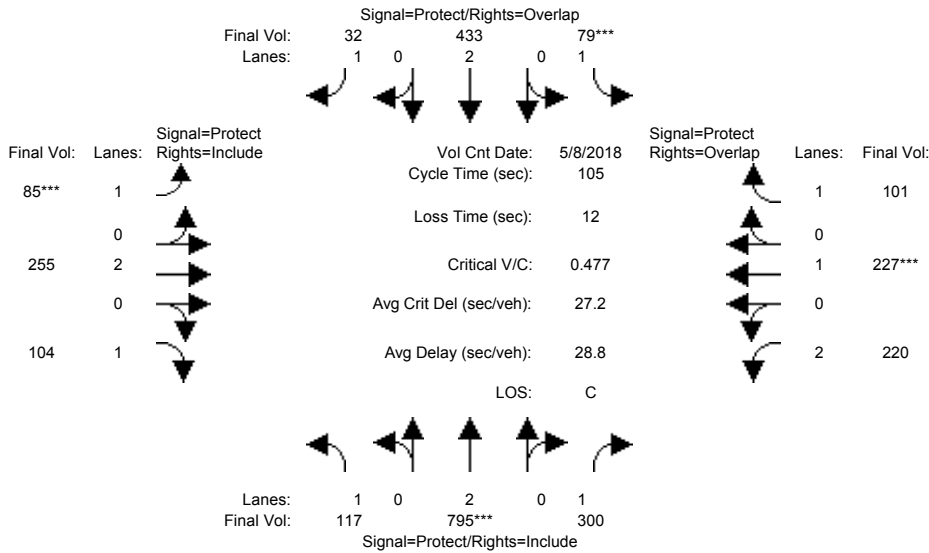

Street Name:	Monterey Road						Dunne Avenue					
	North Bound			South Bound			East Bound			West Bound		
Approach:	L	T	R	L	T	R	L	T	R	L	T	R
Min. Green:	7	10	10	7	10	10	7	10	10	7	10	10
Y+R:	4.0	4.0	4.0	4.0	4.0	4.0	4.0	4.0	4.0	4.0	4.0	4.0

Volume Module:	>>	Count	Date:	8 May 2018	<<											
Base Vol:	115	741	170	79	330	32	85	255	74	144	227	101				
Growth Adj:	1.00	1.00	1.00	1.00	1.00	1.00	1.00	1.00	1.00	1.00	1.00	1.00				
Initial Bse:	115	741	170	79	330	32	85	255	74	144	227	101				
Added Vol:	2	54	130	0	103	0	0	0	30	76	0	0				
PasserByVol:	0	0	0	0	0	0	0	0	0	0	0	0				
Initial Fut:	117	795	300	79	433	32	85	255	104	220	227	101				
User Adj:	1.00	1.00	1.00	1.00	1.00	1.00	1.00	1.00	1.00	1.00	1.00	1.00				
PHF Adj:	1.00	1.00	1.00	1.00	1.00	1.00	1.00	1.00	1.00	1.00	1.00	1.00				
PHF Volume:	117	795	300	79	433	32	85	255	104	220	227	101				
Reduct Vol:	0	0	0	0	0	0	0	0	0	0	0	0				
Reduced Vol:	117	795	300	79	433	32	85	255	104	220	227	101				
PCE Adj:	1.00	1.00	1.00	1.00	1.00	1.00	1.00	1.00	1.00	1.00	1.00	1.00				
MLF Adj:	1.00	1.00	1.00	1.00	1.00	1.00	1.00	1.00	1.00	1.00	1.00	1.00				
Final Volume:	117	795	300	79	433	32	85	255	104	220	227	101				

Saturation Flow Module:												
Sat/Lane:	1900	1900	1900	1900	1900	1900	1900	1900	1900	1900	1900	1900
Adjustment:	0.92	1.00	0.92	0.92	1.00	0.92	0.92	1.00	0.92	0.83	1.00	0.92
Lanes:	1.00	2.00	1.00	1.00	2.00	1.00	1.00	2.00	1.00	2.00	1.00	1.00
Final Sat.:	1750	3800	1750	1750	3800	1750	1750	3800	1750	3150	1900	1750

Capacity Analysis Module:												
Vol/Sat:	0.07	0.21	0.17	0.05	0.11	0.02	0.05	0.07	0.06	0.07	0.12	0.06
Crit Moves:	****			****			****			****		
Green Time:	20.7	46.1	46.1	9.9	35.3	46.0	10.7	21.3	21.3	15.7	26.3	36.2
Volume/Cap:	0.34	0.48	0.39	0.48	0.34	0.04	0.48	0.33	0.29	0.47	0.48	0.17
Delay/Veh:	36.8	21.1	20.3	47.2	26.3	16.9	46.5	36.0	35.9	41.6	34.2	24.0
User DelAdj:	1.00	1.00	1.00	1.00	1.00	1.00	1.00	1.00	1.00	1.00	1.00	1.00
AdjDel/Veh:	36.8	21.1	20.3	47.2	26.3	16.9	46.5	36.0	35.9	41.6	34.2	24.0
LOS by Move:	D	C	C	D	C	B	D	D	D	D	C	C
HCM2kAvgQ:	3	9	7	3	5	1	3	4	3	4	6	2

Note: Queue reported is the number of cars per lane.

Voices School
Morgan Hill, CA
Hexagon Transportation Consultants, Inc.

Level Of Service Computation Report
2000 HCM Operations (Future Volume Alternative)
Existing Plus Project (PM) - 1 Cosmo Full out

Intersection #122: Monterey Road and Dunne Avenue

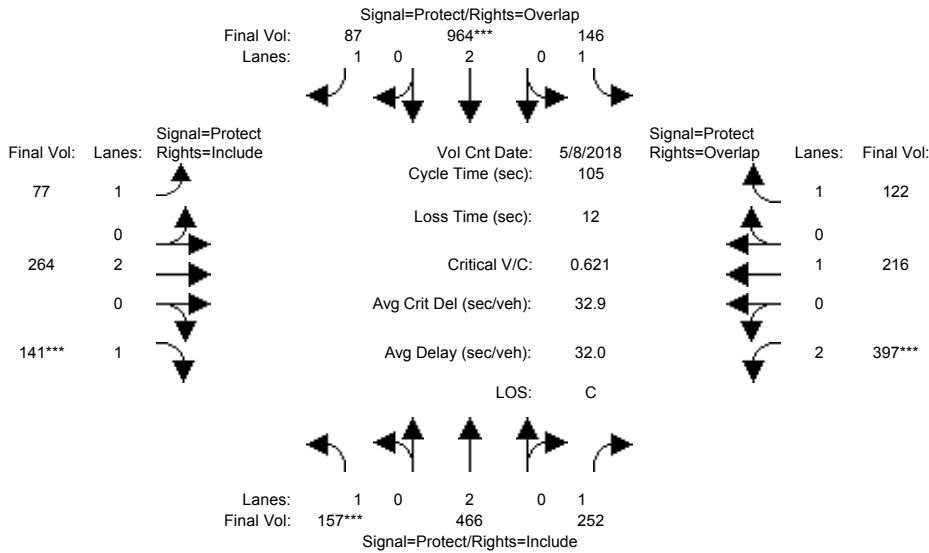

Street Name:	Monterey Road						Dunne Avenue					
	North Bound			South Bound			East Bound			West Bound		
Approach:	L	T	R	L	T	R	L	T	R	L	T	R
Min. Green:	7	10	10	7	10	10	7	10	10	7	10	10
Y+R:	4.0	4.0	4.0	4.0	4.0	4.0	4.0	4.0	4.0	4.0	4.0	4.0

Volume Module:	>>	Count	Date:	8 May 2018	<<							
Base Vol:	153	401	208	146	936	87	77	264	135	329	216	122
Growth Adj:	1.00	1.00	1.00	1.00	1.00	1.00	1.00	1.00	1.00	1.00	1.00	1.00
Initial Bse:	153	401	208	146	936	87	77	264	135	329	216	122
Added Vol:	4	65	44	0	28	0	0	0	6	68	0	0
PasserByVol:	0	0	0	0	0	0	0	0	0	0	0	0
Initial Fut:	157	466	252	146	964	87	77	264	141	397	216	122
User Adj:	1.00	1.00	1.00	1.00	1.00	1.00	1.00	1.00	1.00	1.00	1.00	1.00
PHF Adj:	1.00	1.00	1.00	1.00	1.00	1.00	1.00	1.00	1.00	1.00	1.00	1.00
PHF Volume:	157	466	252	146	964	87	77	264	141	397	216	122
Reduct Vol:	0	0	0	0	0	0	0	0	0	0	0	0
Reduced Vol:	157	466	252	146	964	87	77	264	141	397	216	122
PCE Adj:	1.00	1.00	1.00	1.00	1.00	1.00	1.00	1.00	1.00	1.00	1.00	1.00
MLF Adj:	1.00	1.00	1.00	1.00	1.00	1.00	1.00	1.00	1.00	1.00	1.00	1.00
FinalVolume:	157	466	252	146	964	87	77	264	141	397	216	122

Saturation Flow Module:												
Sat/Lane:	1900	1900	1900	1900	1900	1900	1900	1900	1900	1900	1900	1900
Adjustment:	0.92	1.00	0.92	0.92	1.00	0.92	0.92	1.00	0.92	0.83	1.00	0.92
Lanes:	1.00	2.00	1.00	1.00	2.00	1.00	1.00	2.00	1.00	2.00	1.00	1.00
Final Sat.:	1750	3800	1750	1750	3800	1750	1750	3800	1750	3150	1900	1750

Capacity Analysis Module:												
Vol/Sat:	0.09	0.12	0.14	0.08	0.25	0.05	0.04	0.07	0.08	0.13	0.11	0.07
Crit Moves:	****				****				****	****		
Green Time:	15.2	36.8	36.8	21.3	42.9	55.8	12.9	13.6	13.6	21.3	22.0	43.3
Volume/Cap:	0.62	0.35	0.41	0.41	0.62	0.09	0.36	0.54	0.62	0.62	0.54	0.17
Delay/Veh:	46.9	25.4	26.4	37.2	25.4	12.2	43.3	43.9	48.5	40.0	38.5	19.6
User DelAdj:	1.00	1.00	1.00	1.00	1.00	1.00	1.00	1.00	1.00	1.00	1.00	1.00
AdjDel/Veh:	46.9	25.4	26.4	37.2	25.4	12.2	43.3	43.9	48.5	40.0	38.5	19.6
LOS by Move:	D	C	C	D	C	B	D	D	D	D	D	B
HCM2kAvgQ:	5	5	6	4	12	1	3	5	6	7	6	3

Note: Queue reported is the number of cars per lane.

Voices School
Morgan Hill, CA
Hexagon Transportation Consultants, Inc.

Level Of Service Computation Report
2000 HCM Operations (Future Volume Alternative)
2025 Plus Project (AM) - 1 Cosmo Full out

Intersection #122: Monterey Road and Dunne Avenue

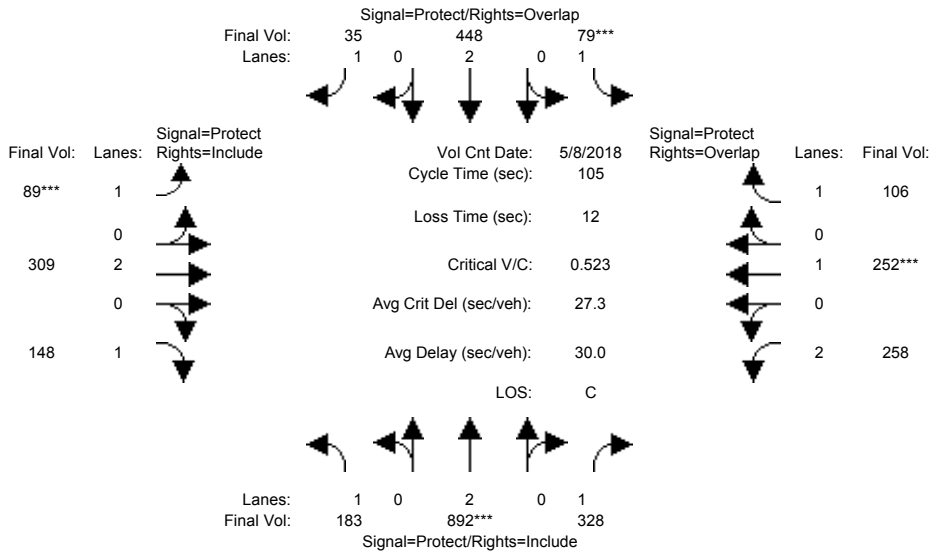

Street Name:	Monterey Road						Dunne Avenue					
	North Bound			South Bound			East Bound			West Bound		
Approach:	L	T	R	L	T	R	L	T	R	L	T	R
Min. Green:	7	10	10	7	10	10	7	10	10	7	10	10
Y+R:	4.0	4.0	4.0	4.0	4.0	4.0	4.0	4.0	4.0	4.0	4.0	4.0

Volume Module:	>>	Count	Date:	8 May 2018	<<											
Base Vol:	115	741	170	79	330	32	85	255	74	144	227	101				
Growth Adj:	1.00	1.00	1.00	1.00	1.00	1.00	1.00	1.00	1.00	1.00	1.00	1.00				
Initial Bse:	115	741	170	79	330	32	85	255	74	144	227	101				
Added Vol:	2	53	126	0	102	0	0	0	30	74	0	0				
PasserByVol:	66	98	32	0	16	3	4	54	44	40	25	5				
Initial Fut:	183	892	328	79	448	35	89	309	148	258	252	106				
User Adj:	1.00	1.00	1.00	1.00	1.00	1.00	1.00	1.00	1.00	1.00	1.00	1.00				
PHF Adj:	1.00	1.00	1.00	1.00	1.00	1.00	1.00	1.00	1.00	1.00	1.00	1.00				
PHF Volume:	183	892	328	79	448	35	89	309	148	258	252	106				
Reduct Vol:	0	0	0	0	0	0	0	0	0	0	0	0				
Reduced Vol:	183	892	328	79	448	35	89	309	148	258	252	106				
PCE Adj:	1.00	1.00	1.00	1.00	1.00	1.00	1.00	1.00	1.00	1.00	1.00	1.00				
MLF Adj:	1.00	1.00	1.00	1.00	1.00	1.00	1.00	1.00	1.00	1.00	1.00	1.00				
FinalVolume:	183	892	328	79	448	35	89	309	148	258	252	106				

Saturation Flow Module:												
Sat/Lane:	1900	1900	1900	1900	1900	1900	1900	1900	1900	1900	1900	1900
Adjustment:	0.92	1.00	0.92	0.92	1.00	0.92	0.92	1.00	0.92	0.83	1.00	0.92
Lanes:	1.00	2.00	1.00	1.00	2.00	1.00	1.00	2.00	1.00	2.00	1.00	1.00
Final Sat.:	1750	3800	1750	1750	3800	1750	1750	3800	1750	3150	1900	1750

Capacity Analysis Module:												
Vol/Sat:	0.10	0.23	0.19	0.05	0.12	0.02	0.05	0.08	0.08	0.08	0.13	0.06
Crit Moves:	****			****			****			****		
Green Time:	26.4	47.1	47.1	9.1	29.8	40.0	10.2	19.8	19.8	17.0	26.6	35.7
Volume/Cap:	0.42	0.52	0.42	0.52	0.42	0.05	0.52	0.43	0.45	0.51	0.52	0.18
Delay/Veh:	33.5	21.1	20.0	49.2	30.8	20.6	48.0	38.0	38.7	41.0	34.8	24.5
User DelAdj:	1.00	1.00	1.00	1.00	1.00	1.00	1.00	1.00	1.00	1.00	1.00	1.00
AdjDel/Veh:	33.5	21.1	20.0	49.2	30.8	20.6	48.0	38.0	38.7	41.0	34.8	24.5
LOS by Move:	C	C	B	D	C	C	D	D	D	D	C	C
HCM2kAvgQ:	5	10	7	3	6	1	4	5	5	4	7	2

Note: Queue reported is the number of cars per lane.

Voices School
Morgan Hill, CA
Hexagon Transportation Consultants, Inc.

Level Of Service Computation Report
2000 HCM Operations (Future Volume Alternative)
2025 Plus Project (PM) - 1 Cosmo Full out

Intersection #122: Monterey Road and Dunne Avenue

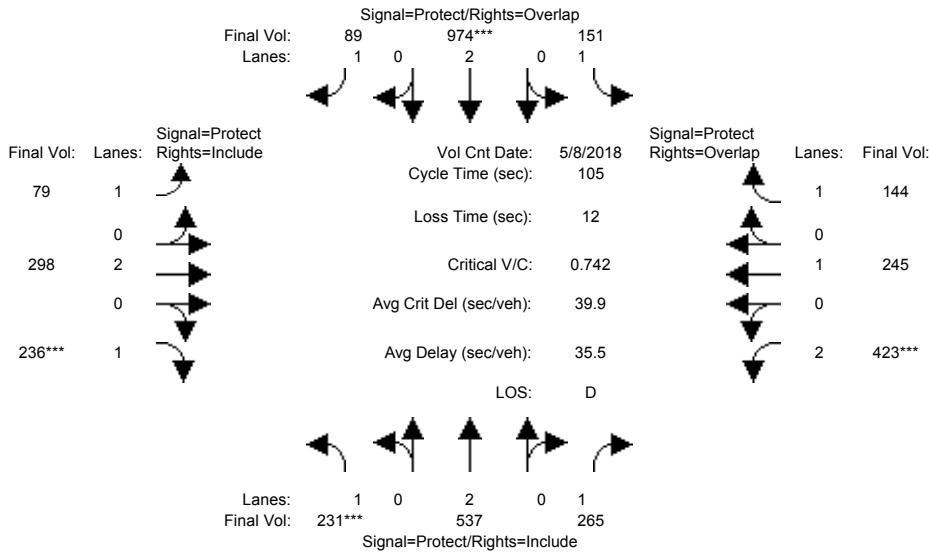

Street Name:	Monterey Road						Dunne Avenue					
	North Bound			South Bound			East Bound			West Bound		
Approach:	L	T	R	L	T	R	L	T	R	L	T	R
Min. Green:	7	10	10	7	10	10	7	10	10	7	10	10
Y+R:	4.0	4.0	4.0	4.0	4.0	4.0	4.0	4.0	4.0	4.0	4.0	4.0

Volume Module:	>>	Count	Date:	8 May 2018	<<							
Base Vol:	153	401	208	146	936	87	77	264	135	329	216	122
Growth Adj:	1.00	1.00	1.00	1.00	1.00	1.00	1.00	1.00	1.00	1.00	1.00	1.00
Initial Bse:	153	401	208	146	936	87	77	264	135	329	216	122
Added Vol:	4	65	41	0	28	0	0	0	5	64	0	0
PasserByVol:	74	71	16	5	10	2	2	34	96	30	29	22
Initial Fut:	231	537	265	151	974	89	79	298	236	423	245	144
User Adj:	1.00	1.00	1.00	1.00	1.00	1.00	1.00	1.00	1.00	1.00	1.00	1.00
PHF Adj:	1.00	1.00	1.00	1.00	1.00	1.00	1.00	1.00	1.00	1.00	1.00	1.00
PHF Volume:	231	537	265	151	974	89	79	298	236	423	245	144
Reduct Vol:	0	0	0	0	0	0	0	0	0	0	0	0
Reduced Vol:	231	537	265	151	974	89	79	298	236	423	245	144
PCE Adj:	1.00	1.00	1.00	1.00	1.00	1.00	1.00	1.00	1.00	1.00	1.00	1.00
MLF Adj:	1.00	1.00	1.00	1.00	1.00	1.00	1.00	1.00	1.00	1.00	1.00	1.00
FinalVolume:	231	537	265	151	974	89	79	298	236	423	245	144

Saturation Flow Module:												
Sat/Lane:	1900	1900	1900	1900	1900	1900	1900	1900	1900	1900	1900	1900
Adjustment:	0.92	1.00	0.92	0.92	1.00	0.92	0.92	1.00	0.92	0.83	1.00	0.92
Lanes:	1.00	2.00	1.00	1.00	2.00	1.00	1.00	2.00	1.00	2.00	1.00	1.00
Final Sat.:	1750	3800	1750	1750	3800	1750	1750	3800	1750	3150	1900	1750

Capacity Analysis Module:												
Vol/Sat:	0.13	0.14	0.15	0.09	0.26	0.05	0.05	0.08	0.13	0.13	0.13	0.08
Crit Moves:	****			****			****		****	****		
Green Time:	18.7	35.0	35.0	19.9	36.3	49.2	13.0	19.1	19.1	19.0	25.1	45.0
Volume/Cap:	0.74	0.42	0.45	0.45	0.74	0.11	0.37	0.43	0.74	0.74	0.54	0.19
Delay/Veh:	50.1	27.4	28.1	38.7	32.6	15.7	43.3	38.6	49.7	45.9	36.2	18.8
User DelAdj:	1.00	1.00	1.00	1.00	1.00	1.00	1.00	1.00	1.00	1.00	1.00	1.00
AdjDel/Veh:	50.1	27.4	28.1	38.7	32.6	15.7	43.3	38.6	49.7	45.9	36.2	18.8
LOS by Move:	D	C	C	D	C	B	D	D	D	D	D	B
HCM2kAvgQ:	8	6	7	4	13	2	3	5	9	8	7	3

Note: Queue reported is the number of cars per lane.

Voices School
Morgan Hill, CA
Hexagon Transportation Consultants, Inc.

Level Of Service Computation Report
2000 HCM Operations (Future Volume Alternative)
Existing Plus Project (AM) - 1 Cosmo Full out

Intersection #123: Butterfield Boulevard and Dunne Avenue

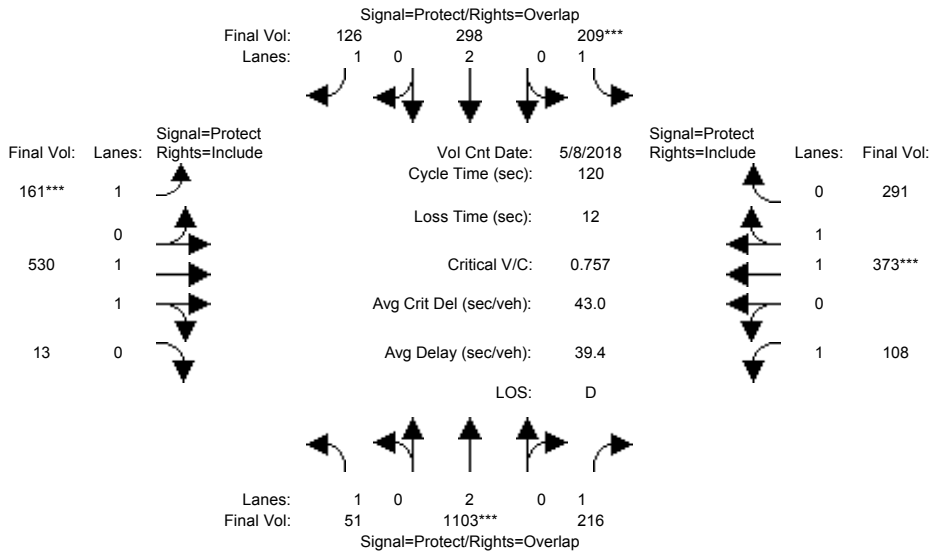

Street Name:	Butterfield Boulevard						Dunne Avenue					
	North Bound			South Bound			East Bound			West Bound		
Approach:	L	T	R	L	T	R	L	T	R	L	T	R
Min. Green:	7	10	10	7	10	10	7	10	10	7	10	10
Y+R:	4.0	4.0	4.0	4.0	4.0	4.0	4.0	4.0	4.0	4.0	4.0	4.0

Volume Module:	>>	Count	Date:	8 May 2018	<<							
Base Vol:	51	1103	216	209	298	111	153	408	13	108	312	291
Growth Adj:	1.00	1.00	1.00	1.00	1.00	1.00	1.00	1.00	1.00	1.00	1.00	1.00
Initial Bse:	51	1103	216	209	298	111	153	408	13	108	312	291
Added Vol:	0	0	0	0	0	15	8	122	0	0	61	0
PasserByVol:	0	0	0	0	0	0	0	0	0	0	0	0
Initial Fut:	51	1103	216	209	298	126	161	530	13	108	373	291
User Adj:	1.00	1.00	1.00	1.00	1.00	1.00	1.00	1.00	1.00	1.00	1.00	1.00
PHF Adj:	1.00	1.00	1.00	1.00	1.00	1.00	1.00	1.00	1.00	1.00	1.00	1.00
PHF Volume:	51	1103	216	209	298	126	161	530	13	108	373	291
Reduct Vol:	0	0	0	0	0	0	0	0	0	0	0	0
Reduced Vol:	51	1103	216	209	298	126	161	530	13	108	373	291
PCE Adj:	1.00	1.00	1.00	1.00	1.00	1.00	1.00	1.00	1.00	1.00	1.00	1.00
MLF Adj:	1.00	1.00	1.00	1.00	1.00	1.00	1.00	1.00	1.00	1.00	1.00	1.00
Final Volume:	51	1103	216	209	298	126	161	530	13	108	373	291

Saturation Flow Module:												
Sat/Lane:	1900	1900	1900	1900	1900	1900	1900	1900	1900	1900	1900	1900
Adjustment:	0.92	1.00	0.92	0.92	1.00	0.92	0.92	0.97	0.95	0.92	0.99	0.95
Lanes:	1.00	2.00	1.00	1.00	2.00	1.00	1.00	1.95	0.05	1.00	1.10	0.90
Final Sat.:	1750	3800	1750	1750	3800	1750	1750	3611	89	1750	2077	1621

Capacity Analysis Module:												
Vol/Sat:	0.03	0.29	0.12	0.12	0.08	0.07	0.09	0.15	0.15	0.06	0.18	0.18
Crit Moves:	****			****			****			****		
Green Time:	26.7	46.0	58.8	18.9	38.2	52.8	14.6	30.3	30.3	12.7	28.5	28.5
Volume/Cap:	0.13	0.76	0.25	0.76	0.25	0.16	0.76	0.58	0.58	0.58	0.76	0.76
Delay/Veh:	37.5	34.5	18.0	59.7	30.4	20.4	65.4	40.2	40.2	55.7	46.4	46.4
User DelAdj:	1.00	1.00	1.00	1.00	1.00	1.00	1.00	1.00	1.00	1.00	1.00	1.00
AdjDel/Veh:	37.5	34.5	18.0	59.7	30.4	20.4	65.4	40.2	40.2	55.7	46.4	46.4
LOS by Move:	D	C	B	E	C	C	E	D	D	E	D	D
HCM2kAvgQ:	2	18	5	10	4	3	6	9	9	4	12	12

Note: Queue reported is the number of cars per lane.

Voices School
Morgan Hill, CA
Hexagon Transportation Consultants, Inc.

Level Of Service Computation Report
2000 HCM Operations (Future Volume Alternative)
Existing Plus Project (PM) - 1 Cosmo Full out

Intersection #123: Butterfield Boulevard and Dunne Avenue

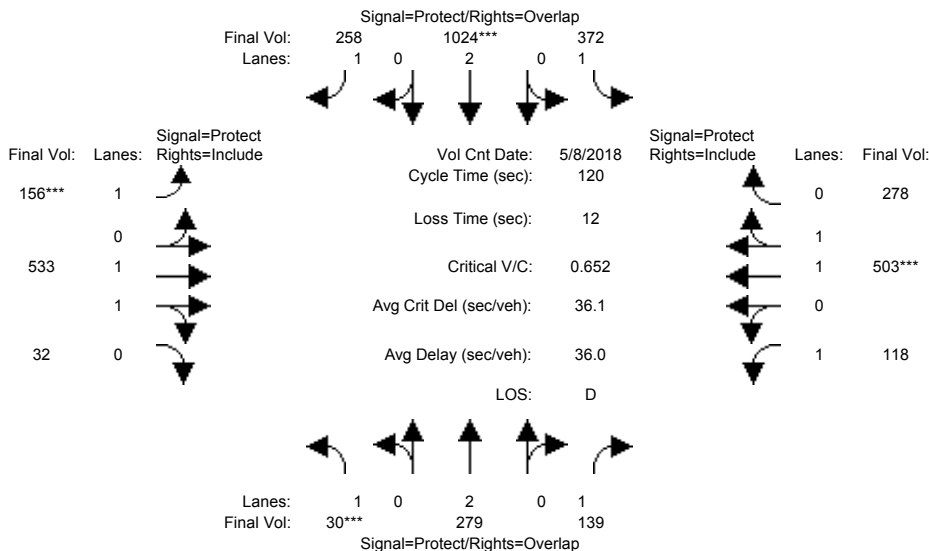

Street Name:	Butterfield Boulevard						Dunne Avenue					
	North Bound			South Bound			East Bound			West Bound		
Approach:	L	T	R	L	T	R	L	T	R	L	T	R
Min. Green:	7	10	10	7	10	10	7	10	10	7	10	10
Y+R:	4.0	4.0	4.0	4.0	4.0	4.0	4.0	4.0	4.0	4.0	4.0	4.0

Volume Module:	>>	Count	Date:	8 May 2018	<<							
Base Vol:	30	279	139	372	1024	254	147	498	32	118	439	278
Growth Adj:	1.00	1.00	1.00	1.00	1.00	1.00	1.00	1.00	1.00	1.00	1.00	1.00
Initial Bse:	30	279	139	372	1024	254	147	498	32	118	439	278
Added Vol:	0	0	0	0	0	4	9	35	0	0	64	0
PasserByVol:	0	0	0	0	0	0	0	0	0	0	0	0
Initial Fut:	30	279	139	372	1024	258	156	533	32	118	503	278
User Adj:	1.00	1.00	1.00	1.00	1.00	1.00	1.00	1.00	1.00	1.00	1.00	1.00
PHF Adj:	1.00	1.00	1.00	1.00	1.00	1.00	1.00	1.00	1.00	1.00	1.00	1.00
PHF Volume:	30	279	139	372	1024	258	156	533	32	118	503	278
Reduct Vol:	0	0	0	0	0	0	0	0	0	0	0	0
Reduced Vol:	30	279	139	372	1024	258	156	533	32	118	503	278
PCE Adj:	1.00	1.00	1.00	1.00	1.00	1.00	1.00	1.00	1.00	1.00	1.00	1.00
MLF Adj:	1.00	1.00	1.00	1.00	1.00	1.00	1.00	1.00	1.00	1.00	1.00	1.00
Final Volume:	30	279	139	372	1024	258	156	533	32	118	503	278

Saturation Flow Module:												
Sat/Lane:	1900	1900	1900	1900	1900	1900	1900	1900	1900	1900	1900	1900
Adjustment:	0.92	1.00	0.92	0.92	1.00	0.92	0.92	0.98	0.95	0.92	0.99	0.95
Lanes:	1.00	2.00	1.00	1.00	2.00	1.00	1.00	1.88	0.12	1.00	1.27	0.73
Final Sat.:	1750	3800	1750	1750	3800	1750	1750	3490	210	1750	2382	1316

Capacity Analysis Module:												
Vol/Sat:	0.02	0.07	0.08	0.21	0.27	0.15	0.09	0.15	0.15	0.07	0.21	0.21
Crit Moves:	****			****			****			****		
Green Time:	7.0	15.4	31.7	39.3	47.8	63.6	15.8	36.9	36.9	16.3	37.4	37.4
Volume/Cap:	0.29	0.57	0.30	0.65	0.68	0.28	0.68	0.50	0.50	0.50	0.68	0.68
Delay/Veh:	55.7	50.8	35.6	37.0	31.0	15.7	57.5	34.3	34.3	49.7	37.6	37.6
User DelAdj:	1.00	1.00	1.00	1.00	1.00	1.00	1.00	1.00	1.00	1.00	1.00	1.00
AdjDel/Veh:	55.7	50.8	35.6	37.0	31.0	15.7	57.5	34.3	34.3	49.7	37.6	37.6
LOS by Move:	E	D	D	D	C	B	E	C	C	D	D	D
HCM2kAvgQ:	1	5	4	13	16	6	6	8	8	4	13	13

Note: Queue reported is the number of cars per lane.

Voices School
Morgan Hill, CA
Hexagon Transportation Consultants, Inc.

Level Of Service Computation Report
2000 HCM Operations (Future Volume Alternative)
2025 Plus Project (AM) - 1 Cosmo Full out

Intersection #123: Butterfield Boulevard and Dunne Avenue

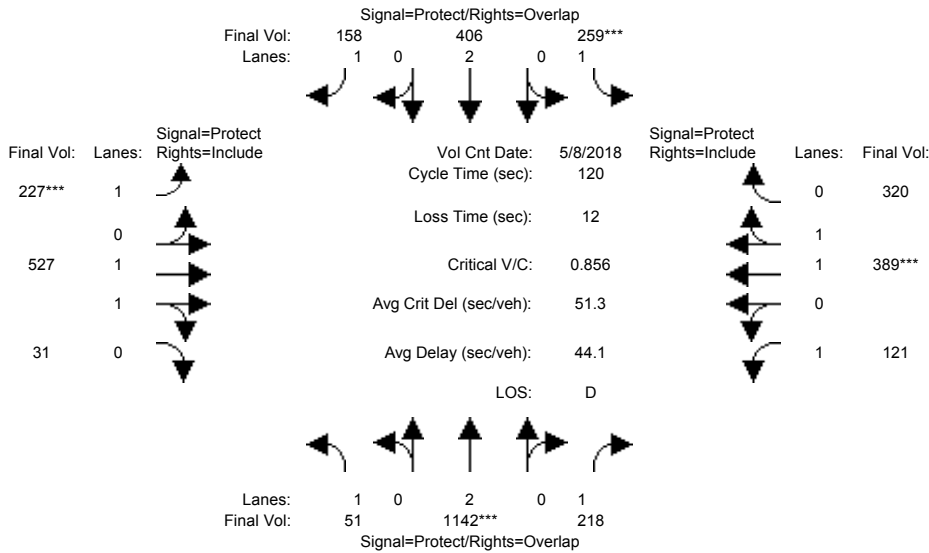

Street Name:	Butterfield Boulevard						Dunne Avenue					
	North Bound			South Bound			East Bound			West Bound		
Approach:	L	T	R	L	T	R	L	T	R	L	T	R
Min. Green:	7	10	10	7	10	10	7	10	10	7	10	10
Y+R:	4.0	4.0	4.0	4.0	4.0	4.0	4.0	4.0	4.0	4.0	4.0	4.0

Volume Module:	>>	Count	Date:	8 May 2018	<<							
Base Vol:	51	1103	216	209	298	111	153	408	13	108	312	291
Growth Adj:	1.00	1.00	1.00	1.00	1.00	1.00	1.00	1.00	1.00	1.00	1.00	1.00
Initial Bse:	51	1103	216	209	298	111	153	408	13	108	312	291
Added Vol:	0	0	0	0	0	15	8	119	0	0	60	0
PasserByVol:	0	39	2	50	108	32	66	0	18	13	17	29
Initial Fut:	51	1142	218	259	406	158	227	527	31	121	389	320
User Adj:	1.00	1.00	1.00	1.00	1.00	1.00	1.00	1.00	1.00	1.00	1.00	1.00
PHF Adj:	1.00	1.00	1.00	1.00	1.00	1.00	1.00	1.00	1.00	1.00	1.00	1.00
PHF Volume:	51	1142	218	259	406	158	227	527	31	121	389	320
Reduct Vol:	0	0	0	0	0	0	0	0	0	0	0	0
Reduced Vol:	51	1142	218	259	406	158	227	527	31	121	389	320
PCE Adj:	1.00	1.00	1.00	1.00	1.00	1.00	1.00	1.00	1.00	1.00	1.00	1.00
MLF Adj:	1.00	1.00	1.00	1.00	1.00	1.00	1.00	1.00	1.00	1.00	1.00	1.00
FinalVolume:	51	1142	218	259	406	158	227	527	31	121	389	320

Saturation Flow Module:												
Sat/Lane:	1900	1900	1900	1900	1900	1900	1900	1900	1900	1900	1900	1900
Adjustment:	0.92	1.00	0.92	0.92	1.00	0.92	0.92	0.98	0.95	0.92	1.00	0.95
Lanes:	1.00	2.00	1.00	1.00	2.00	1.00	1.00	1.89	0.11	1.00	1.07	0.93
Final Sat.:	1750	3800	1750	1750	3800	1750	1750	3494	206	1750	2029	1669

Capacity Analysis Module:												
Vol/Sat:	0.03	0.30	0.12	0.15	0.11	0.09	0.13	0.15	0.15	0.07	0.19	0.19
Crit Moves:	****			****			****			****		
Green Time:	22.2	42.2	56.3	20.8	40.7	58.9	18.2	30.9	30.9	14.2	26.9	26.9
Volume/Cap:	0.16	0.86	0.27	0.86	0.32	0.18	0.86	0.59	0.59	0.59	0.86	0.86
Delay/Veh:	41.3	41.7	19.5	68.7	29.5	17.2	72.5	39.9	39.9	54.4	53.4	53.4
User DelAdj:	1.00	1.00	1.00	1.00	1.00	1.00	1.00	1.00	1.00	1.00	1.00	1.00
AdjDel/Veh:	41.3	41.7	19.5	68.7	29.5	17.2	72.5	39.9	39.9	54.4	53.4	53.4
LOS by Move:	D	D	B	E	C	B	E	D	D	D	D	D
HCM2kAvgQ:	2	20	5	13	5	3	10	9	9	5	14	14

Note: Queue reported is the number of cars per lane.

Voices School
Morgan Hill, CA
Hexagon Transportation Consultants, Inc.

Level Of Service Computation Report
2000 HCM Operations (Future Volume Alternative)
2025 Plus Project (PM) - 1 Cosmo Full out

Intersection #123: Butterfield Boulevard and Dunne Avenue

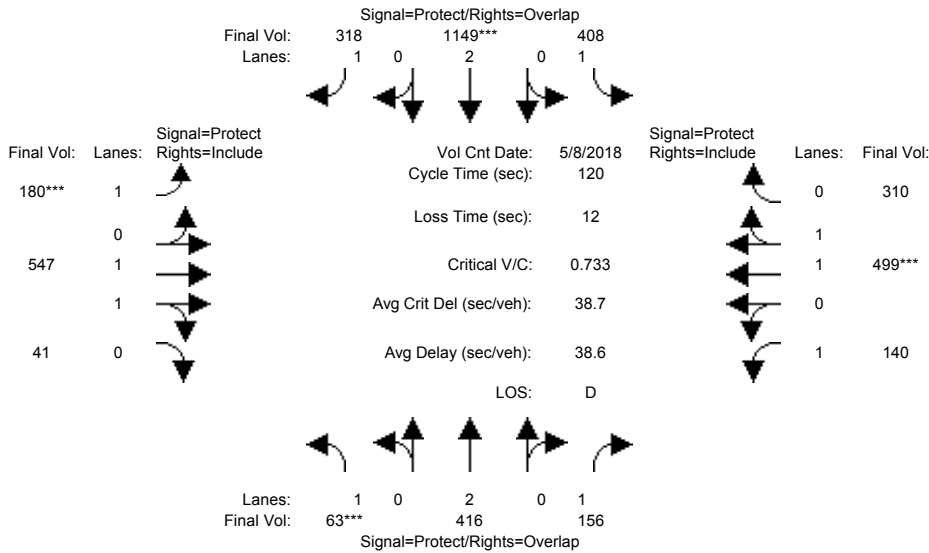

Street Name:	Butterfield Boulevard						Dunne Avenue					
	North Bound			South Bound			East Bound			West Bound		
Approach:	L	T	R	L	T	R	L	T	R	L	T	R
Min. Green:	7	10	10	7	10	10	7	10	10	7	10	10
Y+R:	4.0	4.0	4.0	4.0	4.0	4.0	4.0	4.0	4.0	4.0	4.0	4.0

Volume Module:	>>	Count	Date:	8 May 2018	<<							
Base Vol:	30	279	139	372	1024	254	147	498	32	118	439	278
Growth Adj:	1.00	1.00	1.00	1.00	1.00	1.00	1.00	1.00	1.00	1.00	1.00	1.00
Initial Bse:	30	279	139	372	1024	254	147	498	32	118	439	278
Added Vol:	0	0	0	0	0	4	9	32	0	0	60	0
PasserByVol:	33	137	17	36	125	60	24	17	9	22	0	32
Initial Fut:	63	416	156	408	1149	318	180	547	41	140	499	310
User Adj:	1.00	1.00	1.00	1.00	1.00	1.00	1.00	1.00	1.00	1.00	1.00	1.00
PHF Adj:	1.00	1.00	1.00	1.00	1.00	1.00	1.00	1.00	1.00	1.00	1.00	1.00
PHF Volume:	63	416	156	408	1149	318	180	547	41	140	499	310
Reduct Vol:	0	0	0	0	0	0	0	0	0	0	0	0
Reduced Vol:	63	416	156	408	1149	318	180	547	41	140	499	310
PCE Adj:	1.00	1.00	1.00	1.00	1.00	1.00	1.00	1.00	1.00	1.00	1.00	1.00
MLF Adj:	1.00	1.00	1.00	1.00	1.00	1.00	1.00	1.00	1.00	1.00	1.00	1.00
FinalVolume:	63	416	156	408	1149	318	180	547	41	140	499	310

Saturation Flow Module:												
Sat/Lane:	1900	1900	1900	1900	1900	1900	1900	1900	1900	1900	1900	1900
Adjustment:	0.92	1.00	0.92	0.92	1.00	0.92	0.92	0.98	0.95	0.92	0.99	0.95
Lanes:	1.00	2.00	1.00	1.00	2.00	1.00	1.00	1.86	0.14	1.00	1.21	0.79
Final Sat.:	1750	3800	1750	1750	3800	1750	1750	3442	258	1750	2281	1417

Capacity Analysis Module:												
Vol/Sat:	0.04	0.11	0.09	0.23	0.30	0.18	0.10	0.16	0.16	0.08	0.22	0.22
Crit Moves:	****				****		****				****	
Green Time:	7.0	17.9	35.3	38.1	48.9	65.6	16.6	34.6	34.6	17.4	35.4	35.4
Volume/Cap:	0.62	0.73	0.30	0.73	0.74	0.33	0.74	0.55	0.55	0.55	0.74	0.74
Delay/Veh:	66.1	53.8	33.1	41.6	32.1	15.3	61.2	36.7	36.7	50.2	40.9	40.9
User DelAdj:	1.00	1.00	1.00	1.00	1.00	1.00	1.00	1.00	1.00	1.00	1.00	1.00
AdjDel/Veh:	66.1	53.8	33.1	41.6	32.1	15.3	61.2	36.7	36.7	50.2	40.9	40.9
LOS by Move:	E	D	C	D	C	B	E	D	D	D	D	D
HCM2kAvgQ:	3	8	5	16	19	7	7	9	9	5	14	14

Note: Queue reported is the number of cars per lane.

Voices School
Morgan Hill, CA
Hexagon Transportation Consultants, Inc.

Level Of Service Computation Report
2000 HCM Operations (Future Volume Alternative)
Existing Plus Project (AM) - 1 Cosmo Full out

Intersection #124: US 101 Southbound Ramps and Dunne Avenue

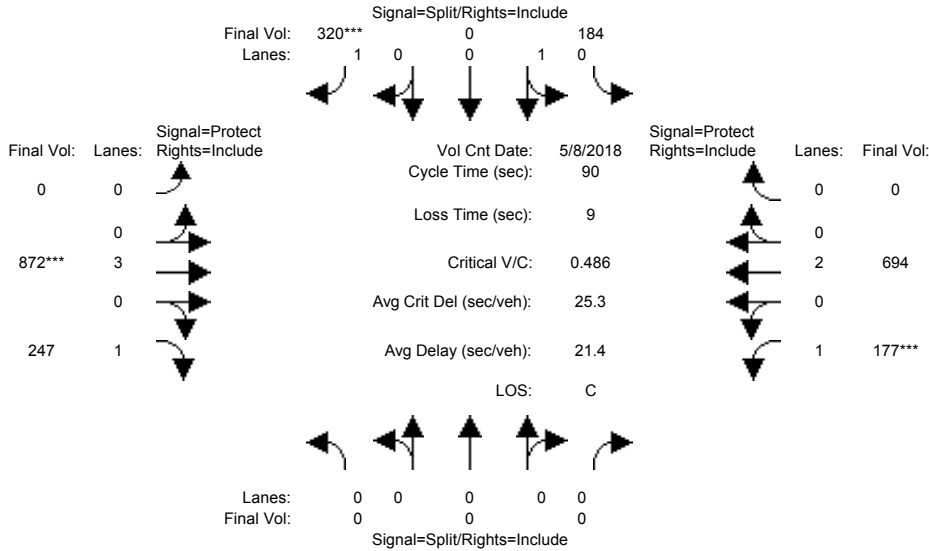

Street Name:	US 101 Southbound Ramps						Dunne Avenue					
Approach:	North Bound			South Bound			East Bound			West Bound		
Movement:	L	T	R	L	T	R	L	T	R	L	T	R

Min. Green:	0	0	0	10	10	10	0	10	10	7	10	0
Y+R:	4.0	4.0	4.0	4.0	4.0	4.0	4.0	4.0	4.0	4.0	4.0	4.0

Volume Module:	>>	Count	Date:	8 May 2018	<<							
Base Vol:	0	0	0	184	0	288	0	750	247	177	664	0
Growth Adj:	1.00	1.00	1.00	1.00	1.00	1.00	1.00	1.00	1.00	1.00	1.00	1.00
Initial Bse:	0	0	0	184	0	288	0	750	247	177	664	0
Added Vol:	0	0	0	0	0	32	0	122	0	0	30	0
PasserByVol:	0	0	0	0	0	0	0	0	0	0	0	0
Initial Fut:	0	0	0	184	0	320	0	872	247	177	694	0
User Adj:	1.00	1.00	1.00	1.00	1.00	1.00	1.00	1.00	1.00	1.00	1.00	1.00
PHF Adj:	1.00	1.00	1.00	1.00	1.00	1.00	1.00	1.00	1.00	1.00	1.00	1.00
PHF Volume:	0	0	0	184	0	320	0	872	247	177	694	0
Reduct Vol:	0	0	0	0	0	0	0	0	0	0	0	0
Reduced Vol:	0	0	0	184	0	320	0	872	247	177	694	0
PCE Adj:	1.00	1.00	1.00	1.00	1.00	1.00	1.00	1.00	1.00	1.00	1.00	1.00
MLF Adj:	1.00	1.00	1.00	1.00	1.00	1.00	1.00	1.00	1.00	1.00	1.00	1.00
FinalVolume:	0	0	0	184	0	320	0	872	247	177	694	0

Saturation Flow Module:												
Sat/Lane:	1900	1900	1900	1900	1900	1900	1900	1900	1900	1900	1900	1900
Adjustment:	0.92	1.00	0.92	0.95	0.95	0.92	0.92	1.00	0.92	0.92	1.00	0.92
Lanes:	0.00	0.00	0.00	1.00	0.00	1.00	0.00	3.00	1.00	1.00	2.00	0.00
Final Sat.:	0	0	0	1800	0	1750	0	5700	1750	1750	3800	0

Capacity Analysis Module:												
Vol/Sat:	0.00	0.00	0.00	0.10	0.00	0.18	0.00	0.15	0.14	0.10	0.18	0.00
Crit Moves:						****		****		****		
Green Time:	0.0	0.0	0.0	33.9	0.0	33.9	0.0	28.4	28.4	18.7	47.1	0.0
Volume/Cap:	0.00	0.00	0.00	0.27	0.00	0.49	0.00	0.49	0.45	0.49	0.35	0.00
Delay/Veh:	0.0	0.0	0.0	19.7	0.0	22.0	0.0	25.1	25.2	32.4	12.6	0.0
User DelAdj:	1.00	1.00	1.00	1.00	1.00	1.00	1.00	1.00	1.00	1.00	1.00	1.00
AdjDel/Veh:	0.0	0.0	0.0	19.7	0.0	22.0	0.0	25.1	25.2	32.4	12.6	0.0
LOS by Move:	A	A	A	B	A	C	A	C	C	C	B	A
HCM2kAvgQ:	0	0	0	4	0	7	0	6	6	5	6	0

Note: Queue reported is the number of cars per lane.

Voices School
Morgan Hill, CA
Hexagon Transportation Consultants, Inc.

Level Of Service Computation Report
2000 HCM Operations (Future Volume Alternative)
Existing Plus Project (PM) - 1 Cosmo Full out

Intersection #124: US 101 Southbound Ramps and Dunne Avenue

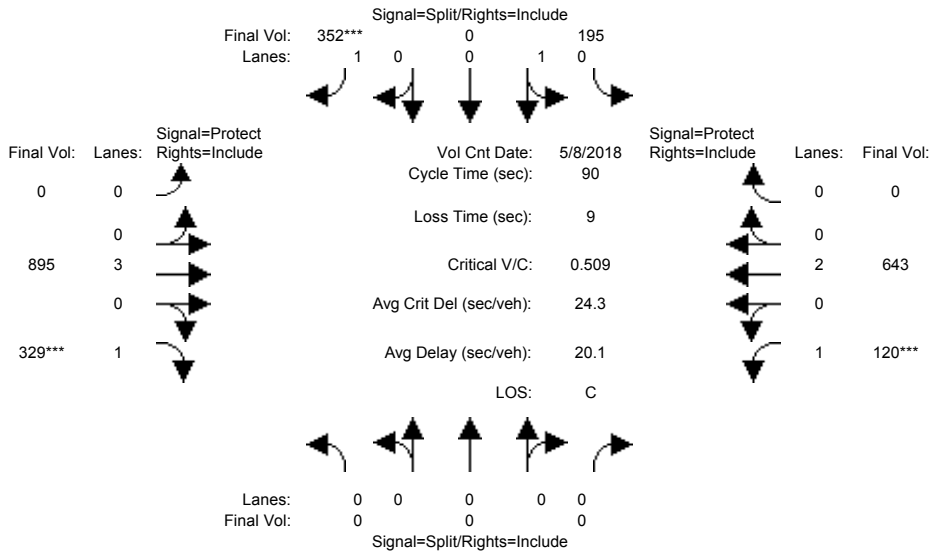

Street Name:	US 101 Southbound Ramps						Dunne Avenue					
	North Bound			South Bound			East Bound			West Bound		
Approach:	L	T	R	L	T	R	L	T	R	L	T	R
Min. Green:	0	0	0	10	10	10	0	10	10	7	10	0
Y+R:	4.0	4.0	4.0	4.0	4.0	4.0	4.0	4.0	4.0	4.0	4.0	4.0

Volume Module:	>>	Count	Date:	8 May 2018	<<							
Base Vol:	0	0	0	195	0	294	0	860	329	120	637	0
Growth Adj:	1.00	1.00	1.00	1.00	1.00	1.00	1.00	1.00	1.00	1.00	1.00	1.00
Initial Bse:	0	0	0	195	0	294	0	860	329	120	637	0
Added Vol:	0	0	0	0	0	58	0	35	0	0	6	0
PasserByVol:	0	0	0	0	0	0	0	0	0	0	0	0
Initial Fut:	0	0	0	195	0	352	0	895	329	120	643	0
User Adj:	1.00	1.00	1.00	1.00	1.00	1.00	1.00	1.00	1.00	1.00	1.00	1.00
PHF Adj:	1.00	1.00	1.00	1.00	1.00	1.00	1.00	1.00	1.00	1.00	1.00	1.00
PHF Volume:	0	0	0	195	0	352	0	895	329	120	643	0
Reduct Vol:	0	0	0	0	0	0	0	0	0	0	0	0
Reduced Vol:	0	0	0	195	0	352	0	895	329	120	643	0
PCE Adj:	1.00	1.00	1.00	1.00	1.00	1.00	1.00	1.00	1.00	1.00	1.00	1.00
MLF Adj:	1.00	1.00	1.00	1.00	1.00	1.00	1.00	1.00	1.00	1.00	1.00	1.00
FinalVolume:	0	0	0	195	0	352	0	895	329	120	643	0

Saturation Flow Module:												
Sat/Lane:	1900	1900	1900	1900	1900	1900	1900	1900	1900	1900	1900	1900
Adjustment:	0.92	1.00	0.92	0.95	0.95	0.92	0.92	1.00	0.92	0.92	1.00	0.92
Lanes:	0.00	0.00	0.00	1.00	0.00	1.00	0.00	3.00	1.00	1.00	2.00	0.00
Final Sat.:	0	0	0	1800	0	1750	0	5700	1750	1750	3800	0

Capacity Analysis Module:												
Vol/Sat:	0.00	0.00	0.00	0.11	0.00	0.20	0.00	0.16	0.19	0.07	0.17	0.00
Crit Moves:						****			****			****
Green Time:	0.0	0.0	0.0	35.6	0.0	35.6	0.0	33.3	33.3	12.1	45.4	0.0
Volume/Cap:	0.00	0.00	0.00	0.27	0.00	0.51	0.00	0.42	0.51	0.51	0.34	0.00
Delay/Veh:	0.0	0.0	0.0	18.7	0.0	21.2	0.0	21.3	22.7	38.0	13.4	0.0
User DelAdj:	1.00	1.00	1.00	1.00	1.00	1.00	1.00	1.00	1.00	1.00	1.00	1.00
AdjDel/Veh:	0.0	0.0	0.0	18.7	0.0	21.2	0.0	21.3	22.7	38.0	13.4	0.0
LOS by Move:	A	A	A	B	A	C	A	C	C	D	B	A
HCM2kAvgQ:	0	0	0	4	0	8	0	6	7	4	5	0

Note: Queue reported is the number of cars per lane.

Voices School
Morgan Hill, CA
Hexagon Transportation Consultants, Inc.

Level Of Service Computation Report
2000 HCM Operations (Future Volume Alternative)
2025 Plus Project (AM) - 1 Cosmo Full out

Intersection #124: US 101 Southbound Ramps and Dunne Avenue

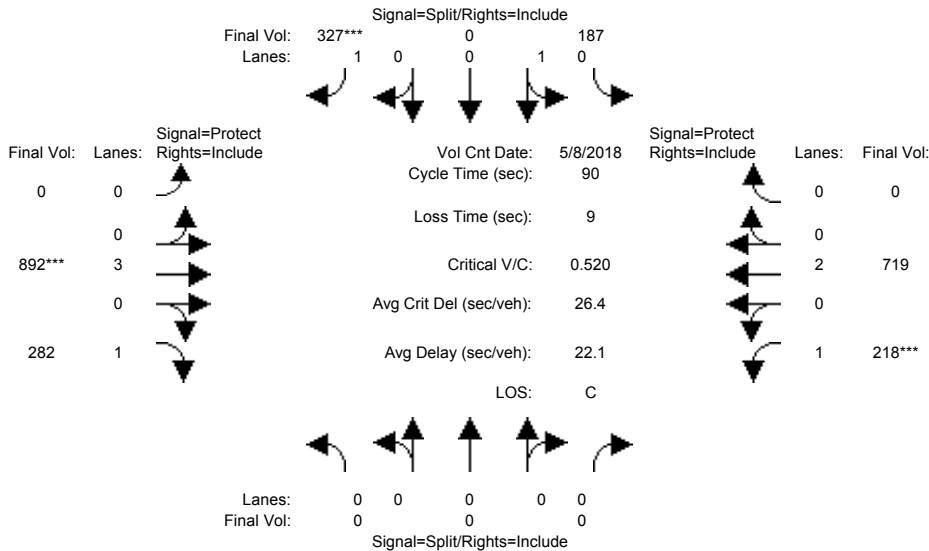

Street Name:	US 101 Southbound Ramps						Dunne Avenue					
Approach:	North Bound			South Bound			East Bound			West Bound		
Movement:	L	T	R	L	T	R	L	T	R	L	T	R
Min. Green:	0	0	0	10	10	10	0	10	10	7	10	0
Y+R:	4.0	4.0	4.0	4.0	4.0	4.0	4.0	4.0	4.0	4.0	4.0	4.0
Volume Module: >> Count Date: 8 May 2018 <<												
Base Vol:	0	0	0	184	0	288	0	750	247	177	664	0
Growth Adj:	1.00	1.00	1.00	1.00	1.00	1.00	1.00	1.00	1.00	1.00	1.00	1.00
Initial Bse:	0	0	0	184	0	288	0	750	247	177	664	0
Added Vol:	0	0	0	0	0	30	0	119	0	0	30	0
PasserByVol:	0	0	0	3	0	9	0	23	35	41	25	0
Initial Fut:	0	0	0	187	0	327	0	892	282	218	719	0
User Adj:	1.00	1.00	1.00	1.00	1.00	1.00	1.00	1.00	1.00	1.00	1.00	1.00
PHF Adj:	1.00	1.00	1.00	1.00	1.00	1.00	1.00	1.00	1.00	1.00	1.00	1.00
PHF Volume:	0	0	0	187	0	327	0	892	282	218	719	0
Reduct Vol:	0	0	0	0	0	0	0	0	0	0	0	0
Reduced Vol:	0	0	0	187	0	327	0	892	282	218	719	0
PCE Adj:	1.00	1.00	1.00	1.00	1.00	1.00	1.00	1.00	1.00	1.00	1.00	1.00
MLF Adj:	1.00	1.00	1.00	1.00	1.00	1.00	1.00	1.00	1.00	1.00	1.00	1.00
Final Volume:	0	0	0	187	0	327	0	892	282	218	719	0
Saturation Flow Module:												
Sat/Lane:	1900	1900	1900	1900	1900	1900	1900	1900	1900	1900	1900	1900
Adjustment:	0.92	1.00	0.92	0.95	0.95	0.92	0.92	1.00	0.92	0.92	1.00	0.92
Lanes:	0.00	0.00	0.00	1.00	0.00	1.00	0.00	3.00	1.00	1.00	2.00	0.00
Final Sat.:	0	0	0	1800	0	1750	0	5700	1750	1750	3800	0
Capacity Analysis Module:												
Vol/Sat:	0.00	0.00	0.00	0.10	0.00	0.19	0.00	0.16	0.16	0.12	0.19	0.00
Crit Moves:						****		****		****		
Green Time:	0.0	0.0	0.0	32.3	0.0	32.3	0.0	27.1	27.1	21.6	48.7	0.0
Volume/Cap:	0.00	0.00	0.00	0.29	0.00	0.52	0.00	0.52	0.54	0.52	0.35	0.00
Delay/Veh:	0.0	0.0	0.0	20.9	0.0	23.5	0.0	26.4	27.3	30.9	11.8	0.0
User DelAdj:	1.00	1.00	1.00	1.00	1.00	1.00	1.00	1.00	1.00	1.00	1.00	1.00
AdjDel/Veh:	0.0	0.0	0.0	20.9	0.0	23.5	0.0	26.4	27.3	30.9	11.8	0.0
LOS by Move:	A	A	A	C	A	C	A	C	C	C	B	A
HCM2kAvgQ:	0	0	0	4	0	8	0	7	7	6	6	0

Note: Queue reported is the number of cars per lane.

Voices School
Morgan Hill, CA
Hexagon Transportation Consultants, Inc.

Level Of Service Computation Report
2000 HCM Operations (Future Volume Alternative)
2025 Plus Project (PM) - 1 Cosmo Full out

Intersection #124: US 101 Southbound Ramps and Dunne Avenue

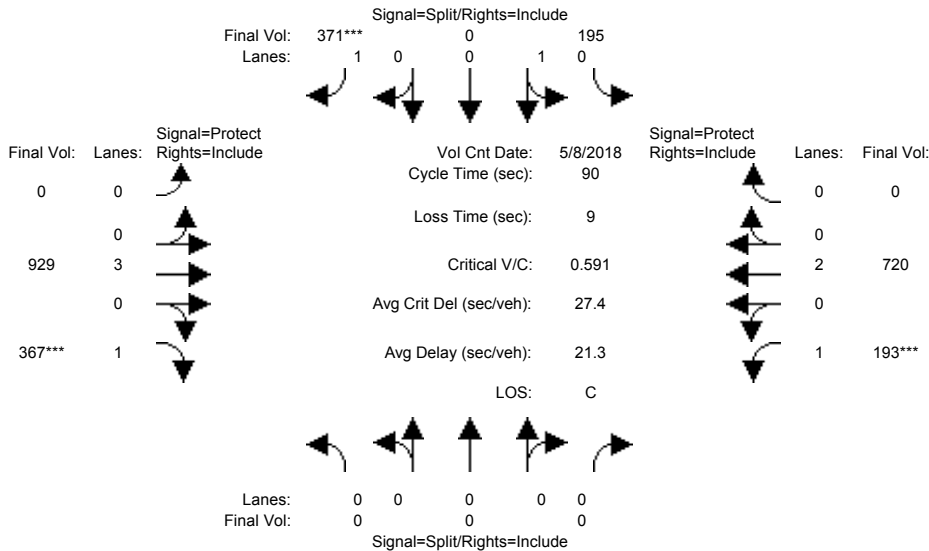

Street Name:	US 101 Southbound Ramps						Dunne Avenue					
Approach:	North Bound			South Bound			East Bound			West Bound		
Movement:	L	T	R	L	T	R	L	T	R	L	T	R
Min. Green:	0	0	0	10	10	10	0	10	10	7	10	0
Y+R:	4.0	4.0	4.0	4.0	4.0	4.0	4.0	4.0	4.0	4.0	4.0	4.0
Volume Module: >> Count Date: 8 May 2018 <<												
Base Vol:	0	0	0	195	0	294	0	860	329	120	637	0
Growth Adj:	1.00	1.00	1.00	1.00	1.00	1.00	1.00	1.00	1.00	1.00	1.00	1.00
Initial Bse:	0	0	0	195	0	294	0	860	329	120	637	0
Added Vol:	0	0	0	0	0	55	0	32	0	0	5	0
PasserByVol:	0	0	0	0	0	22	0	37	38	73	78	0
Initial Fut:	0	0	0	195	0	371	0	929	367	193	720	0
User Adj:	1.00	1.00	1.00	1.00	1.00	1.00	1.00	1.00	1.00	1.00	1.00	1.00
PHF Adj:	1.00	1.00	1.00	1.00	1.00	1.00	1.00	1.00	1.00	1.00	1.00	1.00
PHF Volume:	0	0	0	195	0	371	0	929	367	193	720	0
Reduct Vol:	0	0	0	0	0	0	0	0	0	0	0	0
Reduced Vol:	0	0	0	195	0	371	0	929	367	193	720	0
PCE Adj:	1.00	1.00	1.00	1.00	1.00	1.00	1.00	1.00	1.00	1.00	1.00	1.00
MLF Adj:	1.00	1.00	1.00	1.00	1.00	1.00	1.00	1.00	1.00	1.00	1.00	1.00
FinalVolume:	0	0	0	195	0	371	0	929	367	193	720	0
Saturation Flow Module:												
Sat/Lane:	1900	1900	1900	1900	1900	1900	1900	1900	1900	1900	1900	1900
Adjustment:	0.92	1.00	0.92	0.95	0.95	0.92	0.92	1.00	0.92	0.92	1.00	0.92
Lanes:	0.00	0.00	0.00	1.00	0.00	1.00	0.00	3.00	1.00	1.00	2.00	0.00
Final Sat.:	0	0	0	1800	0	1750	0	5700	1750	1750	3800	0
Capacity Analysis Module:												
Vol/Sat:	0.00	0.00	0.00	0.11	0.00	0.21	0.00	0.16	0.21	0.11	0.19	0.00
Crit Moves:						****			****			****
Green Time:	0.0	0.0	0.0	32.3	0.0	32.3	0.0	31.9	31.9	16.8	48.7	0.0
Volume/Cap:	0.00	0.00	0.00	0.30	0.00	0.59	0.00	0.46	0.59	0.59	0.35	0.00
Delay/Veh:	0.0	0.0	0.0	21.0	0.0	25.0	0.0	22.5	25.2	36.3	11.8	0.0
User DelAdj:	1.00	1.00	1.00	1.00	1.00	1.00	1.00	1.00	1.00	1.00	1.00	1.00
AdjDel/Veh:	0.0	0.0	0.0	21.0	0.0	25.0	0.0	22.5	25.2	36.3	11.8	0.0
LOS by Move:	A	A	A	C	A	C	A	C	C	D	B	A
HCM2kAvgQ:	0	0	0	4	0	9	0	6	9	6	6	0

Note: Queue reported is the number of cars per lane.

Voices School
Morgan Hill, CA
Hexagon Transportation Consultants, Inc.

Level Of Service Computation Report
2000 HCM Operations (Future Volume Alternative)
Existing Plus Project (AM) - 1 Cosmo Full out

Intersection #125: US 101 Northbound Ramps and Dunne Avenue

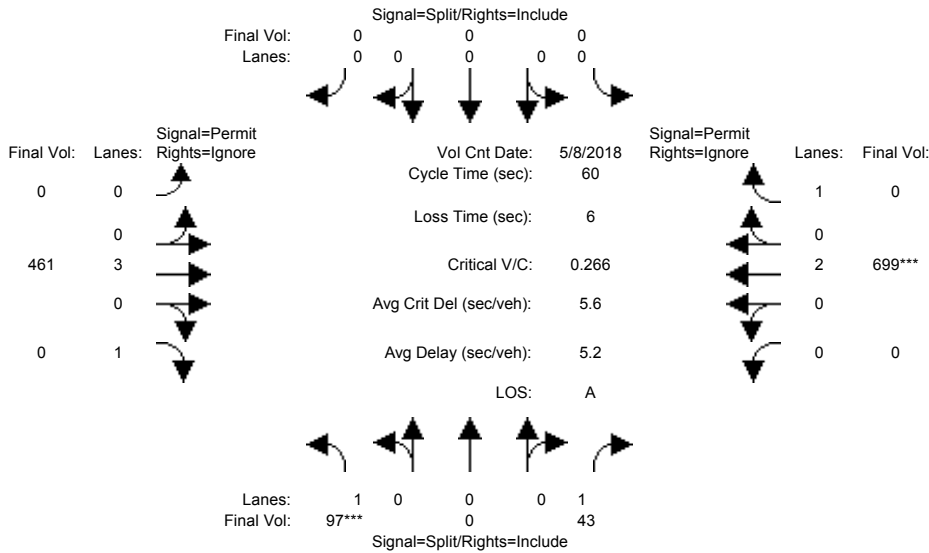

Street Name:	US 101 Northbound Ramps						Dunne Avenue					
	North Bound			South Bound			East Bound			West Bound		
Approach:	L	T	R	L	T	R	L	T	R	L	T	R
Min. Green:	10	0	10	0	0	0	0	10	10	0	10	10
Y+R:	4.0	4.0	4.0	4.0	4.0	4.0	4.0	4.0	4.0	4.0	4.0	4.0

Volume Module:	>>	Count	Date:	8 May 2018	<<							
Base Vol:	97	0	43	0	0	0	0	450	0	0	669	0
Growth Adj:	1.00	1.00	1.00	1.00	1.00	1.00	1.00	1.00	1.00	1.00	1.00	1.00
Initial Bse:	97	0	43	0	0	0	0	450	0	0	669	0
Added Vol:	0	0	0	0	0	0	0	11	111	0	30	0
PasserByVol:	0	0	0	0	0	0	0	0	0	0	0	0
Initial Fut:	97	0	43	0	0	0	0	461	111	0	699	0
User Adj:	1.00	1.00	1.00	1.00	1.00	1.00	1.00	1.00	0.00	1.00	1.00	0.00
PHF Adj:	1.00	1.00	1.00	1.00	1.00	1.00	1.00	1.00	0.00	1.00	1.00	0.00
PHF Volume:	97	0	43	0	0	0	0	461	0	0	699	0
Reduct Vol:	0	0	0	0	0	0	0	0	0	0	0	0
Reduced Vol:	97	0	43	0	0	0	0	461	0	0	699	0
PCE Adj:	1.00	1.00	1.00	1.00	1.00	1.00	1.00	1.00	0.00	1.00	1.00	0.00
MLF Adj:	1.00	1.00	1.00	1.00	1.00	1.00	1.00	1.00	0.00	1.00	1.00	0.00
FinalVolume:	97	0	43	0	0	0	0	461	0	0	699	0

Saturation Flow Module:	
Sat/Lane:	1900 1900 1900 1900 1900 1900 1900 1900 1900 1900 1900 1900
Adjustment:	0.92 1.00 0.92 0.92 1.00 0.92 0.92 1.00 0.92 0.92 1.00 0.92
Lanes:	1.00 0.00 1.00 0.00 0.00 0.00 0.00 3.00 1.00 0.00 2.00 1.00
Final Sat.:	1750 0 1750 0 0 0 0 5700 1750 0 3800 1750

Capacity Analysis Module:	
Vol/Sat:	0.06 0.00 0.02 0.00 0.00 0.00 0.00 0.08 0.00 0.00 0.18 0.00
Crit Moves:	****
Green Time:	12.5 0.0 12.5 0.0 0.0 0.0 0.0 41.5 0.0 0.0 41.5 0.0
Volume/Cap:	0.27 0.00 0.12 0.00 0.00 0.00 0.00 0.12 0.00 0.00 0.27 0.00
Delay/Veh:	20.3 0.0 19.4 0.0 0.0 0.0 0.0 3.1 0.0 0.0 3.6 0.0
User DelAdj:	1.00 1.00 1.00 1.00 1.00 1.00 1.00 1.00 1.00 1.00 1.00 1.00
AdjDel/Veh:	20.3 0.0 19.4 0.0 0.0 0.0 0.0 3.1 0.0 0.0 3.6 0.0
LOS by Move:	C A B A A A A A A A A
HCM2kAvgQ:	2 0 1 0 0 0 0 1 0 0 3 0

Note: Queue reported is the number of cars per lane.

Voices School
Morgan Hill, CA
Hexagon Transportation Consultants, Inc.

Level Of Service Computation Report
2000 HCM Operations (Future Volume Alternative)
Existing Plus Project (PM) - 1 Cosmo Full out

Intersection #125: US 101 Northbound Ramps and Dunne Avenue

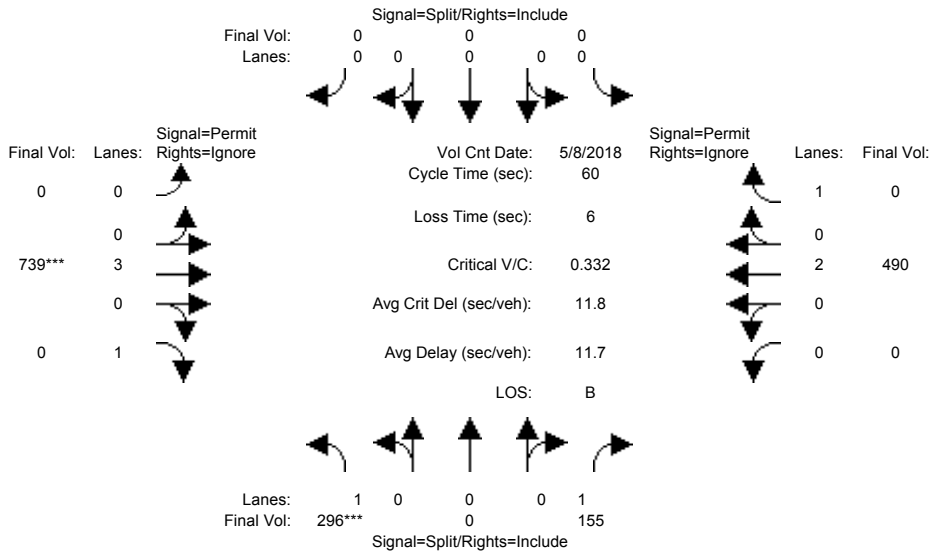

Street Name: US 101 Northbound Ramps Dunne Avenue
Approach: North Bound South Bound East Bound West Bound
Movement: L - T - R L - T - R L - T - R L - T - R

Min. Green: 10 0 10 0 0 0 0 10 10 0 10 10
Y+R: 4.0 4.0 4.0 4.0 4.0 4.0 4.0 4.0 4.0 4.0 4.0 4.0

Volume Module: >> Count Date: 8 May 2018 <<

Base Vol:	296	0	155	0	0	0	0	720	0	0	484	0
Growth Adj:	1.00	1.00	1.00	1.00	1.00	1.00	1.00	1.00	1.00	1.00	1.00	1.00
Initial Bse:	296	0	155	0	0	0	0	720	0	0	484	0
Added Vol:	0	0	0	0	0	0	0	19	17	0	6	0
PasserByVol:	0	0	0	0	0	0	0	0	0	0	0	0
Initial Fut:	296	0	155	0	0	0	0	739	17	0	490	0
User Adj:	1.00	1.00	1.00	1.00	1.00	1.00	1.00	1.00	0.00	1.00	1.00	0.00
PHF Adj:	1.00	1.00	1.00	1.00	1.00	1.00	1.00	1.00	0.00	1.00	1.00	0.00
PHF Volume:	296	0	155	0	0	0	0	739	0	0	490	0
Reduct Vol:	0	0	0	0	0	0	0	0	0	0	0	0
Reduced Vol:	296	0	155	0	0	0	0	739	0	0	490	0
PCE Adj:	1.00	1.00	1.00	1.00	1.00	1.00	1.00	1.00	0.00	1.00	1.00	0.00
MLF Adj:	1.00	1.00	1.00	1.00	1.00	1.00	1.00	1.00	0.00	1.00	1.00	0.00
FinalVolume:	296	0	155	0	0	0	0	739	0	0	490	0

Saturation Flow Module:

Sat/Lane:	1900	1900	1900	1900	1900	1900	1900	1900	1900	1900	1900	1900
Adjustment:	0.92	1.00	0.92	0.92	1.00	0.92	0.92	1.00	0.92	0.92	1.00	0.92
Lanes:	1.00	0.00	1.00	0.00	0.00	0.00	0.00	3.00	1.00	0.00	2.00	1.00
Final Sat.:	1750	0	1750	0	0	0	0	5700	1750	0	3800	1750

Capacity Analysis Module:

Vol/Sat:	0.17	0.00	0.09	0.00	0.00	0.00	0.00	0.13	0.00	0.00	0.13	0.00
Crit Moves:	****							****				
Green Time:	30.6	0.0	30.6	0.0	0.0	0.0	0.0	23.4	0.0	0.0	23.4	0.0
Volume/Cap:	0.33	0.00	0.17	0.00	0.00	0.00	0.00	0.33	0.00	0.00	0.33	0.00
Delay/Veh:	8.9	0.0	8.0	0.0	0.0	0.0	0.0	12.9	0.0	0.0	12.9	0.0
User DelAdj:	1.00	1.00	1.00	1.00	1.00	1.00	1.00	1.00	1.00	1.00	1.00	1.00
AdjDel/Veh:	8.9	0.0	8.0	0.0	0.0	0.0	0.0	12.9	0.0	0.0	12.9	0.0
LOS by Move:	A	A	A	A	A	A	A	B	A	A	B	A
HCM2kAvgQ:	4	0	2	0	0	0	0	3	0	0	3	0

Note: Queue reported is the number of cars per lane.

Voices School
Morgan Hill, CA
Hexagon Transportation Consultants, Inc.

Level Of Service Computation Report
2000 HCM Operations (Future Volume Alternative)
2025 Plus Project (AM) - 1 Cosmo Full out

Intersection #125: US 101 Northbound Ramps and Dunne Avenue

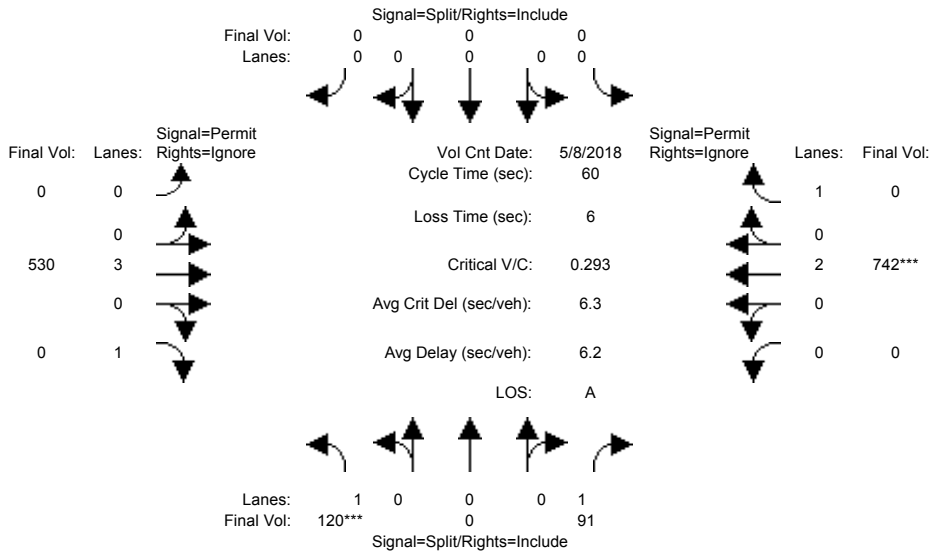

Street Name:	US 101 Northbound Ramps						Dunne Avenue					
	North Bound			South Bound			East Bound			West Bound		
Approach:	L	T	R	L	T	R	L	T	R	L	T	R
Min. Green:	10	0	10	0	0	0	0	10	10	0	10	10
Y+R:	4.0	4.0	4.0	4.0	4.0	4.0	4.0	4.0	4.0	4.0	4.0	4.0

Volume Module:	>>	Count	Date:	8 May 2018	<<							
Base Vol:	97	0	43	0	0	0	0	450	0	0	669	0
Growth Adj:	1.00	1.00	1.00	1.00	1.00	1.00	1.00	1.00	1.00	1.00	1.00	1.00
Initial Bse:	97	0	43	0	0	0	0	450	0	0	669	0
Added Vol:	0	0	0	0	0	0	0	10	108	0	30	0
PasserByVol:	23	0	48	0	0	0	0	70	0	0	43	0
Initial Fut:	120	0	91	0	0	0	0	530	108	0	742	0
User Adj:	1.00	1.00	1.00	1.00	1.00	1.00	1.00	1.00	0.00	1.00	1.00	0.00
PHF Adj:	1.00	1.00	1.00	1.00	1.00	1.00	1.00	1.00	0.00	1.00	1.00	0.00
PHF Volume:	120	0	91	0	0	0	0	530	0	0	742	0
Reduct Vol:	0	0	0	0	0	0	0	0	0	0	0	0
Reduced Vol:	120	0	91	0	0	0	0	530	0	0	742	0
PCE Adj:	1.00	1.00	1.00	1.00	1.00	1.00	1.00	1.00	0.00	1.00	1.00	0.00
MLF Adj:	1.00	1.00	1.00	1.00	1.00	1.00	1.00	1.00	0.00	1.00	1.00	0.00
FinalVolume:	120	0	91	0	0	0	0	530	0	0	742	0

Saturation Flow Module:												
Sat/Lane:	1900	1900	1900	1900	1900	1900	1900	1900	1900	1900	1900	1900
Adjustment:	0.92	1.00	0.92	0.92	1.00	0.92	0.92	1.00	0.92	0.92	1.00	0.92
Lanes:	1.00	0.00	1.00	0.00	0.00	0.00	0.00	3.00	1.00	0.00	2.00	1.00
Final Sat.:	1750	0	1750	0	0	0	0	5700	1750	0	3800	1750

Capacity Analysis Module:												
Vol/Sat:	0.07	0.00	0.05	0.00	0.00	0.00	0.00	0.09	0.00	0.00	0.20	0.00
Crit Moves:	****											
Green Time:	14.0	0.0	14.0	0.0	0.0	0.0	0.0	40.0	0.0	0.0	40.0	0.0
Volume/Cap:	0.29	0.00	0.22	0.00	0.00	0.00	0.00	0.14	0.00	0.00	0.29	0.00
Delay/Veh:	19.3	0.0	18.8	0.0	0.0	0.0	0.0	3.7	0.0	0.0	4.2	0.0
User DelAdj:	1.00	1.00	1.00	1.00	1.00	1.00	1.00	1.00	1.00	1.00	1.00	1.00
AdjDel/Veh:	19.3	0.0	18.8	0.0	0.0	0.0	0.0	3.7	0.0	0.0	4.2	0.0
LOS by Move:	B	A	B	A	A	A	A	A	A	A	A	A
HCM2kAvgQ:	2	0	2	0	0	0	0	1	0	0	3	0

Note: Queue reported is the number of cars per lane.

Voices School
Morgan Hill, CA
Hexagon Transportation Consultants, Inc.

Level Of Service Computation Report
2000 HCM Operations (Future Volume Alternative)
2025 Plus Project (PM) - 1 Cosmo Full out

Intersection #125: US 101 Northbound Ramps and Dunne Avenue

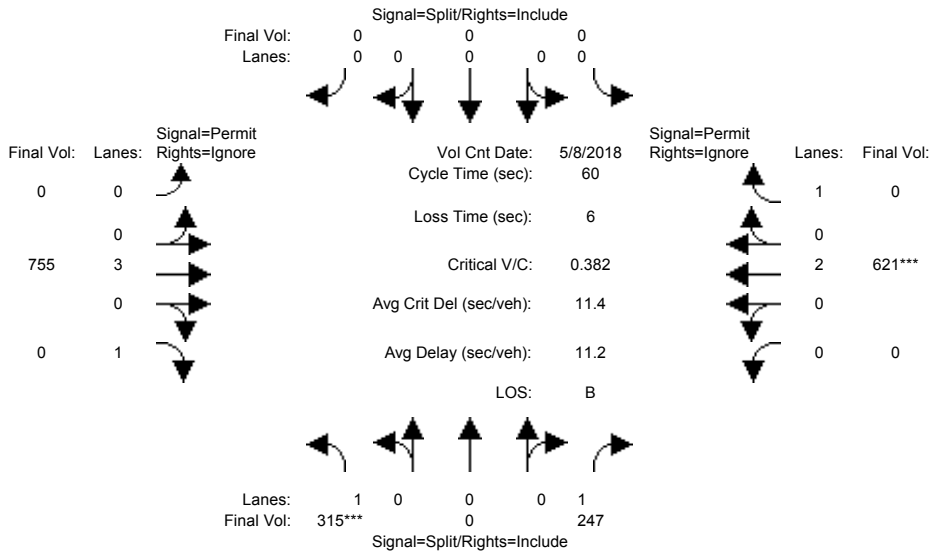

Street Name: US 101 Northbound Ramps Dunne Avenue
Approach: North Bound South Bound East Bound West Bound
Movement: L - T - R L - T - R L - T - R L - T - R

Min. Green: 10 0 10 0 0 0 0 10 10 0 10 10
Y+R: 4.0 4.0 4.0 4.0 4.0 4.0 4.0 4.0 4.0 4.0 4.0 4.0

Volume Module: >> Count Date: 8 May 2018 <<

Base Vol:	296	0	155	0	0	0	0	720	0	0	484	0
Growth Adj:	1.00	1.00	1.00	1.00	1.00	1.00	1.00	1.00	1.00	1.00	1.00	1.00
Initial Bse:	296	0	155	0	0	0	0	720	0	0	484	0
Added Vol:	0	0	0	0	0	0	0	18	14	0	5	0
PasserByVol:	19	0	92	0	0	0	0	17	0	0	132	0
Initial Fut:	315	0	247	0	0	0	0	755	14	0	621	0
User Adj:	1.00	1.00	1.00	1.00	1.00	1.00	1.00	1.00	0.00	1.00	1.00	0.00
PHF Adj:	1.00	1.00	1.00	1.00	1.00	1.00	1.00	1.00	0.00	1.00	1.00	0.00
PHF Volume:	315	0	247	0	0	0	0	755	0	0	621	0
Reduct Vol:	0	0	0	0	0	0	0	0	0	0	0	0
Reduced Vol:	315	0	247	0	0	0	0	755	0	0	621	0
PCE Adj:	1.00	1.00	1.00	1.00	1.00	1.00	1.00	1.00	0.00	1.00	1.00	0.00
MLF Adj:	1.00	1.00	1.00	1.00	1.00	1.00	1.00	1.00	0.00	1.00	1.00	0.00
FinalVolume:	315	0	247	0	0	0	0	755	0	0	621	0

Saturation Flow Module:

Sat/Lane:	1900	1900	1900	1900	1900	1900	1900	1900	1900	1900	1900	1900
Adjustment:	0.92	1.00	0.92	0.92	1.00	0.92	0.92	1.00	0.92	0.92	1.00	0.92
Lanes:	1.00	0.00	1.00	0.00	0.00	0.00	0.00	3.00	1.00	0.00	2.00	1.00
Final Sat.:	1750	0	1750	0	0	0	0	5700	1750	0	3800	1750

Capacity Analysis Module:

Vol/Sat:	0.18	0.00	0.14	0.00	0.00	0.00	0.00	0.13	0.00	0.00	0.16	0.00
Crit Moves:	****										****	
Green Time:	28.3	0.0	28.3	0.0	0.0	0.0	0.0	25.7	0.0	0.0	25.7	0.0
Volume/Cap:	0.38	0.00	0.30	0.00	0.00	0.00	0.00	0.31	0.00	0.00	0.38	0.00
Delay/Veh:	10.5	0.0	10.0	0.0	0.0	0.0	0.0	11.4	0.0	0.0	11.9	0.0
User DelAdj:	1.00	1.00	1.00	1.00	1.00	1.00	1.00	1.00	1.00	1.00	1.00	1.00
AdjDel/Veh:	10.5	0.0	10.0	0.0	0.0	0.0	0.0	11.4	0.0	0.0	11.9	0.0
LOS by Move:	B	A	A	A	A	A	A	B	A	A	B	A
HCM2kAvgQ:	4	0	3	0	0	0	0	3	0	0	4	0

Note: Queue reported is the number of cars per lane.

Voices School
Morgan Hill, CA
Hexagon Transportation Consultants, Inc.

Level Of Service Computation Report
2000 HCM Operations (Future Volume Alternative)
Existing Plus Project (AM) - 1 Cosmo Full out

Intersection #422: Monterey Road and Butterfield Boulevard/Watsonville Road

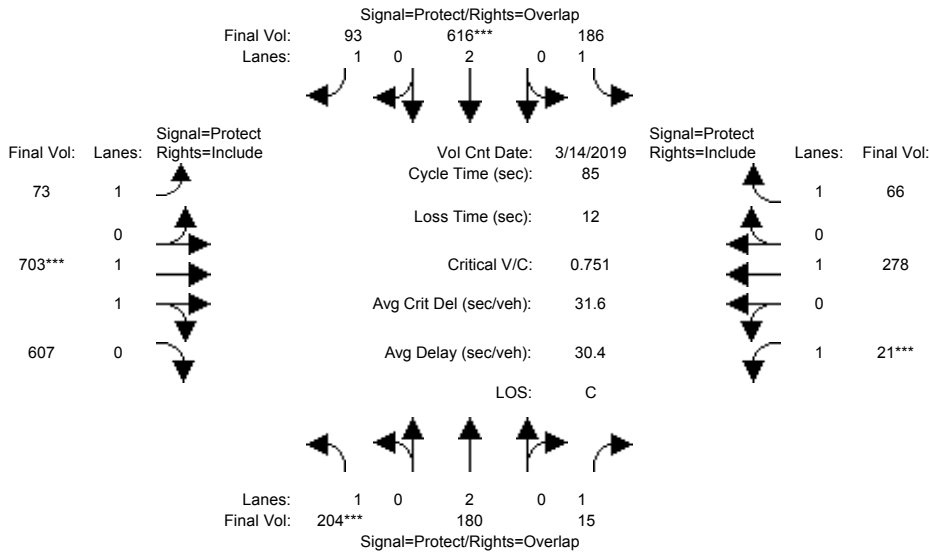

Street Name:	Monterey Rd						Butterfield Blvd/Watsonville Rd					
Approach:	North Bound			South Bound			East Bound			West Bound		
Movement:	L	T	R	L	T	R	L	T	R	L	T	R
Min. Green:	7	10	10	7	10	10	7	10	10	7	10	10
Y+R:	4.0	4.0	4.0	4.0	4.0	4.0	4.0	4.0	4.0	4.0	4.0	4.0

Volume Module:	>>	Count	Date:	14 Mar 2019	<<							
Base Vol:	204	150	15	186	597	88	58	703	607	21	278	66
Growth Adj:	1.00	1.00	1.00	1.00	1.00	1.00	1.00	1.00	1.00	1.00	1.00	1.00
Initial Bse:	204	150	15	186	597	88	58	703	607	21	278	66
Added Vol:	0	30	0	0	19	5	15	0	0	0	0	0
PasserByVol:	0	0	0	0	0	0	0	0	0	0	0	0
Initial Fut:	204	180	15	186	616	93	73	703	607	21	278	66
User Adj:	1.00	1.00	1.00	1.00	1.00	1.00	1.00	1.00	1.00	1.00	1.00	1.00
PHF Adj:	1.00	1.00	1.00	1.00	1.00	1.00	1.00	1.00	1.00	1.00	1.00	1.00
PHF Volume:	204	180	15	186	616	93	73	703	607	21	278	66
Reduct Vol:	0	0	0	0	0	0	0	0	0	0	0	0
Reduced Vol:	204	180	15	186	616	93	73	703	607	21	278	66
PCE Adj:	1.00	1.00	1.00	1.00	1.00	1.00	1.00	1.00	1.00	1.00	1.00	1.00
MLF Adj:	1.00	1.00	1.00	1.00	1.00	1.00	1.00	1.00	1.00	1.00	1.00	1.00
FinalVolume:	204	180	15	186	616	93	73	703	607	21	278	66

Saturation Flow Module:												
Sat/Lane:	1900	1900	1900	1900	1900	1900	1900	1900	1900	1900	1900	1900
Adjustment:	0.92	1.00	0.92	0.92	1.00	0.92	0.92	1.00	0.95	0.92	1.00	0.92
Lanes:	1.00	2.00	1.00	1.00	2.00	1.00	1.00	1.05	0.95	1.00	1.00	1.00
Final Sat.:	1750	3800	1750	1750	3800	1750	1750	1984	1713	1750	1900	1750

Capacity Analysis Module:												
Vol/Sat:	0.12	0.05	0.01	0.11	0.16	0.05	0.04	0.35	0.35	0.01	0.15	0.04
Crit Moves:	***			***			***			***		
Green Time:	12.2	15.3	22.3	13.8	16.9	32.7	15.8	36.9	36.9	7.0	28.1	28.1
Volume/Cap:	0.82	0.26	0.03	0.66	0.82	0.14	0.22	0.82	0.82	0.15	0.44	0.11
Delay/Veh:	53.6	30.2	23.4	38.8	39.4	17.1	29.7	24.4	24.4	36.7	22.8	19.9
User DelAdj:	1.00	1.00	1.00	1.00	1.00	1.00	1.00	1.00	1.00	1.00	1.00	1.00
AdjDel/Veh:	53.6	30.2	23.4	38.8	39.4	17.1	29.7	24.4	24.4	36.7	22.8	19.9
LOS by Move:	D	C	C	D	D	B	C	C	C	D	C	B
HCM2kAvgQ:	8	2	0	5	8	2	2	18	18	1	6	1

Note: Queue reported is the number of cars per lane.

Voices School
Morgan Hill, CA
Hexagon Transportation Consultants, Inc.

Level Of Service Computation Report
2000 HCM Operations (Future Volume Alternative)
Existing Plus Project (PM) - 1 Cosmo Full out

Intersection #422: Monterey Road and Butterfield Boulevard/Watsonville Road

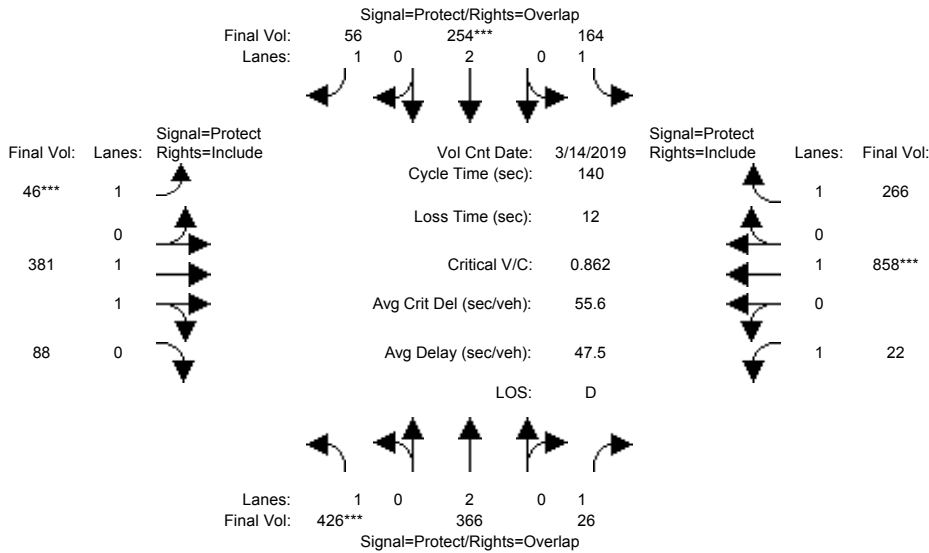

Street Name:	Monterey Rd						Butterfield Blvd/Watsonville Rd					
Approach:	North Bound			South Bound			East Bound			West Bound		
Movement:	L	T	R	L	T	R	L	T	R	L	T	R

Min. Green:	7	10	10	7	10	10	7	10	10	7	10	10
Y+R:	4.0	4.0	4.0	4.0	4.0	4.0	4.0	4.0	4.0	4.0	4.0	4.0

Volume Module:	>>	Count	Date:	14 Mar 2019	<<											
Base Vol:	426	356	26	164	235	47	43	381	88	22	858	266				
Growth Adj:	1.00	1.00	1.00	1.00	1.00	1.00	1.00	1.00	1.00	1.00	1.00	1.00				
Initial Bse:	426	356	26	164	235	47	43	381	88	22	858	266				
Added Vol:	0	10	0	0	19	9	3	0	0	0	0	0				
PasserByVol:	0	0	0	0	0	0	0	0	0	0	0	0				
Initial Fut:	426	366	26	164	254	56	46	381	88	22	858	266				
User Adj:	1.00	1.00	1.00	1.00	1.00	1.00	1.00	1.00	1.00	1.00	1.00	1.00				
PHF Adj:	1.00	1.00	1.00	1.00	1.00	1.00	1.00	1.00	1.00	1.00	1.00	1.00				
PHF Volume:	426	366	26	164	254	56	46	381	88	22	858	266				
Reduct Vol:	0	0	0	0	0	0	0	0	0	0	0	0				
Reduced Vol:	426	366	26	164	254	56	46	381	88	22	858	266				
PCE Adj:	1.00	1.00	1.00	1.00	1.00	1.00	1.00	1.00	1.00	1.00	1.00	1.00				
MLF Adj:	1.00	1.00	1.00	1.00	1.00	1.00	1.00	1.00	1.00	1.00	1.00	1.00				
Final Volume:	426	366	26	164	254	56	46	381	88	22	858	266				

Saturation Flow Module:												
Sat/Lane:	1900	1900	1900	1900	1900	1900	1900	1900	1900	1900	1900	1900
Adjustment:	0.92	1.00	0.92	0.92	1.00	0.92	0.92	0.98	0.95	0.92	1.00	0.92
Lanes:	1.00	2.00	1.00	1.00	2.00	1.00	1.00	1.61	0.39	1.00	1.00	1.00
Final Sat.:	1750	3800	1750	1750	3800	1750	1750	3005	694	1750	1900	1750

Capacity Analysis Module:												
Vol/Sat:	0.24	0.10	0.01	0.09	0.07	0.03	0.03	0.13	0.13	0.01	0.45	0.15
Crit Moves:	***				***		***				***	
Green Time:	38.7	25.0	47.2	24.3	10.6	17.6	7.0	56.5	56.5	22.3	71.7	71.7
Volume/Cap:	0.88	0.54	0.04	0.54	0.88	0.25	0.53	0.31	0.31	0.08	0.88	0.30
Delay/Veh:	65.5	53.2	31.2	54.7	89.5	55.9	70.7	28.7	28.7	50.3	39.8	19.8
User DelAdj:	1.00	1.00	1.00	1.00	1.00	1.00	1.00	1.00	1.00	1.00	1.00	1.00
AdjDel/Veh:	65.5	53.2	31.2	54.7	89.5	55.9	70.7	28.7	28.7	50.3	39.8	19.8
LOS by Move:	E	D	C	D	F	E	E	C	C	D	D	B
HCM2kAvgQ:	22	8	1	7	6	2	3	7	7	1	35	7

Note: Queue reported is the number of cars per lane.

Voices School
Morgan Hill, CA
Hexagon Transportation Consultants, Inc.

Level Of Service Computation Report
2000 HCM Operations (Future Volume Alternative)
2025 Plus Project (AM) - 1 Cosmo Full out

Intersection #422: Monterey Road and Butterfield Boulevard/Watsonville Road

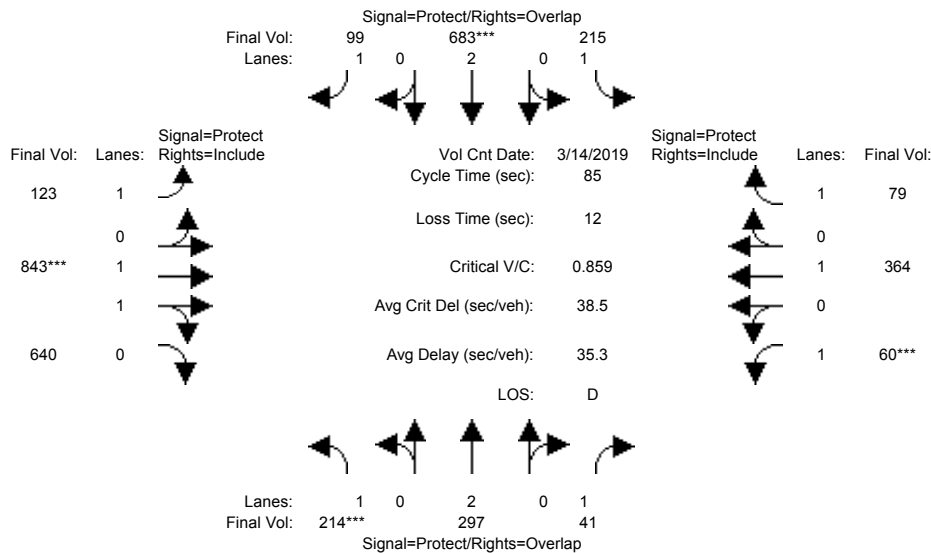

Street Name:	Monterey Rd						Butterfield Blvd/Watsonville Rd					
Approach:	North Bound			South Bound			East Bound			West Bound		
Movement:	L	T	R	L	T	R	L	T	R	L	T	R
Min. Green:	7	10	10	7	10	10	7	10	10	7	10	10
Y+R:	4.0	4.0	4.0	4.0	4.0	4.0	4.0	4.0	4.0	4.0	4.0	4.0

Volume Module:	>>	Count	Date:	14 Mar 2019	<<											
Base Vol:	204	150	15	186	597	88	58	703	607	21	278	66				
Growth Adj:	1.00	1.00	1.00	1.00	1.00	1.00	1.00	1.00	1.00	1.00	1.00	1.00				
Initial Bse:	204	150	15	186	597	88	58	703	607	21	278	66				
Added Vol:	0	30	0	0	18	5	15	0	0	0	0	0				
PasserByVol:	10	117	26	29	68	6	50	140	33	39	86	13				
Initial Fut:	214	297	41	215	683	99	123	843	640	60	364	79				
User Adj:	1.00	1.00	1.00	1.00	1.00	1.00	1.00	1.00	1.00	1.00	1.00	1.00				
PHF Adj:	1.00	1.00	1.00	1.00	1.00	1.00	1.00	1.00	1.00	1.00	1.00	1.00				
PHF Volume:	214	297	41	215	683	99	123	843	640	60	364	79				
Reduct Vol:	0	0	0	0	0	0	0	0	0	0	0	0				
Reduced Vol:	214	297	41	215	683	99	123	843	640	60	364	79				
PCE Adj:	1.00	1.00	1.00	1.00	1.00	1.00	1.00	1.00	1.00	1.00	1.00	1.00				
MLF Adj:	1.00	1.00	1.00	1.00	1.00	1.00	1.00	1.00	1.00	1.00	1.00	1.00				
FinalVolume:	214	297	41	215	683	99	123	843	640	60	364	79				

Saturation Flow Module:												
Sat/Lane:	1900	1900	1900	1900	1900	1900	1900	1900	1900	1900	1900	1900
Adjustment:	0.92	1.00	0.92	0.92	1.00	0.92	0.92	0.99	0.95	0.92	1.00	0.92
Lanes:	1.00	2.00	1.00	1.00	2.00	1.00	1.00	1.11	0.89	1.00	1.00	1.00
Final Sat.:	1750	3800	1750	1750	3800	1750	1750	2102	1596	1750	1900	1750

Capacity Analysis Module:												
Vol/Sat:	0.12	0.08	0.02	0.12	0.18	0.06	0.07	0.40	0.40	0.03	0.19	0.05
Crit Moves:	***			***			***			***		
Green Time:	11.5	13.9	20.9	14.5	16.9	30.3	13.4	37.6	37.6	7.0	31.2	31.2
Volume/Cap:	0.91	0.48	0.10	0.72	0.91	0.16	0.45	0.91	0.91	0.42	0.52	0.12
Delay/Veh:	70.5	32.9	24.9	41.7	47.8	18.8	33.6	29.6	29.6	39.0	21.8	17.9
User DelAdj:	1.00	1.00	1.00	1.00	1.00	1.00	1.00	1.00	1.00	1.00	1.00	1.00
AdjDel/Veh:	70.5	32.9	24.9	41.7	47.8	18.8	33.6	29.6	29.6	39.0	21.8	17.9
LOS by Move:	E	C	C	D	D	B	C	C	C	D	C	B
HCM2kAvgQ:	9	4	1	6	10	2	4	23	23	2	8	1

Note: Queue reported is the number of cars per lane.

Voices School
Morgan Hill, CA
Hexagon Transportation Consultants, Inc.

Level Of Service Computation Report
2000 HCM Operations (Future Volume Alternative)
2025 Plus Project (PM) - 1 Cosmo Full out

Intersection #422: Monterey Road and Butterfield Boulevard/Watsonville Road

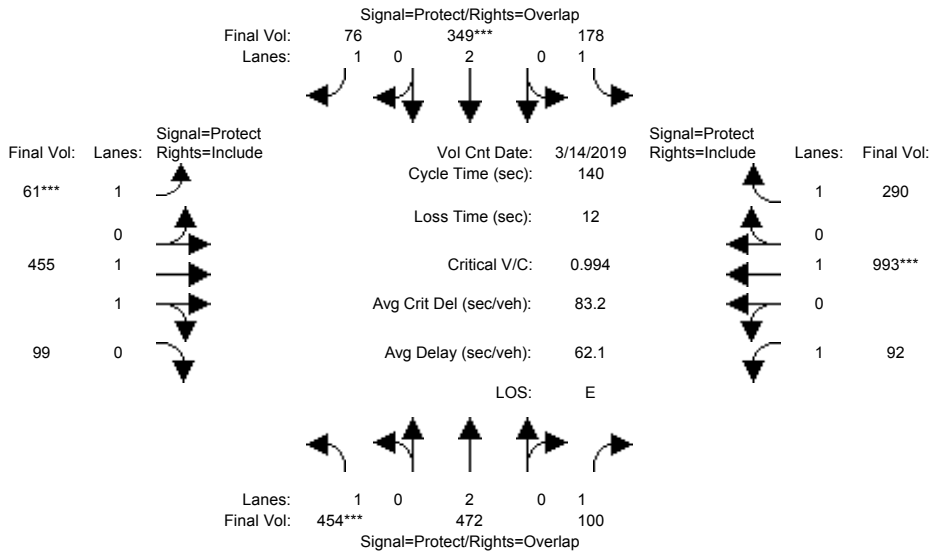

Street Name:	Monterey Rd						Butterfield Blvd/Watsonville Rd					
Approach:	North Bound			South Bound			East Bound			West Bound		
Movement:	L	T	R	L	T	R	L	T	R	L	T	R
Min. Green:	7	10	10	7	10	10	7	10	10	7	10	10
Y+R:	4.0	4.0	4.0	4.0	4.0	4.0	4.0	4.0	4.0	4.0	4.0	4.0

Volume Module:	>> Count Date: 14 Mar 2019 <<											
Base Vol:	426	356	26	164	235	47	43	381	88	22	858	266
Growth Adj:	1.00	1.00	1.00	1.00	1.00	1.00	1.00	1.00	1.00	1.00	1.00	1.00
Initial Bse:	426	356	26	164	235	47	43	381	88	22	858	266
Added Vol:	0	9	0	0	18	9	3	0	0	0	0	0
PasserByVol:	28	107	74	14	96	20	15	74	11	70	135	24
Initial Fut:	454	472	100	178	349	76	61	455	99	92	993	290
User Adj:	1.00	1.00	1.00	1.00	1.00	1.00	1.00	1.00	1.00	1.00	1.00	1.00
PHF Adj:	1.00	1.00	1.00	1.00	1.00	1.00	1.00	1.00	1.00	1.00	1.00	1.00
PHF Volume:	454	472	100	178	349	76	61	455	99	92	993	290
Reduct Vol:	0	0	0	0	0	0	0	0	0	0	0	0
Reduced Vol:	454	472	100	178	349	76	61	455	99	92	993	290
PCE Adj:	1.00	1.00	1.00	1.00	1.00	1.00	1.00	1.00	1.00	1.00	1.00	1.00
MLF Adj:	1.00	1.00	1.00	1.00	1.00	1.00	1.00	1.00	1.00	1.00	1.00	1.00
FinalVolume:	454	472	100	178	349	76	61	455	99	92	993	290

Saturation Flow Module:												
Sat/Lane:	1900	1900	1900	1900	1900	1900	1900	1900	1900	1900	1900	1900
Adjustment:	0.92	1.00	0.92	0.92	1.00	0.92	0.92	0.98	0.95	0.92	1.00	0.92
Lanes:	1.00	2.00	1.00	1.00	2.00	1.00	1.00	1.63	0.37	1.00	1.00	1.00
Final Sat.:	1750	3800	1750	1750	3800	1750	1750	3038	661	1750	1900	1750

Capacity Analysis Module:												
Vol/Sat:	0.26	0.12	0.06	0.10	0.09	0.04	0.03	0.15	0.15	0.05	0.52	0.17
Crit Moves:	***				***		***				***	
Green Time:	35.9	26.7	47.4	21.9	12.7	19.7	7.0	58.7	58.7	20.6	72.4	72.4
Volume/Cap:	1.01	0.65	0.17	0.65	1.01	0.31	0.70	0.36	0.36	0.36	1.01	0.32
Delay/Veh:	97.3	54.4	32.6	60.9	115	54.7	87.3	27.9	27.9	54.6	65.3	19.8
User DelAdj:	1.00	1.00	1.00	1.00	1.00	1.00	1.00	1.00	1.00	1.00	1.00	1.00
AdjDel/Veh:	97.3	54.4	32.6	60.9	115	54.7	87.3	27.9	27.9	54.6	65.3	19.8
LOS by Move:	F	D	C	E	F	D	F	C	C	D	E	B
HCM2kAvgQ:	27	10	3	8	9	3	4	8	8	4	50	8

Note: Queue reported is the number of cars per lane.

Voices School
Morgan Hill, CA
Hexagon Transportation Consultants, Inc.

Level Of Service Computation Report
2000 HCM Operations (Future Volume Alternative)
Existing Plus Project (AM) - 1 Cosmo Full out

Intersection #1004: Church Street and Dunne Avenue

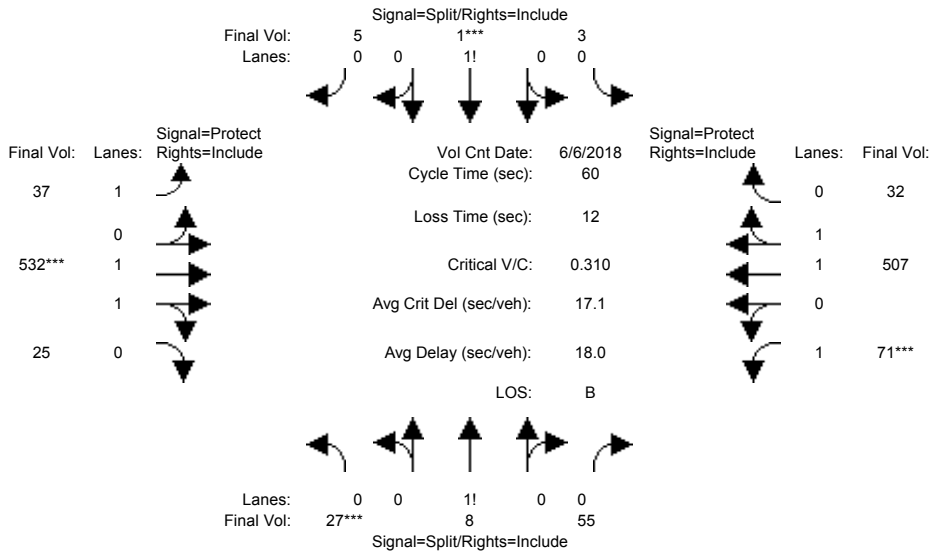

Street Name:	Church Street						Dunne Avenue					
	North Bound			South Bound			East Bound			West Bound		
Approach:	L	T	R	L	T	R	L	T	R	L	T	R
Min. Green:	10	10	10	10	10	10	7	10	10	7	10	10
Y+R:	4.0	4.0	4.0	4.0	4.0	4.0	4.0	4.0	4.0	4.0	4.0	4.0

Volume Module:	>>	Count	Date:	6 Jun 2018	<<							
Base Vol:	27	8	55	3	1	5	37	402	25	71	431	32
Growth Adj:	1.00	1.00	1.00	1.00	1.00	1.00	1.00	1.00	1.00	1.00	1.00	1.00
Initial Bse:	27	8	55	3	1	5	37	402	25	71	431	32
Added Vol:	0	0	0	0	0	0	0	130	0	0	76	0
PasserByVol:	0	0	0	0	0	0	0	0	0	0	0	0
Initial Fut:	27	8	55	3	1	5	37	532	25	71	507	32
User Adj:	1.00	1.00	1.00	1.00	1.00	1.00	1.00	1.00	1.00	1.00	1.00	1.00
PHF Adj:	1.00	1.00	1.00	1.00	1.00	1.00	1.00	1.00	1.00	1.00	1.00	1.00
PHF Volume:	27	8	55	3	1	5	37	532	25	71	507	32
Reduct Vol:	0	0	0	0	0	0	0	0	0	0	0	0
Reduced Vol:	27	8	55	3	1	5	37	532	25	71	507	32
PCE Adj:	1.00	1.00	1.00	1.00	1.00	1.00	1.00	1.00	1.00	1.00	1.00	1.00
MLF Adj:	1.00	1.00	1.00	1.00	1.00	1.00	1.00	1.00	1.00	1.00	1.00	1.00
FinalVolume:	27	8	55	3	1	5	37	532	25	71	507	32

Saturation Flow Module:												
Sat/Lane:	1900	1900	1900	1900	1900	1900	1900	1900	1900	1900	1900	1900
Adjustment:	0.92	0.92	0.92	0.92	0.92	0.92	0.92	0.97	0.95	0.92	0.98	0.95
Lanes:	0.30	0.09	0.61	0.33	0.11	0.56	1.00	1.91	0.09	1.00	1.88	0.12
Final Sat.:	525	156	1069	583	194	972	1750	3534	166	1750	3480	220

Capacity Analysis Module:												
Vol/Sat:	0.05	0.05	0.05	0.01	0.01	0.01	0.02	0.15	0.15	0.04	0.15	0.15
Crit Moves:	****				****			****		****		
Green Time:	10.0	10.0	10.0	10.0	10.0	10.0	11.5	21.0	21.0	7.0	16.5	16.5
Volume/Cap:	0.31	0.31	0.31	0.03	0.03	0.03	0.11	0.43	0.43	0.35	0.53	0.53
Delay/Veh:	22.6	22.6	22.6	21.0	21.0	21.0	20.1	15.2	15.2	25.4	19.0	19.0
User DelAdj:	1.00	1.00	1.00	1.00	1.00	1.00	1.00	1.00	1.00	1.00	1.00	1.00
AdjDel/Veh:	22.6	22.6	22.6	21.0	21.0	21.0	20.1	15.2	15.2	25.4	19.0	19.0
LOS by Move:	C	C	C	C	C	C	C	B	B	C	B	B
HCM2kAvgQ:	2	2	2	0	0	0	1	4	4	1	4	4

Note: Queue reported is the number of cars per lane.

Voices School
Morgan Hill, CA
Hexagon Transportation Consultants, Inc.

Level Of Service Computation Report
2000 HCM Operations (Future Volume Alternative)
Existing Plus Project (PM) - 1 Cosmo Full out

Intersection #1004: Church Street and Dunne Avenue

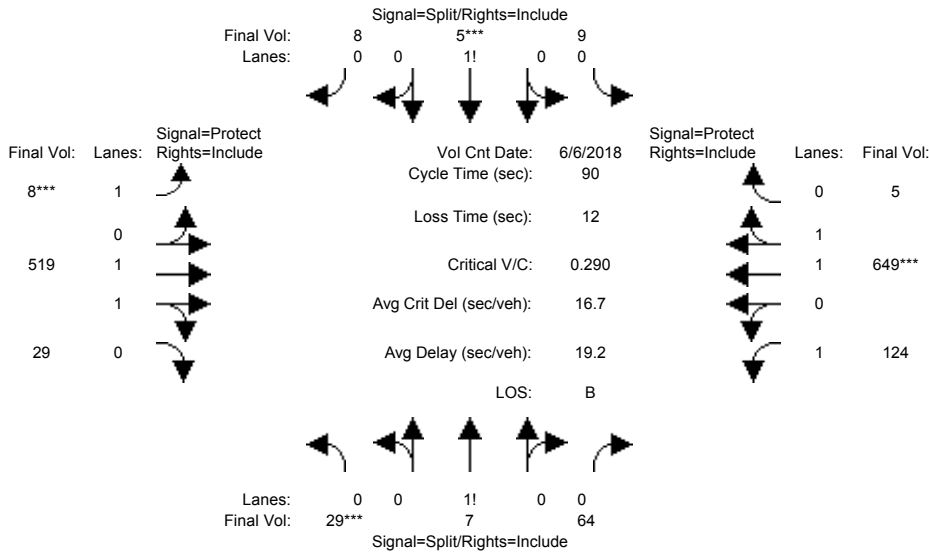

Street Name:	Church Street						Dunne Avenue					
	North Bound			South Bound			East Bound			West Bound		
Approach:	L	T	R	L	T	R	L	T	R	L	T	R
Min. Green:	10	10	10	10	10	10	7	10	10	7	10	10
Y+R:	4.0	4.0	4.0	4.0	4.0	4.0	4.0	4.0	4.0	4.0	4.0	4.0

Volume Module:	>>	Count	Date:	6 Jun 2018	<<							
Base Vol:	29	7	64	9	5	8	8	475	29	124	581	5
Growth Adj:	1.00	1.00	1.00	1.00	1.00	1.00	1.00	1.00	1.00	1.00	1.00	1.00
Initial Bse:	29	7	64	9	5	8	8	475	29	124	581	5
Added Vol:	0	0	0	0	0	0	0	44	0	0	68	0
PasserByVol:	0	0	0	0	0	0	0	0	0	0	0	0
Initial Fut:	29	7	64	9	5	8	8	519	29	124	649	5
User Adj:	1.00	1.00	1.00	1.00	1.00	1.00	1.00	1.00	1.00	1.00	1.00	1.00
PHF Adj:	1.00	1.00	1.00	1.00	1.00	1.00	1.00	1.00	1.00	1.00	1.00	1.00
PHF Volume:	29	7	64	9	5	8	8	519	29	124	649	5
Reduct Vol:	0	0	0	0	0	0	0	0	0	0	0	0
Reduced Vol:	29	7	64	9	5	8	8	519	29	124	649	5
PCE Adj:	1.00	1.00	1.00	1.00	1.00	1.00	1.00	1.00	1.00	1.00	1.00	1.00
MLF Adj:	1.00	1.00	1.00	1.00	1.00	1.00	1.00	1.00	1.00	1.00	1.00	1.00
FinalVolume:	29	7	64	9	5	8	8	519	29	124	649	5

Saturation Flow Module:												
Sat/Lane:	1900	1900	1900	1900	1900	1900	1900	1900	1900	1900	1900	1900
Adjustment:	0.92	0.92	0.92	0.92	0.92	0.92	0.92	0.98	0.95	0.92	0.97	0.95
Lanes:	0.29	0.07	0.64	0.41	0.23	0.36	1.00	1.89	0.11	1.00	1.98	0.02
Final Sat.:	508	123	1120	716	398	636	1750	3504	196	1750	3672	28

Capacity Analysis Module:												
Vol/Sat:	0.06	0.06	0.06	0.01	0.01	0.01	0.00	0.15	0.15	0.07	0.18	0.18
Crit Moves:	***			***			***			***		
Green Time:	14.9	14.9	14.9	10.0	10.0	10.0	7.0	34.8	34.8	18.3	46.1	46.1
Volume/Cap:	0.35	0.35	0.35	0.11	0.11	0.11	0.06	0.38	0.38	0.35	0.35	0.35
Delay/Veh:	33.9	33.9	33.9	36.3	36.3	36.3	38.6	20.0	20.0	31.3	13.1	13.1
User DelAdj:	1.00	1.00	1.00	1.00	1.00	1.00	1.00	1.00	1.00	1.00	1.00	1.00
AdjDel/Veh:	33.9	33.9	33.9	36.3	36.3	36.3	38.6	20.0	20.0	31.3	13.1	13.1
LOS by Move:	C	C	C	D	D	D	D	C	C	C	B	B
HCM2kAvgQ:	3	3	3	1	1	1	0	5	5	3	5	5

Note: Queue reported is the number of cars per lane.

Voices School
Morgan Hill, CA
Hexagon Transportation Consultants, Inc.

Level Of Service Computation Report
2000 HCM Operations (Future Volume Alternative)
2025 Plus Project (AM) - 1 Cosmo Full out

Intersection #1004: Church Street and Dunne Avenue

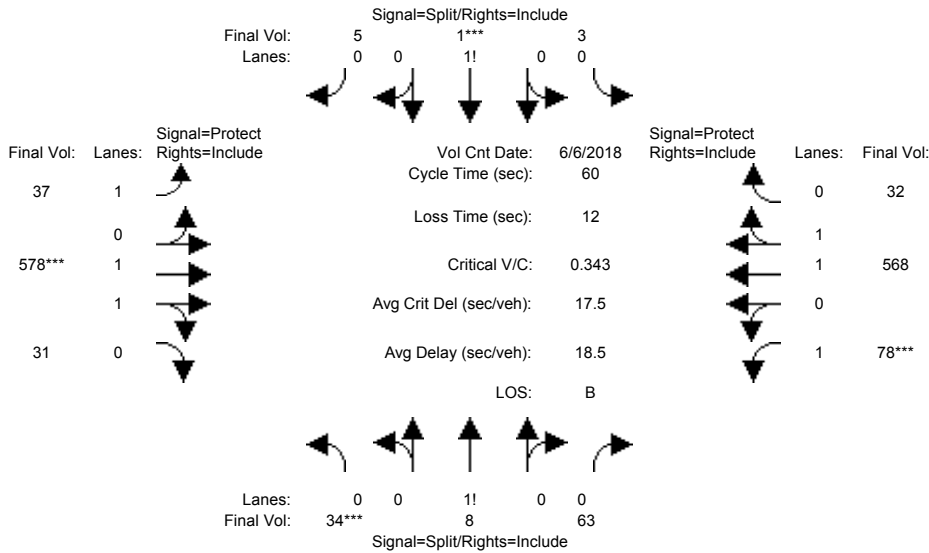

Street Name:	Church Street						Dunne Avenue					
	North Bound			South Bound			East Bound			West Bound		
Approach:	L	T	R	L	T	R	L	T	R	L	T	R
Min. Green:	10	10	10	10	10	10	7	10	10	7	10	10
Y+R:	4.0	4.0	4.0	4.0	4.0	4.0	4.0	4.0	4.0	4.0	4.0	4.0

Volume Module:	>>	Count	Date:	6 Jun 2018	<<							
Base Vol:	27	8	55	3	1	5	37	402	25	71	431	32
Growth Adj:	1.00	1.00	1.00	1.00	1.00	1.00	1.00	1.00	1.00	1.00	1.00	1.00
Initial Bse:	27	8	55	3	1	5	37	402	25	71	431	32
Added Vol:	0	0	0	0	0	0	0	126	0	0	74	0
PasserByVol:	7	0	8	0	0	0	0	50	6	7	63	0
Initial Fut:	34	8	63	3	1	5	37	578	31	78	568	32
User Adj:	1.00	1.00	1.00	1.00	1.00	1.00	1.00	1.00	1.00	1.00	1.00	1.00
PHF Adj:	1.00	1.00	1.00	1.00	1.00	1.00	1.00	1.00	1.00	1.00	1.00	1.00
PHF Volume:	34	8	63	3	1	5	37	578	31	78	568	32
Reduct Vol:	0	0	0	0	0	0	0	0	0	0	0	0
Reduced Vol:	34	8	63	3	1	5	37	578	31	78	568	32
PCE Adj:	1.00	1.00	1.00	1.00	1.00	1.00	1.00	1.00	1.00	1.00	1.00	1.00
MLF Adj:	1.00	1.00	1.00	1.00	1.00	1.00	1.00	1.00	1.00	1.00	1.00	1.00
FinalVolume:	34	8	63	3	1	5	37	578	31	78	568	32

Saturation Flow Module:												
Sat/Lane:	1900	1900	1900	1900	1900	1900	1900	1900	1900	1900	1900	1900
Adjustment:	0.92	0.92	0.92	0.92	0.92	0.92	0.92	0.98	0.95	0.92	0.98	0.95
Lanes:	0.32	0.08	0.60	0.33	0.11	0.56	1.00	1.90	0.10	1.00	1.89	0.11
Final Sat.:	567	133	1050	583	194	972	1750	3512	188	1750	3503	197

Capacity Analysis Module:												
Vol/Sat:	0.06	0.06	0.06	0.01	0.01	0.01	0.02	0.16	0.16	0.04	0.16	0.16
Crit Moves:	****				****			****		****		
Green Time:	10.0	10.0	10.0	10.0	10.0	10.0	11.5	21.0	21.0	7.0	16.5	16.5
Volume/Cap:	0.36	0.36	0.36	0.03	0.03	0.03	0.11	0.47	0.47	0.38	0.59	0.59
Delay/Veh:	22.9	22.9	22.9	21.0	21.0	21.0	20.1	15.4	15.4	25.7	19.8	19.8
User DelAdj:	1.00	1.00	1.00	1.00	1.00	1.00	1.00	1.00	1.00	1.00	1.00	1.00
AdjDel/Veh:	22.9	22.9	22.9	21.0	21.0	21.0	20.1	15.4	15.4	25.7	19.8	19.8
LOS by Move:	C	C	C	C	C	C	C	B	B	C	B	B
HCM2kAvgQ:	2	2	2	0	0	0	1	4	4	1	5	5

Note: Queue reported is the number of cars per lane.

Voices School
Morgan Hill, CA
Hexagon Transportation Consultants, Inc.

Level Of Service Computation Report
2000 HCM Operations (Future Volume Alternative)
2025 Plus Project (PM) - 1 Cosmo Full out

Intersection #1004: Church Street and Dunne Avenue

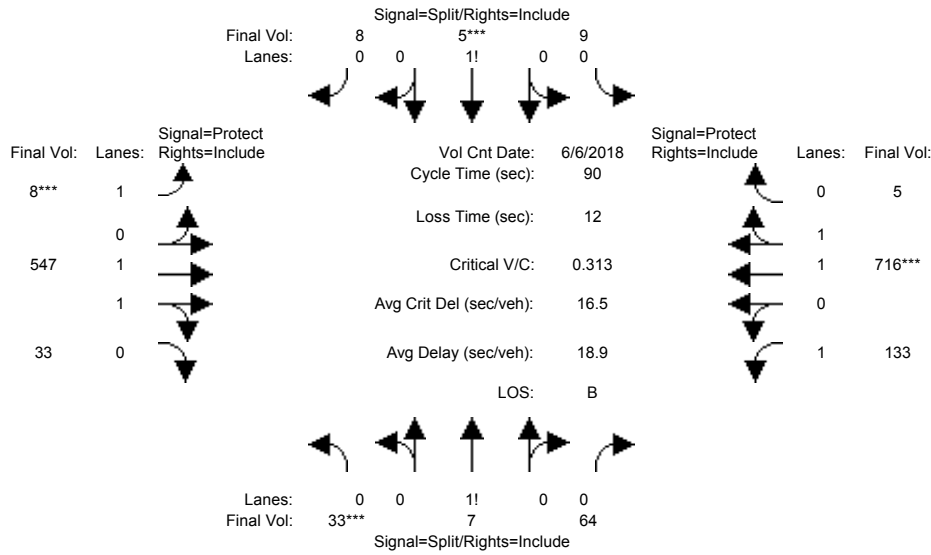

Street Name:	Church Street						Dunne Avenue					
	North Bound			South Bound			East Bound			West Bound		
Approach:	L	T	R	L	T	R	L	T	R	L	T	R
Min. Green:	10	10	10	10	10	10	7	10	10	7	10	10
Y+R:	4.0	4.0	4.0	4.0	4.0	4.0	4.0	4.0	4.0	4.0	4.0	4.0

Volume Module:	>>	Count	Date:	6 Jun 2018	<<							
Base Vol:	29	7	64	9	5	8	8	475	29	124	581	5
Growth Adj:	1.00	1.00	1.00	1.00	1.00	1.00	1.00	1.00	1.00	1.00	1.00	1.00
Initial Bse:	29	7	64	9	5	8	8	475	29	124	581	5
Added Vol:	0	0	0	0	0	0	0	41	0	0	64	0
PasserByVol:	4	0	0	0	0	0	0	31	4	9	71	0
Initial Fut:	33	7	64	9	5	8	8	547	33	133	716	5
User Adj:	1.00	1.00	1.00	1.00	1.00	1.00	1.00	1.00	1.00	1.00	1.00	1.00
PHF Adj:	1.00	1.00	1.00	1.00	1.00	1.00	1.00	1.00	1.00	1.00	1.00	1.00
PHF Volume:	33	7	64	9	5	8	8	547	33	133	716	5
Reduct Vol:	0	0	0	0	0	0	0	0	0	0	0	0
Reduced Vol:	33	7	64	9	5	8	8	547	33	133	716	5
PCE Adj:	1.00	1.00	1.00	1.00	1.00	1.00	1.00	1.00	1.00	1.00	1.00	1.00
MLF Adj:	1.00	1.00	1.00	1.00	1.00	1.00	1.00	1.00	1.00	1.00	1.00	1.00
FinalVolume:	33	7	64	9	5	8	8	547	33	133	716	5

Saturation Flow Module:												
Sat/Lane:	1900	1900	1900	1900	1900	1900	1900	1900	1900	1900	1900	1900
Adjustment:	0.92	0.92	0.92	0.92	0.92	0.92	0.92	0.98	0.95	0.92	0.97	0.95
Lanes:	0.32	0.07	0.61	0.41	0.23	0.36	1.00	1.88	0.12	1.00	1.99	0.01
Final Sat.:	555	118	1077	716	398	636	1750	3489	211	1750	3674	26

Capacity Analysis Module:												
Vol/Sat:	0.06	0.06	0.06	0.01	0.01	0.01	0.00	0.16	0.16	0.08	0.19	0.19
Crit Moves:	***				***		***				***	
Green Time:	14.3	14.3	14.3	10.0	10.0	10.0	7.0	35.9	35.9	17.8	46.7	46.7
Volume/Cap:	0.38	0.38	0.38	0.11	0.11	0.11	0.06	0.39	0.39	0.38	0.38	0.38
Delay/Veh:	34.7	34.7	34.7	36.3	36.3	36.3	38.6	19.4	19.4	32.0	13.0	13.0
User DelAdj:	1.00	1.00	1.00	1.00	1.00	1.00	1.00	1.00	1.00	1.00	1.00	1.00
AdjDel/Veh:	34.7	34.7	34.7	36.3	36.3	36.3	38.6	19.4	19.4	32.0	13.0	13.0
LOS by Move:	C	C	C	D	D	D	D	B	B	C	B	B
HCM2kAvgQ:	3	3	3	1	1	1	0	6	6	3	6	6

Note: Queue reported is the number of cars per lane.

Voices School
Morgan Hill, CA
Hexagon Transportation Consultants, Inc.

Level Of Service Computation Report
2000 HCM Operations (Future Volume Alternative)
Existing Plus Project (AM) - 1 Cosmo Full out

Intersection #1008: Butterfield Boulevard and San Pedro Avenue

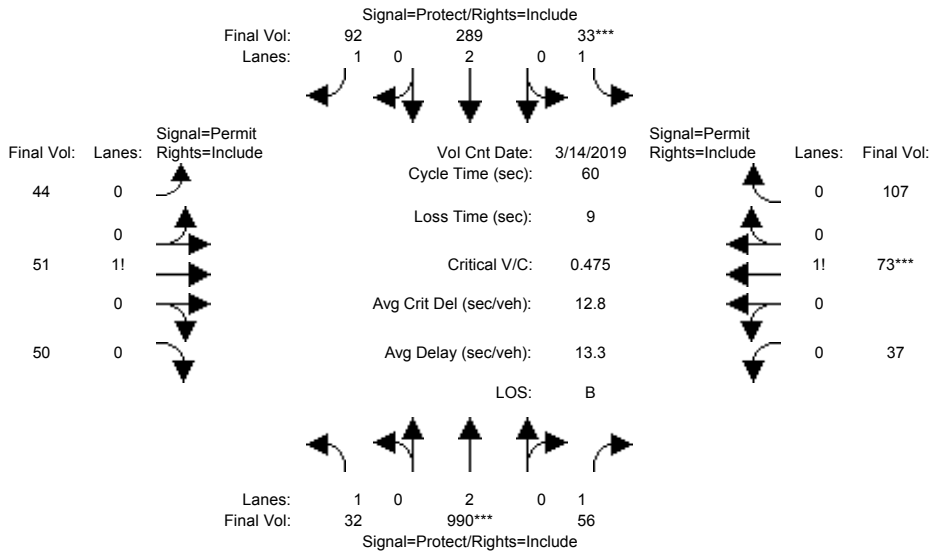

Street Name:	Butterfield Boulevard						San Pedro Avenue					
	North Bound			South Bound			East Bound			West Bound		
Approach:	L	T	R	L	T	R	L	T	R	L	T	R
Min. Green:	7	10	10	7	10	10	10	10	10	10	10	10
Y+R:	4.0	4.0	4.0	4.0	4.0	4.0	4.0	4.0	4.0	4.0	4.0	4.0

Volume Module:	>>	Count	Date:	14 Mar 2019	<<							
Base Vol:	32	990	56	33	289	92	44	46	50	37	60	107
Growth Adj:	1.00	1.00	1.00	1.00	1.00	1.00	1.00	1.00	1.00	1.00	1.00	1.00
Initial Bse:	32	990	56	33	289	92	44	46	50	37	60	107
Added Vol:	0	0	0	0	0	0	0	5	0	0	13	0
PasserByVol:	0	0	0	0	0	0	0	0	0	0	0	0
Initial Fut:	32	990	56	33	289	92	44	51	50	37	73	107
User Adj:	1.00	1.00	1.00	1.00	1.00	1.00	1.00	1.00	1.00	1.00	1.00	1.00
PHF Adj:	1.00	1.00	1.00	1.00	1.00	1.00	1.00	1.00	1.00	1.00	1.00	1.00
PHF Volume:	32	990	56	33	289	92	44	51	50	37	73	107
Reduct Vol:	0	0	0	0	0	0	0	0	0	0	0	0
Reduced Vol:	32	990	56	33	289	92	44	51	50	37	73	107
PCE Adj:	1.00	1.00	1.00	1.00	1.00	1.00	1.00	1.00	1.00	1.00	1.00	1.00
MLF Adj:	1.00	1.00	1.00	1.00	1.00	1.00	1.00	1.00	1.00	1.00	1.00	1.00
FinalVolume:	32	990	56	33	289	92	44	51	50	37	73	107

Saturation Flow Module:												
Sat/Lane:	1900	1900	1900	1900	1900	1900	1900	1900	1900	1900	1900	1900
Adjustment:	0.92	1.00	0.92	0.92	1.00	0.92	0.92	0.92	0.92	0.92	0.92	0.92
Lanes:	1.00	2.00	1.00	1.00	2.00	1.00	0.30	0.36	0.34	0.17	0.34	0.49
Final Sat.:	1750	3800	1750	1750	3800	1750	531	616	603	298	589	863

Capacity Analysis Module:												
Vol/Sat:	0.02	0.26	0.03	0.02	0.08	0.05	0.08	0.08	0.08	0.12	0.12	0.12
Crit Moves:	****			****						****		
Green Time:	15.2	29.8	29.8	7.0	21.7	21.7	14.2	14.2	14.2	14.2	14.2	14.2
Volume/Cap:	0.07	0.52	0.06	0.16	0.21	0.15	0.35	0.35	0.35	0.52	0.52	0.52
Delay/Veh:	17.1	10.5	7.9	24.2	13.3	13.0	19.6	19.6	19.6	21.2	21.2	21.2
User DelAdj:	1.00	1.00	1.00	1.00	1.00	1.00	1.00	1.00	1.00	1.00	1.00	1.00
AdjDel/Veh:	17.1	10.5	7.9	24.2	13.3	13.0	19.6	19.6	19.6	21.2	21.2	21.2
LOS by Move:	B	B	A	C	B	B	B	B	B	C	C	C
HCM2kAvgQ:	0	6	1	1	2	1	3	3	3	4	4	4

Note: Queue reported is the number of cars per lane.

Voices School
Morgan Hill, CA
Hexagon Transportation Consultants, Inc.

Level Of Service Computation Report
2000 HCM Operations (Future Volume Alternative)
Existing Plus Project (PM) - 1 Cosmo Full out

Intersection #1008: Butterfield Boulevard and San Pedro Avenue

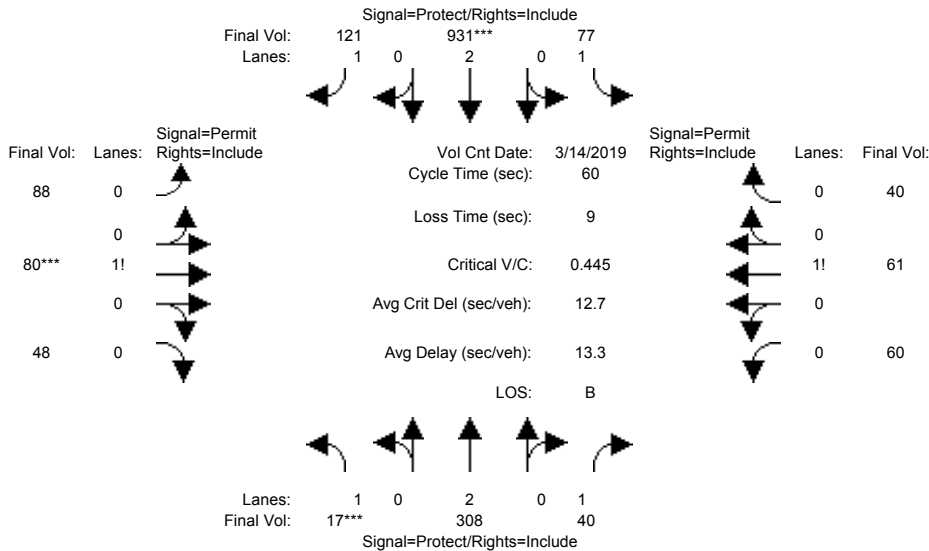

Street Name:	Butterfield Boulevard						San Pedro Avenue					
	North Bound			South Bound			East Bound			West Bound		
Approach:	L	T	R	L	T	R	L	T	R	L	T	R
Min. Green:	7	10	10	7	10	10	10	10	10	10	10	10
Y+R:	4.0	4.0	4.0	4.0	4.0	4.0	4.0	4.0	4.0	4.0	4.0	4.0

Volume Module:	>>	Count	Date:	14 Mar 2019	<<							
Base Vol:	17	308	40	77	931	121	88	72	48	60	58	40
Growth Adj:	1.00	1.00	1.00	1.00	1.00	1.00	1.00	1.00	1.00	1.00	1.00	1.00
Initial Bse:	17	308	40	77	931	121	88	72	48	60	58	40
Added Vol:	0	0	0	0	0	0	0	8	0	0	3	0
PasserByVol:	0	0	0	0	0	0	0	0	0	0	0	0
Initial Fut:	17	308	40	77	931	121	88	80	48	60	61	40
User Adj:	1.00	1.00	1.00	1.00	1.00	1.00	1.00	1.00	1.00	1.00	1.00	1.00
PHF Adj:	1.00	1.00	1.00	1.00	1.00	1.00	1.00	1.00	1.00	1.00	1.00	1.00
PHF Volume:	17	308	40	77	931	121	88	80	48	60	61	40
Reduct Vol:	0	0	0	0	0	0	0	0	0	0	0	0
Reduced Vol:	17	308	40	77	931	121	88	80	48	60	61	40
PCE Adj:	1.00	1.00	1.00	1.00	1.00	1.00	1.00	1.00	1.00	1.00	1.00	1.00
MLF Adj:	1.00	1.00	1.00	1.00	1.00	1.00	1.00	1.00	1.00	1.00	1.00	1.00
Final Volume:	17	308	40	77	931	121	88	80	48	60	61	40

Saturation Flow Module:												
Sat/Lane:	1900	1900	1900	1900	1900	1900	1900	1900	1900	1900	1900	1900
Adjustment:	0.92	1.00	0.92	0.92	1.00	0.92	0.92	0.92	0.92	0.92	0.92	0.92
Lanes:	1.00	2.00	1.00	1.00	2.00	1.00	0.41	0.37	0.22	0.37	0.38	0.25
Final Sat.:	1750	3800	1750	1750	3800	1750	713	648	389	652	663	435

Capacity Analysis Module:												
Vol/Sat:	0.01	0.08	0.02	0.04	0.25	0.07	0.12	0.12	0.12	0.09	0.09	0.09
Crit Moves:	****				****			****				
Green Time:	7.0	21.3	21.3	14.9	29.3	29.3	14.7	14.7	14.7	14.7	14.7	14.7
Volume/Cap:	0.08	0.23	0.06	0.18	0.50	0.14	0.50	0.50	0.50	0.37	0.37	0.37
Delay/Veh:	23.8	13.6	12.8	17.9	10.6	8.5	20.4	20.4	20.4	19.4	19.4	19.4
User DelAdj:	1.00	1.00	1.00	1.00	1.00	1.00	1.00	1.00	1.00	1.00	1.00	1.00
AdjDel/Veh:	23.8	13.6	12.8	17.9	10.6	8.5	20.4	20.4	20.4	19.4	19.4	19.4
LOS by Move:	C	B	B	B	B	A	C	C	C	B	B	B
HCM2kAvgQ:	0	2	1	1	6	1	4	4	4	3	3	3

Note: Queue reported is the number of cars per lane.

Voices School
Morgan Hill, CA
Hexagon Transportation Consultants, Inc.

Level Of Service Computation Report
2000 HCM Operations (Future Volume Alternative)
2025 Plus Project (AM) - 1 Cosmo Full out

Intersection #1008: Butterfield Boulevard and San Pedro Avenue

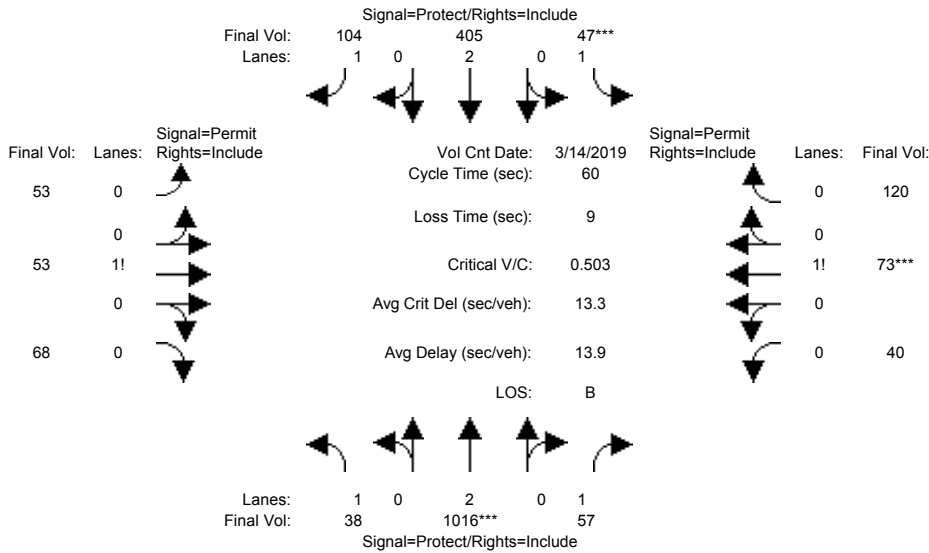

Street Name:	Butterfield Boulevard						San Pedro Avenue					
	North Bound			South Bound			East Bound			West Bound		
Approach:	L	T	R	L	T	R	L	T	R	L	T	R
Min. Green:	7	10	10	7	10	10	10	10	10	10	10	10
Y+R:	4.0	4.0	4.0	4.0	4.0	4.0	4.0	4.0	4.0	4.0	4.0	4.0

Volume Module:	>>	Count	Date:	14 Mar 2019	<<							
Base Vol:	32	990	56	33	289	92	44	46	50	37	60	107
Growth Adj:	1.00	1.00	1.00	1.00	1.00	1.00	1.00	1.00	1.00	1.00	1.00	1.00
Initial Bse:	32	990	56	33	289	92	44	46	50	37	60	107
Added Vol:	0	0	0	0	0	0	0	5	0	0	13	0
PasserByVol:	6	26	1	14	116	12	9	2	18	3	0	13
Initial Fut:	38	1016	57	47	405	104	53	53	68	40	73	120
User Adj:	1.00	1.00	1.00	1.00	1.00	1.00	1.00	1.00	1.00	1.00	1.00	1.00
PHF Adj:	1.00	1.00	1.00	1.00	1.00	1.00	1.00	1.00	1.00	1.00	1.00	1.00
PHF Volume:	38	1016	57	47	405	104	53	53	68	40	73	120
Reduct Vol:	0	0	0	0	0	0	0	0	0	0	0	0
Reduced Vol:	38	1016	57	47	405	104	53	53	68	40	73	120
PCE Adj:	1.00	1.00	1.00	1.00	1.00	1.00	1.00	1.00	1.00	1.00	1.00	1.00
MLF Adj:	1.00	1.00	1.00	1.00	1.00	1.00	1.00	1.00	1.00	1.00	1.00	1.00
FinalVolume:	38	1016	57	47	405	104	53	53	68	40	73	120

Saturation Flow Module:												
Sat/Lane:	1900	1900	1900	1900	1900	1900	1900	1900	1900	1900	1900	1900
Adjustment:	0.92	1.00	0.92	0.92	1.00	0.92	0.92	0.92	0.92	0.92	0.92	0.92
Lanes:	1.00	2.00	1.00	1.00	2.00	1.00	0.30	0.30	0.40	0.17	0.31	0.52
Final Sat.:	1750	3800	1750	1750	3800	1750	533	533	684	300	548	901

Capacity Analysis Module:												
Vol/Sat:	0.02	0.27	0.03	0.03	0.11	0.06	0.10	0.10	0.10	0.13	0.13	0.13
Crit Moves:	****			****						****		
Green Time:	15.0	29.4	29.4	7.0	21.4	21.4	14.6	14.6	14.6	14.6	14.6	14.6
Volume/Cap:	0.09	0.55	0.07	0.23	0.30	0.17	0.41	0.41	0.41	0.55	0.55	0.55
Delay/Veh:	17.4	11.0	8.1	24.6	14.0	13.3	19.7	19.7	19.7	21.3	21.3	21.3
User DelAdj:	1.00	1.00	1.00	1.00	1.00	1.00	1.00	1.00	1.00	1.00	1.00	1.00
AdjDel/Veh:	17.4	11.0	8.1	24.6	14.0	13.3	19.7	19.7	19.7	21.3	21.3	21.3
LOS by Move:	B	B	A	C	B	B	B	B	B	C	C	C
HCM2kAvgQ:	1	6	1	1	3	1	3	3	3	5	5	5

Note: Queue reported is the number of cars per lane.

Voices School
Morgan Hill, CA
Hexagon Transportation Consultants, Inc.

Level Of Service Computation Report
2000 HCM Operations (Future Volume Alternative)
2025 Plus Project (PM) - 1 Cosmo Full out

Intersection #1008: Butterfield Boulevard and San Pedro Avenue

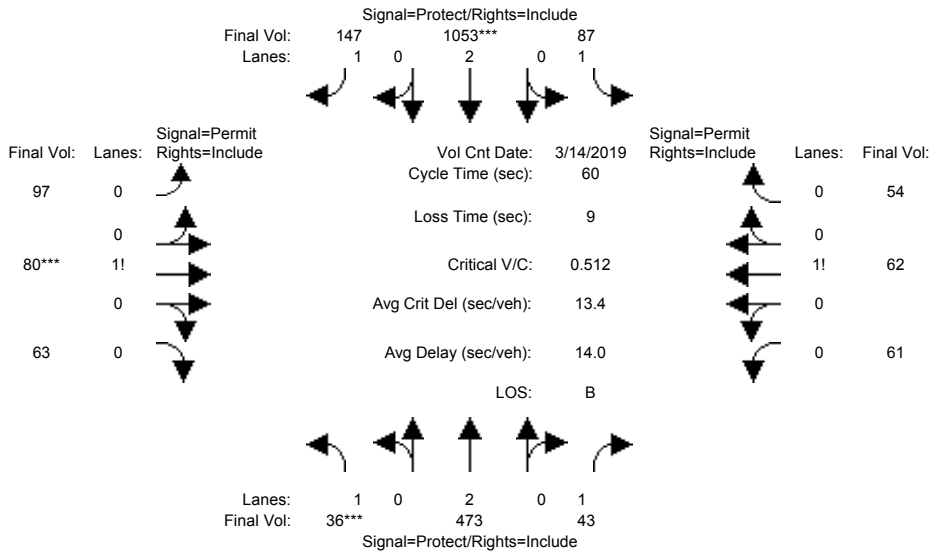

Street Name:	Butterfield Boulevard						San Pedro Avenue					
	North Bound			South Bound			East Bound			West Bound		
Approach:	L	T	R	L	T	R	L	T	R	L	T	R
Min. Green:	7	10	10	7	10	10	10	10	10	10	10	10
Y+R:	4.0	4.0	4.0	4.0	4.0	4.0	4.0	4.0	4.0	4.0	4.0	4.0

Volume Module:	>>	Count	Date:	14 Mar 2019	<<							
Base Vol:	17	308	40	77	931	121	88	72	48	60	58	40
Growth Adj:	1.00	1.00	1.00	1.00	1.00	1.00	1.00	1.00	1.00	1.00	1.00	1.00
Initial Bse:	17	308	40	77	931	121	88	72	48	60	58	40
Added Vol:	0	0	0	0	0	0	0	8	0	0	3	0
PasserByVol:	19	165	3	10	122	26	9	0	15	1	1	14
Initial Fut:	36	473	43	87	1053	147	97	80	63	61	62	54
User Adj:	1.00	1.00	1.00	1.00	1.00	1.00	1.00	1.00	1.00	1.00	1.00	1.00
PHF Adj:	1.00	1.00	1.00	1.00	1.00	1.00	1.00	1.00	1.00	1.00	1.00	1.00
PHF Volume:	36	473	43	87	1053	147	97	80	63	61	62	54
Reduct Vol:	0	0	0	0	0	0	0	0	0	0	0	0
Reduced Vol:	36	473	43	87	1053	147	97	80	63	61	62	54
PCE Adj:	1.00	1.00	1.00	1.00	1.00	1.00	1.00	1.00	1.00	1.00	1.00	1.00
MLF Adj:	1.00	1.00	1.00	1.00	1.00	1.00	1.00	1.00	1.00	1.00	1.00	1.00
Final Volume:	36	473	43	87	1053	147	97	80	63	61	62	54

Saturation Flow Module:												
Sat/Lane:	1900	1900	1900	1900	1900	1900	1900	1900	1900	1900	1900	1900
Adjustment:	0.92	1.00	0.92	0.92	1.00	0.92	0.92	0.92	0.92	0.92	0.92	0.92
Lanes:	1.00	2.00	1.00	1.00	2.00	1.00	0.41	0.33	0.26	0.34	0.35	0.31
Final Sat.:	1750	3800	1750	1750	3800	1750	707	583	459	603	613	534

Capacity Analysis Module:												
Vol/Sat:	0.02	0.12	0.02	0.05	0.28	0.08	0.14	0.14	0.14	0.10	0.10	0.10
Crit Moves:	***			***			***			***		
Green Time:	7.0	21.4	21.4	15.0	29.4	29.4	14.6	14.6	14.6	14.6	14.6	14.6
Volume/Cap:	0.18	0.35	0.07	0.20	0.56	0.17	0.56	0.56	0.56	0.42	0.42	0.42
Delay/Veh:	24.3	14.3	12.8	18.0	11.2	8.6	21.7	21.7	21.7	19.8	19.8	19.8
User DelAdj:	1.00	1.00	1.00	1.00	1.00	1.00	1.00	1.00	1.00	1.00	1.00	1.00
AdjDel/Veh:	24.3	14.3	12.8	18.0	11.2	8.6	21.7	21.7	21.7	19.8	19.8	19.8
LOS by Move:	C	B	B	B	B	A	C	C	C	B	B	B
HCM2kAvgQ:	1	3	1	1	7	2	5	5	5	3	3	3

Note: Queue reported is the number of cars per lane.

Voices School
Morgan Hill, CA
Hexagon Transportation Consultants, Inc.

Level Of Service Computation Report
2000 HCM Operations (Future Volume Alternative)
Existing Plus Project (AM) - 1 Cosmo Full out

Intersection #1111: Butterfield Boulevard and Tennant Avenue

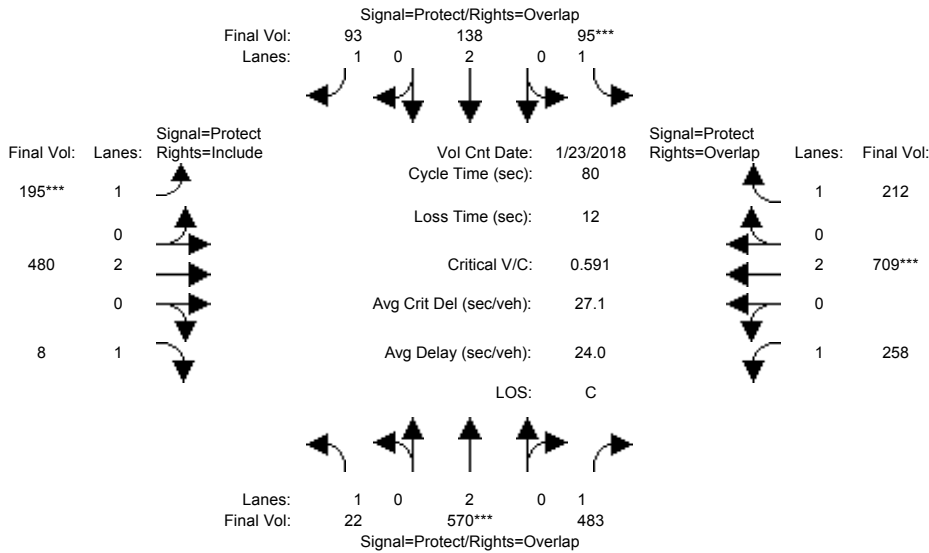

Street Name: Butterfield Boulevard Tennant Avenue
Approach: North Bound South Bound East Bound West Bound
Movement: L - T - R L - T - R L - T - R L - T - R

Min. Green:	7	10	10	7	10	10	7	10	10	7	10	10
Y+R:	4.0	4.0	4.0	4.0	4.0	4.0	4.0	4.0	4.0	4.0	4.0	4.0

Volume Module: >> Count Date: 23 Jan 2018 <<

Base Vol:	22	570	483	95	138	93	195	453	8	258	688	212
Growth Adj:	1.00	1.00	1.00	1.00	1.00	1.00	1.00	1.00	1.00	1.00	1.00	1.00
Initial Bse:	22	570	483	95	138	93	195	453	8	258	688	212
Added Vol:	0	0	0	0	0	0	0	27	0	0	21	0
PasserByVol:	0	0	0	0	0	0	0	0	0	0	0	0
Initial Fut:	22	570	483	95	138	93	195	480	8	258	709	212
User Adj:	1.00	1.00	1.00	1.00	1.00	1.00	1.00	1.00	1.00	1.00	1.00	1.00
PHF Adj:	1.00	1.00	1.00	1.00	1.00	1.00	1.00	1.00	1.00	1.00	1.00	1.00
PHF Volume:	22	570	483	95	138	93	195	480	8	258	709	212
Reduct Vol:	0	0	0	0	0	0	0	0	0	0	0	0
Reduced Vol:	22	570	483	95	138	93	195	480	8	258	709	212
PCE Adj:	1.00	1.00	1.00	1.00	1.00	1.00	1.00	1.00	1.00	1.00	1.00	1.00
MLF Adj:	1.00	1.00	1.00	1.00	1.00	1.00	1.00	1.00	1.00	1.00	1.00	1.00
FinalVolume:	22	570	483	95	138	93	195	480	8	258	709	212

Saturation Flow Module:

Sat/Lane:	1900	1900	1900	1900	1900	1900	1900	1900	1900	1900	1900	1900
Adjustment:	0.92	1.00	0.92	0.92	1.00	0.92	0.92	1.00	0.92	0.92	1.00	0.92
Lanes:	1.00	2.00	1.00	1.00	2.00	1.00	1.00	2.00	1.00	1.00	2.00	1.00
Final Sat.:	1750	3800	1750	1750	3800	1750	1750	3800	1750	1750	3800	1750

Capacity Analysis Module:

Vol/Sat:	0.01	0.15	0.28	0.05	0.04	0.05	0.11	0.13	0.00	0.15	0.19	0.12
Crit Moves:	****			****			****				****	
Green Time:	11.4	20.3	42.0	7.3	16.3	31.4	15.1	18.6	18.6	21.7	25.3	32.6
Volume/Cap:	0.09	0.59	0.53	0.59	0.18	0.14	0.59	0.54	0.02	0.54	0.59	0.30
Delay/Veh:	30.0	27.2	13.0	40.6	26.5	15.7	32.5	27.6	23.7	26.2	23.8	16.2
User DelAdj:	1.00	1.00	1.00	1.00	1.00	1.00	1.00	1.00	1.00	1.00	1.00	1.00
AdjDel/Veh:	30.0	27.2	13.0	40.6	26.5	15.7	32.5	27.6	23.7	26.2	23.8	16.2
LOS by Move:	C	C	B	D	C	B	C	C	C	C	C	B
HCM2kAvgQ:	1	7	9	3	1	2	5	5	0	6	8	4

Note: Queue reported is the number of cars per lane.

Voices School
Morgan Hill, CA
Hexagon Transportation Consultants, Inc.

Level Of Service Computation Report
2000 HCM Operations (Future Volume Alternative)
Existing Plus Project (PM) - 1 Cosmo Full out

Intersection #1111: Butterfield Boulevard and Tennant Avenue

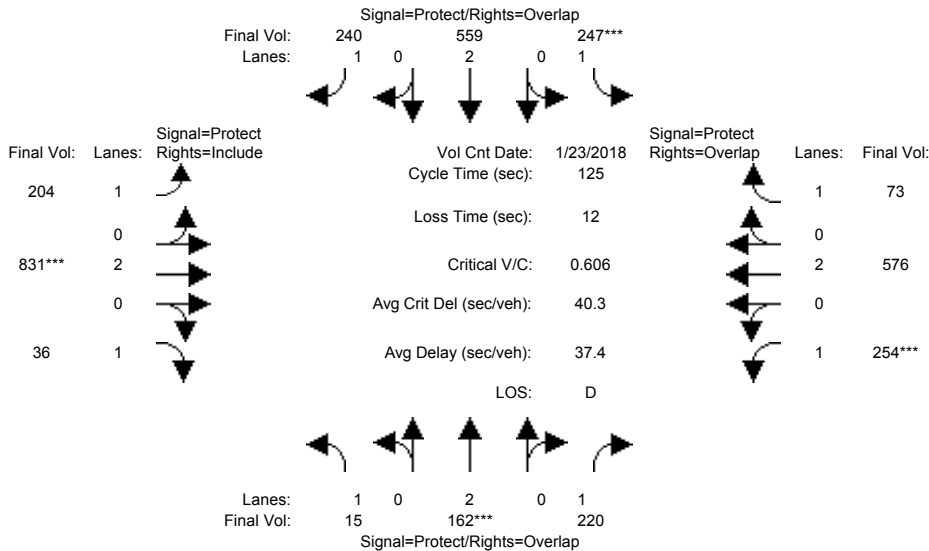

Street Name:	Butterfield Boulevard						Tennant Avenue					
	North Bound			South Bound			East Bound			West Bound		
Approach:	L	T	R	L	T	R	L	T	R	L	T	R
Min. Green:	7	10	10	7	10	10	7	10	10	7	10	10
Y+R:	4.0	4.0	4.0	4.0	4.0	4.0	4.0	4.0	4.0	4.0	4.0	4.0

Volume Module:	>>	Count	Date:	23 Jan 2018	<<											
Base Vol:	15	162	220	247	559	240	204	819	36	254	562	73				
Growth Adj:	1.00	1.00	1.00	1.00	1.00	1.00	1.00	1.00	1.00	1.00	1.00	1.00				
Initial Bse:	15	162	220	247	559	240	204	819	36	254	562	73				
Added Vol:	0	0	0	0	0	0	0	12	0	0	14	0				
PasserByVol:	0	0	0	0	0	0	0	0	0	0	0	0				
Initial Fut:	15	162	220	247	559	240	204	831	36	254	576	73				
User Adj:	1.00	1.00	1.00	1.00	1.00	1.00	1.00	1.00	1.00	1.00	1.00	1.00				
PHF Adj:	1.00	1.00	1.00	1.00	1.00	1.00	1.00	1.00	1.00	1.00	1.00	1.00				
PHF Volume:	15	162	220	247	559	240	204	831	36	254	576	73				
Reduct Vol:	0	0	0	0	0	0	0	0	0	0	0	0				
Reduced Vol:	15	162	220	247	559	240	204	831	36	254	576	73				
PCE Adj:	1.00	1.00	1.00	1.00	1.00	1.00	1.00	1.00	1.00	1.00	1.00	1.00				
MLF Adj:	1.00	1.00	1.00	1.00	1.00	1.00	1.00	1.00	1.00	1.00	1.00	1.00				
Final Volume:	15	162	220	247	559	240	204	831	36	254	576	73				

Saturation Flow Module:												
Sat/Lane:	1900	1900	1900	1900	1900	1900	1900	1900	1900	1900	1900	1900
Adjustment:	0.92	1.00	0.92	0.92	1.00	0.92	0.92	1.00	0.92	0.92	1.00	0.92
Lanes:	1.00	2.00	1.00	1.00	2.00	1.00	1.00	2.00	1.00	1.00	2.00	1.00
Final Sat.:	1750	3800	1750	1750	3800	1750	1750	3800	1750	1750	3800	1750

Capacity Analysis Module:												
Vol/Sat:	0.01	0.04	0.13	0.14	0.15	0.14	0.12	0.22	0.02	0.15	0.15	0.04
Crit Moves:	****			****			****			****		
Green Time:	10.7	10.0	39.6	28.8	28.1	60.4	32.3	44.6	44.6	29.6	41.9	70.7
Volume/Cap:	0.10	0.53	0.40	0.61	0.65	0.28	0.45	0.61	0.06	0.61	0.45	0.07
Delay/Veh:	53.0	57.1	33.8	45.9	45.9	19.6	39.7	33.9	26.4	45.3	32.8	12.3
User DelAdj:	1.00	1.00	1.00	1.00	1.00	1.00	1.00	1.00	1.00	1.00	1.00	1.00
AdjDel/Veh:	53.0	57.1	33.8	45.9	45.9	19.6	39.7	33.9	26.4	45.3	32.8	12.3
LOS by Move:	D	E	C	D	D	B	D	C	C	D	C	B
HCM2kAvgQ:	1	4	7	9	10	6	7	13	1	10	9	1

Note: Queue reported is the number of cars per lane.

Voices School
Morgan Hill, CA
Hexagon Transportation Consultants, Inc.

Level Of Service Computation Report
2000 HCM Operations (Future Volume Alternative)
2025 Plus Project (AM) - 1 Cosmo Full out

Intersection #1111: Butterfield Boulevard and Tennant Avenue

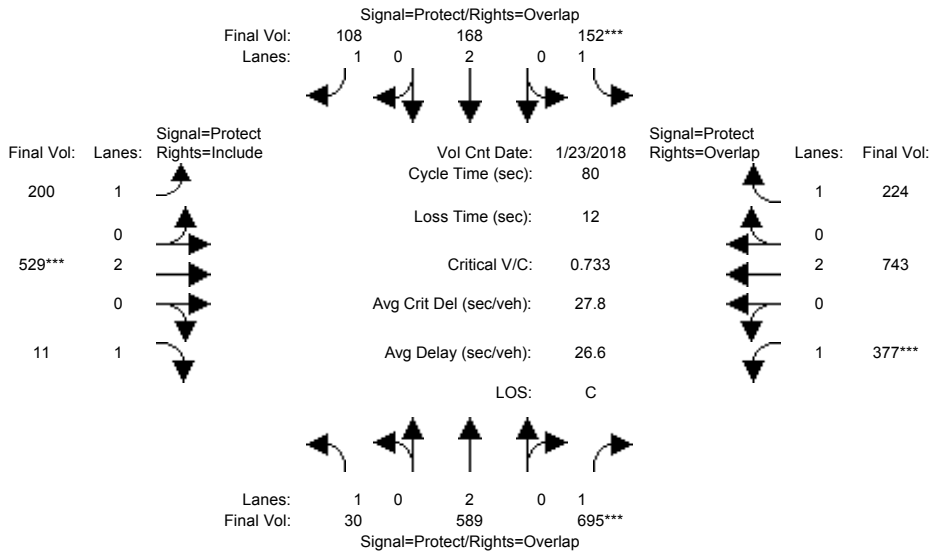

Street Name:	Butterfield Boulevard						Tennant Avenue					
	North Bound			South Bound			East Bound			West Bound		
Approach:	L	T	R	L	T	R	L	T	R	L	T	R
Min. Green:	7	10	10	7	10	10	7	10	10	7	10	10
Y+R:	4.0	4.0	4.0	4.0	4.0	4.0	4.0	4.0	4.0	4.0	4.0	4.0

Volume Module:	>>	Count	Date:	23 Jan 2018	<<											
Base Vol:	22	570	483	95	138	93	195	453	8	258	688	212				
Growth Adj:	1.00	1.00	1.00	1.00	1.00	1.00	1.00	1.00	1.00	1.00	1.00	1.00				
Initial Bse:	22	570	483	95	138	93	195	453	8	258	688	212				
Added Vol:	0	0	0	0	0	0	0	26	0	0	20	0				
PasserByVol:	8	19	212	57	30	15	5	50	3	119	35	12				
Initial Fut:	30	589	695	152	168	108	200	529	11	377	743	224				
User Adj:	1.00	1.00	1.00	1.00	1.00	1.00	1.00	1.00	1.00	1.00	1.00	1.00				
PHF Adj:	1.00	1.00	1.00	1.00	1.00	1.00	1.00	1.00	1.00	1.00	1.00	1.00				
PHF Volume:	30	589	695	152	168	108	200	529	11	377	743	224				
Reduct Vol:	0	0	0	0	0	0	0	0	0	0	0	0				
Reduced Vol:	30	589	695	152	168	108	200	529	11	377	743	224				
PCE Adj:	1.00	1.00	1.00	1.00	1.00	1.00	1.00	1.00	1.00	1.00	1.00	1.00				
MLF Adj:	1.00	1.00	1.00	1.00	1.00	1.00	1.00	1.00	1.00	1.00	1.00	1.00				
FinalVolume:	30	589	695	152	168	108	200	529	11	377	743	224				

Saturation Flow Module:												
Sat/Lane:	1900	1900	1900	1900	1900	1900	1900	1900	1900	1900	1900	1900
Adjustment:	0.92	1.00	0.92	0.92	1.00	0.92	0.92	1.00	0.92	0.92	1.00	0.92
Lanes:	1.00	2.00	1.00	1.00	2.00	1.00	1.00	2.00	1.00	1.00	2.00	1.00
Final Sat.:	1750	3800	1750	1750	3800	1750	1750	3800	1750	1750	3800	1750

Capacity Analysis Module:												
Vol/Sat:	0.02	0.16	0.40	0.09	0.04	0.06	0.11	0.14	0.01	0.22	0.20	0.13
Crit Moves:			****	****				****		****		
Green Time:	12.1	19.8	43.3	9.5	17.2	31.5	14.3	15.2	15.2	23.5	24.4	33.9
Volume/Cap:	0.11	0.63	0.73	0.73	0.21	0.16	0.64	0.73	0.03	0.73	0.64	0.30
Delay/Veh:	29.5	28.1	16.9	46.7	25.9	15.8	34.9	34.4	26.5	30.8	25.2	15.5
User DelAdj:	1.00	1.00	1.00	1.00	1.00	1.00	1.00	1.00	1.00	1.00	1.00	1.00
AdjDel/Veh:	29.5	28.1	16.9	46.7	25.9	15.8	34.9	34.4	26.5	30.8	25.2	15.5
LOS by Move:	C	C	B	D	C	B	C	C	C	C	C	B
HCM2kAvgQ:	1	7	15	4	2	2	5	6	0	11	9	4

Note: Queue reported is the number of cars per lane.

Voices School
Morgan Hill, CA
Hexagon Transportation Consultants, Inc.

Level Of Service Computation Report
2000 HCM Operations (Future Volume Alternative)
2025 Plus Project (PM) - 1 Cosmo Full out

Intersection #1111: Butterfield Boulevard and Tennant Avenue

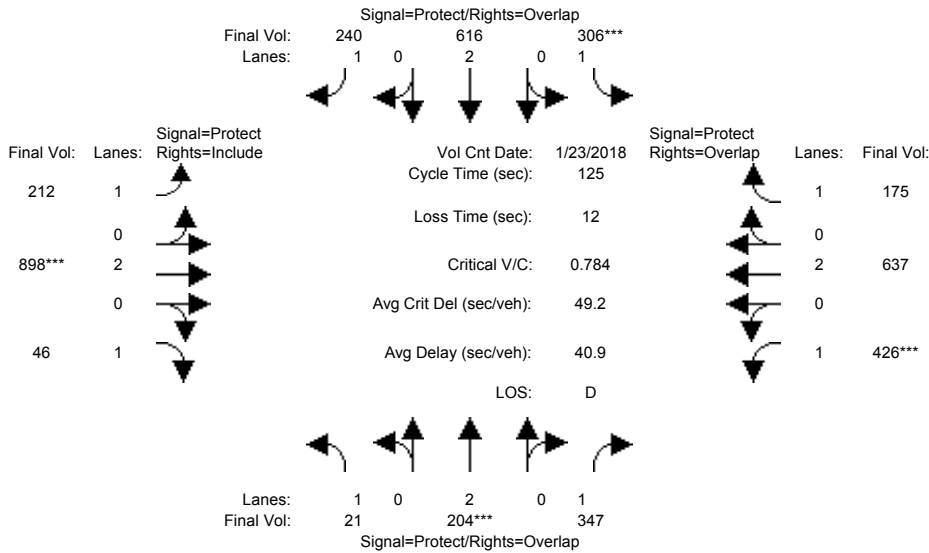

Street Name: Butterfield Boulevard Tennant Avenue
Approach: North Bound South Bound East Bound West Bound
Movement: L - T - R L - T - R L - T - R L - T - R

Min. Green: 7 10 10 7 10 10 7 10 10 7 10 10
Y+R: 4.0 4.0 4.0 4.0 4.0 4.0 4.0 4.0 4.0 4.0 4.0 4.0

Volume Module: >> Count Date: 23 Jan 2018 <<

Base Vol:	15	162	220	247	559	240	204	819	36	254	562	73
Growth Adj:	1.00	1.00	1.00	1.00	1.00	1.00	1.00	1.00	1.00	1.00	1.00	1.00
Initial Bse:	15	162	220	247	559	240	204	819	36	254	562	73
Added Vol:	0	0	0	0	0	0	0	10	0	0	13	0
PasserByVol:	6	42	127	59	57	0	8	69	10	172	62	102
Initial Fut:	21	204	347	306	616	240	212	898	46	426	637	175
User Adj:	1.00	1.00	1.00	1.00	1.00	1.00	1.00	1.00	1.00	1.00	1.00	1.00
PHF Adj:	1.00	1.00	1.00	1.00	1.00	1.00	1.00	1.00	1.00	1.00	1.00	1.00
PHF Volume:	21	204	347	306	616	240	212	898	46	426	637	175
Reduct Vol:	0	0	0	0	0	0	0	0	0	0	0	0
Reduced Vol:	21	204	347	306	616	240	212	898	46	426	637	175
PCE Adj:	1.00	1.00	1.00	1.00	1.00	1.00	1.00	1.00	1.00	1.00	1.00	1.00
MLF Adj:	1.00	1.00	1.00	1.00	1.00	1.00	1.00	1.00	1.00	1.00	1.00	1.00
FinalVolume:	21	204	347	306	616	240	212	898	46	426	637	175

Saturation Flow Module:

Sat/Lane:	1900	1900	1900	1900	1900	1900	1900	1900	1900	1900	1900	1900
Adjustment:	0.92	1.00	0.92	0.92	1.00	0.92	0.92	1.00	0.92	0.92	1.00	0.92
Lanes:	1.00	2.00	1.00	1.00	2.00	1.00	1.00	2.00	1.00	1.00	2.00	1.00
Final Sat.:	1750	3800	1750	1750	3800	1750	1750	3800	1750	1750	3800	1750

Capacity Analysis Module:

Vol/Sat:	0.01	0.05	0.20	0.17	0.16	0.14	0.12	0.24	0.03	0.24	0.17	0.10
Crit Moves:	****	****	****	****	****	****	****	****	****	****	****	****
Green Time:	9.6	10.0	48.3	27.5	27.9	59.5	31.7	37.2	37.2	38.3	43.8	71.3
Volume/Cap:	0.16	0.67	0.51	0.79	0.73	0.29	0.48	0.79	0.09	0.79	0.48	0.18
Delay/Veh:	54.4	61.6	30.0	56.9	48.2	20.1	40.5	44.4	31.8	47.8	31.9	12.9
User DelAdj:	1.00	1.00	1.00	1.00	1.00	1.00	1.00	1.00	1.00	1.00	1.00	1.00
AdjDel/Veh:	54.4	61.6	30.0	56.9	48.2	20.1	40.5	44.4	31.8	47.8	31.9	12.9
LOS by Move:	D	E	C	E	D	C	D	D	C	D	C	B
HCM2kAvgQ:	1	5	11	12	11	6	7	16	1	18	10	3

Note: Queue reported is the number of cars per lane.

Voices School
Morgan Hill, CA
Hexagon Transportation Consultants, Inc.

Level Of Service Computation Report
2000 HCM Unsignalized (Future Volume Alternative)
Existing Plus Project (AM) - 1 Cosmo Full out

Intersection #1112: Monterey Road and San Pedro Avenue

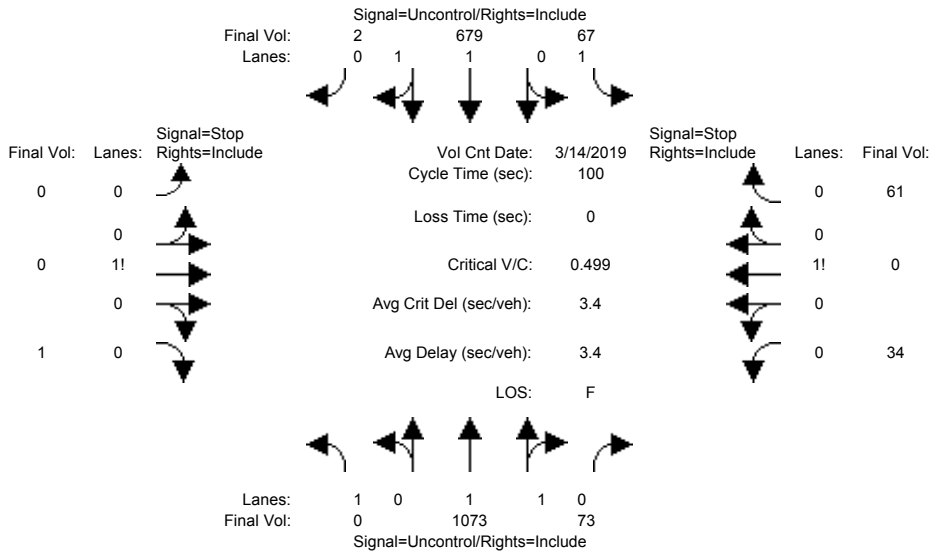

Street Name: Monterey Road San Pedro Avenue
Approach: North Bound South Bound East Bound West Bound
Movement: L - T - R L - T - R L - T - R L - T - R

Volume Module:	>>	Count	Date:	14 Mar 2019	<<							
Base Vol:	0	887	68	67	463	2	0	0	1	27	0	61
Growth Adj:	1.00	1.00	1.00	1.00	1.00	1.00	1.00	1.00	1.00	1.00	1.00	1.00
Initial Bse:	0	887	68	67	463	2	0	0	1	27	0	61
Added Vol:	0	186	5	0	216	0	0	0	0	7	0	0
PasserByVol:	0	0	0	0	0	0	0	0	0	0	0	0
Initial Fut:	0	1073	73	67	679	2	0	0	1	34	0	61
User Adj:	1.00	1.00	1.00	1.00	1.00	1.00	1.00	1.00	1.00	1.00	1.00	1.00
PHF Adj:	1.00	1.00	1.00	1.00	1.00	1.00	1.00	1.00	1.00	1.00	1.00	1.00
PHF Volume:	0	1073	73	67	679	2	0	0	1	34	0	61
Reduct Vol:	0	0	0	0	0	0	0	0	0	0	0	0
FinalVolume:	0	1073	73	67	679	2	0	0	1	34	0	61

Critical Gap Module:

Critical Gp:	xxxxx	xxxx	xxxxx	4.1	xxxx	xxxxx	xxxxx	xxxx	6.9	7.5	6.5	6.9
FollowUpTim:	xxxxx	xxxx	xxxxx	2.2	xxxx	xxxxx	xxxxx	xxxx	3.3	3.5	4.0	3.3

Capacity Module:

Cnflct Vol:	xxxx	xxxx	xxxxx	1146	xxxx	xxxxx	xxxx	xxxx	341	1583	1925	573
Potent Cap.:	xxxx	xxxx	xxxxx	617	xxxx	xxxxx	xxxx	xxxx	661	74	68	468
Move Cap.:	xxxx	xxxx	xxxxx	617	xxxx	xxxxx	xxxx	xxxx	661	68	60	468
Volume/Cap:	xxxx	xxxx	xxxx	0.11	xxxx	xxxx	xxxx	xxxx	0.00	0.50	0.00	0.13

Level Of Service Module:

2Way95thQ:	xxxx	xxxx	xxxxx	0.4	xxxx	xxxxx	xxxx	xxxx	0.0	xxxx	xxxx	xxxxx
Control Del:	xxxxx	xxxx	xxxxx	11.5	xxxx	xxxxx	xxxxx	xxxx	10.5	xxxxx	xxxx	xxxxx
LOS by Move:	*	*	*	B	*	*	*	*	B	*	*	*
Movement:	LT - LTR - RT	LT - LTR - RT	LT - LTR - RT	LT - LTR - RT	LT - LTR - RT	LT - LTR - RT	LT - LTR - RT	LT - LTR - RT	LT - LTR - RT	LT - LTR - RT	LT - LTR - RT	LT - LTR - RT
Shared Cap.:	xxxx	xxxx	xxxxx	xxxx	xxxx	xxxxx	xxxx	xxxx	xxxxx	xxxx	151	xxxxx
SharedQueue:	xxxxx	xxxx	xxxxx	xxxxx	xxxx	xxxxx	xxxxx	xxxx	xxxxx	xxxxx	3.4	xxxxx
Shrd ConDel:	xxxxx	xxxx	xxxxx	xxxxx	xxxx	xxxxx	xxxxx	xxxx	xxxxx	xxxxx	62.5	xxxxx
Shared LOS:	*	*	*	*	*	*	*	*	*	*	F	*
ApproachDel:	xxxxxxx		xxxxxxx						10.5		62.5	
ApproachLOS:	*		*						B		F	

Note: Queue reported is the number of cars per lane.

Voices School
Morgan Hill, CA
Hexagon Transportation Consultants, Inc.

Level Of Service Computation Report
2000 HCM Unsignalized (Future Volume Alternative)
Existing Plus Project (PM) - 1 Cosmo Full out

Intersection #1112: Monterey Road and San Pedro Avenue

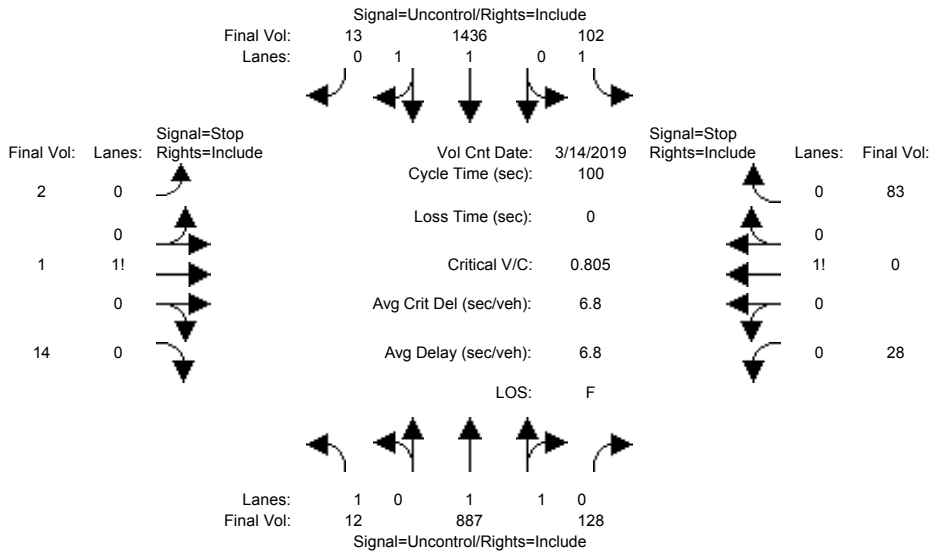

Street Name: Monterey Road San Pedro Avenue
Approach: North Bound South Bound East Bound West Bound
Movement: L - T - R L - T - R L - T - R L - T - R

Volume Module:	>>	Count	Date:	14 Mar 2019	<<							
Base Vol:	12	774	120	102	1333	13	2	1	14	27	0	83
Growth Adj:	1.00	1.00	1.00	1.00	1.00	1.00	1.00	1.00	1.00	1.00	1.00	1.00
Initial Bse:	12	774	120	102	1333	13	2	1	14	27	0	83
Added Vol:	0	113	8	0	103	0	0	0	0	1	0	0
PasserByVol:	0	0	0	0	0	0	0	0	0	0	0	0
Initial Fut:	12	887	128	102	1436	13	2	1	14	28	0	83
User Adj:	1.00	1.00	1.00	1.00	1.00	1.00	1.00	1.00	1.00	1.00	1.00	1.00
PHF Adj:	1.00	1.00	1.00	1.00	1.00	1.00	1.00	1.00	1.00	1.00	1.00	1.00
PHF Volume:	12	887	128	102	1436	13	2	1	14	28	0	83
Reduct Vol:	0	0	0	0	0	0	0	0	0	0	0	0
FinalVolume:	12	887	128	102	1436	13	2	1	14	28	0	83

Critical Gap Module:

Critical Gp:	4.1	xxxx	xxxxx	4.1	xxxx	xxxxx	7.5	6.5	6.9	7.5	6.5	6.9
FollowUpTim:	2.2	xxxx	xxxxx	2.2	xxxx	xxxxx	3.5	4.0	3.3	3.5	4.0	3.3

Capacity Module:

Cnflict Vol:	1449	xxxx	xxxxx	1015	xxxx	xxxxx	2114	2686	725	1898	2628	508
Potent Cap.:	474	xxxx	xxxxx	691	xxxx	xxxxx	30	22	372	43	24	516
Move Cap.:	474	xxxx	xxxxx	691	xxxx	xxxxx	22	18	372	35	20	516
Volume/Cap:	0.03	xxxx	xxxx	0.15	xxxx	xxxx	0.09	0.05	0.04	0.81	0.00	0.16

Level Of Service Module:

2Way95thQ:	0.1	xxxx	xxxxx	0.5	xxxx	xxxxx	xxxx	xxxx	xxxxx	xxxx	xxxx	xxxxx
Control Del:	12.8	xxxx	xxxxx	11.1	xxxx	xxxxx	xxxxx	xxxx	xxxxx	xxxxx	xxxx	xxxxx
LOS by Move:	B	*	*	B	*	*	*	*	*	*	*	*
Movement:	LT - LTR - RT			LT - LTR - RT			LT - LTR - RT			LT - LTR - RT		
Shared Cap.:	xxxx	xxxx	xxxxx	xxxx	xxxx	xxxxx	xxxx	92	xxxxx	xxxx	115	xxxxx
SharedQueue:	xxxxx	xxxx	xxxxx	xxxxx	xxxx	xxxxx	xxxxx	0.6	xxxxx	xxxxx	6.2	xxxxx
Shrd ConDel:	xxxxx	xxxx	xxxxx	xxxxx	xxxx	xxxxx	xxxxx	52.6	xxxxx	xxxxx	146	xxxxx
Shared LOS:	*	*	*	*	*	*	*	F	*	*	F	*
ApproachDel:	xxxxxxx			xxxxxxx				52.6			145.8	
ApproachLOS:	*			*				F			F	

Note: Queue reported is the number of cars per lane.

Voices School
Morgan Hill, CA
Hexagon Transportation Consultants, Inc.

Level Of Service Computation Report
2000 HCM Unsignalized (Future Volume Alternative)
2025 Plus Project (AM) - 1 Cosmo Full out

Intersection #1112: Monterey Road and San Pedro Avenue

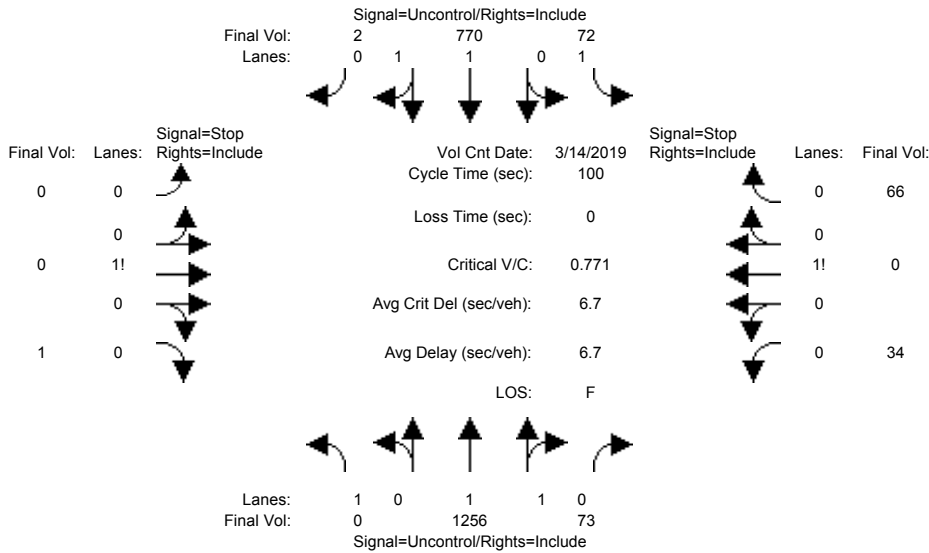

Street Name: Monterey Road San Pedro Avenue
Approach: North Bound South Bound East Bound West Bound
Movement: L - T - R L - T - R L - T - R L - T - R

Volume Module:	>> Count Date: 14 Mar 2019 <<											
Base Vol:	0	887	68	67	463	2	0	0	1	27	0	61
Growth Adj:	1.00	1.00	1.00	1.00	1.00	1.00	1.00	1.00	1.00	1.00	1.00	1.00
Initial Bse:	0	887	68	67	463	2	0	0	1	27	0	61
Added Vol:	0	182	5	0	214	0	0	0	0	7	0	0
PasserByVol:	0	187	0	5	93	0	0	0	0	0	0	5
Initial Fut:	0	1256	73	72	770	2	0	0	1	34	0	66
User Adj:	1.00	1.00	1.00	1.00	1.00	1.00	1.00	1.00	1.00	1.00	1.00	1.00
PHF Adj:	1.00	1.00	1.00	1.00	1.00	1.00	1.00	1.00	1.00	1.00	1.00	1.00
PHF Volume:	0	1256	73	72	770	2	0	0	1	34	0	66
Reduct Vol:	0	0	0	0	0	0	0	0	0	0	0	0
FinalVolume:	0	1256	73	72	770	2	0	0	1	34	0	66

Critical Gap Module:

Critical Gp:	xxxxx	xxxx	xxxxx	4.1	xxxx	xxxxx	xxxxx	xxxx	6.9	7.5	6.5	6.9
FollowUpTim:	xxxxx	xxxx	xxxxx	2.2	xxxx	xxxxx	xxxxx	xxxx	3.3	3.5	4.0	3.3

Capacity Module:

Cnflct Vol:	xxxx	xxxx	xxxxx	1329	xxxx	xxxxx	xxxx	xxxx	386	1822	2209	665
Potent Cap.:	xxxx	xxxx	xxxxx	526	xxxx	xxxxx	xxxx	xxxx	618	49	45	408
Move Cap.:	xxxx	xxxx	xxxxx	526	xxxx	xxxxx	xxxx	xxxx	618	44	39	408
Volume/Cap:	xxxx	xxxx	xxxx	0.14	xxxx	xxxx	xxxx	xxxx	0.00	0.77	0.00	0.16

Level Of Service Module:

2Way95thQ:	xxxx	xxxx	xxxxx	0.5	xxxx	xxxxx	xxxx	xxxx	0.0	xxxx	xxxx	xxxxx
Control Del:	xxxxx	xxxx	xxxxx	12.9	xxxx	xxxxx	xxxxx	xxxx	10.8	xxxxx	xxxx	xxxxx
LOS by Move:	*	*	*	B	*	*	*	*	B	*	*	*
Movement:	LT - LTR - RT	LT - LTR - RT	LT - LTR - RT	LT - LTR - RT	LT - LTR - RT	LT - LTR - RT	LT - LTR - RT	LT - LTR - RT	LT - LTR - RT	LT - LTR - RT	LT - LTR - RT	LT - LTR - RT
Shared Cap.:	xxxx	xxxx	xxxxx	xxxx	xxxx	xxxxx	xxxx	xxxx	xxxxx	xxxx	107	xxxxx
SharedQueue:	xxxxx	xxxx	xxxxx	xxxxx	xxxx	xxxxx	xxxxx	xxxx	xxxxx	xxxxx	5.7	xxxxx
Shrd ConDel:	xxxxx	xxxx	xxxxx	xxxxx	xxxx	xxxxx	xxxxx	xxxx	xxxxx	xxxxx	143	xxxxx
Shared LOS:	*	*	*	*	*	*	*	*	*	*	F	*
ApproachDel:	xxxxxxx	xxxxxxx							10.8		143.1	
ApproachLOS:	*	*							B		F	

Note: Queue reported is the number of cars per lane.

Voices School
Morgan Hill, CA
Hexagon Transportation Consultants, Inc.

Level Of Service Computation Report
2000 HCM Unsignalized (Future Volume Alternative)
2025 Plus Project (PM) - 1 Cosmo Full out

Intersection #1112: Monterey Road and San Pedro Avenue

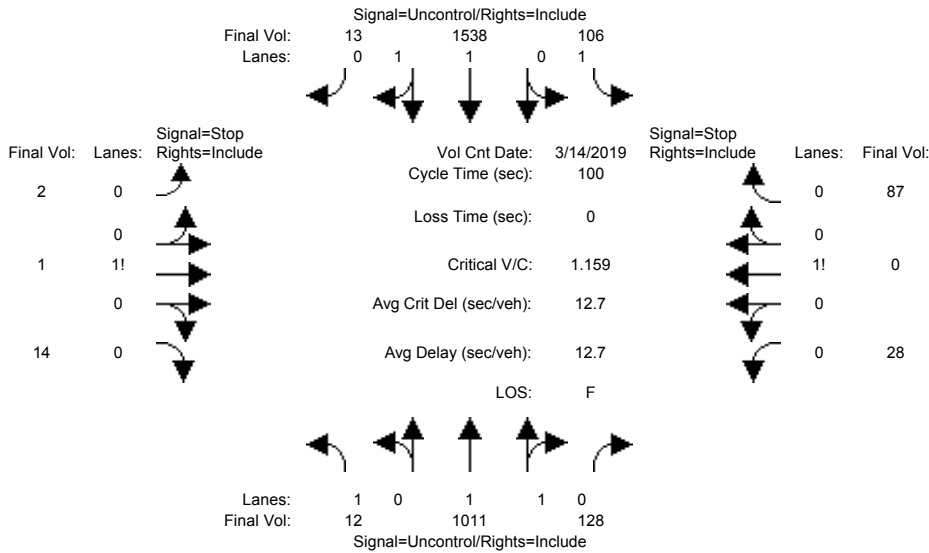

Street Name: Monterey Road San Pedro Avenue
Approach: North Bound South Bound East Bound West Bound
Movement: L - T - R L - T - R L - T - R L - T - R

Volume Module:	>>	Count	Date:	14 Mar 2019	<<							
Base Vol:	12	774	120	102	1333	13	2	1	14	27	0	83
Growth Adj:	1.00	1.00	1.00	1.00	1.00	1.00	1.00	1.00	1.00	1.00	1.00	1.00
Initial Bse:	12	774	120	102	1333	13	2	1	14	27	0	83
Added Vol:	0	109	8	0	98	0	0	0	0	1	0	0
PasserByVol:	0	128	0	4	107	0	0	0	0	0	0	4
Initial Fut:	12	1011	128	106	1538	13	2	1	14	28	0	87
User Adj:	1.00	1.00	1.00	1.00	1.00	1.00	1.00	1.00	1.00	1.00	1.00	1.00
PHF Adj:	1.00	1.00	1.00	1.00	1.00	1.00	1.00	1.00	1.00	1.00	1.00	1.00
PHF Volume:	12	1011	128	106	1538	13	2	1	14	28	0	87
Reduct Vol:	0	0	0	0	0	0	0	0	0	0	0	0
FinalVolume:	12	1011	128	106	1538	13	2	1	14	28	0	87

Critical Gap Module:

Critical Gp:	4.1	xxxx	xxxxxx	4.1	xxxx	xxxxxx	7.5	6.5	6.9	7.5	6.5	6.9
FollowUpTim:	2.2	xxxx	xxxxxx	2.2	xxxx	xxxxxx	3.5	4.0	3.3	3.5	4.0	3.3

Capacity Module:

Cnflct Vol:	1551	xxxx	xxxxxx	1139	xxxx	xxxxxx	2286	2920	776	2081	2862	570
Potent Cap.:	433	xxxx	xxxxxx	621	xxxx	xxxxxx	22	16	345	31	17	470
Move Cap.:	433	xxxx	xxxxxx	621	xxxx	xxxxxx	15	13	345	24	14	470
Volume/Cap:	0.03	xxxx	xxxx	0.17	xxxx	xxxx	0.13	0.08	0.04	1.16	0.00	0.19

Level Of Service Module:

2Way95thQ:	0.1	xxxx	xxxxxx	0.6	xxxx	xxxxxx	xxxx	xxxx	xxxxxx	xxxx	xxxx	xxxxxx
Control Del:	13.6	xxxx	xxxxxx	12.0	xxxx	xxxxxx	xxxxxx	xxxx	xxxxxx	xxxxxx	xxxx	xxxxxx
LOS by Move:	B	*	*	B	*	*	*	*	*	*	*	*
Movement:	LT - LTR - RT			LT - LTR - RT			LT - LTR - RT			LT - LTR - RT		
Shared Cap.:	xxxx	xxxx	xxxxxx	xxxx	xxxx	xxxxxx	xxxx	68	xxxxxx	xxxx	86	xxxxxx
SharedQueue:	xxxxxx	xxxx	xxxxxx	xxxxxx	xxxx	xxxxxx	xxxxxx	0.9	xxxxxx	xxxxxx	8.7	xxxxxx
Shrd ConDel:	xxxxxx	xxxx	xxxxxx	xxxxxx	xxxx	xxxxxx	xxxxxx	75.4	xxxxxx	xxxxxx	302	xxxxxx
Shared LOS:	*	*	*	*	*	*	*	F	*	*	F	*
ApproachDel:	xxxxxxx			xxxxxxx				75.4			301.9	
ApproachLOS:		*			*			F			F	

Note: Queue reported is the number of cars per lane.

Voices School
Morgan Hill, CA
Hexagon Transportation Consultants, Inc.

Level Of Service Computation Report
2000 HCM Operations (Future Volume Alternative)
Existing Plus Project (AM) - 1 Cosmo Full out

Intersection #1200: Monterey Road and Cosmo Avenue

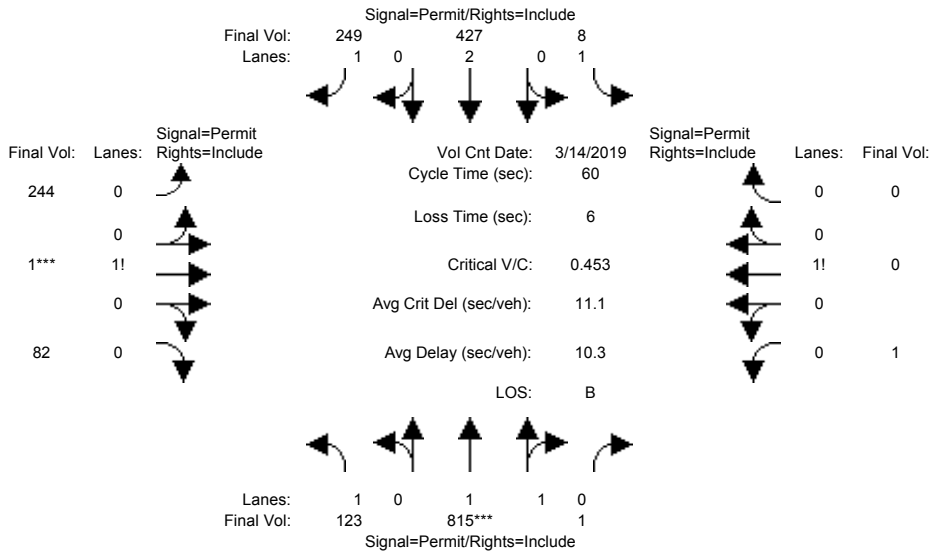

Street Name:	Monterey Rd						Cosmo Ave					
Approach:	North Bound			South Bound			East Bound			West Bound		
Movement:	L	T	R	L	T	R	L	T	R	L	T	R
Min. Green:	10	10	10	10	10	10	10	10	10	10	10	10
Y+R:	4.0	4.0	4.0	4.0	4.0	4.0	4.0	4.0	4.0	4.0	4.0	4.0

Volume Module:	>>	Count	Date:	14 Mar 2019	<<							
Base Vol:	17	815	1	8	427	27	53	1	24	1	0	0
Growth Adj:	1.00	1.00	1.00	1.00	1.00	1.00	1.00	1.00	1.00	1.00	1.00	1.00
Initial Bse:	17	815	1	8	427	27	53	1	24	1	0	0
Added Vol:	106	0	0	0	0	222	191	0	58	0	0	0
PasserByVol:	0	0	0	0	0	0	0	0	0	0	0	0
Initial Fut:	123	815	1	8	427	249	244	1	82	1	0	0
User Adj:	1.00	1.00	1.00	1.00	1.00	1.00	1.00	1.00	1.00	1.00	1.00	1.00
PHF Adj:	1.00	1.00	1.00	1.00	1.00	1.00	1.00	1.00	1.00	1.00	1.00	1.00
PHF Volume:	123	815	1	8	427	249	244	1	82	1	0	0
Reduct Vol:	0	0	0	0	0	0	0	0	0	0	0	0
Reduced Vol:	123	815	1	8	427	249	244	1	82	1	0	0
PCE Adj:	1.00	1.00	1.00	1.00	1.00	1.00	1.00	1.00	1.00	1.00	1.00	1.00
MLF Adj:	1.00	1.00	1.00	1.00	1.00	1.00	1.00	1.00	1.00	1.00	1.00	1.00
FinalVolume:	123	815	1	8	427	249	244	1	82	1	0	0

Saturation Flow Module:	
Sat/Lane:	1900 1900 1900 1900 1900 1900 1900 1900 1900 1900 1900 1900
Adjustment:	0.92 0.97 0.95 0.92 1.00 0.92 0.92 0.92 0.92 0.92 1.00 0.92
Lanes:	1.00 1.99 0.01 1.00 2.00 1.00 0.74 0.01 0.25 1.00 0.00 0.00
Final Sat.:	1750 3695 5 1750 3800 1750 1306 5 439 1750 0 0

Capacity Analysis Module:	
Vol/Sat:	0.07 0.22 0.22 0.00 0.11 0.14 0.19 0.19 0.19 0.00 0.00 0.00
Crit Moves:	****
Green Time:	29.2 29.2 29.2 29.2 29.2 29.2 24.8 24.8 24.8 24.8 0.0 0.0
Volume/Cap:	0.14 0.45 0.45 0.01 0.23 0.29 0.45 0.45 0.45 0.00 0.00 0.00
Delay/Veh:	8.6 10.3 10.3 7.9 9.0 9.4 13.2 13.2 13.2 10.4 0.0 0.0
User DelAdj:	1.00 1.00 1.00 1.00 1.00 1.00 1.00 1.00 1.00 1.00 1.00 1.00
AdjDel/Veh:	8.6 10.3 10.3 7.9 9.0 9.4 13.2 13.2 13.2 10.4 0.0 0.0
LOS by Move:	A B B A A A B B B B A A
HCM2kAvgQ:	1 5 5 0 2 3 5 5 5 0 0 0

Note: Queue reported is the number of cars per lane.

Voices School
Morgan Hill, CA
Hexagon Transportation Consultants, Inc.

Level Of Service Computation Report
2000 HCM Operations (Future Volume Alternative)
Existing Plus Project (PM) - 1 Cosmo Full out

Intersection #1200: Monterey Road and Cosmo Avenue

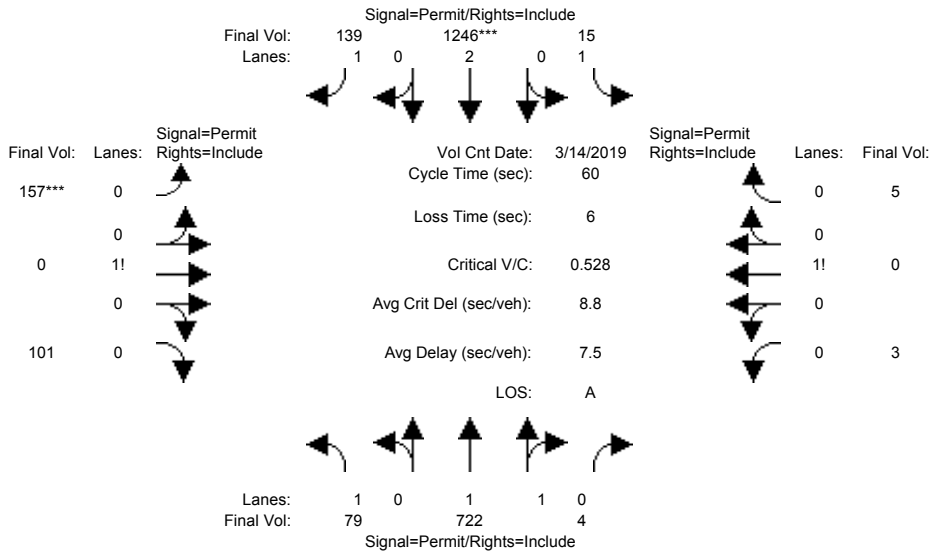

Street Name:	Monterey Rd						Cosmo Ave					
Approach:	North Bound			South Bound			East Bound			West Bound		
Movement:	L	T	R	L	T	R	L	T	R	L	T	R
Min. Green:	10	10	10	10	10	10	10	10	10	10	10	10
Y+R:	4.0	4.0	4.0	4.0	4.0	4.0	4.0	4.0	4.0	4.0	4.0	4.0

Volume Module:	>>	Count	Date:	14 Mar 2019	<<							
Base Vol:	45	722	4	15	1246	35	35	0	49	3	0	5
Growth Adj:	1.00	1.00	1.00	1.00	1.00	1.00	1.00	1.00	1.00	1.00	1.00	1.00
Initial Bse:	45	722	4	15	1246	35	35	0	49	3	0	5
Added Vol:	34	0	0	0	0	104	122	0	52	0	0	0
PasserByVol:	0	0	0	0	0	0	0	0	0	0	0	0
Initial Fut:	79	722	4	15	1246	139	157	0	101	3	0	5
User Adj:	1.00	1.00	1.00	1.00	1.00	1.00	1.00	1.00	1.00	1.00	1.00	1.00
PHF Adj:	1.00	1.00	1.00	1.00	1.00	1.00	1.00	1.00	1.00	1.00	1.00	1.00
PHF Volume:	79	722	4	15	1246	139	157	0	101	3	0	5
Reduct Vol:	0	0	0	0	0	0	0	0	0	0	0	0
Reduced Vol:	79	722	4	15	1246	139	157	0	101	3	0	5
PCE Adj:	1.00	1.00	1.00	1.00	1.00	1.00	1.00	1.00	1.00	1.00	1.00	1.00
MLF Adj:	1.00	1.00	1.00	1.00	1.00	1.00	1.00	1.00	1.00	1.00	1.00	1.00
FinalVolume:	79	722	4	15	1246	139	157	0	101	3	0	5

Saturation Flow Module:	
Sat/Lane:	1900 1900 1900 1900 1900 1900 1900 1900 1900 1900 1900 1900
Adjustment:	0.92 0.97 0.95 0.92 1.00 0.92 0.92 0.92 0.92 0.92 0.92 0.92
Lanes:	1.00 1.99 0.01 1.00 2.00 1.00 0.61 0.00 0.39 0.37 0.00 0.63
Final Sat.:	1750 3680 20 1750 3800 1750 1065 0 685 656 0 1094

Capacity Analysis Module:	
Vol/Sat:	0.05 0.20 0.20 0.01 0.33 0.08 0.15 0.00 0.15 0.00 0.00 0.00
Crit Moves:	****
Green Time:	37.3 37.3 37.3 37.3 37.3 37.3 16.7 0.0 16.7 16.7 0.0 16.7
Volume/Cap:	0.07 0.32 0.32 0.01 0.53 0.13 0.53 0.00 0.53 0.02 0.00 0.02
Delay/Veh:	4.5 5.4 5.4 4.4 6.6 4.7 19.4 0.0 19.4 15.7 0.0 15.7
User DelAdj:	1.00 1.00 1.00 1.00 1.00 1.00 1.00 1.00 1.00 1.00 1.00 1.00
AdjDel/Veh:	4.5 5.4 5.4 4.4 6.6 4.7 19.4 0.0 19.4 15.7 0.0 15.7
LOS by Move:	A A A A A A B A B B A B
HCM2kAvgQ:	1 3 3 0 7 1 5 0 5 0 0 0

Note: Queue reported is the number of cars per lane.

Voices School
Morgan Hill, CA
Hexagon Transportation Consultants, Inc.

Level Of Service Computation Report
2000 HCM Operations (Future Volume Alternative)
2025 Plus Project (AM) - 1 Cosmo Full out

Intersection #1200: Monterey Road and Cosmo Avenue

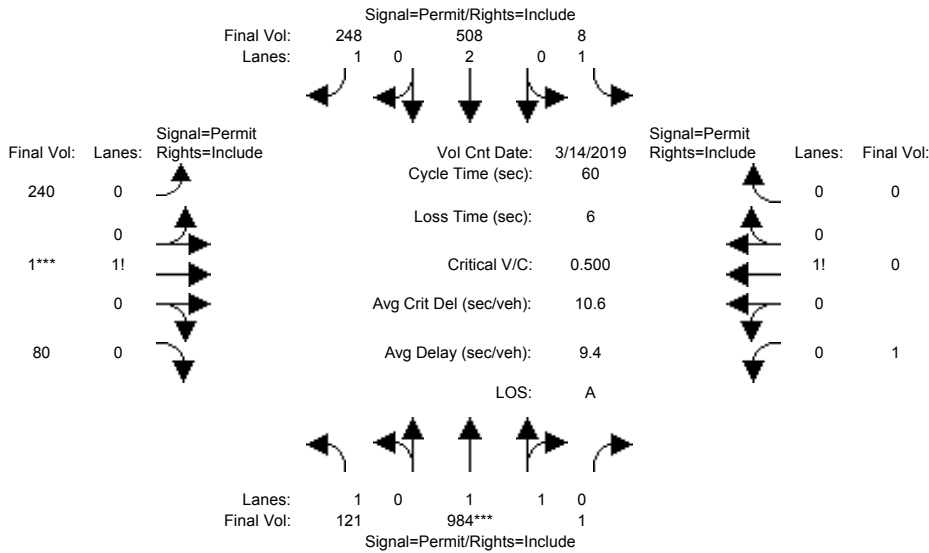

Street Name:	Monterey Rd						Cosmo Ave					
Approach:	North Bound			South Bound			East Bound			West Bound		
Movement:	L	T	R	L	T	R	L	T	R	L	T	R
Min. Green:	10	10	10	10	10	10	10	10	10	10	10	10
Y+R:	4.0	4.0	4.0	4.0	4.0	4.0	4.0	4.0	4.0	4.0	4.0	4.0

Volume Module:	>>	Count	Date:	14 Mar 2019	<<											
Base Vol:	17	815	1	8	427	27	53	1	24	1	0	0				
Growth Adj:	1.00	1.00	1.00	1.00	1.00	1.00	1.00	1.00	1.00	1.00	1.00	1.00				
Initial Bse:	17	815	1	8	427	27	53	1	24	1	0	0				
Added Vol:	104	0	0	0	0	221	187	0	56	0	0	0				
PasserByVol:	0	169	0	0	81	0	0	0	0	0	0	0				
Initial Fut:	121	984	1	8	508	248	240	1	80	1	0	0				
User Adj:	1.00	1.00	1.00	1.00	1.00	1.00	1.00	1.00	1.00	1.00	1.00	1.00				
PHF Adj:	1.00	1.00	1.00	1.00	1.00	1.00	1.00	1.00	1.00	1.00	1.00	1.00				
PHF Volume:	121	984	1	8	508	248	240	1	80	1	0	0				
Reduct Vol:	0	0	0	0	0	0	0	0	0	0	0	0				
Reduced Vol:	121	984	1	8	508	248	240	1	80	1	0	0				
PCE Adj:	1.00	1.00	1.00	1.00	1.00	1.00	1.00	1.00	1.00	1.00	1.00	1.00				
MLF Adj:	1.00	1.00	1.00	1.00	1.00	1.00	1.00	1.00	1.00	1.00	1.00	1.00				
FinalVolume:	121	984	1	8	508	248	240	1	80	1	0	0				

Saturation Flow Module:												
Sat/Lane:	1900	1900	1900	1900	1900	1900	1900	1900	1900	1900	1900	1900
Adjustment:	0.92	0.97	0.95	0.92	1.00	0.92	0.92	0.92	0.92	0.92	1.00	0.92
Lanes:	1.00	1.99	0.01	1.00	2.00	1.00	0.74	0.01	0.25	1.00	0.00	0.00
Final Sat.:	1750	3696	4	1750	3800	1750	1308	5	436	1750	0	0

Capacity Analysis Module:												
Vol/Sat:	0.07	0.27	0.27	0.00	0.13	0.14	0.18	0.18	0.18	0.00	0.00	0.00
Crit Moves:	****									****		
Green Time:	32.0	32.0	32.0	32.0	32.0	32.0	22.0	22.0	22.0	22.0	0.0	0.0
Volume/Cap:	0.13	0.50	0.50	0.01	0.25	0.27	0.50	0.50	0.50	0.00	0.00	0.00
Delay/Veh:	7.1	9.1	9.1	6.6	7.6	7.8	15.3	15.3	15.3	12.0	0.0	0.0
User DelAdj:	1.00	1.00	1.00	1.00	1.00	1.00	1.00	1.00	1.00	1.00	1.00	1.00
AdjDel/Veh:	7.1	9.1	9.1	6.6	7.6	7.8	15.3	15.3	15.3	12.0	0.0	0.0
LOS by Move:	A	A	A	A	A	A	B	B	B	B	A	A
HCM2kAvgQ:	1	6	6	0	3	3	5	5	5	0	0	0

Note: Queue reported is the number of cars per lane.

Voices School
Morgan Hill, CA
Hexagon Transportation Consultants, Inc.

Level Of Service Computation Report
2000 HCM Operations (Future Volume Alternative)
2025 Plus Project (PM) - 1 Cosmo Full out

Intersection #1200: Monterey Road and Cosmo Avenue

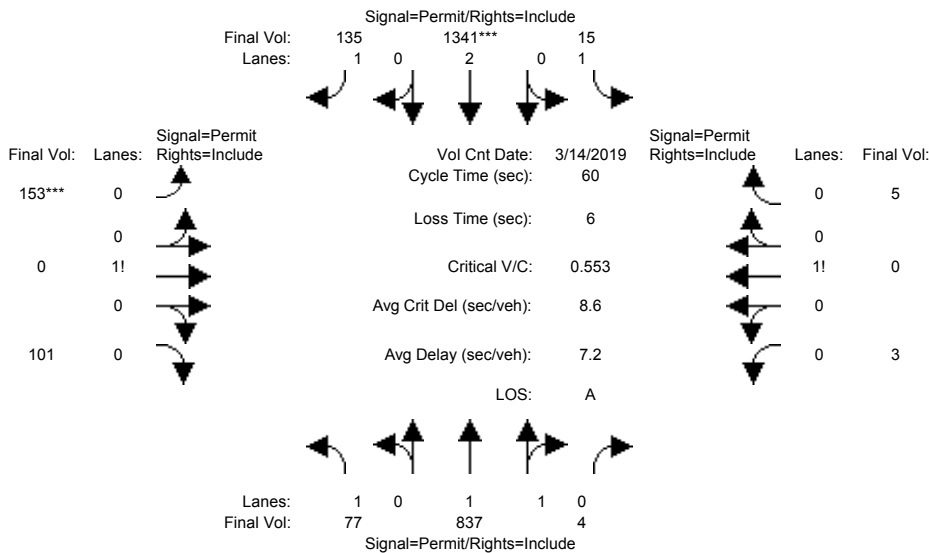

Street Name:	Monterey Rd						Cosmo Ave					
Approach:	North Bound			South Bound			East Bound			West Bound		
Movement:	L	T	R	L	T	R	L	T	R	L	T	R
Min. Green:	10	10	10	10	10	10	10	10	10	10	10	10
Y+R:	4.0	4.0	4.0	4.0	4.0	4.0	4.0	4.0	4.0	4.0	4.0	4.0

Volume Module:	>>	Count	Date:	14 Mar 2019	<<							
Base Vol:	45	722	4	15	1246	35	35	0	49	3	0	5
Growth Adj:	1.00	1.00	1.00	1.00	1.00	1.00	1.00	1.00	1.00	1.00	1.00	1.00
Initial Bse:	45	722	4	15	1246	35	35	0	49	3	0	5
Added Vol:	31	0	0	0	0	100	118	0	51	0	0	0
PasserByVol:	1	115	0	0	95	0	0	0	1	0	0	0
Initial Fut:	77	837	4	15	1341	135	153	0	101	3	0	5
User Adj:	1.00	1.00	1.00	1.00	1.00	1.00	1.00	1.00	1.00	1.00	1.00	1.00
PHF Adj:	1.00	1.00	1.00	1.00	1.00	1.00	1.00	1.00	1.00	1.00	1.00	1.00
PHF Volume:	77	837	4	15	1341	135	153	0	101	3	0	5
Reduct Vol:	0	0	0	0	0	0	0	0	0	0	0	0
Reduced Vol:	77	837	4	15	1341	135	153	0	101	3	0	5
PCE Adj:	1.00	1.00	1.00	1.00	1.00	1.00	1.00	1.00	1.00	1.00	1.00	1.00
MLF Adj:	1.00	1.00	1.00	1.00	1.00	1.00	1.00	1.00	1.00	1.00	1.00	1.00
FinalVolume:	77	837	4	15	1341	135	153	0	101	3	0	5

Saturation Flow Module:												
Sat/Lane:	1900	1900	1900	1900	1900	1900	1900	1900	1900	1900	1900	1900
Adjustment:	0.92	0.97	0.95	0.92	1.00	0.92	0.92	0.92	0.92	0.92	0.92	0.92
Lanes:	1.00	1.99	0.01	1.00	2.00	1.00	0.60	0.00	0.40	0.37	0.00	0.63
Final Sat.:	1750	3682	18	1750	3800	1750	1054	0	696	656	0	1094

Capacity Analysis Module:												
Vol/Sat:	0.04	0.23	0.23	0.01	0.35	0.08	0.15	0.00	0.15	0.00	0.00	0.00
Crit Moves:	*****											
Green Time:	38.3	38.3	38.3	38.3	38.3	38.3	15.7	0.0	15.7	15.7	0.0	15.7
Volume/Cap:	0.07	0.36	0.36	0.01	0.55	0.12	0.55	0.00	0.55	0.02	0.00	0.02
Delay/Veh:	4.1	5.2	5.2	4.0	6.4	4.3	20.6	0.0	20.6	16.4	0.0	16.4
User DelAdj:	1.00	1.00	1.00	1.00	1.00	1.00	1.00	1.00	1.00	1.00	1.00	1.00
AdjDel/Veh:	4.1	5.2	5.2	4.0	6.4	4.3	20.6	0.0	20.6	16.4	0.0	16.4
LOS by Move:	A	A	A	A	A	A	C	A	C	B	A	B
HCM2kAvgQ:	1	4	4	0	7	1	5	0	5	0	0	0

Note: Queue reported is the number of cars per lane.

Voices School
Morgan Hill, CA
Hexagon Transportation Consultants, Inc.

Level Of Service Computation Report
2000 HCM Unsignalized (Future Volume Alternative)
Existing Plus Project (AM) - 1 Cosmo Full out

Intersection #1300: Olympic Drive and Edmundson Avenue

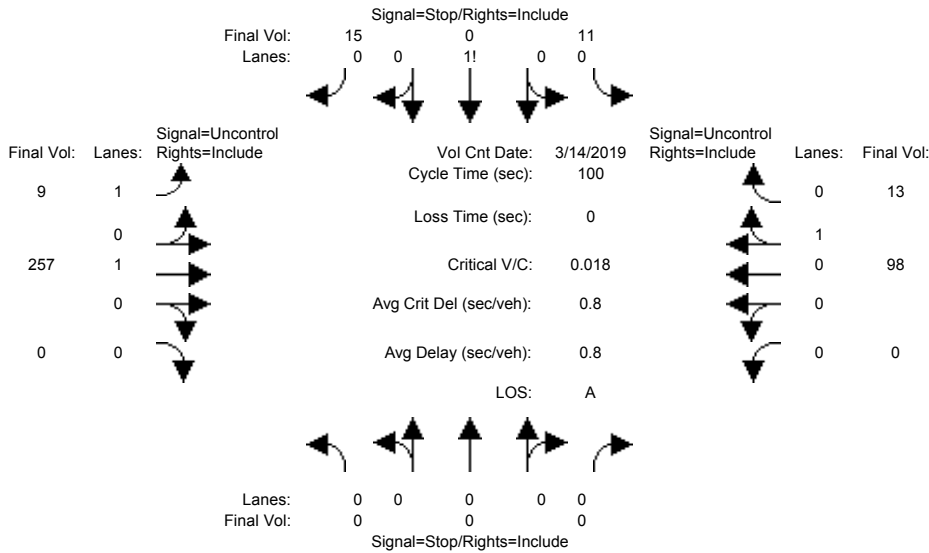

Street Name: Olympic Dr Edmundson Ave
Approach: North Bound South Bound East Bound West Bound
Movement: L - T - R L - T - R L - T - R L - T - R

Volume Module:	>>	Count	Date:	14 Mar 2019	<<							
Base Vol:	0	0	0	11	0	11	9	241	0	0	97	13
Growth Adj:	1.00	1.00	1.00	1.00	1.00	1.00	1.00	1.00	1.00	1.00	1.00	1.00
Initial Bse:	0	0	0	11	0	11	9	241	0	0	97	13
Added Vol:	0	0	0	0	0	4	0	16	0	0	1	0
PasserByVol:	0	0	0	0	0	0	0	0	0	0	0	0
Initial Fut:	0	0	0	11	0	15	9	257	0	0	98	13
User Adj:	1.00	1.00	1.00	1.00	1.00	1.00	1.00	1.00	1.00	1.00	1.00	1.00
PHF Adj:	1.00	1.00	1.00	1.00	1.00	1.00	1.00	1.00	1.00	1.00	1.00	1.00
PHF Volume:	0	0	0	11	0	15	9	257	0	0	98	13
Reduct Vol:	0	0	0	0	0	0	0	0	0	0	0	0
FinalVolume:	0	0	0	11	0	15	9	257	0	0	98	13

Critical Gap Module:

Critical Gp:	xxxxx	xxxx	xxxxx	6.4	6.5	6.2	4.1	xxxx	xxxxx	xxxxx	xxxx	xxxxx
FollowUpTim:	xxxxx	xxxx	xxxxx	3.5	4.0	3.3	2.2	xxxx	xxxxx	xxxxx	xxxx	xxxxx

Capacity Module:

Cnflct Vol:	xxxx	xxxx	xxxxx	380	380	105	111	xxxx	xxxxx	xxxx	xxxx	xxxxx
Potent Cap.:	xxxx	xxxx	xxxxx	626	556	956	1492	xxxx	xxxxx	xxxx	xxxx	xxxxx
Move Cap.:	xxxx	xxxx	xxxxx	624	553	956	1492	xxxx	xxxxx	xxxx	xxxx	xxxxx
Volume/Cap:	xxxx	xxxx	xxxx	0.02	0.00	0.02	0.01	xxxx	xxxx	xxxx	xxxx	xxxx

Level Of Service Module:

2Way95thQ:	xxxx	xxxx	xxxxx	xxxx	xxxx	xxxxx	0.0	xxxx	xxxxx	xxxx	xxxx	xxxxx
Control Del:	xxxxx	xxxx	xxxxx	xxxxx	xxxx	xxxxx	7.4	xxxx	xxxxx	xxxxx	xxxx	xxxxx
LOS by Move:	*	*	*	*	*	*	A	*	*	*	*	*
Movement:	LT - LTR - RT	LT - LTR - RT	LT - LTR - RT	LT - LTR - RT	LT - LTR - RT	LT - LTR - RT	LT - LTR - RT	LT - LTR - RT	LT - LTR - RT	LT - LTR - RT	LT - LTR - RT	LT - LTR - RT
Shared Cap.:	xxxx	xxxx	xxxxx	xxxx	780	xxxxx	xxxx	xxxx	xxxxx	xxxx	xxxx	xxxxx
SharedQueue:	xxxxx	xxxx	xxxxx	xxxxx	0.1	xxxxx	xxxxx	xxxx	xxxxx	xxxxx	xxxx	xxxxx
Shrd ConDel:	xxxxx	xxxx	xxxxx	xxxxx	9.8	xxxxx	xxxxx	xxxx	xxxxx	xxxxx	xxxx	xxxxx
Shared LOS:	*	*	*	*	A	*	*	*	*	*	*	*
ApproachDel:	xxxxxxx			9.8			xxxxxxx			xxxxxxx		
ApproachLOS:	*			A			*			*		*

Note: Queue reported is the number of cars per lane.

Voices School
Morgan Hill, CA
Hexagon Transportation Consultants, Inc.

Level Of Service Computation Report
2000 HCM Unsignalized (Future Volume Alternative)
Existing Plus Project (PM) - 1 Cosmo Full out

Intersection #1300: Olympic Drive and Edmundson Avenue

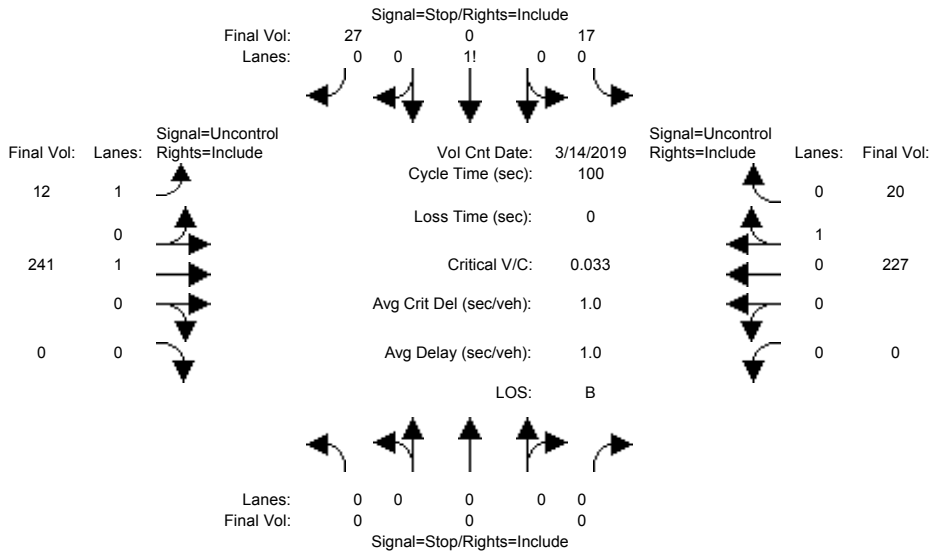

Street Name: Olympic Dr Edmundson Ave
Approach: North Bound South Bound East Bound West Bound
Movement: L - T - R L - T - R L - T - R L - T - R

Volume Module:	>>	Count	Date:	14 Mar 2019	<<							
Base Vol:	0	0	0	17	0	19	12	238	0	0	225	20
Growth Adj:	1.00	1.00	1.00	1.00	1.00	1.00	1.00	1.00	1.00	1.00	1.00	1.00
Initial Bse:	0	0	0	17	0	19	12	238	0	0	225	20
Added Vol:	0	0	0	0	0	8	0	3	0	0	2	0
PasserByVol:	0	0	0	0	0	0	0	0	0	0	0	0
Initial Fut:	0	0	0	17	0	27	12	241	0	0	227	20
User Adj:	1.00	1.00	1.00	1.00	1.00	1.00	1.00	1.00	1.00	1.00	1.00	1.00
PHF Adj:	1.00	1.00	1.00	1.00	1.00	1.00	1.00	1.00	1.00	1.00	1.00	1.00
PHF Volume:	0	0	0	17	0	27	12	241	0	0	227	20
Reduct Vol:	0	0	0	0	0	0	0	0	0	0	0	0
FinalVolume:	0	0	0	17	0	27	12	241	0	0	227	20

Critical Gap Module:

Critical Gp:	xxxxx	xxxx	xxxxx	6.4	6.5	6.2	4.1	xxxx	xxxxx	xxxxx	xxxx	xxxxx
FollowUpTim:	xxxxx	xxxx	xxxxx	3.5	4.0	3.3	2.2	xxxx	xxxxx	xxxxx	xxxx	xxxxx

Capacity Module:

Cnflct Vol:	xxxx	xxxx	xxxxx	502	502	237	247	xxxx	xxxxx	xxxx	xxxx	xxxxx
Potent Cap.:	xxxx	xxxx	xxxxx	533	474	807	1331	xxxx	xxxxx	xxxx	xxxx	xxxxx
Move Cap.:	xxxx	xxxx	xxxxx	529	470	807	1331	xxxx	xxxxx	xxxx	xxxx	xxxxx
Volume/Cap:	xxxx	xxxx	xxxx	0.03	0.00	0.03	0.01	xxxx	xxxx	xxxx	xxxx	xxxx

Level Of Service Module:

2Way95thQ:	xxxx	xxxx	xxxxx	xxxx	xxxx	xxxxx	0.0	xxxx	xxxxx	xxxx	xxxx	xxxxx
Control Del:	xxxxx	xxxx	xxxxx	xxxxx	xxxx	xxxxx	7.7	xxxx	xxxxx	xxxxx	xxxx	xxxxx
LOS by Move:	*	*	*	*	*	*	A	*	*	*	*	*
Movement:	LT - LTR - RT	LT - LTR - RT	LT - LTR - RT	LT - LTR - RT	LT - LTR - RT	LT - LTR - RT	LT - LTR - RT	LT - LTR - RT	LT - LTR - RT	LT - LTR - RT	LT - LTR - RT	LT - LTR - RT
Shared Cap.:	xxxx	xxxx	xxxxx	xxxx	671	xxxxx	xxxx	xxxx	xxxxx	xxxx	xxxx	xxxxx
SharedQueue:	xxxxx	xxxx	xxxxx	xxxxx	0.2	xxxxx	xxxxx	xxxx	xxxxx	xxxxx	xxxx	xxxxx
Shrd ConDel:	xxxxx	xxxx	xxxxx	xxxxx	10.7	xxxxx	xxxxx	xxxx	xxxxx	xxxxx	xxxx	xxxxx
Shared LOS:	*	*	*	*	B	*	*	*	*	*	*	*
ApproachDel:	xxxxxxx			10.7			xxxxxxx			xxxxxxx		
ApproachLOS:	*			B			*			*		*

Note: Queue reported is the number of cars per lane.

Voices School
Morgan Hill, CA
Hexagon Transportation Consultants, Inc.

Level Of Service Computation Report
2000 HCM Unsignalized (Future Volume Alternative)
2025 Plus Project (AM) - 1 Cosmo Full out

Intersection #1300: Olympic Drive and Edmundson Avenue

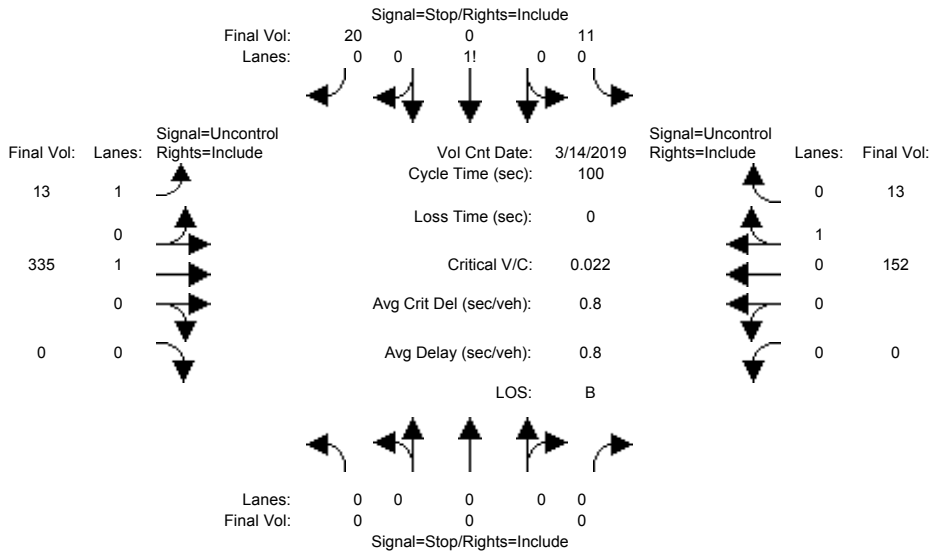

Street Name: Olympic Dr Edmundson Ave
Approach: North Bound South Bound East Bound West Bound
Movement: L - T - R L - T - R L - T - R L - T - R

Volume Module:	>>	Count	Date:	14 Mar 2019	<<							
Base Vol:	0	0	0	11	0	11	9	241	0	0	97	13
Growth Adj:	1.00	1.00	1.00	1.00	1.00	1.00	1.00	1.00	1.00	1.00	1.00	1.00
Initial Bse:	0	0	0	11	0	11	9	241	0	0	97	13
Added Vol:	0	0	0	0	0	4	0	16	0	0	1	0
PasserByVol:	0	0	0	0	0	5	4	78	0	0	54	0
Initial Fut:	0	0	0	11	0	20	13	335	0	0	152	13
User Adj:	1.00	1.00	1.00	1.00	1.00	1.00	1.00	1.00	1.00	1.00	1.00	1.00
PHF Adj:	1.00	1.00	1.00	1.00	1.00	1.00	1.00	1.00	1.00	1.00	1.00	1.00
PHF Volume:	0	0	0	11	0	20	13	335	0	0	152	13
Reduct Vol:	0	0	0	0	0	0	0	0	0	0	0	0
FinalVolume:	0	0	0	11	0	20	13	335	0	0	152	13

Critical Gap Module:

Critical Gp:	xxxxx	xxxx	xxxxx	6.4	6.5	6.2	4.1	xxxx	xxxxx	xxxxx	xxxx	xxxxx
FollowUpTim:	xxxxx	xxxx	xxxxx	3.5	4.0	3.3	2.2	xxxx	xxxxx	xxxxx	xxxx	xxxxx

Capacity Module:

Cnflct Vol:	xxxx	xxxx	xxxxx	520	520	159	165	xxxx	xxxxx	xxxx	xxxx	xxxxx
Potent Cap.:	xxxx	xxxx	xxxxx	520	464	892	1426	xxxx	xxxxx	xxxx	xxxx	xxxxx
Move Cap.:	xxxx	xxxx	xxxxx	517	459	892	1426	xxxx	xxxxx	xxxx	xxxx	xxxxx
Volume/Cap:	xxxx	xxxx	xxxx	0.02	0.00	0.02	0.01	xxxx	xxxx	xxxx	xxxx	xxxx

Level Of Service Module:

2Way95thQ:	xxxx	xxxx	xxxxx	xxxx	xxxx	xxxxx	0.0	xxxx	xxxxx	xxxx	xxxx	xxxxx
Control Del:	xxxxx	xxxx	xxxxx	xxxxx	xxxx	xxxxx	7.5	xxxx	xxxxx	xxxxx	xxxx	xxxxx
LOS by Move:	*	*	*	*	*	*	A	*	*	*	*	*
Movement:	LT - LTR - RT	LT - LTR - RT	LT - LTR - RT	LT - LTR - RT	LT - LTR - RT	LT - LTR - RT	LT - LTR - RT	LT - LTR - RT	LT - LTR - RT	LT - LTR - RT	LT - LTR - RT	LT - LTR - RT
Shared Cap.:	xxxx	xxxx	xxxxx	xxxx	709	xxxxx	xxxx	xxxx	xxxxx	xxxx	xxxx	xxxxx
SharedQueue:	xxxxx	xxxx	xxxxx	xxxxx	0.1	xxxxx	xxxxx	xxxx	xxxxx	xxxxx	xxxx	xxxxx
Shrd ConDel:	xxxxx	xxxx	xxxxx	xxxxx	10.3	xxxxx	xxxxx	xxxx	xxxxx	xxxxx	xxxx	xxxxx
Shared LOS:	*	*	*	*	B	*	*	*	*	*	*	*
ApproachDel:	xxxxxxx			10.3			xxxxxxx			xxxxxxx		
ApproachLOS:	*			B			*			*		*

Note: Queue reported is the number of cars per lane.

Voices School
Morgan Hill, CA
Hexagon Transportation Consultants, Inc.

Level Of Service Computation Report
2000 HCM Unsignalized (Future Volume Alternative)
2025 Plus Project (PM) - 1 Cosmo Full out

Intersection #1300: Olympic Drive and Edmundson Avenue

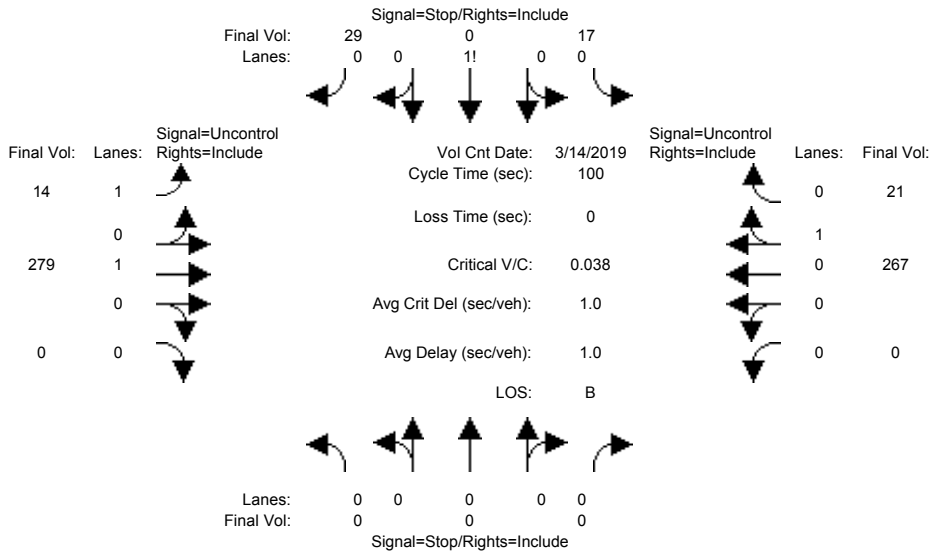

Street Name: Olympic Dr Edmundson Ave
Approach: North Bound South Bound East Bound West Bound
Movement: L - T - R L - T - R L - T - R L - T - R

Volume Module:	>>	Count	Date:	14 Mar 2019	<<							
Base Vol:	0	0	0	17	0	19	12	238	0	0	225	20
Growth Adj:	1.00	1.00	1.00	1.00	1.00	1.00	1.00	1.00	1.00	1.00	1.00	1.00
Initial Bse:	0	0	0	17	0	19	12	238	0	0	225	20
Added Vol:	0	0	0	0	0	8	0	2	0	0	2	0
PasserByVol:	0	0	0	0	0	2	2	39	0	0	40	1
Initial Fut:	0	0	0	17	0	29	14	279	0	0	267	21
User Adj:	1.00	1.00	1.00	1.00	1.00	1.00	1.00	1.00	1.00	1.00	1.00	1.00
PHF Adj:	1.00	1.00	1.00	1.00	1.00	1.00	1.00	1.00	1.00	1.00	1.00	1.00
PHF Volume:	0	0	0	17	0	29	14	279	0	0	267	21
Reduct Vol:	0	0	0	0	0	0	0	0	0	0	0	0
FinalVolume:	0	0	0	17	0	29	14	279	0	0	267	21

Critical Gap Module:

Critical Gp:	xxxxx	xxxx	xxxxx	6.4	6.5	6.2	4.1	xxxx	xxxxx	xxxxx	xxxx	xxxxx
FollowUpTim:	xxxxx	xxxx	xxxxx	3.5	4.0	3.3	2.2	xxxx	xxxxx	xxxxx	xxxx	xxxxx

Capacity Module:

Cnflct Vol:	xxxx	xxxx	xxxxx	585	585	278	288	xxxx	xxxxx	xxxx	xxxx	xxxxx
Potent Cap.:	xxxx	xxxx	xxxxx	477	426	766	1286	xxxx	xxxxx	xxxx	xxxx	xxxxx
Move Cap.:	xxxx	xxxx	xxxxx	473	421	766	1286	xxxx	xxxxx	xxxx	xxxx	xxxxx
Volume/Cap:	xxxx	xxxx	xxxx	0.04	0.00	0.04	0.01	xxxx	xxxx	xxxx	xxxx	xxxx

Level Of Service Module:

2Way95thQ:	xxxx	xxxx	xxxxx	xxxx	xxxx	xxxxx	0.0	xxxx	xxxxx	xxxx	xxxx	xxxxx
Control Del:	xxxxx	xxxx	xxxxx	xxxxx	xxxx	xxxxx	7.8	xxxx	xxxxx	xxxxx	xxxx	xxxxx
LOS by Move:	*	*	*	*	*	*	A	*	*	*	*	*
Movement:	LT - LTR - RT	LT - LTR - RT	LT - LTR - RT	LT - LTR - RT	LT - LTR - RT	LT - LTR - RT	LT - LTR - RT	LT - LTR - RT	LT - LTR - RT	LT - LTR - RT	LT - LTR - RT	LT - LTR - RT
Shared Cap.:	xxxx	xxxx	xxxxx	xxxx	623	xxxxx	xxxx	xxxx	xxxxx	xxxx	xxxx	xxxxx
SharedQueue:	xxxxx	xxxx	xxxxx	xxxxx	0.2	xxxxx	xxxxx	xxxx	xxxxx	xxxxx	xxxx	xxxxx
Shrd ConDel:	xxxxx	xxxx	xxxxx	xxxxx	11.2	xxxxx	xxxxx	xxxx	xxxxx	xxxxx	xxxx	xxxxx
Shared LOS:	*	*	*	*	B	*	*	*	*	*	*	*
ApproachDel:	xxxxxxx			11.2			xxxxxxx			xxxxxxx		
ApproachLOS:	*			B			*			*		*

Note: Queue reported is the number of cars per lane.

Voices School
Morgan Hill, CA
Hexagon Transportation Consultants, Inc.

Level Of Service Computation Report
2000 HCM 4-Way Stop (Future Volume Alternative)
Existing Plus Project (AM) - 1 Cosmo Full out

Intersection #1400: Del Monte Avenue and Cosmo Avenue

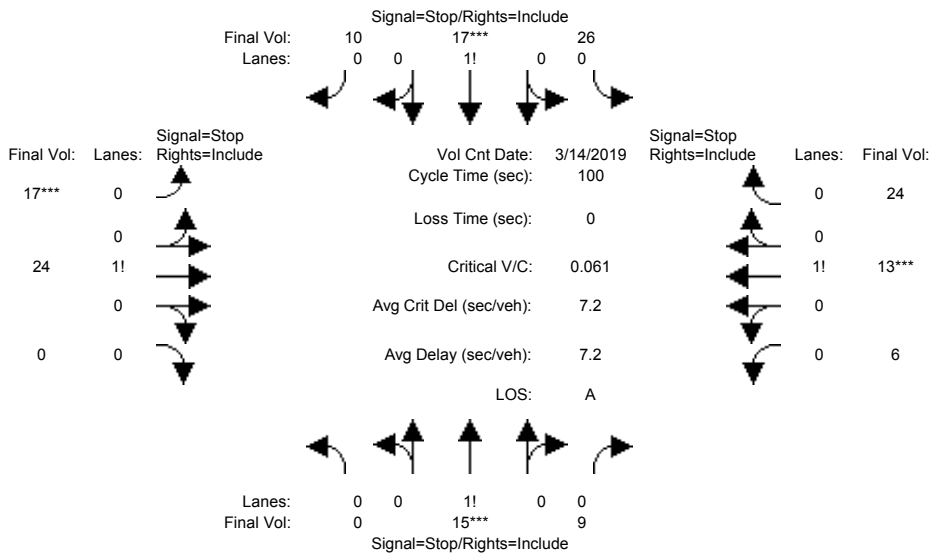

Street Name: Del Monte Ave Cosmo Ave
Approach: North Bound South Bound East Bound West Bound
Movement: L - T - R L - T - R L - T - R L - T - R

Min. Green: 0 0 0 0 0 0 0 0 0 0 0 0

Volume Module: >> Count Date: 14 Mar 2019 <<

Base Vol:	0	15	9	26	17	10	17	24	0	6	9	12
Growth Adj:	1.00	1.00	1.00	1.00	1.00	1.00	1.00	1.00	1.00	1.00	1.00	1.00
Initial Bse:	0	15	9	26	17	10	17	24	0	6	9	12
Added Vol:	0	0	0	0	0	0	0	0	0	0	4	12
PasserByVol:	0	0	0	0	0	0	0	0	0	0	0	0
Initial Fut:	0	15	9	26	17	10	17	24	0	6	13	24
User Adj:	1.00	1.00	1.00	1.00	1.00	1.00	1.00	1.00	1.00	1.00	1.00	1.00
PHF Adj:	1.00	1.00	1.00	1.00	1.00	1.00	1.00	1.00	1.00	1.00	1.00	1.00
PHF Volume:	0	15	9	26	17	10	17	24	0	6	13	24
Reduct Vol:	0	0	0	0	0	0	0	0	0	0	0	0
Reduced Vol:	0	15	9	26	17	10	17	24	0	6	13	24
PCE Adj:	1.00	1.00	1.00	1.00	1.00	1.00	1.00	1.00	1.00	1.00	1.00	1.00
MLF Adj:	1.00	1.00	1.00	1.00	1.00	1.00	1.00	1.00	1.00	1.00	1.00	1.00
FinalVolume:	0	15	9	26	17	10	17	24	0	6	13	24

Saturation Flow Module:

Adjustment:	1.00	1.00	1.00	1.00	1.00	1.00	1.00	1.00	1.00	1.00	1.00	1.00
Lanes:	0.00	0.62	0.38	0.49	0.32	0.19	0.41	0.59	0.00	0.14	0.30	0.56
Final Sat.:	0	565	339	425	278	164	351	495	0	130	281	519

Capacity Analysis Module:

Vol/Sat:	xxxx	0.03	0.03	0.06	0.06	0.06	0.05	0.05	xxxx	0.05	0.05	0.05
Crit Moves:	****			****			****			****		
Delay/Veh:	0.0	7.0	7.0	7.3	7.3	7.3	7.4	7.4	0.0	7.0	7.0	7.0
Delay Adj:	1.00	1.00	1.00	1.00	1.00	1.00	1.00	1.00	1.00	1.00	1.00	1.00
AdjDel/Veh:	0.0	7.0	7.0	7.3	7.3	7.3	7.4	7.4	0.0	7.0	7.0	7.0
LOS by Move:	*	A	A	A	A	A	A	A	*	A	A	A
ApproachDel:		7.0		7.3			7.4			7.0		
Delay Adj:		1.00		1.00			1.00			1.00		
ApprAdjDel:		7.0		7.3			7.4			7.0		
LOS by Appr:		A		A			A			A		
AllWayAvgQ:	0.0	0.0	0.0	0.1	0.1	0.1	0.0	0.0	0.0	0.0	0.0	0.0

Note: Queue reported is the number of cars per lane.

Voices School
Morgan Hill, CA
Hexagon Transportation Consultants, Inc.

Level Of Service Computation Report
2000 HCM 4-Way Stop (Future Volume Alternative)
Existing Plus Project (PM) - 1 Cosmo Full out

Intersection #1400: Del Monte Avenue and Cosmo Avenue

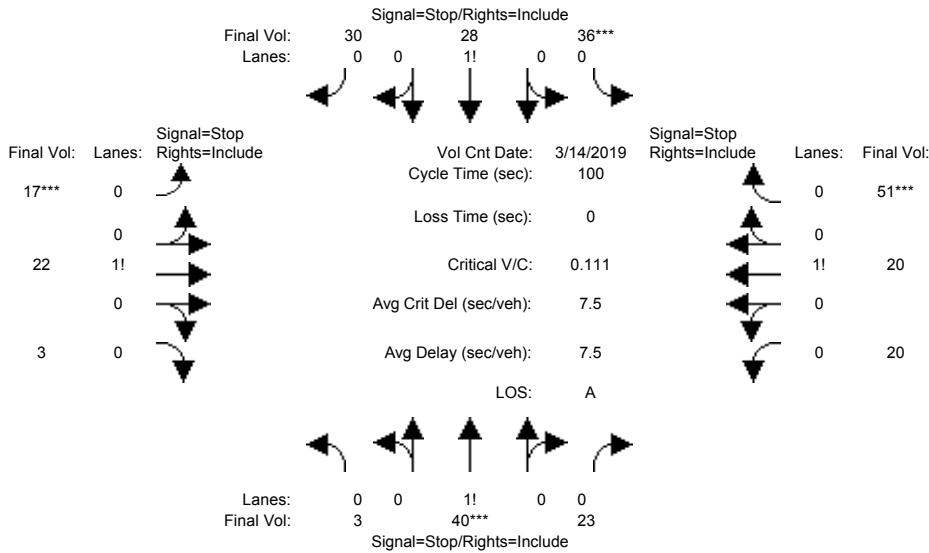

Street Name: Del Monte Ave Cosmo Ave
Approach: North Bound South Bound East Bound West Bound
Movement: L - T - R L - T - R L - T - R L - T - R

Min. Green: 0 0 0 0 0 0 0 0 0 0 0 0

Volume Module: >> Count Date: 14 Mar 2019 <<

Base Vol:	3	40	23	36	28	30	17	22	3	20	12	31
Growth Adj:	1.00	1.00	1.00	1.00	1.00	1.00	1.00	1.00	1.00	1.00	1.00	1.00
Initial Bse:	3	40	23	36	28	30	17	22	3	20	12	31
Added Vol:	0	0	0	0	0	0	0	0	0	0	8	20
PasserByVol:	0	0	0	0	0	0	0	0	0	0	0	0
Initial Fut:	3	40	23	36	28	30	17	22	3	20	20	51
User Adj:	1.00	1.00	1.00	1.00	1.00	1.00	1.00	1.00	1.00	1.00	1.00	1.00
PHF Adj:	1.00	1.00	1.00	1.00	1.00	1.00	1.00	1.00	1.00	1.00	1.00	1.00
PHF Volume:	3	40	23	36	28	30	17	22	3	20	20	51
Reduct Vol:	0	0	0	0	0	0	0	0	0	0	0	0
Reduced Vol:	3	40	23	36	28	30	17	22	3	20	20	51
PCE Adj:	1.00	1.00	1.00	1.00	1.00	1.00	1.00	1.00	1.00	1.00	1.00	1.00
MLF Adj:	1.00	1.00	1.00	1.00	1.00	1.00	1.00	1.00	1.00	1.00	1.00	1.00
FinalVolume:	3	40	23	36	28	30	17	22	3	20	20	51

Saturation Flow Module:

Adjustment:	1.00	1.00	1.00	1.00	1.00	1.00	1.00	1.00	1.00	1.00	1.00	1.00
Lanes:	0.04	0.61	0.35	0.38	0.30	0.32	0.40	0.53	0.07	0.22	0.22	0.56
Final Sat.:	39	519	298	324	252	270	322	417	57	192	192	489

Capacity Analysis Module:

Vol/Sat:	0.08	0.08	0.08	0.11	0.11	0.11	0.05	0.05	0.05	0.10	0.10	0.10
Crit Moves:	****	****	****	****	****	****	****	****	****	****	****	****
Delay/Veh:	7.4	7.4	7.4	7.6	7.6	7.6	7.6	7.6	7.6	7.4	7.4	7.4
Delay Adj:	1.00	1.00	1.00	1.00	1.00	1.00	1.00	1.00	1.00	1.00	1.00	1.00
AdjDel/Veh:	7.4	7.4	7.4	7.6	7.6	7.6	7.6	7.6	7.6	7.4	7.4	7.4
LOS by Move:	A	A	A	A	A	A	A	A	A	A	A	A
ApproachDel:	7.4			7.6			7.6			7.4		
Delay Adj:	1.00			1.00			1.00			1.00		
ApprAdjDel:	7.4			7.6			7.6			7.4		
LOS by Appr:	A			A			A			A		
AllWayAvgQ:	0.1	0.1	0.1	0.1	0.1	0.1	0.1	0.1	0.1	0.1	0.1	0.1

Note: Queue reported is the number of cars per lane.

Voices School
Morgan Hill, CA
Hexagon Transportation Consultants, Inc.

Level Of Service Computation Report
2000 HCM 4-Way Stop (Future Volume Alternative)
2025 Plus Project (AM) - 1 Cosmo Full out

Intersection #1400: Del Monte Avenue and Cosmo Avenue

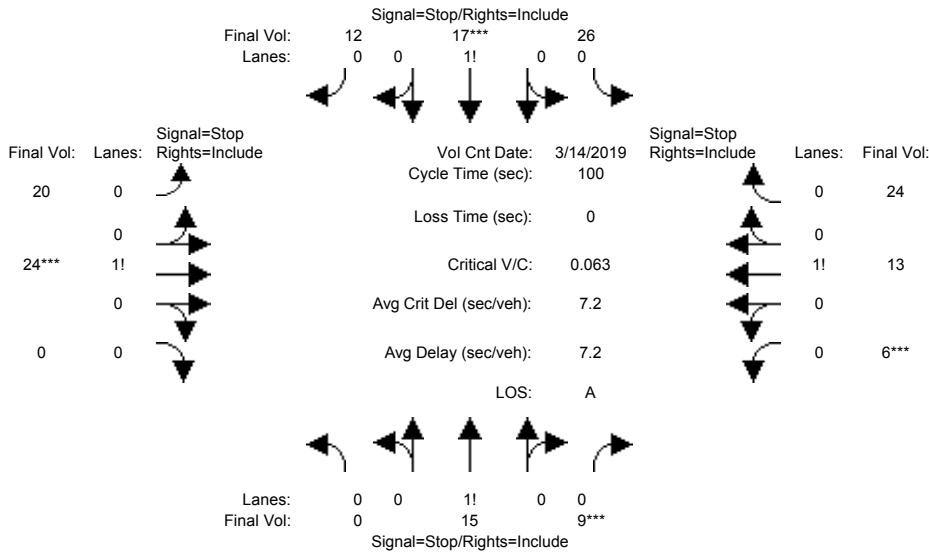

Street Name:	Del Monte Ave						Cosmo Ave					
Approach:	North Bound			South Bound			East Bound			West Bound		
Movement:	L	T	R	L	T	R	L	T	R	L	T	R

Min. Green:	0	0	0	0	0	0	0	0	0	0	0	0
-------------	---	---	---	---	---	---	---	---	---	---	---	---

Volume Module:	>> Count Date: 14 Mar 2019 <<											
Base Vol:	0	15	9	26	17	10	17	24	0	6	9	12
Growth Adj:	1.00	1.00	1.00	1.00	1.00	1.00	1.00	1.00	1.00	1.00	1.00	1.00
Initial Bse:	0	15	9	26	17	10	17	24	0	6	9	12
Added Vol:	0	0	0	0	0	0	0	0	0	0	4	11
PasserByVol:	0	0	0	0	0	2	3	0	0	0	0	1
Initial Fut:	0	15	9	26	17	12	20	24	0	6	13	24
User Adj:	1.00	1.00	1.00	1.00	1.00	1.00	1.00	1.00	1.00	1.00	1.00	1.00
PHF Adj:	1.00	1.00	1.00	1.00	1.00	1.00	1.00	1.00	1.00	1.00	1.00	1.00
PHF Volume:	0	15	9	26	17	12	20	24	0	6	13	24
Reduct Vol:	0	0	0	0	0	0	0	0	0	0	0	0
Reduced Vol:	0	15	9	26	17	12	20	24	0	6	13	24
PCE Adj:	1.00	1.00	1.00	1.00	1.00	1.00	1.00	1.00	1.00	1.00	1.00	1.00
MLF Adj:	1.00	1.00	1.00	1.00	1.00	1.00	1.00	1.00	1.00	1.00	1.00	1.00
FinalVolume:	0	15	9	26	17	12	20	24	0	6	13	24

Saturation Flow Module:												
Adjustment:	1.00	1.00	1.00	1.00	1.00	1.00	1.00	1.00	1.00	1.00	1.00	1.00
Lanes:	0.00	0.62	0.38	0.47	0.31	0.22	0.45	0.55	0.00	0.14	0.30	0.56
Final Sat.:	0	563	338	411	268	189	383	460	0	130	281	518

Capacity Analysis Module:												
Vol/Sat:	xxxx	0.03	0.03	0.06	0.06	0.06	0.05	0.05	xxxx	0.05	0.05	0.05
Crit Moves:			****	****			****			****		
Delay/Veh:	0.0	7.0	7.0	7.3	7.3	7.3	7.4	7.4	0.0	7.0	7.0	7.0
Delay Adj:	1.00	1.00	1.00	1.00	1.00	1.00	1.00	1.00	1.00	1.00	1.00	1.00
AdjDel/Veh:	0.0	7.0	7.0	7.3	7.3	7.3	7.4	7.4	0.0	7.0	7.0	7.0
LOS by Move:	*	A	A	A	A	A	A	A	*	A	A	A
ApproachDel:		7.0			7.3			7.4			7.0	
Delay Adj:		1.00			1.00			1.00			1.00	
ApprAdjDel:		7.0			7.3			7.4			7.0	
LOS by Appr:		A			A			A			A	
AllWayAvgQ:	0.0	0.0	0.0	0.1	0.1	0.1	0.1	0.1	0.1	0.0	0.0	0.0

Note: Queue reported is the number of cars per lane.

Voices School
Morgan Hill, CA
Hexagon Transportation Consultants, Inc.

Level Of Service Computation Report
2000 HCM 4-Way Stop (Future Volume Alternative)
2025 Plus Project (PM) - 1 Cosmo Full out

Intersection #1400: Del Monte Avenue and Cosmo Avenue

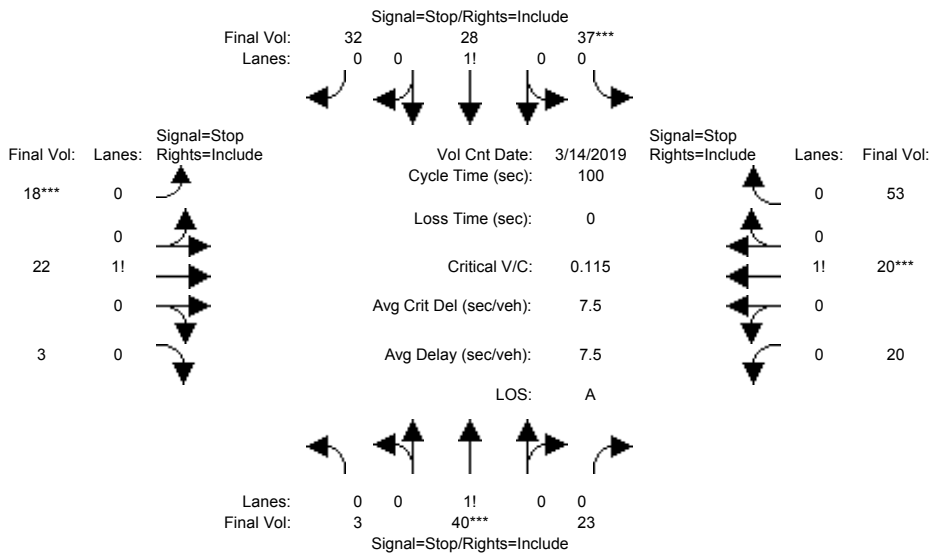

Street Name:	Del Monte Ave						Cosmo Ave					
Approach:	North Bound			South Bound			East Bound			West Bound		
Movement:	L	T	R	L	T	R	L	T	R	L	T	R
Min. Green:	0	0	0	0	0	0	0	0	0	0	0	0
Volume Module: >> Count Date: 14 Mar 2019 <<												
Base Vol:	3	40	23	36	28	30	17	22	3	20	12	31
Growth Adj:	1.00	1.00	1.00	1.00	1.00	1.00	1.00	1.00	1.00	1.00	1.00	1.00
Initial Bse:	3	40	23	36	28	30	17	22	3	20	12	31
Added Vol:	0	0	0	0	0	0	0	0	0	0	8	20
PasserByVol:	0	0	0	1	0	2	1	0	0	0	0	2
Initial Fut:	3	40	23	37	28	32	18	22	3	20	20	53
User Adj:	1.00	1.00	1.00	1.00	1.00	1.00	1.00	1.00	1.00	1.00	1.00	1.00
PHF Adj:	1.00	1.00	1.00	1.00	1.00	1.00	1.00	1.00	1.00	1.00	1.00	1.00
PHF Volume:	3	40	23	37	28	32	18	22	3	20	20	53
Reduct Vol:	0	0	0	0	0	0	0	0	0	0	0	0
Reduced Vol:	3	40	23	37	28	32	18	22	3	20	20	53
PCE Adj:	1.00	1.00	1.00	1.00	1.00	1.00	1.00	1.00	1.00	1.00	1.00	1.00
MLF Adj:	1.00	1.00	1.00	1.00	1.00	1.00	1.00	1.00	1.00	1.00	1.00	1.00
FinalVolume:	3	40	23	37	28	32	18	22	3	20	20	53
Saturation Flow Module:												
Adjustment:	1.00	1.00	1.00	1.00	1.00	1.00	1.00	1.00	1.00	1.00	1.00	1.00
Lanes:	0.04	0.61	0.35	0.38	0.29	0.33	0.42	0.51	0.07	0.21	0.22	0.57
Final Sat.:	39	517	297	323	244	279	332	406	55	187	187	496
Capacity Analysis Module:												
Vol/Sat:	0.08	0.08	0.08	0.11	0.11	0.11	0.05	0.05	0.05	0.11	0.11	0.11
Crit Moves:	****			****			****			****		
Delay/Veh:	7.4	7.4	7.4	7.6	7.6	7.6	7.6	7.6	7.6	7.4	7.4	7.4
Delay Adj:	1.00	1.00	1.00	1.00	1.00	1.00	1.00	1.00	1.00	1.00	1.00	1.00
AdjDel/Veh:	7.4	7.4	7.4	7.6	7.6	7.6	7.6	7.6	7.6	7.4	7.4	7.4
LOS by Move:	A	A	A	A	A	A	A	A	A	A	A	A
ApproachDel:	7.4			7.6			7.6			7.4		
Delay Adj:	1.00			1.00			1.00			1.00		
ApprAdjDel:	7.4			7.6			7.6			7.4		
LOS by Appr:	A			A			A			A		
AllWayAvgQ:	0.1	0.1	0.1	0.1	0.1	0.1	0.1	0.1	0.1	0.1	0.1	0.1

Voices School
Morgan Hill, CA
Hexagon Transportation Consultants, Inc.

Level Of Service Computation Report
2000 HCM 4-Way Stop (Future Volume Alternative)
Existing Plus Project (AM) - 1 Cosmo Full out

Intersection #1500: Del Monte Avenue and Spring Avenue

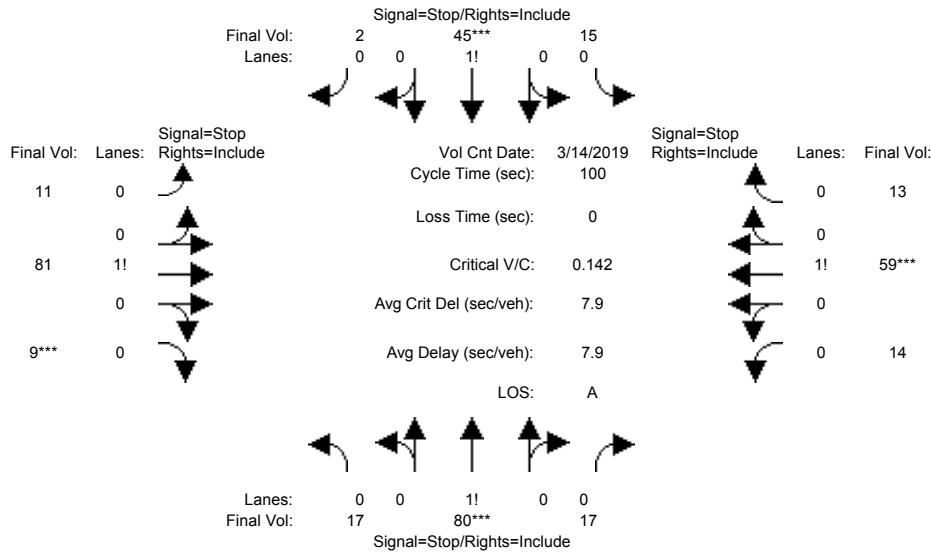

Street Name:	Del Monte Ave						Spring Ave					
Approach:	North Bound			South Bound			East Bound			West Bound		
Movement:	L	T	R	L	T	R	L	T	R	L	T	R

Min. Green:	0	0	0	0	0	0	0	0	0	0	0	0
-------------	---	---	---	---	---	---	---	---	---	---	---	---

Volume Module:	>> Count Date: 14 Mar 2019 <<											
Base Vol:	14	72	17	15	45	2	11	73	9	14	59	13
Growth Adj:	1.00	1.00	1.00	1.00	1.00	1.00	1.00	1.00	1.00	1.00	1.00	1.00
Initial Bse:	14	72	17	15	45	2	11	73	9	14	59	13
Added Vol:	3	8	0	0	0	0	0	8	0	0	0	0
PasserByVol:	0	0	0	0	0	0	0	0	0	0	0	0
Initial Fut:	17	80	17	15	45	2	11	81	9	14	59	13
User Adj:	1.00	1.00	1.00	1.00	1.00	1.00	1.00	1.00	1.00	1.00	1.00	1.00
PHF Adj:	1.00	1.00	1.00	1.00	1.00	1.00	1.00	1.00	1.00	1.00	1.00	1.00
PHF Volume:	17	80	17	15	45	2	11	81	9	14	59	13
Reduct Vol:	0	0	0	0	0	0	0	0	0	0	0	0
Reduced Vol:	17	80	17	15	45	2	11	81	9	14	59	13
PCE Adj:	1.00	1.00	1.00	1.00	1.00	1.00	1.00	1.00	1.00	1.00	1.00	1.00
MLF Adj:	1.00	1.00	1.00	1.00	1.00	1.00	1.00	1.00	1.00	1.00	1.00	1.00
FinalVolume:	17	80	17	15	45	2	11	81	9	14	59	13

Saturation Flow Module:												
Adjustment:	1.00	1.00	1.00	1.00	1.00	1.00	1.00	1.00	1.00	1.00	1.00	1.00
Lanes:	0.15	0.70	0.15	0.24	0.73	0.03	0.11	0.80	0.09	0.16	0.69	0.15
Final Sat.:	120	564	120	187	562	25	87	639	71	130	548	121

Capacity Analysis Module:												
Vol/Sat:	0.14	0.14	0.14	0.08	0.08	0.08	0.13	0.13	0.13	0.11	0.11	0.11
Crit Moves:	****			****			****			****		
Delay/Veh:	8.0	8.0	8.0	7.8	7.8	7.8	7.9	7.9	7.9	7.8	7.8	7.8
Delay Adj:	1.00	1.00	1.00	1.00	1.00	1.00	1.00	1.00	1.00	1.00	1.00	1.00
AdjDel/Veh:	8.0	8.0	8.0	7.8	7.8	7.8	7.9	7.9	7.9	7.8	7.8	7.8
LOS by Move:	A	A	A	A	A	A	A	A	A	A	A	A
ApproachDel:	8.0			7.8			7.9			7.8		
Delay Adj:	1.00			1.00			1.00			1.00		
ApprAdjDel:	8.0			7.8			7.9			7.8		
LOS by Appr:	A			A			A			A		
AllWayAvgQ:	0.2	0.2	0.2	0.1	0.1	0.1	0.1	0.1	0.1	0.1	0.1	0.1

Note: Queue reported is the number of cars per lane.

Voices School
Morgan Hill, CA
Hexagon Transportation Consultants, Inc.

Level Of Service Computation Report
2000 HCM 4-Way Stop (Future Volume Alternative)
Existing Plus Project (PM) - 1 Cosmo Full out

Intersection #1500: Del Monte Avenue and Spring Avenue

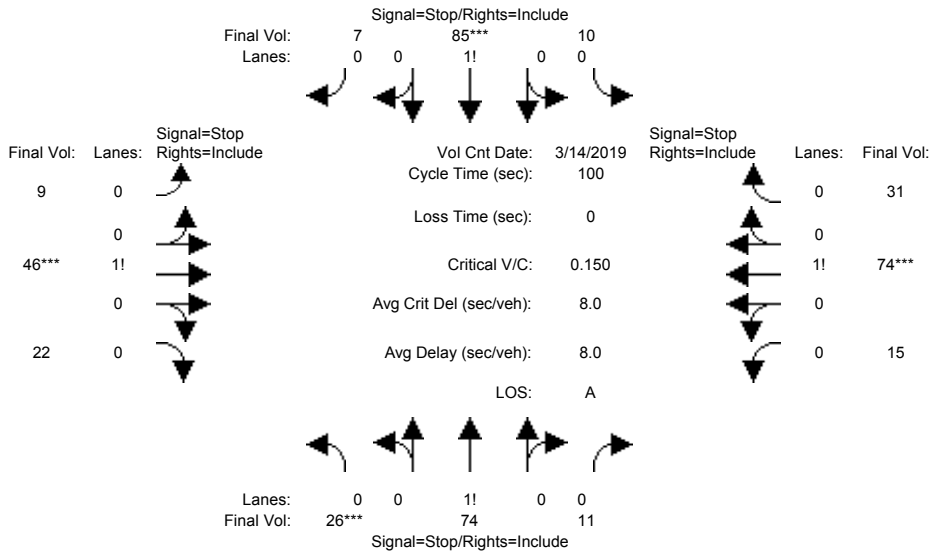

Street Name: Del Monte Ave Spring Ave
Approach: North Bound South Bound East Bound West Bound
Movement: L - T - R L - T - R L - T - R L - T - R

Min. Green: 0 0 0 0 0 0 0 0 0 0 0 0

Volume Module: >> Count Date: 14 Mar 2019 <<

Base Vol:	21	59	11	10	85	7	9	44	22	15	74	31
Growth Adj:	1.00	1.00	1.00	1.00	1.00	1.00	1.00	1.00	1.00	1.00	1.00	1.00
Initial Bse:	21	59	11	10	85	7	9	44	22	15	74	31
Added Vol:	5	15	0	0	0	0	0	2	0	0	0	0
PasserByVol:	0	0	0	0	0	0	0	0	0	0	0	0
Initial Fut:	26	74	11	10	85	7	9	46	22	15	74	31
User Adj:	1.00	1.00	1.00	1.00	1.00	1.00	1.00	1.00	1.00	1.00	1.00	1.00
PHF Adj:	1.00	1.00	1.00	1.00	1.00	1.00	1.00	1.00	1.00	1.00	1.00	1.00
PHF Volume:	26	74	11	10	85	7	9	46	22	15	74	31
Reduct Vol:	0	0	0	0	0	0	0	0	0	0	0	0
Reduced Vol:	26	74	11	10	85	7	9	46	22	15	74	31
PCE Adj:	1.00	1.00	1.00	1.00	1.00	1.00	1.00	1.00	1.00	1.00	1.00	1.00
MLF Adj:	1.00	1.00	1.00	1.00	1.00	1.00	1.00	1.00	1.00	1.00	1.00	1.00
FinalVolume:	26	74	11	10	85	7	9	46	22	15	74	31

Saturation Flow Module:

Adjustment:	1.00	1.00	1.00	1.00	1.00	1.00	1.00	1.00	1.00	1.00	1.00	1.00
Lanes:	0.23	0.67	0.10	0.10	0.83	0.07	0.12	0.60	0.28	0.12	0.62	0.26
Final Sat.:	183	520	77	76	650	54	92	471	225	100	492	206

Capacity Analysis Module:

Vol/Sat:	0.14	0.14	0.14	0.13	0.13	0.13	0.10	0.10	0.10	0.15	0.15	0.15
Crit Moves:	****			****			****			****		
Delay/Veh:	8.1	8.1	8.1	8.1	8.1	8.1	7.8	7.8	7.8	8.1	8.1	8.1
Delay Adj:	1.00	1.00	1.00	1.00	1.00	1.00	1.00	1.00	1.00	1.00	1.00	1.00
AdjDel/Veh:	8.1	8.1	8.1	8.1	8.1	8.1	7.8	7.8	7.8	8.1	8.1	8.1
LOS by Move:	A	A	A	A	A	A	A	A	A	A	A	A
ApproachDel:		8.1			8.1			7.8			8.1	
Delay Adj:		1.00			1.00			1.00			1.00	
ApprAdjDel:		8.1			8.1			7.8			8.1	
LOS by Appr:		A			A			A			A	
AllWayAvgQ:	0.2	0.2	0.2	0.1	0.1	0.1	0.1	0.1	0.1	0.2	0.2	0.2

Note: Queue reported is the number of cars per lane.

Voices School
Morgan Hill, CA
Hexagon Transportation Consultants, Inc.

Level Of Service Computation Report
2000 HCM 4-Way Stop (Future Volume Alternative)
2025 Plus Project (AM) - 1 Cosmo Full out

Intersection #1500: Del Monte Avenue and Spring Avenue

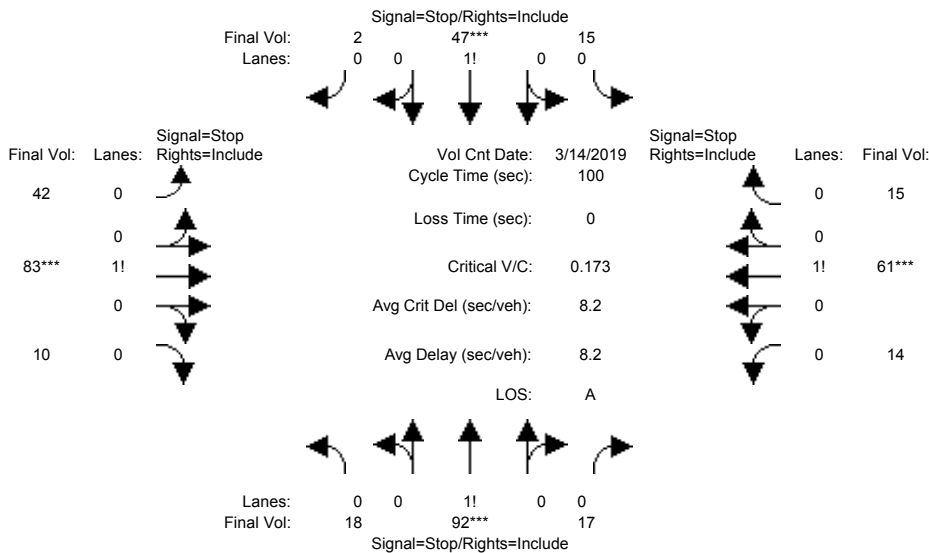

Street Name:	Del Monte Ave						Spring Ave					
Approach:	North Bound			South Bound			East Bound			West Bound		
Movement:	L	T	R	L	T	R	L	T	R	L	T	R

Min. Green:	0	0	0	0	0	0	0	0	0	0	0	0
-------------	---	---	---	---	---	---	---	---	---	---	---	---

Volume Module:	>> Count Date: 14 Mar 2019 <<											
Base Vol:	14	72	17	15	45	2	11	73	9	14	59	13
Growth Adj:	1.00	1.00	1.00	1.00	1.00	1.00	1.00	1.00	1.00	1.00	1.00	1.00
Initial Bse:	14	72	17	15	45	2	11	73	9	14	59	13
Added Vol:	3	8	0	0	0	0	0	8	0	0	0	0
PasserByVol:	1	12	0	0	2	0	31	2	1	0	2	2
Initial Fut:	18	92	17	15	47	2	42	83	10	14	61	15
User Adj:	1.00	1.00	1.00	1.00	1.00	1.00	1.00	1.00	1.00	1.00	1.00	1.00
PHF Adj:	1.00	1.00	1.00	1.00	1.00	1.00	1.00	1.00	1.00	1.00	1.00	1.00
PHF Volume:	18	92	17	15	47	2	42	83	10	14	61	15
Reduct Vol:	0	0	0	0	0	0	0	0	0	0	0	0
Reduced Vol:	18	92	17	15	47	2	42	83	10	14	61	15
PCE Adj:	1.00	1.00	1.00	1.00	1.00	1.00	1.00	1.00	1.00	1.00	1.00	1.00
MLF Adj:	1.00	1.00	1.00	1.00	1.00	1.00	1.00	1.00	1.00	1.00	1.00	1.00
FinalVolume:	18	92	17	15	47	2	42	83	10	14	61	15

Saturation Flow Module:												
Adjustment:	1.00	1.00	1.00	1.00	1.00	1.00	1.00	1.00	1.00	1.00	1.00	1.00
Lanes:	0.14	0.73	0.13	0.23	0.74	0.03	0.31	0.62	0.07	0.15	0.68	0.17
Final Sat.:	111	565	104	176	551	23	243	479	58	122	531	130

Capacity Analysis Module:												
Vol/Sat:	0.16	0.16	0.16	0.09	0.09	0.09	0.17	0.17	0.17	0.11	0.11	0.11
Crit Moves:	****			****			****			****		
Delay/Veh:	8.2	8.2	8.2	8.0	8.0	8.0	8.3	8.3	8.3	8.0	8.0	8.0
Delay Adj:	1.00	1.00	1.00	1.00	1.00	1.00	1.00	1.00	1.00	1.00	1.00	1.00
AdjDel/Veh:	8.2	8.2	8.2	8.0	8.0	8.0	8.3	8.3	8.3	8.0	8.0	8.0
LOS by Move:	A	A	A	A	A	A	A	A	A	A	A	A
ApproachDel:	8.2			8.0			8.3			8.0		
Delay Adj:	1.00			1.00			1.00			1.00		
ApprAdjDel:	8.2			8.0			8.3			8.0		
LOS by Appr:	A			A			A			A		
AllWayAvgQ:	0.2	0.2	0.2	0.1	0.1	0.1	0.2	0.2	0.2	0.1	0.1	0.1

Note: Queue reported is the number of cars per lane.

Voices School
Morgan Hill, CA
Hexagon Transportation Consultants, Inc.

Level Of Service Computation Report
2000 HCM 4-Way Stop (Future Volume Alternative)
2025 Plus Project (PM) - 1 Cosmo Full out

Intersection #1500: Del Monte Avenue and Spring Avenue

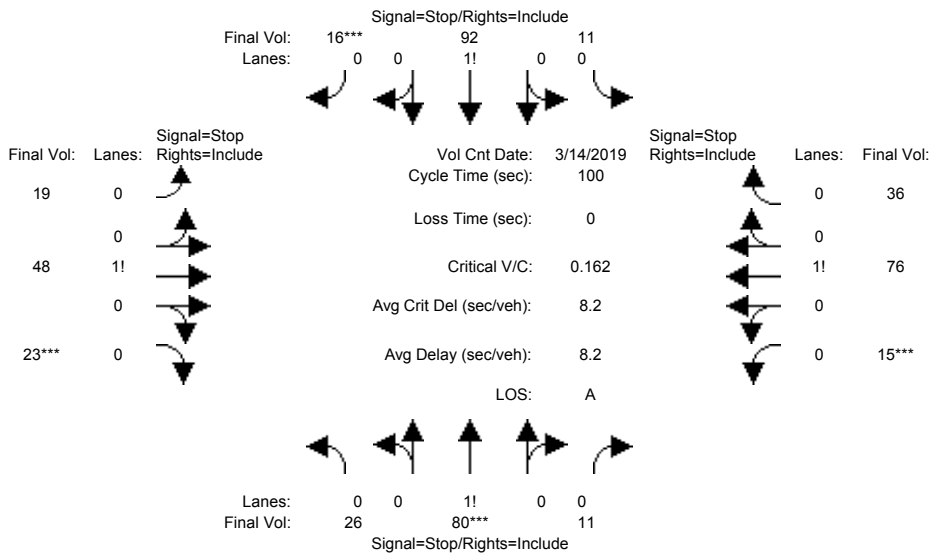

Street Name: Del Monte Ave Spring Ave

Approach: North Bound South Bound East Bound West Bound

Movement: L - T - R L - T - R L - T - R L - T - R

Min. Green: 0 0 0 0 0 0 0 0 0 0 0 0

Volume Module: >> Count Date: 14 Mar 2019 <<

Base Vol:	21	59	11	10	85	7	9	44	22	15	74	31
Growth Adj:	1.00	1.00	1.00	1.00	1.00	1.00	1.00	1.00	1.00	1.00	1.00	1.00
Initial Bse:	21	59	11	10	85	7	9	44	22	15	74	31
Added Vol:	5	15	0	0	0	0	0	2	0	0	0	0
PasserByVol:	0	6	0	1	7	9	10	2	1	0	2	5
Initial Fut:	26	80	11	11	92	16	19	48	23	15	76	36
User Adj:	1.00	1.00	1.00	1.00	1.00	1.00	1.00	1.00	1.00	1.00	1.00	1.00
PHF Adj:	1.00	1.00	1.00	1.00	1.00	1.00	1.00	1.00	1.00	1.00	1.00	1.00
PHF Volume:	26	80	11	11	92	16	19	48	23	15	76	36
Reduct Vol:	0	0	0	0	0	0	0	0	0	0	0	0
Reduced Vol:	26	80	11	11	92	16	19	48	23	15	76	36
PCE Adj:	1.00	1.00	1.00	1.00	1.00	1.00	1.00	1.00	1.00	1.00	1.00	1.00
MLF Adj:	1.00	1.00	1.00	1.00	1.00	1.00	1.00	1.00	1.00	1.00	1.00	1.00
FinalVolume:	26	80	11	11	92	16	19	48	23	15	76	36

Saturation Flow Module:

Adjustment:	1.00	1.00	1.00	1.00	1.00	1.00	1.00	1.00	1.00	1.00	1.00	1.00
Lanes:	0.22	0.69	0.09	0.09	0.78	0.13	0.21	0.53	0.26	0.12	0.60	0.28
Final Sat.:	170	524	72	71	598	104	162	409	196	93	469	222

Capacity Analysis Module:

Vol/Sat:	0.15	0.15	0.15	0.15	0.15	0.15	0.12	0.12	0.12	0.16	0.16	0.16
Crit Moves:	****			****			****			****		
Delay/Veh:	8.3	8.3	8.3	8.2	8.2	8.2	8.0	8.0	8.0	8.2	8.2	8.2
Delay Adj:	1.00	1.00	1.00	1.00	1.00	1.00	1.00	1.00	1.00	1.00	1.00	1.00
AdjDel/Veh:	8.3	8.3	8.3	8.2	8.2	8.2	8.0	8.0	8.0	8.2	8.2	8.2
LOS by Move:	A	A	A	A	A	A	A	A	A	A	A	A
ApproachDel:	8.3			8.2			8.0			8.2		
Delay Adj:	1.00			1.00			1.00			1.00		
ApprAdjDel:	8.3			8.2			8.0			8.2		
LOS by Appr:	A			A			A			A		
AllWayAvgQ:	0.2	0.2	0.2	0.2	0.2	0.2	0.1	0.1	0.1	0.2	0.2	0.2

Note: Queue reported is the number of cars per lane.

Voices School
Morgan Hill, CA
Hexagon Transportation Consultants, Inc.

Level Of Service Computation Report
2000 HCM Operations (Future Volume Alternative)
Existing Plus Project (AM) - 1 Cosmo Full out

Intersection #4111: Monterey Road and Vineyard Boulevard

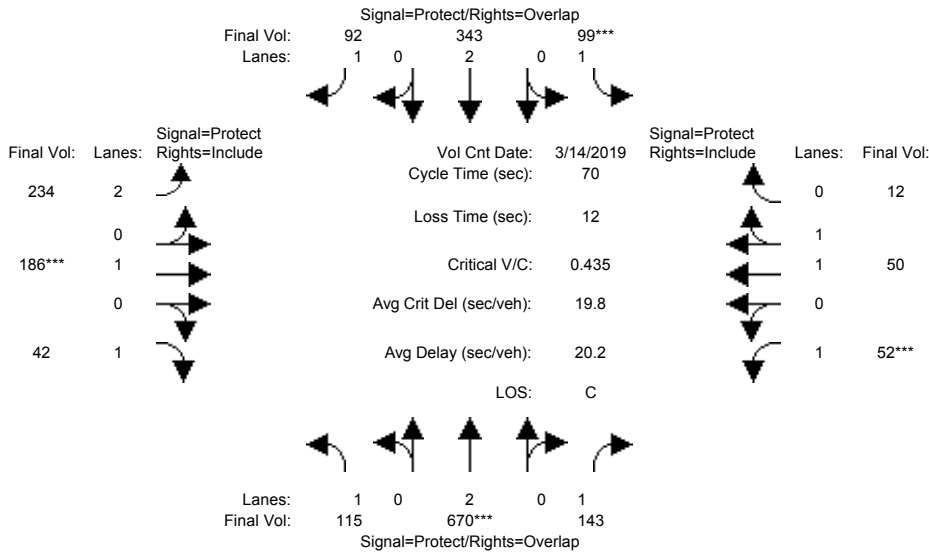

Street Name:	Monterey Road						Vineyard Blvd					
	North Bound			South Bound			East Bound			West Bound		
Approach:	L	T	R	L	T	R	L	T	R	L	T	R
Min. Green:	7	10	10	7	10	10	7	10	10	7	10	10
Y+R:	4.0	4.0	4.0	4.0	4.0	4.0	4.0	4.0	4.0	4.0	4.0	4.0

Volume Module:	>>	Count	Date:	14 Mar 2019	<<							
Base Vol:	115	625	143	99	319	86	217	186	42	52	50	12
Growth Adj:	1.00	1.00	1.00	1.00	1.00	1.00	1.00	1.00	1.00	1.00	1.00	1.00
Initial Bse:	115	625	143	99	319	86	217	186	42	52	50	12
Added Vol:	0	45	0	0	24	6	17	0	0	0	0	0
PasserByVol:	0	0	0	0	0	0	0	0	0	0	0	0
Initial Fut:	115	670	143	99	343	92	234	186	42	52	50	12
User Adj:	1.00	1.00	1.00	1.00	1.00	1.00	1.00	1.00	1.00	1.00	1.00	1.00
PHF Adj:	1.00	1.00	1.00	1.00	1.00	1.00	1.00	1.00	1.00	1.00	1.00	1.00
PHF Volume:	115	670	143	99	343	92	234	186	42	52	50	12
Reduct Vol:	0	0	0	0	0	0	0	0	0	0	0	0
Reduced Vol:	115	670	143	99	343	92	234	186	42	52	50	12
PCE Adj:	1.00	1.00	1.00	1.00	1.00	1.00	1.00	1.00	1.00	1.00	1.00	1.00
MLF Adj:	1.00	1.00	1.00	1.00	1.00	1.00	1.00	1.00	1.00	1.00	1.00	1.00
FinalVolume:	115	670	143	99	343	92	234	186	42	52	50	12

Saturation Flow Module:												
Sat/Lane:	1900	1900	1900	1900	1900	1900	1900	1900	1900	1900	1900	1900
Adjustment:	0.92	1.00	0.92	0.92	1.00	0.92	0.83	1.00	0.92	0.92	0.98	0.95
Lanes:	1.00	2.00	1.00	1.00	2.00	1.00	2.00	1.00	1.00	1.00	1.60	0.40
Final Sat.:	1750	3800	1750	1750	3800	1750	3150	1900	1750	1750	2983	716

Capacity Analysis Module:												
Vol/Sat:	0.07	0.18	0.08	0.06	0.09	0.05	0.07	0.10	0.02	0.03	0.02	0.02
Crit Moves:	****			****			****			****		
Green Time:	14.8	27.2	34.2	8.7	21.1	30.2	9.1	15.1	15.1	7.0	13.0	13.0
Volume/Cap:	0.31	0.45	0.17	0.45	0.30	0.12	0.57	0.45	0.11	0.30	0.09	0.09
Delay/Veh:	23.8	16.1	10.1	29.9	18.9	12.0	30.6	24.7	22.2	30.2	23.7	23.7
User DelAdj:	1.00	1.00	1.00	1.00	1.00	1.00	1.00	1.00	1.00	1.00	1.00	1.00
AdjDel/Veh:	23.8	16.1	10.1	29.9	18.9	12.0	30.6	24.7	22.2	30.2	23.7	23.7
LOS by Move:	C	B	B	C	B	B	C	C	C	C	C	C
HCM2kAvgQ:	2	5	2	2	3	1	4	4	1	1	1	1

Note: Queue reported is the number of cars per lane.

Voices School
Morgan Hill, CA
Hexagon Transportation Consultants, Inc.

Level Of Service Computation Report
2000 HCM Operations (Future Volume Alternative)
Existing Plus Project (PM) - 1 Cosmo Full out

Intersection #4111: Monterey Road and Vineyard Boulevard

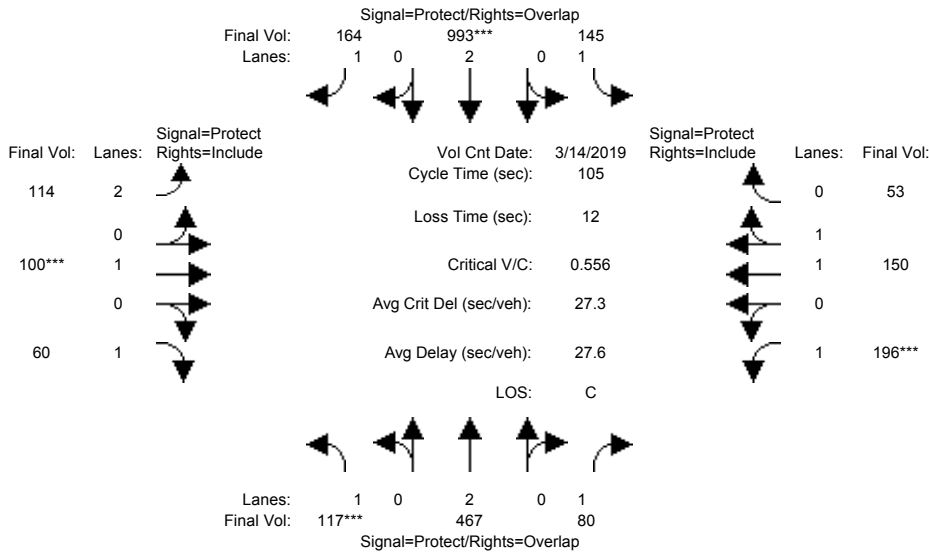

Street Name:	Monterey Road						Vineyard Blvd					
	North Bound			South Bound			East Bound			West Bound		
Approach:	L	T	R	L	T	R	L	T	R	L	T	R
Min. Green:	7	10	10	7	10	10	7	10	10	7	10	10
Y+R:	4.0	4.0	4.0	4.0	4.0	4.0	4.0	4.0	4.0	4.0	4.0	4.0

Volume Module:	>>	Count	Date:	14 Mar 2019	<<							
Base Vol:	117	455	80	145	965	153	111	100	60	196	150	53
Growth Adj:	1.00	1.00	1.00	1.00	1.00	1.00	1.00	1.00	1.00	1.00	1.00	1.00
Initial Bse:	117	455	80	145	965	153	111	100	60	196	150	53
Added Vol:	0	12	0	0	28	11	3	0	0	0	0	0
PasserByVol:	0	0	0	0	0	0	0	0	0	0	0	0
Initial Fut:	117	467	80	145	993	164	114	100	60	196	150	53
User Adj:	1.00	1.00	1.00	1.00	1.00	1.00	1.00	1.00	1.00	1.00	1.00	1.00
PHF Adj:	1.00	1.00	1.00	1.00	1.00	1.00	1.00	1.00	1.00	1.00	1.00	1.00
PHF Volume:	117	467	80	145	993	164	114	100	60	196	150	53
Reduct Vol:	0	0	0	0	0	0	0	0	0	0	0	0
Reduced Vol:	117	467	80	145	993	164	114	100	60	196	150	53
PCE Adj:	1.00	1.00	1.00	1.00	1.00	1.00	1.00	1.00	1.00	1.00	1.00	1.00
MLF Adj:	1.00	1.00	1.00	1.00	1.00	1.00	1.00	1.00	1.00	1.00	1.00	1.00
FinalVolume:	117	467	80	145	993	164	114	100	60	196	150	53

Saturation Flow Module:												
Sat/Lane:	1900	1900	1900	1900	1900	1900	1900	1900	1900	1900	1900	1900
Adjustment:	0.92	1.00	0.92	0.92	1.00	0.92	0.83	1.00	0.92	0.92	0.98	0.95
Lanes:	1.00	2.00	1.00	1.00	2.00	1.00	2.00	1.00	1.00	1.00	1.46	0.54
Final Sat.:	1750	3800	1750	1750	3800	1750	3150	1900	1750	1750	2733	966

Capacity Analysis Module:												
Vol/Sat:	0.07	0.12	0.05	0.08	0.26	0.09	0.04	0.05	0.03	0.11	0.05	0.05
Crit Moves:	****				****			****		****		
Green Time:	12.6	37.0	58.1	24.9	49.3	62.1	12.8	10.0	10.0	21.1	18.3	18.3
Volume/Cap:	0.56	0.35	0.08	0.35	0.56	0.16	0.30	0.55	0.36	0.56	0.31	0.31
Delay/Veh:	46.9	25.3	11.0	33.8	20.4	9.7	42.4	49.0	45.8	39.7	38.2	38.2
User DelAdj:	1.00	1.00	1.00	1.00	1.00	1.00	1.00	1.00	1.00	1.00	1.00	1.00
AdjDel/Veh:	46.9	25.3	11.0	33.8	20.4	9.7	42.4	49.0	45.8	39.7	38.2	38.2
LOS by Move:	D	C	B	C	C	A	D	D	D	D	D	D
HCM2kAvgQ:	4	5	1	4	11	2	2	4	2	7	3	3

Note: Queue reported is the number of cars per lane.

Voices School
Morgan Hill, CA
Hexagon Transportation Consultants, Inc.

Level Of Service Computation Report
2000 HCM Operations (Future Volume Alternative)
2025 Plus Project (AM) - 1 Cosmo Full out

Intersection #4111: Monterey Road and Vineyard Boulevard

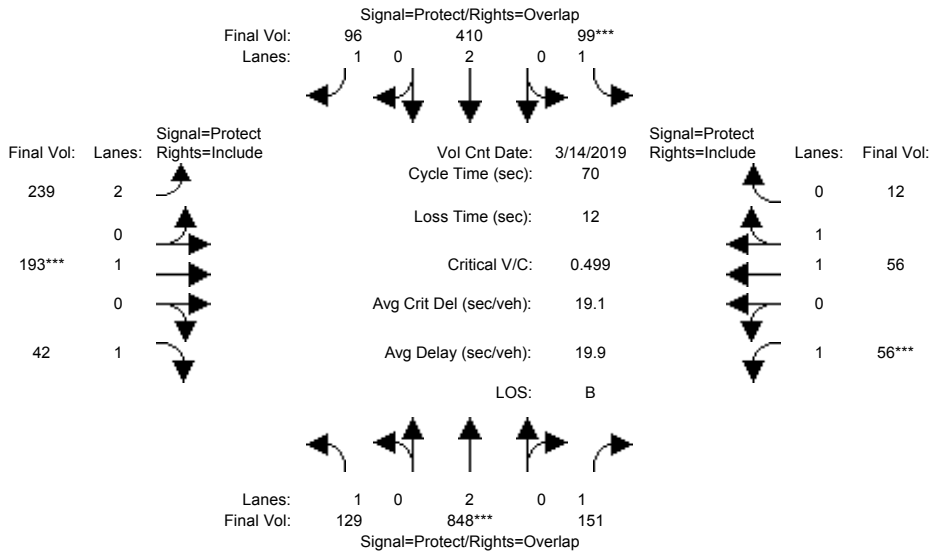

Street Name:	Monterey Road						Vineyard Blvd					
	North Bound			South Bound			East Bound			West Bound		
Approach:	L	T	R	L	T	R	L	T	R	L	T	R
Min. Green:	7	10	10	7	10	10	7	10	10	7	10	10
Y+R:	4.0	4.0	4.0	4.0	4.0	4.0	4.0	4.0	4.0	4.0	4.0	4.0

Volume Module:	>>	Count	Date:	14 Mar 2019	<<							
Base Vol:	115	625	143	99	319	86	217	186	42	52	50	12
Growth Adj:	1.00	1.00	1.00	1.00	1.00	1.00	1.00	1.00	1.00	1.00	1.00	1.00
Initial Bse:	115	625	143	99	319	86	217	186	42	52	50	12
Added Vol:	0	45	0	0	23	6	17	0	0	0	0	0
PasserByVol:	14	178	8	0	68	4	5	7	0	4	6	0
Initial Fut:	129	848	151	99	410	96	239	193	42	56	56	12
User Adj:	1.00	1.00	1.00	1.00	1.00	1.00	1.00	1.00	1.00	1.00	1.00	1.00
PHF Adj:	1.00	1.00	1.00	1.00	1.00	1.00	1.00	1.00	1.00	1.00	1.00	1.00
PHF Volume:	129	848	151	99	410	96	239	193	42	56	56	12
Reduct Vol:	0	0	0	0	0	0	0	0	0	0	0	0
Reduced Vol:	129	848	151	99	410	96	239	193	42	56	56	12
PCE Adj:	1.00	1.00	1.00	1.00	1.00	1.00	1.00	1.00	1.00	1.00	1.00	1.00
MLF Adj:	1.00	1.00	1.00	1.00	1.00	1.00	1.00	1.00	1.00	1.00	1.00	1.00
FinalVolume:	129	848	151	99	410	96	239	193	42	56	56	12

Saturation Flow Module:												
Sat/Lane:	1900	1900	1900	1900	1900	1900	1900	1900	1900	1900	1900	1900
Adjustment:	0.92	1.00	0.92	0.92	1.00	0.92	0.83	1.00	0.92	0.92	0.98	0.95
Lanes:	1.00	2.00	1.00	1.00	2.00	1.00	2.00	1.00	1.00	1.00	1.64	0.36
Final Sat.:	1750	3800	1750	1750	3800	1750	3150	1900	1750	1750	3047	653

Capacity Analysis Module:												
Vol/Sat:	0.07	0.22	0.09	0.06	0.11	0.05	0.08	0.10	0.02	0.03	0.02	0.02
Crit Moves:	****			****			****			****		
Green Time:	15.4	29.8	36.8	7.6	22.0	30.5	8.5	13.6	13.6	7.0	12.1	12.1
Volume/Cap:	0.33	0.52	0.16	0.52	0.34	0.13	0.63	0.52	0.12	0.32	0.11	0.11
Delay/Veh:	23.5	15.1	8.7	32.2	18.6	11.9	32.5	26.7	23.5	30.3	24.5	24.5
User DelAdj:	1.00	1.00	1.00	1.00	1.00	1.00	1.00	1.00	1.00	1.00	1.00	1.00
AdjDel/Veh:	23.5	15.1	8.7	32.2	18.6	11.9	32.5	26.7	23.5	30.3	24.5	24.5
LOS by Move:	C	B	A	C	B	B	C	C	C	C	C	C
HCM2kAvgQ:	2	7	2	2	3	1	4	4	1	2	1	1

Note: Queue reported is the number of cars per lane.

Voices School
Morgan Hill, CA
Hexagon Transportation Consultants, Inc.

Level Of Service Computation Report
2000 HCM Operations (Future Volume Alternative)
2025 Plus Project (PM) - 1 Cosmo Full out

Intersection #4111: Monterey Road and Vineyard Boulevard

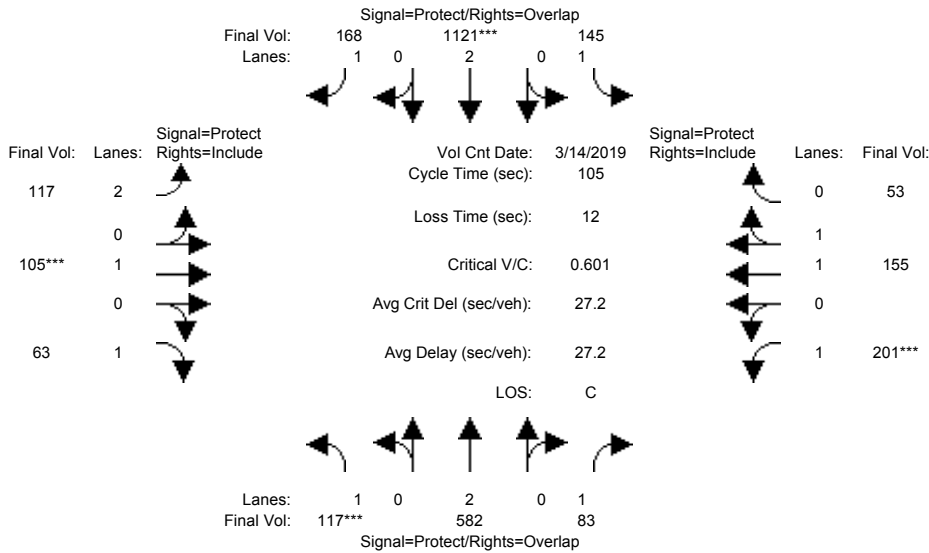

Street Name:	Monterey Road						Vineyard Blvd					
	North Bound			South Bound			East Bound			West Bound		
Approach:	L	T	R	L	T	R	L	T	R	L	T	R
Min. Green:	7	10	10	7	10	10	7	10	10	7	10	10
Y+R:	4.0	4.0	4.0	4.0	4.0	4.0	4.0	4.0	4.0	4.0	4.0	4.0

Volume Module:	>>	Count	Date:	14 Mar 2019	<<							
Base Vol:	117	455	80	145	965	153	111	100	60	196	150	53
Growth Adj:	1.00	1.00	1.00	1.00	1.00	1.00	1.00	1.00	1.00	1.00	1.00	1.00
Initial Bse:	117	455	80	145	965	153	111	100	60	196	150	53
Added Vol:	0	12	0	0	28	11	3	0	0	0	0	0
PasserByVol:	0	115	3	0	128	4	3	5	3	5	5	0
Initial Fut:	117	582	83	145	1121	168	117	105	63	201	155	53
User Adj:	1.00	1.00	1.00	1.00	1.00	1.00	1.00	1.00	1.00	1.00	1.00	1.00
PHF Adj:	1.00	1.00	1.00	1.00	1.00	1.00	1.00	1.00	1.00	1.00	1.00	1.00
PHF Volume:	117	582	83	145	1121	168	117	105	63	201	155	53
Reduct Vol:	0	0	0	0	0	0	0	0	0	0	0	0
Reduced Vol:	117	582	83	145	1121	168	117	105	63	201	155	53
PCE Adj:	1.00	1.00	1.00	1.00	1.00	1.00	1.00	1.00	1.00	1.00	1.00	1.00
MLF Adj:	1.00	1.00	1.00	1.00	1.00	1.00	1.00	1.00	1.00	1.00	1.00	1.00
Final Volume:	117	582	83	145	1121	168	117	105	63	201	155	53

Saturation Flow Module:												
Sat/Lane:	1900	1900	1900	1900	1900	1900	1900	1900	1900	1900	1900	1900
Adjustment:	0.92	1.00	0.92	0.92	1.00	0.92	0.83	1.00	0.92	0.92	0.98	0.95
Lanes:	1.00	2.00	1.00	1.00	2.00	1.00	2.00	1.00	1.00	1.00	1.48	0.52
Final Sat.:	1750	3800	1750	1750	3800	1750	3150	1900	1750	1750	2757	943

Capacity Analysis Module:												
Vol/Sat:	0.07	0.15	0.05	0.08	0.30	0.10	0.04	0.06	0.04	0.11	0.06	0.06
Crit Moves:	***			***			***			***		
Green Time:	11.6	40.9	60.9	22.1	51.4	63.7	12.4	10.0	10.0	20.0	17.6	17.6
Volume/Cap:	0.60	0.39	0.08	0.39	0.60	0.16	0.32	0.58	0.38	0.60	0.33	0.33
Delay/Veh:	49.7	23.3	9.8	36.4	20.0	9.0	42.9	50.2	46.0	42.0	38.8	38.8
User DelAdj:	1.00	1.00	1.00	1.00	1.00	1.00	1.00	1.00	1.00	1.00	1.00	1.00
AdjDel/Veh:	49.7	23.3	9.8	36.4	20.0	9.0	42.9	50.2	46.0	42.0	38.8	38.8
LOS by Move:	D	C	A	D	B	A	D	D	D	D	D	D
HCM2kAvgQ:	4	6	1	4	13	2	2	4	2	7	3	3

Note: Queue reported is the number of cars per lane.

Voices School
Morgan Hill, CA
Hexagon Transportation Consultants, Inc.

Level Of Service Computation Report
2000 HCM Operations (Future Volume Alternative)
Existing Plus Project (AM) - 1 Cosmo Full out

Intersection #6674: Monterey Road and Tennant Avenue/Edmundson Avenue

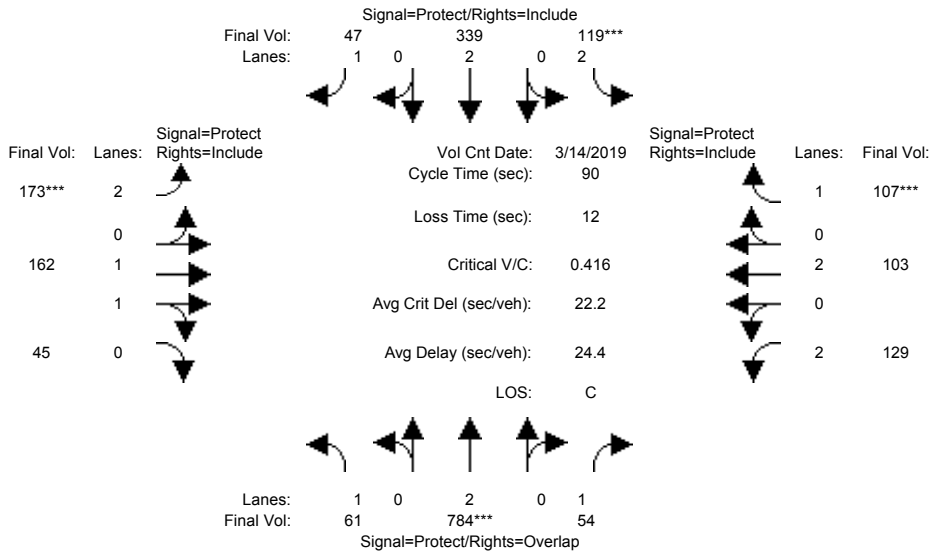

Street Name:	Monterey Rd						Tennant Ave/Edmundson Ave					
	North Bound			South Bound			East Bound			West Bound		
Approach:	L	T	R	L	T	R	L	T	R	L	T	R
Min. Green:	7	10	10	7	10	10	7	10	10	7	10	10
Y+R:	4.0	4.0	4.0	4.0	4.0	4.0	4.0	4.0	4.0	4.0	4.0	4.0

Volume Module:	>>	Count	Date:	14 Mar 2019	<<											
Base Vol:	61	722	54	92	309	46	157	162	45	129	103	86				
Growth Adj:	1.00	1.00	1.00	1.00	1.00	1.00	1.00	1.00	1.00	1.00	1.00	1.00				
Initial Bse:	61	722	54	92	309	46	157	162	45	129	103	86				
Added Vol:	0	62	0	27	30	1	16	0	0	0	0	21				
PasserByVol:	0	0	0	0	0	0	0	0	0	0	0	0				
Initial Fut:	61	784	54	119	339	47	173	162	45	129	103	107				
User Adj:	1.00	1.00	1.00	1.00	1.00	1.00	1.00	1.00	1.00	1.00	1.00	1.00				
PHF Adj:	1.00	1.00	1.00	1.00	1.00	1.00	1.00	1.00	1.00	1.00	1.00	1.00				
PHF Volume:	61	784	54	119	339	47	173	162	45	129	103	107				
Reduct Vol:	0	0	0	0	0	0	0	0	0	0	0	0				
Reduced Vol:	61	784	54	119	339	47	173	162	45	129	103	107				
PCE Adj:	1.00	1.00	1.00	1.00	1.00	1.00	1.00	1.00	1.00	1.00	1.00	1.00				
MLF Adj:	1.00	1.00	1.00	1.00	1.00	1.00	1.00	1.00	1.00	1.00	1.00	1.00				
Final Volume:	61	784	54	119	339	47	173	162	45	129	103	107				

Saturation Flow Module:												
Sat/Lane:	1900	1900	1900	1900	1900	1900	1900	1900	1900	1900	1900	1900
Adjustment:	0.92	1.00	0.92	0.83	1.00	0.92	0.83	0.98	0.95	0.83	1.00	0.92
Lanes:	1.00	2.00	1.00	2.00	2.00	1.00	2.00	1.55	0.45	2.00	2.00	1.00
Final Sat.:	1750	3800	1750	3150	3800	1750	3150	2895	804	3150	3800	1750

Capacity Analysis Module:												
Vol/Sat:	0.03	0.21	0.03	0.04	0.09	0.03	0.05	0.06	0.06	0.04	0.03	0.06
Crit Moves:	****			****			****			****		
Green Time:	21.8	44.7	55.0	8.2	31.1	31.1	11.9	14.8	14.8	10.4	13.2	13.2
Volume/Cap:	0.14	0.42	0.05	0.42	0.26	0.08	0.42	0.34	0.34	0.36	0.18	0.42
Delay/Veh:	27.0	14.5	7.0	39.6	21.3	19.9	36.5	33.6	33.6	37.4	33.8	36.0
User DelAdj:	1.00	1.00	1.00	1.00	1.00	1.00	1.00	1.00	1.00	1.00	1.00	1.00
AdjDel/Veh:	27.0	14.5	7.0	39.6	21.3	19.9	36.5	33.6	33.6	37.4	33.8	36.0
LOS by Move:	C	B	A	D	C	B	D	C	C	D	C	D
HCM2kAvgQ:	1	7	1	2	3	1	3	3	3	2	1	3

Note: Queue reported is the number of cars per lane.

Voices School
Morgan Hill, CA
Hexagon Transportation Consultants, Inc.

Level Of Service Computation Report
2000 HCM Operations (Future Volume Alternative)
Existing Plus Project (PM) - 1 Cosmo Full out

Intersection #6674: Monterey Road and Tennant Avenue/Edmundson Avenue

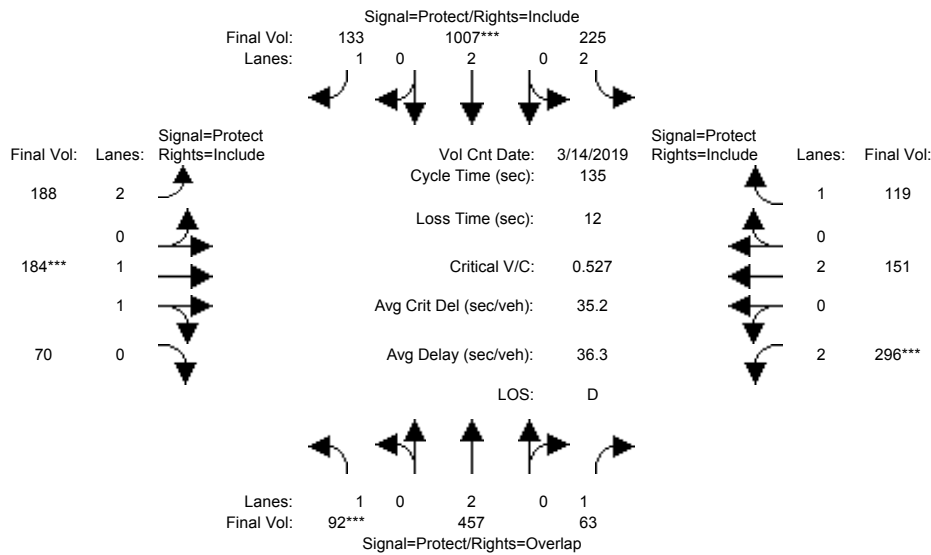

Street Name:	Monterey Rd						Tennant Ave/Edmundson Ave					
	North Bound			South Bound			East Bound			West Bound		
Approach:	L	T	R	L	T	R	L	T	R	L	T	R
Min. Green:	7	10	10	7	10	10	7	10	10	7	10	10
Y+R:	4.0	4.0	4.0	4.0	4.0	4.0	4.0	4.0	4.0	4.0	4.0	4.0

Volume Module:	>>	Count	Date:	14 Mar 2019	<<							
Base Vol:	92	441	63	213	968	131	185	184	70	296	151	105
Growth Adj:	1.00	1.00	1.00	1.00	1.00	1.00	1.00	1.00	1.00	1.00	1.00	1.00
Initial Bse:	92	441	63	213	968	131	185	184	70	296	151	105
Added Vol:	0	16	0	12	39	2	3	0	0	0	0	14
PasserByVol:	0	0	0	0	0	0	0	0	0	0	0	0
Initial Fut:	92	457	63	225	1007	133	188	184	70	296	151	119
User Adj:	1.00	1.00	1.00	1.00	1.00	1.00	1.00	1.00	1.00	1.00	1.00	1.00
PHF Adj:	1.00	1.00	1.00	1.00	1.00	1.00	1.00	1.00	1.00	1.00	1.00	1.00
PHF Volume:	92	457	63	225	1007	133	188	184	70	296	151	119
Reduct Vol:	0	0	0	0	0	0	0	0	0	0	0	0
Reduced Vol:	92	457	63	225	1007	133	188	184	70	296	151	119
PCE Adj:	1.00	1.00	1.00	1.00	1.00	1.00	1.00	1.00	1.00	1.00	1.00	1.00
MLF Adj:	1.00	1.00	1.00	1.00	1.00	1.00	1.00	1.00	1.00	1.00	1.00	1.00
FinalVolume:	92	457	63	225	1007	133	188	184	70	296	151	119

Saturation Flow Module:												
Sat/Lane:	1900	1900	1900	1900	1900	1900	1900	1900	1900	1900	1900	1900
Adjustment:	0.92	1.00	0.92	0.83	1.00	0.92	0.83	0.98	0.95	0.83	1.00	0.92
Lanes:	1.00	2.00	1.00	2.00	2.00	1.00	2.00	1.43	0.57	2.00	2.00	1.00
Final Sat.:	1750	3800	1750	3150	3800	1750	3150	2680	1019	3150	3800	1750

Capacity Analysis Module:												
Vol/Sat:	0.05	0.12	0.04	0.07	0.27	0.08	0.06	0.07	0.07	0.09	0.04	0.07
Crit Moves:	****				****			****		****		
Green Time:	13.5	51.0	75.1	30.3	67.9	67.9	18.6	17.6	17.6	24.1	23.1	23.1
Volume/Cap:	0.53	0.32	0.06	0.32	0.53	0.15	0.43	0.53	0.53	0.53	0.23	0.40
Delay/Veh:	60.7	29.8	13.8	44.0	23.0	18.1	54.1	55.9	55.9	51.2	48.5	50.7
User DelAdj:	1.00	1.00	1.00	1.00	1.00	1.00	1.00	1.00	1.00	1.00	1.00	1.00
AdjDel/Veh:	60.7	29.8	13.8	44.0	23.0	18.1	54.1	55.9	55.9	51.2	48.5	50.7
LOS by Move:	E	C	B	D	C	B	D	E	E	D	D	D
HCM2kAvgQ:	4	6	1	5	14	3	5	6	6	7	3	5

Note: Queue reported is the number of cars per lane.

Voices School
Morgan Hill, CA
Hexagon Transportation Consultants, Inc.

Level Of Service Computation Report
2000 HCM Operations (Future Volume Alternative)
2025 Plus Project (AM) - 1 Cosmo Full out

Intersection #6674: Monterey Road and Tennant Avenue/Edmundson Avenue

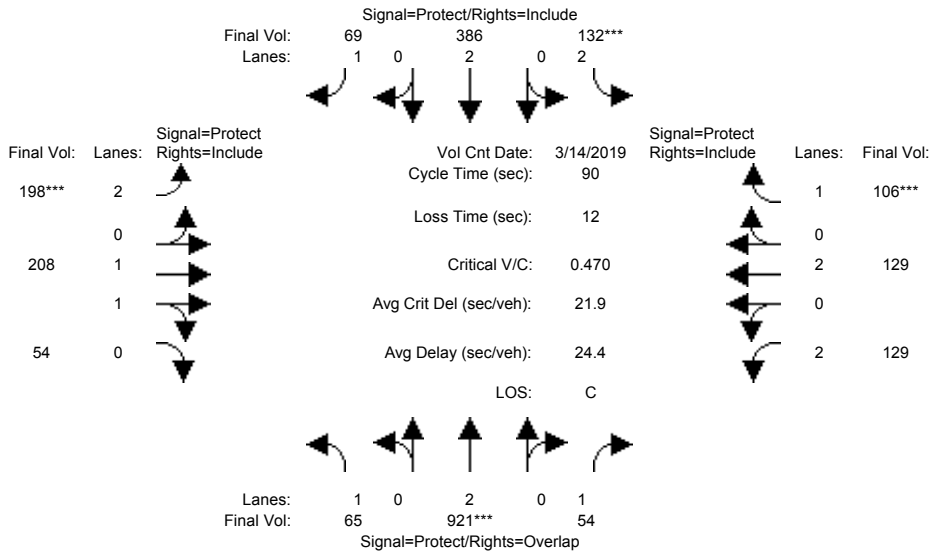

Street Name:	Monterey Rd						Tennant Ave/Edmundson Ave					
	North Bound			South Bound			East Bound			West Bound		
Approach:	L	T	R	L	T	R	L	T	R	L	T	R
Min. Green:	7	10	10	7	10	10	7	10	10	7	10	10
Y+R:	4.0	4.0	4.0	4.0	4.0	4.0	4.0	4.0	4.0	4.0	4.0	4.0

Volume Module:	>>	Count	Date:	14 Mar 2019	<<							
Base Vol:	61	722	54	92	309	46	157	162	45	129	103	86
Growth Adj:	1.00	1.00	1.00	1.00	1.00	1.00	1.00	1.00	1.00	1.00	1.00	1.00
Initial Bse:	61	722	54	92	309	46	157	162	45	129	103	86
Added Vol:	0	62	0	26	30	1	16	0	0	0	0	20
PasserByVol:	4	137	0	14	47	22	25	46	9	0	26	0
Initial Fut:	65	921	54	132	386	69	198	208	54	129	129	106
User Adj:	1.00	1.00	1.00	1.00	1.00	1.00	1.00	1.00	1.00	1.00	1.00	1.00
PHF Adj:	1.00	1.00	1.00	1.00	1.00	1.00	1.00	1.00	1.00	1.00	1.00	1.00
PHF Volume:	65	921	54	132	386	69	198	208	54	129	129	106
Reduct Vol:	0	0	0	0	0	0	0	0	0	0	0	0
Reduced Vol:	65	921	54	132	386	69	198	208	54	129	129	106
PCE Adj:	1.00	1.00	1.00	1.00	1.00	1.00	1.00	1.00	1.00	1.00	1.00	1.00
MLF Adj:	1.00	1.00	1.00	1.00	1.00	1.00	1.00	1.00	1.00	1.00	1.00	1.00
FinalVolume:	65	921	54	132	386	69	198	208	54	129	129	106

Saturation Flow Module:												
Sat/Lane:	1900	1900	1900	1900	1900	1900	1900	1900	1900	1900	1900	1900
Adjustment:	0.92	1.00	0.92	0.83	1.00	0.92	0.83	0.98	0.95	0.83	1.00	0.92
Lanes:	1.00	2.00	1.00	2.00	2.00	1.00	2.00	1.58	0.42	2.00	2.00	1.00
Final Sat.:	1750	3800	1750	3150	3800	1750	3150	2937	762	3150	3800	1750

Capacity Analysis Module:												
Vol/Sat:	0.04	0.24	0.03	0.04	0.10	0.04	0.06	0.07	0.07	0.04	0.03	0.06
Crit Moves:	****			****			****			****		
Green Time:	22.4	46.4	56.1	8.0	32.0	32.0	12.0	13.9	13.9	9.7	11.6	11.6
Volume/Cap:	0.15	0.47	0.05	0.47	0.29	0.11	0.47	0.46	0.46	0.38	0.26	0.47
Delay/Veh:	26.5	14.1	6.6	40.2	20.9	19.5	36.9	35.2	35.2	38.0	35.6	37.9
User DelAdj:	1.00	1.00	1.00	1.00	1.00	1.00	1.00	1.00	1.00	1.00	1.00	1.00
AdjDel/Veh:	26.5	14.1	6.6	40.2	20.9	19.5	36.9	35.2	35.2	38.0	35.6	37.9
LOS by Move:	C	B	A	D	C	B	D	D	D	D	D	D
HCM2kAvgQ:	1	8	1	3	4	1	4	4	4	2	2	3

Note: Queue reported is the number of cars per lane.

Voices School
Morgan Hill, CA
Hexagon Transportation Consultants, Inc.

Level Of Service Computation Report
2000 HCM Operations (Future Volume Alternative)
2025 Plus Project (PM) - 1 Cosmo Full out

Intersection #6674: Monterey Road and Tennant Avenue/Edmundson Avenue

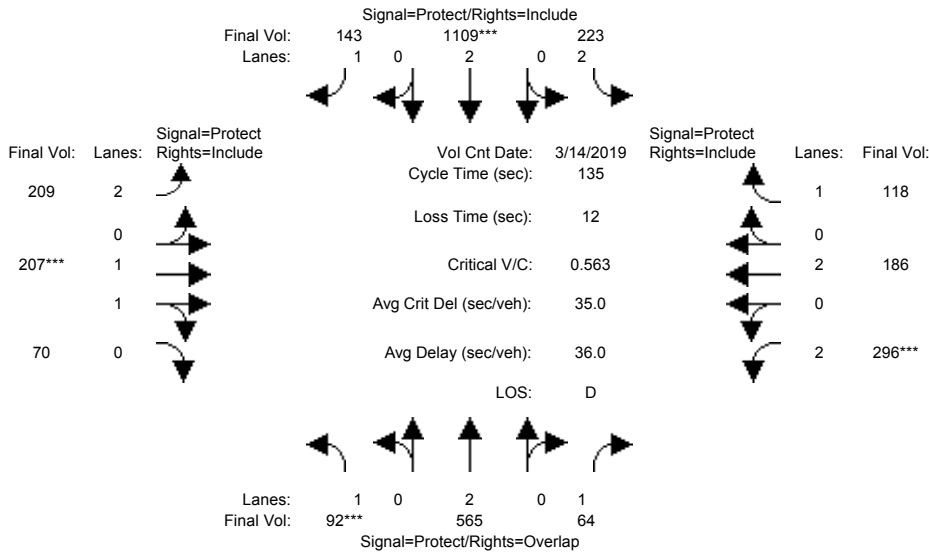

Street Name:	Monterey Rd						Tennant Ave/Edmundson Ave					
	North Bound			South Bound			East Bound			West Bound		
Approach:	L	T	R	L	T	R	L	T	R	L	T	R
Min. Green:	7	10	10	7	10	10	7	10	10	7	10	10
Y+R:	4.0	4.0	4.0	4.0	4.0	4.0	4.0	4.0	4.0	4.0	4.0	4.0

Volume Module:	>>	Count	Date:	14 Mar 2019	<<							
Base Vol:	92	441	63	213	968	131	185	184	70	296	151	105
Growth Adj:	1.00	1.00	1.00	1.00	1.00	1.00	1.00	1.00	1.00	1.00	1.00	1.00
Initial Bse:	92	441	63	213	968	131	185	184	70	296	151	105
Added Vol:	0	15	0	10	38	2	2	0	0	0	0	13
PasserByVol:	0	109	1	0	103	10	22	23	0	0	35	0
Initial Fut:	92	565	64	223	1109	143	209	207	70	296	186	118
User Adj:	1.00	1.00	1.00	1.00	1.00	1.00	1.00	1.00	1.00	1.00	1.00	1.00
PHF Adj:	1.00	1.00	1.00	1.00	1.00	1.00	1.00	1.00	1.00	1.00	1.00	1.00
PHF Volume:	92	565	64	223	1109	143	209	207	70	296	186	118
Reduct Vol:	0	0	0	0	0	0	0	0	0	0	0	0
Reduced Vol:	92	565	64	223	1109	143	209	207	70	296	186	118
PCE Adj:	1.00	1.00	1.00	1.00	1.00	1.00	1.00	1.00	1.00	1.00	1.00	1.00
MLF Adj:	1.00	1.00	1.00	1.00	1.00	1.00	1.00	1.00	1.00	1.00	1.00	1.00
FinalVolume:	92	565	64	223	1109	143	209	207	70	296	186	118

Saturation Flow Module:												
Sat/Lane:	1900	1900	1900	1900	1900	1900	1900	1900	1900	1900	1900	1900
Adjustment:	0.92	1.00	0.92	0.83	1.00	0.92	0.83	0.98	0.95	0.83	1.00	0.92
Lanes:	1.00	2.00	1.00	2.00	2.00	1.00	2.00	1.48	0.52	2.00	2.00	1.00
Final Sat.:	1750	3800	1750	3150	3800	1750	3150	2764	935	3150	3800	1750

Capacity Analysis Module:												
Vol/Sat:	0.05	0.15	0.04	0.07	0.29	0.08	0.07	0.07	0.07	0.09	0.05	0.07
Crit Moves:	***			***			***			***		
Green Time:	12.6	55.9	78.4	26.6	69.9	69.9	19.1	17.9	17.9	22.5	21.3	21.3
Volume/Cap:	0.56	0.36	0.06	0.36	0.56	0.16	0.47	0.56	0.56	0.56	0.31	0.43
Delay/Veh:	63.0	27.4	12.3	47.2	22.5	17.2	54.0	56.4	56.4	53.1	50.6	52.4
User DelAdj:	1.00	1.00	1.00	1.00	1.00	1.00	1.00	1.00	1.00	1.00	1.00	1.00
AdjDel/Veh:	63.0	27.4	12.3	47.2	22.5	17.2	54.0	56.4	56.4	53.1	50.6	52.4
LOS by Move:	E	C	B	D	C	B	D	E	E	D	D	D
HCM2kAvgQ:	4	8	1	5	15	3	5	6	6	7	3	5

Note: Queue reported is the number of cars per lane.

Voices School
Morgan Hill, CA
Hexagon Transportation Consultants, Inc.

Level Of Service Computation Report
2000 HCM Operations (Future Volume Alternative)
Existing Plus Project (AM) - 1 Cosmo Full out

Intersection #6725: Monterey Road and Spring Avenue

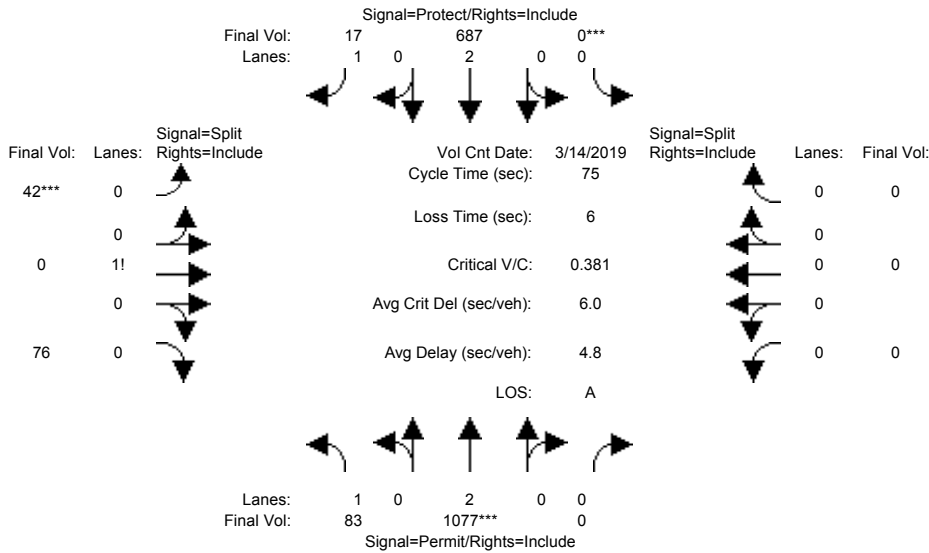

Street Name:	Monterey Road						Spring Avenue					
	North Bound			South Bound			East Bound			West Bound		
Approach:	L	T	R	L	T	R	L	T	R	L	T	R
Min. Green:	10	10	0	0	10	10	10	0	10	0	0	0
Y+R:	4.0	4.0	4.0	4.0	4.0	4.0	4.0	4.0	4.0	4.0	4.0	4.0

Volume Module: >> Count Date: 14 Mar 2019 <<

Base Vol:	83	891	0	0	479	17	42	0	68	0	0	0
Growth Adj:	1.00	1.00	1.00	1.00	1.00	1.00	1.00	1.00	1.00	1.00	1.00	1.00
Initial Bse:	83	891	0	0	479	17	42	0	68	0	0	0
Added Vol:	0	186	0	0	208	0	0	0	8	0	0	0
PasserByVol:	0	0	0	0	0	0	0	0	0	0	0	0
Initial Fut:	83	1077	0	0	687	17	42	0	76	0	0	0
User Adj:	1.00	1.00	1.00	1.00	1.00	1.00	1.00	1.00	1.00	1.00	1.00	1.00
PHF Adj:	1.00	1.00	1.00	1.00	1.00	1.00	1.00	1.00	1.00	1.00	1.00	1.00
PHF Volume:	83	1077	0	0	687	17	42	0	76	0	0	0
Reduct Vol:	0	0	0	0	0	0	0	0	0	0	0	0
Reduced Vol:	83	1077	0	0	687	17	42	0	76	0	0	0
PCE Adj:	1.00	1.00	1.00	1.00	1.00	1.00	1.00	1.00	1.00	1.00	1.00	1.00
MLF Adj:	1.00	1.00	1.00	1.00	1.00	1.00	1.00	1.00	1.00	1.00	1.00	1.00
Final Volume:	83	1077	0	0	687	17	42	0	76	0	0	0

Saturation Flow Module:

Sat/Lane:	1900	1900	1900	1900	1900	1900	1900	1900	1900	1900	1900	1900
Adjustment:	0.92	1.00	0.92	0.92	1.00	0.92	0.92	0.92	0.92	0.92	1.00	0.92
Lanes:	1.00	2.00	0.00	0.00	2.00	1.00	0.36	0.00	0.64	0.00	0.00	0.00
Final Sat.:	1750	3800	0	0	3800	1750	623	0	1127	0	0	0

Capacity Analysis Module:

Vol/Sat:	0.05	0.28	0.00	0.00	0.18	0.01	0.07	0.00	0.07	0.00	0.00	0.00
Crit Moves:	****	****	****	****	****	****	****	****	****	****	****	****
Green Time:	55.7	55.7	0.0	0.0	55.7	55.7	13.3	0.0	13.3	0.0	0.0	0.0
Volume/Cap:	0.06	0.38	0.00	0.00	0.24	0.01	0.38	0.00	0.38	0.00	0.00	0.00
Delay/Veh:	2.6	3.5	0.0	0.0	3.1	2.5	28.0	0.0	28.0	0.0	0.0	0.0
User DelAdj:	1.00	1.00	1.00	1.00	1.00	1.00	1.00	1.00	1.00	1.00	1.00	1.00
AdjDel/Veh:	2.6	3.5	0.0	0.0	3.1	2.5	28.0	0.0	28.0	0.0	0.0	0.0
LOS by Move:	A	A	A	A	A	A	C	A	C	A	A	A
HCM2kAvgQ:	1	5	0	0	2	0	3	0	3	0	0	0

Note: Queue reported is the number of cars per lane.

Voices School
Morgan Hill, CA
Hexagon Transportation Consultants, Inc.

Level Of Service Computation Report
2000 HCM Operations (Future Volume Alternative)
Existing Plus Project (PM) - 1 Cosmo Full out

Intersection #6725: Monterey Road and Spring Avenue

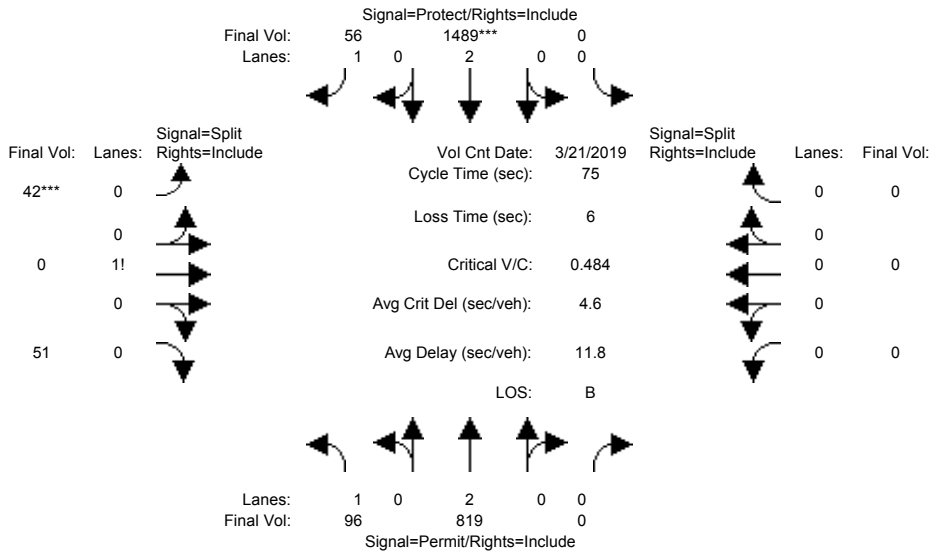

Street Name:	Monterey Road						Spring Avenue					
	North Bound			South Bound			East Bound			West Bound		
Approach:	L	T	R	L	T	R	L	T	R	L	T	R
Min. Green:	10	10	0	0	10	10	10	0	10	0	0	0
Y+R:	4.0	4.0	4.0	4.0	4.0	4.0	4.0	4.0	4.0	4.0	4.0	4.0

Volume Module:	>>	Count	Date:	21 Mar 2019	<<							
Base Vol:	96	706	0	0	1388	56	42	0	49	0	0	0
Growth Adj:	1.00	1.00	1.00	1.00	1.00	1.00	1.00	1.00	1.00	1.00	1.00	1.00
Initial Bse:	96	706	0	0	1388	56	42	0	49	0	0	0
Added Vol:	0	113	0	0	101	0	0	0	2	0	0	0
PasserByVol:	0	0	0	0	0	0	0	0	0	0	0	0
Initial Fut:	96	819	0	0	1489	56	42	0	51	0	0	0
User Adj:	1.00	1.00	1.00	1.00	1.00	1.00	1.00	1.00	1.00	1.00	1.00	1.00
PHF Adj:	1.00	1.00	1.00	1.00	1.00	1.00	1.00	1.00	1.00	1.00	1.00	1.00
PHF Volume:	96	819	0	0	1489	56	42	0	51	0	0	0
Reduct Vol:	0	0	0	0	0	0	0	0	0	0	0	0
Reduced Vol:	96	819	0	0	1489	56	42	0	51	0	0	0
PCE Adj:	1.00	1.00	1.00	1.00	1.00	1.00	1.00	1.00	1.00	1.00	1.00	1.00
MLF Adj:	1.00	1.00	1.00	1.00	1.00	1.00	1.00	1.00	1.00	1.00	1.00	1.00
FinalVolume:	96	819	0	0	1489	56	42	0	51	0	0	0

Saturation Flow Module:												
Sat/Lane:	1900	1900	1900	1900	1900	1900	1900	1900	1900	1900	1900	1900
Adjustment:	0.92	1.00	0.92	0.92	1.00	0.92	0.92	0.92	0.92	0.92	1.00	0.92
Lanes:	1.00	2.00	0.00	0.00	2.00	1.00	0.45	0.00	0.55	0.00	0.00	0.00
Final Sat.:	1750	3800	0	0	3800	1750	790	0	960	0	0	0

Capacity Analysis Module:												
Vol/Sat:	0.05	0.22	0.00	0.00	0.39	0.03	0.05	0.00	0.05	0.00	0.00	0.00
Crit Moves:	****											
Green Time:	22.5	22.5	0.0	0.0	59.0	59.0	10.0	0.0	10.0	0.0	0.0	0.0
Volume/Cap:	0.18	0.72	0.00	0.00	0.50	0.04	0.40	0.00	0.40	0.00	0.00	0.00
Delay/Veh:	19.6	25.6	0.0	0.0	2.9	1.8	30.9	0.0	30.9	0.0	0.0	0.0
User DelAdj:	1.00	1.00	1.00	1.00	1.00	1.00	1.00	1.00	1.00	1.00	1.00	1.00
AdjDel/Veh:	19.6	25.6	0.0	0.0	2.9	1.8	30.9	0.0	30.9	0.0	0.0	0.0
LOS by Move:	B	C	A	A	A	A	C	A	C	A	A	A
HCM2kAvgQ:	2	10	0	0	6	0	3	0	3	0	0	0

Note: Queue reported is the number of cars per lane.

Voices School
Morgan Hill, CA
Hexagon Transportation Consultants, Inc.

Level Of Service Computation Report
2000 HCM Operations (Future Volume Alternative)
2025 Plus Project (AM) - 1 Cosmo Full out

Intersection #6725: Monterey Road and Spring Avenue

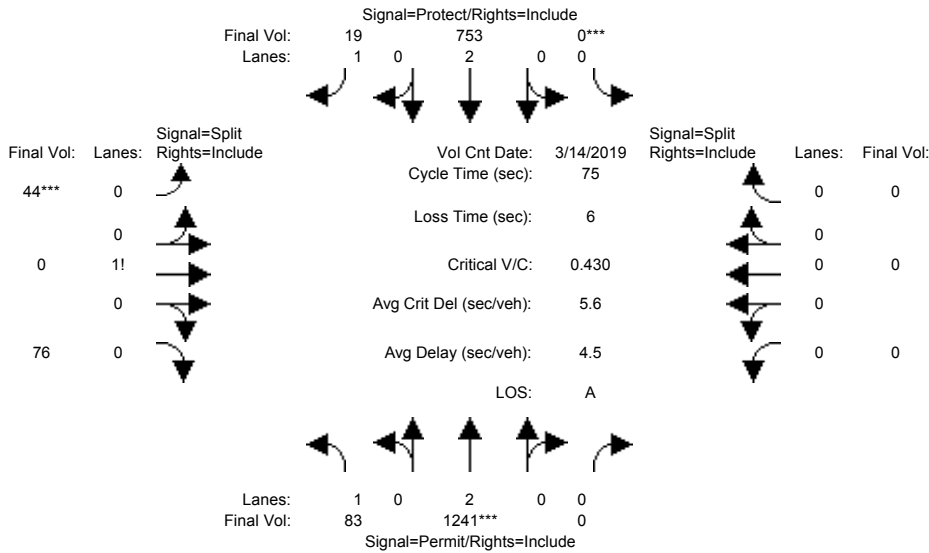

Street Name:	Monterey Road						Spring Avenue					
	North Bound			South Bound			East Bound			West Bound		
Approach:	L	T	R	L	T	R	L	T	R	L	T	R

Min. Green:	10	10	0	0	10	10	10	0	10	0	0	0
Y+R:	4.0	4.0	4.0	4.0	4.0	4.0	4.0	4.0	4.0	4.0	4.0	4.0

Volume Module:	>>	Count	Date:	14 Mar 2019	<<							
Base Vol:	83	891	0	0	479	17	42	0	68	0	0	0
Growth Adj:	1.00	1.00	1.00	1.00	1.00	1.00	1.00	1.00	1.00	1.00	1.00	1.00
Initial Bse:	83	891	0	0	479	17	42	0	68	0	0	0
Added Vol:	0	182	0	0	206	0	0	0	8	0	0	0
PasserByVol:	0	168	0	0	68	2	2	0	0	0	0	0
Initial Fut:	83	1241	0	0	753	19	44	0	76	0	0	0
User Adj:	1.00	1.00	1.00	1.00	1.00	1.00	1.00	1.00	1.00	1.00	1.00	1.00
PHF Adj:	1.00	1.00	1.00	1.00	1.00	1.00	1.00	1.00	1.00	1.00	1.00	1.00
PHF Volume:	83	1241	0	0	753	19	44	0	76	0	0	0
Reduct Vol:	0	0	0	0	0	0	0	0	0	0	0	0
Reduced Vol:	83	1241	0	0	753	19	44	0	76	0	0	0
PCE Adj:	1.00	1.00	1.00	1.00	1.00	1.00	1.00	1.00	1.00	1.00	1.00	1.00
MLF Adj:	1.00	1.00	1.00	1.00	1.00	1.00	1.00	1.00	1.00	1.00	1.00	1.00
FinalVolume:	83	1241	0	0	753	19	44	0	76	0	0	0

Saturation Flow Module:												
Sat/Lane:	1900	1900	1900	1900	1900	1900	1900	1900	1900	1900	1900	1900
Adjustment:	0.92	1.00	0.92	0.92	1.00	0.92	0.92	0.92	0.92	0.92	1.00	0.92
Lanes:	1.00	2.00	0.00	0.00	2.00	1.00	0.37	0.00	0.63	0.00	0.00	0.00
Final Sat.:	1750	3800	0	0	3800	1750	642	0	1108	0	0	0

Capacity Analysis Module:												
Vol/Sat:	0.05	0.33	0.00	0.00	0.20	0.01	0.07	0.00	0.07	0.00	0.00	0.00
Crit Moves:	****			****			****					
Green Time:	57.0	57.0	0.0	0.0	57.0	57.0	12.0	0.0	12.0	0.0	0.0	0.0
Volume/Cap:	0.06	0.43	0.00	0.00	0.26	0.01	0.43	0.00	0.43	0.00	0.00	0.00
Delay/Veh:	2.3	3.3	0.0	0.0	2.7	2.2	29.5	0.0	29.5	0.0	0.0	0.0
User DelAdj:	1.00	1.00	1.00	1.00	1.00	1.00	1.00	1.00	1.00	1.00	1.00	1.00
AdjDel/Veh:	2.3	3.3	0.0	0.0	2.7	2.2	29.5	0.0	29.5	0.0	0.0	0.0
LOS by Move:	A	A	A	A	A	A	C	A	C	A	A	A
HCM2kAvgQ:	1	5	0	0	3	0	3	0	3	0	0	0

Note: Queue reported is the number of cars per lane.

Voices School
Morgan Hill, CA
Hexagon Transportation Consultants, Inc.

Level Of Service Computation Report
2000 HCM Operations (Future Volume Alternative)
2025 Plus Project (PM) - 1 Cosmo Full out

Intersection #6725: Monterey Road and Spring Avenue

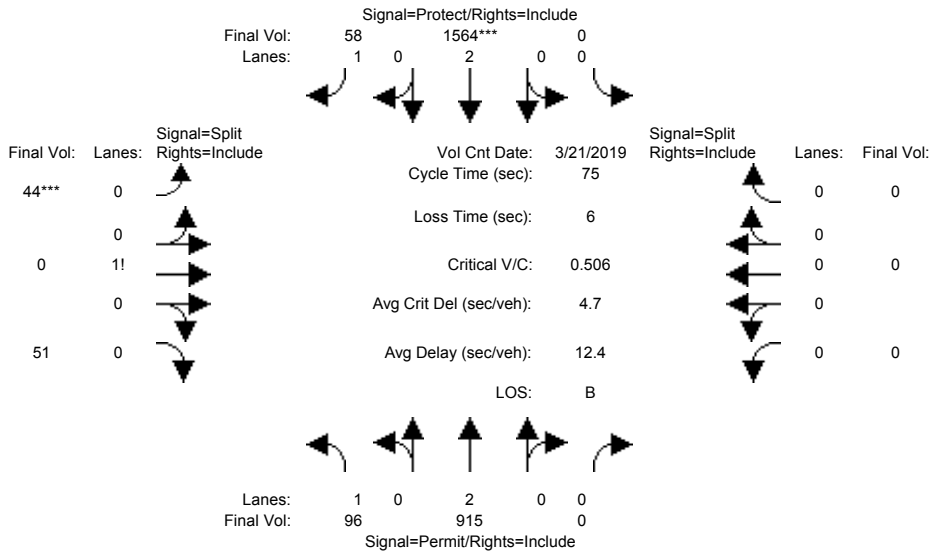

Street Name:	Monterey Road						Spring Avenue					
	North Bound			South Bound			East Bound			West Bound		
Approach:	L	T	R	L	T	R	L	T	R	L	T	R
Min. Green:	10	10	0	0	10	10	10	0	10	0	0	0
Y+R:	4.0	4.0	4.0	4.0	4.0	4.0	4.0	4.0	4.0	4.0	4.0	4.0

Volume Module:	>>	Count	Date:	21 Mar 2019	<<							
Base Vol:	96	706	0	0	1388	56	42	0	49	0	0	0
Growth Adj:	1.00	1.00	1.00	1.00	1.00	1.00	1.00	1.00	1.00	1.00	1.00	1.00
Initial Bse:	96	706	0	0	1388	56	42	0	49	0	0	0
Added Vol:	0	109	0	0	97	0	0	0	2	0	0	0
PasserByVol:	0	100	0	0	79	2	2	0	0	0	0	0
Initial Fut:	96	915	0	0	1564	58	44	0	51	0	0	0
User Adj:	1.00	1.00	1.00	1.00	1.00	1.00	1.00	1.00	1.00	1.00	1.00	1.00
PHF Adj:	1.00	1.00	1.00	1.00	1.00	1.00	1.00	1.00	1.00	1.00	1.00	1.00
PHF Volume:	96	915	0	0	1564	58	44	0	51	0	0	0
Reduct Vol:	0	0	0	0	0	0	0	0	0	0	0	0
Reduced Vol:	96	915	0	0	1564	58	44	0	51	0	0	0
PCE Adj:	1.00	1.00	1.00	1.00	1.00	1.00	1.00	1.00	1.00	1.00	1.00	1.00
MLF Adj:	1.00	1.00	1.00	1.00	1.00	1.00	1.00	1.00	1.00	1.00	1.00	1.00
FinalVolume:	96	915	0	0	1564	58	44	0	51	0	0	0

Saturation Flow Module:												
Sat/Lane:	1900	1900	1900	1900	1900	1900	1900	1900	1900	1900	1900	1900
Adjustment:	0.92	1.00	0.92	0.92	1.00	0.92	0.92	0.92	0.92	0.92	1.00	0.92
Lanes:	1.00	2.00	0.00	0.00	2.00	1.00	0.46	0.00	0.54	0.00	0.00	0.00
Final Sat.:	1750	3800	0	0	3800	1750	811	0	939	0	0	0

Capacity Analysis Module:												
Vol/Sat:	0.05	0.24	0.00	0.00	0.41	0.03	0.05	0.00	0.05	0.00	0.00	0.00
Crit Moves:	****											
Green Time:	23.5	23.5	0.0	0.0	59.0	59.0	10.0	0.0	10.0	0.0	0.0	0.0
Volume/Cap:	0.17	0.77	0.00	0.00	0.52	0.04	0.41	0.00	0.41	0.00	0.00	0.00
Delay/Veh:	18.9	26.4	0.0	0.0	3.1	1.8	30.9	0.0	30.9	0.0	0.0	0.0
User DelAdj:	1.00	1.00	1.00	1.00	1.00	1.00	1.00	1.00	1.00	1.00	1.00	1.00
AdjDel/Veh:	18.9	26.4	0.0	0.0	3.1	1.8	30.9	0.0	30.9	0.0	0.0	0.0
LOS by Move:	B	C	A	A	A	A	C	A	C	A	A	A
HCM2kAvgQ:	2	11	0	0	6	0	3	0	3	0	0	0

Note: Queue reported is the number of cars per lane.

Voices School
Morgan Hill, CA
Hexagon Transportation Consultants, Inc.

Level Of Service Computation Report
2000 HCM Operations (Future Volume Alternative)
Existing Plus Project (AM) - 3 Monterey out

Intersection #118: Monterey Road and Main Avenue

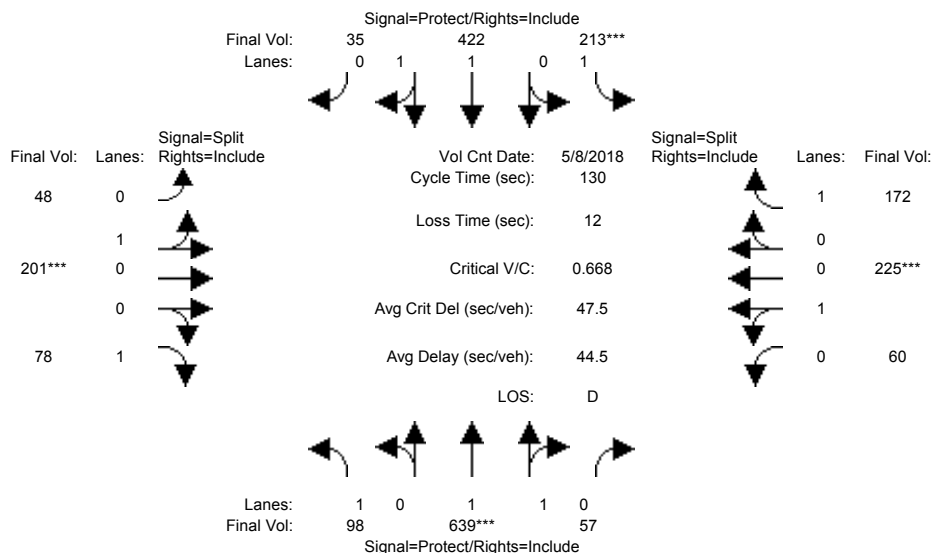

Street Name: Monterey Road Main Avenue
Approach: North Bound South Bound East Bound West Bound
Movement: L - T - R L - T - R L - T - R L - T - R

Min. Green:	7	10	10	7	10	10	10	10	10	10	10	10
Y+R:	4.0	4.0	4.0	4.0	4.0	4.0	4.0	4.0	4.0	4.0	4.0	4.0

Volume Module: >> Count Date: 8 May 2018 <<												
Base Vol:	98	605	38	213	353	35	48	201	78	27	225	172
Growth Adj:	1.00	1.00	1.00	1.00	1.00	1.00	1.00	1.00	1.00	1.00	1.00	1.00
Initial Bse:	98	605	38	213	353	35	48	201	78	27	225	172
Added Vol:	0	34	19	0	69	0	0	0	0	33	0	0
PasserByVol:	0	0	0	0	0	0	0	0	0	0	0	0
Initial Fut:	98	639	57	213	422	35	48	201	78	60	225	172
User Adj:	1.00	1.00	1.00	1.00	1.00	1.00	1.00	1.00	1.00	1.00	1.00	1.00
PHF Adj:	1.00	1.00	1.00	1.00	1.00	1.00	1.00	1.00	1.00	1.00	1.00	1.00
PHF Volume:	98	639	57	213	422	35	48	201	78	60	225	172
Reduct Vol:	0	0	0	0	0	0	0	0	0	0	0	0
Reduced Vol:	98	639	57	213	422	35	48	201	78	60	225	172
PCE Adj:	1.00	1.00	1.00	1.00	1.00	1.00	1.00	1.00	1.00	1.00	1.00	1.00
MLF Adj:	1.00	1.00	1.00	1.00	1.00	1.00	1.00	1.00	1.00	1.00	1.00	1.00
FinalVolume:	98	639	57	213	422	35	48	201	78	60	225	172

Saturation Flow Module:												
Sat/Lane:	1900	1900	1900	1900	1900	1900	1900	1900	1900	1900	1900	1900
Adjustment:	0.92	0.98	0.95	0.92	0.98	0.95	0.95	0.95	0.92	0.95	0.95	0.92
Lanes:	1.00	1.83	0.17	1.00	1.84	0.16	0.19	0.81	1.00	0.21	0.79	1.00
Final Sat.:	1750	3397	303	1750	3416	283	347	1453	1750	379	1421	1750

Capacity Analysis Module:												
Vol/Sat:	0.06	0.19	0.19	0.12	0.12	0.12	0.14	0.14	0.04	0.16	0.16	0.10
Crit Moves:	****			****			****			****		
Green Time:	18.8	36.6	36.6	23.7	41.5	41.5	26.9	26.9	26.9	30.8	30.8	30.8
Volume/Cap:	0.39	0.67	0.67	0.67	0.39	0.39	0.67	0.67	0.22	0.67	0.67	0.41
Delay/Veh:	51.4	43.0	43.0	54.9	34.6	34.6	52.0	52.0	43.1	49.0	49.0	42.6
User DelAdj:	1.00	1.00	1.00	1.00	1.00	1.00	1.00	1.00	1.00	1.00	1.00	1.00
AdjDel/Veh:	51.4	43.0	43.0	54.9	34.6	34.6	52.0	52.0	43.1	49.0	49.0	42.6
LOS by Move:	D	D	D	D	C	C	D	D	D	D	D	D
HCM2kAvgQ:	4	12	12	10	7	7	11	11	3	11	11	6

Note: Queue reported is the number of cars per lane.

Voices School
Morgan Hill, CA
Hexagon Transportation Consultants, Inc.

Level Of Service Computation Report
2000 HCM Operations (Future Volume Alternative)
Existing Plus Project (PM) - 3 Monterey out

Intersection #118: Monterey Road and Main Avenue

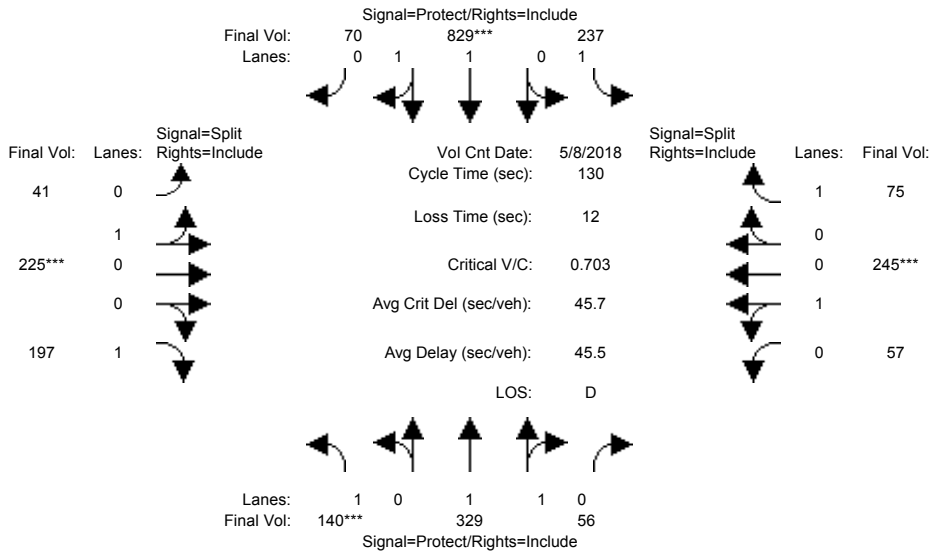

Street Name:	Monterey Road						Main Avenue					
	North Bound			South Bound			East Bound			West Bound		
Approach:	L	T	R	L	T	R	L	T	R	L	T	R
Min. Green:	7	10	10	7	10	10	10	10	10	10	10	10
Y+R:	4.0	4.0	4.0	4.0	4.0	4.0	4.0	4.0	4.0	4.0	4.0	4.0

Volume Module:	>>	Count	Date:	8 May 2018	<<							
Base Vol:	140	285	35	237	811	70	41	225	197	47	245	75
Growth Adj:	1.00	1.00	1.00	1.00	1.00	1.00	1.00	1.00	1.00	1.00	1.00	1.00
Initial Bse:	140	285	35	237	811	70	41	225	197	47	245	75
Added Vol:	0	44	21	0	18	0	0	0	0	10	0	0
PasserByVol:	0	0	0	0	0	0	0	0	0	0	0	0
Initial Fut:	140	329	56	237	829	70	41	225	197	57	245	75
User Adj:	1.00	1.00	1.00	1.00	1.00	1.00	1.00	1.00	1.00	1.00	1.00	1.00
PHF Adj:	1.00	1.00	1.00	1.00	1.00	1.00	1.00	1.00	1.00	1.00	1.00	1.00
PHF Volume:	140	329	56	237	829	70	41	225	197	57	245	75
Reduct Vol:	0	0	0	0	0	0	0	0	0	0	0	0
Reduced Vol:	140	329	56	237	829	70	41	225	197	57	245	75
PCE Adj:	1.00	1.00	1.00	1.00	1.00	1.00	1.00	1.00	1.00	1.00	1.00	1.00
MLF Adj:	1.00	1.00	1.00	1.00	1.00	1.00	1.00	1.00	1.00	1.00	1.00	1.00
FinalVolume:	140	329	56	237	829	70	41	225	197	57	245	75

Saturation Flow Module:												
Sat/Lane:	1900	1900	1900	1900	1900	1900	1900	1900	1900	1900	1900	1900
Adjustment:	0.92	0.98	0.95	0.92	0.98	0.95	0.95	0.95	0.92	0.95	0.95	0.92
Lanes:	1.00	1.70	0.30	1.00	1.84	0.16	0.15	0.85	1.00	0.19	0.81	1.00
Final Sat.:	1750	3161	538	1750	3412	288	277	1523	1750	340	1460	1750

Capacity Analysis Module:												
Vol/Sat:	0.08	0.10	0.10	0.14	0.24	0.24	0.15	0.15	0.11	0.17	0.17	0.04
Crit Moves:	****				****		****			****		
Green Time:	14.8	25.9	25.9	33.8	44.9	44.9	27.3	27.3	27.3	31.0	31.0	31.0
Volume/Cap:	0.70	0.52	0.52	0.52	0.70	0.70	0.70	0.70	0.54	0.70	0.70	0.18
Delay/Veh:	66.3	47.2	47.2	42.3	38.6	38.6	53.5	53.5	47.3	50.5	50.5	39.6
User DelAdj:	1.00	1.00	1.00	1.00	1.00	1.00	1.00	1.00	1.00	1.00	1.00	1.00
AdjDel/Veh:	66.3	47.2	47.2	42.3	38.6	38.6	53.5	53.5	47.3	50.5	50.5	39.6
LOS by Move:	E	D	D	D	D	D	D	D	D	D	D	D
HCM2kAvgQ:	6	7	7	9	17	17	11	11	8	12	12	2

Note: Queue reported is the number of cars per lane.

Voices School
Morgan Hill, CA
Hexagon Transportation Consultants, Inc.

Level Of Service Computation Report
2000 HCM Operations (Future Volume Alternative)
2025 Plus Project (AM) - 3 Monterey out

Intersection #118: Monterey Road and Main Avenue

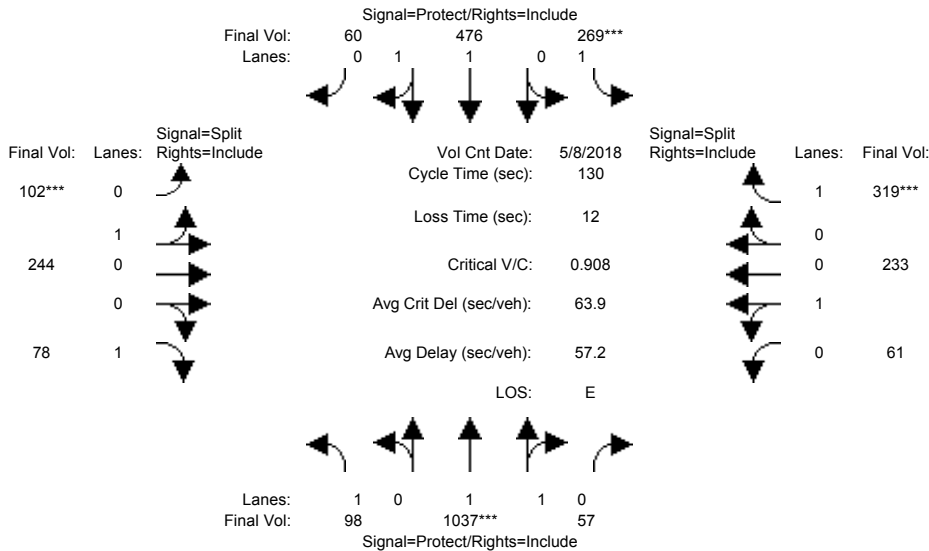

Street Name:	Monterey Road						Main Avenue					
Approach:	North Bound			South Bound			East Bound			West Bound		
Movement:	L	T	R	L	T	R	L	T	R	L	T	R
Min. Green:	7	10	10	7	10	10	10	10	10	10	10	10
Y+R:	4.0	4.0	4.0	4.0	4.0	4.0	4.0	4.0	4.0	4.0	4.0	4.0
Volume Module: >> Count Date: 8 May 2018 <<												
Base Vol:	98	605	38	213	353	35	48	201	78	27	225	172
Growth Adj:	1.00	1.00	1.00	1.00	1.00	1.00	1.00	1.00	1.00	1.00	1.00	1.00
Initial Bse:	98	605	38	213	353	35	48	201	78	27	225	172
Added Vol:	0	34	19	0	69	0	0	0	0	33	0	0
PasserByVol:	0	398	0	56	54	25	54	43	0	1	8	147
Initial Fut:	98	1037	57	269	476	60	102	244	78	61	233	319
User Adj:	1.00	1.00	1.00	1.00	1.00	1.00	1.00	1.00	1.00	1.00	1.00	1.00
PHF Adj:	1.00	1.00	1.00	1.00	1.00	1.00	1.00	1.00	1.00	1.00	1.00	1.00
PHF Volume:	98	1037	57	269	476	60	102	244	78	61	233	319
Reduct Vol:	0	0	0	0	0	0	0	0	0	0	0	0
Reduced Vol:	98	1037	57	269	476	60	102	244	78	61	233	319
PCE Adj:	1.00	1.00	1.00	1.00	1.00	1.00	1.00	1.00	1.00	1.00	1.00	1.00
MLF Adj:	1.00	1.00	1.00	1.00	1.00	1.00	1.00	1.00	1.00	1.00	1.00	1.00
FinalVolume:	98	1037	57	269	476	60	102	244	78	61	233	319
Saturation Flow Module:												
Sat/Lane:	1900	1900	1900	1900	1900	1900	1900	1900	1900	1900	1900	1900
Adjustment:	0.92	0.98	0.95	0.92	0.98	0.95	0.95	0.95	0.92	0.95	0.95	0.92
Lanes:	1.00	1.89	0.11	1.00	1.77	0.23	0.29	0.71	1.00	0.21	0.79	1.00
Final Sat.:	1750	3507	193	1750	3286	414	531	1269	1750	373	1427	1750
Capacity Analysis Module:												
Vol/Sat:	0.06	0.30	0.30	0.15	0.14	0.14	0.19	0.19	0.04	0.16	0.16	0.18
Crit Moves:	****			****			****			****		
Green Time:	17.9	42.3	42.3	22.0	46.4	46.4	27.5	27.5	27.5	26.1	26.1	26.1
Volume/Cap:	0.41	0.91	0.91	0.91	0.41	0.41	0.91	0.91	0.21	0.81	0.81	0.91
Delay/Veh:	52.3	52.0	52.0	82.7	31.6	31.6	74.8	74.8	42.6	62.8	62.8	77.1
User DelAdj:	1.00	1.00	1.00	1.00	1.00	1.00	1.00	1.00	1.00	1.00	1.00	1.00
AdjDel/Veh:	52.3	52.0	52.0	82.7	31.6	31.6	74.8	74.8	42.6	62.8	62.8	77.1
LOS by Move:	D	D	D	F	C	C	E	E	D	E	E	E
HCM2kAvgQ:	4	23	23	15	8	8	18	18	3	12	12	14

Note: Queue reported is the number of cars per lane.

Voices School
Morgan Hill, CA
Hexagon Transportation Consultants, Inc.

Level Of Service Computation Report
2000 HCM Operations (Future Volume Alternative)
2025 Plus Project (PM) - 3 Monterey out

Intersection #118: Monterey Road and Main Avenue

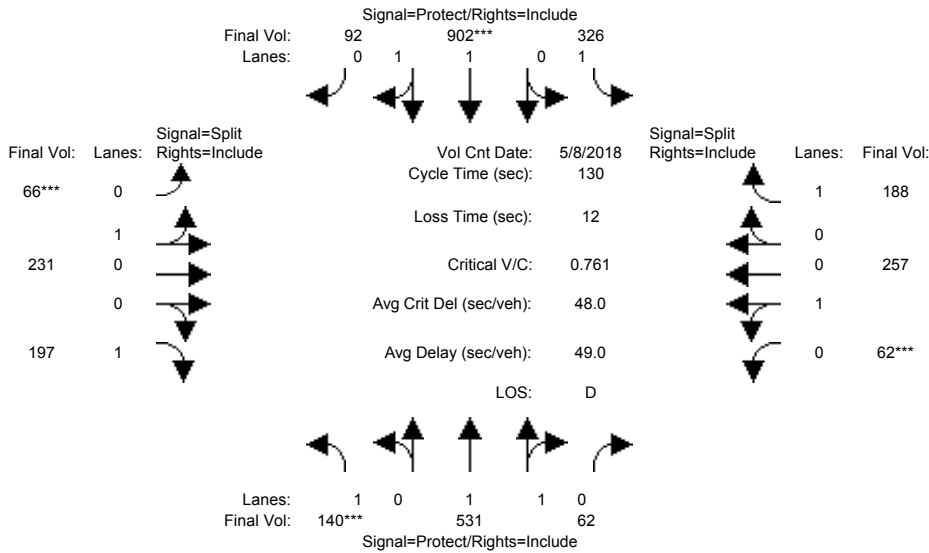

Street Name:	Monterey Road						Main Avenue					
	North Bound			South Bound			East Bound			West Bound		
Approach:	L	T	R	L	T	R	L	T	R	L	T	R
Min. Green:	7	10	10	7	10	10	10	10	10	10	10	10
Y+R:	4.0	4.0	4.0	4.0	4.0	4.0	4.0	4.0	4.0	4.0	4.0	4.0

Volume Module:	>>	Count	Date:	8 May 2018	<<							
Base Vol:	140	285	35	237	811	70	41	225	197	47	245	75
Growth Adj:	1.00	1.00	1.00	1.00	1.00	1.00	1.00	1.00	1.00	1.00	1.00	1.00
Initial Bse:	140	285	35	237	811	70	41	225	197	47	245	75
Added Vol:	0	44	21	0	18	0	0	0	0	10	0	0
PasserByVol:	0	202	6	89	73	22	25	6	0	5	12	113
Initial Fut:	140	531	62	326	902	92	66	231	197	62	257	188
User Adj:	1.00	1.00	1.00	1.00	1.00	1.00	1.00	1.00	1.00	1.00	1.00	1.00
PHF Adj:	1.00	1.00	1.00	1.00	1.00	1.00	1.00	1.00	1.00	1.00	1.00	1.00
PHF Volume:	140	531	62	326	902	92	66	231	197	62	257	188
Reduct Vol:	0	0	0	0	0	0	0	0	0	0	0	0
Reduced Vol:	140	531	62	326	902	92	66	231	197	62	257	188
PCE Adj:	1.00	1.00	1.00	1.00	1.00	1.00	1.00	1.00	1.00	1.00	1.00	1.00
MLF Adj:	1.00	1.00	1.00	1.00	1.00	1.00	1.00	1.00	1.00	1.00	1.00	1.00
FinalVolume:	140	531	62	326	902	92	66	231	197	62	257	188

Saturation Flow Module:												
Sat/Lane:	1900	1900	1900	1900	1900	1900	1900	1900	1900	1900	1900	1900
Adjustment:	0.92	0.98	0.95	0.92	0.98	0.95	0.95	0.95	0.92	0.95	0.95	0.92
Lanes:	1.00	1.79	0.21	1.00	1.81	0.19	0.22	0.78	1.00	0.19	0.81	1.00
Final Sat.:	1750	3313	387	1750	3357	342	400	1400	1750	350	1450	1750

Capacity Analysis Module:												
Vol/Sat:	0.08	0.16	0.16	0.19	0.27	0.27	0.17	0.17	0.11	0.18	0.18	0.11
Crit Moves:	***			***			***			***		
Green Time:	13.7	27.5	27.5	32.0	45.9	45.9	28.2	28.2	28.2	30.3	30.3	30.3
Volume/Cap:	0.76	0.76	0.76	0.76	0.76	0.76	0.76	0.76	0.52	0.76	0.76	0.46
Delay/Veh:	73.4	52.3	52.3	52.9	39.9	39.9	56.3	56.3	46.2	54.5	54.5	43.7
User DelAdj:	1.00	1.00	1.00	1.00	1.00	1.00	1.00	1.00	1.00	1.00	1.00	1.00
AdjDel/Veh:	73.4	52.3	52.3	52.9	39.9	39.9	56.3	56.3	46.2	54.5	54.5	43.7
LOS by Move:	E	D	D	D	D	D	E	E	D	D	D	D
HCM2kAvgQ:	6	12	12	14	19	19	13	13	8	12	12	7

Note: Queue reported is the number of cars per lane.

Voices School
Morgan Hill, CA
Hexagon Transportation Consultants, Inc.

Level Of Service Computation Report
2000 HCM Operations (Future Volume Alternative)
Existing Plus Project (AM) - 3 Monterey out

Intersection #119: Butterfield Boulevard and Main Avenue

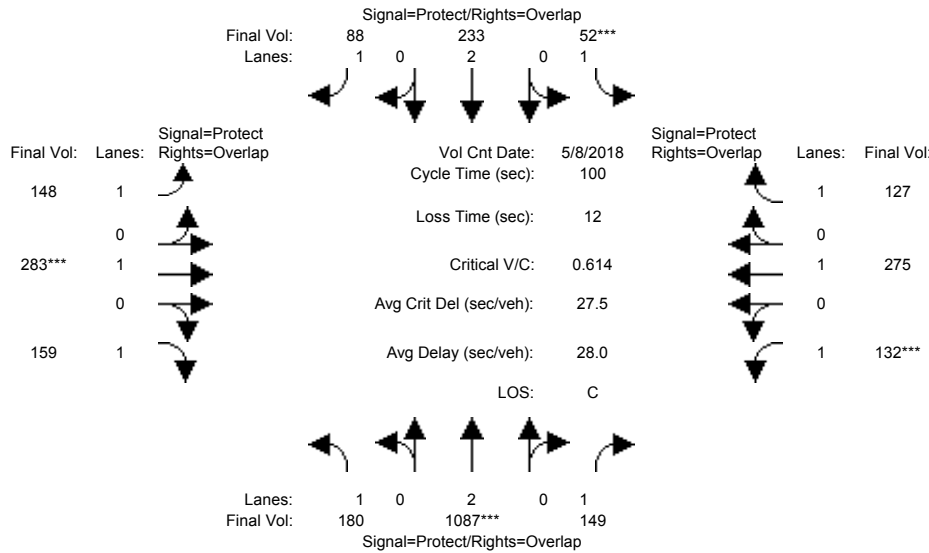

Street Name:	Butterfield Boulevard						Main Avenue					
Approach:	North Bound			South Bound			East Bound			West Bound		
Movement:	L	T	R	L	T	R	L	T	R	L	T	R
Min. Green:	7	10	10	7	10	10	7	10	10	7	10	10
Y+R:	4.0	4.0	4.0	4.0	4.0	4.0	4.0	4.0	4.0	4.0	4.0	4.0

Volume Module:	>>	Count	Date:	8 May 2018	<<											
Base Vol:	180	1082	149	52	226	68	134	278	159	132	262	127				
Growth Adj:	1.00	1.00	1.00	1.00	1.00	1.00	1.00	1.00	1.00	1.00	1.00	1.00				
Initial Bse:	180	1082	149	52	226	68	134	278	159	132	262	127				
Added Vol:	0	5	0	0	7	20	14	5	0	0	13	0				
PasserByVol:	0	0	0	0	0	0	0	0	0	0	0	0				
Initial Fut:	180	1087	149	52	233	88	148	283	159	132	275	127				
User Adj:	1.00	1.00	1.00	1.00	1.00	1.00	1.00	1.00	1.00	1.00	1.00	1.00				
PHF Adj:	1.00	1.00	1.00	1.00	1.00	1.00	1.00	1.00	1.00	1.00	1.00	1.00				
PHF Volume:	180	1087	149	52	233	88	148	283	159	132	275	127				
Reduct Vol:	0	0	0	0	0	0	0	0	0	0	0	0				
Reduced Vol:	180	1087	149	52	233	88	148	283	159	132	275	127				
PCE Adj:	1.00	1.00	1.00	1.00	1.00	1.00	1.00	1.00	1.00	1.00	1.00	1.00				
MLF Adj:	1.00	1.00	1.00	1.00	1.00	1.00	1.00	1.00	1.00	1.00	1.00	1.00				
FinalVolume:	180	1087	149	52	233	88	148	283	159	132	275	127				

Saturation Flow Module:												
Sat/Lane:	1900	1900	1900	1900	1900	1900	1900	1900	1900	1900	1900	1900
Adjustment:	0.92	1.00	0.92	0.92	1.00	0.92	0.92	1.00	0.92	0.92	1.00	0.92
Lanes:	1.00	2.00	1.00	1.00	2.00	1.00	1.00	1.00	1.00	1.00	1.00	1.00
Final Sat.:	1750	3800	1750	1750	3800	1750	1750	1900	1750	1750	1900	1750

Capacity Analysis Module:												
Vol/Sat:	0.10	0.29	0.09	0.03	0.06	0.05	0.08	0.15	0.09	0.08	0.14	0.07
Crit Moves:	****			****			****			****		
Green Time:	26.6	45.4	57.4	7.0	25.8	39.0	13.1	23.6	50.2	12.0	22.5	29.5
Volume/Cap:	0.39	0.63	0.15	0.42	0.24	0.13	0.64	0.63	0.18	0.63	0.64	0.25
Delay/Veh:	30.6	21.6	10.0	46.9	29.4	19.7	47.4	37.1	13.7	48.0	38.5	27.1
User DelAdj:	1.00	1.00	1.00	1.00	1.00	1.00	1.00	1.00	1.00	1.00	1.00	1.00
AdjDel/Veh:	30.6	21.6	10.0	46.9	29.4	19.7	47.4	37.1	13.7	48.0	38.5	27.1
LOS by Move:	C	C	B	D	C	B	D	D	B	D	D	C
HCM2kAvgQ:	5	13	2	2	3	2	5	8	3	5	9	3

Note: Queue reported is the number of cars per lane.

Voices School
Morgan Hill, CA
Hexagon Transportation Consultants, Inc.

Level Of Service Computation Report
2000 HCM Operations (Future Volume Alternative)
Existing Plus Project (PM) - 3 Monterey out

Intersection #119: Butterfield Boulevard and Main Avenue

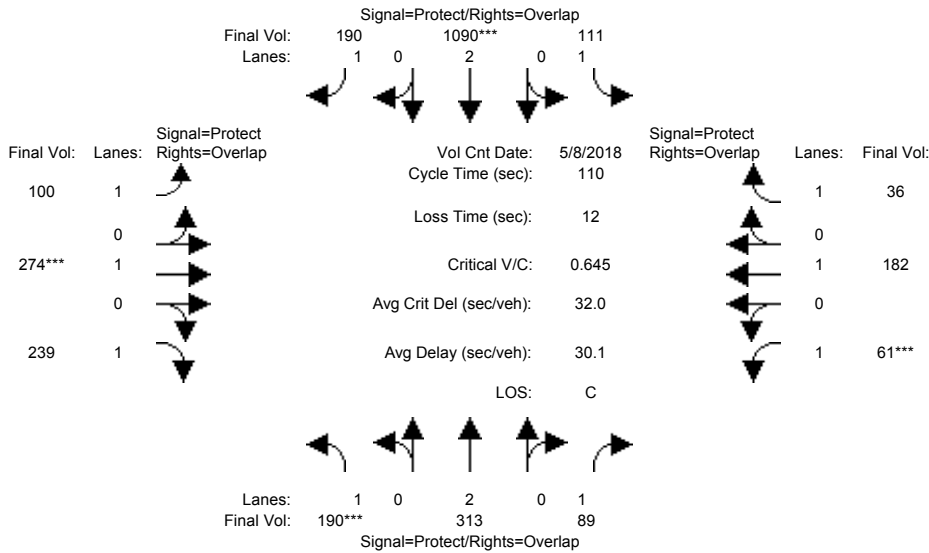

Street Name:	Butterfield Boulevard						Main Avenue					
	North Bound			South Bound			East Bound			West Bound		
Approach:	L	T	R	L	T	R	L	T	R	L	T	R
Min. Green:	7	10	10	7	10	10	7	10	10	7	10	10
Y+R:	4.0	4.0	4.0	4.0	4.0	4.0	4.0	4.0	4.0	4.0	4.0	4.0

Volume Module:	>>	Count	Date:	8 May 2018	<<							
Base Vol:	190	309	89	111	1088	183	87	266	239	61	179	36
Growth Adj:	1.00	1.00	1.00	1.00	1.00	1.00	1.00	1.00	1.00	1.00	1.00	1.00
Initial Bse:	190	309	89	111	1088	183	87	266	239	61	179	36
Added Vol:	0	4	0	0	2	7	13	8	0	0	3	0
PasserByVol:	0	0	0	0	0	0	0	0	0	0	0	0
Initial Fut:	190	313	89	111	1090	190	100	274	239	61	182	36
User Adj:	1.00	1.00	1.00	1.00	1.00	1.00	1.00	1.00	1.00	1.00	1.00	1.00
PHF Adj:	1.00	1.00	1.00	1.00	1.00	1.00	1.00	1.00	1.00	1.00	1.00	1.00
PHF Volume:	190	313	89	111	1090	190	100	274	239	61	182	36
Reduct Vol:	0	0	0	0	0	0	0	0	0	0	0	0
Reduced Vol:	190	313	89	111	1090	190	100	274	239	61	182	36
PCE Adj:	1.00	1.00	1.00	1.00	1.00	1.00	1.00	1.00	1.00	1.00	1.00	1.00
MLF Adj:	1.00	1.00	1.00	1.00	1.00	1.00	1.00	1.00	1.00	1.00	1.00	1.00
Final Volume:	190	313	89	111	1090	190	100	274	239	61	182	36

Saturation Flow Module:												
Sat/Lane:	1900	1900	1900	1900	1900	1900	1900	1900	1900	1900	1900	1900
Adjustment:	0.92	1.00	0.92	0.92	1.00	0.92	0.92	1.00	0.92	0.92	1.00	0.92
Lanes:	1.00	2.00	1.00	1.00	2.00	1.00	1.00	1.00	1.00	1.00	1.00	1.00
Final Sat.:	1750	3800	1750	1750	3800	1750	1750	1900	1750	1750	1900	1750

Capacity Analysis Module:												
Vol/Sat:	0.11	0.08	0.05	0.06	0.29	0.11	0.06	0.14	0.14	0.03	0.10	0.02
Crit Moves:	***			***			***			***		
Green Time:	18.3	39.2	46.2	27.5	48.4	60.9	12.5	24.3	42.6	7.0	18.8	46.3
Volume/Cap:	0.65	0.23	0.12	0.25	0.65	0.20	0.50	0.65	0.35	0.55	0.56	0.05
Delay/Veh:	48.1	24.9	19.6	33.4	25.1	12.4	47.9	42.6	24.2	55.6	44.0	18.9
User DelAdj:	1.00	1.00	1.00	1.00	1.00	1.00	1.00	1.00	1.00	1.00	1.00	1.00
AdjDel/Veh:	48.1	24.9	19.6	33.4	25.1	12.4	47.9	42.6	24.2	55.6	44.0	18.9
LOS by Move:	D	C	B	C	C	B	D	D	C	E	D	B
HCM2kAvgQ:	8	4	2	3	15	3	3	8	6	3	6	1

Note: Queue reported is the number of cars per lane.

Voices School
Morgan Hill, CA
Hexagon Transportation Consultants, Inc.

Level Of Service Computation Report
2000 HCM Operations (Future Volume Alternative)
2025 Plus Project (AM) - 3 Monterey out

Intersection #119: Butterfield Boulevard and Main Avenue

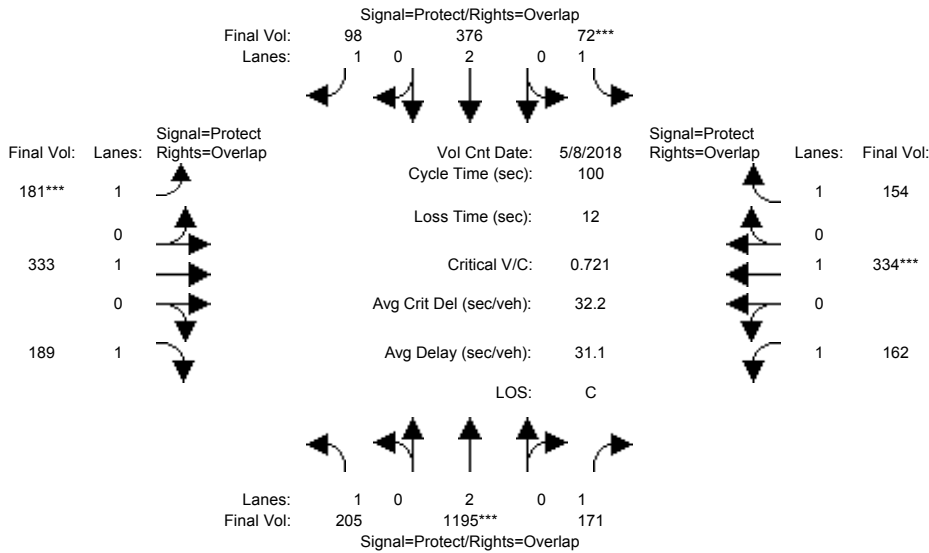

Street Name:	Butterfield Boulevard						Main Avenue					
	North Bound			South Bound			East Bound			West Bound		
Approach:	L	T	R	L	T	R	L	T	R	L	T	R
Min. Green:	7	10	10	7	10	10	7	10	10	7	10	10
Y+R:	4.0	4.0	4.0	4.0	4.0	4.0	4.0	4.0	4.0	4.0	4.0	4.0

Volume Module:	>>	Count	Date:	8 May 2018	<<											
Base Vol:	180	1082	149	52	226	68	134	278	159	132	262	127				
Growth Adj:	1.00	1.00	1.00	1.00	1.00	1.00	1.00	1.00	1.00	1.00	1.00	1.00				
Initial Bse:	180	1082	149	52	226	68	134	278	159	132	262	127				
Added Vol:	0	5	0	0	7	20	14	5	0	0	13	0				
PasserByVol:	25	108	22	20	143	10	33	50	30	30	59	27				
Initial Fut:	205	1195	171	72	376	98	181	333	189	162	334	154				
User Adj:	1.00	1.00	1.00	1.00	1.00	1.00	1.00	1.00	1.00	1.00	1.00	1.00				
PHF Adj:	1.00	1.00	1.00	1.00	1.00	1.00	1.00	1.00	1.00	1.00	1.00	1.00				
PHF Volume:	205	1195	171	72	376	98	181	333	189	162	334	154				
Reduct Vol:	0	0	0	0	0	0	0	0	0	0	0	0				
Reduced Vol:	205	1195	171	72	376	98	181	333	189	162	334	154				
PCE Adj:	1.00	1.00	1.00	1.00	1.00	1.00	1.00	1.00	1.00	1.00	1.00	1.00				
MLF Adj:	1.00	1.00	1.00	1.00	1.00	1.00	1.00	1.00	1.00	1.00	1.00	1.00				
FinalVolume:	205	1195	171	72	376	98	181	333	189	162	334	154				

Saturation Flow Module:												
Sat/Lane:	1900	1900	1900	1900	1900	1900	1900	1900	1900	1900	1900	1900
Adjustment:	0.92	1.00	0.92	0.92	1.00	0.92	0.92	1.00	0.92	0.92	1.00	0.92
Lanes:	1.00	2.00	1.00	1.00	2.00	1.00	1.00	1.00	1.00	1.00	1.00	1.00
Final Sat.:	1750	3800	1750	1750	3800	1750	1750	1900	1750	1750	1900	1750

Capacity Analysis Module:												
Vol/Sat:	0.12	0.31	0.10	0.04	0.10	0.06	0.10	0.18	0.11	0.09	0.18	0.09
Crit Moves:	****			****			****			****		
Green Time:	26.9	42.9	56.1	7.0	23.0	37.1	14.1	24.9	51.9	13.2	24.0	31.0
Volume/Cap:	0.44	0.73	0.17	0.59	0.43	0.15	0.73	0.70	0.21	0.70	0.73	0.28
Delay/Veh:	30.9	25.5	10.8	52.4	33.3	21.1	51.9	38.9	13.1	51.0	41.1	26.4
User DelAdj:	1.00	1.00	1.00	1.00	1.00	1.00	1.00	1.00	1.00	1.00	1.00	1.00
AdjDel/Veh:	30.9	25.5	10.8	52.4	33.3	21.1	51.9	38.9	13.1	51.0	41.1	26.4
LOS by Move:	C	C	B	D	C	C	D	D	B	D	D	C
HCM2kAvgQ:	6	16	3	3	5	2	5	9	3	7	11	4

Note: Queue reported is the number of cars per lane.

Voices School
Morgan Hill, CA
Hexagon Transportation Consultants, Inc.

Level Of Service Computation Report
2000 HCM Operations (Future Volume Alternative)
2025 Plus Project (PM) - 3 Monterey out

Intersection #119: Butterfield Boulevard and Main Avenue

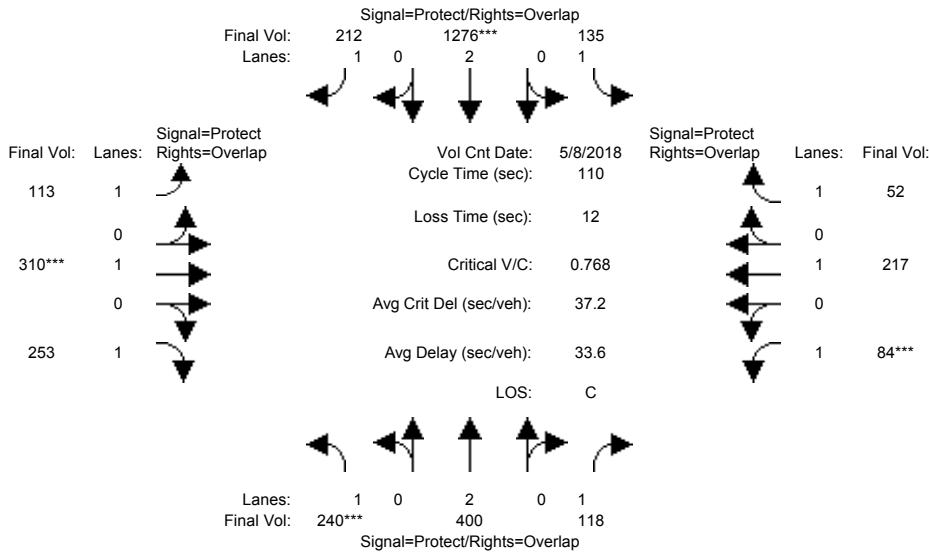

Street Name:	Butterfield Boulevard						Main Avenue					
	North Bound			South Bound			East Bound			West Bound		
Approach:	L	T	R	L	T	R	L	T	R	L	T	R
Min. Green:	7	10	10	7	10	10	7	10	10	7	10	10
Y+R:	4.0	4.0	4.0	4.0	4.0	4.0	4.0	4.0	4.0	4.0	4.0	4.0

Volume Module:	>>	Count	Date:	8 May 2018	<<							
Base Vol:	190	309	89	111	1088	183	87	266	239	61	179	36
Growth Adj:	1.00	1.00	1.00	1.00	1.00	1.00	1.00	1.00	1.00	1.00	1.00	1.00
Initial Bse:	190	309	89	111	1088	183	87	266	239	61	179	36
Added Vol:	0	4	0	0	2	7	13	8	0	0	3	0
PasserByVol:	50	87	29	24	186	22	13	36	14	23	35	16
Initial Fut:	240	400	118	135	1276	212	113	310	253	84	217	52
User Adj:	1.00	1.00	1.00	1.00	1.00	1.00	1.00	1.00	1.00	1.00	1.00	1.00
PHF Adj:	1.00	1.00	1.00	1.00	1.00	1.00	1.00	1.00	1.00	1.00	1.00	1.00
PHF Volume:	240	400	118	135	1276	212	113	310	253	84	217	52
Reduct Vol:	0	0	0	0	0	0	0	0	0	0	0	0
Reduced Vol:	240	400	118	135	1276	212	113	310	253	84	217	52
PCE Adj:	1.00	1.00	1.00	1.00	1.00	1.00	1.00	1.00	1.00	1.00	1.00	1.00
MLF Adj:	1.00	1.00	1.00	1.00	1.00	1.00	1.00	1.00	1.00	1.00	1.00	1.00
Final Volume:	240	400	118	135	1276	212	113	310	253	84	217	52

Saturation Flow Module:												
Sat/Lane:	1900	1900	1900	1900	1900	1900	1900	1900	1900	1900	1900	1900
Adjustment:	0.92	1.00	0.92	0.92	1.00	0.92	0.92	1.00	0.92	0.92	1.00	0.92
Lanes:	1.00	2.00	1.00	1.00	2.00	1.00	1.00	1.00	1.00	1.00	1.00	1.00
Final Sat.:	1750	3800	1750	1750	3800	1750	1750	1900	1750	1750	1900	1750

Capacity Analysis Module:												
Vol/Sat:	0.14	0.11	0.07	0.08	0.34	0.12	0.06	0.16	0.14	0.05	0.11	0.03
Crit Moves:	****				****			****		****		
Green Time:	19.6	39.0	46.0	28.6	48.0	59.0	11.0	23.3	43.0	7.0	19.4	48.0
Volume/Cap:	0.77	0.30	0.16	0.30	0.77	0.23	0.65	0.77	0.37	0.75	0.65	0.07
Delay/Veh:	54.1	25.7	20.0	33.0	28.5	13.6	55.9	49.5	24.2	75.6	46.5	18.0
User DelAdj:	1.00	1.00	1.00	1.00	1.00	1.00	1.00	1.00	1.00	1.00	1.00	1.00
AdjDel/Veh:	54.1	25.7	20.0	33.0	28.5	13.6	55.9	49.5	24.2	75.6	46.5	18.0
LOS by Move:	D	C	C	C	C	B	E	D	C	E	D	B
HCM2kAvgQ:	10	5	3	4	19	4	4	10	6	5	8	1

Note: Queue reported is the number of cars per lane.

Voices School
Morgan Hill, CA
Hexagon Transportation Consultants, Inc.

Level Of Service Computation Report
2000 HCM Operations (Future Volume Alternative)
Existing Plus Project (AM) - 3 Monterey out

Intersection #122: Monterey Road and Dunne Avenue

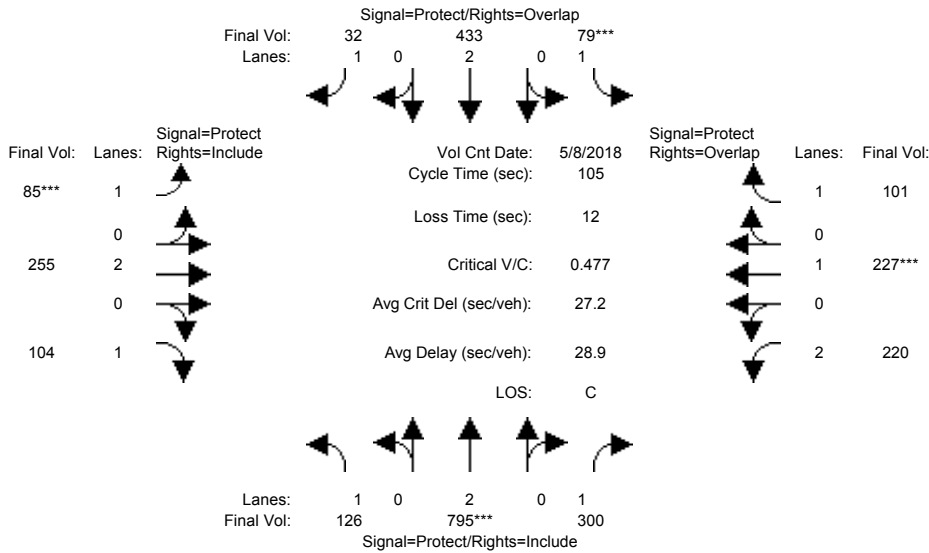

Street Name:	Monterey Road						Dunne Avenue					
	North Bound			South Bound			East Bound			West Bound		
Approach:	L	T	R	L	T	R	L	T	R	L	T	R
Min. Green:	7	10	10	7	10	10	7	10	10	7	10	10
Y+R:	4.0	4.0	4.0	4.0	4.0	4.0	4.0	4.0	4.0	4.0	4.0	4.0

Volume Module:	>>	Count	Date:	8 May 2018	<<												
Base Vol:	115	741	170	79	330	32	85	255	74	144	227	101					
Growth Adj:	1.00	1.00	1.00	1.00	1.00	1.00	1.00	1.00	1.00	1.00	1.00	1.00					
Initial Bse:	115	741	170	79	330	32	85	255	74	144	227	101					
Added Vol:	11	54	130	0	103	0	0	0	30	76	0	0					
PasserByVol:	0	0	0	0	0	0	0	0	0	0	0	0					
Initial Fut:	126	795	300	79	433	32	85	255	104	220	227	101					
User Adj:	1.00	1.00	1.00	1.00	1.00	1.00	1.00	1.00	1.00	1.00	1.00	1.00					
PHF Adj:	1.00	1.00	1.00	1.00	1.00	1.00	1.00	1.00	1.00	1.00	1.00	1.00					
PHF Volume:	126	795	300	79	433	32	85	255	104	220	227	101					
Reduct Vol:	0	0	0	0	0	0	0	0	0	0	0	0					
Reduced Vol:	126	795	300	79	433	32	85	255	104	220	227	101					
PCE Adj:	1.00	1.00	1.00	1.00	1.00	1.00	1.00	1.00	1.00	1.00	1.00	1.00					
MLF Adj:	1.00	1.00	1.00	1.00	1.00	1.00	1.00	1.00	1.00	1.00	1.00	1.00					
Final Volume:	126	795	300	79	433	32	85	255	104	220	227	101					

Saturation Flow Module:												
Sat/Lane:	1900	1900	1900	1900	1900	1900	1900	1900	1900	1900	1900	1900
Adjustment:	0.92	1.00	0.92	0.92	1.00	0.92	0.92	1.00	0.92	0.83	1.00	0.92
Lanes:	1.00	2.00	1.00	1.00	2.00	1.00	1.00	2.00	1.00	2.00	1.00	1.00
Final Sat.:	1750	3800	1750	1750	3800	1750	1750	3800	1750	3150	1900	1750

Capacity Analysis Module:												
Vol/Sat:	0.07	0.21	0.17	0.05	0.11	0.02	0.05	0.07	0.06	0.07	0.12	0.06
Crit Moves:	****			****			****			****		
Green Time:	21.7	46.1	46.1	9.9	34.3	45.0	10.7	21.3	21.3	15.7	26.3	36.2
Volume/Cap:	0.35	0.48	0.39	0.48	0.35	0.04	0.48	0.33	0.29	0.47	0.48	0.17
Delay/Veh:	36.2	21.1	20.3	47.2	27.0	17.5	46.5	36.0	35.9	41.6	34.2	24.0
User DelAdj:	1.00	1.00	1.00	1.00	1.00	1.00	1.00	1.00	1.00	1.00	1.00	1.00
AdjDel/Veh:	36.2	21.1	20.3	47.2	27.0	17.5	46.5	36.0	35.9	41.6	34.2	24.0
LOS by Move:	D	C	C	D	C	B	D	D	D	D	C	C
HCM2kAvgQ:	4	9	7	3	5	1	3	4	3	4	6	2

Note: Queue reported is the number of cars per lane.

Voices School
Morgan Hill, CA
Hexagon Transportation Consultants, Inc.

Level Of Service Computation Report
2000 HCM Operations (Future Volume Alternative)
Existing Plus Project (PM) - 3 Monterey out

Intersection #122: Monterey Road and Dunne Avenue

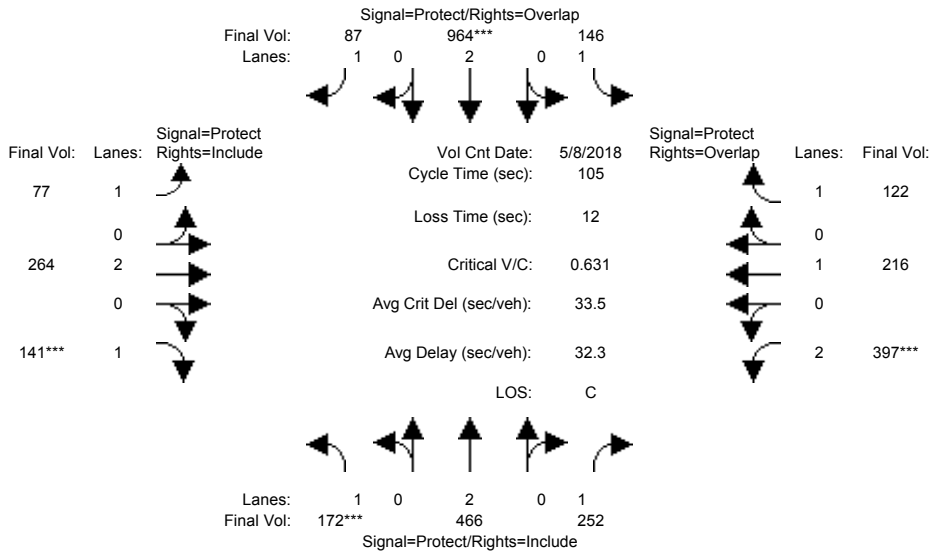

Street Name:	Monterey Road						Dunne Avenue					
	North Bound			South Bound			East Bound			West Bound		
Approach:	L	T	R	L	T	R	L	T	R	L	T	R
Min. Green:	7	10	10	7	10	10	7	10	10	7	10	10
Y+R:	4.0	4.0	4.0	4.0	4.0	4.0	4.0	4.0	4.0	4.0	4.0	4.0

Volume Module:	>>	Count	Date:	8 May 2018	<<							
Base Vol:	153	401	208	146	936	87	77	264	135	329	216	122
Growth Adj:	1.00	1.00	1.00	1.00	1.00	1.00	1.00	1.00	1.00	1.00	1.00	1.00
Initial Bse:	153	401	208	146	936	87	77	264	135	329	216	122
Added Vol:	19	65	44	0	28	0	0	0	6	68	0	0
PasserByVol:	0	0	0	0	0	0	0	0	0	0	0	0
Initial Fut:	172	466	252	146	964	87	77	264	141	397	216	122
User Adj:	1.00	1.00	1.00	1.00	1.00	1.00	1.00	1.00	1.00	1.00	1.00	1.00
PHF Adj:	1.00	1.00	1.00	1.00	1.00	1.00	1.00	1.00	1.00	1.00	1.00	1.00
PHF Volume:	172	466	252	146	964	87	77	264	141	397	216	122
Reduct Vol:	0	0	0	0	0	0	0	0	0	0	0	0
Reduced Vol:	172	466	252	146	964	87	77	264	141	397	216	122
PCE Adj:	1.00	1.00	1.00	1.00	1.00	1.00	1.00	1.00	1.00	1.00	1.00	1.00
MLF Adj:	1.00	1.00	1.00	1.00	1.00	1.00	1.00	1.00	1.00	1.00	1.00	1.00
FinalVolume:	172	466	252	146	964	87	77	264	141	397	216	122

Saturation Flow Module:												
Sat/Lane:	1900	1900	1900	1900	1900	1900	1900	1900	1900	1900	1900	1900
Adjustment:	0.92	1.00	0.92	0.92	1.00	0.92	0.92	1.00	0.92	0.83	1.00	0.92
Lanes:	1.00	2.00	1.00	1.00	2.00	1.00	1.00	2.00	1.00	2.00	1.00	1.00
Final Sat.:	1750	3800	1750	1750	3800	1750	1750	3800	1750	3150	1900	1750

Capacity Analysis Module:												
Vol/Sat:	0.10	0.12	0.14	0.08	0.25	0.05	0.04	0.07	0.08	0.13	0.11	0.07
Crit Moves:	***			***			***		***	***		
Green Time:	16.4	37.1	37.1	21.5	42.2	55.0	12.7	13.4	13.4	21.0	21.7	43.2
Volume/Cap:	0.63	0.35	0.41	0.41	0.63	0.09	0.36	0.54	0.63	0.63	0.55	0.17
Delay/Veh:	46.2	25.2	26.1	37.0	26.0	12.6	43.5	44.2	49.1	40.5	39.0	19.7
User DelAdj:	1.00	1.00	1.00	1.00	1.00	1.00	1.00	1.00	1.00	1.00	1.00	1.00
AdjDel/Veh:	46.2	25.2	26.1	37.0	26.0	12.6	43.5	44.2	49.1	40.5	39.0	19.7
LOS by Move:	D	C	C	D	C	B	D	D	D	D	D	B
HCM2kAvgQ:	5	5	6	4	12	1	3	5	6	7	6	3

Note: Queue reported is the number of cars per lane.

Voices School
Morgan Hill, CA
Hexagon Transportation Consultants, Inc.

Level Of Service Computation Report
2000 HCM Operations (Future Volume Alternative)
2025 Plus Project (AM) - 3 Monterey out

Intersection #122: Monterey Road and Dunne Avenue

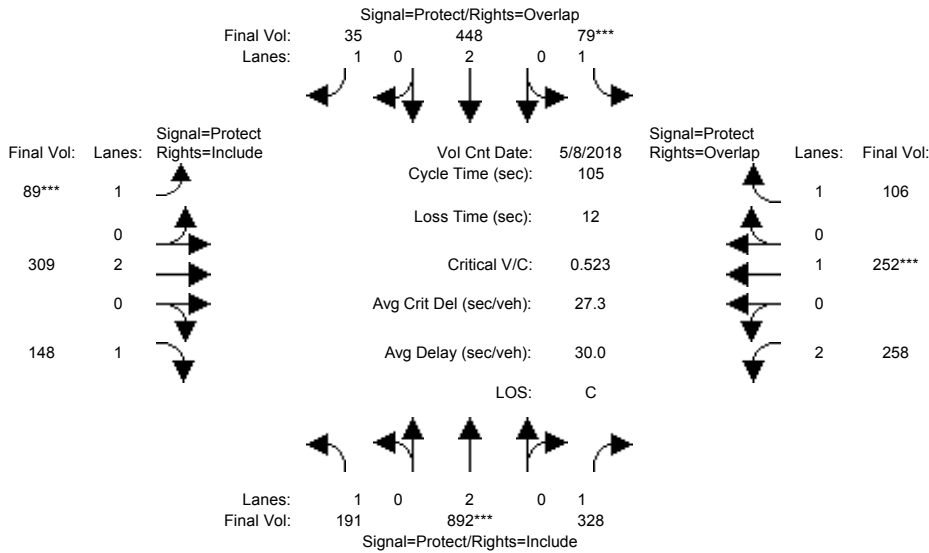

Street Name:	Monterey Road						Dunne Avenue					
	North Bound			South Bound			East Bound			West Bound		
Approach:	L	T	R	L	T	R	L	T	R	L	T	R
Min. Green:	7	10	10	7	10	10	7	10	10	7	10	10
Y+R:	4.0	4.0	4.0	4.0	4.0	4.0	4.0	4.0	4.0	4.0	4.0	4.0

Volume Module:	>>	Count	Date:	8 May 2018	<<											
Base Vol:	115	741	170	79	330	32	85	255	74	144	227	101				
Growth Adj:	1.00	1.00	1.00	1.00	1.00	1.00	1.00	1.00	1.00	1.00	1.00	1.00				
Initial Bse:	115	741	170	79	330	32	85	255	74	144	227	101				
Added Vol:	10	53	126	0	102	0	0	0	30	74	0	0				
PasserByVol:	66	98	32	0	16	3	4	54	44	40	25	5				
Initial Fut:	191	892	328	79	448	35	89	309	148	258	252	106				
User Adj:	1.00	1.00	1.00	1.00	1.00	1.00	1.00	1.00	1.00	1.00	1.00	1.00				
PHF Adj:	1.00	1.00	1.00	1.00	1.00	1.00	1.00	1.00	1.00	1.00	1.00	1.00				
PHF Volume:	191	892	328	79	448	35	89	309	148	258	252	106				
Reduct Vol:	0	0	0	0	0	0	0	0	0	0	0	0				
Reduced Vol:	191	892	328	79	448	35	89	309	148	258	252	106				
PCE Adj:	1.00	1.00	1.00	1.00	1.00	1.00	1.00	1.00	1.00	1.00	1.00	1.00				
MLF Adj:	1.00	1.00	1.00	1.00	1.00	1.00	1.00	1.00	1.00	1.00	1.00	1.00				
FinalVolume:	191	892	328	79	448	35	89	309	148	258	252	106				

Saturation Flow Module:												
Sat/Lane:	1900	1900	1900	1900	1900	1900	1900	1900	1900	1900	1900	1900
Adjustment:	0.92	1.00	0.92	0.92	1.00	0.92	0.92	1.00	0.92	0.83	1.00	0.92
Lanes:	1.00	2.00	1.00	1.00	2.00	1.00	1.00	2.00	1.00	2.00	1.00	1.00
Final Sat.:	1750	3800	1750	1750	3800	1750	1750	3800	1750	3150	1900	1750

Capacity Analysis Module:												
Vol/Sat:	0.11	0.23	0.19	0.05	0.12	0.02	0.05	0.08	0.08	0.08	0.13	0.06
Crit Moves:	****			****			****			****		
Green Time:	27.0	47.1	47.1	9.1	29.2	39.4	10.2	19.8	19.8	17.0	26.6	35.7
Volume/Cap:	0.42	0.52	0.42	0.52	0.42	0.05	0.52	0.43	0.45	0.51	0.52	0.18
Delay/Veh:	33.2	21.1	20.0	49.2	31.3	21.0	48.0	38.0	38.7	41.0	34.8	24.5
User DelAdj:	1.00	1.00	1.00	1.00	1.00	1.00	1.00	1.00	1.00	1.00	1.00	1.00
AdjDel/Veh:	33.2	21.1	20.0	49.2	31.3	21.0	48.0	38.0	38.7	41.0	34.8	24.5
LOS by Move:	C	C	B	D	C	C	D	D	D	D	C	C
HCM2kAvgQ:	5	10	7	3	6	1	4	5	5	4	7	2

Note: Queue reported is the number of cars per lane.

Voices School
Morgan Hill, CA
Hexagon Transportation Consultants, Inc.

Level Of Service Computation Report
2000 HCM Operations (Future Volume Alternative)
2025 Plus Project (PM) - 3 Monterey out

Intersection #122: Monterey Road and Dunne Avenue

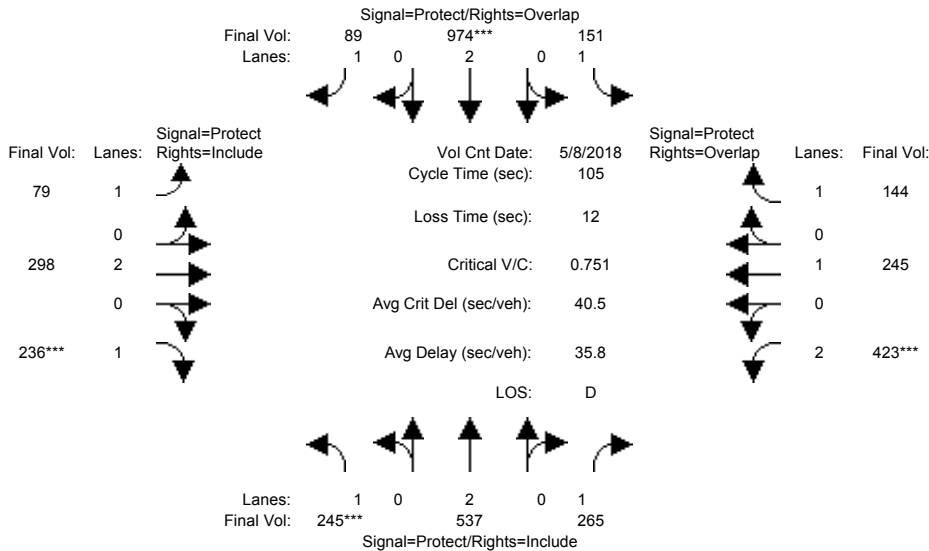

Street Name:	Monterey Road						Dunne Avenue					
	North Bound			South Bound			East Bound			West Bound		
Approach:	L	T	R	L	T	R	L	T	R	L	T	R
Min. Green:	7	10	10	7	10	10	7	10	10	7	10	10
Y+R:	4.0	4.0	4.0	4.0	4.0	4.0	4.0	4.0	4.0	4.0	4.0	4.0

Volume Module:	>>	Count	Date:	8 May 2018	<<							
Base Vol:	153	401	208	146	936	87	77	264	135	329	216	122
Growth Adj:	1.00	1.00	1.00	1.00	1.00	1.00	1.00	1.00	1.00	1.00	1.00	1.00
Initial Bse:	153	401	208	146	936	87	77	264	135	329	216	122
Added Vol:	18	65	41	0	28	0	0	0	5	64	0	0
PasserByVol:	74	71	16	5	10	2	2	34	96	30	29	22
Initial Fut:	245	537	265	151	974	89	79	298	236	423	245	144
User Adj:	1.00	1.00	1.00	1.00	1.00	1.00	1.00	1.00	1.00	1.00	1.00	1.00
PHF Adj:	1.00	1.00	1.00	1.00	1.00	1.00	1.00	1.00	1.00	1.00	1.00	1.00
PHF Volume:	245	537	265	151	974	89	79	298	236	423	245	144
Reduct Vol:	0	0	0	0	0	0	0	0	0	0	0	0
Reduced Vol:	245	537	265	151	974	89	79	298	236	423	245	144
PCE Adj:	1.00	1.00	1.00	1.00	1.00	1.00	1.00	1.00	1.00	1.00	1.00	1.00
MLF Adj:	1.00	1.00	1.00	1.00	1.00	1.00	1.00	1.00	1.00	1.00	1.00	1.00
FinalVolume:	245	537	265	151	974	89	79	298	236	423	245	144

Saturation Flow Module:												
Sat/Lane:	1900	1900	1900	1900	1900	1900	1900	1900	1900	1900	1900	1900
Adjustment:	0.92	1.00	0.92	0.92	1.00	0.92	0.92	1.00	0.92	0.83	1.00	0.92
Lanes:	1.00	2.00	1.00	1.00	2.00	1.00	1.00	2.00	1.00	2.00	1.00	1.00
Final Sat.:	1750	3800	1750	1750	3800	1750	1750	3800	1750	3150	1900	1750

Capacity Analysis Module:												
Vol/Sat:	0.14	0.14	0.15	0.09	0.26	0.05	0.05	0.08	0.13	0.13	0.13	0.08
Crit Moves:	****				****				****	****		
Green Time:	19.6	35.3	35.3	20.1	35.8	48.6	12.8	18.8	18.8	18.8	24.8	44.9
Volume/Cap:	0.75	0.42	0.45	0.45	0.75	0.11	0.37	0.44	0.75	0.75	0.55	0.19
Delay/Veh:	49.8	27.2	27.8	38.5	33.2	16.0	43.5	38.8	50.6	46.5	36.6	18.9
User DelAdj:	1.00	1.00	1.00	1.00	1.00	1.00	1.00	1.00	1.00	1.00	1.00	1.00
AdjDel/Veh:	49.8	27.2	27.8	38.5	33.2	16.0	43.5	38.8	50.6	46.5	36.6	18.9
LOS by Move:	D	C	C	D	C	B	D	D	D	D	D	B
HCM2kAvgQ:	8	6	7	4	14	2	3	5	10	8	7	3

Note: Queue reported is the number of cars per lane.

Voices School
Morgan Hill, CA
Hexagon Transportation Consultants, Inc.

Level Of Service Computation Report
2000 HCM Operations (Future Volume Alternative)
Existing Plus Project (AM) - 3 Monterey out

Intersection #123: Butterfield Boulevard and Dunne Avenue

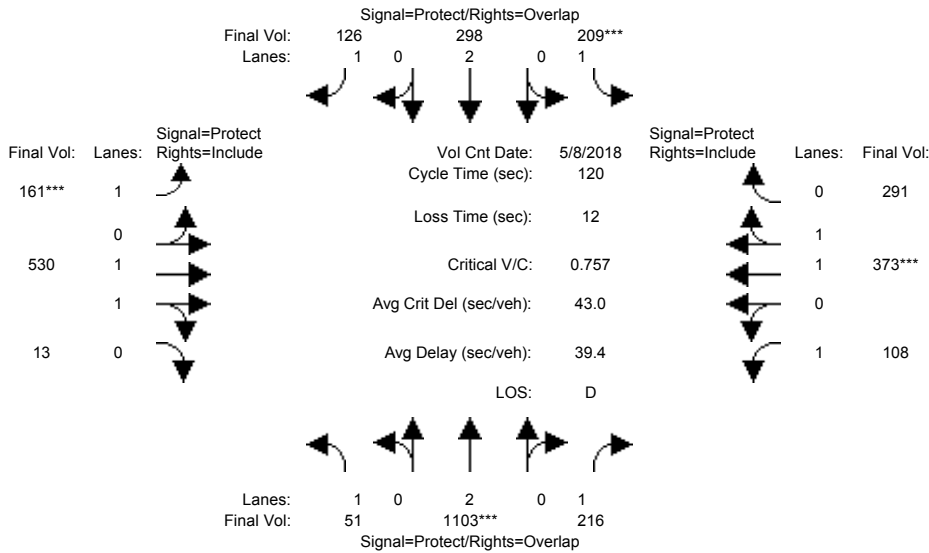

Street Name:	Butterfield Boulevard						Dunne Avenue					
	North Bound			South Bound			East Bound			West Bound		
Approach:	L	T	R	L	T	R	L	T	R	L	T	R
Min. Green:	7	10	10	7	10	10	7	10	10	7	10	10
Y+R:	4.0	4.0	4.0	4.0	4.0	4.0	4.0	4.0	4.0	4.0	4.0	4.0

Volume Module:	>>	Count	Date:	8 May 2018	<<											
Base Vol:	51	1103	216	209	298	111	153	408	13	108	312	291				
Growth Adj:	1.00	1.00	1.00	1.00	1.00	1.00	1.00	1.00	1.00	1.00	1.00	1.00				
Initial Bse:	51	1103	216	209	298	111	153	408	13	108	312	291				
Added Vol:	0	0	0	0	0	15	8	122	0	0	61	0				
PasserByVol:	0	0	0	0	0	0	0	0	0	0	0	0				
Initial Fut:	51	1103	216	209	298	126	161	530	13	108	373	291				
User Adj:	1.00	1.00	1.00	1.00	1.00	1.00	1.00	1.00	1.00	1.00	1.00	1.00				
PHF Adj:	1.00	1.00	1.00	1.00	1.00	1.00	1.00	1.00	1.00	1.00	1.00	1.00				
PHF Volume:	51	1103	216	209	298	126	161	530	13	108	373	291				
Reduct Vol:	0	0	0	0	0	0	0	0	0	0	0	0				
Reduced Vol:	51	1103	216	209	298	126	161	530	13	108	373	291				
PCE Adj:	1.00	1.00	1.00	1.00	1.00	1.00	1.00	1.00	1.00	1.00	1.00	1.00				
MLF Adj:	1.00	1.00	1.00	1.00	1.00	1.00	1.00	1.00	1.00	1.00	1.00	1.00				
FinalVolume:	51	1103	216	209	298	126	161	530	13	108	373	291				

Saturation Flow Module:												
Sat/Lane:	1900	1900	1900	1900	1900	1900	1900	1900	1900	1900	1900	1900
Adjustment:	0.92	1.00	0.92	0.92	1.00	0.92	0.92	0.97	0.95	0.92	0.99	0.95
Lanes:	1.00	2.00	1.00	1.00	2.00	1.00	1.00	1.95	0.05	1.00	1.10	0.90
Final Sat.:	1750	3800	1750	1750	3800	1750	1750	3611	89	1750	2077	1621

Capacity Analysis Module:												
Vol/Sat:	0.03	0.29	0.12	0.12	0.08	0.07	0.09	0.15	0.15	0.06	0.18	0.18
Crit Moves:	****			****			****			****		
Green Time:	26.7	46.0	58.8	18.9	38.2	52.8	14.6	30.3	30.3	12.7	28.5	28.5
Volume/Cap:	0.13	0.76	0.25	0.76	0.25	0.16	0.76	0.58	0.58	0.58	0.76	0.76
Delay/Veh:	37.5	34.5	18.0	59.7	30.4	20.4	65.4	40.2	40.2	55.7	46.4	46.4
User DelAdj:	1.00	1.00	1.00	1.00	1.00	1.00	1.00	1.00	1.00	1.00	1.00	1.00
AdjDel/Veh:	37.5	34.5	18.0	59.7	30.4	20.4	65.4	40.2	40.2	55.7	46.4	46.4
LOS by Move:	D	C	B	E	C	C	E	D	D	E	D	D
HCM2kAvgQ:	2	18	5	10	4	3	6	9	9	4	12	12

Note: Queue reported is the number of cars per lane.

Voices School
Morgan Hill, CA
Hexagon Transportation Consultants, Inc.

Level Of Service Computation Report
2000 HCM Operations (Future Volume Alternative)
Existing Plus Project (PM) - 3 Monterey out

Intersection #123: Butterfield Boulevard and Dunne Avenue

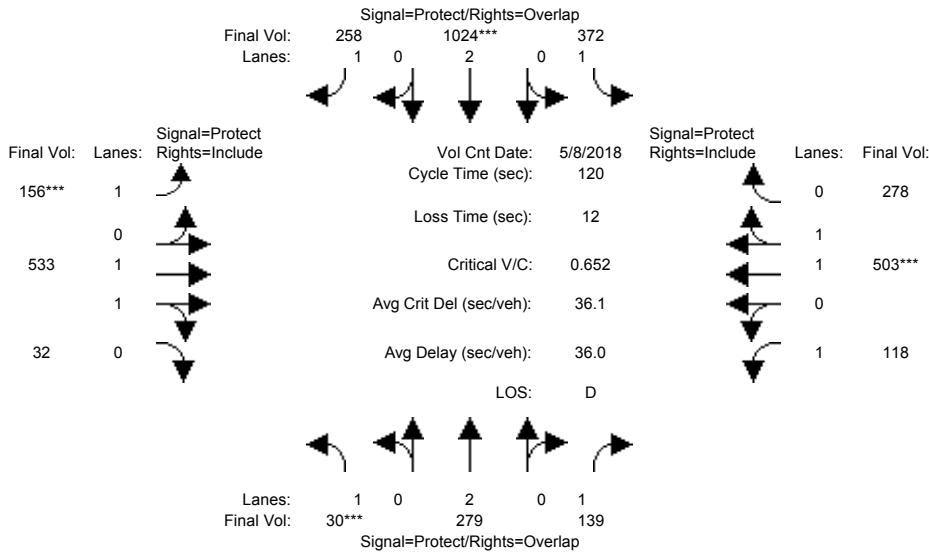

Street Name:	Butterfield Boulevard						Dunne Avenue					
	North Bound			South Bound			East Bound			West Bound		
Approach:	L	T	R	L	T	R	L	T	R	L	T	R
Min. Green:	7	10	10	7	10	10	7	10	10	7	10	10
Y+R:	4.0	4.0	4.0	4.0	4.0	4.0	4.0	4.0	4.0	4.0	4.0	4.0

Volume Module:	>>	Count	Date:	8 May 2018	<<							
Base Vol:	30	279	139	372	1024	254	147	498	32	118	439	278
Growth Adj:	1.00	1.00	1.00	1.00	1.00	1.00	1.00	1.00	1.00	1.00	1.00	1.00
Initial Bse:	30	279	139	372	1024	254	147	498	32	118	439	278
Added Vol:	0	0	0	0	0	4	9	35	0	0	64	0
PasserByVol:	0	0	0	0	0	0	0	0	0	0	0	0
Initial Fut:	30	279	139	372	1024	258	156	533	32	118	503	278
User Adj:	1.00	1.00	1.00	1.00	1.00	1.00	1.00	1.00	1.00	1.00	1.00	1.00
PHF Adj:	1.00	1.00	1.00	1.00	1.00	1.00	1.00	1.00	1.00	1.00	1.00	1.00
PHF Volume:	30	279	139	372	1024	258	156	533	32	118	503	278
Reduct Vol:	0	0	0	0	0	0	0	0	0	0	0	0
Reduced Vol:	30	279	139	372	1024	258	156	533	32	118	503	278
PCE Adj:	1.00	1.00	1.00	1.00	1.00	1.00	1.00	1.00	1.00	1.00	1.00	1.00
MLF Adj:	1.00	1.00	1.00	1.00	1.00	1.00	1.00	1.00	1.00	1.00	1.00	1.00
Final Volume:	30	279	139	372	1024	258	156	533	32	118	503	278

Saturation Flow Module:												
Sat/Lane:	1900	1900	1900	1900	1900	1900	1900	1900	1900	1900	1900	1900
Adjustment:	0.92	1.00	0.92	0.92	1.00	0.92	0.92	0.98	0.95	0.92	0.99	0.95
Lanes:	1.00	2.00	1.00	1.00	2.00	1.00	1.00	1.88	0.12	1.00	1.27	0.73
Final Sat.:	1750	3800	1750	1750	3800	1750	1750	3490	210	1750	2382	1316

Capacity Analysis Module:												
Vol/Sat:	0.02	0.07	0.08	0.21	0.27	0.15	0.09	0.15	0.15	0.07	0.21	0.21
Crit Moves:	****			****			****			****		
Green Time:	7.0	15.4	31.7	39.3	47.8	63.6	15.8	36.9	36.9	16.3	37.4	37.4
Volume/Cap:	0.29	0.57	0.30	0.65	0.68	0.28	0.68	0.50	0.50	0.50	0.68	0.68
Delay/Veh:	55.7	50.8	35.6	37.0	31.0	15.7	57.5	34.3	34.3	49.7	37.6	37.6
User DelAdj:	1.00	1.00	1.00	1.00	1.00	1.00	1.00	1.00	1.00	1.00	1.00	1.00
AdjDel/Veh:	55.7	50.8	35.6	37.0	31.0	15.7	57.5	34.3	34.3	49.7	37.6	37.6
LOS by Move:	E	D	D	D	C	B	E	C	C	D	D	D
HCM2kAvgQ:	1	5	4	13	16	6	6	8	8	4	13	13

Note: Queue reported is the number of cars per lane.

Voices School
Morgan Hill, CA
Hexagon Transportation Consultants, Inc.

Level Of Service Computation Report
2000 HCM Operations (Future Volume Alternative)
2025 Plus Project (AM) - 3 Monterey out

Intersection #123: Butterfield Boulevard and Dunne Avenue

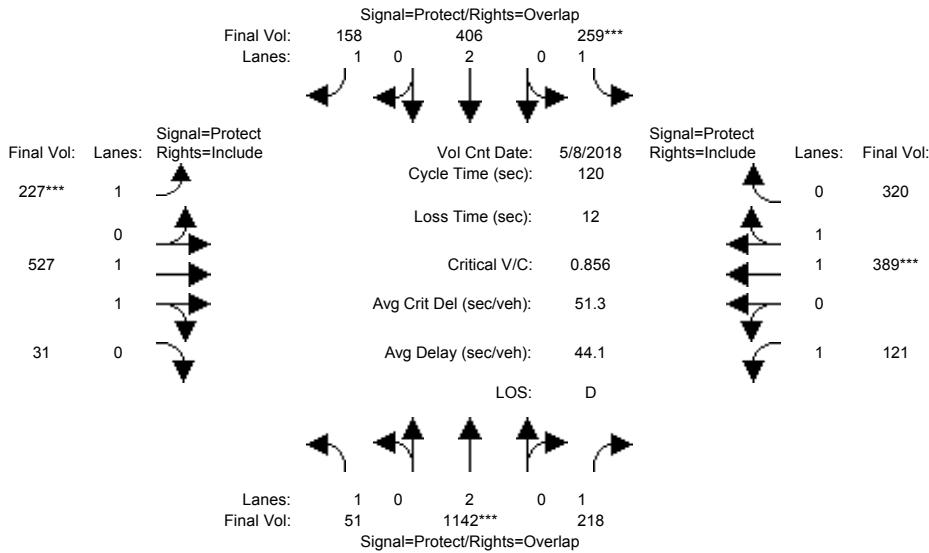

Street Name:	Butterfield Boulevard						Dunne Avenue					
	North Bound			South Bound			East Bound			West Bound		
Approach:	L	T	R	L	T	R	L	T	R	L	T	R
Min. Green:	7	10	10	7	10	10	7	10	10	7	10	10
Y+R:	4.0	4.0	4.0	4.0	4.0	4.0	4.0	4.0	4.0	4.0	4.0	4.0

Volume Module:	>>	Count	Date:	8 May 2018	<<							
Base Vol:	51	1103	216	209	298	111	153	408	13	108	312	291
Growth Adj:	1.00	1.00	1.00	1.00	1.00	1.00	1.00	1.00	1.00	1.00	1.00	1.00
Initial Bse:	51	1103	216	209	298	111	153	408	13	108	312	291
Added Vol:	0	0	0	0	0	15	8	119	0	0	60	0
PasserByVol:	0	39	2	50	108	32	66	0	18	13	17	29
Initial Fut:	51	1142	218	259	406	158	227	527	31	121	389	320
User Adj:	1.00	1.00	1.00	1.00	1.00	1.00	1.00	1.00	1.00	1.00	1.00	1.00
PHF Adj:	1.00	1.00	1.00	1.00	1.00	1.00	1.00	1.00	1.00	1.00	1.00	1.00
PHF Volume:	51	1142	218	259	406	158	227	527	31	121	389	320
Reduct Vol:	0	0	0	0	0	0	0	0	0	0	0	0
Reduced Vol:	51	1142	218	259	406	158	227	527	31	121	389	320
PCE Adj:	1.00	1.00	1.00	1.00	1.00	1.00	1.00	1.00	1.00	1.00	1.00	1.00
MLF Adj:	1.00	1.00	1.00	1.00	1.00	1.00	1.00	1.00	1.00	1.00	1.00	1.00
FinalVolume:	51	1142	218	259	406	158	227	527	31	121	389	320

Saturation Flow Module:												
Sat/Lane:	1900	1900	1900	1900	1900	1900	1900	1900	1900	1900	1900	1900
Adjustment:	0.92	1.00	0.92	0.92	1.00	0.92	0.92	0.98	0.95	0.92	1.00	0.95
Lanes:	1.00	2.00	1.00	1.00	2.00	1.00	1.00	1.89	0.11	1.00	1.07	0.93
Final Sat.:	1750	3800	1750	1750	3800	1750	1750	3494	206	1750	2029	1669

Capacity Analysis Module:												
Vol/Sat:	0.03	0.30	0.12	0.15	0.11	0.09	0.13	0.15	0.15	0.07	0.19	0.19
Crit Moves:	****			****			****			****		
Green Time:	22.2	42.2	56.3	20.8	40.7	58.9	18.2	30.9	30.9	14.2	26.9	26.9
Volume/Cap:	0.16	0.86	0.27	0.86	0.32	0.18	0.86	0.59	0.59	0.59	0.86	0.86
Delay/Veh:	41.3	41.7	19.5	68.7	29.5	17.2	72.5	39.9	39.9	54.4	53.4	53.4
User DelAdj:	1.00	1.00	1.00	1.00	1.00	1.00	1.00	1.00	1.00	1.00	1.00	1.00
AdjDel/Veh:	41.3	41.7	19.5	68.7	29.5	17.2	72.5	39.9	39.9	54.4	53.4	53.4
LOS by Move:	D	D	B	E	C	B	E	D	D	D	D	D
HCM2kAvgQ:	2	20	5	13	5	3	10	9	9	5	14	14

Note: Queue reported is the number of cars per lane.

Voices School
Morgan Hill, CA
Hexagon Transportation Consultants, Inc.

Level Of Service Computation Report
2000 HCM Operations (Future Volume Alternative)
2025 Plus Project (PM) - 3 Monterey out

Intersection #123: Butterfield Boulevard and Dunne Avenue

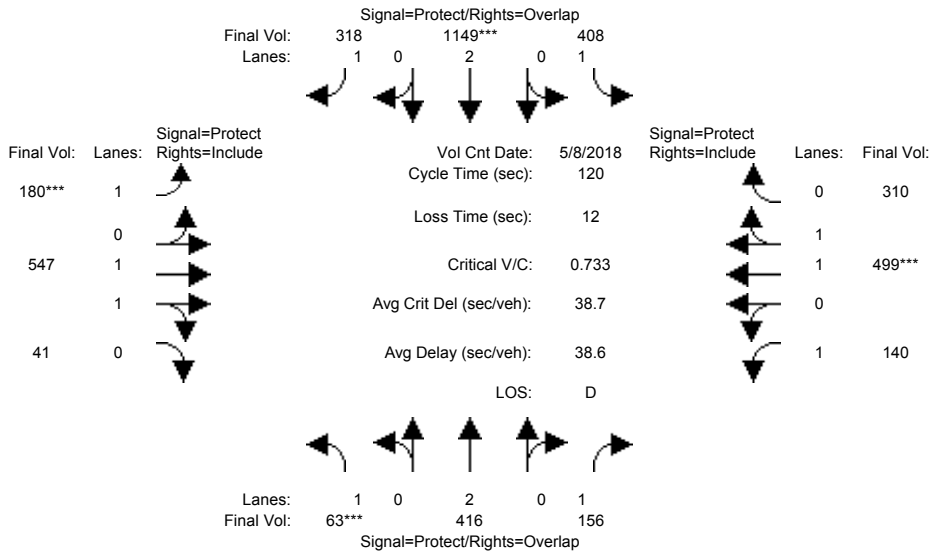

Street Name:	Butterfield Boulevard						Dunne Avenue					
	North Bound			South Bound			East Bound			West Bound		
Approach:	L	T	R	L	T	R	L	T	R	L	T	R
Min. Green:	7	10	10	7	10	10	7	10	10	7	10	10
Y+R:	4.0	4.0	4.0	4.0	4.0	4.0	4.0	4.0	4.0	4.0	4.0	4.0

Volume Module:	>>	Count	Date:	8 May 2018	<<							
Base Vol:	30	279	139	372	1024	254	147	498	32	118	439	278
Growth Adj:	1.00	1.00	1.00	1.00	1.00	1.00	1.00	1.00	1.00	1.00	1.00	1.00
Initial Bse:	30	279	139	372	1024	254	147	498	32	118	439	278
Added Vol:	0	0	0	0	0	4	9	32	0	0	60	0
PasserByVol:	33	137	17	36	125	60	24	17	9	22	0	32
Initial Fut:	63	416	156	408	1149	318	180	547	41	140	499	310
User Adj:	1.00	1.00	1.00	1.00	1.00	1.00	1.00	1.00	1.00	1.00	1.00	1.00
PHF Adj:	1.00	1.00	1.00	1.00	1.00	1.00	1.00	1.00	1.00	1.00	1.00	1.00
PHF Volume:	63	416	156	408	1149	318	180	547	41	140	499	310
Reduct Vol:	0	0	0	0	0	0	0	0	0	0	0	0
Reduced Vol:	63	416	156	408	1149	318	180	547	41	140	499	310
PCE Adj:	1.00	1.00	1.00	1.00	1.00	1.00	1.00	1.00	1.00	1.00	1.00	1.00
MLF Adj:	1.00	1.00	1.00	1.00	1.00	1.00	1.00	1.00	1.00	1.00	1.00	1.00
Final Volume:	63	416	156	408	1149	318	180	547	41	140	499	310

Saturation Flow Module:												
Sat/Lane:	1900	1900	1900	1900	1900	1900	1900	1900	1900	1900	1900	1900
Adjustment:	0.92	1.00	0.92	0.92	1.00	0.92	0.92	0.98	0.95	0.92	0.99	0.95
Lanes:	1.00	2.00	1.00	1.00	2.00	1.00	1.00	1.86	0.14	1.00	1.21	0.79
Final Sat.:	1750	3800	1750	1750	3800	1750	1750	3442	258	1750	2281	1417

Capacity Analysis Module:												
Vol/Sat:	0.04	0.11	0.09	0.23	0.30	0.18	0.10	0.16	0.16	0.08	0.22	0.22
Crit Moves:	****			****			****			****		
Green Time:	7.0	17.9	35.3	38.1	48.9	65.6	16.6	34.6	34.6	17.4	35.4	35.4
Volume/Cap:	0.62	0.73	0.30	0.73	0.74	0.33	0.74	0.55	0.55	0.55	0.74	0.74
Delay/Veh:	66.1	53.8	33.1	41.6	32.1	15.3	61.2	36.7	36.7	50.2	40.9	40.9
User DelAdj:	1.00	1.00	1.00	1.00	1.00	1.00	1.00	1.00	1.00	1.00	1.00	1.00
AdjDel/Veh:	66.1	53.8	33.1	41.6	32.1	15.3	61.2	36.7	36.7	50.2	40.9	40.9
LOS by Move:	E	D	C	D	C	B	E	D	D	D	D	D
HCM2kAvgQ:	3	8	5	16	19	7	7	9	9	5	14	14

Note: Queue reported is the number of cars per lane.

Voices School
Morgan Hill, CA
Hexagon Transportation Consultants, Inc.

Level Of Service Computation Report
2000 HCM Operations (Future Volume Alternative)
Existing Plus Project (AM) - 3 Monterey out

Intersection #124: US 101 Southbound Ramps and Dunne Avenue

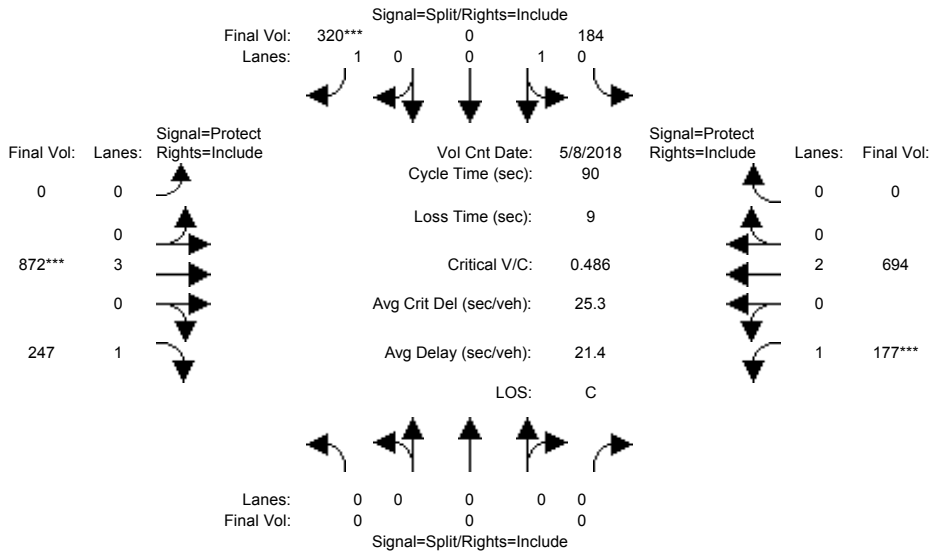

Street Name:	US 101 Southbound Ramps						Dunne Avenue					
Approach:	North Bound			South Bound			East Bound			West Bound		
Movement:	L	T	R	L	T	R	L	T	R	L	T	R
Min. Green:	0	0	0	10	10	10	0	10	10	7	10	0
Y+R:	4.0	4.0	4.0	4.0	4.0	4.0	4.0	4.0	4.0	4.0	4.0	4.0
Volume Module: >> Count Date: 8 May 2018 <<												
Base Vol:	0	0	0	184	0	288	0	750	247	177	664	0
Growth Adj:	1.00	1.00	1.00	1.00	1.00	1.00	1.00	1.00	1.00	1.00	1.00	1.00
Initial Bse:	0	0	0	184	0	288	0	750	247	177	664	0
Added Vol:	0	0	0	0	0	32	0	122	0	0	30	0
PasserByVol:	0	0	0	0	0	0	0	0	0	0	0	0
Initial Fut:	0	0	0	184	0	320	0	872	247	177	694	0
User Adj:	1.00	1.00	1.00	1.00	1.00	1.00	1.00	1.00	1.00	1.00	1.00	1.00
PHF Adj:	1.00	1.00	1.00	1.00	1.00	1.00	1.00	1.00	1.00	1.00	1.00	1.00
PHF Volume:	0	0	0	184	0	320	0	872	247	177	694	0
Reduct Vol:	0	0	0	0	0	0	0	0	0	0	0	0
Reduced Vol:	0	0	0	184	0	320	0	872	247	177	694	0
PCE Adj:	1.00	1.00	1.00	1.00	1.00	1.00	1.00	1.00	1.00	1.00	1.00	1.00
MLF Adj:	1.00	1.00	1.00	1.00	1.00	1.00	1.00	1.00	1.00	1.00	1.00	1.00
FinalVolume:	0	0	0	184	0	320	0	872	247	177	694	0
Saturation Flow Module:												
Sat/Lane:	1900	1900	1900	1900	1900	1900	1900	1900	1900	1900	1900	1900
Adjustment:	0.92	1.00	0.92	0.95	0.95	0.92	0.92	1.00	0.92	0.92	1.00	0.92
Lanes:	0.00	0.00	0.00	1.00	0.00	1.00	0.00	3.00	1.00	1.00	2.00	0.00
Final Sat.:	0	0	0	1800	0	1750	0	5700	1750	1750	3800	0
Capacity Analysis Module:												
Vol/Sat:	0.00	0.00	0.00	0.10	0.00	0.18	0.00	0.15	0.14	0.10	0.18	0.00
Crit Moves:						****		****		****		
Green Time:	0.0	0.0	0.0	33.9	0.0	33.9	0.0	28.4	28.4	18.7	47.1	0.0
Volume/Cap:	0.00	0.00	0.00	0.27	0.00	0.49	0.00	0.49	0.45	0.49	0.35	0.00
Delay/Veh:	0.0	0.0	0.0	19.7	0.0	22.0	0.0	25.1	25.2	32.4	12.6	0.0
User DelAdj:	1.00	1.00	1.00	1.00	1.00	1.00	1.00	1.00	1.00	1.00	1.00	1.00
AdjDel/Veh:	0.0	0.0	0.0	19.7	0.0	22.0	0.0	25.1	25.2	32.4	12.6	0.0
LOS by Move:	A	A	A	B	A	C	A	C	C	C	B	A
HCM2kAvgQ:	0	0	0	4	0	7	0	6	6	5	6	0

Note: Queue reported is the number of cars per lane.

Voices School
Morgan Hill, CA
Hexagon Transportation Consultants, Inc.

Level Of Service Computation Report
2000 HCM Operations (Future Volume Alternative)
Existing Plus Project (PM) - 3 Monterey out

Intersection #124: US 101 Southbound Ramps and Dunne Avenue

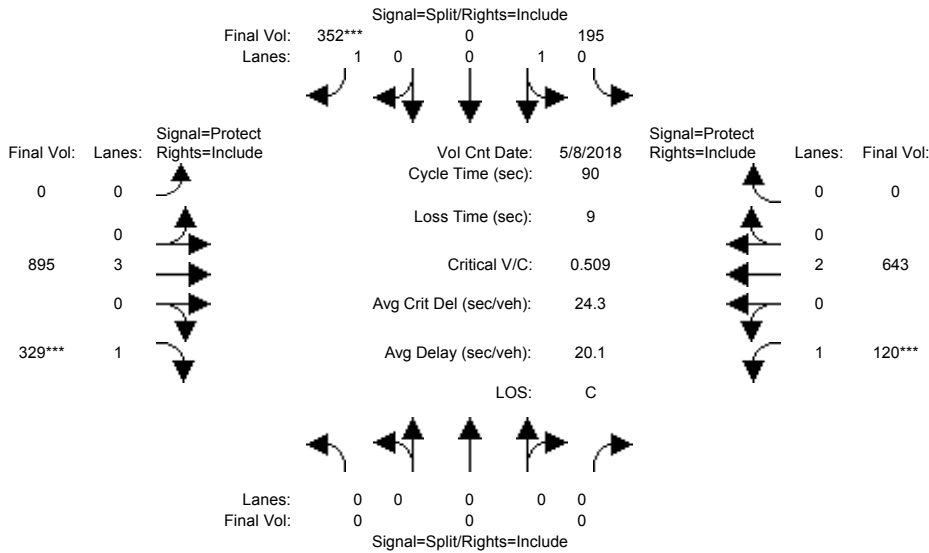

Street Name:	US 101 Southbound Ramps						Dunne Avenue					
	North Bound			South Bound			East Bound			West Bound		
Movement:	L	T	R	L	T	R	L	T	R	L	T	R
Min. Green:	0	0	0	10	10	10	0	10	10	7	10	0
Y+R:	4.0	4.0	4.0	4.0	4.0	4.0	4.0	4.0	4.0	4.0	4.0	4.0
Volume Module: >> Count Date:	8 May 2018 <<											
Base Vol:	0	0	0	195	0	294	0	860	329	120	637	0
Growth Adj:	1.00	1.00	1.00	1.00	1.00	1.00	1.00	1.00	1.00	1.00	1.00	1.00
Initial Bse:	0	0	0	195	0	294	0	860	329	120	637	0
Added Vol:	0	0	0	0	0	58	0	35	0	0	6	0
PasserByVol:	0	0	0	0	0	0	0	0	0	0	0	0
Initial Fut:	0	0	0	195	0	352	0	895	329	120	643	0
User Adj:	1.00	1.00	1.00	1.00	1.00	1.00	1.00	1.00	1.00	1.00	1.00	1.00
PHF Adj:	1.00	1.00	1.00	1.00	1.00	1.00	1.00	1.00	1.00	1.00	1.00	1.00
PHF Volume:	0	0	0	195	0	352	0	895	329	120	643	0
Reduct Vol:	0	0	0	0	0	0	0	0	0	0	0	0
Reduced Vol:	0	0	0	195	0	352	0	895	329	120	643	0
PCE Adj:	1.00	1.00	1.00	1.00	1.00	1.00	1.00	1.00	1.00	1.00	1.00	1.00
MLF Adj:	1.00	1.00	1.00	1.00	1.00	1.00	1.00	1.00	1.00	1.00	1.00	1.00
FinalVolume:	0	0	0	195	0	352	0	895	329	120	643	0
Saturation Flow Module:												
Sat/Lane:	1900	1900	1900	1900	1900	1900	1900	1900	1900	1900	1900	1900
Adjustment:	0.92	1.00	0.92	0.95	0.95	0.92	0.92	1.00	0.92	0.92	1.00	0.92
Lanes:	0.00	0.00	0.00	1.00	0.00	1.00	0.00	3.00	1.00	1.00	2.00	0.00
Final Sat.:	0	0	0	1800	0	1750	0	5700	1750	1750	3800	0
Capacity Analysis Module:												
Vol/Sat:	0.00	0.00	0.00	0.11	0.00	0.20	0.00	0.16	0.19	0.07	0.17	0.00
Crit Moves:						****			****			****
Green Time:	0.0	0.0	0.0	35.6	0.0	35.6	0.0	33.3	33.3	12.1	45.4	0.0
Volume/Cap:	0.00	0.00	0.00	0.27	0.00	0.51	0.00	0.42	0.51	0.51	0.34	0.00
Delay/Veh:	0.0	0.0	0.0	18.7	0.0	21.2	0.0	21.3	22.7	38.0	13.4	0.0
User DelAdj:	1.00	1.00	1.00	1.00	1.00	1.00	1.00	1.00	1.00	1.00	1.00	1.00
AdjDel/Veh:	0.0	0.0	0.0	18.7	0.0	21.2	0.0	21.3	22.7	38.0	13.4	0.0
LOS by Move:	A	A	A	B	A	C	A	C	C	D	B	A
HCM2kAvgQ:	0	0	0	4	0	8	0	6	7	4	5	0

Note: Queue reported is the number of cars per lane.

Voices School
Morgan Hill, CA
Hexagon Transportation Consultants, Inc.

Level Of Service Computation Report
2000 HCM Operations (Future Volume Alternative)
2025 Plus Project (AM) - 3 Monterey out

Intersection #124: US 101 Southbound Ramps and Dunne Avenue

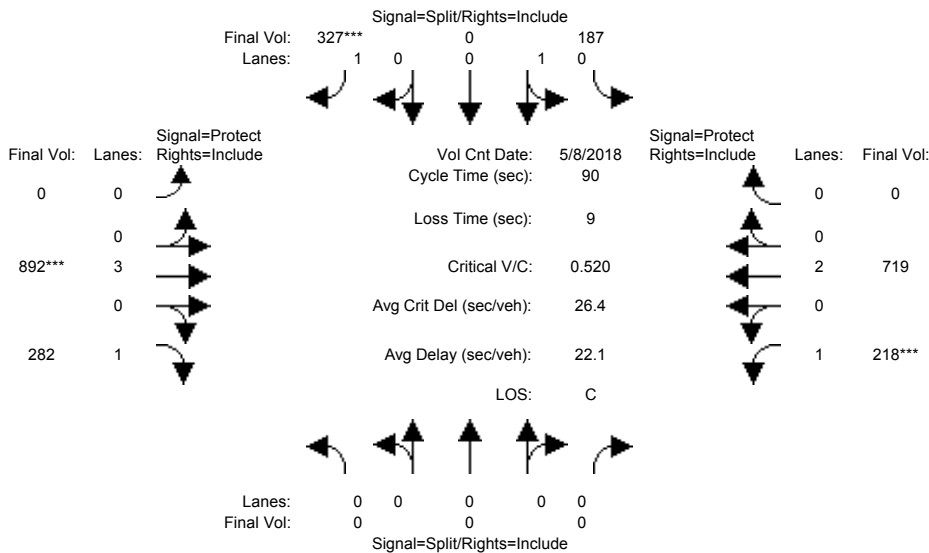

Street Name: US 101 Southbound Ramps Dunne Avenue
Approach: North Bound South Bound East Bound West Bound
Movement: L - T - R L - T - R L - T - R L - T - R

Min. Green: 0 0 0 10 10 10 0 10 10 7 10 0
Y+R: 4.0 4.0 4.0 4.0 4.0 4.0 4.0 4.0 4.0 4.0 4.0 4.0

Volume Module: >> Count Date: 8 May 2018 <<

Base Vol:	0	0	0	184	0	288	0	750	247	177	664	0
Growth Adj:	1.00	1.00	1.00	1.00	1.00	1.00	1.00	1.00	1.00	1.00	1.00	1.00
Initial Bse:	0	0	0	184	0	288	0	750	247	177	664	0
Added Vol:	0	0	0	0	0	30	0	119	0	0	30	0
PasserByVol:	0	0	0	3	0	9	0	23	35	41	25	0
Initial Fut:	0	0	0	187	0	327	0	892	282	218	719	0
User Adj:	1.00	1.00	1.00	1.00	1.00	1.00	1.00	1.00	1.00	1.00	1.00	1.00
PHF Adj:	1.00	1.00	1.00	1.00	1.00	1.00	1.00	1.00	1.00	1.00	1.00	1.00
PHF Volume:	0	0	0	187	0	327	0	892	282	218	719	0
Reduct Vol:	0	0	0	0	0	0	0	0	0	0	0	0
Reduced Vol:	0	0	0	187	0	327	0	892	282	218	719	0
PCE Adj:	1.00	1.00	1.00	1.00	1.00	1.00	1.00	1.00	1.00	1.00	1.00	1.00
MLF Adj:	1.00	1.00	1.00	1.00	1.00	1.00	1.00	1.00	1.00	1.00	1.00	1.00
FinalVolume:	0	0	0	187	0	327	0	892	282	218	719	0

Saturation Flow Module:

Sat/Lane:	1900	1900	1900	1900	1900	1900	1900	1900	1900	1900	1900	1900
Adjustment:	0.92	1.00	0.92	0.95	0.95	0.92	0.92	1.00	0.92	0.92	1.00	0.92
Lanes:	0.00	0.00	0.00	1.00	0.00	1.00	0.00	3.00	1.00	1.00	2.00	0.00
Final Sat.:	0	0	0	1800	0	1750	0	5700	1750	1750	3800	0

Capacity Analysis Module:

Vol/Sat:	0.00	0.00	0.00	0.10	0.00	0.19	0.00	0.16	0.16	0.12	0.19	0.00
Crit Moves:						****		****		****		
Green Time:	0.0	0.0	0.0	32.3	0.0	32.3	0.0	27.1	27.1	21.6	48.7	0.0
Volume/Cap:	0.00	0.00	0.00	0.29	0.00	0.52	0.00	0.52	0.54	0.52	0.35	0.00
Delay/Veh:	0.0	0.0	0.0	20.9	0.0	23.5	0.0	26.4	27.3	30.9	11.8	0.0
User DelAdj:	1.00	1.00	1.00	1.00	1.00	1.00	1.00	1.00	1.00	1.00	1.00	1.00
AdjDel/Veh:	0.0	0.0	0.0	20.9	0.0	23.5	0.0	26.4	27.3	30.9	11.8	0.0
LOS by Move:	A	A	A	C	A	C	A	C	C	C	B	A
HCM2kAvgQ:	0	0	0	4	0	8	0	7	7	6	6	0

Note: Queue reported is the number of cars per lane.

Voices School
Morgan Hill, CA
Hexagon Transportation Consultants, Inc.

Level Of Service Computation Report
2000 HCM Operations (Future Volume Alternative)
2025 Plus Project (PM) - 3 Monterey out

Intersection #124: US 101 Southbound Ramps and Dunne Avenue

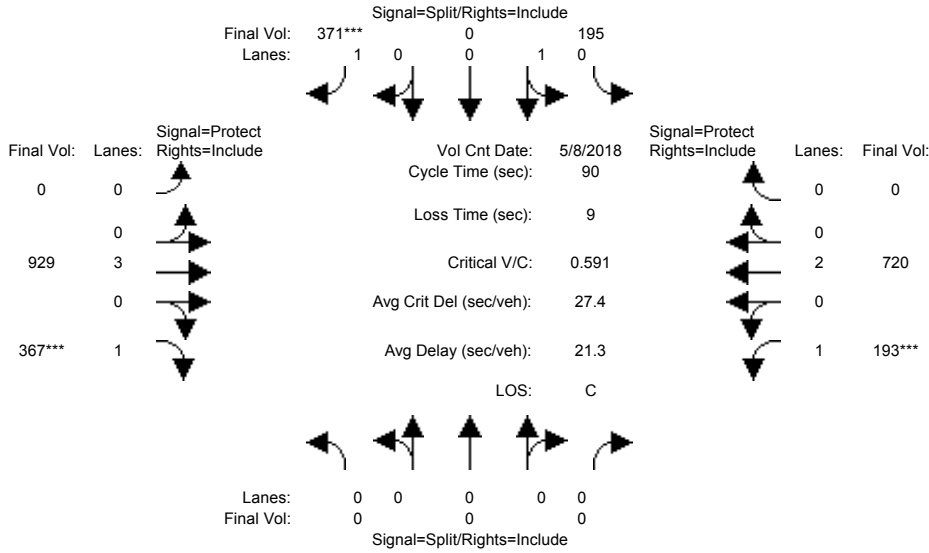

Street Name:	US 101 Southbound Ramps						Dunne Avenue					
	North Bound			South Bound			East Bound			West Bound		
Approach:	L	T	R	L	T	R	L	T	R	L	T	R
Min. Green:	0	0	0	10	10	10	0	10	10	7	10	0
Y+R:	4.0	4.0	4.0	4.0	4.0	4.0	4.0	4.0	4.0	4.0	4.0	4.0

Volume Module:	>>	Count	Date:	8 May 2018	<<							
Base Vol:	0	0	0	195	0	294	0	860	329	120	637	0
Growth Adj:	1.00	1.00	1.00	1.00	1.00	1.00	1.00	1.00	1.00	1.00	1.00	1.00
Initial Bse:	0	0	0	195	0	294	0	860	329	120	637	0
Added Vol:	0	0	0	0	0	55	0	32	0	0	5	0
PasserByVol:	0	0	0	0	0	22	0	37	38	73	78	0
Initial Fut:	0	0	0	195	0	371	0	929	367	193	720	0
User Adj:	1.00	1.00	1.00	1.00	1.00	1.00	1.00	1.00	1.00	1.00	1.00	1.00
PHF Adj:	1.00	1.00	1.00	1.00	1.00	1.00	1.00	1.00	1.00	1.00	1.00	1.00
PHF Volume:	0	0	0	195	0	371	0	929	367	193	720	0
Reduct Vol:	0	0	0	0	0	0	0	0	0	0	0	0
Reduced Vol:	0	0	0	195	0	371	0	929	367	193	720	0
PCE Adj:	1.00	1.00	1.00	1.00	1.00	1.00	1.00	1.00	1.00	1.00	1.00	1.00
MLF Adj:	1.00	1.00	1.00	1.00	1.00	1.00	1.00	1.00	1.00	1.00	1.00	1.00
FinalVolume:	0	0	0	195	0	371	0	929	367	193	720	0

Saturation Flow Module:	
Sat/Lane:	1900 1900 1900 1900 1900 1900 1900 1900 1900 1900 1900 1900
Adjustment:	0.92 1.00 0.92 0.95 0.95 0.92 0.92 1.00 0.92 0.92 1.00 0.92
Lanes:	0.00 0.00 0.00 1.00 0.00 1.00 0.00 3.00 1.00 1.00 2.00 0.00
Final Sat.:	0 0 0 1800 0 1750 0 5700 1750 1750 3800 0

Capacity Analysis Module:	
Vol/Sat:	0.00 0.00 0.00 0.11 0.00 0.21 0.00 0.16 0.21 0.11 0.19 0.00
Crit Moves:	****
Green Time:	0.0 0.0 0.0 32.3 0.0 32.3 0.0 31.9 31.9 16.8 48.7 0.0
Volume/Cap:	0.00 0.00 0.00 0.30 0.00 0.59 0.00 0.46 0.59 0.59 0.35 0.00
Delay/Veh:	0.0 0.0 0.0 21.0 0.0 25.0 0.0 22.5 25.2 36.3 11.8 0.0
User DelAdj:	1.00 1.00 1.00 1.00 1.00 1.00 1.00 1.00 1.00 1.00 1.00 1.00
AdjDel/Veh:	0.0 0.0 0.0 21.0 0.0 25.0 0.0 22.5 25.2 36.3 11.8 0.0
LOS by Move:	A A A C A C A C C D B A
HCM2kAvgQ:	0 0 0 4 0 9 0 6 9 6 6 0

Note: Queue reported is the number of cars per lane.

Voices School
Morgan Hill, CA
Hexagon Transportation Consultants, Inc.

Level Of Service Computation Report
2000 HCM Operations (Future Volume Alternative)
Existing Plus Project (AM) - 3 Monterey out

Intersection #125: US 101 Northbound Ramps and Dunne Avenue

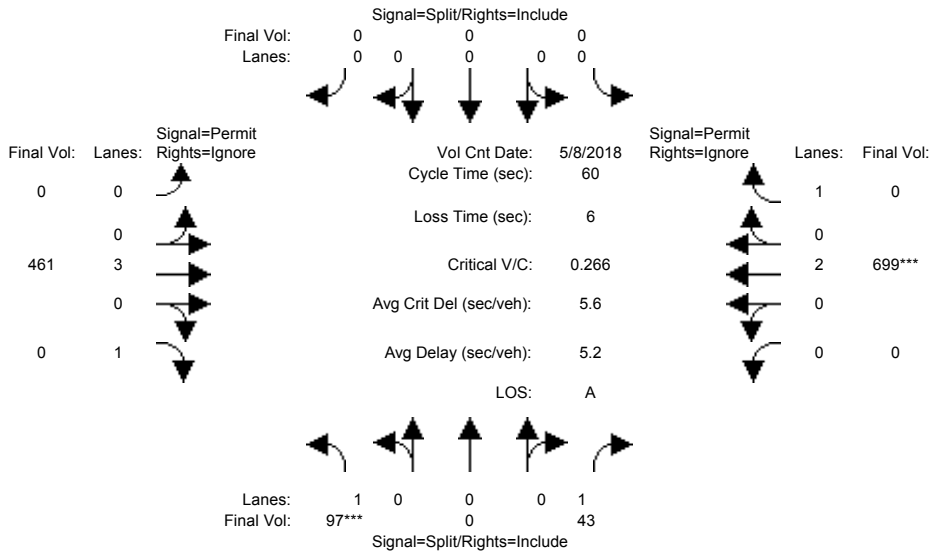

Street Name:	US 101 Northbound Ramps						Dunne Avenue					
	North Bound			South Bound			East Bound			West Bound		
Approach:	L	T	R	L	T	R	L	T	R	L	T	R
Min. Green:	10	0	10	0	0	0	0	10	10	0	10	10
Y+R:	4.0	4.0	4.0	4.0	4.0	4.0	4.0	4.0	4.0	4.0	4.0	4.0

Volume Module:	>>	Count	Date:	8 May 2018	<<							
Base Vol:	97	0	43	0	0	0	0	450	0	0	669	0
Growth Adj:	1.00	1.00	1.00	1.00	1.00	1.00	1.00	1.00	1.00	1.00	1.00	1.00
Initial Bse:	97	0	43	0	0	0	0	450	0	0	669	0
Added Vol:	0	0	0	0	0	0	0	11	111	0	30	0
PasserByVol:	0	0	0	0	0	0	0	0	0	0	0	0
Initial Fut:	97	0	43	0	0	0	0	461	111	0	699	0
User Adj:	1.00	1.00	1.00	1.00	1.00	1.00	1.00	1.00	0.00	1.00	1.00	0.00
PHF Adj:	1.00	1.00	1.00	1.00	1.00	1.00	1.00	1.00	0.00	1.00	1.00	0.00
PHF Volume:	97	0	43	0	0	0	0	461	0	0	699	0
Reduct Vol:	0	0	0	0	0	0	0	0	0	0	0	0
Reduced Vol:	97	0	43	0	0	0	0	461	0	0	699	0
PCE Adj:	1.00	1.00	1.00	1.00	1.00	1.00	1.00	1.00	0.00	1.00	1.00	0.00
MLF Adj:	1.00	1.00	1.00	1.00	1.00	1.00	1.00	1.00	0.00	1.00	1.00	0.00
FinalVolume:	97	0	43	0	0	0	0	461	0	0	699	0

Saturation Flow Module:												
Sat/Lane:	1900	1900	1900	1900	1900	1900	1900	1900	1900	1900	1900	1900
Adjustment:	0.92	1.00	0.92	0.92	1.00	0.92	0.92	1.00	0.92	0.92	1.00	0.92
Lanes:	1.00	0.00	1.00	0.00	0.00	0.00	0.00	3.00	1.00	0.00	2.00	1.00
Final Sat.:	1750	0	1750	0	0	0	0	5700	1750	0	3800	1750

Capacity Analysis Module:															
Vol/Sat:	0.06	0.00	0.02	0.00	0.00	0.00	0.00	0.08	0.00	0.00	0.18	0.00			
Crit Moves:	****												****		
Green Time:	12.5	0.0	12.5	0.0	0.0	0.0	0.0	41.5	0.0	0.0	41.5	0.0			
Volume/Cap:	0.27	0.00	0.12	0.00	0.00	0.00	0.00	0.12	0.00	0.00	0.27	0.00			
Delay/Veh:	20.3	0.0	19.4	0.0	0.0	0.0	0.0	3.1	0.0	0.0	3.6	0.0			
User DelAdj:	1.00	1.00	1.00	1.00	1.00	1.00	1.00	1.00	1.00	1.00	1.00	1.00			
AdjDel/Veh:	20.3	0.0	19.4	0.0	0.0	0.0	0.0	3.1	0.0	0.0	3.6	0.0			
LOS by Move:	C	A	B	A	A	A	A	A	A	A	A	A			
HCM2kAvgQ:	2	0	1	0	0	0	0	1	0	0	3	0			

Note: Queue reported is the number of cars per lane.

Voices School
Morgan Hill, CA
Hexagon Transportation Consultants, Inc.

Level Of Service Computation Report
2000 HCM Operations (Future Volume Alternative)
Existing Plus Project (PM) - 3 Monterey out

Intersection #125: US 101 Northbound Ramps and Dunne Avenue

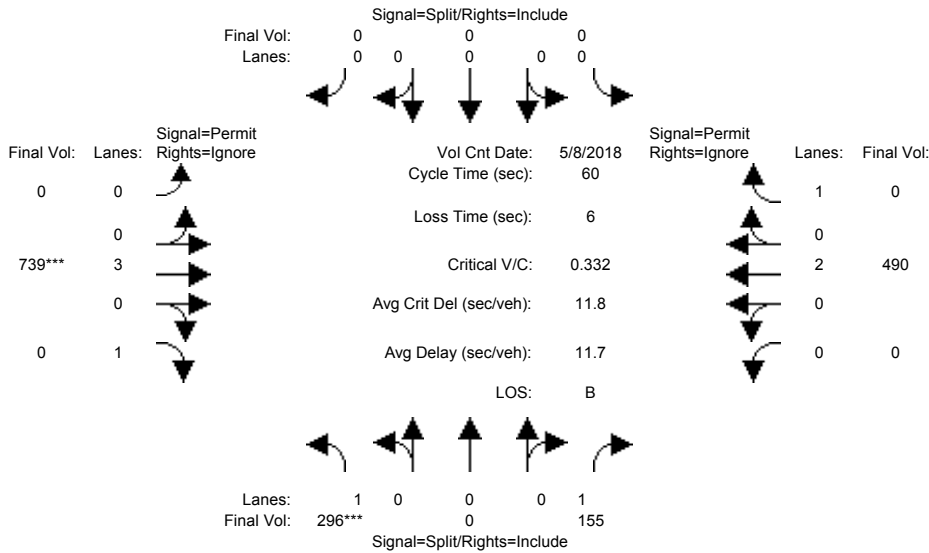

Street Name:	US 101 Northbound Ramps						Dunne Avenue					
	North Bound			South Bound			East Bound			West Bound		
Approach:	L	T	R	L	T	R	L	T	R	L	T	R
Min. Green:	10	0	10	0	0	0	0	10	10	0	10	10
Y+R:	4.0	4.0	4.0	4.0	4.0	4.0	4.0	4.0	4.0	4.0	4.0	4.0

Volume Module:	>>	Count	Date:	8 May 2018	<<							
Base Vol:	296	0	155	0	0	0	0	720	0	0	484	0
Growth Adj:	1.00	1.00	1.00	1.00	1.00	1.00	1.00	1.00	1.00	1.00	1.00	1.00
Initial Bse:	296	0	155	0	0	0	0	720	0	0	484	0
Added Vol:	0	0	0	0	0	0	0	19	17	0	6	0
PasserByVol:	0	0	0	0	0	0	0	0	0	0	0	0
Initial Fut:	296	0	155	0	0	0	0	739	17	0	490	0
User Adj:	1.00	1.00	1.00	1.00	1.00	1.00	1.00	1.00	0.00	1.00	1.00	0.00
PHF Adj:	1.00	1.00	1.00	1.00	1.00	1.00	1.00	1.00	0.00	1.00	1.00	0.00
PHF Volume:	296	0	155	0	0	0	0	739	0	0	490	0
Reduct Vol:	0	0	0	0	0	0	0	0	0	0	0	0
Reduced Vol:	296	0	155	0	0	0	0	739	0	0	490	0
PCE Adj:	1.00	1.00	1.00	1.00	1.00	1.00	1.00	1.00	0.00	1.00	1.00	0.00
MLF Adj:	1.00	1.00	1.00	1.00	1.00	1.00	1.00	1.00	0.00	1.00	1.00	0.00
FinalVolume:	296	0	155	0	0	0	0	739	0	0	490	0

Saturation Flow Module:												
Sat/Lane:	1900	1900	1900	1900	1900	1900	1900	1900	1900	1900	1900	1900
Adjustment:	0.92	1.00	0.92	0.92	1.00	0.92	0.92	1.00	0.92	0.92	1.00	0.92
Lanes:	1.00	0.00	1.00	0.00	0.00	0.00	0.00	3.00	1.00	0.00	2.00	1.00
Final Sat.:	1750	0	1750	0	0	0	0	5700	1750	0	3800	1750

Capacity Analysis Module:												
Vol/Sat:	0.17	0.00	0.09	0.00	0.00	0.00	0.00	0.13	0.00	0.00	0.13	0.00
Crit Moves:	****						****					
Green Time:	30.6	0.0	30.6	0.0	0.0	0.0	0.0	23.4	0.0	0.0	23.4	0.0
Volume/Cap:	0.33	0.00	0.17	0.00	0.00	0.00	0.00	0.33	0.00	0.00	0.33	0.00
Delay/Veh:	8.9	0.0	8.0	0.0	0.0	0.0	0.0	12.9	0.0	0.0	12.9	0.0
User DelAdj:	1.00	1.00	1.00	1.00	1.00	1.00	1.00	1.00	1.00	1.00	1.00	1.00
AdjDel/Veh:	8.9	0.0	8.0	0.0	0.0	0.0	0.0	12.9	0.0	0.0	12.9	0.0
LOS by Move:	A	A	A	A	A	A	A	B	A	A	B	A
HCM2kAvgQ:	4	0	2	0	0	0	0	3	0	0	3	0

Note: Queue reported is the number of cars per lane.

Voices School
Morgan Hill, CA
Hexagon Transportation Consultants, Inc.

Level Of Service Computation Report
2000 HCM Operations (Future Volume Alternative)
2025 Plus Project (AM) - 3 Monterey out

Intersection #125: US 101 Northbound Ramps and Dunne Avenue

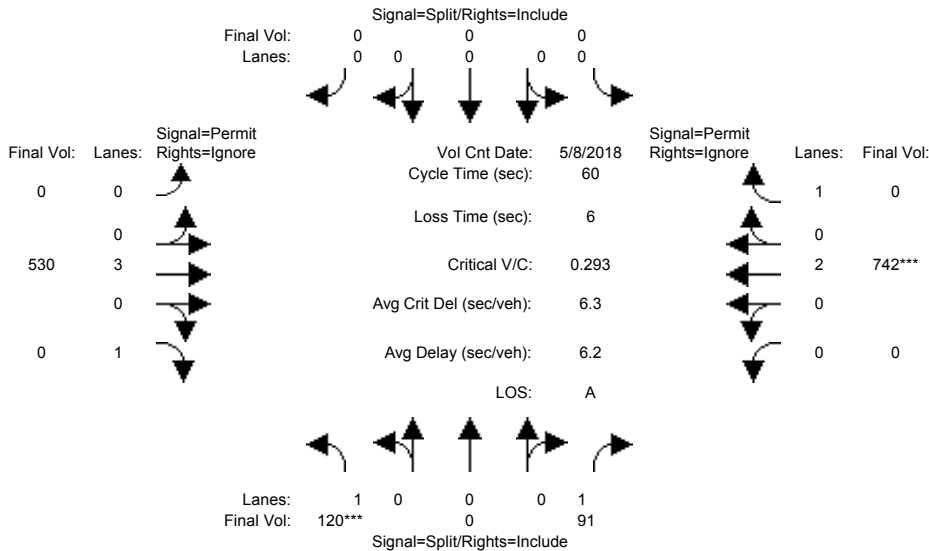

Street Name:	US 101 Northbound Ramps						Dunne Avenue					
	North Bound			South Bound			East Bound			West Bound		
	L	T	R	L	T	R	L	T	R	L	T	R
Min. Green:	10	0	10	0	0	0	0	10	10	0	10	10
Y+R:	4.0	4.0	4.0	4.0	4.0	4.0	4.0	4.0	4.0	4.0	4.0	4.0

Volume Module:	>>	Count	Date:	8 May 2018	<<							
Base Vol:	97	0	43	0	0	0	0	450	0	0	669	0
Growth Adj:	1.00	1.00	1.00	1.00	1.00	1.00	1.00	1.00	1.00	1.00	1.00	1.00
Initial Bse:	97	0	43	0	0	0	0	450	0	0	669	0
Added Vol:	0	0	0	0	0	0	0	10	108	0	30	0
PasserByVol:	23	0	48	0	0	0	0	70	0	0	43	0
Initial Fut:	120	0	91	0	0	0	0	530	108	0	742	0
User Adj:	1.00	1.00	1.00	1.00	1.00	1.00	1.00	1.00	0.00	1.00	1.00	0.00
PHF Adj:	1.00	1.00	1.00	1.00	1.00	1.00	1.00	1.00	0.00	1.00	1.00	0.00
PHF Volume:	120	0	91	0	0	0	0	530	0	0	742	0
Reduct Vol:	0	0	0	0	0	0	0	0	0	0	0	0
Reduced Vol:	120	0	91	0	0	0	0	530	0	0	742	0
PCE Adj:	1.00	1.00	1.00	1.00	1.00	1.00	1.00	1.00	0.00	1.00	1.00	0.00
MLF Adj:	1.00	1.00	1.00	1.00	1.00	1.00	1.00	1.00	0.00	1.00	1.00	0.00
FinalVolume:	120	0	91	0	0	0	0	530	0	0	742	0

Saturation Flow Module:	
Sat/Lane:	1900 1900 1900 1900 1900 1900 1900 1900 1900 1900 1900 1900
Adjustment:	0.92 1.00 0.92 0.92 1.00 0.92 0.92 1.00 0.92 0.92 1.00 0.92
Lanes:	1.00 0.00 1.00 0.00 0.00 0.00 0.00 3.00 1.00 0.00 2.00 1.00
Final Sat.:	1750 0 1750 0 0 0 0 5700 1750 0 3800 1750

Capacity Analysis Module:	
Vol/Sat:	0.07 0.00 0.05 0.00 0.00 0.00 0.00 0.09 0.00 0.00 0.20 0.00
Crit Moves:	****
Green Time:	14.0 0.0 14.0 0.0 0.0 0.0 0.0 40.0 0.0 0.0 40.0 0.0
Volume/Cap:	0.29 0.00 0.22 0.00 0.00 0.00 0.00 0.14 0.00 0.00 0.29 0.00
Delay/Veh:	19.3 0.0 18.8 0.0 0.0 0.0 0.0 3.7 0.0 0.0 4.2 0.0
User DelAdj:	1.00 1.00 1.00 1.00 1.00 1.00 1.00 1.00 1.00 1.00 1.00 1.00
AdjDel/Veh:	19.3 0.0 18.8 0.0 0.0 0.0 0.0 3.7 0.0 0.0 4.2 0.0
LOS by Move:	B A B A A A A A A A A A
HCM2kAvgQ:	2 0 2 0 0 0 0 1 0 0 3 0

Note: Queue reported is the number of cars per lane.

Voices School
Morgan Hill, CA
Hexagon Transportation Consultants, Inc.

Level Of Service Computation Report
2000 HCM Operations (Future Volume Alternative)
2025 Plus Project (PM) - 3 Monterey out

Intersection #125: US 101 Northbound Ramps and Dunne Avenue

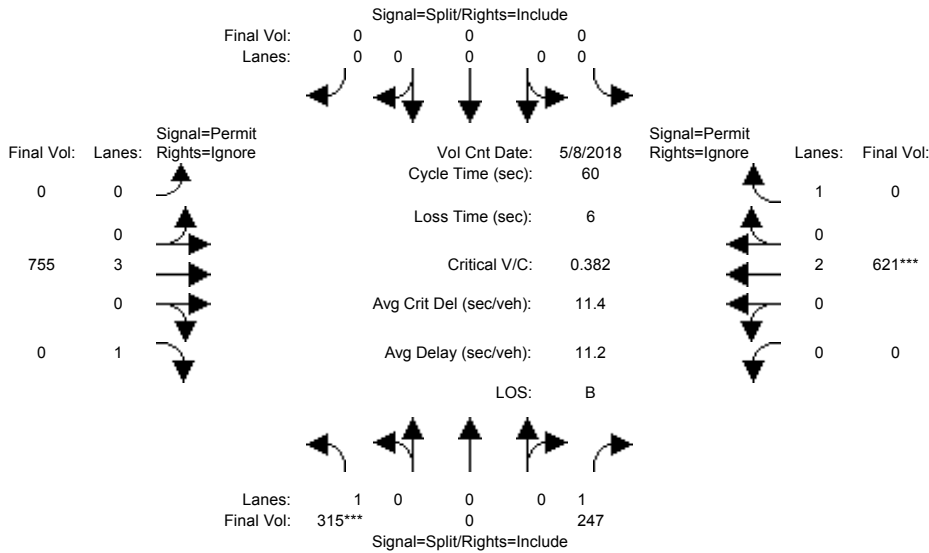

Street Name:	US 101 Northbound Ramps						Dunne Avenue					
	North Bound			South Bound			East Bound			West Bound		
Approach:	L	T	R	L	T	R	L	T	R	L	T	R
Min. Green:	10	0	10	0	0	0	0	10	10	0	10	10
Y+R:	4.0	4.0	4.0	4.0	4.0	4.0	4.0	4.0	4.0	4.0	4.0	4.0

Volume Module:	>>	Count	Date:	8 May 2018	<<							
Base Vol:	296	0	155	0	0	0	0	720	0	0	484	0
Growth Adj:	1.00	1.00	1.00	1.00	1.00	1.00	1.00	1.00	1.00	1.00	1.00	1.00
Initial Bse:	296	0	155	0	0	0	0	720	0	0	484	0
Added Vol:	0	0	0	0	0	0	0	18	14	0	5	0
PasserByVol:	19	0	92	0	0	0	0	17	0	0	132	0
Initial Fut:	315	0	247	0	0	0	0	755	14	0	621	0
User Adj:	1.00	1.00	1.00	1.00	1.00	1.00	1.00	1.00	0.00	1.00	1.00	0.00
PHF Adj:	1.00	1.00	1.00	1.00	1.00	1.00	1.00	1.00	0.00	1.00	1.00	0.00
PHF Volume:	315	0	247	0	0	0	0	755	0	0	621	0
Reduct Vol:	0	0	0	0	0	0	0	0	0	0	0	0
Reduced Vol:	315	0	247	0	0	0	0	755	0	0	621	0
PCE Adj:	1.00	1.00	1.00	1.00	1.00	1.00	1.00	1.00	0.00	1.00	1.00	0.00
MLF Adj:	1.00	1.00	1.00	1.00	1.00	1.00	1.00	1.00	0.00	1.00	1.00	0.00
FinalVolume:	315	0	247	0	0	0	0	755	0	0	621	0

Saturation Flow Module:												
Sat/Lane:	1900	1900	1900	1900	1900	1900	1900	1900	1900	1900	1900	1900
Adjustment:	0.92	1.00	0.92	0.92	1.00	0.92	0.92	1.00	0.92	0.92	1.00	0.92
Lanes:	1.00	0.00	1.00	0.00	0.00	0.00	0.00	3.00	1.00	0.00	2.00	1.00
Final Sat.:	1750	0	1750	0	0	0	0	5700	1750	0	3800	1750

Capacity Analysis Module:												
Vol/Sat:	0.18	0.00	0.14	0.00	0.00	0.00	0.00	0.13	0.00	0.00	0.16	0.00
Crit Moves:	****			****								
Green Time:	28.3	0.0	28.3	0.0	0.0	0.0	0.0	25.7	0.0	0.0	25.7	0.0
Volume/Cap:	0.38	0.00	0.30	0.00	0.00	0.00	0.00	0.31	0.00	0.00	0.38	0.00
Delay/Veh:	10.5	0.0	10.0	0.0	0.0	0.0	0.0	11.4	0.0	0.0	11.9	0.0
User DelAdj:	1.00	1.00	1.00	1.00	1.00	1.00	1.00	1.00	1.00	1.00	1.00	1.00
AdjDel/Veh:	10.5	0.0	10.0	0.0	0.0	0.0	0.0	11.4	0.0	0.0	11.9	0.0
LOS by Move:	B	A	A	A	A	A	A	B	A	A	B	A
HCM2kAvgQ:	4	0	3	0	0	0	0	3	0	0	4	0

Note: Queue reported is the number of cars per lane.

Voices School
Morgan Hill, CA
Hexagon Transportation Consultants, Inc.

Level Of Service Computation Report
2000 HCM Operations (Future Volume Alternative)
Existing Plus Project (AM) - 3 Monterey out

Intersection #422: Monterey Road and Butterfield Boulevard/Watsonville Road

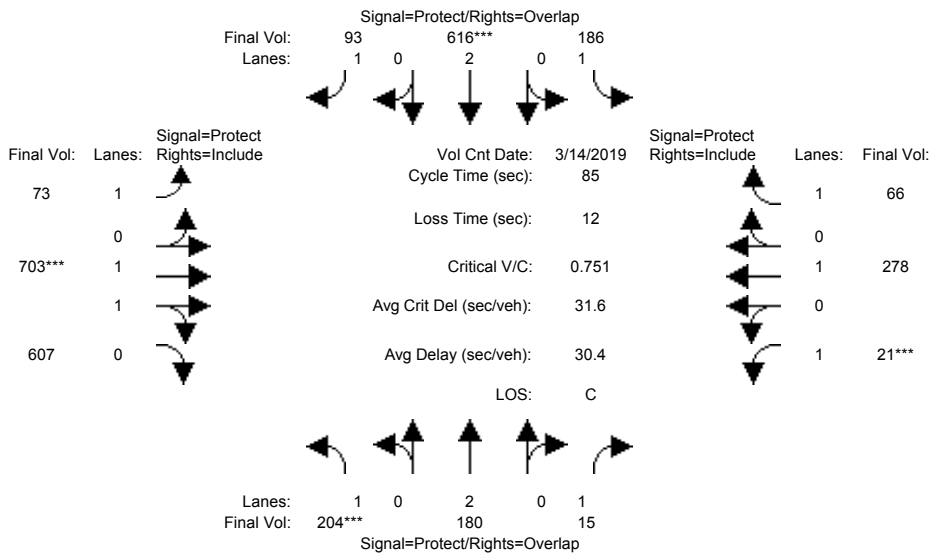

Street Name:	Monterey Rd						Butterfield Blvd/Watsonville Rd					
	North Bound			South Bound			East Bound			West Bound		
Approach:	L	T	R	L	T	R	L	T	R	L	T	R
Min. Green:	7	10	10	7	10	10	7	10	10	7	10	10
Y+R:	4.0	4.0	4.0	4.0	4.0	4.0	4.0	4.0	4.0	4.0	4.0	4.0

Volume Module:	>>	Count	Date:	14 Mar 2019	<<							
Base Vol:	204	150	15	186	597	88	58	703	607	21	278	66
Growth Adj:	1.00	1.00	1.00	1.00	1.00	1.00	1.00	1.00	1.00	1.00	1.00	1.00
Initial Bse:	204	150	15	186	597	88	58	703	607	21	278	66
Added Vol:	0	30	0	0	19	5	15	0	0	0	0	0
PasserByVol:	0	0	0	0	0	0	0	0	0	0	0	0
Initial Fut:	204	180	15	186	616	93	73	703	607	21	278	66
User Adj:	1.00	1.00	1.00	1.00	1.00	1.00	1.00	1.00	1.00	1.00	1.00	1.00
PHF Adj:	1.00	1.00	1.00	1.00	1.00	1.00	1.00	1.00	1.00	1.00	1.00	1.00
PHF Volume:	204	180	15	186	616	93	73	703	607	21	278	66
Reduct Vol:	0	0	0	0	0	0	0	0	0	0	0	0
Reduced Vol:	204	180	15	186	616	93	73	703	607	21	278	66
PCE Adj:	1.00	1.00	1.00	1.00	1.00	1.00	1.00	1.00	1.00	1.00	1.00	1.00
MLF Adj:	1.00	1.00	1.00	1.00	1.00	1.00	1.00	1.00	1.00	1.00	1.00	1.00
FinalVolume:	204	180	15	186	616	93	73	703	607	21	278	66

Saturation Flow Module:												
Sat/Lane:	1900	1900	1900	1900	1900	1900	1900	1900	1900	1900	1900	1900
Adjustment:	0.92	1.00	0.92	0.92	1.00	0.92	0.92	1.00	0.95	0.92	1.00	0.92
Lanes:	1.00	2.00	1.00	1.00	2.00	1.00	1.00	1.05	0.95	1.00	1.00	1.00
Final Sat.:	1750	3800	1750	1750	3800	1750	1750	1984	1713	1750	1900	1750

Capacity Analysis Module:												
Vol/Sat:	0.12	0.05	0.01	0.11	0.16	0.05	0.04	0.35	0.35	0.01	0.15	0.04
Crit Moves:	***				***			***		***		
Green Time:	12.2	15.3	22.3	13.8	16.9	32.7	15.8	36.9	36.9	7.0	28.1	28.1
Volume/Cap:	0.82	0.26	0.03	0.66	0.82	0.14	0.22	0.82	0.82	0.15	0.44	0.11
Delay/Veh:	53.6	30.2	23.4	38.8	39.4	17.1	29.7	24.4	24.4	36.7	22.8	19.9
User DelAdj:	1.00	1.00	1.00	1.00	1.00	1.00	1.00	1.00	1.00	1.00	1.00	1.00
AdjDel/Veh:	53.6	30.2	23.4	38.8	39.4	17.1	29.7	24.4	24.4	36.7	22.8	19.9
LOS by Move:	D	C	C	D	D	B	C	C	C	D	C	B
HCM2kAvgQ:	8	2	0	5	8	2	2	18	18	1	6	1

Note: Queue reported is the number of cars per lane.

Voices School
Morgan Hill, CA
Hexagon Transportation Consultants, Inc.

Level Of Service Computation Report
2000 HCM Operations (Future Volume Alternative)
Existing Plus Project (PM) - 3 Monterey out

Intersection #422: Monterey Road and Butterfield Boulevard/Watsonville Road

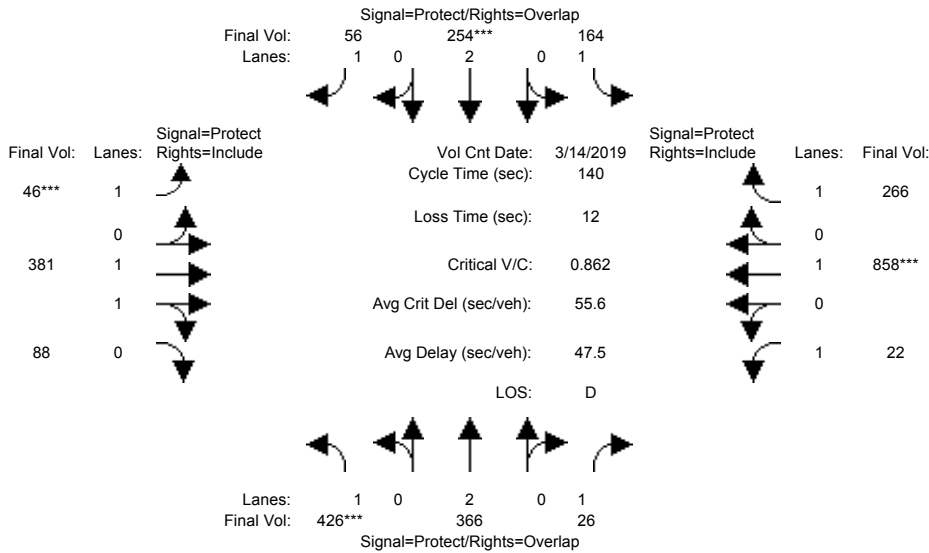

Street Name: Monterey Rd Butterfield Blvd/Watsonville Rd
Approach: North Bound South Bound East Bound West Bound
Movement: L - T - R L - T - R L - T - R L - T - R

Min. Green:	7	10	10	7	10	10	7	10	10	7	10	10
Y+R:	4.0	4.0	4.0	4.0	4.0	4.0	4.0	4.0	4.0	4.0	4.0	4.0

Volume Module: >> Count Date: 14 Mar 2019 <<

Base Vol:	426	356	26	164	235	47	43	381	88	22	858	266
Growth Adj:	1.00	1.00	1.00	1.00	1.00	1.00	1.00	1.00	1.00	1.00	1.00	1.00
Initial Bse:	426	356	26	164	235	47	43	381	88	22	858	266
Added Vol:	0	10	0	0	19	9	3	0	0	0	0	0
PasserByVol:	0	0	0	0	0	0	0	0	0	0	0	0
Initial Fut:	426	366	26	164	254	56	46	381	88	22	858	266
User Adj:	1.00	1.00	1.00	1.00	1.00	1.00	1.00	1.00	1.00	1.00	1.00	1.00
PHF Adj:	1.00	1.00	1.00	1.00	1.00	1.00	1.00	1.00	1.00	1.00	1.00	1.00
PHF Volume:	426	366	26	164	254	56	46	381	88	22	858	266
Reduct Vol:	0	0	0	0	0	0	0	0	0	0	0	0
Reduced Vol:	426	366	26	164	254	56	46	381	88	22	858	266
PCE Adj:	1.00	1.00	1.00	1.00	1.00	1.00	1.00	1.00	1.00	1.00	1.00	1.00
MLF Adj:	1.00	1.00	1.00	1.00	1.00	1.00	1.00	1.00	1.00	1.00	1.00	1.00
FinalVolume:	426	366	26	164	254	56	46	381	88	22	858	266

Saturation Flow Module:

Sat/Lane:	1900	1900	1900	1900	1900	1900	1900	1900	1900	1900	1900	1900
Adjustment:	0.92	1.00	0.92	0.92	1.00	0.92	0.92	0.98	0.95	0.92	1.00	0.92
Lanes:	1.00	2.00	1.00	1.00	2.00	1.00	1.00	1.61	0.39	1.00	1.00	1.00
Final Sat.:	1750	3800	1750	1750	3800	1750	1750	3005	694	1750	1900	1750

Capacity Analysis Module:

Vol/Sat:	0.24	0.10	0.01	0.09	0.07	0.03	0.03	0.13	0.13	0.01	0.45	0.15
Crit Moves:	***				***		***				***	
Green Time:	38.7	25.0	47.2	24.3	10.6	17.6	7.0	56.5	56.5	22.3	71.7	71.7
Volume/Cap:	0.88	0.54	0.04	0.54	0.88	0.25	0.53	0.31	0.31	0.08	0.88	0.30
Delay/Veh:	65.5	53.2	31.2	54.7	89.5	55.9	70.7	28.7	28.7	50.3	39.8	19.8
User DelAdj:	1.00	1.00	1.00	1.00	1.00	1.00	1.00	1.00	1.00	1.00	1.00	1.00
AdjDel/Veh:	65.5	53.2	31.2	54.7	89.5	55.9	70.7	28.7	28.7	50.3	39.8	19.8
LOS by Move:	E	D	C	D	F	E	E	C	C	D	D	B
HCM2kAvgQ:	22	8	1	7	6	2	3	7	7	1	35	7

Note: Queue reported is the number of cars per lane.

Voices School
Morgan Hill, CA
Hexagon Transportation Consultants, Inc.

Level Of Service Computation Report
2000 HCM Operations (Future Volume Alternative)
2025 Plus Project (AM) - 3 Monterey out

Intersection #422: Monterey Road and Butterfield Boulevard/Watsonville Road

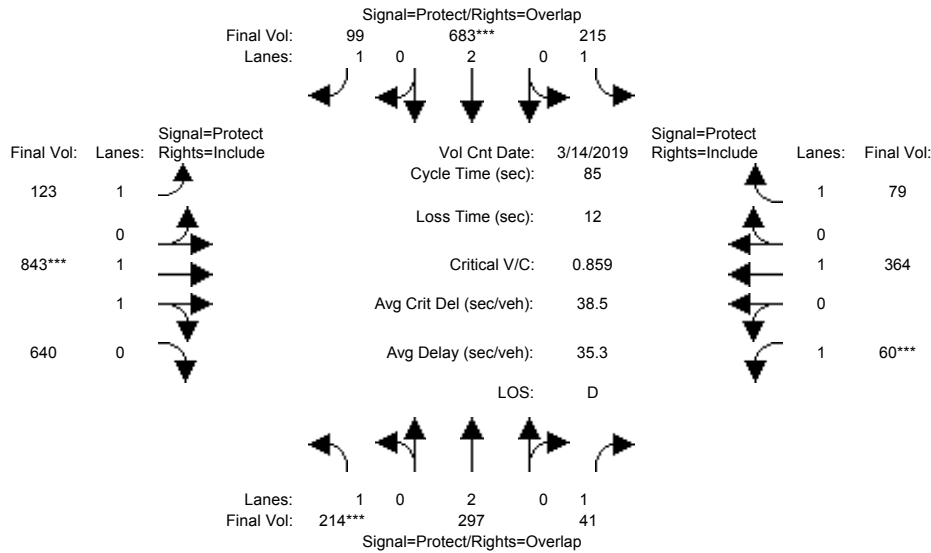

Street Name:	Monterey Rd						Butterfield Blvd/Watsonville Rd					
Approach:	North Bound			South Bound			East Bound			West Bound		
Movement:	L	T	R	L	T	R	L	T	R	L	T	R
Min. Green:	7	10	10	7	10	10	7	10	10	7	10	10
Y+R:	4.0	4.0	4.0	4.0	4.0	4.0	4.0	4.0	4.0	4.0	4.0	4.0

Volume Module:	>>	Count	Date:	14 Mar 2019	<<							
Base Vol:	204	150	15	186	597	88	58	703	607	21	278	66
Growth Adj:	1.00	1.00	1.00	1.00	1.00	1.00	1.00	1.00	1.00	1.00	1.00	1.00
Initial Bse:	204	150	15	186	597	88	58	703	607	21	278	66
Added Vol:	0	30	0	0	18	5	15	0	0	0	0	0
PasserByVol:	10	117	26	29	68	6	50	140	33	39	86	13
Initial Fut:	214	297	41	215	683	99	123	843	640	60	364	79
User Adj:	1.00	1.00	1.00	1.00	1.00	1.00	1.00	1.00	1.00	1.00	1.00	1.00
PHF Adj:	1.00	1.00	1.00	1.00	1.00	1.00	1.00	1.00	1.00	1.00	1.00	1.00
PHF Volume:	214	297	41	215	683	99	123	843	640	60	364	79
Reduct Vol:	0	0	0	0	0	0	0	0	0	0	0	0
Reduced Vol:	214	297	41	215	683	99	123	843	640	60	364	79
PCE Adj:	1.00	1.00	1.00	1.00	1.00	1.00	1.00	1.00	1.00	1.00	1.00	1.00
MLF Adj:	1.00	1.00	1.00	1.00	1.00	1.00	1.00	1.00	1.00	1.00	1.00	1.00
FinalVolume:	214	297	41	215	683	99	123	843	640	60	364	79

Saturation Flow Module:												
Sat/Lane:	1900	1900	1900	1900	1900	1900	1900	1900	1900	1900	1900	1900
Adjustment:	0.92	1.00	0.92	0.92	1.00	0.92	0.92	0.99	0.95	0.92	1.00	0.92
Lanes:	1.00	2.00	1.00	1.00	2.00	1.00	1.00	1.11	0.89	1.00	1.00	1.00
Final Sat.:	1750	3800	1750	1750	3800	1750	1750	2102	1596	1750	1900	1750

Capacity Analysis Module:												
Vol/Sat:	0.12	0.08	0.02	0.12	0.18	0.06	0.07	0.40	0.40	0.03	0.19	0.05
Crit Moves:	***			***			***			***		
Green Time:	11.5	13.9	20.9	14.5	16.9	30.3	13.4	37.6	37.6	7.0	31.2	31.2
Volume/Cap:	0.91	0.48	0.10	0.72	0.91	0.16	0.45	0.91	0.91	0.42	0.52	0.12
Delay/Veh:	70.5	32.9	24.9	41.7	47.8	18.8	33.6	29.6	29.6	39.0	21.8	17.9
User DelAdj:	1.00	1.00	1.00	1.00	1.00	1.00	1.00	1.00	1.00	1.00	1.00	1.00
AdjDel/Veh:	70.5	32.9	24.9	41.7	47.8	18.8	33.6	29.6	29.6	39.0	21.8	17.9
LOS by Move:	E	C	C	D	D	B	C	C	C	D	C	B
HCM2kAvgQ:	9	4	1	6	10	2	4	23	23	2	8	1

Note: Queue reported is the number of cars per lane.

Voices School
Morgan Hill, CA
Hexagon Transportation Consultants, Inc.

Level Of Service Computation Report
2000 HCM Operations (Future Volume Alternative)
2025 Plus Project (PM) - 3 Monterey out

Intersection #422: Monterey Road and Butterfield Boulevard/Watsonville Road

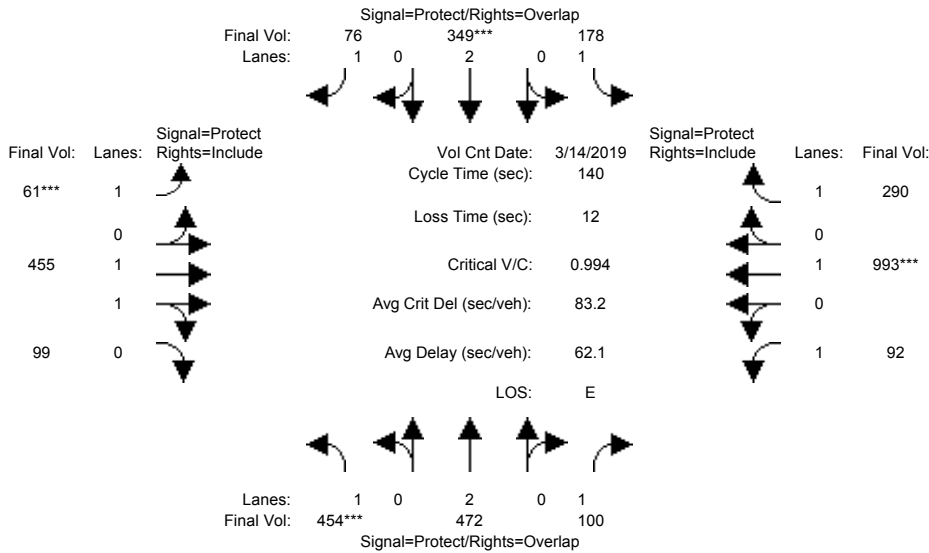

Street Name:	Monterey Rd						Butterfield Blvd/Watsonville Rd					
Approach:	North Bound			South Bound			East Bound			West Bound		
Movement:	L	T	R	L	T	R	L	T	R	L	T	R

Min. Green:	7	10	10	7	10	10	7	10	10	7	10	10
Y+R:	4.0	4.0	4.0	4.0	4.0	4.0	4.0	4.0	4.0	4.0	4.0	4.0

Volume Module:	>>	Count	Date:	14 Mar 2019	<<							
Base Vol:	426	356	26	164	235	47	43	381	88	22	858	266
Growth Adj:	1.00	1.00	1.00	1.00	1.00	1.00	1.00	1.00	1.00	1.00	1.00	1.00
Initial Bse:	426	356	26	164	235	47	43	381	88	22	858	266
Added Vol:	0	9	0	0	18	9	3	0	0	0	0	0
PasserByVol:	28	107	74	14	96	20	15	74	11	70	135	24
Initial Fut:	454	472	100	178	349	76	61	455	99	92	993	290
User Adj:	1.00	1.00	1.00	1.00	1.00	1.00	1.00	1.00	1.00	1.00	1.00	1.00
PHF Adj:	1.00	1.00	1.00	1.00	1.00	1.00	1.00	1.00	1.00	1.00	1.00	1.00
PHF Volume:	454	472	100	178	349	76	61	455	99	92	993	290
Reduct Vol:	0	0	0	0	0	0	0	0	0	0	0	0
Reduced Vol:	454	472	100	178	349	76	61	455	99	92	993	290
PCE Adj:	1.00	1.00	1.00	1.00	1.00	1.00	1.00	1.00	1.00	1.00	1.00	1.00
MLF Adj:	1.00	1.00	1.00	1.00	1.00	1.00	1.00	1.00	1.00	1.00	1.00	1.00
FinalVolume:	454	472	100	178	349	76	61	455	99	92	993	290

Saturation Flow Module:												
Sat/Lane:	1900	1900	1900	1900	1900	1900	1900	1900	1900	1900	1900	1900
Adjustment:	0.92	1.00	0.92	0.92	1.00	0.92	0.92	0.98	0.95	0.92	1.00	0.92
Lanes:	1.00	2.00	1.00	1.00	2.00	1.00	1.00	1.63	0.37	1.00	1.00	1.00
Final Sat.:	1750	3800	1750	1750	3800	1750	1750	3038	661	1750	1900	1750

Capacity Analysis Module:												
Vol/Sat:	0.26	0.12	0.06	0.10	0.09	0.04	0.03	0.15	0.15	0.05	0.52	0.17
Crit Moves:	***				***		***				***	
Green Time:	35.9	26.7	47.4	21.9	12.7	19.7	7.0	58.7	58.7	20.6	72.4	72.4
Volume/Cap:	1.01	0.65	0.17	0.65	1.01	0.31	0.70	0.36	0.36	0.36	1.01	0.32
Delay/Veh:	97.3	54.4	32.6	60.9	115	54.7	87.3	27.9	27.9	54.6	65.3	19.8
User DelAdj:	1.00	1.00	1.00	1.00	1.00	1.00	1.00	1.00	1.00	1.00	1.00	1.00
AdjDel/Veh:	97.3	54.4	32.6	60.9	115	54.7	87.3	27.9	27.9	54.6	65.3	19.8
LOS by Move:	F	D	C	E	F	D	F	C	C	D	E	B
HCM2kAvgQ:	27	10	3	8	9	3	4	8	8	4	50	8

Note: Queue reported is the number of cars per lane.

Voices School
Morgan Hill, CA
Hexagon Transportation Consultants, Inc.

Level Of Service Computation Report
2000 HCM Operations (Future Volume Alternative)
Existing Plus Project (AM) - 3 Monterey out

Intersection #1004: Church Street and Dunne Avenue

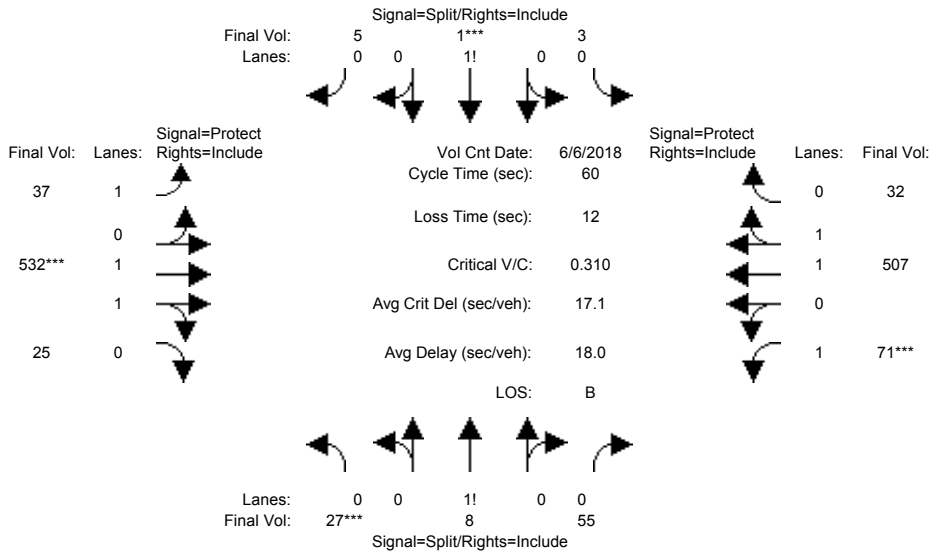

Street Name:	Church Street						Dunne Avenue					
	North Bound			South Bound			East Bound			West Bound		
Approach:	L	T	R	L	T	R	L	T	R	L	T	R
Min. Green:	10	10	10	10	10	10	7	10	10	7	10	10
Y+R:	4.0	4.0	4.0	4.0	4.0	4.0	4.0	4.0	4.0	4.0	4.0	4.0

Volume Module:	>>	Count	Date:	6 Jun 2018	<<											
Base Vol:	27	8	55	3	1	5	37	402	25	71	431	32				
Growth Adj:	1.00	1.00	1.00	1.00	1.00	1.00	1.00	1.00	1.00	1.00	1.00	1.00				
Initial Bse:	27	8	55	3	1	5	37	402	25	71	431	32				
Added Vol:	0	0	0	0	0	0	0	130	0	0	76	0				
PasserByVol:	0	0	0	0	0	0	0	0	0	0	0	0				
Initial Fut:	27	8	55	3	1	5	37	532	25	71	507	32				
User Adj:	1.00	1.00	1.00	1.00	1.00	1.00	1.00	1.00	1.00	1.00	1.00	1.00				
PHF Adj:	1.00	1.00	1.00	1.00	1.00	1.00	1.00	1.00	1.00	1.00	1.00	1.00				
PHF Volume:	27	8	55	3	1	5	37	532	25	71	507	32				
Reduct Vol:	0	0	0	0	0	0	0	0	0	0	0	0				
Reduced Vol:	27	8	55	3	1	5	37	532	25	71	507	32				
PCE Adj:	1.00	1.00	1.00	1.00	1.00	1.00	1.00	1.00	1.00	1.00	1.00	1.00				
MLF Adj:	1.00	1.00	1.00	1.00	1.00	1.00	1.00	1.00	1.00	1.00	1.00	1.00				
FinalVolume:	27	8	55	3	1	5	37	532	25	71	507	32				

Saturation Flow Module:												
Sat/Lane:	1900	1900	1900	1900	1900	1900	1900	1900	1900	1900	1900	1900
Adjustment:	0.92	0.92	0.92	0.92	0.92	0.92	0.92	0.97	0.95	0.92	0.98	0.95
Lanes:	0.30	0.09	0.61	0.33	0.11	0.56	1.00	1.91	0.09	1.00	1.88	0.12
Final Sat.:	525	156	1069	583	194	972	1750	3534	166	1750	3480	220

Capacity Analysis Module:												
Vol/Sat:	0.05	0.05	0.05	0.01	0.01	0.01	0.02	0.15	0.15	0.04	0.15	0.15
Crit Moves:	***				***			***		***		
Green Time:	10.0	10.0	10.0	10.0	10.0	10.0	11.5	21.0	21.0	7.0	16.5	16.5
Volume/Cap:	0.31	0.31	0.31	0.03	0.03	0.03	0.11	0.43	0.43	0.35	0.53	0.53
Delay/Veh:	22.6	22.6	22.6	21.0	21.0	21.0	20.1	15.2	15.2	25.4	19.0	19.0
User DelAdj:	1.00	1.00	1.00	1.00	1.00	1.00	1.00	1.00	1.00	1.00	1.00	1.00
AdjDel/Veh:	22.6	22.6	22.6	21.0	21.0	21.0	20.1	15.2	15.2	25.4	19.0	19.0
LOS by Move:	C	C	C	C	C	C	C	B	B	C	B	B
HCM2kAvgQ:	2	2	2	0	0	0	1	4	4	1	4	4

Note: Queue reported is the number of cars per lane.

Voices School
Morgan Hill, CA
Hexagon Transportation Consultants, Inc.

Level Of Service Computation Report
2000 HCM Operations (Future Volume Alternative)
Existing Plus Project (PM) - 3 Monterey out

Intersection #1004: Church Street and Dunne Avenue

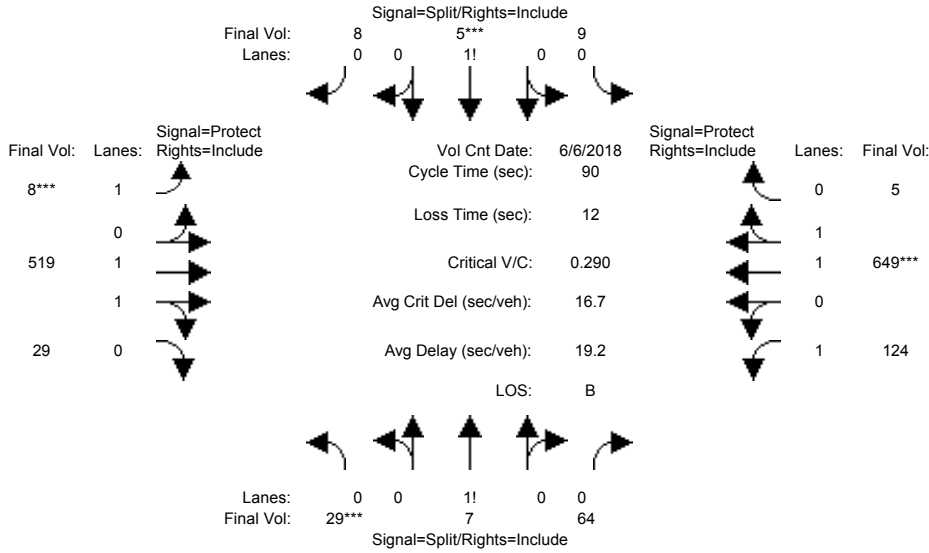

Street Name:	Church Street						Dunne Avenue					
	North Bound			South Bound			East Bound			West Bound		
Approach:	L	T	R	L	T	R	L	T	R	L	T	R
Min. Green:	10	10	10	10	10	10	7	10	10	7	10	10
Y+R:	4.0	4.0	4.0	4.0	4.0	4.0	4.0	4.0	4.0	4.0	4.0	4.0

Volume Module:	>>	Count	Date:	6 Jun 2018	<<							
Base Vol:	29	7	64	9	5	8	8	475	29	124	581	5
Growth Adj:	1.00	1.00	1.00	1.00	1.00	1.00	1.00	1.00	1.00	1.00	1.00	1.00
Initial Bse:	29	7	64	9	5	8	8	475	29	124	581	5
Added Vol:	0	0	0	0	0	0	0	44	0	0	68	0
PasserByVol:	0	0	0	0	0	0	0	0	0	0	0	0
Initial Fut:	29	7	64	9	5	8	8	519	29	124	649	5
User Adj:	1.00	1.00	1.00	1.00	1.00	1.00	1.00	1.00	1.00	1.00	1.00	1.00
PHF Adj:	1.00	1.00	1.00	1.00	1.00	1.00	1.00	1.00	1.00	1.00	1.00	1.00
PHF Volume:	29	7	64	9	5	8	8	519	29	124	649	5
Reduct Vol:	0	0	0	0	0	0	0	0	0	0	0	0
Reduced Vol:	29	7	64	9	5	8	8	519	29	124	649	5
PCE Adj:	1.00	1.00	1.00	1.00	1.00	1.00	1.00	1.00	1.00	1.00	1.00	1.00
MLF Adj:	1.00	1.00	1.00	1.00	1.00	1.00	1.00	1.00	1.00	1.00	1.00	1.00
FinalVolume:	29	7	64	9	5	8	8	519	29	124	649	5

Saturation Flow Module:												
Sat/Lane:	1900	1900	1900	1900	1900	1900	1900	1900	1900	1900	1900	1900
Adjustment:	0.92	0.92	0.92	0.92	0.92	0.92	0.92	0.98	0.95	0.92	0.97	0.95
Lanes:	0.29	0.07	0.64	0.41	0.23	0.36	1.00	1.89	0.11	1.00	1.98	0.02
Final Sat.:	508	123	1120	716	398	636	1750	3504	196	1750	3672	28

Capacity Analysis Module:												
Vol/Sat:	0.06	0.06	0.06	0.01	0.01	0.01	0.00	0.15	0.15	0.07	0.18	0.18
Crit Moves:	****				****		****				****	
Green Time:	14.9	14.9	14.9	10.0	10.0	10.0	7.0	34.8	34.8	18.3	46.1	46.1
Volume/Cap:	0.35	0.35	0.35	0.11	0.11	0.11	0.06	0.38	0.38	0.35	0.35	0.35
Delay/Veh:	33.9	33.9	33.9	36.3	36.3	36.3	38.6	20.0	20.0	31.3	13.1	13.1
User DelAdj:	1.00	1.00	1.00	1.00	1.00	1.00	1.00	1.00	1.00	1.00	1.00	1.00
AdjDel/Veh:	33.9	33.9	33.9	36.3	36.3	36.3	38.6	20.0	20.0	31.3	13.1	13.1
LOS by Move:	C	C	C	D	D	D	D	C	C	C	B	B
HCM2kAvgQ:	3	3	3	1	1	1	0	5	5	3	5	5

Note: Queue reported is the number of cars per lane.

Voices School
Morgan Hill, CA
Hexagon Transportation Consultants, Inc.

Level Of Service Computation Report
2000 HCM Operations (Future Volume Alternative)
2025 Plus Project (AM) - 3 Monterey out

Intersection #1004: Church Street and Dunne Avenue

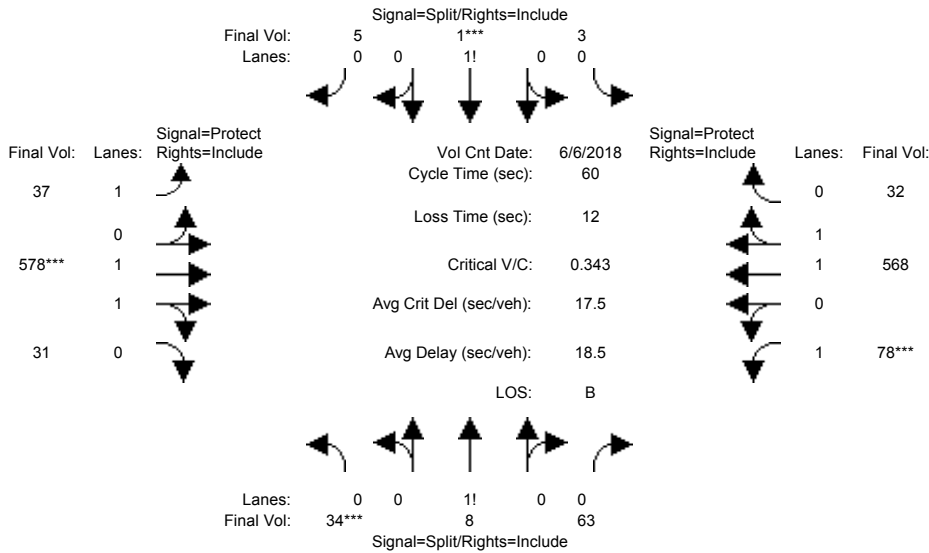

Street Name:	Church Street						Dunne Avenue					
	North Bound			South Bound			East Bound			West Bound		
Approach:	L	T	R	L	T	R	L	T	R	L	T	R
Min. Green:	10	10	10	10	10	10	7	10	10	7	10	10
Y+R:	4.0	4.0	4.0	4.0	4.0	4.0	4.0	4.0	4.0	4.0	4.0	4.0

Volume Module:	>>	Count	Date:	6 Jun 2018	<<							
Base Vol:	27	8	55	3	1	5	37	402	25	71	431	32
Growth Adj:	1.00	1.00	1.00	1.00	1.00	1.00	1.00	1.00	1.00	1.00	1.00	1.00
Initial Bse:	27	8	55	3	1	5	37	402	25	71	431	32
Added Vol:	0	0	0	0	0	0	0	126	0	0	74	0
PasserByVol:	7	0	8	0	0	0	0	50	6	7	63	0
Initial Fut:	34	8	63	3	1	5	37	578	31	78	568	32
User Adj:	1.00	1.00	1.00	1.00	1.00	1.00	1.00	1.00	1.00	1.00	1.00	1.00
PHF Adj:	1.00	1.00	1.00	1.00	1.00	1.00	1.00	1.00	1.00	1.00	1.00	1.00
PHF Volume:	34	8	63	3	1	5	37	578	31	78	568	32
Reduct Vol:	0	0	0	0	0	0	0	0	0	0	0	0
Reduced Vol:	34	8	63	3	1	5	37	578	31	78	568	32
PCE Adj:	1.00	1.00	1.00	1.00	1.00	1.00	1.00	1.00	1.00	1.00	1.00	1.00
MLF Adj:	1.00	1.00	1.00	1.00	1.00	1.00	1.00	1.00	1.00	1.00	1.00	1.00
FinalVolume:	34	8	63	3	1	5	37	578	31	78	568	32

Saturation Flow Module:												
Sat/Lane:	1900	1900	1900	1900	1900	1900	1900	1900	1900	1900	1900	1900
Adjustment:	0.92	0.92	0.92	0.92	0.92	0.92	0.92	0.98	0.95	0.92	0.98	0.95
Lanes:	0.32	0.08	0.60	0.33	0.11	0.56	1.00	1.90	0.10	1.00	1.89	0.11
Final Sat.:	567	133	1050	583	194	972	1750	3512	188	1750	3503	197

Capacity Analysis Module:												
Vol/Sat:	0.06	0.06	0.06	0.01	0.01	0.01	0.02	0.16	0.16	0.04	0.16	0.16
Crit Moves:	****				****			****		****		
Green Time:	10.0	10.0	10.0	10.0	10.0	10.0	11.5	21.0	21.0	7.0	16.5	16.5
Volume/Cap:	0.36	0.36	0.36	0.03	0.03	0.03	0.11	0.47	0.47	0.38	0.59	0.59
Delay/Veh:	22.9	22.9	22.9	21.0	21.0	21.0	20.1	15.4	15.4	25.7	19.8	19.8
User DelAdj:	1.00	1.00	1.00	1.00	1.00	1.00	1.00	1.00	1.00	1.00	1.00	1.00
AdjDel/Veh:	22.9	22.9	22.9	21.0	21.0	21.0	20.1	15.4	15.4	25.7	19.8	19.8
LOS by Move:	C	C	C	C	C	C	C	B	B	C	B	B
HCM2kAvgQ:	2	2	2	0	0	0	1	4	4	1	5	5

Note: Queue reported is the number of cars per lane.

Voices School
Morgan Hill, CA
Hexagon Transportation Consultants, Inc.

Level Of Service Computation Report
2000 HCM Operations (Future Volume Alternative)
2025 Plus Project (PM) - 3 Monterey out

Intersection #1004: Church Street and Dunne Avenue

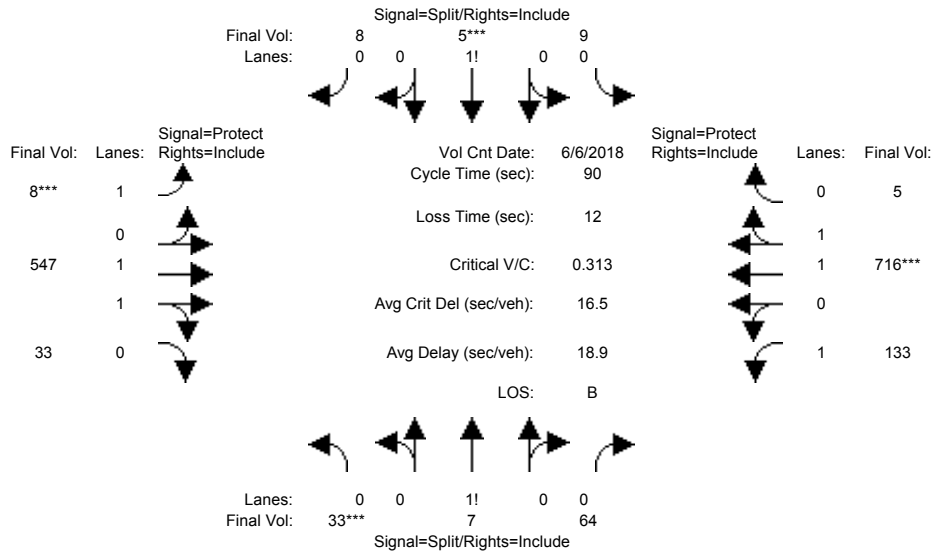

Street Name:	Church Street						Dunne Avenue					
	North Bound			South Bound			East Bound			West Bound		
Approach:	L	T	R	L	T	R	L	T	R	L	T	R
Min. Green:	10	10	10	10	10	10	7	10	10	7	10	10
Y+R:	4.0	4.0	4.0	4.0	4.0	4.0	4.0	4.0	4.0	4.0	4.0	4.0

Volume Module:	>>	Count	Date:	6 Jun 2018	<<							
Base Vol:	29	7	64	9	5	8	8	475	29	124	581	5
Growth Adj:	1.00	1.00	1.00	1.00	1.00	1.00	1.00	1.00	1.00	1.00	1.00	1.00
Initial Bse:	29	7	64	9	5	8	8	475	29	124	581	5
Added Vol:	0	0	0	0	0	0	0	41	0	0	64	0
PasserByVol:	4	0	0	0	0	0	0	31	4	9	71	0
Initial Fut:	33	7	64	9	5	8	8	547	33	133	716	5
User Adj:	1.00	1.00	1.00	1.00	1.00	1.00	1.00	1.00	1.00	1.00	1.00	1.00
PHF Adj:	1.00	1.00	1.00	1.00	1.00	1.00	1.00	1.00	1.00	1.00	1.00	1.00
PHF Volume:	33	7	64	9	5	8	8	547	33	133	716	5
Reduct Vol:	0	0	0	0	0	0	0	0	0	0	0	0
Reduced Vol:	33	7	64	9	5	8	8	547	33	133	716	5
PCE Adj:	1.00	1.00	1.00	1.00	1.00	1.00	1.00	1.00	1.00	1.00	1.00	1.00
MLF Adj:	1.00	1.00	1.00	1.00	1.00	1.00	1.00	1.00	1.00	1.00	1.00	1.00
FinalVolume:	33	7	64	9	5	8	8	547	33	133	716	5

Saturation Flow Module:												
Sat/Lane:	1900	1900	1900	1900	1900	1900	1900	1900	1900	1900	1900	1900
Adjustment:	0.92	0.92	0.92	0.92	0.92	0.92	0.92	0.98	0.95	0.92	0.97	0.95
Lanes:	0.32	0.07	0.61	0.41	0.23	0.36	1.00	1.88	0.12	1.00	1.99	0.01
Final Sat.:	555	118	1077	716	398	636	1750	3489	211	1750	3674	26

Capacity Analysis Module:												
Vol/Sat:	0.06	0.06	0.06	0.01	0.01	0.01	0.00	0.16	0.16	0.08	0.19	0.19
Crit Moves:	***				***		***				***	
Green Time:	14.3	14.3	14.3	10.0	10.0	10.0	7.0	35.9	35.9	17.8	46.7	46.7
Volume/Cap:	0.38	0.38	0.38	0.11	0.11	0.11	0.06	0.39	0.39	0.38	0.38	0.38
Delay/Veh:	34.7	34.7	34.7	36.3	36.3	36.3	38.6	19.4	19.4	32.0	13.0	13.0
User DelAdj:	1.00	1.00	1.00	1.00	1.00	1.00	1.00	1.00	1.00	1.00	1.00	1.00
AdjDel/Veh:	34.7	34.7	34.7	36.3	36.3	36.3	38.6	19.4	19.4	32.0	13.0	13.0
LOS by Move:	C	C	C	D	D	D	D	B	B	C	B	B
HCM2kAvgQ:	3	3	3	1	1	1	0	6	6	3	6	6

Note: Queue reported is the number of cars per lane.

Voices School
Morgan Hill, CA
Hexagon Transportation Consultants, Inc.

Level Of Service Computation Report
2000 HCM Operations (Future Volume Alternative)
Existing Plus Project (AM) - 3 Monterey out

Intersection #1008: Butterfield Boulevard and San Pedro Avenue

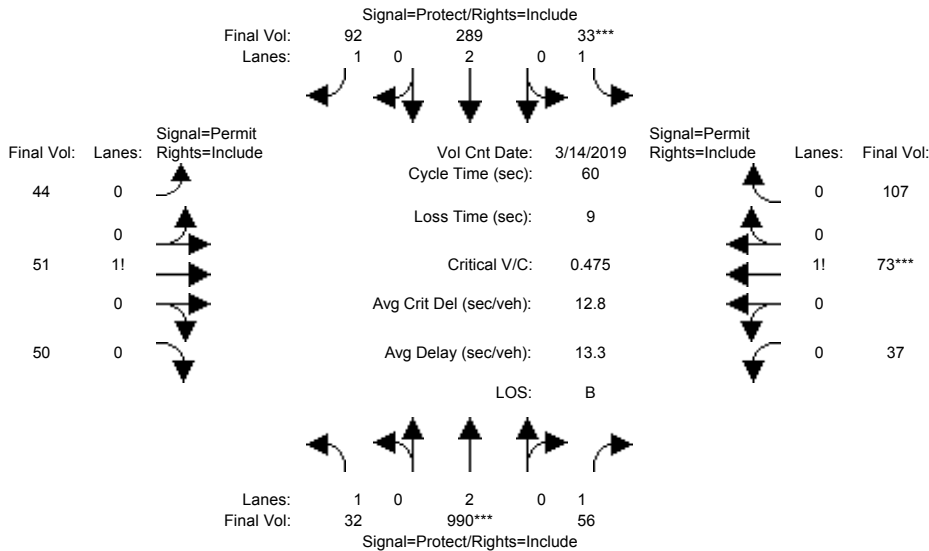

Street Name:	Butterfield Boulevard						San Pedro Avenue					
	North Bound			South Bound			East Bound			West Bound		
Approach:	L	T	R	L	T	R	L	T	R	L	T	R
Min. Green:	7	10	10	7	10	10	10	10	10	10	10	10
Y+R:	4.0	4.0	4.0	4.0	4.0	4.0	4.0	4.0	4.0	4.0	4.0	4.0

Volume Module:	>>	Count	Date:	14 Mar 2019	<<											
Base Vol:	32	990	56	33	289	92	44	46	50	37	60	107				
Growth Adj:	1.00	1.00	1.00	1.00	1.00	1.00	1.00	1.00	1.00	1.00	1.00	1.00				
Initial Bse:	32	990	56	33	289	92	44	46	50	37	60	107				
Added Vol:	0	0	0	0	0	0	0	5	0	0	13	0				
PasserByVol:	0	0	0	0	0	0	0	0	0	0	0	0				
Initial Fut:	32	990	56	33	289	92	44	51	50	37	73	107				
User Adj:	1.00	1.00	1.00	1.00	1.00	1.00	1.00	1.00	1.00	1.00	1.00	1.00				
PHF Adj:	1.00	1.00	1.00	1.00	1.00	1.00	1.00	1.00	1.00	1.00	1.00	1.00				
PHF Volume:	32	990	56	33	289	92	44	51	50	37	73	107				
Reduct Vol:	0	0	0	0	0	0	0	0	0	0	0	0				
Reduced Vol:	32	990	56	33	289	92	44	51	50	37	73	107				
PCE Adj:	1.00	1.00	1.00	1.00	1.00	1.00	1.00	1.00	1.00	1.00	1.00	1.00				
MLF Adj:	1.00	1.00	1.00	1.00	1.00	1.00	1.00	1.00	1.00	1.00	1.00	1.00				
FinalVolume:	32	990	56	33	289	92	44	51	50	37	73	107				

Saturation Flow Module:												
Sat/Lane:	1900	1900	1900	1900	1900	1900	1900	1900	1900	1900	1900	1900
Adjustment:	0.92	1.00	0.92	0.92	1.00	0.92	0.92	0.92	0.92	0.92	0.92	0.92
Lanes:	1.00	2.00	1.00	1.00	2.00	1.00	0.30	0.36	0.34	0.17	0.34	0.49
Final Sat.:	1750	3800	1750	1750	3800	1750	531	616	603	298	589	863

Capacity Analysis Module:												
Vol/Sat:	0.02	0.26	0.03	0.02	0.08	0.05	0.08	0.08	0.08	0.12	0.12	0.12
Crit Moves:	****			****						****		
Green Time:	15.2	29.8	29.8	7.0	21.7	21.7	14.2	14.2	14.2	14.2	14.2	14.2
Volume/Cap:	0.07	0.52	0.06	0.16	0.21	0.15	0.35	0.35	0.35	0.52	0.52	0.52
Delay/Veh:	17.1	10.5	7.9	24.2	13.3	13.0	19.6	19.6	19.6	21.2	21.2	21.2
User DelAdj:	1.00	1.00	1.00	1.00	1.00	1.00	1.00	1.00	1.00	1.00	1.00	1.00
AdjDel/Veh:	17.1	10.5	7.9	24.2	13.3	13.0	19.6	19.6	19.6	21.2	21.2	21.2
LOS by Move:	B	B	A	C	B	B	B	B	B	C	C	C
HCM2kAvgQ:	0	6	1	1	2	1	3	3	3	4	4	4

Note: Queue reported is the number of cars per lane.

Voices School
Morgan Hill, CA
Hexagon Transportation Consultants, Inc.

Level Of Service Computation Report
2000 HCM Operations (Future Volume Alternative)
Existing Plus Project (PM) - 3 Monterey out

Intersection #1008: Butterfield Boulevard and San Pedro Avenue

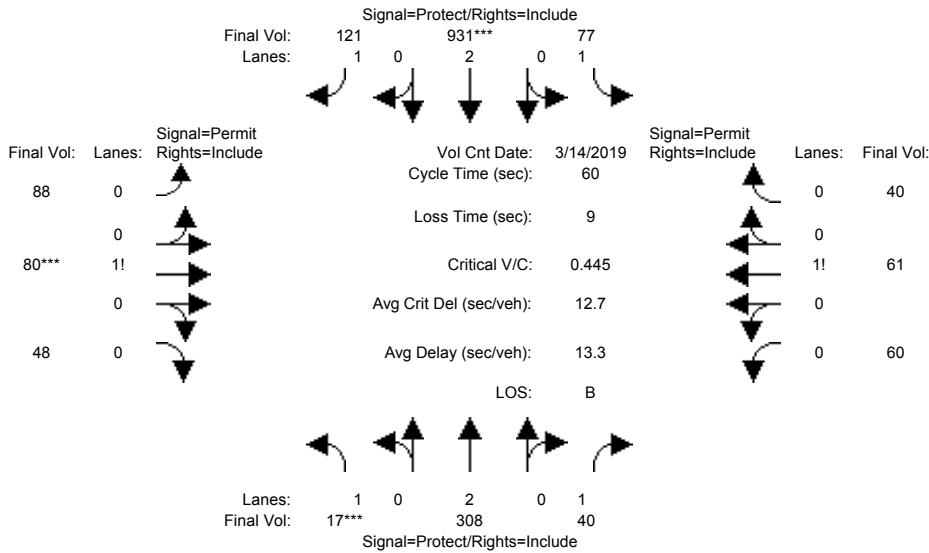

Street Name:	Butterfield Boulevard						San Pedro Avenue					
	North Bound			South Bound			East Bound			West Bound		
Approach:	L	T	R	L	T	R	L	T	R	L	T	R
Min. Green:	7	10	10	7	10	10	10	10	10	10	10	10
Y+R:	4.0	4.0	4.0	4.0	4.0	4.0	4.0	4.0	4.0	4.0	4.0	4.0

Volume Module:	>>	Count	Date:	14 Mar 2019	<<							
Base Vol:	17	308	40	77	931	121	88	72	48	60	58	40
Growth Adj:	1.00	1.00	1.00	1.00	1.00	1.00	1.00	1.00	1.00	1.00	1.00	1.00
Initial Bse:	17	308	40	77	931	121	88	72	48	60	58	40
Added Vol:	0	0	0	0	0	0	0	8	0	0	3	0
PasserByVol:	0	0	0	0	0	0	0	0	0	0	0	0
Initial Fut:	17	308	40	77	931	121	88	80	48	60	61	40
User Adj:	1.00	1.00	1.00	1.00	1.00	1.00	1.00	1.00	1.00	1.00	1.00	1.00
PHF Adj:	1.00	1.00	1.00	1.00	1.00	1.00	1.00	1.00	1.00	1.00	1.00	1.00
PHF Volume:	17	308	40	77	931	121	88	80	48	60	61	40
Reduct Vol:	0	0	0	0	0	0	0	0	0	0	0	0
Reduced Vol:	17	308	40	77	931	121	88	80	48	60	61	40
PCE Adj:	1.00	1.00	1.00	1.00	1.00	1.00	1.00	1.00	1.00	1.00	1.00	1.00
MLF Adj:	1.00	1.00	1.00	1.00	1.00	1.00	1.00	1.00	1.00	1.00	1.00	1.00
Final Volume:	17	308	40	77	931	121	88	80	48	60	61	40

Saturation Flow Module:												
Sat/Lane:	1900	1900	1900	1900	1900	1900	1900	1900	1900	1900	1900	1900
Adjustment:	0.92	1.00	0.92	0.92	1.00	0.92	0.92	0.92	0.92	0.92	0.92	0.92
Lanes:	1.00	2.00	1.00	1.00	2.00	1.00	0.41	0.37	0.22	0.37	0.38	0.25
Final Sat.:	1750	3800	1750	1750	3800	1750	713	648	389	652	663	435

Capacity Analysis Module:												
Vol/Sat:	0.01	0.08	0.02	0.04	0.25	0.07	0.12	0.12	0.12	0.09	0.09	0.09
Crit Moves:	****				****			****				
Green Time:	7.0	21.3	21.3	14.9	29.3	29.3	14.7	14.7	14.7	14.7	14.7	14.7
Volume/Cap:	0.08	0.23	0.06	0.18	0.50	0.14	0.50	0.50	0.50	0.37	0.37	0.37
Delay/Veh:	23.8	13.6	12.8	17.9	10.6	8.5	20.4	20.4	20.4	19.4	19.4	19.4
User DelAdj:	1.00	1.00	1.00	1.00	1.00	1.00	1.00	1.00	1.00	1.00	1.00	1.00
AdjDel/Veh:	23.8	13.6	12.8	17.9	10.6	8.5	20.4	20.4	20.4	19.4	19.4	19.4
LOS by Move:	C	B	B	B	B	A	C	C	C	B	B	B
HCM2kAvgQ:	0	2	1	1	6	1	4	4	4	3	3	3

Note: Queue reported is the number of cars per lane.

Voices School
Morgan Hill, CA
Hexagon Transportation Consultants, Inc.

Level Of Service Computation Report
2000 HCM Operations (Future Volume Alternative)
2025 Plus Project (AM) - 3 Monterey out

Intersection #1008: Butterfield Boulevard and San Pedro Avenue

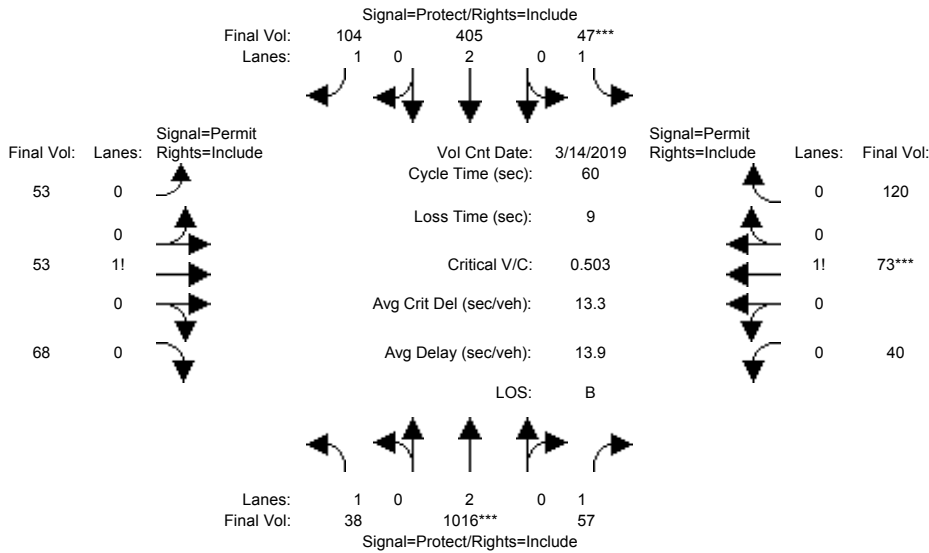

Street Name:	Butterfield Boulevard						San Pedro Avenue					
	North Bound			South Bound			East Bound			West Bound		
Approach:	L	T	R	L	T	R	L	T	R	L	T	R
Min. Green:	7	10	10	7	10	10	10	10	10	10	10	10
Y+R:	4.0	4.0	4.0	4.0	4.0	4.0	4.0	4.0	4.0	4.0	4.0	4.0

Volume Module:	>>	Count	Date:	14 Mar 2019	<<							
Base Vol:	32	990	56	33	289	92	44	46	50	37	60	107
Growth Adj:	1.00	1.00	1.00	1.00	1.00	1.00	1.00	1.00	1.00	1.00	1.00	1.00
Initial Bse:	32	990	56	33	289	92	44	46	50	37	60	107
Added Vol:	0	0	0	0	0	0	0	5	0	0	13	0
PasserByVol:	6	26	1	14	116	12	9	2	18	3	0	13
Initial Fut:	38	1016	57	47	405	104	53	53	68	40	73	120
User Adj:	1.00	1.00	1.00	1.00	1.00	1.00	1.00	1.00	1.00	1.00	1.00	1.00
PHF Adj:	1.00	1.00	1.00	1.00	1.00	1.00	1.00	1.00	1.00	1.00	1.00	1.00
PHF Volume:	38	1016	57	47	405	104	53	53	68	40	73	120
Reduct Vol:	0	0	0	0	0	0	0	0	0	0	0	0
Reduced Vol:	38	1016	57	47	405	104	53	53	68	40	73	120
PCE Adj:	1.00	1.00	1.00	1.00	1.00	1.00	1.00	1.00	1.00	1.00	1.00	1.00
MLF Adj:	1.00	1.00	1.00	1.00	1.00	1.00	1.00	1.00	1.00	1.00	1.00	1.00
Final Volume:	38	1016	57	47	405	104	53	53	68	40	73	120

Saturation Flow Module:												
Sat/Lane:	1900	1900	1900	1900	1900	1900	1900	1900	1900	1900	1900	1900
Adjustment:	0.92	1.00	0.92	0.92	1.00	0.92	0.92	0.92	0.92	0.92	0.92	0.92
Lanes:	1.00	2.00	1.00	1.00	2.00	1.00	0.30	0.30	0.40	0.17	0.31	0.52
Final Sat.:	1750	3800	1750	1750	3800	1750	533	533	684	300	548	901

Capacity Analysis Module:												
Vol/Sat:	0.02	0.27	0.03	0.03	0.11	0.06	0.10	0.10	0.10	0.13	0.13	0.13
Crit Moves:	****			****						****		
Green Time:	15.0	29.4	29.4	7.0	21.4	21.4	14.6	14.6	14.6	14.6	14.6	14.6
Volume/Cap:	0.09	0.55	0.07	0.23	0.30	0.17	0.41	0.41	0.41	0.55	0.55	0.55
Delay/Veh:	17.4	11.0	8.1	24.6	14.0	13.3	19.7	19.7	19.7	21.3	21.3	21.3
User DelAdj:	1.00	1.00	1.00	1.00	1.00	1.00	1.00	1.00	1.00	1.00	1.00	1.00
AdjDel/Veh:	17.4	11.0	8.1	24.6	14.0	13.3	19.7	19.7	19.7	21.3	21.3	21.3
LOS by Move:	B	B	A	C	B	B	B	B	B	C	C	C
HCM2kAvgQ:	1	6	1	1	3	1	3	3	3	5	5	5

Note: Queue reported is the number of cars per lane.

Voices School
Morgan Hill, CA
Hexagon Transportation Consultants, Inc.

Level Of Service Computation Report
2000 HCM Operations (Future Volume Alternative)
2025 Plus Project (PM) - 3 Monterey out

Intersection #1008: Butterfield Boulevard and San Pedro Avenue

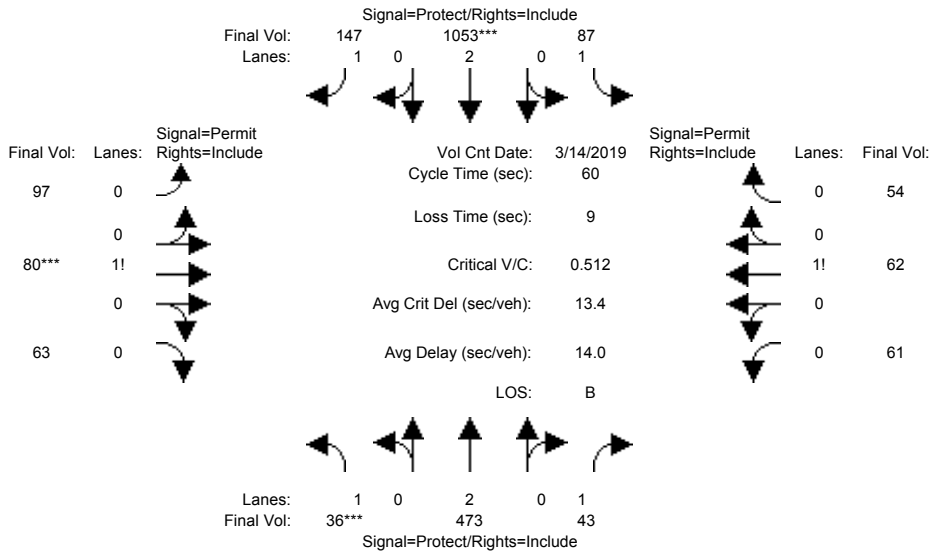

Street Name:	Butterfield Boulevard						San Pedro Avenue					
	North Bound			South Bound			East Bound			West Bound		
Approach:	L	T	R	L	T	R	L	T	R	L	T	R
Min. Green:	7	10	10	7	10	10	10	10	10	10	10	10
Y+R:	4.0	4.0	4.0	4.0	4.0	4.0	4.0	4.0	4.0	4.0	4.0	4.0

Volume Module:	>>	Count	Date:	14 Mar 2019	<<							
Base Vol:	17	308	40	77	931	121	88	72	48	60	58	40
Growth Adj:	1.00	1.00	1.00	1.00	1.00	1.00	1.00	1.00	1.00	1.00	1.00	1.00
Initial Bse:	17	308	40	77	931	121	88	72	48	60	58	40
Added Vol:	0	0	0	0	0	0	0	8	0	0	3	0
PasserByVol:	19	165	3	10	122	26	9	0	15	1	1	14
Initial Fut:	36	473	43	87	1053	147	97	80	63	61	62	54
User Adj:	1.00	1.00	1.00	1.00	1.00	1.00	1.00	1.00	1.00	1.00	1.00	1.00
PHF Adj:	1.00	1.00	1.00	1.00	1.00	1.00	1.00	1.00	1.00	1.00	1.00	1.00
PHF Volume:	36	473	43	87	1053	147	97	80	63	61	62	54
Reduct Vol:	0	0	0	0	0	0	0	0	0	0	0	0
Reduced Vol:	36	473	43	87	1053	147	97	80	63	61	62	54
PCE Adj:	1.00	1.00	1.00	1.00	1.00	1.00	1.00	1.00	1.00	1.00	1.00	1.00
MLF Adj:	1.00	1.00	1.00	1.00	1.00	1.00	1.00	1.00	1.00	1.00	1.00	1.00
FinalVolume:	36	473	43	87	1053	147	97	80	63	61	62	54

Saturation Flow Module:												
Sat/Lane:	1900	1900	1900	1900	1900	1900	1900	1900	1900	1900	1900	1900
Adjustment:	0.92	1.00	0.92	0.92	1.00	0.92	0.92	0.92	0.92	0.92	0.92	0.92
Lanes:	1.00	2.00	1.00	1.00	2.00	1.00	0.41	0.33	0.26	0.34	0.35	0.31
Final Sat.:	1750	3800	1750	1750	3800	1750	707	583	459	603	613	534

Capacity Analysis Module:												
Vol/Sat:	0.02	0.12	0.02	0.05	0.28	0.08	0.14	0.14	0.14	0.10	0.10	0.10
Crit Moves:	****				****			****				
Green Time:	7.0	21.4	21.4	15.0	29.4	29.4	14.6	14.6	14.6	14.6	14.6	14.6
Volume/Cap:	0.18	0.35	0.07	0.20	0.56	0.17	0.56	0.56	0.56	0.42	0.42	0.42
Delay/Veh:	24.3	14.3	12.8	18.0	11.2	8.6	21.7	21.7	21.7	19.8	19.8	19.8
User DelAdj:	1.00	1.00	1.00	1.00	1.00	1.00	1.00	1.00	1.00	1.00	1.00	1.00
AdjDel/Veh:	24.3	14.3	12.8	18.0	11.2	8.6	21.7	21.7	21.7	19.8	19.8	19.8
LOS by Move:	C	B	B	B	B	A	C	C	C	B	B	B
HCM2kAvgQ:	1	3	1	1	7	2	5	5	5	3	3	3

Note: Queue reported is the number of cars per lane.

Voices School
Morgan Hill, CA
Hexagon Transportation Consultants, Inc.

Level Of Service Computation Report
2000 HCM Operations (Future Volume Alternative)
Existing Plus Project (AM) - 3 Monterey out

Intersection #1111: Butterfield Boulevard and Tennant Avenue

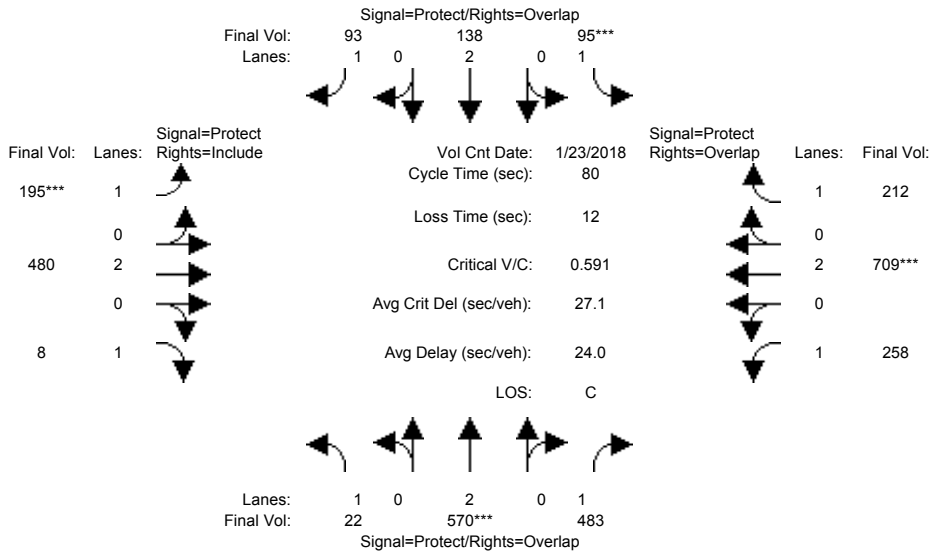

Street Name: Butterfield Boulevard Tennant Avenue
Approach: North Bound South Bound East Bound West Bound
Movement: L - T - R L - T - R L - T - R L - T - R

Min. Green:	7	10	10	7	10	10	7	10	10	7	10	10
Y+R:	4.0	4.0	4.0	4.0	4.0	4.0	4.0	4.0	4.0	4.0	4.0	4.0

Volume Module: >> Count Date: 23 Jan 2018 <<

Base Vol:	22	570	483	95	138	93	195	453	8	258	688	212
Growth Adj:	1.00	1.00	1.00	1.00	1.00	1.00	1.00	1.00	1.00	1.00	1.00	1.00
Initial Bse:	22	570	483	95	138	93	195	453	8	258	688	212
Added Vol:	0	0	0	0	0	0	0	27	0	0	21	0
PasserByVol:	0	0	0	0	0	0	0	0	0	0	0	0
Initial Fut:	22	570	483	95	138	93	195	480	8	258	709	212
User Adj:	1.00	1.00	1.00	1.00	1.00	1.00	1.00	1.00	1.00	1.00	1.00	1.00
PHF Adj:	1.00	1.00	1.00	1.00	1.00	1.00	1.00	1.00	1.00	1.00	1.00	1.00
PHF Volume:	22	570	483	95	138	93	195	480	8	258	709	212
Reduct Vol:	0	0	0	0	0	0	0	0	0	0	0	0
Reduced Vol:	22	570	483	95	138	93	195	480	8	258	709	212
PCE Adj:	1.00	1.00	1.00	1.00	1.00	1.00	1.00	1.00	1.00	1.00	1.00	1.00
MLF Adj:	1.00	1.00	1.00	1.00	1.00	1.00	1.00	1.00	1.00	1.00	1.00	1.00
FinalVolume:	22	570	483	95	138	93	195	480	8	258	709	212

Saturation Flow Module:

Sat/Lane:	1900	1900	1900	1900	1900	1900	1900	1900	1900	1900	1900	1900
Adjustment:	0.92	1.00	0.92	0.92	1.00	0.92	0.92	1.00	0.92	0.92	1.00	0.92
Lanes:	1.00	2.00	1.00	1.00	2.00	1.00	1.00	2.00	1.00	1.00	2.00	1.00
Final Sat.:	1750	3800	1750	1750	3800	1750	1750	3800	1750	1750	3800	1750

Capacity Analysis Module:

Vol/Sat:	0.01	0.15	0.28	0.05	0.04	0.05	0.11	0.13	0.00	0.15	0.19	0.12
Crit Moves:	****			****			****				****	
Green Time:	11.4	20.3	42.0	7.3	16.3	31.4	15.1	18.6	18.6	21.7	25.3	32.6
Volume/Cap:	0.09	0.59	0.53	0.59	0.18	0.14	0.59	0.54	0.02	0.54	0.59	0.30
Delay/Veh:	30.0	27.2	13.0	40.6	26.5	15.7	32.5	27.6	23.7	26.2	23.8	16.2
User DelAdj:	1.00	1.00	1.00	1.00	1.00	1.00	1.00	1.00	1.00	1.00	1.00	1.00
AdjDel/Veh:	30.0	27.2	13.0	40.6	26.5	15.7	32.5	27.6	23.7	26.2	23.8	16.2
LOS by Move:	C	C	B	D	C	B	C	C	C	C	C	B
HCM2kAvgQ:	1	7	9	3	1	2	5	5	0	6	8	4

Note: Queue reported is the number of cars per lane.

Voices School
Morgan Hill, CA
Hexagon Transportation Consultants, Inc.

Level Of Service Computation Report
2000 HCM Operations (Future Volume Alternative)
Existing Plus Project (PM) - 3 Monterey out

Intersection #1111: Butterfield Boulevard and Tennant Avenue

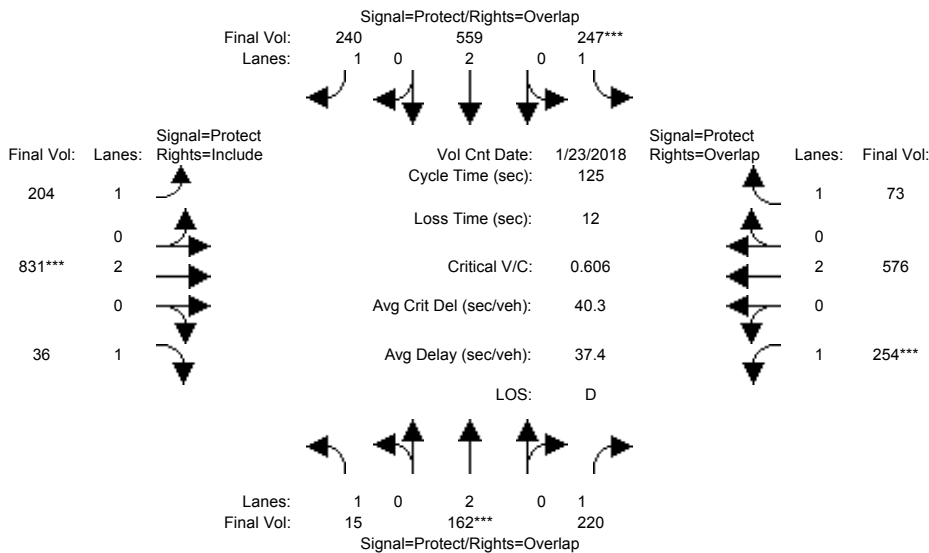

Street Name:	Butterfield Boulevard						Tennant Avenue					
Approach:	North Bound			South Bound			East Bound			West Bound		
Movement:	L	T	R	L	T	R	L	T	R	L	T	R
Min. Green:	7	10	10	7	10	10	7	10	10	7	10	10
Y+R:	4.0	4.0	4.0	4.0	4.0	4.0	4.0	4.0	4.0	4.0	4.0	4.0

Volume Module:	>>	Count	Date:	23 Jan 2018	<<											
Base Vol:	15	162	220	247	559	240	204	819	36	254	562	73				
Growth Adj:	1.00	1.00	1.00	1.00	1.00	1.00	1.00	1.00	1.00	1.00	1.00	1.00				
Initial Bse:	15	162	220	247	559	240	204	819	36	254	562	73				
Added Vol:	0	0	0	0	0	0	0	12	0	0	14	0				
PasserByVol:	0	0	0	0	0	0	0	0	0	0	0	0				
Initial Fut:	15	162	220	247	559	240	204	831	36	254	576	73				
User Adj:	1.00	1.00	1.00	1.00	1.00	1.00	1.00	1.00	1.00	1.00	1.00	1.00				
PHF Adj:	1.00	1.00	1.00	1.00	1.00	1.00	1.00	1.00	1.00	1.00	1.00	1.00				
PHF Volume:	15	162	220	247	559	240	204	831	36	254	576	73				
Reduct Vol:	0	0	0	0	0	0	0	0	0	0	0	0				
Reduced Vol:	15	162	220	247	559	240	204	831	36	254	576	73				
PCE Adj:	1.00	1.00	1.00	1.00	1.00	1.00	1.00	1.00	1.00	1.00	1.00	1.00				
MLF Adj:	1.00	1.00	1.00	1.00	1.00	1.00	1.00	1.00	1.00	1.00	1.00	1.00				
FinalVolume:	15	162	220	247	559	240	204	831	36	254	576	73				

Saturation Flow Module:												
Sat/Lane:	1900	1900	1900	1900	1900	1900	1900	1900	1900	1900	1900	1900
Adjustment:	0.92	1.00	0.92	0.92	1.00	0.92	0.92	1.00	0.92	0.92	1.00	0.92
Lanes:	1.00	2.00	1.00	1.00	2.00	1.00	1.00	2.00	1.00	1.00	2.00	1.00
Final Sat.:	1750	3800	1750	1750	3800	1750	1750	3800	1750	1750	3800	1750

Capacity Analysis Module:												
Vol/Sat:	0.01	0.04	0.13	0.14	0.15	0.14	0.12	0.22	0.02	0.15	0.15	0.04
Crit Moves:	****			****			****			****		
Green Time:	10.7	10.0	39.6	28.8	28.1	60.4	32.3	44.6	44.6	29.6	41.9	70.7
Volume/Cap:	0.10	0.53	0.40	0.61	0.65	0.28	0.45	0.61	0.06	0.61	0.45	0.07
Delay/Veh:	53.0	57.1	33.8	45.9	45.9	19.6	39.7	33.9	26.4	45.3	32.8	12.3
User DelAdj:	1.00	1.00	1.00	1.00	1.00	1.00	1.00	1.00	1.00	1.00	1.00	1.00
AdjDel/Veh:	53.0	57.1	33.8	45.9	45.9	19.6	39.7	33.9	26.4	45.3	32.8	12.3
LOS by Move:	D	E	C	D	D	B	D	C	C	D	C	B
HCM2kAvgQ:	1	4	7	9	10	6	7	13	1	10	9	1

Note: Queue reported is the number of cars per lane.

Voices School
Morgan Hill, CA
Hexagon Transportation Consultants, Inc.

Level Of Service Computation Report
2000 HCM Operations (Future Volume Alternative)
2025 Plus Project (AM) - 3 Monterey out

Intersection #1111: Butterfield Boulevard and Tennant Avenue

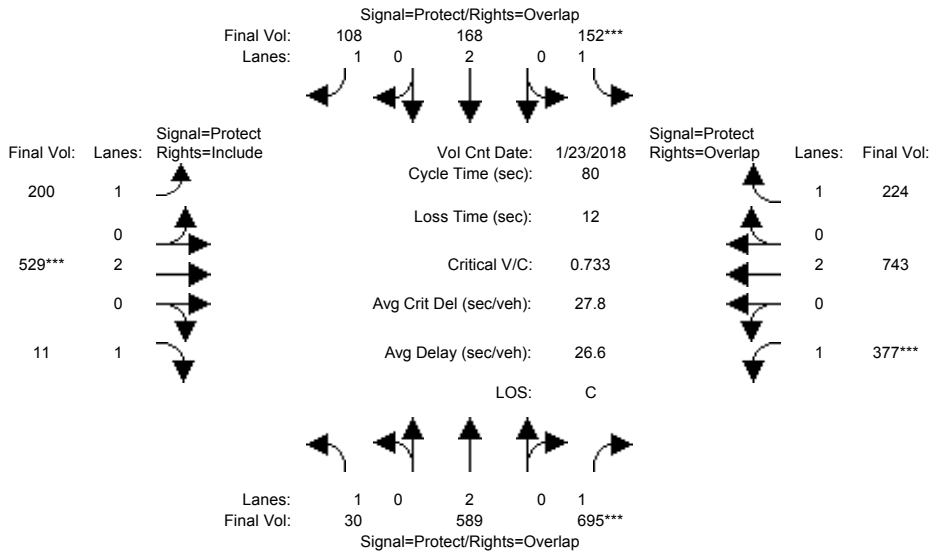

Street Name: Butterfield Boulevard Tennant Avenue
Approach: North Bound South Bound East Bound West Bound
Movement: L - T - R L - T - R L - T - R L - T - R

Min. Green: 7 10 10 7 10 10 7 10 10 7 10 10
Y+R: 4.0 4.0 4.0 4.0 4.0 4.0 4.0 4.0 4.0 4.0 4.0 4.0

Volume Module: >> Count Date: 23 Jan 2018 <<

Base Vol:	22	570	483	95	138	93	195	453	8	258	688	212
Growth Adj:	1.00	1.00	1.00	1.00	1.00	1.00	1.00	1.00	1.00	1.00	1.00	1.00
Initial Bse:	22	570	483	95	138	93	195	453	8	258	688	212
Added Vol:	0	0	0	0	0	0	0	26	0	0	20	0
PasserByVol:	8	19	212	57	30	15	5	50	3	119	35	12
Initial Fut:	30	589	695	152	168	108	200	529	11	377	743	224
User Adj:	1.00	1.00	1.00	1.00	1.00	1.00	1.00	1.00	1.00	1.00	1.00	1.00
PHF Adj:	1.00	1.00	1.00	1.00	1.00	1.00	1.00	1.00	1.00	1.00	1.00	1.00
PHF Volume:	30	589	695	152	168	108	200	529	11	377	743	224
Reduct Vol:	0	0	0	0	0	0	0	0	0	0	0	0
Reduced Vol:	30	589	695	152	168	108	200	529	11	377	743	224
PCE Adj:	1.00	1.00	1.00	1.00	1.00	1.00	1.00	1.00	1.00	1.00	1.00	1.00
MLF Adj:	1.00	1.00	1.00	1.00	1.00	1.00	1.00	1.00	1.00	1.00	1.00	1.00
FinalVolume:	30	589	695	152	168	108	200	529	11	377	743	224

Saturation Flow Module:

Sat/Lane:	1900	1900	1900	1900	1900	1900	1900	1900	1900	1900	1900	1900
Adjustment:	0.92	1.00	0.92	0.92	1.00	0.92	0.92	1.00	0.92	0.92	1.00	0.92
Lanes:	1.00	2.00	1.00	1.00	2.00	1.00	1.00	2.00	1.00	1.00	2.00	1.00
Final Sat.:	1750	3800	1750	1750	3800	1750	1750	3800	1750	1750	3800	1750

Capacity Analysis Module:

Vol/Sat:	0.02	0.16	0.40	0.09	0.04	0.06	0.11	0.14	0.01	0.22	0.20	0.13
Crit Moves:			****		****			****		****		
Green Time:	12.1	19.8	43.3	9.5	17.2	31.5	14.3	15.2	15.2	23.5	24.4	33.9
Volume/Cap:	0.11	0.63	0.73	0.73	0.21	0.16	0.64	0.73	0.03	0.73	0.64	0.30
Delay/Veh:	29.5	28.1	16.9	46.7	25.9	15.8	34.9	34.4	26.5	30.8	25.2	15.5
User DelAdj:	1.00	1.00	1.00	1.00	1.00	1.00	1.00	1.00	1.00	1.00	1.00	1.00
AdjDel/Veh:	29.5	28.1	16.9	46.7	25.9	15.8	34.9	34.4	26.5	30.8	25.2	15.5
LOS by Move:	C	C	B	D	C	B	C	C	C	C	C	B
HCM2kAvgQ:	1	7	15	4	2	2	5	6	0	11	9	4

Note: Queue reported is the number of cars per lane.

Voices School
Morgan Hill, CA
Hexagon Transportation Consultants, Inc.

Level Of Service Computation Report
2000 HCM Operations (Future Volume Alternative)
2025 Plus Project (PM) - 3 Monterey out

Intersection #1111: Butterfield Boulevard and Tennant Avenue

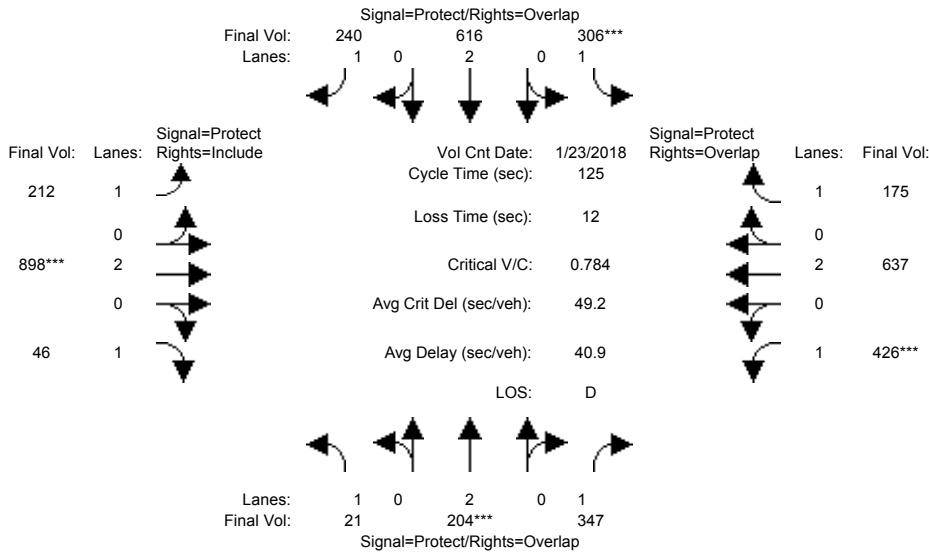

Street Name:	Butterfield Boulevard						Tennant Avenue					
	North Bound			South Bound			East Bound			West Bound		
Approach:	L	T	R	L	T	R	L	T	R	L	T	R
Min. Green:	7	10	10	7	10	10	7	10	10	7	10	10
Y+R:	4.0	4.0	4.0	4.0	4.0	4.0	4.0	4.0	4.0	4.0	4.0	4.0

Volume Module:	>>	Count	Date:	23 Jan 2018	<<							
Base Vol:	15	162	220	247	559	240	204	819	36	254	562	73
Growth Adj:	1.00	1.00	1.00	1.00	1.00	1.00	1.00	1.00	1.00	1.00	1.00	1.00
Initial Bse:	15	162	220	247	559	240	204	819	36	254	562	73
Added Vol:	0	0	0	0	0	0	0	10	0	0	13	0
PasserByVol:	6	42	127	59	57	0	8	69	10	172	62	102
Initial Fut:	21	204	347	306	616	240	212	898	46	426	637	175
User Adj:	1.00	1.00	1.00	1.00	1.00	1.00	1.00	1.00	1.00	1.00	1.00	1.00
PHF Adj:	1.00	1.00	1.00	1.00	1.00	1.00	1.00	1.00	1.00	1.00	1.00	1.00
PHF Volume:	21	204	347	306	616	240	212	898	46	426	637	175
Reduct Vol:	0	0	0	0	0	0	0	0	0	0	0	0
Reduced Vol:	21	204	347	306	616	240	212	898	46	426	637	175
PCE Adj:	1.00	1.00	1.00	1.00	1.00	1.00	1.00	1.00	1.00	1.00	1.00	1.00
MLF Adj:	1.00	1.00	1.00	1.00	1.00	1.00	1.00	1.00	1.00	1.00	1.00	1.00
FinalVolume:	21	204	347	306	616	240	212	898	46	426	637	175

Saturation Flow Module:												
Sat/Lane:	1900	1900	1900	1900	1900	1900	1900	1900	1900	1900	1900	1900
Adjustment:	0.92	1.00	0.92	0.92	1.00	0.92	0.92	1.00	0.92	0.92	1.00	0.92
Lanes:	1.00	2.00	1.00	1.00	2.00	1.00	1.00	2.00	1.00	1.00	2.00	1.00
Final Sat.:	1750	3800	1750	1750	3800	1750	1750	3800	1750	1750	3800	1750

Capacity Analysis Module:												
Vol/Sat:	0.01	0.05	0.20	0.17	0.16	0.14	0.12	0.24	0.03	0.24	0.17	0.10
Crit Moves:	****			****			****			****		
Green Time:	9.6	10.0	48.3	27.5	27.9	59.5	31.7	37.2	37.2	38.3	43.8	71.3
Volume/Cap:	0.16	0.67	0.51	0.79	0.73	0.29	0.48	0.79	0.09	0.79	0.48	0.18
Delay/Veh:	54.4	61.6	30.0	56.9	48.2	20.1	40.5	44.4	31.8	47.8	31.9	12.9
User DelAdj:	1.00	1.00	1.00	1.00	1.00	1.00	1.00	1.00	1.00	1.00	1.00	1.00
AdjDel/Veh:	54.4	61.6	30.0	56.9	48.2	20.1	40.5	44.4	31.8	47.8	31.9	12.9
LOS by Move:	D	E	C	E	D	C	D	D	C	D	C	B
HCM2kAvgQ:	1	5	11	12	11	6	7	16	1	18	10	3

Note: Queue reported is the number of cars per lane.

Voices School
Morgan Hill, CA
Hexagon Transportation Consultants, Inc.

Level Of Service Computation Report
2000 HCM Unsignalized (Future Volume Alternative)
Existing Plus Project (AM) - 3 Monterey out

Intersection #1112: Monterey Road and San Pedro Avenue

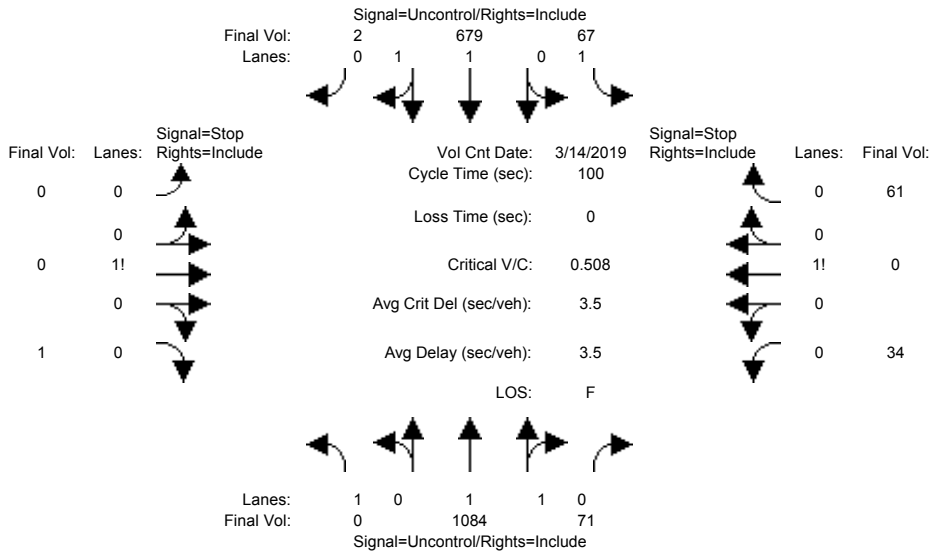

Street Name: Monterey Road San Pedro Avenue
Approach: North Bound South Bound East Bound West Bound
Movement: L - T - R L - T - R L - T - R L - T - R

Volume Module:	>>	Count	Date:	14 Mar 2019	<<							
Base Vol:	0	887	68	67	463	2	0	0	1	27	0	61
Growth Adj:	1.00	1.00	1.00	1.00	1.00	1.00	1.00	1.00	1.00	1.00	1.00	1.00
Initial Bse:	0	887	68	67	463	2	0	0	1	27	0	61
Added Vol:	0	197	3	0	216	0	0	0	0	7	0	0
PasserByVol:	0	0	0	0	0	0	0	0	0	0	0	0
Initial Fut:	0	1084	71	67	679	2	0	0	1	34	0	61
User Adj:	1.00	1.00	1.00	1.00	1.00	1.00	1.00	1.00	1.00	1.00	1.00	1.00
PHF Adj:	1.00	1.00	1.00	1.00	1.00	1.00	1.00	1.00	1.00	1.00	1.00	1.00
PHF Volume:	0	1084	71	67	679	2	0	0	1	34	0	61
Reduct Vol:	0	0	0	0	0	0	0	0	0	0	0	0
FinalVolume:	0	1084	71	67	679	2	0	0	1	34	0	61

Critical Gap Module:

Critical Gp:	xxxxx	xxxx	xxxxx	4.1	xxxx	xxxxx	xxxxx	xxxx	6.9	7.5	6.5	6.9
FollowUpTim:	xxxxx	xxxx	xxxxx	2.2	xxxx	xxxxx	xxxxx	xxxx	3.3	3.5	4.0	3.3

Capacity Module:

Cnflct Vol:	xxxx	xxxx	xxxxx	1155	xxxx	xxxxx	xxxx	xxxx	341	1593	1935	578
Potent Cap.:	xxxx	xxxx	xxxxx	612	xxxx	xxxxx	xxxx	xxxx	661	73	67	464
Move Cap.:	xxxx	xxxx	xxxxx	612	xxxx	xxxxx	xxxx	xxxx	661	67	59	464
Volume/Cap:	xxxx	xxxx	xxxx	0.11	xxxx	xxxx	xxxx	xxxx	0.00	0.51	0.00	0.13

Level Of Service Module:

2Way95thQ:	xxxx	xxxx	xxxxx	0.4	xxxx	xxxxx	xxxx	xxxx	0.0	xxxx	xxxx	xxxxx
Control Del:	xxxxx	xxxx	xxxxx	11.6	xxxx	xxxxx	xxxxx	xxxx	10.5	xxxxx	xxxx	xxxxx
LOS by Move:	*	*	*	B	*	*	*	*	B	*	*	*
Movement:	LT - LTR - RT	LT - LTR - RT	LT - LTR - RT		LT - LTR - RT	LT - LTR - RT	LT - LTR - RT	LT - LTR - RT		LT - LTR - RT	LT - LTR - RT	
Shared Cap.:	xxxx	xxxx	xxxxx	xxxx	xxxx	xxxxx	xxxx	xxxx	xxxxx	xxxx	149	xxxxx
SharedQueue:	xxxxx	xxxx	xxxxx	xxxxx	xxxx	xxxxx	xxxxx	xxxx	xxxxx	xxxxx	3.5	xxxxx
Shrd ConDel:	xxxxx	xxxx	xxxxx	xxxxx	xxxx	xxxxx	xxxxx	xxxx	xxxxx	xxxxx	64.4	xxxxx
Shared LOS:	*	*	*	*	*	*	*	*	*	*	F	*
ApproachDel:	xxxxxxx		xxxxxxx						10.5		64.4	
ApproachLOS:		*		*					B		F	

Note: Queue reported is the number of cars per lane.

Voices School
Morgan Hill, CA
Hexagon Transportation Consultants, Inc.

Level Of Service Computation Report
2000 HCM Unsignalized (Future Volume Alternative)
Existing Plus Project (PM) - 3 Monterey out

Intersection #1112: Monterey Road and San Pedro Avenue

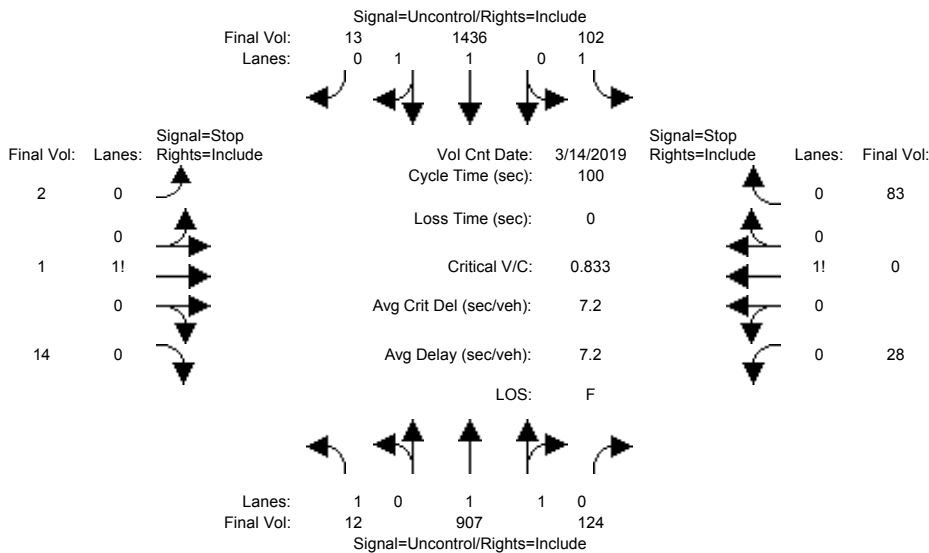

Street Name: Monterey Road San Pedro Avenue
Approach: North Bound South Bound East Bound West Bound
Movement: L - T - R L - T - R L - T - R L - T - R

Volume Module:	>>	Count	Date:	14 Mar 2019	<<							
Base Vol:	12	774	120	102	1333	13	2	1	14	27	0	83
Growth Adj:	1.00	1.00	1.00	1.00	1.00	1.00	1.00	1.00	1.00	1.00	1.00	1.00
Initial Bse:	12	774	120	102	1333	13	2	1	14	27	0	83
Added Vol:	0	133	4	0	103	0	0	0	0	1	0	0
PasserByVol:	0	0	0	0	0	0	0	0	0	0	0	0
Initial Fut:	12	907	124	102	1436	13	2	1	14	28	0	83
User Adj:	1.00	1.00	1.00	1.00	1.00	1.00	1.00	1.00	1.00	1.00	1.00	1.00
PHF Adj:	1.00	1.00	1.00	1.00	1.00	1.00	1.00	1.00	1.00	1.00	1.00	1.00
PHF Volume:	12	907	124	102	1436	13	2	1	14	28	0	83
Reduct Vol:	0	0	0	0	0	0	0	0	0	0	0	0
FinalVolume:	12	907	124	102	1436	13	2	1	14	28	0	83

Critical Gap Module:

Critical Gp:	4.1	xxxx	xxxxxx	4.1	xxxx	xxxxxx	7.5	6.5	6.9	7.5	6.5	6.9
FollowUpTim:	2.2	xxxx	xxxxxx	2.2	xxxx	xxxxxx	3.5	4.0	3.3	3.5	4.0	3.3

Capacity Module:

Cnflct Vol:	1449	xxxx	xxxxxx	1031	xxxx	xxxxxx	2124	2702	725	1916	2646	516
Potent Cap.:	474	xxxx	xxxxxx	682	xxxx	xxxxxx	29	22	372	42	24	510
Move Cap.:	474	xxxx	xxxxxx	682	xxxx	xxxxxx	21	18	372	34	19	510
Volume/Cap:	0.03	xxxx	xxxx	0.15	xxxx	xxxx	0.09	0.06	0.04	0.83	0.00	0.16

Level Of Service Module:

2Way95thQ:	0.1	xxxx	xxxxxx	0.5	xxxx	xxxxxx	xxxx	xxxx	xxxxxx	xxxx	xxxx	xxxxxx
Control Del:	12.8	xxxx	xxxxxx	11.2	xxxx	xxxxxx	xxxxxx	xxxx	xxxxxx	xxxxxx	xxxx	xxxxxx
LOS by Move:	B	*	*	B	*	*	*	*	*	*	*	*
Movement:	LT - LTR - RT			LT - LTR - RT			LT - LTR - RT			LT - LTR - RT		
Shared Cap.:	xxxx	xxxx	xxxxxx	xxxx	xxxx	xxxxxx	xxxx	91	xxxxxx	xxxx	111	xxxxxx
SharedQueue:	xxxxxx	xxxx	xxxxxx	xxxxxx	xxxx	xxxxxx	xxxxxx	0.6	xxxxxx	xxxxxx	6.4	xxxxxx
Shrd ConDel:	xxxxxx	xxxx	xxxxxx	xxxxxx	xxxx	xxxxxx	xxxxxx	53.7	xxxxxx	xxxxxx	157	xxxxxx
Shared LOS:	*	*	*	*	*	*	*	F	*	*	F	*
ApproachDel:	xxxxxxx			xxxxxxx				53.7			156.8	
ApproachLOS:		*			*			F			F	

Note: Queue reported is the number of cars per lane.

Voices School
Morgan Hill, CA
Hexagon Transportation Consultants, Inc.

Level Of Service Computation Report
2000 HCM Unsignalized (Future Volume Alternative)
2025 Plus Project (AM) - 3 Monterey out

Intersection #1112: Monterey Road and San Pedro Avenue

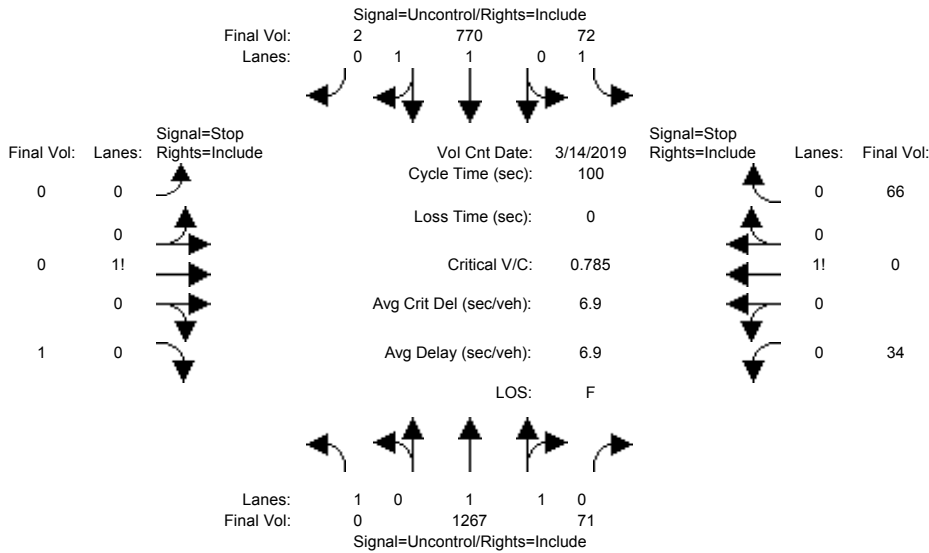

Street Name: Monterey Road San Pedro Avenue
Approach: North Bound South Bound East Bound West Bound
Movement: L - T - R L - T - R L - T - R L - T - R

Volume Module:	>> Count Date: 14 Mar 2019 <<											
Base Vol:	0	887	68	67	463	2	0	0	1	27	0	61
Growth Adj:	1.00	1.00	1.00	1.00	1.00	1.00	1.00	1.00	1.00	1.00	1.00	1.00
Initial Bse:	0	887	68	67	463	2	0	0	1	27	0	61
Added Vol:	0	193	3	0	214	0	0	0	0	7	0	0
PasserByVol:	0	187	0	5	93	0	0	0	0	0	0	5
Initial Fut:	0	1267	71	72	770	2	0	0	1	34	0	66
User Adj:	1.00	1.00	1.00	1.00	1.00	1.00	1.00	1.00	1.00	1.00	1.00	1.00
PHF Adj:	1.00	1.00	1.00	1.00	1.00	1.00	1.00	1.00	1.00	1.00	1.00	1.00
PHF Volume:	0	1267	71	72	770	2	0	0	1	34	0	66
Reduct Vol:	0	0	0	0	0	0	0	0	0	0	0	0
FinalVolume:	0	1267	71	72	770	2	0	0	1	34	0	66

Critical Gap Module:

Critical Gp:	xxxxx	xxxx	xxxxx	4.1	xxxx	xxxxx	xxxxx	xxxx	6.9	7.5	6.5	6.9
FollowUpTim:	xxxxx	xxxx	xxxxx	2.2	xxxx	xxxxx	xxxxx	xxxx	3.3	3.5	4.0	3.3

Capacity Module:

Cnflct Vol:	xxxx	xxxx	xxxxx	1338	xxxx	xxxxx	xxxx	xxxx	386	1832	2219	669
Potent Cap.:	xxxx	xxxx	xxxxx	522	xxxx	xxxxx	xxxx	xxxx	618	49	44	405
Move Cap.:	xxxx	xxxx	xxxxx	522	xxxx	xxxxx	xxxx	xxxx	618	43	38	405
Volume/Cap:	xxxx	xxxx	xxxx	0.14	xxxx	xxxx	xxxx	xxxx	0.00	0.79	0.00	0.16

Level Of Service Module:

2Way95thQ:	xxxx	xxxx	xxxxx	0.5	xxxx	xxxxx	xxxx	xxxx	0.0	xxxx	xxxx	xxxxx
Control Del:	xxxxx	xxxx	xxxxx	13.0	xxxx	xxxxx	xxxxx	xxxx	10.8	xxxxx	xxxx	xxxxx
LOS by Move:	*	*	*	B	*	*	*	*	B	*	*	*
Movement:	LT - LTR - RT	LT - LTR - RT	LT - LTR - RT	LT - LTR - RT	LT - LTR - RT	LT - LTR - RT	LT - LTR - RT	LT - LTR - RT	LT - LTR - RT	LT - LTR - RT	LT - LTR - RT	LT - LTR - RT
Shared Cap.:	xxxx	xxxx	xxxxx	xxxx	xxxx	xxxxx	xxxx	xxxx	xxxxx	xxxx	105	xxxxx
SharedQueue:	xxxxx	xxxx	xxxxx	xxxxx	xxxx	xxxxx	xxxxx	xxxx	xxxxx	xxxxx	5.8	xxxxx
Shrd ConDel:	xxxxx	xxxx	xxxxx	xxxxx	xxxx	xxxxx	xxxxx	xxxx	xxxxx	xxxxx	149	xxxxx
Shared LOS:	*	*	*	*	*	*	*	*	*	*	F	*
ApproachDel:	xxxxxxx	xxxxxxx							10.8	148.7		
ApproachLOS:	*	*							B	F		

Note: Queue reported is the number of cars per lane.

Voices School
Morgan Hill, CA
Hexagon Transportation Consultants, Inc.

Level Of Service Computation Report
2000 HCM Unsignalized (Future Volume Alternative)
2025 Plus Project (PM) - 3 Monterey out

Intersection #1112: Monterey Road and San Pedro Avenue

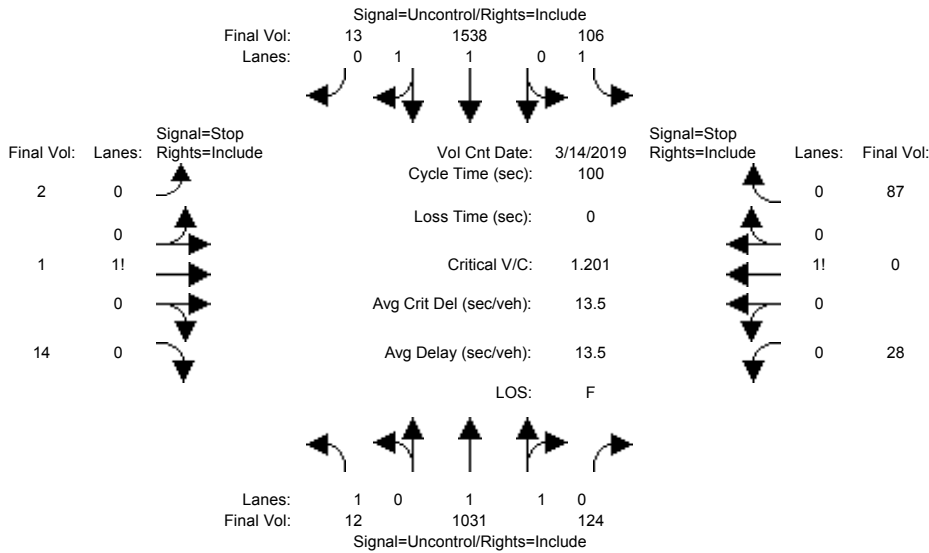

Street Name: Monterey Road San Pedro Avenue
Approach: North Bound South Bound East Bound West Bound
Movement: L - T - R L - T - R L - T - R L - T - R

Volume Module:	>> Count Date: 14 Mar 2019 <<											
Base Vol:	12	774	120	102	1333	13	2	1	14	27	0	83
Growth Adj:	1.00	1.00	1.00	1.00	1.00	1.00	1.00	1.00	1.00	1.00	1.00	1.00
Initial Bse:	12	774	120	102	1333	13	2	1	14	27	0	83
Added Vol:	0	129	4	0	98	0	0	0	0	1	0	0
PasserByVol:	0	128	0	4	107	0	0	0	0	0	0	4
Initial Fut:	12	1031	124	106	1538	13	2	1	14	28	0	87
User Adj:	1.00	1.00	1.00	1.00	1.00	1.00	1.00	1.00	1.00	1.00	1.00	1.00
PHF Adj:	1.00	1.00	1.00	1.00	1.00	1.00	1.00	1.00	1.00	1.00	1.00	1.00
PHF Volume:	12	1031	124	106	1538	13	2	1	14	28	0	87
Reduct Vol:	0	0	0	0	0	0	0	0	0	0	0	0
FinalVolume:	12	1031	124	106	1538	13	2	1	14	28	0	87

Critical Gap Module:

Critical Gp:	4.1	xxxx	xxxxx	4.1	xxxx	xxxxx	7.5	6.5	6.9	7.5	6.5	6.9
FollowUpTim:	2.2	xxxx	xxxxx	2.2	xxxx	xxxxx	3.5	4.0	3.3	3.5	4.0	3.3

Capacity Module:

Cnflct Vol:	1551	xxxx	xxxxx	1155	xxxx	xxxxx	2296	2936	776	2099	2880	578
Potent Cap.:	433	xxxx	xxxxx	612	xxxx	xxxxx	22	15	345	30	17	464
Move Cap.:	433	xxxx	xxxxx	612	xxxx	xxxxx	15	12	345	23	13	464
Volume/Cap:	0.03	xxxx	xxxx	0.17	xxxx	xxxx	0.13	0.08	0.04	1.20	0.00	0.19

Level Of Service Module:

2Way95thQ:	0.1	xxxx	xxxxx	0.6	xxxx	xxxxx	xxxx	xxxx	xxxxx	xxxx	xxxx	xxxxx
Control Del:	13.6	xxxx	xxxxx	12.1	xxxx	xxxxx	xxxxx	xxxx	xxxxx	xxxxx	xxxx	xxxxx
LOS by Move:	B	*	*	B	*	*	*	*	*	*	*	*
Movement:	LT - LTR - RT			LT - LTR - RT			LT - LTR - RT			LT - LTR - RT		
Shared Cap.:	xxxx	xxxx	xxxxx	xxxx	xxxx	xxxxx	xxxx	66	xxxxx	xxxx	83	xxxxx
SharedQueue:	xxxxx	xxxx	xxxxx	xxxxx	xxxx	xxxxx	xxxxx	0.9	xxxxx	xxxxx	8.9	xxxxx
Shrd ConDel:	xxxxx	xxxx	xxxxx	xxxxx	xxxx	xxxxx	xxxxx	77.3	xxxxx	xxxxx	322	xxxxx
Shared LOS:	*	*	*	*	*	*	*	F	*	*	F	*
ApproachDel:	xxxxxxx			xxxxxxx				77.3			322.3	
ApproachLOS:		*			*			F			F	

Note: Queue reported is the number of cars per lane.

Voices School
Morgan Hill, CA
Hexagon Transportation Consultants, Inc.

Level Of Service Computation Report
2000 HCM Operations (Future Volume Alternative)
Existing Plus Project (AM) - 3 Monterey out

Intersection #1200: Monterey Road and Cosmo Avenue

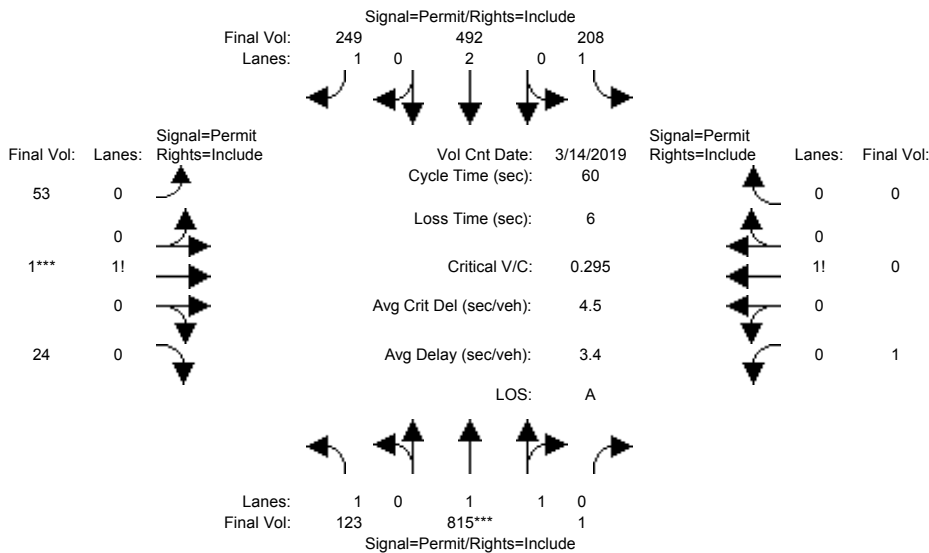

Street Name:	Monterey Rd						Cosmo Ave					
Approach:	North Bound			South Bound			East Bound			West Bound		
Movement:	L	T	R	L	T	R	L	T	R	L	T	R
Min. Green:	10	10	10	10	10	10	10	10	10	10	10	10
Y+R:	4.0	4.0	4.0	4.0	4.0	4.0	4.0	4.0	4.0	4.0	4.0	4.0

Volume Module:	>>	Count	Date:	14 Mar 2019	<<											
Base Vol:	17	815	1	8	427	27	53	1	24	1	0	0				
Growth Adj:	1.00	1.00	1.00	1.00	1.00	1.00	1.00	1.00	1.00	1.00	1.00	1.00				
Initial Bse:	17	815	1	8	427	27	53	1	24	1	0	0				
Added Vol:	106	0	0	200	65	222	0	0	0	0	0	0				
PasserByVol:	0	0	0	0	0	0	0	0	0	0	0	0				
Initial Fut:	123	815	1	208	492	249	53	1	24	1	0	0				
User Adj:	1.00	1.00	1.00	1.00	1.00	1.00	1.00	1.00	1.00	1.00	1.00	1.00				
PHF Adj:	1.00	1.00	1.00	1.00	1.00	1.00	1.00	1.00	1.00	1.00	1.00	1.00				
PHF Volume:	123	815	1	208	492	249	53	1	24	1	0	0				
Reduct Vol:	0	0	0	0	0	0	0	0	0	0	0	0				
Reduced Vol:	123	815	1	208	492	249	53	1	24	1	0	0				
PCE Adj:	1.00	1.00	1.00	1.00	1.00	1.00	1.00	1.00	1.00	1.00	1.00	1.00				
MLF Adj:	1.00	1.00	1.00	1.00	1.00	1.00	1.00	1.00	1.00	1.00	1.00	1.00				
FinalVolume:	123	815	1	208	492	249	53	1	24	1	0	0				

Saturation Flow Module:												
Sat/Lane:	1900	1900	1900	1900	1900	1900	1900	1900	1900	1900	1900	1900
Adjustment:	0.92	0.97	0.95	0.92	1.00	0.92	0.92	0.92	0.92	0.92	1.00	0.92
Lanes:	1.00	1.99	0.01	1.00	2.00	1.00	0.68	0.01	0.31	1.00	0.00	0.00
Final Sat.:	1750	3695	5	1750	3800	1750	1189	22	538	1750	0	0

Capacity Analysis Module:												
Vol/Sat:	0.07	0.22	0.22	0.12	0.13	0.14	0.04	0.04	0.04	0.00	0.00	0.00
Crit Moves:	****									****		
Green Time:	44.0	44.0	44.0	44.0	44.0	44.0	10.0	10.0	10.0	10.0	0.0	0.0
Volume/Cap:	0.10	0.30	0.30	0.16	0.18	0.19	0.27	0.27	0.27	0.00	0.00	0.00
Delay/Veh:	2.3	2.8	2.8	2.5	2.5	2.6	22.3	22.3	22.3	20.8	0.0	0.0
User DelAdj:	1.00	1.00	1.00	1.00	1.00	1.00	1.00	1.00	1.00	1.00	1.00	1.00
AdjDel/Veh:	2.3	2.8	2.8	2.5	2.5	2.6	22.3	22.3	22.3	20.8	0.0	0.0
LOS by Move:	A	A	A	A	A	A	C	C	C	C	A	A
HCM2kAvgQ:	1	3	3	1	1	2	2	2	2	0	0	0

Note: Queue reported is the number of cars per lane.

Voices School
Morgan Hill, CA
Hexagon Transportation Consultants, Inc.

Level Of Service Computation Report
2000 HCM Operations (Future Volume Alternative)
Existing Plus Project (PM) - 3 Monterey out

Intersection #1200: Monterey Road and Cosmo Avenue

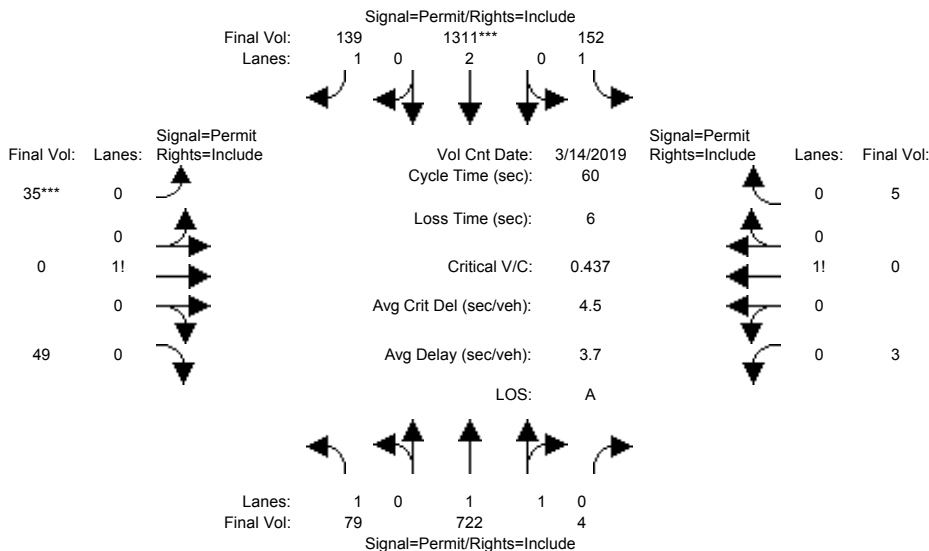

Street Name:	Monterey Rd						Cosmo Ave					
Approach:	North Bound			South Bound			East Bound			West Bound		
Movement:	L	T	R	L	T	R	L	T	R	L	T	R
Min. Green:	10	10	10	10	10	10	10	10	10	10	10	10
Y+R:	4.0	4.0	4.0	4.0	4.0	4.0	4.0	4.0	4.0	4.0	4.0	4.0

Volume Module:	>>	Count	Date:	14 Mar 2019	<<							
Base Vol:	45	722	4	15	1246	35	35	0	49	3	0	5
Growth Adj:	1.00	1.00	1.00	1.00	1.00	1.00	1.00	1.00	1.00	1.00	1.00	1.00
Initial Bse:	45	722	4	15	1246	35	35	0	49	3	0	5
Added Vol:	34	0	0	137	65	104	0	0	0	0	0	0
PasserByVol:	0	0	0	0	0	0	0	0	0	0	0	0
Initial Fut:	79	722	4	152	1311	139	35	0	49	3	0	5
User Adj:	1.00	1.00	1.00	1.00	1.00	1.00	1.00	1.00	1.00	1.00	1.00	1.00
PHF Adj:	1.00	1.00	1.00	1.00	1.00	1.00	1.00	1.00	1.00	1.00	1.00	1.00
PHF Volume:	79	722	4	152	1311	139	35	0	49	3	0	5
Reduct Vol:	0	0	0	0	0	0	0	0	0	0	0	0
Reduced Vol:	79	722	4	152	1311	139	35	0	49	3	0	5
PCE Adj:	1.00	1.00	1.00	1.00	1.00	1.00	1.00	1.00	1.00	1.00	1.00	1.00
MLF Adj:	1.00	1.00	1.00	1.00	1.00	1.00	1.00	1.00	1.00	1.00	1.00	1.00
FinalVolume:	79	722	4	152	1311	139	35	0	49	3	0	5

Saturation Flow Module:	
Sat/Lane:	1900 1900 1900 1900 1900 1900 1900 1900 1900 1900 1900 1900
Adjustment:	0.92 0.97 0.95 0.92 1.00 0.92 0.92 0.92 0.92 0.92 0.92 0.92
Lanes:	1.00 1.99 0.01 1.00 2.00 1.00 0.42 0.00 0.58 0.37 0.00 0.63
Final Sat.:	1750 3680 20 1750 3800 1750 729 0 1021 656 0 1094

Capacity Analysis Module:	
Vol/Sat:	0.05 0.20 0.20 0.09 0.34 0.08 0.05 0.00 0.05 0.00 0.00 0.00
Crit Moves:	****
Green Time:	44.0 44.0 44.0 44.0 44.0 44.0 10.0 0.0 10.0 10.0 0.0 10.0
Volume/Cap:	0.06 0.27 0.27 0.12 0.47 0.11 0.29 0.00 0.29 0.03 0.00 0.03
Delay/Veh:	2.3 2.7 2.7 2.4 3.4 2.4 22.4 0.0 22.4 21.0 0.0 21.0
User DelAdj:	1.00 1.00 1.00 1.00 1.00 1.00 1.00 1.00 1.00 1.00 1.00 1.00
AdjDel/Veh:	2.3 2.7 2.7 2.4 3.4 2.4 22.4 0.0 22.4 21.0 0.0 21.0
LOS by Move:	A A A A A A C A C C A C
HCM2kAvgQ:	0 2 2 1 5 1 2 0 2 0 0 0

Note: Queue reported is the number of cars per lane.

Voices School
Morgan Hill, CA
Hexagon Transportation Consultants, Inc.

Level Of Service Computation Report
2000 HCM Operations (Future Volume Alternative)
2025 Plus Project (AM) - 3 Monterey out

Intersection #1200: Monterey Road and Cosmo Avenue

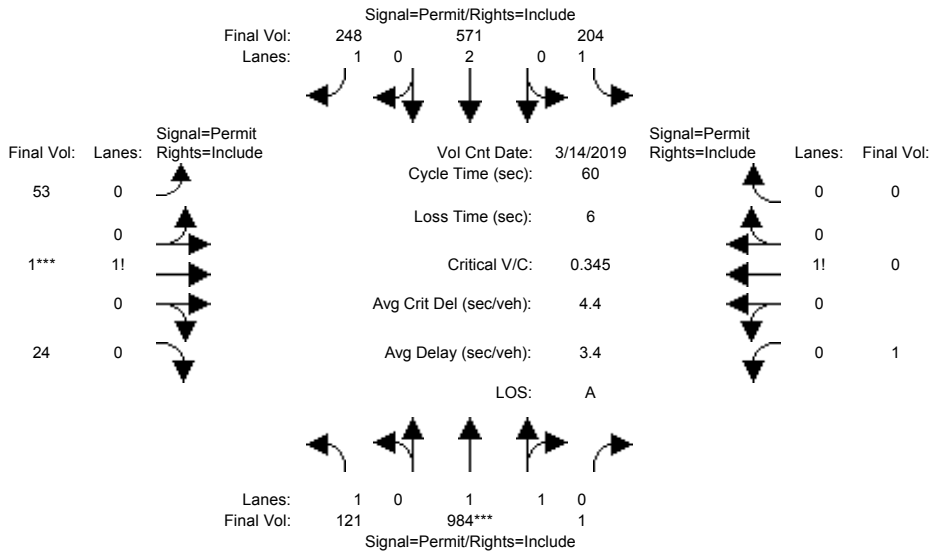

Street Name:	Monterey Rd						Cosmo Ave					
Approach:	North Bound			South Bound			East Bound			West Bound		
Movement:	L	T	R	L	T	R	L	T	R	L	T	R
Min. Green:	10	10	10	10	10	10	10	10	10	10	10	10
Y+R:	4.0	4.0	4.0	4.0	4.0	4.0	4.0	4.0	4.0	4.0	4.0	4.0

Volume Module:	>>	Count	Date:	14 Mar 2019	<<											
Base Vol:	17	815	1	8	427	27	53	1	24	1	0	0				
Growth Adj:	1.00	1.00	1.00	1.00	1.00	1.00	1.00	1.00	1.00	1.00	1.00	1.00				
Initial Bse:	17	815	1	8	427	27	53	1	24	1	0	0				
Added Vol:	104	0	0	196	63	221	0	0	0	0	0	0				
PasserByVol:	0	169	0	0	81	0	0	0	0	0	0	0				
Initial Fut:	121	984	1	204	571	248	53	1	24	1	0	0				
User Adj:	1.00	1.00	1.00	1.00	1.00	1.00	1.00	1.00	1.00	1.00	1.00	1.00				
PHF Adj:	1.00	1.00	1.00	1.00	1.00	1.00	1.00	1.00	1.00	1.00	1.00	1.00				
PHF Volume:	121	984	1	204	571	248	53	1	24	1	0	0				
Reduct Vol:	0	0	0	0	0	0	0	0	0	0	0	0				
Reduced Vol:	121	984	1	204	571	248	53	1	24	1	0	0				
PCE Adj:	1.00	1.00	1.00	1.00	1.00	1.00	1.00	1.00	1.00	1.00	1.00	1.00				
MLF Adj:	1.00	1.00	1.00	1.00	1.00	1.00	1.00	1.00	1.00	1.00	1.00	1.00				
FinalVolume:	121	984	1	204	571	248	53	1	24	1	0	0				

Saturation Flow Module:												
Sat/Lane:	1900	1900	1900	1900	1900	1900	1900	1900	1900	1900	1900	1900
Adjustment:	0.92	0.97	0.95	0.92	1.00	0.92	0.92	0.92	0.92	0.92	1.00	0.92
Lanes:	1.00	1.99	0.01	1.00	2.00	1.00	0.68	0.01	0.31	1.00	0.00	0.00
Final Sat.:	1750	3696	4	1750	3800	1750	1189	22	538	1750	0	0

Capacity Analysis Module:												
Vol/Sat:	0.07	0.27	0.27	0.12	0.15	0.14	0.04	0.04	0.04	0.00	0.00	0.00
Crit Moves:	****									****		
Green Time:	44.0	44.0	44.0	44.0	44.0	44.0	10.0	10.0	10.0	10.0	0.0	0.0
Volume/Cap:	0.09	0.36	0.36	0.16	0.20	0.19	0.27	0.27	0.27	0.00	0.00	0.00
Delay/Veh:	2.3	3.0	3.0	2.5	2.5	2.6	22.3	22.3	22.3	20.8	0.0	0.0
User DelAdj:	1.00	1.00	1.00	1.00	1.00	1.00	1.00	1.00	1.00	1.00	1.00	1.00
AdjDel/Veh:	2.3	3.0	3.0	2.5	2.5	2.6	22.3	22.3	22.3	20.8	0.0	0.0
LOS by Move:	A	A	A	A	A	A	C	C	C	C	A	A
HCM2kAvgQ:	1	4	4	1	2	2	2	2	2	0	0	0

Note: Queue reported is the number of cars per lane.

Voices School
Morgan Hill, CA
Hexagon Transportation Consultants, Inc.

Level Of Service Computation Report
2000 HCM Operations (Future Volume Alternative)
2025 Plus Project (PM) - 3 Monterey out

Intersection #1200: Monterey Road and Cosmo Avenue

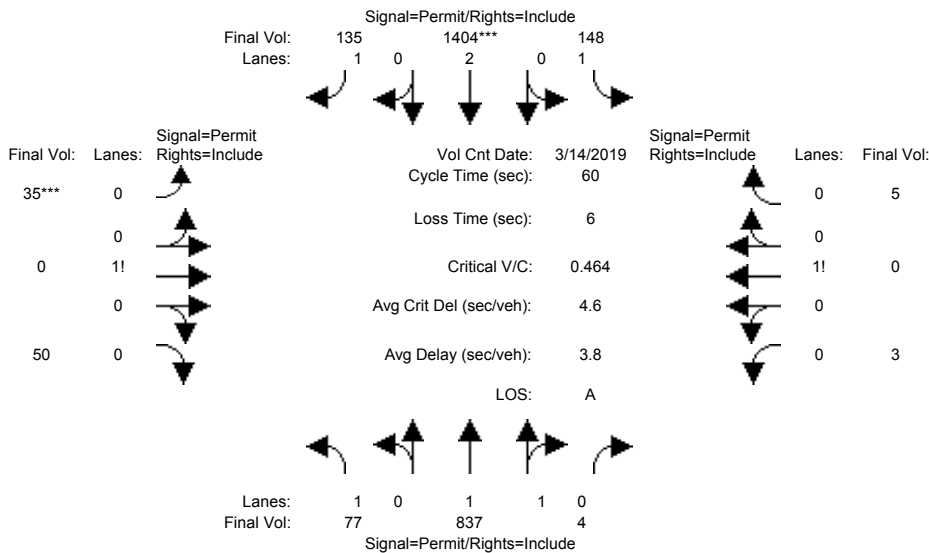

Street Name:	Monterey Rd						Cosmo Ave					
Approach:	North Bound			South Bound			East Bound			West Bound		
Movement:	L	T	R	L	T	R	L	T	R	L	T	R
Min. Green:	10	10	10	10	10	10	10	10	10	10	10	10
Y+R:	4.0	4.0	4.0	4.0	4.0	4.0	4.0	4.0	4.0	4.0	4.0	4.0

Volume Module:	>>	Count	Date:	14 Mar 2019	<<											
Base Vol:	45	722	4	15	1246	35	35	0	49	3	0	5				
Growth Adj:	1.00	1.00	1.00	1.00	1.00	1.00	1.00	1.00	1.00	1.00	1.00	1.00				
Initial Bse:	45	722	4	15	1246	35	35	0	49	3	0	5				
Added Vol:	31	0	0	133	63	100	0	0	0	0	0	0				
PasserByVol:	1	115	0	0	95	0	0	0	1	0	0	0				
Initial Fut:	77	837	4	148	1404	135	35	0	50	3	0	5				
User Adj:	1.00	1.00	1.00	1.00	1.00	1.00	1.00	1.00	1.00	1.00	1.00	1.00				
PHF Adj:	1.00	1.00	1.00	1.00	1.00	1.00	1.00	1.00	1.00	1.00	1.00	1.00				
PHF Volume:	77	837	4	148	1404	135	35	0	50	3	0	5				
Reduct Vol:	0	0	0	0	0	0	0	0	0	0	0	0				
Reduced Vol:	77	837	4	148	1404	135	35	0	50	3	0	5				
PCE Adj:	1.00	1.00	1.00	1.00	1.00	1.00	1.00	1.00	1.00	1.00	1.00	1.00				
MLF Adj:	1.00	1.00	1.00	1.00	1.00	1.00	1.00	1.00	1.00	1.00	1.00	1.00				
FinalVolume:	77	837	4	148	1404	135	35	0	50	3	0	5				

Saturation Flow Module:												
Sat/Lane:	1900	1900	1900	1900	1900	1900	1900	1900	1900	1900	1900	1900
Adjustment:	0.92	0.97	0.95	0.92	1.00	0.92	0.92	0.92	0.92	0.92	0.92	0.92
Lanes:	1.00	1.99	0.01	1.00	2.00	1.00	0.41	0.00	0.59	0.37	0.00	0.63
Final Sat.:	1750	3682	18	1750	3800	1750	721	0	1029	656	0	1094

Capacity Analysis Module:												
Vol/Sat:	0.04	0.23	0.23	0.08	0.37	0.08	0.05	0.00	0.05	0.00	0.00	0.00
Crit Moves:	****											
Green Time:	44.0	44.0	44.0	44.0	44.0	44.0	10.0	0.0	10.0	10.0	0.0	10.0
Volume/Cap:	0.06	0.31	0.31	0.12	0.50	0.11	0.29	0.00	0.29	0.03	0.00	0.03
Delay/Veh:	2.3	2.8	2.8	2.4	3.5	2.3	22.5	0.0	22.5	21.0	0.0	21.0
User DelAdj:	1.00	1.00	1.00	1.00	1.00	1.00	1.00	1.00	1.00	1.00	1.00	1.00
AdjDel/Veh:	2.3	2.8	2.8	2.4	3.5	2.3	22.5	0.0	22.5	21.0	0.0	21.0
LOS by Move:	A	A	A	A	A	A	C	A	C	C	A	C
HCM2kAvgQ:	0	3	3	1	6	1	2	0	2	0	0	0

Note: Queue reported is the number of cars per lane.

Voices School
Morgan Hill, CA
Hexagon Transportation Consultants, Inc.

Level Of Service Computation Report
2000 HCM Unsignalized (Future Volume Alternative)
Existing Plus Project (AM) - 3 Monterey out

Intersection #1300: Olympic Drive and Edmundson Avenue

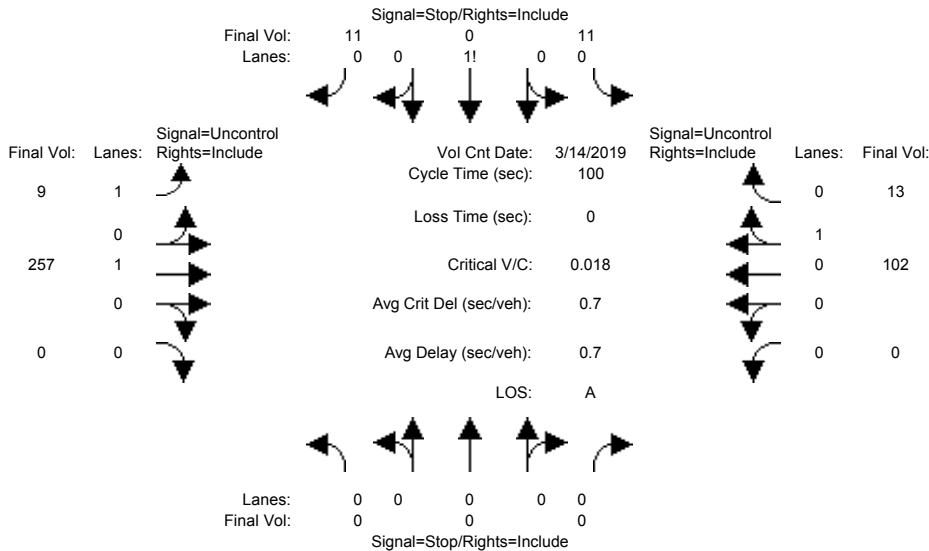

Street Name: Olympic Dr Edmundson Ave

Approach: North Bound South Bound East Bound West Bound

Movement: L - T - R L - T - R L - T - R L - T - R

Volume Module:	>>	Count	Date:	14 Mar 2019	<<							
Base Vol:	0	0	0	11	0	11	9	241	0	0	97	13
Growth Adj:	1.00	1.00	1.00	1.00	1.00	1.00	1.00	1.00	1.00	1.00	1.00	1.00
Initial Bse:	0	0	0	11	0	11	9	241	0	0	97	13
Added Vol:	0	0	0	0	0	0	0	16	0	0	5	0
PasserByVol:	0	0	0	0	0	0	0	0	0	0	0	0
Initial Fut:	0	0	0	11	0	11	9	257	0	0	102	13
User Adj:	1.00	1.00	1.00	1.00	1.00	1.00	1.00	1.00	1.00	1.00	1.00	1.00
PHF Adj:	1.00	1.00	1.00	1.00	1.00	1.00	1.00	1.00	1.00	1.00	1.00	1.00
PHF Volume:	0	0	0	11	0	11	9	257	0	0	102	13
Reduct Vol:	0	0	0	0	0	0	0	0	0	0	0	0
FinalVolume:	0	0	0	11	0	11	9	257	0	0	102	13

Critical Gap Module:

Critical Gp:	xxxxx	xxxx	xxxxx	6.4	6.5	6.2	4.1	xxxx	xxxxx	xxxxx	xxxx	xxxxx
FollowUpTim:	xxxxx	xxxx	xxxxx	3.5	4.0	3.3	2.2	xxxx	xxxxx	xxxxx	xxxx	xxxxx

Capacity Module:

Cnflct Vol:	xxxx	xxxx	xxxxx	384	384	109	115	xxxx	xxxxx	xxxx	xxxx	xxxxx
Potent Cap.:	xxxx	xxxx	xxxxx	623	553	951	1487	xxxx	xxxxx	xxxx	xxxx	xxxxx
Move Cap.:	xxxx	xxxx	xxxxx	620	550	951	1487	xxxx	xxxxx	xxxx	xxxx	xxxxx
Volume/Cap:	xxxx	xxxx	xxxx	0.02	0.00	0.01	0.01	xxxx	xxxx	xxxx	xxxx	xxxx

Level Of Service Module:

2Way95thQ:	xxxx	xxxx	xxxxx	xxxx	xxxx	xxxxx	0.0	xxxx	xxxxx	xxxx	xxxx	xxxxx
Control Del:	xxxxx	xxxx	xxxxx	xxxxx	xxxx	xxxxx	7.4	xxxx	xxxxx	xxxxx	xxxx	xxxxx
LOS by Move:	*	*	*	*	*	*	A	*	*	*	*	*
Movement:	LT - LTR - RT	LT - LTR - RT	LT - LTR - RT	LT - LTR - RT	LT - LTR - RT	LT - LTR - RT	LT - LTR - RT	LT - LTR - RT	LT - LTR - RT	LT - LTR - RT	LT - LTR - RT	LT - LTR - RT
Shared Cap.:	xxxx	xxxx	xxxxx	xxxx	751	xxxxx	xxxx	xxxx	xxxxx	xxxx	xxxx	xxxxx
SharedQueue:	xxxxx	xxxx	xxxxx	xxxxx	0.1	xxxxx	xxxxx	xxxx	xxxxx	xxxxx	xxxx	xxxxx
Shrd ConDel:	xxxxx	xxxx	xxxxx	xxxxx	9.9	xxxxx	xxxxx	xxxx	xxxxx	xxxxx	xxxx	xxxxx
Shared LOS:	*	*	*	*	A	*	*	*	*	*	*	*
ApproachDel:	xxxxxxx			9.9			xxxxxxx			xxxxxxx		
ApproachLOS:	*			A			*			*		*

Note: Queue reported is the number of cars per lane.

Voices School
Morgan Hill, CA
Hexagon Transportation Consultants, Inc.

Level Of Service Computation Report
2000 HCM Unsignalized (Future Volume Alternative)
Existing Plus Project (PM) - 3 Monterey out

Intersection #1300: Olympic Drive and Edmundson Avenue

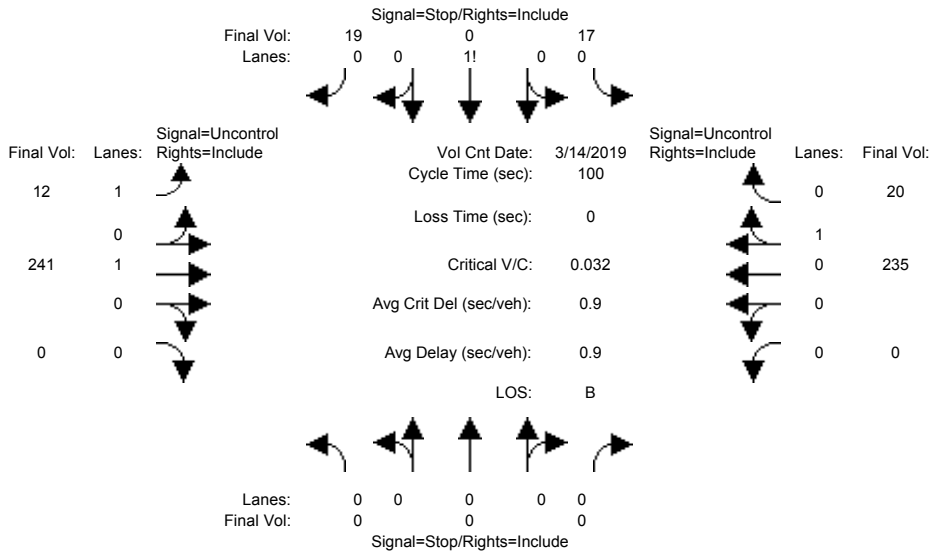

Street Name: Olympic Dr Edmundson Ave
Approach: North Bound South Bound East Bound West Bound
Movement: L - T - R L - T - R L - T - R L - T - R

Volume Module:	>>	Count	Date:	14 Mar 2019	<<							
Base Vol:	0	0	0	17	0	19	12	238	0	0	225	20
Growth Adj:	1.00	1.00	1.00	1.00	1.00	1.00	1.00	1.00	1.00	1.00	1.00	1.00
Initial Bse:	0	0	0	17	0	19	12	238	0	0	225	20
Added Vol:	0	0	0	0	0	0	0	3	0	0	10	0
PasserByVol:	0	0	0	0	0	0	0	0	0	0	0	0
Initial Fut:	0	0	0	17	0	19	12	241	0	0	235	20
User Adj:	1.00	1.00	1.00	1.00	1.00	1.00	1.00	1.00	1.00	1.00	1.00	1.00
PHF Adj:	1.00	1.00	1.00	1.00	1.00	1.00	1.00	1.00	1.00	1.00	1.00	1.00
PHF Volume:	0	0	0	17	0	19	12	241	0	0	235	20
Reduct Vol:	0	0	0	0	0	0	0	0	0	0	0	0
FinalVolume:	0	0	0	17	0	19	12	241	0	0	235	20

Critical Gap Module:

Critical Gp:	xxxxx	xxxx	xxxxx	6.4	6.5	6.2	4.1	xxxx	xxxxx	xxxxx	xxxx	xxxxx
FollowUpTim:	xxxxx	xxxx	xxxxx	3.5	4.0	3.3	2.2	xxxx	xxxxx	xxxxx	xxxx	xxxxx

Capacity Module:

Cnflct Vol:	xxxx	xxxx	xxxxx	510	510	245	255	xxxx	xxxxx	xxxx	xxxx	xxxxx
Potent Cap.:	xxxx	xxxx	xxxxx	527	469	799	1322	xxxx	xxxxx	xxxx	xxxx	xxxxx
Move Cap.:	xxxx	xxxx	xxxxx	523	465	799	1322	xxxx	xxxxx	xxxx	xxxx	xxxxx
Volume/Cap:	xxxx	xxxx	xxxx	0.03	0.00	0.02	0.01	xxxx	xxxx	xxxx	xxxx	xxxx

Level Of Service Module:

2Way95thQ:	xxxx	xxxx	xxxxx	xxxx	xxxx	xxxxx	0.0	xxxx	xxxxx	xxxx	xxxx	xxxxx
Control Del:	xxxxx	xxxx	xxxxx	xxxxx	xxxx	xxxxx	7.7	xxxx	xxxxx	xxxxx	xxxx	xxxxx
LOS by Move:	*	*	*	*	*	*	A	*	*	*	*	*
Movement:	LT - LTR - RT	LT - LTR - RT	LT - LTR - RT	LT - LTR - RT	LT - LTR - RT	LT - LTR - RT	LT - LTR - RT	LT - LTR - RT	LT - LTR - RT	LT - LTR - RT	LT - LTR - RT	LT - LTR - RT
Shared Cap.:	xxxx	xxxx	xxxxx	xxxx	640	xxxxx	xxxx	xxxx	xxxxx	xxxx	xxxx	xxxxx
SharedQueue:	xxxxx	xxxx	xxxxx	xxxxx	0.2	xxxxx	xxxxx	xxxx	xxxxx	xxxxx	xxxx	xxxxx
Shrd ConDel:	xxxxx	xxxx	xxxxx	xxxxx	11.0	xxxxx	xxxxx	xxxx	xxxxx	xxxxx	xxxx	xxxxx
Shared LOS:	*	*	*	*	B	*	*	*	*	*	*	*
ApproachDel:	xxxxxxx			11.0			xxxxxxx			xxxxxxx		
ApproachLOS:	*			B			*			*		*

Note: Queue reported is the number of cars per lane.

Voices School
Morgan Hill, CA
Hexagon Transportation Consultants, Inc.

Level Of Service Computation Report
2000 HCM Unsignalized (Future Volume Alternative)
2025 Plus Project (AM) - 3 Monterey out

Intersection #1300: Olympic Drive and Edmundson Avenue

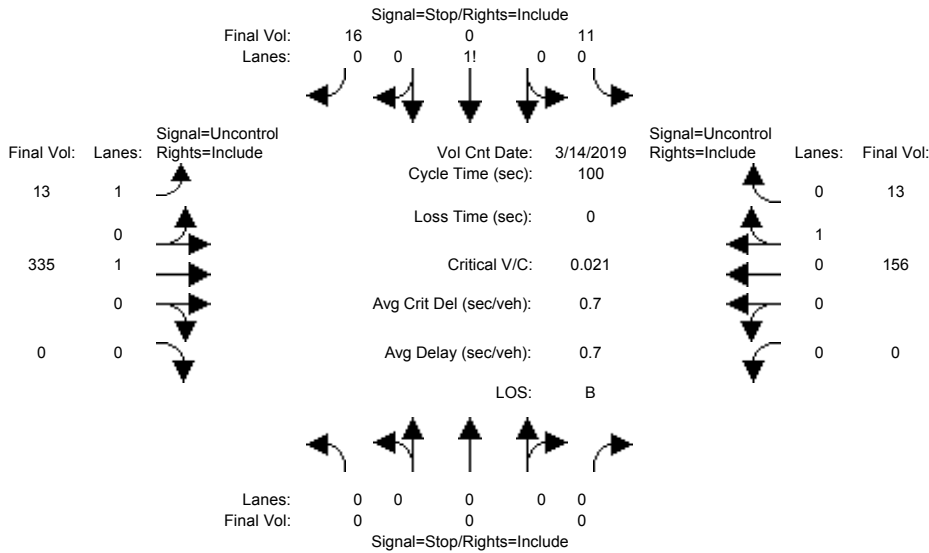

Street Name: Olympic Dr Edmundson Ave
 Approach: North Bound South Bound East Bound West Bound
 Movement: L - T - R L - T - R L - T - R L - T - R

Volume Module:	>>	Count	Date:	14 Mar 2019	<<							
Base Vol:	0	0	0	11	0	11	9	241	0	0	97	13
Growth Adj:	1.00	1.00	1.00	1.00	1.00	1.00	1.00	1.00	1.00	1.00	1.00	1.00
Initial Bse:	0	0	0	11	0	11	9	241	0	0	97	13
Added Vol:	0	0	0	0	0	0	0	16	0	0	5	0
PasserByVol:	0	0	0	0	0	5	4	78	0	0	54	0
Initial Fut:	0	0	0	11	0	16	13	335	0	0	156	13
User Adj:	1.00	1.00	1.00	1.00	1.00	1.00	1.00	1.00	1.00	1.00	1.00	1.00
PHF Adj:	1.00	1.00	1.00	1.00	1.00	1.00	1.00	1.00	1.00	1.00	1.00	1.00
PHF Volume:	0	0	0	11	0	16	13	335	0	0	156	13
Reduct Vol:	0	0	0	0	0	0	0	0	0	0	0	0
FinalVolume:	0	0	0	11	0	16	13	335	0	0	156	13

Critical Gap Module:

Critical Gp:	xxxxx	xxxx	xxxxx	6.4	6.5	6.2	4.1	xxxx	xxxxx	xxxxx	xxxx	xxxxx
FollowUpTim:	xxxxx	xxxx	xxxxx	3.5	4.0	3.3	2.2	xxxx	xxxxx	xxxxx	xxxx	xxxxx

Capacity Module:

Cnflct Vol:	xxxx	xxxx	xxxxx	524	524	163	169	xxxx	xxxxx	xxxx	xxxx	xxxxx
Potent Cap.:	xxxx	xxxx	xxxxx	517	461	888	1421	xxxx	xxxxx	xxxx	xxxx	xxxxx
Move Cap.:	xxxx	xxxx	xxxxx	514	457	888	1421	xxxx	xxxxx	xxxx	xxxx	xxxxx
Volume/Cap:	xxxx	xxxx	xxxx	0.02	0.00	0.02	0.01	xxxx	xxxx	xxxx	xxxx	xxxx

Level Of Service Module:

2Way95thQ:	xxxx	xxxx	xxxxx	xxxx	xxxx	xxxxx	0.0	xxxx	xxxxx	xxxx	xxxx	xxxxx
Control Del:	xxxxx	xxxx	xxxxx	xxxxx	xxxx	xxxxx	7.6	xxxx	xxxxx	xxxxx	xxxx	xxxxx
LOS by Move:	*	*	*	*	*	*	A	*	*	*	*	*
Movement:	LT - LTR - RT	LT - LTR - RT	LT - LTR - RT	LT - LTR - RT	LT - LTR - RT	LT - LTR - RT	LT - LTR - RT	LT - LTR - RT	LT - LTR - RT	LT - LTR - RT	LT - LTR - RT	LT - LTR - RT
Shared Cap.:	xxxx	xxxx	xxxxx	xxxx	685	xxxxx	xxxx	xxxx	xxxxx	xxxx	xxxx	xxxxx
SharedQueue:	xxxxx	xxxx	xxxxx	xxxxx	0.1	xxxxx	xxxxx	xxxx	xxxxx	xxxxx	xxxx	xxxxx
Shrd ConDel:	xxxxx	xxxx	xxxxx	xxxxx	10.5	xxxxx	xxxxx	xxxx	xxxxx	xxxxx	xxxx	xxxxx
Shared LOS:	*	*	*	*	B	*	*	*	*	*	*	*
ApproachDel:	xxxxxxx			10.5			xxxxxxx			xxxxxxx		
ApproachLOS:	*			B			*			*		*

Note: Queue reported is the number of cars per lane.

Voices School
Morgan Hill, CA
Hexagon Transportation Consultants, Inc.

Level Of Service Computation Report
2000 HCM Unsignalized (Future Volume Alternative)
2025 Plus Project (PM) - 3 Monterey out

Intersection #1300: Olympic Drive and Edmundson Avenue

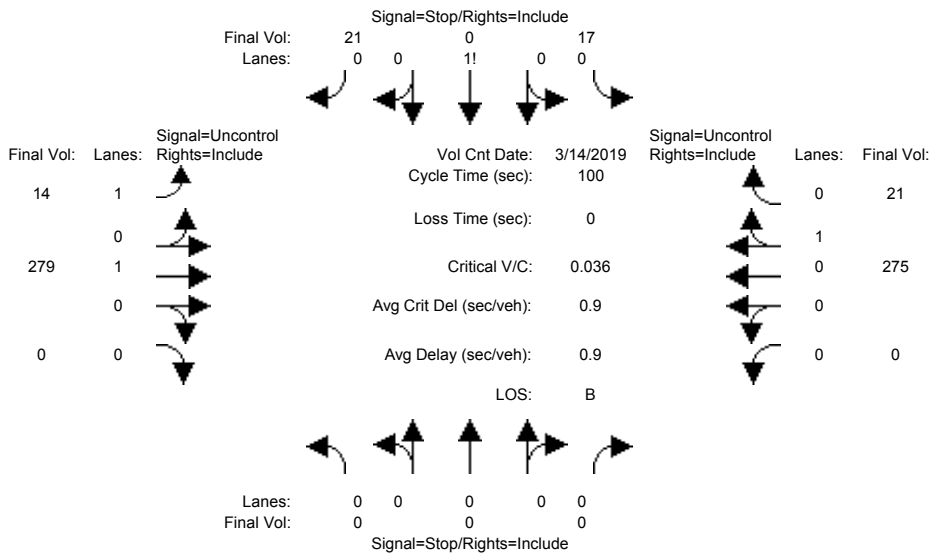

Street Name: Olympic Dr Edmundson Ave
Approach: North Bound South Bound East Bound West Bound
Movement: L - T - R L - T - R L - T - R L - T - R

Volume Module:	>>	Count	Date:	14 Mar 2019	<<							
Base Vol:	0	0	0	17	0	19	12	238	0	0	225	20
Growth Adj:	1.00	1.00	1.00	1.00	1.00	1.00	1.00	1.00	1.00	1.00	1.00	1.00
Initial Bse:	0	0	0	17	0	19	12	238	0	0	225	20
Added Vol:	0	0	0	0	0	0	0	2	0	0	10	0
PasserByVol:	0	0	0	0	0	2	2	39	0	0	40	1
Initial Fut:	0	0	0	17	0	21	14	279	0	0	275	21
User Adj:	1.00	1.00	1.00	1.00	1.00	1.00	1.00	1.00	1.00	1.00	1.00	1.00
PHF Adj:	1.00	1.00	1.00	1.00	1.00	1.00	1.00	1.00	1.00	1.00	1.00	1.00
PHF Volume:	0	0	0	17	0	21	14	279	0	0	275	21
Reduct Vol:	0	0	0	0	0	0	0	0	0	0	0	0
FinalVolume:	0	0	0	17	0	21	14	279	0	0	275	21

Critical Gap Module:

Critical Gp:	xxxxx	xxxx	xxxxx	6.4	6.5	6.2	4.1	xxxx	xxxxx	xxxxx	xxxx	xxxxx
FollowUpTim:	xxxxx	xxxx	xxxxx	3.5	4.0	3.3	2.2	xxxx	xxxxx	xxxxx	xxxx	xxxxx

Capacity Module:

Cnflct Vol:	xxxx	xxxx	xxxxx	593	593	286	296	xxxx	xxxxx	xxxx	xxxx	xxxxx
Potent Cap.:	xxxx	xxxx	xxxxx	472	421	758	1277	xxxx	xxxxx	xxxx	xxxx	xxxxx
Move Cap.:	xxxx	xxxx	xxxxx	468	417	758	1277	xxxx	xxxxx	xxxx	xxxx	xxxxx
Volume/Cap:	xxxx	xxxx	xxxx	0.04	0.00	0.03	0.01	xxxx	xxxx	xxxx	xxxx	xxxx

Level Of Service Module:

2Way95thQ:	xxxx	xxxx	xxxxx	xxxx	xxxx	xxxxx	0.0	xxxx	xxxxx	xxxx	xxxx	xxxxx
Control Del:	xxxxx	xxxx	xxxxx	xxxxx	xxxx	xxxxx	7.9	xxxx	xxxxx	xxxxx	xxxx	xxxxx
LOS by Move:	*	*	*	*	*	*	A	*	*	*	*	*
Movement:	LT - LTR - RT	LT - LTR - RT	LT - LTR - RT	LT - LTR - RT	LT - LTR - RT	LT - LTR - RT	LT - LTR - RT	LT - LTR - RT	LT - LTR - RT	LT - LTR - RT	LT - LTR - RT	LT - LTR - RT
Shared Cap.:	xxxx	xxxx	xxxxx	xxxx	594	xxxxx	xxxx	xxxx	xxxxx	xxxx	xxxx	xxxxx
SharedQueue:	xxxxx	xxxx	xxxxx	xxxxx	0.2	xxxxx	xxxxx	xxxx	xxxxx	xxxxx	xxxx	xxxxx
Shrd ConDel:	xxxxx	xxxx	xxxxx	xxxxx	11.5	xxxxx	xxxxx	xxxx	xxxxx	xxxxx	xxxx	xxxxx
Shared LOS:	*	*	*	*	B	*	*	*	*	*	*	*
ApproachDel:	xxxxxxx			11.5			xxxxxxx			xxxxxxx		
ApproachLOS:	*			B			*			*		*

Note: Queue reported is the number of cars per lane.

Voices School
Morgan Hill, CA
Hexagon Transportation Consultants, Inc.

Level Of Service Computation Report
2000 HCM 4-Way Stop (Future Volume Alternative)
Existing Plus Project (AM) - 3 Monterey out

Intersection #1400: Del Monte Avenue and Cosmo Avenue

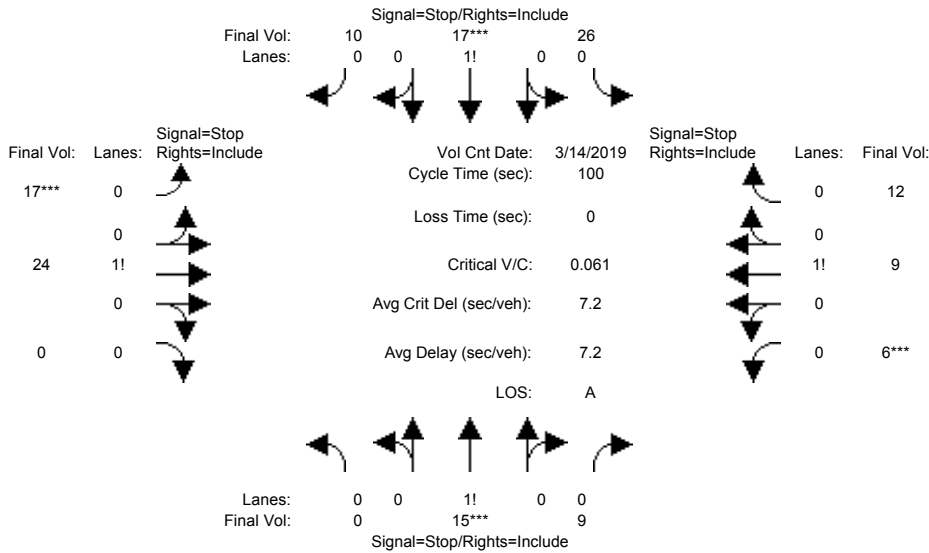

Street Name: Del Monte Ave Cosmo Ave
Approach: North Bound South Bound East Bound West Bound
Movement: L - T - R L - T - R L - T - R L - T - R

Min. Green: 0 0 0 0 0 0 0 0 0 0 0 0

Volume Module: >> Count Date: 14 Mar 2019 <<

Base Vol:	0	15	9	26	17	10	17	24	0	6	9	12
Growth Adj:	1.00	1.00	1.00	1.00	1.00	1.00	1.00	1.00	1.00	1.00	1.00	1.00
Initial Bse:	0	15	9	26	17	10	17	24	0	6	9	12
Added Vol:	0	0	0	0	0	0	0	0	0	0	0	0
PasserByVol:	0	0	0	0	0	0	0	0	0	0	0	0
Initial Fut:	0	15	9	26	17	10	17	24	0	6	9	12
User Adj:	1.00	1.00	1.00	1.00	1.00	1.00	1.00	1.00	1.00	1.00	1.00	1.00
PHF Adj:	1.00	1.00	1.00	1.00	1.00	1.00	1.00	1.00	1.00	1.00	1.00	1.00
PHF Volume:	0	15	9	26	17	10	17	24	0	6	9	12
Reduct Vol:	0	0	0	0	0	0	0	0	0	0	0	0
Reduced Vol:	0	15	9	26	17	10	17	24	0	6	9	12
PCE Adj:	1.00	1.00	1.00	1.00	1.00	1.00	1.00	1.00	1.00	1.00	1.00	1.00
MLF Adj:	1.00	1.00	1.00	1.00	1.00	1.00	1.00	1.00	1.00	1.00	1.00	1.00
FinalVolume:	0	15	9	26	17	10	17	24	0	6	9	12

Saturation Flow Module:

Adjustment:	1.00	1.00	1.00	1.00	1.00	1.00	1.00	1.00	1.00	1.00	1.00	1.00
Lanes:	0.00	0.62	0.38	0.49	0.32	0.19	0.41	0.59	0.00	0.22	0.33	0.45
Final Sat.:	0	571	343	429	281	165	353	498	0	202	303	404

Capacity Analysis Module:

Vol/Sat:	xxxx	0.03	0.03	0.06	0.06	0.06	0.05	0.05	xxxx	0.03	0.03	0.03
Crit Moves:	****			****			****			****		
Delay/Veh:	0.0	7.0	7.0	7.3	7.3	7.3	7.4	7.4	0.0	7.0	7.0	7.0
Delay Adj:	1.00	1.00	1.00	1.00	1.00	1.00	1.00	1.00	1.00	1.00	1.00	1.00
AdjDel/Veh:	0.0	7.0	7.0	7.3	7.3	7.3	7.4	7.4	0.0	7.0	7.0	7.0
LOS by Move:	*	A	A	A	A	A	A	A	*	A	A	A
ApproachDel:		7.0			7.3			7.4			7.0	
Delay Adj:		1.00			1.00			1.00			1.00	
ApprAdjDel:		7.0			7.3			7.4			7.0	
LOS by Appr:		A			A			A			A	
AllWayAvgQ:	0.0	0.0	0.0	0.1	0.1	0.1	0.0	0.0	0.0	0.0	0.0	0.0

Note: Queue reported is the number of cars per lane.

Voices School
Morgan Hill, CA
Hexagon Transportation Consultants, Inc.

Level Of Service Computation Report
2000 HCM 4-Way Stop (Future Volume Alternative)
Existing Plus Project (PM) - 3 Monterey out

Intersection #1400: Del Monte Avenue and Cosmo Avenue

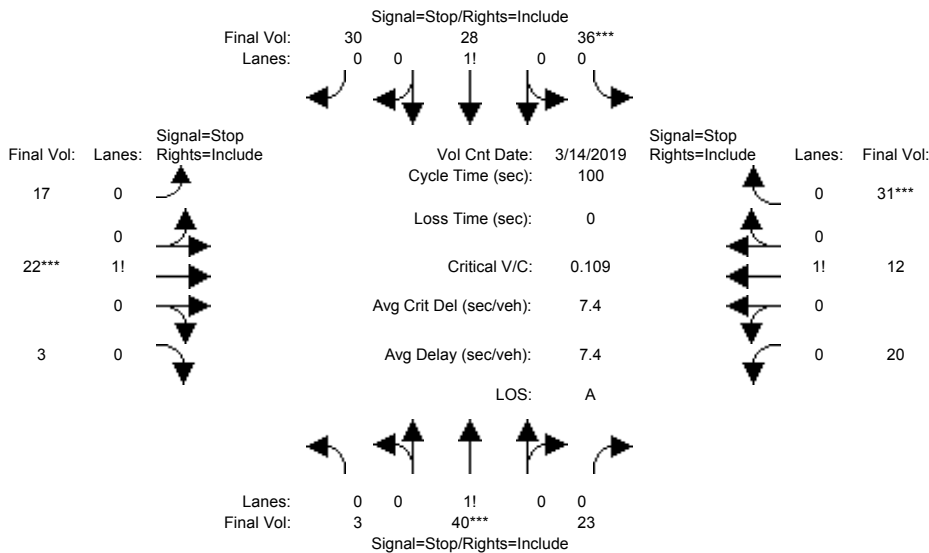

Street Name:	Del Monte Ave						Cosmo Ave					
Approach:	North Bound			South Bound			East Bound			West Bound		
Movement:	L	T	R	L	T	R	L	T	R	L	T	R
Min. Green:	0	0	0	0	0	0	0	0	0	0	0	0
Volume Module: >> Count Date: 14 Mar 2019 <<												
Base Vol:	3	40	23	36	28	30	17	22	3	20	12	31
Growth Adj:	1.00	1.00	1.00	1.00	1.00	1.00	1.00	1.00	1.00	1.00	1.00	1.00
Initial Bse:	3	40	23	36	28	30	17	22	3	20	12	31
Added Vol:	0	0	0	0	0	0	0	0	0	0	0	0
PasserByVol:	0	0	0	0	0	0	0	0	0	0	0	0
Initial Fut:	3	40	23	36	28	30	17	22	3	20	12	31
User Adj:	1.00	1.00	1.00	1.00	1.00	1.00	1.00	1.00	1.00	1.00	1.00	1.00
PHF Adj:	1.00	1.00	1.00	1.00	1.00	1.00	1.00	1.00	1.00	1.00	1.00	1.00
PHF Volume:	3	40	23	36	28	30	17	22	3	20	12	31
Reduct Vol:	0	0	0	0	0	0	0	0	0	0	0	0
Reduced Vol:	3	40	23	36	28	30	17	22	3	20	12	31
PCE Adj:	1.00	1.00	1.00	1.00	1.00	1.00	1.00	1.00	1.00	1.00	1.00	1.00
MLF Adj:	1.00	1.00	1.00	1.00	1.00	1.00	1.00	1.00	1.00	1.00	1.00	1.00
FinalVolume:	3	40	23	36	28	30	17	22	3	20	12	31
Saturation Flow Module:												
Adjustment:	1.00	1.00	1.00	1.00	1.00	1.00	1.00	1.00	1.00	1.00	1.00	1.00
Lanes:	0.04	0.61	0.35	0.38	0.30	0.32	0.40	0.53	0.07	0.32	0.19	0.49
Final Sat.:	40	529	304	331	257	276	325	421	57	273	164	423
Capacity Analysis Module:												
Vol/Sat:	0.08	0.08	0.08	0.11	0.11	0.11	0.05	0.05	0.05	0.07	0.07	0.07
Crit Moves:	****			****			****			****		
Delay/Veh:	7.3	7.3	7.3	7.6	7.6	7.6	7.6	7.6	7.6	7.3	7.3	7.3
Delay Adj:	1.00	1.00	1.00	1.00	1.00	1.00	1.00	1.00	1.00	1.00	1.00	1.00
AdjDel/Veh:	7.3	7.3	7.3	7.6	7.6	7.6	7.6	7.6	7.6	7.3	7.3	7.3
LOS by Move:	A	A	A	A	A	A	A	A	A	A	A	A
ApproachDel:		7.3			7.6			7.6			7.3	
Delay Adj:		1.00			1.00			1.00			1.00	
ApprAdjDel:		7.3			7.6			7.6			7.3	
LOS by Appr:		A			A			A			A	
AllWayAvgQ:	0.1	0.1	0.1	0.1	0.1	0.1	0.1	0.1	0.1	0.1	0.1	0.1

Voices School
Morgan Hill, CA
Hexagon Transportation Consultants, Inc.

Level Of Service Computation Report
2000 HCM 4-Way Stop (Future Volume Alternative)
2025 Plus Project (AM) - 3 Monterey out

Intersection #1400: Del Monte Avenue and Cosmo Avenue

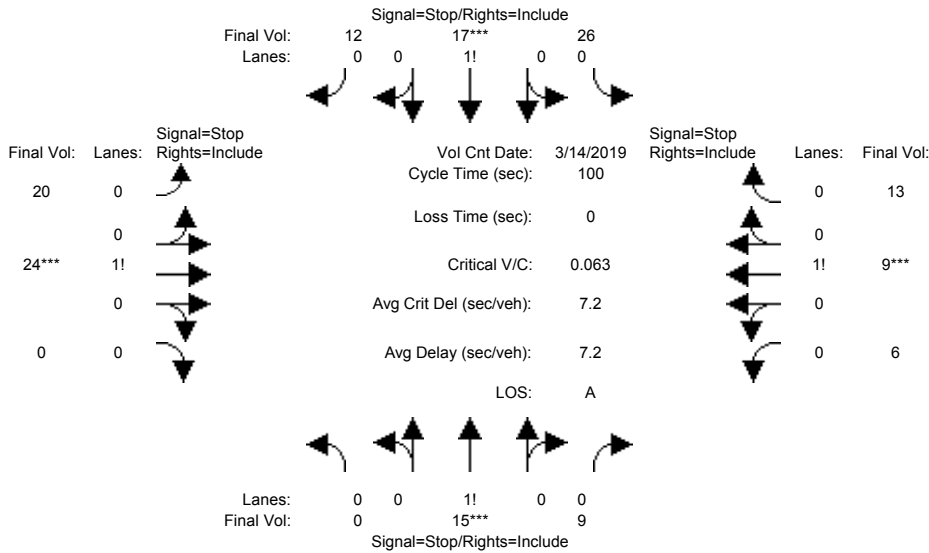

Street Name: Del Monte Ave Cosmo Ave
Approach: North Bound South Bound East Bound West Bound
Movement: L - T - R L - T - R L - T - R L - T - R

Min. Green: 0 0 0 0 0 0 0 0 0 0 0 0

Volume Module: >> Count Date: 14 Mar 2019 <<

Base Vol:	0	15	9	26	17	10	17	24	0	6	9	12
Growth Adj:	1.00	1.00	1.00	1.00	1.00	1.00	1.00	1.00	1.00	1.00	1.00	1.00
Initial Bse:	0	15	9	26	17	10	17	24	0	6	9	12
Added Vol:	0	0	0	0	0	0	0	0	0	0	0	0
PasserByVol:	0	0	0	0	0	2	3	0	0	0	0	1
Initial Fut:	0	15	9	26	17	12	20	24	0	6	9	13
User Adj:	1.00	1.00	1.00	1.00	1.00	1.00	1.00	1.00	1.00	1.00	1.00	1.00
PHF Adj:	1.00	1.00	1.00	1.00	1.00	1.00	1.00	1.00	1.00	1.00	1.00	1.00
PHF Volume:	0	15	9	26	17	12	20	24	0	6	9	13
Reduct Vol:	0	0	0	0	0	0	0	0	0	0	0	0
Reduced Vol:	0	15	9	26	17	12	20	24	0	6	9	13
PCE Adj:	1.00	1.00	1.00	1.00	1.00	1.00	1.00	1.00	1.00	1.00	1.00	1.00
MLF Adj:	1.00	1.00	1.00	1.00	1.00	1.00	1.00	1.00	1.00	1.00	1.00	1.00
FinalVolume:	0	15	9	26	17	12	20	24	0	6	9	13

Saturation Flow Module:

Adjustment:	1.00	1.00	1.00	1.00	1.00	1.00	1.00	1.00	1.00	1.00	1.00	1.00
Lanes:	0.00	0.62	0.38	0.47	0.31	0.22	0.45	0.55	0.00	0.21	0.32	0.47
Final Sat.:	0	570	342	415	271	192	385	461	0	195	293	423

Capacity Analysis Module:

Vol/Sat:	xxxx	0.03	0.03	0.06	0.06	0.06	0.05	0.05	xxxx	0.03	0.03	0.03
Crit Moves:	****			****			****			****		
Delay/Veh:	0.0	7.0	7.0	7.3	7.3	7.3	7.4	7.4	0.0	7.0	7.0	7.0
Delay Adj:	1.00	1.00	1.00	1.00	1.00	1.00	1.00	1.00	1.00	1.00	1.00	1.00
AdjDel/Veh:	0.0	7.0	7.0	7.3	7.3	7.3	7.4	7.4	0.0	7.0	7.0	7.0
LOS by Move:	*	A	A	A	A	A	A	A	*	A	A	A
ApproachDel:		7.0		7.3			7.4			7.0		
Delay Adj:		1.00		1.00			1.00			1.00		
ApprAdjDel:		7.0		7.3			7.4			7.0		
LOS by Appr:		A		A			A			A		
AllWayAvgQ:	0.0	0.0	0.0	0.1	0.1	0.1	0.1	0.1	0.1	0.0	0.0	0.0

Note: Queue reported is the number of cars per lane.

Voices School
Morgan Hill, CA
Hexagon Transportation Consultants, Inc.

Level Of Service Computation Report
2000 HCM 4-Way Stop (Future Volume Alternative)
2025 Plus Project (PM) - 3 Monterey out

Intersection #1400: Del Monte Avenue and Cosmo Avenue

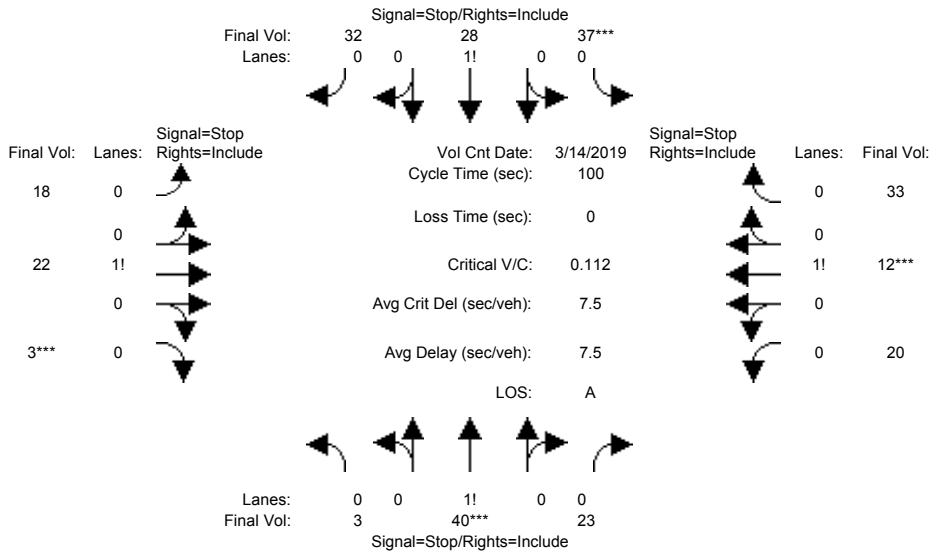

Street Name: Del Monte Ave Cosmo Ave
Approach: North Bound South Bound East Bound West Bound
Movement: L - T - R L - T - R L - T - R L - T - R

Min. Green: 0 0 0 0 0 0 0 0 0 0 0 0

Volume Module: >> Count Date: 14 Mar 2019 <<

Base Vol:	3	40	23	36	28	30	17	22	3	20	12	31
Growth Adj:	1.00	1.00	1.00	1.00	1.00	1.00	1.00	1.00	1.00	1.00	1.00	1.00
Initial Bse:	3	40	23	36	28	30	17	22	3	20	12	31
Added Vol:	0	0	0	0	0	0	0	0	0	0	0	0
PasserByVol:	0	0	0	1	0	2	1	0	0	0	0	2
Initial Fut:	3	40	23	37	28	32	18	22	3	20	12	33
User Adj:	1.00	1.00	1.00	1.00	1.00	1.00	1.00	1.00	1.00	1.00	1.00	1.00
PHF Adj:	1.00	1.00	1.00	1.00	1.00	1.00	1.00	1.00	1.00	1.00	1.00	1.00
PHF Volume:	3	40	23	37	28	32	18	22	3	20	12	33
Reduct Vol:	0	0	0	0	0	0	0	0	0	0	0	0
Reduced Vol:	3	40	23	37	28	32	18	22	3	20	12	33
PCE Adj:	1.00	1.00	1.00	1.00	1.00	1.00	1.00	1.00	1.00	1.00	1.00	1.00
MLF Adj:	1.00	1.00	1.00	1.00	1.00	1.00	1.00	1.00	1.00	1.00	1.00	1.00
FinalVolume:	3	40	23	37	28	32	18	22	3	20	12	33

Saturation Flow Module:

Adjustment:	1.00	1.00	1.00	1.00	1.00	1.00	1.00	1.00	1.00	1.00	1.00	1.00
Lanes:	0.04	0.61	0.35	0.38	0.29	0.33	0.42	0.51	0.07	0.31	0.18	0.51
Final Sat.:	40	528	304	329	249	285	335	409	56	265	159	437

Capacity Analysis Module:

Vol/Sat:	0.08	0.08	0.08	0.11	0.11	0.11	0.05	0.05	0.05	0.08	0.08	0.08
Crit Moves:	****	****	****	****	****	****	****	****	****	****	****	****
Delay/Veh:	7.3	7.3	7.3	7.6	7.6	7.6	7.6	7.6	7.6	7.4	7.4	7.4
Delay Adj:	1.00	1.00	1.00	1.00	1.00	1.00	1.00	1.00	1.00	1.00	1.00	1.00
AdjDel/Veh:	7.3	7.3	7.3	7.6	7.6	7.6	7.6	7.6	7.6	7.4	7.4	7.4
LOS by Move:	A	A	A	A	A	A	A	A	A	A	A	A
ApproachDel:	7.3			7.6			7.6			7.4		
Delay Adj:	1.00			1.00			1.00			1.00		
ApprAdjDel:	7.3			7.6			7.6			7.4		
LOS by Appr:	A			A			A			A		
AllWayAvgQ:	0.1	0.1	0.1	0.1	0.1	0.1	0.1	0.1	0.1	0.1	0.1	0.1

Note: Queue reported is the number of cars per lane.

Voices School
Morgan Hill, CA
Hexagon Transportation Consultants, Inc.

Level Of Service Computation Report
2000 HCM 4-Way Stop (Future Volume Alternative)
Existing Plus Project (AM) - 3 Monterey out

Intersection #1500: Del Monte Avenue and Spring Avenue

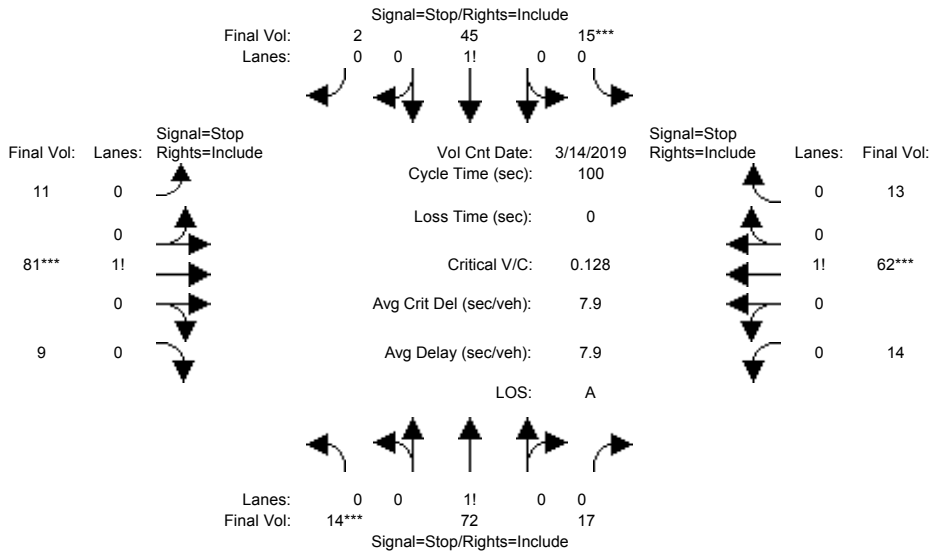

Street Name: Del Monte Ave Spring Ave
Approach: North Bound South Bound East Bound West Bound
Movement: L - T - R L - T - R L - T - R L - T - R

Min. Green: 0 0 0 0 0 0 0 0 0 0 0 0

Volume Module: >> Count Date: 14 Mar 2019 <<

Base Vol:	14	72	17	15	45	2	11	73	9	14	59	13
Growth Adj:	1.00	1.00	1.00	1.00	1.00	1.00	1.00	1.00	1.00	1.00	1.00	1.00
Initial Bse:	14	72	17	15	45	2	11	73	9	14	59	13
Added Vol:	0	0	0	0	0	0	0	8	0	0	3	0
PasserByVol:	0	0	0	0	0	0	0	0	0	0	0	0
Initial Fut:	14	72	17	15	45	2	11	81	9	14	62	13
User Adj:	1.00	1.00	1.00	1.00	1.00	1.00	1.00	1.00	1.00	1.00	1.00	1.00
PHF Adj:	1.00	1.00	1.00	1.00	1.00	1.00	1.00	1.00	1.00	1.00	1.00	1.00
PHF Volume:	14	72	17	15	45	2	11	81	9	14	62	13
Reduct Vol:	0	0	0	0	0	0	0	0	0	0	0	0
Reduced Vol:	14	72	17	15	45	2	11	81	9	14	62	13
PCE Adj:	1.00	1.00	1.00	1.00	1.00	1.00	1.00	1.00	1.00	1.00	1.00	1.00
MLF Adj:	1.00	1.00	1.00	1.00	1.00	1.00	1.00	1.00	1.00	1.00	1.00	1.00
FinalVolume:	14	72	17	15	45	2	11	81	9	14	62	13

Saturation Flow Module:

Adjustment:	1.00	1.00	1.00	1.00	1.00	1.00	1.00	1.00	1.00	1.00	1.00	1.00
Lanes:	0.14	0.70	0.16	0.24	0.73	0.03	0.11	0.80	0.09	0.16	0.70	0.14
Final Sat.:	109	562	133	188	563	25	88	645	72	127	560	118

Capacity Analysis Module:

Vol/Sat:	0.13	0.13	0.13	0.08	0.08	0.08	0.13	0.13	0.13	0.11	0.11	0.11
Crit Moves:	****			****			****			****		
Delay/Veh:	7.9	7.9	7.9	7.8	7.8	7.8	7.9	7.9	7.9	7.8	7.8	7.8
Delay Adj:	1.00	1.00	1.00	1.00	1.00	1.00	1.00	1.00	1.00	1.00	1.00	1.00
AdjDel/Veh:	7.9	7.9	7.9	7.8	7.8	7.8	7.9	7.9	7.9	7.8	7.8	7.8
LOS by Move:	A	A	A	A	A	A	A	A	A	A	A	A
ApproachDel:		7.9			7.8			7.9			7.8	
Delay Adj:		1.00			1.00			1.00			1.00	
ApprAdjDel:		7.9			7.8			7.9			7.8	
LOS by Appr:		A			A			A			A	
AllWayAvgQ:	0.1	0.1	0.1	0.1	0.1	0.1	0.1	0.1	0.1	0.1	0.1	0.1

Note: Queue reported is the number of cars per lane.

Voices School
Morgan Hill, CA
Hexagon Transportation Consultants, Inc.

Level Of Service Computation Report
2000 HCM 4-Way Stop (Future Volume Alternative)
Existing Plus Project (PM) - 3 Monterey out

Intersection #1500: Del Monte Avenue and Spring Avenue

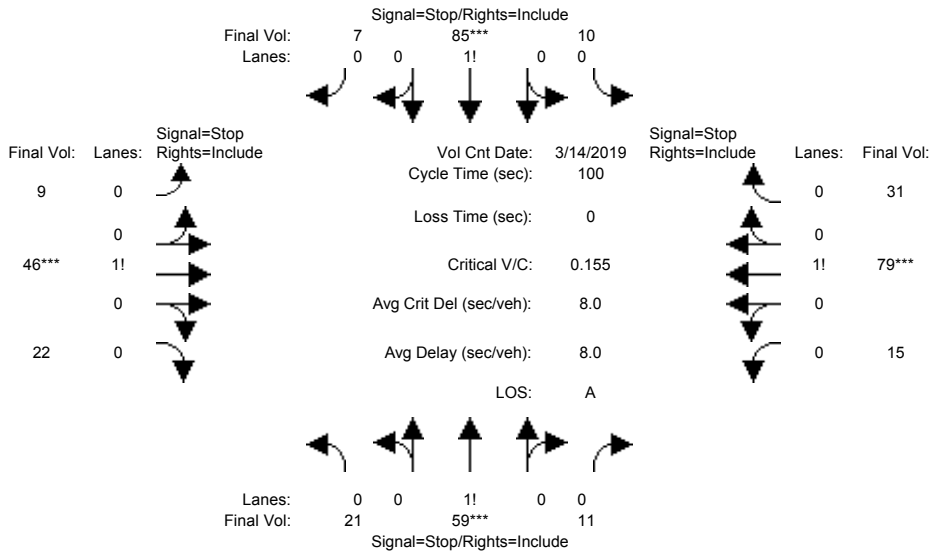

Street Name: Del Monte Ave Spring Ave
Approach: North Bound South Bound East Bound West Bound
Movement: L - T - R L - T - R L - T - R L - T - R

Min. Green: 0 0 0 0 0 0 0 0 0 0 0 0

Volume Module: >> Count Date: 14 Mar 2019 <<

Base Vol:	21	59	11	10	85	7	9	44	22	15	74	31
Growth Adj:	1.00	1.00	1.00	1.00	1.00	1.00	1.00	1.00	1.00	1.00	1.00	1.00
Initial Bse:	21	59	11	10	85	7	9	44	22	15	74	31
Added Vol:	0	0	0	0	0	0	0	2	0	0	5	0
PasserByVol:	0	0	0	0	0	0	0	0	0	0	0	0
Initial Fut:	21	59	11	10	85	7	9	46	22	15	79	31
User Adj:	1.00	1.00	1.00	1.00	1.00	1.00	1.00	1.00	1.00	1.00	1.00	1.00
PHF Adj:	1.00	1.00	1.00	1.00	1.00	1.00	1.00	1.00	1.00	1.00	1.00	1.00
PHF Volume:	21	59	11	10	85	7	9	46	22	15	79	31
Reduct Vol:	0	0	0	0	0	0	0	0	0	0	0	0
Reduced Vol:	21	59	11	10	85	7	9	46	22	15	79	31
PCE Adj:	1.00	1.00	1.00	1.00	1.00	1.00	1.00	1.00	1.00	1.00	1.00	1.00
MLF Adj:	1.00	1.00	1.00	1.00	1.00	1.00	1.00	1.00	1.00	1.00	1.00	1.00
FinalVolume:	21	59	11	10	85	7	9	46	22	15	79	31

Saturation Flow Module:

Adjustment:	1.00	1.00	1.00	1.00	1.00	1.00	1.00	1.00	1.00	1.00	1.00	1.00
Lanes:	0.23	0.65	0.12	0.10	0.83	0.07	0.12	0.60	0.28	0.12	0.63	0.25
Final Sat.:	180	506	94	77	652	54	93	477	228	97	510	200

Capacity Analysis Module:

Vol/Sat:	0.12	0.12	0.12	0.13	0.13	0.13	0.10	0.10	0.10	0.15	0.15	0.15
Crit Moves:	****			****			****			****		
Delay/Veh:	8.0	8.0	8.0	8.0	8.0	8.0	7.7	7.7	7.7	8.0	8.0	8.0
Delay Adj:	1.00	1.00	1.00	1.00	1.00	1.00	1.00	1.00	1.00	1.00	1.00	1.00
AdjDel/Veh:	8.0	8.0	8.0	8.0	8.0	8.0	7.7	7.7	7.7	8.0	8.0	8.0
LOS by Move:	A	A	A	A	A	A	A	A	A	A	A	A
ApproachDel:	8.0			8.0			7.7			8.0		
Delay Adj:	1.00			1.00			1.00			1.00		
ApprAdjDel:	8.0			8.0			7.7			8.0		
LOS by Appr:	A			A			A			A		
AllWayAvgQ:	0.1	0.1	0.1	0.1	0.1	0.1	0.1	0.1	0.1	0.2	0.2	0.2

Note: Queue reported is the number of cars per lane.

Voices School
Morgan Hill, CA
Hexagon Transportation Consultants, Inc.

Level Of Service Computation Report
2000 HCM 4-Way Stop (Future Volume Alternative)
2025 Plus Project (AM) - 3 Monterey out

Intersection #1500: Del Monte Avenue and Spring Avenue

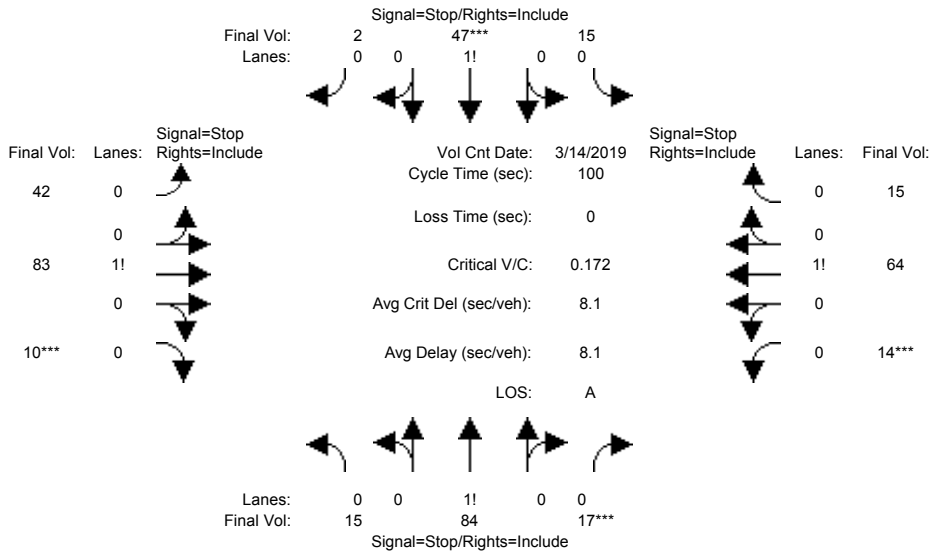

Street Name:	Del Monte Ave						Spring Ave					
Approach:	North Bound			South Bound			East Bound			West Bound		
Movement:	L	T	R	L	T	R	L	T	R	L	T	R

Min. Green:	0	0	0	0	0	0	0	0	0	0	0	0
-------------	---	---	---	---	---	---	---	---	---	---	---	---

Volume Module:	>> Count Date: 14 Mar 2019 <<											
Base Vol:	14	72	17	15	45	2	11	73	9	14	59	13
Growth Adj:	1.00	1.00	1.00	1.00	1.00	1.00	1.00	1.00	1.00	1.00	1.00	1.00
Initial Bse:	14	72	17	15	45	2	11	73	9	14	59	13
Added Vol:	0	0	0	0	0	0	0	8	0	0	3	0
PasserByVol:	1	12	0	0	2	0	31	2	1	0	2	2
Initial Fut:	15	84	17	15	47	2	42	83	10	14	64	15
User Adj:	1.00	1.00	1.00	1.00	1.00	1.00	1.00	1.00	1.00	1.00	1.00	1.00
PHF Adj:	1.00	1.00	1.00	1.00	1.00	1.00	1.00	1.00	1.00	1.00	1.00	1.00
PHF Volume:	15	84	17	15	47	2	42	83	10	14	64	15
Reduct Vol:	0	0	0	0	0	0	0	0	0	0	0	0
Reduced Vol:	15	84	17	15	47	2	42	83	10	14	64	15
PCE Adj:	1.00	1.00	1.00	1.00	1.00	1.00	1.00	1.00	1.00	1.00	1.00	1.00
MLF Adj:	1.00	1.00	1.00	1.00	1.00	1.00	1.00	1.00	1.00	1.00	1.00	1.00
FinalVolume:	15	84	17	15	47	2	42	83	10	14	64	15

Saturation Flow Module:												
Adjustment:	1.00	1.00	1.00	1.00	1.00	1.00	1.00	1.00	1.00	1.00	1.00	1.00
Lanes:	0.13	0.72	0.15	0.23	0.74	0.03	0.31	0.62	0.07	0.15	0.69	0.16
Final Sat.:	101	565	114	176	552	23	244	483	58	119	543	127

Capacity Analysis Module:												
Vol/Sat:	0.15	0.15	0.15	0.09	0.09	0.09	0.17	0.17	0.17	0.12	0.12	0.12
Crit Moves:			****			****			****			****
Delay/Veh:	8.1	8.1	8.1	8.0	8.0	8.0	8.3	8.3	8.3	7.9	7.9	7.9
Delay Adj:	1.00	1.00	1.00	1.00	1.00	1.00	1.00	1.00	1.00	1.00	1.00	1.00
AdjDel/Veh:	8.1	8.1	8.1	8.0	8.0	8.0	8.3	8.3	8.3	7.9	7.9	7.9
LOS by Move:	A	A	A	A	A	A	A	A	A	A	A	A
ApproachDel:		8.1			8.0			8.3			7.9	
Delay Adj:		1.00			1.00			1.00			1.00	
ApprAdjDel:		8.1			8.0			8.3			7.9	
LOS by Appr:		A			A			A			A	
AllWayAvgQ:	0.2	0.2	0.2	0.1	0.1	0.1	0.2	0.2	0.2	0.1	0.1	0.1

Note: Queue reported is the number of cars per lane.

Voices School
Morgan Hill, CA
Hexagon Transportation Consultants, Inc.

Level Of Service Computation Report
2000 HCM 4-Way Stop (Future Volume Alternative)
2025 Plus Project (PM) - 3 Monterey out

Intersection #1500: Del Monte Avenue and Spring Avenue

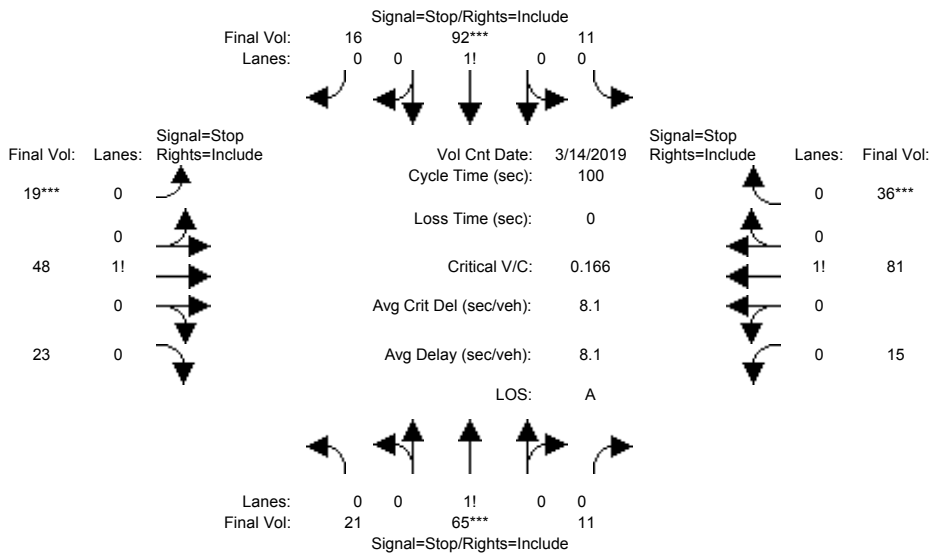

Street Name:	Del Monte Ave						Spring Ave					
Approach:	North Bound			South Bound			East Bound			West Bound		
Movement:	L	T	R	L	T	R	L	T	R	L	T	R

Min. Green:	0	0	0	0	0	0	0	0	0	0	0	0
-------------	---	---	---	---	---	---	---	---	---	---	---	---

Volume Module:	>> Count Date: 14 Mar 2019 <<											
Base Vol:	21	59	11	10	85	7	9	44	22	15	74	31
Growth Adj:	1.00	1.00	1.00	1.00	1.00	1.00	1.00	1.00	1.00	1.00	1.00	1.00
Initial Bse:	21	59	11	10	85	7	9	44	22	15	74	31
Added Vol:	0	0	0	0	0	0	0	2	0	0	5	0
PasserByVol:	0	6	0	1	7	9	10	2	1	0	2	5
Initial Fut:	21	65	11	11	92	16	19	48	23	15	81	36
User Adj:	1.00	1.00	1.00	1.00	1.00	1.00	1.00	1.00	1.00	1.00	1.00	1.00
PHF Adj:	1.00	1.00	1.00	1.00	1.00	1.00	1.00	1.00	1.00	1.00	1.00	1.00
PHF Volume:	21	65	11	11	92	16	19	48	23	15	81	36
Reduct Vol:	0	0	0	0	0	0	0	0	0	0	0	0
Reduced Vol:	21	65	11	11	92	16	19	48	23	15	81	36
PCE Adj:	1.00	1.00	1.00	1.00	1.00	1.00	1.00	1.00	1.00	1.00	1.00	1.00
MLF Adj:	1.00	1.00	1.00	1.00	1.00	1.00	1.00	1.00	1.00	1.00	1.00	1.00
FinalVolume:	21	65	11	11	92	16	19	48	23	15	81	36

Saturation Flow Module:												
Adjustment:	1.00	1.00	1.00	1.00	1.00	1.00	1.00	1.00	1.00	1.00	1.00	1.00
Lanes:	0.22	0.67	0.11	0.09	0.78	0.13	0.21	0.53	0.26	0.11	0.62	0.27
Final Sat.:	166	512	87	72	600	104	164	415	199	90	487	217

Capacity Analysis Module:												
Vol/Sat:	0.13	0.13	0.13	0.15	0.15	0.15	0.12	0.12	0.12	0.17	0.17	0.17
Crit Moves:	****			****			****			****		
Delay/Veh:	8.1	8.1	8.1	8.2	8.2	8.2	8.0	8.0	8.0	8.2	8.2	8.2
Delay Adj:	1.00	1.00	1.00	1.00	1.00	1.00	1.00	1.00	1.00	1.00	1.00	1.00
AdjDel/Veh:	8.1	8.1	8.1	8.2	8.2	8.2	8.0	8.0	8.0	8.2	8.2	8.2
LOS by Move:	A	A	A	A	A	A	A	A	A	A	A	A
ApproachDel:	8.1			8.2			8.0			8.2		
Delay Adj:	1.00			1.00			1.00			1.00		
ApprAdjDel:	8.1			8.2			8.0			8.2		
LOS by Appr:	A			A			A			A		
AllWayAvgQ:	0.1	0.1	0.1	0.2	0.2	0.2	0.1	0.1	0.1	0.2	0.2	0.2

Note: Queue reported is the number of cars per lane.

Voices School
Morgan Hill, CA
Hexagon Transportation Consultants, Inc.

Level Of Service Computation Report
2000 HCM Operations (Future Volume Alternative)
Existing Plus Project (AM) - 3 Monterey out

Intersection #4111: Monterey Road and Vineyard Boulevard

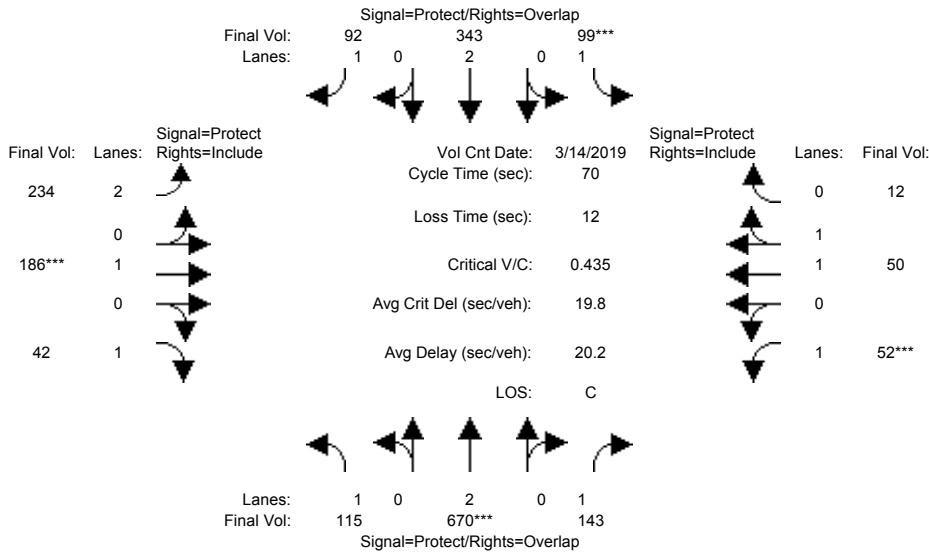

Street Name:	Monterey Road						Vineyard Blvd					
	North Bound			South Bound			East Bound			West Bound		
Approach:	L	T	R	L	T	R	L	T	R	L	T	R
Min. Green:	7	10	10	7	10	10	7	10	10	7	10	10
Y+R:	4.0	4.0	4.0	4.0	4.0	4.0	4.0	4.0	4.0	4.0	4.0	4.0

Volume Module:	>>	Count	Date:	14 Mar 2019	<<							
Base Vol:	115	625	143	99	319	86	217	186	42	52	50	12
Growth Adj:	1.00	1.00	1.00	1.00	1.00	1.00	1.00	1.00	1.00	1.00	1.00	1.00
Initial Bse:	115	625	143	99	319	86	217	186	42	52	50	12
Added Vol:	0	45	0	0	24	6	17	0	0	0	0	0
PasserByVol:	0	0	0	0	0	0	0	0	0	0	0	0
Initial Fut:	115	670	143	99	343	92	234	186	42	52	50	12
User Adj:	1.00	1.00	1.00	1.00	1.00	1.00	1.00	1.00	1.00	1.00	1.00	1.00
PHF Adj:	1.00	1.00	1.00	1.00	1.00	1.00	1.00	1.00	1.00	1.00	1.00	1.00
PHF Volume:	115	670	143	99	343	92	234	186	42	52	50	12
Reduct Vol:	0	0	0	0	0	0	0	0	0	0	0	0
Reduced Vol:	115	670	143	99	343	92	234	186	42	52	50	12
PCE Adj:	1.00	1.00	1.00	1.00	1.00	1.00	1.00	1.00	1.00	1.00	1.00	1.00
MLF Adj:	1.00	1.00	1.00	1.00	1.00	1.00	1.00	1.00	1.00	1.00	1.00	1.00
Final Volume:	115	670	143	99	343	92	234	186	42	52	50	12

Saturation Flow Module:												
Sat/Lane:	1900	1900	1900	1900	1900	1900	1900	1900	1900	1900	1900	1900
Adjustment:	0.92	1.00	0.92	0.92	1.00	0.92	0.83	1.00	0.92	0.92	0.98	0.95
Lanes:	1.00	2.00	1.00	1.00	2.00	1.00	2.00	1.00	1.00	1.00	1.60	0.40
Final Sat.:	1750	3800	1750	1750	3800	1750	3150	1900	1750	1750	2983	716

Capacity Analysis Module:												
Vol/Sat:	0.07	0.18	0.08	0.06	0.09	0.05	0.07	0.10	0.02	0.03	0.02	0.02
Crit Moves:	****			****			****			****		
Green Time:	14.8	27.2	34.2	8.7	21.1	30.2	9.1	15.1	15.1	7.0	13.0	13.0
Volume/Cap:	0.31	0.45	0.17	0.45	0.30	0.12	0.57	0.45	0.11	0.30	0.09	0.09
Delay/Veh:	23.8	16.1	10.1	29.9	18.9	12.0	30.6	24.7	22.2	30.2	23.7	23.7
User DelAdj:	1.00	1.00	1.00	1.00	1.00	1.00	1.00	1.00	1.00	1.00	1.00	1.00
AdjDel/Veh:	23.8	16.1	10.1	29.9	18.9	12.0	30.6	24.7	22.2	30.2	23.7	23.7
LOS by Move:	C	B	B	C	B	B	C	C	C	C	C	C
HCM2kAvgQ:	2	5	2	2	3	1	4	4	1	1	1	1

Note: Queue reported is the number of cars per lane.

Voices School
Morgan Hill, CA
Hexagon Transportation Consultants, Inc.

Level Of Service Computation Report
2000 HCM Operations (Future Volume Alternative)
Existing Plus Project (PM) - 3 Monterey out

Intersection #4111: Monterey Road and Vineyard Boulevard

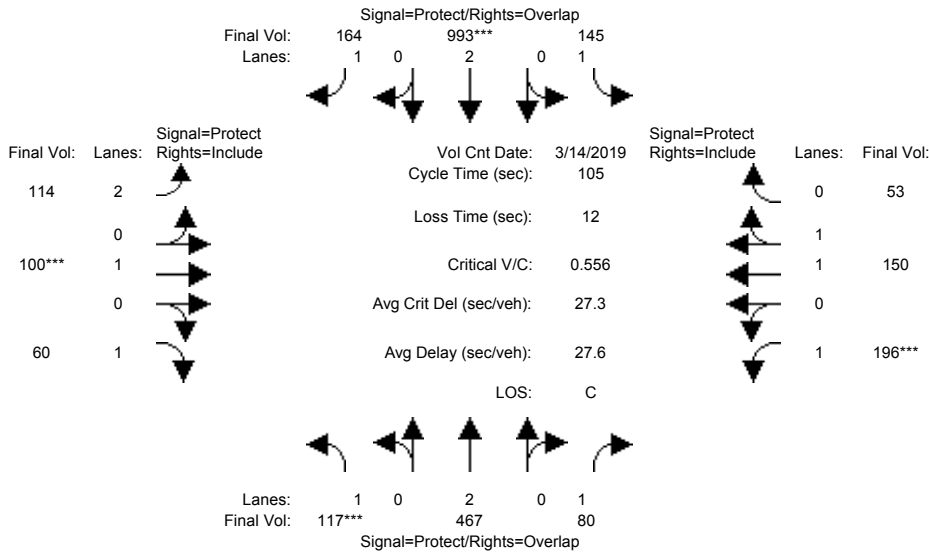

Street Name:	Monterey Road						Vineyard Blvd					
	North Bound			South Bound			East Bound			West Bound		
Approach:	L	T	R	L	T	R	L	T	R	L	T	R
Min. Green:	7	10	10	7	10	10	7	10	10	7	10	10
Y+R:	4.0	4.0	4.0	4.0	4.0	4.0	4.0	4.0	4.0	4.0	4.0	4.0

Volume Module:	>>	Count	Date:	14 Mar 2019	<<							
Base Vol:	117	455	80	145	965	153	111	100	60	196	150	53
Growth Adj:	1.00	1.00	1.00	1.00	1.00	1.00	1.00	1.00	1.00	1.00	1.00	1.00
Initial Bse:	117	455	80	145	965	153	111	100	60	196	150	53
Added Vol:	0	12	0	0	28	11	3	0	0	0	0	0
PasserByVol:	0	0	0	0	0	0	0	0	0	0	0	0
Initial Fut:	117	467	80	145	993	164	114	100	60	196	150	53
User Adj:	1.00	1.00	1.00	1.00	1.00	1.00	1.00	1.00	1.00	1.00	1.00	1.00
PHF Adj:	1.00	1.00	1.00	1.00	1.00	1.00	1.00	1.00	1.00	1.00	1.00	1.00
PHF Volume:	117	467	80	145	993	164	114	100	60	196	150	53
Reduct Vol:	0	0	0	0	0	0	0	0	0	0	0	0
Reduced Vol:	117	467	80	145	993	164	114	100	60	196	150	53
PCE Adj:	1.00	1.00	1.00	1.00	1.00	1.00	1.00	1.00	1.00	1.00	1.00	1.00
MLF Adj:	1.00	1.00	1.00	1.00	1.00	1.00	1.00	1.00	1.00	1.00	1.00	1.00
FinalVolume:	117	467	80	145	993	164	114	100	60	196	150	53

Saturation Flow Module:												
Sat/Lane:	1900	1900	1900	1900	1900	1900	1900	1900	1900	1900	1900	1900
Adjustment:	0.92	1.00	0.92	0.92	1.00	0.92	0.83	1.00	0.92	0.92	0.98	0.95
Lanes:	1.00	2.00	1.00	1.00	2.00	1.00	2.00	1.00	1.00	1.00	1.46	0.54
Final Sat.:	1750	3800	1750	1750	3800	1750	3150	1900	1750	1750	2733	966

Capacity Analysis Module:												
Vol/Sat:	0.07	0.12	0.05	0.08	0.26	0.09	0.04	0.05	0.03	0.11	0.05	0.05
Crit Moves:	****				****			****		****		
Green Time:	12.6	37.0	58.1	24.9	49.3	62.1	12.8	10.0	10.0	21.1	18.3	18.3
Volume/Cap:	0.56	0.35	0.08	0.35	0.56	0.16	0.30	0.55	0.36	0.56	0.31	0.31
Delay/Veh:	46.9	25.3	11.0	33.8	20.4	9.7	42.4	49.0	45.8	39.7	38.2	38.2
User DelAdj:	1.00	1.00	1.00	1.00	1.00	1.00	1.00	1.00	1.00	1.00	1.00	1.00
AdjDel/Veh:	46.9	25.3	11.0	33.8	20.4	9.7	42.4	49.0	45.8	39.7	38.2	38.2
LOS by Move:	D	C	B	C	C	A	D	D	D	D	D	D
HCM2kAvgQ:	4	5	1	4	11	2	2	4	2	7	3	3

Note: Queue reported is the number of cars per lane.

Voices School
Morgan Hill, CA
Hexagon Transportation Consultants, Inc.

Level Of Service Computation Report
2000 HCM Operations (Future Volume Alternative)
2025 Plus Project (AM) - 3 Monterey out

Intersection #4111: Monterey Road and Vineyard Boulevard

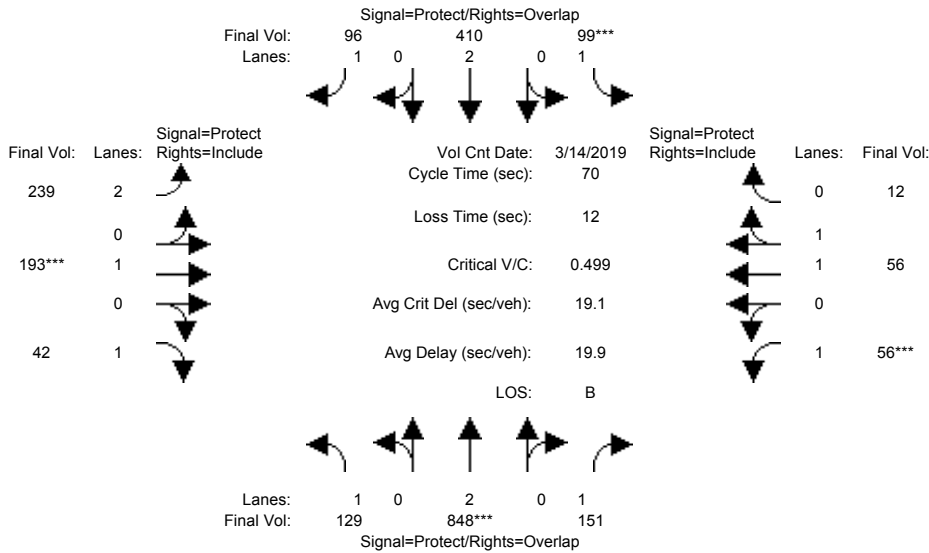

Street Name:	Monterey Road						Vineyard Blvd					
Approach:	North Bound			South Bound			East Bound			West Bound		
Movement:	L	T	R	L	T	R	L	T	R	L	T	R
Min. Green:	7	10	10	7	10	10	7	10	10	7	10	10
Y+R:	4.0	4.0	4.0	4.0	4.0	4.0	4.0	4.0	4.0	4.0	4.0	4.0

Volume Module:	>>	Count	Date:	14 Mar 2019	<<							
Base Vol:	115	625	143	99	319	86	217	186	42	52	50	12
Growth Adj:	1.00	1.00	1.00	1.00	1.00	1.00	1.00	1.00	1.00	1.00	1.00	1.00
Initial Bse:	115	625	143	99	319	86	217	186	42	52	50	12
Added Vol:	0	45	0	0	23	6	17	0	0	0	0	0
PasserByVol:	14	178	8	0	68	4	5	7	0	4	6	0
Initial Fut:	129	848	151	99	410	96	239	193	42	56	56	12
User Adj:	1.00	1.00	1.00	1.00	1.00	1.00	1.00	1.00	1.00	1.00	1.00	1.00
PHF Adj:	1.00	1.00	1.00	1.00	1.00	1.00	1.00	1.00	1.00	1.00	1.00	1.00
PHF Volume:	129	848	151	99	410	96	239	193	42	56	56	12
Reduct Vol:	0	0	0	0	0	0	0	0	0	0	0	0
Reduced Vol:	129	848	151	99	410	96	239	193	42	56	56	12
PCE Adj:	1.00	1.00	1.00	1.00	1.00	1.00	1.00	1.00	1.00	1.00	1.00	1.00
MLF Adj:	1.00	1.00	1.00	1.00	1.00	1.00	1.00	1.00	1.00	1.00	1.00	1.00
FinalVolume:	129	848	151	99	410	96	239	193	42	56	56	12

Saturation Flow Module:	
Sat/Lane:	1900 1900 1900 1900 1900 1900 1900 1900 1900 1900 1900 1900
Adjustment:	0.92 1.00 0.92 0.92 1.00 0.92 0.83 1.00 0.92 0.92 0.98 0.95
Lanes:	1.00 2.00 1.00 1.00 2.00 1.00 2.00 1.00 1.00 1.00 1.64 0.36
Final Sat.:	1750 3800 1750 1750 3800 1750 3150 1900 1750 1750 3047 653

Capacity Analysis Module:	
Vol/Sat:	0.07 0.22 0.09 0.06 0.11 0.05 0.08 0.10 0.02 0.03 0.02 0.02
Crit Moves:	**** **** ****
Green Time:	15.4 29.8 36.8 7.6 22.0 30.5 8.5 13.6 13.6 7.0 12.1 12.1
Volume/Cap:	0.33 0.52 0.16 0.52 0.34 0.13 0.63 0.52 0.12 0.32 0.11 0.11
Delay/Veh:	23.5 15.1 8.7 32.2 18.6 11.9 32.5 26.7 23.5 30.3 24.5 24.5
User DelAdj:	1.00 1.00 1.00 1.00 1.00 1.00 1.00 1.00 1.00 1.00 1.00 1.00
AdjDel/Veh:	23.5 15.1 8.7 32.2 18.6 11.9 32.5 26.7 23.5 30.3 24.5 24.5
LOS by Move:	C B A C B B C C C C C C
HCM2kAvgQ:	2 7 2 2 3 1 4 4 1 2 1 1

Note: Queue reported is the number of cars per lane.

Voices School
Morgan Hill, CA
Hexagon Transportation Consultants, Inc.

Level Of Service Computation Report
2000 HCM Operations (Future Volume Alternative)
2025 Plus Project (PM) - 3 Monterey out

Intersection #4111: Monterey Road and Vineyard Boulevard

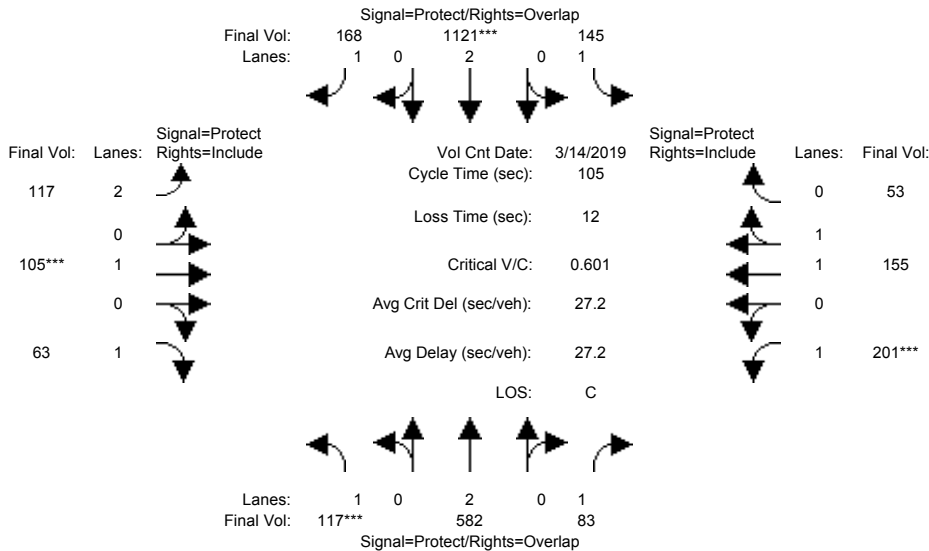

Street Name:	Monterey Road						Vineyard Blvd					
	North Bound			South Bound			East Bound			West Bound		
Approach:	L	T	R	L	T	R	L	T	R	L	T	R
Min. Green:	7	10	10	7	10	10	7	10	10	7	10	10
Y+R:	4.0	4.0	4.0	4.0	4.0	4.0	4.0	4.0	4.0	4.0	4.0	4.0
Volume Module: >> Count Date: 14 Mar 2019 <<												
Base Vol:	117	455	80	145	965	153	111	100	60	196	150	53
Growth Adj:	1.00	1.00	1.00	1.00	1.00	1.00	1.00	1.00	1.00	1.00	1.00	1.00
Initial Bse:	117	455	80	145	965	153	111	100	60	196	150	53
Added Vol:	0	12	0	0	28	11	3	0	0	0	0	0
PasserByVol:	0	115	3	0	128	4	3	5	3	5	5	0
Initial Fut:	117	582	83	145	1121	168	117	105	63	201	155	53
User Adj:	1.00	1.00	1.00	1.00	1.00	1.00	1.00	1.00	1.00	1.00	1.00	1.00
PHF Adj:	1.00	1.00	1.00	1.00	1.00	1.00	1.00	1.00	1.00	1.00	1.00	1.00
PHF Volume:	117	582	83	145	1121	168	117	105	63	201	155	53
Reduct Vol:	0	0	0	0	0	0	0	0	0	0	0	0
Reduced Vol:	117	582	83	145	1121	168	117	105	63	201	155	53
PCE Adj:	1.00	1.00	1.00	1.00	1.00	1.00	1.00	1.00	1.00	1.00	1.00	1.00
MLF Adj:	1.00	1.00	1.00	1.00	1.00	1.00	1.00	1.00	1.00	1.00	1.00	1.00
FinalVolume:	117	582	83	145	1121	168	117	105	63	201	155	53
Saturation Flow Module:												
Sat/Lane:	1900	1900	1900	1900	1900	1900	1900	1900	1900	1900	1900	1900
Adjustment:	0.92	1.00	0.92	0.92	1.00	0.92	0.83	1.00	0.92	0.92	0.98	0.95
Lanes:	1.00	2.00	1.00	1.00	2.00	1.00	2.00	1.00	1.00	1.00	1.48	0.52
Final Sat.:	1750	3800	1750	1750	3800	1750	3150	1900	1750	1750	2757	943
Capacity Analysis Module:												
Vol/Sat:	0.07	0.15	0.05	0.08	0.30	0.10	0.04	0.06	0.04	0.11	0.06	0.06
Crit Moves:	***			***			***			***		
Green Time:	11.6	40.9	60.9	22.1	51.4	63.7	12.4	10.0	10.0	20.0	17.6	17.6
Volume/Cap:	0.60	0.39	0.08	0.39	0.60	0.16	0.32	0.58	0.38	0.60	0.33	0.33
Delay/Veh:	49.7	23.3	9.8	36.4	20.0	9.0	42.9	50.2	46.0	42.0	38.8	38.8
User DelAdj:	1.00	1.00	1.00	1.00	1.00	1.00	1.00	1.00	1.00	1.00	1.00	1.00
AdjDel/Veh:	49.7	23.3	9.8	36.4	20.0	9.0	42.9	50.2	46.0	42.0	38.8	38.8
LOS by Move:	D	C	A	D	B	A	D	D	D	D	D	D
HCM2kAvgQ:	4	6	1	4	13	2	2	4	2	7	3	3

Note: Queue reported is the number of cars per lane.

Voices School
Morgan Hill, CA
Hexagon Transportation Consultants, Inc.

Level Of Service Computation Report
2000 HCM Operations (Future Volume Alternative)
Existing Plus Project (AM) - 3 Monterey out

Intersection #6674: Monterey Road and Tennant Avenue/Edmundson Avenue

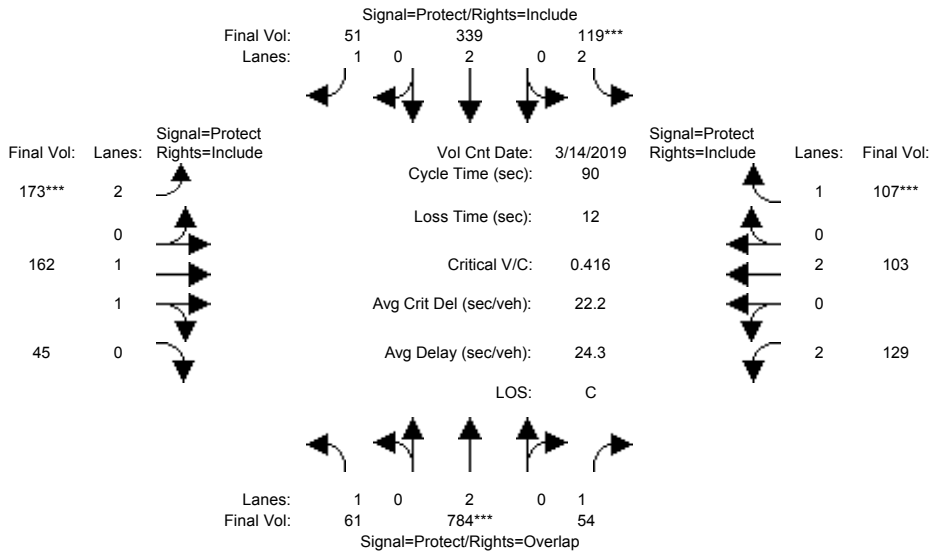

Street Name:	Monterey Rd						Tennant Ave/Edmundson Ave					
	North Bound			South Bound			East Bound			West Bound		
Approach:	L	T	R	L	T	R	L	T	R	L	T	R
Min. Green:	7	10	10	7	10	10	7	10	10	7	10	10
Y+R:	4.0	4.0	4.0	4.0	4.0	4.0	4.0	4.0	4.0	4.0	4.0	4.0

Volume Module:	>>	Count	Date:	14 Mar 2019	<<											
Base Vol:	61	722	54	92	309	46	157	162	45	129	103	86				
Growth Adj:	1.00	1.00	1.00	1.00	1.00	1.00	1.00	1.00	1.00	1.00	1.00	1.00				
Initial Bse:	61	722	54	92	309	46	157	162	45	129	103	86				
Added Vol:	0	62	0	27	30	5	16	0	0	0	0	21				
PasserByVol:	0	0	0	0	0	0	0	0	0	0	0	0				
Initial Fut:	61	784	54	119	339	51	173	162	45	129	103	107				
User Adj:	1.00	1.00	1.00	1.00	1.00	1.00	1.00	1.00	1.00	1.00	1.00	1.00				
PHF Adj:	1.00	1.00	1.00	1.00	1.00	1.00	1.00	1.00	1.00	1.00	1.00	1.00				
PHF Volume:	61	784	54	119	339	51	173	162	45	129	103	107				
Reduct Vol:	0	0	0	0	0	0	0	0	0	0	0	0				
Reduced Vol:	61	784	54	119	339	51	173	162	45	129	103	107				
PCE Adj:	1.00	1.00	1.00	1.00	1.00	1.00	1.00	1.00	1.00	1.00	1.00	1.00				
MLF Adj:	1.00	1.00	1.00	1.00	1.00	1.00	1.00	1.00	1.00	1.00	1.00	1.00				
Final Volume:	61	784	54	119	339	51	173	162	45	129	103	107				

Saturation Flow Module:												
Sat/Lane:	1900	1900	1900	1900	1900	1900	1900	1900	1900	1900	1900	1900
Adjustment:	0.92	1.00	0.92	0.83	1.00	0.92	0.83	0.98	0.95	0.83	1.00	0.92
Lanes:	1.00	2.00	1.00	2.00	2.00	1.00	2.00	1.55	0.45	2.00	2.00	1.00
Final Sat.:	1750	3800	1750	3150	3800	1750	3150	2895	804	3150	3800	1750

Capacity Analysis Module:												
Vol/Sat:	0.03	0.21	0.03	0.04	0.09	0.03	0.05	0.06	0.06	0.04	0.03	0.06
Crit Moves:	****			****			****			****		
Green Time:	21.8	44.7	55.0	8.2	31.1	31.1	11.9	14.8	14.8	10.4	13.2	13.2
Volume/Cap:	0.14	0.42	0.05	0.42	0.26	0.08	0.42	0.34	0.34	0.36	0.18	0.42
Delay/Veh:	27.0	14.5	7.0	39.6	21.3	19.9	36.5	33.6	33.6	37.4	33.8	36.0
User DelAdj:	1.00	1.00	1.00	1.00	1.00	1.00	1.00	1.00	1.00	1.00	1.00	1.00
AdjDel/Veh:	27.0	14.5	7.0	39.6	21.3	19.9	36.5	33.6	33.6	37.4	33.8	36.0
LOS by Move:	C	B	A	D	C	B	D	C	C	D	C	D
HCM2kAvgQ:	1	7	1	2	3	1	3	3	3	2	1	3

Note: Queue reported is the number of cars per lane.

Voices School
Morgan Hill, CA
Hexagon Transportation Consultants, Inc.

Level Of Service Computation Report
2000 HCM Operations (Future Volume Alternative)
Existing Plus Project (PM) - 3 Monterey out

Intersection #6674: Monterey Road and Tennant Avenue/Edmundson Avenue

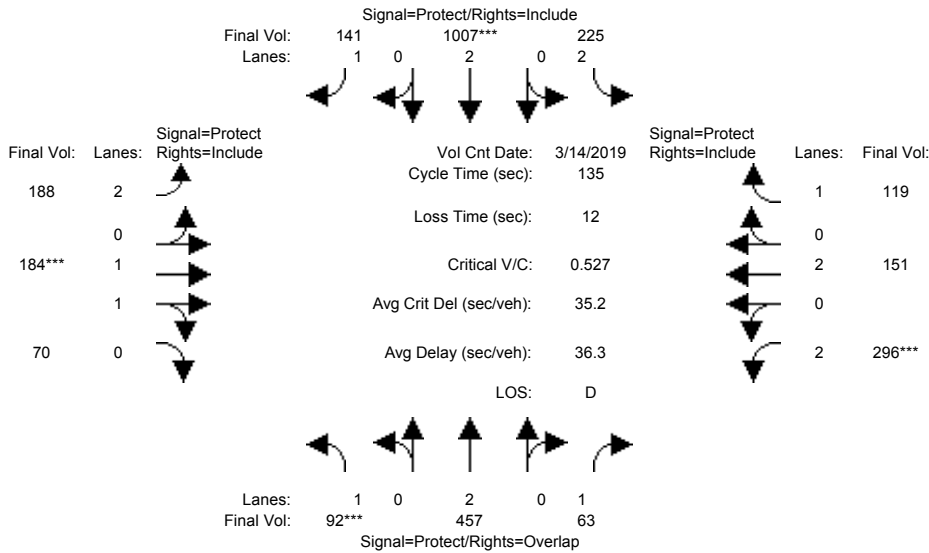

Street Name:	Monterey Rd						Tennant Ave/Edmundson Ave					
	North Bound			South Bound			East Bound			West Bound		
Movement:	L	T	R	L	T	R	L	T	R	L	T	R
Min. Green:	7	10	10	7	10	10	7	10	10	7	10	10
Y+R:	4.0	4.0	4.0	4.0	4.0	4.0	4.0	4.0	4.0	4.0	4.0	4.0

Volume Module:	>>	Count	Date:	14 Mar 2019	<<							
Base Vol:	92	441	63	213	968	131	185	184	70	296	151	105
Growth Adj:	1.00	1.00	1.00	1.00	1.00	1.00	1.00	1.00	1.00	1.00	1.00	1.00
Initial Bse:	92	441	63	213	968	131	185	184	70	296	151	105
Added Vol:	0	16	0	12	39	10	3	0	0	0	0	14
PasserByVol:	0	0	0	0	0	0	0	0	0	0	0	0
Initial Fut:	92	457	63	225	1007	141	188	184	70	296	151	119
User Adj:	1.00	1.00	1.00	1.00	1.00	1.00	1.00	1.00	1.00	1.00	1.00	1.00
PHF Adj:	1.00	1.00	1.00	1.00	1.00	1.00	1.00	1.00	1.00	1.00	1.00	1.00
PHF Volume:	92	457	63	225	1007	141	188	184	70	296	151	119
Reduct Vol:	0	0	0	0	0	0	0	0	0	0	0	0
Reduced Vol:	92	457	63	225	1007	141	188	184	70	296	151	119
PCE Adj:	1.00	1.00	1.00	1.00	1.00	1.00	1.00	1.00	1.00	1.00	1.00	1.00
MLF Adj:	1.00	1.00	1.00	1.00	1.00	1.00	1.00	1.00	1.00	1.00	1.00	1.00
FinalVolume:	92	457	63	225	1007	141	188	184	70	296	151	119

Saturation Flow Module:												
Sat/Lane:	1900	1900	1900	1900	1900	1900	1900	1900	1900	1900	1900	1900
Adjustment:	0.92	1.00	0.92	0.83	1.00	0.92	0.83	0.98	0.95	0.83	1.00	0.92
Lanes:	1.00	2.00	1.00	2.00	2.00	1.00	2.00	1.43	0.57	2.00	2.00	1.00
Final Sat.:	1750	3800	1750	3150	3800	1750	3150	2680	1019	3150	3800	1750

Capacity Analysis Module:												
Vol/Sat:	0.05	0.12	0.04	0.07	0.27	0.08	0.06	0.07	0.07	0.09	0.04	0.07
Crit Moves:	***			***			***			***		
Green Time:	13.5	51.0	75.1	30.3	67.9	67.9	18.6	17.6	17.6	24.1	23.1	23.1
Volume/Cap:	0.53	0.32	0.06	0.32	0.53	0.16	0.43	0.53	0.53	0.53	0.23	0.40
Delay/Veh:	60.7	29.8	13.8	44.0	23.0	18.2	54.1	55.9	55.9	51.2	48.5	50.7
User DelAdj:	1.00	1.00	1.00	1.00	1.00	1.00	1.00	1.00	1.00	1.00	1.00	1.00
AdjDel/Veh:	60.7	29.8	13.8	44.0	23.0	18.2	54.1	55.9	55.9	51.2	48.5	50.7
LOS by Move:	E	C	B	D	C	B	D	E	E	D	D	D
HCM2kAvgQ:	4	6	1	5	14	3	5	6	6	7	3	5

Note: Queue reported is the number of cars per lane.

Voices School
Morgan Hill, CA
Hexagon Transportation Consultants, Inc.

Level Of Service Computation Report
2000 HCM Operations (Future Volume Alternative)
2025 Plus Project (AM) - 3 Monterey out

Intersection #6674: Monterey Road and Tennant Avenue/Edmundson Avenue

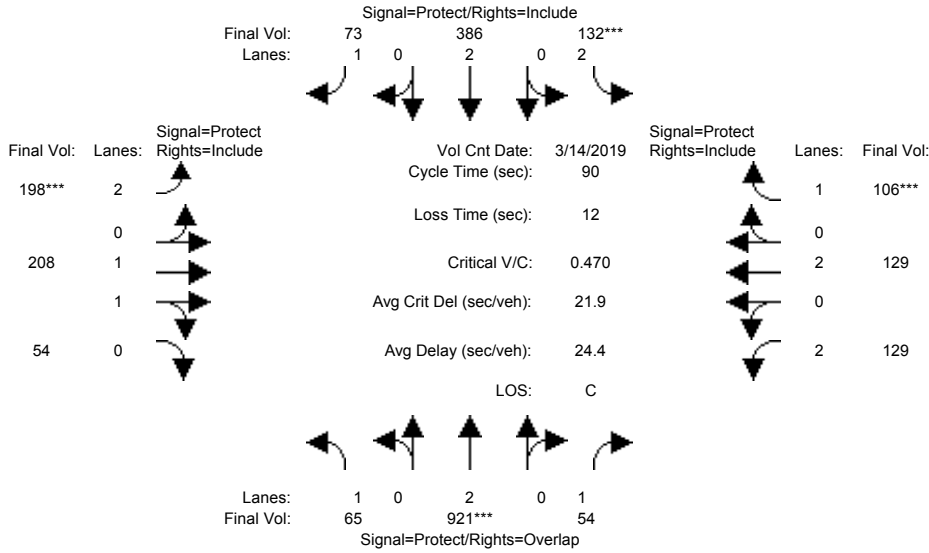

Street Name:	Monterey Rd						Tennant Ave/Edmundson Ave					
	North Bound			South Bound			East Bound			West Bound		
Approach:	L	T	R	L	T	R	L	T	R	L	T	R
Min. Green:	7	10	10	7	10	10	7	10	10	7	10	10
Y+R:	4.0	4.0	4.0	4.0	4.0	4.0	4.0	4.0	4.0	4.0	4.0	4.0

Volume Module:	>>	Count	Date:	14 Mar 2019	<<							
Base Vol:	61	722	54	92	309	46	157	162	45	129	103	86
Growth Adj:	1.00	1.00	1.00	1.00	1.00	1.00	1.00	1.00	1.00	1.00	1.00	1.00
Initial Bse:	61	722	54	92	309	46	157	162	45	129	103	86
Added Vol:	0	62	0	26	30	5	16	0	0	0	0	20
PasserByVol:	4	137	0	14	47	22	25	46	9	0	26	0
Initial Fut:	65	921	54	132	386	73	198	208	54	129	129	106
User Adj:	1.00	1.00	1.00	1.00	1.00	1.00	1.00	1.00	1.00	1.00	1.00	1.00
PHF Adj:	1.00	1.00	1.00	1.00	1.00	1.00	1.00	1.00	1.00	1.00	1.00	1.00
PHF Volume:	65	921	54	132	386	73	198	208	54	129	129	106
Reduct Vol:	0	0	0	0	0	0	0	0	0	0	0	0
Reduced Vol:	65	921	54	132	386	73	198	208	54	129	129	106
PCE Adj:	1.00	1.00	1.00	1.00	1.00	1.00	1.00	1.00	1.00	1.00	1.00	1.00
MLF Adj:	1.00	1.00	1.00	1.00	1.00	1.00	1.00	1.00	1.00	1.00	1.00	1.00
FinalVolume:	65	921	54	132	386	73	198	208	54	129	129	106

Saturation Flow Module:												
Sat/Lane:	1900	1900	1900	1900	1900	1900	1900	1900	1900	1900	1900	1900
Adjustment:	0.92	1.00	0.92	0.83	1.00	0.92	0.83	0.98	0.95	0.83	1.00	0.92
Lanes:	1.00	2.00	1.00	2.00	2.00	1.00	2.00	1.58	0.42	2.00	2.00	1.00
Final Sat.:	1750	3800	1750	3150	3800	1750	3150	2937	762	3150	3800	1750

Capacity Analysis Module:												
Vol/Sat:	0.04	0.24	0.03	0.04	0.10	0.04	0.06	0.07	0.07	0.04	0.03	0.06
Crit Moves:	****			****			****			****		
Green Time:	22.4	46.4	56.1	8.0	32.0	32.0	12.0	13.9	13.9	9.7	11.6	11.6
Volume/Cap:	0.15	0.47	0.05	0.47	0.29	0.12	0.47	0.46	0.46	0.38	0.26	0.47
Delay/Veh:	26.5	14.1	6.6	40.2	20.9	19.6	36.9	35.2	35.2	38.0	35.6	37.9
User DelAdj:	1.00	1.00	1.00	1.00	1.00	1.00	1.00	1.00	1.00	1.00	1.00	1.00
AdjDel/Veh:	26.5	14.1	6.6	40.2	20.9	19.6	36.9	35.2	35.2	38.0	35.6	37.9
LOS by Move:	C	B	A	D	C	B	D	D	D	D	D	D
HCM2kAvgQ:	1	8	1	3	4	1	4	4	4	2	2	3

Note: Queue reported is the number of cars per lane.

Voices School
Morgan Hill, CA
Hexagon Transportation Consultants, Inc.

Level Of Service Computation Report
2000 HCM Operations (Future Volume Alternative)
2025 Plus Project (PM) - 3 Monterey out

Intersection #6674: Monterey Road and Tennant Avenue/Edmundson Avenue

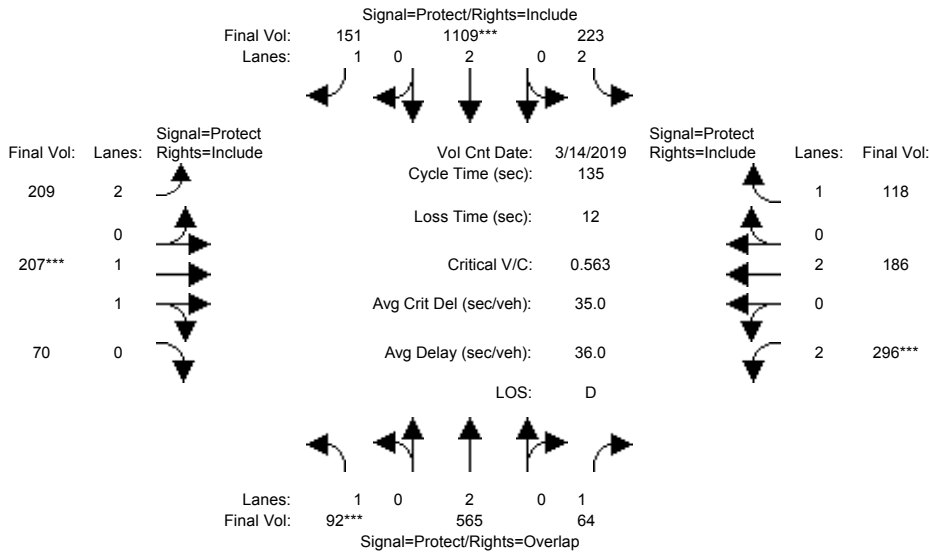

Street Name:	Monterey Rd						Tennant Ave/Edmundson Ave					
	North Bound			South Bound			East Bound			West Bound		
Approach:	L	T	R	L	T	R	L	T	R	L	T	R
Min. Green:	7	10	10	7	10	10	7	10	10	7	10	10
Y+R:	4.0	4.0	4.0	4.0	4.0	4.0	4.0	4.0	4.0	4.0	4.0	4.0

Volume Module:	>>	Count	Date:	14 Mar 2019	<<							
Base Vol:	92	441	63	213	968	131	185	184	70	296	151	105
Growth Adj:	1.00	1.00	1.00	1.00	1.00	1.00	1.00	1.00	1.00	1.00	1.00	1.00
Initial Bse:	92	441	63	213	968	131	185	184	70	296	151	105
Added Vol:	0	15	0	10	38	10	2	0	0	0	0	13
PasserByVol:	0	109	1	0	103	10	22	23	0	0	35	0
Initial Fut:	92	565	64	223	1109	151	209	207	70	296	186	118
User Adj:	1.00	1.00	1.00	1.00	1.00	1.00	1.00	1.00	1.00	1.00	1.00	1.00
PHF Adj:	1.00	1.00	1.00	1.00	1.00	1.00	1.00	1.00	1.00	1.00	1.00	1.00
PHF Volume:	92	565	64	223	1109	151	209	207	70	296	186	118
Reduct Vol:	0	0	0	0	0	0	0	0	0	0	0	0
Reduced Vol:	92	565	64	223	1109	151	209	207	70	296	186	118
PCE Adj:	1.00	1.00	1.00	1.00	1.00	1.00	1.00	1.00	1.00	1.00	1.00	1.00
MLF Adj:	1.00	1.00	1.00	1.00	1.00	1.00	1.00	1.00	1.00	1.00	1.00	1.00
FinalVolume:	92	565	64	223	1109	151	209	207	70	296	186	118

Saturation Flow Module:												
Sat/Lane:	1900	1900	1900	1900	1900	1900	1900	1900	1900	1900	1900	1900
Adjustment:	0.92	1.00	0.92	0.83	1.00	0.92	0.83	0.98	0.95	0.83	1.00	0.92
Lanes:	1.00	2.00	1.00	2.00	2.00	1.00	2.00	1.48	0.52	2.00	2.00	1.00
Final Sat.:	1750	3800	1750	3150	3800	1750	3150	2764	935	3150	3800	1750

Capacity Analysis Module:												
Vol/Sat:	0.05	0.15	0.04	0.07	0.29	0.09	0.07	0.07	0.07	0.09	0.05	0.07
Crit Moves:	***			***			***			***		
Green Time:	12.6	55.9	78.4	26.6	69.9	69.9	19.1	17.9	17.9	22.5	21.3	21.3
Volume/Cap:	0.56	0.36	0.06	0.36	0.56	0.17	0.47	0.56	0.56	0.56	0.31	0.43
Delay/Veh:	63.0	27.4	12.3	47.2	22.5	17.2	54.0	56.4	56.4	53.1	50.6	52.4
User DelAdj:	1.00	1.00	1.00	1.00	1.00	1.00	1.00	1.00	1.00	1.00	1.00	1.00
AdjDel/Veh:	63.0	27.4	12.3	47.2	22.5	17.2	54.0	56.4	56.4	53.1	50.6	52.4
LOS by Move:	E	C	B	D	C	B	D	E	E	D	D	D
HCM2kAvgQ:	4	8	1	5	15	3	5	6	6	7	3	5

Note: Queue reported is the number of cars per lane.

Voices School
Morgan Hill, CA
Hexagon Transportation Consultants, Inc.

Level Of Service Computation Report
2000 HCM Operations (Future Volume Alternative)
Existing Plus Project (AM) - 3 Monterey out

Intersection #6725: Monterey Road and Spring Avenue

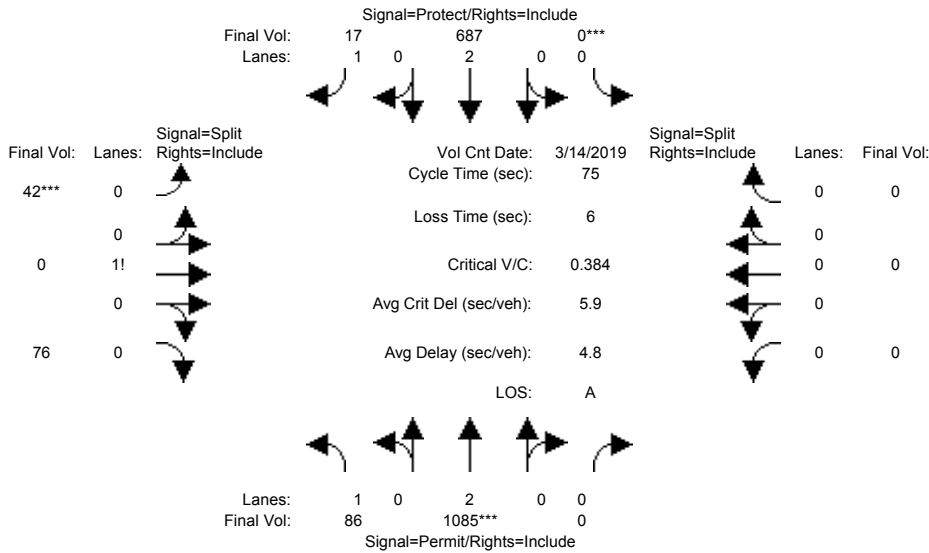

Street Name:	Monterey Road						Spring Avenue					
	North Bound			South Bound			East Bound			West Bound		
Approach:	L	T	R	L	T	R	L	T	R	L	T	R
Min. Green:	10	10	0	0	10	10	10	0	10	0	0	0
Y+R:	4.0	4.0	4.0	4.0	4.0	4.0	4.0	4.0	4.0	4.0	4.0	4.0

Volume Module: >> Count Date: 14 Mar 2019 <<

Base Vol:	83	891	0	0	479	17	42	0	68	0	0	0
Growth Adj:	1.00	1.00	1.00	1.00	1.00	1.00	1.00	1.00	1.00	1.00	1.00	1.00
Initial Bse:	83	891	0	0	479	17	42	0	68	0	0	0
Added Vol:	3	194	0	0	208	0	0	0	8	0	0	0
PasserByVol:	0	0	0	0	0	0	0	0	0	0	0	0
Initial Fut:	86	1085	0	0	687	17	42	0	76	0	0	0
User Adj:	1.00	1.00	1.00	1.00	1.00	1.00	1.00	1.00	1.00	1.00	1.00	1.00
PHF Adj:	1.00	1.00	1.00	1.00	1.00	1.00	1.00	1.00	1.00	1.00	1.00	1.00
PHF Volume:	86	1085	0	0	687	17	42	0	76	0	0	0
Reduct Vol:	0	0	0	0	0	0	0	0	0	0	0	0
Reduced Vol:	86	1085	0	0	687	17	42	0	76	0	0	0
PCE Adj:	1.00	1.00	1.00	1.00	1.00	1.00	1.00	1.00	1.00	1.00	1.00	1.00
MLF Adj:	1.00	1.00	1.00	1.00	1.00	1.00	1.00	1.00	1.00	1.00	1.00	1.00
Final Volume:	86	1085	0	0	687	17	42	0	76	0	0	0

Saturation Flow Module:

Sat/Lane:	1900	1900	1900	1900	1900	1900	1900	1900	1900	1900	1900	1900
Adjustment:	0.92	1.00	0.92	0.92	1.00	0.92	0.92	0.92	0.92	0.92	1.00	0.92
Lanes:	1.00	2.00	0.00	0.00	2.00	1.00	0.36	0.00	0.64	0.00	0.00	0.00
Final Sat.:	1750	3800	0	0	3800	1750	623	0	1127	0	0	0

Capacity Analysis Module:

Vol/Sat:	0.05	0.29	0.00	0.00	0.18	0.01	0.07	0.00	0.07	0.00	0.00	0.00
Crit Moves:	****	****	****	****	****	****	****	****	****	****	****	****
Green Time:	55.8	55.8	0.0	0.0	55.8	55.8	13.2	0.0	13.2	0.0	0.0	0.0
Volume/Cap:	0.07	0.38	0.00	0.00	0.24	0.01	0.38	0.00	0.38	0.00	0.00	0.00
Delay/Veh:	2.6	3.5	0.0	0.0	3.0	2.5	28.1	0.0	28.1	0.0	0.0	0.0
User DelAdj:	1.00	1.00	1.00	1.00	1.00	1.00	1.00	1.00	1.00	1.00	1.00	1.00
AdjDel/Veh:	2.6	3.5	0.0	0.0	3.0	2.5	28.1	0.0	28.1	0.0	0.0	0.0
LOS by Move:	A	A	A	A	A	A	C	A	C	A	A	A
HCM2kAvgQ:	1	5	0	0	2	0	3	0	3	0	0	0

Note: Queue reported is the number of cars per lane.

Voices School
Morgan Hill, CA
Hexagon Transportation Consultants, Inc.

Level Of Service Computation Report
2000 HCM Operations (Future Volume Alternative)
Existing Plus Project (PM) - 3 Monterey out

Intersection #6725: Monterey Road and Spring Avenue

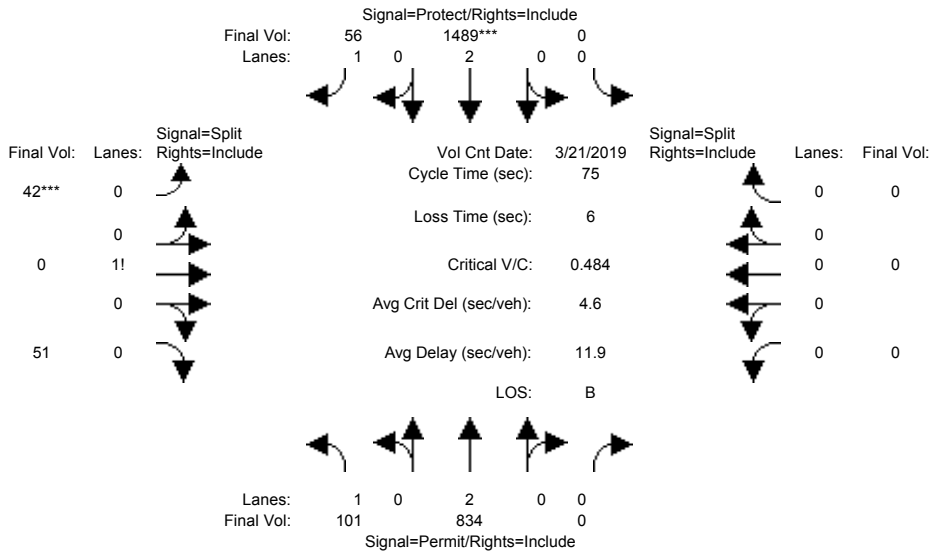

Street Name:	Monterey Road						Spring Avenue					
	North Bound			South Bound			East Bound			West Bound		
Approach:	L	T	R	L	T	R	L	T	R	L	T	R
Min. Green:	10	10	0	0	10	10	10	0	10	0	0	0
Y+R:	4.0	4.0	4.0	4.0	4.0	4.0	4.0	4.0	4.0	4.0	4.0	4.0

Volume Module:	>>	Count	Date:	21 Mar 2019	<<							
Base Vol:	96	706	0	0	1388	56	42	0	49	0	0	0
Growth Adj:	1.00	1.00	1.00	1.00	1.00	1.00	1.00	1.00	1.00	1.00	1.00	1.00
Initial Bse:	96	706	0	0	1388	56	42	0	49	0	0	0
Added Vol:	5	128	0	0	101	0	0	0	2	0	0	0
PasserByVol:	0	0	0	0	0	0	0	0	0	0	0	0
Initial Fut:	101	834	0	0	1489	56	42	0	51	0	0	0
User Adj:	1.00	1.00	1.00	1.00	1.00	1.00	1.00	1.00	1.00	1.00	1.00	1.00
PHF Adj:	1.00	1.00	1.00	1.00	1.00	1.00	1.00	1.00	1.00	1.00	1.00	1.00
PHF Volume:	101	834	0	0	1489	56	42	0	51	0	0	0
Reduct Vol:	0	0	0	0	0	0	0	0	0	0	0	0
Reduced Vol:	101	834	0	0	1489	56	42	0	51	0	0	0
PCE Adj:	1.00	1.00	1.00	1.00	1.00	1.00	1.00	1.00	1.00	1.00	1.00	1.00
MLF Adj:	1.00	1.00	1.00	1.00	1.00	1.00	1.00	1.00	1.00	1.00	1.00	1.00
FinalVolume:	101	834	0	0	1489	56	42	0	51	0	0	0

Saturation Flow Module:												
Sat/Lane:	1900	1900	1900	1900	1900	1900	1900	1900	1900	1900	1900	1900
Adjustment:	0.92	1.00	0.92	0.92	1.00	0.92	0.92	0.92	0.92	0.92	1.00	0.92
Lanes:	1.00	2.00	0.00	0.00	2.00	1.00	0.45	0.00	0.55	0.00	0.00	0.00
Final Sat.:	1750	3800	0	0	3800	1750	790	0	960	0	0	0

Capacity Analysis Module:												
Vol/Sat:	0.06	0.22	0.00	0.00	0.39	0.03	0.05	0.00	0.05	0.00	0.00	0.00
Crit Moves:	****											
Green Time:	22.8	22.8	0.0	0.0	59.0	59.0	10.0	0.0	10.0	0.0	0.0	0.0
Volume/Cap:	0.19	0.72	0.00	0.00	0.50	0.04	0.40	0.00	0.40	0.00	0.00	0.00
Delay/Veh:	19.5	25.6	0.0	0.0	2.9	1.8	30.9	0.0	30.9	0.0	0.0	0.0
User DelAdj:	1.00	1.00	1.00	1.00	1.00	1.00	1.00	1.00	1.00	1.00	1.00	1.00
AdjDel/Veh:	19.5	25.6	0.0	0.0	2.9	1.8	30.9	0.0	30.9	0.0	0.0	0.0
LOS by Move:	B	C	A	A	A	A	C	A	C	A	A	A
HCM2kAvgQ:	2	10	0	0	6	0	3	0	3	0	0	0

Note: Queue reported is the number of cars per lane.

Voices School
Morgan Hill, CA
Hexagon Transportation Consultants, Inc.

Level Of Service Computation Report
2000 HCM Operations (Future Volume Alternative)
2025 Plus Project (AM) - 3 Monterey out

Intersection #6725: Monterey Road and Spring Avenue

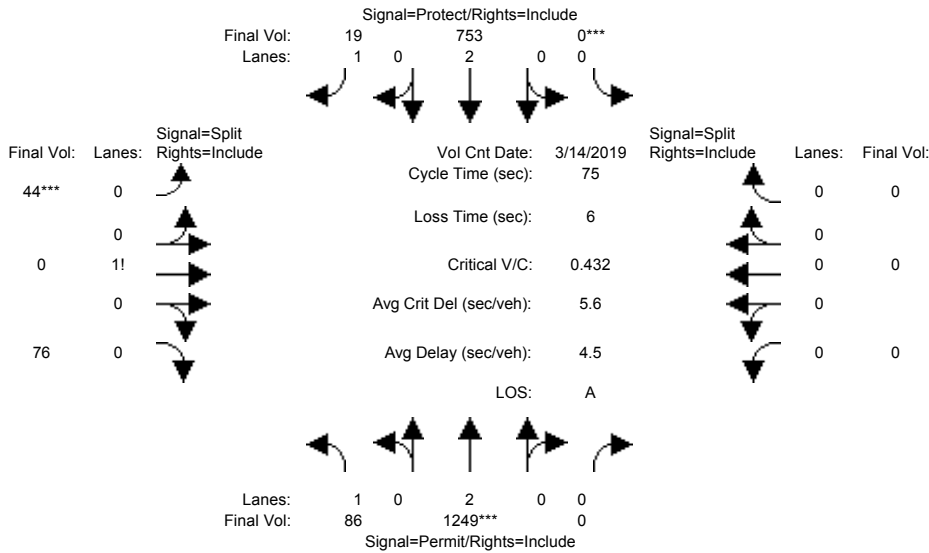

Street Name:	Monterey Road						Spring Avenue					
	North Bound			South Bound			East Bound			West Bound		
Approach:	L	T	R	L	T	R	L	T	R	L	T	R
Min. Green:	10	10	0	0	10	10	10	0	10	0	0	0
Y+R:	4.0	4.0	4.0	4.0	4.0	4.0	4.0	4.0	4.0	4.0	4.0	4.0

Volume Module:	>>	Count	Date:	14 Mar 2019	<<											
Base Vol:	83	891	0	0	479	17	42	0	68	0	0	0	0	0	0	
Growth Adj:	1.00	1.00	1.00	1.00	1.00	1.00	1.00	1.00	1.00	1.00	1.00	1.00	1.00	1.00	1.00	
Initial Bse:	83	891	0	0	479	17	42	0	68	0	0	0	0	0	0	
Added Vol:	3	190	0	0	206	0	0	0	8	0	0	0	0	0	0	
PasserByVol:	0	168	0	0	68	2	2	0	0	0	0	0	0	0	0	
Initial Fut:	86	1249	0	0	753	19	44	0	76	0	0	0	0	0	0	
User Adj:	1.00	1.00	1.00	1.00	1.00	1.00	1.00	1.00	1.00	1.00	1.00	1.00	1.00	1.00	1.00	
PHF Adj:	1.00	1.00	1.00	1.00	1.00	1.00	1.00	1.00	1.00	1.00	1.00	1.00	1.00	1.00	1.00	
PHF Volume:	86	1249	0	0	753	19	44	0	76	0	0	0	0	0	0	
Reduct Vol:	0	0	0	0	0	0	0	0	0	0	0	0	0	0	0	
Reduced Vol:	86	1249	0	0	753	19	44	0	76	0	0	0	0	0	0	
PCE Adj:	1.00	1.00	1.00	1.00	1.00	1.00	1.00	1.00	1.00	1.00	1.00	1.00	1.00	1.00	1.00	
MLF Adj:	1.00	1.00	1.00	1.00	1.00	1.00	1.00	1.00	1.00	1.00	1.00	1.00	1.00	1.00	1.00	
FinalVolume:	86	1249	0	0	753	19	44	0	76	0	0	0	0	0	0	

Saturation Flow Module:												
Sat/Lane:	1900	1900	1900	1900	1900	1900	1900	1900	1900	1900	1900	1900
Adjustment:	0.92	1.00	0.92	0.92	1.00	0.92	0.92	0.92	0.92	0.92	1.00	0.92
Lanes:	1.00	2.00	0.00	0.00	2.00	1.00	0.37	0.00	0.63	0.00	0.00	0.00
Final Sat.:	1750	3800	0	0	3800	1750	642	0	1108	0	0	0

Capacity Analysis Module:												
Vol/Sat:	0.05	0.33	0.00	0.00	0.20	0.01	0.07	0.00	0.07	0.00	0.00	0.00
Crit Moves:	****			****			****					
Green Time:	57.1	57.1	0.0	0.0	57.1	57.1	11.9	0.0	11.9	0.0	0.0	0.0
Volume/Cap:	0.06	0.43	0.00	0.00	0.26	0.01	0.43	0.00	0.43	0.00	0.00	0.00
Delay/Veh:	2.3	3.3	0.0	0.0	2.7	2.2	29.6	0.0	29.6	0.0	0.0	0.0
User DelAdj:	1.00	1.00	1.00	1.00	1.00	1.00	1.00	1.00	1.00	1.00	1.00	1.00
AdjDel/Veh:	2.3	3.3	0.0	0.0	2.7	2.2	29.6	0.0	29.6	0.0	0.0	0.0
LOS by Move:	A	A	A	A	A	A	C	A	C	A	A	A
HCM2kAvgQ:	1	5	0	0	3	0	3	0	3	0	0	0

Note: Queue reported is the number of cars per lane.

Voices School
Morgan Hill, CA
Hexagon Transportation Consultants, Inc.

Level Of Service Computation Report
2000 HCM Operations (Future Volume Alternative)
2025 Plus Project (PM) - 3 Monterey out

Intersection #6725: Monterey Road and Spring Avenue

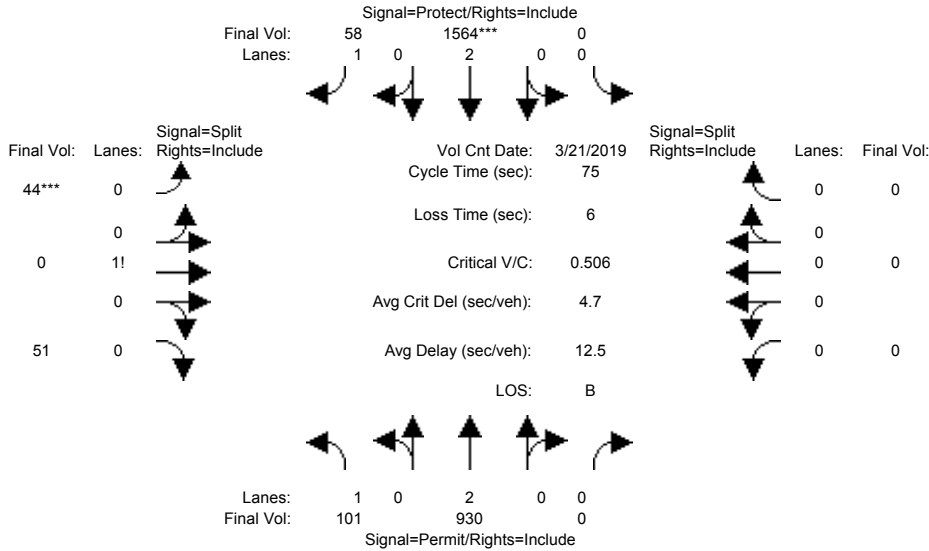

Street Name:	Monterey Road						Spring Avenue					
	North Bound			South Bound			East Bound			West Bound		
Approach:	L	T	R	L	T	R	L	T	R	L	T	R
Min. Green:	10	10	0	0	10	10	10	0	10	0	0	0
Y+R:	4.0	4.0	4.0	4.0	4.0	4.0	4.0	4.0	4.0	4.0	4.0	4.0

Volume Module:	>>	Count	Date:	21 Mar 2019	<<							
Base Vol:	96	706	0	0	1388	56	42	0	49	0	0	0
Growth Adj:	1.00	1.00	1.00	1.00	1.00	1.00	1.00	1.00	1.00	1.00	1.00	1.00
Initial Bse:	96	706	0	0	1388	56	42	0	49	0	0	0
Added Vol:	5	124	0	0	97	0	0	0	2	0	0	0
PasserByVol:	0	100	0	0	79	2	2	0	0	0	0	0
Initial Fut:	101	930	0	0	1564	58	44	0	51	0	0	0
User Adj:	1.00	1.00	1.00	1.00	1.00	1.00	1.00	1.00	1.00	1.00	1.00	1.00
PHF Adj:	1.00	1.00	1.00	1.00	1.00	1.00	1.00	1.00	1.00	1.00	1.00	1.00
PHF Volume:	101	930	0	0	1564	58	44	0	51	0	0	0
Reduct Vol:	0	0	0	0	0	0	0	0	0	0	0	0
Reduced Vol:	101	930	0	0	1564	58	44	0	51	0	0	0
PCE Adj:	1.00	1.00	1.00	1.00	1.00	1.00	1.00	1.00	1.00	1.00	1.00	1.00
MLF Adj:	1.00	1.00	1.00	1.00	1.00	1.00	1.00	1.00	1.00	1.00	1.00	1.00
FinalVolume:	101	930	0	0	1564	58	44	0	51	0	0	0

Saturation Flow Module:												
Sat/Lane:	1900	1900	1900	1900	1900	1900	1900	1900	1900	1900	1900	1900
Adjustment:	0.92	1.00	0.92	0.92	1.00	0.92	0.92	0.92	0.92	0.92	1.00	0.92
Lanes:	1.00	2.00	0.00	0.00	2.00	1.00	0.46	0.00	0.54	0.00	0.00	0.00
Final Sat.:	1750	3800	0	0	3800	1750	811	0	939	0	0	0

Capacity Analysis Module:												
Vol/Sat:	0.06	0.24	0.00	0.00	0.41	0.03	0.05	0.00	0.05	0.00	0.00	0.00
Crit Moves:	****											
Green Time:	23.8	23.8	0.0	0.0	59.0	59.0	10.0	0.0	10.0	0.0	0.0	0.0
Volume/Cap:	0.18	0.77	0.00	0.00	0.52	0.04	0.41	0.00	0.41	0.00	0.00	0.00
Delay/Veh:	18.7	26.3	0.0	0.0	3.1	1.8	30.9	0.0	30.9	0.0	0.0	0.0
User DelAdj:	1.00	1.00	1.00	1.00	1.00	1.00	1.00	1.00	1.00	1.00	1.00	1.00
AdjDel/Veh:	18.7	26.3	0.0	0.0	3.1	1.8	30.9	0.0	30.9	0.0	0.0	0.0
LOS by Move:	B	C	A	A	A	A	C	A	C	A	A	A
HCM2kAvgQ:	2	12	0	0	6	0	3	0	3	0	0	0

Note: Queue reported is the number of cars per lane.

2. Monterey/Dunne

EBL
AM
Existing Conditions
Avg. Queue Per Lane in Veh= 2.5
Percentile = 0.95 5

2. Monterey/Dunne

EBL
AM
Existing Plus Project Conditions with Proposed Site A
Avg. Queue Per Lane in Veh= 5.6
Percentile = 0.95 10

2. Monterey/Dunne

EBL
AM
Existing Plus Project Conditions Alternative I (Right-i
Avg. Queue Per Lane in Veh= 2.5
Percentile = 0.95 5

2. Monterey/Dunne

EBL
AM
Existing Plus Project Conditions Alternative II (Right-i
Avg. Queue Per Lane in Veh= 2.5
Percentile = 0.95 5

Individual Probability	Cumulative Probability	Number of Queued Vehicles
0.0838	0.0838	0
0.2078	0.2916	1
0.2576	0.5492	2
0.2129	0.7620	3
0.1319	0.8939	4
0.0654	0.9594	5
0.0270	0.9864	6
0.0096	0.9960	7
0.0030	0.9989	8
0.0008	0.9997	9
0.0002	0.9999	10
0.0000	1.0000	11
0.0000	1.0000	12
0.0000	1.0000	13
0.0000	1.0000	14
0.0000	1.0000	15
0.0000	1.0000	16
0.0000	1.0000	17
0.0000	1.0000	18
0.0000	1.0000	19
0.0000	1.0000	20
0.0000	1.0000	21
0.0000	1.0000	22
0.0000	1.0000	23
0.0000	1.0000	24
0.0000	1.0000	25
0.0000	1.0000	26
0.0000	1.0000	27
0.0000	1.0000	28
0.0000	1.0000	29
0.0000	1.0000	30
0.0000	1.0000	31
0.0000	1.0000	32
0.0000	1.0000	33
0.0000	1.0000	34
0.0000	1.0000	35
0.0000	1.0000	36
0.0000	1.0000	37
0.0000	1.0000	38
0.0000	1.0000	39
0.0000	1.0000	40
0.0000	1.0000	41
0.0000	1.0000	42
0.0000	1.0000	43
0.0000	1.0000	44
0.0000	1.0000	45

Individual Probability	Cumulative Probability	Number of Queued Vehicles
0.0036	0.0036	0
0.0202	0.0238	1
0.0569	0.0807	2
0.1068	0.1875	3
0.1503	0.3377	4
0.1692	0.5069	5
0.1587	0.6656	6
0.1276	0.7933	7
0.0898	0.8831	8
0.0562	0.9392	9
0.0316	0.9709	10
0.0162	0.9870	11
0.0076	0.9946	12
0.0033	0.9979	13
0.0013	0.9992	14
0.0005	0.9997	15
0.0002	0.9999	16
0.0001	1.0000	17
0.0000	1.0000	18
0.0000	1.0000	19
0.0000	1.0000	20
0.0000	1.0000	21
0.0000	1.0000	22
0.0000	1.0000	23
0.0000	1.0000	24
0.0000	1.0000	25
0.0000	1.0000	26
0.0000	1.0000	27
0.0000	1.0000	28
0.0000	1.0000	29
0.0000	1.0000	30
0.0000	1.0000	31
0.0000	1.0000	32
0.0000	1.0000	33
0.0000	1.0000	34
0.0000	1.0000	35
0.0000	1.0000	36
0.0000	1.0000	37
0.0000	1.0000	38
0.0000	1.0000	39
0.0000	1.0000	40
0.0000	1.0000	41
0.0000	1.0000	42
0.0000	1.0000	43
0.0000	1.0000	44
0.0000	1.0000	45

Individual Probability	Cumulative Probability	Number of Queued Vehicles
0.0838	0.0838	0
0.2078	0.2916	1
0.2576	0.5492	2
0.2129	0.7620	3
0.1319	0.8939	4
0.0654	0.9594	5
0.0270	0.9864	6
0.0096	0.9960	7
0.0030	0.9989	8
0.0008	0.9997	9
0.0002	0.9999	10
0.0000	1.0000	11
0.0000	1.0000	12
0.0000	1.0000	13
0.0000	1.0000	14
0.0000	1.0000	15
0.0000	1.0000	16
0.0000	1.0000	17
0.0000	1.0000	18
0.0000	1.0000	19
0.0000	1.0000	20
0.0000	1.0000	21
0.0000	1.0000	22
0.0000	1.0000	23
0.0000	1.0000	24
0.0000	1.0000	25
0.0000	1.0000	26
0.0000	1.0000	27
0.0000	1.0000	28
0.0000	1.0000	29
0.0000	1.0000	30
0.0000	1.0000	31
0.0000	1.0000	32
0.0000	1.0000	33
0.0000	1.0000	34
0.0000	1.0000	35
0.0000	1.0000	36
0.0000	1.0000	37
0.0000	1.0000	38
0.0000	1.0000	39
0.0000	1.0000	40
0.0000	1.0000	41
0.0000	1.0000	42
0.0000	1.0000	43
0.0000	1.0000	44
0.0000	1.0000	45

Individual Probability	Cumulative Probability	Number of Queued Vehicles
0.0838	0.0838	0
0.2078	0.2916	1
0.2576	0.5492	2
0.2129	0.7620	3
0.1319	0.8939	4
0.0654	0.9594	5
0.0270	0.9864	6
0.0096	0.9960	7
0.0030	0.9989	8
0.0008	0.9997	9
0.0002	0.9999	10
0.0000	1.0000	11
0.0000	1.0000	12
0.0000	1.0000	13
0.0000	1.0000	14
0.0000	1.0000	15
0.0000	1.0000	16
0.0000	1.0000	17
0.0000	1.0000	18
0.0000	1.0000	19
0.0000	1.0000	20
0.0000	1.0000	21
0.0000	1.0000	22
0.0000	1.0000	23
0.0000	1.0000	24
0.0000	1.0000	25
0.0000	1.0000	26
0.0000	1.0000	27
0.0000	1.0000	28
0.0000	1.0000	29
0.0000	1.0000	30
0.0000	1.0000	31
0.0000	1.0000	32
0.0000	1.0000	33
0.0000	1.0000	34
0.0000	1.0000	35
0.0000	1.0000	36
0.0000	1.0000	37
0.0000	1.0000	38
0.0000	1.0000	39
0.0000	1.0000	40
0.0000	1.0000	41
0.0000	1.0000	42
0.0000	1.0000	43
0.0000	1.0000	44
0.0000	1.0000	45

2. Monterey/Dunne
 EBL
 PM
 Existing Conditions
 Avg. Queue Per Lane in Veh= 2.2
 Percentile = 0.95 5

2. Monterey/Dunne
 EBL
 PM
 Existing Plus Project Conditions with Proposed Site A
 Avg. Queue Per Lane in Veh= 6.6
 Percentile = 0.95 11

2. Monterey/Dunne
 EBL
 PM
 Existing Plus Project Conditions Alternative I (Right-i
 Avg. Queue Per Lane in Veh= 2.2
 Percentile = 0.95 5

2. Monterey/Dunne
 EBL
 PM
 Existing Plus Project Conditions Alternative II (Right-i
 Avg. Queue Per Lane in Veh= 2.2
 Percentile = 0.95 5

Individual Probability	Cumulative Probability	Number of Queued Vehicles
0.1058	0.1058	0
0.2377	0.3435	1
0.2669	0.6105	2
0.1998	0.8103	3
0.1122	0.9225	4
0.0504	0.9728	5
0.0189	0.9917	6
0.0061	0.9978	7
0.0017	0.9995	8
0.0004	0.9999	9
0.0001	1.0000	10
0.0000	1.0000	11
0.0000	1.0000	12
0.0000	1.0000	13
0.0000	1.0000	14
0.0000	1.0000	15
0.0000	1.0000	16
0.0000	1.0000	17
0.0000	1.0000	18
0.0000	1.0000	19
0.0000	1.0000	20
0.0000	1.0000	21
0.0000	1.0000	22
0.0000	1.0000	23
0.0000	1.0000	24
0.0000	1.0000	25
0.0000	1.0000	26
0.0000	1.0000	27
0.0000	1.0000	28
0.0000	1.0000	29
0.0000	1.0000	30
0.0000	1.0000	31
0.0000	1.0000	32
0.0000	1.0000	33
0.0000	1.0000	34
0.0000	1.0000	35
0.0000	1.0000	36
0.0000	1.0000	37
0.0000	1.0000	38
0.0000	1.0000	39
0.0000	1.0000	40
0.0000	1.0000	41
0.0000	1.0000	42
0.0000	1.0000	43
0.0000	1.0000	44
0.0000	1.0000	45

Individual Probability	Cumulative Probability	Number of Queued Vehicles
0.0013	0.0013	0
0.0088	0.0102	1
0.0292	0.0394	2
0.0644	0.1038	3
0.1067	0.2105	4
0.1413	0.3517	5
0.1559	0.5076	6
0.1474	0.6550	7
0.1220	0.7770	8
0.0898	0.8668	9
0.0594	0.9262	10
0.0358	0.9620	11
0.0197	0.9817	12
0.0101	0.9918	13
0.0048	0.9965	14
0.0021	0.9986	15
0.0009	0.9995	16
0.0003	0.9998	17
0.0001	0.9999	18
0.0000	1.0000	19
0.0000	1.0000	20
0.0000	1.0000	21
0.0000	1.0000	22
0.0000	1.0000	23
0.0000	1.0000	24
0.0000	1.0000	25
0.0000	1.0000	26
0.0000	1.0000	27
0.0000	1.0000	28
0.0000	1.0000	29
0.0000	1.0000	30
0.0000	1.0000	31
0.0000	1.0000	32
0.0000	1.0000	33
0.0000	1.0000	34
0.0000	1.0000	35
0.0000	1.0000	36
0.0000	1.0000	37
0.0000	1.0000	38
0.0000	1.0000	39
0.0000	1.0000	40
0.0000	1.0000	41
0.0000	1.0000	42
0.0000	1.0000	43
0.0000	1.0000	44
0.0000	1.0000	45

Individual Probability	Cumulative Probability	Number of Queued Vehicles
0.1058	0.1058	0
0.2377	0.3435	1
0.2669	0.6105	2
0.1998	0.8103	3
0.1122	0.9225	4
0.0504	0.9728	5
0.0189	0.9917	6
0.0061	0.9978	7
0.0017	0.9995	8
0.0004	0.9999	9
0.0001	1.0000	10
0.0000	1.0000	11
0.0000	1.0000	12
0.0000	1.0000	13
0.0000	1.0000	14
0.0000	1.0000	15
0.0000	1.0000	16
0.0000	1.0000	17
0.0000	1.0000	18
0.0000	1.0000	19
0.0000	1.0000	20
0.0000	1.0000	21
0.0000	1.0000	22
0.0000	1.0000	23
0.0000	1.0000	24
0.0000	1.0000	25
0.0000	1.0000	26
0.0000	1.0000	27
0.0000	1.0000	28
0.0000	1.0000	29
0.0000	1.0000	30
0.0000	1.0000	31
0.0000	1.0000	32
0.0000	1.0000	33
0.0000	1.0000	34
0.0000	1.0000	35
0.0000	1.0000	36
0.0000	1.0000	37
0.0000	1.0000	38
0.0000	1.0000	39
0.0000	1.0000	40
0.0000	1.0000	41
0.0000	1.0000	42
0.0000	1.0000	43
0.0000	1.0000	44
0.0000	1.0000	45

Individual Probability	Cumulative Probability	Number of Queued Vehicles
0.1058	0.1058	0
0.2377	0.3435	1
0.2669	0.6105	2
0.1998	0.8103	3
0.1122	0.9225	4
0.0504	0.9728	5
0.0189	0.9917	6
0.0061	0.9978	7
0.0017	0.9995	8
0.0004	0.9999	9
0.0001	1.0000	10
0.0000	1.0000	11
0.0000	1.0000	12
0.0000	1.0000	13
0.0000	1.0000	14
0.0000	1.0000	15
0.0000	1.0000	16
0.0000	1.0000	17
0.0000	1.0000	18
0.0000	1.0000	19
0.0000	1.0000	20
0.0000	1.0000	21
0.0000	1.0000	22
0.0000	1.0000	23
0.0000	1.0000	24
0.0000	1.0000	25
0.0000	1.0000	26
0.0000	1.0000	27
0.0000	1.0000	28
0.0000	1.0000	29
0.0000	1.0000	30
0.0000	1.0000	31
0.0000	1.0000	32
0.0000	1.0000	33
0.0000	1.0000	34
0.0000	1.0000	35
0.0000	1.0000	36
0.0000	1.0000	37
0.0000	1.0000	38
0.0000	1.0000	39
0.0000	1.0000	40
0.0000	1.0000	41
0.0000	1.0000	42
0.0000	1.0000	43
0.0000	1.0000	44
0.0000	1.0000	45

2. Monterey/Dunne
 WBL
 AM
 Existing Conditions
 Avg. Queue Per Lane in Veh= 2.1
 Percentile = 0.95 5

2. Monterey/Dunne
 WBL
 AM
 Existing Plus Project Conditions with Proposed Site A
 Avg. Queue Per Lane in Veh= 4.6
 Percentile = 0.95 8

2. Monterey/Dunne
 WBL
 AM
 Existing Plus Project Conditions Alternative I (Right-i
 Avg. Queue Per Lane in Veh= 4.6
 Percentile = 0.95 8

2. Monterey/Dunne
 WBL
 AM
 Existing Plus Project Conditions Alternative II (Right-i
 Avg. Queue Per Lane in Veh= 4.6
 Percentile = 0.95 8

Individual Probability	Cumulative Probability	Number of Queued Vehicles
0.1225	0.1225	0
0.2572	0.3796	1
0.2700	0.6496	2
0.1890	0.8386	3
0.0992	0.9379	4
0.0417	0.9796	5
0.0146	0.9941	6
0.0044	0.9985	7
0.0011	0.9997	8
0.0003	0.9999	9
0.0001	1.0000	10
0.0000	1.0000	11
0.0000	1.0000	12
0.0000	1.0000	13
0.0000	1.0000	14
0.0000	1.0000	15
0.0000	1.0000	16
0.0000	1.0000	17
0.0000	1.0000	18
0.0000	1.0000	19
0.0000	1.0000	20
0.0000	1.0000	21
0.0000	1.0000	22
0.0000	1.0000	23
0.0000	1.0000	24
0.0000	1.0000	25
0.0000	1.0000	26
0.0000	1.0000	27
0.0000	1.0000	28
0.0000	1.0000	29
0.0000	1.0000	30
0.0000	1.0000	31
0.0000	1.0000	32
0.0000	1.0000	33
0.0000	1.0000	34
0.0000	1.0000	35
0.0000	1.0000	36
0.0000	1.0000	37
0.0000	1.0000	38
0.0000	1.0000	39
0.0000	1.0000	40
0.0000	1.0000	41
0.0000	1.0000	42
0.0000	1.0000	43
0.0000	1.0000	44
0.0000	1.0000	45

Individual Probability	Cumulative Probability	Number of Queued Vehicles
0.0106	0.0106	0
0.0481	0.0586	1
0.1094	0.1680	2
0.1659	0.3339	3
0.1887	0.5226	4
0.1717	0.6944	5
0.1302	0.8246	6
0.0846	0.9092	7
0.0481	0.9574	8
0.0243	0.9817	9
0.0111	0.9928	10
0.0046	0.9974	11
0.0017	0.9991	12
0.0006	0.9997	13
0.0002	0.9999	14
0.0001	1.0000	15
0.0000	1.0000	16
0.0000	1.0000	17
0.0000	1.0000	18
0.0000	1.0000	19
0.0000	1.0000	20
0.0000	1.0000	21
0.0000	1.0000	22
0.0000	1.0000	23
0.0000	1.0000	24
0.0000	1.0000	25
0.0000	1.0000	26
0.0000	1.0000	27
0.0000	1.0000	28
0.0000	1.0000	29
0.0000	1.0000	30
0.0000	1.0000	31
0.0000	1.0000	32
0.0000	1.0000	33
0.0000	1.0000	34
0.0000	1.0000	35
0.0000	1.0000	36
0.0000	1.0000	37
0.0000	1.0000	38
0.0000	1.0000	39
0.0000	1.0000	40
0.0000	1.0000	41
0.0000	1.0000	42
0.0000	1.0000	43
0.0000	1.0000	44
0.0000	1.0000	45

Individual Probability	Cumulative Probability	Number of Queued Vehicles
0.0106	0.0106	0
0.0481	0.0586	1
0.1094	0.1680	2
0.1659	0.3339	3
0.1887	0.5226	4
0.1717	0.6944	5
0.1302	0.8246	6
0.0846	0.9092	7
0.0481	0.9574	8
0.0243	0.9817	9
0.0111	0.9928	10
0.0046	0.9974	11
0.0017	0.9991	12
0.0006	0.9997	13
0.0002	0.9999	14
0.0001	1.0000	15
0.0000	1.0000	16
0.0000	1.0000	17
0.0000	1.0000	18
0.0000	1.0000	19
0.0000	1.0000	20
0.0000	1.0000	21
0.0000	1.0000	22
0.0000	1.0000	23
0.0000	1.0000	24
0.0000	1.0000	25
0.0000	1.0000	26
0.0000	1.0000	27
0.0000	1.0000	28
0.0000	1.0000	29
0.0000	1.0000	30
0.0000	1.0000	31
0.0000	1.0000	32
0.0000	1.0000	33
0.0000	1.0000	34
0.0000	1.0000	35
0.0000	1.0000	36
0.0000	1.0000	37
0.0000	1.0000	38
0.0000	1.0000	39
0.0000	1.0000	40
0.0000	1.0000	41
0.0000	1.0000	42
0.0000	1.0000	43
0.0000	1.0000	44
0.0000	1.0000	45

Individual Probability	Cumulative Probability	Number of Queued Vehicles
0.0106	0.0106	0
0.0481	0.0586	1
0.1094	0.1680	2
0.1659	0.3339	3
0.1887	0.5226	4
0.1717	0.6944	5
0.1302	0.8246	6
0.0846	0.9092	7
0.0481	0.9574	8
0.0243	0.9817	9
0.0111	0.9928	10
0.0046	0.9974	11
0.0017	0.9991	12
0.0006	0.9997	13
0.0002	0.9999	14
0.0001	1.0000	15
0.0000	1.0000	16
0.0000	1.0000	17
0.0000	1.0000	18
0.0000	1.0000	19
0.0000	1.0000	20
0.0000	1.0000	21
0.0000	1.0000	22
0.0000	1.0000	23
0.0000	1.0000	24
0.0000	1.0000	25
0.0000	1.0000	26
0.0000	1.0000	27
0.0000	1.0000	28
0.0000	1.0000	29
0.0000	1.0000	30
0.0000	1.0000	31
0.0000	1.0000	32
0.0000	1.0000	33
0.0000	1.0000	34
0.0000	1.0000	35
0.0000	1.0000	36
0.0000	1.0000	37
0.0000	1.0000	38
0.0000	1.0000	39
0.0000	1.0000	40
0.0000	1.0000	41
0.0000	1.0000	42
0.0000	1.0000	43
0.0000	1.0000	44
0.0000	1.0000	45

2. Monterey/Dunne
WBL
PM
Existing Conditions
Avg. Queue Per Lane in Veh= 4.8
Percentile = 0.95 9

2. Monterey/Dunne
WBL
PM
Existing Plus Project Conditions with Proposed Site A
Avg. Queue Per Lane in Veh= 7.2
Percentile = 0.95 12

2. Monterey/Dunne
WBL
PM
Existing Plus Project Conditions Alternative I (Right-i
Avg. Queue Per Lane in Veh= 7.2
Percentile = 0.95 12

2. Monterey/Dunne
WBL
PM
Existing Plus Project Conditions Alternative II (Right-i
Avg. Queue Per Lane in Veh= 7.2
Percentile = 0.95 12

Individual Probability	Cumulative Probability	Number of Queued Vehicles
0.0082	0.0082	0
0.0396	0.0478	1
0.0949	0.1427	2
0.1518	0.2945	3
0.1821	0.4766	4
0.1747	0.6514	5
0.1397	0.7911	6
0.0958	0.8869	7
0.0574	0.9443	8
0.0306	0.9749	9
0.0147	0.9896	10
0.0064	0.9960	11
0.0026	0.9986	12
0.0009	0.9995	13
0.0003	0.9999	14
0.0001	1.0000	15
0.0000	1.0000	16
0.0000	1.0000	17
0.0000	1.0000	18
0.0000	1.0000	19
0.0000	1.0000	20
0.0000	1.0000	21
0.0000	1.0000	22
0.0000	1.0000	23
0.0000	1.0000	24
0.0000	1.0000	25
0.0000	1.0000	26
0.0000	1.0000	27
0.0000	1.0000	28
0.0000	1.0000	29
0.0000	1.0000	30
0.0000	1.0000	31
0.0000	1.0000	32
0.0000	1.0000	33
0.0000	1.0000	34
0.0000	1.0000	35
0.0000	1.0000	36
0.0000	1.0000	37
0.0000	1.0000	38
0.0000	1.0000	39
0.0000	1.0000	40
0.0000	1.0000	41
0.0000	1.0000	42
0.0000	1.0000	43
0.0000	1.0000	44
0.0000	1.0000	45

Individual Probability	Cumulative Probability	Number of Queued Vehicles
0.0007	0.0007	0
0.0054	0.0061	1
0.0193	0.0254	2
0.0463	0.0717	3
0.0834	0.1552	4
0.1202	0.2754	5
0.1444	0.4198	6
0.1486	0.5683	7
0.1338	0.7021	8
0.1071	0.8092	9
0.0772	0.8864	10
0.0505	0.9369	11
0.0303	0.9672	12
0.0168	0.9840	13
0.0087	0.9927	14
0.0042	0.9968	15
0.0019	0.9987	16
0.0008	0.9995	17
0.0003	0.9998	18
0.0001	0.9999	19
0.0000	1.0000	20
0.0000	1.0000	21
0.0000	1.0000	22
0.0000	1.0000	23
0.0000	1.0000	24
0.0000	1.0000	25
0.0000	1.0000	26
0.0000	1.0000	27
0.0000	1.0000	28
0.0000	1.0000	29
0.0000	1.0000	30
0.0000	1.0000	31
0.0000	1.0000	32
0.0000	1.0000	33
0.0000	1.0000	34
0.0000	1.0000	35
0.0000	1.0000	36
0.0000	1.0000	37
0.0000	1.0000	38
0.0000	1.0000	39
0.0000	1.0000	40
0.0000	1.0000	41
0.0000	1.0000	42
0.0000	1.0000	43
0.0000	1.0000	44
0.0000	1.0000	45

Individual Probability	Cumulative Probability	Number of Queued Vehicles
0.0007	0.0007	0
0.0054	0.0061	1
0.0193	0.0254	2
0.0463	0.0717	3
0.0834	0.1552	4
0.1202	0.2754	5
0.1444	0.4198	6
0.1486	0.5683	7
0.1338	0.7021	8
0.1071	0.8092	9
0.0772	0.8864	10
0.0505	0.9369	11
0.0303	0.9672	12
0.0168	0.9840	13
0.0087	0.9927	14
0.0042	0.9968	15
0.0019	0.9987	16
0.0008	0.9995	17
0.0003	0.9998	18
0.0001	0.9999	19
0.0000	1.0000	20
0.0000	1.0000	21
0.0000	1.0000	22
0.0000	1.0000	23
0.0000	1.0000	24
0.0000	1.0000	25
0.0000	1.0000	26
0.0000	1.0000	27
0.0000	1.0000	28
0.0000	1.0000	29
0.0000	1.0000	30
0.0000	1.0000	31
0.0000	1.0000	32
0.0000	1.0000	33
0.0000	1.0000	34
0.0000	1.0000	35
0.0000	1.0000	36
0.0000	1.0000	37
0.0000	1.0000	38
0.0000	1.0000	39
0.0000	1.0000	40
0.0000	1.0000	41
0.0000	1.0000	42
0.0000	1.0000	43
0.0000	1.0000	44
0.0000	1.0000	45

Individual Probability	Cumulative Probability	Number of Queued Vehicles
0.0007	0.0007	0
0.0054	0.0061	1
0.0193	0.0254	2
0.0463	0.0717	3
0.0834	0.1552	4
0.1202	0.2754	5
0.1444	0.4198	6
0.1486	0.5683	7
0.1338	0.7021	8
0.1071	0.8092	9
0.0772	0.8864	10
0.0505	0.9369	11
0.0303	0.9672	12
0.0168	0.9840	13
0.0087	0.9927	14
0.0042	0.9968	15
0.0019	0.9987	16
0.0008	0.9995	17
0.0003	0.9998	18
0.0001	0.9999	19
0.0000	1.0000	20
0.0000	1.0000	21
0.0000	1.0000	22
0.0000	1.0000	23
0.0000	1.0000	24
0.0000	1.0000	25
0.0000	1.0000	26
0.0000	1.0000	27
0.0000	1.0000	28
0.0000	1.0000	29
0.0000	1.0000	30
0.0000	1.0000	31
0.0000	1.0000	32
0.0000	1.0000	33
0.0000	1.0000	34
0.0000	1.0000	35
0.0000	1.0000	36
0.0000	1.0000	37
0.0000	1.0000	38
0.0000	1.0000	39
0.0000	1.0000	40
0.0000	1.0000	41
0.0000	1.0000	42
0.0000	1.0000	43
0.0000	1.0000	44
0.0000	1.0000	45

5. Monterey/Cosmo

NBL
AM
Existing Conditions
Avg. Queue Per Lane in Veh= 0.3
Percentile = 0.95 1

5. Monterey/Cosmo

NBL
AM
Existing Plus Project Conditions with Proposed Site A
Avg. Queue Per Lane in Veh= 4.2
Percentile = 0.95 8

5. Monterey/Cosmo

NBL
AM
Existing Plus Project Conditions Alternative I (Right-i
Avg. Queue Per Lane in Veh= 4.2
Percentile = 0.95 8

5. Monterey/Cosmo

NBL
AM
Existing Plus Project Conditions Alternative II (Right-i
Avg. Queue Per Lane in Veh= 4.2
Percentile = 0.95 8

Individual Probability	Cumulative Probability	Number of Queued Vehicles
0.7533	0.7533	0
0.2134	0.9667	1
0.0302	0.9969	2
0.0029	0.9998	3
0.0002	1.0000	4
0.0000	1.0000	5
0.0000	1.0000	6
0.0000	1.0000	7
0.0000	1.0000	8
0.0000	1.0000	9
0.0000	1.0000	10
0.0000	1.0000	11
0.0000	1.0000	12
0.0000	1.0000	13
0.0000	1.0000	14
0.0000	1.0000	15
0.0000	1.0000	16
0.0000	1.0000	17
0.0000	1.0000	18
0.0000	1.0000	19
0.0000	1.0000	20
0.0000	1.0000	21
0.0000	1.0000	22
0.0000	1.0000	23
0.0000	1.0000	24
0.0000	1.0000	25
0.0000	1.0000	26
0.0000	1.0000	27
0.0000	1.0000	28
0.0000	1.0000	29
0.0000	1.0000	30
0.0000	1.0000	31
0.0000	1.0000	32
0.0000	1.0000	33
0.0000	1.0000	34
0.0000	1.0000	35
0.0000	1.0000	36
0.0000	1.0000	37
0.0000	1.0000	38
0.0000	1.0000	39
0.0000	1.0000	40
0.0000	1.0000	41
0.0000	1.0000	42
0.0000	1.0000	43
0.0000	1.0000	44
0.0000	1.0000	45

Individual Probability	Cumulative Probability	Number of Queued Vehicles
0.0152	0.0152	0
0.0638	0.0790	1
0.1334	0.2125	2
0.1860	0.3985	3
0.1946	0.5931	4
0.1628	0.7559	5
0.1135	0.8694	6
0.0678	0.9372	7
0.0355	0.9727	8
0.0165	0.9892	9
0.0069	0.9960	10
0.0026	0.9987	11
0.0009	0.9996	12
0.0003	0.9999	13
0.0001	1.0000	14
0.0000	1.0000	15
0.0000	1.0000	16
0.0000	1.0000	17
0.0000	1.0000	18
0.0000	1.0000	19
0.0000	1.0000	20
0.0000	1.0000	21
0.0000	1.0000	22
0.0000	1.0000	23
0.0000	1.0000	24
0.0000	1.0000	25
0.0000	1.0000	26
0.0000	1.0000	27
0.0000	1.0000	28
0.0000	1.0000	29
0.0000	1.0000	30
0.0000	1.0000	31
0.0000	1.0000	32
0.0000	1.0000	33
0.0000	1.0000	34
0.0000	1.0000	35
0.0000	1.0000	36
0.0000	1.0000	37
0.0000	1.0000	38
0.0000	1.0000	39
0.0000	1.0000	40
0.0000	1.0000	41
0.0000	1.0000	42
0.0000	1.0000	43
0.0000	1.0000	44
0.0000	1.0000	45

Individual Probability	Cumulative Probability	Number of Queued Vehicles
0.0152	0.0152	0
0.0638	0.0790	1
0.1334	0.2125	2
0.1860	0.3985	3
0.1946	0.5931	4
0.1628	0.7559	5
0.1135	0.8694	6
0.0678	0.9372	7
0.0355	0.9727	8
0.0165	0.9892	9
0.0069	0.9960	10
0.0026	0.9987	11
0.0009	0.9996	12
0.0003	0.9999	13
0.0001	1.0000	14
0.0000	1.0000	15
0.0000	1.0000	16
0.0000	1.0000	17
0.0000	1.0000	18
0.0000	1.0000	19
0.0000	1.0000	20
0.0000	1.0000	21
0.0000	1.0000	22
0.0000	1.0000	23
0.0000	1.0000	24
0.0000	1.0000	25
0.0000	1.0000	26
0.0000	1.0000	27
0.0000	1.0000	28
0.0000	1.0000	29
0.0000	1.0000	30
0.0000	1.0000	31
0.0000	1.0000	32
0.0000	1.0000	33
0.0000	1.0000	34
0.0000	1.0000	35
0.0000	1.0000	36
0.0000	1.0000	37
0.0000	1.0000	38
0.0000	1.0000	39
0.0000	1.0000	40
0.0000	1.0000	41
0.0000	1.0000	42
0.0000	1.0000	43
0.0000	1.0000	44
0.0000	1.0000	45

Individual Probability	Cumulative Probability	Number of Queued Vehicles
0.0152	0.0152	0
0.0638	0.0790	1
0.1334	0.2125	2
0.1860	0.3985	3
0.1946	0.5931	4
0.1628	0.7559	5
0.1135	0.8694	6
0.0678	0.9372	7
0.0355	0.9727	8
0.0165	0.9892	9
0.0069	0.9960	10
0.0026	0.9987	11
0.0009	0.9996	12
0.0003	0.9999	13
0.0001	1.0000	14
0.0000	1.0000	15
0.0000	1.0000	16
0.0000	1.0000	17
0.0000	1.0000	18
0.0000	1.0000	19
0.0000	1.0000	20
0.0000	1.0000	21
0.0000	1.0000	22
0.0000	1.0000	23
0.0000	1.0000	24
0.0000	1.0000	25
0.0000	1.0000	26
0.0000	1.0000	27
0.0000	1.0000	28
0.0000	1.0000	29
0.0000	1.0000	30
0.0000	1.0000	31
0.0000	1.0000	32
0.0000	1.0000	33
0.0000	1.0000	34
0.0000	1.0000	35
0.0000	1.0000	36
0.0000	1.0000	37
0.0000	1.0000	38
0.0000	1.0000	39
0.0000	1.0000	40
0.0000	1.0000	41
0.0000	1.0000	42
0.0000	1.0000	43
0.0000	1.0000	44
0.0000	1.0000	45

5. Monterey/Cosmo
 NBL
 PM
 Existing Conditions
 Avg. Queue Per Lane in Veh= 0.8
 Percentile = 0.95 2

5. Monterey/Cosmo
 NBL
 PM
 Existing Plus Project Conditions with Proposed Site A
 Avg. Queue Per Lane in Veh= 2.1
 Percentile = 0.95 5

5. Monterey/Cosmo
 NBL
 PM
 Existing Plus Project Conditions Alternative I (Right-i
 Avg. Queue Per Lane in Veh= 2.1
 Percentile = 0.95 5

5. Monterey/Cosmo
 NBL
 PM
 Existing Plus Project Conditions Alternative II (Right-i
 Avg. Queue Per Lane in Veh= 2.1
 Percentile = 0.95 5

Individual Probability	Cumulative Probability	Number of Queued Vehicles
0.4724	0.4724	0
0.3543	0.8266	1
0.1329	0.9595	2
0.0332	0.9927	3
0.0062	0.9989	4
0.0009	0.9999	5
0.0001	1.0000	6
0.0000	1.0000	7
0.0000	1.0000	8
0.0000	1.0000	9
0.0000	1.0000	10
0.0000	1.0000	11
0.0000	1.0000	12
0.0000	1.0000	13
0.0000	1.0000	14
0.0000	1.0000	15
0.0000	1.0000	16
0.0000	1.0000	17
0.0000	1.0000	18
0.0000	1.0000	19
0.0000	1.0000	20
0.0000	1.0000	21
0.0000	1.0000	22
0.0000	1.0000	23
0.0000	1.0000	24
0.0000	1.0000	25
0.0000	1.0000	26
0.0000	1.0000	27
0.0000	1.0000	28
0.0000	1.0000	29
0.0000	1.0000	30
0.0000	1.0000	31
0.0000	1.0000	32
0.0000	1.0000	33
0.0000	1.0000	34
0.0000	1.0000	35
0.0000	1.0000	36
0.0000	1.0000	37
0.0000	1.0000	38
0.0000	1.0000	39
0.0000	1.0000	40
0.0000	1.0000	41
0.0000	1.0000	42
0.0000	1.0000	43
0.0000	1.0000	44
0.0000	1.0000	45

Individual Probability	Cumulative Probability	Number of Queued Vehicles
0.1184	0.1184	0
0.2527	0.3711	1
0.2695	0.6406	2
0.1917	0.8323	3
0.1022	0.9345	4
0.0436	0.9781	5
0.0155	0.9936	6
0.0047	0.9984	7
0.0013	0.9996	8
0.0003	0.9999	9
0.0001	1.0000	10
0.0000	1.0000	11
0.0000	1.0000	12
0.0000	1.0000	13
0.0000	1.0000	14
0.0000	1.0000	15
0.0000	1.0000	16
0.0000	1.0000	17
0.0000	1.0000	18
0.0000	1.0000	19
0.0000	1.0000	20
0.0000	1.0000	21
0.0000	1.0000	22
0.0000	1.0000	23
0.0000	1.0000	24
0.0000	1.0000	25
0.0000	1.0000	26
0.0000	1.0000	27
0.0000	1.0000	28
0.0000	1.0000	29
0.0000	1.0000	30
0.0000	1.0000	31
0.0000	1.0000	32
0.0000	1.0000	33
0.0000	1.0000	34
0.0000	1.0000	35
0.0000	1.0000	36
0.0000	1.0000	37
0.0000	1.0000	38
0.0000	1.0000	39
0.0000	1.0000	40
0.0000	1.0000	41
0.0000	1.0000	42
0.0000	1.0000	43
0.0000	1.0000	44
0.0000	1.0000	45

Individual Probability	Cumulative Probability	Number of Queued Vehicles
0.1184	0.1184	0
0.2527	0.3711	1
0.2695	0.6406	2
0.1917	0.8323	3
0.1022	0.9345	4
0.0436	0.9781	5
0.0155	0.9936	6
0.0047	0.9984	7
0.0013	0.9996	8
0.0003	0.9999	9
0.0001	1.0000	10
0.0000	1.0000	11
0.0000	1.0000	12
0.0000	1.0000	13
0.0000	1.0000	14
0.0000	1.0000	15
0.0000	1.0000	16
0.0000	1.0000	17
0.0000	1.0000	18
0.0000	1.0000	19
0.0000	1.0000	20
0.0000	1.0000	21
0.0000	1.0000	22
0.0000	1.0000	23
0.0000	1.0000	24
0.0000	1.0000	25
0.0000	1.0000	26
0.0000	1.0000	27
0.0000	1.0000	28
0.0000	1.0000	29
0.0000	1.0000	30
0.0000	1.0000	31
0.0000	1.0000	32
0.0000	1.0000	33
0.0000	1.0000	34
0.0000	1.0000	35
0.0000	1.0000	36
0.0000	1.0000	37
0.0000	1.0000	38
0.0000	1.0000	39
0.0000	1.0000	40
0.0000	1.0000	41
0.0000	1.0000	42
0.0000	1.0000	43
0.0000	1.0000	44
0.0000	1.0000	45

Individual Probability	Cumulative Probability	Number of Queued Vehicles
0.1184	0.1184	0
0.2527	0.3711	1
0.2695	0.6406	2
0.1917	0.8323	3
0.1022	0.9345	4
0.0436	0.9781	5
0.0155	0.9936	6
0.0047	0.9984	7
0.0013	0.9996	8
0.0003	0.9999	9
0.0001	1.0000	10
0.0000	1.0000	11
0.0000	1.0000	12
0.0000	1.0000	13
0.0000	1.0000	14
0.0000	1.0000	15
0.0000	1.0000	16
0.0000	1.0000	17
0.0000	1.0000	18
0.0000	1.0000	19
0.0000	1.0000	20
0.0000	1.0000	21
0.0000	1.0000	22
0.0000	1.0000	23
0.0000	1.0000	24
0.0000	1.0000	25
0.0000	1.0000	26
0.0000	1.0000	27
0.0000	1.0000	28
0.0000	1.0000	29
0.0000	1.0000	30
0.0000	1.0000	31
0.0000	1.0000	32
0.0000	1.0000	33
0.0000	1.0000	34
0.0000	1.0000	35
0.0000	1.0000	36
0.0000	1.0000	37
0.0000	1.0000	38
0.0000	1.0000	39
0.0000	1.0000	40
0.0000	1.0000	41
0.0000	1.0000	42
0.0000	1.0000	43
0.0000	1.0000	44
0.0000	1.0000	45

6. Monterey/Tennant
 SBL
 AM
 Existing Conditions
 Avg. Queue Per Lane in Veh= 1.2
 Percentile = 0.95 3

6. Monterey/Tennant
 SBL
 AM
 Existing Plus Project Conditions with Proposed Site A
 Avg. Queue Per Lane in Veh= 1.2
 Percentile = 0.95 3

6. Monterey/Tennant
 SBL
 AM
 Existing Plus Project Conditions Alternative I (Right-i
 Avg. Queue Per Lane in Veh= 2.0
 Percentile = 0.95 5

6. Monterey/Tennant
 SBL
 AM
 Existing Plus Project Conditions Alternative II (Right-i
 Avg. Queue Per Lane in Veh= 2.0
 Percentile = 0.95 5

Individual Probability	Cumulative Probability	Number of Queued Vehicles
0.3166	0.3166	0
0.3641	0.6808	1
0.2094	0.8901	2
0.0803	0.9704	3
0.0231	0.9935	4
0.0053	0.9988	5
0.0010	0.9998	6
0.0002	1.0000	7
0.0000	1.0000	8
0.0000	1.0000	9
0.0000	1.0000	10
0.0000	1.0000	11
0.0000	1.0000	12
0.0000	1.0000	13
0.0000	1.0000	14
0.0000	1.0000	15
0.0000	1.0000	16
0.0000	1.0000	17
0.0000	1.0000	18
0.0000	1.0000	19
0.0000	1.0000	20
0.0000	1.0000	21
0.0000	1.0000	22
0.0000	1.0000	23
0.0000	1.0000	24
0.0000	1.0000	25
0.0000	1.0000	26
0.0000	1.0000	27
0.0000	1.0000	28
0.0000	1.0000	29
0.0000	1.0000	30
0.0000	1.0000	31
0.0000	1.0000	32
0.0000	1.0000	33
0.0000	1.0000	34
0.0000	1.0000	35
0.0000	1.0000	36
0.0000	1.0000	37
0.0000	1.0000	38
0.0000	1.0000	39
0.0000	1.0000	40
0.0000	1.0000	41
0.0000	1.0000	42
0.0000	1.0000	43
0.0000	1.0000	44
0.0000	1.0000	45

Individual Probability	Cumulative Probability	Number of Queued Vehicles
0.3166	0.3166	0
0.3641	0.6808	1
0.2094	0.8901	2
0.0803	0.9704	3
0.0231	0.9935	4
0.0053	0.9988	5
0.0010	0.9998	6
0.0002	1.0000	7
0.0000	1.0000	8
0.0000	1.0000	9
0.0000	1.0000	10
0.0000	1.0000	11
0.0000	1.0000	12
0.0000	1.0000	13
0.0000	1.0000	14
0.0000	1.0000	15
0.0000	1.0000	16
0.0000	1.0000	17
0.0000	1.0000	18
0.0000	1.0000	19
0.0000	1.0000	20
0.0000	1.0000	21
0.0000	1.0000	22
0.0000	1.0000	23
0.0000	1.0000	24
0.0000	1.0000	25
0.0000	1.0000	26
0.0000	1.0000	27
0.0000	1.0000	28
0.0000	1.0000	29
0.0000	1.0000	30
0.0000	1.0000	31
0.0000	1.0000	32
0.0000	1.0000	33
0.0000	1.0000	34
0.0000	1.0000	35
0.0000	1.0000	36
0.0000	1.0000	37
0.0000	1.0000	38
0.0000	1.0000	39
0.0000	1.0000	40
0.0000	1.0000	41
0.0000	1.0000	42
0.0000	1.0000	43
0.0000	1.0000	44
0.0000	1.0000	45

Individual Probability	Cumulative Probability	Number of Queued Vehicles
0.1388	0.1388	0
0.2741	0.4128	1
0.2706	0.6834	2
0.1782	0.8616	3
0.0880	0.9496	4
0.0347	0.9843	5
0.0114	0.9958	6
0.0032	0.9990	7
0.0008	0.9998	8
0.0002	1.0000	9
0.0000	1.0000	10
0.0000	1.0000	11
0.0000	1.0000	12
0.0000	1.0000	13
0.0000	1.0000	14
0.0000	1.0000	15
0.0000	1.0000	16
0.0000	1.0000	17
0.0000	1.0000	18
0.0000	1.0000	19
0.0000	1.0000	20
0.0000	1.0000	21
0.0000	1.0000	22
0.0000	1.0000	23
0.0000	1.0000	24
0.0000	1.0000	25
0.0000	1.0000	26
0.0000	1.0000	27
0.0000	1.0000	28
0.0000	1.0000	29
0.0000	1.0000	30
0.0000	1.0000	31
0.0000	1.0000	32
0.0000	1.0000	33
0.0000	1.0000	34
0.0000	1.0000	35
0.0000	1.0000	36
0.0000	1.0000	37
0.0000	1.0000	38
0.0000	1.0000	39
0.0000	1.0000	40
0.0000	1.0000	41
0.0000	1.0000	42
0.0000	1.0000	43
0.0000	1.0000	44
0.0000	1.0000	45

Individual Probability	Cumulative Probability	Number of Queued Vehicles
0.1388	0.1388	0
0.2741	0.4128	1
0.2706	0.6834	2
0.1782	0.8616	3
0.0880	0.9496	4
0.0347	0.9843	5
0.0114	0.9958	6
0.0032	0.9990	7
0.0008	0.9998	8
0.0002	1.0000	9
0.0000	1.0000	10
0.0000	1.0000	11
0.0000	1.0000	12
0.0000	1.0000	13
0.0000	1.0000	14
0.0000	1.0000	15
0.0000	1.0000	16
0.0000	1.0000	17
0.0000	1.0000	18
0.0000	1.0000	19
0.0000	1.0000	20
0.0000	1.0000	21
0.0000	1.0000	22
0.0000	1.0000	23
0.0000	1.0000	24
0.0000	1.0000	25
0.0000	1.0000	26
0.0000	1.0000	27
0.0000	1.0000	28
0.0000	1.0000	29
0.0000	1.0000	30
0.0000	1.0000	31
0.0000	1.0000	32
0.0000	1.0000	33
0.0000	1.0000	34
0.0000	1.0000	35
0.0000	1.0000	36
0.0000	1.0000	37
0.0000	1.0000	38
0.0000	1.0000	39
0.0000	1.0000	40
0.0000	1.0000	41
0.0000	1.0000	42
0.0000	1.0000	43
0.0000	1.0000	44
0.0000	1.0000	45

6. Monterey/Tennant
 SBL
 PM
 Existing Conditions
 Avg. Queue Per Lane in Veh= 4.0
 Percentile = 0.95 8

6. Monterey/Tennant
 SBL
 PM
 Existing Plus Project Conditions with Proposed Site A
 Avg. Queue Per Lane in Veh= 4.0
 Percentile = 0.95 8

6. Monterey/Tennant
 SBL
 PM
 Existing Plus Project Conditions Alternative I (Right-i
 Avg. Queue Per Lane in Veh= 4.6
 Percentile = 0.95 8

6. Monterey/Tennant
 SBL
 PM
 Existing Plus Project Conditions Alternative II (Right-i
 Avg. Queue Per Lane in Veh= 4.6
 Percentile = 0.95 8

Individual Probability	Cumulative Probability	Number of Queued Vehicles
0.0184	0.0184	0
0.0736	0.0920	1
0.1470	0.2390	2
0.1957	0.4347	3
0.1954	0.6301	4
0.1560	0.7861	5
0.1039	0.8900	6
0.0593	0.9492	7
0.0296	0.9788	8
0.0131	0.9920	9
0.0052	0.9972	10
0.0019	0.9991	11
0.0006	0.9997	12
0.0002	0.9999	13
0.0001	1.0000	14
0.0000	1.0000	15
0.0000	1.0000	16
0.0000	1.0000	17
0.0000	1.0000	18
0.0000	1.0000	19
0.0000	1.0000	20
0.0000	1.0000	21
0.0000	1.0000	22
0.0000	1.0000	23
0.0000	1.0000	24
0.0000	1.0000	25
0.0000	1.0000	26
0.0000	1.0000	27
0.0000	1.0000	28
0.0000	1.0000	29
0.0000	1.0000	30
0.0000	1.0000	31
0.0000	1.0000	32
0.0000	1.0000	33
0.0000	1.0000	34
0.0000	1.0000	35
0.0000	1.0000	36
0.0000	1.0000	37
0.0000	1.0000	38
0.0000	1.0000	39
0.0000	1.0000	40
0.0000	1.0000	41
0.0000	1.0000	42
0.0000	1.0000	43
0.0000	1.0000	44
0.0000	1.0000	45

Individual Probability	Cumulative Probability	Number of Queued Vehicles
0.0184	0.0184	0
0.0736	0.0920	1
0.1470	0.2390	2
0.1957	0.4347	3
0.1954	0.6301	4
0.1560	0.7861	5
0.1039	0.8900	6
0.0593	0.9492	7
0.0296	0.9788	8
0.0131	0.9920	9
0.0052	0.9972	10
0.0019	0.9991	11
0.0006	0.9997	12
0.0002	0.9999	13
0.0001	1.0000	14
0.0000	1.0000	15
0.0000	1.0000	16
0.0000	1.0000	17
0.0000	1.0000	18
0.0000	1.0000	19
0.0000	1.0000	20
0.0000	1.0000	21
0.0000	1.0000	22
0.0000	1.0000	23
0.0000	1.0000	24
0.0000	1.0000	25
0.0000	1.0000	26
0.0000	1.0000	27
0.0000	1.0000	28
0.0000	1.0000	29
0.0000	1.0000	30
0.0000	1.0000	31
0.0000	1.0000	32
0.0000	1.0000	33
0.0000	1.0000	34
0.0000	1.0000	35
0.0000	1.0000	36
0.0000	1.0000	37
0.0000	1.0000	38
0.0000	1.0000	39
0.0000	1.0000	40
0.0000	1.0000	41
0.0000	1.0000	42
0.0000	1.0000	43
0.0000	1.0000	44
0.0000	1.0000	45

Individual Probability	Cumulative Probability	Number of Queued Vehicles
0.0103	0.0103	0
0.0472	0.0575	1
0.1079	0.1653	2
0.1645	0.3298	3
0.1881	0.5179	4
0.1721	0.6901	5
0.1313	0.8213	6
0.0858	0.9071	7
0.0491	0.9562	8
0.0249	0.9811	9
0.0114	0.9925	10
0.0047	0.9973	11
0.0018	0.9991	12
0.0006	0.9997	13
0.0002	0.9999	14
0.0001	1.0000	15
0.0000	1.0000	16
0.0000	1.0000	17
0.0000	1.0000	18
0.0000	1.0000	19
0.0000	1.0000	20
0.0000	1.0000	21
0.0000	1.0000	22
0.0000	1.0000	23
0.0000	1.0000	24
0.0000	1.0000	25
0.0000	1.0000	26
0.0000	1.0000	27
0.0000	1.0000	28
0.0000	1.0000	29
0.0000	1.0000	30
0.0000	1.0000	31
0.0000	1.0000	32
0.0000	1.0000	33
0.0000	1.0000	34
0.0000	1.0000	35
0.0000	1.0000	36
0.0000	1.0000	37
0.0000	1.0000	38
0.0000	1.0000	39
0.0000	1.0000	40
0.0000	1.0000	41
0.0000	1.0000	42
0.0000	1.0000	43
0.0000	1.0000	44
0.0000	1.0000	45

Individual Probability	Cumulative Probability	Number of Queued Vehicles
0.0103	0.0103	0
0.0472	0.0575	1
0.1079	0.1653	2
0.1645	0.3298	3
0.1881	0.5179	4
0.1721	0.6901	5
0.1313	0.8213	6
0.0858	0.9071	7
0.0491	0.9562	8
0.0249	0.9811	9
0.0114	0.9925	10
0.0047	0.9973	11
0.0018	0.9991	12
0.0006	0.9997	13
0.0002	0.9999	14
0.0001	1.0000	15
0.0000	1.0000	16
0.0000	1.0000	17
0.0000	1.0000	18
0.0000	1.0000	19
0.0000	1.0000	20
0.0000	1.0000	21
0.0000	1.0000	22
0.0000	1.0000	23
0.0000	1.0000	24
0.0000	1.0000	25
0.0000	1.0000	26
0.0000	1.0000	27
0.0000	1.0000	28
0.0000	1.0000	29
0.0000	1.0000	30
0.0000	1.0000	31
0.0000	1.0000	32
0.0000	1.0000	33
0.0000	1.0000	34
0.0000	1.0000	35
0.0000	1.0000	36
0.0000	1.0000	37
0.0000	1.0000	38
0.0000	1.0000	39
0.0000	1.0000	40
0.0000	1.0000	41
0.0000	1.0000	42
0.0000	1.0000	43
0.0000	1.0000	44
0.0000	1.0000	45

9. Butterfield/Main
EBL
AM
Existing Conditions
Avg. Queue Per Lane in Veh= 1.4
Percentile = 0.95 4

9. Butterfield/Main
EBL
AM
Existing Plus Project Conditions with Proposed Site A
Avg. Queue Per Lane in Veh= 2.2
Percentile = 0.95 5

9. Butterfield/Main
EBL
AM
Existing Plus Project Conditions Alternative I (Right-i
Avg. Queue Per Lane in Veh= 2.2
Percentile = 0.95 5

9. Butterfield/Main
EBL
AM
Existing Plus Project Conditions Alternative II (Right-i
Avg. Queue Per Lane in Veh= 2.2
Percentile = 0.95 5

Individual Probability	Cumulative Probability	Number of Queued Vehicles
0.2542	0.2542	0
0.3482	0.6024	1
0.2384	0.8408	2
0.1088	0.9497	3
0.0373	0.9869	4
0.0102	0.9971	5
0.0023	0.9995	6
0.0005	0.9999	7
0.0001	1.0000	8
0.0000	1.0000	9
0.0000	1.0000	10
0.0000	1.0000	11
0.0000	1.0000	12
0.0000	1.0000	13
0.0000	1.0000	14
0.0000	1.0000	15
0.0000	1.0000	16
0.0000	1.0000	17
0.0000	1.0000	18
0.0000	1.0000	19
0.0000	1.0000	20
0.0000	1.0000	21
0.0000	1.0000	22
0.0000	1.0000	23
0.0000	1.0000	24
0.0000	1.0000	25
0.0000	1.0000	26
0.0000	1.0000	27
0.0000	1.0000	28
0.0000	1.0000	29
0.0000	1.0000	30
0.0000	1.0000	31
0.0000	1.0000	32
0.0000	1.0000	33
0.0000	1.0000	34
0.0000	1.0000	35
0.0000	1.0000	36
0.0000	1.0000	37
0.0000	1.0000	38
0.0000	1.0000	39
0.0000	1.0000	40
0.0000	1.0000	41
0.0000	1.0000	42
0.0000	1.0000	43
0.0000	1.0000	44
0.0000	1.0000	45

Individual Probability	Cumulative Probability	Number of Queued Vehicles
0.1139	0.1139	0
0.2475	0.3614	1
0.2688	0.6302	2
0.1946	0.8248	3
0.1057	0.9305	4
0.0459	0.9764	5
0.0166	0.9930	6
0.0052	0.9982	7
0.0014	0.9996	8
0.0003	0.9999	9
0.0001	1.0000	10
0.0000	1.0000	11
0.0000	1.0000	12
0.0000	1.0000	13
0.0000	1.0000	14
0.0000	1.0000	15
0.0000	1.0000	16
0.0000	1.0000	17
0.0000	1.0000	18
0.0000	1.0000	19
0.0000	1.0000	20
0.0000	1.0000	21
0.0000	1.0000	22
0.0000	1.0000	23
0.0000	1.0000	24
0.0000	1.0000	25
0.0000	1.0000	26
0.0000	1.0000	27
0.0000	1.0000	28
0.0000	1.0000	29
0.0000	1.0000	30
0.0000	1.0000	31
0.0000	1.0000	32
0.0000	1.0000	33
0.0000	1.0000	34
0.0000	1.0000	35
0.0000	1.0000	36
0.0000	1.0000	37
0.0000	1.0000	38
0.0000	1.0000	39
0.0000	1.0000	40
0.0000	1.0000	41
0.0000	1.0000	42
0.0000	1.0000	43
0.0000	1.0000	44
0.0000	1.0000	45

Individual Probability	Cumulative Probability	Number of Queued Vehicles
0.1139	0.1139	0
0.2475	0.3614	1
0.2688	0.6302	2
0.1946	0.8248	3
0.1057	0.9305	4
0.0459	0.9764	5
0.0166	0.9930	6
0.0052	0.9982	7
0.0014	0.9996	8
0.0003	0.9999	9
0.0001	1.0000	10
0.0000	1.0000	11
0.0000	1.0000	12
0.0000	1.0000	13
0.0000	1.0000	14
0.0000	1.0000	15
0.0000	1.0000	16
0.0000	1.0000	17
0.0000	1.0000	18
0.0000	1.0000	19
0.0000	1.0000	20
0.0000	1.0000	21
0.0000	1.0000	22
0.0000	1.0000	23
0.0000	1.0000	24
0.0000	1.0000	25
0.0000	1.0000	26
0.0000	1.0000	27
0.0000	1.0000	28
0.0000	1.0000	29
0.0000	1.0000	30
0.0000	1.0000	31
0.0000	1.0000	32
0.0000	1.0000	33
0.0000	1.0000	34
0.0000	1.0000	35
0.0000	1.0000	36
0.0000	1.0000	37
0.0000	1.0000	38
0.0000	1.0000	39
0.0000	1.0000	40
0.0000	1.0000	41
0.0000	1.0000	42
0.0000	1.0000	43
0.0000	1.0000	44
0.0000	1.0000	45

Individual Probability	Cumulative Probability	Number of Queued Vehicles
0.1139	0.1139	0
0.2475	0.3614	1
0.2688	0.6302	2
0.1946	0.8248	3
0.1057	0.9305	4
0.0459	0.9764	5
0.0166	0.9930	6
0.0052	0.9982	7
0.0014	0.9996	8
0.0003	0.9999	9
0.0001	1.0000	10
0.0000	1.0000	11
0.0000	1.0000	12
0.0000	1.0000	13
0.0000	1.0000	14
0.0000	1.0000	15
0.0000	1.0000	16
0.0000	1.0000	17
0.0000	1.0000	18
0.0000	1.0000	19
0.0000	1.0000	20
0.0000	1.0000	21
0.0000	1.0000	22
0.0000	1.0000	23
0.0000	1.0000	24
0.0000	1.0000	25
0.0000	1.0000	26
0.0000	1.0000	27
0.0000	1.0000	28
0.0000	1.0000	29
0.0000	1.0000	30
0.0000	1.0000	31
0.0000	1.0000	32
0.0000	1.0000	33
0.0000	1.0000	34
0.0000	1.0000	35
0.0000	1.0000	36
0.0000	1.0000	37
0.0000	1.0000	38
0.0000	1.0000	39
0.0000	1.0000	40
0.0000	1.0000	41
0.0000	1.0000	42
0.0000	1.0000	43
0.0000	1.0000	44
0.0000	1.0000	45

9. Butterfield/Main
 EBL
 PM
 Existing Conditions
 Avg. Queue Per Lane in Veh= 1.7
 Percentile = 0.95 4

9. Butterfield/Main
 EBL
 PM
 Existing Plus Project Conditions with Proposed Site A
 Avg. Queue Per Lane in Veh= 1.9
 Percentile = 0.95 4

9. Butterfield/Main
 EBL
 PM
 Existing Plus Project Conditions Alternative I (Right-i
 Avg. Queue Per Lane in Veh= 1.9
 Percentile = 0.95 4

9. Butterfield/Main
 EBL
 PM
 Existing Plus Project Conditions Alternative II (Right-i
 Avg. Queue Per Lane in Veh= 1.9
 Percentile = 0.95 4

Individual Probability	Cumulative Probability	Number of Queued Vehicles
0.1878	0.1878	0
0.3141	0.5019	1
0.2626	0.7645	2
0.1464	0.9109	3
0.0612	0.9721	4
0.0205	0.9926	5
0.0057	0.9983	6
0.0014	0.9997	7
0.0003	0.9999	8
0.0001	1.0000	9
0.0000	1.0000	10
0.0000	1.0000	11
0.0000	1.0000	12
0.0000	1.0000	13
0.0000	1.0000	14
0.0000	1.0000	15
0.0000	1.0000	16
0.0000	1.0000	17
0.0000	1.0000	18
0.0000	1.0000	19
0.0000	1.0000	20
0.0000	1.0000	21
0.0000	1.0000	22
0.0000	1.0000	23
0.0000	1.0000	24
0.0000	1.0000	25
0.0000	1.0000	26
0.0000	1.0000	27
0.0000	1.0000	28
0.0000	1.0000	29
0.0000	1.0000	30
0.0000	1.0000	31
0.0000	1.0000	32
0.0000	1.0000	33
0.0000	1.0000	34
0.0000	1.0000	35
0.0000	1.0000	36
0.0000	1.0000	37
0.0000	1.0000	38
0.0000	1.0000	39
0.0000	1.0000	40
0.0000	1.0000	41
0.0000	1.0000	42
0.0000	1.0000	43
0.0000	1.0000	44
0.0000	1.0000	45

Individual Probability	Cumulative Probability	Number of Queued Vehicles
0.1431	0.1431	0
0.2782	0.4213	1
0.2705	0.6917	2
0.1753	0.8670	3
0.0852	0.9522	4
0.0331	0.9854	5
0.0107	0.9961	6
0.0030	0.9991	7
0.0007	0.9998	8
0.0002	1.0000	9
0.0000	1.0000	10
0.0000	1.0000	11
0.0000	1.0000	12
0.0000	1.0000	13
0.0000	1.0000	14
0.0000	1.0000	15
0.0000	1.0000	16
0.0000	1.0000	17
0.0000	1.0000	18
0.0000	1.0000	19
0.0000	1.0000	20
0.0000	1.0000	21
0.0000	1.0000	22
0.0000	1.0000	23
0.0000	1.0000	24
0.0000	1.0000	25
0.0000	1.0000	26
0.0000	1.0000	27
0.0000	1.0000	28
0.0000	1.0000	29
0.0000	1.0000	30
0.0000	1.0000	31
0.0000	1.0000	32
0.0000	1.0000	33
0.0000	1.0000	34
0.0000	1.0000	35
0.0000	1.0000	36
0.0000	1.0000	37
0.0000	1.0000	38
0.0000	1.0000	39
0.0000	1.0000	40
0.0000	1.0000	41
0.0000	1.0000	42
0.0000	1.0000	43
0.0000	1.0000	44
0.0000	1.0000	45

Individual Probability	Cumulative Probability	Number of Queued Vehicles
0.1431	0.1431	0
0.2782	0.4213	1
0.2705	0.6917	2
0.1753	0.8670	3
0.0852	0.9522	4
0.0331	0.9854	5
0.0107	0.9961	6
0.0030	0.9991	7
0.0007	0.9998	8
0.0002	1.0000	9
0.0000	1.0000	10
0.0000	1.0000	11
0.0000	1.0000	12
0.0000	1.0000	13
0.0000	1.0000	14
0.0000	1.0000	15
0.0000	1.0000	16
0.0000	1.0000	17
0.0000	1.0000	18
0.0000	1.0000	19
0.0000	1.0000	20
0.0000	1.0000	21
0.0000	1.0000	22
0.0000	1.0000	23
0.0000	1.0000	24
0.0000	1.0000	25
0.0000	1.0000	26
0.0000	1.0000	27
0.0000	1.0000	28
0.0000	1.0000	29
0.0000	1.0000	30
0.0000	1.0000	31
0.0000	1.0000	32
0.0000	1.0000	33
0.0000	1.0000	34
0.0000	1.0000	35
0.0000	1.0000	36
0.0000	1.0000	37
0.0000	1.0000	38
0.0000	1.0000	39
0.0000	1.0000	40
0.0000	1.0000	41
0.0000	1.0000	42
0.0000	1.0000	43
0.0000	1.0000	44
0.0000	1.0000	45

Individual Probability	Cumulative Probability	Number of Queued Vehicles
0.1431	0.1431	0
0.2782	0.4213	1
0.2705	0.6917	2
0.1753	0.8670	3
0.0852	0.9522	4
0.0331	0.9854	5
0.0107	0.9961	6
0.0030	0.9991	7
0.0007	0.9998	8
0.0002	1.0000	9
0.0000	1.0000	10
0.0000	1.0000	11
0.0000	1.0000	12
0.0000	1.0000	13
0.0000	1.0000	14
0.0000	1.0000	15
0.0000	1.0000	16
0.0000	1.0000	17
0.0000	1.0000	18
0.0000	1.0000	19
0.0000	1.0000	20
0.0000	1.0000	21
0.0000	1.0000	22
0.0000	1.0000	23
0.0000	1.0000	24
0.0000	1.0000	25
0.0000	1.0000	26
0.0000	1.0000	27
0.0000	1.0000	28
0.0000	1.0000	29
0.0000	1.0000	30
0.0000	1.0000	31
0.0000	1.0000	32
0.0000	1.0000	33
0.0000	1.0000	34
0.0000	1.0000	35
0.0000	1.0000	36
0.0000	1.0000	37
0.0000	1.0000	38
0.0000	1.0000	39
0.0000	1.0000	40
0.0000	1.0000	41
0.0000	1.0000	42
0.0000	1.0000	43
0.0000	1.0000	44
0.0000	1.0000	45

9. Butterfield/Main
EBL
AM
Existing Conditions
Avg. Queue Per Lane in Veh= 3.7
Percentile = 0.95 7

9. Butterfield/Main
EBL
AM
Existing Plus Project Conditions with Proposed Site A
Avg. Queue Per Lane in Veh= 4.0
Percentile = 0.95 8

9. Butterfield/Main
EBL
AM
Existing Plus Project Conditions Alternative I (Right-i
Avg. Queue Per Lane in Veh= 4.7
Percentile = 0.95 8

9. Butterfield/Main
EBL
AM
Existing Plus Project Conditions Alternative II (Right-i
Avg. Queue Per Lane in Veh= 4.7
Percentile = 0.95 8

Individual Probability	Cumulative Probability	Number of Queued Vehicles
0.0242	0.0242	0
0.0900	0.1142	1
0.1675	0.2817	2
0.2078	0.4895	3
0.1934	0.6829	4
0.1440	0.8269	5
0.0893	0.9162	6
0.0475	0.9637	7
0.0221	0.9858	8
0.0091	0.9950	9
0.0034	0.9984	10
0.0012	0.9995	11
0.0004	0.9999	12
0.0001	1.0000	13
0.0000	1.0000	14
0.0000	1.0000	15
0.0000	1.0000	16
0.0000	1.0000	17
0.0000	1.0000	18
0.0000	1.0000	19
0.0000	1.0000	20
0.0000	1.0000	21
0.0000	1.0000	22
0.0000	1.0000	23
0.0000	1.0000	24
0.0000	1.0000	25
0.0000	1.0000	26
0.0000	1.0000	27
0.0000	1.0000	28
0.0000	1.0000	29
0.0000	1.0000	30
0.0000	1.0000	31
0.0000	1.0000	32
0.0000	1.0000	33
0.0000	1.0000	34
0.0000	1.0000	35
0.0000	1.0000	36
0.0000	1.0000	37
0.0000	1.0000	38
0.0000	1.0000	39
0.0000	1.0000	40
0.0000	1.0000	41
0.0000	1.0000	42
0.0000	1.0000	43
0.0000	1.0000	44
0.0000	1.0000	45

Individual Probability	Cumulative Probability	Number of Queued Vehicles
0.0178	0.0178	0
0.0718	0.0896	1
0.1445	0.2341	2
0.1940	0.4281	3
0.1953	0.6234	4
0.1574	0.7808	5
0.1056	0.8864	6
0.0608	0.9472	7
0.0306	0.9778	8
0.0137	0.9915	9
0.0055	0.9970	10
0.0020	0.9990	11
0.0007	0.9997	12
0.0002	0.9999	13
0.0001	1.0000	14
0.0000	1.0000	15
0.0000	1.0000	16
0.0000	1.0000	17
0.0000	1.0000	18
0.0000	1.0000	19
0.0000	1.0000	20
0.0000	1.0000	21
0.0000	1.0000	22
0.0000	1.0000	23
0.0000	1.0000	24
0.0000	1.0000	25
0.0000	1.0000	26
0.0000	1.0000	27
0.0000	1.0000	28
0.0000	1.0000	29
0.0000	1.0000	30
0.0000	1.0000	31
0.0000	1.0000	32
0.0000	1.0000	33
0.0000	1.0000	34
0.0000	1.0000	35
0.0000	1.0000	36
0.0000	1.0000	37
0.0000	1.0000	38
0.0000	1.0000	39
0.0000	1.0000	40
0.0000	1.0000	41
0.0000	1.0000	42
0.0000	1.0000	43
0.0000	1.0000	44
0.0000	1.0000	45

Individual Probability	Cumulative Probability	Number of Queued Vehicles
0.0094	0.0094	0
0.0439	0.0533	1
0.1024	0.1557	2
0.1593	0.3150	3
0.1858	0.5008	4
0.1734	0.6742	5
0.1349	0.8091	6
0.0899	0.8991	7
0.0525	0.9515	8
0.0272	0.9787	9
0.0127	0.9914	10
0.0054	0.9968	11
0.0021	0.9989	12
0.0008	0.9996	13
0.0003	0.9999	14
0.0001	1.0000	15
0.0000	1.0000	16
0.0000	1.0000	17
0.0000	1.0000	18
0.0000	1.0000	19
0.0000	1.0000	20
0.0000	1.0000	21
0.0000	1.0000	22
0.0000	1.0000	23
0.0000	1.0000	24
0.0000	1.0000	25
0.0000	1.0000	26
0.0000	1.0000	27
0.0000	1.0000	28
0.0000	1.0000	29
0.0000	1.0000	30
0.0000	1.0000	31
0.0000	1.0000	32
0.0000	1.0000	33
0.0000	1.0000	34
0.0000	1.0000	35
0.0000	1.0000	36
0.0000	1.0000	37
0.0000	1.0000	38
0.0000	1.0000	39
0.0000	1.0000	40
0.0000	1.0000	41
0.0000	1.0000	42
0.0000	1.0000	43
0.0000	1.0000	44
0.0000	1.0000	45

Individual Probability	Cumulative Probability	Number of Queued Vehicles
0.0094	0.0094	0
0.0439	0.0533	1
0.1024	0.1557	2
0.1593	0.3150	3
0.1858	0.5008	4
0.1734	0.6742	5
0.1349	0.8091	6
0.0899	0.8991	7
0.0525	0.9515	8
0.0272	0.9787	9
0.0127	0.9914	10
0.0054	0.9968	11
0.0021	0.9989	12
0.0008	0.9996	13
0.0003	0.9999	14
0.0001	1.0000	15
0.0000	1.0000	16
0.0000	1.0000	17
0.0000	1.0000	18
0.0000	1.0000	19
0.0000	1.0000	20
0.0000	1.0000	21
0.0000	1.0000	22
0.0000	1.0000	23
0.0000	1.0000	24
0.0000	1.0000	25
0.0000	1.0000	26
0.0000	1.0000	27
0.0000	1.0000	28
0.0000	1.0000	29
0.0000	1.0000	30
0.0000	1.0000	31
0.0000	1.0000	32
0.0000	1.0000	33
0.0000	1.0000	34
0.0000	1.0000	35
0.0000	1.0000	36
0.0000	1.0000	37
0.0000	1.0000	38
0.0000	1.0000	39
0.0000	1.0000	40
0.0000	1.0000	41
0.0000	1.0000	42
0.0000	1.0000	43
0.0000	1.0000	44
0.0000	1.0000	45

9. Butterfield/Main
EBL
PM
Existing Conditions
Avg. Queue Per Lane in Veh= 2.7
Percentile = 0.95 6

9. Butterfield/Main
EBL
PM
Existing Plus Project Conditions with Proposed Site A
Avg. Queue Per Lane in Veh= 3.0
Percentile = 0.95 6

9. Butterfield/Main
EBL
PM
Existing Plus Project Conditions Alternative I (Right-in)
Avg. Queue Per Lane in Veh= 3.7
Percentile = 0.95 7

9. Butterfield/Main
EBL
PM
Existing Plus Project Conditions Alternative II (Right-in)
Avg. Queue Per Lane in Veh= 3.7
Percentile = 0.95 7

Individual Probability	Cumulative Probability	Number of Queued Vehicles
0.0701	0.0701	0
0.1863	0.2563	1
0.2476	0.5039	2
0.2194	0.7233	3
0.1458	0.8690	4
0.0775	0.9466	5
0.0343	0.9809	6
0.0130	0.9939	7
0.0043	0.9983	8
0.0013	0.9996	9
0.0003	0.9999	10
0.0001	1.0000	11
0.0000	1.0000	12
0.0000	1.0000	13
0.0000	1.0000	14
0.0000	1.0000	15
0.0000	1.0000	16
0.0000	1.0000	17
0.0000	1.0000	18
0.0000	1.0000	19
0.0000	1.0000	20
0.0000	1.0000	21
0.0000	1.0000	22
0.0000	1.0000	23
0.0000	1.0000	24
0.0000	1.0000	25
0.0000	1.0000	26
0.0000	1.0000	27
0.0000	1.0000	28
0.0000	1.0000	29
0.0000	1.0000	30
0.0000	1.0000	31
0.0000	1.0000	32
0.0000	1.0000	33
0.0000	1.0000	34
0.0000	1.0000	35
0.0000	1.0000	36
0.0000	1.0000	37
0.0000	1.0000	38
0.0000	1.0000	39
0.0000	1.0000	40
0.0000	1.0000	41
0.0000	1.0000	42
0.0000	1.0000	43
0.0000	1.0000	44
0.0000	1.0000	45

Individual Probability	Cumulative Probability	Number of Queued Vehicles
0.0501	0.0501	0
0.1499	0.2000	1
0.2245	0.4244	2
0.2240	0.6485	3
0.1677	0.8162	4
0.1004	0.9166	5
0.0501	0.9668	6
0.0214	0.9882	7
0.0080	0.9962	8
0.0027	0.9989	9
0.0008	0.9997	10
0.0002	0.9999	11
0.0001	1.0000	12
0.0000	1.0000	13
0.0000	1.0000	14
0.0000	1.0000	15
0.0000	1.0000	16
0.0000	1.0000	17
0.0000	1.0000	18
0.0000	1.0000	19
0.0000	1.0000	20
0.0000	1.0000	21
0.0000	1.0000	22
0.0000	1.0000	23
0.0000	1.0000	24
0.0000	1.0000	25
0.0000	1.0000	26
0.0000	1.0000	27
0.0000	1.0000	28
0.0000	1.0000	29
0.0000	1.0000	30
0.0000	1.0000	31
0.0000	1.0000	32
0.0000	1.0000	33
0.0000	1.0000	34
0.0000	1.0000	35
0.0000	1.0000	36
0.0000	1.0000	37
0.0000	1.0000	38
0.0000	1.0000	39
0.0000	1.0000	40
0.0000	1.0000	41
0.0000	1.0000	42
0.0000	1.0000	43
0.0000	1.0000	44
0.0000	1.0000	45

Individual Probability	Cumulative Probability	Number of Queued Vehicles
0.0248	0.0248	0
0.0917	0.1165	1
0.1694	0.2859	2
0.2088	0.4947	3
0.1930	0.6878	4
0.1427	0.8305	5
0.0880	0.9184	6
0.0465	0.9649	7
0.0215	0.9864	8
0.0088	0.9952	9
0.0033	0.9984	10
0.0011	0.9995	11
0.0003	0.9999	12
0.0001	1.0000	13
0.0000	1.0000	14
0.0000	1.0000	15
0.0000	1.0000	16
0.0000	1.0000	17
0.0000	1.0000	18
0.0000	1.0000	19
0.0000	1.0000	20
0.0000	1.0000	21
0.0000	1.0000	22
0.0000	1.0000	23
0.0000	1.0000	24
0.0000	1.0000	25
0.0000	1.0000	26
0.0000	1.0000	27
0.0000	1.0000	28
0.0000	1.0000	29
0.0000	1.0000	30
0.0000	1.0000	31
0.0000	1.0000	32
0.0000	1.0000	33
0.0000	1.0000	34
0.0000	1.0000	35
0.0000	1.0000	36
0.0000	1.0000	37
0.0000	1.0000	38
0.0000	1.0000	39
0.0000	1.0000	40
0.0000	1.0000	41
0.0000	1.0000	42
0.0000	1.0000	43
0.0000	1.0000	44
0.0000	1.0000	45

Individual Probability	Cumulative Probability	Number of Queued Vehicles
0.0248	0.0248	0
0.0917	0.1165	1
0.1694	0.2859	2
0.2088	0.4947	3
0.1930	0.6878	4
0.1427	0.8305	5
0.0880	0.9184	6
0.0465	0.9649	7
0.0215	0.9864	8
0.0088	0.9952	9
0.0033	0.9984	10
0.0011	0.9995	11
0.0003	0.9999	12
0.0001	1.0000	13
0.0000	1.0000	14
0.0000	1.0000	15
0.0000	1.0000	16
0.0000	1.0000	17
0.0000	1.0000	18
0.0000	1.0000	19
0.0000	1.0000	20
0.0000	1.0000	21
0.0000	1.0000	22
0.0000	1.0000	23
0.0000	1.0000	24
0.0000	1.0000	25
0.0000	1.0000	26
0.0000	1.0000	27
0.0000	1.0000	28
0.0000	1.0000	29
0.0000	1.0000	30
0.0000	1.0000	31
0.0000	1.0000	32
0.0000	1.0000	33
0.0000	1.0000	34
0.0000	1.0000	35
0.0000	1.0000	36
0.0000	1.0000	37
0.0000	1.0000	38
0.0000	1.0000	39
0.0000	1.0000	40
0.0000	1.0000	41
0.0000	1.0000	42
0.0000	1.0000	43
0.0000	1.0000	44
0.0000	1.0000	45

10. Butterfield/Dunne

EBL
AM

Existing Conditions

Avg. Queue Per Lane in Veh= 5.1
Percentile = 0.95 9

10. Butterfield/Dunne

EBL
AM

Existing Plus Project Conditions with Proposed Site A

Avg. Queue Per Lane in Veh= 6.5
Percentile = 0.95 11

10. Butterfield/Dunne

EBL
AM

Existing Plus Project Conditions Alternative I (Right-i

Avg. Queue Per Lane in Veh= 5.7
Percentile = 0.95 10

10. Butterfield/Dunne

EBL
AM

Existing Plus Project Conditions Alternative II (Right-i

Avg. Queue Per Lane in Veh= 5.7
Percentile = 0.95 10

Individual Probability	Cumulative Probability	Number of Queued Vehicles
0.0061	0.0061	0
0.0311	0.0372	1
0.0793	0.1165	2
0.1348	0.2513	3
0.1719	0.4231	4
0.1753	0.5984	5
0.1490	0.7474	6
0.1086	0.8560	7
0.0692	0.9252	8
0.0392	0.9644	9
0.0200	0.9844	10
0.0093	0.9937	11
0.0039	0.9976	12
0.0015	0.9992	13
0.0006	0.9997	14
0.0002	0.9999	15
0.0001	1.0000	16
0.0000	1.0000	17
0.0000	1.0000	18
0.0000	1.0000	19
0.0000	1.0000	20
0.0000	1.0000	21
0.0000	1.0000	22
0.0000	1.0000	23
0.0000	1.0000	24
0.0000	1.0000	25
0.0000	1.0000	26
0.0000	1.0000	27
0.0000	1.0000	28
0.0000	1.0000	29
0.0000	1.0000	30
0.0000	1.0000	31
0.0000	1.0000	32
0.0000	1.0000	33
0.0000	1.0000	34
0.0000	1.0000	35
0.0000	1.0000	36
0.0000	1.0000	37
0.0000	1.0000	38
0.0000	1.0000	39
0.0000	1.0000	40
0.0000	1.0000	41
0.0000	1.0000	42
0.0000	1.0000	43
0.0000	1.0000	44
0.0000	1.0000	45

Individual Probability	Cumulative Probability	Number of Queued Vehicles
0.0015	0.0015	0
0.0098	0.0113	1
0.0318	0.0430	2
0.0688	0.1118	3
0.1118	0.2237	4
0.1454	0.3690	5
0.1575	0.5265	6
0.1462	0.6728	7
0.1188	0.7916	8
0.0858	0.8774	9
0.0558	0.9332	10
0.0330	0.9661	11
0.0179	0.9840	12
0.0089	0.9929	13
0.0041	0.9970	14
0.0018	0.9988	15
0.0007	0.9996	16
0.0003	0.9998	17
0.0001	0.9999	18
0.0000	1.0000	19
0.0000	1.0000	20
0.0000	1.0000	21
0.0000	1.0000	22
0.0000	1.0000	23
0.0000	1.0000	24
0.0000	1.0000	25
0.0000	1.0000	26
0.0000	1.0000	27
0.0000	1.0000	28
0.0000	1.0000	29
0.0000	1.0000	30
0.0000	1.0000	31
0.0000	1.0000	32
0.0000	1.0000	33
0.0000	1.0000	34
0.0000	1.0000	35
0.0000	1.0000	36
0.0000	1.0000	37
0.0000	1.0000	38
0.0000	1.0000	39
0.0000	1.0000	40
0.0000	1.0000	41
0.0000	1.0000	42
0.0000	1.0000	43
0.0000	1.0000	44
0.0000	1.0000	45

Individual Probability	Cumulative Probability	Number of Queued Vehicles
0.0032	0.0032	0
0.0186	0.0218	1
0.0532	0.0750	2
0.1017	0.1766	3
0.1457	0.3223	4
0.1671	0.4894	5
0.1596	0.6490	6
0.1308	0.7798	7
0.0937	0.8735	8
0.0597	0.9332	9
0.0342	0.9674	10
0.0178	0.9853	11
0.0085	0.9938	12
0.0038	0.9976	13
0.0015	0.9991	14
0.0006	0.9997	15
0.0002	0.9999	16
0.0001	1.0000	17
0.0000	1.0000	18
0.0000	1.0000	19
0.0000	1.0000	20
0.0000	1.0000	21
0.0000	1.0000	22
0.0000	1.0000	23
0.0000	1.0000	24
0.0000	1.0000	25
0.0000	1.0000	26
0.0000	1.0000	27
0.0000	1.0000	28
0.0000	1.0000	29
0.0000	1.0000	30
0.0000	1.0000	31
0.0000	1.0000	32
0.0000	1.0000	33
0.0000	1.0000	34
0.0000	1.0000	35
0.0000	1.0000	36
0.0000	1.0000	37
0.0000	1.0000	38
0.0000	1.0000	39
0.0000	1.0000	40
0.0000	1.0000	41
0.0000	1.0000	42
0.0000	1.0000	43
0.0000	1.0000	44
0.0000	1.0000	45

Individual Probability	Cumulative Probability	Number of Queued Vehicles
0.0032	0.0032	0
0.0186	0.0218	1
0.0532	0.0750	2
0.1017	0.1766	3
0.1457	0.3223	4
0.1671	0.4894	5
0.1596	0.6490	6
0.1308	0.7798	7
0.0937	0.8735	8
0.0597	0.9332	9
0.0342	0.9674	10
0.0178	0.9853	11
0.0085	0.9938	12
0.0038	0.9976	13
0.0015	0.9991	14
0.0006	0.9997	15
0.0002	0.9999	16
0.0001	1.0000	17
0.0000	1.0000	18
0.0000	1.0000	19
0.0000	1.0000	20
0.0000	1.0000	21
0.0000	1.0000	22
0.0000	1.0000	23
0.0000	1.0000	24
0.0000	1.0000	25
0.0000	1.0000	26
0.0000	1.0000	27
0.0000	1.0000	28
0.0000	1.0000	29
0.0000	1.0000	30
0.0000	1.0000	31
0.0000	1.0000	32
0.0000	1.0000	33
0.0000	1.0000	34
0.0000	1.0000	35
0.0000	1.0000	36
0.0000	1.0000	37
0.0000	1.0000	38
0.0000	1.0000	39
0.0000	1.0000	40
0.0000	1.0000	41
0.0000	1.0000	42
0.0000	1.0000	43
0.0000	1.0000	44
0.0000	1.0000	45

10. Butterfield/Dunne
 EBL
 AM
 Existing Conditions
 Avg. Queue Per Lane in Veh= 5.1
 Percentile = 0.95 9

10. Butterfield/Dunne
 EBL
 AM
 Existing Plus Project Conditions with Proposed Site A
 Avg. Queue Per Lane in Veh= 6.5
 Percentile = 0.95 11

10. Butterfield/Dunne
 EBL
 AM
 Existing Plus Project Conditions Alternative I (Right-in)
 Avg. Queue Per Lane in Veh= 5.7
 Percentile = 0.95 10

10. Butterfield/Dunne
 EBL
 AM
 Existing Plus Project Conditions Alternative II (Right-in)
 Avg. Queue Per Lane in Veh= 5.7
 Percentile = 0.95 10

Individual Probability	Cumulative Probability	Number of Queued Vehicles
0.0061	0.0061	0
0.0311	0.0372	1
0.0793	0.1165	2
0.1348	0.2513	3
0.1719	0.4231	4
0.1753	0.5984	5
0.1490	0.7474	6
0.1086	0.8560	7
0.0692	0.9252	8
0.0392	0.9644	9
0.0200	0.9844	10
0.0093	0.9937	11
0.0039	0.9976	12
0.0015	0.9992	13
0.0006	0.9997	14
0.0002	0.9999	15
0.0001	1.0000	16
0.0000	1.0000	17
0.0000	1.0000	18
0.0000	1.0000	19
0.0000	1.0000	20
0.0000	1.0000	21
0.0000	1.0000	22
0.0000	1.0000	23
0.0000	1.0000	24
0.0000	1.0000	25
0.0000	1.0000	26
0.0000	1.0000	27
0.0000	1.0000	28
0.0000	1.0000	29
0.0000	1.0000	30
0.0000	1.0000	31
0.0000	1.0000	32
0.0000	1.0000	33
0.0000	1.0000	34
0.0000	1.0000	35
0.0000	1.0000	36
0.0000	1.0000	37
0.0000	1.0000	38
0.0000	1.0000	39
0.0000	1.0000	40
0.0000	1.0000	41
0.0000	1.0000	42
0.0000	1.0000	43
0.0000	1.0000	44
0.0000	1.0000	45

Individual Probability	Cumulative Probability	Number of Queued Vehicles
0.0015	0.0015	0
0.0098	0.0113	1
0.0318	0.0430	2
0.0688	0.1118	3
0.1118	0.2237	4
0.1454	0.3690	5
0.1575	0.5265	6
0.1462	0.6728	7
0.1188	0.7916	8
0.0858	0.8774	9
0.0558	0.9332	10
0.0330	0.9661	11
0.0179	0.9840	12
0.0089	0.9929	13
0.0041	0.9970	14
0.0018	0.9988	15
0.0007	0.9996	16
0.0003	0.9998	17
0.0001	0.9999	18
0.0000	1.0000	19
0.0000	1.0000	20
0.0000	1.0000	21
0.0000	1.0000	22
0.0000	1.0000	23
0.0000	1.0000	24
0.0000	1.0000	25
0.0000	1.0000	26
0.0000	1.0000	27
0.0000	1.0000	28
0.0000	1.0000	29
0.0000	1.0000	30
0.0000	1.0000	31
0.0000	1.0000	32
0.0000	1.0000	33
0.0000	1.0000	34
0.0000	1.0000	35
0.0000	1.0000	36
0.0000	1.0000	37
0.0000	1.0000	38
0.0000	1.0000	39
0.0000	1.0000	40
0.0000	1.0000	41
0.0000	1.0000	42
0.0000	1.0000	43
0.0000	1.0000	44
0.0000	1.0000	45

Individual Probability	Cumulative Probability	Number of Queued Vehicles
0.0032	0.0032	0
0.0186	0.0218	1
0.0532	0.0750	2
0.1017	0.1766	3
0.1457	0.3223	4
0.1671	0.4894	5
0.1596	0.6490	6
0.1308	0.7798	7
0.0937	0.8735	8
0.0597	0.9332	9
0.0342	0.9674	10
0.0178	0.9853	11
0.0085	0.9938	12
0.0038	0.9976	13
0.0015	0.9991	14
0.0006	0.9997	15
0.0002	0.9999	16
0.0001	1.0000	17
0.0000	1.0000	18
0.0000	1.0000	19
0.0000	1.0000	20
0.0000	1.0000	21
0.0000	1.0000	22
0.0000	1.0000	23
0.0000	1.0000	24
0.0000	1.0000	25
0.0000	1.0000	26
0.0000	1.0000	27
0.0000	1.0000	28
0.0000	1.0000	29
0.0000	1.0000	30
0.0000	1.0000	31
0.0000	1.0000	32
0.0000	1.0000	33
0.0000	1.0000	34
0.0000	1.0000	35
0.0000	1.0000	36
0.0000	1.0000	37
0.0000	1.0000	38
0.0000	1.0000	39
0.0000	1.0000	40
0.0000	1.0000	41
0.0000	1.0000	42
0.0000	1.0000	43
0.0000	1.0000	44
0.0000	1.0000	45

Individual Probability	Cumulative Probability	Number of Queued Vehicles
0.0032	0.0032	0
0.0186	0.0218	1
0.0532	0.0750	2
0.1017	0.1766	3
0.1457	0.3223	4
0.1671	0.4894	5
0.1596	0.6490	6
0.1308	0.7798	7
0.0937	0.8735	8
0.0597	0.9332	9
0.0342	0.9674	10
0.0178	0.9853	11
0.0085	0.9938	12
0.0038	0.9976	13
0.0015	0.9991	14
0.0006	0.9997	15
0.0002	0.9999	16
0.0001	1.0000	17
0.0000	1.0000	18
0.0000	1.0000	19
0.0000	1.0000	20
0.0000	1.0000	21
0.0000	1.0000	22
0.0000	1.0000	23
0.0000	1.0000	24
0.0000	1.0000	25
0.0000	1.0000	26
0.0000	1.0000	27
0.0000	1.0000	28
0.0000	1.0000	29
0.0000	1.0000	30
0.0000	1.0000	31
0.0000	1.0000	32
0.0000	1.0000	33
0.0000	1.0000	34
0.0000	1.0000	35
0.0000	1.0000	36
0.0000	1.0000	37
0.0000	1.0000	38
0.0000	1.0000	39
0.0000	1.0000	40
0.0000	1.0000	41
0.0000	1.0000	42
0.0000	1.0000	43
0.0000	1.0000	44
0.0000	1.0000	45