

**PRELIMINARY DRAINAGE
STUDY FOR
MURRIETA APARTMENTS
*DP-2018-1761, ZC-2018-1763, GP-2018-1762***

**CITY OF MURRIETA
CALIFORNIA**

PREPARED FOR:

**VSL ENGINEERING
31805 TEMECULA PARKWAY, SUITE 129
TEMECULA, CA 92592
(951) 296-3930**

PREPARED BY:



**41660 IVY STREET, SUITE A
MURRIETA, CA 92562
(951) 304-9552 • FAX (951) 304-3568**

DATE PREPARED:

MARCH 11, 2019

REVISED:

AUGUST 21, 2019

OCTOBER 11, 2019

**PRELIMINARY DRAINAGE STUDY FOR
FOR MURRIETA APARTMENTS
CITY OF MURRIETA, CALIFORNIA**

This report has been prepared by or under the direction of the following registered civil engineer who attests to the technical information contained herein. The registered civil engineer has also judged the qualifications of any technical specialists providing engineering data upon which recommendations, conclusions, and decisions are based.



10/11/2019



Joseph L. Castaneda RCE 59835
Registered Civil Engineer

Date

Seal

**PRELIMINARY DRAINAGE STUDY FOR
FOR MURRIETA APARTMENTS
CITY OF MURRIETA, CALIFORNIA**

Table of Contents

I.	INTRODUCTION.....	1
II.	PROJECT SITE AND DRAINAGE AREA OVERVIEW	2
III.	HYDROLOGY ANALYSIS	2
IV.	STORM DRAIN FACILITIES.....	3
V.	CONCLUSIONS	5
IV.	CAPACITY OF EXIST. STORM DRAIN	6

FIGURES

FIGURE 1: VICINITY MAP

APPENDICES

APPENDIX A: PRE-PROJECT CONDITION RATIONAL METHOD ANALYSIS

APPENDIX A.1: AREA "A"

APPENDIX A.2: AREA "B"

APPENDIX A.3: AREA "C"

APPENDIX B: POST-PROJECT CONDITION RATIONAL METHOD ANALYSIS

APPENDIX B.1: AREA "A"

APPENDIX B.2: AREA "B"

APPENDIX B.3: AREA "C"

APPENDIX C: INLET CALCULATIONS

APPENDIX D: STORM DRAIN CALCULATIONS

EXCERPTS

EXCERPT A: WINCHESTER ROAD STORM DRAIN

EXHIBITS

EXHIBIT A: PRE-PROJECT CONDITION RATIONAL METHOD HYDROLOGY MAP

EXHIBIT B: POST-PROJECT CONDITION RATIONAL METHOD HYDROLOGY MAP

EXHIBIT C: DRAINAGE FACILITIES MAP

EXHIBIT D: NRCS HYDROLOGIC SOILS MAP



**PRELIMINARY DRAINAGE STUDY FOR
FOR MURRIETA APARTMENTS
CITY OF MURRIETA, CALIFORNIA**

I. INTRODUCTION

APNs 913-210-005, 006, 007, 913-010-013, 033, 034, 035 and portions of 913-210.032 are in the process of entitlement review for the development of proposed apartments. The following **project description** has been developed by the project team:

“The project is a General Plan Amendment, Zone Change and Development Plan to change the existing Commercial General Plan land use, Neighborhood Commercial zoning to Multifamily Residential General Plan land use, Multi-Family 3 zoning and to develop multi-family housing totaling 234 units on a 8.37 acre site. The project site is located at the intersection of Delhaven Avenue and Date Street the south east corner and is comprised of Assessor Parcel Numbers (APN) 913-210-005, 006, 007, 010-013, 033, 034, 035 and portions of 913-210-032. The site is subject to the Commercial General Plan Land Use Designation and is Zoned Neighborhood Commercial. A General Plan and Zone Change Amendment is proposed. The site is undeveloped. Access would be provided by two private drives proposed to be located at Date Street and at Rising Hill Drive. Currently Earthwork being proposed would have an excavation depth of four feet below finish grade or two feet below the deepest footing, whichever is greater.”

The Murrieta Apartment is a proposed high density residential project in the City of Murrieta, California. The site is bounded by Date Street to the north, detached medium density residential units to the south, commercial land use to the west and existing commercial development to the east, see Figure 1. The project area drains into storm drain infrastructure constructed by Assessment District 161. The existing drainage area currently drains into the Winchester Road Storm Drain system that was constructed as part of Assessment District 161 which is a regional storm drain maintained and operated by RCFC&WCD, see Excerpt A.

The purpose of this study is to determine the required storm drain improvements and infrastructure that will adequately convey the peak 100-year flows from the project site and treat the required water quality volume prior to discharging from the project site. The scope of work for this report includes:

- Determine the peak 100-year and 10-year flow rates for the post-project condition for the onsite and offsite areas using the Rational Method as outlined in the RCFC&WCD Hydrology Manual.
- Identify storm drain alignments to protect the project site and can adequately convey the peak tributary flow rates.
- Preparation of a hydrology and hydraulics report supporting the design, which consists of hydrological and analytical results and exhibits.

**PRELIMINARY DRAINAGE STUDY FOR
FOR MURRIETA APARTMENTS
CITY OF MURRIETA, CALIFORNIA**

II. PROJECT SITE AND DRAINAGE OVERVIEW

The Murrieta Apartments (DP-2018-1761) is proposing a high density multi-family development in the City of Murrieta. The project is proposing 234 residential lots. The proposed project is proposing a subsurface water quality basin that will promote infiltration of the water quality runoff and will mitigate hydromodifications. All runoff generated by the project site will be collected and conveyed into the Winchester Road Storm Drain which has been designed to collect runoff from the project area.

The existing terrain currently slopes from a ridge point on the project and slopes downward in the northerly, southerly and easterly directions. The current runoff is a sheet flow condition that flows over terrain that is sparsely covered with natural vegetation. The natural terrain slopes from approximately 10% to a maximum of 50%. The existing terrain flows into the adjacent communities and properties and will eventually surface flow into the existing Winchester Road Storm Drain.

The Winchester Road Storm Drain is a 54-inch concrete pipe that extends along Winchester Road and ultimately terminates into the existing golf course north of Murrieta Hot Springs Road. The 54-inch storm drain will ultimately discharge flows into Tocalota Creek.

III. HYDROLOGY ANALYSIS

The RCFC&WCD Hydrology Manual (Reference 1) was used to develop the hydrological parameters for the rational method. The calculations were performed using the computer program developed by Civil Cadd/Civil Design.

The existing soil classification for the area consists of Soil "A" and Soil "C", as shown in the soils map provided in Exhibit D. The soils information was obtained from the United States Department of Agriculture, Natural Resources Conservation Service (NRCS).

The following rainfall depths were obtained from RCFC&WCD Hydrology Manual which are included as Exhibit E.

Storm Event	1-hour (in)
2-Year	0.50
100-Year	1.20
Slope Intensity Curve	0.55

The rational method hydrology analyses utilized apartments as designated in the RCFC&WCD Hydrology Manual to represent the proposed development for the drainage areas within the project site. The apartment land use implements an impervious area of 80%.



**PRELIMINARY DRAINAGE STUDY FOR
FOR MURRIETA APARTMENTS
CITY OF MURRIETA, CALIFORNIA**

The rational method hydrology was completed using three hydrology models for the pre-project condition and 1 model for the post project condition. The results of the pre-project hydrology analyses are as follows:

Table 1 - Pre-Project Flow Rates

Area	Acreage	100 Year Flow Rate (ft ³ /s)	10 Year Flow Rate (ft ³ /s)
A	4.23	12.59	8.01
B	1.62	4.65	2.86
C	1.93	5.73	3.68

The results of the post-project hydrology analyses are as follows:

Table 2 - Post-Project Flow Rates

Area	Acreage	100 Year Flow Rate (ft ³ /s)	10 Year Flow Rate (ft ³ /s)
A	7.29	15.55	9.96
B	0.42	0.43	0.23
C	0.70	1.78	1.11

The pre-project analyses modeled three watershed areas designated as Areas A, B, and C. Area A is tributary to the northerly portion of the project site, Area B is tributary to the south easterly portion of the project site, and Area C is tributary to Rising Hill Drive. The post-project condition utilized these same watershed designations to represent the areas tributary to those same areas.

Area C1 in the post-project condition utilized ¼ acre residential land use in the hydrology calculations since user defined land use is not permitted within the CivilD program for initial areas, therefore the closest representation of the land use must be selected. Since the area is composed of landscaped slopes and commercial streets, ¼ acre residential land use was chosen since it has an impervious percentage of 50%. Area C1 is approximately 50% streets and 50% landscaped slopes, resulting in approximately 50% impervious.

Based upon the hydrology analyses, it would appear that the project site is diverting area between the three watersheds, all areas are tributary to the existing Winchester Road Storm Drain. Additionally, the area that is receiving more area is Area A, which all onsite Area A is tributary to the subsurface basin, which will significantly reduce the 100-year flow rate with the incorporation of the subsurface system. Currently, flows from existing Area C discharge into Rising Hill Drive, and based upon Google Imagery, the flows are eroding the existing slope and causing sediment to be conveyed into the street. During the post-project condition, a large portion of these flows will be conveyed to the subsurface system, and the remaining sloped area tributary to Rising Hill Drive will be landscaped. Therefore, the project will be improving the current flooding condition.



**PRELIMINARY DRAINAGE STUDY FOR
FOR MURRIETA APARTMENTS
CITY OF MURRIETA, CALIFORNIA**

During Final Engineering, detailed basin routing will be performed for the 100-year storm event for the subsurface system to demonstrate the actual reduction in flows.

IV. STORM DRAIN FACILITIES

The project site will construct subsurface storm drain to convey the peak 100-year flow rates emanating from the project site to a proposed subsurface basin that has been sized for to mitigate hydromodifications. The project will use a total of 3 catch basins and 2 grate inlets. The flow rate and the opening length to each catch basin are listed in Table 3 based on the post-project condition nodes.

Table 3 - Flow Rates to Proposed Catch Basins

Node	Catch Basin Number	100 Year Flow Rate (ft ³ /s)	10 Year Flow Rate (ft ³ /s)	Catch Basin Length (ft)
102	#1	4.7	3.0	4
104	#2	4.4	2.8	4
107	#3	8.8	5.7	7

The proposed catch basins are located in sump conditions. The proposed catch basins will be required to have the minimum openings shown on Table 3.

In addition to the catch basins, the project will implement the use of two grate inlets at the project entrance from Date Street. These grate inlets will maximize capturing flow rate before leaving the project site. Additionally, the inlets will be used to dewater the porous paver area that was identified in the WQMP. The porous paver area defined as DMA C, has been designed as source control area or self-retaining area that will allow 3 inches of maximum ponding in the porous paver reservoir.

The proposed project is proposing a total of 4 storm drain systems, as shown on Exhibit B, that are defined as follows:

Line A is a proposed 24-inch storm drain system that will convey flows from the subsurface basin to the existing Winchester Road Storm Drain. Additionally, the Line A system will include a connector pipe that will collect low flows from the modular wetlands and proposed catch basin on Date Street. The catch basin on Date Street has been provided to collect the flows from Area A5 that bypass the trench drain and discharge from the sloped area adjacent to Date Street. The minimum slope of Line A shall be 2%.

Line A1 is a storm drain system that collects flows from Area A2 at a sump location at the most easterly point of the project. The Line A1 system will also confluence with the Line A2 System. The flow rate for Line A1 will range from 4.4 ft³/s to 8.5 ft³/s. The Line A1 system downstream of the confluence point shall be a 24-inch storm drain



**PRELIMINARY DRAINAGE STUDY FOR
FOR MURRIETA APARTMENTS
CITY OF MURRIETA, CALIFORNIA**

with a minimum slope of 0.5%. Upstream of the confluence point the storm drain will be an 18-inch storm drain.

Line A2 is a storm drain that collects flows from Area A1 at a sump location. The flows for the 100 year storm event are 4.7 ft³/s. The Line A2 system from the confluence point to the proposed catch basin will be an 18-inch storm drain.

Line A3 is a storm drain that collects flows from Area A3 and A4 at a sump location. The flows for the 100 year storm event are 8.8 ft³/s. The proposed storm drain will be a 24-inch storm drain.

V. CONCLUSIONS

The hydrology analyses evaluated the project site to determine the peak flow rates emanating from the project and the necessary drainage improvements required to flood protect the site. Based upon the results, the following can be concluded:

- The proposed subsurface basin and storm drain systems have been designed to adequately convey the peak 100-year flow rates emanating from the project.
- The proposed subsurface basins will adequately address water quality treatment and hydromodifications as discussed in the WQMP.

IV. Capacity of Existing Storm Drain in Old Date Street

Riverside County Flood Control and Water Conservation District currently owns and maintains a 54-inch diameter storm drain pipeline in Old Date Street. This facility (Assessment District No. 161 Winchester Road Storm Drain) currently collects storm runoff from the subject property and surrounding properties and conveys accumulated flows downstream to Tualota Creek. Currently, this storm drain collects local flows from the subject site further downstream than is being proposed by the project design. In order to determine if moving the inflows to a point further upstream in the storm drain will have a detrimental affect, the following steps were taken:

- 1) Attempts were made to obtain copies of the hydrology report for the Winchester Road Storm Drain, however the report and associated computations could not be located.
- 2) The watershed upstream of Murrieta Hot Springs Road was then analyzed to determine the time of concentration, which was established as 32.2 minutes the intersection of Old Date Street and Del Haven Avenue. According to the storm drain plans, the accepted Q100 at that location is 166.4 cfs. The main purpose of this step was to model the time of concentration for the longest flow path in order to develop a time of concentration that could be used for the confluence analyses
- 3) Flows from the subject property and the adjacent 2.6 acres were confluenced with flows from the upper watershed using a time of concentration of 32.2 minutes (Node 6)
- 4) Flows from the two commercial developments on both sides of Old Date Street were then confluenced with the cumulative upstream runoff (Node 9).
- 5) Street flows from Old Date Street were confluence in at the end of the existing culdesac (Node 11)
- 6) Street flows from Winchester Road were confluence at the existing catch basin (Node 14)
- 7) Flows from the two existing commercial developments on Winchester Road were confluence at Nodes 16 and 18.
- 8) The cumulative Q100 at Node 18 was calculated to be 196 cfs vs 203.4 cfs shown on the storm drain plans, a difference of about 3 and a half percent.
- 9) Hydraulic grade line computations were performed using the newly computed runoff values and plotted on the storm drain plans
- 10) These HGL computations show that the storm drain is expected to function in an acceptable manner if flows from the subject site enter the storm drain at the proposed location.

Attachments:

- A) Hydrology Computations
- B) Hydraulic Computations
- C) Regional Hydrology Map
- D) Storm Drain Plans With HGL

A. HYDROLOGY COMPUTATIONS

Riverside County Rational Hydrology Program

CIVILCADD/CIVILDESIGN Engineering Software,(c) 1989 - 2014 Version 9.0
Rational Hydrology Study Date: 10/02/19 File:APARTMENT.out

NODE 1 TO 2 TIME OF CONCENTRATION CALC ONLY

***** Hydrology Study Control Information *****

English (in-lb) Units used in input data file

Program License Serial Number 6109

Rational Method Hydrology Program based on
Riverside County Flood Control & Water Conservation District
1978 hydrology manual

Storm event (year) = 100.00 Antecedent Moisture Condition = 2

2 year, 1 hour precipitation = 0.500(In.)
100 year, 1 hour precipitation = 1.200(In.)

Storm event year = 100.0
Calculated rainfall intensity data:
1 hour intensity = 1.200(In/Hr)
Slope of intensity duration curve = 0.5500

Process from Point/Station 1.000 to Point/Station 2.000
**** INITIAL AREA EVALUATION ****

Initial area flow distance = 1000.000(Ft.)
Top (of initial area) elevation = 1295.000(Ft.)
Bottom (of initial area) elevation = 1243.000(Ft.)
Difference in elevation = 52.000(Ft.)
Slope = 0.05200 s(percent)= 5.20
TC = $k(0.940) * [(length^3)/(elevation\ change)]^{0.2}$
Initial area time of concentration = 26.911 min.
Rainfall intensity = 1.865(In/Hr) for a 100.0 year storm
UNDEVELOPED (good cover) subarea
Runoff Coefficient = 0.719
Decimal fraction soil group A = 0.000
Decimal fraction soil group B = 0.000
Decimal fraction soil group C = 1.000
Decimal fraction soil group D = 0.000
RI index for soil(AMC 2) = 74.00
Pervious area fraction = 1.000; Impervious fraction = 0.000
Initial subarea runoff = 9.391(CFS)
Total initial stream area = 7.000(Ac.)
Pervious area fraction = 1.000

Process from Point/Station 2.000 to Point/Station 3.000
**** NATURAL CHANNEL TIME + SUBAREA FLOW ADDITION ****

Top of natural channel elevation = 1243.000(Ft.)
End of natural channel elevation = 1118.000(Ft.)
Length of natural channel = 2781.000(Ft.)
Estimated mean flow rate at midpoint of channel = 64.398(CFS)

Natural valley channel type used
L.A. County flood control district formula for channel velocity:
Velocity(ft/s) = $(7 + 8(q(\text{English Units})^{.352})(\text{slope}^{0.5}))$
Velocity using mean channel flow = 8.83(Ft/s)

Correction to map slope used on extremely rugged channels with
drops and waterfalls (Plate D-6.2)
Normal channel slope = 0.0449
Corrected/adjusted channel slope = 0.0449
Travel time = 5.25 min. TC = 32.16 min.

Adding area flow to channel
UNDEVELOPED (good cover) subarea
Runoff Coefficient = 0.705
Decimal fraction soil group A = 0.000
Decimal fraction soil group B = 0.000
Decimal fraction soil group C = 1.000
Decimal fraction soil group D = 0.000
RI index for soil(AMC 2) = 74.00

Pervious area fraction = 1.000; Impervious fraction = 0.000
Rainfall intensity = 1.691(In/Hr) for a 100.0 year storm
Subarea runoff = 97.725(CFS) for 82.000(Ac.)
Total runoff = 107.116(CFS) Total area = 89.000(Ac.)
End of computations, total study area = 89.00 (Ac.)
The following figures may
be used for a unit hydrograph study of the same area.

Area averaged pervious area fraction(Ap) = 1.000
Area averaged RI index number = 74.0

Riverside County Rational Hydrology Program

CIVILCADD/CIVILDESIGN Engineering Software,(c) 1989 - 2014 Version 9.0
Rational Hydrology Study Date: 10/02/19 File:APARTMENT2.out

NODE 3 TO 18

***** Hydrology Study Control Information *****

English (in-lb) Units used in input data file

Program License Serial Number 6109

Rational Method Hydrology Program based on
Riverside County Flood Control & Water Conservation District
1978 hydrology manual

Storm event (year) = 100.00 Antecedent Moisture Condition = 2

2 year, 1 hour precipitation = 0.500(In.)
100 year, 1 hour precipitation = 1.200(In.)

Storm event year = 100.0
Calculated rainfall intensity data:
1 hour intensity = 1.200(In/Hr)
Slope of intensity duration curve = 0.5500

Process from Point/Station 3.000 to Point/Station 6.000
**** USER DEFINED FLOW INFORMATION AT A POINT ****

Rainfall intensity = 1.690(In/Hr) for a 100.0 year storm
COMMERCIAL subarea type
Runoff Coefficient = 0.876
Decimal fraction soil group A = 0.000
Decimal fraction soil group B = 0.000
Decimal fraction soil group C = 1.000
Decimal fraction soil group D = 0.000
RI index for soil(AMC 2) = 69.00
Pervious area fraction = 0.100; Impervious fraction = 0.900
User specified values are as follows:
TC = 32.20 min. Rain intensity = 1.69(In/Hr)
Total area = 89.00(Ac.) Total runoff = 166.40(CFS)

Process from Point/Station 3.000 to Point/Station 6.000
**** CONFLUENCE OF MAIN STREAMS ****

The following data inside Main Stream is listed:
In Main Stream number: 1
Stream flow area = 89.000(Ac.)
Runoff from this stream = 166.400(CFS)
Time of concentration = 32.20 min.
Rainfall intensity = 1.690(In/Hr)
Program is now starting with Main Stream No. 2

Process from Point/Station 4.000 to Point/Station 6.000
**** USER DEFINED FLOW INFORMATION AT A POINT ****

Rainfall intensity = 3.288(In/Hr) for a 100.0 year storm
COMMERCIAL subarea type
Runoff Coefficient = 0.886
Decimal fraction soil group A = 0.000
Decimal fraction soil group B = 0.000
Decimal fraction soil group C = 1.000
Decimal fraction soil group D = 0.000
RI index for soil(AMC 2) = 69.00
Pervious area fraction = 0.100; Impervious fraction = 0.900
User specified values are as follows:
TC = 9.60 min. Rain intensity = 3.29(In/Hr)
Total area = 6.80(Ac.) Total runoff = 14.80(CFS)

Process from Point/Station 4.000 to Point/Station 6.000
**** CONFLUENCE OF MAIN STREAMS ****

The following data inside Main Stream is listed:

In Main Stream number: 2
 Stream flow area = 6.800(Ac.)
 Runoff from this stream = 14.800(CFS)
 Time of concentration = 9.60 min.
 Rainfall intensity = 3.288(In/Hr)
 Program is now starting with Main Stream No. 3

 Process from Point/Station 5.000 to Point/Station 6.000
 **** INITIAL AREA EVALUATION ****

Initial area flow distance = 450.000(Ft.)
 Top (of initial area) elevation = 1160.000(Ft.)
 Bottom (of initial area) elevation = 1117.000(Ft.)
 Difference in elevation = 43.000(Ft.)
 Slope = 0.09556 s(percent)= 9.56
 $TC = k(0.300) * [(length^3)/(elevation\ change)]^{0.2}$
 Initial area time of concentration = 5.525 min.
 Rainfall intensity = 4.455(In/Hr) for a 100.0 year storm
 COMMERCIAL subarea type
 Runoff Coefficient = 0.889
 Decimal fraction soil group A = 0.000
 Decimal fraction soil group B = 0.000
 Decimal fraction soil group C = 1.000
 Decimal fraction soil group D = 0.000
 RI index for soil(AMC 2) = 69.00
 Pervious area fraction = 0.100; Impervious fraction = 0.900
 Initial subarea runoff = 10.302(CFS)
 Total initial stream area = 2.600(Ac.)
 Pervious area fraction = 0.100

 Process from Point/Station 5.000 to Point/Station 6.000
 **** CONFLUENCE OF MAIN STREAMS ****

The following data inside Main Stream is listed:

In Main Stream number: 3
 Stream flow area = 2.600(Ac.)
 Runoff from this stream = 10.302(CFS)
 Time of concentration = 5.53 min.
 Rainfall intensity = 4.455(In/Hr)
 Summary of stream data:

Stream No.	Flow rate (CFS)	TC (min)	Rainfall Intensity (In/Hr)
1	166.400	32.20	1.690
2	14.800	9.60	3.288
3	10.302	5.53	4.455

Largest stream flow has longer time of concentration

Qp = 166.400 + sum of
 Qb Ia/Ib
 14.800 * 0.514 = 7.607
 Qb Ia/Ib
 10.302 * 0.379 = 3.907
 Qp = 177.914

Total of 3 main streams to confluence:
 Flow rates before confluence point:
 166.400 14.800 10.302
 Area of streams before confluence:
 89.000 6.800 2.600

Results of confluence:
 Total flow rate = 177.914(CFS)
 Time of concentration = 32.200 min.
 Effective stream area after confluence = 98.400(Ac.)

 Process from Point/Station 6.000 to Point/Station 9.000
 **** PIPEFLOW TRAVEL TIME (User specified size) ****

Upstream point/station elevation = 1117.000(Ft.)
 Downstream point/station elevation = 1110.000(Ft.)
 Pipe length = 440.00(Ft.) Manning's N = 0.013
 No. of pipes = 1 Required pipe flow = 177.914(CFS)
 Given pipe size = 54.00(In.)
 Calculated individual pipe flow = 177.914(CFS)
 Normal flow depth in pipe = 33.84(In.)
 Flow top width inside pipe = 52.24(In.)
 Critical Depth = 46.41(In.)
 Pipe flow velocity = 16.96(Ft/s)
 Travel time through pipe = 0.43 min.
 Time of concentration (TC) = 32.63 min.

 Process from Point/Station 6.000 to Point/Station 9.000

**** CONFLUENCE OF MAIN STREAMS ****

The following data inside Main Stream is listed:
 In Main Stream number: 1
 Stream flow area = 98.400(Ac.)
 Runoff from this stream = 177.914(CFS)
 Time of concentration = 32.63 min.
 Rainfall intensity = 1.677(In/Hr)
 Program is now starting with Main Stream No. 2

 Process from Point/Station 7.000 to Point/Station 9.000
 **** INITIAL AREA EVALUATION ****

Initial area flow distance = 350.000(Ft.)
 Top (of initial area) elevation = 1130.000(Ft.)
 Bottom (of initial area) elevation = 1110.000(Ft.)
 Difference in elevation = 20.000(Ft.)
 Slope = 0.05714 s(percent)= 5.71
 $TC = k(0.300)*[(length^3)/(elevation\ change)]^{0.2}$
 Initial area time of concentration = 5.538 min.
 Rainfall intensity = 4.450(In/Hr) for a 100.0 year storm
 COMMERCIAL subarea type
 Runoff Coefficient = 0.889
 Decimal fraction soil group A = 0.000
 Decimal fraction soil group B = 0.000
 Decimal fraction soil group C = 1.000
 Decimal fraction soil group D = 0.000
 RI index for soil(AMC 2) = 69.00
 Pervious area fraction = 0.100; Impervious fraction = 0.900
 Initial subarea runoff = 12.663(CFS)
 Total initial stream area = 3.200(Ac.)
 Pervious area fraction = 0.100

 Process from Point/Station 7.000 to Point/Station 9.000
 **** CONFLUENCE OF MAIN STREAMS ****

The following data inside Main Stream is listed:
 In Main Stream number: 2
 Stream flow area = 3.200(Ac.)
 Runoff from this stream = 12.663(CFS)
 Time of concentration = 5.54 min.
 Rainfall intensity = 4.450(In/Hr)
 Program is now starting with Main Stream No. 3

 Process from Point/Station 8.000 to Point/Station 9.000
 **** INITIAL AREA EVALUATION ****

Initial area flow distance = 350.000(Ft.)
 Top (of initial area) elevation = 1130.000(Ft.)
 Bottom (of initial area) elevation = 1110.000(Ft.)
 Difference in elevation = 20.000(Ft.)
 Slope = 0.05714 s(percent)= 5.71
 $TC = k(0.300)*[(length^3)/(elevation\ change)]^{0.2}$
 Initial area time of concentration = 5.538 min.
 Rainfall intensity = 4.450(In/Hr) for a 100.0 year storm
 COMMERCIAL subarea type
 Runoff Coefficient = 0.889
 Decimal fraction soil group A = 0.000
 Decimal fraction soil group B = 0.000
 Decimal fraction soil group C = 1.000
 Decimal fraction soil group D = 0.000
 RI index for soil(AMC 2) = 69.00
 Pervious area fraction = 0.100; Impervious fraction = 0.900
 Initial subarea runoff = 9.893(CFS)
 Total initial stream area = 2.500(Ac.)
 Pervious area fraction = 0.100

 Process from Point/Station 8.000 to Point/Station 9.000
 **** CONFLUENCE OF MAIN STREAMS ****

The following data inside Main Stream is listed:
 In Main Stream number: 3
 Stream flow area = 2.500(Ac.)
 Runoff from this stream = 9.893(CFS)
 Time of concentration = 5.54 min.
 Rainfall intensity = 4.450(In/Hr)
 Summary of stream data:

Stream No.	Flow rate (CFS)	TC (min)	Rainfall Intensity (In/Hr)
1	177.914	32.63	1.677
2	12.663	5.54	4.450
3	9.893	5.54	4.450

Largest stream flow has longer time of concentration

Qp = 177.914 + sum of
 Qb Ia/Ib
 12.663 * 0.377 = 4.774
 Qb Ia/Ib
 9.893 * 0.377 = 3.730
Qp = 186.417

Total of 3 main streams to confluence:
Flow rates before confluence point:
177.914 12.663 9.893
Area of streams before confluence:
98.400 3.200 2.500

Results of confluence:
Total flow rate = 186.417(CFS)
Time of concentration = 32.632 min.
Effective stream area after confluence = 104.100(Ac.)

Process from Point/Station 9.000 to Point/Station 11.000
**** PIPEFLOW TRAVEL TIME (User specified size) ****

Upstream point/station elevation = 1110.000(Ft.)
Downstream point/station elevation = 1103.000(Ft.)
Pipe length = 360.00(Ft.) Manning's N = 0.013
No. of pipes = 1 Required pipe flow = 186.417(CFS)
Given pipe size = 54.00(In.)
Calculated individual pipe flow = 186.417(CFS)
Normal flow depth in pipe = 32.67(In.)
Flow top width inside pipe = 52.80(In.)
Critical Depth = 47.25(In.)
Pipe flow velocity = 18.54(Ft/s)
Travel time through pipe = 0.32 min.
Time of concentration (TC) = 32.96 min.

Process from Point/Station 9.000 to Point/Station 11.000
**** CONFLUENCE OF MAIN STREAMS ****

The following data inside Main Stream is listed:
In Main Stream number: 1
Stream flow area = 104.100(Ac.)
Runoff from this stream = 186.417(CFS)
Time of concentration = 32.96 min.
Rainfall intensity = 1.668(In/Hr)
Program is now starting with Main Stream No. 2

Process from Point/Station 10.000 to Point/Station 11.000
**** INITIAL AREA EVALUATION ****

Initial area flow distance = 1000.000(Ft.)
Top (of initial area) elevation = 1165.000(Ft.)
Bottom (of initial area) elevation = 1103.000(Ft.)
Difference in elevation = 62.000(Ft.)
Slope = 0.06200 s(percent) = 6.20
TC = k(0.300)*[(length^3)/(elevation change)]^0.2
Initial area time of concentration = 8.292 min.
Rainfall intensity = 3.564(In/Hr) for a 100.0 year storm
COMMERCIAL subarea type
Runoff Coefficient = 0.887
Decimal fraction soil group A = 0.000
Decimal fraction soil group B = 0.000
Decimal fraction soil group C = 1.000
Decimal fraction soil group D = 0.000
RI index for soil(AMC 2) = 69.00
Pervious area fraction = 0.100; Impervious fraction = 0.900
Initial subarea runoff = 9.168(CFS)
Total initial stream area = 2.900(Ac.)
Pervious area fraction = 0.100

Process from Point/Station 10.000 to Point/Station 11.000
**** CONFLUENCE OF MAIN STREAMS ****

The following data inside Main Stream is listed:
In Main Stream number: 2
Stream flow area = 2.900(Ac.)
Runoff from this stream = 9.168(CFS)
Time of concentration = 8.29 min.
Rainfall intensity = 3.564(In/Hr)
Summary of stream data:

Stream No.	Flow rate (CFS)	TC (min)	Rainfall Intensity (In/Hr)
------------	-----------------	----------	----------------------------

1 186.417 32.96 1.668
2 9.168 8.29 3.564

Largest stream flow has longer time of concentration

Qp = 186.417 + sum of
Qb Ia/Ib
9.168 * 0.468 = 4.292
Qp = 190.709

Total of 2 main streams to confluence:

Flow rates before confluence point:
186.417 9.168

Area of streams before confluence:
104.100 2.900

Results of confluence:

Total flow rate = 190.709(CFS)
Time of concentration = 32.956 min.
Effective stream area after confluence = 107.000(Ac.)

Process from Point/Station 11.000 to Point/Station 14.000
**** PIPEFLOW TRAVEL TIME (User specified size) ****

Upstream point/station elevation = 1103.000(Ft.)
Downstream point/station elevation = 1101.000(Ft.)
Pipe length = 130.00(Ft.) Manning's N = 0.013
No. of pipes = 1 Required pipe flow = 190.709(CFS)
Given pipe size = 54.00(In.)
Calculated individual pipe flow = 190.709(CFS)
Normal flow depth in pipe = 35.95(In.)
Flow top width inside pipe = 50.94(In.)
Critical Depth = 47.63(In.)
Pipe flow velocity = 16.97(Ft/s)
Travel time through pipe = 0.13 min.
Time of concentration (TC) = 33.08 min.

Process from Point/Station 11.000 to Point/Station 14.000
**** CONFLUENCE OF MAIN STREAMS ****

The following data inside Main Stream is listed:

In Main Stream number: 1
Stream flow area = 107.000(Ac.)
Runoff from this stream = 190.709(CFS)
Time of concentration = 33.08 min.
Rainfall intensity = 1.665(In/Hr)
Program is now starting with Main Stream No. 2

Process from Point/Station 13.000 to Point/Station 14.000
**** INITIAL AREA EVALUATION ****

Initial area flow distance = 480.000(Ft.)
Top (of initial area) elevation = 1125.000(Ft.)
Bottom (of initial area) elevation = 1104.000(Ft.)
Difference in elevation = 21.000(Ft.)
Slope = 0.04375 s(percent) = 4.38
TC = k(0.300)*[(length^3)/(elevation change)]^0.2
Initial area time of concentration = 6.629 min.
Rainfall intensity = 4.031(In/Hr) for a 100.0 year storm
COMMERCIAL subarea type
Runoff Coefficient = 0.888
Decimal fraction soil group A = 0.000
Decimal fraction soil group B = 0.000
Decimal fraction soil group C = 1.000
Decimal fraction soil group D = 0.000
RI index for soil(AMC 2) = 69.00
Pervious area fraction = 0.100; Impervious fraction = 0.900
Initial subarea runoff = 2.865(CFS)
Total initial stream area = 0.800(Ac.)
Pervious area fraction = 0.100

Process from Point/Station 13.000 to Point/Station 14.000
**** CONFLUENCE OF MAIN STREAMS ****

The following data inside Main Stream is listed:

In Main Stream number: 2
Stream flow area = 0.800(Ac.)
Runoff from this stream = 2.865(CFS)
Time of concentration = 6.63 min.
Rainfall intensity = 4.031(In/Hr)
Summary of stream data:

Stream No.	Flow rate (CFS)	TC (min)	Rainfall Intensity (In/Hr)
------------	-----------------	----------	----------------------------

1 190.709 33.08 1.665
 2 2.865 6.63 4.031
 Largest stream flow has longer time of concentration
 Qp = 190.709 + sum of
 Qb Ia/Ib
 2.865 * 0.413 = 1.183
 Qp = 191.892

Total of 2 main streams to confluence:
 Flow rates before confluence point:
 190.709 2.865
 Area of streams before confluence:
 107.000 0.800

Results of confluence:
 Total flow rate = 191.892(CFS)
 Time of concentration = 33.084 min.
 Effective stream area after confluence = 107.800(Ac.)

++++++
 Process from Point/Station 14.000 to Point/Station 16.000
 **** PIPEFLOW TRAVEL TIME (User specified size) ****

Upstream point/station elevation = 1101.000(Ft.)
 Downstream point/station elevation = 1100.000(Ft.)
 Pipe length = 130.00(Ft.) Manning's N = 0.013
 No. of pipes = 1 Required pipe flow = 191.892(CFS)
 Given pipe size = 54.00(In.)
 NOTE: Normal flow is pressure flow in user selected pipe size.
 The approximate hydraulic grade line above the pipe invert is
 3.628(Ft.) at the headworks or inlet of the pipe(s)
 Pipe friction loss = 1.237(Ft.)
 Minor friction loss = 3.391(Ft.) K-factor = 1.50
 Pipe flow velocity = 12.07(Ft/s)
 Travel time through pipe = 0.18 min.
 Time of concentration (TC) = 33.26 min.

++++++
 Process from Point/Station 14.000 to Point/Station 16.000
 **** CONFLUENCE OF MAIN STREAMS ****

The following data inside Main Stream is listed:
 In Main Stream number: 1
 Stream flow area = 107.800(Ac.)
 Runoff from this stream = 191.892(CFS)
 Time of concentration = 33.26 min.
 Rainfall intensity = 1.660(In/Hr)
 Program is now starting with Main Stream No. 2

++++++
 Process from Point/Station 15.000 to Point/Station 16.000
 **** INITIAL AREA EVALUATION ****

Initial area flow distance = 250.000(Ft.)
 Top (of initial area) elevation = 1130.000(Ft.)
 Bottom (of initial area) elevation = 1100.000(Ft.)
 Difference in elevation = 30.000(Ft.)
 Slope = 0.12000 s(percent)= 12.00
 TC = k(0.300)*(length^3)/(elevation change)^0.2
 Warning: TC computed to be less than 5 min.; program is assuming the
 time of concentration is 5 minutes.
 Initial area time of concentration = 5.000 min.
 Rainfall intensity = 4.707(In/Hr) for a 100.0 year storm
 COMMERCIAL subarea type
 Runoff Coefficient = 0.890
 Decimal fraction soil group A = 0.000
 Decimal fraction soil group B = 0.000
 Decimal fraction soil group C = 1.000
 Decimal fraction soil group D = 0.000
 RI index for soil(AMC 2) = 69.00
 Pervious area fraction = 0.100; Impervious fraction = 0.900
 Initial subarea runoff = 5.026(CFS)
 Total initial stream area = 1.200(Ac.)
 Pervious area fraction = 0.100

++++++
 Process from Point/Station 15.000 to Point/Station 16.000
 **** CONFLUENCE OF MAIN STREAMS ****

The following data inside Main Stream is listed:
 In Main Stream number: 2
 Stream flow area = 1.200(Ac.)
 Runoff from this stream = 5.026(CFS)
 Time of concentration = 5.00 min.
 Rainfall intensity = 4.707(In/Hr)
 Summary of stream data:

Stream	Flow rate	TC	Rainfall Intensity
--------	-----------	----	--------------------

No. (CFS) (min) (In/Hr)

1 191.892 33.26 1.660
2 5.026 5.00 4.707

Largest stream flow has longer time of concentration

Qp = 191.892 + sum of
Qb Ia/Ib
5.026 * 0.353 = 1.772
Qp = 193.665

Total of 2 main streams to confluence:

Flow rates before confluence point:

191.892 5.026

Area of streams before confluence:

107.800 1.200

Results of confluence:

Total flow rate = 193.665(CFS)

Time of concentration = 33.263 min.

Effective stream area after confluence = 109.000(Ac.)

Process from Point/Station 16.000 to Point/Station 18.000
**** PIPEFLOW TRAVEL TIME (User specified size) ****

Upstream point/station elevation = 1100.000(Ft.)
Downstream point/station elevation = 1096.000(Ft.)
Pipe length = 360.00(Ft.) Manning's N = 0.013
No. of pipes = 1 Required pipe flow = 193.665(CFS)
Given pipe size = 54.00(In.)
Calculated individual pipe flow = 193.665(CFS)
Normal flow depth in pipe = 41.34(In.)
Flow top width inside pipe = 45.75(In.)
Critical Depth = 47.88(In.)
Pipe flow velocity = 14.81(Ft/s)
Travel time through pipe = 0.41 min.
Time of concentration (TC) = 33.67 min.

Process from Point/Station 16.000 to Point/Station 18.000
**** CONFLUENCE OF MAIN STREAMS ****

The following data inside Main Stream is listed:

In Main Stream number: 1
Stream flow area = 109.000(Ac.)
Runoff from this stream = 193.665(CFS)
Time of concentration = 33.67 min.
Rainfall intensity = 1.649(In/Hr)
Program is now starting with Main Stream No. 2

Process from Point/Station 17.000 to Point/Station 18.000
**** INITIAL AREA EVALUATION ****

Initial area flow distance = 290.000(Ft.)
Top (of initial area) elevation = 1120.000(Ft.)
Bottom (of initial area) elevation = 1096.000(Ft.)
Difference in elevation = 24.000(Ft.)
Slope = 0.08276 s(percent)= 8.28
TC = k(0.300)*[(length^3)/(elevation change)]^0.2
Warning: TC computed to be less than 5 min.; program is assuming the
time of concentration is 5 minutes.
Initial area time of concentration = 5.000 min.
Rainfall intensity = 4.707(In/Hr) for a 100.0 year storm
COMMERCIAL subarea type
Runoff Coefficient = 0.890
Decimal fraction soil group A = 0.000
Decimal fraction soil group B = 0.000
Decimal fraction soil group C = 1.000
Decimal fraction soil group D = 0.000
RI index for soil(AMC 2) = 69.00
Pervious area fraction = 0.100; Impervious fraction = 0.900
Initial subarea runoff = 5.864(CFS)
Total initial stream area = 1.400(Ac.)
Pervious area fraction = 0.100

Process from Point/Station 17.000 to Point/Station 18.000
**** CONFLUENCE OF MAIN STREAMS ****

The following data inside Main Stream is listed:

In Main Stream number: 2
Stream flow area = 1.400(Ac.)
Runoff from this stream = 5.864(CFS)
Time of concentration = 5.00 min.
Rainfall intensity = 4.707(In/Hr)
Summary of stream data:

Stream No.	Flow rate (CFS)	TC (min)	Rainfall Intensity (In/Hr)
------------	-----------------	----------	----------------------------

1	193.665	33.67	1.649
2	5.864	5.00	4.707

Largest stream flow has longer time of concentration

$Q_p = 193.665 + \text{sum of}$
 $Q_b \quad I_a/I_b$
 $5.864 * 0.350 = 2.054$
 $Q_p = 195.719$

Total of 2 main streams to confluence:

Flow rates before confluence point:

193.665 5.864

Area of streams before confluence:

109.000 1.400

Results of confluence:

Total flow rate = 195.719(CFS)

Time of concentration = 33.668 min.

Effective stream area after confluence = 110.400(Ac.)

End of computations, total study area = 110.40 (Ac.)

The following figures may be used for a unit hydrograph study of the same area.

Area averaged pervious area fraction(A_p) = 0.100

Area averaged RI index number = 69.0

B. HYDRAULIC COMPUTATIONS

WATER SURFACE PROFILE LISTING

Date:10- 2-2019 Time: 5:58:38

MHSR ROAD EXIST 54" RCP

Station	Invert Elev	Depth (FT)	Water Elev	Q (CFS)	Vel (FPS)	Vel Head	Energy Grd.El.	Super Elev	Critical Depth	Flow Top Width	Height/Dia.-FT	Base Wt/ I.D.	ZL	No Wth Prs/Pip
L/Elem	Ch Slope					SF Ave	HF	SE Dpth	Froude N	Norm Dp	"N"	X-Fall	ZR	Type Ch
2228.370	1096.030	5.770	1101.800	196.00	12.32	2.36	1104.16	.00	4.01	.00	4.500	.000	.00	1 .0
JUNCT STR	.0050					.0098	.02	5.77	.00		.013	.00	.00	PIPE
2230.370	1096.040	5.874	1101.914	194.00	12.20	2.31	1104.22	.00	3.99	.00	4.500	.000	.00	1 .0
379.390	.0104					.0097	3.69	5.87	.00	3.56	.013	.00	.00	PIPE
2609.760	1100.000	5.722	1105.722	194.00	12.20	2.31	1108.03	.00	3.99	.00	4.500	.000	.00	1 .0
JUNCT STR	.0150					.0096	.02	5.72	.00		.013	.00	.00	PIPE
2611.760	1100.030	5.804	1105.834	192.00	12.07	2.26	1108.10	.00	3.98	.00	4.500	.000	.00	1 .0
127.730	.0108					.0095	1.22	5.80	.00	3.46	.013	.00	.00	PIPE
2739.490	1101.410	5.755	1107.165	192.00	12.07	2.26	1109.43	.00	3.98	.00	4.500	.000	.00	1 .0
JUNCT STR	.0150					.0095	.02	5.75	.00		.013	.00	.00	PIPE
2741.490	1101.440	5.790	1107.230	191.00	12.01	2.24	1109.47	.00	3.97	.00	4.500	.000	.00	1 .0
137.970	.0111					.0094	1.30	5.79	.00	3.41	.013	.00	.00	PIPE
2879.460	1102.970	5.562	1108.532	191.00	12.01	2.24	1110.77	.00	3.97	.00	4.500	.000	.00	1 .0
JUNCT STR	.0100					.0092	.02	5.56	.00		.013	.00	.00	PIPE
2881.460	1102.990	5.739	1108.729	187.00	11.76	2.15	1110.88	.00	3.94	.00	4.500	.000	.00	1 .0
99.916	.0110					.0090	.90	5.74	.00	3.36	.013	.00	.00	PIPE
2981.375	1104.086	5.625	1109.711	187.00	11.76	2.15	1111.86	.00	3.94	.00	4.500	.000	.00	1 .0

HYDRAULIC JUMP

WATER SURFACE PROFILE LISTING

Date:10- 2-2019 Time: 5:58:38

MHSR ROAD EXIST 54" RCP

Station	Invert Elev	Depth (FT)	Water Elev	Q (CFS)	Vel (FPS)	Vel Head	Energy Grd.El.	Super Elev	Critical Depth	Flow Top Width	Height/Dia.-FT	Base Wt/ I.D.	ZL	No Wth Prs/Pip
L/Elem	Ch Slope					SF Ave	HF	SE Dpth	Froude N	Norm Dp	"N"	X-Fall	ZR	Type Ch
2981.375	1104.086	2.666	1106.752	187.00	19.06	5.64	1112.39	.00	3.94	4.42	4.500	.000	.00	1 .0
35.915	.0110					.0220	.79	2.67	2.25	3.36	.013	.00	.00	PIPE
3017.290	1104.480	2.578	1107.057	187.00	19.85	6.12	1113.18	.00	3.94	4.45	4.500	.000	.00	1 .0
72.685	.0256					.0225	1.63	2.58	2.40	2.50	.013	.00	.00	PIPE
3089.975	1106.339	2.627	1108.966	187.00	19.40	5.84	1114.81	.00	3.94	4.44	4.500	.000	.00	1 .0
84.572	.0256					.0206	1.74	2.63	2.32	2.50	.013	.00	.00	PIPE
3174.547	1108.503	2.733	1111.236	187.00	18.50	5.31	1116.55	.00	3.94	4.40	4.500	.000	.00	1 .0
50.152	.0256					.0182	.91	2.73	2.15	2.50	.013	.00	.00	PIPE
3224.699	1109.786	2.846	1112.632	187.00	17.64	4.83	1117.46	.00	3.94	4.34	4.500	.000	.00	1 .0
33.791	.0256					.0161	.55	2.85	1.99	2.50	.013	.00	.00	PIPE
3258.490	1110.650	2.966	1113.616	187.00	16.82	4.39	1118.01	.00	3.94	4.27	4.500	.000	.00	1 .0
JUNCT STR	.0200					.0171	.03	2.97	1.84		.013	.00	.00	PIPE
3260.490	1110.690	2.662	1113.352	178.00	18.17	5.13	1118.48	.00	3.87	4.42	4.500	.000	.00	1 .0
59.786	.0232					.0180	1.08	2.66	2.15	2.50	.013	.00	.00	PIPE
3320.276	1112.074	2.754	1114.828	178.00	17.45	4.73	1119.56	.00	3.87	4.39	4.500	.000	.00	1 .0
44.979	.0232					.0161	.73	2.75	2.02	2.50	.013	.00	.00	PIPE

3365.254 1113.115 2.868 1115.983 178.00 16.64 4.30 1120.28 .00 3.87 4.33 4.500 .000 .00 1 .0
 -|- -|- -|- -|- -|- -|- -|- -|- -|- -|- -|- -|- -|- -|-
 30.456 .0232 .0143 .44 2.87 1.87 2.50 .013 .00 .00 PIPE
 ▲ FILE: APARTMENT.WSW W S P G W - CIVILDESIGN Version 14.08 PAGE 3
 Program Package Serial Number: 7165

WATER SURFACE PROFILE LISTING Date:10- 2-2019 Time: 5:58:38
 MHSR ROAD EXIST 54" RCP

Station	Invert Elev	Depth (FT)	Water Elev	Q (CFS)	Vel (FPS)	Vel Head	Energy Grd.El.	Super Elev	Critical Depth	Flow Top Width	Height/Dia.-FT	Base Wt or I.D.	ZL	No Wth Prs/Pip
L/Elem	Ch Slope					SF Ave	HF	SE Dpth	Froude N	Norm Dp	"N"	X-Fall	ZR	Type Ch
3395.710	1113.820	2.989	1116.810	178.00	15.87	3.91	1120.72	.00	3.87	4.25	4.500	.000	.00	1 .0
21.580	.0232					.0127	.27	2.99	1.72	2.50	.013	.00	.00	PIPE
3417.290	1114.320	3.120	1117.440	178.00	15.13	3.55	1120.99	.00	3.87	4.15	4.500	.000	.00	1 .0
106.436	.0125					.0117	1.24	3.12	1.58	3.07	.013	.00	.00	PIPE
3523.726	1115.651	3.181	1118.832	178.00	14.81	3.41	1122.24	.00	3.87	4.10	4.500	.000	.00	1 .0
95.949	.0125					.0108	1.04	3.18	1.52	3.07	.013	.00	.00	PIPE
3619.675	1116.851	3.327	1120.177	178.00	14.12	3.10	1123.27	.00	3.87	3.95	4.500	.000	.00	1 .0
43.222	.0125					.0097	.42	3.33	1.39	3.07	.013	.00	.00	PIPE
3662.896	1117.391	3.486	1120.877	178.00	13.46	2.82	1123.69	.00	3.87	3.76	4.500	.000	.00	1 .0
20.770	.0125					.0087	.18	3.49	1.27	3.07	.013	.00	.00	PIPE
3683.666	1117.651	3.663	1121.314	178.00	12.84	2.56	1123.87	.00	3.87	3.50	4.500	.000	.00	1 .0
6.334	.0125					.0079	.05	3.66	1.14	3.07	.013	.00	.00	PIPE
3690.000	1117.730	3.868	1121.598	178.00	12.24	2.33	1123.92	.00	3.87	3.13	4.500	.000	.00	1 .0
JUNCT STR	.0120					.0074	.02	3.87	1.00		.013	.00	.00	PIPE
3692.500	1117.760	4.687	1122.447	166.40	10.46	1.70	1124.15	.00	3.76	.00	4.500	.000	.00	1 .0
61.922	.0110					.0071	.44	4.69	.00	3.06	.013	.00	.00	PIPE
3754.422	1118.443	4.500	1122.943	166.40	10.46	1.70	1124.64	.00	3.76	.00	4.500	.000	.00	1 .0
37.798	.0110					.0066	.25	4.50	.00	3.06	.013	.00	.00	PIPE

▲ FILE: APARTMENT.WSW W S P G W - CIVILDESIGN Version 14.08 PAGE 4
 Program Package Serial Number: 7165
 WATER SURFACE PROFILE LISTING Date:10- 2-2019 Time: 5:58:38
 MHSR ROAD EXIST 54" RCP

Station	Invert Elev	Depth (FT)	Water Elev	Q (CFS)	Vel (FPS)	Vel Head	Energy Grd.El.	Super Elev	Critical Depth	Flow Top Width	Height/Dia.-FT	Base Wt or I.D.	ZL	No Wth Prs/Pip
L/Elem	Ch Slope					SF Ave	HF	SE Dpth	Froude N	Norm Dp	"N"	X-Fall	ZR	Type Ch
3792.220	1118.860	4.262	1123.122	166.40	10.68	1.77	1124.89	.00	3.76	2.01	4.500	.000	.00	1 .0

T1	MHSR ROAD EXIST 54" RCP								0
T2									
T3									
SO	2228.3701096.030	1				1101.800			
JX	2230.3701096.040	3	2	.013	2.000	1097.280	45.0	.000	.000
R	2609.7601100.000	3		.013			.000	.000	1
JX	2611.7601100.030	5	4	.013	2.000	1101.250	45.0	.000	.000
R	2739.4901101.410	5		.013			.000	.000	1
JX	2741.4901101.440	7	6	.013	1.000	1102.660	45.0	.000	.000
R	2879.4601102.970	7		.013			.000	.000	0
JX	2881.4601102.990	9	8	.013	4.000	1104.220	45.0	.000	.000
R	3017.2901104.480	9		.013			.000	.000	1
R	3258.4901110.650	9		.013			.000	.000	0
JX	3260.4901110.690	12	10	11.013	4.500	4.5001111.9001111.900	45.0	45.0	.000
R	3417.2901114.320	12		.013			.000	.000	1
R	3690.0001117.730	12		.013			.000	.000	0
JX	3692.5001117.760	15	14	.013	11.600	1118.980	45.0	.000	.000
R	3792.2201118.860	15		.013			.000	.000	1
SH	3792.2201118.860	15				1118.860			
CD	1	4	1	.000	4.500	.000	.000	.000	.00
CD	2	4	1	.000	2.000	.000	.000	.000	.00
CD	3	4	1	.000	4.500	.000	.000	.000	.00
CD	4	4	1	.000	2.000	.000	.000	.000	.00
CD	5	4	1	.000	4.500	.000	.000	.000	.00
CD	6	4	1	.000	2.000	.000	.000	.000	.00
CD	7	4	1	.000	4.500	.000	.000	.000	.00
CD	8	4	1	.000	2.000	.000	.000	.000	.00
CD	9	4	1	.000	4.500	.000	.000	.000	.00
CD	10	4	1	.000	2.000	.000	.000	.000	.00
CD	11	4	1	.000	2.000	.000	.000	.000	.00
CD	12	4	1	.000	4.500	.000	.000	.000	.00
CD	13	4	1	.000	2.000	.000	.000	.000	.00
CD	14	4	1	.000	2.000	.000	.000	.000	.00
CD	15	4	1	.000	4.500	.000	.000	.000	.00
Q	166.400	.0							

C. REGIONAL HYDROLOGY MAP

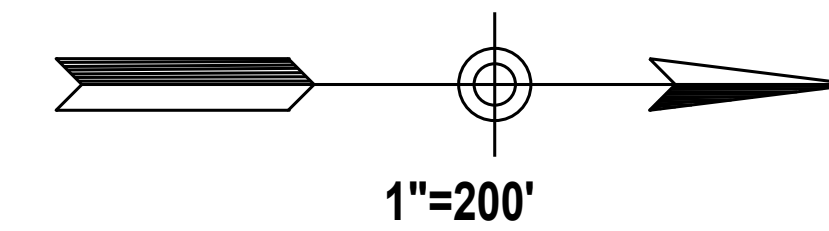
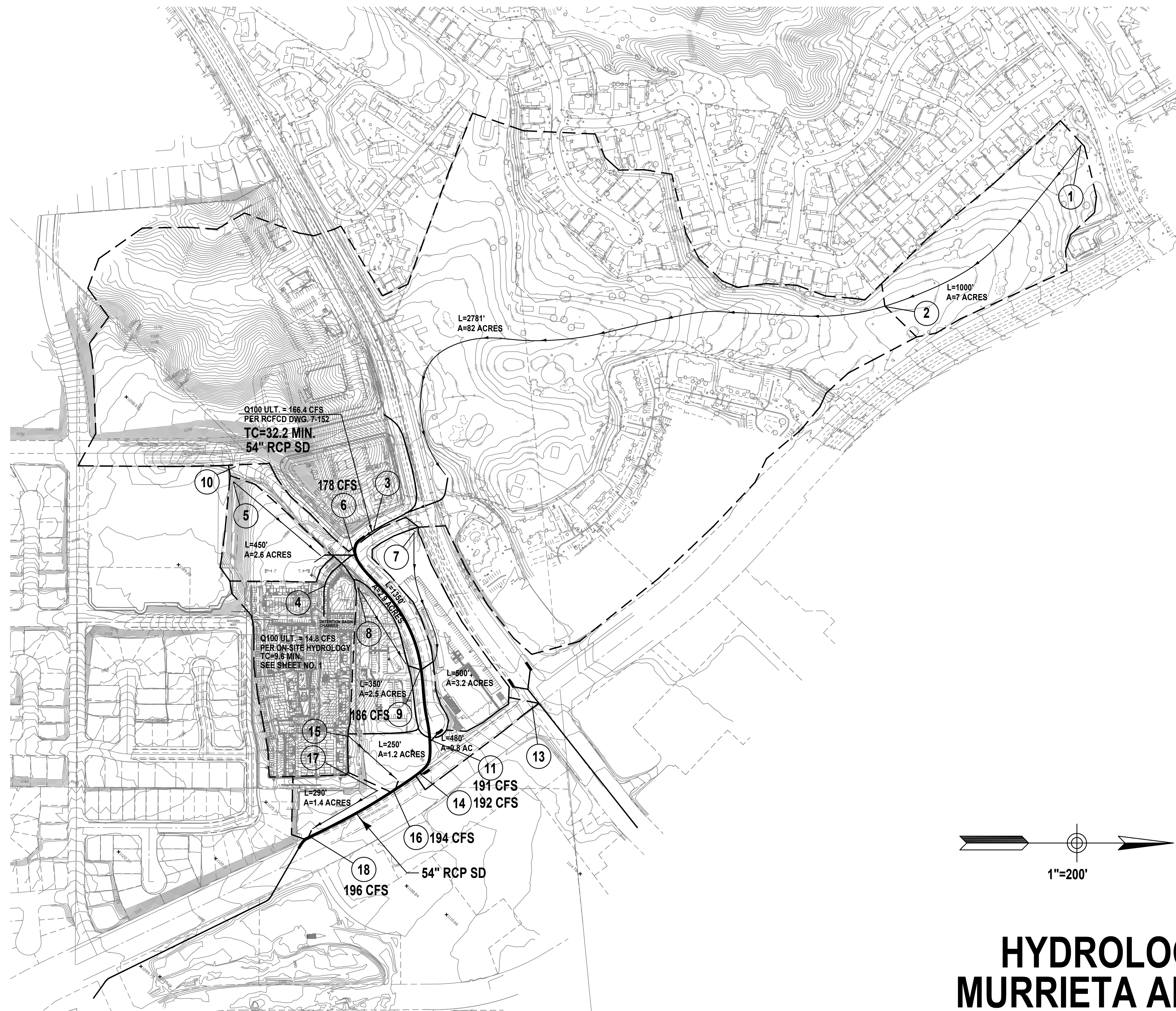

HYDROLOGY MAP MURRIETA APARTMENT

D. STORM DRAIN PLANS W/HGL

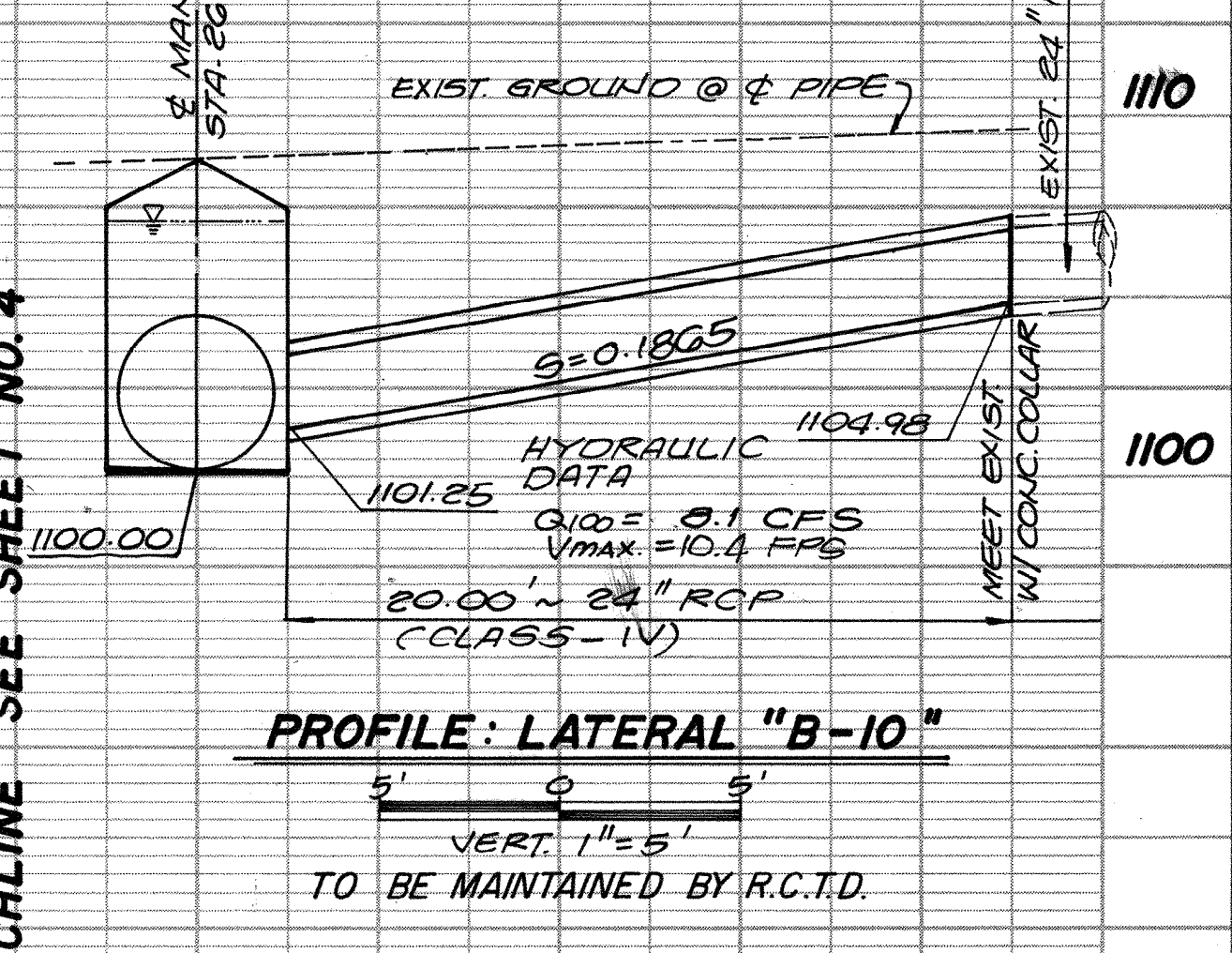
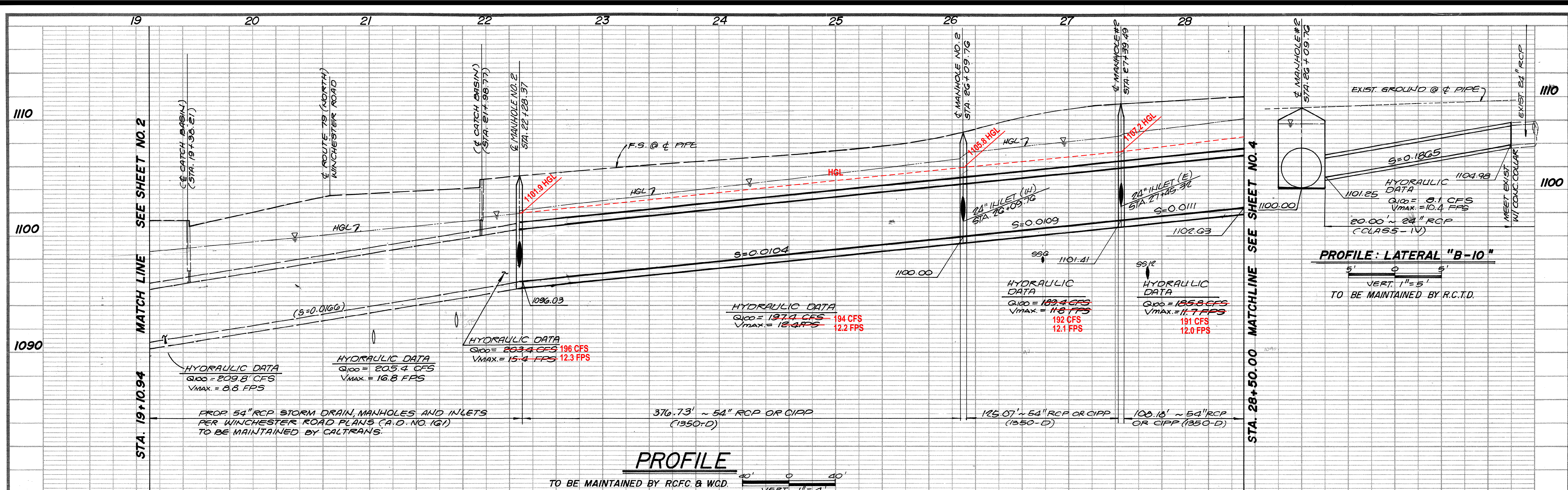

NO.	DELTA	LENGTH	RADIUS	TANGENT	B.C.	E.C.
1	07°12'08"	304.45'	2422'	152.42'	23+02.98	26+07.93
2	02°57'31"	125.07'	2422'	02.55'	26+12.09	27+37.16
3	01°03'52"	45.00'	2422'	22.50'	27+41.82	27+86.82
4	22°58'29"	36.09'	90.00'	18.09'	22+30.70	22+66.79
5	70°22'49"	92.13'	75.00'	52.89'	27+86.82	28+78.95

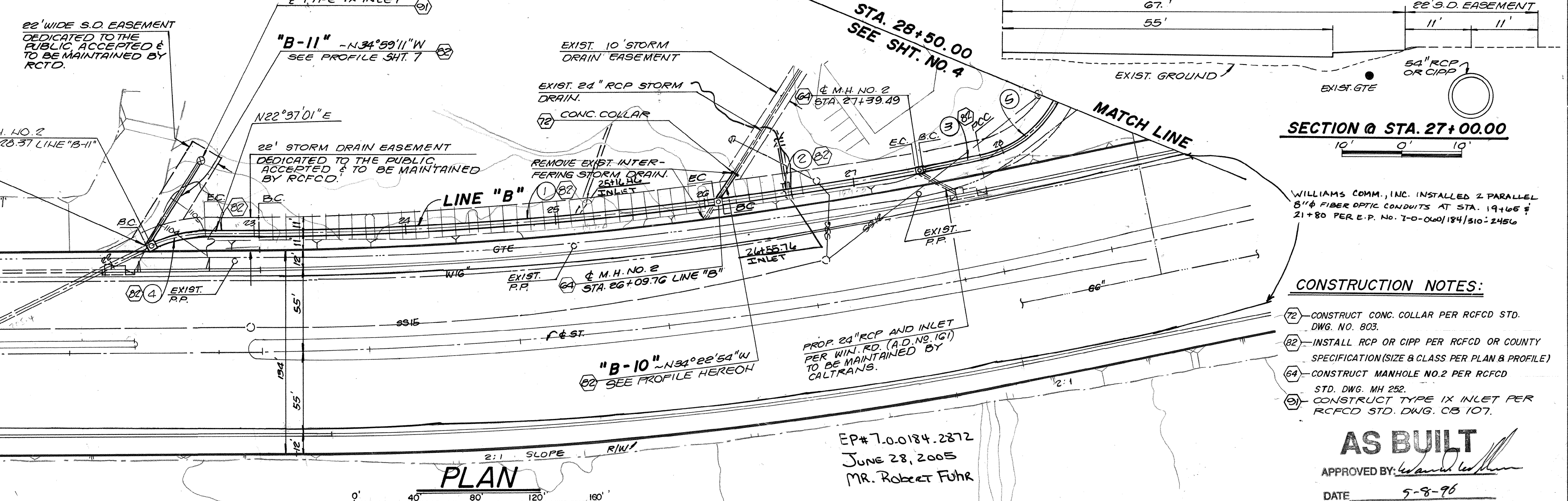

PROP. 54" RCP STORM DRAIN & CATCH BASIN PER WINCHESTER ROAD PLANS AD 161 TO BE MAINTAINED BY CALTRANS; TO BE BUILT IN CONJUNCTION WITH THIS PLAN.

EXIST. 2:1 SLOPE

WINCHESTER ROAD

STA. 19+10.94 E.C.



RANPAC ENGINEERING CORP.
27447 Enterprise Circle West
Temecula, California 92390
Tel. (909) 676-7000

SUBMITTED BY: *[Signature]*
REGISTERED CIVIL ENGINEER NO. 34490
DATE: 3/31/97 EXP. 9/30/95

REF.	DESCRIPTION	APPR. DATE

RIVERSIDE COUNTY FLOOD CONTROL AND WATER CONSERVATION DISTRICT

RECOMMENDED FOR APPROVAL BY: *[Signature]*
PLANNING ENGINEERING
DATE: 6/29/94

APPROVED BY: *[Signature]*
CHIEF ENGINEER
DATE: 7-5-94

County of Riverside

APPROVED BY: *[Signature]*
FOR TRANS. DEPT. RIVERSIDE COUNTY, CALIF. DATE: 3/8/94

ASSESSMENT DISTRICT NO.161
WINCHESTER ROAD STORM DRAIN
STA. 19+10.94 TO STA. 28+50.00

PROJECT NO. 7-0-184
DRAWING NO. 7-152
SHEET NO. 3 OF 8

EP# 7.0-0184.2872
JUNE 28, 2005
MR. Robert Fuhr

AS BUILT
APPROVED BY: *[Signature]*
DATE: 5-8-96

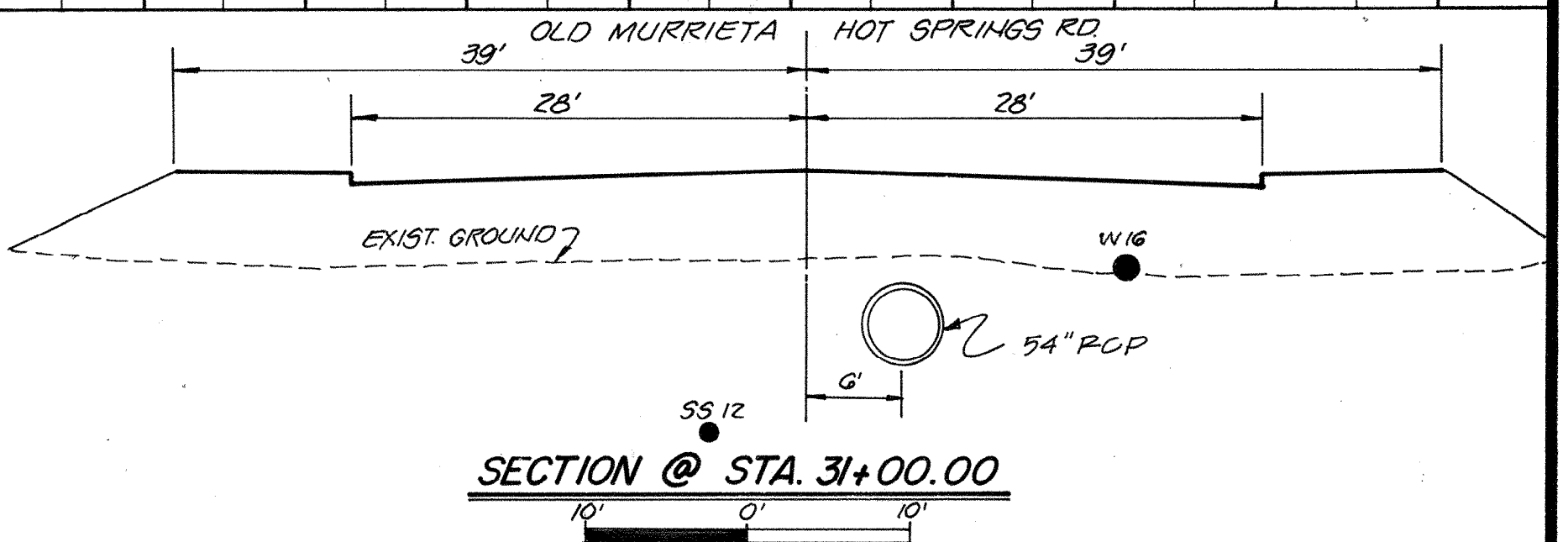
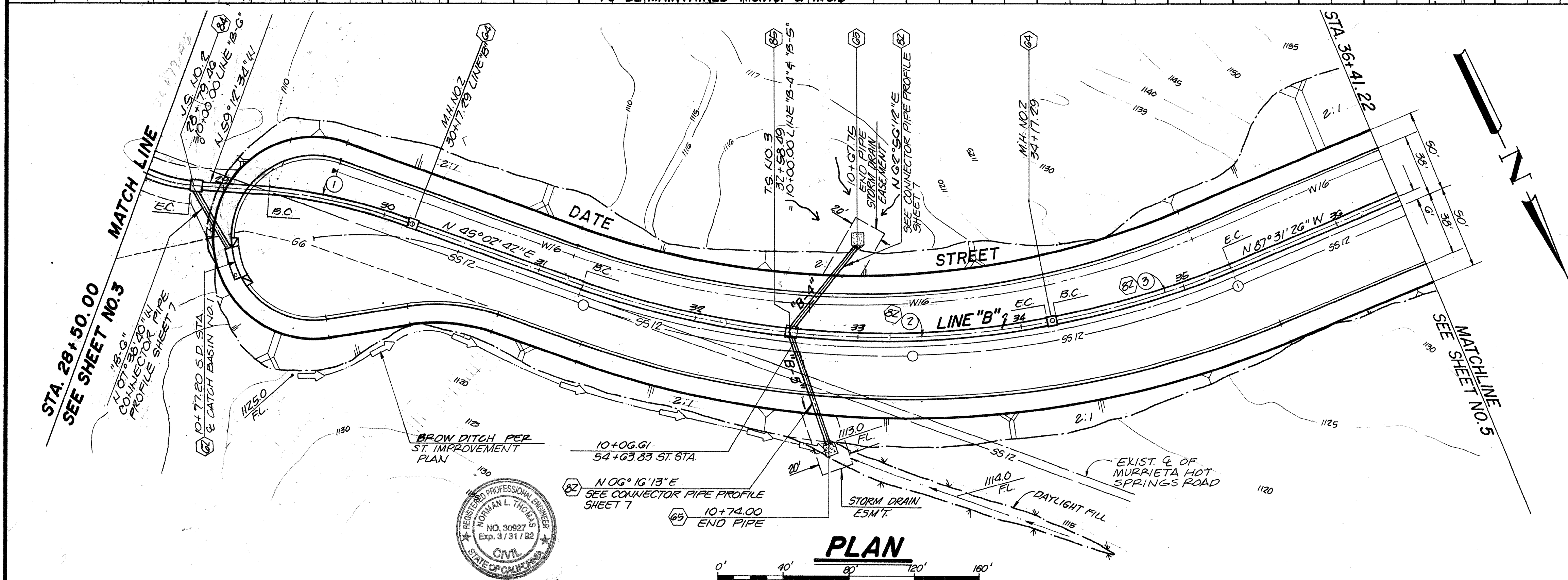
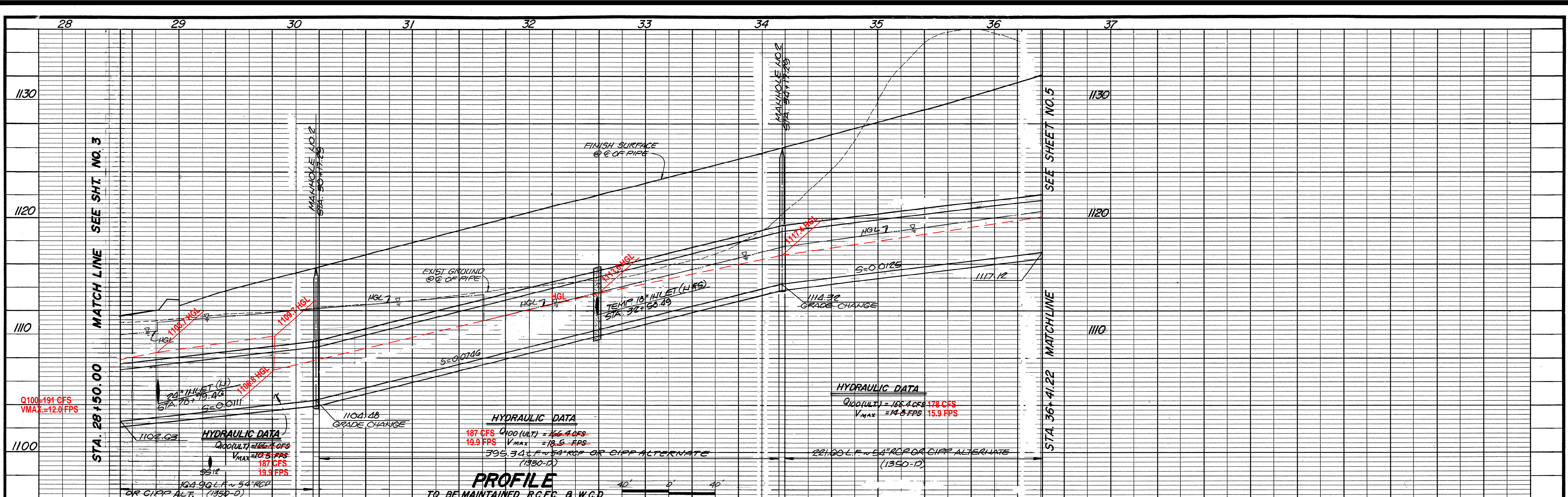

CURVE DATA						
NO.	DELTA	RADIUS	LENGTH	TANGENT	B.C.	E.C.
1	14°09'52"	350'	88.00'	44.73'	29+26.96	30+14.96
2	30°17'27"	544'	287.60'	147.25'	31+27.36	34+14.96
3	11°41'50"	544'	111.06'	55.72'	34+19.62	35+30.68
4						
5						
6						

CONSTRUCTION NOTES

- 62 CONSTRUCT CATCH BASIN NO.1 LOCAL DEPRESSION NO.2 CASE "C" PER RCPCD STD. DWG. NO. CB. 100 & LD 201 (W=21' & V=8.25')
- 64 CONSTRUCT MANHOLE NO.2 PER RCPCD STD. DWG. M.H.352
- 65 CONSTRUCT TEMPORARY INLET APPROX SEE DETAIL ON SHEET NO. 8
- 82 INSTALL REINFORCED CONCRETE PIPE PER RCPCD OR COUNTY SPECIFICATIONS
- 84 CONSTRUCT JUNCTION STRUCTURE NO.2 PER RCPCD ST. J.S.227 SEE DET. ON SHEET NO.8
- 88 CONSTRUCT TRANSITION STRUCTURE NO.3 PER RCPCD STD. DWG. NO. TS303

AS BUILT
 APPROVED BY: *[Signature]*
 DATE: 5-8-96

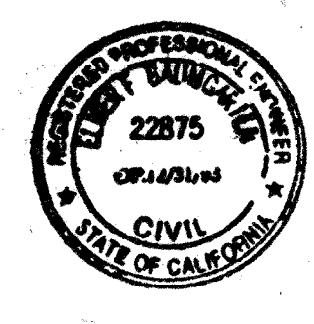

RANPAC ENGINEERING CORP.
 27447 Enterprise Circle West
 Temecula, California 92390
 Tel. (714) 676-7000
 SUBMITTED BY: *[Signature]*
 REGISTERED CIVIL ENGINEER NO. 30927
 DATE: 4/11/91 EXP. 3/31/96

REF.	DESCRIPTION	APPR.	DATE

RIVERSIDE COUNTY FLOOD CONTROL AND WATER CONSERVATION DISTRICT
 RECOMMENDED FOR APPROVAL BY: *[Signature]*
 PLANNING ENGINEERING
 DATE: 6/29/91
 APPROVED BY: *[Signature]*
 CHIEF ENGINEER
 DATE: 7-5-91

County of Riverside
 APPROVED BY: *[Signature]*
 FOR TRANS. DEPT. RIVERSIDE COUNTY, CALIF. DATE: 4/24/91

ASSESSMENT DISTRICT NO. 161
WINCHESTER RD. STORM DRAIN
 STA. 28+50.00 TO STA. 36+41.22
 (DATE STREET)

PROJECT NO. 7-0-184
 DRAWING NO. 7-152
 SHEET NO. 4 OF 8

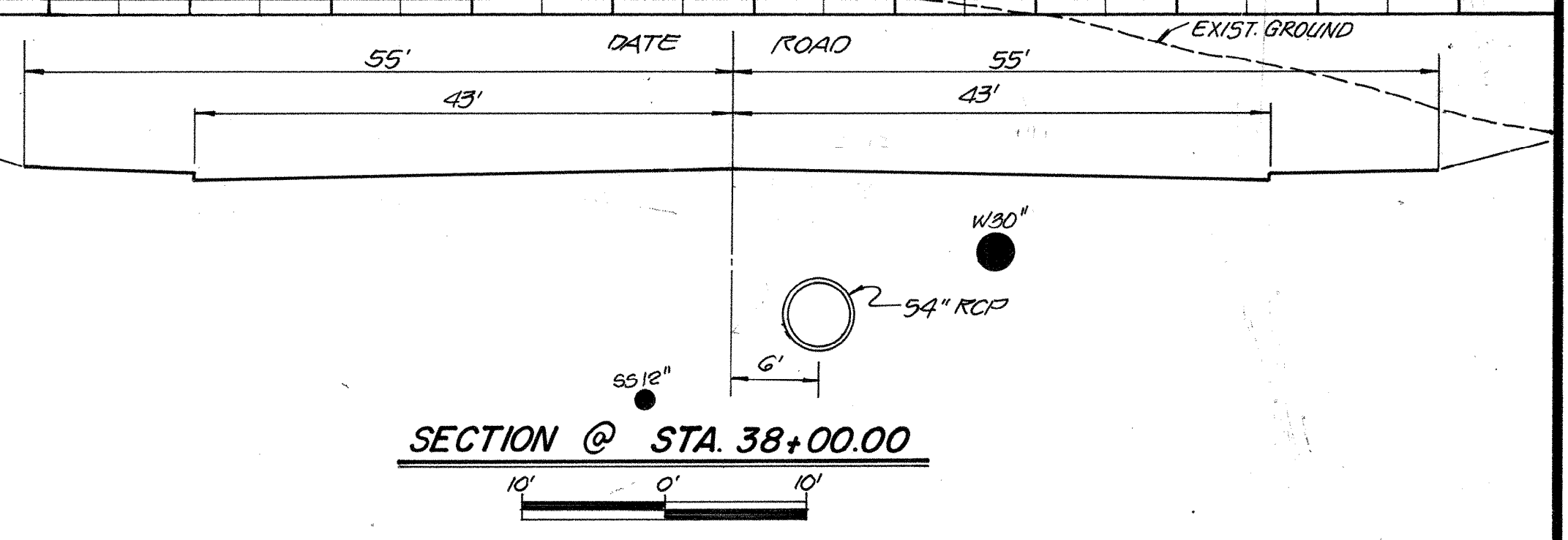
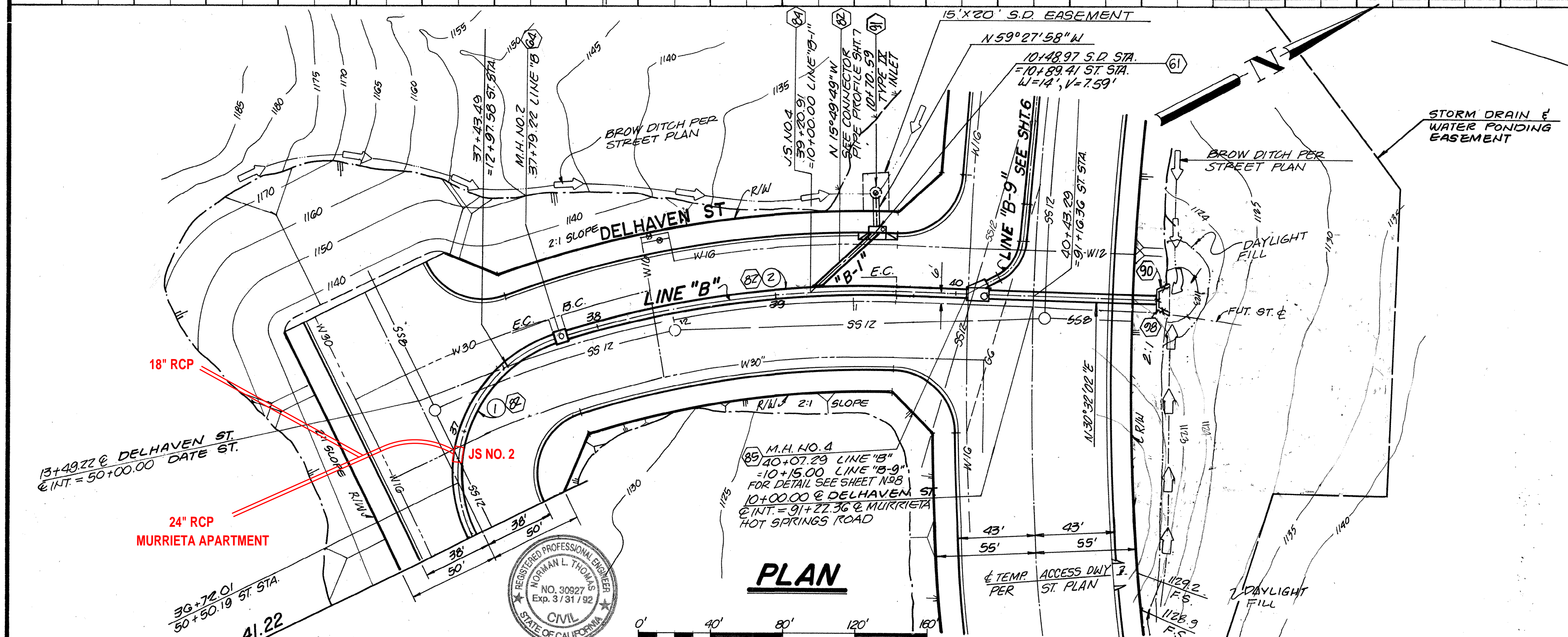
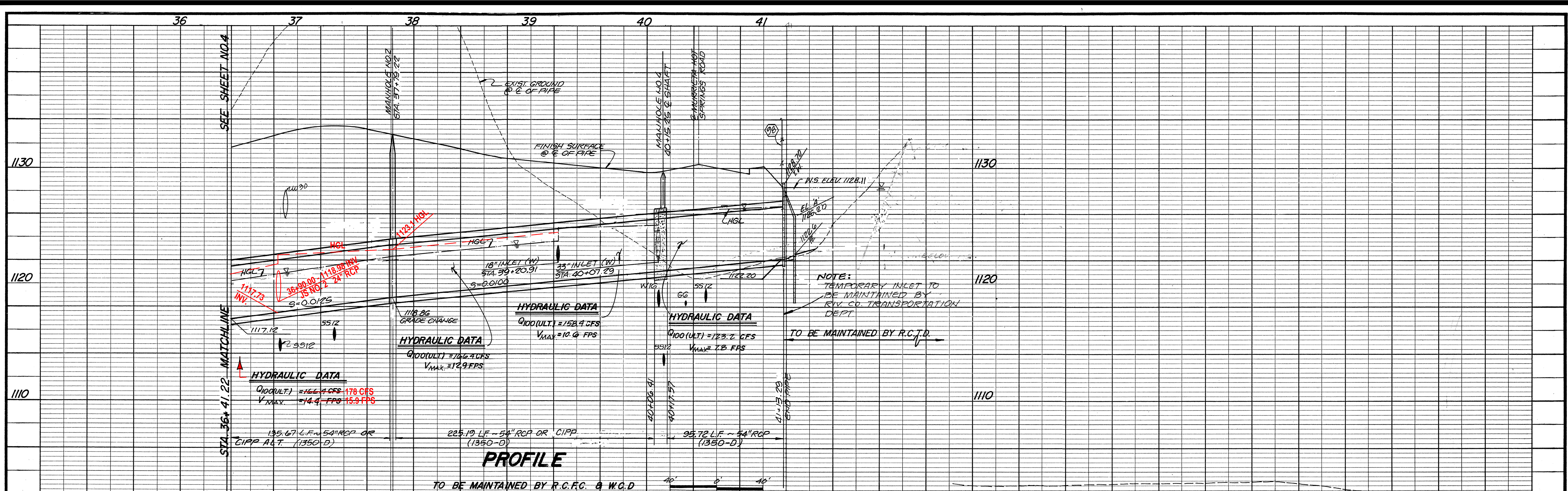

CURVE DATA

NO.	DELTA	RADIUS	LENGTH	TANGENT	B.C.	E.C.
1	98°23'47"	79.00'	135.67'	91.52'	36+41.22	37+76.89
2	19°0'52"	956'	186.13'	93.95'	37+01.55	39+07.08

- CONSTRUCTION NOTES**
- 61 CONSTRUCT MOD. CATCH BASIN NO. 1 LOCAL DEPRESSION NO. 2 CASE "C" PER RCPCD STD. DWG. NO. CB. 100 & LD 201
 - 64 CONSTRUCT MANHOLE NO. 2 PER RCPCD STD. DWG. M.H. 252
 - 68 INSTALL REINFORCED CONCRETE PIPE PER RCPCD OR COUNTY SPECIFICATIONS:
 - 84 CONSTRUCT JUNCTION STRUCTURE NO. 4 PER RCPCD STD. J.S. 229
 - 85 CONSTRUCT MANHOLE NO. 4 PER RCPCD STD. M.H. 254 (SEE DET. ON SHT. 8)
 - 90 CONSTRUCT PIPE CULVERT HEADWALL PER CALTRANS STD. PLANS D-86-B (W=5.5', L=7', ELEV. 'A'=1125.20)
 - 98 CONSTRUCT FENCE PER RCPCD & WCD STD. DWG. NO. M 801. (6' HIGH)
 - 91 CONSTRUCT TYPE IX INLET PER R.C.F.C.D. STD. DWG. CB-107.
 - 99 INSTALL 14' CHAIN LINK DOUBLE GATE PER RCPCD & WCD STD. DWG. NO. 801.
 - 92 CONSTRUCT 3" GRANITE SLOPE PROTECTION (AIR PLACED) WITH 3" x 6" 10/10 GAGE W.W.F. REINFORCEMENT

AS BUILT
APPROVED BY: *[Signature]*
DATE: 5-8-96

 RANPAC ENGINEERING CORP. 27447 Enterprise Circle West Temecula, California 92390 Tel. (714) 676-7000 SUBMITTED BY: <i>[Signature]</i> REGISTERED CIVIL ENGINEER NO. 30927 DATE: 4/11/91 EXP. 3/31/96	BENCH MARK: SEE SHEET NO. 1	REVISIONS REF. DESCRIPTION APPR. DATE	RIVERSIDE COUNTY FLOOD CONTROL AND WATER CONSERVATION DISTRICT RECOMMENDED FOR APPROVAL BY: <i>[Signature]</i> PLANNING ENGINEERING DATE: 6/29/94	APPROVED BY: <i>[Signature]</i> CHIEF ENGINEER DATE: 7-5-94	County of Riverside APPROVED BY: <i>[Signature]</i> FOR TRANS. DEPT. RIVERSIDE COUNTY, CALIF. DATE: 4/26/91	PROJECT NO. 7-0-184 DRAWING NO. 7-152 SHEET NO. 5 OF 8
		ASSESSMENT DISTRICT NO. 161 WINCHESTER RD. STORM DRAIN STA. 36+23.93 TO STA. 40+96.00 (DELHAVEN ST.)				

FIGURES

FIGURE 1: VICINITY MAP

Drawing Name: O:\124.16.18\Engineering\Hydrology_Plan\Exhibits\FIGURE 1.dwg
Last Opened: Mar 12, 2019 - 2:45pm by Joe

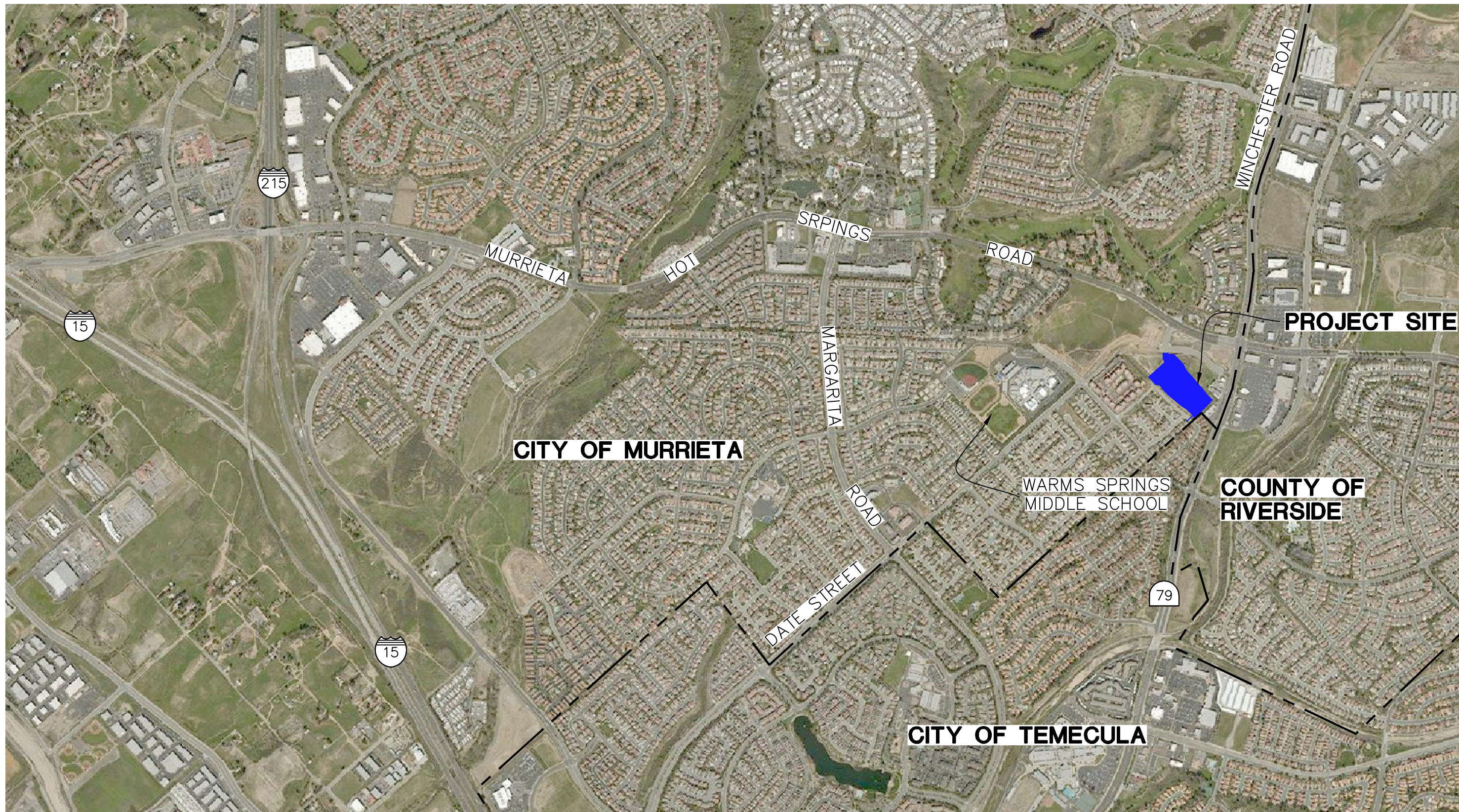

MURRIETA APARTMENTS - DP-2018-1761



41660 IVY STREET, SUITE A
MURRIETA, CA 92562
PH. 951.304.9552 FAX 951.304.3568

FIGURE 1

APPENDICES

APPENDIX A: PRE-PROJECT CONDITION RATIONAL METHOD ANALYSIS

APPENDIX A.1: AREA "A"

Riverside County Rational Hydrology Program

CIVILCADD/CIVILDESIGN Engineering Software, (c) 1989 - 2004 Version 7.0
Rational Hydrology Study Date: 10/10/19 File:ARA1EX100.out

MURRIETA APARTMENTS EXISTING CONDITION HYDROLOGY
RATIONAL METHOD ANALYSIS, 100-YEAR STORM EVENT
FILENAME: ARA1EX100

***** Hydrology Study Control Information *****

English (in-lb) Units used in input data file

Program License Serial Number 433

Rational Method Hydrology Program based on
Riverside County Flood Control & Water Conservation District
1978 hydrology manual

Storm event (year) = 100.00 Antecedent Moisture Condition = 2

2 year, 1 hour precipitation = 0.500(In.)
100 year, 1 hour precipitation = 1.200(In.)

Storm event year = 100.0
Calculated rainfall intensity data:
1 hour intensity = 1.200(In/Hr)
Slope of intensity duration curve = 0.5500

Process from Point/Station 101.000 to Point/Station 102.000
**** INITIAL AREA EVALUATION ****

Initial area flow distance = 433.000(Ft.)
Top (of initial area) elevation = 1171.000(Ft.)
Bottom (of initial area) elevation = 1148.000(Ft.)
Difference in elevation = 23.000(Ft.)
Slope = 0.05312 s(percent)= 5.31
TC = $k(0.530)*[(\text{length}^3)/(\text{elevation change})]^{0.2}$
Initial area time of concentration = 10.810 min.
Rainfall intensity = 3.080(In/Hr) for a 100.0 year storm
UNDEVELOPED (poor cover) subarea
Runoff Coefficient = 0.841
Decimal fraction soil group A = 0.000
Decimal fraction soil group B = 0.000
Decimal fraction soil group C = 1.000
Decimal fraction soil group D = 0.000
RI index for soil(AMC 2) = 86.00
Pervious area fraction = 1.000; Impervious fraction = 0.000
Initial subarea runoff = 3.677(CFS)
Total initial stream area = 1.420(Ac.)
Pervious area fraction = 1.000
End of computations, total study area = 1.42 (Ac.)
The following figures may
be used for a unit hydrograph study of the same area.

Area averaged pervious area fraction(Ap) = 1.000
Area averaged RI index number = 86.0

Riverside County Rational Hydrology Program

CIVILCADD/CIVILDESIGN Engineering Software, (c) 1989 - 2004 Version 7.0
Rational Hydrology Study Date: 08/20/19 File:ARA2EX100.out

MURRIETA APARTMENTS EXISTING CONDITION HYDROLOGY
RATIONAL METHOD ANALYSIS, 100-YEAR STORM EVENT
FILENAME: ARA2EX100

***** Hydrology Study Control Information *****

English (in-lb) Units used in input data file

Program License Serial Number 433

Rational Method Hydrology Program based on
Riverside County Flood Control & Water Conservation District
1978 hydrology manual

Storm event (year) = 100.00 Antecedent Moisture Condition = 2

2 year, 1 hour precipitation = 0.500(In.)
100 year, 1 hour precipitation = 1.200(In.)

Storm event year = 100.0
Calculated rainfall intensity data:
1 hour intensity = 1.200(In/Hr)
Slope of intensity duration curve = 0.5500

Process from Point/Station 103.000 to Point/Station 104.000
**** INITIAL AREA EVALUATION ****

Initial area flow distance = 285.000(Ft.)
Top (of initial area) elevation = 1172.000(Ft.)
Bottom (of initial area) elevation = 1125.000(Ft.)
Difference in elevation = 47.000(Ft.)
Slope = 0.16491 s(percent)= 16.49
TC = $k(0.530)*[(\text{length}^3)/(\text{elevation change})]^{0.2}$
Initial area time of concentration = 7.291 min.
Rainfall intensity = 3.825(In/Hr) for a 100.0 year storm
UNDEVELOPED (poor cover) subarea
Runoff Coefficient = 0.852
Decimal fraction soil group A = 0.000
Decimal fraction soil group B = 0.000
Decimal fraction soil group C = 1.000
Decimal fraction soil group D = 0.000
RI index for soil(AMC 2) = 86.00
Pervious area fraction = 1.000; Impervious fraction = 0.000
Initial subarea runoff = 6.385(CFS)
Total initial stream area = 1.960(Ac.)
Pervious area fraction = 1.000
End of computations, total study area = 1.96 (Ac.)
The following figures may
be used for a unit hydrograph study of the same area.

Area averaged pervious area fraction(Ap) = 1.000
Area averaged RI index number = 86.0

Riverside County Rational Hydrology Program

CIVILCADD/CIVILDESIGN Engineering Software, (c) 1989 - 2004 Version 7.0
Rational Hydrology Study Date: 08/20/19 File:ARA3EX100.out

MURRIETA APARTMENTS EXISTING CONDITION HYDROLOGY
RATIONAL METHOD ANALYSIS, 100-YEAR STORM EVENT
FILENAME: ARA3EX100

***** Hydrology Study Control Information *****

English (in-lb) Units used in input data file

Program License Serial Number 433

Rational Method Hydrology Program based on
Riverside County Flood Control & Water Conservation District
1978 hydrology manual

Storm event (year) = 100.00 Antecedent Moisture Condition = 2

2 year, 1 hour precipitation = 0.500(In.)
100 year, 1 hour precipitation = 1.200(In.)

Storm event year = 100.0
Calculated rainfall intensity data:
1 hour intensity = 1.200(In/Hr)
Slope of intensity duration curve = 0.5500

Process from Point/Station 105.000 to Point/Station 106.000
**** INITIAL AREA EVALUATION ****

Initial area flow distance = 385.000(Ft.)
Top (of initial area) elevation = 1172.000(Ft.)
Bottom (of initial area) elevation = 1121.000(Ft.)
Difference in elevation = 51.000(Ft.)
Slope = 0.13247 s(percent)= 13.25
TC = $k(0.530)*[(\text{length}^3)/(\text{elevation change})]^{0.2}$
Initial area time of concentration = 8.591 min.
Rainfall intensity = 3.495(In/Hr) for a 100.0 year storm
UNDEVELOPED (poor cover) subarea
Runoff Coefficient = 0.847
Decimal fraction soil group A = 0.000
Decimal fraction soil group B = 0.000
Decimal fraction soil group C = 1.000
Decimal fraction soil group D = 0.000
RI index for soil(AMC 2) = 86.00
Pervious area fraction = 1.000; Impervious fraction = 0.000
Initial subarea runoff = 2.517(CFS)
Total initial stream area = 0.850(Ac.)
Pervious area fraction = 1.000
End of computations, total study area = 0.85 (Ac.)
The following figures may
be used for a unit hydrograph study of the same area.

Area averaged pervious area fraction(Ap) = 1.000
Area averaged RI index number = 86.0

Riverside County Rational Hydrology Program

CIVILCADD/CIVILDESIGN Engineering Software, (c) 1989 - 2004 Version 7.0
Rational Hydrology Study Date: 10/10/19 File:ARA1EX10.out

MURRIETA APARTMENTS EXISTING CONDITION HYDROLOGY
RATIONAL METHOD ANALYSIS, 10-YEAR STORM EVENT
FILENAME: ARA1EX10

***** Hydrology Study Control Information *****

English (in-lb) Units used in input data file

Program License Serial Number 433

Rational Method Hydrology Program based on
Riverside County Flood Control & Water Conservation District
1978 hydrology manual

Storm event (year) = 10.00 Antecedent Moisture Condition = 2

2 year, 1 hour precipitation = 0.500(In.)
100 year, 1 hour precipitation = 1.200(In.)

Storm event year = 10.0
Calculated rainfall intensity data:
1 hour intensity = 0.788(In/Hr)
Slope of intensity duration curve = 0.5500

Process from Point/Station 101.000 to Point/Station 102.000
**** INITIAL AREA EVALUATION ****

Initial area flow distance = 433.000(Ft.)
Top (of initial area) elevation = 1171.000(Ft.)
Bottom (of initial area) elevation = 1148.000(Ft.)
Difference in elevation = 23.000(Ft.)
Slope = 0.05312 s(percent)= 5.31
TC = $k(0.530)*[(\text{length}^3)/(\text{elevation change})]^{0.2}$
Initial area time of concentration = 10.810 min.
Rainfall intensity = 2.023(In/Hr) for a 10.0 year storm
UNDEVELOPED (poor cover) subarea
Runoff Coefficient = 0.813
Decimal fraction soil group A = 0.000
Decimal fraction soil group B = 0.000
Decimal fraction soil group C = 1.000
Decimal fraction soil group D = 0.000
RI index for soil(AMC 2) = 86.00
Pervious area fraction = 1.000; Impervious fraction = 0.000
Initial subarea runoff = 2.334(CFS)
Total initial stream area = 1.420(Ac.)
Pervious area fraction = 1.000
End of computations, total study area = 1.42 (Ac.)
The following figures may
be used for a unit hydrograph study of the same area.

Area averaged pervious area fraction(Ap) = 1.000
Area averaged RI index number = 86.0

Riverside County Rational Hydrology Program

CIVILCADD/CIVILDESIGN Engineering Software, (c) 1989 - 2004 Version 7.0
Rational Hydrology Study Date: 08/20/19 File:ARA2EX10.out

MURRIETA APARTMENTS EXISTING CONDITION HYDROLOGY
RATIONAL METHOD ANALYSIS, 10-YEAR STORM EVENT
FILENAME: ARA2EX10

***** Hydrology Study Control Information *****

English (in-lb) Units used in input data file

Program License Serial Number 433

Rational Method Hydrology Program based on
Riverside County Flood Control & Water Conservation District
1978 hydrology manual

Storm event (year) = 10.00 Antecedent Moisture Condition = 2

2 year, 1 hour precipitation = 0.500(In.)
100 year, 1 hour precipitation = 1.200(In.)

Storm event year = 10.0
Calculated rainfall intensity data:
1 hour intensity = 0.788(In/Hr)
Slope of intensity duration curve = 0.5500

Process from Point/Station 103.000 to Point/Station 104.000
**** INITIAL AREA EVALUATION ****

Initial area flow distance = 285.000(Ft.)
Top (of initial area) elevation = 1172.000(Ft.)
Bottom (of initial area) elevation = 1125.000(Ft.)
Difference in elevation = 47.000(Ft.)
Slope = 0.16491 s(percent)= 16.49
TC = $k(0.530)*[(\text{length}^3)/(\text{elevation change})]^{0.2}$
Initial area time of concentration = 7.291 min.
Rainfall intensity = 2.512(In/Hr) for a 10.0 year storm
UNDEVELOPED (poor cover) subarea
Runoff Coefficient = 0.828
Decimal fraction soil group A = 0.000
Decimal fraction soil group B = 0.000
Decimal fraction soil group C = 1.000
Decimal fraction soil group D = 0.000
RI index for soil(AMC 2) = 86.00
Pervious area fraction = 1.000; Impervious fraction = 0.000
Initial subarea runoff = 4.078(CFS)
Total initial stream area = 1.960(Ac.)
Pervious area fraction = 1.000
End of computations, total study area = 1.96 (Ac.)
The following figures may
be used for a unit hydrograph study of the same area.

Area averaged pervious area fraction(Ap) = 1.000
Area averaged RI index number = 86.0

Riverside County Rational Hydrology Program

CIVILCADD/CIVILDESIGN Engineering Software, (c) 1989 - 2004 Version 7.0
Rational Hydrology Study Date: 08/20/19 File:ARA3EX10.out

MURRIETA APARTMENTS EXISTING CONDITION HYDROLOGY
RATIONAL METHOD ANALYSIS, 10-YEAR STORM EVENT
FILENAME: ARA3EX10

***** Hydrology Study Control Information *****

English (in-lb) Units used in input data file

Program License Serial Number 433

Rational Method Hydrology Program based on
Riverside County Flood Control & Water Conservation District
1978 hydrology manual

Storm event (year) = 10.00 Antecedent Moisture Condition = 2

2 year, 1 hour precipitation = 0.500(In.)
100 year, 1 hour precipitation = 1.200(In.)

Storm event year = 10.0
Calculated rainfall intensity data:
1 hour intensity = 0.788(In/Hr)
Slope of intensity duration curve = 0.5500

Process from Point/Station 105.000 to Point/Station 106.000
**** INITIAL AREA EVALUATION ****

Initial area flow distance = 385.000(Ft.)
Top (of initial area) elevation = 1172.000(Ft.)
Bottom (of initial area) elevation = 1121.000(Ft.)
Difference in elevation = 51.000(Ft.)
Slope = 0.13247 s(percent)= 13.25
TC = $k(0.530)*[(\text{length}^3)/(\text{elevation change})]^{0.2}$
Initial area time of concentration = 8.591 min.
Rainfall intensity = 2.295(In/Hr) for a 10.0 year storm
UNDEVELOPED (poor cover) subarea
Runoff Coefficient = 0.822
Decimal fraction soil group A = 0.000
Decimal fraction soil group B = 0.000
Decimal fraction soil group C = 1.000
Decimal fraction soil group D = 0.000
RI index for soil(AMC 2) = 86.00
Pervious area fraction = 1.000; Impervious fraction = 0.000
Initial subarea runoff = 1.604(CFS)
Total initial stream area = 0.850(Ac.)
Pervious area fraction = 1.000
End of computations, total study area = 0.85 (Ac.)
The following figures may
be used for a unit hydrograph study of the same area.

Area averaged pervious area fraction(Ap) = 1.000
Area averaged RI index number = 86.0

APPENDIX A.2: AREA "B"

Riverside County Rational Hydrology Program

CIVILCADD/CIVILDESIGN Engineering Software, (c) 1989 - 2004 Version 7.0
Rational Hydrology Study Date: 08/20/19 File:ARBEX100.out

MURRIETA APARTMENTS EXISTING CONDITION HYDROLOGY
RATIONAL METHOD ANALYSIS, 100-YEAR STORM EVENT
FILENAME: ARBEX100

***** Hydrology Study Control Information *****

English (in-lb) Units used in input data file

Program License Serial Number 433

Rational Method Hydrology Program based on
Riverside County Flood Control & Water Conservation District
1978 hydrology manual

Storm event (year) = 100.00 Antecedent Moisture Condition = 2

2 year, 1 hour precipitation = 0.500(In.)
100 year, 1 hour precipitation = 1.200(In.)

Storm event year = 100.0
Calculated rainfall intensity data:
1 hour intensity = 1.200(In/Hr)
Slope of intensity duration curve = 0.5500

Process from Point/Station 201.000 to Point/Station 202.000
**** INITIAL AREA EVALUATION ****

Initial area flow distance = 312.000(Ft.)
Top (of initial area) elevation = 1159.000(Ft.)
Bottom (of initial area) elevation = 1118.000(Ft.)
Difference in elevation = 41.000(Ft.)
Slope = 0.13141 s(percent)= 13.14
TC = $k(0.530)*[(\text{length}^3)/(\text{elevation change})]^{0.2}$
Initial area time of concentration = 7.911 min.
Rainfall intensity = 3.657(In/Hr) for a 100.0 year storm
UNDEVELOPED (poor cover) subarea
Runoff Coefficient = 0.785
Decimal fraction soil group A = 0.769
Decimal fraction soil group B = 0.000
Decimal fraction soil group C = 0.231
Decimal fraction soil group D = 0.000
RI index for soil(AMC 2) = 71.39
Pervious area fraction = 1.000; Impervious fraction = 0.000
Initial subarea runoff = 4.652(CFS)
Total initial stream area = 1.620(Ac.)
Pervious area fraction = 1.000
End of computations, total study area = 1.62 (Ac.)
The following figures may
be used for a unit hydrograph study of the same area.

Area averaged pervious area fraction(Ap) = 1.000
Area averaged RI index number = 71.4

Riverside County Rational Hydrology Program

CIVILCADD/CIVILDESIGN Engineering Software, (c) 1989 - 2004 Version 7.0
Rational Hydrology Study Date: 08/20/19 File:ARBEX10.out

MURRIETA APARTMENTS EXISTING CONDITION HYDROLOGY
RATIONAL METHOD ANALYSIS, 10-YEAR STORM EVENT
FILENAME: ARBEX10

***** Hydrology Study Control Information *****

English (in-lb) Units used in input data file

Program License Serial Number 433

Rational Method Hydrology Program based on
Riverside County Flood Control & Water Conservation District
1978 hydrology manual

Storm event (year) = 10.00 Antecedent Moisture Condition = 2

2 year, 1 hour precipitation = 0.500(In.)
100 year, 1 hour precipitation = 1.200(In.)

Storm event year = 10.0
Calculated rainfall intensity data:
1 hour intensity = 0.788(In/Hr)
Slope of intensity duration curve = 0.5500

Process from Point/Station 201.000 to Point/Station 202.000
**** INITIAL AREA EVALUATION ****

Initial area flow distance = 312.000(Ft.)
Top (of initial area) elevation = 1159.000(Ft.)
Bottom (of initial area) elevation = 1118.000(Ft.)
Difference in elevation = 41.000(Ft.)
Slope = 0.13141 s(percent)= 13.14
TC = $k(0.530)*[(\text{length}^3)/(\text{elevation change})]^{0.2}$
Initial area time of concentration = 7.911 min.
Rainfall intensity = 2.402(In/Hr) for a 10.0 year storm
UNDEVELOPED (poor cover) subarea
Runoff Coefficient = 0.736
Decimal fraction soil group A = 0.769
Decimal fraction soil group B = 0.000
Decimal fraction soil group C = 0.231
Decimal fraction soil group D = 0.000
RI index for soil(AMC 2) = 71.39
Pervious area fraction = 1.000; Impervious fraction = 0.000
Initial subarea runoff = 2.864(CFS)
Total initial stream area = 1.620(Ac.)
Pervious area fraction = 1.000
End of computations, total study area = 1.62 (Ac.)
The following figures may
be used for a unit hydrograph study of the same area.

Area averaged pervious area fraction(Ap) = 1.000
Area averaged RI index number = 71.4

APPENDIX A.3: AREA "C"

Riverside County Rational Hydrology Program

CIVILCADD/CIVILDESIGN Engineering Software, (c) 1989 - 2004 Version 7.0
Rational Hydrology Study Date: 08/20/19 File:ARCEX100.out

MURRIETA APARTMENTS EXISTING CONDITION HYDROLOGY
RATIONAL METHOD ANALYSIS, 100-YEAR STORM EVENT
FILENAME: ARCEX100

***** Hydrology Study Control Information *****

English (in-lb) Units used in input data file

Program License Serial Number 433

Rational Method Hydrology Program based on
Riverside County Flood Control & Water Conservation District
1978 hydrology manual

Storm event (year) = 100.00 Antecedent Moisture Condition = 2

2 year, 1 hour precipitation = 0.500(In.)
100 year, 1 hour precipitation = 1.200(In.)

Storm event year = 100.0
Calculated rainfall intensity data:
1 hour intensity = 1.200(In/Hr)
Slope of intensity duration curve = 0.5500

Process from Point/Station 301.000 to Point/Station 302.000
**** INITIAL AREA EVALUATION ****

Initial area flow distance = 138.000(Ft.)
Top (of initial area) elevation = 1172.000(Ft.)
Bottom (of initial area) elevation = 1147.000(Ft.)
Difference in elevation = 25.000(Ft.)
Slope = 0.18116 s(percent)= 18.12
TC = $k(0.530)*[(\text{length}^3)/(\text{elevation change})]^{0.2}$
Initial area time of concentration = 5.353 min.
Rainfall intensity = 4.533(In/Hr) for a 100.0 year storm
UNDEVELOPED (poor cover) subarea
Runoff Coefficient = 0.859
Decimal fraction soil group A = 0.000
Decimal fraction soil group B = 0.000
Decimal fraction soil group C = 1.000
Decimal fraction soil group D = 0.000
RI index for soil(AMC 2) = 86.00
Pervious area fraction = 1.000; Impervious fraction = 0.000
Initial subarea runoff = 2.687(CFS)
Total initial stream area = 0.690(Ac.)
Pervious area fraction = 1.000

Process from Point/Station 302.000 to Point/Station 304.000
**** STREET FLOW TRAVEL TIME + SUBAREA FLOW ADDITION ****

Top of street segment elevation = 1147.000(Ft.)
End of street segment elevation = 1125.000(Ft.)
Length of street segment = 534.000(Ft.)

Height of curb above gutter flowline = 6.0(In.)
 Width of half street (curb to crown) = 22.000(Ft.)
 Distance from crown to crossfall grade break = 18.000(Ft.)
 Slope from gutter to grade break (v/hz) = 0.020
 Slope from grade break to crown (v/hz) = 0.020
 Street flow is on [2] side(s) of the street
 Distance from curb to property line = 10.000(Ft.)
 Slope from curb to property line (v/hz) = 0.025
 Gutter width = 2.000(Ft.)
 Gutter hike from flowline = 2.000(In.)
 Manning's N in gutter = 0.0150
 Manning's N from gutter to grade break = 0.0150
 Manning's N from grade break to crown = 0.0150
 Estimated mean flow rate at midpoint of street = 3.420(CFS)
 Depth of flow = 0.244(Ft.), Average velocity = 3.637(Ft/s)
 Streetflow hydraulics at midpoint of street travel:
 Halfstreet flow width = 5.861(Ft.)
 Flow velocity = 3.64(Ft/s)
 Travel time = 2.45 min. TC = 7.80 min.
 Adding area flow to street
 COMMERCIAL subarea type
 Runoff Coefficient = 0.884
 Decimal fraction soil group A = 0.173
 Decimal fraction soil group B = 0.000
 Decimal fraction soil group C = 0.827
 Decimal fraction soil group D = 0.000
 RI index for soil(AMC 2) = 62.60
 Pervious area fraction = 0.100; Impervious fraction = 0.900
 Rainfall intensity = 3.686(In/Hr) for a 100.0 year storm
 Subarea runoff = 1.336(CFS) for 0.410(Ac.)
 Total runoff = 4.022(CFS) Total area = 1.100(Ac.)
 Street flow at end of street = 4.022(CFS)
 Half street flow at end of street = 2.011(CFS)
 Depth of flow = 0.255(Ft.), Average velocity = 3.749(Ft/s)
 Flow width (from curb towards crown)= 6.402(Ft.)

++++++
 Process from Point/Station 302.000 to Point/Station 304.000
 **** CONFLUENCE OF MINOR STREAMS ****

Along Main Stream number: 1 in normal stream number 1
 Stream flow area = 1.100(Ac.)
 Runoff from this stream = 4.022(CFS)
 Time of concentration = 7.80 min.
 Rainfall intensity = 3.686(In/Hr)

++++++
 Process from Point/Station 303.000 to Point/Station 304.000
 **** INITIAL AREA EVALUATION ****

Initial area flow distance = 479.000(Ft.)
 Top (of initial area) elevation = 1169.000(Ft.)
 Bottom (of initial area) elevation = 1125.000(Ft.)
 Difference in elevation = 44.000(Ft.)
 Slope = 0.09186 s(percent)= 9.19
 TC = $k(0.530)*[(\text{length}^3)/(\text{elevation change})]^{0.2}$
 Initial area time of concentration = 10.088 min.
 Rainfall intensity = 3.199(In/Hr) for a 100.0 year storm
 UNDEVELOPED (poor cover) subarea
 Runoff Coefficient = 0.831
 Decimal fraction soil group A = 0.137
 Decimal fraction soil group B = 0.000
 Decimal fraction soil group C = 0.863
 Decimal fraction soil group D = 0.000
 RI index for soil(AMC 2) = 83.40
 Pervious area fraction = 1.000; Impervious fraction = 0.000
 Initial subarea runoff = 2.207(CFS)
 Total initial stream area = 0.830(Ac.)
 Pervious area fraction = 1.000

 Process from Point/Station 303.000 to Point/Station 304.000
 **** CONFLUENCE OF MINOR STREAMS ****

 Along Main Stream number: 1 in normal stream number 2
 Stream flow area = 0.830 (Ac.)
 Runoff from this stream = 2.207 (CFS)
 Time of concentration = 10.09 min.
 Rainfall intensity = 3.199 (In/Hr)
 Summary of stream data:

Stream No.	Flow rate (CFS)	TC (min)	Rainfall Intensity (In/Hr)
------------	-----------------	----------	----------------------------

1	4.022	7.80	3.686
2	2.207	10.09	3.199

Largest stream flow has longer or shorter time of concentration

Qp = 4.022 + sum of
 Qa Tb/Ta
 2.207 * 0.773 = 1.707
 Qp = 5.729

Total of 2 streams to confluence:
 Flow rates before confluence point:
 4.022 2.207
 Area of streams before confluence:
 1.100 0.830

Results of confluence:
 Total flow rate = 5.729 (CFS)
 Time of concentration = 7.800 min.
 Effective stream area after confluence = 1.930 (Ac.)
 End of computations, total study area = 1.93 (Ac.)
 The following figures may
 be used for a unit hydrograph study of the same area.

Area averaged pervious area fraction (Ap) = 0.809
 Area averaged RI index number = 79.9

Riverside County Rational Hydrology Program

CIVILCADD/CIVILDESIGN Engineering Software, (c) 1989 - 2004 Version 7.0
Rational Hydrology Study Date: 08/20/19 File:ARCEX10.out

MURRIETA APARTMENTS EXISTING CONDITION HYDROLOGY
RATIONAL METHOD ANALYSIS, 10-YEAR STORM EVENT
FILENAME: ARCEX10

***** Hydrology Study Control Information *****

English (in-lb) Units used in input data file

Program License Serial Number 433

Rational Method Hydrology Program based on
Riverside County Flood Control & Water Conservation District
1978 hydrology manual

Storm event (year) = 10.00 Antecedent Moisture Condition = 2

2 year, 1 hour precipitation = 0.500(In.)
100 year, 1 hour precipitation = 1.200(In.)

Storm event year = 10.0
Calculated rainfall intensity data:
1 hour intensity = 0.788(In/Hr)
Slope of intensity duration curve = 0.5500

Process from Point/Station 301.000 to Point/Station 302.000
**** INITIAL AREA EVALUATION ****

Initial area flow distance = 138.000(Ft.)
Top (of initial area) elevation = 1172.000(Ft.)
Bottom (of initial area) elevation = 1147.000(Ft.)
Difference in elevation = 25.000(Ft.)
Slope = 0.18116 s(percent)= 18.12
TC = $k(0.530)*[(\text{length}^3)/(\text{elevation change})]^{0.2}$
Initial area time of concentration = 5.353 min.
Rainfall intensity = 2.977(In/Hr) for a 10.0 year storm
UNDEVELOPED (poor cover) subarea
Runoff Coefficient = 0.839
Decimal fraction soil group A = 0.000
Decimal fraction soil group B = 0.000
Decimal fraction soil group C = 1.000
Decimal fraction soil group D = 0.000
RI index for soil(AMC 2) = 86.00
Pervious area fraction = 1.000; Impervious fraction = 0.000
Initial subarea runoff = 1.723(CFS)
Total initial stream area = 0.690(Ac.)
Pervious area fraction = 1.000

Process from Point/Station 302.000 to Point/Station 304.000
**** STREET FLOW TRAVEL TIME + SUBAREA FLOW ADDITION ****

Top of street segment elevation = 1147.000(Ft.)
End of street segment elevation = 1125.000(Ft.)
Length of street segment = 534.000(Ft.)

Height of curb above gutter flowline = 6.0(In.)
 Width of half street (curb to crown) = 22.000(Ft.)
 Distance from crown to crossfall grade break = 18.000(Ft.)
 Slope from gutter to grade break (v/hz) = 0.020
 Slope from grade break to crown (v/hz) = 0.020
 Street flow is on [2] side(s) of the street
 Distance from curb to property line = 10.000(Ft.)
 Slope from curb to property line (v/hz) = 0.025
 Gutter width = 2.000(Ft.)
 Gutter hike from flowline = 2.000(In.)
 Manning's N in gutter = 0.0150
 Manning's N from gutter to grade break = 0.0150
 Manning's N from grade break to crown = 0.0150
 Estimated mean flow rate at midpoint of street = 2.235(CFS)
 Depth of flow = 0.216(Ft.), Average velocity = 3.404(Ft/s)
 Streetflow hydraulics at midpoint of street travel:
 Halfstreet flow width = 4.490(Ft.)
 Flow velocity = 3.40(Ft/s)
 Travel time = 2.61 min. TC = 7.97 min.
 Adding area flow to street
 COMMERCIAL subarea type
 Runoff Coefficient = 0.878
 Decimal fraction soil group A = 0.173
 Decimal fraction soil group B = 0.000
 Decimal fraction soil group C = 0.827
 Decimal fraction soil group D = 0.000
 RI index for soil(AMC 2) = 62.60
 Pervious area fraction = 0.100; Impervious fraction = 0.900
 Rainfall intensity = 2.392(In/Hr) for a 10.0 year storm
 Subarea runoff = 0.861(CFS) for 0.410(Ac.)
 Total runoff = 2.584(CFS) Total area = 1.100(Ac.)
 Street flow at end of street = 2.584(CFS)
 Half street flow at end of street = 1.292(CFS)
 Depth of flow = 0.226(Ft.), Average velocity = 3.471(Ft/s)
 Flow width (from curb towards crown)= 4.954(Ft.)

++++++
 Process from Point/Station 302.000 to Point/Station 304.000
 **** CONFLUENCE OF MINOR STREAMS ****

Along Main Stream number: 1 in normal stream number 1
 Stream flow area = 1.100(Ac.)
 Runoff from this stream = 2.584(CFS)
 Time of concentration = 7.97 min.
 Rainfall intensity = 2.392(In/Hr)

++++++
 Process from Point/Station 303.000 to Point/Station 304.000
 **** INITIAL AREA EVALUATION ****

Initial area flow distance = 479.000(Ft.)
 Top (of initial area) elevation = 1169.000(Ft.)
 Bottom (of initial area) elevation = 1125.000(Ft.)
 Difference in elevation = 44.000(Ft.)
 Slope = 0.09186 s(percent)= 9.19
 TC = $k(0.530)*[(\text{length}^3)/(\text{elevation change})]^{0.2}$
 Initial area time of concentration = 10.088 min.
 Rainfall intensity = 2.101(In/Hr) for a 10.0 year storm
 UNDEVELOPED (poor cover) subarea
 Runoff Coefficient = 0.799
 Decimal fraction soil group A = 0.137
 Decimal fraction soil group B = 0.000
 Decimal fraction soil group C = 0.863
 Decimal fraction soil group D = 0.000
 RI index for soil(AMC 2) = 83.40
 Pervious area fraction = 1.000; Impervious fraction = 0.000
 Initial subarea runoff = 1.393(CFS)
 Total initial stream area = 0.830(Ac.)
 Pervious area fraction = 1.000

 Process from Point/Station 303.000 to Point/Station 304.000
 **** CONFLUENCE OF MINOR STREAMS ****

Along Main Stream number: 1 in normal stream number 2
 Stream flow area = 0.830 (Ac.)
 Runoff from this stream = 1.393 (CFS)
 Time of concentration = 10.09 min.
 Rainfall intensity = 2.101 (In/Hr)
 Summary of stream data:

Stream No.	Flow rate (CFS)	TC (min)	Rainfall Intensity (In/Hr)
------------	-----------------	----------	----------------------------

1	2.584	7.97	2.392
2	1.393	10.09	2.101

Largest stream flow has longer or shorter time of concentration

Qp = 2.584 + sum of

$$Qa \cdot \frac{Tb}{Ta}$$

$$1.393 * 0.790 = 1.101$$
 Qp = 3.684

Total of 2 streams to confluence:
 Flow rates before confluence point:
 2.584 1.393
 Area of streams before confluence:
 1.100 0.830

Results of confluence:
 Total flow rate = 3.684 (CFS)
 Time of concentration = 7.968 min.
 Effective stream area after confluence = 1.930 (Ac.)
 End of computations, total study area = 1.93 (Ac.)
 The following figures may
 be used for a unit hydrograph study of the same area.

Area averaged pervious area fraction (Ap) = 0.809
 Area averaged RI index number = 79.9

APPENDIX B: POST-PROJECT CONDITION RATIONAL METHOD ANALYSIS

APPENDIX B.1: AREA "A"

Riverside County Rational Hydrology Program

CIVILCADD/CIVILDESIGN Engineering Software, (c) 1989 - 2004 Version 7.0
Rational Hydrology Study Date: 08/20/19 File:ARA1P100.out

MURRIETA APARTMENTS POST-PROJECT CONDITION HYDROLOGY
RATIONAL METHOD ANALYSIS, 100-YEAR STORM EVENT
FILENAME: ARA1P100

***** Hydrology Study Control Information *****

English (in-lb) Units used in input data file

Program License Serial Number 433

Rational Method Hydrology Program based on
Riverside County Flood Control & Water Conservation District
1978 hydrology manual

Storm event (year) = 100.00 Antecedent Moisture Condition = 2

2 year, 1 hour precipitation = 0.500(In.)
100 year, 1 hour precipitation = 1.200(In.)

Storm event year = 100.0
Calculated rainfall intensity data:
1 hour intensity = 1.200(In/Hr)
Slope of intensity duration curve = 0.5500

Process from Point/Station 101.000 to Point/Station 102.000
**** INITIAL AREA EVALUATION ****

Initial area flow distance = 643.000(Ft.)
Top (of initial area) elevation = 1147.000(Ft.)
Bottom (of initial area) elevation = 1144.000(Ft.)
Difference in elevation = 3.000(Ft.)
Slope = 0.00467 s(percent)= 0.47
TC = $k(0.323)*[(\text{length}^3)/(\text{elevation change})]^{0.2}$
Initial area time of concentration = 12.552 min.
Rainfall intensity = 2.837(In/Hr) for a 100.0 year storm
APARTMENT subarea type
Runoff Coefficient = 0.861
Decimal fraction soil group A = 0.170
Decimal fraction soil group B = 0.000
Decimal fraction soil group C = 0.830
Decimal fraction soil group D = 0.000
RI index for soil(AMC 2) = 62.71
Pervious area fraction = 0.200; Impervious fraction = 0.800
Initial subarea runoff = 4.664(CFS)
Total initial stream area = 1.910(Ac.)
Pervious area fraction = 0.200

Process from Point/Station 102.000 to Point/Station 105.000
**** PIPEFLOW TRAVEL TIME (Program estimated size) ****

Upstream point/station elevation = 1140.000(Ft.)
Downstream point/station elevation = 1138.000(Ft.)
Pipe length = 350.00(Ft.) Manning's N = 0.013

No. of pipes = 1 Required pipe flow = 4.664(CFS)
Nearest computed pipe diameter = 15.00(In.)
Calculated individual pipe flow = 4.664(CFS)
Normal flow depth in pipe = 11.73(In.)
Flow top width inside pipe = 12.39(In.)
Critical Depth = 10.51(In.)
Pipe flow velocity = 4.53(Ft/s)
Travel time through pipe = 1.29 min.
Time of concentration (TC) = 13.84 min.

Process from Point/Station 102.000 to Point/Station 105.000
**** CONFLUENCE OF MINOR STREAMS ****

Along Main Stream number: 1 in normal stream number 1
Stream flow area = 1.910(Ac.)
Runoff from this stream = 4.664(CFS)
Time of concentration = 13.84 min.
Rainfall intensity = 2.689(In/Hr)

Process from Point/Station 103.000 to Point/Station 104.000
**** INITIAL AREA EVALUATION ****

Initial area flow distance = 384.000(Ft.)
Top (of initial area) elevation = 1146.000(Ft.)
Bottom (of initial area) elevation = 1144.300(Ft.)
Difference in elevation = 1.700(Ft.)
Slope = 0.00443 s(percent) = 0.44
TC = $k(0.323)*[(length^3)/(elevation\ change)]^{0.2}$
Initial area time of concentration = 10.321 min.
Rainfall intensity = 3.160(In/Hr) for a 100.0 year storm
APARTMENT subarea type
Runoff Coefficient = 0.858
Decimal fraction soil group A = 0.290
Decimal fraction soil group B = 0.000
Decimal fraction soil group C = 0.710
Decimal fraction soil group D = 0.000
RI index for soil(AMC 2) = 58.27
Pervious area fraction = 0.200; Impervious fraction = 0.800
Initial subarea runoff = 4.366(CFS)
Total initial stream area = 1.610(Ac.)
Pervious area fraction = 0.200

Process from Point/Station 104.000 to Point/Station 105.000
**** PIPEFLOW TRAVEL TIME (Program estimated size) ****

Upstream point/station elevation = 1140.300(Ft.)
Downstream point/station elevation = 1138.000(Ft.)
Pipe length = 227.00(Ft.) Manning's N = 0.013
No. of pipes = 1 Required pipe flow = 4.366(CFS)
Nearest computed pipe diameter = 15.00(In.)
Calculated individual pipe flow = 4.366(CFS)
Normal flow depth in pipe = 9.00(In.)
Flow top width inside pipe = 14.70(In.)
Critical Depth = 10.16(In.)
Pipe flow velocity = 5.68(Ft/s)
Travel time through pipe = 0.67 min.
Time of concentration (TC) = 10.99 min.

Process from Point/Station 104.000 to Point/Station 105.000
**** CONFLUENCE OF MINOR STREAMS ****

Along Main Stream number: 1 in normal stream number 2
Stream flow area = 1.610(Ac.)

Runoff from this stream = 4.366(CFS)
 Time of concentration = 10.99 min.
 Rainfall intensity = 3.053(In/Hr)
 Summary of stream data:

Stream No.	Flow rate (CFS)	TC (min)	Rainfall Intensity (In/Hr)
1	4.664	13.84	2.689
2	4.366	10.99	3.053

Largest stream flow has longer time of concentration
 $Q_p = 4.664 + \text{sum of } Q_b \text{ Ia/Ib}$
 $4.366 * 0.881 = 3.845$
 $Q_p = 8.509$

Total of 2 streams to confluence:
 Flow rates before confluence point:
 4.664 4.366
 Area of streams before confluence:
 1.910 1.610
 Results of confluence:
 Total flow rate = 8.509(CFS)
 Time of concentration = 13.840 min.
 Effective stream area after confluence = 3.520(Ac.)

 Process from Point/Station 105.000 to Point/Station 108.000
 **** PIPEFLOW TRAVEL TIME (Program estimated size) ****

Upstream point/station elevation = 1138.000(Ft.)
 Downstream point/station elevation = 1136.000(Ft.)
 Pipe length = 356.00(Ft.) Manning's N = 0.013
 No. of pipes = 1 Required pipe flow = 8.509(CFS)
 Nearest computed pipe diameter = 21.00(In.)
 Calculated individual pipe flow = 8.509(CFS)
 Normal flow depth in pipe = 13.15(In.)
 Flow top width inside pipe = 20.32(In.)
 Critical Depth = 13.01(In.)
 Pipe flow velocity = 5.37(Ft/s)
 Travel time through pipe = 1.11 min.
 Time of concentration (TC) = 14.94 min.

 Process from Point/Station 105.000 to Point/Station 108.000
 **** CONFLUENCE OF MINOR STREAMS ****

Along Main Stream number: 1 in normal stream number 1
 Stream flow area = 3.520(Ac.)
 Runoff from this stream = 8.509(CFS)
 Time of concentration = 14.94 min.
 Rainfall intensity = 2.577(In/Hr)

 Process from Point/Station 106.000 to Point/Station 107.000
 **** INITIAL AREA EVALUATION ****

Initial area flow distance = 491.000(Ft.)
 Top (of initial area) elevation = 1147.600(Ft.)
 Bottom (of initial area) elevation = 1141.000(Ft.)
 Difference in elevation = 6.600(Ft.)
 Slope = 0.01344 s(percent) = 1.34
 $TC = k(0.323) * [(length^3) / (elevation change)]^{0.2}$
 Initial area time of concentration = 9.119 min.
 Rainfall intensity = 3.382(In/Hr) for a 100.0 year storm
 APARTMENT subarea type
 Runoff Coefficient = 0.873

Decimal fraction soil group A = 0.000
 Decimal fraction soil group B = 0.000
 Decimal fraction soil group C = 1.000
 Decimal fraction soil group D = 0.000
 RI index for soil(AMC 2) = 69.00
 Pervious area fraction = 0.200; Impervious fraction = 0.800
 Initial subarea runoff = 4.842(CFS)
 Total initial stream area = 1.640(Ac.)
 Pervious area fraction = 0.200

+-----+
 Process from Point/Station 106.000 to Point/Station 107.000
 **** SUBAREA FLOW ADDITION ****

APARTMENT subarea type
 Runoff Coefficient = 0.873
 Decimal fraction soil group A = 0.000
 Decimal fraction soil group B = 0.000
 Decimal fraction soil group C = 1.000
 Decimal fraction soil group D = 0.000
 RI index for soil(AMC 2) = 69.00
 Pervious area fraction = 0.200; Impervious fraction = 0.800
 Time of concentration = 9.12 min.
 Rainfall intensity = 3.382(In/Hr) for a 100.0 year storm
 Subarea runoff = 3.927(CFS) for 1.330(Ac.)
 Total runoff = 8.768(CFS) Total area = 2.970(Ac.)

+-----+
 Process from Point/Station 107.000 to Point/Station 108.000
 **** PIPEFLOW TRAVEL TIME (Program estimated size) ****

Upstream point/station elevation = 1137.000(Ft.)
 Downstream point/station elevation = 1136.000(Ft.)
 Pipe length = 4.00(Ft.) Manning's N = 0.013
 No. of pipes = 1 Required pipe flow = 8.768(CFS)
 Nearest computed pipe diameter = 12.00(In.)
 Calculated individual pipe flow = 8.768(CFS)
 Normal flow depth in pipe = 5.95(In.)
 Flow top width inside pipe = 12.00(In.)
 Critical depth could not be calculated.
 Pipe flow velocity = 22.60(Ft/s)
 Travel time through pipe = 0.00 min.
 Time of concentration (TC) = 9.12 min.

+-----+
 Process from Point/Station 107.000 to Point/Station 108.000
 **** CONFLUENCE OF MINOR STREAMS ****

Along Main Stream number: 1 in normal stream number 2
 Stream flow area = 2.970(Ac.)
 Runoff from this stream = 8.768(CFS)
 Time of concentration = 9.12 min.
 Rainfall intensity = 3.382(In/Hr)
 Summary of stream data:

Stream No.	Flow rate (CFS)	TC (min)	Rainfall Intensity (In/Hr)
1	8.509	14.94	2.577
2	8.768	9.12	3.382

Largest stream flow has longer or shorter time of concentration
 Qp = 8.768 + sum of
 Qa Tb/Ta
 8.509 * 0.610 = 5.194
 Qp = 13.962

Total of 2 streams to confluence:

Flow rates before confluence point:
8.509 8.768
Area of streams before confluence:
3.520 2.970
Results of confluence:
Total flow rate = 13.962(CFS)
Time of concentration = 9.122 min.
Effective stream area after confluence = 6.490 (Ac.)

Process from Point/Station 108.000 to Point/Station 109.000
**** PIPEFLOW TRAVEL TIME (Program estimated size) ****

Upstream point/station elevation = 1136.000 (Ft.)
Downstream point/station elevation = 1131.000 (Ft.)
Pipe length = 293.00 (Ft.) Manning's N = 0.013
No. of pipes = 1 Required pipe flow = 13.962 (CFS)
Nearest computed pipe diameter = 21.00 (In.)
Calculated individual pipe flow = 13.962 (CFS)
Normal flow depth in pipe = 12.63 (In.)
Flow top width inside pipe = 20.56 (In.)
Critical Depth = 16.65 (In.)
Pipe flow velocity = 9.24 (Ft/s)
Travel time through pipe = 0.53 min.
Time of concentration (TC) = 9.65 min.

Process from Point/Station 108.000 to Point/Station 109.000
**** SUBAREA FLOW ADDITION ****

COMMERCIAL subarea type
Runoff Coefficient = 0.886
Decimal fraction soil group A = 0.000
Decimal fraction soil group B = 0.000
Decimal fraction soil group C = 1.000
Decimal fraction soil group D = 0.000
RI index for soil (AMC 2) = 69.00
Pervious area fraction = 0.100; Impervious fraction = 0.900
Time of concentration = 9.65 min.
Rainfall intensity = 3.278 (In/Hr) for a 100.0 year storm
Subarea runoff = 0.784 (CFS) for 0.270 (Ac.)
Total runoff = 14.747 (CFS) Total area = 6.760 (Ac.)
End of computations, total study area = 6.76 (Ac.)
The following figures may
be used for a unit hydrograph study of the same area.

Area averaged pervious area fraction (Ap) = 0.196
Area averaged RI index number = 64.7

Riverside County Rational Hydrology Program

CIVILCADD/CIVILDESIGN Engineering Software, (c) 1989 - 2004 Version 7.0
Rational Hydrology Study Date: 10/10/19 File:ARA6P100.out

MURRIETA APARTMENTS POST-PROJECT CONDITION HYDROLOGY
RATIONAL METHOD ANALYSIS, 100-YEAR STORM EVENT
FILENAME: ARA6P100

***** Hydrology Study Control Information *****

English (in-lb) Units used in input data file

Program License Serial Number 433

Rational Method Hydrology Program based on
Riverside County Flood Control & Water Conservation District
1978 hydrology manual

Storm event (year) = 100.00 Antecedent Moisture Condition = 2

2 year, 1 hour precipitation = 0.500(In.)
100 year, 1 hour precipitation = 1.200(In.)

Storm event year = 100.0
Calculated rainfall intensity data:
1 hour intensity = 1.200(In/Hr)
Slope of intensity duration curve = 0.5500

Process from Point/Station 111.000 to Point/Station 112.000
**** INITIAL AREA EVALUATION ****

Initial area flow distance = 477.000(Ft.)
Top (of initial area) elevation = 1141.000(Ft.)
Bottom (of initial area) elevation = 1123.000(Ft.)
Difference in elevation = 18.000(Ft.)
Slope = 0.03774 s(percent)= 3.77
TC = $k(0.940)*[(\text{length}^3)/(\text{elevation change})]^{0.2}$
Initial area time of concentration = 21.340 min.
Rainfall intensity = 2.119(In/Hr) for a 100.0 year storm
UNDEVELOPED (good cover) subarea
Runoff Coefficient = 0.712
Decimal fraction soil group A = 0.100
Decimal fraction soil group B = 0.000
Decimal fraction soil group C = 0.900
Decimal fraction soil group D = 0.000
RI index for soil(AMC 2) = 70.40
Pervious area fraction = 1.000; Impervious fraction = 0.000
Initial subarea runoff = 0.799(CFS)
Total initial stream area = 0.530(Ac.)
Pervious area fraction = 1.000
End of computations, total study area = 0.53 (Ac.)
The following figures may
be used for a unit hydrograph study of the same area.

Area averaged pervious area fraction(Ap) = 1.000
Area averaged RI index number = 70.4

Riverside County Rational Hydrology Program

CIVILCADD/CIVILDESIGN Engineering Software, (c) 1989 - 2004 Version 7.0
Rational Hydrology Study Date: 08/20/19 File:ARA1P10.out

MURRIETA APARTMENTS POST-PROJECT CONDITION HYDROLOGY
RATIONAL METHOD ANALYSIS, 10-YEAR STORM EVENT
FILENAME: ARA1P10

***** Hydrology Study Control Information *****

English (in-lb) Units used in input data file

Program License Serial Number 433

Rational Method Hydrology Program based on
Riverside County Flood Control & Water Conservation District
1978 hydrology manual

Storm event (year) = 10.00 Antecedent Moisture Condition = 2

2 year, 1 hour precipitation = 0.500(In.)
100 year, 1 hour precipitation = 1.200(In.)

Storm event year = 10.0
Calculated rainfall intensity data:
1 hour intensity = 0.788(In/Hr)
Slope of intensity duration curve = 0.5500

Process from Point/Station 101.000 to Point/Station 102.000
**** INITIAL AREA EVALUATION ****

Initial area flow distance = 643.000(Ft.)
Top (of initial area) elevation = 1147.000(Ft.)
Bottom (of initial area) elevation = 1144.000(Ft.)
Difference in elevation = 3.000(Ft.)
Slope = 0.00467 s(percent)= 0.47
TC = $k(0.323)*[(\text{length}^3)/(\text{elevation change})]^{0.2}$
Initial area time of concentration = 12.552 min.
Rainfall intensity = 1.863(In/Hr) for a 10.0 year storm
APARTMENT subarea type
Runoff Coefficient = 0.846
Decimal fraction soil group A = 0.170
Decimal fraction soil group B = 0.000
Decimal fraction soil group C = 0.830
Decimal fraction soil group D = 0.000
RI index for soil(AMC 2) = 62.71
Pervious area fraction = 0.200; Impervious fraction = 0.800
Initial subarea runoff = 3.011(CFS)
Total initial stream area = 1.910(Ac.)
Pervious area fraction = 0.200

Process from Point/Station 102.000 to Point/Station 105.000
**** PIPEFLOW TRAVEL TIME (Program estimated size) ****

Upstream point/station elevation = 1140.000(Ft.)
Downstream point/station elevation = 1138.000(Ft.)
Pipe length = 350.00(Ft.) Manning's N = 0.013

No. of pipes = 1 Required pipe flow = 3.011(CFS)
Nearest computed pipe diameter = 15.00(In.)
Calculated individual pipe flow = 3.011(CFS)
Normal flow depth in pipe = 8.52(In.)
Flow top width inside pipe = 14.86(In.)
Critical Depth = 8.38(In.)
Pipe flow velocity = 4.19(Ft/s)
Travel time through pipe = 1.39 min.
Time of concentration (TC) = 13.95 min.

Process from Point/Station 102.000 to Point/Station 105.000
**** CONFLUENCE OF MINOR STREAMS ****

Along Main Stream number: 1 in normal stream number 1
Stream flow area = 1.910(Ac.)
Runoff from this stream = 3.011(CFS)
Time of concentration = 13.95 min.
Rainfall intensity = 1.758(In/Hr)

Process from Point/Station 103.000 to Point/Station 104.000
**** INITIAL AREA EVALUATION ****

Initial area flow distance = 384.000(Ft.)
Top (of initial area) elevation = 1146.000(Ft.)
Bottom (of initial area) elevation = 1144.300(Ft.)
Difference in elevation = 1.700(Ft.)
Slope = 0.00443 s(percent) = 0.44
TC = $k(0.323)*[(length^3)/(elevation\ change)]^{0.2}$
Initial area time of concentration = 10.321 min.
Rainfall intensity = 2.075(In/Hr) for a 10.0 year storm
APARTMENT subarea type
Runoff Coefficient = 0.843
Decimal fraction soil group A = 0.290
Decimal fraction soil group B = 0.000
Decimal fraction soil group C = 0.710
Decimal fraction soil group D = 0.000
RI index for soil(AMC 2) = 58.27
Pervious area fraction = 0.200; Impervious fraction = 0.800
Initial subarea runoff = 2.817(CFS)
Total initial stream area = 1.610(Ac.)
Pervious area fraction = 0.200

Process from Point/Station 104.000 to Point/Station 105.000
**** PIPEFLOW TRAVEL TIME (Program estimated size) ****

Upstream point/station elevation = 1140.300(Ft.)
Downstream point/station elevation = 1138.000(Ft.)
Pipe length = 227.00(Ft.) Manning's N = 0.013
No. of pipes = 1 Required pipe flow = 2.817(CFS)
Nearest computed pipe diameter = 12.00(In.)
Calculated individual pipe flow = 2.817(CFS)
Normal flow depth in pipe = 8.02(In.)
Flow top width inside pipe = 11.30(In.)
Critical Depth = 8.63(In.)
Pipe flow velocity = 5.06(Ft/s)
Travel time through pipe = 0.75 min.
Time of concentration (TC) = 11.07 min.

Process from Point/Station 104.000 to Point/Station 105.000
**** CONFLUENCE OF MINOR STREAMS ****

Along Main Stream number: 1 in normal stream number 2
Stream flow area = 1.610(Ac.)

Runoff from this stream = 2.817(CFS)
 Time of concentration = 11.07 min.
 Rainfall intensity = 1.996(In/Hr)
 Summary of stream data:

Stream No.	Flow rate (CFS)	TC (min)	Rainfall Intensity (In/Hr)
1	3.011	13.95	1.758
2	2.817	11.07	1.996

Largest stream flow has longer time of concentration
 $Q_p = 3.011 + \text{sum of } Q_b \text{ Ia/Ib}$
 $2.817 * 0.881 = 2.481$
 $Q_p = 5.492$

Total of 2 streams to confluence:
 Flow rates before confluence point:
 3.011 2.817
 Area of streams before confluence:
 1.910 1.610
 Results of confluence:
 Total flow rate = 5.492(CFS)
 Time of concentration = 13.945 min.
 Effective stream area after confluence = 3.520(Ac.)

 Process from Point/Station 105.000 to Point/Station 108.000
 **** PIPEFLOW TRAVEL TIME (Program estimated size) ****

Upstream point/station elevation = 1138.000(Ft.)
 Downstream point/station elevation = 1136.000(Ft.)
 Pipe length = 356.00(Ft.) Manning's N = 0.013
 No. of pipes = 1 Required pipe flow = 5.492(CFS)
 Nearest computed pipe diameter = 18.00(In.)
 Calculated individual pipe flow = 5.492(CFS)
 Normal flow depth in pipe = 11.07(In.)
 Flow top width inside pipe = 17.52(In.)
 Critical Depth = 10.84(In.)
 Pipe flow velocity = 4.82(Ft/s)
 Travel time through pipe = 1.23 min.
 Time of concentration (TC) = 15.18 min.

 Process from Point/Station 105.000 to Point/Station 108.000
 **** CONFLUENCE OF MINOR STREAMS ****

Along Main Stream number: 1 in normal stream number 1
 Stream flow area = 3.520(Ac.)
 Runoff from this stream = 5.492(CFS)
 Time of concentration = 15.18 min.
 Rainfall intensity = 1.678(In/Hr)

 Process from Point/Station 106.000 to Point/Station 107.000
 **** INITIAL AREA EVALUATION ****

Initial area flow distance = 491.000(Ft.)
 Top (of initial area) elevation = 1147.600(Ft.)
 Bottom (of initial area) elevation = 1141.000(Ft.)
 Difference in elevation = 6.600(Ft.)
 Slope = 0.01344 s(percent) = 1.34
 $TC = k(0.323) * [(length^3) / (elevation change)]^{0.2}$
 Initial area time of concentration = 9.119 min.
 Rainfall intensity = 2.221(In/Hr) for a 10.0 year storm
 APARTMENT subarea type
 Runoff Coefficient = 0.862

Decimal fraction soil group A = 0.000
 Decimal fraction soil group B = 0.000
 Decimal fraction soil group C = 1.000
 Decimal fraction soil group D = 0.000
 RI index for soil(AMC 2) = 69.00
 Pervious area fraction = 0.200; Impervious fraction = 0.800
 Initial subarea runoff = 3.139(CFS)
 Total initial stream area = 1.640(Ac.)
 Pervious area fraction = 0.200

++++++
 Process from Point/Station 106.000 to Point/Station 107.000
 **** SUBAREA FLOW ADDITION ****

APARTMENT subarea type
 Runoff Coefficient = 0.862
 Decimal fraction soil group A = 0.000
 Decimal fraction soil group B = 0.000
 Decimal fraction soil group C = 1.000
 Decimal fraction soil group D = 0.000
 RI index for soil(AMC 2) = 69.00
 Pervious area fraction = 0.200; Impervious fraction = 0.800
 Time of concentration = 9.12 min.
 Rainfall intensity = 2.221(In/Hr) for a 10.0 year storm
 Subarea runoff = 2.545(CFS) for 1.330(Ac.)
 Total runoff = 5.684(CFS) Total area = 2.970(Ac.)

++++++
 Process from Point/Station 107.000 to Point/Station 108.000
 **** PIPEFLOW TRAVEL TIME (Program estimated size) ****

Upstream point/station elevation = 1137.000(Ft.)
 Downstream point/station elevation = 1136.000(Ft.)
 Pipe length = 4.00(Ft.) Manning's N = 0.013
 No. of pipes = 1 Required pipe flow = 5.684(CFS)
 Nearest computed pipe diameter = 9.00(In.)
 Calculated individual pipe flow = 5.684(CFS)
 Normal flow depth in pipe = 5.48(In.)
 Flow top width inside pipe = 8.78(In.)
 Critical depth could not be calculated.
 Pipe flow velocity = 20.18(Ft/s)
 Travel time through pipe = 0.00 min.
 Time of concentration (TC) = 9.12 min.

++++++
 Process from Point/Station 107.000 to Point/Station 108.000
 **** CONFLUENCE OF MINOR STREAMS ****

Along Main Stream number: 1 in normal stream number 2
 Stream flow area = 2.970(Ac.)
 Runoff from this stream = 5.684(CFS)
 Time of concentration = 9.12 min.
 Rainfall intensity = 2.220(In/Hr)
 Summary of stream data:

Stream No.	Flow rate (CFS)	TC (min)	Rainfall Intensity (In/Hr)
1	5.492	15.18	1.678
2	5.684	9.12	2.220

Largest stream flow has longer or shorter time of concentration
 $Q_p = 5.684 + \sum \frac{Q_a}{T_b/T_a}$
 $Q_p = 5.492 * 0.601 = 3.301$
 $Q_p = 8.985$

Total of 2 streams to confluence:

Flow rates before confluence point:
5.492 5.684
Area of streams before confluence:
3.520 2.970
Results of confluence:
Total flow rate = 8.985(CFS)
Time of concentration = 9.122 min.
Effective stream area after confluence = 6.490 (Ac.)

Process from Point/Station 108.000 to Point/Station 109.000
**** PIPEFLOW TRAVEL TIME (Program estimated size) ****

Upstream point/station elevation = 1136.000 (Ft.)
Downstream point/station elevation = 1131.000 (Ft.)
Pipe length = 293.00 (Ft.) Manning's N = 0.013
No. of pipes = 1 Required pipe flow = 8.985 (CFS)
Nearest computed pipe diameter = 15.00 (In.)
Calculated individual pipe flow = 8.985 (CFS)
Normal flow depth in pipe = 13.50 (In.)
Flow top width inside pipe = 9.00 (In.)
Critical Depth = 13.86 (In.)
Pipe flow velocity = 7.73 (Ft/s)
Travel time through pipe = 0.63 min.
Time of concentration (TC) = 9.75 min.

Process from Point/Station 108.000 to Point/Station 109.000
**** SUBAREA FLOW ADDITION ****

COMMERCIAL subarea type
Runoff Coefficient = 0.880
Decimal fraction soil group A = 0.000
Decimal fraction soil group B = 0.000
Decimal fraction soil group C = 1.000
Decimal fraction soil group D = 0.000
RI index for soil (AMC 2) = 69.00
Pervious area fraction = 0.100; Impervious fraction = 0.900
Time of concentration = 9.75 min.
Rainfall intensity = 2.140 (In/Hr) for a 10.0 year storm
Subarea runoff = 0.509 (CFS) for 0.270 (Ac.)
Total runoff = 9.494 (CFS) Total area = 6.760 (Ac.)
End of computations, total study area = 6.76 (Ac.)
The following figures may
be used for a unit hydrograph study of the same area.

Area averaged pervious area fraction (Ap) = 0.196
Area averaged RI index number = 64.7

Riverside County Rational Hydrology Program

CIVILCADD/CIVILDESIGN Engineering Software, (c) 1989 - 2004 Version 7.0
Rational Hydrology Study Date: 10/10/19 File:ARA6P10.out

MURRIETA APARTMENTS POST-PROJECT CONDITION HYDROLOGY
RATIONAL METHOD ANALYSIS, 10-YEAR STORM EVENT
FILENAME: ARA6P10

***** Hydrology Study Control Information *****

English (in-lb) Units used in input data file

Program License Serial Number 433

Rational Method Hydrology Program based on
Riverside County Flood Control & Water Conservation District
1978 hydrology manual

Storm event (year) = 10.00 Antecedent Moisture Condition = 2

2 year, 1 hour precipitation = 0.500(In.)
100 year, 1 hour precipitation = 1.200(In.)

Storm event year = 10.0
Calculated rainfall intensity data:
1 hour intensity = 0.788(In/Hr)
Slope of intensity duration curve = 0.5500

Process from Point/Station 111.000 to Point/Station 112.000
**** INITIAL AREA EVALUATION ****

Initial area flow distance = 477.000(Ft.)
Top (of initial area) elevation = 1141.000(Ft.)
Bottom (of initial area) elevation = 1123.000(Ft.)
Difference in elevation = 18.000(Ft.)
Slope = 0.03774 s(percent)= 3.77
TC = $k(0.940)*[(\text{length}^3)/(\text{elevation change})]^{0.2}$
Initial area time of concentration = 21.340 min.
Rainfall intensity = 1.391(In/Hr) for a 10.0 year storm
UNDEVELOPED (good cover) subarea
Runoff Coefficient = 0.642
Decimal fraction soil group A = 0.100
Decimal fraction soil group B = 0.000
Decimal fraction soil group C = 0.900
Decimal fraction soil group D = 0.000
RI index for soil(AMC 2) = 70.40
Pervious area fraction = 1.000; Impervious fraction = 0.000
Initial subarea runoff = 0.473(CFS)
Total initial stream area = 0.530(Ac.)
Pervious area fraction = 1.000
End of computations, total study area = 0.53 (Ac.)
The following figures may
be used for a unit hydrograph study of the same area.

Area averaged pervious area fraction(Ap) = 1.000
Area averaged RI index number = 70.4

APPENDIX B.2: AREA "B"

Riverside County Rational Hydrology Program

CIVILCADD/CIVILDESIGN Engineering Software, (c) 1989 - 2004 Version 7.0
Rational Hydrology Study Date: 08/20/19 File: ARBP100.out

MURRIETA APARTMENTS POST-PROJECT CONDITION HYDROLOGY
RATIONAL METHOD ANALYSIS, 100-YEAR STORM EVENT
FILENAME: ARBP100

***** Hydrology Study Control Information *****

English (in-lb) Units used in input data file

Program License Serial Number 433

Rational Method Hydrology Program based on
Riverside County Flood Control & Water Conservation District
1978 hydrology manual

Storm event (year) = 100.00 Antecedent Moisture Condition = 2

2 year, 1 hour precipitation = 0.500(In.)
100 year, 1 hour precipitation = 1.200(In.)

Storm event year = 100.0
Calculated rainfall intensity data:
1 hour intensity = 1.200(In/Hr)
Slope of intensity duration curve = 0.5500

Process from Point/Station 201.000 to Point/Station 202.000
**** INITIAL AREA EVALUATION ****

Initial area flow distance = 218.000(Ft.)
Top (of initial area) elevation = 1121.000(Ft.)
Bottom (of initial area) elevation = 1118.000(Ft.)
Difference in elevation = 3.000(Ft.)
Slope = 0.01376 s(percent)= 1.38
TC = $k(0.940)*[(\text{length}^3)/(\text{elevation change})]^{0.2}$
Initial area time of concentration = 19.089 min.
Rainfall intensity = 2.253(In/Hr) for a 100.0 year storm
UNDEVELOPED (good cover) subarea
Runoff Coefficient = 0.458
Decimal fraction soil group A = 1.000
Decimal fraction soil group B = 0.000
Decimal fraction soil group C = 0.000
Decimal fraction soil group D = 0.000
RI index for soil(AMC 2) = 38.00
Pervious area fraction = 1.000; Impervious fraction = 0.000
Initial subarea runoff = 0.433(CFS)
Total initial stream area = 0.420(Ac.)
Pervious area fraction = 1.000
End of computations, total study area = 0.42 (Ac.)
The following figures may
be used for a unit hydrograph study of the same area.

Area averaged pervious area fraction(Ap) = 1.000
Area averaged RI index number = 38.0

Riverside County Rational Hydrology Program

CIVILCADD/CIVILDESIGN Engineering Software, (c) 1989 - 2004 Version 7.0
Rational Hydrology Study Date: 08/20/19 File: ARBP10.out

MURRIETA APARTMENTS POST-PROJECT CONDITION HYDROLOGY
RATIONAL METHOD ANALYSIS, 10-YEAR STORM EVENT
FILENAME: ARBP10

***** Hydrology Study Control Information *****

English (in-lb) Units used in input data file

Program License Serial Number 433

Rational Method Hydrology Program based on
Riverside County Flood Control & Water Conservation District
1978 hydrology manual

Storm event (year) = 10.00 Antecedent Moisture Condition = 2

2 year, 1 hour precipitation = 0.500(In.)
100 year, 1 hour precipitation = 1.200(In.)

Storm event year = 10.0
Calculated rainfall intensity data:
1 hour intensity = 0.788(In/Hr)
Slope of intensity duration curve = 0.5500

Process from Point/Station 201.000 to Point/Station 202.000
**** INITIAL AREA EVALUATION ****

Initial area flow distance = 218.000(Ft.)
Top (of initial area) elevation = 1121.000(Ft.)
Bottom (of initial area) elevation = 1118.000(Ft.)
Difference in elevation = 3.000(Ft.)
Slope = 0.01376 s(percent)= 1.38
TC = $k(0.940)*[(\text{length}^3)/(\text{elevation change})]^{0.2}$
Initial area time of concentration = 19.089 min.
Rainfall intensity = 1.479(In/Hr) for a 10.0 year storm
UNDEVELOPED (good cover) subarea
Runoff Coefficient = 0.364
Decimal fraction soil group A = 1.000
Decimal fraction soil group B = 0.000
Decimal fraction soil group C = 0.000
Decimal fraction soil group D = 0.000
RI index for soil(AMC 2) = 38.00
Pervious area fraction = 1.000; Impervious fraction = 0.000
Initial subarea runoff = 0.226(CFS)
Total initial stream area = 0.420(Ac.)
Pervious area fraction = 1.000
End of computations, total study area = 0.42 (Ac.)
The following figures may
be used for a unit hydrograph study of the same area.

Area averaged pervious area fraction(Ap) = 1.000
Area averaged RI index number = 38.0

APPENDIX B.3: AREA "C"

Riverside County Rational Hydrology Program

CIVILCADD/CIVILDESIGN Engineering Software, (c) 1989 - 2004 Version 7.0
Rational Hydrology Study Date: 08/20/19 File:ARCP100.out

MURRIETA APARTMENTS POST-PROJECT CONDITION HYDROLOGY
RATIONAL METHOD ANALYSIS, 100-YEAR STORM EVENT
FILENAME: ARCP100

***** Hydrology Study Control Information *****

English (in-lb) Units used in input data file

Program License Serial Number 433

Rational Method Hydrology Program based on
Riverside County Flood Control & Water Conservation District
1978 hydrology manual

Storm event (year) = 100.00 Antecedent Moisture Condition = 2

2 year, 1 hour precipitation = 0.500(In.)
100 year, 1 hour precipitation = 1.200(In.)

Storm event year = 100.0
Calculated rainfall intensity data:
1 hour intensity = 1.200(In/Hr)
Slope of intensity duration curve = 0.5500

Process from Point/Station 301.000 to Point/Station 302.000
**** INITIAL AREA EVALUATION ****

Initial area flow distance = 636.000(Ft.)
Top (of initial area) elevation = 1147.000(Ft.)
Bottom (of initial area) elevation = 1125.000(Ft.)
Difference in elevation = 22.000(Ft.)
Slope = 0.03459 s(percent)= 3.46
TC = $k(0.390)*[(\text{length}^3)/(\text{elevation change})]^{0.2}$
Initial area time of concentration = 10.108 min.
Rainfall intensity = 3.196(In/Hr) for a 100.0 year storm
SINGLE FAMILY (1/4 Acre Lot)
Runoff Coefficient = 0.794
Decimal fraction soil group A = 0.310
Decimal fraction soil group B = 0.000
Decimal fraction soil group C = 0.690
Decimal fraction soil group D = 0.000
RI index for soil(AMC 2) = 57.53
Pervious area fraction = 0.500; Impervious fraction = 0.500
Initial subarea runoff = 1.776(CFS)
Total initial stream area = 0.700(Ac.)
Pervious area fraction = 0.500
End of computations, total study area = 0.70 (Ac.)
The following figures may
be used for a unit hydrograph study of the same area.

Area averaged pervious area fraction(Ap) = 0.500
Area averaged RI index number = 57.5

Riverside County Rational Hydrology Program

CIVILCADD/CIVILDESIGN Engineering Software, (c) 1989 - 2004 Version 7.0
Rational Hydrology Study Date: 08/20/19 File:ARCP10.out

MURRIETA APARTMENTS POST-PROJECT CONDITION HYDROLOGY
RATIONAL METHOD ANALYSIS, 10-YEAR STORM EVENT
FILENAME: ARCP10

***** Hydrology Study Control Information *****

English (in-lb) Units used in input data file

Program License Serial Number 433

Rational Method Hydrology Program based on
Riverside County Flood Control & Water Conservation District
1978 hydrology manual

Storm event (year) = 10.00 Antecedent Moisture Condition = 2

2 year, 1 hour precipitation = 0.500(In.)
100 year, 1 hour precipitation = 1.200(In.)

Storm event year = 10.0
Calculated rainfall intensity data:
1 hour intensity = 0.788(In/Hr)
Slope of intensity duration curve = 0.5500

Process from Point/Station 301.000 to Point/Station 302.000
**** INITIAL AREA EVALUATION ****

Initial area flow distance = 636.000(Ft.)
Top (of initial area) elevation = 1147.000(Ft.)
Bottom (of initial area) elevation = 1125.000(Ft.)
Difference in elevation = 22.000(Ft.)
Slope = 0.03459 s(percent)= 3.46
TC = $k(0.390)*[(\text{length}^3)/(\text{elevation change})]^{0.2}$
Initial area time of concentration = 10.108 min.
Rainfall intensity = 2.099(In/Hr) for a 10.0 year storm
SINGLE FAMILY (1/4 Acre Lot)
Runoff Coefficient = 0.756
Decimal fraction soil group A = 0.310
Decimal fraction soil group B = 0.000
Decimal fraction soil group C = 0.690
Decimal fraction soil group D = 0.000
RI index for soil(AMC 2) = 57.53
Pervious area fraction = 0.500; Impervious fraction = 0.500
Initial subarea runoff = 1.111(CFS)
Total initial stream area = 0.700(Ac.)
Pervious area fraction = 0.500
End of computations, total study area = 0.70 (Ac.)
The following figures may
be used for a unit hydrograph study of the same area.

Area averaged pervious area fraction(Ap) = 0.500
Area averaged RI index number = 57.5

APPENDIX C: INLET CALCULATIONS

Worksheet for Catch Basin #1

Project Description

Solve For Spread

Input Data

Discharge		4.70	ft ³ /s
Gutter Width		2.00	ft
Gutter Cross Slope		0.06	ft/ft
Road Cross Slope		0.02	ft/ft
Curb Opening Length		4.00	ft
Opening Height		0.83	ft
Curb Throat Type	Horizontal		
Local Depression		4.00	in
Local Depression Width		4.00	ft
Throat Incline Angle		90.00	degrees

Results

Spread		16.08	ft
Depth		0.41	ft
Gutter Depression		0.09	ft
Total Depression		0.42	ft

Worksheet for Catch Basin #2

Project Description

Solve For Spread

Input Data

Discharge		4.40	ft ³ /s
Gutter Width		2.00	ft
Gutter Cross Slope		0.06	ft/ft
Road Cross Slope		0.02	ft/ft
Curb Opening Length		4.00	ft
Opening Height		0.83	ft
Curb Throat Type	Horizontal		
Local Depression		4.00	in
Local Depression Width		4.00	ft
Throat Incline Angle		90.00	degrees

Results

Spread		15.39	ft
Depth		0.39	ft
Gutter Depression		0.09	ft
Total Depression		0.42	ft

APPENDIX D: STORM DRAIN CALCULATIONS

Worksheet for Line A-R1

Project Description

Friction Method	Manning Formula
Solve For	Normal Depth

Input Data

Roughness Coefficient	0.013	
Channel Slope	0.01000	ft/ft
Diameter	2.00	ft
Discharge	14.80	ft ³ /s

Results

Normal Depth	1.18	ft
Flow Area	1.93	ft ²
Wetted Perimeter	3.50	ft
Hydraulic Radius	0.55	ft
Top Width	1.97	ft
Critical Depth	1.39	ft
Percent Full	59.0	%
Critical Slope	0.00626	ft/ft
Velocity	7.68	ft/s
Velocity Head	0.92	ft
Specific Energy	2.10	ft
Froude Number	1.37	
Maximum Discharge	24.33	ft ³ /s
Discharge Full	22.62	ft ³ /s
Slope Full	0.00428	ft/ft
Flow Type	SuperCritical	

GVF Input Data

Downstream Depth	0.00	ft
Length	0.00	ft
Number Of Steps	0	

GVF Output Data

Upstream Depth	0.00	ft
Profile Description		
Profile Headloss	0.00	ft
Average End Depth Over Rise	0.00	%
Normal Depth Over Rise	58.98	%
Downstream Velocity	Infinity	ft/s

Worksheet for Line A-R1

GVF Output Data

Upstream Velocity	Infinity	ft/s
Normal Depth	1.18	ft
Critical Depth	1.39	ft
Channel Slope	0.01000	ft/ft
Critical Slope	0.00626	ft/ft

Worksheet for Line A-R2

Project Description

Friction Method	Manning Formula
Solve For	Normal Depth

Input Data

Roughness Coefficient	0.013	
Channel Slope	0.01000	ft/ft
Diameter	2.00	ft
Discharge	14.00	ft ³ /s

Results

Normal Depth	1.14	ft
Flow Area	1.85	ft ²
Wetted Perimeter	3.42	ft
Hydraulic Radius	0.54	ft
Top Width	1.98	ft
Critical Depth	1.35	ft
Percent Full	56.9	%
Critical Slope	0.00605	ft/ft
Velocity	7.58	ft/s
Velocity Head	0.89	ft
Specific Energy	2.03	ft
Froude Number	1.38	
Maximum Discharge	24.33	ft ³ /s
Discharge Full	22.62	ft ³ /s
Slope Full	0.00383	ft/ft
Flow Type	SuperCritical	

GVF Input Data

Downstream Depth	0.00	ft
Length	0.00	ft
Number Of Steps	0	

GVF Output Data

Upstream Depth	0.00	ft
Profile Description		
Profile Headloss	0.00	ft
Average End Depth Over Rise	0.00	%
Normal Depth Over Rise	56.93	%
Downstream Velocity	Infinity	ft/s

Worksheet for Line A-R2

GVF Output Data

Upstream Velocity	Infinity	ft/s
Normal Depth	1.14	ft
Critical Depth	1.35	ft
Channel Slope	0.01000	ft/ft
Critical Slope	0.00605	ft/ft

Worksheet for Line A1-R1

Project Description

Friction Method Manning Formula
Solve For Normal Depth

Input Data

Roughness Coefficient	0.013	
Channel Slope	0.00500	ft/ft
Diameter	2.00	ft
Discharge	8.50	ft ³ /s

Results

Normal Depth	1.04	ft
Flow Area	1.64	ft ²
Wetted Perimeter	3.22	ft
Hydraulic Radius	0.51	ft
Top Width	2.00	ft
Critical Depth	1.04	ft
Percent Full	51.8	%
Critical Slope	0.00496	ft/ft
Velocity	5.17	ft/s
Velocity Head	0.42	ft
Specific Energy	1.45	ft
Froude Number	1.00	
Maximum Discharge	17.21	ft ³ /s
Discharge Full	16.00	ft ³ /s
Slope Full	0.00141	ft/ft
Flow Type	SuperCritical	

GVF Input Data

Downstream Depth	0.00	ft
Length	0.00	ft
Number Of Steps	0	

GVF Output Data

Upstream Depth	0.00	ft
Profile Description		
Profile Headloss	0.00	ft
Average End Depth Over Rise	0.00	%
Normal Depth Over Rise	51.84	%
Downstream Velocity	Infinity	ft/s

Worksheet for Line A1-R1

GVF Output Data

Upstream Velocity	Infinity	ft/s
Normal Depth	1.04	ft
Critical Depth	1.04	ft
Channel Slope	0.00500	ft/ft
Critical Slope	0.00496	ft/ft

Worksheet for Line A1-R2

Project Description

Friction Method	Manning Formula
Solve For	Normal Depth

Input Data

Roughness Coefficient	0.013	
Channel Slope	0.00500	ft/ft
Diameter	1.50	ft
Discharge	4.40	ft ³ /s

Results

Normal Depth	0.83	ft
Flow Area	1.00	ft ²
Wetted Perimeter	2.52	ft
Hydraulic Radius	0.40	ft
Top Width	1.49	ft
Critical Depth	0.80	ft
Percent Full	55.4	%
Critical Slope	0.00555	ft/ft
Velocity	4.38	ft/s
Velocity Head	0.30	ft
Specific Energy	1.13	ft
Froude Number	0.94	
Maximum Discharge	7.99	ft ³ /s
Discharge Full	7.43	ft ³ /s
Slope Full	0.00175	ft/ft
Flow Type	SubCritical	

GVF Input Data

Downstream Depth	0.00	ft
Length	0.00	ft
Number Of Steps	0	

GVF Output Data

Upstream Depth	0.00	ft
Profile Description		
Profile Headloss	0.00	ft
Average End Depth Over Rise	0.00	%
Normal Depth Over Rise	55.39	%
Downstream Velocity	Infinity	ft/s

Worksheet for Line A1-R2

GVF Output Data

Upstream Velocity	Infinity	ft/s
Normal Depth	0.83	ft
Critical Depth	0.80	ft
Channel Slope	0.00500	ft/ft
Critical Slope	0.00555	ft/ft

Worksheet for Line A3

Project Description

Friction Method Manning Formula
Solve For Normal Depth

Input Data

Roughness Coefficient	0.013	
Channel Slope	0.00500	ft/ft
Diameter	2.00	ft
Discharge	8.80	ft ³ /s

Results

Normal Depth	1.06	ft
Flow Area	1.69	ft ²
Wetted Perimeter	3.26	ft
Hydraulic Radius	0.52	ft
Top Width	2.00	ft
Critical Depth	1.06	ft
Percent Full	52.9	%
Critical Slope	0.00501	ft/ft
Velocity	5.21	ft/s
Velocity Head	0.42	ft
Specific Energy	1.48	ft
Froude Number	1.00	
Maximum Discharge	17.21	ft ³ /s
Discharge Full	16.00	ft ³ /s
Slope Full	0.00151	ft/ft
Flow Type	SubCritical	

GVF Input Data

Downstream Depth	0.00	ft
Length	0.00	ft
Number Of Steps	0	

GVF Output Data

Upstream Depth	0.00	ft
Profile Description		
Profile Headloss	0.00	ft
Average End Depth Over Rise	0.00	%
Normal Depth Over Rise	52.93	%
Downstream Velocity	Infinity	ft/s

Worksheet for Line A3

GVF Output Data

Upstream Velocity	Infinity	ft/s
Normal Depth	1.06	ft
Critical Depth	1.06	ft
Channel Slope	0.00500	ft/ft
Critical Slope	0.00501	ft/ft

Worksheet for Line A2

Project Description

Friction Method Manning Formula
Solve For Normal Depth

Input Data

Roughness Coefficient	0.013	
Channel Slope	0.00500	ft/ft
Diameter	1.50	ft
Discharge	4.70	ft ³ /s

Results

Normal Depth	0.87	ft
Flow Area	1.06	ft ²
Wetted Perimeter	2.59	ft
Hydraulic Radius	0.41	ft
Top Width	1.48	ft
Critical Depth	0.83	ft
Percent Full	57.7	%
Critical Slope	0.00566	ft/ft
Velocity	4.45	ft/s
Velocity Head	0.31	ft
Specific Energy	1.17	ft
Froude Number	0.93	
Maximum Discharge	7.99	ft ³ /s
Discharge Full	7.43	ft ³ /s
Slope Full	0.00200	ft/ft
Flow Type	SubCritical	

GVF Input Data

Downstream Depth	0.00	ft
Length	0.00	ft
Number Of Steps	0	

GVF Output Data

Upstream Depth	0.00	ft
Profile Description		
Profile Headloss	0.00	ft
Average End Depth Over Rise	0.00	%
Normal Depth Over Rise	57.73	%
Downstream Velocity	Infinity	ft/s

Worksheet for Line A2

GVF Output Data

Upstream Velocity	Infinity	ft/s
Normal Depth	0.87	ft
Critical Depth	0.83	ft
Channel Slope	0.00500	ft/ft
Critical Slope	0.00566	ft/ft

EXCERPTS

EXCERPT A: WINCHESTER ROAD STORM DRAIN

RIVERSIDE COUNTY FLOOD CONTROL AND WATER CONSERVATION DISTRICT ASSESSMENT DISTRICT NO. 161

GENERAL NOTES

1. THE CONTRACTOR SHALL CONSTRUCT THE FLOOD CONTROL IMPROVEMENTS SHOWN ON THE DRAWINGS IN CONFORMANCE WITH THE REQUIREMENTS OF THE RIVERSIDE COUNTY FLOOD CONTROL AND WATER CONSERVATION DISTRICT'S MEMORANDUM OF UNDERSTANDING STANDARD SPECIFICATIONS DATED SEPTEMBER 1984, AND DESIGN MANUAL STANDARD DRAWINGS DATED MAY 1971.
2. IF AN ENCROACHMENT PERMIT IS REQUIRED FROM RIVERSIDE COUNTY FLOOD CONTROL, THEN CONTACT COEN COUWENBERG AT 714/275-1277. AFTER THE PERMIT IS ISSUED THE DISTRICT MUST BE NOTIFIED ONE WEEK PRIOR TO CONSTRUCTION.
3. CONSTRUCTION INSPECTION WILL BE PERFORMED BY RIVERSIDE COUNTY FLOOD CONTROL. CONTACT LEONARD DUNN AT 714/275-1288. THE DISTRICT MUST BE NOTIFIED TWO WEEKS PRIOR TO CONSTRUCTION.
4. ALL STATIONING REFERS TO CENTERLINE OF CONSTRUCTION UNLESS OTHERWISE NOTED.
5. STATIONING FOR LATERALS AND CONNECTOR PIPE REFER TO THE CENTERLINE-CENTERLINE INTERSECTION STATION.
6. FORTY-EIGHT HOURS BEFORE EXCAVATION, CALL UNDERGROUND SERVICE ALERT 1-800-422-4133.
7. ALL ELEVATIONS SHOWN ARE IN FEET AND DECIMALS THEREOF BASED ON U.S.C. & G.S. DATUM.
8. ALL CROSS SECTIONS ARE TAKEN LOOKING DOWNSTREAM.
9. ELEVATIONS OF UTILITIES ARE APPROXIMATE UNLESS OTHERWISE NOTED.
10. OPENINGS RESULTING FROM THE CUTTING OR PARTIAL REMOVAL OF EXISTING CULVERTS, PIPES OR SIMILAR STRUCTURES TO BE ABANDONED SHALL BE SEALED WITH 6" OF CLASS "B" CONCRETE.
11. PIPE CONNECTED TO THE MAINLINE PIPE SHALL CONFORM TO JUNCTION STRUCTURE NO. 4 (JS 229) UNLESS OTHERWISE NOTED.
12. BEDDING PIPE WITH LESS THAN TWO FEET OF COVER SHALL CONFORM TO LOS ANGELES COUNTY FLOOD CONTROL DISTRICT STANDARD DRAWINGS 2-D213.3 AND 2-D177 FOR CONCRETE BACKFILL IN TRENCHES. ALL OTHER PIPE SHALL CONFORM TO RCFC & WCD STD. DWG. M815.
13. BH-1 INDICATES SOIL BORING LOCATIONS BASED ON THE SOILS REPORT DATED 2/2/90. LOCATIONS SHOWN ARE APPROXIMATE.
14. "H" IS THE DEPTH OF INLET OF CATCH BASINS MEASURED FROM THE TOP OF CURB TO INVERT OF CONNECTOR PIPE.
15. CATCH BASINS SHALL BE LOCATED SO THAT LOCAL DEPRESSION SHALL BEGIN AT EXISTING CURB RETURN JOINT, UNLESS OTHERWISE SPECIFIED.
16. ALL CURBS, GUTTERS, SIDEWALKS, DRIVEWAYS AND OTHER EXISTING IMPROVEMENTS TO BE RECONSTRUCTED IN KIND AND AT THE SAME ELEVATION AND LOCATION AS THE EXISTING IMPROVEMENTS UNLESS OTHERWISE NOTED.
17. FILTER BLANKET MATERIAL SHALL BE 12" THICK AND BE WELL GRADED WITHIN THE LIMITS SPECIFIED BELOW

STONE SIZE IN INCHES	% SMALLER BY WEIGHT
12	100
8	75 - 100
6	60 - 80
4	40 - 60
1	5 - 25
3/8	0 - 10

18. ROCK RIPRAP SHALL CONFORM TO CALTRANS STANDARD SPECIFICATION SECTION 72 METHOD. ROCK SIZE AS PER PLAN.

FILTER FABRIC:
MIRAFI 700X OR EQUIVALENT FILTER BLANKET SHALL BE 12" THICK AND WELL GRADED WITHIN THE LIMITS SPECIFIED.

- NOTES:
- a) ROCK CLASS AND THICKNESS (T)
 - b) FILTER MATERIAL NUMBER OF LAYERS & THICKNESS

INDEX

TITLE SHEET	1
MAINLINE PLAN & PROFILE	2-6
CONNECTOR PIPE PROFILE	7
DETAIL SHEET	8

R.C.F.C.D. STANDARD DRAWINGS

CB 100	CATCH BASIN NO. 1
LD 201	LOCAL DEPRESSION NO.2
MH 252	MANHOLE NO. 2
JS 227	JUNCTION STRUCTURE NO. 2
JS 229	JUNCTION STRUCTURE NO. 4
M 803	CONCRETE COLLAR
MH 251	MANHOLE NO. 1

CALTRANS STANDARD DRAWINGS

D86B	PIPE CULVERT HEADWALL
------	-----------------------

BENCHMARK DESCRIPTION

ELEVATION 4091.074 DATE: 9-13-82
RIVERSIDE COUNTY DESIGNATION: T-46-81 STAMPED ON 2 & 1/2" BRASS DISK IN CONCRETE WALL FROM THE INTERSECTION OF RANCHO CALIFORNIA ROAD AND FRONT STREET, 1.7 MILES NORTHWEST ON FRONT STREET-JEFFERSON AVENUE TO THE INTERSECTION OF JEFFERSON AND WINCHESTER (HWY. 79), 2.0 MILES NORTHEAST ON WINCHESTER ROAD (HWY. 79), TO A BRIDGE OVER THE TUCALOTA CREEK AND THE SANTA GERTRUDIS CREEKFORK. IN THE SOUTHEAST WINGWALL, 6 FEET SOUTHEAST OF CORNER OF BRIDGE ABUTMENT 3 FEET EAST OF STEEL GUARDRAIL, 19 FEET NORTH OF TELEPHONE SERVICE BOX.

NOTICE

THE CONTRACTOR SHALL NOTIFY THE COUNTY (OR DISTRICT, AS APPROPRIATE) IN WRITING A MINIMUM OF TWO WEEKS BEFORE BEGINNING CONSTRUCTION, AND SHALL NOT BEGIN CONSTRUCTION BEFORE OBTAINING AUTHORIZATION TO PROCEED.

UNDERGROUND STRUCTURES

ALL UNDERGROUND UTILITIES OR STRUCTURES REPORTED BY THE OWNER OR OTHERS AND THOSE SHOWN ON THE RECORDS EXAMINED ARE INDICATED WITH THEIR APPROXIMATE LOCATION AND EXTENT. THE OWNER BY ACCEPTING THESE PLANS OR PROCEEDING WITH IMPROVEMENTS PURSUANT THERETO AGREES TO ASSUME LIABILITY AND TO HOLD UNDERSIGNED HARMLESS FOR ANY DAMAGES RESULTING FROM THE EXISTENCE OF UNDERGROUND UTILITIES OR STRUCTURES NOT REPORTED TO THE UNDERSIGNED; NOT INDICATED ON THE PUBLIC RECORDS EXAMINED; LOCATED AT VARIANCE WITH THAT REPORTED OR SHOWN ON RECORDS EXAMINED. THE CONTRACTOR IS REQUIRED TO TAKE DUE PRECAUTIONARY MEASURES TO PROTECT THE UTILITIES OR STRUCTURES SHOWN AND ANY OTHER UTILITIES OR STRUCTURES FOUND AT THE SITE. IT SHALL BE THE CONTRACTOR'S RESPONSIBILITY TO NOTIFY THE OWNERS OF THE UTILITIES OR STRUCTURES CONCERNED BEFORE STARTING WORK.

UNAUTHORIZED CHANGES & USES

CAUTION: THE ENGINEER PREPARING THESE PLANS WILL NOT BE RESPONSIBLE FOR, OR LIABLE FOR, UNAUTHORIZED CHANGES TO OR USES OF THESE PLANS. ALL CHANGES TO THE PLANS MUST BE IN WRITING AND MUST BE APPROVED BY THE PREPARER OF THESE PLANS.

AS BUILT

APPROVED BY: *[Signature]*
DATE: 5-8-95

CALIFORNIA COUNCIL OF CIVIL ENGINEERS & LAND SURVEYORS

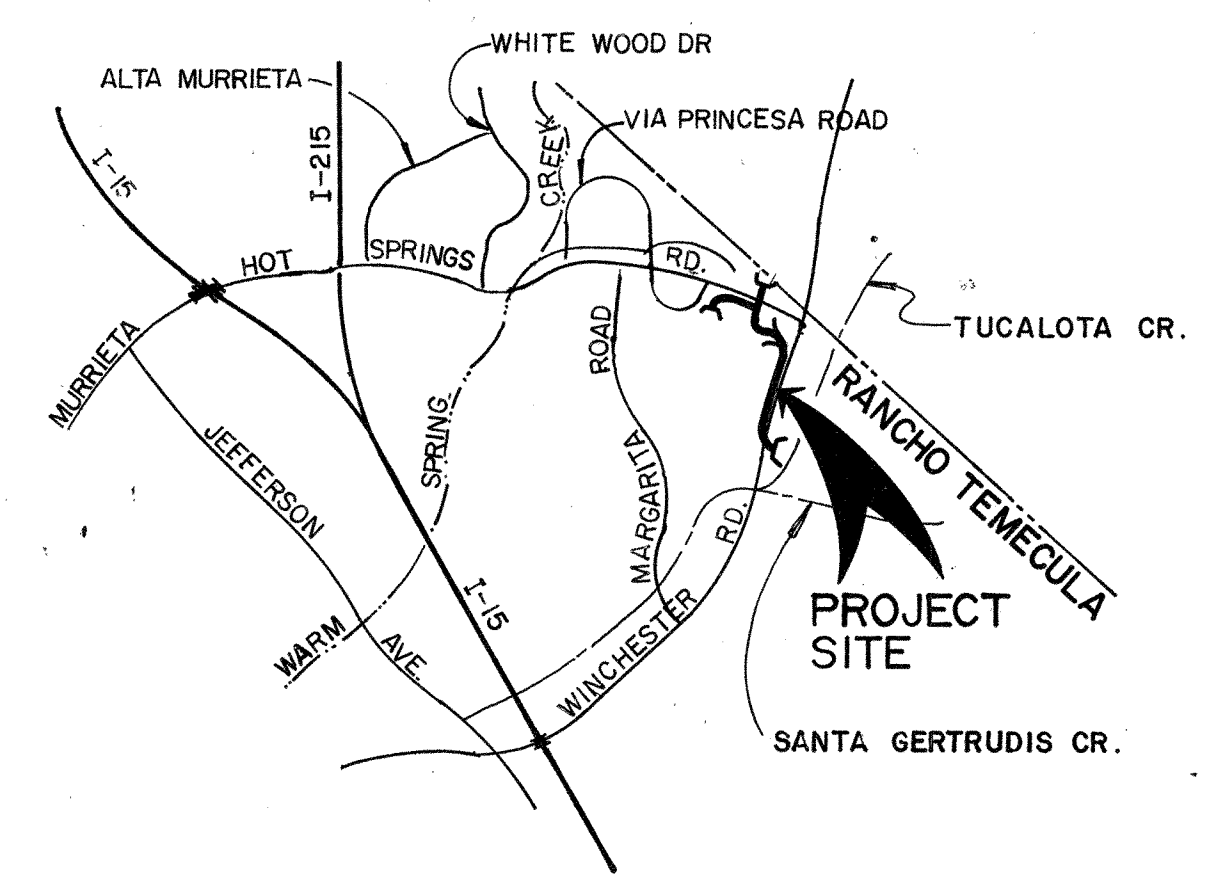
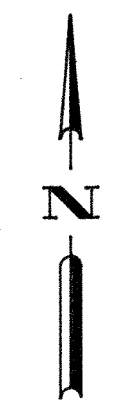

VICINITY MAP

NOT TO SCALE

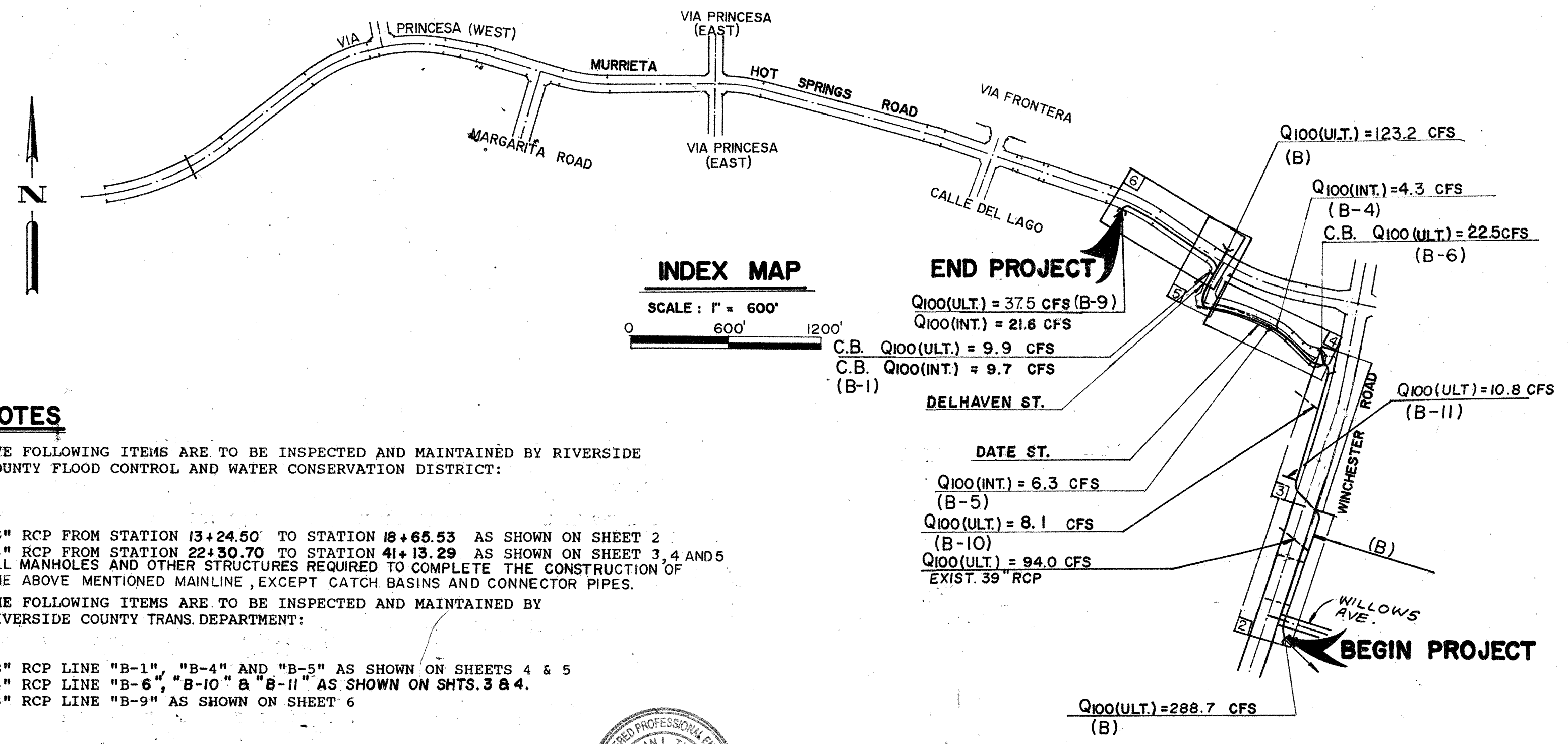

INDEX MAP

SCALE: 1" = 600'
0 600' 1200'

NOTES

THE FOLLOWING ITEMS ARE TO BE INSPECTED AND MAINTAINED BY RIVERSIDE COUNTY FLOOD CONTROL AND WATER CONSERVATION DISTRICT:

66" RCP FROM STATION 13+24.50 TO STATION 19+65.53 AS SHOWN ON SHEET 2
54" RCP FROM STATION 22+30.70 TO STATION 41+13.29 AS SHOWN ON SHEETS 3, 4 AND 5
ALL MANHOLES AND OTHER STRUCTURES REQUIRED TO COMPLETE THE CONSTRUCTION OF THE ABOVE MENTIONED MAINLINE, EXCEPT CATCH BASINS AND CONNECTOR PIPES.

THE FOLLOWING ITEMS ARE TO BE INSPECTED AND MAINTAINED BY RIVERSIDE COUNTY TRANS. DEPARTMENT:

18" RCP LINE "B-1", "B-4" AND "B-5" AS SHOWN ON SHEETS 4 & 5
24" RCP LINE "B-6", "B-10" & "B-11" AS SHOWN ON SHTS. 3 & 4.
33" RCP LINE "B-9" AS SHOWN ON SHEET 6

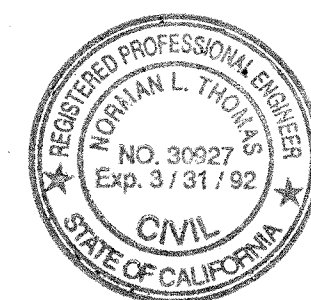

RANPAC ENGINEERING CORP.
27447 Enterprise Circle West
Temecula, California 92390
Tel. (714) 676-7000

SUBMITTED BY: *[Signature]*
REGISTERED CIVIL ENGINEER NO. 30927
EXP. 3/31/96

DATE: 4/11/91

BENCH MARK:
SEE ABOVE RIGHT

REVISIONS	DESCRIPTION	DATE

RIVERSIDE COUNTY FLOOD CONTROL
AND
WATER CONSERVATION DISTRICT

RECOMMENDED FOR APPROVAL BY: *[Signature]*
PLANNING ENGINEER

APPROVED BY: *[Signature]*
CHIEF ENGINEER

DATE: 6/29/94

County of Riverside

APPROVED BY: *[Signature]*

FOR TRANS. DEPT.
RIVERSIDE COUNTY, CALIF. DATE: 4/11/91

ASSESSMENT DISTRICT NO. 161

WINCHESTER RD. STORM DRAIN

TITLE SHEET

PROJECT NO.
7-0-184

DRAWING NO.
7-152

SHEET NO.
1 OF 8

DESIGNED BY: E.R.S.
DRAWN BY: R.L.
CHECKED BY: CHUCK

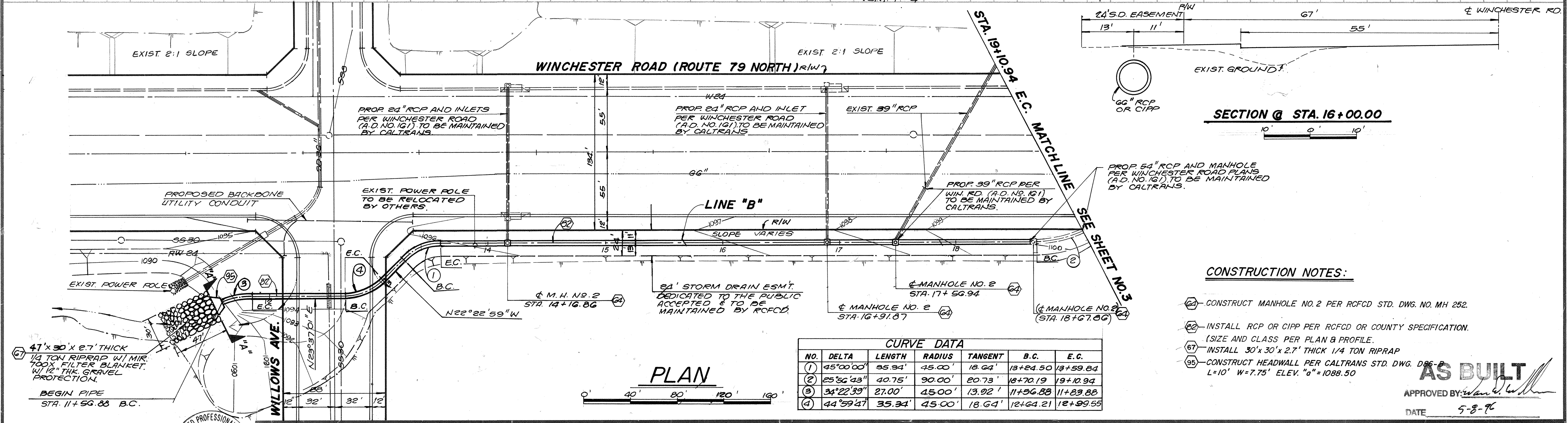
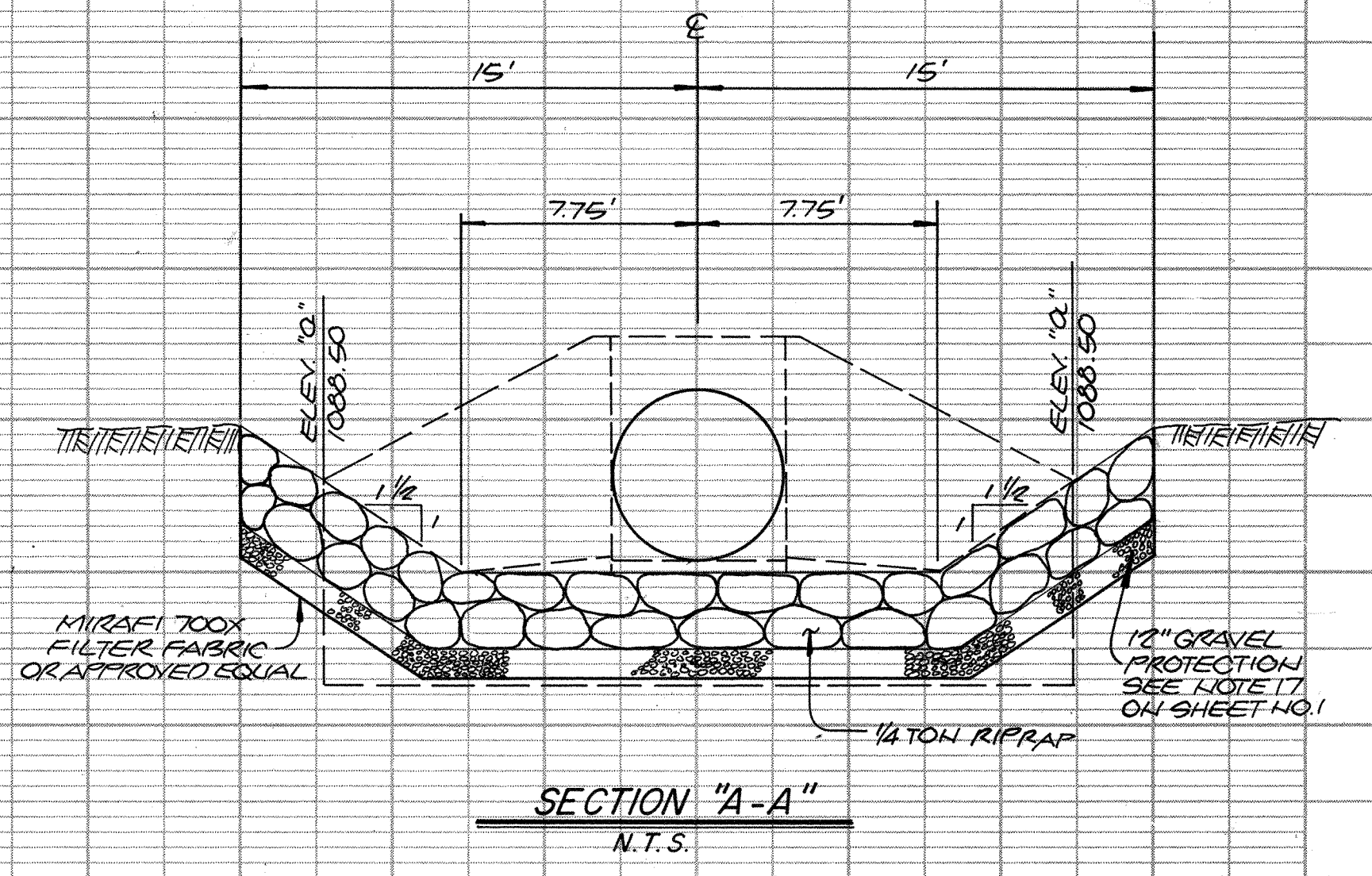
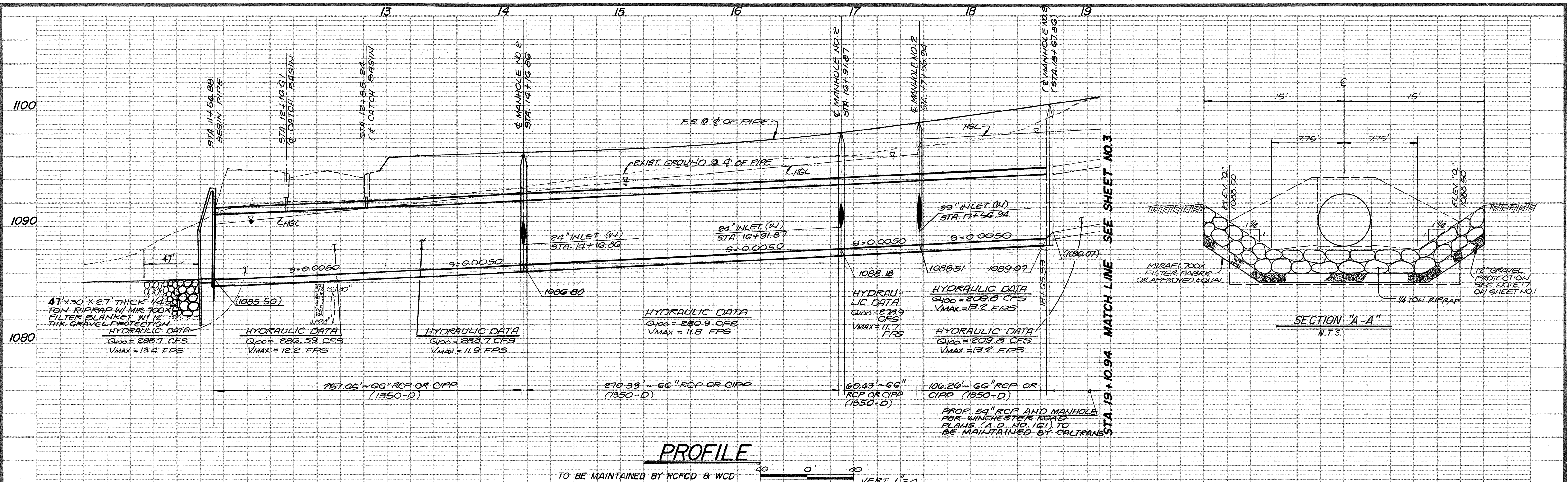

RANPAC ENGINEERING CORP.
27447 Enterprise Circle West
Temecula, California 92390
Tel. (909) 676-7000

SUBMITTED BY: *Charles A. Collins*
REGISTERED CIVIL ENGINEER NO. 32490
EXP. 9/30/95

BENCH MARK: SEE SHEET NO. 1

NO.	REVISIONS	DATE	DESCRIPTION

RIVERSIDE COUNTY FLOOD CONTROL AND WATER CONSERVATION DISTRICT

RECOMMENDED FOR APPROVAL BY: *Frank J. Hail*
PLANNING ENGINEERING
DATE: 6/29/94

APPROVED BY: *Samuel J. Edwards*
CHIEF ENGINEER
DATE: 7-5-94

County of Riverside

APPROVED BY: *John T. Rungate*
FOR TRANS. DEPT. RIVERSIDE COUNTY, CALIF. DATE: 2/8/94

ASSESSMENT DISTRICT NO. 161
WINCHESTER ROAD STORM DRAIN
STA. 13+24.50 TO STA. 19+10.94

PROJECT NO. 7-0-184
DRAWING NO. 7-152
SHEET NO. 2 OF 8

AS BUILT
APPROVED BY: *John T. Rungate*
DATE: 5-8-96

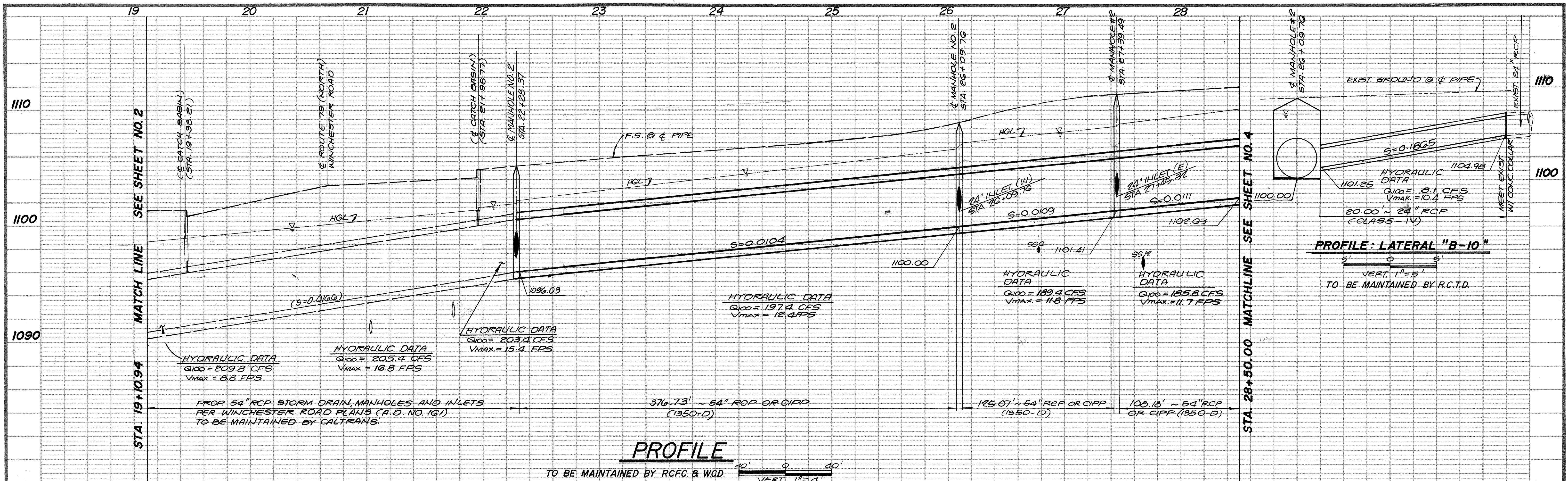

CURVE DATA

NO.	DELTA	LENGTH	RADIUS	TANGENT	B.C.	E.C.
1	07°12'08"	304.45'	2422'	157.42'	23+02.98	26+07.43
2	02°57'31"	125.07'	2422'	07.55'	26+12.09	27+37.10
3	01°03'52"	45.00'	2422'	22.50'	27+41.82	27+86.82
4	22°58'29"	36.09'	90.00'	18.09'	22+30.70	22+66.79
5	70°22'49"	92.13'	75.00'	52.89'	27+80.82	28+72.95

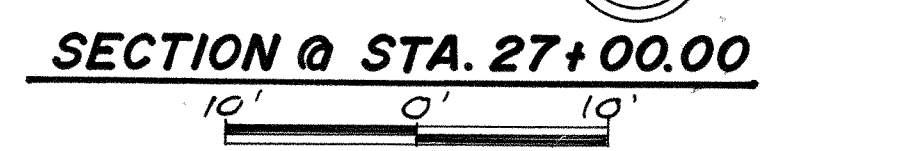
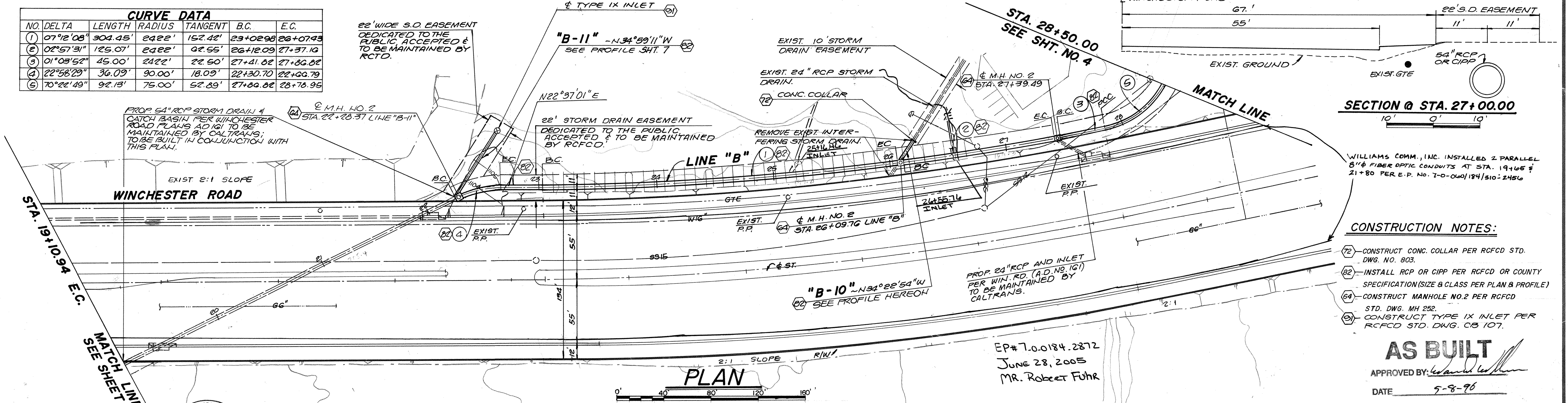

- CONSTRUCTION NOTES:**
- (72) CONSTRUCT CONC. COLLAR PER RCFCO STD. DWG. NO. 803.
 - (82) INSTALL RCP OR CIPP PER RCFCO OR COUNTY SPECIFICATION (SIZE & CLASS PER PLAN & PROFILE)
 - (64) CONSTRUCT MANHOLE NO.2 PER RCFCO STD. DWG. MH 252.
 - (80) CONSTRUCT TYPE IX INLET PER RCFCO STD. DWG. CB 107.

AS BUILT
 APPROVED BY: *[Signature]*
 DATE: 5-8-96

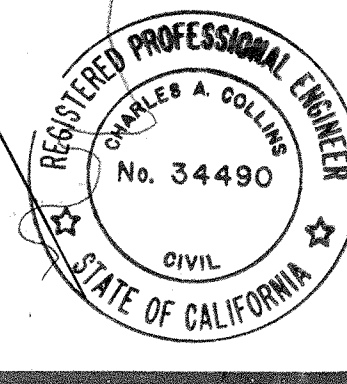

RANPAC ENGINEERING CORP.
 27447 Enterprise Circle West
 Temecula, California 92390
 Tel. (909) 676-7000

SUBMITTED BY: *[Signature]*
 REGISTERED CIVIL ENGINEER NO. 34490
 DATE: 3/31/92 EXP. 9/30/95

BENCH MARK: SEE SHEET NO. 1

NO.	REVISIONS	DATE	DESCRIPTION	APPR. DATE

RIVERSIDE COUNTY FLOOD CONTROL AND WATER CONSERVATION DISTRICT

RECOMMENDED FOR APPROVAL BY: *[Signature]*
 PLANNING ENGINEER
 DATE: 6/29/94

APPROVED BY: *[Signature]*
 CHIEF ENGINEER
 DATE: 7-5-94

County of Riverside

APPROVED BY: *[Signature]*
 FOR TRANS. DEPT. RIVERSIDE COUNTY, CALIF. DATE: 3/8/94

ASSESSMENT DISTRICT NO. 161
 WINCHESTER ROAD STORM DRAIN
 STA. 19+10.94 TO STA. 28+50.00

PROJECT NO. 7-0-184
 DRAWING NO. 7-152
 SHEET NO. 3 OF 8

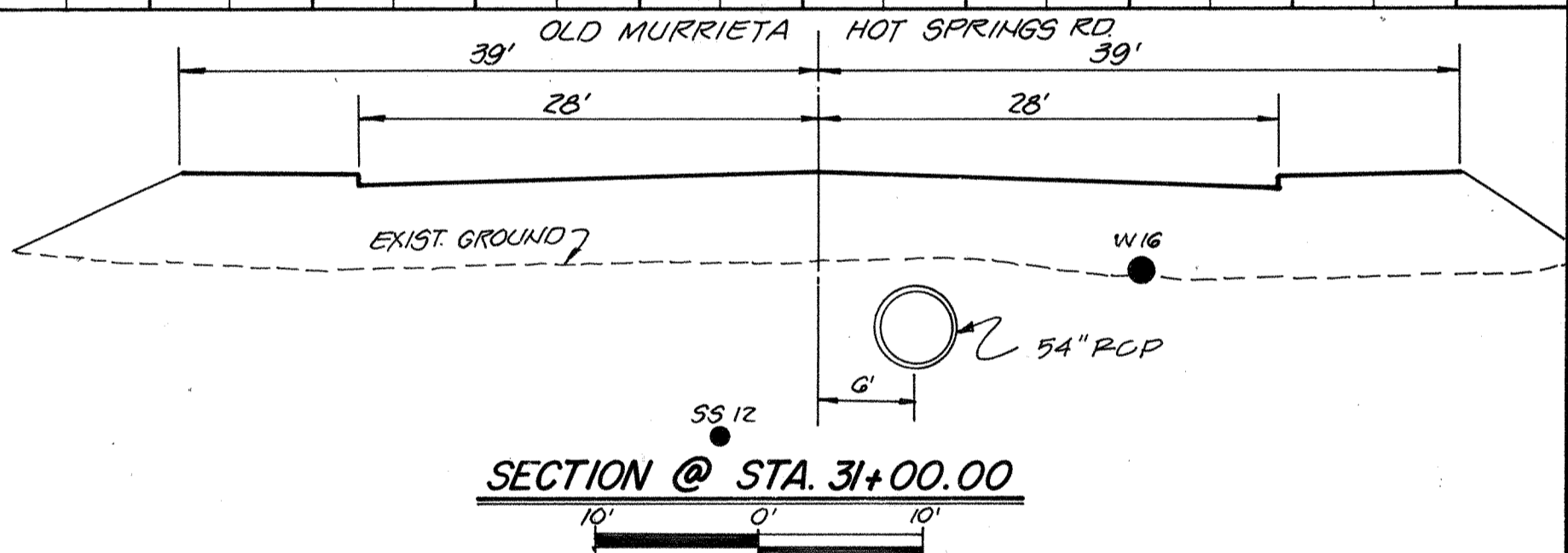
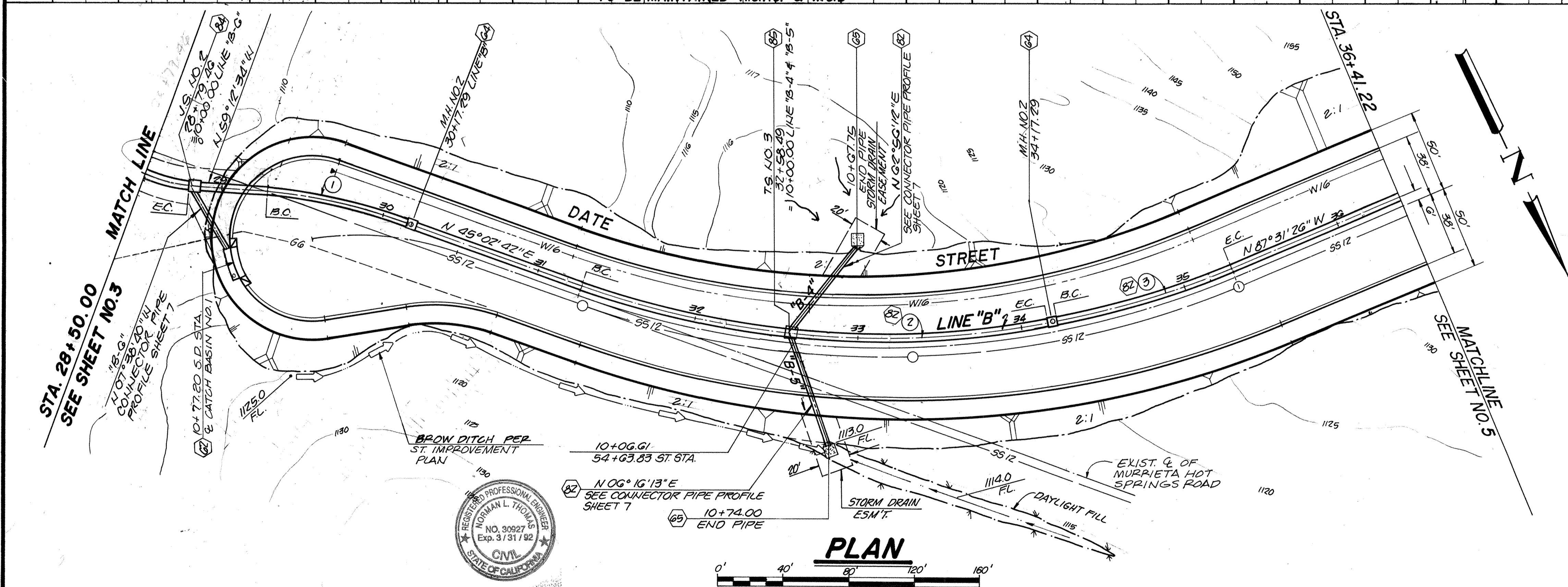
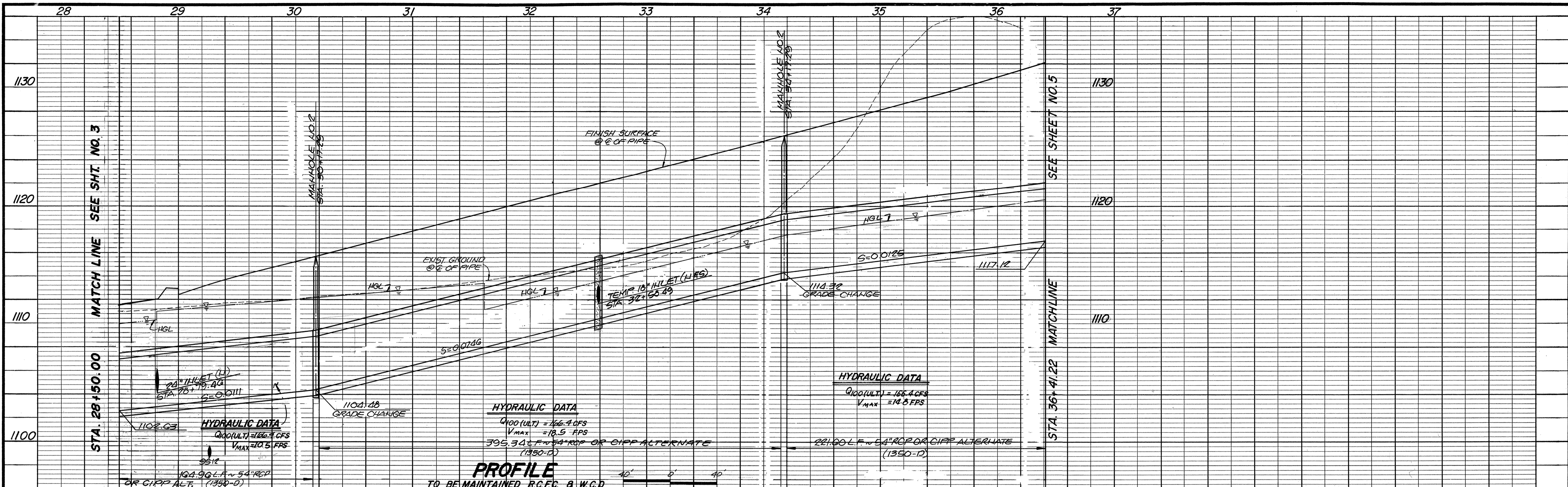

CURVE DATA

NO.	DELTA	RADIUS	LENGTH	TANGENT	B.C.	E.C.
①	14°09'52"	350'	88.00'	44.23'	29+26.96	30+14.96
②	30°17'27"	544'	287.60'	147.25'	31+27.36	34+14.96
③	11°41'50"	544'	111.06'	55.72'	34+19.62	35+20.68
④						
⑤						
⑥						

- CONSTRUCTION NOTES**
- ⑥2 CONSTRUCT CATCH BASIN NO. 1 LOCAL DEPRESSION NO. 2 CASE "C" PER RCPCD STD. DWG. NO. CB. 100 & LD 201 (W=21' & V=8.29')
 - ⑥4 CONSTRUCT MANHOLE NO. 2 PER RCPCD STD. DWG. M.H. 252
 - ⑥5 CONSTRUCT TEMPORARY INLET APRON SEE DETAIL ON SHEET NO. 8
 - ⑥2 INSTALL REINFORCED CONCRETE PIPE PER RCPCD OR COUNTY SPECIFICATIONS
 - ⑥4 CONSTRUCT JUNCTION STRUCTURE NO. 2 PER RCPCD ST. J.S. 227 SEE DET. ON SHEET NO. 8
 - ⑥5 CONSTRUCT TRANSITION STRUCTURE NO. 3 PER RCPCD STD. DWG. NO. TS 303

AS BUILT

APPROVED BY: *[Signature]*

DATE: 5-8-96



RANPAC ENGINEERING CORP.
 27447 Enterprise Circle West
 Temecula, California 92390
 Tel. (714) 676-7000

SUBMITTED BY: *[Signature]*
 REGISTERED CIVIL ENGINEER NO. 30927
 EXP. 3/31/90

DATE: 4/11/91

BENCH MARK: SEE SHEET NO. 1

NO.	DESCRIPTION	DATE

RIVERSIDE COUNTY FLOOD CONTROL AND WATER CONSERVATION DISTRICT

RECOMMENDED FOR APPROVAL BY: *[Signature]*
 PLANNING ENGINEERING
 DATE: 6/27/91

APPROVED BY: *[Signature]*
 CHIEF ENGINEER
 DATE: 2-5-94

County of Riverside

APPROVED BY: *[Signature]*
 FOR TRANS. DEPT. RIVERSIDE COUNTY, CALIF. DATE: 4/24/91

ASSESSMENT DISTRICT NO. 161

WINCHESTER RD. STORM DRAIN

STA. 28+50.00 TO STA. 36+41.22
 (DATE STREET)

PROJECT NO. 7-0-184

DRAWING NO. 7-152

SHEET NO. 4 OF 8

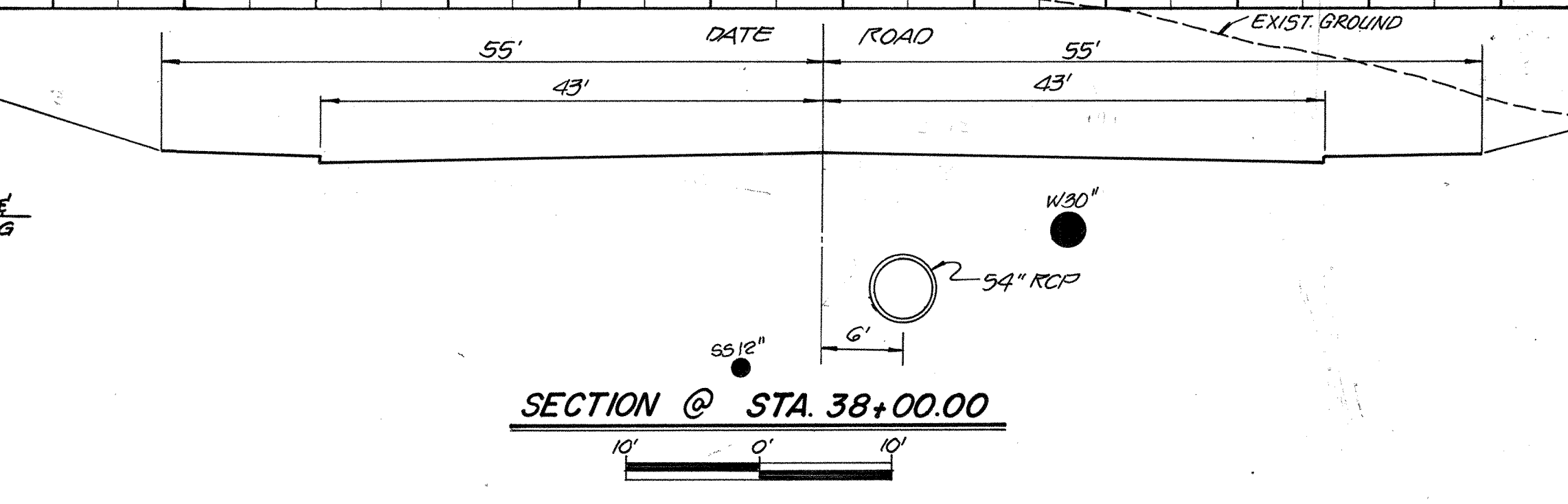
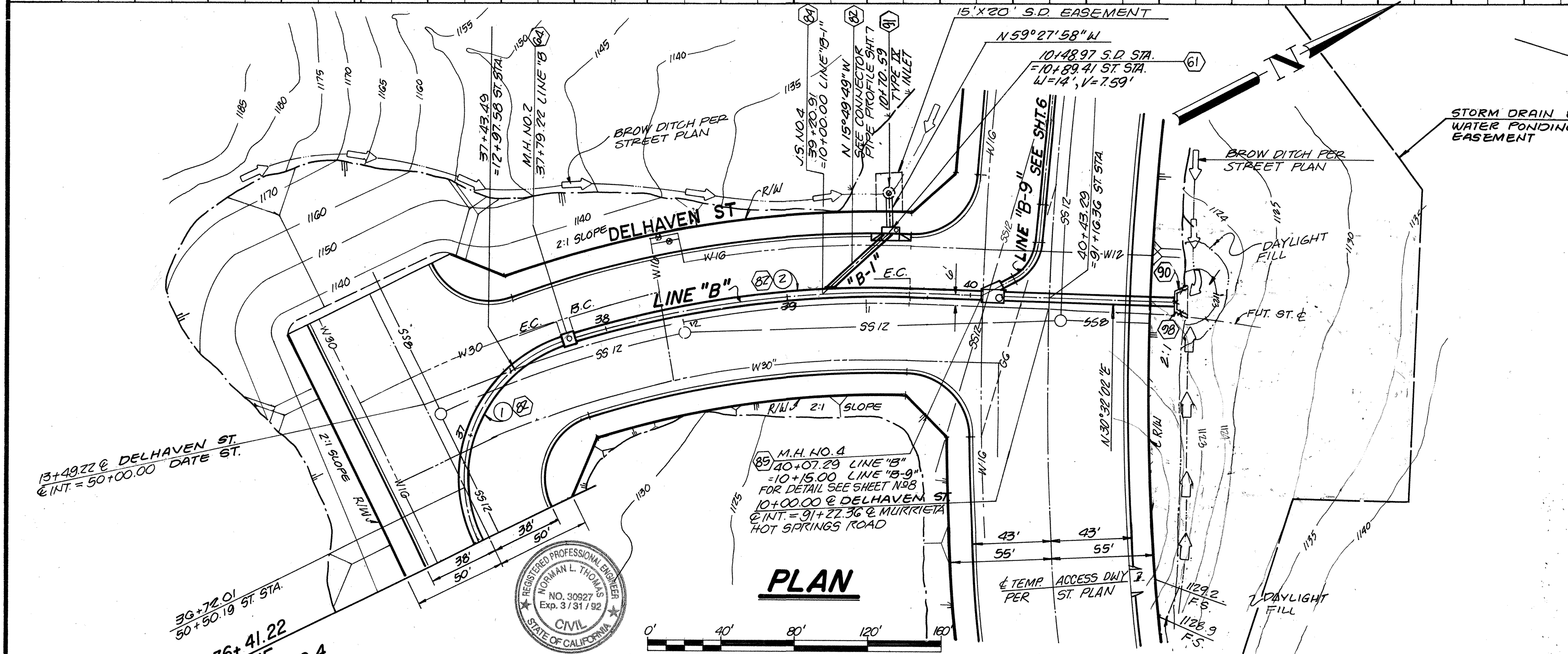
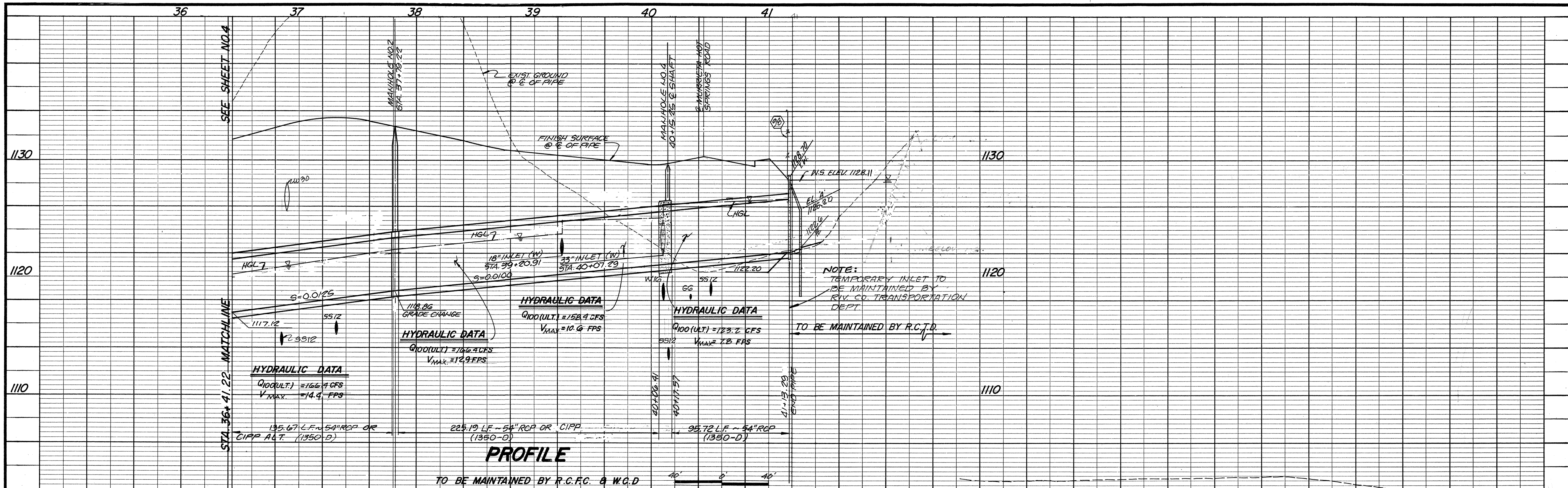

CURVE DATA						
NO.	DELTA	RADIUS	LENGTH	TANGENT	B.C.	E.C.
①	33° 23' 47"	79.00'	135.67'	91.52'	36+41.22	37+76.89
②	19° 10' 52"	556'	186.13'	93.95'	37+81.55	39+07.68

- CONSTRUCTION NOTES**
- ⑥1 CONSTRUCT MOD. CATCH BASIN NO. 1 LOCAL DEPRESSION NO. 2 CASE "C" PER RCPCD STD. DWG. NO. CB. 100 & LD 201
 - ⑥4 CONSTRUCT MANHOLE NO. 2 PER RCPCD STD. DWG. M.H. 252
 - ⑥2 INSTALL REINFORCED CONCRETE PIPE PER RCPCD OR COUNTY SPECIFICATIONS:
 - ⑥84 CONSTRUCT JUNCTION STRUCTURE NO. 4 PER RCPCD STD. J.S. 229
 - ⑥85 CONSTRUCT MANHOLE NO. 4 PER RCPCD STD. M.H. 254 (SEE DET. ON SHT. 8)
 - ⑨0 CONSTRUCT PIPE CULVERT HEADWALL PER CALTRANS STD. PLANS D-86-B (W=5.5', L=7', ELEV "A" = 1125.20)
 - ⑨8 CONSTRUCT FENCE PER RCPCD & WCD STD. DWG. NO. M 801. (6' HIGH)
 - ⑨1 CONSTRUCT TYPE IX INLET PER R.C.F.C.D. STD. DWG. CB-107.
 - ⑨9 INSTALL 14" CHAIN LINK DOUBLE GATE PER RCPCD & WCD STD. DWG. NO. 801.
 - ⑨6 CONSTRUCT 3" GRANITE SLOPE PROTECTION (AIR-PLACED) WITH 8" x 8" 10' 10' GAGE W.W.F. REINFORCEMENT.

AS BUILT
 APPROVED BY: *[Signature]*
 DATE: 5-8-96

STA. 36+41.22
 MATCHLINE
 SEE SHEET NO. 4

RANPAC ENGINEERING CORP.
 27447 Enterprise Circle West
 Temecula, California 92390
 Tel. (714) 676-7000

SUBMITTED BY: *[Signature]*
 REGISTERED CIVIL ENGINEER NO. 30927
 EXP. 3/31/96

DATE: 4/11/91

BENCH MARK:
 SEE SHEET NO. 1

REF.	DESCRIPTION	APPR. DATE

RIVERSIDE COUNTY FLOOD CONTROL AND WATER CONSERVATION DISTRICT

RECOMMENDED FOR APPROVAL BY: *[Signature]*
 PLANNING ENGINEERING
 DATE: 6/29/94

APPROVED BY: *[Signature]*
 CHIEF ENGINEER
 DATE: 7-5-94

County of Riverside

APPROVED BY: *[Signature]*
 FOR TRANS. DEPT. RIVERSIDE COUNTY, CALIF. DATE: 4/26/91

PROJECT NO. 7-0-184
 DRAWING NO. 7-152
 SHEET NO. 5 OF 8

ASSESSMENT DISTRICT NO. 161
 WINCHESTER RD. STORM DRAIN
 STA. 36+23.93 TO STA. 40+96.00
 (DELHAVEN ST.)

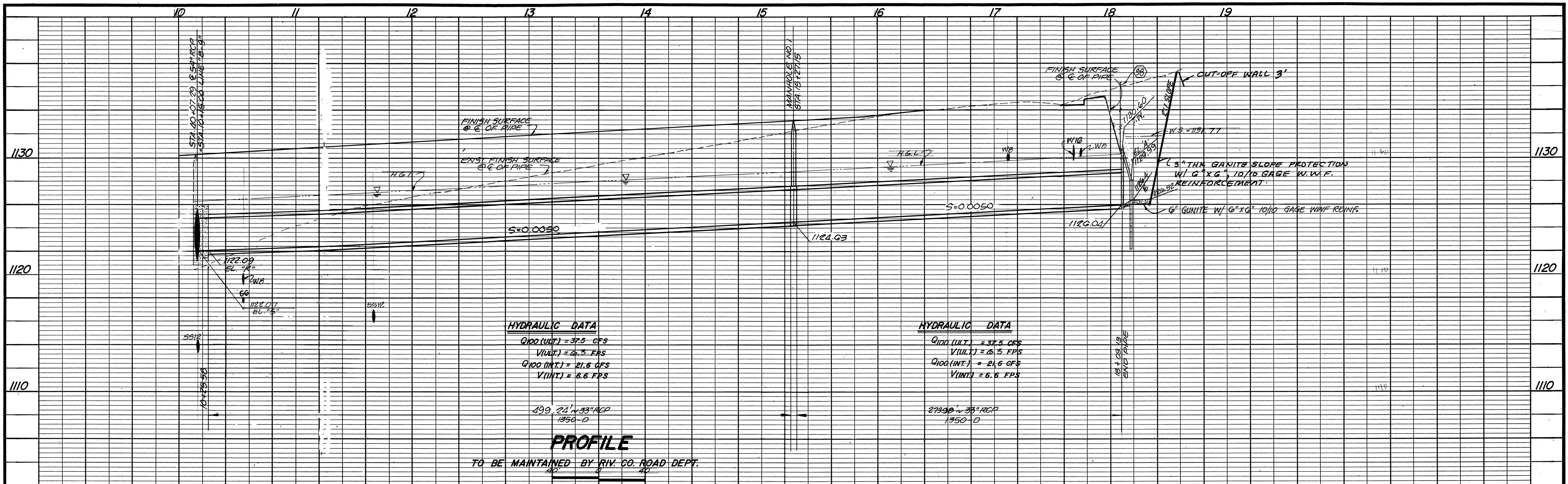

HYDRAULIC DATA
 Q100 (INT.) = 37.5 CFS
 V (ULT.) = 6.5 FPS
 Q100 (INT.) = 21.6 CFS
 V (INT.) = 6.6 FPS

199.21' 33" RCP
 1350-D

PROFILE
 TO BE MAINTAINED BY RIV. CO. ROAD DEPT.

HYDRAULIC DATA
 Q100 (INT.) = 37.5 CFS
 V (ULT.) = 6.5 FPS
 Q100 (INT.) = 21.6 CFS
 V (INT.) = 6.6 FPS

279.95' 33" RCP
 1350-D

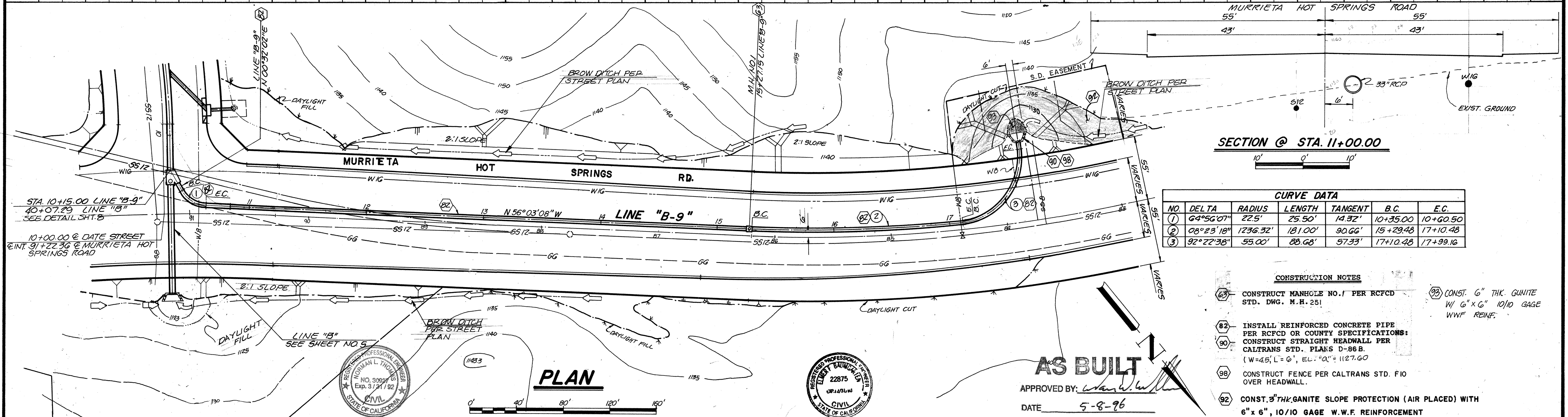

CURVE DATA

NO.	DELTA	RADIUS	LENGTH	TANGENT	B.C.	E.C.
1	64°56'07"	22.5'	25.50'	14.32'	10+35.00	10+60.50
2	08°23'18"	1236.32'	181.00'	90.66'	15+29.48	17+10.48
3	92°22'38"	55.00'	88.68'	57.33'	17+10.48	17+99.16

- CONSTRUCTION NOTES**
- 81 CONSTRUCT MANHOLE NO. 1 PER RCFC D. STD. DWG. H.H. 251
 - 82 INSTALL REINFORCED CONCRETE PIPE PER RCFC OR COUNTY SPECIFICATIONS; CONSTRUCT STRAIGHT HEADWALL PER CALTRANS STD. PLANS D-86 B. (W=4.5', L=6', EL. "A" = 1127.60)
 - 83 CONSTRUCT FENCE PER CALTRANS STD. F10 OVER HEADWALL.
 - 84 CONST. 3" THK. GUNITE SLOPE PROTECTION (AIR PLACED) WITH 6" x 6", 10/10 GAGE W.W.F. REINFORCEMENT
 - 85 CONST. 6" THK. GUNITE W/ 6" x 6" 10/10 GAGE W.W.F. REINF.

AS BUILT
 APPROVED BY: *[Signature]*
 DATE: 5-8-96

RANPAC ENGINEERING CORP. 27447 Enterprise Circle West Temecula, California 92390 Tel. (714) 676-7000 SUBMITTED BY: <i>[Signature]</i> REGISTERED CIVIL ENGINEER NO. 30927 EXP. 3/31/96 DATE: 4/11/91	BENCH MARK: SEE SHEET NO. 1	REVISIONS <table border="1"> <tr> <th>NO.</th> <th>DESCRIPTION</th> <th>DATE</th> </tr> <tr> <td> </td> <td> </td> <td> </td> </tr> </table>		NO.	DESCRIPTION	DATE				RIVERSIDE COUNTY FLOOD CONTROL AND WATER CONSERVATION DISTRICT RECOMMENDED FOR APPROVAL BY: <i>[Signature]</i> APPROVED BY: <i>[Signature]</i> PLANNING ENGINEER DATE: <i>[Date]</i> CHIEF ENGINEER DATE: <i>[Date]</i>	County of Riverside APPROVED BY: <i>[Signature]</i> FOR TRANS. DEPT. RIVERSIDE COUNTY, CALIF. DATE: 4/24/91	PROJECT NO. 7-0-184 DRAWING NO. 7-152 SHEET NO. 6 OF 8
		NO.	DESCRIPTION	DATE								
ASSESSMENT DISTRICT NO. 161 STORM DRAIN PLANS WINCHESTER RD. STORM DRAIN STA. 10+00.00 TO STA. 18+21.13 (MURRIETA HOT SPRINGS ROAD)												

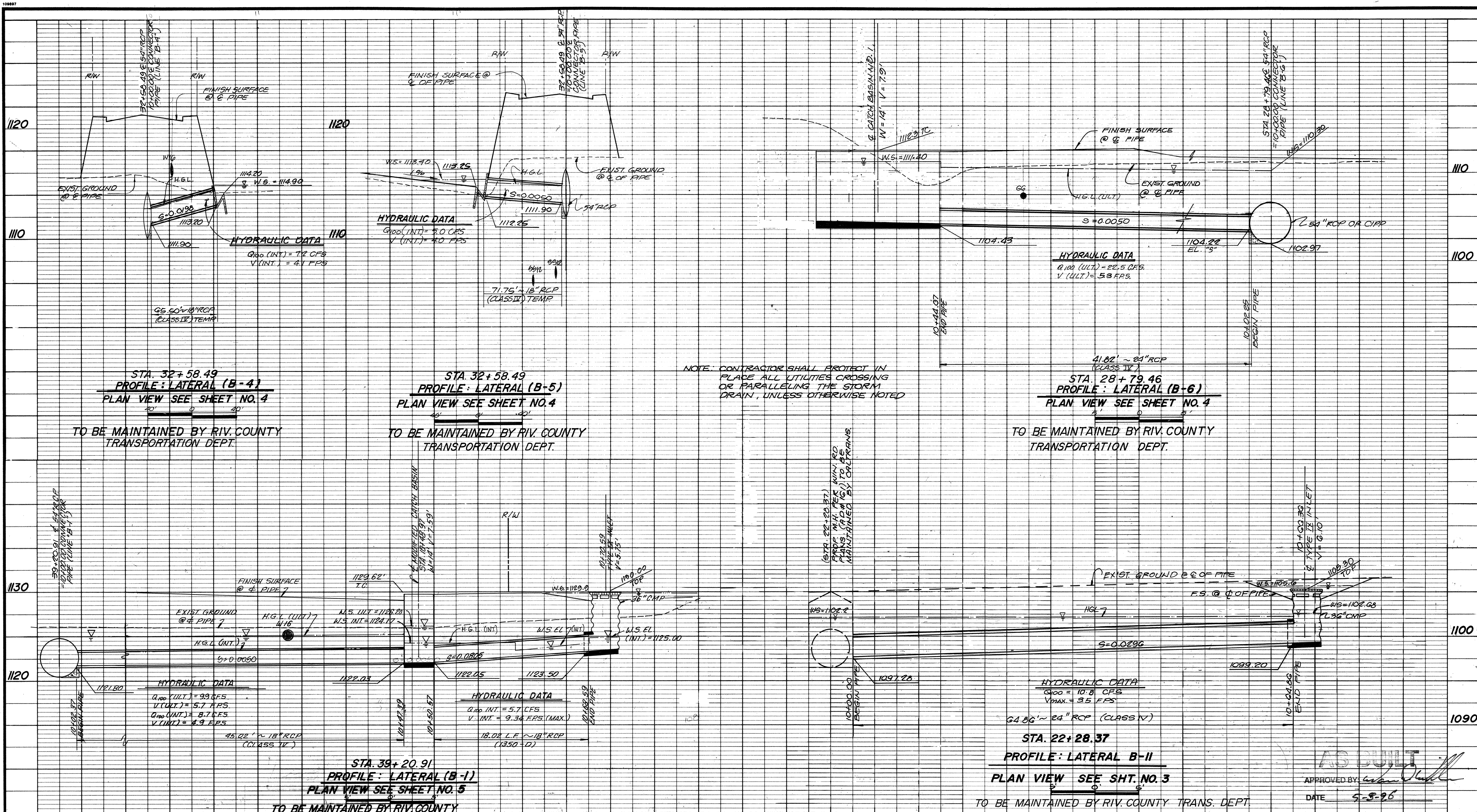

NOTE: CONTRACTOR SHALL PROTECT IN PLACE ALL UTILITIES CROSSING OR PARALLELING THE STORM DRAIN, UNLESS OTHERWISE NOTED

AS BUILT
 APPROVED BY: *[Signature]*
 DATE: 5-8-96

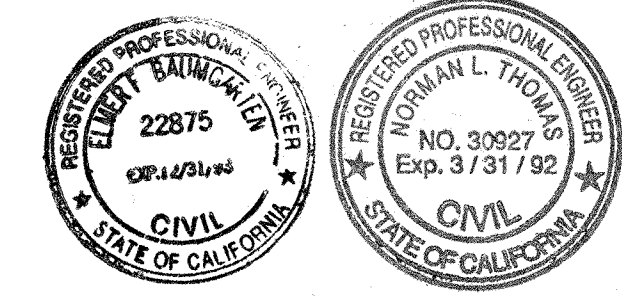

RANPAC ENGINEERING CORP.
 27447 Enterprise Circle West
 Temecula, California 92590
 Tel: (714) 676-7000

SUBMITTED BY: *[Signature]*
 REGISTERED CIVIL ENGINEER NO. 30927
 EXP. 3/31/96

DATE: 4/1/91

BENCH MARK:
 SEE SHEET NO. 1

REF.	DESCRIPTION	APPR DATE

RIVERSIDE COUNTY FLOOD CONTROL AND WATER CONSERVATION DISTRICT

RECOMMENDED FOR APPROVAL BY: _____
 PLANNING ENGINEERING DATE: _____

APPROVED BY: _____
 CHIEF ENGINEER DATE: _____

County of Riverside

APPROVED BY: *[Signature]*
 FOR TRANS. DEPT. RIVERSIDE COUNTY, CALIF. DATE: 4/21/91

ASSESSMENT DISTRICT NO. 161
WINCHESTER RD. STORM DRAIN
 CONNECTOR PIPE PROFILES

PROJECT NO. 7-0-184
 DRAWING NO. 7-152
 SHEET NO. 7 OF 8

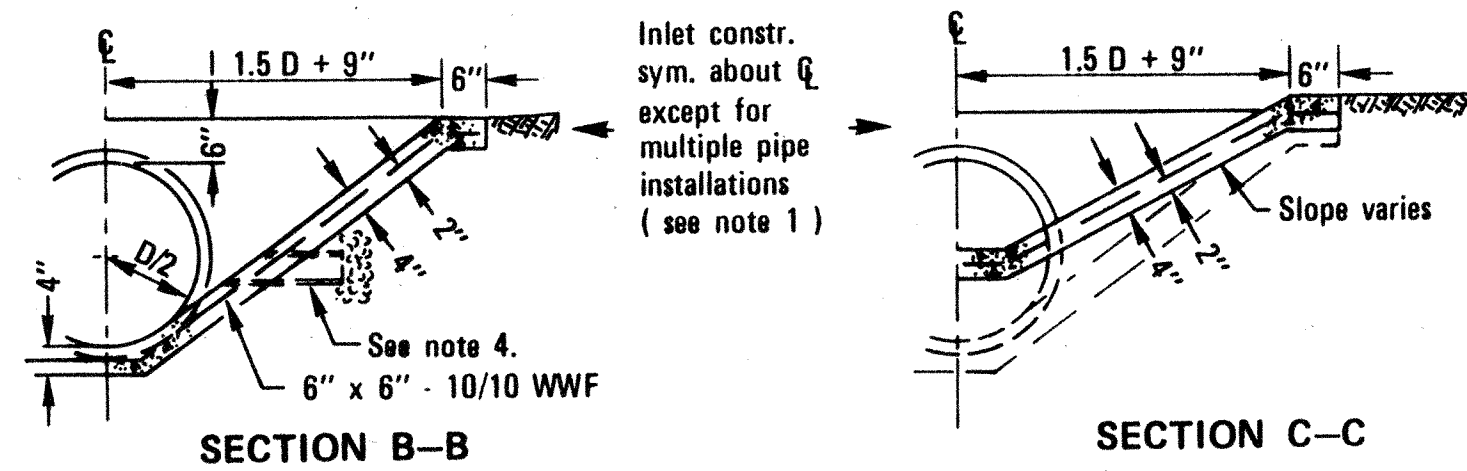
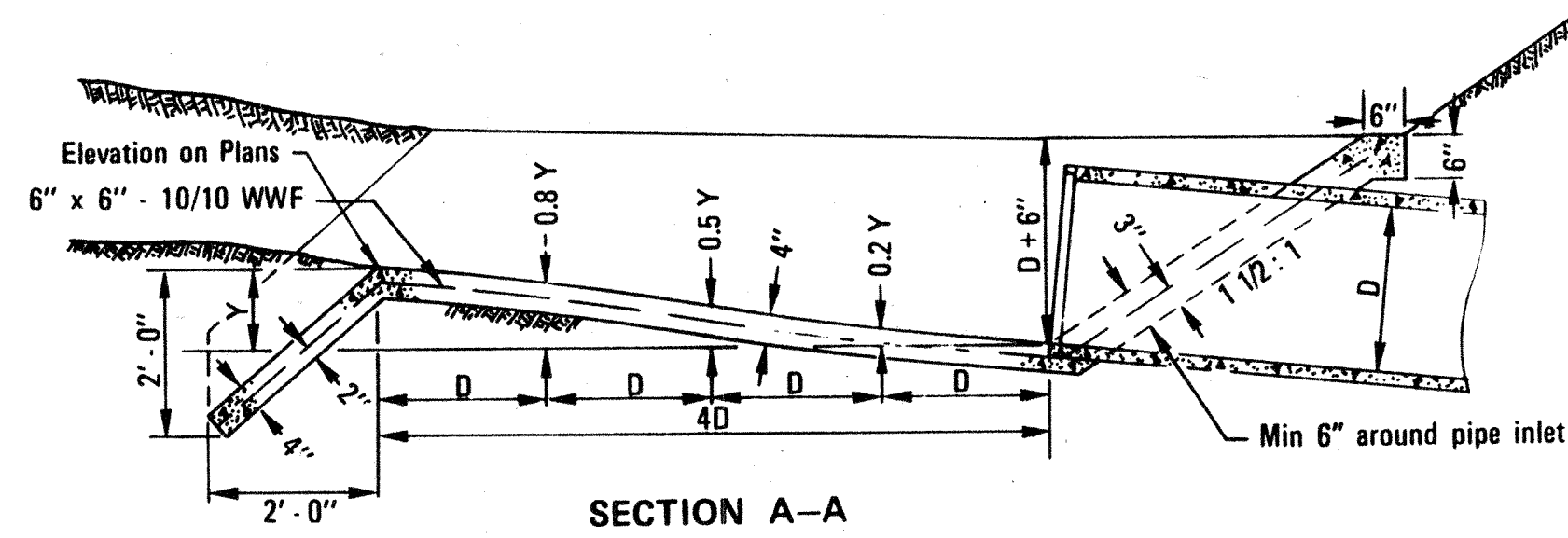
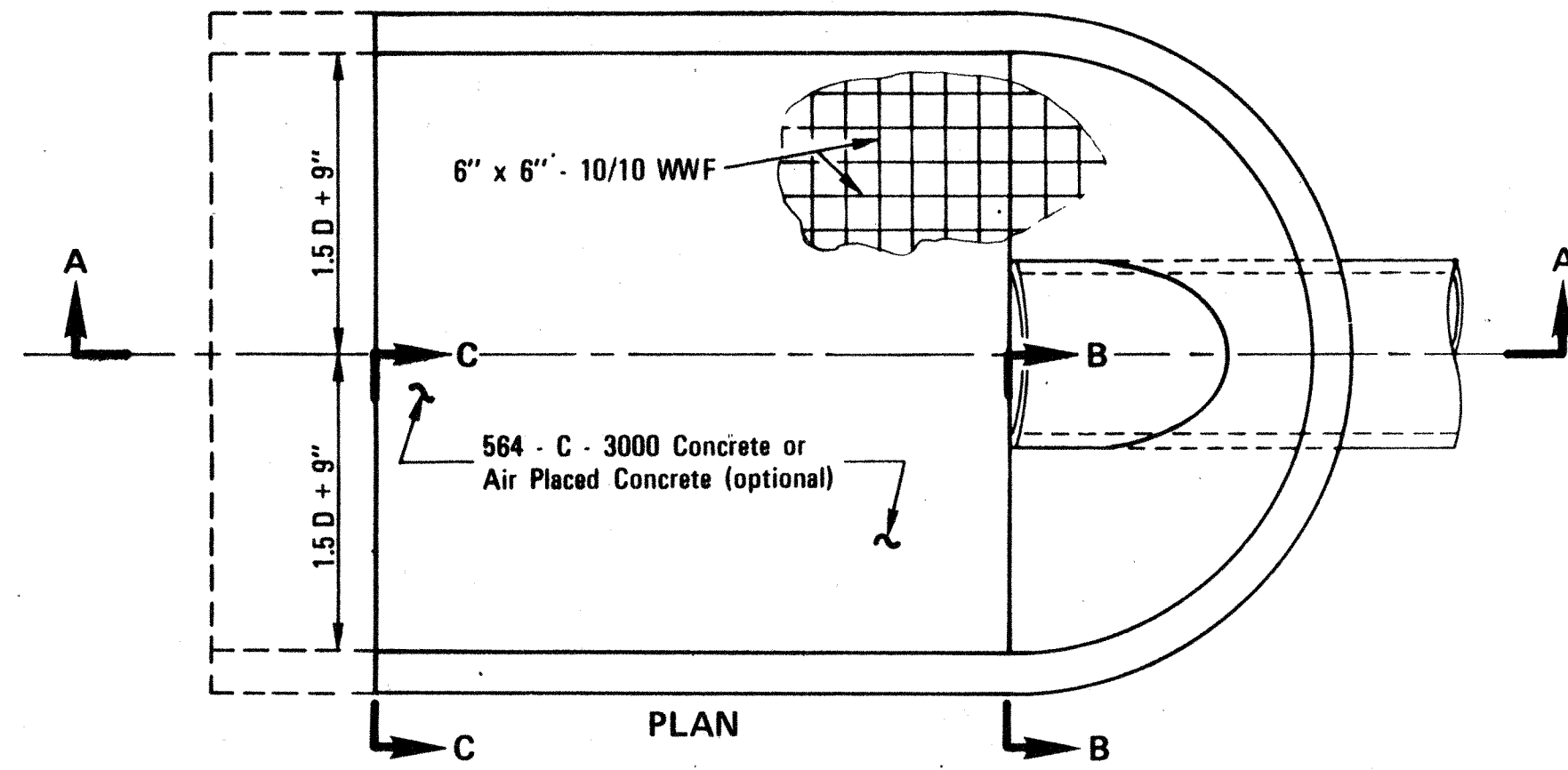

NOTES

1. When more than one pipe is used the profile view shown shall hold for the distance across all pipe openings. Sections A-A and B-B shall be from the outermost pipe. The distance between pipes shall be D/2 for round and Span/3 for arch pipe. (12" minimum)
2. Culvert shall be cut off even with apron surface when required by the Agency.
3. Use Inlet Apron only where a flared end section can not be utilized.
4. Place weep holes when required by the Agency.

DETAIL: TEMPORARY INLET APRON
NO SCALE



RANPAC ENGINEERING CORP. 27447 Enterprise Circle West Temecula, California 92390 Tel. (714) 676-7000 SUBMITTED BY: <i>Raymond L. Truitt</i> REGISTERED CIVIL ENGINEER NO. 30927 DATE: 4/11/91 EXP. 3/31/92	BENCH MARK: SEE SHT. NO. 1	REVISIONS		RIVERSIDE COUNTY FLOOD CONTROL AND WATER CONSERVATION DISTRICT		County of Riverside	ASSESSMENT DISTRICT NO. 161	PROJECT NO. 7-0-184
		REF.	DESCRIPTION	APPR. DATE	RECOMMENDED FOR APPROVAL BY: <i>Frank J. Veris</i> PLANNING ENGINEER DATE: 6/29/94	APPROVED BY: <i>Kenneth Blum</i> CHIEF ENGINEER DATE: 7-5-94	APPROVED BY: <i>Raymond L. Truitt</i> FOR TRANS. DEPT. RIVERSIDE COUNTY, CALIF. DATE: 4/26/91	WINCHESTER ROAD STORM DRAIN DETAIL SHEET

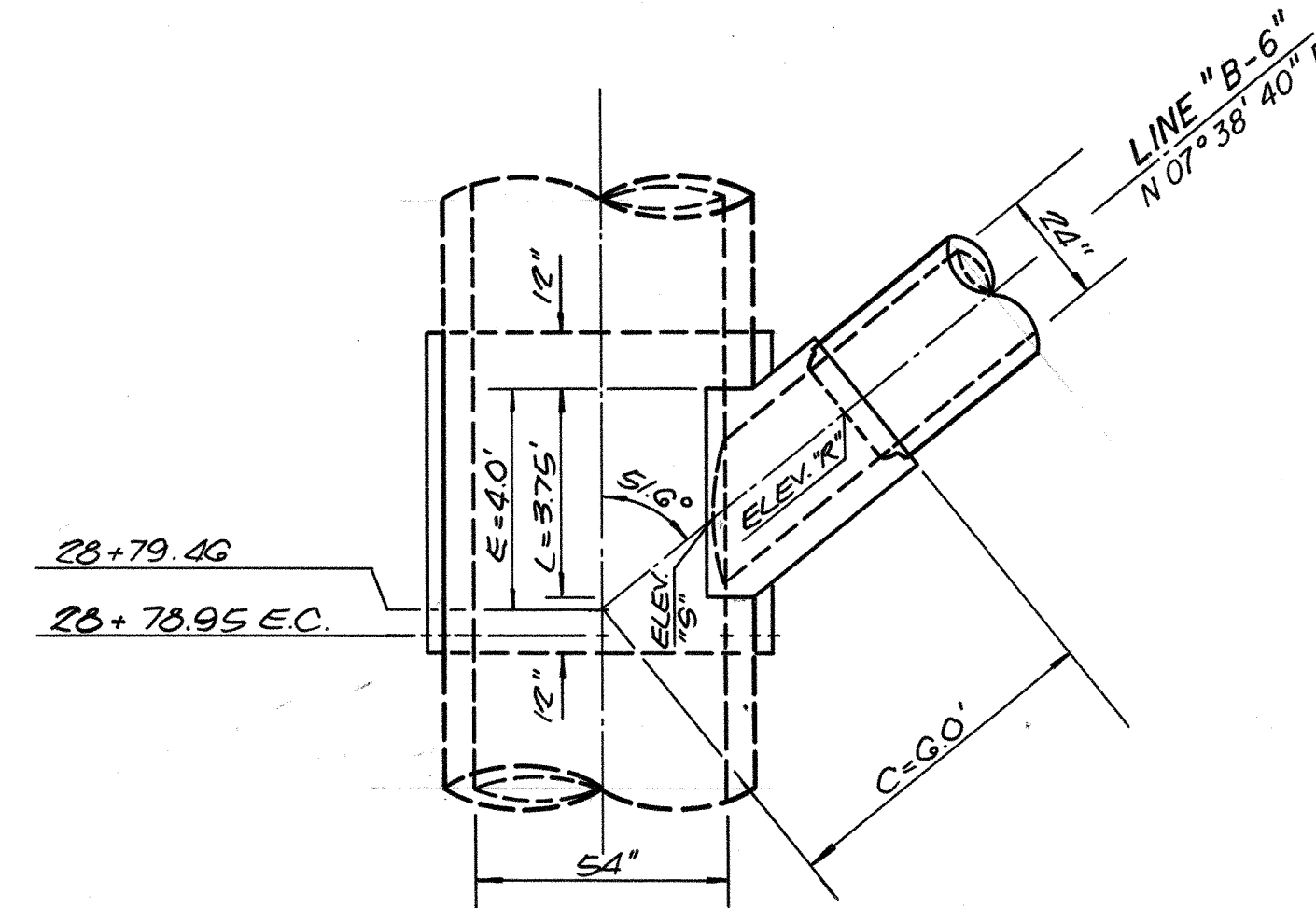

DATA:
 A=51.6°, C=6.0', E=4.0', G=1.90'
 B=24", D=54", F=2.35', L=3.75'
 ELEV. "R"=1104.23 ELEV. "S"=1104.22
JUNCTION STRUCTURE NO. 2
 STA. 28+79.46
 PLAN VIEW SHEET NO. 4

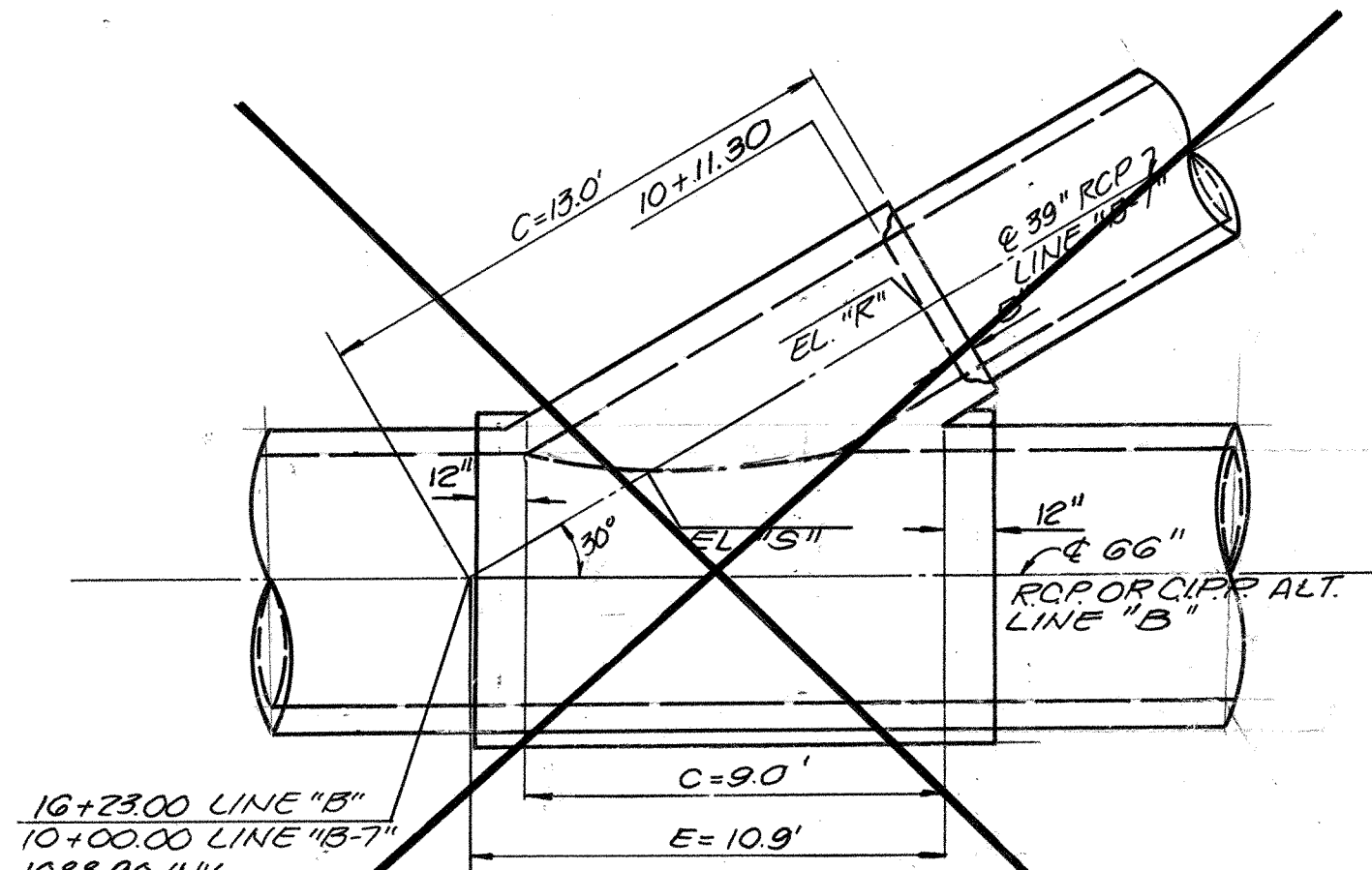

JUNCTION STRUCTURE NO. 2
 @ STA. 16+23.00
 PLAN VIEW SHEET NO. 2

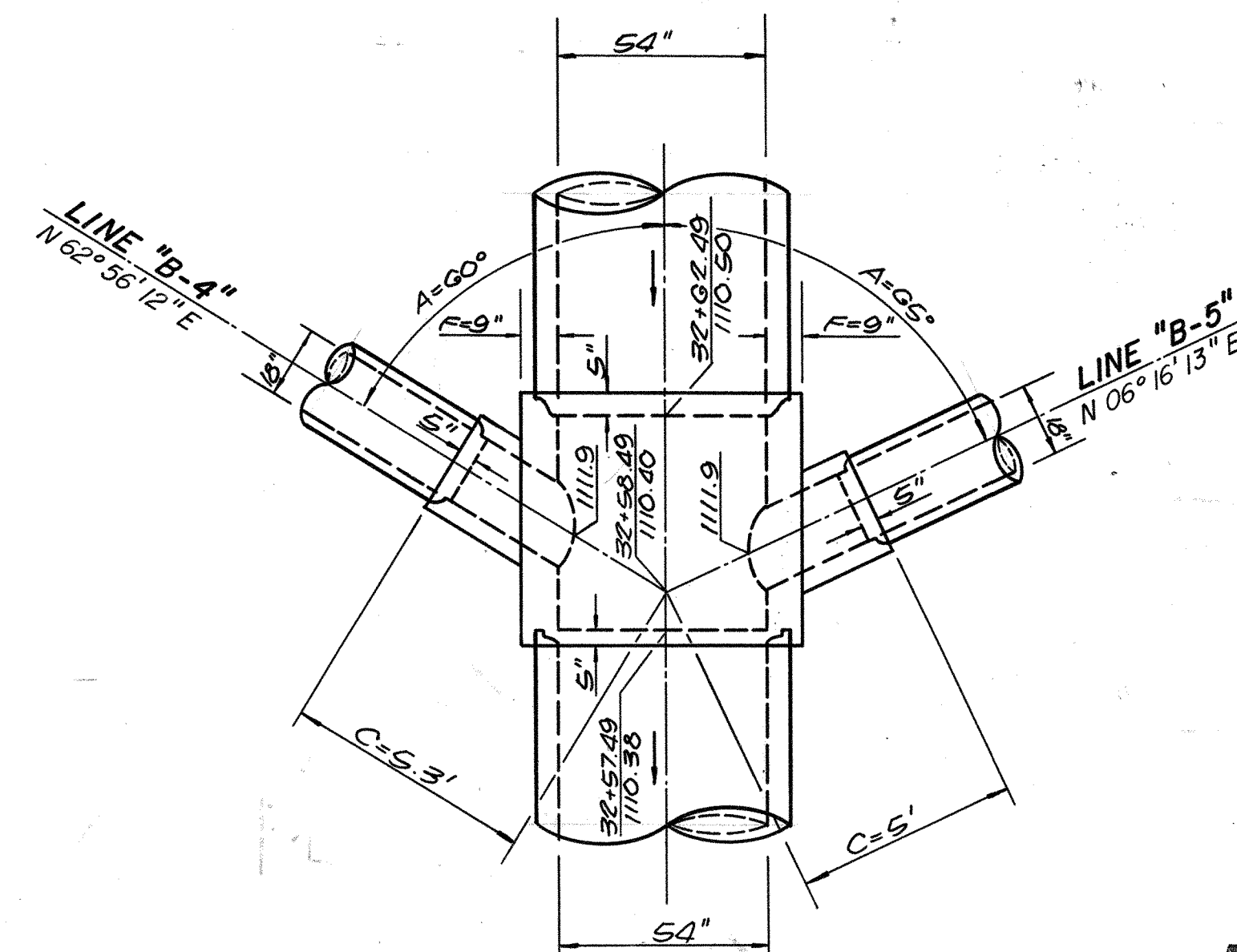

TRANSITION STRUCTURE NO. 3
 STA. 32+58.49
 PLAN VIEW SHEET NO. 4

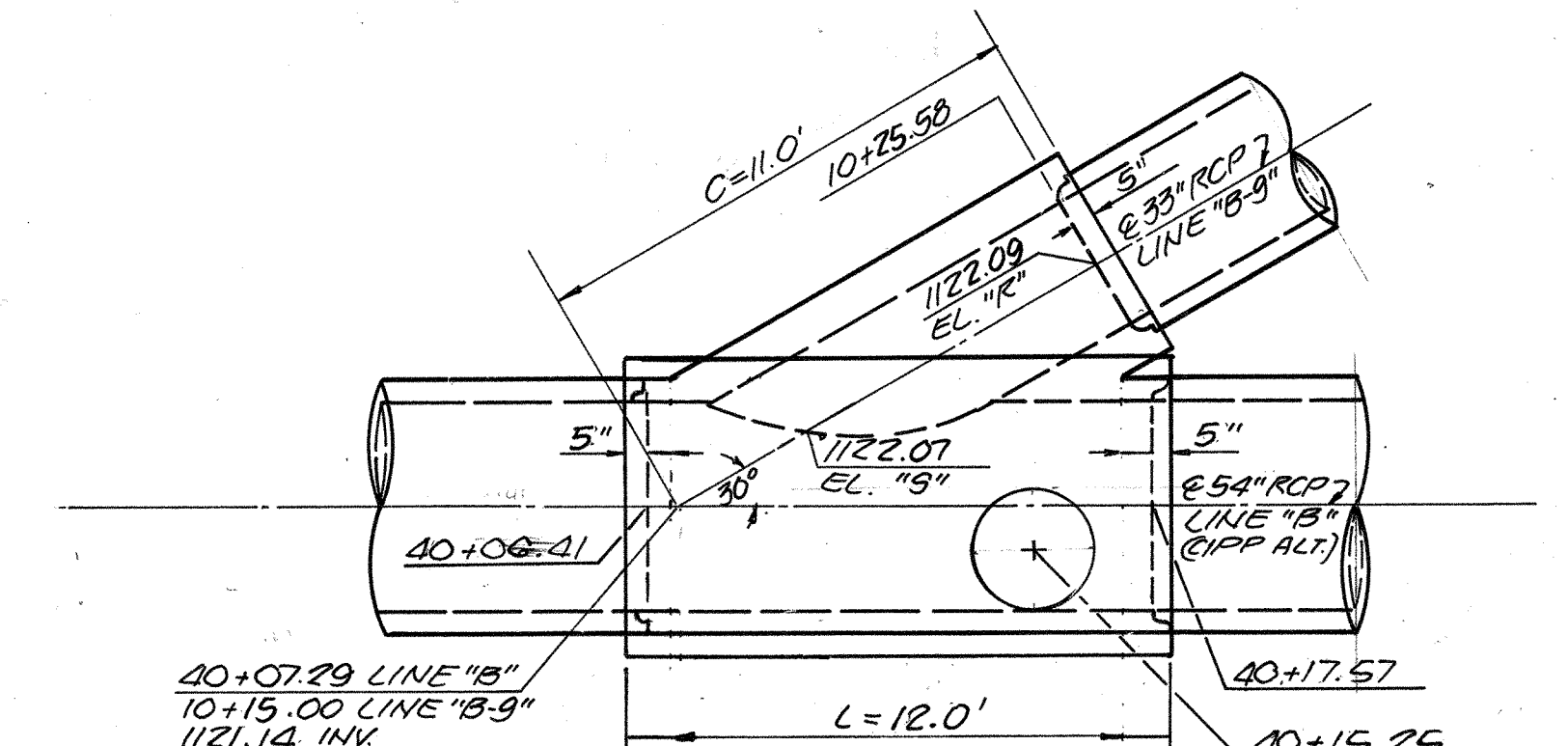

AS BUILT
 APPROVED BY: *Raymond L. Truitt*
 DATE: 5-8-96
MANHOLE NO. 4 MH 254
 STA. 40+07.29
 PLAN VIEW SHEET NO. 5

EXHIBITS

EXHIBIT A: PRE-PROJECT CONDITION RATIONAL METHOD HYDROLOGY MAP

DP-2018-1761, ZC-2018-1763, GP-2018-1762
 IN THE CITY OF MURRIETA, COUNTY OF RIVERSIDE, STATE OF CALIFORNIA
POST-PROJECT HYDROLOGY MAP

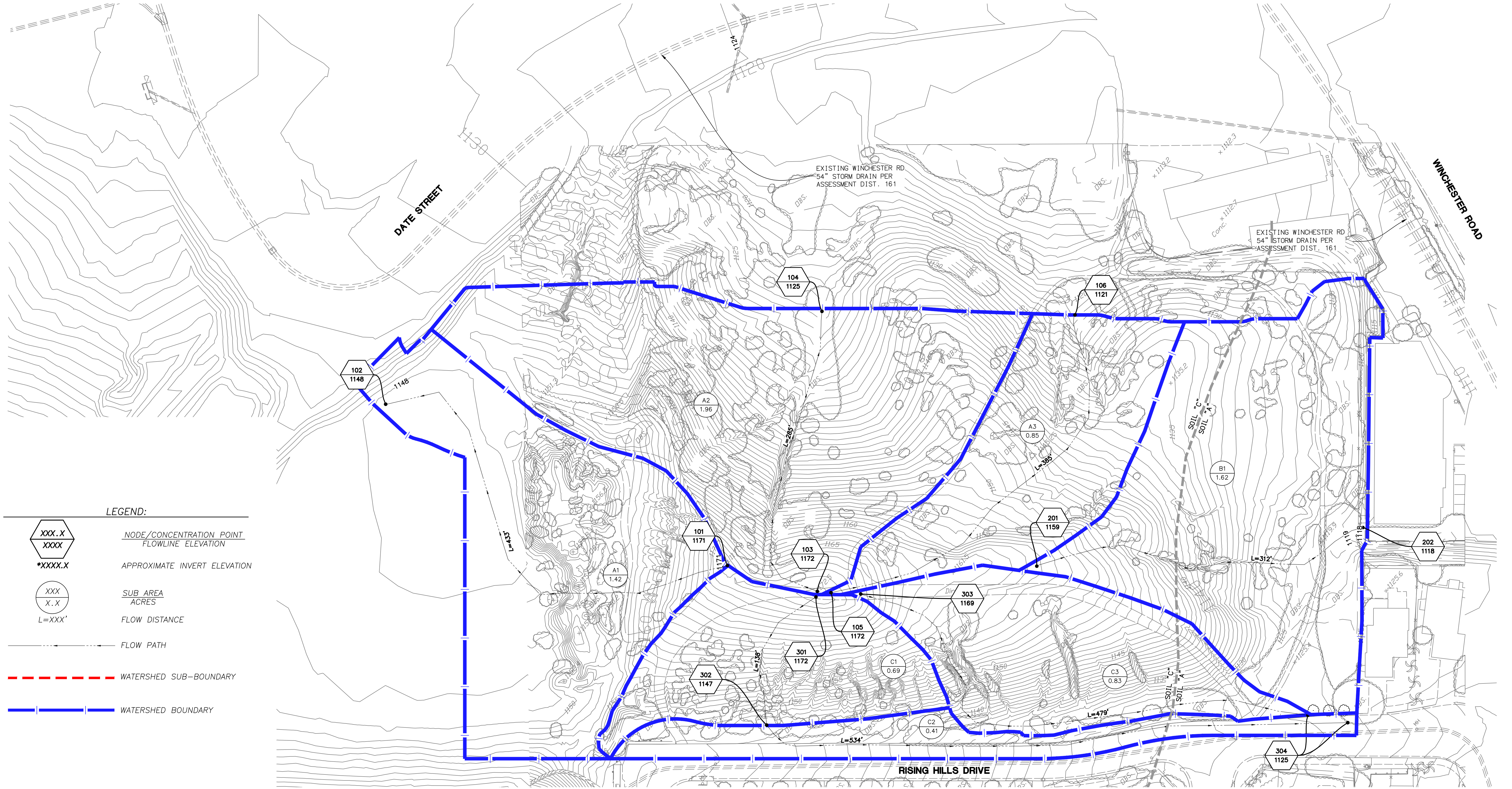

LEGEND:

- XXX.X
XXXX NODE/CONCENTRATION POINT
FLOWLINE ELEVATION
- *XXXX.X APPROXIMATE INVERT ELEVATION
- XXX
X.X SUB AREA
ACRES
- L=XXX' FLOW DISTANCE
- FLOW PATH
- WATERSHED SUB-BOUNDARY
- WATERSHED BOUNDARY

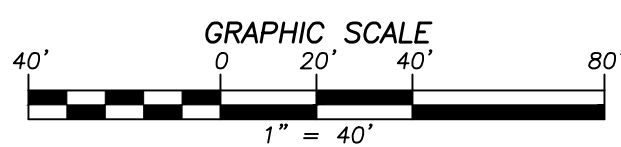
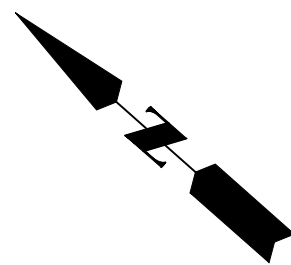

EXHIBIT A

DP-2018-1761

**PRE-PROJECT
HYDROLOGY MAP**



41660 IVY STREET, SUITE A
 MURRIETA, CA 92562
 PH. 951.304.9552 FAX 951.304.3568

EXHIBIT B: POST-PROJECT CONDITION RATIONAL METHOD HYDROLOGY MAP

DP-2018-1761, ZC-2018-1763, GP-2018-1762
 IN THE CITY OF MURRIETA, COUNTY OF RIVERSIDE, STATE OF CALIFORNIA
POST-PROJECT HYDROLOGY MAP

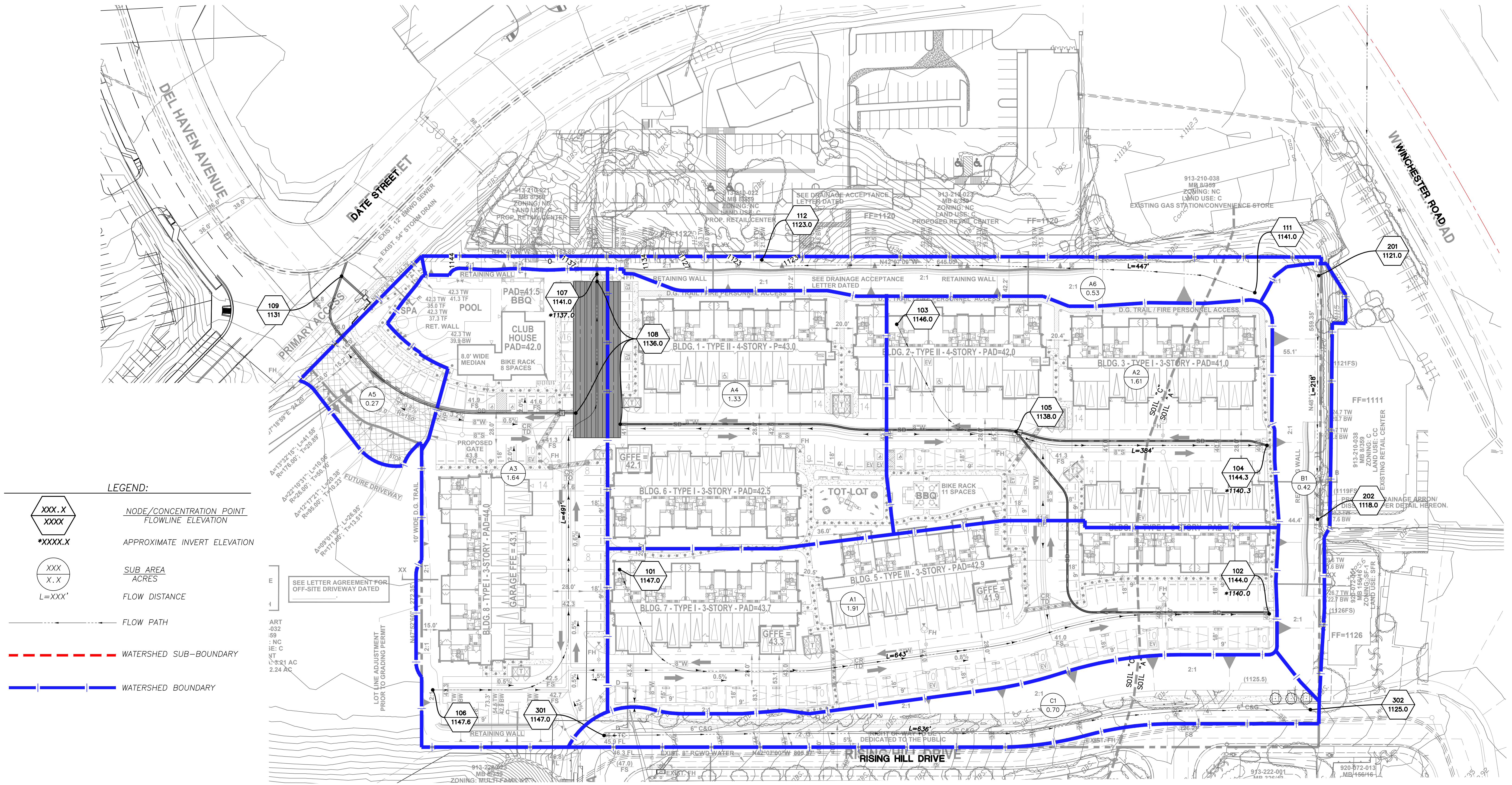

LEGEND:

- XXX.X NODE/CONCENTRATION POINT FLOWLINE ELEVATION
- XXXX APPROXIMATE INVERT ELEVATION
- XXX SUB AREA ACRES
- X.X FLOW DISTANCE
- FLOW PATH
- WATERSHED SUB-BOUNDARY
- WATERSHED BOUNDARY

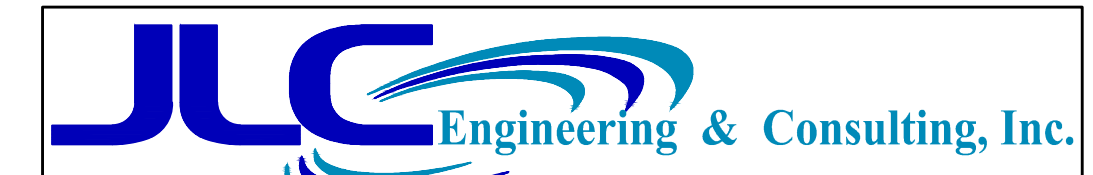
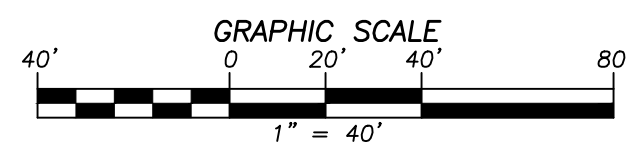
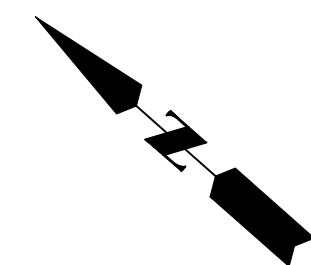

41660 IVY STREET, SUITE A
 MURRIETA, CA 92562
 PH. 951.304.9552 FAX 951.304.3568

EXHIBIT B

DP-2018-1761,
 POST-PROJECT
 HYDROLOGY MAP

EXHIBIT C: DRAINAGE FACILITIES MAP

MURRIETA APARTMENTS

IN THE CITY OF MURRIETA, COUNTY OF RIVERSIDE, STATE OF CALIFORNIA

DRAINAGE FACILITIES MAP

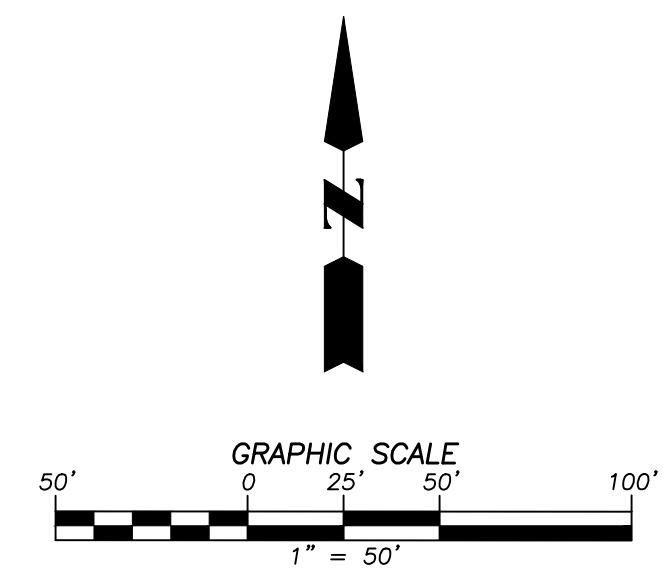
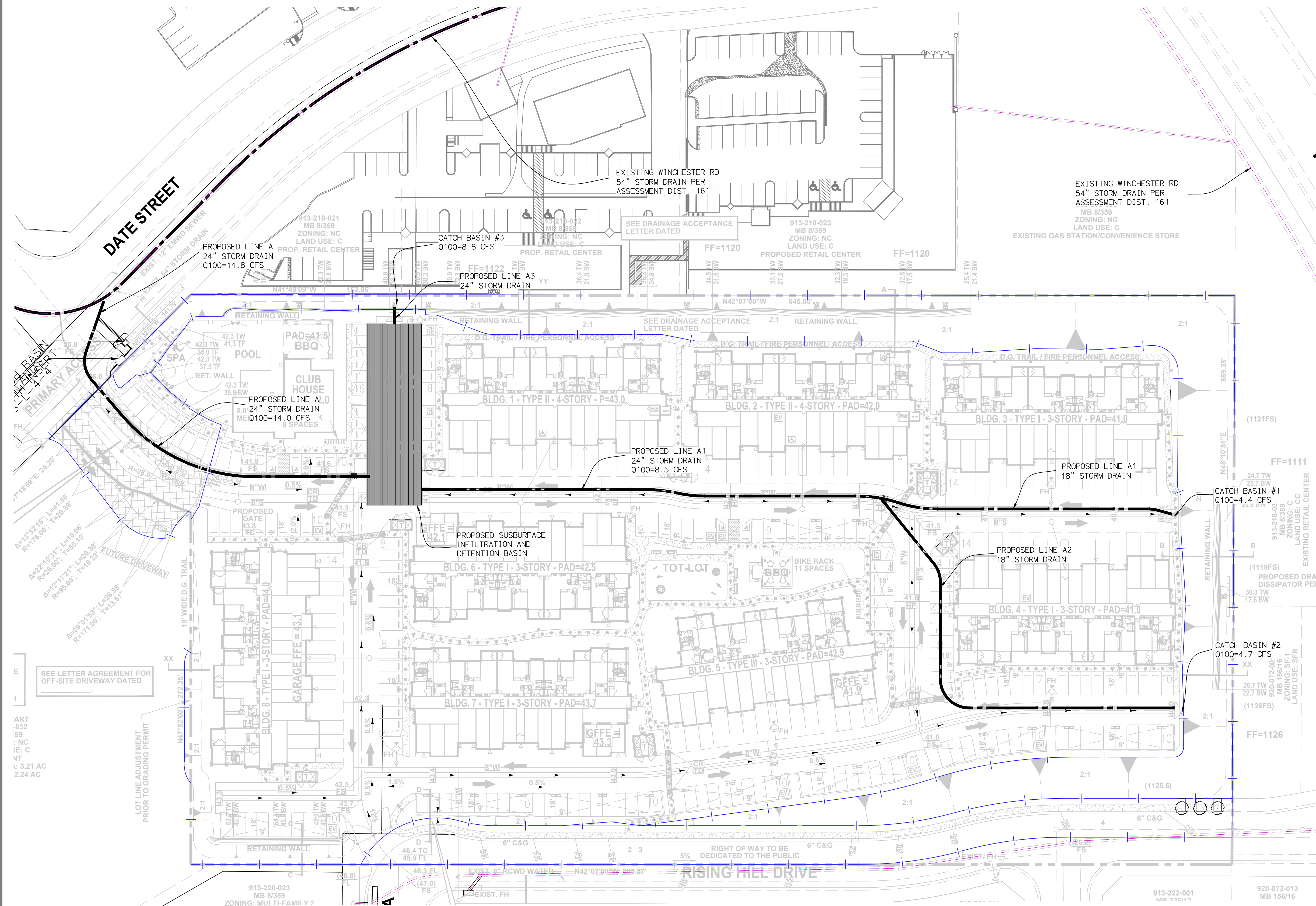

Drawing Name: C:\124.16.18\Engineering\Hydrology_Plan\Exhibits\124.16.17-Drainage Facilities Map.dwg
Last Opened: Aug 21, 2019 9:55am by jcarver

ART -032
:59
: NC
: E: C
NT
L: 3.21 AC
2.24 AC

LOT LINE ADJUSTMENT
PRIOR TO GRADING PERMIT

SEE LETTER AGREEMENT FOR
OFF-SITE DRIVEWAY DATED

JLC Engineering & Consulting, Inc.
41660 IVY STREET, SUITE A
MURRIETA, CA 92562
PH. 951.304.9552 FAX 951.304.3568

EXHIBIT "C"
MURRIETA APARTMENTS
DRAINAGE FACILITIES
MAP

EXHIBIT D: NRCS HYDROLOGIC SOILS MAP

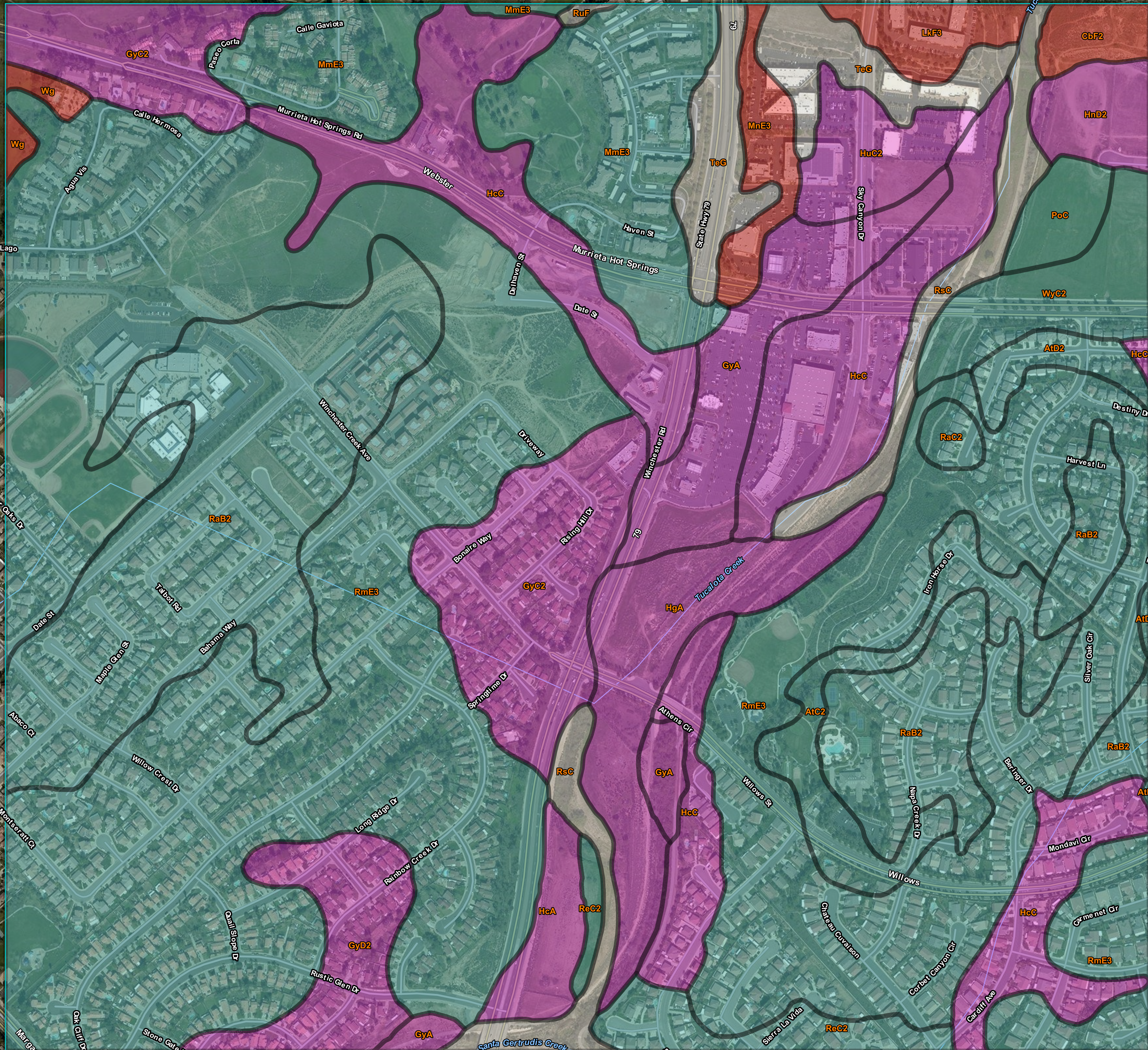

EXHIBIT C
NRCS SOILS MAP

Map Scale: 1:3,930 if printed on D landscape (34" x 22") sheet.
0 50 100 200 300 Meters
0 150 300 600 900 Feet
Map projection: Web Mercator Corner coordinates: WGS84 Edge files: UTM Zone 11N WGS84



Natural Resources
Conservation Service

Web Soil Survey
National Cooperative Soil Survey

EXHIBIT E: RCFC&WCD RAINFALL MAPS

2 YEAR, 1 HOUR

**ADOBE SPRINGS
RAINFALL VALUE = 0.50**

**PROJECT
SITE**



41660 IVY STREET, SUITE A
MURRIETA, CA 92562
PH. 951.304.9552 FAX 951.304.3568

Isopleths based on NOAA Atlas 14
Volume XI - California, 1973

RCFC & WCD

RIVERSIDE COUNTY FLOOD CONTROL
AND
WATER CONSERVATION DISTRICT

**2-YEAR — 1-HOUR
PRECIPITATION**

APPROVED	DATE	CHIEF ENGINEER	BY	NO.	DATE	DRAWN BY	SHEET NO.
						<i>P.L.S.</i>	
PLATE D-43							Of No.

100 YEAR, 1 HOUR

**ADOBE SPRINGS
RAINFALL VALUE = 1.2**

**PROJECT
SITE**



41660 IVY STREET, SUITE A
MURRIETA, CA 92562
PH. 951.304.9552 FAX 951.304.3568



Contours based on NOAA Atlas
Volume XI - California, 1973

RCFC & WCD

Hydrology Manual

**RIVERSIDE COUNTY FLOOD CONTROL
AND
WATER CONSERVATION DISTRICT**

**100-YEAR — 1-HOUR
PRECIPITATION**

APPROVED: _____ DATE: _____	CHIEF ENGINEER (P.E. NO. 5687)	DRAWN BY: <i>C.A.S.</i>	SHEET NO. _____ PLATE D-4.4
--------------------------------	--------------------------------	-------------------------	--------------------------------

SLOPE INTENSITY CURVE

**ADOBE SPRINGS
SLOPE INTENSITY = 0.55**

**PROJECT
SITE**



JLC Engineering & Consulting, Inc.
41660 IVY STREET, SUITE A
MURRIETA, CA 92562
PH. 951.304.9552 FAX 951.304.3568

Scale: 30,000
Slope Intensity Duration Curve based on District analysis of automatic recording rain gage records.

RCFC & WCD
RIVERSIDE COUNTY FLOOD CONTROL AND WATER CONSERVATION DISTRICT

RIVERSIDE COUNTY FLOOD CONTROL AND WATER CONSERVATION DISTRICT		
SLOPE OF INTENSITY DURATION CURVE		
APPROVED DATE	DRAWN BY <i>R.C.S.</i>	SHEET NO. PLATE D-4.6