

Miles Lane Development Traffic Impact Study City of Watsonville, CA

TRAFFIC IMPACT STUDY

MAY 2019

Prepared For:



**CITY OF
WATSONVILLE**

Watsonville Development Office
275 Main Street, Suite 204
Watsonville, CA 95076

Prepared By:

Kimley»Horn

100 West San Fernando Street, Suite 250
San Jose, CA 95113

Contents

EXECUTIVE SUMMARY	1
Project Description	1
Analysis Methodology	1
Study Intersections.....	2
Trip Generation Estimates	2
Parking Analysis.....	2
Site Circulation	2
Sight Distance Analysis at Auto Center Drive & Marin Street.....	2
Impacts and Mitigations Measures	4
1.0 INTRODUCTION	5
1.1 Study Methodology	5
1.2 Study Intersections included in Analysis.....	9
2.0 THRESHOLDS OF SIGNIFICANCE	10
2.1 Level of Service Standards	10
3.0 EXISTING CONDITIONS (2018)	11
3.1 Existing (2018) Intersection and Roadway Network	11
3.2 Existing (2018) Conditions Level of Service	15
3.3 Existing (2018) Pedestrian and Bicycle Network.....	15
3.4 Existing (2018) Transit Network.....	16
4.0 PROPOSED PROJECT	18
4.1 Project Site Plan.....	18
4.2 Project Trip Generation.....	18
4.3 Project Trip Distribution and Assignment.....	21
4.4 Existing (2018) Plus Project Conditions Level of Service.....	24
5.0 NEAR TERM CONDITIONS (2021).....	26
5.1 Near Term (2021) Intersection and Roadway Network	26
5.2 Near Term (2021) Volume Growth.....	26
5.3 Near Term Conditions (2021) Level of Service.....	26

5.4 Near Term (2021) Plus Project Conditions Level of Service	28
6.0 CUMULATIVE (2040) CONDITIONS	30
6.1 Cumulative (2040) Roadway Network	30
6.2 Cumulative (2040) Intersection Level of Service	30
6.3 Cumulative (2040) Plus Project Intersection Level of Service	32
7.0 POTENTIAL IMPACTS ON PEDESTRIAN, BICYCLE, AND TRANSIT MOBILITY	34
7.1 Pedestrian Mobility	34
7.2 Bicycle Mobility	34
7.3 Transit Mobility	34
8.0 PARKING REQUIREMENTS	36
8.1 On-Site Parking	36
9.0 ON SITE CIRCULATION AND SIGHT DISTANCE ANALYSIS	38
9.1 Site Circulation	38
9.2 Sight Distance Analysis at Auto Center Drive & Marin Street	38
10.0 TRAFFIC IMPACT FEES AND RECOMMENDED IMPROVEMENTS	47
10.1 Traffic Impact Fees	47
10.2 Recommended Improvements	47
APPENDIX	49

Figures

Figure 1 – Site Location and Study Area	6
Figure 2 – Project Site Plan	7
Figure 3 – Existing Lane Geometry and Traffic Control	13
Figure 4 – Existing Peak Hour Turning Movement Volumes	14
Figure 5 – Project Trip Distribution	22
Figure 6 – Project Peak Hour Turning Movement Volumes	23
Figure 7 – Existing Plus Project Peak Hour Turning Movement Volumes	25
Figure 8 – Existing Plus Near Term Project Peak Hour Turning Movement Volumes	27
Figure 9 – Existing Plus Near Term Project Plus Peak Hour Turning Movement Volumes	29
Figure 10 – Cumulative Conditions Peak Hour Turning Movement Volumes	31
Figure 11 – Cumulative Plus Project Turning Movement Counts	33
Figure 12 – Existing Sight Distance Analysis	41
Figure 13 – Proposed Intersection Improvements	44
Figure 14 – Sight Distance Analysis with Recommended Improvements	46

Tables

Table 1 – Intersection Level of Service Definitions	8
Table 2 – Existing Conditions Level of Service	15
Table 3 – Project Trip Generation	20
Table 4 – Existing Plus Project Level of Service	24
Table 5 – Near Term (2021) Level of Service	26
Table 6 – Existing Plus Near Term Plus Project Level of Service	28
Table 7 – Cumulative (2040) Project Level of Service	30
Table 8 – Cumulative (2040) Plus Project Intersection Level of Service Summary	32
Table 9 – Automobile Parking Requirements	36
Table 10 – Bicycle Parking Requirements	37
Table 11 – Traffic Impact Fee	47

EXECUTIVE SUMMARY

This study evaluates existing and future traffic conditions for the proposed Project located along Miles Lane, west of Freedom Boulevard, in the City of Watsonville, California. This analysis evaluates traffic conditions for both onsite and surrounding area intersections within the City of Watsonville (City).

PROJECT DESCRIPTION

The Project proposes to construct 60 affordable housing units (plus one manager's unit), as well as an Encompass Community Center, which will include a 7,100 square foot Residential Treatment Facility and a 3,810 square foot Out-Patient Center.

The Project site is located along Miles Lane and will provide vehicular access along Miles Lane only. Existing uses on the site include single family residential and a Residential Treatment Facility. The development will accommodate on-site parking for 36 bicycle spaces and 125 passenger vehicle spaces (with the future option to increase to 156 vehicle spaces).

ANALYSIS METHODOLOGY

Impacts associated with the Project were evaluated for the weekday AM and PM peak one-hour periods, consistent with accepted City guidelines and criteria. This analysis represents the peak Project trip generation as well as the busiest one hour at each study intersection during each morning and afternoon/evening peak period. Peak road network traffic in the study area was observed between 7:00am – 9:00am and between 4:00pm-6:00pm. The peak hour traffic analysis included in this report were conducted for the following analysis scenarios:

- **Existing Conditions (2018)** represents current traffic count data collected in December 2018 and existing roadway geometry and traffic control.
- **Project Characteristics** include descriptions of Project trip generation, distribution and assignment.
- **Existing plus Project Conditions (2018)** represents existing traffic count data and existing roadway geometry and traffic control plus the proposed Project.
- **Near Term Conditions (2021)** represents existing roadway geometry and traffic control plus trips associated with the near term (3 years) growth in the City of Watsonville.
- **Near Term plus Project Conditions (2021)** represents existing roadway geometry and traffic control plus trips associated with both the proposed Project and the near term (3 years) growth in the City of Watsonville.
- **Cumulative Conditions (2040)** represents build out of the City of Watsonville General Plan. Traffic volumes for 2040 were forecasted using the regional travel demand forecasting model developed by the Association of Monterey Bay Area Governments (AMBAG). This scenario addresses cumulative intersection and roadway operations on the future transportation network as discussed in the City of Watsonville General Plan.
- **Cumulative plus Project Conditions (2040)** represents the addition of Project trips to the Cumulative Conditions 2040 baseline traffic volumes and roadway network.

STUDY INTERSECTIONS

The Project trip assignment was developed based on traffic patterns in the study area and knowledge of the study area. The study intersections below were selected based on the proposed trip assignment and in consultation with City of Watsonville Staff.

#	Intersection
1	Freedom Boulevard & Miles Lane
2	Santa Clara Street/Kimberly Lane & Miles Lane
3	Santa Clara Street & Marin Street
4	Auto Center Drive & Marin Street

TRIP GENERATION ESTIMATES

The Project will generate approximately 36 AM peak hour, 45 PM peak hour, and 422 gross daily trips on average weekdays, based on Institute of Transportation Engineers (ITE) Trip Generation 10th Edition data and methodologies. Consistent with standard City of Watsonville traffic engineering practices, the Project will receive an existing use trip credit, which includes the existing single-family homes and a Residential Treatment Facility. The resulting gross existing trips are approximately 9 AM peak hour, 7 PM peak hour, and 70 daily trips. **Therefore, the traffic analysis is based on the Project generating a net of 27 new AM peak hour trips, 38 new PM peak hour trips, and 334 daily trips.**

PARKING ANALYSIS

City of Watsonville Municipal Code (June 2014) Chapter 14-17 Parking and Loading Facilities On-Site Circulation and Sight Distance Analysis. According to the City of Watsonville Municipal Code 125 spaces are required for the Project site. The Project will provide 125 spaces with a future option to increase to 156 spaces.

SITE CIRCULATION

To access the Encompass Community Center, patients, visitors and employees are expected to use Driveway 1 along Miles Lane. To access the affordable housing, Driveways 2, 3, and 4 along Miles Lane will be utilized by residents, employees, and patrons. Volumes to the Project site are expected to be distributed among each of the Project driveways. No significant vehicle queues or delays are expected at the Project driveways due to low peak hour volumes.

SIGHT DISTANCE ANALYSIS AT AUTO CENTER DRIVE & MARIN STREET

At the intersection of Auto Center Drive and Marin Street, stopping sight distance and intersection sight distance were analyzed using the American Association of State Highway Transportation Officials (AASHTO) methodology. It was determined that the existing stopping sight distance and intersection was inadequate in existing conditions.

The following mitigations are recommended for the intersection of Auto Center Drive and Marin Street to improve sight distance.

- *Auto Center Drive South of Marin Street*
 - Provide approximately 280 feet of Striping Detail 22 (Centerline)
 - Provide approximately 350 feet of Striping Detail 27B (Right Edgeline) and create a painted bulb-out for vehicles entering from Auto Center Drive. Within the painted bulb-out, add 6" diagonal white striping with 15' spacing. The right edgeline striping would move the center of the road away from the curb allowing for better visibility.
 - Provide "Intersection Ahead" signage (W1-10e) with "Speed Sign" (W13-1P) with 20 mph speed and a custom "Limited Sight Distance" sign. Place at point of curvature for Northbound approach according to MUCTD Table 2C-4. This sign would warn drivers of the approaching intersection to be aware of cross traffic and to reduce speed.

- *Marin Street*
 - Move the 12 inch stop bar closer to the curb line along with new "STOP" markings. This will allow drivers to pull up further into the new 8-foot parking lane to increase visibility along Auto Center Drive.
 - Provide approximately 75 feet of Striping Detail 22 (Centerline) to shift the westbound intersection approach to the north. This would allow for more visibility on the Auto Center Drive northbound approach.
 - Extend red curb on the south curb approximately 85 feet. This red curb would remove approximately three on-street parking spaces. This would prevent drivers from parking in the painted bulb-out.
 - Extend red curb on the north curb approximately 30 feet. This red curb would remove approximately one on-street parking space to allow more space for drivers to approach the intersection.

- *Auto Center Drive North of Marin Street*
 - Extend red curb approximately 120 feet on the east curb and provide "No Parking Anytime" signage. This would remove approximately five (5) on-street parking spaces. Red curb would make parking illegal along the eastern curb allowing southbound sight distance to be unobstructed.
 - Provide "Intersection Ahead" signage (W1-10e) with "Speed Sign" (W13-1P) with 20 mph speed and a custom "Limited Sight Distance" sign. Place at point of curvature for southbound approach according to MUCTD Table 2C-4. This sign would warn drivers of the approaching intersection to be aware of cross traffic and to reduce speed.
 - Provide speed feedback sign similar to existing signage on east side of Auto Center Drive. Place at point of curvature for southbound approach according to MUCTD Table 2C-4.
 - Provide approximately 200 feet of Striping Detail 22 (Centerline) and Striping Detail 27B (Right Edgeline) for the Northbound approach. Right edgeline striping would be 8-feet from the curb. This striping would reduce confusion for vehicles traveling northbound.
 - Provide approximately 490 feet of Striping Detail 27B (Right Edgeline) for the Southbound approach. This striping would move the center of the road away from the curb allowing for better visibility.

With these mitigations, it was determined that both stopping sight distance and intersection sight distance would improve and would be compliant with AASHTO standards.

IMPACTS AND MITIGATIONS MEASURES

MITIGATIONS

Based on the analysis completed in this report, no mitigations are required for the study intersections. All intersections in each scenario will perform at a Level of Service (LOS) D or better with and without the Project.

Mitigations to improve sight distance at the intersection of Auto Center Drive and Marin Street are described in the previous section.

TRAFFIC IMPACT FEES

Based on City of Watsonville Development Summary Fees (2017-2018) the total traffic impact fee for the proposed Project would be approximately **\$109,520**.

1.0 INTRODUCTION

This study evaluates existing and future traffic for the proposed Project and assesses the potential traffic impacts on the City of Watsonville road network. The analysis evaluates on-site and off-site traffic conditions in the Project vicinity.

The Project proposes to construct 60 affordable housing units (plus one manager's unit), as well as an Encompass Community Center, which will include a 7,100 square foot Residential Treatment Facility and a 3,810 square foot Out-Patient Center.

Primary access for the affordable housing and Encompass Community Center would be provided off Miles Lane. A total of four (4) driveways are proposed along Miles Lane and. The development will accommodate on-site parking for 36 bicycle spaces and 125 passenger vehicle spaces. **Figure 1** illustrates the location of the Project site in relation to other streets in the City of Watsonville with the existing road network. **Figure 2** shows the Project site plan.

1.1 STUDY METHODOLOGY

DEVELOPMENT CONDITIONS

This traffic impact study is based upon the following development conditions:

- **Existing Conditions (2018)** represents current traffic count data collected in December 2018 and existing roadway geometry and traffic control.
- **Project Characteristics** include descriptions of Project trip generation, distribution and assignment.
- **Existing plus Project Conditions (2018)** represents existing traffic count data and existing roadway geometry and traffic control plus the proposed Project.
- **Near Term Conditions (2021)** represents existing roadway geometry and traffic control plus trips associated with the near term (3 years) growth in the City of Watsonville.
- **Near Term plus Project Conditions (2021)** represents existing roadway geometry and traffic control plus trips associated with both the proposed Project and the near term (3 years) growth in the City of Watsonville.
- **Cumulative Conditions (2040)** represents build out of the City of Watsonville General Plan. Traffic volumes for 2040 were forecasted using the regional travel demand forecasting model developed by the Association of Monterey Bay Area Governments (AMBAG). This scenario addresses cumulative intersection and roadway operations on the future transportation network as discussed in the City of Watsonville General Plan.
- **Cumulative plus Project Conditions (2040)** represents the addition of Project trips to the Cumulative Conditions 2040 baseline traffic volumes and roadway network.



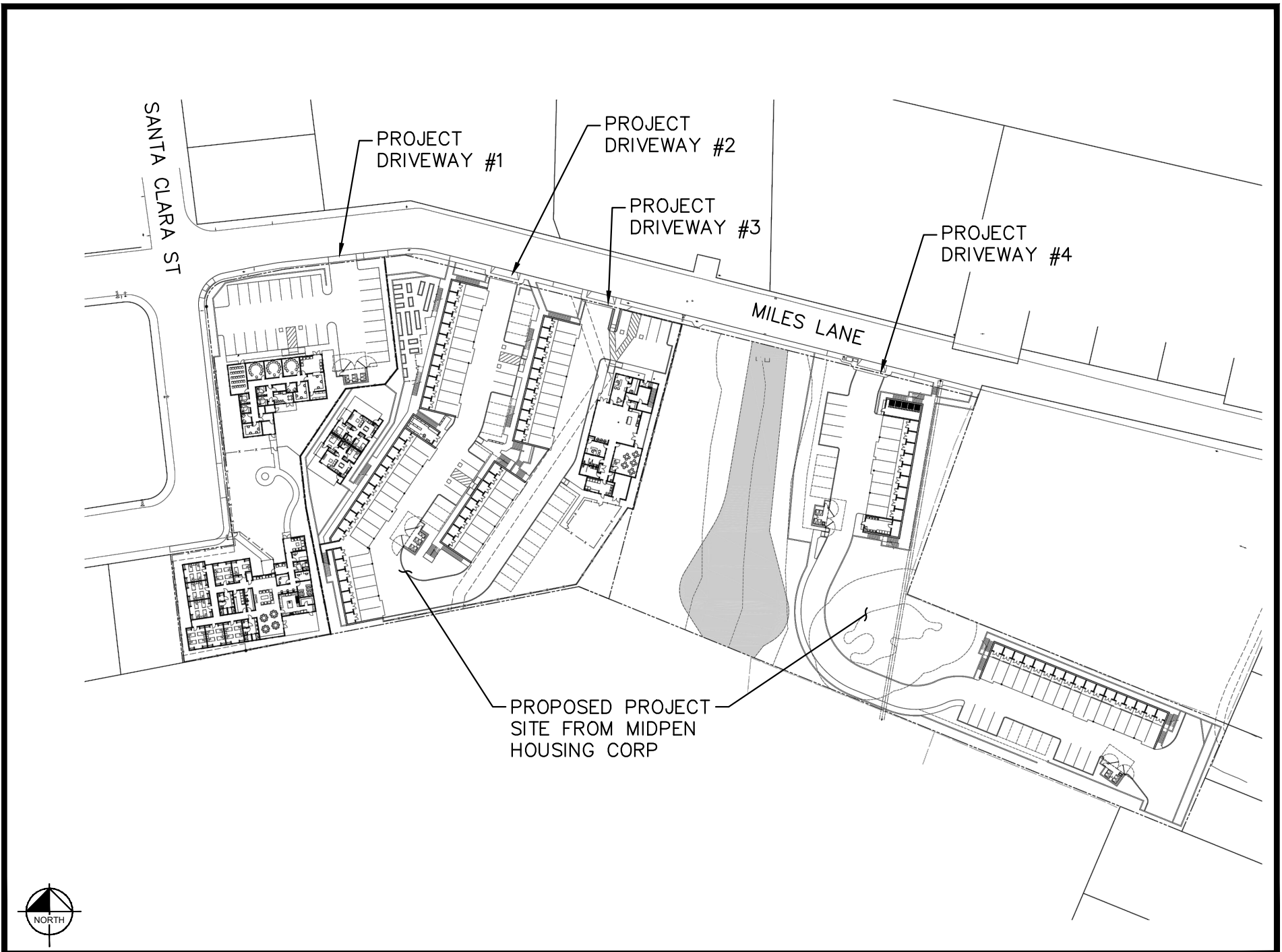

OPERATING CONDITIONS AND CRITERIA FOR INTERSECTIONS

Analysis of potential environmental impacts at intersections is based on the concept of Level of Service (LOS). The LOS of an intersection is a qualitative measure used to describe operational conditions. LOS ranges from A (best), which represents minimal delay, to F (worst), which represents heavy delay and a facility that is operating at or near its functional capacity. Levels of Service for this study were determined using methods defined in the *Highway Capacity Manual, 2010* (HCM) and Synchro traffic analysis software.

The HCM 2010 methodologies include procedures for analyzing side-street stop-controlled (SSSC), all-way stop-controlled (AWSC), and signalized intersections. The SSSC procedure defines LOS as a function of average control delay for each minor street approach movement. Conversely, the AWSC and signalized intersection procedures define LOS as a function of average control delay for the intersection. **Table 1** relates the operational characteristics associated with each LOS category for signalized and unsignalized intersections.

Table 1 – Intersection Level of Service Definitions

Level of Service	Description	Signalized (Avg. control delay per vehicle-sec/vet.)	Unsignalized (Avg. control delay per vehicle-sec/veh.)
A	Free flow with no delays. Users are virtually unaffected by others in the traffic stream	< 10	≤ 10
B	Stable traffic. Traffic flows smoothly with few delays.	> 10 – 20	> 10 – 15
C	Stable flow but the operation of individual users becomes affected by other vehicles. Modest delays.	> 20 – 35	> 15 – 25
D	Approaching unstable flow. Operation of individual users becomes significantly affected by other vehicles. Delays may be more than one cycle during peak hours.	> 35 – 55	> 25 – 35
E	Unstable flow with operating conditions at or near the capacity level. Long delays and vehicle queuing.	> 55 – 80	> 35 – 50
F	Forced or breakdown flow that causes reduced capacity. Stop and go traffic conditions. Excessive long delays and vehicle queuing.	> 80	> 50

Sources: Transportation Research Board, *Highway Capacity Manual 2010*, National Research Council,

Project impacts are determined by comparing conditions without the proposed Project to those with the proposed Project. Significant impacts for intersections are created when traffic from the proposed Project causes the LOS to fall below the City LOS threshold and causes any impacted intersections to deteriorate further. Significant impact criteria are discussed further in Section 2 of this report.

1.2 STUDY INTERSECTIONS INCLUDED IN ANALYSIS

The proposed Project will generate new vehicular trips that will increase traffic volumes on the City street network. To assess changes in traffic conditions associated with the proposed Project, the following intersections, listed with the existing control type, were selected based on City criteria for evaluation in this traffic study:

1. Freedom Boulevard & Miles Lane (Side Street Stop Control)
2. Santa Clara Street/Kimberly Lane & Miles Lane (All Way Stop Control)
3. Santa Clara Street & Marin Street (All Way Stop Control)
4. Auto Center Drive & Marin Street (Side Street Stop Control)

The Project will also construct four (4) driveways that will generate a relatively low number of trips. Therefore, the driveway operations are evaluated qualitatively in this study.

2.0 THRESHOLDS OF SIGNIFICANCE

Significance criteria are used to identify Project impacts. Currently, the City specifies LOS thresholds that are utilized for roadways and intersection under their respective jurisdictions. The following significance criteria were used for this TIA and are consistent with the thresholds from the 2030 General Plan Update, and Appendix G of the CEQA Guidelines. Accordingly, the Project would have a significant traffic impact if any of the criteria discussed in the following sections are met.

2.1 LEVEL OF SERVICE STANDARDS

Per the *Watsonville Vista 2030 General Plan*, the City has established LOS D as the minimum acceptable LOS for overall intersection operations (Chapter 10 Transportation and Circulation – Level of Service (LOS)). However, there are certain locations where this standard does not apply. The following provides a list and description of exceptions to the LOS D standard:

- ◆ Unsignalized intersections where peak hour operations may exceed LOS D, but a traffic signal is not warranted. Unsignalized intersections that operate worse than LOS D should be evaluated for feasible improvements to improve operations.
- ◆ Roadway segments and signalized intersections identified to operate at less than LOS D in the *2005 -2030 Major Streets Master Plan (MSMP)*. The MSMP evaluates the City's current and proposed roadway system under the proposed general plan's land use Projections to determine compliance with level of service standards. There are no intersections within the Project study area identified as operating worse than LOS D in the MSMP.

3.0 EXISTING CONDITIONS (2018)

3.1 EXISTING (2018) INTERSECTION AND ROADWAY NETWORK

To determine potential significant impacts related to the proposed Project, existing intersections were selected for analysis based on trip assignment and discussion with City Staff. All intersections were analyzed for weekday AM and PM peak periods, which are the peak periods during which the Project will generate the most trips onto the City road network. **Figure 3** shows the location of existing study intersections within the Project area as well as the lane configurations.

Weekday intersection turning movement volumes were collected on Tuesday December 18, 2019. Volumes for the intersections were collected during the AM and PM peak periods of 7:00am-9:00am and 4:00pm-6:00pm, respectively. These traffic counts were collected when local schools were in session and the weather was fair. Existing turning movements are shown in **Figure 4**. Intersection volume data sheets for all traffic counts are provided in **Appendix A**.

EXISTING STUDY NETWORK

Local Roadways

The following local roadways provide access to the site:

- ◆ **Freedom Boulevard** is a major arterial roadway that spans 9.5 miles from Highway 1 to State Route 152 / Main Street in the City of Watsonville. It provides local and regional access to downtown businesses and residences. The facility consists of two-lanes from Highway 1 to Buena Vista Drive, four lanes from Buena Vista Drive to Lincoln Street, and two lanes from Lincoln Street to State Route 152 / Main Street. The speed limit varies along Freedom Boulevard with a posted speed limit of 40 from State Route 1 to Buena Vista and a posted speed limit of 35 from Buena Vista to State Route 152 / Main Street.
- ◆ **Auto Center Drive & Arthur Road** is an undivided two-lane collector street that provides access to local businesses and residences as well as Cesar E. Chavez Middle School and various car dealerships west of Marin Street. Auto Center Drive spans 0.4 miles from State Route 152 / Main Street to San Benito Street while Arthur Road spans 0.7 miles from San Benito Street to Freedom Boulevard. The speed limit along Auto Center Drive and Arthur Road is 25 miles per hour and on street parking is allowed.
- ◆ **Miles Lane** is a two-lane undivided collector street that would provide direct access to the Project site. The facility spans 0.2 miles from Freedom Boulevard to Santa Clara Street and provides access to residences. The posted speed limit is 25 miles per hour and on street parking is allowed. Vehicles wanting to access Freedom Boulevard from Miles Lane are restricted to a right turn only.
- ◆ **Marin Street** is a two-lane collector street that spans 0.4 miles from Auto Center Drive to Freedom Boulevard and provides access to residences. The posted speed limit is 25 miles per hour and on street parking is allowed. Vehicles wanting to access Freedom Boulevard would use Marin Street to make either a right or left turn.

- ◆ **Santa Clara Street** is a local two-lane undivided road that spans 0.5 miles from Arthur Road to Miles Lane. Santa Clara Street provides access to residences and Hyde Elementary School. The posted speed limit is 25 miles per hour and on street parking is allowed.

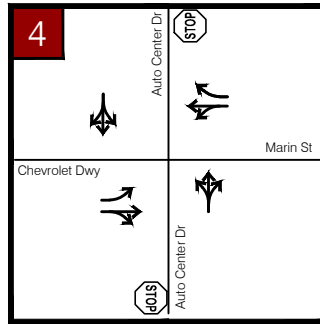
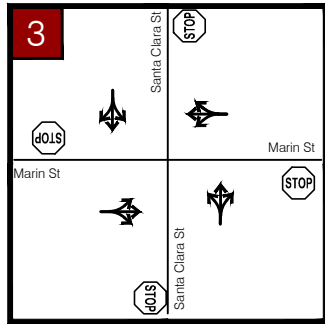
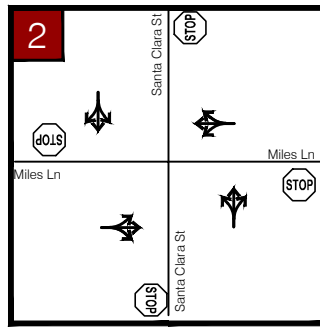
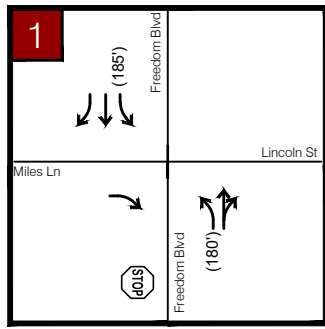

LEGEND	
#	INTERSECTION
	TRAFFIC SIGNAL
	STOP SIGN
	PROJECT SITE



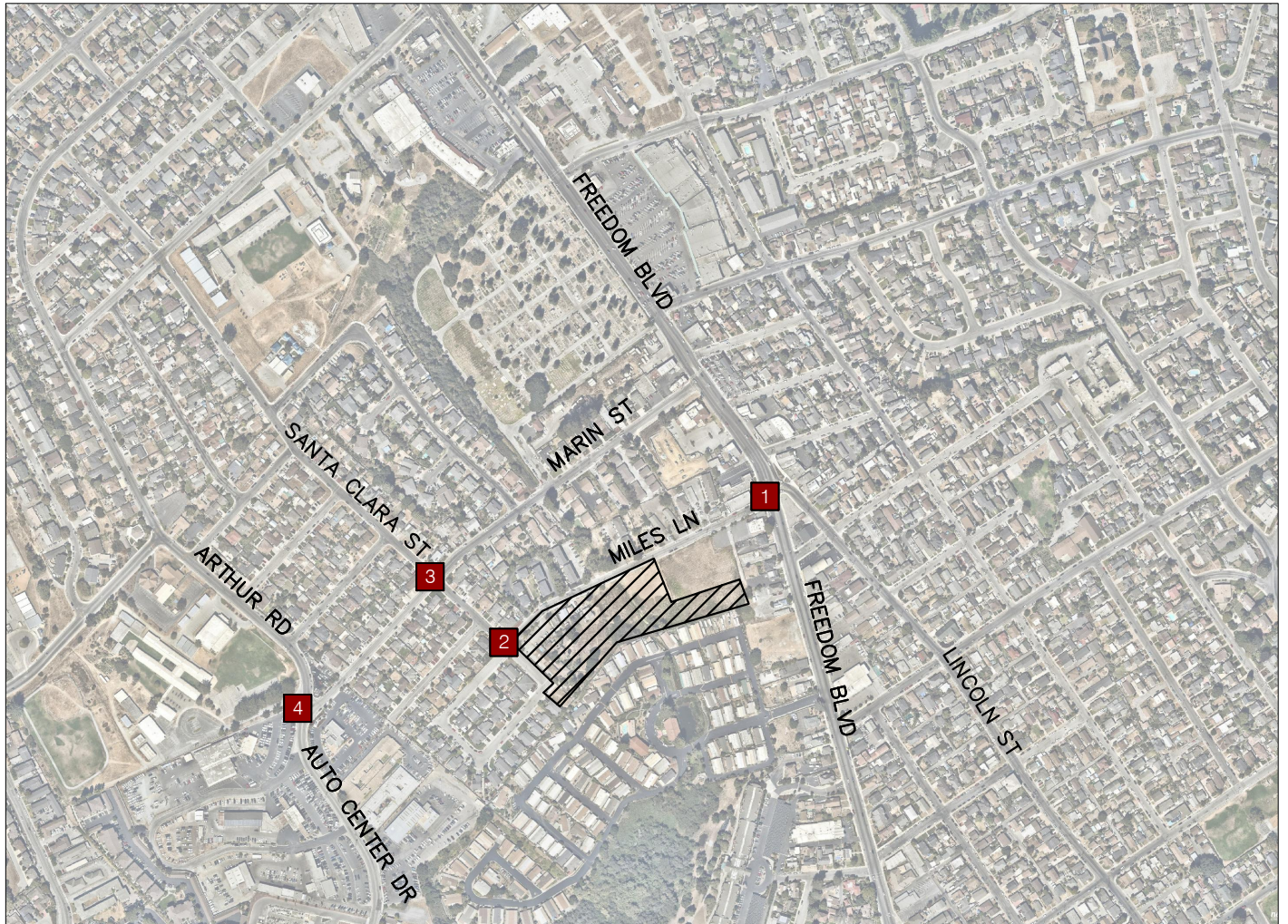
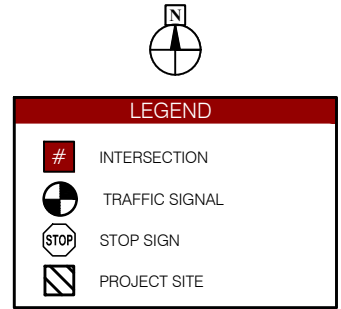
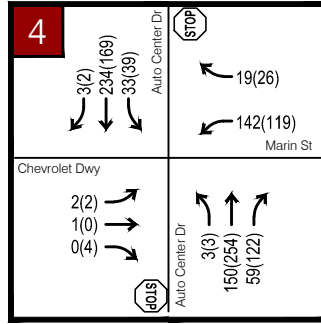
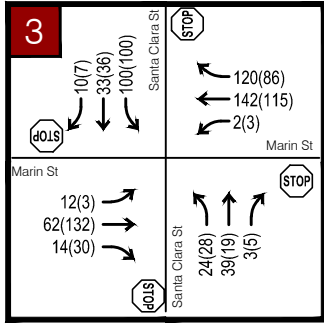
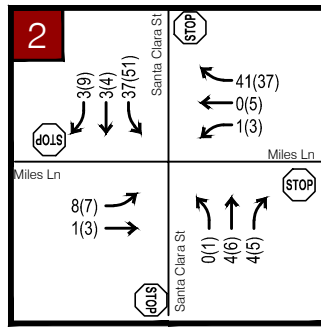
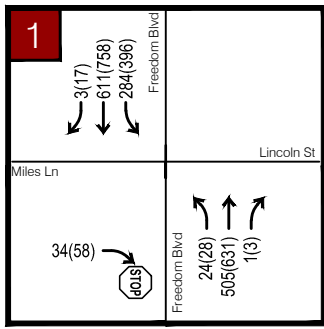

FIGURE 4
EXISTING (2018) CONDITIONS
PEAK HOUR TURNING MOVEMENT VOLUMES
MILES LANE DEVELOPMENT TRAFFIC IMPACT STUDY

3.2 EXISTING (2018) CONDITIONS LEVEL OF SERVICE

Traffic operations were evaluated at the study intersections under existing traffic conditions. Results of the analysis are presented in **Table 2**. As shown in **Table 2**, all study intersections are currently operating at LOS D or better during the AM and PM peak hour. Synchro analysis sheets are provided in the **Appendix**.

Table 2 – Existing Conditions Level of Service

#	Intersection	LOS Standard	Control Type	Existing Conditions					
				AM Peak Hour			PM Peak Hour		
				Movement	Delay	LOS	Movement	Delay	LOS
1	Freedom Boulevard & Miles Lane	D	SSSC	Overall	2.4	A	Overall	3.1	A
			<i>Worst Approach</i>	EB	11.0	B	EB	12.2	B
2	Santa Clara Street & Miles Lane	D	AWSC	Overall	7.1	A	Overall	7.3	A
3	Santa Clara Street & Marin Street	D	AWSC	Overall	10.7	B	Overall	9.2	A
4	Auto Center Drive & Marin Street	D	SSSC	Overall	6.2	A	Overall	3.9	A
			<i>Worst Approach</i>	WB	22.8	C	WB	16.9	C

Notes:

1. Analysis performed using HCM 2010 methodologies.
2. Delay indicated in seconds/vehicle.
3. Overall level of service (LOS) standard for the City is D.
4. Intersections that fall below City standard are shown in **bold**.

3.3 EXISTING (2018) PEDESTRIAN AND BICYCLE NETWORK

BICYCLES

A map of the existing City of Watsonville bicycle network can be found in Figure 3-14, *Existing and Proposed Bicycle Network* in the City of Watsonville Trails and Bicycle Master Plan from November 2012. The map is included in the **Appendix** of this report. Existing Class I, II, & III bikeway facilities (within ½ mile from the Project site) are discussed below:

Class I facilities are paved bicycle paths that are physically separated from the vehicular travel lane. A Class I bike lane is provided along the south side of Main Street from Pennsylvania Drive to Main Street/Freedom Blvd and can be accessed from Auto Center Drive. To access the Class I bike lane, a bicyclist would expect to travel approximately 3,500 feet from the project site and would use Miles Lane, Santa Clara Street, Marin Street, and Auto Center Drive.

Class II facilities, which are striped bike lanes along the street, are generally found along the eastern portion of the existing urbanized area of the City. There are Class II bike lanes along Freedom Boulevard just south of Miles Lane. To access the Class II bike lane, a bicyclist would expect to travel approximately 550 feet from the project site and would use Miles Lane.

Class III bicycle facilities are bike routes denoted by signs that are shared with vehicles along the roadway. Class III bicycle facilities in the Project vicinity are located along Freedom Boulevard north and south of Miles Lane and on Auto Center Drive/Arthur Road. To access the Class III bike lanes, a bicyclist would

expect to travel approximately 2,400 feet to access Freedom Blvd and approximately 1,900 feet to access Auto Center Drive/Arthur Road. Both routes would use Miles Lanes, Santa Clara Street, and Marin Street.

PEDESTRIANS

Existing pedestrian facilities in the study area include sidewalks along both sides of Freedom Boulevard, Miles Lane, Santa Clara Street, Marin Street, and Auto Center Drive.

There are no existing crosswalks at the intersections of Freedom Boulevard and Miles Lane, Santa Clara Street and Miles Lane, and Auto Center Drive and Marin Street. There are existing crosswalks at the intersection of Santa Clara Street and Marin Street along the west, south, and east legs.

3.4 EXISTING (2018) TRANSIT NETWORK

The Santa Cruz Metropolitan Transit District (SCMTD) and Monterey Salinas Transit (MST) public bus system provides local and regional connectivity to residents of the City of Watsonville. These services all route through the Watsonville Transit Center located in downtown Watsonville at the Rodriguez Street and West Lake Avenue intersection which serves as a transit hub for the county of Santa Cruz.

SANTA CRUZ METRO BUS FIXED-ROUTE BUS SERVICE

The Santa Cruz METRO routes several bus lines through the City of Watsonville and has an existing bus stop approximately 800 feet from the Project site just south of the intersection Freedom Boulevard and Miles Lane. This bus stop only serves passengers traveling to downtown Watsonville. Residents, employees, and patrons wishing to travel to Santa Cruz may experience difficulties because there are few crosswalks along Freedom Boulevard. The nearest crosswalks on Freedom Boulevard are approximately 1,950 feet to the south and 990 feet to the north. In addition, the bus stops are far away from the crosswalks for a total distance of 2,700 feet to the south 2,300 feet to the north.

Local and regional bus services that travel near the Project include the following:

- ◆ Route 71 is a regional route connecting Santa Cruz, Capitola, and Watsonville. It runs along Soquel Avenue and Freedom Boulevard and serves major destinations including the Santa Cruz and Watsonville Transit Centers and Cabrillo College. Route 71 operates on two schedules an outbound schedule (Santa Cruz to Watsonville) and an inbound schedule (Watsonville to Santa Cruz) each with a weekday and weekend schedule. Route 71 operates between 5:30am-12:00am during the weekday and weekend. The weekday and weekend schedules operate on intervals of a half an hour.
- ◆ Route 79 is a local loop that services Downtown Watsonville. It runs on East Lake Avenue, Freedom Boulevard, and East Beach Street within Watsonville and serves major destinations including East Lake Village Shopping Center, the Watsonville Transit Center, and Lake Tynan. Route 79 operates between 7:25 AM and 6:10 PM with 60-minute intervals on weekdays. On weekends, Route 79 operates between 8:30 AM and 5:15 PM with four (4) hour intervals.
- ◆ Route 69A is a regional route connecting Santa Cruz, Capitola, and Watsonville. It runs along Soquel Avenue, Capitola Road, Highway 1, Airport Boulevard, Freedom Boulevard, and Lincoln Street and serves major destinations including the Santa Cruz and Watsonville Transit Centers and Cabrillo College. Route 69A operates on two schedules an outbound schedule (Santa Cruz to

Watsonville) and an inbound schedule (Watsonville to Santa Cruz). Route 69A operates between 7:00am-6:00pm on the weekdays and 8:00am-7:00pm on the weekends. The weekday schedule operates on one (1) hour intervals, while the weekend schedule operates on half hour intervals.

MST FIXED-ROUTE BUS SERVICE

The MST operates three regional bus lines (Route 27, 28, and 29) that connect the City of Marina and Salinas with Watsonville. These routes services major destinations including Castroville, Moss Landing, Pajaro, Prunedale, Los Lomas, and the Watsonville Transit Center. The MST routes operate daily with varying time intervals. Connection to the Watsonville Transit Center is via Route 71 and Route 79 services.

4.0 PROPOSED PROJECT

4.1 PROJECT SITE PLAN

The Project proposes to construct 60 affordable housing units (plus one manager's unit) as well as an Encompass Community Center, which will include a 7,100 square foot Residential Treatment Facility and a 3,810 square foot Out-Patient Center.

The affordable housing and Encompass Community Center would be accessed along the four (4) driveways on Miles Lane. Access to Freedom Boulevard is provided from Miles Lane approximately 550 feet to the east; however, this access point only accommodates right in right out movements. If residents, employees, or patrons wish to travel north on Freedom Boulevard, they must either travel north on Auto Center Drive or north on Santa Clara Street.

The development will accommodate on-site parking for 36 bicycle spaces and 125 passenger vehicle spaces. An overview of the proposed Project site is illustrated in **Figure 2**.

4.2 PROJECT TRIP GENERATION

Trip generation for the Project was calculated using the land use rates from the Institute of Transportation Engineer's (ITE) publication *Trip Generation 10th Edition (2017)*, which is a standard reference used by jurisdictions throughout the country for the estimation of trip generation. A trip is defined in *Trip Generation* as a single or one-directional vehicle movement with either the origin or destination at the Project site. In other words, a trip can be either "to" or "from" the site. In addition, a single customer visit to a site is counted as two trips (i.e., one to and one from the site).

To determine existing trip credits, the existing land uses were categorized under the following ITE land uses:

- 4 Single Family Residential Dwelling Units – Single Family Detached Housing (Land Use 210)
- 3,442 square foot Residential Treatment Facility – Assisted Living (Land Use 254)

In existing conditions, there are a total of five (5) dwelling units; however, one dwelling unit is currently vacant due to structural deficiencies and is conservatively not assumed for existing trip credits. A small workshop also currently exists on the Project site that is used for storage. It is conservatively assumed that this storage unit does not generate any existing trips (i.e. no existing trip credits are assumed for the storage unit).

To determine Project trips, the Project land uses were categorized under the following ITE land uses based on the Project description and discussions with the developer/future tenant:

- 60 Multifamily Housing Dwelling Units (plus one manager's unit) – Multi-Family Housing (Mid Rise) (Land Use Code 221)
- 7,100 square foot Residential Treatment Facility – Assisted Living (Land Use 254)
- 3,810 square foot Out-Patient Center – Medical Office Building (Land Use 720)

The Project proposes to construct one manager's unit in addition to the 60 proposed affordable housing units. It is assumed that the manager's unit will generate trips throughout the day similar to other multifamily housing units. Furthermore, it is assumed that the property manager will not travel via motor vehicle during the AM or PM peak hours since the manager will already be onsite for work and will not need to commute.

ITE land uses for the Encompass Community Center facility were selected based on the Project description and discussions with the developer. Based on these details, ITE land use 254 (Assisted Living) and ITE land use 720 (Medical Office Building) were selected for analysis and trip generation estimation due to their similarities to the proposed uses. The following describes potential ITE land uses that were also considered:

Residential Treatment Facility:

- Assisted Living (Land Use 254): ITE defines this land use as “typically includes dining, housekeeping, social and physical activities, medication administration, and transportation”. Furthermore, ITE states “assisted care commonly bridges the gap between independent living and nursing homes and in some areas of the country, assisted living residences may be called personal care, residential care, or domiciliary care”. Additionally, “staff may be provided 24-hours per day”. This ITE land use description is consistent with the Project description provided by the developer/future tenant. Therefore, the ITE Assisted Living (254) land use was **SELECTED FOR ANALYSIS**.
- Nursing Home (Land Use 620) and Congregate Care (Land Use 253) were not selected based on the project description and activities related to these uses.

Out-Patient Center:

- Medical Office Building (Land Use 720): ITE defines this land use as “a facility that provides diagnoses and outpatient care services on a routine basis but is unable to provide prolonged in-house medical and surgical care.” This ITE land use description is consistent with the Project description provided by the developer/future tenant. Therefore, the ITE Medical Office Building (720) land use was **SELECTED FOR ANALYSIS**.
- Clinic (Land Use 630) was not selected since no pharmacy or medical lab facilities will be provided on the site.

Table 3 shows trips generated by the proposed development based on the previously discussed methodology. For the baseline scenario, the existing site generates 70 daily, 9 AM peak hour trips (3 IN / 6 OUT), and 7 PM peak hour trips (4 IN / 3 OUT). Development of the proposed Project is anticipated to generate 422 daily, 36 AM peak hour trips (16 IN / 20 OUT), and 45 PM peak hour trips (22 IN / 23 OUT). As illustrated in **Table 3**, the proposed Project is anticipated to add a net total of 334 daily, 27 AM peak hour trips (13 IN / 14 OUT), and 38 PM peak hour trips (18 IN / 20 OUT) to the roadway network.

An existing bus stop is located approximately 800 feet from the Project Site. It is anticipated that some Project trips could use this transit mode; however, this analysis conservatively does not take any trip reductions for transit uses. The trip reduction for the bus service is approximately 1 AM peak hour trip and 1 PM peak hour trip. For more information on how these trips were determined refer to **Section 7.3 Transit Mobility**.

Table 3 – Project Trip Generation

Land Use	ITE Land Use Code	Size	Unit	Daily		AM Peak Hour			PM Peak Hour				
				Rate	Trips	Rate	In	Out	Total	Rate	In	Out	Total
Existing Conditions													
Single-Family Detached Housing ¹	210	4	DU	13.50	54	2.00	2	6	8	1.25	3	2	5
Assisted Living ²	254	3.442	1,000 SQFT	4.19	16	0.39	1	0	1	0.48	1	1	2
Total Existing Trip Credit					70		3	6	9		4	3	7
Proposed Project													
Multifamily Housing (Mid-Rise) ³	221	60	DU	5.43	326	0.35	5	16	21	0.45	17	10	27
Multifamily Housing (Mid-Rise) ⁶	221	1	DU	5.43	6	0.00	0	0	0	0.00	0	0	0
Assisted Living ⁴	254	7.100	1,000 SQFT	4.19	30	0.39	2	1	3	0.48	1	2	3
Medical Office Building ⁵	720	3.810	1,000 SQFT	15.40	60	3.19	9	3	12	3.98	4	11	15
Total Proposed Gross Trips					422		16	20	36		22	23	45
Proposed Net New Project Trips													
<i>Total Existing Trip Credit</i>					<i>-70</i>		<i>-3</i>	<i>-6</i>	<i>-9</i>		<i>-4</i>	<i>-3</i>	<i>-7</i>
<i>Total Proposed Project Trips</i>					<i>422</i>		<i>16</i>	<i>20</i>	<i>36</i>		<i>22</i>	<i>23</i>	<i>45</i>
Net New Project Trips					334		13	14	27		18	20	38

Notes:

1. ITE Code 210 (Single-Family Detached Housing); Based on ITE equation.
 2. ITE Code 720 (Medical Office Building) assumed for Residential Treatment Facility; Based on ITE equation. Storage building not included in floor area estimate.
 3. ITE Code 221 (Multi-Family Housing, Mid-Rise); Based on ITE equation.
 4. ITE Code 254 (Assisted Living) assumed for Residential Treatment Facility; Based on ITE average rate. No equation available.
 5. ITE Code 720 (Medical Office Building) assumed for Out-Patient Center; Based on ITE equation.
 6. Manager's Unit. No commute peak hour trips assumed (AM & PM peaks). ITE Code 221 (Multi-Family Housing, Mid-Rise) used for daily trip estimate.
- Source: Institute of Transportation Engineers (ITE) Trip Generation 10th Edition, 2017;

4.3 PROJECT TRIP DISTRIBUTION AND ASSIGNMENT

Due to the nature of the proposed development, most residents, employees, patients, and patrons accessing the site are expected to travel along Freedom Boulevard and Main Street. These roadways provide local and regional access within the City of Watsonville and Santa Cruz County.

Trip distribution and assignment for the proposed Project was determined from the Association of Monterey Bay Area Governments (AMBAG) 2040 travel demand forecast model and engineering judgement. The following illustrates the distribution assumed for the Project:

- Freedom Boulevard – Approximately 20% of Project trips would distribute north while approximately 30% would distribute south towards downtown Watsonville.
- Auto Center Drive / Arthur Road – Approximately 30% of Project trips would distribute south towards SR 152 / Main Street while approximately 20% would distribute north.
- Arthur Road – Approximately 20% of Project would be distributed towards the schools in the surrounding area.

Figure 5 and **Figure 6** present the traffic distribution and assignment for the analysis.

During the peak hours, the four (4) driveways would experience approximately 36 AM and 45 PM total gross trips, and these Project trips would be shared by each of the Project driveways. Project driveways volumes and through volumes along Miles Lane is relatively low, therefore, LOS analysis at the Project driveways are not warranted.

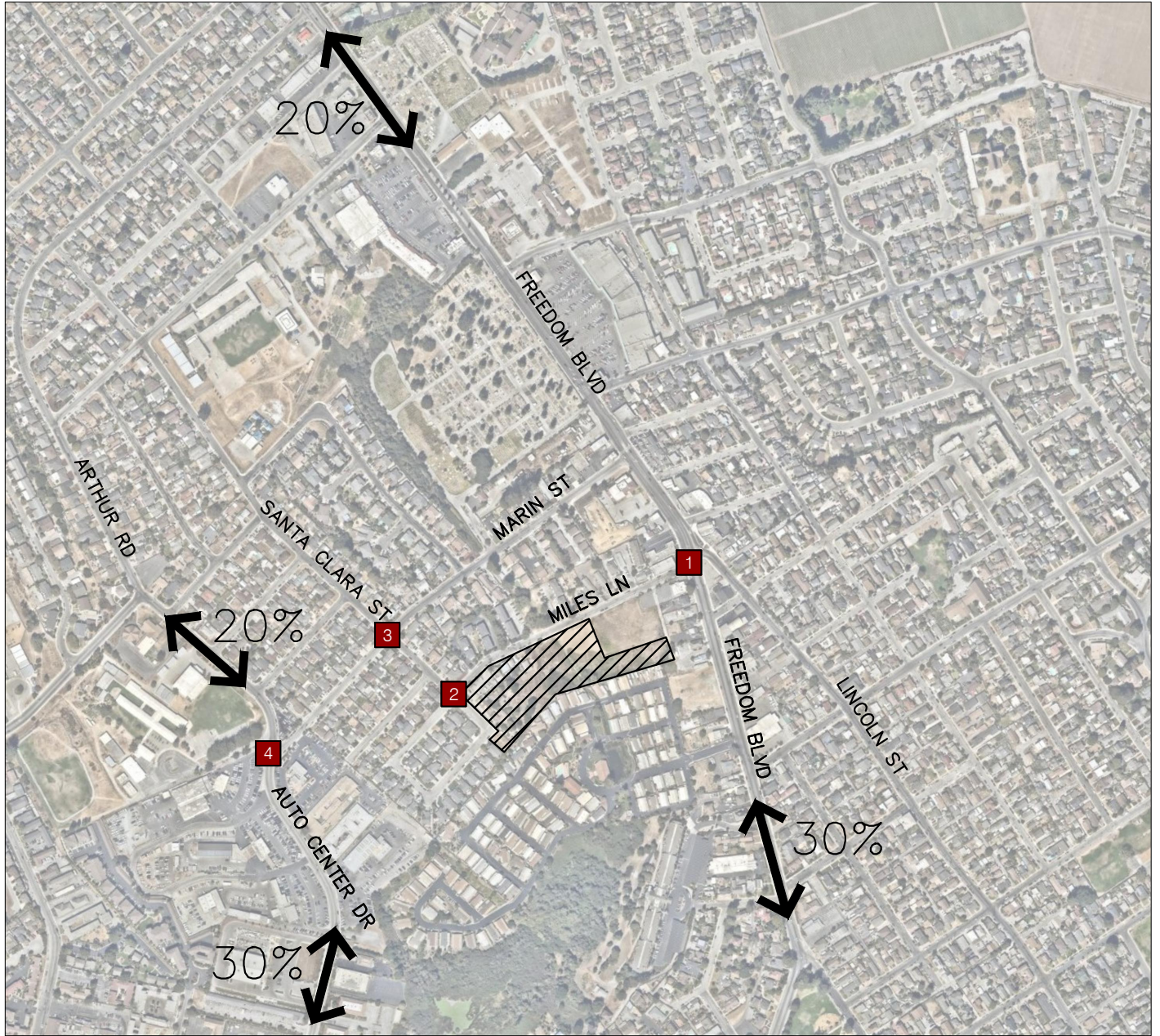

LEGEND	
#	INTERSECTION
	PROJECT SITE

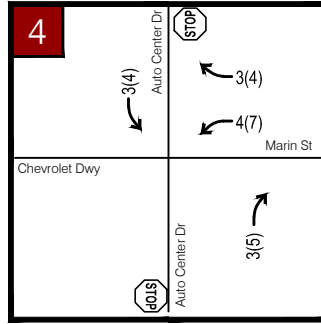
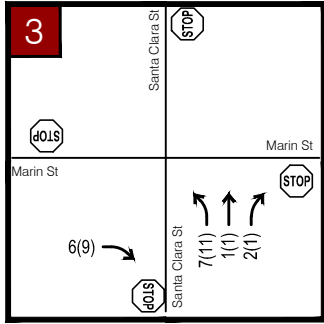
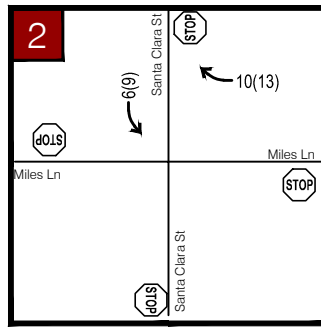
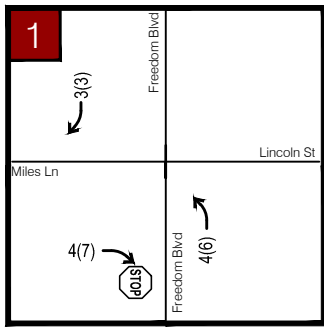

N

LEGEND	
	INTERSECTION #
	TRAFFIC SIGNAL
	STOP SIGN APPROACH
	PROJECT AREA

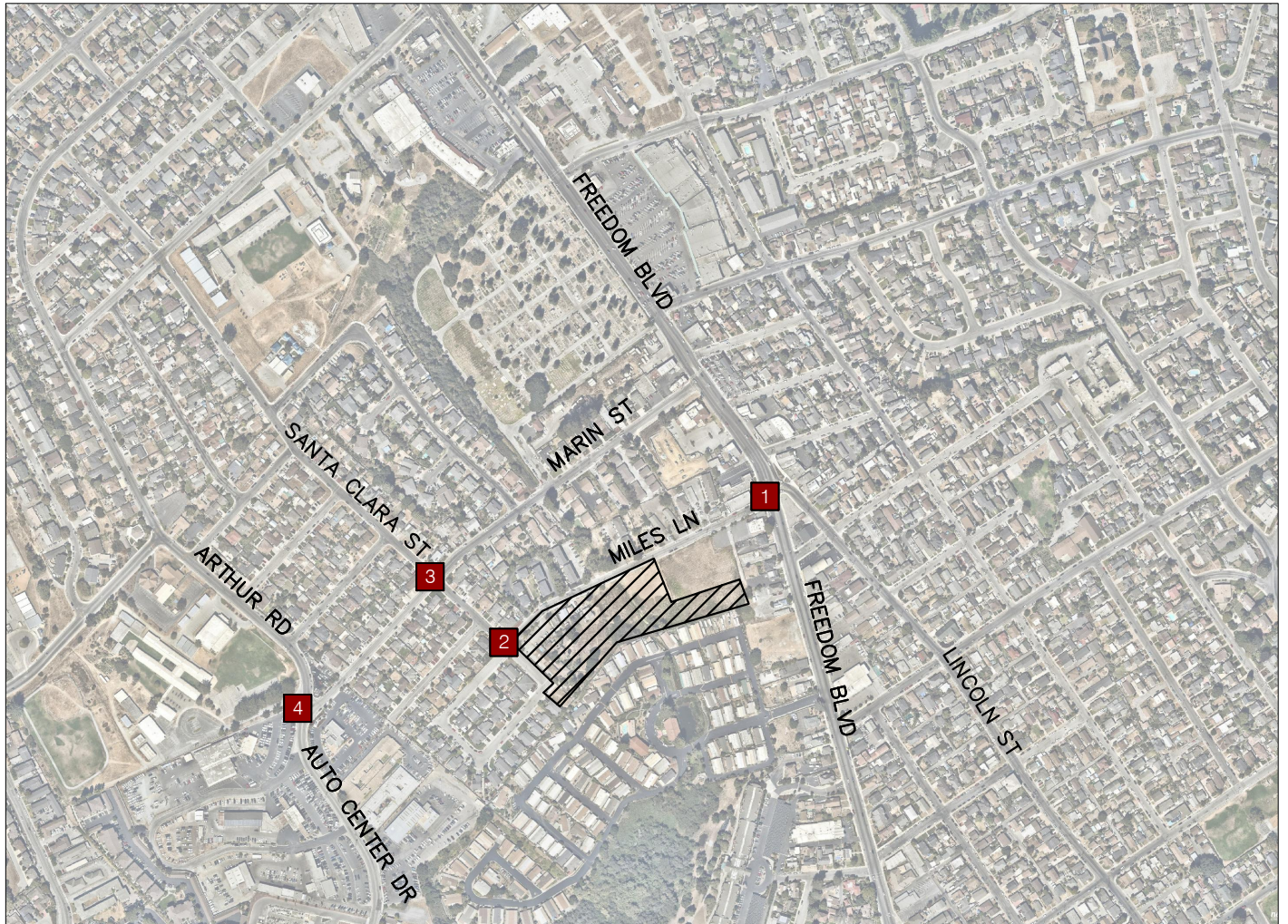

4.4 EXISTING (2018) PLUS PROJECT CONDITIONS LEVEL OF SERVICE

Traffic operations were evaluated at the study intersections under Existing Plus Project conditions and traffic generated by the proposed Project. Project trips were added to existing volumes and are shown in **Figure 7**. Results of the analysis are presented in **Table 4**. Synchro analysis sheets are provided in the **Appendix**. As shown in **Table 4**, all study intersections are anticipated to operate at LOS D or better under Existing Plus Project conditions for the AM and PM peak hour. No mitigations would be required for the Existing Plus Project conditions.

Table 4 – Existing Plus Project Level of Service

#	Intersection	LOS Standard	Control Type	Existing Conditions					
				AM Peak Hour			PM Peak Hour		
				Movement	Delay	LOS	Movement	Delay	LOS
1	Freedom Boulevard & Miles Lane	D	SSSC	Overall	2.5	A	Overall	3.1	A
			<i>Worst Approach</i>	EB	11.1	B	EB	12.3	B
2	Santa Clara Street & Miles Lane	D	AWSC	Overall	7.1	A	Overall	7.4	A
3	Santa Clara Street & Marin Street	D	AWSC	Overall	11.0	B	Overall	9.3	A
4	Auto Center Drive & Marin Street	D	SSSC	Overall	6.6	A	Overall	4.2	A
			<i>Worst Approach</i>	WB	23.8	C	WB	17.5	C

Notes:

1. Analysis performed using HCM 2010 methodologies.
2. Delay indicated in seconds/vehicle.
3. Overall level of service (LOS) standard for the City is D.
4. Intersections that fall below City standard are shown in **bold**.

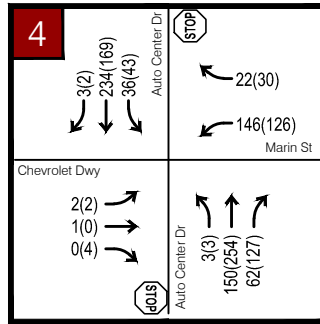
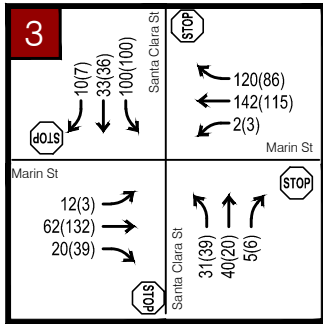
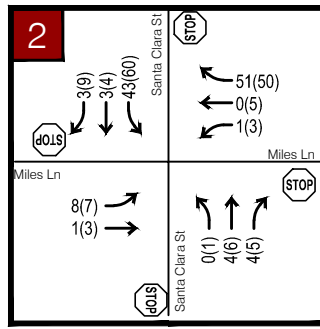
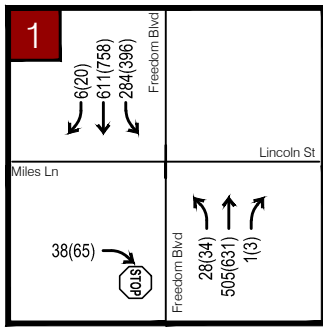

FIGURE 7
 EXISTING PLUS PROJECT CONDITIONS
 PEAK HOUR TURNING MOVEMENT VOLUMES
 MILES LANE DEVELOPMENT TRAFFIC IMPACT STUDY

5.0 NEAR TERM CONDITIONS (2021)

5.1 NEAR TERM (2021) INTERSECTION AND ROADWAY NETWORK

For the Near Term conditions, it is assumed that all existing intersection geometries and roadway networks remain the same. Traffic operations were evaluated at the study intersections under Near Term conditions and traffic generated by the Near-Term Conditions is illustrated on **Figure 8**.

5.2 NEAR TERM (2021) VOLUME GROWTH

Two sources were considered when developing the Near Term volumes:

- Sunshine Vista Phased Development Project Traffic Impact Analysis prepared by Keith Higgins (January 2017)
- The Association of Monterey Bay Area Governments (AMBAG) 2040 Model

The Sunshine Vista TIA was provided by City of Watsonville Staff and was used to determine if any Project trips would carry over to the intersections effected by the Project. No trips were assigned to the study intersections. The model was then used to determine an annual growth rate to develop near term volumes. An annual growth rate of 0.35% was determined for the neighborhood traffic, while an annual growth rate of 0.93%, as determined for Freedom Boulevard.

5.3 NEAR TERM CONDITIONS (2021) LEVEL OF SERVICE

Results of the analysis are presented in **Table 5**. Analysis sheets are provided in the **Appendix**. As shown in **Table 5**, all study intersections are anticipated to operate at LOS D or better under Near Term conditions for the AM and PM peak hour. As shown in **Table 5**, all study intersections are anticipated to operate at LOS D or better under Near Term conditions for the AM and PM peak hour. No mitigations would be required under Near Term conditions.

Table 5 – Near Term (2021) Level of Service

#	Intersection	LOS Standard	Control Type	Near Term (2021) Conditions					
				AM Peak Hour			PM Peak Hour		
				Movement	Delay	LOS	Movement	Delay	LOS
1	Freedom Boulevard & Miles Lane	D	SSSC	Overall	2.5	A	Overall	3.1	A
			<i>Worst Approach</i>	EB	11.1	B	EB	12.3	B
2	Santa Clara Street & Miles Lane	D	AWSC	Overall	7.1	A	Overall	7.3	A
3	Santa Clara Street & Marin Street	D	AWSC	Overall	10.8	B	Overall	9.3	A
4	Auto Center Drive & Marin Street	D	SSSC	Overall	6.3	A	Overall	3.9	A
			<i>Worst Approach</i>	WB	23.2	C	WB	17.1	C

Notes:

1. Analysis performed using HCM 2010 methodologies.
2. Delay indicated in seconds/vehicle.
3. Overall level of service (LOS) standard for the City is D.
4. Intersections that fall below City standard are shown in **bold**.

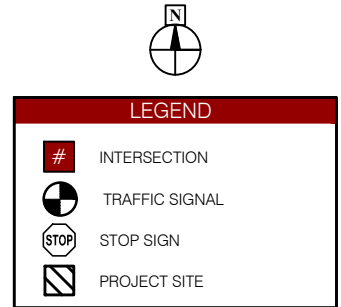
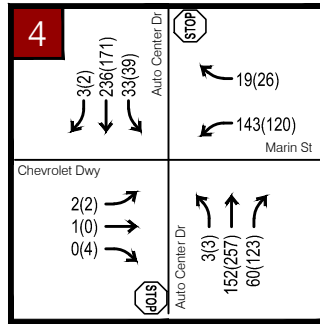
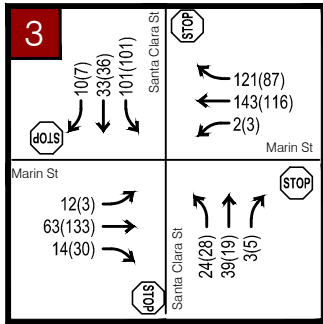
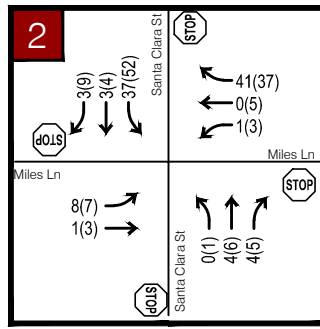
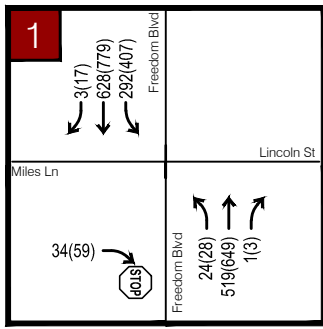

5.4 NEAR TERM (2021) PLUS PROJECT CONDITIONS LEVEL OF SERVICE

Traffic operations were evaluated at the study intersections under Near Term Plus Project Conditions and traffic generated by this scenario is illustrated on **Figure 9**. Results of the analysis are presented in **Table 6**. Synchro Analysis sheets are provided in the **Appendix**. As shown in **Table 6**, all study intersections are anticipated to operate at LOS D or better under Near Term Plus Project conditions for the AM and PM peak hour. As shown in **Table 6**, all study intersections are anticipated to operate at LOS D or better under Near Term Plus Project conditions for the AM and PM peak hour. No mitigations would be required under the Near Term Plus Project conditions.

Table 6 – Existing Plus Near Term Plus Project Level of Service

#	Intersection	LOS Standard	Control Type	Near Term Plus Project Conditions					
				AM Peak Hour			PM Peak Hour		
				Movement	Delay	LOS	Movement	Delay	LOS
1	Freedom Boulevard / Miles Lane	D	SSSC	Overall	2.5	A	Overall	3.2	A
			<i>Worst Approach</i>	EB	11.2	B	EB	12.5	B
2	Santa Clara Street / Miles Lane	D	AWSC	Overall	7.1	A	Overall	7.4	A
3	Santa Clara Street / Marin Street	D	AWSC	Overall	11.0	B	Overall	9.4	A
4	Auto Center Drive / Marin Street	D	SSSC	Overall	6.7	A	Overall	4.2	A
			<i>Worst Approach</i>	WB	24.3	C	WB	17.7	C

Notes:

1. Analysis performed using HCM 2010 methodologies.
2. Delay indicated in seconds/vehicle.
3. Overall level of service (LOS) standard for the City is D.
4. Intersections that fall below City standard are shown in **bold**.

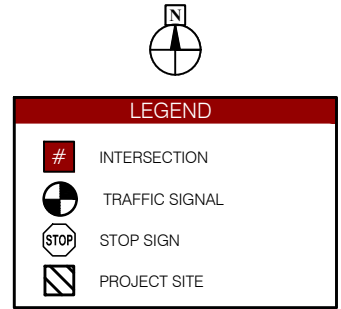
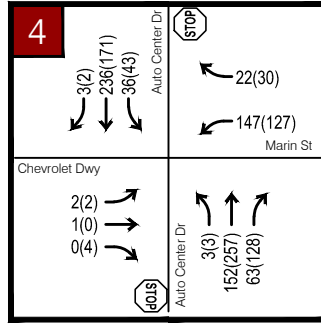
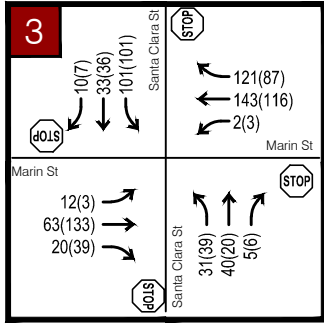
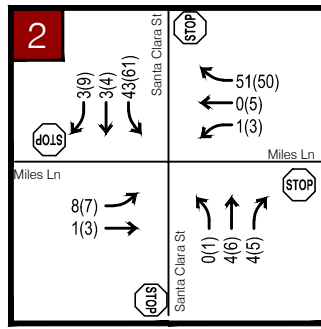
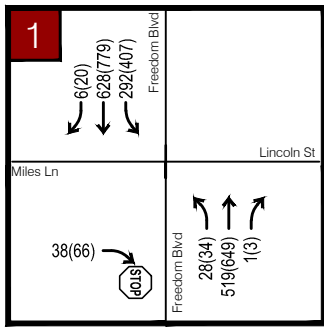

FIGURE 9
 NEAR TERM (2021) PLUS PROJECT CONDITIONS
 PEAK HOUR TURNING MOVEMENT VOLUMES
 MILES LANE DEVELOPMENT TRAFFIC IMPACT STUDY

6.0 CUMULATIVE (2040) CONDITIONS

6.1 CUMULATIVE (2040) ROADWAY NETWORK

The *Watsonville Vista 2030 General Plan* and Major Street Master Plan (MSMP) describes several improvements to the City of Watsonville roadway network. According to the General Plan and the MSMP, the Project intersections that were analyzed with the Project would not be affected. Therefore, the geometry used for the Existing Conditions are assumed for the Cumulative Conditions.

6.2 CUMULATIVE (2040) INTERSECTION LEVEL OF SERVICE

Traffic operations at the study intersections were evaluated under cumulative traffic conditions based on the AMBAG regional travel demand forecasting model, which reflects buildout of the General Plan and other regional growth anticipated outside of the City of Watsonville. The model was used to plot bi-directional AM and PM peak hour traffic volumes on each segment along roadways within the study area. Model output was used to compare base year volumes and year 2040 model forecasts to determine the annual incremental growth in traffic volumes at study intersections. For this analysis an annual growth rate of 0.35% per year was estimated for Auto Center Drive, Arthur Road, Miles Lane, Santa Clara Street, and Marin Street roadways, while an annual growth rate of 0.93% per year was estimated for Freedom Boulevard.

Cumulative traffic volumes are shown in **Figure 10**. Results of the analysis are presented in **Table 7**. As shown in **Table 7**, all study intersections are anticipated to operate at LOS D or better under Cumulative conditions for the AM and PM peak hour. No mitigations would be required under the Cumulative conditions.

Table 7 – Cumulative (2040) Project Level of Service

#	Intersection	LOS Standard	Control Type	Cumulative (2040) Conditions					
				AM Peak Hour			PM Peak Hour		
				Movement	Delay	LOS	Movement	Delay	LOS
1	Freedom Boulevard / Miles Lane	D	SSSC	Overall	2.9	A	Overall	4.3	A
			<i>Worst Approach</i>	EB	12.0	B	EB	13.7	B
2	Santa Clara Street / Miles Lane	D	AWSC	Overall	7.1	A	Overall	7.4	A
3	Santa Clara Street / Marin Street	D	AWSC	Overall	11.7	C	Overall	9.6	B
4	Auto Center Drive / Marin Street	D	SSSC	Overall	7.7	A	Overall	4.3	A
			<i>Worst Approach</i>	WB	28.7	D	WB	19.1	C

Notes:

1. Analysis performed using HCM 2010 methodologies.
2. Delay indicated in seconds/vehicle.
3. Overall level of service (LOS) standard for the City is D.
4. Intersections that fall below City standard are shown in **bold**.

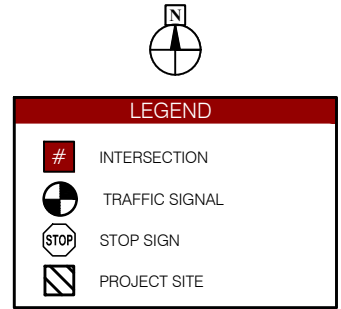
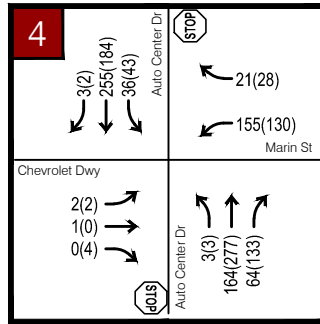
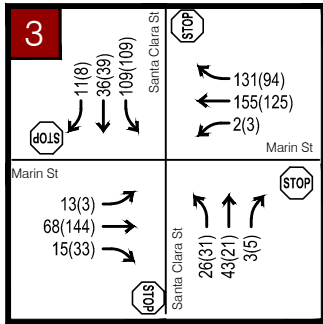
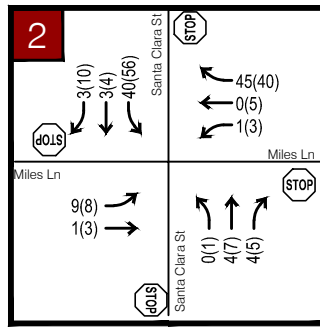
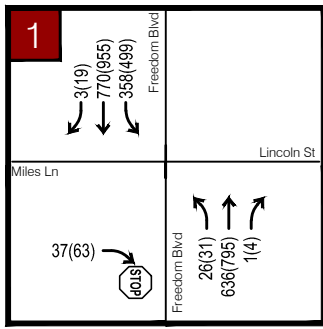

FIGURE 10
 CUMULATIVE (2040) CONDITIONS
 PEAK HOUR TURNING MOVEMENT VOLUMES
 MILES LANE DEVELOPMENT TRAFFIC IMPACT STUDY

6.3 CUMULATIVE (2040) PLUS PROJECT INTERSECTION LEVEL OF SERVICE

Trips generated by the Project were assigned in the cumulative Year 2040 conditions and are shown in **Figure 11**. Cumulative plus Project conditions were evaluated at study intersections and are presented in **Table 8** with the same geometry as existing conditions. As shown in **Table 8**, all study intersections are anticipated to operate at LOS D or better under Cumulative Plus Project conditions for the AM and PM peak hour. No mitigations would be required under the Cumulative Plus Project conditions.

Table 8 – Cumulative (2040) Plus Project Intersection Level of Service Summary

#	Intersection	LOS Standard	Control Type	Cumulative (2040) Plus Project Conditions					
				AM Peak Hour			PM Peak Hour		
				Movement	Delay	LOS	Movement	Delay	LOS
1	Freedom Boulevard / Miles Lane	D	SSSC	Overall	3.0	A	Overall	4.4	A
			<i>Worst Approach</i>	EB	12.1	B	EB	13.8	B
2	Santa Clara Street / Miles Lane	D	AWSC	Overall	7.1	A	Overall	7.5	A
3	Santa Clara Street / Marin Street	D	AWSC	Overall	11.9	B	Overall	9.7	A
4	Auto Center Drive / Marin Street	D	SSSC	Overall	8.3	A	Overall	4.7	A
			<i>Worst Approach</i>	WB	30.3	D	EB	19.9	C

Notes:

1. Analysis performed using HCM 2010 methodologies.
2. Delay indicated in seconds/vehicle.
3. Overall level of service (LOS) standard for the City is D.
4. Intersections that fall below City standard are shown in **bold**.

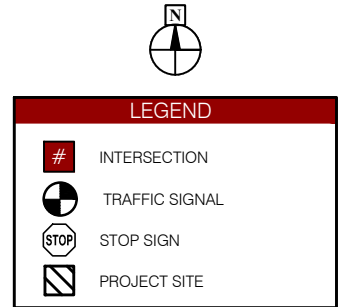
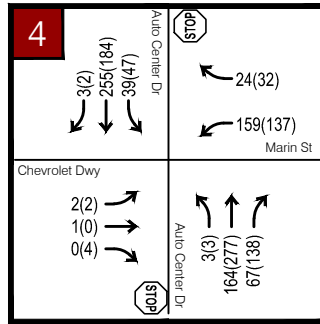
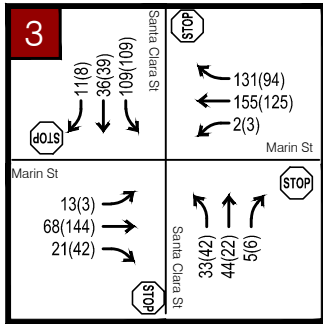
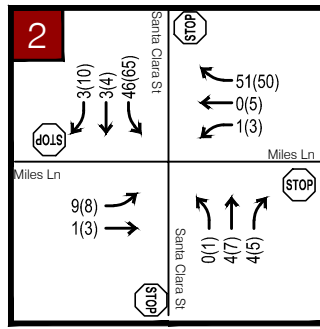
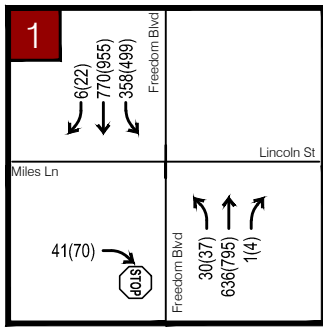

FIGURE 11
 CUMULATIVE (2040) PLUS PROJECT CONDITIONS
 PEAK HOUR TURNING MOVEMENT VOLUMES
 MILES LANE DEVELOPMENT TRAFFIC IMPACT STUDY

7.0 POTENTIAL IMPACTS ON PEDESTRIAN, BICYCLE, AND TRANSIT MOBILITY

The Project was evaluated to determine if it would adversely affect adopted policies, plans, or programs supporting alternative transportation (e.g., bus turnouts, bicycle racks and pedestrian flow) or generate pedestrian, bicycle, or transit travel demand that would not be accommodated by transit, bicycle, or pedestrian facilities and plans. The following sections describe the evaluation.

7.1 PEDESTRIAN MOBILITY

Residents, employees, patients, and patrons choosing to walk to the site would not be adversely impacted based on pedestrian mobility, accessibility, or safety once frontage improvements are constructed. Light pedestrian trips both in the weekday AM peak period and weekday PM peak period are anticipated for the Project. It is also expected that pedestrians would walk from their homes to the existing bus stop on Freedom Boulevard.

Internal pedestrian connections will link the proposed site's entrance with the parking areas.

7.2 BICYCLE MOBILITY

Residents, employees, patients, and patrons choosing to bike to the site would not be adversely impacted based on bicyclist mobility, accessibility, or safety. Some bicycle trips both in the weekday AM peak period and weekday PM peak period are anticipated for the Project. Existing Class II facilities exist on Freedom Boulevard just south of Miles Lane, while Class III bicycle facilities exist along Auto Center Drive, Arthur Road, and Freedom Boulevard. Pavement markings and signage indicate that bicycles will share the roadway with vehicles.

Existing bicycle facilities are discussed in **Section 3.3 Existing (2018) Pedestrian and Bicycle Network**.

7.3 TRANSIT MOBILITY

Residents, employees, and patrons choosing to utilize transit would not be adversely impacted based on pedestrian mobility, accessibility, or safety at the Project site. Pedestrian trips to the Project are anticipated as Santa Cruz Metro bus stops are located along Freedom Boulevard. Sidewalks exist along Miles Lane and Freedom Boulevard that will provide connectivity between the Project site and existing Santa Cruz Metro bus stops. A bus stop is located approximately 800 feet from the Project site. Service routes and stops are discussed in detail in **Section 3.4 Existing (2018) Transit Network**.

Residents, employees, and patrons of the proposed Project have the option of driving, taking transit, walking, or bicycling to the site. Those that choose to take transit have access to a bus stop on Freedom Boulevard. According to 2013-2017 American Community Survey (S0801) indicates that approximately 1.4% of City of Watsonville residents use transit to travel to/from home while approximately 2.8% of Santa Cruz County residents use transit to travel to/from home. The AM and PM commute periods typically represent the highest level of transit ridership during the day, with other periods being lower. It is anticipated that Project transit ridership will range between 1.4% and 2.8%. This percentage was then applied to the net new trips determined in the Project trip generation in section **4.2 Project Trip Generation**. Therefore, approximately 1 new passenger trip during the weekday AM peak period and approximately 1 new passenger trip during the weekday PM peak period, could be generated by the Project. These new trips

would have a negligible adverse impact on transit mobility, accessibility, and safety at any of the study intersections. To provide a more conservative analysis, transit trips were not reduced from the trip generation provided in **Table 3**.

8.0 PARKING REQUIREMENTS

The following sections discuss the proposed on-site parking supply to be constructed by the Project.

8.1 ON-SITE PARKING

CITY OF WATSONVILLE AUTOMOBILE PARKING REQUIREMENTS

Table 9 provides the automobile parking requirements for all the land uses expected to be constructed at the Project. Automobile parking rates were taken from the City of Watsonville Municipal Code (June 2014) Chapter 14-17 Parking and Loading Facilities. For this site, guest parking is required because the site is zoned as RM-2 (Multiple Residential-Medium Density). The following sections were used for each land use:

- Multi-Family Housing (Affordable Housing) – Section 14-47.110(f) (assumes density bonus is approved by the City)
- Residential Treatment Facility – Article 3 (Section 14-17.301, DLU:0721 & 0722 (f & g))
- Out-Patient Center – Article 10 (Section 14-17.1001, GLU:66 (3))

Table 9 – Automobile Parking Requirements

Land Use Description	Rate		No. of Units	Spaces Required
Multi-Family Housing (Section 14-47.110(f))	0-1 bedrooms	1 space per unit	22 units	22
	2-3 bedrooms	2 spaces per unit	38 units	76
Residential Treatment Facility (Article 3)	1 space per 3 beds		30 beds	10
Employees per Shift (Article 3)	1 space per employee on shift with maximum personnel		4 employees	4
Out-Patient Center (Article 10)	1 space for each 300 SQFT of floor area		3,810	13
Total Spaces Required				125

Based on **Table 9**, the Project is required to provide 125 vehicle parking spaces. According to the Property Information, located on **Figure 2**, the Project proposes to provide a total of 125 parking spaces. Therefore, the proposed parking supply would meet City requirements.

AMERICANS WITH DISABILITIES ACT (ADA) PARKING REQUIREMENTS

Minimum ADA parking requirements are provided in the 2010 ADA Standards for Accessible Design (2010) Table 208.2. The Project provides 125 spaces which would require a minimum of five (5) ADA spaces. The Project provides a total of eight (8) (4 van accessible spaces and 4 standard accessible spaces) ADA spaces.

Therefore, the Project would provide enough ADA parking. Table 208.2 is provided in the Appendix of this report.

CITY OF WATSONVILLE BICYCLE PARKING REQUIREMENTS

Table 10 provides the bicycle parking requirements for the Project. Bicycle parking rates were taken from the City of Watsonville Municipal Code (June 2014) Chapter 14-17 Parking and Loading Facilities.

According to City of Watsonville Municipal Code (14-17.113), bicycle parking shall be required except for land uses MLU-0 and MLU-9. The Project site is proposed to be zoned in the RM-2/PD zone which means that bicycle parking is required. **Table 10** provides the bicycle parking requirements according to the City of Watsonville Municipal Code.

Table 10 – Bicycle Parking Requirements

Rate	No. of Parking Spaces Required	Bicycle Spaces Required
Equivalent of 5% of the automobile parking requirement where 20 or more spaces are required	125	7

Base on **Table 10**, the Project is required to provide seven (7) bicycle parking spaces. The Project proposes to provide a total of 36 bicycle parking spaces. Therefore, the Project would provide a surplus of 29 bicycle parking spaces.

9.0 ON SITE CIRCULATION AND SIGHT DISTANCE ANALYSIS

9.1 SITE CIRCULATION

The following describes on-site circulation of the proposed Project driveways along Miles Lane and Kimberly Lane.

MILES LANE & PROJECT DRIVEWAY #1

Project Driveway #1 is located along Miles Lane and will be a full access driveway to motorists entering and leaving the Project site. The driveway will be for patrons and employees that want to access the Encompass Community Center.

Project Driveway #1 is not expected to experience significant vehicle queues and delay since volumes to/from the site are relatively low.

MILES LANE & PROJECT DRIVEWAYS #2 AND #3

Project Driveway #2 and #3 are located on Miles Lane and will be a full access driveway to motorists entering and leaving the Project site. These driveways will be used primarily for residents and guests that want to access the affordable housing units; however, employees and patrons are also able to access the community gardens and the retail space using these driveways.

Project Driveways #2 and #3 are not expected to experience significant vehicle queues and delay since volumes to/from the site are relatively low.

MILES LANE & PROJECT DRIVEWAY #4

Project Driveway #4 is located east of driveways #2 and #3. This driveway will provide full access primarily for residents who want to access the residences. Residents who want to access their home on the south east portion of the Project site would use this driveway and an access road would be provided to go to/from this driveway.

Project Driveway #4 is not expected to experience significant vehicle queues or delay since volumes to/from the site are relatively low.

9.2 SIGHT DISTANCE ANALYSIS AT AUTO CENTER DRIVE & MARIN STREET

SIGHT DISTANCE DEFINITIONS

A preliminary stopping sight distance and intersection sight distance analysis was conducted to determine if the intersection of Auto Center Drive & Marin Street were operating at acceptable levels. AASHTO methodology was used in this analysis. The sight distance needed under various assumptions of physical conditions and driver behavior is directly related to vehicle speeds and to the resultant distances traversed during perception-reaction time and braking.

Stopping sight distance is defined as the sum of reaction distance and braking distance. The reaction distance is based upon the driver reaction time while the braking distance is dependent upon the vehicle speed and the coefficient of friction between the tires and roadway as the vehicle decelerates to a complete stop. This sight distance analysis indicates the minimum visibility that is required for an approaching vehicle

on Auto Center Drive to stop safely if a vehicle from Marin Street enters or exits the approaching road. The driver should also have an unobstructed view of the intersection, including any traffic-control devices, and sufficient lengths along the intersecting road to permit the driver to anticipate and avoid potential collisions.

For vehicles entering Auto Center Drive from Marin Street, the AASHTO method evaluates sight distance from a vehicle exiting the driveway to a vehicle approaching from either direction. The intersection sight distance is defined along intersection approach legs and across their included corners known as departure sight triangles. These specified areas should be clear of obstructions that might block a driver's view of potentially conflicting vehicles. Intersection sight distance is measured from a point 3.5-feet above the existing grade (driver's eye) along the potential driveway to a 3.5-foot object height in the center of the approaching lane on Auto Center Drive. A vehicle setback in a stopped position from edge of travel way was assumed for determining intersection sight distance.

EXISTING SITE DISTANCE ANALYSIS AT AUTO CENTER DRIVE & MARIN STREET

The critical variable for determining actual sight distance is the vehicle and driver's eye setback. The AASHTO standard setback is 14.5 feet from the edge of the vehicle traveled way. Due to existing constraints from the existing S-curve and Romo's Auto Group, a 14.5-foot setback provides insufficient sight distance. AASHTO also states that that the distance from the front of a passenger vehicle to the driver's eye is nearly always eight (8) feet. To illustrate this intersection more realistically, sight distance was analyzed from the car stopped at the outside edge of the traveled lane (8-foot setback from travel-way).

Minimum sight distance criteria for the potential driveway along Auto Center Drive was determined from the AASHTO Geometric Design of Highways and Streets 6th Edition (Green Book). Speed data was provided by City of Watsonville staff and the 85th percentile speed was determined to be 25 miles per hour. For the purposes of this analysis, a design speed of 30 mph (25 mph posted speed limit) was assumed along Auto Center Drive to be conservative.

Along Auto Center Drive, as southbound drivers approach the intersection, they would experience a downgrade of approximately 5%, while northbound drivers would experience an upgrade of approximately 2%. Along Marin Street, drivers would experience an upgrade of approximately 6.4% as they approach the intersection. These grades have been verified with field calculations.

Based on the existing traffic control, minimum sight distance was calculated for the following scenarios:

- Stopping Sight Distance on Auto Center Drive
- Intersection Sight Distance Case B – Stop control at Marin Street
 - Case B1 – Left turn from the minor road
 - Case B2 – Right turn from the minor road

AASHTO standard time gap variables for passenger cars stopped on the proposed project driveways were used. Additional time gap was added to Case B1 and B2 because the existing grade exceeded 3%. This was a more conservative approach because a car may pull up into the 6.4% grade and perform a left turn or a right turn movement.

From Equations 3-4 and 3-5 of the Green Book, the minimum stopping sight distance for southbound drivers is approximately 211 feet and is approximately 192 feet for northbound drivers. From Equations 9-38 and 9-41, the intersection sight distance is approximately 387 feet for Case B1 and approximately 315 feet for Case B2 assuming approach grades mentioned above and a design speed of 30 mph.

Figure 12 shows the intersection and stopping sight distance for an 8-foot setback from the vehicular traveled way (8-foot setback from curb). This assumes that a vehicle has stopped at the stop bar, confirmed that no crossing pedestrians are present, pulled forward and stopped before the traveled way. Vehicles entering Auto Center Drive from the Marin Street will not have sufficient intersection sight distance in either direction to make a right or left turn onto the road per AASHTO Case B1 and B2 scenarios.

From **Figure 12**, stopping sight distance is adequate for vehicles traveling northbound on Auto Center Drive; however, vehicles traveling southbound on Auto Center Drive would have sight distance impeded by the existing fence and parked cars. The intersection sight distance is insufficient for both the northbound and southbound approaches due to the grade and parked vehicles.

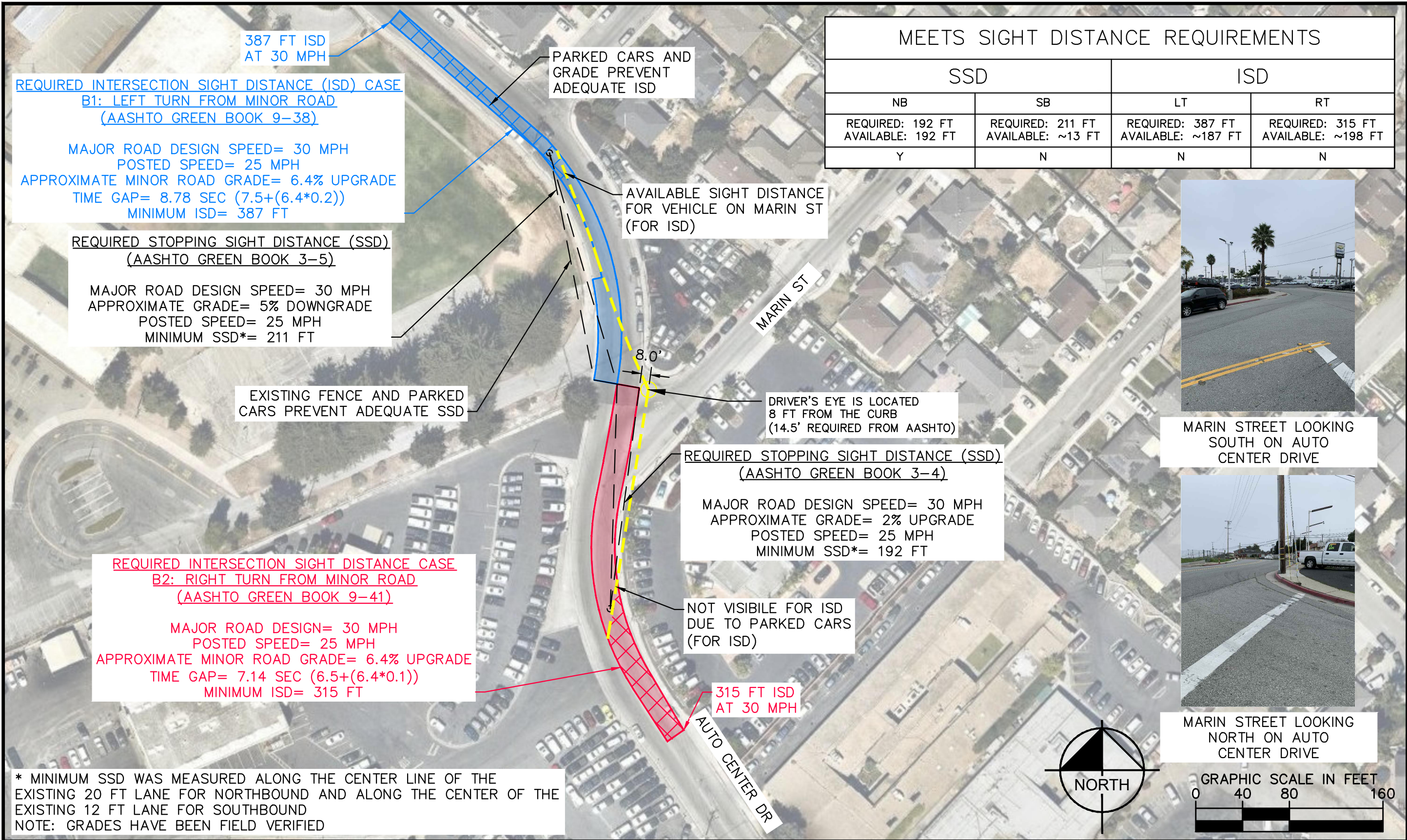

RECOMMENDED IMPROVEMENTS

Figure 13 shows the recommended improvements along Auto Center Drive to improve the safety of vehicles at the Auto Center Drive & Marin Street intersection and are summarized below. All striping details are from Caltrans Standard Plans (2018).

- *Auto Center Drive South of Marin Street*
 - Provide approximately 280 feet of Striping Detail 22 (Centerline)
 - Provide approximately 350 feet of Striping Detail 27B (Right Edgeline) and create a painted bulb-out for vehicles entering from Auto Center Drive. Within the painted bulb-out, add 6" diagonal white striping with 15' spacing. The right edgeline striping would move the center of the road away from the curb allowing for better visibility.
 - Provide "Intersection Ahead" signage (W1-10e) with "Speed Sign" (W13-1P) with 20 mph speed and a custom "Limited Sight Distance" sign. Place at point of curvature for Northbound approach according to MUCTD Table 2C-4. This sign would warn drivers of the approaching intersection to be aware of cross traffic and to reduce speed.

- *Marin Street*
 - Move the 12 inch stop bar closer to the curb line along with new "STOP" markings. This will allow drivers to pull up further into the new 8-foot parking lane to increase visibility along Auto Center Drive.
 - Provide approximately 75 feet of Striping Detail 22 (Centerline) to shift the westbound intersection approach to the north. This would allow for more visibility on the Auto Center Drive northbound approach.
 - Extend red curb on the south curb approximately 85 feet. This red curb would remove approximately three on-street parking spaces. This would prevent drivers from parking in the painted bulb-out.
 - Extend red curb on the north curb approximately 30 feet. This red curb would remove approximately one on-street parking space to allow more space for drivers to approach the intersection.

- *Auto Center Drive North of Marin Street*
 - Extend red curb approximately 120 feet on the east curb and provide "No Parking Anytime" signage. This would remove approximately five (5) on-street parking spaces. Red curb would make parking illegal along the eastern curb allowing southbound sight distance to be unobstructed.
 - Provide "Intersection Ahead" signage (W1-10e) with "Speed Sign" (W13-1P) with 20 mph speed and a custom "Limited Sight Distance" sign. Place at point of curvature for

southbound approach according to MUCTD Table 2C-4. This sign would warn drivers of the approaching intersection to be aware of cross traffic and to reduce speed.

- Provide speed feedback sign similar to existing signage on east side of Auto Center Drive. Place at point of curvature for southbound approach according to MUCTD Table 2C-4.
- Provide approximately 200 feet of Striping Detail 22 (Centerline) and Striping Detail 27B (Right Edgeline) for the Northbound approach. Right edgeline striping would be 8-feet from the curb. This striping would reduce confusion for vehicles traveling northbound.
- Provide approximately 490 feet of Striping Detail 27B (Right Edgeline) for the Southbound approach. This striping would move the center of the road away from the curb allowing for better visibility.

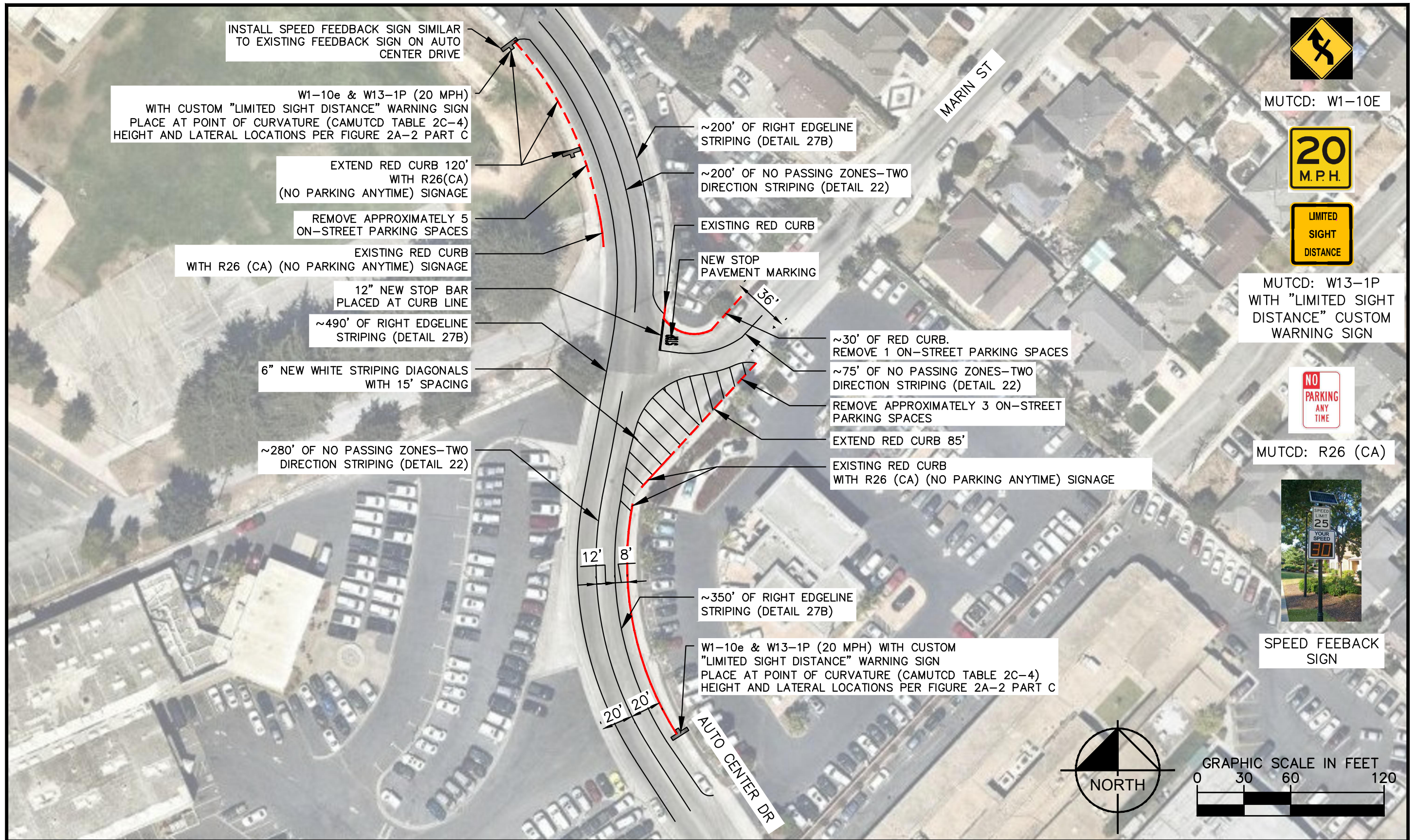

SIGHT DISTANCE WITH RECOMMENDED IMPROVEMENTS

With the improvements to Auto Center and Marin Street the drivers eye can now be measured from the edge of the parking lane instead of the curb since the edge of the traveled way is at the edge of the parking lane. In addition, the drivers eye can be located per the AASHTO standard of 14.5 feet from the edge of the traveled way. This assumes that the vehicle has stopped at the stop bar and confirmed that no pedestrians are present; however, an additional 6.5-foot buffer, between the front of the vehicle and the traveled way is now available. This is a more conservative analysis because this assumes that a vehicle will not completely pull up to the edge of the traveled way. This means a driver would require more visibility because they are further away from intersection.

Along with the change in the striping, warning signs are also installed to warn drivers to travel at 20 mph instead of 30 MPH. The City of Watsonville provided speed data for Auto Center Drive, and it was determined that the 85th percentile speed is 25 miles per hour. Based on the 85th percentile, this would mean drivers would need to travel five (5) miles per hour slower which is a reasonable reduction in speed. The reduction in speed means the required stopping sight and intersection sight distance will also decrease because vehicles are traveling slower and do not need as much time to stop. From Equations 3-3 and 3-4 of the AASHTO Green Book, the minimum stopping sight distance for southbound drivers is approximately 119 feet and is approximately 110 feet for northbound drivers. From Equations 9-38 and 9-41, the intersection sight distance is 258 feet for Case B1 and 210 feet for Case B2 assuming existing approach grades at a warning speed of 20 mph.

Figure 14 shows the new stopping sight distance and intersection sight distance for all approaches. As seen in **Figure 14** there is some hatching for both the northbound and southbound intersection sight distance zones. This hatching is the area where a driver cannot see; however, the driver can see the center of the driving lane. Cars are expected to drive along the center of the lane, which means this hatching will not impede sight distance for drivers performing movements out of Marin Street.

With these improvements, the intersection of Auto Center Drive and Marin Street are now compliant with AASHTO stopping sight and intersection sight distance.

MEETS SIGHT DISTANCE REQUIREMENTS			
SSD		ISD	
NB	SB	LT	RT
REQUIRED: 110 FT AVAILABLE: 110 FT	REQUIRED: 119 FT AVAILABLE: 119 FT	REQUIRED: 258 FT AVAILABLE: ~258 FT	REQUIRED: 210 FT AVAILABLE: ~210 FT
Y	Y	Y	Y

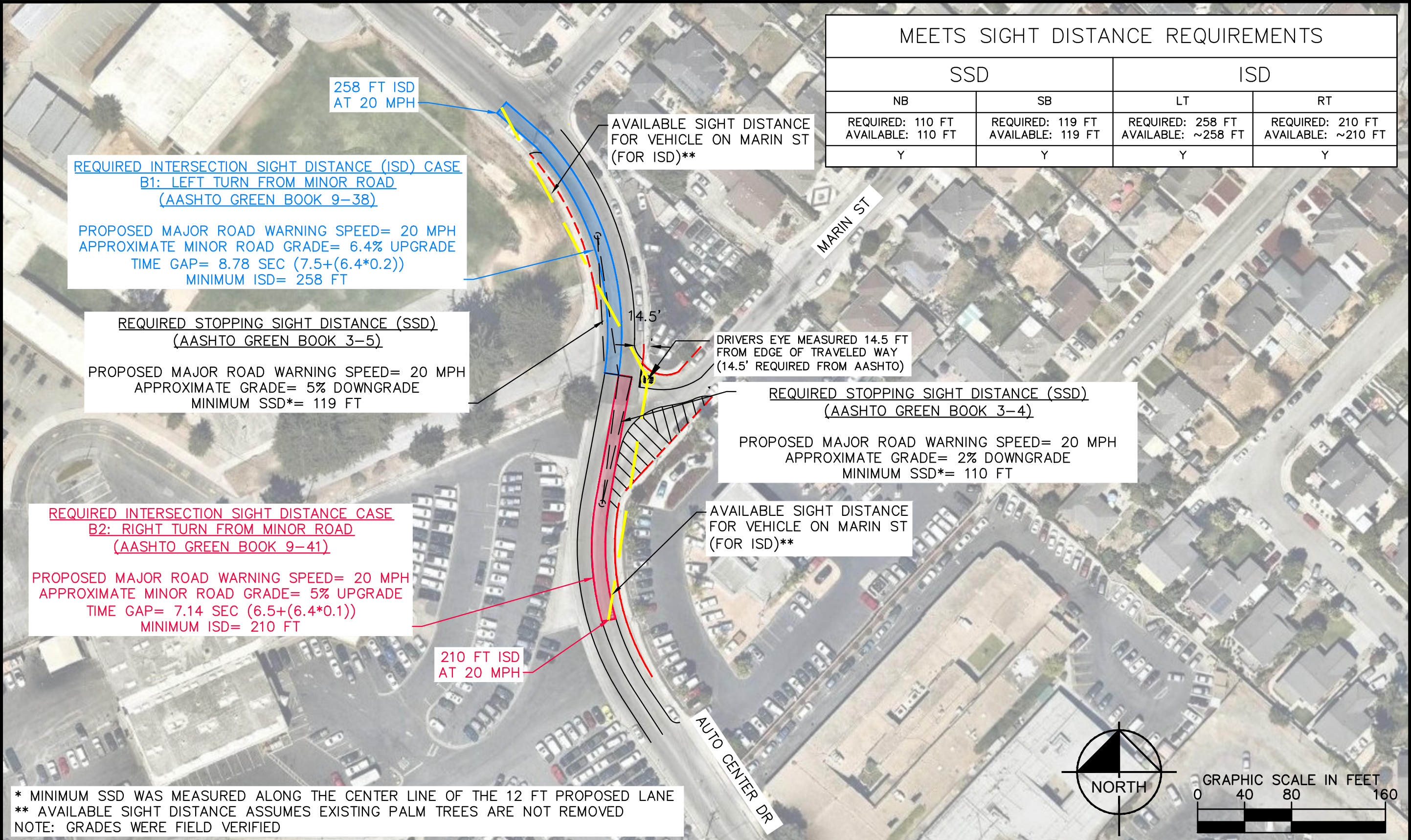

10.0 TRAFFIC IMPACT FEES AND RECOMMENDED IMPROVEMENTS

10.1 TRAFFIC IMPACT FEES

To determine traffic impact fees, the City of Watsonville provides a Development Fee Summary (2017-2018) that lists all the development fees for a Project. This document is provided in the **Appendix** of this report.

When calculating the traffic impact fee for the Project, analysis needed to be broken into existing and proposed conditions to determine the total net traffic impact fee. For the existing conditions, Single Family detached and Non-Residential (other) were used to determine the trips per unit. For this analysis, the managers unit was included in proposed conditions because the manager will contribute to the daily traffic on the roadway network. For the proposed conditions, Multi-Family and Non-Residential (other) were used to determine the trips per unit. **Table 11** summarizes the traffic impact fee for the Project.

Table 11 – Traffic Impact Fee

Land Use	Units	Rate ¹	Total Trips	Fee	Total
Existing Conditions					
Single Family Residential	4 DU	14 trips per unit	56 trips	\$185 per trip	\$10,360
Residential Treatment Facility	3.442 KSF	-	16 daily trips	\$95 per trip	\$1,520
Total Existing Conditions Traffic Impact Fee					\$11,880
Proposed Conditions					
Multi-Family Residential	61 DU	10 trips per unit	610 trips	\$185 per trip	\$112,850
Residential Treatment Facility	7.100 KSF	-	30 daily trips	\$95 per trip	\$2,850
Out-Patient Care	3.810 KSF	-	60 daily trips	\$95 per trip	\$5,700
Total Proposed Conditions Traffic Impact Fee					\$121,400
Total Net Traffic Impact Fee					\$109,520

1. For Non-Residential land uses, daily trips were used from Table 3

Based on **Table 11**, the Project would require a net traffic impact fee of **\$109,520**.

10.2 RECOMMENDED IMPROVEMENTS

Based on the findings of this report, the Project would require no additional improvements to study intersections or roadway network would be required. All intersections would be expected to operate at a Level of Service (LOS) of D or better with the implementation of the Project which means further intersection improvements are not necessary.

At the intersection of Auto Center Drive and Marin Street, the following improvements are recommended to improve the sight distance at the intersection:

- *Auto Center Drive South of Marin Street*

- Provide approximately 280 feet of Striping Detail 22 (Centerline)
- Provide approximately 350 feet of Striping Detail 27B (Right Edgeline) and create a painted bulb-out for vehicles entering from Auto Center Drive. Within the painted bulb-out, add 6" diagonal white striping with 15' spacing. The right edgeline striping would move the center of the road away from the curb allowing for better visibility.
- Provide "Intersection Ahead" signage (W1-10e) with "Speed Sign" (W13-1P) with 20 mph speed and a custom "Limited Sight Distance" sign. Place at point of curvature for Northbound approach according to MUCTD Table 2C-4. This sign would warn drivers of the approaching intersection to be aware of cross traffic and to reduce speed.
- *Marin Street*
 - Move the 12-inch stop bar closer to the curb line along with new "STOP" markings. This will allow drivers to pull up further into the new 8-foot parking lane to increase visibility along Auto Center Drive.
 - Provide approximately 75-feet of Striping Detail 22 (Centerline) to shift the westbound intersection approach to the north. This would allow for more visibility on the Auto Center Drive northbound approach.
 - Extend red curb on the south curb approximately 85 feet. This red curb would remove approximately three on-street parking spaces. This would prevent drivers from parking in the painted bulb-out.
 - Extend red curb on the north curb approximately 30 feet. This red curb would remove approximately one on-street parking space to allow more space for drivers to approach the intersection.
- *Auto Center Drive North of Marin Street*
 - Extend red curb approximately 120 feet on the east curb and provide "No Parking Anytime" signage. This would remove approximately five (5) on-street parking spaces. Red curb would make parking illegal along the eastern curb allowing southbound sight distance to be unobstructed.
 - Provide "Intersection Ahead" signage (W1-10e) with "Speed Sign" (W13-1P) with 20 mph speed and a custom "Limited Sight Distance" sign. Place at point of curvature for southbound approach according to MUCTD Table 2C-4. This sign would warn drivers of the approaching intersection to be aware of cross traffic and to reduce speed.
 - Provide speed feedback sign similar to existing signage on east side of Auto Center Drive. Place at point of curvature for southbound approach according to MUCTD Table 2C-4.
 - Provide approximately 200 feet of Striping Detail 22 (Centerline) and Striping Detail 27B (Right Edgeline) for the Northbound approach. Right edgeline striping would be 8-feet from the curb. This striping would reduce confusion for vehicles traveling northbound.
 - Provide approximately 490 feet of Striping Detail 27B (Right Edgeline) for the Southbound approach. This striping would move the center of the road away from the curb allowing for better visibility.

APPENDIX

A: TURNING MOVEMENT VOLUMES

B: EXISTING TRAFFIC CONDITIONS (2018) ANALYSIS SHEETS

C: EXISTING (2018) PLUS PROJECT TRAFFIC CONDITIONS ANALYSIS SHEETS

D: NEAR TERM (2021) TRAFFIC CONDITIONS ANALYSIS SHEETS

E: NEAR TERM (2021) PLUS PROJECT TRAFFIC CONDITIONS ANALYSIS SHEETS

F: CUMULATIVE (2040) TRAFFIC CONDITIONS ANALYSIS SHEETS

G: CUMULATIVE (2040) PLUS PROJECT TRAFFIC CONDITIONS ANALYSIS SHEETS

H: CITY OF WATSONVILLE DEVELOPMENT FEE SUMMARY 2017-2018

I: ADA 2010 STANDARDS FOR ACCESSIBLE DESIGN: TABLE 208.2 PARKING SPACES

J: EXISTING AND PROPOSED BICYCLE NETWORK AND TRANSIT FACILITIES

APPENDIX A: TURNING MOVEMENT VOLUMES

Freedom Blvd Miles Ln



Date: 12-18-2018

Count Period: 7:00 AM to 9:00 AM

Peak Hour: 7:30 AM to 8:30 AM

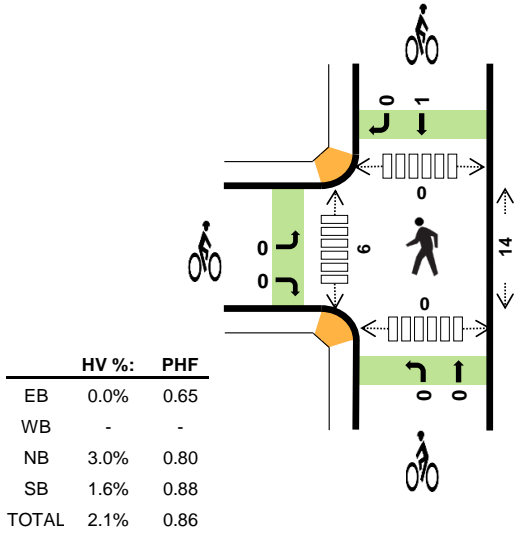
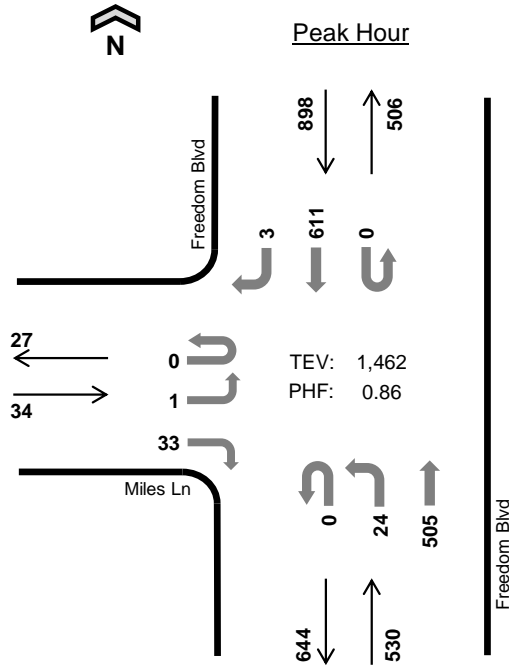

	HV %:	PHF
EB	0.0%	0.65
WB	-	-
NB	3.0%	0.80
SB	1.6%	0.88
TOTAL	2.1%	0.86

Two-Hour Count Summaries

Interval Start	Miles Ln				0				Freedom Blvd				Freedom Blvd				15-min Total	Rolling One Hour	
	Eastbound				Westbound				Northbound				Southbound						
	UT	LT	TH	RT	UT	LT	TH	RT	UT	LT	TH	RT	UT	LT	TH	RT			
7:00 AM	0	0	0	3	0	0	0	0	0	1	60	0	0	32	59	0	155	0	
7:15 AM	0	0	0	4	0	0	0	0	0	2	82	0	0	48	77	0	213	0	
7:30 AM	0	0	0	13	0	0	0	0	0	7	124	0	0	81	138	0	363	0	
7:45 AM	0	0	0	6	0	0	0	0	0	11	154	1	0	81	172	1	426	1,157	
8:00 AM	0	0	0	6	0	0	0	0	0	4	120	0	0	76	148	0	354	1,356	
8:15 AM	0	1	0	8	0	0	0	0	0	2	107	0	0	46	153	2	319	1,462	
8:30 AM	0	0	0	8	0	0	0	0	0	2	104	0	0	53	134	0	301	1,400	
8:45 AM	0	0	0	10	0	0	0	0	0	3	84	0	0	36	96	2	231	1,205	
Count Total	0	1	0	58	0	0	0	0	0	32	835	1	0	453	977	5	2,362	0	
Peak Hour	All	0	1	0	33	0	0	0	0	0	24	505	1	0	284	611	3	1,462	0
	HV	0	0	0	0	0	0	0	0	0	1	14	1	0	6	8	0	30	0
	HV%	-	0%	-	0%	-	-	-	-	-	4%	3%	100%	-	2%	1%	0%	2%	0

Note: Two-hour count summary volumes include heavy vehicles but exclude bicycles in overall count.

Interval Start	Heavy Vehicle Totals					Bicycles					Pedestrians (Crossing Leg)				
	EB	WB	NB	SB	Total	EB	WB	NB	SB	Total	East	West	North	South	Total
7:00 AM	0	0	0	0	0	0	0	0	0	0	2	1	0	0	3
7:15 AM	0	0	2	3	5	0	0	0	0	0	6	7	0	0	13
7:30 AM	0	0	5	5	10	0	0	0	1	1	6	2	0	0	8
7:45 AM	0	0	4	5	9	0	0	0	0	0	5	1	0	0	6
8:00 AM	0	0	4	0	4	0	0	0	0	0	2	0	0	0	2
8:15 AM	0	0	3	4	7	0	0	0	0	0	1	3	0	0	4
8:30 AM	1	0	4	6	11	0	0	0	0	0	1	2	0	2	5
8:45 AM	0	0	3	4	7	0	0	0	0	0	4	6	0	0	10
Count Total	1	0	25	27	53	0	0	0	1	1	27	22	0	2	51
Peak Hr	0	0	16	14	30	0	0	0	1	1	14	6	0	0	20

Two-Hour Count Summaries - Heavy Vehicles																		
Interval Start	Miles Ln				0				Freedom Blvd				Freedom Blvd				15-min Total	Rolling One Hour
	Eastbound				Westbound				Northbound				Southbound					
	UT	LT	TH	RT	UT	LT	TH	RT	UT	LT	TH	RT	UT	LT	TH	RT		
7:00 AM	0	0	0	0	0	0	0	0	0	0	0	0	0	0	0	0	0	
7:15 AM	0	0	0	0	0	0	0	0	0	0	2	0	0	0	3	0	5	
7:30 AM	0	0	0	0	0	0	0	0	0	1	4	0	0	3	2	0	10	
7:45 AM	0	0	0	0	0	0	0	0	0	0	3	1	0	2	3	0	9	
8:00 AM	0	0	0	0	0	0	0	0	0	0	4	0	0	0	0	0	4	
8:15 AM	0	0	0	0	0	0	0	0	0	0	3	0	0	1	3	0	7	
8:30 AM	0	0	0	1	0	0	0	0	0	1	3	0	0	1	5	0	11	
8:45 AM	0	0	0	0	0	0	0	0	0	0	3	0	0	1	3	0	7	
Count Total	0	0	0	1	0	0	0	0	0	2	22	1	0	8	19	0	53	
Peak Hour	0	0	0	0	0	0	0	0	0	1	14	1	0	6	8	0	30	
Two-Hour Count Summaries - Bikes																		
Interval Start	Miles Ln			0			Freedom Blvd			Freedom Blvd			15-min Total	Rolling One Hour				
	Eastbound			Westbound			Northbound			Southbound								
	LT	TH	RT	LT	TH	RT	LT	TH	RT	LT	TH	RT						
7:00 AM	0	0	0	0	0	0	0	0	0	0	0	0	0	0	0	0	0	
7:15 AM	0	0	0	0	0	0	0	0	0	0	0	0	0	0	0	0	0	
7:30 AM	0	0	0	0	0	0	0	0	0	0	0	0	0	1	0	0	1	
7:45 AM	0	0	0	0	0	0	0	0	0	0	0	0	0	0	0	0	0	
8:00 AM	0	0	0	0	0	0	0	0	0	0	0	0	0	0	0	0	0	
8:15 AM	0	0	0	0	0	0	0	0	0	0	0	0	0	0	0	0	0	
8:30 AM	0	0	0	0	0	0	0	0	0	0	0	0	0	0	0	0	0	
8:45 AM	0	0	0	0	0	0	0	0	0	0	0	0	0	0	0	0	0	
Count Total	0	0	0	0	0	0	0	0	0	0	0	0	0	1	0	0	1	
Peak Hour	0	0	0	0	0	0	0	0	0	0	0	0	0	1	0	0	1	
<i>Note: U-Turn volumes for bikes are included in Left-Turn, if any.</i>																		

Freedom Blvd Miles Ln



Date: 12-18-2018

Count Period: 4:00 PM to 6:00 PM

Peak Hour: 4:45 PM to 5:45 PM

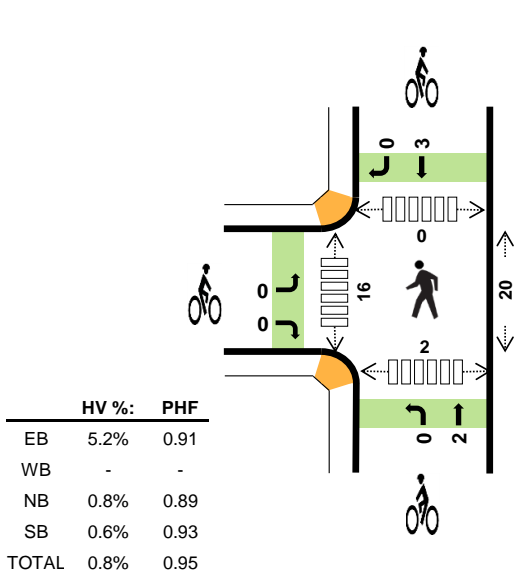
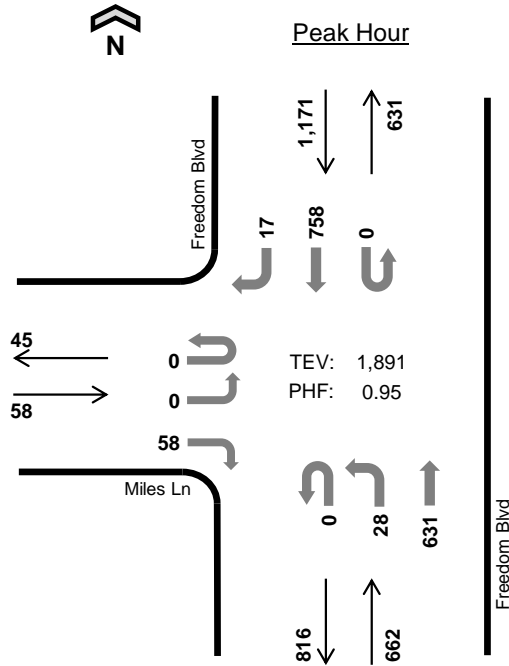

	HV %:	PHF
EB	5.2%	0.91
WB	-	-
NB	0.8%	0.89
SB	0.6%	0.93
TOTAL	0.8%	0.95

Two-Hour Count Summaries

Interval Start	Miles Ln				0				Freedom Blvd				Freedom Blvd				15-min Total	Rolling One Hour	
	Eastbound				Westbound				Northbound				Southbound						
	UT	LT	TH	RT	UT	LT	TH	RT	UT	LT	TH	RT	UT	LT	TH	RT			
4:00 PM	0	0	0	12	0	0	0	0	0	8	176	2	0	83	172	1	454	0	
4:15 PM	0	0	0	12	0	0	0	0	0	6	154	1	0	94	181	4	452	0	
4:30 PM	0	0	0	8	0	0	0	0	0	5	157	0	0	85	158	5	418	0	
4:45 PM	0	0	0	14	0	0	0	0	0	5	145	0	0	85	174	7	430	1,754	
5:00 PM	0	0	0	13	0	0	0	0	0	8	179	0	0	98	198	3	499	1,799	
5:15 PM	0	0	0	16	0	0	0	0	0	7	151	2	0	113	195	6	490	1,837	
5:30 PM	0	0	0	15	0	0	0	0	0	8	156	1	0	100	191	1	472	1,891	
5:45 PM	0	0	0	2	0	0	0	0	0	6	160	0	0	73	135	1	377	1,838	
Count Total	0	0	0	92	0	0	0	0	0	53	1,278	6	0	731	1,404	28	3,592	0	
Peak Hour	All	0	0	0	58	0	0	0	0	0	28	631	3	0	396	758	17	1,891	0
	HV	0	0	0	3	0	0	0	0	0	2	3	0	0	3	3	1	15	0
	HV%	-	-	-	5%	-	-	-	-	-	7%	0%	0%	-	1%	0%	6%	1%	0

Note: Two-hour count summary volumes include heavy vehicles but exclude bicycles in overall count.

Interval Start	Heavy Vehicle Totals					Bicycles					Pedestrians (Crossing Leg)				
	EB	WB	NB	SB	Total	EB	WB	NB	SB	Total	East	West	North	South	Total
4:00 PM	0	0	1	2	3	0	0	0	0	0	4	0	0	0	4
4:15 PM	0	0	1	2	3	0	0	1	0	1	4	3	1	0	8
4:30 PM	1	0	0	3	4	0	0	0	0	0	4	4	0	0	8
4:45 PM	0	0	3	2	5	0	0	0	1	1	8	3	0	0	11
5:00 PM	1	0	0	0	1	0	0	0	1	1	3	3	0	2	8
5:15 PM	1	0	1	3	5	0	0	1	0	1	8	9	0	0	17
5:30 PM	1	0	1	2	4	0	0	1	1	2	1	1	0	0	2
5:45 PM	0	0	0	1	1	0	0	0	0	0	1	4	0	1	6
Count Total	4	0	7	15	26	0	0	3	3	6	33	27	1	3	64
Peak Hr	3	0	5	7	15	0	0	2	3	5	20	16	0	2	38

Two-Hour Count Summaries - Heavy Vehicles																		
Interval Start	Miles Ln				0				Freedom Blvd				Freedom Blvd				15-min Total	Rolling One Hour
	Eastbound				Westbound				Northbound				Southbound					
	UT	LT	TH	RT	UT	LT	TH	RT	UT	LT	TH	RT	UT	LT	TH	RT		
4:00 PM	0	0	0	0	0	0	0	0	0	1	0	0	0	1	1	0	3	0
4:15 PM	0	0	0	0	0	0	0	0	0	0	1	0	0	1	0	1	3	0
4:30 PM	0	0	0	1	0	0	0	0	0	0	0	0	0	1	2	0	4	0
4:45 PM	0	0	0	0	0	0	0	0	0	1	2	0	0	1	1	0	5	15
5:00 PM	0	0	0	1	0	0	0	0	0	0	0	0	0	0	0	0	1	13
5:15 PM	0	0	0	1	0	0	0	0	0	0	1	0	0	2	0	1	5	15
5:30 PM	0	0	0	1	0	0	0	0	0	1	0	0	0	0	2	0	4	15
5:45 PM	0	0	0	0	0	0	0	0	0	0	0	0	0	0	1	0	1	11
Count Total	0	0	0	4	0	0	0	0	0	3	4	0	0	6	7	2	26	0
Peak Hour	0	0	0	3	0	0	0	0	0	2	3	0	0	3	3	1	15	0
Two-Hour Count Summaries - Bikes																		
Interval Start	Miles Ln			0			Freedom Blvd			Freedom Blvd			15-min Total	Rolling One Hour				
	Eastbound			Westbound			Northbound			Southbound								
	LT	TH	RT	LT	TH	RT	LT	TH	RT	LT	TH	RT						
4:00 PM	0	0	0	0	0	0	0	0	0	0	0	0	0	0	0	0	0	0
4:15 PM	0	0	0	0	0	0	0	0	1	0	0	0	0	0	0	1	0	0
4:30 PM	0	0	0	0	0	0	0	0	0	0	0	0	0	0	0	0	0	0
4:45 PM	0	0	0	0	0	0	0	0	0	0	0	0	1	0	0	1	2	2
5:00 PM	0	0	0	0	0	0	0	0	0	0	0	0	1	0	0	1	3	3
5:15 PM	0	0	0	0	0	0	0	0	1	0	0	0	0	0	0	1	3	3
5:30 PM	0	0	0	0	0	0	0	0	1	0	0	0	1	0	0	2	5	5
5:45 PM	0	0	0	0	0	0	0	0	0	0	0	0	0	0	0	0	0	4
Count Total	0	0	0	0	0	0	0	0	3	0	0	0	3	0	0	6	0	0
Peak Hour	0	0	0	0	0	0	0	0	2	0	0	0	3	0	0	5	0	0
Note: U-Turn volumes for bikes are included in Left-Turn, if any.																		

Santa Clara St Miles Ln



Date: 12-18-2018
 Count Period: 7:00 AM to 9:00 AM
 Peak Hour: 7:30 AM to 8:30 AM

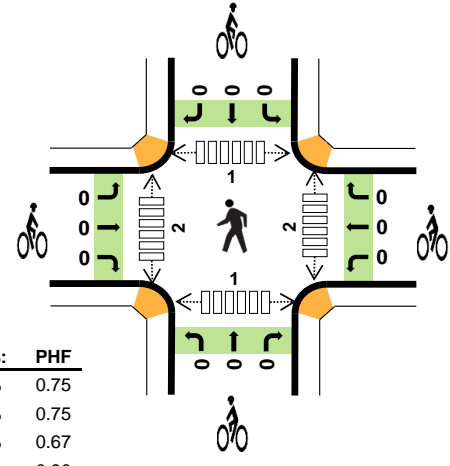
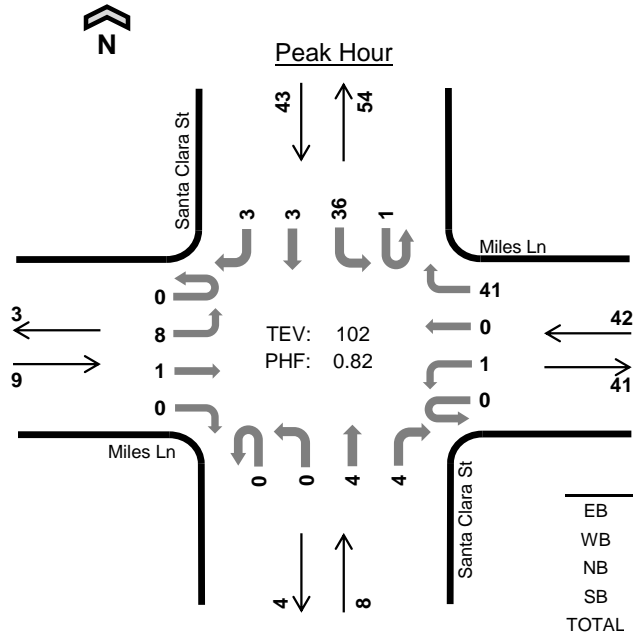

	HV %:	PHF
EB	0.0%	0.75
WB	2.4%	0.75
NB	0.0%	0.67
SB	0.0%	0.90
TOTAL	1.0%	0.82

Two-Hour Count Summaries

Interval Start	Miles Ln Eastbound				Miles Ln Westbound				Santa Clara St Northbound				Santa Clara St Southbound				15-min Total	Rolling One Hour	
	UT	LT	TH	RT	UT	LT	TH	RT	UT	LT	TH	RT	UT	LT	TH	RT			
7:00 AM	0	1	1	0	0	0	0	4	0	0	1	1	0	3	0	0	11	0	
7:15 AM	0	0	0	0	0	0	0	9	0	0	1	0	0	6	0	2	18	0	
7:30 AM	0	2	1	0	0	1	0	13	0	0	1	2	0	9	1	0	30	0	
7:45 AM	0	3	0	0	0	0	0	14	0	0	2	1	1	8	1	1	31	90	
8:00 AM	0	2	0	0	0	0	0	9	0	0	0	1	0	8	1	1	22	101	
8:15 AM	0	1	0	0	0	0	0	5	0	0	1	0	0	11	0	1	19	102	
8:30 AM	0	0	0	0	0	0	0	5	0	0	0	0	0	7	0	1	13	85	
8:45 AM	0	1	1	0	0	0	0	4	0	0	1	1	0	10	1	0	19	73	
Count Total	0	10	3	0	0	1	0	63	0	0	7	6	1	62	4	6	163	0	
Peak Hour	All	0	8	1	0	0	1	0	41	0	0	4	4	1	36	3	3	102	0
	HV	0	0	0	0	0	0	0	1	0	0	0	0	0	0	0	0	1	0
	HV%	-	0%	0%	-	-	0%	-	2%	-	-	0%	0%	0%	0%	0%	0%	1%	0

Note: Two-hour count summary volumes include heavy vehicles but exclude bicycles in overall count.

Interval Start	Heavy Vehicle Totals					Bicycles					Pedestrians (Crossing Leg)				
	EB	WB	NB	SB	Total	EB	WB	NB	SB	Total	East	West	North	South	Total
7:00 AM	0	0	0	0	0	0	0	0	0	0	0	0	0	0	0
7:15 AM	0	0	0	0	0	0	0	0	0	0	1	0	0	0	1
7:30 AM	0	1	0	0	1	0	0	0	0	0	1	0	0	1	2
7:45 AM	0	0	0	0	0	0	0	0	0	0	0	0	0	0	0
8:00 AM	0	0	0	0	0	0	0	0	0	0	0	1	1	0	2
8:15 AM	0	0	0	0	0	0	0	0	0	0	1	1	0	0	2
8:30 AM	0	1	0	0	1	0	0	0	0	0	0	0	0	0	0
8:45 AM	0	0	0	1	1	0	0	0	0	0	0	0	0	0	0
Count Total	0	2	0	1	3	0	0	0	0	0	3	2	1	1	7
Peak Hour	0	1	0	0	1	0	0	0	0	0	2	2	1	1	6

Two-Hour Count Summaries - Heavy Vehicles																		
Interval Start	Miles Ln				Miles Ln				Santa Clara St				Santa Clara St				15-min Total	Rolling One Hour
	Eastbound				Westbound				Northbound				Southbound					
	UT	LT	TH	RT	UT	LT	TH	RT	UT	LT	TH	RT	UT	LT	TH	RT		
7:00 AM	0	0	0	0	0	0	0	0	0	0	0	0	0	0	0	0	0	
7:15 AM	0	0	0	0	0	0	0	0	0	0	0	0	0	0	0	0	0	
7:30 AM	0	0	0	0	0	0	0	1	0	0	0	0	0	0	0	1	0	
7:45 AM	0	0	0	0	0	0	0	0	0	0	0	0	0	0	0	0	1	
8:00 AM	0	0	0	0	0	0	0	0	0	0	0	0	0	0	0	0	1	
8:15 AM	0	0	0	0	0	0	0	0	0	0	0	0	0	0	0	0	1	
8:30 AM	0	0	0	0	0	0	0	1	0	0	0	0	0	0	0	1	1	
8:45 AM	0	0	0	0	0	0	0	0	0	0	0	0	0	1	0	1	2	
Count Total	0	0	0	0	0	0	0	2	0	0	0	0	0	1	0	3	0	
Peak Hour	0	0	0	0	0	0	0	1	0	0	0	0	0	0	0	1	0	

Two-Hour Count Summaries - Bikes														
Interval Start	Miles Ln			Miles Ln			Santa Clara St			Santa Clara St			15-min Total	Rolling One Hour
	Eastbound			Westbound			Northbound			Southbound				
	LT	TH	RT	LT	TH	RT	LT	TH	RT	LT	TH	RT		
7:00 AM	0	0	0	0	0	0	0	0	0	0	0	0	0	0
7:15 AM	0	0	0	0	0	0	0	0	0	0	0	0	0	0
7:30 AM	0	0	0	0	0	0	0	0	0	0	0	0	0	0
7:45 AM	0	0	0	0	0	0	0	0	0	0	0	0	0	0
8:00 AM	0	0	0	0	0	0	0	0	0	0	0	0	0	0
8:15 AM	0	0	0	0	0	0	0	0	0	0	0	0	0	0
8:30 AM	0	0	0	0	0	0	0	0	0	0	0	0	0	0
8:45 AM	0	0	0	0	0	0	0	0	0	0	0	0	0	0
Count Total	0	0	0	0	0	0	0	0	0	0	0	0	0	0
Peak Hour	0	0	0	0	0	0	0	0	0	0	0	0	0	0

Note: U-Turn volumes for bikes are included in Left-Turn, if any.

Santa Clara St Miles Ln



Date: 12-18-2018
 Count Period: 4:00 PM to 6:00 PM
 Peak Hour: 4:45 PM to 5:45 PM

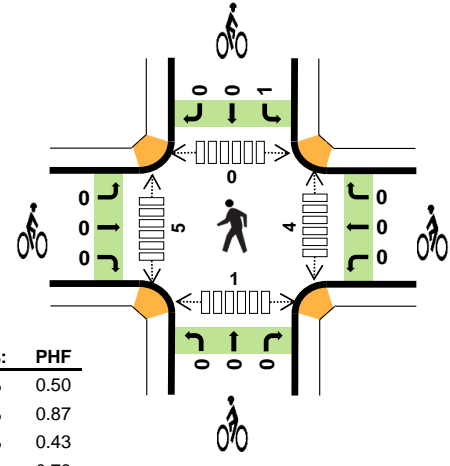
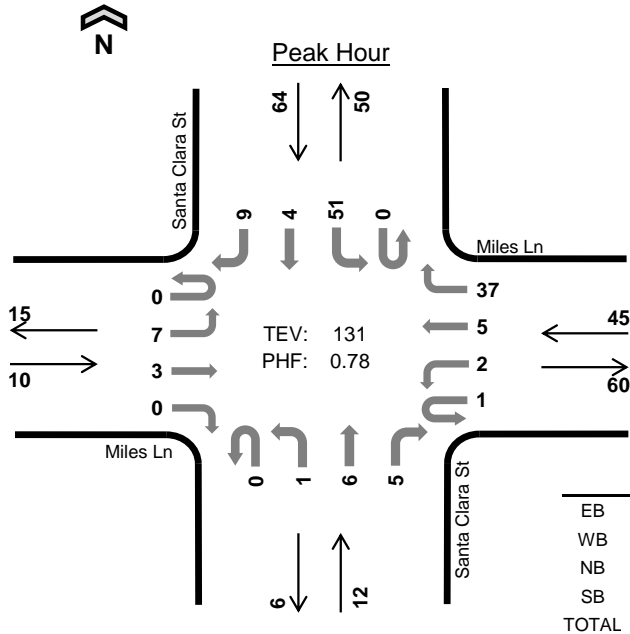

	HV %:	PHF
EB	0.0%	0.50
WB	4.4%	0.87
NB	0.0%	0.43
SB	1.6%	0.73
TOTAL	2.3%	0.78

Two-Hour Count Summaries

Interval Start	Miles Ln Eastbound				Miles Ln Westbound				Santa Clara St Northbound				Santa Clara St Southbound				15-min Total	Rolling One Hour	
	UT	LT	TH	RT	UT	LT	TH	RT	UT	LT	TH	RT	UT	LT	TH	RT			
4:00 PM	0	1	1	0	0	0	3	7	0	0	2	1	0	16	5	1	37	0	
4:15 PM	0	0	1	0	0	1	0	7	0	0	2	0	0	12	2	1	26	0	
4:30 PM	0	2	0	0	0	1	0	8	0	0	1	0	0	5	2	4	23	0	
4:45 PM	0	2	1	0	0	1	1	8	0	1	5	1	0	16	2	4	42	128	
5:00 PM	0	0	1	0	0	1	1	8	0	0	0	0	0	13	1	4	29	120	
5:15 PM	0	0	1	0	1	0	2	10	0	0	1	3	0	12	1	0	31	125	
5:30 PM	0	5	0	0	0	0	1	11	0	0	0	1	0	10	0	1	29	131	
5:45 PM	0	1	0	0	0	0	0	8	0	0	4	0	0	7	3	3	26	115	
Count Total	0	11	5	0	1	4	8	67	0	1	15	6	0	91	16	18	243	0	
Peak Hour	All	0	7	3	0	1	2	5	37	0	1	6	5	0	51	4	9	131	0
	HV	0	0	0	0	0	0	0	2	0	0	0	0	0	1	0	0	3	0
	HV%	-	0%	0%	-	0%	0%	0%	5%	-	0%	0%	0%	-	2%	0%	0%	2%	0

Note: Two-hour count summary volumes include heavy vehicles but exclude bicycles in overall count.

Interval Start	Heavy Vehicle Totals					Bicycles					Pedestrians (Crossing Leg)				
	EB	WB	NB	SB	Total	EB	WB	NB	SB	Total	East	West	North	South	Total
4:00 PM	1	1	0	1	3	0	0	0	1	1	0	1	0	0	1
4:15 PM	0	1	1	0	2	0	0	0	0	0	0	0	0	0	0
4:30 PM	0	0	0	0	0	0	0	0	0	0	0	0	0	0	0
4:45 PM	0	1	0	1	2	0	0	0	0	0	1	0	0	0	1
5:00 PM	0	0	0	0	0	0	0	0	0	0	0	0	0	0	0
5:15 PM	0	0	0	0	0	0	0	0	1	1	3	4	0	1	8
5:30 PM	0	1	0	0	1	0	0	0	0	0	0	1	0	0	1
5:45 PM	0	0	0	0	0	0	0	0	0	0	1	2	0	2	5
Count Total	1	4	1	2	8	0	0	0	2	2	5	8	0	3	16
Peak Hour	0	2	0	1	3	0	0	0	1	1	4	5	0	1	10

Two-Hour Count Summaries - Heavy Vehicles																		
Interval Start	Miles Ln				Miles Ln				Santa Clara St				15-min Total	Rolling One Hour				
	Eastbound				Westbound				Northbound						Southbound			
	UT	LT	TH	RT	UT	LT	TH	RT	UT	LT	TH	RT			UT	LT	TH	RT
4:00 PM	0	0	1	0	0	0	1	0	0	0	0	0	0	0	0	1	3	0
4:15 PM	0	0	0	0	0	0	0	1	0	0	1	0	0	0	0	0	2	0
4:30 PM	0	0	0	0	0	0	0	0	0	0	0	0	0	0	0	0	0	0
4:45 PM	0	0	0	0	0	0	0	1	0	0	0	0	0	1	0	0	2	7
5:00 PM	0	0	0	0	0	0	0	0	0	0	0	0	0	0	0	0	0	4
5:15 PM	0	0	0	0	0	0	0	0	0	0	0	0	0	0	0	0	0	2
5:30 PM	0	0	0	0	0	0	0	1	0	0	0	0	0	0	0	0	1	3
5:45 PM	0	0	0	0	0	0	0	0	0	0	0	0	0	0	0	0	0	1
Count Total	0	0	1	0	0	0	1	3	0	0	1	0	0	1	0	1	8	0
Peak Hour	0	0	0	0	0	0	0	2	0	0	0	0	0	1	0	0	3	0

Two-Hour Count Summaries - Bikes														
Interval Start	Miles Ln			Miles Ln			Santa Clara St			Santa Clara St			15-min Total	Rolling One Hour
	Eastbound			Westbound			Northbound			Southbound				
	LT	TH	RT	LT	TH	RT	LT	TH	RT	LT	TH	RT		
4:00 PM	0	0	0	0	0	0	0	0	0	0	1	0	1	0
4:15 PM	0	0	0	0	0	0	0	0	0	0	0	0	0	0
4:30 PM	0	0	0	0	0	0	0	0	0	0	0	0	0	0
4:45 PM	0	0	0	0	0	0	0	0	0	0	0	0	0	1
5:00 PM	0	0	0	0	0	0	0	0	0	0	0	0	0	0
5:15 PM	0	0	0	0	0	0	0	0	0	1	0	0	1	1
5:30 PM	0	0	0	0	0	0	0	0	0	0	0	0	0	1
5:45 PM	0	0	0	0	0	0	0	0	0	0	0	0	0	1
Count Total	0	0	0	0	0	0	0	0	0	1	1	0	2	0
Peak Hour	0	0	0	0	0	0	0	0	0	1	0	0	1	0

Note: U-Turn volumes for bikes are included in Left-Turn, if any.

Santa Clara St Marin St



Date: 12-18-2018
 Count Period: 7:00 AM to 9:00 AM
 Peak Hour: 7:30 AM to 8:30 AM

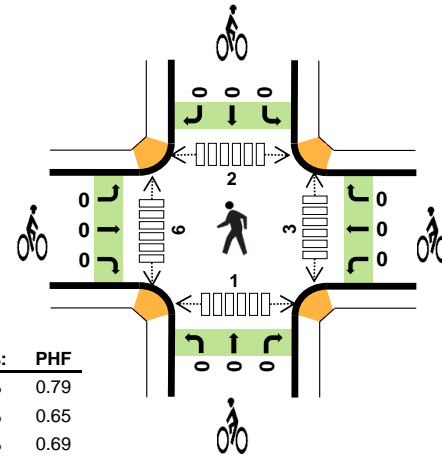
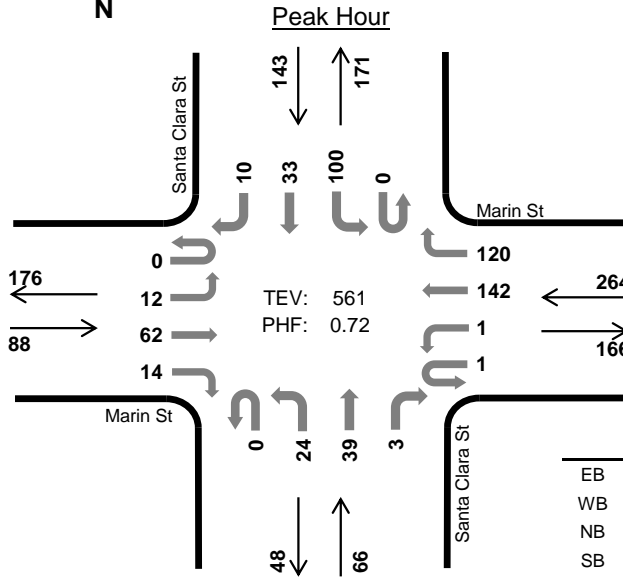

	HV %:	PHF
EB	0.0%	0.79
WB	1.1%	0.65
NB	1.5%	0.69
SB	0.7%	0.81
TOTAL	0.9%	0.72

Two-Hour Count Summaries

Interval Start	Marin St Eastbound				Marin St Westbound				Santa Clara St Northbound				Santa Clara St Southbound				15-min Total	Rolling One Hour	
	UT	LT	TH	RT	UT	LT	TH	RT	UT	LT	TH	RT	UT	LT	TH	RT			
7:00 AM	0	0	6	2	0	0	20	6	0	6	2	1	0	9	0	0	52	0	
7:15 AM	0	0	12	3	0	0	25	16	0	6	5	0	0	14	5	1	87	0	
7:30 AM	0	4	18	3	0	0	27	18	0	7	11	2	0	34	8	2	134	0	
7:45 AM	0	4	19	5	1	1	45	54	0	8	15	1	0	30	9	3	195	468	
8:00 AM	0	3	15	4	0	0	41	24	0	6	8	0	0	22	6	2	131	547	
8:15 AM	0	1	10	2	0	0	29	24	0	3	5	0	0	14	10	3	101	561	
8:30 AM	0	2	15	2	1	0	20	15	0	3	4	0	0	18	7	0	87	514	
8:45 AM	0	1	5	6	0	0	28	8	0	5	2	0	0	5	4	0	64	383	
Count Total	0	15	100	27	2	1	235	165	0	44	52	4	0	146	49	11	851	0	
Peak Hour	All	0	12	62	14	1	1	142	120	0	24	39	3	0	100	33	10	561	0
	HV	0	0	0	0	0	0	2	1	0	0	0	1	0	1	0	0	5	0
	HV%	-	0%	0%	0%	0%	0%	1%	1%	-	0%	0%	33%	-	1%	0%	0%	1%	0

Note: Two-hour count summary volumes include heavy vehicles but exclude bicycles in overall count.

Interval Start	Heavy Vehicle Totals					Bicycles					Pedestrians (Crossing Leg)				
	EB	WB	NB	SB	Total	EB	WB	NB	SB	Total	East	West	North	South	Total
7:00 AM	1	0	0	1	2	0	0	0	0	0	0	0	1	0	1
7:15 AM	0	0	0	0	0	0	0	0	0	0	0	0	1	0	1
7:30 AM	0	1	1	1	3	0	0	0	0	0	1	2	2	0	5
7:45 AM	0	2	0	0	2	0	0	0	0	0	0	0	0	0	0
8:00 AM	0	0	0	0	0	0	0	0	0	0	1	3	0	1	5
8:15 AM	0	0	0	0	0	0	0	0	0	0	1	1	0	0	2
8:30 AM	0	1	1	1	3	0	0	0	0	0	0	3	0	0	3
8:45 AM	0	1	0	1	2	0	0	0	0	0	0	1	0	0	1
Count Total	1	5	2	4	12	0	0	0	0	0	3	10	4	1	18
Peak Hour	0	3	1	1	5	0	0	0	0	0	3	6	2	1	12

Two-Hour Count Summaries - Heavy Vehicles																		
Interval Start	Marin St				Marin St				Santa Clara St				Santa Clara St				15-min Total	Rolling One Hour
	Eastbound				Westbound				Northbound				Southbound					
	UT	LT	TH	RT	UT	LT	TH	RT	UT	LT	TH	RT	UT	LT	TH	RT		
7:00 AM	0	0	1	0	0	0	0	0	0	0	0	0	0	1	0	0	2	0
7:15 AM	0	0	0	0	0	0	0	0	0	0	0	0	0	0	0	0	0	0
7:30 AM	0	0	0	0	0	0	1	0	0	0	0	1	0	1	0	0	3	0
7:45 AM	0	0	0	0	0	0	1	1	0	0	0	0	0	0	0	0	2	7
8:00 AM	0	0	0	0	0	0	0	0	0	0	0	0	0	0	0	0	0	5
8:15 AM	0	0	0	0	0	0	0	0	0	0	0	0	0	0	0	0	0	5
8:30 AM	0	0	0	0	0	0	1	0	0	0	1	0	0	1	0	0	3	5
8:45 AM	0	0	0	0	0	0	1	0	0	0	0	0	0	0	1	0	2	5
Count Total	0	0	1	0	0	0	4	1	0	0	1	1	0	3	1	0	12	0
Peak Hour	0	0	0	0	0	0	2	1	0	0	0	1	0	1	0	0	5	0

Two-Hour Count Summaries - Bikes														
Interval Start	Marin St			Marin St			Santa Clara St			Santa Clara St			15-min Total	Rolling One Hour
	Eastbound			Westbound			Northbound			Southbound				
	LT	TH	RT	LT	TH	RT	LT	TH	RT	LT	TH	RT		
7:00 AM	0	0	0	0	0	0	0	0	0	0	0	0	0	0
7:15 AM	0	0	0	0	0	0	0	0	0	0	0	0	0	0
7:30 AM	0	0	0	0	0	0	0	0	0	0	0	0	0	0
7:45 AM	0	0	0	0	0	0	0	0	0	0	0	0	0	0
8:00 AM	0	0	0	0	0	0	0	0	0	0	0	0	0	0
8:15 AM	0	0	0	0	0	0	0	0	0	0	0	0	0	0
8:30 AM	0	0	0	0	0	0	0	0	0	0	0	0	0	0
8:45 AM	0	0	0	0	0	0	0	0	0	0	0	0	0	0
Count Total	0	0	0	0	0	0	0	0	0	0	0	0	0	0
Peak Hour	0	0	0	0	0	0	0	0	0	0	0	0	0	0

Note: U-Turn volumes for bikes are included in Left-Turn, if any.

Santa Clara St Marin St



Date: 12-18-2018
 Count Period: 4:00 PM to 6:00 PM
 Peak Hour: 4:45 PM to 5:45 PM

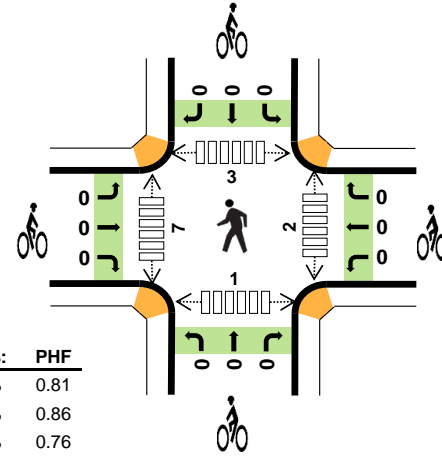
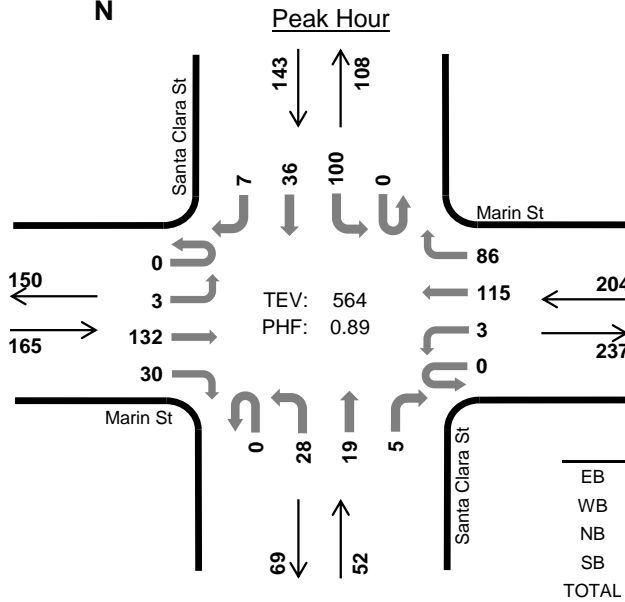

	HV %:	PHF
EB	0.6%	0.81
WB	0.0%	0.86
NB	0.0%	0.76
SB	0.7%	0.83
TOTAL	0.4%	0.89

Two-Hour Count Summaries

Interval Start	Marin St Eastbound				Marin St Westbound				Santa Clara St Northbound				Santa Clara St Southbound				15-min Total	Rolling One Hour	
	UT	LT	TH	RT	UT	LT	TH	RT	UT	LT	TH	RT	UT	LT	TH	RT			
4:00 PM	0	2	29	11	0	2	19	12	0	3	6	1	0	12	12	2	111	0	
4:15 PM	0	2	34	11	0	1	17	24	0	1	8	1	0	20	5	0	124	0	
4:30 PM	0	2	25	6	0	0	18	16	0	9	3	1	0	11	6	3	100	0	
4:45 PM	0	0	27	14	0	2	32	25	0	8	8	1	0	26	9	2	154	489	
5:00 PM	0	2	31	5	0	0	25	22	0	6	1	2	0	29	12	2	137	515	
5:15 PM	0	0	43	8	0	1	29	24	0	6	4	2	0	32	8	1	158	549	
5:30 PM	0	1	31	3	0	0	29	15	0	8	6	0	0	13	7	2	115	564	
5:45 PM	0	3	25	9	0	1	25	14	0	6	7	1	0	18	7	2	118	528	
Count Total	0	12	245	67	0	7	194	152	0	47	43	9	0	161	66	14	1,017	0	
Peak Hour	All	0	3	132	30	0	3	115	86	0	28	19	5	0	100	36	7	564	0
	HV	0	0	1	0	0	0	0	0	0	0	0	0	0	1	0	0	2	0
	HV%	-	0%	1%	0%	-	0%	0%	0%	-	0%	0%	0%	-	1%	0%	0%	0%	0

Note: Two-hour count summary volumes include heavy vehicles but exclude bicycles in overall count.

Interval Start	Heavy Vehicle Totals					Bicycles					Pedestrians (Crossing Leg)				
	EB	WB	NB	SB	Total	EB	WB	NB	SB	Total	East	West	North	South	Total
4:00 PM	0	1	0	1	2	1	1	0	0	2	1	2	2	0	5
4:15 PM	0	0	2	0	2	0	0	0	0	0	2	2	0	0	4
4:30 PM	0	0	1	1	2	0	0	0	0	0	1	3	2	2	8
4:45 PM	1	0	0	0	1	0	0	0	0	0	2	2	0	0	4
5:00 PM	0	0	0	0	0	0	0	0	0	0	0	3	3	1	7
5:15 PM	0	0	0	1	1	0	0	0	0	0	0	0	0	0	0
5:30 PM	0	0	0	0	0	0	0	0	0	0	0	2	0	0	2
5:45 PM	0	0	1	0	1	0	0	0	0	0	0	0	0	4	4
Count Total	1	1	4	3	9	1	1	0	0	2	6	14	7	7	34
Peak Hour	1	0	0	1	2	0	0	0	0	0	2	7	3	1	13

Two-Hour Count Summaries - Heavy Vehicles																		
Interval Start	Marin St				Marin St				Santa Clara St				Santa Clara St				15-min Total	Rolling One Hour
	Eastbound				Westbound				Northbound				Southbound					
	UT	LT	TH	RT	UT	LT	TH	RT	UT	LT	TH	RT	UT	LT	TH	RT		
4:00 PM	0	0	0	0	0	0	0	1	0	0	0	0	0	0	1	0	2	0
4:15 PM	0	0	0	0	0	0	0	0	0	1	0	1	0	0	0	0	2	0
4:30 PM	0	0	0	0	0	0	0	0	0	0	1	0	0	0	1	0	2	0
4:45 PM	0	0	1	0	0	0	0	0	0	0	0	0	0	0	0	0	1	7
5:00 PM	0	0	0	0	0	0	0	0	0	0	0	0	0	0	0	0	0	5
5:15 PM	0	0	0	0	0	0	0	0	0	0	0	0	0	1	0	0	1	4
5:30 PM	0	0	0	0	0	0	0	0	0	0	0	0	0	0	0	0	0	2
5:45 PM	0	0	0	0	0	0	0	0	0	0	0	1	0	0	0	0	1	2
Count Total	0	0	1	0	0	0	0	1	0	1	1	2	0	1	2	0	9	0
Peak Hour	0	0	1	0	0	0	0	0	0	0	0	0	0	1	0	0	2	0

Two-Hour Count Summaries - Bikes														
Interval Start	Marin St			Marin St			Santa Clara St			Santa Clara St			15-min Total	Rolling One Hour
	Eastbound			Westbound			Northbound			Southbound				
	LT	TH	RT	LT	TH	RT	LT	TH	RT	LT	TH	RT		
4:00 PM	0	0	1	0	0	1	0	0	0	0	0	0	2	0
4:15 PM	0	0	0	0	0	0	0	0	0	0	0	0	0	0
4:30 PM	0	0	0	0	0	0	0	0	0	0	0	0	0	0
4:45 PM	0	0	0	0	0	0	0	0	0	0	0	0	0	2
5:00 PM	0	0	0	0	0	0	0	0	0	0	0	0	0	0
5:15 PM	0	0	0	0	0	0	0	0	0	0	0	0	0	0
5:30 PM	0	0	0	0	0	0	0	0	0	0	0	0	0	0
5:45 PM	0	0	0	0	0	0	0	0	0	0	0	0	0	0
Count Total	0	0	1	0	0	1	0	0	0	0	0	0	2	0
Peak Hour	0	0	0	0	0	0	0	0	0	0	0	0	0	0

Note: U-Turn volumes for bikes are included in Left-Turn, if any.

Auto Center Dr Marin St



Date: 12-18-2018

Count Period: 7:00 AM to 9:00 AM

Peak Hour: 7:30 AM to 8:30 AM

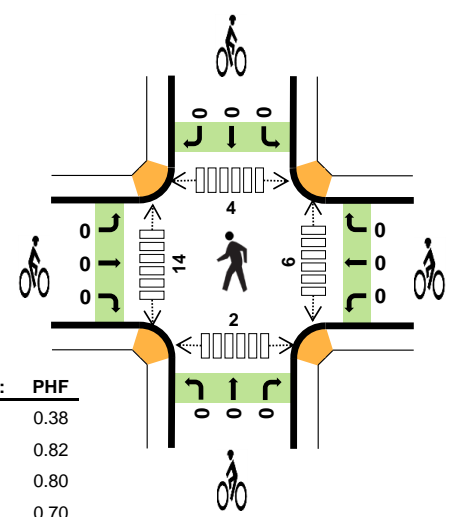
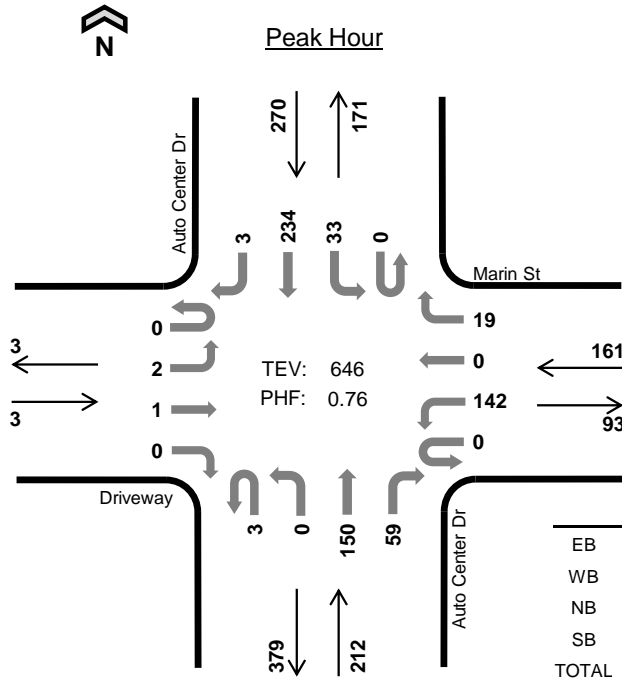

	HV %:	PHF
EB	0.0%	0.38
WB	1.2%	0.82
NB	0.9%	0.80
SB	0.7%	0.70
TOTAL	0.9%	0.76

Two-Hour Count Summaries

Interval Start	Driveway				Marin St				Auto Center Dr				Auto Center Dr				15-min Total	Rolling One Hour	
	UT	LT	TH	RT	UT	LT	TH	RT	UT	LT	TH	RT	UT	LT	TH	RT			
7:00 AM	0	0	0	0	0	24	0	1	0	0	7	6	0	2	13	0	53	0	
7:15 AM	0	0	0	0	0	34	0	1	0	0	15	11	0	4	35	0	100	0	
7:30 AM	0	0	1	0	0	34	0	6	2	0	34	12	0	11	62	1	163	0	
7:45 AM	0	2	0	0	0	43	0	6	1	0	46	19	0	10	85	1	213	529	
8:00 AM	0	0	0	0	0	36	0	4	0	0	36	17	0	7	44	1	145	621	
8:15 AM	0	0	0	0	0	29	0	3	0	0	34	11	0	5	43	0	125	646	
8:30 AM	0	0	0	1	0	27	0	1	0	1	35	16	0	5	35	1	122	605	
8:45 AM	0	0	0	0	0	26	0	0	0	1	23	12	0	3	34	0	99	491	
Count Total	0	2	1	1	0	253	0	22	3	2	230	104	0	47	351	4	1,020	0	
Peak Hour	All	0	2	1	0	0	142	0	19	3	0	150	59	0	33	234	3	646	0
	HV	0	0	0	0	0	1	0	1	0	0	2	0	0	0	2	0	6	0
	HV%	-	0%	0%	-	-	1%	-	5%	0%	-	1%	0%	-	0%	1%	0%	1%	0

Note: Two-hour count summary volumes include heavy vehicles but exclude bicycles in overall count.

Interval Start	Heavy Vehicle Totals					Bicycles					Pedestrians (Crossing Leg)				
	EB	WB	NB	SB	Total	EB	WB	NB	SB	Total	East	West	North	South	Total
7:00 AM	0	0	1	2	3	0	0	0	0	0	1	0	0	0	1
7:15 AM	0	0	0	0	0	0	0	0	0	0	0	0	0	0	0
7:30 AM	0	1	0	2	3	0	0	0	0	0	0	5	1	0	6
7:45 AM	0	1	1	0	2	0	0	0	0	0	1	7	1	2	11
8:00 AM	0	0	0	0	0	0	0	0	0	0	5	1	2	0	8
8:15 AM	0	0	1	0	1	0	0	0	0	0	0	1	0	0	1
8:30 AM	0	1	0	1	2	0	0	0	1	1	0	5	0	0	5
8:45 AM	0	0	1	0	1	0	0	0	0	0	4	0	0	0	4
Count Total	0	3	4	5	12	0	0	0	1	1	11	19	4	2	36
Peak Hour	0	2	2	2	6	0	0	0	0	0	6	14	4	2	26

Two-Hour Count Summaries - Heavy Vehicles																		
Interval Start	Driveway				Marin St				Auto Center Dr				Auto Center Dr				15-min Total	Rolling One Hour
	Eastbound				Westbound				Northbound				Southbound					
	UT	LT	TH	RT	UT	LT	TH	RT	UT	LT	TH	RT	UT	LT	TH	RT		
7:00 AM	0	0	0	0	0	0	0	0	0	0	1	0	0	1	1	0	3	0
7:15 AM	0	0	0	0	0	0	0	0	0	0	0	0	0	0	0	0	0	0
7:30 AM	0	0	0	0	0	1	0	0	0	0	0	0	0	0	2	0	3	0
7:45 AM	0	0	0	0	0	0	0	1	0	0	1	0	0	0	0	0	2	8
8:00 AM	0	0	0	0	0	0	0	0	0	0	0	0	0	0	0	0	0	5
8:15 AM	0	0	0	0	0	0	0	0	0	0	1	0	0	0	0	0	1	6
8:30 AM	0	0	0	0	0	1	0	0	0	0	0	0	0	0	1	0	2	5
8:45 AM	0	0	0	0	0	0	0	0	0	0	1	0	0	0	0	0	1	4
Count Total	0	0	0	0	0	2	0	1	0	0	4	0	0	1	4	0	12	0
Peak Hour	0	0	0	0	0	1	0	1	0	0	2	0	0	0	2	0	6	0
Two-Hour Count Summaries - Bikes																		
Interval Start	Driveway			Marin St			Auto Center Dr			Auto Center Dr			15-min Total	Rolling One Hour				
	Eastbound			Westbound			Northbound			Southbound								
	LT	TH	RT	LT	TH	RT	LT	TH	RT	LT	TH	RT						
7:00 AM	0	0	0	0	0	0	0	0	0	0	0	0	0	0	0	0	0	0
7:15 AM	0	0	0	0	0	0	0	0	0	0	0	0	0	0	0	0	0	0
7:30 AM	0	0	0	0	0	0	0	0	0	0	0	0	0	0	0	0	0	0
7:45 AM	0	0	0	0	0	0	0	0	0	0	0	0	0	0	0	0	0	0
8:00 AM	0	0	0	0	0	0	0	0	0	0	0	0	0	0	0	0	0	0
8:15 AM	0	0	0	0	0	0	0	0	0	0	0	0	0	0	0	0	0	0
8:30 AM	0	0	0	0	0	0	0	0	0	0	0	0	0	1	0	1	1	1
8:45 AM	0	0	0	0	0	0	0	0	0	0	0	0	0	0	0	0	0	1
Count Total	0	0	0	0	0	0	0	0	0	0	0	0	0	1	0	1	1	0
Peak Hour	0	0	0	0	0	0	0	0	0	0	0	0	0	0	0	0	0	0
<i>Note: U-Turn volumes for bikes are included in Left-Turn, if any.</i>																		

Auto Center Dr Marin St



Date: 12-18-2018

Count Period: 4:00 PM to 6:00 PM

Peak Hour: 4:30 PM to 5:30 PM

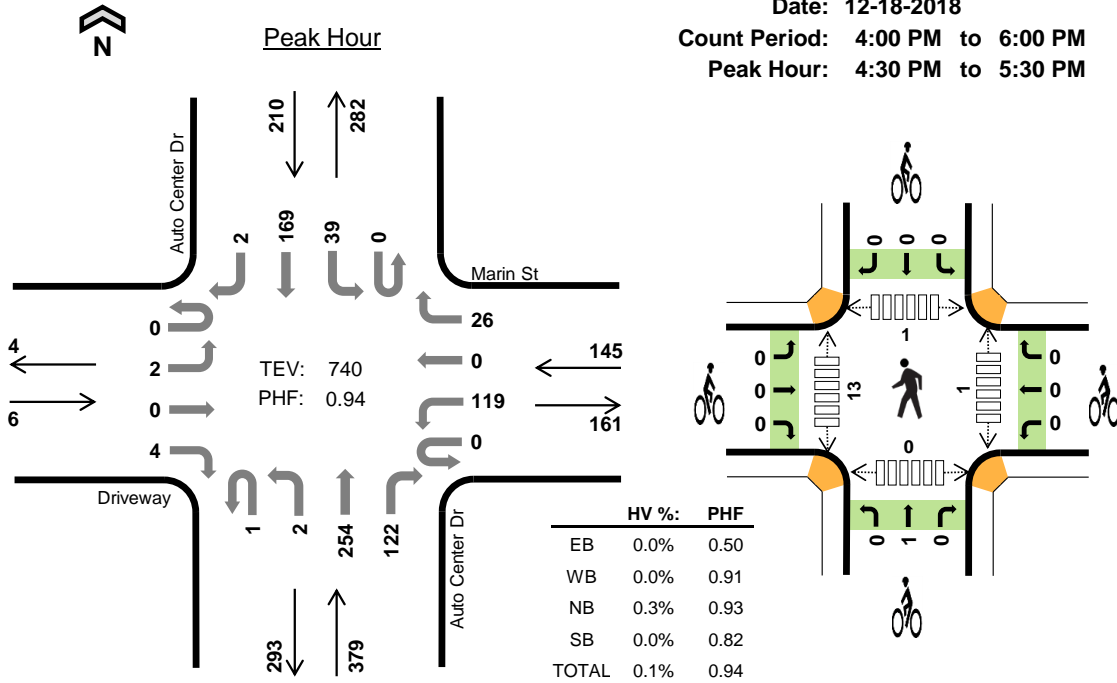

Two-Hour Count Summaries

Interval Start	Driveway				Marin St				Auto Center Dr				Auto Center Dr				15-min Total	Rolling One Hour	
	UT	LT	TH	RT	UT	LT	TH	RT	UT	LT	TH	RT	UT	LT	TH	RT			
4:00 PM	0	0	0	1	0	25	1	2	0	2	44	32	0	7	35	0	149	0	
4:15 PM	0	0	0	0	0	16	0	4	0	0	42	33	0	14	47	0	156	0	
4:30 PM	0	1	0	1	0	27	0	4	0	2	69	31	0	5	38	0	178	0	
4:45 PM	0	0	0	0	0	35	0	5	0	0	54	26	0	12	50	2	184	667	
5:00 PM	0	1	0	2	0	28	0	12	1	0	68	33	0	6	46	0	197	715	
5:15 PM	0	0	0	1	0	29	0	5	0	0	63	32	0	16	35	0	181	740	
5:30 PM	0	0	0	0	0	39	0	6	0	0	57	29	0	10	24	1	166	728	
5:45 PM	0	0	0	0	0	25	0	3	1	0	42	27	0	8	25	0	131	675	
Count Total	0	2	0	5	0	224	1	41	2	4	439	243	0	78	300	3	1,342	0	
Peak Hour	All	0	2	0	4	0	119	0	26	1	2	254	122	0	39	169	2	740	0
	HV	0	0	0	0	0	0	0	0	0	0	0	1	0	0	0	0	1	0
	HV%	-	0%	-	0%	-	0%	-	0%	0%	0%	0%	1%	-	0%	0%	0%	0%	0

Note: Two-hour count summary volumes include heavy vehicles but exclude bicycles in overall count.

Interval Start	Heavy Vehicle Totals					Bicycles					Pedestrians (Crossing Leg)				
	EB	WB	NB	SB	Total	EB	WB	NB	SB	Total	East	West	North	South	Total
4:00 PM	0	0	0	0	0	0	0	1	0	1	0	3	2	0	5
4:15 PM	0	1	0	0	1	0	0	0	0	0	6	4	0	0	10
4:30 PM	0	0	0	0	0	0	0	0	0	0	0	4	1	0	5
4:45 PM	0	0	1	0	1	0	0	1	0	1	0	4	0	0	4
5:00 PM	0	0	0	0	0	0	0	0	0	0	0	2	0	0	2
5:15 PM	0	0	0	0	0	0	0	0	0	0	1	3	0	0	4
5:30 PM	0	0	1	0	1	0	0	0	0	0	1	1	0	0	2
5:45 PM	0	0	0	0	0	0	0	0	0	0	0	0	0	0	0
Count Total	0	1	2	0	3	0	0	2	0	2	8	21	3	0	32
Peak Hour	0	0	1	0	1	0	0	1	0	1	1	13	1	0	15

Two-Hour Count Summaries - Heavy Vehicles																		
Interval Start	Driveway				Marin St				Auto Center Dr				Auto Center Dr				15-min Total	Rolling One Hour
	Eastbound				Westbound				Northbound				Southbound					
	UT	LT	TH	RT	UT	LT	TH	RT	UT	LT	TH	RT	UT	LT	TH	RT		
4:00 PM	0	0	0	0	0	0	0	0	0	0	0	0	0	0	0	0	0	
4:15 PM	0	0	0	0	0	1	0	0	0	0	0	0	0	0	0	1	0	
4:30 PM	0	0	0	0	0	0	0	0	0	0	0	0	0	0	0	0	0	
4:45 PM	0	0	0	0	0	0	0	0	0	0	0	1	0	0	0	1	2	
5:00 PM	0	0	0	0	0	0	0	0	0	0	0	0	0	0	0	0	2	
5:15 PM	0	0	0	0	0	0	0	0	0	0	0	0	0	0	0	0	1	
5:30 PM	0	0	0	0	0	0	0	0	0	1	0	0	0	0	1	2		
5:45 PM	0	0	0	0	0	0	0	0	0	0	0	0	0	0	0	1		
Count Total	0	0	0	0	0	1	0	0	0	1	1	0	0	0	0	3	0	
Peak Hour	0	0	0	0	0	0	0	0	0	0	1	0	0	0	0	1	0	
Two-Hour Count Summaries - Bikes																		
Interval Start	Driveway			Marin St			Auto Center Dr			Auto Center Dr			15-min Total	Rolling One Hour				
	Eastbound			Westbound			Northbound			Southbound								
	LT	TH	RT	LT	TH	RT	LT	TH	RT	LT	TH	RT						
4:00 PM	0	0	0	0	0	0	0	1	0	0	0	0	1	0				
4:15 PM	0	0	0	0	0	0	0	0	0	0	0	0	0	0				
4:30 PM	0	0	0	0	0	0	0	0	0	0	0	0	0	0				
4:45 PM	0	0	0	0	0	0	0	1	0	0	0	0	1	2				
5:00 PM	0	0	0	0	0	0	0	0	0	0	0	0	0	1				
5:15 PM	0	0	0	0	0	0	0	0	0	0	0	0	0	1				
5:30 PM	0	0	0	0	0	0	0	0	0	0	0	0	0	1				
5:45 PM	0	0	0	0	0	0	0	0	0	0	0	0	0	0				
Count Total	0	0	0	0	0	0	0	2	0	0	0	0	2	0				
Peak Hour	0	0	0	0	0	0	0	1	0	0	0	0	1	0				
<i>Note: U-Turn volumes for bikes are included in Left-Turn, if any.</i>																		

APPENDIX B: EXISTING (2018) TRAFFIC CONDITIONS ANALYSIS SHEETS

Intersection

Int Delay, s/veh 2.4

Movement	EBL	EBT	EBR	WBL	WBT	WBR	NBL	NBT	NBR	SBL	SBT	SBR
Lane Configurations			↗				↖	↗		↖	↗↘	
Traffic Vol, veh/h	0	0	34	0	0	0	24	505	1	284	611	3
Future Vol, veh/h	0	0	34	0	0	0	24	505	1	284	611	3
Conflicting Peds, #/hr	0	0	0	0	0	0	6	0	0	0	0	6
Sign Control	Stop	Stop	Stop	Stop	Stop	Stop	Free	Free	Free	Free	Free	Free
RT Channelized	-	-	None	-	-	None	-	-	None	-	-	None
Storage Length	-	-	0	-	-	-	190	-	-	100	-	-
Veh in Median Storage, #	-	0	-	-	-	-	-	0	-	-	0	-
Grade, %	-	0	-	-	0	-	-	0	-	-	0	-
Peak Hour Factor	86	86	86	82	82	82	86	86	86	86	86	86
Heavy Vehicles, %	0	2	0	2	2	2	3	3	2	2	1	1
Mvmt Flow	0	0	40	0	0	0	28	587	1	330	710	3

Major/Minor	Minor2			Major1			Major2				
Conflicting Flow All	-	-	363	-	-	720	0	0	588	0	0
Stage 1	-	-	-	-	-	-	-	-	-	-	-
Stage 2	-	-	-	-	-	-	-	-	-	-	-
Critical Hdwy	-	-	6.9	-	-	4.145	-	-	4.13	-	-
Critical Hdwy Stg 1	-	-	-	-	-	-	-	-	-	-	-
Critical Hdwy Stg 2	-	-	-	-	-	-	-	-	-	-	-
Follow-up Hdwy	-	-	3.3	-	-	2.2285	-	-	2.219	-	-
Pot Cap-1 Maneuver	0	0	640	-	-	874	-	-	985	-	-
Stage 1	0	0	-	-	-	-	-	-	-	-	-
Stage 2	0	0	-	-	-	-	-	-	-	-	-
Platoon blocked, %	-	-	-	-	-	-	-	-	-	-	-
Mov Cap-1 Maneuver	-	0	636	-	-	874	-	-	985	-	-
Mov Cap-2 Maneuver	-	0	-	-	-	-	-	-	-	-	-
Stage 1	-	0	-	-	-	-	-	-	-	-	-
Stage 2	-	0	-	-	-	-	-	-	-	-	-

Approach	EB	NB	SB
HCM Control Delay, s	11	0.4	3.3
HCM LOS	B		

Minor Lane/Major Mvmt	NBL	NBT	NBR	EBLn1	SBL	SBT	SBR
Capacity (veh/h)	874	-	-	636	985	-	-
HCM Lane V/C Ratio	0.032	-	-	0.062	0.335	-	-
HCM Control Delay (s)	9.3	-	-	11	10.5	-	-
HCM Lane LOS	A	-	-	B	B	-	-
HCM 95th %tile Q(veh)	0.1	-	-	0.2	1.5	-	-

Intersection	
Intersection Delay, s/veh	7.1
Intersection LOS	A

Movement	EBL	EBT	EBR	WBL	WBT	WBR	NBL	NBT	NBR	SBL	SBT	SBR
Lane Configurations		↕			↕			↕			↕	
Traffic Vol, veh/h	8	1	0	1	0	41	0	4	4	37	3	3
Future Vol, veh/h	8	1	0	1	0	41	0	4	4	37	3	3
Peak Hour Factor	0.82	0.82	0.82	0.82	0.82	0.82	0.82	0.82	0.82	0.82	0.82	0.82
Heavy Vehicles, %	0	0	0	2	2	2	0	0	0	0	0	0
Mvmt Flow	10	1	0	1	0	50	0	5	5	45	4	4
Number of Lanes	0	1	0	0	1	0	0	1	0	0	1	0

Approach	EB	WB	NB	SB
Opposing Approach	WB	EB	SB	NB
Opposing Lanes	1	1	1	1
Conflicting Approach Left	SB	NB	EB	WB
Conflicting Lanes Left	1	1	1	1
Conflicting Approach Right	NB	SB	WB	EB
Conflicting Lanes Right	1	1	1	1
HCM Control Delay	7.3	6.7	6.8	7.4
HCM LOS	A	A	A	A

Lane	NBLn1	EBLn1	WBLn1	SBLn1
Vol Left, %	0%	89%	2%	86%
Vol Thru, %	50%	11%	0%	7%
Vol Right, %	50%	0%	98%	7%
Sign Control	Stop	Stop	Stop	Stop
Traffic Vol by Lane	8	9	42	43
LT Vol	0	8	1	37
Through Vol	4	1	0	3
RT Vol	4	0	41	3
Lane Flow Rate	10	11	51	52
Geometry Grp	1	1	1	1
Degree of Util (X)	0.01	0.013	0.049	0.06
Departure Headway (Hd)	3.749	4.227	3.471	4.148
Convergence, Y/N	Yes	Yes	Yes	Yes
Cap	955	846	1030	866
Service Time	1.772	2.257	1.5	2.16
HCM Lane V/C Ratio	0.01	0.013	0.05	0.06
HCM Control Delay	6.8	7.3	6.7	7.4
HCM Lane LOS	A	A	A	A
HCM 95th-tile Q	0	0	0.2	0.2

Intersection

Intersection Delay, s/veh 10.7

Intersection LOS B

Movement	EBL	EBT	EBR	WBL	WBT	WBR	NBL	NBT	NBR	SBL	SBT	SBR
Lane Configurations		↕			↕			↕			↕	
Traffic Vol, veh/h	12	62	14	2	142	120	24	39	3	100	33	10
Future Vol, veh/h	12	62	14	2	142	120	24	39	3	100	33	10
Peak Hour Factor	0.72	0.72	0.72	0.72	0.72	0.72	0.72	0.72	0.72	0.72	0.72	0.72
Heavy Vehicles, %	0	0	0	1	1	1	2	2	2	1	1	1
Mvmt Flow	17	86	19	3	197	167	33	54	4	139	46	14
Number of Lanes	0	1	0	0	1	0	0	1	0	0	1	0

Approach	EB	WB	NB	SB
Opposing Approach	WB	EB	SB	NB
Opposing Lanes	1	1	1	1
Conflicting Approach Left SB		NB	EB	WB
Conflicting Lanes Left	1	1	1	1
Conflicting Approach Right NB		SB	WB	EB
Conflicting Lanes Right	1	1	1	1
HCM Control Delay	9.2	11.6	9.4	10.6
HCM LOS	A	B	A	B

Lane	NBLn1	EBLn1	WBLn1	SBLn1
Vol Left, %	36%	14%	1%	70%
Vol Thru, %	59%	70%	54%	23%
Vol Right, %	5%	16%	45%	7%
Sign Control	Stop	Stop	Stop	Stop
Traffic Vol by Lane	66	88	264	143
LT Vol	24	12	2	100
Through Vol	39	62	142	33
RT Vol	3	14	120	10
Lane Flow Rate	92	122	367	199
Geometry Grp	1	1	1	1
Degree of Util (X)	0.141	0.175	0.465	0.297
Departure Headway (Hd)	5.518	5.143	4.566	5.375
Convergence, Y/N	Yes	Yes	Yes	Yes
Cap	652	700	777	671
Service Time	3.532	3.155	2.659	3.382
HCM Lane V/C Ratio	0.141	0.174	0.472	0.297
HCM Control Delay	9.4	9.2	11.6	10.6
HCM Lane LOS	A	A	B	B
HCM 95th-tile Q	0.5	0.6	2.5	1.2

MidPen Housing
4: Auto Center Dr & Marin St

Existing Am
Timing Plan: Default

Intersection												
Int Delay, s/veh	6.2											
Movement	EBL	EBT	EBR	WBL	WBT	WBR	NBL	NBT	NBR	SBL	SBT	SBR
Lane Configurations												
Traffic Vol, veh/h	2	1	0	142	0	19	3	150	59	33	234	3
Future Vol, veh/h	2	1	0	142	0	19	3	150	59	33	234	3
Conflicting Peds, #/hr	4	0	2	2	0	4	14	0	6	6	0	14
Sign Control	Stop	Stop	Stop	Stop	Stop	Stop	Free	Free	Free	Free	Free	Free
RT Channelized	-	-	None	-	-	None	-	-	None	-	-	None
Storage Length	20	-	-	-	-	20	-	-	-	-	-	-
Veh in Median Storage, #	-	0	-	-	0	-	-	0	-	-	0	-
Grade, %	-	0	-	-	0	-	-	0	-	-	0	-
Peak Hour Factor	76	76	76	76	76	76	76	76	76	76	76	76
Heavy Vehicles, %	0	0	0	1	1	1	1	1	1	1	1	1
Mvmt Flow	3	1	0	187	0	25	4	197	78	43	308	4

Major/Minor	Minor2		Minor1			Major1		Major2				
Conflicting Flow All	659	700	326	649	663	246	326	0	0	281	0	0
Stage 1	411	411	-	250	250	-	-	-	-	-	-	-
Stage 2	248	289	-	399	413	-	-	-	-	-	-	-
Critical Hdwy	7.1	6.5	6.2	7.11	6.51	6.21	4.11	-	-	4.11	-	-
Critical Hdwy Stg 1	6.1	5.5	-	6.11	5.51	-	-	-	-	-	-	-
Critical Hdwy Stg 2	6.1	5.5	-	6.11	5.51	-	-	-	-	-	-	-
Follow-up Hdwy	3.5	4	3.3	3.509	4.009	3.309	2.209	-	-	2.209	-	-
Pot Cap-1 Maneuver	380	366	720	384	383	795	1239	-	-	1287	-	-
Stage 1	622	598	-	756	702	-	-	-	-	-	-	-
Stage 2	760	677	-	629	595	-	-	-	-	-	-	-
Platoon blocked, %								-	-	-	-	-
Mov Cap-1 Maneuver	349	343	709	367	359	787	1237	-	-	1282	-	-
Mov Cap-2 Maneuver	349	343	-	367	359	-	-	-	-	-	-	-
Stage 1	611	566	-	749	695	-	-	-	-	-	-	-
Stage 2	730	670	-	601	563	-	-	-	-	-	-	-

Approach	EB		WB		NB		SB	
HCM Control Delay, s	15.4		22.8		0.1		1	
HCM LOS	C		C					

Minor Lane/Major Mvmt	NBL	NBT	NBR	EBLn1	EBLn2	WBLn1	WBLn2	SBL	SBT	SBR
Capacity (veh/h)	1237	-	-	349	343	367	787	1282	-	-
HCM Lane V/C Ratio	0.003	-	-	0.008	0.004	0.509	0.032	0.034	-	-
HCM Control Delay (s)	7.9	0	-	15.4	15.5	24.6	9.7	7.9	0	-
HCM Lane LOS	A	A	-	C	C	C	A	A	A	-
HCM 95th %tile Q(veh)	0	-	-	0	0	2.8	0.1	0.1	-	-

Intersection

Int Delay, s/veh 3.1

Movement	EBL	EBT	EBR	WBL	WBT	WBR	NBL	NBT	NBR	SBL	SBT	SBR
Lane Configurations			↗				↖	↗		↖	↗↘	
Traffic Vol, veh/h	0	0	58	0	0	0	28	631	3	396	758	17
Future Vol, veh/h	0	0	58	0	0	0	28	631	3	396	758	17
Conflicting Peds, #/hr	0	0	0	0	0	0	16	0	0	0	0	16
Sign Control	Stop	Stop	Stop	Stop	Stop	Stop	Free	Free	Free	Free	Free	Free
RT Channelized	-	-	None	-	-	None	-	-	None	-	-	None
Storage Length	-	-	0	-	-	-	190	-	-	100	-	-
Veh in Median Storage, #	-	0	-	-	-	-	-	0	-	-	0	-
Grade, %	-	0	-	-	0	-	-	0	-	-	0	-
Peak Hour Factor	95	95	95	82	82	82	95	95	95	95	95	95
Heavy Vehicles, %	5	2	5	2	2	2	1	1	2	2	1	1
Mvmt Flow	0	0	61	0	0	0	29	664	3	417	798	18

Major/Minor	Minor2			Major1			Major2				
Conflicting Flow All	-	-	424			832	0	0	667	0	0
Stage 1	-	-	-			-	-	-	-	-	-
Stage 2	-	-	-			-	-	-	-	-	-
Critical Hdwy	-	-	6.975			4.115	-	-	4.13	-	-
Critical Hdwy Stg 1	-	-	-			-	-	-	-	-	-
Critical Hdwy Stg 2	-	-	-			-	-	-	-	-	-
Follow-up Hdwy	-	-	3.3475			2.2095	-	-	2.219	-	-
Pot Cap-1 Maneuver	0	0	572			804	-	-	921	-	-
Stage 1	0	0	-			-	-	-	-	-	-
Stage 2	0	0	-			-	-	-	-	-	-
Platoon blocked, %							-	-	-	-	-
Mov Cap-1 Maneuver	-	0	563			804	-	-	921	-	-
Mov Cap-2 Maneuver	-	0	-			-	-	-	-	-	-
Stage 1	-	0	-			-	-	-	-	-	-
Stage 2	-	0	-			-	-	-	-	-	-

Approach	EB	NB	SB
HCM Control Delay, s	12.2	0.4	4.1
HCM LOS	B		

Minor Lane/Major Mvmt	NBL	NBT	NBR	EBLn1	SBL	SBT	SBR
Capacity (veh/h)	804	-	-	563	921	-	-
HCM Lane V/C Ratio	0.037	-	-	0.108	0.453	-	-
HCM Control Delay (s)	9.6	-	-	12.2	12.1	-	-
HCM Lane LOS	A	-	-	B	B	-	-
HCM 95th %tile Q(veh)	0.1	-	-	0.4	2.4	-	-

Intersection	
Intersection Delay, s/veh	7.3
Intersection LOS	A

Movement	EBL	EBT	EBR	WBL	WBT	WBR	NBL	NBT	NBR	SBL	SBT	SBR
Lane Configurations		↕			↕			↕			↕	
Traffic Vol, veh/h	7	3	0	3	5	37	1	6	5	51	4	9
Future Vol, veh/h	7	3	0	3	5	37	1	6	5	51	4	9
Peak Hour Factor	0.78	0.78	0.78	0.78	0.78	0.78	0.78	0.78	0.78	0.78	0.78	0.78
Heavy Vehicles, %	0	0	0	4	4	4	0	0	0	2	2	2
Mvmt Flow	9	4	0	4	6	47	1	8	6	65	5	12
Number of Lanes	0	1	0	0	1	0	0	1	0	0	1	0

Approach	EB	WB	NB	SB
Opposing Approach	WB	EB	SB	NB
Opposing Lanes	1	1	1	1
Conflicting Approach Left	SB	NB	EB	WB
Conflicting Lanes Left	1	1	1	1
Conflicting Approach Right	NB	SB	WB	EB
Conflicting Lanes Right	1	1	1	1
HCM Control Delay	7.4	6.9	7	7.6
HCM LOS	A	A	A	A

Lane	NBLn1	EBLn1	WBLn1	SBLn1	
Vol Left, %		8%	70%	7%	80%
Vol Thru, %		50%	30%	11%	6%
Vol Right, %		42%	0%	82%	14%
Sign Control		Stop	Stop	Stop	Stop
Traffic Vol by Lane		12	10	45	64
LT Vol		1	7	3	51
Through Vol		6	3	5	4
RT Vol		5	0	37	9
Lane Flow Rate		15	13	58	82
Geometry Grp		1	1	1	1
Degree of Util (X)		0.016	0.015	0.059	0.094
Departure Headway (Hd)		3.85	4.255	3.667	4.142
Convergence, Y/N		Yes	Yes	Yes	Yes
Cap		925	836	970	865
Service Time		1.892	2.307	1.715	2.167
HCM Lane V/C Ratio		0.016	0.016	0.06	0.095
HCM Control Delay		7	7.4	6.9	7.6
HCM Lane LOS		A	A	A	A
HCM 95th-tile Q		0	0	0.2	0.3

Intersection

Intersection Delay, s/veh 9.2
Intersection LOS A

Movement	EBL	EBT	EBR	WBL	WBT	WBR	NBL	NBT	NBR	SBL	SBT	SBR
Lane Configurations		↕			↕			↕			↕	
Traffic Vol, veh/h	3	132	30	3	115	86	28	19	5	100	36	7
Future Vol, veh/h	3	132	30	3	115	86	28	19	5	100	36	7
Peak Hour Factor	0.89	0.89	0.89	0.89	0.89	0.89	0.89	0.89	0.89	0.89	0.89	0.89
Heavy Vehicles, %	1	1	1	0	0	0	0	0	0	1	1	1
Mvmt Flow	3	148	34	3	129	97	31	21	6	112	40	8
Number of Lanes	0	1	0	0	1	0	0	1	0	0	1	0

Approach	EB	WB	NB	SB
Opposing Approach	WB	EB	SB	NB
Opposing Lanes	1	1	1	1
Conflicting Approach Left	SB	NB	EB	WB
Conflicting Lanes Left	1	1	1	1
Conflicting Approach Right	NB	SB	WB	EB
Conflicting Lanes Right	1	1	1	1
HCM Control Delay	9.1	9.2	8.6	9.6
HCM LOS	A	A	A	A

Lane	NBLn1	EBLn1	WBLn1	SBLn1
Vol Left, %	54%	2%	1%	70%
Vol Thru, %	37%	80%	56%	25%
Vol Right, %	10%	18%	42%	5%
Sign Control	Stop	Stop	Stop	Stop
Traffic Vol by Lane	52	165	204	143
LT Vol	28	3	3	100
Through Vol	19	132	115	36
RT Vol	5	30	86	7
Lane Flow Rate	58	185	229	161
Geometry Grp	1	1	1	1
Degree of Util (X)	0.083	0.238	0.282	0.225
Departure Headway (Hd)	5.107	4.629	4.427	5.036
Convergence, Y/N	Yes	Yes	Yes	Yes
Cap	696	773	809	709
Service Time	3.176	2.679	2.473	3.095
HCM Lane V/C Ratio	0.083	0.239	0.283	0.227
HCM Control Delay	8.6	9.1	9.2	9.6
HCM Lane LOS	A	A	A	A
HCM 95th-tile Q	0.3	0.9	1.2	0.9

MidPen Housing
4: Auto Center Dr & Marin St

Existing PM
Timing Plan: Default

Intersection

Int Delay, s/veh 3.9

Movement	EBL	EBT	EBR	WBL	WBT	WBR	NBL	NBT	NBR	SBL	SBT	SBR
Lane Configurations												
Traffic Vol, veh/h	2	0	4	119	0	26	3	254	122	39	169	2
Future Vol, veh/h	2	0	4	119	0	26	3	254	122	39	169	2
Conflicting Peds, #/hr	1	0	0	0	0	1	13	0	1	1	0	13
Sign Control	Stop	Stop	Stop	Stop	Stop	Stop	Free	Free	Free	Free	Free	Free
RT Channelized	-	-	None	-	-	None	-	-	None	-	-	None
Storage Length	20	-	-	-	-	20	-	-	-	-	-	-
Veh in Median Storage, #	-	0	-	-	0	-	-	0	-	-	0	-
Grade, %	-	0	-	-	0	-	-	0	-	-	0	-
Peak Hour Factor	94	94	94	94	94	94	94	94	94	94	94	94
Heavy Vehicles, %	0	0	0	0	0	0	0	0	0	0	0	0
Mvmt Flow	2	0	4	127	0	28	3	270	130	41	180	2

Major/Minor	Minor2		Minor1			Major1		Major2				
Conflicting Flow All	619	684	194	608	620	337	195	0	0	401	0	0
Stage 1	277	277	-	342	342	-	-	-	-	-	-	-
Stage 2	342	407	-	266	278	-	-	-	-	-	-	-
Critical Hdwy	7.1	6.5	6.2	7.1	6.5	6.2	4.1	-	-	4.1	-	-
Critical Hdwy Stg 1	6.1	5.5	-	6.1	5.5	-	-	-	-	-	-	-
Critical Hdwy Stg 2	6.1	5.5	-	6.1	5.5	-	-	-	-	-	-	-
Follow-up Hdwy	3.5	4	3.3	3.5	4	3.3	2.2	-	-	2.2	-	-
Pot Cap-1 Maneuver	404	374	853	411	407	710	1390	-	-	1169	-	-
Stage 1	734	685	-	677	642	-	-	-	-	-	-	-
Stage 2	677	601	-	744	684	-	-	-	-	-	-	-
Platoon blocked, %								-	-	-	-	-
Mov Cap-1 Maneuver	371	354	842	395	385	709	1390	-	-	1168	-	-
Mov Cap-2 Maneuver	371	354	-	395	385	-	-	-	-	-	-	-
Stage 1	723	650	-	674	639	-	-	-	-	-	-	-
Stage 2	648	599	-	711	649	-	-	-	-	-	-	-

Approach	EB		WB		NB		SB	
HCM Control Delay, s	11.1		16.9		0.1		1.5	
HCM LOS	B		C					

Minor Lane/Major Mvmt	NBL	NBT	NBR	EBLn1	EBLn2	WBLn1	WBLn2	SBL	SBT	SBR
Capacity (veh/h)	1390	-	-	371	842	395	709	1168	-	-
HCM Lane V/C Ratio	0.002	-	-	0.006	0.005	0.32	0.039	0.036	-	-
HCM Control Delay (s)	7.6	0	-	14.8	9.3	18.4	10.3	8.2	0	-
HCM Lane LOS	A	A	-	B	A	C	B	A	A	-
HCM 95th %tile Q(veh)	0	-	-	0	0	1.4	0.1	0.1	-	-

APPENDIX C: EXISTING (2018) PLUS PROJECT TRAFFIC CONDITIONS ANALYSIS SHEETS

Intersection

Int Delay, s/veh 2.5

Movement	EBL	EBT	EBR	WBL	WBT	WBR	NBL	NBT	NBR	SBL	SBT	SBR
Lane Configurations			↗				↖	↗		↖	↗↘	
Traffic Vol, veh/h	0	0	38	0	0	0	28	505	1	284	611	6
Future Vol, veh/h	0	0	38	0	0	0	28	505	1	284	611	6
Conflicting Peds, #/hr	0	0	0	0	0	0	6	0	0	0	0	6
Sign Control	Stop	Stop	Stop	Stop	Stop	Stop	Free	Free	Free	Free	Free	Free
RT Channelized	-	-	None	-	-	None	-	-	None	-	-	None
Storage Length	-	-	0	-	-	-	190	-	-	100	-	-
Veh in Median Storage, #	-	0	-	-	-	-	-	0	-	-	0	-
Grade, %	-	0	-	-	0	-	-	0	-	-	0	-
Peak Hour Factor	86	86	86	82	82	82	86	86	86	86	86	86
Heavy Vehicles, %	0	2	0	2	2	2	3	3	2	2	1	1
Mvmt Flow	0	0	44	0	0	0	33	587	1	330	710	7

Major/Minor	Minor2			Major1			Major2					
Conflicting Flow All	-	-	365				723	0	0	588	0	0
Stage 1	-	-	-				-	-	-	-	-	-
Stage 2	-	-	-				-	-	-	-	-	-
Critical Hdwy	-	-	6.9				4.145	-	-	4.13	-	-
Critical Hdwy Stg 1	-	-	-				-	-	-	-	-	-
Critical Hdwy Stg 2	-	-	-				-	-	-	-	-	-
Follow-up Hdwy	-	-	3.3				2.2285	-	-	2.219	-	-
Pot Cap-1 Maneuver	0	0	638				872	-	-	985	-	-
Stage 1	0	0	-				-	-	-	-	-	-
Stage 2	0	0	-				-	-	-	-	-	-
Platoon blocked, %								-	-		-	-
Mov Cap-1 Maneuver	-	0	634				867	-	-	985	-	-
Mov Cap-2 Maneuver	-	0	-				-	-	-	-	-	-
Stage 1	-	0	-				-	-	-	-	-	-
Stage 2	-	0	-				-	-	-	-	-	-

Approach	EB	NB	SB
HCM Control Delay, s	11.1	0.5	3.3
HCM LOS	B		

Minor Lane/Major Mvmt	NBL	NBT	NBR	EBLn1	SBL	SBT	SBR
Capacity (veh/h)	867	-	-	634	985	-	-
HCM Lane V/C Ratio	0.038	-	-	0.07	0.335	-	-
HCM Control Delay (s)	9.3	-	-	11.1	10.5	-	-
HCM Lane LOS	A	-	-	B	B	-	-
HCM 95th %tile Q(veh)	0.1	-	-	0.2	1.5	-	-

Intersection	
Intersection Delay, s/veh	7.1
Intersection LOS	A

Movement	EBL	EBT	EBR	WBL	WBT	WBR	NBL	NBT	NBR	SBL	SBT	SBR
Lane Configurations		↕			↕			↕			↕	
Traffic Vol, veh/h	8	1	0	1	0	51	0	4	4	43	3	3
Future Vol, veh/h	8	1	0	1	0	51	0	4	4	43	3	3
Peak Hour Factor	0.82	0.82	0.82	0.82	0.82	0.82	0.82	0.82	0.82	0.82	0.82	0.82
Heavy Vehicles, %	0	0	0	2	2	2	0	0	0	0	0	0
Mvmt Flow	10	1	0	1	0	62	0	5	5	52	4	4
Number of Lanes	0	1	0	0	1	0	0	1	0	0	1	0

Approach	EB	WB	NB	SB
Opposing Approach	WB	EB	SB	NB
Opposing Lanes	1	1	1	1
Conflicting Approach Left	SB	NB	EB	WB
Conflicting Lanes Left	1	1	1	1
Conflicting Approach Right	NB	SB	WB	EB
Conflicting Lanes Right	1	1	1	1
HCM Control Delay	7.3	6.7	6.8	7.5
HCM LOS	A	A	A	A

Lane	NBLn1	EBLn1	WBLn1	SBLn1
Vol Left, %	0%	89%	2%	88%
Vol Thru, %	50%	11%	0%	6%
Vol Right, %	50%	0%	98%	6%
Sign Control	Stop	Stop	Stop	Stop
Traffic Vol by Lane	8	9	52	49
LT Vol	0	8	1	43
Through Vol	4	1	0	3
RT Vol	4	0	51	3
Lane Flow Rate	10	11	63	60
Geometry Grp	1	1	1	1
Degree of Util (X)	0.01	0.013	0.061	0.069
Departure Headway (Hd)	3.774	4.247	3.479	4.176
Convergence, Y/N	Yes	Yes	Yes	Yes
Cap	947	840	1025	860
Service Time	1.804	2.285	1.514	2.192
HCM Lane V/C Ratio	0.011	0.013	0.061	0.07
HCM Control Delay	6.8	7.3	6.7	7.5
HCM Lane LOS	A	A	A	A
HCM 95th-tile Q	0	0	0.2	0.2

Intersection

Intersection Delay, s/veh	11
Intersection LOS	B

Movement	EBL	EBT	EBR	WBL	WBT	WBR	NBL	NBT	NBR	SBL	SBT	SBR
Lane Configurations		↕			↕			↕			↕	
Traffic Vol, veh/h	12	62	20	2	142	120	31	40	5	100	33	10
Future Vol, veh/h	12	62	20	2	142	120	31	40	5	100	33	10
Peak Hour Factor	0.72	0.72	0.72	0.72	0.72	0.72	0.72	0.72	0.72	0.72	0.72	0.72
Heavy Vehicles, %	0	0	0	1	1	1	2	2	2	1	1	1
Mvmt Flow	17	86	28	3	197	167	43	56	7	139	46	14
Number of Lanes	0	1	0	0	1	0	0	1	0	0	1	0

Approach	EB	WB	NB	SB
Opposing Approach	WB	EB	SB	NB
Opposing Lanes	1	1	1	1
Conflicting Approach Left	SB	NB	EB	WB
Conflicting Lanes Left	1	1	1	1
Conflicting Approach Right	NB	SB	WB	EB
Conflicting Lanes Right	1	1	1	1
HCM Control Delay	9.4	12	9.7	10.8
HCM LOS	A	B	A	B

Lane	NBLn1	EBLn1	WBLn1	SBLn1
Vol Left, %	41%	13%	1%	70%
Vol Thru, %	53%	66%	54%	23%
Vol Right, %	7%	21%	45%	7%
Sign Control	Stop	Stop	Stop	Stop
Traffic Vol by Lane	76	94	264	143
LT Vol	31	12	2	100
Through Vol	40	62	142	33
RT Vol	5	20	120	10
Lane Flow Rate	106	131	367	199
Geometry Grp	1	1	1	1
Degree of Util (X)	0.163	0.187	0.48	0.299
Departure Headway (Hd)	5.551	5.157	4.717	5.428
Convergence, Y/N	Yes	Yes	Yes	Yes
Cap	646	696	770	663
Service Time	3.584	3.187	2.717	3.459
HCM Lane V/C Ratio	0.164	0.188	0.477	0.3
HCM Control Delay	9.7	9.4	12	10.8
HCM Lane LOS	A	A	B	B
HCM 95th-tile Q	0.6	0.7	2.6	1.3

Intersection												
Int Delay, s/veh	6.6											
Movement	EBL	EBT	EBR	WBL	WBT	WBR	NBL	NBT	NBR	SBL	SBT	SBR
Lane Configurations												
Traffic Vol, veh/h	2	1	0	146	0	22	3	150	62	36	234	3
Future Vol, veh/h	2	1	0	146	0	22	3	150	62	36	234	3
Conflicting Peds, #/hr	4	0	2	2	0	4	14	0	6	6	0	14
Sign Control	Stop	Stop	Stop	Stop	Stop	Stop	Free	Free	Free	Free	Free	Free
RT Channelized	-	-	None	-	-	None	-	-	None	-	-	None
Storage Length	20	-	-	-	-	20	-	-	-	-	-	-
Veh in Median Storage, #	-	0	-	-	0	-	-	0	-	-	0	-
Grade, %	-	0	-	-	0	-	-	0	-	-	0	-
Peak Hour Factor	76	76	76	76	76	76	76	76	76	76	76	76
Heavy Vehicles, %	0	0	0	1	1	1	1	1	1	1	1	1
Mvmt Flow	3	1	0	192	0	29	4	197	82	47	308	4

Major/Minor	Minor2		Minor1			Major1		Major2				
Conflicting Flow All	683	711	326	659	672	248	326	0	0	285	0	0
Stage 1	418	418	-	252	252	-	-	-	-	-	-	-
Stage 2	265	293	-	407	420	-	-	-	-	-	-	-
Critical Hdwy	7.1	6.5	6.2	7.11	6.51	6.21	4.11	-	-	4.11	-	-
Critical Hdwy Stg 1	6.1	5.5	-	6.11	5.51	-	-	-	-	-	-	-
Critical Hdwy Stg 2	6.1	5.5	-	6.11	5.51	-	-	-	-	-	-	-
Follow-up Hdwy	3.5	4	3.3	3.509	4.009	3.309	2.209	-	-	2.209	-	-
Pot Cap-1 Maneuver	366	361	720	378	378	793	1239	-	-	1283	-	-
Stage 1	616	594	-	754	700	-	-	-	-	-	-	-
Stage 2	745	674	-	623	591	-	-	-	-	-	-	-
Platoon blocked, %								-	-	-	-	-
Mov Cap-1 Maneuver	333	337	709	360	353	785	1222	-	-	1276	-	-
Mov Cap-2 Maneuver	333	337	-	360	353	-	-	-	-	-	-	-
Stage 1	606	560	-	746	693	-	-	-	-	-	-	-
Stage 2	712	667	-	592	557	-	-	-	-	-	-	-

Approach	EB	WB	NB	SB
HCM Control Delay, s	15.8	23.8	0.1	1
HCM LOS	C	C		

Minor Lane/Major Mvmt	NBL	NBT	NBR	EBLn1	EBLn2	WBLn1	WBLn2	SBL	SBT	SBR
Capacity (veh/h)	1222	-	-	333	337	360	785	1276	-	-
HCM Lane V/C Ratio	0.003	-	-	0.008	0.004	0.534	0.037	0.037	-	-
HCM Control Delay (s)	8	0	-	15.9	15.7	25.9	9.8	7.9	0	-
HCM Lane LOS	A	A	-	C	C	D	A	A	A	-
HCM 95th %tile Q(veh)	0	-	-	0	0	3	0.1	0.1	-	-

Intersection

Int Delay, s/veh 3.1

Movement	EBL	EBT	EBR	WBL	WBT	WBR	NBL	NBT	NBR	SBL	SBT	SBR
Lane Configurations			↗				↖	↗		↖	↗↘	
Traffic Vol, veh/h	0	0	65	0	0	0	34	631	3	396	758	20
Future Vol, veh/h	0	0	65	0	0	0	34	631	3	396	758	20
Conflicting Peds, #/hr	0	0	0	0	0	0	16	0	0	0	0	16
Sign Control	Stop	Stop	Stop	Stop	Stop	Stop	Free	Free	Free	Free	Free	Free
RT Channelized	-	-	None	-	-	None	-	-	None	-	-	None
Storage Length	-	-	0	-	-	-	190	-	-	100	-	-
Veh in Median Storage, #	-	0	-	-	-	-	-	0	-	-	0	-
Grade, %	-	0	-	-	0	-	-	0	-	-	0	-
Peak Hour Factor	95	95	95	82	82	82	95	95	95	95	95	95
Heavy Vehicles, %	5	2	5	2	2	2	1	1	2	2	1	1
Mvmt Flow	0	0	68	0	0	0	36	664	3	417	798	21

Major/Minor	Minor2			Major1			Major2				
Conflicting Flow All	-	-	426			835	0	0	667	0	0
Stage 1	-	-	-			-	-	-	-	-	-
Stage 2	-	-	-			-	-	-	-	-	-
Critical Hdwy	-	-	6.975			4.115	-	-	4.13	-	-
Critical Hdwy Stg 1	-	-	-			-	-	-	-	-	-
Critical Hdwy Stg 2	-	-	-			-	-	-	-	-	-
Follow-up Hdwy	-	-	3.3475			2.2095	-	-	2.219	-	-
Pot Cap-1 Maneuver	0	0	571			802	-	-	921	-	-
Stage 1	0	0	-			-	-	-	-	-	-
Stage 2	0	0	-			-	-	-	-	-	-
Platoon blocked, %							-	-	-	-	-
Mov Cap-1 Maneuver	-	0	562			790	-	-	921	-	-
Mov Cap-2 Maneuver	-	0	-			-	-	-	-	-	-
Stage 1	-	0	-			-	-	-	-	-	-
Stage 2	-	0	-			-	-	-	-	-	-

Approach	EB	NB	SB
HCM Control Delay, s	12.3	0.5	4.1
HCM LOS	B		

Minor Lane/Major Mvmt	NBL	NBT	NBR	EBLn1	SBL	SBT	SBR
Capacity (veh/h)	790	-	-	562	921	-	-
HCM Lane V/C Ratio	0.045	-	-	0.122	0.453	-	-
HCM Control Delay (s)	9.8	-	-	12.3	12.1	-	-
HCM Lane LOS	A	-	-	B	B	-	-
HCM 95th %tile Q(veh)	0.1	-	-	0.4	2.4	-	-

Intersection	
Intersection Delay, s/veh	7.4
Intersection LOS	A

Movement	EBL	EBT	EBR	WBL	WBT	WBR	NBL	NBT	NBR	SBL	SBT	SBR
Lane Configurations		↕			↕			↕			↕	
Traffic Vol, veh/h	7	3	0	3	5	50	1	6	5	60	4	9
Future Vol, veh/h	7	3	0	3	5	50	1	6	5	60	4	9
Peak Hour Factor	0.78	0.78	0.78	0.78	0.78	0.78	0.78	0.78	0.78	0.78	0.78	0.78
Heavy Vehicles, %	0	0	0	4	4	4	0	0	0	2	2	2
Mvmt Flow	9	4	0	4	6	64	1	8	6	77	5	12
Number of Lanes	0	1	0	0	1	0	0	1	0	0	1	0

Approach	EB	WB	NB	SB
Opposing Approach	WB	EB	SB	NB
Opposing Lanes	1	1	1	1
Conflicting Approach Left	SB	NB	EB	WB
Conflicting Lanes Left	1	1	1	1
Conflicting Approach Right	NB	SB	WB	EB
Conflicting Lanes Right	1	1	1	1
HCM Control Delay	7.4	7	7	7.7
HCM LOS	A	A	A	A

Lane	NBLn1	EBLn1	WBLn1	SBLn1
Vol Left, %	8%	70%	5%	82%
Vol Thru, %	50%	30%	9%	5%
Vol Right, %	42%	0%	86%	12%
Sign Control	Stop	Stop	Stop	Stop
Traffic Vol by Lane	12	10	58	73
LT Vol	1	7	3	60
Through Vol	6	3	5	4
RT Vol	5	0	50	9
Lane Flow Rate	15	13	74	94
Geometry Grp	1	1	1	1
Degree of Util (X)	0.017	0.015	0.076	0.109
Departure Headway (Hd)	3.889	4.287	3.659	4.187
Convergence, Y/N	Yes	Yes	Yes	Yes
Cap	914	827	969	855
Service Time	1.939	2.354	1.719	2.217
HCM Lane V/C Ratio	0.016	0.016	0.076	0.11
HCM Control Delay	7	7.4	7	7.7
HCM Lane LOS	A	A	A	A
HCM 95th-tile Q	0.1	0	0.2	0.4

Intersection

Intersection Delay, s/veh 9.3
Intersection LOS A

Movement	EBL	EBT	EBR	WBL	WBT	WBR	NBL	NBT	NBR	SBL	SBT	SBR
Lane Configurations		↕			↕			↕			↕	
Traffic Vol, veh/h	3	132	39	3	115	86	39	20	6	100	36	7
Future Vol, veh/h	3	132	39	3	115	86	39	20	6	100	36	7
Peak Hour Factor	0.89	0.89	0.89	0.89	0.89	0.89	0.89	0.89	0.89	0.89	0.89	0.89
Heavy Vehicles, %	1	1	1	0	0	0	0	0	0	1	1	1
Mvmt Flow	3	148	44	3	129	97	44	22	7	112	40	8
Number of Lanes	0	1	0	0	1	0	0	1	0	0	1	0

Approach	EB	WB	NB	SB
Opposing Approach	WB	EB	SB	NB
Opposing Lanes	1	1	1	1
Conflicting Approach Left	SB	NB	EB	WB
Conflicting Lanes Left	1	1	1	1
Conflicting Approach Right	NB	SB	WB	EB
Conflicting Lanes Right	1	1	1	1
HCM Control Delay	9.3	9.3	8.8	9.7
HCM LOS	A	A	A	A

Lane	NBLn1	EBLn1	WBLn1	SBLn1
Vol Left, %	60%	2%	1%	70%
Vol Thru, %	31%	76%	56%	25%
Vol Right, %	9%	22%	42%	5%
Sign Control	Stop	Stop	Stop	Stop
Traffic Vol by Lane	65	174	204	143
LT Vol	39	3	3	100
Through Vol	20	132	115	36
RT Vol	6	39	86	7
Lane Flow Rate	73	196	229	161
Geometry Grp	1	1	1	1
Degree of Util (X)	0.105	0.252	0.285	0.227
Departure Headway (Hd)	5.153	4.649	4.482	5.086
Convergence, Y/N	Yes	Yes	Yes	Yes
Cap	690	768	798	701
Service Time	3.226	2.704	2.534	3.151
HCM Lane V/C Ratio	0.106	0.255	0.287	0.23
HCM Control Delay	8.8	9.3	9.3	9.7
HCM Lane LOS	A	A	A	A
HCM 95th-tile Q	0.4	1	1.2	0.9

Intersection												
Int Delay, s/veh	4.2											
Movement	EBL	EBT	EBR	WBL	WBT	WBR	NBL	NBT	NBR	SBL	SBT	SBR
Lane Configurations												
Traffic Vol, veh/h	2	0	4	126	0	30	3	254	127	43	169	2
Future Vol, veh/h	2	0	4	126	0	30	3	254	127	43	169	2
Conflicting Peds, #/hr	1	0	0	0	0	1	13	0	1	1	0	13
Sign Control	Stop	Stop	Stop	Stop	Stop	Stop	Free	Free	Free	Free	Free	Free
RT Channelized	-	-	None	-	-	None	-	-	None	-	-	None
Storage Length	20	-	-	-	-	20	-	-	-	-	-	-
Veh in Median Storage, #	-	0	-	-	0	-	-	0	-	-	0	-
Grade, %	-	0	-	-	0	-	-	0	-	-	0	-
Peak Hour Factor	94	94	94	94	94	94	94	94	94	94	94	94
Heavy Vehicles, %	0	0	0	0	0	0	0	0	0	0	0	0
Mvmt Flow	2	0	4	134	0	32	3	270	135	46	180	2

Major/Minor	Minor2		Minor1			Major1		Major2				
Conflicting Flow All	647	698	194	620	632	340	195	0	0	406	0	0
Stage 1	286	286	-	345	345	-	-	-	-	-	-	-
Stage 2	361	412	-	275	287	-	-	-	-	-	-	-
Critical Hdwy	7.1	6.5	6.2	7.1	6.5	6.2	4.1	-	-	4.1	-	-
Critical Hdwy Stg 1	6.1	5.5	-	6.1	5.5	-	-	-	-	-	-	-
Critical Hdwy Stg 2	6.1	5.5	-	6.1	5.5	-	-	-	-	-	-	-
Follow-up Hdwy	3.5	4	3.3	3.5	4	3.3	2.2	-	-	2.2	-	-
Pot Cap-1 Maneuver	387	367	853	403	400	707	1390	-	-	1164	-	-
Stage 1	726	679	-	675	640	-	-	-	-	-	-	-
Stage 2	662	598	-	736	678	-	-	-	-	-	-	-
Platoon blocked, %								-	-	-	-	-
Mov Cap-1 Maneuver	351	345	842	386	376	706	1373	-	-	1163	-	-
Mov Cap-2 Maneuver	351	345	-	386	376	-	-	-	-	-	-	-
Stage 1	715	642	-	672	637	-	-	-	-	-	-	-
Stage 2	630	596	-	700	641	-	-	-	-	-	-	-

Approach	EB		WB		NB		SB	
HCM Control Delay, s	11.3		17.5		0.1		1.7	
HCM LOS	B		C					

Minor Lane/Major Mvmt	NBL	NBT	NBR	EBLn1	EBLn2	WBLn1	WBLn2	SBL	SBT	SBR
Capacity (veh/h)	1373	-	-	351	842	386	706	1163	-	-
HCM Lane V/C Ratio	0.002	-	-	0.006	0.005	0.347	0.045	0.039	-	-
HCM Control Delay (s)	7.6	0	-	15.3	9.3	19.2	10.3	8.2	0	-
HCM Lane LOS	A	A	-	C	A	C	B	A	A	-
HCM 95th %tile Q(veh)	0	-	-	0	0	1.5	0.1	0.1	-	-

APPENDIX D: NEAR TERM (2021) TRAFFIC CONDITIONS ANALYSIS SHEETS

MidPen Housing
1: Freedom Blvd & Miles Ln

Ex+NT Am
Timing Plan: Default

Intersection												
Int Delay, s/veh	2.5											
Movement	EBL	EBT	EBR	WBL	WBT	WBR	NBL	NBT	NBR	SBL	SBT	SBR
Lane Configurations			↗				↖	↗		↖	↗↘	
Traffic Vol, veh/h	0	0	34	0	0	0	24	519	1	292	628	3
Future Vol, veh/h	0	0	34	0	0	0	24	519	1	292	628	3
Conflicting Peds, #/hr	0	0	0	0	0	0	6	0	0	0	0	6
Sign Control	Stop	Stop	Stop	Stop	Stop	Stop	Free	Free	Free	Free	Free	Free
RT Channelized	-	-	None	-	-	None	-	-	None	-	-	None
Storage Length	-	-	0	-	-	-	190	-	-	100	-	-
Veh in Median Storage, #	-	0	-	-	-	-	-	0	-	-	0	-
Grade, %	-	0	-	-	0	-	-	0	-	-	0	-
Peak Hour Factor	86	86	86	82	82	82	86	86	86	86	86	86
Heavy Vehicles, %	0	2	0	2	2	2	3	3	2	2	1	1
Mvmt Flow	0	0	40	0	0	0	28	603	1	340	730	3

Major/Minor	Minor2			Major1			Major2				
Conflicting Flow All	-	-	373			740	0	0	605	0	0
Stage 1	-	-	-			-	-	-	-	-	-
Stage 2	-	-	-			-	-	-	-	-	-
Critical Hdwy	-	-	6.9			4.145	-	-	4.13	-	-
Critical Hdwy Stg 1	-	-	-			-	-	-	-	-	-
Critical Hdwy Stg 2	-	-	-			-	-	-	-	-	-
Follow-up Hdwy	-	-	3.3			2.2285	-	-	2.219	-	-
Pot Cap-1 Maneuver	0	0	630			859	-	-	971	-	-
Stage 1	0	0	-			-	-	-	-	-	-
Stage 2	0	0	-			-	-	-	-	-	-
Platoon blocked, %							-	-	-	-	-
Mov Cap-1 Maneuver	-	0	626			859	-	-	971	-	-
Mov Cap-2 Maneuver	-	0	-			-	-	-	-	-	-
Stage 1	-	0	-			-	-	-	-	-	-
Stage 2	-	0	-			-	-	-	-	-	-

Approach	EB	NB	SB
HCM Control Delay, s	11.1	0.4	3.4
HCM LOS	B		

Minor Lane/Major Mvmt	NBL	NBT	NBR	EBLn1	SBL	SBT	SBR
Capacity (veh/h)	859	-	-	626	971	-	-
HCM Lane V/C Ratio	0.032	-	-	0.063	0.35	-	-
HCM Control Delay (s)	9.3	-	-	11.1	10.7	-	-
HCM Lane LOS	A	-	-	B	B	-	-
HCM 95th %tile Q(veh)	0.1	-	-	0.2	1.6	-	-

MidPen Housing
2: Kimberley Ln/Santa Clara St & Miles Ln

Ex+NT Am
Timing Plan: Default

Intersection	
Intersection Delay, s/veh	7.1
Intersection LOS	A

Movement	EBL	EBT	EBR	WBL	WBT	WBR	NBL	NBT	NBR	SBL	SBT	SBR
Lane Configurations		↕			↕			↕			↕	
Traffic Vol, veh/h	8	1	0	1	0	41	0	4	4	37	3	3
Future Vol, veh/h	8	1	0	1	0	41	0	4	4	37	3	3
Peak Hour Factor	0.82	0.82	0.82	0.82	0.82	0.82	0.82	0.82	0.82	0.82	0.82	0.82
Heavy Vehicles, %	0	0	0	2	2	2	0	0	0	0	0	0
Mvmt Flow	10	1	0	1	0	50	0	5	5	45	4	4
Number of Lanes	0	1	0	0	1	0	0	1	0	0	1	0

Approach	EB	WB	NB	SB
Opposing Approach	WB	EB	SB	NB
Opposing Lanes	1	1	1	1
Conflicting Approach Left	SB	NB	EB	WB
Conflicting Lanes Left	1	1	1	1
Conflicting Approach Right	NB	SB	WB	EB
Conflicting Lanes Right	1	1	1	1
HCM Control Delay	7.3	6.7	6.8	7.4
HCM LOS	A	A	A	A

Lane	NBLn1	EBLn1	WBLn1	SBLn1
Vol Left, %	0%	89%	2%	86%
Vol Thru, %	50%	11%	0%	7%
Vol Right, %	50%	0%	98%	7%
Sign Control	Stop	Stop	Stop	Stop
Traffic Vol by Lane	8	9	42	43
LT Vol	0	8	1	37
Through Vol	4	1	0	3
RT Vol	4	0	41	3
Lane Flow Rate	10	11	51	52
Geometry Grp	1	1	1	1
Degree of Util (X)	0.01	0.013	0.049	0.06
Departure Headway (Hd)	3.749	4.227	3.471	4.148
Convergence, Y/N	Yes	Yes	Yes	Yes
Cap	955	846	1030	866
Service Time	1.772	2.257	1.5	2.16
HCM Lane V/C Ratio	0.01	0.013	0.05	0.06
HCM Control Delay	6.8	7.3	6.7	7.4
HCM Lane LOS	A	A	A	A
HCM 95th-tile Q	0	0	0.2	0.2

Intersection

Intersection Delay, s/veh 10.8
Intersection LOS B

Movement	EBL	EBT	EBR	WBL	WBT	WBR	NBL	NBT	NBR	SBL	SBT	SBR
Lane Configurations		↕			↕			↕			↕	
Traffic Vol, veh/h	12	63	14	2	143	121	24	39	3	101	33	10
Future Vol, veh/h	12	63	14	2	143	121	24	39	3	101	33	10
Peak Hour Factor	0.72	0.72	0.72	0.72	0.72	0.72	0.72	0.72	0.72	0.72	0.72	0.72
Heavy Vehicles, %	0	0	0	1	1	1	2	2	2	1	1	1
Mvmt Flow	17	88	19	3	199	168	33	54	4	140	46	14
Number of Lanes	0	1	0	0	1	0	0	1	0	0	1	0

Approach	EB	WB	NB	SB
Opposing Approach	WB	EB	SB	NB
Opposing Lanes	1	1	1	1
Conflicting Approach Left	SB	NB	EB	WB
Conflicting Lanes Left	1	1	1	1
Conflicting Approach Right	NB	SB	WB	EB
Conflicting Lanes Right	1	1	1	1
HCM Control Delay	9.3	11.7	9.5	10.7
HCM LOS	A	B	A	B

Lane	NBLn1	EBLn1	WBLn1	SBLn1
Vol Left, %	36%	13%	1%	70%
Vol Thru, %	59%	71%	54%	23%
Vol Right, %	5%	16%	45%	7%
Sign Control	Stop	Stop	Stop	Stop
Traffic Vol by Lane	66	89	266	144
LT Vol	24	12	2	101
Through Vol	39	63	143	33
RT Vol	3	14	121	10
Lane Flow Rate	92	124	369	200
Geometry Grp	1	1	1	1
Degree of Util (X)	0.141	0.177	0.469	0.299
Departure Headway (Hd)	5.532	5.165	4.571	5.384
Convergence, Y/N	Yes	Yes	Yes	Yes
Cap	650	698	776	670
Service Time	3.547	3.165	2.665	3.394
HCM Lane V/C Ratio	0.142	0.178	0.476	0.299
HCM Control Delay	9.5	9.3	11.7	10.7
HCM Lane LOS	A	A	B	B
HCM 95th-tile Q	0.5	0.6	2.5	1.3

MidPen Housing
4: Auto Center Dr & Marin St

Ex+NT Am
Timing Plan: Default

Intersection

Int Delay, s/veh 6.3

Movement	EBL	EBT	EBR	WBL	WBT	WBR	NBL	NBT	NBR	SBL	SBT	SBR
Lane Configurations												
Traffic Vol, veh/h	2	1	0	143	0	19	3	152	60	33	236	3
Future Vol, veh/h	2	1	0	143	0	19	3	152	60	33	236	3
Conflicting Peds, #/hr	4	0	2	2	0	4	14	0	6	6	0	14
Sign Control	Stop	Stop	Stop	Stop	Stop	Stop	Free	Free	Free	Free	Free	Free
RT Channelized	-	-	None	-	-	None	-	-	None	-	-	None
Storage Length	20	-	-	-	-	20	-	-	-	-	-	-
Veh in Median Storage, #	-	0	-	-	0	-	-	0	-	-	0	-
Grade, %	-	0	-	-	0	-	-	0	-	-	0	-
Peak Hour Factor	76	76	76	76	76	76	76	76	76	76	76	76
Heavy Vehicles, %	0	0	0	1	1	1	1	1	1	1	1	1
Mvmt Flow	3	1	0	188	0	25	4	200	79	43	311	4

Major/Minor	Minor2		Minor1			Major1		Major2				
Conflicting Flow All	664	706	329	655	668	249	328	0	0	285	0	0
Stage 1	413	413	-	253	253	-	-	-	-	-	-	-
Stage 2	251	293	-	402	415	-	-	-	-	-	-	-
Critical Hdwy	7.1	6.5	6.2	7.11	6.51	6.21	4.11	-	-	4.11	-	-
Critical Hdwy Stg 1	6.1	5.5	-	6.11	5.51	-	-	-	-	-	-	-
Critical Hdwy Stg 2	6.1	5.5	-	6.11	5.51	-	-	-	-	-	-	-
Follow-up Hdwy	3.5	4	3.3	3.509	4.009	3.309	2.209	-	-	2.209	-	-
Pot Cap-1 Maneuver	377	363	717	381	380	792	1237	-	-	1283	-	-
Stage 1	620	597	-	754	700	-	-	-	-	-	-	-
Stage 2	758	674	-	627	594	-	-	-	-	-	-	-
Platoon blocked, %								-	-	-	-	-
Mov Cap-1 Maneuver	346	340	706	364	356	784	1235	-	-	1278	-	-
Mov Cap-2 Maneuver	346	340	-	364	356	-	-	-	-	-	-	-
Stage 1	609	565	-	747	693	-	-	-	-	-	-	-
Stage 2	728	667	-	599	562	-	-	-	-	-	-	-

Approach	EB		WB		NB		SB	
HCM Control Delay, s	15.5		23.2		0.1		1	
HCM LOS	C		C					

Minor Lane/Major Mvmt	NBL	NBT	NBR	EBLn1	EBLn2	WBLn1	WBLn2	SBL	SBT	SBR
Capacity (veh/h)	1235	-	-	346	340	364	784	1278	-	-
HCM Lane V/C Ratio	0.003	-	-	0.008	0.004	0.517	0.032	0.034	-	-
HCM Control Delay (s)	7.9	0	-	15.5	15.6	25	9.7	7.9	0	-
HCM Lane LOS	A	A	-	C	C	D	A	A	A	-
HCM 95th %tile Q(veh)	0	-	-	0	0	2.8	0.1	0.1	-	-

MidPen Housing
1: Freedom Blvd & Miles Ln

Ex+NT PM
Timing Plan: Default

Intersection												
Int Delay, s/veh	3.1											
Movement	EBL	EBT	EBR	WBL	WBT	WBR	NBL	NBT	NBR	SBL	SBT	SBR
Lane Configurations			↗				↖	↗		↖	↗↘	
Traffic Vol, veh/h	0	0	59	0	0	0	28	649	3	407	779	17
Future Vol, veh/h	0	0	59	0	0	0	28	649	3	407	779	17
Conflicting Peds, #/hr	0	0	0	0	0	0	16	0	0	0	0	16
Sign Control	Stop	Stop	Stop	Stop	Stop	Stop	Free	Free	Free	Free	Free	Free
RT Channelized	-	-	None	-	-	None	-	-	None	-	-	None
Storage Length	-	-	0	-	-	-	190	-	-	100	-	-
Veh in Median Storage, #	-	0	-	-	-	-	-	0	-	-	0	-
Grade, %	-	0	-	-	0	-	-	0	-	-	0	-
Peak Hour Factor	95	95	95	82	82	82	95	95	95	95	95	95
Heavy Vehicles, %	5	2	5	2	2	2	1	1	2	2	1	1
Mvmt Flow	0	0	62	0	0	0	29	683	3	428	820	18

Major/Minor	Minor2			Major1			Major2				
Conflicting Flow All	-	-	435			854	0	0	686	0	0
Stage 1	-	-	-			-	-	-	-	-	-
Stage 2	-	-	-			-	-	-	-	-	-
Critical Hdwy	-	-	6.975			4.115	-	-	4.13	-	-
Critical Hdwy Stg 1	-	-	-			-	-	-	-	-	-
Critical Hdwy Stg 2	-	-	-			-	-	-	-	-	-
Follow-up Hdwy	-	-	3.3475			2.2095	-	-	2.219	-	-
Pot Cap-1 Maneuver	0	0	563			789	-	-	906	-	-
Stage 1	0	0	-			-	-	-	-	-	-
Stage 2	0	0	-			-	-	-	-	-	-
Platoon blocked, %							-	-	-	-	-
Mov Cap-1 Maneuver	-	0	554			789	-	-	906	-	-
Mov Cap-2 Maneuver	-	0	-			-	-	-	-	-	-
Stage 1	-	0	-			-	-	-	-	-	-
Stage 2	-	0	-			-	-	-	-	-	-

Approach	EB	NB	SB
HCM Control Delay, s	12.3	0.4	4.2
HCM LOS	B		

Minor Lane/Major Mvmt	NBL	NBT	NBR	EBLn1	SBL	SBT	SBR
Capacity (veh/h)	789	-	-	554	906	-	-
HCM Lane V/C Ratio	0.037	-	-	0.112	0.473	-	-
HCM Control Delay (s)	9.7	-	-	12.3	12.5	-	-
HCM Lane LOS	A	-	-	B	B	-	-
HCM 95th %tile Q(veh)	0.1	-	-	0.4	2.6	-	-

Intersection	
Intersection Delay, s/veh	7.3
Intersection LOS	A

Movement	EBL	EBT	EBR	WBL	WBT	WBR	NBL	NBT	NBR	SBL	SBT	SBR
Lane Configurations		↕			↕			↕			↕	
Traffic Vol, veh/h	7	3	0	3	5	37	1	6	5	52	4	9
Future Vol, veh/h	7	3	0	3	5	37	1	6	5	52	4	9
Peak Hour Factor	0.78	0.78	0.78	0.78	0.78	0.78	0.78	0.78	0.78	0.78	0.78	0.78
Heavy Vehicles, %	0	0	0	4	4	4	0	0	0	2	2	2
Mvmt Flow	9	4	0	4	6	47	1	8	6	67	5	12
Number of Lanes	0	1	0	0	1	0	0	1	0	0	1	0

Approach	EB	WB	NB	SB
Opposing Approach	WB	EB	SB	NB
Opposing Lanes	1	1	1	1
Conflicting Approach Left	SB	NB	EB	WB
Conflicting Lanes Left	1	1	1	1
Conflicting Approach Right	NB	SB	WB	EB
Conflicting Lanes Right	1	1	1	1
HCM Control Delay	7.4	7	7	7.6
HCM LOS	A	A	A	A

Lane	NBLn1	EBLn1	WBLn1	SBLn1
Vol Left, %	8%	70%	7%	80%
Vol Thru, %	50%	30%	11%	6%
Vol Right, %	42%	0%	82%	14%
Sign Control	Stop	Stop	Stop	Stop
Traffic Vol by Lane	12	10	45	65
LT Vol	1	7	3	52
Through Vol	6	3	5	4
RT Vol	5	0	37	9
Lane Flow Rate	15	13	58	83
Geometry Grp	1	1	1	1
Degree of Util (X)	0.016	0.015	0.059	0.096
Departure Headway (Hd)	3.851	4.256	3.669	4.144
Convergence, Y/N	Yes	Yes	Yes	Yes
Cap	925	835	969	865
Service Time	1.894	2.311	1.719	2.169
HCM Lane V/C Ratio	0.016	0.016	0.06	0.096
HCM Control Delay	7	7.4	7	7.6
HCM Lane LOS	A	A	A	A
HCM 95th-tile Q	0	0	0.2	0.3

Intersection

Intersection Delay, s/veh	9.3
Intersection LOS	A

Movement	EBL	EBT	EBR	WBL	WBT	WBR	NBL	NBT	NBR	SBL	SBT	SBR
Lane Configurations		↕			↕			↕			↕	
Traffic Vol, veh/h	3	133	30	3	116	87	28	19	5	101	36	7
Future Vol, veh/h	3	133	30	3	116	87	28	19	5	101	36	7
Peak Hour Factor	0.89	0.89	0.89	0.89	0.89	0.89	0.89	0.89	0.89	0.89	0.89	0.89
Heavy Vehicles, %	1	1	1	0	0	0	0	0	0	1	1	1
Mvmt Flow	3	149	34	3	130	98	31	21	6	113	40	8
Number of Lanes	0	1	0	0	1	0	0	1	0	0	1	0

Approach	EB	WB	NB	SB
Opposing Approach	WB	EB	SB	NB
Opposing Lanes	1	1	1	1
Conflicting Approach Left	SB	NB	EB	WB
Conflicting Lanes Left	1	1	1	1
Conflicting Approach Right	NB	SB	WB	EB
Conflicting Lanes Right	1	1	1	1
HCM Control Delay	9.2	9.3	8.7	9.6
HCM LOS	A	A	A	A

Lane	NBLn1	EBLn1	WBLn1	SBLn1
Vol Left, %	54%	2%	1%	70%
Vol Thru, %	37%	80%	56%	25%
Vol Right, %	10%	18%	42%	5%
Sign Control	Stop	Stop	Stop	Stop
Traffic Vol by Lane	52	166	206	144
LT Vol	28	3	3	101
Through Vol	19	133	116	36
RT Vol	5	30	87	7
Lane Flow Rate	58	187	231	162
Geometry Grp	1	1	1	1
Degree of Util (X)	0.083	0.24	0.285	0.227
Departure Headway (Hd)	5.119	4.637	4.432	5.046
Convergence, Y/N	Yes	Yes	Yes	Yes
Cap	695	770	808	707
Service Time	3.188	2.687	2.479	3.105
HCM Lane V/C Ratio	0.083	0.243	0.286	0.229
HCM Control Delay	8.7	9.2	9.3	9.6
HCM Lane LOS	A	A	A	A
HCM 95th-tile Q	0.3	0.9	1.2	0.9

MidPen Housing
4: Auto Center Dr & Marin St

Ex+NT PM
Timing Plan: Default

Intersection												
Int Delay, s/veh	3.9											
Movement	EBL	EBT	EBR	WBL	WBT	WBR	NBL	NBT	NBR	SBL	SBT	SBR
Lane Configurations												
Traffic Vol, veh/h	2	0	4	120	0	26	3	257	123	39	171	2
Future Vol, veh/h	2	0	4	120	0	26	3	257	123	39	171	2
Conflicting Peds, #/hr	1	0	0	0	0	1	13	0	1	1	0	13
Sign Control	Stop	Stop	Stop	Stop	Stop	Stop	Free	Free	Free	Free	Free	Free
RT Channelized	-	-	None	-	-	None	-	-	None	-	-	None
Storage Length	20	-	-	-	-	20	-	-	-	-	-	-
Veh in Median Storage, #	-	0	-	-	0	-	-	0	-	-	0	-
Grade, %	-	0	-	-	0	-	-	0	-	-	0	-
Peak Hour Factor	94	94	94	94	94	94	94	94	94	94	94	94
Heavy Vehicles, %	0	0	0	0	0	0	0	0	0	0	0	0
Mvmt Flow	2	0	4	128	0	28	3	273	131	41	182	2

Major/Minor	Minor2		Minor1			Major1		Major2				
Conflicting Flow All	625	691	196	614	626	341	197	0	0	405	0	0
Stage 1	279	279	-	346	346	-	-	-	-	-	-	-
Stage 2	346	412	-	268	280	-	-	-	-	-	-	-
Critical Hdwy	7.1	6.5	6.2	7.1	6.5	6.2	4.1	-	-	4.1	-	-
Critical Hdwy Stg 1	6.1	5.5	-	6.1	5.5	-	-	-	-	-	-	-
Critical Hdwy Stg 2	6.1	5.5	-	6.1	5.5	-	-	-	-	-	-	-
Follow-up Hdwy	3.5	4	3.3	3.5	4	3.3	2.2	-	-	2.2	-	-
Pot Cap-1 Maneuver	400	370	850	407	403	706	1388	-	-	1165	-	-
Stage 1	732	683	-	674	639	-	-	-	-	-	-	-
Stage 2	674	598	-	742	683	-	-	-	-	-	-	-
Platoon blocked, %								-	-	-	-	-
Mov Cap-1 Maneuver	367	350	839	392	381	705	1388	-	-	1164	-	-
Mov Cap-2 Maneuver	367	350	-	392	381	-	-	-	-	-	-	-
Stage 1	721	648	-	671	636	-	-	-	-	-	-	-
Stage 2	645	596	-	709	648	-	-	-	-	-	-	-

Approach	EB		WB			NB		SB			
HCM Control Delay, s	11.2		17.1			0.1		1.5			
HCM LOS	B		C								

Minor Lane/Major Mvmt	NBL	NBT	NBR	EBLn1	EBLn2	WBLn1	WBLn2	SBL	SBT	SBR
Capacity (veh/h)	1388	-	-	367	839	392	705	1164	-	-
HCM Lane V/C Ratio	0.002	-	-	0.006	0.005	0.326	0.039	0.036	-	-
HCM Control Delay (s)	7.6	0	-	14.9	9.3	18.6	10.3	8.2	0	-
HCM Lane LOS	A	A	-	B	A	C	B	A	A	-
HCM 95th %tile Q(veh)	0	-	-	0	0	1.4	0.1	0.1	-	-

**APPENDIX E: NEAR TERM (2021) PROJECT PLUS PROJECT TRAFFIC
CONDITIONS ANALYSIS SHEETS**

Intersection												
Int Delay, s/veh	2.5											
Movement	EBL	EBT	EBR	WBL	WBT	WBR	NBL	NBT	NBR	SBL	SBT	SBR
Lane Configurations			↗				↖	↗		↖	↗↖	
Traffic Vol, veh/h	0	0	38	0	0	0	28	519	1	292	628	6
Future Vol, veh/h	0	0	38	0	0	0	28	519	1	292	628	6
Conflicting Peds, #/hr	0	0	0	0	0	0	6	0	0	0	0	6
Sign Control	Stop	Stop	Stop	Stop	Stop	Stop	Free	Free	Free	Free	Free	Free
RT Channelized	-	-	None	-	-	None	-	-	None	-	-	None
Storage Length	-	-	0	-	-	-	190	-	-	100	-	-
Veh in Median Storage, #	-	0	-	-	-	-	-	0	-	-	0	-
Grade, %	-	0	-	-	0	-	-	0	-	-	0	-
Peak Hour Factor	86	86	86	82	82	82	86	86	86	86	86	86
Heavy Vehicles, %	0	2	0	2	2	2	3	3	2	2	1	1
Mvmt Flow	0	0	44	0	0	0	33	603	1	340	730	7

Major/Minor	Minor2			Major1			Major2				
Conflicting Flow All	-	-	375			743	0	0	604	0	0
Stage 1	-	-	-			-	-	-	-	-	-
Stage 2	-	-	-			-	-	-	-	-	-
Critical Hdwy	-	-	6.9			4.145	-	-	4.13	-	-
Critical Hdwy Stg 1	-	-	-			-	-	-	-	-	-
Critical Hdwy Stg 2	-	-	-			-	-	-	-	-	-
Follow-up Hdwy	-	-	3.3			2.2285	-	-	2.219	-	-
Pot Cap-1 Maneuver	0	0	628			857	-	-	972	-	-
Stage 1	0	0	-			-	-	-	-	-	-
Stage 2	0	0	-			-	-	-	-	-	-
Platoon blocked, %							-	-	-	-	-
Mov Cap-1 Maneuver	-	0	624			852	-	-	972	-	-
Mov Cap-2 Maneuver	-	0	-			-	-	-	-	-	-
Stage 1	-	0	-			-	-	-	-	-	-
Stage 2	-	0	-			-	-	-	-	-	-

Approach	EB	NB	SB
HCM Control Delay, s	11.2	0.5	3.4
HCM LOS	B		

Minor Lane/Major Mvmt	NBL	NBT	NBR	EBLn1	SBL	SBT	SBR
Capacity (veh/h)	852	-	-	624	972	-	-
HCM Lane V/C Ratio	0.038	-	-	0.071	0.349	-	-
HCM Control Delay (s)	9.4	-	-	11.2	10.7	-	-
HCM Lane LOS	A	-	-	B	B	-	-
HCM 95th %tile Q(veh)	0.1	-	-	0.2	1.6	-	-

Intersection	
Intersection Delay, s/veh	7.1
Intersection LOS	A

Movement	EBL	EBT	EBR	WBL	WBT	WBR	NBL	NBT	NBR	SBL	SBT	SBR
Lane Configurations		↕			↕			↕			↕	
Traffic Vol, veh/h	8	1	0	1	0	51	0	4	4	43	3	3
Future Vol, veh/h	8	1	0	1	0	51	0	4	4	43	3	3
Peak Hour Factor	0.82	0.82	0.82	0.82	0.82	0.82	0.82	0.82	0.82	0.82	0.82	0.82
Heavy Vehicles, %	0	0	0	2	2	2	0	0	0	0	0	0
Mvmt Flow	10	1	0	1	0	62	0	5	5	52	4	4
Number of Lanes	0	1	0	0	1	0	0	1	0	0	1	0

Approach	EB	WB	NB	SB
Opposing Approach	WB	EB	SB	NB
Opposing Lanes	1	1	1	1
Conflicting Approach Left	SB	NB	EB	WB
Conflicting Lanes Left	1	1	1	1
Conflicting Approach Right	NB	SB	WB	EB
Conflicting Lanes Right	1	1	1	1
HCM Control Delay	7.3	6.7	6.8	7.5
HCM LOS	A	A	A	A

Lane	NBLn1	EBLn1	WBLn1	SBLn1
Vol Left, %	0%	89%	2%	88%
Vol Thru, %	50%	11%	0%	6%
Vol Right, %	50%	0%	98%	6%
Sign Control	Stop	Stop	Stop	Stop
Traffic Vol by Lane	8	9	52	49
LT Vol	0	8	1	43
Through Vol	4	1	0	3
RT Vol	4	0	51	3
Lane Flow Rate	10	11	63	60
Geometry Grp	1	1	1	1
Degree of Util (X)	0.01	0.013	0.061	0.069
Departure Headway (Hd)	3.774	4.247	3.479	4.176
Convergence, Y/N	Yes	Yes	Yes	Yes
Cap	947	840	1025	860
Service Time	1.804	2.285	1.514	2.192
HCM Lane V/C Ratio	0.011	0.013	0.061	0.07
HCM Control Delay	6.8	7.3	6.7	7.5
HCM Lane LOS	A	A	A	A
HCM 95th-tile Q	0	0	0.2	0.2

Intersection

Intersection Delay, s/veh	11
Intersection LOS	B

Movement	EBL	EBT	EBR	WBL	WBT	WBR	NBL	NBT	NBR	SBL	SBT	SBR
Lane Configurations		↕			↕			↕			↕	
Traffic Vol, veh/h	12	63	20	2	143	121	31	40	5	101	33	10
Future Vol, veh/h	12	63	20	2	143	121	31	40	5	101	33	10
Peak Hour Factor	0.72	0.72	0.72	0.72	0.72	0.72	0.72	0.72	0.72	0.72	0.72	0.72
Heavy Vehicles, %	0	0	0	1	1	1	2	2	2	1	1	1
Mvmt Flow	17	88	28	3	199	168	43	56	7	140	46	14
Number of Lanes	0	1	0	0	1	0	0	1	0	0	1	0

Approach	EB	WB	NB	SB
Opposing Approach	WB	EB	SB	NB
Opposing Lanes	1	1	1	1
Conflicting Approach Left	SB	NB	EB	WB
Conflicting Lanes Left	1	1	1	1
Conflicting Approach Right	NB	SB	WB	EB
Conflicting Lanes Right	1	1	1	1
HCM Control Delay	9.4	12.1	9.7	10.8
HCM LOS	A	B	A	B

Lane	NBLn1	EBLn1	WBLn1	SBLn1
Vol Left, %	41%	13%	1%	70%
Vol Thru, %	53%	66%	54%	23%
Vol Right, %	7%	21%	45%	7%
Sign Control	Stop	Stop	Stop	Stop
Traffic Vol by Lane	76	95	266	144
LT Vol	31	12	2	101
Through Vol	40	63	143	33
RT Vol	5	20	121	10
Lane Flow Rate	106	132	369	200
Geometry Grp	1	1	1	1
Degree of Util (X)	0.163	0.189	0.485	0.303
Departure Headway (Hd)	5.569	5.17	4.727	5.445
Convergence, Y/N	Yes	Yes	Yes	Yes
Cap	644	694	768	660
Service Time	3.603	3.202	2.727	3.473
HCM Lane V/C Ratio	0.165	0.19	0.48	0.303
HCM Control Delay	9.7	9.4	12.1	10.8
HCM Lane LOS	A	A	B	B
HCM 95th-tile Q	0.6	0.7	2.7	1.3

Intersection												
Int Delay, s/veh	6.7											
Movement	EBL	EBT	EBR	WBL	WBT	WBR	NBL	NBT	NBR	SBL	SBT	SBR
Lane Configurations												
Traffic Vol, veh/h	2	1	0	147	0	22	3	152	63	36	236	3
Future Vol, veh/h	2	1	0	147	0	22	3	152	63	36	236	3
Conflicting Peds, #/hr	4	0	2	2	0	4	14	0	6	6	0	14
Sign Control	Stop	Stop	Stop	Stop	Stop	Stop	Free	Free	Free	Free	Free	Free
RT Channelized	-	-	None	-	-	None	-	-	None	-	-	None
Storage Length	20	-	-	-	-	20	-	-	-	-	-	-
Veh in Median Storage, #	-	0	-	-	0	-	-	0	-	-	0	-
Grade, %	-	0	-	-	0	-	-	0	-	-	0	-
Peak Hour Factor	76	76	76	76	76	76	76	76	76	76	76	76
Heavy Vehicles, %	0	0	0	1	1	1	1	1	1	1	1	1
Mvmt Flow	3	1	0	193	0	29	4	200	83	47	311	4

Major/Minor	Minor2		Minor1		Major1		Major2					
Conflicting Flow All	689	718	329	666	679	252	329	0	0	289	0	0
Stage 1	421	421	-	256	256	-	-	-	-	-	-	-
Stage 2	268	297	-	410	423	-	-	-	-	-	-	-
Critical Hdwy	7.1	6.5	6.2	7.11	6.51	6.21	4.11	-	-	4.11	-	-
Critical Hdwy Stg 1	6.1	5.5	-	6.11	5.51	-	-	-	-	-	-	-
Critical Hdwy Stg 2	6.1	5.5	-	6.11	5.51	-	-	-	-	-	-	-
Follow-up Hdwy	3.5	4	3.3	3.509	4.009	3.309	2.209	-	-	2.209	-	-
Pot Cap-1 Maneuver	363	357	717	374	375	789	1236	-	-	1279	-	-
Stage 1	614	592	-	751	697	-	-	-	-	-	-	-
Stage 2	742	671	-	621	589	-	-	-	-	-	-	-
Platoon blocked, %								-	-	-	-	-
Mov Cap-1 Maneuver	331	333	706	356	350	782	1220	-	-	1272	-	-
Mov Cap-2 Maneuver	331	333	-	356	350	-	-	-	-	-	-	-
Stage 1	604	558	-	743	690	-	-	-	-	-	-	-
Stage 2	709	664	-	591	555	-	-	-	-	-	-	-

Approach	EB	WB	NB	SB
HCM Control Delay, s	16	24.3	0.1	1
HCM LOS	C	C		

Minor Lane/Major Mvmt	NBL	NBT	NBR	EBLn1	EBLn2	WBLn1	WBLn2	SBL	SBT	SBR
Capacity (veh/h)	1220	-	-	331	333	356	782	1272	-	-
HCM Lane V/C Ratio	0.003	-	-	0.008	0.004	0.543	0.037	0.037	-	-
HCM Control Delay (s)	8	0	-	16	15.9	26.5	9.8	7.9	0	-
HCM Lane LOS	A	A	-	C	C	D	A	A	A	-
HCM 95th %tile Q(veh)	0	-	-	0	0	3.1	0.1	0.1	-	-

Intersection												
Int Delay, s/veh	3.2											
Movement	EBL	EBT	EBR	WBL	WBT	WBR	NBL	NBT	NBR	SBL	SBT	SBR
Lane Configurations			↗				↖	↗		↖	↗↘	
Traffic Vol, veh/h	0	0	66	0	0	0	34	649	3	407	779	20
Future Vol, veh/h	0	0	66	0	0	0	34	649	3	407	779	20
Conflicting Peds, #/hr	0	0	0	0	0	0	16	0	0	0	0	16
Sign Control	Stop	Stop	Stop	Stop	Stop	Stop	Free	Free	Free	Free	Free	Free
RT Channelized	-	-	None	-	-	None	-	-	None	-	-	None
Storage Length	-	-	0	-	-	-	190	-	-	100	-	-
Veh in Median Storage, #	-	0	-	-	-	-	-	0	-	-	0	-
Grade, %	-	0	-	-	0	-	-	0	-	-	0	-
Peak Hour Factor	95	95	95	82	82	82	95	95	95	95	95	95
Heavy Vehicles, %	5	2	5	2	2	2	1	1	2	2	1	1
Mvmt Flow	0	0	69	0	0	0	36	683	3	428	820	21

Major/Minor	Minor2			Major1			Major2		
Conflicting Flow All	-	-	437	857	0	0	686	0	0
Stage 1	-	-	-	-	-	-	-	-	-
Stage 2	-	-	-	-	-	-	-	-	-
Critical Hdwy	-	-	6.975	4.115	-	-	4.13	-	-
Critical Hdwy Stg 1	-	-	-	-	-	-	-	-	-
Critical Hdwy Stg 2	-	-	-	-	-	-	-	-	-
Follow-up Hdwy	-	-3.3475	-	2.2095	-	-	2.219	-	-
Pot Cap-1 Maneuver	0	0	561	787	-	-	906	-	-
Stage 1	0	0	-	-	-	-	-	-	-
Stage 2	0	0	-	-	-	-	-	-	-
Platoon blocked, %	-	-	-	-	-	-	-	-	-
Mov Cap-1 Maneuver	-	0	552	775	-	-	906	-	-
Mov Cap-2 Maneuver	-	0	-	-	-	-	-	-	-
Stage 1	-	0	-	-	-	-	-	-	-
Stage 2	-	0	-	-	-	-	-	-	-

Approach	EB	NB	SB
HCM Control Delay, s	12.5	0.5	4.2
HCM LOS	B		

Minor Lane/Major Mvmt	NBL	NBT	NBR	EBLn1	SBL	SBT	SBR
Capacity (veh/h)	775	-	-	552	906	-	-
HCM Lane V/C Ratio	0.046	-	-	0.126	0.473	-	-
HCM Control Delay (s)	9.9	-	-	12.5	12.5	-	-
HCM Lane LOS	A	-	-	B	B	-	-
HCM 95th %tile Q(veh)	0.1	-	-	0.4	2.6	-	-

Intersection	
Intersection Delay, s/veh	7.4
Intersection LOS	A

Movement	EBL	EBT	EBR	WBL	WBT	WBR	NBL	NBT	NBR	SBL	SBT	SBR
Lane Configurations		↕			↕			↕			↕	
Traffic Vol, veh/h	7	3	0	3	5	50	1	6	5	61	4	9
Future Vol, veh/h	7	3	0	3	5	50	1	6	5	61	4	9
Peak Hour Factor	0.78	0.78	0.78	0.78	0.78	0.78	0.78	0.78	0.78	0.78	0.78	0.78
Heavy Vehicles, %	0	0	0	4	4	4	0	0	0	2	2	2
Mvmt Flow	9	4	0	4	6	64	1	8	6	78	5	12
Number of Lanes	0	1	0	0	1	0	0	1	0	0	1	0

Approach	EB	WB	NB	SB
Opposing Approach	WB	EB	SB	NB
Opposing Lanes	1	1	1	1
Conflicting Approach Left	SB	NB	EB	WB
Conflicting Lanes Left	1	1	1	1
Conflicting Approach Right	NB	SB	WB	EB
Conflicting Lanes Right	1	1	1	1
HCM Control Delay	7.4	7	7	7.7
HCM LOS	A	A	A	A

Lane	NBLn1	EBLn1	WBLn1	SBLn1	
Vol Left, %		8%	70%	5%	82%
Vol Thru, %		50%	30%	9%	5%
Vol Right, %		42%	0%	86%	12%
Sign Control		Stop	Stop	Stop	Stop
Traffic Vol by Lane		12	10	58	74
LT Vol		1	7	3	61
Through Vol		6	3	5	4
RT Vol		5	0	50	9
Lane Flow Rate		15	13	74	95
Geometry Grp		1	1	1	1
Degree of Util (X)		0.017	0.015	0.076	0.11
Departure Headway (Hd)		3.889	4.289	3.661	4.189
Convergence, Y/N		Yes	Yes	Yes	Yes
Cap		914	827	969	855
Service Time		1.94	2.356	1.721	2.219
HCM Lane V/C Ratio		0.016	0.016	0.076	0.111
HCM Control Delay		7	7.4	7	7.7
HCM Lane LOS		A	A	A	A
HCM 95th-tile Q		0.1	0	0.2	0.4

Intersection

Intersection Delay, s/veh 9.4
Intersection LOS A

Movement	EBL	EBT	EBR	WBL	WBT	WBR	NBL	NBT	NBR	SBL	SBT	SBR
Lane Configurations		↕			↕			↕			↕	
Traffic Vol, veh/h	3	133	39	3	116	87	39	20	6	101	36	7
Future Vol, veh/h	3	133	39	3	116	87	39	20	6	101	36	7
Peak Hour Factor	0.89	0.89	0.89	0.89	0.89	0.89	0.89	0.89	0.89	0.89	0.89	0.89
Heavy Vehicles, %	1	1	1	0	0	0	0	0	0	1	1	1
Mvmt Flow	3	149	44	3	130	98	44	22	7	113	40	8
Number of Lanes	0	1	0	0	1	0	0	1	0	0	1	0

Approach	EB	WB	NB	SB
Opposing Approach	WB	EB	SB	NB
Opposing Lanes	1	1	1	1
Conflicting Approach Left	SB	NB	EB	WB
Conflicting Lanes Left	1	1	1	1
Conflicting Approach Right	NB	SB	WB	EB
Conflicting Lanes Right	1	1	1	1
HCM Control Delay	9.3	9.4	8.9	9.7
HCM LOS	A	A	A	A

Lane	NBLn1	EBLn1	WBLn1	SBLn1
Vol Left, %	60%	2%	1%	70%
Vol Thru, %	31%	76%	56%	25%
Vol Right, %	9%	22%	42%	5%
Sign Control	Stop	Stop	Stop	Stop
Traffic Vol by Lane	65	175	206	144
LT Vol	39	3	3	101
Through Vol	20	133	116	36
RT Vol	6	39	87	7
Lane Flow Rate	73	197	231	162
Geometry Grp	1	1	1	1
Degree of Util (X)	0.105	0.254	0.288	0.229
Departure Headway (Hd)	5.163	4.657	4.487	5.094
Convergence, Y/N	Yes	Yes	Yes	Yes
Cap	689	767	796	701
Service Time	3.238	2.712	2.54	3.161
HCM Lane V/C Ratio	0.106	0.257	0.29	0.231
HCM Control Delay	8.9	9.3	9.4	9.7
HCM Lane LOS	A	A	A	A
HCM 95th-tile Q	0.4	1	1.2	0.9

Intersection												
Int Delay, s/veh	4.2											
Movement	EBL	EBT	EBR	WBL	WBT	WBR	NBL	NBT	NBR	SBL	SBT	SBR
Lane Configurations												
Traffic Vol, veh/h	2	0	4	127	0	30	3	257	128	43	171	2
Future Vol, veh/h	2	0	4	127	0	30	3	257	128	43	171	2
Conflicting Peds, #/hr	1	0	0	0	0	1	13	0	1	1	0	13
Sign Control	Stop	Stop	Stop	Stop	Stop	Stop	Free	Free	Free	Free	Free	Free
RT Channelized	-	-	None	-	-	None	-	-	None	-	-	None
Storage Length	20	-	-	-	-	20	-	-	-	-	-	-
Veh in Median Storage, #	-	0	-	-	0	-	-	0	-	-	0	-
Grade, %	-	0	-	-	0	-	-	0	-	-	0	-
Peak Hour Factor	94	94	94	94	94	94	94	94	94	94	94	94
Heavy Vehicles, %	0	0	0	0	0	0	0	0	0	0	0	0
Mvmt Flow	2	0	4	135	0	32	3	273	136	46	182	2

Major/Minor	Minor2		Minor1			Major1		Major2				
Conflicting Flow All	652	704	196	625	637	343	197	0	0	410	0	0
Stage 1	288	288	-	348	348	-	-	-	-	-	-	-
Stage 2	364	416	-	277	289	-	-	-	-	-	-	-
Critical Hdwy	7.1	6.5	6.2	7.1	6.5	6.2	4.1	-	-	4.1	-	-
Critical Hdwy Stg 1	6.1	5.5	-	6.1	5.5	-	-	-	-	-	-	-
Critical Hdwy Stg 2	6.1	5.5	-	6.1	5.5	-	-	-	-	-	-	-
Follow-up Hdwy	3.5	4	3.3	3.5	4	3.3	2.2	-	-	2.2	-	-
Pot Cap-1 Maneuver	384	364	850	400	398	704	1388	-	-	1160	-	-
Stage 1	724	677	-	672	638	-	-	-	-	-	-	-
Stage 2	659	595	-	734	677	-	-	-	-	-	-	-
Platoon blocked, %								-	-	-	-	-
Mov Cap-1 Maneuver	349	343	839	383	375	703	1371	-	-	1159	-	-
Mov Cap-2 Maneuver	349	343	-	383	375	-	-	-	-	-	-	-
Stage 1	713	640	-	669	635	-	-	-	-	-	-	-
Stage 2	627	593	-	698	640	-	-	-	-	-	-	-

Approach	EB		WB		NB		SB	
HCM Control Delay, s	11.3		17.7		0.1		1.6	
HCM LOS	B		C					

Minor Lane/Major Mvmt	NBL	NBT	NBR	EBLn1	EBLn2	WBLn1	WBLn2	SBL	SBT	SBR
Capacity (veh/h)	1371	-	-	349	839	383	703	1159	-	-
HCM Lane V/C Ratio	0.002	-	-	0.006	0.005	0.353	0.045	0.039	-	-
HCM Control Delay (s)	7.6	0	-	15.4	9.3	19.4	10.4	8.2	0	-
HCM Lane LOS	A	A	-	C	A	C	B	A	A	-
HCM 95th %tile Q(veh)	0	-	-	0	0	1.6	0.1	0.1	-	-

APPENDIX F: CUMULATIVE (2040) TRAFFIC CONDITIONS ANALYSIS SHEETS

MidPen Housing
1: Freedom Blvd & Miles Ln

Cumulative AM
Timing Plan: Default

Intersection												
Int Delay, s/veh	2.9											
Movement	EBL	EBT	EBR	WBL	WBT	WBR	NBL	NBT	NBR	SBL	SBT	SBR
Lane Configurations			↗				↖	↗		↖	↗↘	
Traffic Vol, veh/h	0	0	37	0	0	0	26	636	1	358	770	3
Future Vol, veh/h	0	0	37	0	0	0	26	636	1	358	770	3
Conflicting Peds, #/hr	0	0	0	0	0	0	6	0	0	0	0	6
Sign Control	Stop	Stop	Stop	Stop	Stop	Stop	Free	Free	Free	Free	Free	Free
RT Channelized	-	-	None	-	-	None	-	-	None	-	-	None
Storage Length	-	-	0	-	-	-	190	-	-	100	-	-
Veh in Median Storage, #	-	0	-	-	-	-	-	0	-	-	0	-
Grade, %	-	0	-	-	0	-	-	0	-	-	0	-
Peak Hour Factor	86	86	86	82	82	82	86	86	86	86	86	86
Heavy Vehicles, %	0	2	0	2	2	2	3	3	2	2	1	1
Mvmt Flow	0	0	43	0	0	0	30	740	1	416	895	3

Major/Minor	Minor2			Major1			Major2			
Conflicting Flow All	-	-	455		905	0	0	741	0	0
Stage 1	-	-	-		-	-	-	-	-	-
Stage 2	-	-	-		-	-	-	-	-	-
Critical Hdwy	-	-	6.9		4.145	-	-	4.13	-	-
Critical Hdwy Stg 1	-	-	-		-	-	-	-	-	-
Critical Hdwy Stg 2	-	-	-		-	-	-	-	-	-
Follow-up Hdwy	-	-	3.3		2.2285	-	-	2.219	-	-
Pot Cap-1 Maneuver	0	0	558		744	-	-	864	-	-
Stage 1	0	0	-		-	-	-	-	-	-
Stage 2	0	0	-		-	-	-	-	-	-
Platoon blocked, %						-	-	-	-	-
Mov Cap-1 Maneuver	-	0	555		744	-	-	864	-	-
Mov Cap-2 Maneuver	-	0	-		-	-	-	-	-	-
Stage 1	-	0	-		-	-	-	-	-	-
Stage 2	-	0	-		-	-	-	-	-	-

Approach	EB	NB	SB
HCM Control Delay, s	12	0.4	4.1
HCM LOS	B		

Minor Lane/Major Mvmt	NBL	NBT	NBR	EBLn1	SBL	SBT	SBR
Capacity (veh/h)	744	-	-	555	864	-	-
HCM Lane V/C Ratio	0.041	-	-	0.078	0.482	-	-
HCM Control Delay (s)	10	-	-	12	13	-	-
HCM Lane LOS	B	-	-	B	B	-	-
HCM 95th %tile Q(veh)	0.1	-	-	0.3	2.7	-	-

MidPen Housing
2: Kimberley Ln/Santa Clara St & Miles Ln

Cumulative AM
Timing Plan: Default

Intersection	
Intersection Delay, s/veh	7.1
Intersection LOS	A

Movement	EBL	EBT	EBR	WBL	WBT	WBR	NBL	NBT	NBR	SBL	SBT	SBR
Lane Configurations		↕			↕			↕			↕	
Traffic Vol, veh/h	9	1	0	1	0	45	0	4	4	40	3	3
Future Vol, veh/h	9	1	0	1	0	45	0	4	4	40	3	3
Peak Hour Factor	0.82	0.82	0.82	0.82	0.82	0.82	0.82	0.82	0.82	0.82	0.82	0.82
Heavy Vehicles, %	0	0	0	2	2	2	0	0	0	0	0	0
Mvmt Flow	11	1	0	1	0	55	0	5	5	49	4	4
Number of Lanes	0	1	0	0	1	0	0	1	0	0	1	0

Approach	EB	WB	NB	SB
Opposing Approach	WB	EB	SB	NB
Opposing Lanes	1	1	1	1
Conflicting Approach Left	SB	NB	EB	WB
Conflicting Lanes Left	1	1	1	1
Conflicting Approach Right	NB	SB	WB	EB
Conflicting Lanes Right	1	1	1	1
HCM Control Delay	7.3	6.7	6.8	7.5
HCM LOS	A	A	A	A

Lane	NBLn1	EBLn1	WBLn1	SBLn1
Vol Left, %	0%	90%	2%	87%
Vol Thru, %	50%	10%	0%	7%
Vol Right, %	50%	0%	98%	7%
Sign Control	Stop	Stop	Stop	Stop
Traffic Vol by Lane	8	10	46	46
LT Vol	0	9	1	40
Through Vol	4	1	0	3
RT Vol	4	0	45	3
Lane Flow Rate	10	12	56	56
Geometry Grp	1	1	1	1
Degree of Util (X)	0.01	0.014	0.054	0.065
Departure Headway (Hd)	3.762	4.239	3.476	4.162
Convergence, Y/N	Yes	Yes	Yes	Yes
Cap	951	842	1027	863
Service Time	1.788	2.274	1.509	2.176
HCM Lane V/C Ratio	0.011	0.014	0.055	0.065
HCM Control Delay	6.8	7.3	6.7	7.5
HCM Lane LOS	A	A	A	A
HCM 95th-tile Q	0	0	0.2	0.2

Intersection

Intersection Delay, s/veh 11.7

Intersection LOS B

Movement	EBL	EBT	EBR	WBL	WBT	WBR	NBL	NBT	NBR	SBL	SBT	SBR
Lane Configurations		↕			↕			↕			↕	
Traffic Vol, veh/h	13	68	15	2	155	131	26	43	3	109	36	11
Future Vol, veh/h	13	68	15	2	155	131	26	43	3	109	36	11
Peak Hour Factor	0.72	0.72	0.72	0.72	0.72	0.72	0.72	0.72	0.72	0.72	0.72	0.72
Heavy Vehicles, %	0	0	0	1	1	1	2	2	2	1	1	1
Mvmt Flow	18	94	21	3	215	182	36	60	4	151	50	15
Number of Lanes	0	1	0	0	1	0	0	1	0	0	1	0

Approach	EB	WB	NB	SB
Opposing Approach	WB	EB	SB	NB
Opposing Lanes	1	1	1	1
Conflicting Approach Left SB		NB	EB	WB
Conflicting Lanes Left	1	1	1	1
Conflicting Approach Right NB		SB	WB	EB
Conflicting Lanes Right	1	1	1	1
HCM Control Delay	9.6	13.1	9.8	11.3
HCM LOS	A	B	A	B

Lane	NBLn1	EBLn1	WBLn1	SBLn1
Vol Left, %	36%	14%	1%	70%
Vol Thru, %	60%	71%	54%	23%
Vol Right, %	4%	16%	45%	7%
Sign Control	Stop	Stop	Stop	Stop
Traffic Vol by Lane	72	96	288	156
LT Vol	26	13	2	109
Through Vol	43	68	155	36
RT Vol	3	15	131	11
Lane Flow Rate	100	133	400	217
Geometry Grp	1	1	1	1
Degree of Util (X)	0.159	0.196	0.532	0.333
Departure Headway (Hd)	5.71	5.304	4.786	5.533
Convergence, Y/N	Yes	Yes	Yes	Yes
Cap	627	676	760	650
Service Time	3.754	3.344	2.786	3.57
HCM Lane V/C Ratio	0.159	0.197	0.526	0.334
HCM Control Delay	9.8	9.6	13.1	11.3
HCM Lane LOS	A	A	B	B
HCM 95th-tile Q	0.6	0.7	3.2	1.5

MidPen Housing
4: Auto Center Dr & Marin St

Cumulative AM
Timing Plan: Default

Intersection												
Int Delay, s/veh	7.7											
Movement	EBL	EBT	EBR	WBL	WBT	WBR	NBL	NBT	NBR	SBL	SBT	SBR
Lane Configurations												
Traffic Vol, veh/h	2	1	0	155	0	21	3	164	64	36	255	3
Future Vol, veh/h	2	1	0	155	0	21	3	164	64	36	255	3
Conflicting Peds, #/hr	4	0	2	2	0	4	14	0	6	6	0	14
Sign Control	Stop	Stop	Stop	Stop	Stop	Stop	Free	Free	Free	Free	Free	Free
RT Channelized	-	-	None	-	-	None	-	-	None	-	-	None
Storage Length	20	-	-	-	-	20	-	-	-	-	-	-
Veh in Median Storage, #	-	0	-	-	0	-	-	0	-	-	0	-
Grade, %	-	0	-	-	0	-	-	0	-	-	0	-
Peak Hour Factor	76	76	76	76	76	76	76	76	76	76	76	76
Heavy Vehicles, %	0	0	0	1	1	1	1	1	1	1	1	1
Mvmt Flow	3	1	0	204	0	28	4	216	84	47	336	4

Major/Minor	Minor2		Minor1		Major1		Major2					
Conflicting Flow All	716	760	354	707	720	268	353	0	0	306	0	0
Stage 1	446	446	-	272	272	-	-	-	-	-	-	-
Stage 2	270	314	-	435	448	-	-	-	-	-	-	-
Critical Hdwy	7.1	6.5	6.2	7.11	6.51	6.21	4.11	-	-	4.11	-	-
Critical Hdwy Stg 1	6.1	5.5	-	6.11	5.51	-	-	-	-	-	-	-
Critical Hdwy Stg 2	6.1	5.5	-	6.11	5.51	-	-	-	-	-	-	-
Follow-up Hdwy	3.5	4	3.3	3.509	4.009	3.309	2.209	-	-	2.209	-	-
Pot Cap-1 Maneuver	348	338	694	351	355	773	1211	-	-	1260	-	-
Stage 1	595	577	-	736	686	-	-	-	-	-	-	-
Stage 2	740	660	-	602	575	-	-	-	-	-	-	-
Platoon blocked, %								-	-	-	-	-
Mov Cap-1 Maneuver	317	315	683	334	331	766	1209	-	-	1255	-	-
Mov Cap-2 Maneuver	317	315	-	334	331	-	-	-	-	-	-	-
Stage 1	585	543	-	729	679	-	-	-	-	-	-	-
Stage 2	708	654	-	572	541	-	-	-	-	-	-	-

Approach	EB	WB	NB	SB
HCM Control Delay, s	16.5	28.7	0.1	1
HCM LOS	C	D		

Minor Lane/Major Mvmt	NBL	NBT	NBR	EBLn1	EBLn2	WBLn1	WBLn2	SBL	SBT	SBR
Capacity (veh/h)	1209	-	-	317	315	334	766	1255	-	-
HCM Lane V/C Ratio	0.003	-	-	0.008	0.004	0.611	0.036	0.038	-	-
HCM Control Delay (s)	8	0	-	16.5	16.5	31.3	9.9	8	0	-
HCM Lane LOS	A	A	-	C	C	D	A	A	A	-
HCM 95th %tile Q(veh)	0	-	-	0	0	3.8	0.1	0.1	-	-

Intersection												
Int Delay, s/veh	4.3											
Movement	EBL	EBT	EBR	WBL	WBT	WBR	NBL	NBT	NBR	SBL	SBT	SBR
Lane Configurations			↗				↖	↗		↖	↗↘	
Traffic Vol, veh/h	0	0	63	0	0	0	31	795	4	499	955	19
Future Vol, veh/h	0	0	63	0	0	0	31	795	4	499	955	19
Conflicting Peds, #/hr	0	0	0	0	0	0	16	0	0	0	0	16
Sign Control	Stop	Stop	Stop	Stop	Stop	Stop	Free	Free	Free	Free	Free	Free
RT Channelized	-	-	None	-	-	None	-	-	None	-	-	None
Storage Length	-	-	0	-	-	-	190	-	-	100	-	-
Veh in Median Storage, #	-	0	-	-	-	-	-	0	-	-	0	-
Grade, %	-	0	-	-	0	-	-	0	-	-	0	-
Peak Hour Factor	95	95	95	82	82	82	95	95	95	95	95	95
Heavy Vehicles, %	5	2	5	2	2	2	1	1	2	2	1	1
Mvmt Flow	0	0	66	0	0	0	33	837	4	525	1005	20

Major/Minor	Minor2			Major1			Major2				
Conflicting Flow All	-	-	529			1041	0	0	841	0	0
Stage 1	-	-	-			-	-	-	-	-	-
Stage 2	-	-	-			-	-	-	-	-	-
Critical Hdwy	-	-	6.975			4.115	-	-	4.13	-	-
Critical Hdwy Stg 1	-	-	-			-	-	-	-	-	-
Critical Hdwy Stg 2	-	-	-			-	-	-	-	-	-
Follow-up Hdwy	-	-	3.3475			2.2095	-	-	2.219	-	-
Pot Cap-1 Maneuver	0	0	489			671	-	-	792	-	-
Stage 1	0	0	-			-	-	-	-	-	-
Stage 2	0	0	-			-	-	-	-	-	-
Platoon blocked, %							-	-	-	-	-
Mov Cap-1 Maneuver	-	0	482			671	-	-	792	-	-
Mov Cap-2 Maneuver	-	0	-			-	-	-	-	-	-
Stage 1	-	0	-			-	-	-	-	-	-
Stage 2	-	0	-			-	-	-	-	-	-

Approach	EB	NB	SB
HCM Control Delay, s	13.7	0.4	6.1
HCM LOS	B		

Minor Lane/Major Mvmt	NBL	NBT	NBR	EBLn1	SBL	SBT	SBR
Capacity (veh/h)	671	-	-	482	792	-	-
HCM Lane V/C Ratio	0.049	-	-	0.138	0.663	-	-
HCM Control Delay (s)	10.6	-	-	13.7	18	-	-
HCM Lane LOS	B	-	-	B	C	-	-
HCM 95th %tile Q(veh)	0.2	-	-	0.5	5.1	-	-

MidPen Housing
2: Kimberley Ln/Santa Clara St & Miles Ln

Cumulative PM
Timing Plan: Default

Intersection	
Intersection Delay, s/veh	7.4
Intersection LOS	A

Movement	EBL	EBT	EBR	WBL	WBT	WBR	NBL	NBT	NBR	SBL	SBT	SBR
Lane Configurations		↕			↕			↕			↕	
Traffic Vol, veh/h	8	3	0	3	5	40	1	7	5	56	4	10
Future Vol, veh/h	8	3	0	3	5	40	1	7	5	56	4	10
Peak Hour Factor	0.78	0.78	0.78	0.78	0.78	0.78	0.78	0.78	0.78	0.78	0.78	0.78
Heavy Vehicles, %	0	0	0	4	4	4	0	0	0	2	2	2
Mvmt Flow	10	4	0	4	6	51	1	9	6	72	5	13
Number of Lanes	0	1	0	0	1	0	0	1	0	0	1	0

Approach	EB	WB	NB	SB
Opposing Approach	WB	EB	SB	NB
Opposing Lanes	1	1	1	1
Conflicting Approach Left	SB	NB	EB	WB
Conflicting Lanes Left	1	1	1	1
Conflicting Approach Right	NB	SB	WB	EB
Conflicting Lanes Right	1	1	1	1
HCM Control Delay	7.4	7	7	7.7
HCM LOS	A	A	A	A

Lane	NBLn1	EBLn1	WBLn1	SBLn1
Vol Left, %	8%	73%	6%	80%
Vol Thru, %	54%	27%	10%	6%
Vol Right, %	38%	0%	83%	14%
Sign Control	Stop	Stop	Stop	Stop
Traffic Vol by Lane	13	11	48	70
LT Vol	1	8	3	56
Through Vol	7	3	5	4
RT Vol	5	0	40	10
Lane Flow Rate	17	14	62	90
Geometry Grp	1	1	1	1
Degree of Util (X)	0.018	0.017	0.063	0.104
Departure Headway (Hd)	3.886	4.279	3.677	4.154
Convergence, Y/N	Yes	Yes	Yes	Yes
Cap	916	830	966	862
Service Time	1.93	2.34	1.732	2.18
HCM Lane V/C Ratio	0.019	0.017	0.064	0.104
HCM Control Delay	7	7.4	7	7.7
HCM Lane LOS	A	A	A	A
HCM 95th-tile Q	0.1	0.1	0.2	0.3

Intersection

Intersection Delay, s/veh	9.6
Intersection LOS	A

Movement	EBL	EBT	EBR	WBL	WBT	WBR	NBL	NBT	NBR	SBL	SBT	SBR
Lane Configurations		↕			↕			↕			↕	
Traffic Vol, veh/h	3	144	33	3	125	94	31	21	5	109	39	8
Future Vol, veh/h	3	144	33	3	125	94	31	21	5	109	39	8
Peak Hour Factor	0.89	0.89	0.89	0.89	0.89	0.89	0.89	0.89	0.89	0.89	0.89	0.89
Heavy Vehicles, %	1	1	1	0	0	0	0	0	0	1	1	1
Mvmt Flow	3	162	37	3	140	106	35	24	6	122	44	9
Number of Lanes	0	1	0	0	1	0	0	1	0	0	1	0

Approach	EB	WB	NB	SB
Opposing Approach	WB	EB	SB	NB
Opposing Lanes	1	1	1	1
Conflicting Approach Left	SB	NB	EB	WB
Conflicting Lanes Left	1	1	1	1
Conflicting Approach Right	NB	SB	WB	EB
Conflicting Lanes Right	1	1	1	1
HCM Control Delay	9.5	9.6	8.9	9.9
HCM LOS	A	A	A	A

Lane	NBLn1	EBLn1	WBLn1	SBLn1
Vol Left, %	54%	2%	1%	70%
Vol Thru, %	37%	80%	56%	25%
Vol Right, %	9%	18%	42%	5%
Sign Control	Stop	Stop	Stop	Stop
Traffic Vol by Lane	57	180	222	156
LT Vol	31	3	3	109
Through Vol	21	144	125	39
RT Vol	5	33	94	8
Lane Flow Rate	64	202	249	175
Geometry Grp	1	1	1	1
Degree of Util (X)	0.093	0.265	0.313	0.25
Departure Headway (Hd)	5.238	4.719	4.513	5.138
Convergence, Y/N	Yes	Yes	Yes	Yes
Cap	677	756	791	694
Service Time	3.324	2.78	2.569	3.211
HCM Lane V/C Ratio	0.095	0.267	0.315	0.252
HCM Control Delay	8.9	9.5	9.6	9.9
HCM Lane LOS	A	A	A	A
HCM 95th-tile Q	0.3	1.1	1.3	1

MidPen Housing
4: Auto Center Dr & Marin St

Cumulative PM
Timing Plan: Default

Intersection												
Int Delay, s/veh	4.3											
Movement	EBL	EBT	EBR	WBL	WBT	WBR	NBL	NBT	NBR	SBL	SBT	SBR
Lane Configurations												
Traffic Vol, veh/h	2	0	4	130	0	28	3	277	133	43	184	2
Future Vol, veh/h	2	0	4	130	0	28	3	277	133	43	184	2
Conflicting Peds, #/hr	1	0	0	0	0	1	13	0	1	1	0	13
Sign Control	Stop	Stop	Stop	Stop	Stop	Stop	Free	Free	Free	Free	Free	Free
RT Channelized	-	-	None	-	-	None	-	-	None	-	-	None
Storage Length	20	-	-	-	-	20	-	-	-	-	-	-
Veh in Median Storage, #	-	0	-	-	0	-	-	0	-	-	0	-
Grade, %	-	0	-	-	0	-	-	0	-	-	0	-
Peak Hour Factor	94	94	94	94	94	94	94	94	94	94	94	94
Heavy Vehicles, %	0	0	0	0	0	0	0	0	0	0	0	0
Mvmt Flow	2	0	4	138	0	30	3	295	141	46	196	2

Major/Minor	Minor2		Minor1			Major1			Major2			
Conflicting Flow All	674	745	210	663	675	367	211	0	0	437	0	0
Stage 1	301	301	-	373	373	-	-	-	-	-	-	-
Stage 2	373	444	-	290	302	-	-	-	-	-	-	-
Critical Hdwy	7.1	6.5	6.2	7.1	6.5	6.2	4.1	-	-	4.1	-	-
Critical Hdwy Stg 1	6.1	5.5	-	6.1	5.5	-	-	-	-	-	-	-
Critical Hdwy Stg 2	6.1	5.5	-	6.1	5.5	-	-	-	-	-	-	-
Follow-up Hdwy	3.5	4	3.3	3.5	4	3.3	2.2	-	-	2.2	-	-
Pot Cap-1 Maneuver	371	345	835	377	378	683	1372	-	-	1134	-	-
Stage 1	712	669	-	652	622	-	-	-	-	-	-	-
Stage 2	652	579	-	722	668	-	-	-	-	-	-	-
Platoon blocked, %								-	-	-	-	-
Mov Cap-1 Maneuver	337	324	825	361	355	682	1372	-	-	1133	-	-
Mov Cap-2 Maneuver	337	324	-	361	355	-	-	-	-	-	-	-
Stage 1	701	630	-	649	620	-	-	-	-	-	-	-
Stage 2	621	577	-	685	629	-	-	-	-	-	-	-

Approach	EB		WB			NB			SB		
HCM Control Delay, s	11.5		19.1			0.1			1.6		
HCM LOS	B		C								

Minor Lane/Major Mvmt	NBL	NBT	NBR	EBLn1	EBLn2	WBLn1	WBLn2	SBL	SBT	SBR
Capacity (veh/h)	1372	-	-	337	825	361	682	1133	-	-
HCM Lane V/C Ratio	0.002	-	-	0.006	0.005	0.383	0.044	0.04	-	-
HCM Control Delay (s)	7.6	0	-	15.8	9.4	21	10.5	8.3	0	-
HCM Lane LOS	A	A	-	C	A	C	B	A	A	-
HCM 95th %tile Q(veh)	0	-	-	0	0	1.8	0.1	0.1	-	-

**APPENDIX G: CUMULATIVE (2040) PLUS PROJECT TRAFFIC CONDITIONS
ANALYSIS SHEETS**

Intersection												
Int Delay, s/veh	3											
Movement	EBL	EBT	EBR	WBL	WBT	WBR	NBL	NBT	NBR	SBL	SBT	SBR
Lane Configurations			↗				↖	↖		↗	↗↖	
Traffic Vol, veh/h	0	0	41	0	0	0	30	636	1	358	770	6
Future Vol, veh/h	0	0	41	0	0	0	30	636	1	358	770	6
Conflicting Peds, #/hr	0	0	0	0	0	0	6	0	0	0	0	6
Sign Control	Stop	Stop	Stop	Stop	Stop	Stop	Free	Free	Free	Free	Free	Free
RT Channelized	-	-	None	-	-	None	-	-	None	-	-	None
Storage Length	-	-	0	-	-	-	190	-	-	100	-	-
Veh in Median Storage, #	-	0	-	-	-	-	-	0	-	-	0	-
Grade, %	-	0	-	-	0	-	-	0	-	-	0	-
Peak Hour Factor	86	86	86	82	82	82	86	86	86	86	86	86
Heavy Vehicles, %	0	2	0	2	2	2	3	3	2	2	1	1
Mvmt Flow	0	0	48	0	0	0	35	740	1	416	895	7

Major/Minor	Minor2			Major1			Major2		
Conflicting Flow All	-	-	457	908	0	0	741	0	0
Stage 1	-	-	-	-	-	-	-	-	-
Stage 2	-	-	-	-	-	-	-	-	-
Critical Hdwy	-	-	6.9	4.145	-	-	4.13	-	-
Critical Hdwy Stg 1	-	-	-	-	-	-	-	-	-
Critical Hdwy Stg 2	-	-	-	-	-	-	-	-	-
Follow-up Hdwy	-	-	3.3	2.2285	-	-	2.219	-	-
Pot Cap-1 Maneuver	0	0	556	742	-	-	864	-	-
Stage 1	0	0	-	-	-	-	-	-	-
Stage 2	0	0	-	-	-	-	-	-	-
Platoon blocked, %									
Mov Cap-1 Maneuver	-	0	553	738	-	-	864	-	-
Mov Cap-2 Maneuver	-	0	-	-	-	-	-	-	-
Stage 1	-	0	-	-	-	-	-	-	-
Stage 2	-	0	-	-	-	-	-	-	-

Approach	EB	NB	SB
HCM Control Delay, s	12.1	0.5	4.1
HCM LOS	B		

Minor Lane/Major Mvmt	NBL	NBT	NBR	EBLn1	SBL	SBT	SBR
Capacity (veh/h)	738	-	-	553	864	-	-
HCM Lane V/C Ratio	0.047	-	-	0.086	0.482	-	-
HCM Control Delay (s)	10.1	-	-	12.1	13	-	-
HCM Lane LOS	B	-	-	B	B	-	-
HCM 95th %tile Q(veh)	0.1	-	-	0.3	2.7	-	-

Intersection

Intersection Delay, s/veh	7.1
Intersection LOS	A

Movement	EBL	EBT	EBR	WBL	WBT	WBR	NBL	NBT	NBR	SBL	SBT	SBR
Lane Configurations		↕			↕			↕			↕	
Traffic Vol, veh/h	9	1	0	1	0	55	0	4	4	46	3	3
Future Vol, veh/h	9	1	0	1	0	55	0	4	4	46	3	3
Peak Hour Factor	0.82	0.82	0.82	0.82	0.82	0.82	0.82	0.82	0.82	0.82	0.82	0.82
Heavy Vehicles, %	0	0	0	2	2	2	0	0	0	0	0	0
Mvmt Flow	11	1	0	1	0	67	0	5	5	56	4	4
Number of Lanes	0	1	0	0	1	0	0	1	0	0	1	0

Approach	EB	WB	NB	SB
Opposing Approach	WB	EB	SB	NB
Opposing Lanes	1	1	1	1
Conflicting Approach Left	SB	NB	EB	WB
Conflicting Lanes Left	1	1	1	1
Conflicting Approach Right	NB	SB	WB	EB
Conflicting Lanes Right	1	1	1	1
HCM Control Delay	7.4	6.8	6.9	7.5
HCM LOS	A	A	A	A

Lane	NBLn1	EBLn1	WBLn1	SBLn1
Vol Left, %	0%	90%	2%	88%
Vol Thru, %	50%	10%	0%	6%
Vol Right, %	50%	0%	98%	6%
Sign Control	Stop	Stop	Stop	Stop
Traffic Vol by Lane	8	10	56	52
LT Vol	0	9	1	46
Through Vol	4	1	0	3
RT Vol	4	0	55	3
Lane Flow Rate	10	12	68	63
Geometry Grp	1	1	1	1
Degree of Util (X)	0.01	0.014	0.066	0.074
Departure Headway (Hd)	3.789	4.26	3.484	4.191
Convergence, Y/N	Yes	Yes	Yes	Yes
Cap	943	837	1022	857
Service Time	1.82	2.302	1.524	2.207
HCM Lane V/C Ratio	0.011	0.014	0.067	0.074
HCM Control Delay	6.9	7.4	6.8	7.5
HCM Lane LOS	A	A	A	A
HCM 95th-tile Q	0	0	0.2	0.2

Intersection

Intersection Delay, s/veh 11.9
Intersection LOS B

Movement	EBL	EBT	EBR	WBL	WBT	WBR	NBL	NBT	NBR	SBL	SBT	SBR
Lane Configurations		↕			↕			↕			↕	
Traffic Vol, veh/h	13	68	21	2	155	131	33	44	5	109	36	11
Future Vol, veh/h	13	68	21	2	155	131	33	44	5	109	36	11
Peak Hour Factor	0.72	0.72	0.72	0.72	0.72	0.72	0.72	0.72	0.72	0.72	0.72	0.72
Heavy Vehicles, %	0	0	0	1	1	1	2	2	2	1	1	1
Mvmt Flow	18	94	29	3	215	182	46	61	7	151	50	15
Number of Lanes	0	1	0	0	1	0	0	1	0	0	1	0

Approach	EB	WB	NB	SB
Opposing Approach	WB	EB	SB	NB
Opposing Lanes	1	1	1	1
Conflicting Approach Left SB		NB	EB	WB
Conflicting Lanes Left	1	1	1	1
Conflicting Approach Right NB		SB	WB	EB
Conflicting Lanes Right	1	1	1	1
HCM Control Delay	9.8	13.3	10.1	11.5
HCM LOS	A	B	B	B

Lane	NBLn1	EBLn1	WBLn1	SBLn1
Vol Left, %	40%	13%	1%	70%
Vol Thru, %	54%	67%	54%	23%
Vol Right, %	6%	21%	45%	7%
Sign Control	Stop	Stop	Stop	Stop
Traffic Vol by Lane	82	102	288	156
LT Vol	33	13	2	109
Through Vol	44	68	155	36
RT Vol	5	21	131	11
Lane Flow Rate	114	142	400	217
Geometry Grp	1	1	1	1
Degree of Util (X)	0.182	0.21	0.536	0.337
Departure Headway (Hd)	5.745	5.331	4.82	5.593
Convergence, Y/N	Yes	Yes	Yes	Yes
Cap	623	671	748	643
Service Time	3.79	3.375	2.852	3.631
HCM Lane V/C Ratio	0.183	0.212	0.535	0.337
HCM Control Delay	10.1	9.8	13.3	11.5
HCM Lane LOS	B	A	B	B
HCM 95th-tile Q	0.7	0.8	3.2	1.5

Intersection												
Int Delay, s/veh	8.3											
Movement	EBL	EBT	EBR	WBL	WBT	WBR	NBL	NBT	NBR	SBL	SBT	SBR
Lane Configurations												
Traffic Vol, veh/h	2	1	0	159	0	24	3	164	67	39	255	3
Future Vol, veh/h	2	1	0	159	0	24	3	164	67	39	255	3
Conflicting Peds, #/hr	4	0	2	2	0	4	14	0	6	6	0	14
Sign Control	Stop	Stop	Stop	Stop	Stop	Stop	Free	Free	Free	Free	Free	Free
RT Channelized	-	-	None	-	-	None	-	-	None	-	-	None
Storage Length	20	-	-	-	-	20	-	-	-	-	-	-
Veh in Median Storage, #	-	0	-	-	0	-	-	0	-	-	0	-
Grade, %	-	0	-	-	0	-	-	0	-	-	0	-
Peak Hour Factor	76	76	76	76	76	76	76	76	76	76	76	76
Heavy Vehicles, %	0	0	0	1	1	1	1	1	1	1	1	1
Mvmt Flow	3	1	0	209	0	32	4	216	88	51	336	4

Major/Minor	Minor2		Minor1			Major1		Major2				
Conflicting Flow All	742	772	354	717	730	270	354	0	0	310	0	0
Stage 1	454	454	-	274	274	-	-	-	-	-	-	-
Stage 2	288	318	-	443	456	-	-	-	-	-	-	-
Critical Hdwy	7.1	6.5	6.2	7.11	6.51	6.21	4.11	-	-	4.11	-	-
Critical Hdwy Stg 1	6.1	5.5	-	6.11	5.51	-	-	-	-	-	-	-
Critical Hdwy Stg 2	6.1	5.5	-	6.11	5.51	-	-	-	-	-	-	-
Follow-up Hdwy	3.5	4	3.3	3.509	4.009	3.309	2.209	-	-	2.209	-	-
Pot Cap-1 Maneuver	334	333	694	346	350	771	1210	-	-	1256	-	-
Stage 1	589	573	-	734	685	-	-	-	-	-	-	-
Stage 2	724	657	-	596	570	-	-	-	-	-	-	-
Platoon blocked, %								-	-	-	-	-
Mov Cap-1 Maneuver	302	309	683	328	325	764	1194	-	-	1249	-	-
Mov Cap-2 Maneuver	302	309	-	328	325	-	-	-	-	-	-	-
Stage 1	579	537	-	727	678	-	-	-	-	-	-	-
Stage 2	689	650	-	564	535	-	-	-	-	-	-	-

Approach	EB	WB	NB	SB
HCM Control Delay, s	16.9	30.3	0.1	1.1
HCM LOS	C	D		

Minor Lane/Major Mvmt	NBL	NBT	NBR	EBLn1	EBLn2	WBLn1	WBLn2	SBL	SBT	SBR
Capacity (veh/h)	1194	-	-	302	309	328	764	1249	-	-
HCM Lane V/C Ratio	0.003	-	-	0.009	0.004	0.638	0.041	0.041	-	-
HCM Control Delay (s)	8	0	-	17	16.7	33.4	9.9	8	0	-
HCM Lane LOS	A	A	-	C	C	D	A	A	A	-
HCM 95th %tile Q(veh)	0	-	-	0	0	4.1	0.1	0.1	-	-

Intersection												
Int Delay, s/veh	4.4											
Movement	EBL	EBT	EBR	WBL	WBT	WBR	NBL	NBT	NBR	SBL	SBT	SBR
Lane Configurations			↗				↖	↗		↖	↗↘	
Traffic Vol, veh/h	0	0	70	0	0	0	37	795	4	499	955	22
Future Vol, veh/h	0	0	70	0	0	0	37	795	4	499	955	22
Conflicting Peds, #/hr	0	0	0	0	0	0	16	0	0	0	0	16
Sign Control	Stop	Stop	Stop	Stop	Stop	Stop	Free	Free	Free	Free	Free	Free
RT Channelized	-	-	None	-	-	None	-	-	None	-	-	None
Storage Length	-	-	0	-	-	-	190	-	-	100	-	-
Veh in Median Storage, #	-	0	-	-	-	-	-	0	-	-	0	-
Grade, %	-	0	-	-	0	-	-	0	-	-	0	-
Peak Hour Factor	95	95	95	82	82	82	95	95	95	95	95	95
Heavy Vehicles, %	5	2	5	2	2	2	1	1	2	2	1	1
Mvmt Flow	0	0	74	0	0	0	39	837	4	525	1005	23

Major/Minor	Minor2			Major1			Major2		
Conflicting Flow All	-	-	530	1044	0	0	841	0	0
Stage 1	-	-	-	-	-	-	-	-	-
Stage 2	-	-	-	-	-	-	-	-	-
Critical Hdwy	-	-	6.975	4.115	-	-	4.13	-	-
Critical Hdwy Stg 1	-	-	-	-	-	-	-	-	-
Critical Hdwy Stg 2	-	-	-	-	-	-	-	-	-
Follow-up Hdwy	-	-3.3475	-	2.2095	-	-	2.219	-	-
Pot Cap-1 Maneuver	0	0	488	669	-	-	792	-	-
Stage 1	0	0	-	-	-	-	-	-	-
Stage 2	0	0	-	-	-	-	-	-	-
Platoon blocked, %	-	-	-	-	-	-	-	-	-
Mov Cap-1 Maneuver	-	0	481	659	-	-	792	-	-
Mov Cap-2 Maneuver	-	0	-	-	-	-	-	-	-
Stage 1	-	0	-	-	-	-	-	-	-
Stage 2	-	0	-	-	-	-	-	-	-

Approach	EB	NB	SB
HCM Control Delay, s	13.8	0.5	6.1
HCM LOS	B		

Minor Lane/Major Mvmt	NBL	NBT	NBR	EBLn1	SBL	SBT	SBR
Capacity (veh/h)	659	-	-	481	792	-	-
HCM Lane V/C Ratio	0.059	-	-	0.153	0.663	-	-
HCM Control Delay (s)	10.8	-	-	13.8	18	-	-
HCM Lane LOS	B	-	-	B	C	-	-
HCM 95th %tile Q(veh)	0.2	-	-	0.5	5.1	-	-

Intersection	
Intersection Delay, s/veh	7.5
Intersection LOS	A

Movement	EBL	EBT	EBR	WBL	WBT	WBR	NBL	NBT	NBR	SBL	SBT	SBR
Lane Configurations		↕			↕			↕			↕	
Traffic Vol, veh/h	8	3	0	3	5	53	1	7	5	65	4	10
Future Vol, veh/h	8	3	0	3	5	53	1	7	5	65	4	10
Peak Hour Factor	0.78	0.78	0.78	0.78	0.78	0.78	0.78	0.78	0.78	0.78	0.78	0.78
Heavy Vehicles, %	0	0	0	4	4	4	0	0	0	2	2	2
Mvmt Flow	10	4	0	4	6	68	1	9	6	83	5	13
Number of Lanes	0	1	0	0	1	0	0	1	0	0	1	0

Approach	EB	WB	NB	SB
Opposing Approach	WB	EB	SB	NB
Opposing Lanes	1	1	1	1
Conflicting Approach Left	SB	NB	EB	WB
Conflicting Lanes Left	1	1	1	1
Conflicting Approach Right	NB	SB	WB	EB
Conflicting Lanes Right	1	1	1	1
HCM Control Delay	7.5	7.1	7	7.8
HCM LOS	A	A	A	A

Lane	NBLn1	EBLn1	WBLn1	SBLn1
Vol Left, %		8%	73%	5%
Vol Thru, %		54%	27%	8%
Vol Right, %		38%	0%	87%
Sign Control		Stop	Stop	Stop
Traffic Vol by Lane		13	11	61
LT Vol		1	8	3
Through Vol		7	3	5
RT Vol		5	0	53
Lane Flow Rate		17	14	78
Geometry Grp		1	1	1
Degree of Util (X)		0.018	0.017	0.08
Departure Headway (Hd)		3.924	4.312	3.672
Convergence, Y/N		Yes	Yes	Yes
Cap		905	822	965
Service Time		1.977	2.382	1.736
HCM Lane V/C Ratio		0.019	0.017	0.081
HCM Control Delay		7	7.5	7.1
HCM Lane LOS		A	A	A
HCM 95th-tile Q		0.1	0.1	0.3

Intersection

Intersection Delay, s/veh 9.7
Intersection LOS A

Movement	EBL	EBT	EBR	WBL	WBT	WBR	NBL	NBT	NBR	SBL	SBT	SBR
Lane Configurations		↕			↕			↕			↕	
Traffic Vol, veh/h	3	144	42	3	125	94	42	22	6	109	39	8
Future Vol, veh/h	3	144	42	3	125	94	42	22	6	109	39	8
Peak Hour Factor	0.89	0.89	0.89	0.89	0.89	0.89	0.89	0.89	0.89	0.89	0.89	0.89
Heavy Vehicles, %	1	1	1	0	0	0	0	0	0	1	1	1
Mvmt Flow	3	162	47	3	140	106	47	25	7	122	44	9
Number of Lanes	0	1	0	0	1	0	0	1	0	0	1	0

Approach	EB	WB	NB	SB
Opposing Approach	WB	EB	SB	NB
Opposing Lanes	1	1	1	1
Conflicting Approach Left	SB	NB	EB	WB
Conflicting Lanes Left	1	1	1	1
Conflicting Approach Right	NB	SB	WB	EB
Conflicting Lanes Right	1	1	1	1
HCM Control Delay	9.7	9.8	9.1	10
HCM LOS	A	A	A	A

Lane	NBLn1	EBLn1	WBLn1	SBLn1
Vol Left, %	60%	2%	1%	70%
Vol Thru, %	31%	76%	56%	25%
Vol Right, %	9%	22%	42%	5%
Sign Control	Stop	Stop	Stop	Stop
Traffic Vol by Lane	70	189	222	156
LT Vol	42	3	3	109
Through Vol	22	144	125	39
RT Vol	6	42	94	8
Lane Flow Rate	79	212	249	175
Geometry Grp	1	1	1	1
Degree of Util (X)	0.115	0.28	0.316	0.253
Departure Headway (Hd)	5.278	4.74	4.566	5.187
Convergence, Y/N	Yes	Yes	Yes	Yes
Cap	671	752	781	685
Service Time	3.374	2.81	2.633	3.27
HCM Lane V/C Ratio	0.118	0.282	0.319	0.255
HCM Control Delay	9.1	9.7	9.8	10
HCM Lane LOS	A	A	A	A
HCM 95th-tile Q	0.4	1.1	1.4	1

Intersection

Int Delay, s/veh 4.7

Movement	EBL	EBT	EBR	WBL	WBT	WBR	NBL	NBT	NBR	SBL	SBT	SBR
Lane Configurations												
Traffic Vol, veh/h	2	0	4	137	0	32	3	277	138	47	184	2
Future Vol, veh/h	2	0	4	137	0	32	3	277	138	47	184	2
Conflicting Peds, #/hr	1	0	0	0	0	1	13	0	1	1	0	13
Sign Control	Stop	Stop	Stop	Stop	Stop	Stop	Free	Free	Free	Free	Free	Free
RT Channelized	-	-	None	-	-	None	-	-	None	-	-	None
Storage Length	20	-	-	-	-	20	-	-	-	-	-	-
Veh in Median Storage, #	-	0	-	-	0	-	-	0	-	-	0	-
Grade, %	-	0	-	-	0	-	-	0	-	-	0	-
Peak Hour Factor	94	94	94	94	94	94	94	94	94	94	94	94
Heavy Vehicles, %	0	0	0	0	0	0	0	0	0	0	0	0
Mvmt Flow	2	0	4	146	0	34	3	295	147	50	196	2

Major/Minor	Minor2		Minor1		Major1		Major2					
Conflicting Flow All	703	759	210	675	687	371	211	0	0	443	0	0
Stage 1	310	310	-	376	376	-	-	-	-	-	-	-
Stage 2	393	449	-	299	311	-	-	-	-	-	-	-
Critical Hdwy	7.1	6.5	6.2	7.1	6.5	6.2	4.1	-	-	4.1	-	-
Critical Hdwy Stg 1	6.1	5.5	-	6.1	5.5	-	-	-	-	-	-	-
Critical Hdwy Stg 2	6.1	5.5	-	6.1	5.5	-	-	-	-	-	-	-
Follow-up Hdwy	3.5	4	3.3	3.5	4	3.3	2.2	-	-	2.2	-	-
Pot Cap-1 Maneuver	355	338	835	371	372	679	1372	-	-	1128	-	-
Stage 1	705	663	-	649	620	-	-	-	-	-	-	-
Stage 2	636	576	-	714	662	-	-	-	-	-	-	-
Platoon blocked, %								-	-	-	-	-
Mov Cap-1 Maneuver	319	316	825	354	348	678	1355	-	-	1127	-	-
Mov Cap-2 Maneuver	319	316	-	354	348	-	-	-	-	-	-	-
Stage 1	694	623	-	646	618	-	-	-	-	-	-	-
Stage 2	602	574	-	675	622	-	-	-	-	-	-	-

Approach	EB		WB		NB		SB	
HCM Control Delay, s	11.7		19.9		0.1		1.7	
HCM LOS	B		C					

Minor Lane/Major Mvmt	NBL	NBT	NBR	EBLn1	EBLn2	WBLn1	WBLn2	SBL	SBT	SBR
Capacity (veh/h)	1355	-	-	319	825	354	678	1127	-	-
HCM Lane V/C Ratio	0.002	-	-	0.007	0.005	0.412	0.05	0.044	-	-
HCM Control Delay (s)	7.7	0	-	16.4	9.4	22.1	10.6	8.3	0	-
HCM Lane LOS	A	A	-	C	A	C	B	A	A	-
HCM 95th %tile Q(veh)	0	-	-	0	0	2	0.2	0.1	-	-

APPENDIX H: CITY OF WATSONVILLE (2017-2018) DEVELOPMENT FEES

DEVELOPMENT FEE SUMMARY 2017-2018

CITY OF WATSONVILLE – *Community Development Department*

250 Main Street, Watsonville CA 95076
(831) 768-3050



This reference is a summary of common development and impact fees.
Actual project fees are calculated from submittal plans.
Additional fees may include permits, plan review, and inspections.

A. CITY-WIDE TRAFFIC IMPACT FEE

Single Family detached	14 trips per unit	\$185.00	per trip
Multi-Family (apartments, townhouses)	10 trips per unit	\$185.00	per trip
Non-Residential (remodel/addition)	trips based on use	\$141.00	per trip
Non-Residential (other)	trips based on use	\$95.00	per trip

B. SANITARY SEWER CONNECTION FEE

Residential and all others		\$1,868.47	per unit
Commercial & Industrial: Sum of following, but not less than		\$1,868.47	minimum
Based on peak month discharge of flow		\$5.20	per gpd
BOD (Biochemical oxygen demand)		\$330.41	lb/day BOD
SS (suspended solids)		\$417.29	lb/day SS

C. WATER SERVICE

Connection Fee (residential)		\$2,414.52	per connection
Construction Fee (1" domestic/fire service combination meter)		\$5,544.61	per meter

D. GROUNDWATER IMPACT FEE

Residential		\$429.68	per bedroom
Commercial & Industrial		\$0.00	no fees

E. STORM DRAINAGE FEE

Additions to Existing (per acre of new impermeable area)		\$11,413.00	per acre
New Development Projects:			
Low residential (4.5 units/acre)		\$4,594.00	per acre
Med. Residential (4.5-7.5 units /acre)		\$5,711.00	per acre
High residential (7.5 units/acre)		\$6,846.00	per acre
Commercial & Industrial		\$9,134.00	per acre
Area "C" (NE of City, S of Corralitos & Salsipuedes Creeks)		\$23,964.00	per acre

F. IMPERVIOUS AREA IMPACT FEE

per square foot of new impervious area		\$0.40	per sq. ft.
----------------------------------------	--	--------	-------------

G. RECREATION & PARKS FACILITIES FEE

(New construction, bedroom additions)			
1-2 bedroom dwelling unit		\$1,500.00	per bedroom
3 bedroom dwelling unit		\$1,667.00	per bedroom

4+ bedroom dwelling unit	\$1,875.00	per bedroom
Commercial & Industrial	\$0.50	per sq. ft.
H. PUBLIC FACILITIES IMPACT FEE		
New detached structures or additions over 1,000 sq. ft. Calculated on total square footage.	\$0.40	per sq. ft.
I. FIRE IMPACT FEE		
Residential new construction	\$951.00	per unit
Residential addition	\$0.40	per sq. ft.
Commercial & Industrial	\$0.40	per sq. ft.
J. AFFORDABLE HOUSING ORDINANCE - IN LIEU FEES		
Residential		
Single-Family detached	\$12,730.00	per unit
Accessory dwelling unit (14-46.050 exceptions)	\$0.00	
Multi-Family (apartments, townhouses, co-op, condos)	\$6,366.00	per unit
Commercial		
0-1,000 sq. ft.	\$0.00	per sq. ft.
1,001 sq. ft. or more	\$0.40	per sq. ft.
K. STREET IMPROVEMENT IN-LIEU FEES		
Industrially Zoned Parcels	\$107.00	per lineal ft
fee per lineal foot of street frontage or 5% of actual on-site project improvements whichever is less		
Other Parcels	\$178.00	per lineal ft
fee per lineal foot of street frontage or 10% of actual on-site project improvements whichever is less		
L. CARBON FUND IMPACT FEE		
Carbon fund fee is based on a percentage of the total building permit fees paid including engineering plan check and review fees. Building permit fees do not include planning permit fees, inspection fees, utility fees or impact fees.		
New residential and nonresidential construction	50% of total	building permit fee
Multi family residential & nonresidential additions and alteration	30% of total	building permit fee
Single family residential additions of 500 SF or greater	30% of total	building permit fee
M. UNDERGROUND UTILITY IN-LIEU FEE		
	\$69.00	per lineal ft
fee per lineal foot of frontage or 1.25% of actual project improvement whichever is less		
N. SCHOOL FEE		
Collected by Pajaro Valley Unified School District 831-786-2380		
Residential	\$5.56	per sq. ft.
Commercial & Industrial	\$0.51	per sq. ft.
Parking lots/structures	\$0.10	per sq. ft.
Self Storage	\$0.30	per sq. ft.

**APPENDIX I: ADA 2010 STANDARDS FOR ACCESSIBLE DESIGN: TABLE 208.2
PARKING SPACES**

208 Parking Spaces

208.1 General. Where parking spaces are provided, parking spaces shall be provided in accordance with 208.

EXCEPTION: Parking spaces used exclusively for buses, trucks, other delivery vehicles, law enforcement vehicles, or vehicular impound shall not be required to comply with 208 provided that lots accessed by the public are provided with a passenger loading zone complying with 503.

208.2 Minimum Number. Parking spaces complying with 502 shall be provided in accordance with Table 208.2 except as required by 208.2.1, 208.2.2, and 208.2.3. Where more than one parking facility is provided on a site, the number of accessible spaces provided on the site shall be calculated according to the number of spaces required for each parking facility.

Table 208.2 Parking Spaces

Total Number of Parking Spaces Provided in Parking Facility	Minimum Number of Required Accessible Parking Spaces
1 to 25	1
26 to 50	2
51 to 75	3
76 to 100	4
101 to 150	5
151 to 200	6
201 to 300	7
301 to 400	8
401 to 500	9
501 to 1000	2 percent of total
1001 and over	20, plus 1 for each 100, or fraction thereof, over 1000

Advisory 208.2 Minimum Number. The term “parking facility” is used Section 208.2 instead of the term “parking lot” so that it is clear that both parking lots and parking structures are required to comply with this section. The number of parking spaces required to be accessible is to be calculated separately for each parking facility; the required number is not to be based on the total number of parking spaces provided in all of the parking facilities provided on the site.

APPENDIX J: EXISTING AND PROPOSED BICYCLE NETWORK & TRANSIT FACILITIES

Figure 3-14: Existing & Proposed Bicycle Network & Transit Facilities

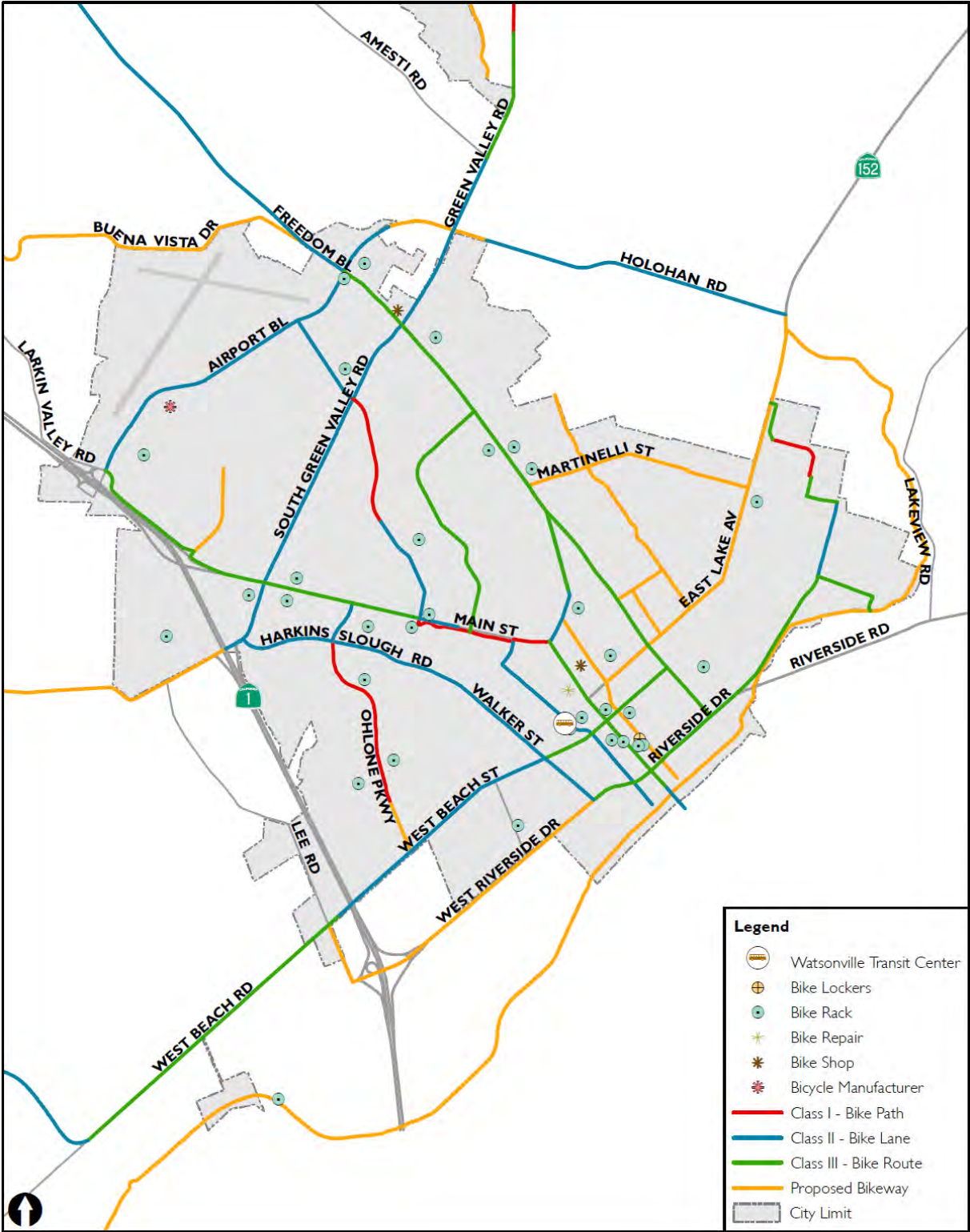

Source: City of Watsonville and RBF Consulting, 2012.