APPENDIX A

PROJECT PLANS

INDEX OF PLANS

SHEET No.	SHEET ID	DESCRIPTION
1	T-1	TITLE SHEET
2-6	X-1 TO X-5	CROSS SECTIONS
7	K-1	KEY MAP
8-32	L-1 TO L-26	LAYOUTS

**CITY OF SALINAS
PUBLIC WORKS DEPARTMENT**

**PROJECT PLANS FOR CONSTRUCTION OF
BORONDA RD CONGESTION RELIEF PROJECT
ULTIMATE CONCEPT
IN THE CITY OF SALINAS
IN MONTEREY COUNTY**

CIP No. 9510

FOR USE IN CONJUNCTION WITH THE PROJECT SPECIFICATIONS, THE REVISED 2008 STANDARD PLANS AND SPECIFICATIONS OF THE CITY OF SALINAS, AND THE STANDARD PLANS AND SPECIFICATIONS OF THE STATE OF CALIFORNIA DEPARTMENT OF TRANSPORTATION DATED 2018

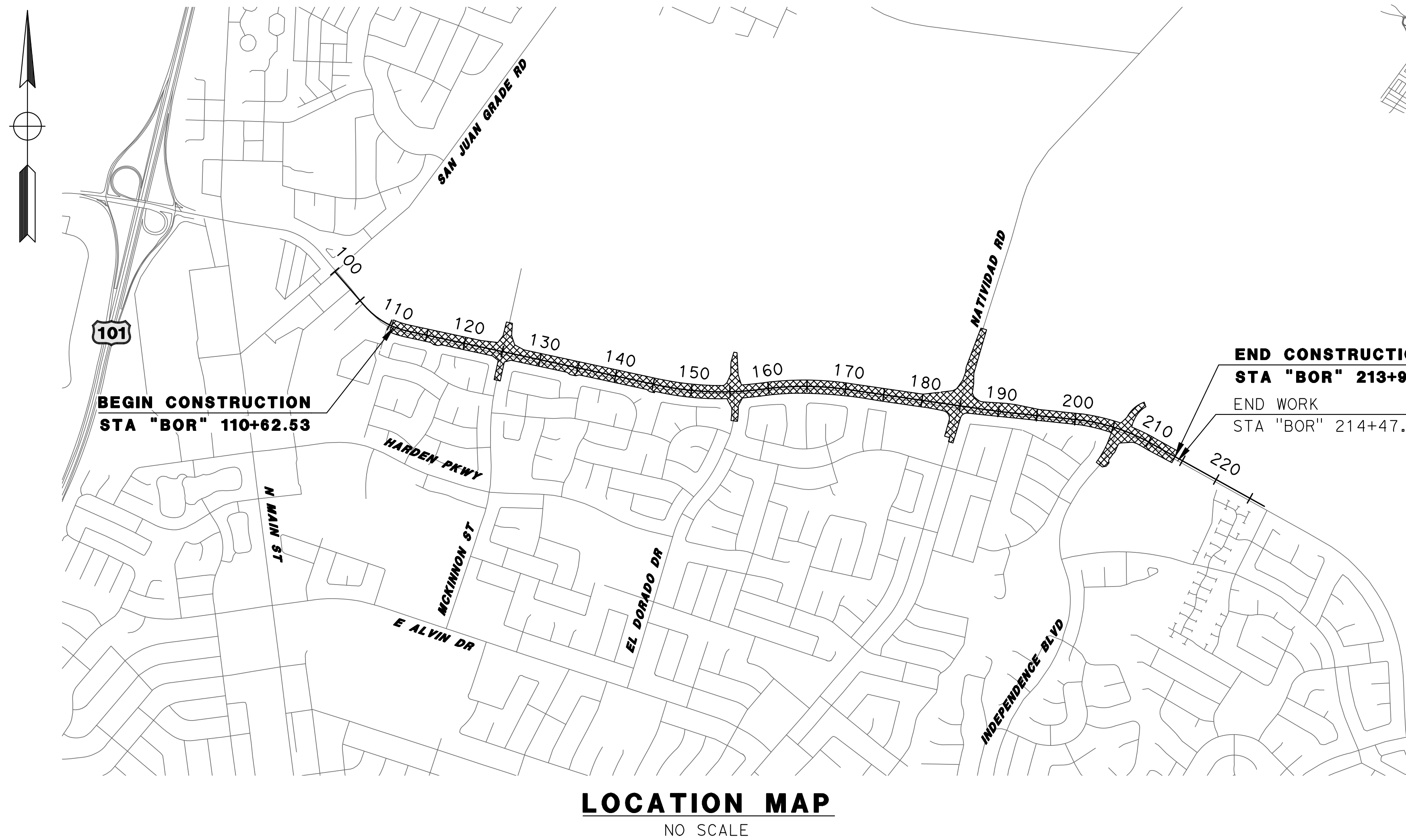
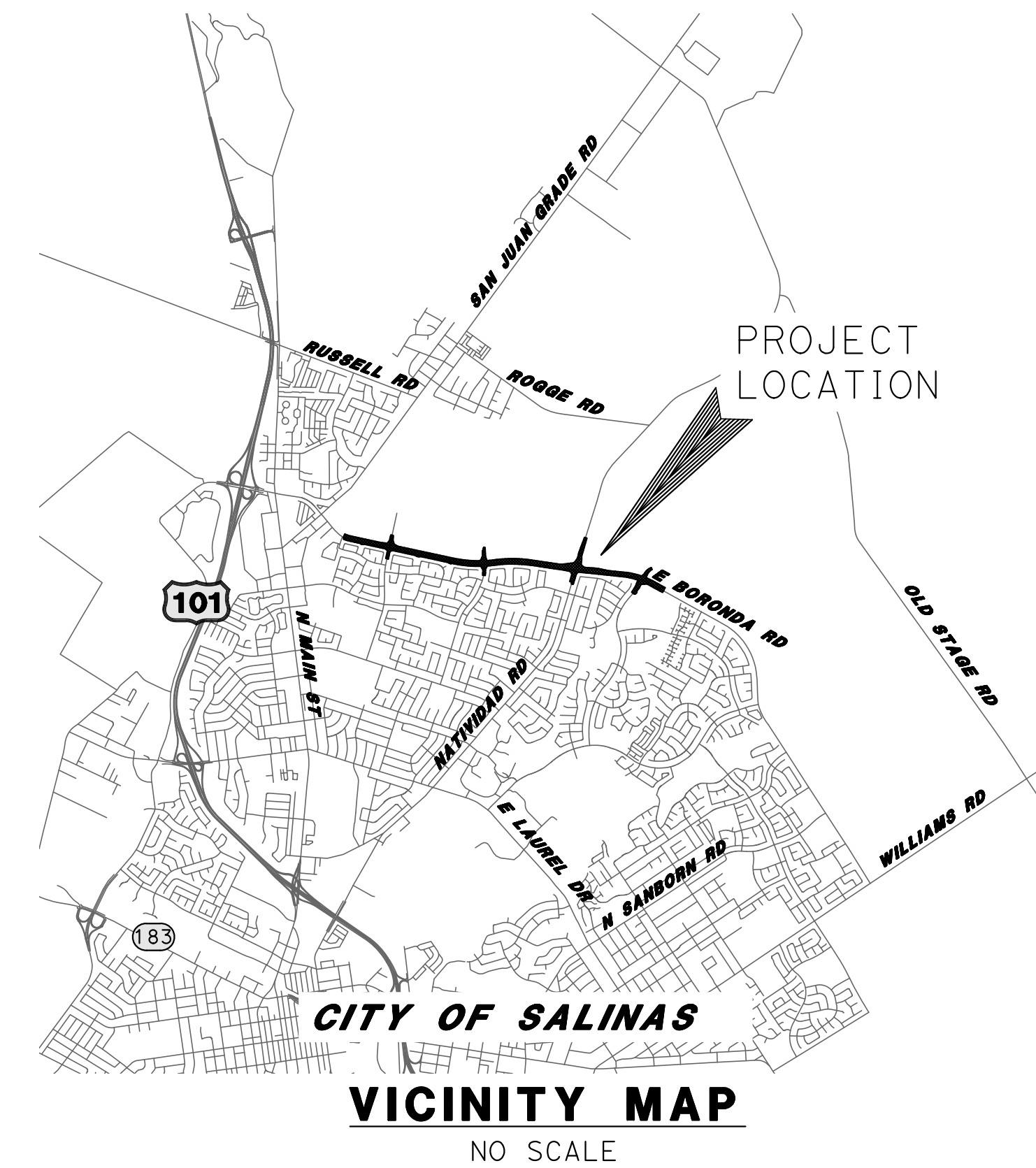

END CONSTRUCTION
STA "BOR" 213+92.48
END WORK
STA "BOR" 214+47.00

BEGIN CONSTRUCTION
STA "BOR" 110+62.53

THE CITY OF SALINAS & WALLACE GROUP OR ITS OFFICERS OR AGENTS SHALL NOT BE RESPONSIBLE FOR THE ACCURACY OR COMPLETENESS OF SCANNED COPIES OF THESE PLANS.

FILE NAME: 0886-0009_U1-T1.DWG
PLOT DATE: 6/8/2020 6:33 PM
BY: SARAH HUFFMAN



CITY OF SALINAS
PUBLIC WORKS DEPARTMENT
200 LINCOLN AVENUE
SALINAS, CA 93908

SCALE: NTS
ORIGINAL SCALE IN INCHES
FOR REDUCED PLANS
0 1 2



CIVIL AND TRANSPORTATION ENGINEERING
CONSTRUCTION MANAGEMENT
LANDSCAPE ARCHITECTURE
MECHANICAL ENGINEERING
PLANNING
PUBLIC WORKS ADMINISTRATION
SURVEYING / GIS SOLUTIONS
WATER RESOURCES
612 CLARION COURT
SAN LUIS OBISPO, CA 93401
T 805 544-4011 F 805 544-4294
www.wallacegroup.us

PROJECT ENGINEER
PLANS APPROVAL DATE



REVISIONS						
NO.	BY	DATE	DESCRIPTION	APPROVED BY	DATE	

ACCEPTED BY THE CITY CAPITAL PROJECTS ENGINEER

JOSIE LANTACA RCE: RCE_NO

BORONDA RD CONGESTION RELIEF PROJECT (ULTIMATE CONCEPT)						
TITLE SHEET						
T-1						
DESIGNED BY	DRAWN BY	CHECKED BY	JOB NUMBER	SHEET	OF	
SMH	SMH	JAA	0886-0009	1	32	
DISREGARD PRINTS BEARING EARLIER REVISION DATE			REVISION DATES (PRELIMINARY STAGE ONLY)			

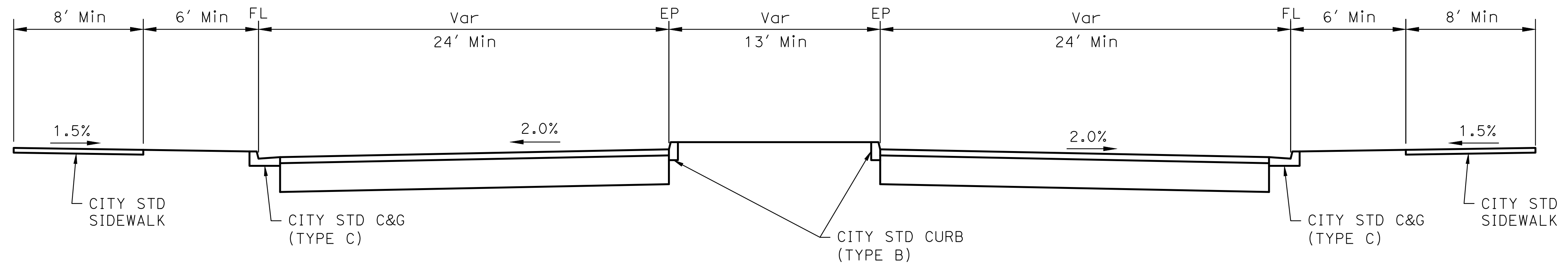

**BORONDA ROAD
AT ROUNDABOUT APPROACHES**

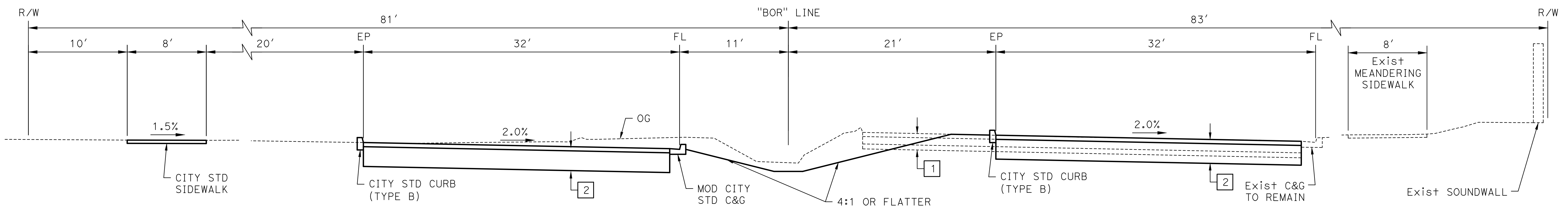

**BORONDA ROAD
BETWEEN INTERSECTIONS**

FILE NAME: 0886-0009_U1-XSEC.DWG PLOT DATE: 6/8/2020 6:34 PM BY: SARAH HUFFMAN



CITY OF SALINAS
PUBLIC WORKS DEPARTMENT
200 LINCOLN AVENUE
SALINAS, CA 93908

SCALE: NTS
ORIGINAL SCALE IN INCHES
FOR REDUCED PLANS
0 1 2

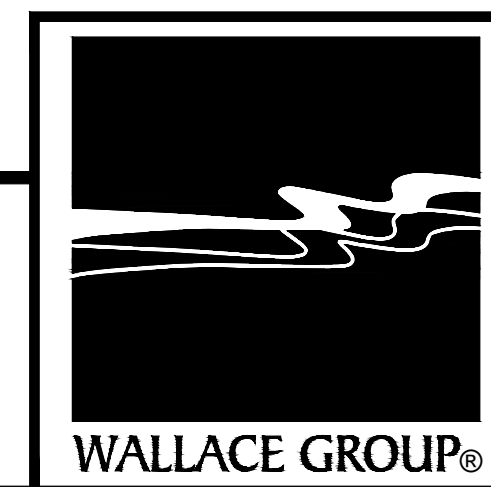

CIVIL AND TRANSPORTATION ENGINEERING
CONSTRUCTION MANAGEMENT
LANDSCAPE ARCHITECTURE
MECHANICAL ENGINEERING
PLANNING
PUBLIC WORKS ADMINISTRATION
SURVEYING / GIS SOLUTIONS
WATER RESOURCES
**612 CLARION COURT
SAN LUIS OBISPO, CA 93401
T 805 544-4011 F 805 544-4294
www.wallacegroup.us**

PROJECT ENGINEER
PLANS APPROVAL DATE

REVISIONS					
NO.	BY	DATE	DESCRIPTION	APPROVED BY	DATE

ACCEPTED BY THE CITY CAPITAL PROJECTS ENGINEER
JOSIE LANTACA RCE: RCE_NO

BORONDA RD CONGESTION RELIEF PROJECT (ULTIMATE CONCEPT)					
CROSS SECTIONS					
X-1					
DESIGNED BY SMH	DRAWN BY SMH	CHECKED BY JAA	JOB NUMBER 0886-0009	SHEET 2	OF 32
DISREGARD PRINTS BEARING EARLIER REVISION DATE			REVISION DATES (PRELIMINARY STAGE ONLY)		

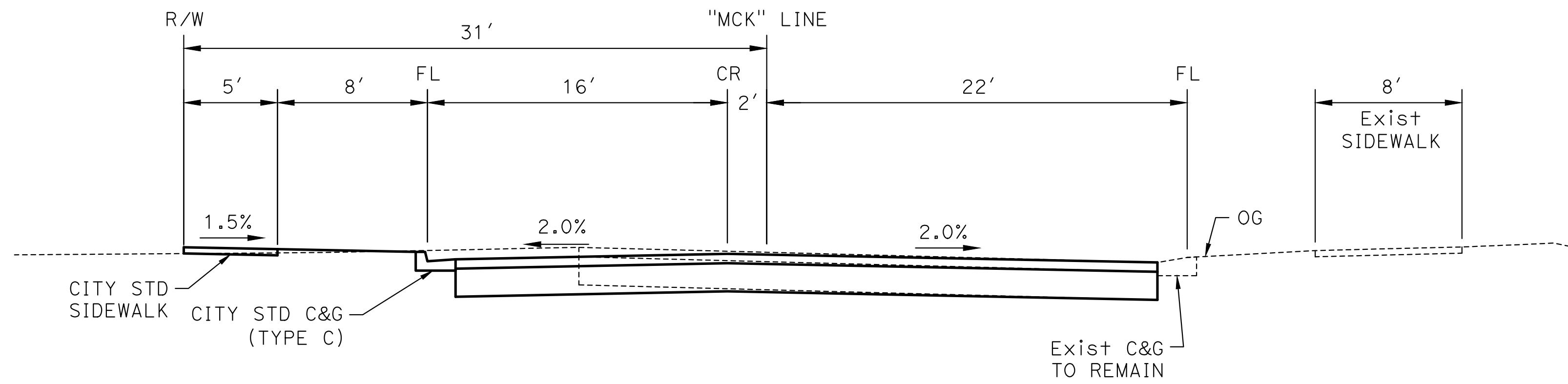

**MCKINNON STREET
AT NORTHERN CONFORM (BY OTHERS)**

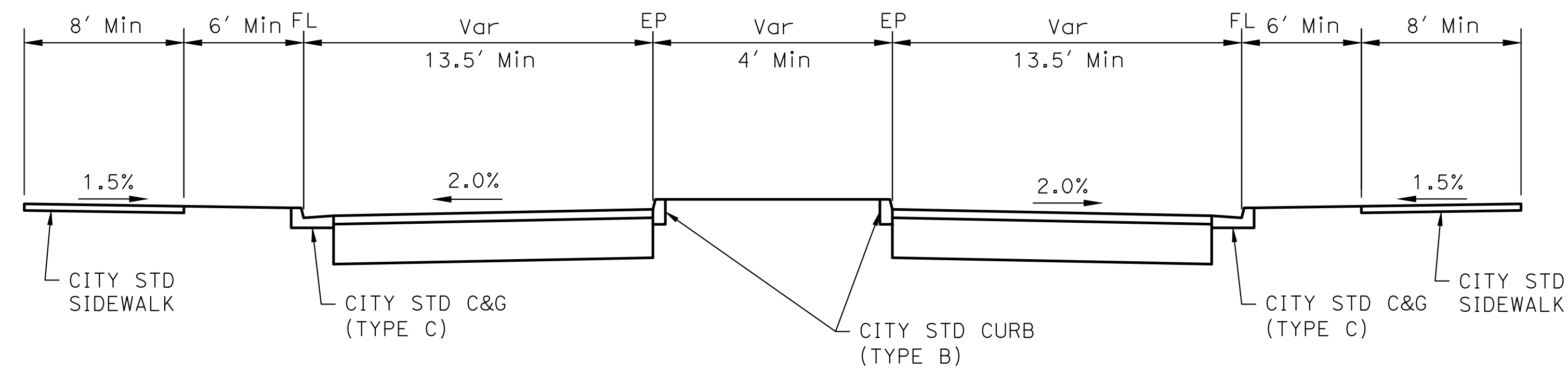

**MCKINNON STREET
AT ROUNDABOUT APPROACHES**

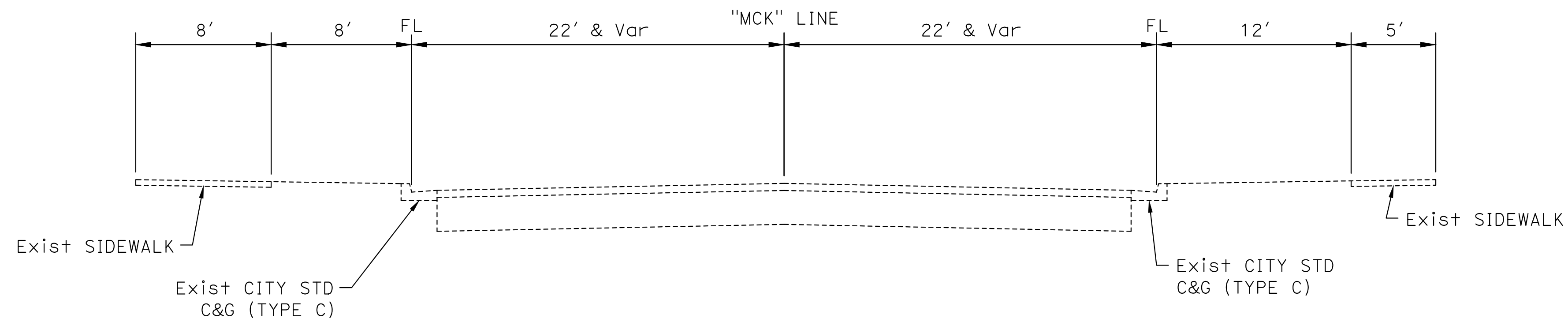

**MCKINNON STREET
AT SOUTHERN CONFORM (EXISTING)**

FILE NAME: 0886-0009_U1-XSEC.DWG PLOT DATE: 6/8/2020 6:34 PM BY: SARAH HUFFMAN



CITY OF SALINAS
PUBLIC WORKS DEPARTMENT
200 LINCOLN AVENUE
SALINAS, CA 93908

SCALE: NTS
ORIGINAL SCALE IN INCHES
FOR REDUCED PLANS
0 1 2



CIVIL AND TRANSPORTATION ENGINEERING
CONSTRUCTION MANAGEMENT
LANDSCAPE ARCHITECTURE
MECHANICAL ENGINEERING
PLANNING
PUBLIC WORKS ADMINISTRATION
SURVEYING / GIS SOLUTIONS
WATER RESOURCES
612 CLARION COURT
SAN LUIS OBISPO, CA 93401
T 805 544-4011 F 805 544-4294
www.wallacegroup.us

PROJECT ENGINEER
PLANS APPROVAL DATE



REVISIONS			
NO.	BY	DATE	DESCRIPTION

APPROVED BY: _____ DATE: _____
ACCEPTED BY THE CITY CAPITAL PROJECTS ENGINEER
JOSIE LANTACA RCE: RCE_NO

BORONDA RD CONGESTION RELIEF PROJECT (ULTIMATE CONCEPT)					
CROSS SECTIONS					
X-2					
DESIGNED BY	DRAWN BY	CHECKED BY	JOB NUMBER	SHEET	OF
SMH	SMH	JAA	0886-0009	3	32
DISREGARD PRINTS BEARING EARLIER REVISION DATE			REVISION DATES (PRELIMINARY STAGE ONLY)		

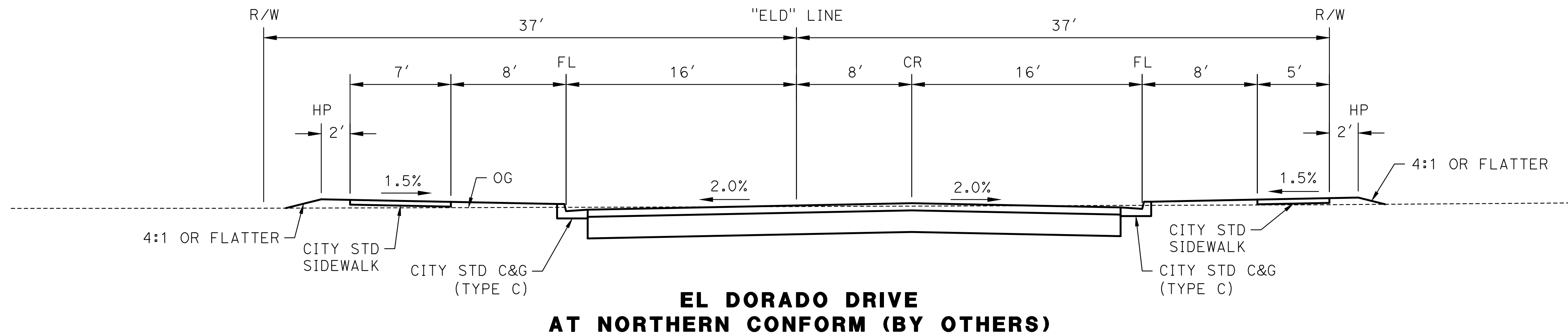

**EL DORADO DRIVE
AT NORTHERN CONFORM (BY OTHERS)**

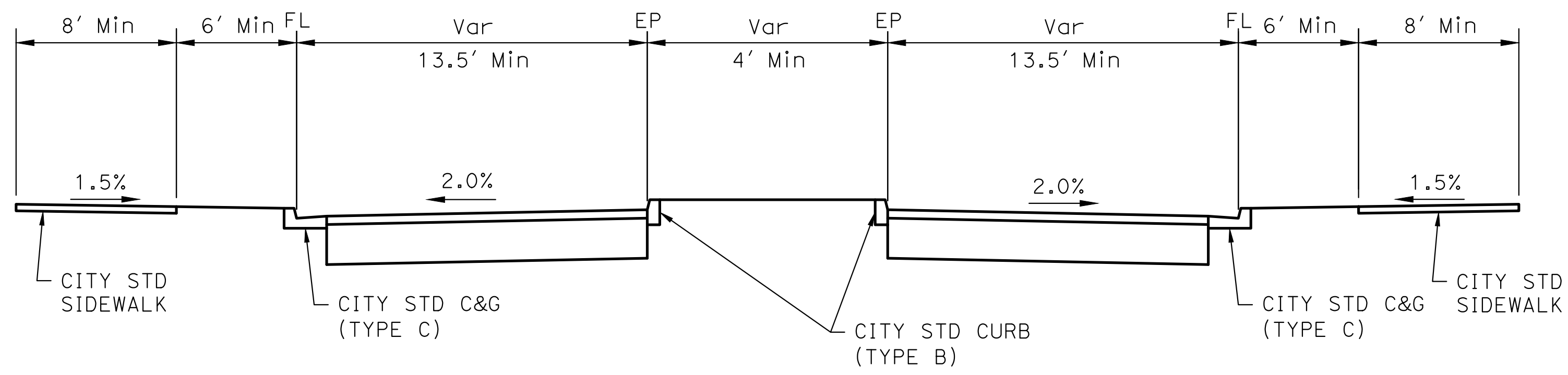

**EL DORADO DRIVE
AT ROUNDABOUT APPROACHES**

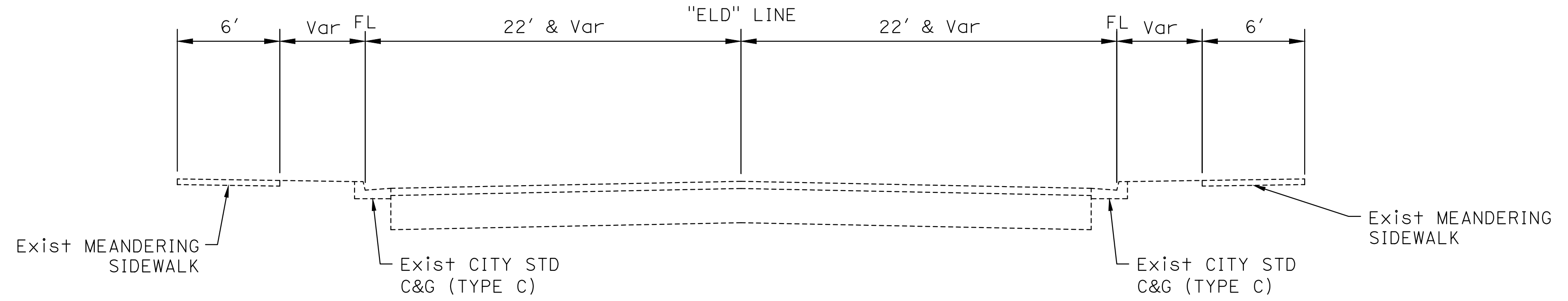

**EL DORADO DRIVE
AT SOUTHERN CONFORM (EXISTING)**

FILE NAME: 0886-0009_U1-XSEC.DWG PLOT DATE: 6/8/2020 6:34 PM BY: SARAH HUFFMAN



CITY OF SALINAS
PUBLIC WORKS DEPARTMENT
200 LINCOLN AVENUE
SALINAS, CA 93908

SCALE: NTS
ORIGINAL SCALE IN INCHES
FOR REDUCED PLANS
0 1 2

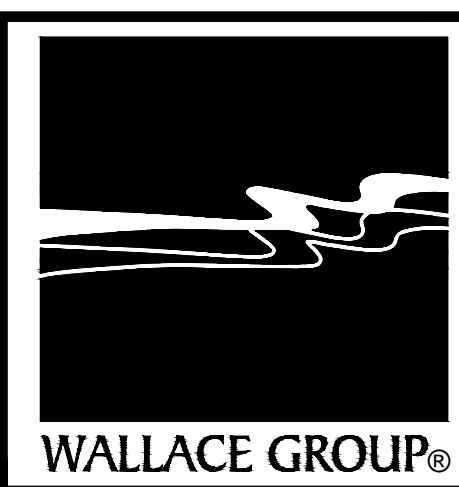

CIVIL AND TRANSPORTATION ENGINEERING
CONSTRUCTION MANAGEMENT
LANDSCAPE ARCHITECTURE
MECHANICAL ENGINEERING
PLANNING
PUBLIC WORKS ADMINISTRATION
SURVEYING / GIS SOLUTIONS
WATER RESOURCES
**612 CLARION COURT
SAN LUIS OBISPO, CA 93401
T 805 544-4011 F 805 544-4294
www.wallacegroup.us**

PROJECT ENGINEER
PLANS APPROVAL DATE

REVISIONS			
NO.	BY	DATE	DESCRIPTION

ACCEPTED BY THE CITY CAPITAL PROJECTS ENGINEER
JOSIE LANTACA RCE: RCE_NO

BORONDA RD CONGESTION RELIEF PROJECT (ULTIMATE CONCEPT)					
CROSS SECTIONS					
X-3					
DESIGNED BY	DRAWN BY	CHECKED BY	JOB NUMBER	SHEET	OF
SMH	SMH	JAA	0886-0009	4	32
DISREGARD PRINTS BEARING EARLIER REVISION DATE			REVISION DATES (PRELIMINARY STAGE ONLY)		

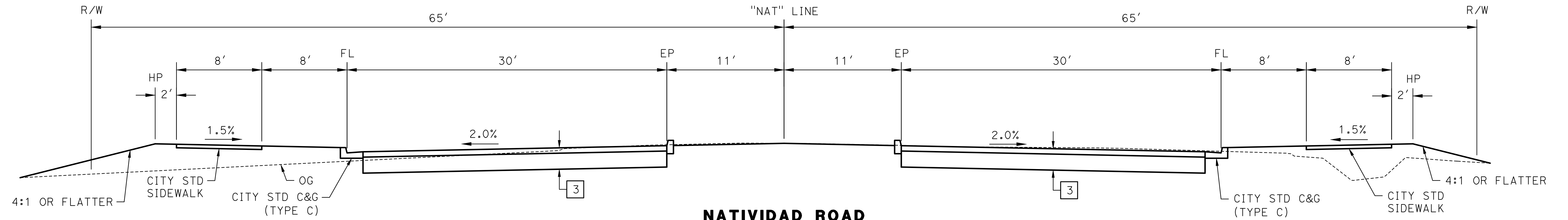

**NATIVIDAD ROAD
AT NORTHERN CONFORM (BY OTHERS)**

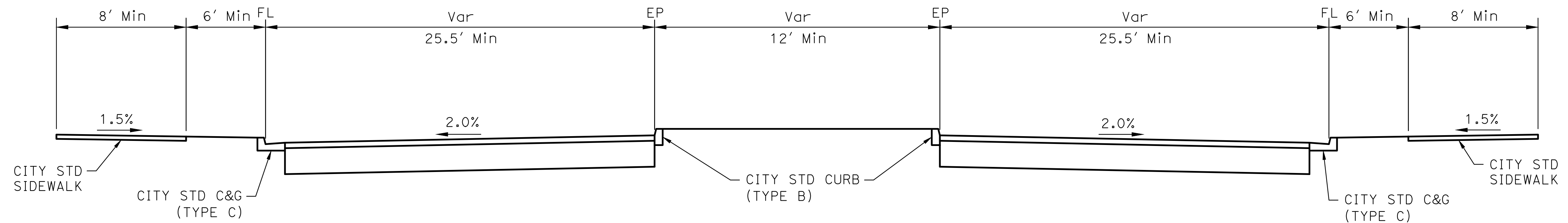

**NATIVIDAD ROAD
AT ROUNDABOUT APPROACHES**

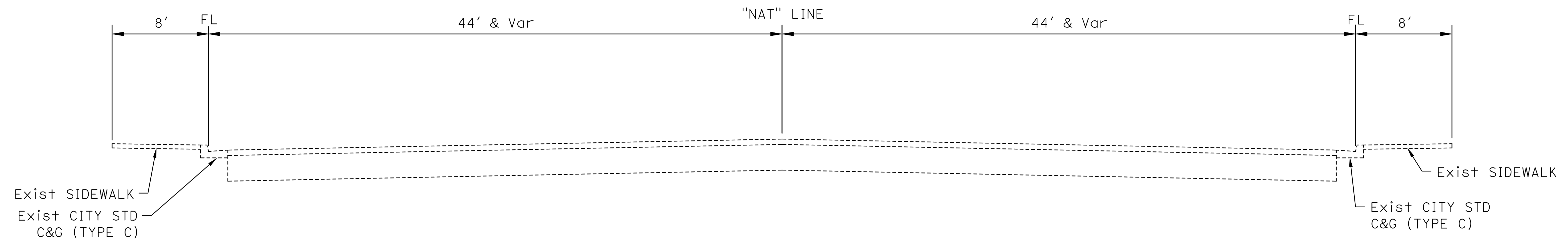

**NATIVIDAD ROAD
AT SOUTHERN CONFORM (EXISTING)**

FILE NAME: 0886-0009_U1-XSEC.DWG
PLOT DATE: 6/8/2020 6:34 PM
BY: SARAH HUFFMAN



CITY OF SALINAS
PUBLIC WORKS DEPARTMENT
200 LINCOLN AVENUE
SALINAS, CA 93908

SCALE: NTS
ORIGINAL SCALE IN INCHES
FOR REDUCED PLANS
0 1 2

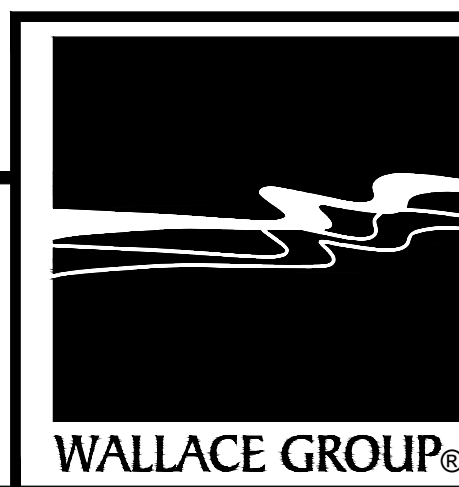

CIVIL AND TRANSPORTATION ENGINEERING
CONSTRUCTION MANAGEMENT
LANDSCAPE ARCHITECTURE
MECHANICAL ENGINEERING
PLANNING
PUBLIC WORKS ADMINISTRATION
SURVEYING / GIS SOLUTIONS
WATER RESOURCES
612 CLARION COURT
SAN LUIS OBISPO, CA 93401
T 805 544-4011 F 805 544-4294
www.wallacegroup.us

PROJECT ENGINEER
PLANS APPROVAL DATE



REVISIONS					
NO.	BY	DATE	DESCRIPTION	APPROVED BY	DATE

ACCEPTED BY THE CITY CAPITAL PROJECTS ENGINEER

JOSIE LANTACA RCE: RCE_NO

BORONDA RD CONGESTION RELIEF PROJECT (ULTIMATE CONCEPT)						
CROSS SECTIONS						
X-4						
DESIGNED BY	DRAWN BY	CHECKED BY	JOB NUMBER	SHEET	OF	
SMH	SMH	JAA	0886-0009	5	32	
DISREGARD PRINTS BEARING EARLIER REVISION DATE			REVISION DATES (PRELIMINARY STAGE ONLY)			

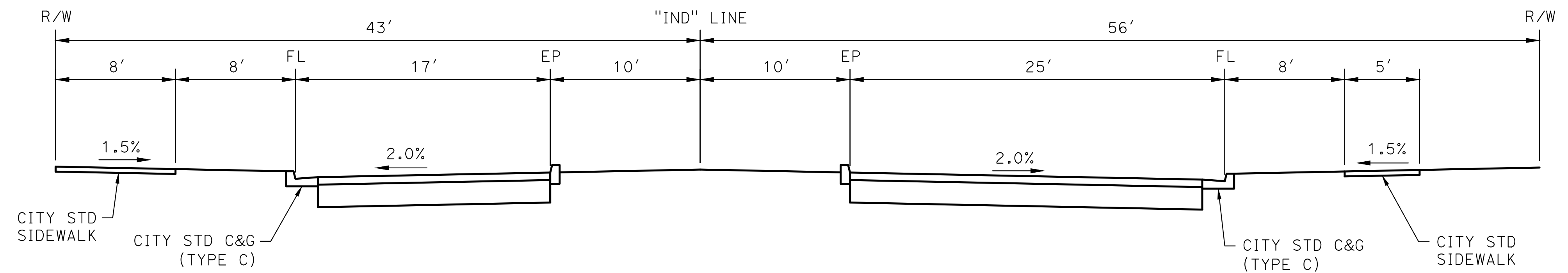

**INDEPENDENCE BOULEVARD
AT NORTHERN CONFORM (BY OTHERS)**

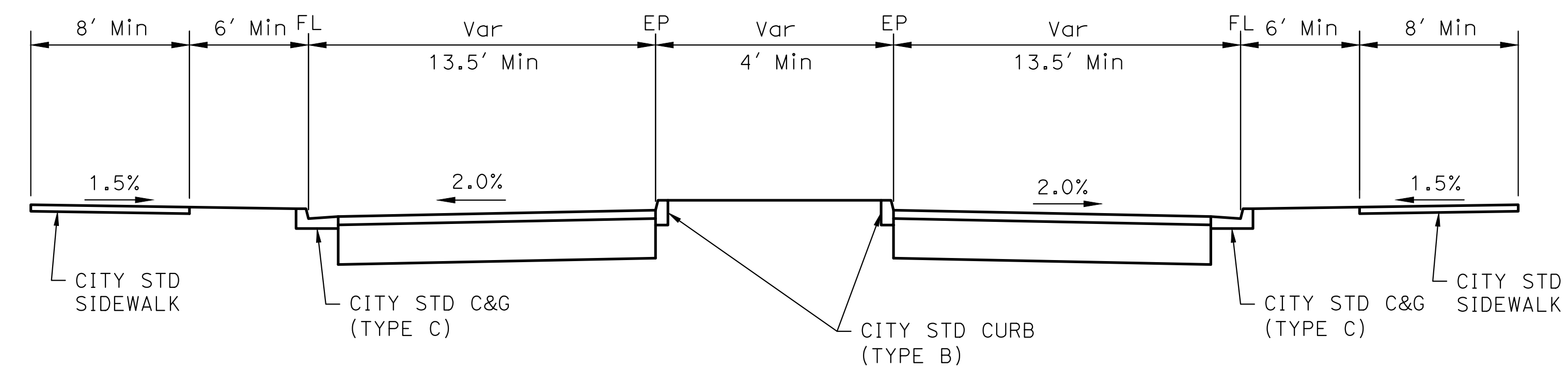

**INDEPENDENCE BOULEVARD
AT ROUNDABOUT APPROACHES**

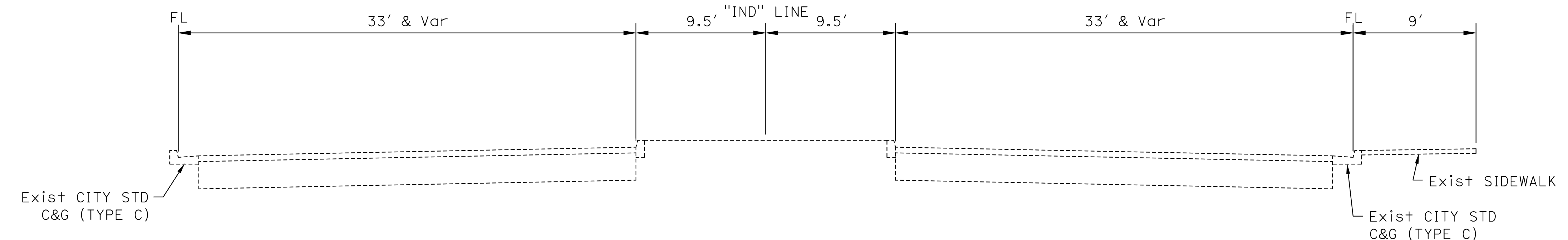

**INDEPENDENCE BOULEVARD
AT SOUTHERN CONFORM (EXISTING)**

FILE NAME: 0886-0009_U1-XSEC.DWG PLOT DATE: 6/8/2020 6:34 PM BY: SARAH HUFFMAN



CITY OF SALINAS
PUBLIC WORKS DEPARTMENT
200 LINCOLN AVENUE
SALINAS, CA 93908

SCALE: NTS
ORIGINAL SCALE IN INCHES
FOR REDUCED PLANS
0 1 2

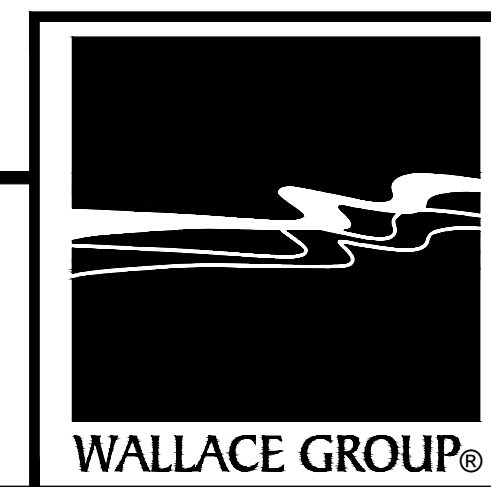

CIVIL AND TRANSPORTATION ENGINEERING
CONSTRUCTION MANAGEMENT
LANDSCAPE ARCHITECTURE
MECHANICAL ENGINEERING
PLANNING
PUBLIC WORKS ADMINISTRATION
SURVEYING / GIS SOLUTIONS
WATER RESOURCES
612 CLARION COURT
SAN LUIS OBISPO, CA 93401
T 805 544-4011 F 805 544-4294
www.wallacegroup.us

PROJECT ENGINEER
PLANS APPROVAL DATE
REGISTERED PROFESSIONAL ENGINEER
SARAH M. HUFFMAN
No. 85233
FOR PLAN REVIEW ONLY
NOT FOR CONSTRUCTION
CIVIL
STATE OF CALIFORNIA

REVISIONS			
NO.	BY	DATE	DESCRIPTION

APPROVED BY: _____ DATE: _____
ACCEPTED BY THE CITY CAPITAL PROJECTS ENGINEER
JOSIE LANTACA RCE: RCE_NO

BORONDA RD CONGESTION RELIEF PROJECT (ULTIMATE CONCEPT)					
CROSS SECTIONS					
X-5					
DESIGNED BY	DRAWN BY	CHECKED BY	JOB NUMBER	SHEET	OF
SMH	SMH	JAA	0886-0009	6	32
DISREGARD PRINTS BEARING EARLIER REVISION DATE			REVISION DATES (PRELIMINARY STAGE ONLY)		

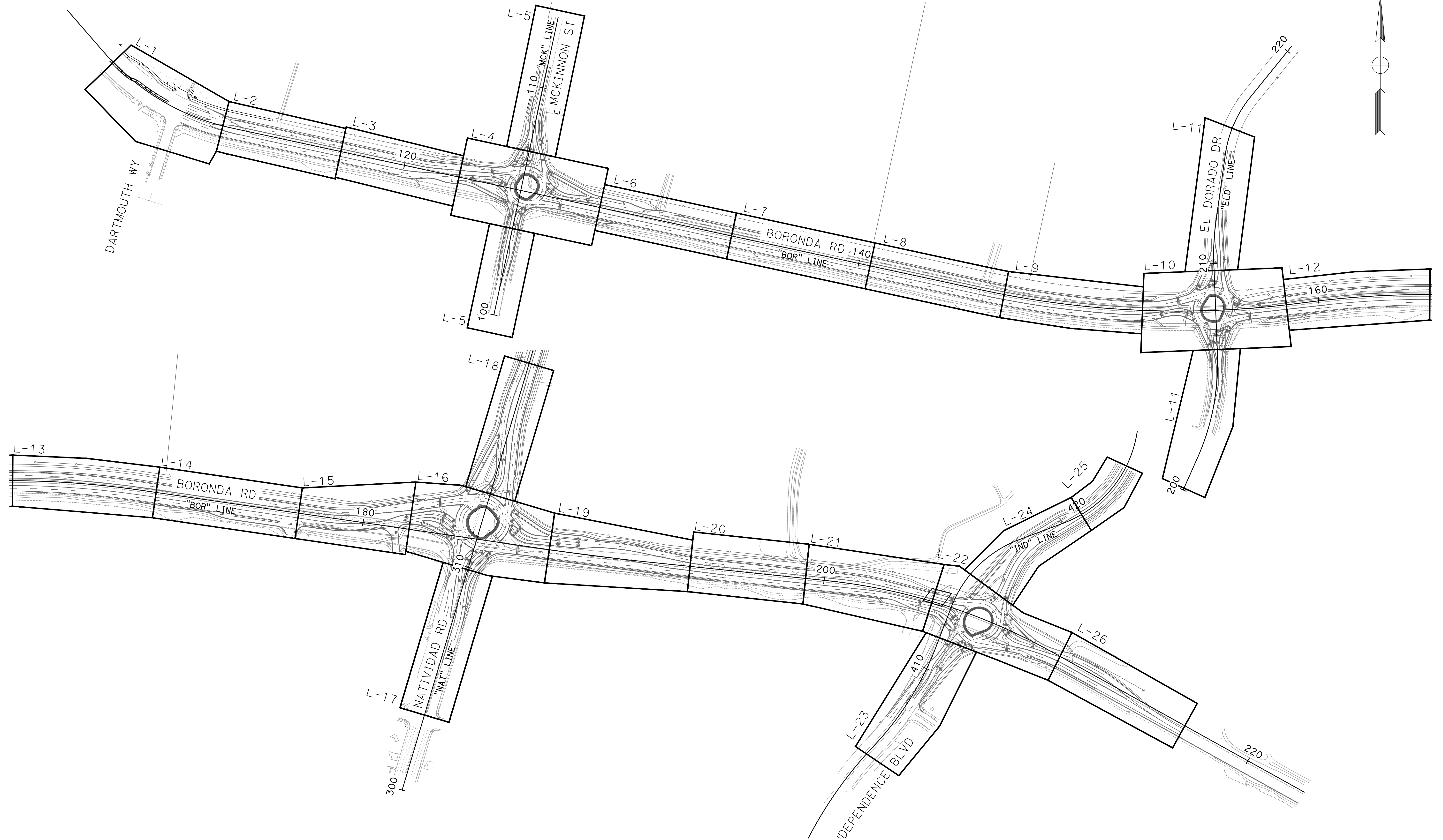
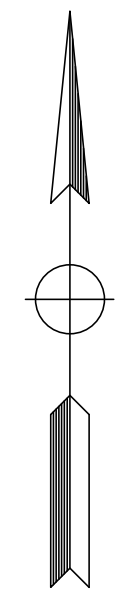

FILE NAME: 0886-0009_Ult-KYMP.DWG
PLOT DATE: 6/8/2020 6:35 PM
BY: SARAH HUFFMAN



CITY OF SALINAS
PUBLIC WORKS DEPARTMENT
200 LINCOLN AVENUE
SALINAS, CA 93908

SCALE: 1" = 200'
ORIGINAL SCALE IN INCHES
FOR REDUCED PLANS

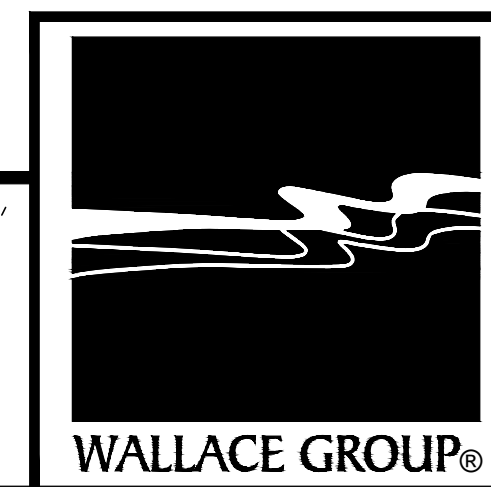

CIVIL AND TRANSPORTATION ENGINEERING
CONSTRUCTION MANAGEMENT
LANDSCAPE ARCHITECTURE
MECHANICAL ENGINEERING
PLANNING
PUBLIC WORKS ADMINISTRATION
SURVEYING / GIS SOLUTIONS
WATER RESOURCES

612 CLARION COURT
SAN LUIS OBISPO, CA 93401
T 805 544-4011 F 805 544-4294
www.wallacegroup.us

PROJECT ENGINEER
PLANS APPROVAL DATE

REVISIONS			
NO.	BY	DATE	DESCRIPTION

APPROVED BY: _____ DATE: _____

ACCEPTED BY THE CITY CAPITAL PROJECTS ENGINEER

JOSIE LANTACA RCE: RCE_NO

BORONDA RD CONGESTION RELIEF PROJECT (ULTIMATE CONCEPT)					
KEY MAP					
K-1					
DESIGNED BY	DRAWN BY	CHECKED BY	JOB NUMBER	SHEET	OF
SMH	SMH	JAA	0886-0009	7	32
DISREGARD PRINTS BEARING EARLIER REVISION DATE			REVISION DATES (PRELIMINARY STAGE ONLY)		

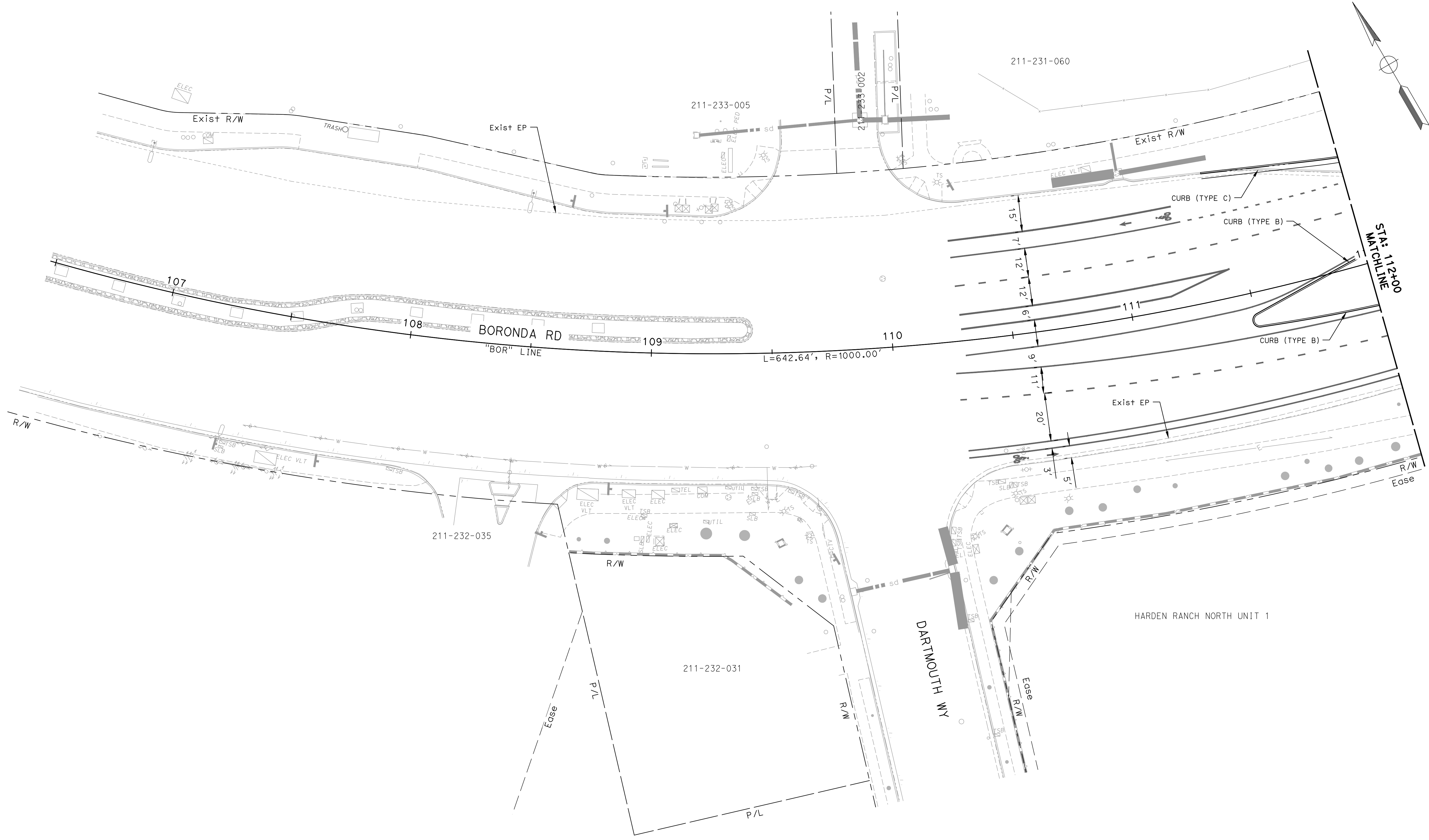
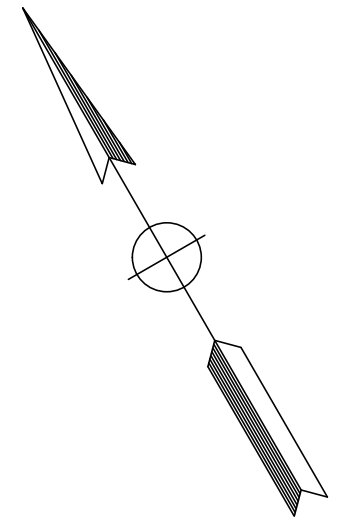

FILE NAME: 0886-0009_U1-LAY-01.DWG PLOT DATE: 6/8/2020 6:36 PM BY: SARAH HUFFMAN



CITY OF SALINAS
 PUBLIC WORKS DEPARTMENT
 200 LINCOLN AVENUE
 SALINAS, CA 93908

SCALE: 1" = 20'
 ORIGINAL SCALE IN INCHES
 FOR REDUCED PLANS



CIVIL AND TRANSPORTATION ENGINEERING
 CONSTRUCTION MANAGEMENT
 LANDSCAPE ARCHITECTURE
 MECHANICAL ENGINEERING
 PLANNING
 PUBLIC WORKS ADMINISTRATION
 SURVEYING / GIS SOLUTIONS
 WATER RESOURCES

612 CLARION COURT
 SAN LUIS OBISPO, CA 93401
 T 805 544-4011 F 805 544-4294
 www.wallacegroup.us

PROJECT ENGINEER _____
 PLANS APPROVAL DATE _____

REVISIONS					
NO.	BY	DATE	DESCRIPTION	APPROVED BY	DATE

ACCEPTED BY THE CITY CAPITAL PROJECTS ENGINEER

JOSIE LANTACA RCE: RCE_NO

BORONDA RD CONGESTION RELIEF PROJECT (ULTIMATE CONCEPT)					
LAYOUT					
L-1					
DESIGNED BY	DRAWN BY	CHECKED BY	JOB NUMBER	SHEET	OF
SMH	SMH	JAA	0886-0009	8	32
DISREGARD PRINTS BEARING EARLIER REVISION DATE			REVISION DATES (PRELIMINARY STAGE ONLY)		

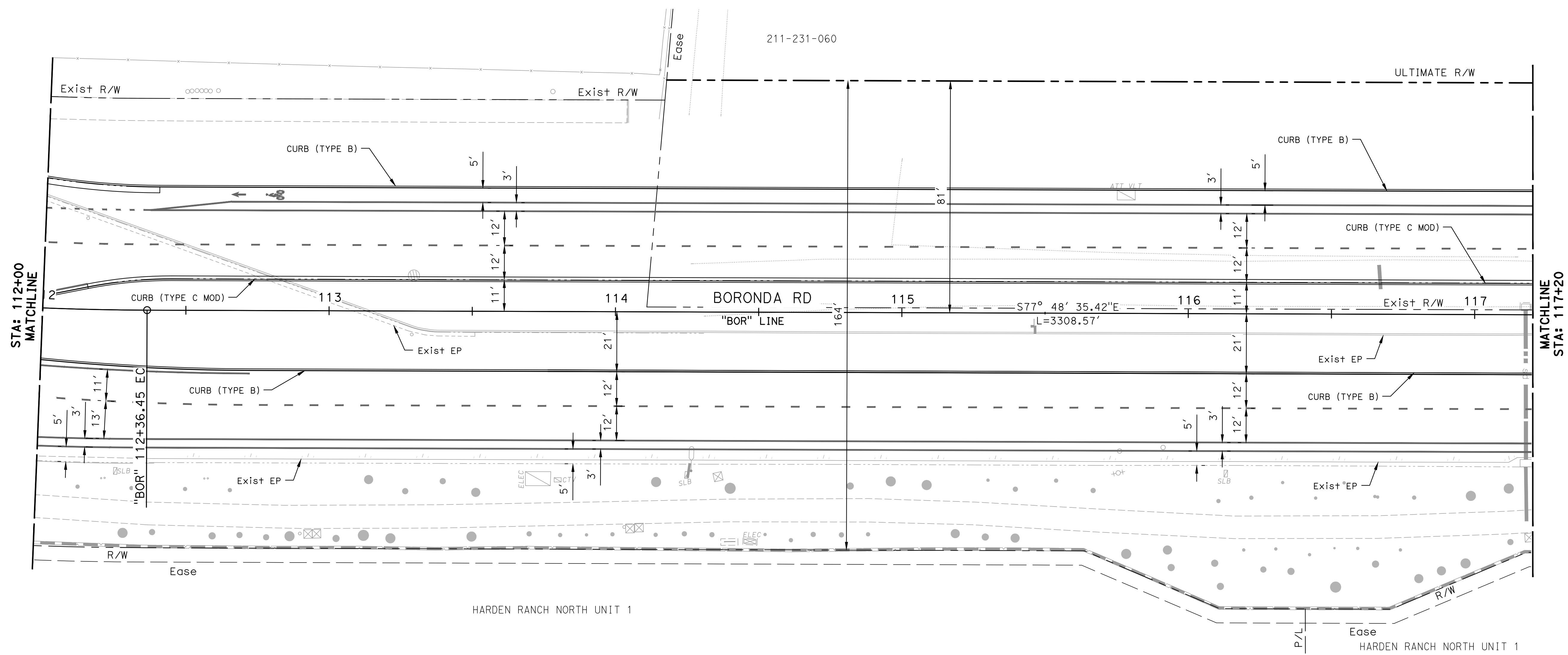
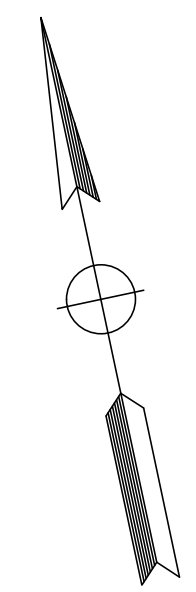

FILE NAME: 0886-0009_U1-LAY-01.DWG PLOT DATE: 6/8/2020 6:36 PM BY: SARAH HUFFMAN



CITY OF SALINAS
 PUBLIC WORKS DEPARTMENT
 200 LINCOLN AVENUE
 SALINAS, CA 93908

SCALE: 1" = 20'
 ORIGINAL SCALE IN INCHES
 FOR REDUCED PLANS

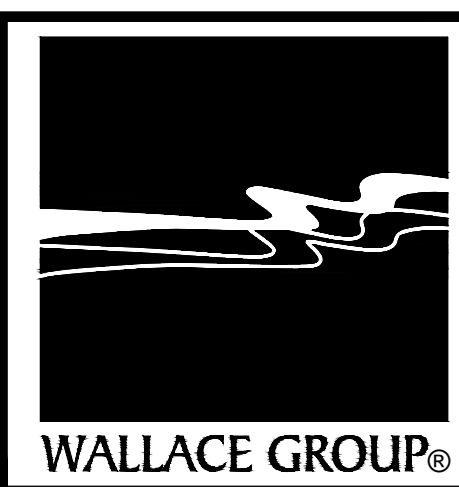

CIVIL AND TRANSPORTATION ENGINEERING
 CONSTRUCTION MANAGEMENT
 LANDSCAPE ARCHITECTURE
 MECHANICAL ENGINEERING
 PLANNING
 PUBLIC WORKS ADMINISTRATION
 SURVEYING / GIS SOLUTIONS
 WATER RESOURCES

612 CLARION COURT
 SAN LUIS OBISPO, CA 93401
 T 805 544-4011 F 805 544-4294
 www.wallacegroup.us

PROJECT ENGINEER
 PLANS APPROVAL DATE

REVISIONS					
NO.	BY	DATE	DESCRIPTION	APPROVED BY	DATE

ACCEPTED BY THE CITY CAPITAL PROJECTS ENGINEER

JOSIE LANTACA RCE: RCE_NO

BORONDA RD CONGESTION RELIEF PROJECT (ULTIMATE CONCEPT)					
LAYOUT					
L-2					
DESIGNED BY	DRAWN BY	CHECKED BY	JOB NUMBER	SHEET	OF
SMH	SMH	JAA	0886-0009	9	32
DISREGARD PRINTS BEARING EARLIER REVISION DATE			REVISION DATES (PRELIMINARY STAGE ONLY)		

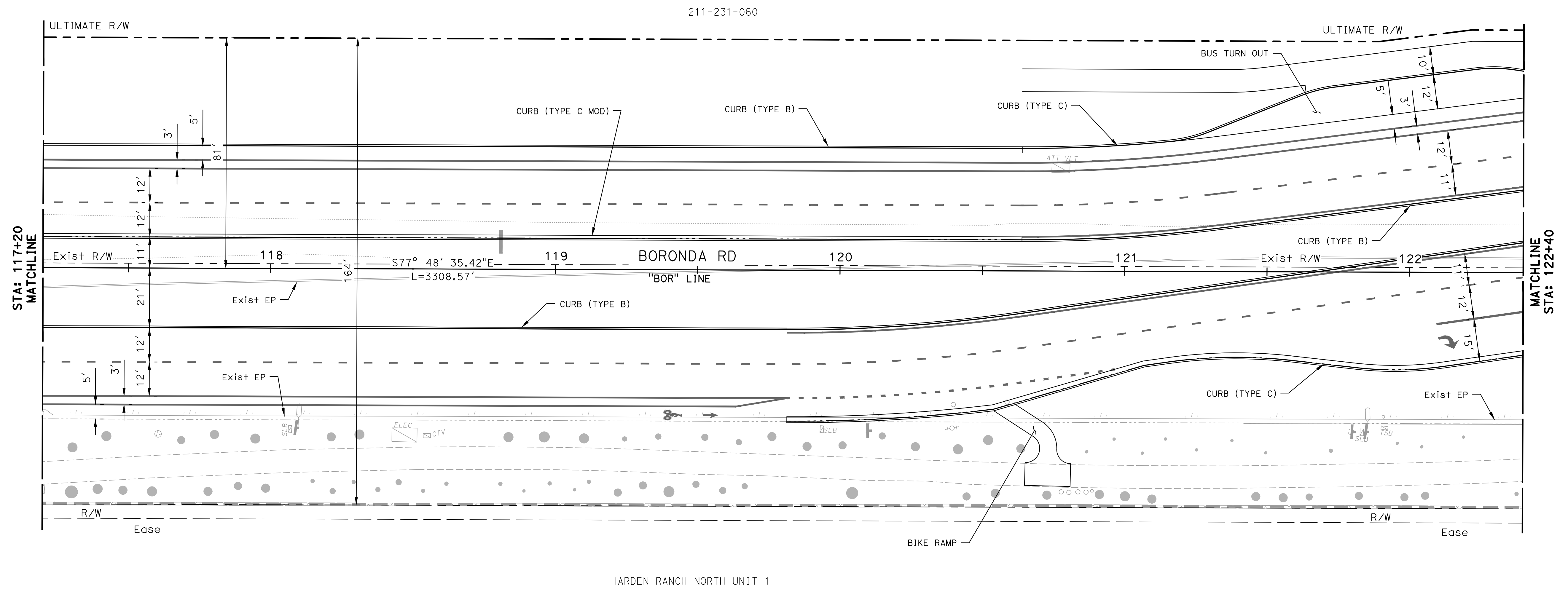
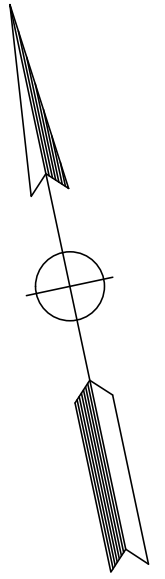

FILE NAME: 0886-0009_Ult-LAY-01.DWG
 PLOT DATE: 6/8/2020 6:36 PM
 BY: SARAH HUFFMAN



CITY OF SALINAS
 PUBLIC WORKS DEPARTMENT
 200 LINCOLN AVENUE
 SALINAS, CA 93908

SCALE: 1" = 20'
 ORIGINAL SCALE IN INCHES
 FOR REDUCED PLANS

WALLACE GROUP®
 CIVIL AND TRANSPORTATION ENGINEERING
 CONSTRUCTION MANAGEMENT
 LANDSCAPE ARCHITECTURE
 MECHANICAL ENGINEERING
 PLANNING
 PUBLIC WORKS ADMINISTRATION
 SURVEYING / GIS SOLUTIONS
 WATER RESOURCES
 612 CLARION COURT
 SAN LUIS OBISPO, CA 93401
 T 805 544-4011 F 805 544-4294
 www.wallacegroup.us

PROJECT ENGINEER
 PLANS APPROVAL DATE

REVISIONS						
NO.	BY	DATE	DESCRIPTION	APPROVED BY	DATE	

ACCEPTED BY THE CITY CAPITAL PROJECTS ENGINEER

JOSIE LANTACA RCE: RCE_NO

BORONDA RD CONGESTION RELIEF PROJECT (ULTIMATE CONCEPT)
LAYOUT
L-3

DESIGNED BY	DRAWN BY	CHECKED BY	JOB NUMBER	SHEET	OF
SMH	SMH	JAA	0886-0009	10	32

DISREGARD PRINTS BEARING EARLIER REVISION DATE
 REVISION DATES (PRELIMINARY STAGE ONLY)

STA: 108+20
MATCHLINE

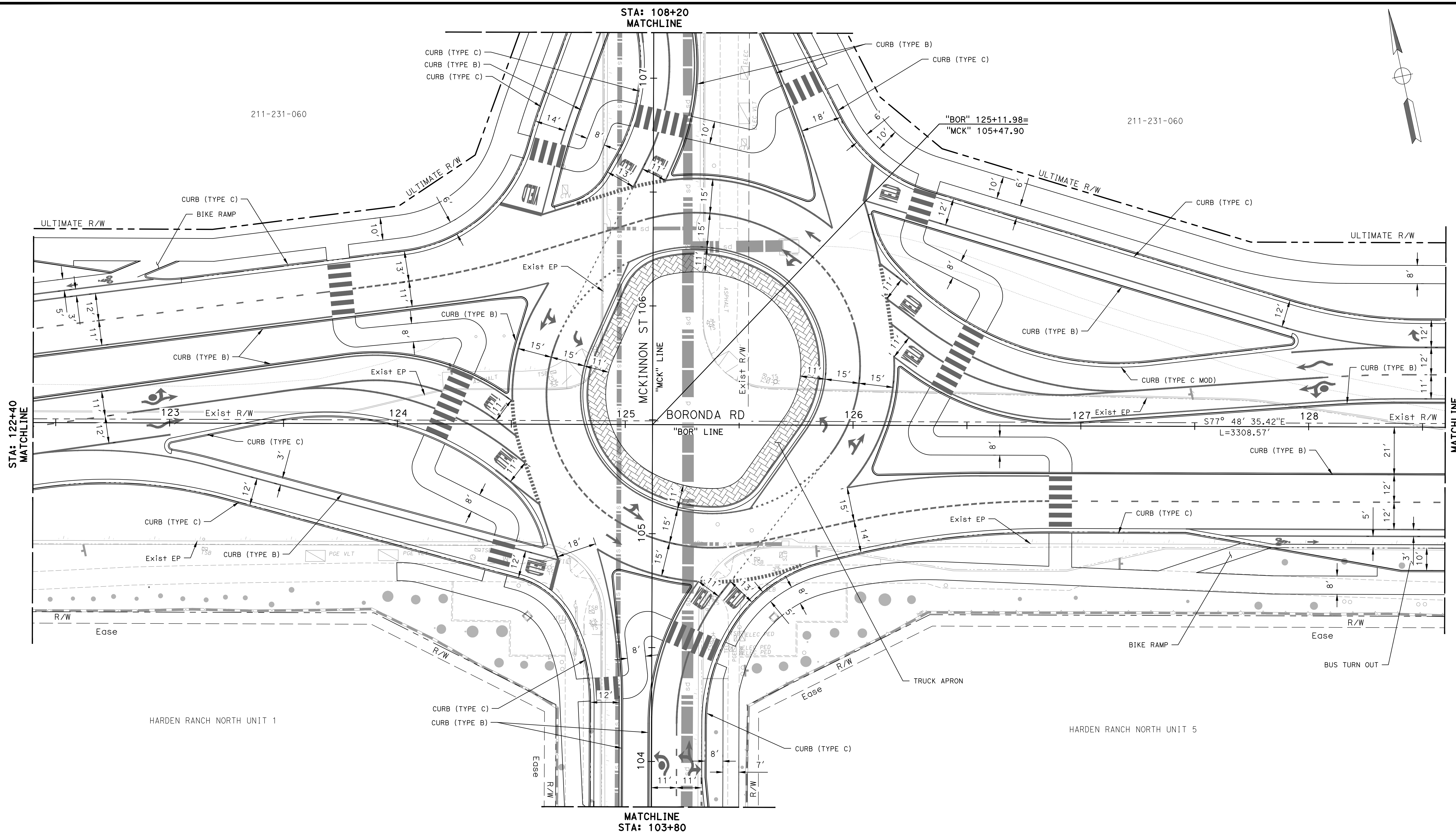
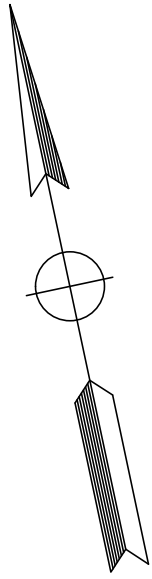

STA: 122+40
MATCHLINE

MATCHLINE
STA: 128+60

MATCHLINE
STA: 103+80

FILE NAME: 0886-0009_Ult-LAY-01.DWG
PLOT DATE: 6/8/2020 6:36 PM
BY: SARAH HUFFMAN



CITY OF SALINAS
PUBLIC WORKS DEPARTMENT
200 LINCOLN AVENUE
SALINAS, CA 93908

SCALE: 1" = 20'
ORIGINAL SCALE IN INCHES
FOR REDUCED PLANS

WALLACE GROUP
CIVIL AND TRANSPORTATION ENGINEERING
CONSTRUCTION MANAGEMENT
LANDSCAPE ARCHITECTURE
MECHANICAL ENGINEERING
PLANNING
PUBLIC WORKS ADMINISTRATION
SURVEYING / GIS SOLUTIONS
WATER RESOURCES
612 CLARION COURT
SAN LUIS OBISPO, CA 93401
T 805 544-4011 F 805 544-4294
www.wallacegroup.us

PROJECT ENGINEER
PLANS APPROVAL DATE

REVISIONS					
NO.	BY	DATE	DESCRIPTION	APPROVED BY	DATE

ACCEPTED BY THE CITY CAPITAL PROJECTS ENGINEER

JOSIE LANTACA RCE: RCE_NO

**BORONDA RD CONGESTION RELIEF
PROJECT (ULTIMATE CONCEPT)**

LAYOUT

L-4

DESIGNED BY	DRAWN BY	CHECKED BY	JOB NUMBER	SHEET	OF
SMH	SMH	JAA	0886-0009	11	32

DISREGARD PRINTS BEARING EARLIER REVISION DATE

REVISION DATES (PRELIMINARY STAGE ONLY)

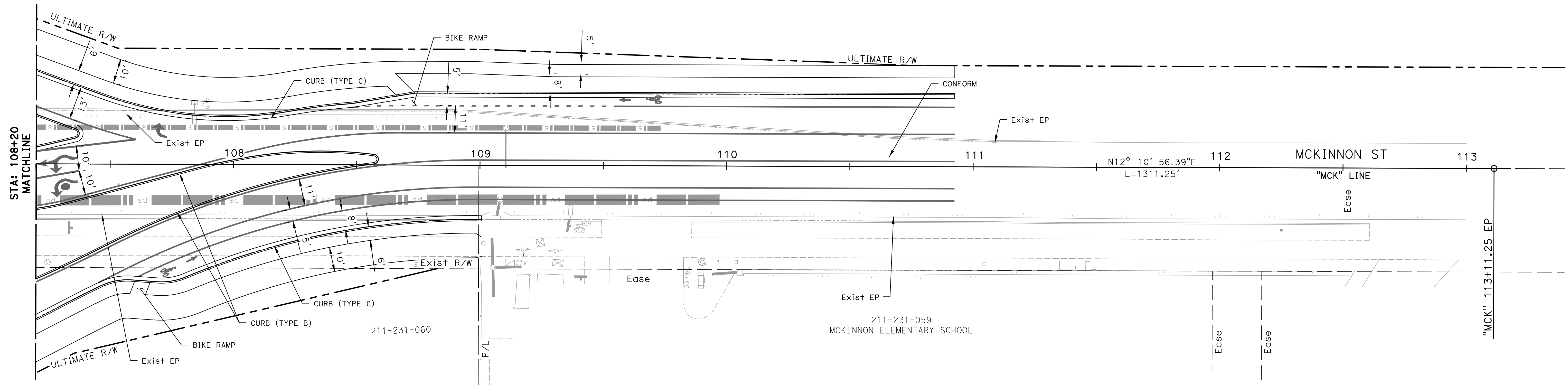
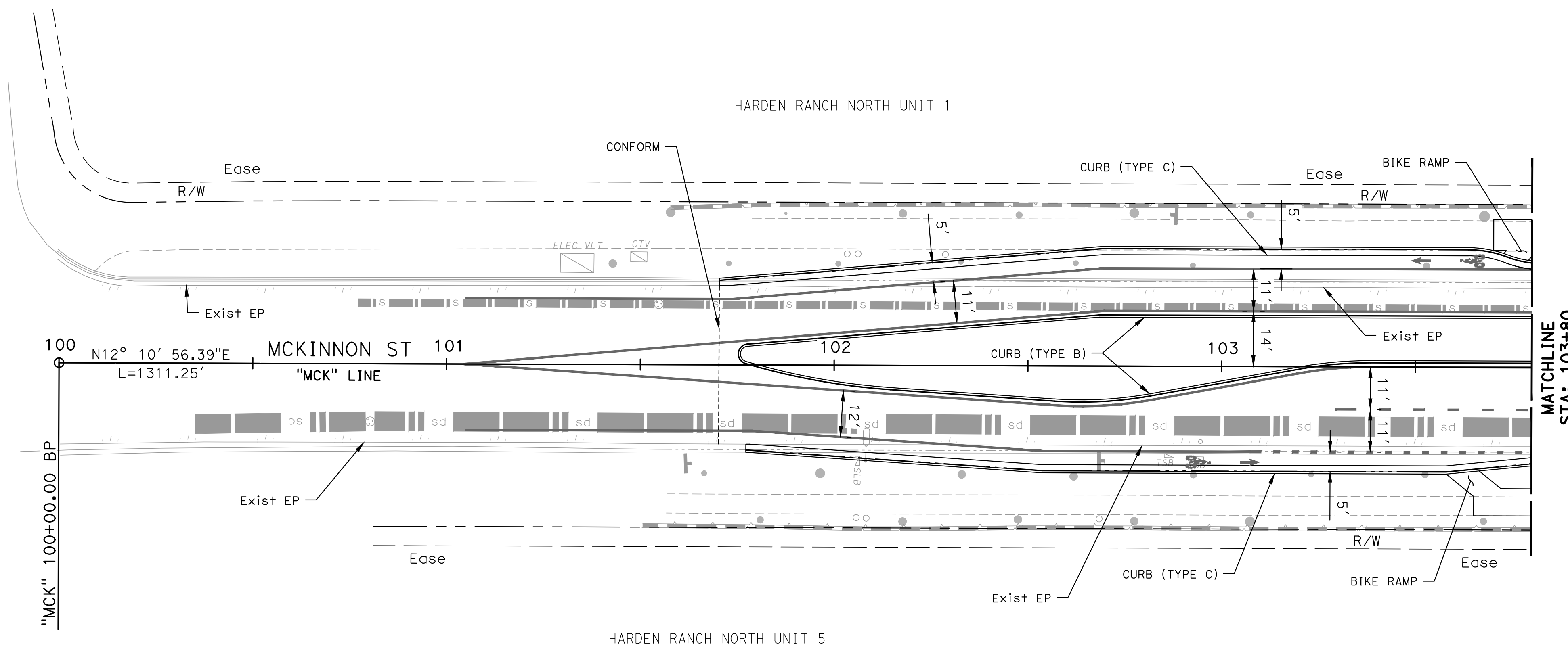
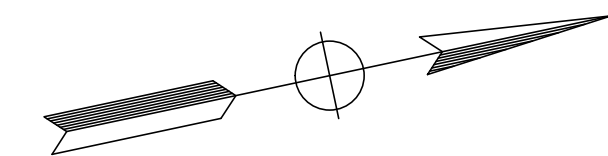

FILE NAME: 0886-0009_Ult-LAY-01.DWG PLOT DATE: 6/8/2020 6:37 PM BY: SARAH HUFFMAN



CITY OF SALINAS
PUBLIC WORKS DEPARTMENT
200 LINCOLN AVENUE
SALINAS, CA 93908

SCALE: 1" = 20'
ORIGINAL SCALE IN INCHES
FOR REDUCED PLANS

WALLACE GROUP
CIVIL AND TRANSPORTATION ENGINEERING
CONSTRUCTION MANAGEMENT
LANDSCAPE ARCHITECTURE
MECHANICAL ENGINEERING
PLANNING
PUBLIC WORKS ADMINISTRATION
SURVEYING / GIS SOLUTIONS
WATER RESOURCES
612 CLARION COURT
SAN LUIS OBISPO, CA 93401
T 805 544-4011 F 805 544-4294
www.wallacegroup.us

PROJECT ENGINEER _____
PLANS APPROVAL DATE _____

REVISIONS			
NO.	BY	DATE	DESCRIPTION

APPROVED BY: _____ DATE: _____
ACCEPTED BY THE CITY CAPITAL PROJECTS ENGINEER: _____ DATE: _____

JOSIE LANTACA RCE: RCE_NO

BORONDA RD CONGESTION RELIEF PROJECT (ULTIMATE CONCEPT) LAYOUT

L-5

DESIGNED BY	DRAWN BY	CHECKED BY	JOB NUMBER	SHEET	OF
SMH	SMH	JAA	0886-0009	12	32

DISREGARD PRINTS BEARING EARLIER REVISION DATE

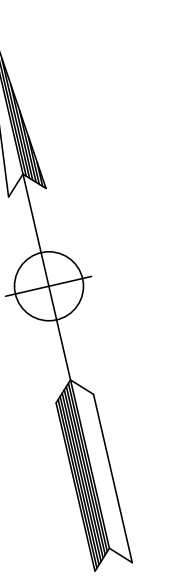

211-231-060

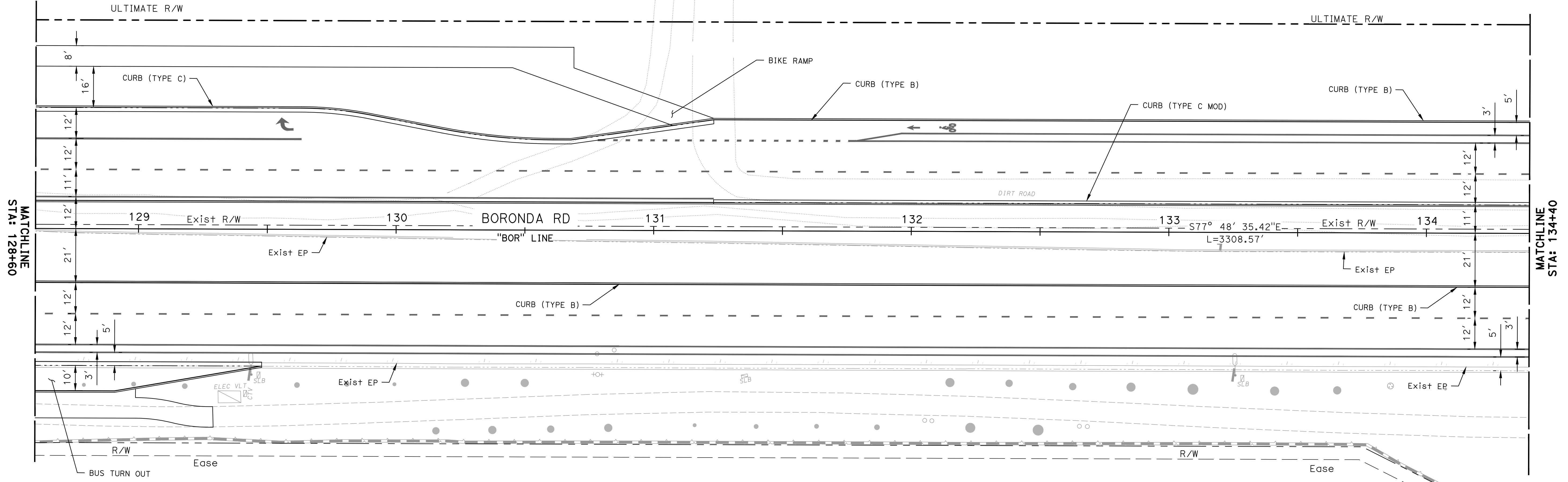

MATCHLINE
STA: 128+60

MATCHLINE
STA: 134+40

FILE NAME: 0886-0009_UJT-LAY-01.DWG
PLOT DATE: 6/8/2020 6:37 PM
BY: SARAH HUFFMAN



CITY OF SALINAS
PUBLIC WORKS DEPARTMENT
200 LINCOLN AVENUE
SALINAS, CA 93908

SCALE: 1" = 20'
ORIGINAL SCALE IN INCHES
FOR REDUCED PLANS

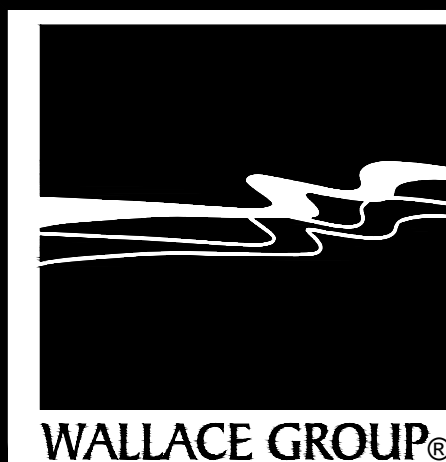

CIVIL AND TRANSPORTATION ENGINEERING
CONSTRUCTION MANAGEMENT
LANDSCAPE ARCHITECTURE
MECHANICAL ENGINEERING
PLANNING
PUBLIC WORKS ADMINISTRATION
SURVEYING / GIS SOLUTIONS
WATER RESOURCES

612 CLARION COURT
SAN LUIS OBISPO, CA 93401
T 805 544-4011 F 805 544-4294
www.wallacegroup.us

PROJECT ENGINEER
PLANS APPROVAL DATE



REVISIONS					
NO.	BY	DATE	DESCRIPTION	APPROVED BY	DATE

ACCEPTED BY THE CITY CAPITAL PROJECTS ENGINEER

JOSIE LANTACA RCE: RCE_NO

BORONDA RD CONGESTION RELIEF PROJECT (ULTIMATE CONCEPT)					
LAYOUT					
L-6					
DESIGNED BY	DRAWN BY	CHECKED BY	JOB NUMBER	SHEET	OF
SMH	SMH	JAA	0886-0009	13	32
DISREGARD PRINTS BEARING EARLIER REVISION DATE			REVISION DATES (PRELIMINARY STAGE ONLY)		

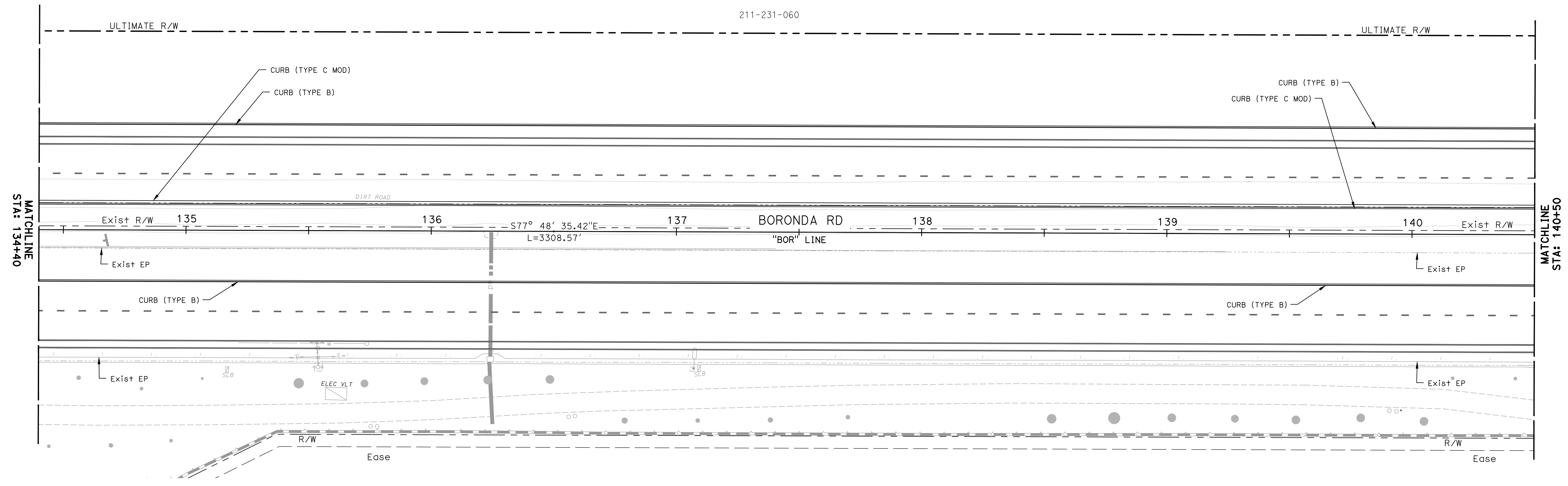
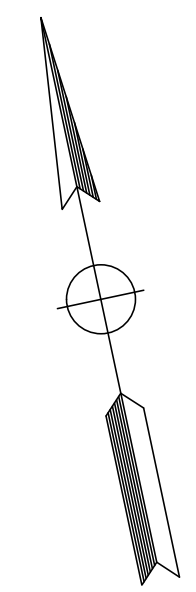

FILE NAME: 0886-0009_UJT-LAY-01.DWG PLOT DATE: 6/8/2020 6:37 PM BY: SARAH HUFFMAN



CITY OF SALINAS
 PUBLIC WORKS DEPARTMENT
 200 LINCOLN AVENUE
 SALINAS, CA 93908

SCALE: 1" = 20'
 ORIGINAL SCALE IN INCHES
 FOR REDUCED PLANS

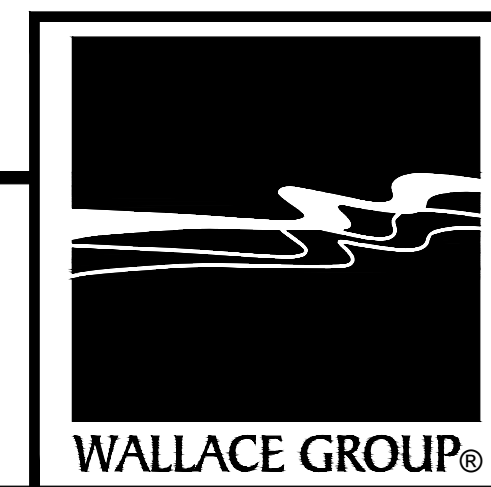

CIVIL AND TRANSPORTATION ENGINEERING
 CONSTRUCTION MANAGEMENT
 LANDSCAPE ARCHITECTURE
 MECHANICAL ENGINEERING
 PLANNING
 PUBLIC WORKS ADMINISTRATION
 SURVEYING / GIS SOLUTIONS
 WATER RESOURCES

612 CLARION COURT
 SAN LUIS OBISPO, CA 93401
 T 805 544-4011 F 805 544-4294
 www.wallacegroup.us

PROJECT ENGINEER _____
 PLANS APPROVAL DATE _____

REVISIONS						
NO.	BY	DATE	DESCRIPTION	APPROVED BY	DATE	

ACCEPTED BY THE CITY CAPITAL PROJECTS ENGINEER

JOSIE LANTACA RCE: RCE_NO

BORONDA RD CONGESTION RELIEF PROJECT (ULTIMATE CONCEPT)						
LAYOUT						
L-7						
DESIGNED BY	DRAWN BY	CHECKED BY	JOB NUMBER	SHEET	OF	
SMH	SMH	JAA	0886-0009	14	32	
DISREGARD PRINTS BEARING EARLIER REVISION DATE			REVISION DATES (PRELIMINARY STAGE ONLY)			

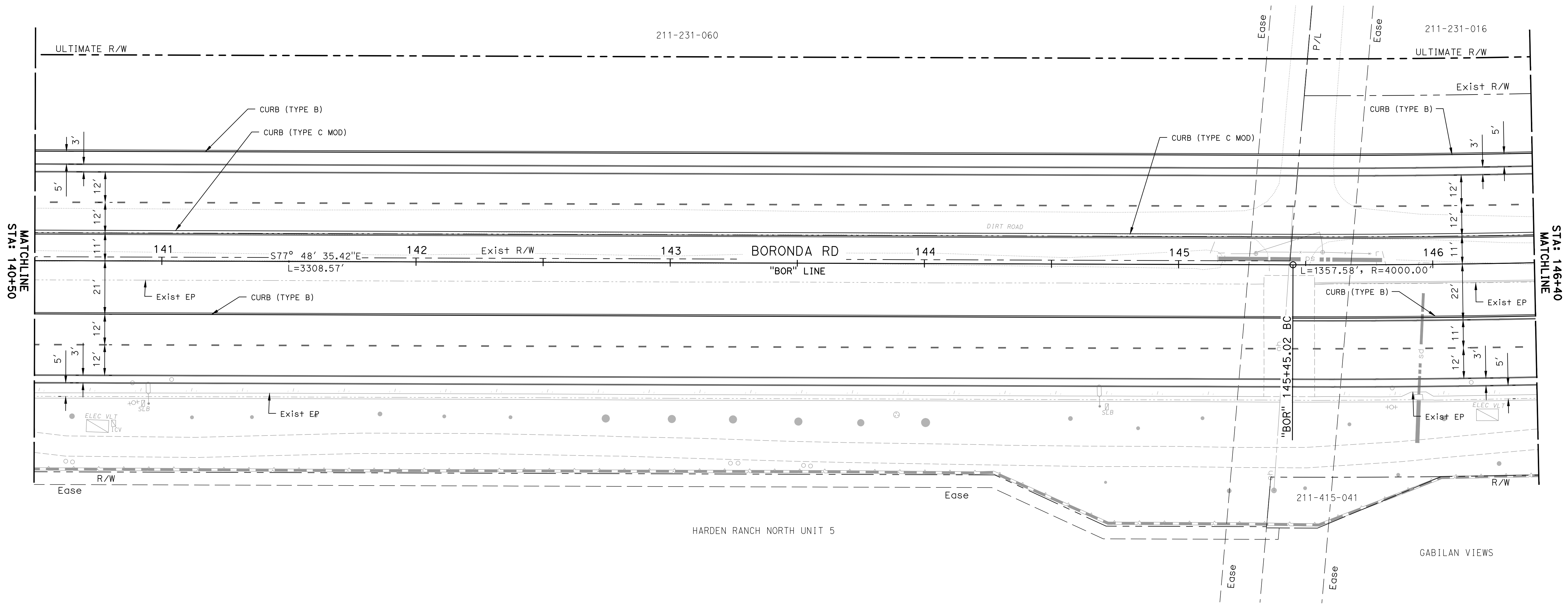
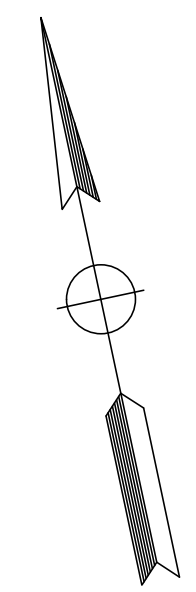

FILE NAME: 0886-0009_UIT-LAY-01.DWG
PLOT DATE: 6/8/2020 6:37 PM
BY: SARAH HUFFMAN



CITY OF SALINAS
PUBLIC WORKS DEPARTMENT
200 LINCOLN AVENUE
SALINAS, CA 93908

SCALE: 1" = 20'
ORIGINAL SCALE IN INCHES
FOR REDUCED PLANS

WALLACE GROUP®

CIVIL AND TRANSPORTATION ENGINEERING
CONSTRUCTION MANAGEMENT
LANDSCAPE ARCHITECTURE
MECHANICAL ENGINEERING
PLANNING
PUBLIC WORKS ADMINISTRATION
SURVEYING / GIS SOLUTIONS
WATER RESOURCES

612 CLARION COURT
SAN LUIS OBISPO, CA 93401
T 805 544-4011 F 805 544-4294
www.wallacegroup.us

PROJECT ENGINEER _____
PLANS APPROVAL DATE _____

REVISIONS					
NO.	BY	DATE	DESCRIPTION	APPROVED BY	DATE

ACCEPTED BY THE CITY CAPITAL PROJECTS ENGINEER

JOSIE LANTACA RCE: RCE_NO

BORONDA RD CONGESTION RELIEF PROJECT (ULTIMATE CONCEPT)

LAYOUT

L-8

DESIGNED BY SMH	DRAWN BY SMH	CHECKED BY JAA	JOB NUMBER 0886-0009	SHEET 15	OF 32
DISREGARD PRINTS BEARING EARLIER REVISION DATE			REVISION DATES (PRELIMINARY STAGE ONLY)		

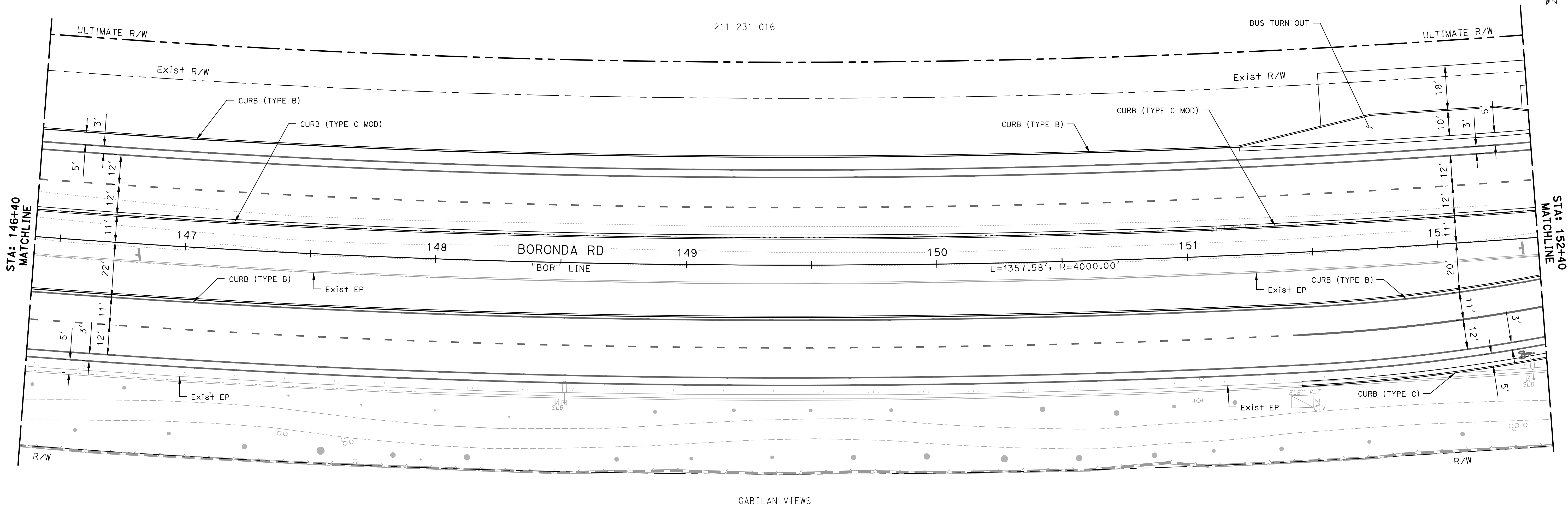
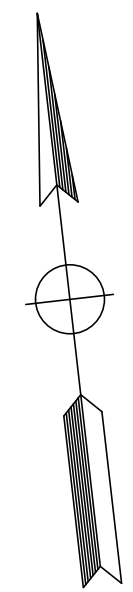

STA: 146+40
MATCHLINE

STA: 152+40
MATCHLINE

211-231-016

BORONDA RD

"BOR" LINE

L=1357.58', R=4000.00'

GABILAN VIEWS

FILE NAME: 0886-0009_UIT-LAY-01.DWG
PLOT DATE: 6/8/2020 6:37 PM
BY: SARAH HUFFMAN



CITY OF SALINAS
PUBLIC WORKS DEPARTMENT
200 LINCOLN AVENUE
SALINAS, CA 93908

SCALE: 1" = 20'
ORIGINAL SCALE IN INCHES
FOR REDUCED PLANS

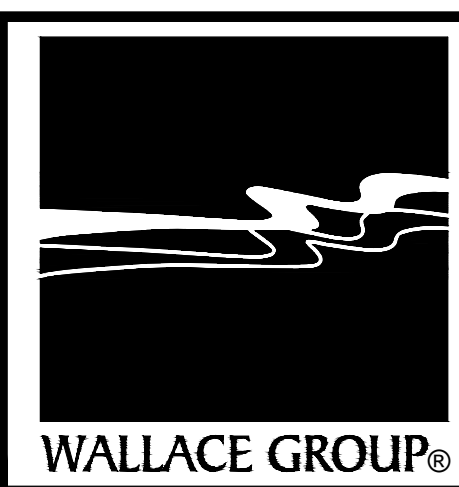

CIVIL AND TRANSPORTATION ENGINEERING
CONSTRUCTION MANAGEMENT
LANDSCAPE ARCHITECTURE
MECHANICAL ENGINEERING
PLANNING
PUBLIC WORKS ADMINISTRATION
SURVEYING / GIS SOLUTIONS
WATER RESOURCES

612 CLARION COURT
SAN LUIS OBISPO, CA 93401
T 805 544-4011 F 805 544-4294
www.wallacegroup.us

PROJECT ENGINEER

PLANS APPROVAL DATE



REVISIONS						
NO.	BY	DATE	DESCRIPTION	APPROVED BY	DATE	

ACCEPTED BY THE CITY CAPITAL PROJECTS ENGINEER

JOSIE LANTACA RCE: RCE_NO

BORONDA RD CONGESTION RELIEF PROJECT (ULTIMATE CONCEPT)						
LAYOUT						
L-9						
DESIGNED BY	DRAWN BY	CHECKED BY	JOB NUMBER	SHEET	OF	
SMH	SMH	JAA	0886-0009	16	32	
DISREGARD PRINTS BEARING EARLIER REVISION DATE			REVISION DATES (PRELIMINARY STAGE ONLY)			

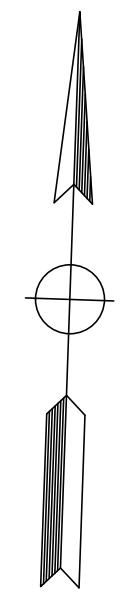
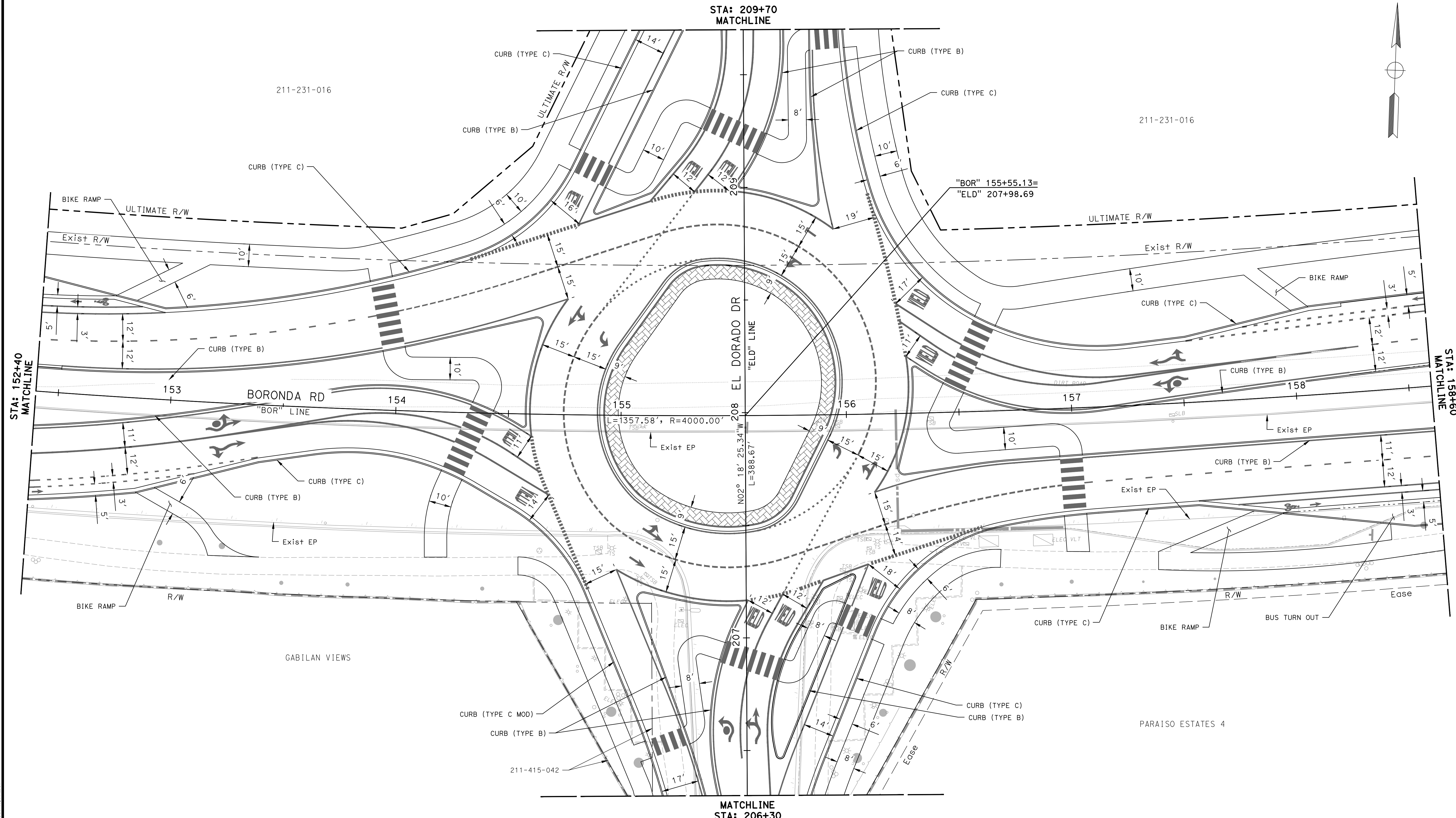

FILE NAME: 0886-0009_UJT-LAY-01.DWG
 PLOT DATE: 6/8/2020 6:37 PM
 BY: SARAH HUFFMAN



CITY OF SALINAS
 PUBLIC WORKS DEPARTMENT
 200 LINCOLN AVENUE
 SALINAS, CA 93908

SCALE: 1" = 20'
 ORIGINAL SCALE IN INCHES
 FOR REDUCED PLANS

WALLACE GROUP

CIVIL AND TRANSPORTATION ENGINEERING
 CONSTRUCTION MANAGEMENT
 LANDSCAPE ARCHITECTURE
 MECHANICAL ENGINEERING
 PLANNING
 PUBLIC WORKS ADMINISTRATION
 SURVEYING / GIS SOLUTIONS
 WATER RESOURCES

612 CLARION COURT
 SAN LUIS OBISPO, CA 93401
 T 805 544-4011 F 805 544-4294
 www.wallacegroup.us

PROJECT ENGINEER
 PLANS APPROVAL DATE

SARAH M. HUFFMAN
 No. 85233
 REGISTERED PROFESSIONAL ENGINEER
 CIVIL
 STATE OF CALIFORNIA
 FOR PLAN REVIEW ONLY
 NOT FOR CONSTRUCTION

REVISIONS					
NO.	BY	DATE	DESCRIPTION	APPROVED BY	DATE

ACCEPTED BY THE CITY CAPITAL PROJECTS ENGINEER

JOSIE LANTACA RCE: RCE_NO

BORONDA RD CONGESTION RELIEF PROJECT (ULTIMATE CONCEPT)

LAYOUT

L-10

DESIGNED BY	DRAWN BY	CHECKED BY	JOB NUMBER	SHEET	OF
SMH	SMH	JAA	0886-0009	17	32

DISREGARD PRINTS BEARING EARLIER REVISION DATE

REVISION DATES (PRELIMINARY STAGE ONLY)

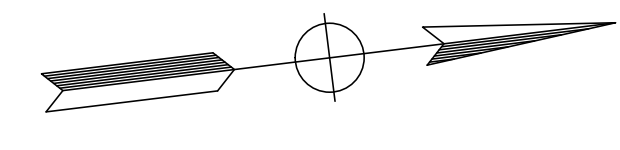
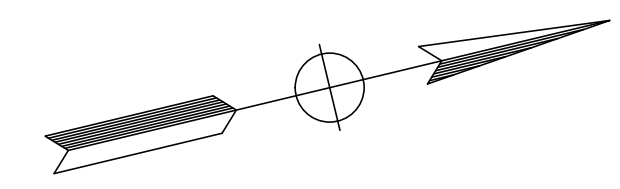
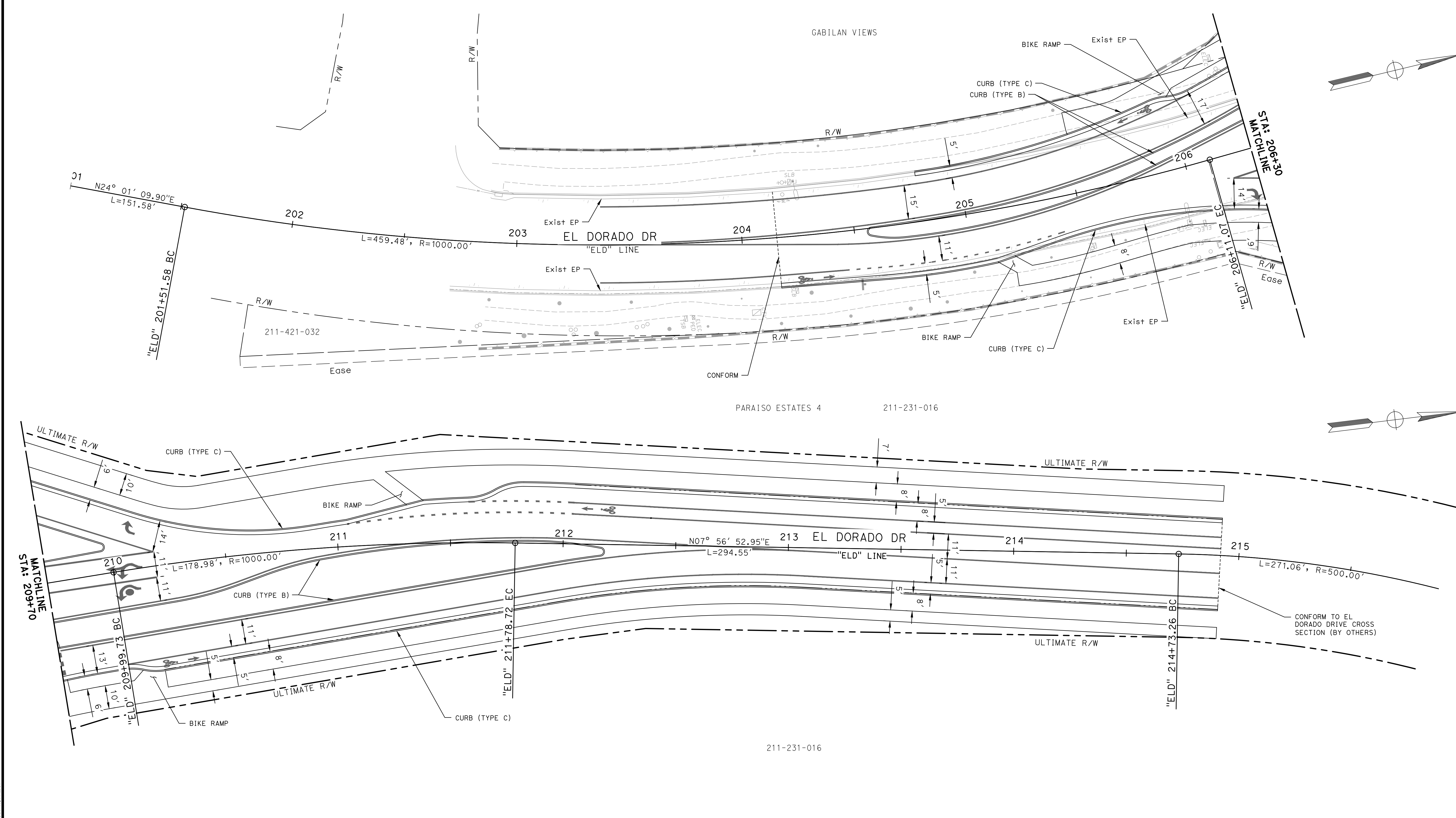

FILE NAME: 0886-0009_UJT-LAY-01.DWG
 PLOT DATE: 6/8/2020 6:37 PM
 BY: SARAH HUFFMAN



CITY OF SALINAS
 PUBLIC WORKS DEPARTMENT
 200 LINCOLN AVENUE
 SALINAS, CA 93908

SCALE: 1" = 20'
 ORIGINAL SCALE IN INCHES
 FOR REDUCED PLANS

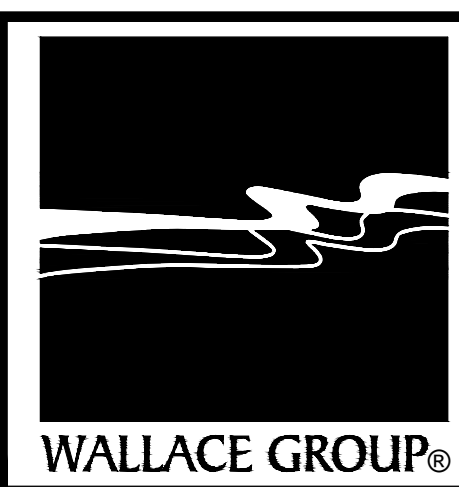

CIVIL AND TRANSPORTATION ENGINEERING
 CONSTRUCTION MANAGEMENT
 LANDSCAPE ARCHITECTURE
 MECHANICAL ENGINEERING
 PLANNING
 PUBLIC WORKS ADMINISTRATION
 SURVEYING / GIS SOLUTIONS
 WATER RESOURCES
 612 CLARION COURT
 SAN LUIS OBISPO, CA 93401
 T 805 544-4011 F 805 544-4294
 www.wallacegroup.us

PROJECT ENGINEER
 PLANS APPROVAL DATE



REVISIONS					
NO.	BY	DATE	DESCRIPTION	APPROVED BY	DATE

ACCEPTED BY THE CITY CAPITAL PROJECTS ENGINEER

JOSIE LANTACA RCE: RCE_NO

BORONDA RD CONGESTION RELIEF PROJECT (ULTIMATE CONCEPT)					
LAYOUT					
L-11					
DESIGNED BY	DRAWN BY	CHECKED BY	JOB NUMBER	SHEET	OF
SMH	SMH	JAA	0886-0009	18	32
DISREGARD PRINTS BEARING EARLIER REVISION DATE			REVISION DATES (PRELIMINARY STAGE ONLY)		

211-231-016

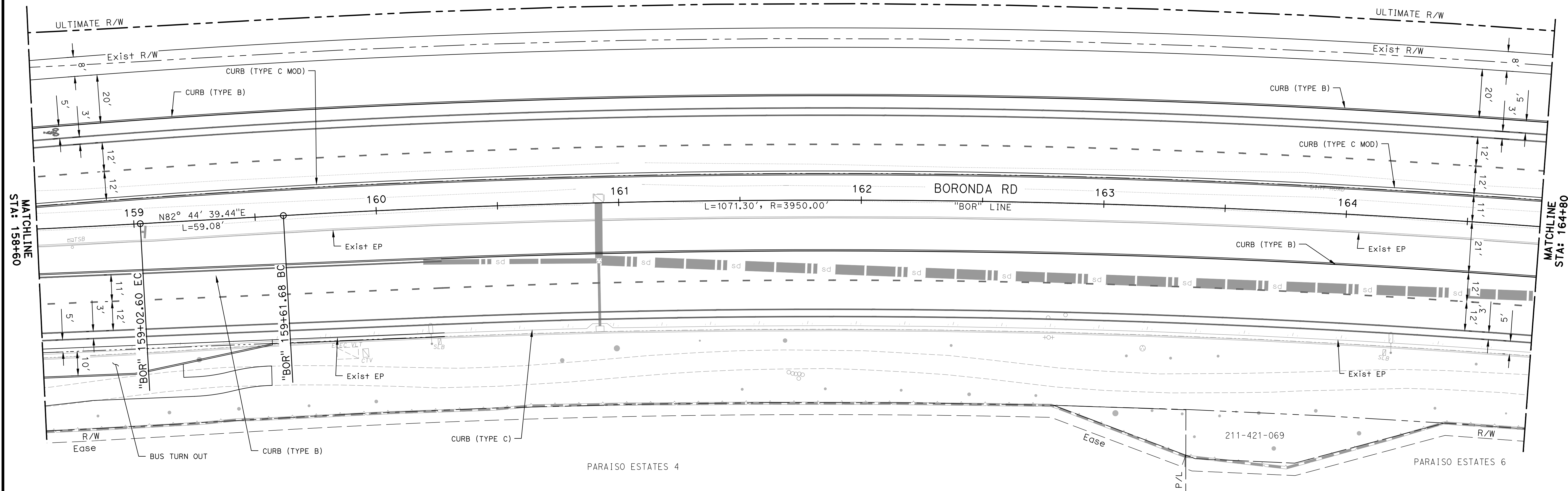
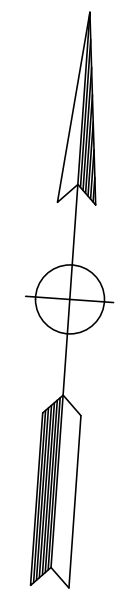

MATCHLINE
STA: 158+60

MATCHLINE
STA: 164+80

FILE NAME: 0886-0009_UJT-LAY-01.DWG
PLOT DATE: 6/8/2020 6:37 PM
BY: SARAH HUFFMAN



CITY OF SALINAS
PUBLIC WORKS DEPARTMENT
200 LINCOLN AVENUE
SALINAS, CA 93908

SCALE: 1" = 20'
ORIGINAL SCALE IN INCHES
FOR REDUCED PLANS

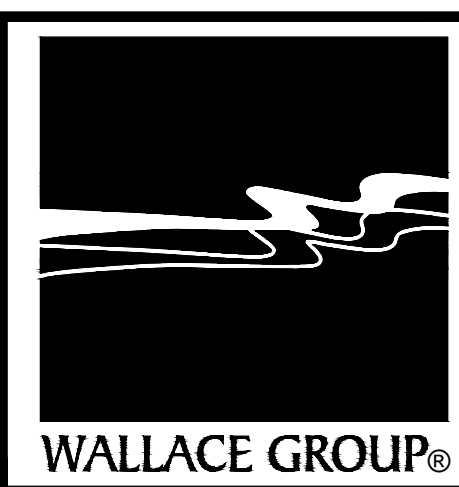

CIVIL AND TRANSPORTATION ENGINEERING
CONSTRUCTION MANAGEMENT
LANDSCAPE ARCHITECTURE
MECHANICAL ENGINEERING
PLANNING
PUBLIC WORKS ADMINISTRATION
SURVEYING / GIS SOLUTIONS
WATER RESOURCES

612 CLARION COURT
SAN LUIS OBISPO, CA 93401
T 805 544-4011 F 805 544-4294
www.wallacegroup.us

PROJECT ENGINEER

PLANS APPROVAL DATE



REVISIONS					
NO.	BY	DATE	DESCRIPTION	APPROVED BY	DATE

ACCEPTED BY THE CITY CAPITAL PROJECTS ENGINEER

JOSIE LANTACA RCE: RCE_NO

BORONDA RD CONGESTION RELIEF PROJECT (ULTIMATE CONCEPT)					
LAYOUT					
L-12					
DESIGNED BY	DRAWN BY	CHECKED BY	JOB NUMBER	SHEET	OF
SMH	SMH	JAA	0886-0009	19	32
DISREGARD PRINTS BEARING EARLIER REVISION DATE			REVISION DATES (PRELIMINARY STAGE ONLY)		

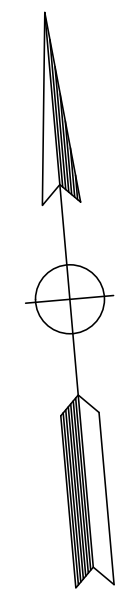

211-231-016

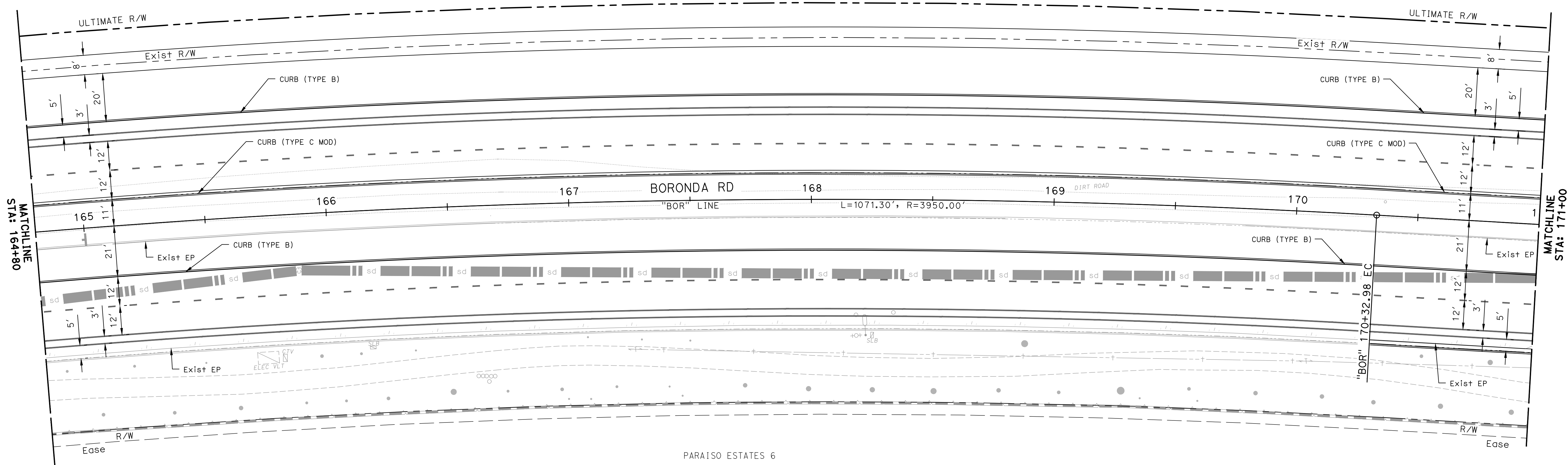

FILE NAME: 0886-0009_Ult-LAY-01.DWG
PLOT DATE: 6/8/2020 6:38 PM BY: SARAH HUFFMAN



CITY OF SALINAS
 PUBLIC WORKS DEPARTMENT
 200 LINCOLN AVENUE
 SALINAS, CA 93908

SCALE: 1" = 20'
 ORIGINAL SCALE IN INCHES
 FOR REDUCED PLANS

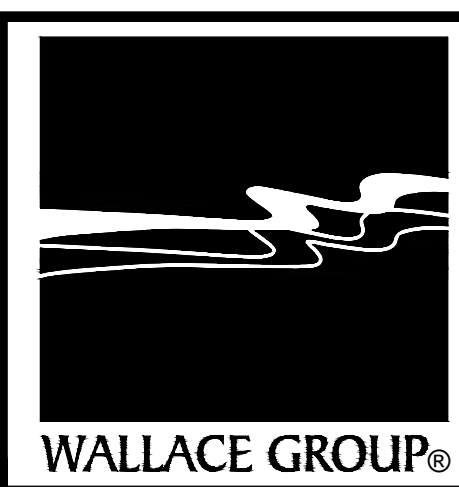

CIVIL AND TRANSPORTATION ENGINEERING
 CONSTRUCTION MANAGEMENT
 LANDSCAPE ARCHITECTURE
 MECHANICAL ENGINEERING
 PLANNING
 PUBLIC WORKS ADMINISTRATION
 SURVEYING / GIS SOLUTIONS
 WATER RESOURCES

612 CLARION COURT
 SAN LUIS OBISPO, CA 93401
 T 805 544-4011 F 805 544-4294
 www.wallacegroup.us

PROJECT ENGINEER
 PLANS APPROVAL DATE

REVISIONS						
NO.	BY	DATE	DESCRIPTION	APPROVED BY	DATE	
△						
△						
△						

ACCEPTED BY THE CITY CAPITAL PROJECTS ENGINEER

JOSIE LANTACA RCE: RCE_NO

BORONDA RD CONGESTION RELIEF PROJECT (ULTIMATE CONCEPT)						
LAYOUT						
L-13						
DESIGNED BY	DRAWN BY	CHECKED BY	JOB NUMBER	SHEET	OF	
SMH	SMH	JAA	0886-0009	20	32	
DISREGARD PRINTS BEARING EARLIER REVISION DATE			REVISION DATES (PRELIMINARY STAGE ONLY)			

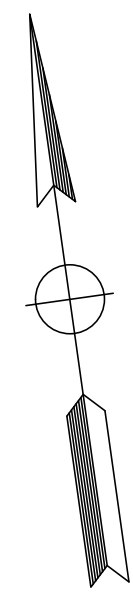

211-231-016

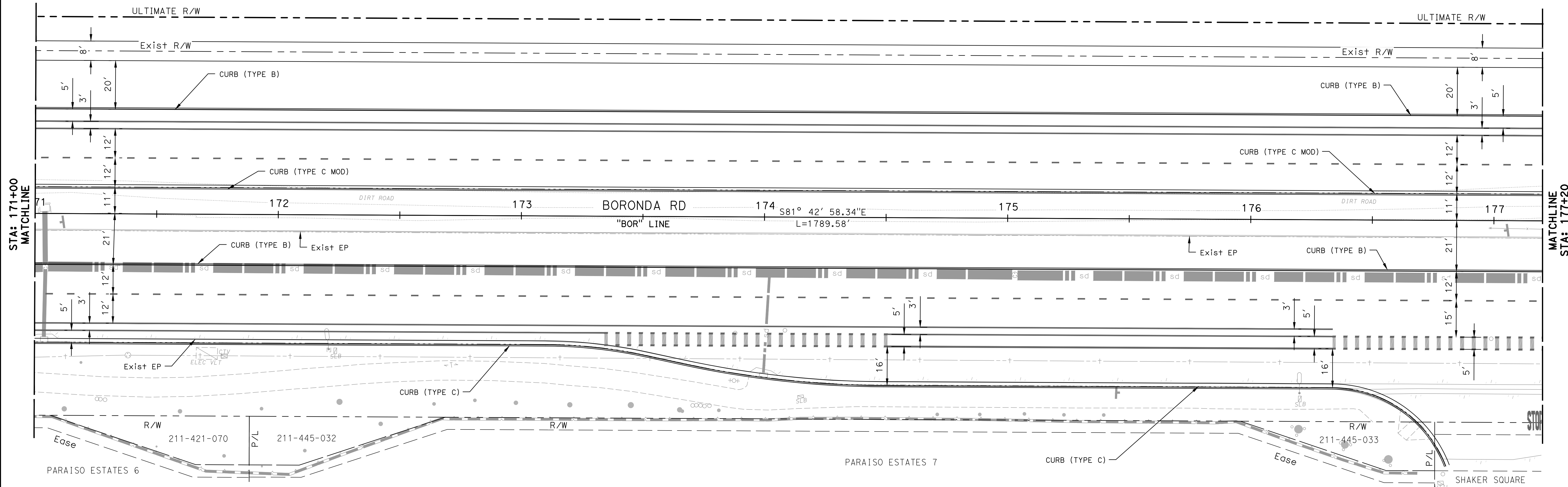

STA: 171+00
MATCHLINE

MATCHLINE
STA: 177+20

FILE NAME: 0886-0009_Ult-LAY-01.DWG
PLOT DATE: 6/8/2020 6:38 PM
BY: SARAH HUFFMAN



CITY OF SALINAS
PUBLIC WORKS DEPARTMENT
200 LINCOLN AVENUE
SALINAS, CA 93908

SCALE: 1" = 20'
ORIGINAL SCALE IN INCHES
FOR REDUCED PLANS

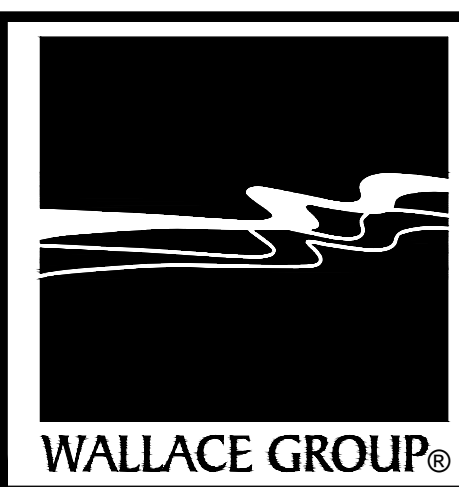

CIVIL AND TRANSPORTATION ENGINEERING
CONSTRUCTION MANAGEMENT
LANDSCAPE ARCHITECTURE
MECHANICAL ENGINEERING
PLANNING
PUBLIC WORKS ADMINISTRATION
SURVEYING / GIS SOLUTIONS
WATER RESOURCES

612 CLARION COURT
SAN LUIS OBISPO, CA 93401
T 805 544-4011 F 805 544-4294
www.wallacegroup.us

PROJECT ENGINEER
PLANS APPROVAL DATE

REVISIONS						
NO.	BY	DATE	DESCRIPTION	APPROVED BY	DATE	

ACCEPTED BY THE CITY CAPITAL PROJECTS ENGINEER

JOSIE LANTACA RCE: RCE_NO

BORONDA RD CONGESTION RELIEF PROJECT (ULTIMATE CONCEPT)						
LAYOUT						
L-14						
DESIGNED BY	DRAWN BY	CHECKED BY	JOB NUMBER	SHEET	OF	
SMH	SMH	JAA	0886-0009	21	32	
DISREGARD PRINTS BEARING EARLIER REVISION DATE			REVISION DATES (PRELIMINARY STAGE ONLY)			

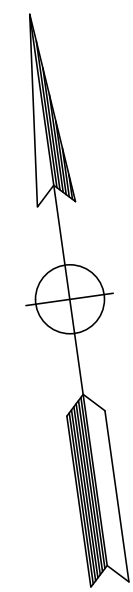

211-231-016

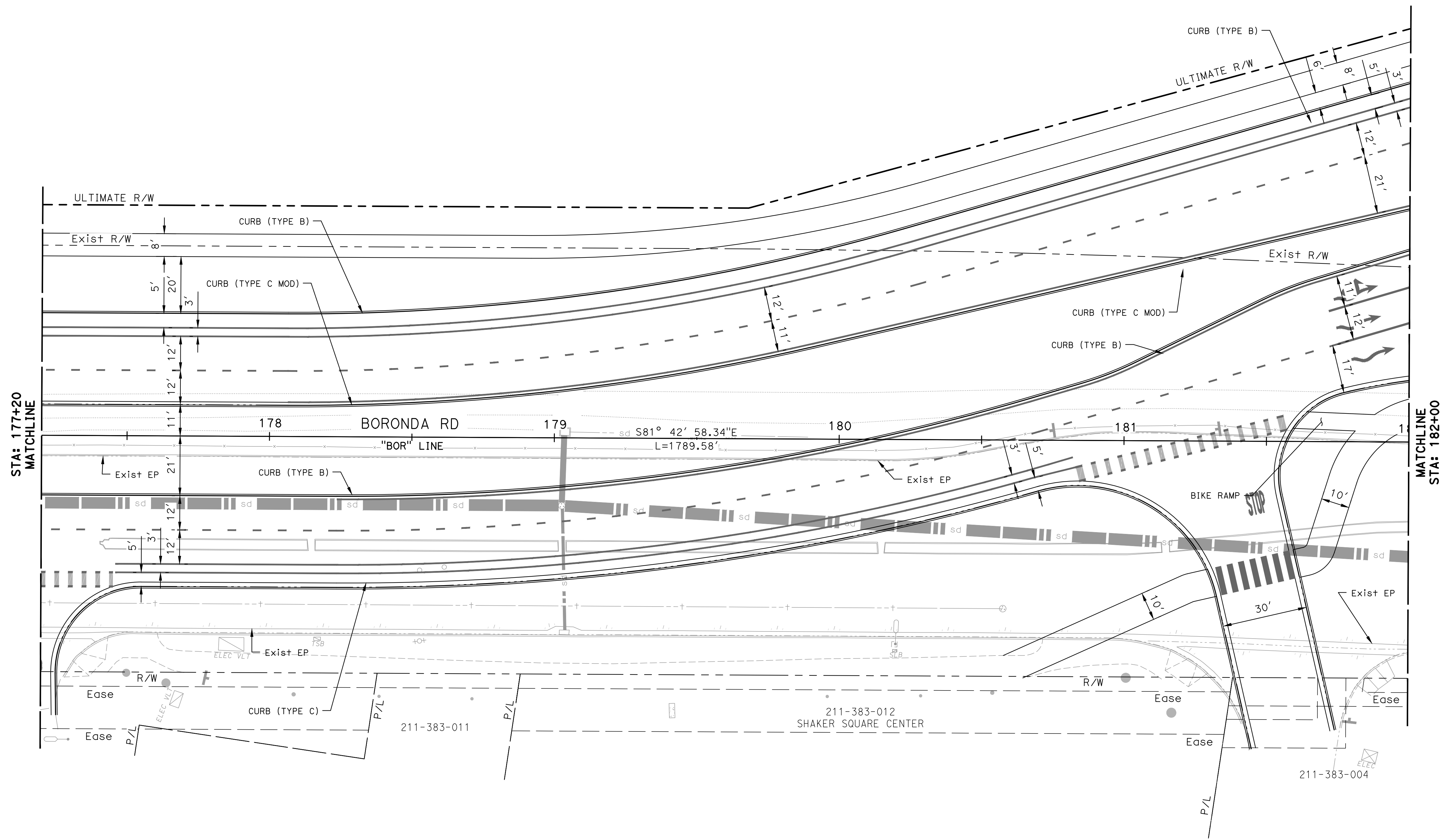

STA: 177+20
MATCHLINE

MATCHLINE
STA: 182+00

FILE NAME: 0886-0009_UJT-LAY-01.DWG
PLOT DATE: 6/8/2020 6:38 PM
BY: SARAH HUFFMAN



CITY OF SALINAS
PUBLIC WORKS DEPARTMENT
200 LINCOLN AVENUE
SALINAS, CA 93908

SCALE: 1" = 20'
ORIGINAL SCALE IN INCHES
FOR REDUCED PLANS

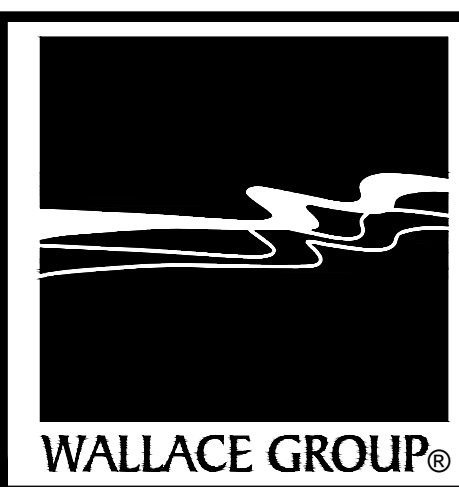

CIVIL AND TRANSPORTATION ENGINEERING
CONSTRUCTION MANAGEMENT
LANDSCAPE ARCHITECTURE
MECHANICAL ENGINEERING
PLANNING
PUBLIC WORKS ADMINISTRATION
SURVEYING / GIS SOLUTIONS
WATER RESOURCES

612 CLARION COURT
SAN LUIS OBISPO, CA 93401
T 805 544-4011 F 805 544-4294
www.wallacegroup.us

PROJECT ENGINEER
PLANS APPROVAL DATE



REVISIONS					
NO.	BY	DATE	DESCRIPTION	APPROVED BY	DATE

ACCEPTED BY THE CITY CAPITAL PROJECTS ENGINEER

JOSIE LANTACA RCE: RCE_NO

BORONDA RD CONGESTION RELIEF PROJECT (ULTIMATE CONCEPT)					
LAYOUT					
L-15					
DESIGNED BY	DRAWN BY	CHECKED BY	JOB NUMBER	SHEET	OF
SMH	SMH	JAA	0886-0009	22	32
DISREGARD PRINTS BEARING EARLIER REVISION DATE			REVISION DATES (PRELIMINARY STAGE ONLY)		

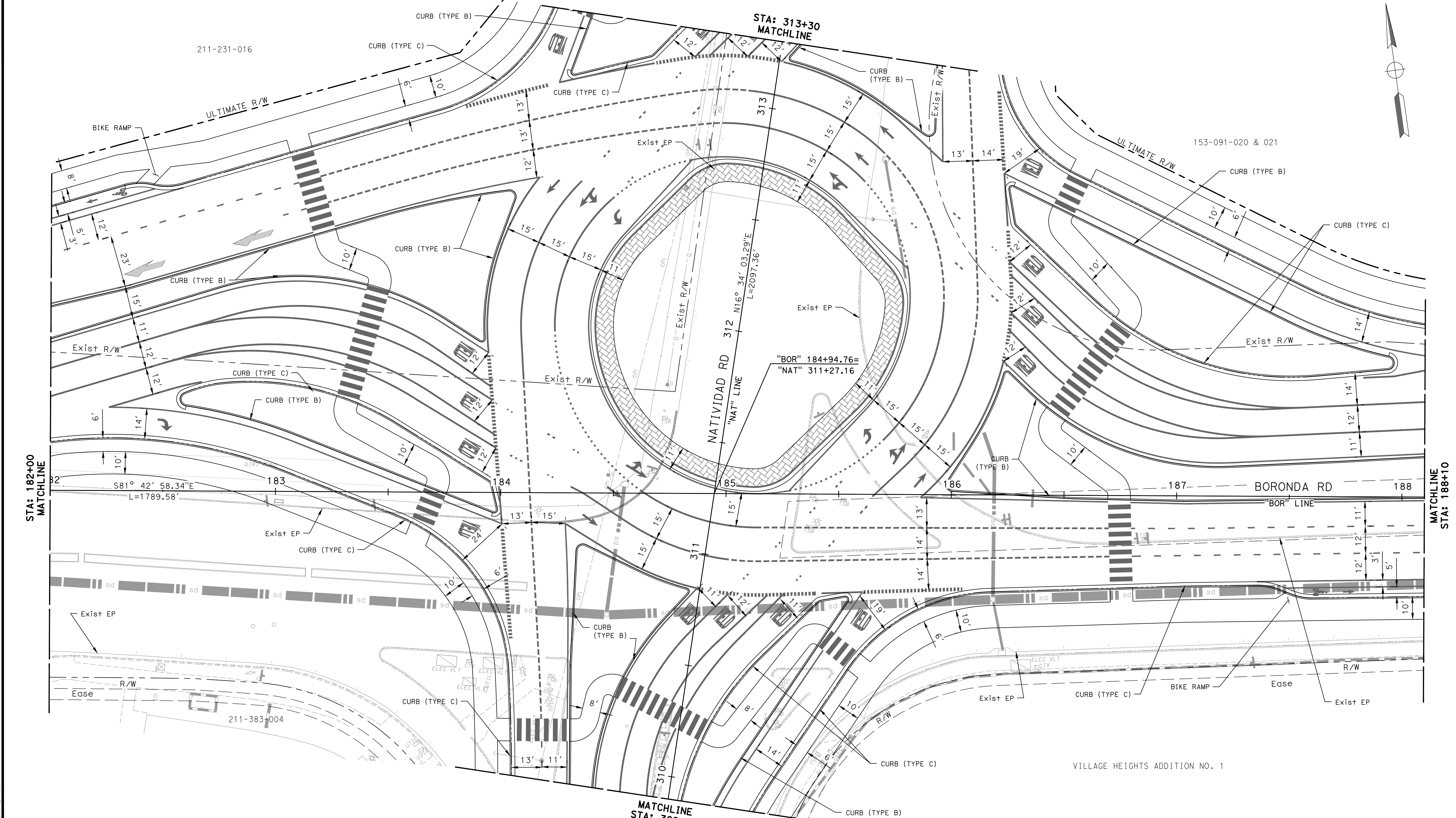

FILE NAME: 0886-0009_Ult-LAY-01.DWG
 PLOT DATE: 6/8/2020 6:38 PM
 BY: SARAH HUFFMAN



CITY OF SALINAS
 PUBLIC WORKS DEPARTMENT
 200 LINCOLN AVENUE
 SALINAS, CA 93908

SCALE: 1" = 20'
 ORIGINAL SCALE IN INCHES
 FOR REDUCED PLANS

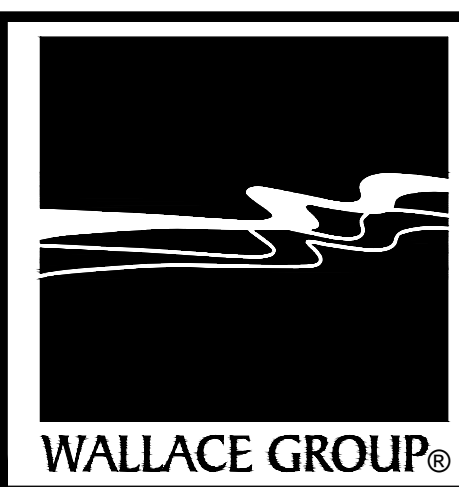

CIVIL AND TRANSPORTATION ENGINEERING
 CONSTRUCTION MANAGEMENT
 LANDSCAPE ARCHITECTURE
 MECHANICAL ENGINEERING
 PLANNING
 PUBLIC WORKS ADMINISTRATION
 SURVEYING / GIS SOLUTIONS
 WATER RESOURCES
 612 CLARION COURT
 SAN LUIS OBISPO, CA 93401
 T 805 544-4011 F 805 544-4294
 www.wallacegroup.us

PROJECT ENGINEER
 PLANS APPROVAL DATE

REGISTERED PROFESSIONAL ENGINEER
 SARAH M. HUFFMAN
 No. 85233
**FOR PLAN REVIEW ONLY
 NOT FOR CONSTRUCTION**
 CIVIL
 STATE OF CALIFORNIA

REVISIONS						
NO.	BY	DATE	DESCRIPTION	APPROVED BY	DATE	

ACCEPTED BY THE CITY CAPITAL PROJECTS ENGINEER

JOSIE LANTACA RCE: RCE_NO

BORONDA RD CONGESTION RELIEF PROJECT (ULTIMATE CONCEPT)						
LAYOUT						
L-16						
DESIGNED BY	DRAWN BY	CHECKED BY	JOB NUMBER	SHEET	OF	
SMH	SMH	JAA	0886-0009	23	32	
DISREGARD PRINTS BEARING EARLIER REVISION DATE			REVISION DATES (PRELIMINARY STAGE ONLY)			

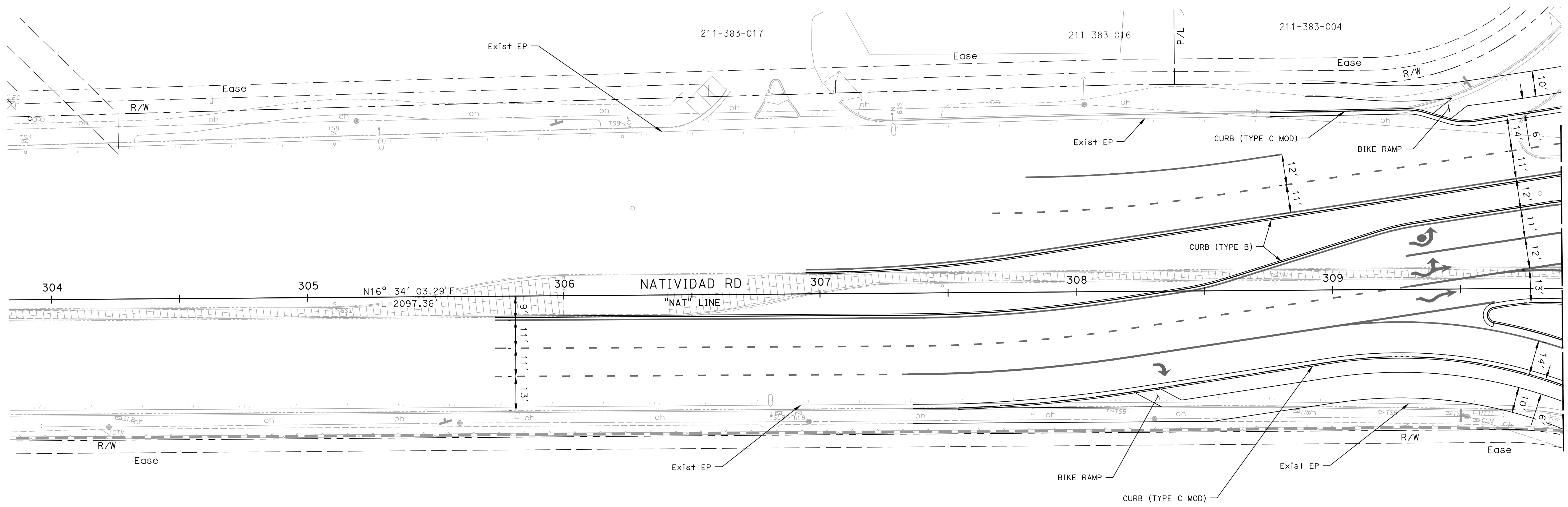
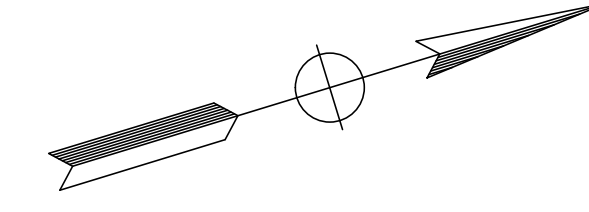

MATCHLINE
STA: 309+90

VILLAGE HEIGHTS ADDITION NO. 1

FILE NAME: 0886-0009_U1-LAY-01.DWG
PLOT DATE: 6/8/2020 6:38 PM
BY: SARAH HUFFMAN



CITY OF SALINAS
PUBLIC WORKS DEPARTMENT
200 LINCOLN AVENUE
SALINAS, CA 93908

SCALE: 1" = 20'
ORIGINAL SCALE IN INCHES
FOR REDUCED PLANS

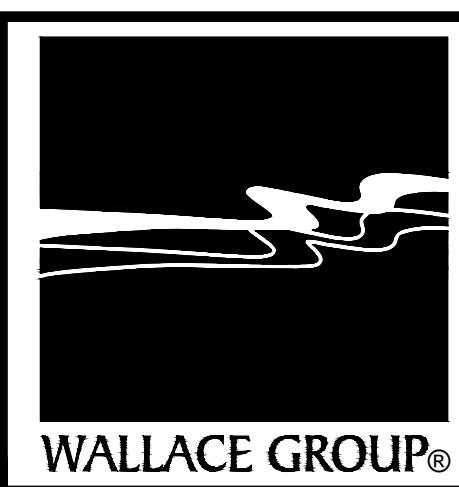

CIVIL AND TRANSPORTATION ENGINEERING
CONSTRUCTION MANAGEMENT
LANDSCAPE ARCHITECTURE
MECHANICAL ENGINEERING
PLANNING
PUBLIC WORKS ADMINISTRATION
SURVEYING / GIS SOLUTIONS
WATER RESOURCES

612 CLARION COURT
SAN LUIS OBISPO, CA 93401
T 805 544-4011 F 805 544-4294
www.wallacegroup.us

PROJECT ENGINEER
PLANS APPROVAL DATE

REVISIONS						
NO.	BY	DATE	DESCRIPTION	APPROVED BY	DATE	

ACCEPTED BY THE CITY CAPITAL PROJECTS ENGINEER

JOSIE LANTACA RCE: RCE_NO

BORONDA RD CONGESTION RELIEF PROJECT (ULTIMATE CONCEPT)						
LAYOUT						
L-17						
DESIGNED BY	DRAWN BY	CHECKED BY	JOB NUMBER	SHEET	OF	
SMH	SMH	JAA	0886-0009	24	32	
DISREGARD PRINTS BEARING EARLIER REVISION DATE			REVISION DATES (PRELIMINARY STAGE ONLY)			

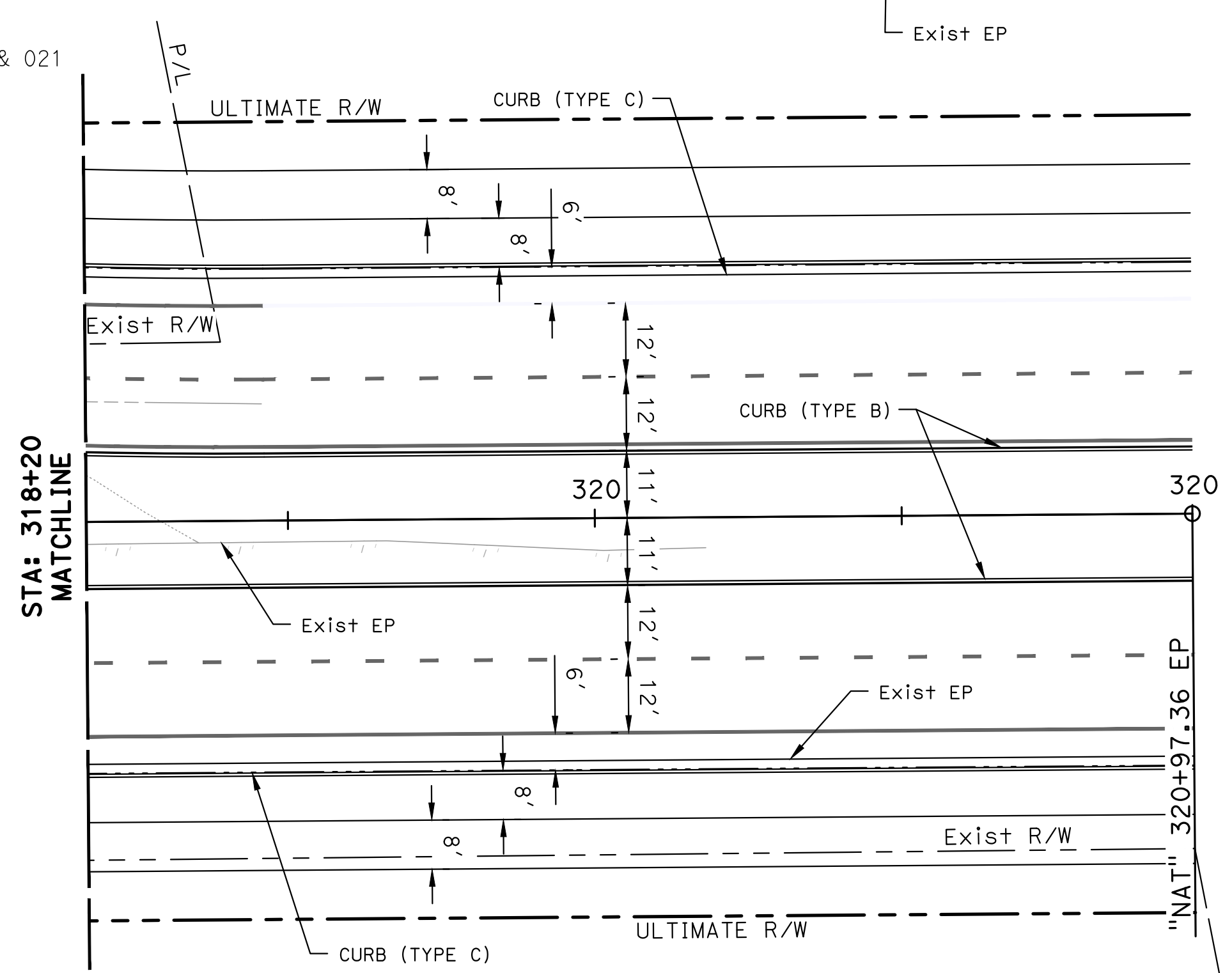
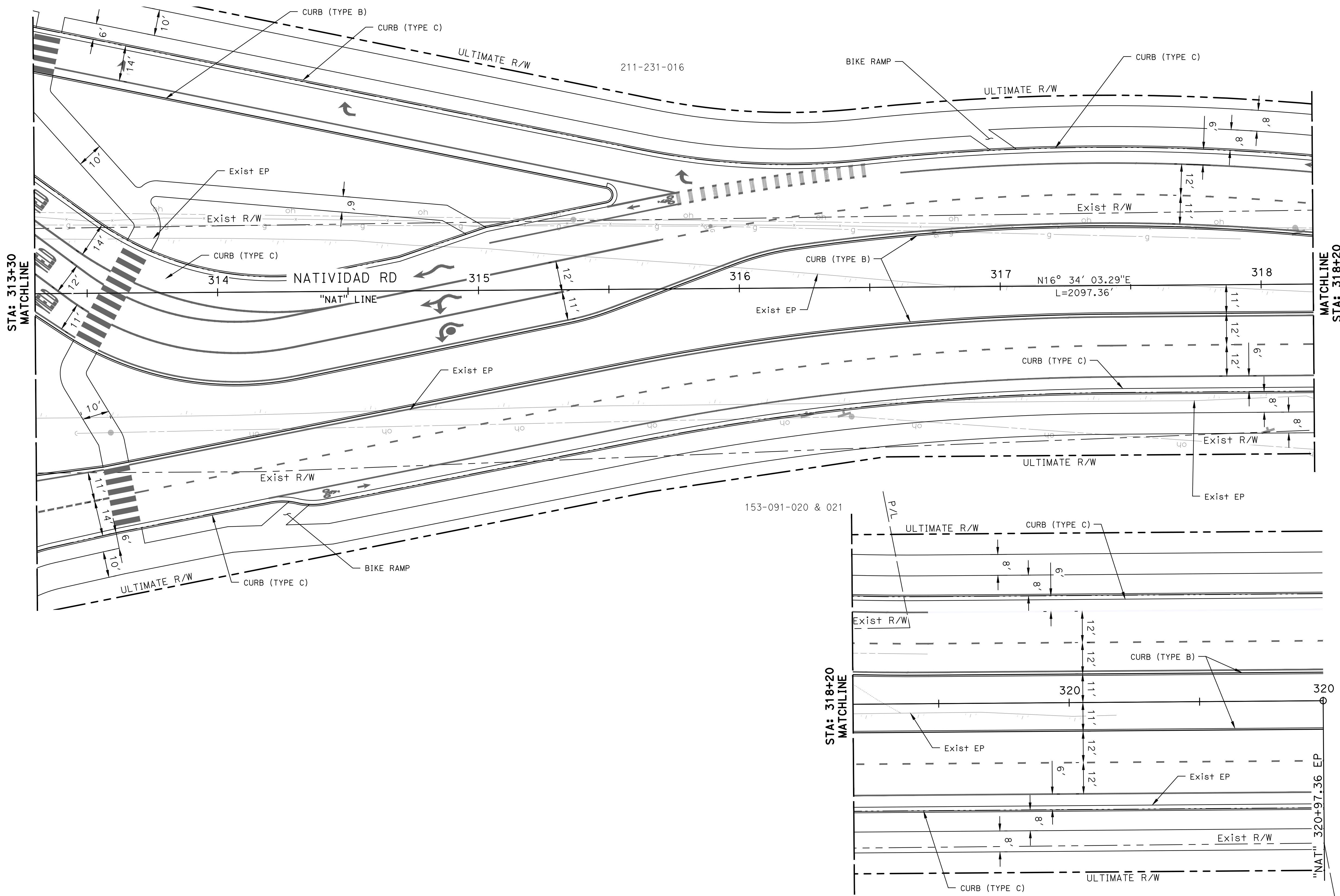
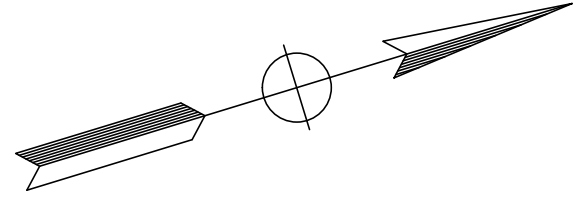

FILE NAME: 0886-0009_UIT-LAY-01.DWG
PLOT DATE: 6/8/2020 6:38 PM
BY: SARAH HUFFMAN



CITY OF SALINAS
PUBLIC WORKS DEPARTMENT
200 LINCOLN AVENUE
SALINAS, CA 93908

SCALE: 1" = 20'
ORIGINAL SCALE IN INCHES
FOR REDUCED PLANS

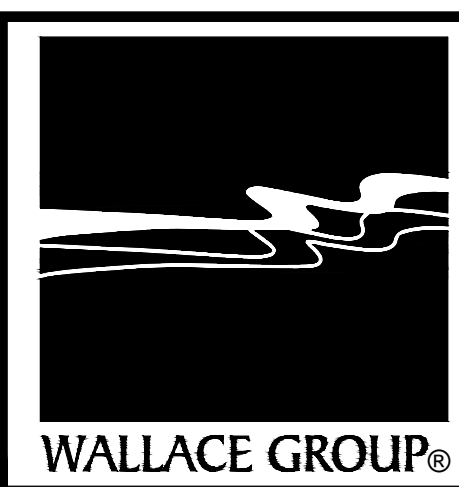

CIVIL AND TRANSPORTATION ENGINEERING
CONSTRUCTION MANAGEMENT
LANDSCAPE ARCHITECTURE
MECHANICAL ENGINEERING
PLANNING
PUBLIC WORKS ADMINISTRATION
SURVEYING / GIS SOLUTIONS
WATER RESOURCES

612 CLARION COURT
SAN LUIS OBISPO, CA 93401
T 805 544-4011 F 805 544-4294
www.wallacegroup.us

PROJECT ENGINEER
PLANS APPROVAL DATE

REVISIONS					
NO.	BY	DATE	DESCRIPTION	APPROVED BY	DATE

ACCEPTED BY THE CITY CAPITAL PROJECTS ENGINEER

JOSIE LANTACA RCE: RCE_NO

BORONDA RD CONGESTION RELIEF PROJECT (ULTIMATE CONCEPT)						
LAYOUT						
L-18						
DESIGNED BY	DRAWN BY	CHECKED BY	JOB NUMBER	SHEET	OF	
SMH	SMH	JAA	0886-0009	25	32	
DISREGARD PRINTS BEARING EARLIER REVISION DATE			REVISION DATES (PRELIMINARY STAGE ONLY)			

153-091-020 & 021

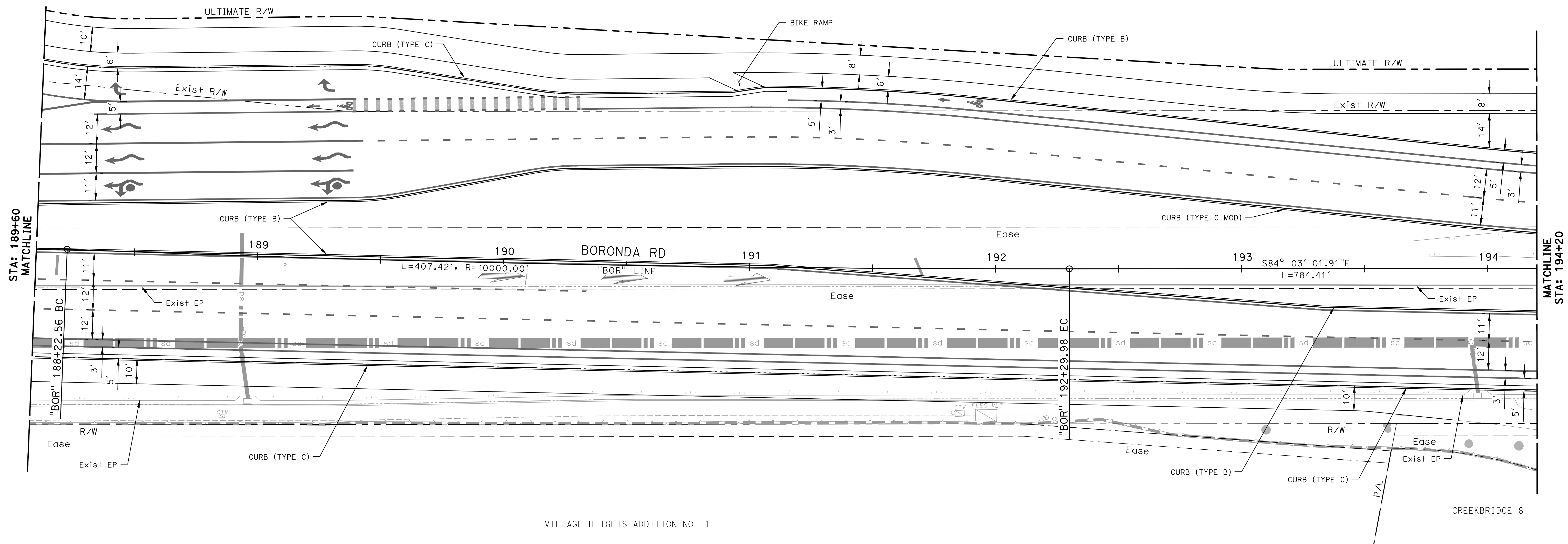
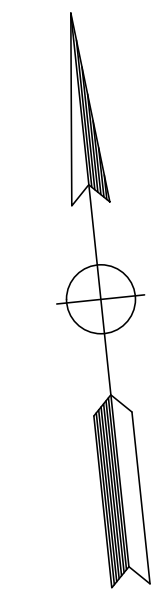

VILLAGE HEIGHTS ADDITION NO. 1

FILE NAME: 0886-0009_Ult-LAY-01.DWG PLOT DATE: 6/8/2020 6:38 PM BY: SARAH HUFFMAN



CITY OF SALINAS
PUBLIC WORKS DEPARTMENT
200 LINCOLN AVENUE
SALINAS, CA 93908

SCALE: 1" = 20'
ORIGINAL SCALE IN INCHES
FOR REDUCED PLANS

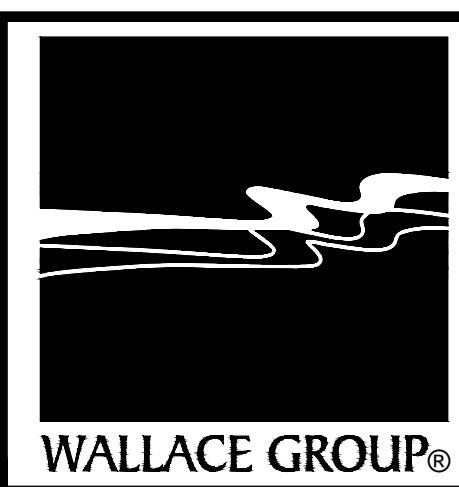

CIVIL AND TRANSPORTATION ENGINEERING
CONSTRUCTION MANAGEMENT
LANDSCAPE ARCHITECTURE
MECHANICAL ENGINEERING
PLANNING
PUBLIC WORKS ADMINISTRATION
SURVEYING / GIS SOLUTIONS
WATER RESOURCES

612 CLARION COURT
SAN LUIS OBISPO, CA 93401
T 805 544-4011 F 805 544-4294
www.wallacegroup.us

PROJECT ENGINEER
PLANS APPROVAL DATE

REVISIONS						
NO.	BY	DATE	DESCRIPTION	APPROVED BY	DATE	

ACCEPTED BY THE CITY CAPITAL PROJECTS ENGINEER

JOSIE LANTACA RCE: RCE_NO

BORONDA RD CONGESTION RELIEF PROJECT (ULTIMATE CONCEPT)						
LAYOUT						
L-19						
DESIGNED BY SMH	DRAWN BY SMH	CHECKED BY JAA	JOB NUMBER 0886-0009	SHEET 26	OF 32	
DISREGARD PRINTS BEARING EARLIER REVISION DATE			REVISION DATES (PRELIMINARY STAGE ONLY)			

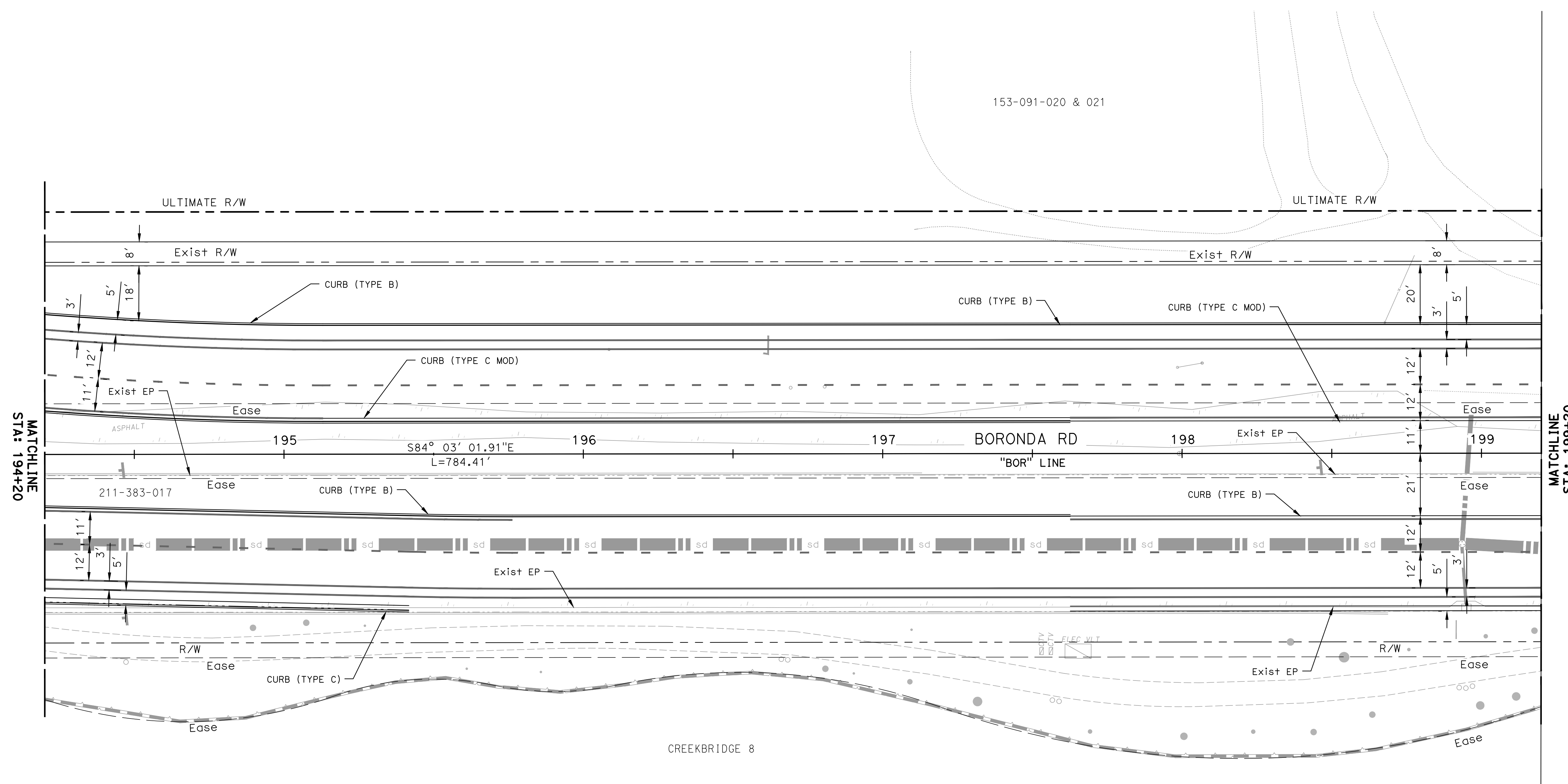
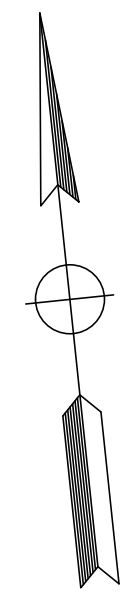

FILE NAME: 0886-0009_UJT-LAY-01.DWG
 PLOT DATE: 6/8/2020 6:38 PM
 BY: SARAH HUFFMAN



CITY OF SALINAS
 PUBLIC WORKS DEPARTMENT
 200 LINCOLN AVENUE
 SALINAS, CA 93908

SCALE: 1" = 20'
 ORIGINAL SCALE IN INCHES
 FOR REDUCED PLANS

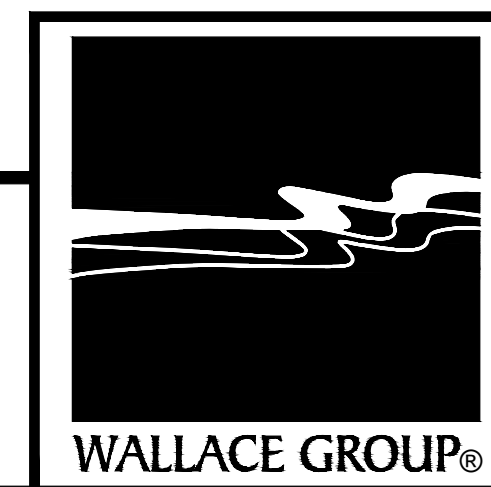

CIVIL AND TRANSPORTATION ENGINEERING
 CONSTRUCTION MANAGEMENT
 LANDSCAPE ARCHITECTURE
 MECHANICAL ENGINEERING
 PLANNING
 PUBLIC WORKS ADMINISTRATION
 SURVEYING / GIS SOLUTIONS
 WATER RESOURCES

612 CLARION COURT
 SAN LUIS OBISPO, CA 93401
 T 805 544-4011 F 805 544-4294
 www.wallacegroup.us

PROJECT ENGINEER
 PLANS APPROVAL DATE

REGISTERED PROFESSIONAL ENGINEER
 SARAH M. HUFFMAN
 No. 85233
 FOR PLAN REVIEW ONLY
 NOT FOR CONSTRUCTION
 CIVIL
 STATE OF CALIFORNIA

REVISIONS						
NO.	BY	DATE	DESCRIPTION	APPROVED BY	DATE	

ACCEPTED BY THE CITY CAPITAL PROJECTS ENGINEER

JOSIE LANTACA RCE: RCE_NO

BORONDA RD CONGESTION RELIEF PROJECT (ULTIMATE CONCEPT)						
LAYOUT						
L-20						
DESIGNED BY	DRAWN BY	CHECKED BY	JOB NUMBER	SHEET	OF	
SMH	SMH	JAA	0886-0009	27	32	
DISREGARD PRINTS BEARING EARLIER REVISION DATE			REVISION DATES (PRELIMINARY STAGE ONLY)			

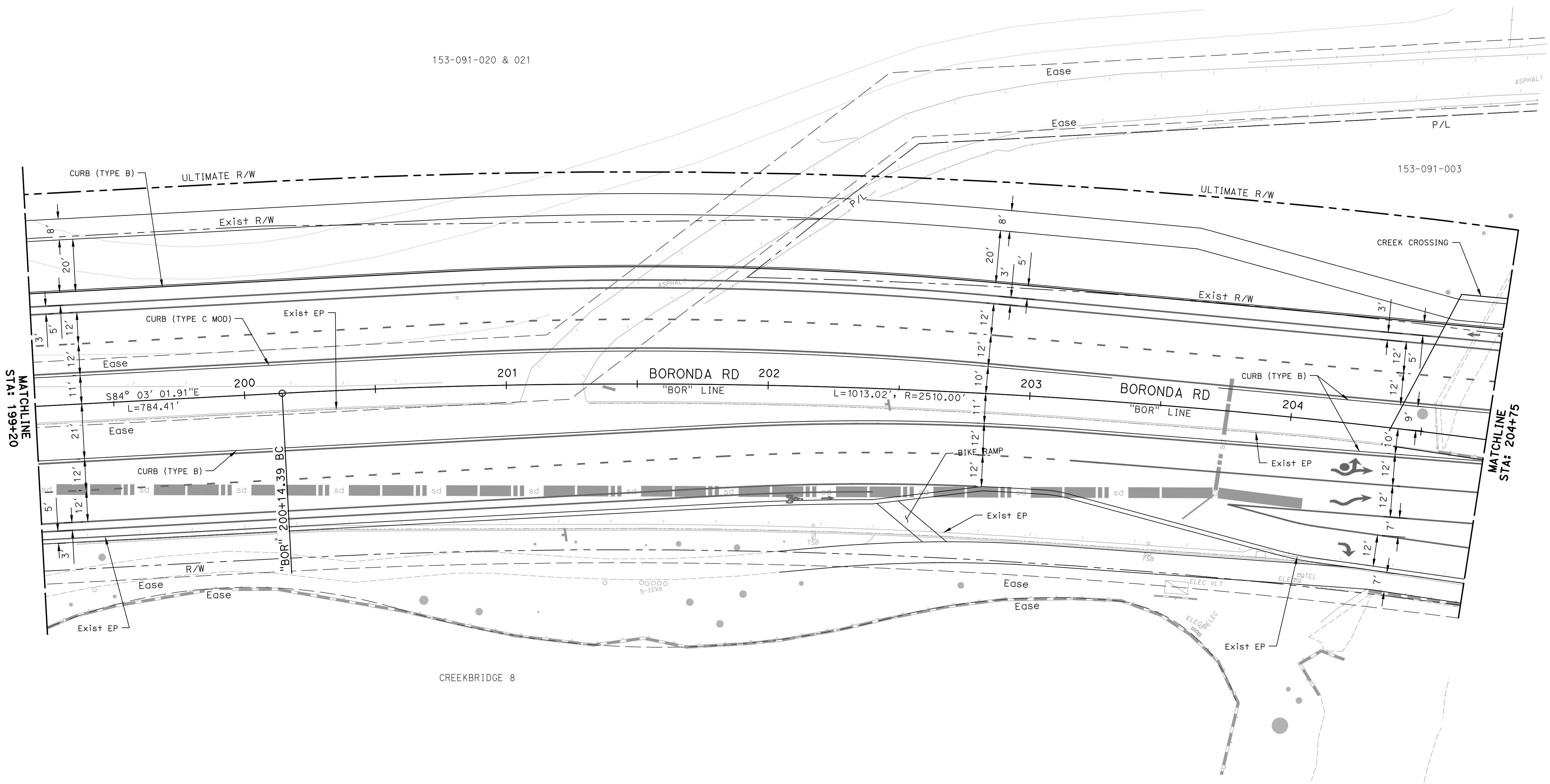
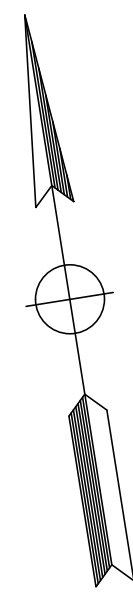

153-091-020 & 021

153-091-003

MATCHLINE
STA: 199+20

MATCHLINE
STA: 204+75

FILE NAME: 0886-0009_UIT-LAY-01.DWG
PLOT DATE: 6/8/2020 6:38 PM
BY: SARAH HUFFMAN



CITY OF SALINAS
PUBLIC WORKS DEPARTMENT
200 LINCOLN AVENUE
SALINAS, CA 93908

SCALE: 1" = 20'
ORIGINAL SCALE IN INCHES
FOR REDUCED PLANS

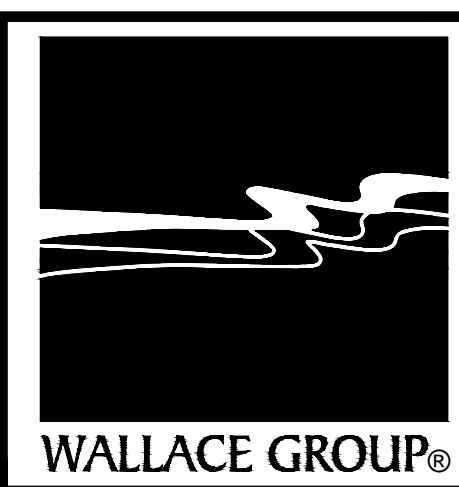

CIVIL AND TRANSPORTATION ENGINEERING
CONSTRUCTION MANAGEMENT
LANDSCAPE ARCHITECTURE
MECHANICAL ENGINEERING
PLANNING
PUBLIC WORKS ADMINISTRATION
SURVEYING / GIS SOLUTIONS
WATER RESOURCES

612 CLARION COURT
SAN LUIS OBISPO, CA 93401
T 805 544-4011 F 805 544-4294
www.wallacegroup.us

PROJECT ENGINEER

PLANS APPROVAL DATE



REVISIONS					
NO.	BY	DATE	DESCRIPTION	APPROVED BY	DATE

ACCEPTED BY THE CITY CAPITAL PROJECTS ENGINEER

JOSIE LANTACA RCE: RCE_NO

BORONDA RD CONGESTION RELIEF PROJECT (ULTIMATE CONCEPT)					
LAYOUT					
L-21					
DESIGNED BY	DRAWN BY	CHECKED BY	JOB NUMBER	SHEET	OF
SMH	SMH	JAA	0886-0009	28	32
DISREGARD PRINTS BEARING EARLIER REVISION DATE			REVISION DATES (PRELIMINARY STAGE ONLY)		

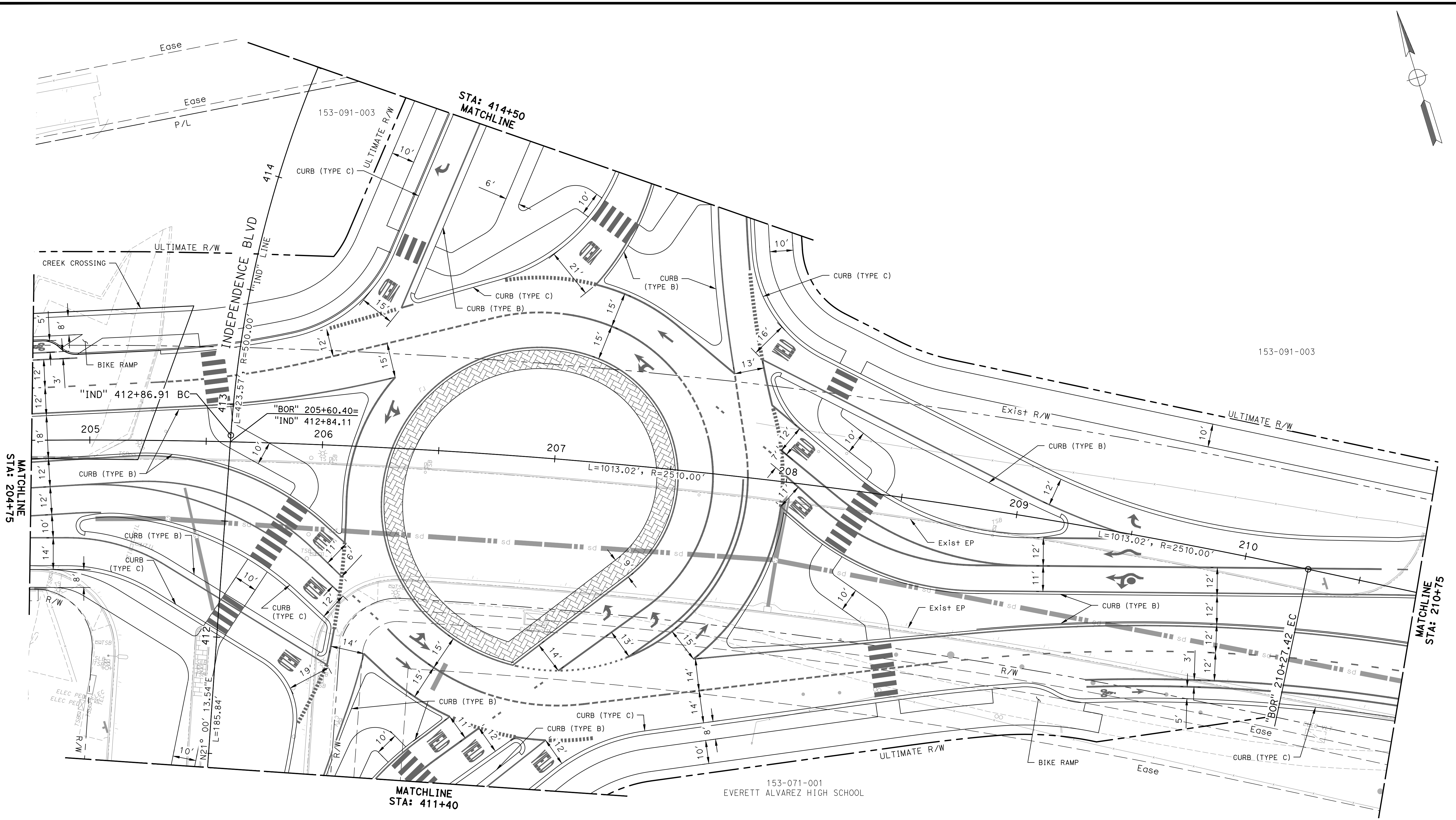
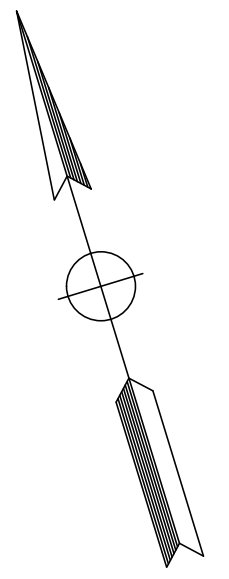

FILE NAME: 0886-0009_UJT-LAY-01.DWG PLOT DATE: 6/8/2020 6:38 PM BY: SARAH HUFFMAN



CITY OF SALINAS
 PUBLIC WORKS DEPARTMENT
 200 LINCOLN AVENUE
 SALINAS, CA 93908

SCALE: 1" = 20'
 ORIGINAL SCALE IN INCHES
 FOR REDUCED PLANS

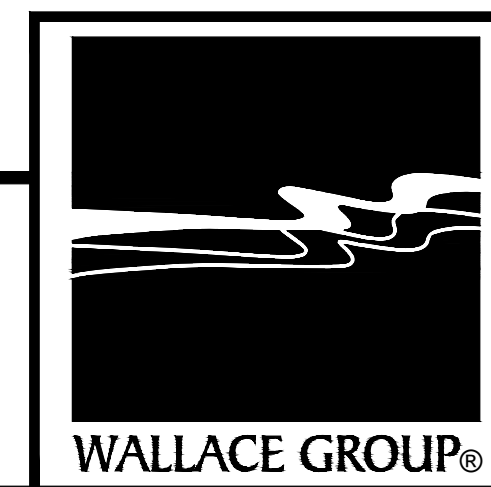

CIVIL AND TRANSPORTATION ENGINEERING
 CONSTRUCTION MANAGEMENT
 LANDSCAPE ARCHITECTURE
 MECHANICAL ENGINEERING
 PLANNING
 PUBLIC WORKS ADMINISTRATION
 SURVEYING / GIS SOLUTIONS
 WATER RESOURCES

612 CLARION COURT
 SAN LUIS OBISPO, CA 93401
 T 805 544-4011 F 805 544-4294
 www.wallacegroup.us

PROJECT ENGINEER
 PLANS APPROVAL DATE

REGISTERED PROFESSIONAL ENGINEER
 SARAH M. HUFFMAN
 No. 85233
 FOR PLAN REVIEW ONLY
 NOT FOR CONSTRUCTION
 CIVIL
 STATE OF CALIFORNIA

REVISIONS					
NO.	BY	DATE	DESCRIPTION	APPROVED BY	DATE

ACCEPTED BY THE CITY CAPITAL PROJECTS ENGINEER

JOSIE LANTACA RCE: RCE_NO

BORONDA RD CONGESTION RELIEF PROJECT (ULTIMATE CONCEPT)					
LAYOUT					
L-22					
DESIGNED BY	DRAWN BY	CHECKED BY	JOB NUMBER	SHEET	OF
SMH	SMH	JAA	0886-0009	29	32
DISREGARD PRINTS BEARING EARLIER REVISION DATE			REVISION DATES (PRELIMINARY STAGE ONLY)		

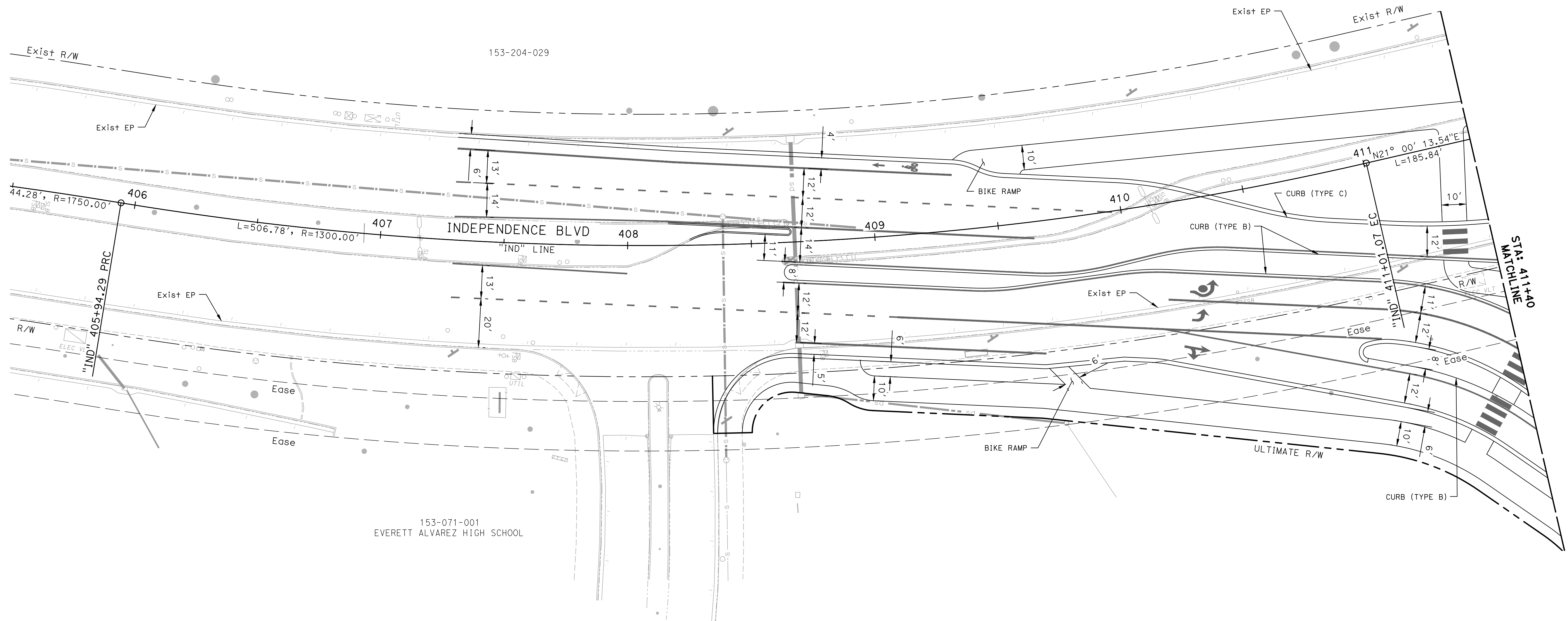
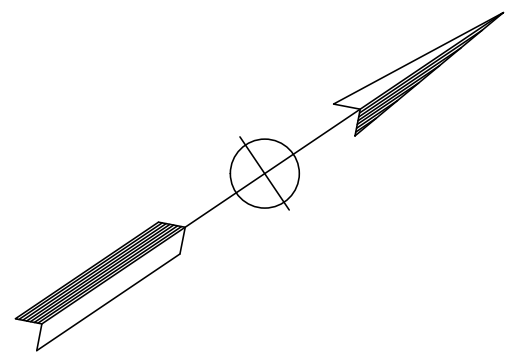

FILE NAME: 0886-0009_UIT-LAY-01.DWG PLOT DATE: 6/8/2020 6:39 PM BY: SARAH HUFFMAN



CITY OF SALINAS
 PUBLIC WORKS DEPARTMENT
 200 LINCOLN AVENUE
 SALINAS, CA 93908

SCALE: 1" = 20'
 ORIGINAL SCALE IN INCHES
 FOR REDUCED PLANS

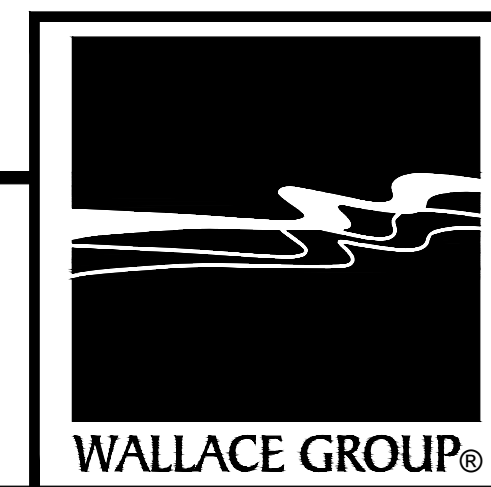

CIVIL AND TRANSPORTATION ENGINEERING
 CONSTRUCTION MANAGEMENT
 LANDSCAPE ARCHITECTURE
 MECHANICAL ENGINEERING
 PLANNING
 PUBLIC WORKS ADMINISTRATION
 SURVEYING / GIS SOLUTIONS
 WATER RESOURCES

612 CLARION COURT
 SAN LUIS OBISPO, CA 93401
 T 805 544-4011 F 805 544-4294
 www.wallacegroup.us

PROJECT ENGINEER _____
 PLANS APPROVAL DATE _____

REVISIONS					
NO.	BY	DATE	DESCRIPTION	APPROVED BY	DATE

ACCEPTED BY THE CITY CAPITAL PROJECTS ENGINEER

JOSIE LANTACA RCE: RCE_NO

BORONDA RD CONGESTION RELIEF PROJECT (ULTIMATE CONCEPT)					
LAYOUT					
L-23					
DESIGNED BY	DRAWN BY	CHECKED BY	JOB NUMBER	SHEET	OF
SMH	SMH	JAA	0886-0009	30	32
DISREGARD PRINTS BEARING EARLIER REVISION DATE			REVISION DATES (PRELIMINARY STAGE ONLY)		

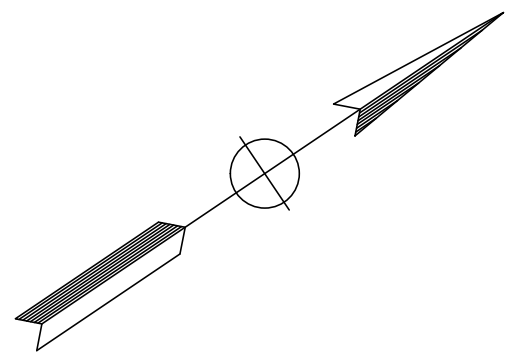

153-091-020 & 021

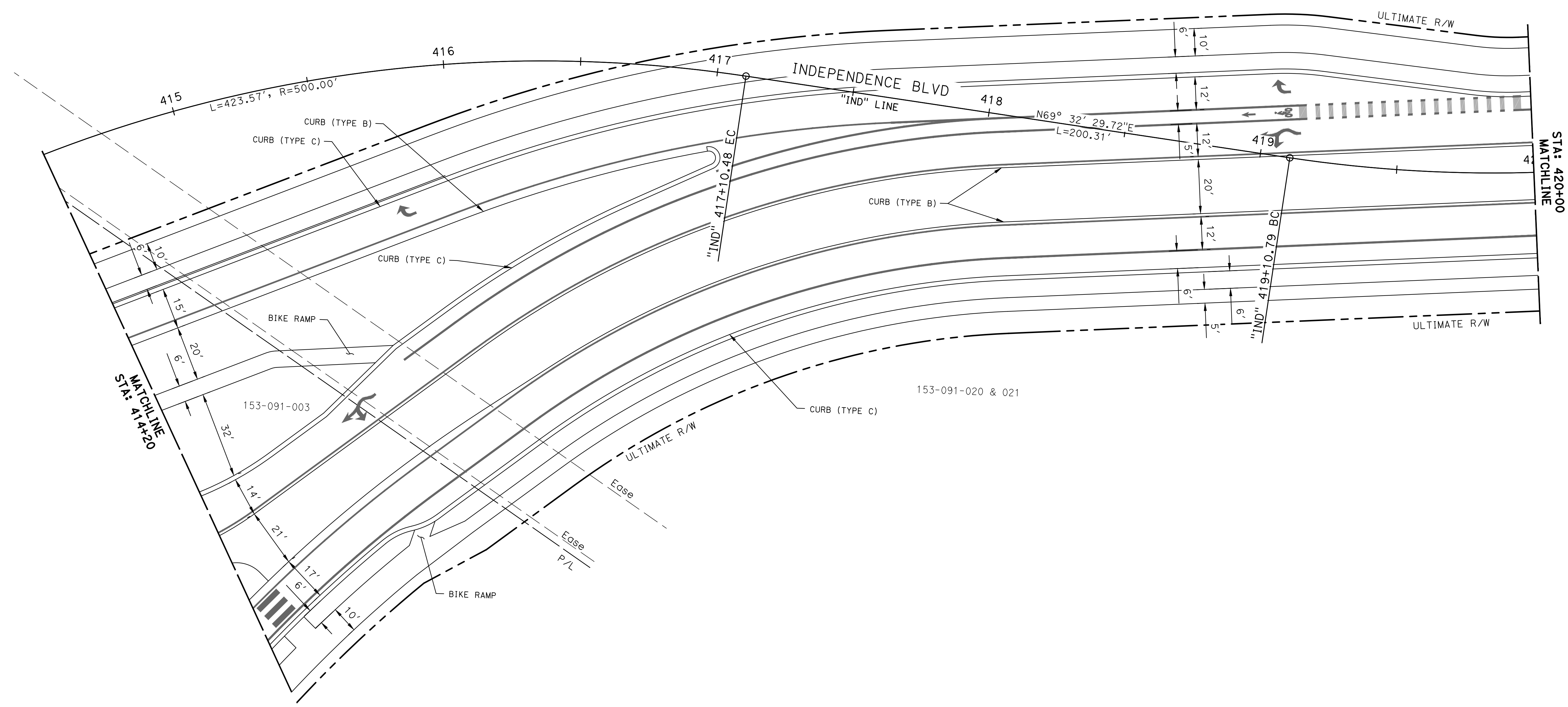

FILE NAME: 0886-0009_UIT-LAY-01.DWG PLOT DATE: 6/8/2020 6:39 PM BY: SARAH HUFFMAN



CITY OF SALINAS
 PUBLIC WORKS DEPARTMENT
 200 LINCOLN AVENUE
 SALINAS, CA 93908

SCALE: 1" = 20'
 ORIGINAL SCALE IN INCHES
 FOR REDUCED PLANS

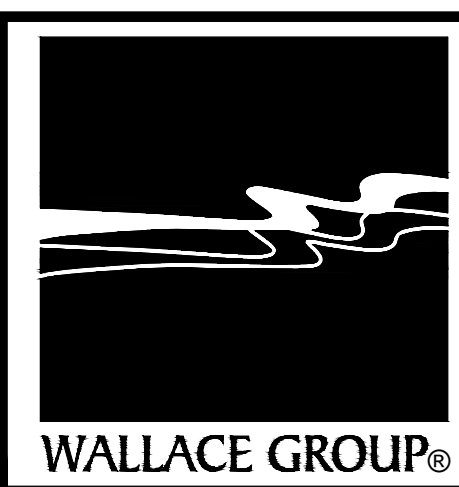

CIVIL AND TRANSPORTATION ENGINEERING
 CONSTRUCTION MANAGEMENT
 LANDSCAPE ARCHITECTURE
 MECHANICAL ENGINEERING
 PLANNING
 PUBLIC WORKS ADMINISTRATION
 SURVEYING / GIS SOLUTIONS
 WATER RESOURCES

612 CLARION COURT
 SAN LUIS OBISPO, CA 93401
 T 805 544-4011 F 805 544-4294
 www.wallacegroup.us

PROJECT ENGINEER
 PLANS APPROVAL DATE

REGISTERED PROFESSIONAL ENGINEER
 SARAH M. HUFFMAN
 No. 85233
 CIVIL
 STATE OF CALIFORNIA

REVISIONS					
NO.	BY	DATE	DESCRIPTION	APPROVED BY	DATE

ACCEPTED BY THE CITY CAPITAL PROJECTS ENGINEER

JOSIE LANTACA RCE: RCE_NO

BORONDA RD CONGESTION RELIEF PROJECT (ULTIMATE CONCEPT)					
LAYOUT					
L-24					
DESIGNED BY	DRAWN BY	CHECKED BY	JOB NUMBER	SHEET	OF
SMH	SMH	JAA	0886-0009	31	32
DISREGARD PRINTS BEARING EARLIER REVISION DATE			REVISION DATES (PRELIMINARY STAGE ONLY)		

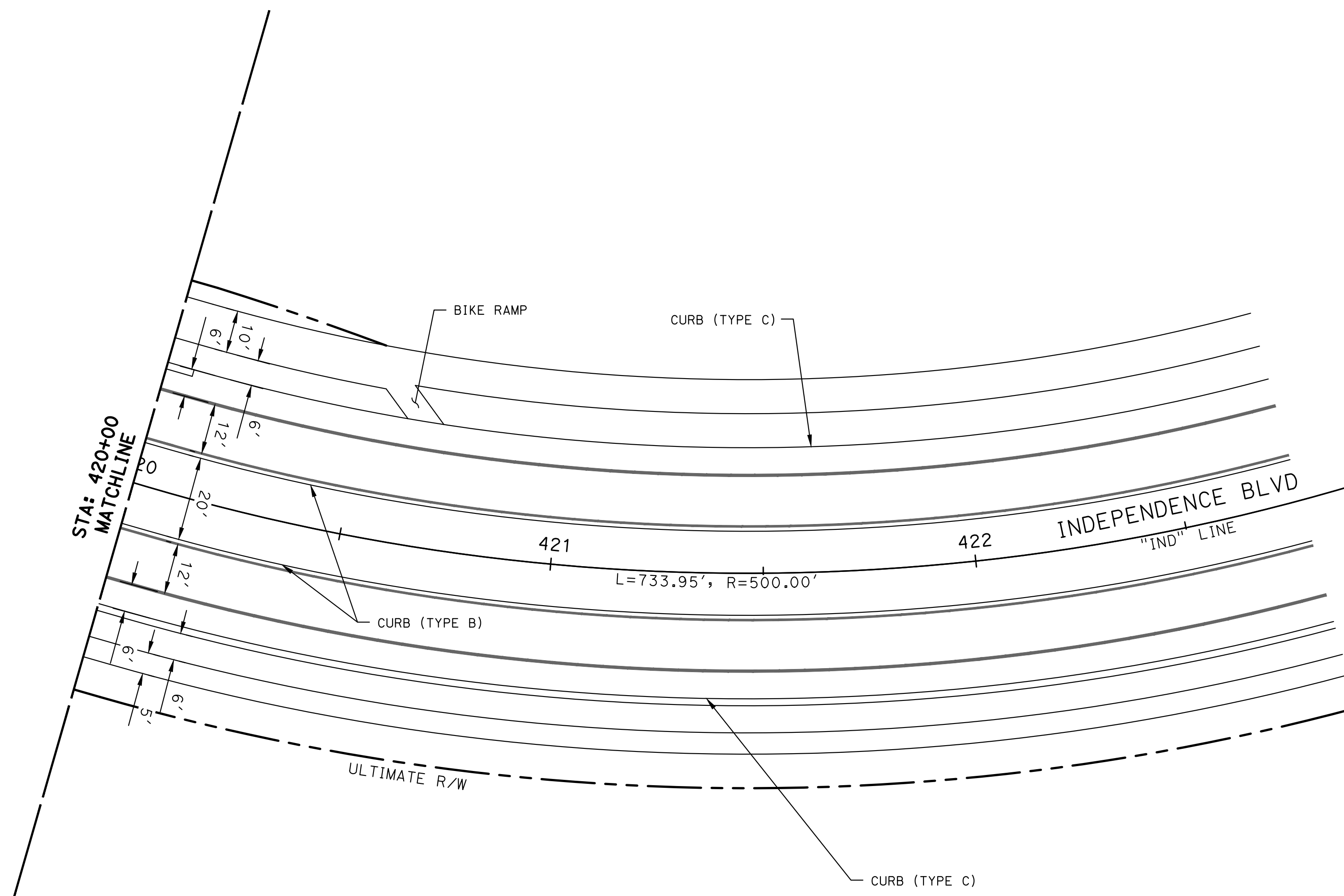
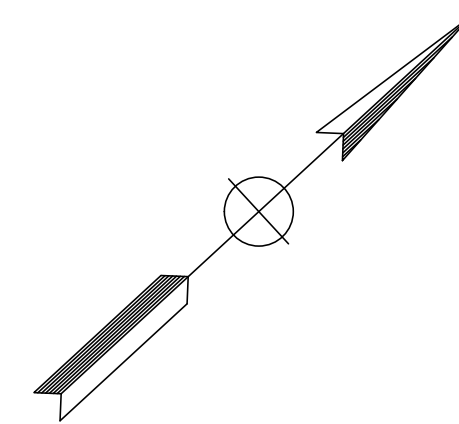

FILE NAME: 0886-0009_UIT-LAY-01.DWG
PLOT DATE: 6/8/2020 6:39 PM
BY: SARAH HUFFMAN



CITY OF SALINAS

PUBLIC WORKS DEPARTMENT
200 LINCOLN AVENUE
SALINAS, CA 93908

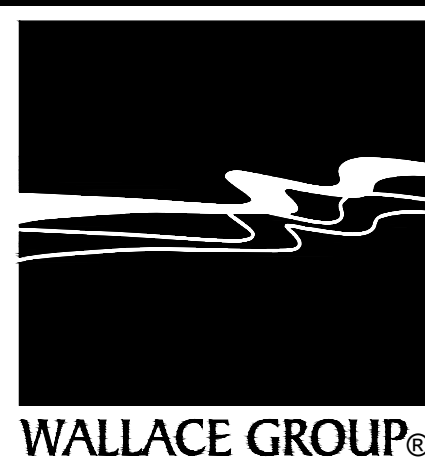
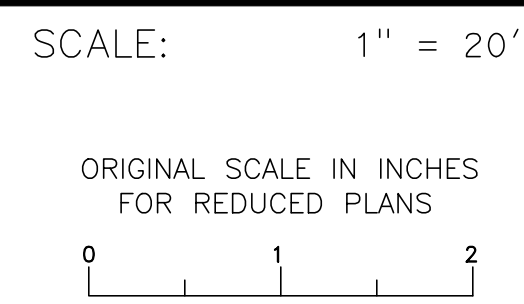

CIVIL AND TRANSPORTATION ENGINEERING
CONSTRUCTION MANAGEMENT
LANDSCAPE ARCHITECTURE
MECHANICAL ENGINEERING
PLANNING
PUBLIC WORKS ADMINISTRATION
SURVEYING / GIS SOLUTIONS
WATER RESOURCES

612 CLARION COURT
SAN LUIS OBISPO, CA 93401
T 805 544-4011 F 805 544-4294
www.wallacegroup.us

PROJECT ENGINEER

PLANS APPROVAL DATE



REVISIONS					
NO.	BY	DATE	DESCRIPTION	APPROVED BY	DATE

ACCEPTED BY THE CITY CAPITAL PROJECTS ENGINEER

JOSIE LANTACA RCE: RCE_NO

BORONDA RD CONGESTION RELIEF PROJECT (ULTIMATE CONCEPT)					
LAYOUT					
L-25					
DESIGNED BY	DRAWN BY	CHECKED BY	JOB NUMBER	SHEET	OF
SMH	SMH	JAA	0886-0009	0	32
DISREGARD PRINTS BEARING EARLIER REVISION DATE			REVISION DATES (PRELIMINARY STAGE ONLY)		

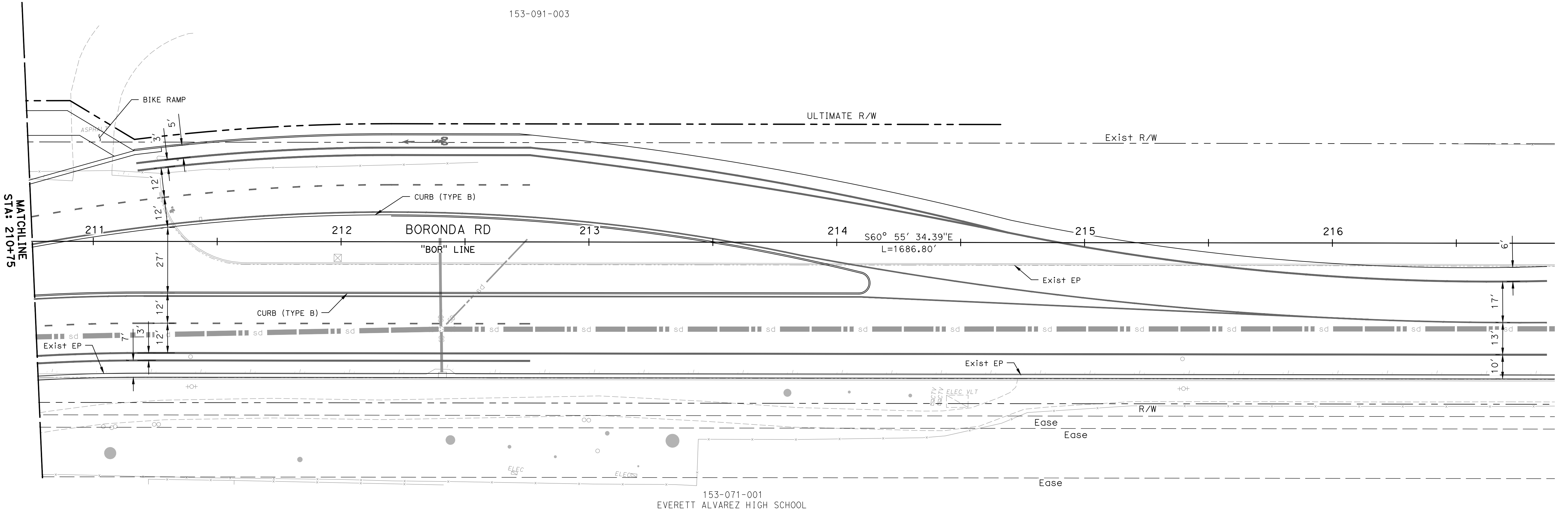
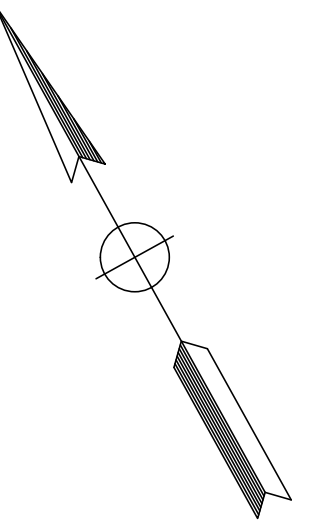

FILE NAME: 0886-0009_UJT-LAY-01.DWG
PLOT DATE: 6/8/2020 6:39 PM
BY: SARAH HUFFMAN



CITY OF SALINAS
PUBLIC WORKS DEPARTMENT
200 LINCOLN AVENUE
SALINAS, CA 93908

SCALE: 1" = 20'
ORIGINAL SCALE IN INCHES
FOR REDUCED PLANS

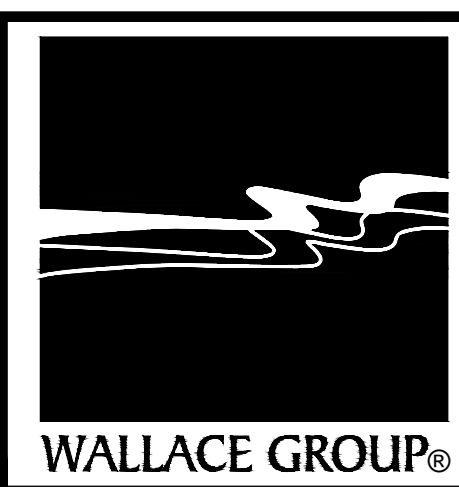

CIVIL AND TRANSPORTATION ENGINEERING
CONSTRUCTION MANAGEMENT
LANDSCAPE ARCHITECTURE
MECHANICAL ENGINEERING
PLANNING
PUBLIC WORKS ADMINISTRATION
SURVEYING / GIS SOLUTIONS
WATER RESOURCES

612 CLARION COURT
SAN LUIS OBISPO, CA 93401
T 805 544-4011 F 805 544-4294
www.wallacegroup.us

PROJECT ENGINEER _____
PLANS APPROVAL DATE _____

REVISIONS						
NO.	BY	DATE	DESCRIPTION	APPROVED BY	DATE	
△						
△						
△						
△						

ACCEPTED BY THE CITY CAPITAL PROJECTS ENGINEER

JOSIE LANTACA RCE: RCE_NO

BORONDA RD CONGESTION RELIEF PROJECT (ULTIMATE CONCEPT)					
LAYOUT					
L-26					
DESIGNED BY	DRAWN BY	CHECKED BY	JOB NUMBER	SHEET	OF
SMH	SMH	JAA	0886-0009	32	32
DISREGARD PRINTS BEARING EARLIER REVISION DATE			REVISION DATES (PRELIMINARY STAGE ONLY)		