

APPENDIX A

**Notice of Preparation for the Draft Environmental Impact Report and
Comment Letters**



CITY OF SANTA MARIA

Environmental Checklist / Initial Study

**SANTA MARIA AIRPORT BUSINESS PARK SPECIFIC PLAN AMENDMENT
GPZ2019-0002, SPZ2019-0001**

Project Title and Location

Santa Maria Airport Business Park Specific Plan Amendment
Assessor's Parcel Number 111-231-011 (portion of)
Northwest Corner of State Route 135 and Union Valley Parkway
Santa Maria, CA 93455

Lead Agency, Contact and Preparer

City of Santa Maria
Frank Albro
Community Development Department
110 South Pine Street, #101
Santa Maria, CA 93458
(805) 925-0951 x2379
falbro@cityofsantamaria.org

Project Sponsor's Name and Address

G3, LLC
1655 Dalidio Avenue, Unit 3018
San Luis Obispo, CA 93401

General Plan Designation

Existing: Community Facilities (CF), Recreation Open Space – Detention Basin (ROS-DB)
Proposed: Light Industrial (LI), Airport Commercial (AC), Open Space (OS)

Specific Plan Designation

Existing: Community Facilities (CF), Recreation Open Space – Detention Basin (ROS-DB)
Proposed: Light Industrial (LI), Airport Commercial (AC), Recreation Open Space – Detention Basin (ROS-DB)

Zoning Designation

Existing: Planned Development/Public Facilities – Airport (PD/PF-A),
Open Space – Recreation (OS)
Proposed: East side – Planned Development Airport Commercial/Public Facilities – Airport (PD-C-3/PF-A),
West side – Planned Development Light Manufacturing/Public Facilities – Airport (PD-M-1/PF-A), Open Space – Recreation/Detention Basin (OS/DB)

Project Description

BACKGROUND

In June 2007, the City of Santa Maria (City) certified a Programmatic Environmental Impact Report (EIR) (State Clearinghouse [SCH] No. 2005051172) for the City of Santa Maria Airport Business Park Specific Plan (Specific Plan) (Certified EIR; Rincon Consultants, Inc. 2007). The Certified EIR evaluated the potential environmental impacts resulting from future development of the 740-acre Specific Plan area located in the southwestern corner of the city, immediately south of the Santa Maria Public Airport (referred to herein as the Approved Project).

The approved Specific Plan seeks to combine light industrial, research, manufacturing, and commercial land uses around an 18-hole golf course. Additional uses proposed include retail opportunities, government facilities, and commercial and professional office space with mixed use potential. Large areas of open space are intended to be reserved for recreational or conservation uses, and a portion of the Specific Plan area is set aside as a biological preserve. The Specific Plan's proposed land use pattern is designated to accommodate future growth of development over the Specific Plan area while maintaining full compatibility with Airport operational requirements and minimizing impacts to the environment.

The subject of this Initial Study/Notice of Preparation (IS/NOP) is a proposed General Plan Amendment, Specific Plan Amendment, and Zoning Modification of an approximately 28-acre parcel (Assessor's Parcel Number [APN] 111-231-011) at the southeast corner of the Specific Plan area (project site). The project site is located at the northwest corner of the intersection of State Route (SR) 135 and Union Valley Parkway (see Figures 1 and 2). The City is preparing a Supplemental EIR (SEIR) to evaluate these changes.

2007 BASELINE CONDITIONS

Project Site

Within the 28-acre project site, the adopted Specific Plan proposed 314,067 square feet of community facilities floor area, while the Certified EIR evaluated the development of 41,948 square feet of floor area (Approved Project; refer to Table 1)¹. This development was to occur over 19.3 acres at the southern and western portions of the parcel. The project site is the only parcel within the Specific Plan area where the Community Facilities (CF) land use designation was applied. This land use designation allows for a variety of public/governmental facilities to be developed, including a local fire station, California Department of Motor Vehicles, charitable and philanthropic centers, cemeteries, crematories or mausoleums, or public service facilities.

Although the Specific Plan permits the development of 41,948 square feet of CF land uses, planning documents for the Santa Maria Public Airport District (Airport District) have long identified flood control management as a use of the project site. As early as the 1995 Specific Plan, "a land use designation for community facilities was assigned to an area in the southeast corner of the project area to accommodate a detention basin needed to address regional flooding in both the adjoining Community of Orcutt, City of Santa Maria, and a portion of the Airport District. The Santa Barbara County Flood Control and Water Conservation District (Flood Control) has approved a flood control plan that includes a storm drain system along Foster Road and a detention basin." In the Specific Plan, the 9-acre detention basin was retained and assigned a land use designation of Recreation Open Space – Detention Basin (ROS-DB) (and corresponding Open Space [OS] zone) (see Table 1; Figures 1 through

¹ Within the project site, the adopted Specific Plan proposed 314,067 square feet of CF floor area, or 272,119 square feet more than evaluated in the Certified EIR. Pursuant to Section 15163 of the State California Environmental Quality Act (CEQA) Guidelines and to provide a conservative analysis, this IS/NOP and the Supplemental EIR evaluates the potential for environmental impacts of the 223,002-square-foot increase in proposed development from the Certified EIR.

4). Per the Santa Barbara County Flood Control and Water Conservation District Flood Control Plan, the on-site detention basin would be designed to retain approximately 30 acre-feet of stormwater.

The project site is relatively flat, with the topography sloping slightly downward to the north toward Foster Road. When the Certified EIR was approved in 2007, the project site was undeveloped and consisted mostly of non-native annual grassland habitat, with a small patch of central coast scrub, and eucalyptus woodland along the western edge and scattered in the northern portion of the site. Scattered mature trees lined the eastern and northern edges of the parcel. Foxenwood Lane traversed the project site as a north–south road with a single lane in each direction. Proximate land uses to the north and west generally consisted of vacant open space and cultivated agricultural lands, as well as airport operations and runways within the city. Land uses to the south and east generally consist of residential neighborhoods, commercial services, offices, and school uses within the community of Orcutt.

Surrounding Land Uses and Setting

In 2007, the project site was bordered to the north by Foster Road and agricultural fields within parcels zoned Airport Approach; to the east by SR 135, single-family homes zoned Single-Family Residential (R-1), and The Jetty Restaurant zoned Neighborhood Commercial (CN); to the south by single-family residential neighborhoods (Foxenwood Estates, Foxenwood Garden Villa) zoned R-1 and Planned Development/R-1; and to the west by public facilities uses zoned Public Facilities (PF), including the Foodbank of Santa Barbara County, Santa Maria Animal Shelter, and Santa Barbara County Santa Maria Mental Health Services clinic.

The project site is located within the city and the adjacent SR 135 and Union Valley Parkway generally serve as the boundary between the city and the unincorporated community of Orcutt in Santa Barbara County (see Figure 2).

2020 EXISTING CONDITIONS

Project Site

The baseline conditions on the project site and evaluated in the Certified EIR have changed since 2007. Most notably, the agricultural cultivation of strawberries was introduced to the previously undeveloped project site in late 2018. The stands of eucalyptus trees were removed to improve airport operations and safety and accommodate this agricultural use.

The project site continues to be bisected by Foxenwood Lane, which is a paved single-lane north–south running roadway that runs parallel to SR 135 and provides access to several residential neighborhoods south of the project site.

Surrounding Land Uses and Setting

As shown in Figure 2, the surrounding land uses and setting are largely the same as they were in 2007. The principal change is that Union Valley Parkway was extended in 2015 to provide a continuous east–west roadway connection from U.S. Highway 101 (U.S. 101) to Blosser Road. Since Union Valley Parkway forms the southern site boundary and provides direct site access, the completion of this convenient, 1.5-mile-long roadway between U.S. 101 and the project site requires reevaluation of the project site’s role in the strategic development of the Specific Plan.

While flood control remains a needed function, site access to the regional transportation network now also provides the City and Airport District with an extra tool to realize several goals identified in Specific Plan. These goals include providing the Airport District a steady income stream for long-term land leases; enhancing economic development opportunities for the City relative to the previously adopted land use pattern; protecting biologically sensitive areas to the extent feasible; and developing airport-

compatible uses that are compatible with the Airport’s neighbors, serve the employment needs of the City, and are responsive to City’s ongoing economic goals.

REVISED PROJECT

G3, LLC (Applicant) is requesting approval of a General Plan Amendment, Specific Plan Amendment, and Rezoning to more effectively arrange land uses on the 28-acre project site and increase the amount of airport-compatible development allowed within this portion of the Specific Plan (Revised Project). These approvals would modify the land use designations and corresponding zoning applied throughout the project site (see Figures 3 through 5).

West of Foxenwood Lane, the ROS-DB land use designation (and corresponding Planned Development/Open Space [PD/OS] zone) would be applied to the site’s northwest corner so that the previously identified 9-acre detention basin can be moved to this location. By relocating the detention basin, the northeast portion of the site adjacent to SR 135 becomes available for more productive commercial and Airport leasing uses. Project engineers have also determined that the capacity of the detention basin can be reduced when placed at the northwest corner of the project site, although the IS/NOP conservatively assumes the relocated detention basin would also occupy a site area of approximately 9 acres and be designed to accommodate approximately 30+ acre-feet of stormwater per the approved Flood Control Plan. The Light Industrial (LI) land use designation (and corresponding Planned Development Light Manufacturing/Public Facilities – Airport [PD-M-1/PF-A] zone) would be applied to the southwest corner of the project site.

East of Foxenwood Lane, the Airport Commercial (AC) land use designation (and corresponding Planned Development Airport Commercial/Public Facilities – Airport PD-C-3/PF-A] zone) would be applied to the entire area.

The Applicant has coordinated with the Santa Maria Public Airport District (Airport District) to develop a Conceptual Development Plan to guide future development within the project site and to provide informed decision-making during the agency approval process. Although the Revised Project does not currently propose any particular development at the project site, the Conceptual Development Plan represents a reasonable development scenario at the project site for evaluation in the SEIR.

Several airport-compatible land uses are proposed, including commercial, light industrial, and public facility buildings (Figure 7). Under the Conceptual Development Plan, the Revised Project would develop this area within the Airport Specific Plan (the project site) with approximately 264,500 square feet of floor area (see Table 1), which is less than the development allowed under the adopted Specific Plan for this location by 49,567 square feet. However, the Certified EIR evaluated only a total of 41,498 square feet of CF floor area within the 28-acre project site. Pursuant to Section 15163 of the California Environmental Quality Act (CEQA) Guidelines and to provide a conservative analysis, this IS/NOP and the Supplemental EIR evaluate the potential for environmental impacts of the 223,002-square-foot increase in proposed development area from the use areas evaluated in the Certified EIR.

Table 1. Revised Project – Conceptual Development Plan

Land Use	Building Footprint*
Approved Project (Certified EIR)	
Community Facilities (CF) Land Uses	41,498 sf ¹
Approved Project (Certified EIR) Total	41,498 sf¹

Land Use	Building Footprint*
Revised Project / Conceptual Development Plan	
West Area (West of Foxenwood Lane)	
Public Safety	7,000 sf
Self-Storage Facility	100,000 sf
State Office Building	15,100 sf
<i>West Area Subtotal</i>	<i>122,100 sf</i>
East Area (East of Foxenwood Lane)	
Market Place Commercial (e.g., coffee/bagels, deli, brewpub, ice cream, wine tasting, specialty grocery)	36,000 sf
Professional Office Buildings	40,000 sf
Medical Office	20,000 sf
Home Furnishings/Appliances	32,000 sf
Quick-Serve Restaurants/Mini Mart/Gas	
Fast Food	6,000 sf
Family Restaurant	5,000 sf
Convenience Store & Gas Station	3,400 sf
<i>East Area Subtotal</i>	<i>142,400 sf</i>
Revised Project Total	264,500 sf

* sf = square feet

¹ Within the project site, the adopted Specific Plan proposed 314,067 sf of CF floor area, or 272,119 sf more than evaluated in the Certified EIR. Per Section 15163 of the State CEQA Guidelines and to provide a conservative analysis, this IS/NOP and the Supplemental EIR evaluates the potential for environmental impacts of the 223,002-sf increase in proposed development from the Certified EIR.

Infrastructure improvements would be completed to accommodate the Revised Project. At the intersection of Union Valley Parkway and Foxenwood Lane, the intersection would be signalized and dedicated turn lanes onto Foxenwood Lane would be provided. The Revised Project would also make all necessary utility connections to provide water, wastewater conveyance, and electrical service to the proposed development. It is expected that 10 of the existing on-site trees would be removed and that approximately 350 new trees would be planted under the Revised Project.

For purposes of evaluating a reasonable worst-case scenario in the SEIR, the Conceptual Development Plan assumes the Revised Project would be constructed over a 20-month period, beginning in fall 2021. Approximately 24.5 acres of the project site would be graded, with the volume cut and fill being balanced on-site. Approximately 7.8 acres would be paved to provide parking and internal site circulation. Construction of the detention basin would require the excavation of approximately 152,460 square feet of soil material, which would be used as fill throughout the site. As with the Approved Project, the detention basin would be excavated to a maximum depth of 30 feet.

Project Objectives

The City and the Applicant have identified the following objectives for the Revised Project:

- Create a development framework that attracts community-serving businesses that complement the surrounding airport and residential land uses and accommodates public facility uses.
- Set aside sufficient land for accommodation of a regional detention basin to meet the needs for local stormwater retention.
- Create a development framework for the project site that provides the Airport District with a steady income stream for long-term land leases within the project area.
- Create a development framework that recognizes the adopted Specific Plan and allows for future development under an amended Specific Plan to enhance economic development opportunities for the City relative to the land use pattern that was previously adopted.
- Create a development framework that is consistent with the noise, height, and safety guidelines of the adopted Santa Barbara County Airport Land Use Plan (ALUP) and the Santa Maria Airport Land Use Compatibility Plan (ALUCP).
- Protect and enhance designated open space lands and biologically sensitive areas to the maximum extent reasonably feasible.
- Develop the project site with airport-compatible uses that are also compatible with the Airport's neighbors, particularly the neighborhoods to the south and east; likely to serve employment needs of the City and region; and responsive to the City's ongoing economic goals.

Legal Authority & Project Approvals

This IS/NOP has been prepared in accordance with CEQA Section 15082 and the State CEQA Guidelines to evaluate the potential environmental impacts of the Revised Project in anticipation that an SEIR is the appropriate CEQA document to compare the potential environmental effects of the Revised Project with those of the Approved Project, as identified in the 2007 Certified EIR.

State CEQA Guidelines Section 15162 requires the preparation of an SEIR when one or more of the following conditions would result from the Revised Project:

- (1) Substantial changes are proposed in the project which will require major revisions of the previous EIR or negative declaration due to the involvement of new significant environmental effects or a substantial increase in the severity of previously identified significant effects;
- (2) Substantial changes occur with respect to the circumstances under which the project is undertaken which will require major revisions of the previous EIR or negative declaration due to the involvement of new significant environmental effects or a substantial increase in the severity of previously identified significant effects; or
- (3) New information of substantial importance, which was not known and could not have been known with the exercise of reasonable diligence at the time the previous EIR was certified as complete or the negative declaration was adopted, shows any of the following:
 - (A) The project will have one or more significant effects not discussed in the previous EIR or negative declaration;
 - (B) Significant effects previously examined will be substantially more severe than shown in the previous EIR;
 - (C) Mitigation measures or alternatives previously found not to be feasible would in fact be feasible and would substantially reduce one or more significant effects of the project, but the project proponents decline to adopt the mitigation measure or alternative; or

- (D) Mitigation measures or alternatives which are considerably different from those analyzed in the previous EIR would substantially reduce one or more significant effects on the environment, but the project proponents decline to adopt the mitigation measure or alternative.

Per State CEQA Guidelines Section 15162, an SEIR need contain only the information necessary to make the previous EIR adequate for the project as revised. While an SEIR requires the same kind of notice and public review as is given to a Draft EIR under Section 15087, an SEIR may be circulated by itself without recirculating the previous Draft or Final EIR. When the lead agency decides whether to approve the Revised Project, the decision-making body shall consider the previous EIR as revised by the SEIR. A finding under Section 15091 shall be made for each significant effect shown in the previous EIR as revised.

The City has the role of the CEQA Lead Agency in preparing an SEIR to evaluate the potential environmental impacts of the Revised Project. Implementation of the Revised Project would require the following discretionary approvals from the City:

- Amendment of the Santa Maria Airport Business Park Specific Plan
- General Plan Maps and Zoning Map Amendments

Other Public Agencies Whose Approval is Required

The Project would require Santa Barbara County Association of Governments (SBCAG), in its role as the Airport Land Use Commission, approval of the Airport Business Park Specific Plan, as amended.

California Native American Tribes Consultation

The City (as the CEQA Lead Agency) provided notification to Native American tribes affiliated with the project area pursuant to Assembly Bill (AB) 52 and Senate Bill (SB) 18. Letters were sent to the City's list of local tribes on May 15, 2020. Tribal consultation has not completed.

Figure 1. Project Vicinity Map

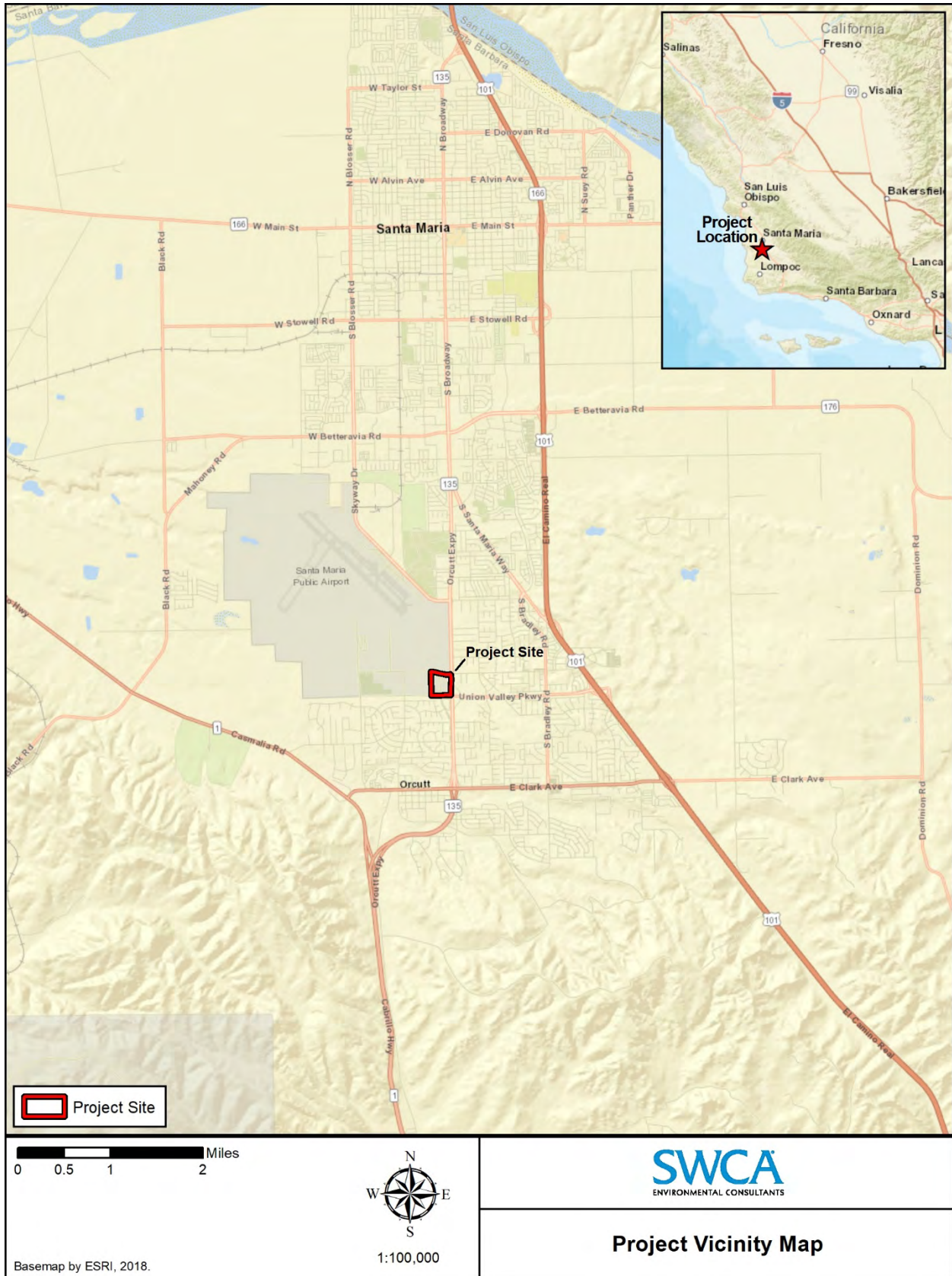

Figure 2. Project Location Map



Figure 3. Existing General Plan Designations Map

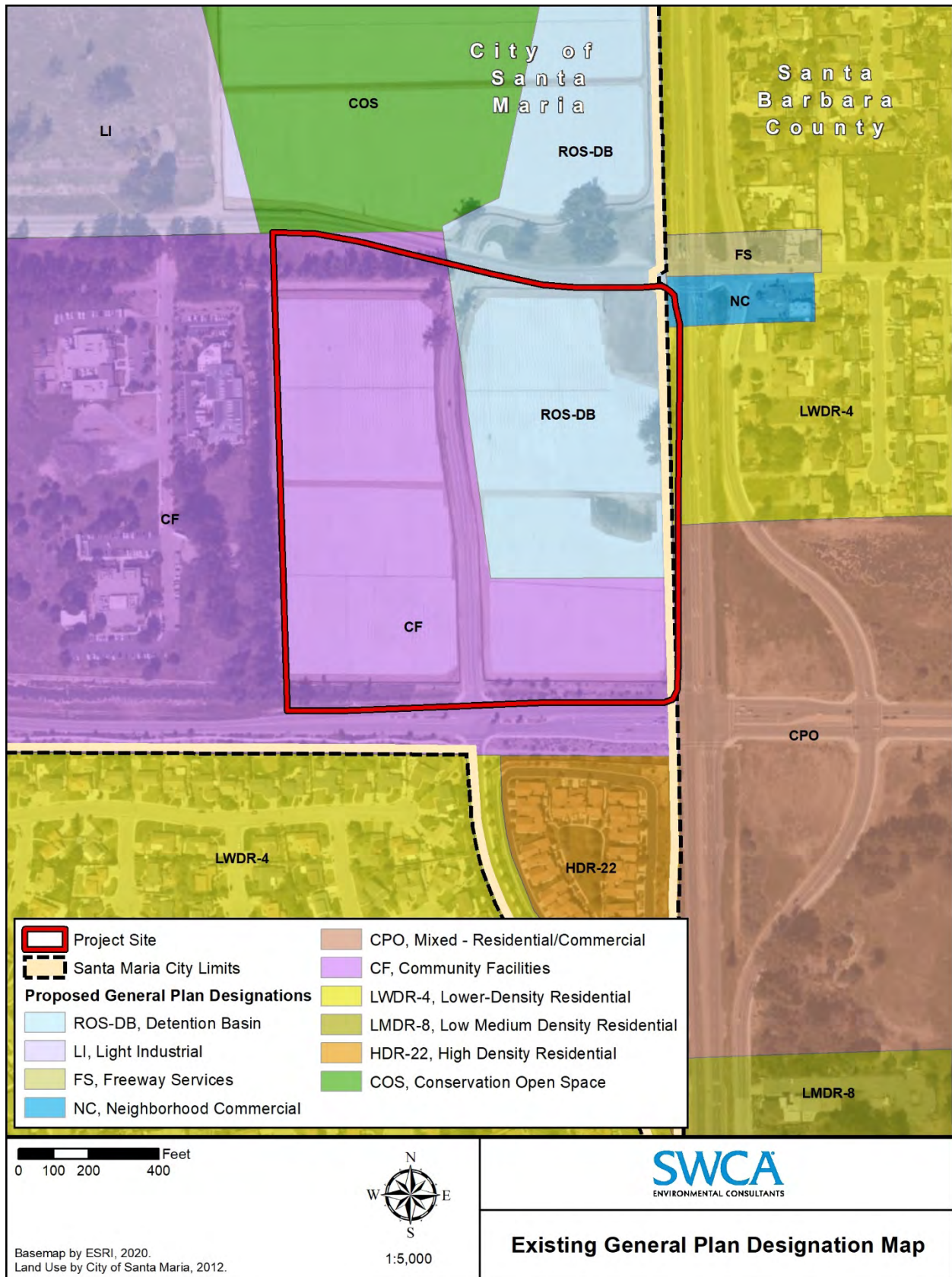

Figure 4. Proposed General Plan Designation Map

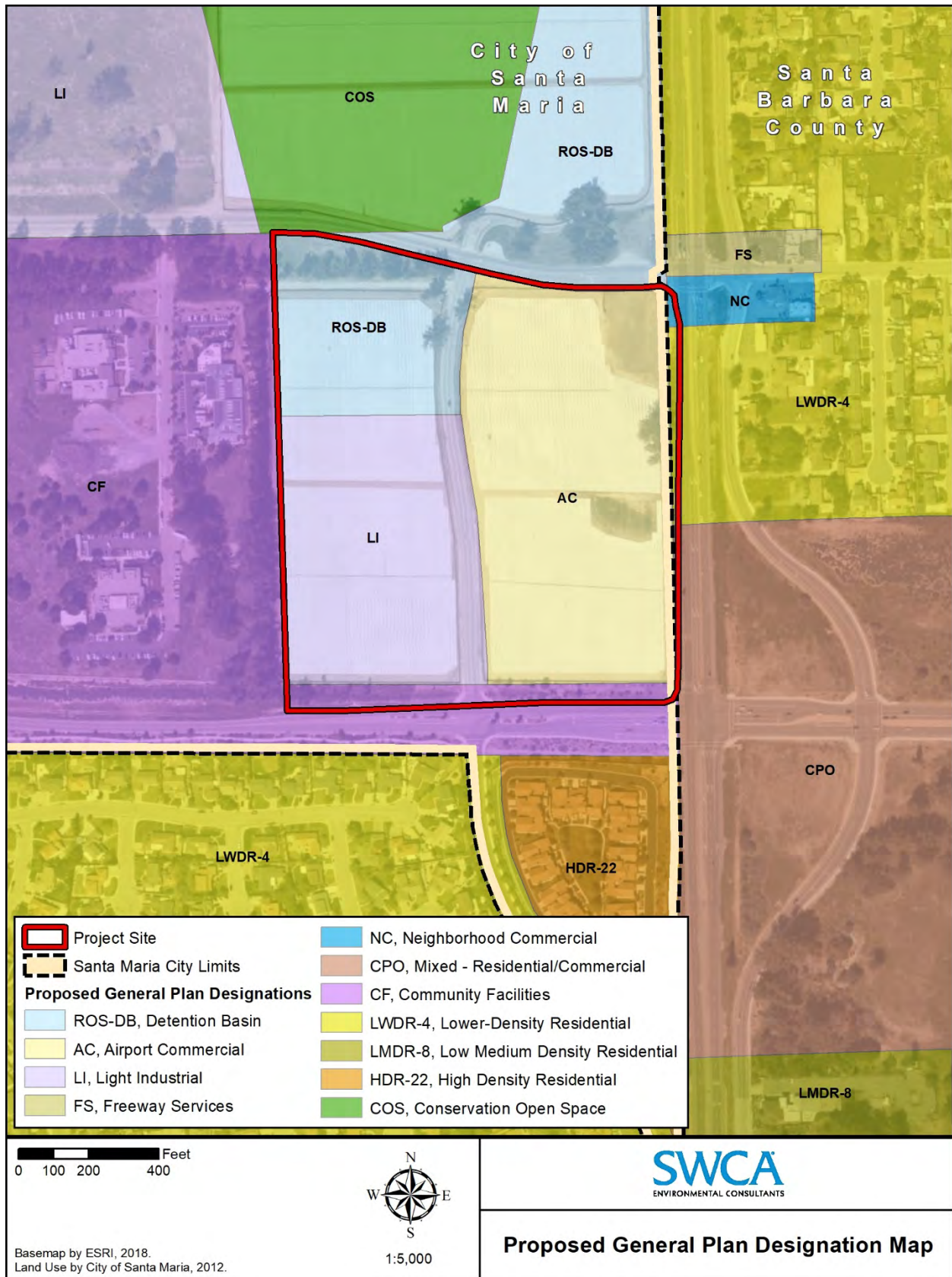

Figure 5. Existing Zoning Designation Map



Figure 6. Proposed Zoning Designation Map.



Figure 7. Conceptual Development Plan.



Source: RRM Design Group, 2020.



Conceptual Development Plan

1. AESTHETICS

Except as provided in Public Resources Code Section 21099, would the project:	Potentially Significant Impact	Less Than Significant with Mitigation Incorporated	Less Than Significant Impact	No Impact
a. Have a substantial adverse effect on a scenic vista?			X	
b. Substantially damage scenic resources, including, but not limited to, trees, rock outcroppings, and historic buildings within a state scenic highway?			X	
c. In non-urbanized areas, substantially degrade the existing visual character or quality of public views of the site and its surroundings? (Public views are those that are experienced from publicly accessible vantage point). If the project is in an urbanized area, would the project conflict with applicable zoning and other regulations governing scenic quality?			X	
d. Create a new source of substantial light or glare which would adversely affect day or nighttime views in the area?			X	

Setting

The project site is in the southwestern portion of the city of Santa Maria, immediately west of SR 135. The 28-acre project site has a relatively flat to slightly sloping topography and is currently used for agricultural cultivation of strawberries. The project site supports several scattered mature trees around the northern and eastern edges of the parcel. The project site is bisected by Foxenwood Lane, which is a paved single-lane north-south running roadway that runs parallel to SR 135 and provides access to several residential neighborhoods south of the project site. During the growing season, views of the project site from public vantage points are of the strawberry crop and agricultural support infrastructure. In between growing seasons, views of the project site consist of a fallow agricultural field and vegetation and fencing along the perimeter of the project site. Views across the project site are largely unobstructed and include longer range views of the existing surrounding development.

The project site is surrounded to the north by undeveloped agricultural land within the Airport Approach zoning designation, to the east by SR 135 and single-family homes and commercial uses, to the south by single-family neighborhoods, and to the west by public facilities uses, including the Foodbank of Santa Barbara County, the Santa Maria Animal Shelter, and a Santa Barbara County behavioral health clinic.

The project site is located within the Specific Plan area. The Specific Plan identifies design guidelines for uses within the Specific Plan area, including maximum building height, screening standards, landscaping provisions, and other special design requirements, including standards for exterior lighting. The Certified EIR identified no potentially significant impacts associated with aesthetics.

Impact Discussion

- a. For purposes of determining significance under CEQA, a scenic vista is defined as a viewpoint that provides expansive views of a highly valued landscape for the benefit of the general public. According to the City of Santa Maria General Plan Land Use Element (City of Santa Maria 2011b)

and Resources Management Element (City of Santa Maria 2001), the project site is not located within a designated scenic vista. Consistent with the analysis provided in Section 1.5 of the Certified EIR, the project site is not located within or in close proximity to a known or designated scenic vista; therefore, potential impacts would be consistent with those identified in the Certified EIR and would be *less than significant*.

- b. The project site is located adjacent to SR 135, which is not a designated state scenic highway, and approximately 1.2 miles west of U.S. 101, which is designated as eligible for listing as a state scenic highway at this location. Due to distance, intervening development, and topography, the Revised Project would not be within the viewshed of viewers traveling along U.S. 101. In addition, the project site is relatively flat and consists of row crops, ornamental perimeter trees, and ruderal areas. The project site does not contain any visually significant trees, rock outcroppings, historic structures, or other notable scenic resources. Section 1.5 of the Certified EIR concluded that the project site is flat and does not contain any notable scenic resources, and that implementation of the Approved Project would not obstruct views of identified scenic resources within a state scenic highway. Therefore, potential impacts associated with damage of scenic resources within a scenic highway under the Revised Project are consistent with those identified in the Certified EIR and would be *less than significant*.
- c. Development of the project site under the Revised Project would be guided by a Conceptual Development Plan prepared by the Applicant in conjunction with the Airport District. The Conceptual Development Plan proposes to develop the 28-acre project site with a regional stormwater detention basin and approximately 264,500 square feet of Airport Commercial uses, including potentially government/public facility uses, retail uses, commercial office/professional office uses, quick-serve restaurant/mini-mart/gas station uses, and/or a self-storage facility. The Revised Project is located within an urbanized area of the city, with developed uses, including public facilities and residential neighborhoods, bordering the project site to the east, south, and west.

As with the CF land uses proposed under the Approved Project, the proposed uses envisioned in the Conceptual Development Plan under the Revised Project would also be subject to the design standards set forth in the Specific Plan. Section 1.5 of the Certified EIR concluded that the Specific Plan included guidelines for land use and design to integrate the aesthetic elements of the surrounding environment, which would provide continuity between the existing and proposed land uses within the project area. Therefore, the Certified EIR concluded that the Approved Project would not significantly degrade the existing visual character of the site or surrounding area. Similarly, the Revised Project would be required to comply with design standards set forth by the Specific Plan Chapter 4.0 (Land Development Regulations), and where more restrictive, those established in Title 12 of the City Municipal Code, including, but not limited to, maximum building height, minimum front setback, minimum side and rear setbacks, screening standards, landscaping standards, and arrangement/hooding of lights so as to not impair visibility for incoming/outgoing pilots (City of Santa Maria 2007). Thus, the Revised Project would not result in a conflict with applicable zoning or other regulations governing scenic quality; therefore, potential impacts would continue to be *less than significant*.

- d. The Approved Project proposed 41,948 square feet of CF land uses on the 28-acre project site. This analysis assumes that the CF land uses would have been accommodated by just one or two buildings. Section 1.5 of the Certified EIR concluded that the Specific Plan includes guidelines for effective site design and architectural and landscape treatment to minimize the overflow of light from the development within the Specific Plan Area to surrounding residential uses, and that Union Valley Parkway would provide a buffer between the on-site uses under the Approved Project and the residential areas to the south; therefore, the Approved Project would not create a new source of substantial light or glare affecting day or nighttime views in the area.

The Revised Project proposes approximately 264,500 square feet of floor area and could increase nighttime lighting that was identified for the Approved Project. Specifically, the Revised Project

would include installation of new exterior lighting on proposed buildings or standalone light fixtures along walkways and/or in parking lots. Nonetheless, as with the Approved Project, the Revised Project's proposed lighting would be required to be designed in compliance with applicable Specific Plan Special Design Standards, which requires all exterior lighting to be arranged or hooded in a manner so as to not impair visibility for incoming/outgoing pilots. As with the Approved Project, the Revised Project would also be required to comply with Federal Aviation Administration (FAA) rules and regulations, including, but not limited to, avoidance of specific characteristics such as sources of glare through use of highly reflective buildings or building features and use of bright/distracting lights (Santa Barbara County Association of Governments [SBCAG] 2019). The level of development and lighting allowed under the Revised Project would also be generally consistent with surrounding major roadways and developed adjacent areas, and therefore would not result in a significant change to night lighting in the project area. Therefore, potential impacts associated with creation of a new source of substantial light or glare are consistent with those identified in the Certified EIR and would be *less than significant*.

Conclusion

Implementation of the Revised Project would not result in potentially significant impacts related to aesthetic resources; therefore, mitigation or further evaluation of this issue in the SEIR is not necessary.

2. AGRICULTURE AND FOREST RESOURCES

In determining whether impacts to agricultural resources are significant environmental effects, lead agencies may refer to the California Agricultural Land Evaluation and Site Assessment Model (1997) prepared by the California Dept. of Conservation as an optional model to use in assessing impacts on agriculture and farmland. In determining whether impacts to forest resources, including timberland, are significant environmental effects, lead agencies may refer to information compiled by the California Department of Forestry and Fire Protection regarding the state's inventory of forest land, including the Forest and Range Assessment Project and the Forest Legacy Assessment project; and forest carbon measurement methodology provided in Forest Protocols adopted by the California Air Resources Board.

Would the project:	Potentially Significant Impact	Less Than Significant with Mitigation Incorporated	Less Than Significant Impact	No Impact
a. Convert Prime Farmland, Unique Farmland, or Farmland of Statewide Importance (Farmland), as shown on the maps prepared pursuant to the Farmland Mapping and Monitoring Program of the California Resources Agency, to non-agricultural use?				X
b. Conflict with existing zoning for agricultural use, or a Williamson Act contract?				X
c. Conflict with existing zoning for, or cause rezoning of, forest land (as defined in Public Resources Code section 12220(g)), timberland (as defined by Public Resources Code section 4526), or timberland zoned Timberland Production (as defined by Government Code section 51104(g))?				X

Would the project:	Potentially Significant Impact	Less Than Significant with Mitigation Incorporated	Less Than Significant Impact	No Impact
d. Result in the loss of forest land or conversion of forest land to non-forest use?			X	
e. Involve other changes in the existing environment which, due to their location or nature, could result in conversion of Farmland, to non-agricultural use or conversion of forest land to non-forest use?			X	

Setting

Agriculture has historically played an important role in the economy and development of the City and the Santa Maria Valley. Soil quality, water supply, a year-round growing season, and level topography have made the Santa Maria Valley one of the most productive agricultural regions in the country. Most of the land under agricultural production within the project vicinity is in the unincorporated areas surrounding the city. Land under agricultural production within City Limits includes a small area near the City landfill and several acres recently annexed to the City of Santa Maria.

The California Department of Conservation (DOC) classifies and maps agricultural lands in the state in the Farmland Mapping and Monitoring Program (FMMP). The FMMP identifies five farmland categories: Prime Farmland, Farmland of Statewide Importance, Unique Farmland, Farmland of Local Importance, and Farmland of Local Potential. The Certified EIR identified the project site as being designated as Grazing Land, a condition that has not changed since certification of the EIR even though the project site was subsequently converted to the agricultural cultivation of strawberries in late 2018 (DOC 2016).

According to California Public Resources Code (PRC) Section 12220(g), forest land is defined as land that can support 10% native tree cover of any species, including hardwoods, under natural conditions, and that allows for management of one or more forest resources, including timber, aesthetics, fish and wildlife, biodiversity, water quality, recreation, and other public benefits. Timberland is defined as land, other than land owned by the federal government and land designated by the State Board of Forestry and Fire Protection as experimental forest land, that is available for and capable of growing a crop of trees of a commercial species used to produce lumber and other forest products, including Christmas trees. At the time of the Certified EIR, the project site was undeveloped and supported several large stands of eucalyptus trees. The project site currently supports several scattered mature trees around the northern and eastern edges of the parcel.

Impact Discussion

- a. According to the DOC FMMP Important Farmland Map for Santa Barbara County (DOC 2016), the project site is mapped as Grazing Land, as it was in the Certified EIR. The project site does not include any land that is designated as Prime Farmland, Unique Farmland, or Farmland of Statewide Importance, as designated by the FMMP; therefore, the potential impacts of the Revised Project are consistent with those identified in the Certified EIR and would not result in conversion of Farmland to a non-agricultural use and *no impacts would occur*.
- b. Based on Section 4.1 of the Certified EIR, none of the open land in the Approved Project area or immediate vicinity is within an agricultural zoning designation or is under a Williamson Act contract. The 28-acre project site currently is within the PF-A and OS zoning designations. The project site is not adjacent to any land under an agricultural zoning designation. Similarly, based on Figure

RME-2 of the Resources Management Element, the project site is not currently located on or adjacent to a property under a Williamson Act Contract; therefore, the project would be consistent with the analysis within the Certified EIR and would not result in a conflict with zoning for agricultural use or Williamson Act contract and *no impacts would occur*.

- c. At the time of the Certified EIR, consideration of potential impacts associated with a potential conflict with zoning of forest land or timberland was not identified within State CEQA Guidelines Appendix G. The 28-acre project site currently is within the PF-A and OS zoning designations. Therefore, implementation of the Revised Project would not result in a new potentially significant impact associated with a conflict with existing zoning for, or cause rezoning of, forest land, timberland, or timberland zoned Timberland Production and *no impacts would occur*.
- d. At the time of the Certified EIR, consideration of potential impacts associated with the conversion of forest land or timberland uses was not identified within State CEQA Guidelines Appendix G. On-site vegetation at the project site consists primarily of agricultural row crops with several scattered trees located along the edges of the site, consisting mostly of eucalyptus trees. The Revised Project would result in the removal of 10 trees on-site. However, it is estimated that approximately 340 new trees would be required to meet the Design Standards of the Specific Plan and City Municipal Code. The project site does not support sufficient tree cover or density that could provide for the management of forest resources; therefore, implementation of the Revised Project would not result in a new potentially significant impact associated with loss of forest land or conversion of forest land to non-forest use and impacts would be *less than significant*.
- e. The Certified EIR identified a Class II, significant but mitigable impact associated with land use conflicts between existing agricultural operations on-site and new non-agricultural uses, such as increased potential of dust and noise emissions from construction activities. The Certified EIR concluded that implementation of mitigation measures requiring the applicant to provide notice to adjacent agricultural landowners prior to spraying chemicals and to maintain a 100-foot buffer between future development and agricultural uses would reduce potential impacts to less than significant.

The parcel located to the north of the project site is designated Unique Farmland by the FMMP. The project would result in temporary noise and dust emissions during the future uses allowed under the Revised Project and Conceptual Development Plan, which may have the potential to result in a nuisance to adjacent agricultural uses. However, these construction activities would be temporary in nature and, given the high level of additional surrounding urban development, site development under the Revised Project would not be substantially incompatible with surrounding uses and would not result in the direct or indirect conversion of adjacent Farmland to non-agricultural uses. The project site is not located adjacent to any forest land or timberland or zoning for those uses. Therefore, potential impacts associated with other changes in the environment that could result in conversion of Farmland or forest land would be *less than significant*.

Conclusion

Implementation of the Revised Project would not result in potentially significant impacts related to agriculture and forest resources; therefore, mitigation or further evaluation of this issue in the SEIR is not necessary. None of the mitigation measures identified in the Certified EIR for agricultural resources are necessary for implementation of the Revised Project.

3. AIR QUALITY

Where available, the significance criteria established by the applicable air quality management district or air pollution control district may be relied upon to make the following determinations.

Would the project:	Potentially Significant Impact	Less Than Significant with Mitigation Incorporated	Less Than Significant Impact	No Impact
a. Conflict with or obstruct implementation of the applicable air quality plan?	X			
b. Result in a cumulatively considerable net increase of any criteria pollutant for which the project region is non-attainment under an applicable federal or state ambient air quality standard?	X			
c. Expose sensitive receptors to substantial pollutant concentrations?	X			
d. Result in other emissions (such as those leading to odors) adversely affecting a substantial number of people?	X			

Setting

The project site is in the South Central Coast Air Basin (SCCAB), which includes all of San Luis Obispo, Santa Barbara, and Ventura Counties.

Criteria Pollutant Regulation. In accordance with the California Clean Air Act, the California Air Resources Board (CARB) regulates the emission of airborne pollutants and have established ambient air quality standards for the protection of public health. Local control in air quality management is provided by the CARB through multi-county and county-level Air Pollution Control Districts (APCDs). The CARB establishes statewide air quality standards, while the local APCDs are responsible for enforcing standards and regulating local mobile and stationary sources. The project site is in the Santa Barbara County portion of the SCCAB and is under the jurisdiction of the Santa Barbara County Air Pollution Control District (SBCAPCD). The SBCAPCD administers many programs under the CARB review and permit authority over sources of air pollution.

Federal and state standards have been established for six criteria pollutants: ozone (O₃), carbon monoxide (CO), nitrogen dioxide (NO₂), sulfur dioxide (SO₂), particulates less than 10 and 2.5 microns in diameter (PM₁₀ and PM_{2.5}), and lead (Pb) (Table 2). California air quality standards are identical to or stricter than federal standards for all criteria pollutants. Table 2 illustrates the current federal and state ambient air quality standards. Section 4.2 of the Certified EIR notes that Santa Barbara County was in nonattainment for the federal and state O₃ standards and state PM₁₀ standards in 2007. According to the CARB 2017 State and National Area Designation Maps, the county is still in nonattainment for the state O₃ and PM₁₀ standards.

Table 2. Current Federal and State Ambient Air Quality Standards

Pollutant	Federal Standard	California Standard
Ozone (O ₃)	0.070 ppm (8-hr avg)	0.09 ppm (1-hr avg) 0.070 ppm (8-hr avg)
Carbon Monoxide (CO)	9.0 ppm (8-hr avg) 35.0 ppm (1-hr avg)	9.0 ppm (8-hr avg) 20.0 ppm (1-hr avg)
Nitrogen Dioxide (NO ₂)	0.053 ppm (annual avg)	0.18 ppm (1-hr avg) 0.030 ppm (annual avg)
Sulfur Dioxide (SO ₂)	0.030 ppm (annual avg) 0.14 ppm (24-hr avg) 0.5 ppm (3-hr avg)	0.04 ppm (24-hr avg) 0.25 ppm (1-hr avg)
Lead (Pb)	1.5 µg/m ³ (calendar quarter)	1.5 µg/m ³ (30-day avg)
Particulate Matter (PM ₁₀)	150 µg/m ³ (24-hr avg)	20 µg/m ³ (annual avg) 50 µg/m ³ (24-hr avg)
Particulate Matter (PM _{2.5})	12 µg/m ³ (annual avg) 35 µg/m ³ (24-hr avg)	12 µg/m ³ (annual avg)
Sulfates	No National Standards	25 µg/m ³ (24-hr avg)
Hydrogen Sulfide		0.03 ppm (1-hr avg)
Vinyl Chloride		ppm (24-hr avg)

ppm= parts per million

µg/m³ = micrograms per cubic meter

Source: California Air Resources Board 2016.

Sensitive Receptors. Certain population groups are considered more sensitive to air pollution than others. Sensitive population groups include children, the elderly, the acutely ill, and the chronically ill, especially those with cardio-respiratory diseases. Sensitive receptor locations include residences, schools, and hospitals. The nearest sensitive receptors to the project site include the single-family residences located within 500 feet to the south of the project site.

Impact Discussion

a-d. The Certified EIR concludes that all potentially significant impacts to air quality would be reduced to a less-than-significant level with identified mitigation. However, the Revised Project proposes 264,500 square feet of floor area, or 223,002 square feet more than permitted under the Approved Project. An Air Quality and Greenhouse Gas Emissions Modeling Assessment Technical Memorandum was prepared for the Revised Project and found that the associated increase in vehicle trips would result in nitrogen oxide (NO_x) emissions that are well above the established threshold (AMBIENT Air Quality and Noise Consulting 2020). Further, the Conceptual Development Plan for the Revised Project proposes a new gas station, which may prompt additional air quality modeling by the SBCAPCD. Thus, the Revised Project may result in a substantial increase in the severity of significant air quality impacts identified in the Certified EIR and this topic area will be evaluated in the SEIR.

Conclusion

The Revised Project may result in a substantial increase in the severity of the significant air quality impacts identified in the Certified EIR; therefore, air quality will be evaluated in the SEIR.

4. BIOLOGICAL RESOURCES

Would the project:	Potentially Significant Impact	Less Than Significant with Mitigation Incorporated	Less Than Significant Impact	No Impact
a. Have a substantial adverse effect, either directly or through habitat modifications, on any species identified as a candidate, sensitive, or special status species in local or regional plans, policies, or regulations, or by the California Department of Fish and Game or U.S. Fish and Wildlife Service?	X			
b. Have a substantial adverse effect on any riparian habitat or other sensitive natural community identified in local or regional plans, policies, regulations or by the California Department of Fish and Game or U.S. Fish and Wildlife Service?			X	
c. Have a substantial adverse effect on state or federally protected wetlands (including, but not limited to, marsh, vernal pool, coastal, etc.) through direct removal, filling, hydrological interruption, or other means?				X
d. Interfere substantially with the movement of any native resident or migratory fish or wildlife species or with established native resident or migratory wildlife corridors, or impede the use of native wildlife nursery sites?	X			
e. Conflict with any local policies or ordinances protecting biological resources, such as a tree preservation policy or ordinance?	X			
f. Conflict with the provisions of an adopted Habitat Conservation Plan, Natural Community Conservation Plan, or other approved local, regional, or state habitat conservation plan?	X			

Setting

The project site is in an urbanized area of the city. The project site is developed with agricultural cultivation of strawberries. According to the Certified EIR, prior to strawberry cultivation, the site supported mostly non-native annual grassland habitat, with a small patch of central coastal scrub, and eucalyptus woodland along the western edge and scattered in the northern portion of the site.

Impact Discussion

a, d-f. Upon completing a preliminary review, the project site has the potential to support habitat for at least one special-status species—California tiger salamander (CTS)—which is designated as a Species of Special Concern (SSC) by the California Department of Fish and Wildlife (CDFW), and is listed as Endangered by the Federal Endangered Species Act (FESA). The Certified EIR concluded that the Specific Plan would impact the CTS breeding and upland refuge habitat and would create significant barriers to the movement of CTS, some of which may directly increase mortality.

The Certified EIR then identified four mitigation measures to reduce the Specific Plan's impacts on CTS. Mitigation Measure B-5(a), *FESA Consultation*, required the Airport District to continue consultation with the U.S. Fish and Wildlife Service (USFWS) until a Biological Opinion was issued by the USFWS for CTS and their habitat. The measure further required the Airport District to implement all measures identified in the Biological Opinion that avoid and minimize the Specific Plan's adverse effects on CTS, including the implementation of a salvage and relocation program and the development of educational or research programs. Mitigation Measure B-5(b), *CTS Habitat Avoidance*, required the Airport District to determine and maintain appropriate buffers/setbacks around certain ponds and pools with confirmed occurrences of CTS. Lastly, Mitigation Measure B-5(c), *CTS Upland Habitat Restoration*, and Mitigation Measure B-5(d), *CTS Breeding Habitat Restoration*, required the Airport District to develop conservation strategies that include the preservation, restoration, and enhancement of suitable breeding and upland habitat at an approximate 2.5 to 1 ratio (habitat preserved, restored, or enhanced to habitat impacted) developed in consultation with the USFWS. Because USFWS consultation was still ongoing when adopted, the Certified EIR could not conclude with certainty that the measures would reduce potential impacts to a less-than-significant level, and therefore conservatively concluded these impacts would be *significant and unavoidable*.

After the EIR was certified, the USFWS issued a Biological Opinion and Incidental Take Permit (ITP) for CTS. Included in the Biological Opinion were conservation measures and habitat replacement ratios. However, this subsequent Biological Opinion and ITP did not address or provide take coverage for proposed development at the 28-acre project site. Because the Certified EIR mitigation measures have not been satisfied on the project site, the Revised Project has the potential to result in new potentially significant environmental effects to biological resources, including CTS habitat. Therefore, impacts associated with biological resources, including CTS, will be evaluated in detail in the SEIR.

- b. The Certified EIR identifies habitats within the project site as including eucalyptus woodland, non-riparian annual grassland, and critical coastal scrub, none of which are classified as a sensitive natural community by the CDFW or other jurisdictions. There are no bodies of water, riparian habitat features, or other sensitive communities located within the project site. Therefore, the project would not have a substantial adverse effect on any riparian habitat or other sensitive natural community and potential impacts would be *less than significant*.
- c. The Certified EIR does not identify any wetlands or water features within the project site. In addition, the National Wetlands Inventory was reviewed and confirmed this determination. The nearest water body to the project site is Orcutt Creek, which is located approximately 0.8 mile south of the southern boundary of the project site. The project would not result in a substantial adverse effect on federally or state-protected wetlands; therefore, there would be *no impact*.

Conclusion

The Revised Project has the potential to result in new potentially significant impacts related to candidate, sensitive, or special-status species; the movement of any native resident or migratory fish or wildlife species; and adopted and/or proposed Habitat Conservation Plans. Therefore, biological resources will be evaluated in the SEIR.

5. CULTURAL RESOURCES

Would the project:	Potentially Significant Impact	Less Than Significant with Mitigation Incorporated	Less Than Significant Impact	No Impact
a. Cause a substantial adverse change in the significance of a historical resource pursuant to §15064.5?			X	
b. Cause a substantial adverse change in the significance of an archaeological resource pursuant to §15064.5?		X		
c. Disturb any human remains, including those interred outside of formal cemeteries?		X		

Setting

As defined by CEQA, a historical resource includes:

1. A resource listed in or determined to be eligible for listing in the California Register of Historical Resources (CRHR).
2. Any object, building, structure, site, area, place, record, or manuscript that a lead agency determines to be historically significant or significant in the architectural, engineering, scientific, economic, agricultural, educational, social, political, military, or cultural records of California may be considered to be a historical resource, provided the lead agency's determination is supported by substantial evidence.

According to the Resources Management Element, the Santa Maria Valley is within lands traditionally occupied by the Chumash until European contact in the mid-eighteenth century. Areas within close proximity to perennial water sources tend to have higher archaeological sensitivity. The project site is not located within close proximity to any blue-line streams or bodies of water, the northern portion of the project site is located in an area designated to have low sensitivity for archaeological resources, and the southern portion of the project site is located in an area designated to have high or moderate sensitivity for archaeological resources.

The establishment of Mission San Luis Obispo de Tolosa to the north and Mission La Purísima Concepción near the city of Lompoc was the beginning of development and settlement in the Santa Maria area. Industrialization and the connection of the Pacific Coast Railroad to the city further stimulated commercial and residential growth in the area. Historical resources in Santa Maria consist of several landmarks and structures. The City has officially designated 10 historic structures and landmarks, with additional sites designated by the Landmark Committee, none of which are located within the project site.

Impact Discussion

- a. The Certified EIR concluded that the project site does not contain, nor is it located near, any historic resources identified in the National Register of Historic Places (NRHP) or CRHR. The project site is not identified on the City's Landmark Map or on the City's Objects of Historic Merit map. Further, there are no structures on the project site that are proposed to be removed; therefore, potential impacts associated with a substantial adverse change in the significance of a historical resource are consistent with those identified in the Certified EIR and would be *less than significant*.

- b. According to the Resources Management Element, the northern portion of the project site is located in an area designated as having low sensitivity for archaeological resources, and the southern portion of the project site is located in an area designated as having high or moderate sensitivity for archaeological resources. In 2002, a records search of the California Historical Resources Information System (CHRIS) and an on-site assessment were conducted, and five archaeological sites were identified within 5 miles of the southern border of the site. Per the Certified EIR, no resources were identified within or immediately adjacent to the project site. Although no resources were identified on the surface, the Certified EIR noted that ground disturbance associated with the Approved Project could inadvertently uncover previously unknown, buried archaeological deposits. The Certified EIR concluded that impacts from the inadvertent discovery of archaeological resources would be less than significant through the implementation of procedures prescribed by state law.

The project site has been subject to extensive ground disturbance since the EIR was certified in 2007. The agricultural cultivation of strawberries began in late 2018; several stands of mature eucalyptus trees were removed to accommodate the cultivation activities. Agricultural activities routinely disturb the upper soil layers to an approximate depth of 6 feet. Thus, the ongoing strawberry cultivation would have likely exposed, disturbed, and/or removed any unknown subsurface archaeological resources within the upper soil layers. No archaeological resources have been identified during the routine cultivation activities; therefore, the potential for such resources to exist within the project site is very low.

Even so, as with the Approved Project, the Revised Project would result in future extensive excavation into undisturbed native soils (e.g., at depths greater than 6 feet). Excavation would be greatest at the proposed ROS-DB zoning designation area, where future development of a detention basin would result in excavation of up to 30 feet); at the location of any underground storage tanks at the anticipated gas station; at building foundations/footings; and where trenching is required for utility connections. While the potential to encounter archaeological resources generally decreases with depth, ground disturbance associated with the Revised Project could inadvertently uncover previously unknown, buried archaeological deposits. Therefore, potential impacts associated with substantial adverse changes in the significance of archaeological resources will be evaluated in the SEIR and standard mitigation measures are expected to reduce potential impacts associated with inadvertent discovery of archaeological resources.

- d. In 2002, a CHRIS records search and an on-site assessment were conducted, and five archaeological sites were identified within 5 miles of the southern border of the site; no resources were identified within or immediately adjacent to the project site (Rincon Consultants, Inc. 2007). The Certified EIR concluded that that the Approved Project's potential impacts to human remains would be less than significant based on required compliance with state and local regulations.

The cultivation of strawberries began on the project site in late 2018. As a result, the project site has been subject to substantial ground disturbance since the survey was completed in 2002, and the potential for inadvertently encountering human remains has been reduced. However, as with the Approved Project, in the unlikely event that human remains are discovered during construction of the Revised Project, and the remains are determined to be Native American and recovered as a result of an action brought pursuant to this section, the requirements of PRC Section 5097.9 shall be implemented. Based on required compliance with state and local policies, the Revised Project's potential impacts associated with disturbance of human remains would be consistent with those identified in the Certified EIR and *less than significant*.

Mitigation Measure(s) Incorporated into the Revised Project

Implementation of the Revised Project may encounter the presence of previously identified archaeological resources. Therefore, this topic will be evaluated in the SEIR and mitigation measures are expected to address the potential for inadvertent discovery of significant archaeological resources.

Conclusion

Implementation of the Revised Project may result in impacts associated with the inadvertent discovery of significant archaeological resources. Therefore, potential impacts associated with substantial adverse changes in the significance of archaeological resources will be evaluated in the SEIR and mitigation measures are expected to reduce potential impacts associated with inadvertent discovery of archaeological resources to less than significant. No other potentially significant impacts not previously analyzed within the Certified EIR would occur.

6. ENERGY

Would the project:	Potentially Significant Impact	Less Than Significant with Mitigation Incorporated	Less Than Significant Impact	No Impact
a. Result in potentially significant environmental impact due to wasteful, inefficient, or unnecessary consumption of energy resources, during project construction or operation?		X		
b. Conflict with or obstruct a state or local plan for renewable energy or energy efficiency?		X		

Setting

Pacific Gas and Electric Company (PG&E) is the primary electricity provider for the City. Approximately 39% of electricity provided by PG&E is sourced from renewable resources and an additional 47% is sourced from greenhouse gas (GHG)-free resources (PG&E 2019). Southern California Gas Company (SoCalGas) is the primary provider of natural gas for development within the city. SoCalGas has committed to replacing 20% of its traditional natural gas supply with renewable natural gas by 2030 (Sempra Energy 2019). Renewable natural gas is generated from waste and agricultural byproducts and is carbon-neutral/carbon-negative, which means it can take more GHG emissions out of the atmosphere than it emits as an energy source.

The California Building Code (CBC) contains standards that regulate the method of use, properties, performance, or types of materials used in the construction, alteration, improvement, repair, or rehabilitation of a building or other improvement to real property. The CBC includes mandatory green building standards for residential and nonresidential structures, the most recent version of which are referred to as the *2019 Building Energy Efficiency Standards* (effective January 1, 2020). These standards focus on four key areas: smart residential photovoltaic systems, updated thermal envelope standards (preventing heat transfer from the interior to the exterior and vice versa), residential and nonresidential ventilation requirements, and non-residential lighting requirements.

The City has not adopted a climate action plan; however, the Resources Management Element includes goals for achieving increased energy conservation use within the city through increasing the energy efficiency of buildings, appliances, and buildings, as well as encouragement for development and the use of alternative forms of energy. Current measures applied in the city include energy-conserving building standards, recycling, and transportation system improvements. The Resources Management Element also identifies energy conservation policies, including encouraging the use of innovative site and building orientation and landscaping to maximize energy efficiency.

Impact Discussion

a-b. When the Certified EIR was approved in 2007, CEQA did not yet require the evaluation of a proposed project’s impacts on the consumption of energy resources. A 2016 court case, *Ukiah Citizens for Safety First v. City of Ukiah (248 Cal.App.4th 256)*, first confirmed that EIRs must include an energy analysis. In 2019, Energy was added to the State CEQA Guidelines Appendix G Checklist as a standalone section. Since the potential impacts of the Approved Project on energy resources was never evaluated, the Revised Project has the potential to result in a new potentially significant impact related to energy and this topic will be further evaluated in the SEIR. Based on the Revised Project’s Conceptual Development Plan and required compliance with CBC energy efficiency requirements, it is expected that project impacts associated with consumption of energy resources and consistency with state and local plans associated with energy efficiency would be *less than significant*, although mitigation may be required to reduce impacts to a less-than-significant level.

Conclusion

The Revised Project’s potential impacts relating to the inefficient or wasteful consumption of energy resources and/or potential to conflict with a local plan will be evaluated in further detail in the SEIR.

7. GEOLOGY AND SOILS

Would the project:	Potentially Significant Impact	Less Than Significant with Mitigation Incorporated	Less Than Significant Impact	No Impact
a. Directly or indirectly cause potential substantial adverse effects, including the risk of loss, injury, or death involving:				
i. Rupture of a known earthquake fault, as delineated on the most recent Alquist-Priolo Earthquake Fault Zoning Map issued by the State Geologist for the area or based on other substantial evidence of a known fault? Refer to Division of Mines and Geology Special Publication 42.			X	
ii. Strong seismic ground shaking?			X	
iii. Seismic-related ground failure, including liquefaction?			X	
iv. Landslides?			X	
b. Result in substantial soil erosion or the loss of topsoil?			X	
c. Be located on a geologic unit or soil that is unstable, or that would become unstable as a result of the project, and potentially result in on- or off-site landslide, lateral spreading, subsidence, liquefaction or collapse?			X	

Would the project:	Potentially Significant Impact	Less Than Significant with Mitigation Incorporated	Less Than Significant Impact	No Impact
d. Be located on expansive soil, as defined in Table 18-1-B of the most recent Uniform Building Code (1994), creating substantial direct or indirect risks to life or property?			X	
e. Have soils incapable of adequately supporting the use of septic tanks or alternative wastewater disposal systems where sewers are not available for the disposal of wastewater?				X
f. Directly or indirectly destroy a unique paleontological resource or site or unique geologic feature?		X		

Setting

The project site is located within the Santa Maria Valley, an east–west trending alluvial valley bounded to the north by the San Rafael Range and to the south by the Casmalia Range and Solomon Hills. The Santa Maria River traverses the valley from east to west before its confluence with the Pacific Ocean just west of the town of Guadalupe. The Santa Maria River is formed by the convergence of the Cuyama and Sisquoc Rivers at Fugler Point near the town of Garey.

The Santa Maria Basin is a significant hydrocarbon-producing (i.e., oil and gas) coastal (and off-shore) basin in California. The basin lies at the juncture between the north–west-trending southern Coast Range province and the east–west-trending Transverse Range province. The basin contains a relatively thick Miocene through Holocene-age sequence of sedimentary rocks, some of which are prolific petroleum producing formations and others that are highly productive groundwater aquifers.

The Santa Maria Valley is located within a structural fold and thrust fault area; the axes of most of the structural elements in the region run northwest–southeast, parallel to the valley. The Santa Maria basin and adjacent southern Coast Ranges have been subjected to considerable uplift during the last 2 to 5 million years and are seismically active. Relatively little direct evidence of active faulting (such as offset of bedding or structures observed at a surface fault) has been observed in the region; however, broad bands of seismicity unrelated to surface faults and other evidence indicate the region is seismically active.

According to the City of Santa Maria General Plan Safety Element (City of Santa Maria 1995), several active, potentially active, and inactive faults exist within the basin and region, and generally trend north–west. The major faults include the Santa Maria, Santa Maria River, and Casmalia Faults. None of these faults qualify as an Active Fault under the Alquist-Priolo Earthquake Fault Zones Act. As noted in Section 1.0 of the Certified EIR, the project site is located approximately 3.1 miles southwest of the Santa Maria Fault zone and 3 miles northeast from the Casmalia Fault zone, which are listed as “potentially active.”

Consistent with information provided in Section 10 of the Certified EIR, a review of the U.S. Department of Agriculture (USDA) Natural Resources Conservation Service (NRCS) Web Soil Survey (USDA NRCS 2020) and the Soil Survey of Northern Santa Barbara Area, California (USDA Soil Conservation [SCS] 1972) indicates that the project site is underlain by the following two soil types:

- **BmA – Betteravia loamy sand, 0–2% slopes.** This soil unit underlies approximately 66% of the project site, occurring in the center and southeastern corner of the site. This nearly level soil has

slow permeability and very slow surface runoff. The hazard of water erosion is slight to none. The hazard of wind erosion is high. The typical depth to the subsoil is 36 to 50 inches. This soil unit is used primarily for range and for non-farm purposes. A few areas are used for dry farmed grain and for irrigated row crops, particularly strawberries.

- **OcD3 – Oceano sand, 2–15% slopes.** This soil unit underlies approximately 33% of the project site, occurring in the center, southeastern corner, and northeastern corner of the site. This soil is gently sloping to strongly sloping. Permeability is rapid and surface runoff is slow to moderate. The hazard of water erosion is moderate, and the hazard of wind erosion is very high. This soil is used to a limited extent for irrigated alfalfa and walnuts and for rangeland.

Based on the geologic map of Santa Maria and Twitchell dam quadrangles (Dibblee and Ehrenspeck 1994), the project site is underlain by older alluvium, consisting of wind-deposited sand. Older Alluvium is considered to have high paleontologic sensitivity (County of Santa Barbara 2018). Fossils that have been historically encountered in formations of this age include tide-pool and rock-cliff mollusks and barnacles in marine deposits (Woodring and Bramlette 1950).

Impact Discussion

- a.i. The project site is located approximately 3.1 miles southwest of the Santa Maria Fault zone and 3 miles northeast from the Casmalia Fault zone. Neither the Santa Maria Fault nor the Casmalia Fault are classified as Active Faults under the Alquist-Priolo Earthquake Fault Zones Act. As with the Approved Project, all buildings developed as part of the Revised Project would be subject to standard construction standards and the seismic requirements specified in the most current version of the CBC, which have been developed to establish the minimum requirements necessary for building design to safeguard the public health, safety, and general welfare through structural strength, stability, access, and other standards. Therefore, through compliance with these existing standards, all new buildings would be constructed to withstand the magnitude of earthquakes that could potentially occur within this area. Therefore, potential impacts would be consistent with the findings in the Certified EIR and *less than significant*.
- a.ii. Seismic ground shaking is influenced by the proximity of the site to an earthquake fault, the intensity of the seismic event, and the underlying soil composition. Based on the Geologic Hazards Map provided in the Safety Element, the project site is not located within an identified ground-shaking zone. In addition, the Certified EIR notes that the effects of seismic ground shaking would be minimized through implementation of the seismic requirements specified in applicable building codes, such as the CBC; therefore, potential impacts would be consistent with the findings of the Certified EIR and *less than significant*.
- a.iii. Based on the Geologic Hazards Map provided in the Safety Element, the project site is located within an area with shallow groundwater and liquefaction potential. As with the Approved Project evaluated in the Certified EIR, the Revised Project would also be required to comply with applicable building codes, such as the CBC seismic requirements and the City's building standards to reduce risk associated with seismic-related ground failure, including liquefaction. These measures could include, but would not be limited to, specific design features in building foundations to make structures resistant to liquefaction or use of soil improvement techniques to reduce risk of liquefaction on-site. Based on compliance with applicable CBC and City building standards, potential impacts related to liquefaction would be consistent with the findings of the Certified EIR and *less than significant*.
- a.iv. Landslides typically occur in areas with steep slopes or in areas containing escarpments. The project site topography ranges from nearly level to gently sloping. Based on the Geologic Hazards Map provided in the Safety Element, the project site is not located within an area with steep slopes susceptible to local failure; therefore, the potential for impacts related to landslides would be consistent with the findings in the Certified EIR and *less than significant*.

- b. Development of the Revised Project will be guided by a Conceptual Development Plan. Full buildout would require grading on approximately 24.5 acres of the project site, including removal of 10 existing trees on-site. The project site has nearly level to gently sloping topography and the Certified EIR notes that the erosion potential of the two soil types found on-site ranges from “none to slight” to “moderate.” Further, development activities would be subject to the City Landscape and Irrigation Standards that require soil erosion control on-site. The Certified EIR required a Grading and Drainage Plan to be prepared and submitted prior to construction of the Approved Project. The plans have subsequently been supplanted by the more stringent requirements of the National Pollution Discharge Elimination System Permit (NPDES) Storm Water Pollution Prevention Plan (SWPPP) requirements, although the intent and mechanisms of the SWPPP are materially the same. The Revised Project would be required to adhere to conditions under the NPDES issued by the Regional Water Quality Control Board (RWQCB) and prepare and submit a SWPPP for all projects that would require 1 acre or more of ground disturbance, to be administered throughout project construction. The SWPPP would incorporate Best Management Practices (BMPs) to ensure that potential water quality impacts during construction from soil erosion would be reduced to be less than significant. The Revised Project would implement a more extensive landscaping plan than the Approved Project. It would also result in greater coverage by impervious surface areas that inherently prevent soil erosion, such as parking lots, sidewalks, and other hardscapes.

As with the Approved Project, the relocated detention basin would be designed to capture runoff from the project vicinity per the approved Flood Control Plan. Runoff directed to the basin would be allowed to pond, de-silt, and/or infiltrate into the underlying soils, thus reducing and capturing sediment loads in runoff flows. The basin would be regularly maintained to ensure its long-term operation. Therefore, potential impacts related to soil erosion and loss of topsoil would be consistent with the Certified EIR and *less than significant*.

- c. The following analysis is based on the Safety Element:

Liquefaction or collapse: The project site is in an area with soils with the potential to result in liquefaction in the event of a seismic event. As with the Approved Project, standard construction techniques would be employed to ensure no significant risk to human life would occur as a result of liquefaction of on-site soils; therefore, impacts related to liquefaction would be consistent with the Certified EIR and *less than significant*.

Landslide: Landslides typically occur in areas with steep slopes or in areas containing escarpments. Based on the Geologic Hazards Map in the Safety Element, the project site is not located within an area with steep slopes susceptible to local failure; therefore, the potential for impacts related to landslides would be consistent with the Certified EIR and *less than significant*.

Lateral Spreading: According to the Safety Element, the project site is not located within an area known to contain expansive soils. Additionally, build out of the Revised Project would be required to comply with the most recent CBC requirements, which would ensure protection of structures and occupants from seismic hazards, such as expansive soils; therefore, impacts related to lateral spreading would be consistent with the Certified EIR and *less than significant*.

Subsidence: The project site is not located in an area of historical or current land subsidence (U.S. Geological Survey [USGS] 2020). The Santa Maria area has not had significant subsidence issues despite historical oil drilling in the area. Although subsidence could occur, it is perceived to be an insignificant risk due to the absence of reported incidences (City of Santa Maria 1995); therefore, impacts related to subsidence would be consistent with the Certified EIR and *less than significant*.

- d. According to the Safety Element, the project site is not located within an area known to contain expansive soils. Additionally, all future development would be required to comply with the most recent CBC requirements, which would ensure protection of structures and occupants from seismic hazards, such as expansive soils; therefore, impacts related to seismic soils would be consistent with the Certified EIR and *less than significant*.

- e. The Revised Project would include installation of a new service connection to existing City wastewater treatment facilities; therefore, the findings are consistent with the Certified EIR and *no impacts would result*.
- f. Topsoil at the project site consist of the two surface soils: Betteravia loamy sand (BmA) and Oceano sand (OcD3). Betteravia loamy sand underlies approximately 66% of the project site, occurring on the northern and western portions of the site. The Oceano sand unit underlies approximately 33% of the project site, occurring in the center, southeastern corner, and northeastern corner of the site. Soils Maps prepared for Santa Barbara County indicate the surface soils are underlain by Older Alluvium consisting of dissected alluvial gravel, sand, and clay (Qoa), which is considered to have high sensitivity for paleontological resources (Dibblee and Ehrenspeck 1994; County of Santa Barbara 2018). Fossils that have been historically encountered in formations of this age include tide-pool and rock-cliff mollusks and barnacles in marine deposits (Woodring and Bramlette 1950).

The project site consists of previously disturbed terrain with mostly flat topography. Apart from the detention basin, the Revised Project would not require any substantial cuts into any hillsides or deep excavations with the potential to disturb underlying geological units (i.e., the Older Alluvium [Qos]). Construction of the detention basin would require the excavation of soils over an area of roughly 9 acres to a maximum depth of approximately 30 feet. By relocating the detention basin to the northwest portion of the project site, excavation would be within the Betteravia loamy sand surface soil unit. The thickness of the soil unit varies, but it typically extends at least 36 inches in the project vicinity.

Although the project site requires excavation into undisturbed native soils, it is unlikely that the project excavation will encounter paleontological resources. The project would not result in substantial deep cuts into underlying foundations and the presence of paleontological resources is highly inconsistent in the underlying Older Alluvium. Nonetheless, there is always a potential that project excavation could encounter the presence of paleontological resources. This issue will be evaluated in the SEIR and mitigation that identifies proper inadvertent discovery protocol in order to reduce potential impacts to paleontological resources to *less than significant* will likely be required.

Mitigation Measure(s) Incorporated into the Revised Project

Implementation of the Revised Project may encounter the presence of paleontological resources. Therefore, this issue will be evaluated in the SEIR and mitigation will be recommended to address the potential for inadvertent discovery of significant paleontological resources.

Conclusion

Implementation of standard mitigation would ensure paleontological resources are properly protected and curated in the event of an inadvertent discovery and would address inadvertent discovery protocol in order to reduce potential impacts to paleontological resources to less than significant.

8. GREENHOUSE GAS EMISSIONS

Would the project:	Potentially Significant Impact	Less Than Significant with Mitigation Incorporated	Less Than Significant Impact	No Impact
a. Generate greenhouse gas emissions, either directly or indirectly, that may have a significant impact on the environment?	X			
b. Conflict with an applicable plan, policy or regulation adopted for the purpose of reducing the emissions of greenhouse gases?	X			

Setting

GHGs are gases that absorb infrared radiation in the atmosphere and are different from the criteria pollutants discussed in Section 3, Air Quality, above. The primary GHGs that are emitted into the atmosphere as a result of human activities are carbon dioxide (CO₂), methane (CH₄), nitrous oxide (N₂O), and fluorinated gases. These are most commonly emitted through the burning of fossil fuels (e.g., oil, natural gas, and coal), agricultural practices, decay of organic waste in landfills, and a variety of other chemical reactions and industrial processes (e.g., the manufacturing of cement).

CO₂ is the most abundant GHG and is estimated to represent approximately 80–90% of the principal GHGs that are currently affecting the earth's climate. According to the CARB, transportation (vehicle exhaust) and electricity generation are the main sources of GHGs in the state.

Statewide legislation, rules, and regulations have been adopted to reduce GHG emissions from significant sources. The California State Legislature enacted AB 32, the California Global Warming Solutions Act of 2006. AB 32 required that GHGs emitted in California be reduced to 1990 levels by the year 2020. SB 32 and Executive Order (EO) S-3-05 were enacted in 2017 and extended the State's GHG reduction goals and required the CARB to regulate sources of GHGs to meet a state goal of reducing GHG emissions to 1990 levels by 2020, 40% below 1990 levels by 2030, and 80% below 1990 levels by 2050. Other statewide policies adopted to reduce GHG emissions include SB 375 and SB 97, and the Clean Car Standards, Low Carbon Fuel Standard, Renewable Portfolio Standard, CBC, and California Solar Initiative.

The vast majority of individual projects do not generate sufficient GHG emissions to create a project-specific impact through a direct influence on climate change. Therefore, the issue of climate change typically involves an analysis of whether a project's contribution towards an impact is cumulatively considerable. "Cumulatively considerable" indicates that the incremental effects of an individual project are significant when viewed in connection with the effects of past projects, other current projects, and probable future projects (State CEQA Guidelines Section 15355). GHG emissions were not evaluated in the Certified EIR.

Impact Discussion

a-b. When the EIR was certified in 2007, CEQA did not yet require the evaluation of a proposed project's impacts on GHGs. By enacting SB 97 in 2007, California's lawmakers expressly recognized the need to analyze GHG emissions as a part of the CEQA process and the California Office of Planning and Research (OPR) amendments to the State CEQA Guidelines first became effective in March 2010.

For the Revised Project, GHG emissions were estimated in an Air Quality and Greenhouse Gas Emissions Modeling Assessment Technical Memorandum (AMBIENT Air Quality & Noise Consulting 2020) and then compared against the GHG-efficiency threshold based on the AB 32 Year 2020 GHG-reduction target and adjusted to account for the more stringent Year 2030 GHG-reduction target mandated by SB 32. Based on the Emissions Modeling Assessment Technical Memorandum, the Revised Project has the potential to exceed the efficiency threshold and result in a potentially significant impact related to GHG emissions. Therefore, GHG emissions will be evaluated in further detail in the SEIR.

Conclusion

Implementation of the Revised Project has the potential to result in potentially significant impacts related to GHG emissions; therefore, GHG emissions will be evaluated in the SEIR.

9. HAZARDS AND HAZARDOUS MATERIALS

Would the project:	Potentially Significant Impact	Less Than Significant with Mitigation Incorporated	Less Than Significant Impact	No Impact
a. Create a significant hazard to the public or the environment through the routine transport, use, or disposal of hazardous materials?			X	
b. Create a significant hazard to the public or the environment through reasonably foreseeable upset and accident conditions involving the release of hazardous materials into the environment?			X	
c. Emit hazardous emissions or handle hazardous or acutely hazardous materials, substances, or waste within one-quarter mile of an existing or proposed school?			X	
d. Be located on a site which is included on a list of hazardous materials sites compiled pursuant to Government Code Section 65962.5 and, as a result, would it create a significant hazard to the public or the environment?			X	
e. For a project located within an airport land use plan or, where such a plan has not been adopted, within two miles of a public airport or public use airport, would the project result in a safety hazard or excessive noise for people residing or working in the project area?		X		
f. Impair implementation of or physically interfere with an adopted emergency response plan or emergency evacuation plan?			X	
g. Expose people or structures, either directly or indirectly, to a significant risk of loss, injury or death involving wildland fires?			X	

Setting

As summarized in the Certified EIR, a review of historic aerial photographs indicates that the project site was undeveloped until Foxenwood Lane was extended north to Foster Road in the mid-1980s. No further development occurred at the project site until late 2018 when the agricultural cultivation of strawberries commenced. A record search of applicable environmental databases and a field reconnaissance survey were completed during preparation of the Certified EIR. The records search indicated that two aircraft fuel dispensing areas and/or associated tanks may have been located at two different locations along the western site boundary. No information pertaining to the assessment or removal of fuel dispensers was identified during a database search for the Phase I Environmental Site Assessment (ESA) prepared for the Specific Plan area. Further, no evidence of these fueling locations (e.g., stained soils, stressed vegetation) were observed. The Certified EIR noted that the project site does not contain any underground storage tanks (UST) or former fuel dispenser locations.

These existing setting and potential for hazardous materials concerns have not changed materially since the Certified EIR. No release of hazardous materials into the environment has been reported at the project site. Based on a search of the California Department of Toxic Substance Control (DTSC) EnviroStor database and the State Water Resources Control Board (SWRCB) GeoTracker system (DTSC 2020; SWRCB 2020), there are no environmental or toxic waste cleanup sites within the project area. There is an active Waste Discharge Requirement (WDR) site located approximately 950 feet (0.18 mile) west of the project site, associated with the Laguna County Sanitation District (LCSD) Wastewater Treatment Plant.

The agricultural cultivation of strawberries began in late 2018; however, agricultural uses are carried out in accordance with applicable regulations and there are no known concerns regarding the use of herbicides or pesticides at the project site.

The project site is located within the Santa Maria Airport Influence Area (AIA). The project is located outside of the airport noise contours (SBCAG 2019).

Impact Discussion

- a. The Approved Project proposed land uses consistent with the CF land uses designation, which typically do not require the routine transport, use, or disposal of hazardous materials in quantities that would result in a significant hazard to the public or the environment. While also true for most uses proposed by the Revised Project (e.g., government/public uses, commercial, marketplace), the Conceptual Development Plan includes a gas station at the intersection of SR 135 and Union Valley Parkway.

All fuel-dispensing facilities, such as the proposed gas station, are required to be constructed and operated in accordance with the CBC, California Plumbing Code, and California Fire Code. These standards include, but are not limited to, location limitations from buildings with combustible exterior wall surfaces and fixed ignition sources, supervision of self-serve fuel-dispensing activities, standards for equipment maintenance and inspection, and installation of emergency disconnect switches to be used in the event of a fuel spill or other emergency. Santa Barbara County is certified by the California Environmental Protection Agency (CalEPA) as the Certified Unified Program Agency (CUPA) for the County of Santa Barbara (County). As the CUPA, the County implements the Hazardous Materials Plan Program, which requires businesses handling, using, or storing reportable amounts of hazardous materials to submit inventories, site maps, and other documentation relating to those materials, and to develop appropriate employee training and emergency procedures. The County also regulates the installation and operation of USTs through the UST Construction Standards, including requirements for a continuous monitoring system and routine inspections.

Thus, although the Revised Project would transport, use, and dispose of hazardous materials in higher quantities than the Approved Project, gas stations are common throughout the city and do not represent an unusually dangerous land use. Compliance with existing regulations would reduce

the potential for the Revised Project to result in a significant hazard to the public or the environment through the routine use or transport of hazardous materials. Since impacts would be *less than significant*, the Revised Project would not result in a new potentially significant impact not identified in the Certified EIR.

- b. As with the Approved Project, construction and operation of the Revised Project would require limited quantities of hazardous substances, including gasoline, diesel fuel, hydraulic fluid, solvents, oils, paints, etc. Temporary storage containers (e.g., bulk above-ground storage tanks, 55-gallon drums, sheds/trailers, etc.) may be used by the project contractor for equipment refueling and maintenance purposes during construction. As discussed in impact discussion a., above, the Conceptual Development Plan includes the location of a potential gas station, which would require on-site storage of gasoline and other hazardous substances. Handling of these materials has the potential to result in an accidental release. Construction contractors and on-site operators would be required to comply with applicable federal and state environmental and workplace safety laws, including the Federal Occupational Safety and Health Administration (OSHA) Process Safety Management Standard (California Code of Regulations [CCR] 29.1910.119), which includes requirements for preventing and minimizing the consequences of accidental release of hazardous materials. Additionally, the construction contractor would be required to implement BMPs for the storage, use, and transportation of hazardous materials during all construction activities.

During operation, the project would include storage, use, and refilling of petroleum products associated with the proposed gas station. Although the Revised Project would transport, use, and dispose of hazardous materials in higher quantities than the Approved Project, gas stations are common throughout the city and do not represent an unusually dangerous use of regulated hazardous materials. The project would be subject to applicable state and local policies governing underground storage of hazardous substances, including the statutes of Chapter 6.7 of the California Health and Safety Code, which include, but are not limited to, being equipped with an automatic line leak detector and annual testing of the leak detector (SWRCB 2019). Compliance with existing regulations would reduce the potential for the Revised Project to result in a significant hazard to the public or the environment through reasonably foreseeable accident or upset conditions. Since impacts would be *less than significant*, the Revised Project would not result in a new potentially significant impact not identified in the Certified EIR.

- c. The project site is located approximately 0.23 mile (1,235.84 feet) from Gloria Dei Lutheran Church, which includes a preschool. As with the Approved Project, the Revised Project would be subject to the requirements for use and transport of hazardous materials of the Uniform Fire Code, including placement of safeguards to minimize risk of exposure of hazardous materials that could lead to the endangerment of people or property. Fuel-dispensing facilities, such as the proposed gas station, would be required to be constructed and operated in accordance with applicable regulations. In addition, the project site is physically separated from the nearest school facilities by SR 135, which further reduces risk of any potential project hazardous materials uses from affecting those facilities. Therefore, potential impacts associated with hazardous emissions or handling of acutely hazardous materials within proximity to existing or proposed schools would be consistent with the Certified EIR and *less than significant*.
- d. Based on a search of the CalEPA Cortese List, DTSC EnviroStor website, and SWRCB GeoTracker website, there are no known active hazardous material sites located near the project site; therefore, as with the Approved Project and consistent with the findings of the Certified EIR, *no impacts would occur*.
- e. The project is located within the Santa Maria AIA but is located outside of the airport noise contours. The Approved Project was evaluated for consistency with the adopted Santa Maria ALUP. The Certified EIR concluded that the Approved Project would be consistent with the ALUP through the implementation of Mitigation Measure H-2(b), *Lot Coverage*, which required that all development will conform in strict adherence to the development parameters of the Land Use Intensity Table (Specific Plan Table 8).

SBCAG prepared the Draft Santa Maria ALUCP in August 2019; however, this plan has not yet been adopted. Future development resulting from the Revised Project would be required to comply with the lot coverage and design guidelines of the adopted ALUP for uses within the Specific Plan area, including maximum building height and use of reflective building materials, and exterior lighting, intended to avoid potential hazards associated with the regular ingress/egress of planes near the project site. Future development that would require conditions to be consistent with the ALUP/ALUCP would be subject to the review and would require approval by the SBCAG, in its role as the Airport Land Use Commission. Certified EIR Mitigation Measure H-2(b), *Lot Coverage*, would not be applicable to the Revised Project as the project includes different land use designations than what is detailed in the Land Use Intensity Table (Specific Plan Table 8).

As with the Approved Project, the Revised Project includes an approximately 9-acre stormwater detention basin. In general, detention ponds and open drainage ditches may have a potential to result in the creation of standing bodies of water after storm events that can attract birds in significant numbers that are hazardous to aircraft operations.

The Certified EIR evaluated a proposed 9-acre area for development of a drainage basin within the project site and identified a potentially significant impact associated with the drainage basin's potential to increase aircraft-bird hazards. Mitigation Measure H-2(a), *Minimize Aircraft-Bird Interactions*, was identified to require areas designed for retention basins to incorporate mitigation measures to prevent accumulation of standing water for more than 48 hours in order to prevent attraction of birds in significant numbers and minimize aircraft-bird interactions. This measure has been revised to include the requirement that the detention basin be designed in compliance with the design guidance for new stormwater management facilities in the Federal Aviation Administration (FAA) Advisory Circular on Hazardous Wildlife Attractants on or Near Airports (FAA 2020) in order to provide additional guidance on how to satisfy the measure. This revision would not change the overall effectiveness of the mitigation measure. This measure would be applied to the Revised Project to ensure potential impacts associated with wildlife hazards are reduced to *less than significant with mitigation*. Wildlife hazards will also be addressed in the Biological Resources section of the SEIR.

- f. As with the Approved Project, the Revised Project does not include any characteristics or features that would interfere with an adopted emergency response plan or emergency evacuation plan. The project would not result in the closure of any roads. All access and circulation routes to and from the project site would be developed in compliance with local and state safety regulations and all improvements would be required to comply with applicable California Fire Code and CBC requirements pertaining to emergency access; therefore, impacts related to interference with an adopted emergency response plan or evacuation plan would be consistent with the Certified EIR and *less than significant*.
- g. The project is not located within or adjacent to a wildland area. The project would be required to comply with all applicable fire safety rules and regulations including the California Fire Code and PRC prior to issuance of building permits; therefore, potential impacts would be consistent with the Certified EIR and *less than significant*.

Mitigation Measure(s) Incorporated into the Revised Project

Implementation of Mitigation Measure H-2(a) of the Certified EIR would apply to the Revised Project and would effectively reduce hazards associated with aircraft-bird interactions to less than significant. With incorporation of the Certified EIR Mitigation Measure H-2(a) detailed below, potential impacts associated with hazards and hazardous materials would be consistent with the Certified EIR and less than significant with mitigation.

H-2(a) Minimize Aircraft-Bird Interactions. Area 4 and two other small areas adjacent to Runway 30 designed for retention basins must incorporate mitigation measures to prevent accumulation of standing water for more than 48 hours in order to prevent attraction of birds in significant

numbers to open water and to minimize aircraft-bird interactions. These measures shall be consistent with the design guidelines provided in the Federal Aviation Administration Advisory Circular on Hazardous Wildlife Attractants on or Near Airports (FAA 2020) for new stormwater management facilities.

Conclusion

Implementation of Certified EIR Mitigation Measure H-2(a), as modified, would ensure potential hazards related to the project site’s proximity to a public airport would be reduced to less than significant, consistent with the Certified EIR. Therefore, potential impacts would be *less than significant with mitigation* and no new or more severe impacts would occur. No additional mitigation or further evaluation of this issue in the SEIR is necessary. In addition, potential wildlife hazards will be further addressed in the Biological Resources section of the SEIR.

10. HYDROLOGY AND WATER QUALITY

Would the project:	Potentially Significant Impact	Less Than Significant with Mitigation Incorporated	Less Than Significant Impact	No Impact
a. Violate any water quality standards or waste discharge requirements or otherwise substantially degrade surface or ground water quality?			X	
b. Substantially decrease groundwater supplies or interfere substantially with groundwater recharge such that the project may impede sustainable groundwater management of the basin?			X	
c. Substantially alter the existing drainage pattern of the site or area, including through the alteration of the course of a stream or river or through the addition of impervious surfaces, in a manner which would:				
i. result in substantial erosion or siltation on- or off-site;		X		
ii. substantially increase the rate or amount of surface runoff in a manner which would result in flooding on- or offsite;		X		
iii. create or contribute runoff water which would exceed the capacity of existing or planned stormwater drainage systems or provide substantial additional sources of polluted runoff; or		X		
iv. impede or redirect flood flows?				X
d. In flood hazard, tsunami, or seiche zones, risk release of pollutants due to project inundation?				X

Would the project:	Potentially Significant Impact	Less Than Significant with Mitigation Incorporated	Less Than Significant Impact	No Impact
e. Conflict with or obstruct implementation of a water quality control plan or sustainable groundwater management plan?			X	

Setting

The project site is located within the Santa Maria Watershed, one of the largest coastal drainage basins in California, which includes all tributaries and watersheds for the Cuyama, Sisquoc, and Santa Maria Rivers. The Santa Maria Watershed overlies the Santa Maria Valley Groundwater Basin, covering more than 280 square miles in the southwestern corner of San Luis Obispo County and the northwestern corner of Santa Barbara County. Historically, the City pumped water from the Santa Maria Valley Groundwater Basin as its sole water supply until the City began receiving California State Water Project (SWP) water from the Central Coast Water Authority (CCWA) in 1997. The Santa Maria Valley Groundwater Basin is currently under a court-ordered stipulation that allows the City to derive its water supply from local groundwater, associated return flows from imported SWP water that may be recaptured in the Basin, and a share of the yield of Twitchell Reservoir operations.

Based on the Federal Emergency Management Agency (FEMA) National Flood Hazard Layer Viewer, the project site is not located within a 100-year flood plain (FEMA 2020). Based on the DOC Santa Barbara County Tsunami Inundation Maps, the project site is not located within an area with the potential for tsunami inundation (DOC 2019).

Impact Discussion

- a. The nearest water body to the project site is Orcutt Creek, which is located approximately 0.8 mile south of the southern boundary of the project site. The proposed project would require on-site grading, which could result in the erosion of on-site soils, runoff, and sedimentation during heavy wind or rain events. The Revised Project would be required to comply with all federal, state, and local requirements, including the state Construction General Permit, which requires the preparation of a SWPPP for all projects that would require 1 acre or more of ground disturbance. The SWPPP would include BMPs to control the discharge of pollutants, including sediment and erosion, into local surface water drainages. The project would further be required to comply with the adopted standards contained within City Municipal Code Section 8-12 (wastewater) and Section 8-12A (stormwater). Section 8-12A.04 also incorporates the Post-Construction Stormwater Management Requirements for Development Projects in the Central Coast Region (Central Coast RWQCB Resolution No. R3-2013-0032). By incorporating these design provisions and permit review and approval procedures by the City, the Revised Project would not violate water quality standards and waste discharge requirements; therefore, impacts would be consistent with the Certified EIR and *less than significant*.
- b. The proposed development uses on-site would be served by the City water system. The City of Santa Maria utilizes the following available water supply sources: local groundwater, purchased water from the SWP, associated return flows recaptured from the Santa Maria Groundwater Basin, assigned rights to water from the Santa Maria Groundwater Basin, and assigned rights to augmented yield from Twitchell Reservoir. The City’s water supply is expected to reliably meet the projected water demands and have an available supply in excess through 2040, with most of this demand being met by imported surface water (City of Santa Maria 2016). Since the City has adequate water to supply the project and through compliance with the Sustainable Groundwater

Management Act (SGMA), sustainable yield of the Santa Maria Valley Groundwater Basin would be maintained and the project would not lead to the substantial depletion of groundwater supplies.

The project site does not measurably contribute to groundwater recharge under existing conditions. As explained in Section 4.5 of the Specific Plan, "The entire [Specific Plan area] is situated over a perched groundwater area created by a layer of densely compacted sandy silt which prohibits recharge activity from naturally occurring." Thus, development of the project site with impervious surface areas, such as parking lots, hardscapes, and buildings, would not measurably reduce groundwater recharge. Therefore, impacts would be consistent with the Certified EIR and *less than significant*.

- c.i.-iii. The project site is primarily undeveloped and there are no streams or rivers on-site or within close proximity to the project site. The Revised Project would result in grading of approximately 24.5 acres on-site and development of approximately 7.8 acres of new impervious area. As with the Approved Project, stormwater under the Revised Project would be collected on-site via gutters and directed to the proposed 9-acre detention basin on-site.

Beyond accommodating stormwater flows from the project site, the proposed detention basin (Detention Basin No. 9) has been a key part of the long-planned flood control measures for this portion of the Airport District. Although existing conditions have changed somewhat, the Certified EIR notes: "The County [flood control] system from the 594 acres southeast of Foster Road and State Route 135 delivers a 25-year peak flow of 83 cubic feet per second (cfs) to that intersection. The county will construct improvements to take the runoff under State Route 135 and retain the majority of the flow in a retention basin proposed by the Airport to be constructed between State Route 135 and Foxenwood Lane south of Foster Road, this basin is labeled Retention Basin No. 9. This retention of the flows will greatly reduce the need for infrastructure to convey the water across the proposed business park area."

To achieve this goal, the Certified EIR identified Mitigation Measure D-2(a), *Stormwater Drainage Systems Design*, which requires the Applicant to provide an engineered hydrologic analysis and drainage plan that identifies drainage facilities to accommodate the expected flows, up to a 25-year event with freeboard, and also designed to withstand a 100-year event without damage to any proposed structure. Mitigation Measure D-2(b), *Stormwater Detention Specifications*, establishes the design specifications for detention basins in the Specific Plan area. Of note, the mitigation measures identified in the Certified EIR exceed the design requirements of applicable City and RWQCB standards and better address local conditions. Mitigation Measures D-2(a) and D-2(b) would also be applied to the Revised Project.

The Revised Project would also be required to demonstrate compliance with applicable state and City requirements, which would be subject to review and approval by the City of Santa Maria Utilities Department as part of the grading and building plan review and approval process. Continued implementation of Mitigation Measures D-2(a) and D-2(b) would avoid potential impacts related to on-site erosion, siltation, flooding, and exceedance of stormwater systems and reduce impacts to a less-than-significant level. Therefore, potential impacts would be consistent with the Certified EIR and *less than significant with mitigation*.

- c.iv. Based on the Safety Element and FEMA's National Flood Hazard Layer Viewer, the project site is not located within an area that overlaps with a 100-year floodplain, a 500-year floodplain, or an area that becomes inundated after a major storm (City of Santa Maria 1995; FEMA 2020). Therefore, implementation of the project would not impede or redirect flood flows, would be consistent with the Certified EIR, and *no impacts would occur*.
- d. Based on the FEMA National Flood Hazard Layer Viewer, the project site is not located within a 100-year flood plain (FEMA 2020). Based on the DOC Santa Barbara County Tsunami Inundation Maps, the project site is not located within an area with the potential for tsunami inundation (DOC 2019). The project is not located adjacent to or within close proximity to a large body of water that

would have the potential to generate a seiche. Therefore, potential impacts associated with project inundation are consistent with the Certified EIR and *no impacts would occur*.

- e. The Revised Project would comply with all federal, state, and local requirements, including the state Construction General Permit, which requires the preparation of a SWPPP for all projects that would require 1 acre or more of ground disturbance. The SWPPP would include BMPs to control the discharge of pollutants, including sediment and erosion, into local surface water drainages. By incorporating these design provisions and permit review and approval procedures by the City, the project would not conflict with or obstruct implementation of a water quality control plan or sustainable groundwater management plan; therefore, potential impacts would be consistent with the Certified EIR and *less than significant*.

Mitigation Measure(s) Incorporated into the Revised Project

Implementation of Certified EIR Mitigation Measure D-2(a), *Storm Water Drainage Systems Design*, and Mitigation Measure D-2(b), *Stormwater Detention Specifications*, would ensure the proposed detention basin continues to meet the stormwater and flood control demands of the project site and County flood control system across Foster Road. With incorporation of the Certified EIR Mitigation Measures D-2(a) and D-2(b) detailed below, potential impacts associated with stormwater drainage would be consistent with the Certified EIR and *less than significant with mitigation*.

D-2(a) Storm Water Drainage Systems Design. The Applicant shall provide an engineered hydrologic analysis and drainage plan for the project, prepared by a qualified engineer, which evaluates the added runoff that would result from site development, in relation to the existing drainage system under 10-, 25-, and 100-year flood conditions. The hydrologic analysis shall specify design standards for drainage facilities that would adequately convey storm water runoff under 100-year flood conditions in accordance with City standards. The stormwater conveyance devices shall be sized to accommodate the expected flows, up to a Q25 event with freeboard, and also designed to withstand a Q100 event without damage to any proposed structure.

D-2(b) Storm Water Detention Specifications. The Applicant shall implement on-site physical improvements (e.g., detention basins, etc.) that ensure that existing peak discharge to downstream drainages is not increased as a result of development. Detention basins shall be designed in accordance with applicable City standards. The design must consider the volume of water that the basin is expected to store as well as operation and maintenance of the basins. The detention basins are to have a filtering device on the inflow side to prevent the flow of contaminants and sediments into the basins. Basins shall be designed to meet the following standards:

1. Volume: Detention basins shall be sized to provide capacity for a 100-year storm event (minimum) and to meet the outflow requirements listed below.
2. Outflow Device: All detention basins are to be designed to be free draining. Underground basins are not allowed. Outlet pipes shall be oversized (18-inch minimum) with an orifice restriction to limit outflow to 0.07 cubic feet per second per acre of developed land or as determined by the City. Orifice restriction plates shall be removable for emergency situations. A removable trash rack shall be provided at the outlet.
3. Slopes: Maximum side slopes shall be four horizontal to one vertical on interior slopes and two horizontal to one vertical on exterior slopes. A soils engineering and geotechnical report shall be required for all fill levee sections. The report shall address remedial grading, benching, and slope stability of the level sections.
4. Emergency Overflow: An emergency overflow spillway shall be sized for the peak 100-year storm runoff. The spillway shall be engineered and shall be reinforced concrete. The spillway

should be designed with a minimum of one foot of freeboard above the 100-year spill water surface elevation.

5. Low Flow Drainage: The bottom of the basin shall have a minimum gradient of 2% draining to the outlet, or a low flow reinforced concrete swale shall be provided with a minimum gradient of 0.5% draining to the basin outlet.
6. Access Ramp: A maintenance access ramp shall be provided down into the basin in a manner and dimensions acceptable to City staff.
7. Landscaping. The City shall require review and approval of any proposed basin landscape plan. Landscaping shall be selected to minimize maintenance, while minimizing impact to native and sensitive species that could be harmed by invasive plant species. No trees or shrubs shall be planted within 15 feet of the basin outlet. Floating objects such as railroad ties and landscape bark are not permissible.
8. Maintenance: Prior to final development approval, the applicant shall enter into a maintenance agreement with the City to assure perpetual maintenance of the basin and related on-site private drainage improvements and to allow the City emergency access.
9. Mosquito Abatement: The City shall require review and approval of detention basins for public safety and mosquito abatement.

Conclusion

Implementation of Certified EIR Mitigation Measure D-2(a), *Storm Water Drainage Systems Design*, and Mitigation Measure D-2(b), *Stormwater Detention Specifications*, would ensure the proposed detention basin continues to meet the stormwater and flood control demands of the project site and County flood control system across Foster Road. With implementation of these mitigation measures, potential impacts to hydrology would be reduced to a less-than-significant level. Therefore, potential impacts would be *less than significant with mitigation* and no new or more severe impacts would occur. No additional mitigation or further evaluation of this issue in the SEIR is necessary.

11. LAND USE AND PLANNING

Would the project:	Potentially Significant Impact	Less Than Significant with Mitigation Incorporated	Less Than Significant Impact	No Impact
a. Physically divide an established community?				X
b. Cause a significant environmental impact due to a conflict with any land use plan, policy, or regulation adopted for the purpose of avoiding or mitigating an environmental effect?			X	

Setting

The Revised Project would modify the existing Specific Plan land use designations and associated zoning to more effectively arrange land uses on the 28-acre project site and increase the amount of airport-compatible development allowed within this portion of the Specific Plan.

The project site is currently used for the cultivation of strawberries and is surrounded to the north by undeveloped agricultural land within the Airport Approach zoning designation, to the east by SR 135 and single-family residential and commercial uses, to the south by a single-family residential neighborhood, and to the west by public facilities uses including the Foodbank of Santa Barbara County, the Santa Maria Animal Shelter, and a Santa Barbara County behavioral health clinic.

Impact Discussion

- a. As with the Approved Project, the Revised Project proposes infill development within the built community and would not create, close, or impede any existing public or private roads, or create any other barriers to movement and accessibility within the community. Therefore, the Revised Project would not physically divide an established community, would be consistent with the Certified EIR, and *no impacts would occur*.
- b. SBCAG prepared the Draft Santa Maria ALUCP in August 2019; however, this plan has not yet been adopted. Future development proposed under the Revised Project would be required to comply with the lot coverage and design guidelines of either the adopted ALUP for uses within the Specific Plan area, including maximum building height and use of reflective building materials, and exterior lighting, intended to avoid potential hazards associated with the regular ingress/egress of planes near the project site. Future development that would require conditions to be consistent with the ALUP/ALUCP would require review and approval by the SBCAG, in its role as the Airport Land Use Commission. The project would not result in a conflict with applicable land use plan, policy, or regulation adopted for the purpose of avoiding or mitigating an environmental effect; therefore, potential impacts would be consistent with the Certified EIR and *less than significant*.

Conclusion

Implementation of the Revised Project would not result in potentially significant impacts related to land use and planning; therefore, no mitigation or further evaluation of this issue in the SEIR is necessary.

12. MINERAL RESOURCES

Would the project:	Potentially Significant Impact	Less Than Significant with Mitigation Incorporated	Less Than Significant Impact	No Impact
a. Result in the loss of availability of a known mineral resource that would be of value to the region and the residents of the state?			X	
b. Result in the loss of availability of a locally-important mineral resource recovery site delineated on a local general plan, specific plan or other land use plan?			X	

Setting

The California Surface Mining and Reclamation Act of 1975 (SMARA) requires that the State Geologist classify land into mineral resource zones (MRZ) according to the known or inferred mineral potential of the land (California PRC Sections 2710–2796). The three MRZs used in the SMARA classification-designation process in the San Luis Obispo-Santa Barbara Production-Consumption Region are defined below:

- **MRZ-1:** Areas where available geologic information indicates that little likelihood exists for the presence of significant mineral resources.
- **MRZ-2:** Areas where adequate information indicates that significant mineral deposits are present, or where it is judged that a high likelihood for their presence exists. This zone shall be applied to known mineral deposits or where well-developed lines of reasoning, based upon economic-geologic principles and adequate data, demonstrate that the likelihood for occurrence of significant mineral deposits is high.
- **MRZ-3:** Areas containing known or inferred aggregate resources of undetermined significance.

The city's primary mineral resources are sand, rock, and oil. The Santa Maria River channel is considered to be a valuable mineral resource, and the river contains the largest resources of Portland Cement Concrete-grade aggregate and almost 90% of the available alluvial sand and gravel resources in the Santa Barbara-San Luis Obispo County region. The Santa Maria basin is also a significant hydrocarbon-producing (i.e., oil and gas) basin in California, historically allowing for the development of the oil industry throughout the region. Many of the area's oil wells have since been capped and abandoned due to the development and urbanization of the city.

Impact Discussion

- a-b. Based on the City of Santa Maria Resources Management Element, the project site is within an MRX-3 zone (City of Santa Maria 2001). There are no known significant or locally important mineral resources in the project area; therefore, potential impacts would be consistent with the Certified EIR and *less than significant*.

Conclusion

Implementation of the Revised Project would not result in potentially significant impacts related to mineral resources; therefore, no mitigation or further evaluation of this issue in the SEIR is necessary.

13. NOISE

Would the project result in:	Potentially Significant Impact	Less Than Significant with Mitigation Incorporated	Less Than Significant Impact	No Impact
a. Generation of a substantial temporary or permanent increase in ambient noise levels in excess of standards established in the local general plan or noise ordinance, or applicable standards of other agencies?		X		
b. Generation of excessive groundborne vibration or groundborne noise levels?			X	
c. For a project located within the vicinity of a private airstrip or an airport land use plan or, where such a plan has not been adopted, within two miles of a public airport or public use airport, would the project expose people residing or working in the project area to excessive noise levels?			X	

Setting

Community noise levels are typically measured in terms of A-weighted decibels (dBA). A-weighting is a frequency correction that correlates overall sound pressure levels with the frequency response of the human ear. Equivalent noise level (Leq) is the average noise level on an energy basis for a specific time. The duration of noise and the time of day at which it occurs are important factors in determining the impact of noise on communities. The Community Noise Equivalent Level (CNEL) and Day-Night Average Level (Ldn) account for the time of day and duration of noise generation. These indices are time-weighted average values equal to the amount of acoustic energy equivalent to a time-varying sound over a 24-hour period.

The City of Santa Maria General Plan Noise Element (City of Santa Maria 2009) includes noise compatibility standards for noise exposure by land use. These include interior and exterior noise standards as shown in Table 3, below.

Table 3. Interior and Exterior Noise Standards

Land Use Categories		Standard dB CNEL	
Category	Uses	Interior	Exterior
Residential	Single Family, Duplex, Multiple Family, Mobile Home	45	60
Noise-Sensitive Land Uses	Motel, Hospital, School, Nursing Home, Church, Library, and Other	45	60
Commercial	Retail, Restaurant, Professional Offices	55	65
Industrial	Manufacturing, Utilities, Warehousing, Agriculture	65	70
Open Space	Passive Outdoor Recreation	--	65

Source: City of Santa Maria 2009, Table N-4.

Noise exposure goals for various types of land uses reflect the varying noise sensitivities associated with those uses. Residences, hospitals, schools, and libraries are most sensitive to noise intrusion and therefore have more stringent noise exposure targets than manufacturing or agricultural uses that are not subject to certain impacts, such as sleep disturbance. Noise sensitive land uses near the project site include residential areas located to the east and south, approximately 200 feet from proposed development activities.

The project site is in an urbanized area surrounded by residential development, public facilities, and public roadways, including SR 135 and Union Valley Parkway. SR 135, which is adjacent to the eastern boundary of the project site, and Union Valley Parkway, which is adjacent to the southern boundary of the project site, are the primary traffic conduits in the project vicinity, and are also the primary noise contributors. Based on the Noise Element, the 70 dB CNEL noise contour line extends approximately 40 feet from the centerline of SR 135, and the 65 dB CNEL noise contour line extends approximately 87 feet from the roadway centerline (City of Santa Maria 2009).

West Foster Road, located adjacent to the northern boundary of the project site, is another noise contributor in the project vicinity. Based on the Noise Element, the 70 dB CNEL noise contour line for this section of Foster Road is approximately 15 feet from the roadway centerline, and the 65 dB CNEL noise contour line is approximately 32 feet from the roadway centerline (City of Santa Maria 2009).

Union Valley Parkway is located adjacent to the southern boundary of the project site and contributes to the ambient noise levels in the project vicinity. Based on the Noise Element, the 2010 projected 70 dB CNEL noise contour line for this section of Union Valley Parkway is approximately 20 feet from the roadway centerline, and the projected 65 dB CNEL noise contour line is approximately 42 feet from the roadway centerline (City of Santa Maria 2009).

The project is located within the Santa Maria AIA. The project is located outside of the airport noise contours (SBCAG 2019; Santa Barbara County Airport Land Use Commission 1993).

Impact Discussion

- a. According to Santa Maria land use compatibility guidelines, noise is considered a significant impact if sensitive land uses are exposed to an exterior noise level of greater than 60 dB CNEL or an interior level of 45 dB CNEL for habitable rooms. An impact is considered significant if project implementation would cause the ambient noise level to both exceed land use compatibility thresholds and increase by 3 dB or more. Exterior noise level changes of 1-3 dB are not considered significant since they are generally not perceptible.

The project is in an urbanized area surrounded by residential development, public facilities, and public roadways, including SR 135 and Union Valley Parkway. Proposed construction activities on-site would take place within 500 feet of residential single-family dwellings located to the south of the project site and therefore would have the potential to exceed City exterior noise thresholds for those land uses (Table 4).

Table 4. Typical Noise Levels for Construction Equipment

Equipment	Typical Noise Level (dBA) 50 feet from Source
Backhoes, excavators	80–85
Concrete pumps, mixers	82–85
Cranes (moveable)	81
Pick-up truck	55
Dump truck	76
Equipment/tool van	55
Dozer	82
Compactors	82
Water truck	76
Grader	85
Drill rigs	70–85
Pneumatic tools	85
Rock transport	76
Roller	80
Hole auger	84
Line truck and trailer	55

Source: U.S. Environmental Protection Agency 1971.

Noise sensitive land uses near the project site include residential areas located to the east and south, approximately 200 feet from proposed development activities. The operation of heavy equipment during construction would result in temporary increases in noise in the immediate vicinity of the project site. Noise naturally attenuates (diminishes) at a rate of approximately 6 dB per doubling of distance (OSHA 2013); therefore, from a reference distance of 50 feet, equipment

generating 85 dBA at the edge of the project site would attenuate to a minimum of 73 dBA at the nearest off-site residential use.

Construction activities could intermittently generate noise levels in exceedance of thresholds in the Noise Element at off-site residential locations. Mitigation Measures N-1(a), N-1(b), and N-1(c) identified in the Certified EIR would effectively reduce construction noise levels to below City noise thresholds. These measures have been revised to be consistent with current City Municipal Code Requirements and to remove language that does not apply to the project site. These revisions would not result in a change in mitigation intent and the revised measures would be equally as effective as the original measures as detailed in the Certified EIR.

The Revised Project would result in a greater increase in ambient noise levels along the roadways in the project vicinity than the approved Project due to increased vehicle traffic to and from the project site. The Revised Project would generate 12,066 net new vehicle trips per weekday, including 574 AM peak hour trips and 505 PM peak hour trips. As currently proposed, the project will generate 11,291 more daily and 400 more PM peak hour vehicle trips than the land uses evaluated in the Certified EIR.

Residential uses located south of the project site are located within an unincorporated area of Santa Barbara County. Based on the noise analysis prepared for the Certified EIR, roadway noise generated by project implementation under the 10-Year and Buildout Scenarios would not exceed the County's 65 dBA CNEL exterior or 45 dBA CNEL interior noise thresholds for residential uses located along Foxenwood Lane south of Union Valley Parkway. While the project would generate additional daily trips on Union Valley Parkway, traffic noise generated from the project would be effectively reduced by the existing brick soundwall that is located between these residences and Union Valley Parkway.

Along SR 135, the nearest sensitive receptors are residential uses located approximately 130 feet from the roadway centerline. Based on the Certified EIR, due to the noise attenuation associated with the distance between the roadway noise source and adjacent receptors, noise levels would not exceed thresholds under either the 10-Year or Buildout Scenario. The 65 dB CNEL noise contour line for SR 135 is approximately 87 feet from the roadway centerline (City of Santa Maria 2009). Additional vehicle traffic generated from the project would not be substantial enough to extend the 65-dB noise contour line from 87 feet to 130 feet. In addition, a doubling of existing vehicle trips on a roadway is a standard threshold for significant noise impacts. Based on the City of Santa Maria General Plan Circulation Element (City of Santa Maria 2011a), SR 135 carries approximately 26,000 to 39,500 average daily trips. The Revised Project would not result in a doubling of current vehicle trips along SR 135, and would also not likely double traffic trips along Union Valley Parkway or Foster Road.

As with the Approved Project, the Revised Project does not propose any uses that would result in a substantial stationary source of noise. Based on the analysis provided above, the project would have the potential to generate noise levels in exceedance of local thresholds during construction. Mitigation measures N-1(a) through N-1(c) identified in the Certified EIR would effectively reduce potential impacts; therefore, potential impacts would be consistent with the Certified EIR and *less than significant with mitigation*.

- b. The Revised Project does not propose pile-driving or other high impact activities that would generate substantial groundborne noise or groundborne vibration during construction. Regarding human perception, vibration levels would begin to be perceptible at levels of 0.04 inches per second peak particle velocity (in/sec ppv), strongly perceptible at 0.10 in/sec ppv, and disturbing at 0.7 in/sec ppv. Groundborne vibration levels associated with representative construction equipment are summarized in Table 5 below.

Table 5. Representative Vibration Source Levels for Construction Equipment

Equipment	Peak Particle Velocity at 25 feet (in/sec)
Large bulldozer	0.089
Caisson drilling	0.089
Loaded trucks	0.076
Jackhammer	0.035
Small Bulldozers	0.0003

While some construction activities may result in perceptible vibration, vibration levels generated by the Revised Project would be below the threshold identified as being strongly perceptible to humans. The Certified EIR did not identify any potentially significant impacts associated with groundborne noise or vibration. Therefore, potential impacts would be consistent with the Certified EIR and *less than significant*.

- c. At the time of the Certified EIR, consideration of potential impacts associated with exposure of project residents or tenants to excessive noise from a nearby airport or airstrip was not identified within State CEQA Guidelines Appendix G. The project site is located within the Santa Maria AIA. The project is located outside of the airport noise contours (SBCAG 2019; Santa Barbara County Airport Land Use Commission 1993). Since impacts would be *less than significant*, the Revised Project does not result in a new potentially significant impact not identified in the Certified EIR.

Mitigation Measure(s) Incorporated into the Revised Project

N-1(a) Construction Activity Timing. Construction activity for site preparation and for future development shall be limited to the hours between 7:00 AM and 6:00 PM, Monday through Friday and Saturday through Sunday 8:00 AM to 5:00 PM, or otherwise as allowed by permit issued by the Noise Controlling Officer per Municipal Code Chapter 5-5. No movement of heavy equipment, demolition, or construction shall occur on State holidays (i.e. Thanksgiving, Labor Day). Demolition and construction equipment maintenance shall be limited to the same hours. Non-noise generating construction activities are not subject to these restrictions.

N-1(b) Construction Noise Attenuation. For all demolition and construction activity on the Specific Plan area, additional noise attenuation techniques shall be employed as needed to ensure that noise remains within levels allowed by the City of Santa Maria noise standards. The following measures shall be incorporated into contract specifications to reduce the impact of construction noise.

1. Equip each internal combustion engine, used for any purpose on the job or related to the job, with a muffler of a type recommended by the manufacturer. No internal combustion engine would be operated on the study area without said muffler. All diesel equipment would be operated with closed engine doors and would be equipped with factory-recommended mufflers.
2. Contractors shall implement appropriate additional noise mitigation measures including, but not limited to, changing the location of stationary construction equipment, shutting off idling equipment, rescheduling construction activity, notifying adjacent residents 24- hours in advance of construction work, or installing acoustic barriers around stationary construction noise sources.
3. All active construction areas located within 50 feet of adjacent sensitive receptors shall be shielded with a ½-inch plywood wall of at least seven feet in height, or other barrier that

reduces noise transmission to ensure the noise levels are within the City of Santa Maria noise standards.

4. The applicant shall notify residents and tenants located within 250 feet of work areas at least 24 hours prior to all construction activities. This notification shall include the anticipated hours and duration of construction and a description of noise reduction measures, including implementation of a temporary plywood wall or other barrier.

N-1(c) Construction Equipment. Stationary demolition and construction equipment that generates noise that exceeds 60 dBA Leq at the boundaries of any identified on- or off-site residential, recreational, park, or office use shall be shielded. All construction equipment powered by internal combustion engines shall be properly muffled and maintained. Unnecessary idling of internal combustion engines shall be prohibited. Electrical power shall be used to run air compressors and similar power tools, when available within 150 feet.

Conclusion

Implementation of Certified EIR Mitigation Measures N-1(a), N-1(b), and N-1(c) would ensure potential hazards related to the project site's proximity to a public airport would be reduced to less than significant, consistent with the Certified EIR. Therefore, potential impacts would be *less than significant with mitigation* and no new or more severe impacts would occur. No additional mitigation or further evaluation of this issue in the SEIR is necessary.

14. POPULATION AND HOUSING

Would the project:	Potentially Significant Impact	Less Than Significant with Mitigation Incorporated	Less Than Significant Impact	No Impact
a. Induce substantial unplanned population growth in an area, either directly (for example, by proposing new homes and businesses) or indirectly (for example, through extension of roads or other infrastructure)?			X	
b. Displace substantial numbers of existing people or housing, necessitating the construction of replacement housing elsewhere?				X

Setting

Since the early 1990s, the city has experienced a consistent increase in population, largely due to a growing migrant workforce for nearby agriculture. The city is one of the fastest growing areas in Santa Barbara County, due in part to the affordable housing it provides relative to the cities of Santa Barbara and San Luis Obispo Counties. The City has also developed several programs and policies to further encourage growth and development.

Impact Discussion

- a. The Revised Project includes a Conceptual Development Plan that proposes to develop the 28-acre portion of the Specific Plan with government/public facility uses, retail uses, commercial office/professional office uses, quick-serve restaurant/mini-mart/gas station uses, a self-storage

facility, and a regional stormwater detention basin. These proposed uses would be located adjacent to existing residential neighborhoods and have been planned to serve local residents. Construction needs of the project would be temporary and would likely be filled by the local workforce. Therefore, the project would not induce substantial unplanned population growth and potential impacts would be consistent with the Certified EIR and *less than significant*.

- b. The project site is currently undeveloped and is utilized for row crop cultivation. Neither the Approved Project or Revised Project would result in the displacement of any existing housing or people, and would not necessitate the construction of new housing off-site; therefore, potential impacts associated with displacement of existing housing would be consistent with the Certified EIR and *no impacts would occur*.

Conclusion

Implementation of the Revised Project would not result in potentially significant impacts related to population and housing; no mitigation or further evaluation of this issue in the SEIR is necessary.

15. PUBLIC SERVICES

Would the project:	Potentially Significant Impact	Less Than Significant with Mitigation Incorporated	Less Than Significant Impact	No Impact
a. Result in substantial adverse physical impacts associated with the provision of new or physically altered governmental facilities, need for new or physically altered governmental facilities, the construction of which could cause significant environmental impacts, in order to maintain acceptable service ratios, response times or other performance objectives for any of the public services:				
i. Fire protection?			X	
ii. Police protection?			X	
iii. Schools?			X	
iv. Parks?			X	
v. Other public facilities?			X	

Setting

Fire and police protection services are provided by the City. The City is served by six fire stations, where all risk emergency services, as well as public education programs, fire prevention, and life safety measures are provided to the city's residents by the City of Santa Maria Fire Department.

The City of Santa Maria Police Department would provide law enforcement services to the project site. The City Police Department has 129 sworn officers and 51 full-time support personnel and provides a full range of professional police services including civil order, preventative patrol, investigations, traffic control and enforcement, criminalistics, crime prevention, drug enforcement, and drug abuse prevention. The city's

elementary and junior high schools are within the Santa Maria-Bonita School District, and the city's high schools are within the Santa Maria Joint Union High School District.

Impact Discussion

- a.i. The project site would be served by the City of Santa Maria Fire Department. The proposed infill development would not substantially increase demand on fire services. Development Impact Fees would be collected for the provision of capital facilities for fire services, which would provide for future facilities needed as growth within the city occurs. No new or physically altered public service facilities or personnel would be required as a result of the proposed project; therefore, potential impacts would be consistent with the Certified EIR and *less than significant*.
- a.ii. The project site would continue to be served by the City of Santa Maria Police Department. The Revised Project does not propose a new use or activity that would require additional police services above what is normally provided for surrounding public facility and residential developments. Development Impact Fees would be collected for the provision of capital facilities for police services, which would provide for future facilities needed as growth within the city occurs. The Revised Project would not result in a substantial increase in demand for police protection; therefore, potential impacts would be consistent with the Certified EIR and *less than significant*.
- a.iii. The project site is located within the Santa Maria-Bonita School District and Santa Maria Joint Union High School District. The Revised Project would improve the city's jobs/housing balance by providing additional employment opportunities in the city. The Revised Project would not include development of new residential units or otherwise result in an increase in population of school-aged children within the area. Therefore, potential impacts would be consistent with the Certified EIR and *less than significant*.
- a.iv. The Revised Project would not include development of new residential units or otherwise result in an increase in the need for new or physically altered park facilities. Therefore, potential impacts would be consistent with the Certified EIR and *less than significant*.
- a.v. As discussed previously, the Revised Project would not substantially increase demand on public facilities and would be subject to applicable fees to offset impacts to public facilities; therefore, impacts related to other public facilities would be consistent with the Certified EIR and *less than significant*.

Conclusion

Implementation of the Revised Project would not result in potentially significant impacts related to public services; no mitigation or further evaluation of this issue in the SEIR is necessary.

16. RECREATION

	Potentially Significant Impact	Less Than Significant with Mitigation Incorporated	Less Than Significant Impact	No Impact
a. Would the project increase the use of existing neighborhood and regional parks or other recreational facilities such that substantial physical deterioration of the facility would occur or be accelerated?			X	
b. Does the project include recreational facilities or require the construction or expansion of recreational facilities which might have an adverse physical effect on the environment?			X	

Setting

The City's recreation system is comprised of several local parks and recreational facilities, which are managed by the City of Santa Maria Department of Recreation and Parks. The department operates 234 acres of developed parkland in 27 neighborhood and community parks.

Impact Discussion

- a, b. Potential future development activities that would be allowed under the Revised Project, including development of government/public facility uses, retail uses, commercial office/professional office uses, quick-serve restaurant/mini-mart/gas station uses, a self-storage facility, and a regional stormwater detention basin, would not result in material increase in the use of existing park facilities in the vicinity. Like the Approved Project, the Revised Project would improve the city's jobs/housing balance by providing additional employment opportunities in the city. Neither the Approved Project nor the Revised Project include new residential development and would not result in the need for new or physically altered park facilities. Further, neither project includes construction of recreational facilities or expansion of existing recreational facilities that could result in adverse impacts on the environment; therefore, potential impacts would be consistent with the Certified EIR and *less than significant*.

Conclusion

Implementation of the Revised Project would not result in potentially significant impacts related to recreation; therefore, no mitigation or further evaluation of this issue in the SEIR is necessary.

17. TRANSPORTATION

Would the project:	Potentially Significant Impact	Less Than Significant with Mitigation Incorporated	Less Than Significant Impact	No Impact
a. Conflict with a program, plan, ordinance or policy addressing the circulation system, including transit, roadway, bicycle and pedestrian facilities?	X			
b. Conflict or be inconsistent with CEQA Guidelines section 15064.3, subdivision (b)?	X			
c. Substantially increase hazards due to a geometric design feature (e.g., sharp curves or dangerous intersections) or incompatible uses (e.g., farm equipment)?	X			
d. Result in inadequate emergency access?	X			

Setting

The project site is located at the northwest corner of the intersection of SR 135 (Orcutt Expressway) and Union Valley Parkway and is bisected by Foxenwood Lane. All roadway intersections within the immediate project vicinity currently operate at acceptable Level of Service levels (CCTC 2020).

The City provides four types of public transportation services. Santa Maria Area Transit (SMAT) is a local bus service that operates in Santa Maria and Orcutt. The Breeze is an intercity service that operates between Santa Maria, Lompoc, and Vandenberg Air Force Base. Americans with Disabilities Act (ADA) Paratransit is a complementary paratransit service for persons with disabilities. The Clean Air Express (CAE) is an interregional service that operates between Santa Maria, Lompoc, Goleta, and Santa Barbara. The bus stops closest to the project site are served by SMAT and are the Santa Maria Way at K-Mart Center (southbound) and Santa Maria Way at Drive-In (northbound) bus stops.

Impact Discussion

a-d. The Revised Project would generate approximately 12,066 net new vehicle trips per weekday, including 574 AM peak hour trips and 505 PM peak hour trips. As currently proposed the Revised Project would generate approximately 11,291 more daily and 400 more peak-hour vehicle trips than the Approved Project evaluated in the Certified EIR (CCTC 2020).

Based on the number of new vehicle trips the Revised Project would generate, especially in comparison to the Approved Project, the Revised Project has the potential to result in significant environmental impacts associated with transportation, including cumulative impacts. Therefore, potential impacts related to transportation will be evaluated in detail in the SEIR.

Conclusion

Implementation of the Revised Project would have the potential to result in potentially significant impacts related to transportation; therefore, transportation will be evaluated in the SEIR.

18. TRIBAL CULTURAL RESOURCES

	Potentially Significant Impact	Less Than Significant with Mitigation Incorporated	Less Than Significant Impact	No Impact
a. Would the project cause a substantial adverse change in the significance of a tribal cultural resource, defined in Public Resources Code section 21074 as either a site, feature, place or cultural landscape that is geographically defined in terms of the size and scope of the landscape, sacred place, or object with cultural value to a California Native American tribe, and that is:				
i. Listed or eligible for listing in the California Register of Historical Resources, or in a local register of historical resources as defined in Public Resources Code section 5020.1(k), or	X			
ii. A resource determined by the lead agency, in its discretion and supported by substantial evidence, to be significant pursuant to criteria set forth in subdivision (c) of Public Resources Code Section 5024.1, the lead agency shall consider the significance of the resource to a California Native American tribe.	X			

Setting

When the EIR was certified in 2007, CEQA did not require the evaluation of a proposed project's impacts on Tribal Cultural Resources. Adopted in 2014, AB 52 added tribal cultural resources to the categories of resources that must be evaluated under CEQA. Tribal cultural resources are defined as either of the following:

1. Sites, features, cultural landscapes, sacred places, and objects with cultural value to a California Native American tribe that are either of the following:
 - a. Included or determined to be eligible for inclusion in the CRHR; or
 - b. Included in a local register of historical resources as defined in PRC Section 5020.1(k).
2. A resource determined by the lead agency, in its discretion and supported by substantial evidence, to be significant pursuant to criteria set forth in PRC Section 5024.1(c).

In applying these criteria, the Lead Agency shall consider the significance of the resource to a California Native American Tribe. The City (as the CEQA Lead Agency) provided notification to Native American tribes affiliated with the project area pursuant to AB 52 and SB 18. Letters were sent to the City's list of local tribes on May 15, 2020.

Per the Certified EIR, no sites listed in or eligible for listing in the CRHR, or in a local register of historical resources, are known to exist within the project area.

Impact Discussion

a.i.-ii. The City (as the CEQA Lead Agency) provided notification to Native American tribes affiliated with the project area pursuant to AB 52 and SB 18. Letters were sent to the City’s list of local tribes on May 15, 2020. Tribal consultation has not completed. The AB 52 and SB 18 tribal consultation processes will be completed as part of the SEIR process and this issue will be further evaluated in the SEIR.

Conclusion

Because Tribal Cultural Resources were not evaluated in the Certified EIR, implementation of the Revised Project may result in a new potentially significant impact related to tribal cultural resources; therefore, tribal cultural resources will be evaluated in the SEIR.

19. UTILITIES AND SERVICE SYSTEMS

Would the project:	Potentially Significant Impact	Less Than Significant with Mitigation Incorporated	Less Than Significant Impact	No Impact
a. Require or result in the relocation or construction of new or expanded water, wastewater treatment or storm water drainage, electric power, natural gas, or telecommunications facilities, the construction or relocation of which could cause significant environmental effects?			X	
b. Have sufficient water supplies available to serve the project and reasonably foreseeable future development during normal, dry and multiple dry years?			X	
c. Result in a determination by the wastewater treatment provider which serves or may serve the project that it has adequate capacity to serve the project’s projected demand in addition to the provider’s existing commitments?			X	
d. Generate solid waste in excess of State or local standards, or in excess of the capacity of local infrastructure, or otherwise impair the attainment of solid waste reduction goals?			X	
e. Comply with federal, state, and local management and reduction statutes and regulations related to solid waste?			X	

Setting

The City of Santa Maria Department of Utilities is responsible for delivering water, treating wastewater, collecting refuse, recycling, operating the Santa Maria Regional Landfill and its Household Hazardous Waste Facility, street sweeping, and regulatory compliance. The City operates its own wastewater collection and treatment system, which consists of eight wastewater basins with associated trunk sewers and one

treatment plant. The City's Water Resources Operation and Maintenance Section is responsible for supplying residents with potable water for domestic, industrial, and fire protection purposes.

The City's Solid Waste Collection and Disposal Services consist of six distinct areas: refuse collection/residential, refuse collection/commercial, landfill disposal operations, street sweeping, recycling operations, and regulatory compliance. The Santa Maria Regional Landfill has a remaining capacity of 2,172,542 cubic yards as of March 2018 and is expected to reach capacity by 2027 (California Department of Resources Recycling and Recovery [CalRecycle] 2019).

Impact Discussion

- a. The Revised Project would require new connections to the City wastewater and water systems as well as new connections to existing PG&E electrical service to serve allowable uses consistent with the Revised Project and Conceptual Development Plan. These proposed connections would occur within existing developed roadways and right-of-way areas and would be subject to applicable local and state policies that avoid and/or minimize potential environmental effects. These regulations include, but are not limited to, standards set forth by the California Public Utilities Commission (CPUC), policies within the City Municipal Code, and regulations set forth in the California Health and Safety Code and PRC. Based on the scope and location of proposed utility connections and compliance with applicable state and local regulations, potential impacts would be consistent with the Certified EIR and *less than significant*.
- b. The allowed uses under the Revised Project and Conceptual Development Plan would be served by the City water system. The City of Santa Maria utilizes the following available water supply sources: local groundwater, purchased water from the SWP, associated return flows recaptured from the Santa Maria Groundwater Basin, assigned rights to water from the Santa Maria Groundwater Basin, and assigned rights to augmented yield from Twitchell Reservoir. The City's water supply is expected to reliably meet the projected water demands and have an available supply in excess through 2040, with most of this demand being met by imported surface water (City of Santa Maria 2016). Therefore, the project and reasonably foreseeable future development would have sufficient water supplies during normal, dry, and multiple dry years and potential impacts would be consistent with the Certified EIR and *less than significant*.
- c. The Certified EIR concluded that both the City and LCSD had adequate capacity to serve the Approved Project, and that future development would be subject to pay standard City Wastewater Impact Fees and LCSD Connection Fees to mitigate the cumulative effects on wastewater treatment systems.

The project site is in a portion of the City's sewer service area that is part of an ongoing district. Due to the location of the boundaries of the City and LCSD, it was determined to be economical for both the City and LCSD to accept waste into each other's sewer and treatment facilities in certain areas. As of August 7, 2017, the LCSD accepted responsibility for the treatment and disposal of waste from area "A1," within which the project site is located (City of Santa Maria 2017).

Based on the wastewater generation rates provided in the LCSD Engineering Design Standards for the Construction of Sanitary Sewers (LCSD 2020) and the project Conceptual Development Plan, the project's wastewater generation rates have been estimated and detailed in Table 6, below.

Table 6. Revised Project Estimated Wastewater Generation Rates

Land Use	Flow Generation Rate ¹	Floor Area	Estimated Wastewater Flows
Public Safety ²	1,500 gpd/acre	7,000 sf	241 gpd
Self-Storage Facility (Leasing Office & Caretaker Unit) ^{3,4}	200 gpd/1,000 sf 178 gpd/connection	500 sf & 1 unit	278 gpd
State Office Building ⁴	200 gallons/1,000 sf/day	15,100 sf	3,020 gpd
Market Place Commercial ²	1,500 gpd/acre	36,000 sf	1,240 gpd
Professional Office Buildings ⁴	200 gallons/1,000 sf/day	40,000 sf	8,000 gpd
Medical Office ⁵	1,500 gpd/acre	20,000 sf	689 gpd
Home Commercial ²	1,500 gpd/acre	32,000 sf	1,102 gpd
Family Restaurant ²	1,500 gpd/acre	5,000 sf	172 gpd
Convenience Store & Gas Station ³	6,011 gpd/acre	3,400 sf	469 gpd
Fast Food ³	6,011 gpd/acre	6,000 sf	828 gpd
Total			16,039 gpd
¹ Source: LCSD 2020 ² Calculated using "General Commercial" duty factor ³ Calculated using "Office Space" duty factor ⁴ Calculated using the "Accessory Dwelling Unit" duty factor ⁵ Calculated using "Professional" duty factor			

Based on the estimated wastewater flows the Revised Project would generate, which surpass the estimated flows analyzed within the Approved Project, the Revised Project has the potential to result in significant environmental impacts associated with wastewater treatment capacity, including cumulative impacts. Therefore, potential impacts related to wastewater capacity will be evaluated in detail in the SEIR. The evaluation within the SEIR will likely include direct coordination with the LCSD to determine if their facilities can adequately serve the proposed project in addition to its existing service commitments.

- d, e. The City currently disposes of solid waste at the Santa Maria Regional Landfill, located at 2065 East Main Street in Santa Maria, with estimated remaining capacity of 3,030,720 cubic yards. The City has also initiated development of a new landfill—the Santa Maria Integrated Waste Management Facility (Los Flores Ranch Landfill; Facility No. 42-AA-0076), located in the Solomon Hills approximately 8 miles southwest of the city and 0.5 mile east of U.S. 101 in an unincorporated portion of Santa Barbara County. The new facility will have a design capacity of approximately 131 million cubic yards of waste with an estimated closure date of 2105. The permit for the new facility is consistent with the Santa Barbara County Integrated Waste Management Plan, which was approved by the CalRecycle on October 18, 2011, as well as the standards adopted by CalRecycle, pursuant to PRC 44010.

The Revised Project would rely on the City's solid waste collection services and facilities. Based on the existing and projected available capacity, the proposed development would not result in the need for new or expanded solid waste facilities. Therefore, the Revised Project would not generate solid waste in excess of state or local standards, or in excess of the capacity of local solid waste facilities and would be in compliance with federal, state, and local solid waste reduction regulations. Therefore, impacts would be consistent with the Certified EIR and *less than significant*.

Conclusion

Implementation of the Revised Project would have the potential to result in potentially significant impacts related to wastewater treatment capacity; therefore, evaluation of this issue in the SEIR is necessary.

20. WILDFIRE

Would the project:	Potentially Significant Impact	Less Than Significant with Mitigation Incorporated	Less Than Significant Impact	No Impact
a. Substantially impair an adopted emergency response plan or emergency evacuation plan?			X	
b. Due to slope, prevailing winds, and other factors, exacerbate wildfire risks, and thereby expose project occupants to pollutant concentrations from a wildfire or the uncontrolled spread of a wildfire?			X	
c. Require the installation or maintenance of associated infrastructure (such as roads, fuel breaks, emergency water sources, power lines or other utilities) that may exacerbate fire risk or that may result in temporary or ongoing impacts to the environment?			X	
d. Expose people or structures to significant risks, including downslope or downstream flooding or landslides, as a result of runoff, post-fire slope instability, or drainage changes?		X		

Setting

The California Fire Code provides minimum standards for many aspects of fire prevention and suppression activities. These standards include provisions for emergency vehicle access, water supply, fire protection systems, and the use of fire-resistant building materials.

Impact Discussion

- a. The Revised Project does not require any road closures and would be designed to accommodate emergency vehicle access. Implementation of the Revised Project would not have a permanent impact on any adopted emergency response plans or emergency evacuation plans. Temporary construction activities and staging would not substantially alter existing circulation patterns or trips and no road closures would be required. Access to adjacent areas would be maintained throughout the duration of the project. There are adequate alternative routes available to accommodate any rerouted trips through the project area for the short-term construction period.

At the time of the Certified EIR, potential impacts associated with impairing an adopted emergency response plan or emergency evacuation plan was evaluated under Section 4.8, Hazards and Hazardous Materials. The Certified EIR did not identify any potentially significant impacts associated with the Approved Project’s potential to impair local emergency response or evacuation plans. Therefore, the Revised Project would be consistent with the Certified EIR and potential impacts would be *less than significant*.

- b. The project site is not located within or adjacent to a wildland area. The Revised Project would not result in any major changes to site topography or the removal of any major natural wind barriers. Both projects would be required to comply with all applicable fire safety rules and regulations including the California Fire Code and PRC prior to issuance of building permits. At the time of the Certified EIR, consideration of potential impacts associated with exacerbation of wildfire risks and exposure of project occupants to wildfire pollutants was not identified within State CEQA Guidelines Appendix G. Since impacts would be *less than significant*, the Revised Project would not result in a new potentially significant impact not identified in the Certified EIR.
- c. The Revised Project would be designed to comply with all fire safety rules and regulations, including the California Fire Code and PRC. Proposed new connections to local infrastructure, such as installation of powerlines and connections to the required fire suppression water systems, would be within existing disturbed and/or developed areas and designed and implemented in full compliance with current California Fire Code requirements. At the time of the Certified EIR, consideration of potential impacts associated with exacerbation of wildfire risks due to installation or maintenance of infrastructure was not identified within State CEQA Guidelines Appendix G. Since impacts would be *less than significant*, the Revised Project would not result in a new potentially significant impact not identified in the Certified EIR.
- d. The Certified EIR evaluated potential impacts associated with exposing people or structures to significant risk of loss involving flooding, runoff, and drainage changes in Section 4.5, Drainage and Water Quality. The Certified EIR identified a Class II, Significant but Mitigable Impact, associated with the increase of peak stormwater discharges and runoff from the installation of new paved areas and roofed areas of the Approved Project. Continued implementation of Mitigation Measures D-2(a) and D-2(b) would avoid potential impacts related to flooding, runoff, and drainage changes and reduce impacts to a less-than-significant level.

At the time of the Certified EIR, consideration of potential impacts associated with exposure of people or structures to significant risks as a result of post-fire slope instability was not identified within State CEQA Guidelines Appendix G. The project site is nearly level and the project would not substantially alter on-site topography. Since impacts associated with post-fire slope instability would be *less than significant*, the Revised Project would not result in a new potentially significant impact not identified in the Certified EIR.

Mitigation Measure(s) Incorporated into the Revised Project

Implementation of Certified EIR Mitigation Measure D-2(a), *Storm Water Drainage Systems Design*, and Mitigation Measure D-2(b), *Stormwater Detention Specifications*, would ensure the on-site stormwater control systems are designed and constructed in compliance with applicable City standards and Uniform Building code requirements. With incorporation of the Certified EIR Mitigation Measures D-2(a) and D-2(b) detailed in Section 10 of this document, potential impacts associated with stormwater drainage would be consistent with the Certified EIR and *less than significant with mitigation*.

Conclusion

Implementation of the Revised Project would not result in potentially significant impacts related to wildfire; therefore, no mitigation or further evaluation of this issue in the SEIR is necessary.

REFERENCES

- AMBIENT Air Quality and Noise Consulting. 2020. Emissions Modeling Assessment Technical Memorandum.
- California Department of Conservation (DOC). 2016. California Important Farmland Finder. Available at: <https://maps.conservation.ca.gov/DLRP/CIFF/>. Accessed May 21, 2020.
- _____. 2019. Santa Barbara County Tsunami Inundation Maps. Available at: <https://www.conservation.ca.gov/cgs/tsunami/maps/Santa-Barbara>. Accessed May 25, 2020.
- California Department of Resources Recycling and Recovery (CalRecycle). 2019. SWIS Facility Detail: Santa Maria Regional Landfill (42-AA-0016). Available at: <https://www2.calrecycle.ca.gov/swfacilities/Directory/42-AA-0016>. Accessed May 25, 2020.
- California Department of Toxic Substance Control (DTSC). 2020. Envirostor. Available at: <https://www.envirostor.dtsc.ca.gov/public/>. Accessed May 25, 2020.
- Central Coast Transportation Consulting (CCTC). 2020. Santa Maria Airport Business Park SP – TIS Memorandum of Assumptions.
- City of Santa Maria. 1995. City of Santa Maria General Plan Safety Element. Available at: <https://www.cityofsantamaria.org/home/showdocument?id=612>. Accessed May 25, 2020.
- _____. 2001. City of Santa Maria General Plan Resources Management Element. Available at: <https://www.cityofsantamaria.org/home/showdocument?id=598>. Accessed May 22, 2020.
- _____. 2009. City of Santa Maria General Plan Noise Element. Available at: <https://www.cityofsantamaria.org/home/showdocument?id=596>. Accessed May 25, 2020.
- _____. 2011a. City of Santa Maria General Plan Circulation Element. Available at: <https://www.cityofsantamaria.org/home/showdocument?id=608>. Accessed May 25, 2020.
- _____. 2011b. City of Santa Maria General Plan Land Use Element. Available at: <https://www.cityofsantamaria.org/home/showdocument?id=610>. Accessed May 25, 2020.
- _____. 2016. 2015 Urban Water Management Plan. May 2016. Available at: <https://www.cityofsantamaria.org/home/showdocument?id=15109>. Accessed May 25, 2020.
- _____. 2017. Council Agenda Report, Agreement with Laguna County Sanitation District. Available at: http://archive.cityofsantamaria.org/CouncilAgendas/2017/Aug_01/3M.pdf. Accessed June 25, 2020.
- County of Santa Barbara. 2018. AERA East Cat Canyon Oil Field Redevelopment Plan Draft Environmental Impact Report, Section 4.5 Cultural, Tribal Cultural, and Paleontological Resources. Available at: <https://www.countyofsb.org/uploadedFiles/plndev/Content/Projects/4-05%20Cultural%20Tribal%20Cultural%20and%20Paleontological%20Resources.pdf>. Accessed May 22, 2020.
- Dibblee, T.W., and Ehrenspeck, H.E. 1994. Geologic Map of the Santa Maria and Twitchell Dam Quadrangles, Santa Barbara and San Luis Obispo Counties, California. Available at: https://ngmdb.usgs.gov/ngm-bin/pdp/zui_viewer.pl?id=34280. Accessed May 21, 2020.
- Federal Aviation Administration (FAA). 2020. Advisory Circular on Hazardous Wildlife Attractants on or Near Airports. Available at: https://www.faa.gov/documentLibrary/media/Advisory_Circular/150-5200-33C.pdf. Accessed June 25th, 2020.

- Federal Emergency Management Agency (FEMA). 2020. FEMA's National Flood Hazard Layer (NFHL) Viewer. Available at: <https://hazards-fema.maps.arcgis.com/apps/webappviewer/index.html?id=8b0adb51996444d4879338b5529aa9cd&extent=-119.52305501330595,34.389289302821936,-119.50228398669405,34.39814247501446>. Accessed May 25, 2020.
- Laguna County Sanitation District (LCSD). 2020. Engineering Design Standards for the Construction of Sanitary Sewers. Available at: https://www.countyofsb.org/uploadedFiles/pwd/content/RRWMD/AttachmentA_-_LCSDsewerspecs.pdf. Accessed June 25, 2020.
- Occupational Safety and Health Administration (OSHA). 2013. OSHA Technical Manual (OTM) Section III: Chapter 5. Available at: https://www.osha.gov/dts/osta/otm/new_noise/. Accessed May 22, 2020.
- Pacific Gas and Electric Company (PG&E). 2019. Delivering Low-Emission Energy. Available at: https://www.pge.com/en_US/about-pge/environment/what-we-are-doing/clean-energy-solutions/clean-energy-solutions.page. Accessed May 22, 2020.
- Rincon Consultants, Inc. 2007. Final Environmental Impact Report for the Santa Maria Airport Business Park Specific Plan.
- Santa Barbara County Airport Land Use Commission. 1993. Santa Barbara County Airport Land Use Plan. Available at: http://www.sbcag.org/uploads/2/4/5/4/24540302/adopted_1993_airport_land_use_plan.pdf. Accessed May 25, 2020.
- Santa Barbara County Association of Governments (SBCAG). 2019. Draft Santa Maria Airport Land Use Compatibility Plan. August 2019. Available at: http://www.sbcag.org/uploads/2/4/5/4/24540302/santa_maria_draft_alucp.pdf. Accessed May 21, 2020.
- Sempra Energy. 2019. SoCalGas Seeks to Offer Renewable Natural Gas to Customers. Available at: <https://www.sempra.com/socalgas-seeks-offer-renewable-natural-gas-customers>. Accessed May 22, 2020.
- State Water Resources Control Board (SWRCB). 2019. Statutes of Chapter 6.7 Health and Safety Code. Available at: https://www.waterboards.ca.gov/ust/regulatory/docs/hsc_6_7_01_2019.pdf. Accessed June 2020.
- _____. 2020. GeoTracker. Available at: <https://geotracker.waterboards.ca.gov/>. Accessed May 25, 2020.
- U.S. Department of Agriculture Natural Resources Conservation Service (USDA NRCS). 2020. Web Soil Survey. Available at: <https://websoilsurvey.sc.egov.usda.gov/App/WebSoilSurvey.aspx>. Accessed May 25, 2020.
- U.S. Department of Agriculture Soil Conservation Service (USDA SCS). 1972. Soil Survey of Northern Santa Barbara Area, California. Available at: https://www.nrcs.usda.gov/Internet/FSE_MANUSCRIPTS/california/CA672/0/ca_Northern_SB.pdf. Accessed May 25, 2020.
- U.S. Department of Transportation Federal Railroad Administration. 2004. California High-Speed Train Program Environmental Impact Report/Environmental Impact Statement: Paleontological Resources Technical Evaluation. Available at: http://www.hsr.ca.gov/docs/programs/eir-eis/statewide_EIR_BayMerc_techrpt_Paleo.pdf. Accessed May 22, 2020.

U.S. Environmental Protection Agency (USEPA). 1971. Noise from Construction Equipment and Operations, Building Equipment, and Home Appliances. Available at: <https://nepis.epa.gov/Exe/tiff2png.cgi/9101NN3I.PNG?-r+75+g+7+D%3A%5CZYFILES%5CINDEX%20DATA%5C70THRU75%5CTIFF%5C00003321%5C9101NN3I.TIF>. Accessed May 22, 2020.

U.S. Geological Survey (USGS). 2020. Areas of Land Subsidence in California. Available at: https://ca.water.usgs.gov/land_subsidence/california-subsidence-areas.html. Accessed May 25, 2020.

Woodring, W.P., and Bramlette, M.N. 1950. Geology and Paleontology of the Santa Maria District California, *Geological Survey Professional Paper 222*. Available at: <https://pubs.usgs.gov/pp/0222/report.pdf>. Accessed May 22, 2020.

CONSULTATION AND DATA SOURCES

CONSULTATION SOURCES

City Departments Consulted

<input type="checkbox"/>	Administrative Services
<input type="checkbox"/>	Attorney
<input type="checkbox"/>	Fire
<input type="checkbox"/>	Library
<input type="checkbox"/>	City Manager
<input type="checkbox"/>	Police
<input type="checkbox"/>	Public Works
<input checked="" type="checkbox"/>	Utilities
<input type="checkbox"/>	Recreation and Parks

County Agencies/Departments Consulted

<input type="checkbox"/>	Air Pollution Control District
<input type="checkbox"/>	Association of Governments
<input type="checkbox"/>	Flood Control District
<input type="checkbox"/>	Environmental Health
<input type="checkbox"/>	Fire (Hazardous Materials)
<input type="checkbox"/>	LAFCO
<input type="checkbox"/>	Public Works
<input type="checkbox"/>	Planning and Development
<input type="checkbox"/>	Other (list): Certified Unified Program Agency

Special Districts Consulted

<input checked="" type="checkbox"/>	Santa Maria Public Airport
<input type="checkbox"/>	Airport Land Use Commission
<input type="checkbox"/>	Cemetery
<input type="checkbox"/>	Santa-Maria Bonita School District
<input type="checkbox"/>	Santa Maria Joint Union High School
<input checked="" type="checkbox"/>	Laguna County Sanitation District
<input type="checkbox"/>	Cal Cities Water Company

State/Federal Agencies Consulted

<input type="checkbox"/>	Army Corps of Engineers
<input type="checkbox"/>	Caltrans
<input type="checkbox"/>	CA Fish and Game
<input checked="" type="checkbox"/>	Federal Fish and Wildlife
<input type="checkbox"/>	FAA
<input type="checkbox"/>	Regional Water Quality Control Bd.
<input type="checkbox"/>	Integrated Waste Management Bd.
<input type="checkbox"/>	Other (list)

DATA SOURCES

General Plan

<input checked="" type="checkbox"/>	Land Use Element
<input checked="" type="checkbox"/>	Circulation Element
<input checked="" type="checkbox"/>	Safety Element
<input checked="" type="checkbox"/>	Noise Element
<input type="checkbox"/>	Housing Element
<input checked="" type="checkbox"/>	Resources Management Element

Other

<input checked="" type="checkbox"/>	Agricultural Preserve Maps
<input checked="" type="checkbox"/>	Archaeological Maps/Reports
<input type="checkbox"/>	Architectural Elevations
<input type="checkbox"/>	Biology Reports
<input checked="" type="checkbox"/>	CA Oil and Gas Maps
<input checked="" type="checkbox"/>	FEMA Maps (Flood)
<input type="checkbox"/>	Grading Plans
<input checked="" type="checkbox"/>	Site Plan
<input type="checkbox"/>	Topographic Maps
<input checked="" type="checkbox"/>	Aerial Photos
<input checked="" type="checkbox"/>	Traffic Studies
<input type="checkbox"/>	Trip Generation Manual (ITE)
<input type="checkbox"/>	URBEMIS Air Quality Model
<input checked="" type="checkbox"/>	Zoning Maps
<input type="checkbox"/>	Other (list)

SUMMARY OF POTENTIALLY SIGNIFICANT IMPACTS

	Aesthetics		Mineral Resources
	Agriculture and Forest Resources	X	Noise
X	Air Quality		Population and Housing
X	Biological Resources		Public Services
X	Cultural Resources		Recreation
X	Energy	X	Transportation
X	Geology and Soils	X	Tribal Cultural Resources
X	Greenhouse Gas Emissions	X	Utilities and Service Systems
X	Hazards and Hazardous Materials	X	Wildfire
X	Hydrology and Water Quality		Mandatory Findings of Significance
X	Land Use and Planning		

DETERMINATION

On the basis of the Initial Study, the staff of the Community Development Department:

- _____ Finds that the proposed project is a Class ____ **CATEGORICAL EXEMPTION** and no further environmental review is required.
- _____ Finds that the proposed project **COULD NOT** have a significant effect on the environment, and a **NEGATIVE DECLARATION** will be prepared.
- _____ Finds that although the proposed project could have a significant effect on the environment, there will not be a significant effect in this case because revisions in the project have been made by or agreed to by the project proponent. A **MITIGATED NEGATIVE DECLARATION** will be prepared.
- _____ Finds that the proposed project **MAY** have a significant effect on the environment, and an **ENVIRONMENTAL IMPACT REPORT** is required.
- X
_____ Finds that the proposed project **MAY** have a “potentially significant impact” or “potentially significant unless mitigated” impact on the environment, but at least one effect 1) has been adequately analyzed in an earlier document pursuant to acceptable standards, and 2) has been addressed by mitigation measures based on the earlier analysis as described on the attached sheets. A **SUPPLEMENTAL EIR** is required, but it must analyze only the effects that remain to be addressed.
- _____ Finds that although the proposed project could have a significant effect on the environment, because all significant effects (a) have been analyzed adequately in an earlier **EIR** or **NEGATIVE DECLARATION** pursuant to acceptable standards, and (b) have been avoided or mitigated pursuant to that earlier **EIR** or **NEGATIVE DECLARATION**, including revisions or mitigation measures that are imposed upon the proposed project, nothing further is required.

(planner)
Environmental Analyst

Lawrence W. Appel
Environmental Officer

Date

Date



City of Santa Maria
Community Development Department
110 South Pine Street, #101
Santa Maria, CA 93458
805-925-0951



08/07/2020

City: Santa Maria - Community Development Center
Frank Albro
falbro@cityofsantamaria.org

Construction Site Well Review (CSWR) ID: 1012007

Assessor Parcel Number(s): 111231011

Property Owner(s): Santa Maria Public Airport District

Project Location Address: NW Corner of SR 135 and Union Valley Parkway, Santa Maria, California, 93455

Project Title: Santa Maria Airport Business Park Specific Plan Amendment, SCH Number 2020070055, APN 111-231-011

Public Resources Code (PRC) § 3208.1 establishes well reabandonment responsibility when a previously plugged and abandoned well will be impacted by planned property development or construction activities. Local permitting agencies, property owners, and/or developers should be aware of, and fully understand, that significant and potentially dangerous issues may be associated with development near oil, gas, and geothermal wells.

The Division of Oil, Gas, and Geothermal Resources (Division) has received and reviewed the above referenced project dated 7/31/2020. To assist local permitting agencies, property owners, and developers in making wise land use decisions regarding potential development near oil, gas, or geothermal wells, the Division provides the following well evaluation.

The project is located in Santa Barbara County, within the boundaries of the following fields:

The project location is just west of the Santa Maria Valley Oil Field. The nearest oil and gas well to the project location is approximately 1,800 feet to the east along Union Valley Parkway. To view records of California oil and gas wells and their locations please visit <https://maps.conservation.ca.gov/doggr/wellfinder>.

Our records indicate there are 0 known oil or gas wells located within the project boundary as identified in the application.

- Number of wells Not Abandoned to Current Division Requirements as Prescribed by Law and Projected to Be Built Over or Have Future Access Impeded by this project: 0
- Number of wells Not Abandoned to Current Division Requirements as Prescribed by Law and Not Projected to Be Built Over or Have Future Access Impeded by this project: 0
- Number of wells Abandoned to Current Division Requirements as Prescribed by Law and Projected to Be Built Over or Have Future Access Impeded by this project: 0



- Number of wells Abandoned to Current Division Requirements as Prescribed by Law and Not Projected to Be Built Over or Have Future Access Impeded by this project: 0

As indicated in PRC § 3106, the Division has statutory authority over the drilling, operation, maintenance, and abandonment of oil, gas, and geothermal wells, and attendant facilities, to prevent, as far as possible, damage to life, health, property, and natural resources; damage to underground oil, gas, and geothermal deposits; and damage to underground and surface waters suitable for irrigation or domestic purposes. In addition to the Division's authority to order work on wells pursuant to PRC §§ 3208.1 and 3224, it has authority to issue civil and criminal penalties under PRC §§ 3236, 3236.5, and 3359 for violations within the Division's jurisdictional authority. The Division does not regulate grading, excavations, or other land use issues.

If during development activities, any wells are encountered that were not part of this review, the property owner is expected to immediately notify the Division's construction site well review engineer in the Coastal district office, and file for Division review an amended site plan with well casing diagrams. The District office will send a follow-up well evaluation letter to the property owner and local permitting agency.

Should you have any questions, please contact me at (805) 465-9642 or via email at Pat.Abel@conservation.ca.gov

Sincerely,

A handwritten signature in black ink that reads "Pat Abel".

Pat Abel
Coastal District Deputy



State of California – Natural Resources Agency

DEPARTMENT OF FISH AND WILDLIFE

South Coast Region
3883 Ruffin Road
San Diego, CA 92123
(858) 467-4201
www.wildlife.ca.gov

GAVIN NEWSOM, Governor
CHARLTON H. BONHAM, Director



August 5, 2020

Frank Albro
Senior Planner
City of Santa Maria
110 S. Pine St. Suite 101
Santa Marin, CA 93458
Falbro@cityofsantamaria.org

Subject: Comments on the Initial Study/Notice of Preparation of a Draft Environmental Impact Report for Santa Maria Airport Business Park Specific Plan Amendment, SCH #2020070055, Santa Barbara County

Dear Mr. Albro:

The California Department of Fish and Wildlife (CDFW) has reviewed the above-referenced Initial Study/Notice of Preparation (IS/NOP) of a Draft Environmental Impact Report (DEIR) for Santa Maria Airport Business Park Specific Plan Amendment (Project).

Thank you for the opportunity to provide comments and recommendations regarding those activities involved in the Project that may affect California fish and wildlife. Likewise, we appreciate the opportunity to provide comments regarding those aspects of the Project that CDFW, by law, may be required to carry out or approve through the exercise of its own regulatory authority under the Fish and Game Code.

CDFW's Role

CDFW is California's Trustee Agency for fish and wildlife resources and holds those resources in trust by statute for all the people of the State [Fish & G. Code, §§ 711.7, subdivision (a) & 1802; Pub. Resources Code, § 21070; California Environmental Quality Act (CEQA) Guidelines, § 15386, subdivision (a)]. CDFW, in its trustee capacity, has jurisdiction over the conservation, protection, and management of fish, wildlife, native plants, and habitat necessary for biologically sustainable populations of those species (Id., § 1802). Similarly, for purposes of CEQA, CDFW is charged by law to provide, as available, biological expertise during public agency environmental review efforts, focusing specifically on projects and related activities that have the potential to adversely affect state fish and wildlife resources.

CDFW is also submitting comments as a Responsible Agency under CEQA (Pub. Resources Code, § 21069; CEQA Guidelines, § 15381). CDFW expects that it may need to exercise regulatory authority as provided by the Fish and Game Code, including lake and streambed alteration regulatory authority (Fish & G. Code, § 1600 et seq.). Likewise, to the extent implementation of the Project as proposed may result in "take" (see Fish & G. Code, § 2050) of any species protected under the California Endangered Species Act (CESA; Fish & G. Code, § 2050 et seq.) or the Native Plant Protection Act (NPPA; Fish & G. Code, §1900 et seq.), CDFW recommends the Project proponent obtain appropriate authorization under the Fish and Game Code.

Frank Albro
City of Santa Maria
August 5, 2020
Page 2 of 10

Project Location: The project site is located at the northwest corner of the intersection of State Route 135 and Union Valley Parkway, south of the Santa Maria Airport, in the City of Santa Maria.

Project Description/Objectives: In June 2007, the City of Santa Maria (City) certified a Programmatic Environmental Impact Report (PEIR) (State Clearinghouse [SCH] No. 2005051172) for the City of Santa Maria Airport Business Park Specific Plan (Specific Plan). The Certified PEIR evaluated the potential environmental impacts resulting from future development of the 740-acre Specific Plan area located in the southwestern corner of the City, immediately south of the Santa Maria Public Airport. The subject of this IS/NOP is a proposed General Plan Amendment, Specific Plan Amendment, and Zoning Modification of an approximately 28-acre parcel (Assessor's Parcel Number [APN] 111-231-011) at the southeast corner of the Specific Plan area (Project site).

In late 2018, the previously undisturbed Project site was graded for the agricultural cultivation of strawberries. The stands of eucalyptus trees were removed to improve airport operations and safety and accommodate this agricultural use.

COMMENTS AND RECOMMENDATIONS

CDFW offers the following comments and recommendations to assist the City in adequately identifying and/or mitigating the Project's significant, or potentially significant, direct and indirect impacts on fish and wildlife (biological) resources.

Specific Comments

- 1) **California Tiger Salamander.** The IS/NOP incorrectly states that California Tiger Salamander (*Ambystoma californiense*) is only a species of special concern to CDFW. California tiger salamander was listed as threatened across its entire range under CESA in 2010 (Fish & G. Code, § 2050 et seq.; Cal. Code Regs., tit. 14 § 670.5, subd. (b)(G)). CDFW does not have any records of consultation or issuance of any permits for take of California tiger salamander for this location.

The Project is known to support California Tiger Salamander (*Ambystoma californiense*) upland dispersal habitat adjacent to a breeding pond.

Under the CESA, take of any endangered, threatened, candidate species, or state-listed rare plant species that results a project is prohibited, except as authorized by state law (Fish and Game Code, §§ 2080, 2085; Cal. Code Regs., tit. 14, §786.9). Consequently, any activity during the life of a project will result in take of a species designated as endangered or threatened, or a candidate for listing under CESA, CDFW recommends that the Project proponent seek appropriate take authorization under CESA prior to implementing the Project. Appropriate authorization from CDFW may include an Incidental Take Permit (ITP) or a consistency determination in certain circumstances, among other options (Fish and Game Code §§ 2080.1, 2081, subds. (b),(c)).

Adult and juvenile California tiger salamander are known to migrate and occupy small mammal burrows in upland habitat up to 1.3 miles from a breeding pond (Orloff, 2007). The Project site is within the 1.3 miles dispersal distance from two California tiger salamander breeding ponds. The entire Project site falls within the 1.3-mile maximum migration distance

Frank Albro
City of Santa Maria
August 5, 2020
Page 3 of 10

of these two potential California tiger salamander breeding ponds. CDFW is concerned the Project would result in take of California tiger salamander by impacting aquatic and upland habitat on the Project site known to be occupied by California tiger salamander. CDFW and the United States Fish and Wildlife Service (USFWS) have developed survey protocol (Guidelines) to be used to detect California tiger salamander in aquatic and upland habitat with the potential to support California tiger salamander (Interim Guidance on Site Assessment and Field Surveys for Determining Presence or a Negative Finding of the California Tiger Salamander, <http://www.dfg.ca.gov/wildlife/nongame/docs/CTSFinalGuide10-03.pdf>). In order to establish a Negative Finding of California tiger salamander on the Project site, focused surveys according to the Guidelines must be conducted for the Project. California Tiger Salamander were documented as being present on this parcel during previous surveys (USFWS personnel communication). If the Project, Project construction, or any Project-related activity during the life of the Project will result in "take" of California tiger salamander as defined by the Fish and Game Code (Fish & G. Code, §§86, 2080, 2081(b)(c)) an ITP from CDFW may be required.

Revisions to the Fish and Game Code, effective January 1998, require the CDFW to comply with CEQA when issuing a CESA permit. CDFW can utilize the Lead Agencies CEQA document if that document addresses all project impacts to the listed species and specifies a mitigation monitoring and reporting program that will meet the requirements of a CESA permit. The CEQA document must include a thorough and robust analysis of the potentially significant impacts to California tiger salamander and their habitat which may occur as a result of the proposed Project. For any such potentially significant impacts, the City should also analyze and describe specific, potentially feasible mitigation measures to avoid or substantially lessen any such impacts as required by CEQA and, if an ITP is necessary, as required by the relevant permitting criteria prescribed by Fish and Game Code section 2081, subdivisions (b) and (c). The failure to include this analysis in the CEQA documents could preclude the CDFW from relying on the City's analysis to issue an ITP without CDFW first conducting its own, separate lead agency subsequent or supplemental analysis for the project (See, e.g., Cal. Code Regs., tit. 14, § 15096(f); Pub. Resources Code, § 21166).

Recommended Potentially Feasible Mitigation Measure(s):

Mitigation Measure #1: CDFW recommends the City consult with CDFW under CESA for potential take coverage resulting from this Projects.

- 2) **Sensitive Vegetation Communities.** The IS/NOP states "The Certified EIR identifies habitats within the project site as including eucalyptus woodland, non- riparian annual grassland, and critical coastal scrub, none of which are classified as a sensitive natural community by CDFW or other jurisdictions. There are no bodies of water, riparian habitat features, or other sensitive communities located within the project site. Therefore, the project would not have a substantial adverse effect on any riparian habitat or other sensitive natural community and potential impacts would be *less than significant.*"

The IS/MND uses a vegetation classification system that does not align with the State's vegetation mapping standard, which is how CDFW tracks Sensitive Natural Communities.

Frank Albro
City of Santa Maria
August 5, 2020
Page 4 of 10

In 2007, the State Legislature required CDFW to develop and maintain a vegetation mapping standard for the state (Fish and Game Code Section 1940). This standard complies with the National Vegetation Classification System which utilizes alliance and association-based classification of unique vegetation stands. CDFW utilizes vegetation descriptions found in the Manual of California Vegetation (MCV), found online at <http://vegetation.cnps.org/>. Through this MCV vegetation classification system, CDFW tracks Sensitive Natural Communities and their respective rankings using the MCV alliance and association names for vegetation communities.

Without MCV names and updated rankings identified for the vegetation communities potentially affected by the Project, CDFW is unable to determine if the project may impact sensitive vegetation communities or wildlife species that depend on these communities or recommend appropriate avoidance, minimization and/or mitigation measures. If a vegetation community in the project area has not previously been described, it may be a rare type. In this case, please contact CDFW about documenting and validating the vegetation community.

CDFW considers natural communities with ranks of S1-S3 to be sensitive natural communities that meet the CEQA definition (CEQA Guidelines, §§ 15380, 15063, 15065) to be addressed in CEQA (CEQA Guidelines, § 15125[c]). An S3 ranking indicates there are 21-80 occurrences of this community in existence in California, S2 has 6-20 occurrences, and S1 has less than 6 occurrences.

Recommended Potentially Feasible Mitigation Measure(s):

Mitigation Measure #1: CDFW recommends that floristic, alliance- and/or association-based mapping and vegetation impact assessments be conducted at the Project site and neighboring vicinity. The IS/MND should use the vegetation data collected for the PEIR and Specific Plan to crosswalk these species into current alliances for the purposes of establishing baseline for the IS/MND. The IS/MND document should identify, map, and discuss the specific vegetation alliances within the Project Area following CDFW's Protocols for Surveying and Evaluating Impacts to Special Status Native Plant Populations and Natural Communities (Survey Protocols) see: (<https://www.wildlife.ca.gov/Data/VegCAMP/Natural-Communities>).

- 3) **Bumble Bee.** A review of CNDDDB indicate Crotch bumble bee (*Bombus crotchii*) within five (5) miles west of the Project vicinity. Project ground disturbing activities may result in crushing or filling of active bee colonies, causing the death or injury of adults, eggs, and larvae. The Project may remove bee habitat by eliminating vegetation that may support essential foraging habitat. Impacts to Crotch's bumble bee could result from ground disturbing activities. Project disturbance activities could result in mortality or injury to hibernating bees, as well as temporary or long-term loss of suitable foraging habitats. Construction during the breeding season of bees could result in the incidental loss of breeding success or otherwise lead to nest abandonment.
 - a) CDFW recommends that measures be taken, primarily, to avoid Project impacts to Crotch bumble bee. On June 12, 2019, the California Fish and Game Commission accepted a petition to list the crotch bumble bee as endangered under the California Endangered Species Act ("CESA"), determining the listing "may be warranted" and advancing the species to the candidacy stage of the CESA listing process.

Frank Albro
City of Santa Maria
August 5, 2020
Page 5 of 10

- b) CDFW recommends, a qualified entomologist familiar with the species behavior and life history should conduct surveys to determine the presence/absence of Crotch's bumble bee and disclose presence or absence in the DEIR. Surveys should be conducted during flying season when the species is most likely to be detected above ground, between March 1 to September 1 (Thorp et al. 1983). Survey results including negative findings should be submitted to CDFW prior to initiation of Project activities. If "take" or adverse impacts to Crotch's bumble bee cannot be avoided either during Project activities or over the life of the Project, the City must consult CDFW to determine if a CESA incidental take permit is required (pursuant to Fish & Game Code, § 2080 et seq.).

General Comments

- 4) **Project Description and Alternatives.** To enable CDFW to adequately review and comment on the proposed Project from the standpoint of the protection of plants, fish, and wildlife, we recommend the following information be included in the DEIR:
 - a) A complete discussion of the purpose and need for, and description of, the proposed Project, including all staging areas and access routes to the construction and staging areas; and,
 - b) A range of feasible alternatives to Project component location and design features to ensure that alternatives to the proposed Project are fully considered and evaluated. The alternatives should avoid or otherwise minimize direct and indirect impacts to sensitive biological resources and wildlife movement areas.
- 5) **Wetlands Resources.** CDFW, as described in Fish and Game Code section 703(a), is guided by the Fish and Game Commission's policies. The Wetlands Resources policy (<http://www.fgc.ca.gov/policy/>) of the Fish and Game Commission "...seek[s] to provide for the protection, preservation, restoration, enhancement and expansion of wetland habitat in California. Further, it is the policy of the Fish and Game Commission to strongly discourage development in or conversion of wetlands. It opposes, consistent with its legal authority, any development or conversion that would result in a reduction of wetland acreage or wetland habitat values. To that end, the Commission opposes wetland development proposals unless, at a minimum, project mitigation assures there will be 'no net loss' of either wetland habitat values or acreage. The Commission strongly prefers mitigation which would achieve expansion of wetland acreage and enhancement of wetland habitat values."
 - a) The Wetlands Resources policy provides a framework for maintaining wetland resources and establishes mitigation guidance. CDFW encourages avoidance of wetland resources as a primary mitigation measure and discourages the development or type conversion of wetlands to uplands. CDFW encourages activities that would avoid the reduction of wetland acreage, function, or habitat values. Once avoidance and minimization measures have been exhausted, the Project must include mitigation measures to assure a "no net loss" of either wetland habitat values, or acreage, for unavoidable impacts to wetland resources. Conversions include, but are not limited to, conversion to subsurface drains, placement of fill or building of structures within the wetland, and channelization or removal of materials from the streambed. All wetlands and watercourses, whether ephemeral, intermittent, or perennial, should be retained and provided with substantial

Frank Albro
City of Santa Maria
August 5, 2020
Page 6 of 10

setbacks, which preserve the riparian and aquatic values and functions for the benefit to on-site and off-site wildlife populations. CDFW recommends mitigation measures to compensate for unavoidable impacts be included in the DEIR and these measures should compensate for the loss of function and value.

- b) The Fish and Game Commission's Water policy guides CDFW on the quantity and quality of the waters of this state that should be apportioned and maintained respectively so as to produce and sustain maximum numbers of fish and wildlife; to provide maximum protection and enhancement of fish and wildlife and their habitat; encourage and support programs to maintain or restore a high quality of the waters of this state; prevent the degradation thereof caused by pollution and contamination; and, endeavor to keep as much water as possible open and accessible to the public for the use and enjoyment of fish and wildlife. CDFW recommends avoidance of water practices and structures that use excessive amounts of water, and minimization of impacts that negatively affect water quality, to the extent feasible (Fish & Game Code, § 5650).
- 6) **CESA**. CDFW considers adverse impacts to a species protected by CESA to be significant without mitigation under CEQA. As to CESA, take of any endangered, threatened, candidate species, or State-listed rare plant species that results from the Project is prohibited, except as authorized by state law (Fish and Game Code, §§ 2080, 2085; Cal. Code Regs., tit. 14, §786.9). Consequently, if the Project, Project construction, or any Project-related activity during the life of the Project will result in take of a species designated as endangered or threatened, or a candidate for listing under CESA, CDFW recommends that the Project proponent seek appropriate take authorization under CESA prior to implementing the Project. Appropriate authorization from CDFW may include an Incidental Take Permit (ITP) or a consistency determination in certain circumstances, among other options [Fish & Game Code, §§ 2080.1, 2081, subds. (b) and (c)]. Early consultation is encouraged, as significant modification to a Project and mitigation measures may be required in order to obtain a CESA Permit. Revisions to the Fish and Game Code, effective January 1998, may require that CDFW issue a separate CEQA document for the issuance of an ITP unless the Project CEQA document addresses all Project impacts to CESA-listed species and specifies a mitigation monitoring and reporting program that will meet the requirements of an ITP. For these reasons, biological mitigation monitoring and reporting proposals should be of sufficient detail and resolution to satisfy the requirements for a CESA ITP.
- 7) **Biological Baseline Assessment**. To provide a complete assessment of the flora and fauna within and adjacent to the project area, with particular emphasis upon identifying endangered, threatened, sensitive, regionally and locally unique species, and sensitive habitats, the DEIR should include the following information:
- a) Information on the regional setting that is critical to an assessment of environmental impacts, with special emphasis on resources that are rare or unique to the region [CEQA Guidelines, § 15125(c)];
 - b) A thorough, recent, floristic-based assessment of special status plants and natural communities, following CDFW's *Protocols for Surveying and Evaluating Impacts to Special Status Native Plant Populations and Natural Communities* (see <https://nrm.dfg.ca.gov/FileHandler.ashx?DocumentID=18959&inline>);

Frank Albro
City of Santa Maria
August 5, 2020
Page 7 of 10

- c) Floristic, alliance- and/or association-based mapping and vegetation impact assessments conducted at the Project site and within the neighboring vicinity. *The Manual of California Vegetation*, second edition, should also be used to inform this mapping and assessment (Sawyer, 2008). Adjoining habitat areas should be included in this assessment where site activities could lead to direct or indirect impacts offsite. Habitat mapping at the alliance level will help establish baseline vegetation conditions;
 - d) A complete, recent, assessment of the biological resources associated with each habitat type on site and within adjacent areas that could also be affected by the project. CDFW's California Natural Diversity Data Base (CNDDDB) in Sacramento should be contacted to obtain current information on any previously reported sensitive species and habitat. CDFW recommends that CNDDDB Field Survey Forms be completed and submitted to CNDDDB to document survey results. Online forms can be obtained and submitted at http://www.dfg.ca.gov/biogeodata/cnddb/submitting_data_to_cnddb.asp;
 - e) A complete, recent, assessment of rare, threatened, and endangered, and other sensitive species on site and within the area of potential effect, including California SSC and California Fully Protected Species (Fish & Game Code, §§ 3511, 4700, 5050 and 5515). Species to be addressed should include all those which meet the CEQA definition of endangered, rare or threatened species (CEQA Guidelines, § 15380). Seasonal variations in use of the project area should also be addressed. Focused species-specific surveys, conducted at the appropriate time of year and time of day when the sensitive species are active or otherwise identifiable, are required. Acceptable species-specific survey procedures should be developed in consultation with CDFW and the USFWS; and,
 - f) A recent, wildlife and rare plant survey. CDFW generally considers biological field assessments for wildlife to be valid for a one-year period, and assessments for rare plants may be considered valid for a period of up to three years. Some aspects of the proposed project may warrant periodic updated surveys for certain sensitive taxa, particularly if build out could occur over a protracted time frame, or in phases.
- 8) **Biological Direct, Indirect, and Cumulative Impacts.** To provide a thorough discussion of direct, indirect, and cumulative impacts expected to adversely affect biological resources, with specific measures to offset such impacts, the following should be addressed in the DEIR:
- a) A discussion of potential adverse impacts from lighting, noise, human activity, exotic species, and drainage. The latter subject should address Project-related changes on drainage patterns and downstream of the project site; the volume, velocity, and frequency of existing and post-Project surface flows; polluted runoff; soil erosion and/or sedimentation in streams and water bodies; and, post-Project fate of runoff from the project site. The discussion should also address the proximity of the extraction activities to the water table, whether dewatering would be necessary and the potential resulting impacts on the habitat (if any) supported by the groundwater. Mitigation measures proposed to alleviate such Project impacts should be included;
 - b) A discussion regarding indirect Project impacts on biological resources, including resources in nearby public lands, open space, adjacent natural habitats, riparian ecosystems, and any designated and/or proposed or existing reserve lands (e.g.,

Frank Albro
City of Santa Maria
August 5, 2020
Page 8 of 10

preserve lands associated with a Natural Community Conservation Plan (NCCP, Fish & Game Code, § 2800 et. seq.). Impacts on, and maintenance of, wildlife corridor/movement areas, including access to undisturbed habitats in adjacent areas, should be fully evaluated in the DEIR;

- c) An analysis of impacts from land use designations and zoning located nearby or adjacent to natural areas that may inadvertently contribute to wildlife-human interactions. A discussion of possible conflicts and mitigation measures to reduce these conflicts should be included in the DEIR; and,
 - d) A cumulative effects analysis, as described under CEQA Guidelines section 15130. General and specific plans, as well as past, present, and anticipated future projects, should be analyzed relative to their impacts on similar plant communities and wildlife habitats.
- 9) **Compensatory Mitigation.** The DEIR should include mitigation measures for adverse Project-related impacts to sensitive plants, animals, and habitats. Mitigation measures should emphasize avoidance and reduction of Project impacts. For unavoidable impacts, on-site habitat restoration or enhancement should be discussed in detail. If on-site mitigation is not feasible or would not be biologically viable and therefore not adequately mitigate the loss of biological functions and values, off-site mitigation through habitat creation and/or acquisition and preservation in perpetuity should be addressed. Areas proposed as mitigation lands should be protected in perpetuity with a conservation easement, financial assurance and dedicated to a qualified entity for long-term management and monitoring. Under Government Code section 65967, the lead agency must exercise due diligence in reviewing the qualifications of a governmental entity, special district, or nonprofit organization to effectively manage and steward land, water, or natural resources on mitigation lands it approves.
- 10) **Long-term Management of Mitigation Lands.** For proposed preservation and/or restoration, the DEIR should include measures to protect the targeted habitat values from direct and indirect negative impacts in perpetuity. The objective should be to offset the Project-induced qualitative and quantitative losses of wildlife habitat values. Issues that should be addressed include (but are not limited to) restrictions on access, proposed land dedications, monitoring and management programs, control of illegal dumping, water pollution, and increased human intrusion. An appropriate non-wasting endowment should be set aside to provide for long-term management of mitigation lands.
- 11) **Nesting Birds.** CDFW recommends that measures be taken to avoid Project impacts to nesting birds. Migratory nongame native bird species are protected by international treaty under the Federal Migratory Bird Treaty Act (MBTA) of 1918 (Title 50, § 10.13, Code of Federal Regulations). Sections 3503, 3503.5, and 3513 of the California Fish and Game Code prohibit take of all birds and their active nests including raptors and other migratory nongame birds (as listed under the Federal MBTA). Proposed Project activities including (but not limited to) staging and disturbances to native and nonnative vegetation, structures, and substrates should occur outside of the avian breeding season which generally runs from February 1 through September 1 (as early as January 1 for some raptors) to avoid take of birds or their eggs. If avoidance of the avian breeding season is not feasible, CDFW recommends surveys by a qualified biologist with experience in conducting breeding bird surveys to detect protected native birds occurring in suitable nesting habitat that is to be

Frank Albro
City of Santa Maria
August 5, 2020
Page 9 of 10

disturbed and (as access to adjacent areas allows) any other such habitat within 300-feet of the disturbance area (within 500-feet for raptors). Project personnel, including all contractors working on site, should be instructed on the sensitivity of the area. Reductions in the nest buffer distance may be appropriate depending on the avian species involved, ambient levels of human activity, screening vegetation, or possibly other factors.

- 12) **Translocation/Salvage of Plants and Animal Species.** Translocation and transplantation is the process of moving an individual from the Project site and permanently moving it to a new location. CDFW generally does not support the use of, translocation or transplantation as the primary mitigation strategy for unavoidable impacts to rare, threatened, or endangered plant or animal species. Studies have shown that these efforts are experimental and the outcome unreliable. CDFW has found that permanent preservation and management of habitat capable of supporting these species is often a more effective long-term strategy for conserving sensitive plants and animals and their habitats.
- 13) **Moving out of Harm's Way.** The proposed Project is anticipated to result in clearing of natural habitats that support many species of indigenous wildlife. To avoid direct mortality, we recommend that a qualified biological monitor approved by CDFW be on-site prior to and during ground and habitat disturbing activities to move out of harm's way special status species or other wildlife of low mobility that would be injured or killed by grubbing or Project-related construction activities. It should be noted that the temporary relocation of on-site wildlife does not constitute effective mitigation for the purposes of offsetting project impacts associated with habitat loss. If the project requires species to be removed, disturbed, or otherwise handled, we recommend that the DEIR clearly identify that the designated entity shall obtain all appropriate state and federal permits.
- 14) **Revegetation/Restoration Plan.** Plans for restoration and re-vegetation should be prepared by persons with expertise in southern California ecosystems and native plant restoration techniques. Plans should identify the assumptions used to develop the proposed restoration strategy. Each plan should include, at a minimum: (a) the location of restoration sites and assessment of appropriate reference sites; (b) the plant species to be used, sources of local propagules, container sizes, and seeding rates; (c) a schematic depicting the mitigation area; (d) a local seed and cuttings and planting schedule; (e) a description of the irrigation methodology; (f) measures to control exotic vegetation on site; (g) specific success criteria; (h) a detailed monitoring program; (i) contingency measures should the success criteria not be met; and (j) identification of the party responsible for meeting the success criteria and providing for conservation of the mitigation site in perpetuity. Monitoring of restoration areas should extend across a sufficient time frame to ensure that the new habitat is established, self-sustaining, and capable of surviving drought.
 - a) CDFW recommends that local on-site propagules from the Project area and nearby vicinity be collected and used for restoration purposes. On-site seed collection should be initiated in the near future to accumulate sufficient propagule material for subsequent use in future years. On-site vegetation mapping at the alliance and/or association level should be used to develop appropriate restoration goals and local plant palettes. Reference areas should be identified to help guide restoration efforts. Specific restoration plans should be developed for various Project components as appropriate.

Frank Albro
City of Santa Maria
August 5, 2020
Page 10 of 10

- b) Restoration objectives should include providing special habitat elements where feasible to benefit key wildlife species. These physical and biological features can include (for example) retention of woody material, logs, snags, rocks and brush piles.

CONCLUSION

CDFW appreciates the opportunity to comment on the NOP to assist the City of Santa Maria in identifying and mitigating Project impacts on biological resources. If you have any questions or comments regarding this letter, please contact Kelly Schmoker, Senior Environmental Scientist (Specialist), at (626) 335-9092, or by email at Kelly.Schmoker@wildlife.ca.gov.

Sincerely,

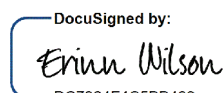
DocuSigned by:

DC7324F4C5BB489...

Erinn Wilson
Environmental Program Manager I

ec: CDFW
Steve Gibson – Los Alamitos
Susan Howell – San Diego
CEQA Program Coordinator – Sacramento

State Clearinghouse

References

Orloff, S. 2007. Migratory Movements of California tiger salamander in upland habitat – a five year study (Pittsburg, California). Ibis Environmental, Inc., prepared for Bailey Estates LLC, May 2008. 47 pp. + appendices.

Sawyer, J. O., Keeler-Wolf, T., and Evens J.M. 2008. A manual of California Vegetation, 2nd ed. ISBN 978-0-943460-49-9.

Thorp, Robbin W., Horning Jr, Donald S., and Dunning, Lorry L. 1983. Bumble Bees and Cuckoo Bumble Bees of California. Bulletin of the California Insect Survey 23.



Making Conservation
a California Way of Life.

DEPARTMENT OF TRANSPORTATION

CALTRANS DISTRICT 5
50 HIGUERA STREET
SAN LUIS OBISPO, CA 93401-5415
PHONE (805) 549-3101
FAX (805) 549-3329
TTY 711
www.dot.ca.gov/dist05/

August 3, 2020

SB-135-11.73
SCH #: 2005051172

Frank Albro, Senior Planner
City of Santa Maria
110 S. Pine Street, Suite 101
Santa Maria, CA 93456

COMMENTS FOR THE NOTICE OF PREPARATION OF THE SUPPLEMENTAL ENVIRONMENTAL IMPACT REPORT FOR THE SANTA MARIA AIRPORT BUSINESS PARK SPECIFIC PLAN REZONE PROJECT

Dear Mr. Albro:

The California Department of Transportation (Caltrans) thanks you for the opportunity to review the Notice of Preparation (NOP) for the Supplemental Environmental Impact Report (SEIR) for the Santa Maria Airport Business Park (SMABP) Specific Plan Rezone Project and offers the following comments at this time.

General Comments

The project proposes to amend the SMABP Specific Plan by rezoning a parcel at the northwest corner of Union Valley Parkway (UVP) and State Route (SR) 135 for future development opportunities. Caltrans previously commented on the Notice of Preparation of the 2005 Draft Environmental Impact Report (EIR), the 2007 Draft EIR, and most recently the Transportation Impact Study (TIS) Scope and Memorandum of Assumptions (MOA). Those letters are attached for historical perspective and since some of the comments still apply.

Caltrans supports local planning efforts that are consistent with State planning priorities intended to promote equity, strengthen the economy, protect the environment, and promote public health and safety. We accomplish this by working with local jurisdictions to achieve a shared vision of how the transportation system should and can accommodate interregional and local travel.

Mr. Frank Albro

August 3, 2020

Page 2

Projects that support smart growth principles which include improvements to pedestrian, bicycle, and transit infrastructure (or other key Transportation Demand Strategies) are supported by Caltrans and are consistent with our mission, vision, and goals. Since the passage of SB 743 and the change of metric from Level of Service to Vehicle Miles Traveled (VMT), we look forward to seeing what trip-reducing elements are included with any future project to lower its' impacts and potential mitigation.

Specific Comments

We look forward to early coordination with the City on this project, and reviewing the additional studies in the PEIR particularly related to permits, hydraulics, and traffic operations.

Caltrans is particularly concerned about the intersections of SR 135/UVP and SR 135/Foster Road. Any current or future analysis provided should use Caltrans-accepted methodologies and indicate that these locations will be able to accommodate the additional net trips. Also, this segment of SR 135 is controlled access and therefore new driveways directly on the highway are not allowed. Access will need to be taken from the local street network and preferably as far away from the intersection as possible. Part of the analysis may also include an Intersection Control Evaluation.

Please be aware that any encroachment in the State's right-of-way it will require a permit from Caltrans and must be done to our engineering and environmental standards, and at no cost to the State. The conditions of approval and the requirements for the permit are issued at the discretion of the Permits Office, and nothing in this letter shall be implied as limiting those future conditioned and requirements. For more information regarding the encroachment permit process, please visit our Encroachment Permit Website at: <https://dot.ca.gov/programs/traffic-operations/ep>.

Depending on the complexity of the project improvements requiring an encroachment permit, Caltrans oversight may be the more appropriate avenue for project review and approval by Caltrans as determined by the District Permit Engineer. Please consult with the Permit's Office to determine the most appropriate Caltrans project permitting system.

All future work will need to conform to the Caltrans Encroachment Permits Manual, Chapter 600. Additional utility installation requirements, which may apply, are found in Chapter 17 of the Project Development Procedures Manual.

*"Provide a safe, sustainable, integrated and efficient transportation system
to enhance California's economy and livability"*

Mr. Frank Albro
August 3, 2020
Page 3

Deviations to these policies may require an exception. These requirements and processes will be outlined by the District Permit Engineer in the pre-submittal conference.

Caltrans Hydraulics requests early coordination on the drainage basins adjacent to SR 135 as we have facilities that could be impacted. No future projects should direct any drainage flow toward SR 135 or impact existing Caltrans drainage facilities, see attached. Please provide detailed plans and calculations for the detention basins when available.

Additional comments discussing airport land-use compatibility may come from the Caltrans Headquarters Division of Aeronautics.

We look forward to continued coordination with the County on this project. If you have any questions, or need further clarification on items discussed above, please contact me at (805) 835-6555 or ingrid.mcroberts@dot.ca.gov.

Sincerely,



Ingrid McRoberts
Development Review Coordinator
District 5, LD-IGR South Branch

Attachments

cc: Joe Fernandez



Making Conservation
a California Way of Life.

DEPARTMENT OF TRANSPORTATION

CALTRANS DISTRICT 5
50 HIGUERA STREET
SAN LUIS OBISPO, CA 93401-5415
PHONE (805) 549-3101
FAX (805) 549-3329
TTY 711
www.dot.ca.gov/dist05/

July 2, 2020

SB-135-11.73
SCH #: 2005051172

Frank Albro, Senior Planner
City of Santa Maria
110 S. Pine Street, Suite 101
Santa Maria, CA 93456

COMMENTS FOR THE TRANSPORTATION IMPACT STUDY SCOPE AND MEMORANDUM OF ASSUMPTIONS FOR THE SANTA MARIA AIRPORT BUSINESS PARK SPECIFIC PLAN REZONE PROJECT

Dear Mr. Albro:

The California Department of Transportation (Caltrans) thanks you for the opportunity to review the Transportation Impact Study (TIS) Scope and Memorandum of Assumptions (MOA) dated March 20, 2020 for the Santa Maria Airport Business Park (SMABP) Specific Plan Rezone Project and offers the following comments at this time.

General Comments

The project proposes to amend the SMABP Specific Plan by rezoning a parcel at the northwest corner of Union Valley Parkway (UVP) and State Route (SR) 135 for future development opportunities. Caltrans previously commented on the Notice of Preparation of the 2005 Draft Environmental Impact Report (EIR), and for the 2007 Draft EIR. Those letters are attached for historical perspective and since some of the comments still apply.

Caltrans supports local planning efforts that are consistent with State planning priorities intended to promote equity, strengthen the economy, protect the environment, and promote public health and safety. We accomplish this by working with local jurisdictions to achieve a shared vision of how the transportation system should and can accommodate interregional and local travel.

Mr. Frank Albro

July 2, 2020

Page 2

Projects that support smart growth principles which include improvements to pedestrian, bicycle, and transit infrastructure (or other key Transportation Demand Strategies) are supported by Caltrans and are consistent with our mission, vision, and goals. Since the passage of SB 743 and the change of metric from Level of Service to Vehicle Miles Traveled (VMT), we look forward to seeing what trip-reducing elements are included with any future project to lower its' impacts and potential mitigation.

Specific Comments

Caltrans is particularly concerned about the intersections of SR 135/UVP and SR 135/Foster Road. Any current or future analysis provided should use Caltrans-accepted methodologies and indicate that these locations will be able to accommodate the additional net trips. Also, this segment of SR 135 is controlled access and therefore new driveways directly on the highway are not allowed. Access will need to be taken from the local street network and preferably as far away from the intersection as possible. Part of the analysis may also include an Intersection Control Evaluation.

Please be aware that any encroachment in the State's right-of-way it will require a permit from Caltrans and must be done to our engineering and environmental standards, and at no cost to the State. The conditions of approval and the requirements for the permit are issued at the discretion of the Permits Office, and nothing in this letter shall be implied as limiting those future conditioned and requirements. For more information regarding the encroachment permit process, please visit our Encroachment Permit Website at: <https://dot.ca.gov/programs/traffic-operations/ep>.

Depending on the complexity of the project improvements requiring an encroachment permit, Caltrans oversight may be the more appropriate avenue for project review and approval by Caltrans as determined by the District Permit Engineer. Please consult with the Permit's Office to determine the most appropriate Caltrans project permitting system.

All future work will need to conform to the Caltrans Encroachment Permits Manual, Chapter 600. Additional utility installation requirements, which may apply, are found in Chapter 17 of the Project Development Procedures Manual. Deviations to these policies may require an exception. These requirements and processes will be outlined by the District Permit Engineer in the pre-submittal conference.

Mr. Frank Albro

July 2, 2020

Page 3

Caltrans Hydraulics requests early coordination on the drainage basins adjacent to SR 135 as we have facilities that could be impacted. No future projects should direct any drainage flow toward SR 135, currently the natural grade falls away from SR 135 and should continue as such. Please provide detailed plans and calculations for the detention basins when available.

Additional comments discussing airport land-use compatibility may come from the Caltrans Headquarters Division of Aeronautics.

We look forward to continued coordination with the County on this project. If you have any questions, or need further clarification on items discussed above, please contact me at (805) 835-6555 or ingrid.mcroberts@dot.ca.gov.

Sincerely,

A handwritten signature in blue ink that reads "Ingrid McRoberts". The signature is written in a cursive, flowing style.

Ingrid McRoberts
Development Review Coordinator
District 5, LD-IGR South Branch

Attachments

cc: Joe Fernandez

DEPARTMENT OF TRANSPORTATION

50 HIGUERA STREET
SAN LUIS OBISPO, CA 93401-5415
PHONE (805) 549-3101
FAX (805) 549-3077
TDD (805) 549-3259
<http://www.dot.ca.gov/dist05/>



*Flex your power!
Be energy efficient!*

January 17, 2007

SB-135 PM10.73-11.73
SCH#2005051172

Peggy Woods
City of Santa Maria
110 S. Pine Street, Suite 101
Santa Maria CA 93456

COMMENTS TO: Santa Maria Airport Business Park Specific Plan - Draft EIR

Dear Ms. Woods:

The California Department of Transportation (Caltrans), District 5, Development Review, has reviewed the above-referenced project and offers the following comments for your consideration:

1. There is no discussion or analysis of traffic impacts on the State Highway facilities along Hwy 101 at the following interchanges: Clark Avenue (existing interchange), Union Valley Parkway (proposed interchange), Santa Maria Way (existing interchange), McCoy (proposed interchange), and Betteravia (existing interchange).
2. The intersection of Foster Road and Orcutt Road was not analyzed as to its effects on the intersection of Foster Road and State Route 135.
3. There is no mitigation identified to address the increase of traffic expected on Lakeview Road if the funding plan for Union Valley Parkway does not follow through.

District 5 staff has been, and will continue to be, committed to working very closely with you to achieve a shared vision of how the transportation system should and can accommodate interregional and local travel. Please don't hesitate to call me at (805) 549-3615.

Sincerely,

A handwritten signature in black ink that reads "Joseph A. Londono".

Joseph A. Londono
District 5 Development Review Coordinator

DEPARTMENT OF TRANSPORTATION

50 HIGUERA STREET
SAN LUIS OBISPO, CA 93401-5415
PHONE (805) 549-3101
FAX (805) 549-3077
TDD (805) 549-3259
<http://www.dot.ca.gov/dist05/>



*Flex your power!
Be energy efficient!*

June 29, 2005

SB-135-PM10.73-11.73
SCH#2005051172

Bill Shipsey
City of Santa Maria
110 S. Pine Street, suite 101
Santa Maria CA 93456

**COMMENTS TO: Notice of Preparation – Santa Maria Airport Business Park Specific Plan
Draft EIR**

Dear Mr. Shipsey:

The California Department of Transportation (Department), District 5, Development Review, has reviewed the above-referenced project and offers the following comments for your consideration:

1. The Department supports local development that is consistent with State planning priorities which intend to promote equity, strengthen the economy, protect the environment, and promote public health and safety. Because this project is of statewide and regional significance, it is recommended that the City of Santa Maria and their consultant meet with Department representatives regarding scoping of the traffic study. In this way we can maintain a shared vision on how the transportation system should and can accommodate interregional and local travel and development.
2. To ensure the traffic study in the Draft EIR includes the information needed by the Department to analyze the impacts (both cumulative and project-specific) of this project, it is recommended that the analysis be prepared in accordance with the *Department's "Guide for the Preparation of Traffic Impact Studies."* The City of Santa Maria is currently developing several project study reports along the Hwy 101 Corridor. The traffic study for this specific plan and those being prepared for the PSRs need to be consistent with one another. In general, the traffic study needs to look at Hwy 135 and Hwy 101. The traffic study will also need to look at the Hwy 101 & Clark Avenue Interchange (existing interchange), Hwy 101 & Union Valley Parkway (proposed interchange), Hwy 101 & Santa Maria Way (existing interchange), Hwy 101 & McCoy (proposed interchange), and Hwy 101 & Betteravia (existing interchange). The Department approved a supplemental PSR on 11/15/2001 proposing to widen SB 135 to six lanes. The City of Santa Maria is the implementing agency. The project is EA 05-45580 and is need of funding sources. This could be a funding source.

Subject - Addressee

Date

Page 2

3. Because the Department is responsible for the safety, operations, and maintenance of the State transportation system, our Level of Service (LOS) standards should be used to determine the significance of the project's impact. We endeavor to maintain a target LOS at the transition between LOS C and LOS D on all State transportation facilities. In cases where a State facility is already operating at an unacceptable LOS, *any* additional trips added should be considered a significant cumulative traffic impact, and should be mitigated accordingly.
4. The methodologies used to calculate the LOS should be consistent with the methods in the current version of the Highway Capacity Manual. All LOS calculations should also be included in the Draft EIR as an appendix made available for review. Additionally, the project trip generation rates should be based on the latest edition of the Institute of Transportation Engineers Trip Generation Report
5. It is suggest that a copy of the draft EIR be sent to Caltrans, Division of Aeronautics for their review. Noise and safety issues associated with the close proximity of this development (especially the residential) to the airport are of particular concern.
6. The EIR should address the availability of transit and the location of bus stops within walking distance of the subsidized housing units. Residents there will have mobility needs. In addition, the proposed project needs to fully explore and explain what type of alternative modes of transportation for the residential section, as well as for workers at the commercial site (e.g. transit, rideshare program, bicycles, walkability) will be accessible.
7. The map on Figure 1 does not identify Hwy 135. Hwy 1 and Hwy 101 are identified but Hwy 135 is only referred to as Orcutt Expressway. Since the project fronts SR 135, Figure 1 needs to be changed to reflect this.
8. Goods movement and commercial vehicle operations are critical components of the Santa Maria Airport community and transportation system. A thorough analysis of truck movements (origin and destination) is required. This would also include comprehensive truck counts by number of axles.

We look forward to receiving the Draft EIR, and providing comments from a more thorough analysis. At that time, we may include comments on other pertinent issues related to environmental justice, water quality, and hydrology.

Subject - Addressee

Date

Page 3

District 5 staff has been, and will continue to be, committed to working very closely with you to achieve a shared vision of how the transportation system should and can accommodate interregional and local travel. Please don't hesitate to call me at (805) 549-3615.

Sincerely,

A handwritten signature in cursive script that reads "Tamara S. Babcock". The signature is written in black ink and is positioned below the word "Sincerely,".

Tamara S. Babcock
District 5 Development Review Coordinator

cc: Roger Barnes (D5)
David M. Murray (D5)
Lyn Wickham (D5)
Pat Mickelson (D5)
Gary Ruggerone (D5)
Paul Martinez (D5)
Leslie Snow (Div Aero)
Michael Powers (SBCAG)
File



NATIVE AMERICAN HERITAGE COMMISSION

July 3, 2020

Frank Albro
City of Santa Maria
110 South Pine Street, #101
Santa Maria, CA 93458

RECEIVED

JUL 13 2020

COMMUNITY DEVELOPMENT DEPT.
DV.

CHAIRPERSON
Laura Miranda
Luiseño

VICE CHAIRPERSON
Reginald Pagaling
Chumash

SECRETARY
Merrl Lopez-Keifer
Luiseño

PARLIAMENTARIAN
Russell Atebery
Karuk

COMMISSIONER
Marshall McKay
Wintun

COMMISSIONER
William Mungary
Paiute/White Mountain
Apache

COMMISSIONER
Julie Tumamait-
Stenslie
Chumash

COMMISSIONER
[Vacant]

COMMISSIONER
[Vacant]

EXECUTIVE SECRETARY
Christina Snider
Pomo

NAHC HEADQUARTERS
1550 Harbor Boulevard
Suite 100
West Sacramento,
California 95691
(916) 373-3710
nahc@nahc.ca.gov
NAHC.ca.gov

Re: 2020070055, Santa Maria Airport Business Park Specific Plan Amendment Project, Santa Barbara County

Dear Mr. Albro:

The Native American Heritage Commission (NAHC) has received the Notice of Preparation (NOP), Draft Environmental Impact Report (DEIR) or Early Consultation for the project referenced above. The California Environmental Quality Act (CEQA) (Pub. Resources Code §21000 et seq.), specifically Public Resources Code §21084.1, states that a project that may cause a substantial adverse change in the significance of a historical resource, is a project that may have a significant effect on the environment. (Pub. Resources Code § 21084.1; Cal. Code Regs., tit.14, §15064.5 (b) (CEQA Guidelines §15064.5 (b)). If there is substantial evidence, in light of the whole record before a lead agency, that a project may have a significant effect on the environment, an Environmental Impact Report (EIR) shall be prepared. (Pub. Resources Code §21080 (d); Cal. Code Regs., tit. 14, § 5064 subd.(a)(1) (CEQA Guidelines §15064 (a)(1)). In order to determine whether a project will cause a substantial adverse change in the significance of a historical resource, a lead agency will need to determine whether there are historical resources within the area of potential effect (APE).

CEQA was amended significantly in 2014. Assembly Bill 52 (Gatto, Chapter 532, Statutes of 2014) (AB 52) amended CEQA to create a separate category of cultural resources, "tribal cultural resources" (Pub. Resources Code §21074) and provides that a project with an effect that may cause a substantial adverse change in the significance of a tribal cultural resource is a project that may have a significant effect on the environment. (Pub. Resources Code §21084.2). Public agencies shall, when feasible, avoid damaging effects to any tribal cultural resource. (Pub. Resources Code §21084.3 (a)). **AB 52 applies to any project for which a notice of preparation, a notice of negative declaration, or a mitigated negative declaration is filed on or after July 1, 2015.** If your project involves the adoption of or amendment to a general plan or a specific plan, or the designation or proposed designation of open space, on or after March 1, 2005, it may also be subject to Senate Bill 18 (Burton, Chapter 905, Statutes of 2004) (SB 18). **Both SB 18 and AB 52 have tribal consultation requirements.** If your project is also subject to the federal National Environmental Policy Act (42 U.S.C. § 4321 et seq.) (NEPA), the tribal consultation requirements of Section 106 of the National Historic Preservation Act of 1966 (154 U.S.C. 300101, 36 C.F.R. §800 et seq.) may also apply.

The NAHC recommends consultation with California Native American tribes that are traditionally and culturally affiliated with the geographic area of your proposed project as early as possible in order to avoid inadvertent discoveries of Native American human remains and best protect tribal cultural resources. Below is a brief summary of portions of AB 52 and SB 18 as well as the NAHC's recommendations for conducting cultural resources assessments.

Consult your legal counsel about compliance with AB 52 and SB 18 as well as compliance with any other applicable laws.

AB 52

AB 52 has added to CEQA the additional requirements listed below, along with many other requirements:

1. Fourteen Day Period to Provide Notice of Completion of an Application/Decision to Undertake a Project:

Within fourteen (14) days of determining that an application for a project is complete or of a decision by a public agency to undertake a project, a lead agency shall provide formal notification to a designated contact of, or tribal representative of, traditionally and culturally affiliated California Native American tribes that have requested notice, to be accomplished by at least one written notice that includes:

- a. A brief description of the project.
- b. The lead agency contact information.
- c. Notification that the California Native American tribe has 30 days to request consultation. (Pub. Resources Code §21080.3.1 (d)).
- d. A "California Native American tribe" is defined as a Native American tribe located in California that is on the contact list maintained by the NAHC for the purposes of Chapter 905 of Statutes of 2004 (SB 18). (Pub. Resources Code §21073).

2. Begin Consultation Within 30 Days of Receiving a Tribe's Request for Consultation and Before Releasing a Negative Declaration, Mitigated Negative Declaration, or Environmental Impact Report:

A lead agency shall begin the consultation process within 30 days of receiving a request for consultation from a California Native American tribe that is traditionally and culturally affiliated with the geographic area of the proposed project. (Pub. Resources Code §21080.3.1, subds. (d) and (e)) and prior to the release of a negative declaration, mitigated negative declaration or Environmental Impact Report. (Pub. Resources Code §21080.3.1 (b)).

- a. For purposes of AB 52, "consultation shall have the same meaning as provided in Gov. Code § 65352.4 (SB 18). (Pub. Resources Code §21080.3.1 (b)).

3. Mandatory Topics of Consultation If Requested by a Tribe: The following topics of consultation, if a tribe requests to discuss them, are mandatory topics of consultation:

- a. Alternatives to the project.
- b. Recommended mitigation measures.
- c. Significant effects. (Pub. Resources Code §21080.3.2 (a)).

4. Discretionary Topics of Consultation: The following topics are discretionary topics of consultation:

- a. Type of environmental review necessary.
- b. Significance of the tribal cultural resources.
- c. Significance of the project's impacts on tribal cultural resources.
- d. If necessary, project alternatives or appropriate measures for preservation or mitigation that the tribe may recommend to the lead agency. (Pub. Resources Code §21080.3.2 (a)).

5. Confidentiality of Information Submitted by a Tribe During the Environmental Review Process: With some exceptions, any information, including but not limited to, the location, description, and use of tribal cultural resources submitted by a California Native American tribe during the environmental review process shall not be included in the environmental document or otherwise disclosed by the lead agency or any other public agency to the public, consistent with Government Code § 6254 (r) and § 6254.10. Any information submitted by a California Native American tribe during the consultation or environmental review process shall be published in a confidential appendix to the environmental document unless the tribe that provided the information consents, in writing, to the disclosure of some or all of the information to the public. (Pub. Resources Code §21082.3 (c)(1)).

6. Discussion of Impacts to Tribal Cultural Resources in the Environmental Document: If a project may have a significant impact on a tribal cultural resource, the lead agency's environmental document shall discuss both of the following:

- a. Whether the proposed project has a significant impact on an identified tribal cultural resource.
- b. Whether feasible alternatives or mitigation measures, including those measures that may be agreed to pursuant to Public Resources Code §21082.3, subdivision (a), avoid or substantially lessen the impact on the identified tribal cultural resource. (Pub. Resources Code §21082.3 (b)).

- 7. Conclusion of Consultation:** Consultation with a tribe shall be considered concluded when either of the following occurs:
- a.** The parties agree to measures to mitigate or avoid a significant effect, if a significant effect exists, on a tribal cultural resource; or
 - b.** A party, acting in good faith and after reasonable effort, concludes that mutual agreement cannot be reached. (Pub. Resources Code §21080.3.2 (b)).
- 8. Recommending Mitigation Measures Agreed Upon in Consultation in the Environmental Document:** Any mitigation measures agreed upon in the consultation conducted pursuant to Public Resources Code §21080.3.2 shall be recommended for inclusion in the environmental document and in an adopted mitigation monitoring and reporting program, if determined to avoid or lessen the impact pursuant to Public Resources Code §21082.3, subdivision (b), paragraph 2, and shall be fully enforceable. (Pub. Resources Code §21082.3 (a)).
- 9. Required Consideration of Feasible Mitigation:** If mitigation measures recommended by the staff of the lead agency as a result of the consultation process are not included in the environmental document or if there are no agreed upon mitigation measures at the conclusion of consultation, or if consultation does not occur, and if substantial evidence demonstrates that a project will cause a significant effect to a tribal cultural resource, the lead agency shall consider feasible mitigation pursuant to Public Resources Code §21084.3 (b). (Pub. Resources Code §21082.3 (e)).
- 10. Examples of Mitigation Measures That, If Feasible, May Be Considered to Avoid or Minimize Significant Adverse Impacts to Tribal Cultural Resources:**
- a.** Avoidance and preservation of the resources in place, including, but not limited to:
 - i.** Planning and construction to avoid the resources and protect the cultural and natural context.
 - ii.** Planning greenspace, parks, or other open space, to incorporate the resources with culturally appropriate protection and management criteria.
 - b.** Treating the resource with culturally appropriate dignity, taking into account the tribal cultural values and meaning of the resource, including, but not limited to, the following:
 - i.** Protecting the cultural character and integrity of the resource.
 - ii.** Protecting the traditional use of the resource.
 - iii.** Protecting the confidentiality of the resource.
 - c.** Permanent conservation easements or other interests in real property, with culturally appropriate management criteria for the purposes of preserving or utilizing the resources or places.
 - d.** Protecting the resource. (Pub. Resource Code §21084.3 (b)).
 - e.** Please note that a federally recognized California Native American tribe or a non-federally recognized California Native American tribe that is on the contact list maintained by the NAHC to protect a California prehistoric, archaeological, cultural, spiritual, or ceremonial place may acquire and hold conservation easements if the conservation easement is voluntarily conveyed. (Civ. Code §815.3 (c)).
 - f.** Please note that it is the policy of the state that Native American remains and associated grave artifacts shall be repatriated. (Pub. Resources Code §5097.991).
- 11. Prerequisites for Certifying an Environmental Impact Report or Adopting a Mitigated Negative Declaration or Negative Declaration with a Significant Impact on an Identified Tribal Cultural Resource:** An Environmental Impact Report may not be certified, nor may a mitigated negative declaration or a negative declaration be adopted unless one of the following occurs:
- a.** The consultation process between the tribes and the lead agency has occurred as provided in Public Resources Code §21080.3.1 and §21080.3.2 and concluded pursuant to Public Resources Code §21080.3.2.
 - b.** The tribe that requested consultation failed to provide comments to the lead agency or otherwise failed to engage in the consultation process.
 - c.** The lead agency provided notice of the project to the tribe in compliance with Public Resources Code §21080.3.1 (d) and the tribe failed to request consultation within 30 days. (Pub. Resources Code §21082.3 (d)).

The NAHC's PowerPoint presentation titled, "Tribal Consultation Under AB 52: Requirements and Best Practices" may be found online at: http://nahc.ca.gov/wp-content/uploads/2015/10/AB52TribalConsultation_CalEPAPDF.pdf

SB 18

SB 18 applies to local governments and requires local governments to contact, provide notice to, refer plans to, and consult with tribes prior to the adoption or amendment of a general plan or a specific plan, or the designation of open space. (Gov. Code §65352.3). Local governments should consult the Governor's Office of Planning and Research's "Tribal Consultation Guidelines," which can be found online at: https://www.opr.ca.gov/docs/09_14_05_Updated_Guidelines_922.pdf.

Some of SB 18's provisions include:

1. **Tribal Consultation:** If a local government considers a proposal to adopt or amend a general plan or a specific plan, or to designate open space it is required to contact the appropriate tribes identified by the NAHC by requesting a "Tribal Consultation List." If a tribe, once contacted, requests consultation the local government must consult with the tribe on the plan proposal. **A tribe has 90 days from the date of receipt of notification to request consultation unless a shorter timeframe has been agreed to by the tribe.** (Gov. Code §65352.3 (a)(2)).
2. **No Statutory Time Limit on SB 18 Tribal Consultation.** There is no statutory time limit on SB 18 tribal consultation.
3. **Confidentiality:** Consistent with the guidelines developed and adopted by the Office of Planning and Research pursuant to Gov. Code §65040.2, the city or county shall protect the confidentiality of the information concerning the specific identity, location, character, and use of places, features and objects described in Public Resources Code §5097.9 and §5097.993 that are within the city's or county's jurisdiction. (Gov. Code §65352.3 (b)).
4. **Conclusion of SB 18 Tribal Consultation:** Consultation should be concluded at the point in which:
 - a. The parties to the consultation come to a mutual agreement concerning the appropriate measures for preservation or mitigation; or
 - b. Either the local government or the tribe, acting in good faith and after reasonable effort, concludes that mutual agreement cannot be reached concerning the appropriate measures of preservation or mitigation. (Tribal Consultation Guidelines, Governor's Office of Planning and Research (2005) at p. 18).

Agencies should be aware that neither AB 52 nor SB 18 precludes agencies from initiating tribal consultation with tribes that are traditionally and culturally affiliated with their jurisdictions before the timeframes provided in AB 52 and SB 18. For that reason, we urge you to continue to request Native American Tribal Contact Lists and "Sacred Lands File" searches from the NAHC. The request forms can be found online at: <http://nahc.ca.gov/resources/forms/>.

NAHC Recommendations for Cultural Resources Assessments

To adequately assess the existence and significance of tribal cultural resources and plan for avoidance, preservation in place, or barring both, mitigation of project-related impacts to tribal cultural resources, the NAHC recommends the following actions:

1. Contact the appropriate regional California Historical Research Information System (CHRIS) Center (http://ohp.parks.ca.gov/?page_id=1068) for an archaeological records search. The records search will determine:
 - a. If part or all of the APE has been previously surveyed for cultural resources.
 - b. If any known cultural resources have already been recorded on or adjacent to the APE.
 - c. If the probability is low, moderate, or high that cultural resources are located in the APE.
 - d. If a survey is required to determine whether previously unrecorded cultural resources are present.
2. If an archaeological inventory survey is required, the final stage is the preparation of a professional report detailing the findings and recommendations of the records search and field survey.
 - a. The final report containing site forms, site significance, and mitigation measures should be submitted immediately to the planning department. All information regarding site locations, Native American human remains, and associated funerary objects should be in a separate confidential addendum and not be made available for public disclosure.

- b.** The final written report should be submitted within 3 months after work has been completed to the appropriate regional CHRIS center.
- 3.** Contact the NAHC for:
- a.** A Sacred Lands File search. Remember that tribes do not always record their sacred sites in the Sacred Lands File, nor are they required to do so. A Sacred Lands File search is not a substitute for consultation with tribes that are traditionally and culturally affiliated with the geographic area of the project's APE.
 - b.** A Native American Tribal Consultation List of appropriate tribes for consultation concerning the project site and to assist in planning for avoidance, preservation in place, or, failing both, mitigation measures.
- 4.** Remember that the lack of surface evidence of archaeological resources (including tribal cultural resources) does not preclude their subsurface existence.
- a.** Lead agencies should include in their mitigation and monitoring reporting program plan provisions for the identification and evaluation of inadvertently discovered archaeological resources per Cal. Code Regs., tit. 14, §15064.5(f) (CEQA Guidelines §15064.5(f)). In areas of identified archaeological sensitivity, a certified archaeologist and a culturally affiliated Native American with knowledge of cultural resources should monitor all ground-disturbing activities.
 - b.** Lead agencies should include in their mitigation and monitoring reporting program plans provisions for the disposition of recovered cultural items that are not burial associated in consultation with culturally affiliated Native Americans.
 - c.** Lead agencies should include in their mitigation and monitoring reporting program plans provisions for the treatment and disposition of inadvertently discovered Native American human remains. Health and Safety Code §7050.5, Public Resources Code §5097.98, and Cal. Code Regs., tit. 14, §15064.5, subdivisions (d) and (e) (CEQA Guidelines §15064.5, subds. (d) and (e)) address the processes to be followed in the event of an inadvertent discovery of any Native American human remains and associated grave goods in a location other than a dedicated cemetery.

If you have any questions or need additional information, please contact me at my email address: Nancy.Gonzalez-Lopez@nahc.ca.gov.

Sincerely,



Nancy Gonzalez-Lopez
Cultural Resources Analyst

cc: State Clearinghouse



air pollution control district
SANTA BARBARA COUNTY

August 5, 2020

Frank Albro
City of Santa Maria
Community Development Department
110 South Pine Street, #101
Santa Maria, CA 93458

Re: Air Pollution Control District Response to Notice of Preparation of an Environmental Impact Report for the Santa Maria Airport Business Park Specific Plan Amendment

Dear Frank Albro:

The Santa Barbara County Air Pollution Control District (District) appreciates the opportunity to provide comments on the Notice of Preparation (NOP) of a Draft Supplemental Environmental Impact Report (EIR) for the Santa Maria Airport Business Park Specific Plan Amendment. The applicant, G3 LLC, proposes a General Plan Amendment, Specific Plan Amendment, and Zoning Modification for an approximately 28-acre parcel at the southeast corner of the Specific Plan area, south of the Santa Maria Public Airport in the City of Santa Maria. The original Programmatic EIR for approximately 41,978 square feet (SF) of Communities Facilities Land Uses was approved by the City in 2007. The revised project proposes 264,500 SF of development including retail, government facilities, commercial and professional office space, two quick serve restaurants, and a convenience store with gas station.

The proposed project would allow for new commercial uses in close proximity to existing residential development. Some proposed uses may not be compatible with the existing setting and could result in potential nuisance problems (i.e., odors, dust, or toxic air contaminants). The District recommends that the siting of individual commercial uses near residential dwellings be carefully evaluated to avoid potential conflicts and nuisance issues.

District staff reviewed the Initial Study and NOP of a Draft EIR and concurs that **air quality impacts may be potentially significant, requiring the consideration of all feasible measures which could minimize significant adverse impacts.** The District's guidance document, entitled *Scope and Content of Air Quality Sections in Environmental Documents* (updated June, 2017), is available online at www.ourair.org/land-use. This document should be referenced for general guidance in assessing air quality impacts in the Draft EIR. The EIR should evaluate the following potential impacts related to the Santa Maria Airport Business Park Specific Plan Amendment:

1. District Permitting Authority and Stationary Source Emissions. The proposed project includes equipment and operations that are subject to District permit requirements and prohibitory rules. Therefore, **the District will be a responsible agency under the California Environmental Quality Act (CEQA)**, and will rely on the EIR when evaluating any District permits for proposed equipment. The EIR

should include the air pollutant emissions for all proposed equipment to avoid additional CEQA documentation requirements related to District permit issuance.

The proposed gasoline station is required to obtain a District Authority to Construct permit.

Additionally, the following equipment/operations may be proposed onsite and would also require a District Authority to Construct permit:

- Diesel or gasoline-fueled engines rated at 50 bhp or greater (e.g., emergency generators, firewater pumps)
- Boilers and large water heaters with combined heat input rating exceeding 2.0 million BTUs per hour
- Dry cleaners
- Breweries (must obtain District permit or written permit exemption)

2. Attainment Status and Consistency with the District's Ozone Plan. Attainment status for the County is posted on the District website at www.ourair.org/air-quality-standards. The most recent Ozone Plan (previously known as the Clean Air Plan) was adopted in December 2019 and is available at www.ourair.org/clean-air-plans. The District website should be consulted for the most up-to-date air quality information prior to the release of the Public Draft EIR.

Consistency with local and regional plans, including the District's 2019 Ozone Plan, is required under CEQA for all projects. Consistency with the Ozone Plan should be evaluated on a case-by-case basis, and the EIR should include an assessment of whether the proposed project will be consistent with the Ozone Plan. The Ozone Plan relies primarily on land use, population, and on-road emissions projections provided by the California Air Resources Board (CARB) as a basis for vehicle emission forecasting. All development projects should be evaluated to determine whether direct and indirect emissions associated with the project are accounted for in the Ozone Plan's emissions growth assumptions, and whether the project is consistent with policies adopted in the Ozone Plan.

Many industrial and manufacturing sources, as well as buildings with large heating devices or generator engines, may be subject to District rules and permit requirements. Commercial or industrial stationary source projects will generally be considered consistent with the Ozone Plan if they are consistent with District rules and regulations.

3. Land Use Conflicts and Health Risk Related to Air Pollutant Emissions. The EIR should examine whether any of the operations associated with the proposed project will result in air quality impacts to sensitive land uses such as residential, childcare facilities, schools, or senior living communities. Examples of this type of impact include odors from restaurants, gas station emissions, dust, or toxic air contaminants such as diesel particulate emissions from trucks and stationary engines.

The proposed gas station, and possibly other equipment as outlined in comment 1, will require a District permit. **As part of District permit issuance, an evaluation of health risk will be required to demonstrate that the operation of project-related equipment does not cause a significant risk to the surrounding community and nearby sensitive receptors. We recommend that health risk assessments be performed up front during the land use review process to ensure that project-related equipment will not result in a significant impact. Whenever a Health Risk Assessment analysis is required, the**

results should be incorporated into the EIR for the project. The applicant should refer to the District's website at www.ourair.org/gas-station/ for more information on gas station permitting, and contact William Sarraf, Supervisor of the District's Engineering Division, at SarrafW@sbcapcd.org or (805) 961-8888, for information regarding potential HRA requirements for the proposed gas station and other proposed operations/equipment requiring a District permit.

4. Increase in Criteria Pollutant Emissions from Proposed Project. The EIR should present significance thresholds for ozone precursor emissions (reactive organic compounds [ROC], and oxides of nitrogen [NO_x]) and particulate matter and determine whether the proposed project will produce emissions in excess of the thresholds. The District's *Scope and Content* document contains the District Board-adopted criteria for evaluating the significance of air quality impacts for District projects. In the absence of locally-adopted thresholds, the District recommends that these thresholds be used to determine significance of air quality impacts.

The proposed project will involve air quality impacts associated with approximately 12,066 average daily motor vehicle trips. Motor vehicle use would derive from customers patronizing the commercial businesses, employee commutes, and truck deliveries for commercial goods. Given the magnitude of average daily vehicle trips associated with the proposed project, mobile source emissions have the potential to be significant. All feasible mitigation should be applied to reduce project emissions to the maximum extent possible. The air quality impact analysis for mobile source emissions should be based on project-specific information and supported by a traffic study whenever possible. In addition to motor vehicle emissions, the analysis should include emissions associated with unpermitted stationary sources such as commercial heating and cooling equipment. These emissions (termed "area source" emissions) should be included in the operational phase emission evaluation. The emissions from commercial land uses that require District permits (for example, gas stations or drycleaners, termed "stationary sources"), should also be presented in the analysis.

Stationary and area source emissions should be added to transportation source emissions prior to applying the project-specific thresholds of significance. If the proposed project exceeds the significance thresholds for air quality, mitigation should be applied to reduce those emissions as appropriate under CEQA. Section 6 of the District's *Scope and Content* document offers ideas for air quality mitigation. However, project-specific measures should be developed that are pertinent to the specific project and are enforceable by the lead agency.

5. Construction Impacts. The EIR should include a description and quantification of potential air quality impacts associated with construction activities for the proposed project. The District's June, 2017 *Scope and Content* document, Section 6, presents recommended mitigation measures for fugitive dust and equipment exhaust emissions associated with construction projects. Construction mitigation measures should be enforced as conditions of approval for the project. The EIR should include a Mitigation Monitoring and Reporting Plan that explicitly states the required mitigation and establishes a mechanism for enforcement.

6. Transportation Measures to Reduce Air Quality Impacts. The Santa Maria Airport Business Park Specific Plan Amendment project and the associated EIR should include measures that promote the use of alternate modes of transportation and focus on reducing vehicle miles traveled, vehicle trips, and

peak-hour travel. Because the proposed project involves a substantial amount of new commercial development, the City should consider if additional transit services or enhancements to existing services, schedules or routes would be beneficial for the project area and surrounding community. Other transportation measures could include: pedestrian- and bicycle-friendly features, employee commute trip reduction programs, such as ride-sharing programs and alternative transportation options, such as public transit, local shuttles, park-and-ride lots, etc.

7. Global Climate Change/Greenhouse Gas Impacts. Greenhouse gas (GHG) emissions and global climate change impacts should be addressed in the CEQA document. Global climate change is a cumulative impact; a project participates in this potential impact through its incremental contribution combined with the cumulative increase of all other sources of greenhouse gases.

The EIR should include a quantification of GHG emissions from all project sources (direct and indirect), present significance thresholds, and make a determination regarding the significance of impacts. In addition, we recommend that climate change impacts be mitigated to the extent reasonably possible, whether or not they are determined to be significant.

At a minimum, the project should include any feasible greenhouse gas reduction measures as applicable from the following sector-based list:

- Energy use (energy efficiency, low carbon fuels, renewable energy)
- Water conservation (improved practices and equipment, landscaping)
- Waste reduction (material re-use/recycling, composting, waste diversion, waste minimization)
- Architectural features (green building practices, cool roofs)
- Transportation (reduce vehicle miles traveled, compact and transit-oriented development, pedestrian- and bicycle-friendly communities)
- Electric Vehicle Infrastructure (EV charger installation, installation of pre-wiring for future EV chargers) see www.ourair.org/sbc/plug-in-central-coast for more information.

For guidance regarding greenhouse gas analysis for CEQA environmental documents, please refer to the *CAPCOA CEQA & Climate Change* document. CAPCOA has also published *Quantifying Greenhouse Gas Mitigation Measures*, an extensive sector-by-sector compendium of project-specific mitigation measures, including quantification methods to calculate GHG reductions. Both of these documents are available online at www.capcoa.org.

The District has identified some potential strategies for local GHG mitigation that could be implemented in Santa Barbara County. The District solicited feedback from the community on these strategies in a series of workshops. The strategies research by the District and the input received from the public has been summarized and posted on the District's website at www.ourair.org/ghgmitigation-sbc.

We hope you find our comments useful. We look forward to reviewing the Draft EIR. Please contact me at (805) 961-8878 or by e-mail at WaddingtonE@sbcapcd.org if you have questions.

Sincerely,

A handwritten signature in black ink that reads "Emily Waddington". The signature is written in a cursive, flowing style.

Emily Waddington
Air Quality Specialist
Planning Division

cc: William Sarraf, Supervisor, District Engineering Division [email only]
Planning Chron File

CONSISTENCY REVIEW PROCESS SANTA BARBARA COUNTY AIRPORT LAND USE PLAN

The purpose of this letter is to articulate the procedures used by SBCAG, acting in its capacity as the Santa Barbara County Airport Land Use Commission, and affected local agencies to fulfill the airport land use compatibility review requirements set forth in the Aeronautics Act (Public Utilities Code §21670 et seq.). Specifically these procedures define the steps to be taken by local agencies in submitting land use actions to the airport land use commission for review.

Project Referrals to Airport Land Use Commission

As required by State law, the following types of land use actions shall be referred to the Airport Land Use Commission (ALUC) for determination of consistency with the Airport Land Use Plan prior to their approval by the local agency:

- The adoption, approval or amendment of any General Plan (Public Utilities Code §21676(b)) that affects allowable land uses within the Airport Influence Area (AIA).
- Adoption or modification of an airport master plan for any one of the Airports (Public Utilities Code §21676(c)).
- Any proposal for construction of a new airport or heliport (Public Utilities Code §21661.5).

Project Background Information

A proposed land use action submitted to the ALUC for review that requires a new or amended general plan shall include this information:

- Property location data (assessor's parcel number, street address)
- An accurately scaled map showing the relationship (distance and direction) of the project site to the Airport boundary and runways. If available, a digital version should be provided via e-mail or CD-ROM along with a paper copy. The map should not exceed 24 x 36 inches.
- A description of the existing use(s) of the land in question, including current general plan and zoning designations, height of structures, maximum intensity limits, and other applicable information.
- A description of the proposed use(s) and the type of land use action being sought from the local agency (e.g. general plan amendment, zoning change).

- For residential uses, the proposed number of dwelling units per acre (excluding any secondary units on a parcel); or, for nonresidential uses, the number of people potentially occupying the total site or portions of it at any one time, and the proposed lot coverage of the land use action.
- If applicable (as determined by ALUC staff) a detailed site plan showing ground elevations, the location of structures, open spaces, and water bodies, the heights of structures and trees above mean sea level and above ground level, and a profile view of proposed features and all relevant information provided in connection with a Part 77 submittal. If available, a digital version of the drawings should be provided via e-mail or CD-ROM along with a paper version.
- Identification of any features that would increase the attraction of birds or cause other wildlife hazards to aircraft operations on the Airport or in its environs.
- Identification of any characteristics that could create electrical interference, confusing or bright lights, glare, smoke, or other electrical, visual, or thermal hazards to aircraft flight.
- Any draft or final environmental document (initial study, negative declaration, mitigated negative declaration, environmental assessment, or environmental impact report) that has been prepared for the land use action.
- Any staff reports regarding the land use action that may have been presented to local agency decision makers.
- Any land use action submittal information and final airspace determination that has been obtained from the Federal Aviation Administration (FAA) in accordance with Part 77.
- Other relevant information that the ALUC determines to be necessary to enable a comprehensive review of the land use action.

60-Day Review Period

The ALUC must respond to a local agency's request for a consistency determination on a general plan or specific plan, or the adoption or approval of a zoning ordinance or building regulation within the AIA and to an airport operator's request for a consistency determination on modification to its airport master plan within 60 days from the date of submittal (Pub. Util. Code §21676(d)). However, this response period does not begin until the ALUC staff has determined that all information necessary for accomplishment of the land use action review has been submitted to the ALUC (see bulleted items above). If the ALUC fails to make a determination within the 60-day review period, the proposed action shall be deemed consistent with the Compatibility Plan (Pub. Util. Code §21676(d)).

County Of Santa Barbara

Mona Miyasato
County Executive Officer

105 East Anapamu Street
Room 406
Santa Barbara, California 93101
805-568-3400 • Fax 805-568-3414
www.countyofsb.org



Executive Office

Assistant County Executive Officers
Nancy Anderson
Jeff Frapwell
Bernard Melekian
Terri Nisich

July 31, 2020

Frank Albro
City of Santa Maria
Community Development Department
110 South Pine Street, #101
Santa Maria, CA 93458
Falbro@cityofsantamaria.org

RE: Notice of Preparation for a Supplemental Environmental Impact Report for the Santa Maria Airport Business Park Specific Plan Amendment Project

Dear Mr. Albro:

Thank you for the opportunity to comment on the Notice of Preparation for a Supplemental Environmental Impact Report for the Santa Maria Airport Business Park Specific Plan Amendment Project. At this time, the County submits comments from the Planning and Development Department and Public Works Department, Water Resources Division.

If you should have further questions, please do not hesitate to contact my office directly, or Lisa Plowman, Director of the Planning and Development Department, at (805) 568-2086 or Jon Frye, Engineering Manager, at (805) 568-3440.

Sincerely,

Nancy Anderson
Assistant County Executive Officer

cc: Lisa Plowman, Director, Santa Barbara County Planning and Development Department
Daniel Klemann, Deputy Director of Long Range Planning, Planning and Development Department
Jon Frye, Engineering Manager, Public Works Department, Water Resources Division

Enclosure: Santa Barbara County Planning and Development Department Letter,
dated May 22, 2020

LAGUNA
COUNTY SANITATION DISTRICT
SANTA BARBARA COUNTY
620 West Foster Road
Santa Maria, California 93455
(805) 803-8756 FAX (805) 803-8753

July 20, 2020

Frank Albro, Senior Planner
City of Santa Maria Community Development Department
110 South Pine Street, Suite 101
Santa Maria, CA 93458

Re: SEIR to the Santa Maria Public Airport District Business Park (TM 5966) for
APN 111-231-011

Dear Frank:

Thank you for providing the Notice of Preparation of a Supplemental Environmental Impact Report (SEIR) for an amendment to the Santa Maria Public Airport District Business Park Specific Plan received by our office on July 6, 2020. Upon review of the notice and the Environmental Checklist/Initial Study, Laguna County Sanitation District (LCSD) has the following comments:

1. Laguna County Sanitation District owns sewage collection facilities in the immediate vicinity of the proposed project as shown in record drawings and atlas maps (attached). The use of these collection facilities are subject to the terms of the joint powers agreement between LCSD and the City of Santa Maria effective August 9, 2017 and expiring June 30, 2057 unless terminated pursuant to terms of the agreement. The provision of the agreement is that LCSD will accept wastewater from this project. The wastewater flows must be tracked and used for reconciling wastewater billing between LCSD and the City. Capacity charges and sewer charges would be paid to City. However, the project would become a direct LCSD customer in the event of agreement termination, if LCSD exercises its rights pursuant to Health and Safety Code Section 5471, or if the service area were to be annexed to LCSD.
2. The onsite sewer systems may be private, however any new public sewer systems will be owned and maintained by the City of Santa Maria unless otherwise indicated.
3. Although included in the latest LCSD sewer model, wastewater flow generation estimations for this development are required to confirm trunk sewer line capacity. LCSD Engineering Design Standards (attached) list typical wastewater flow generation rates and can be used for preliminary estimations (see sections 3.29 and 3.30).
4. This project is subject to the issuance of LCSD approval for connection to the LCSD sewer system (location, design, etc.).

5. LCSD and the Santa Maria Public Airport District (SMPAD) have a recycled water user agreement in which LCSD provides or will provide recycled water to certain areas under ownership of SMPAD. LCSD and SMPAD have the right to prescribe the use of recycled water from LCSD on this property should those uses be considered as useful to the project.
6. Wastewater flow generation estimations are also required to ensure LCSD has adequate effluent (recycled water) discharge capacity.
7. Pretreatment for commercial food service establishments for fats, oils, and grease (FOG) is required.
8. The use of salt load style water softeners is prohibited.

For questions, please contact me at (805) 803-8755 or by email at mwilder@cosbpw.net.

Sincerely,



Martin Wilder, P.E., Manager
Laguna County Sanitation District

Copy: Chris Hastert, General Manager, SMPAD
File: SEIR to SMPAD Business Park TM 5966

LAGUNA COUNTY SANITATION DISTRICT
SANTA BARBARA COUNTY
CALIFORNIA

PLANS

FOR THE CONSTRUCTION OF

TRUNK SEWER LINES

PROJECT UNITS 2, 3, 4, 5, AND 6

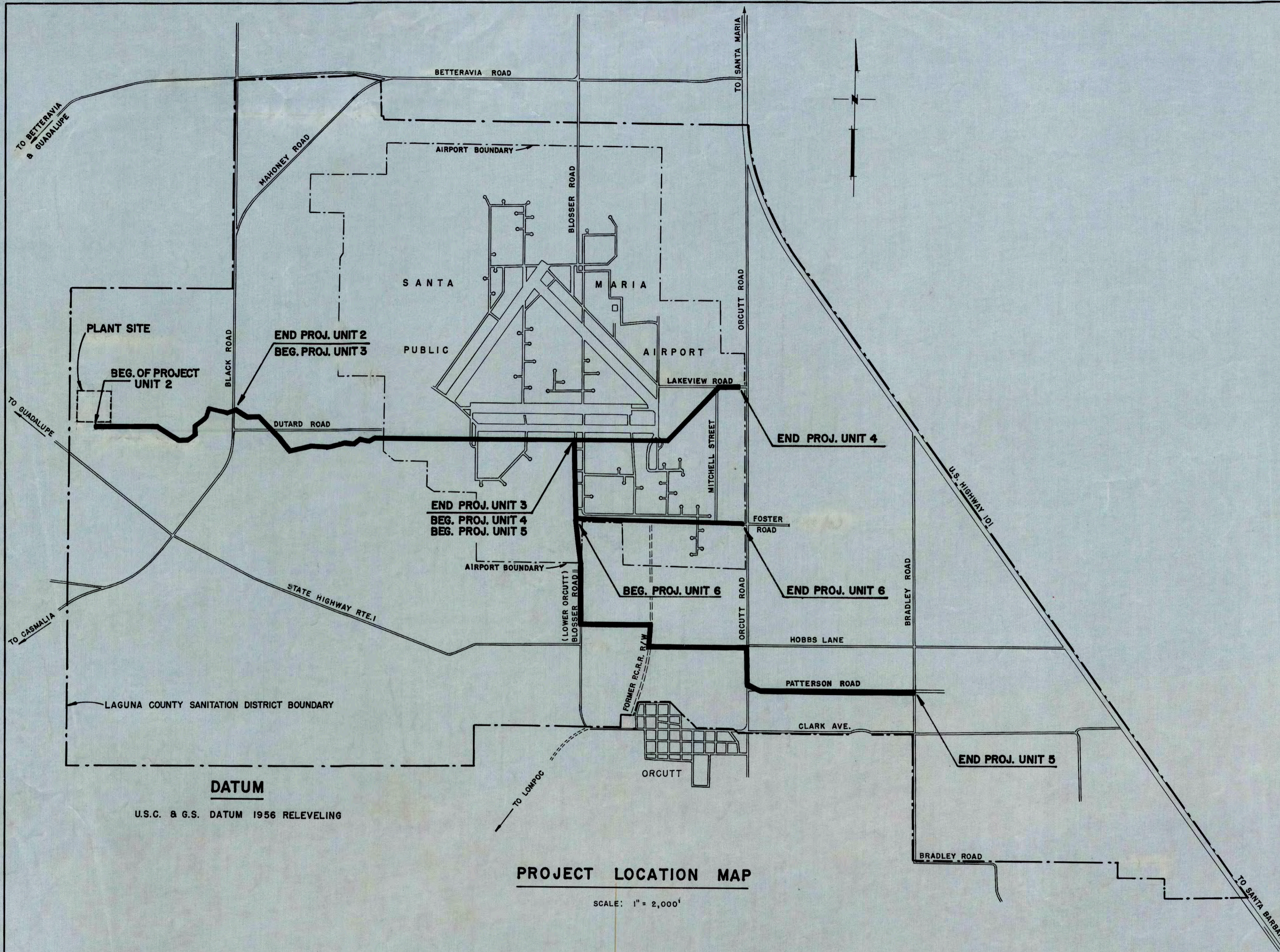

DATUM

U.S.C. & G.S. DATUM 1956 RELEVELING

PROJECT LOCATION MAP

SCALE: 1" = 2,000'

DISTRICT BOARD

ALFRED E. GRACIA — CHAIRMAN

CLIFFORD W. BRADBURY
JOE J. CALLAHAN

WILLIAM N. HOLLISTER
ROBERT C. LILLEY

CLARK F. WELLS — DISTRICT MANAGER

INDEX TO PLANS

SH. NO.	TITLE	SH. NO.	TITLE
1.	PROJECT LOCATION MAP & INDEX TO PLANS	14.	PROJECT UNIT 4 PLAN & PROFILE STA. 51+00 TO STA. 61+84.30
2.	PROJECT UNIT 2 PLAN & PROFILE STA. 11+90.20 TO STA. 23+00	15.	PROJECT UNIT 5 PLAN & PROFILE STA. 1+00 TO STA. 28+00
3.	" " " " " " " " 23+00 " " 38+00	16.	" " " " " " " " 28+00 " " 56+00
4.	" " " " " " " " 38+00 " " 53+00	17.	" " " " " " " " 56+00 " " 79+72.36
5.	END PROJ. UNIT 2 - BEG. PROJ. UNIT 3 PLAN & PROFILE STA. 53+00 TO STA. 65+00	18.	" " " " " " " " 79+72.36 " " 94+00
6.	PROJECT UNIT 3 PLAN & PROFILE STA. 65+00 TO STA. 80+00	19.	" " " " " " " " 94+00 " " 117+23.25
7.	" " " " " " " " 80+00 " " 95+00	20.	" " " " " " " " 117+23.25 " " 130+79.63
8.	" " " " " " " " 95+00 " " 109+83.35	21.	" " " " " " " " 201+10.11 " " 227+83.45
9.	" " " " " " " " 109+70.91 " " 138+00	22.	" " " " " " " " 227+83.45 " " 252+67.60
10.	" " " " " " " " 138+00 " " 166+00	23.	PROJECT UNIT 6 PLAN & PROFILE STA. 1+00 TO STA. 28+00
11.	" " " " " " " " 166+00 " " 173+24.62	24.	" " " " " " " " 28+00 " " 56+30
12.	PROJECT UNIT 4. PLAN & PROFILE STA. 0+93.64 TO STA. 28+00	25.	MISCELLANEOUS DETAILS
13.	" " " " " " " " 28+00 " " 51+00		

SUBMITTED BY
WHIPPLE, ADAMSON, MURPHY & PEARSON
CONSULTING ENGINEERS, INC.

BY: *Geo. E. Pearson*
R.C.E. NO. 8288

APPROVED BY: *Clark F. Wells*
DISTRICT MANAGER

ADOPTED BY DISTRICT BOARD Nov. 9 1959

A. E. Gracia CHAIRMAN
J. F. Lewis CLERK

LAGUNA COUNTY SANITATION DISTRICT
SANTA BARBARA COUNTY, CALIFORNIA
TRUNK SEWER LINES

PROJECT LOCATION MAP
& INDEX TO PLANS

WHIPPLE, ADAMSON, MURPHY & PEARSON
CONSULTING ENGINEERS, INC.
PALO ALTO, CALIFORNIA

SCALE: AS SHOWN
DATE: AUGUST, 1959
SHEET NO. 1 OF 25 SHEETS



- LCSD SEWER PIPES
- ABANDONED SEWER PIPES
- PRIVATE SEWER PIPES
- SEWER MANHOLES
- SEWER CLEANOUTS
- ▣ LCSD BOUNDARY
- (#-#) RECORD DRAWING REFERENCE NUMBER

**COUNTY OF SANTA BARBARA
LAGUNA SANITATION DISTRICT**

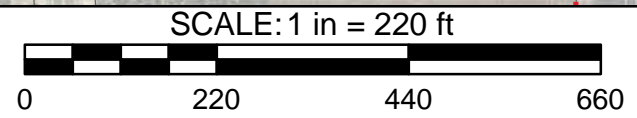

16 - 4	16 - 1
16 - 3	16 - 2

27					
26		22	21		
24	23		20	19	
25	14	15	16	17	18
	13	12	11	10	09
		05	06	07	08
		04	03	02	01

REVISED: 7/29/2019
SHEET 16-3

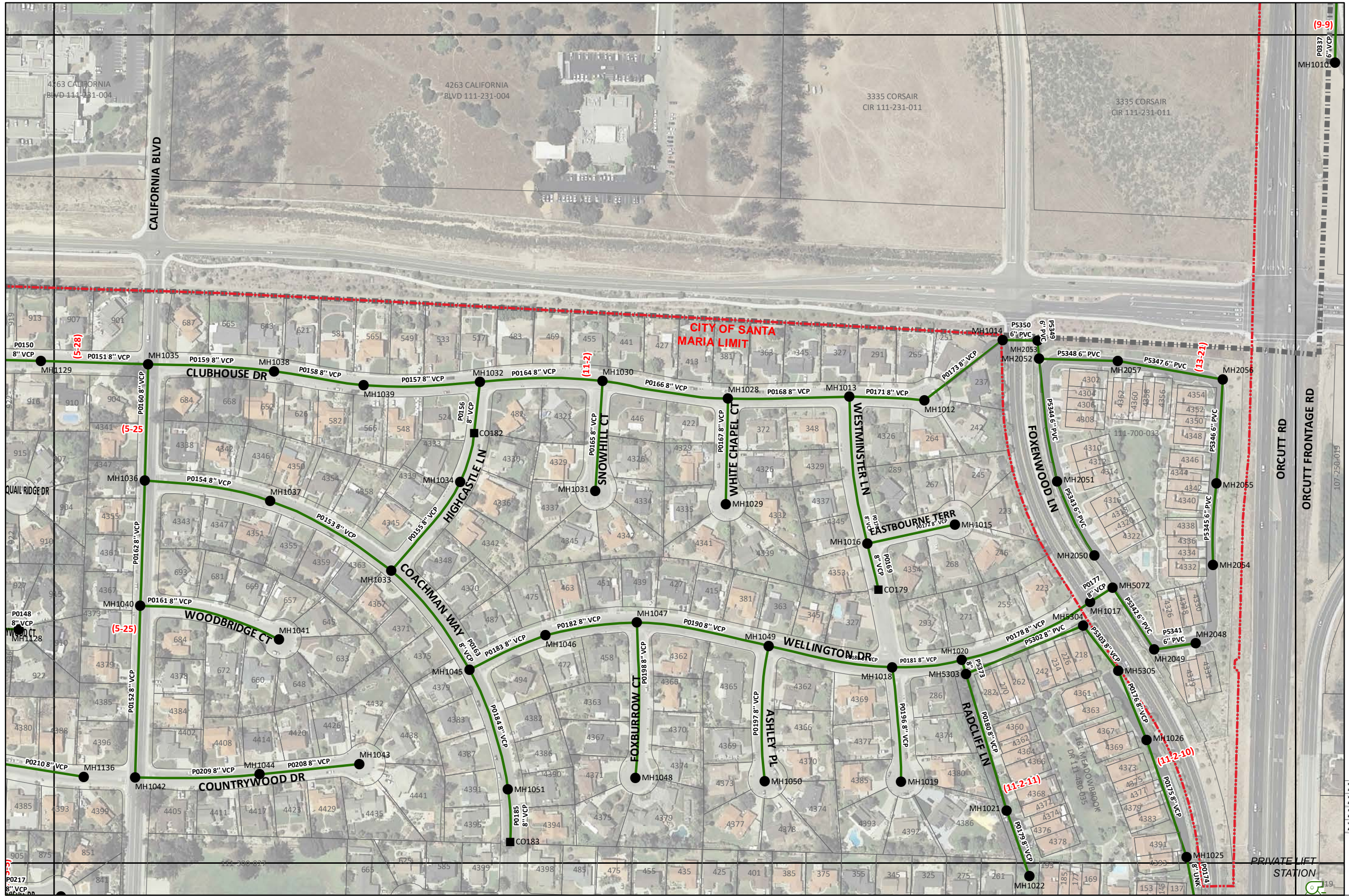

- LCSD SEWER PIPES
- - - PRIVATE SEWER PIPES
- SEWER MANHOLES
- SEWER CLEANOUTS
- - - ABANDONED SEWER PIPES
- - - LCSD BOUNDARY
- (#-#) RECORD DRAWING REFERENCE NUMBER

**COUNTY OF SANTA BARBARA
LAGUNA SANITATION DISTRICT**

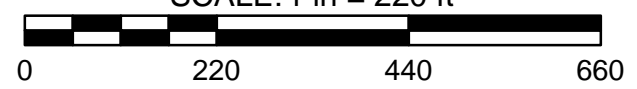

REVISED: 7/29/2019
SHEET 11-4

11 - 4	11 - 1						
11 - 3	11 - 2						
27	22	21					
24	23	20	19				
25	14	15	16	17	18		
13	12	11	10	09	08		
05	06	07	08	04	03	02	01

PLAN
 SURVEYED...
 PLOTTED...
 CHECKED...
 DATE...
 BY...

PROFILE
 SURVEYED...
 PLOTTED...
 CHECKED...
 DATE...
 BY...

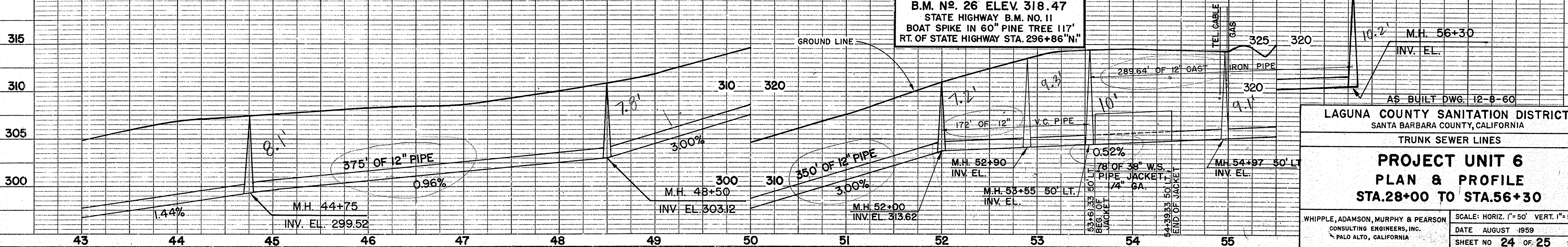
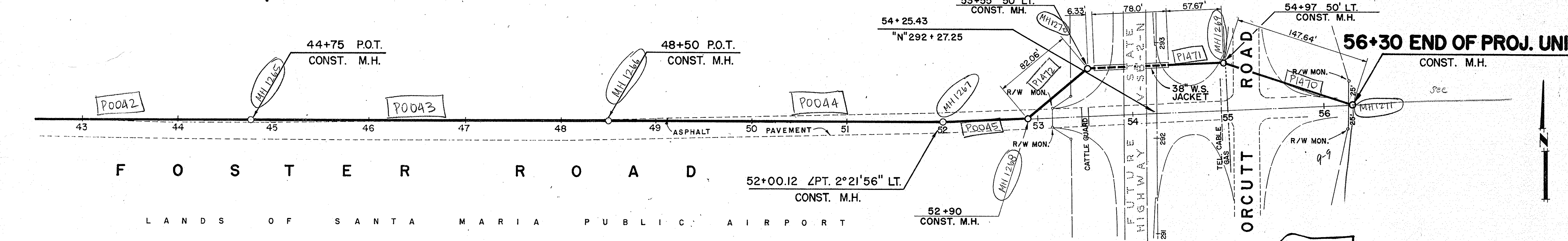
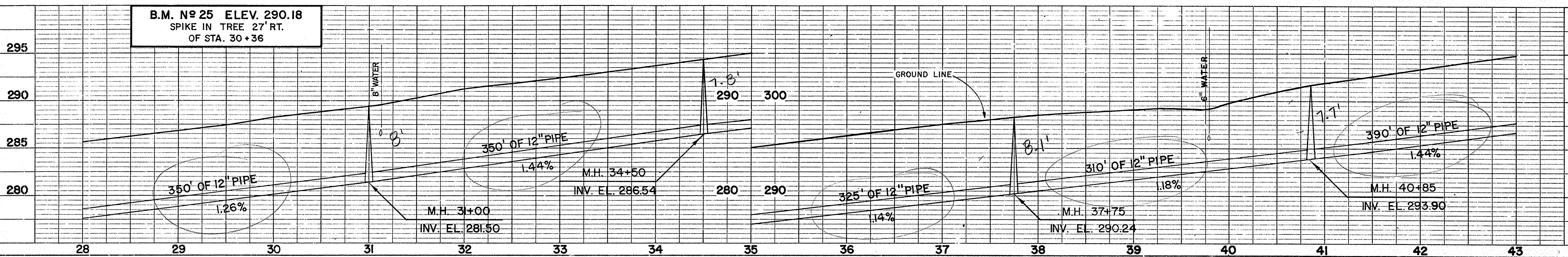
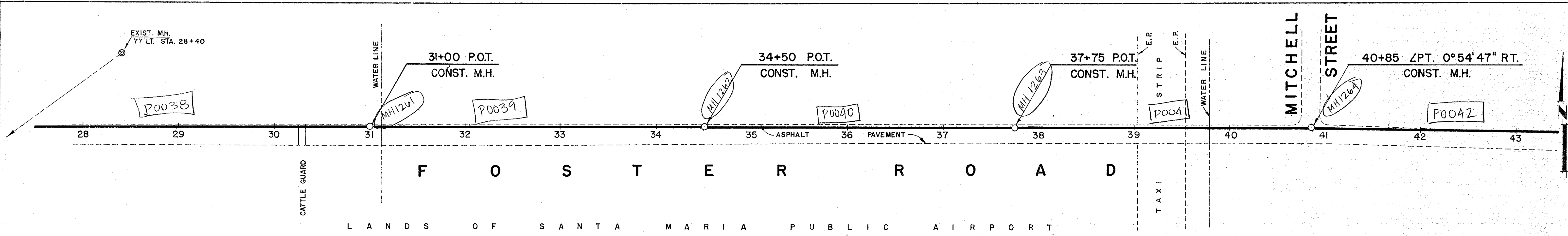

LAGUNA COUNTY SANITATION DISTRICT
 SANTA BARBARA COUNTY, CALIFORNIA
 TRUNK SEWER LINES

PROJECT UNIT 6
PLAN & PROFILE
STA. 28+00 TO STA. 56+30

WHIPPLE, ADAMSON, MURPHY & PEARSON
 CONSULTING ENGINEERS, INC.
 PALO ALTO, CALIFORNIA

SCALE: HORIZ. 1" = 50' VERT. 1" = 5'
 DATE: AUGUST 1959
 SHEET NO. 24 OF 25 SHEETS



**LAGUNA COUNTY SANITATION DISTRICT
SANTA BARBARA COUNTY
CALIFORNIA**

**ENGINEERING DESIGN STANDARDS
FOR THE CONSTRUCTION OF SANITARY SEWERS**

Board of Directors

Mr. Das Williams

Mr. Gregg Hart

Ms. Joan Hartmann

Mr. Peter Adam

Mr. Steve Lavagnino

Public Works Department Director

Mr. Scott D. McGolpin

Resource Recovery and Waste Management Division Deputy Director

Ms. Leslie Wells

Utilities Manager

Mr. Martin Wilder



**LAGUNA COUNTY SANITATION DISTRICT
SANTA BARBARA COUNTY
CALIFORNIA**

Approved by District Engineer / Manager:



Martin Wilder

Martin Wilder

January 28, 2020

Date

**ENGINEERING DESIGN STANDARDS
FOR THE CONSTRUCTION OF SANITARY SEWERS**

- SECTION 1 INTRODUCTION
- SECTION 2 GENERAL
- SECTION 3 ENGINEERING DESIGN STANDARDS
- SECTION 4 PROCESSING AND DOCUMENTATION
- SECTION 5 CONSTRUCTION NOTES
- SECTION 6 RULES AND REGULATIONS
- SECTION 7 STANDARD DRAWINGS AND ATTACHMENTS

TABLE OF CONTENTS

SECTION 1 - INTRODUCTION	1-1
1.01 HISTORY AND SERVICE AREA	1-1
1.02 STANDARDS	1-1
1.03 OTHER STANDARDS	1-1
1.04 EXCEPTIONS	1-1
1.05 ADOPTION	1-1
SECTION 2 - GENERAL	2-1
2.01 SEWER SYSTEM JURISDICTION	2-1
2.02 PERSONS AUTHORIZED TO CONSTRUCT SEWER IMPROVEMENTS	2-1
2.03 CONSTRUCTION AUTHORIZATION	2-1
2.04 LIABILITY OF SEWER IMPROVEMENTS	2-1
SECTION 3 - ENGINEERING DESIGN STANDARDS	3-1
3.01 EXISTING UNDERGROUND UTILITIES	3-1
3.02 CONNECTING TO EXISTING SEWER	3-1
3.03 SEWER LINES NEAR WELLS	3-1
3.04 SEWER LINES NEAR WATER LINES	3-1
3.05 OTHER UTILITY SEPARATION	3-1
3.06 SEWER LINES IN FILL AREAS	3-2
3.07 SEWER LINES NEAR BUILDINGS	3-2
3.08 DEPTH OF MAIN LINE SEWER	3-2
3.09 MINIMUM SIZE SEWER	3-2
3.10 ACCEPTABLE PIPE MATERIALS	3-2
3.11 SEWER REPAIR AND REPLACEMENT MATERIAL	3-3
3.12 SEWERS IN STREETS	3-3
3.13 SEWERS IN ALLEYS	3-3
3.14 SEWERS IN EASEMENTS AND PRIVATE ROADS	3-3
3.15 HORIZONTAL CURVES	3-4
3.16 VERTICAL CURVES	3-4
3.17 TRUNK SEWERS AND COLLECTOR SEWERS	3-4
3.18 BEDDING AND BACKFILL	3-4
3.19 WYES	3-5
3.20 LATERAL SEWERS	3-5
3.21 BACKWATER CONTROL DEVICE	3-6
3.22 MANHOLE CONFIGURATION	3-6
3.23 MANHOLE SPACING AND LOCATION	3-6
3.24 PIPE ANGLES AT MANHOLES	3-7
3.25 MANHOLE FRAME AND COVERS	3-7
3.26 RIM ELEVATIONS OF MANHOLES	3-7
3.27 MANHOLE LINING	3-7
3.28 DROP MANHOLES	3-7
3.29 WASTEWATER FLOW GENERATION	3-7

3.30	SEWER CAPACITY STUDY	3-9
3.31	LIFT STATIONS AND FORCE MAINS	3-9
3.32	PRIVATE LIFT STATIONS	3-10
3.33	INDIVIDUAL PRIVATE LIFT STATIONS	3-10
3.34	UNUSED FACILITIES	3-10
3.35	GREASE CONTROL	3-10
3.36	SWIMMING POOLS	3-10
3.37	DEFINITIONS	3-11
SECTION 4 - PROCESSING AND DOCUMENTATION		4-1
4.01	APPLICATION FOR SEWER SERVICE	4-1
4.02	AVAILABILITY AND CAN-AND-WILL SERVE LETTERS	4-1
4.03	BOUNDARY REORGANIZATION AND SPHERE OF INFLUENCE	4-1
4.04	FINAL MAPS, PARCEL MAPS AND DEEDS	4-2
4.05	FEES AND CHARGES	4-2
4.06	SEWER SERVICE BY USER CATEGORY	4-2
4.07	MULTIPLE SEWER CONNECTIONS	4-2
4.08	ILLEGAL CONNECTIONS	4-2
4.09	IMPROVEMENT PLANS	4-3
4.10	SITE, PLUMBING, LANDSCAPING AND GRADING PLANS	4-4
4.11	ROAD ENCROACHMENT PERMITS	4-4
4.12	OTHER PERMITS	4-4
4.13	SPECIALIZED WORK	4-4
4.14	DEVELOPER AGREEMENTS	4-4
4.15	REIMBURSEMENT FOR OVER SIZING SEWER TRUNK LINES	4-4
4.16	CONSTRUCTION OF SEWER IMPROVEMENTS	4-5
4.17	SEWER SYSTEM INSTALLATION INSPECTION	4-5
4.18	ONSITE INSPECTIONS	4-5
4.19	TESTING	4-5
4.20	CCTV VIDEO INSPECTION	4-6
4.21	PROTECTION OF EXISTING BUILDINGS DURING CONSTRUCTION	4-6
4.22	PROTECTION OF EXISTING SEWER SYSTEM DURING CONSTRUCTION	4-6
4.23	TIME LIMITS	4-6
4.24	CHANGES IN WORK	4-6
4.25	RECORD DRAWINGS	4-6
4.26	CONSTRUCTION ACCEPTANCE	4-7
4.27	PROJECT COST INFORMATION	4-7
SECTION 5 - CONSTRUCTION NOTES		5-1
5.01	PUBLIC IMPROVEMENT PLAN NOTES	5-1
5.02	STANDARD DRAWINGS	5-3
SECTION 6 - RULES AND REGULATIONS		6-1
6.01	GOVERNMENTAL STRUCTURE	6-1
	<i>SANTA BARBARA COUNTY CODE, CHAPTER 29, ARTICLE I. IN GENERAL</i>	6-1
	<i>SANTA BARBARA COUNTY CODE, CHAPTER 29, ARTICLE II. NOT</i>	

<i>APPLICABLE TO SEWER SYSTEMS</i>	6-2
<i>SANTA BARBARA COUNTY CODE, CHAPTER 29, ARTICLE III. DISCHARGE INTO LAGUNA COUNTY SANITATION DISTRICT TREATMENT SYSTEM</i>	6-2
<i>SANTA BARBARA COUNTY CODE, CHAPTER 29, ARTICLE IV. NOT APPLICABLE TO SEWER SYSTEMS</i>	6-17
<i>SANTA BARBARA COUNTY CODE, CHAPTER 24A</i>	6-17
SECTION 7 - STANDARD DRAWINGS AND ATTACHMENTS	7-1

ATTACHMENTS

A - Water Main Separation

B - Laguna County Sanitation District Sewer Service Application

LAGUNA COUNTY SANITATION DISTRICT
ENGINEERING DESIGN STANDARDS

SECTION 1 - INTRODUCTION

1.01 **History and Service Area**

The Laguna County Sanitation District (District) was formed December 29, 1958 by the Santa Barbara County Board of Supervisors (ex-officio District Board of Directors) per Resolution 18598 pursuant to the County Sanitation District Act as contained in Division 5, Part 3, Chapter 3 of the State Health and Safety Code commencing with Section 4700. The District provides sewer service for the Orcutt and southern and mostly unincorporated Santa Maria area. This area loosely defines the District's service territory.

1.02 **Standards**

The District is authorized to prescribe development standards pursuant to Health and Safety Code Section 4762.1. This manual covers the rules, regulations and standards for the preparation and processing of plans and specifications for sanitary sewers to be constructed under public and private contracts under the jurisdiction of the District. This manual also addresses documentation for obtaining wastewater collection services from the District.

1.03 **Other Standards**

In addition to the requirements given in this manual, the applicant shall comply with the applicable sections in the latest edition of the *Standard Specifications for Public Works Construction* (SSPWC), "The Greenbook," and the latest edition of the *California Plumbing Code* as adopted by the enforcing jurisdiction. In the event of any inconsistency or conflict between said publications and this manual, this manual shall control. Any special conditions of construction imposed by the District and will supersede conditions that may be in conflict with this manual.

1.04 **Exceptions**

The policies prescribed in these standards are expected to apply to the majority of sewer design and construction situations. The District may in its sole and absolute discretion, make exceptions where application of the policies to a particular situation result in an unreasonable requirement not in the District's and/or the public's best interest.

1.05 **Adoption**

This manual and these standards were adopted by the District Board of Directors on January 28, 2020. The adoption of this manual and standards supersede any adopted prior.

SECTION 2 - GENERAL

2.01 Sewer System Jurisdiction

The Laguna County Sanitation District has jurisdiction of sewage conveyance facilities in public road rights of way, and designated easements as well as on properties served by the District for the purposes of inspection, observation, measurement, sampling and testing. Private roadways and easements shall be dedicated and accepted by the District by map or deed. The District, upon acceptance, shall own sewer mains and trunk lines inclusive of wyes. The lateral pipeline from the wye to a structure being served shall be considered as privately owned by the landowner. Onsite sewer collection systems serving commercial or condominium developments, shall be considered to be privately owned unless otherwise indicated. The local planning or building agency has inspection jurisdiction for onsite sanitary drainage facilities.

2.02 Persons Authorized to Construct Sewer Improvements

Public sewer construction related to land development projects shall be performed by authorized contractors, licensed by the State of California. The requirements of this section shall also apply to lateral connections to public sewer mains.

2.03 Construction Authorization

No unauthorized person shall uncover, connect onto, open, use, alter, or disturb any public sewer or appurtenance, or perform work on any public sewer system without first obtaining written authorization from the District. Such authorization shall be shown upon the demand of any District authorized representative.

2.04 Liability of Sewer Improvements

The applicant, and/or the applicant's agents shall be solely liable for any defects or failure during performance of the work or any failure, which may develop therein for the period of one (1) year from the date of acceptance. The District, its officers, employees, agents, contractors, representatives, successors and assigns shall not be answerable for any liability, death or injury to persons or property damage due to or arising out of the performance of the work by the applicant or the applicant's agents. The applicant shall answer for and save the District, its officers, employees, agents, contractors, representatives, successors and assigns from all liabilities imposed by law, including all costs, expenses, fees and interest incurred in seeking to enforce this provision.

SECTION 3 - ENGINEERING DESIGN STANDARDS

3.01 Existing Underground Utilities

The location and depth of underground utilities affect the layout of proposed sewer improvements. Plans must show existing and proposed underground works with respect to horizontal and vertical alignment. The applicant, at their expense, may be required to excavate and expose existing utilities to determine their location and elevation. The contractor shall notify Underground Service Alert as required per Government Code section 4216 et seq. for existing underground utility marking.

The District is not responsible for the accuracy of the location of these underground lines. Approval of sewer plans by the Laguna County Sanitation District does not constitute a representation for the accuracy of the location of, or the existence of, any underground utility, conduit or structure within the limits of the project.

3.02 Connecting to Existing Sewer

Where the proposed sewer connects to an existing manhole, the elevation of the inlets and outlets of the existing manhole shall be shown in profile as determined by field survey. In the event a new manhole is proposed on an existing sewer pipeline, the elevations of the existing sewer in the first manhole on each side of the proposed junction structures shall be determined by field survey. The engineer should be prepared to submit the field notes of the survey if requested to do so.

3.03 Sewer Lines near Wells

The spacing between sewer lines and potable supply wells shall be per *California Department of Water Resources Bulletins 74-81 and 74-90*, any applicable updates thereto, and Section 721.1 of the *California Plumbing Code*, which require a minimum horizontal spacing of 50'.

3.04 Sewer Lines near Water Lines

Separation between water and sewer lines for parallel and perpendicular construction shall comply with Title 22, Division 4, Chapter 16, Article 4 Section 64572 of the California Code of Regulations (CCR) "*Water Main Separation*" or code section of current date. This requires a vertical water separation of 12" above sewer lines and a horizontal separation of 10' between water and sewer lines. This document is included as Attachment A.

3.05 Other Utility Separation

Vertical clearance between sewer lines crossing under or over underground utilities (except water lines) shall be not less than 6" or as directed by the other utility. Any clearance less than 6" shall require concrete encasement of the sewer line. Horizontal clearance between sewer lines and facilities from utilities (except

water lines) shall be not less than 12" from the outside edge of the pipe or as directed by the other utility.

3.06 **Sewer Lines in Fill Areas**

Fill areas above sewer lines must be shown on the profile. The proposed finished surface over the sewer line must be shown by a solid line and the original surface must be shown by a dashed line and labeled "Compacted Fill" with arrows to the limits.

3.07 **Sewer Lines near Buildings**

Sewer lines shall be located outside the building load distribution line considered to begin 3' from the wall of the building and extending downward at a 45° angle.

3.08 **Depth of Main Line Sewer**

The minimum depth of a sewer main shall be designed so that laterals connected to them have a minimum cover of 4' within the right of way (typically at the property line). The District may require greater depths when it is necessary to extend the main line sewer to serve other areas to provide for future improvements.

3.09 **Minimum Size Sewer**

The minimum size of any public sewer main shall be 8" in diameter. A 6" main may be considered at the end of the line such as in a cul-de-sac provided minimum slopes are adequate and the number of residential unit equivalents to be served does not exceed ten.

3.10 **Acceptable Pipe Materials**

The type of pipe materials used shall be clearly shown on the profile. The following is a list of acceptable pipe materials used in the construction of new District sewer lines:

PVC - Polyvinyl Chloride Pipe/ ASTM D 3034 (4 inch - 15 inch), ASTM F679 (18 inch - 30inch). SDR 26 may be required when heavier loads are anticipated.

PE - Polyethylene/ ASTM D 3350 or ASTM F 714

Where reference is made to an American National Standards Institute (ANSI), American Society of Testing Materials (ASTM), or American Water Works Association (AWWA) designation, it shall be the latest revision at the time of construction, except as noted on the plans or special provisions.

Class of pipe, material composition, and all fitting and joint materials and installation shall comply with the latest edition of the *Standard Specifications for Public Works Construction*.

Solvent joints are not acceptable on sewer main and sewer lateral installations.

3.11 **Sewer Repair and Replacement Material**

Polyvinyl chloride (PVC) or polyethylene (PE) materials shall be used when replacing or repairing sections on existing sewers with approved coupling devices that centers the inside of the pipe, and has lateral restraint such as MaxAdaptor or approved equal.

3.12 **Sewers in Streets**

Every effort shall be made to locate sewers in paved areas accessible by sewer pipeline cleaning and inspection equipment even though a greater depth is required than in a non-paved alignment. This is to avoid access issues and difficulties in maintaining and repairing sewers located in offsite such as in easements.

Sewer lines shall be constructed in straight lines where possible, and generally along the street centerline. No portion of the sewer line shall be constructed such that a manhole cover is within 5' of the edge of a concrete gutter. No manhole cover shall be constructed more than 6' from the centerline of the street unless permitted by the District. See District Standard Drawing No. 1.

3.13 **Sewers in Alleys**

Sewers constructed in alleys shall be located in the center of the alley, except where center gutters are used. Sewers shall not be located closer than five feet to the adjacent property line and shall be a minimum of five feet from the gutter line.

3.14 **Sewers in Easements and Private Roads**

When proposed sewer main lines are not located in existing or proposed public roadways, easements shall be dedicated to the Laguna County Sanitation District pursuant to Health and Safety Code Section 4740 and shall be subject to review and approval by the District. This includes sewer facilities to be located in private streets and offsite locations. Dedication to and acceptance by the District is required on parcel and final maps. Easement deeds granting rights of way to the District are required for offsite sewer lines. Public utility easements (PUE) are not acceptable for dedicating easements to the District.

Sewer lines located in easements must include access for maintenance and repair equipment. An approved all-weather surface, i.e., class 2 aggregate base over compacted subgrade, is allowed for grades not exceeding 10%. The surface shall be paved with a minimum of 2" asphalt over 6" class 2 aggregate base for grades exceeding 10%. Grades may not exceed 15% and turnarounds may be required at convenient locations as determined by the District. Roadway horizontal and vertical curves must accommodate District cleaning and camera vehicles.

Encroachments into the easement such as buildings, minor structures, large vegetation, etc., are prohibited as they interfere with the use of the easement.

The minimum width for easements, in feet, shall be per the following table:

Sewer Size Size	Depth of Sewer in Feet				
	0 to 15	15 to 20	20 to 25	25 to 30	Over 30
8 inch	15	15	20	25	30
10 inch	15	15	20	25	30
12 inch	15	15	20	25	30
15 inch	15	20	20	25	30
18 inch	20	20	20	25	30
21 inch	20	20	20	25	30
24 inch	20	20	25	25	30
27 inch	20	20	25	30	35
30 inch	20	20	25	30	35
33 inch	20	20	25	30	35
36 inch	20	20	25	30	35

3.15 **Horizontal Curves**

Horizontal curves shall not be used in sewer lines greater than 8" in diameter. When horizontal curves are used, they shall not exceed be per the pipeline manufacturer's recommendations but must be able to pass a mandrel. Horizontal curves shall be concentric with the street centerline where possible. Manholes are required at reverse or compound curves. Horizontal curve data to be shown on plan sheets includes radii, beginning and end of curve, and intersection angle.

3.16 **Vertical Curves**

The use of vertical curves on sewer lines is prohibited.

3.17 **Trunk Sewers and Collector Sewers**

Trunk and collector sewers shall be located according to the District approved plans and shall be designed pursuant to the District's most recent sewer master plan or sewer model study.

3.18 **Bedding and Backfill**

The owner or developer shall provide a copy of the geotechnical engineering report and test data for various parameters including sand equivalent (SE) of proposed embedment zone material. The embedment zone is defined as that area that extends from 4" to 6" below the pipe to 12" above the pipe. Pipe embedment zone material shall be sand, gravel, crushed aggregate, or native free draining granular material having a sand equivalent of not less than 30 or having

a permeability greater than 1 ½" per hour pursuant to test method ASTM D2434 or California Test 220, or other material approved by the District, and shall be placed on a competent subgrade foundation and shall be compacted to 85% minimum relative compaction. This material shall be placed on competent foundation and compacted in the trench before the pipe is placed. Upon laying and securing the pipe on the bedding, the bedding material shall be shoveled and walked into the haunching area simultaneously on both sides of the pipe to the pipe spring line in such a way to eliminate voids.

Trench backfill material extending from 12" above the pipe to ground surface or to a roadway structural section shall be as prescribed in a geotechnical report or encroachment permit requirements. The backfill shall be placed in horizontal layers of such thickness as are considered proper for the type of compaction equipment being used in relation to the backfill material being placed.

When not prescribed in a geotechnical report or encroachment permit, backfill material, whether native or imported, shall be free from shale, sod, roots, rubbish, trash, lumber, organic material, ashes and other debris, unusual color, contamination, and sulfide odor. Rocks, including pieces of broken concrete or bituminous pavement, originating from the native material shall have a maximum size of 6 inches and shall be dispersed within, or mixed with, the backfill material such that voids or pockets of large pieces ("nesting") are not created. Backfill material shall be compacted to a required minimum relative compaction of 90%. When pavement is to be placed directly on the backfill material, 95% relative compaction is required in the top 6". See District Standard Drawing Number 2.

Compaction tests are generally required in each lift and two tests are required in pipeline runs between manholes. Compaction test results and geotechnical test data from a certified testing laboratory shall be provided to the District prior to acceptance.

3.19 Wyes

All wyes shall be shown on the plans and labeled with the alignment stationing. See District Standard Drawing Number 3 for wye replacements or new installations.

3.20 Lateral Sewers

Pursuant to the *California Plumbing Code*, separate lots shall not be permitted to use the same lateral or building sewer, and every commercial building or industrial facility shall be separately connected to a public or private sewer.

All lateral sewers shall be constructed with a wye and eighth bend installed on the sewer main at an upward 45° angle per District Standard Drawing Number 4, at right angles to the sewer main, and extending straight toward to property to

be served unless shown otherwise on the approved plans. Long longitudinal lateral runs are prohibited. The lateral sewer shall be appropriately sized per the *California Plumbing Code*, however a 4" minimum diameter for residential and 6" minimum diameter for multiple residential and commercial development is required. The slope shall be a minimum of 2% to the property line. A cleanout shall be installed just behind the property line per District Standard Drawing Number 4. Cleanouts located in driveways or other paved areas shall be protected with a traffic worthy concrete cleanout box and cover labeled "sewer".

Existing unused sewer laterals may be used when connecting new buildings. The applicant may be required to test or inspect the lateral prior to connection.

Pursuant to Section 29-27.1(b) of the County Code, the owner shall be responsible for repair and maintenance of the lateral and building sewer from the building connection to the wye connection at the public sewer line. The District is not responsible for line breaks or damage to the owner's lateral or building sewer for any reason including but not limited to tree roots, utility work, earthquake, etc. Owner shall be responsible for construction of laterals and connection to the main sewer in the event that a lateral or wye connection is not present.

3.21 **Backwater Control Device**

Pursuant to District ordinance in County Code Section 29-27.1, a backwater valve shall be installed on all new sewer connections and sewer connection retrofits even when not required by the *California Plumbing Code*. When not required per *California Plumbing Code* criteria but related to a multi-storied building, the backwater valve shall be installed as for a single story building. The backwater valve is typically be installed at the junction of the building sewer and building drain, generally 18" from the foundation wall. The configuration of a typical backwater valve is shown on District Standard Drawing Number 5.

3.22 **Manhole Configuration**

The invert drop across a manhole or transition structure shall be a minimum of 0.1'. When the exit pipe size increases, the crown elevations of smaller diameter upstream pipe(s) shall match the crown elevation of the larger diameter downstream pipe. Manholes for sewer lines up to 15" shall have a 4' inside diameter shaft with concentric cones. Sewer lines 18" to 27" and greater shall have a 5' diameter shaft with eccentric cones. The configuration of a standard sewer manhole is shown on District Standard Drawing Number 6.

3.23 **Manhole Spacing and Location**

The maximum spacing between manholes shall be per the following table except in steep grades, which may require shorter distances:

Sewer Size	Maximum Spacing
24 inch and less	350 feet
27 inch and over	400 feet

Manholes shall be located in roadways where possible. Manholes shall be located at all grade changes, changes in horizontal alignment, point of reverse or compound curves, changes in pipe size, pipe termini and at sewer junctions. Cleanouts may not be used at the terminus of sewer lines in order to facilitate inspection and maintenance equipment.

3.24 **Pipe Angles at Manholes**

Pipes entering a manhole must do so at an angle of not less than 90° from the exiting sewer line.

3.25 **Manhole Frame and Covers**

Manhole frames and covers shall be South Bay Foundry SBF 1254-07, or approved equivalent, and shall be stamped "LCSD SEWER" or "LAGUNA SANITATION SEWER." Manholes not located in paved streets shall have an approved bolt down cover and shall have a concrete jacket per the District Standard Drawing Number 6. Covers for privately owned manholes shall be labeled "SEWER" or "SANITARY SEWER."

3.26 **Rim Elevations of Manholes**

In paved areas, the manhole rim elevation shall match the finished grade. In areas outside of the traveled way, the height of the manhole rim shall be 18" above the finished ground grade, high water mark, or above future fill. In maintained landscaped areas, the manhole rim shall be 6" above finished grade and protected from damage by methods subject to approval of the District. Manhole rims may be at grade in lawn areas but shall not be located in low areas. Manholes shall be placed as unobtrusively as possible in landscaped or highly visible areas, however vegetation shall not inhibit access.

3.27 **Manhole Lining**

Manholes exceeding 15' in depth in paved areas or of any depth in non-paved areas must be coated on the interior with an approved coating system.

3.28 **Drop Manholes**

Drop manholes shall not be used unless approved by the District.

3.29 **Wastewater Flow Generation**

Main line pipe capacities shall be designed per the following criteria:

Flow: The flow generation rates shown in the following tables were derived for anticipated development in and near the Laguna County Sanitation District

service areas. The flow generation rates shall be based on the appropriate duty factor shown below in the following table to determine the average flow rate:

Service Type	Duty Factor	Unit
Single family	220	gpd/connection
Multiple family	178	gpd/connection
Accessory Dwelling Unit	178	gpd/connection
General Commercial	1,500	gpd / acre
Professional	1,500	gpd / acre
Commercial - High Demand	6,011	gpd / acre
Parks and open space	27	gpd/acre
Office space	200	gallons/1,000 sf/ day
School staff / student	15	gpd per capita

Alternatively for commercial development, the flow generation can be determined by using the drainage fixture units if known.

The design flow rate shall be the peak flow rate, with a peaking factor appropriate to the development to be approved by the District.

The design flow rate for maximum pipe capacity shall be half full for pipes up to 8" in diameter and three-quarters full for pipes 10" in diameter and greater.

Velocity: The design velocity for full or half-full pipe depth design flow shall not be less than 2.0 feet/second. Maximum design velocity should not exceed 15 feet/second without the use of special pipe or manhole energy dissipation design but may be up to 20 feet/second in standard straight through manholes. At multiple inlet or manholes with directional changes, the maximum velocity should not exceed 8 feet/second.

Slope: Minimum slope values listed in the table below are based upon maintaining a self-cleaning velocity in the sewer.

Pipe Size	Minimum Slope
6 inch	0.49%
8 inch	0.34%
10 inch	0.25%
12 inch	0.20%
15 inch	0.15%
18 inch	0.12%
21 inch and greater	0.09%

Slopes of sewer lines shall be computed using the outlet flow line elevation of the upstream manhole and the inlet flow line elevation of the next downstream manhole.

Plans: The calculated flow (Q), velocity (v) and depth to diameter ratio (d/D) for the peak flow condition shall be labeled on the plans for each pipe.

3.30 Sewer Capacity Study

A sewer capacity study may be required of the developer or owner by the District in order to assess capacity impacts of the proposed project to the existing sewer system. The developer's or owner's engineer should consult with the District regarding wastewater flow generation. District staff will use this information in its flow model to assess impacts to pipeline capacities and determine if upgrades are required. Costs for system improvements, or prorated cost share thereof, are to be borne by the developer or owner.

Results of the model showing impacts to flow (Q), velocity (v), and the depth to diameter ratio (d/D) in the peak flow condition will be determined and compared to design parameters. In general, when these parameters exceed design values, pipe improvements are required. In cases where an area is considered built out, parameter values exceeding design values may be considered. The reduction in pipe size downstream is prohibited. When a larger pipe size is required, the larger sized pipe shall continue downstream until a pipe of equal or greater size is encountered.

3.31 Lift Stations and Force Mains

In some cases, lift stations and force mains may be required to meet the wastewater collection needs of a specific property or tract.

Lift stations and force mains will not be accepted if an option for providing sewer service by means of gravity flow exists. Factors such as access rights, construction requirements or costs shall not be the sole or sufficient reason for allowing lift stations and force mains. Any deviation from this requirement is subject to the prior approval of the District.

Any lift station and force main to be accepted by the District must include primary and secondary pumps, backup power generation, alarm systems, security fencing, appropriate force main air release/vacuum valves, and any other necessary features useful to the District.

A lift station must generally provide service to a large number of parcels. Said parcels must be included in a separate benefit assessment zone to be established pursuant to Section 4850 et seq. of the Health and Safety Code. A special benefit assessment to provide for the costs of replacement, operation and maintenance of

the lift station will be assessed the benefitting parcels in addition to the sewer charge. Developer shall pay the initial benefit assessment for the first year, or portion of the fiscal year remaining, prior to occupancy approval along with other applicable fees and charges.

3.32 **Private Lift Stations**

Privately owned, constructed, operated and maintained lift stations and force mains may be connected to the public sewer collection system provided that the private lift station system is subject to review and approval by the local building authority pursuant to the *California Plumbing Code*, the Environmental Health Services office of the Santa Barbara County Public Health Department, and the District. A body such as a homeowner's association may be required own a private lift station system and to provide the approving agency with a recorded maintenance agreement.

3.33 **Individual Private Lift Stations**

When a building is too low in elevation to allow gravity flow to a sewer main, an individual private lift station shall be employed. The lift station shall be subject to permitting by the local planning or building authority and must comply with the *California Plumbing Code*. Access to a public sewer main in a public road right of way is subject to the local road encroachment authority. The District will dictate how the connection to the sewer main is completed.

3.34 **Unused Facilities**

Sewer manholes, sewer main, sewer trunk, and sewer laterals that may be constructed for future use must be appropriately sealed, enclosed and capped to prevent debris from entering the system.

3.35 **Grease Control**

A fats, oils and grease control device is required for all food service establishments. Grease interceptors shall be sized in accordance with the *California Plumbing Code* with a minimum capacity of 500 gallons. Interceptors shall be identified on the plans as located outside the building on private property and shall be constructed per the District Standard Drawing Number 7. Hydromechanical grease interceptors (grease traps) may be authorized for smaller applications and shall be of the type and capacity conforming the *California Plumbing Code* with a minimum capacity of 20 gpm (40 pounds). Permitting and approval will typically be provided by the building authority with input provided by the District.

3.36 **Swimming Pools**

Swimming pool water and backwash water typically contains high concentrations of dissolved solids. Because the District is regulated by the Regional Water Quality Control Board as to the content of dissolved solids in its

effluent, the discharge of swimming pool water and backwash water shall be considered on a case by case basis. The discharge of swimming pool water and backwash water is regulated by Section 813.0 of the *California Plumbing Code* and Title 24 (Building Standards Codes) of the California Code of Regulations under Part 2 (California Building Code) Volume 2, Chapter 31B (Public Swimming Pools) Section 3142B (Wastewater Disposal) and is subject to approval by the local wastewater agency in addition to the County Environmental Health Services office of the Santa Barbara County Public Health Department. Issues to be considered are the times and duration of the discharge in order to accommodate the removal of dissolved solids at the treatment plant and the discharge flow rate to ensure the sewer collection system is not overtaxed. Note that nonpressurized sanitary sewer pipelines are designed to flow as open channels and are not designed to accommodate extreme peak flow rates without surcharging. Overflows of the sewer system caused by the pool operator shall be subject to fines and other penalties.

In addition, the discharge of dechlorinated swimming pool water to the public storm drain system is regulated by the appropriate agency managing the storm drain system under federal and state law (see Chapter 29, Article IV of the County Code for discharges in the unincorporated areas of the county).

3.37 Definitions

Unless the context requires otherwise, the definitions in this section shall govern the construction of these standards. Other definitions used by the District are included in the District's Ordinances, applicable sections of the "*California Plumbing Code*", as adopted, and the *Standard Specifications for Public Works Construction*, latest addition.

ANSI - American National Standards Institute.

Applicant - Any person, entity, or agent making application for District services. This may be the owner, developer, contractor or agent for any of these.

Approved - Accepted under an applicable specification or standard stated or cited in this document for the proposed use.

ASTM - American Society for Testing and Materials.

Backwater Valve - A device installed on the sewer drainage system generally located adjacent to the exterior foundation of a building to prevent reverse flow from entering. Also referred to as a backflow prevention device in the Santa Barbara County Code, section 29-27.1.

Building - A structure built, erected, and framed of component structural parts designed for the housing, shelter, enclosure, or support of persons, animals, or

property of any kind.

Building Sewer - That portion of the sewer drainage system that continues from the end of a building drain system and extends to the connection of a sewer main. This pipeline is privately owned and maintained by the land owner.

Capacity Charge - Also known as a connection charge. A one-time charge assessed new customers granted connection to the District's collection, treatment and discharge facilities in existence at the time as well as for new public facilities to be acquired or constructed in the future that are of proportional benefit to the person or property being charged pursuant to Government Code 66013(b)(3) and Health and Safety Code 5470.

CO - Cleanout (Sewer).

Commercial - A site or building used for nonresidential purposes, typically for the exchange or buying and/or selling of commodities and/or services.

County - The County of Santa Barbara, State of California, and the various agencies and departments thereof.

District - The Laguna County Sanitation District or its authorized representatives.

District Engineer/District Manager - The manager of the District.

District Personnel - Anyone engaged or employed to represent the District.

District Board - The Santa Barbara County Board of Supervisors acting as the ex officio District Board of Directors.

Domestic Sewage - Domestic sewage means the liquid and water-borne wastes derived from the ordinary living processes, free from industrial wastes, and of such character as to permit satisfactory disposal, without special treatment, into the public sewer or by means of a private sewage disposal system.

Dwelling - A structure for residential occupancy.

Engineer - An individual with a current and valid civil engineer's license issued by the State of California, under whose direction plans, profiles, and details are submitted to the District for review and approval.

Fixture Unit - A quantity in terms of which the load-producing effects on the plumbing system of different kinds of plumbing fixtures are expressed on some arbitrarily chosen scale.

Grade - Grade is the slope or fall of a line of pipe in reference to a horizontal plane. In drainage, it is usually expressed as the fall in a fraction of an inch (or mm) or percentage slope per foot (or meter) length of pipe.

Grease Interceptor - A plumbing appurtenance or appliance that is installed in a sanitary drainage system to intercept nonpetroleum fats, oils, and grease (FOG) from a wastewater discharge.

Horizontal Pipe - A pipe or fitting that is installed in a horizontal position or which makes an angle of 45° with the horizontal.

Industrial - A site, structure, building or works which is, or which is designed, to be used for the manufacture, processing, or distribution of materials, equipment, supplies, food or commodities of any description.

Industrial Waste - Any and all liquid or water-borne waste from industrial or commercial processes, except domestic sewage.

Inspector - The sewer inspector for the District duly authorized by the District and responsible for particular as delegated by the District.

Institutional - Any educational, assembly, hospital or penal facility.

Interceptor (Clarifier) - A device designed and installed so as to separate and retain deleterious, hazardous, or undesirable matter from normal wastes and permit normal sewage or liquid wastes to discharge into the disposal terminal by gravity.

Lateral Sewer - That portion of a Building Sewer that extends from the property line or right of way line to the connection of a sewer main. This segment of the Building Sewer is privately owned and maintained by the landowner.

MH - Manhole or maintenance hole.

Pipe/Pipeline - A cylindrical conduit or conductor, conforming to the particular diameter dimension commonly known as "pipe size".

Plans - The official plans, profiles and drawings, or re-productions thereof, approved by the District, which show the location, character, dimensions, and details of work to be done.

Private Sewer - A sewer line owned by private individuals who are responsible its repair and maintenance that eventually discharges to a public sewer system.

Public Sewer - A common sewer line directly controlled by a public authority.

Sampling Manhole - A standard or modified manhole approved by the District that serves to isolate the wastewater flow from a single commercial or industrial facility and provides access for sampling and/or monitoring purposes.

Service Charge - Also called a sewer charge. Cost for service to a customer for the collection and treatment of wastewater and for the discharge of the recycled water and residual waste. Typically billed on the tax roll.

Service Connection - All or any portion of the building and lateral sewer lines between a main sewer line and an individual building.

Sewage - Also called wastewater. Any liquid waste containing animal or vegetable matter in suspension or solution and may include liquids containing chemicals in solution.

Sewer / Sewer Line - Any conduit intended for the reception and transfer of sewage and fluid industrial waste.

Sewer Main (Main Sewer) - A sewer line which has been constructed to accommodate more than one building sewer and which has been approved and accepted by the District.

Sewer Trunk (Trunk Sewer) - A sewer line which collects wastewater from the sewer mains and conveys the wastewater to the treatment facility or larger collection systems, and considered to be 10" in diameter or greater.

Single Family Residence - A standard unit of development, also known as a Residential Unit Equivalent (RUE) or Equivalent Dwelling Unit (EDU) used for determining the relative level of development on a property. Multiple family residential, commercial and institutional development is converted to single-family residential family equivalents based on waste strength and flow generation.

State - The State of California.

Storm Drain - Any conduit and appurtenances intended for the reception and transfer of stormwater.

Trunk Fee - A one-time fee charged for the buy-in of an existing or proposed trunk sewer line.

Vertical Pipe - Any pipe or fitting which is installed in a vertical position or which makes an angle of not more than 45° with the vertical.

Work - All of the work of the project contemplated and called for or shown in the contract documents.

SECTION 4 - PROCESSING AND DOCUMENTATION

The following is a list of development processes that may be required to approve a development project:

4.01 Application for Sewer Service

Any person legally entitled to apply for and receive sewer service authorization may submit a Sewer Service application to the District, which is included as Attachment B. The signature of the applicant on the Sewer Service application shall constitute an agreement to comply with all provisions, terms and requirements of these rules and regulations and the Laguna County Sanitation District and shall authorize right of entry for District personnel, representatives, consultants, contractors, successors and assigns.

Calculations, plans, specifications, cost estimates, and other required information shall be provided by a civil engineer licensed by the State of California, for review and approval for any proposed public sewer infrastructure.

4.02 Availability and Can-and-Will Serve Letters

An availability letter will typically be issued to an applicant in response to a project application. This correspondence states conditions, addresses submittal corrections, list fees, and identifies right of way issues.

The approval of the application is evidenced by the issuance of a Can-and-Will-Serve letter by the District, which must be able to indicate that all project conditions will be met, that all necessary rights of way have been addressed and that all financial arrangements will be satisfied. This letter will be issued upon payment of certain fees and charges, after public sewer improvement plans are signed and inspection copies of plans are provided, map and easement requirements are met, and any special agreements or permits are executed (FOG, industrial pretreatment, etc.). Other fees and charges are due prior to District sign-off for building department occupancy approval. Changes to approved public sewer improvement plans are prohibited without written authorization from the District's manager or other authorized District representative. This offer of service can expire upon expiration of the applicant's project with the planning agency.

4.03 Boundary Reorganization and Sphere of Influence

Annexation to the District is required in order to receive sewer service if the land is not already located within the District's service area boundary. In addition, the District's sphere of influence must be amended if the area is outside of its current sphere, which defines the boundary of the District's political interest. This process involves the Santa Barbara County Local Area Formation Commission and the California Board of Equalization. All fees for this process are to be borne by the applicant. Documents can be found at www.sblafco.org.

4.04 **Final Maps, Parcel Maps and Deeds**

The District must review and approve any final maps, parcel maps, deeds or any other mechanism for transferring real property rights to the District. Easements or other rights to be granted to the District must be specifically dedicated and accepted in a final map or parcel map as well as being called out on the layout sheets. Dedication by public utility easement (PUE) is not appropriate and therefore not acceptable.

4.05 **Fees and Charges**

Trunk line, plan check, inspection and testing fees shall be paid prior to map recordation. In the case when the development does not involve a subdivision of land, these fees are due prior to occupancy approval. Capacity charges, prorated sewer services charges and other fees and charges are due prior to occupancy approval.

4.06 **Sewer Service by User Category**

Sewer charges are collected on the tax roll and are based on the type of user (residential, multiple residential, commercial, industrial and institutional). Properties that operate businesses out of residential buildings shall be billed for sewer service as commercial establishments (based on water use). The District shall authorize the conversion of residential billing to commercial billing and may require separate water metering in order to develop sewer service charges.

4.07 **Multiple Sewer Connections**

Property zoned and sized to accommodate multiple family housing development such as a mobile home park, condominium, or apartment complexes that are on a single parcel will be billed for all the units on that parcel.

Conversions of floor space within an existing residential unit or conversion of an existing accessory detached structure to an Accessory Dwelling Unit (ADU), as defined in Government Code section 65852.2, are exempt from capacity charges but are subject to the assessment of sewer service (commodity) charges. ADUs constructed with new exterior walls will be considered as new habitable housing units and subject to capacity charges.

4.08 **Illegal Connections**

Illegal connections shall be assessed all applicable fees as well as sewer service charges from the date of original building permit, date of construction if the building permit date is not known, or to ownership date of current owner. Certain fees may be waived if the current owner did not construct the illegal structure. The planning or building agency having jurisdiction will be informed. In certain cases, the illegal connection may be required to be removed and the structure returned to its original permitted function.

4.09 **Improvement Plans**

The applicant shall be responsible for providing improvement plans showing the layout and design of all proposed sewer improvements. Plans and specifications shall be prepared by a civil engineer licensed by the State of California for review and acceptance by the District.

The title sheet must show a key map referencing plan sheets, sewer and access road easement boundaries, building structures, proposed sewer mains, a project vicinity map, general sewer notes, construction notes, plan set index, elevation datum, and all benchmarks.

Plan sheets must show all pipeline layout, stationing, horizontal curve data, lateral, pertinent topographic data, rights of way, easements (label out recorded instruments when not located within a public road right of way), pipe length and slopes, manhole inlet and outlet flow line elevations, manhole rim elevations, and existing and proposed features. All existing piping and underground structures shall be shown in plan and profile. Construction notes shall call out specific work, equipment and materials. Sheets showing improvements to be dedicated to the District must provide an approval signature and date block.

The plans shall delineate the size and ownership of all existing and future underground works that cross or parallel the sewer. Any line which crosses the sewer, especially gas, TV or fiber optic cable, storm drains, telephone, water, electrical, gasoline and oil lines, shall be shown and labeled on the plan and profile.

The profile grid must be located on the upper half of the sheet. The scale used for plan and profile drawings shall be appropriate for the drawings such as:

- 1" = 10' Horizontal and 1" = 1' Vertical
- 1" = 20' Horizontal and 1" = 2' Vertical
- 1" = 30' Horizontal and 1" = 3' Vertical
- 1" = 40' Horizontal and 1" = 4' Vertical
- 1" = 50' Horizontal and 1" = 5' Vertical
- 1" = 60' Horizontal and 1" = 6' Vertical

The detail sheets are for special details of structural and piping designs and may include District standard drawings. The use of standard drawings or details by other agencies is acceptable provided it is labeled to be approved by the District.

Final approved plans for signature shall be matt film (mylar) with black text.

Standard sheet size shall have a vertical dimension of 24" and a horizontal dimension of 36" to the outside edges.

All plans shall be drawn with the intent of having them reduced by one half such that text and objects will be legible at the reduced scale.

Datum requirements shall be the 1983 North American Datum (NAD) for horizontal control and the 1988 North American Vertical Datum (NAVD) for vertical control as established by the National Geodetic Survey. Datum and benchmark information is to appear on the title sheet. Local benchmark information should appear on the plan sheet where the benchmark can be readily identified.

4.10 **Site, Plumbing, Landscaping and Grading Plans**

Review of other plans may be required in order for the District to ascertain the impacts of other proposed improvements.

4.11 **Road Encroachment Permits**

A permit to excavate in public roadways must be obtained from the appropriate authority prior to construction.

4.12 **Other Permits**

Compliance with any other applicable regulations and permits such as CalOSHA Construction Safety Orders for Excavations, Confined Spaces, etc., environmental regulations, and storm water control is required. A new sewer system not yet in service but connected to the existing live sewer system is considered as subject to inundation by gas and liquid unless properly capped or plugged. Access into an existing manhole is considered live and the contractor is required to follow the District's Confined Space Entry Program.

4.13 **Specialized Work**

Special work such as sewage bypasses requires written work plans and approval by the District. Costs for any needed backup support by District personnel and equipment shall be borne by the applicant's contractor.

4.14 **Developer Agreements**

In some cases the District may require agreements with the owner and/or developer to address offsite improvements related to trunk lines, lift stations, pipeline upsizing, etc. Any cost incurred by the District shall be borne by the developer.

4.15 **Reimbursement for Over Sizing Sewer Trunk Lines**

The District may consider a reimbursement agreement with a developer when a trunk sewer (10" or greater) is conditioned for a project that is intended to serve other existing and anticipated future development. The agreement shall reimburse the developer for the costs beyond those to serve the developer's development based on a prorated residential unit equivalent basis pursuant to

Section 4742.3 of the Health and Safety Code. The construction of sewer mains (6" and 8") regardless of capacity and future connections, shall be considered as property of the District and shall not be subject to reimbursement.

4.16 **Construction of Sewer Improvements**

The applicant may begin the construction of public sewer improvements upon providing a copy of the fully executed public sewer improvement plans giving at least 48 hours advance notice. Preconstruction meetings with the applicant's contractor on larger projects is advised.

4.17 **Sewer System Installation Inspection**

All work relative to sewer system installation shall be subject to inspection by the District's representative and passing any prescribed testing. Upon the exhibition of proper credentials and identification, the appropriate District representative or inspector shall be permitted to enter into residential, commercial, institutional and industrial facilities for the purposes of inspection, observation, measurement, sampling, testing or other duties necessary to enforce or ensure compliance with the provisions of District codes, ordinances and standards.

Visual inspections of all pipes and structures is required prior to covering with backfill cover.

It shall be the duty of the person performing the work to notify the District that said work is ready for inspection or testing. Such notification shall be given not less than 48 hours before the work is to be inspected or tested. Any construction done without prior notification to the District can be rejected, and any rework will be done at the contractor's expense.

4.18 **Onsite Inspections**

Onsite inspections regarding required devices or prohibitions may also be performed on development improvements and structures prior to occupancy approval. These inspections are to ensure that certain devices have been installed including but not limited to backwater valves, property line cleanouts, grease interceptors or traps, and commercial domestic water service submeters; and to ensure that certain devices are not installed including but not limited to salt load water softeners.

4.19 **Testing**

Pipeline air pressure testing shall be proceeded with a system flush with a hydrojetter and tested for roundness with an appropriately sized mandrel and pressure tested. The air pressure test shall be in accordance with section 306-7.8.2.4 of the *Standard Specifications for Public Works Construction* once the trench has been backfilled and compacted but before paving. The air test must be properly prepared and all plugs must be installed and braced in such a way as to prevent blowouts. Pressurizing equipment should include a regulator set at

approximately 5 psig to avoid over pressurizing and damaging a pipeline. No shall be allowed in the manholes during testing.

Soil compaction requirements are detailed in the Design Criteria section of the District's Engineering Design Standards. Costs for performing testing shall be borne by the owner or owner's agent or contractor.

The equipment, material and labor necessary for inspection or tests shall be furnished by the owner, owner's agent or contractor.

4.20 **CCTV Video Inspection**

A closed caption television (CCTV) inspection shall be made of the newly constructed and installed sewer facilities at owner's or contractor's expense is required to ensure compliance with the District's standards with regard to pipeline integrity and alignment. Deficiencies in the pipeline must be corrected and poor video or inconclusive data will require re-video inspection.

4.21 **Protection of Existing Buildings During Construction**

The contractor shall consider the proximity of a trench excavation in relation to existing buildings or other surcharges and shall comply with safety orders and permit conditions when performing the work.

4.22 **Protection of Existing Sewer System During Construction**

The contractor shall consider the proximity of the existing sewer system when performing the work. Manhole channels shall be protected with false bottoms until all grading and roadwork is complete. Sand traps shall be installed upstream of the existing sewer system to prevent debris from entering until work is complete. Debris, including construction related material, shall not be stored inside installed manholes, to prevent debris from lodging inside pipes. Manhole rims shall be raised and sealed to protect against inflow from stormwater.

4.23 **Time Limits**

A suspension of work may not exceed 14 days unless owner implements measures to protect newly installed facilities. Phased or partially completed work must have passed inspection and testing and be in an allowable state for use and access. Improvements to be placed into service at a later date must have passed inspection and testing and be appropriately closed and protected from stormwater, debris, public access and any other hazards.

4.24 **Changes in Work**

Changes, deviations, additions or deletions of items of work from the approved plans, specifications or submittals must be approved by the District's manager.

4.25 **Record Drawings**

Drawings showing any changes to the planned location of all mains, structures,

wyes, lateral, manholes, easements, etc., shall be filed with the District before final acceptance of the work by the applicant's contractor. In addition, an electronic drawing compatible with AutoCAD format showing the actual location of mains, wyes, laterals, manholes, cleanouts and appurtenant structures, and including elevations for inverts and rims thereof, shall be submitted to the District before final acceptance of the work.

Non-residential development such as food service establishments or certain industrial facilities will require the issuance of a District Industrial Wastewater Discharge Permit to control and monitor industrial wastes or wastes from food services establishments (fats, oils, and grease), or other regulated wastes.

4.26 **Construction Acceptance**

Before the acceptance of any sewer line or facility by the District, and prior to the introduction of any sewage into the system, sewer lines shall have been completed, tested, and video inspected to assure full compliance with all requirements of the District's *Standard Specifications for the Construction of Sanitary Sewers* and any other facilities must pass startup testing and procedures.

If the sewer system is deemed satisfactory, the District shall issue a notice of satisfactory completion and acceptance at inspection sign-off of the constructed facilities when all work, including changes and revisions have been completed. Copies of such notice will be distributed to the contractor and the developer and to the agency with road encroachment authority for public roadways.

4.27 **Project Cost Information**

Project construction cost information for new public sewer improvements must be submitted by the applicant's engineer for the purpose of estimating the District's capitalization and depreciation on these infrastructure components. Labor costs must be based on prevailing wage rates.

SECTION 5 - CONSTRUCTION NOTES

5.01 Public Improvement Plan Notes

The following plan notes are based on standards and specifications that have been adopted by the District and shall be shown on the public sewer improvement plans, subject to any amendments required by the District:

1. The construction of public sewer system improvements shall comply with Laguna County Sanitation District standards and specifications and shall be subject to testing and inspection. An acceptance letter will be provided upon final acceptance of the work.
2. Geotechnical reports, sand equivalent (SE) test data, and any other bedding and backfill information shall be provided to the District prior to the start of construction.
3. The developer, developer's agents, contractors, vendors, etc., shall abide by all applicable safety orders such as those described in Section 7-10.4.2 Safety Orders of the *Standard Specifications for Public Works Construction*, latest edition. Copies of any shoring plans, confined space entry permits, or excavation permits shall be submitted to the District prior to the start of construction.
4. Commencement of construction of public sewer system improvements shall not be authorized until the public sewer improvement plans have been signed by the District manager or authorized agent and material submittals have been approved. A signed field set shall be available onsite.
5. Approval of the public improvement plans by the District does not constitute a representation as to the accuracy of the location of, or the existence of, any underground utility pipe or structure within the limits of this project. The contractor shall verify the location of all existing underground utilities such as water, sewer, storm drain, gas, etc., prior to commencing construction.
6. The District shall be notified at least 48 hours prior to starting construction. Any construction done without approved plans or without prior notification will be subject to rejection and rework at the contractor's expense.
7. No revision to the sewer system shall be made to these plans without District approval.
8. The District shall not survey or layout any portion of the work. District reserves the right to require field notes generated by developer's surveyor and to field check work in progress.
9. Pipeline deflection on horizontal curves shall not exceed the manufacture's

recommendations.

10. All lateral sewers shall be constructed with a wye installed on the sewer main at an upward 45° angle, at right angles to the sewer main, and extending straight toward to property to be served unless shown otherwise on the approved plans. The building sewer shall be appropriately sized per the *California Plumbing Code*, however the lateral sewer portion of the building sewer shall be 4" minimum for residential and 6" minimum for multiple residential and commercial development and shall be installed with a minimum grade of 2% to the property line. The depth of the lateral sewer at the property line shall be ≥ 4'. A cleanout shall be installed immediately behind the property line for the property owner's use.
11. Solvent joints are not acceptable on sewer main and sewer lateral installations.
12. Inspection of trench alignment, preparation of bedding, placement of pipe and embedment zone backfill, placement of manhole, and installation of frames and covers is required. Submittals of soil compaction testing, air testing, flushing, mandrel pull, and closed circuit television (CCTV) inspection are required. Approval of all inspection and testing is required prior to acceptance.
13. Sewer lines shall be air pressure tested in accordance with section 306-7.8.2.4 of the *Standard Specifications for Public Works Construction*, latest edition, once the trench has been backfilled and compacted but before paving.
14. Separation and clearance between sewer lines and water lines shall be per the California Department of Public Health's *Criteria for the Separation of Water Mains and Sanitary Sewers*. Separation and clearance between sewer lines and all other underground utilities shall be a minimum of 6" unless otherwise specified by the other utility. Water line thrust blocks shall not be located on top of sewer pipes.
15. Manhole frames and covers shall be South Bay Foundry SBF 1254-07, or approved equivalent, and shall be stamped "LCSD SEWER" or "LAGUNA SANITATION SEWER." Manholes not located in paved streets shall have an approved bolt down cover and shall have a concrete jacket per the District Standard Drawing Number 3. Covers for privately owned manholes shall be labeled "SEWER" or "SANITARY SEWER."
16. 4' diameter manholes shall use concentric cones. Manhole interiors shall be coated per manufacturer's recommendations with an approved coating product consistent with the sanitary sewer environment when manhole depths exceed fifteen feet (15'), for drop manholes, and on manholes not located in paved areas.
17. Manhole covers shall extend 18" above finished grade in unimproved rights of way and 6" above grade in landscaped areas and shall be protected from damage

with bollards when determined necessary.

18. Manhole channels shall be protected with false bottoms until all grading and roadwork is complete.
19. Record drawings showing the actual location of all sewer mains, structures, wyes, laterals, manholes, cleanouts, easements, etc., shall be submitted to the District before final acceptance of the work.

5.02 *Standard Drawings*

Standard drawings applicable to the work shall be included in the public improvement plans. Special details as may be required must also be included on the plans.

SECTION 6 - RULES AND REGULATIONS

6.01 Governmental Structure

The Laguna County Sanitation District is a county sanitation district formed pursuant to Health and Safety Code Section 4700 et seq. It is a dependent district to the County of Santa Barbara such that the Board of Supervisors acts as its ex-officio Board of Directors. The District's local rules and regulations are located primarily in Chapters 29 Articles I and III of the Santa Barbara County Code and may be amended. Chapter 24A of the Santa Barbara County Code contains enforcement provisions for violations to Chapter 29 Articles I and III. Establishment of standards for facilities connecting to the sewerage system of the District may be prescribed pursuant to Health and Safety Code Section 4762.1. Requirements of outside regulatory agencies may apply, replace or amend criteria set forth in these rules and regulations.

SANTA BARBARA COUNTY CODE, CHAPTER 29, ARTICLE I. IN GENERAL

§ 29-1. "Sanitary sewer system" defined. Sanitary sewer system, as used in this article, includes the treatment plant, trunk lines, collectors, laterals, pumps, pumping stations and other lines and facilities of sanitary districts, sanitation districts and any other community sewer system rendering sewer service to the public, whether publicly owned or privately owned.

§ 29-2. Discharge of surface water, etc., into sanitary system. No person shall discharge surface waters, storm waters, stream waters or any other runoff of water or any other substance from the surface of the land into any sanitary sewer system or into any pipe, conduit or fixture leading into a sanitary sewer system, without first obtaining consent from the owner or manager of the sewer system.

§ 29-3. Flushing new sewer lines into sanitary system. No person whether as agent or principal, in the course of constructing or testing or cleaning out any new sewer lines, shall ball or flush the new sewer lines into a sanitary sewer system without first obtaining the express consent of the manager or owner of the sanitary sewer system.

§ 29-4. Removing manhole covers; throwing rubbish, etc., into sanitary system. No person shall remove any manhole cover or covers from any manhole of a sanitary sewer system, except in an emergency, without first having obtained the consent of the manager or owner of the sanitary sewer system; and no person shall throw, place or discharge, or cause to be thrown, placed or discharged, any rubbish or refuse or sewage or any other matter into a manhole or other facility or line of any sanitary sewer system, except with the express authorization of the manager or other authorized officer.

§ 29-5. Tampering, etc., with sanitary system; unlawful connection. No person shall tamper with, damage, cut into, perforate, or make or maintain any connection whatsoever to any sanitary sewer system or any portion thereof, or any pipeline of the sanitary sewer system without having previously obtained the consent of the manager or other authorized officer of the district or other owner or operator of the sanitary sewer system and having paid any applicable connection fees or other charges. Any unauthorized connection to a sanitary sewer system shall constitute a continuing offense so long as such connection exists.

SANTA BARBARA COUNTY CODE, CHAPTER 29, ARTICLE II. NOT APPLICABLE TO SEWER SYSTEMS

SANTA BARBARA COUNTY CODE, CHAPTER 29, ARTICLE III. DISCHARGE INTO LAGUNA COUNTY SANITATION DISTRICT TREATMENT SYSTEM

§ 29-21. Purpose of article. The purpose of this article is to prevent waste discharge from adversely affecting the district's sewer system, the operation of the district's treatment facilities or the quality of the effluent from the district's treatment plant, through regulations and control of the quality of wastes received by the district's sewer system.

§ 29-22. Authority. This article is adopted pursuant to provisions of section 4700 et seq. of the state Health and Safety Code.

§ 29-23. Administration and implementation of article. The manager of the Laguna County Sanitation District shall administer and implement the provisions of this article. Any powers granted to or duties imposed upon the manager may be delegated by him to persons acting in the beneficial interest of or in the employ of the district. The manager may issue such rules and regulations as are necessary for the proper and ordinary administration of this article.

§ 29-24. Penalties for violation.

- (a) Pursuant to Section 4766 of the Health and Safety Code, a violation of a regulation or ordinance of the district shall be a misdemeanor, punishable by fine not to exceed one thousand dollars, imprisonment not to exceed 30 days, or both. Each day of violation shall be a separate offense.
- (b) Any person responsible for violating any provision of this or any other ordinance of the district shall be held strictly responsible for any and all acts of agents or employees done under the provision of this or any other ordinance, rule, or regulations of the district.
- (c) Pursuant to Section 54739 of the Government Code, any violation of any

industrial waste discharge or pretreatment requirement related to the district's collection system and treatment works may be subject to the imposition of civil liabilities pursuant to Section 54740 of the Government Code or administrative complaints and penalties pursuant to Section 54740.5 of the Government Code, including but is not limited to violating the following standards and requirements, as may be amended, superseded, or replaced from time to time: the discharge limits and appropriate protective facilities requirements for fats, oils, and grease in food service establishments pursuant to the district's Ordinance No. 4867 (adopted Sept. 17, 2013) and/or as set forth in this Chapter; all other prohibited discharges or pretreatment requirements identified in this Chapter; the State Water Resource Control Board's Statewide General Waste Discharge Requirements for Sanitary Sewer Systems, Order No. 2006-0003 and district's associated Sewer System Management Plan; the Central Coast Region Regional Water Quality Control Board's Waste Discharge Requirements and Master Recycling Permit for the district, Order No. R3-2011-0217; and any other relevant or related discharge or pretreatment requirements set forth in federal, state, or local rules, regulations, or laws.

The district may issue an administrative complaint and impose civil penalties, as follows:

- 1) An administrative complaint will be served on the person subject to the discharge or pretreatment requirement either personally or by certified mail.
- 2) The administrative complaint will identify the following: (1) the act or failure to act that constitutes a violation of the local agency's requirements; (2) the provisions of law authorizing civil liability to be imposed; (3) the proposed civil penalty; (4) that a hearing will be conducted within 60 days of serving the complaint; and (5) that a right to a hearing may be waived.
- 3) Unless waived, a hearing will be conducted before the manager, serving as the hearing officer for the district, within 60 days of serving the complaint on the person. The person may appeal the manager's decision to the district's Board within 30 days of the notice of the manager's decision.
- 4) At the hearing (or appeal), the manager (or Board) may assess a civil penalty against the person based on all relevant circumstances including the following:
 - i. The economic benefit derived through non-compliance;
 - ii. The nature and persistence of the violation;
 - iii. The length of time over which the violation occurred; and

- iv. Corrective action taken or attempted by the person
- 5) Civil penalties may be imposed by the district, as follows:
- i. Not to exceed two thousand dollars for each day for failing or refusing to furnish technical or monitoring reports.
 - ii. Not to exceed three thousand dollars for each day for failing or refusing to timely comply with any compliance schedule established by the district.
 - iii. Not to exceed five thousand dollars per violation for each day for discharges in violation of any waste discharge limitation, permit condition, or requirement issued, reissued, or adopted by the district.
 - iv. Not to exceed ten dollars per gallon for discharges in violation of any suspension, cease and desist order or other orders, or prohibition issued, reissued, or adopted by the district.
 - v. The amount of any civil penalties imposed under this subsection which have remained delinquent for a period of 60 days shall constitute a lien against the real property of the discharger from which the discharge originated resulting in the imposition of the civil penalty. The lien provided herein shall have no force and effect until recorded with the county recorder and when recorded shall have the force and effect and priority of a judgment lien and continue for 10 years from the time of recording unless sooner released, and shall be renewable in accordance with the provisions of Sections 683.110 to 683.220, inclusive, of the Code of Civil Procedure.
 - vi. Monies collected will be placed in a special account for monitoring, treatment, and control of discharges or other mitigation measures.
- 6) Unless appealed, an order setting administrative civil penalties will be effective and final upon issuance, and payment shall be made within 30 days thereof. Copies will be served by personal service or by registered mail upon the party served with the administrative complaint and upon other persons who appeared at the hearing and requested a copy.
- 7) The district may petition the superior court to confirm any order establishing civil penalties, and an aggrieved party may obtain review in superior court pursuant to Government Code Section 54740.6.
- (d) Pursuant to Section 53069.4 of the Government Code, any violation of any ordinance enacted by the district may be subject to an administrative fine or penalty. Any person found to be violating any provision of this or any other ordinance, rule or regulation of the district is subject to the

procedures provided for in Chapter 24A of the Santa Barbara County Code, as may be amended from time to time. Pursuant to Section 4766 of the Health and Safety Code, any violation of a regulation or ordinance of the district is a misdemeanor and may be subject to a fine up to one thousand dollars, imprisonment not exceeding 30 days, or both.

- (e) Continued habitation of any building or continued operation of any facility in violation of the provisions of this Chapter or any other ordinance, rule or regulation of the district is hereby declared to be a public nuisance. The district may cause proceedings to be brought for injunctive relief and/or for the abatement of the occupancy of the building or facility during the period of such violation. In such event there is to be paid to the district reasonable attorney's fees and costs of suit arising in said action in an amount to be set by the court.
- (f) When necessary to correct an existing or imminent threat to public safety, the environment, or the district sewer facilities, including sewer blockages and sanitary sewer overflows, the district may enter upon the property and summarily abate, restore, and take those actions necessary to prevent further harm from the threat, including severing pertinent connections to the district sewer facilities, at the responsible party's expense.
- (g) Any person violating any of the provisions of the ordinances, rules or regulations of the district shall become liable to the district for any expense, loss or damage occasioned by the district by reason of such violation, including but not limited to all costs to clean and repair facilities and any liability in civil proceedings to the district for any expense, loss or damage to the district's sewer system, treatment facilities, or treatment process and for any fines imposed on the district under section 13350 of the California Water Code or pursuant to section 5650 of the California Fish and Game Code, as the result of a discharge in violation of this article.
- (h) In addition to the enforcement and collection provisions in Chapter 24A, any moneys owed to the district pursuant to this section that are not paid in the time and manner prescribed by the district may be collected as delinquent charges. Pursuant to Section 5473.10 of the Health & Safety Code, the district may impose a 10% basic penalty and a 1 and one-half percent per month penalty for nonpayment of said charges. If the amounts remain delinquent and unpaid for 60 days, the district may secure such delinquent charges by filing a certificate of lien in the office of the county recorder pursuant to Section 5473.11 of the Health & Safety Code or Section 54740.5(d)(5) of the Government Code, as applicable, and/or the district may elect to have said charges collected on the tax roll pursuant to Section 5473 et seq. of the Health & Safety Code.

- (i) The district's manager may revoke or suspend any permit and/or sewer or water service when it is determined that the customer:
- 1) Knowingly provides a false statement, representation, record, report, or other document to the District.
 - 2) Refuses to provide records, reports, plans, or other documents required by the District.
 - 3) Falsifies, tampers with, or knowingly renders inaccurate any monitoring device or sample collection method.
 - 4) Fails to comply with the terms and conditions of permit suspension.
 - 5) Discharges effluent to the District's sewer system while its permit is suspended.
 - 6) Refuses reasonable access to the permittee's premises for the purpose of inspection and monitoring.
 - 7) Does not make timely payment of all amounts owed to the District for user charges, permit fees, or any other fees imposed pursuant to this Ordinance.
 - 8) Causes interference, sewer blockages, or sewer system overflows with the District collection, treatment, or disposal system.
 - 9) Violates grease interceptor installation or maintenance requirements, any condition or limit of its discharge permit, or any other provision of the District's fats, oils and grease requirements.

§ 29-25. Definitions. For the purposes of this article, the following words and phrases shall have the meanings respectively ascribed to them by this section:

Backflow Prevention Device. A backwater valve or other device approved for use by the Uniform Plumbing Code used to prevent reverse flow.

Brine Waste. A concentrated solution of dissolved solids which may be produced as a result of regeneration of a water softener exchange bed that has been used to soften water.

Discharge. To place or cause to be placed in the district's sewer system.

District. Laguna County Sanitation District.

District's Sewer System. All district's facilities required for the conveyance of wastes to the district's treatment facility.

District Treatment Facilities. Any works, equipment or structure utilized by the district in the physical, chemical or biological treatment of waste prior to final disposal.

Fats, Oils, and Grease. Any substance such as vegetable or animal product used in or is a byproduct of cooking or food preparation that may turn viscous or may solidify with a change in temperature.

Food Service Establishment. An establishment that prepares and serves foodstuffs by frying, baking, grilling, sautéing, rotisserie cooking, broiling, boiling, blanching, roasting, toasting, poaching. Also included are heating, searing, barbecuing, and other food preparation activity that produces a hot, non-drinkable food product in or on a receptacle that requires washing.

Manager. Manager of the Laguna County Sanitation District or his duly authorized representative.

Pretreatment Facility. Any works, equipment or structure employed by the user for the physical, chemical or biological treatment or flow limitation of waste prior to its discharge into the district's sewer system.

Properly Shredded Garbage. Solid waste derived from domestic, commercial or industrial preparation, cooking and dispensing of food which has been shredded to such a degree that all particles will be carried freely under the flow conditions normally prevailing in the district's sewer system.

Protective Facilities. Any works, equipment or structure required to insure that industrial waste does not have a deleterious effect on the receiving waters, the district's sewer system or treatment facilities (1) including physical, chemical and biological treatment prior to discharge to the district's sewer system, (2) storage to contain accidental spillage or eliminate sludge flows, and (3) all other facilities for the proper management of industrial wastes.

Receiving Waters. Those waters (including groundwater) to which effluent or its constituents, in total or in part, are ultimately returned after having passed through the district's sewer system and treatment facility.

Recycled Water. Water which, as a result of treatment of waste, is suitable for direct beneficial use or a controlled use that would not otherwise occur and is therefore considered a valuable resource.

Strong Concentrations. Any material not specifically mentioned in this article which is of sufficient concentration to result in deleterious effects on the district's sewer system or the receiving waters.

Unusual Strength or Character Waste. Waste treatable by the district using processes designed for domestic waste but exhibiting higher concentrations of specific constituents such as chemical oxygen demands, biochemical oxygen demand and suspended solids.

User. Any person that discharges, causes or permits the discharge of waste into the district's sewer system.

Waste. Any material discharged into the district's sewer system.

Waste, Domestic. The water derived from the ordinary living processes, free from industrial waste and of such character as to permit satisfactory discharge without special treatment into the district's sewer system.

Waste Constituents and Characteristics. The individual chemical, physical, bacteriological and radiological parameters, including volume and flow rate and such other parameters, that serve to define, classify or measure the contents, quality, quantity and strength of waste.

Waste, Industrial. Any waste, as distinct from domestic waste, including but not limited to liquid, solid, gaseous and radioactive material resulting from any producing, manufacturing, processing of either a commercial or industrial operation of whatever nature, discharged in the district's sewer system.

Water-Softening System or Device. Any apparatus which removes compounds of calcium and magnesium from the water supply.

§ 29-26. **Prohibited wastes.** It shall be unlawful for any person to

knowingly discharge any of the following described wastes into the sewer system of the district:

- (a) Any waste having a temperature higher than one hundred forty degrees Fahrenheit.
- (b) Any waste which may contain more than one hundred milligrams per liter of fat, oil or grease.
- (c) Mineral oils, greases or other products of petroleum origin.
- (d) Any flammable or explosive waste.
- (e) Any garbage which has not been properly shredded.
- (f) Any ashes, cinders, sand, mud, straw, and shavings, metal, glass, rags, feathers, tar, plastics, wood, paunch manure, viscera or other solid or viscous substances capable of causing obstruction to the flow or undue maintenance of the district's sewer system or other interference with the proper operation of the district's treatment facility.
- (g) Any waste having pH lower than 6.0 or higher than 9.0 or waste having any other corrosive properties capable of causing damage or injury to the district's sewer system or treatment facilities or district personnel.
- (h) Any waste containing algaecides, fungicides, antibiotics, insecticides, strong concentrations of oxidizing agents or strong concentrations of reducing agents.
- (i) Any noxious or malodorous gas or substance capable of creating a public nuisance either by itself or by interaction with other substances.
- (j) Any domestic or other wastes obtained from a septic tank or chemical toilet.
- (k) Any storm water, surface water, groundwater, roof runoff, subsurface drainage or uncontaminated process water.
- (l) Any waste which exhibits or causes discoloration differing from that of domestic usage.
- (m) Any waste containing in excess of any of the following:
 - 0.2 mg/l arsenic,
 - 0.2 mg/l cadmium,
 - 0.5 mg/l copper,
 - 1.0 mg/l cyanide,
 - 1.0 mg/l lead,
 - 0.01 mg/l mercury,
 - 1.0 mg/l nickel,
 - 0.2 mg/l silver,
 - 0.5 mg/l total chromium, or
 - 2.0 mg/l zinc.
- (n) Any waste containing substances which are not amenable to treatment or which cause the treatment plant effluent to fail to meet the discharge requirements established by the California State Water Resources Control Board, the California Regional Water Quality Control Board or any other state or regulatory agency.
- (o) Any brine waste resulting from the regeneration of any water

softening system or device installed in any discretionary development project approved on or after January 1, 2012. The district may provide for such conditions, protections and improvements necessary to assure the exclusion of these wastes.

§ 29-26.1. Water-softening systems or devices.

- (a) It shall be unlawful for anyone to install any water softening system or device which discharges brine waste into the district's sewer system, to the ground or to a storm drain in any structure with occupancy approved on or after January 1, 2012.
- (b) Anyone operating a water-treating apparatus of any kind, including any water-softening system or device, shall make such apparatus accessible to the manager for inspections upon reasonable notice, and shall provide such information, as the manager may require, relative to the apparatus and its operation and maintenance.

§ 29-27. Interceptors; Fats, Oil and Grease Control. Grease, oil and sand interceptors shall be provided by any user when, in the opinion of the district, it is necessary for the proper handling of liquid wastes containing grease in excessive amounts or any flammable wastes, sand or other waste harmful to the district's sewer system or treatment facilities. All interceptors shall be of a type and capacity approved by the district and shall be so located as to be readily and easily accessible for cleaning and inspection.

Grease and oil interceptors shall be constructed of impervious materials capable of withstanding abrupt and extreme changes in temperature and shall be of substantial construction and equipped with easily removable covers, which, when bolted in place, shall be gas-tight and water-tight. When installed, all grease, oil and sand interceptors shall be maintained by and at user's expense, in continuously efficient operation.

All food service establishments shall install, operate and maintain appropriately designed interceptors to control fats, oils and grease. Multiple food service establishments may be served by a single interceptor when located on a single parcel of land. The operation of fats, oils and grease control devices by food service establishments shall include industry best management practices such as:

- (a) Removal of accumulated material when the material depth exceeds 25% of the design hydraulic depth, but not less frequently than every 6 months. Collection of accumulated material shall be by appropriately licensed waste haulers and disposal shall be pursuant to federal, state and local laws.
- (b) Use of drain screens.
- (c) Dry wiping to remove and disposal of food waste to trash receptacles.
- (d) Collection of waste cooking oil.
- (e) Maintenance of exhaust filters.

- (f) Employee training.
- (g) Kitchen signage.
- (h) Record keeping.

The following prohibitions shall apply to all food services establishments:

- (a) The installation of food grinders in new construction and the use of food grinders in existing construction after 180 days of the effective date of this ordinance unless authorized by the district manager.
- (b) The introduction of additives for the purpose of emulsifying or biologically or chemically treating fats, oils and grease for remediation or as a supplement to interceptor maintenance.
- (c) The disposal of waste cooking oil into a sewer drainage system.
- (d) The discharge of wastewater from dishwashers to any trap or interceptor.
- (e) The discharge of any waste removed or unauthorized bypass from the trap or interceptor to the sewer system.

§ 29-27.1. Sewer laterals and backflow prevention devices.

- (a) Connection to Sewer Main. The sewer lateral from the building structure to the sewer main must be constructed in accordance with the California Plumbing Code. Where the sewer lateral joins or connects to the sewer main, the connection shall be made with the use of a wye fitting. New sewer lateral connections to an existing sewer main may be made with the use of alternate wye connections.
- (b) Owner Responsibility. The owner of a property shall be responsible for ownership and maintenance of the entire sewer lateral from the building structure to the public sewer line (sewer main) connection. The district is not responsible for damage caused by line breaks or leaks occurring to the property owner's sewer lateral. The property owner shall be responsible for construction of sewer laterals and connections to the sewer main in the event no existing wye or sewer lateral stub out is available.

Installation of Backflow Prevention Device, Responsibility for Operation and Maintenance.

- 1) All new sewer laterals and all sewer lateral replacements shall be equipped with a cleanout riser fitted with a backflow prevention device of type and materials meeting California Plumbing Code requirements.
- 2) Any sewer lateral serving an existing building structure having plumbing fixtures with drain outlets at an elevation below the elevation of the rim of the manhole or cleanout on the sewer main upstream of the sewer lateral connection, shall be equipped with a cleanout riser fitted with a backflow prevention device of type and

materials meeting California Plumbing Code requirements.

- 3) The responsibility for the ownership, operation, and maintenance of the backflow prevention device and its appurtenant fittings shall be that of the property owner. Damage caused to property for the failure to comply with the requirements of the California Plumbing Code or this ordinance shall be the responsibility of the property owner.

- (c) When required, traps or interceptors, or any other pretreatment control devices, shall be installed on the sewer lateral on private property.

§ 29-28. Discharge reports. The district may require that any industrial waste user file a periodic discharge report. The discharge report may be required to include, but shall not be limited to, nature of process, volume, rates of flow, mass emission rate, production quantities, hours of operation, number and classification of employees or other information which relates to the generation of waste including waste constituents and characteristics. Such reports may also include the chemical constituents and quantity of liquid or gaseous materials stored on site even though they may not normally be discharged. In addition to discharge reports, the district may require information in the form of waste discharge permit applications and self-monitoring reports.

§ 29-29. Waste discharge permit.

- (a) Industrial Waste User. Any industrial waste user (1) who has a discharge flow in excess of fifty thousand gallons per average day or (2) who has a discharge flow in excess of five percent of the district's treatment facility or (3) who has in his discharge toxic pollutants in amounts in excess of the standards established by section 307(a) of the Federal Water Pollution Control Act, PL 92-500 and any amendments, guidelines, rules or regulations adopted thereunder, or (4) who is found by the district to have a significant impact on the district's sewer system or treatment facilities, whether singly or in combination with other industrial waste users, or (5) who discharges waste with a five day twenty degree centigrade biochemical oxygen demand greater than two hundred and forty milligrams per liter or (6) who discharges waste containing more than two hundred and fifty milligrams per liter of suspended solids or (7) who discharges waste containing any substances having the prohibited characteristics described in sections 29-26, may be required by the district to obtain a waste discharge permit and provide protective facilities, including but not limited to pretreatment facilities, before discharging any waste in the district's sewer system.
- (b) Food Service Establishment. All food service establishments must obtain a fats, oil, and grease discharge permit and must install the appropriate protective facilities, including but not limited to traps or interceptors, before discharging any waste in the district's sewer system. New food service establishments or existing development being converted to a new food

service establishment must comply with fats, oils and grease control measures prior to occupancy approval. Existing food services establishments found to not be in compliance must do so within 180 days from notice by the district. A waiver delaying this requirement for up to three years may be issued by the district to allow the food service establishment to either complete the appropriate plumbing retrofit or to demonstrate alternative technology or practices. A variance may be issued by the district where it may be physically infeasible to install the appropriate fats, oils and grease control device (provided alternate measures are employed), or for a food service establishment deemed by the district to be have limited food preparation.

- (c) A permittee shall be subject to inspections by the district and is required to maintain records for at least two years. Permittee shall notify district of any operational problems such as onsite backups or overflows. Permittee shall notify district not less than 60 days prior to any planned changes on the premises that may result in new or increased discharges.
- (d) A discharger of waste that requires a permit, or land owner housing multiple discharges on a single parcel, that has failed to install or properly operate a waste discharge control device and is found to be responsible for damage or impact to the district's facilities, a sanitary sewer overflow, or fines, shall be subject to the cost of remediating said impacts. District shall have the right to place a lien on the property to recover these costs. In addition to the penalties for violations described in section 29-24, the district may physically terminate sewer service by providing 30-day written notice via first-class mail to the landowner's last known address as indicated in the district's records for owner's failure to comply with permit requirements when in the judgment of the district there is a threat of substantial endangerment to the public, employees, the environment, overflows, or violations of federal, state or local laws. A decision to terminate service may be appealed per section 29-38.

§ 29-30. Same – Failure to obtain. It shall be unlawful for any person to knowingly fail to obtain a waste discharge permit when such is required.

§ 29-31. Protective facilities.

- (a) Plans, specifications and other pertinent information relating to proposed protective facilities (including pretreatment facilities) shall be submitted for review by the district and any other public agency which may have jurisdiction, prior to the construction. Where protective or pretreatment facilities are provided for any waste, they shall be maintained continuously in satisfactory and effective operation, without expense to the district. Submission of plans for review by the district will not relieve such person of his expense or providing additional facilities should those installed prove to be inadequate or incapable of meeting requirements for discharging established by the district.

In special cases, the district manager may require construction of sewer lines by the discharger to convey certain industrial wastes to a specific district sewer. All pretreatment systems or protective facilities determined by the district manager to require engineering design shall have plans prepared and signed by an engineer of suitable discipline licensed in the state.

A gravity separation interceptor, equalizing tank, neutralization chamber and control manhole may be required by the district to remove prohibited settleable and floatable solids, to equalize waste streams varying greatly in quantity and/or quality, to neutralize low or high pH flows and to facilitate inspection, flow measurement and sampling. Floor drains from commercial or manufacturing buildings, warehouses or multi-use structures shall not discharge directly to the sewer, but shall first discharge to a gravity separation interceptor.

(b) Any user may be required by the district to provide protection from accidental discharge or prohibited materials or other wastes discharged into the district sewer system. Retention basins, dikes, storage tanks or other facilities designed to eliminate, neutralize, offset or otherwise negate the effects of prohibited materials or wastes may be required by the district prior to the user's discharge into the district's sewer system.

Users shall notify the district immediately when accidental discharges of wastes in violation of this article occur so that countermeasures may be taken by the district to minimize damages to the sewer system, treatment plant, treatment processes and the receiving waters. Such notification will not relieve the user of liability for any expense, loss or damage to the sewer system, treatment plant or treatment process or for any fines imposed on the district on account thereof under section 13350 of the California Water Code or for violation of section 5650 of the California Fish and Game Code.

(c) Within fifteen days of the date of any accidental discharge, the user shall furnish to the district a detailed written statement describing the causes of the accidental discharge.

(d) In order that any employees of a waste discharge permittee be more fully informed of district requirements, copies of this article shall be permanently posted on the premises of the waste discharge permittee together with such other industrial waste information and notices which may be furnished by the district from time to time directed toward more effective water pollution control.

§ 29-32. Control manholes. Any waste discharge permittee may be required by the district to install a control manhole to facilitate observation, sampling and measurement of the wastes. Such manhole, when required, shall be accessible and safely located, may be required to separate industrial waste

from domestic waste until the industrial wastes have passed through any required protective facility or pretreatment system or device and shall be constructed in accordance with standardized plans approved by the district. The manhole shall be installed and maintained without expense to the district in a safe condition and accessible to district personnel at all reasonable times.

§ 29-33. Waste volume determination. The district may determine the volume of waste discharge for the purposes of user charges and fees based upon one of the following methods:

- (a) The total amount of water used from all sources including public or private, less that portion of such water diverted from the district's sewer system for which the user presents to the district evidence satisfactory to the district of the amount of such diversion.
- (b) In the event that the user discharges materials that will increase the volume of discharge over and above the volume as determined by subsection (a) of this section, the district may require the user to meter the discharge.
- (c) In the event the volume of discharge is unable to be determined by measurement, the district shall prepare an estimate of the volume of discharge based upon such factors as numbers of fixtures, seating capacity, population equivalent, annual production of goods and/or services and such other determination of volume of waste discharged.

§ 29-34. Measurements, tests and analyses. All measurements, tests or analyses of the characteristics of waste to which reference is made in this article shall be determined in accordance with "Standard Methods for the Examination of Water and Waste-Water," 13th Ed., published by the American Waterworks Association and later editions and amendments thereto or other methods acceptable to the district and shall be determined by suitable samples.

§ 29-35. Right of entry. The manager and other duly authorized employees of the district shall be permitted to enter all properties served by the district for the purposes of inspection, observation, measurement, sampling and testing in accordance with the provisions of this article.

§ 29-36. Waste users charges and fees.

- (a) Classification of Users. All users shall be classified by the district according to the principal activity conducted on the user's premises and based on the typical waste constituents and characteristics for that type of user as determined by the district. The purpose of such classification is to facilitate the regulation of waste discharges based on waste constituents and characteristics to provide an effective means of source control and to establish a system of user charges and fees which will insure an equitable

recovery of the district's costs. Waste constituents and characteristics may include but not be limited to the following: Volume, Suspended Solids, Chemical Oxygen Demand (COD), Biochemical Oxygen Demand (BOD), Oil and Grease and Chlorine Demand.

(b) Types of Charges and Fees. A user classification service charge may be adopted for each user category based upon the charges for the average waste constituents and characteristics for each user classification. The charges for each waste constituent and characteristics shall be established by the district. The district may adopt a schedule of service charges and fees which may include:

- 1) User classification charges.
- 2) Fees for monitoring.
- 3) Fees for permit applications.
- 4) Appeal fees.
- 5) Charges and fees based on waste constituents and characteristics to include industrial cost recovery provisions of the Federal Water Pollution Control Act, PL 92-500, and amendments thereto.
- 6) Connection charges.

(c) Determination of User Charges. Each user shall pay the applicable charge as established by the district for service charges, connection charges and other fees and methods of fee collection by the district. Should the district manager determine a user is discharging waste which does not have levels of biochemical oxygen demand, chemical oxygen demand, suspended solids or other constituents comparable with domestic waste, the district shall establish a service charge for such a user which is based on that user's proportional contribution to the total treatment works loading and the district's operational and maintenance costs.

For any user, including but not limited to industrial or commercial users, the district may establish a service charge by use of the following user charge models:

- 1) Model No. 1. If the treatment works is primarily flow dependent or if the BOD, suspended solids and other wastes constituents and characteristics discharged by all users are approximately equal, then user charges can be developed on a volume basis in accordance with the model below:

$$C_u = CT/VT (V_u)$$

- 2) Model No. 2. When BOD, COD, suspended solids, or other waste constituents and characteristics from a user exceed the range of concentration in normal domestic waste, a surcharge added to a base charge, calculated by means of Model No. 1 can be levied. The surcharge

can be computed by the model below:

$$C_s = (B_c(B) + S C(S) + P_c(P)) V_u$$

- 3) Model No. 3. This model is commonly called the "quantity/quality formula": $C_u = V_c V_u + B_c B_u + S_c S_u + P_c P_u$. The symbols used in the models are as defined below:

C_T = Total operation and maintenance (O. & M.) costs per unit of time.

C_u = A user's charge for O. & M. per unit of time.

C_s = A surcharge for waste of excessive strength.

V_c = O. & M. cost for transportation and treatment of a unit of waste volume.

V_u = Volume contribution from a user per unit of time.

V_T = Total volume contribution from all users per unit of time.

B_c = O. & M. cost for treatment of a unit of biochemical oxygen demand (BOD).

B_u = Total BOD contribution from a user per unit of time.

B_T = Total BOD contribution from all users per unit of time.

B = Concentration of BOD from a user above a base level.

S_c = O. & M. cost for treatment of a unit of suspended solids.

S_u = Total suspended solids contribution from a user per unit of time.

S = Concentration of SS from a user above a base level.

P_c = O. & M. cost for treatment of a unit of any waste constituent and characteristic.

P_u = Total contribution of any waste constituent and characteristic from a user per unit of time.

P_T = Total contribution of any waste constituent and characteristic from all users per unit of time.

P = Concentration of any waste constituent and characteristic from a user above a base level.

§ 29-37. Special agreements. Special agreements and arrangements between the district and any persons or agencies may be established when in the opinion of the district unusual or extraordinary circumstances compel special terms and conditions.

§ 29-38. Appeals. All decisions, interpretations or acts of the district manager shall be subject to appeal to the board of directors of the district. Any person affected by such decision may, within thirty days after such decision is rendered, file with the clerk of the board of directors of the district an appeal in writing protesting against such decision. The board of directors of the district may, after a public hearing thereon, amend, overrule or approve the decision of the district manager.

§ 29-39. Recycled water, use of.

- (a) It is the policy of the Laguna County Sanitation District that recycled water be used wherever it is available in conformance with California Water Code sections 13550 and 13551.
- (b) A person or public agency, as used in California Water Code section 13551, shall not use water from any source of quality suitable for potable domestic use for nonpotable uses if suitable recycled water is available as provided in section 13550.
- (c) The district shall review the facts and make a preliminary determination pursuant to California Water Code section 13550 if a parcel or parcels of land are required to comply with subsection (b) of this section and establish a time schedule for compliance. A notice of that preliminary determination and a time schedule for compliance shall be sent to the owner of the parcel(s) using for this purpose, the last known name and address of such owners as shown upon the last assessment roll of the County of Santa Barbara. Any notice by the district under this section shall be deemed given when properly addressed and deposited into the United States mail with postage fully pre-paid or personally delivered to the owner. The owner may file a notice of objection which must be in writing, must specify the reasons for the objections and must be filed with the district within twenty days after it is given or mailed to the owner. The preliminary determination and time schedule for compliance shall be final if the owner does not file a timely objection. The district shall meet with the owner to attempt to resolve the objections. If the objections cannot be resolved to the mutual satisfaction of the district and owner, the district shall give the owner a final determination and make a request pursuant to article 2 (commencing with section 648) of chapter 1.5 of division 3 of title 23 of the California Code of Regulations that the State Water Resources Control Board, Regional Water Quality Control Board and any other appropriate agencies conduct a hearing to determine if the parcel or parcels must use recycled water pursuant to Water Code sections 13550 and 13551.

SANTA BARBARA COUNTY CODE, CHAPTER 29, ARTICLE IV. NOT APPLICABLE TO SEWER SYSTEMS

SANTA BARBARA COUNTY CODE, CHAPTER 24A

§ 24A-1 Administrative fines or penalties in addition to other remedies – Authority, definitions

In addition to any other remedy allowed by this Code or applicable law, any violation of the provisions of Santa Barbara County Code chapters 6 (article III), 7, 9A, 10, 11, 14 (excluding the "potential for significant environmental damage"

clause of section 14-8(c)(8)), 14C, 15, 16, 17, 18 (articles I, III, IV and V), 18C, 23 (article III), 25, 26, 29 (articles I, III and IV), 34A, 34B, 34C, 35, 37 and 44, shall be subject to an administrative fine or penalty, enforcement and collection proceedings, as set forth in this chapter and authorized by California Government Code Section 53069.4. For purposes of this article, "director" shall include the treasurer-tax collector, the director of animal services, the director of planning and development, the agricultural commissioner, the fire chief, the director of public works, the director of environmental health services, the director of community services, and their designees. Unless otherwise specified, "owner" shall include the owner of property upon which a violation of this article exists, the occupant of that property and any other party responsible for the violation.

§ 24A-2 Procedures

- (a) The treasurer-tax collector or his or her designee shall be responsible for implementing the procedures set forth in this chapter with respect to violations of chapter 6 (article III). The director of animal services or his or her designee shall be responsible for implementing the procedures set forth in this chapter with respect to violations of chapter 7. The director of planning and development or his or her designee shall be responsible for implementing the procedures, set forth in this chapter with respect to violations of chapters 9A, 10, 11, 14 (excluding the "potential for significant environmental damage" clause of section 14-8(c)(8)), 14C, 25 and 35 of the Santa Barbara County Code. The agricultural commissioner or designee shall be responsible for implementing the procedures set forth in this chapter with respect to violations involving native oak tree removal under chapter 14 and violations of the weights and measures registration requirements under chapter 34C of the Santa Barbara County Code.

The fire chief or his or her designee shall be responsible for implementing the procedures set forth in this chapter with respect to violations of chapters 15 and 18 (articles III, IV and V). The director of environmental health services or his or her designee shall be responsible for implementing the procedures set forth in this chapter with respect to violations of chapters 16, 18 (article I), 18C, 34A and 34B of the Santa Barbara County Code. The director of public works or his or her designee shall be responsible for implementing the procedures set forth in this chapter with respect to violations of chapters 17, 23 (article III) and 29 (articles I, III and IV) of the Santa Barbara County Code. The director of community services, or his or her designee shall be responsible for implementing the procedures set forth in this chapter with respect to violations of chapter 26, 37 and 44.

- (b) Upon determining that a violation of any provision of chapters 6 (article III), 9A, 10, 11, 14 (excluding the "potential for significant environmental damage" clause of section 14-8(c)(8)), 14C, 15, 16, 17, 18 (articles I, III, IV and V), 18C, 23 (article III), 25, 26, 29 (articles I, III and IV), 34A, 34B, 34C,

35, 37 or 44 of this Code exists with respect to any property, the director shall transmit a notice of violation to the owner by certified mail or by personal service by a public officer, or other service methods in accordance with California Code of Civil Procedure Section 415.20, as amended. The notice of violation shall specify:

- 1) The conditions constituting violations;
 - 2) A specified time period not less than thirty days from receipt of the notice of violation within which the violation must be abated;
 - 3) That the conduct, activity or circumstances constituting the violation must be stopped immediately or immediate steps must be taken to make the correction;
 - 4) That, in the event the violation is not corrected by the expiration of the specified time period ("effective date of the notice of violation"), the owner shall be subject to an administrative fine under this chapter; and
 - 5) That the owner may submit in writing, to the director, any information relating to a determination of the existence of a violation or the amount of the fine to be imposed. If the director determines that an effort is being made to correct the violation, he or she may grant an additional period of time for correction of the violation.
- (c) Notwithstanding subsection (b) of this section, the director may require immediate correction of a violation if the violation creates an immediate danger to the health and safety of persons or property.
- (d) The director may condition any building permit, grading permit or land use permit issued to remediate a violation to require that the work or project described in the permit be completed by a certain date or in a certain period of time. Failure to complete the work or project by the date or within the time stated in a permit condition shall be good cause in the discretion of the director to:
- 1) Issue a stop work order; and/or
 - 2) Suspend or revoke the permit; and/or
 - 3) Impose administrative fines for the permit violation.

§ 24A-3 Amount of fine - General.

Any person who violates any provision of chapters 6 (article III), 7, 10, 11, 14 (excluding the "potential for significant environmental damage" clause of section 14-8(c)(8)), 14C, 15, 16, 17, 18 (articles I, III, IV and V), 18C, 23 (article III), 25, 26, 29 (articles I, III and IV), 34A, 34B, 34C, 35, 37 or 44 of this Code, or any person who owns property upon which a violation exists, irrespective of whether that

person caused the violation, shall be subject to an administrative fine up to the maximum amounts as set forth below.

Notwithstanding any other provision of law, a violation of local building and safety codes determined to be an infraction is punishable by (1) a fine not exceeding one hundred dollars for a first violation; (2) a fine not exceeding five hundred dollars for a second violation of the same ordinance within one year; (3) a fine not exceeding one thousand dollars for each additional violation of the same ordinance within one year of the first violation.

§ 24A-4 Amount of fine - Infraction

If this code designates the violation as an infraction, the director shall impose as the administrative fine up to the maximum fine or penalty amounts for infractions set forth in subdivision (b) of California Government Code Section 25132; the director shall impose the fine if the violation is not abated by the effective date of the notice of violation.

§ 24A-5 Amount of fine - Other

If this Code does not designate the violation as an infraction, or deems as a separate and distinct violation each and every day during which a violation continues to exist or, if it provides in the alternative for civil remedies and penalties in amounts greater than set forth in subdivision (b) of California Government Code Section 25132, the director shall impose an administrative fine within the amounts set forth below:

- (a) If the violation arises from an unlawful commercial, industrial, rental (residential or nonresidential), owner-occupied residential or similar use or structure on the property, the director, in his or her discretion, shall impose a fine in one of the following sums:
 - 1) One hundred dollars for the date of transmittal of the notice of violation, and up to one hundred dollars for each calendar day thereafter that the violation exists on the property through the effective date of the notice of violation for initial notice of violation, two hundred dollars per day for second notice of violation and five hundred dollars per day for any third or subsequent notice of violation for the same violation, within one year.
 - 2) In addition to the fines described in subsection (a)(1), in the event that the use of a structure in violation may be permitted with an appropriate permit, up to a maximum of five times the amount of the standard fee for such permit.
- (b) In the event that an action results in a "one-time" violation which cannot be corrected/cured (e.g., violation of permit conditions, use violations, etc.) the director may impose fines under an immediate notice of

determination of fines up to one thousand dollars per each one-time action.

- (c) If a violation is corrected pursuant to a notice of violation and the same conduct is committed within forty-five days of the correction, the violation will be deemed a continuing violation and immediate fines will be incurred dating back to the date of the original notice of violation.
- (d) Violations of Chapter 29, Articles I and III shall be subject to penalties set forth in Section 29-24.

§ 24A-6 Determination of fine – Notice of determination of fine – Recordation of notice.

- (a) In making a fine determination, the director shall take into account the facts and circumstances of the violation, including without limitation:
 - 1) The length of time the violation existed;
 - 2) The culpability of the owner and the willfulness of the violation;
 - 3) The number of previous violations of the same or related type committed by the owner within the preceding thirty-six months;
 - 4) The extent of the violation and the effect of the violation on neighboring properties;
 - 5) Attempts, if any, to comply with the applicable ordinances;
 - 6) The time necessary to abate the violation;
 - 7) Any other information relevant to a determination of the fine. In making a determination of the fine, the director shall consider any information submitted by the owner. In the event that the director determines that the violation was not caused by, or with the knowledge of, the current owner, the director may reduce or eliminate the fine. In the event the director determines that the correction of the violation is not feasible, and the violation does not present a threat to public health or safety, the director may reduce or eliminate the fine.
- (b) After making a determination of the fine, the director shall transmit a notice of determination of fine by certified mail or personal service by a public officer, or other service methods in accordance with California Code of Civil Procedures Section 415.20, as amended, to the person upon whom the fine has been imposed. The notice of determination of fine shall contain a statement that if the owner fails to request an appeal of the administrative fine, the notice of determination of fine shall be final and

that any responsible party upon whom an administrative fine has been imposed may seek judicial review of the order imposing the penalty pursuant to Government Code § 53069.4.

- (c) The director may, in his discretion, record a copy of the notice of determination of fine with the Santa Barbara County Recorder. In the event of such recordation, and in the event that the violation is subsequently corrected, the director shall record a notice of correction. Correction of the violation shall not excuse the owner's liability for costs incurred during the administrative abatement process or for payment of all fines accrued prior to correction.

§ 24A-7 Appeals

- (a) Any person upon whom an administrative fine is imposed by the director may appeal such fine pursuant to the procedures set forth in this section. The appellant must file a written appeal with the director within ten working days of personal service or the date of mailing of the notice of determination of fine. The written appeal shall contain:

- 1) A brief statement setting forth the interest the appealing party has in the matter relating to the imposition of the penalty;
- 2) A brief statement of the material facts which the appellant claims supports his or her contention that no administrative penalty should be imposed or that an administrative penalty of a different amount is warranted.

- (b) An appeal of an administrative fine imposed for violations of chapter 6, (article III) shall be heard by the treasurer-tax collector as the hearing examiner. An appeal of an administrative fine imposed for violations of chapter 7 of this Code shall be heard by the director of animal services as the hearing examiner. An appeal of an administrative fine imposed for violations of chapters 9A, 10, 11, 14 (excluding the "potential for significant environmental damage" clause of section 14-8(c)(8)), 14C, 25 and/or chapter 35 of this Code shall be heard by the director of planning and development as the hearing examiner. An appeal of an administrative fine imposed for violations of chapter 14 involving native oak tree removal or violations of the weights and measures registration requirements under chapter 34C shall be heard by the agricultural commissioner as the hearing examiner. An appeal of an administrative fine imposed for violations of chapter 15 and chapter 18 (articles III, IV and V) of this Code shall be heard by the fire chief as the hearing examiner. An appeal of an administrative fine imposed for violations of chapters 16, 18 (article I), 18C, 34A and/or 34B of this Code shall be heard by the director of environmental health services as the hearing examiner. An appeal of an administrative fine imposed for violations of chapters 17,

23 (article III) and/or 29 (articles I, III and IV) of this Code shall be heard by the director of public works as the hearing examiner. An appeal of an administrative fine imposed for violations of chapters 26, 37 and/or 44 shall be heard by the director of community services. The above-specified hearing examiner may, at his or her discretion, appoint an alternate hearing examiner. The administrative fine appeal hearing shall be set no sooner than twenty days and no later than forty-five days following a request for an appeal hearing, unless otherwise waived by the appellant in writing. Notice of the appeal hearing shall be mailed at least twelve calendar days before the date set for the hearing. Failure to appear timely will cause the administrative fine to become a final order or decision.

- (c) In reviewing the fine, the hearing examiner shall consider the factors set forth in subsection (a) of this section, and shall uphold the fine imposed by the director or his or her designee, eliminate the fine, or modify it. The decision of the hearing examiner shall constitute the final administrative order or decision of the local agency within the meaning of Government Code Section 53069.4(b)(1) and (c). The hearing examiner shall serve a copy of his or her written decision on the appellant by first class mail to the address provided by appellant in the written notice of appeal.
- (d) Alternate Hearing Examiner. Should the specified hearing examiner deem it appropriate to appoint an alternate hearing examiner, such alternate hearing examiner shall have the experience, subject matter expertise and/or knowledge of administrative procedure to properly perform those duties. An experienced public agency employee, licensed professional (attorney, engineer, accountant, health professional, etc.) or qualified administrative law judge may, as deemed appropriate by the specified hearing officer, be appointed to such duties.

§ 24A-8 Enforcement and collection

When an administrative fine or penalty becomes a final order under this section or Government Code Section 53069.4, the county may proceed to collect the fine or penalty as follows:

- (a) In the event a civil action is commenced to collect the administrative penalty, the county shall be entitled to recover all costs associated with the collection of the penalty. Costs include, without limitation, staff time incurred in the collection of the penalty and those costs set forth in Code of Civil Procedure Section 1033.5.
- (b) An administrative penalty shall accrue interest at the same annual rate as any civil judgment. Interest shall accrue commencing on the 20th day after the penalty becomes a final decision or order.
- (c) The amount of any unpaid administrative fine, plus interest, plus any

other costs as provided in this chapter, may be declared a lien on any real property owned by the owner within the county against whom an administrative penalty has been imposed, as follows:

- 1) Notice shall be given to the owner before recordation of the lien, and shall be served in the same manner as a summons in the civil action pursuant to Code of Civil Procedure Section 415.10 et seq.;
 - 2) The lien shall attach when the county records it with the county recorder's office. The lien shall specify the amount of the lien, the date of the code violations, the date of the final decision, the street address, legal description, and assessor's parcel number of the parcel on which the lien is imposed, and the name and address of the record owner of the parcel; and
 - 3) In the event that the lien is discharged, released, or satisfied, either through payment or foreclosure, the county shall record a notice of the discharge containing the information specified in subsection (2) of this section.
- (d) The county may withhold issuance of licenses, permits and other entitlements to a responsible party on any project, property, or application of any kind whenever an administrative penalty remains unpaid.
- (e) County may take such other actions as are allowed for enforcement of a civil judgment as provided for pursuant to the Enforcement of Judgment Law, California Code of Civil Procedure Section 680.010 et seq.

§ 24A-9 Judicial review

Any person aggrieved by a final administrative order or decision imposing an administrative fine may seek review with the superior court in Santa Barbara County pursuant to Government Code Section 53069.4.

SECTION 7 - STANDARD DRAWINGS AND ATTACHMENTS

Standard Drawing	Title
1	Sewer Location in Public Roads
2	Sewer Pipe Trench
3	Wye Installation in Existing Sewer Main
4	Sewer Lateral
5	Backflow Prevention Device
6	Sewer Manhole
7	Grease Interceptor

Attachments

A - Water Main Separation

B - Laguna County Sanitation District Sewer Service Application form

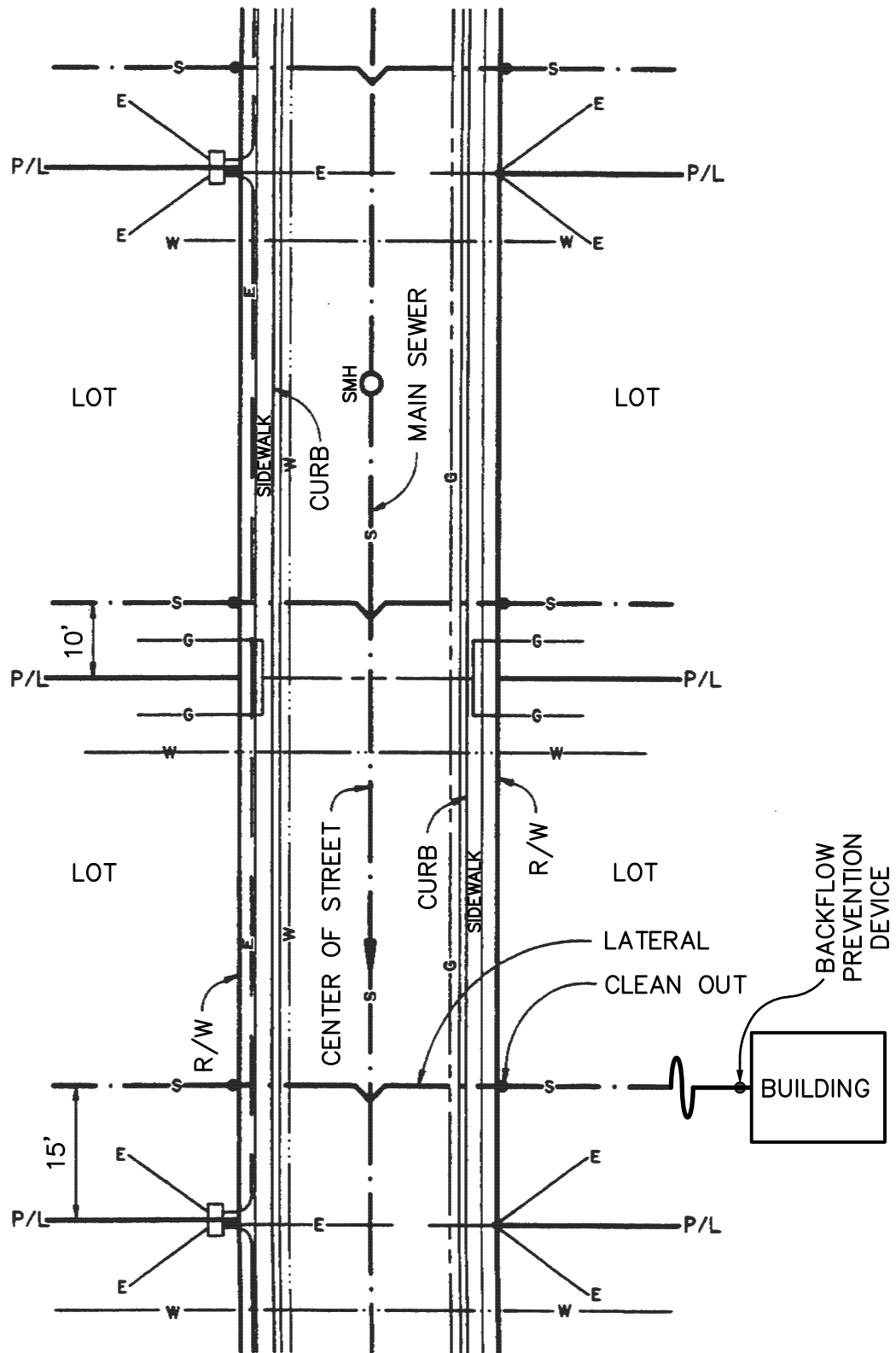

LAGUNA
COUNTY
SANITATION
DISTRICT

SEWER LOCATION IN
PUBLIC ROADS

STANDARD
DRAWING
NO. 1

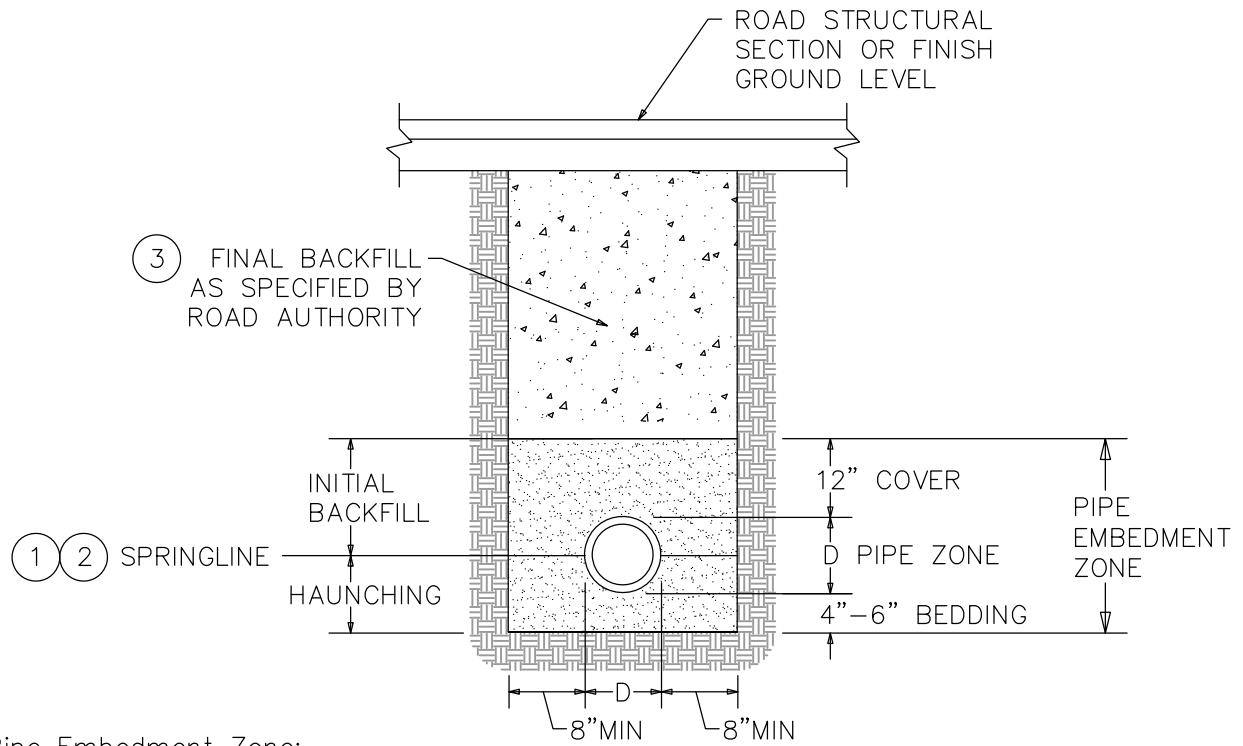

1. Pipe Embedment Zone:

The pipe embedment zone material shall be sand, gravel, crushed aggregate, or native free draining granular material having a sand equivalent of not less than 30 or having a permeability greater than 1½" per hour, or other material approved by the District.

2. Placement of Backfill Material:

Pipe bedding material shall be placed on competent foundation and compacted in the trench before the pipe is laid in place. Upon laying and securing the pipe on the bedding, the bedding material shall be shoveled and walked into the haunching area simultaneously on both sides of the pipe to the pipe spring line in such a way to eliminate voids. The balance of the material shall be placed from the pipe spring line to the 12" over the pipe and compacted. Compaction tests to be performed at developer's expense shall meet or exceed a relative compaction of 85% in the pipe embedment zone, and as specified by road authority above it. The backfill shall be placed in horizontal layers of such depths as are considered proper for the type of compaction equipment being used in relation to the backfill material being placed.

3. Approved Backfill Material:

Backfill material extending from 12" above the pipe to below a roadway structural section shall be as prescribed in a geotechnical report or encroachment permit requirements.

When not prescribed in a geotechnical report or encroachment permit, backfill material, whether native or imported, shall be free from shale, sod, roots, rubbish, trash, lumber, organic material, ashes and other debris, unusual color, contamination, and sulfide odor. Rocks, including pieces of broken concrete or bituminous pavement, originating from the native material shall have a maximum size of 6 inches and shall be dispersed within, or mixed with, the backfill material such that voids or pockets of large pieces ("nesting") are not created. Backfill material shall be compacted to a required minimum relative compaction of 90%. when pavement is to be placed directly on the backfill material, 95% relative compaction is required in the top 6".



LAGUNA
COUNTY
SANITATION
DISTRICT

SEWER PIPE
TRENCH

STANDARD
DRAWING
NO. 2

OVEREXCAVATE A MIN. OF 12" FROM COUPLING AND BACKFILL TO A MIN.

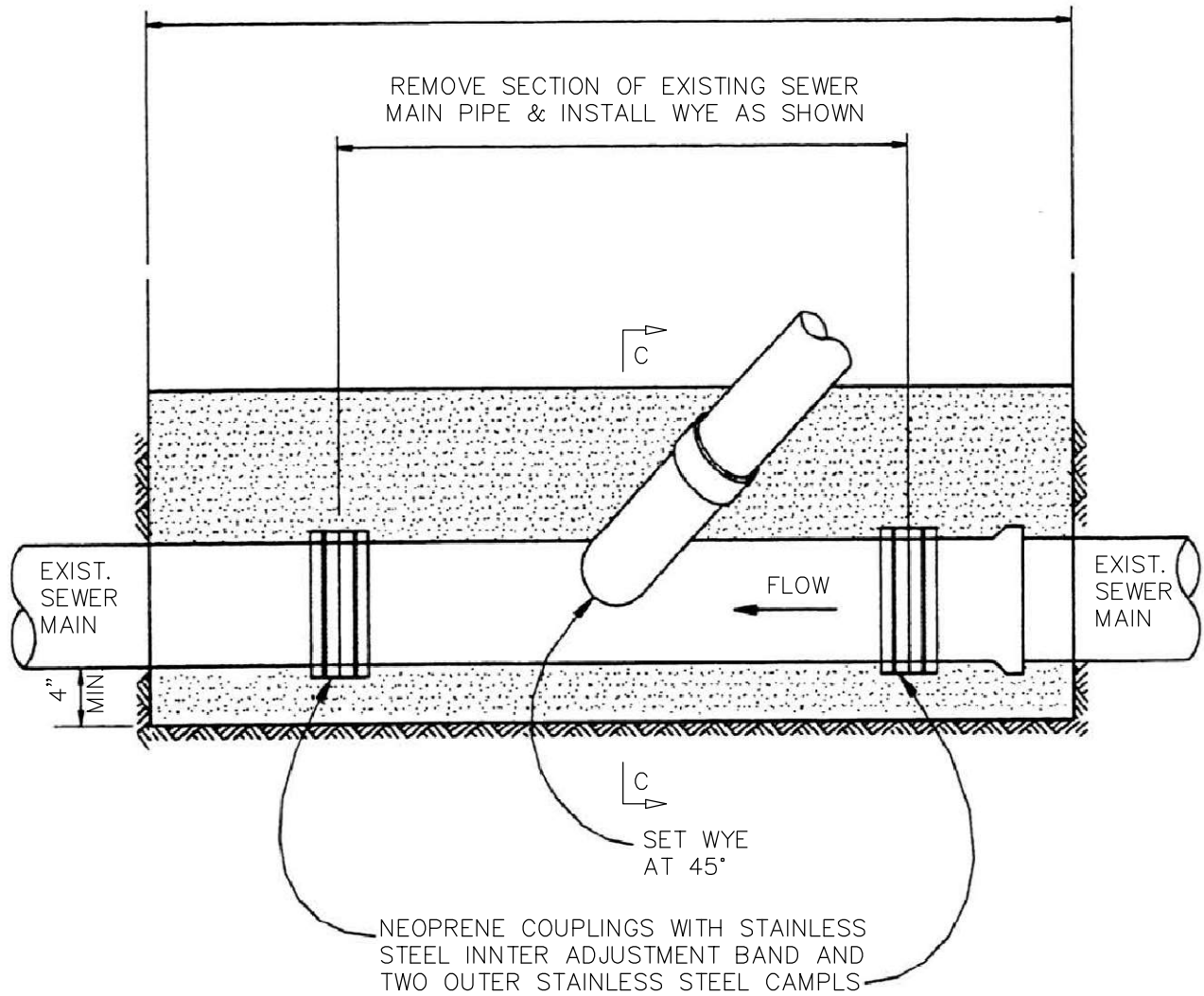

NOTE: TAPPING OR SADDLE TYPE MAY BE CONSIDERED FOR APPROVAL.

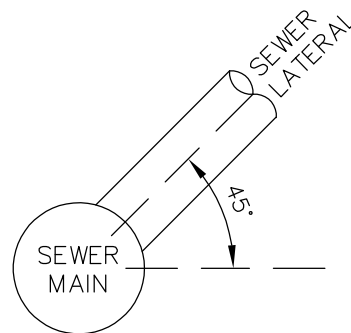

SECTION C-C



LAGUNA
COUNTY
SANITATION
DISTRICT

WYE
INSTALLATION IN
EXISTING SEWER

STANDARD
DRAWING
NO. 3

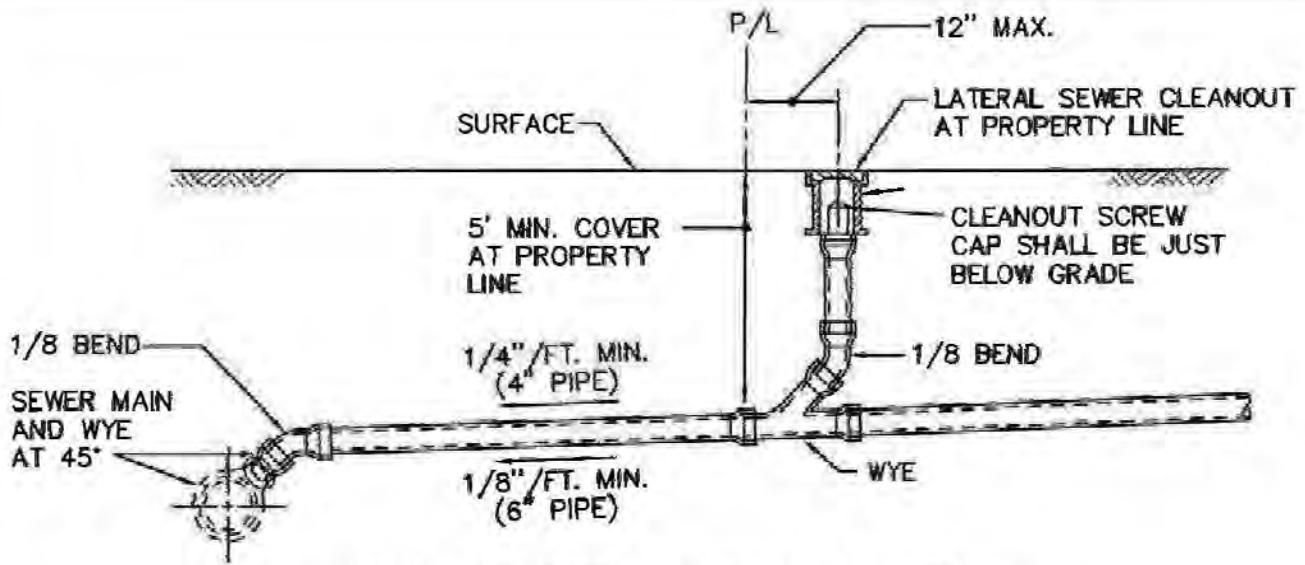

4" & 6" LATERALS AT TYPICAL DEPTH

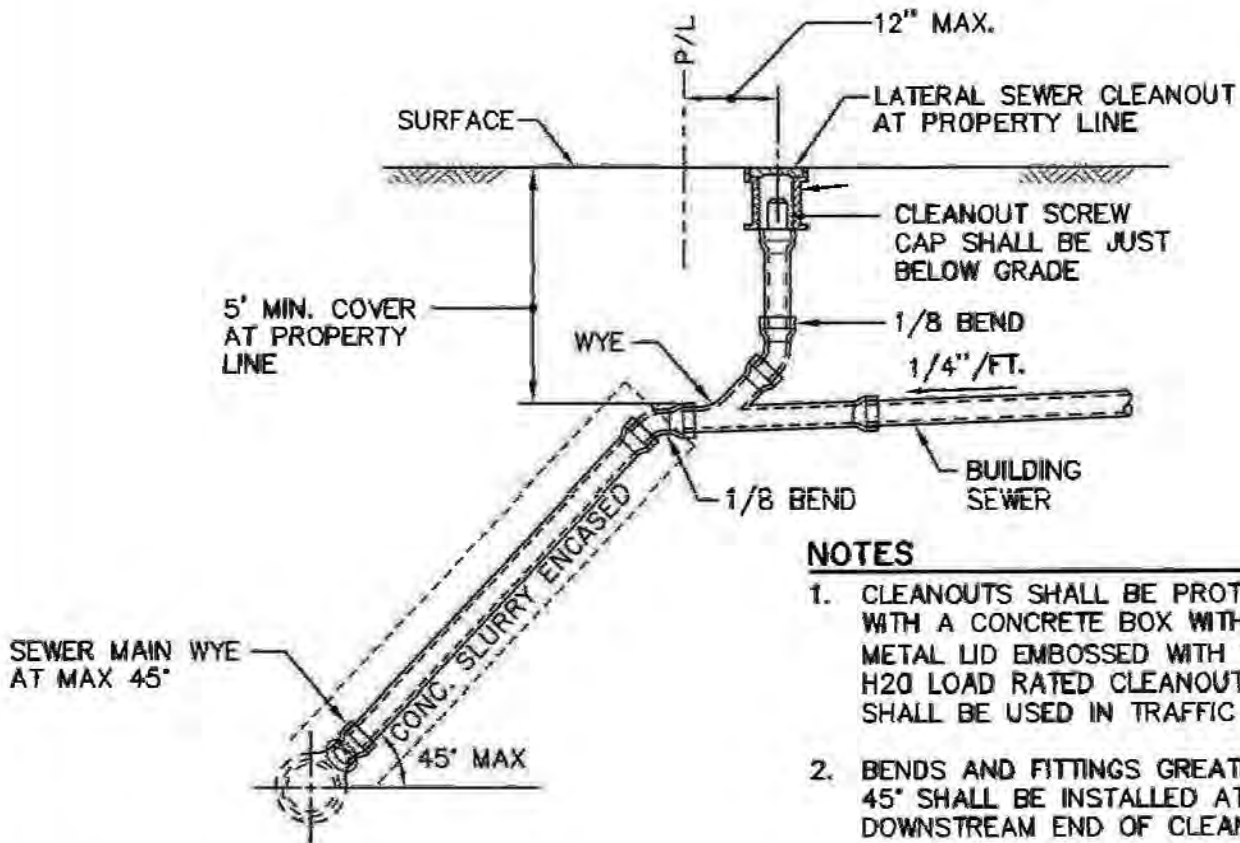

4" & 6" DEEP LATERALS

NOTES

1. CLEANOUTS SHALL BE PROTECTED WITH A CONCRETE BOX WITH A METAL LID EMBOSSED WITH "SEWER". H20 LOAD RATED CLEANOUT BOXES SHALL BE USED IN TRAFFIC AREAS.
2. BENDS AND FITTINGS GREATER THAN 45° SHALL BE INSTALLED AT THE DOWNSTREAM END OF CLEANOUTS.
3. LATERALS SHALL BE INSTALLED PERPENDICULAR TO SEWER MAIN AND CONTINUE STRAIGHT TO THE PROPERTY OR EASEMENT LINE.



LAGUNA
COUNTY
SANITATION
DISTRICT

LATERAL SEWER

STANDARD
DRAWING
NO. 4

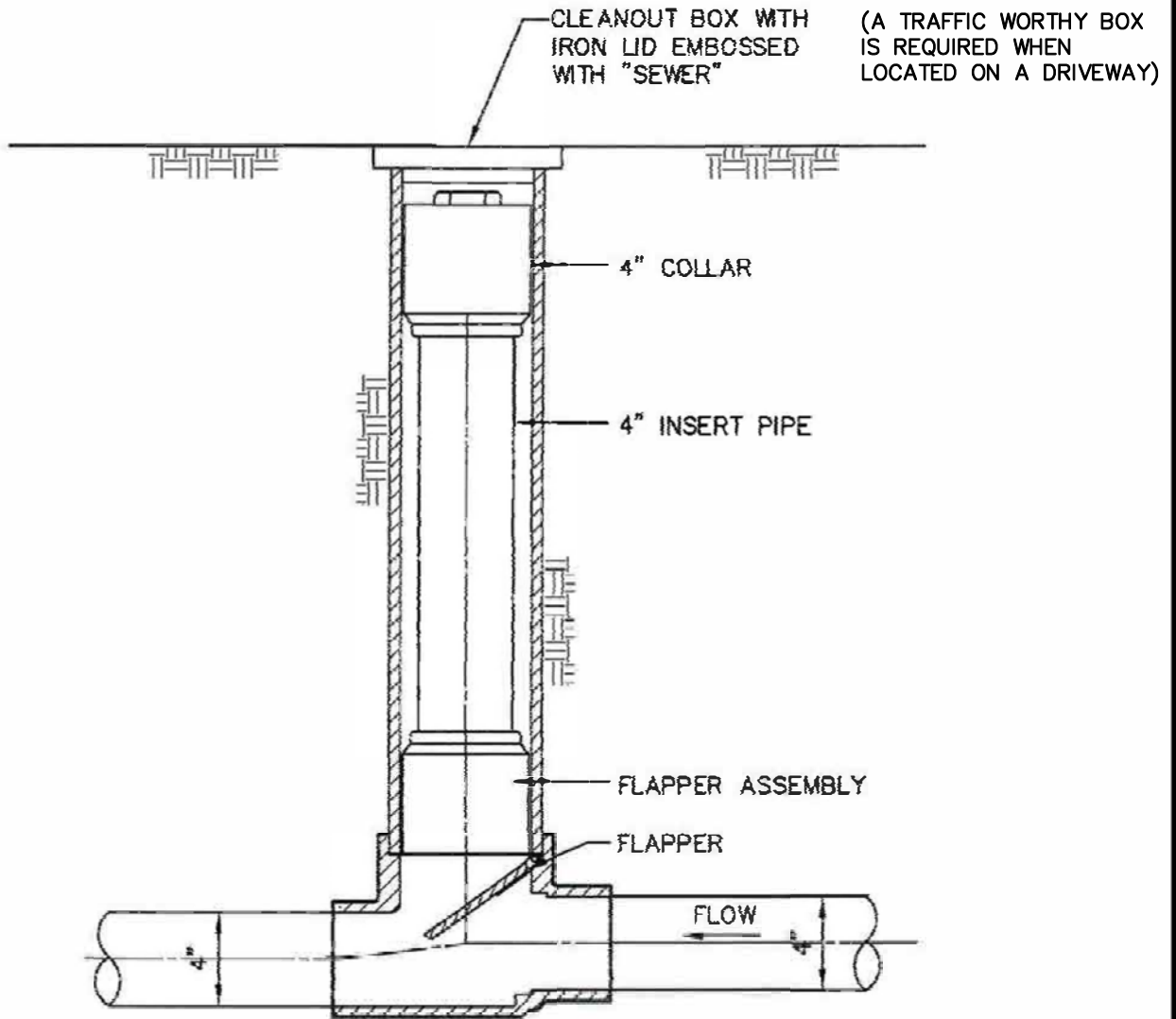

TYPICAL SECTION

COUNTY CODE SECTION 29-27.1.C, INSTALLATION OF BACKFLOW PREVENTION DEVICE, RESPONSIBILITY FOR OPERATION AND MAINTENANCE

(ORD. No. 4497 JUNE 3, 2003, & ORD. No. 4867 SEPT. 17, 2013)

1. ALL NEW SEWER SEWER LATERALS AND ALL SEWER LATERAL REPLACEMENTS SHALL BE EQUIPPED WITH A CLEANOUT RISER FITTED WITH A BACKFLOW PREVENTION DEVICE OF TYPE AND MATERIALS MEETING CALIFORNIA PLUMBING CODE REQUIREMENTS.
2. ANY SEWER LATERAL SERVING AN EXISTING BUILDING STRUCTURE HAVING PLUMBING FIXTURES WITH DRAIN OUTLETS AT AN ELEVATION BELOW THE ELEVATION OF THE RIM OF THE MANHOLE OR CLEANOUT ON THE SEWER MAIN UPSTREAM OF THE SEWER LATERAL CONNECTION, SHALL BE QUIPPED WITH A CLEANOUT RISER FITTED WITH A BACKFLOW PREVENTION DEVICE OF TYPE AND MATERIALS MEETING CALIFORNIA PLUMBING CODE REQUIREMENTS.
3. THE RESPONSIBILITY FOR THE OWNERSHIP, OPERATION, AND MAINTENANCE OF THE BACKFLOW PREVENTION DEVICE AND ITS APPURTENANT FITTINGS SHALL BE THAT OF THE PROPERTY OWNER. DAMAGE CAUSED TO THE PROPERTY FOR THE FAILURE TO COMPLY WITH THE REQUIREMENTS OF THE CALIFORNIA PLUMBING CODE OR THIS ORDINANCE SHALL BE THE RESPONSIBILITY OF THE PROPERTY OWNER.



LAGUNA
COUNTY
SANITATION
DISTRICT

BACKFLOW
PREVENTION
DEVICE

STANDARD
DRAWING
NO. 5

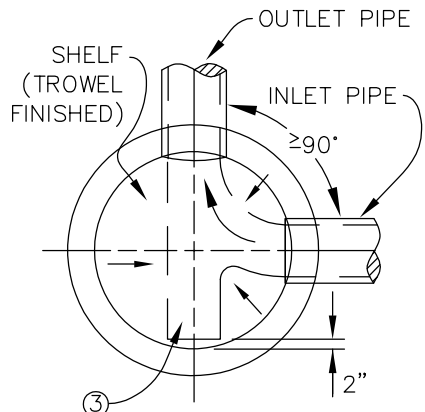
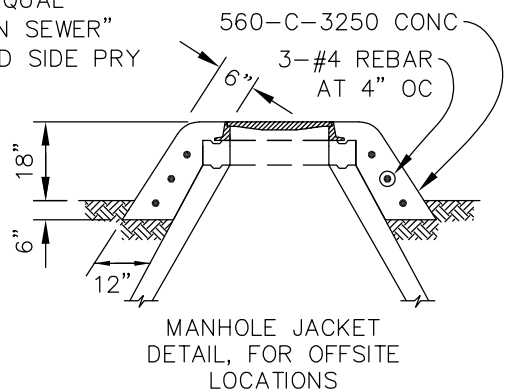
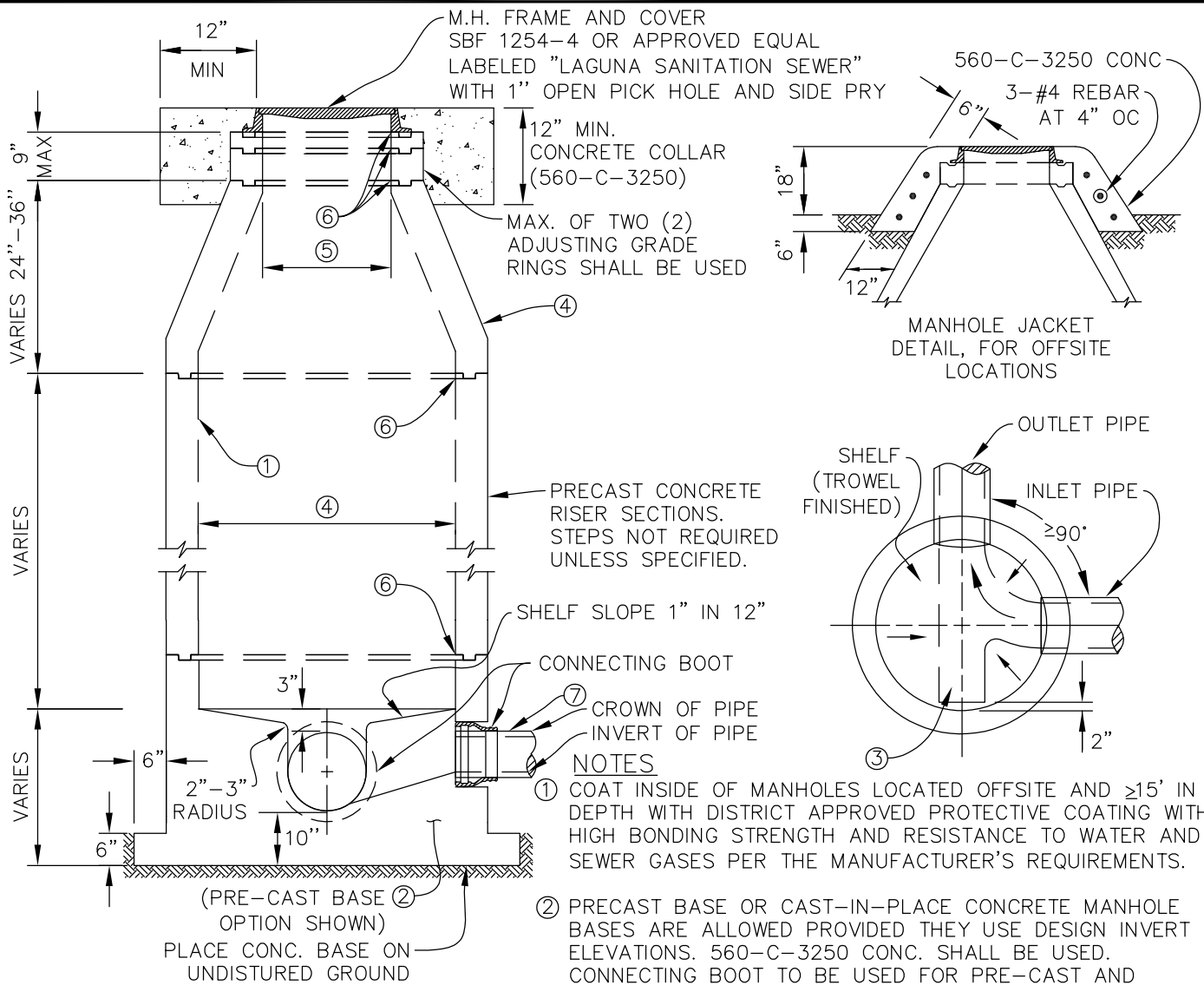

NOTES

- ① COAT INSIDE OF MANHOLES LOCATED OFFSITE AND ≥15' IN DEPTH WITH DISTRICT APPROVED PROTECTIVE COATING WITH HIGH BONDING STRENGTH AND RESISTANCE TO WATER AND SEWER GASES PER THE MANUFACTURER'S REQUIREMENTS.
- ② PRECAST BASE OR CAST-IN-PLACE CONCRETE MANHOLE BASES ARE ALLOWED PROVIDED THEY USE DESIGN INVERT ELEVATIONS. 560-C-3250 CONC. SHALL BE USED. CONNECTING BOOT TO BE USED FOR PRE-CAST AND WATER STOP O-RING TO BE USED FOR CAST-IN-PLACE.
- ③ CHANNELS ENTERING AT ANGLES SHALL BE FORMED AS SHOWN ABOVE TO ALLOW ACCESS FOR CAMERA AND MAINTENANCE EQUIPMENT.
- ④ 48" INSIDE DIAMETER AND CONCENTRIC CONE WHEN <18" PIPES ARE USED, AND 60" INSIDE DIAMETER AND ECCENTRIC CONE WHEN 18" TO 27" PIPES ARE USED. PIPES >27" REQUIRE SPECIAL DESIGN.
- ⑤ 24" OPENING WHEN <18" PIPES ARE USED, AND 30" OPENING WHEN ≥ 18" PIPES ARE USED.
- ⑥ CONCRETE JOINTS SHALL BE SET WITH BUTYL RUBBER SEALANT. INSIDE AND OUTSIDE OF JOINTS SHALL BE GROUTED,
- ⑦ IF OUTLET PIPE SIZE IS GREATER THAN INLET PIPE SIZE, CROWNS ELEVATIONS OF THE TWO PIPES MUST BE MATCHED AT THE MANHOLE.

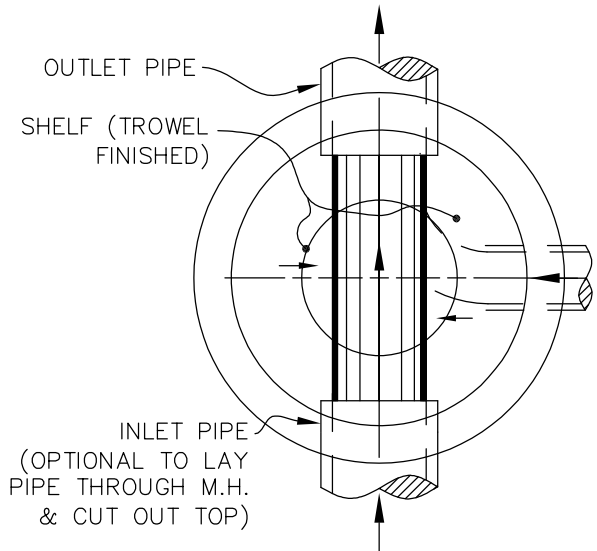

LAGUNA
COUNTY
SANITATION
DISTRICT

STANDARD
MANHOLE

STANDARD
DRAWING
NO. 6

WASTEWATER
DRAIN LINES
WITH THE
POTENTIAL TO
DISCHARGE
LIQUID
CONTAINING
SAND, GREASE
& OIL →

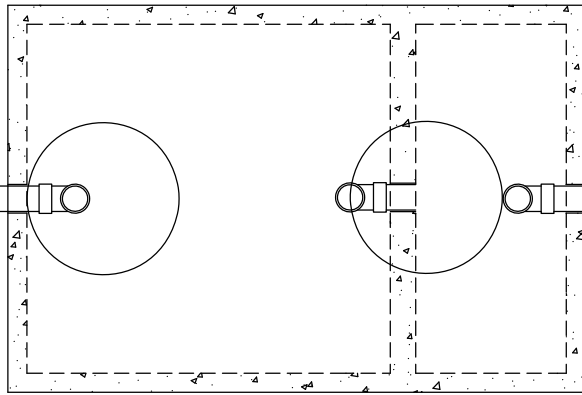

PLAN

SAMPLE BOX

ALL REMAINING BUILDING
WASTEWATER DRAIN LINES
WITH NO POTENTIAL TO
DISCHARGE LIQUID
CONTAINING GREASE & OIL

FINISHED GRADE

24" CAST IRON GASTIGHT
MANHOLE FRAME AND COVER

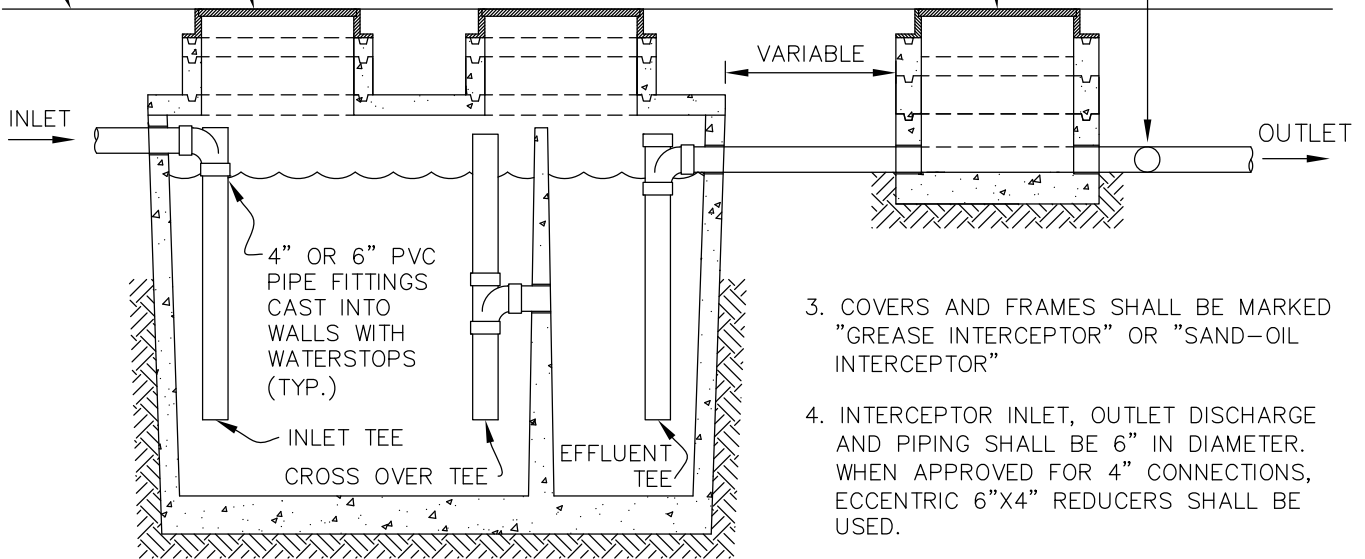

SECTION

NOTES:

1. GREASE INTERCEPTORS SHALL BE SIZED IN ACCORDANCE WITH THE UNIFORM PLUMBING CODE REQUIREMENTS. THE MINIMUM GREASE INTERCEPTOR SIZE SHALL BE A 500 GAL. UNIT.
2. INTERCEPTOR STRUCTURES SHALL BE COATED ON THE INTERIOR AND TESTED PER STANDARD SPECIFICATIONS.

3. COVERS AND FRAMES SHALL BE MARKED "GREASE INTERCEPTOR" OR "SAND-OIL INTERCEPTOR"
4. INTERCEPTOR INLET, OUTLET DISCHARGE AND PIPING SHALL BE 6" IN DIAMETER. WHEN APPROVED FOR 4" CONNECTIONS, ECCENTRIC 6"x4" REDUCERS SHALL BE USED.
5. ALL INTERCEPTORS SHALL BE VENTED PER PLUMBING CODE.
6. GREASE INTERCEPTORS 1,500 GALLONS AND LESS ARE ALLOWED TO HAVE ONLY TWO MANHOLE OPENINGS, AS SHOWN IN THIS DETAIL. LARGER GREASE INTERCEPTORS SHALL HAVE THREE MANHOLE OPENINGS, POSITIONED OVER THE INLET, CROSS OVER, AND EFFLUENT TEE.



LAGUNA
COUNTY
SANITATION
DISTRICT

GREASE
INTERCEPTOR

STANDARD
DRAWING
NO. 7

Attachment A

Water Main Separation

The installation of sewer lines in relation to water lines must comply with the California Code of Regulations as described in the following excerpt (or of latest register).

Specific criteria or approvals for waivers and alternatives are to be directed to:

State Water Resources Control Board
Division of Drinking Water, District 6 – Santa Barbara
1180 Eugenia Place, Suite 200
Carpinteria, CA 93013
(805) 566-1326

Attachment A

California Code of Regulations
Title 22. Social Security
Division 4. Environmental Health
Chapter 16. California Waterworks Standards

Article 1.5. Waivers and Alternatives
§64551.100. Waivers and Alternatives.

(a) A water system that proposes to use an alternative to a requirement in this chapter shall:

- (1) Demonstrate to the Department that the proposed alternative would provide at least the same level of protection to public health; and
- (2) Obtain written approval from the Department prior to implementation of the alternative.

Article 4. Materials and Installation of Water Mains and Appurtenances
§ 64572. Water Main Separation.

(a) New water mains and new supply lines shall not be installed in the same trench as, and shall be at least 10 feet horizontally from and one foot vertically above, any parallel pipeline conveying:

- (1) Untreated sewage,
- (2) Primary or secondary treated sewage,
- (3) Disinfected secondary-2.2 recycled water (defined in section 60301.220),
- (4) Disinfected secondary-23 recycled water (defined in section 60301.225), and
- (5) Hazardous fluids such as fuels, industrial wastes, and wastewater sludge.

(b) New water mains and new supply lines shall be installed at least 4 feet horizontally from, and one foot vertically above, any parallel pipeline conveying:

- (1) Disinfected tertiary recycled water (defined in section 60301.230), and
- (2) Storm drainage.

(c) New supply lines conveying raw water to be treated for drinking purposes shall be installed at least 4 feet horizontally from, and one foot vertically below, any water main.

(d) If crossing a pipeline conveying a fluid listed in subsection (a) or (b), a new water main shall be constructed no less than 45-degrees to and at least one foot above that pipeline. No connection joints shall be made in the water main within eight horizontal

Attachment A

feet of the fluid pipeline.

(e) The vertical separation specified in subsections (a), (b), and (c) is required only when the horizontal distance between a water main and pipeline is less than ten feet.

(f) New water mains shall not be installed within 100 horizontal feet of the nearest edge of any sanitary landfill, wastewater disposal pond, or hazardous waste disposal site, or within 25 horizontal feet of the nearest edge of any cesspool, septic tank, sewage leach field, seepage pit, underground hazardous material storage tank, or groundwater recharge project site.

(g) The minimum separation distances set forth in this section shall be measured from the nearest outside edge of each pipe barrel.

(h) With State Board approval, newly installed water mains may be exempt from the separation distances in this section, except subsection (f), if the newly installed main is:

(1) Less than 1,320 linear feet,

(2) Replacing an existing main, installed in the same location, and has a diameter no greater than six inches more than the diameter of the main it is replacing, and

(3) Installed in a manner that minimizes the potential for contamination, including, but not limited to:

(A) Sleeving the newly installed main, or

(B) Utilizing upgraded piping material.

Attachment B

Laguna County Sanitation District
Sewer Service Application

Permit No. _____



LAGUNA COUNTY SANITATION DISTRICT

620 West Foster Road

SANTA MARIA, CA 93455

PHONE: (805) 803-8750 PLANT: (805) 934-6282 FAX: (805) 803-8753

SEWER SERVICE APPLICATION

Date: _____

Name of Owner/Agent: _____

Telephone No: _____

Location: _____

APN: _____

Owner of Property: _____

Telephone No: _____

Contractor: _____

Telephone No: _____

Permit For: New Connection Connection Repair/Replacement Addition Other (see description below)

Description of Work: _____

TO BE FILLED OUT BY LAGUNA COUNTY SANITATION DISTRICT

Check (✓) the connection type:

- | | | | |
|--------------------------------------------------|--------------------|----------------------------------------|-------|
| <input type="checkbox"/> Single Family Residence | No. of Units _____ | <input type="checkbox"/> Commercial | _____ |
| <input type="checkbox"/> Apartment/Condo | No. of Units _____ | <input type="checkbox"/> Industrial | _____ |
| | | <input type="checkbox"/> Institutional | _____ |

The following conditions are required if checked (✓):

- | | |
|------------------------------------------------------------------|-----------------------------------------------------------------------|
| <input type="checkbox"/> Sampling Manhole | <input type="checkbox"/> Layout Sketch to be Submitted as Shown Below |
| <input type="checkbox"/> Grease Interceptor (750-gallon minimum) | <input type="checkbox"/> Backwater Valve |

Facility Description:

FEES:	AMOUNT	DATE PAID	RECEIPT
Annexation fee:	_____	_____	_____
Application fee:	_____	_____	_____
Plan check fee:	_____	_____	_____
Inspection fee:	_____	_____	_____
Trunk line fee:	_____	_____	_____
Connection fee:	_____	_____	_____
Sewer service charge:	_____	_____	_____
Other fees:	_____	_____	_____
TOTAL FEES DUE:	_____	_____	_____

INSPECTION RECORD		
INSPECTION	DATE	APPROVED BY
Pipe line and wye	_____	_____
Air or water test	_____	_____
Mandrel test	_____	_____
Manhole inspection	_____	_____
Video inspection	_____	_____
Final ball and flush	_____	_____
Inspection complet	_____	_____

Accurate layout drawings of the main and lateral sewers shall be submitted to, and approved by the District prior to construction, installation and inspection of such facilities. The layout drawings shall be in accordance with the District's Standard Specifications. In-lieu of other District written correspondence, this application may serve as the District's "Can-and-Will Serve" commitment of service. This commitment is valid unless the project application with the planning agency expires. I hereby certify that I have read this Application and the information given to me is correct. I hereby agree to comply with all rules and regulations of the Laguna County Sanitation District, County/City Ordinances and laws of the State of California regulating sewers and sanitation. I hereby certify that I am a licensed contractor, the legal owner, or his/her authorized agent of the above described property.

OWNER/AGENT SIGNATURE _____ PRINT NAME _____ DATE _____

IMPORTANT REQUIREMENTS ON REVERSE SIDE

LAGUNA
COUNTY SANITATION DISTRICT
SANTA BARBARA COUNTY
620 West Foster Road
Santa Maria, California 93455
(805) 803-8756 FAX (805) 803-8753

August 24, 2020

Frank Albro, Senior Planner
City of Santa Maria Community Development Department
110 South Pine Street, Suite 101
Santa Maria, CA 93458

Re: SEIR to the Santa Maria Public Airport District Business Park (TM 5966) for
APN 111-231-011

Dear Frank:

Thank you for providing the wastewater generation estimations received by our office on August 20, 2020. We reviewed the estimations and determined that in accordance with the current District sewer model, the downstream sewer collection system has adequate capacity. When construction level plans are ready that would indicate drainage fixture unit types and counts, please forward to the District for further review to confirm the wastewater generation estimations.

For questions, please contact me at (805) 803-8756 or by email at kethomp@cosbpw.net.

Sincerely,

Kevin Thompson

Kevin Thompson, P.E., Civil Engineer
Laguna County Sanitation District

Copy: Chris Hastert, General Manager, SMPAD
File: SEIR to SMPAD Business Park TM 5966

APPENDIX B

Santa Maria Airport Business Park Project Emissions Modeling Assessment



TECHNICAL MEMORANDUM

Date: October 27, 2020

To: Emily Creel, Planning Team Lead
SWCA Environmental Consultants

From: Kurt Legleiter, Principal

Project: Santa Maria Airport Business Park Project

Subject: Emissions Modeling Assessment

This memorandum provides a summary of the emissions modeling conducted for the proposed Santa Maria Airport Business Park Project. The proposed project site plan is depicted in Figure 1. Emissions modeling output files are included as an appendix to this memorandum.

AIR QUALITY AND GREENHOUSE GAS QUANTIFICATION METHODOLOGY

Short-term Construction

Short-term construction emissions associated with the proposed project were calculated using the California Emission Estimator Model (CalEEMod), version 2016.3.2, computer program. Emissions were quantified for site preparation, grading, building construction, paving, and architectural coating. Detailed construction information, including construction schedules and equipment requirements, were provided by the project applicant. Area of disturbance was based on the model defaults, which calculates potential area of disturbance based on equipment usage for both site preparation and grading activities. The project is not anticipated to require the import or export of soil. Construction vehicle trips were, likewise, based on model defaults. Construction-generated emissions were conservatively calculated assuming that construction would begin in 2021. Due to anticipated reductions in future fleet-average emission rates, emissions for post-year 2021 conditions would likely be less. Mitigated construction emissions were quantified assuming implementation of Santa Barbara County Air Pollution Control District (SBCAPCD)-recommended measures for the control of fugitive dust. For informational purposes, reductions associated with the use of newer Tier-3 off-road equipment was also included. Construction modeling assumptions are summarized in Table 1.

Table 1. Summary of Construction Modeling Assumptions

CONSTRUCTION START DATE	JANUARY 1 ST , 2021
CONSTRUCTION END DATE	SEPTEMBER 30 TH , 2023
AMOUNT OF FILL TO BE IMPORTED/EXPORTED	0/0 CUBIC YARDS
TOTAL AREA TO BE GRADED	24.5 ACRES
TOTAL AREA TO BE PAVED	10 ACRES
REGIONAL BASIN*	152,460 SQUARE FEET

*Assumes regional basin would be constructed during the site grading phase.

Figure 1. Conceptual Site Plan





Long-term Operations

Long-term operational emissions were calculated using the CalEEMod computer program. Modeling was conducted based on traffic data derived, in part, from the traffic analysis prepared for this project (CCTC 2020).¹ The CalEEMod computer program is based on the 2016 building and energy-efficiency standards. These standards were most recently updated in 2018. In comparison to the 2016 standards, these newer standards are projected to achieve additional reductions in energy use of approximately 30 percent for nonresidential buildings (CEC 2018).² Anticipated reductions in energy use associated with the newer building code are predominantly associated with increases in energy-efficient lighting requirements. The use of water-efficient irrigation systems, water-efficient building fixtures, and energy-efficient appliances is also required by the California building code. Operational emissions were quantified to include reductions in energy and water use, consistent with current building standards. Utility intensity factors were adjusted to reflect compliance with the State's renewable portfolio standards. All other assumptions were based on modelled defaults from CalEEMod for the northern portion of Santa Barbara County.

Within Santa Barbara County, each service provider is required to recover or divert from landfilling a specific percentage of material collected in each service area. These requirements are part of the County's overall program for meeting the state's goal of diverting 75 percent of the waste generated from landfills, consistent with the state-wide goal. Emissions associated with waste generation for the proposed project were based on an assumed waste-diversion rate of 50 percent for initial operational year 2023 conditions and 75 percent for year 2030, consistent with current waste-diversion requirements.

Vehicle trip-generation rates were derived from the traffic analysis prepared for this project (CCTC 2020) and are summarized in Table 2. Emissions were adjusted to include Emfac off-model adjustment factors for the Safer Affordable Fuel-Efficient (SAFE) Vehicles Rule, Part One, adopted by the U.S. EPA and the National Highway Traffic Safety Administration, in accordance with California Air Resources Board recommendations. Operational emissions of criteria air pollutants and GHGs were quantified for an assumed initial operational year of 2023. GHG emissions were also quantified for year 2030 conditions. All other modeling assumptions were based on default parameters contained in the CalEEMod computer program for the northern portion of Santa Barbara County. Vehicle trip-generation rates included in the modeling account for internal capture and vehicle pass-by trips. Internal capture identified in the traffic report was allocated, by land use type, based on the calculated percent contribution to total project-generated trips. Weekend trip-generation rates were adjusted based on CalEEMod default adjustment rates for weekday vs. weekend vehicle trips for the proposed land uses. Mitigated operational emissions were also quantified assuming that proposed project would incorporate an improved pedestrian network to link proposed onsite land uses and to connect to adjacent land uses, as well as, any future planned bicycle lanes and transit stops located contiguous to the project site.

¹ Central Coast Transportation Consulting (CCTC). 2020. *Project Trip Generation for the Santa Maria Airport Business Park*.

² California Energy Commission (CEC). May 9, 2018. *Energy Commission Adopts Standards Requiring Solar Systems for New Homes, First in Nation*. Available at website url: <https://www.energy.ca.gov/news/2018-05/energy-commission-adopts-standards-requiring-solar-systems-new-homes-first>.



THRESHOLDS OF SIGNIFICANCE

Criteria Air Pollutants

Thresholds of significance were derived from the Santa Barbara County Air Pollution Control District's (SBCAPCD) *Scope and Content for Air Quality Sections in Environmental Documents*.³ Accordingly, construction-related emissions would be considered to have a potentially significant impact if emissions were to exceed 25 tons/year of either reactive organic gases (ROG) or oxides of nitrogen (NO_x). In addition, the SBCAPCD recommends incorporation of standard mitigation measures to minimize localized air quality impacts commonly associated with construction activities and to ensure consistency with air quality attainment and maintenance efforts. Long-term air quality impacts would be considered to have a potentially significant impact if operation of the project would:

- Emit (from all project sources, including area, stationary, and mobile sources) more than 240 lbs/day of either ROG or NO_x, or more than 80 lbs/day of PM₁₀;
- Emit (from mobile sources only) more than 25 lbs/day of either ROG or NO_x;
- Cause or contribute to a violation of any California or National Ambient Air Quality Standard;
- Exceed the APCD health risk public notification thresholds adopted by the APCD Board (10 excess cancer cases in a million for cancer risk and a Hazard Index of more than 1.0 for noncancer risk); and/or
- Be inconsistent with the latest adopted federal and state air quality plans.

GHG Emissions

GHG emissions were evaluated based on a GHG-efficiency threshold. The GHG-efficiency threshold was based on AB 32 year 2020 GHG-reduction target and adjusted to account for the more stringent year 2030 GHG-reduction target mandated by SB 32. The GHG-efficiency threshold was calculated by dividing the GHG emissions inventory goal (allowable emissions) by the estimated service population (SP). The efficiency threshold was calculated based on ARB's GHG emissions inventory identified in the *2017 Scoping Plan Update*. Emissions sectors that do not apply to the proposed project (i.e., industrial, agriculture) were excluded from the calculation. The GHG emissions inventory for the land use sectors applicable to the proposed project were then divided by the projected service population. The service population was calculated based on the most current population and employment projections derived from the California Department of Finance Demographic Research Unit and California Employment Development Department, respectively. The methodology used for quantification of the target efficiency threshold applied to the proposed project is summarized in Table 2. Refer to Appendix A for calculation assumptions. Project-generated GHG emissions would exceed the efficiency threshold of 4.2 MTCO_{2e}/SP/year in year 2023 or 3.3 MTCO_{2e}/SP/year in 2030 would be considered to have a potentially significant impact on the environment that could conflict with GHG-reduction planning efforts. To be conservative, amortized construction-generated GHG emissions were included in annual operational GHG emissions estimates.

³ SBCAPCD. June 2017. *Scope and Content of Air Quality Section in Environmental Documents*. Available at website url:

<https://www.ourair.org/wp-content/uploads/ScopeContentJune2017-LimitedUpdate.pdf>.



Table 2. Land Uses and Daily Trips

LAND USES	BUILDING SQUARE FEET (KSF) ¹	DAILY WEEKDAY TRIPS ¹	TRIP GENERATION RATE ADJUSTED FOR PASS-BY TRIPS & INTERNAL CAPTURE (DAILY TRIPS/KSF) ²		
			WEEKDAY	SATURDAY	SUNDAY
STORAGE (WAREHOUSE UNREFRIGERATED)	100.0	151	1.365	1.365	1.365
PROFESSIONAL OFFICE	40.0	436	9.855	2.198	0.938
MEDICAL OFFICE	20.0	681	30.784	7.634	1.321
PROFESSIONAL OFFICE (GOVERNMENT)	22.1	499	20.414	0.000	0.000
MARKET PLACE (SHOPPING CENTER)	36.0	2,666	66.953	63.509	30.863
HOME FURNISHINGS/APPLIANCES (RETAIL)	32.0	177	5.001	6.209	4.924
QUICK SERVE RESTAURANT	11.0	4,490	369.034	459.645	382.646
CONVENIENCE STORE WITH GAS PUMPS	3.4	4,246	1,129.050	1,933.819	1,578.320
PAVEMENT – OTHER ASPHALT SURFACES	(2 ACRES)	Not Applicable			
PAVEMENT – OTHER NON-ASPHALT SURFACES	(0.5 ACRES)				
PAVEMENT – PARKING LOT	(8 ACRES)				
TOTAL WITH PASS-BY TRIPS		13,346			
INTERNAL CAPTURE TRIPS		-1,280			
TOTAL WITH INTERNAL CAPTURE TRIPS		12,066			
<p>1. Building square footage and weekday trip-generation information derived from the traffic analysis prepared for this project (CCTC 2020).</p> <p>2. Trip-generation rates were adjusted to include reductions for pass-by trips and internal capture. Weekend trip-generation rates were calculated based on weekday trip-generation rates and CalEEMod default percentage rates for Saturday and Sunday operational conditions.</p> <p>3. Pavement includes asphalt and non-asphalt surfaces. Surface areas were estimated based on proposed site plan and aerial photo interpretation.</p>					



Table 3. Project-Level GHG Efficiency Threshold Calculation

	2023	2030
Land Use Sectors GHG Emissions Target ¹	255	213
Population ²	41,659,526	43,939,250
Employment ³	19,442,770	20,795,940
Service Population (SP)	61,102,296	64,735,190
GHG Efficiency Threshold (MTCO _{2e} /SP/yr)	4.2	3.3
<p><i>Note: Employment data for interim years are estimated based on proportionality with population trends based on historical data. Based on AB 32 Scoping Plan's land use inventory sectors for years 2024 and 2030; Includes transportation sources.</i></p> <p><i>1. Based on ARB 2017 Climate Scoping Plan Update/SB 32 Scoping Plan Emissions Sector targets.</i></p> <p><i>2. California Department of Finance Demographic Research Unit. 2019. Report P-1 "State Population Projections (2010 - 2060)".</i></p> <p><i>3. California Employment Development Department. Employment Projections Labor Market Information Resources and Data, "CA Long-Term. 2016-2026 Statewide Employment Projections". Projected year 2030 employment data was projected based on the average-annual increase for years 2016 through 2026.</i></p> <p><i>Refer to Appendix A for calculation assumptions.</i></p>		

SUMMARY OF EMISSIONS MODELING RESULTS

Short-Term Construction

Criteria Air Pollutants

Construction generated emissions, without and with implementation of fugitive dust control measures, are summarized in Tables 4 and 5, respectively. As shown, construction emissions would not exceed Santa Barbara County Air Pollution Control District's (SBCAPCD) recommended thresholds of significance of 25 tons/year for either ROG or NOx. The SBCAPCD has not adopted significance thresholds for other construction-related emissions, including fugitive dust. However, the SBCAPCD recommends inclusion of control measures to minimize localized impacts to nearby land uses and sensitive receptors. Recommended control measures include dust control measures, as well as, measures to reduce diesel-exhaust emissions from mobile sources. SBCAPCD-recommended significance thresholds and control measures are identified in SBCAPCD's *Scope and Content of Air Quality Section in Environmental Documents* (2017).⁴

GHG Emissions

Annual construction-generated GHG emissions would range from approximately 697.9 to 907.5 MTCO_{2e}/year. In total, project construction would generate approximately 2,390 MTCO_{2e}. When amortized over an approximate 30-year project life, annual construction-generated GHG emissions would average approximately 79.7 MTCO_{2e}/year.

⁴ SBCAPCD. June 2017. *Scope and Content of Air Quality Section in Environmental Documents*. Available at website url: <https://www.ourair.org/wp-content/uploads/ScopeContentJune2017-LimitedUpdate.pdf>.



Long-Term Operations

Criteria Air Pollutants

Daily operational emissions of criteria air pollutants for opening year conditions, without and with implementation of pedestrian and transit improvements, are summarized in Tables 6 and 7, respectively. For informational purposes, annual operational emissions of criteria air pollutants have also been quantified and are summarized in Tables 8 and 9. As indicated in Tables 7 and 8, total daily operational emissions from all emission sources (e.g., area, energy use, and mobile) would not exceed the SBCAPCD's significance thresholds of 240 lbs/day of ROG or NO_x, or 80 lbs/day of PM₁₀. However, maximum daily emissions would exceed the SBCAPCD's significance threshold of 25 lbs/day for mobile sources. The SBCAPCD has not identified recommended annual significance thresholds for criteria air pollutants.

GHG Emissions

Annual GHG emissions for opening year 2023 conditions, without and with implementation of pedestrian and transit improvements, are summarized in Tables 6 and 7, respectively. Annual GHG emissions for future year 2030 conditions are, likewise, summarized in Tables 8 and 9, respectively. With the inclusion of amortized construction GHG emissions, year 2023 operational emissions would total approximately 5,156.42 MTCO_{2e}/year without implementation of pedestrian improvements. With continued improvements in vehicle emission standards, annual operational emissions are projected to decrease to approximately 4,557.90 MTCO_{2e}/year by year 2030. With implementation of measures to promote improved pedestrian access, annual operational GHG emissions would be reduced to approximately 5,153.6 MTCO_{2e}/year and 4,440.3 MTCO_{2e}/year for years 2023 and 2030, respectively.

The service population (SP) for nonresidential development is typically quantified based on the estimated number of on-site employees. Based on information provided, the proposed project is estimated to have a total of approximately 440 on-site employees. Based on this estimate, operational GHG emissions, with the inclusion of measures to promote alternative means of transportation, would total approximately 11.7 MTCO_{2e}/SP in year 2023 and 10.1 MTCO_{2e}/SP in year 2030.



Table 4. Construction Emissions without Fugitive Dust Control Measures

YEAR	EMISSIONS (TONS/YEAR)										
	ROG	NO _x	CO	SO _x	PM ₁₀			PM _{2.5}			MTCO _{2e}
					FUG	EXH	TOT	FUG	EXH	TOT	
2021	0.78	4.92	4.16	0.01	0.60	0.21	0.81	0.24	0.20	0.43	784.86
2022	2.11	4.19	4.49	0.01	0.27	0.16	0.43	0.07	0.16	0.23	907.48
2023	1.58	2.96	3.45	0.01	0.20	0.11	0.31	0.05	0.11	0.16	697.88
SBCAPCD Significance Thresholds:	25	25	--	--	--	--	--	--	--	--	--
Exceeds Significance Thresholds?:	NO	NO	--	--	--	--	--	--	--	--	--

ROG=Reactive Organic Gases; NOX=Oxides of Nitrogen; CO=Carbon Monoxide; SOX=Sulphur Oxides; PM=Particulate Matter; FUG=Fugitive; EXH=Exhaust; MT=Metric Tons; CO2e=Carbon Dioxide Equivalent; SBCAPCD=Santa Barbara County Air Pollution Control District
 Construction emissions were quantified based on project-specific information and default parameters contained in the CalEEMod computer program for northern Santa Barbara County. Does not include application of emission control measures. Totals may not sum due to rounding.

Table 5. Construction Emissions with Fugitive Dust Control Measures & Tier 3 Off-Road Equipment

YEAR	EMISSIONS (TONS/YEAR)										
	ROG	NO _x	CO	SO _x	PM ₁₀			PM _{2.5}			MTCO _{2e}
					FUG	EXH	TOT	FUG	EXH	TOT	
2021	0.51	3.83	4.59	0.01	0.32	0.17	0.50	0.12	0.17	0.29	784.86
2022	1.90	4.07	4.82	0.01	0.27	0.19	0.45	0.07	0.19	0.26	907.48
2023	1.44	3.04	3.74	0.01	0.20	0.15	0.34	0.05	0.15	0.20	697.88
SBCAPCD Significance Thresholds:	25	25	--	--	--	--	--	--	--	--	--
Exceeds Significance Thresholds?:	NO	NO	--	--	--	--	--	--	--	--	--

ROG=Reactive Organic Gases; NOX=Oxides of Nitrogen; CO=Carbon Monoxide; SOX=Sulphur Oxides; PM=Particulate Matter; FUG=Fugitive; EXH=Exhaust; MT=Metric Tons; CO2e=Carbon Dioxide Equivalent; SBCAPCD=Santa Barbara County Air Pollution Control District
 Construction emissions were quantified based on project-specific information and default parameters contained in the CalEEMod computer program for northern Santa Barbara County. Includes watering of exposed graded surfaces and on-site vehicle travel areas and maximum allowable on-site vehicle speed of 15 miles per hour for the control of fugitive dust. Reductions of ROG and NOX associated with the use of heavy-duty off-road equipment meeting Tier 3 emission standards has been included and is provided for informational purposes. Totals may not sum due to rounding.



Table 6. Maximum Daily Operational Emissions without Pedestrian Improvements (Year 2023)

SOURCE	EMISSIONS (POUNDS/DAY)									
	ROG	NO _x	CO	SO _x	PM ₁₀			PM _{2.5}		
					FUG	EXH	TOT	FUG	EXH	TOT
AREA	7.55	0.00	0.10	0.00	0.00	0.00	0.00	0.00	0.00	0.00
NATURAL GAS USE	0.12	1.11	0.94	0.01	0.00	0.09	0.09	0.00	0.09	0.09
MOBILE SOURCES ²	20.71	59.13	158.62	0.32	27.42	0.30	27.72	7.35	0.28	7.63
TOTAL ALL SOURCES:	28.38	60.24	159.66	0.33	27.42	0.39	27.81	7.35	0.37	7.72
SBCAPCD THRESHOLD (ALL SOURCES):	240	240	--	--	--	--	80	--	--	--
EXCEEDS THRESHOLD?:	NO	NO					NO			
SBCAPCD THRESHOLD (MOBILE SOURCES):	25	25								
EXCEEDS THRESHOLD?:	NO	YES								
<p>1. Electricity use was adjusted to reflect compliance with 2019 Building Energy Efficiency Standards. Under the new standards, nonresidential buildings will use about 30 percent less energy, compared to previous standards. (California Energy Commission. May 9, 2018. Energy Commission Adopts Standards Requiring Solar Systems for New Homes, First in Nation.</p> <p>2. Mobile source emissions include internal capture and pass-by trips, based on information derived from the traffic analysis prepared for this project (CCTC 2020). Includes SAFE Vehicle Off-Model Adjustment Factors.</p>										



Table 7. Maximum Daily Operational Emissions with Pedestrian Improvements

SOURCE	EMISSIONS (POUNDS/DAY)									
	ROG	NO _x	CO	SO _x	PM ₁₀			PM _{2.5}		
					FUG	EXH	TOT	FUG	EXH	TOT
AREA	7.49	0.00	0.10	0.00	0.00	0.00	0.00	0.00	0.00	0.00
NATURAL GAS USE	0.12	1.11	0.94	0.01	0.00	0.09	0.09	0.00	0.09	0.09
MOBILE SOURCES ²	20.65	58.75	157.24	0.30	26.87	0.29	27.17	7.20	0.28	7.48
TOTAL ALL SOURCES:	28.32	59.86	158.27	0.31	26.87	0.38	27.26	7.20	0.37	7.57
SBCAPCD THRESHOLD (ALL SOURCES):	240	240	--	--	--	--	80	--	--	--
EXCEEDS THRESHOLD?:	NO	NO					NO			
SBCAPCD THRESHOLD (MOBILE SOURCES):	25	25								
EXCEEDS THRESHOLD?:	NO	YES								

1. Electricity use was adjusted to reflect compliance with 2019 Building Energy Efficiency Standards. Under the new standards, nonresidential buildings will use about 30 percent less energy, compared to previous standards. (California Energy Commission. May 9, 2018. Energy Commission Adopts Standards Requiring Solar Systems for New Homes, First in Nation.

2. Mobile source emissions include internal capture and pass-by trips, based on information derived from the traffic analysis prepared for this project (CCTC 2020). Includes SAFE Vehicle Off-Model Adjustment Factors.



Table 8. Annual Operational Emissions - Year 2023 without Pedestrian Improvements

SOURCE	EMISSIONS (POUNDS/DAY)										
	ROG	NO _x	CO	SO _x	PM ₁₀			PM _{2.5}			MTCO _{2e}
					FUG	EXH	TOT	FUG	EXH	TOT	
AREA	1.37	0.00	0.01	0.00	0.00	0.00	0.00	0.00	0.00	0.00	0.02
ELECTRICITY USE (2016 T24)	0.00	0.00	0.00	0.00	0.00	0.00	0.00	0.00	0.00	0.00	659.65
ELECTRICITY USE (2019 T24) ¹	0.00	0.00	0.00	0.00	0.00	0.00	0.00	0.00	0.00	0.00	461.76
NATURAL GAS USE	0.02	0.20	0.17	0.00	0.00	0.02	0.02	0.00	0.02	0.02	222.61
MOBILE SOURCES ²	2.82	8.46	21.67	0.05	3.94	0.04	3.99	1.06	0.04	1.09	4,271.42
TOTAL ALL SOURCES:	4.21	8.66	21.84	0.05	3.94	0.06	4.01	1.06	0.06	1.11	5,076.72
AMORTIZED CONSTRUCTION EMISSIONS:											79.7
TOTAL WITH AMORTIZED CONSTRUCTION EMISSIONS:											5,156.42
SERVICE POPULATION (SP):											440
MTCO _{2e} /SP:											11.7
<p>ROG=Reactive Organic Gases; NOX=Oxides of Nitrogen; CO=Carbon Monoxide; SOX=Sulphur Oxides; PM=Particulate Matter; FUG=Fugitive; EXH=Exhaust; MT=Metric Tons; CO2e=Carbon Dioxide Equivalent; SP=Service Population (On-site Employees)</p> <p>Annual operational emissions are provided for informational purposes. The SBCAPCD does not have annual significance thresholds. Refer to estimated daily operational emissions for comparison to SBCAPCD significance thresholds. Totals may not sum due to rounding.</p> <p>1. Electricity use was adjusted to reflect compliance with 2019 Building Energy Efficiency Standards. Under the new standards, nonresidential buildings will use about 30 percent less energy, compared to previous standards. (California Energy Commission. May 9, 2018. Energy Commission Adopts Standards Requiring Solar Systems for New Homes, First in Nation.</p> <p>2. Mobile source emissions include internal capture trips and pass-by trips based on information derived from the traffic analysis prepared for this project (CCTC 2020). Includes SAFE Vehicle Off-Model Adjustment Factors for the Emfac model, per California Air Resources Board recommendations (2019).</p>											



Table 9. Annual Operational Emissions - Year 2023 with Pedestrian Improvements

SOURCE	EMISSIONS (TONS/YEAR)										
	ROG	NO _x	CO	SO _x	PM ₁₀			PM _{2.5}			MTCO _{2e}
					FUG	EXH	TOT	FUG	EXH	TOT	
AREA	1.37	0.00	0.01	0.00	0.00	0.00	0.00	0.00	0.00	0.00	0.02
ELECTRICITY USE (2016 T24)	0.00	0.00	0.00	0.00	0.00	0.00	0.00	0.00	0.00	0.00	659.65
ELECTRICITY USE (2019 T24)	0.00	0.00	0.00	0.00	0.00	0.00	0.00	0.00	0.00	0.00	461.76
NATURAL GAS USE	0.02	0.20	0.17	0.00	0.00	0.02	0.02	0.00	0.02	0.02	222.61
MOBILE SOURCES ²	2.81	8.41	21.47	0.05	3.86	0.04	3.91	1.04	0.04	1.08	4,199.42
TOTAL ALL SOURCES:	4.20	8.61	21.64	0.05	3.86	0.06	3.93	1.04	0.06	1.10	5,073.90
AMORTIZED CONSTRUCTION EMISSIONS:											79.7
TOTAL WITH AMORTIZED CONSTRUCTION EMISSIONS:											5,153.60
SERVICE POPULATION (SP):											440
MTCO _{2e} /SP:											11.7
<p><i>ROG=Reactive Organic Gases; NOX=Oxides of Nitrogen; CO=Carbon Monoxide; SOX=Sulphur Oxides; PM=Particulate Matter; FUG=Fugitive; EXH=Exhaust; MT=Metric Tons; CO2e=Carbon Dioxide Equivalent; SP=Service Population (On-site Employees)</i></p> <p><i>Annual operational emissions are provided for informational purposes. The SBCAPCD does not have annual significance thresholds. Refer to estimated daily operational emissions for comparison to SBCAPCD significance thresholds. Totals may not sum due to rounding.</i></p> <p><i>1. Electricity use was adjusted to reflect compliance with 2019 Building Energy Efficiency Standards. Under the new standards, nonresidential buildings will use about 30 percent less energy, compared to previous standards. (California Energy Commission. May 9, 2018. Energy Commission Adopts Standards Requiring Solar Systems for New Homes, First in Nation.</i></p> <p><i>2. Mobile source emissions include internal capture and pass-by trips, based on information derived from the traffic analysis prepared for this project (CCTC 2020). Includes SAFE Vehicle Off-Model Adjustment Factors. Includes measures for providing an improved pedestrian network linking on-site land uses to off-site uses, including bicycle and pedestrian facilities, installation of improvements to promote the use of public transit (e.g., transit stops, shelters, pullouts).</i></p>											



Table 10. Annual Operational GHG Emissions - Year 2030 without Pedestrian Improvements

SOURCE	EMISSIONS MTCO _{2e} /YEAR
AREA	0.02
ELECTRICITY USE (2016 T24)	451.12
ELECTRICITY USE (2019 T24)	315.78
NATURAL GAS USE	222.61
MOBILE SOURCES ²	3,833.29
TOTAL ALL SOURCES:	4,478.29
AMORTIZED CONSTRUCTION EMISSIONS:	79.7
TOTAL WITH AMORTIZED CONSTRUCTION EMISSIONS:	4,557.90
SERVICE POPULATION (SP):	440
MTCO _{2e} /SP:	10.4
<p><i>ROG=Reactive Organic Gases; NOX=Oxides of Nitrogen; CO=Carbon Monoxide; SOX=Sulphur Oxides; PM=Particulate Matter; FUG=Fugitive; EXH=Exhaust; MT=Metric Tons; CO2e=Carbon Dioxide Equivalent; SP=Service Population (On-site Employees)</i></p> <p><i>1. Electricity use was adjusted to reflect compliance with 2019 Building Energy Efficiency Standards. Under the new standards, nonresidential buildings will use about 30 percent less energy, compared to previous standards. (California Energy Commission. May 9, 2018. Energy Commission Adopts Standards Requiring Solar Systems for New Homes, First in Nation.</i></p> <p><i>2. Mobile source emissions include internal capture and pass-by trips, based on information derived from the traffic analysis prepared for this project (CCTC 2020). Includes SAFE Vehicle Off-Model Adjustment Factors.</i></p> <p><i>Totals may not sum due to rounding.</i></p>	



Table 11. Annual Operational GHG Emissions - Year 2030 with Pedestrian Improvements

SOURCE	EMISSIONS MTCO _{2e} /YEAR
AREA	0.02
ELECTRICITY USE (2016 T24)	451.12
ELECTRICITY USE (2019 T24)	315.78
NATURAL GAS USE	222.61
MOBILE SOURCES ²	3,769.95
TOTAL ALL SOURCES:	4,360.58
AMORTIZED CONSTRUCTION EMISSIONS:	79.7
TOTAL WITH AMORTIZED CONSTRUCTION EMISSIONS:	4,440.28
SERVICE POPULATION (SP):	440
MTCO _{2e} /SP:	10.1
<p><i>ROG=Reactive Organic Gases; NOX=Oxides of Nitrogen; CO=Carbon Monoxide; SOX=Sulphur Oxides; PM=Particulate Matter; FUG=Fugitive; EXH=Exhaust; MT=Metric Tons; CO2e=Carbon Dioxide Equivalent; SP=Service Population (On-site Employees)</i></p> <p><i>1. Electricity use was adjusted to reflect compliance with 2019 Building Energy Efficiency Standards. Under the new standards, nonresidential buildings will use about 30 percent less energy, compared to previous standards. (California Energy Commission. May 9, 2018. Energy Commission Adopts Standards Requiring Solar Systems for New Homes, First in Nation.</i></p> <p><i>2. Mobile source emissions include internal capture and pass-by trips, based on information derived from the traffic analysis prepared for this project (CCTC 2020). Includes SAFE Vehicle Off-Model Adjustment Factors. Includes measures for providing an improved pedestrian network linking on-site land uses to off-site uses, including bicycle and pedestrian facilities, installation of improvements to promote the use of public transit (e.g., transit stops, shelters, pullouts).</i></p> <p><i>Totals may not sum due to rounding.</i></p>	

EMISSIONS MODELING ASSUMPTIONS

LAND USES	KSF	DAILY TRIPS	TRIP GEN RATE		WEEKDAY TRIPS		WEEKDAY TRIP-GEN		SUNDAY TRIP-GEN
			ADJUSTED FOR	PERCENT OF TRIP	ADJUSTED FOR PASS-BY	ADJUSTED FOR PASS-BY			
			PASS-BY TRIPS	TOTAL	TRIPS & INTERNAL	TRIPS & INTERNAL			
STORAGE (WAREHOUSE UNREFRIGERATED)	100	151	1.51	1.13%	-14	137	1.365	1.365	1.365
PROFESSIONAL OFFICE	40	436	10.90	3.27%	-42	394	9.855	2.198	0.938
MEDICAL OFFICE	20	681	34.05	5.10%	-65	616	30.784	7.634	1.321
PROFESSIONAL OFFICE (GOVERNMENT)	22.1	499	22.58	3.74%	-48	451	20.414	0.000	0.000
MARKET PLACE (SHOPPING CENTER)	36	2666	74.06	19.98%	-256	2410	66.953	63.509	30.863
HOME FURNISHINGS/APPLIANCES (RETAIL)	32	177	5.53	1.33%	-17	160	5.001	6.209	4.924
QUICK SERVE RESTAURANT	11	4490	408.18	33.64%	-431	4059	369.034	459.645	382.646
CONVENIENCE STORE WITH GAS PUMPS	3.4	4246	1248.82	31.81%	-407	3839	1129.050	1933.819	1578.320
TOTAL WITH PASS-BY TRIPS		13346			-1280	12066			
INTERNAL CAPTURE		-1280							
TOTAL WITH INTERNAL CAPTURE		12066							

Source: CCTC 2020

Internal capture was distributed among proposed land uses based on percentage of total trip gen by land use.

Weekend trip-gen was adjusted based on CalEEMod default percentage of weekday trip gen.

ASPHALT PARKING 663 SPACES

General Construction Data

Construction start	2121
Construction Duration	36 months
Amount of Fill to be imported/exported (CY)	0--site balances
Total area to be graded	24.50 ac
Total area of paved surface	7.8 ac
Number of new trees (variety per City approved list)	350 ea
Number of trees removed (Eucalyptus)	10 ea
Regional Basin*	152,460 sf

*Assumes basin would be constructed during site grading phase. All material balanced on site.

CONSTRUCTION EMISSIONS SUMMARY

(Totals may not sum due to rounding)

YEAR	ANNUAL EMISSIONS WITHOUT MITIGATION										MTCO2e
	ROG	NOX	CO	SOX	PM10			PM2.5			
					FUG	EXH	TOT	FUG	EXH	TOT	
2021	0.78	4.92	4.16	0.01	0.60	0.21	0.81	0.24	0.20	0.43	784.86
2022	2.11	4.19	4.49	0.01	0.27	0.16	0.43	0.07	0.16	0.23	907.48
2023	1.58	2.96	3.45	0.01	0.20	0.11	0.31	0.05	0.11	0.16	697.88

SBCAPCD THRESHOLD: 25 25
 EXCEEDS THRESHOLD?: NO NO

YEAR	ANNUAL EMISSIONS WITH DUST CONTROL MEASURES										MTCO2e
	ROG	NOX	CO	SOX	PM10			PM2.5			
					FUG	EXH	TOT	FUG	EXH	TOT	
2021	0.51	3.83	4.59	0.01	0.32	0.17	0.50	0.12	0.17	0.29	784.86
2022	1.90	4.07	4.82	0.01	0.27	0.19	0.45	0.07	0.19	0.26	907.48
2023	1.44	3.04	3.74	0.01	0.20	0.15	0.35	0.06	0.15	0.20	697.88

SBCAPCD THRESHOLD: 25 25
 EXCEEDS THRESHOLD?: NO NO

OPERATIONAL EMISSIONS SUMMARY - YEAR 2023 ANNUAL CONDITIONS

SOURCE	ANNUAL YR 2023 EMISSIONS WITHOUT MITIGATION										
	ROG	NOX	CO	SOX	PM10			PM2.5			MTCO2e
					FUG	EXH	TOT	FUG	EXH	TOT	
AREA	1.37	0.00	0.01	0.00	0.00	0.00	0.00	0.00	0.00	0.00	0.02
WASTE GENERATION	0.00	0.00	0.00	0.00	0.00	0.00	0.00	0.00	0.00	0.00	159.13
WATER USE	0.00	0.00	0.00	0.00	0.00	0.00	0.00	0.00	0.00	0.00	69.18
ELECTRICITY USE (2016 T24)	0.00	0.00	0.00	0.00	0.00	0.00	0.00	0.00	0.00	0.00	605.05
ELECTRICITY USE (2019 T24)	0.00	0.00	0.00	0.00	0.00	0.00	0.00	0.00	0.00	0.00	423.54
NATURAL GAS USE	0.02	0.20	0.17	0.00	0.00	0.02	0.02	0.00	0.02	0.02	222.61
MOBILE WITH INTERNAL CAPTURE & PASS-BY ADJUSTMENTS	2.82	8.46	21.61	0.05	3.94	0.04	3.99	1.06	0.04	1.09	4,186.97
MOBILE WITH SAFE VEH. ADJ. FACTORS	2.82	8.46	21.67	0.05	3.94	0.04	3.99	1.06	0.04	1.09	4,271.42
TOTAL:	4.21	8.66	21.84	0.05	3.94	0.06	4.01	1.06	0.06	1.11	5,076.72

1. Electricity use was adjusted to reflect compliance with 2019 Building Energy Efficiency Standards. Under the new standards, nonresidential buildings will use about 30 percent less energy, compared to previous standards. (California Energy Commission. May 9, 2018. Energy Commission Adopts Standards Requiring Solar Systems for New Homes, First in Nation.

2. Mobile source emissions were adjusted to reflect internal capture trips, based on information derived from the traffic analysis prepared for this project (CCTC 2020). Includes SAFE Vehicle Off-Model Adjustment Factors. All mobile-source emissions include reductions for pass-by trips.

3. Water use includes installation of water-efficient irrigation and low-flow fixtures, per current building standards.

SOURCE	ANNUAL YR 2023 EMISSIONS WITH PEDESTRIAN & TRANSIT IMPROVEMENTS										
	ROG	NOX	CO	SOX	PM10			PM2.5			MTCO2e
					FUG	EXH	TOT	FUG	EXH	TOT	
AREA	1.37	0.00	0.01	0.00	0.00	0.00	0.00	0.00	0.00	0.00	0.02
WASTE GENERATION	0.00	0.00	0.00	0.00	0.00	0.00	0.00	0.00	0.00	0.00	159.13
WATER USE	0.00	0.00	0.00	0.00	0.00	0.00	0.00	0.00	0.00	0.00	69.18
ELECTRICITY USE (2016 T24)	0.00	0.00	0.00	0.00	0.00	0.00	0.00	0.00	0.00	0.00	605.05
ELECTRICITY USE (2019 T24)	0.00	0.00	0.00	0.00	0.00	0.00	0.00	0.00	0.00	0.00	423.54
NATURAL GAS USE	0.02	0.20	0.17	0.00	0.00	0.02	0.02	0.00	0.02	0.02	222.61
MOBILE WITH INTERNAL CAPTURE & PASS-BY ADJUSTMENTS	2.81	8.41	21.41	0.05	3.86	0.04	3.91	1.04	0.04	1.08	4,116.40
MOBILE WITH SAFE VEH. ADJ. FACTORS	2.81	8.41	21.47	0.05	3.86	0.04	3.91	1.04	0.04	1.08	4,199.42
TOTAL:	4.20	8.61	21.64	0.05	3.86	0.06	3.93	1.04	0.06	1.10	5,073.90

1. Electricity use was adjusted to reflect compliance with 2019 Building Energy Efficiency Standards. Under the new standards, nonresidential buildings will use about 30 percent less energy, compared to previous standards. (California Energy Commission. May 9, 2018. Energy Commission Adopts Standards Requiring Solar Systems for New Homes, First in Nation.

2. Mobile source emissions were adjusted to reflect internal capture trips, based on information derived from the traffic analysis prepared for this project (CCTC 2020). Includes SAFE Vehicle Off-Model Adjustment Factors. All mobile-source emissions include reductions for pass-by trips.

3. Water use includes installation of water-efficient irrigation and low-flow fixtures, per current building standards.

OPERATIONAL EMISSIONS SUMMARY - YEAR 2030 ANNUAL CONDITIONS

SOURCE	ANNUAL YR 2030 EMISSIONS WITHOUT MITIGATION										MTCO2e	
	ROG	NOX	CO	SOX	PM10			PM2.5				
					FUG	EXH	TOT	FUG	EXH	TOT		
AREA												0.02
WASTE GENERATION												79.57
WATER USE												54.28
ELECTRICITY USE (2016 T24)												412.04
ELECTRICITY USE (2019 T24)												288.43
NATURAL GAS USE												222.61
MOBILE WITH INTERNAL CAPTURE & PASS-BY ADJUSTMENTS												3,493.51
MOBILE WITH SAFE VEH. ADJ. FACTORS												3,833.29
TOTAL:												4,478.20

1. Electricity use was adjusted to reflect compliance with 2019 Building Energy Efficiency Standards. Under the new standards, nonresidential buildings will use about 30 percent less energy, compared to previous standards. (California Energy Commission. May 9, 2018. Energy Commission Adopts Standards Requiring Solar Systems for New Homes, First in Nation.

2. Mobile source emissions were adjusted to reflect internal capture and pass-by trips, based on information derived from the traffic analysis prepared for this project (CCTC 2020). Includes SAFE Vehicle Off-Model Adjustment Factors.

3. Water use includes installation of water-efficient irrigation and low-flow fixtures, per current building standards.

SOURCE	ANNUAL YR 2030 EMISSIONS WITH PEDESTRIAN & TRANSIT IMPROVEMENTS										MTCO2e	
	ROG	NOX	CO	SOX	PM10			PM2.5				
					FUG	EXH	TOT	FUG	EXH	TOT		
AREA												0.02
WASTE GENERATION												79.57
WATER USE												54.28
ELECTRICITY USE (2016 T24)												412.04
ELECTRICITY USE (2019 T24)												288.43
NATURAL GAS USE												222.61
MOBILE WITH INTERNAL CAPTURE & PASS-BY ADJUSTMENTS												3,718.08
MOBILE WITH SAFE VEH. ADJ. FACTORS												3,769.95
TOTAL:												4,360.58

1. Electricity use was adjusted to reflect compliance with 2019 Building Energy Efficiency Standards. Under the new standards, nonresidential buildings will use about 30 percent less energy, compared to previous standards. (California Energy Commission. May 9, 2018. Energy Commission Adopts Standards Requiring Solar Systems for New Homes, First in Nation.

2. Mobile source emissions were adjusted to reflect internal capture and pass-by trips, based on information derived from the traffic analysis prepared for this project (CCTC 2020). Includes SAFE Vehicle Off-Model Adjustment Factors.

3. Water use includes installation of water-efficient irrigation and low-flow fixtures, per current building standards.

DEFAULT CALEEMOD TRIP GEN

Weekend trips were adjusted based on the default percent change in trips contained in CalEEMod compared to weekday trips.

		WEEKDAY	SATURDAY	SUNDAY	PERCENT OF WEEKDAY	
					SATURDAY	SUNDAY
Convenience Market With Gas Pumps	1000sqft	845.6	1,448.33	1,182.08	1.712783822	1.397918638
Free-Standing Discount Store	1000sqft	57.24	71.07	56.36	1.241614256	0.984626136
General Office Building	1000sqft	11.03	2.46	1.05	0.223028105	0.095194923
Government Office Building	1000sqft	68.93	0	0	0	0
High Turnover (Sit Down Restaurant)	1000sqft	127.15	158.37	131.84	1.245536768	1.036885568
Medical Office Building	1000sqft	36.13	8.96	1.55	0.247993357	0.042900637
Strip Mall	1000sqft	44.32	42.04	20.43	0.948555957	0.460965704
Unrefrigerated Warehouse-No Rail	1000sqft	1.68	1.68	1.68	1	1

Santa Maria Airport Commercial Rezone - Santa Barbara-North of Santa Ynez County, Summer

Santa Maria Airport Commercial Rezone
Santa Barbara-North of Santa Ynez County, Summer

1.0 Project Characteristics

1.1 Land Usage

Land Uses	Size	Metric	Lot Acreage	Floor Surface Area	Population
General Office Building	40.00	1000sqft	0.92	40,000.00	0
Government Office Building	22.10	1000sqft	0.51	22,100.00	0
Medical Office Building	20.00	1000sqft	0.46	20,000.00	0
Unrefrigerated Warehouse-No Rail	100.00	1000sqft	2.30	100,000.00	0
Parking Lot	663.00	Space	8.00	265,200.00	0
High Turnover (Sit Down Restaurant)	11.00	1000sqft	0.25	11,000.00	0
Convenience Market With Gas Pumps	3.40	1000sqft	0.08	3,400.00	0
Free-Standing Discount Store	32.00	1000sqft	0.73	32,000.00	0
Strip Mall	36.00	1000sqft	0.83	36,000.00	0
Other Asphalt Surfaces	2.00	Acre	2.00	87,120.00	0
Other Non-Asphalt Surfaces	0.50	Acre	0.50	21,780.00	0

1.2 Other Project Characteristics

Urbanization	Urban	Wind Speed (m/s)	3.1	Precipitation Freq (Days)	37
Climate Zone	4			Operational Year	2023
Utility Company	Pacific Gas & Electric Company				
CO2 Intensity (lb/MWhr)	438.13	CH4 Intensity (lb/MWhr)	0.02	N2O Intensity (lb/MWhr)	0.004

1.3 User Entered Comments & Non-Default Data

Santa Maria Airport Commercial Rezone - Santa Barbara-North of Santa Ynez County, Summer

Project Characteristics - Includes adjustments for RPS.

Land Use - Based on land use information provided.

Construction Phase - Based on information provided. Demo not required. Site prep 10 days, grading 80 days, building 606 days, paving 20 days, arch coating 500 days.

Off-road Equipment - Based on model defaults

Off-road Equipment - Based on model defaults. Additional equipment included based on information provided.

Off-road Equipment - Based on model defaults. Additional equipment included based on information provided.

Off-road Equipment - Based on model defaults. Additional equipment included based on information provided.

Off-road Equipment - Includes 2 scrapers based on info provided and defaults.

Trips and VMT - Construction vehicle trips based on model defaults.

Grading - All material balanced on site. Area graded based on model defaults/equipment usage rates. Graded area is calculated by CalEEMod based on equipment usage/8-hr day and const. schedule.

Vehicle Trips - Trip-gen rates derived from the traffic analysis (CCTC 2020). Rates were adjusted for internal capture and pass-by. Trip lengths based on model defaults.

Area Coating - Arch coatings based on model defaults.

Energy Use - Energy use based on model defaults.

Water And Wastewater - Water, wastewater, and solid waste based on model defaults.

Sequestration - Assumes net increase of 340 trees. Provided for informational purposes only.

Construction Off-road Equipment Mitigation - Includes 50% CE for watering unpaved roads/travel areas; 61% CE for watering graded surfaces, 15 mph onsite speed limit. T3 offroad equipment included for informational purposes.

Mobile Land Use Mitigation - Site Enhancements include improved pedestrian access on-site and connecting off-site. Install transit features to increase accessibility (benches, pullouts, etc.)

Area Mitigation - .

Energy Mitigation - Compliance with current energy-efficiency building standards calculated separately.

Water Mitigation - Includes use of low-flow water fixtures and water-efficient irrigation systems.

Waste Mitigation - Assumes 75% diversion rate per current targets.

Architectural Coating - Arch coating based on model defaults.

Vehicle Emission Factors - Emfac based on model defaults. SAFE veh adjustments calculated separately.

Vehicle Emission Factors -

Vehicle Emission Factors -

Santa Maria Airport Commercial Rezone - Santa Barbara-North of Santa Ynez County, Summer

Fleet Mix -

Table Name	Column Name	Default Value	New Value
tblArchitecturalCoating	ConstArea_Parking	22,446.00	15,912.00
tblAreaMitigation	UseLowVOCPaintNonresidentialExteriorValue	250	50
tblAreaMitigation	UseLowVOCPaintNonresidentialInteriorValue	250	50
tblConstDustMitigation	WaterUnpavedRoadVehicleSpeed	0	15
tblConstEquipMitigation	NumberOfEquipmentMitigated	0.00	1.00
tblConstEquipMitigation	NumberOfEquipmentMitigated	0.00	1.00
tblConstEquipMitigation	NumberOfEquipmentMitigated	0.00	1.00
tblConstEquipMitigation	NumberOfEquipmentMitigated	0.00	3.00
tblConstEquipMitigation	NumberOfEquipmentMitigated	0.00	3.00
tblConstEquipMitigation	NumberOfEquipmentMitigated	0.00	1.00
tblConstEquipMitigation	NumberOfEquipmentMitigated	0.00	2.00
tblConstEquipMitigation	NumberOfEquipmentMitigated	0.00	1.00
tblConstEquipMitigation	NumberOfEquipmentMitigated	0.00	1.00
tblConstEquipMitigation	NumberOfEquipmentMitigated	0.00	4.00
tblConstEquipMitigation	NumberOfEquipmentMitigated	0.00	4.00
tblConstEquipMitigation	NumberOfEquipmentMitigated	0.00	4.00
tblConstEquipMitigation	NumberOfEquipmentMitigated	0.00	1.00
tblConstEquipMitigation	NumberOfEquipmentMitigated	0.00	12.00
tblConstEquipMitigation	NumberOfEquipmentMitigated	0.00	1.00
tblConstEquipMitigation	Tier	No Change	Tier 3
tblConstEquipMitigation	Tier	No Change	Tier 3
tblConstEquipMitigation	Tier	No Change	Tier 3
tblConstEquipMitigation	Tier	No Change	Tier 3
tblConstEquipMitigation	Tier	No Change	Tier 3

Santa Maria Airport Commercial Rezone - Santa Barbara-North of Santa Ynez County, Summer

tblConstEquipMitigation	Tier	No Change	Tier 3
tblConstEquipMitigation	Tier	No Change	Tier 3
tblConstEquipMitigation	Tier	No Change	Tier 3
tblConstEquipMitigation	Tier	No Change	Tier 3
tblConstEquipMitigation	Tier	No Change	Tier 3
tblConstEquipMitigation	Tier	No Change	Tier 3
tblConstEquipMitigation	Tier	No Change	Tier 3
tblConstEquipMitigation	Tier	No Change	Tier 3
tblConstEquipMitigation	Tier	No Change	Tier 3
tblConstEquipMitigation	Tier	No Change	Tier 3
tblConstructionPhase	NumDays	30.00	80.00
tblConstructionPhase	NumDays	300.00	606.00
tblConstructionPhase	NumDays	20.00	500.00
tblLandUse	LotAcreage	5.97	8.00
tblOffRoadEquipment	OffRoadEquipmentUnitAmount	2.00	1.00
tblOffRoadEquipment	OffRoadEquipmentUnitAmount	2.00	1.00
tblOffRoadEquipment	OffRoadEquipmentUnitAmount	2.00	3.00
tblProjectCharacteristics	CH4IntensityFactor	0.029	0.02
tblProjectCharacteristics	CO2IntensityFactor	641.35	438.13
tblProjectCharacteristics	N2OIntensityFactor	0.006	0.004
tblSequestration	NumberOfNewTrees	0.00	340.00
tblTripsAndVMT	VendorTripNumber	105.00	87.00
tblTripsAndVMT	WorkerTripNumber	253.00	207.00
tblTripsAndVMT	WorkerTripNumber	51.00	41.00
tblTripsAndVMT	WorkerTripNumber	20.00	25.00
tblVehicleTrips	ST_TR	1,448.33	1,933.82
tblVehicleTrips	ST_TR	71.07	6.21

Santa Maria Airport Commercial Rezone - Santa Barbara-North of Santa Ynez County, Summer

tblVehicleTrips	ST_TR	2.46	2.20
tblVehicleTrips	ST_TR	158.37	459.65
tblVehicleTrips	ST_TR	8.96	7.63
tblVehicleTrips	ST_TR	42.04	63.51
tblVehicleTrips	ST_TR	1.68	1.37
tblVehicleTrips	SU_TR	1,182.08	1,578.32
tblVehicleTrips	SU_TR	56.36	4.92
tblVehicleTrips	SU_TR	1.05	0.94
tblVehicleTrips	SU_TR	131.84	382.65
tblVehicleTrips	SU_TR	1.55	1.32
tblVehicleTrips	SU_TR	20.43	30.86
tblVehicleTrips	SU_TR	1.68	1.37
tblVehicleTrips	WD_TR	845.60	1,129.05
tblVehicleTrips	WD_TR	57.24	5.00
tblVehicleTrips	WD_TR	11.03	9.86
tblVehicleTrips	WD_TR	68.93	20.41
tblVehicleTrips	WD_TR	127.15	369.03
tblVehicleTrips	WD_TR	36.13	30.78
tblVehicleTrips	WD_TR	44.32	66.95
tblVehicleTrips	WD_TR	1.68	1.37

2.0 Emissions Summary

Santa Maria Airport Commercial Rezone - Santa Barbara-North of Santa Ynez County, Summer

2.1 Overall Construction (Maximum Daily Emission)

Unmitigated Construction

	ROG	NOx	CO	SO2	Fugitive PM10	Exhaust PM10	PM10 Total	Fugitive PM2.5	Exhaust PM2.5	PM2.5 Total	Bio- CO2	NBio- CO2	Total CO2	CH4	N2O	CO2e
Year	lb/day										lb/day					
2021	16.5519	61.9523	35.9298	0.0782	20.3325	2.8781	23.2106	10.1982	2.6479	12.8461			7,784.3294	2.1454	0.0000	7,812.3520
2022	16.1937	32.1152	34.3869	0.0775	2.0814	1.2582	3.3396	0.5637	1.1938	1.7576			7,717.9130	1.1113	0.0000	7,745.6949
2023	18.6837	43.6797	49.2495	0.1049	2.2393	1.7569	3.9962	0.6056	1.6485	2.2541			10,361.6081	1.9267	0.0000	10,409.7751
Maximum	18.6837	61.9523	49.2495	0.1049	20.3325	2.8781	23.2106	10.1982	2.6479	12.8461			10,361.6081	2.1454	0.0000	10,409.7751

Mitigated Construction

	ROG	NOx	CO	SO2	Fugitive PM10	Exhaust PM10	PM10 Total	Fugitive PM2.5	Exhaust PM2.5	PM2.5 Total	Bio- CO2	NBio- CO2	Total CO2	CH4	N2O	CO2e
Year	lb/day										lb/day					
2021	14.6785	33.5314	41.9376	0.0782	8.0183	1.5435	9.5122	4.0008	1.5434	5.4946			7,784.3294	2.1454	0.0000	7,812.3520
2022	14.6064	31.1534	36.8964	0.0775	2.0814	1.4524	3.5338	0.5637	1.4506	2.0144			7,717.9130	1.1113	0.0000	7,745.6949
2023	16.5245	43.2083	55.1454	0.1049	2.2393	2.1924	4.4317	0.6056	2.1911	2.7968			10,361.6081	1.9267	0.0000	10,409.7751
Maximum	16.5245	43.2083	55.1454	0.1049	8.0183	2.1924	9.5122	4.0008	2.1911	5.4946			10,361.6081	2.1454	0.0000	10,409.7751

Santa Maria Airport Commercial Rezone - Santa Barbara-North of Santa Ynez County, Summer

	ROG	NOx	CO	SO2	Fugitive PM10	Exhaust PM10	PM10 Total	Fugitive PM2.5	Exhaust PM2.5	PM2.5 Total	Bio- CO2	NBio-CO2	Total CO2	CH4	N2O	CO2e
Percent Reduction	10.93	21.67	-12.05	0.00	49.95	11.96	42.78	54.52	5.56	38.87	0.00	0.00	0.00	0.00	0.00	0.00

Santa Maria Airport Commercial Rezone - Santa Barbara-North of Santa Ynez County, Summer

2.2 Overall Operational

Unmitigated Operational

	ROG	NOx	CO	SO2	Fugitive PM10	Exhaust PM10	PM10 Total	Fugitive PM2.5	Exhaust PM2.5	PM2.5 Total	Bio- CO2	NBio- CO2	Total CO2	CH4	N2O	CO2e
Category	lb/day										lb/day					
Area	7.5523	8.6000e-004	0.0949	1.0000e-005		3.4000e-004	3.4000e-004		3.4000e-004	3.4000e-004			0.2035	5.3000e-004		0.2169
Energy	0.1225	1.1139	0.9356	6.6800e-003		0.0847	0.0847		0.0847	0.0847			1,336.6237	0.0256	0.0245	1,344.5666
Mobile	20.6901	57.8215	140.4087	0.3165	27.4150	0.2984	27.7135	7.3479	0.2784	7.6263			32,224.6205	1.8331		32,270.4470
Total	28.3649	58.9362	141.4392	0.3231	27.4150	0.3834	27.7985	7.3479	0.3634	7.7113			33,561.4477	1.8592	0.0245	33,615.2304

Mitigated Operational

	ROG	NOx	CO	SO2	Fugitive PM10	Exhaust PM10	PM10 Total	Fugitive PM2.5	Exhaust PM2.5	PM2.5 Total	Bio- CO2	NBio- CO2	Total CO2	CH4	N2O	CO2e
Category	lb/day										lb/day					
Area	7.5523	8.6000e-004	0.0949	1.0000e-005		3.4000e-004	3.4000e-004		3.4000e-004	3.4000e-004			0.2035	5.3000e-004		0.2169
Energy	0.1225	1.1139	0.9356	6.6800e-003		0.0847	0.0847		0.0847	0.0847			1,336.6237	0.0256	0.0245	1,344.5666
Mobile	20.6339	57.4728	139.0099	0.3111	26.8667	0.2943	27.1610	7.2009	0.2745	7.4754			31,686.0660	1.8129		31,731.3879
Total	28.3086	58.5875	140.0405	0.3178	26.8667	0.3793	27.2460	7.2009	0.3595	7.5604			33,022.8932	1.8390	0.0245	33,076.1714

Santa Maria Airport Commercial Rezone - Santa Barbara-North of Santa Ynez County, Summer

	ROG	NOx	CO	SO2	Fugitive PM10	Exhaust PM10	PM10 Total	Fugitive PM2.5	Exhaust PM2.5	PM2.5 Total	Bio- CO2	NBio-CO2	Total CO2	CH4	N2O	CO2e
Percent Reduction	0.20	0.59	0.99	1.64	2.00	1.08	1.99	2.00	1.07	1.96	0.00	0.00	1.60	1.09	0.00	1.60

3.0 Construction Detail

Construction Phase

Phase Number	Phase Name	Phase Type	Start Date	End Date	Num Days Week	Num Days	Phase Description
1	Site Preparation	Site Preparation	1/29/2021	2/11/2021	5	10	
2	Grading	Grading	2/12/2021	6/3/2021	5	80	
3	Building Construction	Building Construction	6/4/2021	9/29/2023	5	606	
4	Architectural Coating	Architectural Coating	11/1/2021	9/29/2023	5	500	
5	Paving	Paving	8/20/2023	9/15/2023	5	20	

Acres of Grading (Site Preparation Phase): 20

Acres of Grading (Grading Phase): 200

Acres of Paving: 10.5

Residential Indoor: 0; Residential Outdoor: 0; Non-Residential Indoor: 396,750; Non-Residential Outdoor: 132,250; Striped Parking Area: 15,912 (Architectural Coating – sqft)

OffRoad Equipment

Santa Maria Airport Commercial Rezone - Santa Barbara-North of Santa Ynez County, Summer

Phase Name	Offroad Equipment Type	Amount	Usage Hours	Horse Power	Load Factor
Site Preparation	Rubber Tired Dozers	3	8.00	247	0.40
Site Preparation	Scrapers	2	8.00	367	0.48
Site Preparation	Tractors/Loaders/Backhoes	4	8.00	97	0.37
Grading	Excavators	2	8.00	158	0.38
Grading	Graders	1	8.00	187	0.41
Grading	Rubber Tired Dozers	1	8.00	247	0.40
Grading	Scrapers	2	8.00	367	0.48
Grading	Tractors/Loaders/Backhoes	2	8.00	97	0.37
Grading	Tractors/Loaders/Backhoes	2	8.00	97	0.37
Building Construction	Concrete/Industrial Saws	1	8.00	81	0.73
Building Construction	Cranes	1	7.00	231	0.29
Building Construction	Excavators	1	8.00	158	0.38
Building Construction	Forklifts	3	8.00	89	0.20
Building Construction	Generator Sets	1	8.00	84	0.74
Building Construction	Rollers	1	8.00	80	0.38
Building Construction	Tractors/Loaders/Backhoes	3	7.00	97	0.37
Building Construction	Welders	1	8.00	46	0.45
Architectural Coating	Air Compressors	1	6.00	78	0.48
Paving	Graders	1	8.00	187	0.41
Paving	Pavers	1	8.00	130	0.42
Paving	Paving Equipment	1	8.00	132	0.36
Paving	Rollers	3	8.00	80	0.38
Paving	Signal Boards	1	8.00	6	0.82
Paving	Tractors/Loaders/Backhoes	1	8.00	97	0.37

Trips and VMT

Santa Maria Airport Commercial Rezone - Santa Barbara-North of Santa Ynez County, Summer

Phase Name	Offroad Equipment Count	Worker Trip Number	Vendor Trip Number	Hauling Trip Number	Worker Trip Length	Vendor Trip Length	Hauling Trip Length	Worker Vehicle Class	Vendor Vehicle Class	Hauling Vehicle Class
Site Preparation	9	23.00	0.00	0.00	8.30	6.40	20.00	LD_Mix	HDT_Mix	HHDT
Grading	10	25.00	0.00	0.00	8.30	6.40	20.00	LD_Mix	HDT_Mix	HHDT
Building Construction	12	207.00	87.00	0.00	8.30	6.40	20.00	LD_Mix	HDT_Mix	HHDT
Architectural Coating	1	41.00	0.00	0.00	8.30	6.40	20.00	LD_Mix	HDT_Mix	HHDT
Paving	8	25.00	0.00	0.00	8.30	6.40	20.00	LD_Mix	HDT_Mix	HHDT

3.1 Mitigation Measures Construction

Use Cleaner Engines for Construction Equipment

Use Soil Stabilizer

Water Exposed Area

Reduce Vehicle Speed on Unpaved Roads

3.2 Site Preparation - 2021

Unmitigated Construction On-Site

	ROG	NOx	CO	SO2	Fugitive PM10	Exhaust PM10	PM10 Total	Fugitive PM2.5	Exhaust PM2.5	PM2.5 Total	Bio- CO2	NBio- CO2	Total CO2	CH4	N2O	CO2e
Category	lb/day										lb/day					
Fugitive Dust					20.1873	0.0000	20.1873	10.1597	0.0000	10.1597			0.0000			0.0000
Off-Road	5.7471	61.9027	35.1637	0.0683		2.8772	2.8772		2.6470	2.6470			6,621.4799	2.1415		6,675.0179
Total	5.7471	61.9027	35.1637	0.0683	20.1873	2.8772	23.0645	10.1597	2.6470	12.8067			6,621.4799	2.1415		6,675.0179

Santa Maria Airport Commercial Rezone - Santa Barbara-North of Santa Ynez County, Summer

3.2 Site Preparation - 2021

Unmitigated Construction Off-Site

	ROG	NOx	CO	SO2	Fugitive PM10	Exhaust PM10	PM10 Total	Fugitive PM2.5	Exhaust PM2.5	PM2.5 Total	Bio- CO2	NBio- CO2	Total CO2	CH4	N2O	CO2e
Category	lb/day										lb/day					
Hauling	0.0000	0.0000	0.0000	0.0000	0.0000	0.0000	0.0000	0.0000	0.0000	0.0000			0.0000	0.0000		0.0000
Vendor	0.0000	0.0000	0.0000	0.0000	0.0000	0.0000	0.0000	0.0000	0.0000	0.0000			0.0000	0.0000		0.0000
Worker	0.0666	0.0496	0.4884	1.2700e-003	0.1453	9.0000e-004	0.1462	0.0385	8.3000e-004	0.0394			126.2985	3.8800e-003		126.3956
Total	0.0666	0.0496	0.4884	1.2700e-003	0.1453	9.0000e-004	0.1462	0.0385	8.3000e-004	0.0394			126.2985	3.8800e-003		126.3956

Mitigated Construction On-Site

	ROG	NOx	CO	SO2	Fugitive PM10	Exhaust PM10	PM10 Total	Fugitive PM2.5	Exhaust PM2.5	PM2.5 Total	Bio- CO2	NBio- CO2	Total CO2	CH4	N2O	CO2e
Category	lb/day										lb/day					
Fugitive Dust					7.8730	0.0000	7.8730	3.9623	0.0000	3.9623			0.0000			0.0000
Off-Road	1.6768	33.4818	39.1161	0.0683		1.4930	1.4930		1.4930	1.4930			6,621.4799	2.1415		6,675.0179
Total	1.6768	33.4818	39.1161	0.0683	7.8730	1.4930	9.3660	3.9623	1.4930	5.4553			6,621.4799	2.1415		6,675.0179

Santa Maria Airport Commercial Rezone - Santa Barbara-North of Santa Ynez County, Summer

3.2 Site Preparation - 2021

Mitigated Construction Off-Site

	ROG	NOx	CO	SO2	Fugitive PM10	Exhaust PM10	PM10 Total	Fugitive PM2.5	Exhaust PM2.5	PM2.5 Total	Bio- CO2	NBio- CO2	Total CO2	CH4	N2O	CO2e
Category	lb/day										lb/day					
Hauling	0.0000	0.0000	0.0000	0.0000	0.0000	0.0000	0.0000	0.0000	0.0000	0.0000			0.0000	0.0000		0.0000
Vendor	0.0000	0.0000	0.0000	0.0000	0.0000	0.0000	0.0000	0.0000	0.0000	0.0000			0.0000	0.0000		0.0000
Worker	0.0666	0.0496	0.4884	1.2700e-003	0.1453	9.0000e-004	0.1462	0.0385	8.3000e-004	0.0394			126.2985	3.8800e-003		126.3956
Total	0.0666	0.0496	0.4884	1.2700e-003	0.1453	9.0000e-004	0.1462	0.0385	8.3000e-004	0.0394			126.2985	3.8800e-003		126.3956

3.3 Grading - 2021

Unmitigated Construction On-Site

	ROG	NOx	CO	SO2	Fugitive PM10	Exhaust PM10	PM10 Total	Fugitive PM2.5	Exhaust PM2.5	PM2.5 Total	Bio- CO2	NBio- CO2	Total CO2	CH4	N2O	CO2e
Category	lb/day										lb/day					
Fugitive Dust					8.6733	0.0000	8.6733	3.5965	0.0000	3.5965			0.0000			0.0000
Off-Road	4.5657	50.1915	35.3989	0.0682		2.2089	2.2089		2.0322	2.0322			6,608.8436	2.1374		6,662.2794
Total	4.5657	50.1915	35.3989	0.0682	8.6733	2.2089	10.8822	3.5965	2.0322	5.6287			6,608.8436	2.1374		6,662.2794

Santa Maria Airport Commercial Rezone - Santa Barbara-North of Santa Ynez County, Summer

3.3 Grading - 2021

Unmitigated Construction Off-Site

	ROG	NOx	CO	SO2	Fugitive PM10	Exhaust PM10	PM10 Total	Fugitive PM2.5	Exhaust PM2.5	PM2.5 Total	Bio- CO2	NBio- CO2	Total CO2	CH4	N2O	CO2e
Category	lb/day										lb/day					
Hauling	0.0000	0.0000	0.0000	0.0000	0.0000	0.0000	0.0000	0.0000	0.0000	0.0000			0.0000	0.0000		0.0000
Vendor	0.0000	0.0000	0.0000	0.0000	0.0000	0.0000	0.0000	0.0000	0.0000	0.0000			0.0000	0.0000		0.0000
Worker	0.0724	0.0540	0.5309	1.3800e-003	0.1579	9.7000e-004	0.1589	0.0419	9.0000e-004	0.0428			137.2810	4.2200e-003		137.3865
Total	0.0724	0.0540	0.5309	1.3800e-003	0.1579	9.7000e-004	0.1589	0.0419	9.0000e-004	0.0428			137.2810	4.2200e-003		137.3865

Mitigated Construction On-Site

	ROG	NOx	CO	SO2	Fugitive PM10	Exhaust PM10	PM10 Total	Fugitive PM2.5	Exhaust PM2.5	PM2.5 Total	Bio- CO2	NBio- CO2	Total CO2	CH4	N2O	CO2e
Category	lb/day										lb/day					
Fugitive Dust					3.3826	0.0000	3.3826	1.4026	0.0000	1.4026			0.0000			0.0000
Off-Road	1.6750	33.4470	41.4067	0.0682		1.5425	1.5425		1.5425	1.5425			6,608.8436	2.1374		6,662.2794
Total	1.6750	33.4470	41.4067	0.0682	3.3826	1.5425	4.9251	1.4026	1.5425	2.9451			6,608.8436	2.1374		6,662.2794

Santa Maria Airport Commercial Rezone - Santa Barbara-North of Santa Ynez County, Summer

3.3 Grading - 2021

Mitigated Construction Off-Site

	ROG	NOx	CO	SO2	Fugitive PM10	Exhaust PM10	PM10 Total	Fugitive PM2.5	Exhaust PM2.5	PM2.5 Total	Bio- CO2	NBio- CO2	Total CO2	CH4	N2O	CO2e
Category	lb/day										lb/day					
Hauling	0.0000	0.0000	0.0000	0.0000	0.0000	0.0000	0.0000	0.0000	0.0000	0.0000			0.0000	0.0000		0.0000
Vendor	0.0000	0.0000	0.0000	0.0000	0.0000	0.0000	0.0000	0.0000	0.0000	0.0000			0.0000	0.0000		0.0000
Worker	0.0724	0.0540	0.5309	1.3800e-003	0.1579	9.7000e-004	0.1589	0.0419	9.0000e-004	0.0428			137.2810	4.2200e-003		137.3865
Total	0.0724	0.0540	0.5309	1.3800e-003	0.1579	9.7000e-004	0.1589	0.0419	9.0000e-004	0.0428			137.2810	4.2200e-003		137.3865

3.4 Building Construction - 2021

Unmitigated Construction On-Site

	ROG	NOx	CO	SO2	Fugitive PM10	Exhaust PM10	PM10 Total	Fugitive PM2.5	Exhaust PM2.5	PM2.5 Total	Bio- CO2	NBio- CO2	Total CO2	CH4	N2O	CO2e
Category	lb/day										lb/day					
Off-Road	2.7044	24.5476	25.4015	0.0410		1.3538	1.3538		1.2787	1.2787			3,900.3094	0.8944		3,922.6689
Total	2.7044	24.5476	25.4015	0.0410		1.3538	1.3538		1.2787	1.2787			3,900.3094	0.8944		3,922.6689

Santa Maria Airport Commercial Rezone - Santa Barbara-North of Santa Ynez County, Summer

3.4 Building Construction - 2021

Unmitigated Construction Off-Site

	ROG	NOx	CO	SO2	Fugitive PM10	Exhaust PM10	PM10 Total	Fugitive PM2.5	Exhaust PM2.5	PM2.5 Total	Bio- CO2	NBio- CO2	Total CO2	CH4	N2O	CO2e
Category	lb/day										lb/day					
Hauling	0.0000	0.0000	0.0000	0.0000	0.0000	0.0000	0.0000	0.0000	0.0000	0.0000			0.0000	0.0000		0.0000
Vendor	0.2817	8.7511	2.8579	0.0206	0.5152	0.0257	0.5409	0.1482	0.0246	0.1728			2,240.7446	0.1653		2,244.8782
Worker	0.5998	0.4468	4.3958	0.0114	1.3073	8.0600e-003	1.3154	0.3468	7.4300e-003	0.3543			1,136.6865	0.0349		1,137.5601
Total	0.8815	9.1979	7.2537	0.0320	1.8225	0.0338	1.8563	0.4951	0.0320	0.5271			3,377.4312	0.2003		3,382.4383

Mitigated Construction On-Site

	ROG	NOx	CO	SO2	Fugitive PM10	Exhaust PM10	PM10 Total	Fugitive PM2.5	Exhaust PM2.5	PM2.5 Total	Bio- CO2	NBio- CO2	Total CO2	CH4	N2O	CO2e
Category	lb/day										lb/day					
Off-Road	0.9905	21.0093	27.6342	0.0410		1.3253	1.3253		1.3253	1.3253			3,900.3094	0.8944		3,922.6689
Total	0.9905	21.0093	27.6342	0.0410		1.3253	1.3253		1.3253	1.3253			3,900.3094	0.8944		3,922.6689

Santa Maria Airport Commercial Rezone - Santa Barbara-North of Santa Ynez County, Summer

3.4 Building Construction - 2021

Mitigated Construction Off-Site

	ROG	NOx	CO	SO2	Fugitive PM10	Exhaust PM10	PM10 Total	Fugitive PM2.5	Exhaust PM2.5	PM2.5 Total	Bio- CO2	NBio- CO2	Total CO2	CH4	N2O	CO2e
Category	lb/day										lb/day					
Hauling	0.0000	0.0000	0.0000	0.0000	0.0000	0.0000	0.0000	0.0000	0.0000	0.0000			0.0000	0.0000		0.0000
Vendor	0.2817	8.7511	2.8579	0.0206	0.5152	0.0257	0.5409	0.1482	0.0246	0.1728			2,240.744 6	0.1653		2,244.878 2
Worker	0.5998	0.4468	4.3958	0.0114	1.3073	8.0600e-003	1.3154	0.3468	7.4300e-003	0.3543			1,136.686 5	0.0349		1,137.560 1
Total	0.8815	9.1979	7.2537	0.0320	1.8225	0.0338	1.8563	0.4951	0.0320	0.5271			3,377.431 2	0.2003		3,382.438 3

3.4 Building Construction - 2022

Unmitigated Construction On-Site

	ROG	NOx	CO	SO2	Fugitive PM10	Exhaust PM10	PM10 Total	Fugitive PM2.5	Exhaust PM2.5	PM2.5 Total	Bio- CO2	NBio- CO2	Total CO2	CH4	N2O	CO2e
Category	lb/day										lb/day					
Off-Road	2.4327	21.9197	25.1436	0.0410		1.1446	1.1446		1.0819	1.0819			3,901.117 3	0.8882		3,923.321 6
Total	2.4327	21.9197	25.1436	0.0410		1.1446	1.1446		1.0819	1.0819			3,901.117 3	0.8882		3,923.321 6

Santa Maria Airport Commercial Rezone - Santa Barbara-North of Santa Ynez County, Summer

3.4 Building Construction - 2022

Unmitigated Construction Off-Site

	ROG	NOx	CO	SO2	Fugitive PM10	Exhaust PM10	PM10 Total	Fugitive PM2.5	Exhaust PM2.5	PM2.5 Total	Bio- CO2	NBio- CO2	Total CO2	CH4	N2O	CO2e
Category	lb/day										lb/day					
Hauling	0.0000	0.0000	0.0000	0.0000	0.0000	0.0000	0.0000	0.0000	0.0000	0.0000			0.0000	0.0000		0.0000
Vendor	0.2591	8.3087	2.6312	0.0203	0.5152	0.0226	0.5377	0.1482	0.0216	0.1698			2,222.1006	0.1675		2,226.2880
Worker	0.5584	0.3993	4.0053	0.0110	1.3073	7.8300e-003	1.3151	0.3468	7.2100e-003	0.3540			1,096.1376	0.0311		1,096.9157
Total	0.8176	8.7080	6.6364	0.0314	1.8225	0.0304	1.8529	0.4951	0.0288	0.5238			3,318.2382	0.1986		3,323.2036

Mitigated Construction On-Site

	ROG	NOx	CO	SO2	Fugitive PM10	Exhaust PM10	PM10 Total	Fugitive PM2.5	Exhaust PM2.5	PM2.5 Total	Bio- CO2	NBio- CO2	Total CO2	CH4	N2O	CO2e
Category	lb/day										lb/day					
Off-Road	0.9905	21.0093	27.6342	0.0410		1.3253	1.3253		1.3253	1.3253			3,901.1173	0.8882		3,923.3216
Total	0.9905	21.0093	27.6342	0.0410		1.3253	1.3253		1.3253	1.3253			3,901.1173	0.8882		3,923.3216

Santa Maria Airport Commercial Rezone - Santa Barbara-North of Santa Ynez County, Summer

3.4 Building Construction - 2022

Mitigated Construction Off-Site

	ROG	NOx	CO	SO2	Fugitive PM10	Exhaust PM10	PM10 Total	Fugitive PM2.5	Exhaust PM2.5	PM2.5 Total	Bio- CO2	NBio- CO2	Total CO2	CH4	N2O	CO2e
Category	lb/day										lb/day					
Hauling	0.0000	0.0000	0.0000	0.0000	0.0000	0.0000	0.0000	0.0000	0.0000	0.0000			0.0000	0.0000		0.0000
Vendor	0.2591	8.3087	2.6312	0.0203	0.5152	0.0226	0.5377	0.1482	0.0216	0.1698			2,222.1006	0.1675		2,226.2880
Worker	0.5584	0.3993	4.0053	0.0110	1.3073	7.8300e-003	1.3151	0.3468	7.2100e-003	0.3540			1,096.1376	0.0311		1,096.9157
Total	0.8176	8.7080	6.6364	0.0314	1.8225	0.0304	1.8529	0.4951	0.0288	0.5238			3,318.2382	0.1986		3,323.2036

3.4 Building Construction - 2023

Unmitigated Construction On-Site

	ROG	NOx	CO	SO2	Fugitive PM10	Exhaust PM10	PM10 Total	Fugitive PM2.5	Exhaust PM2.5	PM2.5 Total	Bio- CO2	NBio- CO2	Total CO2	CH4	N2O	CO2e
Category	lb/day										lb/day					
Off-Road	2.2489	20.1279	25.0114	0.0410		0.9924	0.9924		0.9379	0.9379			3,902.0889	0.8810		3,924.1133
Total	2.2489	20.1279	25.0114	0.0410		0.9924	0.9924		0.9379	0.9379			3,902.0889	0.8810		3,924.1133

Santa Maria Airport Commercial Rezone - Santa Barbara-North of Santa Ynez County, Summer

3.4 Building Construction - 2023

Unmitigated Construction Off-Site

	ROG	NOx	CO	SO2	Fugitive PM10	Exhaust PM10	PM10 Total	Fugitive PM2.5	Exhaust PM2.5	PM2.5 Total	Bio- CO2	NBio- CO2	Total CO2	CH4	N2O	CO2e
Category	lb/day										lb/day					
Hauling	0.0000	0.0000	0.0000	0.0000	0.0000	0.0000	0.0000	0.0000	0.0000	0.0000			0.0000	0.0000		0.0000
Vendor	0.2014	6.9130	2.3789	0.0199	0.5152	0.0109	0.5260	0.1482	0.0104	0.1586			2,182.7238	0.1610		2,186.7481
Worker	0.5213	0.3577	3.6597	0.0106	1.3073	7.6300e-003	1.3149	0.3468	7.0300e-003	0.3539			1,055.1652	0.0278		1,055.8594
Total	0.7227	7.2706	6.0386	0.0305	1.8225	0.0185	1.8409	0.4950	0.0174	0.5125			3,237.8890	0.1887		3,242.6075

Mitigated Construction On-Site

	ROG	NOx	CO	SO2	Fugitive PM10	Exhaust PM10	PM10 Total	Fugitive PM2.5	Exhaust PM2.5	PM2.5 Total	Bio- CO2	NBio- CO2	Total CO2	CH4	N2O	CO2e
Category	lb/day										lb/day					
Off-Road	0.9905	21.0093	27.6342	0.0410		1.3253	1.3253		1.3253	1.3253			3,902.0889	0.8810		3,924.1133
Total	0.9905	21.0093	27.6342	0.0410		1.3253	1.3253		1.3253	1.3253			3,902.0889	0.8810		3,924.1133

Santa Maria Airport Commercial Rezone - Santa Barbara-North of Santa Ynez County, Summer

3.4 Building Construction - 2023

Mitigated Construction Off-Site

	ROG	NOx	CO	SO2	Fugitive PM10	Exhaust PM10	PM10 Total	Fugitive PM2.5	Exhaust PM2.5	PM2.5 Total	Bio- CO2	NBio- CO2	Total CO2	CH4	N2O	CO2e
Category	lb/day										lb/day					
Hauling	0.0000	0.0000	0.0000	0.0000	0.0000	0.0000	0.0000	0.0000	0.0000	0.0000			0.0000	0.0000		0.0000
Vendor	0.2014	6.9130	2.3789	0.0199	0.5152	0.0109	0.5260	0.1482	0.0104	0.1586			2,182.7238	0.1610		2,186.7481
Worker	0.5213	0.3577	3.6597	0.0106	1.3073	7.6300e-003	1.3149	0.3468	7.0300e-003	0.3539			1,055.1652	0.0278		1,055.8594
Total	0.7227	7.2706	6.0386	0.0305	1.8225	0.0185	1.8409	0.4950	0.0174	0.5125			3,237.8890	0.1887		3,242.6075

3.5 Architectural Coating - 2021

Unmitigated Construction On-Site

	ROG	NOx	CO	SO2	Fugitive PM10	Exhaust PM10	PM10 Total	Fugitive PM2.5	Exhaust PM2.5	PM2.5 Total	Bio- CO2	NBio- CO2	Total CO2	CH4	N2O	CO2e
Category	lb/day										lb/day					
Archit. Coating	12.6283					0.0000	0.0000		0.0000	0.0000			0.0000			0.0000
Off-Road	0.2189	1.5268	1.8176	2.9700e-003		0.0941	0.0941		0.0941	0.0941			281.4481	0.0193		281.9309
Total	12.8472	1.5268	1.8176	2.9700e-003		0.0941	0.0941		0.0941	0.0941			281.4481	0.0193		281.9309

Santa Maria Airport Commercial Rezone - Santa Barbara-North of Santa Ynez County, Summer

3.5 Architectural Coating - 2021

Unmitigated Construction Off-Site

	ROG	NOx	CO	SO2	Fugitive PM10	Exhaust PM10	PM10 Total	Fugitive PM2.5	Exhaust PM2.5	PM2.5 Total	Bio- CO2	NBio- CO2	Total CO2	CH4	N2O	CO2e
Category	lb/day										lb/day					
Hauling	0.0000	0.0000	0.0000	0.0000	0.0000	0.0000	0.0000	0.0000	0.0000	0.0000			0.0000	0.0000		0.0000
Vendor	0.0000	0.0000	0.0000	0.0000	0.0000	0.0000	0.0000	0.0000	0.0000	0.0000			0.0000	0.0000		0.0000
Worker	0.1188	0.0885	0.8707	2.2600e-003	0.2589	1.6000e-003	0.2605	0.0687	1.4700e-003	0.0702			225.1408	6.9200e-003		225.3138
Total	0.1188	0.0885	0.8707	2.2600e-003	0.2589	1.6000e-003	0.2605	0.0687	1.4700e-003	0.0702			225.1408	6.9200e-003		225.3138

Mitigated Construction On-Site

	ROG	NOx	CO	SO2	Fugitive PM10	Exhaust PM10	PM10 Total	Fugitive PM2.5	Exhaust PM2.5	PM2.5 Total	Bio- CO2	NBio- CO2	Total CO2	CH4	N2O	CO2e
Category	lb/day										lb/day					
Archit. Coating	12.6283					0.0000	0.0000		0.0000	0.0000			0.0000			0.0000
Off-Road	0.0594	1.3570	1.8324	2.9700e-003		0.0951	0.0951		0.0951	0.0951			281.4481	0.0193		281.9309
Total	12.6878	1.3570	1.8324	2.9700e-003		0.0951	0.0951		0.0951	0.0951			281.4481	0.0193		281.9309

Santa Maria Airport Commercial Rezone - Santa Barbara-North of Santa Ynez County, Summer

3.5 Architectural Coating - 2021

Mitigated Construction Off-Site

	ROG	NOx	CO	SO2	Fugitive PM10	Exhaust PM10	PM10 Total	Fugitive PM2.5	Exhaust PM2.5	PM2.5 Total	Bio- CO2	NBio- CO2	Total CO2	CH4	N2O	CO2e
Category	lb/day										lb/day					
Hauling	0.0000	0.0000	0.0000	0.0000	0.0000	0.0000	0.0000	0.0000	0.0000	0.0000			0.0000	0.0000		0.0000
Vendor	0.0000	0.0000	0.0000	0.0000	0.0000	0.0000	0.0000	0.0000	0.0000	0.0000			0.0000	0.0000		0.0000
Worker	0.1188	0.0885	0.8707	2.2600e-003	0.2589	1.6000e-003	0.2605	0.0687	1.4700e-003	0.0702			225.1408	6.9200e-003		225.3138
Total	0.1188	0.0885	0.8707	2.2600e-003	0.2589	1.6000e-003	0.2605	0.0687	1.4700e-003	0.0702			225.1408	6.9200e-003		225.3138

3.5 Architectural Coating - 2022

Unmitigated Construction On-Site

	ROG	NOx	CO	SO2	Fugitive PM10	Exhaust PM10	PM10 Total	Fugitive PM2.5	Exhaust PM2.5	PM2.5 Total	Bio- CO2	NBio- CO2	Total CO2	CH4	N2O	CO2e
Category	lb/day										lb/day					
Archit. Coating	12.6283					0.0000	0.0000		0.0000	0.0000			0.0000			0.0000
Off-Road	0.2045	1.4085	1.8136	2.9700e-003		0.0817	0.0817		0.0817	0.0817			281.4481	0.0183		281.9062
Total	12.8329	1.4085	1.8136	2.9700e-003		0.0817	0.0817		0.0817	0.0817			281.4481	0.0183		281.9062

Santa Maria Airport Commercial Rezone - Santa Barbara-North of Santa Ynez County, Summer

3.5 Architectural Coating - 2022

Unmitigated Construction Off-Site

	ROG	NOx	CO	SO2	Fugitive PM10	Exhaust PM10	PM10 Total	Fugitive PM2.5	Exhaust PM2.5	PM2.5 Total	Bio- CO2	NBio- CO2	Total CO2	CH4	N2O	CO2e
Category	lb/day										lb/day					
Hauling	0.0000	0.0000	0.0000	0.0000	0.0000	0.0000	0.0000	0.0000	0.0000	0.0000			0.0000	0.0000		0.0000
Vendor	0.0000	0.0000	0.0000	0.0000	0.0000	0.0000	0.0000	0.0000	0.0000	0.0000			0.0000	0.0000		0.0000
Worker	0.1106	0.0791	0.7933	2.1800e-003	0.2589	1.5500e-003	0.2605	0.0687	1.4300e-003	0.0701			217.1094	6.1600e-003		217.2635
Total	0.1106	0.0791	0.7933	2.1800e-003	0.2589	1.5500e-003	0.2605	0.0687	1.4300e-003	0.0701			217.1094	6.1600e-003		217.2635

Mitigated Construction On-Site

	ROG	NOx	CO	SO2	Fugitive PM10	Exhaust PM10	PM10 Total	Fugitive PM2.5	Exhaust PM2.5	PM2.5 Total	Bio- CO2	NBio- CO2	Total CO2	CH4	N2O	CO2e
Category	lb/day										lb/day					
Archit. Coating	12.6283					0.0000	0.0000		0.0000	0.0000			0.0000			0.0000
Off-Road	0.0594	1.3570	1.8324	2.9700e-003		0.0951	0.0951		0.0951	0.0951			281.4481	0.0183		281.9062
Total	12.6878	1.3570	1.8324	2.9700e-003		0.0951	0.0951		0.0951	0.0951			281.4481	0.0183		281.9062

Santa Maria Airport Commercial Rezone - Santa Barbara-North of Santa Ynez County, Summer

3.5 Architectural Coating - 2022

Mitigated Construction Off-Site

	ROG	NOx	CO	SO2	Fugitive PM10	Exhaust PM10	PM10 Total	Fugitive PM2.5	Exhaust PM2.5	PM2.5 Total	Bio- CO2	NBio- CO2	Total CO2	CH4	N2O	CO2e
Category	lb/day										lb/day					
Hauling	0.0000	0.0000	0.0000	0.0000	0.0000	0.0000	0.0000	0.0000	0.0000	0.0000			0.0000	0.0000		0.0000
Vendor	0.0000	0.0000	0.0000	0.0000	0.0000	0.0000	0.0000	0.0000	0.0000	0.0000			0.0000	0.0000		0.0000
Worker	0.1106	0.0791	0.7933	2.1800e-003	0.2589	1.5500e-003	0.2605	0.0687	1.4300e-003	0.0701			217.1094	6.1600e-003		217.2635
Total	0.1106	0.0791	0.7933	2.1800e-003	0.2589	1.5500e-003	0.2605	0.0687	1.4300e-003	0.0701			217.1094	6.1600e-003		217.2635

3.5 Architectural Coating - 2023

Unmitigated Construction On-Site

	ROG	NOx	CO	SO2	Fugitive PM10	Exhaust PM10	PM10 Total	Fugitive PM2.5	Exhaust PM2.5	PM2.5 Total	Bio- CO2	NBio- CO2	Total CO2	CH4	N2O	CO2e
Category	lb/day										lb/day					
Archit. Coating	12.6283					0.0000	0.0000		0.0000	0.0000			0.0000			0.0000
Off-Road	0.1917	1.3030	1.8111	2.9700e-003		0.0708	0.0708		0.0708	0.0708			281.4481	0.0168		281.8690
Total	12.8200	1.3030	1.8111	2.9700e-003		0.0708	0.0708		0.0708	0.0708			281.4481	0.0168		281.8690

Santa Maria Airport Commercial Rezone - Santa Barbara-North of Santa Ynez County, Summer

3.5 Architectural Coating - 2023

Unmitigated Construction Off-Site

	ROG	NOx	CO	SO2	Fugitive PM10	Exhaust PM10	PM10 Total	Fugitive PM2.5	Exhaust PM2.5	PM2.5 Total	Bio- CO2	NBio- CO2	Total CO2	CH4	N2O	CO2e
Category	lb/day										lb/day					
Hauling	0.0000	0.0000	0.0000	0.0000	0.0000	0.0000	0.0000	0.0000	0.0000	0.0000			0.0000	0.0000		0.0000
Vendor	0.0000	0.0000	0.0000	0.0000	0.0000	0.0000	0.0000	0.0000	0.0000	0.0000			0.0000	0.0000		0.0000
Worker	0.1032	0.0708	0.7249	2.1000e-003	0.2589	1.5100e-003	0.2605	0.0687	1.3900e-003	0.0701			208.9941	5.5000e-003		209.1316
Total	0.1032	0.0708	0.7249	2.1000e-003	0.2589	1.5100e-003	0.2605	0.0687	1.3900e-003	0.0701			208.9941	5.5000e-003		209.1316

Mitigated Construction On-Site

	ROG	NOx	CO	SO2	Fugitive PM10	Exhaust PM10	PM10 Total	Fugitive PM2.5	Exhaust PM2.5	PM2.5 Total	Bio- CO2	NBio- CO2	Total CO2	CH4	N2O	CO2e
Category	lb/day										lb/day					
Archit. Coating	12.6283					0.0000	0.0000		0.0000	0.0000			0.0000			0.0000
Off-Road	0.0594	1.3570	1.8324	2.9700e-003		0.0951	0.0951		0.0951	0.0951			281.4481	0.0168		281.8690
Total	12.6878	1.3570	1.8324	2.9700e-003		0.0951	0.0951		0.0951	0.0951			281.4481	0.0168		281.8690

Santa Maria Airport Commercial Rezone - Santa Barbara-North of Santa Ynez County, Summer

3.5 Architectural Coating - 2023

Mitigated Construction Off-Site

	ROG	NOx	CO	SO2	Fugitive PM10	Exhaust PM10	PM10 Total	Fugitive PM2.5	Exhaust PM2.5	PM2.5 Total	Bio- CO2	NBio- CO2	Total CO2	CH4	N2O	CO2e
Category	lb/day										lb/day					
Hauling	0.0000	0.0000	0.0000	0.0000	0.0000	0.0000	0.0000	0.0000	0.0000	0.0000			0.0000	0.0000		0.0000
Vendor	0.0000	0.0000	0.0000	0.0000	0.0000	0.0000	0.0000	0.0000	0.0000	0.0000			0.0000	0.0000		0.0000
Worker	0.1032	0.0708	0.7249	2.1000e-003	0.2589	1.5100e-003	0.2605	0.0687	1.3900e-003	0.0701			208.9941	5.5000e-003		209.1316
Total	0.1032	0.0708	0.7249	2.1000e-003	0.2589	1.5100e-003	0.2605	0.0687	1.3900e-003	0.0701			208.9941	5.5000e-003		209.1316

3.6 Paving - 2023

Unmitigated Construction On-Site

	ROG	NOx	CO	SO2	Fugitive PM10	Exhaust PM10	PM10 Total	Fugitive PM2.5	Exhaust PM2.5	PM2.5 Total	Bio- CO2	NBio- CO2	Total CO2	CH4	N2O	CO2e
Category	lb/day										lb/day					
Off-Road	1.4160	14.8642	15.2215	0.0271		0.6728	0.6728		0.6201	0.6201			2,603.7526	0.8313		2,624.5345
Paving	1.3100					0.0000	0.0000		0.0000	0.0000			0.0000			0.0000
Total	2.7260	14.8642	15.2215	0.0271		0.6728	0.6728		0.6201	0.6201			2,603.7526	0.8313		2,624.5345

Santa Maria Airport Commercial Rezone - Santa Barbara-North of Santa Ynez County, Summer

3.6 Paving - 2023

Unmitigated Construction Off-Site

	ROG	NOx	CO	SO2	Fugitive PM10	Exhaust PM10	PM10 Total	Fugitive PM2.5	Exhaust PM2.5	PM2.5 Total	Bio- CO2	NBio- CO2	Total CO2	CH4	N2O	CO2e
Category	lb/day										lb/day					
Hauling	0.0000	0.0000	0.0000	0.0000	0.0000	0.0000	0.0000	0.0000	0.0000	0.0000			0.0000	0.0000		0.0000
Vendor	0.0000	0.0000	0.0000	0.0000	0.0000	0.0000	0.0000	0.0000	0.0000	0.0000			0.0000	0.0000		0.0000
Worker	0.0630	0.0432	0.4420	1.2800e-003	0.1579	9.2000e-004	0.1588	0.0419	8.5000e-004	0.0427			127.4354	3.3500e-003		127.5193
Total	0.0630	0.0432	0.4420	1.2800e-003	0.1579	9.2000e-004	0.1588	0.0419	8.5000e-004	0.0427			127.4354	3.3500e-003		127.5193

Mitigated Construction On-Site

	ROG	NOx	CO	SO2	Fugitive PM10	Exhaust PM10	PM10 Total	Fugitive PM2.5	Exhaust PM2.5	PM2.5 Total	Bio- CO2	NBio- CO2	Total CO2	CH4	N2O	CO2e
Category	lb/day										lb/day					
Off-Road	0.6474	13.4574	18.4733	0.0271		0.7511	0.7511		0.7511	0.7511			2,603.7526	0.8313		2,624.5345
Paving	1.3100					0.0000	0.0000		0.0000	0.0000			0.0000			0.0000
Total	1.9574	13.4574	18.4733	0.0271		0.7511	0.7511		0.7511	0.7511			2,603.7526	0.8313		2,624.5345

Santa Maria Airport Commercial Rezone - Santa Barbara-North of Santa Ynez County, Summer

3.6 Paving - 2023

Mitigated Construction Off-Site

	ROG	NOx	CO	SO2	Fugitive PM10	Exhaust PM10	PM10 Total	Fugitive PM2.5	Exhaust PM2.5	PM2.5 Total	Bio- CO2	NBio- CO2	Total CO2	CH4	N2O	CO2e
Category	lb/day										lb/day					
Hauling	0.0000	0.0000	0.0000	0.0000	0.0000	0.0000	0.0000	0.0000	0.0000	0.0000			0.0000	0.0000		0.0000
Vendor	0.0000	0.0000	0.0000	0.0000	0.0000	0.0000	0.0000	0.0000	0.0000	0.0000			0.0000	0.0000		0.0000
Worker	0.0630	0.0432	0.4420	1.2800e-003	0.1579	9.2000e-004	0.1588	0.0419	8.5000e-004	0.0427			127.4354	3.3500e-003		127.5193
Total	0.0630	0.0432	0.4420	1.2800e-003	0.1579	9.2000e-004	0.1588	0.0419	8.5000e-004	0.0427			127.4354	3.3500e-003		127.5193

4.0 Operational Detail - Mobile

4.1 Mitigation Measures Mobile

Increase Transit Accessibility

Improve Pedestrian Network

Santa Maria Airport Commercial Rezone - Santa Barbara-North of Santa Ynez County, Summer

	ROG	NOx	CO	SO2	Fugitive PM10	Exhaust PM10	PM10 Total	Fugitive PM2.5	Exhaust PM2.5	PM2.5 Total	Bio- CO2	NBio- CO2	Total CO2	CH4	N2O	CO2e
Category	lb/day										lb/day					
Mitigated	20.6339	57.4728	139.0099	0.3111	26.8667	0.2943	27.1610	7.2009	0.2745	7.4754			31,686.0660	1.8129		31,731.3879
Unmitigated	20.6901	57.8215	140.4087	0.3165	27.4150	0.2984	27.7135	7.3479	0.2784	7.6263			32,224.6205	1.8331		32,270.4470

4.2 Trip Summary Information

Land Use	Average Daily Trip Rate			Unmitigated	Mitigated
	Weekday	Saturday	Sunday	Annual VMT	Annual VMT
Convenience Market With Gas Pumps	3,838.77	6,574.98	5366.29	1,875,418	1,837,909
Free-Standing Discount Store	160.03	198.69	157.57	197,820	193,864
General Office Building	394.20	87.92	37.52	538,184	527,420
Government Office Building	451.15	0.00	0.00	407,283	399,137
High Turnover (Sit Down Restaurant)	4,059.37	5,056.10	4209.11	3,787,867	3,712,110
Medical Office Building	615.68	152.68	26.42	687,335	673,588
Parking Lot	0.00	0.00	0.00		
Strip Mall	2,410.31	2,286.32	1111.07	2,598,402	2,546,434
Unrefrigerated Warehouse-No Rail	136.50	136.50	136.50	302,142	296,099
Other Asphalt Surfaces	0.00	0.00	0.00		
Other Non-Asphalt Surfaces	0.00	0.00	0.00		
Total	12,066.01	14,493.19	11,044.47	10,394,451	10,186,562

4.3 Trip Type Information

Santa Maria Airport Commercial Rezone - Santa Barbara-North of Santa Ynez County, Summer

Land Use	Miles			Trip %			Trip Purpose %		
	H-W or C-W	H-S or C-C	H-O or C-NW	H-W or C-W	H-S or C-C	H-O or C-NW	Primary	Diverted	Pass-by
Convenience Market With Gas	6.60	5.50	6.40	0.80	80.20	19.00	14	21	65
Free-Standing Discount Store	6.60	5.50	6.40	12.20	68.80	19.00	47.5	35.5	17
General Office Building	6.60	5.50	6.40	33.00	48.00	19.00	77	19	4
Government Office Building	6.60	5.50	6.40	33.00	62.00	5.00	50	34	16
High Turnover (Sit Down	6.60	5.50	6.40	8.50	72.50	19.00	37	20	43
Medical Office Building	6.60	5.50	6.40	29.60	51.40	19.00	60	30	10
Parking Lot	6.60	5.50	6.40	0.00	0.00	0.00	0	0	0
Strip Mall	6.60	5.50	6.40	16.60	64.40	19.00	45	40	15
Unrefrigerated Warehouse-No	6.60	5.50	6.40	59.00	0.00	41.00	92	5	3
Other Asphalt Surfaces	6.60	5.50	6.40	0.00	0.00	0.00	0	0	0
Other Non-Asphalt Surfaces	6.60	5.50	6.40	0.00	0.00	0.00	0	0	0

4.4 Fleet Mix

Land Use	LDA	LDT1	LDT2	MDV	LHD1	LHD2	MHD	HHD	OBUS	UBUS	MCY	SBUS	MH
Convenience Market With Gas Pumps	0.567965	0.027871	0.206163	0.120389	0.019588	0.005343	0.017610	0.019838	0.002797	0.002169	0.006725	0.002609	0.000932
Free-Standing Discount Store	0.567965	0.027871	0.206163	0.120389	0.019588	0.005343	0.017610	0.019838	0.002797	0.002169	0.006725	0.002609	0.000932
General Office Building	0.567965	0.027871	0.206163	0.120389	0.019588	0.005343	0.017610	0.019838	0.002797	0.002169	0.006725	0.002609	0.000932
Government Office Building	0.567965	0.027871	0.206163	0.120389	0.019588	0.005343	0.017610	0.019838	0.002797	0.002169	0.006725	0.002609	0.000932
High Turnover (Sit Down Restaurant)	0.567965	0.027871	0.206163	0.120389	0.019588	0.005343	0.017610	0.019838	0.002797	0.002169	0.006725	0.002609	0.000932
Medical Office Building	0.567965	0.027871	0.206163	0.120389	0.019588	0.005343	0.017610	0.019838	0.002797	0.002169	0.006725	0.002609	0.000932
Parking Lot	0.567965	0.027871	0.206163	0.120389	0.019588	0.005343	0.017610	0.019838	0.002797	0.002169	0.006725	0.002609	0.000932
Strip Mall	0.567965	0.027871	0.206163	0.120389	0.019588	0.005343	0.017610	0.019838	0.002797	0.002169	0.006725	0.002609	0.000932
Unrefrigerated Warehouse-No Rail	0.567965	0.027871	0.206163	0.120389	0.019588	0.005343	0.017610	0.019838	0.002797	0.002169	0.006725	0.002609	0.000932
Other Asphalt Surfaces	0.567965	0.027871	0.206163	0.120389	0.019588	0.005343	0.017610	0.019838	0.002797	0.002169	0.006725	0.002609	0.000932
Other Non-Asphalt Surfaces	0.567965	0.027871	0.206163	0.120389	0.019588	0.005343	0.017610	0.019838	0.002797	0.002169	0.006725	0.002609	0.000932

5.0 Energy Detail

Santa Maria Airport Commercial Rezone - Santa Barbara-North of Santa Ynez County, Summer

Historical Energy Use: N

5.1 Mitigation Measures Energy

	ROG	NOx	CO	SO2	Fugitive PM10	Exhaust PM10	PM10 Total	Fugitive PM2.5	Exhaust PM2.5	PM2.5 Total	Bio- CO2	NBio- CO2	Total CO2	CH4	N2O	CO2e
Category	lb/day										lb/day					
NaturalGas Mitigated	0.1225	1.1139	0.9356	6.6800e-003		0.0847	0.0847		0.0847	0.0847			1,336.6237	0.0256	0.0245	1,344.5666
NaturalGas Unmitigated	0.1225	1.1139	0.9356	6.6800e-003		0.0847	0.0847		0.0847	0.0847			1,336.6237	0.0256	0.0245	1,344.5666

Santa Maria Airport Commercial Rezone - Santa Barbara-North of Santa Ynez County, Summer

5.2 Energy by Land Use - NaturalGas

Unmitigated

	NaturalGas Use	ROG	NOx	CO	SO2	Fugitive PM10	Exhaust PM10	PM10 Total	Fugitive PM2.5	Exhaust PM2.5	PM2.5 Total	Bio- CO2	NBio- CO2	Total CO2	CH4	N2O	CO2e
Land Use	kBTU/yr	lb/day										lb/day					
Convenience Market With Gas Pumps	22.0767	2.4000e-004	2.1600e-003	1.8200e-003	1.0000e-005		1.6000e-004	1.6000e-004		1.6000e-004	1.6000e-004			2.5973	5.0000e-005	5.0000e-005	2.6127
Free-Standing Discount Store	207.781	2.2400e-003	0.0204	0.0171	1.2000e-004		1.5500e-003	1.5500e-003		1.5500e-003	1.5500e-003			24.4448	4.7000e-004	4.5000e-004	24.5901
General Office Building	1793.97	0.0194	0.1759	0.1477	1.0600e-003		0.0134	0.0134		0.0134	0.0134			211.0556	4.0500e-003	3.8700e-003	212.3098
Government Office Building	991.17	0.0107	0.0972	0.0816	5.8000e-004		7.3900e-003	7.3900e-003		7.3900e-003	7.3900e-003			116.6082	2.2300e-003	2.1400e-003	117.3012
High Turnover (Sit Down Restaurant)	6264.88	0.0676	0.6142	0.5159	3.6900e-003		0.0467	0.0467		0.0467	0.0467			737.0443	0.0141	0.0135	741.4242
Medical Office Building	896.986	9.6700e-003	0.0879	0.0739	5.3000e-004		6.6800e-003	6.6800e-003		6.6800e-003	6.6800e-003			105.5278	2.0200e-003	1.9300e-003	106.1549
Other Asphalt Surfaces	0	0.0000	0.0000	0.0000	0.0000		0.0000	0.0000		0.0000	0.0000			0.0000	0.0000	0.0000	0.0000
Other Non-Asphalt Surfaces	0	0.0000	0.0000	0.0000	0.0000		0.0000	0.0000		0.0000	0.0000			0.0000	0.0000	0.0000	0.0000
Parking Lot	0	0.0000	0.0000	0.0000	0.0000		0.0000	0.0000		0.0000	0.0000			0.0000	0.0000	0.0000	0.0000
Strip Mall	233.753	2.5200e-003	0.0229	0.0193	1.4000e-004		1.7400e-003	1.7400e-003		1.7400e-003	1.7400e-003			27.5004	5.3000e-004	5.0000e-004	27.6638
Unrefrigerated Warehouse-No Rail	950.685	0.0103	0.0932	0.0783	5.6000e-004		7.0800e-003	7.0800e-003		7.0800e-003	7.0800e-003			111.8453	2.1400e-003	2.0500e-003	112.5099
Total		0.1225	1.1138	0.9356	6.6900e-003		0.0847	0.0847		0.0847	0.0847			1,336.6237	0.0256	0.0245	1,344.5666

Santa Maria Airport Commercial Rezone - Santa Barbara-North of Santa Ynez County, Summer

5.2 Energy by Land Use - NaturalGas

Mitigated

	NaturalGas Use	ROG	NOx	CO	SO2	Fugitive PM10	Exhaust PM10	PM10 Total	Fugitive PM2.5	Exhaust PM2.5	PM2.5 Total	Bio- CO2	NBio- CO2	Total CO2	CH4	N2O	CO2e
Land Use	kBTU/yr	lb/day										lb/day					
Convenience Market With Gas Pumps	0.0220767	2.4000e-004	2.1600e-003	1.8200e-003	1.0000e-005		1.6000e-004	1.6000e-004		1.6000e-004	1.6000e-004			2.5973	5.0000e-005	5.0000e-005	2.6127
Free-Standing Discount Store	0.207781	2.2400e-003	0.0204	0.0171	1.2000e-004		1.5500e-003	1.5500e-003		1.5500e-003	1.5500e-003			24.4448	4.7000e-004	4.5000e-004	24.5901
General Office Building	1.79397	0.0194	0.1759	0.1477	1.0600e-003		0.0134	0.0134		0.0134	0.0134			211.0556	4.0500e-003	3.8700e-003	212.3098
Government Office Building	0.99117	0.0107	0.0972	0.0816	5.8000e-004		7.3900e-003	7.3900e-003		7.3900e-003	7.3900e-003			116.6082	2.2300e-003	2.1400e-003	117.3012
High Turnover (Sit Down Restaurant)	6.26488	0.0676	0.6142	0.5159	3.6900e-003		0.0467	0.0467		0.0467	0.0467			737.0443	0.0141	0.0135	741.4242
Medical Office Building	0.896986	9.6700e-003	0.0879	0.0739	5.3000e-004		6.6800e-003	6.6800e-003		6.6800e-003	6.6800e-003			105.5278	2.0200e-003	1.9300e-003	106.1549
Other Asphalt Surfaces	0	0.0000	0.0000	0.0000	0.0000		0.0000	0.0000		0.0000	0.0000			0.0000	0.0000	0.0000	0.0000
Other Non-Asphalt Surfaces	0	0.0000	0.0000	0.0000	0.0000		0.0000	0.0000		0.0000	0.0000			0.0000	0.0000	0.0000	0.0000
Parking Lot	0	0.0000	0.0000	0.0000	0.0000		0.0000	0.0000		0.0000	0.0000			0.0000	0.0000	0.0000	0.0000
Strip Mall	0.233753	2.5200e-003	0.0229	0.0193	1.4000e-004		1.7400e-003	1.7400e-003		1.7400e-003	1.7400e-003			27.5004	5.3000e-004	5.0000e-004	27.6638
Unrefrigerated Warehouse-No Rail	0.950685	0.0103	0.0932	0.0783	5.6000e-004		7.0800e-003	7.0800e-003		7.0800e-003	7.0800e-003			111.8453	2.1400e-003	2.0500e-003	112.5099
Total		0.1225	1.1138	0.9356	6.6900e-003		0.0847	0.0847		0.0847	0.0847			1,336.6237	0.0256	0.0245	1,344.5666

6.0 Area Detail

6.1 Mitigation Measures Area

Santa Maria Airport Commercial Rezone - Santa Barbara-North of Santa Ynez County, Summer

	ROG	NOx	CO	SO2	Fugitive PM10	Exhaust PM10	PM10 Total	Fugitive PM2.5	Exhaust PM2.5	PM2.5 Total	Bio- CO2	NBio- CO2	Total CO2	CH4	N2O	CO2e
Category	lb/day										lb/day					
Mitigated	7.5523	8.6000e-004	0.0949	1.0000e-005		3.4000e-004	3.4000e-004		3.4000e-004	3.4000e-004			0.2035	5.3000e-004		0.2169
Unmitigated	7.5523	8.6000e-004	0.0949	1.0000e-005		3.4000e-004	3.4000e-004		3.4000e-004	3.4000e-004			0.2035	5.3000e-004		0.2169

6.2 Area by SubCategory

Unmitigated

	ROG	NOx	CO	SO2	Fugitive PM10	Exhaust PM10	PM10 Total	Fugitive PM2.5	Exhaust PM2.5	PM2.5 Total	Bio- CO2	NBio- CO2	Total CO2	CH4	N2O	CO2e
SubCategory	lb/day										lb/day					
Architectural Coating	1.7507					0.0000	0.0000		0.0000	0.0000			0.0000			0.0000
Consumer Products	5.7928					0.0000	0.0000		0.0000	0.0000			0.0000			0.0000
Landscaping	8.7900e-003	8.6000e-004	0.0949	1.0000e-005		3.4000e-004	3.4000e-004		3.4000e-004	3.4000e-004			0.2035	5.3000e-004		0.2169
Total	7.5523	8.6000e-004	0.0949	1.0000e-005		3.4000e-004	3.4000e-004		3.4000e-004	3.4000e-004			0.2035	5.3000e-004		0.2169

Santa Maria Airport Commercial Rezone - Santa Barbara-North of Santa Ynez County, Summer

6.2 Area by SubCategory

Mitigated

	ROG	NOx	CO	SO2	Fugitive PM10	Exhaust PM10	PM10 Total	Fugitive PM2.5	Exhaust PM2.5	PM2.5 Total	Bio- CO2	NBio- CO2	Total CO2	CH4	N2O	CO2e
SubCategory	lb/day										lb/day					
Architectural Coating	1.7507					0.0000	0.0000		0.0000	0.0000			0.0000			0.0000
Consumer Products	5.7928					0.0000	0.0000		0.0000	0.0000			0.0000			0.0000
Landscaping	8.7900e-003	8.6000e-004	0.0949	1.0000e-005		3.4000e-004	3.4000e-004		3.4000e-004	3.4000e-004			0.2035	5.3000e-004		0.2169
Total	7.5523	8.6000e-004	0.0949	1.0000e-005		3.4000e-004	3.4000e-004		3.4000e-004	3.4000e-004			0.2035	5.3000e-004		0.2169

7.0 Water Detail

7.1 Mitigation Measures Water

- Install Low Flow Bathroom Faucet
- Install Low Flow Kitchen Faucet
- Install Low Flow Toilet
- Install Low Flow Shower
- Use Water Efficient Irrigation System

8.0 Waste Detail

8.1 Mitigation Measures Waste

- Institute Recycling and Composting Services

Santa Maria Airport Commercial Rezone - Santa Barbara-North of Santa Ynez County, Summer

9.0 Operational Offroad

Equipment Type	Number	Hours/Day	Days/Year	Horse Power	Load Factor	Fuel Type
----------------	--------	-----------	-----------	-------------	-------------	-----------

10.0 Stationary Equipment

Fire Pumps and Emergency Generators

Equipment Type	Number	Hours/Day	Hours/Year	Horse Power	Load Factor	Fuel Type
----------------	--------	-----------	------------	-------------	-------------	-----------

Boilers

Equipment Type	Number	Heat Input/Day	Heat Input/Year	Boiler Rating	Fuel Type
----------------	--------	----------------	-----------------	---------------	-----------

User Defined Equipment

Equipment Type	Number
----------------	--------

11.0 Vegetation

Santa Maria Airport Commercial Rezone - Santa Barbara-North of Santa Ynez County, Winter

Santa Maria Airport Commercial Rezone
Santa Barbara-North of Santa Ynez County, Winter

1.0 Project Characteristics

1.1 Land Usage

Land Uses	Size	Metric	Lot Acreage	Floor Surface Area	Population
General Office Building	40.00	1000sqft	0.92	40,000.00	0
Government Office Building	22.10	1000sqft	0.51	22,100.00	0
Medical Office Building	20.00	1000sqft	0.46	20,000.00	0
Unrefrigerated Warehouse-No Rail	100.00	1000sqft	2.30	100,000.00	0
Parking Lot	663.00	Space	8.00	265,200.00	0
High Turnover (Sit Down Restaurant)	11.00	1000sqft	0.25	11,000.00	0
Convenience Market With Gas Pumps	3.40	1000sqft	0.08	3,400.00	0
Free-Standing Discount Store	32.00	1000sqft	0.73	32,000.00	0
Strip Mall	36.00	1000sqft	0.83	36,000.00	0
Other Asphalt Surfaces	2.00	Acre	2.00	87,120.00	0
Other Non-Asphalt Surfaces	0.50	Acre	0.50	21,780.00	0

1.2 Other Project Characteristics

Urbanization	Urban	Wind Speed (m/s)	3.1	Precipitation Freq (Days)	37
Climate Zone	4			Operational Year	2023
Utility Company	Pacific Gas & Electric Company				
CO2 Intensity (lb/MWhr)	438.13	CH4 Intensity (lb/MWhr)	0.02	N2O Intensity (lb/MWhr)	0.004

1.3 User Entered Comments & Non-Default Data

Santa Maria Airport Commercial Rezone - Santa Barbara-North of Santa Ynez County, Winter

Project Characteristics - Includes adjustments for RPS.

Land Use - Based on land use information provided.

Construction Phase - Based on information provided. Demo not required. Site prep 10 days, grading 80 days, building 606 days, paving 20 days, arch coating 500 days.

Off-road Equipment - Based on model defaults

Off-road Equipment - Based on model defaults. Additional equipment included based on information provided.

Off-road Equipment - Based on model defaults. Additional equipment included based on information provided.

Off-road Equipment - Based on model defaults. Additional equipment included based on information provided.

Off-road Equipment - Includes 2 scrapers based on info provided and defaults.

Trips and VMT - Construction vehicle trips based on model defaults.

Grading - All material balanced on site. Area graded based on model defaults/equipment usage rates. Graded area is calculated by CalEEMod based on equipment usage/8-hr day and const. schedule.

Vehicle Trips - Trip-gen rates derived from the traffic analysis (CCTC 2020). Rates were adjusted for internal capture and pass-by. Trip lengths based on model defaults.

Area Coating - Arch coatings based on model defaults.

Energy Use - Energy use based on model defaults.

Water And Wastewater - Water, wastewater, and solid waste based on model defaults.

Sequestration - Assumes net increase of 340 trees. Provided for informational purposes only.

Construction Off-road Equipment Mitigation - Includes 50% CE for watering unpaved roads/travel areas; 61% CE for watering graded surfaces, 15 mph onsite speed limit. T3 offroad equipment included for informational purposes.

Mobile Land Use Mitigation - Site Enhancements include improved pedestrian access on-site and connecting off-site. Install transit features to increase accessibility (benches, pullouts, etc.)

Area Mitigation - .

Energy Mitigation - Compliance with current energy-efficiency building standards calculated separately.

Water Mitigation - Includes use of low-flow water fixtures and water-efficient irrigation systems.

Waste Mitigation - Assumes 75% diversion rate per current targets.

Architectural Coating - Arch coating based on model defaults.

Vehicle Emission Factors - Emfac based on model defaults. SAFE veh adjustments calculated separately.

Vehicle Emission Factors -

Vehicle Emission Factors -

Santa Maria Airport Commercial Rezone - Santa Barbara-North of Santa Ynez County, Winter

Fleet Mix -

Table Name	Column Name	Default Value	New Value
tblArchitecturalCoating	ConstArea_Parking	22,446.00	15,912.00
tblAreaMitigation	UseLowVOCPaintNonresidentialExteriorValue	250	50
tblAreaMitigation	UseLowVOCPaintNonresidentialInteriorValue	250	50
tblConstDustMitigation	WaterUnpavedRoadVehicleSpeed	0	15
tblConstEquipMitigation	NumberOfEquipmentMitigated	0.00	1.00
tblConstEquipMitigation	NumberOfEquipmentMitigated	0.00	1.00
tblConstEquipMitigation	NumberOfEquipmentMitigated	0.00	1.00
tblConstEquipMitigation	NumberOfEquipmentMitigated	0.00	3.00
tblConstEquipMitigation	NumberOfEquipmentMitigated	0.00	3.00
tblConstEquipMitigation	NumberOfEquipmentMitigated	0.00	1.00
tblConstEquipMitigation	NumberOfEquipmentMitigated	0.00	2.00
tblConstEquipMitigation	NumberOfEquipmentMitigated	0.00	1.00
tblConstEquipMitigation	NumberOfEquipmentMitigated	0.00	1.00
tblConstEquipMitigation	NumberOfEquipmentMitigated	0.00	4.00
tblConstEquipMitigation	NumberOfEquipmentMitigated	0.00	4.00
tblConstEquipMitigation	NumberOfEquipmentMitigated	0.00	4.00
tblConstEquipMitigation	NumberOfEquipmentMitigated	0.00	1.00
tblConstEquipMitigation	NumberOfEquipmentMitigated	0.00	12.00
tblConstEquipMitigation	NumberOfEquipmentMitigated	0.00	1.00
tblConstEquipMitigation	Tier	No Change	Tier 3
tblConstEquipMitigation	Tier	No Change	Tier 3
tblConstEquipMitigation	Tier	No Change	Tier 3
tblConstEquipMitigation	Tier	No Change	Tier 3
tblConstEquipMitigation	Tier	No Change	Tier 3

Santa Maria Airport Commercial Rezone - Santa Barbara-North of Santa Ynez County, Winter

tblConstEquipMitigation	Tier	No Change	Tier 3
tblConstEquipMitigation	Tier	No Change	Tier 3
tblConstEquipMitigation	Tier	No Change	Tier 3
tblConstEquipMitigation	Tier	No Change	Tier 3
tblConstEquipMitigation	Tier	No Change	Tier 3
tblConstEquipMitigation	Tier	No Change	Tier 3
tblConstEquipMitigation	Tier	No Change	Tier 3
tblConstEquipMitigation	Tier	No Change	Tier 3
tblConstEquipMitigation	Tier	No Change	Tier 3
tblConstEquipMitigation	Tier	No Change	Tier 3
tblConstructionPhase	NumDays	30.00	80.00
tblConstructionPhase	NumDays	300.00	606.00
tblConstructionPhase	NumDays	20.00	500.00
tblLandUse	LotAcreage	5.97	8.00
tblOffRoadEquipment	OffRoadEquipmentUnitAmount	2.00	1.00
tblOffRoadEquipment	OffRoadEquipmentUnitAmount	2.00	1.00
tblOffRoadEquipment	OffRoadEquipmentUnitAmount	2.00	3.00
tblProjectCharacteristics	CH4IntensityFactor	0.029	0.02
tblProjectCharacteristics	CO2IntensityFactor	641.35	438.13
tblProjectCharacteristics	N2OIntensityFactor	0.006	0.004
tblSequestration	NumberOfNewTrees	0.00	340.00
tblTripsAndVMT	VendorTripNumber	105.00	87.00
tblTripsAndVMT	WorkerTripNumber	253.00	207.00
tblTripsAndVMT	WorkerTripNumber	51.00	41.00
tblTripsAndVMT	WorkerTripNumber	20.00	25.00
tblVehicleTrips	ST_TR	1,448.33	1,933.82
tblVehicleTrips	ST_TR	71.07	6.21

Santa Maria Airport Commercial Rezone - Santa Barbara-North of Santa Ynez County, Winter

tblVehicleTrips	ST_TR	2.46	2.20
tblVehicleTrips	ST_TR	158.37	459.65
tblVehicleTrips	ST_TR	8.96	7.63
tblVehicleTrips	ST_TR	42.04	63.51
tblVehicleTrips	ST_TR	1.68	1.37
tblVehicleTrips	SU_TR	1,182.08	1,578.32
tblVehicleTrips	SU_TR	56.36	4.92
tblVehicleTrips	SU_TR	1.05	0.94
tblVehicleTrips	SU_TR	131.84	382.65
tblVehicleTrips	SU_TR	1.55	1.32
tblVehicleTrips	SU_TR	20.43	30.86
tblVehicleTrips	SU_TR	1.68	1.37
tblVehicleTrips	WD_TR	845.60	1,129.05
tblVehicleTrips	WD_TR	57.24	5.00
tblVehicleTrips	WD_TR	11.03	9.86
tblVehicleTrips	WD_TR	68.93	20.41
tblVehicleTrips	WD_TR	127.15	369.03
tblVehicleTrips	WD_TR	36.13	30.78
tblVehicleTrips	WD_TR	44.32	66.95
tblVehicleTrips	WD_TR	1.68	1.37

2.0 Emissions Summary

Santa Maria Airport Commercial Rezone - Santa Barbara-North of Santa Ynez County, Winter

2.1 Overall Construction (Maximum Daily Emission)

Unmitigated Construction

	ROG	NOx	CO	SO2	Fugitive PM10	Exhaust PM10	PM10 Total	Fugitive PM2.5	Exhaust PM2.5	PM2.5 Total	Bio- CO2	NBio- CO2	Total CO2	CH4	N2O	CO2e
Year	lb/day										lb/day					
2021	16.6612	61.9595	35.9491	0.0774	20.3325	2.8781	23.2106	10.1982	2.6479	12.8461			7,699.9555	2.1454	0.0000	7,728.1717
2022	16.2966	32.1450	34.8177	0.0767	2.0814	1.2594	3.3409	0.5637	1.1950	1.7587			7,634.3881	1.1191	0.0000	7,662.3652
2023	18.7876	43.7108	49.6183	0.1041	2.2393	1.7575	3.9968	0.6056	1.6490	2.2546			10,276.5827	1.9334	0.0000	10,324.9186
Maximum	18.7876	61.9595	49.6183	0.1041	20.3325	2.8781	23.2106	10.1982	2.6479	12.8461			10,276.5827	2.1454	0.0000	10,324.9186

Mitigated Construction

	ROG	NOx	CO	SO2	Fugitive PM10	Exhaust PM10	PM10 Total	Fugitive PM2.5	Exhaust PM2.5	PM2.5 Total	Bio- CO2	NBio- CO2	Total CO2	CH4	N2O	CO2e
Year	lb/day										lb/day					
2021	14.7878	33.5386	41.9569	0.0774	8.0183	1.5435	9.5122	4.0008	1.5434	5.4946			7,699.9555	2.1454	0.0000	7,728.1717
2022	14.7093	31.1831	37.3272	0.0767	2.0814	1.4536	3.5350	0.5637	1.4518	2.0155			7,634.3880	1.1191	0.0000	7,662.3652
2023	16.6284	43.2394	55.5142	0.1041	2.2393	2.1929	4.4322	0.6056	2.1916	2.7973			10,276.5827	1.9334	0.0000	10,324.9186
Maximum	16.6284	43.2394	55.5142	0.1041	8.0183	2.1929	9.5122	4.0008	2.1916	5.4946			10,276.5827	2.1454	0.0000	10,324.9186

Santa Maria Airport Commercial Rezone - Santa Barbara-North of Santa Ynez County, Winter

	ROG	NOx	CO	SO2	Fugitive PM10	Exhaust PM10	PM10 Total	Fugitive PM2.5	Exhaust PM2.5	PM2.5 Total	Bio- CO2	NBio-CO2	Total CO2	CH4	N2O	CO2e
Percent Reduction	10.86	21.66	-11.97	0.00	49.95	11.96	42.78	54.52	5.55	38.86	0.00	0.00	0.00	0.00	0.00	0.00

Santa Maria Airport Commercial Rezone - Santa Barbara-North of Santa Ynez County, Winter

2.2 Overall Operational

Unmitigated Operational

	ROG	NOx	CO	SO2	Fugitive PM10	Exhaust PM10	PM10 Total	Fugitive PM2.5	Exhaust PM2.5	PM2.5 Total	Bio- CO2	NBio- CO2	Total CO2	CH4	N2O	CO2e
Category	lb/day										lb/day					
Area	7.5523	8.6000e-004	0.0949	1.0000e-005		3.4000e-004	3.4000e-004		3.4000e-004	3.4000e-004			0.2035	5.3000e-004		0.2169
Energy	0.1225	1.1139	0.9356	6.6800e-003		0.0847	0.0847		0.0847	0.0847			1,336.6237	0.0256	0.0245	1,344.5666
Mobile	20.1583	59.0965	158.2089	0.3085	27.4150	0.3024	27.7174	7.3479	0.2822	7.6301			31,351.3425	1.9488		31,400.0633
Total	27.8331	60.2113	159.2395	0.3152	27.4150	0.3874	27.8024	7.3479	0.3672	7.7151			32,688.1697	1.9750	0.0245	32,744.8468

Mitigated Operational

	ROG	NOx	CO	SO2	Fugitive PM10	Exhaust PM10	PM10 Total	Fugitive PM2.5	Exhaust PM2.5	PM2.5 Total	Bio- CO2	NBio- CO2	Total CO2	CH4	N2O	CO2e
Category	lb/day										lb/day					
Area	7.5523	8.6000e-004	0.0949	1.0000e-005		3.4000e-004	3.4000e-004		3.4000e-004	3.4000e-004			0.2035	5.3000e-004		0.2169
Energy	0.1225	1.1139	0.9356	6.6800e-003		0.0847	0.0847		0.0847	0.0847			1,336.6237	0.0256	0.0245	1,344.5666
Mobile	20.1015	58.7238	156.8288	0.3033	26.8667	0.2983	27.1650	7.2009	0.2783	7.4792			30,822.4278	1.9288		30,870.6483
Total	27.7763	59.8385	157.8594	0.3100	26.8667	0.3833	27.2500	7.2009	0.3633	7.5642			32,159.2550	1.9550	0.0245	32,215.4318

Santa Maria Airport Commercial Rezone - Santa Barbara-North of Santa Ynez County, Winter

	ROG	NOx	CO	SO2	Fugitive PM10	Exhaust PM10	PM10 Total	Fugitive PM2.5	Exhaust PM2.5	PM2.5 Total	Bio- CO2	NBio-CO2	Total CO2	CH4	N2O	CO2e
Percent Reduction	0.20	0.62	0.87	1.65	2.00	1.07	1.99	2.00	1.06	1.96	0.00	0.00	1.62	1.01	0.00	1.62

3.0 Construction Detail

Construction Phase

Phase Number	Phase Name	Phase Type	Start Date	End Date	Num Days Week	Num Days	Phase Description
1	Site Preparation	Site Preparation	1/29/2021	2/11/2021	5	10	
2	Grading	Grading	2/12/2021	6/3/2021	5	80	
3	Building Construction	Building Construction	6/4/2021	9/29/2023	5	606	
4	Architectural Coating	Architectural Coating	11/1/2021	9/29/2023	5	500	
5	Paving	Paving	8/20/2023	9/15/2023	5	20	

Acres of Grading (Site Preparation Phase): 20

Acres of Grading (Grading Phase): 200

Acres of Paving: 10.5

Residential Indoor: 0; Residential Outdoor: 0; Non-Residential Indoor: 396,750; Non-Residential Outdoor: 132,250; Striped Parking Area: 15,912 (Architectural Coating – sqft)

OffRoad Equipment

Santa Maria Airport Commercial Rezone - Santa Barbara-North of Santa Ynez County, Winter

Phase Name	Offroad Equipment Type	Amount	Usage Hours	Horse Power	Load Factor
Site Preparation	Rubber Tired Dozers	3	8.00	247	0.40
Site Preparation	Scrapers	2	8.00	367	0.48
Site Preparation	Tractors/Loaders/Backhoes	4	8.00	97	0.37
Grading	Excavators	2	8.00	158	0.38
Grading	Graders	1	8.00	187	0.41
Grading	Rubber Tired Dozers	1	8.00	247	0.40
Grading	Scrapers	2	8.00	367	0.48
Grading	Tractors/Loaders/Backhoes	2	8.00	97	0.37
Grading	Tractors/Loaders/Backhoes	2	8.00	97	0.37
Building Construction	Concrete/Industrial Saws	1	8.00	81	0.73
Building Construction	Cranes	1	7.00	231	0.29
Building Construction	Excavators	1	8.00	158	0.38
Building Construction	Forklifts	3	8.00	89	0.20
Building Construction	Generator Sets	1	8.00	84	0.74
Building Construction	Rollers	1	8.00	80	0.38
Building Construction	Tractors/Loaders/Backhoes	3	7.00	97	0.37
Building Construction	Welders	1	8.00	46	0.45
Architectural Coating	Air Compressors	1	6.00	78	0.48
Paving	Graders	1	8.00	187	0.41
Paving	Pavers	1	8.00	130	0.42
Paving	Paving Equipment	1	8.00	132	0.36
Paving	Rollers	3	8.00	80	0.38
Paving	Signal Boards	1	8.00	6	0.82
Paving	Tractors/Loaders/Backhoes	1	8.00	97	0.37

Trips and VMT

Santa Maria Airport Commercial Rezone - Santa Barbara-North of Santa Ynez County, Winter

Phase Name	Offroad Equipment Count	Worker Trip Number	Vendor Trip Number	Hauling Trip Number	Worker Trip Length	Vendor Trip Length	Hauling Trip Length	Worker Vehicle Class	Vendor Vehicle Class	Hauling Vehicle Class
Site Preparation	9	23.00	0.00	0.00	8.30	6.40	20.00	LD_Mix	HDT_Mix	HHDT
Grading	10	25.00	0.00	0.00	8.30	6.40	20.00	LD_Mix	HDT_Mix	HHDT
Building Construction	12	207.00	87.00	0.00	8.30	6.40	20.00	LD_Mix	HDT_Mix	HHDT
Architectural Coating	1	41.00	0.00	0.00	8.30	6.40	20.00	LD_Mix	HDT_Mix	HHDT
Paving	8	25.00	0.00	0.00	8.30	6.40	20.00	LD_Mix	HDT_Mix	HHDT

3.1 Mitigation Measures Construction

Use Cleaner Engines for Construction Equipment

Use Soil Stabilizer

Water Exposed Area

Reduce Vehicle Speed on Unpaved Roads

3.2 Site Preparation - 2021

Unmitigated Construction On-Site

	ROG	NOx	CO	SO2	Fugitive PM10	Exhaust PM10	PM10 Total	Fugitive PM2.5	Exhaust PM2.5	PM2.5 Total	Bio- CO2	NBio- CO2	Total CO2	CH4	N2O	CO2e
Category	lb/day										lb/day					
Fugitive Dust					20.1873	0.0000	20.1873	10.1597	0.0000	10.1597			0.0000			0.0000
Off-Road	5.7471	61.9027	35.1637	0.0683		2.8772	2.8772		2.6470	2.6470			6,621.4799	2.1415		6,675.0179
Total	5.7471	61.9027	35.1637	0.0683	20.1873	2.8772	23.0645	10.1597	2.6470	12.8067			6,621.4799	2.1415		6,675.0179

Santa Maria Airport Commercial Rezone - Santa Barbara-North of Santa Ynez County, Winter

3.2 Site Preparation - 2021

Unmitigated Construction Off-Site

	ROG	NOx	CO	SO2	Fugitive PM10	Exhaust PM10	PM10 Total	Fugitive PM2.5	Exhaust PM2.5	PM2.5 Total	Bio- CO2	NBio- CO2	Total CO2	CH4	N2O	CO2e
Category	lb/day										lb/day					
Hauling	0.0000	0.0000	0.0000	0.0000	0.0000	0.0000	0.0000	0.0000	0.0000	0.0000			0.0000	0.0000		0.0000
Vendor	0.0000	0.0000	0.0000	0.0000	0.0000	0.0000	0.0000	0.0000	0.0000	0.0000			0.0000	0.0000		0.0000
Worker	0.0752	0.0568	0.5062	1.2400e-003	0.1453	9.0000e-004	0.1462	0.0385	8.3000e-004	0.0394			123.3779	3.8900e-003		123.4752
Total	0.0752	0.0568	0.5062	1.2400e-003	0.1453	9.0000e-004	0.1462	0.0385	8.3000e-004	0.0394			123.3779	3.8900e-003		123.4752

Mitigated Construction On-Site

	ROG	NOx	CO	SO2	Fugitive PM10	Exhaust PM10	PM10 Total	Fugitive PM2.5	Exhaust PM2.5	PM2.5 Total	Bio- CO2	NBio- CO2	Total CO2	CH4	N2O	CO2e
Category	lb/day										lb/day					
Fugitive Dust					7.8730	0.0000	7.8730	3.9623	0.0000	3.9623			0.0000			0.0000
Off-Road	1.6768	33.4818	39.1161	0.0683		1.4930	1.4930		1.4930	1.4930			6,621.4799	2.1415		6,675.0179
Total	1.6768	33.4818	39.1161	0.0683	7.8730	1.4930	9.3660	3.9623	1.4930	5.4553			6,621.4799	2.1415		6,675.0179

Santa Maria Airport Commercial Rezone - Santa Barbara-North of Santa Ynez County, Winter

3.2 Site Preparation - 2021

Mitigated Construction Off-Site

	ROG	NOx	CO	SO2	Fugitive PM10	Exhaust PM10	PM10 Total	Fugitive PM2.5	Exhaust PM2.5	PM2.5 Total	Bio- CO2	NBio- CO2	Total CO2	CH4	N2O	CO2e
Category	lb/day										lb/day					
Hauling	0.0000	0.0000	0.0000	0.0000	0.0000	0.0000	0.0000	0.0000	0.0000	0.0000			0.0000	0.0000		0.0000
Vendor	0.0000	0.0000	0.0000	0.0000	0.0000	0.0000	0.0000	0.0000	0.0000	0.0000			0.0000	0.0000		0.0000
Worker	0.0752	0.0568	0.5062	1.2400e-003	0.1453	9.0000e-004	0.1462	0.0385	8.3000e-004	0.0394			123.3779	3.8900e-003		123.4752
Total	0.0752	0.0568	0.5062	1.2400e-003	0.1453	9.0000e-004	0.1462	0.0385	8.3000e-004	0.0394			123.3779	3.8900e-003		123.4752

3.3 Grading - 2021

Unmitigated Construction On-Site

	ROG	NOx	CO	SO2	Fugitive PM10	Exhaust PM10	PM10 Total	Fugitive PM2.5	Exhaust PM2.5	PM2.5 Total	Bio- CO2	NBio- CO2	Total CO2	CH4	N2O	CO2e
Category	lb/day										lb/day					
Fugitive Dust					8.6733	0.0000	8.6733	3.5965	0.0000	3.5965			0.0000			0.0000
Off-Road	4.5657	50.1915	35.3989	0.0682		2.2089	2.2089		2.0322	2.0322			6,608.8436	2.1374		6,662.2794
Total	4.5657	50.1915	35.3989	0.0682	8.6733	2.2089	10.8822	3.5965	2.0322	5.6287			6,608.8436	2.1374		6,662.2794

Santa Maria Airport Commercial Rezone - Santa Barbara-North of Santa Ynez County, Winter

3.3 Grading - 2021

Unmitigated Construction Off-Site

	ROG	NOx	CO	SO2	Fugitive PM10	Exhaust PM10	PM10 Total	Fugitive PM2.5	Exhaust PM2.5	PM2.5 Total	Bio- CO2	NBio- CO2	Total CO2	CH4	N2O	CO2e
Category	lb/day										lb/day					
Hauling	0.0000	0.0000	0.0000	0.0000	0.0000	0.0000	0.0000	0.0000	0.0000	0.0000			0.0000	0.0000		0.0000
Vendor	0.0000	0.0000	0.0000	0.0000	0.0000	0.0000	0.0000	0.0000	0.0000	0.0000			0.0000	0.0000		0.0000
Worker	0.0818	0.0617	0.5502	1.3500e-003	0.1579	9.7000e-004	0.1589	0.0419	9.0000e-004	0.0428			134.1064	4.2300e-003		134.2121
Total	0.0818	0.0617	0.5502	1.3500e-003	0.1579	9.7000e-004	0.1589	0.0419	9.0000e-004	0.0428			134.1064	4.2300e-003		134.2121

Mitigated Construction On-Site

	ROG	NOx	CO	SO2	Fugitive PM10	Exhaust PM10	PM10 Total	Fugitive PM2.5	Exhaust PM2.5	PM2.5 Total	Bio- CO2	NBio- CO2	Total CO2	CH4	N2O	CO2e
Category	lb/day										lb/day					
Fugitive Dust					3.3826	0.0000	3.3826	1.4026	0.0000	1.4026			0.0000			0.0000
Off-Road	1.6750	33.4470	41.4067	0.0682		1.5425	1.5425		1.5425	1.5425			6,608.8436	2.1374		6,662.2794
Total	1.6750	33.4470	41.4067	0.0682	3.3826	1.5425	4.9251	1.4026	1.5425	2.9451			6,608.8436	2.1374		6,662.2794

Santa Maria Airport Commercial Rezone - Santa Barbara-North of Santa Ynez County, Winter

3.3 Grading - 2021

Mitigated Construction Off-Site

	ROG	NOx	CO	SO2	Fugitive PM10	Exhaust PM10	PM10 Total	Fugitive PM2.5	Exhaust PM2.5	PM2.5 Total	Bio- CO2	NBio- CO2	Total CO2	CH4	N2O	CO2e
Category	lb/day										lb/day					
Hauling	0.0000	0.0000	0.0000	0.0000	0.0000	0.0000	0.0000	0.0000	0.0000	0.0000			0.0000	0.0000		0.0000
Vendor	0.0000	0.0000	0.0000	0.0000	0.0000	0.0000	0.0000	0.0000	0.0000	0.0000			0.0000	0.0000		0.0000
Worker	0.0818	0.0617	0.5502	1.3500e-003	0.1579	9.7000e-004	0.1589	0.0419	9.0000e-004	0.0428			134.1064	4.2300e-003		134.2121
Total	0.0818	0.0617	0.5502	1.3500e-003	0.1579	9.7000e-004	0.1589	0.0419	9.0000e-004	0.0428			134.1064	4.2300e-003		134.2121

3.4 Building Construction - 2021

Unmitigated Construction On-Site

	ROG	NOx	CO	SO2	Fugitive PM10	Exhaust PM10	PM10 Total	Fugitive PM2.5	Exhaust PM2.5	PM2.5 Total	Bio- CO2	NBio- CO2	Total CO2	CH4	N2O	CO2e
Category	lb/day										lb/day					
Off-Road	2.7044	24.5476	25.4015	0.0410		1.3538	1.3538		1.2787	1.2787			3,900.3094	0.8944		3,922.6689
Total	2.7044	24.5476	25.4015	0.0410		1.3538	1.3538		1.2787	1.2787			3,900.3094	0.8944		3,922.6689

Santa Maria Airport Commercial Rezone - Santa Barbara-North of Santa Ynez County, Winter

3.4 Building Construction - 2021

Unmitigated Construction Off-Site

	ROG	NOx	CO	SO2	Fugitive PM10	Exhaust PM10	PM10 Total	Fugitive PM2.5	Exhaust PM2.5	PM2.5 Total	Bio- CO2	NBio- CO2	Total CO2	CH4	N2O	CO2e
Category	lb/day										lb/day					
Hauling	0.0000	0.0000	0.0000	0.0000	0.0000	0.0000	0.0000	0.0000	0.0000	0.0000			0.0000	0.0000		0.0000
Vendor	0.2985	8.7165	3.1469	0.0201	0.5152	0.0270	0.5422	0.1482	0.0258	0.1741			2,187.8625	0.1730		2,192.1876
Worker	0.6769	0.5111	4.5556	0.0112	1.3073	8.0600e-003	1.3154	0.3468	7.4300e-003	0.3543			1,110.4011	0.0350		1,111.2764
Total	0.9755	9.2276	7.7025	0.0313	1.8225	0.0351	1.8576	0.4951	0.0333	0.5283			3,298.2636	0.2080		3,303.4640

Mitigated Construction On-Site

	ROG	NOx	CO	SO2	Fugitive PM10	Exhaust PM10	PM10 Total	Fugitive PM2.5	Exhaust PM2.5	PM2.5 Total	Bio- CO2	NBio- CO2	Total CO2	CH4	N2O	CO2e
Category	lb/day										lb/day					
Off-Road	0.9905	21.0093	27.6342	0.0410		1.3253	1.3253		1.3253	1.3253			3,900.3094	0.8944		3,922.6689
Total	0.9905	21.0093	27.6342	0.0410		1.3253	1.3253		1.3253	1.3253			3,900.3094	0.8944		3,922.6689

Santa Maria Airport Commercial Rezone - Santa Barbara-North of Santa Ynez County, Winter

3.4 Building Construction - 2021

Mitigated Construction Off-Site

	ROG	NOx	CO	SO2	Fugitive PM10	Exhaust PM10	PM10 Total	Fugitive PM2.5	Exhaust PM2.5	PM2.5 Total	Bio- CO2	NBio- CO2	Total CO2	CH4	N2O	CO2e
Category	lb/day										lb/day					
Hauling	0.0000	0.0000	0.0000	0.0000	0.0000	0.0000	0.0000	0.0000	0.0000	0.0000			0.0000	0.0000		0.0000
Vendor	0.2985	8.7165	3.1469	0.0201	0.5152	0.0270	0.5422	0.1482	0.0258	0.1741			2,187.8625	0.1730		2,192.1876
Worker	0.6769	0.5111	4.5556	0.0112	1.3073	8.0600e-003	1.3154	0.3468	7.4300e-003	0.3543			1,110.4011	0.0350		1,111.2764
Total	0.9755	9.2276	7.7025	0.0313	1.8225	0.0351	1.8576	0.4951	0.0333	0.5283			3,298.2636	0.2080		3,303.4640

3.4 Building Construction - 2022

Unmitigated Construction On-Site

	ROG	NOx	CO	SO2	Fugitive PM10	Exhaust PM10	PM10 Total	Fugitive PM2.5	Exhaust PM2.5	PM2.5 Total	Bio- CO2	NBio- CO2	Total CO2	CH4	N2O	CO2e
Category	lb/day										lb/day					
Off-Road	2.4327	21.9197	25.1436	0.0410		1.1446	1.1446		1.0819	1.0819			3,901.1173	0.8882		3,923.3216
Total	2.4327	21.9197	25.1436	0.0410		1.1446	1.1446		1.0819	1.0819			3,901.1173	0.8882		3,923.3216

Santa Maria Airport Commercial Rezone - Santa Barbara-North of Santa Ynez County, Winter

3.4 Building Construction - 2022

Unmitigated Construction Off-Site

	ROG	NOx	CO	SO2	Fugitive PM10	Exhaust PM10	PM10 Total	Fugitive PM2.5	Exhaust PM2.5	PM2.5 Total	Bio- CO2	NBio- CO2	Total CO2	CH4	N2O	CO2e
Category	lb/day										lb/day					
Hauling	0.0000	0.0000	0.0000	0.0000	0.0000	0.0000	0.0000	0.0000	0.0000	0.0000			0.0000	0.0000		0.0000
Vendor	0.2747	8.2697	2.9002	0.0199	0.5152	0.0238	0.5390	0.1482	0.0227	0.1710			2,168.9318	0.1753		2,173.3148
Worker	0.6314	0.4566	4.1403	0.0108	1.3073	7.8300e-003	1.3151	0.3468	7.2100e-003	0.3540			1,070.8001	0.0311		1,071.5778
Total	0.9060	8.7264	7.0405	0.0306	1.8225	0.0316	1.8541	0.4951	0.0299	0.5250			3,239.7319	0.2064		3,244.8926

Mitigated Construction On-Site

	ROG	NOx	CO	SO2	Fugitive PM10	Exhaust PM10	PM10 Total	Fugitive PM2.5	Exhaust PM2.5	PM2.5 Total	Bio- CO2	NBio- CO2	Total CO2	CH4	N2O	CO2e
Category	lb/day										lb/day					
Off-Road	0.9905	21.0093	27.6342	0.0410		1.3253	1.3253		1.3253	1.3253			3,901.1173	0.8882		3,923.3216
Total	0.9905	21.0093	27.6342	0.0410		1.3253	1.3253		1.3253	1.3253			3,901.1173	0.8882		3,923.3216

Santa Maria Airport Commercial Rezone - Santa Barbara-North of Santa Ynez County, Winter

3.4 Building Construction - 2022

Mitigated Construction Off-Site

	ROG	NOx	CO	SO2	Fugitive PM10	Exhaust PM10	PM10 Total	Fugitive PM2.5	Exhaust PM2.5	PM2.5 Total	Bio- CO2	NBio- CO2	Total CO2	CH4	N2O	CO2e
Category	lb/day										lb/day					
Hauling	0.0000	0.0000	0.0000	0.0000	0.0000	0.0000	0.0000	0.0000	0.0000	0.0000			0.0000	0.0000		0.0000
Vendor	0.2747	8.2697	2.9002	0.0199	0.5152	0.0238	0.5390	0.1482	0.0227	0.1710			2,168.9318	0.1753		2,173.3148
Worker	0.6314	0.4566	4.1403	0.0108	1.3073	7.8300e-003	1.3151	0.3468	7.2100e-003	0.3540			1,070.8001	0.0311		1,071.5778
Total	0.9060	8.7264	7.0405	0.0306	1.8225	0.0316	1.8541	0.4951	0.0299	0.5250			3,239.7319	0.2064		3,244.8926

3.4 Building Construction - 2023

Unmitigated Construction On-Site

	ROG	NOx	CO	SO2	Fugitive PM10	Exhaust PM10	PM10 Total	Fugitive PM2.5	Exhaust PM2.5	PM2.5 Total	Bio- CO2	NBio- CO2	Total CO2	CH4	N2O	CO2e
Category	lb/day										lb/day					
Off-Road	2.2489	20.1279	25.0114	0.0410		0.9924	0.9924		0.9379	0.9379			3,902.0889	0.8810		3,924.1133
Total	2.2489	20.1279	25.0114	0.0410		0.9924	0.9924		0.9379	0.9379			3,902.0889	0.8810		3,924.1133

Santa Maria Airport Commercial Rezone - Santa Barbara-North of Santa Ynez County, Winter

3.4 Building Construction - 2023

Unmitigated Construction Off-Site

	ROG	NOx	CO	SO2	Fugitive PM10	Exhaust PM10	PM10 Total	Fugitive PM2.5	Exhaust PM2.5	PM2.5 Total	Bio- CO2	NBio- CO2	Total CO2	CH4	N2O	CO2e
Category	lb/day										lb/day					
Hauling	0.0000	0.0000	0.0000	0.0000	0.0000	0.0000	0.0000	0.0000	0.0000	0.0000			0.0000	0.0000		0.0000
Vendor	0.2139	6.8764	2.5978	0.0194	0.5152	0.0114	0.5265	0.1482	0.0109	0.1591			2,129.8499	0.1678		2,134.0458
Worker	0.5906	0.4090	3.7734	0.0104	1.3073	7.6300e-003	1.3149	0.3468	7.0300e-003	0.3539			1,030.7866	0.0277		1,031.4787
Total	0.8045	7.2854	6.3712	0.0298	1.8225	0.0190	1.8415	0.4950	0.0179	0.5129			3,160.6365	0.1955		3,165.5245

Mitigated Construction On-Site

	ROG	NOx	CO	SO2	Fugitive PM10	Exhaust PM10	PM10 Total	Fugitive PM2.5	Exhaust PM2.5	PM2.5 Total	Bio- CO2	NBio- CO2	Total CO2	CH4	N2O	CO2e
Category	lb/day										lb/day					
Off-Road	0.9905	21.0093	27.6342	0.0410		1.3253	1.3253		1.3253	1.3253			3,902.0889	0.8810		3,924.1133
Total	0.9905	21.0093	27.6342	0.0410		1.3253	1.3253		1.3253	1.3253			3,902.0889	0.8810		3,924.1133

Santa Maria Airport Commercial Rezone - Santa Barbara-North of Santa Ynez County, Winter

3.4 Building Construction - 2023

Mitigated Construction Off-Site

	ROG	NOx	CO	SO2	Fugitive PM10	Exhaust PM10	PM10 Total	Fugitive PM2.5	Exhaust PM2.5	PM2.5 Total	Bio- CO2	NBio- CO2	Total CO2	CH4	N2O	CO2e
Category	lb/day										lb/day					
Hauling	0.0000	0.0000	0.0000	0.0000	0.0000	0.0000	0.0000	0.0000	0.0000	0.0000			0.0000	0.0000		0.0000
Vendor	0.2139	6.8764	2.5978	0.0194	0.5152	0.0114	0.5265	0.1482	0.0109	0.1591			2,129.8499	0.1678		2,134.0458
Worker	0.5906	0.4090	3.7734	0.0104	1.3073	7.6300e-003	1.3149	0.3468	7.0300e-003	0.3539			1,030.7866	0.0277		1,031.4787
Total	0.8045	7.2854	6.3712	0.0298	1.8225	0.0190	1.8415	0.4950	0.0179	0.5129			3,160.6365	0.1955		3,165.5245

3.5 Architectural Coating - 2021

Unmitigated Construction On-Site

	ROG	NOx	CO	SO2	Fugitive PM10	Exhaust PM10	PM10 Total	Fugitive PM2.5	Exhaust PM2.5	PM2.5 Total	Bio- CO2	NBio- CO2	Total CO2	CH4	N2O	CO2e
Category	lb/day										lb/day					
Archit. Coating	12.6283					0.0000	0.0000		0.0000	0.0000			0.0000			0.0000
Off-Road	0.2189	1.5268	1.8176	2.9700e-003		0.0941	0.0941		0.0941	0.0941			281.4481	0.0193		281.9309
Total	12.8472	1.5268	1.8176	2.9700e-003		0.0941	0.0941		0.0941	0.0941			281.4481	0.0193		281.9309

Santa Maria Airport Commercial Rezone - Santa Barbara-North of Santa Ynez County, Winter

3.5 Architectural Coating - 2021

Unmitigated Construction Off-Site

	ROG	NOx	CO	SO2	Fugitive PM10	Exhaust PM10	PM10 Total	Fugitive PM2.5	Exhaust PM2.5	PM2.5 Total	Bio- CO2	NBio- CO2	Total CO2	CH4	N2O	CO2e
Category	lb/day										lb/day					
Hauling	0.0000	0.0000	0.0000	0.0000	0.0000	0.0000	0.0000	0.0000	0.0000	0.0000			0.0000	0.0000		0.0000
Vendor	0.0000	0.0000	0.0000	0.0000	0.0000	0.0000	0.0000	0.0000	0.0000	0.0000			0.0000	0.0000		0.0000
Worker	0.1341	0.1012	0.9023	2.2100e-003	0.2589	1.6000e-003	0.2605	0.0687	1.4700e-003	0.0702			219.9345	6.9400e-003		220.1079
Total	0.1341	0.1012	0.9023	2.2100e-003	0.2589	1.6000e-003	0.2605	0.0687	1.4700e-003	0.0702			219.9345	6.9400e-003		220.1079

Mitigated Construction On-Site

	ROG	NOx	CO	SO2	Fugitive PM10	Exhaust PM10	PM10 Total	Fugitive PM2.5	Exhaust PM2.5	PM2.5 Total	Bio- CO2	NBio- CO2	Total CO2	CH4	N2O	CO2e
Category	lb/day										lb/day					
Archit. Coating	12.6283					0.0000	0.0000		0.0000	0.0000			0.0000			0.0000
Off-Road	0.0594	1.3570	1.8324	2.9700e-003		0.0951	0.0951		0.0951	0.0951			281.4481	0.0193		281.9309
Total	12.6878	1.3570	1.8324	2.9700e-003		0.0951	0.0951		0.0951	0.0951			281.4481	0.0193		281.9309

Santa Maria Airport Commercial Rezone - Santa Barbara-North of Santa Ynez County, Winter

3.5 Architectural Coating - 2021

Mitigated Construction Off-Site

	ROG	NOx	CO	SO2	Fugitive PM10	Exhaust PM10	PM10 Total	Fugitive PM2.5	Exhaust PM2.5	PM2.5 Total	Bio- CO2	NBio- CO2	Total CO2	CH4	N2O	CO2e
Category	lb/day										lb/day					
Hauling	0.0000	0.0000	0.0000	0.0000	0.0000	0.0000	0.0000	0.0000	0.0000	0.0000			0.0000	0.0000		0.0000
Vendor	0.0000	0.0000	0.0000	0.0000	0.0000	0.0000	0.0000	0.0000	0.0000	0.0000			0.0000	0.0000		0.0000
Worker	0.1341	0.1012	0.9023	2.2100e-003	0.2589	1.6000e-003	0.2605	0.0687	1.4700e-003	0.0702			219.9345	6.9400e-003		220.1079
Total	0.1341	0.1012	0.9023	2.2100e-003	0.2589	1.6000e-003	0.2605	0.0687	1.4700e-003	0.0702			219.9345	6.9400e-003		220.1079

3.5 Architectural Coating - 2022

Unmitigated Construction On-Site

	ROG	NOx	CO	SO2	Fugitive PM10	Exhaust PM10	PM10 Total	Fugitive PM2.5	Exhaust PM2.5	PM2.5 Total	Bio- CO2	NBio- CO2	Total CO2	CH4	N2O	CO2e
Category	lb/day										lb/day					
Archit. Coating	12.6283					0.0000	0.0000		0.0000	0.0000			0.0000			0.0000
Off-Road	0.2045	1.4085	1.8136	2.9700e-003		0.0817	0.0817		0.0817	0.0817			281.4481	0.0183		281.9062
Total	12.8329	1.4085	1.8136	2.9700e-003		0.0817	0.0817		0.0817	0.0817			281.4481	0.0183		281.9062

Santa Maria Airport Commercial Rezone - Santa Barbara-North of Santa Ynez County, Winter

3.5 Architectural Coating - 2022

Unmitigated Construction Off-Site

	ROG	NOx	CO	SO2	Fugitive PM10	Exhaust PM10	PM10 Total	Fugitive PM2.5	Exhaust PM2.5	PM2.5 Total	Bio- CO2	NBio- CO2	Total CO2	CH4	N2O	CO2e
Category	lb/day										lb/day					
Hauling	0.0000	0.0000	0.0000	0.0000	0.0000	0.0000	0.0000	0.0000	0.0000	0.0000			0.0000	0.0000		0.0000
Vendor	0.0000	0.0000	0.0000	0.0000	0.0000	0.0000	0.0000	0.0000	0.0000	0.0000			0.0000	0.0000		0.0000
Worker	0.1251	0.0905	0.8201	2.1300e-003	0.2589	1.5500e-003	0.2605	0.0687	1.4300e-003	0.0701			212.0908	6.1600e-003		212.2449
Total	0.1251	0.0905	0.8201	2.1300e-003	0.2589	1.5500e-003	0.2605	0.0687	1.4300e-003	0.0701			212.0908	6.1600e-003		212.2449

Mitigated Construction On-Site

	ROG	NOx	CO	SO2	Fugitive PM10	Exhaust PM10	PM10 Total	Fugitive PM2.5	Exhaust PM2.5	PM2.5 Total	Bio- CO2	NBio- CO2	Total CO2	CH4	N2O	CO2e
Category	lb/day										lb/day					
Archit. Coating	12.6283					0.0000	0.0000		0.0000	0.0000			0.0000			0.0000
Off-Road	0.0594	1.3570	1.8324	2.9700e-003		0.0951	0.0951		0.0951	0.0951			281.4481	0.0183		281.9062
Total	12.6878	1.3570	1.8324	2.9700e-003		0.0951	0.0951		0.0951	0.0951			281.4481	0.0183		281.9062

Santa Maria Airport Commercial Rezone - Santa Barbara-North of Santa Ynez County, Winter

3.5 Architectural Coating - 2022

Mitigated Construction Off-Site

	ROG	NOx	CO	SO2	Fugitive PM10	Exhaust PM10	PM10 Total	Fugitive PM2.5	Exhaust PM2.5	PM2.5 Total	Bio- CO2	NBio- CO2	Total CO2	CH4	N2O	CO2e
Category	lb/day										lb/day					
Hauling	0.0000	0.0000	0.0000	0.0000	0.0000	0.0000	0.0000	0.0000	0.0000	0.0000			0.0000	0.0000		0.0000
Vendor	0.0000	0.0000	0.0000	0.0000	0.0000	0.0000	0.0000	0.0000	0.0000	0.0000			0.0000	0.0000		0.0000
Worker	0.1251	0.0905	0.8201	2.1300e-003	0.2589	1.5500e-003	0.2605	0.0687	1.4300e-003	0.0701			212.0908	6.1600e-003		212.2449
Total	0.1251	0.0905	0.8201	2.1300e-003	0.2589	1.5500e-003	0.2605	0.0687	1.4300e-003	0.0701			212.0908	6.1600e-003		212.2449

3.5 Architectural Coating - 2023

Unmitigated Construction On-Site

	ROG	NOx	CO	SO2	Fugitive PM10	Exhaust PM10	PM10 Total	Fugitive PM2.5	Exhaust PM2.5	PM2.5 Total	Bio- CO2	NBio- CO2	Total CO2	CH4	N2O	CO2e
Category	lb/day										lb/day					
Archit. Coating	12.6283					0.0000	0.0000		0.0000	0.0000			0.0000			0.0000
Off-Road	0.1917	1.3030	1.8111	2.9700e-003		0.0708	0.0708		0.0708	0.0708			281.4481	0.0168		281.8690
Total	12.8200	1.3030	1.8111	2.9700e-003		0.0708	0.0708		0.0708	0.0708			281.4481	0.0168		281.8690

Santa Maria Airport Commercial Rezone - Santa Barbara-North of Santa Ynez County, Winter

3.5 Architectural Coating - 2023

Unmitigated Construction Off-Site

	ROG	NOx	CO	SO2	Fugitive PM10	Exhaust PM10	PM10 Total	Fugitive PM2.5	Exhaust PM2.5	PM2.5 Total	Bio- CO2	NBio- CO2	Total CO2	CH4	N2O	CO2e
Category	lb/day										lb/day					
Hauling	0.0000	0.0000	0.0000	0.0000	0.0000	0.0000	0.0000	0.0000	0.0000	0.0000			0.0000	0.0000		0.0000
Vendor	0.0000	0.0000	0.0000	0.0000	0.0000	0.0000	0.0000	0.0000	0.0000	0.0000			0.0000	0.0000		0.0000
Worker	0.1170	0.0810	0.7474	2.0500e-003	0.2589	1.5100e-003	0.2605	0.0687	1.3900e-003	0.0701			204.1655	5.4800e-003		204.3025
Total	0.1170	0.0810	0.7474	2.0500e-003	0.2589	1.5100e-003	0.2605	0.0687	1.3900e-003	0.0701			204.1655	5.4800e-003		204.3025

Mitigated Construction On-Site

	ROG	NOx	CO	SO2	Fugitive PM10	Exhaust PM10	PM10 Total	Fugitive PM2.5	Exhaust PM2.5	PM2.5 Total	Bio- CO2	NBio- CO2	Total CO2	CH4	N2O	CO2e
Category	lb/day										lb/day					
Archit. Coating	12.6283					0.0000	0.0000		0.0000	0.0000			0.0000			0.0000
Off-Road	0.0594	1.3570	1.8324	2.9700e-003		0.0951	0.0951		0.0951	0.0951			281.4481	0.0168		281.8690
Total	12.6878	1.3570	1.8324	2.9700e-003		0.0951	0.0951		0.0951	0.0951			281.4481	0.0168		281.8690

Santa Maria Airport Commercial Rezone - Santa Barbara-North of Santa Ynez County, Winter

3.5 Architectural Coating - 2023

Mitigated Construction Off-Site

	ROG	NOx	CO	SO2	Fugitive PM10	Exhaust PM10	PM10 Total	Fugitive PM2.5	Exhaust PM2.5	PM2.5 Total	Bio- CO2	NBio- CO2	Total CO2	CH4	N2O	CO2e
Category	lb/day										lb/day					
Hauling	0.0000	0.0000	0.0000	0.0000	0.0000	0.0000	0.0000	0.0000	0.0000	0.0000			0.0000	0.0000		0.0000
Vendor	0.0000	0.0000	0.0000	0.0000	0.0000	0.0000	0.0000	0.0000	0.0000	0.0000			0.0000	0.0000		0.0000
Worker	0.1170	0.0810	0.7474	2.0500e-003	0.2589	1.5100e-003	0.2605	0.0687	1.3900e-003	0.0701			204.1655	5.4800e-003		204.3025
Total	0.1170	0.0810	0.7474	2.0500e-003	0.2589	1.5100e-003	0.2605	0.0687	1.3900e-003	0.0701			204.1655	5.4800e-003		204.3025

3.6 Paving - 2023

Unmitigated Construction On-Site

	ROG	NOx	CO	SO2	Fugitive PM10	Exhaust PM10	PM10 Total	Fugitive PM2.5	Exhaust PM2.5	PM2.5 Total	Bio- CO2	NBio- CO2	Total CO2	CH4	N2O	CO2e
Category	lb/day										lb/day					
Off-Road	1.4160	14.8642	15.2215	0.0271		0.6728	0.6728		0.6201	0.6201			2,603.7526	0.8313		2,624.5345
Paving	1.3100					0.0000	0.0000		0.0000	0.0000			0.0000			0.0000
Total	2.7260	14.8642	15.2215	0.0271		0.6728	0.6728		0.6201	0.6201			2,603.7526	0.8313		2,624.5345

Santa Maria Airport Commercial Rezone - Santa Barbara-North of Santa Ynez County, Winter

3.6 Paving - 2023

Unmitigated Construction Off-Site

	ROG	NOx	CO	SO2	Fugitive PM10	Exhaust PM10	PM10 Total	Fugitive PM2.5	Exhaust PM2.5	PM2.5 Total	Bio- CO2	NBio- CO2	Total CO2	CH4	N2O	CO2e
Category	lb/day										lb/day					
Hauling	0.0000	0.0000	0.0000	0.0000	0.0000	0.0000	0.0000	0.0000	0.0000	0.0000			0.0000	0.0000		0.0000
Vendor	0.0000	0.0000	0.0000	0.0000	0.0000	0.0000	0.0000	0.0000	0.0000	0.0000			0.0000	0.0000		0.0000
Worker	0.0713	0.0494	0.4557	1.2500e-003	0.1579	9.2000e-004	0.1588	0.0419	8.5000e-004	0.0427			124.4911	3.3400e-003		124.5747
Total	0.0713	0.0494	0.4557	1.2500e-003	0.1579	9.2000e-004	0.1588	0.0419	8.5000e-004	0.0427			124.4911	3.3400e-003		124.5747

Mitigated Construction On-Site

	ROG	NOx	CO	SO2	Fugitive PM10	Exhaust PM10	PM10 Total	Fugitive PM2.5	Exhaust PM2.5	PM2.5 Total	Bio- CO2	NBio- CO2	Total CO2	CH4	N2O	CO2e
Category	lb/day										lb/day					
Off-Road	0.6474	13.4574	18.4733	0.0271		0.7511	0.7511		0.7511	0.7511			2,603.7526	0.8313		2,624.5345
Paving	1.3100					0.0000	0.0000		0.0000	0.0000			0.0000			0.0000
Total	1.9574	13.4574	18.4733	0.0271		0.7511	0.7511		0.7511	0.7511			2,603.7526	0.8313		2,624.5345

Santa Maria Airport Commercial Rezone - Santa Barbara-North of Santa Ynez County, Winter

3.6 Paving - 2023

Mitigated Construction Off-Site

	ROG	NOx	CO	SO2	Fugitive PM10	Exhaust PM10	PM10 Total	Fugitive PM2.5	Exhaust PM2.5	PM2.5 Total	Bio- CO2	NBio- CO2	Total CO2	CH4	N2O	CO2e
Category	lb/day										lb/day					
Hauling	0.0000	0.0000	0.0000	0.0000	0.0000	0.0000	0.0000	0.0000	0.0000	0.0000			0.0000	0.0000		0.0000
Vendor	0.0000	0.0000	0.0000	0.0000	0.0000	0.0000	0.0000	0.0000	0.0000	0.0000			0.0000	0.0000		0.0000
Worker	0.0713	0.0494	0.4557	1.2500e-003	0.1579	9.2000e-004	0.1588	0.0419	8.5000e-004	0.0427			124.4911	3.3400e-003		124.5747
Total	0.0713	0.0494	0.4557	1.2500e-003	0.1579	9.2000e-004	0.1588	0.0419	8.5000e-004	0.0427			124.4911	3.3400e-003		124.5747

4.0 Operational Detail - Mobile

4.1 Mitigation Measures Mobile

Increase Transit Accessibility

Improve Pedestrian Network

Santa Maria Airport Commercial Rezone - Santa Barbara-North of Santa Ynez County, Winter

	ROG	NOx	CO	SO2	Fugitive PM10	Exhaust PM10	PM10 Total	Fugitive PM2.5	Exhaust PM2.5	PM2.5 Total	Bio- CO2	NBio- CO2	Total CO2	CH4	N2O	CO2e
Category	lb/day										lb/day					
Mitigated	20.1015	58.7238	156.8288	0.3033	26.8667	0.2983	27.1650	7.2009	0.2783	7.4792			30,822.4278	1.9288		30,870.6483
Unmitigated	20.1583	59.0965	158.2089	0.3085	27.4150	0.3024	27.7174	7.3479	0.2822	7.6301			31,351.3425	1.9488		31,400.0633

4.2 Trip Summary Information

Land Use	Average Daily Trip Rate			Unmitigated	Mitigated
	Weekday	Saturday	Sunday	Annual VMT	Annual VMT
Convenience Market With Gas Pumps	3,838.77	6,574.98	5366.29	1,875,418	1,837,909
Free-Standing Discount Store	160.03	198.69	157.57	197,820	193,864
General Office Building	394.20	87.92	37.52	538,184	527,420
Government Office Building	451.15	0.00	0.00	407,283	399,137
High Turnover (Sit Down Restaurant)	4,059.37	5,056.10	4209.11	3,787,867	3,712,110
Medical Office Building	615.68	152.68	26.42	687,335	673,588
Parking Lot	0.00	0.00	0.00		
Strip Mall	2,410.31	2,286.32	1111.07	2,598,402	2,546,434
Unrefrigerated Warehouse-No Rail	136.50	136.50	136.50	302,142	296,099
Other Asphalt Surfaces	0.00	0.00	0.00		
Other Non-Asphalt Surfaces	0.00	0.00	0.00		
Total	12,066.01	14,493.19	11,044.47	10,394,451	10,186,562

4.3 Trip Type Information

Santa Maria Airport Commercial Rezone - Santa Barbara-North of Santa Ynez County, Winter

Land Use	Miles			Trip %			Trip Purpose %		
	H-W or C-W	H-S or C-C	H-O or C-NW	H-W or C-W	H-S or C-C	H-O or C-NW	Primary	Diverted	Pass-by
Convenience Market With Gas	6.60	5.50	6.40	0.80	80.20	19.00	14	21	65
Free-Standing Discount Store	6.60	5.50	6.40	12.20	68.80	19.00	47.5	35.5	17
General Office Building	6.60	5.50	6.40	33.00	48.00	19.00	77	19	4
Government Office Building	6.60	5.50	6.40	33.00	62.00	5.00	50	34	16
High Turnover (Sit Down	6.60	5.50	6.40	8.50	72.50	19.00	37	20	43
Medical Office Building	6.60	5.50	6.40	29.60	51.40	19.00	60	30	10
Parking Lot	6.60	5.50	6.40	0.00	0.00	0.00	0	0	0
Strip Mall	6.60	5.50	6.40	16.60	64.40	19.00	45	40	15
Unrefrigerated Warehouse-No	6.60	5.50	6.40	59.00	0.00	41.00	92	5	3
Other Asphalt Surfaces	6.60	5.50	6.40	0.00	0.00	0.00	0	0	0
Other Non-Asphalt Surfaces	6.60	5.50	6.40	0.00	0.00	0.00	0	0	0

4.4 Fleet Mix

Land Use	LDA	LDT1	LDT2	MDV	LHD1	LHD2	MHD	HHD	OBUS	UBUS	MCY	SBUS	MH
Convenience Market With Gas Pumps	0.567965	0.027871	0.206163	0.120389	0.019588	0.005343	0.017610	0.019838	0.002797	0.002169	0.006725	0.002609	0.000932
Free-Standing Discount Store	0.567965	0.027871	0.206163	0.120389	0.019588	0.005343	0.017610	0.019838	0.002797	0.002169	0.006725	0.002609	0.000932
General Office Building	0.567965	0.027871	0.206163	0.120389	0.019588	0.005343	0.017610	0.019838	0.002797	0.002169	0.006725	0.002609	0.000932
Government Office Building	0.567965	0.027871	0.206163	0.120389	0.019588	0.005343	0.017610	0.019838	0.002797	0.002169	0.006725	0.002609	0.000932
High Turnover (Sit Down Restaurant)	0.567965	0.027871	0.206163	0.120389	0.019588	0.005343	0.017610	0.019838	0.002797	0.002169	0.006725	0.002609	0.000932
Medical Office Building	0.567965	0.027871	0.206163	0.120389	0.019588	0.005343	0.017610	0.019838	0.002797	0.002169	0.006725	0.002609	0.000932
Parking Lot	0.567965	0.027871	0.206163	0.120389	0.019588	0.005343	0.017610	0.019838	0.002797	0.002169	0.006725	0.002609	0.000932
Strip Mall	0.567965	0.027871	0.206163	0.120389	0.019588	0.005343	0.017610	0.019838	0.002797	0.002169	0.006725	0.002609	0.000932
Unrefrigerated Warehouse-No Rail	0.567965	0.027871	0.206163	0.120389	0.019588	0.005343	0.017610	0.019838	0.002797	0.002169	0.006725	0.002609	0.000932
Other Asphalt Surfaces	0.567965	0.027871	0.206163	0.120389	0.019588	0.005343	0.017610	0.019838	0.002797	0.002169	0.006725	0.002609	0.000932
Other Non-Asphalt Surfaces	0.567965	0.027871	0.206163	0.120389	0.019588	0.005343	0.017610	0.019838	0.002797	0.002169	0.006725	0.002609	0.000932

5.0 Energy Detail

Santa Maria Airport Commercial Rezone - Santa Barbara-North of Santa Ynez County, Winter

Historical Energy Use: N

5.1 Mitigation Measures Energy

	ROG	NOx	CO	SO2	Fugitive PM10	Exhaust PM10	PM10 Total	Fugitive PM2.5	Exhaust PM2.5	PM2.5 Total	Bio- CO2	NBio- CO2	Total CO2	CH4	N2O	CO2e
Category	lb/day										lb/day					
NaturalGas Mitigated	0.1225	1.1139	0.9356	6.6800e-003		0.0847	0.0847		0.0847	0.0847			1,336.6237	0.0256	0.0245	1,344.5666
NaturalGas Unmitigated	0.1225	1.1139	0.9356	6.6800e-003		0.0847	0.0847		0.0847	0.0847			1,336.6237	0.0256	0.0245	1,344.5666

Santa Maria Airport Commercial Rezone - Santa Barbara-North of Santa Ynez County, Winter

5.2 Energy by Land Use - NaturalGas

Unmitigated

	NaturalGas Use	ROG	NOx	CO	SO2	Fugitive PM10	Exhaust PM10	PM10 Total	Fugitive PM2.5	Exhaust PM2.5	PM2.5 Total	Bio- CO2	NBio- CO2	Total CO2	CH4	N2O	CO2e
Land Use	kBTU/yr	lb/day										lb/day					
Convenience Market With Gas Pumps	22.0767	2.4000e-004	2.1600e-003	1.8200e-003	1.0000e-005		1.6000e-004	1.6000e-004		1.6000e-004	1.6000e-004			2.5973	5.0000e-005	5.0000e-005	2.6127
Free-Standing Discount Store	207.781	2.2400e-003	0.0204	0.0171	1.2000e-004		1.5500e-003	1.5500e-003		1.5500e-003	1.5500e-003			24.4448	4.7000e-004	4.5000e-004	24.5901
General Office Building	1793.97	0.0194	0.1759	0.1477	1.0600e-003		0.0134	0.0134		0.0134	0.0134			211.0556	4.0500e-003	3.8700e-003	212.3098
Government Office Building	991.17	0.0107	0.0972	0.0816	5.8000e-004		7.3900e-003	7.3900e-003		7.3900e-003	7.3900e-003			116.6082	2.2300e-003	2.1400e-003	117.3012
High Turnover (Sit Down Restaurant)	6264.88	0.0676	0.6142	0.5159	3.6900e-003		0.0467	0.0467		0.0467	0.0467			737.0443	0.0141	0.0135	741.4242
Medical Office Building	896.986	9.6700e-003	0.0879	0.0739	5.3000e-004		6.6800e-003	6.6800e-003		6.6800e-003	6.6800e-003			105.5278	2.0200e-003	1.9300e-003	106.1549
Other Asphalt Surfaces	0	0.0000	0.0000	0.0000	0.0000		0.0000	0.0000		0.0000	0.0000			0.0000	0.0000	0.0000	0.0000
Other Non-Asphalt Surfaces	0	0.0000	0.0000	0.0000	0.0000		0.0000	0.0000		0.0000	0.0000			0.0000	0.0000	0.0000	0.0000
Parking Lot	0	0.0000	0.0000	0.0000	0.0000		0.0000	0.0000		0.0000	0.0000			0.0000	0.0000	0.0000	0.0000
Strip Mall	233.753	2.5200e-003	0.0229	0.0193	1.4000e-004		1.7400e-003	1.7400e-003		1.7400e-003	1.7400e-003			27.5004	5.3000e-004	5.0000e-004	27.6638
Unrefrigerated Warehouse-No Rail	950.685	0.0103	0.0932	0.0783	5.6000e-004		7.0800e-003	7.0800e-003		7.0800e-003	7.0800e-003			111.8453	2.1400e-003	2.0500e-003	112.5099
Total		0.1225	1.1138	0.9356	6.6900e-003		0.0847	0.0847		0.0847	0.0847			1,336.6237	0.0256	0.0245	1,344.5666

Santa Maria Airport Commercial Rezone - Santa Barbara-North of Santa Ynez County, Winter

5.2 Energy by Land Use - NaturalGas

Mitigated

	NaturalGas Use	ROG	NOx	CO	SO2	Fugitive PM10	Exhaust PM10	PM10 Total	Fugitive PM2.5	Exhaust PM2.5	PM2.5 Total	Bio- CO2	NBio- CO2	Total CO2	CH4	N2O	CO2e
Land Use	kBTU/yr	lb/day										lb/day					
Convenience Market With Gas Pumps	0.0220767	2.4000e-004	2.1600e-003	1.8200e-003	1.0000e-005		1.6000e-004	1.6000e-004		1.6000e-004	1.6000e-004			2.5973	5.0000e-005	5.0000e-005	2.6127
Free-Standing Discount Store	0.207781	2.2400e-003	0.0204	0.0171	1.2000e-004		1.5500e-003	1.5500e-003		1.5500e-003	1.5500e-003			24.4448	4.7000e-004	4.5000e-004	24.5901
General Office Building	1.79397	0.0194	0.1759	0.1477	1.0600e-003		0.0134	0.0134		0.0134	0.0134			211.0556	4.0500e-003	3.8700e-003	212.3098
Government Office Building	0.99117	0.0107	0.0972	0.0816	5.8000e-004		7.3900e-003	7.3900e-003		7.3900e-003	7.3900e-003			116.6082	2.2300e-003	2.1400e-003	117.3012
High Turnover (Sit Down Restaurant)	6.26488	0.0676	0.6142	0.5159	3.6900e-003		0.0467	0.0467		0.0467	0.0467			737.0443	0.0141	0.0135	741.4242
Medical Office Building	0.896986	9.6700e-003	0.0879	0.0739	5.3000e-004		6.6800e-003	6.6800e-003		6.6800e-003	6.6800e-003			105.5278	2.0200e-003	1.9300e-003	106.1549
Other Asphalt Surfaces	0	0.0000	0.0000	0.0000	0.0000		0.0000	0.0000		0.0000	0.0000			0.0000	0.0000	0.0000	0.0000
Other Non-Asphalt Surfaces	0	0.0000	0.0000	0.0000	0.0000		0.0000	0.0000		0.0000	0.0000			0.0000	0.0000	0.0000	0.0000
Parking Lot	0	0.0000	0.0000	0.0000	0.0000		0.0000	0.0000		0.0000	0.0000			0.0000	0.0000	0.0000	0.0000
Strip Mall	0.233753	2.5200e-003	0.0229	0.0193	1.4000e-004		1.7400e-003	1.7400e-003		1.7400e-003	1.7400e-003			27.5004	5.3000e-004	5.0000e-004	27.6638
Unrefrigerated Warehouse-No Rail	0.950685	0.0103	0.0932	0.0783	5.6000e-004		7.0800e-003	7.0800e-003		7.0800e-003	7.0800e-003			111.8453	2.1400e-003	2.0500e-003	112.5099
Total		0.1225	1.1138	0.9356	6.6900e-003		0.0847	0.0847		0.0847	0.0847			1,336.6237	0.0256	0.0245	1,344.5666

6.0 Area Detail

6.1 Mitigation Measures Area

Santa Maria Airport Commercial Rezone - Santa Barbara-North of Santa Ynez County, Winter

	ROG	NOx	CO	SO2	Fugitive PM10	Exhaust PM10	PM10 Total	Fugitive PM2.5	Exhaust PM2.5	PM2.5 Total	Bio- CO2	NBio- CO2	Total CO2	CH4	N2O	CO2e
Category	lb/day										lb/day					
Mitigated	7.5523	8.6000e-004	0.0949	1.0000e-005		3.4000e-004	3.4000e-004		3.4000e-004	3.4000e-004			0.2035	5.3000e-004		0.2169
Unmitigated	7.5523	8.6000e-004	0.0949	1.0000e-005		3.4000e-004	3.4000e-004		3.4000e-004	3.4000e-004			0.2035	5.3000e-004		0.2169

6.2 Area by SubCategory

Unmitigated

	ROG	NOx	CO	SO2	Fugitive PM10	Exhaust PM10	PM10 Total	Fugitive PM2.5	Exhaust PM2.5	PM2.5 Total	Bio- CO2	NBio- CO2	Total CO2	CH4	N2O	CO2e
SubCategory	lb/day										lb/day					
Architectural Coating	1.7507					0.0000	0.0000		0.0000	0.0000			0.0000			0.0000
Consumer Products	5.7928					0.0000	0.0000		0.0000	0.0000			0.0000			0.0000
Landscaping	8.7900e-003	8.6000e-004	0.0949	1.0000e-005		3.4000e-004	3.4000e-004		3.4000e-004	3.4000e-004			0.2035	5.3000e-004		0.2169
Total	7.5523	8.6000e-004	0.0949	1.0000e-005		3.4000e-004	3.4000e-004		3.4000e-004	3.4000e-004			0.2035	5.3000e-004		0.2169

Santa Maria Airport Commercial Rezone - Santa Barbara-North of Santa Ynez County, Winter

6.2 Area by SubCategory

Mitigated

	ROG	NOx	CO	SO2	Fugitive PM10	Exhaust PM10	PM10 Total	Fugitive PM2.5	Exhaust PM2.5	PM2.5 Total	Bio- CO2	NBio- CO2	Total CO2	CH4	N2O	CO2e
SubCategory	lb/day										lb/day					
Architectural Coating	1.7507					0.0000	0.0000		0.0000	0.0000			0.0000			0.0000
Consumer Products	5.7928					0.0000	0.0000		0.0000	0.0000			0.0000			0.0000
Landscaping	8.7900e-003	8.6000e-004	0.0949	1.0000e-005		3.4000e-004	3.4000e-004		3.4000e-004	3.4000e-004			0.2035	5.3000e-004		0.2169
Total	7.5523	8.6000e-004	0.0949	1.0000e-005		3.4000e-004	3.4000e-004		3.4000e-004	3.4000e-004			0.2035	5.3000e-004		0.2169

7.0 Water Detail

7.1 Mitigation Measures Water

- Install Low Flow Bathroom Faucet
- Install Low Flow Kitchen Faucet
- Install Low Flow Toilet
- Install Low Flow Shower
- Use Water Efficient Irrigation System

8.0 Waste Detail

8.1 Mitigation Measures Waste

- Institute Recycling and Composting Services

Santa Maria Airport Commercial Rezone - Santa Barbara-North of Santa Ynez County, Winter

9.0 Operational Offroad

Equipment Type	Number	Hours/Day	Days/Year	Horse Power	Load Factor	Fuel Type
----------------	--------	-----------	-----------	-------------	-------------	-----------

10.0 Stationary Equipment

Fire Pumps and Emergency Generators

Equipment Type	Number	Hours/Day	Hours/Year	Horse Power	Load Factor	Fuel Type
----------------	--------	-----------	------------	-------------	-------------	-----------

Boilers

Equipment Type	Number	Heat Input/Day	Heat Input/Year	Boiler Rating	Fuel Type
----------------	--------	----------------	-----------------	---------------	-----------

User Defined Equipment

Equipment Type	Number
----------------	--------

11.0 Vegetation

Santa Maria Airport Commercial Rezone - Santa Barbara-North of Santa Ynez County, Annual

Santa Maria Airport Commercial Rezone
Santa Barbara-North of Santa Ynez County, Annual

1.0 Project Characteristics

1.1 Land Usage

Land Uses	Size	Metric	Lot Acreage	Floor Surface Area	Population
General Office Building	40.00	1000sqft	0.92	40,000.00	0
Government Office Building	22.10	1000sqft	0.51	22,100.00	0
Medical Office Building	20.00	1000sqft	0.46	20,000.00	0
Unrefrigerated Warehouse-No Rail	100.00	1000sqft	2.30	100,000.00	0
Parking Lot	663.00	Space	8.00	265,200.00	0
High Turnover (Sit Down Restaurant)	11.00	1000sqft	0.25	11,000.00	0
Convenience Market With Gas Pumps	3.40	1000sqft	0.08	3,400.00	0
Free-Standing Discount Store	32.00	1000sqft	0.73	32,000.00	0
Strip Mall	36.00	1000sqft	0.83	36,000.00	0
Other Asphalt Surfaces	2.00	Acre	2.00	87,120.00	0
Other Non-Asphalt Surfaces	0.50	Acre	0.50	21,780.00	0

1.2 Other Project Characteristics

Urbanization	Urban	Wind Speed (m/s)	3.1	Precipitation Freq (Days)	37
Climate Zone	4			Operational Year	2023
Utility Company	Pacific Gas & Electric Company				
CO2 Intensity (lb/MWhr)	438.13	CH4 Intensity (lb/MWhr)	0.02	N2O Intensity (lb/MWhr)	0.004

1.3 User Entered Comments & Non-Default Data

Santa Maria Airport Commercial Rezone - Santa Barbara-North of Santa Ynez County, Annual

Project Characteristics - Includes adjustments for RPS.

Land Use - Based on land use information provided.

Construction Phase - Based on information provided. Demo not required. Site prep 10 days, grading 80 days, building 606 days, paving 20 days, arch coating 500 days.

Off-road Equipment - Based on model defaults

Off-road Equipment - Based on model defaults. Additional equipment included based on information provided.

Off-road Equipment - Based on model defaults. Additional equipment included based on information provided.

Off-road Equipment - Based on model defaults. Additional equipment included based on information provided.

Off-road Equipment - Includes 2 scrapers based on info provided and defaults.

Trips and VMT - Construction vehicle trips based on model defaults.

Grading - All material balanced on site. Area graded based on model defaults/equipment usage rates. Graded area is calculated by CalEEMod based on equipment usage/8-hr day and const. schedule.

Vehicle Trips - Trip-gen rates derived from the traffic analysis (CCTC 2020). Rates were adjusted for internal capture and pass-by. Trip lengths based on model defaults.

Area Coating - Arch coatings based on model defaults.

Energy Use - Energy use based on model defaults.

Water And Wastewater - Water, wastewater, and solid waste based on model defaults.

Sequestration - Assumes net increase of 340 trees. Provided for informational purposes only.

Construction Off-road Equipment Mitigation - Includes 50% CE for watering unpaved roads/travel areas; 61% CE for watering graded surfaces, 15 mph onsite speed limit. T3 offroad equipment included for informational purposes.

Mobile Land Use Mitigation - Site Enhancements include improved pedestrian access on-site and connecting off-site. Install transit features to increase accessibility (benches, pullouts, etc.)

Area Mitigation - .

Energy Mitigation - Compliance with current energy-efficiency building standards calculated separately.

Water Mitigation - Includes use of low-flow water fixtures and water-efficient irrigation systems.

Waste Mitigation - Assumes 75% diversion rate per current targets.

Architectural Coating - Arch coating based on model defaults.

Vehicle Emission Factors - Emfac based on model defaults. SAFE veh adjustments calculated separately.

Vehicle Emission Factors -

Vehicle Emission Factors -

Santa Maria Airport Commercial Rezone - Santa Barbara-North of Santa Ynez County, Annual

Fleet Mix -

Table Name	Column Name	Default Value	New Value
tblArchitecturalCoating	ConstArea_Parking	22,446.00	15,912.00
tblAreaMitigation	UseLowVOCPaintNonresidentialExteriorValue	250	50
tblAreaMitigation	UseLowVOCPaintNonresidentialInteriorValue	250	50
tblConstDustMitigation	WaterUnpavedRoadVehicleSpeed	0	15
tblConstEquipMitigation	NumberOfEquipmentMitigated	0.00	1.00
tblConstEquipMitigation	NumberOfEquipmentMitigated	0.00	1.00
tblConstEquipMitigation	NumberOfEquipmentMitigated	0.00	1.00
tblConstEquipMitigation	NumberOfEquipmentMitigated	0.00	3.00
tblConstEquipMitigation	NumberOfEquipmentMitigated	0.00	3.00
tblConstEquipMitigation	NumberOfEquipmentMitigated	0.00	1.00
tblConstEquipMitigation	NumberOfEquipmentMitigated	0.00	2.00
tblConstEquipMitigation	NumberOfEquipmentMitigated	0.00	1.00
tblConstEquipMitigation	NumberOfEquipmentMitigated	0.00	1.00
tblConstEquipMitigation	NumberOfEquipmentMitigated	0.00	4.00
tblConstEquipMitigation	NumberOfEquipmentMitigated	0.00	4.00
tblConstEquipMitigation	NumberOfEquipmentMitigated	0.00	4.00
tblConstEquipMitigation	NumberOfEquipmentMitigated	0.00	1.00
tblConstEquipMitigation	NumberOfEquipmentMitigated	0.00	12.00
tblConstEquipMitigation	NumberOfEquipmentMitigated	0.00	1.00
tblConstEquipMitigation	Tier	No Change	Tier 3
tblConstEquipMitigation	Tier	No Change	Tier 3
tblConstEquipMitigation	Tier	No Change	Tier 3
tblConstEquipMitigation	Tier	No Change	Tier 3
tblConstEquipMitigation	Tier	No Change	Tier 3

Santa Maria Airport Commercial Rezone - Santa Barbara-North of Santa Ynez County, Annual

tblConstEquipMitigation	Tier	No Change	Tier 3
tblConstEquipMitigation	Tier	No Change	Tier 3
tblConstEquipMitigation	Tier	No Change	Tier 3
tblConstEquipMitigation	Tier	No Change	Tier 3
tblConstEquipMitigation	Tier	No Change	Tier 3
tblConstEquipMitigation	Tier	No Change	Tier 3
tblConstEquipMitigation	Tier	No Change	Tier 3
tblConstEquipMitigation	Tier	No Change	Tier 3
tblConstEquipMitigation	Tier	No Change	Tier 3
tblConstEquipMitigation	Tier	No Change	Tier 3
tblConstructionPhase	NumDays	30.00	80.00
tblConstructionPhase	NumDays	300.00	606.00
tblConstructionPhase	NumDays	20.00	500.00
tblLandUse	LotAcreage	5.97	8.00
tblOffRoadEquipment	OffRoadEquipmentUnitAmount	2.00	1.00
tblOffRoadEquipment	OffRoadEquipmentUnitAmount	2.00	1.00
tblOffRoadEquipment	OffRoadEquipmentUnitAmount	2.00	3.00
tblProjectCharacteristics	CH4IntensityFactor	0.029	0.02
tblProjectCharacteristics	CO2IntensityFactor	641.35	438.13
tblProjectCharacteristics	N2OIntensityFactor	0.006	0.004
tblSequestration	NumberOfNewTrees	0.00	340.00
tblTripsAndVMT	VendorTripNumber	105.00	87.00
tblTripsAndVMT	WorkerTripNumber	253.00	207.00
tblTripsAndVMT	WorkerTripNumber	51.00	41.00
tblTripsAndVMT	WorkerTripNumber	20.00	25.00
tblVehicleTrips	ST_TR	1,448.33	1,933.82
tblVehicleTrips	ST_TR	71.07	6.21

Santa Maria Airport Commercial Rezone - Santa Barbara-North of Santa Ynez County, Annual

tblVehicleTrips	ST_TR	2.46	2.20
tblVehicleTrips	ST_TR	158.37	459.65
tblVehicleTrips	ST_TR	8.96	7.63
tblVehicleTrips	ST_TR	42.04	63.51
tblVehicleTrips	ST_TR	1.68	1.37
tblVehicleTrips	SU_TR	1,182.08	1,578.32
tblVehicleTrips	SU_TR	56.36	4.92
tblVehicleTrips	SU_TR	1.05	0.94
tblVehicleTrips	SU_TR	131.84	382.65
tblVehicleTrips	SU_TR	1.55	1.32
tblVehicleTrips	SU_TR	20.43	30.86
tblVehicleTrips	SU_TR	1.68	1.37
tblVehicleTrips	WD_TR	845.60	1,129.05
tblVehicleTrips	WD_TR	57.24	5.00
tblVehicleTrips	WD_TR	11.03	9.86
tblVehicleTrips	WD_TR	68.93	20.41
tblVehicleTrips	WD_TR	127.15	369.03
tblVehicleTrips	WD_TR	36.13	30.78
tblVehicleTrips	WD_TR	44.32	66.95
tblVehicleTrips	WD_TR	1.68	1.37

2.0 Emissions Summary

Santa Maria Airport Commercial Rezone - Santa Barbara-North of Santa Ynez County, Annual

2.1 Overall Construction

Unmitigated Construction

	ROG	NOx	CO	SO2	Fugitive PM10	Exhaust PM10	PM10 Total	Fugitive PM2.5	Exhaust PM2.5	PM2.5 Total	Bio- CO2	NBio- CO2	Total CO2	CH4	N2O	CO2e
Year	tons/yr										MT/yr					
2021	0.7790	4.9157	4.1568	8.7200e-003	0.5952	0.2097	0.8049	0.2347	0.1957	0.4304			780.7773	0.1632	0.0000	784.8569
2022	2.1085	4.1936	4.4940	0.0100	0.2649	0.1636	0.4285	0.0719	0.1553	0.2272			904.1958	0.1315	0.0000	907.4819
2023	1.5799	2.9651	3.4457	7.7000e-003	0.2002	0.1124	0.3126	0.0543	0.1064	0.1607			695.2665	0.1044	0.0000	697.8769
Maximum	2.1085	4.9157	4.4940	0.0100	0.5952	0.2097	0.8049	0.2347	0.1957	0.4304			904.1958	0.1632	0.0000	907.4819

Mitigated Construction

	ROG	NOx	CO	SO2	Fugitive PM10	Exhaust PM10	PM10 Total	Fugitive PM2.5	Exhaust PM2.5	PM2.5 Total	Bio- CO2	NBio- CO2	Total CO2	CH4	N2O	CO2e
Year	tons/yr										MT/yr					
2021	0.5101	3.8329	4.5857	8.7200e-003	0.3220	0.1740	0.4960	0.1159	0.1739	0.2898			780.7766	0.1632	0.0000	784.8562
2022	1.9022	4.0685	4.8202	0.0100	0.2649	0.1889	0.4538	0.0719	0.1886	0.2605			904.1952	0.1315	0.0000	907.4813
2023	1.4367	3.0422	3.7361	7.7000e-003	0.2002	0.1480	0.3482	0.0543	0.1479	0.2022			695.2660	0.1044	0.0000	697.8765
Maximum	1.9022	4.0685	4.8202	0.0100	0.3220	0.1889	0.4960	0.1159	0.1886	0.2898			904.1952	0.1632	0.0000	907.4813

Santa Maria Airport Commercial Rezone - Santa Barbara-North of Santa Ynez County, Annual

	ROG	NOx	CO	SO2	Fugitive PM10	Exhaust PM10	PM10 Total	Fugitive PM2.5	Exhaust PM2.5	PM2.5 Total	Bio- CO2	NBio-CO2	Total CO2	CH4	N2O	CO2e
Percent Reduction	13.85	9.36	-8.64	0.00	25.77	-5.18	16.05	32.90	-11.59	8.03	0.00	0.00	0.00	0.00	0.00	0.00

Quarter	Start Date	End Date	Maximum Unmitigated ROG + NOX (tons/quarter)	Maximum Mitigated ROG + NOX (tons/quarter)
1	1-1-2021	3-31-2021	1.2801	0.7810
2	4-1-2021	6-30-2021	1.6145	1.1150
3	7-1-2021	9-30-2021	1.2266	1.0540
4	10-1-2021	12-31-2021	1.5489	1.3692
5	1-1-2022	3-31-2022	1.5571	1.4751
6	4-1-2022	6-30-2022	1.5700	1.4872
7	7-1-2022	9-30-2022	1.5873	1.5035
8	10-1-2022	12-31-2022	1.5917	1.5079
9	1-1-2023	3-31-2023	1.4396	1.4250
10	4-1-2023	6-30-2023	1.4517	1.4369
11	7-1-2023	9-30-2023	1.6223	1.5866
		Highest	1.6223	1.5866

Santa Maria Airport Commercial Rezone - Santa Barbara-North of Santa Ynez County, Annual

2.2 Overall Operational

Unmitigated Operational

	ROG	NOx	CO	SO2	Fugitive PM10	Exhaust PM10	PM10 Total	Fugitive PM2.5	Exhaust PM2.5	PM2.5 Total	Bio- CO2	NBio- CO2	Total CO2	CH4	N2O	CO2e
Category	tons/yr										MT/yr					
Area	1.3775	8.0000e-005	8.5400e-003	0.0000		3.0000e-005	3.0000e-005		3.0000e-005	3.0000e-005			0.0166	4.0000e-005	0.0000	0.0177
Energy	0.0224	0.2033	0.1708	1.2200e-003		0.0155	0.0155		0.0155	0.0155			824.0185	0.0318	9.5600e-003	827.6612
Mobile	2.8191	8.4595	21.6103	0.0453	3.9418	0.0435	3.9853	1.0585	0.0406	1.0990			4,180.7839	0.2474	0.0000	4,186.9677
Waste						0.0000	0.0000		0.0000	0.0000			142.1020	7.0464	0.0000	318.2615
Water						0.0000	0.0000		0.0000	0.0000			73.0383	0.0583	0.0357	85.1434
Total	4.2190	8.6629	21.7896	0.0465	3.9418	0.0590	4.0008	1.0585	0.0561	1.1145			5,219.9593	7.3838	0.0453	5,418.0514

Santa Maria Airport Commercial Rezone - Santa Barbara-North of Santa Ynez County, Annual

2.2 Overall Operational

Mitigated Operational

	ROG	NOx	CO	SO2	Fugitive PM10	Exhaust PM10	PM10 Total	Fugitive PM2.5	Exhaust PM2.5	PM2.5 Total	Bio- CO2	NBio- CO2	Total CO2	CH4	N2O	CO2e
Category	tons/yr										MT/yr					
Area	1.3775	8.0000e-005	8.5400e-003	0.0000		3.0000e-005	3.0000e-005		3.0000e-005	3.0000e-005			0.0166	4.0000e-005	0.0000	0.0177
Energy	0.0224	0.2033	0.1708	1.2200e-003		0.0155	0.0155		0.0155	0.0155			824.0185	0.0318	9.5600e-003	827.6612
Mobile	2.8108	8.4047	21.4091	0.0445	3.8630	0.0429	3.9058	1.0373	0.0400	1.0773			4,110.2794	0.2447	0.0000	4,116.3965
Waste						0.0000	0.0000		0.0000	0.0000			35.5255	1.7616	0.0000	79.5654
Water						0.0000	0.0000		0.0000	0.0000			59.4923	0.0467	0.0286	69.1805
Total	4.2107	8.6081	21.5884	0.0458	3.8630	0.0584	3.9213	1.0373	0.0555	1.0928			5,029.3323	2.0848	0.0382	5,092.8213

	ROG	NOx	CO	SO2	Fugitive PM10	Exhaust PM10	PM10 Total	Fugitive PM2.5	Exhaust PM2.5	PM2.5 Total	Bio- CO2	NBio-CO2	Total CO2	CH4	N2O	CO2e
Percent Reduction	0.20	0.63	0.92	1.63	2.00	1.03	1.99	2.00	1.02	1.95	0.00	0.00	3.65	71.77	15.77	6.00

Santa Maria Airport Commercial Rezone - Santa Barbara-North of Santa Ynez County, Annual

2.3 Vegetation

Vegetation

	CO2e
Category	MT
New Trees	240.7200
Total	240.7200

3.0 Construction Detail

Construction Phase

Phase Number	Phase Name	Phase Type	Start Date	End Date	Num Days Week	Num Days	Phase Description
1	Site Preparation	Site Preparation	1/29/2021	2/11/2021	5	10	
2	Grading	Grading	2/12/2021	6/3/2021	5	80	
3	Building Construction	Building Construction	6/4/2021	9/29/2023	5	606	
4	Architectural Coating	Architectural Coating	11/1/2021	9/29/2023	5	500	
5	Paving	Paving	8/20/2023	9/15/2023	5	20	

Acres of Grading (Site Preparation Phase): 20

Acres of Grading (Grading Phase): 200

Acres of Paving: 10.5

Santa Maria Airport Commercial Rezone - Santa Barbara-North of Santa Ynez County, Annual

Residential Indoor: 0; Residential Outdoor: 0; Non-Residential Indoor: 396,750; Non-Residential Outdoor: 132,250; Striped Parking Area: 15,912 (Architectural Coating – sqft)

OffRoad Equipment

Santa Maria Airport Commercial Rezone - Santa Barbara-North of Santa Ynez County, Annual

Phase Name	Offroad Equipment Type	Amount	Usage Hours	Horse Power	Load Factor
Site Preparation	Rubber Tired Dozers	3	8.00	247	0.40
Site Preparation	Scrapers	2	8.00	367	0.48
Site Preparation	Tractors/Loaders/Backhoes	4	8.00	97	0.37
Grading	Excavators	2	8.00	158	0.38
Grading	Graders	1	8.00	187	0.41
Grading	Rubber Tired Dozers	1	8.00	247	0.40
Grading	Scrapers	2	8.00	367	0.48
Grading	Tractors/Loaders/Backhoes	2	8.00	97	0.37
Grading	Tractors/Loaders/Backhoes	2	8.00	97	0.37
Building Construction	Concrete/Industrial Saws	1	8.00	81	0.73
Building Construction	Cranes	1	7.00	231	0.29
Building Construction	Excavators	1	8.00	158	0.38
Building Construction	Forklifts	3	8.00	89	0.20
Building Construction	Generator Sets	1	8.00	84	0.74
Building Construction	Rollers	1	8.00	80	0.38
Building Construction	Tractors/Loaders/Backhoes	3	7.00	97	0.37
Building Construction	Welders	1	8.00	46	0.45
Architectural Coating	Air Compressors	1	6.00	78	0.48
Paving	Graders	1	8.00	187	0.41
Paving	Pavers	1	8.00	130	0.42
Paving	Paving Equipment	1	8.00	132	0.36
Paving	Rollers	3	8.00	80	0.38
Paving	Signal Boards	1	8.00	6	0.82
Paving	Tractors/Loaders/Backhoes	1	8.00	97	0.37

Trips and VMT

Santa Maria Airport Commercial Rezone - Santa Barbara-North of Santa Ynez County, Annual

Phase Name	Offroad Equipment Count	Worker Trip Number	Vendor Trip Number	Hauling Trip Number	Worker Trip Length	Vendor Trip Length	Hauling Trip Length	Worker Vehicle Class	Vendor Vehicle Class	Hauling Vehicle Class
Site Preparation	9	23.00	0.00	0.00	8.30	6.40	20.00	LD_Mix	HDT_Mix	HHDT
Grading	10	25.00	0.00	0.00	8.30	6.40	20.00	LD_Mix	HDT_Mix	HHDT
Building Construction	12	207.00	87.00	0.00	8.30	6.40	20.00	LD_Mix	HDT_Mix	HHDT
Architectural Coating	1	41.00	0.00	0.00	8.30	6.40	20.00	LD_Mix	HDT_Mix	HHDT
Paving	8	25.00	0.00	0.00	8.30	6.40	20.00	LD_Mix	HDT_Mix	HHDT

3.1 Mitigation Measures Construction

Use Cleaner Engines for Construction Equipment

Use Soil Stabilizer

Water Exposed Area

Reduce Vehicle Speed on Unpaved Roads

3.2 Site Preparation - 2021

Unmitigated Construction On-Site

	ROG	NOx	CO	SO2	Fugitive PM10	Exhaust PM10	PM10 Total	Fugitive PM2.5	Exhaust PM2.5	PM2.5 Total	Bio- CO2	NBio- CO2	Total CO2	CH4	N2O	CO2e
Category	tons/yr										MT/yr					
Fugitive Dust					0.1009	0.0000	0.1009	0.0508	0.0000	0.0508			0.0000	0.0000	0.0000	0.0000
Off-Road	0.0287	0.3095	0.1758	3.4000e-004		0.0144	0.0144		0.0132	0.0132			30.0345	9.7100e-003	0.0000	30.2774
Total	0.0287	0.3095	0.1758	3.4000e-004	0.1009	0.0144	0.1153	0.0508	0.0132	0.0640			30.0345	9.7100e-003	0.0000	30.2774

Santa Maria Airport Commercial Rezone - Santa Barbara-North of Santa Ynez County, Annual

3.2 Site Preparation - 2021

Unmitigated Construction Off-Site

	ROG	NOx	CO	SO2	Fugitive PM10	Exhaust PM10	PM10 Total	Fugitive PM2.5	Exhaust PM2.5	PM2.5 Total	Bio- CO2	NBio- CO2	Total CO2	CH4	N2O	CO2e
Category	tons/yr										MT/yr					
Hauling	0.0000	0.0000	0.0000	0.0000	0.0000	0.0000	0.0000	0.0000	0.0000	0.0000			0.0000	0.0000	0.0000	0.0000
Vendor	0.0000	0.0000	0.0000	0.0000	0.0000	0.0000	0.0000	0.0000	0.0000	0.0000			0.0000	0.0000	0.0000	0.0000
Worker	3.4000e-004	2.8000e-004	2.4700e-003	1.0000e-005	7.1000e-004	0.0000	7.1000e-004	1.9000e-004	0.0000	1.9000e-004			0.5604	2.0000e-005	0.0000	0.5608
Total	3.4000e-004	2.8000e-004	2.4700e-003	1.0000e-005	7.1000e-004	0.0000	7.1000e-004	1.9000e-004	0.0000	1.9000e-004			0.5604	2.0000e-005	0.0000	0.5608

Mitigated Construction On-Site

	ROG	NOx	CO	SO2	Fugitive PM10	Exhaust PM10	PM10 Total	Fugitive PM2.5	Exhaust PM2.5	PM2.5 Total	Bio- CO2	NBio- CO2	Total CO2	CH4	N2O	CO2e
Category	tons/yr										MT/yr					
Fugitive Dust					0.0394	0.0000	0.0394	0.0198	0.0000	0.0198			0.0000	0.0000	0.0000	0.0000
Off-Road	8.3800e-003	0.1674	0.1956	3.4000e-004		7.4600e-003	7.4600e-003		7.4600e-003	7.4600e-003			30.0345	9.7100e-003	0.0000	30.2773
Total	8.3800e-003	0.1674	0.1956	3.4000e-004	0.0394	7.4600e-003	0.0468	0.0198	7.4600e-003	0.0273			30.0345	9.7100e-003	0.0000	30.2773

Santa Maria Airport Commercial Rezone - Santa Barbara-North of Santa Ynez County, Annual

3.2 Site Preparation - 2021

Mitigated Construction Off-Site

	ROG	NOx	CO	SO2	Fugitive PM10	Exhaust PM10	PM10 Total	Fugitive PM2.5	Exhaust PM2.5	PM2.5 Total	Bio- CO2	NBio- CO2	Total CO2	CH4	N2O	CO2e
Category	tons/yr										MT/yr					
Hauling	0.0000	0.0000	0.0000	0.0000	0.0000	0.0000	0.0000	0.0000	0.0000	0.0000			0.0000	0.0000	0.0000	0.0000
Vendor	0.0000	0.0000	0.0000	0.0000	0.0000	0.0000	0.0000	0.0000	0.0000	0.0000			0.0000	0.0000	0.0000	0.0000
Worker	3.4000e-004	2.8000e-004	2.4700e-003	1.0000e-005	7.1000e-004	0.0000	7.1000e-004	1.9000e-004	0.0000	1.9000e-004			0.5604	2.0000e-005	0.0000	0.5608
Total	3.4000e-004	2.8000e-004	2.4700e-003	1.0000e-005	7.1000e-004	0.0000	7.1000e-004	1.9000e-004	0.0000	1.9000e-004			0.5604	2.0000e-005	0.0000	0.5608

3.3 Grading - 2021

Unmitigated Construction On-Site

	ROG	NOx	CO	SO2	Fugitive PM10	Exhaust PM10	PM10 Total	Fugitive PM2.5	Exhaust PM2.5	PM2.5 Total	Bio- CO2	NBio- CO2	Total CO2	CH4	N2O	CO2e
Category	tons/yr										MT/yr					
Fugitive Dust					0.3469	0.0000	0.3469	0.1439	0.0000	0.1439			0.0000	0.0000	0.0000	0.0000
Off-Road	0.1826	2.0077	1.4160	2.7300e-003		0.0884	0.0884		0.0813	0.0813			239.8177	0.0776	0.0000	241.7567
Total	0.1826	2.0077	1.4160	2.7300e-003	0.3469	0.0884	0.4353	0.1439	0.0813	0.2252			239.8177	0.0776	0.0000	241.7567

Santa Maria Airport Commercial Rezone - Santa Barbara-North of Santa Ynez County, Annual

3.3 Grading - 2021

Unmitigated Construction Off-Site

	ROG	NOx	CO	SO2	Fugitive PM10	Exhaust PM10	PM10 Total	Fugitive PM2.5	Exhaust PM2.5	PM2.5 Total	Bio- CO2	NBio- CO2	Total CO2	CH4	N2O	CO2e
Category	tons/yr										MT/yr					
Hauling	0.0000	0.0000	0.0000	0.0000	0.0000	0.0000	0.0000	0.0000	0.0000	0.0000			0.0000	0.0000	0.0000	0.0000
Vendor	0.0000	0.0000	0.0000	0.0000	0.0000	0.0000	0.0000	0.0000	0.0000	0.0000			0.0000	0.0000	0.0000	0.0000
Worker	2.9800e-003	2.4200e-003	0.0215	5.0000e-005	6.1800e-003	4.0000e-005	6.2200e-003	1.6400e-003	4.0000e-005	1.6800e-003			4.8731	1.5000e-004	0.0000	4.8769
Total	2.9800e-003	2.4200e-003	0.0215	5.0000e-005	6.1800e-003	4.0000e-005	6.2200e-003	1.6400e-003	4.0000e-005	1.6800e-003			4.8731	1.5000e-004	0.0000	4.8769

Mitigated Construction On-Site

	ROG	NOx	CO	SO2	Fugitive PM10	Exhaust PM10	PM10 Total	Fugitive PM2.5	Exhaust PM2.5	PM2.5 Total	Bio- CO2	NBio- CO2	Total CO2	CH4	N2O	CO2e
Category	tons/yr										MT/yr					
Fugitive Dust					0.1353	0.0000	0.1353	0.0561	0.0000	0.0561			0.0000	0.0000	0.0000	0.0000
Off-Road	0.0670	1.3379	1.6563	2.7300e-003		0.0617	0.0617		0.0617	0.0617			239.8174	0.0776	0.0000	241.7564
Total	0.0670	1.3379	1.6563	2.7300e-003	0.1353	0.0617	0.1970	0.0561	0.0617	0.1178			239.8174	0.0776	0.0000	241.7564

Santa Maria Airport Commercial Rezone - Santa Barbara-North of Santa Ynez County, Annual

3.3 Grading - 2021

Mitigated Construction Off-Site

	ROG	NOx	CO	SO2	Fugitive PM10	Exhaust PM10	PM10 Total	Fugitive PM2.5	Exhaust PM2.5	PM2.5 Total	Bio- CO2	NBio- CO2	Total CO2	CH4	N2O	CO2e
Category	tons/yr										MT/yr					
Hauling	0.0000	0.0000	0.0000	0.0000	0.0000	0.0000	0.0000	0.0000	0.0000	0.0000			0.0000	0.0000	0.0000	0.0000
Vendor	0.0000	0.0000	0.0000	0.0000	0.0000	0.0000	0.0000	0.0000	0.0000	0.0000			0.0000	0.0000	0.0000	0.0000
Worker	2.9800e-003	2.4200e-003	0.0215	5.0000e-005	6.1800e-003	4.0000e-005	6.2200e-003	1.6400e-003	4.0000e-005	1.6800e-003			4.8731	1.5000e-004	0.0000	4.8769
Total	2.9800e-003	2.4200e-003	0.0215	5.0000e-005	6.1800e-003	4.0000e-005	6.2200e-003	1.6400e-003	4.0000e-005	1.6800e-003			4.8731	1.5000e-004	0.0000	4.8769

3.4 Building Construction - 2021

Unmitigated Construction On-Site

	ROG	NOx	CO	SO2	Fugitive PM10	Exhaust PM10	PM10 Total	Fugitive PM2.5	Exhaust PM2.5	PM2.5 Total	Bio- CO2	NBio- CO2	Total CO2	CH4	N2O	CO2e
Category	tons/yr										MT/yr					
Off-Road	0.2042	1.8534	1.9178	3.0900e-003		0.1022	0.1022		0.0965	0.0965			267.1417	0.0613	0.0000	268.6732
Total	0.2042	1.8534	1.9178	3.0900e-003		0.1022	0.1022		0.0965	0.0965			267.1417	0.0613	0.0000	268.6732

Santa Maria Airport Commercial Rezone - Santa Barbara-North of Santa Ynez County, Annual

3.4 Building Construction - 2021

Unmitigated Construction Off-Site

	ROG	NOx	CO	SO2	Fugitive PM10	Exhaust PM10	PM10 Total	Fugitive PM2.5	Exhaust PM2.5	PM2.5 Total	Bio- CO2	NBio- CO2	Total CO2	CH4	N2O	CO2e
Category	tons/yr										MT/yr					
Hauling	0.0000	0.0000	0.0000	0.0000	0.0000	0.0000	0.0000	0.0000	0.0000	0.0000			0.0000	0.0000	0.0000	0.0000
Vendor	0.0218	0.6682	0.2269	1.5400e-003	0.0382	1.9800e-003	0.0402	0.0110	1.9000e-003	0.0129			151.9508	0.0116	0.0000	152.2399
Worker	0.0465	0.0378	0.3356	8.4000e-004	0.0965	6.1000e-004	0.0971	0.0257	5.6000e-004	0.0262			76.1589	2.3800e-003	0.0000	76.2184
Total	0.0684	0.7059	0.5625	2.3800e-003	0.1347	2.5900e-003	0.1373	0.0367	2.4600e-003	0.0391			228.1096	0.0139	0.0000	228.4583

Mitigated Construction On-Site

	ROG	NOx	CO	SO2	Fugitive PM10	Exhaust PM10	PM10 Total	Fugitive PM2.5	Exhaust PM2.5	PM2.5 Total	Bio- CO2	NBio- CO2	Total CO2	CH4	N2O	CO2e
Category	tons/yr										MT/yr					
Off-Road	0.0748	1.5862	2.0864	3.0900e-003		0.1001	0.1001		0.1001	0.1001			267.1414	0.0613	0.0000	268.6729
Total	0.0748	1.5862	2.0864	3.0900e-003		0.1001	0.1001		0.1001	0.1001			267.1414	0.0613	0.0000	268.6729

Santa Maria Airport Commercial Rezone - Santa Barbara-North of Santa Ynez County, Annual

3.4 Building Construction - 2021

Mitigated Construction Off-Site

	ROG	NOx	CO	SO2	Fugitive PM10	Exhaust PM10	PM10 Total	Fugitive PM2.5	Exhaust PM2.5	PM2.5 Total	Bio- CO2	NBio- CO2	Total CO2	CH4	N2O	CO2e
Category	tons/yr										MT/yr					
Hauling	0.0000	0.0000	0.0000	0.0000	0.0000	0.0000	0.0000	0.0000	0.0000	0.0000			0.0000	0.0000	0.0000	0.0000
Vendor	0.0218	0.6682	0.2269	1.5400e-003	0.0382	1.9800e-003	0.0402	0.0110	1.9000e-003	0.0129			151.9508	0.0116	0.0000	152.2399
Worker	0.0465	0.0378	0.3356	8.4000e-004	0.0965	6.1000e-004	0.0971	0.0257	5.6000e-004	0.0262			76.1589	2.3800e-003	0.0000	76.2184
Total	0.0684	0.7059	0.5625	2.3800e-003	0.1347	2.5900e-003	0.1373	0.0367	2.4600e-003	0.0391			228.1096	0.0139	0.0000	228.4583

3.4 Building Construction - 2022

Unmitigated Construction On-Site

	ROG	NOx	CO	SO2	Fugitive PM10	Exhaust PM10	PM10 Total	Fugitive PM2.5	Exhaust PM2.5	PM2.5 Total	Bio- CO2	NBio- CO2	Total CO2	CH4	N2O	CO2e
Category	tons/yr										MT/yr					
Off-Road	0.3162	2.8496	3.2687	5.3300e-003		0.1488	0.1488		0.1406	0.1406			460.0744	0.1048	0.0000	462.6931
Total	0.3162	2.8496	3.2687	5.3300e-003		0.1488	0.1488		0.1406	0.1406			460.0744	0.1048	0.0000	462.6931

Santa Maria Airport Commercial Rezone - Santa Barbara-North of Santa Ynez County, Annual

3.4 Building Construction - 2022

Unmitigated Construction Off-Site

	ROG	NOx	CO	SO2	Fugitive PM10	Exhaust PM10	PM10 Total	Fugitive PM2.5	Exhaust PM2.5	PM2.5 Total	Bio- CO2	NBio- CO2	Total CO2	CH4	N2O	CO2e
Category	tons/yr										MT/yr					
Hauling	0.0000	0.0000	0.0000	0.0000	0.0000	0.0000	0.0000	0.0000	0.0000	0.0000			0.0000	0.0000	0.0000	0.0000
Vendor	0.0346	1.0913	0.3599	2.6200e-003	0.0658	3.0000e-003	0.0688	0.0190	2.8700e-003	0.0218			259.4242	0.0202	0.0000	259.9285
Worker	0.0746	0.0581	0.5256	1.4000e-003	0.1662	1.0200e-003	0.1672	0.0442	9.4000e-004	0.0451			126.4576	3.6500e-003	0.0000	126.5488
Total	0.1092	1.1494	0.8854	4.0200e-003	0.2320	4.0200e-003	0.2360	0.0631	3.8100e-003	0.0670			385.8819	0.0238	0.0000	386.4773

Mitigated Construction On-Site

	ROG	NOx	CO	SO2	Fugitive PM10	Exhaust PM10	PM10 Total	Fugitive PM2.5	Exhaust PM2.5	PM2.5 Total	Bio- CO2	NBio- CO2	Total CO2	CH4	N2O	CO2e
Category	tons/yr										MT/yr					
Off-Road	0.1288	2.7312	3.5925	5.3300e-003		0.1723	0.1723		0.1723	0.1723			460.0739	0.1048	0.0000	462.6925
Total	0.1288	2.7312	3.5925	5.3300e-003		0.1723	0.1723		0.1723	0.1723			460.0739	0.1048	0.0000	462.6925

Santa Maria Airport Commercial Rezone - Santa Barbara-North of Santa Ynez County, Annual

3.4 Building Construction - 2022

Mitigated Construction Off-Site

	ROG	NOx	CO	SO2	Fugitive PM10	Exhaust PM10	PM10 Total	Fugitive PM2.5	Exhaust PM2.5	PM2.5 Total	Bio- CO2	NBio- CO2	Total CO2	CH4	N2O	CO2e
Category	tons/yr										MT/yr					
Hauling	0.0000	0.0000	0.0000	0.0000	0.0000	0.0000	0.0000	0.0000	0.0000	0.0000			0.0000	0.0000	0.0000	0.0000
Vendor	0.0346	1.0913	0.3599	2.6200e-003	0.0658	3.0000e-003	0.0688	0.0190	2.8700e-003	0.0218			259.4242	0.0202	0.0000	259.9285
Worker	0.0746	0.0581	0.5256	1.4000e-003	0.1662	1.0200e-003	0.1672	0.0442	9.4000e-004	0.0451			126.4576	3.6500e-003	0.0000	126.5488
Total	0.1092	1.1494	0.8854	4.0200e-003	0.2320	4.0200e-003	0.2360	0.0631	3.8100e-003	0.0670			385.8819	0.0238	0.0000	386.4773

3.4 Building Construction - 2023

Unmitigated Construction On-Site

	ROG	NOx	CO	SO2	Fugitive PM10	Exhaust PM10	PM10 Total	Fugitive PM2.5	Exhaust PM2.5	PM2.5 Total	Bio- CO2	NBio- CO2	Total CO2	CH4	N2O	CO2e
Category	tons/yr										MT/yr					
Off-Road	0.2193	1.9625	2.4386	4.0000e-003		0.0968	0.0968		0.0915	0.0915			345.1418	0.0779	0.0000	347.0898
Total	0.2193	1.9625	2.4386	4.0000e-003		0.0968	0.0968		0.0915	0.0915			345.1418	0.0779	0.0000	347.0898

Santa Maria Airport Commercial Rezone - Santa Barbara-North of Santa Ynez County, Annual

3.4 Building Construction - 2023

Unmitigated Construction Off-Site

	ROG	NOx	CO	SO2	Fugitive PM10	Exhaust PM10	PM10 Total	Fugitive PM2.5	Exhaust PM2.5	PM2.5 Total	Bio- CO2	NBio- CO2	Total CO2	CH4	N2O	CO2e
Category	tons/yr										MT/yr					
Hauling	0.0000	0.0000	0.0000	0.0000	0.0000	0.0000	0.0000	0.0000	0.0000	0.0000			0.0000	0.0000	0.0000	0.0000
Vendor	0.0202	0.6797	0.2431	1.9200e-003	0.0493	1.0800e-003	0.0504	0.0142	1.0300e-003	0.0153			191.0963	0.0145	0.0000	191.4591
Worker	0.0523	0.0390	0.3596	1.0100e-003	0.1247	7.4000e-004	0.1254	0.0331	6.9000e-004	0.0338			91.2991	2.4400e-003	0.0000	91.3600
Total	0.0724	0.7187	0.6027	2.9300e-003	0.1740	1.8200e-003	0.1758	0.0474	1.7200e-003	0.0491			282.3954	0.0170	0.0000	282.8191

Mitigated Construction On-Site

	ROG	NOx	CO	SO2	Fugitive PM10	Exhaust PM10	PM10 Total	Fugitive PM2.5	Exhaust PM2.5	PM2.5 Total	Bio- CO2	NBio- CO2	Total CO2	CH4	N2O	CO2e
Category	tons/yr										MT/yr					
Off-Road	0.0966	2.0484	2.6943	4.0000e-003		0.1292	0.1292		0.1292	0.1292			345.1414	0.0779	0.0000	347.0894
Total	0.0966	2.0484	2.6943	4.0000e-003		0.1292	0.1292		0.1292	0.1292			345.1414	0.0779	0.0000	347.0894

Santa Maria Airport Commercial Rezone - Santa Barbara-North of Santa Ynez County, Annual

3.4 Building Construction - 2023

Mitigated Construction Off-Site

	ROG	NOx	CO	SO2	Fugitive PM10	Exhaust PM10	PM10 Total	Fugitive PM2.5	Exhaust PM2.5	PM2.5 Total	Bio- CO2	NBio- CO2	Total CO2	CH4	N2O	CO2e
Category	tons/yr										MT/yr					
Hauling	0.0000	0.0000	0.0000	0.0000	0.0000	0.0000	0.0000	0.0000	0.0000	0.0000			0.0000	0.0000	0.0000	0.0000
Vendor	0.0202	0.6797	0.2431	1.9200e-003	0.0493	1.0800e-003	0.0504	0.0142	1.0300e-003	0.0153			191.0963	0.0145	0.0000	191.4591
Worker	0.0523	0.0390	0.3596	1.0100e-003	0.1247	7.4000e-004	0.1254	0.0331	6.9000e-004	0.0338			91.2991	2.4400e-003	0.0000	91.3600
Total	0.0724	0.7187	0.6027	2.9300e-003	0.1740	1.8200e-003	0.1758	0.0474	1.7200e-003	0.0491			282.3954	0.0170	0.0000	282.8191

3.5 Architectural Coating - 2021

Unmitigated Construction On-Site

	ROG	NOx	CO	SO2	Fugitive PM10	Exhaust PM10	PM10 Total	Fugitive PM2.5	Exhaust PM2.5	PM2.5 Total	Bio- CO2	NBio- CO2	Total CO2	CH4	N2O	CO2e
Category	tons/yr										MT/yr					
Archit. Coating	0.2841					0.0000	0.0000		0.0000	0.0000			0.0000	0.0000	0.0000	0.0000
Off-Road	4.9300e-003	0.0344	0.0409	7.0000e-005		2.1200e-003	2.1200e-003		2.1200e-003	2.1200e-003			5.7448	3.9000e-004	0.0000	5.7547
Total	0.2891	0.0344	0.0409	7.0000e-005		2.1200e-003	2.1200e-003		2.1200e-003	2.1200e-003			5.7448	3.9000e-004	0.0000	5.7547

Santa Maria Airport Commercial Rezone - Santa Barbara-North of Santa Ynez County, Annual

3.5 Architectural Coating - 2021

Unmitigated Construction Off-Site

	ROG	NOx	CO	SO2	Fugitive PM10	Exhaust PM10	PM10 Total	Fugitive PM2.5	Exhaust PM2.5	PM2.5 Total	Bio- CO2	NBio- CO2	Total CO2	CH4	N2O	CO2e
Category	tons/yr										MT/yr					
Hauling	0.0000	0.0000	0.0000	0.0000	0.0000	0.0000	0.0000	0.0000	0.0000	0.0000			0.0000	0.0000	0.0000	0.0000
Vendor	0.0000	0.0000	0.0000	0.0000	0.0000	0.0000	0.0000	0.0000	0.0000	0.0000			0.0000	0.0000	0.0000	0.0000
Worker	2.7500e-003	2.2300e-003	0.0198	5.0000e-005	5.7000e-003	4.0000e-005	5.7300e-003	1.5100e-003	3.0000e-005	1.5500e-003			4.4954	1.4000e-004	0.0000	4.4989
Total	2.7500e-003	2.2300e-003	0.0198	5.0000e-005	5.7000e-003	4.0000e-005	5.7300e-003	1.5100e-003	3.0000e-005	1.5500e-003			4.4954	1.4000e-004	0.0000	4.4989

Mitigated Construction On-Site

	ROG	NOx	CO	SO2	Fugitive PM10	Exhaust PM10	PM10 Total	Fugitive PM2.5	Exhaust PM2.5	PM2.5 Total	Bio- CO2	NBio- CO2	Total CO2	CH4	N2O	CO2e
Category	tons/yr										MT/yr					
Archit. Coating	0.2841					0.0000	0.0000		0.0000	0.0000			0.0000	0.0000	0.0000	0.0000
Off-Road	1.3400e-003	0.0305	0.0412	7.0000e-005		2.1400e-003	2.1400e-003		2.1400e-003	2.1400e-003			5.7448	3.9000e-004	0.0000	5.7547
Total	0.2855	0.0305	0.0412	7.0000e-005		2.1400e-003	2.1400e-003		2.1400e-003	2.1400e-003			5.7448	3.9000e-004	0.0000	5.7547

Santa Maria Airport Commercial Rezone - Santa Barbara-North of Santa Ynez County, Annual

3.5 Architectural Coating - 2021

Mitigated Construction Off-Site

	ROG	NOx	CO	SO2	Fugitive PM10	Exhaust PM10	PM10 Total	Fugitive PM2.5	Exhaust PM2.5	PM2.5 Total	Bio- CO2	NBio- CO2	Total CO2	CH4	N2O	CO2e
Category	tons/yr										MT/yr					
Hauling	0.0000	0.0000	0.0000	0.0000	0.0000	0.0000	0.0000	0.0000	0.0000	0.0000			0.0000	0.0000	0.0000	0.0000
Vendor	0.0000	0.0000	0.0000	0.0000	0.0000	0.0000	0.0000	0.0000	0.0000	0.0000			0.0000	0.0000	0.0000	0.0000
Worker	2.7500e-003	2.2300e-003	0.0198	5.0000e-005	5.7000e-003	4.0000e-005	5.7300e-003	1.5100e-003	3.0000e-005	1.5500e-003			4.4954	1.4000e-004	0.0000	4.4989
Total	2.7500e-003	2.2300e-003	0.0198	5.0000e-005	5.7000e-003	4.0000e-005	5.7300e-003	1.5100e-003	3.0000e-005	1.5500e-003			4.4954	1.4000e-004	0.0000	4.4989

3.5 Architectural Coating - 2022

Unmitigated Construction On-Site

	ROG	NOx	CO	SO2	Fugitive PM10	Exhaust PM10	PM10 Total	Fugitive PM2.5	Exhaust PM2.5	PM2.5 Total	Bio- CO2	NBio- CO2	Total CO2	CH4	N2O	CO2e
Category	tons/yr										MT/yr					
Archit. Coating	1.6417					0.0000	0.0000		0.0000	0.0000			0.0000	0.0000	0.0000	0.0000
Off-Road	0.0266	0.1831	0.2358	3.9000e-004		0.0106	0.0106		0.0106	0.0106			33.1923	2.1600e-003	0.0000	33.2463
Total	1.6683	0.1831	0.2358	3.9000e-004		0.0106	0.0106		0.0106	0.0106			33.1923	2.1600e-003	0.0000	33.2463

Santa Maria Airport Commercial Rezone - Santa Barbara-North of Santa Ynez County, Annual

3.5 Architectural Coating - 2022

Unmitigated Construction Off-Site

	ROG	NOx	CO	SO2	Fugitive PM10	Exhaust PM10	PM10 Total	Fugitive PM2.5	Exhaust PM2.5	PM2.5 Total	Bio- CO2	NBio- CO2	Total CO2	CH4	N2O	CO2e
Category	tons/yr										MT/yr					
Hauling	0.0000	0.0000	0.0000	0.0000	0.0000	0.0000	0.0000	0.0000	0.0000	0.0000			0.0000	0.0000	0.0000	0.0000
Vendor	0.0000	0.0000	0.0000	0.0000	0.0000	0.0000	0.0000	0.0000	0.0000	0.0000			0.0000	0.0000	0.0000	0.0000
Worker	0.0148	0.0115	0.1041	2.8000e-004	0.0329	2.0000e-004	0.0331	8.7500e-003	1.9000e-004	8.9300e-003			25.0472	7.2000e-004	0.0000	25.0652
Total	0.0148	0.0115	0.1041	2.8000e-004	0.0329	2.0000e-004	0.0331	8.7500e-003	1.9000e-004	8.9300e-003			25.0472	7.2000e-004	0.0000	25.0652

Mitigated Construction On-Site

	ROG	NOx	CO	SO2	Fugitive PM10	Exhaust PM10	PM10 Total	Fugitive PM2.5	Exhaust PM2.5	PM2.5 Total	Bio- CO2	NBio- CO2	Total CO2	CH4	N2O	CO2e
Category	tons/yr										MT/yr					
Archit. Coating	1.6417					0.0000	0.0000		0.0000	0.0000			0.0000	0.0000	0.0000	0.0000
Off-Road	7.7300e-003	0.1764	0.2382	3.9000e-004		0.0124	0.0124		0.0124	0.0124			33.1923	2.1600e-003	0.0000	33.2463
Total	1.6494	0.1764	0.2382	3.9000e-004		0.0124	0.0124		0.0124	0.0124			33.1923	2.1600e-003	0.0000	33.2463

Santa Maria Airport Commercial Rezone - Santa Barbara-North of Santa Ynez County, Annual

3.5 Architectural Coating - 2022

Mitigated Construction Off-Site

	ROG	NOx	CO	SO2	Fugitive PM10	Exhaust PM10	PM10 Total	Fugitive PM2.5	Exhaust PM2.5	PM2.5 Total	Bio- CO2	NBio- CO2	Total CO2	CH4	N2O	CO2e
Category	tons/yr										MT/yr					
Hauling	0.0000	0.0000	0.0000	0.0000	0.0000	0.0000	0.0000	0.0000	0.0000	0.0000			0.0000	0.0000	0.0000	0.0000
Vendor	0.0000	0.0000	0.0000	0.0000	0.0000	0.0000	0.0000	0.0000	0.0000	0.0000			0.0000	0.0000	0.0000	0.0000
Worker	0.0148	0.0115	0.1041	2.8000e-004	0.0329	2.0000e-004	0.0331	8.7500e-003	1.9000e-004	8.9300e-003			25.0472	7.2000e-004	0.0000	25.0652
Total	0.0148	0.0115	0.1041	2.8000e-004	0.0329	2.0000e-004	0.0331	8.7500e-003	1.9000e-004	8.9300e-003			25.0472	7.2000e-004	0.0000	25.0652

3.5 Architectural Coating - 2023

Unmitigated Construction On-Site

	ROG	NOx	CO	SO2	Fugitive PM10	Exhaust PM10	PM10 Total	Fugitive PM2.5	Exhaust PM2.5	PM2.5 Total	Bio- CO2	NBio- CO2	Total CO2	CH4	N2O	CO2e
Category	tons/yr										MT/yr					
Archit. Coating	1.2313					0.0000	0.0000		0.0000	0.0000			0.0000	0.0000	0.0000	0.0000
Off-Road	0.0187	0.1270	0.1766	2.9000e-004		6.9000e-003	6.9000e-003		6.9000e-003	6.9000e-003			24.8942	1.4900e-003	0.0000	24.9315
Total	1.2500	0.1270	0.1766	2.9000e-004		6.9000e-003	6.9000e-003		6.9000e-003	6.9000e-003			24.8942	1.4900e-003	0.0000	24.9315

Santa Maria Airport Commercial Rezone - Santa Barbara-North of Santa Ynez County, Annual

3.5 Architectural Coating - 2023

Unmitigated Construction Off-Site

	ROG	NOx	CO	SO2	Fugitive PM10	Exhaust PM10	PM10 Total	Fugitive PM2.5	Exhaust PM2.5	PM2.5 Total	Bio- CO2	NBio- CO2	Total CO2	CH4	N2O	CO2e
Category	tons/yr										MT/yr					
Hauling	0.0000	0.0000	0.0000	0.0000	0.0000	0.0000	0.0000	0.0000	0.0000	0.0000			0.0000	0.0000	0.0000	0.0000
Vendor	0.0000	0.0000	0.0000	0.0000	0.0000	0.0000	0.0000	0.0000	0.0000	0.0000			0.0000	0.0000	0.0000	0.0000
Worker	0.0104	7.7300e-003	0.0712	2.0000e-004	0.0247	1.5000e-004	0.0248	6.5600e-003	1.4000e-004	6.7000e-003			18.0834	4.8000e-004	0.0000	18.0955
Total	0.0104	7.7300e-003	0.0712	2.0000e-004	0.0247	1.5000e-004	0.0248	6.5600e-003	1.4000e-004	6.7000e-003			18.0834	4.8000e-004	0.0000	18.0955

Mitigated Construction On-Site

	ROG	NOx	CO	SO2	Fugitive PM10	Exhaust PM10	PM10 Total	Fugitive PM2.5	Exhaust PM2.5	PM2.5 Total	Bio- CO2	NBio- CO2	Total CO2	CH4	N2O	CO2e
Category	tons/yr										MT/yr					
Archit. Coating	1.2313					0.0000	0.0000		0.0000	0.0000			0.0000	0.0000	0.0000	0.0000
Off-Road	5.7900e-003	0.1323	0.1787	2.9000e-004		9.2700e-003	9.2700e-003		9.2700e-003	9.2700e-003			24.8942	1.4900e-003	0.0000	24.9314
Total	1.2371	0.1323	0.1787	2.9000e-004		9.2700e-003	9.2700e-003		9.2700e-003	9.2700e-003			24.8942	1.4900e-003	0.0000	24.9314

Santa Maria Airport Commercial Rezone - Santa Barbara-North of Santa Ynez County, Annual

3.5 Architectural Coating - 2023

Mitigated Construction Off-Site

	ROG	NOx	CO	SO2	Fugitive PM10	Exhaust PM10	PM10 Total	Fugitive PM2.5	Exhaust PM2.5	PM2.5 Total	Bio- CO2	NBio- CO2	Total CO2	CH4	N2O	CO2e
Category	tons/yr										MT/yr					
Hauling	0.0000	0.0000	0.0000	0.0000	0.0000	0.0000	0.0000	0.0000	0.0000	0.0000			0.0000	0.0000	0.0000	0.0000
Vendor	0.0000	0.0000	0.0000	0.0000	0.0000	0.0000	0.0000	0.0000	0.0000	0.0000			0.0000	0.0000	0.0000	0.0000
Worker	0.0104	7.7300e-003	0.0712	2.0000e-004	0.0247	1.5000e-004	0.0248	6.5600e-003	1.4000e-004	6.7000e-003			18.0834	4.8000e-004	0.0000	18.0955
Total	0.0104	7.7300e-003	0.0712	2.0000e-004	0.0247	1.5000e-004	0.0248	6.5600e-003	1.4000e-004	6.7000e-003			18.0834	4.8000e-004	0.0000	18.0955

3.6 Paving - 2023

Unmitigated Construction On-Site

	ROG	NOx	CO	SO2	Fugitive PM10	Exhaust PM10	PM10 Total	Fugitive PM2.5	Exhaust PM2.5	PM2.5 Total	Bio- CO2	NBio- CO2	Total CO2	CH4	N2O	CO2e
Category	tons/yr										MT/yr					
Off-Road	0.0142	0.1486	0.1522	2.7000e-004		6.7300e-003	6.7300e-003		6.2000e-003	6.2000e-003			23.6209	7.5400e-003	0.0000	23.8094
Paving	0.0131					0.0000	0.0000		0.0000	0.0000			0.0000	0.0000	0.0000	0.0000
Total	0.0273	0.1486	0.1522	2.7000e-004		6.7300e-003	6.7300e-003		6.2000e-003	6.2000e-003			23.6209	7.5400e-003	0.0000	23.8094

Santa Maria Airport Commercial Rezone - Santa Barbara-North of Santa Ynez County, Annual

3.6 Paving - 2023

Unmitigated Construction Off-Site

	ROG	NOx	CO	SO2	Fugitive PM10	Exhaust PM10	PM10 Total	Fugitive PM2.5	Exhaust PM2.5	PM2.5 Total	Bio- CO2	NBio- CO2	Total CO2	CH4	N2O	CO2e
Category	tons/yr										MT/yr					
Hauling	0.0000	0.0000	0.0000	0.0000	0.0000	0.0000	0.0000	0.0000	0.0000	0.0000			0.0000	0.0000	0.0000	0.0000
Vendor	0.0000	0.0000	0.0000	0.0000	0.0000	0.0000	0.0000	0.0000	0.0000	0.0000			0.0000	0.0000	0.0000	0.0000
Worker	6.5000e-004	4.8000e-004	4.4500e-003	1.0000e-005	1.5400e-003	1.0000e-005	1.5500e-003	4.1000e-004	1.0000e-005	4.2000e-004			1.1309	3.0000e-005	0.0000	1.1317
Total	6.5000e-004	4.8000e-004	4.4500e-003	1.0000e-005	1.5400e-003	1.0000e-005	1.5500e-003	4.1000e-004	1.0000e-005	4.2000e-004			1.1309	3.0000e-005	0.0000	1.1317

Mitigated Construction On-Site

	ROG	NOx	CO	SO2	Fugitive PM10	Exhaust PM10	PM10 Total	Fugitive PM2.5	Exhaust PM2.5	PM2.5 Total	Bio- CO2	NBio- CO2	Total CO2	CH4	N2O	CO2e
Category	tons/yr										MT/yr					
Off-Road	6.4700e-003	0.1346	0.1847	2.7000e-004		7.5100e-003	7.5100e-003		7.5100e-003	7.5100e-003			23.6208	7.5400e-003	0.0000	23.8094
Paving	0.0131					0.0000	0.0000		0.0000	0.0000			0.0000	0.0000	0.0000	0.0000
Total	0.0196	0.1346	0.1847	2.7000e-004		7.5100e-003	7.5100e-003		7.5100e-003	7.5100e-003			23.6208	7.5400e-003	0.0000	23.8094

Santa Maria Airport Commercial Rezone - Santa Barbara-North of Santa Ynez County, Annual

3.6 Paving - 2023

Mitigated Construction Off-Site

	ROG	NOx	CO	SO2	Fugitive PM10	Exhaust PM10	PM10 Total	Fugitive PM2.5	Exhaust PM2.5	PM2.5 Total	Bio- CO2	NBio- CO2	Total CO2	CH4	N2O	CO2e
Category	tons/yr										MT/yr					
Hauling	0.0000	0.0000	0.0000	0.0000	0.0000	0.0000	0.0000	0.0000	0.0000	0.0000			0.0000	0.0000	0.0000	0.0000
Vendor	0.0000	0.0000	0.0000	0.0000	0.0000	0.0000	0.0000	0.0000	0.0000	0.0000			0.0000	0.0000	0.0000	0.0000
Worker	6.5000e-004	4.8000e-004	4.4500e-003	1.0000e-005	1.5400e-003	1.0000e-005	1.5500e-003	4.1000e-004	1.0000e-005	4.2000e-004			1.1309	3.0000e-005	0.0000	1.1317
Total	6.5000e-004	4.8000e-004	4.4500e-003	1.0000e-005	1.5400e-003	1.0000e-005	1.5500e-003	4.1000e-004	1.0000e-005	4.2000e-004			1.1309	3.0000e-005	0.0000	1.1317

4.0 Operational Detail - Mobile

4.1 Mitigation Measures Mobile

Increase Transit Accessibility

Improve Pedestrian Network

Santa Maria Airport Commercial Rezone - Santa Barbara-North of Santa Ynez County, Annual

	ROG	NOx	CO	SO2	Fugitive PM10	Exhaust PM10	PM10 Total	Fugitive PM2.5	Exhaust PM2.5	PM2.5 Total	Bio- CO2	NBio- CO2	Total CO2	CH4	N2O	CO2e
Category	tons/yr										MT/yr					
Mitigated	2.8108	8.4047	21.4091	0.0445	3.8630	0.0429	3.9058	1.0373	0.0400	1.0773			4,110.2794	0.2447	0.0000	4,116.3965
Unmitigated	2.8191	8.4595	21.6103	0.0453	3.9418	0.0435	3.9853	1.0585	0.0406	1.0990			4,180.7839	0.2474	0.0000	4,186.9677

4.2 Trip Summary Information

Land Use	Average Daily Trip Rate			Unmitigated	Mitigated
	Weekday	Saturday	Sunday	Annual VMT	Annual VMT
Convenience Market With Gas Pumps	3,838.77	6,574.98	5366.29	1,875,418	1,837,909
Free-Standing Discount Store	160.03	198.69	157.57	197,820	193,864
General Office Building	394.20	87.92	37.52	538,184	527,420
Government Office Building	451.15	0.00	0.00	407,283	399,137
High Turnover (Sit Down Restaurant)	4,059.37	5,056.10	4209.11	3,787,867	3,712,110
Medical Office Building	615.68	152.68	26.42	687,335	673,588
Parking Lot	0.00	0.00	0.00		
Strip Mall	2,410.31	2,286.32	1111.07	2,598,402	2,546,434
Unrefrigerated Warehouse-No Rail	136.50	136.50	136.50	302,142	296,099
Other Asphalt Surfaces	0.00	0.00	0.00		
Other Non-Asphalt Surfaces	0.00	0.00	0.00		
Total	12,066.01	14,493.19	11,044.47	10,394,451	10,186,562

4.3 Trip Type Information

Santa Maria Airport Commercial Rezone - Santa Barbara-North of Santa Ynez County, Annual

Land Use	Miles			Trip %			Trip Purpose %		
	H-W or C-W	H-S or C-C	H-O or C-NW	H-W or C-W	H-S or C-C	H-O or C-NW	Primary	Diverted	Pass-by
Convenience Market With Gas	6.60	5.50	6.40	0.80	80.20	19.00	14	21	65
Free-Standing Discount Store	6.60	5.50	6.40	12.20	68.80	19.00	47.5	35.5	17
General Office Building	6.60	5.50	6.40	33.00	48.00	19.00	77	19	4
Government Office Building	6.60	5.50	6.40	33.00	62.00	5.00	50	34	16
High Turnover (Sit Down	6.60	5.50	6.40	8.50	72.50	19.00	37	20	43
Medical Office Building	6.60	5.50	6.40	29.60	51.40	19.00	60	30	10
Parking Lot	6.60	5.50	6.40	0.00	0.00	0.00	0	0	0
Strip Mall	6.60	5.50	6.40	16.60	64.40	19.00	45	40	15
Unrefrigerated Warehouse-No	6.60	5.50	6.40	59.00	0.00	41.00	92	5	3
Other Asphalt Surfaces	6.60	5.50	6.40	0.00	0.00	0.00	0	0	0
Other Non-Asphalt Surfaces	6.60	5.50	6.40	0.00	0.00	0.00	0	0	0

4.4 Fleet Mix

Land Use	LDA	LDT1	LDT2	MDV	LHD1	LHD2	MHD	HHD	OBUS	UBUS	MCY	SBUS	MH
Convenience Market With Gas Pumps	0.567965	0.027871	0.206163	0.120389	0.019588	0.005343	0.017610	0.019838	0.002797	0.002169	0.006725	0.002609	0.000932
Free-Standing Discount Store	0.567965	0.027871	0.206163	0.120389	0.019588	0.005343	0.017610	0.019838	0.002797	0.002169	0.006725	0.002609	0.000932
General Office Building	0.567965	0.027871	0.206163	0.120389	0.019588	0.005343	0.017610	0.019838	0.002797	0.002169	0.006725	0.002609	0.000932
Government Office Building	0.567965	0.027871	0.206163	0.120389	0.019588	0.005343	0.017610	0.019838	0.002797	0.002169	0.006725	0.002609	0.000932
High Turnover (Sit Down Restaurant)	0.567965	0.027871	0.206163	0.120389	0.019588	0.005343	0.017610	0.019838	0.002797	0.002169	0.006725	0.002609	0.000932
Medical Office Building	0.567965	0.027871	0.206163	0.120389	0.019588	0.005343	0.017610	0.019838	0.002797	0.002169	0.006725	0.002609	0.000932
Parking Lot	0.567965	0.027871	0.206163	0.120389	0.019588	0.005343	0.017610	0.019838	0.002797	0.002169	0.006725	0.002609	0.000932
Strip Mall	0.567965	0.027871	0.206163	0.120389	0.019588	0.005343	0.017610	0.019838	0.002797	0.002169	0.006725	0.002609	0.000932
Unrefrigerated Warehouse-No Rail	0.567965	0.027871	0.206163	0.120389	0.019588	0.005343	0.017610	0.019838	0.002797	0.002169	0.006725	0.002609	0.000932
Other Asphalt Surfaces	0.567965	0.027871	0.206163	0.120389	0.019588	0.005343	0.017610	0.019838	0.002797	0.002169	0.006725	0.002609	0.000932
Other Non-Asphalt Surfaces	0.567965	0.027871	0.206163	0.120389	0.019588	0.005343	0.017610	0.019838	0.002797	0.002169	0.006725	0.002609	0.000932

5.0 Energy Detail

Santa Maria Airport Commercial Rezone - Santa Barbara-North of Santa Ynez County, Annual

Historical Energy Use: N

5.1 Mitigation Measures Energy

	ROG	NOx	CO	SO2	Fugitive PM10	Exhaust PM10	PM10 Total	Fugitive PM2.5	Exhaust PM2.5	PM2.5 Total	Bio- CO2	NBio- CO2	Total CO2	CH4	N2O	CO2e
Category	tons/yr										MT/yr					
Electricity Mitigated						0.0000	0.0000		0.0000	0.0000			602.7254	0.0275	5.5000e-003	605.0531
Electricity Unmitigated						0.0000	0.0000		0.0000	0.0000			602.7254	0.0275	5.5000e-003	605.0531
NaturalGas Mitigated	0.0224	0.2033	0.1708	1.2200e-003		0.0155	0.0155		0.0155	0.0155			221.2930	4.2400e-003	4.0600e-003	222.6081
NaturalGas Unmitigated	0.0224	0.2033	0.1708	1.2200e-003		0.0155	0.0155		0.0155	0.0155			221.2930	4.2400e-003	4.0600e-003	222.6081

Santa Maria Airport Commercial Rezone - Santa Barbara-North of Santa Ynez County, Annual

5.2 Energy by Land Use - NaturalGas

Unmitigated

	NaturalGas Use	ROG	NOx	CO	SO2	Fugitive PM10	Exhaust PM10	PM10 Total	Fugitive PM2.5	Exhaust PM2.5	PM2.5 Total	Bio- CO2	NBio- CO2	Total CO2	CH4	N2O	CO2e
Land Use	kBTU/yr	tons/yr										MT/yr					
Convenience Market With Gas Pumps	8058	4.0000e-005	3.9000e-004	3.3000e-004	0.0000		3.0000e-005	3.0000e-005		3.0000e-005	3.0000e-005			0.4300	1.0000e-005	1.0000e-005	0.4326
Free-Standing Discount Store	75840	4.1000e-004	3.7200e-003	3.1200e-003	2.0000e-005		2.8000e-004	2.8000e-004		2.8000e-004	2.8000e-004			4.0471	8.0000e-005	7.0000e-005	4.0712
General Office Building	654800	3.5300e-003	0.0321	0.0270	1.9000e-004		2.4400e-003	2.4400e-003		2.4400e-003	2.4400e-003			34.9426	6.7000e-004	6.4000e-004	35.1503
Government Office Building	361777	1.9500e-003	0.0177	0.0149	1.1000e-004		1.3500e-003	1.3500e-003		1.3500e-003	1.3500e-003			19.3058	3.7000e-004	3.5000e-004	19.4205
High Turnover (Sit Down Restaurant)	2.28668e+006	0.0123	0.1121	0.0942	6.7000e-004		8.5200e-003	8.5200e-003		8.5200e-003	8.5200e-003			122.0260	2.3400e-003	2.2400e-003	122.7511
Medical Office Building	327400	1.7700e-003	0.0161	0.0135	1.0000e-004		1.2200e-003	1.2200e-003		1.2200e-003	1.2200e-003			17.4713	3.3000e-004	3.2000e-004	17.5751
Other Asphalt Surfaces	0	0.0000	0.0000	0.0000	0.0000		0.0000	0.0000		0.0000	0.0000			0.0000	0.0000	0.0000	0.0000
Other Non-Asphalt Surfaces	0	0.0000	0.0000	0.0000	0.0000		0.0000	0.0000		0.0000	0.0000			0.0000	0.0000	0.0000	0.0000
Parking Lot	0	0.0000	0.0000	0.0000	0.0000		0.0000	0.0000		0.0000	0.0000			0.0000	0.0000	0.0000	0.0000
Strip Mall	85320	4.6000e-004	4.1800e-003	3.5100e-003	3.0000e-005		3.2000e-004	3.2000e-004		3.2000e-004	3.2000e-004			4.5530	9.0000e-005	8.0000e-005	4.5801
Unrefrigerated Warehouse-No Rail	347000	1.8700e-003	0.0170	0.0143	1.0000e-004		1.2900e-003	1.2900e-003		1.2900e-003	1.2900e-003			18.5172	3.5000e-004	3.4000e-004	18.6273
Total		0.0224	0.2033	0.1708	1.2200e-003		0.0155	0.0155		0.0155	0.0155			221.2930	4.2400e-003	4.0500e-003	222.6081

Santa Maria Airport Commercial Rezone - Santa Barbara-North of Santa Ynez County, Annual

5.2 Energy by Land Use - NaturalGas

Mitigated

	NaturalGas Use	ROG	NOx	CO	SO2	Fugitive PM10	Exhaust PM10	PM10 Total	Fugitive PM2.5	Exhaust PM2.5	PM2.5 Total	Bio- CO2	NBio- CO2	Total CO2	CH4	N2O	CO2e
Land Use	kBTU/yr	tons/yr										MT/yr					
Convenience Market With Gas Pumps	8058	4.0000e-005	3.9000e-004	3.3000e-004	0.0000		3.0000e-005	3.0000e-005		3.0000e-005	3.0000e-005			0.4300	1.0000e-005	1.0000e-005	0.4326
Free-Standing Discount Store	75840	4.1000e-004	3.7200e-003	3.1200e-003	2.0000e-005		2.8000e-004	2.8000e-004		2.8000e-004	2.8000e-004			4.0471	8.0000e-005	7.0000e-005	4.0712
General Office Building	654800	3.5300e-003	0.0321	0.0270	1.9000e-004		2.4400e-003	2.4400e-003		2.4400e-003	2.4400e-003			34.9426	6.7000e-004	6.4000e-004	35.1503
Government Office Building	361777	1.9500e-003	0.0177	0.0149	1.1000e-004		1.3500e-003	1.3500e-003		1.3500e-003	1.3500e-003			19.3058	3.7000e-004	3.5000e-004	19.4205
High Turnover (Sit Down Restaurant)	2.28668e+006	0.0123	0.1121	0.0942	6.7000e-004		8.5200e-003	8.5200e-003		8.5200e-003	8.5200e-003			122.0260	2.3400e-003	2.2400e-003	122.7511
Medical Office Building	327400	1.7700e-003	0.0161	0.0135	1.0000e-004		1.2200e-003	1.2200e-003		1.2200e-003	1.2200e-003			17.4713	3.3000e-004	3.2000e-004	17.5751
Other Asphalt Surfaces	0	0.0000	0.0000	0.0000	0.0000		0.0000	0.0000		0.0000	0.0000			0.0000	0.0000	0.0000	0.0000
Other Non-Asphalt Surfaces	0	0.0000	0.0000	0.0000	0.0000		0.0000	0.0000		0.0000	0.0000			0.0000	0.0000	0.0000	0.0000
Parking Lot	0	0.0000	0.0000	0.0000	0.0000		0.0000	0.0000		0.0000	0.0000			0.0000	0.0000	0.0000	0.0000
Strip Mall	85320	4.6000e-004	4.1800e-003	3.5100e-003	3.0000e-005		3.2000e-004	3.2000e-004		3.2000e-004	3.2000e-004			4.5530	9.0000e-005	8.0000e-005	4.5801
Unrefrigerated Warehouse-No Rail	347000	1.8700e-003	0.0170	0.0143	1.0000e-004		1.2900e-003	1.2900e-003		1.2900e-003	1.2900e-003			18.5172	3.5000e-004	3.4000e-004	18.6273
Total		0.0224	0.2033	0.1708	1.2200e-003		0.0155	0.0155		0.0155	0.0155			221.2930	4.2400e-003	4.0500e-003	222.6081

Santa Maria Airport Commercial Rezone - Santa Barbara-North of Santa Ynez County, Annual

5.3 Energy by Land Use - Electricity

Unmitigated

	Electricity Use	Total CO2	CH4	N2O	CO2e
Land Use	kWh/yr	MT/yr			
Convenience Market With Gas Pumps	36346	7.2231	3.3000e-004	7.0000e-005	7.2510
Free-Standing Discount Store	342080	67.9824	3.1000e-003	6.2000e-004	68.2449
General Office Building	713200	141.7360	6.4700e-003	1.2900e-003	142.2833
Government Office Building	394043	78.3091	3.5700e-003	7.1000e-004	78.6115
High Turnover (Sit Down Restaurant)	359920	71.5278	3.2700e-003	6.5000e-004	71.8040
Medical Office Building	356600	70.8680	3.2400e-003	6.5000e-004	71.1417
Other Asphalt Surfaces	0	0.0000	0.0000	0.0000	0.0000
Other Non-Asphalt Surfaces	0	0.0000	0.0000	0.0000	0.0000
Parking Lot	92820	18.4463	8.4000e-004	1.7000e-004	18.5176
Strip Mall	384840	76.4802	3.4900e-003	7.0000e-004	76.7755
Unrefrigerated Warehouse-No Rail	353000	70.1526	3.2000e-003	6.4000e-004	70.4235
Total		602.7254	0.0275	5.5000e-003	605.0531

Santa Maria Airport Commercial Rezone - Santa Barbara-North of Santa Ynez County, Annual

5.3 Energy by Land Use - Electricity

Mitigated

Land Use	Electricity Use kWh/yr	Total CO2 MT/yr	CH4 MT/yr	N2O MT/yr	CO2e MT/yr
Convenience Market With Gas Pumps	36346	7.2231	3.3000e-004	7.0000e-005	7.2510
Free-Standing Discount Store	342080	67.9824	3.1000e-003	6.2000e-004	68.2449
General Office Building	713200	141.7360	6.4700e-003	1.2900e-003	142.2833
Government Office Building	394043	78.3091	3.5700e-003	7.1000e-004	78.6115
High Turnover (Sit Down Restaurant)	359920	71.5278	3.2700e-003	6.5000e-004	71.8040
Medical Office Building	356600	70.8680	3.2400e-003	6.5000e-004	71.1417
Other Asphalt Surfaces	0	0.0000	0.0000	0.0000	0.0000
Other Non-Asphalt Surfaces	0	0.0000	0.0000	0.0000	0.0000
Parking Lot	92820	18.4463	8.4000e-004	1.7000e-004	18.5176
Strip Mall	384840	76.4802	3.4900e-003	7.0000e-004	76.7755
Unrefrigerated Warehouse-No Rail	353000	70.1526	3.2000e-003	6.4000e-004	70.4235
Total		602.7254	0.0275	5.5000e-003	605.0531

6.0 Area Detail

6.1 Mitigation Measures Area

Santa Maria Airport Commercial Rezone - Santa Barbara-North of Santa Ynez County, Annual

	ROG	NOx	CO	SO2	Fugitive PM10	Exhaust PM10	PM10 Total	Fugitive PM2.5	Exhaust PM2.5	PM2.5 Total	Bio- CO2	NBio- CO2	Total CO2	CH4	N2O	CO2e
Category	tons/yr										MT/yr					
Mitigated	1.3775	8.0000e-005	8.5400e-003	0.0000		3.0000e-005	3.0000e-005		3.0000e-005	3.0000e-005			0.0166	4.0000e-005	0.0000	0.0177
Unmitigated	1.3775	8.0000e-005	8.5400e-003	0.0000		3.0000e-005	3.0000e-005		3.0000e-005	3.0000e-005			0.0166	4.0000e-005	0.0000	0.0177

6.2 Area by SubCategory

Unmitigated

	ROG	NOx	CO	SO2	Fugitive PM10	Exhaust PM10	PM10 Total	Fugitive PM2.5	Exhaust PM2.5	PM2.5 Total	Bio- CO2	NBio- CO2	Total CO2	CH4	N2O	CO2e
SubCategory	tons/yr										MT/yr					
Architectural Coating	0.3195					0.0000	0.0000		0.0000	0.0000			0.0000	0.0000	0.0000	0.0000
Consumer Products	1.0572					0.0000	0.0000		0.0000	0.0000			0.0000	0.0000	0.0000	0.0000
Landscaping	7.9000e-004	8.0000e-005	8.5400e-003	0.0000		3.0000e-005	3.0000e-005		3.0000e-005	3.0000e-005			0.0166	4.0000e-005	0.0000	0.0177
Total	1.3775	8.0000e-005	8.5400e-003	0.0000		3.0000e-005	3.0000e-005		3.0000e-005	3.0000e-005			0.0166	4.0000e-005	0.0000	0.0177

Santa Maria Airport Commercial Rezone - Santa Barbara-North of Santa Ynez County, Annual

6.2 Area by SubCategory

Mitigated

	ROG	NOx	CO	SO2	Fugitive PM10	Exhaust PM10	PM10 Total	Fugitive PM2.5	Exhaust PM2.5	PM2.5 Total	Bio- CO2	NBio- CO2	Total CO2	CH4	N2O	CO2e
SubCategory	tons/yr										MT/yr					
Architectural Coating	0.3195					0.0000	0.0000		0.0000	0.0000			0.0000	0.0000	0.0000	0.0000
Consumer Products	1.0572					0.0000	0.0000		0.0000	0.0000			0.0000	0.0000	0.0000	0.0000
Landscaping	7.9000e-004	8.0000e-005	8.5400e-003	0.0000		3.0000e-005	3.0000e-005		3.0000e-005	3.0000e-005			0.0166	4.0000e-005	0.0000	0.0177
Total	1.3775	8.0000e-005	8.5400e-003	0.0000		3.0000e-005	3.0000e-005		3.0000e-005	3.0000e-005			0.0166	4.0000e-005	0.0000	0.0177

7.0 Water Detail

7.1 Mitigation Measures Water

Install Low Flow Bathroom Faucet

Install Low Flow Kitchen Faucet

Install Low Flow Toilet

Install Low Flow Shower

Use Water Efficient Irrigation System

Santa Maria Airport Commercial Rezone - Santa Barbara-North of Santa Ynez County, Annual

	Total CO2	CH4	N2O	CO2e
Category	MT/yr			
Mitigated	59.4923	0.0467	0.0286	69.1805
Unmitigated	73.0383	0.0583	0.0357	85.1434

Santa Maria Airport Commercial Rezone - Santa Barbara-North of Santa Ynez County, Annual

7.2 Water by Land Use

Unmitigated

	Indoor/Outdoor Use	Total CO2	CH4	N2O	CO2e
Land Use	Mgal	MT/yr			
Convenience Market With Gas Pumps	0.251847 / 0.154358	0.4673	3.2000e-004	2.0000e-004	0.5342
Free-Standing Discount Store	2.37032 / 1.45278	4.3980	3.0500e-003	1.8600e-003	5.0274
General Office Building	7.10935 / 4.35734	13.1911	9.1400e-003	5.5700e-003	15.0788
Government Office Building	4.39038 / 2.69088	8.1462	5.6500e-003	3.4400e-003	9.3119
High Turnover (Sit Down Restaurant)	3.33887 / 0.213119	4.9200	4.2400e-003	2.6000e-003	5.8016
Medical Office Building	2.50961 / 0.478021	3.9191	3.1900e-003	1.9600e-003	4.5826
Other Asphalt Surfaces	0 / 0	0.0000	0.0000	0.0000	0.0000
Other Non-Asphalt Surfaces	0 / 0	0.0000	0.0000	0.0000	0.0000
Parking Lot	0 / 0	0.0000	0.0000	0.0000	0.0000
Strip Mall	2.66661 / 1.63437	4.9478	3.4300e-003	2.0900e-003	5.6558
Unrefrigerated Warehouse-No Rail	23.125 / 0	33.0489	0.0293	0.0180	39.1511
Total		73.0383	0.0583	0.0357	85.1434

Santa Maria Airport Commercial Rezone - Santa Barbara-North of Santa Ynez County, Annual

7.2 Water by Land Use

Mitigated

	Indoor/Outdoor Use	Total CO2	CH4	N2O	CO2e
Land Use	Mgal	MT/yr			
Convenience Market With Gas Pumps	0.201477 / 0.144942	0.3888	2.6000e-004	1.6000e-004	0.4423
Free-Standing Discount Store	1.89626 / 1.36416	3.6589	2.4500e-003	1.4900e-003	4.1629
General Office Building	5.68748 / 4.09155	10.9742	7.3400e-003	4.4600e-003	12.4859
Government Office Building	3.5123 / 2.52673	6.7771	4.5300e-003	2.7500e-003	7.7107
High Turnover (Sit Down Restaurant)	2.6711 / 0.200119	3.9566	3.3900e-003	2.0800e-003	4.6620
Medical Office Building	2.00769 / 0.448862	3.1815	2.5600e-003	1.5700e-003	3.7125
Other Asphalt Surfaces	0 / 0	0.0000	0.0000	0.0000	0.0000
Other Non-Asphalt Surfaces	0 / 0	0.0000	0.0000	0.0000	0.0000
Parking Lot	0 / 0	0.0000	0.0000	0.0000	0.0000
Strip Mall	2.13329 / 1.53468	4.1162	2.7500e-003	1.6700e-003	4.6833
Unrefrigerated Warehouse-No Rail	18.5 / 0	26.4391	0.0234	0.0144	31.3209
Total		59.4923	0.0467	0.0286	69.1805

8.0 Waste Detail

8.1 Mitigation Measures Waste

Santa Maria Airport Commercial Rezone - Santa Barbara-North of Santa Ynez County, Annual

Institute Recycling and Composting Services

Category/Year

	Total CO2	CH4	N2O	CO2e
	MT/yr			
Mitigated	35.5255	1.7616	0.0000	79.5654
Unmitigated	142.1020	7.0464	0.0000	318.2615

Santa Maria Airport Commercial Rezone - Santa Barbara-North of Santa Ynez County, Annual

8.2 Waste by Land Use

Unmitigated

	Waste Disposed	Total CO2	CH4	N2O	CO2e
Land Use	tons	MT/yr			
Convenience Market With Gas Pumps	10.22	2.1223	0.1052	0.0000	4.7533
Free-Standing Discount Store	137.62	28.5786	1.4171	0.0000	64.0067
General Office Building	37.2	7.7251	0.3831	0.0000	17.3016
Government Office Building	20.55	4.2675	0.2116	0.0000	9.5578
High Turnover (Sit Down Restaurant)	130.9	27.1831	1.3479	0.0000	60.8812
Medical Office Building	216	44.8553	2.2242	0.0000	100.4610
Other Asphalt Surfaces	0	0.0000	0.0000	0.0000	0.0000
Other Non-Asphalt Surfaces	0	0.0000	0.0000	0.0000	0.0000
Parking Lot	0	0.0000	0.0000	0.0000	0.0000
Strip Mall	37.8	7.8497	0.3892	0.0000	17.5807
Unrefrigerated Warehouse-No Rail	94	19.5204	0.9680	0.0000	43.7192
Total		142.1020	7.0464	0.0000	318.2615

Santa Maria Airport Commercial Rezone - Santa Barbara-North of Santa Ynez County, Annual

8.2 Waste by Land Use

Mitigated

	Waste Disposed	Total CO2	CH4	N2O	CO2e
Land Use	tons	MT/yr			
Convenience Market With Gas Pumps	2.555	0.5306	0.0263	0.0000	1.1883
Free-Standing Discount Store	34.405	7.1447	0.3543	0.0000	16.0017
General Office Building	9.3	1.9313	0.0958	0.0000	4.3254
Government Office Building	5.1375	1.0669	0.0529	0.0000	2.3894
High Turnover (Sit Down Restaurant)	32.725	6.7958	0.3370	0.0000	15.2203
Medical Office Building	54	11.2138	0.5561	0.0000	25.1153
Other Asphalt Surfaces	0	0.0000	0.0000	0.0000	0.0000
Other Non-Asphalt Surfaces	0	0.0000	0.0000	0.0000	0.0000
Parking Lot	0	0.0000	0.0000	0.0000	0.0000
Strip Mall	9.45	1.9624	0.0973	0.0000	4.3952
Unrefrigerated Warehouse-No Rail	23.5	4.8801	0.2420	0.0000	10.9298
Total		35.5255	1.7616	0.0000	79.5654

9.0 Operational Offroad

Santa Maria Airport Commercial Rezone - Santa Barbara-North of Santa Ynez County, Annual

Equipment Type	Number	Hours/Day	Days/Year	Horse Power	Load Factor	Fuel Type
----------------	--------	-----------	-----------	-------------	-------------	-----------

10.0 Stationary Equipment

Fire Pumps and Emergency Generators

Equipment Type	Number	Hours/Day	Hours/Year	Horse Power	Load Factor	Fuel Type
----------------	--------	-----------	------------	-------------	-------------	-----------

Boilers

Equipment Type	Number	Heat Input/Day	Heat Input/Year	Boiler Rating	Fuel Type
----------------	--------	----------------	-----------------	---------------	-----------

User Defined Equipment

Equipment Type	Number
----------------	--------

11.0 Vegetation

Santa Maria Airport Commercial Rezone - Santa Barbara-North of Santa Ynez County, Annual

	Total CO2	CH4	N2O	CO2e
Category	MT			
Unmitigated	240.7200	0.0000	0.0000	240.7200

11.2 Net New Trees

Species Class

	Number of Trees	Total CO2	CH4	N2O	CO2e
		MT			
Miscellaneous	340	240.7200	0.0000	0.0000	240.7200
Total		240.7200	0.0000	0.0000	240.7200

Santa Maria Airport Commercial Rezone - Year 2030 - Santa Barbara-North of Santa Ynez County, Annual

Santa Maria Airport Commercial Rezone - Year 2030
Santa Barbara-North of Santa Ynez County, Annual

1.0 Project Characteristics

1.1 Land Usage

Land Uses	Size	Metric	Lot Acreage	Floor Surface Area	Population
General Office Building	40.00	1000sqft	0.92	40,000.00	0
Government Office Building	22.10	1000sqft	0.51	22,100.00	0
Medical Office Building	20.00	1000sqft	0.46	20,000.00	0
Unrefrigerated Warehouse-No Rail	100.00	1000sqft	2.30	100,000.00	0
Parking Lot	663.00	Space	8.00	265,200.00	0
High Turnover (Sit Down Restaurant)	11.00	1000sqft	0.25	11,000.00	0
Convenience Market With Gas Pumps	3.40	1000sqft	0.08	3,400.00	0
Free-Standing Discount Store	32.00	1000sqft	0.73	32,000.00	0
Strip Mall	36.00	1000sqft	0.83	36,000.00	0
Other Asphalt Surfaces	2.00	Acre	2.00	87,120.00	0
Other Non-Asphalt Surfaces	0.50	Acre	0.50	21,780.00	0

1.2 Other Project Characteristics

Urbanization	Urban	Wind Speed (m/s)	3.1	Precipitation Freq (Days)	37
Climate Zone	4			Operational Year	2030
Utility Company	Pacific Gas & Electric Company				
CO2 Intensity (lb/MWhr)	298.3	CH4 Intensity (lb/MWhr)	0.013	N2O Intensity (lb/MWhr)	0.003

1.3 User Entered Comments & Non-Default Data

Santa Maria Airport Commercial Rezone - Year 2030 - Santa Barbara-North of Santa Ynez County, Annual

Project Characteristics - Includes adjustments for RPS.

Land Use - Based on land use information provided.

Construction Phase - Based on information provided. Demo not required. Site prep 10 days, grading 80 days, building 606 days, paving 20 days, arch coating 500 days.

Off-road Equipment - Based on model defaults

Off-road Equipment - Based on model defaults. Additional equipment included based on information provided.

Off-road Equipment - Based on model defaults. Additional equipment included based on information provided.

Off-road Equipment - Based on model defaults. Additional equipment included based on information provided.

Off-road Equipment - Includes 2 scrapers based on info provided and defaults.

Trips and VMT - Construction vehicle trips based on model defaults.

Grading - All material balanced on site. Area graded based on model defaults/equipment usage rates. Graded area is calculated by CalEEMod based on equipment usage/8-hr day and const. schedule.

Vehicle Trips - Trip-gen rates derived from the traffic analysis (CCTC 2020). Rates were adjusted for internal capture and pass-by. Trip lengths based on model defaults.

Area Coating - Arch coatings based on model defaults.

Energy Use - Energy use based on model defaults.

Water And Wastewater - Water, wastewater, and solid waste based on model defaults.

Sequestration - Assumes net increase of 340 trees. Provided for informational purposes only.

Construction Off-road Equipment Mitigation - Includes 50% CE for watering unpaved roads/travel areas; 61% CE for watering graded surfaces, 15 mph onsite speed limit. T3 offroad equipment included for informational purposes.

Mobile Land Use Mitigation - Site Enhancements include improved pedestrian access on-site and connecting off-site. Install transit features to increase accessibility (benches, pullouts, etc.)

Area Mitigation - .

Energy Mitigation - Compliance with current energy-efficiency building standards calculated separately.

Water Mitigation - Includes use of low-flow water fixtures and water-efficient irrigation systems.

Waste Mitigation - Assumes 75% diversion rate per current targets.

Architectural Coating - Arch coating based on model defaults.

Vehicle Emission Factors - Emfac based on model defaults. SAFE veh adjustments calculated separately.

Vehicle Emission Factors -

Vehicle Emission Factors -

Santa Maria Airport Commercial Rezone - Year 2030 - Santa Barbara-North of Santa Ynez County, Annual

Fleet Mix -

Table Name	Column Name	Default Value	New Value
tblArchitecturalCoating	ConstArea_Parking	22,446.00	15,912.00
tblAreaMitigation	UseLowVOCPaintNonresidentialExteriorValue	250	50
tblAreaMitigation	UseLowVOCPaintNonresidentialInteriorValue	250	50
tblConstDustMitigation	WaterUnpavedRoadVehicleSpeed	0	15
tblConstEquipMitigation	NumberOfEquipmentMitigated	0.00	1.00
tblConstEquipMitigation	NumberOfEquipmentMitigated	0.00	1.00
tblConstEquipMitigation	NumberOfEquipmentMitigated	0.00	1.00
tblConstEquipMitigation	NumberOfEquipmentMitigated	0.00	3.00
tblConstEquipMitigation	NumberOfEquipmentMitigated	0.00	3.00
tblConstEquipMitigation	NumberOfEquipmentMitigated	0.00	1.00
tblConstEquipMitigation	NumberOfEquipmentMitigated	0.00	2.00
tblConstEquipMitigation	NumberOfEquipmentMitigated	0.00	1.00
tblConstEquipMitigation	NumberOfEquipmentMitigated	0.00	1.00
tblConstEquipMitigation	NumberOfEquipmentMitigated	0.00	4.00
tblConstEquipMitigation	NumberOfEquipmentMitigated	0.00	4.00
tblConstEquipMitigation	NumberOfEquipmentMitigated	0.00	4.00
tblConstEquipMitigation	NumberOfEquipmentMitigated	0.00	1.00
tblConstEquipMitigation	NumberOfEquipmentMitigated	0.00	12.00
tblConstEquipMitigation	NumberOfEquipmentMitigated	0.00	1.00
tblConstEquipMitigation	Tier	No Change	Tier 3
tblConstEquipMitigation	Tier	No Change	Tier 3
tblConstEquipMitigation	Tier	No Change	Tier 3
tblConstEquipMitigation	Tier	No Change	Tier 3
tblConstEquipMitigation	Tier	No Change	Tier 3

Santa Maria Airport Commercial Rezone - Year 2030 - Santa Barbara-North of Santa Ynez County, Annual

tblConstEquipMitigation	Tier	No Change	Tier 3
tblConstEquipMitigation	Tier	No Change	Tier 3
tblConstEquipMitigation	Tier	No Change	Tier 3
tblConstEquipMitigation	Tier	No Change	Tier 3
tblConstEquipMitigation	Tier	No Change	Tier 3
tblConstEquipMitigation	Tier	No Change	Tier 3
tblConstEquipMitigation	Tier	No Change	Tier 3
tblConstEquipMitigation	Tier	No Change	Tier 3
tblConstEquipMitigation	Tier	No Change	Tier 3
tblConstEquipMitigation	Tier	No Change	Tier 3
tblConstructionPhase	NumDays	30.00	80.00
tblConstructionPhase	NumDays	300.00	606.00
tblConstructionPhase	NumDays	20.00	500.00
tblLandUse	LotAcreage	5.97	8.00
tblOffRoadEquipment	OffRoadEquipmentUnitAmount	2.00	1.00
tblOffRoadEquipment	OffRoadEquipmentUnitAmount	2.00	1.00
tblOffRoadEquipment	OffRoadEquipmentUnitAmount	2.00	3.00
tblProjectCharacteristics	CH4IntensityFactor	0.029	0.013
tblProjectCharacteristics	CO2IntensityFactor	641.35	298.3
tblProjectCharacteristics	N2OIntensityFactor	0.006	0.003
tblSequestration	NumberOfNewTrees	0.00	340.00
tblTripsAndVMT	VendorTripNumber	105.00	87.00
tblTripsAndVMT	WorkerTripNumber	253.00	207.00
tblTripsAndVMT	WorkerTripNumber	51.00	41.00
tblTripsAndVMT	WorkerTripNumber	20.00	25.00
tblVehicleTrips	ST_TR	1,448.33	1,933.82
tblVehicleTrips	ST_TR	71.07	6.21

Santa Maria Airport Commercial Rezone - Year 2030 - Santa Barbara-North of Santa Ynez County, Annual

tblVehicleTrips	ST_TR	2.46	2.20
tblVehicleTrips	ST_TR	158.37	459.64
tblVehicleTrips	ST_TR	8.96	7.63
tblVehicleTrips	ST_TR	42.04	63.51
tblVehicleTrips	ST_TR	1.68	1.37
tblVehicleTrips	SU_TR	1,182.08	1,578.32
tblVehicleTrips	SU_TR	56.36	4.92
tblVehicleTrips	SU_TR	1.05	0.94
tblVehicleTrips	SU_TR	131.84	382.65
tblVehicleTrips	SU_TR	1.55	1.32
tblVehicleTrips	SU_TR	20.43	30.86
tblVehicleTrips	SU_TR	1.68	1.37
tblVehicleTrips	WD_TR	845.60	1,129.05
tblVehicleTrips	WD_TR	57.24	5.00
tblVehicleTrips	WD_TR	11.03	9.86
tblVehicleTrips	WD_TR	68.93	20.41
tblVehicleTrips	WD_TR	127.15	369.03
tblVehicleTrips	WD_TR	36.13	30.78
tblVehicleTrips	WD_TR	44.32	66.95
tblVehicleTrips	WD_TR	1.68	1.37

2.0 Emissions Summary

Santa Maria Airport Commercial Rezone - Year 2030 - Santa Barbara-North of Santa Ynez County, Annual

2.1 Overall Construction

Unmitigated Construction

	ROG	NOx	CO	SO2	Fugitive PM10	Exhaust PM10	PM10 Total	Fugitive PM2.5	Exhaust PM2.5	PM2.5 Total	Bio- CO2	NBio- CO2	Total CO2	CH4	N2O	CO2e
Year	tons/yr										MT/yr					
2021	0.7790	4.9157	4.1568	8.7200e-003	0.5952	0.2097	0.8049	0.2347	0.1957	0.4304			780.7773	0.1632	0.0000	784.8569
2022	2.1085	4.1936	4.4940	0.0100	0.2649	0.1636	0.4285	0.0719	0.1553	0.2272			904.1958	0.1315	0.0000	907.4819
2023	1.5799	2.9651	3.4457	7.7000e-003	0.2002	0.1124	0.3126	0.0543	0.1064	0.1607			695.2665	0.1044	0.0000	697.8769
Maximum	2.1085	4.9157	4.4940	0.0100	0.5952	0.2097	0.8049	0.2347	0.1957	0.4304			904.1958	0.1632	0.0000	907.4819

Mitigated Construction

	ROG	NOx	CO	SO2	Fugitive PM10	Exhaust PM10	PM10 Total	Fugitive PM2.5	Exhaust PM2.5	PM2.5 Total	Bio- CO2	NBio- CO2	Total CO2	CH4	N2O	CO2e
Year	tons/yr										MT/yr					
2021	0.5101	3.8329	4.5857	8.7200e-003	0.3220	0.1740	0.4960	0.1159	0.1739	0.2898			780.7766	0.1632	0.0000	784.8562
2022	1.9022	4.0685	4.8202	0.0100	0.2649	0.1889	0.4538	0.0719	0.1886	0.2605			904.1952	0.1315	0.0000	907.4813
2023	1.4367	3.0422	3.7361	7.7000e-003	0.2002	0.1480	0.3482	0.0543	0.1479	0.2022			695.2660	0.1044	0.0000	697.8765
Maximum	1.9022	4.0685	4.8202	0.0100	0.3220	0.1889	0.4960	0.1159	0.1886	0.2898			904.1952	0.1632	0.0000	907.4813

Santa Maria Airport Commercial Rezone - Year 2030 - Santa Barbara-North of Santa Ynez County, Annual

	ROG	NOx	CO	SO2	Fugitive PM10	Exhaust PM10	PM10 Total	Fugitive PM2.5	Exhaust PM2.5	PM2.5 Total	Bio- CO2	NBio-CO2	Total CO2	CH4	N2O	CO2e
Percent Reduction	13.85	9.36	-8.64	0.00	25.77	-5.18	16.05	32.90	-11.59	8.03	0.00	0.00	0.00	0.00	0.00	0.00

Quarter	Start Date	End Date	Maximum Unmitigated ROG + NOX (tons/quarter)	Maximum Mitigated ROG + NOX (tons/quarter)
1	1-1-2021	3-31-2021	1.2801	0.7810
2	4-1-2021	6-30-2021	1.6145	1.1150
3	7-1-2021	9-30-2021	1.2266	1.0540
4	10-1-2021	12-31-2021	1.5489	1.3692
5	1-1-2022	3-31-2022	1.5571	1.4751
6	4-1-2022	6-30-2022	1.5700	1.4872
7	7-1-2022	9-30-2022	1.5873	1.5035
8	10-1-2022	12-31-2022	1.5917	1.5079
9	1-1-2023	3-31-2023	1.4396	1.4250
10	4-1-2023	6-30-2023	1.4517	1.4369
11	7-1-2023	9-30-2023	1.6223	1.5866
		Highest	1.6223	1.5866

Santa Maria Airport Commercial Rezone - Year 2030 - Santa Barbara-North of Santa Ynez County, Annual

2.2 Overall Operational

Unmitigated Operational

	ROG	NOx	CO	SO2	Fugitive PM10	Exhaust PM10	PM10 Total	Fugitive PM2.5	Exhaust PM2.5	PM2.5 Total	Bio- CO2	NBio- CO2	Total CO2	CH4	N2O	CO2e
Category	tons/yr										MT/yr					
Area	1.3775	8.0000e-005	8.5000e-003	0.0000		3.0000e-005	3.0000e-005		3.0000e-005	3.0000e-005			0.0166	4.0000e-005	0.0000	0.0177
Energy	0.0224	0.2033	0.1708	1.2200e-003		0.0155	0.0155		0.0155	0.0155			631.6575	0.0221	8.1800e-003	634.6495
Mobile	1.8451	6.9004	13.3012	0.0374	3.9332	0.0294	3.9625	1.0546	0.0273	1.0819			3,488.4853	0.2010	0.0000	3,493.5098
Waste						0.0000	0.0000		0.0000	0.0000			142.1020	7.0464	0.0000	318.2615
Water						0.0000	0.0000		0.0000	0.0000			54.8953	0.0574	0.0356	66.9390
Total	3.2450	7.1037	13.4805	0.0386	3.9332	0.0448	3.9780	1.0546	0.0428	1.0974			4,317.1568	7.3269	0.0438	4,513.3775

Santa Maria Airport Commercial Rezone - Year 2030 - Santa Barbara-North of Santa Ynez County, Annual

2.2 Overall Operational

Mitigated Operational

	ROG	NOx	CO	SO2	Fugitive PM10	Exhaust PM10	PM10 Total	Fugitive PM2.5	Exhaust PM2.5	PM2.5 Total	Bio- CO2	NBio- CO2	Total CO2	CH4	N2O	CO2e
Category	tons/yr										MT/yr					
Area	1.3775	8.0000e-005	8.5000e-003	0.0000		3.0000e-005	3.0000e-005		3.0000e-005	3.0000e-005			0.0166	4.0000e-005	0.0000	0.0177
Energy	0.0224	0.2033	0.1708	1.2200e-003		0.0155	0.0155		0.0155	0.0155			631.6575	0.0221	8.1800e-003	634.6495
Mobile	1.8396	6.8677	13.1700	0.0368	3.8545	0.0290	3.8835	1.0335	0.0269	1.0605			3,430.8180	0.1989	0.0000	3,435.7893
Waste						0.0000	0.0000		0.0000	0.0000			35.5255	1.7616	0.0000	79.5654
Water						0.0000	0.0000		0.0000	0.0000			44.6391	0.0460	0.0285	54.2770
Total	3.2394	7.0711	13.3492	0.0380	3.8545	0.0445	3.8990	1.0335	0.0424	1.0759			4,142.6567	2.0286	0.0367	4,204.2988

	ROG	NOx	CO	SO2	Fugitive PM10	Exhaust PM10	PM10 Total	Fugitive PM2.5	Exhaust PM2.5	PM2.5 Total	Bio- CO2	NBio-CO2	Total CO2	CH4	N2O	CO2e
Percent Reduction	0.17	0.46	0.97	1.61	2.00	0.87	1.99	2.00	0.84	1.95	0.00	0.00	4.04	72.31	16.24	6.85

Santa Maria Airport Commercial Rezone - Year 2030 - Santa Barbara-North of Santa Ynez County, Annual

2.3 Vegetation

Vegetation

	CO2e
Category	MT
New Trees	240.7200
Total	240.7200

3.0 Construction Detail

Construction Phase

Phase Number	Phase Name	Phase Type	Start Date	End Date	Num Days Week	Num Days	Phase Description
1	Site Preparation	Site Preparation	1/29/2021	2/11/2021	5	10	
2	Grading	Grading	2/12/2021	6/3/2021	5	80	
3	Building Construction	Building Construction	6/4/2021	9/29/2023	5	606	
4	Architectural Coating	Architectural Coating	11/1/2021	9/29/2023	5	500	
5	Paving	Paving	8/20/2023	9/15/2023	5	20	

Acres of Grading (Site Preparation Phase): 20

Acres of Grading (Grading Phase): 200

Acres of Paving: 10.5

Santa Maria Airport Commercial Rezone - Year 2030 - Santa Barbara-North of Santa Ynez County, Annual

Residential Indoor: 0; Residential Outdoor: 0; Non-Residential Indoor: 396,750; Non-Residential Outdoor: 132,250; Striped Parking Area: 15,912 (Architectural Coating – sqft)

OffRoad Equipment

Santa Maria Airport Commercial Rezone - Year 2030 - Santa Barbara-North of Santa Ynez County, Annual

Phase Name	Offroad Equipment Type	Amount	Usage Hours	Horse Power	Load Factor
Site Preparation	Rubber Tired Dozers	3	8.00	247	0.40
Site Preparation	Scrapers	2	8.00	367	0.48
Site Preparation	Tractors/Loaders/Backhoes	4	8.00	97	0.37
Grading	Excavators	2	8.00	158	0.38
Grading	Graders	1	8.00	187	0.41
Grading	Rubber Tired Dozers	1	8.00	247	0.40
Grading	Scrapers	2	8.00	367	0.48
Grading	Tractors/Loaders/Backhoes	2	8.00	97	0.37
Grading	Tractors/Loaders/Backhoes	2	8.00	97	0.37
Building Construction	Concrete/Industrial Saws	1	8.00	81	0.73
Building Construction	Cranes	1	7.00	231	0.29
Building Construction	Excavators	1	8.00	158	0.38
Building Construction	Forklifts	3	8.00	89	0.20
Building Construction	Generator Sets	1	8.00	84	0.74
Building Construction	Rollers	1	8.00	80	0.38
Building Construction	Tractors/Loaders/Backhoes	3	7.00	97	0.37
Building Construction	Welders	1	8.00	46	0.45
Architectural Coating	Air Compressors	1	6.00	78	0.48
Paving	Graders	1	8.00	187	0.41
Paving	Pavers	1	8.00	130	0.42
Paving	Paving Equipment	1	8.00	132	0.36
Paving	Rollers	3	8.00	80	0.38
Paving	Signal Boards	1	8.00	6	0.82
Paving	Tractors/Loaders/Backhoes	1	8.00	97	0.37

Trips and VMT

Santa Maria Airport Commercial Rezone - Year 2030 - Santa Barbara-North of Santa Ynez County, Annual

Phase Name	Offroad Equipment Count	Worker Trip Number	Vendor Trip Number	Hauling Trip Number	Worker Trip Length	Vendor Trip Length	Hauling Trip Length	Worker Vehicle Class	Vendor Vehicle Class	Hauling Vehicle Class
Site Preparation	9	23.00	0.00	0.00	8.30	6.40	20.00	LD_Mix	HDT_Mix	HHDT
Grading	10	25.00	0.00	0.00	8.30	6.40	20.00	LD_Mix	HDT_Mix	HHDT
Building Construction	12	207.00	87.00	0.00	8.30	6.40	20.00	LD_Mix	HDT_Mix	HHDT
Architectural Coating	1	41.00	0.00	0.00	8.30	6.40	20.00	LD_Mix	HDT_Mix	HHDT
Paving	8	25.00	0.00	0.00	8.30	6.40	20.00	LD_Mix	HDT_Mix	HHDT

3.1 Mitigation Measures Construction

Use Cleaner Engines for Construction Equipment

Use Soil Stabilizer

Water Exposed Area

Reduce Vehicle Speed on Unpaved Roads

3.2 Site Preparation - 2021

Unmitigated Construction On-Site

	ROG	NOx	CO	SO2	Fugitive PM10	Exhaust PM10	PM10 Total	Fugitive PM2.5	Exhaust PM2.5	PM2.5 Total	Bio- CO2	NBio- CO2	Total CO2	CH4	N2O	CO2e
Category	tons/yr										MT/yr					
Fugitive Dust					0.1009	0.0000	0.1009	0.0508	0.0000	0.0508			0.0000	0.0000	0.0000	0.0000
Off-Road	0.0287	0.3095	0.1758	3.4000e-004		0.0144	0.0144		0.0132	0.0132			30.0345	9.7100e-003	0.0000	30.2774
Total	0.0287	0.3095	0.1758	3.4000e-004	0.1009	0.0144	0.1153	0.0508	0.0132	0.0640			30.0345	9.7100e-003	0.0000	30.2774

Santa Maria Airport Commercial Rezone - Year 2030 - Santa Barbara-North of Santa Ynez County, Annual

3.2 Site Preparation - 2021

Unmitigated Construction Off-Site

	ROG	NOx	CO	SO2	Fugitive PM10	Exhaust PM10	PM10 Total	Fugitive PM2.5	Exhaust PM2.5	PM2.5 Total	Bio- CO2	NBio- CO2	Total CO2	CH4	N2O	CO2e
Category	tons/yr										MT/yr					
Hauling	0.0000	0.0000	0.0000	0.0000	0.0000	0.0000	0.0000	0.0000	0.0000	0.0000			0.0000	0.0000	0.0000	0.0000
Vendor	0.0000	0.0000	0.0000	0.0000	0.0000	0.0000	0.0000	0.0000	0.0000	0.0000			0.0000	0.0000	0.0000	0.0000
Worker	3.4000e-004	2.8000e-004	2.4700e-003	1.0000e-005	7.1000e-004	0.0000	7.1000e-004	1.9000e-004	0.0000	1.9000e-004			0.5604	2.0000e-005	0.0000	0.5608
Total	3.4000e-004	2.8000e-004	2.4700e-003	1.0000e-005	7.1000e-004	0.0000	7.1000e-004	1.9000e-004	0.0000	1.9000e-004			0.5604	2.0000e-005	0.0000	0.5608

Mitigated Construction On-Site

	ROG	NOx	CO	SO2	Fugitive PM10	Exhaust PM10	PM10 Total	Fugitive PM2.5	Exhaust PM2.5	PM2.5 Total	Bio- CO2	NBio- CO2	Total CO2	CH4	N2O	CO2e
Category	tons/yr										MT/yr					
Fugitive Dust					0.0394	0.0000	0.0394	0.0198	0.0000	0.0198			0.0000	0.0000	0.0000	0.0000
Off-Road	8.3800e-003	0.1674	0.1956	3.4000e-004		7.4600e-003	7.4600e-003		7.4600e-003	7.4600e-003			30.0345	9.7100e-003	0.0000	30.2773
Total	8.3800e-003	0.1674	0.1956	3.4000e-004	0.0394	7.4600e-003	0.0468	0.0198	7.4600e-003	0.0273			30.0345	9.7100e-003	0.0000	30.2773

Santa Maria Airport Commercial Rezone - Year 2030 - Santa Barbara-North of Santa Ynez County, Annual

3.2 Site Preparation - 2021

Mitigated Construction Off-Site

	ROG	NOx	CO	SO2	Fugitive PM10	Exhaust PM10	PM10 Total	Fugitive PM2.5	Exhaust PM2.5	PM2.5 Total	Bio- CO2	NBio- CO2	Total CO2	CH4	N2O	CO2e
Category	tons/yr										MT/yr					
Hauling	0.0000	0.0000	0.0000	0.0000	0.0000	0.0000	0.0000	0.0000	0.0000	0.0000			0.0000	0.0000	0.0000	0.0000
Vendor	0.0000	0.0000	0.0000	0.0000	0.0000	0.0000	0.0000	0.0000	0.0000	0.0000			0.0000	0.0000	0.0000	0.0000
Worker	3.4000e-004	2.8000e-004	2.4700e-003	1.0000e-005	7.1000e-004	0.0000	7.1000e-004	1.9000e-004	0.0000	1.9000e-004			0.5604	2.0000e-005	0.0000	0.5608
Total	3.4000e-004	2.8000e-004	2.4700e-003	1.0000e-005	7.1000e-004	0.0000	7.1000e-004	1.9000e-004	0.0000	1.9000e-004			0.5604	2.0000e-005	0.0000	0.5608

3.3 Grading - 2021

Unmitigated Construction On-Site

	ROG	NOx	CO	SO2	Fugitive PM10	Exhaust PM10	PM10 Total	Fugitive PM2.5	Exhaust PM2.5	PM2.5 Total	Bio- CO2	NBio- CO2	Total CO2	CH4	N2O	CO2e
Category	tons/yr										MT/yr					
Fugitive Dust					0.3469	0.0000	0.3469	0.1439	0.0000	0.1439			0.0000	0.0000	0.0000	0.0000
Off-Road	0.1826	2.0077	1.4160	2.7300e-003		0.0884	0.0884		0.0813	0.0813			239.8177	0.0776	0.0000	241.7567
Total	0.1826	2.0077	1.4160	2.7300e-003	0.3469	0.0884	0.4353	0.1439	0.0813	0.2252			239.8177	0.0776	0.0000	241.7567

Santa Maria Airport Commercial Rezone - Year 2030 - Santa Barbara-North of Santa Ynez County, Annual

3.3 Grading - 2021

Unmitigated Construction Off-Site

	ROG	NOx	CO	SO2	Fugitive PM10	Exhaust PM10	PM10 Total	Fugitive PM2.5	Exhaust PM2.5	PM2.5 Total	Bio- CO2	NBio- CO2	Total CO2	CH4	N2O	CO2e
Category	tons/yr										MT/yr					
Hauling	0.0000	0.0000	0.0000	0.0000	0.0000	0.0000	0.0000	0.0000	0.0000	0.0000			0.0000	0.0000	0.0000	0.0000
Vendor	0.0000	0.0000	0.0000	0.0000	0.0000	0.0000	0.0000	0.0000	0.0000	0.0000			0.0000	0.0000	0.0000	0.0000
Worker	2.9800e-003	2.4200e-003	0.0215	5.0000e-005	6.1800e-003	4.0000e-005	6.2200e-003	1.6400e-003	4.0000e-005	1.6800e-003			4.8731	1.5000e-004	0.0000	4.8769
Total	2.9800e-003	2.4200e-003	0.0215	5.0000e-005	6.1800e-003	4.0000e-005	6.2200e-003	1.6400e-003	4.0000e-005	1.6800e-003			4.8731	1.5000e-004	0.0000	4.8769

Mitigated Construction On-Site

	ROG	NOx	CO	SO2	Fugitive PM10	Exhaust PM10	PM10 Total	Fugitive PM2.5	Exhaust PM2.5	PM2.5 Total	Bio- CO2	NBio- CO2	Total CO2	CH4	N2O	CO2e
Category	tons/yr										MT/yr					
Fugitive Dust					0.1353	0.0000	0.1353	0.0561	0.0000	0.0561			0.0000	0.0000	0.0000	0.0000
Off-Road	0.0670	1.3379	1.6563	2.7300e-003		0.0617	0.0617		0.0617	0.0617			239.8174	0.0776	0.0000	241.7564
Total	0.0670	1.3379	1.6563	2.7300e-003	0.1353	0.0617	0.1970	0.0561	0.0617	0.1178			239.8174	0.0776	0.0000	241.7564

Santa Maria Airport Commercial Rezone - Year 2030 - Santa Barbara-North of Santa Ynez County, Annual

3.3 Grading - 2021

Mitigated Construction Off-Site

	ROG	NOx	CO	SO2	Fugitive PM10	Exhaust PM10	PM10 Total	Fugitive PM2.5	Exhaust PM2.5	PM2.5 Total	Bio- CO2	NBio- CO2	Total CO2	CH4	N2O	CO2e
Category	tons/yr										MT/yr					
Hauling	0.0000	0.0000	0.0000	0.0000	0.0000	0.0000	0.0000	0.0000	0.0000	0.0000			0.0000	0.0000	0.0000	0.0000
Vendor	0.0000	0.0000	0.0000	0.0000	0.0000	0.0000	0.0000	0.0000	0.0000	0.0000			0.0000	0.0000	0.0000	0.0000
Worker	2.9800e-003	2.4200e-003	0.0215	5.0000e-005	6.1800e-003	4.0000e-005	6.2200e-003	1.6400e-003	4.0000e-005	1.6800e-003			4.8731	1.5000e-004	0.0000	4.8769
Total	2.9800e-003	2.4200e-003	0.0215	5.0000e-005	6.1800e-003	4.0000e-005	6.2200e-003	1.6400e-003	4.0000e-005	1.6800e-003			4.8731	1.5000e-004	0.0000	4.8769

3.4 Building Construction - 2021

Unmitigated Construction On-Site

	ROG	NOx	CO	SO2	Fugitive PM10	Exhaust PM10	PM10 Total	Fugitive PM2.5	Exhaust PM2.5	PM2.5 Total	Bio- CO2	NBio- CO2	Total CO2	CH4	N2O	CO2e
Category	tons/yr										MT/yr					
Off-Road	0.2042	1.8534	1.9178	3.0900e-003		0.1022	0.1022		0.0965	0.0965			267.1417	0.0613	0.0000	268.6732
Total	0.2042	1.8534	1.9178	3.0900e-003		0.1022	0.1022		0.0965	0.0965			267.1417	0.0613	0.0000	268.6732

Santa Maria Airport Commercial Rezone - Year 2030 - Santa Barbara-North of Santa Ynez County, Annual

3.4 Building Construction - 2021

Unmitigated Construction Off-Site

	ROG	NOx	CO	SO2	Fugitive PM10	Exhaust PM10	PM10 Total	Fugitive PM2.5	Exhaust PM2.5	PM2.5 Total	Bio- CO2	NBio- CO2	Total CO2	CH4	N2O	CO2e
Category	tons/yr										MT/yr					
Hauling	0.0000	0.0000	0.0000	0.0000	0.0000	0.0000	0.0000	0.0000	0.0000	0.0000			0.0000	0.0000	0.0000	0.0000
Vendor	0.0218	0.6682	0.2269	1.5400e-003	0.0382	1.9800e-003	0.0402	0.0110	1.9000e-003	0.0129			151.9508	0.0116	0.0000	152.2399
Worker	0.0465	0.0378	0.3356	8.4000e-004	0.0965	6.1000e-004	0.0971	0.0257	5.6000e-004	0.0262			76.1589	2.3800e-003	0.0000	76.2184
Total	0.0684	0.7059	0.5625	2.3800e-003	0.1347	2.5900e-003	0.1373	0.0367	2.4600e-003	0.0391			228.1096	0.0139	0.0000	228.4583

Mitigated Construction On-Site

	ROG	NOx	CO	SO2	Fugitive PM10	Exhaust PM10	PM10 Total	Fugitive PM2.5	Exhaust PM2.5	PM2.5 Total	Bio- CO2	NBio- CO2	Total CO2	CH4	N2O	CO2e
Category	tons/yr										MT/yr					
Off-Road	0.0748	1.5862	2.0864	3.0900e-003		0.1001	0.1001		0.1001	0.1001			267.1414	0.0613	0.0000	268.6729
Total	0.0748	1.5862	2.0864	3.0900e-003		0.1001	0.1001		0.1001	0.1001			267.1414	0.0613	0.0000	268.6729

Santa Maria Airport Commercial Rezone - Year 2030 - Santa Barbara-North of Santa Ynez County, Annual

3.4 Building Construction - 2021

Mitigated Construction Off-Site

	ROG	NOx	CO	SO2	Fugitive PM10	Exhaust PM10	PM10 Total	Fugitive PM2.5	Exhaust PM2.5	PM2.5 Total	Bio- CO2	NBio- CO2	Total CO2	CH4	N2O	CO2e
Category	tons/yr										MT/yr					
Hauling	0.0000	0.0000	0.0000	0.0000	0.0000	0.0000	0.0000	0.0000	0.0000	0.0000			0.0000	0.0000	0.0000	0.0000
Vendor	0.0218	0.6682	0.2269	1.5400e-003	0.0382	1.9800e-003	0.0402	0.0110	1.9000e-003	0.0129			151.9508	0.0116	0.0000	152.2399
Worker	0.0465	0.0378	0.3356	8.4000e-004	0.0965	6.1000e-004	0.0971	0.0257	5.6000e-004	0.0262			76.1589	2.3800e-003	0.0000	76.2184
Total	0.0684	0.7059	0.5625	2.3800e-003	0.1347	2.5900e-003	0.1373	0.0367	2.4600e-003	0.0391			228.1096	0.0139	0.0000	228.4583

3.4 Building Construction - 2022

Unmitigated Construction On-Site

	ROG	NOx	CO	SO2	Fugitive PM10	Exhaust PM10	PM10 Total	Fugitive PM2.5	Exhaust PM2.5	PM2.5 Total	Bio- CO2	NBio- CO2	Total CO2	CH4	N2O	CO2e
Category	tons/yr										MT/yr					
Off-Road	0.3162	2.8496	3.2687	5.3300e-003		0.1488	0.1488		0.1406	0.1406			460.0744	0.1048	0.0000	462.6931
Total	0.3162	2.8496	3.2687	5.3300e-003		0.1488	0.1488		0.1406	0.1406			460.0744	0.1048	0.0000	462.6931

Santa Maria Airport Commercial Rezone - Year 2030 - Santa Barbara-North of Santa Ynez County, Annual

3.4 Building Construction - 2022

Unmitigated Construction Off-Site

	ROG	NOx	CO	SO2	Fugitive PM10	Exhaust PM10	PM10 Total	Fugitive PM2.5	Exhaust PM2.5	PM2.5 Total	Bio- CO2	NBio- CO2	Total CO2	CH4	N2O	CO2e
Category	tons/yr										MT/yr					
Hauling	0.0000	0.0000	0.0000	0.0000	0.0000	0.0000	0.0000	0.0000	0.0000	0.0000			0.0000	0.0000	0.0000	0.0000
Vendor	0.0346	1.0913	0.3599	2.6200e-003	0.0658	3.0000e-003	0.0688	0.0190	2.8700e-003	0.0218			259.4242	0.0202	0.0000	259.9285
Worker	0.0746	0.0581	0.5256	1.4000e-003	0.1662	1.0200e-003	0.1672	0.0442	9.4000e-004	0.0451			126.4576	3.6500e-003	0.0000	126.5488
Total	0.1092	1.1494	0.8854	4.0200e-003	0.2320	4.0200e-003	0.2360	0.0631	3.8100e-003	0.0670			385.8819	0.0238	0.0000	386.4773

Mitigated Construction On-Site

	ROG	NOx	CO	SO2	Fugitive PM10	Exhaust PM10	PM10 Total	Fugitive PM2.5	Exhaust PM2.5	PM2.5 Total	Bio- CO2	NBio- CO2	Total CO2	CH4	N2O	CO2e
Category	tons/yr										MT/yr					
Off-Road	0.1288	2.7312	3.5925	5.3300e-003		0.1723	0.1723		0.1723	0.1723			460.0739	0.1048	0.0000	462.6925
Total	0.1288	2.7312	3.5925	5.3300e-003		0.1723	0.1723		0.1723	0.1723			460.0739	0.1048	0.0000	462.6925

Santa Maria Airport Commercial Rezone - Year 2030 - Santa Barbara-North of Santa Ynez County, Annual

3.4 Building Construction - 2022

Mitigated Construction Off-Site

	ROG	NOx	CO	SO2	Fugitive PM10	Exhaust PM10	PM10 Total	Fugitive PM2.5	Exhaust PM2.5	PM2.5 Total	Bio- CO2	NBio- CO2	Total CO2	CH4	N2O	CO2e
Category	tons/yr										MT/yr					
Hauling	0.0000	0.0000	0.0000	0.0000	0.0000	0.0000	0.0000	0.0000	0.0000	0.0000			0.0000	0.0000	0.0000	0.0000
Vendor	0.0346	1.0913	0.3599	2.6200e-003	0.0658	3.0000e-003	0.0688	0.0190	2.8700e-003	0.0218			259.4242	0.0202	0.0000	259.9285
Worker	0.0746	0.0581	0.5256	1.4000e-003	0.1662	1.0200e-003	0.1672	0.0442	9.4000e-004	0.0451			126.4576	3.6500e-003	0.0000	126.5488
Total	0.1092	1.1494	0.8854	4.0200e-003	0.2320	4.0200e-003	0.2360	0.0631	3.8100e-003	0.0670			385.8819	0.0238	0.0000	386.4773

3.4 Building Construction - 2023

Unmitigated Construction On-Site

	ROG	NOx	CO	SO2	Fugitive PM10	Exhaust PM10	PM10 Total	Fugitive PM2.5	Exhaust PM2.5	PM2.5 Total	Bio- CO2	NBio- CO2	Total CO2	CH4	N2O	CO2e
Category	tons/yr										MT/yr					
Off-Road	0.2193	1.9625	2.4386	4.0000e-003		0.0968	0.0968		0.0915	0.0915			345.1418	0.0779	0.0000	347.0898
Total	0.2193	1.9625	2.4386	4.0000e-003		0.0968	0.0968		0.0915	0.0915			345.1418	0.0779	0.0000	347.0898

Santa Maria Airport Commercial Rezone - Year 2030 - Santa Barbara-North of Santa Ynez County, Annual

3.4 Building Construction - 2023

Unmitigated Construction Off-Site

	ROG	NOx	CO	SO2	Fugitive PM10	Exhaust PM10	PM10 Total	Fugitive PM2.5	Exhaust PM2.5	PM2.5 Total	Bio- CO2	NBio- CO2	Total CO2	CH4	N2O	CO2e
Category	tons/yr										MT/yr					
Hauling	0.0000	0.0000	0.0000	0.0000	0.0000	0.0000	0.0000	0.0000	0.0000	0.0000			0.0000	0.0000	0.0000	0.0000
Vendor	0.0202	0.6797	0.2431	1.9200e-003	0.0493	1.0800e-003	0.0504	0.0142	1.0300e-003	0.0153			191.0963	0.0145	0.0000	191.4591
Worker	0.0523	0.0390	0.3596	1.0100e-003	0.1247	7.4000e-004	0.1254	0.0331	6.9000e-004	0.0338			91.2991	2.4400e-003	0.0000	91.3600
Total	0.0724	0.7187	0.6027	2.9300e-003	0.1740	1.8200e-003	0.1758	0.0474	1.7200e-003	0.0491			282.3954	0.0170	0.0000	282.8191

Mitigated Construction On-Site

	ROG	NOx	CO	SO2	Fugitive PM10	Exhaust PM10	PM10 Total	Fugitive PM2.5	Exhaust PM2.5	PM2.5 Total	Bio- CO2	NBio- CO2	Total CO2	CH4	N2O	CO2e
Category	tons/yr										MT/yr					
Off-Road	0.0966	2.0484	2.6943	4.0000e-003		0.1292	0.1292		0.1292	0.1292			345.1414	0.0779	0.0000	347.0894
Total	0.0966	2.0484	2.6943	4.0000e-003		0.1292	0.1292		0.1292	0.1292			345.1414	0.0779	0.0000	347.0894

Santa Maria Airport Commercial Rezone - Year 2030 - Santa Barbara-North of Santa Ynez County, Annual

3.4 Building Construction - 2023

Mitigated Construction Off-Site

	ROG	NOx	CO	SO2	Fugitive PM10	Exhaust PM10	PM10 Total	Fugitive PM2.5	Exhaust PM2.5	PM2.5 Total	Bio- CO2	NBio- CO2	Total CO2	CH4	N2O	CO2e
Category	tons/yr										MT/yr					
Hauling	0.0000	0.0000	0.0000	0.0000	0.0000	0.0000	0.0000	0.0000	0.0000	0.0000			0.0000	0.0000	0.0000	0.0000
Vendor	0.0202	0.6797	0.2431	1.9200e-003	0.0493	1.0800e-003	0.0504	0.0142	1.0300e-003	0.0153			191.0963	0.0145	0.0000	191.4591
Worker	0.0523	0.0390	0.3596	1.0100e-003	0.1247	7.4000e-004	0.1254	0.0331	6.9000e-004	0.0338			91.2991	2.4400e-003	0.0000	91.3600
Total	0.0724	0.7187	0.6027	2.9300e-003	0.1740	1.8200e-003	0.1758	0.0474	1.7200e-003	0.0491			282.3954	0.0170	0.0000	282.8191

3.5 Architectural Coating - 2021

Unmitigated Construction On-Site

	ROG	NOx	CO	SO2	Fugitive PM10	Exhaust PM10	PM10 Total	Fugitive PM2.5	Exhaust PM2.5	PM2.5 Total	Bio- CO2	NBio- CO2	Total CO2	CH4	N2O	CO2e
Category	tons/yr										MT/yr					
Archit. Coating	0.2841					0.0000	0.0000		0.0000	0.0000			0.0000	0.0000	0.0000	0.0000
Off-Road	4.9300e-003	0.0344	0.0409	7.0000e-005		2.1200e-003	2.1200e-003		2.1200e-003	2.1200e-003			5.7448	3.9000e-004	0.0000	5.7547
Total	0.2891	0.0344	0.0409	7.0000e-005		2.1200e-003	2.1200e-003		2.1200e-003	2.1200e-003			5.7448	3.9000e-004	0.0000	5.7547

Santa Maria Airport Commercial Rezone - Year 2030 - Santa Barbara-North of Santa Ynez County, Annual

3.5 Architectural Coating - 2021

Unmitigated Construction Off-Site

	ROG	NOx	CO	SO2	Fugitive PM10	Exhaust PM10	PM10 Total	Fugitive PM2.5	Exhaust PM2.5	PM2.5 Total	Bio- CO2	NBio- CO2	Total CO2	CH4	N2O	CO2e
Category	tons/yr										MT/yr					
Hauling	0.0000	0.0000	0.0000	0.0000	0.0000	0.0000	0.0000	0.0000	0.0000	0.0000			0.0000	0.0000	0.0000	0.0000
Vendor	0.0000	0.0000	0.0000	0.0000	0.0000	0.0000	0.0000	0.0000	0.0000	0.0000			0.0000	0.0000	0.0000	0.0000
Worker	2.7500e-003	2.2300e-003	0.0198	5.0000e-005	5.7000e-003	4.0000e-005	5.7300e-003	1.5100e-003	3.0000e-005	1.5500e-003			4.4954	1.4000e-004	0.0000	4.4989
Total	2.7500e-003	2.2300e-003	0.0198	5.0000e-005	5.7000e-003	4.0000e-005	5.7300e-003	1.5100e-003	3.0000e-005	1.5500e-003			4.4954	1.4000e-004	0.0000	4.4989

Mitigated Construction On-Site

	ROG	NOx	CO	SO2	Fugitive PM10	Exhaust PM10	PM10 Total	Fugitive PM2.5	Exhaust PM2.5	PM2.5 Total	Bio- CO2	NBio- CO2	Total CO2	CH4	N2O	CO2e
Category	tons/yr										MT/yr					
Archit. Coating	0.2841					0.0000	0.0000		0.0000	0.0000			0.0000	0.0000	0.0000	0.0000
Off-Road	1.3400e-003	0.0305	0.0412	7.0000e-005		2.1400e-003	2.1400e-003		2.1400e-003	2.1400e-003			5.7448	3.9000e-004	0.0000	5.7547
Total	0.2855	0.0305	0.0412	7.0000e-005		2.1400e-003	2.1400e-003		2.1400e-003	2.1400e-003			5.7448	3.9000e-004	0.0000	5.7547

Santa Maria Airport Commercial Rezone - Year 2030 - Santa Barbara-North of Santa Ynez County, Annual

3.5 Architectural Coating - 2021

Mitigated Construction Off-Site

	ROG	NOx	CO	SO2	Fugitive PM10	Exhaust PM10	PM10 Total	Fugitive PM2.5	Exhaust PM2.5	PM2.5 Total	Bio- CO2	NBio- CO2	Total CO2	CH4	N2O	CO2e
Category	tons/yr										MT/yr					
Hauling	0.0000	0.0000	0.0000	0.0000	0.0000	0.0000	0.0000	0.0000	0.0000	0.0000			0.0000	0.0000	0.0000	0.0000
Vendor	0.0000	0.0000	0.0000	0.0000	0.0000	0.0000	0.0000	0.0000	0.0000	0.0000			0.0000	0.0000	0.0000	0.0000
Worker	2.7500e-003	2.2300e-003	0.0198	5.0000e-005	5.7000e-003	4.0000e-005	5.7300e-003	1.5100e-003	3.0000e-005	1.5500e-003			4.4954	1.4000e-004	0.0000	4.4989
Total	2.7500e-003	2.2300e-003	0.0198	5.0000e-005	5.7000e-003	4.0000e-005	5.7300e-003	1.5100e-003	3.0000e-005	1.5500e-003			4.4954	1.4000e-004	0.0000	4.4989

3.5 Architectural Coating - 2022

Unmitigated Construction On-Site

	ROG	NOx	CO	SO2	Fugitive PM10	Exhaust PM10	PM10 Total	Fugitive PM2.5	Exhaust PM2.5	PM2.5 Total	Bio- CO2	NBio- CO2	Total CO2	CH4	N2O	CO2e
Category	tons/yr										MT/yr					
Archit. Coating	1.6417					0.0000	0.0000		0.0000	0.0000			0.0000	0.0000	0.0000	0.0000
Off-Road	0.0266	0.1831	0.2358	3.9000e-004		0.0106	0.0106		0.0106	0.0106			33.1923	2.1600e-003	0.0000	33.2463
Total	1.6683	0.1831	0.2358	3.9000e-004		0.0106	0.0106		0.0106	0.0106			33.1923	2.1600e-003	0.0000	33.2463

Santa Maria Airport Commercial Rezone - Year 2030 - Santa Barbara-North of Santa Ynez County, Annual

3.5 Architectural Coating - 2022

Unmitigated Construction Off-Site

	ROG	NOx	CO	SO2	Fugitive PM10	Exhaust PM10	PM10 Total	Fugitive PM2.5	Exhaust PM2.5	PM2.5 Total	Bio- CO2	NBio- CO2	Total CO2	CH4	N2O	CO2e
Category	tons/yr										MT/yr					
Hauling	0.0000	0.0000	0.0000	0.0000	0.0000	0.0000	0.0000	0.0000	0.0000	0.0000			0.0000	0.0000	0.0000	0.0000
Vendor	0.0000	0.0000	0.0000	0.0000	0.0000	0.0000	0.0000	0.0000	0.0000	0.0000			0.0000	0.0000	0.0000	0.0000
Worker	0.0148	0.0115	0.1041	2.8000e-004	0.0329	2.0000e-004	0.0331	8.7500e-003	1.9000e-004	8.9300e-003			25.0472	7.2000e-004	0.0000	25.0652
Total	0.0148	0.0115	0.1041	2.8000e-004	0.0329	2.0000e-004	0.0331	8.7500e-003	1.9000e-004	8.9300e-003			25.0472	7.2000e-004	0.0000	25.0652

Mitigated Construction On-Site

	ROG	NOx	CO	SO2	Fugitive PM10	Exhaust PM10	PM10 Total	Fugitive PM2.5	Exhaust PM2.5	PM2.5 Total	Bio- CO2	NBio- CO2	Total CO2	CH4	N2O	CO2e
Category	tons/yr										MT/yr					
Archit. Coating	1.6417					0.0000	0.0000		0.0000	0.0000			0.0000	0.0000	0.0000	0.0000
Off-Road	7.7300e-003	0.1764	0.2382	3.9000e-004		0.0124	0.0124		0.0124	0.0124			33.1923	2.1600e-003	0.0000	33.2463
Total	1.6494	0.1764	0.2382	3.9000e-004		0.0124	0.0124		0.0124	0.0124			33.1923	2.1600e-003	0.0000	33.2463

Santa Maria Airport Commercial Rezone - Year 2030 - Santa Barbara-North of Santa Ynez County, Annual

3.5 Architectural Coating - 2022

Mitigated Construction Off-Site

	ROG	NOx	CO	SO2	Fugitive PM10	Exhaust PM10	PM10 Total	Fugitive PM2.5	Exhaust PM2.5	PM2.5 Total	Bio- CO2	NBio- CO2	Total CO2	CH4	N2O	CO2e
Category	tons/yr										MT/yr					
Hauling	0.0000	0.0000	0.0000	0.0000	0.0000	0.0000	0.0000	0.0000	0.0000	0.0000			0.0000	0.0000	0.0000	0.0000
Vendor	0.0000	0.0000	0.0000	0.0000	0.0000	0.0000	0.0000	0.0000	0.0000	0.0000			0.0000	0.0000	0.0000	0.0000
Worker	0.0148	0.0115	0.1041	2.8000e-004	0.0329	2.0000e-004	0.0331	8.7500e-003	1.9000e-004	8.9300e-003			25.0472	7.2000e-004	0.0000	25.0652
Total	0.0148	0.0115	0.1041	2.8000e-004	0.0329	2.0000e-004	0.0331	8.7500e-003	1.9000e-004	8.9300e-003			25.0472	7.2000e-004	0.0000	25.0652

3.5 Architectural Coating - 2023

Unmitigated Construction On-Site

	ROG	NOx	CO	SO2	Fugitive PM10	Exhaust PM10	PM10 Total	Fugitive PM2.5	Exhaust PM2.5	PM2.5 Total	Bio- CO2	NBio- CO2	Total CO2	CH4	N2O	CO2e
Category	tons/yr										MT/yr					
Archit. Coating	1.2313					0.0000	0.0000		0.0000	0.0000			0.0000	0.0000	0.0000	0.0000
Off-Road	0.0187	0.1270	0.1766	2.9000e-004		6.9000e-003	6.9000e-003		6.9000e-003	6.9000e-003			24.8942	1.4900e-003	0.0000	24.9315
Total	1.2500	0.1270	0.1766	2.9000e-004		6.9000e-003	6.9000e-003		6.9000e-003	6.9000e-003			24.8942	1.4900e-003	0.0000	24.9315

Santa Maria Airport Commercial Rezone - Year 2030 - Santa Barbara-North of Santa Ynez County, Annual

3.5 Architectural Coating - 2023

Unmitigated Construction Off-Site

	ROG	NOx	CO	SO2	Fugitive PM10	Exhaust PM10	PM10 Total	Fugitive PM2.5	Exhaust PM2.5	PM2.5 Total	Bio- CO2	NBio- CO2	Total CO2	CH4	N2O	CO2e
Category	tons/yr										MT/yr					
Hauling	0.0000	0.0000	0.0000	0.0000	0.0000	0.0000	0.0000	0.0000	0.0000	0.0000			0.0000	0.0000	0.0000	0.0000
Vendor	0.0000	0.0000	0.0000	0.0000	0.0000	0.0000	0.0000	0.0000	0.0000	0.0000			0.0000	0.0000	0.0000	0.0000
Worker	0.0104	7.7300e-003	0.0712	2.0000e-004	0.0247	1.5000e-004	0.0248	6.5600e-003	1.4000e-004	6.7000e-003			18.0834	4.8000e-004	0.0000	18.0955
Total	0.0104	7.7300e-003	0.0712	2.0000e-004	0.0247	1.5000e-004	0.0248	6.5600e-003	1.4000e-004	6.7000e-003			18.0834	4.8000e-004	0.0000	18.0955

Mitigated Construction On-Site

	ROG	NOx	CO	SO2	Fugitive PM10	Exhaust PM10	PM10 Total	Fugitive PM2.5	Exhaust PM2.5	PM2.5 Total	Bio- CO2	NBio- CO2	Total CO2	CH4	N2O	CO2e
Category	tons/yr										MT/yr					
Archit. Coating	1.2313					0.0000	0.0000		0.0000	0.0000			0.0000	0.0000	0.0000	0.0000
Off-Road	5.7900e-003	0.1323	0.1787	2.9000e-004		9.2700e-003	9.2700e-003		9.2700e-003	9.2700e-003			24.8942	1.4900e-003	0.0000	24.9314
Total	1.2371	0.1323	0.1787	2.9000e-004		9.2700e-003	9.2700e-003		9.2700e-003	9.2700e-003			24.8942	1.4900e-003	0.0000	24.9314

Santa Maria Airport Commercial Rezone - Year 2030 - Santa Barbara-North of Santa Ynez County, Annual

3.5 Architectural Coating - 2023

Mitigated Construction Off-Site

	ROG	NOx	CO	SO2	Fugitive PM10	Exhaust PM10	PM10 Total	Fugitive PM2.5	Exhaust PM2.5	PM2.5 Total	Bio- CO2	NBio- CO2	Total CO2	CH4	N2O	CO2e
Category	tons/yr										MT/yr					
Hauling	0.0000	0.0000	0.0000	0.0000	0.0000	0.0000	0.0000	0.0000	0.0000	0.0000			0.0000	0.0000	0.0000	0.0000
Vendor	0.0000	0.0000	0.0000	0.0000	0.0000	0.0000	0.0000	0.0000	0.0000	0.0000			0.0000	0.0000	0.0000	0.0000
Worker	0.0104	7.7300e-003	0.0712	2.0000e-004	0.0247	1.5000e-004	0.0248	6.5600e-003	1.4000e-004	6.7000e-003			18.0834	4.8000e-004	0.0000	18.0955
Total	0.0104	7.7300e-003	0.0712	2.0000e-004	0.0247	1.5000e-004	0.0248	6.5600e-003	1.4000e-004	6.7000e-003			18.0834	4.8000e-004	0.0000	18.0955

3.6 Paving - 2023

Unmitigated Construction On-Site

	ROG	NOx	CO	SO2	Fugitive PM10	Exhaust PM10	PM10 Total	Fugitive PM2.5	Exhaust PM2.5	PM2.5 Total	Bio- CO2	NBio- CO2	Total CO2	CH4	N2O	CO2e
Category	tons/yr										MT/yr					
Off-Road	0.0142	0.1486	0.1522	2.7000e-004		6.7300e-003	6.7300e-003		6.2000e-003	6.2000e-003			23.6209	7.5400e-003	0.0000	23.8094
Paving	0.0131					0.0000	0.0000		0.0000	0.0000			0.0000	0.0000	0.0000	0.0000
Total	0.0273	0.1486	0.1522	2.7000e-004		6.7300e-003	6.7300e-003		6.2000e-003	6.2000e-003			23.6209	7.5400e-003	0.0000	23.8094

Santa Maria Airport Commercial Rezone - Year 2030 - Santa Barbara-North of Santa Ynez County, Annual

3.6 Paving - 2023

Unmitigated Construction Off-Site

	ROG	NOx	CO	SO2	Fugitive PM10	Exhaust PM10	PM10 Total	Fugitive PM2.5	Exhaust PM2.5	PM2.5 Total	Bio- CO2	NBio- CO2	Total CO2	CH4	N2O	CO2e
Category	tons/yr										MT/yr					
Hauling	0.0000	0.0000	0.0000	0.0000	0.0000	0.0000	0.0000	0.0000	0.0000	0.0000			0.0000	0.0000	0.0000	0.0000
Vendor	0.0000	0.0000	0.0000	0.0000	0.0000	0.0000	0.0000	0.0000	0.0000	0.0000			0.0000	0.0000	0.0000	0.0000
Worker	6.5000e-004	4.8000e-004	4.4500e-003	1.0000e-005	1.5400e-003	1.0000e-005	1.5500e-003	4.1000e-004	1.0000e-005	4.2000e-004			1.1309	3.0000e-005	0.0000	1.1317
Total	6.5000e-004	4.8000e-004	4.4500e-003	1.0000e-005	1.5400e-003	1.0000e-005	1.5500e-003	4.1000e-004	1.0000e-005	4.2000e-004			1.1309	3.0000e-005	0.0000	1.1317

Mitigated Construction On-Site

	ROG	NOx	CO	SO2	Fugitive PM10	Exhaust PM10	PM10 Total	Fugitive PM2.5	Exhaust PM2.5	PM2.5 Total	Bio- CO2	NBio- CO2	Total CO2	CH4	N2O	CO2e
Category	tons/yr										MT/yr					
Off-Road	6.4700e-003	0.1346	0.1847	2.7000e-004		7.5100e-003	7.5100e-003		7.5100e-003	7.5100e-003			23.6208	7.5400e-003	0.0000	23.8094
Paving	0.0131					0.0000	0.0000		0.0000	0.0000			0.0000	0.0000	0.0000	0.0000
Total	0.0196	0.1346	0.1847	2.7000e-004		7.5100e-003	7.5100e-003		7.5100e-003	7.5100e-003			23.6208	7.5400e-003	0.0000	23.8094

Santa Maria Airport Commercial Rezone - Year 2030 - Santa Barbara-North of Santa Ynez County, Annual

3.6 Paving - 2023

Mitigated Construction Off-Site

	ROG	NOx	CO	SO2	Fugitive PM10	Exhaust PM10	PM10 Total	Fugitive PM2.5	Exhaust PM2.5	PM2.5 Total	Bio- CO2	NBio- CO2	Total CO2	CH4	N2O	CO2e
Category	tons/yr										MT/yr					
Hauling	0.0000	0.0000	0.0000	0.0000	0.0000	0.0000	0.0000	0.0000	0.0000	0.0000			0.0000	0.0000	0.0000	0.0000
Vendor	0.0000	0.0000	0.0000	0.0000	0.0000	0.0000	0.0000	0.0000	0.0000	0.0000			0.0000	0.0000	0.0000	0.0000
Worker	6.5000e-004	4.8000e-004	4.4500e-003	1.0000e-005	1.5400e-003	1.0000e-005	1.5500e-003	4.1000e-004	1.0000e-005	4.2000e-004			1.1309	3.0000e-005	0.0000	1.1317
Total	6.5000e-004	4.8000e-004	4.4500e-003	1.0000e-005	1.5400e-003	1.0000e-005	1.5500e-003	4.1000e-004	1.0000e-005	4.2000e-004			1.1309	3.0000e-005	0.0000	1.1317

4.0 Operational Detail - Mobile

4.1 Mitigation Measures Mobile

Increase Transit Accessibility

Improve Pedestrian Network

Santa Maria Airport Commercial Rezone - Year 2030 - Santa Barbara-North of Santa Ynez County, Annual

	ROG	NOx	CO	SO2	Fugitive PM10	Exhaust PM10	PM10 Total	Fugitive PM2.5	Exhaust PM2.5	PM2.5 Total	Bio- CO2	NBio- CO2	Total CO2	CH4	N2O	CO2e
Category	tons/yr										MT/yr					
Mitigated	1.8396	6.8677	13.1700	0.0368	3.8545	0.0290	3.8835	1.0335	0.0269	1.0605			3,430.8180	0.1989	0.0000	3,435.7893
Unmitigated	1.8451	6.9004	13.3012	0.0374	3.9332	0.0294	3.9625	1.0546	0.0273	1.0819			3,488.4853	0.2010	0.0000	3,493.5098

4.2 Trip Summary Information

Land Use	Average Daily Trip Rate			Unmitigated	Mitigated
	Weekday	Saturday	Sunday	Annual VMT	Annual VMT
Convenience Market With Gas Pumps	3,838.77	6,574.99	5366.29	1,875,418	1,837,910
Free-Standing Discount Store	160.00	198.72	157.44	197,777	193,821
General Office Building	394.40	88.00	37.60	538,482	527,712
Government Office Building	451.06	0.00	0.00	407,203	399,059
High Turnover (Sit Down Restaurant)	4,059.33	5,056.04	4209.15	3,787,838	3,712,081
Medical Office Building	615.60	152.60	26.40	687,229	673,485
Parking Lot	0.00	0.00	0.00		
Strip Mall	2,410.20	2,286.36	1110.96	2,598,299	2,546,333
Unrefrigerated Warehouse-No Rail	137.00	137.00	137.00	303,249	297,184
Other Asphalt Surfaces	0.00	0.00	0.00		
Other Non-Asphalt Surfaces	0.00	0.00	0.00		
Total	12,066.36	14,493.71	11,044.84	10,395,494	10,187,584

4.3 Trip Type Information

Santa Maria Airport Commercial Rezone - Year 2030 - Santa Barbara-North of Santa Ynez County, Annual

Land Use	Miles			Trip %			Trip Purpose %		
	H-W or C-W	H-S or C-C	H-O or C-NW	H-W or C-W	H-S or C-C	H-O or C-NW	Primary	Diverted	Pass-by
Convenience Market With Gas	6.60	5.50	6.40	0.80	80.20	19.00	14	21	65
Free-Standing Discount Store	6.60	5.50	6.40	12.20	68.80	19.00	47.5	35.5	17
General Office Building	6.60	5.50	6.40	33.00	48.00	19.00	77	19	4
Government Office Building	6.60	5.50	6.40	33.00	62.00	5.00	50	34	16
High Turnover (Sit Down	6.60	5.50	6.40	8.50	72.50	19.00	37	20	43
Medical Office Building	6.60	5.50	6.40	29.60	51.40	19.00	60	30	10
Parking Lot	6.60	5.50	6.40	0.00	0.00	0.00	0	0	0
Strip Mall	6.60	5.50	6.40	16.60	64.40	19.00	45	40	15
Unrefrigerated Warehouse-No	6.60	5.50	6.40	59.00	0.00	41.00	92	5	3
Other Asphalt Surfaces	6.60	5.50	6.40	0.00	0.00	0.00	0	0	0
Other Non-Asphalt Surfaces	6.60	5.50	6.40	0.00	0.00	0.00	0	0	0

4.4 Fleet Mix

Land Use	LDA	LDT1	LDT2	MDV	LHD1	LHD2	MHD	HHD	OBUS	UBUS	MCY	SBUS	MH
Convenience Market With Gas Pumps	0.586995	0.024930	0.209264	0.108263	0.013258	0.004355	0.018072	0.021482	0.002798	0.001725	0.005977	0.002241	0.000641
Free-Standing Discount Store	0.586995	0.024930	0.209264	0.108263	0.013258	0.004355	0.018072	0.021482	0.002798	0.001725	0.005977	0.002241	0.000641
General Office Building	0.586995	0.024930	0.209264	0.108263	0.013258	0.004355	0.018072	0.021482	0.002798	0.001725	0.005977	0.002241	0.000641
Government Office Building	0.586995	0.024930	0.209264	0.108263	0.013258	0.004355	0.018072	0.021482	0.002798	0.001725	0.005977	0.002241	0.000641
High Turnover (Sit Down Restaurant)	0.586995	0.024930	0.209264	0.108263	0.013258	0.004355	0.018072	0.021482	0.002798	0.001725	0.005977	0.002241	0.000641
Medical Office Building	0.586995	0.024930	0.209264	0.108263	0.013258	0.004355	0.018072	0.021482	0.002798	0.001725	0.005977	0.002241	0.000641
Parking Lot	0.586995	0.024930	0.209264	0.108263	0.013258	0.004355	0.018072	0.021482	0.002798	0.001725	0.005977	0.002241	0.000641
Strip Mall	0.586995	0.024930	0.209264	0.108263	0.013258	0.004355	0.018072	0.021482	0.002798	0.001725	0.005977	0.002241	0.000641
Unrefrigerated Warehouse-No Rail	0.586995	0.024930	0.209264	0.108263	0.013258	0.004355	0.018072	0.021482	0.002798	0.001725	0.005977	0.002241	0.000641
Other Asphalt Surfaces	0.586995	0.024930	0.209264	0.108263	0.013258	0.004355	0.018072	0.021482	0.002798	0.001725	0.005977	0.002241	0.000641
Other Non-Asphalt Surfaces	0.586995	0.024930	0.209264	0.108263	0.013258	0.004355	0.018072	0.021482	0.002798	0.001725	0.005977	0.002241	0.000641

5.0 Energy Detail

Santa Maria Airport Commercial Rezone - Year 2030 - Santa Barbara-North of Santa Ynez County, Annual

Historical Energy Use: N

5.1 Mitigation Measures Energy

	ROG	NOx	CO	SO2	Fugitive PM10	Exhaust PM10	PM10 Total	Fugitive PM2.5	Exhaust PM2.5	PM2.5 Total	Bio- CO2	NBio- CO2	Total CO2	CH4	N2O	CO2e
Category	tons/yr										MT/yr					
Electricity Mitigated						0.0000	0.0000		0.0000	0.0000			410.3645	0.0179	4.1300e-003	412.0415
Electricity Unmitigated						0.0000	0.0000		0.0000	0.0000			410.3645	0.0179	4.1300e-003	412.0415
NaturalGas Mitigated	0.0224	0.2033	0.1708	1.2200e-003		0.0155	0.0155		0.0155	0.0155			221.2930	4.2400e-003	4.0600e-003	222.6081
NaturalGas Unmitigated	0.0224	0.2033	0.1708	1.2200e-003		0.0155	0.0155		0.0155	0.0155			221.2930	4.2400e-003	4.0600e-003	222.6081

Santa Maria Airport Commercial Rezone - Year 2030 - Santa Barbara-North of Santa Ynez County, Annual

5.2 Energy by Land Use - NaturalGas

Unmitigated

	NaturalGas Use	ROG	NOx	CO	SO2	Fugitive PM10	Exhaust PM10	PM10 Total	Fugitive PM2.5	Exhaust PM2.5	PM2.5 Total	Bio- CO2	NBio- CO2	Total CO2	CH4	N2O	CO2e
Land Use	kBTU/yr	tons/yr										MT/yr					
Convenience Market With Gas Pumps	8058	4.0000e-005	3.9000e-004	3.3000e-004	0.0000		3.0000e-005	3.0000e-005		3.0000e-005	3.0000e-005			0.4300	1.0000e-005	1.0000e-005	0.4326
Free-Standing Discount Store	75840	4.1000e-004	3.7200e-003	3.1200e-003	2.0000e-005		2.8000e-004	2.8000e-004		2.8000e-004	2.8000e-004			4.0471	8.0000e-005	7.0000e-005	4.0712
General Office Building	654800	3.5300e-003	0.0321	0.0270	1.9000e-004		2.4400e-003	2.4400e-003		2.4400e-003	2.4400e-003			34.9426	6.7000e-004	6.4000e-004	35.1503
Government Office Building	361777	1.9500e-003	0.0177	0.0149	1.1000e-004		1.3500e-003	1.3500e-003		1.3500e-003	1.3500e-003			19.3058	3.7000e-004	3.5000e-004	19.4205
High Turnover (Sit Down Restaurant)	2.28668e+006	0.0123	0.1121	0.0942	6.7000e-004		8.5200e-003	8.5200e-003		8.5200e-003	8.5200e-003			122.0260	2.3400e-003	2.2400e-003	122.7511
Medical Office Building	327400	1.7700e-003	0.0161	0.0135	1.0000e-004		1.2200e-003	1.2200e-003		1.2200e-003	1.2200e-003			17.4713	3.3000e-004	3.2000e-004	17.5751
Other Asphalt Surfaces	0	0.0000	0.0000	0.0000	0.0000		0.0000	0.0000		0.0000	0.0000			0.0000	0.0000	0.0000	0.0000
Other Non-Asphalt Surfaces	0	0.0000	0.0000	0.0000	0.0000		0.0000	0.0000		0.0000	0.0000			0.0000	0.0000	0.0000	0.0000
Parking Lot	0	0.0000	0.0000	0.0000	0.0000		0.0000	0.0000		0.0000	0.0000			0.0000	0.0000	0.0000	0.0000
Strip Mall	85320	4.6000e-004	4.1800e-003	3.5100e-003	3.0000e-005		3.2000e-004	3.2000e-004		3.2000e-004	3.2000e-004			4.5530	9.0000e-005	8.0000e-005	4.5801
Unrefrigerated Warehouse-No Rail	347000	1.8700e-003	0.0170	0.0143	1.0000e-004		1.2900e-003	1.2900e-003		1.2900e-003	1.2900e-003			18.5172	3.5000e-004	3.4000e-004	18.6273
Total		0.0224	0.2033	0.1708	1.2200e-003		0.0155	0.0155		0.0155	0.0155			221.2930	4.2400e-003	4.0500e-003	222.6081

Santa Maria Airport Commercial Rezone - Year 2030 - Santa Barbara-North of Santa Ynez County, Annual

5.2 Energy by Land Use - NaturalGas

Mitigated

	NaturalGas Use	ROG	NOx	CO	SO2	Fugitive PM10	Exhaust PM10	PM10 Total	Fugitive PM2.5	Exhaust PM2.5	PM2.5 Total	Bio- CO2	NBio- CO2	Total CO2	CH4	N2O	CO2e
Land Use	kBTU/yr	tons/yr										MT/yr					
Convenience Market With Gas Pumps	8058	4.0000e-005	3.9000e-004	3.3000e-004	0.0000		3.0000e-005	3.0000e-005		3.0000e-005	3.0000e-005			0.4300	1.0000e-005	1.0000e-005	0.4326
Free-Standing Discount Store	75840	4.1000e-004	3.7200e-003	3.1200e-003	2.0000e-005		2.8000e-004	2.8000e-004		2.8000e-004	2.8000e-004			4.0471	8.0000e-005	7.0000e-005	4.0712
General Office Building	654800	3.5300e-003	0.0321	0.0270	1.9000e-004		2.4400e-003	2.4400e-003		2.4400e-003	2.4400e-003			34.9426	6.7000e-004	6.4000e-004	35.1503
Government Office Building	361777	1.9500e-003	0.0177	0.0149	1.1000e-004		1.3500e-003	1.3500e-003		1.3500e-003	1.3500e-003			19.3058	3.7000e-004	3.5000e-004	19.4205
High Turnover (Sit Down Restaurant)	2.28668e+006	0.0123	0.1121	0.0942	6.7000e-004		8.5200e-003	8.5200e-003		8.5200e-003	8.5200e-003			122.0260	2.3400e-003	2.2400e-003	122.7511
Medical Office Building	327400	1.7700e-003	0.0161	0.0135	1.0000e-004		1.2200e-003	1.2200e-003		1.2200e-003	1.2200e-003			17.4713	3.3000e-004	3.2000e-004	17.5751
Other Asphalt Surfaces	0	0.0000	0.0000	0.0000	0.0000		0.0000	0.0000		0.0000	0.0000			0.0000	0.0000	0.0000	0.0000
Other Non-Asphalt Surfaces	0	0.0000	0.0000	0.0000	0.0000		0.0000	0.0000		0.0000	0.0000			0.0000	0.0000	0.0000	0.0000
Parking Lot	0	0.0000	0.0000	0.0000	0.0000		0.0000	0.0000		0.0000	0.0000			0.0000	0.0000	0.0000	0.0000
Strip Mall	85320	4.6000e-004	4.1800e-003	3.5100e-003	3.0000e-005		3.2000e-004	3.2000e-004		3.2000e-004	3.2000e-004			4.5530	9.0000e-005	8.0000e-005	4.5801
Unrefrigerated Warehouse-No Rail	347000	1.8700e-003	0.0170	0.0143	1.0000e-004		1.2900e-003	1.2900e-003		1.2900e-003	1.2900e-003			18.5172	3.5000e-004	3.4000e-004	18.6273
Total		0.0224	0.2033	0.1708	1.2200e-003		0.0155	0.0155		0.0155	0.0155			221.2930	4.2400e-003	4.0500e-003	222.6081

Santa Maria Airport Commercial Rezone - Year 2030 - Santa Barbara-North of Santa Ynez County, Annual

5.3 Energy by Land Use - Electricity

Unmitigated

Land Use	Electricity Use kWh/yr	Total CO2 MT/yr	CH4 MT/yr	N2O MT/yr	CO2e MT/yr
Convenience Market With Gas Pumps	36346	4.9179	2.1000e-004	5.0000e-005	4.9380
Free-Standing Discount Store	342080	46.2857	2.0200e-003	4.7000e-004	46.4748
General Office Building	713200	96.5007	4.2100e-003	9.7000e-004	96.8950
Government Office Building	394043	53.3166	2.3200e-003	5.4000e-004	53.5345
High Turnover (Sit Down Restaurant)	359920	48.6996	2.1200e-003	4.9000e-004	48.8986
Medical Office Building	356600	48.2503	2.1000e-003	4.9000e-004	48.4475
Other Asphalt Surfaces	0	0.0000	0.0000	0.0000	0.0000
Other Non-Asphalt Surfaces	0	0.0000	0.0000	0.0000	0.0000
Parking Lot	92820	12.5592	5.5000e-004	1.3000e-004	12.6105
Strip Mall	384840	52.0714	2.2700e-003	5.2000e-004	52.2842
Unrefrigerated Warehouse-No Rail	353000	47.7632	2.0800e-003	4.8000e-004	47.9584
Total		410.3645	0.0179	4.1400e-003	412.0415

Santa Maria Airport Commercial Rezone - Year 2030 - Santa Barbara-North of Santa Ynez County, Annual

5.3 Energy by Land Use - Electricity

Mitigated

	Electricity Use	Total CO2	CH4	N2O	CO2e
Land Use	kWh/yr	MT/yr			
Convenience Market With Gas Pumps	36346	4.9179	2.1000e-004	5.0000e-005	4.9380
Free-Standing Discount Store	342080	46.2857	2.0200e-003	4.7000e-004	46.4748
General Office Building	713200	96.5007	4.2100e-003	9.7000e-004	96.8950
Government Office Building	394043	53.3166	2.3200e-003	5.4000e-004	53.5345
High Turnover (Sit Down Restaurant)	359920	48.6996	2.1200e-003	4.9000e-004	48.8986
Medical Office Building	356600	48.2503	2.1000e-003	4.9000e-004	48.4475
Other Asphalt Surfaces	0	0.0000	0.0000	0.0000	0.0000
Other Non-Asphalt Surfaces	0	0.0000	0.0000	0.0000	0.0000
Parking Lot	92820	12.5592	5.5000e-004	1.3000e-004	12.6105
Strip Mall	384840	52.0714	2.2700e-003	5.2000e-004	52.2842
Unrefrigerated Warehouse-No Rail	353000	47.7632	2.0800e-003	4.8000e-004	47.9584
Total		410.3645	0.0179	4.1400e-003	412.0415

6.0 Area Detail

6.1 Mitigation Measures Area

Santa Maria Airport Commercial Rezone - Year 2030 - Santa Barbara-North of Santa Ynez County, Annual

	ROG	NOx	CO	SO2	Fugitive PM10	Exhaust PM10	PM10 Total	Fugitive PM2.5	Exhaust PM2.5	PM2.5 Total	Bio- CO2	NBio- CO2	Total CO2	CH4	N2O	CO2e
Category	tons/yr										MT/yr					
Mitigated	1.3775	8.0000e-005	8.5000e-003	0.0000		3.0000e-005	3.0000e-005		3.0000e-005	3.0000e-005			0.0166	4.0000e-005	0.0000	0.0177
Unmitigated	1.3775	8.0000e-005	8.5000e-003	0.0000		3.0000e-005	3.0000e-005		3.0000e-005	3.0000e-005			0.0166	4.0000e-005	0.0000	0.0177

6.2 Area by SubCategory

Unmitigated

	ROG	NOx	CO	SO2	Fugitive PM10	Exhaust PM10	PM10 Total	Fugitive PM2.5	Exhaust PM2.5	PM2.5 Total	Bio- CO2	NBio- CO2	Total CO2	CH4	N2O	CO2e
SubCategory	tons/yr										MT/yr					
Architectural Coating	0.3195					0.0000	0.0000		0.0000	0.0000			0.0000	0.0000	0.0000	0.0000
Consumer Products	1.0572					0.0000	0.0000		0.0000	0.0000			0.0000	0.0000	0.0000	0.0000
Landscaping	7.8000e-004	8.0000e-005	8.5000e-003	0.0000		3.0000e-005	3.0000e-005		3.0000e-005	3.0000e-005			0.0166	4.0000e-005	0.0000	0.0177
Total	1.3775	8.0000e-005	8.5000e-003	0.0000		3.0000e-005	3.0000e-005		3.0000e-005	3.0000e-005			0.0166	4.0000e-005	0.0000	0.0177

Santa Maria Airport Commercial Rezone - Year 2030 - Santa Barbara-North of Santa Ynez County, Annual

6.2 Area by SubCategory

Mitigated

	ROG	NOx	CO	SO2	Fugitive PM10	Exhaust PM10	PM10 Total	Fugitive PM2.5	Exhaust PM2.5	PM2.5 Total	Bio- CO2	NBio- CO2	Total CO2	CH4	N2O	CO2e
SubCategory	tons/yr										MT/yr					
Architectural Coating	0.3195					0.0000	0.0000		0.0000	0.0000			0.0000	0.0000	0.0000	0.0000
Consumer Products	1.0572					0.0000	0.0000		0.0000	0.0000			0.0000	0.0000	0.0000	0.0000
Landscaping	7.8000e-004	8.0000e-005	8.5000e-003	0.0000		3.0000e-005	3.0000e-005		3.0000e-005	3.0000e-005			0.0166	4.0000e-005	0.0000	0.0177
Total	1.3775	8.0000e-005	8.5000e-003	0.0000		3.0000e-005	3.0000e-005		3.0000e-005	3.0000e-005			0.0166	4.0000e-005	0.0000	0.0177

7.0 Water Detail

7.1 Mitigation Measures Water

Install Low Flow Bathroom Faucet

Install Low Flow Kitchen Faucet

Install Low Flow Toilet

Install Low Flow Shower

Use Water Efficient Irrigation System

Santa Maria Airport Commercial Rezone - Year 2030 - Santa Barbara-North of Santa Ynez County, Annual

	Total CO2	CH4	N2O	CO2e
Category	MT/yr			
Mitigated	44.6391	0.0460	0.0285	54.2770
Unmitigated	54.8953	0.0574	0.0356	66.9390

Santa Maria Airport Commercial Rezone - Year 2030 - Santa Barbara-North of Santa Ynez County, Annual

7.2 Water by Land Use

Unmitigated

	Indoor/Outdoor Use	Total CO2	CH4	N2O	CO2e
Land Use	Mgal	MT/yr			
Convenience Market With Gas Pumps	0.251847 / 0.154358	0.3466	3.2000e-004	2.0000e-004	0.4131
Free-Standing Discount Store	2.37032 / 1.45278	3.2620	2.9900e-003	1.8500e-003	3.8876
General Office Building	7.10935 / 4.35734	9.7839	8.9700e-003	5.5400e-003	11.6601
Government Office Building	4.39038 / 2.69088	6.0420	5.5400e-003	3.4200e-003	7.2007
High Turnover (Sit Down Restaurant)	3.33887 / 0.213119	3.7268	4.1800e-003	2.5900e-003	4.6044
Medical Office Building	2.50961 / 0.478021	2.9517	3.1500e-003	1.9500e-003	3.6119
Other Asphalt Surfaces	0 / 0	0.0000	0.0000	0.0000	0.0000
Other Non-Asphalt Surfaces	0 / 0	0.0000	0.0000	0.0000	0.0000
Parking Lot	0 / 0	0.0000	0.0000	0.0000	0.0000
Strip Mall	2.66661 / 1.63437	3.6698	3.3700e-003	2.0800e-003	4.3735
Unrefrigerated Warehouse-No Rail	23.125 / 0	25.1125	0.0289	0.0180	31.1878
Total		54.8953	0.0574	0.0356	66.9390

Santa Maria Airport Commercial Rezone - Year 2030 - Santa Barbara-North of Santa Ynez County, Annual

7.2 Water by Land Use

Mitigated

	Indoor/Outdoor Use	Total CO2	CH4	N2O	CO2e
Land Use	Mgal	MT/yr			
Convenience Market With Gas Pumps	0.201477 / 0.144942	0.2874	2.5000e-004	1.6000e-004	0.3407
Free-Standing Discount Store	1.89626 / 1.36416	2.7053	2.4000e-003	1.4800e-003	3.2061
General Office Building	5.68748 / 4.09155	8.1139	7.1900e-003	4.4400e-003	9.6161
Government Office Building	3.5123 / 2.52673	5.0108	4.4400e-003	2.7400e-003	5.9384
High Turnover (Sit Down Restaurant)	2.6711 / 0.200119	2.9954	3.3400e-003	2.0800e-003	3.6976
Medical Office Building	2.00769 / 0.448862	2.3928	2.5200e-003	1.5600e-003	2.9211
Other Asphalt Surfaces	0 / 0	0.0000	0.0000	0.0000	0.0000
Other Non-Asphalt Surfaces	0 / 0	0.0000	0.0000	0.0000	0.0000
Parking Lot	0 / 0	0.0000	0.0000	0.0000	0.0000
Strip Mall	2.13329 / 1.53468	3.0434	2.7000e-003	1.6600e-003	3.6068
Unrefrigerated Warehouse-No Rail	18.5 / 0	20.0900	0.0231	0.0144	24.9503
Total		44.6391	0.0460	0.0285	54.2770

8.0 Waste Detail

8.1 Mitigation Measures Waste

Santa Maria Airport Commercial Rezone - Year 2030 - Santa Barbara-North of Santa Ynez County, Annual

Institute Recycling and Composting Services

Category/Year

	Total CO2	CH4	N2O	CO2e
	MT/yr			
Mitigated	35.5255	1.7616	0.0000	79.5654
Unmitigated	142.1020	7.0464	0.0000	318.2615

Santa Maria Airport Commercial Rezone - Year 2030 - Santa Barbara-North of Santa Ynez County, Annual

8.2 Waste by Land Use

Unmitigated

	Waste Disposed	Total CO2	CH4	N2O	CO2e
Land Use	tons	MT/yr			
Convenience Market With Gas Pumps	10.22	2.1223	0.1052	0.0000	4.7533
Free-Standing Discount Store	137.62	28.5786	1.4171	0.0000	64.0067
General Office Building	37.2	7.7251	0.3831	0.0000	17.3016
Government Office Building	20.55	4.2675	0.2116	0.0000	9.5578
High Turnover (Sit Down Restaurant)	130.9	27.1831	1.3479	0.0000	60.8812
Medical Office Building	216	44.8553	2.2242	0.0000	100.4610
Other Asphalt Surfaces	0	0.0000	0.0000	0.0000	0.0000
Other Non-Asphalt Surfaces	0	0.0000	0.0000	0.0000	0.0000
Parking Lot	0	0.0000	0.0000	0.0000	0.0000
Strip Mall	37.8	7.8497	0.3892	0.0000	17.5807
Unrefrigerated Warehouse-No Rail	94	19.5204	0.9680	0.0000	43.7192
Total		142.1020	7.0464	0.0000	318.2615

Santa Maria Airport Commercial Rezone - Year 2030 - Santa Barbara-North of Santa Ynez County, Annual

8.2 Waste by Land Use

Mitigated

	Waste Disposed	Total CO2	CH4	N2O	CO2e
Land Use	tons	MT/yr			
Convenience Market With Gas Pumps	2.555	0.5306	0.0263	0.0000	1.1883
Free-Standing Discount Store	34.405	7.1447	0.3543	0.0000	16.0017
General Office Building	9.3	1.9313	0.0958	0.0000	4.3254
Government Office Building	5.1375	1.0669	0.0529	0.0000	2.3894
High Turnover (Sit Down Restaurant)	32.725	6.7958	0.3370	0.0000	15.2203
Medical Office Building	54	11.2138	0.5561	0.0000	25.1153
Other Asphalt Surfaces	0	0.0000	0.0000	0.0000	0.0000
Other Non-Asphalt Surfaces	0	0.0000	0.0000	0.0000	0.0000
Parking Lot	0	0.0000	0.0000	0.0000	0.0000
Strip Mall	9.45	1.9624	0.0973	0.0000	4.3952
Unrefrigerated Warehouse-No Rail	23.5	4.8801	0.2420	0.0000	10.9298
Total		35.5255	1.7616	0.0000	79.5654

9.0 Operational Offroad

Santa Maria Airport Commercial Rezone - Year 2030 - Santa Barbara-North of Santa Ynez County, Annual

Equipment Type	Number	Hours/Day	Days/Year	Horse Power	Load Factor	Fuel Type
----------------	--------	-----------	-----------	-------------	-------------	-----------

10.0 Stationary Equipment

Fire Pumps and Emergency Generators

Equipment Type	Number	Hours/Day	Hours/Year	Horse Power	Load Factor	Fuel Type
----------------	--------	-----------	------------	-------------	-------------	-----------

Boilers

Equipment Type	Number	Heat Input/Day	Heat Input/Year	Boiler Rating	Fuel Type
----------------	--------	----------------	-----------------	---------------	-----------

User Defined Equipment

Equipment Type	Number
----------------	--------

11.0 Vegetation

Santa Maria Airport Commercial Rezone - Year 2030 - Santa Barbara-North of Santa Ynez County, Annual

	Total CO2	CH4	N2O	CO2e
Category	MT			
Unmitigated	240.7200	0.0000	0.0000	240.7200

11.2 Net New Trees

Species Class

	Number of Trees	Total CO2	CH4	N2O	CO2e
		MT			
Miscellaneous	340	240.7200	0.0000	0.0000	240.7200
Total		240.7200	0.0000	0.0000	240.7200

APPENDIX C

Santa Maria Airport Business Park Project Energy Use Assessment



TECHNICAL MEMORANDUM

Date: February 6, 2020

To: Shawn Gaver, Project Manager/Senior Environmental Planner
SWCA Environmental Consultants

From: Kurt Legleiter, Principal

Project: Santa Maria Airport Business Park Project

Subject: Energy Use Assessment

This memorandum provides a summary of the energy usage assessment prepared for the proposed Santa Maria Airport Business Park Project. The proposed project site plan is depicted in Figure 1. Modeling files are included as an appendix to this memorandum.

ENERGY USE METHODOLOGY

Fuel usage and consumption rates were derived, in part, from information derived from the California Emission Estimator Model (CalEEMod) Version 2016.3.2 and Emfac Model 2017, version 1.0.2. Fuel usage was converted to British Thermal Units (BTU) based on energy-coefficient rates (i.e., British thermal units (BTU) per gallon of diesel, BTU per gallon of gasoline, BTU per kilowatt-hour (kWh)) derived from the U.S. Energy Information Administration (EIA).

Energy use associated with project operations included electricity and natural gas use. Usage rates were derived from the CalEEMod emissions modeling conducted for this project and converted to BTUs using an energy coefficient. Annual energy use associated with indoor and outdoor water use/conveyance was calculated based on the usage rates and electric intensity factor provided in CalEEMod and also converted to BTUs for comparison purposes.

ENERGY USE METHODOLOGY

Energy use associated with project construction and operation are summarized in Table 1. As shown in Table 1, annual fuel use associated with project construction would total approximately 26,705 million British thermal units (MMBTUs). Assuming construction were to occur over an estimate 2.75 years, based on the CalEEMod emissions modeling conducted for the proposed project, annual construction-related energy use would average approximately 9,711 MMBTUs/year.

As shown in Table 1, annual fuel use associated with project operations would total approximately 54,470 MMBTUs, electricity use would total approximately 11,026 MMBTUs, and natural gas use would total 4,147 MMBTUs. In total, annual energy use associated with project operations would total roughly 69,643 MMBTUs/year under year 2023 operational conditions. By year 2030, energy use is projected to decrease to approximately 57,867 MMBTUs, due largely to improvements in vehicle fuel-efficiency standards.

Figure 1. Conceptual Site Plan



SANTA MARIA
AIRPORT BUSINESS PARK
 Conceptual Site Plan

BUILDING USE	
■	The Marketplace 34,700 SF
■	Commercial/Office 82,400 SF
■	Fast Food/Mini Mart/Gas 14,400 SF
■	Government/Public 14,100 SF

STATS (Commercial Area Only)	
Total Building Footprint:	145,800 SF
Total Parking Spaces:	522
Parking Ratio:	284 (260 target)
Parking Reduction Needed:	8.5%

Notes/Sources: NOV 30, 2017
 1) Aerial photos from Google Earth - 12/2016.
 2) Parcel boundaries from existing plans.





Table 1. Energy Use Summary

Source	Energy Use	
Construction¹		
	Gallons	MMBTU
Off-Road Equipment Fuel (Diesel)	142,928	19,636
On-Road Vehicle Fuel (Gasoline)	44,848	5,397
On-Road Vehicle Fuel (Diesel)	12,178	1,673
	Total Energy Use:	26,705
	Construction Period (Years):	2.75
	Average Annual Energy Use:	9,711
Operational – Year 2023²		
Fuel Use	Gallons/Year	MMBTU
Mobile Fuel (Diesel)	68,613	9,426
Mobile Fuel (Gasoline)	374,327	45,044
	Total:	54,470
Electricity Use	kWh/Year	MMBTU
Electricity (kWh/yr, MMBTU)	3,032,849	10,348
Water Use, Treatment & Conveyance (kWh/Yr, MBTU)	198,600	678
	Total:	11,026
	kBTU/Year	MMBTU
Natural Gas Use	4,146,875	4,147
	Total All Sources:	69,643
Operational – Year 2030²		
Fuel Use	Gallons/Year	MMBTU
Mobile Fuel (Diesel)	58,755	8,072
Mobile Fuel (Gasoline)	287,723	34,623
	Total:	42,694
Electricity Use	kWh/Year	MMBTU
Electricity (kWh/yr, MMBTU)	3,032,849	10,348
Water Use, Treatment & Conveyance (kWh/Yr, MMBTU)	198,600	678
	Total:	11,026
	kBTU/Year	MMBTU
Natural Gas Use	4,146,875	4,147
	Total All Sources:	57,867

MMBTU = one million British Thermal Units (BTU); kBTU=one thousand BTU; kWh=kilowatt hours

1. Construction energy use was calculated based on off-road and on-road fuel usage, including worker trips, vendor trips, and haul truck trips. Fuel usage was converted to BTUs for comparison purposes.

2. Operational mobile fuel use is based on year 2023 and year 2030 operational conditions. Fuel use is anticipated to decrease in future years due to improvements in fuel-efficiency standards. Electricity use and natural gas usage rates are not anticipated to change significantly in future years. Does not reflect changes in source contributions (e.g., renewable, non-renewable sources). Energy usage was converted to BTUs for comparison purposes.



Appendix A

Energy Use Calculations

Energy Use Summary Operational Year 2023 Mitigated

Construction Energy Use

	Gallons	Annual MMBTU
Off-Road Equipment Fuel (Diesel)	142,928	19,636
On-Road Vehicle Fuel (Gasoline)	44,848	5,397
On-Road Vehicle Fuel (Diesel)	12,178	1,673
	Total:	26,705

Operational Fuel Use

	Gallons	Annual MMBTU
Mobile Fuel (Diesel)	68,613	9,426
Mobile Fuel (Gasoline)	374,327	45,044
	Total:	54,470

Operational Electricity & Natural Gas Use

	Annual Energy	Annual MMBTU
Electricity (kWh/yr, MMBTU)	3,032,849	10,348
Water Use, Treatment & Conveyance (kWh/Yr, MMBTU)	198,600	678
Natural Gas (kBTU/yr, MMBTU)	4,146,875	4,147
	Total:	15,173

Construction Equipment Fuel Use

OFF-ROAD EQUIPMENT FUEL USE

Primary Construction Activity	Activity Duration (Days)	Equipment Type	Size (hp)	Number of Pieces	Hours of Daily Use/Piece of Equipment	Total Days of Use	Load Factor	Fuel Usage Rate (g/bhph)	Total Fuel Diesel (Gallons)
Site Preparation	10	Scrapers	367	2	8	10	0.48	0.05	1409
		Tractors/Loaders/Backhoes	97	4	8	10	0.37	0.05	574
		Rubber Tired Dozers	247	3	8	10	0.40	0.05	1186
Grading	80	Excavators	158	2	8	80	0.38	0.05	3843
		Graders	187	1	8	80	0.41	0.05	2453
		Rubber Tired Dozers	247	1	8	80	0.40	0.05	3162
		Tractors/Loaders/Backhoes	97	4	8	80	0.37	0.05	4594
		Scrapers	367	2	8	80	0.48	0.05	11274
		Cranes	231	1	7	606	0.29	0.05	14209
Building Construction	606	Forklifts	89	3	8	606	0.20	0.05	12944
		Generator Sets	84	1	8	606	0.74	0.05	15068
		Excavators	158	1	8	606	0.38	0.05	14554
		Tractors/Loaders/Backhoes	97	3	7	606	0.37	0.05	22837
		Welders	46	1	8	606	0.45	0.05	5018
		Concrete/Industrial Saws	81	1	8	606	0.73	0.05	14333
		Rollers	80	1	8	606	0.38	0.05	7369
		Pavers	130	1	8	20	0.42	0.05	437
		Paving Equipment	132	1	8	20	0.36	0.05	380
		Rollers	80	3	8	20	0.38	0.05	730
Paving	20	Graders	187	1	8	20	0.41	0.05	613
		Signal Boards	6	1	8	20	0.82	0.05	39
		Tractors/Loaders/Backhoes	97	1	8	20	0.37	0.05	287
		Architectural Coating	500	1	6	500	0.48	0.05	5616
		Air Compressors	78	1	6	500	0.48	0.05	5616
Total Diesel Fuel Use (Gallons):									142928
Number of Construction Years:									2.75
Average Diesel Fuel Use/Year:									51974
BTU/Gallon:									137381
BTU:									19635572060
MMBTU:									19636

Equipment usage assumptions based on default assumptions contained in CalEEMod.

Construction Fuel Use - On-Road Vehicles

Activity	Site Prep	Grading	Bldg	Pav	Arc Coat	Total	LDA	LDT1	LDT2	MDV
Days	10	80	606	20	500					
Worker Trips	23	25	207	25	41					
Miles/Trip	8.3	8.3	8.3	8.3	8.3					
Total VMT	1909	16600	1041168.6	4150	170150	1233977.6	411325.9	411325.9	411325.9	0
Vendor Trips	0	0	87	0	0					
Miles/Trip	6.4	6.4	6.4	6.4	6.4					
Total VMT	0	0	337420.8	0	0	337420.8	0	0	0	337420.8
Haul Trips	0	0	0	0	0					
Miles/Trip	20	20	20	20	20					
Total VMT	0	0	0	0	0	0	0	0	0	0

	Annual VMT	Gallons/Mile*	Gallons	BTU/gallon**	BTU	MMBTU
HDT	0	0.18609383	0	137381	0	0.00
LDA	411326	0.03141995	12924	120333	1555164104	1555.16
LDT1	411326	0.03642770	14984	120333	1803028378	1803.03
LDT2	411326	0.04118580	16941	120333	2038535713	2038.54
MDV	337421	0.03609284	12178	137381	1673091024	1673.09

*Gallons per mile based on year 2021 conditions for Santa Barbara County. Derived from Emfac2017 (v1.0.2) Emissions Inventory.

**Energy coefficient derived from US EIA.

https://www.eia.gov/energyexplained/index.php?page=about_energy_units

EMFAC2017 Fuel Rate Calculation	Fuel Consumption (1000 Gallons/Day)*		VMT (Miles/Day)**		
	Diesel	Gasoline	Diesel	Gasoline	TOTAL
LDA	1.56732996	173.7986273	77744.39644	5531474.113	
LDT1	0.014388292	21.12623283	353.7104788	579949.616	
LDT2	0.470804534	93.398813	17222.23218	2267742.808	
MDV	1.574519892	83.6468936	43624.16292	1679831.445	
HDT***	3.461395295	0.046230813	18600.26949	181.9970735	
Total	7.088437973	372.0167975	157544.7715	10059179.98	10216724.75
Percent of Total			1.54%	98.46%	
LDA-Miles/Gallon	49.60308194	31.82691486			
LDA-Gallons/Mile	0.020160038	0.031419948			
LDT1-Miles/Gallon	24.58321503	27.45163422			
LDT1-Gallons/Mile	0.040678162	0.036427704			
LDT2-Miles/Gallon	36.58042977	24.28021016			
LDT2-Gallons/Mile	0.027337022	0.041185805			
MDV-Miles/Gallon	27.70632694	20.08241278			
MDV-Gallons/Mile	0.036092839	0.049794814			
HDT-Miles/Gallon	5.373633435	0.00025402			
HDT-Gallons/Mile	0.186093825	3936.704985			

*Fuel consumptions derived from EMFAC2017 (v1.0.2) for year 2021 conditions.

**VMT derived from EMFAC2017 (v1.0.2) for year 2021 conditions.

***HDT diesel engine T7 CAIRP construction, T7 single construction, T7 tractor construction. HDT gasoline engine T7IS.

Fuel consumption and VMT based on the Santa Barbara County.

Operational Fuel Use - Proposed Project Year 2023 Mitigated

LAND USE	Total Annual VMT
Santa Maria Airport Commercial Rezone	10,142,902

	VMT	Gallons/Mile*	Gallons	BTU/gallon**	BTU	MMBTU
Diesel	722962	0.09490507	68613	137381	9426085779	9426.09
Gasoline	9419940	0.03973770	374327	120333	45043856346	45043.86

*Gallons per mile based on year 2021 conditions for Santa Barbara County. Derived from Emfac2017 (v1.0.2) Emissions Inventory.

**Energy coefficient derived from US EIA.

https://www.eia.gov/energyexplained/index.php?page=about_energy_units

EMFAC2017 Fuel Rate Calculation	Fuel Consumption (1000 Gallons/Day)*		VMT (Miles/Day)**	
	Diesel	Gasoline	Diesel	Gasoline
All Other Buses	0.867335178		7776.863771	
LDA	1.56732996	173.7986273	77744.39644	5531474.113
LDT1	0.014388292	21.12623283	353.7104788	579949.616
LDT2	0.470804534	93.398813	17222.23218	2267742.808
LHD1	9.285773294	22.42518545	163550.7779	184175.1397
LHD2	3.550951109	4.058488433	55872.97732	29093.12936
MDV	1.574519892	83.6468936	43624.16292	1679831.445
MH	0.352637963	2.042942269	3431.680088	9632.980042
Motor Coach	0.611808985		3826.774324	
PTO	1.299409748		6203.975214	
SBUS	3.510187816	1.975172786	27697.54633	17703.79474
T6 Ag	0.030276215		270.9722381	
T6 CAIRP heavy	0.229826347		2549.361508	
T6 CAIRP small	0.026547462		273.2333029	
T6 instate construction heavy	0.582971165		4684.868081	
T6 instate construction small	2.280528907		18448.35917	
T6 instate heavy	8.577050676		81039.97184	
T6 instate small	8.928245705		82783.70252	
T6 OOS heavy	0.125564895		1390.215619	
T6 OOS small	0.016368793		168.8975115	
T6 Public	0.537519732		3767.635741	
T6 utility	0.102680485		924.472509	
T7 Ag	0.016527475		96.30604549	
T7 CAIRP	4.499150832		29967.50503	
T7 CAIRP construction	0.58505176		3365.181439	
T7 NNOOS	5.282126436		36547.34106	
T7 NOOS	1.808634408		11770.34978	
T7 other port	1.390576446		7604.006869	
T7 Public	1.088142899		5573.309938	
T7 Single	5.24773337		31244.45925	
T7 single construction	1.571012727		8348.396191	
T7 SWCV	0.933567507		2070.872771	
T7 tractor	5.861926601		41815.39701	
T7 tractor construction	1.305330809		6886.691858	
T7 utility	0.050186883		294.9429209	
UBUS	1.817481152	0.583117712	11610.51436	3020.045788
MCY		2.2697166		88002.73404
OBUS		2.069316625		9679.525292
T6TS		7.189248515		33685.64616
T7IS		0.046230813		181.9970735
Total	76.00017646	414.6299859	800802.0616	10434172.97
Percent of Total			7.13%	92.87%
Miles/Gallon	10.53684477	25.16502262		
Gallons/Mile	0.094905071	0.039737695		

11234975.04

*Fuel consumptions derived from EMFAC2017 (v1.0.2) for year 2021 conditons.

**VMT derived from EMFAC2017 (v1.0.2) for year 2021 conditons.

Fuel consumption and VMT based on the Santa Barbara County.

Operational Electricity & Natural Gas Use Year 2023 Mitigated

	kWh/yr	MWh/Yr	BTU/kWh*	BTU	MMBTU
Electricity	3032849	3033	3412	10348080788	10348

*Energy coefficient derived from US EIA.

https://www.eia.gov/energyexplained/index.php?page=about_energy_units

	kBTU/yr			BTU	MMBTU
Natural Gas	4146875			4146875000	4147

*Energy coefficient derived from US EIA.

https://www.eia.gov/energyexplained/index.php?page=about_energy_units

Water Energy Use Year 2023 Mitigated

	WATER USE*	ELECTRIC INTENSITY FACTORS		ANNUAL ELECTRIC USE (kWh/Yr)		
	MGAL/YR	INDOOR	OUTDOOR	INDOOR	OUTDOOR	TOTAL
ANNUAL INDOOR WATER USE	45.76	3500		160167		198,600
ANNUAL OUTDOOR WATER USE	10.98		3500		38433	

*Based on estimated water use derived from CalEEMod.

**Energy coefficient derived from US EIA.

https://www.eia.gov/energyexplained/index.php?page=about_energy_units

BTU/kWh** 3412

BTU: 677623174

MMBTU: 677.62

Energy Use Summary Operational Year 2030 Mitigated

Construction Fuel Use

	Gallons of Fuel	Annual MMBTU
Off-Road Equipment Fuel (Diesel)	142,928	19,636
On-Road Vehicle Fuel (Gasoline)	44,848	5,397
On-Road Vehicle Fuel (Diesel)	12,178	1,673
Total:		26,705

Operational Fuel Use

	Gallons of Fuel	Annual MMBTU
Mobile Fuel (Diesel)	58,755	8,072
Mobile Fuel (Gasoline)	287,723	34,623
Total:		42,694

Operational Electricity & Natural Gas Use

	Annual Energy	Annual MMBTU
Electricity (kWh/yr, MMBTU)	3,032,849	10,348
Water Use, Treatment & Conveyance (kWh/Yr, MMBTU)	198,600	678
Natural Gas (kBTU/yr, MMBTU)	4,146,875	4,147
Total:		15,173

Construction Equipment Fuel Use

OFF-ROAD EQUIPMENT FUEL USE

Primary Construction Activity	Activity Duration (Days)	Equipment Type	Size (hp)	Number of Pieces	Hours of Daily Use/Piece of Equipment	Total Days of Use	Load Factor	Fuel Usage Rate (g/bhph)	Total Fuel Diesel (Gallons)		
Site Preparation	10	Scrapers	367	2	8	10	0.48	0.05	1409		
		Tractors/Loaders/Backhoes	97	4	8	10	0.37	0.05	574		
		Rubber Tired Dozers	247	3	8	10	0.40	0.05	1186		
Grading	80	Excavators	158	2	8	80	0.38	0.05	3843		
		Graders	187	1	8	80	0.41	0.05	2453		
		Rubber Tired Dozers	247	1	8	80	0.40	0.05	3162		
		Tractors/Loaders/Backhoes	97	4	8	80	0.37	0.05	4594		
		Scrapers	367	2	8	80	0.48	0.05	11274		
		Cranes	231	1	7	606	0.29	0.05	14209		
Building Construction	606	Forklifts	89	3	8	606	0.20	0.05	12944		
		Generator Sets	84	1	8	606	0.74	0.05	15068		
		Excavators	158	1	8	606	0.38	0.05	14554		
		Tractors/Loaders/Backhoes	97	3	7	606	0.37	0.05	22837		
		Welders	46	1	8	606	0.45	0.05	5018		
		Concrete/Industrial Saws	81	1	8	606	0.73	0.05	14333		
		Rollers	80	1	8	606	0.38	0.05	7369		
		Pavers	130	1	8	20	0.42	0.05	437		
		Paving Equipment	132	1	8	20	0.36	0.05	380		
Paving	20	Rollers	80	3	8	20	0.38	0.05	730		
		Graders	187	1	8	20	0.41	0.05	613		
		Signal Boards	6	1	8	20	0.82	0.05	39		
		Tractors/Loaders/Backhoes	97	1	8	20	0.37	0.05	287		
		Architectural Coating	500	Air Compressors	78	1	6	500	0.48	0.05	5616

Equipment usage assumptions based on default assumptions contained in CalEEMod.

Total Diesel Fuel Use (Gallons):	142928
Number of Construction Years:	2.75
Average Diesel Fuel Use/Year:	51974
BTU/Gallon:	137381
BTU:	19635572060
MMBTU:	19636

Construction Fuel Use - On-Road Vehicles

Activity	Site Prep	Grading	Bldg	Pav	Arc Coat	Total	LDA	LDT1	LDT2	MDV	HDV
Days	10	80	606	20	500						
Worker Trips	23	25	207	25	41						
Miles/Trip	8.3	8.3	8.3	8.3	8.3						
Total VMT	1909	16600	1041168.6	4150	170150	1233977.6	411325.9	411325.9	411325.9	0	0
Vendor Trips	0	0	87	0	0						
Miles/Trip	6.4	6.4	6.4	6.4	6.4						
Total VMT	0	0	337420.8	0	0	337420.8	0	0	0	337420.8	0
Haul Trips	0	0	0	0	0						
Miles/Trip	20	20	20	20	20						
Total VMT	0	0	0	0	0	0	0	0	0	0	0

	Annual VMT	Gallons/Mile*	Gallons	BTU/gallon**	BTU	MMBTU
HDT	0	0.18609383	0	137381	0	0.00
LDA	411326	0.03141995	12924	120333	1555164104	1555.16
LDT1	411326	0.03642770	14984	120333	1803028378	1803.03
LDT2	411326	0.04118580	16941	120333	2038535713	2038.54
MDV	337421	0.03609284	12178	137381	1673091024	1673.09

*Gallons per mile based on year 2021 conditions for Santa Barbara County. Derived from Emfac2017 (v1.0.2) Emissions Inventory.

**Energy coefficient derived from US EIA.

https://www.eia.gov/energyexplained/index.php?page=about_energy_units

EMFAC2017 Fuel Rate Calculation	Fuel Consumption (1000 Gallons/Day)*		VMT (Miles/Day)**		
	Diesel	Gasoline	Diesel	Gasoline	TOTAL
LDA	1.56732996	173.7986273	77744.39644	5531474.113	
LDT1	0.014388292	21.12623283	353.7104788	579949.616	
LDT2	0.470804534	93.398813	17222.23218	2267742.808	
MDV	1.574519892	83.6468936	43624.16292	1679831.445	
HDT***	3.461395295	0.046230813	18600.26949	181.9970735	
Total	7.088437973	372.0167975	157544.7715	10059179.98	10216724.75
Percent of Total			1.54%	98.46%	
LDA-Miles/Gallon	49.60308194	31.82691486			
LDA-Gallons/Mile	0.020160038	0.031419948			
LDT1-Miles/Gallon	24.58321503	27.45163422			
LDT1-Gallons/Mile	0.040678162	0.036427704			
LDT2-Miles/Gallon	36.58042977	24.28021016			
LDT2-Gallons/Mile	0.027337022	0.041185805			
MDV-Miles/Gallon	27.70632694	20.08241278			
MDV-Gallons/Mile	0.036092839	0.049794814			
HDT-Miles/Gallon	5.373633435	0.00025402			
HDT-Gallons/Mile	0.186093825	3936.704985			

*Fuel consumptions derived from EMFAC2017 (v1.0.2) for year 2021 conditions.

**VMT derived from EMFAC2017 (v1.0.2) for year 2021 conditions.

***HDT diesel engine T7 CAIRP construction, T7 single construction, T7 tractor construction. HDT gasoline engine T7IS.

Fuel consumption and VMT based on the Santa Barbara County.

Operational Fuel Use - Proposed Project Year 2030 Mitigated

LAND USE	Total Annual VMT
Santa Maria Airport Commercial Rezone	10,142,902

	VMT	Gallons/Mile*	Gallons	BTU/gallon**	BTU	MMBTU
Diesel	716612	0.08199044	58755	137381	8071861282	8071.86
Gasoline	9426290	0.03052343	287723	120333	34622538683	34622.54

*Gallons per mile based on year 2030 conditions for Santa Barbara County. Derived from Emfac2017 (v1.0.2) Emissions Inventory.

**Energy coefficient derived from US EIA.

https://www.eia.gov/energyexplained/index.php?page=about_energy_units

EMFAC2017 Fuel Rate Calculation	Fuel Consumption (1000 Gallons/Day)*		VMT (Miles/Day)**	
	Diesel	Gasoline	Diesel	Gasoline
All Other Buses	0.932783184		9936.760783	
LDA	1.304630028	150.9777906	79683.17912	6044158.871
LDT1	0.003280396	19.68334661	97.46206436	661524.2587
LDT2	0.505004621	71.92990448	22767.79557	2304571.382
LHD1	6.648503737	15.70370057	132531.3342	143890.3151
LHD2	2.803689641	2.650552665	49848.00003	21086.02268
MDV	1.500150346	57.26096107	51518.91452	1501198.063
MH	0.277154477	1.206260363	2957.665312	6470.617212
Motor Coach	0.60025127		4380.276425	
PTO	1.385821769		7756.651102	
SBUS	3.366506556	1.765633608	28344.98588	16104.5386
T6 Ag	0.012240394		103.3670166	
T6 CAIRP heavy	0.225730684		3139.212363	
T6 CAIRP small	0.022620499		280.4263423	
T6 instate construction heavy	0.681879742		6139.761271	
T6 instate construction small	2.519006575		24177.52628	
T6 instate heavy	6.946144604		77291.84375	
T6 instate small	7.959471865		88960.85732	
T6 OOS heavy	0.11942492		1659.903523	
T6 OOS small	0.01480205		183.6135865	
T6 Public	0.373310308		2993.656789	
T6 utility	0.092097228		993.3146505	
T7 Ag	0.008752586		44.73586034	
T7 CAIRP	4.01839051		34349.99854	
T7 CAIRP construction	0.6208278		4410.243855	
T7 NNOOS	4.798112856		41896.06897	
T7 NOOS	1.620426162		13481.64756	
T7 other port	1.278681756		9612.983191	
T7 Public	0.921316167		5471.046233	
T7 Single	5.473022605		39064.04537	
T7 single construction	1.751042155		10941.00383	
T7 SWCV	0.409882219		912.5469504	
T7 tractor	5.398620953		47483.73252	
T7 tractor construction	1.449860534		9025.364903	
T7 utility	0.046993383		315.4104512	
UBUS	1.301501544	0.521871514	9193.324409	3020.045788
MCY		1.948894306		75403.41092
OBUS		1.224393146		6536.601886
T6TS		5.100714979		27715.1254
T7IS		0.042041415		213.5825208
Total	67.39193612	330.0160653	821948.6605	10811892.83
Percent of Total			7.07%	92.93%
Miles/Gallon	12.1965432	32.76171669		
Gallons/Mile	0.081990445	0.030523431		

11633841.49

*Fuel consumptions derived from EMFAC2017 (v1.0.2) for year 2030 conditons.

**VMT derived from EMFAC2017 (v1.0.2) for year 2030 conditons.

Fuel consumption and VMT based on the Santa Barbara County.

Operational Electricity & Natural Gas Use Year 2030 Mitigated

	kWh/yr	MWh/Yr	BTU/kWh*	BTU	MMBTU
Electricity	3032849	3033	3412	10348080788	10348

*Energy coefficient derived from US EIA.

https://www.eia.gov/energyexplained/index.php?page=about_energy_units

	kBTU/yr			BTU	MMBTU
Natural Gas	4146875			4146875000	4147

*Energy coefficient derived from US EIA.

https://www.eia.gov/energyexplained/index.php?page=about_energy_units

Water Energy Use Year 2030 Mitigated

	WATER USE*	ELECTRIC INTENSITY FACTORS		ANNUAL ELECTRIC USE (kWh/Yr)		
	MGAL/YR	INDOOR	OUTDOOR	INDOOR	OUTDOOR	TOTAL
ANNUAL INDOOR WATER USE	45.76	3500		160167		198,600
ANNUAL OUTDOOR WATER USE	10.98		3500		38433	

*Based on estimated water use derived from CalEEMod.

**Energy coefficient derived from US EIA.

https://www.eia.gov/energyexplained/index.php?page=about_energy_units

BTU/kWh** 3412

BTU: 677623174

MMBTU: 677.62

APPENDIX D

Santa Maria Airport Business Park Specific Plan Rezone Transportation Impact Study

Santa Maria Airport Business Park

Specific Plan Rezone

Transportation Impact Study

Prepared For: SWCA Environmental Consultants

Central Coast Transportation Consulting

895 Napa Avenue, Suite A-6

Morro Bay, CA 93442

(805) 316-0101

October 2020



Contents

Executive Summary	3
Introduction	4
Analysis Methods.....	7
Existing Conditions.....	9
Existing Plus Project Conditions	12
Cumulative (10-Year) Conditions	18
References.....	23
Figure 1: Study Locations.....	5
Figure 2: Project Site Plan.....	6
Figure 3: Existing Volumes and Lane Configurations	11
Figure 4: Project Trip Distribution and Assignment.....	14
Figure 5: Existing Plus Project Volumes	16
Figure 6: Cumulative Volumes.....	19
Figure 7: Cumulative Plus Project Volumes	20
Table 1: Intersection LOS Thresholds.....	7
Table 2: Santa Barbara County Significance Criteria	8
Table 3: Existing Intersection LOS	10
Table 4: 2007 EIR Specific Plan Trip Generation	12
Table 5: Current Project Trip Generation.....	13
Table 6: Existing and Existing Plus Project Intersection LOS	15
Table 7: Cumulative and Cumulative Plus Project Intersection LOS.....	21
Table 8: VMT Estimates	22
Appendix A: Traffic Counts	
Appendix B: Intersection LOS Calculation Sheets	
Appendix C: Warrant Analysis Sheets	

Executive Summary

This Transportation Impact Study (TIS) evaluates the potential transportation impacts of the rezoning proposed within the Santa Maria Airport Business Park Specific Plan area, located in the southwestern corner of the City of Santa Maria. The 28-acre site within the Specific Plan area is currently zoned for 19.3 acres of Public/Community Facilities and approximately nine acres of Conservation Open Space for a drainage basin. The proposed project will rezone the area to Airport Commercial and Light Industrial as well as Conservation Open Space.

KEY FINDINGS

The proposed project would generate 12,066 net new vehicle trips per weekday, including 574 AM peak hour trips and 505 PM peak hour trips. As currently proposed, the rezone will generate 11,291 more daily and 400 more PM peak hour vehicle trips than previously evaluated.

Intersection Operations

Union Valley Parkway/Foxenwood Lane (#3) would operate at LOS F under Existing Plus Project and Cumulative (10-Year) Plus Project conditions. We recommend that the project construct a traffic signal at this location. With signalization, the intersection would operate at LOS C under Existing and Cumulative Conditions.

Site Access and On-Site Circulation

We recommend the driveways on Foxenwood Lane be consolidated where possible to reduce conflict points, in accordance with best practices for access management. We recommend the driveway on Foster Road be restricted to right-in-right-out only due to its proximity to SR 135 Orcutt Expressway.

In addition, we recommend convenient pedestrian access be provided between the land uses on the project site, including across Foxenwood Lane and Foster Road. The proposed site plan does not show all frontage improvement sidewalks on Foster Road and Union Valley Parkway. Additionally, the site plan does not show the proposed Class I and II bikeways from the City's Bikeway Master Plan on Foster Road, Foxenwood Lane, and Union Valley Parkway.

Vehicle Miles Traveled (VMT)

The project would reduce regional VMT by adding a diversity of land uses, including jobs and commercial uses, to a predominantly residential area. This will reduce the trip length for many local drivers thereby reducing VMT.

Introduction

This Transportation Impact Study (TIS) evaluates the potential transportation impacts of the rezoning proposed within the Santa Maria Airport Business Park Specific Plan area, located in the southwestern corner of the City of Santa Maria. The 28-acre site within the Specific Plan area is currently zoned for 19.3 acres of Public/Community Facilities and approximately nine acres of Conservation Open Space for a drainage basin. The proposed project will rezone the area to Airport Commercial and Light Industrial as well as Conservation Open Space. The study locations are shown in **Figure 1** and the project site plan is shown in **Figure 2**.

BACKGROUND

The 2007 Environmental Impact Report (EIR) prepared for the Specific Plan was based on a 2005 TIS which reflected conditions prior to the completion of the Union Valley Parkway and its interchange at US 101. This major roadway network change, combined with land use growth over the past 15 years, the proposed rezoning, and modified CEQA guidelines supported the need for an updated transportation analysis.

STUDY LOCATIONS AND SCENARIOS

The study locations, analysis scenarios, and analysis methods were developed in consultation with the City of Santa Maria, County of Santa Barbara, and Caltrans. The TIS evaluates the following intersections during the weekday AM and PM peak hours:

1. Foster Road/Foxenwood Lane (Stop Controlled – City of Santa Maria)
2. Foster Road/SR 135 Orcutt Expressway (Traffic Signal – Caltrans)
3. Union Valley Parkway/Foxenwood Lane (Stop Controlled – City of Santa Maria)
4. Union Valley Parkway/SR 135 Orcutt Expressway (Traffic Signal – Caltrans)
5. Union Valley Parkway/Orcutt Road (Traffic Signal – County of Santa Barbara)

Vehicular level of service (LOS) is evaluated at each study intersection.

The study locations were evaluated under these scenarios:

- **Existing Conditions** reflects existing traffic counts and the existing transportation network.
- **Existing Plus Project** adds Project-generated traffic to Existing Conditions volumes.
- **Cumulative (10-Year) Conditions** represents future traffic conditions including partial development of the Specific Plan in conjunction with other approved and proposed developments in the area, not including the proposed Project.
- **Cumulative (10-Year) Plus Project** represents future traffic conditions including partial development of the Specific Plan in conjunction with other approved and proposed developments in the area, including the proposed Project.

Each scenario is described in more detail in the appropriate chapter.

Figure 1: Study Locations

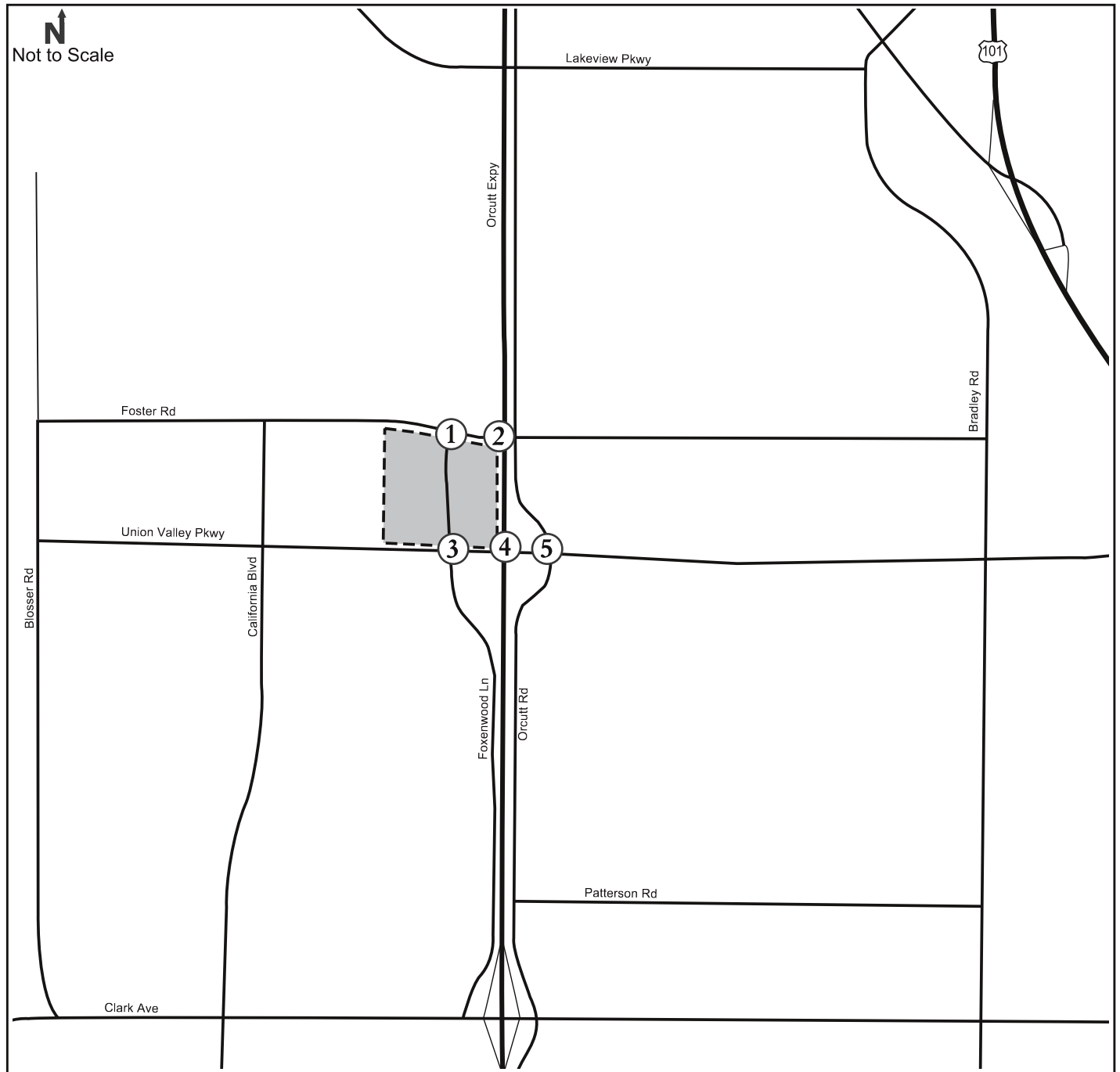

July 2020

Legend:

- xx(yy) - AM(PM) Peak Hour Traffic Volumes
- (x) - Study Intersection
- Project Site

Santa Maria Airport Business Park SP

Figure 2: Project Site Plan



Source: RRM Design Group



Analysis Methods

The analysis approach was developed based on City of Santa Maria, County of Santa Barbara, and Caltrans thresholds.

The State Office of Planning and Research (OPR) published a Technical Advisory in December 2018 with recommendations for evaluating VMT for various project types. The Technical Advisory notes that for mixed use projects the lead agency can evaluate each component of the project independently or may consider only the project’s dominant use.

Approximately 90 percent of the Project’s daily trips would be generated by the non-office commercial uses proposed on the site. Therefore, this study applies OPR’s recommended threshold for retail projects, where a net increase in total VMT may indicate a significant transportation impact. This approach is also consistent with Caltrans’ Draft TIS Guidelines, which conform to the OPR guidance. The SBCAG Travel Demand Model is used to evaluate the project’s change to VMT.

While LOS is not an allowable CEQA metric it remains in planning documents for the City of Santa Maria and County of Santa Barbara. The level of service thresholds for intersections based on the 6th Edition Highway Capacity Manual (HCM) are presented in **Table 1**.

Table 1: Intersection LOS Thresholds

Intersection Level of Service Thresholds			
Signalized Intersections ¹		Stop Controlled Intersections ²	
Control Delay (sec/vehicle)	Level of Service	Control Delay (sec/vehicle)	Level of Service
≤ 10	A	≤ 10	A
> 10 - 20	B	> 10 - 15	B
> 20 - 35	C	> 15 - 25	C
> 35 - 55	D	> 25 - 35	D
> 55 - 80	E	> 35 - 50	E
> 80	F	> 50 or v/c > 1	F

1. Source: Exhibit 19-8 of the Highway Capacity Manual 6th Edition.
 2. Source: Exhibits 20-2 and 21-8 of the Highway Capacity Manual 6th Edition.

Caltrans strives to maintain operations at the LOS C/D threshold on state-operated facilities. If an existing State Highway facility is operating at LOS D, E, or F the existing measure of effectiveness should be maintained.

The County of Santa Barbara also defines acceptable LOS as C or better. The County’s Significance Criteria is summarized in **Table 2**.

Table 2: Santa Barbara County Significance Criteria

Santa Barbara County Significance Thresholds	
Level of Service	Increase in V/C or peak hour trips
A	> 0.20 (V/C)
B	> 0.15 (V/C)
C	> 0.10 (V/C)
D	> 15 trips
E	> 10 trips
F	> 5 trips
Source: Santa Barbara County Environmental Thresholds, October 2008.	

The City of Santa Maria considers LOS D acceptable for roadway and intersection operations.

The intersection LOS was calculated using the Synchro 10 software package applying the Highway Capacity Manual (HCM) 6th Edition methodology. The intersection volume to capacity (v/c) ratio for Santa Barbara County intersections was calculated with the HCM 2000 methodology since the HCM 6th Edition calculates only the movement v/c ratios and not the overall intersection v/c ratio.

Existing Conditions

This section describes the existing transportation system and current operating conditions.

EXISTING CIRCULATION NETWORK

This section describes the existing roadways adjacent to the proposed project. Bicycle facilities in the study area consist of Class I and II bikeways. A Class I facilities provides a completely separated right-of-way for the exclusive use of bicycles and pedestrians with crossflow by motorists minimized. A Class II bike lane provides a striped lane for one-way bicycle travel on the side of the street adjacent to vehicle traffic.

- *SR 135 Orcutt Expressway* is a north-south, four-lane primary arterial in the study area and connects downtown Santa Maria to Orcutt, as well as to Vandenberg Air Force Base and Lompoc via SR 1. There are no bikeways or sidewalks and vehicle access is limited. South of Union Valley Parkway, the roadway becomes a four-lane freeway.
- *Union Valley Parkway* is an east-west, four-lane primary arterial in the study area, terminating with an interchange at US 101 to the east. There are sidewalks and Class II bikeways on both sides of the roadway in the study area. There are proposed Class I and II bikeways from US 101 to Blosser Road.
- *Foster Road* is an east-west, two-lane collector road in the study area. It primarily serves institutional facilities to the west and residential neighborhoods to the east. There are intermittent sidewalks east of SR 135 Orcutt Expressway. There are existing Class II bikeways west of Foxenwood Lane to California Boulevard which are proposed to be extended east to Bradley Road and west to Blosser Road. There is a proposed Class I bikeway from Foxenwood Lane to Blosser Road and a parallel proposed Class I bikeway south of Foster Road connecting Foxenwood Lane to Pioneer Park.
- *Foxenwood Lane* is a north-south, two-lane collector road in the study area paralleling SR 135 Orcutt Expressway. There are Class II bikeways on both sides of the roadway and a Class I bikeway extends from the Foster Road terminus north to Skyway Drive. There are sidewalks on both sides of the roadway south of Union Valley Parkway.
- *Orcutt Road* is a north-south, two-lane frontage road in the study area paralleling SR 135 Orcutt Expressway. In the study area there are Class II bikeways on both sides of the roadway and a sidewalk on the east side of the roadway.

The existing crosswalks at the study intersections are described below.

- Foster Road/Foxenwood Lane (#1): No marked crosswalks, side-street stop controlled.
- Foster Road/SR 135 Orcutt Expressway (#2): Marked crosswalks with pedestrian signals on all but the north leg.
- Union Valley Parkway/Foxenwood Lane (#3): No marked crosswalks, side-street stop controlled.
- Union Valley Parkway/SR 135 Orcutt Expressway (#4): Marked crosswalks with pedestrian signals on all but the north leg.
- Union Valley Parkway/Orcutt Road (#5): Marked crosswalks with pedestrian signals on all legs.

Santa Maria Area Transit (SMAT) operates transit service in the City of Santa Maria and in Orcutt. *SMAT Route 5* and *Route 6* are weekday and weekend bus services with 90-minute headways that travel from the Santa Maria Transit Center through Orcutt in a counterclockwise and clockwise direction, respectively. The closest stops to the project site are on Foster Road west of Foxenwood Lane and east of Orcutt Road.

The Breeze Bus operates commuter services between Santa Maria, Vandenberg AFB, Lompoc, Los Alamos, Buellton, and Solvang. *Breeze Route 100* is a weekday bus service between the Santa Maria and Lompoc Transit Centers with seven trips per day in each direction. The closest stops to the project site are on Orcutt Road south of Foster Road.

SBCAG manages the Clean Air Express bus service for commuters traveling between Northern Santa Barbara County and Goleta/Santa Barbara. The closest stop to the project is the Santa Maria Hagerman Softball Complex, where three trips depart each morning to Goleta and two trips depart each morning to Santa Barbara, with the same number of trips returning in the afternoon.

Connections to other services are available at both the Santa Maria and Lompoc Transit Centers.

EXISTING INTERSECTION OPERATIONS

Weekday peak hour vehicle, pedestrian, and bicycle turning movement counts were collected in December 2019 from 7-9 AM and 2-6 PM during clear weather when local schools were in session. CCTC conducted a field visit to the study intersections to observe existing traffic operations and right turn on red turning volumes. Timing sheets for the signalized intersections were also obtained from Caltrans and the County.

Figure 3 shows the Existing weekday peak hour intersection traffic volumes and lane configurations. Traffic count sheets are provided in **Appendix A**. Under Existing Conditions, the observed intersection peak hour factor (PHF) was used.

Table 3 shows the vehicular LOS for the study intersections, with detailed calculation sheets included in **Appendix B**.

Table 3: Existing Intersection LOS

Existing Intersection Levels of Service					
Intersection	Control	Peak Hour	Delay ¹	LOS	LOS Standard
1. Foster Road/Foxenwood Lane	TWSC	AM	2.1 (11.6)	- (B)	D
		PM	0.7 (10.7)	- (B)	
2. Foster Road/SR 135 Orcutt Expressway	Signal	AM	25.9	C	C
		PM	23.2	C	
3. Union Valley Parkway/Foxenwood Lane	TWSC	AM	5.7 (16.7)	- (C)	D
		PM	3.8 (17.7)	- (C)	
4. Union Valley Parkway/SR 135 Orcutt Expressway	Signal	AM	29.2	C	C
		PM	23.4	C	
5. Union Valley Parkway/Orcutt Road	Signal	AM	16.2	B	C
		PM	12.0	B	

1. HCM 6th average control delay in seconds per vehicle. For side-street-stop controlled intersections the worst approach's delay is reported in parentheses next to the overall intersection delay.
Note: Unacceptable operations shown in **bold** text.

All study intersections operate acceptably under Existing Conditions.

Figure 3: Existing Volumes and Lane Configurations

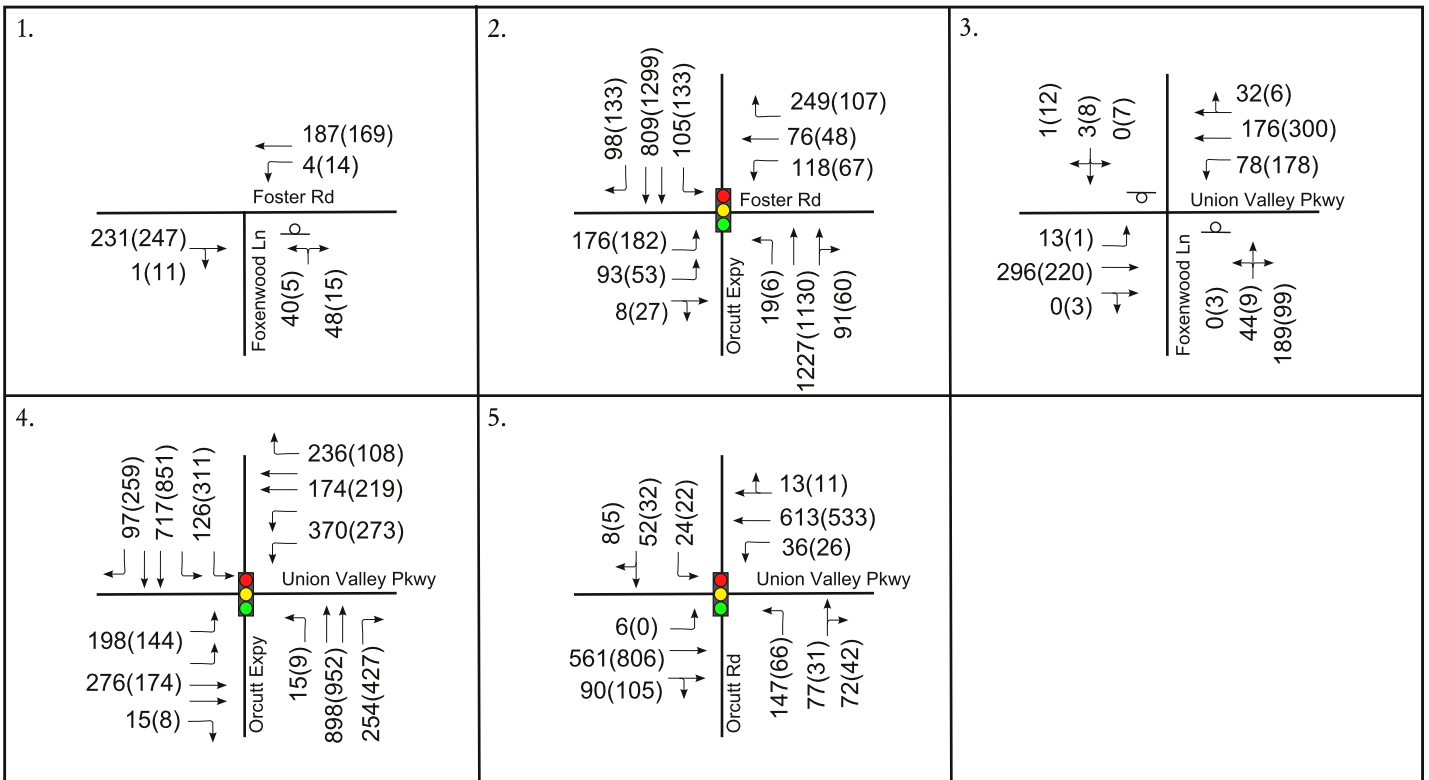
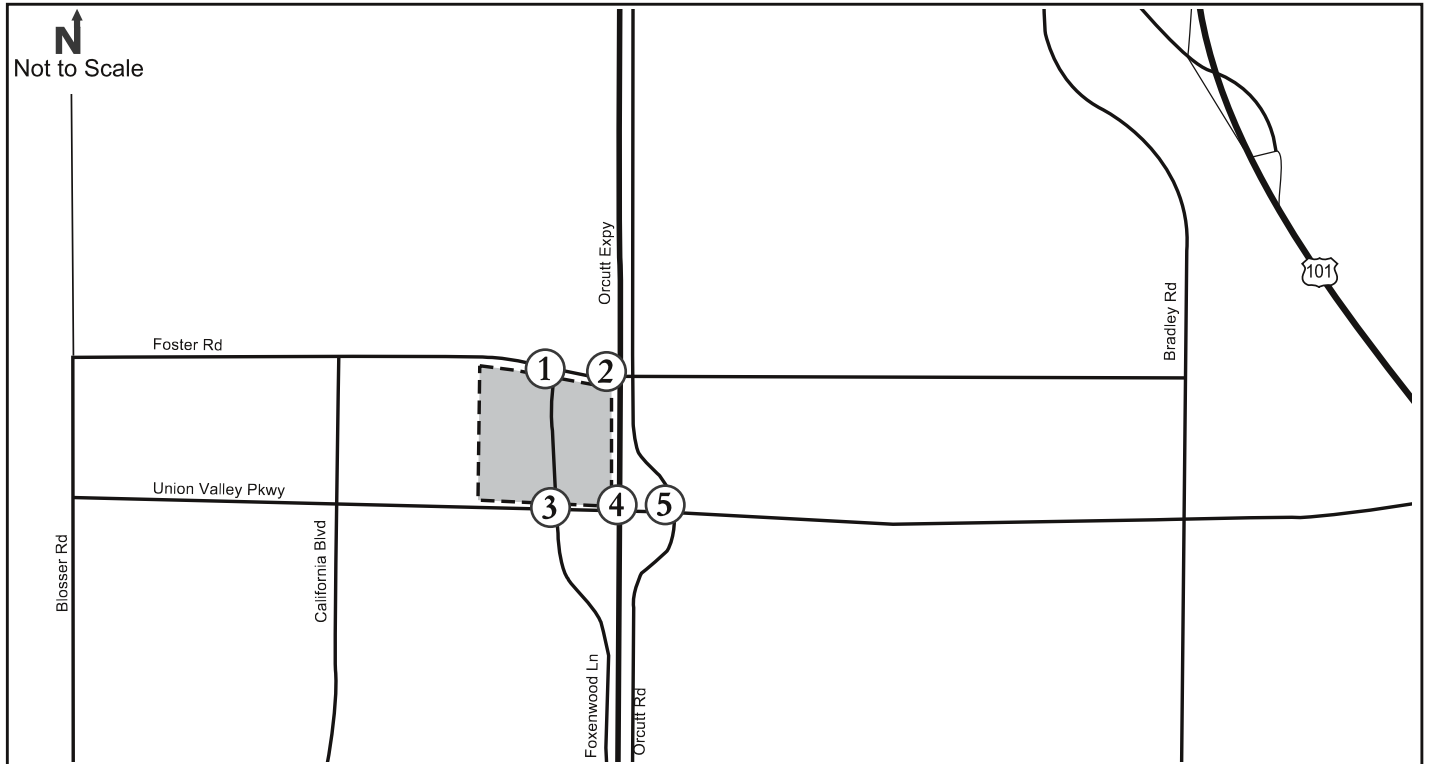

Legend:

- xx(yy) - AM(PM) Peak Hour Traffic Volumes
- ⊠ - Stop Sign
- ⊙ - Study Intersection
- ⓧ - Project Site
- 🚦 - Traffic Signal

Existing Plus Project Conditions

This section evaluates the impacts of the proposed project on the surrounding transportation network. Existing Plus Project Conditions reflect existing traffic levels plus the estimated traffic generated by the proposed project.

PROJECT TRAFFIC

The amount of project traffic affecting the study locations is estimated in three steps: trip generation, trip distribution, and trip assignment. Trip generation refers to the total number of trips generated by the site. Trip distribution identifies the general origins and destination of these trips, and trip assignment specifies the routes taken to reach these origins and destinations.

The Institute of Transportation Engineers (ITE) *Trip Generation Manual* 10th Edition was used to estimate the project trip generation. Currently the 28-acre site is zoned for 19.3 acres of Public/Community Facilities and approximately nine acres of Conservation Open Space for a drainage basin. The proposed project will rezone the area to Airport Commercial and Light Industrial as well as Conservation Open Space.

Table 4 summarizes the trip generation for the entire Specific Plan area from the 2007 EIR.

Table 4: 2007 EIR Specific Plan Trip Generation

2007 EIR Trip Generation					
Land Use	Size	Daily		PM Peak Hour	
		Rate	Trips	Rate	Trips
Airport Commerical (AC)	402,625 SF	42.87	17,260	2.45	990
Airport Services (AS)	346,694 SF	1.50	520	0.19	65
Community Facilities (CF)	41,948 SF	18.47	775	2.50	105
Commercial Professional Office (CPO)	213,008 SF	13.34	2,840	1.91	405
Light Manufacturing (LI)	2,011,100 SF	6.97	14,015	0.98	1,970
Recreation Open Space (ROS) - Golf Course	18 holes	35.74	675	2.74	52
<i>Existing Mobile Homes</i>	<i>-97 DU</i>	<i>4.99</i>	<i>-485</i>	<i>0.59</i>	<i>-55</i>
Total Project Trips			35,600	3,532	

Assuming the community facilities land use, the 19.3-acre Project site was estimated to generate 775 daily vehicle trips and 105 weekday PM peak hour vehicle trips in the 2007 EIR. **Table 5** summarizes the site trip generation using the currently proposed land uses.

Table 5: Current Project Trip Generation

Project Trip Generation								
Land Use	Size	Daily Total	AM Peak Hour			PM Peak Hour		
			In	Out	Total	In	Out	Total
Self Storage ¹	100,000 SF	151	6	4	10	8	9	17
Professional Office ²	40,000 SF	436	55	9	64	8	40	48
Medical Office ³	20,000 SF	681	41	12	53	20	50	70
Professional Office (Government) ⁴	22,100 SF	499	56	18	74	10	28	38
Market Place ⁵	36,000 SF	3,001	105	65	170	122	133	255
Home Furnishings and Appliances ⁶	32,000 SF	212	6	3	9	8	8	16
Quick Serve/Family Restaurant ⁷	11,000 SF	5,180	225	217	442	187	172	359
Gasoline/Service Station ⁸	3,400 SF	4,896	132	126	258	153	147	300
Subtotal		15,056	626	454	1,080	516	587	1,103
Internal Capture Trips ⁹		-1,280	-81	-81	-162	-128	-128	-256
Total External Trips		13,776	545	373	918	388	459	847
Pass-by Trips (Market Place) ^{5,10}		-335	0	0	0	-33	-34	-67
Pass-by Trips (Home Furnishings and Appliances) ^{6,10}		-35	0	0	0	-4	-3	-7
Pass-by Trips (Quick Serve/Family Restaurant) ^{7,10}		-690	-92	-92	-184	-69	-69	-138
Pass-by Trips (Gasoline/Service Station & Car Wash) ^{8,10}		-650	-80	-80	-160	-65	-65	-130
Net New Vehicle Trips		12,066	373	201	574	217	288	505

SF = Square Feet; ITE = Institute of Transportation Engineers.

- ITE Land Use Code #151, Mini-Warehouse. Average rates used.
- ITE Land Use Code #710, General Office Building. Fitted curve equations used.
- ITE Land Use Code #720, Medical-Dental Office. Fitted curve equations used.
- ITE Land Use Code #730, Government Office Building. Average rates used.
- ITE Land Use Code #820, Shopping Center. Fitted curve equations used. AM pass-by not given; PM pass-by 34%.
- ITE Land Use Code #890, Furniture Store. Fitted curve equations used. AM pass-by not given; PM pass-by 53%.
- ITE Land Use Code #934, Fast Food Restaurant with Drive-Thru. Average rates used. AM pass-by 49%; PM pass-by 50%.
- ITE Land Use Code #944, Gasoline/Service Station w/Convenience Store. Average rates used. AM pass-by 62%; PM pass-by 56%.
- AM (15%) & PM (23%) Internal Trips from TripGen 10 software; Daily Internal Trips assumed five times PM internal trips.
- PM peak hour pass-by trips multiplied by a factor of 5 to determine daily pass-by trips.

Source: ITE Trip Generation Manual, 10th Ed. and Trip Generation Handbook, 3rd Ed., 2017; CCTC, 2020.

The proposed project would generate 12,066 net new vehicle trips per weekday, including 574 AM peak hour trips and 505 PM peak hour trips. As currently proposed, the Project will generate 11,291 more daily and 400 more PM peak hour vehicle trips than the land uses evaluated in the 2007 EIR.

The trip distribution was estimated using volumes from the 2007 EIR. **Figure 4** summarizes the project trip distribution and assignment.

Figure 4: Trip Distribution and Existing Trip Assignment

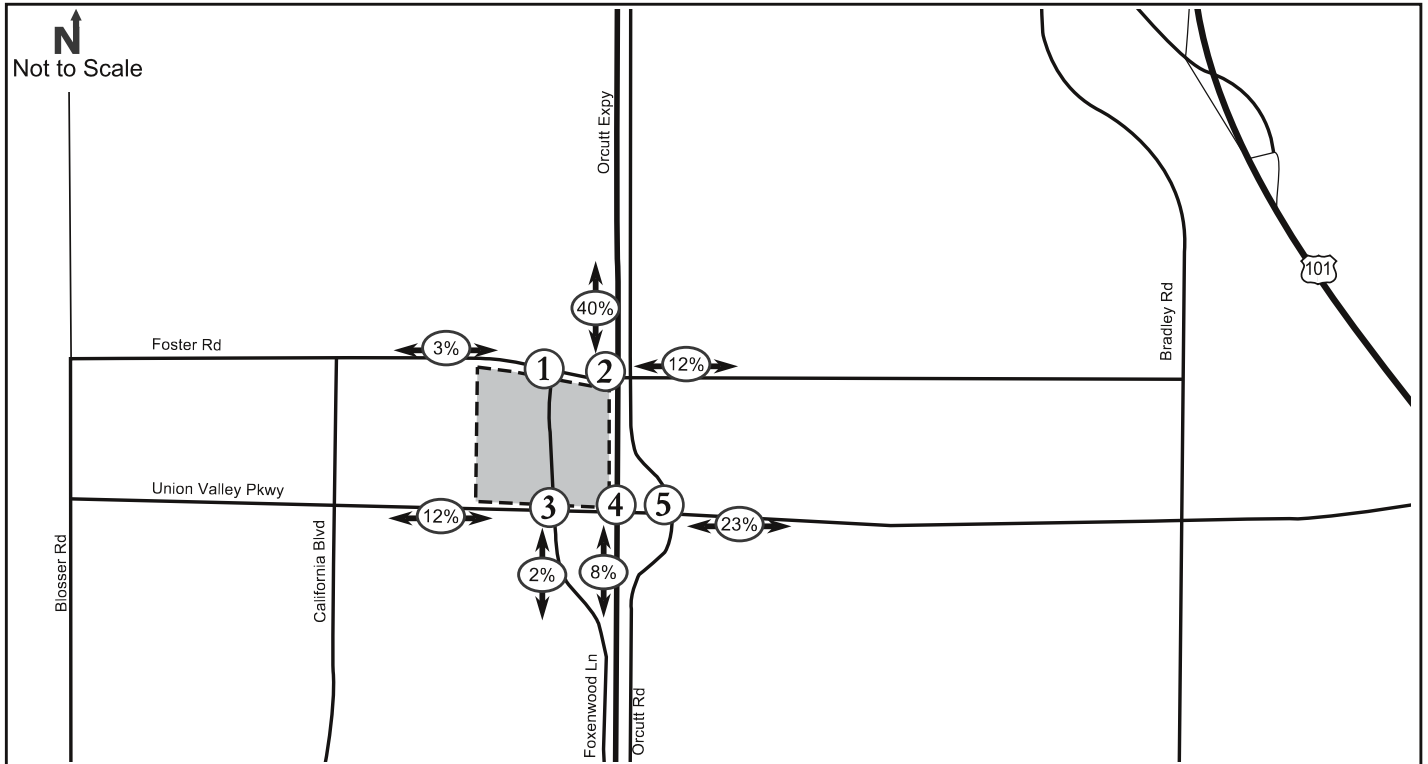

<p>1.</p> <table border="1"> <tr> <td colspan="2"> ↑ 0(0) ↓ 250(181) Foster Rd </td> <td colspan="2"></td> </tr> <tr> <td>4(2) ↓</td> <td>Foxenwood Ln</td> <td>6(9) ↑</td> <td>121(155) ↓</td> </tr> <tr> <td>7(4) ↓</td> <td></td> <td></td> <td></td> </tr> </table>	↑ 0(0) ↓ 250(181) Foster Rd				4(2) ↓	Foxenwood Ln	6(9) ↑	121(155) ↓	7(4) ↓				<p>2.</p> <table border="1"> <tr> <td colspan="2"> ↑ 177(130) ↓ -114(-128) Foster Rd </td> <td colspan="2"> ↑ 0(0) ↓ 45(26) Foster Rd </td> </tr> <tr> <td>145(180) ↓</td> <td>Orcutt Expy</td> <td>28(25) ↓</td> <td>0(0) ↓</td> </tr> <tr> <td>24(35) ↓</td> <td></td> <td>-151(-150) ↓</td> <td>0(0) ↓</td> </tr> <tr> <td>37(44) ↓</td> <td></td> <td></td> <td></td> </tr> </table>	↑ 177(130) ↓ -114(-128) Foster Rd		↑ 0(0) ↓ 45(26) Foster Rd		145(180) ↓	Orcutt Expy	28(25) ↓	0(0) ↓	24(35) ↓		-151(-150) ↓	0(0) ↓	37(44) ↓				<p>3.</p> <table border="1"> <tr> <td colspan="2"> ↑ 24(35) ↓ 4(6) Union Valley Pkwy </td> <td colspan="2"> ↑ 108(75) ↓ 0(0) Union Valley Pkwy </td> </tr> <tr> <td>45(26) ↓</td> <td>Foxenwood Ln</td> <td>0(0) ↓</td> <td>7(4) ↓</td> </tr> <tr> <td>0(0) ↓</td> <td></td> <td></td> <td></td> </tr> <tr> <td>0(0) ↓</td> <td></td> <td></td> <td></td> </tr> </table>	↑ 24(35) ↓ 4(6) Union Valley Pkwy		↑ 108(75) ↓ 0(0) Union Valley Pkwy		45(26) ↓	Foxenwood Ln	0(0) ↓	7(4) ↓	0(0) ↓				0(0) ↓			
↑ 0(0) ↓ 250(181) Foster Rd																																														
4(2) ↓	Foxenwood Ln	6(9) ↑	121(155) ↓																																											
7(4) ↓																																														
↑ 177(130) ↓ -114(-128) Foster Rd		↑ 0(0) ↓ 45(26) Foster Rd																																												
145(180) ↓	Orcutt Expy	28(25) ↓	0(0) ↓																																											
24(35) ↓		-151(-150) ↓	0(0) ↓																																											
37(44) ↓																																														
↑ 24(35) ↓ 4(6) Union Valley Pkwy		↑ 108(75) ↓ 0(0) Union Valley Pkwy																																												
45(26) ↓	Foxenwood Ln	0(0) ↓	7(4) ↓																																											
0(0) ↓																																														
0(0) ↓																																														
<p>4.</p> <table border="1"> <tr> <td colspan="2"> ↑ 58(43) ↓ -147(-144) Union Valley Pkwy </td> <td colspan="2"> ↑ 0(0) ↓ 86(50) Union Valley Pkwy </td> </tr> <tr> <td>21(21) ↓</td> <td>Orcutt Expy</td> <td>87(78) ↓</td> <td>0(0) ↓</td> </tr> <tr> <td>34(49) ↓</td> <td></td> <td>-144(-146) ↓</td> <td></td> </tr> <tr> <td>77(82) ↓</td> <td></td> <td></td> <td></td> </tr> </table>	↑ 58(43) ↓ -147(-144) Union Valley Pkwy		↑ 0(0) ↓ 86(50) Union Valley Pkwy		21(21) ↓	Orcutt Expy	87(78) ↓	0(0) ↓	34(49) ↓		-144(-146) ↓		77(82) ↓				<p>5.</p> <table border="1"> <tr> <td colspan="2"> ↑ 0(0) ↓ 0(0) Union Valley Pkwy </td> <td colspan="2"> ↑ 0(0) ↓ 86(50) Union Valley Pkwy </td> </tr> <tr> <td>0(0) ↓</td> <td>Orcutt Rd</td> <td>0(0) ↓</td> <td>0(0) ↓</td> </tr> <tr> <td>46(66) ↓</td> <td></td> <td>0(0) ↓</td> <td>0(0) ↓</td> </tr> <tr> <td>0(0) ↓</td> <td></td> <td></td> <td></td> </tr> </table>	↑ 0(0) ↓ 0(0) Union Valley Pkwy		↑ 0(0) ↓ 86(50) Union Valley Pkwy		0(0) ↓	Orcutt Rd	0(0) ↓	0(0) ↓	46(66) ↓		0(0) ↓	0(0) ↓	0(0) ↓																
↑ 58(43) ↓ -147(-144) Union Valley Pkwy		↑ 0(0) ↓ 86(50) Union Valley Pkwy																																												
21(21) ↓	Orcutt Expy	87(78) ↓	0(0) ↓																																											
34(49) ↓		-144(-146) ↓																																												
77(82) ↓																																														
↑ 0(0) ↓ 0(0) Union Valley Pkwy		↑ 0(0) ↓ 86(50) Union Valley Pkwy																																												
0(0) ↓	Orcutt Rd	0(0) ↓	0(0) ↓																																											
46(66) ↓		0(0) ↓	0(0) ↓																																											
0(0) ↓																																														



Legend:

- xx(yy) - AM(PM) Peak Hour Traffic Volumes
- ⓧ - Study Intersection
- ▭ - Project Site
- ↔(x%) - Project Trip Distribution

EXISTING PLUS PROJECT INTERSECTION OPERATIONS

Figure 5 shows the Existing Plus Project peak hour traffic volumes. Table 6 shows the vehicular LOS for the study intersections under Existing Plus Project Conditions, with detailed calculation sheets included in Appendix B and warrant analysis sheets included in Appendix C.

Table 6: Existing and Existing Plus Project Intersection LOS

Existing and Existing Plus Project Intersection Levels of Service					
Intersection	Peak Hour	Existing		Existing + Project	
		Delay ¹	LOS	Delay ¹	LOS
1. Foster Road/Foxenwood Lane	AM	2.1 (11.6)	- (B)	7.1 (19.6)	- (C)
	PM	0.7 (10.7)	- (B)	5.1 (13.4)	- (B)
2. Foster Road/SR 135 Orcutt Expressway	AM	25.9	C	28.1	C
	PM	23.2	C	25.6	C
3. Union Valley Parkway/Foxenwood Lane	AM	5.7 (16.7)	- (C)	48.1 (>200)	- (F)
	PM	3.8 (17.7)	- (C)	39.8 (192.7)	- (F)
4. Union Valley Parkway/SR 135 Orcutt Expressway	AM	29.2	C	29.5	C
	PM	23.4	C	26.0	C
5. Union Valley Parkway/Orcutt Road	AM	16.2	B	16.4	B
	PM	12.0	B	12.0	B

1. HCM 6th average control delay in seconds per vehicle. For side-street-stop controlled intersections the worst approach's delay is reported in parentheses next to the overall intersection delay.
 Note: Unacceptable operations shown in **bold** text.

All study intersections operate acceptably under Existing and Existing Plus Project conditions except Union Valley Parkway/Foxenwood Lane (#3) which operates at LOS F in both peak hours with the addition of project traffic. The intersection meets the peak hour signal warrant for both the AM and PM peak hours. Consistent with the 2007 EIR, we recommend that the project construct a traffic signal at this location. With signalization, the intersection would operate at LOS C in both peak hours.

Figure 5: Existing Plus Project Volumes

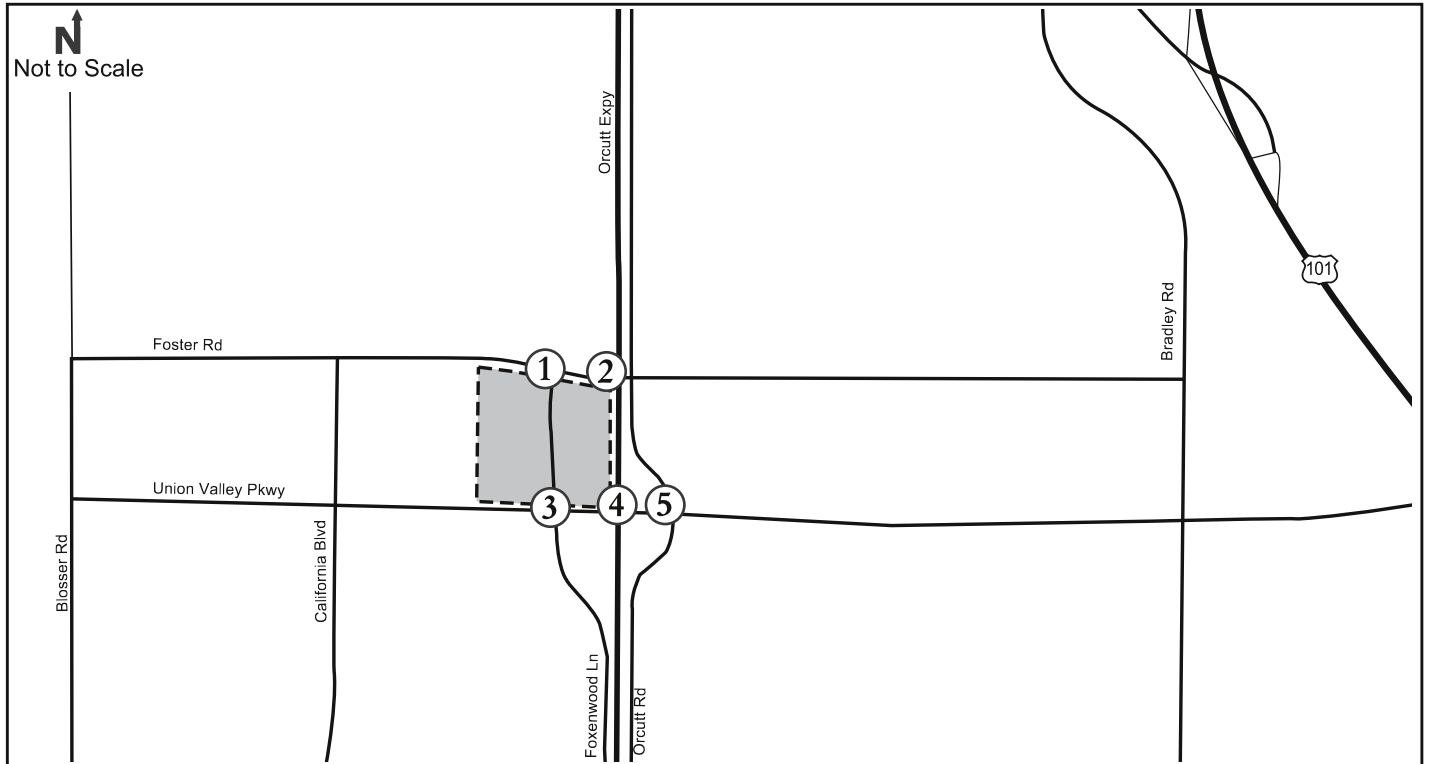

<p>1.</p> <table border="0"> <tr> <td colspan="2"> ↑ 187(169) ↓ 254(195) Foster Rd </td> </tr> <tr> <td> 235(249) → 8(15) ↓ </td> <td> Foxenwood Ln ↑ 46(14) ↓ 169(170) </td> </tr> </table>	↑ 187(169) ↓ 254(195) Foster Rd		235(249) → 8(15) ↓	Foxenwood Ln ↑ 46(14) ↓ 169(170)	<p>2.</p> <table border="0"> <tr> <td> ↑ 275(263) ↓ 695(1171) ↓ 105(133) </td> <td> ↑ 249(107) ↓ 121(74) ↓ 118(67) </td> </tr> <tr> <td colspan="2"> Foster Rd </td> </tr> <tr> <td> 321(362) ↑ 117(88) → 45(71) ↓ </td> <td> Orcutt Expy ↑ 47(31) ↓ 1076(980) ↑ 91(60) </td> </tr> </table>	↑ 275(263) ↓ 695(1171) ↓ 105(133)	↑ 249(107) ↓ 121(74) ↓ 118(67)	Foster Rd		321(362) ↑ 117(88) → 45(71) ↓	Orcutt Expy ↑ 47(31) ↓ 1076(980) ↑ 91(60)	<p>3.</p> <table border="0"> <tr> <td> ↑ 25(47) ↓ 7(14) ↓ 132(159) </td> <td> ↑ 140(81) ↓ 176(300) ↓ 78(178) </td> </tr> <tr> <td colspan="2"> Union Valley Pkwy </td> </tr> <tr> <td> 58(27) ↑ 296(220) → 0(3) ↓ </td> <td> Foxenwood Ln ↑ 0(3) ↓ 51(13) ↓ 189(99) </td> </tr> </table>	↑ 25(47) ↓ 7(14) ↓ 132(159)	↑ 140(81) ↓ 176(300) ↓ 78(178)	Union Valley Pkwy		58(27) ↑ 296(220) → 0(3) ↓	Foxenwood Ln ↑ 0(3) ↓ 51(13) ↓ 189(99)
↑ 187(169) ↓ 254(195) Foster Rd																		
235(249) → 8(15) ↓	Foxenwood Ln ↑ 46(14) ↓ 169(170)																	
↑ 275(263) ↓ 695(1171) ↓ 105(133)	↑ 249(107) ↓ 121(74) ↓ 118(67)																	
Foster Rd																		
321(362) ↑ 117(88) → 45(71) ↓	Orcutt Expy ↑ 47(31) ↓ 1076(980) ↑ 91(60)																	
↑ 25(47) ↓ 7(14) ↓ 132(159)	↑ 140(81) ↓ 176(300) ↓ 78(178)																	
Union Valley Pkwy																		
58(27) ↑ 296(220) → 0(3) ↓	Foxenwood Ln ↑ 0(3) ↓ 51(13) ↓ 189(99)																	
<p>4.</p> <table border="0"> <tr> <td> ↑ 155(302) ↓ 570(707) ↓ 138(328) </td> <td> ↑ 236(108) ↓ 260(269) ↓ 370(273) </td> </tr> <tr> <td colspan="2"> Union Valley Pkwy </td> </tr> <tr> <td> 219(165) ↑ 310(223) → 92(90) ↓ </td> <td> Orcutt Expy ↑ 102(87) ↓ 754(806) ↓ 254(427) </td> </tr> </table>	↑ 155(302) ↓ 570(707) ↓ 138(328)	↑ 236(108) ↓ 260(269) ↓ 370(273)	Union Valley Pkwy		219(165) ↑ 310(223) → 92(90) ↓	Orcutt Expy ↑ 102(87) ↓ 754(806) ↓ 254(427)	<p>5.</p> <table border="0"> <tr> <td> ↑ 8(5) ↓ 52(32) ↓ 24(22) </td> <td> ↑ 13(11) ↓ 699(583) ↓ 36(26) </td> </tr> <tr> <td colspan="2"> Union Valley Pkwy </td> </tr> <tr> <td> 6(0) ↑ 607(872) → 90(105) ↓ </td> <td> Orcutt Rd ↑ 147(66) ↓ 77(31) ↓ 72(42) </td> </tr> </table>	↑ 8(5) ↓ 52(32) ↓ 24(22)	↑ 13(11) ↓ 699(583) ↓ 36(26)	Union Valley Pkwy		6(0) ↑ 607(872) → 90(105) ↓	Orcutt Rd ↑ 147(66) ↓ 77(31) ↓ 72(42)					
↑ 155(302) ↓ 570(707) ↓ 138(328)	↑ 236(108) ↓ 260(269) ↓ 370(273)																	
Union Valley Pkwy																		
219(165) ↑ 310(223) → 92(90) ↓	Orcutt Expy ↑ 102(87) ↓ 754(806) ↓ 254(427)																	
↑ 8(5) ↓ 52(32) ↓ 24(22)	↑ 13(11) ↓ 699(583) ↓ 36(26)																	
Union Valley Pkwy																		
6(0) ↑ 607(872) → 90(105) ↓	Orcutt Rd ↑ 147(66) ↓ 77(31) ↓ 72(42)																	



Legend:

- xx(yy) - AM(PM) Peak Hour Traffic Volumes
- ⊗ - Study Intersection
- Project Site

SITE ACCESS AND ON-SITE CIRCULATION

CCTC reviewed the proposed site plan, shown on **Figure 2**, for vehicle, truck, pedestrian, and bike circulation. The site plan is conceptual at this time and will be refined as the project progresses to the design phase. Site access is proposed from seven full-access driveways on either side of Foxenwood Lane, one outbound only driveway exiting the self storage facility, one full-access driveway on Foster Road east of Foxenwood Lane, and one right-in driveway on Union Valley Parkway east of Foxenwood Lane.

Recommendations

We recommend the following changes to the site plan as it is refined:

- The driveways on Foxenwood Lane should be consolidated where possible to reduce conflict points, in accordance with the Transportation Research Board's best practices for access management. Depending on the tenant, the public facilities building may not require two full access driveways and converting to a one-way loop would reduce conflict points.
- The driveway on Foster Road should be restricted to right-in-right-out only due to its proximity to SR 135 Orcutt Expressway.
- The site plan does not include the previously proposed roundabout at Foster Road/Foxenwood Lane (#1). Although the northern extension of Foxenwood Lane is now an existing Class I bike path with no vehicles, a controlled crossing of Foxenwood Lane would be desirable for bicycles and pedestrians. The site plan should accommodate the future roundabout footprint.
- Driveway approaches should be stop controlled. The need for all-way stop control at major driveways on Foxenwood Lane should be monitored after the project is fully occupied.
- The self storage driveway is slightly offset north of the market place driveway. It should be realigned so it is directly opposite the market place driveway.
- Convenient pedestrian access should be provided between the land uses on the project site, including across Foxenwood Lane. Employees at the office uses west of Foxenwood Lane should have a convenient path of travel to walk to the market place. At a minimum, striped crosswalks should be provided at the driveways north and south of the market place. In addition, a raised crosswalk could be considered on Foxenwood Lane adjacent to the market place promenade. The raised crosswalk will increase the pedestrian visibility and potentially reduce vehicular speeds.
- The site plan does not show all frontage improvement sidewalks on Foster Road and Union Valley Parkway. Sidewalks should be provided along the project frontages.
- The site plan does not show proposed Class I and II bikeways from the City's Bikeway Master Plan, as described in the Existing Circulation Network section of this report. We recommend that the project incorporate planned bikeways into the frontage improvements.

Cumulative (10-Year) Conditions

Cumulative (10-Year) Conditions represents future traffic conditions including partial development of the Specific Plan in conjunction with other approved and proposed developments in the area.

CUMULATIVE METHODOLOGY

Cumulative traffic volume forecasts, shown on **Figure 6**, were developed using outputs from the City's Travel Demand Model (TDM). No improvements were assumed at the study intersections under Cumulative Conditions.

Under Cumulative Conditions a PHF of 0.92 was used for the analysis. However, if the existing PHF exceeded this value the higher PHF was used.

Cumulative Plus Project volumes are shown on **Figure 7**.

Figure 6: Cumulative Volumes

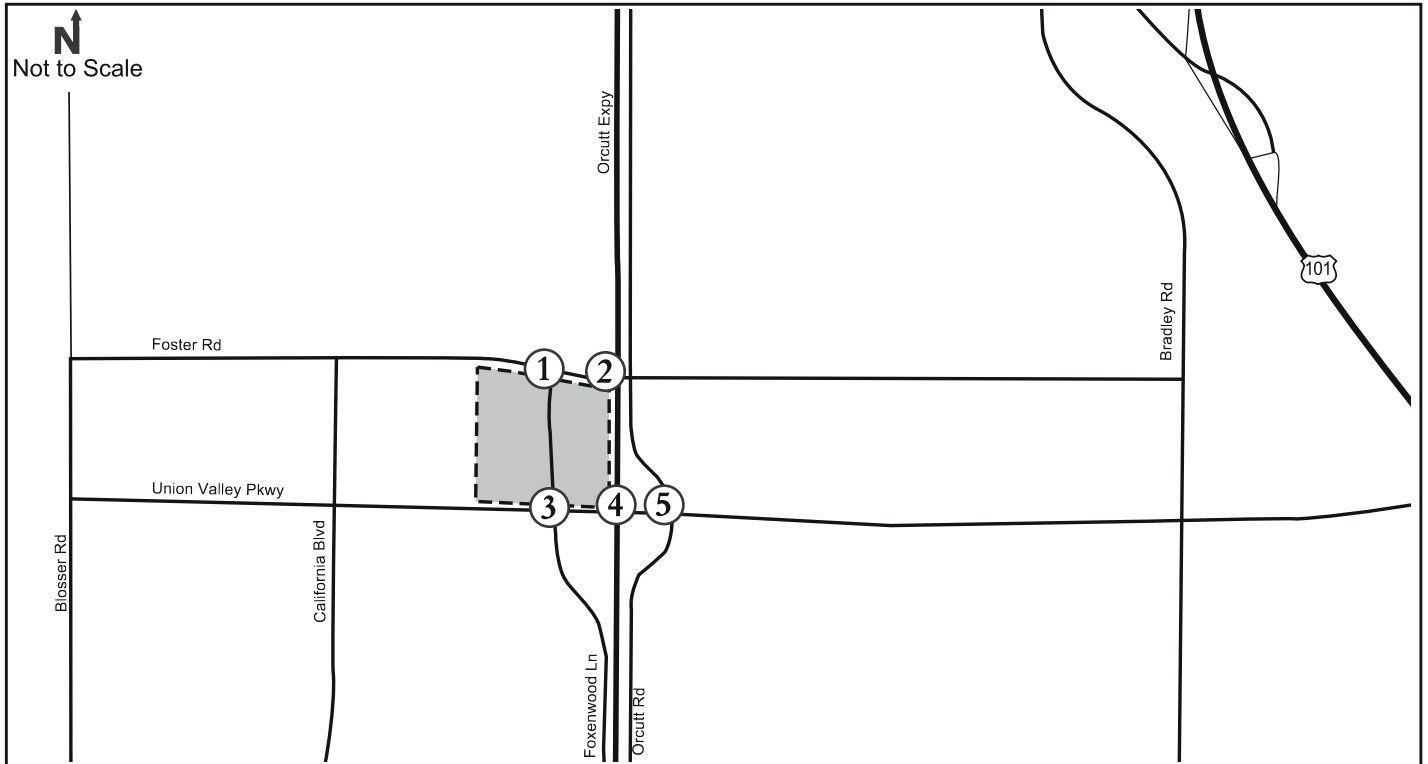

<p>1.</p> <table border="0" style="margin-left: auto; margin-right: auto;"> <tr> <td colspan="2"></td> <td colspan="2" style="text-align: center;">← 190(220)</td> <td colspan="2"></td> </tr> <tr> <td colspan="2"></td> <td colspan="2" style="text-align: center;">← 10(30)</td> <td colspan="2"></td> </tr> <tr> <td colspan="2"></td> <td colspan="4" style="text-align: center;">Foster Rd</td> </tr> <tr> <td style="text-align: center;">240(260) →</td> <td style="text-align: center;">20(20) ↓</td> <td style="text-align: center;">Foxenwood Ln</td> <td style="text-align: center;">50(10) ↑</td> <td style="text-align: center;">50(20) →</td> <td></td> </tr> </table>			← 190(220)						← 10(30)						Foster Rd				240(260) →	20(20) ↓	Foxenwood Ln	50(10) ↑	50(20) →		<p>2.</p> <table border="0" style="margin-left: auto; margin-right: auto;"> <tr> <td colspan="2"></td> <td colspan="2" style="text-align: center;">← 100(180)</td> <td colspan="2"></td> </tr> <tr> <td colspan="2"></td> <td colspan="2" style="text-align: center;">← 810(1520)</td> <td colspan="2"></td> </tr> <tr> <td colspan="2"></td> <td colspan="2" style="text-align: center;">← 190(140)</td> <td colspan="2"></td> </tr> <tr> <td colspan="2"></td> <td colspan="4" style="text-align: center;">Foster Rd</td> </tr> <tr> <td style="text-align: center;">180(200) ↑</td> <td style="text-align: center;">100(60) →</td> <td style="text-align: center;">Orcutt Expy</td> <td style="text-align: center;">20(10) ↓</td> <td style="text-align: center;">1410(1150) ↑</td> <td style="text-align: center;">100(60) →</td> </tr> <tr> <td colspan="2"></td> <td colspan="2"></td> <td colspan="2" style="text-align: center;">260(110)</td> </tr> <tr> <td colspan="2"></td> <td colspan="2"></td> <td colspan="2" style="text-align: center;">80(60)</td> </tr> <tr> <td colspan="2"></td> <td colspan="2"></td> <td colspan="2" style="text-align: center;">120(70)</td> </tr> </table>			← 100(180)						← 810(1520)						← 190(140)						Foster Rd				180(200) ↑	100(60) →	Orcutt Expy	20(10) ↓	1410(1150) ↑	100(60) →					260(110)						80(60)						120(70)		<p>3.</p> <table border="0" style="margin-left: auto; margin-right: auto;"> <tr> <td colspan="2"></td> <td colspan="2" style="text-align: center;">← 10(20)</td> <td colspan="2"></td> </tr> <tr> <td colspan="2"></td> <td colspan="2" style="text-align: center;">← 40(10)</td> <td colspan="2"></td> </tr> <tr> <td colspan="2"></td> <td colspan="2" style="text-align: center;">← 0(30)</td> <td colspan="2"></td> </tr> <tr> <td colspan="2"></td> <td colspan="4" style="text-align: center;">Union Valley Pkwy</td> </tr> <tr> <td style="text-align: center;">20(10) ↑</td> <td style="text-align: center;">330(260) →</td> <td style="text-align: center;">Foxenwood Ln</td> <td style="text-align: center;">10(10) ↓</td> <td style="text-align: center;">10(10) ↑</td> <td style="text-align: center;">190(120) →</td> </tr> <tr> <td colspan="2"></td> <td colspan="2"></td> <td colspan="2" style="text-align: center;">40(10)</td> </tr> <tr> <td colspan="2"></td> <td colspan="2"></td> <td colspan="2" style="text-align: center;">210(330)</td> </tr> <tr> <td colspan="2"></td> <td colspan="2"></td> <td colspan="2" style="text-align: center;">80(190)</td> </tr> </table>			← 10(20)						← 40(10)						← 0(30)						Union Valley Pkwy				20(10) ↑	330(260) →	Foxenwood Ln	10(10) ↓	10(10) ↑	190(120) →					40(10)						210(330)						80(190)	
		← 190(220)																																																																																																																								
		← 10(30)																																																																																																																								
		Foster Rd																																																																																																																								
240(260) →	20(20) ↓	Foxenwood Ln	50(10) ↑	50(20) →																																																																																																																						
		← 100(180)																																																																																																																								
		← 810(1520)																																																																																																																								
		← 190(140)																																																																																																																								
		Foster Rd																																																																																																																								
180(200) ↑	100(60) →	Orcutt Expy	20(10) ↓	1410(1150) ↑	100(60) →																																																																																																																					
				260(110)																																																																																																																						
				80(60)																																																																																																																						
				120(70)																																																																																																																						
		← 10(20)																																																																																																																								
		← 40(10)																																																																																																																								
		← 0(30)																																																																																																																								
		Union Valley Pkwy																																																																																																																								
20(10) ↑	330(260) →	Foxenwood Ln	10(10) ↓	10(10) ↑	190(120) →																																																																																																																					
				40(10)																																																																																																																						
				210(330)																																																																																																																						
				80(190)																																																																																																																						
<p>4.</p> <table border="0" style="margin-left: auto; margin-right: auto;"> <tr> <td colspan="2"></td> <td colspan="2" style="text-align: center;">← 100(260)</td> <td colspan="2"></td> </tr> <tr> <td colspan="2"></td> <td colspan="2" style="text-align: center;">← 730(1110)</td> <td colspan="2"></td> </tr> <tr> <td colspan="2"></td> <td colspan="2" style="text-align: center;">← 130(320)</td> <td colspan="2"></td> </tr> <tr> <td colspan="2"></td> <td colspan="4" style="text-align: center;">Union Valley Pkwy</td> </tr> <tr> <td style="text-align: center;">200(170) ↑</td> <td style="text-align: center;">330(230) →</td> <td style="text-align: center;">Orcutt Expy</td> <td style="text-align: center;">50(10) ↓</td> <td style="text-align: center;">970(960) ↑</td> <td style="text-align: center;">260(430) →</td> </tr> <tr> <td colspan="2"></td> <td colspan="2"></td> <td colspan="2" style="text-align: center;">360(110)</td> </tr> <tr> <td colspan="2"></td> <td colspan="2"></td> <td colspan="2" style="text-align: center;">180(260)</td> </tr> <tr> <td colspan="2"></td> <td colspan="2"></td> <td colspan="2" style="text-align: center;">400(280)</td> </tr> </table>			← 100(260)						← 730(1110)						← 130(320)						Union Valley Pkwy				200(170) ↑	330(230) →	Orcutt Expy	50(10) ↓	970(960) ↑	260(430) →					360(110)						180(260)						400(280)		<p>5.</p> <table border="0" style="margin-left: auto; margin-right: auto;"> <tr> <td colspan="2"></td> <td colspan="2" style="text-align: center;">← 10(10)</td> <td colspan="2"></td> </tr> <tr> <td colspan="2"></td> <td colspan="2" style="text-align: center;">← 100(190)</td> <td colspan="2"></td> </tr> <tr> <td colspan="2"></td> <td colspan="2" style="text-align: center;">← 30(30)</td> <td colspan="2"></td> </tr> <tr> <td colspan="2"></td> <td colspan="4" style="text-align: center;">Union Valley Pkwy</td> </tr> <tr> <td style="text-align: center;">10(0) ↑</td> <td style="text-align: center;">580(890) →</td> <td style="text-align: center;">Orcutt Rd</td> <td style="text-align: center;">270(70) ↓</td> <td style="text-align: center;">120(120) ↑</td> <td style="text-align: center;">80(60) →</td> </tr> <tr> <td colspan="2"></td> <td colspan="2"></td> <td colspan="2" style="text-align: center;">20(20)</td> </tr> <tr> <td colspan="2"></td> <td colspan="2"></td> <td colspan="2" style="text-align: center;">650(580)</td> </tr> <tr> <td colspan="2"></td> <td colspan="2"></td> <td colspan="2" style="text-align: center;">60(30)</td> </tr> </table>			← 10(10)						← 100(190)						← 30(30)						Union Valley Pkwy				10(0) ↑	580(890) →	Orcutt Rd	270(70) ↓	120(120) ↑	80(60) →					20(20)						650(580)						60(30)																										
		← 100(260)																																																																																																																								
		← 730(1110)																																																																																																																								
		← 130(320)																																																																																																																								
		Union Valley Pkwy																																																																																																																								
200(170) ↑	330(230) →	Orcutt Expy	50(10) ↓	970(960) ↑	260(430) →																																																																																																																					
				360(110)																																																																																																																						
				180(260)																																																																																																																						
				400(280)																																																																																																																						
		← 10(10)																																																																																																																								
		← 100(190)																																																																																																																								
		← 30(30)																																																																																																																								
		Union Valley Pkwy																																																																																																																								
10(0) ↑	580(890) →	Orcutt Rd	270(70) ↓	120(120) ↑	80(60) →																																																																																																																					
				20(20)																																																																																																																						
				650(580)																																																																																																																						
				60(30)																																																																																																																						



Legend:

- xx(yy) - AM(PM) Peak Hour Traffic Volumes
- ⊗ - Study Intersection
- Project Site

Figure 7: Cumulative Plus Project Volumes

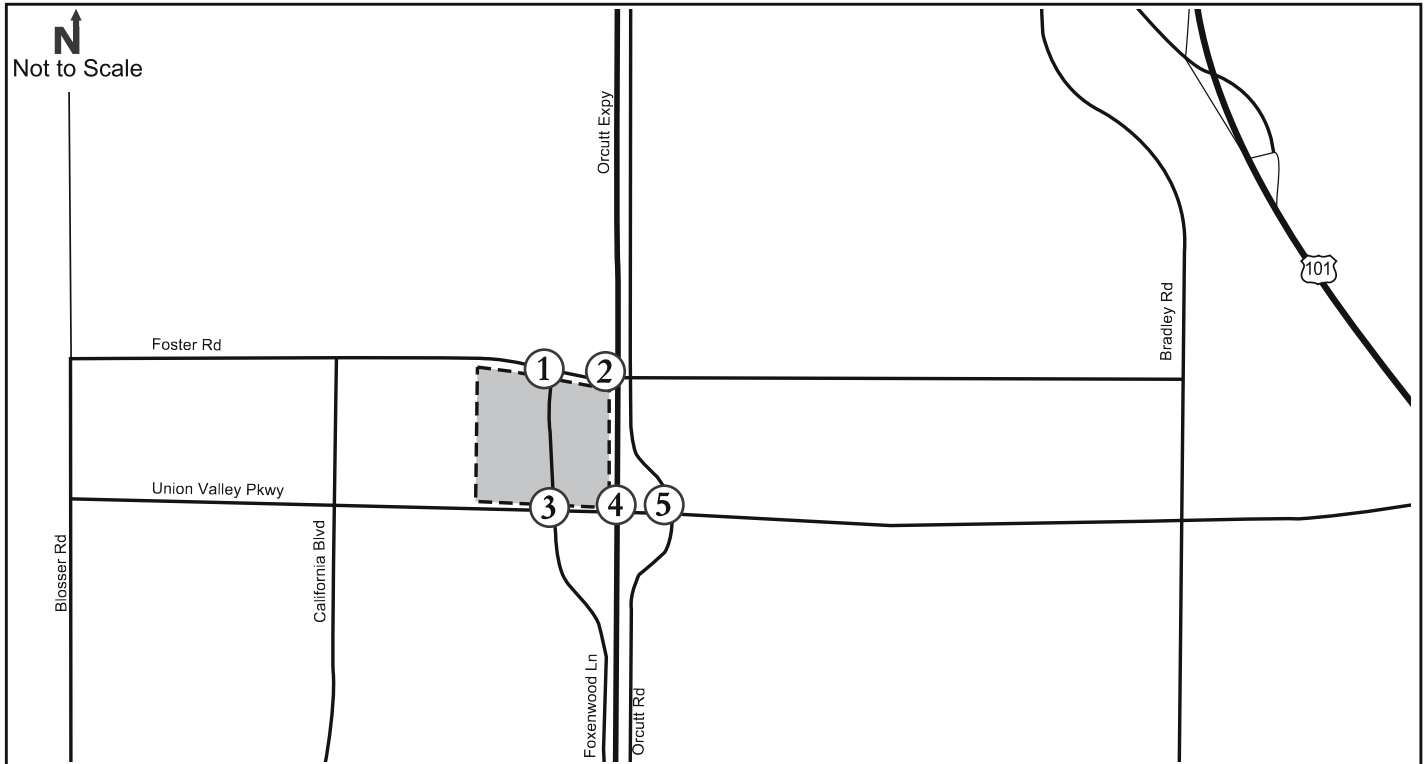

<p>1.</p> <table border="0"> <tr> <td></td> <td>← 190(220)</td> <td></td> </tr> <tr> <td></td> <td>↙ 260(211)</td> <td></td> </tr> <tr> <td></td> <td colspan="2" style="text-align: center;">Foster Rd</td> </tr> <tr> <td>244(262) →</td> <td>Foxenwood Ln ↗</td> <td>↘ 171(175)</td> </tr> <tr> <td>27(24) ↘</td> <td>56(19) ↗</td> <td></td> </tr> </table>		← 190(220)			↙ 260(211)			Foster Rd		244(262) →	Foxenwood Ln ↗	↘ 171(175)	27(24) ↘	56(19) ↗		<p>2.</p> <table border="0"> <tr> <td>↙ 277(310)</td> <td>↘ 696(1392)</td> <td>↘ 190(140)</td> <td>↗ 260(110)</td> </tr> <tr> <td></td> <td></td> <td></td> <td>← 125(86)</td> </tr> <tr> <td></td> <td></td> <td></td> <td>↙ 120(70)</td> </tr> <tr> <td></td> <td colspan="3" style="text-align: center;">Foster Rd</td> </tr> <tr> <td>325(380) ↗</td> <td>Orcutt Expy ↗</td> <td>↘ 48(35)</td> <td>↘ 100(60)</td> </tr> <tr> <td>124(95) →</td> <td></td> <td>↗ 1259(1000)</td> <td></td> </tr> <tr> <td>47(74) ↘</td> <td></td> <td></td> <td></td> </tr> </table>	↙ 277(310)	↘ 696(1392)	↘ 190(140)	↗ 260(110)				← 125(86)				↙ 120(70)		Foster Rd			325(380) ↗	Orcutt Expy ↗	↘ 48(35)	↘ 100(60)	124(95) →		↗ 1259(1000)		47(74) ↘				<p>3.</p> <table border="0"> <tr> <td>↙ 34(55)</td> <td>↘ 44(16)</td> <td>↘ 132(182)</td> <td>↗ 148(85)</td> </tr> <tr> <td></td> <td></td> <td></td> <td>← 210(330)</td> </tr> <tr> <td></td> <td></td> <td></td> <td>↙ 80(190)</td> </tr> <tr> <td></td> <td colspan="3" style="text-align: center;">Union Valley Pkwy</td> </tr> <tr> <td>65(36) ↗</td> <td>Foxenwood Ln ↗</td> <td>↘ 10(10)</td> <td>↘ 190(120)</td> </tr> <tr> <td>330(260) →</td> <td>10(10) ↗</td> <td>↗ 57(14)</td> <td></td> </tr> <tr> <td>10(10) ↘</td> <td></td> <td></td> <td></td> </tr> </table>	↙ 34(55)	↘ 44(16)	↘ 132(182)	↗ 148(85)				← 210(330)				↙ 80(190)		Union Valley Pkwy			65(36) ↗	Foxenwood Ln ↗	↘ 10(10)	↘ 190(120)	330(260) →	10(10) ↗	↗ 57(14)		10(10) ↘			
	← 190(220)																																																																								
	↙ 260(211)																																																																								
	Foster Rd																																																																								
244(262) →	Foxenwood Ln ↗	↘ 171(175)																																																																							
27(24) ↘	56(19) ↗																																																																								
↙ 277(310)	↘ 696(1392)	↘ 190(140)	↗ 260(110)																																																																						
			← 125(86)																																																																						
			↙ 120(70)																																																																						
	Foster Rd																																																																								
325(380) ↗	Orcutt Expy ↗	↘ 48(35)	↘ 100(60)																																																																						
124(95) →		↗ 1259(1000)																																																																							
47(74) ↘																																																																									
↙ 34(55)	↘ 44(16)	↘ 132(182)	↗ 148(85)																																																																						
			← 210(330)																																																																						
			↙ 80(190)																																																																						
	Union Valley Pkwy																																																																								
65(36) ↗	Foxenwood Ln ↗	↘ 10(10)	↘ 190(120)																																																																						
330(260) →	10(10) ↗	↗ 57(14)																																																																							
10(10) ↘																																																																									
<p>4.</p> <table border="0"> <tr> <td>↙ 158(303)</td> <td>↘ 583(966)</td> <td>↘ 142(337)</td> <td>↗ 360(110)</td> </tr> <tr> <td></td> <td></td> <td></td> <td>← 266(310)</td> </tr> <tr> <td></td> <td></td> <td></td> <td>↙ 400(280)</td> </tr> <tr> <td></td> <td colspan="3" style="text-align: center;">Union Valley Pkwy</td> </tr> <tr> <td>221(191) ↗</td> <td>Orcutt Expy ↗</td> <td>↘ 137(88)</td> <td>↘ 260(430)</td> </tr> <tr> <td>364(279) →</td> <td>826(814) ↗</td> <td></td> <td></td> </tr> <tr> <td>97(92) ↘</td> <td></td> <td></td> <td></td> </tr> </table>	↙ 158(303)	↘ 583(966)	↘ 142(337)	↗ 360(110)				← 266(310)				↙ 400(280)		Union Valley Pkwy			221(191) ↗	Orcutt Expy ↗	↘ 137(88)	↘ 260(430)	364(279) →	826(814) ↗			97(92) ↘				<p>5.</p> <table border="0"> <tr> <td>↙ 10(10)</td> <td>↘ 100(190)</td> <td>↘ 30(30)</td> <td>↗ 20(20)</td> </tr> <tr> <td></td> <td></td> <td></td> <td>← 736(630)</td> </tr> <tr> <td></td> <td></td> <td></td> <td>↙ 60(30)</td> </tr> <tr> <td></td> <td colspan="3" style="text-align: center;">Union Valley Pkwy</td> </tr> <tr> <td>10(0) ↗</td> <td>Orcutt Rd ↗</td> <td>↘ 270(70)</td> <td>↘ 80(60)</td> </tr> <tr> <td>626(956) →</td> <td></td> <td>↗ 120(120)</td> <td></td> </tr> <tr> <td>110(110) ↘</td> <td></td> <td></td> <td></td> </tr> </table>	↙ 10(10)	↘ 100(190)	↘ 30(30)	↗ 20(20)				← 736(630)				↙ 60(30)		Union Valley Pkwy			10(0) ↗	Orcutt Rd ↗	↘ 270(70)	↘ 80(60)	626(956) →		↗ 120(120)		110(110) ↘																			
↙ 158(303)	↘ 583(966)	↘ 142(337)	↗ 360(110)																																																																						
			← 266(310)																																																																						
			↙ 400(280)																																																																						
	Union Valley Pkwy																																																																								
221(191) ↗	Orcutt Expy ↗	↘ 137(88)	↘ 260(430)																																																																						
364(279) →	826(814) ↗																																																																								
97(92) ↘																																																																									
↙ 10(10)	↘ 100(190)	↘ 30(30)	↗ 20(20)																																																																						
			← 736(630)																																																																						
			↙ 60(30)																																																																						
	Union Valley Pkwy																																																																								
10(0) ↗	Orcutt Rd ↗	↘ 270(70)	↘ 80(60)																																																																						
626(956) →		↗ 120(120)																																																																							
110(110) ↘																																																																									



Legend:

- xx(yy) - AM(PM) Peak Hour Traffic Volumes
- ⊗ - Study Intersection
- Project Site

CUMULATIVE INTERSECTION OPERATIONS

Table 7 shows the vehicular LOS for the study intersections under Cumulative and Cumulative Plus Project Conditions, with detailed calculation sheets included in **Appendix B** and warrant analysis sheets included in **Appendix C**.

Table 7: Cumulative and Cumulative Plus Project Intersection LOS

Cumulative and Cumulative Plus Project Intersection Levels of Service					
Intersection	Peak Hour	Cumulative (10-year)		Cumulative (10-year) + Project	
		Delay ¹	LOS	Delay ¹	LOS
1. Foster Road/Foxenwood Lane	AM	2.3 (12.3)	- (B)	8.2 (24.2)	- (C)
	PM	1.1 (11.5)	- (B)	5.1 (14.7)	- (B)
2. Foster Road/SR 135 Orcutt Expressway	AM	44.7	D	45.6	D
	PM	26.1	C	28.9	C
3. Union Valley Parkway/Foxenwood Lane	AM	6.3 (18.7)	- (C)	46.9 (>200)	- (F)
	PM	5.3 (28.7)	- (D)	88.3 (>200)	- (F)
4. Union Valley Parkway/SR 135 Orcutt Expressway	AM	36.5	D	37.3	D
	PM	24.7	C	27.7	C
5. Union Valley Parkway/Orcutt Road	AM	25.6	C	26.7	C
	PM	16.8	B	17.5	B
1. HCM 6th average control delay in seconds per vehicle. For side-street-stop controlled intersections the worst approach's delay is reported in parentheses next to the overall intersection delay. Note: Unacceptable operations shown in bold text.					

The following intersections operate below their respective LOS threshold:

- Foster Road/SR 135 Orcutt Expressway (#2) operates at LOS D during the AM peak hour. With SR 135 Orcutt Expressway widened to six lanes, the intersection would operate at LOS C. The widening project is currently planned in the Fast Forward 2040 SBCAG Regional Transportation Plan and Sustainable Communities Strategy (RTP-SCS).
- Union Valley Parkway/Foxenwood Lane (#3) operates at LOS F in both peak hours with the addition of project traffic. The intersection meets the peak hour signal warrant for both the AM and PM peak hours. Consistent with the 2007 EIR, we recommend that the project construct a traffic signal at this location. With signalization, the intersection would operate at LOS C in both peak hours.
- Union Valley Parkway/SR 135 Orcutt Expressway (#4) operates at LOS D during the AM peak hour. With SR 135 Orcutt Expressway widened to six lanes, the intersection would operate at LOS C. The widening project is currently planned in the RTP-SCS.

VEHICLE MILES TRAVELED (VMT)

The SBCAG Travel Demand Model was used to develop VMT estimates with and without the project. The model’s base year is 2010, and an interim scenario of 2020 is also available. **Table 8** summarizes the VMT estimates for both of these years with and without the project.

Table 8: VMT Estimates

Santa Barbara County VMT		
	2010	2020
No Project	9,540,676	9,525,614
With Project	9,404,634	9,491,776
Change	-136,042	-33,838

Source: SBCAG Model, CCTC, 2020

The project would reduce regional VMT by adding a diversity of land uses to a predominantly residential area.

References

- Associated Transportation Engineers. October 10, 2005. Santa Maria Airport Business Park Specific Plan Traffic and Circulation Study.
- California Department of Transportation. 2012, 2018. Highway Design Manual.
- _____. 2014, Revision 4. California Manual on Uniform Traffic Control Devices.
- _____. February 2020. Transportation Impact Study Guide Vehicle Miles Traveled-Focused DRAFT.
- California Governor's Office of Planning and Research (OPR). December 2018. Technical Advisory on Evaluating Transportation Impacts in CEQA.
- City of Santa Maria. 1994, amended 2011. General Plan Circulation Element.
- _____. 2009. Bikeway Master Plan.
- Institute of Transportation Engineers (ITE). 2017. Trip Generation Handbook, 3rd Edition.
- _____. 2017. Trip Generation Manual, 10th Edition.
- Rincon Consultants. 2007. Final Environmental Impact Report for the Santa Maria Airport Business Park Specific Plan.
- Santa Barbara County Association of Governments (SBCAG). 2017. Fast Forward 2040 Regional Transportation Plan and Sustainable Communities Strategy.
- _____. 2016. Congestion Management Program.
- Transportation Research Board. 2014. Access Management Manual, 2nd Edition.
- _____. 2017. Highway Capacity Manual, 6th Edition and 2010 Edition.

Appendix A: Traffic Counts



Metro Traffic Data Inc.
 310 N. Irwin Street - Suite 20
 Hanford, CA 93230
 800-975-6938 Phone/Fax
 www.metrotrafficdata.com

Turning Movement Report

Prepared For:
Central Coast Transportation Consulting
 895 Napa Avenue, Suite A-6
 Morro Bay, CA 93442

LOCATION Foster Rd @ Foxenwood Ln

LATITUDE 34.8832

COUNTY Santa Barbara

LONGITUDE -120.4387

COLLECTION DATE Tuesday, December 17, 2019

WEATHER Clear

Time	Northbound				Southbound				Eastbound				Westbound			
	Left	Thru	Right	Trucks	Left	Thru	Right	Trucks	Left	Thru	Right	Trucks	Left	Thru	Right	Trucks
7:00 AM - 7:15 AM	3	0	7	0	0	0	0	0	0	39	0	1	0	27	0	2
7:15 AM - 7:30 AM	7	0	9	0	0	0	0	0	0	69	0	3	0	47	0	4
7:30 AM - 7:45 AM	7	0	14	1	0	0	0	0	0	46	0	4	2	45	0	0
7:45 AM - 8:00 AM	15	0	18	1	0	0	0	0	0	48	1	2	0	53	0	0
8:00 AM - 8:15 AM	11	0	7	0	0	0	0	0	0	68	0	2	2	42	0	2
8:15 AM - 8:30 AM	2	0	11	0	0	0	0	0	0	45	0	1	2	44	0	0
8:30 AM - 8:45 AM	5	0	2	0	0	0	0	0	0	26	0	3	1	38	0	1
8:45 AM - 9:00 AM	1	0	3	0	0	0	0	0	0	48	2	2	4	39	0	1
TOTAL	51	0	71	2	0	0	0	0	0	389	3	18	11	335	0	10

Time	Northbound				Southbound				Eastbound				Westbound			
	Left	Thru	Right	Trucks	Left	Thru	Right	Trucks	Left	Thru	Right	Trucks	Left	Thru	Right	Trucks
2:00 PM - 2:15 PM	0	0	5	0	0	0	0	0	0	51	4	2	2	34	0	4
2:15 PM - 2:30 PM	0	0	3	0	0	0	0	0	0	33	0	1	5	40	0	2
2:30 PM - 2:45 PM	2	0	2	0	0	0	0	0	0	45	1	2	3	36	0	1
2:45 PM - 3:00 PM	2	0	9	0	0	0	0	0	0	45	2	3	4	40	0	2
3:00 PM - 3:15 PM	2	0	4	0	0	0	0	0	0	55	1	3	6	59	0	3
3:15 PM - 3:30 PM	5	0	5	0	0	0	0	0	0	37	5	0	4	41	0	1
3:30 PM - 3:45 PM	2	0	4	0	0	0	0	0	0	66	2	3	4	34	0	2
3:45 PM - 4:00 PM	1	0	2	0	0	0	0	0	0	60	1	2	5	56	0	2
4:00 PM - 4:15 PM	1	0	4	0	0	0	0	0	0	67	0	1	5	47	0	0
4:15 PM - 4:30 PM	1	0	1	0	0	0	0	0	0	39	1	1	4	42	0	2
4:30 PM - 4:45 PM	2	0	3	0	0	0	0	0	0	71	1	1	4	37	0	0
4:45 PM - 5:00 PM	1	0	7	0	0	0	0	0	0	62	1	0	3	48	0	0
5:00 PM - 5:15 PM	2	0	2	0	0	0	0	0	0	72	5	0	1	47	0	1
5:15 PM - 5:30 PM	0	0	3	0	0	0	0	0	0	42	4	0	6	37	0	0
5:30 PM - 5:45 PM	1	0	2	0	0	0	0	0	0	39	1	1	4	31	0	0
5:45 PM - 6:00 PM	1	0	3	0	0	0	0	0	0	47	5	0	1	39	0	1
TOTAL	23	0	59	0	0	0	0	0	0	831	34	20	61	668	0	21

PEAK HOUR	Northbound				Southbound				Eastbound				Westbound			
	Left	Thru	Right	Trucks	Left	Thru	Right	Trucks	Left	Thru	Right	Trucks	Left	Thru	Right	Trucks
7:15 AM - 8:15 AM	40	0	48	2	0	0	0	0	0	231	1	11	4	187	0	6
4:30 PM - 5:30 PM*	5	0	15	0	0	0	0	0	0	247	11	1	14	169	0	1

*Uniform peak hour

	PHF	Trucks
AM	0.946	3.7%
PM	0.893	0.4%

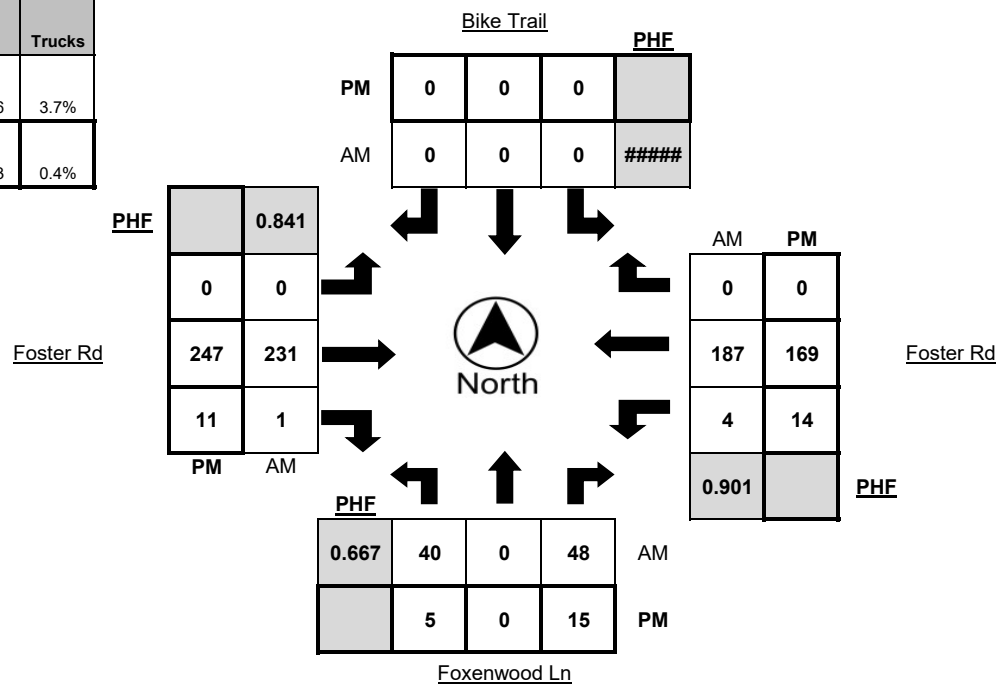



Metro Traffic Data Inc.
 310 N. Irwin Street - Suite 20
 Hanford, CA 93230
 800-975-6938 Phone/Fax
 www.metrotrafficdata.com

Turning Movement Report

Prepared For:
Central Coast Transportation Consulting
 895 Napa Avenue, Suite A-6
 Morro Bay, CA 93442

LOCATION Foster Rd @ Foxenwood Ln

LATITUDE 34.8832

COUNTY Santa Barbara

LONGITUDE -120.4387

COLLECTION DATE Tuesday, December 17, 2019

WEATHER Clear

Time	Northbound Bikes				N.Leg Peds	Southbound Bikes				S.Leg Peds	Eastbound Bikes				E.Leg Peds	Westbound Bikes				W.Leg Peds
	Left	Thru	Right			Left	Thru	Right			Left	Thru	Right			Left	Thru	Right		
7:00 AM - 7:15 AM	0	0	0		0	0	0	0		0	0	0	0	0	0	0	0	0	0	0
7:15 AM - 7:30 AM	0	0	0		0	0	0	0		0	0	0	0	0	0	0	0	0	0	0
7:30 AM - 7:45 AM	0	0	0		0	0	0	0		0	0	0	0	0	0	0	0	0	0	0
7:45 AM - 8:00 AM	0	0	0		0	0	0	0		0	0	0	0	0	0	0	0	0	0	0
8:00 AM - 8:15 AM	0	0	0		0	0	0	0		0	0	0	0	0	0	0	0	0	0	0
8:15 AM - 8:30 AM	0	0	0		0	0	0	0		1	0	0	0	0	0	0	0	0	0	0
8:30 AM - 8:45 AM	0	0	0		0	0	0	0		0	0	0	0	0	0	0	0	0	0	0
8:45 AM - 9:00 AM	0	0	0		0	1	0	0		0	0	0	0	0	0	0	0	1	0	0
TOTAL	0	0	0		0	1	0	1		0	0	0	0	0	0	0	0	1	0	0

Time	Northbound Bikes				N.Leg Peds	Southbound Bikes				S.Leg Peds	Eastbound Bikes				E.Leg Peds	Westbound Bikes				W.Leg Peds
	Left	Thru	Right			Left	Thru	Right			Left	Thru	Right			Left	Thru	Right		
2:00 PM - 2:15 PM	0	0	0		0	0	1	0		0	0	0	0	0	0	0	0	0	0	0
2:15 PM - 2:30 PM	0	0	0		0	0	0	0		0	0	0	0	0	0	0	0	0	0	1
2:30 PM - 2:45 PM	0	0	0		0	0	0	1		1	0	0	0	0	0	0	0	0	0	0
2:45 PM - 3:00 PM	0	0	1		0	0	1	0		0	0	0	0	0	0	0	0	0	0	0
3:00 PM - 3:15 PM	0	0	0		0	0	0	0		0	0	0	0	0	0	0	0	0	0	0
3:15 PM - 3:30 PM	0	0	0		0	2	0	0		0	0	0	0	0	0	0	0	0	0	0
3:30 PM - 3:45 PM	0	0	0		0	0	1	0		0	0	0	0	0	0	0	0	0	0	0
3:45 PM - 4:00 PM	0	0	0		0	0	1	0		0	0	0	0	0	0	1	0	0	0	1
4:00 PM - 4:15 PM	0	0	0		0	0	0	0		0	0	0	0	0	0	0	0	0	0	0
4:15 PM - 4:30 PM	0	0	0		0	0	0	0		0	0	0	0	0	0	0	0	0	0	0
4:30 PM - 4:45 PM	0	0	0		1	1	0	0		0	0	0	0	0	0	0	0	0	0	0
4:45 PM - 5:00 PM	0	0	1		1	0	0	0		0	0	0	0	0	0	0	0	0	0	0
5:00 PM - 5:15 PM	0	0	0		1	1	1	0		0	0	0	0	0	0	0	0	0	0	0
5:15 PM - 5:30 PM	0	0	0		0	0	0	0		0	0	0	0	0	0	0	0	0	0	0
5:30 PM - 5:45 PM	0	0	0		0	0	1	0		0	0	0	0	0	0	0	0	0	0	1
5:45 PM - 6:00 PM	0	0	0		0	2	0	0		0	0	0	0	0	0	0	0	0	0	0
TOTAL	0	0	2		3	2	9	2		1	0	0	0	0	0	1	0	0	3	3

PEAK HOUR	Northbound Bikes				N.Leg Peds	Southbound Bikes				S.Leg Peds	Eastbound Bikes				E.Leg Peds	Westbound Bikes				W.Leg Peds
	Left	Thru	Right			Left	Thru	Right			Left	Thru	Right			Left	Thru	Right		
7:15 AM - 8:15 AM	0	0	0		0	0	0	0		0	0	0	0	0	0	0	0	0	0	0
3:00 PM - 4:00 PM	0	0	0		0	4	0	0		0	0	0	0	0	1	0	0	0	0	1

	Bikes	Peds
AM Peak Total	0	0
PM Peak Total	5	1

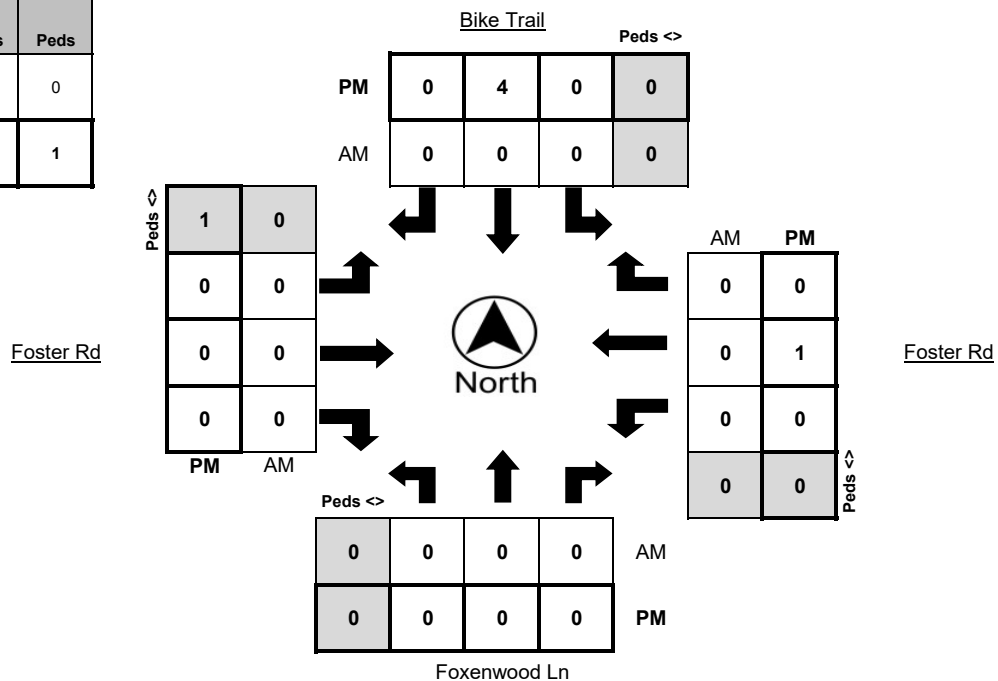



Metro Traffic Data Inc.
 310 N. Irwin Street - Suite 20
 Hanford, CA 93230
 800-975-6938 Phone/Fax
 www.metrotrafficdata.com

Turning Movement Report

Prepared For:
Central Coast Transportation Consulting
 895 Napa Avenue, Suite A-6
 Morro Bay, CA 93442

LOCATION Foster Rd @ Foxenwood Ln
COUNTY Santa Barbara
COLLECTION DATE Tuesday, December 17, 2019
CYCLE TIME N/A

N/S STREET Bike Trail / Foxenwood Ln
E/W STREET Foster Rd / Foster Rd
WEATHER Clear
CONTROL TYPE One-Way Stop

COMMENTS

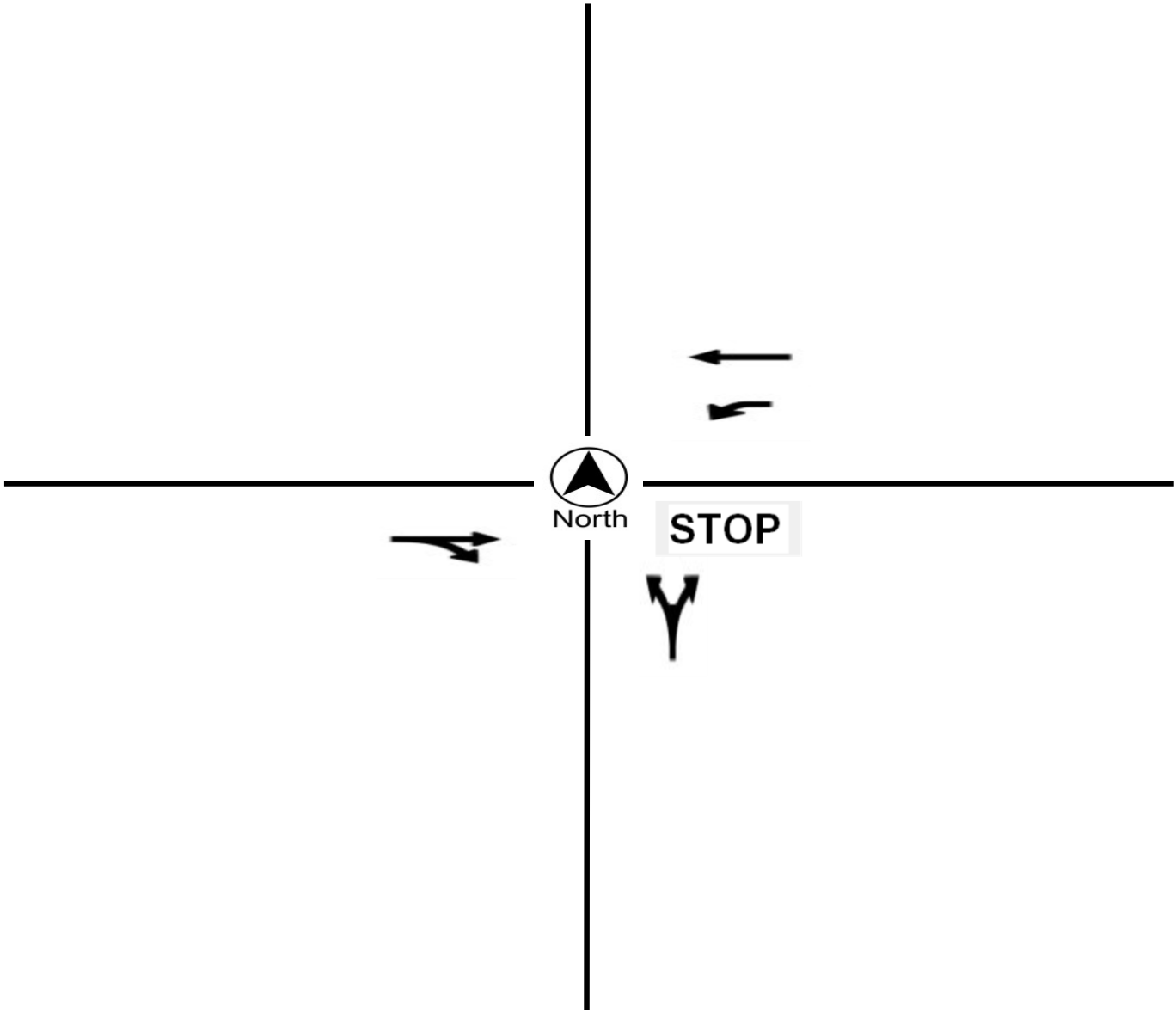



Metro Traffic Data Inc.
 310 N. Irwin Street - Suite 20
 Hanford, CA 93230
 800-975-6938 Phone/Fax
 www.metrotrafficdata.com

Turning Movement Report

Prepared For:
Central Coast Transportation Consulting
 895 Napa Avenue, Suite A-6
 Morro Bay, CA 93442

LOCATION Foster Rd @ Orcutt Expwy

LATITUDE 34.8831

COUNTY Santa Barbara

LONGITUDE -120.4366

COLLECTION DATE Tuesday, December 17, 2019

WEATHER Clear

Time	Northbound				Southbound				Eastbound				Westbound			
	Left	Thru	Right	Trucks	Left	Thru	Right	Trucks	Left	Thru	Right	Trucks	Left	Thru	Right	Trucks
7:00 AM - 7:15 AM	2	164	20	8	39	171	13	9	22	26	0	3	24	13	48	5
7:15 AM - 7:30 AM	5	234	41	7	52	195	18	9	35	42	2	3	35	25	88	3
7:30 AM - 7:45 AM	2	290	15	5	21	248	19	11	40	21	1	2	47	27	85	2
7:45 AM - 8:00 AM	4	432	20	7	15	194	32	9	53	13	2	3	19	13	39	1
8:00 AM - 8:15 AM	8	271	15	3	17	172	29	8	48	17	3	2	17	11	37	1
8:15 AM - 8:30 AM	4	248	18	5	42	160	31	13	47	17	1	1	12	9	55	3
8:30 AM - 8:45 AM	5	223	14	6	16	152	22	9	18	4	2	3	25	12	37	2
8:45 AM - 9:00 AM	4	247	7	10	16	156	30	9	38	18	0	2	20	14	37	3
TOTAL	34	2109	150	51	218	1448	194	77	301	158	11	19	199	124	426	20

Time	Northbound				Southbound				Eastbound				Westbound			
	Left	Thru	Right	Trucks	Left	Thru	Right	Trucks	Left	Thru	Right	Trucks	Left	Thru	Right	Trucks
2:00 PM - 2:15 PM	0	248	15	10	41	222	12	4	37	14	3	2	31	23	60	7
2:15 PM - 2:30 PM	1	217	6	12	25	217	29	6	27	7	3	1	12	15	30	3
2:30 PM - 2:45 PM	3	229	13	4	35	231	29	14	26	10	5	2	8	8	21	0
2:45 PM - 3:00 PM	0	232	18	11	53	243	30	6	26	20	9	3	10	13	24	2
3:00 PM - 3:15 PM	3	237	17	9	23	255	32	10	39	11	3	2	27	29	59	4
3:15 PM - 3:30 PM	2	280	21	9	28	233	30	7	31	17	5	1	22	14	32	2
3:30 PM - 3:45 PM	2	272	18	11	28	260	24	8	54	12	1	4	23	13	35	1
3:45 PM - 4:00 PM	3	315	19	7	35	275	42	5	34	21	4	1	13	12	32	2
4:00 PM - 4:15 PM	2	262	25	7	37	295	42	2	48	16	6	1	11	12	16	0
4:15 PM - 4:30 PM	3	297	14	7	33	301	35	4	31	11	3	1	16	7	30	2
4:30 PM - 4:45 PM	2	291	12	2	24	258	33	0	44	15	11	1	12	10	18	1
4:45 PM - 5:00 PM	2	323	19	5	35	319	36	6	38	12	5	0	12	15	22	0
5:00 PM - 5:15 PM	1	279	18	4	34	334	31	4	60	19	8	0	23	13	23	0
5:15 PM - 5:30 PM	1	237	11	3	40	388	33	6	40	7	3	0	20	10	44	1
5:30 PM - 5:45 PM	1	222	14	6	27	315	22	4	31	9	4	1	11	8	24	0
5:45 PM - 6:00 PM	1	209	15	4	27	239	35	3	26	18	3	0	10	9	24	1
TOTAL	27	4150	255	111	525	4385	495	89	592	219	76	20	261	211	494	26

PEAK HOUR	Northbound				Southbound				Eastbound				Westbound			
	Left	Thru	Right	Trucks	Left	Thru	Right	Trucks	Left	Thru	Right	Trucks	Left	Thru	Right	Trucks
7:15 AM - 8:15 AM	19	1227	91	22	105	809	98	37	176	93	8	10	118	76	249	7
4:30 PM - 5:30 PM	6	1130	60	14	133	1299	133	16	182	53	27	1	67	48	107	2

	PHF	Trucks
AM	0.918	2.5%
PM	0.962	1.0%

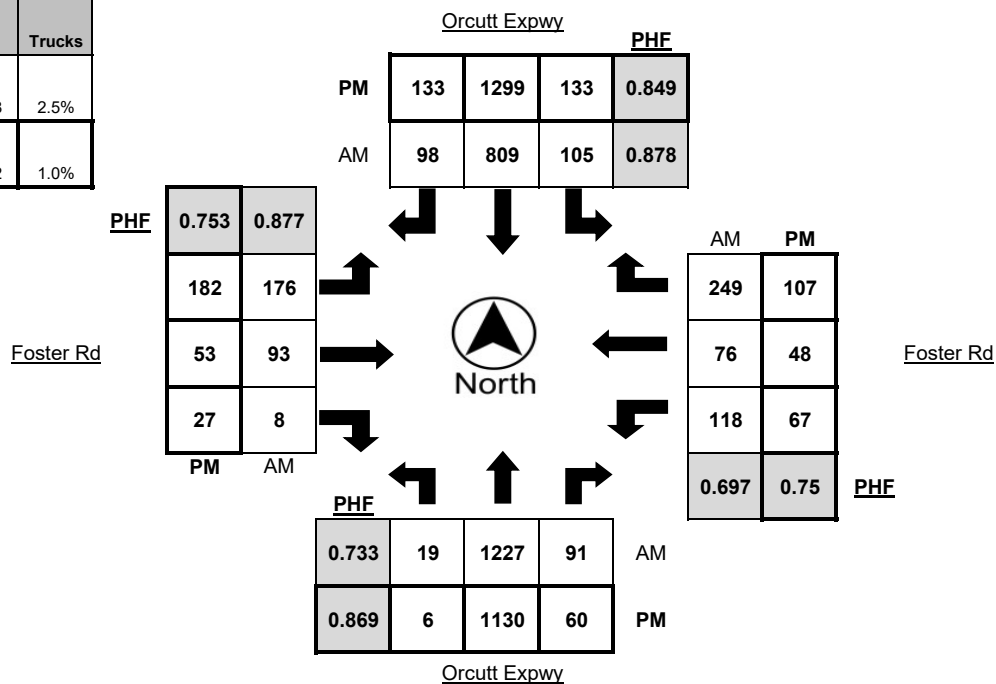



Metro Traffic Data Inc.
 310 N. Irwin Street - Suite 20
 Hanford, CA 93230
 800-975-6938 Phone/Fax
 www.metrotrafficdata.com

Turning Movement Report

Prepared For:
Central Coast Transportation Consulting
 895 Napa Avenue, Suite A-6
 Morro Bay, CA 93442

LOCATION Foster Rd @ Orcutt Expwy

LATITUDE 34.8831

COUNTY Santa Barbara

LONGITUDE -120.4366

COLLECTION DATE Tuesday, December 17, 2019

WEATHER Clear

Time	Northbound Bikes				N.Leg Peds	Southbound Bikes				S.Leg Peds	Eastbound Bikes				E.Leg Peds	Westbound Bikes				W.Leg Peds
	Left	Thru	Right	Peds		Left	Thru	Right	Peds		Left	Thru	Right	Peds		Left	Thru	Right	Peds	
7:00 AM - 7:15 AM	0	0	0	0	0	0	0	0	0	0	0	0	0	0	0	0	0	0	0	0
7:15 AM - 7:30 AM	0	0	0	0	0	0	1	0	0	0	0	0	0	0	0	0	0	0	0	0
7:30 AM - 7:45 AM	0	1	0	0	0	0	0	0	0	0	0	0	0	0	0	0	0	0	0	0
7:45 AM - 8:00 AM	0	0	0	0	0	0	0	0	0	0	0	0	0	0	0	0	0	0	0	0
8:00 AM - 8:15 AM	0	0	0	0	0	0	0	0	0	0	0	0	0	0	0	0	0	0	0	0
8:15 AM - 8:30 AM	0	0	0	0	0	0	0	0	1	0	0	0	0	0	0	0	0	0	0	0
8:30 AM - 8:45 AM	0	0	0	0	0	0	0	0	0	0	0	0	0	0	0	0	0	0	0	0
8:45 AM - 9:00 AM	0	0	0	0	0	0	0	1	0	0	0	0	0	0	0	0	0	0	0	0
TOTAL	0	1	0	0	0	0	1	1	1	0	0	0	0	0	0	0	0	0	0	0

Time	Northbound Bikes				N.Leg Peds	Southbound Bikes				S.Leg Peds	Eastbound Bikes				E.Leg Peds	Westbound Bikes				W.Leg Peds
	Left	Thru	Right	Peds		Left	Thru	Right	Peds		Left	Thru	Right	Peds		Left	Thru	Right	Peds	
2:00 PM - 2:15 PM	0	0	0	0	0	0	0	0	0	0	0	0	0	0	0	0	0	0	0	0
2:15 PM - 2:30 PM	0	0	0	0	0	0	0	0	0	0	0	0	0	0	0	0	0	0	0	0
2:30 PM - 2:45 PM	0	0	0	0	0	0	0	0	0	0	0	0	0	0	0	0	0	0	0	0
2:45 PM - 3:00 PM	0	0	0	0	0	0	0	0	0	0	1	0	0	0	0	0	0	0	0	0
3:00 PM - 3:15 PM	0	0	0	0	0	0	0	0	0	0	0	0	0	0	0	0	0	0	0	0
3:15 PM - 3:30 PM	0	0	0	0	0	0	0	0	0	0	0	0	0	0	0	0	0	0	0	0
3:30 PM - 3:45 PM	0	0	0	0	0	0	0	0	0	0	0	0	0	0	0	0	0	0	0	0
3:45 PM - 4:00 PM	0	0	0	0	0	0	0	0	0	0	0	0	0	0	1	0	0	0	0	0
4:00 PM - 4:15 PM	0	0	0	0	0	0	0	0	0	0	0	0	0	0	0	0	0	0	0	0
4:15 PM - 4:30 PM	0	0	0	0	0	0	0	0	0	0	0	0	0	0	0	0	0	0	0	0
4:30 PM - 4:45 PM	0	0	0	0	0	0	0	0	0	0	1	0	0	0	0	0	0	0	0	0
4:45 PM - 5:00 PM	0	0	0	0	0	0	0	0	0	0	1	0	0	0	0	0	0	0	0	0
5:00 PM - 5:15 PM	0	0	0	0	0	0	0	0	0	0	1	0	0	0	0	0	0	0	0	0
5:15 PM - 5:30 PM	0	0	0	0	0	0	0	0	1	0	0	0	0	0	0	0	0	0	0	0
5:30 PM - 5:45 PM	0	0	0	2	0	0	0	0	0	0	0	0	0	0	0	0	0	0	0	0
5:45 PM - 6:00 PM	0	0	0	0	0	0	0	0	0	0	0	0	0	0	0	0	0	0	0	0
TOTAL	0	0	0	2	0	0	0	0	1	0	4	0	0	0	1	0	0	0	0	0

PEAK HOUR	Northbound Bikes				N.Leg Peds	Southbound Bikes				S.Leg Peds	Eastbound Bikes				E.Leg Peds	Westbound Bikes				W.Leg Peds
	Left	Thru	Right	Peds		Left	Thru	Right	Peds		Left	Thru	Right	Peds		Left	Thru	Right	Peds	
7:15 AM - 8:15 AM	0	1	0	0	0	0	1	0	0	0	0	0	0	0	0	0	0	0	0	0
4:30 PM - 5:30 PM	0	0	0	0	0	0	0	0	1	0	3	0	0	0	0	0	0	0	0	0

	Bikes	Peds
AM Peak Total	2	0
PM Peak Total	3	1

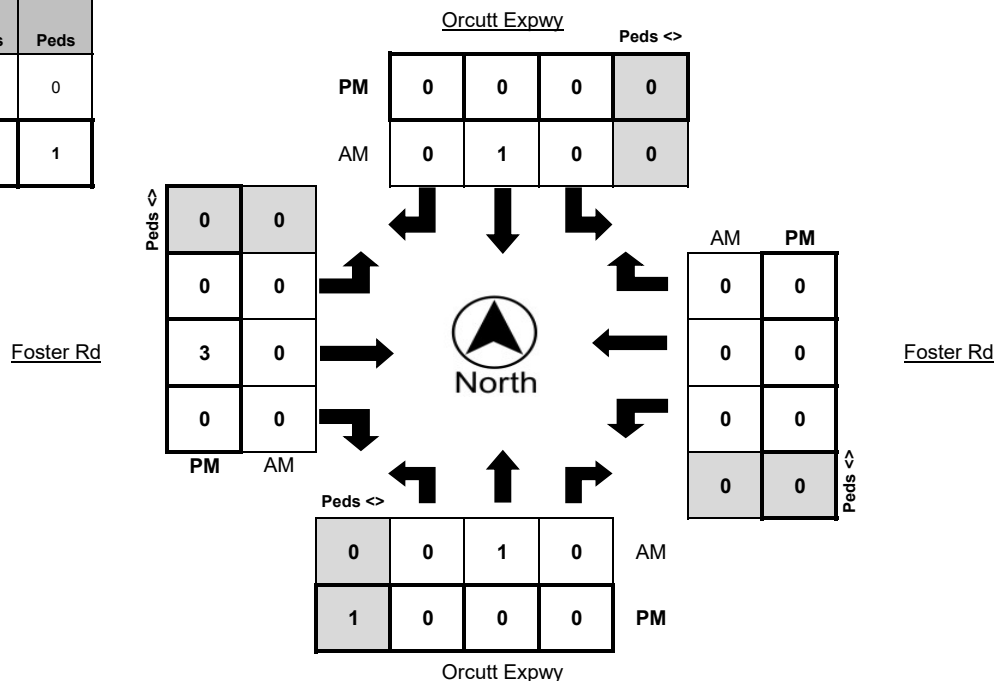



Metro Traffic Data Inc.
 310 N. Irwin Street - Suite 20
 Hanford, CA 93230
 800-975-6938 Phone/Fax
 www.metrotrafficdata.com

Turning Movement Report

Prepared For:
Central Coast Transportation Consulting
 895 Napa Avenue, Suite A-6
 Morro Bay, CA 93442

LOCATION Foster Rd @ Orcutt Expwy
COUNTY Santa Barbara
COLLECTION DATE Tuesday, December 17, 2019
CYCLE TIME 102 Seconds

N/S STREET Orcutt Expwy / Orcutt Expwy
E/W STREET Foster Rd / Foster Rd
WEATHER Clear
CONTROL TYPE Signal

COMMENTS All approaches have protected left turns.

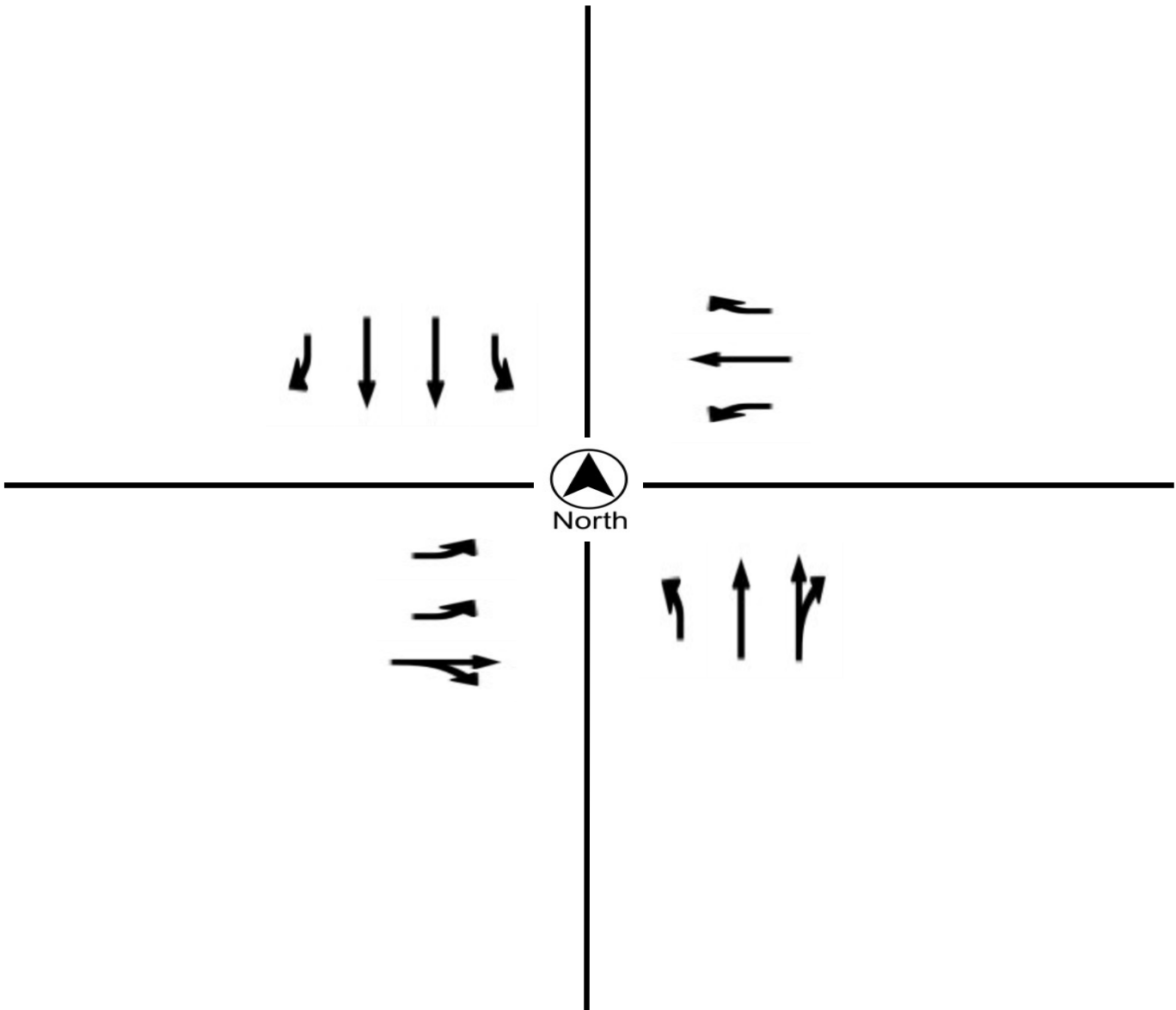



Metro Traffic Data Inc.
 310 N. Irwin Street - Suite 20
 Hanford, CA 93230
 800-975-6938 Phone/Fax
 www.metrotrafficdata.com

Turning Movement Report

Prepared For:
Central Coast Transportation Consulting
 895 Napa Avenue, Suite A-6
 Morro Bay, CA 93442

LOCATION Union Valley Pkwy @ Foxenwood Ln

LATITUDE 34.8796

COUNTY Santa Barbara

LONGITUDE -120.4388

COLLECTION DATE Tuesday, December 17, 2019

WEATHER Clear

Time	Northbound				Southbound				Eastbound				Westbound			
	Left	Thru	Right	Trucks	Left	Thru	Right	Trucks	Left	Thru	Right	Trucks	Left	Thru	Right	Trucks
7:00 AM - 7:15 AM	0	7	42	0	0	0	0	0	2	49	0	0	8	27	2	1
7:15 AM - 7:30 AM	0	5	47	0	0	0	0	0	5	84	0	1	17	32	7	3
7:30 AM - 7:45 AM	0	12	45	2	0	2	0	0	3	76	0	2	17	39	6	0
7:45 AM - 8:00 AM	0	18	62	1	0	0	0	0	4	88	0	2	26	48	12	4
8:00 AM - 8:15 AM	0	9	35	0	0	1	1	0	1	48	0	1	18	57	7	1
8:15 AM - 8:30 AM	0	9	34	0	0	2	0	0	2	58	1	0	17	53	2	0
8:30 AM - 8:45 AM	0	2	35	0	0	1	0	0	1	44	0	2	22	55	3	1
8:45 AM - 9:00 AM	0	3	35	1	2	1	5	0	1	62	0	0	14	29	5	1
TOTAL	0	65	335	4	2	7	6	0	19	509	1	8	139	340	44	11

Time	Northbound				Southbound				Eastbound				Westbound			
	Left	Thru	Right	Trucks	Left	Thru	Right	Trucks	Left	Thru	Right	Trucks	Left	Thru	Right	Trucks
2:00 PM - 2:15 PM	0	3	31	0	0	7	0	0	2	51	2	1	40	63	0	2
2:15 PM - 2:30 PM	0	2	21	0	0	3	2	0	1	64	1	0	37	50	0	2
2:30 PM - 2:45 PM	0	3	31	1	0	4	0	0	4	59	0	1	26	84	1	4
2:45 PM - 3:00 PM	0	3	29	0	0	5	1	0	2	47	0	1	35	67	1	2
3:00 PM - 3:15 PM	3	3	31	0	1	7	0	0	1	70	0	2	39	73	2	4
3:15 PM - 3:30 PM	0	4	37	0	0	7	3	0	3	45	0	1	35	77	3	1
3:30 PM - 3:45 PM	2	3	30	0	1	2	2	0	2	53	0	0	38	58	2	1
3:45 PM - 4:00 PM	0	2	22	0	1	3	2	0	0	57	1	1	30	68	0	1
4:00 PM - 4:15 PM	0	5	23	1	0	4	1	0	0	45	0	0	53	57	1	2
4:15 PM - 4:30 PM	0	2	21	0	0	2	2	0	0	62	0	0	37	76	0	1
4:30 PM - 4:45 PM	2	3	17	0	0	3	2	0	1	59	0	0	36	56	2	0
4:45 PM - 5:00 PM	0	2	33	1	1	2	1	0	0	48	0	0	38	77	1	2
5:00 PM - 5:15 PM	0	2	23	0	6	0	1	0	0	61	1	1	51	84	2	1
5:15 PM - 5:30 PM	1	2	26	1	0	3	8	0	0	52	2	1	53	83	1	1
5:30 PM - 5:45 PM	0	2	30	1	0	3	1	0	1	46	2	2	41	85	0	1
5:45 PM - 6:00 PM	0	1	25	0	5	2	0	0	2	42	2	0	39	57	1	2
TOTAL	8	42	430	5	15	57	26	0	19	861	11	11	628	1115	17	27

PEAK HOUR	Northbound				Southbound				Eastbound				Westbound			
	Left	Thru	Right	Trucks	Left	Thru	Right	Trucks	Left	Thru	Right	Trucks	Left	Thru	Right	Trucks
7:15 AM - 8:15 AM	0	44	189	3	0	3	1	0	13	296	0	6	78	176	32	8
4:30 PM - 5:30 PM*	3	9	99	2	7	8	12	0	1	220	3	2	178	300	6	4

*Uniform peak hour

	PHF	Trucks
AM	0.806	2.0%
PM	0.916	0.9%

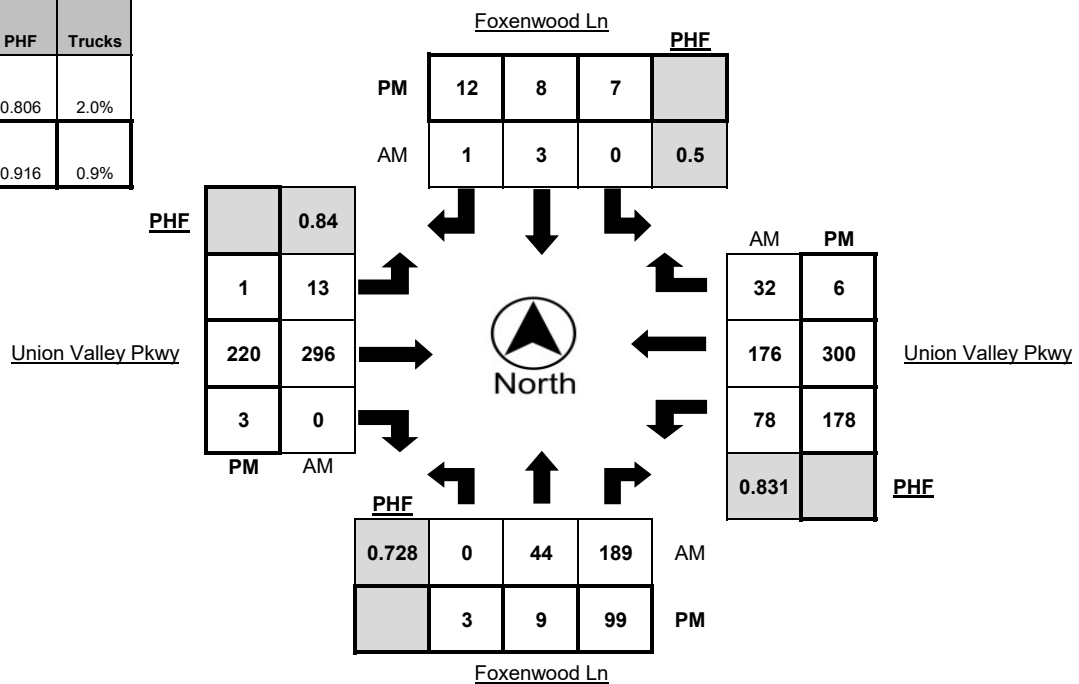



Metro Traffic Data Inc.
 310 N. Irwin Street - Suite 20
 Hanford, CA 93230
 800-975-6938 Phone/Fax
 www.metrotrafficdata.com

Turning Movement Report

Prepared For:
Central Coast Transportation Consulting
 895 Napa Avenue, Suite A-6
 Morro Bay, CA 93442

LOCATION Union Valley Pkwy @ Foxenwood Ln

LATITUDE 34.8796

COUNTY Santa Barbara

LONGITUDE -120.4388

COLLECTION DATE Tuesday, December 17, 2019

WEATHER Clear

Time	Northbound Bikes				Southbound Bikes				Eastbound Bikes				Westbound Bikes				W.Leg Peds
	Left	Thru	Right	N.Leg Peds	Left	Thru	Right	S.Leg Peds	Left	Thru	Right	E.Leg Peds	Left	Thru	Right		
7:00 AM - 7:15 AM	0	0	0	0	0	0	0	0	0	0	0	0	0	0	0	0	
7:15 AM - 7:30 AM	0	0	0	0	0	0	0	0	0	0	0	0	0	0	0	0	
7:30 AM - 7:45 AM	0	0	0	0	0	0	0	0	0	0	0	0	0	0	0	0	
7:45 AM - 8:00 AM	0	0	0	0	0	0	0	0	0	0	0	0	0	0	0	0	
8:00 AM - 8:15 AM	0	0	0	0	0	0	0	0	1	0	0	0	0	0	0	0	
8:15 AM - 8:30 AM	0	0	0	0	0	0	0	0	1	0	0	0	0	0	0	0	
8:30 AM - 8:45 AM	0	0	0	0	0	0	0	0	0	0	0	0	0	0	0	0	
8:45 AM - 9:00 AM	0	0	0	0	0	0	1	0	0	0	0	0	0	0	1	1	
TOTAL	0	0	0	0	0	0	1	2	0	0	0	0	0	0	1	1	

Time	Northbound Bikes				Southbound Bikes				Eastbound Bikes				Westbound Bikes				W.Leg Peds
	Left	Thru	Right	N.Leg Peds	Left	Thru	Right	S.Leg Peds	Left	Thru	Right	E.Leg Peds	Left	Thru	Right		
2:00 PM - 2:15 PM	0	0	0	0	0	1	0	0	1	0	0	0	0	0	0	0	
2:15 PM - 2:30 PM	0	0	0	0	0	0	0	0	1	0	0	0	0	0	0	0	
2:30 PM - 2:45 PM	0	0	0	0	0	0	0	0	0	1	0	0	0	0	0	0	
2:45 PM - 3:00 PM	0	0	0	0	0	1	0	0	0	0	0	0	0	0	0	0	
3:00 PM - 3:15 PM	0	0	0	0	0	0	0	0	0	0	0	0	0	0	0	0	
3:15 PM - 3:30 PM	0	0	0	0	0	1	1	0	0	0	0	0	0	0	0	0	
3:30 PM - 3:45 PM	0	0	0	0	0	0	0	0	0	0	0	0	0	0	0	0	
3:45 PM - 4:00 PM	0	0	0	0	0	0	0	2	0	0	0	0	0	0	0	0	
4:00 PM - 4:15 PM	0	0	0	0	0	0	0	0	0	0	0	0	0	0	0	2	
4:15 PM - 4:30 PM	0	0	0	0	0	0	0	0	0	0	0	0	0	0	0	0	
4:30 PM - 4:45 PM	0	0	0	0	0	0	0	0	0	0	0	0	0	0	0	0	
4:45 PM - 5:00 PM	0	0	0	0	0	0	0	0	0	0	0	0	0	0	0	0	
5:00 PM - 5:15 PM	0	0	0	0	1	0	0	0	0	0	0	0	0	0	0	0	
5:15 PM - 5:30 PM	0	0	0	0	0	0	1	0	0	0	0	1	0	0	0	0	
5:30 PM - 5:45 PM	0	0	0	1	0	0	0	0	0	0	0	0	0	0	0	0	
5:45 PM - 6:00 PM	0	0	0	0	1	0	0	0	0	0	0	0	0	0	0	0	
TOTAL	0	0	0	1	2	3	2	4	1	0	0	1	0	0	0	2	

PEAK HOUR	Northbound Bikes				Southbound Bikes				Eastbound Bikes				Westbound Bikes				W.Leg Peds
	Left	Thru	Right	N.Leg Peds	Left	Thru	Right	S.Leg Peds	Left	Thru	Right	E.Leg Peds	Left	Thru	Right		
7:15 AM - 8:15 AM	0	0	0	0	0	0	0	1	0	0	0	0	0	0	0	0	
4:45 PM - 5:45 PM	0	0	0	1	1	0	1	0	0	0	0	1	0	0	0	0	

	Bikes	Peds
AM Peak Total	0	1
PM Peak Total	2	2

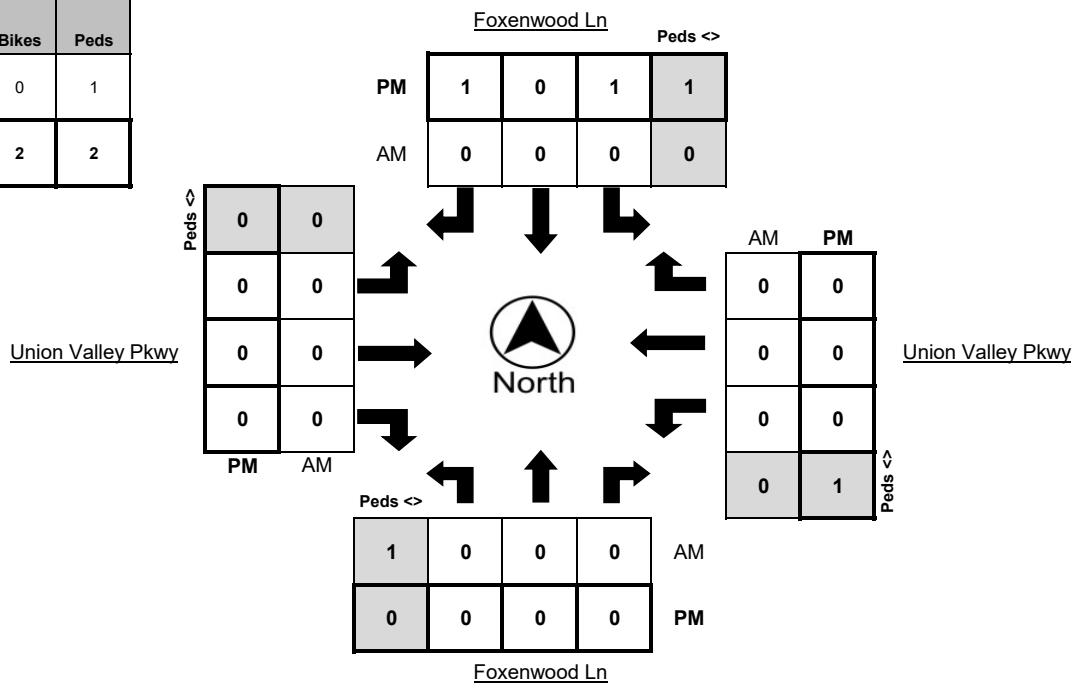



Metro Traffic Data Inc.
 310 N. Irwin Street - Suite 20
 Hanford, CA 93230
 800-975-6938 Phone/Fax
 www.metrotrafficdata.com

Turning Movement Report

Prepared For:
Central Coast Transportation Consulting
 895 Napa Avenue, Suite A-6
 Morro Bay, CA 93442

LOCATION Union Valley Pkwy @ Foxenwood Ln
COUNTY Santa Barbara
COLLECTION DATE Tuesday, December 17, 2019
CYCLE TIME N/A

N/S STREET Foxenwood Ln / Foxenwood Ln
E/W STREET Union Valley Pkwy / Union Valley Pkwy
WEATHER Clear
CONTROL TYPE Two-Way Stop

COMMENTS

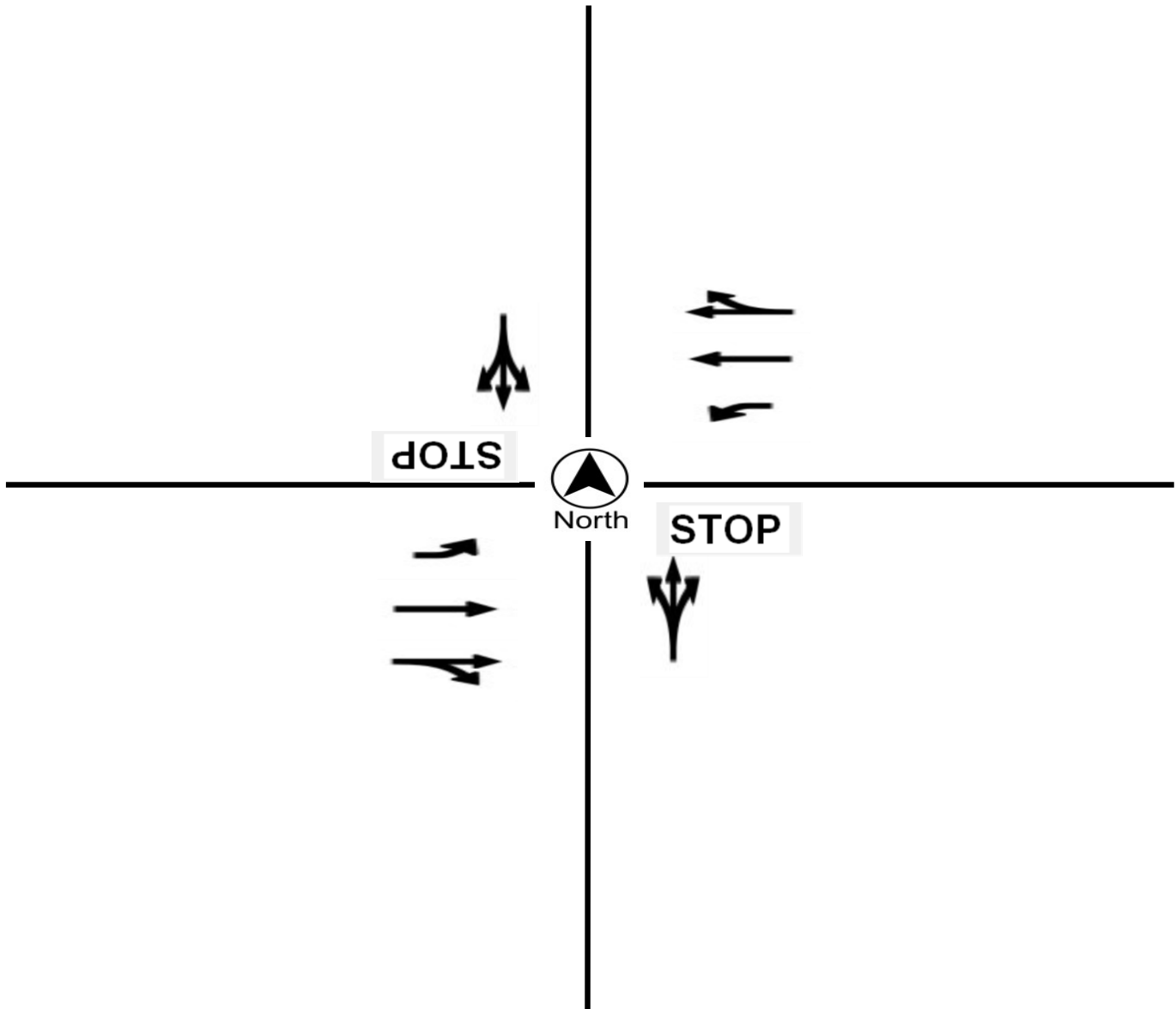



Metro Traffic Data Inc.
 310 N. Irwin Street - Suite 20
 Hanford, CA 93230
 800-975-6938 Phone/Fax
 www.metrotrafficdata.com

Turning Movement Report

Prepared For:
Central Coast Transportation Consulting
 895 Napa Avenue, Suite A-6
 Morro Bay, CA 93442

LOCATION Union Valley Pkwy @ Orcutt Expwy

LATITUDE 34.8796

COUNTY Santa Barbara

LONGITUDE -120.4366

COLLECTION DATE Tuesday, December 17, 2019

WEATHER Clear

Time	Northbound				Southbound				Eastbound				Westbound			
	Left	Thru	Right	Trucks	Left	Thru	Right	Trucks	Left	Thru	Right	Trucks	Left	Thru	Right	Trucks
7:00 AM - 7:15 AM	1	125	44	9	13	166	16	6	44	44	1	0	98	21	33	3
7:15 AM - 7:30 AM	1	172	47	4	23	177	22	8	57	76	3	1	107	32	48	9
7:30 AM - 7:45 AM	4	225	78	3	39	251	22	11	36	77	5	3	113	37	59	4
7:45 AM - 8:00 AM	4	317	75	5	28	153	31	12	62	77	3	3	95	52	76	6
8:00 AM - 8:15 AM	6	184	54	4	36	136	22	7	43	46	4	1	55	53	53	6
8:15 AM - 8:30 AM	1	178	62	3	30	111	29	10	48	39	2	0	37	42	31	3
8:30 AM - 8:45 AM	4	161	35	8	31	109	32	8	44	40	3	2	57	42	42	6
8:45 AM - 9:00 AM	0	179	33	4	33	119	23	10	45	47	3	1	40	18	38	8
TOTAL	21	1541	428	40	233	1222	197	72	379	446	24	11	602	297	380	45

Time	Northbound				Southbound				Eastbound				Westbound			
	Left	Thru	Right	Trucks	Left	Thru	Right	Trucks	Left	Thru	Right	Trucks	Left	Thru	Right	Trucks
2:00 PM - 2:15 PM	0	179	42	8	49	138	65	5	26	56	1	0	41	36	38	3
2:15 PM - 2:30 PM	0	177	56	8	67	132	39	7	37	37	2	2	50	46	35	6
2:30 PM - 2:45 PM	3	159	44	5	54	138	40	7	43	47	3	2	44	67	37	8
2:45 PM - 3:00 PM	3	174	59	6	44	172	54	5	43	37	0	0	51	49	30	7
3:00 PM - 3:15 PM	3	172	51	8	52	174	56	8	41	59	2	3	52	51	48	6
3:15 PM - 3:30 PM	1	205	80	7	31	170	55	7	42	44	2	0	60	62	45	7
3:30 PM - 3:45 PM	3	238	82	6	66	165	61	6	36	38	3	0	52	35	32	6
3:45 PM - 4:00 PM	1	261	97	10	57	186	45	5	48	31	0	1	63	49	29	7
4:00 PM - 4:15 PM	1	217	113	4	48	192	61	3	31	42	0	0	53	46	23	6
4:15 PM - 4:30 PM	3	255	101	9	72	191	61	4	35	47	0	2	69	53	27	4
4:30 PM - 4:45 PM	2	270	118	4	73	185	51	3	27	43	2	0	64	43	26	1
4:45 PM - 5:00 PM	2	257	128	6	64	190	60	5	46	34	3	0	74	46	39	4
5:00 PM - 5:15 PM	4	229	94	6	74	225	67	3	33	54	0	1	68	73	25	1
5:15 PM - 5:30 PM	1	196	87	4	100	251	81	6	38	43	3	2	67	57	18	3
5:30 PM - 5:45 PM	0	178	81	3	49	185	70	2	44	30	2	3	54	58	20	3
5:45 PM - 6:00 PM	4	152	65	4	49	153	54	3	36	24	1	0	60	44	29	1
TOTAL	31	3319	1298	98	949	2847	920	79	606	666	24	16	922	815	501	73

PEAK HOUR	Northbound				Southbound				Eastbound				Westbound			
	Left	Thru	Right	Trucks	Left	Thru	Right	Trucks	Left	Thru	Right	Trucks	Left	Thru	Right	Trucks
7:15 AM - 8:15 AM	15	898	254	16	126	717	97	38	198	276	15	8	370	174	236	25
4:30 PM - 5:30 PM	9	952	427	20	311	851	259	17	144	174	8	3	273	219	108	9

	PHF	Trucks
AM	0.867	2.6%
PM	0.987	1.3%

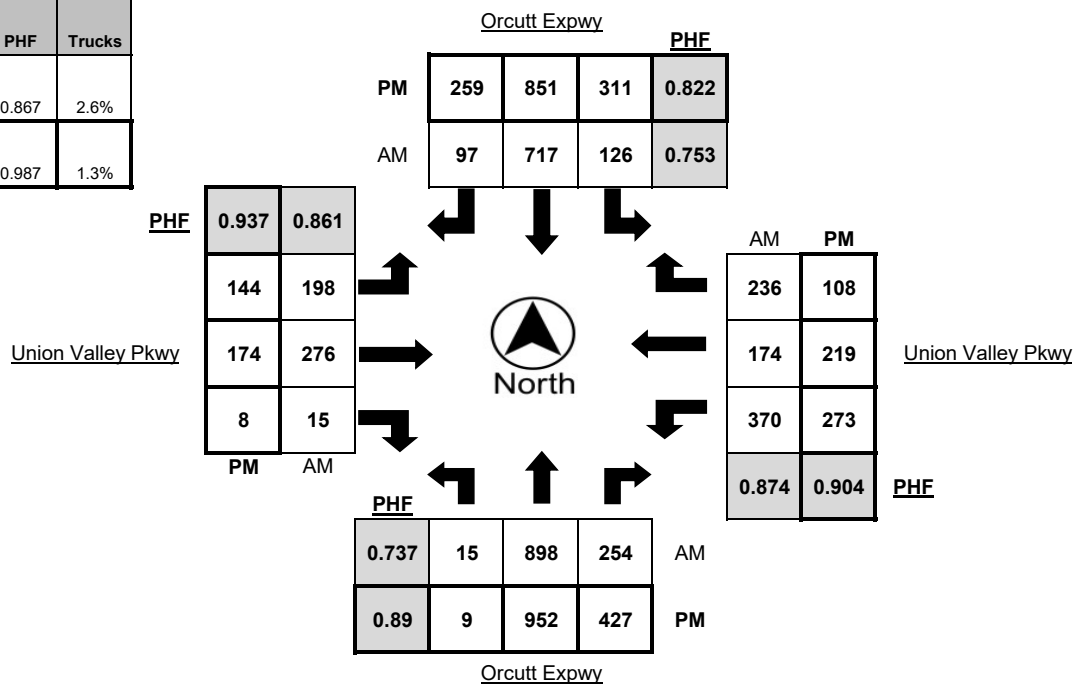



Metro Traffic Data Inc.
 310 N. Irwin Street - Suite 20
 Hanford, CA 93230
 800-975-6938 Phone/Fax
 www.metrotrafficdata.com

Turning Movement Report

Prepared For:
Central Coast Transportation Consulting
 895 Napa Avenue, Suite A-6
 Morro Bay, CA 93442

LOCATION Union Valley Pkwy @ Orcutt Expwy

LATITUDE 34.8796

COUNTY Santa Barbara

LONGITUDE -120.4366

COLLECTION DATE Tuesday, December 17, 2019

WEATHER Clear

Time	Northbound Bikes				N.Leg Peds	Southbound Bikes				S.Leg Peds	Eastbound Bikes				E.Leg Peds	Westbound Bikes				W.Leg Peds
	Left	Thru	Right	Right		Left	Thru	Right	Right		Left	Thru	Right	Right		Left	Thru	Right	Right	
7:00 AM - 7:15 AM	0	0	0	0	0	0	0	0	0	0	0	0	0	0	0	0	0	0	0	0
7:15 AM - 7:30 AM	0	0	0	0	0	0	0	0	0	0	0	0	0	0	0	0	0	0	1	0
7:30 AM - 7:45 AM	0	0	0	0	0	0	1	0	0	0	0	0	0	0	0	0	0	0	0	0
7:45 AM - 8:00 AM	0	0	0	0	0	0	0	0	0	0	0	0	0	0	0	0	0	0	0	0
8:00 AM - 8:15 AM	0	0	0	0	0	0	0	0	0	0	0	0	0	0	0	0	0	0	0	0
8:15 AM - 8:30 AM	0	0	0	0	0	0	0	0	0	0	0	0	0	0	0	0	0	0	0	0
8:30 AM - 8:45 AM	0	0	0	0	0	0	0	0	0	0	0	0	0	0	0	0	0	0	0	0
8:45 AM - 9:00 AM	0	0	0	0	0	0	0	0	0	0	0	0	0	0	0	0	0	0	0	0
TOTAL	0	0	0	0	0	0	1	0	0	0	0	0	0	0	0	0	0	1	0	0

Time	Northbound Bikes				N.Leg Peds	Southbound Bikes				S.Leg Peds	Eastbound Bikes				E.Leg Peds	Westbound Bikes				W.Leg Peds
	Left	Thru	Right	Right		Left	Thru	Right	Right		Left	Thru	Right	Right		Left	Thru	Right	Right	
2:00 PM - 2:15 PM	0	0	1	0	0	0	0	0	0	2	0	0	0	0	0	0	0	0	0	0
2:15 PM - 2:30 PM	0	0	0	0	0	0	0	0	0	1	0	0	0	0	0	0	0	0	0	0
2:30 PM - 2:45 PM	0	0	0	0	0	0	0	0	0	0	0	0	0	0	0	0	0	0	0	0
2:45 PM - 3:00 PM	0	0	0	0	0	0	0	0	0	0	0	0	0	2	0	0	0	0	0	0
3:00 PM - 3:15 PM	0	0	0	0	0	0	0	0	0	0	0	0	0	0	0	0	0	0	0	0
3:15 PM - 3:30 PM	0	0	0	0	0	0	0	0	0	0	0	0	0	0	0	0	0	0	0	0
3:30 PM - 3:45 PM	0	0	0	0	0	0	0	0	0	0	0	0	0	0	0	0	0	0	0	0
3:45 PM - 4:00 PM	0	0	0	0	0	0	0	0	0	0	0	0	0	0	0	0	0	0	0	0
4:00 PM - 4:15 PM	0	0	0	0	0	0	0	0	0	0	0	0	0	0	0	0	0	0	0	0
4:15 PM - 4:30 PM	0	0	0	0	0	0	0	0	0	0	0	0	0	0	0	0	0	0	0	0
4:30 PM - 4:45 PM	0	0	0	0	0	0	0	0	0	0	0	0	0	0	0	0	0	0	0	0
4:45 PM - 5:00 PM	0	0	0	0	0	0	0	0	0	0	0	0	0	0	0	0	0	0	0	0
5:00 PM - 5:15 PM	0	0	0	0	0	0	0	0	0	0	0	0	0	0	0	0	0	0	0	0
5:15 PM - 5:30 PM	0	0	0	0	0	0	0	0	0	0	0	0	0	0	0	0	0	0	0	0
5:30 PM - 5:45 PM	0	0	0	0	0	0	0	0	0	0	0	0	0	0	0	0	0	0	0	0
5:45 PM - 6:00 PM	0	0	0	0	0	0	0	0	0	0	0	0	0	0	0	0	0	0	0	0
TOTAL	0	0	1	0	0	0	0	0	3	0	0	0	2	0	0	0	0	0	0	0

PEAK HOUR	Northbound Bikes				N.Leg Peds	Southbound Bikes				S.Leg Peds	Eastbound Bikes				E.Leg Peds	Westbound Bikes				W.Leg Peds
	Left	Thru	Right	Right		Left	Thru	Right	Right		Left	Thru	Right	Right		Left	Thru	Right	Right	
7:15 AM - 8:15 AM	0	0	0	0	0	0	1	0	0	0	0	0	0	0	0	0	1	0	0	0
4:30 PM - 5:30 PM	0	0	0	0	0	0	0	0	0	0	0	0	0	0	0	0	0	0	0	0

	Bikes	Peds
AM Peak Total	2	0
PM Peak Total	0	0

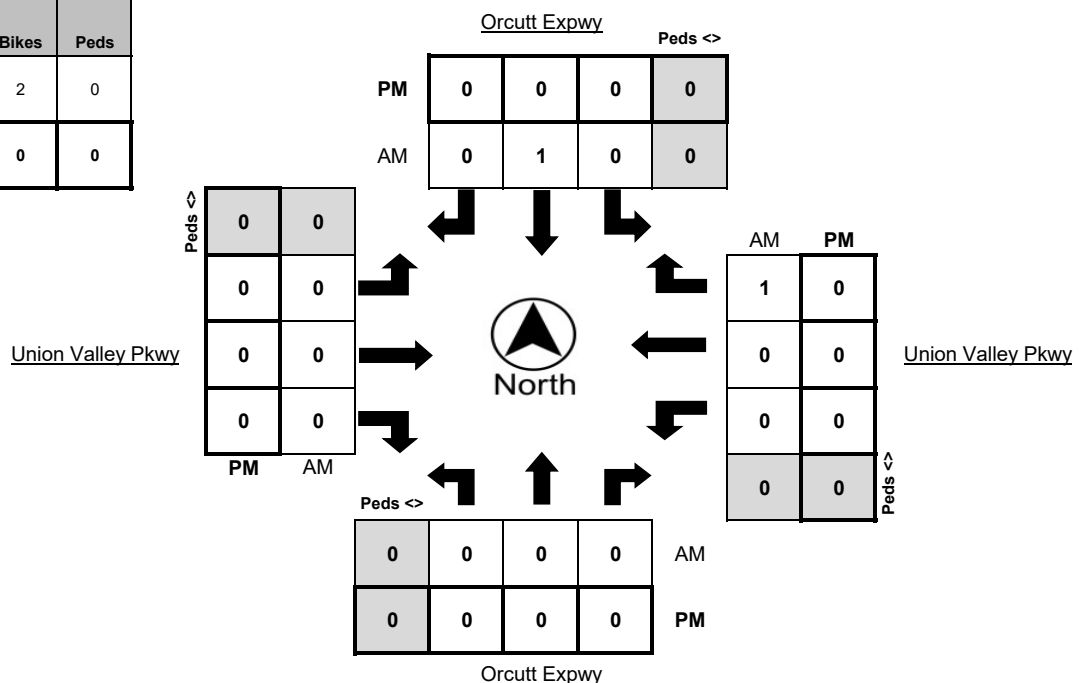



Metro Traffic Data Inc.
 310 N. Irwin Street - Suite 20
 Hanford, CA 93230
 800-975-6938 Phone/Fax
 www.metrotrafficdata.com

Turning Movement Report

Prepared For:
Central Coast Transportation Consulting
 895 Napa Avenue, Suite A-6
 Morro Bay, CA 93442

LOCATION Union Valley Pkwy @ Orcutt Expwy
COUNTY Santa Barbara
COLLECTION DATE Tuesday, December 17, 2019
CYCLE TIME 105 Seconds

N/S STREET Orcutt Expwy / Orcutt Expwy
E/W STREET Union Valley Pkwy / Union Valley Pkwy
WEATHER Clear
CONTROL TYPE Signal

COMMENTS All approaches have protected left turns.

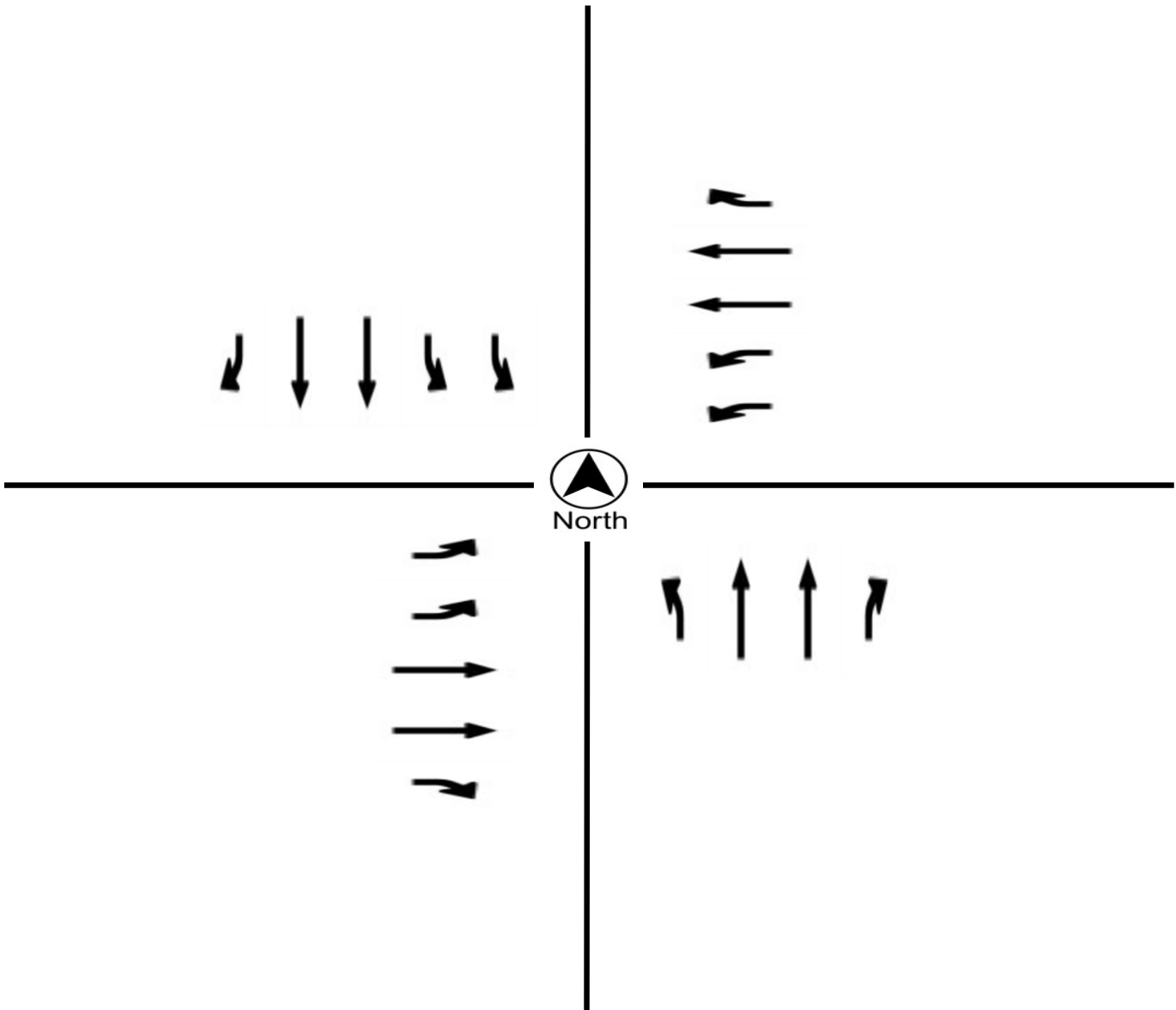



Metro Traffic Data Inc.
 310 N. Inwin Street - Suite 20
 Hanford, CA 93230
 800-975-6938 Phone/Fax
 www.metrotrafficdata.com

Turning Movement Report

Prepared For:
Central Coast Transportation Consulting
 895 Napa Avenue, Suite A-6
 Morro Bay, CA 93442

LOCATION Union Valley Pkwy @ Orcutt Rd **LATITUDE** 34.8795
COUNTY Santa Barbara **LONGITUDE** -120.4350
COLLECTION DATE Tuesday, December 17, 2019 **WEATHER** Clear

Time	Northbound				Southbound				Eastbound				Westbound			
	Left	Thru	Right	Trucks	Left	Thru	Right	Trucks	Left	Thru	Right	Trucks	Left	Thru	Right	Trucks
7:00 AM - 7:15 AM	16	12	10	0	2	4	2	2	0	97	5	5	3	147	2	3
7:15 AM - 7:30 AM	26	12	16	3	6	11	1	1	1	127	10	4	8	145	4	6
7:30 AM - 7:45 AM	37	12	16	3	5	14	2	1	3	162	32	9	16	189	3	3
7:45 AM - 8:00 AM	49	33	21	1	6	19	2	0	0	152	31	3	10	156	4	7
8:00 AM - 8:15 AM	35	20	19	0	7	8	3	1	2	120	17	4	2	123	2	5
8:15 AM - 8:30 AM	13	14	10	0	3	6	4	1	1	121	11	4	7	103	3	4
8:30 AM - 8:45 AM	15	8	11	1	3	8	1	0	0	93	11	8	3	114	2	4
8:45 AM - 9:00 AM	16	9	4	0	10	8	1	0	0	101	16	2	7	82	5	9
TOTAL	207	120	107	8	42	78	16	6	7	973	133	39	56	1059	25	41

Time	Northbound				Southbound				Eastbound				Westbound			
	Left	Thru	Right	Trucks	Left	Thru	Right	Trucks	Left	Thru	Right	Trucks	Left	Thru	Right	Trucks
2:00 PM - 2:15 PM	16	6	10	0	9	15	1	2	0	105	31	3	12	96	2	4
2:15 PM - 2:30 PM	31	24	7	3	1	10	2	0	0	139	29	6	6	103	2	5
2:30 PM - 2:45 PM	24	10	19	3	4	5	0	0	0	129	10	6	1	123	2	5
2:45 PM - 3:00 PM	13	9	7	3	3	8	5	1	0	127	19	2	9	111	2	7
3:00 PM - 3:15 PM	33	12	23	3	4	8	3	1	0	145	19	6	14	127	3	6
3:15 PM - 3:30 PM	25	13	11	1	14	16	1	1	0	132	18	5	5	122	5	6
3:30 PM - 3:45 PM	17	12	12	1	2	9	0	0	0	161	29	4	10	106	4	5
3:45 PM - 4:00 PM	15	5	5	1	5	6	2	1	0	159	23	4	7	130	5	6
4:00 PM - 4:15 PM	15	12	3	0	8	11	4	1	0	193	16	2	14	103	6	5
4:15 PM - 4:30 PM	13	14	7	1	6	8	0	1	0	194	18	4	9	132	1	2
4:30 PM - 4:45 PM	13	6	12	0	2	8	1	0	0	222	17	2	9	123	1	2
4:45 PM - 5:00 PM	20	7	13	0	7	4	2	0	0	194	28	3	5	135	5	5
5:00 PM - 5:15 PM	22	6	8	1	7	9	1	0	0	190	28	5	5	134	3	1
5:15 PM - 5:30 PM	11	12	9	1	6	11	1	0	0	200	32	5	7	141	2	3
5:30 PM - 5:45 PM	9	7	12	1	5	11	1	1	0	153	18	3	10	136	3	2
5:45 PM - 6:00 PM	10	10	5	0	9	10	0	0	0	113	16	0	19	109	10	2
TOTAL	287	165	163	19	92	149	24	9	0	2556	351	60	142	1931	56	66

PEAK HOUR	Northbound				Southbound				Eastbound				Westbound			
	Left	Thru	Right	Trucks	Left	Thru	Right	Trucks	Left	Thru	Right	Trucks	Left	Thru	Right	Trucks
7:15 AM - 8:15 AM	147	77	72	7	24	52	8	3	6	561	90	20	36	613	13	21
4:30 PM - 5:30 PM	66	31	42	2	22	32	5	0	0	806	105	15	26	533	11	11

	PHF	Trucks
AM	0.865	3.0%
PM	0.972	1.7%

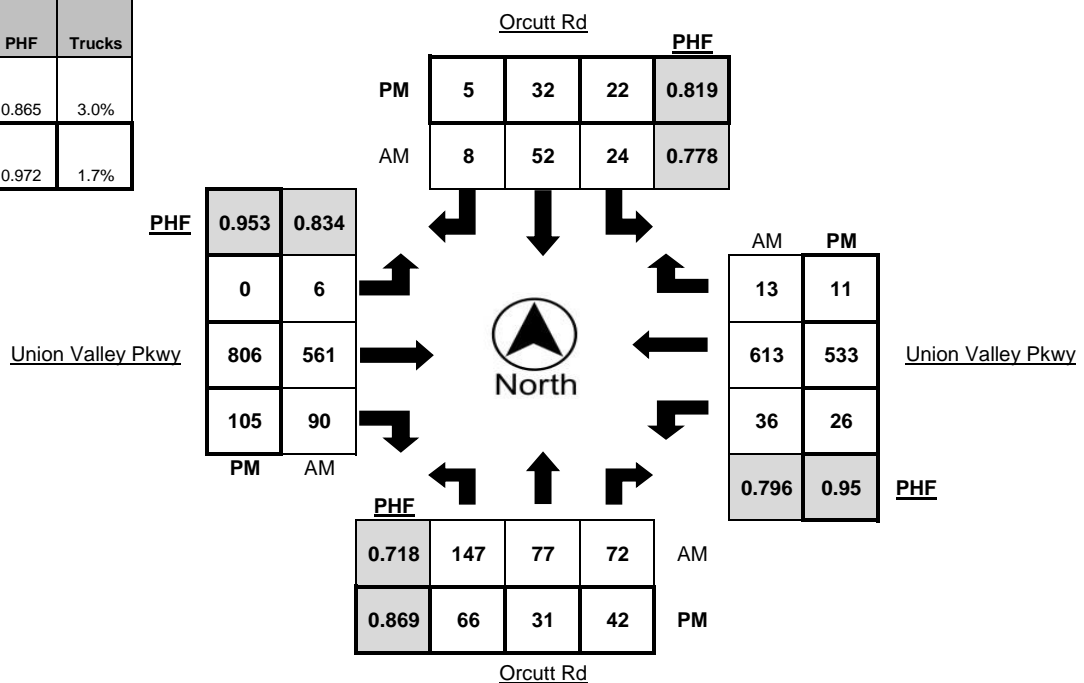



Metro Traffic Data Inc.
 310 N. Irwin Street - Suite 20
 Hanford, CA 93230
 800-975-6938 Phone/Fax
 www.metrotrafficdata.com

Turning Movement Report

Prepared For:
Central Coast Transportation Consulting
 895 Napa Avenue, Suite A-6
 Morro Bay, CA 93442

LOCATION Union Valley Pkwy @ Orcutt Rd

LATITUDE 34.8795

COUNTY Santa Barbara

LONGITUDE -120.4350

COLLECTION DATE Tuesday, December 17, 2019

WEATHER Clear

Time	Northbound Bikes			N.Leg Peds	Southbound Bikes			S.Leg Peds	Eastbound Bikes			E.Leg Peds	Westbound Bikes			W.Leg Peds
	Left	Thru	Right		Left	Thru	Right		Left	Thru	Right		Left	Thru	Right	
7:00 AM - 7:15 AM	0	1	0	0	0	0	0	0	0	0	0	0	0	0	0	0
7:15 AM - 7:30 AM	0	0	0	0	0	0	0	0	0	0	0	0	0	1	0	0
7:30 AM - 7:45 AM	0	0	0	0	0	0	0	0	0	0	0	0	0	0	0	0
7:45 AM - 8:00 AM	0	0	0	0	0	0	0	0	0	0	0	0	0	0	0	0
8:00 AM - 8:15 AM	0	0	0	0	0	0	0	0	0	0	0	0	0	0	0	0
8:15 AM - 8:30 AM	0	0	0	0	0	0	0	0	0	0	0	0	0	0	0	0
8:30 AM - 8:45 AM	0	0	0	0	0	0	0	0	0	0	0	0	0	0	0	0
8:45 AM - 9:00 AM	0	0	0	0	0	0	0	0	0	0	0	0	0	0	0	0
TOTAL	0	1	0	0	0	0	0	0	0	0	0	0	0	1	0	0

Time	Northbound Bikes			N.Leg Peds	Southbound Bikes			S.Leg Peds	Eastbound Bikes			E.Leg Peds	Westbound Bikes			W.Leg Peds
	Left	Thru	Right		Left	Thru	Right		Left	Thru	Right		Left	Thru	Right	
2:00 PM - 2:15 PM	0	0	0	0	0	0	0	2	0	0	0	0	0	0	0	0
2:15 PM - 2:30 PM	0	0	0	0	0	0	0	1	0	0	0	0	0	0	0	0
2:30 PM - 2:45 PM	0	0	0	0	0	0	0	0	0	0	0	0	0	0	0	0
2:45 PM - 3:00 PM	0	0	0	1	0	0	0	0	0	0	0	0	0	0	0	0
3:00 PM - 3:15 PM	0	0	0	0	0	0	0	0	0	0	0	0	0	0	0	0
3:15 PM - 3:30 PM	0	0	0	0	0	0	0	0	0	0	0	1	0	0	0	0
3:30 PM - 3:45 PM	0	1	0	0	0	0	0	0	0	0	0	0	0	0	0	0
3:45 PM - 4:00 PM	0	0	0	0	0	0	0	0	0	0	0	0	0	0	0	0
4:00 PM - 4:15 PM	0	0	0	0	0	0	0	0	0	0	0	0	0	0	0	0
4:15 PM - 4:30 PM	0	0	0	0	0	0	0	1	0	0	0	0	0	0	0	0
4:30 PM - 4:45 PM	0	0	0	0	0	0	0	1	0	0	0	0	0	0	0	0
4:45 PM - 5:00 PM	0	0	0	0	0	0	0	0	0	0	0	0	0	0	0	0
5:00 PM - 5:15 PM	0	0	0	0	0	0	0	0	0	0	0	1	0	0	0	0
5:15 PM - 5:30 PM	0	0	0	0	0	0	0	0	0	0	0	0	0	0	0	0
5:30 PM - 5:45 PM	0	0	0	0	0	0	0	0	0	0	0	0	0	0	0	0
5:45 PM - 6:00 PM	0	0	0	0	0	0	0	0	0	0	0	1	0	0	0	0
TOTAL	0	1	0	1	0	0	0	5	0	0	0	3	0	0	0	0

PEAK HOUR	Northbound Bikes			N.Leg Peds	Southbound Bikes			S.Leg Peds	Eastbound Bikes			E.Leg Peds	Westbound Bikes			W.Leg Peds
	Left	Thru	Right		Left	Thru	Right		Left	Thru	Right		Left	Thru	Right	
7:15 AM - 8:15 AM	0	0	0	0	0	0	0	0	0	0	0	0	0	1	0	0
4:30 PM - 5:30 PM	0	0	0	0	0	0	0	1	0	0	0	1	0	0	0	0

	Bikes	Peds
AM Peak Total	1	0
PM Peak Total	0	2

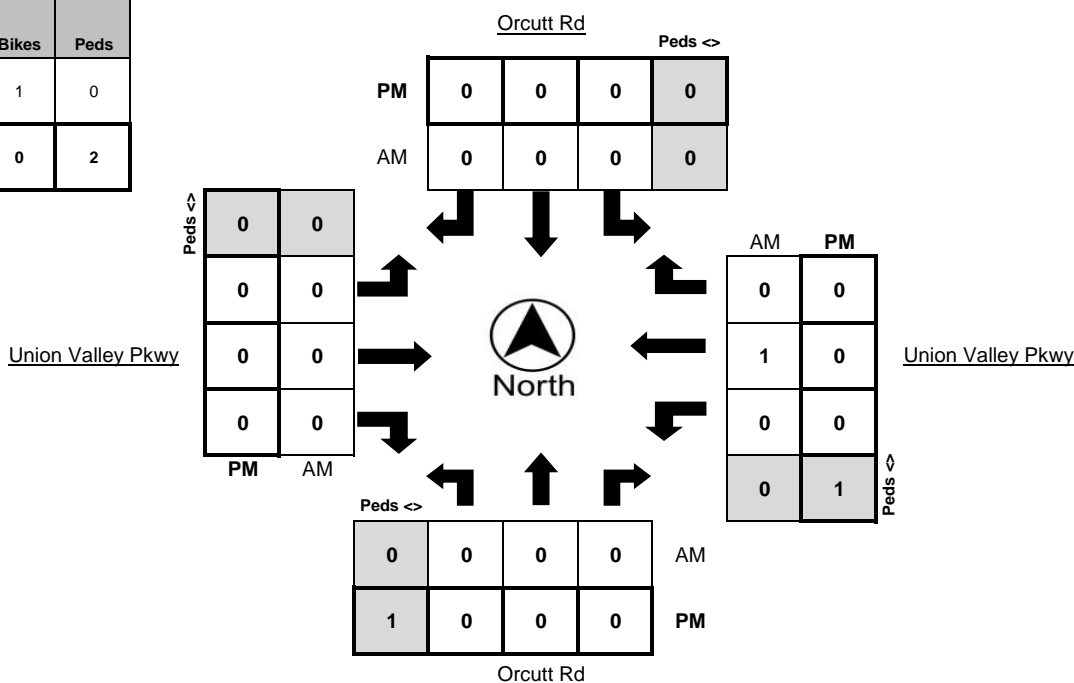



Metro Traffic Data Inc.
 310 N. Irwin Street - Suite 20
 Hanford, CA 93230
 800-975-6938 Phone/Fax
 www.metrotrafficdata.com

Turning Movement Report

Prepared For:
Central Coast Transportation Consulting
 895 Napa Avenue, Suite A-6
 Morro Bay, CA 93442

LOCATION Union Valley Pkwy @ Orcutt Rd
COUNTY Santa Barbara
COLLECTION DATE Tuesday, December 17, 2019
CYCLE TIME 89 Seconds

N/S STREET Orcutt Rd / Orcutt Rd
E/W STREET Union Valley Pkwy / Union Valley Pkwy
WEATHER Clear
CONTROL TYPE Signal

COMMENTS All approaches have protected left turns.

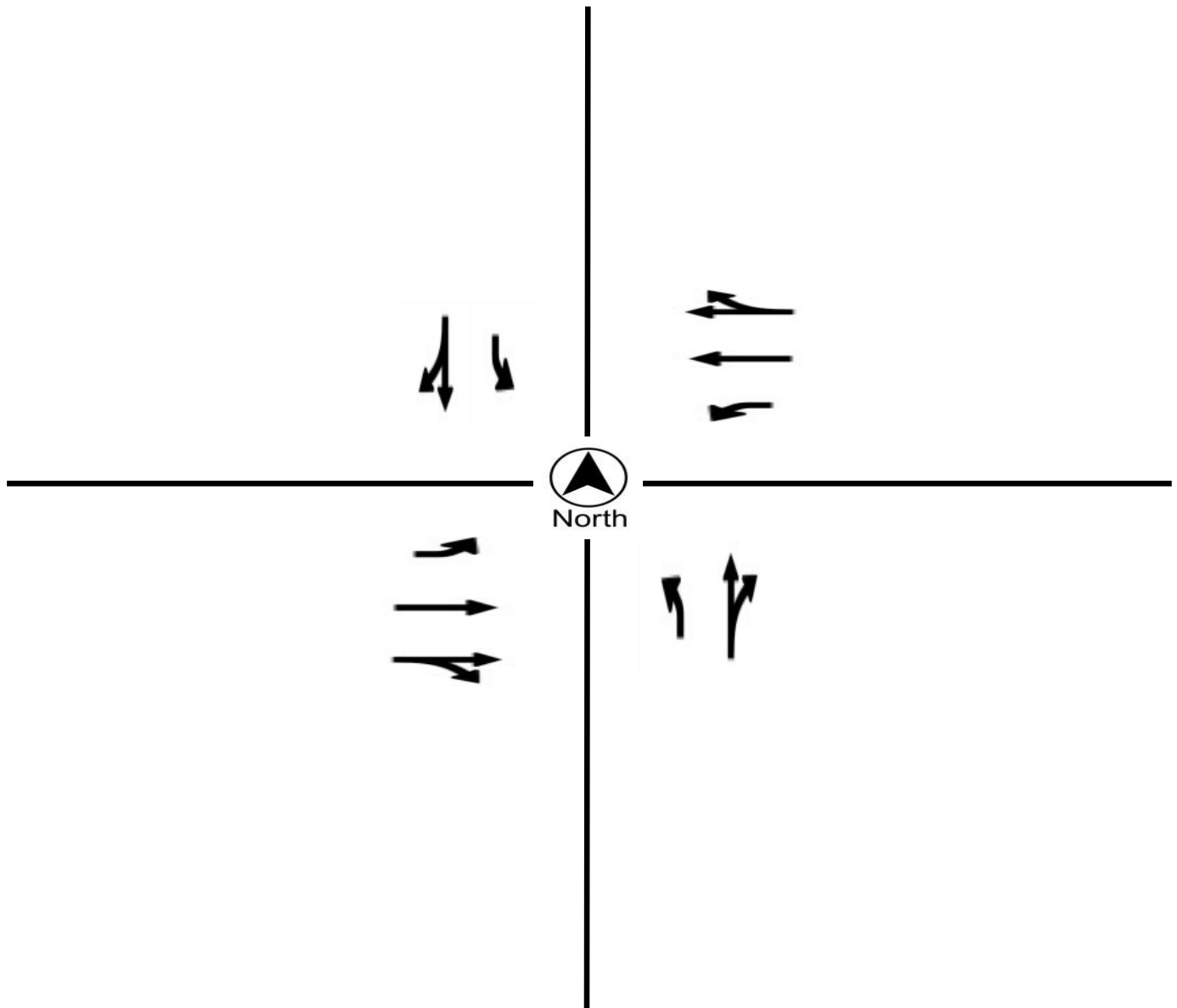

Appendix B: Intersection LOS Calculation Sheets

Existing

Intersection												
Int Delay, s/veh	2.1											
Movement	EBL	EBT	EBR	WBL	WBT	WBR	NBL	NBT	NBR	SBL	SBT	SBR
Lane Configurations		↕		↕	↕			↕			↕	
Traffic Vol, veh/h	0	231	1	4	187	0	40	0	48	0	0	0
Future Vol, veh/h	0	231	1	4	187	0	40	0	48	0	0	0
Conflicting Peds, #/hr	0	0	0	0	0	0	0	0	0	0	0	0
Sign Control	Free	Free	Free	Free	Free	Free	Stop	Stop	Stop	Stop	Stop	Stop
RT Channelized	-	-	None	-	-	None	-	-	None	-	-	None
Storage Length	-	-	-	160	-	-	-	-	-	-	-	-
Veh in Median Storage, #	-	0	-	-	0	-	-	0	-	-	0	-
Grade, %	-	0	-	-	0	-	-	0	-	-	0	-
Peak Hour Factor	95	95	95	95	95	95	95	95	95	95	95	95
Heavy Vehicles, %	4	4	4	4	4	4	4	4	4	4	4	4
Mvmt Flow	0	243	1	4	197	0	42	0	51	0	0	0

























Major/Minor	Major1			Major2			Minor1			Minor2		
Conflicting Flow All	197	0	0	244	0	0	449	449	244	474	449	197
Stage 1	-	-	-	-	-	-	244	244	-	205	205	-
Stage 2	-	-	-	-	-	-	205	205	-	269	244	-
Critical Hdwy	4.14	-	-	4.14	-	-	7.14	6.54	6.24	7.14	6.54	6.24
Critical Hdwy Stg 1	-	-	-	-	-	-	6.14	5.54	-	6.14	5.54	-
Critical Hdwy Stg 2	-	-	-	-	-	-	6.14	5.54	-	6.14	5.54	-
Follow-up Hdwy	2.236	-	-	2.236	-	-	3.536	4.036	3.336	3.536	4.036	3.336
Pot Cap-1 Maneuver	1364	-	-	1311	-	-	517	502	790	497	502	839
Stage 1	-	-	-	-	-	-	755	700	-	792	728	-
Stage 2	-	-	-	-	-	-	792	728	-	732	700	-
Platoon blocked, %		-	-		-	-						
Mov Cap-1 Maneuver	1364	-	-	1311	-	-	516	500	790	464	500	839
Mov Cap-2 Maneuver	-	-	-	-	-	-	516	500	-	464	500	-
Stage 1	-	-	-	-	-	-	755	700	-	792	726	-
Stage 2	-	-	-	-	-	-	790	726	-	685	700	-

Approach	EB			WB			NB			SB		
HCM Control Delay, s	0			0.2			11.6			0		
HCM LOS							B			A		

Minor Lane/Major Mvmt	NBLn1	EBL	EBT	EBR	WBL	WBT	WBR	SBLn1
Capacity (veh/h)	636	1364	-	-	1311	-	-	-
HCM Lane V/C Ratio	0.146	-	-	-	0.003	-	-	-
HCM Control Delay (s)	11.6	0	-	-	7.8	-	-	0
HCM Lane LOS	B	A	-	-	A	-	-	A
HCM 95th %tile Q(veh)	0.5	0	-	-	0	-	-	-

Santa Maria Airport Business Park SP
2: Orcutt Expressway & Foster Road

Existing AM
HCM 6th Signalized Intersection Summary

												
Movement	EBL	EBT	EBR	WBL	WBT	WBR	NBL	NBT	NBR	SBL	SBT	SBR
Lane Configurations	 							 			 	
Traffic Volume (veh/h)	176	93	8	118	76	249	19	1227	91	105	809	98
Future Volume (veh/h)	176	93	8	118	76	249	19	1227	91	105	809	98
Initial Q (Qb), veh	0	0	0	0	0	0	0	0	0	0	0	0
Ped-Bike Adj(A_pbT)	1.00		1.00	1.00		1.00	1.00		0.98	1.00		0.98
Parking Bus, Adj	1.00	1.00	1.00	1.00	1.00	1.00	1.00	1.00	1.00	1.00	1.00	1.00
Work Zone On Approach		No			No			No			No	
Adj Sat Flow, veh/h/ln	1856	1856	1856	1856	1856	1856	1856	1856	1856	1856	1856	1856
Adj Flow Rate, veh/h	191	101	9	128	83	128	21	1334	99	114	879	107
Peak Hour Factor	0.92	0.92	0.92	0.92	0.92	0.92	0.92	0.92	0.92	0.92	0.92	0.92
Percent Heavy Veh, %	3	3	3	3	3	3	3	3	3	3	3	3
Cap, veh/h	337	165	15	187	196	166	49	1557	115	144	1841	804
Arrive On Green	0.10	0.10	0.10	0.11	0.11	0.11	0.03	0.47	0.47	0.08	0.52	0.52
Sat Flow, veh/h	3428	1679	150	1767	1856	1572	1767	3322	246	1767	3526	1540
Grp Volume(v), veh/h	191	0	110	128	83	128	21	706	727	114	879	107
Grp Sat Flow(s),veh/h/ln	1714	0	1829	1767	1856	1572	1767	1763	1805	1767	1763	1540
Q Serve(g_s), s	4.3	0.0	4.7	5.7	3.4	6.4	1.0	28.8	29.1	5.2	12.9	2.9
Cycle Q Clear(g_c), s	4.3	0.0	4.7	5.7	3.4	6.4	1.0	28.8	29.1	5.2	12.9	2.9
Prop In Lane	1.00		0.08	1.00		1.00	1.00		0.14	1.00		1.00
Lane Grp Cap(c), veh/h	337	0	180	187	196	166	49	826	846	144	1841	804
V/C Ratio(X)	0.57	0.00	0.61	0.69	0.42	0.77	0.43	0.85	0.86	0.79	0.48	0.13
Avail Cap(c_a), veh/h	1181	0	630	206	217	184	130	960	983	178	2016	881
HCM Platoon Ratio	1.00	1.00	1.00	1.00	1.00	1.00	1.00	1.00	1.00	1.00	1.00	1.00
Upstream Filter(I)	1.00	0.00	1.00	1.00	1.00	1.00	1.00	1.00	1.00	1.00	1.00	1.00
Uniform Delay (d), s/veh	35.0	0.0	35.2	35.1	34.0	35.4	38.9	19.1	19.2	36.7	12.4	10.0
Incr Delay (d2), s/veh	1.5	0.0	3.4	8.1	1.5	16.5	5.7	6.8	6.9	17.4	0.2	0.1
Initial Q Delay(d3),s/veh	0.0	0.0	0.0	0.0	0.0	0.0	0.0	0.0	0.0	0.0	0.0	0.0
%ile BackOfQ(50%),veh/ln	1.8	0.0	2.2	2.7	1.5	3.1	0.5	11.0	11.4	2.7	4.0	0.8
Unsig. Movement Delay, s/veh												
LnGrp Delay(d),s/veh	36.5	0.0	38.5	43.1	35.5	51.9	44.6	25.9	26.2	54.1	12.6	10.0
LnGrp LOS	D	A	D	D	D	D	D	C	C	D	B	B
Approach Vol, veh/h		301			339			1454			1100	
Approach Delay, s/veh		37.2			44.6			26.3			16.6	
Approach LOS		D			D			C			B	
Timer - Assigned Phs	1	2		4	5	6		8				
Phs Duration (G+Y+Rc), s	10.8	44.1		12.9	6.5	48.5		13.5				
Change Period (Y+Rc), s	* 4.2	6.0		4.9	* 4.2	6.0		4.9				
Max Green Setting (Gmax), s	* 8.2	44.3		28.0	* 6	46.5		9.5				
Max Q Clear Time (g_c+I1), s	7.2	31.1		6.7	3.0	14.9		8.4				
Green Ext Time (p_c), s	0.0	7.0		1.1	0.0	6.3		0.1				
Intersection Summary												
HCM 6th Ctrl Delay				25.9								
HCM 6th LOS				C								
Notes												
* HCM 6th computational engine requires equal clearance times for the phases crossing the barrier.												

Santa Maria Airport Business Park SP
3: Foxenwood Lane & Union Valley Parkway

Existing AM
HCM 6th TWSC

Intersection												
Int Delay, s/veh	5.7											
Movement	EBL	EBT	EBR	WBL	WBT	WBR	NBL	NBT	NBR	SBL	SBT	SBR
Lane Configurations	↖	↕		↖	↕			↕			↕	
Traffic Vol, veh/h	13	296	0	78	176	32	0	44	189	0	3	1
Future Vol, veh/h	13	296	0	78	176	32	0	44	189	0	3	1
Conflicting Peds, #/hr	0	0	1	1	0	0	0	0	0	0	0	0
Sign Control	Free	Free	Free	Free	Free	Free	Stop	Stop	Stop	Stop	Stop	Stop
RT Channelized	-	-	None	-	-	None	-	-	None	-	-	None
Storage Length	195	-	-	155	-	-	-	-	-	-	-	-
Veh in Median Storage, #	-	0	-	-	0	-	-	0	-	-	0	-
Grade, %	-	0	-	-	0	-	-	0	-	-	0	-
Peak Hour Factor	81	81	81	81	81	81	81	81	81	81	81	81
Heavy Vehicles, %	3	3	3	3	3	3	3	3	3	3	3	3
Mvmt Flow	16	365	0	96	217	40	0	54	233	0	4	1

























Major/Minor	Major1			Major2			Minor1			Minor2		
Conflicting Flow All	257	0	0	366	0	0	701	847	184	671	827	129
Stage 1	-	-	-	-	-	-	398	398	-	429	429	-
Stage 2	-	-	-	-	-	-	303	449	-	242	398	-
Critical Hdwy	4.16	-	-	4.16	-	-	7.56	6.56	6.96	7.56	6.56	6.96
Critical Hdwy Stg 1	-	-	-	-	-	-	6.56	5.56	-	6.56	5.56	-
Critical Hdwy Stg 2	-	-	-	-	-	-	6.56	5.56	-	6.56	5.56	-
Follow-up Hdwy	2.23	-	-	2.23	-	-	3.53	4.03	3.33	3.53	4.03	3.33
Pot Cap-1 Maneuver	1298	-	-	1182	-	-	324	295	824	340	303	894
Stage 1	-	-	-	-	-	-	596	599	-	572	580	-
Stage 2	-	-	-	-	-	-	679	568	-	737	599	-
Platoon blocked, %	-	-	-	-	-	-	-	-	-	-	-	-
Mov Cap-1 Maneuver	1298	-	-	1181	-	-	297	268	823	191	275	894
Mov Cap-2 Maneuver	-	-	-	-	-	-	297	268	-	191	275	-
Stage 1	-	-	-	-	-	-	588	591	-	565	533	-
Stage 2	-	-	-	-	-	-	619	522	-	474	591	-

Approach	EB			WB			NB			SB		
HCM Control Delay, s	0.3			2.3			16.7			16		
HCM LOS							C			C		

Minor Lane/Major Mvmt	NBLn1	EBL	EBT	EBR	WBL	WBT	WBR	SBLn1
Capacity (veh/h)	592	1298	-	-	1181	-	-	333
HCM Lane V/C Ratio	0.486	0.012	-	-	0.082	-	-	0.015
HCM Control Delay (s)	16.7	7.8	-	-	8.3	-	-	16
HCM Lane LOS	C	A	-	-	A	-	-	C
HCM 95th %tile Q(veh)	2.7	0	-	-	0.3	-	-	0

Santa Maria Airport Business Park SP
4: Orcutt Expressway & Union Valley Parkway

Existing AM
HCM 6th Signalized Intersection Summary

												
Movement	EBL	EBT	EBR	WBL	WBT	WBR	NBL	NBT	NBR	SBL	SBT	SBR
Lane Configurations												
Traffic Volume (veh/h)	198	276	15	370	174	236	15	898	254	126	717	97
Future Volume (veh/h)	198	276	15	370	174	236	15	898	254	126	717	97
Initial Q (Qb), veh	0	0	0	0	0	0	0	0	0	0	0	0
Ped-Bike Adj(A_pbT)	1.00		1.00	1.00		1.00	1.00		1.00	1.00		0.99
Parking Bus, Adj	1.00	1.00	1.00	1.00	1.00	1.00	1.00	1.00	1.00	1.00	1.00	1.00
Work Zone On Approach		No			No			No			No	
Adj Sat Flow, veh/h/ln	1856	1856	1856	1856	1856	1856	1856	1856	1856	1856	1856	1856
Adj Flow Rate, veh/h	228	317	17	425	200	271	17	1032	292	145	824	111
Peak Hour Factor	0.87	0.87	0.87	0.87	0.87	0.87	0.87	0.87	0.87	0.87	0.87	0.87
Percent Heavy Veh, %	3	3	3	3	3	3	3	3	3	3	3	3
Cap, veh/h	316	558	249	518	746	333	55	1271	567	307	1498	660
Arrive On Green	0.09	0.16	0.16	0.15	0.21	0.21	0.03	0.36	0.36	0.09	0.43	0.43
Sat Flow, veh/h	3428	3526	1572	3428	3526	1572	1767	3526	1572	3428	3526	1553
Grp Volume(v), veh/h	228	317	17	425	200	271	17	1032	292	145	824	111
Grp Sat Flow(s),veh/h/ln	1714	1763	1572	1714	1763	1572	1767	1763	1572	1714	1763	1553
Q Serve(g_s), s	5.6	7.2	0.8	10.4	4.1	14.2	0.8	22.9	12.6	3.5	15.2	3.8
Cycle Q Clear(g_c), s	5.6	7.2	0.8	10.4	4.1	14.2	0.8	22.9	12.6	3.5	15.2	3.8
Prop In Lane	1.00		1.00	1.00		1.00	1.00		1.00	1.00		1.00
Lane Grp Cap(c), veh/h	316	558	249	518	746	333	55	1271	567	307	1498	660
V/C Ratio(X)	0.72	0.57	0.07	0.82	0.27	0.81	0.31	0.81	0.51	0.47	0.55	0.17
Avail Cap(c_a), veh/h	575	1834	818	678	1919	856	163	1593	711	317	1614	711
HCM Platoon Ratio	1.00	1.00	1.00	1.00	1.00	1.00	1.00	1.00	1.00	1.00	1.00	1.00
Upstream Filter(I)	1.00	1.00	1.00	1.00	1.00	1.00	1.00	1.00	1.00	1.00	1.00	1.00
Uniform Delay (d), s/veh	38.2	33.7	31.0	35.6	28.5	32.5	41.0	25.0	21.7	37.4	18.7	15.4
Incr Delay (d2), s/veh	3.1	0.9	0.1	6.1	0.2	4.9	3.2	2.6	0.7	1.1	0.3	0.1
Initial Q Delay(d3),s/veh	0.0	0.0	0.0	0.0	0.0	0.0	0.0	0.0	0.0	0.0	0.0	0.0
%ile BackOfQ(50%),veh/ln	2.4	3.0	0.3	4.5	1.7	5.5	0.4	8.8	4.3	1.4	5.3	1.2
Unsig. Movement Delay, s/veh												
LnGrp Delay(d),s/veh	41.3	34.6	31.1	41.7	28.7	37.4	44.2	27.7	22.4	38.6	19.0	15.5
LnGrp LOS	D	C	C	D	C	D	D	C	C	D	B	B
Approach Vol, veh/h		562			896			1341			1080	
Approach Delay, s/veh		37.2			37.5			26.7			21.3	
Approach LOS		D			D			C			C	
Timer - Assigned Phs	1	2	3	4	5	6	7	8				
Phs Duration (G+Y+Rc), s	12.8	37.2	18.0	18.6	7.2	42.8	13.4	23.2				
Change Period (Y+Rc), s	5.0	6.0	4.9	4.9	4.5	6.0	5.4	4.9				
Max Green Setting (Gmax), s	8.0	39.1	17.1	45.0	8.0	39.6	14.5	47.1				
Max Q Clear Time (g_c+I1), s	5.5	24.9	12.4	9.2	2.8	17.2	7.6	16.2				
Green Ext Time (p_c), s	0.1	6.3	0.7	2.0	0.0	5.4	0.4	2.1				
Intersection Summary												
HCM 6th Ctrl Delay											29.2	
HCM 6th LOS											C	

Santa Maria Airport Business Park SP
5: Orcutt Road & Union Valley Parkway

Existing AM
HCM Signalized Intersection Capacity Analysis



Movement	EBL	EBT	EBR	WBL	WBT	WBR	NBL	NBT	NBR	SBL	SBT	SBR
Lane Configurations	↖	↗		↖	↗		↖	↗		↖	↗	
Traffic Volume (vph)	6	561	90	36	613	13	147	77	72	24	52	8
Future Volume (vph)	6	561	90	36	613	13	147	77	72	24	52	8
Ideal Flow (vphp)	1900	1900	1900	1900	1900	1900	1900	1900	1900	1900	1900	1900
Total Lost time (s)	4.2	6.0		4.2	6.0		4.2	4.9		4.2	4.9	
Lane Util. Factor	1.00	0.95		1.00	0.95		1.00	1.00		1.00	1.00	
Frbp, ped/bikes	1.00	1.00		1.00	1.00		1.00	1.00		1.00	1.00	
Flpb, ped/bikes	1.00	1.00		1.00	1.00		1.00	1.00		1.00	1.00	
Frt	1.00	0.98		1.00	1.00		1.00	0.93		1.00	0.98	
Flt Protected	0.95	1.00		0.95	1.00		0.95	1.00		0.95	1.00	
Satd. Flow (prot)	1736	3399		1736	3459		1736	1695		1736	1791	
Flt Permitted	0.95	1.00		0.95	1.00		0.95	1.00		0.95	1.00	
Satd. Flow (perm)	1736	3399		1736	3459		1736	1695		1736	1791	
Peak-hour factor, PHF	0.87	0.87	0.87	0.87	0.87	0.87	0.87	0.87	0.87	0.87	0.87	0.87
Adj. Flow (vph)	7	645	103	41	705	15	169	89	83	28	60	9
RTOR Reduction (vph)	0	13	0	0	1	0	0	53	0	0	8	0
Lane Group Flow (vph)	7	735	0	41	719	0	169	119	0	28	61	0
Confl. Bikes (#/hr)						1						
Heavy Vehicles (%)	4%	4%	4%	4%	4%	4%	4%	4%	4%	4%	4%	4%
Turn Type	Prot	NA		Prot	NA		Prot	NA		Prot	NA	
Protected Phases	5	2		1	6		3	8		7	4	
Permitted Phases												
Actuated Green, G (s)	0.6	20.2		2.0	21.6		9.3	12.0		1.9	4.6	
Effective Green, g (s)	0.6	20.2		2.0	21.6		9.3	12.0		1.9	4.6	
Actuated g/C Ratio	0.01	0.36		0.04	0.39		0.17	0.22		0.03	0.08	
Clearance Time (s)	4.2	6.0		4.2	6.0		4.2	4.9		4.2	4.9	
Vehicle Extension (s)	3.0	3.0		3.0	3.0		3.0	3.0		3.0	3.0	
Lane Grp Cap (vph)	18	1239		62	1348		291	367		59	148	
v/s Ratio Prot	0.00	c0.22		c0.02	0.21		c0.10	c0.07		0.02	0.03	
v/s Ratio Perm												
v/c Ratio	0.39	0.59		0.66	0.53		0.58	0.32		0.47	0.41	
Uniform Delay, d1	27.2	14.3		26.4	13.0		21.3	18.3		26.3	24.1	
Progression Factor	1.00	1.00		1.00	1.00		1.00	1.00		1.00	1.00	
Incremental Delay, d2	13.4	0.8		23.4	0.4		2.9	0.5		5.9	1.8	
Delay (s)	40.6	15.0		49.8	13.4		24.2	18.8		32.2	26.0	
Level of Service	D	B		D	B		C	B		C	C	
Approach Delay (s)		15.3			15.4			21.5			27.8	
Approach LOS		B			B			C			C	
Intersection Summary												
HCM 2000 Control Delay			17.0				HCM 2000 Level of Service				B	
HCM 2000 Volume to Capacity ratio			0.58									
Actuated Cycle Length (s)			55.4			Sum of lost time (s)				19.3		
Intersection Capacity Utilization			49.6%			ICU Level of Service				A		
Analysis Period (min)			15									
c Critical Lane Group												

Santa Maria Airport Business Park SP
5: Orcutt Road & Union Valley Parkway

Existing AM
HCM 6th Signalized Intersection Summary



Movement	EBL	EBT	EBR	WBL	WBT	WBR	NBL	NBT	NBR	SBL	SBT	SBR
Lane Configurations	↖	↕		↖	↕		↖	↕		↖	↕	
Traffic Volume (veh/h)	6	561	90	36	613	13	147	77	72	24	52	8
Future Volume (veh/h)	6	561	90	36	613	13	147	77	72	24	52	8
Initial Q (Qb), veh	0	0	0	0	0	0	0	0	0	0	0	0
Ped-Bike Adj(A_pbT)	1.00		1.00	1.00		0.98	1.00		1.00	1.00		1.00
Parking Bus, Adj	1.00	1.00	1.00	1.00	1.00	1.00	1.00	1.00	1.00	1.00	1.00	1.00
Work Zone On Approach		No			No			No			No	
Adj Sat Flow, veh/h/ln	1841	1841	1841	1841	1841	1841	1841	1841	1841	1841	1841	1841
Adj Flow Rate, veh/h	7	645	103	41	705	15	169	89	83	28	60	9
Peak Hour Factor	0.87	0.87	0.87	0.87	0.87	0.87	0.87	0.87	0.87	0.87	0.87	0.87
Percent Heavy Veh, %	4	4	4	4	4	4	4	4	4	4	4	4
Cap, veh/h	13	922	147	63	1168	25	216	163	152	46	139	21
Arrive On Green	0.01	0.31	0.31	0.04	0.33	0.33	0.12	0.19	0.19	0.03	0.09	0.09
Sat Flow, veh/h	1753	3021	482	1753	3500	74	1753	876	817	1753	1564	235
Grp Volume(v), veh/h	7	373	375	41	352	368	169	0	172	28	0	69
Grp Sat Flow(s),veh/h/ln	1753	1749	1754	1753	1749	1825	1753	0	1694	1753	0	1798
Q Serve(g_s), s	0.2	8.1	8.2	1.0	7.3	7.3	4.0	0.0	4.0	0.7	0.0	1.6
Cycle Q Clear(g_c), s	0.2	8.1	8.2	1.0	7.3	7.3	4.0	0.0	4.0	0.7	0.0	1.6
Prop In Lane	1.00		0.27	1.00		0.04	1.00		0.48	1.00		0.13
Lane Grp Cap(c), veh/h	13	534	535	63	584	609	216	0	315	46	0	160
V/C Ratio(X)	0.54	0.70	0.70	0.65	0.60	0.60	0.78	0.00	0.55	0.60	0.00	0.43
Avail Cap(c_a), veh/h	162	813	816	162	813	849	349	0	1407	231	0	1373
HCM Platoon Ratio	1.00	1.00	1.00	1.00	1.00	1.00	1.00	1.00	1.00	1.00	1.00	1.00
Upstream Filter(I)	1.00	1.00	1.00	1.00	1.00	1.00	1.00	0.00	1.00	1.00	0.00	1.00
Uniform Delay (d), s/veh	21.4	13.3	13.3	20.6	12.0	12.0	18.4	0.0	15.9	20.8	0.0	18.7
Incr Delay (d2), s/veh	30.0	1.7	1.7	10.7	1.0	1.0	6.0	0.0	1.5	12.0	0.0	1.8
Initial Q Delay(d3),s/veh	0.0	0.0	0.0	0.0	0.0	0.0	0.0	0.0	0.0	0.0	0.0	0.0
%ile BackOfQ(50%),veh/ln	0.2	2.5	2.5	0.5	2.1	2.2	1.7	0.0	1.3	0.4	0.0	0.6
Unsig. Movement Delay, s/veh												
LnGrp Delay(d),s/veh	51.3	14.9	14.9	31.3	13.0	13.0	24.4	0.0	17.4	32.8	0.0	20.5
LnGrp LOS	D	B	B	C	B	B	C	A	B	C	A	C
Approach Vol, veh/h		755			761			341				97
Approach Delay, s/veh		15.3			14.0			20.9				24.1
Approach LOS		B			B			C				C
Timer - Assigned Phs	1	2	3	4	5	6	7	8				
Phs Duration (G+Y+Rc), s	5.8	19.2	9.5	8.7	4.5	20.4	5.3	12.9				
Change Period (Y+Rc), s	* 4.2	6.0	* 4.2	4.9	* 4.2	6.0	* 4.2	4.9				
Max Green Setting (Gmax), s	* 4	20.1	* 8.6	33.0	* 4	20.1	* 5.7	35.9				
Max Q Clear Time (g_c+I1), s	3.0	10.2	6.0	3.6	2.2	9.3	2.7	6.0				
Green Ext Time (p_c), s	0.0	3.0	0.1	0.3	0.0	3.0	0.0	0.9				

Intersection Summary

HCM 6th Ctrl Delay	16.2
HCM 6th LOS	B

Notes

* HCM 6th computational engine requires equal clearance times for the phases crossing the barrier.

Intersection												
Int Delay, s/veh	0.7											
Movement	EBL	EBT	EBR	WBL	WBT	WBR	NBL	NBT	NBR	SBL	SBT	SBR
Lane Configurations		↕		↕	↕			↕			↕	
Traffic Vol, veh/h	0	247	11	14	169	0	5	0	15	0	0	0
Future Vol, veh/h	0	247	11	14	169	0	5	0	15	0	0	0
Conflicting Peds, #/hr	0	0	0	0	0	0	1	0	0	0	0	1
Sign Control	Free	Free	Free	Free	Free	Free	Stop	Stop	Stop	Stop	Stop	Stop
RT Channelized	-	-	None	-	-	None	-	-	None	-	-	None
Storage Length	-	-	-	160	-	-	-	-	-	-	-	-
Veh in Median Storage, #	-	0	-	-	0	-	-	0	-	-	0	-
Grade, %	-	0	-	-	0	-	-	0	-	-	0	-
Peak Hour Factor	89	89	89	89	89	89	89	89	89	89	89	89
Heavy Vehicles, %	1	1	1	1	1	1	1	1	1	1	1	1
Mvmt Flow	0	278	12	16	190	0	6	0	17	0	0	0

























Major/Minor	Major1			Major2			Minor1			Minor2		
Conflicting Flow All	190	0	0	290	0	0	507	506	284	515	512	191
Stage 1	-	-	-	-	-	-	284	284	-	222	222	-
Stage 2	-	-	-	-	-	-	223	222	-	293	290	-
Critical Hdwy	4.11	-	-	4.11	-	-	7.11	6.51	6.21	7.11	6.51	6.21
Critical Hdwy Stg 1	-	-	-	-	-	-	6.11	5.51	-	6.11	5.51	-
Critical Hdwy Stg 2	-	-	-	-	-	-	6.11	5.51	-	6.11	5.51	-
Follow-up Hdwy	2.209	-	-	2.209	-	-	3.509	4.009	3.309	3.509	4.009	3.309
Pot Cap-1 Maneuver	1390	-	-	1278	-	-	478	470	757	472	467	853
Stage 1	-	-	-	-	-	-	725	678	-	783	722	-
Stage 2	-	-	-	-	-	-	782	722	-	717	674	-
Platoon blocked, %	-	-	-	-	-	-	-	-	-	-	-	-
Mov Cap-1 Maneuver	1390	-	-	1278	-	-	473	464	757	457	461	852
Mov Cap-2 Maneuver	-	-	-	-	-	-	473	464	-	457	461	-
Stage 1	-	-	-	-	-	-	725	678	-	783	713	-
Stage 2	-	-	-	-	-	-	771	713	-	701	674	-

Approach	EB			WB			NB			SB		
HCM Control Delay, s	0			0.6			10.7			0		
HCM LOS							B			A		

Minor Lane/Major Mvmt	NBLn1	EBL	EBT	EBR	WBL	WBT	WBR	SBLn1
Capacity (veh/h)	658	1390	-	-	1278	-	-	-
HCM Lane V/C Ratio	0.034	-	-	-	0.012	-	-	-
HCM Control Delay (s)	10.7	0	-	-	7.9	-	-	0
HCM Lane LOS	B	A	-	-	A	-	-	A
HCM 95th %tile Q(veh)	0.1	0	-	-	0	-	-	-

Santa Maria Airport Business Park SP
2: Orcutt Expressway & Foster Road

Existing PM
HCM 6th Signalized Intersection Summary

												
Movement	EBL	EBT	EBR	WBL	WBT	WBR	NBL	NBT	NBR	SBL	SBT	SBR
Lane Configurations	 							 			 	
Traffic Volume (veh/h)	182	53	27	67	48	107	6	1130	60	133	1299	133
Future Volume (veh/h)	182	53	27	67	48	107	6	1130	60	133	1299	133
Initial Q (Qb), veh	0	0	0	0	0	0	0	0	0	0	0	0
Ped-Bike Adj(A_pbT)	1.00		0.98	1.00		1.00	1.00		1.00	1.00		1.00
Parking Bus, Adj	1.00	1.00	1.00	1.00	1.00	1.00	1.00	1.00	1.00	1.00	1.00	1.00
Work Zone On Approach		No			No			No			No	
Adj Sat Flow, veh/h/ln	1870	1870	1870	1870	1870	1870	1870	1870	1870	1870	1870	1870
Adj Flow Rate, veh/h	190	55	28	70	50	52	6	1177	62	139	1353	139
Peak Hour Factor	0.96	0.96	0.96	0.96	0.96	0.96	0.96	0.96	0.96	0.96	0.96	0.96
Percent Heavy Veh, %	2	2	2	2	2	2	2	2	2	2	2	2
Cap, veh/h	389	130	66	190	200	169	17	1399	74	175	1763	786
Arrive On Green	0.11	0.11	0.11	0.11	0.11	0.11	0.01	0.41	0.41	0.10	0.50	0.50
Sat Flow, veh/h	3456	1159	590	1781	1870	1585	1781	3434	181	1781	3554	1585
Grp Volume(v), veh/h	190	0	83	70	50	52	6	609	630	139	1353	139
Grp Sat Flow(s),veh/h/ln	1728	0	1750	1781	1870	1585	1781	1777	1838	1781	1777	1585
Q Serve(g_s), s	3.8	0.0	3.2	2.7	1.8	2.2	0.2	22.4	22.5	5.5	22.5	3.5
Cycle Q Clear(g_c), s	3.8	0.0	3.2	2.7	1.8	2.2	0.2	22.4	22.5	5.5	22.5	3.5
Prop In Lane	1.00		0.34	1.00		1.00	1.00		0.10	1.00		1.00
Lane Grp Cap(c), veh/h	389	0	197	190	200	169	17	724	749	175	1763	786
V/C Ratio(X)	0.49	0.00	0.42	0.37	0.25	0.31	0.36	0.84	0.84	0.80	0.77	0.18
Avail Cap(c_a), veh/h	1332	0	674	196	206	175	147	856	885	221	1859	829
HCM Platoon Ratio	1.00	1.00	1.00	1.00	1.00	1.00	1.00	1.00	1.00	1.00	1.00	1.00
Upstream Filter(I)	1.00	0.00	1.00	1.00	1.00	1.00	1.00	1.00	1.00	1.00	1.00	1.00
Uniform Delay (d), s/veh	30.3	0.0	30.0	30.2	29.8	30.0	35.8	19.4	19.4	32.0	14.9	10.1
Incr Delay (d2), s/veh	1.0	0.0	1.4	1.2	0.7	1.0	12.4	6.6	6.4	14.5	1.9	0.1
Initial Q Delay(d3),s/veh	0.0	0.0	0.0	0.0	0.0	0.0	0.0	0.0	0.0	0.0	0.0	0.0
%ile BackOfQ(50%),veh/ln	1.5	0.0	1.3	1.1	0.8	0.8	0.2	8.7	9.0	2.8	7.2	1.0
Unsig. Movement Delay, s/veh												
LnGrp Delay(d),s/veh	31.2	0.0	31.5	31.4	30.4	31.0	48.1	26.0	25.9	46.5	16.8	10.2
LnGrp LOS	C	A	C	C	C	C	D	C	C	D	B	B
Approach Vol, veh/h		273			172			1245			1631	
Approach Delay, s/veh		31.3			31.0			26.0			18.8	
Approach LOS		C			C			C			B	
Timer - Assigned Phs	1	2		4	5	6		8				
Phs Duration (G+Y+Rc), s	11.3	35.6		13.1	4.9	42.0		12.7				
Change Period (Y+Rc), s	* 4.2	6.0		4.9	* 4.2	6.0		4.9				
Max Green Setting (Gmax), s	* 9	35.0		28.0	* 6	38.0		8.0				
Max Q Clear Time (g_c+I1), s	7.5	24.5		5.8	2.2	24.5		4.7				
Green Ext Time (p_c), s	0.0	5.1		1.0	0.0	7.4		0.2				
Intersection Summary												
HCM 6th Ctrl Delay				23.2								
HCM 6th LOS				C								
Notes												
* HCM 6th computational engine requires equal clearance times for the phases crossing the barrier.												

Santa Maria Airport Business Park SP
3: Foxenwood Lane & Union Valley Parkway

Existing PM
HCM 6th TWSC

Intersection												
Int Delay, s/veh	3.8											
Movement	EBL	EBT	EBR	WBL	WBT	WBR	NBL	NBT	NBR	SBL	SBT	SBR
Lane Configurations	↖	↕		↖	↕			↕			↕	
Traffic Vol, veh/h	1	220	3	178	300	6	3	9	99	7	8	12
Future Vol, veh/h	1	220	3	178	300	6	3	9	99	7	8	12
Conflicting Peds, #/hr	1	0	0	0	0	1	0	0	1	1	0	0
Sign Control	Free	Free	Free	Free	Free	Free	Stop	Stop	Stop	Stop	Stop	Stop
RT Channelized	-	-	None	-	-	None	-	-	None	-	-	None
Storage Length	195	-	-	155	-	-	-	-	-	-	-	-
Veh in Median Storage, #	-	0	-	-	0	-	-	0	-	-	0	-
Grade, %	-	0	-	-	0	-	-	0	-	-	0	-
Peak Hour Factor	92	92	92	92	92	92	92	92	92	92	92	92
Heavy Vehicles, %	1	1	1	1	1	1	1	1	1	1	1	1
Mvmt Flow	1	239	3	193	326	7	3	10	108	8	9	13































Major/Minor	Major1			Major2			Minor1			Minor2		
Conflicting Flow All	334	0	0	242	0	0	797	963	122	845	961	168
Stage 1	-	-	-	-	-	-	243	243	-	717	717	-
Stage 2	-	-	-	-	-	-	554	720	-	128	244	-
Critical Hdwy	4.12	-	-	4.12	-	-	7.52	6.52	6.92	7.52	6.52	6.92
Critical Hdwy Stg 1	-	-	-	-	-	-	6.52	5.52	-	6.52	5.52	-
Critical Hdwy Stg 2	-	-	-	-	-	-	6.52	5.52	-	6.52	5.52	-
Follow-up Hdwy	2.21	-	-	2.21	-	-	3.51	4.01	3.31	3.51	4.01	3.31
Pot Cap-1 Maneuver	1229	-	-	1329	-	-	279	256	909	258	257	850
Stage 1	-	-	-	-	-	-	742	706	-	389	434	-
Stage 2	-	-	-	-	-	-	487	433	-	865	705	-
Platoon blocked, %	-	-	-	-	-	-	-	-	-	-	-	-
Mov Cap-1 Maneuver	1228	-	-	1329	-	-	237	218	908	195	219	849
Mov Cap-2 Maneuver	-	-	-	-	-	-	237	218	-	195	219	-
Stage 1	-	-	-	-	-	-	741	705	-	388	371	-
Stage 2	-	-	-	-	-	-	400	370	-	751	704	-

Approach	EB			WB			NB			SB		
HCM Control Delay, s	0			3			11.4			17.7		
HCM LOS							B			C		

Minor Lane/Major Mvmt	NBLn1	EBL	EBT	EBR	WBL	WBT	WBR	SBLn1
Capacity (veh/h)	681	1228	-	-	1329	-	-	312
HCM Lane V/C Ratio	0.177	0.001	-	-	0.146	-	-	0.094
HCM Control Delay (s)	11.4	7.9	-	-	8.2	-	-	17.7
HCM Lane LOS	B	A	-	-	A	-	-	C
HCM 95th %tile Q(veh)	0.6	0	-	-	0.5	-	-	0.3

Santa Maria Airport Business Park SP
4: Orcutt Expressway & Union Valley Parkway

Existing PM
HCM 6th Signalized Intersection Summary

												
Movement	EBL	EBT	EBR	WBL	WBT	WBR	NBL	NBT	NBR	SBL	SBT	SBR
Lane Configurations	 	 		 	 			 		 	 	
Traffic Volume (veh/h)	144	174	8	273	219	108	9	952	427	311	851	259
Future Volume (veh/h)	144	174	8	273	219	108	9	952	427	311	851	259
Initial Q (Qb), veh	0	0	0	0	0	0	0	0	0	0	0	0
Ped-Bike Adj(A_pbT)	1.00		1.00	1.00		1.00	1.00		1.00	1.00		1.00
Parking Bus, Adj	1.00	1.00	1.00	1.00	1.00	1.00	1.00	1.00	1.00	1.00	1.00	1.00
Work Zone On Approach		No			No			No			No	
Adj Sat Flow, veh/h/ln	1870	1870	1870	1870	1870	1870	1870	1870	1870	1870	1870	1870
Adj Flow Rate, veh/h	145	176	8	276	221	109	9	962	431	314	860	262
Peak Hour Factor	0.99	0.99	0.99	0.99	0.99	0.99	0.99	0.99	0.99	0.99	0.99	0.99
Percent Heavy Veh, %	2	2	2	2	2	2	2	2	2	2	2	2
Cap, veh/h	365	418	187	385	414	185	33	1307	583	387	1665	743
Arrive On Green	0.11	0.12	0.12	0.11	0.12	0.12	0.02	0.37	0.37	0.11	0.47	0.47
Sat Flow, veh/h	3456	3554	1585	3456	3554	1585	1781	3554	1585	3456	3554	1585
Grp Volume(v), veh/h	145	176	8	276	221	109	9	962	431	314	860	262
Grp Sat Flow(s),veh/h/ln	1728	1777	1585	1728	1777	1585	1781	1777	1585	1728	1777	1585
Q Serve(g_s), s	2.8	3.3	0.3	5.5	4.2	4.7	0.4	16.8	16.9	6.3	12.1	7.5
Cycle Q Clear(g_c), s	2.8	3.3	0.3	5.5	4.2	4.7	0.4	16.8	16.9	6.3	12.1	7.5
Prop In Lane	1.00		1.00	1.00		1.00	1.00		1.00	1.00		1.00
Lane Grp Cap(c), veh/h	365	418	187	385	414	185	33	1307	583	387	1665	743
V/C Ratio(X)	0.40	0.42	0.04	0.72	0.53	0.59	0.28	0.74	0.74	0.81	0.52	0.35
Avail Cap(c_a), veh/h	474	2238	998	387	2123	947	199	1900	847	387	1924	858
HCM Platoon Ratio	1.00	1.00	1.00	1.00	1.00	1.00	1.00	1.00	1.00	1.00	1.00	1.00
Upstream Filter(I)	1.00	1.00	1.00	1.00	1.00	1.00	1.00	1.00	1.00	1.00	1.00	1.00
Uniform Delay (d), s/veh	29.8	29.3	28.0	30.7	29.7	30.0	34.6	19.6	19.6	31.0	13.3	12.1
Incr Delay (d2), s/veh	0.7	0.7	0.1	6.2	1.1	3.0	4.5	0.9	2.0	12.3	0.2	0.3
Initial Q Delay(d3),s/veh	0.0	0.0	0.0	0.0	0.0	0.0	0.0	0.0	0.0	0.0	0.0	0.0
%ile BackOfQ(50%),veh/ln	1.1	1.3	0.1	2.4	1.7	1.8	0.2	5.8	5.6	3.0	3.8	2.2
Unsig. Movement Delay, s/veh												
LnGrp Delay(d),s/veh	30.5	29.9	28.1	36.9	30.8	32.9	39.1	20.4	21.6	43.3	13.6	12.4
LnGrp LOS	C	C	C	D	C	C	D	C	C	D	B	B
Approach Vol, veh/h		329			606			1402			1436	
Approach Delay, s/veh		30.2			33.9			20.9			19.9	
Approach LOS		C			C			C			B	
Timer - Assigned Phs	1	2	3	4	5	6	7	8				
Phs Duration (G+Y+Rc), s	13.0	32.3	12.9	13.3	5.8	39.5	13.0	13.2				
Change Period (Y+Rc), s	5.0	6.0	4.9	4.9	4.5	6.0	5.4	4.9				
Max Green Setting (Gmax), s	8.0	38.2	8.0	45.0	8.0	38.7	9.8	42.7				
Max Q Clear Time (g_c+I1), s	8.3	18.9	7.5	5.3	2.4	14.1	4.8	6.7				
Green Ext Time (p_c), s	0.0	7.4	0.1	1.1	0.0	6.4	0.2	1.7				
Intersection Summary												
HCM 6th Ctrl Delay				23.4								
HCM 6th LOS				C								

Santa Maria Airport Business Park SP
5: Orcutt Road & Union Valley Parkway

Existing PM
HCM Signalized Intersection Capacity Analysis



Movement	EBL	EBT	EBR	WBL	WBT	WBR	NBL	NBT	NBR	SBL	SBT	SBR	
Lane Configurations	↖	↗		↖	↗		↖	↗		↖	↗		
Traffic Volume (vph)	0	806	105	26	533	11	66	31	42	22	32	5	
Future Volume (vph)	0	806	105	26	533	11	66	31	42	22	32	5	
Ideal Flow (vphp)	1900	1900	1900	1900	1900	1900	1900	1900	1900	1900	1900	1900	
Total Lost time (s)		6.0		4.2	6.0		4.2	4.9		4.2	4.9		
Lane Util. Factor		0.95		1.00	0.95		1.00	1.00		1.00	1.00		
Frbp, ped/bikes		1.00		1.00	1.00		1.00	0.99		1.00	1.00		
Flpb, ped/bikes		1.00		1.00	1.00		1.00	1.00		1.00	1.00		
Frt		0.98		1.00	1.00		1.00	0.91		1.00	0.98		
Flt Protected		1.00		0.95	1.00		0.95	1.00		0.95	1.00		
Satd. Flow (prot)		3470		1770	3529		1770	1690		1770	1826		
Flt Permitted		1.00		0.95	1.00		0.95	1.00		0.95	1.00		
Satd. Flow (perm)		3470		1770	3529		1770	1690		1770	1826		
Peak-hour factor, PHF	0.97	0.97	0.97	0.97	0.97	0.97	0.97	0.97	0.97	0.97	0.97	0.97	
Adj. Flow (vph)	0	831	108	27	549	11	68	32	43	23	33	5	
RTOR Reduction (vph)	0	9	0	0	1	0	0	36	0	0	5	0	
Lane Group Flow (vph)	0	930	0	27	559	0	68	39	0	23	33	0	
Confl. Peds. (#/hr)			1						1				
Turn Type	Prot	NA		Prot	NA		Prot	NA		Prot	NA		
Protected Phases	5	2		1	6		3	8		7	4		
Permitted Phases													
Actuated Green, G (s)		26.7		1.2	32.1		4.9	9.8		0.5	5.4		
Effective Green, g (s)		26.7		1.2	32.1		4.9	9.8		0.5	5.4		
Actuated g/C Ratio		0.46		0.02	0.56		0.09	0.17		0.01	0.09		
Clearance Time (s)		6.0		4.2	6.0		4.2	4.9		4.2	4.9		
Vehicle Extension (s)		3.0		3.0	3.0		3.0	3.0		3.0	3.0		
Lane Grp Cap (vph)		1611		36	1970		150	288		15	171		
v/s Ratio Prot		c0.27		c0.02	0.16		c0.04	c0.02		0.01	0.02		
v/s Ratio Perm													
v/c Ratio		0.58		0.75	0.28		0.45	0.14		1.53	0.20		
Uniform Delay, d1		11.3		28.0	6.7		25.0	20.3		28.5	24.0		
Progression Factor		1.00		1.00	1.00		1.00	1.00		1.00	1.00		
Incremental Delay, d2		0.5		59.8	0.1		2.2	0.2		431.8	0.6		
Delay (s)		11.8		87.8	6.7		27.2	20.5		460.3	24.6		
Level of Service		B		F	A		C	C		F	C		
Approach Delay (s)		11.8			10.5			23.7			188.9		
Approach LOS		B			B			C			F		
Intersection Summary													
HCM 2000 Control Delay			18.6									HCM 2000 Level of Service	B
HCM 2000 Volume to Capacity ratio			0.51										
Actuated Cycle Length (s)			57.5									Sum of lost time (s)	19.3
Intersection Capacity Utilization			45.6%									ICU Level of Service	A
Analysis Period (min)			15										
c Critical Lane Group													

Santa Maria Airport Business Park SP
5: Orcutt Road & Union Valley Parkway

Existing PM
HCM 6th Signalized Intersection Summary



Movement	EBL	EBT	EBR	WBL	WBT	WBR	NBL	NBT	NBR	SBL	SBT	SBR
Lane Configurations	↖	↗		↖	↗		↖	↗		↖	↗	
Traffic Volume (veh/h)	0	806	105	26	533	11	66	31	42	22	32	5
Future Volume (veh/h)	0	806	105	26	533	11	66	31	42	22	32	5
Initial Q (Qb), veh	0	0	0	0	0	0	0	0	0	0	0	0
Ped-Bike Adj(A_pbT)	1.00		1.00	1.00		1.00	1.00		1.00	1.00		1.00
Parking Bus, Adj	1.00	1.00	1.00	1.00	1.00	1.00	1.00	1.00	1.00	1.00	1.00	1.00
Work Zone On Approach		No			No			No			No	
Adj Sat Flow, veh/h/ln	1870	1870	1870	1870	1870	1870	1870	1870	1870	1870	1870	1870
Adj Flow Rate, veh/h	0	831	108	27	549	11	68	32	43	23	33	5
Peak Hour Factor	0.97	0.97	0.97	0.97	0.97	0.97	0.97	0.97	0.97	0.97	0.97	0.97
Percent Heavy Veh, %	2	2	2	2	2	2	2	2	2	2	2	2
Cap, veh/h	4	1194	155	46	1797	36	93	80	107	40	128	19
Arrive On Green	0.00	0.38	0.38	0.03	0.50	0.50	0.05	0.11	0.11	0.02	0.08	0.08
Sat Flow, veh/h	1781	3162	411	1781	3563	71	1781	722	970	1781	1587	240
Grp Volume(v), veh/h	0	467	472	27	274	286	68	0	75	23	0	38
Grp Sat Flow(s),veh/h/ln	1781	1777	1796	1781	1777	1858	1781	0	1693	1781	0	1827
Q Serve(g_s), s	0.0	9.2	9.2	0.6	3.8	3.8	1.6	0.0	1.7	0.5	0.0	0.8
Cycle Q Clear(g_c), s	0.0	9.2	9.2	0.6	3.8	3.8	1.6	0.0	1.7	0.5	0.0	0.8
Prop In Lane	1.00		0.23	1.00		0.04	1.00		0.57	1.00		0.13
Lane Grp Cap(c), veh/h	4	671	678	46	896	937	93	0	187	40	0	147
V/C Ratio(X)	0.00	0.70	0.70	0.59	0.31	0.31	0.73	0.00	0.40	0.58	0.00	0.26
Avail Cap(c_a), veh/h	171	1021	1031	171	1021	1067	205	0	1371	176	0	1449
HCM Platoon Ratio	1.00	1.00	1.00	1.00	1.00	1.00	1.00	1.00	1.00	1.00	1.00	1.00
Upstream Filter(I)	0.00	1.00	1.00	1.00	1.00	1.00	1.00	0.00	1.00	1.00	0.00	1.00
Uniform Delay (d), s/veh	0.0	10.9	10.9	20.1	6.0	6.0	19.4	0.0	17.2	20.1	0.0	18.0
Incr Delay (d2), s/veh	0.0	1.3	1.3	11.4	0.2	0.2	10.4	0.0	1.4	12.4	0.0	0.9
Initial Q Delay(d3),s/veh	0.0	0.0	0.0	0.0	0.0	0.0	0.0	0.0	0.0	0.0	0.0	0.0
%ile BackOfQ(50%),veh/ln	0.0	2.5	2.6	0.4	0.7	0.8	0.8	0.0	0.6	0.3	0.0	0.3
Unsig. Movement Delay, s/veh												
LnGrp Delay(d),s/veh	0.0	12.2	12.2	31.5	6.2	6.2	29.8	0.0	18.6	32.5	0.0	18.9
LnGrp LOS	A	B	B	C	A	A	C	A	B	C	A	B
Approach Vol, veh/h		939			587			143				61
Approach Delay, s/veh		12.2			7.4			23.9				24.0
Approach LOS		B			A			C				C
Timer - Assigned Phs	1	2	3	4	5	6	7	8				
Phs Duration (G+Y+Rc), s	5.3	21.7	6.4	8.2	0.0	27.0	5.1	9.5				
Change Period (Y+Rc), s	* 4.2	6.0	* 4.2	4.9	* 4.2	6.0	* 4.2	4.9				
Max Green Setting (Gmax), s	* 4	23.9	* 4.8	33.0	* 4	23.9	* 4.1	33.7				
Max Q Clear Time (g_c+I1), s	2.6	11.2	3.6	2.8	0.0	5.8	2.5	3.7				
Green Ext Time (p_c), s	0.0	4.5	0.0	0.1	0.0	2.8	0.0	0.3				

Intersection Summary

HCM 6th Ctrl Delay	12.0
HCM 6th LOS	B

Notes

* HCM 6th computational engine requires equal clearance times for the phases crossing the barrier.

Existing Plus Project

Intersection												
Int Delay, s/veh	7.1											
Movement	EBL	EBT	EBR	WBL	WBT	WBR	NBL	NBT	NBR	SBL	SBT	SBR
Lane Configurations		↕		↕	↕			↕			↕	
Traffic Vol, veh/h	0	235	8	254	187	0	46	0	169	0	0	0
Future Vol, veh/h	0	235	8	254	187	0	46	0	169	0	0	0
Conflicting Peds, #/hr	0	0	0	0	0	0	0	0	0	0	0	0
Sign Control	Free	Free	Free	Free	Free	Free	Stop	Stop	Stop	Stop	Stop	Stop
RT Channelized	-	-	None	-	-	None	-	-	None	-	-	None
Storage Length	-	-	-	160	-	-	-	-	-	-	-	-
Veh in Median Storage, #	-	0	-	-	0	-	-	0	-	-	0	-
Grade, %	-	0	-	-	0	-	-	0	-	-	0	-
Peak Hour Factor	95	95	95	95	95	95	95	95	95	95	95	95
Heavy Vehicles, %	4	4	4	4	4	4	4	4	4	4	4	4
Mvmt Flow	0	247	8	267	197	0	48	0	178	0	0	0























Major/Minor	Major1			Major2			Minor1			Minor2		
Conflicting Flow All	197	0	0	255	0	0	982	982	251	1071	986	197
Stage 1	-	-	-	-	-	-	251	251	-	731	731	-
Stage 2	-	-	-	-	-	-	731	731	-	340	255	-
Critical Hdwy	4.14	-	-	4.14	-	-	7.14	6.54	6.24	7.14	6.54	6.24
Critical Hdwy Stg 1	-	-	-	-	-	-	6.14	5.54	-	6.14	5.54	-
Critical Hdwy Stg 2	-	-	-	-	-	-	6.14	5.54	-	6.14	5.54	-
Follow-up Hdwy	2.236	-	-	2.236	-	-	3.536	4.036	3.336	3.536	4.036	3.336
Pot Cap-1 Maneuver	1364	-	-	1298	-	-	226	247	783	197	246	839
Stage 1	-	-	-	-	-	-	749	695	-	410	424	-
Stage 2	-	-	-	-	-	-	410	424	-	671	693	-
Platoon blocked, %		-	-	-	-	-						
Mov Cap-1 Maneuver	1364	-	-	1298	-	-	190	196	783	128	195	839
Mov Cap-2 Maneuver	-	-	-	-	-	-	190	196	-	128	195	-
Stage 1	-	-	-	-	-	-	749	695	-	410	337	-
Stage 2	-	-	-	-	-	-	326	337	-	519	693	-

Approach	EB			WB			NB			SB		
HCM Control Delay, s	0			4.9			19.6			0		
HCM LOS							C			A		

Minor Lane/Major Mvmt	NBLn1	EBL	EBT	EBR	WBL	WBT	WBR	SBLn1
Capacity (veh/h)	469	1364	-	-	1298	-	-	-
HCM Lane V/C Ratio	0.483	-	-	-	0.206	-	-	-
HCM Control Delay (s)	19.6	0	-	-	8.5	-	-	0
HCM Lane LOS	C	A	-	-	A	-	-	A
HCM 95th %tile Q(veh)	2.6	0	-	-	0.8	-	-	-

Santa Maria Airport Business Park SP
2: Orcutt Expressway & Foster Road

Existing Plus Project AM
HCM 6th Signalized Intersection Summary

												
Movement	EBL	EBT	EBR	WBL	WBT	WBR	NBL	NBT	NBR	SBL	SBT	SBR
Lane Configurations												
Traffic Volume (veh/h)	321	117	45	118	121	249	47	1076	91	105	695	275
Future Volume (veh/h)	321	117	45	118	121	249	47	1076	91	105	695	275
Initial Q (Qb), veh	0	0	0	0	0	0	0	0	0	0	0	0
Ped-Bike Adj(A_pbT)	1.00		1.00	1.00		1.00	1.00		0.98	1.00		0.98
Parking Bus, Adj	1.00	1.00	1.00	1.00	1.00	1.00	1.00	1.00	1.00	1.00	1.00	1.00
Work Zone On Approach		No			No			No			No	
Adj Sat Flow, veh/h/ln	1856	1856	1856	1856	1856	1856	1856	1856	1856	1856	1856	1856
Adj Flow Rate, veh/h	349	127	49	128	132	128	51	1170	99	114	755	299
Peak Hour Factor	0.92	0.92	0.92	0.92	0.92	0.92	0.92	0.92	0.92	0.92	0.92	0.92
Percent Heavy Veh, %	3	3	3	3	3	3	3	3	3	3	3	3
Cap, veh/h	500	186	72	186	196	166	89	1396	118	144	1609	703
Arrive On Green	0.15	0.15	0.15	0.11	0.11	0.11	0.05	0.42	0.42	0.08	0.46	0.46
Sat Flow, veh/h	3428	1275	492	1767	1856	1572	1767	3284	277	1767	3526	1540
Grp Volume(v), veh/h	349	0	176	128	132	128	51	627	642	114	755	299
Grp Sat Flow(s),veh/h/ln	1714	0	1767	1767	1856	1572	1767	1763	1799	1767	1763	1540
Q Serve(g_s), s	8.0	0.0	7.8	5.8	5.7	6.5	2.3	26.2	26.3	5.2	12.2	10.8
Cycle Q Clear(g_c), s	8.0	0.0	7.8	5.8	5.7	6.5	2.3	26.2	26.3	5.2	12.2	10.8
Prop In Lane	1.00		0.28	1.00		1.00	1.00		0.15	1.00		1.00
Lane Grp Cap(c), veh/h	500	0	258	186	196	166	89	749	764	144	1609	703
V/C Ratio(X)	0.70	0.00	0.68	0.69	0.67	0.77	0.58	0.84	0.84	0.79	0.47	0.43
Avail Cap(c_a), veh/h	1163	0	599	203	214	181	128	946	965	176	1986	868
HCM Platoon Ratio	1.00	1.00	1.00	1.00	1.00	1.00	1.00	1.00	1.00	1.00	1.00	1.00
Upstream Filter(I)	1.00	0.00	1.00	1.00	1.00	1.00	1.00	1.00	1.00	1.00	1.00	1.00
Uniform Delay (d), s/veh	33.5	0.0	33.4	35.6	35.5	35.9	38.3	21.2	21.2	37.2	15.5	15.1
Incr Delay (d2), s/veh	1.8	0.0	3.2	8.4	7.3	17.0	5.8	5.4	5.4	18.0	0.2	0.4
Initial Q Delay(d3),s/veh	0.0	0.0	0.0	0.0	0.0	0.0	0.0	0.0	0.0	0.0	0.0	0.0
%ile BackOfQ(50%),veh/ln	3.3	0.0	3.4	2.8	2.8	3.2	1.1	10.0	10.3	2.8	4.1	3.2
Unsig. Movement Delay, s/veh												
LnGrp Delay(d),s/veh	35.3	0.0	36.6	44.0	42.8	53.0	44.1	26.6	26.7	55.3	15.7	15.5
LnGrp LOS	D	A	D	D	D	D	D	C	C	E	B	B
Approach Vol, veh/h		525			388			1320			1168	
Approach Delay, s/veh		35.7			46.6			27.3			19.5	
Approach LOS		D			D			C			B	
Timer - Assigned Phs	1	2		4	5	6		8				
Phs Duration (G+Y+Rc), s	10.9	41.1		16.9	8.3	43.7		13.6				
Change Period (Y+Rc), s	* 4.2	6.0		4.9	* 4.2	6.0		4.9				
Max Green Setting (Gmax), s	* 8.2	44.3		28.0	* 6	46.5		9.5				
Max Q Clear Time (g_c+I1), s	7.2	28.3		10.0	4.3	14.2		8.5				
Green Ext Time (p_c), s	0.0	6.7		2.0	0.0	6.1		0.2				

Intersection Summary

HCM 6th Ctrl Delay	28.1
HCM 6th LOS	C

Notes

* HCM 6th computational engine requires equal clearance times for the phases crossing the barrier.

Intersection												
Int Delay, s/veh	48.1											
Movement	EBL	EBT	EBR	WBL	WBT	WBR	NBL	NBT	NBR	SBL	SBT	SBR
Lane Configurations	↖	↗		↖	↗			↕			↕	
Traffic Vol, veh/h	58	296	0	78	176	140	0	51	189	132	7	25
Future Vol, veh/h	58	296	0	78	176	140	0	51	189	132	7	25
Conflicting Peds, #/hr	0	0	1	1	0	0	0	0	0	0	0	0
Sign Control	Free	Free	Free	Free	Free	Free	Stop	Stop	Stop	Stop	Stop	Stop
RT Channelized	-	-	None	-	-	None	-	-	None	-	-	None
Storage Length	195	-	-	155	-	-	-	-	-	-	-	-
Veh in Median Storage, #	-	0	-	-	0	-	-	0	-	-	0	-
Grade, %	-	0	-	-	0	-	-	0	-	-	0	-
Peak Hour Factor	81	81	81	81	81	81	81	81	81	81	81	81
Heavy Vehicles, %	3	3	3	3	3	3	3	3	3	3	3	3
Mvmt Flow	72	365	0	96	217	173	0	63	233	163	9	31

Major/Minor	Major1			Major2			Minor1			Minor2		
Conflicting Flow All	390	0	0	366	0	0	815	1092	184	854	1006	195
Stage 1	-	-	-	-	-	-	510	510	-	496	496	-
Stage 2	-	-	-	-	-	-	305	582	-	358	510	-
Critical Hdwy	4.16	-	-	4.16	-	-	7.56	6.56	6.96	7.56	6.56	6.96
Critical Hdwy Stg 1	-	-	-	-	-	-	6.56	5.56	-	6.56	5.56	-
Critical Hdwy Stg 2	-	-	-	-	-	-	6.56	5.56	-	6.56	5.56	-
Follow-up Hdwy	2.23	-	-	2.23	-	-	3.53	4.03	3.33	3.53	4.03	3.33
Pot Cap-1 Maneuver	1158	-	-	1182	-	-	267	212	824	251	238	810
Stage 1	-	-	-	-	-	-	512	533	-	522	541	-
Stage 2	-	-	-	-	-	-	677	495	-	630	533	-
Platoon blocked, %	-	-	-	-	-	-	-	-	-	-	-	-
Mov Cap-1 Maneuver	1158	-	-	1181	-	-	222	183	823	~ 119	205	810
Mov Cap-2 Maneuver	-	-	-	-	-	-	222	183	-	~ 119	205	-
Stage 1	-	-	-	-	-	-	480	499	-	490	497	-
Stage 2	-	-	-	-	-	-	588	455	-	370	499	-































Approach	EB			WB			NB			SB		
HCM Control Delay, s	1.4			1.6			24.6			294.9		
HCM LOS							C			F		

Minor Lane/Major Mvmt	NBLn1	EBL	EBT	EBR	WBL	WBT	WBR	SBLn1
Capacity (veh/h)	472	1158	-	-	1181	-	-	140
HCM Lane V/C Ratio	0.628	0.062	-	-	0.082	-	-	1.446
HCM Control Delay (s)	24.6	8.3	-	-	8.3	-	-	294.9
HCM Lane LOS	C	A	-	-	A	-	-	F
HCM 95th %tile Q(veh)	4.2	0.2	-	-	0.3	-	-	13.5

Notes
 -: Volume exceeds capacity \$: Delay exceeds 300s +: Computation Not Defined *: All major volume in platoon

Santa Maria Airport Business Park SP
4: Orcutt Expressway & Union Valley Parkway

Existing Plus Project AM
HCM 6th Signalized Intersection Summary

												
Movement	EBL	EBT	EBR	WBL	WBT	WBR	NBL	NBT	NBR	SBL	SBT	SBR
Lane Configurations	 	 		 	 			 		 	 	
Traffic Volume (veh/h)	219	310	92	370	260	236	102	754	254	138	570	155
Future Volume (veh/h)	219	310	92	370	260	236	102	754	254	138	570	155
Initial Q (Qb), veh	0	0	0	0	0	0	0	0	0	0	0	0
Ped-Bike Adj(A_pbT)	1.00		1.00	1.00		1.00	1.00		1.00	1.00		0.99
Parking Bus, Adj	1.00	1.00	1.00	1.00	1.00	1.00	1.00	1.00	1.00	1.00	1.00	1.00
Work Zone On Approach		No			No			No			No	
Adj Sat Flow, veh/h/ln	1856	1856	1856	1856	1856	1856	1856	1856	1856	1856	1856	1856
Adj Flow Rate, veh/h	252	356	106	425	299	271	117	867	292	159	655	178
Peak Hour Factor	0.87	0.87	0.87	0.87	0.87	0.87	0.87	0.87	0.87	0.87	0.87	0.87
Percent Heavy Veh, %	3	3	3	3	3	3	3	3	3	3	3	3
Cap, veh/h	346	615	274	526	778	347	161	1132	505	328	1169	515
Arrive On Green	0.10	0.17	0.17	0.15	0.22	0.22	0.09	0.32	0.32	0.10	0.33	0.33
Sat Flow, veh/h	3428	3526	1572	3428	3526	1572	1767	3526	1572	3428	3526	1553
Grp Volume(v), veh/h	252	356	106	425	299	271	117	867	292	159	655	178
Grp Sat Flow(s),veh/h/ln	1714	1763	1572	1714	1763	1572	1767	1763	1572	1714	1763	1553
Q Serve(g_s), s	5.8	7.5	4.9	9.7	5.9	13.2	5.2	18.0	12.6	3.6	12.4	7.0
Cycle Q Clear(g_c), s	5.8	7.5	4.9	9.7	5.9	13.2	5.2	18.0	12.6	3.6	12.4	7.0
Prop In Lane	1.00		1.00	1.00		1.00	1.00		1.00	1.00		1.00
Lane Grp Cap(c), veh/h	346	615	274	526	778	347	161	1132	505	328	1169	515
V/C Ratio(X)	0.73	0.58	0.39	0.81	0.38	0.78	0.73	0.77	0.58	0.49	0.56	0.35
Avail Cap(c_a), veh/h	611	1949	869	720	2040	910	174	1694	755	337	1715	755
HCM Platoon Ratio	1.00	1.00	1.00	1.00	1.00	1.00	1.00	1.00	1.00	1.00	1.00	1.00
Upstream Filter(I)	1.00	1.00	1.00	1.00	1.00	1.00	1.00	1.00	1.00	1.00	1.00	1.00
Uniform Delay (d), s/veh	35.5	30.9	29.8	33.3	27.0	29.9	36.0	24.9	23.0	34.9	22.3	20.5
Incr Delay (d2), s/veh	2.9	0.9	0.9	4.9	0.3	3.8	13.0	1.2	1.1	1.1	0.4	0.4
Initial Q Delay(d3),s/veh	0.0	0.0	0.0	0.0	0.0	0.0	0.0	0.0	0.0	0.0	0.0	0.0
%ile BackOfQ(50%),veh/ln	2.4	3.1	1.8	4.1	2.3	5.0	2.7	6.7	4.4	1.4	4.5	2.4
Unsig. Movement Delay, s/veh												
LnGrp Delay(d),s/veh	38.4	31.7	30.6	38.1	27.3	33.7	49.0	26.1	24.1	36.0	22.8	20.9
LnGrp LOS	D	C	C	D	C	C	D	C	C	D	C	C
Approach Vol, veh/h		714			995			1276			992	
Approach Delay, s/veh		33.9			33.7			27.7			24.6	
Approach LOS		C			C			C			C	
Timer - Assigned Phs	1	2	3	4	5	6	7	8				
Phs Duration (G+Y+Rc), s	12.8	32.1	17.4	19.1	11.9	33.0	13.6	22.9				
Change Period (Y+Rc), s	5.0	6.0	4.9	4.9	4.5	6.0	5.4	4.9				
Max Green Setting (Gmax), s	8.0	39.1	17.1	45.0	8.0	39.6	14.5	47.1				
Max Q Clear Time (g_c+I1), s	5.6	20.0	11.7	9.5	7.2	14.4	7.8	15.2				
Green Ext Time (p_c), s	0.1	6.1	0.7	2.6	0.0	4.6	0.4	2.8				
Intersection Summary												
HCM 6th Ctrl Delay				29.5								
HCM 6th LOS				C								

Santa Maria Airport Business Park SP
5: Orcutt Road & Union Valley Parkway

Existing Plus Project AM
HCM Signalized Intersection Capacity Analysis



Movement	EBL	EBT	EBR	WBL	WBT	WBR	NBL	NBT	NBR	SBL	SBT	SBR
Lane Configurations	↖	↗		↖	↗		↖	↗		↖	↗	
Traffic Volume (vph)	6	607	90	36	699	13	147	77	72	24	52	8
Future Volume (vph)	6	607	90	36	699	13	147	77	72	24	52	8
Ideal Flow (vphp)	1900	1900	1900	1900	1900	1900	1900	1900	1900	1900	1900	1900
Total Lost time (s)	4.2	6.0		4.2	6.0		4.2	4.9		4.2	4.9	
Lane Util. Factor	1.00	0.95		1.00	0.95		1.00	1.00		1.00	1.00	
Frbp, ped/bikes	1.00	1.00		1.00	1.00		1.00	1.00		1.00	1.00	
Flpb, ped/bikes	1.00	1.00		1.00	1.00		1.00	1.00		1.00	1.00	
Frt	1.00	0.98		1.00	1.00		1.00	0.93		1.00	0.98	
Flt Protected	0.95	1.00		0.95	1.00		0.95	1.00		0.95	1.00	
Satd. Flow (prot)	1736	3404		1736	3460		1736	1695		1736	1791	
Flt Permitted	0.95	1.00		0.95	1.00		0.95	1.00		0.95	1.00	
Satd. Flow (perm)	1736	3404		1736	3460		1736	1695		1736	1791	
Peak-hour factor, PHF	0.87	0.87	0.87	0.87	0.87	0.87	0.87	0.87	0.87	0.87	0.87	0.87
Adj. Flow (vph)	7	698	103	41	803	15	169	89	83	28	60	9
RTOR Reduction (vph)	0	11	0	0	1	0	0	54	0	0	8	0
Lane Group Flow (vph)	7	790	0	41	817	0	169	118	0	28	61	0
Confl. Bikes (#/hr)						1						
Heavy Vehicles (%)	4%	4%	4%	4%	4%	4%	4%	4%	4%	4%	4%	4%
Turn Type	Prot	NA		Prot	NA		Prot	NA		Prot	NA	
Protected Phases	5	2		1	6		3	8		7	4	
Permitted Phases												
Actuated Green, G (s)	0.7	22.7		2.1	24.1		9.0	11.9		1.9	4.8	
Effective Green, g (s)	0.7	22.7		2.1	24.1		9.0	11.9		1.9	4.8	
Actuated g/C Ratio	0.01	0.39		0.04	0.42		0.16	0.21		0.03	0.08	
Clearance Time (s)	4.2	6.0		4.2	6.0		4.2	4.9		4.2	4.9	
Vehicle Extension (s)	3.0	3.0		3.0	3.0		3.0	3.0		3.0	3.0	
Lane Grp Cap (vph)	20	1334		62	1440		269	348		56	148	
v/s Ratio Prot	0.00	0.23		c0.02	c0.24		c0.10	c0.07		0.02	0.03	
v/s Ratio Perm												
v/c Ratio	0.35	0.59		0.66	0.57		0.63	0.34		0.50	0.41	
Uniform Delay, d1	28.4	13.9		27.5	12.9		22.9	19.6		27.5	25.2	
Progression Factor	1.00	1.00		1.00	1.00		1.00	1.00		1.00	1.00	
Incremental Delay, d2	10.3	0.7		23.4	0.5		4.5	0.6		6.9	1.8	
Delay (s)	38.7	14.6		50.9	13.4		27.4	20.2		34.4	27.1	
Level of Service	D	B		D	B		C	C		C	C	
Approach Delay (s)		14.9			15.2			23.8			29.2	
Approach LOS		B			B			C			C	
Intersection Summary												
HCM 2000 Control Delay			17.1				HCM 2000 Level of Service				B	
HCM 2000 Volume to Capacity ratio			0.60									
Actuated Cycle Length (s)			57.9			Sum of lost time (s)				19.3		
Intersection Capacity Utilization			50.9%			ICU Level of Service				A		
Analysis Period (min)			15									

c Critical Lane Group

Santa Maria Airport Business Park SP
5: Orcutt Road & Union Valley Parkway

Existing Plus Project AM
HCM 6th Signalized Intersection Summary



Movement	EBL	EBT	EBR	WBL	WBT	WBR	NBL	NBT	NBR	SBL	SBT	SBR
Lane Configurations	↖	↕		↖	↕		↖	↕		↖	↕	
Traffic Volume (veh/h)	6	607	90	36	699	13	147	77	72	24	52	8
Future Volume (veh/h)	6	607	90	36	699	13	147	77	72	24	52	8
Initial Q (Qb), veh	0	0	0	0	0	0	0	0	0	0	0	0
Ped-Bike Adj(A_pbT)	1.00		1.00	1.00		0.98	1.00		1.00	1.00		1.00
Parking Bus, Adj	1.00	1.00	1.00	1.00	1.00	1.00	1.00	1.00	1.00	1.00	1.00	1.00
Work Zone On Approach		No			No			No			No	
Adj Sat Flow, veh/h/ln	1841	1841	1841	1841	1841	1841	1841	1841	1841	1841	1841	1841
Adj Flow Rate, veh/h	7	698	103	41	803	15	169	89	83	28	60	9
Peak Hour Factor	0.87	0.87	0.87	0.87	0.87	0.87	0.87	0.87	0.87	0.87	0.87	0.87
Percent Heavy Veh, %	4	4	4	4	4	4	4	4	4	4	4	4
Cap, veh/h	13	971	143	63	1214	23	216	161	150	46	136	20
Arrive On Green	0.01	0.32	0.32	0.04	0.35	0.35	0.12	0.18	0.18	0.03	0.09	0.09
Sat Flow, veh/h	1753	3057	451	1753	3510	66	1753	876	817	1753	1564	235
Grp Volume(v), veh/h	7	399	402	41	400	418	169	0	172	28	0	69
Grp Sat Flow(s),veh/h/ln	1753	1749	1760	1753	1749	1827	1753	0	1694	1753	0	1798
Q Serve(g_s), s	0.2	8.9	8.9	1.0	8.6	8.6	4.1	0.0	4.1	0.7	0.0	1.6
Cycle Q Clear(g_c), s	0.2	8.9	8.9	1.0	8.6	8.6	4.1	0.0	4.1	0.7	0.0	1.6
Prop In Lane	1.00		0.26	1.00		0.04	1.00		0.48	1.00		0.13
Lane Grp Cap(c), veh/h	13	555	559	63	605	632	216	0	312	46	0	157
V/C Ratio(X)	0.54	0.72	0.72	0.65	0.66	0.66	0.78	0.00	0.55	0.61	0.00	0.44
Avail Cap(c_a), veh/h	159	795	799	159	795	830	341	0	1374	226	0	1342
HCM Platoon Ratio	1.00	1.00	1.00	1.00	1.00	1.00	1.00	1.00	1.00	1.00	1.00	1.00
Upstream Filter(I)	1.00	1.00	1.00	1.00	1.00	1.00	1.00	0.00	1.00	1.00	0.00	1.00
Uniform Delay (d), s/veh	21.9	13.3	13.4	21.1	12.3	12.3	18.8	0.0	16.4	21.3	0.0	19.2
Incr Delay (d2), s/veh	30.0	1.8	1.8	10.9	1.3	1.2	6.1	0.0	1.5	12.2	0.0	1.9
Initial Q Delay(d3),s/veh	0.0	0.0	0.0	0.0	0.0	0.0	0.0	0.0	0.0	0.0	0.0	0.0
%ile BackOfQ(50%),veh/ln	0.2	2.8	2.8	0.5	2.5	2.6	1.7	0.0	1.4	0.4	0.0	0.6
Unsig. Movement Delay, s/veh												
LnGrp Delay(d),s/veh	51.9	15.1	15.1	32.0	13.5	13.5	24.9	0.0	17.9	33.5	0.0	21.1
LnGrp LOS	D	B	B	C	B	B	C	A	B	C	A	C
Approach Vol, veh/h		808			859			341				97
Approach Delay, s/veh		15.5			14.4			21.4				24.7
Approach LOS		B			B			C				C
Timer - Assigned Phs	1	2	3	4	5	6	7	8				
Phs Duration (G+Y+Rc), s	5.8	20.0	9.7	8.8	4.5	21.3	5.4	13.0				
Change Period (Y+Rc), s	* 4.2	6.0	* 4.2	4.9	* 4.2	6.0	* 4.2	4.9				
Max Green Setting (Gmax), s	* 4	20.1	* 8.6	33.0	* 4	20.1	* 5.7	35.9				
Max Q Clear Time (g_c+I1), s	3.0	10.9	6.1	3.6	2.2	10.6	2.7	6.1				
Green Ext Time (p_c), s	0.0	3.1	0.1	0.3	0.0	3.2	0.0	0.9				

Intersection Summary

HCM 6th Ctrl Delay	16.4
HCM 6th LOS	B

Notes

* HCM 6th computational engine requires equal clearance times for the phases crossing the barrier.

Intersection												
Int Delay, s/veh	5.1											
Movement	EBL	EBT	EBR	WBL	WBT	WBR	NBL	NBT	NBR	SBL	SBT	SBR
Lane Configurations		↕		↕	↕			↕			↕	
Traffic Vol, veh/h	0	249	15	195	169	0	14	0	170	0	0	0
Future Vol, veh/h	0	249	15	195	169	0	14	0	170	0	0	0
Conflicting Peds, #/hr	0	0	0	0	0	0	1	0	0	0	0	1
Sign Control	Free	Free	Free	Free	Free	Free	Stop	Stop	Stop	Stop	Stop	Stop
RT Channelized	-	-	None	-	-	None	-	-	None	-	-	None
Storage Length	-	-	-	160	-	-	-	-	-	-	-	-
Veh in Median Storage, #	-	0	-	-	0	-	-	0	-	-	0	-
Grade, %	-	0	-	-	0	-	-	0	-	-	0	-
Peak Hour Factor	89	89	89	89	89	89	89	89	89	89	89	89
Heavy Vehicles, %	1	1	1	1	1	1	1	1	1	1	1	1
Mvmt Flow	0	280	17	219	190	0	16	0	191	0	0	0

























Major/Minor	Major1			Major2			Minor1			Minor2		
Conflicting Flow All	190	0	0	297	0	0	918	917	289	1012	925	191
Stage 1	-	-	-	-	-	-	289	289	-	628	628	-
Stage 2	-	-	-	-	-	-	629	628	-	384	297	-
Critical Hdwy	4.11	-	-	4.11	-	-	7.11	6.51	6.21	7.11	6.51	6.21
Critical Hdwy Stg 1	-	-	-	-	-	-	6.11	5.51	-	6.11	5.51	-
Critical Hdwy Stg 2	-	-	-	-	-	-	6.11	5.51	-	6.11	5.51	-
Follow-up Hdwy	2.209	-	-	2.209	-	-	3.509	4.009	3.309	3.509	4.009	3.309
Pot Cap-1 Maneuver	1390	-	-	1270	-	-	253	273	752	219	270	853
Stage 1	-	-	-	-	-	-	721	675	-	472	477	-
Stage 2	-	-	-	-	-	-	472	477	-	641	669	-
Platoon blocked, %		-	-		-	-						
Mov Cap-1 Maneuver	1390	-	-	1270	-	-	219	226	752	142	224	852
Mov Cap-2 Maneuver	-	-	-	-	-	-	219	226	-	142	224	-
Stage 1	-	-	-	-	-	-	721	675	-	472	395	-
Stage 2	-	-	-	-	-	-	390	395	-	478	669	-

Approach	EB			WB			NB			SB		
HCM Control Delay, s	0			4.5			13.4			0		
HCM LOS							B			A		

Minor Lane/Major Mvmt	NBLn1	EBL	EBT	EBR	WBL	WBT	WBR	SBLn1
Capacity (veh/h)	635	1390	-	-	1270	-	-	-
HCM Lane V/C Ratio	0.326	-	-	-	0.173	-	-	-
HCM Control Delay (s)	13.4	0	-	-	8.4	-	-	0
HCM Lane LOS	B	A	-	-	A	-	-	A
HCM 95th %tile Q(veh)	1.4	0	-	-	0.6	-	-	-

Santa Maria Airport Business Park SP
2: Orcutt Expressway & Foster Road

Existing Plus Project PM
HCM 6th Signalized Intersection Summary

												
Movement	EBL	EBT	EBR	WBL	WBT	WBR	NBL	NBT	NBR	SBL	SBT	SBR
Lane Configurations	 							 			 	
Traffic Volume (veh/h)	362	88	71	67	74	107	31	980	60	133	1171	263
Future Volume (veh/h)	362	88	71	67	74	107	31	980	60	133	1171	263
Initial Q (Qb), veh	0	0	0	0	0	0	0	0	0	0	0	0
Ped-Bike Adj(A_pbT)	1.00		0.98	1.00		1.00	1.00		1.00	1.00		1.00
Parking Bus, Adj	1.00	1.00	1.00	1.00	1.00	1.00	1.00	1.00	1.00	1.00	1.00	1.00
Work Zone On Approach		No			No			No			No	
Adj Sat Flow, veh/h/ln	1870	1870	1870	1870	1870	1870	1870	1870	1870	1870	1870	1870
Adj Flow Rate, veh/h	377	92	74	70	77	52	32	1021	62	139	1220	274
Peak Hour Factor	0.96	0.96	0.96	0.96	0.96	0.96	0.96	0.96	0.96	0.96	0.96	0.96
Percent Heavy Veh, %	2	2	2	2	2	2	2	2	2	2	2	2
Cap, veh/h	555	153	123	189	198	168	70	1244	76	174	1508	673
Arrive On Green	0.16	0.16	0.16	0.11	0.11	0.11	0.04	0.37	0.37	0.10	0.42	0.42
Sat Flow, veh/h	3456	951	765	1781	1870	1585	1781	3403	207	1781	3554	1585
Grp Volume(v), veh/h	377	0	166	70	77	52	32	533	550	139	1220	274
Grp Sat Flow(s),veh/h/ln	1728	0	1716	1781	1870	1585	1781	1777	1833	1781	1777	1585
Q Serve(g_s), s	7.6	0.0	6.7	2.7	2.8	2.2	1.3	20.2	20.2	5.7	22.3	8.9
Cycle Q Clear(g_c), s	7.6	0.0	6.7	2.7	2.8	2.2	1.3	20.2	20.2	5.7	22.3	8.9
Prop In Lane	1.00		0.45	1.00		1.00	1.00		0.11	1.00		1.00
Lane Grp Cap(c), veh/h	555	0	276	189	198	168	70	650	670	174	1508	673
V/C Ratio(X)	0.68	0.00	0.60	0.37	0.39	0.31	0.46	0.82	0.82	0.80	0.81	0.41
Avail Cap(c_a), veh/h	1305	0	648	192	202	171	144	839	865	216	1821	812
HCM Platoon Ratio	1.00	1.00	1.00	1.00	1.00	1.00	1.00	1.00	1.00	1.00	1.00	1.00
Upstream Filter(I)	1.00	0.00	1.00	1.00	1.00	1.00	1.00	1.00	1.00	1.00	1.00	1.00
Uniform Delay (d), s/veh	29.3	0.0	28.9	30.8	30.9	30.6	34.9	21.3	21.3	32.7	18.7	14.8
Incr Delay (d2), s/veh	1.5	0.0	2.1	1.2	1.2	1.0	4.7	5.1	5.0	15.3	2.4	0.4
Initial Q Delay(d3),s/veh	0.0	0.0	0.0	0.0	0.0	0.0	0.0	0.0	0.0	0.0	0.0	0.0
%ile BackOfQ(50%),veh/ln	3.1	0.0	2.7	1.2	1.3	0.9	0.6	7.8	8.0	2.9	7.8	2.7
Unsig. Movement Delay, s/veh												
LnGrp Delay(d),s/veh	30.8	0.0	31.0	32.0	32.1	31.7	39.5	26.4	26.3	48.0	21.1	15.2
LnGrp LOS	C	A	C	C	C	C	D	C	C	D	C	B
Approach Vol, veh/h		543			199			1115			1633	
Approach Delay, s/veh		30.9			32.0			26.7			22.4	
Approach LOS		C			C			C			C	
Timer - Assigned Phs	1	2		4	5	6		8				
Phs Duration (G+Y+Rc), s	11.5	33.1		16.8	7.1	37.5		12.8				
Change Period (Y+Rc), s	* 4.2	6.0		4.9	* 4.2	6.0		4.9				
Max Green Setting (Gmax), s	* 9	35.0		28.0	* 6	38.0		8.0				
Max Q Clear Time (g_c+I1), s	7.7	22.2		9.6	3.3	24.3		4.8				
Green Ext Time (p_c), s	0.0	4.9		2.1	0.0	7.2		0.2				

Intersection Summary

HCM 6th Ctrl Delay	25.6
HCM 6th LOS	C

Notes

* HCM 6th computational engine requires equal clearance times for the phases crossing the barrier.

Intersection												
Int Delay, s/veh	39.8											
Movement	EBL	EBT	EBR	WBL	WBT	WBR	NBL	NBT	NBR	SBL	SBT	SBR
Lane Configurations	↖	↕		↖	↕			↕			↕	
Traffic Vol, veh/h	27	220	3	178	300	81	3	13	99	159	14	47
Future Vol, veh/h	27	220	3	178	300	81	3	13	99	159	14	47
Conflicting Peds, #/hr	1	0	0	0	0	1	0	0	1	1	0	0
Sign Control	Free	Free	Free	Free	Free	Free	Stop	Stop	Stop	Stop	Stop	Stop
RT Channelized	-	-	None	-	-	None	-	-	None	-	-	None
Storage Length	195	-	-	155	-	-	-	-	-	-	-	-
Veh in Median Storage, #	-	0	-	-	0	-	-	0	-	-	0	-
Grade, %	-	0	-	-	0	-	-	0	-	-	0	-
Peak Hour Factor	92	92	92	92	92	92	92	92	92	92	92	92
Heavy Vehicles, %	1	1	1	1	1	1	1	1	1	1	1	1
Mvmt Flow	29	239	3	193	326	88	3	14	108	173	15	51

Major/Minor	Major1			Major2			Minor1			Minor2		
Conflicting Flow All	415	0	0	242	0	0	856	1100	122	943	1057	208
Stage 1	-	-	-	-	-	-	299	299	-	757	757	-
Stage 2	-	-	-	-	-	-	557	801	-	186	300	-
Critical Hdwy	4.12	-	-	4.12	-	-	7.52	6.52	6.92	7.52	6.52	6.92
Critical Hdwy Stg 1	-	-	-	-	-	-	6.52	5.52	-	6.52	5.52	-
Critical Hdwy Stg 2	-	-	-	-	-	-	6.52	5.52	-	6.52	5.52	-
Follow-up Hdwy	2.21	-	-	2.21	-	-	3.51	4.01	3.31	3.51	4.01	3.31
Pot Cap-1 Maneuver	1148	-	-	1329	-	-	253	212	909	219	225	801
Stage 1	-	-	-	-	-	-	688	667	-	368	416	-
Stage 2	-	-	-	-	-	-	485	397	-	801	667	-
Platoon blocked, %		-	-		-	-						
Mov Cap-1 Maneuver	1147	-	-	1329	-	-	194	177	908	~ 158	187	800
Mov Cap-2 Maneuver	-	-	-	-	-	-	194	177	-	~ 158	187	-
Stage 1	-	-	-	-	-	-	671	650	-	358	355	-
Stage 2	-	-	-	-	-	-	371	339	-	673	650	-

























Approach	EB			WB			NB			SB		
HCM Control Delay, s	0.9			2.6			12.9			192.7		
HCM LOS							B			F		

Minor Lane/Major Mvmt	NBLn1	EBL	EBT	EBR	WBL	WBT	WBR	SBLn1
Capacity (veh/h)	581	1147	-	-	1329	-	-	193
HCM Lane V/C Ratio	0.215	0.026	-	-	0.146	-	-	1.239
HCM Control Delay (s)	12.9	8.2	-	-	8.2	-	-	192.7
HCM Lane LOS	B	A	-	-	A	-	-	F
HCM 95th %tile Q(veh)	0.8	0.1	-	-	0.5	-	-	12.8

Notes
 -: Volume exceeds capacity \$: Delay exceeds 300s +: Computation Not Defined *: All major volume in platoon

Santa Maria Airport Business Park SP
4: Orcutt Expressway & Union Valley Parkway

Existing Plus Project PM
HCM 6th Signalized Intersection Summary

												
Movement	EBL	EBT	EBR	WBL	WBT	WBR	NBL	NBT	NBR	SBL	SBT	SBR
Lane Configurations												
Traffic Volume (veh/h)	165	223	90	273	269	108	87	806	427	328	707	302
Future Volume (veh/h)	165	223	90	273	269	108	87	806	427	328	707	302
Initial Q (Qb), veh	0	0	0	0	0	0	0	0	0	0	0	0
Ped-Bike Adj(A_pbT)	1.00		1.00	1.00		1.00	1.00		1.00	1.00		1.00
Parking Bus, Adj	1.00	1.00	1.00	1.00	1.00	1.00	1.00	1.00	1.00	1.00	1.00	1.00
Work Zone On Approach		No			No			No			No	
Adj Sat Flow, veh/h/ln	1870	1870	1870	1870	1870	1870	1870	1870	1870	1870	1870	1870
Adj Flow Rate, veh/h	167	225	91	276	272	109	88	814	431	331	714	305
Peak Hour Factor	0.99	0.99	0.99	0.99	0.99	0.99	0.99	0.99	0.99	0.99	0.99	0.99
Percent Heavy Veh, %	2	2	2	2	2	2	2	2	2	2	2	2
Cap, veh/h	372	467	208	384	455	203	164	1266	565	385	1359	606
Arrive On Green	0.11	0.13	0.13	0.11	0.13	0.13	0.09	0.36	0.36	0.11	0.38	0.38
Sat Flow, veh/h	3456	3554	1585	3456	3554	1585	1781	3554	1585	3456	3554	1585
Grp Volume(v), veh/h	167	225	91	276	272	109	88	814	431	331	714	305
Grp Sat Flow(s),veh/h/ln	1728	1777	1585	1728	1777	1585	1781	1777	1585	1728	1777	1585
Q Serve(g_s), s	3.3	4.2	3.8	5.5	5.2	4.6	3.4	13.7	17.3	6.8	11.1	10.6
Cycle Q Clear(g_c), s	3.3	4.2	3.8	5.5	5.2	4.6	3.4	13.7	17.3	6.8	11.1	10.6
Prop In Lane	1.00		1.00	1.00		1.00	1.00		1.00	1.00		1.00
Lane Grp Cap(c), veh/h	372	467	208	384	455	203	164	1266	565	385	1359	606
V/C Ratio(X)	0.45	0.48	0.44	0.72	0.60	0.54	0.54	0.64	0.76	0.86	0.53	0.50
Avail Cap(c_a), veh/h	472	2229	994	385	2115	943	199	1892	844	385	1917	855
HCM Platoon Ratio	1.00	1.00	1.00	1.00	1.00	1.00	1.00	1.00	1.00	1.00	1.00	1.00
Upstream Filter(I)	1.00	1.00	1.00	1.00	1.00	1.00	1.00	1.00	1.00	1.00	1.00	1.00
Uniform Delay (d), s/veh	30.0	28.9	28.7	30.8	29.5	29.3	31.1	19.3	20.4	31.3	17.1	16.9
Incr Delay (d2), s/veh	0.9	0.8	1.4	6.4	1.3	2.2	2.7	0.6	2.3	17.4	0.3	0.6
Initial Q Delay(d3),s/veh	0.0	0.0	0.0	0.0	0.0	0.0	0.0	0.0	0.0	0.0	0.0	0.0
%ile BackOfQ(50%),veh/ln	1.3	1.7	1.4	2.5	2.1	1.7	1.4	4.7	5.8	3.4	3.8	3.4
Unsig. Movement Delay, s/veh												
LnGrp Delay(d),s/veh	30.9	29.7	30.2	37.2	30.8	31.5	33.8	19.8	22.8	48.7	17.4	17.6
LnGrp LOS	C	C	C	D	C	C	C	B	C	D	B	B
Approach Vol, veh/h		483			657			1333			1350	
Approach Delay, s/veh		30.2			33.6			21.7			25.1	
Approach LOS		C			C			C			C	
Timer - Assigned Phs	1	2	3	4	5	6	7	8				
Phs Duration (G+Y+Rc), s	13.0	31.6	12.9	14.3	11.1	33.4	13.1	14.1				
Change Period (Y+Rc), s	5.0	6.0	4.9	4.9	4.5	6.0	5.4	4.9				
Max Green Setting (Gmax), s	8.0	38.2	8.0	45.0	8.0	38.7	9.8	42.7				
Max Q Clear Time (g_c+I1), s	8.8	19.3	7.5	6.2	5.4	13.1	5.3	7.2				
Green Ext Time (p_c), s	0.0	6.3	0.0	1.6	0.0	5.5	0.2	2.0				
Intersection Summary												
HCM 6th Ctrl Delay			26.0									
HCM 6th LOS			C									

Santa Maria Airport Business Park SP
5: Orcutt Road & Union Valley Parkway

Existing Plus Project PM
HCM Signalized Intersection Capacity Analysis



Movement	EBL	EBT	EBR	WBL	WBT	WBR	NBL	NBT	NBR	SBL	SBT	SBR	
Lane Configurations	↖	↗		↖	↗		↖	↗		↖	↗		
Traffic Volume (vph)	0	872	105	26	583	11	66	31	42	22	32	5	
Future Volume (vph)	0	872	105	26	583	11	66	31	42	22	32	5	
Ideal Flow (vphp)	1900	1900	1900	1900	1900	1900	1900	1900	1900	1900	1900	1900	
Total Lost time (s)		6.0		4.2	6.0		4.2	4.9		4.2	4.9		
Lane Util. Factor		0.95		1.00	0.95		1.00	1.00		1.00	1.00		
Frbp, ped/bikes		1.00		1.00	1.00		1.00	0.99		1.00	1.00		
Flpb, ped/bikes		1.00		1.00	1.00		1.00	1.00		1.00	1.00		
Frt		0.98		1.00	1.00		1.00	0.91		1.00	0.98		
Flt Protected		1.00		0.95	1.00		0.95	1.00		0.95	1.00		
Satd. Flow (prot)		3474		1770	3530		1770	1690		1770	1826		
Flt Permitted		1.00		0.95	1.00		0.95	1.00		0.95	1.00		
Satd. Flow (perm)		3474		1770	3530		1770	1690		1770	1826		
Peak-hour factor, PHF	0.97	0.97	0.97	0.97	0.97	0.97	0.97	0.97	0.97	0.97	0.97	0.97	
Adj. Flow (vph)	0	899	108	27	601	11	68	32	43	23	33	5	
RTOR Reduction (vph)	0	8	0	0	1	0	0	36	0	0	5	0	
Lane Group Flow (vph)	0	999	0	27	611	0	68	39	0	23	33	0	
Confl. Peds. (#/hr)			1						1				
Turn Type	Prot	NA		Prot	NA		Prot	NA		Prot	NA		
Protected Phases	5	2		1	6		3	8		7	4		
Permitted Phases													
Actuated Green, G (s)		29.3		1.2	34.7		4.9	10.1		0.5	5.7		
Effective Green, g (s)		29.3		1.2	34.7		4.9	10.1		0.5	5.7		
Actuated g/C Ratio		0.49		0.02	0.57		0.08	0.17		0.01	0.09		
Clearance Time (s)		6.0		4.2	6.0		4.2	4.9		4.2	4.9		
Vehicle Extension (s)		3.0		3.0	3.0		3.0	3.0		3.0	3.0		
Lane Grp Cap (vph)		1685		35	2027		143	282		14	172		
v/s Ratio Prot		c0.29		c0.02	0.17		c0.04	c0.02		0.01	0.02		
v/s Ratio Perm													
v/c Ratio		0.59		0.77	0.30		0.48	0.14		1.64	0.19		
Uniform Delay, d1		11.2		29.5	6.6		26.5	21.4		29.9	25.2		
Progression Factor		1.00		1.00	1.00		1.00	1.00		1.00	1.00		
Incremental Delay, d2		0.6		67.0	0.1		2.5	0.2		485.2	0.6		
Delay (s)		11.8		96.5	6.7		29.0	21.7		515.1	25.8		
Level of Service		B		F	A		C	C		F	C		
Approach Delay (s)		11.8			10.5			25.2			210.3		
Approach LOS		B			B			C			F		
Intersection Summary													
HCM 2000 Control Delay			18.9									HCM 2000 Level of Service	B
HCM 2000 Volume to Capacity ratio			0.53										
Actuated Cycle Length (s)			60.4									Sum of lost time (s)	19.3
Intersection Capacity Utilization			47.4%									ICU Level of Service	A
Analysis Period (min)			15										
c	Critical Lane Group												

Santa Maria Airport Business Park SP
5: Orcutt Road & Union Valley Parkway

Existing Plus Project PM
HCM 6th Signalized Intersection Summary



Movement	EBL	EBT	EBR	WBL	WBT	WBR	NBL	NBT	NBR	SBL	SBT	SBR
Lane Configurations	↖	↗		↖	↗		↖	↗		↖	↗	
Traffic Volume (veh/h)	0	872	105	26	583	11	66	31	42	22	32	5
Future Volume (veh/h)	0	872	105	26	583	11	66	31	42	22	32	5
Initial Q (Qb), veh	0	0	0	0	0	0	0	0	0	0	0	0
Ped-Bike Adj(A_pbT)	1.00		1.00	1.00		1.00	1.00		1.00	1.00		1.00
Parking Bus, Adj	1.00	1.00	1.00	1.00	1.00	1.00	1.00	1.00	1.00	1.00	1.00	1.00
Work Zone On Approach		No			No			No			No	
Adj Sat Flow, veh/h/ln	1870	1870	1870	1870	1870	1870	1870	1870	1870	1870	1870	1870
Adj Flow Rate, veh/h	0	899	108	27	601	11	68	32	43	23	33	5
Peak Hour Factor	0.97	0.97	0.97	0.97	0.97	0.97	0.97	0.97	0.97	0.97	0.97	0.97
Percent Heavy Veh, %	2	2	2	2	2	2	2	2	2	2	2	2
Cap, veh/h	4	1255	151	46	1844	34	92	78	105	40	125	19
Arrive On Green	0.00	0.39	0.39	0.03	0.52	0.52	0.05	0.11	0.11	0.02	0.08	0.08
Sat Flow, veh/h	1781	3194	384	1781	3570	65	1781	722	970	1781	1587	240
Grp Volume(v), veh/h	0	500	507	27	299	313	68	0	75	23	0	38
Grp Sat Flow(s),veh/h/ln	1781	1777	1801	1781	1777	1859	1781	0	1693	1781	0	1827
Q Serve(g_s), s	0.0	10.2	10.2	0.6	4.2	4.2	1.6	0.0	1.8	0.5	0.0	0.8
Cycle Q Clear(g_c), s	0.0	10.2	10.2	0.6	4.2	4.2	1.6	0.0	1.8	0.5	0.0	0.8
Prop In Lane	1.00		0.21	1.00		0.04	1.00		0.57	1.00		0.13
Lane Grp Cap(c), veh/h	4	698	707	46	918	960	92	0	184	40	0	144
V/C Ratio(X)	0.00	0.72	0.72	0.59	0.33	0.33	0.74	0.00	0.41	0.58	0.00	0.26
Avail Cap(c_a), veh/h	166	992	1005	166	992	1037	200	0	1332	171	0	1408
HCM Platoon Ratio	1.00	1.00	1.00	1.00	1.00	1.00	1.00	1.00	1.00	1.00	1.00	1.00
Upstream Filter(I)	0.00	1.00	1.00	1.00	1.00	1.00	1.00	0.00	1.00	1.00	0.00	1.00
Uniform Delay (d), s/veh	0.0	11.0	11.0	20.6	6.0	6.0	20.0	0.0	17.8	20.7	0.0	18.5
Incr Delay (d2), s/veh	0.0	1.4	1.4	11.6	0.2	0.2	10.8	0.0	1.5	12.5	0.0	1.0
Initial Q Delay(d3),s/veh	0.0	0.0	0.0	0.0	0.0	0.0	0.0	0.0	0.0	0.0	0.0	0.0
%ile BackOfQ(50%),veh/ln	0.0	2.8	2.9	0.4	0.8	0.9	0.8	0.0	0.6	0.3	0.0	0.3
Unsig. Movement Delay, s/veh												
LnGrp Delay(d),s/veh	0.0	12.4	12.4	32.2	6.2	6.2	30.8	0.0	19.3	33.3	0.0	19.5
LnGrp LOS	A	B	B	C	A	A	C	A	B	C	A	B
Approach Vol, veh/h		1007			639			143				61
Approach Delay, s/veh		12.4			7.3			24.8				24.7
Approach LOS		B			A			C				C
Timer - Assigned Phs	1	2	3	4	5	6	7	8				
Phs Duration (G+Y+Rc), s	5.3	22.8	6.4	8.3	0.0	28.1	5.2	9.5				
Change Period (Y+Rc), s	* 4.2	6.0	* 4.2	4.9	* 4.2	6.0	* 4.2	4.9				
Max Green Setting (Gmax), s	* 4	23.9	* 4.8	33.0	* 4	23.9	* 4.1	33.7				
Max Q Clear Time (g_c+I1), s	2.6	12.2	3.6	2.8	0.0	6.2	2.5	3.8				
Green Ext Time (p_c), s	0.0	4.6	0.0	0.1	0.0	3.1	0.0	0.3				

Intersection Summary

HCM 6th Ctrl Delay	12.0
HCM 6th LOS	B



















Notes

* HCM 6th computational engine requires equal clearance times for the phases crossing the barrier.

Mitigated Existing Plus Project



















Santa Maria Airport Business Park SP
3: Foxenwood Lane & Union Valley Parkway

Mitigated Existing Plus Project AM
HCM 6th Signalized Intersection Summary

												
Movement	EBL	EBT	EBR	WBL	WBT	WBR	NBL	NBT	NBR	SBL	SBT	SBR
Lane Configurations												
Traffic Volume (veh/h)	58	296	0	78	176	140	0	51	189	132	7	25
Future Volume (veh/h)	58	296	0	78	176	140	0	51	189	132	7	25
Initial Q (Qb), veh	0	0	0	0	0	0	0	0	0	0	0	0
Ped-Bike Adj(A_pbT)	1.00		1.00	1.00		1.00	1.00		1.00	1.00		1.00
Parking Bus, Adj	1.00	1.00	1.00	1.00	1.00	1.00	1.00	1.00	1.00	1.00	1.00	1.00
Work Zone On Approach	No			No			No			No		
Adj Sat Flow, veh/h/ln	1856	1856	1856	1856	1856	1856	1856	1856	1856	1856	1856	1856
Adj Flow Rate, veh/h	72	365	0	96	217	173	0	63	233	163	9	31
Peak Hour Factor	0.81	0.81	0.81	0.81	0.81	0.81	0.81	0.81	0.81	0.81	0.81	0.81
Percent Heavy Veh, %	3	3	3	3	3	3	3	3	3	3	3	3
Cap, veh/h	110	628	0	128	359	272	0	83	305	225	12	43
Arrive On Green	0.06	0.18	0.00	0.07	0.19	0.19	0.00	0.24	0.24	0.16	0.16	0.16
Sat Flow, veh/h	1767	3618	0	1767	1906	1447	0	346	1279	1396	77	265
Grp Volume(v), veh/h	72	365	0	96	200	190	0	0	296	203	0	0
Grp Sat Flow(s),veh/h/ln	1767	1763	0	1767	1763	1590	0	0	1625	1738	0	0
Q Serve(g_s), s	2.1	4.9	0.0	2.7	5.4	5.7	0.0	0.0	8.7	5.7	0.0	0.0
Cycle Q Clear(g_c), s	2.1	4.9	0.0	2.7	5.4	5.7	0.0	0.0	8.7	5.7	0.0	0.0
Prop In Lane	1.00		0.00	1.00		0.91	0.00		0.79	0.80		0.15
Lane Grp Cap(c), veh/h	110	628	0	128	332	299	0	0	388	280	0	0
V/C Ratio(X)	0.65	0.58	0.00	0.75	0.60	0.64	0.00	0.00	0.76	0.72	0.00	0.00
Avail Cap(c_a), veh/h	171	1539	0	189	787	710	0	0	1167	1248	0	0
HCM Platoon Ratio	1.00	1.00	1.00	1.00	1.00	1.00	1.00	1.00	1.00	1.00	1.00	1.00
Upstream Filter(l)	1.00	1.00	0.00	1.00	1.00	1.00	0.00	0.00	1.00	1.00	0.00	0.00
Uniform Delay (d), s/veh	23.6	19.4	0.0	23.4	19.1	19.3	0.0	0.0	18.3	20.5	0.0	0.0
Incr Delay (d2), s/veh	6.4	0.9	0.0	9.0	1.8	2.2	0.0	0.0	3.1	3.5	0.0	0.0
Initial Q Delay(d3),s/veh	0.0	0.0	0.0	0.0	0.0	0.0	0.0	0.0	0.0	0.0	0.0	0.0
%ile BackOfQ(50%),veh/ln	0.9	1.7	0.0	1.3	2.0	1.9	0.0	0.0	3.0	2.2	0.0	0.0
Unsig. Movement Delay, s/veh												
LnGrp Delay(d),s/veh	30.0	20.3	0.0	32.4	20.9	21.5	0.0	0.0	21.4	24.0	0.0	0.0
LnGrp LOS	C	C	A	C	C	C	A	A	C	C	A	A
Approach Vol, veh/h	437			486			296			203		
Approach Delay, s/veh	21.9			23.4			21.4			24.0		
Approach LOS	C			C			C			C		
Timer - Assigned Phs	1	2		4	5	6		8				
Phs Duration (G+Y+Rc), s	8.2	13.7		12.8	7.7	14.2		16.8				
Change Period (Y+Rc), s	4.5	4.5		4.5	4.5	4.5		4.5				
Max Green Setting (Gmax),s	55	22.5		37.0	5.0	23.0		37.0				
Max Q Clear Time (g_c+l1),s	4.7	6.9		7.7	4.1	7.7		10.7				
Green Ext Time (p_c), s	0.0	1.8		1.1	0.0	1.8		1.7				
Intersection Summary												
HCM 6th Ctrl Delay				22.6								
HCM 6th LOS				C								

Santa Maria Airport Business Park SP
3: Foxenwood Lane & Union Valley Parkway

Mitigated Existing Plus Project PM
HCM 6th Signalized Intersection Summary

												
Movement	EBL	EBT	EBR	WBL	WBT	WBR	NBL	NBT	NBR	SBL	SBT	SBR
Lane Configurations												
Traffic Volume (veh/h)	27	220	3	178	300	81	3	13	99	159	14	47
Future Volume (veh/h)	27	220	3	178	300	81	3	13	99	159	14	47
Initial Q (Qb), veh	0	0	0	0	0	0	0	0	0	0	0	0
Ped-Bike Adj(A_pbT)	1.00		1.00	1.00		1.00	1.00		1.00	1.00		1.00
Parking Bus, Adj	1.00	1.00	1.00	1.00	1.00	1.00	1.00	1.00	1.00	1.00	1.00	1.00
Work Zone On Approach		No			No			No			No	
Adj Sat Flow, veh/h/ln	1885	1885	1885	1885	1885	1885	1885	1885	1885	1885	1885	1885
Adj Flow Rate, veh/h	29	239	3	193	326	88	3	14	108	173	15	51
Peak Hour Factor	0.92	0.92	0.92	0.92	0.92	0.92	0.92	0.92	0.92	0.92	0.92	0.92
Percent Heavy Veh, %	1	1	1	1	1	1	1	1	1	1	1	1
Cap, veh/h	61	499	6	233	653	174	4	20	155	250	22	74
Arrive On Green	0.03	0.14	0.14	0.13	0.23	0.23	0.11	0.11	0.11	0.20	0.20	0.20
Sat Flow, veh/h	1795	3622	45	1795	2797	744	39	182	1405	1269	110	374
Grp Volume(v), veh/h	29	118	124	193	207	207	125	0	0	239	0	0
Grp Sat Flow(s),veh/h/ln	1795	1791	1877	1795	1791	1749	1626	0	0	1754	0	0
Q Serve(g_s), s	0.7	2.6	2.6	4.4	4.2	4.4	3.1	0.0	0.0	5.4	0.0	0.0
Cycle Q Clear(g_c), s	0.7	2.6	2.6	4.4	4.2	4.4	3.1	0.0	0.0	5.4	0.0	0.0
Prop In Lane	1.00		0.02	1.00		0.42	0.02		0.86	0.72		0.21
Lane Grp Cap(c), veh/h	61	246	258	233	418	408	179	0	0	345	0	0
V/C Ratio(X)	0.47	0.48	0.48	0.83	0.49	0.51	0.70	0.00	0.00	0.69	0.00	0.00
Avail Cap(c_a), veh/h	212	952	998	233	973	951	1422	0	0	1533	0	0
HCM Platoon Ratio	1.00	1.00	1.00	1.00	1.00	1.00	1.00	1.00	1.00	1.00	1.00	1.00
Upstream Filter(l)	1.00	1.00	1.00	1.00	1.00	1.00	1.00	0.00	0.00	1.00	0.00	0.00
Uniform Delay (d), s/veh	20.1	16.8	16.8	17.9	14.1	14.1	18.1	0.0	0.0	15.8	0.0	0.0
Incr Delay (d2), s/veh	5.6	1.4	1.4	21.1	0.9	1.0	4.8	0.0	0.0	2.5	0.0	0.0
Initial Q Delay(d3),s/veh	0.0	0.0	0.0	0.0	0.0	0.0	0.0	0.0	0.0	0.0	0.0	0.0
%ile BackOfQ(50%),veh/ln	0.3	0.9	1.0	2.8	1.4	1.4	1.2	0.0	0.0	1.9	0.0	0.0
Unsig. Movement Delay, s/veh												
LnGrp Delay(d),s/veh	25.6	18.3	18.2	39.1	15.0	15.1	23.0	0.0	0.0	18.3	0.0	0.0
LnGrp LOS	C	B	B	D	B	B	C	A	A	B	A	A
Approach Vol, veh/h		271			607			125			239	
Approach Delay, s/veh		19.0			22.7			23.0			18.3	
Approach LOS		B			C			C			B	
Timer - Assigned Phs	1	2		4	5	6		8				
Phs Duration (G+Y+Rc), s	10.0	10.3		12.8	5.9	14.4		9.2				
Change Period (Y+Rc), s	4.5	4.5		4.5	4.5	4.5		4.5				
Max Green Setting (Gmax),s	55	22.5		37.0	5.0	23.0		37.0				
Max Q Clear Time (g_c+l1),s	6.4	4.6		7.4	2.7	6.4		5.1				
Green Ext Time (p_c), s	0.0	1.0		1.3	0.0	2.0		0.7				
Intersection Summary												
HCM 6th Ctrl Delay				21.1								
HCM 6th LOS				C								

Cumulative

Intersection												
Int Delay, s/veh	2.3											
Movement	EBL	EBT	EBR	WBL	WBT	WBR	NBL	NBT	NBR	SBL	SBT	SBR
Lane Configurations		↕		↕	↕			↕			↕	
Traffic Vol, veh/h	0	240	20	10	190	0	50	0	50	0	0	0
Future Vol, veh/h	0	240	20	10	190	0	50	0	50	0	0	0
Conflicting Peds, #/hr	0	0	0	0	0	0	0	0	0	0	0	0
Sign Control	Free	Free	Free	Free	Free	Free	Stop	Stop	Stop	Stop	Stop	Stop
RT Channelized	-	-	None	-	-	None	-	-	None	-	-	None
Storage Length	-	-	-	160	-	-	-	-	-	-	-	-
Veh in Median Storage, #	-	0	-	-	0	-	-	0	-	-	0	-
Grade, %	-	0	-	-	0	-	-	0	-	-	0	-
Peak Hour Factor	95	95	95	95	95	95	95	95	95	95	95	95
Heavy Vehicles, %	4	4	4	4	4	4	4	4	4	4	4	4
Mvmt Flow	0	253	21	11	200	0	53	0	53	0	0	0

























Major/Minor	Major1			Major2			Minor1			Minor2		
Conflicting Flow All	200	0	0	274	0	0	486	486	264	512	496	200
Stage 1	-	-	-	-	-	-	264	264	-	222	222	-
Stage 2	-	-	-	-	-	-	222	222	-	290	274	-
Critical Hdwy	4.14	-	-	4.14	-	-	7.14	6.54	6.24	7.14	6.54	6.24
Critical Hdwy Stg 1	-	-	-	-	-	-	6.14	5.54	-	6.14	5.54	-
Critical Hdwy Stg 2	-	-	-	-	-	-	6.14	5.54	-	6.14	5.54	-
Follow-up Hdwy	2.236	-	-	2.236	-	-	3.536	4.036	3.336	3.536	4.036	3.336
Pot Cap-1 Maneuver	1360	-	-	1278	-	-	488	478	770	469	472	836
Stage 1	-	-	-	-	-	-	737	686	-	776	716	-
Stage 2	-	-	-	-	-	-	776	716	-	713	680	-
Platoon blocked, %		-	-		-	-						
Mov Cap-1 Maneuver	1360	-	-	1278	-	-	485	474	770	434	468	836
Mov Cap-2 Maneuver	-	-	-	-	-	-	485	474	-	434	468	-
Stage 1	-	-	-	-	-	-	737	686	-	776	710	-
Stage 2	-	-	-	-	-	-	769	710	-	664	680	-

Approach	EB			WB			NB			SB		
HCM Control Delay, s	0			0.4			12.3			0		
HCM LOS							B			A		

Minor Lane/Major Mvmt	NBLn1	EBL	EBT	EBR	WBL	WBT	WBR	SBLn1
Capacity (veh/h)	595	1360	-	-	1278	-	-	-
HCM Lane V/C Ratio	0.177	-	-	-	0.008	-	-	-
HCM Control Delay (s)	12.3	0	-	-	7.8	-	-	0
HCM Lane LOS	B	A	-	-	A	-	-	A
HCM 95th %tile Q(veh)	0.6	0	-	-	0	-	-	-

Santa Maria Airport Business Park SP
2: Orcutt Expressway & Foster Road

























Cumulative (10-year) AM
HCM Signalized Intersection Capacity Analysis

													
Movement	EBL	EBT	EBR	WBL	WBT	WBR	NBL	NBT	NBR	SBL	SBT	SBR	
Lane Configurations	 							 			 		
Traffic Volume (vph)	180	100	10	120	80	260	20	1410	100	190	810	100	
Future Volume (vph)	180	100	10	120	80	260	20	1410	100	190	810	100	
Ideal Flow (vphp)	1900	1900	1900	1900	1900	1900	1900	1900	1900	1900	1900	1900	
Total Lost time (s)	4.9	4.9		4.9	4.9	4.9	4.2	6.0		4.2	6.0	6.0	
Lane Util. Factor	0.97	1.00		1.00	1.00	1.00	1.00	0.95		1.00	0.95	1.00	
Frbp, ped/bikes	1.00	1.00		1.00	1.00	1.00	1.00	1.00		1.00	1.00	0.98	
Flpb, ped/bikes	1.00	1.00		1.00	1.00	1.00	1.00	1.00		1.00	1.00	1.00	
Frt	1.00	0.99		1.00	1.00	0.85	1.00	0.99		1.00	1.00	0.85	
Flt Protected	0.95	1.00		0.95	1.00	1.00	0.95	1.00		0.95	1.00	1.00	
Satd. Flow (prot)	3400	1819		1752	1845	1568	1752	3465		1752	3505	1536	
Flt Permitted	0.95	1.00		0.95	1.00	1.00	0.95	1.00		0.95	1.00	1.00	
Satd. Flow (perm)	3400	1819		1752	1845	1568	1752	3465		1752	3505	1536	
Peak-hour factor, PHF	0.92	0.92	0.92	0.92	0.92	0.92	0.92	0.92	0.92	0.92	0.92	0.92	
Adj. Flow (vph)	196	109	11	130	87	283	22	1533	109	207	880	109	
RTOR Reduction (vph)	0	4	0	0	0	208	0	4	0	0	0	49	
Lane Group Flow (vph)	196	116	0	130	87	75	22	1638	0	207	880	60	
Confl. Bikes (#/hr)									1			1	
Heavy Vehicles (%)	3%	3%	3%	3%	3%	3%	3%	3%	3%	3%	3%	3%	
Turn Type	Split	NA		Split	NA	Perm	Prot	NA		Prot	NA	Perm	
Protected Phases	4	4		8	8		5	2		1	6		
Permitted Phases						8						6	
Actuated Green, G (s)	11.4	11.4		9.5	9.5	9.5	2.3	46.9		8.2	52.8	52.8	
Effective Green, g (s)	11.4	11.4		9.5	9.5	9.5	2.3	46.9		8.2	52.8	52.8	
Actuated g/C Ratio	0.12	0.12		0.10	0.10	0.10	0.02	0.49		0.09	0.55	0.55	
Clearance Time (s)	4.9	4.9		4.9	4.9	4.9	4.2	6.0		4.2	6.0	6.0	
Vehicle Extension (s)	3.0	3.0		3.0	3.0	3.0	3.0	3.0		3.0	3.0	3.0	
Lane Grp Cap (vph)	403	216		173	182	155	41	1692		149	1927	844	
v/s Ratio Prot	0.06	c0.06		c0.07	0.05		0.01	c0.47		c0.12	0.25		
v/s Ratio Perm						0.05						0.04	
v/c Ratio	0.49	0.54		0.75	0.48	0.48	0.54	0.97		1.39	0.46	0.07	
Uniform Delay, d1	39.6	39.8		42.1	40.9	40.9	46.3	23.8		43.9	13.0	10.1	
Progression Factor	1.00	1.00		1.00	1.00	1.00	1.00	1.00		1.00	1.00	1.00	
Incremental Delay, d2	0.9	2.6		16.7	2.0	2.4	12.8	14.8		211.0	0.2	0.0	
Delay (s)	40.5	42.4		58.8	42.9	43.3	59.2	38.7		254.9	13.2	10.2	
Level of Service	D	D		E	D	D	E	D		F	B	B	
Approach Delay (s)		41.2			47.2			38.9			54.7		
Approach LOS		D			D			D			D		
Intersection Summary													
HCM 2000 Control Delay			45.4		HCM 2000 Level of Service						D		
HCM 2000 Volume to Capacity ratio			0.92										
Actuated Cycle Length (s)			96.0		Sum of lost time (s)					20.0			
Intersection Capacity Utilization			78.6%		ICU Level of Service					D			
Analysis Period (min)			15										

c Critical Lane Group

Santa Maria Airport Business Park SP
2: Orcutt Expressway & Foster Road

Cumulative (10-year) AM
HCM 6th Signalized Intersection Summary

												
Movement	EBL	EBT	EBR	WBL	WBT	WBR	NBL	NBT	NBR	SBL	SBT	SBR
Lane Configurations	 							 			 	
Traffic Volume (veh/h)	180	100	10	120	80	260	20	1410	100	190	810	100
Future Volume (veh/h)	180	100	10	120	80	260	20	1410	100	190	810	100
Initial Q (Qb), veh	0	0	0	0	0	0	0	0	0	0	0	0
Ped-Bike Adj(A_pbT)	1.00		1.00	1.00		1.00	1.00		0.98	1.00		0.98
Parking Bus, Adj	1.00	1.00	1.00	1.00	1.00	1.00	1.00	1.00	1.00	1.00	1.00	1.00
Work Zone On Approach		No			No			No			No	
Adj Sat Flow, veh/h/ln	1856	1856	1856	1856	1856	1856	1856	1856	1856	1856	1856	1856
Adj Flow Rate, veh/h	196	109	11	130	87	140	22	1533	109	207	880	109
Peak Hour Factor	0.92	0.92	0.92	0.92	0.92	0.92	0.92	0.92	0.92	0.92	0.92	0.92
Percent Heavy Veh, %	3	3	3	3	3	3	3	3	3	3	3	3
Cap, veh/h	339	164	17	185	195	165	50	1616	114	160	1929	843
Arrive On Green	0.10	0.10	0.10	0.10	0.10	0.10	0.03	0.48	0.48	0.09	0.55	0.55
Sat Flow, veh/h	3428	1658	167	1767	1856	1572	1767	3334	236	1767	3526	1540
Grp Volume(v), veh/h	196	0	120	130	87	140	22	806	836	207	880	109
Grp Sat Flow(s),veh/h/ln	1714	0	1825	1767	1856	1572	1767	1763	1807	1767	1763	1540
Q Serve(g_s), s	4.9	0.0	5.7	6.4	4.0	7.9	1.1	39.3	40.2	8.2	13.6	3.1
Cycle Q Clear(g_c), s	4.9	0.0	5.7	6.4	4.0	7.9	1.1	39.3	40.2	8.2	13.6	3.1
Prop In Lane	1.00		0.09	1.00		1.00	1.00		0.13	1.00		1.00
Lane Grp Cap(c), veh/h	339	0	180	185	195	165	50	854	876	160	1929	843
V/C Ratio(X)	0.58	0.00	0.67	0.70	0.45	0.85	0.44	0.94	0.95	1.29	0.46	0.13
Avail Cap(c_a), veh/h	1061	0	565	185	195	165	117	863	884	160	1929	843
HCM Platoon Ratio	1.00	1.00	1.00	1.00	1.00	1.00	1.00	1.00	1.00	1.00	1.00	1.00
Upstream Filter(I)	1.00	0.00	1.00	1.00	1.00	1.00	1.00	1.00	1.00	1.00	1.00	1.00
Uniform Delay (d), s/veh	39.0	0.0	39.3	39.1	38.0	39.8	43.3	22.1	22.4	41.2	12.4	10.0
Incr Delay (d2), s/veh	1.6	0.0	4.2	11.2	1.6	31.7	6.0	18.2	20.0	170.3	0.2	0.1
Initial Q Delay(d3),s/veh	0.0	0.0	0.0	0.0	0.0	0.0	0.0	0.0	0.0	0.0	0.0	0.0
%ile BackOfQ(50%),veh/ln	2.1	0.0	2.7	3.3	1.8	4.4	0.5	17.6	18.8	10.9	4.4	0.9
Unsig. Movement Delay, s/veh												
LnGrp Delay(d),s/veh	40.6	0.0	43.5	50.3	39.6	71.5	49.3	40.4	42.3	211.4	12.5	10.1
LnGrp LOS	D	A	D	D	D	E	D	D	D	F	B	B
Approach Vol, veh/h		316			357			1664			1196	
Approach Delay, s/veh		41.7			56.0			41.5			46.7	
Approach LOS		D			E			D			D	
Timer - Assigned Phs	1	2		4	5	6		8				
Phs Duration (G+Y+Rc), s	12.4	49.9		13.8	6.7	55.5		14.4				
Change Period (Y+Rc), s	* 4.2	6.0		4.9	* 4.2	6.0		4.9				
Max Green Setting (Gmax), s	* 8.2	44.3		28.0	* 6	46.5		9.5				
Max Q Clear Time (g_c+I1), s	10.2	42.2		7.7	3.1	15.6		9.9				
Green Ext Time (p_c), s	0.0	1.7		1.2	0.0	6.3		0.0				

Intersection Summary

HCM 6th Ctrl Delay	44.7
HCM 6th LOS	D

Notes

* HCM 6th computational engine requires equal clearance times for the phases crossing the barrier.

Santa Maria Airport Business Park SP
 3: Foxenwood Lane & Union Valley Parkway

Cumulative (10-year) AM
 HCM 6th TWSC

Intersection												
Int Delay, s/veh	6.3											
Movement	EBL	EBT	EBR	WBL	WBT	WBR	NBL	NBT	NBR	SBL	SBT	SBR
Lane Configurations	↖	↕		↖	↕			↕			↕	↕
Traffic Vol, veh/h	20	330	10	80	210	40	10	50	190	0	40	10
Future Vol, veh/h	20	330	10	80	210	40	10	50	190	0	40	10
Conflicting Peds, #/hr	0	0	1	1	0	0	0	0	0	0	0	0
Sign Control	Free	Free	Free	Free	Free	Free	Stop	Stop	Stop	Stop	Stop	Stop
RT Channelized	-	-	None	-	-	None	-	-	None	-	-	None
Storage Length	195	-	-	155	-	-	-	-	-	-	-	-
Veh in Median Storage, #	-	0	-	-	0	-	-	0	-	-	0	-
Grade, %	-	0	-	-	0	-	-	0	-	-	0	-
Peak Hour Factor	92	92	92	92	92	92	92	92	92	92	92	92
Heavy Vehicles, %	3	3	3	3	3	3	3	3	3	3	3	3
Mvmt Flow	22	359	11	87	228	43	11	54	207	0	43	11































Major/Minor	Major1			Major2			Minor1			Minor2		
Conflicting Flow All	271	0	0	371	0	0	720	855	186	675	839	136
Stage 1	-	-	-	-	-	-	410	410	-	424	424	-
Stage 2	-	-	-	-	-	-	310	445	-	251	415	-
Critical Hdwy	4.16	-	-	4.16	-	-	7.56	6.56	6.96	7.56	6.56	6.96
Critical Hdwy Stg 1	-	-	-	-	-	-	6.56	5.56	-	6.56	5.56	-
Critical Hdwy Stg 2	-	-	-	-	-	-	6.56	5.56	-	6.56	5.56	-
Follow-up Hdwy	2.23	-	-	2.23	-	-	3.53	4.03	3.33	3.53	4.03	3.33
Pot Cap-1 Maneuver	1282	-	-	1177	-	-	313	292	821	338	299	885
Stage 1	-	-	-	-	-	-	587	591	-	576	583	-
Stage 2	-	-	-	-	-	-	672	570	-	728	588	-
Platoon blocked, %	-	-	-	-	-	-	-	-	-	-	-	-
Mov Cap-1 Maneuver	1282	-	-	1176	-	-	253	265	820	199	272	885
Mov Cap-2 Maneuver	-	-	-	-	-	-	253	265	-	199	272	-
Stage 1	-	-	-	-	-	-	576	580	-	566	540	-
Stage 2	-	-	-	-	-	-	565	528	-	485	577	-

Approach	EB	WB	NB	SB
HCM Control Delay, s	0.4	2	18	18.7
HCM LOS			C	C

Minor Lane/Major Mvmt	NBLn1	EBL	EBT	EBR	WBL	WBT	WBR	SBLn1
Capacity (veh/h)	544	1282	-	-	1176	-	-	316
HCM Lane V/C Ratio	0.5	0.017	-	-	0.074	-	-	0.172
HCM Control Delay (s)	18	7.9	-	-	8.3	-	-	18.7
HCM Lane LOS	C	A	-	-	A	-	-	C
HCM 95th %tile Q(veh)	2.8	0.1	-	-	0.2	-	-	0.6

Santa Maria Airport Business Park SP
4: Orcutt Expressway & Union Valley Parkway































Cumulative (10-year) AM
HCM Signalized Intersection Capacity Analysis

												
Movement	EBL	EBT	EBR	WBL	WBT	WBR	NBL	NBT	NBR	SBL	SBT	SBR
Lane Configurations	 	 		 	 			 		 	 	
Traffic Volume (vph)	200	330	20	400	180	360	50	970	260	130	730	100
Future Volume (vph)	200	330	20	400	180	360	50	970	260	130	730	100
Ideal Flow (vphp)	1900	1900	1900	1900	1900	1900	1900	1900	1900	1900	1900	1900
Total Lost time (s)	5.4	4.9	4.9	4.9	4.9	4.9	4.5	6.0	6.0	5.0	6.0	6.0
Lane Util. Factor	0.97	0.95	1.00	0.97	0.95	1.00	1.00	0.95	1.00	0.97	0.95	1.00
Frbp, ped/bikes	1.00	1.00	1.00	1.00	1.00	1.00	1.00	1.00	1.00	1.00	1.00	0.99
Flpb, ped/bikes	1.00	1.00	1.00	1.00	1.00	1.00	1.00	1.00	1.00	1.00	1.00	1.00
Frt	1.00	1.00	0.85	1.00	1.00	0.85	1.00	1.00	0.85	1.00	1.00	0.85
Flt Protected	0.95	1.00	1.00	0.95	1.00	1.00	0.95	1.00	1.00	0.95	1.00	1.00
Satd. Flow (prot)	3400	3505	1568	3400	3505	1568	1752	3505	1568	3400	3505	1548
Flt Permitted	0.95	1.00	1.00	0.95	1.00	1.00	0.95	1.00	1.00	0.95	1.00	1.00
Satd. Flow (perm)	3400	3505	1568	3400	3505	1568	1752	3505	1568	3400	3505	1548
Peak-hour factor, PHF	0.92	0.92	0.92	0.92	0.92	0.92	0.92	0.92	0.92	0.92	0.92	0.92
Adj. Flow (vph)	217	359	22	435	196	391	54	1054	283	141	793	109
RTOR Reduction (vph)	0	0	18	0	0	127	0	0	166	0	0	65
Lane Group Flow (vph)	217	359	4	435	196	264	54	1054	117	141	793	44
Confl. Bikes (#/hr)												1
Heavy Vehicles (%)	3%	3%	3%	3%	3%	3%	3%	3%	3%	3%	3%	3%
Turn Type	Prot	NA	Perm	Prot	NA	Perm	Prot	NA	Perm	Prot	NA	Perm
Protected Phases	7	4		3	8		5	2		1	6	
Permitted Phases			4			8			2			6
Actuated Green, G (s)	11.7	20.0	20.0	17.2	25.0	25.0	6.3	40.1	40.1	8.1	42.4	42.4
Effective Green, g (s)	11.7	20.0	20.0	17.2	25.0	25.0	6.3	40.1	40.1	8.1	42.4	42.4
Actuated g/C Ratio	0.11	0.19	0.19	0.16	0.24	0.24	0.06	0.38	0.38	0.08	0.40	0.40
Clearance Time (s)	5.4	4.9	4.9	4.9	4.9	4.9	4.5	6.0	6.0	5.0	6.0	6.0
Vehicle Extension (s)	3.0	3.0	3.0	3.0	3.0	3.0	3.0	3.0	3.0	3.0	3.0	3.0
Lane Grp Cap (vph)	374	660	295	550	825	369	103	1323	592	259	1399	618
v/s Ratio Prot	0.06	0.10		c0.13	0.06		0.03	c0.30		c0.04	0.23	
v/s Ratio Perm			0.00			c0.17			0.07			0.03
v/c Ratio	0.58	0.54	0.01	0.79	0.24	0.72	0.52	0.80	0.20	0.54	0.57	0.07
Uniform Delay, d1	44.9	39.0	35.1	42.8	32.9	37.3	48.5	29.4	22.2	47.3	24.8	19.7
Progression Factor	1.00	1.00	1.00	1.00	1.00	1.00	1.00	1.00	1.00	1.00	1.00	1.00
Incremental Delay, d2	2.3	0.9	0.0	7.6	0.1	6.5	4.7	3.4	0.2	2.3	0.5	0.0
Delay (s)	47.2	39.9	35.1	50.4	33.0	43.8	53.2	32.8	22.4	49.6	25.3	19.8
Level of Service	D	D	D	D	C	D	D	C	C	D	C	B
Approach Delay (s)		42.4			44.5			31.5			28.0	
Approach LOS		D			D			C			C	
Intersection Summary												
HCM 2000 Control Delay			35.5								HCM 2000 Level of Service	D
HCM 2000 Volume to Capacity ratio			0.78									
Actuated Cycle Length (s)			106.2								Sum of lost time (s)	21.3
Intersection Capacity Utilization			71.3%								ICU Level of Service	C
Analysis Period (min)			15									

c Critical Lane Group





















Santa Maria Airport Business Park SP
4: Orcutt Expressway & Union Valley Parkway

Cumulative (10-year) AM
HCM 6th Signalized Intersection Summary

												
Movement	EBL	EBT	EBR	WBL	WBT	WBR	NBL	NBT	NBR	SBL	SBT	SBR
Lane Configurations	 	 		 	 			 		 	 	
Traffic Volume (veh/h)	200	330	20	400	180	360	50	970	260	130	730	100
Future Volume (veh/h)	200	330	20	400	180	360	50	970	260	130	730	100
Initial Q (Qb), veh	0	0	0	0	0	0	0	0	0	0	0	0
Ped-Bike Adj(A_pbT)	1.00		1.00	1.00		1.00	1.00		1.00	1.00		0.99
Parking Bus, Adj	1.00	1.00	1.00	1.00	1.00	1.00	1.00	1.00	1.00	1.00	1.00	1.00
Work Zone On Approach		No			No			No			No	
Adj Sat Flow, veh/h/ln	1856	1856	1856	1856	1856	1856	1856	1856	1856	1856	1856	1856
Adj Flow Rate, veh/h	217	359	22	435	196	391	54	1054	283	141	793	109
Peak Hour Factor	0.92	0.92	0.92	0.92	0.92	0.92	0.92	0.92	0.92	0.92	0.92	0.92
Percent Heavy Veh, %	3	3	3	3	3	3	3	3	3	3	3	3
Cap, veh/h	291	787	351	507	992	443	109	1219	544	266	1292	569
Arrive On Green	0.08	0.22	0.22	0.15	0.28	0.28	0.06	0.35	0.35	0.08	0.37	0.37
Sat Flow, veh/h	3428	3526	1572	3428	3526	1572	1767	3526	1572	3428	3526	1553
Grp Volume(v), veh/h	217	359	22	435	196	391	54	1054	283	141	793	109
Grp Sat Flow(s),veh/h/ln	1714	1763	1572	1714	1763	1572	1767	1763	1572	1714	1763	1553
Q Serve(g_s), s	6.3	8.9	1.1	12.5	4.3	24.1	3.0	28.2	14.5	4.0	18.6	4.8
Cycle Q Clear(g_c), s	6.3	8.9	1.1	12.5	4.3	24.1	3.0	28.2	14.5	4.0	18.6	4.8
Prop In Lane	1.00		1.00	1.00		1.00	1.00		1.00	1.00		1.00
Lane Grp Cap(c), veh/h	291	787	351	507	992	443	109	1219	544	266	1292	569
V/C Ratio(X)	0.75	0.46	0.06	0.86	0.20	0.88	0.50	0.86	0.52	0.53	0.61	0.19
Avail Cap(c_a), veh/h	491	1568	699	579	1641	732	140	1362	607	271	1379	608
HCM Platoon Ratio	1.00	1.00	1.00	1.00	1.00	1.00	1.00	1.00	1.00	1.00	1.00	1.00
Upstream Filter(I)	1.00	1.00	1.00	1.00	1.00	1.00	1.00	1.00	1.00	1.00	1.00	1.00
Uniform Delay (d), s/veh	45.2	34.0	31.0	42.1	27.7	34.8	46.0	30.9	26.4	44.9	26.2	21.8
Incr Delay (d2), s/veh	3.8	0.4	0.1	11.1	0.1	7.3	3.4	5.6	0.8	1.9	0.7	0.2
Initial Q Delay(d3),s/veh	0.0	0.0	0.0	0.0	0.0	0.0	0.0	0.0	0.0	0.0	0.0	0.0
%ile BackOfQ(50%),veh/ln	2.7	3.7	0.4	5.9	1.7	9.6	1.3	11.8	5.2	1.7	7.2	1.7
Unsig. Movement Delay, s/veh												
LnGrp Delay(d),s/veh	49.1	34.4	31.0	53.2	27.8	42.1	49.4	36.5	27.2	46.8	26.9	22.0
LnGrp LOS	D	C	C	D	C	D	D	D	C	D	C	C
Approach Vol, veh/h		598			1022			1391			1043	
Approach Delay, s/veh		39.6			44.1			35.1			29.1	
Approach LOS		D			D			D			C	
Timer - Assigned Phs	1	2	3	4	5	6	7	8				
Phs Duration (G+Y+Rc), s	12.8	41.0	19.9	27.5	10.7	43.1	14.0	33.4				
Change Period (Y+Rc), s	5.0	6.0	4.9	4.9	4.5	6.0	5.4	4.9				
Max Green Setting (Gmax), s	8.0	39.1	17.1	45.0	8.0	39.6	14.5	47.1				
Max Q Clear Time (g_c+I1), s	6.0	30.2	14.5	10.9	5.0	20.6	8.3	26.1				
Green Ext Time (p_c), s	0.1	4.7	0.4	2.3	0.0	4.9	0.3	2.4				
Intersection Summary												
HCM 6th Ctrl Delay				36.5								
HCM 6th LOS				D								

Santa Maria Airport Business Park SP
5: Orcutt Road & Union Valley Parkway

Cumulative (10-year) AM
HCM Signalized Intersection Capacity Analysis

												
Movement	EBL	EBT	EBR	WBL	WBT	WBR	NBL	NBT	NBR	SBL	SBT	SBR
Lane Configurations												
Traffic Volume (vph)	10	580	110	60	650	20	270	120	80	30	100	10
Future Volume (vph)	10	580	110	60	650	20	270	120	80	30	100	10
Ideal Flow (vphpl)	1900	1900	1900	1900	1900	1900	1900	1900	1900	1900	1900	1900
Total Lost time (s)	4.2	6.0		4.2	6.0		4.2	4.9		4.2	4.9	
Lane Util. Factor	1.00	0.95		1.00	0.95		1.00	1.00		1.00	1.00	
Frbp, ped/bikes	1.00	1.00		1.00	1.00		1.00	1.00		1.00	1.00	
Flpb, ped/bikes	1.00	1.00		1.00	1.00		1.00	1.00		1.00	1.00	
Frt	1.00	0.98		1.00	1.00		1.00	0.94		1.00	0.99	
Flt Protected	0.95	1.00		0.95	1.00		0.95	1.00		0.95	1.00	
Satd. Flow (prot)	1736	3388		1736	3453		1736	1717		1736	1802	
Flt Permitted	0.95	1.00		0.95	1.00		0.95	1.00		0.95	1.00	
Satd. Flow (perm)	1736	3388		1736	3453		1736	1717		1736	1802	
Peak-hour factor, PHF	0.92	0.92	0.92	0.92	0.92	0.92	0.92	0.92	0.92	0.92	0.92	0.92
Adj. Flow (vph)	11	630	120	65	707	22	293	130	87	33	109	11
RTOR Reduction (vph)	0	16	0	0	2	0	0	36	0	0	6	0
Lane Group Flow (vph)	11	734	0	65	727	0	293	181	0	33	114	0
Confl. Bikes (#/hr)						1						
Heavy Vehicles (%)	4%	4%	4%	4%	4%	4%	4%	4%	4%	4%	4%	4%
Turn Type	Prot	NA		Prot	NA		Prot	NA		Prot	NA	
Protected Phases	5	2		1	6		3	8		7	4	
Permitted Phases												
Actuated Green, G (s)	0.7	20.5		2.9	22.7		9.4	16.0		2.0	8.6	
Effective Green, g (s)	0.7	20.5		2.9	22.7		9.4	16.0		2.0	8.6	
Actuated g/C Ratio	0.01	0.34		0.05	0.37		0.15	0.26		0.03	0.14	
Clearance Time (s)	4.2	6.0		4.2	6.0		4.2	4.9		4.2	4.9	
Vehicle Extension (s)	3.0	3.0		3.0	3.0		3.0	3.0		3.0	3.0	
Lane Grp Cap (vph)	20	1144		82	1291		268	452		57	255	
v/s Ratio Prot	0.01	c0.22		c0.04	0.21		c0.17	c0.11		0.02	0.06	
v/s Ratio Perm												
v/c Ratio	0.55	0.64		0.79	0.56		1.09	0.40		0.58	0.45	
Uniform Delay, d1	29.8	17.0		28.6	15.1		25.7	18.4		28.9	23.9	
Progression Factor	1.00	1.00		1.00	1.00		1.00	1.00		1.00	1.00	
Incremental Delay, d2	28.9	1.2		39.3	0.6		82.2	0.6		13.5	1.2	
Delay (s)	58.7	18.2		67.9	15.6		107.8	19.0		42.4	25.1	
Level of Service	E	B		E	B		F	B		D	C	
Approach Delay (s)		18.8			19.9			70.0			28.8	
Approach LOS		B			B			E			C	
Intersection Summary												
HCM 2000 Control Delay			31.7				HCM 2000 Level of Service				C	
HCM 2000 Volume to Capacity ratio			0.72									
Actuated Cycle Length (s)			60.7				Sum of lost time (s)			19.3		
Intersection Capacity Utilization			59.8%				ICU Level of Service			B		
Analysis Period (min)			15									

c Critical Lane Group

Santa Maria Airport Business Park SP
5: Orcutt Road & Union Valley Parkway

Cumulative (10-year) AM
HCM 6th Signalized Intersection Summary



Movement	EBL	EBT	EBR	WBL	WBT	WBR	NBL	NBT	NBR	SBL	SBT	SBR
Lane Configurations	↔	↕		↔	↕		↔	↕		↔	↕	
Traffic Volume (veh/h)	10	580	110	60	650	20	270	120	80	30	100	10
Future Volume (veh/h)	10	580	110	60	650	20	270	120	80	30	100	10
Initial Q (Qb), veh	0	0	0	0	0	0	0	0	0	0	0	0
Ped-Bike Adj(A_pbT)	1.00		1.00	1.00		0.98	1.00		1.00	1.00		1.00
Parking Bus, Adj	1.00	1.00	1.00	1.00	1.00	1.00	1.00	1.00	1.00	1.00	1.00	1.00
Work Zone On Approach		No			No			No			No	
Adj Sat Flow, veh/h/ln	1841	1841	1841	1841	1841	1841	1841	1841	1841	1841	1841	1841
Adj Flow Rate, veh/h	11	630	120	65	707	22	293	130	87	33	109	11
Peak Hour Factor	0.92	0.92	0.92	0.92	0.92	0.92	0.92	0.92	0.92	0.92	0.92	0.92
Percent Heavy Veh, %	4	4	4	4	4	4	4	4	4	4	4	4
Cap, veh/h	20	845	161	83	1122	35	298	261	174	51	185	19
Arrive On Green	0.01	0.29	0.29	0.05	0.32	0.32	0.17	0.25	0.25	0.03	0.11	0.11
Sat Flow, veh/h	1753	2932	557	1753	3460	108	1753	1029	688	1753	1645	166
Grp Volume(v), veh/h	11	375	375	65	357	372	293	0	217	33	0	120
Grp Sat Flow(s),veh/h/ln	1753	1749	1740	1753	1749	1819	1753	0	1717	1753	0	1811
Q Serve(g_s), s	0.3	9.8	9.9	1.9	8.8	8.8	8.4	0.0	5.5	0.9	0.0	3.2
Cycle Q Clear(g_c), s	0.3	9.8	9.9	1.9	8.8	8.8	8.4	0.0	5.5	0.9	0.0	3.2
Prop In Lane	1.00		0.32	1.00		0.06	1.00		0.40	1.00		0.09
Lane Grp Cap(c), veh/h	20	504	502	83	567	590	298	0	435	51	0	204
V/C Ratio(X)	0.55	0.74	0.75	0.78	0.63	0.63	0.98	0.00	0.50	0.64	0.00	0.59
Avail Cap(c_a), veh/h	139	695	692	139	695	723	298	0	1219	198	0	1181
HCM Platoon Ratio	1.00	1.00	1.00	1.00	1.00	1.00	1.00	1.00	1.00	1.00	1.00	1.00
Upstream Filter(I)	1.00	1.00	1.00	1.00	1.00	1.00	1.00	0.00	1.00	1.00	0.00	1.00
Uniform Delay (d), s/veh	24.9	16.3	16.3	23.8	14.5	14.5	20.9	0.0	16.1	24.3	0.0	21.3
Incr Delay (d2), s/veh	21.9	2.8	2.9	14.7	1.3	1.2	47.3	0.0	0.9	12.6	0.0	2.7
Initial Q Delay(d3),s/veh	0.0	0.0	0.0	0.0	0.0	0.0	0.0	0.0	0.0	0.0	0.0	0.0
%ile BackOfQ(50%),veh/ln	0.2	3.5	3.5	1.0	2.9	3.0	6.8	0.0	1.8	0.5	0.0	1.3
Unsig. Movement Delay, s/veh												
LnGrp Delay(d),s/veh	46.8	19.1	19.2	38.5	15.8	15.7	68.2	0.0	17.0	36.8	0.0	24.0
LnGrp LOS	D	B	B	D	B	B	E	A	B	D	A	C
Approach Vol, veh/h		761			794			510				153
Approach Delay, s/veh		19.6			17.6			46.4				26.8
Approach LOS		B			B			D				C
Timer - Assigned Phs	1	2	3	4	5	6	7	8				
Phs Duration (G+Y+Rc), s	6.6	20.6	12.8	10.6	4.8	22.4	5.7	17.7				
Change Period (Y+Rc), s	* 4.2	6.0	* 4.2	4.9	* 4.2	6.0	* 4.2	4.9				
Max Green Setting (Gmax), s	* 4	20.1	* 8.6	33.0	* 4	20.1	* 5.7	35.9				
Max Q Clear Time (g_c+I1), s	3.9	11.9	10.4	5.2	2.3	10.8	2.9	7.5				
Green Ext Time (p_c), s	0.0	2.7	0.0	0.5	0.0	2.8	0.0	1.2				

Intersection Summary

HCM 6th Ctrl Delay	25.6
HCM 6th LOS	C

Notes

* HCM 6th computational engine requires equal clearance times for the phases crossing the barrier.

Intersection												
Int Delay, s/veh	1.1											
Movement	EBL	EBT	EBR	WBL	WBT	WBR	NBL	NBT	NBR	SBL	SBT	SBR
Lane Configurations		↕		↕	↕			↕			↕	
Traffic Vol, veh/h	0	260	20	30	220	0	10	0	20	0	0	0
Future Vol, veh/h	0	260	20	30	220	0	10	0	20	0	0	0
Conflicting Peds, #/hr	0	0	0	0	0	0	1	0	0	0	0	1
Sign Control	Free	Free	Free	Free	Free	Free	Stop	Stop	Stop	Stop	Stop	Stop
RT Channelized	-	-	None	-	-	None	-	-	None	-	-	None
Storage Length	-	-	-	160	-	-	-	-	-	-	-	-
Veh in Median Storage, #	-	0	-	-	0	-	-	0	-	-	0	-
Grade, %	-	0	-	-	0	-	-	0	-	-	0	-
Peak Hour Factor	92	92	92	92	92	92	92	92	92	92	92	92
Heavy Vehicles, %	1	1	1	1	1	1	1	1	1	1	1	1
Mvmt Flow	0	283	22	33	239	0	11	0	22	0	0	0

























Major/Minor	Major1			Major2			Minor1			Minor2		
Conflicting Flow All	239	0	0	305	0	0	600	599	294	610	610	240
Stage 1	-	-	-	-	-	-	294	294	-	305	305	-
Stage 2	-	-	-	-	-	-	306	305	-	305	305	-
Critical Hdwy	4.11	-	-	4.11	-	-	7.11	6.51	6.21	7.11	6.51	6.21
Critical Hdwy Stg 1	-	-	-	-	-	-	6.11	5.51	-	6.11	5.51	-
Critical Hdwy Stg 2	-	-	-	-	-	-	6.11	5.51	-	6.11	5.51	-
Follow-up Hdwy	2.209	-	-	2.209	-	-	3.509	4.009	3.309	3.509	4.009	3.309
Pot Cap-1 Maneuver	1334	-	-	1262	-	-	414	417	748	408	411	801
Stage 1	-	-	-	-	-	-	716	671	-	707	664	-
Stage 2	-	-	-	-	-	-	706	664	-	707	664	-
Platoon blocked, %		-	-		-	-						
Mov Cap-1 Maneuver	1334	-	-	1262	-	-	405	406	748	388	400	800
Mov Cap-2 Maneuver	-	-	-	-	-	-	405	406	-	388	400	-
Stage 1	-	-	-	-	-	-	716	671	-	707	647	-
Stage 2	-	-	-	-	-	-	687	647	-	686	664	-

Approach	EB			WB			NB			SB		
HCM Control Delay, s	0			1			11.5			0		
HCM LOS							B			A		

Minor Lane/Major Mvmt	NBLn1	EBL	EBT	EBR	WBL	WBT	WBR	SBLn1
Capacity (veh/h)	583	1334	-	-	1262	-	-	-
HCM Lane V/C Ratio	0.056	-	-	-	0.026	-	-	-
HCM Control Delay (s)	11.5	0	-	-	7.9	-	-	0
HCM Lane LOS	B	A	-	-	A	-	-	A
HCM 95th %tile Q(veh)	0.2	0	-	-	0.1	-	-	-

Santa Maria Airport Business Park SP
2: Orcutt Expressway & Foster Road























Cumulative (10-year) PM
HCM Signalized Intersection Capacity Analysis

													
Movement	EBL	EBT	EBR	WBL	WBT	WBR	NBL	NBT	NBR	SBL	SBT	SBR	
Lane Configurations	 							 			 		
Traffic Volume (vph)	200	60	30	70	60	110	10	1150	60	140	1520	180	
Future Volume (vph)	200	60	30	70	60	110	10	1150	60	140	1520	180	
Ideal Flow (vphp)	1900	1900	1900	1900	1900	1900	1900	1900	1900	1900	1900	1900	
Total Lost time (s)	4.9	4.9		4.9	4.9	4.9	4.2	6.0		4.2	6.0	6.0	
Lane Util. Factor	0.97	1.00		1.00	1.00	1.00	1.00	0.95		1.00	0.95	1.00	
Frbp, ped/bikes	1.00	0.99		1.00	1.00	1.00	1.00	1.00		1.00	1.00	1.00	
Flpb, ped/bikes	1.00	1.00		1.00	1.00	1.00	1.00	1.00		1.00	1.00	1.00	
Frt	1.00	0.95		1.00	1.00	0.85	1.00	0.99		1.00	1.00	0.85	
Flt Protected	0.95	1.00		0.95	1.00	1.00	0.95	1.00		0.95	1.00	1.00	
Satd. Flow (prot)	3433	1760		1770	1863	1583	1770	3513		1770	3539	1583	
Flt Permitted	0.95	1.00		0.95	1.00	1.00	0.95	1.00		0.95	1.00	1.00	
Satd. Flow (perm)	3433	1760		1770	1863	1583	1770	3513		1770	3539	1583	
Peak-hour factor, PHF	0.96	0.96	0.96	0.96	0.96	0.96	0.96	0.96	0.96	0.96	0.96	0.96	
Adj. Flow (vph)	208	62	31	73	62	115	10	1198	62	146	1583	188	
RTOR Reduction (vph)	0	21	0	0	0	105	0	3	0	0	0	57	
Lane Group Flow (vph)	208	73	0	73	63	10	10	1258	0	146	1583	131	
Confl. Peds. (#/hr)			1										
Confl. Bikes (#/hr)			3										
Turn Type	Split	NA		Split	NA	Perm	Prot	NA		Prot	NA	Perm	
Protected Phases	4	4		8	8		5	2		1	6		
Permitted Phases						8						6	
Actuated Green, G (s)	12.9	12.9		8.1	8.1	8.1	1.0	38.7		9.1	46.8	46.8	
Effective Green, g (s)	12.9	12.9		8.1	8.1	8.1	1.0	38.7		9.1	46.8	46.8	
Actuated g/C Ratio	0.15	0.15		0.09	0.09	0.09	0.01	0.44		0.10	0.53	0.53	
Clearance Time (s)	4.9	4.9		4.9	4.9	4.9	4.2	6.0		4.2	6.0	6.0	
Vehicle Extension (s)	3.0	3.0		3.0	3.0	3.0	3.0	3.0		3.0	3.0	3.0	
Lane Grp Cap (vph)	498	255		161	169	144	19	1531		181	1865	834	
v/s Ratio Prot	c0.06	0.04		c0.04	0.03		0.01	0.36		c0.08	c0.45		
v/s Ratio Perm						0.01						0.08	
v/c Ratio	0.42	0.28		0.45	0.37	0.07	0.53	0.82		0.81	0.85	0.16	
Uniform Delay, d1	34.5	33.8		38.3	38.0	36.9	43.7	22.0		39.0	18.0	10.8	
Progression Factor	1.00	1.00		1.00	1.00	1.00	1.00	1.00		1.00	1.00	1.00	
Incremental Delay, d2	0.6	0.6		2.0	1.4	0.2	23.9	3.7		22.4	3.8	0.1	
Delay (s)	35.1	34.5		40.3	39.3	37.1	67.5	25.7		61.4	21.8	10.9	
Level of Service	D	C		D	D	D	E	C		E	C	B	
Approach Delay (s)		34.9			38.6			26.0			23.7		
Approach LOS		C			D			C			C		
Intersection Summary													
HCM 2000 Control Delay			26.4									HCM 2000 Level of Service	C
HCM 2000 Volume to Capacity ratio			0.75										
Actuated Cycle Length (s)			88.8									Sum of lost time (s)	20.0
Intersection Capacity Utilization			72.3%									ICU Level of Service	C
Analysis Period (min)			15										

c Critical Lane Group

Santa Maria Airport Business Park SP
2: Orcutt Expressway & Foster Road

Cumulative (10-year) PM
HCM 6th Signalized Intersection Summary

												
Movement	EBL	EBT	EBR	WBL	WBT	WBR	NBL	NBT	NBR	SBL	SBT	SBR
Lane Configurations												
Traffic Volume (veh/h)	200	60	30	70	60	110	10	1150	60	140	1520	180
Future Volume (veh/h)	200	60	30	70	60	110	10	1150	60	140	1520	180
Initial Q (Qb), veh	0	0	0	0	0	0	0	0	0	0	0	0
Ped-Bike Adj(A_pbT)	1.00		0.98	1.00		1.00	1.00		1.00	1.00		1.00
Parking Bus, Adj	1.00	1.00	1.00	1.00	1.00	1.00	1.00	1.00	1.00	1.00	1.00	1.00
Work Zone On Approach		No			No			No			No	
Adj Sat Flow, veh/h/ln	1870	1870	1870	1870	1870	1870	1870	1870	1870	1870	1870	1870
Adj Flow Rate, veh/h	208	62	31	73	62	56	10	1198	62	146	1583	188
Peak Hour Factor	0.96	0.96	0.96	0.96	0.96	0.96	0.96	0.96	0.96	0.96	0.96	0.96
Percent Heavy Veh, %	2	2	2	2	2	2	2	2	2	2	2	2
Cap, veh/h	383	129	65	189	199	168	27	1409	73	182	1766	788
Arrive On Green	0.11	0.11	0.11	0.11	0.11	0.11	0.02	0.41	0.41	0.10	0.50	0.50
Sat Flow, veh/h	3456	1167	584	1781	1870	1585	1781	3437	178	1781	3554	1585
Grp Volume(v), veh/h	208	0	93	73	62	56	10	619	641	146	1583	188
Grp Sat Flow(s),veh/h/ln	1728	0	1751	1781	1870	1585	1781	1777	1838	1781	1777	1585
Q Serve(g_s), s	4.2	0.0	3.7	2.8	2.3	2.4	0.4	23.3	23.3	5.9	29.8	5.0
Cycle Q Clear(g_c), s	4.2	0.0	3.7	2.8	2.3	2.4	0.4	23.3	23.3	5.9	29.8	5.0
Prop In Lane	1.00		0.33	1.00		1.00	1.00		0.10	1.00		1.00
Lane Grp Cap(c), veh/h	383	0	194	189	199	168	27	728	753	182	1766	788
V/C Ratio(X)	0.54	0.00	0.48	0.39	0.31	0.33	0.37	0.85	0.85	0.80	0.90	0.24
Avail Cap(c_a), veh/h	1310	0	664	193	203	172	145	842	871	217	1828	816
HCM Platoon Ratio	1.00	1.00	1.00	1.00	1.00	1.00	1.00	1.00	1.00	1.00	1.00	1.00
Upstream Filter(I)	1.00	0.00	1.00	1.00	1.00	1.00	1.00	1.00	1.00	1.00	1.00	1.00
Uniform Delay (d), s/veh	31.1	0.0	30.8	30.8	30.5	30.6	36.0	19.7	19.8	32.4	16.8	10.6
Incr Delay (d2), s/veh	1.2	0.0	1.8	1.3	0.9	1.1	8.4	7.4	7.2	16.4	6.1	0.2
Initial Q Delay(d3),s/veh	0.0	0.0	0.0	0.0	0.0	0.0	0.0	0.0	0.0	0.0	0.0	0.0
%ile BackOfQ(50%),veh/ln	1.7	0.0	1.6	1.2	1.0	0.9	0.2	9.2	9.5	3.1	10.5	1.4
Unsig. Movement Delay, s/veh												
LnGrp Delay(d),s/veh	32.3	0.0	32.7	32.0	31.4	31.7	44.4	27.1	27.0	48.8	23.0	10.8
LnGrp LOS	C	A	C	C	C	C	D	C	C	D	C	B
Approach Vol, veh/h		301			191			1270			1917	
Approach Delay, s/veh		32.4			31.7			27.2			23.8	
Approach LOS		C			C			C			C	
Timer - Assigned Phs	1	2		4	5	6		8				
Phs Duration (G+Y+Rc), s	11.8	36.3		13.1	5.3	42.7		12.7				
Change Period (Y+Rc), s	* 4.2	6.0		4.9	* 4.2	6.0		4.9				
Max Green Setting (Gmax), s	* 9	35.0		28.0	* 6	38.0		8.0				
Max Q Clear Time (g_c+I1), s	7.9	25.3		6.2	2.4	31.8		4.8				
Green Ext Time (p_c), s	0.0	4.9		1.1	0.0	4.7		0.2				

Intersection Summary

HCM 6th Ctrl Delay	26.1
HCM 6th LOS	C

Notes

* HCM 6th computational engine requires equal clearance times for the phases crossing the barrier.

Santa Maria Airport Business Park SP
 3: Foxenwood Lane & Union Valley Parkway

Cumulative (10-year) PM
 HCM 6th TWSC

Intersection												
Int Delay, s/veh	5.3											
Movement	EBL	EBT	EBR	WBL	WBT	WBR	NBL	NBT	NBR	SBL	SBT	SBR
Lane Configurations	↖	↕		↖	↕			↕			↕	
Traffic Vol, veh/h	10	260	10	190	330	10	10	10	120	30	10	20
Future Vol, veh/h	10	260	10	190	330	10	10	10	120	30	10	20
Conflicting Peds, #/hr	1	0	0	0	0	1	0	0	1	1	0	0
Sign Control	Free	Free	Free	Free	Free	Free	Stop	Stop	Stop	Stop	Stop	Stop
RT Channelized	-	-	None	-	-	None	-	-	None	-	-	None
Storage Length	195	-	-	155	-	-	-	-	-	-	-	-
Veh in Median Storage, #	-	0	-	-	0	-	-	0	-	-	0	-
Grade, %	-	0	-	-	0	-	-	0	-	-	0	-
Peak Hour Factor	92	92	92	92	92	92	92	92	92	92	92	92
Heavy Vehicles, %	1	1	1	1	1	1	1	1	1	1	1	1
Mvmt Flow	11	283	11	207	359	11	11	11	130	33	11	22































Major/Minor	Major1			Major2			Minor1			Minor2		
Conflicting Flow All	371	0	0	294	0	0	910	1096	148	950	1096	186
Stage 1	-	-	-	-	-	-	311	311	-	780	780	-
Stage 2	-	-	-	-	-	-	599	785	-	170	316	-
Critical Hdwy	4.12	-	-	4.12	-	-	7.52	6.52	6.92	7.52	6.52	6.92
Critical Hdwy Stg 1	-	-	-	-	-	-	6.52	5.52	-	6.52	5.52	-
Critical Hdwy Stg 2	-	-	-	-	-	-	6.52	5.52	-	6.52	5.52	-
Follow-up Hdwy	2.21	-	-	2.21	-	-	3.51	4.01	3.31	3.51	4.01	3.31
Pot Cap-1 Maneuver	1191	-	-	1272	-	-	231	214	875	216	214	828
Stage 1	-	-	-	-	-	-	677	659	-	357	406	-
Stage 2	-	-	-	-	-	-	458	404	-	818	656	-
Platoon blocked, %	-	-	-	-	-	-	-	-	-	-	-	-
Mov Cap-1 Maneuver	1190	-	-	1272	-	-	187	177	874	152	177	827
Mov Cap-2 Maneuver	-	-	-	-	-	-	187	177	-	152	177	-
Stage 1	-	-	-	-	-	-	671	653	-	353	339	-
Stage 2	-	-	-	-	-	-	361	338	-	677	650	-

Approach	EB			WB			NB			SB		
HCM Control Delay, s	0.3			3			13.7			28.7		
HCM LOS							B			D		

Minor Lane/Major Mvmt	NBLn1	EBL	EBT	EBR	WBL	WBT	WBR	SBLn1
Capacity (veh/h)	566	1190	-	-	1272	-	-	216
HCM Lane V/C Ratio	0.269	0.009	-	-	0.162	-	-	0.302
HCM Control Delay (s)	13.7	8.1	-	-	8.4	-	-	28.7
HCM Lane LOS	B	A	-	-	A	-	-	D
HCM 95th %tile Q(veh)	1.1	0	-	-	0.6	-	-	1.2

Santa Maria Airport Business Park SP
4: Orcutt Expressway & Union Valley Parkway































Cumulative (10-year) PM
HCM Signalized Intersection Capacity Analysis

												
Movement	EBL	EBT	EBR	WBL	WBT	WBR	NBL	NBT	NBR	SBL	SBT	SBR
Lane Configurations	 	 		 	 			 		 	 	
Traffic Volume (vph)	170	230	10	280	260	110	10	960	430	320	1110	260
Future Volume (vph)	170	230	10	280	260	110	10	960	430	320	1110	260
Ideal Flow (vphpl)	1900	1900	1900	1900	1900	1900	1900	1900	1900	1900	1900	1900
Total Lost time (s)	5.4	4.9	4.9	4.9	4.9	4.9	4.5	6.0	6.0	5.0	6.0	6.0
Lane Util. Factor	0.97	0.95	1.00	0.97	0.95	1.00	1.00	0.95	1.00	0.97	0.95	1.00
Frt	1.00	1.00	0.85	1.00	1.00	0.85	1.00	1.00	0.85	1.00	1.00	0.85
Flt Protected	0.95	1.00	1.00	0.95	1.00	1.00	0.95	1.00	1.00	0.95	1.00	1.00
Satd. Flow (prot)	3433	3539	1583	3433	3539	1583	1770	3539	1583	3433	3539	1583
Flt Permitted	0.95	1.00	1.00	0.95	1.00	1.00	0.95	1.00	1.00	0.95	1.00	1.00
Satd. Flow (perm)	3433	3539	1583	3433	3539	1583	1770	3539	1583	3433	3539	1583
Peak-hour factor, PHF	0.99	0.99	0.99	0.99	0.99	0.99	0.99	0.99	0.99	0.99	0.99	0.99
Adj. Flow (vph)	172	232	10	283	263	111	10	970	434	323	1121	263
RTOR Reduction (vph)	0	0	8	0	0	96	0	0	257	0	0	133
Lane Group Flow (vph)	172	232	2	283	263	15	10	970	177	323	1121	130
Turn Type	Prot	NA	Perm	Prot	NA	Perm	Prot	NA	Perm	Prot	NA	Perm
Protected Phases	7	4		3	8		5	2		1	6	
Permitted Phases			4			8			2			6
Actuated Green, G (s)	9.3	13.6	13.6	8.1	11.9	11.9	1.4	34.9	34.9	8.1	42.1	42.1
Effective Green, g (s)	9.3	13.6	13.6	8.1	11.9	11.9	1.4	34.9	34.9	8.1	42.1	42.1
Actuated g/C Ratio	0.11	0.16	0.16	0.09	0.14	0.14	0.02	0.41	0.41	0.09	0.49	0.49
Clearance Time (s)	5.4	4.9	4.9	4.9	4.9	4.9	4.5	6.0	6.0	5.0	6.0	6.0
Vehicle Extension (s)	3.0	3.0	3.0	3.0	3.0	3.0	3.0	3.0	3.0	3.0	3.0	3.0
Lane Grp Cap (vph)	373	562	251	325	492	220	28	1444	646	325	1742	779
v/s Ratio Prot	0.05	0.07		c0.08	c0.07		0.01	0.27		c0.09	c0.32	
v/s Ratio Perm			0.00			0.01			0.11			0.08
v/c Ratio	0.46	0.41	0.01	0.87	0.53	0.07	0.36	0.67	0.27	0.99	0.64	0.17
Uniform Delay, d1	35.7	32.4	30.3	38.2	34.2	32.0	41.6	20.6	16.9	38.7	16.1	12.0
Progression Factor	1.00	1.00	1.00	1.00	1.00	1.00	1.00	1.00	1.00	1.00	1.00	1.00
Incremental Delay, d2	0.9	0.5	0.0	21.6	1.1	0.1	7.7	1.2	0.2	48.0	0.8	0.1
Delay (s)	36.7	32.9	30.3	59.7	35.3	32.1	49.3	21.9	17.1	86.7	16.9	12.1
Level of Service	D	C	C	E	D	C	D	C	B	F	B	B
Approach Delay (s)		34.4			45.3			20.6			29.4	
Approach LOS		C			D			C			C	
Intersection Summary												
HCM 2000 Control Delay			29.4	HCM 2000 Level of Service				C				
HCM 2000 Volume to Capacity ratio			0.71									
Actuated Cycle Length (s)			85.5	Sum of lost time (s)				21.3				
Intersection Capacity Utilization			68.9%	ICU Level of Service				C				
Analysis Period (min)			15									

c Critical Lane Group























Santa Maria Airport Business Park SP
 4: Orcutt Expressway & Union Valley Parkway

Cumulative (10-year) PM
 HCM 6th Signalized Intersection Summary

												
Movement	EBL	EBT	EBR	WBL	WBT	WBR	NBL	NBT	NBR	SBL	SBT	SBR
Lane Configurations	 	 		 	 			 		 	 	
Traffic Volume (veh/h)	170	230	10	280	260	110	10	960	430	320	1110	260
Future Volume (veh/h)	170	230	10	280	260	110	10	960	430	320	1110	260
Initial Q (Qb), veh	0	0	0	0	0	0	0	0	0	0	0	0
Ped-Bike Adj(A_pbT)	1.00		1.00	1.00		1.00	1.00		1.00	1.00		1.00
Parking Bus, Adj	1.00	1.00	1.00	1.00	1.00	1.00	1.00	1.00	1.00	1.00	1.00	1.00
Work Zone On Approach		No			No			No			No	
Adj Sat Flow, veh/h/ln	1870	1870	1870	1870	1870	1870	1870	1870	1870	1870	1870	1870
Adj Flow Rate, veh/h	172	232	10	283	263	111	10	970	434	323	1121	263
Peak Hour Factor	0.99	0.99	0.99	0.99	0.99	0.99	0.99	0.99	0.99	0.99	0.99	0.99
Percent Heavy Veh, %	2	2	2	2	2	2	2	2	2	2	2	2
Cap, veh/h	368	455	203	378	441	197	36	1306	582	379	1649	735
Arrive On Green	0.11	0.13	0.13	0.11	0.12	0.12	0.02	0.37	0.37	0.11	0.46	0.46
Sat Flow, veh/h	3456	3554	1585	3456	3554	1585	1781	3554	1585	3456	3554	1585
Grp Volume(v), veh/h	172	232	10	283	263	111	10	970	434	323	1121	263
Grp Sat Flow(s),veh/h/ln	1728	1777	1585	1728	1777	1585	1781	1777	1585	1728	1777	1585
Q Serve(g_s), s	3.4	4.4	0.4	5.8	5.1	4.8	0.4	17.3	17.4	6.7	18.0	7.8
Cycle Q Clear(g_c), s	3.4	4.4	0.4	5.8	5.1	4.8	0.4	17.3	17.4	6.7	18.0	7.8
Prop In Lane	1.00		1.00	1.00		1.00	1.00		1.00	1.00		1.00
Lane Grp Cap(c), veh/h	368	455	203	378	441	197	36	1306	582	379	1649	735
V/C Ratio(X)	0.47	0.51	0.05	0.75	0.60	0.56	0.28	0.74	0.75	0.85	0.68	0.36
Avail Cap(c_a), veh/h	465	2194	979	379	2082	929	196	1863	831	379	1887	842
HCM Platoon Ratio	1.00	1.00	1.00	1.00	1.00	1.00	1.00	1.00	1.00	1.00	1.00	1.00
Upstream Filter(I)	1.00	1.00	1.00	1.00	1.00	1.00	1.00	1.00	1.00	1.00	1.00	1.00
Uniform Delay (d), s/veh	30.6	29.6	27.9	31.5	30.2	30.1	35.2	20.1	20.1	31.9	15.3	12.6
Incr Delay (d2), s/veh	0.9	0.9	0.1	8.0	1.3	2.5	4.1	1.0	2.2	16.7	0.8	0.3
Initial Q Delay(d3),s/veh	0.0	0.0	0.0	0.0	0.0	0.0	0.0	0.0	0.0	0.0	0.0	0.0
%ile BackOfQ(50%),veh/ln	1.4	1.8	0.1	2.7	2.1	1.8	0.2	6.0	5.9	3.4	5.8	2.4
Unsig. Movement Delay, s/veh												
LnGrp Delay(d),s/veh	31.5	30.5	28.0	39.4	31.5	32.6	39.3	21.0	22.3	48.6	16.1	12.8
LnGrp LOS	C	C	C	D	C	C	D	C	C	D	B	B
Approach Vol, veh/h		414			657			1414			1707	
Approach Delay, s/veh		30.9			35.1			21.6			21.8	
Approach LOS		C			D			C			C	
Timer - Assigned Phs	1	2	3	4	5	6	7	8				
Phs Duration (G+Y+Rc), s	13.0	32.8	12.9	14.2	6.0	39.8	13.2	13.9				
Change Period (Y+Rc), s	5.0	6.0	4.9	4.9	4.5	6.0	5.4	4.9				
Max Green Setting (Gmax), s	8.0	38.2	8.0	45.0	8.0	38.7	9.8	42.7				
Max Q Clear Time (g_c+I1), s	8.7	19.4	7.8	6.4	2.4	20.0	5.4	7.1				
Green Ext Time (p_c), s	0.0	7.4	0.0	1.4	0.0	7.8	0.2	1.9				
Intersection Summary												
HCM 6th Ctrl Delay				24.7								
HCM 6th LOS				C								

Santa Maria Airport Business Park SP
5: Orcutt Road & Union Valley Parkway

Cumulative (10-year) PM
HCM Signalized Intersection Capacity Analysis

													
Movement	EBL	EBT	EBR	WBL	WBT	WBR	NBL	NBT	NBR	SBL	SBT	SBR	
Lane Configurations		 			 								
Traffic Volume (vph)	0	890	110	30	580	20	70	120	60	30	190	10	
Future Volume (vph)	0	890	110	30	580	20	70	120	60	30	190	10	
Ideal Flow (vphp)	1900	1900	1900	1900	1900	1900	1900	1900	1900	1900	1900	1900	
Total Lost time (s)		6.0		4.2	6.0		4.2	4.9		4.2	4.9		
Lane Util. Factor		0.95		1.00	0.95		1.00	1.00		1.00	1.00		
Frbp, ped/bikes		1.00		1.00	1.00		1.00	1.00		1.00	1.00		
Flpb, ped/bikes		1.00		1.00	1.00		1.00	1.00		1.00	1.00		
Frt		0.98		1.00	0.99		1.00	0.95		1.00	0.99		
Flt Protected		1.00		0.95	1.00		0.95	1.00		0.95	1.00		
Satd. Flow (prot)		3473		1770	3521		1770	1762		1770	1849		
Flt Permitted		1.00		0.95	1.00		0.95	1.00		0.95	1.00		
Satd. Flow (perm)		3473		1770	3521		1770	1762		1770	1849		
Peak-hour factor, PHF	0.97	0.97	0.97	0.97	0.97	0.97	0.97	0.97	0.97	0.97	0.97	0.97	
Adj. Flow (vph)	0	918	113	31	598	21	72	124	62	31	196	10	
RTOR Reduction (vph)	0	9	0	0	2	0	0	25	0	0	3	0	
Lane Group Flow (vph)	0	1022	0	31	617	0	72	161	0	31	203	0	
Confl. Peds. (#/hr)			1						1				
Turn Type	Prot	NA		Prot	NA		Prot	NA		Prot	NA		
Protected Phases	5	2		1	6		3	8		7	4		
Permitted Phases													
Actuated Green, G (s)		25.4		1.3	30.9		3.7	18.2		1.3	15.8		
Effective Green, g (s)		25.4		1.3	30.9		3.7	18.2		1.3	15.8		
Actuated g/C Ratio		0.39		0.02	0.47		0.06	0.28		0.02	0.24		
Clearance Time (s)		6.0		4.2	6.0		4.2	4.9		4.2	4.9		
Vehicle Extension (s)		3.0		3.0	3.0		3.0	3.0		3.0	3.0		
Lane Grp Cap (vph)		1346		35	1661		99	489		35	446		
v/s Ratio Prot		c0.29		c0.02	0.18		c0.04	0.09		0.02	c0.11		
v/s Ratio Perm													
v/c Ratio		0.76		0.89	0.37		0.73	0.33		0.89	0.46		
Uniform Delay, d1		17.4		32.0	11.1		30.4	18.8		32.0	21.2		
Progression Factor		1.00		1.00	1.00		1.00	1.00		1.00	1.00		
Incremental Delay, d2		2.5		105.5	0.1		23.2	0.4		105.5	0.7		
Delay (s)		19.9		137.6	11.2		53.6	19.2		137.6	21.9		
Level of Service		B		F	B		D	B		F	C		
Approach Delay (s)		19.9			17.2			28.8			37.0		
Approach LOS		B			B			C			D		
Intersection Summary													
HCM 2000 Control Delay			22.0									HCM 2000 Level of Service	C
HCM 2000 Volume to Capacity ratio			0.64										
Actuated Cycle Length (s)			65.5									Sum of lost time (s)	19.3
Intersection Capacity Utilization			55.2%									ICU Level of Service	B
Analysis Period (min)			15										
c	Critical Lane Group												

Santa Maria Airport Business Park SP
5: Orcutt Road & Union Valley Parkway

Cumulative (10-year) PM
HCM 6th Signalized Intersection Summary



Movement	EBL	EBT	EBR	WBL	WBT	WBR	NBL	NBT	NBR	SBL	SBT	SBR
Lane Configurations	↖	↕		↖	↕		↖	↕		↖	↕	
Traffic Volume (veh/h)	0	890	110	30	580	20	70	120	60	30	190	10
Future Volume (veh/h)	0	890	110	30	580	20	70	120	60	30	190	10
Initial Q (Qb), veh	0	0	0	0	0	0	0	0	0	0	0	0
Ped-Bike Adj(A_pbT)	1.00		1.00	1.00		1.00	1.00		1.00	1.00		1.00
Parking Bus, Adj	1.00	1.00	1.00	1.00	1.00	1.00	1.00	1.00	1.00	1.00	1.00	1.00
Work Zone On Approach		No			No			No			No	
Adj Sat Flow, veh/h/ln	1870	1870	1870	1870	1870	1870	1870	1870	1870	1870	1870	1870
Adj Flow Rate, veh/h	0	918	113	31	598	21	72	124	62	31	196	10
Peak Hour Factor	0.97	0.97	0.97	0.97	0.97	0.97	0.97	0.97	0.97	0.97	0.97	0.97
Percent Heavy Veh, %	2	2	2	2	2	2	2	2	2	2	2	2
Cap, veh/h	4	1189	146	50	1696	60	90	223	111	50	294	15
Arrive On Green	0.00	0.37	0.37	0.03	0.48	0.48	0.05	0.19	0.19	0.03	0.17	0.17
Sat Flow, veh/h	1781	3184	392	1781	3502	123	1781	1176	588	1781	1764	90
Grp Volume(v), veh/h	0	512	519	31	303	316	72	0	186	31	0	206
Grp Sat Flow(s),veh/h/ln	1781	1777	1799	1781	1777	1848	1781	0	1763	1781	0	1854
Q Serve(g_s), s	0.0	12.8	12.9	0.9	5.4	5.4	2.0	0.0	4.8	0.9	0.0	5.3
Cycle Q Clear(g_c), s	0.0	12.8	12.9	0.9	5.4	5.4	2.0	0.0	4.8	0.9	0.0	5.3
Prop In Lane	1.00		0.22	1.00		0.07	1.00		0.33	1.00		0.05
Lane Grp Cap(c), veh/h	4	663	672	50	860	895	90	0	334	50	0	309
V/C Ratio(X)	0.00	0.77	0.77	0.62	0.35	0.35	0.80	0.00	0.56	0.62	0.00	0.67
Avail Cap(c_a), veh/h	141	839	850	141	860	895	169	0	1174	144	0	1209
HCM Platoon Ratio	1.00	1.00	1.00	1.00	1.00	1.00	1.00	1.00	1.00	1.00	1.00	1.00
Upstream Filter(I)	0.00	1.00	1.00	1.00	1.00	1.00	1.00	0.00	1.00	1.00	0.00	1.00
Uniform Delay (d), s/veh	0.0	14.0	14.0	24.3	8.1	8.1	23.8	0.0	18.6	24.3	0.0	19.8
Incr Delay (d2), s/veh	0.0	3.5	3.4	12.1	0.2	0.2	14.6	0.0	1.4	12.1	0.0	2.5
Initial Q Delay(d3),s/veh	0.0	0.0	0.0	0.0	0.0	0.0	0.0	0.0	0.0	0.0	0.0	0.0
%ile BackOfQ(50%),veh/ln	0.0	4.4	4.5	0.5	1.4	1.5	1.1	0.0	1.8	0.5	0.0	2.1
Unsig. Movement Delay, s/veh												
LnGrp Delay(d),s/veh	0.0	17.4	17.4	36.4	8.4	8.4	38.3	0.0	20.0	36.4	0.0	22.2
LnGrp LOS	A	B	B	D	A	A	D	A	C	D	A	C
Approach Vol, veh/h		1031			650			258			237	
Approach Delay, s/veh		17.4			9.7			25.1			24.1	
Approach LOS		B			A			C			C	
Timer - Assigned Phs	1	2	3	4	5	6	7	8				
Phs Duration (G+Y+Rc), s	5.6	24.9	6.8	13.3	0.0	30.5	5.6	14.5				
Change Period (Y+Rc), s	* 4.2	6.0	* 4.2	4.9	* 4.2	6.0	* 4.2	4.9				
Max Green Setting (Gmax), s	* 4	23.9	* 4.8	33.0	* 4	23.9	* 4.1	33.7				
Max Q Clear Time (g_c+I1), s	2.9	14.9	4.0	7.3	0.0	7.4	2.9	6.8				
Green Ext Time (p_c), s	0.0	4.0	0.0	1.0	0.0	3.1	0.0	0.9				

Intersection Summary

HCM 6th Ctrl Delay	16.8
HCM 6th LOS	B

Notes

* HCM 6th computational engine requires equal clearance times for the phases crossing the barrier.

Cumulative Plus Project

Intersection												
Int Delay, s/veh	8.2											
Movement	EBL	EBT	EBR	WBL	WBT	WBR	NBL	NBT	NBR	SBL	SBT	SBR
Lane Configurations		↕		↕	↕			↕			↕	
Traffic Vol, veh/h	0	244	27	260	190	0	56	0	171	0	0	0
Future Vol, veh/h	0	244	27	260	190	0	56	0	171	0	0	0
Conflicting Peds, #/hr	0	0	0	0	0	0	0	0	0	0	0	0
Sign Control	Free	Free	Free	Free	Free	Free	Stop	Stop	Stop	Stop	Stop	Stop
RT Channelized	-	-	None	-	-	None	-	-	None	-	-	None
Storage Length	-	-	-	160	-	-	-	-	-	-	-	-
Veh in Median Storage, #	-	0	-	-	0	-	-	0	-	-	0	-
Grade, %	-	0	-	-	0	-	-	0	-	-	0	-
Peak Hour Factor	95	95	95	95	95	95	95	95	95	95	95	95
Heavy Vehicles, %	4	4	4	4	4	4	4	4	4	4	4	4
Mvmt Flow	0	257	28	274	200	0	59	0	180	0	0	0

























Major/Minor	Major1			Major2			Minor1			Minor2		
Conflicting Flow All	200	0	0	285	0	0	1019	1019	271	1109	1033	200
Stage 1	-	-	-	-	-	-	271	271	-	748	748	-
Stage 2	-	-	-	-	-	-	748	748	-	361	285	-
Critical Hdwy	4.14	-	-	4.14	-	-	7.14	6.54	6.24	7.14	6.54	6.24
Critical Hdwy Stg 1	-	-	-	-	-	-	6.14	5.54	-	6.14	5.54	-
Critical Hdwy Stg 2	-	-	-	-	-	-	6.14	5.54	-	6.14	5.54	-
Follow-up Hdwy	2.236	-	-	2.236	-	-	3.536	4.036	3.336	3.536	4.036	3.336
Pot Cap-1 Maneuver	1360	-	-	1266	-	-	214	235	763	185	231	836
Stage 1	-	-	-	-	-	-	730	682	-	401	417	-
Stage 2	-	-	-	-	-	-	401	417	-	653	672	-
Platoon blocked, %	-	-	-	-	-	-	-	-	-	-	-	-
Mov Cap-1 Maneuver	1360	-	-	1266	-	-	178	184	763	118	181	836
Mov Cap-2 Maneuver	-	-	-	-	-	-	178	184	-	118	181	-
Stage 1	-	-	-	-	-	-	730	682	-	401	327	-
Stage 2	-	-	-	-	-	-	314	327	-	499	672	-

Approach	EB	WB	NB	SB
HCM Control Delay, s	0	5	24.2	0
HCM LOS			C	A

Minor Lane/Major Mvmt	NBLn1	EBL	EBT	EBR	WBL	WBT	WBR	SBLn1
Capacity (veh/h)	421	1360	-	-	1266	-	-	-
HCM Lane V/C Ratio	0.568	-	-	-	0.216	-	-	-
HCM Control Delay (s)	24.2	0	-	-	8.6	-	-	0
HCM Lane LOS	C	A	-	-	A	-	-	A
HCM 95th %tile Q(veh)	3.4	0	-	-	0.8	-	-	-

Santa Maria Airport Business Park SP
2: Orcutt Expressway & Foster Road























Cumulative (10-year) Plus Project AM
HCM Signalized Intersection Capacity Analysis

													
Movement	EBL	EBT	EBR	WBL	WBT	WBR	NBL	NBT	NBR	SBL	SBT	SBR	
Lane Configurations	 							 			 		
Traffic Volume (vph)	325	124	47	120	125	260	48	1259	100	190	696	277	
Future Volume (vph)	325	124	47	120	125	260	48	1259	100	190	696	277	
Ideal Flow (vphp)	1900	1900	1900	1900	1900	1900	1900	1900	1900	1900	1900	1900	
Total Lost time (s)	4.9	4.9		4.9	4.9	4.9	4.2	6.0		4.2	6.0	6.0	
Lane Util. Factor	0.97	1.00		1.00	1.00	1.00	1.00	0.95		1.00	0.95	1.00	
Frbp, ped/bikes	1.00	1.00		1.00	1.00	1.00	1.00	1.00		1.00	1.00	0.98	
Flpb, ped/bikes	1.00	1.00		1.00	1.00	1.00	1.00	1.00		1.00	1.00	1.00	
Frt	1.00	0.96		1.00	1.00	0.85	1.00	0.99		1.00	1.00	0.85	
Flt Protected	0.95	1.00		0.95	1.00	1.00	0.95	1.00		0.95	1.00	1.00	
Satd. Flow (prot)	3400	1769		1752	1845	1568	1752	3461		1752	3505	1535	
Flt Permitted	0.95	1.00		0.95	1.00	1.00	0.95	1.00		0.95	1.00	1.00	
Satd. Flow (perm)	3400	1769		1752	1845	1568	1752	3461		1752	3505	1535	
Peak-hour factor, PHF	0.92	0.92	0.92	0.92	0.92	0.92	0.92	0.92	0.92	0.92	0.92	0.92	
Adj. Flow (vph)	353	135	51	130	136	283	52	1368	109	207	757	301	
RTOR Reduction (vph)	0	14	0	0	0	138	0	5	0	0	0	153	
Lane Group Flow (vph)	353	172	0	130	136	145	52	1472	0	207	757	148	
Confl. Bikes (#/hr)									1			1	
Heavy Vehicles (%)	3%	3%	3%	3%	3%	3%	3%	3%	3%	3%	3%	3%	
Turn Type	Split	NA		Split	NA	Perm	Prot	NA		Prot	NA	Perm	
Protected Phases	4	4		8	8		5	2		1	6		
Permitted Phases						8						6	
Actuated Green, G (s)	16.2	16.2		9.5	9.5	9.5	4.7	45.2		8.2	48.7	48.7	
Effective Green, g (s)	16.2	16.2		9.5	9.5	9.5	4.7	45.2		8.2	48.7	48.7	
Actuated g/C Ratio	0.16	0.16		0.10	0.10	0.10	0.05	0.46		0.08	0.49	0.49	
Clearance Time (s)	4.9	4.9		4.9	4.9	4.9	4.2	6.0		4.2	6.0	6.0	
Vehicle Extension (s)	3.0	3.0		3.0	3.0	3.0	3.0	3.0		3.0	3.0	3.0	
Lane Grp Cap (vph)	555	289		167	176	150	83	1578		144	1722	754	
v/s Ratio Prot	c0.10	0.10		0.07	0.07		0.03	c0.43		c0.12	c0.22		
v/s Ratio Perm						c0.09						0.10	
v/c Ratio	0.64	0.59		0.78	0.77	0.96	0.63	0.93		1.44	0.44	0.20	
Uniform Delay, d1	38.7	38.4		43.8	43.7	44.6	46.3	25.5		45.4	16.3	14.2	
Progression Factor	1.00	1.00		1.00	1.00	1.00	1.00	1.00		1.00	1.00	1.00	
Incremental Delay, d2	2.4	3.3		20.1	18.7	62.3	13.8	10.5		231.8	0.2	0.1	
Delay (s)	41.1	41.7		63.9	62.5	106.9	60.2	36.0		277.2	16.5	14.3	
Level of Service	D	D		E	E	F	E	D		F	B	B	
Approach Delay (s)		41.3			85.7			36.8			58.7		
Approach LOS		D			F			D			E		
Intersection Summary													
HCM 2000 Control Delay			51.5									HCM 2000 Level of Service	D
HCM 2000 Volume to Capacity ratio			0.90										
Actuated Cycle Length (s)			99.1									Sum of lost time (s)	20.0
Intersection Capacity Utilization			81.2%									ICU Level of Service	D
Analysis Period (min)			15										

c Critical Lane Group

Santa Maria Airport Business Park SP
2: Orcutt Expressway & Foster Road

Cumulative (10-year) Plus Project AM
HCM 6th Signalized Intersection Summary

												
Movement	EBL	EBT	EBR	WBL	WBT	WBR	NBL	NBT	NBR	SBL	SBT	SBR
Lane Configurations												
Traffic Volume (veh/h)	325	124	47	120	125	260	48	1259	100	190	696	277
Future Volume (veh/h)	325	124	47	120	125	260	48	1259	100	190	696	277
Initial Q (Qb), veh	0	0	0	0	0	0	0	0	0	0	0	0
Ped-Bike Adj(A_pbT)	1.00		1.00	1.00		1.00	1.00		0.98	1.00		0.98
Parking Bus, Adj	1.00	1.00	1.00	1.00	1.00	1.00	1.00	1.00	1.00	1.00	1.00	1.00
Work Zone On Approach		No			No			No			No	
Adj Sat Flow, veh/h/ln	1856	1856	1856	1856	1856	1856	1856	1856	1856	1856	1856	1856
Adj Flow Rate, veh/h	353	135	51	130	136	140	52	1368	109	207	757	301
Peak Hour Factor	0.92	0.92	0.92	0.92	0.92	0.92	0.92	0.92	0.92	0.92	0.92	0.92
Percent Heavy Veh, %	3	3	3	3	3	3	3	3	3	3	3	3
Cap, veh/h	494	185	70	179	188	160	84	1496	119	155	1738	759
Arrive On Green	0.14	0.14	0.14	0.10	0.10	0.10	0.05	0.45	0.45	0.09	0.49	0.49
Sat Flow, veh/h	3428	1283	485	1767	1856	1572	1767	3303	262	1767	3526	1540
Grp Volume(v), veh/h	353	0	186	130	136	140	52	728	749	207	757	301
Grp Sat Flow(s),veh/h/ln	1714	0	1768	1767	1856	1572	1767	1763	1802	1767	1763	1540
Q Serve(g_s), s	9.2	0.0	9.4	6.7	6.6	8.2	2.7	36.0	36.4	8.2	13.0	11.5
Cycle Q Clear(g_c), s	9.2	0.0	9.4	6.7	6.6	8.2	2.7	36.0	36.4	8.2	13.0	11.5
Prop In Lane	1.00		0.27	1.00		1.00	1.00		0.15	1.00		1.00
Lane Grp Cap(c), veh/h	494	0	255	179	188	160	84	798	816	155	1738	759
V/C Ratio(X)	0.71	0.00	0.73	0.72	0.72	0.88	0.62	0.91	0.92	1.34	0.44	0.40
Avail Cap(c_a), veh/h	1026	0	529	179	188	160	113	835	853	155	1752	765
HCM Platoon Ratio	1.00	1.00	1.00	1.00	1.00	1.00	1.00	1.00	1.00	1.00	1.00	1.00
Upstream Filter(I)	1.00	0.00	1.00	1.00	1.00	1.00	1.00	1.00	1.00	1.00	1.00	1.00
Uniform Delay (d), s/veh	38.2	0.0	38.3	40.8	40.7	41.5	43.7	23.8	24.0	42.7	15.3	14.9
Incr Delay (d2), s/veh	1.9	0.0	4.0	13.5	12.7	38.3	7.2	13.7	14.4	188.5	0.2	0.3
Initial Q Delay(d3),s/veh	0.0	0.0	0.0	0.0	0.0	0.0	0.0	0.0	0.0	0.0	0.0	0.0
%ile BackOfQ(50%),veh/ln	3.8	0.0	4.2	3.5	3.6	4.8	1.3	15.7	16.4	11.5	4.5	3.5
Unsig. Movement Delay, s/veh												
LnGrp Delay(d),s/veh	40.1	0.0	42.3	54.3	53.4	79.7	50.9	37.6	38.4	231.2	15.5	15.3
LnGrp LOS	D	A	D	D	D	E	D	D	D	F	B	B
Approach Vol, veh/h		539			406			1529			1265	
Approach Delay, s/veh		40.9			62.8			38.4			50.7	
Approach LOS		D			E			D			D	
Timer - Assigned Phs	1	2		4	5	6		8				
Phs Duration (G+Y+Rc), s	12.4	48.4		18.4	8.6	52.1		14.4				
Change Period (Y+Rc), s	* 4.2	6.0		4.9	* 4.2	6.0		4.9				
Max Green Setting (Gmax), s	* 8.2	44.3		28.0	* 6	46.5		9.5				
Max Q Clear Time (g_c+I1), s	10.2	38.4		11.4	4.7	15.0		10.2				
Green Ext Time (p_c), s	0.0	3.9		2.1	0.0	6.1		0.0				
Intersection Summary												
HCM 6th Ctrl Delay				45.6								
HCM 6th LOS				D								
Notes												
* HCM 6th computational engine requires equal clearance times for the phases crossing the barrier.												

Intersection												
Int Delay, s/veh	46.9											
Movement	EBL	EBT	EBR	WBL	WBT	WBR	NBL	NBT	NBR	SBL	SBT	SBR
Lane Configurations	↖	↕		↖	↕			↕			↕	↕
Traffic Vol, veh/h	65	330	10	80	210	148	10	57	190	132	44	34
Future Vol, veh/h	65	330	10	80	210	148	10	57	190	132	44	34
Conflicting Peds, #/hr	0	0	1	1	0	0	0	0	0	0	0	0
Sign Control	Free	Free	Free	Free	Free	Free	Stop	Stop	Stop	Stop	Stop	Stop
RT Channelized	-	-	None	-	-	None	-	-	None	-	-	None
Storage Length	195	-	-	155	-	-	-	-	-	-	-	-
Veh in Median Storage, #	-	0	-	-	0	-	-	0	-	-	0	-
Grade, %	-	0	-	-	0	-	-	0	-	-	0	-
Peak Hour Factor	92	92	92	92	92	92	92	92	92	92	92	92
Heavy Vehicles, %	3	3	3	3	3	3	3	3	3	3	3	3
Mvmt Flow	71	359	11	87	228	161	11	62	207	143	48	37

Major/Minor	Major1			Major2			Minor1			Minor2		
Conflicting Flow All	389	0	0	371	0	0	820	1071	186	836	996	195
Stage 1	-	-	-	-	-	-	508	508	-	483	483	-
Stage 2	-	-	-	-	-	-	312	563	-	353	513	-
Critical Hdwy	4.16	-	-	4.16	-	-	7.56	6.56	6.96	7.56	6.56	6.96
Critical Hdwy Stg 1	-	-	-	-	-	-	6.56	5.56	-	6.56	5.56	-
Critical Hdwy Stg 2	-	-	-	-	-	-	6.56	5.56	-	6.56	5.56	-
Follow-up Hdwy	2.23	-	-	2.23	-	-	3.53	4.03	3.33	3.53	4.03	3.33
Pot Cap-1 Maneuver	1159	-	-	1177	-	-	265	218	821	258	241	810
Stage 1	-	-	-	-	-	-	513	534	-	531	548	-
Stage 2	-	-	-	-	-	-	670	505	-	634	532	-
Platoon blocked, %	-	-	-	-	-	-	-	-	-	-	-	-
Mov Cap-1 Maneuver	1159	-	-	1176	-	-	188	189	820	~ 130	209	810
Mov Cap-2 Maneuver	-	-	-	-	-	-	188	189	-	~ 130	209	-
Stage 1	-	-	-	-	-	-	481	501	-	499	507	-
Stage 2	-	-	-	-	-	-	536	468	-	390	499	-

























Approach	EB			WB			NB			SB		
HCM Control Delay, s	1.3			1.5			26.6			254.4		
HCM LOS							D			F		

Minor Lane/Major Mvmt	NBLn1	EBL	EBT	EBR	WBL	WBT	WBR	SBLn1
Capacity (veh/h)	438	1159	-	-	1176	-	-	166
HCM Lane V/C Ratio	0.638	0.061	-	-	0.074	-	-	1.375
HCM Control Delay (s)	26.6	8.3	-	-	8.3	-	-	254.4
HCM Lane LOS	D	A	-	-	A	-	-	F
HCM 95th %tile Q(veh)	4.3	0.2	-	-	0.2	-	-	13.9

Notes			
-: Volume exceeds capacity	\$. Delay exceeds 300s	+: Computation Not Defined	*: All major volume in platoon

Santa Maria Airport Business Park SP
4: Orcutt Expressway & Union Valley Parkway































Cumulative (10-year) Plus Project AM
HCM Signalized Intersection Capacity Analysis

												
Movement	EBL	EBT	EBR	WBL	WBT	WBR	NBL	NBT	NBR	SBL	SBT	SBR
Lane Configurations												
Traffic Volume (vph)	221	364	97	400	266	360	137	826	260	142	583	158
Future Volume (vph)	221	364	97	400	266	360	137	826	260	142	583	158
Ideal Flow (vphp)	1900	1900	1900	1900	1900	1900	1900	1900	1900	1900	1900	1900
Total Lost time (s)	5.4	4.9	4.9	4.9	4.9	4.9	4.5	6.0	6.0	5.0	6.0	6.0
Lane Util. Factor	0.97	0.95	1.00	0.97	0.95	1.00	1.00	0.95	1.00	0.97	0.95	1.00
Frbp, ped/bikes	1.00	1.00	1.00	1.00	1.00	1.00	1.00	1.00	1.00	1.00	1.00	0.99
Flpb, ped/bikes	1.00	1.00	1.00	1.00	1.00	1.00	1.00	1.00	1.00	1.00	1.00	1.00
Frt	1.00	1.00	0.85	1.00	1.00	0.85	1.00	1.00	0.85	1.00	1.00	0.85
Flt Protected	0.95	1.00	1.00	0.95	1.00	1.00	0.95	1.00	1.00	0.95	1.00	1.00
Satd. Flow (prot)	3400	3505	1568	3400	3505	1568	1752	3505	1568	3400	3505	1548
Flt Permitted	0.95	1.00	1.00	0.95	1.00	1.00	0.95	1.00	1.00	0.95	1.00	1.00
Satd. Flow (perm)	3400	3505	1568	3400	3505	1568	1752	3505	1568	3400	3505	1548
Peak-hour factor, PHF	0.92	0.92	0.92	0.92	0.92	0.92	0.92	0.92	0.92	0.92	0.92	0.92
Adj. Flow (vph)	240	396	105	435	289	391	149	898	283	154	634	172
RTOR Reduction (vph)	0	0	83	0	0	125	0	0	191	0	0	115
Lane Group Flow (vph)	240	396	22	435	289	266	149	898	92	154	634	57
Confl. Bikes (#/hr)												1
Heavy Vehicles (%)	3%	3%	3%	3%	3%	3%	3%	3%	3%	3%	3%	3%
Turn Type	Prot	NA	Perm	Prot	NA	Perm	Prot	NA	Perm	Prot	NA	Perm
Protected Phases	7	4		3	8		5	2		1	6	
Permitted Phases			4			8			2			6
Actuated Green, G (s)	12.2	20.7	20.7	17.3	25.3	25.3	8.2	32.4	32.4	8.2	32.9	32.9
Effective Green, g (s)	12.2	20.7	20.7	17.3	25.3	25.3	8.2	32.4	32.4	8.2	32.9	32.9
Actuated g/C Ratio	0.12	0.21	0.21	0.17	0.25	0.25	0.08	0.33	0.33	0.08	0.33	0.33
Clearance Time (s)	5.4	4.9	4.9	4.9	4.9	4.9	4.5	6.0	6.0	5.0	6.0	6.0
Vehicle Extension (s)	3.0	3.0	3.0	3.0	3.0	3.0	3.0	3.0	3.0	3.0	3.0	3.0
Lane Grp Cap (vph)	417	729	326	591	892	399	144	1142	511	280	1160	512
v/s Ratio Prot	0.07	0.11		c0.13	0.08		c0.09	c0.26		0.05	0.18	
v/s Ratio Perm			0.01			c0.17			0.06			0.04
v/c Ratio	0.58	0.54	0.07	0.74	0.32	0.67	1.03	0.79	0.18	0.55	0.55	0.11
Uniform Delay, d1	41.2	35.1	31.6	38.9	30.1	33.3	45.6	30.4	24.0	43.8	27.2	23.1
Progression Factor	1.00	1.00	1.00	1.00	1.00	1.00	1.00	1.00	1.00	1.00	1.00	1.00
Incremental Delay, d2	1.9	0.8	0.1	4.8	0.2	4.2	84.5	3.6	0.2	2.3	0.5	0.1
Delay (s)	43.1	36.0	31.7	43.6	30.3	37.4	130.1	34.0	24.2	46.2	27.7	23.2
Level of Service	D	D	C	D	C	D	F	C	C	D	C	C
Approach Delay (s)		37.7			38.0			42.7			29.8	
Approach LOS		D			D			D			C	
Intersection Summary												
HCM 2000 Control Delay			37.6								HCM 2000 Level of Service	D
HCM 2000 Volume to Capacity ratio			0.79									
Actuated Cycle Length (s)			99.4								Sum of lost time (s)	21.3
Intersection Capacity Utilization			68.3%								ICU Level of Service	C
Analysis Period (min)			15									

c Critical Lane Group





















Santa Maria Airport Business Park SP
4: Orcutt Expressway & Union Valley Parkway

Cumulative (10-year) Plus Project AM
HCM 6th Signalized Intersection Summary

												
Movement	EBL	EBT	EBR	WBL	WBT	WBR	NBL	NBT	NBR	SBL	SBT	SBR
Lane Configurations	 	 		 	 			 		 	 	
Traffic Volume (veh/h)	221	364	97	400	266	360	137	826	260	142	583	158
Future Volume (veh/h)	221	364	97	400	266	360	137	826	260	142	583	158
Initial Q (Qb), veh	0	0	0	0	0	0	0	0	0	0	0	0
Ped-Bike Adj(A_pbT)	1.00		1.00	1.00		1.00	1.00		1.00	1.00		0.99
Parking Bus, Adj	1.00	1.00	1.00	1.00	1.00	1.00	1.00	1.00	1.00	1.00	1.00	1.00
Work Zone On Approach		No			No			No			No	
Adj Sat Flow, veh/h/ln	1856	1856	1856	1856	1856	1856	1856	1856	1856	1856	1856	1856
Adj Flow Rate, veh/h	240	396	105	435	289	391	149	898	283	154	634	172
Peak Hour Factor	0.92	0.92	0.92	0.92	0.92	0.92	0.92	0.92	0.92	0.92	0.92	0.92
Percent Heavy Veh, %	3	3	3	3	3	3	3	3	3	3	3	3
Cap, veh/h	319	834	372	514	1016	453	148	1107	494	282	1120	493
Arrive On Green	0.09	0.24	0.24	0.15	0.29	0.29	0.08	0.31	0.31	0.08	0.32	0.32
Sat Flow, veh/h	3428	3526	1572	3428	3526	1572	1767	3526	1572	3428	3526	1553
Grp Volume(v), veh/h	240	396	105	435	289	391	149	898	283	154	634	172
Grp Sat Flow(s),veh/h/ln	1714	1763	1572	1714	1763	1572	1767	1763	1572	1714	1763	1553
Q Serve(g_s), s	6.5	9.2	5.2	11.8	6.1	22.5	8.0	22.4	14.4	4.1	14.3	8.1
Cycle Q Clear(g_c), s	6.5	9.2	5.2	11.8	6.1	22.5	8.0	22.4	14.4	4.1	14.3	8.1
Prop In Lane	1.00		1.00	1.00		1.00	1.00		1.00	1.00		1.00
Lane Grp Cap(c), veh/h	319	834	372	514	1016	453	148	1107	494	282	1120	493
V/C Ratio(X)	0.75	0.47	0.28	0.85	0.28	0.86	1.01	0.81	0.57	0.55	0.57	0.35
Avail Cap(c_a), veh/h	520	1658	740	613	1736	774	148	1441	643	287	1459	643
HCM Platoon Ratio	1.00	1.00	1.00	1.00	1.00	1.00	1.00	1.00	1.00	1.00	1.00	1.00
Upstream Filter(I)	1.00	1.00	1.00	1.00	1.00	1.00	1.00	1.00	1.00	1.00	1.00	1.00
Uniform Delay (d), s/veh	42.3	31.4	29.9	39.6	26.4	32.3	43.8	30.2	27.5	42.2	27.2	25.0
Incr Delay (d2), s/veh	3.6	0.4	0.4	9.3	0.2	5.2	76.3	2.8	1.1	2.1	0.5	0.4
Initial Q Delay(d3),s/veh	0.0	0.0	0.0	0.0	0.0	0.0	0.0	0.0	0.0	0.0	0.0	0.0
%ile BackOfQ(50%),veh/ln	2.8	3.8	1.9	5.4	2.4	8.6	6.4	9.0	5.2	1.7	5.5	2.9
Unsig. Movement Delay, s/veh												
LnGrp Delay(d),s/veh	45.9	31.8	30.3	48.8	26.6	37.4	120.1	33.0	28.5	44.3	27.6	25.5
LnGrp LOS	D	C	C	D	C	D	F	C	C	D	C	C
Approach Vol, veh/h		741			1115			1330			960	
Approach Delay, s/veh		36.2			39.1			41.8			29.9	
Approach LOS		D			D			D			C	
Timer - Assigned Phs	1	2	3	4	5	6	7	8				
Phs Duration (G+Y+Rc), s	12.9	36.0	19.2	27.5	12.5	36.4	14.3	32.5				
Change Period (Y+Rc), s	5.0	6.0	4.9	4.9	4.5	6.0	5.4	4.9				
Max Green Setting (Gmax), s	8.0	39.1	17.1	45.0	8.0	39.6	14.5	47.1				
Max Q Clear Time (g_c+I1), s	6.1	24.4	13.8	11.2	10.0	16.3	8.5	24.5				
Green Ext Time (p_c), s	0.1	5.6	0.5	2.8	0.0	4.3	0.4	3.0				
Intersection Summary												
HCM 6th Ctrl Delay				37.3								
HCM 6th LOS				D								

Santa Maria Airport Business Park SP
5: Orcutt Road & Union Valley Parkway

Cumulative (10-year) Plus Project AM
HCM Signalized Intersection Capacity Analysis

												
Movement	EBL	EBT	EBR	WBL	WBT	WBR	NBL	NBT	NBR	SBL	SBT	SBR
Lane Configurations												
Traffic Volume (vph)	10	626	110	60	736	20	270	120	80	30	100	10
Future Volume (vph)	10	626	110	60	736	20	270	120	80	30	100	10
Ideal Flow (vphp)	1900	1900	1900	1900	1900	1900	1900	1900	1900	1900	1900	1900
Total Lost time (s)	4.2	6.0		4.2	6.0		4.2	4.9		4.2	4.9	
Lane Util. Factor	1.00	0.95		1.00	0.95		1.00	1.00		1.00	1.00	
Frbp, ped/bikes	1.00	1.00		1.00	1.00		1.00	1.00		1.00	1.00	
Flpb, ped/bikes	1.00	1.00		1.00	1.00		1.00	1.00		1.00	1.00	
Frt	1.00	0.98		1.00	1.00		1.00	0.94		1.00	0.99	
Flt Protected	0.95	1.00		0.95	1.00		0.95	1.00		0.95	1.00	
Satd. Flow (prot)	1736	3393		1736	3455		1736	1717		1736	1802	
Flt Permitted	0.95	1.00		0.95	1.00		0.95	1.00		0.95	1.00	
Satd. Flow (perm)	1736	3393		1736	3455		1736	1717		1736	1802	
Peak-hour factor, PHF	0.92	0.92	0.92	0.92	0.92	0.92	0.92	0.92	0.92	0.92	0.92	0.92
Adj. Flow (vph)	11	680	120	65	800	22	293	130	87	33	109	11
RTOR Reduction (vph)	0	14	0	0	2	0	0	37	0	0	6	0
Lane Group Flow (vph)	11	786	0	65	820	0	293	180	0	33	114	0
Confl. Bikes (#/hr)						1						
Heavy Vehicles (%)	4%	4%	4%	4%	4%	4%	4%	4%	4%	4%	4%	4%
Turn Type	Prot	NA		Prot	NA		Prot	NA		Prot	NA	
Protected Phases	5	2		1	6		3	8		7	4	
Permitted Phases												
Actuated Green, G (s)	0.7	22.8		2.9	25.0		9.0	15.8		2.0	8.8	
Effective Green, g (s)	0.7	22.8		2.9	25.0		9.0	15.8		2.0	8.8	
Actuated g/C Ratio	0.01	0.36		0.05	0.40		0.14	0.25		0.03	0.14	
Clearance Time (s)	4.2	6.0		4.2	6.0		4.2	4.9		4.2	4.9	
Vehicle Extension (s)	3.0	3.0		3.0	3.0		3.0	3.0		3.0	3.0	
Lane Grp Cap (vph)	19	1231		80	1375		248	431		55	252	
v/s Ratio Prot	0.01	0.23		c0.04	c0.24		c0.17	c0.11		0.02	0.06	
v/s Ratio Perm												
v/c Ratio	0.58	0.64		0.81	0.60		1.18	0.42		0.60	0.45	
Uniform Delay, d1	30.9	16.6		29.7	14.9		26.9	19.7		30.0	24.8	
Progression Factor	1.00	1.00		1.00	1.00		1.00	1.00		1.00	1.00	
Incremental Delay, d2	36.3	1.1		44.4	0.7		115.2	0.7		16.4	1.3	
Delay (s)	67.2	17.7		74.1	15.6		142.1	20.3		46.4	26.1	
Level of Service	E	B		E	B		F	C		D	C	
Approach Delay (s)		18.4			19.9			90.3			30.5	
Approach LOS		B			B			F			C	
Intersection Summary												
HCM 2000 Control Delay			35.3				HCM 2000 Level of Service				D	
HCM 2000 Volume to Capacity ratio			0.74									
Actuated Cycle Length (s)			62.8			Sum of lost time (s)				19.3		
Intersection Capacity Utilization			61.2%			ICU Level of Service				B		
Analysis Period (min)			15									

c Critical Lane Group

Santa Maria Airport Business Park SP
5: Orcutt Road & Union Valley Parkway

Cumulative (10-year) Plus Project AM
HCM 6th Signalized Intersection Summary



Movement	EBL	EBT	EBR	WBL	WBT	WBR	NBL	NBT	NBR	SBL	SBT	SBR
Lane Configurations	↖	↗		↖	↗		↖	↗		↖	↗	
Traffic Volume (veh/h)	10	626	110	60	736	20	270	120	80	30	100	10
Future Volume (veh/h)	10	626	110	60	736	20	270	120	80	30	100	10
Initial Q (Qb), veh	0	0	0	0	0	0	0	0	0	0	0	0
Ped-Bike Adj(A_pbT)	1.00		1.00	1.00		0.98	1.00		1.00	1.00		1.00
Parking Bus, Adj	1.00	1.00	1.00	1.00	1.00	1.00	1.00	1.00	1.00	1.00	1.00	1.00
Work Zone On Approach		No			No			No			No	
Adj Sat Flow, veh/h/ln	1841	1841	1841	1841	1841	1841	1841	1841	1841	1841	1841	1841
Adj Flow Rate, veh/h	11	680	120	65	800	22	293	130	87	33	109	11
Peak Hour Factor	0.92	0.92	0.92	0.92	0.92	0.92	0.92	0.92	0.92	0.92	0.92	0.92
Percent Heavy Veh, %	4	4	4	4	4	4	4	4	4	4	4	4
Cap, veh/h	20	890	157	82	1164	32	293	257	172	51	184	19
Arrive On Green	0.01	0.30	0.30	0.05	0.34	0.34	0.17	0.25	0.25	0.03	0.11	0.11
Sat Flow, veh/h	1753	2971	524	1753	3474	96	1753	1029	688	1753	1645	166
Grp Volume(v), veh/h	11	400	400	65	403	419	293	0	217	33	0	120
Grp Sat Flow(s),veh/h/ln	1753	1749	1746	1753	1749	1821	1753	0	1717	1753	0	1811
Q Serve(g_s), s	0.3	10.7	10.7	1.9	10.2	10.2	8.6	0.0	5.6	1.0	0.0	3.2
Cycle Q Clear(g_c), s	0.3	10.7	10.7	1.9	10.2	10.2	8.6	0.0	5.6	1.0	0.0	3.2
Prop In Lane	1.00		0.30	1.00		0.05	1.00		0.40	1.00		0.09
Lane Grp Cap(c), veh/h	20	524	523	82	586	610	293	0	429	51	0	203
V/C Ratio(X)	0.55	0.76	0.77	0.79	0.69	0.69	1.00	0.00	0.51	0.64	0.00	0.59
Avail Cap(c_a), veh/h	136	682	681	136	682	711	293	0	1197	194	0	1160
HCM Platoon Ratio	1.00	1.00	1.00	1.00	1.00	1.00	1.00	1.00	1.00	1.00	1.00	1.00
Upstream Filter(I)	1.00	1.00	1.00	1.00	1.00	1.00	1.00	0.00	1.00	1.00	0.00	1.00
Uniform Delay (d), s/veh	25.3	16.4	16.4	24.3	14.8	14.8	21.5	0.0	16.6	24.7	0.0	21.8
Incr Delay (d2), s/veh	22.0	3.8	3.8	15.2	2.4	2.3	52.9	0.0	0.9	12.7	0.0	2.7
Initial Q Delay(d3),s/veh	0.0	0.0	0.0	0.0	0.0	0.0	0.0	0.0	0.0	0.0	0.0	0.0
%ile BackOfQ(50%),veh/ln	0.2	3.9	3.9	1.0	3.5	3.6	7.2	0.0	1.9	0.5	0.0	1.3
Unsig. Movement Delay, s/veh												
LnGrp Delay(d),s/veh	47.4	20.2	20.2	39.5	17.2	17.1	74.3	0.0	17.5	37.5	0.0	24.5
LnGrp LOS	D	C	C	D	B	B	F	A	B	D	A	C
Approach Vol, veh/h		811			887			510				153
Approach Delay, s/veh		20.6			18.8			50.2				27.3
Approach LOS		C			B			D				C
Timer - Assigned Phs	1	2	3	4	5	6	7	8				
Phs Duration (G+Y+Rc), s	6.6	21.4	12.8	10.7	4.8	23.3	5.7	17.8				
Change Period (Y+Rc), s	* 4.2	6.0	* 4.2	4.9	* 4.2	6.0	* 4.2	4.9				
Max Green Setting (Gmax), s	* 4	20.1	* 8.6	33.0	* 4	20.1	* 5.7	35.9				
Max Q Clear Time (g_c+I1), s	3.9	12.7	10.6	5.2	2.3	12.2	3.0	7.6				
Green Ext Time (p_c), s	0.0	2.7	0.0	0.5	0.0	2.9	0.0	1.2				

Intersection Summary

HCM 6th Ctrl Delay	26.7
HCM 6th LOS	C

Notes

* HCM 6th computational engine requires equal clearance times for the phases crossing the barrier.

Intersection												
Int Delay, s/veh	5.1											
Movement	EBL	EBT	EBR	WBL	WBT	WBR	NBL	NBT	NBR	SBL	SBT	SBR
Lane Configurations		↕		↕	↕			↕			↕	
Traffic Vol, veh/h	0	262	24	211	220	0	19	0	175	0	0	0
Future Vol, veh/h	0	262	24	211	220	0	19	0	175	0	0	0
Conflicting Peds, #/hr	0	0	0	0	0	0	1	0	0	0	0	1
Sign Control	Free	Free	Free	Free	Free	Free	Stop	Stop	Stop	Stop	Stop	Stop
RT Channelized	-	-	None	-	-	None	-	-	None	-	-	None
Storage Length	-	-	-	160	-	-	-	-	-	-	-	-
Veh in Median Storage, #	-	0	-	-	0	-	-	0	-	-	0	-
Grade, %	-	0	-	-	0	-	-	0	-	-	0	-
Peak Hour Factor	92	92	92	92	92	92	92	92	92	92	92	92
Heavy Vehicles, %	1	1	1	1	1	1	1	1	1	1	1	1
Mvmt Flow	0	285	26	229	239	0	21	0	190	0	0	0

























Major/Minor	Major1			Major2			Minor1			Minor2		
Conflicting Flow All	239	0	0	311	0	0	996	995	298	1090	1008	240
Stage 1	-	-	-	-	-	-	298	298	-	697	697	-
Stage 2	-	-	-	-	-	-	698	697	-	393	311	-
Critical Hdwy	4.11	-	-	4.11	-	-	7.11	6.51	6.21	7.11	6.51	6.21
Critical Hdwy Stg 1	-	-	-	-	-	-	6.11	5.51	-	6.11	5.51	-
Critical Hdwy Stg 2	-	-	-	-	-	-	6.11	5.51	-	6.11	5.51	-
Follow-up Hdwy	2.209	-	-	2.209	-	-	3.509	4.009	3.309	3.509	4.009	3.309
Pot Cap-1 Maneuver	1334	-	-	1255	-	-	224	246	744	193	241	801
Stage 1	-	-	-	-	-	-	713	669	-	433	444	-
Stage 2	-	-	-	-	-	-	433	444	-	634	660	-
Platoon blocked, %		-	-		-	-						
Mov Cap-1 Maneuver	1334	-	-	1255	-	-	192	201	744	124	197	800
Mov Cap-2 Maneuver	-	-	-	-	-	-	192	201	-	124	197	-
Stage 1	-	-	-	-	-	-	713	669	-	433	363	-
Stage 2	-	-	-	-	-	-	354	363	-	472	660	-

Approach	EB			WB			NB			SB		
HCM Control Delay, s	0			4.2			14.7			0		
HCM LOS							B			A		

Minor Lane/Major Mvmt	NBLn1	EBL	EBT	EBR	WBL	WBT	WBR	SBLn1
Capacity (veh/h)	581	1334	-	-	1255	-	-	-
HCM Lane V/C Ratio	0.363	-	-	-	0.183	-	-	-
HCM Control Delay (s)	14.7	0	-	-	8.5	-	-	0
HCM Lane LOS	B	A	-	-	A	-	-	A
HCM 95th %tile Q(veh)	1.6	0	-	-	0.7	-	-	-

Santa Maria Airport Business Park SP
2: Orcutt Expressway & Foster Road

























Cumulative (10-year) Plus Project PM
HCM Signalized Intersection Capacity Analysis

												
Movement	EBL	EBT	EBR	WBL	WBT	WBR	NBL	NBT	NBR	SBL	SBT	SBR
Lane Configurations	 							 			 	
Traffic Volume (vph)	380	95	74	70	86	110	35	1000	60	140	1392	310
Future Volume (vph)	380	95	74	70	86	110	35	1000	60	140	1392	310
Ideal Flow (vphp)	1900	1900	1900	1900	1900	1900	1900	1900	1900	1900	1900	1900
Total Lost time (s)	4.9	4.9		4.9	4.9	4.9	4.2	6.0		4.2	6.0	6.0
Lane Util. Factor	0.97	1.00		1.00	1.00	1.00	1.00	0.95		1.00	0.95	1.00
Frbp, ped/bikes	1.00	0.99		1.00	1.00	1.00	1.00	1.00		1.00	1.00	1.00
Flpb, ped/bikes	1.00	1.00		1.00	1.00	1.00	1.00	1.00		1.00	1.00	1.00
Frt	1.00	0.93		1.00	1.00	0.85	1.00	0.99		1.00	1.00	0.85
Flt Protected	0.95	1.00		0.95	1.00	1.00	0.95	1.00		0.95	1.00	1.00
Satd. Flow (prot)	3433	1728		1770	1863	1583	1770	3509		1770	3539	1583
Flt Permitted	0.95	1.00		0.95	1.00	1.00	0.95	1.00		0.95	1.00	1.00
Satd. Flow (perm)	3433	1728		1770	1863	1583	1770	3509		1770	3539	1583
Peak-hour factor, PHF	0.96	0.96	0.96	0.96	0.96	0.96	0.96	0.96	0.96	0.96	0.96	0.96
Adj. Flow (vph)	396	99	77	73	90	115	36	1042	62	146	1450	323
RTOR Reduction (vph)	0	32	0	0	0	104	0	4	0	0	0	121
Lane Group Flow (vph)	396	144	0	73	90	11	36	1101	0	146	1450	202
Confl. Peds. (#/hr)			1									
Confl. Bikes (#/hr)			3									
Turn Type	Split	NA		Split	NA	Perm	Prot	NA		Prot	NA	Perm
Protected Phases	4	4		8	8		5	2		1	6	
Permitted Phases						8						6
Actuated Green, G (s)	16.9	16.9		8.1	8.1	8.1	3.4	34.0		9.1	39.7	39.7
Effective Green, g (s)	16.9	16.9		8.1	8.1	8.1	3.4	34.0		9.1	39.7	39.7
Actuated g/C Ratio	0.19	0.19		0.09	0.09	0.09	0.04	0.39		0.10	0.45	0.45
Clearance Time (s)	4.9	4.9		4.9	4.9	4.9	4.2	6.0		4.2	6.0	6.0
Vehicle Extension (s)	3.0	3.0		3.0	3.0	3.0	3.0	3.0		3.0	3.0	3.0
Lane Grp Cap (vph)	658	331		162	171	145	68	1354		182	1594	713
v/s Ratio Prot	c0.12	0.08		0.04	c0.05		0.02	0.31		c0.08	c0.41	
v/s Ratio Perm						0.01						0.13
v/c Ratio	0.60	0.44		0.45	0.53	0.07	0.53	0.81		0.80	0.91	0.28
Uniform Delay, d1	32.5	31.4		37.9	38.2	36.6	41.6	24.2		38.6	22.5	15.2
Progression Factor	1.00	1.00		1.00	1.00	1.00	1.00	1.00		1.00	1.00	1.00
Incremental Delay, d2	1.6	0.9		2.0	2.9	0.2	7.3	3.8		21.9	8.0	0.2
Delay (s)	34.1	32.3		39.9	41.1	36.8	48.8	28.0		60.5	30.5	15.5
Level of Service	C	C		D	D	D	D	C		E	C	B
Approach Delay (s)		33.5			39.0			28.7			30.3	
Approach LOS		C			D			C			C	
Intersection Summary												
HCM 2000 Control Delay			30.9									C
HCM 2000 Volume to Capacity ratio			0.81									
Actuated Cycle Length (s)			88.1						20.0			
Intersection Capacity Utilization			77.7%									D
Analysis Period (min)			15									

c Critical Lane Group

Santa Maria Airport Business Park SP
2: Orcutt Expressway & Foster Road

Cumulative (10-year) Plus Project PM
HCM 6th Signalized Intersection Summary

												
Movement	EBL	EBT	EBR	WBL	WBT	WBR	NBL	NBT	NBR	SBL	SBT	SBR
Lane Configurations	 							 			 	
Traffic Volume (veh/h)	380	95	74	70	86	110	35	1000	60	140	1392	310
Future Volume (veh/h)	380	95	74	70	86	110	35	1000	60	140	1392	310
Initial Q (Qb), veh	0	0	0	0	0	0	0	0	0	0	0	0
Ped-Bike Adj(A_pbT)	1.00		0.98	1.00		1.00	1.00		1.00	1.00		1.00
Parking Bus, Adj	1.00	1.00	1.00	1.00	1.00	1.00	1.00	1.00	1.00	1.00	1.00	1.00
Work Zone On Approach		No			No			No			No	
Adj Sat Flow, veh/h/ln	1870	1870	1870	1870	1870	1870	1870	1870	1870	1870	1870	1870
Adj Flow Rate, veh/h	396	99	77	73	90	56	36	1042	62	146	1450	323
Peak Hour Factor	0.96	0.96	0.96	0.96	0.96	0.96	0.96	0.96	0.96	0.96	0.96	0.96
Percent Heavy Veh, %	2	2	2	2	2	2	2	2	2	2	2	2
Cap, veh/h	561	157	122	174	183	155	73	1336	79	180	1606	717
Arrive On Green	0.16	0.16	0.16	0.10	0.10	0.10	0.04	0.39	0.39	0.10	0.45	0.45
Sat Flow, veh/h	3456	967	752	1781	1870	1585	1781	3408	203	1781	3554	1585
Grp Volume(v), veh/h	396	0	176	73	90	56	36	543	561	146	1450	323
Grp Sat Flow(s),veh/h/ln	1728	0	1719	1781	1870	1585	1781	1777	1834	1781	1777	1585
Q Serve(g_s), s	8.8	0.0	7.8	3.1	3.7	2.7	1.6	21.7	21.7	6.5	30.6	11.4
Cycle Q Clear(g_c), s	8.8	0.0	7.8	3.1	3.7	2.7	1.6	21.7	21.7	6.5	30.6	11.4
Prop In Lane	1.00		0.44	1.00		1.00	1.00		0.11	1.00		1.00
Lane Grp Cap(c), veh/h	561	0	279	174	183	155	73	696	719	180	1606	717
V/C Ratio(X)	0.71	0.00	0.63	0.42	0.49	0.36	0.49	0.78	0.78	0.81	0.90	0.45
Avail Cap(c_a), veh/h	1193	0	593	176	184	156	132	766	791	198	1664	742
HCM Platoon Ratio	1.00	1.00	1.00	1.00	1.00	1.00	1.00	1.00	1.00	1.00	1.00	1.00
Upstream Filter(I)	1.00	0.00	1.00	1.00	1.00	1.00	1.00	1.00	1.00	1.00	1.00	1.00
Uniform Delay (d), s/veh	32.1	0.0	31.7	34.4	34.7	34.2	38.1	21.6	21.6	35.7	20.6	15.3
Incr Delay (d2), s/veh	1.6	0.0	2.3	1.6	2.0	1.4	5.0	4.7	4.6	20.3	7.1	0.4
Initial Q Delay(d3),s/veh	0.0	0.0	0.0	0.0	0.0	0.0	0.0	0.0	0.0	0.0	0.0	0.0
%ile BackOfQ(50%),veh/ln	3.6	0.0	3.2	1.4	1.7	1.0	0.7	8.5	8.8	3.6	11.8	3.5
Unsig. Movement Delay, s/veh												
LnGrp Delay(d),s/veh	33.8	0.0	34.0	36.0	36.7	35.6	43.1	26.3	26.2	56.0	27.7	15.7
LnGrp LOS	C	A	C	D	D	D	D	C	C	E	C	B
Approach Vol, veh/h		572			219			1140			1919	
Approach Delay, s/veh		33.9			36.2			26.8			27.8	
Approach LOS		C			D			C			C	
Timer - Assigned Phs	1	2		4	5	6		8				
Phs Duration (G+Y+Rc), s	12.4	37.8		18.1	7.5	42.7		12.8				
Change Period (Y+Rc), s	* 4.2	6.0		4.9	* 4.2	6.0		4.9				
Max Green Setting (Gmax), s	* 9	35.0		28.0	* 6	38.0		8.0				
Max Q Clear Time (g_c+I1), s	8.5	23.7		10.8	3.6	32.6		5.7				
Green Ext Time (p_c), s	0.0	4.7		2.2	0.0	4.0		0.2				
Intersection Summary												
HCM 6th Ctrl Delay				28.9								
HCM 6th LOS				C								
Notes												
* HCM 6th computational engine requires equal clearance times for the phases crossing the barrier.												

Intersection												
Int Delay, s/veh	88.3											
Movement	EBL	EBT	EBR	WBL	WBT	WBR	NBL	NBT	NBR	SBL	SBT	SBR
Lane Configurations	↖	↕		↖	↕			↕			↕	
Traffic Vol, veh/h	36	260	10	190	330	85	10	14	120	182	16	55
Future Vol, veh/h	36	260	10	190	330	85	10	14	120	182	16	55
Conflicting Peds, #/hr	1	0	0	0	0	1	0	0	1	1	0	0
Sign Control	Free	Free	Free	Free	Free	Free	Stop	Stop	Stop	Stop	Stop	Stop
RT Channelized	-	-	None	-	-	None	-	-	None	-	-	None
Storage Length	195	-	-	155	-	-	-	-	-	-	-	-
Veh in Median Storage, #	-	0	-	-	0	-	-	0	-	-	0	-
Grade, %	-	0	-	-	0	-	-	0	-	-	0	-
Peak Hour Factor	92	92	92	92	92	92	92	92	92	92	92	92
Heavy Vehicles, %	1	1	1	1	1	1	1	1	1	1	1	1
Mvmt Flow	39	283	11	207	359	92	11	15	130	198	17	60

Major/Minor	Major1			Major2			Minor1			Minor2		
Conflicting Flow All	452	0	0	294	0	0	969	1233	148	1048	1192	227
Stage 1	-	-	-	-	-	-	367	367	-	820	820	-
Stage 2	-	-	-	-	-	-	602	866	-	228	372	-
Critical Hdwy	4.12	-	-	4.12	-	-	7.52	6.52	6.92	7.52	6.52	6.92
Critical Hdwy Stg 1	-	-	-	-	-	-	6.52	5.52	-	6.52	5.52	-
Critical Hdwy Stg 2	-	-	-	-	-	-	6.52	5.52	-	6.52	5.52	-
Follow-up Hdwy	2.21	-	-	2.21	-	-	3.51	4.01	3.31	3.51	4.01	3.31
Pot Cap-1 Maneuver	1112	-	-	1272	-	-	209	177	875	~ 183	187	779
Stage 1	-	-	-	-	-	-	628	623	-	337	389	-
Stage 2	-	-	-	-	-	-	456	371	-	757	620	-
Platoon blocked, %		-	-		-	-						
Mov Cap-1 Maneuver	1111	-	-	1272	-	-	150	143	874	~ 122	151	778
Mov Cap-2 Maneuver	-	-	-	-	-	-	150	143	-	~ 122	151	-
Stage 1	-	-	-	-	-	-	606	601	-	325	325	-
Stage 2	-	-	-	-	-	-	334	310	-	605	598	-































Approach	EB			WB			NB			SB		
HCM Control Delay, s	1			2.6			16.2			\$ 439.7		
HCM LOS							C			F		

Minor Lane/Major Mvmt	NBLn1	EBL	EBT	EBR	WBL	WBT	WBR	SBLn1
Capacity (veh/h)	477	1111	-	-	1272	-	-	152
HCM Lane V/C Ratio	0.328	0.035	-	-	0.162	-	-	1.809
HCM Control Delay (s)	16.2	8.4	-	-	8.4	-	-	\$ 439.7
HCM Lane LOS	C	A	-	-	A	-	-	F
HCM 95th %tile Q(veh)	1.4	0.1	-	-	0.6	-	-	20.4

Notes
 -: Volume exceeds capacity \$: Delay exceeds 300s +: Computation Not Defined *: All major volume in platoon

Santa Maria Airport Business Park SP
4: Orcutt Expressway & Union Valley Parkway































Cumulative (10-year) Plus Project PM
HCM Signalized Intersection Capacity Analysis

													
Movement	EBL	EBT	EBR	WBL	WBT	WBR	NBL	NBT	NBR	SBL	SBT	SBR	
Lane Configurations	 	 		 	 			 		 	 		
Traffic Volume (vph)	191	279	92	280	310	110	88	814	430	337	966	303	
Future Volume (vph)	191	279	92	280	310	110	88	814	430	337	966	303	
Ideal Flow (vphpl)	1900	1900	1900	1900	1900	1900	1900	1900	1900	1900	1900	1900	
Total Lost time (s)	5.4	4.9	4.9	4.9	4.9	4.9	4.5	6.0	6.0	5.0	6.0	6.0	
Lane Util. Factor	0.97	0.95	1.00	0.97	0.95	1.00	1.00	0.95	1.00	0.97	0.95	1.00	
Frt	1.00	1.00	0.85	1.00	1.00	0.85	1.00	1.00	0.85	1.00	1.00	0.85	
Flt Protected	0.95	1.00	1.00	0.95	1.00	1.00	0.95	1.00	1.00	0.95	1.00	1.00	
Satd. Flow (prot)	3433	3539	1583	3433	3539	1583	1770	3539	1583	3433	3539	1583	
Flt Permitted	0.95	1.00	1.00	0.95	1.00	1.00	0.95	1.00	1.00	0.95	1.00	1.00	
Satd. Flow (perm)	3433	3539	1583	3433	3539	1583	1770	3539	1583	3433	3539	1583	
Peak-hour factor, PHF	0.99	0.99	0.99	0.99	0.99	0.99	0.99	0.99	0.99	0.99	0.99	0.99	
Adj. Flow (vph)	193	282	93	283	313	111	89	822	434	340	976	306	
RTOR Reduction (vph)	0	0	76	0	0	93	0	0	275	0	0	192	
Lane Group Flow (vph)	193	282	17	283	313	18	89	822	159	340	976	114	
Turn Type	Prot	NA	Perm	Prot	NA	Perm	Prot	NA	Perm	Prot	NA	Perm	
Protected Phases	7	4		3	8		5	2		1	6		
Permitted Phases			4			8			2			6	
Actuated Green, G (s)	9.4	15.0	15.0	8.1	13.2	13.2	8.1	30.0	30.0	8.1	30.5	30.5	
Effective Green, g (s)	9.4	15.0	15.0	8.1	13.2	13.2	8.1	30.0	30.0	8.1	30.5	30.5	
Actuated g/C Ratio	0.11	0.18	0.18	0.10	0.16	0.16	0.10	0.37	0.37	0.10	0.37	0.37	
Clearance Time (s)	5.4	4.9	4.9	4.9	4.9	4.9	4.5	6.0	6.0	5.0	6.0	6.0	
Vehicle Extension (s)	3.0	3.0	3.0	3.0	3.0	3.0	3.0	3.0	3.0	3.0	3.0	3.0	
Lane Grp Cap (vph)	393	647	289	339	569	254	174	1294	579	339	1316	588	
v/s Ratio Prot	0.06	0.08		c0.08	c0.09		0.05	0.23		c0.10	c0.28		
v/s Ratio Perm			0.01			0.01			0.10			0.07	
v/c Ratio	0.49	0.44	0.06	0.83	0.55	0.07	0.51	0.64	0.27	1.00	0.74	0.19	
Uniform Delay, d1	34.1	29.7	27.7	36.3	31.7	29.2	35.1	21.5	18.3	37.0	22.3	17.4	
Progression Factor	1.00	1.00	1.00	1.00	1.00	1.00	1.00	1.00	1.00	1.00	1.00	1.00	
Incremental Delay, d2	1.0	0.5	0.1	16.1	1.2	0.1	2.5	1.0	0.3	49.6	2.3	0.2	
Delay (s)	35.0	30.2	27.8	52.4	32.8	29.3	37.6	22.5	18.6	86.6	24.6	17.6	
Level of Service	D	C	C	D	C	C	D	C	B	F	C	B	
Approach Delay (s)		31.4			40.1			22.2			36.3		
Approach LOS		C			D			C			D		
Intersection Summary													
HCM 2000 Control Delay			31.8									HCM 2000 Level of Service	C
HCM 2000 Volume to Capacity ratio			0.74										
Actuated Cycle Length (s)			82.0									Sum of lost time (s)	21.3
Intersection Capacity Utilization			66.0%									ICU Level of Service	C
Analysis Period (min)			15										

c Critical Lane Group























Santa Maria Airport Business Park SP
4: Orcutt Expressway & Union Valley Parkway

Cumulative (10-year) Plus Project PM
HCM 6th Signalized Intersection Summary

												
Movement	EBL	EBT	EBR	WBL	WBT	WBR	NBL	NBT	NBR	SBL	SBT	SBR
Lane Configurations	 	 		 	 			 		 	 	
Traffic Volume (veh/h)	191	279	92	280	310	110	88	814	430	337	966	303
Future Volume (veh/h)	191	279	92	280	310	110	88	814	430	337	966	303
Initial Q (Qb), veh	0	0	0	0	0	0	0	0	0	0	0	0
Ped-Bike Adj(A_pbT)	1.00		1.00	1.00		1.00	1.00		1.00	1.00		1.00
Parking Bus, Adj	1.00	1.00	1.00	1.00	1.00	1.00	1.00	1.00	1.00	1.00	1.00	1.00
Work Zone On Approach		No			No			No			No	
Adj Sat Flow, veh/h/ln	1870	1870	1870	1870	1870	1870	1870	1870	1870	1870	1870	1870
Adj Flow Rate, veh/h	193	282	93	283	313	111	89	822	434	340	976	306
Peak Hour Factor	0.99	0.99	0.99	0.99	0.99	0.99	0.99	0.99	0.99	0.99	0.99	0.99
Percent Heavy Veh, %	2	2	2	2	2	2	2	2	2	2	2	2
Cap, veh/h	368	519	231	374	501	223	162	1263	563	375	1349	602
Arrive On Green	0.11	0.15	0.15	0.11	0.14	0.14	0.09	0.36	0.36	0.11	0.38	0.38
Sat Flow, veh/h	3456	3554	1585	3456	3554	1585	1781	3554	1585	3456	3554	1585
Grp Volume(v), veh/h	193	282	93	283	313	111	89	822	434	340	976	306
Grp Sat Flow(s),veh/h/ln	1728	1777	1585	1728	1777	1585	1781	1777	1585	1728	1777	1585
Q Serve(g_s), s	3.9	5.4	3.9	5.9	6.1	4.8	3.5	14.3	17.9	7.2	17.3	10.9
Cycle Q Clear(g_c), s	3.9	5.4	3.9	5.9	6.1	4.8	3.5	14.3	17.9	7.2	17.3	10.9
Prop In Lane	1.00		1.00	1.00		1.00	1.00		1.00	1.00		1.00
Lane Grp Cap(c), veh/h	368	519	231	374	501	223	162	1263	563	375	1349	602
V/C Ratio(X)	0.52	0.54	0.40	0.76	0.63	0.50	0.55	0.65	0.77	0.91	0.72	0.51
Avail Cap(c_a), veh/h	459	2169	967	375	2058	918	193	1841	821	375	1865	832
HCM Platoon Ratio	1.00	1.00	1.00	1.00	1.00	1.00	1.00	1.00	1.00	1.00	1.00	1.00
Upstream Filter(I)	1.00	1.00	1.00	1.00	1.00	1.00	1.00	1.00	1.00	1.00	1.00	1.00
Uniform Delay (d), s/veh	31.2	29.2	28.6	31.9	29.8	29.3	32.1	19.9	21.1	32.5	19.6	17.6
Incr Delay (d2), s/veh	1.2	0.9	1.1	8.6	1.3	1.7	2.9	0.6	2.7	25.0	0.9	0.7
Initial Q Delay(d3),s/veh	0.0	0.0	0.0	0.0	0.0	0.0	0.0	0.0	0.0	0.0	0.0	0.0
%ile BackOfQ(50%),veh/ln	1.6	2.2	1.4	2.7	2.5	1.8	1.5	5.0	6.2	4.0	6.0	3.6
Unsig. Movement Delay, s/veh												
LnGrp Delay(d),s/veh	32.3	30.1	29.7	40.5	31.1	31.0	35.0	20.5	23.8	57.5	20.4	18.2
LnGrp LOS	C	C	C	D	C	C	C	C	C	E	C	B
Approach Vol, veh/h		568			707			1345			1622	
Approach Delay, s/veh		30.8			34.9			22.5			27.8	
Approach LOS		C			C			C			C	
Timer - Assigned Phs	1	2	3	4	5	6	7	8				
Phs Duration (G+Y+Rc), s	13.0	32.2	12.9	15.7	11.2	34.0	13.2	15.3				
Change Period (Y+Rc), s	5.0	6.0	4.9	4.9	4.5	6.0	5.4	4.9				
Max Green Setting (Gmax), s	8.0	38.2	8.0	45.0	8.0	38.7	9.8	42.7				
Max Q Clear Time (g_c+I1), s	9.2	19.9	7.9	7.4	5.5	19.3	5.9	8.1				
Green Ext Time (p_c), s	0.0	6.3	0.0	2.0	0.0	7.0	0.2	2.3				
Intersection Summary												
HCM 6th Ctrl Delay				27.7								
HCM 6th LOS				C								

Santa Maria Airport Business Park SP
5: Orcutt Road & Union Valley Parkway

Cumulative (10-year) Plus Project PM
HCM Signalized Intersection Capacity Analysis

												
Movement	EBL	EBT	EBR	WBL	WBT	WBR	NBL	NBT	NBR	SBL	SBT	SBR
Lane Configurations		 			 							
Traffic Volume (vph)	0	956	110	30	630	20	70	120	60	30	190	10
Future Volume (vph)	0	956	110	30	630	20	70	120	60	30	190	10
Ideal Flow (vphp)	1900	1900	1900	1900	1900	1900	1900	1900	1900	1900	1900	1900
Total Lost time (s)		6.0		4.2	6.0		4.2	4.9		4.2	4.9	
Lane Util. Factor		0.95		1.00	0.95		1.00	1.00		1.00	1.00	
Frbp, ped/bikes		1.00		1.00	1.00		1.00	1.00		1.00	1.00	
Flpb, ped/bikes		1.00		1.00	1.00		1.00	1.00		1.00	1.00	
Frt		0.98		1.00	1.00		1.00	0.95		1.00	0.99	
Flt Protected		1.00		0.95	1.00		0.95	1.00		0.95	1.00	
Satd. Flow (prot)		3477		1770	3523		1770	1762		1770	1849	
Flt Permitted		1.00		0.95	1.00		0.95	1.00		0.95	1.00	
Satd. Flow (perm)		3477		1770	3523		1770	1762		1770	1849	
Peak-hour factor, PHF	0.97	0.97	0.97	0.97	0.97	0.97	0.97	0.97	0.97	0.97	0.97	0.97
Adj. Flow (vph)	0	986	113	31	649	21	72	124	62	31	196	10
RTOR Reduction (vph)	0	9	0	0	2	0	0	25	0	0	3	0
Lane Group Flow (vph)	0	1090	0	31	668	0	72	161	0	31	203	0
Confl. Peds. (#/hr)			1						1			
Turn Type	Prot	NA		Prot	NA		Prot	NA		Prot	NA	
Protected Phases	5	2		1	6		3	8		7	4	
Permitted Phases												
Actuated Green, G (s)		25.4		1.3	30.9		3.7	18.2		1.3	15.8	
Effective Green, g (s)		25.4		1.3	30.9		3.7	18.2		1.3	15.8	
Actuated g/C Ratio		0.39		0.02	0.47		0.06	0.28		0.02	0.24	
Clearance Time (s)		6.0		4.2	6.0		4.2	4.9		4.2	4.9	
Vehicle Extension (s)		3.0		3.0	3.0		3.0	3.0		3.0	3.0	
Lane Grp Cap (vph)		1348		35	1661		99	489		35	446	
v/s Ratio Prot		c0.31		0.02	c0.19		c0.04	0.09		0.02	c0.11	
v/s Ratio Perm												
v/c Ratio		0.81		0.89	0.40		0.73	0.33		0.89	0.46	
Uniform Delay, d1		17.9		32.0	11.3		30.4	18.8		32.0	21.2	
Progression Factor		1.00		1.00	1.00		1.00	1.00		1.00	1.00	
Incremental Delay, d2		3.7		105.5	0.2		23.2	0.4		105.5	0.7	
Delay (s)		21.6		137.6	11.4		53.6	19.2		137.6	21.9	
Level of Service		C		F	B		D	B		F	C	
Approach Delay (s)		21.6		17.0			28.8			37.0		
Approach LOS		C		B			C			D		
Intersection Summary												
HCM 2000 Control Delay			22.6									C
HCM 2000 Volume to Capacity ratio			0.67									
Actuated Cycle Length (s)			65.5						19.3			
Intersection Capacity Utilization			57.0%									B
Analysis Period (min)			15									
c Critical Lane Group												

Santa Maria Airport Business Park SP
5: Orcutt Road & Union Valley Parkway

Cumulative (10-year) Plus Project PM
HCM 6th Signalized Intersection Summary



Movement	EBL	EBT	EBR	WBL	WBT	WBR	NBL	NBT	NBR	SBL	SBT	SBR
Lane Configurations	↖	↕		↖	↕		↖	↕		↖	↕	
Traffic Volume (veh/h)	0	956	110	30	630	20	70	120	60	30	190	10
Future Volume (veh/h)	0	956	110	30	630	20	70	120	60	30	190	10
Initial Q (Qb), veh	0	0	0	0	0	0	0	0	0	0	0	0
Ped-Bike Adj(A_pbT)	1.00		1.00	1.00		1.00	1.00		1.00	1.00		1.00
Parking Bus, Adj	1.00	1.00	1.00	1.00	1.00	1.00	1.00	1.00	1.00	1.00	1.00	1.00
Work Zone On Approach		No			No			No			No	
Adj Sat Flow, veh/h/ln	1870	1870	1870	1870	1870	1870	1870	1870	1870	1870	1870	1870
Adj Flow Rate, veh/h	0	986	113	31	649	21	72	124	62	31	196	10
Peak Hour Factor	0.97	0.97	0.97	0.97	0.97	0.97	0.97	0.97	0.97	0.97	0.97	0.97
Percent Heavy Veh, %	2	2	2	2	2	2	2	2	2	2	2	2
Cap, veh/h	3	1237	142	49	1734	56	91	221	111	49	292	15
Arrive On Green	0.00	0.39	0.39	0.03	0.49	0.49	0.05	0.19	0.19	0.03	0.17	0.17
Sat Flow, veh/h	1781	3212	368	1781	3513	114	1781	1176	588	1781	1764	90
Grp Volume(v), veh/h	0	545	554	31	328	342	72	0	186	31	0	206
Grp Sat Flow(s),veh/h/ln	1781	1777	1804	1781	1777	1850	1781	0	1763	1781	0	1854
Q Serve(g_s), s	0.0	14.2	14.2	0.9	6.0	6.0	2.1	0.0	5.0	0.9	0.0	5.4
Cycle Q Clear(g_c), s	0.0	14.2	14.2	0.9	6.0	6.0	2.1	0.0	5.0	0.9	0.0	5.4
Prop In Lane	1.00		0.20	1.00		0.06	1.00		0.33	1.00		0.05
Lane Grp Cap(c), veh/h	3	684	695	49	877	913	91	0	332	49	0	307
V/C Ratio(X)	0.00	0.80	0.80	0.63	0.37	0.37	0.80	0.00	0.56	0.63	0.00	0.67
Avail Cap(c_a), veh/h	137	816	829	137	877	913	164	0	1142	140	0	1176
HCM Platoon Ratio	1.00	1.00	1.00	1.00	1.00	1.00	1.00	1.00	1.00	1.00	1.00	1.00
Upstream Filter(I)	0.00	1.00	1.00	1.00	1.00	1.00	1.00	0.00	1.00	1.00	0.00	1.00
Uniform Delay (d), s/veh	0.0	14.2	14.2	25.0	8.2	8.2	24.4	0.0	19.2	25.0	0.0	20.4
Incr Delay (d2), s/veh	0.0	4.7	4.7	12.3	0.3	0.3	14.4	0.0	1.5	12.3	0.0	2.6
Initial Q Delay(d3),s/veh	0.0	0.0	0.0	0.0	0.0	0.0	0.0	0.0	0.0	0.0	0.0	0.0
%ile BackOfQ(50%),veh/ln	0.0	5.1	5.1	0.5	1.6	1.6	1.1	0.0	1.8	0.5	0.0	2.2
Unsig. Movement Delay, s/veh												
LnGrp Delay(d),s/veh	0.0	18.9	18.8	37.3	8.4	8.4	38.9	0.0	20.6	37.3	0.0	22.9
LnGrp LOS	A	B	B	D	A	A	D	A	C	D	A	C
Approach Vol, veh/h		1099			701			258				237
Approach Delay, s/veh		18.9			9.7			25.7				24.8
Approach LOS		B			A			C				C
Timer - Assigned Phs	1	2	3	4	5	6	7	8				
Phs Duration (G+Y+Rc), s	5.6	26.0	6.8	13.5	0.0	31.7	5.6	14.7				
Change Period (Y+Rc), s	* 4.2	6.0	* 4.2	4.9	* 4.2	6.0	* 4.2	4.9				
Max Green Setting (Gmax), s	* 4	23.9	* 4.8	33.0	* 4	23.9	* 4.1	33.7				
Max Q Clear Time (g_c+I1), s	2.9	16.2	4.1	7.4	0.0	8.0	2.9	7.0				
Green Ext Time (p_c), s	0.0	3.9	0.0	1.0	0.0	3.3	0.0	0.9				

Intersection Summary

HCM 6th Ctrl Delay	17.5
HCM 6th LOS	B



























Notes

* HCM 6th computational engine requires equal clearance times for the phases crossing the barrier.

Mitigated Cumulative Plus Project

Santa Maria Airport Business Park SP
2: Orcutt Expressway & Foster Road

Mitigated Cumulative (10-year) Plus Project AM
HCM 6th Signalized Intersection Summary

												
Movement	EBL	EBT	EBR	WBL	WBT	WBR	NBL	NBT	NBR	SBL	SBT	SBR
Lane Configurations	 							  			  	
Traffic Volume (veh/h)	325	124	47	120	125	260	48	1259	100	190	696	277
Future Volume (veh/h)	325	124	47	120	125	260	48	1259	100	190	696	277
Initial Q (Qb), veh	0	0	0	0	0	0	0	0	0	0	0	0
Ped-Bike Adj(A_pbT)	1.00		1.00	1.00		1.00	1.00		0.98	1.00		0.98
Parking Bus, Adj	1.00	1.00	1.00	1.00	1.00	1.00	1.00	1.00	1.00	1.00	1.00	1.00
Work Zone On Approach		No			No			No			No	
Adj Sat Flow, veh/h/ln	1856	1856	1856	1856	1856	1856	1856	1856	1856	1856	1856	1856
Adj Flow Rate, veh/h	353	135	51	130	136	140	52	1368	109	207	757	301
Peak Hour Factor	0.92	0.92	0.92	0.92	0.92	0.92	0.92	0.92	0.92	0.92	0.92	0.92
Percent Heavy Veh, %	3	3	3	3	3	3	3	3	3	3	3	3
Cap, veh/h	519	194	73	199	209	177	89	1713	136	245	2267	689
Arrive On Green	0.15	0.15	0.15	0.11	0.11	0.11	0.05	0.36	0.36	0.14	0.45	0.45
Sat Flow, veh/h	3428	1283	485	1767	1856	1572	1767	4774	380	1767	5066	1540
Grp Volume(v), veh/h	353	0	186	130	136	140	52	968	509	207	757	301
Grp Sat Flow(s),veh/h/ln	1714	0	1768	1767	1856	1572	1767	1689	1777	1767	1689	1540
Q Serve(g_s), s	8.2	0.0	8.4	5.9	5.9	7.3	2.4	21.6	21.6	9.6	8.1	11.3
Cycle Q Clear(g_c), s	8.2	0.0	8.4	5.9	5.9	7.3	2.4	21.6	21.6	9.6	8.1	11.3
Prop In Lane	1.00		0.27	1.00		1.00	1.00		0.21	1.00		1.00
Lane Grp Cap(c), veh/h	519	0	268	199	209	177	89	1212	638	245	2267	689
V/C Ratio(X)	0.68	0.00	0.70	0.65	0.65	0.79	0.59	0.80	0.80	0.84	0.33	0.44
Avail Cap(c_a), veh/h	1636	0	844	213	224	189	194	1414	744	312	2460	748
HCM Platoon Ratio	1.00	1.00	1.00	1.00	1.00	1.00	1.00	1.00	1.00	1.00	1.00	1.00
Upstream Filter(I)	1.00	0.00	1.00	1.00	1.00	1.00	1.00	1.00	1.00	1.00	1.00	1.00
Uniform Delay (d), s/veh	33.7	0.0	33.7	35.6	35.6	36.2	39.0	24.2	24.2	35.2	15.0	15.9
Incr Delay (d2), s/veh	1.6	0.0	3.2	6.4	6.0	19.0	6.0	2.9	5.3	15.3	0.1	0.4
Initial Q Delay(d3),s/veh	0.0	0.0	0.0	0.0	0.0	0.0	0.0	0.0	0.0	0.0	0.0	0.0
%ile BackOfQ(50%),veh/ln	3.3	0.0	3.7	2.8	2.9	0.9	1.1	7.9	8.7	4.8	2.6	3.4
Unsig. Movement Delay, s/veh												
LnGrp Delay(d),s/veh	35.2	0.0	37.0	42.1	41.6	55.3	44.9	27.0	29.5	50.5	15.1	16.3
LnGrp LOS	D	A	D	D	D	E	D	C	C	D	B	B
Approach Vol, veh/h		539			406			1529			1265	
Approach Delay, s/veh		35.8			46.5			28.5			21.2	
Approach LOS		D			D			C			C	
Timer - Assigned Phs	1	2		4	5	6		8				
Phs Duration (G+Y+Rc), s	15.8	36.1		17.6	8.4	43.5		14.3				
Change Period (Y+Rc), s	* 4.2	6.0		4.9	* 4.2	6.0		4.9				
Max Green Setting (Gmax), s	* 15	35.1		40.0	* 9.2	40.7		10.1				
Max Q Clear Time (g_c+I1), s	11.6	23.6		10.4	4.4	13.3		9.3				
Green Ext Time (p_c), s	0.2	6.5		2.3	0.0	6.0		0.2				

Intersection Summary

HCM 6th Ctrl Delay	29.0
HCM 6th LOS	C

Notes

* HCM 6th computational engine requires equal clearance times for the phases crossing the barrier.

Santa Maria Airport Business Park SP
3: Foxenwood Lane & Union Valley Parkway

Mitigated Cumulative (10-year) Plus Project AM
HCM 6th Signalized Intersection Summary



Movement	EBL	EBT	EBR	WBL	WBT	WBR	NBL	NBT	NBR	SBL	SBT	SBR
Lane Configurations												
Traffic Volume (veh/h)	65	330	10	80	210	148	10	57	190	132	44	34
Future Volume (veh/h)	65	330	10	80	210	148	10	57	190	132	44	34
Initial Q (Qb), veh	0	0	0	0	0	0	0	0	0	0	0	0
Ped-Bike Adj(A_pbT)	1.00		1.00	1.00		1.00	1.00		1.00	1.00		1.00
Parking Bus, Adj	1.00	1.00	1.00	1.00	1.00	1.00	1.00	1.00	1.00	1.00	1.00	1.00
Work Zone On Approach		No			No			No			No	
Adj Sat Flow, veh/h/ln	1856	1856	1856	1856	1856	1856	1856	1856	1856	1856	1856	1856
Adj Flow Rate, veh/h	71	359	11	87	228	161	11	62	207	143	48	37
Peak Hour Factor	0.92	0.92	0.92	0.92	0.92	0.92	0.92	0.92	0.92	0.92	0.92	0.92
Percent Heavy Veh, %	3	3	3	3	3	3	3	3	3	3	3	3
Cap, veh/h	109	621	19	122	372	252	15	82	273	196	66	51
Arrive On Green	0.06	0.18	0.18	0.07	0.19	0.19	0.23	0.23	0.23	0.18	0.18	0.18
Sat Flow, veh/h	1767	3492	107	1767	2012	1361	64	362	1209	1097	368	284
Grp Volume(v), veh/h	71	181	189	87	199	190	280	0	0	228	0	0
Grp Sat Flow(s),veh/h/ln	1767	1763	1836	1767	1763	1610	1635	0	0	1750	0	0
Q Serve(g_s), s	2.0	4.9	4.9	2.5	5.3	5.6	8.3	0.0	0.0	6.4	0.0	0.0
Cycle Q Clear(g_c), s	2.0	4.9	4.9	2.5	5.3	5.6	8.3	0.0	0.0	6.4	0.0	0.0
Prop In Lane	1.00		0.06	1.00		0.85	0.04		0.74	0.63		0.16
Lane Grp Cap(c), veh/h	109	314	327	122	326	298	370	0	0	312	0	0
V/C Ratio(X)	0.65	0.58	0.58	0.71	0.61	0.64	0.76	0.00	0.00	0.73	0.00	0.00
Avail Cap(c_a), veh/h	171	768	800	188	785	717	1171	0	0	1253	0	0
HCM Platoon Ratio	1.00	1.00	1.00	1.00	1.00	1.00	1.00	1.00	1.00	1.00	1.00	1.00
Upstream Filter(I)	1.00	1.00	1.00	1.00	1.00	1.00	1.00	0.00	0.00	1.00	0.00	0.00
Uniform Delay (d), s/veh	23.7	19.4	19.5	23.5	19.3	19.5	18.7	0.0	0.0	20.0	0.0	0.0
Incr Delay (d2), s/veh	6.3	1.7	1.6	7.5	1.8	2.3	3.2	0.0	0.0	3.3	0.0	0.0
Initial Q Delay(d3),s/veh	0.0	0.0	0.0	0.0	0.0	0.0	0.0	0.0	0.0	0.0	0.0	0.0
%ile BackOfQ(50%),veh/ln	0.9	1.8	1.9	1.1	2.0	1.9	2.9	0.0	0.0	2.4	0.0	0.0
Unsig. Movement Delay, s/veh												
LnGrp Delay(d),s/veh	30.0	21.1	21.1	31.0	21.2	21.7	21.9	0.0	0.0	23.3	0.0	0.0
LnGrp LOS	C	C	C	C	C	C	C	A	A	C	A	A
Approach Vol, veh/h		441			476			280			228	
Approach Delay, s/veh		22.5			23.2			21.9			23.3	
Approach LOS		C			C			C			C	
Timer - Assigned Phs	1	2		4	5	6		8				
Phs Duration (G+Y+Rc), s	8.1	13.7		13.7	7.7	14.1		16.2				
Change Period (Y+Rc), s	4.5	4.5		4.5	4.5	4.5		4.5				
Max Green Setting (Gmax), s	5.5	22.5		37.0	5.0	23.0		37.0				
Max Q Clear Time (g_c+1),s	11.5	6.9		8.4	4.0	7.6		10.3				
Green Ext Time (p_c), s	0.0	1.6		1.2	0.0	1.8		1.6				
Intersection Summary												
HCM 6th Ctrl Delay											22.7	
HCM 6th LOS											C	

Santa Maria Airport Business Park SP
4: Orcutt Expressway & Union Valley Parkway





























Mitigated Cumulative (10-year) Plus Project AM
HCM 6th Signalized Intersection Summary



Movement	EBL	EBT	EBR	WBL	WBT	WBR	NBL	NBT	NBR	SBL	SBT	SBR
Lane Configurations	↖↗	↑↑	↖	↖↗	↑↑	↖	↖	↑↑↑	↖	↖↗	↑↑↑	↖
Traffic Volume (veh/h)	221	364	97	400	266	360	137	826	260	142	583	158
Future Volume (veh/h)	221	364	97	400	266	360	137	826	260	142	583	158
Initial Q (Qb), veh	0	0	0	0	0	0	0	0	0	0	0	0
Ped-Bike Adj(A_pbT)	1.00		1.00	1.00		1.00	1.00		1.00	1.00		0.99
Parking Bus, Adj	1.00	1.00	1.00	1.00	1.00	1.00	1.00	1.00	1.00	1.00	1.00	1.00
Work Zone On Approach		No			No			No			No	
Adj Sat Flow, veh/h/ln	1856	1856	1856	1856	1856	1856	1856	1856	1856	1856	1856	1856
Adj Flow Rate, veh/h	240	396	105	435	289	391	149	898	283	154	634	172
Peak Hour Factor	0.92	0.92	0.92	0.92	0.92	0.92	0.92	0.92	0.92	0.92	0.92	0.92
Percent Heavy Veh, %	3	3	3	3	3	3	3	3	3	3	3	3
Cap, veh/h	332	849	379	535	1037	463	184	1338	415	317	1307	401
Arrive On Green	0.10	0.24	0.24	0.16	0.29	0.29	0.10	0.26	0.26	0.09	0.26	0.26
Sat Flow, veh/h	3428	3526	1572	3428	3526	1572	1767	5066	1572	3428	5066	1552
Grp Volume(v), veh/h	240	396	105	435	289	391	149	898	283	154	634	172
Grp Sat Flow(s),veh/h/ln	1714	1763	1572	1714	1763	1572	1767	1689	1572	1714	1689	1552
Q Serve(g_s), s	5.7	8.1	4.6	10.3	5.3	19.7	7.0	13.4	13.6	3.6	8.9	7.8
Cycle Q Clear(g_c), s	5.7	8.1	4.6	10.3	5.3	19.7	7.0	13.4	13.6	3.6	8.9	7.8
Prop In Lane	1.00		1.00	1.00		1.00	1.00		1.00	1.00		1.00
Lane Grp Cap(c), veh/h	332	849	379	535	1037	463	184	1338	415	317	1307	401
V/C Ratio(X)	0.72	0.47	0.28	0.81	0.28	0.85	0.81	0.67	0.68	0.49	0.48	0.43
Avail Cap(c_a), veh/h	622	1882	839	736	1978	882	262	2290	711	325	2049	628
HCM Platoon Ratio	1.00	1.00	1.00	1.00	1.00	1.00	1.00	1.00	1.00	1.00	1.00	1.00
Upstream Filter(I)	1.00	1.00	1.00	1.00	1.00	1.00	1.00	1.00	1.00	1.00	1.00	1.00
Uniform Delay (d), s/veh	37.0	27.4	26.0	34.4	22.9	27.9	36.9	27.7	27.8	36.4	26.5	26.1
Incr Delay (d2), s/veh	3.0	0.4	0.4	5.0	0.1	4.3	11.8	0.6	2.0	1.2	0.3	0.7
Initial Q Delay(d3),s/veh	0.0	0.0	0.0	0.0	0.0	0.0	0.0	0.0	0.0	0.0	0.0	0.0
%ile BackOfQ(50%),veh/ln	2.4	3.2	1.6	4.4	2.1	7.3	3.4	4.9	4.9	1.4	3.3	2.7
Unsig. Movement Delay, s/veh												
LnGrp Delay(d),s/veh	40.0	27.8	26.4	39.4	23.0	32.3	48.7	28.3	29.8	37.5	26.8	26.8
LnGrp LOS	D	C	C	D	C	C	D	C	C	D	C	C
Approach Vol, veh/h		741			1115			1330			960	
Approach Delay, s/veh		31.5			32.6			30.9			28.5	
Approach LOS		C			C			C			C	
Timer - Assigned Phs	1	2	3	4	5	6	7	8				
Phs Duration (G+Y+Rc), s	22.8	28.3	18.0	25.2	13.3	27.8	13.6	29.7				
Change Period (Y+Rc), s	5.0	6.0	4.9	4.9	4.5	6.0	5.4	4.9				
Max Green Setting (Gmax), s	38.1	38.1	18.1	45.0	12.5	34.1	15.3	47.3				
Max Q Clear Time (g_c+1), s	15.6	15.6	12.3	10.1	9.0	10.9	7.7	21.7				
Green Ext Time (p_c), s	0.1	6.6	0.8	2.8	0.1	4.4	0.5	3.1				
Intersection Summary												
HCM 6th Ctrl Delay											30.9	
HCM 6th LOS											C	

Santa Maria Airport Business Park SP
2: Orcutt Expressway & Foster Road

Mitigated Cumulative (10-year) Plus Project PM
HCM 6th Signalized Intersection Summary

												
Movement	EBL	EBT	EBR	WBL	WBT	WBR	NBL	NBT	NBR	SBL	SBT	SBR
Lane Configurations	 							  		  	  	
Traffic Volume (veh/h)	380	95	74	70	86	110	35	1000	60	140	1392	310
Future Volume (veh/h)	380	95	74	70	86	110	35	1000	60	140	1392	310
Initial Q (Qb), veh	0	0	0	0	0	0	0	0	0	0	0	0
Ped-Bike Adj(A_pbT)	1.00		0.98	1.00		1.00	1.00		1.00	1.00		1.00
Parking Bus, Adj	1.00	1.00	1.00	1.00	1.00	1.00	1.00	1.00	1.00	1.00	1.00	1.00
Work Zone On Approach		No			No			No			No	
Adj Sat Flow, veh/h/ln	1870	1870	1870	1870	1870	1870	1870	1870	1870	1870	1870	1870
Adj Flow Rate, veh/h	396	99	77	73	90	56	36	1042	62	146	1450	323
Peak Hour Factor	0.96	0.96	0.96	0.96	0.96	0.96	0.96	0.96	0.96	0.96	0.96	0.96
Percent Heavy Veh, %	2	2	2	2	2	2	2	2	2	2	2	2
Cap, veh/h	590	165	128	188	197	167	75	1740	103	185	2118	657
Arrive On Green	0.17	0.17	0.17	0.11	0.11	0.11	0.04	0.35	0.35	0.10	0.41	0.41
Sat Flow, veh/h	3456	967	752	1781	1870	1585	1781	4929	293	1781	5106	1585
Grp Volume(v), veh/h	396	0	176	73	90	56	36	719	385	146	1450	323
Grp Sat Flow(s),veh/h/ln	1728	0	1719	1781	1870	1585	1781	1702	1818	1781	1702	1585
Q Serve(g_s), s	8.0	0.0	7.1	2.9	3.4	2.5	1.5	13.0	13.0	6.0	17.4	11.2
Cycle Q Clear(g_c), s	8.0	0.0	7.1	2.9	3.4	2.5	1.5	13.0	13.0	6.0	17.4	11.2
Prop In Lane	1.00		0.44	1.00		1.00	1.00		0.16	1.00		1.00
Lane Grp Cap(c), veh/h	590	0	293	188	197	167	75	1202	642	185	2118	657
V/C Ratio(X)	0.67	0.00	0.60	0.39	0.46	0.33	0.48	0.60	0.60	0.79	0.68	0.49
Avail Cap(c_a), veh/h	1844	0	917	240	252	214	143	1548	827	375	2990	928
HCM Platoon Ratio	1.00	1.00	1.00	1.00	1.00	1.00	1.00	1.00	1.00	1.00	1.00	1.00
Upstream Filter(I)	1.00	0.00	1.00	1.00	1.00	1.00	1.00	1.00	1.00	1.00	1.00	1.00
Uniform Delay (d), s/veh	29.1	0.0	28.7	31.3	31.5	31.1	35.1	19.9	19.9	32.8	17.9	16.1
Incr Delay (d2), s/veh	1.3	0.0	2.0	1.3	1.6	1.2	4.7	0.5	0.9	7.3	0.4	0.6
Initial Q Delay(d3),s/veh	0.0	0.0	0.0	0.0	0.0	0.0	0.0	0.0	0.0	0.0	0.0	0.0
%ile BackOfQ(50%),veh/ln	3.2	0.0	2.9	1.2	1.5	0.9	0.7	4.4	4.8	2.7	5.6	3.4
Unsig. Movement Delay, s/veh												
LnGrp Delay(d),s/veh	30.5	0.0	30.7	32.6	33.1	32.3	39.8	20.4	20.8	40.0	18.3	16.7
LnGrp LOS	C	A	C	C	C	C	D	C	C	D	B	B
Approach Vol, veh/h		572			219			1140			1919	
Approach Delay, s/veh		30.5			32.7			21.1			19.7	
Approach LOS		C			C			C			B	
Timer - Assigned Phs	1	2		4	5	6		8				
Phs Duration (G+Y+Rc), s	12.0	32.5		17.7	7.4	37.1		12.8				
Change Period (Y+Rc), s	* 4.2	6.0		4.9	* 4.2	6.0		4.9				
Max Green Setting (Gmax), s	* 16	34.1		40.0	* 6	43.9		10.1				
Max Q Clear Time (g_c+I1), s	8.0	15.0		10.0	3.5	19.4		5.4				
Green Ext Time (p_c), s	0.2	6.2		2.5	0.0	11.7		0.3				
Intersection Summary												
HCM 6th Ctrl Delay				22.5								
HCM 6th LOS				C								
Notes												
* HCM 6th computational engine requires equal clearance times for the phases crossing the barrier.												

Santa Maria Airport Business Park SP
3: Foxenwood Lane & Union Valley Parkway

Mitigated Cumulative (10-year) Plus Project PM
HCM 6th Signalized Intersection Summary



Movement	EBL	EBT	EBR	WBL	WBT	WBR	NBL	NBT	NBR	SBL	SBT	SBR
Lane Configurations												
Traffic Volume (veh/h)	36	260	10	190	330	85	10	14	120	182	16	55
Future Volume (veh/h)	36	260	10	190	330	85	10	14	120	182	16	55
Initial Q (Qb), veh	0	0	0	0	0	0	0	0	0	0	0	0
Ped-Bike Adj(A_pbT)	1.00		1.00	1.00		1.00	1.00		1.00	1.00		1.00
Parking Bus, Adj	1.00	1.00	1.00	1.00	1.00	1.00	1.00	1.00	1.00	1.00	1.00	1.00
Work Zone On Approach		No			No			No			No	
Adj Sat Flow, veh/h/ln	1885	1885	1885	1885	1885	1885	1885	1885	1885	1885	1885	1885
Adj Flow Rate, veh/h	39	283	11	207	359	92	11	15	130	198	17	60
Peak Hour Factor	0.92	0.92	0.92	0.92	0.92	0.92	0.92	0.92	0.92	0.92	0.92	0.92
Percent Heavy Veh, %	1	1	1	1	1	1	1	1	1	1	1	1
Cap, veh/h	76	518	20	210	628	159	16	21	186	272	23	82
Arrive On Green	0.04	0.15	0.15	0.12	0.22	0.22	0.14	0.14	0.14	0.22	0.22	0.22
Sat Flow, veh/h	1795	3515	136	1795	2829	716	115	157	1359	1262	108	383
Grp Volume(v), veh/h	39	144	150	207	226	225	156	0	0	275	0	0
Grp Sat Flow(s),veh/h/ln	1795	1791	1861	1795	1791	1754	1631	0	0	1753	0	0
Q Serve(g_s), s	1.0	3.5	3.5	5.4	5.3	5.4	4.3	0.0	0.0	6.9	0.0	0.0
Cycle Q Clear(g_c), s	1.0	3.5	3.5	5.4	5.3	5.4	4.3	0.0	0.0	6.9	0.0	0.0
Prop In Lane	1.00		0.07	1.00		0.41	0.07		0.83	0.72		0.22
Lane Grp Cap(c), veh/h	76	264	274	210	398	390	223	0	0	377	0	0
V/C Ratio(X)	0.51	0.54	0.55	0.98	0.57	0.58	0.70	0.00	0.00	0.73	0.00	0.00
Avail Cap(c_a), veh/h	191	859	892	210	878	860	1286	0	0	1382	0	0
HCM Platoon Ratio	1.00	1.00	1.00	1.00	1.00	1.00	1.00	1.00	1.00	1.00	1.00	1.00
Upstream Filter(I)	1.00	1.00	1.00	1.00	1.00	1.00	1.00	0.00	0.00	1.00	0.00	0.00
Uniform Delay (d), s/veh	22.0	18.5	18.6	20.7	16.2	16.3	19.3	0.0	0.0	17.1	0.0	0.0
Incr Delay (d2), s/veh	5.2	1.7	1.7	57.2	1.3	1.4	4.0	0.0	0.0	2.7	0.0	0.0
Initial Q Delay(d3),s/veh	0.0	0.0	0.0	0.0	0.0	0.0	0.0	0.0	0.0	0.0	0.0	0.0
%ile BackOfQ(50%),veh/ln	0.5	1.3	1.4	5.2	1.8	1.9	1.6	0.0	0.0	2.5	0.0	0.0
Unsig. Movement Delay, s/veh												
LnGrp Delay(d),s/veh	27.2	20.3	20.3	77.8	17.5	17.7	23.3	0.0	0.0	19.8	0.0	0.0
LnGrp LOS	C	C	C	E	B	B	C	A	A	B	A	A
Approach Vol, veh/h		333			658			156			275	
Approach Delay, s/veh		21.1			36.5			23.3			19.8	
Approach LOS		C			D			C			B	
Timer - Assigned Phs	1	2		4	5	6		8				
Phs Duration (G+Y+Rc), s	10.0	11.4		14.6	6.5	14.9		10.9				
Change Period (Y+Rc), s	4.5	4.5		4.5	4.5	4.5		4.5				
Max Green Setting (Gmax), s	5.5	22.5		37.0	5.0	23.0		37.0				
Max Q Clear Time (g_c+1T), s	4.5	5.5		8.9	3.0	7.4		6.3				
Green Ext Time (p_c), s	0.0	1.3		1.5	0.0	2.1		0.9				
Intersection Summary												
HCM 6th Ctrl Delay											28.2	
HCM 6th LOS											C	

Santa Maria Airport Business Park SP
4: Orcutt Expressway & Union Valley Parkway

Mitigated Cumulative (10-year) Plus Project PM
HCM 6th Signalized Intersection Summary



Movement	EBL	EBT	EBR	WBL	WBT	WBR	NBL	NBT	NBR	SBL	SBT	SBR
Lane Configurations	↔↔	↑↑	↗	↔↔	↑↑	↗	↗	↑↑↑	↗	↔↔	↑↑↑	↗
Traffic Volume (veh/h)	191	279	92	280	310	110	88	814	430	337	966	303
Future Volume (veh/h)	191	279	92	280	310	110	88	814	430	337	966	303
Initial Q (Qb), veh	0	0	0	0	0	0	0	0	0	0	0	0
Ped-Bike Adj(A_pbT)	1.00		1.00	1.00		1.00	1.00		1.00	1.00		1.00
Parking Bus, Adj	1.00	1.00	1.00	1.00	1.00	1.00	1.00	1.00	1.00	1.00	1.00	1.00
Work Zone On Approach		No			No			No			No	
Adj Sat Flow, veh/h/ln	1870	1870	1870	1870	1870	1870	1870	1870	1870	1870	1870	1870
Adj Flow Rate, veh/h	193	282	93	283	313	111	89	822	434	340	976	306
Peak Hour Factor	0.99	0.99	0.99	0.99	0.99	0.99	0.99	0.99	0.99	0.99	0.99	0.99
Percent Heavy Veh, %	2	2	2	2	2	2	2	2	2	2	2	2
Cap, veh/h	368	518	231	374	500	223	162	1814	563	375	1939	602
Arrive On Green	0.11	0.15	0.15	0.11	0.14	0.14	0.09	0.36	0.36	0.11	0.38	0.38
Sat Flow, veh/h	3456	3554	1585	3456	3554	1585	1781	5106	1585	3456	5106	1585
Grp Volume(v), veh/h	193	282	93	283	313	111	89	822	434	340	976	306
Grp Sat Flow(s),veh/h/ln	1728	1777	1585	1728	1777	1585	1781	1702	1585	1728	1702	1585
Q Serve(g_s), s	3.9	5.4	3.9	5.9	6.1	4.8	3.5	9.1	17.9	7.2	10.8	10.9
Cycle Q Clear(g_c), s	3.9	5.4	3.9	5.9	6.1	4.8	3.5	9.1	17.9	7.2	10.8	10.9
Prop In Lane	1.00		1.00	1.00		1.00	1.00		1.00	1.00		1.00
Lane Grp Cap(c), veh/h	368	518	231	374	500	223	162	1814	563	375	1939	602
V/C Ratio(X)	0.52	0.54	0.40	0.76	0.63	0.50	0.55	0.45	0.77	0.91	0.50	0.51
Avail Cap(c_a), veh/h	553	2169	968	375	1962	875	304	2646	821	375	2362	733
HCM Platoon Ratio	1.00	1.00	1.00	1.00	1.00	1.00	1.00	1.00	1.00	1.00	1.00	1.00
Upstream Filter(I)	1.00	1.00	1.00	1.00	1.00	1.00	1.00	1.00	1.00	1.00	1.00	1.00
Uniform Delay (d), s/veh	31.2	29.2	28.6	31.9	29.8	29.3	32.1	18.3	21.1	32.5	17.5	17.6
Incr Delay (d2), s/veh	1.2	0.9	1.1	8.6	1.3	1.7	2.9	0.2	2.7	25.0	0.2	0.7
Initial Q Delay(d3),s/veh	0.0	0.0	0.0	0.0	0.0	0.0	0.0	0.0	0.0	0.0	0.0	0.0
%ile BackOfQ(50%),veh/ln	1.6	2.2	1.4	2.7	2.5	1.8	1.5	3.0	6.2	4.0	3.5	3.6
Unsig. Movement Delay, s/veh												
LnGrp Delay(d),s/veh	32.3	30.1	29.7	40.5	31.1	31.0	34.9	18.4	23.8	57.4	17.7	18.2
LnGrp LOS	C	C	C	D	C	C	C	B	C	E	B	B
Approach Vol, veh/h		568			707			1345			1622	
Approach Delay, s/veh		30.8			34.8			21.3			26.2	
Approach LOS		C			C			C			C	
Timer - Assigned Phs	1	2	3	4	5	6	7	8				
Phs Duration (G+Y+Rc), s	13.0	32.2	12.9	15.6	11.2	34.0	13.2	15.3				
Change Period (Y+Rc), s	5.0	6.0	4.9	4.9	4.5	6.0	5.4	4.9				
Max Green Setting (Gmax), s	38.2	38.2	8.0	45.0	12.6	34.1	11.8	40.7				
Max Q Clear Time (g_c+1/2), s	19.9	19.9	7.9	7.4	5.5	12.9	5.9	8.1				
Green Ext Time (p_c), s	0.0	6.3	0.0	2.0	0.1	7.2	0.3	2.3				
Intersection Summary												
HCM 6th Ctrl Delay											26.7	
HCM 6th LOS											C	

Appendix C: Warrant Analysis Sheets



Traffic Signal Warrant Analysis

Warrants 1 - 3 (Volume Warrants)

Project Name	Santa Maria Airport Business Park SP
Project/File #	2019_157
Scenario	Existing Plus Project

Intersection Information			
Major Street (E/W Road)	Union Valley Pkwy	Minor Street (N/S Road)	Foxenwood Ln
Analyzed with	2 or more approach lanes	Analyzed with	1 Approach Lane
Total Approach Volume	1557 vehicles	Total Approach Volume	739 vehicles
Total Ped/Bike Volume	0 crossings	Total Ped/Bike Volume	0 crossings
Right turn reduction of	0 percent applied	Right turn reduction of	0 percent applied

No high speed or isolated community reduction applied to the Volume Warrant thresholds.

Warrant 1, Eight Hour Vehicular Volume			
Condition Satisfied?	Not Satisfied	Not Satisfied	Not Satisfied
Required values reached for	2 hours	2 hours	2 (Cond. A) & 2 (Cond. B)
Criteria - Major Street (veh/hr)	420	630	336 (Cond. A) & 504 (Cond. B)
Criteria - Minor Street (veh/hr)	105	53	84 (Cond. A) & 42 (Cond. B)

* Should be applied only after an adequate trial of other alternatives that could cause less delay and inconvenience to traffic has failed to solve the traffic problems.

Warrant 2, Four Hour Vehicular Volume	
Condition Satisfied?	Not Satisfied
Required values reached for	2 hours
Criteria	See Figure Below

Warrant 3, Peak Hour Vehicular Volume		
Condition Satisfied?	Satisfied	Satisfied
Required values reached for	1144 total, 220 minor, 11.8 delay	2 hours
Criteria - Total Approach Volume (veh in one hour)	800	See Figure Below
Criteria - Minor Street High Side Volume (veh in one hour)	100	
Criteria - Minor Street High Side Delay (veh-hrs)	4	

Figure 4C-2 (Warrant 2 - 70% Factor) & Figure 4C-4 (Warrant 3 - 70% Factor)

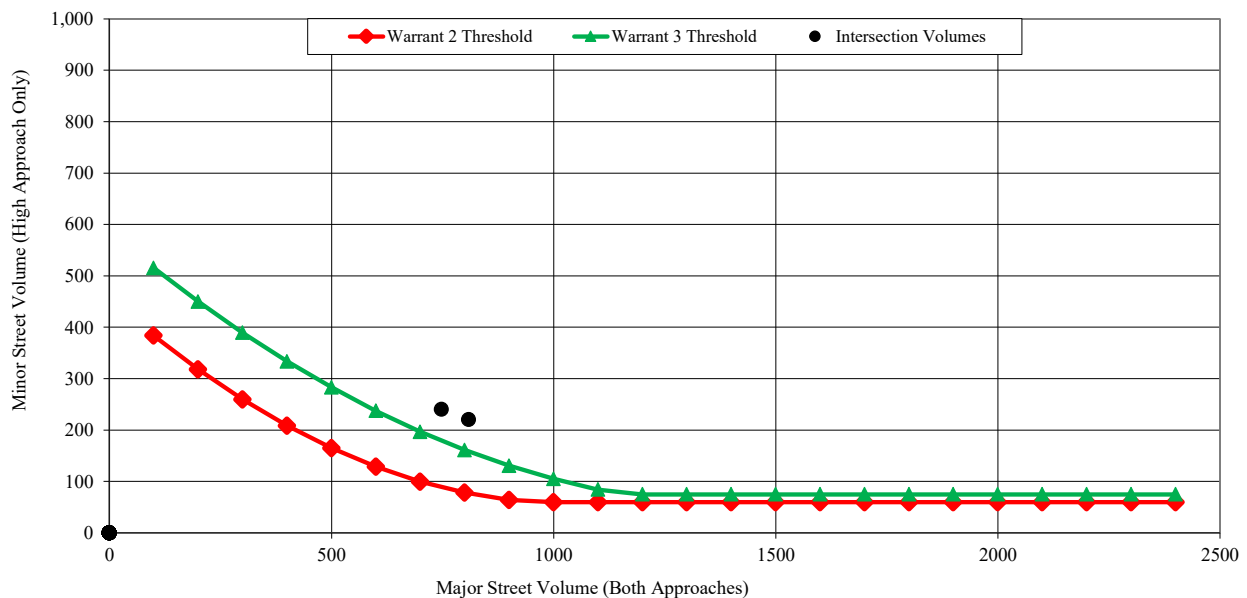



Traffic Signal Warrant Analysis

Warrants 1 - 3 (Volume Warrants)

Project Name	Santa Maria Airport Business Park SP
Project/File #	2019_157
Scenario	Cumulative (10-year) Plus Project

Intersection Information			
Major Street (E/W Road)	Union Valley Pkwy	Minor Street (N/S Road)	Foxenwood Ln
Analyzed with	2 or more approach lanes	Analyzed with	1 Approach Lane
Total Approach Volume	1754 vehicles	Total Approach Volume	864 vehicles
Total Ped/Bike Volume	0 crossings	Total Ped/Bike Volume	0 crossings
Right turn reduction of	0 percent applied	Right turn reduction of	0 percent applied

No high speed or isolated community reduction applied to the Volume Warrant thresholds.

Warrant 1, Eight Hour Vehicular Volume			
	Condition A	Condition B	Condition A+B*
Condition Satisfied?	Not Satisfied	Not Satisfied	Not Satisfied
Required values reached for	2 hours	2 hours	2 (Cond. A) & 2 (Cond. B)
Criteria - Major Street (veh/hr)	420	630	336 (Cond. A) & 504 (Cond. B)
Criteria - Minor Street (veh/hr)	105	53	84 (Cond. A) & 42 (Cond. B)

* Should be applied only after an adequate trial of other alternatives that could cause less delay and inconvenience to traffic has failed to solve the traffic problems.

Warrant 2, Four Hour Vehicular Volume	
Condition Satisfied?	Not Satisfied
Required values reached for	2 hours
Criteria	See Figure Below

Warrant 3, Peak Hour Vehicular Volume		
	Condition A	Condition B
Condition Satisfied?	Satisfied	Satisfied
Required values reached for	1308 total, 253 minor, 30.9 delay	2 hours
Criteria - Total Approach Volume (veh in one hour)	800	See Figure Below
Criteria - Minor Street High Side Volume (veh in one hour)	100	
Criteria - Minor Street High Side Delay (veh-hrs)	4	

Figure 4C-2 (Warrant 2 - 70% Factor) & Figure 4C-4 (Warrant 3 - 70% Factor)

