

GREAT OAKS SOUTH BACKUP GENERATING FACILITY

Draft Environmental Impact Report

SCH # 2020100431



**CALIFORNIA
ENERGY
COMMISSION**
Gavin Newsom,
Governor

May 2021
CEC-700-2021-001

DOCKET NUMBER 20-SPPE-01

Draft Environmental Impact Report

Great Oaks South Backup Generating Facility

(20-SPPE-01)

Lead Agency

California Energy Commission



May 2021

Table of Contents

1	Summary	1-1
2	Introduction.....	2-1
3	Project Description	3-1
4	Environmental Setting and Environmental Impacts.....	4.1-1
	4.1 Aesthetics	4.1-1
	4.2 Agriculture and Forestry Resources.....	4.2-1
	4.3 Air Quality.....	4.3-1
	4.4 Biological Resources	4.4-1
	4.5 Cultural and Tribal Cultural Resources	4.5-1
	4.6 Energy and Energy Resources	4.6-1
	4.7 Geology and Soils	4.7-1
	4.8 Greenhouse Gas Emissions	4.8-1
	4.9 Hazards and Hazardous Materials	4.9-1
	4.10 Hydrology and Water Quality	4.10-1
	4.11 Land Use and Planning	4.11-1
	4.12 Mineral Resources	4.12-1
	4.13 Noise.....	4.13-1
	4.14 Population and Housing.....	4.14-1
	4.15 Public Services.....	4.15-1
	4.16 Recreation	4.16-1
	4.17 Transportation	4.17-1
	4.18 Utilities and Service Systems.....	4.18-1
	4.19 Wildfire	4.19-1
	4.20 Mandatory Findings of Significance.....	4.20-1
	4.21 Environmental Justice	4.21-1
5	Alternatives	5-1
6	Authors and Reviewers	6-1

- Appendix A: Project’s Jurisdictional and Generating Capacity Analysis**
- Appendix B: Pacific Gas & Electric System Details and Emergency Operations**
- Appendix C: Nitrogen Deposition Modeling**
- Appendix D: Renewable Diesel and Natural Gas Supplemental Information**
- Appendix E: Mailing List**

Section 1

Summary

1 Summary

This environmental impact report (EIR) has been prepared by the California Energy Commission (CEC) to evaluate the potential environmental effects of the development of the Great Oaks South Backup Generating Facility and associated data center (project), in compliance with the California Environmental Quality Act (CEQA), the CEQA Guidelines, the Warren-Alquist Act, and California Code of Regulations, Title 20 (Small Power Plant Exemptions).

The CEC has the exclusive authority to certify all thermal power plants (50 megawatts [MW] and greater) and related facilities proposed for construction in California. The Small Power Plant Exemption (SPPE) process allows applicants with facilities between 50 and 100 MW to obtain an exemption from CEC's jurisdiction and proceed with local permitting rather than requiring CEC certification. CEC can grant an exemption if it finds that the proposed facility would not create a substantial adverse impact on the environment or energy resources. Public Resources Code section 25519(c) designates CEC as the lead agency, in accordance with CEQA, for all facilities seeking an SPPE.

1.1 Project Summary

SV1, LLC, a wholly owned subsidiary of Equinix, LLC (SV1 or applicant) filed an SPPE application seeking an exemption from the CEC's jurisdiction for the Great Oaks South Backup Generating Facility (GOSBGF) (20-SPPE-01). The GOSBGF would be part of the Great Oaks South Data Center (GOSDC) to be located in the City of San Jose. The project was approved by the City of San Jose on February 1, 2017. Since its approval, SV1, LLC has made project design changes and is now seeking approval of an SPPE for the GOSBGF.

The GOSDC would consist of three 182,350 square foot, two-story data center buildings. The approximately 18-acre project site is associated with three addresses (123, 127, and 131 Great Oaks Boulevard) in the City of San Jose.

The GOSBGF would consist of 36 3.25-MW diesel-fired generators in six generation yards that would each be separately electrically interconnected to the three data center buildings. The GOSBGF would be used exclusively to provide backup generation and uninterruptible power supply for the GOSDC, and other than for routine maintenance and testing, would only operate in the event of a failure of the electrical service from Pacific Gas and Electric Company (PG&E) to the data center. In addition, the GOSBGF would include three life safety diesel fired generators, each capable of generating 0.50 MW. GOSBGF would have a generating capacity of up to 99.0 MW.

The GOSDC would connect to a new PG&E substation via five new 21 kilovolt (kV) distribution feeders that would extend underground along Via Del Oro and/or Santa Teresa to the project site. The California Public Utilities Commission has granted PG&E approval to construct the new substation, which is called the "Santa Teresa Substation".

Project Goals and Objectives

The applicant's primary goal is to develop a state-of-the-art data center that would be part of the single, largest internet hub on the west coast. The primary project objective is to reliably meet the increased demand of the digital economy and its customers (SV1 2020k).

In addition to its primary goal, the applicant has set forth these project objectives:

- Develop a state-of-the-art data center with up to 547,000 square feet.
- Develop the data center on land that has been previously approved for a similar size data center.
- Develop a data center that can be constructed in phases which can be timed to match projected customer growth.
- Meet high sustainability and green building standards by designing the data center to meet U.S. Green Building Code LEED and Cal-Green standards for new construction.
- Incorporate the most reliable and flexible form of backup electric generating technology considering the following evaluation criteria:
 - Commercial Availability and Feasibility. The selected backup electric generation technology must currently be in use and proven as an accepted industry standard for technology. It must be operational within a reasonable timeframe where permits and approvals are required.
 - Technical Feasibility. The selected backup electric generation technology must utilize systems that are compatible with one another.
 - Reliability. The selected backup electric generation technology must be extremely reliable in the case of an emergency loss of electricity from the utility.
 - Industry Standard. The selected backup electric generation technology must be considered industry standard or best practice. The customers of SV1 are informed consumers and will request SV1 to provide a detailed description of the type of backup generation that it delivers as part of the customer's due diligence. If the selected technology does not meet customers' requirements, they will not put their servers in the Great Oaks South Data Center.

1.2 Summary of Environmental Impacts and Mitigation Measures

The applicant proposed design measures (PD) listed in Table 1-1 are considered part of the project design and would help avoid potentially significant impacts from construction and operation of the project. The measures listed below are those proposed design measures that staff has found adequate. For the measures that were not found sufficient, staff edited the measures, now termed mitigation measures (Table 1-2).

In accordance with section 25519(c) of the Public Resources Code and CEQA, CEC serves as the lead agency to review an SPPE application and perform any required environmental

analyses. Upon granting of an exemption, the local permitting authorities—in this case the City of San Jose and Bay Area Air Quality Management District (BAAQMD)—would perform any follow-up CEQA analysis and impose mitigation, as necessary, for granting approval of the project.

Table 1-1 provides an overview of the analysis in **Section 4 Environmental Setting, Impacts, and Mitigation**. Impacts are categorized by the type of impact as follows:

- No Impact. The scenario in which no adverse physical changes to (or impacts on) the environment would be expected.
- Less Than Significant Impact. An impact that would not exceed the defined significance criteria or would be eliminated or reduced to a less than significant level through implementation of the applicant’s project design measures and/or compliance with existing federal, state, and local laws and regulations.
- Less Than Significant with Mitigation Incorporated. An impact that would be reduced to a less than significant level through implementation of the identified mitigation measure(s).
- Significant and Unavoidable Impact. An adverse effect that meets the significance criteria, but there appears to be no feasible mitigation available that would reduce the impact to a less than significant level. In some cases, mitigation may be available to lessen a given impact, but the residual effects of that impact would continue to be significant even after implementation of the mitigation measure(s).

Staff concludes that with the implementation of the following applicant project design measures (PDs) and the addition of the proposed mitigation measures (MMs) presented in **Table 1-2**, potentially significant impacts identified in this EIR would be avoided or reduced to less than significant levels. Staff concluded that impacts in the areas of Air Quality, Biological Resources, Cultural and Tribal Cultural Resources, Geology and Soils (paleontology), and Noise would be potentially significant, but with mitigation measures would be reduced to less than significant. Agriculture and Forestry Resources, Mineral Resources, and Wildfire would have no impact from the project. The remaining environmental topic areas would have a less than significant impact. The following summarizes the potential impacts and mitigation as required.

Aesthetics. Construction and operation of the project would not have a substantial adverse effect on a scenic vista or substantially damage scenic resources. Furthermore, construction and operation of the project would not conflict with applicable zoning and other regulations governing scenic quality. Impacts to aesthetic resources would be **less than significant**.

Agriculture and Forestry Resources. The Farmland Mapping Monitoring Program maps show that the project site is not mapped as Prime Farmland, Farmland of Statewide Importance, or Unique Farmland. The project site is zoned IP, Industrial Park and is within an area designated for urban uses in the General Plan. No land in the area is zoned for

forest land, timberland, or timberland production, nor is the project site contain forest land or is in a region where forest land is present. Project construction, operation, and maintenance would cause no changes in the existing environment that would cause conversion of Farmland to a non-agricultural use or forest land to a non-forest use. Therefore, the project would not convert Farmland to a non-agricultural use, not conflict with zoning for agricultural use or a Williamson Act contract and would not cause the loss of forest land. The project's construction and operation would have **no impact** on agriculture and forestry resources.

Air Quality. The project would not conflict with or obstruct implementation of the applicable air quality plan. The project would not expose sensitive receptors to substantial pollutant concentrations. The project would not result in other emissions (such as those leading to odors) adversely affecting a substantial number of people. The applicant proposes project design (PD) measure PD AQ-1 to reduce air quality impacts during project construction. This measure requires incorporation of the BAAQMD's best management practices to control fugitive dust. Staff recommends mitigation measure (MM) **AQ-1**, which adds exhaust control measures to reduce emissions from construction equipment. During readiness testing and maintenance, the oxides of nitrogen (NO_x [as an ozone precursor]) emissions of the standby generators would be fully offset through the permitting process with the BAAQMD. With implementation of these measures during construction and NO_x offsets for readiness testing and maintenance through BAAQMD's permitting requirements, the project would not cause a cumulatively considerable net increase of any criteria pollutant, and impacts would be reduced to **less than significant with mitigation incorporated**.

Biological Resources. The project would not affect state or federally protected wetlands, or interfere with the movement of any native resident or migratory fish or wildlife species or established wildlife corridors, or impede the use of native wildlife nursery sites. To avoid conflict with City of San Jose (City) policies and its Municipal Code regarding tree removal and protection of the Heritage Tree at the northeast corner of the project site, the applicant proposes project design measure PD BIO-1 specifying the tree replacement ratio and other mitigation to compensate for loss of trees on the site. The applicant proposes project design measure PD BIO-2 specifying protection measures to reduce impacts on the Heritage Tree during project construction. The applicant also proposes project design measure PD BIO-3 specifying pre-construction nesting bird surveys. Incorporation of PD BIO-1, PD BIO-2, and PD BIO-3 would reduce impacts on trees and nesting birds to **less than significant**. The project as proposed would not conflict with an adopted Habitat Conservation Plan, Natural Community Conservation Plan, or other approved local, regional, or state habitat conservation plan. Staff has proposed mitigation to mitigate potentially significant impacts on special-status species through habitat modifications. Staff recommends **MM BIO-1** to reduce the proposed project's significant impacts from nitrogen deposition on serpentine habitat to **less than significant with mitigation incorporated**. **MM BIO-1** would also mitigate the proposed project's incremental contribution towards nitrogen deposition to less than cumulatively considerable.

Cultural and Tribal Cultural Resources. The project would not impact any known resources that could meet CEQA's criteria for historical resources. However, previous cultural resources studies in the project area indicate that buried archaeological or ethnographic resources could be encountered during ground disturbing activities at the site. The applicant proposed design measure, PD CUL-2 includes procedures for the treatment of any human remains encountered during construction. Staff recommends a set of **MM CUL-1** through **MM CUL-4**, which are similar to the measures the City included in its Special Use Permit (SP15-031) issued in 2017 for the previously approved data center on the project site (SV1 2020d). The mitigation measures for the proposed project include a supplementary presence/absence trenching program (**MM CUL-1**). **MM CUL-2** through **MM CUL-4** consist of implementing a workers' environmental awareness program during construction (**MM CUL-2**), procedures for evaluating and mitigating any buried cultural resources encountered during construction (**MM CUL-3**), and a final report of findings from implementing **MM CUL-1** through **CUL-3** (**MM CUL-4**). With implementation of PD CUL-2 and these mitigation measures, potential impacts on cultural and tribal cultural resources would be reduced to **less than significant with mitigation incorporated**.

Energy and Energy Resources. Construction activities would consume nonrenewable energy resources, primarily fossil fuels (oil, gasoline, and diesel), for construction equipment and vehicles. It is anticipated that these nonrenewable energy resources would be used efficiently during construction activities and would not result in long-term significant depletion of these energy resources or permanently increase the project's reliance on them. PD AQ-1 would minimize the idling of construction equipment and would require all such equipment to be maintained and properly tuned, ensuring that fuel consumed during construction would not be wasted through unnecessary idling or operation of poorly maintained equipment. The project's use of fuel constitutes a small fraction of available resources and the supply is more than sufficient to meet necessary demand. For these reasons, the project's use of fuel is less than significant. Impacts related to energy and energy resources would be **less than significant**.

Geology and Soils (paleontology). Construction would temporarily increase sedimentation and erosion by exposing soils to wind and runoff until construction is complete and new vegetation is established. The city's National Pollutant Discharge Elimination System Municipal Permit, urban runoff policies, and the Municipal Code are the primary means of enforcing erosion control measures through the grading and building permit process. In accordance with General Plan policies, implementation of the regulatory programs and policies in place would reduce possible impacts of accelerated erosion during construction to a less than significant level. Continuous operation and maintenance work would not result in increased erosion or topsoil loss. The project site is located on expansive soil. With implementation of the anticipated project-specific recommendations in the final geotechnical engineering report (PD GEO-1) construction of the project would not expose people or property, directly or indirectly, to significant impacts associated with expansive soil. To reduce impacts relating to seismic hazards, the applicant proposes project design measure PD GEO-1 to ensure conformance with

requirements of a final geotechnical engineering investigation and California and local building standards and codes. Incorporation of this measure would reduce potential impacts from seismic hazards to less than significant. Earth moving during project construction has the potential to disturb paleontological resources. Staff recommends **MM GEO-1** to train construction personnel and guide recovery and processing of any significant paleontological finds; implementation of this measure would reduce the impact to **less than significant with mitigation incorporated**.

Greenhouse Gas Emissions. The greenhouse gas (GHG) emissions for the annual testing and maintenance emissions from the facility's stationary sources would be well below the BAAQMD significance thresholds of 10,000 MTCO₂e/yr. The City of San Jose's GHG Reduction Strategy is a Qualified Climate Action Plan under CEQA. This project would comply with the requirements of that plan with implementation of **MM GHG-1**, which would require the applicant to participate in San Jose Clean Energy at the TotalGreen level. Pursuant to California Code of Regulations, title 14, section 15183.5, the CEC may rely on that compliance in its analysis of GHG emissions impacts. Accordingly, staff concludes with implementation of **MM GHG-1**, the project's GHG emissions would not have a significant direct or indirect impact on the environment. The project's likelihood of operating for non-testing/non-maintenance (emergency) purposes is low and if such operation did occur it would be infrequent and of short duration. Staff concludes that these emissions would be less than significant. With implementation of the efficiency measures to be incorporated into the project, and **MM GHG-1**, GHG emissions related to the project would not conflict with the City's GHG Reduction Strategy or other plans, policies, or regulations adopted for the purpose of reducing the emissions of GHGs. Because the project would be consistent with applicable plans and policies adopted to reduce GHG emissions and would comply with all regulations or requirements adopted to implement a statewide, regional, or local plan for the reduction or mitigation of GHG emissions, the potential for the project to conflict with an applicable plan, policy or regulation for GHG reductions would be less than significant. With implementation of **MM GHG-1**, impacts related to GHG emissions would be **less than significant with mitigation incorporated**.

Hazards and Hazardous Materials. During the construction phase of the project, the only hazardous materials used would be paints, cleaners, solvents, gasoline, motor oil, welding gases, and lubricants. When not in use, any hazardous material would be stored in designated construction staging areas in compliance with local, state, and federal requirements. Any impacts resulting from spills or other accidental releases of these materials would be limited to the site due to the small quantities involved and their infrequent use, hence reduced chances of release. Temporary containment berms would also be used to help contain any spills during the construction of the project. The transportation of the diesel fuel to the site would take many tanker truck trips for the initial fill. Deliveries of diesel fuel during the project's operation would be scheduled on an as-needed basis resulting in twenty fuel tanker truck trips annually. Diesel fuel has a long history of being routinely transported and used as a common motor fuel. Projects with diesel-fired back up generators would use standard practice for fuel quality and

maintenance of stored diesel fuel. The risk to the off-site public or environment through the routine transport, use or disposal of hazardous materials would have a less than significant impact. Hazardous materials would be stored, handled, and used in accordance with applicable regulations. Personnel would be required to follow instructions on health and safety precautions and procedures to follow in the event of a release of hazardous materials. All equipment and materials storage would be routinely inspected for leaks. Records would be maintained for documenting compliance with the storage and handling of hazardous materials. The risk to the off-site public or environment through reasonably foreseeable upset and accident conditions involving the release of hazardous materials would have a less than significant impact. Soil samples collected from the adjacent parcel south of the project site indicate concentrations of organochlorine pesticides and lead that exceeds residential and commercial screening levels (assessor parcel number 706-02-058). The applicant proposes project design measure PD HAZ-1, which requires fencing the adjacent parcel to eliminate the potential to track contaminated soil onto the project site during project construction. Implementation of this measure would reduce the impact to **less than significant**.

Hydrology and Water Quality. The project's proposed use of 4 acre-feet (AF) of water during construction and 4 acre-feet per year (AFY) during operation would not substantially decrease critical groundwater supplies. The project's impact on groundwater supplies, recharge, or sustainable groundwater management during construction and operation would therefore be **less than significant**. The proposed project also would not be expected to add significantly to the existing potential of the site to impede or redirect flood flows, therefore, significant obstruction of floods is not expected from the proposed project. The project has the potential to degrade the quality of storm water runoff during project construction and operation. However, the project will be required to prepare a Storm Water Pollution Prevention Plan for the construction phase of the project and will be required to comply with the city of San Jose's Post-Construction Urban Runoff Policy No. 6-29 and the Santa Clara Valley Urban Runoff Pollution Prevention Program during operations. These requirements would reduce potential construction and operations-related impacts on water quality to **less than significant**.

Land Use and Planning. The project would not physically divide a community. The project is consistent with the General Plan and the Zoning Code. With the issuance of an amendment to the Special Permit by the City of San Jose, which is contingent on the City's decision makers determining that the findings are satisfied, the project would not cause a significant impact due to a conflict with any land use plan, policy, or regulation adopted for the purpose of avoiding or mitigating an environmental effect. Impacts on land use and planning would be **less than significant**.

Minerals. The project's construction and operation would have **no impact** on minerals as the project site is in a developed urban area and does not contain any known or designated mineral resources; therefore, the project would not result in the loss of availability of a known mineral resource or locally important mineral resource recovery site.

Noise. Sources of groundborne vibration associated with project operation would include the backup generators and rooftop equipment. These pieces of equipment would be well-balanced, as they are designed to produce very low vibration levels throughout the life of a project. In most cases, even when there is an imbalance, they could contribute to ground vibration levels only in the vicinity of the equipment and would be dampened within a short distance. Furthermore, the backup generators would be equipped with specifications that ensure sufficient exhaust silencing to reduce vibration. Therefore, vibration impacts due to project operation would be less than significant. The project site is not in the vicinity of a private airport and it would not place sensitive land uses within an airport noise contour (the site is 11 miles from the Norman Y. Mineta San Jose International Airport). Thus, the project would not combine with the airport to expose people to excessive noise levels. Construction activities would elevate noise levels at adjacent businesses and residences nearest the project site. The applicant proposes project design measures PD NOI-1 and PD NOI-2 to reduce temporary noise from construction. Staff recommends **MM NOI-1** to add nearby residents to the construction notification requirements. The inclusion of **MM NOI-1** with PD NOI-1 and PD-NOI-2 would reduce noise impacts to **less than significant with mitigation incorporated**.

Population and Housing. The project would not directly or indirectly induce substantial unplanned growth in the City of San Jose. The project does not propose new housing or land use designation changes and it would not facilitate growth through the extension of roads, water supply pipelines, or other growth inducing infrastructure. If the few new operation workers were to relocate closer to the project site, it would not result in unplanned population growth. Impacts would be **less than significant**.

Public Services. The slight increased need for fire protection response during project construction would not be sufficient to induce the construction of new or physically altered governmental facilities that could result in significant environmental impacts. The project facilities would be constructed to conform with current building and fire codes. The impacts to the fire protection service would be less than significant. Construction of the project may result in a slight increase in the need for police services. However, the average response times for the police department would not be significantly affected by the project construction. The project would not induce construction of new or physically altered governmental facilities, such as police stations that could result in significant environmental impacts. Therefore, impacts would be less than significant. The project would not result in substantial adverse physical environmental impacts associated with the provision of new or physically altered police service facilities to maintain acceptable service ratios, response times, or other performance objectives. Impacts would be less than significant. Based on the proposed size of the three buildings, an estimated \$292,173 school impact fee would be assessed and collected at the time the applicant applies for building permits from the City of San Jose. Impacts on schools would be less than significant. The project's approximately 42 operations workers would be drawn from the greater Bay Area and are not likely to relocate closer to the project. If some operations workers were to relocate, the few new residents would have a negligible increase on the

usage of or demand for parks or other recreational facilities. Therefore, the project would not result in substantial adverse physical environmental impacts associated with the provision of new or physically altered park facilities to maintain acceptable service ratios or other performance objectives. Impacts would be less than significant. If some construction workers were to temporarily relocate closer to the project site, they are not likely to visit public facilities such as public libraries while working in the project area and tend to return to their primary residence for the weekends. If some operations workers were to relocate closer to the project site, the few new residents would likely have a negligible increase in the usage of or demand for the surrounding libraries or public facilities. Impacts to public services would be **less than significant**.

Recreation. The construction needs of the project would be supplied by the existing workforce from the greater Bay Area and would not require an influx of new workers. Construction workers would commute to the project site during construction and they are not likely to temporarily relocate closer to the project. If some operations workers did move closer to the project, they would not be in numbers that would require the construction or expansion of recreational facilities. Therefore, operation of the project would have a less than significant impact on recreation facilities and would not require the construction or expansion of recreational facilities to accommodate the project. Impacts to recreation would be **less than significant**.

Transportation. Project construction would not significantly obstruct any transit, roadway, bicycle, or pedestrian facilities in the area. Construction activities would occur mostly onsite and not in the public right-of-way, with the exceptions of: installation of underground electrical distribution feeders at Via Del Oro; sidewalk improvements along Great Oaks Boulevard, San Ignacio Avenue, and Via Del Oro; removal of triangular raised (“pork chop”) islands at Great Oaks Boulevard and Santa Teresa Boulevard intersection; addition of a new Class II bicycle lane along Via Del Oro; and construction of project access points at Great Oaks Boulevard, San Ignacio Avenue and Via Del Oro. Project construction would not otherwise temporarily or permanently alter any public roadways or intersections. Project operation would occur on-site. Project-generated vehicle miles traveled (VMT) per employee would exceed the City’s thresholds for industrial employment and office employment uses. The applicant proposes project design measure PD TRA-1 requiring preparation and implementation of Transportation Demand Management measures, which would cause the project VMT to fall below the thresholds, thereby reducing the impact to less than significant. The project would not result in hazards to aircraft from either a geometric design feature, such as structure height, or incompatible uses, including land uses or thermal plumes. The project would not increase any other hazards. A fire access lane would be constructed along the southern property boundary of the site to provide site access for emergency vehicles. The project would not physically block any access roads or result in traffic congestion that could significantly compromise timely access to this facility or other facilities located within the project vicinity during construction and operation. Impacts to transportation would be **less than significant**.

Utilities and Service Systems. San Jose Clean Energy has sufficient energy to serve the expected future demand of the project. Project electric demand during construction and operation would not be substantial and would not be expected to affect existing users. The applicant anticipates that buildout of the project would occur based on market conditions, and thus full electrical load may develop over a phased period. To serve the full electrical load of the project, reconductoring of the existing Metcalf-Edenvale 115 kV transmission line or line re-rate, may be necessary. The early phases of the project would not require any changes to the transmission line and any changes necessitated by the third phase would be reviewed by the California Public Utilities Commission (CPUC) pursuant to CEQA. Telecommunication services for the proposed project would be provided by providers that have been serving the existing business in the project area. Those providers have adequate available capacity to accommodate the project needs during construction and operation. Natural gas for the project would be supplied by PG&E. PG&E has adequate natural gas supplies to supply the project and therefore, construction and operation of the project would not require the construction of any additional off-site facilities. Great Oaks Water Company (GOWC) would have sufficient supplies between 2020 and 2040 during normal, single-dry, and multiple-dry years to serve the proposed project and foreseeable future development. GOWC and the Santa Clara Valley Water District have adopted water conservation policies to reduce demand such that available supplies are sufficient to meet demand. There is an abundance of capacity at the San Jose-Santa Clara Regional Wastewater Facility to accommodate project wastewater flows. Construction activities for the project would result in minor amounts of solid waste and a temporary increase in solid waste. Operations would result in long-term generation of a small amount of solid waste. The project would not significantly increase solid waste generation and could be accommodated by existing solid waste facilities. Impacts to utilities and service systems would be **less than significant**.

Wildfire. A project could have an impact related to wildfire if it is located in or near a State Responsibility Area or a very high Fire Hazard Severity Zone, or on land classified as having a fire threat by the CPUC (wildland and urban interface or in the vicinity of wildlands). The project's construction and operation would have **no impact** on wildfire as the project is not located in or near a State Responsibility Area or a very high Fire Hazard Severity Zone and is on land classified industrial and in an urban environment

Summary

The CEC determines whether the project qualifies for an SPPE and if the project is granted the exemption, the project would seek permits from the local responsible agencies. The applicant project design measures and mitigation measures proposed in **Table 1-1** would be enforced by the appropriate responsible agency under CEQA, which includes the City of San Jose.

TABLE 1-1 SUMMARY OF IMPACTS AND MITIGATION

CEQA Criterion	Level of Significance Prior to Mitigation	Mitigation	Level of Significance After Mitigation
Impact Codes			
NA- Not Applicable	NI- No Impact	LTS- Less than Significant Impact	
LTS With Mitigation- Less Than Significant with Mitigation Incorporated		PS- Potentially Significant Impact	
Aesthetics			
4.1-a Have a substantial adverse effect on a scenic vista?	LTS	None required	LTS
4.1-b Substantially damage scenic resources, including, but not limited to, trees, rock outcroppings, and historic buildings within a State scenic highway?	LTS	None required	LTS
4.1-c In non-urbanized areas, substantially degrade the existing visual character or quality of public views of the site and its surroundings? (Public views are those that are experienced from publicly accessible vantage point). If the project is in an urbanized area, would the project conflict with applicable zoning and other regulations governing scenic quality?	LTS	None required	LTS
4.1-d Create a new source of substantial light or glare which would adversely affect day or nighttime views in the area?	LTS	None required	LTS
Agriculture and Farmland			
4.2-a Convert Prime Farmland, Unique Farmland, or Farmland of Statewide Importance (Farmland), as shown on the maps prepared pursuant to the Farmland Mapping and Monitoring Program of the California Resources Agency, to non-agricultural use?	NI	None required	NA
4.2-b Conflict with existing zoning for agricultural use, or a Williamson Act contract?	NI	None required	NA
4.2-c Conflict with existing zoning for, or cause rezoning of, forest land (as defined in Public Resources Code section 12220(g)), timberland	NI	None required	NA

(as defined by Public Resources Code section 4526), or timberland zoned Timberland Production (as defined by Government Code section 51104(g))?			
4.2-d Result in the loss of forest land or conversion of forest land to non-forest use?	NI	None required	NA
4.2-e Involve other changes in the existing environment which, due to their location or nature, could result in conversion of Farmland to non-agricultural use or conversion of forest land to non-forest use?	NI	None required	NA
Air Quality (including Public Health)			
4.3-a Conflict with or obstruct implementation of the applicable air quality plan?	LTS	None required	LTS
4.3-b Result in a cumulatively considerable net increase of any criteria pollutant for which the project region is non-attainment under an applicable federal or state ambient air quality standard?	PS	<p>PD AQ-1: To ensure that fugitive dust impacts are less than significant, the project will implement the BAAQMD's recommended BMPs [best management practices] during the construction phase. These BMPs are incorporated into the design of the project and will include:</p> <ul style="list-style-type: none"> • All exposed surfaces (soil piles, graded areas, and unpaved access roads) shall be watered at least two times per day. • All haul trucks transporting material offsite shall be covered. • All track-out onto adjacent public roads shall be removed using wet power vacuum street sweepers at least once per day. • All vehicle speeds on onsite unpaved surfaces shall be limited to 5 miles per hour. • All roadways, driveways, and sidewalks shall be paved as soon as possible. Building pads shall be completed as soon as possible after grading unless seeding or soil binders are used. • Equipment idling times shall be minimized to 5 minutes per the Air Toxics Control Measure (ATCM). Idling time signage shall be provided for construction workers at all access points. 	LTS with Mitigation

		<ul style="list-style-type: none"> All construction equipment shall be maintained and properly tuned in accordance with manufacturer specifications. All equipment shall be checked by a certified visible emissions evaluator. Information on who to contact, contact phone number, and how to initiate complaints about fugitive dust problems will be posted at the site. 	
		<p>MM AQ-1: To minimize the exhaust emissions during construction, the project owner shall implement the following measures:</p> <ul style="list-style-type: none"> Use diesel construction equipment that meets US EPA Tier 4 interim or Tier 4 final emission standards if commercially available. If Tier 4 engines are not available, all construction equipment larger than 25 horsepower used at the site for more than two continuous days or 20 hours total shall meet US EPA emission standards for Tier 3 engines. If such are not available, Tier 2 or lower Tier engines using retrofit controls verified by ARB or US EPA can be used. Provide line power, if available, to the site to minimize the use of diesel-powered stationary equipment, such as generators. 	
4.3-c Expose sensitive receptors to substantial pollutant concentrations?	LTS	None required	LTS
4.3-d Result in other emissions (such as those leading to odors) adversely affecting a substantial number of people?	LTS	None required	LTS
Biological Resources			
4.4-a Have a substantial adverse effect, either directly or through habitat modifications, on any species identified as a candidate, sensitive, or special-status species in local or regional plans, policies, or regulations, or by the California Department of Fish and Wildlife or U.S. Fish and Wildlife Service?	PS	<p>PD BIO-3: The following measure will be implemented to reduce impacts to nesting birds:</p> <ul style="list-style-type: none"> If possible, construction should be scheduled between September and January (inclusive) to avoid the nesting season. If this is not possible, pre-construction surveys for nesting raptors and other migratory breeding birds shall be conducted by a qualified ornithologist to identify active nests that 	LTS with Mitigation

		<p>may be disturbed during project implementation onsite and within 250 feet of the site. Between February 1 and August 31 pre-construction surveys shall be conducted no more than 14 days prior to construction activities or tree relocation or removal. The surveying ornithologist shall inspect all trees in and immediately adjacent to the construction area for nests.</p> <ul style="list-style-type: none"> • If an active nest is found in or close enough to the construction area to be disturbed by these activities, the ornithologist shall, in consultation with the California Department of Fish and Wildlife (CDFW), designate a construction free buffer zone (typically 250 feet for raptors and 100 feet for other birds) around the nest, which shall be maintained until after the breeding season has ended and/or a qualified ornithologist has determined that the young birds have fledged. • The applicant shall submit a report indicating the results of the survey and any designated buffer zones to the satisfaction of the Director of Planning, Building and Code Enforcement prior to the issuance of any grading or building permit. 	
		<p>MM BIO-1: Additional Nitrogen Deposition Fee for Point Source Emissions.</p> <p>Complete and submit an Application for Nitrogen Deposition-Only Projects to the city of San Jose and reference the original data center project. Pay the additional one-time nitrogen deposition fee of \$864.01 to the city of San Jose.</p>	
4.4-b Have a substantial adverse effect on any riparian habitat or other sensitive natural community identified in local or regional plans, policies, regulations or by the California Department of Fish and Wildlife or U.S. Fish and Wildlife Service?	PS	MM BIO-1. See impact 4.4-a.	LTS with Mitigation

4.4-c Have a substantial adverse effect on state or federally protected wetlands (including, but not limited to, marsh, vernal pool, coastal, etc.) through direct removal, filling, hydrological interruption, or other means?	NI	None required	NA
4.4-d Interfere substantially with the movement of any native resident or migratory fish or wildlife species or with established native resident or migratory wildlife corridors, or impede the use of native wildlife nursery sites?	NI	None required	NA
4.4-e Conflict with any local policies or ordinances protecting biological resources, such as a tree preservation policy or ordinance?	LTS	<p>PD BIO-1: In accordance with current City policies and Municipal regulations, trees removed will be replaced at the ratios identified in Table 4.6-1 [SPPE Application, pg. 105].</p> <ul style="list-style-type: none"> In the event replacement/mitigation trees cannot be accommodated on the site, tree removal shall be mitigated through a donation of \$300 per mitigation tree to Our City Forest for in-lieu off-site tree planting in the community. The species of trees to be planted shall be determined in consultation with the City Arborist and the Department of Planning, Building and Code Enforcement. Trees removed shall be replaced at these ratios, or the applicant shall pay an in-lieu fee to Our City Forest to compensate for the loss of trees on-site. 	LTS
		<p>PD BIO-2: In accordance with guidelines established by the International Society for Arboriculture, the following tree protection measures will be implemented to reduce impacts to the Heritage Tree:</p> <ul style="list-style-type: none"> Establish an area surrounding the Heritage Tree to be protected during construction as defined by a circle concentric with each tree with a radius 1-1/2 times the diameter of the tree canopy drip line. This "tree protection zone" is established to protect the tree trunk, canopy and root system from damage during construction activities and to 	

		<p>ensure the long-term survival of the protected trees. The tree protection zone shall: (1) ensure that no structures or buildings, that might restrict sunlight relative to the existing conditions, will be constructed in close proximity to the trees; and (2) that no improvements are constructed on the ground around the tree within the tree protection zone, thus ensuring that there is sufficient undisturbed native soil surrounding the tree to provide adequate moisture, soil nutrients and oxygen for healthy root growth.</p> <ul style="list-style-type: none"> • Protect tree root systems from damage caused by (a) runoff or spillage of noxious materials while mixing, placing, or storing construction materials and (b) ponding, eroding, or excessive wetting caused by incident rainfall through use of the following measures during excavation and grading: <ul style="list-style-type: none"> ○ Excavation: Do not trench inside tree protection zones. Hand excavate under or around tree roots to a depth of three feet. Do not cut main lateral tree roots or taproots. Protect exposed roots from drying out before placing permanent backfill. ○ Grading: Maintain existing grades within tree protection zones. Where existing grade is two inches or less below elevation of finish grade, backfill with topsoil or native soil from the project site. Place fill soil in a single uncompacted layer and hand grade to required finish elevation. ○ Apply six-inch average thickness of wood bark mulch inside tree protection zones. Keep mulch six inches from tree trunks. • Provide 48-inch tall orange plastic construction fencing fastened to steel T-posts, minimum six feet in length, using heavyweight plastic ratchet ties. Install fence along edges of tree protection 	
--	--	---	--

		<p>zones before materials or equipment are brought on site and construction operations begin. Maintain fence in place until construction operations are completed and equipment has been removed from site.</p> <ul style="list-style-type: none"> • Provide temporary irrigation to all trees in protection zones using a temporary on-grade drip or bubbler irrigation system sufficient to wet the soil within tree protection zones to a depth of 30 inches per bi-weekly irrigation event. <p>Heritage Tree Design Recommendations</p> <ul style="list-style-type: none"> • Establish the horizontal and vertical elevation of the Heritage Tree. Include the trunk location and tag number on all plans. • Design finish grades so that no water accumulates around the base of the trunk of the Heritage Tree. • Allow the Consulting Arborist to review all future project submittals including grading, utility, drainage, irrigation, and landscape plans. • Maintain the tree protection zone around the Heritage Tree as depicted on the Grading and Drainage Plan prepared by Ruth and Going. The tree protection zone shall be the limit of work. • Route underground services including utilities, sub-drains, water or sewer around the tree protection zone. Where encroachment cannot be avoided, special construction techniques such as hand digging or tunneling under roots shall be employed where necessary to minimize root injury. • Use only herbicides safe for use around trees and labeled for that use, even below pavement. • Design the landscape around the Heritage Tree to be compatible with the cultural requirements of native oak trees. 	
--	--	---	--

		<ul style="list-style-type: none"> Any irrigation system must be designed so that no trenching will occur within the dripline of the Heritage Tree. <p>Pre-construction and demolition treatments and recommendations</p> <ul style="list-style-type: none"> The demolition contractor shall meet with the Consulting Arborist before beginning work to discuss work procedures and tree protection. Install protection at the tree protection zone prior to demolition, grubbing, or grading. No entry is permitted into a tree protection zone without permission of the project superintendent. The Heritage Tree should be pruned to reduce the length and weight of long, horizontal branches. Remove stubs only when there is well-developed woundwood present at the attachment. Do not remove the large stub in the center of the crown. All pruning shall be completed by an ISA Certified Arborist or Tree Worker and adhere to the latest editions of the American National Standards for tree work (Z133 and A300) and International Society of Arboriculture Best Management Practices, Pruning. The Heritage Tree should also be evaluated for installation of new cables to support heavy horizontal limbs. <p>Tree protection during construction</p> <ul style="list-style-type: none"> Any grading, construction, demolition or other work that occurs within the tree protection zone should be monitored by the Consulting Arborist. If injury occurs to any tree during construction, it should be evaluated as soon as possible by the Consulting Arborist so that appropriate treatments can be applied. 	
--	--	---	--

		<ul style="list-style-type: none"> Fences are to remain until all site work has been completed. Fences may not be relocated or removed without permission of the project superintendent. Construction trailers, traffic and storage areas must remain outside fenced areas at all times. No materials, equipment, soil, waste, or wash-out water may be deposited, stored, or parked within the tree protection zone (fenced area). Any tree pruning needed for clearance during construction must be performed by a qualified arborist and not by construction personnel. Any roots damaged during grading or construction shall be exposed to sound tissue and cut cleanly with a saw. 	
4.4-f Conflict with the provisions of an adopted Habitat Conservation Plan, Natural Community Conservation Plan, or other approved local, regional, or State habitat conservation plan?	PS	MM BIO-1. See impact 4.4.a	LTS with Mitigation
Cultural and Tribal Cultural Resources			
4.5-a Cause a substantial adverse change in the significance of a historical resource pursuant to §15064.5?	PS	<p>PD CUL-2: The following project-specific measures shall be implemented during construction to avoid significant impacts to unknown subsurface cultural resources:</p> <ul style="list-style-type: none"> In the event that human remains are discovered during on-site construction activities, all activity within a 50-foot radius of the find shall be stopped. The Santa Clara County Coroner shall be notified and shall make a determination as to whether the remains are of Native American origin or whether an investigation into the cause of death is required. If the remains are determined to be Native American, the Coroner shall notify the Native American Heritage Commission. All actions taken under this mitigation measure shall comply with Health and Human Safety Code § 7050.5(b). 	LTS with Mitigation
		MM CUL-1: An archaeologist qualified in local historical and prehistory archaeology shall augment the applicant's subsurface presence/absence program by excavating	

		<p>additional backhoe trenches in the archaeological PAA prior to construction. The purpose of excavating the trenches is to determine whether any intact archaeological deposits are present on-site. Based on the archaeological site dimensions presented in Table 5.5-2, a trenching interval with a reasonable chance of finding buried archaeological resources (if present) would be about 150 feet (the median value of site dimensions in Table 5.5-2 is 153 feet). Should any archaeological features or deposits be identified, a focused research design and treatment plan shall be prepared to address any potential resources exposed during construction activities followed by archaeological excavation of these features. The applicant will secure the services of a Secretary of the Interior-qualified archaeologist and a Native American monitor to observe grading of native soil once all pavement is removed from the project site. The applicant shall submit the name and qualifications of the selected archaeologist and Native American Monitor to the Director of Community Development prior to the issuance of a grading permit. Preference in selecting Native American monitors shall be given to Native Americans with:</p> <ol style="list-style-type: none"> 1. Traditional ties to the area being monitored. 2. Knowledge of local historic and prehistoric Native American village sites. 3. Knowledge and understanding of Health and Safety Code, section 7050.5, and Public Resources Code, section 5097.9 et seq. 4. Ability to effectively communicate the requirements of Health and Safety Code, section 7050.5, and Public Resources Code, section 5097.9 et seq. 5. Ability to work with law enforcement officials and the Native American Heritage Commission to ensure the return of all associated grave goods taken from a Native American grave during excavation. 	
--	--	---	--

		<ol style="list-style-type: none"> 6. Ability to travel to project sites within traditional tribal territory. 7. Knowledge and understanding of Title 14, California Code of Regulations, section 15064.5. 8. Ability to advocate for the preservation in place of Native American cultural features through knowledge and understanding CEQA mitigation provisions. 9. Ability to read a topographical map and be able to locate site and reburial locations for future inclusions in the Native American Heritage Commission's Sacred Lands Inventory. 10. Knowledge and understanding of archaeological practices, including the phases of archaeological investigation. 	
		<p>MM CUL-2: Prior to and for the duration of ground disturbance, the project owner shall provide Worker Environmental Awareness Program training to all existing and any new employees. This training should include: a discussion of applicable laws and penalties under the laws; samples or visual aids of artifacts that could be encountered in the project vicinity, including what those artifacts may look like partially buried, or wholly buried and freshly exposed; and instructions to halt work in the vicinity of any potential cultural resources discovery, and notify the city-approved archaeologist and Native American cultural resources monitor. The applicant shall contract with qualified cultural resources specialists to prepare the training materials.</p>	
		<p>MM CUL-3: If prehistoric and/or historic resources are encountered during construction, all activity within a 50-foot radius of the find will be stopped and the archaeologist and Native American monitor will examine the find and record the site, including field notes, measurements, and photography for a Department of Parks and Recreation 523 Primary Record form. The archaeologist will provide recommendations regarding</p>	

		eligibility for the California Register of Historical Resources, data recovery, curation, or other appropriate mitigation. Ground disturbance within the 50-foot radius can resume once these steps are taken and the City of San Jose has concurred with the recommendations.	
		MM CUL-4: Within 30 days of the completion of construction, the applicant shall have the archaeologist/Native American monitor prepare a report of findings. The report shall document the archaeological/Native American resource finds, if any, recommendations, data recovery efforts, and other pertinent information gleaned during construction. The report shall be submitted to the City of San Jose for review and approval. The applicant shall submit the final report to the Northwest Information Center of the California Historical Resources Information System.	
4.5-b Cause a substantial adverse change in the significance of a unique archaeological resource pursuant to §15064.5?	PS	PD CUL-2, and MM CUL-1 through MM CUL-4 . See impact 4.5-a.	LTS with Mitigation
4.5-c Disturb any human remains, including those interred outside of formal cemeteries?	PS	PD CUL-2, and MM CUL-1 through MM CUL-4 . See impact 4.5-a.	LTS with Mitigation
4.5-d Listed or eligible for listing in the California Register of Historical Resources, or in a local register of historical resources as defined in Public Resources Code section 5020.1(k)?	LTS	None required	LTS
4.5-e A resource determined by the lead agency, in its discretion and supported by substantial evidence, to be significant pursuant to criteria set forth in subdivision (c) of Public Resources Code Section 5024.1. In applying the criteria set forth in subdivision (c) of Public Resource Code Section 5024.1, the lead agency shall consider the significance of the resource to a California Native American tribe?	PS	PD CUL-2, and MM CUL-1 through MM CUL-4 . See impact 4.5-a.	LTS with Mitigation
Energy and Energy Resources			
4.6-a Result in potentially significant environmental impact due to wasteful, inefficient, or unnecessary consumption of	LTS	None required	LTS

energy resources, during project construction or operation?			
4.6-b Conflict with or obstruct a state or local plan for renewable energy or energy efficiency?	NI	None required	NA
Geology and Soils			
4.7-a Directly or indirectly cause potential substantial adverse effects, including the risk of loss, injury, or death involving: i. Rupture of a known earthquake fault, as delineated on the most recent Alquist-Priolo Earthquake Fault Zoning Map issued by the State Geologist for the area or based on other substantial evidence of a known fault? Refer to Division of Mines and Geology Special Publication 42.	NI	None required	NA
ii. Strong seismic ground shaking?	LTS	None required	LTS
iii. Seismic-related ground failure, including liquefaction?	LTS	None required	LTS
iv. Landslides?	NI	None required	NA
4.7-b Result in substantial soil erosion or the loss of topsoil?	LTS	None required	LTS
4.7-c Be located on geologic units or soil that is unstable, or that would become unstable as a result of the project, and potentially result in on- or off-site landslide, lateral spreading, subsidence, liquefaction, or collapse?	LTS	PD GEO-1: In order to ensure the project design conforms to the requirements of a final geotechnical engineering investigation and California and local building standards and codes, the following is proposed as mitigation incorporated into the project. Incorporation will ensure seismic hazards are reduced to less than significant levels. The project shall be constructed in conformance with the recommendations of the design-level geotechnical investigation prepared for the project, as well as at the 2017 California Building Code, or subsequent adopted codes.	LTS
4.7-d Be located on expansive soil, as defined in Section 1803.5.3 of the California Building Code (2010), creating substantial direct or indirect risks to life or property?*	LTS	None required	LTS

4.7-e Have soils incapable of adequately supporting the use of septic tanks or alternative wastewater disposal systems where sewers are not available for the disposal of waste water?	NI	None required	NA
4.7-f Directly or indirectly destroy a unique paleontological resource or site or unique geologic feature?	PS	<p>MM GEO-1: To ensure impacts to paleontological resources are less than significant:</p> <ul style="list-style-type: none"> • Prior to the start of any subsurface excavations that would extend beyond previously disturbed soils, all construction forepersons and field supervisors shall receive training by a qualified professional paleontologist, as defined by the Society of Vertebrate Paleontology, who is experienced in teaching non-specialists, to ensure they can recognize fossil materials and shall follow proper notification procedures in the event any are uncovered during construction. Procedures to be conveyed to workers include halting construction within 50 feet of any potential fossil find and notifying a qualified paleontologist, who shall evaluate its significance. • If a fossil is found and determined by the qualified paleontologist to be significant and avoidance is not feasible, the paleontologist shall develop and implement an excavation and salvage plan in accordance with Society of Vertebrate Paleontology standards. Construction work in these areas shall be halted or diverted to allow recovery of fossil remains in a timely manner. Fossil remains collected during the monitoring and salvage portion of the mitigation program shall be cleaned, repaired, sorted, and cataloged. Prepared fossils, along with copies of all pertinent field notes, photos, and maps, shall then be deposited in a scientific institution with paleontological collections. A final Paleontological Mitigation Plan Report shall be prepared that outlines the results of the mitigation program. The Director of Planning and Inspection shall be 	LTS with Mitigation

		responsible for ensuring that the paleontologist's recommendations regarding treatment and reporting are implemented.	
Greenhouse Gas Emissions			
4.8-a Generate greenhouse gas emissions, either directly or indirectly, that may have a significant impact on the environment?	LTS	None required	LTS
4.8-b Conflict with an applicable plan, policy or regulation adopted for the purpose of reducing the emissions of greenhouse gases?	PS	MM GHG-1: The project owner shall participate in San Jose Clean Energy at the TotalGreen level (i.e., 100% carbon-free electricity) for electricity accounts associated with the project.	LTS with Mitigation
Hazards and Hazardous Materials			
4.9-a Create a significant hazard to the public or the environment through the routine transport, use, or disposal of hazardous materials?	LTS	None required	LTS
4.9-a Create a significant hazard to the public or the environment through the routine transport, use, or disposal of hazardous materials?	LTS	None required	LTS
4.9-b Emit hazardous emissions or handle hazardous or acutely hazardous materials, substances, or waste within one-quarter mile of an existing or proposed school?	NI	None required	LTS
4.9-c Be located on a site which is included on a list of hazardous materials sites compiled pursuant to Government Code Section 65962.5 and, as a result, would it create a significant hazard to the public or the environment?	LTS	PD HAZ-1: The project proposes to implement the following measures which will reduce the potential for tracking of impacted soil from the adjacent parcel to the project site. <ul style="list-style-type: none"> During construction activities (e.g. grading, vehicle travel, movement of equipment or materials, etc.), adjacent to APN 706-02-058, the project contractor shall fence the southwesterly adjacent parcel (APN 706-02-058) separately from the rest of the site. 	LTS
4.9-d For a project located within an airport land use plan or, where such a plan has not been adopted, within two miles of a public airport or public use airport, would the project result in a safety hazard or excessive noise for people residing or working in the project area?	NI	None required	NA

4.9-e Impair implementation of or physically interfere with an adopted emergency response plan or emergency evacuation plan?	NI	None required	NA
4.9-f Expose people or structures, either directly or indirectly, to a significant risk of loss, injury or death involving wildland fires?	NI	None required	NA
Hydrology and Water Quality			
4.10-a Violate water quality standards or waste discharge requirements or otherwise substantially degrade surface or ground water quality?	LTS	<p>PD HYD-1: The project will incorporate the following into the design and these measures should be treated as mitigation incorporated into the project. The following will reduce construction-related water quality impacts:</p> <ul style="list-style-type: none"> • Burlap bags filled with drain rock shall be installed around storm drains to route sediment and other debris away from the drains. • Earthmoving or other dust-producing activities shall be suspended during periods of high winds. • All exposed or disturbed soil surfaces shall be watered at least twice daily to control dust as necessary. • Stockpiles of soil or other materials that can be blown by the wind shall be watered or covered. • All trucks hauling soil, sand, and other loose materials shall be required to be covered trucks or maintain at least two feet of freeboard. • All paved access roads, parking areas, staging areas and residential streets adjacent to the construction site shall be swept daily (with water sweepers). • Vegetation in disturbed areas shall be replanted as quickly as possible. • All unpaved entrances to the site shall be filled with rock to knock mud from truck tires prior to entering City streets. A tire wash system may also be employed at the request of the City. • The project proponent shall comply with the City of San Jose Grading Ordinance, including 	LTS

		<p>implementing erosion and dust control during site preparation and with the City of San Jose Zoning Ordinance requirements for keeping adjacent streets free of dirt and mud during construction.</p> <ul style="list-style-type: none"> • A Storm Water Permit shall be administered by the SWRCB. Prior to construction grading for the proposed land uses, the project proponents will file an NOI to comply with the General Permit and prepare a SWPPP which addresses measures that will be included in the project to minimize and control construction and post-construction runoff. Measures will include, but are not limited to, the aforementioned RWQCB Best Management Practices. • The SWPPP shall be posted at the project site and shall be updated to reflect current site conditions. • When construction is complete, a Notice of Termination for the General Permit for Construction shall be filed with the SWRCB. The Notice of Termination shall document that all elements of the SWPPP have been executed, construction materials and waste have been properly disposed of, and a post-construction stormwater management plan is in place as described in the SWPPP for the site. 	
4.10-b Substantially decrease groundwater supplies or interfere substantially with groundwater discharge such that the project may impede sustainable groundwater management of the basin?	LTS	None required	LTS
4.10-c Substantially alter the existing drainage pattern of the site or area, including through the alteration of the course of a stream or river, or through the addition of impervious surfaces in a manner which would:	LTS	None required	LTS

i. result in substantial erosion or siltation, on- or offsite;			
ii. substantially increase the rate or amount of surface runoff in a manner which would result in flooding on- or offsite;	LTS	None required	LTS
iii. create or contribute runoff water which would exceed the capacity of existing or planned stormwater drainage systems or provide substantial additional sources of polluted runoff; or	LTS	None required	LTS
iv. impede or redirect flood flows?	LTS	None required	LTS
4.10-d Would the project, in flood hazard, tsunami, or seiche zones, risk release of pollutants due to project inundation?	LTS	None required	LTS
4.10-e Would the project conflict with or obstruct implementation of a water quality control plan or sustainable groundwater management plan?	LTS	None required	LTS
Land Use and Planning			
4.11-a Physically divide an established community?	NI	None required	NA
4.11-b Cause a significant environmental impact due to a conflict with any land use plan, policy, or regulation adopted for the purpose of avoiding or mitigating an environmental effect?	LTS	None required	LTS
Mineral Resources			
4.12-a Result in the loss of availability of a known mineral resource that would be of value to the region and the residents of the State?	NI	None required	NA
4.12-b Result in the loss of availability of a locally important mineral resource recovery site delineated on a local general plan, specific plan or other land use plan?	NI	None required	NA
Noise			
4.13-a Generation of a substantial temporary or permanent increase in ambient noise levels in the vicinity of the project in excess of standards	PS	PD NOI-1: The project proposes to implement the following measures to reduce temporary construction noise to less than significant levels.	LTS with Mitigation

<p>established in the local general plan or noise ordinance, or applicable standards of other agencies?</p>		<ul style="list-style-type: none"> • Construction activities within 200 feet of commercial uses shall be limited to the hours between 7:00 AM and 7:00 PM, Monday through Friday. • Equip all internal combustion engine-driven equipment with intake and exhaust mufflers that are in good condition and appropriate for the equipment. • Unnecessary idling of internal combustion engines within 200 feet of commercial uses is strictly prohibited. Equipment shall be turned off when not in use and the maximum idling time shall be limited to five minutes. • Locate stationary noise-generating equipment such as air compressors or portable power generators at least 200 feet from adjacent office and commercial uses to the greatest extent feasible. • Utilize "quiet" air compressors and other stationary noise sources where technology exists. • Notify all adjacent business and other noise-sensitive land uses of the construction schedule, in writing, and provide a written schedule of "noisy" construction activities to the adjacent land uses. 	
		<p>PD NOI-2: The project applicant shall prepare a noise logistics plan, which shall be submitted for review and approval by the Supervising Planner of the Environmental Review Division of the Department of Planning, Building, and Code Enforcement prior to issuance of grading and building permits. This plan shall include, at a minimum, the following measures to reduce the exposure of adjacent office buildings to construction noise:</p> <ul style="list-style-type: none"> • All internal combustion engine-driven equipment shall use best available noise control practices and equipment (including mufflers, intake silencers, ducts, engine enclosures, and acoustically attenuating shields or shrouds). A letter from a qualified acoustic specialist shall be attached to the noise logistics plan along with a list of proposed 	

		<p>construction equipment, certifying that the proposed construction equipment includes the best available noise attenuating technologies.</p> <ul style="list-style-type: none"> • The contractor will prepare a detailed construction plan identifying a schedule of major noise generating construction activities. This plan shall identify a noise control "disturbance coordinator" and procedure for coordination with the adjacent noise sensitive facilities so that construction activities can be scheduled to minimize noise disturbance. This plan shall be made publicly available for interested community members. The disturbance coordinator will be responsible for responding to any local complaints about construction noise. The disturbance coordinator will determine the cause of the noise complaint (e.g. starting too early, bad muffler, etc.) and will require that reasonable measures warranted to correct the problem be implemented. The telephone number for the disturbance coordinator construction site shall be posted on the construction site and included in a notice sent to adjacent commercial businesses regarding the construction schedule. • All measures in the approved noise logistics plan shall be printed on all approved plans for grading and building permits. 	
		<p>MM NOI-1: The project shall implement the following measures to reduce temporary construction noise to less than significant levels.</p> <ul style="list-style-type: none"> • Notify the residents south of the project site immediately across Santa Teresa Boulevard of the construction schedule, in writing, and provide a written schedule of "noisy" construction activities to the adjacent land uses. • Include the telephone number for the disturbance coordinator construction site in a notice regarding the construction schedule sent to residents south of 	

		the project site immediately across Santa Teresa Boulevard.	
4.13-b Generation of excessive groundborne vibration or groundborne noise levels?	LTS	None required	LTS
4.13-c For a project located within the vicinity of a private airstrip or an airport land use plan or, where such a plan has not been adopted, within two miles of a public airport or public use airport, would the project expose people residing or working in the project area to excessive noise levels?	LTS	None required	LTS
Population and Housing			
4.14-a Induce substantial unplanned population growth in an area, either directly (for example, by proposing new homes and businesses) or indirectly (for example, through extension of roads or other infrastructure)?	LTS	None required	LTS
4.14-b Displace substantial numbers of existing people or housing, necessitating the construction of replacement housing elsewhere?	LTS	None required	LTS
Public Services			
4.15-a Would the project result in substantial adverse physical impacts associated with the provision of new or physically altered governmental facilities, need for new or physically altered governmental facilities, the construction of which could cause significant environmental impacts, in order to maintain acceptable service ratios, response times, or other performance objectives for any of the public services:	LTS	None required	LTS
i. Fire protection?			
ii. Police Protection?	LTS	None required	LTS
iii. Schools?	LTS	None required	LTS
iv. Parks?	LTS	None required	LTS
v. Other public facilities?	LTS	None required	LTS
Recreation	LTS	None required	LTS

4.16-a Would the project increase the use of existing neighborhood and regional parks or other recreational facilities such that substantial physical deterioration of the facility would occur or be accelerated?	LTS	None required	LTS
4.16-b Does the project include recreational facilities or require the construction or expansion of recreational facilities, which might have an adverse physical effect on the environment?	LTS	None required	LTS
Transportation			
4.17-a Conflict with a program, plan, ordinance or policy addressing the circulation system, including transit, roadway, bicycle and pedestrian facilities?	LTS	None required	LTS
4.17-b Conflict or be inconsistent with CEQA Guidelines section 15064.3, subdivision (b)?	LTS	<p>PD TRA-1: Prior to the issuance of any Public Works clearances, the project shall implement the following Transportation Demand Management (TDM) measures:</p> <ul style="list-style-type: none"> • Expand the Reach of Bike Access with Investment in Infrastructure (Tier 2- Bike Access Improvements): Implement bicycle facilities that close gaps in the bicycle network and/or improve the existing bicycle network (e.g. construct barrier or buffer for an existing bike lane). Improving bike access to the project promotes biking as an alternative to driving and reduces vehicle miles travelled (VMT). The San Jose Better Bike Plan 2025 identifies Class II bike lanes along Via Del Oro between Bernal Road and Raleigh Road. Additionally, the existing Class II bike lanes along Great Oaks Boulevard, San Ignacio Avenue, and Santa Teresa Boulevard in the project vicinity are planned to be converted to Class IV protected bike lanes. The project would be required to implement Class II bike lanes along Via Del Oro on the opposing side of the project frontage between San Ignacio Avenue and Great Oaks Boulevard. AND • Provide Pedestrian Network Improvements for Active Transportation (Tier 2- Pedestrian Access 	LTS

		improvements): Implement pedestrian improvements both on-site and in the surrounding area. Improving pedestrian connections encourages people to walk instead of drive and reduces VMT. The project would be required to remove each of the pork chop islands on the north leg (Great Oaks Boulevard) at the Santa Teresa Boulevard/Great Oaks Boulevard intersection to improve pedestrian safety and access. A signal modification will be needed for the implementation of the pork-chop island removal at the northeast and northwest corners of Santa Teresa Boulevard/Via Del Oro intersection. In-lieu of the installed ADA curb ramps at Great Oaks Boulevard/Via Del Oro intersection, the project will be required to provide contribution towards the signal improvements including pan, tilt, zoom (PTZ) cameras at the Via Del Oro/San Ignacio Avenue and Via Del Oro/ Great Oaks Boulevard intersections to improve the pedestrian network in the project vicinity.	
4.17-c Substantially increase hazards due to a geometric design feature (e.g., sharp curves or dangerous intersections) or incompatible uses (e.g., farm equipment)?	LTS	None required	LTS
4.17-d Result in inadequate emergency access?	LTS	None required	LTS
Utilities and Service Systems			
4.18-a Require or result in the relocation or construction of new or expanded water, wastewater treatment or storm water drainage, electric power, natural gas, or telecommunications facilities, the construction or relocation of which could cause significant environmental effects?	LTS	None required	LTS
4.18-b Have sufficient water supplies available to serve the project and reasonably foreseeable future development during normal, dry and multiple dry years?	LTS	None required	LTS

4.18-c Result in a determination by the wastewater treatment provider which serves or may serve the project that it has adequate capacity to serve the project's projected demand in addition to the provider's existing commitments?	LTS	None required	LTS
4.18-d Generate solid waste in excess of State or local standards, or in excess of the capacity of local infrastructure, or otherwise impair the attainment of solid waste reduction goals?	LTS	None required	LTS
4.18-e Comply with federal, state, and local management and reduction statutes and regulations related to solid waste?	NI	None required	NA
Wildfire			
If located in or near state responsibility areas or lands classified as very high fire hazard severity zones, would the project:			
4.19-a Substantially impair an adopted emergency response plan or emergency evacuation plan?	NI	None required	NA
4.19-b Due to slope, prevailing winds, and other factors, exacerbate wildfire risks, and thereby expose project occupants to, pollutant concentrations from a wildfire or the uncontrolled spread of a wildfire?	NI	None required	NA
4.19-c Require the installation or maintenance of associated infrastructure (such as roads, fuel breaks, emergency water sources, power lines or other utilities) that may exacerbate fire risk or that may result in temporary or ongoing impacts to the environment?	NI	None required	NA
4.19-d Expose people or structures to significant risks, including downslope or downstream flooding or landslides, as a result of runoff, post-fire slope instability, or drainage changes?	NI	None required	NA
Mandatory Findings of Significance			
4.20-a Does the project have the potential to substantially degrade the quality of the	PS	MM BIO-1, MM CUL-1 through MM-CUL-4 . See impact 4.4-a and 4.5-a.	LTS with Mitigation

environment, substantially reduce the habitat of a fish or wildlife species, cause a fish or wildlife population to drop below self-sustaining levels, threaten to eliminate a plant or animal community, substantially reduce the number or restrict the range of a rare or endangered plant or animal or eliminate important examples of the major periods of California history or prehistory?			
4.20-b Does the project have impacts that are individually limited, but cumulatively considerable? ("Cumulatively considerable" means that the incremental effects of a project are considerable when viewed in connection with the effects of past projects, the effects of other current projects, and the effects of probable future projects)	PS	MM AQ-1, MM BIO-1, MM CUL-1 through MM-CUL-4, MM GEO-1, MM GHG-1, and MM NOI-1 . See impact 4.3.b, 4.4.a, 4.5.a, 4.7-f, and 4.13-a.	LTS with Mitigation
4.20-c Does the project have environmental effects which will cause substantial adverse effects on human beings, either directly or indirectly?	PS	MM AQ-1, MM GHG-1, and MM NOI-1 . See impact 4.3.b, 4.8.b, and 4.13-a.	LTS with Mitigation

1.4 Summary of Alternatives to the Project

CEQA requires that an EIR identify alternatives to the project as proposed and evaluate their comparative merits. CEQA Guidelines Section 15126.6 states that an EIR must describe a “reasonable range of potentially feasible alternatives,” focusing on those that “would feasibly attain most of the basic objectives of the project, but would avoid or substantially lessen any of the significant environmental effects of the project.” Based on the requirements of CEQA and the summary of environmental impacts presented above, this EIR describes and analyzes three alternatives to the proposed project. A summary of project alternatives follows. A full analysis of project alternatives is provided in **Section 5 Alternatives**, along with a description of other alternatives considered but not carried forward for full analysis.

1.4.1 Alternative 1a: No Project – No Build Alternative

Staff evaluated a No Project scenario in which no development of the project site would occur, and current conditions would continue at the site for an unknown period. Although a different project would likely be proposed at the site in the future, no development plan exists to allow a comparison with the proposed project, and it would be speculative to assume the characteristics of such an alternative. Alternative 1a would avoid the proposed project’s potentially significant impacts identified in this environmental impact report (EIR) (no impact compared to the proposed project), and therefore would be *environmentally superior*. If the project were not constructed, the applicant’s project objectives would not be attained.

1.4.2 Alternative 1b: No Project – Development of Previously Approved Data Center Project

Staff evaluated a second No Project scenario that assumes development of the previously approved Equinix Data Center’s project on the GOSBGF site. The applicant would be required to change the diesel-fueled engines to meet the more stringent Tier 4 emission standards. Staff concluded that this alternative is *somewhat environmentally superior* to the proposed project because of the reduced number of engines and the accompanying reduction in air emissions compared to the proposed project. For biological resources, staff compared the impact of nitrogen deposition on serpentine habitat and concluded that this alternative would have a lower impact. Staff has insufficient data to reach comparative conclusions for health risks and GHG emissions for this alternative. This alternative would meet all the objectives except being able to match the projected customer growth for the proposed project as stated by the applicant’s project objectives.

1.4.3 Alternative 2: Alternative Fuel – Renewable Diesel

The Renewable Diesel Alternative would substitute renewable diesel fuel for the GOSBGF’s conventional, petroleum-based diesel fuel. Air quality and public health impacts using renewable diesel during project operations would likely be less than those that would occur under the proposed project. However, the reduction would need to be

confirmed with testing under controlled conditions for the engines with diesel particulate filters and selective catalytic reduction being operative. Biological resources staff compared the impact of nitrogen deposition on serpentine habitat and concluded that this alternative would have a lower impact. Staff concluded that this alternative is *somewhat environmentally superior* to the proposed project although further study and analysis would be needed to fully compare this alternative to the proposed project. The GHG impacts from this alternative would likely be less than those of the GOSBGF due to the reduced GHG emissions during the entire fuel cycle. Two options would make this alternative potentially feasible. One option is to use renewable diesel as the primary source for the project, with conventional diesel as its backup fuel. The second option is to solely use renewable diesel. To only use renewable diesel, a second renewable fuel source should be available for reliability purposes. Future renewable diesel fuel suppliers have announced plans to provide additional fuel for California as early as 2022. If these plans are implemented and the supply becomes plentiful, the project owner should revisit the feasibility of replacing conventional diesel with renewable diesel.

This alternative could potentially attain the project objectives if a reliable fuel source could be obtained.

1.4.4 Alternative 3: Natural Gas Internal Combustion Engines

The Natural Gas ICEs Alternative would replace the GOSBGF's generators with engines that would be fueled by natural gas. Criteria pollutant emissions and air quality impacts using natural gas ICEs are expected to be much less than those that would occur with the GOSBGF's diesel engines. Although no testing data has been provided for toxics emissions, these emissions are expected to be reduced due to the reductions reported for volatile organic compounds and particulate matter. Therefore, public health impacts using natural gas ICEs would likely be less than those that would occur with the GOSBGF's diesel engines. Biological resources staff compared the impact of nitrogen deposition on serpentine habitat and concluded that this alternative would have a much lower impact. The GHG impacts of this alternative would likely be less than those of the GOSBGF due to the reduced GHG emissions during the entire fuel cycle. Staff concluded that this alternative is *environmentally superior* to the proposed project due to its deep reductions in criteria air pollutants.

Redesigning the project with natural gas ICEs technology would increase the number of engines onsite. Onsite storage as a secondary supply source is considered potentially infeasible. Therefore, the preferred option to supply fuel would be through pipeline connection. Two independent pipelines may be needed to match the fuel supply reliability of the proposed project.

There are two PG&E feeder pipelines in the project area that could potentially connect to GOSDC. The route to the first nearby pipeline located to the west of the project site is approximately 1.2 miles long. The route of the second pipeline, which would connect to a transmission pipeline east of the project site, is approximately 4.3 miles long. Permitting and construction of the new pipelines would take time to complete.

This alternative could potentially attain the project objectives if a reliable fuel source could be obtained and the technology were to become industry standard.

1.5 Known Areas of Controversy

The CEC issued a Notice of Preparation on October 26, 2020, seeking input from responsible (City of San Jose and Bay Area Air Quality Management District) and trustee agencies (California Fish and Wildlife and Santa Clara Valley Habitat Agency) and the public regarding the scope and context of environmental areas in the EIR. CEC staff also hosted a public scoping meeting on November 17, 2020 and a continuation of the public scoping meeting on December 11, 2020, during which environmental areas with potential significant impacts were discussed and comments heard. The comment period was extended beyond the required 30 days to include the continued scoping meeting. The comment period began on October 26, 2021 and ended on December 18, 2021. In total, six comment letters and emails were received. Questions and issues of concern reflected in these letters and emails include, but are not limited to, the following:

- Air Quality and Greenhouse Gas Emissions:
 - Concern about the potential increase in air emissions from the proposed project and the location of the diesel backup generators behind the data center buildings.
 - The greenhouse gas (GHG) impact analysis should include an evaluation of the project's consistency with the most recent draft of the AB 32 Scoping Plan by the California Air Resources Board and with the State's 2030, 2045, and 2050 climate goals.
 - The EIR should estimate and evaluate the potential health risk to existing and future sensitive populations within and near the project area from toxic air contaminants (TAC) and fine particulate matter (PM_{2.5}) as a result of the project's construction and operation.
 - The EIR should include various scenarios of backup power generation operations beyond routine testing and maintenance.
 - The EIR should evaluate all feasible measures, both onsite and offsite, to minimize air quality and GHG impacts.
 - The EIR should evaluate the project's consistency with the Bay Area Air Quality Management District's 2017 Clean Air Plan (2017 CAP).
 - Will Tier 4 equipment be used during construction of the project to minimize air quality impacts?
 - Identify and assess the direct and indirect air quality impacts of the project on sensitive receptors, including students and staff attending the Oak Grove School District's (school district) Santa Teresa Elementary School and Bernal Intermediate School, and students/staff traveling to and from the school district's administrative office.

- Identify and assess cumulative air quality impacts on schools and the community in general resulting from the proposed project.
- What impact will the project have on climate change? Is the project in compliance with State goals to reduce greenhouse gas emissions?
- Alternatives:
 - The EIR should include a robust alternatives analysis, with consistent application of analytical standards and substantiation of claims.
- Energy and Energy Resources:
 - Will the data centers be designed to achieve LEED or other green building standards by using recycling materials, natural lighting, and other measures to reduce energy, water, and other natural resources?
- Hazards and Hazardous Materials
 - What is the "blast area" of the generators? Please thoroughly discuss the public health risks associated with the project particularly the risks to Kaiser facilities, day care centers, residents, and schools.
- Hydrology and Water Quality:
 - What water conservation measures will the data centers employ? Will recycled water be used?
- Noise:
 - Identify any noise sources and volumes which may affect school facilities, classrooms, and outdoor school areas.
- Public Services:
 - Describe existing and future conditions within the school district, on a school-by-school basis, including size, location and capacity of facilities.
 - Describe the adequacy of both existing infrastructure serving schools and anticipated infrastructure needed to serve future schools.
 - Describe the school district's past and present enrollment trends.
 - Describe the school district's current uses of its facilities.
 - Describe projected teacher/staffing requirements based on anticipated population growth and existing State and school district policies.
 - Describe any impacts on curriculum because of anticipated population growth.
 - Identify the cost of providing capital facilities to properly accommodate students on a per-student basis, by the school district (including land costs).
 - Identify the expected shortfall or excess between the estimated development fees to be generated by the Project and the cost for provision of capital facilities.

- Assess the school district's present and projected capital facility, operations, maintenance, and personnel costs.
- Assess financing and funding sources available to the school district, including but not limited to those mitigation measures set forth in Section 65996 of the Government Code.
- Identify any expected fiscal impacts on the school district, including an assessment of projected cost of land acquisition, school construction, and other facilities needs.
- Assess cumulative impacts on schools resulting from additional development already approved, pending, or anticipated.
- Identify how the school district will accommodate students from the project who are not accommodated at current school district schools, including the effects on the overall operation and administration of the district, the students and employees.
- Transportation:
 - The project should include features (e.g., improved access to bike and pedestrian facilities, electric vehicle (EV) charging) that promote alternative commutes to reduce employee vehicle miles traveled (VMT).
 - Describe the existing and the anticipated vehicular traffic and student pedestrian movement patterns to and from school sites, including movement patterns to and from Santa Teresa Elementary School and Bernal Intermediate School, and including consideration of bus routes.
 - Assess the impact(s) of increased vehicular movement and volumes caused by the project, including but not limited to potential conflicts with school pedestrian movement, school transportation, and busing activities to and from Santa Teresa Elementary School and Bernal Intermediate School.
 - Estimate travel demand and trip generation, trip distribution, and trip assignment by including consideration of school sites and home-to-school travel.
 - Assess the impacts on the routes and safety of students traveling to school and the school district office by vehicle, bus, walking, and bicycles.
- Tribal Cultural Resources
 - Ensure that the CEC complies with Assembly Bill 52 (includes tribal consultation requirements) in its review of the proposed project.
- Cumulative (Mandatory Findings of Significance):
 - The EIR needs to consider the China Mobile site directly across the street as well as the Equinix sites already operational just a half mile away from this proposed site. There are three Equinix data centers currently operational and one more nearly completed just a half a mile from this proposed site. Additionally, directly across the street from this proposed site is a China Mobile data center under

construction. An EIR needs to consider the environmental impact of all the data centers in immediate location of each other.

- Assess cumulative impacts on schools and the community in general resulting from increased vehicular movement and volumes expected from additional development already approved or pending in the City and neighborhood.
- General:
 - All direct and indirect impacts related to the project's proximity to the school district's schools and administrative office should be thoroughly reviewed, analyzed, and mitigated in the forthcoming Draft EIR.
 - The project is located near Santa Teresa Light Rail Station, an end-of-the-line facility which encompasses a storage yard, light rail platform, bus transit center, operator facility, and park-and-ride lot. Please coordinate with the Santa Clara Valley Transportation Authority (VTA) regarding electrical substations and other operations that may be impacted by the project.

In addition to the comments received during the NOP comment period, several comments were received during the development of the Draft EIR. Comments and concerns include: air quality, duration of construction noise, use of diesel-powered equipment for backup power generation, amount of diesel fuel storage, property value impacts, and the proximity of residents. The VTA Santa Teresa Light Rail Station is located approximately one-block to the west of the site and the VTA has approximately 30 plus acres at that location that the VTA Board of Directors has designated for future Transit-Oriented Development (TOD). Property owners in the area are interested in creating more mixed-use development in the future that includes employment uses as well as significant residential uses. CEC staff has reviewed and considered the comments received and addressed them as appropriate in the applicable sections of this EIR.

1.5 Issues to be Resolved

Staff concluded that all potentially significant impacts can be mitigated to a less than significant level. There are no remaining issues to be resolved.

Section 2

Introduction

2 Introduction

2.1 Energy Commission Jurisdiction and the Small Power Plant Exemption Process

The California Energy Commission (CEC) is responsible for reviewing, and ultimately approving or denying, all thermal electric power plants, 50 megawatts (MW) and greater, proposed for construction in California. CEC has a regulatory process, referred to as the Small Power Plant Exemption (SPPE) process, which allows applicants with projects between 50 and 100 MW to obtain an exemption from the CEC’s jurisdiction and proceed with local approval rather than requiring a CEC license. CEC can grant an exemption if it finds that the proposed project would not create a substantial adverse impact on the environment or energy resources. See **Appendix A** for more information about the project’s jurisdictional and generating capacity analysis.

2.2 CEQA Lead Agency

In accordance with section 25519(c) of the Public Resources Code and the California Environmental Quality Act (CEQA), CEC serves as the lead agency to review an SPPE application and perform any required environmental analyses. Upon granting of an exemption, the local permitting authority—in this case the City of San Jose—would perform any follow-up CEQA analysis and impose mitigation, as necessary, for granting approval of the project.

2.3 Purpose of the Environmental Impact Report

The purpose of this document is to provide agency decision makers and the public with objective information regarding the project’s significant effects on the environment and energy resources, identify possible ways to minimize the significant effects, and describe reasonable alternatives to the project. This information will be used by the CEC Commissioners in considering the applicant’s request for an SPPE to exempt the project from CEC’s power plant licensing jurisdiction and the responsible agencies for project approval and permitting.

2.4 Environmental Process

2.4.1 Notice of Preparation

A Notice of Preparation (NOP) of the Environmental Impact Report (EIR) was circulated to the public and public agencies from October 26, 2020 to December 18, 2020 (State Clearinghouse #2020100431), an extension beyond the required 30-day comment period to accommodate the public scoping meeting and continued public scoping meeting.

2.4.2 Draft EIR

The Draft EIR will be circulated for agency and public review during a 45-day public review period prior to certification of the document by the CEC. This includes submitting

the Draft EIR to the State Clearinghouse and posting the document to the project's CEC docket.

2.4.3 Final EIR

Substantive comments received on the Draft EIR will be formally addressed in the Final EIR. The Final EIR will be submitted to the State Clearinghouse, agencies, and posted to the project's docket.

The decision-making body must certify that it has reviewed and considered the information in the Final EIR and that the EIR has been completed in conformity with the requirements of CEQA. The CEC must consider the information in the EIR and respond to each significant effect identified in the EIR. If the CEC Commissioners find that the proposed project would create a substantial adverse impact on the environment or energy resources, the SPPE would be denied.

If the project is determined as qualifying for an exemption, the project would seek permits from the responsible agencies. Any required mitigation measures would be enforced by the appropriate responsible agency, which includes the City of San Jose.

2.5 CEQA Analysis Format

The environmental analysis of this SPPE application takes the form of an EIR, which is prepared to conform to the requirements of CEQA, the CEQA Guidelines (California Code of Regulations, section 15000 et. seq.), and CEC's regulations and policies. The EIR is based on information from the applicant's SPPE application and associated submittals, site visits, data requests and responses, and additional staff research, including consultation with other agencies, such as responsible and trustee agencies.

2.5.1 Notification and Coordination

Noticing of documents is governed by both CEC's regulations set forth in California Code of Regulations Title 20 and the CEQA guidelines set forth in Title 14. The specific noticing requirements depend on the document at issue and are described below.

2.5.1.1 Application for Small Power Plant Exemption

The Application for SPPE (Application for Exemption) is filed by the project applicant to initiate the exemption proceeding. Noticing of the Application for Exemption is set forth in Title 20 section 1936(d), which requires that a summary of the Application for Exemption be sent to public libraries in the communities near the proposed site as well as libraries in Eureka, Fresno, Los Angeles, San Diego and San Francisco, and to any person who requests such mailing. The summary is also required to be published in a newspaper of general circulation in the county of the project site. In this case the advertisements ran in the San Jose Mercury News (in English) and the Daily News (in Vietnamese). The relevant mailing lists covering the requirements of section 1936(d) are found in **Appendix E**.

In addition to the required noticing set forth in section 1936(d), CEC staff provided public notice of the Application for Exemption on June 30, 2020 through a Notice of Receipt (NOR). This notice was mailed to property owners and occupants within 1,000 feet of the project site and 500 feet of project linears. The NOR was also mailed to a list of environmental and environmental justice organizations developed in collaboration with the CEC Public Advisor's Office with the goal of reaching groups with potential interest in energy generation projects in the San Jose region. The NOR pointed recipients to the CEC's project webpage and included instructions on how to sign up for the project list serve to receive electronic notification of events and the availability of documents related to the SPPE proceeding. The relevant mailing lists staff used for this outreach can be found in **Appendix E**.

Staff provided notification to stakeholder agencies via an Agency Request for Participation letter. This letter provided information on how to participate in CEC's evaluation and decision-making process to agencies with potential interest in the project, most notably the California Department of Fish and Wildlife, the Regional Water Quality Control Board, the local Air Pollution Control District, and various departments of the City of San Jose's local government. The mailing list used to engage with stakeholder agencies can be found in **Appendix E**.

Staff conducted further outreach to and consultation with regional tribal governments as described in **Section 4.5 Cultural and Tribal Cultural Resources**.

2.5.1.2 Notice of Preparation and Public Scoping Meeting

On October 26, 2020, staff issued a Notice of Preparation of an EIR to responsible and trustee agencies, starting a 30-day comment period. On November 17, 2020 staff hosted a public scoping meeting and on December 11, 2020 staff hosted a continuation of the public scoping meeting. During these meetings environmental areas with potential significant impacts were discussed and comments on the context and scope of the environmental areas in the EIR and general project comments were heard. The comment period was extended beyond the required 30 days to include the continued scoping meeting. The notice for the initial November 17, 2020 scoping meeting was published on November 4, 2020, consistent with CEC noticing requirements. Due to robust public and agency engagement, this meeting was continued to December 11, 2020 in accordance with CEC noticing requirements. Staff has reviewed and considered the comments received during the extended NOP comment period and address them as appropriate in the applicable technical section.

2.5.1.3 Draft Environmental Impact Report

The process for public notification of the Draft Environmental Impact Report is set forth in section 15087 of the CEQA guidelines and requires at least one of the following procedures:

- (1) Publication at least one time in a newspaper of general circulation in the area affected by the proposed project.
- (2) Posting of notice by the lead agency on and off site in the area where the project is to be located.
- (3) Direct mailing to the owners and occupants of property contiguous to the parcel or parcels on which the project is located. Owners of such property shall be identified as shown on the latest equalized assessment roll.

To comply with section 15087, staff exceeded the requirements by mailing notification of the Draft EIR to all owners and occupants not just contiguous to the project site but also to property owners within 1,000 feet of the project site and 500 feet of project linears. The Draft EIR was also filed with the State Clearinghouse.

2.6 Organization of this EIR

This EIR is organized into five sections, as described below:

- Section 1 Summary. This section provides a concise overview of the proposed project and the necessary approvals; the environmental impacts that would result from the proposed project; mitigation measures identified to reduce or eliminate these impacts; project alternatives; and areas of known controversy and issues to be resolved.
- Section 2 Introduction. This section summarizes the proposed project and describes the type, purpose, and function of the EIR; the environmental review process and the nature of comments received on the NOP; and the organization of the EIR.
- Section 3 Project Description. This section presents the location of the site and project boundaries, characteristics of the proposed project, and objectives sought by the proposed project.
- Section 4 Environmental Setting, Impacts, and Mitigation. This section includes the environmental setting; regulatory framework; approach to analysis; project-specific and cumulative impacts; and mitigation measures, when appropriate. Staff evaluates the potential environmental impacts that might reasonably be anticipated to result from construction and operation of the proposed project. Staff's analysis is broken down into the following environmental resource topics derived from CEQA Appendix G:

- Aesthetics
- Agricultural and Forestry Resources
- Air Quality
- Biological Resources
- Land Use and Planning
- Mineral Resources
- Noise
- Population and Housing
- Public Services

- Cultural and Tribal Resources
- Energy
- Geology and Soils
- Greenhouse Gases
- Hazards and Hazardous Materials
- Hydrology and Water Quality
- Recreation
- Transportation
- Utilities and Service Systems
- Wildfire
- Mandatory Findings of Significance

In addition, CEC CEQA analysis documents include an analysis of how the project would potentially impact an Environmental Justice¹ population.

For each subject area, the analysis includes a description of the existing conditions and setting related to the subject area, an analysis of the proposed project's potential environmental impacts, and a discussion of mitigation measures, if necessary, to reduce potentially significant impacts to less than significant levels.

- Section 5 Alternatives. This section includes a discussion of a reasonable range of alternatives to the proposed project, or to the location of the project, which could feasibly attain most of the basic objectives of the project but would avoid or substantially lessen any of the significant effects of the project, and an evaluation of the comparative merits of the alternatives. This section also includes an evaluation of the no project alternative.

¹ An environmental justice population is based on race and ethnicity or low income status. See **Section 4.21 Environmental Justice** for more information.

Section 3

Project Description

3 Project Description

SV1, LLC, a wholly owned subsidiary of Equinix, LLC (SV1 or applicant) filed an application with the California Energy Commission (CEC) seeking an exemption from the CEC's jurisdiction (Small Power Plant Exemption, or SPPE) for the Great Oaks South Backup Generating Facility (GOSBGF) (20-SPPE-01). The GOSBGF would be part of the Great Oaks South Data Center (GOSDC) to be located in the City of San Jose. The project was approved by the city on February 1, 2017. Since its approval, SV1, LLC has made project design changes and is now seeking approval of an SPPE for the GOSBGF.

The GOSDC would consist of three 182,350 square foot, two-story data center buildings. The approximately 18-acre project site is associated with three addresses (123, 127, and 131 Great Oaks Boulevard) in the City of San Jose.

The GOSBGF would consist of 36 3.25-megawatt (MW) diesel-fired generators in six generation yards that would each be separately electrically interconnected to the three data center buildings. The GOSBGF would be used exclusively to provide backup generation and uninterruptible power supply for the GOSDC, and other than for routine maintenance and testing, would only operate in the event of a failure of the electrical service from Pacific Gas and Electric Company (PG&E) to the data center. In addition, the GOSBGF would include three life safety diesel fired generators, each capable of generating 0.50 MW. GOSBGF would have a generating capacity of up to 99.0 MW.

The GOSDC would connect to a new PG&E substation via five new 21 kilovolt (kV) distribution feeders that would extend underground along three proposed trench routes: Via Del Oro Santa Teresa Route 1, and Santa Teresa Route 2 to the project site. The California Public Utilities Commission (CPUC) has granted PG&E approval to construct the new substation, which is called the "Santa Teresa Substation".

3.1 Project Title

Great Oaks South Backup Generating Facility

3.2 Lead Agency Name and Address

California Energy Commission
1516 Ninth Street
Sacramento, California 95814

3.3 Lead Agency Contact Person and Phone Number

Lisa Worrall, Senior Environmental Planner
Siting, Transmission and Environmental Protection Division
California Energy Commission
(916) 661-8367

3.4 Project Location

The project is located at 123, 127, and 131 Great Oaks Boulevard in San Jose, California. **Figure 3-1** shows the regional location and **Figure 3-2** identifies the project location.

3.5 Project Overview

GOSBGF would be a backup generating facility with a generation capacity of up to 99.0 MW to support the GOSDC. The GOSBGF would consist of 36 diesel-fired back up generators, arranged in six generation yards, each designed to serve one of the three data center buildings that make up the GOSDC. Project elements would also include switchgear and distribution cabling to interconnect the six generation yards to their respective buildings. In addition, the GOSBGF would include three life safety diesel-fired generators, each capable of generating 0.50 MW.

The project proposes to construct three, two-story data center buildings that would each be approximately 182,350 square feet in size with a building footprint of approximately 92,000 square feet. Each building would contain server cabinets on each floor and three loading docks for shipping and receiving uses. A conceptual site plan is provided in **Figure 3-3**.

A two-story office component, approximately 49 feet in height (53 feet to top of parapet) and 15,000 square feet in size, would also be part of each building. The office space would provide customer care, security, building operations, and flex office functions.

The new data center buildings would house computer servers and supporting equipment for private clients in environmentally controlled structures. The proposed data center buildings would each include twelve generators (ten primary and two redundant) located adjacent to the buildings. Each generator would have an electric capacity of 3.25 MW and provide standby backup electricity for the new buildings. Diesel fuel for the generators would be stored in 9,200 gallon above ground tanks under each generator. The project would be supported from a new PG&E Santa Teresa Substation, a 115 kV transmission line extension to the substation from the existing Metcalf-Edenvale 115 kV transmission line, and five new 21 kV distribution feeders that would extend along Via Del Oro and/or Santa Teresa Boulevard to the data center site.

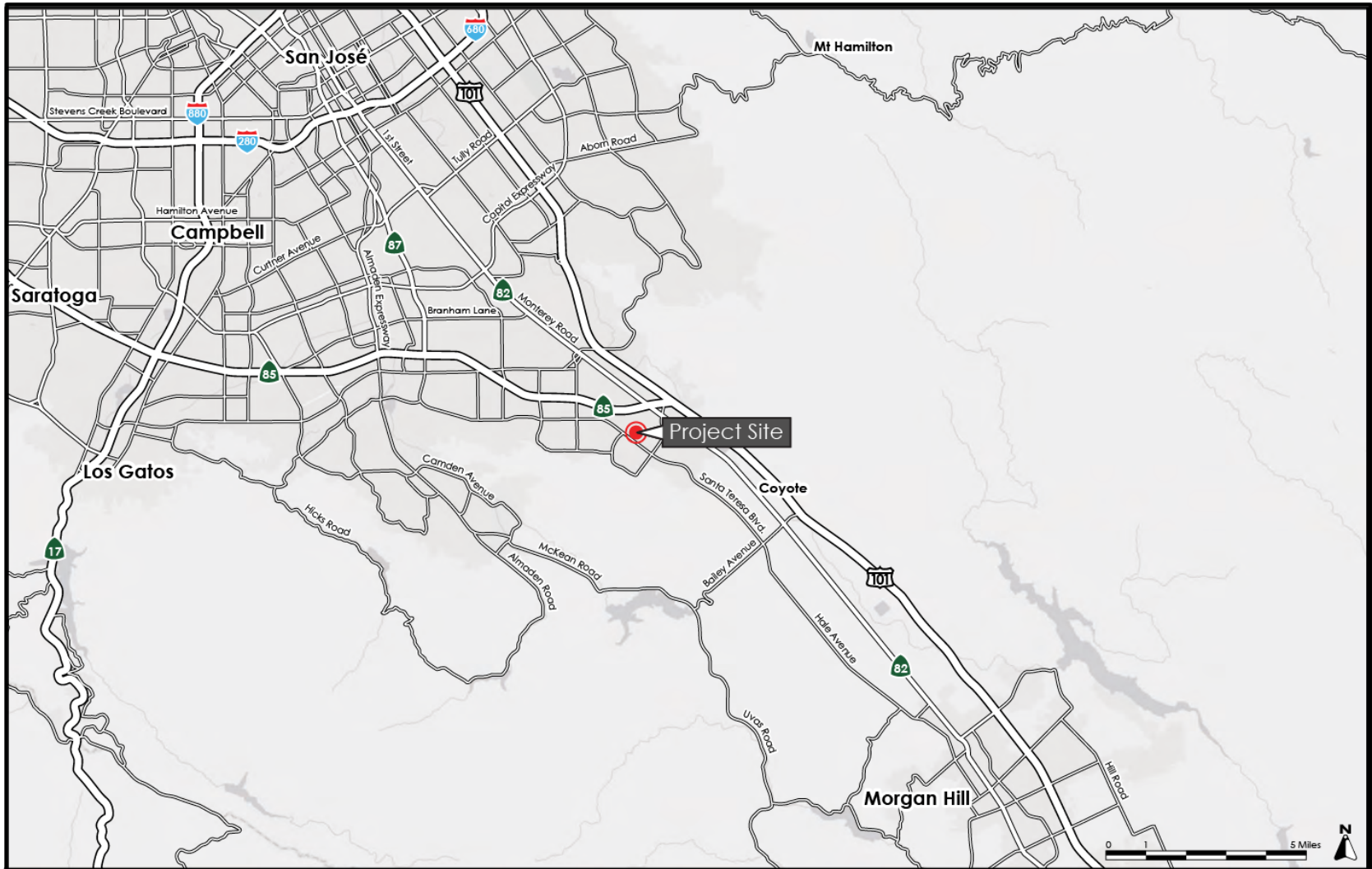

Figure 3-1
Regional Map

Source: SV1 2020a



Figure 3-2
Aerial Photograph and
Surrounding Land Uses

Source: SV1 2020a

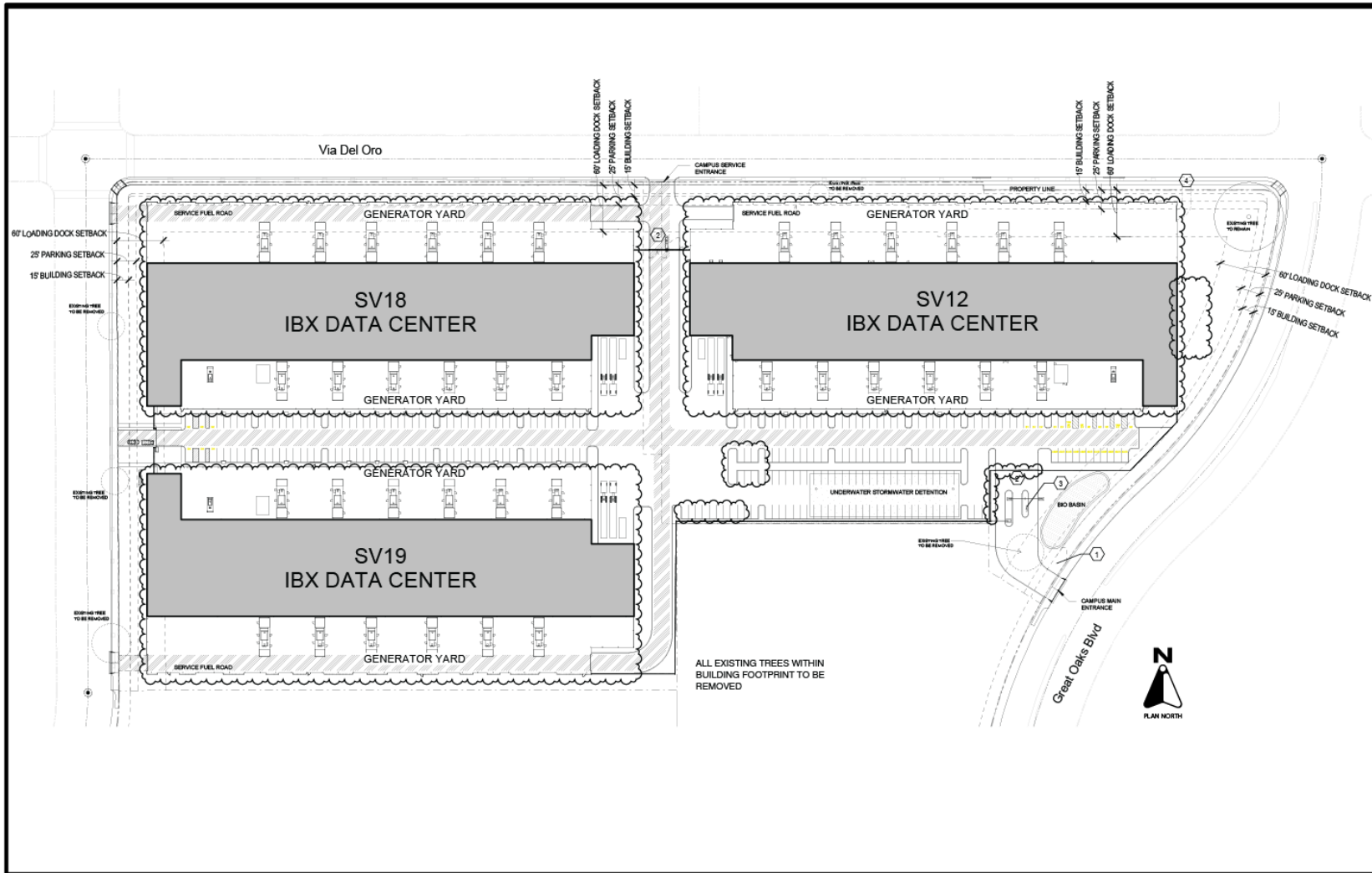

Figure 3-3
Site Plan

Source: SV1 2020a

3.5.1 Electrical Power Delivery

Electrical Supply

Electricity for the GOSDC would be supplied by the new PG&E Santa Teresa Substation, which would be located approximately 2,000 northwest of the GOSDC. The Santa Teresa Substation is designed to loop into the existing Metcalf-Edenvale 115 kV transmission lines. The Santa Teresa Substation would have a ring configuration. Power could come from either the Metcalf or Edenvale Substation. With one 23/36/45 megavolt ampere (MVA) (115/21 kV) transformer in the current planned Santa Teresa Substation design, second and third transformers would be installed at the substation when needed.

The project would require five 21 kV distribution lines. The five 21 kV distribution lines, built with underground 1100 AL EPRC (Aluminum Ethylene Propylene Rubber Concentric) cables with a 615-ampere rating, would be required to supply the full build out of GOSDC from the Santa Teresa Substation. Two distribution lines would be located in a single trench. PG&E requires six feet of separation between trenches. The initial power requirements would be met with one trench from Santa Teresa Substation to the site containing two distribution lines. The remaining three distribution lines would be constructed as needed and would require two additional trenches (three trenches in total). According to PG&E practices, a typical trench for the distribution lines would be 3 to 5 feet deep and approximately 18 to 30 inches wide (SV1 2020d - TN 233005-1).

The current planned Santa Teresa Substation design allows for four 21 kV distribution feeders. Eight 21 kV feeders plus the second and third transformers at the Santa Teresa Substation are required to support the full build out of the GOSDC and other PG&E customers. The GOSDC would be required to submit an application for service for one or more phases of the GOSDC and PG&E would study the impact to the transmission and distribution systems to consider when the second and third transformers would be needed. At that time PG&E would determine whether, as indicated in the Data Response Set 2, reconductoring for the Metcalf-Edenvale #1 115 kV line and Metcalf-Edenvale #2 115 kV lines may be required for each line to meet the full demand of the data center site independently. As the regulator, the CPUC would ensure compliance with CEQA, as needed, for changes to PG&E's system to serve the full buildout of the data center.

Electrical Generation Equipment

Each of the 36 generators would be an emergency diesel fired generator equipped with Miratech Selective Catalytic Reduction (SCR) system and diesel particulate filters (DPF) to achieve compliance with Tier 4 emission standards (SV1 2021g). The three life safety generators would be equipped with Tier 2 engines with DPF to meet the Tier 4 emission standard for particulate matter (SV1 2020j; SV1 2021i). The 36 generators would be Cummins model C3250D6e. The maximum peak generating capacity of each model is 3.25 MW with a steady state continuous generating capacity of 2.5 MW. Each individual generator would be provided with its own package system. Within that package, the prime mover and alternator would be made ready for the immediate call for the request for power controlled by the Uninterruptible Power Supply (UPS). The UPS would protect

the load against surges, sags, and voltage fluctuation and with the built-in protection against permanent damage to itself.

The UPS system consists of batteries, inverters, and switches to facilitate the uninterrupted transfer of electrical power supply from Santa Teresa Substation to the onsite backup generators. When supply power is lost, the UPS would transfer data center load from the PG&E system to UPS battery power, which triggers the start of the backup generators. Each generator package would integrate a dedicated fuel tank with a capacity of 9,200 gallons. There would be six generator yards total for the three buildings, two generator yards per each building. The 10+2 generators per each building would be configured and installed on concrete slab. Half of the generators for each building would be installed in the first equipment yard and the other half would be located in the second equipment yard next to the building. The generators are approximately 13.3 feet wide, 52.5 feet long, and 24 feet high. Each generator would have a stack height of approximately 27 feet 3 inches. When placed on slab, they would be spaced approximately 56 feet apart horizontally. Each generator yard would be located adjacent to the GOSDC building it serves. The generator yards would be housed in pre-manufactured and UL Listed metal enclosures.

Fuel System. The backup generators would use ultra-low sulfur diesel as fuel (< 15 parts per million sulfur by weight). Each generator package would include an integrated fuel tank with a capacity of 9,200 gallons and a urea tank for operating the SCR system, which is sufficient for operating at steady state continuous load for at least 30 hours.

Cooling System. Each generator would be air cooled independently as part of its integrated package and therefore there is no common cooling system for the GOSBGF. Each building would be cooled by an Air-Cooled Chilled Water System with refrigerant-side economizer. The new mechanical system would consist of 72 total 400-ton chillers, 24 per building. Each building's cooling system would operate in a 22+2 redundancy configuration. The administrative and service areas of the building will be cooled with high-efficiency split system variable refrigerant flow (VRF) cooling systems with simultaneous heating, cooling and heat recovery capabilities for optimum efficiency operation.

3.5.2 Water Use

The GOSBGF would not require any consumption of water.

The GOSDC estimates that it would use approximately 1.3-acre feet of water for each phase of construction, and approximately less than 4 acre-feet per year for operation for all three buildings. The theoretical maximum operational usage for each building is approximately 1.2 acre-feet per year. (SV1 2020f).

The project site is within the jurisdiction and service territory of the Great Oaks Water Company and would supply the GOSDC with water. SV1 met with the South Bay Water Recycling Program (SBWRP) who explained that the Great Oaks Water Company would

have to join its program in order for the SBWRP to serve recycled water to the site. SV1 met with Great Oaks Water Company who explained that they have no plans to join the SBWRP Program and as a condition of it serving the site with potable water, no recycled water could be delivered to the site. Therefore, recycled water is not feasible for the GOSDC (SV1 2020a).

3.5.3 Proposed Utility Connections

The following sections describe the GOSDC facilities that would interconnect to the existing utilities.

Electrical

The GOSDC would connect to the new Santa Teresa Substation via five new 21 kV underground distribution lines. A total of three trenches would be needed, typically 3 to 5 feet deep and approximately 18 to 30 inches wide (SV1 2020d - TN 233005-1). The three proposed trench routes are designated as Via Del Oro, Santa Teresa 1, and Santa Teresa 2 (SV1 2020p).

Storm Drainage

Drainage from the site would discharge from the hydromodification basin into an on-site 24-inch diameter pipe that would then flow out to an existing 48-inch diameter storm drain pipe in Great Oaks Boulevard at approximately eight feet deep.

Domestic Water

Each building would have a four-inch diameter and a 2.5-inch diameter domestic water service. Two 4-inch diameter and two 2.5-inch diameter domestic water services would connect to an existing 12-inch diameter water pipe in Via Del Oro. One four-inch diameter domestic water service will connect to an existing 12-inch diameter water pipe in San Ignacio Avenue located in an easement on the far side of the street, behind the west curb and gutter. The depth of domestic water services would be 4 feet minimum.

Fire Water

There would be four 10-inch diameter fire water services. One would connect to an existing 12-inch diameter water pipe in Great Oaks Boulevard. One would connect to an existing 12-inch diameter water pipe in Via Del Oro. Two would connect to an existing 12-inch diameter water pipe in San Ignacio Avenue located in an easement on the far side of the street, behind the west curb and gutter. The depth of fire water services would be 4 feet minimum.

Sanitary Sewer

Sewer discharge from the buildings would be collected in an on-site eight-inch diameter pipe and connect to an existing 15-inch diameter sanitary sewer pipe in Great Oaks Boulevard at approximately 15 feet deep.

3.5.4 Landscaping

Landscaping would be planted throughout the main project site in accordance with City of San Jose General Plan policies. Approximately 133,500 square feet of landscaping is proposed around the data center buildings. In addition, street trees would be planted along the project frontages to help soften views of the project site from the surrounding area. Prior to the approval of the original Special Use Permit (SUP) on January 23, 2017, there were 15 on-site trees (including the one heritage tree) and five off-site trees within the right of way of the street fronting the property. After approval of the original SUP, 13 of the on-site trees were removed. For this current project, an amendment to the SUP would be necessary and it is anticipated that six additional trees would be removed (one on-site and five off-site), four of which are ordinance size trees. The landscape plan for this SUP amendment (from the City of San Jose) proposes to plant 51 new street trees and 177 on-site trees.

3.5.5 Storm Water Management

According to the Hydromodification Management Applicability Map for the City of San Jose, published by the Santa Clara Valley Urban Runoff Pollution Prevention Program, the property is located in a catchment or sub-watershed that is less than 65 percent impervious. Development of any property located in such a catchment area that results in more than one acre of impervious surfaces would require the incorporation of hydromodification management controls in accordance with Provision C.3.g of the Regional Water Quality Control Board's "Municipal Stormwater NPDES Permit" and City of San Jose Policy 8-14: Post-Construction Hydromodification Management. The project proposes to implement an underground detention basin with a storage volume of about 100,000 cubic feet.

Since development of the property would result in the construction of new impervious surfaces totaling more than 10,000 square feet, the project would be required to incorporate post-construction storm water treatment control measures adhering to the current requirements of Provision C.3 of the Regional Water Quality Control Board's "Municipal Stormwater NPDES Permit" and City of San Jose Policy 6-29: Post-Construction Urban Runoff Management.

The measures to be implemented would include but are not limited to:

- Site Design Measures:
 - Protect existing trees, vegetation, and soil
 - Plant trees adjacent to and in parking areas and adjacent to other impervious areas
 - Cluster structures/pavement
- Source Control Measures:
 - Beneficial landscaping (minimize irrigation, runoff, pesticides and fertilizers)
 - Good housekeeping (sweep pavement and clean catch basin)

- Label storm drains
- Connect covered trash/recycling enclosures and covered loading docks to the sanitary sewer
- Treatment Systems
 - Bioretention/biotreatment basin area approximately 3,000 square feet

3.5.6 Waste Management

Other than minor amounts of solid waste created during construction and maintenance activities, the GOSBGF and GOSDC would not create any waste materials.

3.5.7 Hazardous Materials Management

The project applicant would prepare a Spill Prevention, Control and Countermeasure Plan (SPCC) to address the storage, use and delivery of diesel fuel for the generators. Each generator unit and its integrated fuel tanks have been designed with double walls. The interstitial space between the walls of each tanks is continuously monitored electronically for the existence of liquids. This monitoring system is electronically linked to an alarm system in the security office that alerts personnel if a leak is detected. Additionally, the standby generator units are housed within a self-sheltering enclosure that prevents the intrusion of storm water.

Diesel fuel would be delivered on an as-needed basis in a compartmentalized tanker truck with maximum capacity of 8,500 gallons. The tanker truck would park at the gated entrances to the generator yard for re-fueling. There would be no loading/unloading racks or containment for re-fueling events; however, a spill catch basin would be located at each fill port for the generators. To prevent a release from entering the storm drain system, drains would be blocked off by the truck driver and/or facility staff during fueling events. Rubber pads or similar devices would be kept in the generation yard to allow quick blockage of the storm sewer drains during fueling events. To further minimize the potential for diesel fuel to come into contact with stormwater, to the extent feasible, fueling operations would be scheduled at times when storm events are improbable. Warning signs and/or wheel chocks would be used in the loading and/or unloading areas to prevent vehicles from departing before complete disconnection of flexible or fixed transfer lines. An emergency pump shut-off would be utilized if a pump hose breaks while fueling the tanks. Tanker truck loading and unloading procedures would be posted at the loading and unloading areas. Spill containment kits would always be kept onsite to address any unlikely spill events. To guard against degradation, fuel would be polished a minimum of every 12 months. Fuel polishing is a process that removes contamination from fuels in storage. Sources of contamination include water, microbial growth, and solid particles such as dirt.

3.6 Project Construction

Project construction would take up to 52 months. The actual construction period for the buildings, parking lots, engine pad areas, and support infrastructure, would be

approximately 4.3 years . The start and end dates of the construction period are based upon the applicant's best estimate. The 52-month period included construction downtime between phases and lag times between the start and end of construction. The start date for engine operations subsequent to completion of Phase 1 (SV12) will occur at some point during the interim period between the end of Phase 1 and the start of construction of Phase 2 (SV18). The same situation is expected for the interim period between Phase 2 and Phase 3 (SV19), i.e., all of the engines for SV12 and SV18 are assumed to be operated under normal maintenance and readiness testing prior to the start of construction of Phase 3. Based on the above, there will be an overlap of emissions during construction of Phase 2 and Phase 3. (SV1 2020j)

Construction activities would include site preparation (ground preparation and grading) and the construction of concrete slabs, fencing, above ground conduit to install the electrical cabling to interconnect to the GOSDC building switchgear, and placement and securing the generators. Drilled piles would be used for the construction of foundations. The generators would be assembled offsite and delivered to site by truck then placed within their respective generation yard by a crane.

Construction of the GOSBGF would take place in three phases. Each phase represents two generation yards constructed to serve one of the three GOSDC buildings. Therefore, Phase I would include 12 generators and one life safety emergency generator for Building SV-12. Phase II would include 12 generators and the life safety emergency generator for Building SV-18, and Phase III would include 12 generators and the life safety emergency generator for Building SV-19. Construction of each generation yard and placement of the generators is expected to take nine months.

The data center buildings would also be constructed in three separate phases. One building would be constructed per phase, with construction over an approximately 13 to 15-month period per phase. Construction of the first GOSDC building, SV12, would take up to 18 months. Following completion of SV12 construction, the second GOSDC building, SV18, would take up to 17 months. Following completion of SV18, construction of the third GOSDC building, SV19, would take up to 17 months. (SV1 2020j)

3.7 Workforce

Construction personnel are estimated to range from 15 to 20 workers per generation yard including one crane operator. SV1 estimates approximately 200-225 construction workers during the peak month and an average of 125-150 construction workers for each phase.

Operations personnel for each building would include eight employees/external staff (i.e. security guards) per day shift, three per mid shift, and three per night shift. For each building, visitors would average about seven per day shift, two per mid shift, and one per night shift.

3.8 Site Access

The site would be accessed by three entry points: two for passenger vehicles and one for delivery trucks. The main passenger vehicle driveway would be located on Great Oaks Boulevard near an existing curb cut in the boulevard median. The secondary passenger vehicle access point would be located on San Ignacio Avenue. Delivery trucks would be able to access the main loading dock areas via a truck driveway located on Via Del Oro. Each access point would be gated and electronically secured.

The project proposes to construct 266¹ surface parking spaces to be located throughout the approximately 18-acre site. In addition, 21 bicycle parking spaces would be provided and there would be nine loading dock spaces for delivery trucks.

3.9 Existing Site Condition

The project site is located in an office park area and is surrounded by one- to two-story commercial office buildings to the west, north, and east. There is no development south of the site.

The approximately 18-acre project site is flat, undeveloped, and consists of an open vacant lot with scattered trees, including a large valley oak, a City designated Heritage Tree, at the corner of Via Del Oro and Great Oaks Boulevard. The project site is located in an urban area and bound by Via Del Oro (a two-lane roadway with a center turn lane) to the north, Great Oaks Boulevard (a four-lane roadway with a center median) to the east, vacant land to the south, and San Ignacio Avenue (a two-lane roadway with a center turn lane) to the west. Surrounding development consists of one- to two-story modern office buildings, constructed with stucco, steel, and reflective glass windows. Street trees are planted on Via Del Oro, Great Oaks Boulevard, and San Ignacio Avenue on the opposite side of the street (not along the project frontage). See **Figure 3-1**, **Figure 3-2**, and **Figure 3-3** for regional, vicinity, and aerial site location maps.

There are 48-inch diameter and 54-inch diameter storm drainpipes in Great Oaks Boulevard. There is a 48-inch diameter storm drainpipe along the entire San Ignacio Avenue frontage. In Via Del Oro, there are two storm drainpipes. One is an 18-inch diameter pipe flowing towards Great Oaks Boulevard and the other is a 24-inch diameter pipe flowing towards San Ignacio Avenue.

There are 12-inch diameter water pipes along Great Oaks Boulevard, Via Del Oro and San Ignacio Avenue.

There is a 15-inch diameter sanitary sewer pipe along the entire Great Oaks Boulevard frontage, an 8-inch diameter sanitary sewer pipe along the entire frontage of Via Del Oro and a 15-inch diameter sanitary sewer pipe along the entire San Ignacio Avenue frontage.

¹ The transportation analysis recommended reducing the number of parking spaces, which is a consideration the City of San Jose can make if they choose.

3.10 Project Objectives

The applicant's primary goal is to develop a state-of-the-art data center that would be part of the single, largest internet hub on the west coast. The project is intended to reliably meet the increased demand of the digital economy and its customers.

In addition to its primary goal, the applicant has set forth these project objectives:

- Develop a state-of-the-art data center with up to 547,000 square feet.
- Develop the data center on land that has been previously approved for a similar size data center.
- Develop a data center that can be constructed in phases which can be timed to match projected customer growth.
- Meet high sustainability and green building standards by designing the data center to meet U.S. Green Building Code LEED and Cal-Green standards for new construction.
- Incorporate the most reliable and flexible form of backup electric generating technology considering the following evaluation criteria:
 - Commercial Availability and Feasibility. The selected backup electric generation technology must currently be in use and proven as an accepted industry standard for technology. It must be operational within a reasonable timeframe where permits and approvals are required.
 - Technical Feasibility. The selected backup electric generation technology must utilize systems that are compatible with one another.
 - Reliability. The selected backup electric generation technology must be extremely reliable in the case of an emergency loss of electricity from the utility.
 - Industry Standard. The selected backup electric generation technology must be considered industry standard or best practice. The customers of SV1 are informed consumers and will request SV1 to provide a detailed description of the type of backup generation that it delivers as part of the customer's due diligence. If the selected technology does not meet customers' requirements, they will not put their servers in the Great Oaks South Data Center.

3.11 Facility Operation

3.11.1 Backup Generators

The backup generators would be run for short periods for testing and maintenance purposes and otherwise would not operate unless there is a disturbance or interruption of the utility supply. Bay Area Air Quality Management District's (BAAQMD) Authority to Construct and the California Air Resources Board's Airborne Toxic Control Measures (ATCM) limits each engine to no more than 50 hours annually for reliability purposes (i.e., testing and maintenance). The applicant is proposing an annual readiness and maintenance testing schedule that would be comprised of 20 hours per year (per engine).

Therefore, the maintenance and readiness testing would occur at loads in the range of 10 percent to 100 percent based upon the EPA D2 cycle emissions rates. (SV1 2020j)

In addition, SV1 proposes to limit operation to one engine at a time for maintenance and testing activities.

3.11.2 Building Load

The projected maximum load demand for each of the proposed data center buildings is approximately 33.0 MW. This load includes the power required to operate tenant information technology (IT) equipment as well as mechanical cooling systems, UPS, and general building lighting and power loads. The project applicant estimates the demand for maximum load anticipated with the proposed site improvements based on the occupancy of the data center buildings with data center uses supported by the proposed mechanical and electrical infrastructure.

3.11.3 Energy and Water Efficiency Measures

Due to heat generated by the data center IT equipment, cooling systems are one of the primary uses of energy in the buildings. In order to reduce greenhouse gas emissions and reduce energy use related to building operations, the project proposes to implement a number of efficiency measures related to selection and operation of electrical and mechanical equipment for building cooling. Refer to Table 2.3-1 in the Project Description section of the SPPE application for a list of the proposed efficiency measures related to mechanical and electrical systems in the buildings. Refer to Table 2.3-2 in the Project Description section of the SPPE application for additional energy efficiency measures associated with tenant improvements and water use reduction.

3.12 Required Approvals and Permits

If the CEC grants an SPPE exemption for the project, the City of San Jose would then be responsible for the approval or denial of the project. BAAQMD would need to grant an approval for an Authority to Construct and a Permit to Operate.

3.13 Mitigation Incorporated Into Project Design

The applicant has incorporated mitigation from the project that was approved by the city on February 1, 2017. The applicant added PD NO-2 and PD TRA-1 to the list of project design measures (SV1 2020d, SV1 2021h). CEC staff made some minor revisions to survey periods in PD BIO-3, and the applicant is in agreement with these changes (CEC 2020i). These mitigation measures have been incorporated as part of the project design.

Air Quality

PD AQ-1: To ensure that fugitive dust impacts are less than significant, the project will implement the BAAQMD's recommended BMPs [best management practices] during the construction phase. These BMPs are incorporated into the design of the project and will include:

- All exposed surfaces (soil piles, graded areas, and unpaved access roads) shall be watered at least two times per day.
- All haul trucks transporting material offsite shall be covered.
- All track-out onto adjacent public roads shall be removed using wet power vacuum street sweepers at least once per day.
- All vehicle speeds on onsite unpaved surfaces shall be limited to 5 miles per hour.
- All roadways, driveways, and sidewalks shall be paved as soon as possible. Building pads shall be completed as soon as possible after grading unless seeding or soil binders are used.
- Equipment idling times shall be minimized to 5 minutes per the Air Toxics Control Measure (ATCM). Idling time signage shall be provided for construction workers at all access points.
- All construction equipment shall be maintained and properly tuned in accordance with manufacturer specifications. All equipment shall be checked by a certified visible emissions evaluator.
- Information on who to contact, contact phone number, and how to initiate complaints about fugitive dust problems will be posted at the site.

PD AQ-2, is no longer accurate for the proposed project, as it was designed for the previous iteration of the project and has not been updated.

Biological Resources

PD BIO-1: In accordance with current City policies and Municipal regulations, trees removed will be replaced at the ratios identified in Table 4.6-1.

- In the event replacement/mitigation trees cannot be accommodated on the site, tree removal shall be mitigated through a donation of \$300 per mitigation tree to Our City Forest for in-lieu off-site tree planting in the community. The species of trees to be planted shall be determined in consultation with the City Arborist and the Department of Planning, Building and Code Enforcement. Trees removed shall be replaced at these ratios, or the applicant shall pay an in-lieu fee to Our City Forest to compensate for the loss of trees on-site.

PD BIO-2: In accordance with guidelines established by the International Society for Arboriculture, the following tree protection measures will be implemented to reduce impacts to the Heritage Tree:

- Establish an area surrounding the Heritage Tree to be protected during construction as defined by a circle concentric with each tree with a radius 1-1/2 times the diameter of the tree canopy drip line. This "tree protection zone" is established to protect the tree trunk, canopy and root system from damage during construction activities and to ensure the long-term survival of the protected trees. The tree protection zone shall: (1) ensure that no structures or buildings, that might restrict sunlight relative to the

existing conditions, will be constructed in close proximity to the trees; and (2) that no improvements are constructed on the ground around the tree within the tree protection zone, thus ensuring that there is sufficient undisturbed native soil surrounding the tree to provide adequate moisture, soil nutrients and oxygen for healthy root growth.

- Protect tree root systems from damage caused by (a) runoff or spillage of noxious materials while mixing, placing, or storing construction materials and (b) ponding, eroding, or excessive wetting caused by incident rainfall through use of the following measures during excavation and grading:
 - Excavation: Do not trench inside tree protection zones. Hand excavate under or around tree roots to a depth of three feet. Do not cut main lateral tree roots or taproots. Protect exposed roots from drying out before placing permanent backfill.
 - Grading: Maintain existing grades within tree protection zones. Where existing grade is two inches or less below elevation of finish grade, backfill with topsoil or hand grade to required finish elevation.
 - Apply six-inch average thickness of wood bark mulch inside tree protection zones. Keep mulch six inches from tree trunks.
- Provide 48-inch tall orange plastic construction fencing fastened to steel T-posts, minimum six feet in length, using heavyweight plastic ratchet ties. Install fence along edges of tree protection zones before materials or equipment are brought on site and construction operations begin. Maintain fence in place until construction operations are completed and equipment has been removed from site.
- Provide temporary irrigation to all trees in protection zones using a temporary on-grade drip or bubbler irrigation system sufficient to wet the soil within tree protection zones to a depth of 30 inches per bi-weekly irrigation event.

Heritage Tree Design Recommendations

- Establish the horizontal and vertical elevation of the Heritage Tree. Include the trunk location and tag number on all plans.
- Design finish grades so that no water accumulates around the base of the trunk of the Heritage Tree.
- Allow the Consulting Arborist to review all future project submittals including grading, utility, drainage, irrigation, and landscape plans.
- Maintain the tree protection zone around the Heritage Tree as depicted on the Grading and Drainage Plan prepared by Ruth and Going. The tree protection zone shall be the limit of work.
- Route underground services including utilities, sub-drains, water or sewer around the tree protection zone. Where encroachment cannot be avoided, special construction techniques such as hand digging or tunneling under roots shall be employed where necessary to minimize root injury.

- Use only herbicides safe for use around trees and labeled for that use, even below pavement.
- Design the landscape around the Heritage Tree to be compatible with the cultural requirements of native oak trees.
- Any irrigation system must be designed so that no trenching will occur within the dripline of the Heritage Tree.

Pre-construction and demolition treatments and recommendations

The demolition contractor shall meet with the Consulting Arborist before beginning work to discuss work procedures and tree protection.

- Install protection at the tree protection zone prior to demolition, grubbing, or grading.
- No entry is permitted into a tree protection zone without permission of the project superintendent.
- The Heritage Tree should be pruned to reduce the length and weight of long, horizontal branches. Remove stubs only when there is well-developed woundwood present at the attachment. Do not remove the large stub in the center of the crown. All pruning shall be completed by an ISA Certified Arborist or Tree Worker and adhere to the latest editions of the American National Standards for tree work (Z133 and A300) and International Society of Arboriculture Best Management Practices, Pruning.
- The Heritage Tree should also be evaluated for installation of new cables to support heavy horizontal limbs.

Tree protection during construction

- Any grading, construction, demolition or other work that occurs within the tree protection zone should be monitored by the Consulting Arborist.
- If injury occurs to any tree during construction, it should be evaluated as soon as possible by the Consulting Arborist so that appropriate treatments can be applied.
- Fences are to remain until all site work has been completed. Fences may not be relocated or removed without permission of the project superintendent.
- Construction trailers, traffic and storage areas must remain outside fenced areas at all times.
- No materials, equipment, soil, waste, or wash-out water may be deposited, stored, or parked within the tree protection zone (fenced area).
- Any tree pruning needed for clearance during construction must be performed by a qualified arborist and not by construction personnel.
- Any roots damaged during grading or construction shall be exposed to sound tissue and cut cleanly with a saw.

CEC staff made some minor revisions to survey periods in PD BIO-3, and the applicant is in agreement with these changes (CEC 2020i).

PD BIO-3: The following measure will be implemented to reduce impacts to nesting birds:

- If possible, construction should be scheduled between September and January (inclusive) to avoid the nesting season. If this is not possible, pre-construction surveys for nesting raptors and other migratory breeding birds shall be conducted by a qualified ornithologist to identify active nests that may be disturbed during project implementation onsite and within 250 feet of the site. Between February 1 and August 31 pre-construction surveys shall be conducted no more than 14 days prior to construction activities or tree relocation or removal. The surveying ornithologist shall inspect all trees in and immediately adjacent to the construction area for nests.
- If an active nest is found in or close enough to the construction area to be disturbed by these activities, the ornithologist shall, in consultation with the California Department of Fish and Wildlife (CDFW), designate a construction free buffer zone (typically 250 feet for raptors and 100 feet for other birds) around the nest, which shall be maintained until after the breeding season has ended and/or a qualified ornithologist has determined that the young birds have fledged.
- The applicant shall submit a report indicating the results of the survey and any designated buffer zones to the satisfaction of the Director of Planning, Building and Code Enforcement prior to the issuance of any grading or building permit.

Cultural and Tribal Cultural Resources

PD CUL-1: The following project-specific measures shall be implemented during construction to avoid significant impacts to unknown subsurface cultural resources:

- In the event that prehistoric or historic resources are encountered during on-site construction activities, all activity within a 50-foot radius of the find shall be stopped, the Director of Community Development shall be notified, and a Secretary of the Interior-qualified archaeologist shall examine the find and record the site, including field notes, measurements, and photography for a Department of Parks and Recreation 523 Primary Record form. The archaeologist shall make a recommendation regarding eligibility for the California Register of Historical Resources, data recovery, curation, or other appropriate mitigation. Ground disturbance within the 50-foot radius can resume once these steps are taken and the Director of Planning, Building, and Code Enforcement has concurred with the recommendations. Within 30 days of the completion of construction or cultural resources monitoring, whichever comes first, a report of findings documenting any cultural resource finds, recommendations, data recovery efforts, and other pertinent information gleaned during cultural resources monitoring shall then be submitted to the Director of Planning, Building, and Code Enforcement. Once finalized, this report shall be submitted to the Northwest Information Center at Sonoma State University.

- Prior to and for the duration of ground disturbance, the project owner shall provide Worker Environmental Awareness Program training to all existing and any new employees. This training should include: a discussion of applicable laws and penalties under the laws; samples or visual aids of artifacts that could be encountered in the project vicinity, including what those artifacts may look like partially buried, or wholly buried and freshly exposed; and instructions to halt work in the vicinity of any potential cultural resources discovery, and notify the city-approved archaeologist and Native American cultural resources monitor.

PD CUL-2: The following project-specific measures shall be implemented during construction to avoid significant impacts to unknown subsurface cultural resources:

- In the event that human remains are discovered during on-site construction activities, all activity within a 50-foot radius of the find shall be stopped. The Santa Clara County Coroner shall be notified and shall make a determination as to whether the remains are of Native American origin or whether an investigation into the cause of death is required. If the remains are determined to be Native American, the Coroner shall notify the Native American Heritage Commission. All actions taken under this mitigation measure shall comply with Health and Human Safety Code § 7050.5(b).

Geology and Soils

PD GEO-1: In order to ensure the project design conforms to the requirements of a final geotechnical engineering investigation and California and local building standards and codes, the following is proposed as mitigation incorporated into the project. Incorporation will ensure seismic hazards are reduced to less than significant levels.

- The project shall be constructed in conformance with the recommendations of the design level geotechnical investigation prepared for the project, as well as at [sic] the 2017 California Building Code, or subsequent adopted codes.

Hazards and Hazardous Materials

PD HAZ-1: The project proposes to implement the following measures which will reduce the potential for tracking of impacted soil from the adjacent parcel to the project site.

- During construction activities (e.g. grading, vehicle travel, movement of equipment or materials, etc.), adjacent to APN 706-02-058, the project contractor shall fence the southwesterly adjacent parcel (APN 706-02-058) separately from the rest of the site.

Hydrology and Water Quality

PD HYD-1: The project will incorporate the following into the design and these measures should be treated as mitigation incorporated into the project. The following will reduce construction-related water quality impacts:

- Burlap bags filled with drain rock shall be installed around storm drains to route sediment and other debris away from the drains.

- Earthmoving or other dust-producing activities shall be suspended during periods of high winds.
- All exposed or disturbed soil surfaces shall be watered at least twice daily to control dust as necessary.
- Stockpiles of soil or other materials that can be blown by the wind shall be watered or covered.
- All trucks hauling soil, sand, and other loose materials shall be required to be covered trucks or maintain at least two feet of freeboard.
- All paved access roads, parking areas, staging areas and residential streets adjacent to the construction site shall be swept daily (with water sweepers).
- Vegetation in disturbed areas shall be replanted as quickly as possible.
- All unpaved entrances to the site shall be filled with rock to knock mud from truck tires prior to entering City streets. A tire wash system may also be employed at the request of the City.
- The project proponent shall comply with the City of San Jose Grading Ordinance, including implementing erosion and dust control during site preparation and with the City of San Jose Zoning Ordinance requirements for keeping adjacent streets free of dirt and mud during construction.
- A Storm Water Permit shall be administered by the SWRCB. Prior to construction grading for the proposed land uses, the project proponents will file an NOI to comply with the General Permit and prepare a SWPPP which addresses measures that will be included in the project to minimize and control construction and post-construction runoff. Measures will include, but are not limited to, the aforementioned RWQCB Best Management Practices.
- The SWPPP shall be posted at the project site and shall be updated to reflect current site conditions.
- When construction is complete, a Notice of Termination for the General Permit for Construction shall be filed with the SWRCB. The Notice of Termination shall document that all elements of the SWPPP have been executed, construction materials and waste have been properly disposed of, and a post-construction stormwater management plan is in place as described in the SWPPP for the site.

Noise and Vibration

PD NOI-1: The project proposes to implement the following measures to reduce temporary construction noise to less than significant levels.

- Construction activities within 200 feet of commercial uses shall be limited to the hours between 7:00 AM and 7:00 PM, Monday through Friday.
- Equip all internal combustion engine-driven equipment with intake and exhaust mufflers that are in good condition and appropriate for the equipment.

- Unnecessary idling of internal combustion engines within 200 feet of commercial uses is strictly prohibited. Equipment shall be turned off when not in use and the maximum idling time shall be limited to five minutes.
- Locate stationary noise-generating equipment such as air compressors or portable power generators at least 200 feet from adjacent office and commercial uses to the greatest extent feasible.
- Utilize “quiet” air compressors and other stationary noise sources where technology exists.
- Notify all adjacent business other noise-sensitive land uses of the construction schedule, in writing, and provide a written schedule of “noisy” construction activities to the adjacent land uses.

PD NOI-2: The project applicant shall prepare a noise logistics plan, which shall be submitted for review and approval by the Supervising Planner of the Environmental Review Division of the Department of Planning, Building, and Code Enforcement prior to issuance of grading and building permits. This plan shall include, at a minimum, the following measures to reduce the exposure of adjacent office buildings to construction noise:

- All internal combustion engine-driven equipment shall use best available noise control practices and equipment (including mufflers, intake silencers, ducts, engine enclosures, and acoustically attenuating shields or shrouds). A letter from a qualified acoustic specialist shall be attached to the noise logistics plan along with a list of proposed construction equipment, certifying that the proposed construction equipment includes the best available noise attenuating technologies.
- The contractor will prepare a detailed construction plan identifying a schedule of major noise generating construction activities. This plan shall identify a noise control “disturbance coordinator” and procedure for coordination with the adjacent noise sensitive facilities so that construction activities can be scheduled to minimize noise disturbance. This plan shall be made publicly available for interested community members. The disturbance coordinator will be responsible for responding to any local complaints about construction noise. The disturbance coordinator will determine the case of the noise complaint (e.g. starting too early, bad muffler, etc.) and will require that reasonable measures warranted to correct the problem be implemented. The telephone number for the disturbance coordinator construction site shall be posted on the construction site and included in a notice sent to adjacent commercial businesses regarding the construction schedule.
- All measures in the approved noise logistics plan shall be printed on all approved plans for grading and building permits.

Transportation

PD TRA-1: Prior to the issuance of any Public Works clearances, the project shall implement the following Transportation Demand Management (TDM) measures:

- Expand the Reach of Bike Access with Investment in Infrastructure (Tier 2- Bike Access Improvements): Implement bicycle facilities that close gaps in the bicycle network and/or improve the existing bicycle network (e.g. construct barrier or buffer for an existing bike lane). Improving bike access to the project promotes biking as an alternative to driving and reduces VMT. The San Jose Better Bike Plan 2025 identifies Class II bike lanes along Via Del Oro between Bernal Road and Raleigh Road. Additionally, the existing Class II bike lanes along Great Oaks Boulevard, San Ignacio Avenue, and Santa Teresa Boulevard in the project vicinity are planned to be converted to Class IV protected bike lanes. The project would be required to implement Class II bike lanes along Via Del Oro on the opposing side of the project frontage between San Ignacio Avenue and Great Oaks Boulevard. AND
- Provide Pedestrian Network Improvements for Active Transportation (Tier 2- Pedestrian Access improvements): Implement pedestrian improvements both on-site and in the surrounding area. Improving pedestrian connections encourages people to walk instead of drive and reduces VMT. The project would be required to remove each of the pork chop islands on the north leg (Great Oaks Boulevard) at the Santa Teresa Boulevard/Great Oaks Boulevard intersection to improve pedestrian safety and access. A signal modification will be needed for the implementation of the pork-chop island removal at the northeast and northwest corners of Santa Teresa Boulevard/Via Del Oro intersection. In-lieu of the installed ADA curb ramps at Great Oaks Boulevard/Via Del Oro intersection, the project will be required to provide contribution towards the signal improvements including pan, tilt, zoom (PTZ) cameras at the Via Del Oro/San Ignacio Avenue and Via Del Oro/ Great Oaks Boulevard intersections to improve the pedestrian network in the project vicinity.

3.14 References

CEC 2020i – California Energy Commission (CEC). Report of Conversation – Edits to PD BIO-3: Great Oaks South Backup Generating Facility (TN 233485), June 2020.

Available online at:

<https://efiling.energy.ca.gov/Lists/DocketLog.aspx?docketnumber=20-SPPE-01>

PG&E 2020a – Pacific Gas and Electric Company (PG&E). PG&E Responses to Staff Requests Concerning Interconnection of Great Oaks South Backup Generating Facility (TN 234392), August 2020. Available online at:

<https://efiling.energy.ca.gov/Lists/DocketLog.aspx?docketnumber=20-SPPE-01>

SV1 2020a – SV1, LLC. (SV1). Application for Small Power Plant Exemption: Great Oaks South Backup Generating Facility (TN 232466), March 2020. Available online at:

<https://efiling.energy.ca.gov/Lists/DocketLog.aspx?docketnumber=20-SPPE-01>

SV1 2020d – SV1, LLC. (SV1). SV1 Responses to CEC Data Request Set 2: Great Oaks South Backup Generating Facility Part 1 through Part 4 (TN 233005-1,2,3,4), May 2020. Available online at:

<https://efiling.energy.ca.gov/Lists/DocketLog.aspx?docketnumber=20-SPPE-01>

SV1 2020f – SV1, LLC. (SV1). SV1 Supplemental Responses to CEC Data Requests 18 and 56: Great Oaks South Backup Generating Facility (TN 233681), June 2020. Available online at:

<https://efiling.energy.ca.gov/Lists/DocketLog.aspx?docketnumber=20-SPPE-01>

SV1 2020h – SV1, LLC. (SV1). SV1 Supplemental Responses to DR 65-69: Great Oaks South Backup Generating Facility (TN 233924), July 2020. Available online at:

<https://efiling.energy.ca.gov/Lists/DocketLog.aspx?docketnumber=20-SPPE-01>

SV1 2020p – SV, LLC. (SV1). SV1 Revised SV1 Supplemental DR-47 Response: Great Oaks South Backup Generating Facility (TN 235566), November 2020. Available online at: <https://efiling.energy.ca.gov/Lists/DocketLog.aspx?docketnumber=20-SPPE-01>

SV1 2021g – SV1, LLC. (SV1). SV 1 Revised Project Description: Great Oaks South Backup Generating Facility (TN 237149), March 2021. Available online at:

<https://efiling.energy.ca.gov/Lists/DocketLog.aspx?docketnumber=20-SPPE-01>

SV1 2021h – SV1, LLC. (SV1). SV 1 Hexagon Consultants Transportation Analysis: Great Oaks South Backup Generating Facility (TN 237150), March 2021. Available

online at: <https://efiling.energy.ca.gov/Lists/DocketLog.aspx?docketnumber=20-SPPE-01>

Section 4

Environmental Setting and Environmental Impacts

4 Environmental Setting and Environmental Impacts

4.1 Aesthetics

This section describes the environmental and regulatory setting and discusses impacts specific to aesthetics associated with the construction and operation of the project in the existing landscape.¹

AESTHETICS	Potentially Significant Impact	Less Than Significant with Mitigation Incorporated	Less Than Significant Impact	No Impact
Except as provided in Public Resources Code Section 21099 ² , would the project:				
a. Have a substantial adverse effect on a scenic vista?	<input type="checkbox"/>	<input type="checkbox"/>	<input checked="" type="checkbox"/>	<input type="checkbox"/>
b. Substantially damage scenic resources, including, but not limited to, trees, rock outcroppings, and historic buildings within a State scenic highway?	<input type="checkbox"/>	<input type="checkbox"/>	<input checked="" type="checkbox"/>	<input type="checkbox"/>
c. In non-urbanized areas, substantially degrade the existing visual character or quality of public views of the site and its surroundings? (Public views are those that are experienced from publicly accessible vantage point). If the project is in an urbanized area, would the project conflict with applicable zoning and other regulations governing scenic quality?	<input type="checkbox"/>	<input type="checkbox"/>	<input checked="" type="checkbox"/>	<input type="checkbox"/>
d. Create a new source of substantial light or glare which would adversely affect day or nighttime views in the area?	<input type="checkbox"/>	<input type="checkbox"/>	<input checked="" type="checkbox"/>	<input type="checkbox"/>

Environmental checklist established by CEQA Guidelines, Appendix G.

4.1.1 Setting

The proposed project is to be constructed on relatively flat land in a highly developed urban area in the southern portion of the City of San Jose, California. The Diablo foothills are to the east, the Santa Cruz Mountains to the west, and the Santa Teresa Hills to the

1 Landscape is defined as, "The outdoor environment, natural or built, which can be directly perceived by a person visiting and using that environment. A scene is the subset of a landscape which is viewed from one location (vantage point) looking in one direction." (Hull and Revell 1989) "The term landscape clearly focuses upon the visual properties or characteristics of the environment, these include natural and man-made elements and physical and biological resources which could be identified visually; thus non-visual biological functions, cultural/historical values, wildlife and endangered species, wilderness value, opportunities for recreation activities and a large array of tastes, smells and feelings are not included." (Daniel and Vining 1983; Amir and Gidalizon 1990)

2 Public Resources Code (PRC) section 21099 asks is the proposed project an "employment center project" on an "infill site" within a "transit priority area" as defined in this section. PRC § 21099(d)(1) states, "Aesthetic and parking impacts of a residential, mixed-use residential, or employment center project on an infill site within a transit priority area shall not be considered significant impacts on the environment."

south. U.S. Highway 101 is approximately a mile to the east. State Route (SR) 85 a mile north. Industrial uses fill-in the area between the highways that include assembly, manufacturing, offices, and research and development. Residential uses are to the south and west.

The project would be constructed on 18 acres and include three two-story buildings each 182,350 square feet and supporting facilities. It would have 36 diesel-fired back up generators arranged in six generation yards. Approximately 133,500 square feet of landscaping would be installed or planted around the data center buildings and along road frontages. Refer to **Section 3 Project Description** for details regarding the project.

Regulatory Background

Federal

No federal regulations related to aesthetics apply to the project.

State

California Scenic Highway Program. The California Scenic Highway Program a provision of the Streets and Highways Code (Sections 260 through 263) created by the Legislature in 1963 established the State's responsibility in identified areas to preserve and enhance the natural beauty of California adjacent to the state highway system. Review of the California State Scenic Highway System Map shows no designated state scenic highway in the vicinity of the project.

Local

City of San Jose General Plan. *Envision San Jose 2040 General Plan* (General Plan) shows the project site designated Industrial Park and Transit Employment Center. The Industrial Park "designation is an industrial designation intended for a wide variety of industrial users such as research and development, manufacturing, assembly, testing and offices.... Industrial Park uses are limited to those for which the functional or operational characteristics of a hazardous or nuisance nature can be mitigated through design controls.... Areas identified exclusively for Industrial Park uses may contain a very limited number of supportive and compatible commercial uses, when those uses are of a scale and design providing support only to the needs of businesses and their employees in the immediate industrial area." (San Jose 2020, Chapter 5, pgs. 10-11) The maximum floor area ratio (FAR) is 10.0. Typical building height is 2 to 15 stories.

The Transit Employment Center designation "is applied to areas planned for intensive job growth because of their importance as employment districts to the City and high degree of access to transit and other facilities and services. To support San Jose's growth as a Regional Employment Center, it is useful to designate such key Employment Centers along the light rail corridor.... All of these areas fall within identified Growth Areas and have access to transit and other important infrastructure to support their intensification.

Uses allowed in the Industrial Park designation are appropriate in the Transit Employment Center designation, as are supportive commercial uses.... This designation permits development with retail and service commercial uses on the first two floors; with office, research and development or industrial use on upper floors; as well as wholly office, research and development, or industrial projects." (San Jose 2020, Chapter 5, pgs. 8-9) The FAR is up to 12.0 (4 to 25 stories).

Scenic Resources

"The City of San Jose has many scenic resources which include the broad sweep of the Santa Clara Valley, the hills and mountains which frame the Valley floor, the baylands and the urban skyline itself, particularly high-rise development. It is important to preserve public thoroughfares which provide visual access to these scenic resources. The designation of a scenic route applies to routes which afford especially aesthetic views. Gateways are locations which announce to a visitor or resident that they are entering the city, or a unique neighborhood. San Jose has a number of Gateway locations including Coleman Avenue at Interstate 880, 13th Street at US 101, and Highway 101 in the vicinity of the Highway 85 Interchange." (San Jose 2040, Chapter 4, pg. 25)

City of San Jose Municipal Code. The San Jose Land Use Zoning shows the project site within the Industrial Park (IP) zoning district. "The industrial park zoning designation is an exclusive designation intended for a wide variety of industrial users such as research and development, manufacturing, assembly, testing, and offices. Industrial uses are consistent with this designation insofar as any functional or operational characteristics of a hazardous or nuisance nature can be mitigated through design controls. Areas exclusively for industrial uses may contain a very limited amount of supportive commercial uses, in addition to industrial uses, when those uses are of a scale and design providing support only to the needs of businesses and their employees in the immediate industrial area" (San Jose 2021, § 20.50.100C.3)

Staff reviewed the following zoning code requirements that have some relation to scenic quality. They are discussed under "Environmental Impacts and Mitigation Measures."

- The IP zoning district maximum building height is 50 feet (San Jose 2020a, § 20.50.200).
- The IP zoning district requires landscaping on the project site and its maintenance. All setback areas, exclusive of permitted off-street parking areas and private egress, or circulation, shall be landscaped. (San Jose 2019a, § 20.50.260).
- The IP zoning district requires that ground mounted light fixtures not exceed twenty-five feet in height. Light fixture heights should not exceed eight feet when adjacent to residential uses unless the setback of the fixture from the property line is twice the height of the fixture (San Jose 2020a, § 20.50.250).

San Jose City Council Policy No.: 4-3 – Outdoor Lighting On Private Developments. The "City Council, on March 1, 1983 approved Resolution No. 56286 adopting as the City policy the requirement that low-pressure sodium illumination be used

in the outdoor areas of new private developments. The regulation of outdoor lighting fixtures has resulted in energy conservation which furthers the goals of the Sustainable City Major Strategy of the General Plan....

The purpose of this policy is to promote energy-efficient outdoor lighting on private development in the City of San Jose that provides adequate light for nighttime activities while benefiting the continued enjoyment of the night sky and continuing operation of the Lick Observatory by reducing light pollution and sky glow." (San Jose 2000)

Industrial Design Guidelines. The Industrial Design Guidelines adopted by the San Jose City Council on August 25, 1992 provide guidelines to address issues of area compatibility, project function and aesthetics. The Guidelines provide minimum design standards applied to various land uses, development types, and locations, and facilitate an efficient review process by the City on industrial development. "Because creativity is always encouraged, deviation from guidelines may be appropriate, particularly when deviation results in a higher quality design and project." (San Jose 1992, pg. 1)

Site Development Permit. The purposes of a Site Development Permit are to promote orderly development, to enhance the character, stability, integrity and appearance of neighborhoods and zoning districts, to maintain and protect the stability and integrity of land values, and to secure the general purposes of the Zoning Code and the San Jose General Plan. The city reviews and regulates the aesthetic and functional aspects of structures and sites, to require, as the city determines necessary, the aesthetic and functional improvements to the site and to any structures thereon, and to require offsite improvements through the Site Development Permit (San Jose 2020a, § 20.100.600).

4.1.2 Applicant Proposed Measures

None.

4.1.3 Environmental Impacts and Mitigation Measures

a. Would the project have a substantial adverse effect on a scenic vista?

Neither CEQA nor the CEQA Guidelines provide a clear-cut definition of what constitutes a scenic vista. Lead agencies may look to local planning thresholds for guidance when defining the visual impact standard for the purpose of CEQA.³ A general plan, specific plan, zoning code or other planning document may provide guidance.

Construction and Operation

Less Than Significant Impact. Construction and operation of the project would not have a substantial adverse effect on a scenic vista.

3 Mira Mar Mobile Community v. City of Oceanside (2004) 119 Cal. App. 4th 477.

The City's General Plan does not identify a distinct scenic vista or a specific related policy. The General Plan identifies Gateways. As shown on the Envision San Jose 2040 General Plan Scenic Corridors Diagram dated June 6, 2016, the nearest Gateway to the project is the US Highway 101/State Route 85 interchange. It is about one-mile to the north and north-northeast. State Route 85 is shown as a city designated "Rural Scenic Corridor." Review of aerial and street view imagery using Google Earth Pro (build date July 21, 2020) concluded that a viewer from the 101/85 Gateway would not have a public view of the project due to aboveground buildings, structures, earthwork, trees, and vegetation.

In addition, this analysis uses as the definition for a scenic vista "a distant view of high pictorial quality perceived through and along a corridor or opening." The California Energy Commission in its decisions for a number of thermal power plant projects used this definition.⁴ Review of aerial and street view imagery, and site photographs concluded the project would be on a relatively unenclosed plain—the Santa Clara Valley floor and not within a scenic vista as defined.

Required Mitigation Measures: None.

b. Would the project substantially damage scenic resources, including, but not limited to, trees, rock outcroppings, and historic buildings within a state scenic highway?

Neither CEQA nor the CEQA Guidelines provide a clear-cut definition of what constitutes a scenic resource. A scenic resource may be explained as a widely recognized natural or man-made feature tangible in the landscape (e.g., a scenic resource designated in an adopted federal, state, or local government document, plan, or regulation, a landmark, or a cultural resource [historic values however differ from aesthetic or scenic values]). This analysis evaluated if the project would substantially damage—eliminate or obstruct—the public view⁵ of a scenic resource, and if the project is situated so that it changes the visual aspect of the scenic resource by being different or in sharp contrast.

Construction and Operation

Less Than Significant Impact. Construction and operation of the project would not substantially damage scenic resources.

⁴ California Energy Commission Final Decision for GWF Tracy Combined Cycle Power Plant Project Docket Number 08-AFC-7, Visual Resources, p. 321; California Energy Commission Decision for Mariposa Energy Project Docket Number 09-AFC-3, Visual Resources, p. 5; California Energy Commission Decision for Blythe Solar Power Project Docket Number 09-AFC-6, Visual Resources, p. 514; California Energy Commission Decision for Genesis Solar Energy Project Docket Number 09-AFC-8, Visual Resources, p. 7-8; California Energy Commission Decision for Pio Pico Energy Center Docket Number 11-AFC-01, Visual Resources, p. 8.5-4.

⁵ Public view is the visible area from a location where the public has a legal and physical right of access to real property (e.g., city sidewalk, public park, town square, state highway). CEQA Guidelines Appendix G Environmental Checklist Form, I. Aesthetics, c. states "Public views are those that are experienced from publicly accessible vantage point."

Review of Google Earth Pro aerial and street view imagery, site photographs, and the General Plan found no scenic resource on the site or in the vicinity.

The General Plan states "The City of San Jose has many scenic resources which include the broad sweep of the Santa Clara Valley, the hills and mountains which frame the Valley floor, the baylands and the urban skyline itself, particularly high-rise development." (San Jose 2020, Chapter 4, pg. 25)

A five-mile distance zone surrounding the project is generally used when evaluating a scenic resource. In a visual impact assessment, the U.S. Bureau of Land Management subdivides landscapes into three distance zones based on relative visibility from a viewpoint. The three zones are foreground-midground, background, and seldom seen. Foreground-midground zone includes viewing locations that are less than three to five miles away. Areas beyond the foreground-midground zone but usually less than 15 miles away are in the background zone. Areas not seen as foreground-midground or background are in the seldom-seen zone. (BLM 1986) The Santa Cruz Mountains and Diablo Mountain range are in the seldom-seen zone from the project site. The background and seldom-seen zones are viewed in less detail by the observer, and most impacts blend with the landscape because of distance. The baylands are in the northern tip of the city about 20 miles from the project site. The downtown San Jose high-rise skyline is about 14 miles north of the project site. The baylands and downtown skyline are not visible from the project site due to distance, and aboveground buildings, structures, earthwork, trees, and vegetation.

The General Plan states "All large specimen and heritage trees, especially native oaks, have special aesthetic and historical value." (San Jose 2020, Chapter 3, pg. 23). As shown in CEQA criterion "b", a scenic resource includes "trees;" this could mean a heritage tree. In general, a heritage tree is recognized for its aesthetic, botanical, ecological and historical value, in addition to age, rarity, and size.

The application states "The approximately 18-acre project site is flat, undeveloped, and consists of an open vacant lot with scattered trees, including a large valley oak, a City designated Heritage Tree, at the corner of Via Del Oro and Great Oaks Boulevard." (SV1 2019a, pg. 8) The tree is on the city list of Heritage Trees (Tree ID#: HT-02-006).

The project would not result in the removal of this tree, and the applicant has proposed PD BIO-2 as a mitigation measure incorporated into the project design to ensure its preservation. The Mitigation and Monitoring Compliance memo prepared for the City includes the preparation of a Tree Preservation Plan for the heritage tree and lists tree preservation guidelines to be implemented for all phases of project construction. Refer to **Section 4.4 Biology** for details regarding the heritage tree.

The project is in an industrial zoned, urbanized area where it would be fully or partially in public view. However, there are other land uses of similar scale, design, density, dimension, or location both nearby and far away so that the context of the scenic resource, in this case the heritage tree, would not change.

Required Mitigation Measures: None.

c. Would the project, in non-urbanized areas, substantially degrade the existing visual character or quality of public views of the site and its surroundings? (Public views are those that are experienced from publicly accessible vantage point). If the project is in an urbanized area, would the project conflict with applicable zoning and other regulations governing scenic quality?

The proposed project is within an urbanized area.⁶ Based on information from the U.S. Census Bureau, the City of San Jose 2019-population estimate was 1,021,795 (US Census 2019). A population greater than 100,000 constitutes an urbanized area. As a result, the applicable part of the above question pertaining to zoning and other regulations governing scenic quality is discussed.

Construction and Operation

Less Than Significant Impact. Construction and operation of the project would not conflict with applicable zoning and other regulations governing scenic quality.

“The industrial park zoning designation is an exclusive designation intended for a wide variety of industrial users such as research and development, manufacturing, assembly, testing, and offices. Industrial uses are consistent with this designation insofar as any functional or operational characteristics of a hazardous or nuisance nature can be mitigated through design controls.” (San Jose 2021, § 20.50.010.3)

The project would have 36 diesel-fired generators to provide backup generation in case of an interruption in electrical supply from Pacific Gas and Electric Company. The Cummins C3250D6e model diesel generator would be used on the site. The Cummins C3250D6e diesel generator performance specification sheet prepared by the vendor (Cummins Inc.) shows exhaust stack gas temperatures at standby 872 degrees, prime 825 degrees, and continuous 742 degrees. (SV1 2019b) These extremely high temperatures evaporate (eliminate) the necessary saturated moisture rising from the exhaust stack that could condense in the atmosphere becoming a publicly visible water vapor plume (visible plume). As a result, operation of the generators would not result in visible plumes that would be hazardous or a nuisance to the site and adjacent properties.

- The IP zoning district has a maximum building height of 50 feet. (San Jose 2021, § 20.50.200)

⁶ For the purposes of Public Resources Code section 21071 an “urbanized area” includes “(a) An incorporated city that meets either of the following criteria: (1) Has a population of a least 100,000 persons. (2) Has a population of less than 100,000 persons if the population of that city and not more than two contiguous incorporated cities combined equals at least 100,000 persons.”

“The data center buildings would be approximately 49 feet in height to the top of the building parapet except for the office portion of the building where the top of parapet would be approximately 53 feet in height.” (SV1 2019a, p. 50)

A few purposes of a height limit include to preserve a scenic vista, protect the public view of a scenic resource (e.g., architectural structure, a landmark, natural feature), and to maintain the character of a site and surrounding area (e.g., residential or commercial area). As previously discussed, review of aerial and street imagery shows the project site is not located within a scenic vista, and the project would not eliminate the public view of a scenic resource. Review of the project’s elevation plan and aerial and street imagery shows the building height to be concordant with heights of buildings and structures in the area and the city’s industrial zone.

- The IP zoning district requires landscaping on the project site and its maintenance (San Jose 2021, § 20.50.260).

“Landscaping would be planted throughout the main project site in accordance with General Plan policies. Approximately 133,500 square feet of landscaping is proposed around the data center buildings. In addition, street trees would be planted along the project frontages to help soften views of the project site from the surrounding area. The large Heritage valley oak tree would be retained at the northwest corner of Great Oaks Boulevard and Via del Oro and trees would also be planted along project frontages to create a more pedestrian-friendly environment.” (SV1 2019a, p. 50)

The applicant has provided a conceptual landscape plan (SV1 2019a, Figure 2.3-2). Previous surface data about the project shows the proposed surface to be replaced at 124,220 square feet and new proposed surface 9,262 square feet together totaling 133,482 square feet (SV1 2019a, Figure 2.3-3).

Required Mitigation Measures: None.

d. Would the project create a new source of substantial light or glare which would adversely affect day or nighttime views in the area?

Light trespass is “light falling where it is not wanted or needed” (e.g., light spill) (IDA 2017). Sky glow is a result of light fixtures that emit a portion of their light directly upward into the sky where light scatters, creating an orange-yellow glow in the nighttime sky. Glare is “intense and blinding light that reduces visibility. A light within the field of vision that is brighter than the brightness to which the eyes are adapted” (IDA 2017). In addition, there is reflectivity. Reflectivity “... does not create its own light. It borrows light from another source. The borrowed light waves strike an object and ‘bounce’ from it. The reflectance of the object—how bright it shines—depends on the intensity of the light striking it and the materials from which it is made.” (3M)

Construction and Operation

Less Than Significant Impact. Construction and operation of the project would not create a new source of substantial light or glare adversely affecting day or nighttime views in the area.

The elevation plan shows directional and shielded light fixtures. Pole-mounted lighting shown does not exceed 25 feet in height. The project design includes installing LED lighting throughout the project site.

The construction laydown and staging areas may have nighttime lighting for security purposes. Outdoor construction-related lighting would be directed onsite and away from surrounding properties.

Required Mitigation Measures: None.

4.1.4 References

Amir and Gidalizon 1990 – S. Amir and E. Gidalizon (Amir and Gidalizon). "Expert-based method for the evaluation of visual absorption capacity of the landscape." *Journal of Environmental Management*, Vol. 30, No. 3, April 1990, cited by *The James Hutton Institute*, August 12, 2014. Accessed on: September 4, 2019. Available online at: <http://www.macaulay.ac.uk/-ccw/task-two/evaluate.html>

BLM 1986 – Bureau of Land Management (BLM). U.S. Department of Interior Bureau of Land Management Manual H-8410-1 Visual Resources Inventory, January 17, 1986. Accessed on: September 6, 2019. Available online at: <http://blmwyomingvisual.anl.gov/documents/>

Daniel and Vining 1983 – Terry C. Daniel and Joanne Vining. (Daniel and Vining). *Behaviour and the Natural Environment*, Plenum Press, New York, 1983, "Methodological Issues in the Assessment of Landscape Quality," cited by *The James Hutton Institute*, August 12, 2014. Accessed on: September 4, 2019. Available online at: <http://www.macaulay.ac.uk/-ccw/task-two/evaluate.html>

Hull and Revell 1989 – R. Bruce Hull and Grant R.B. Revell (Hull and Revell). "Issues in sampling landscapes for visual quality assessments," *Landscape and Urban Planning*, Vol. 17, No. 4, August 1989, pp. 323-330 cited by *The James Hutton Institute*, August 12, 2014. Accessed on: September 4, 2019. Available online at: <http://www.macaulay.ac.uk/ccw/task-two/evaluate.html>

IDA 2017 – International Dark-Sky Association (IDA). Accessed on: September 4, 2019. Available online at: <https://www.darksky.org/our-work/grassroots-advocacy/resources/glossary/>

SV1 2019a – SV1 LLC. (SV1). (TN 232466). GOSBGF Data Center SPPE Application, dated March 19, 2020. Available online at: <https://efiling.energy.ca.gov/Lists/DocketLog.aspx?docketnumber=20-SPPE-01>

- SV1 2019b – SV1 LLC. (SV1). (TN 232467-1). GOSBGF SPPE Application Appendices A-F, dated March 19, 2020. Available online at: <https://efiling.energy.ca.gov/Lists/DocketLog.aspx?docketnumber=20-SPPE-01>
- San Jose 1992 – City of San Jose (San Jose). City of San Jose Industrial Design Guidelines adopted August 25, 1992. Accessed on April 14, 2020. Available online at: <https://www.sanjoseca.gov/home/showdocument?id=15615>
- San Jose 2000 – City of San Jose (San Jose). City of San Jose Council Policy “Outdoor Lighting On Private Developments” adopted March 1, 1983. Revised June 20, 2000. Accessed on: March 3, 2021. Available online at: <https://www.sanjoseca.gov/home/showdocument?id=12835>
- San Jose 2020 – City of San Jose (San Jose). City of San Jose 2040 General Plan adopted November 1, 2011 as amended. Accessed on April 14, 2020. Available online at: <https://www.sanjoseca.gov/home/showdocument?id=22359>
- San Jose 2021 – City of San Jose (San Jose). City of San Jose Zoning Code. January 2019. Accessed on: April 14, 2020. Available online at: https://library.municode.com/ca/san_jose/codes/code_of_ordinances?nodeId=TIT20ZO
- 3M – 3M Traffic Safety Systems Division (3M). “Reflectivity,” 2004. Available online at: May 8, 2017. Available online at: <http://multimedia.3m.com/mws/media/2957670/reflectivity-flyer.pdf>
- US Census 2019 – United States Census Bureau (US Census). QuickFacts. Last updated: July 1, 2019. Available online at: <https://www.census.gov/quickfacts/fact/table/sanjosecitycalifornia,santaclaracitycalifornia,US/PST045219>

4.2 Agriculture and Forestry Resources

This section describes the environmental and regulatory setting and discusses impacts associated with the construction and operation of the project specific to agriculture and forestry resources.

AGRICULTURE AND FORESTRY RESOURCES In determining whether impacts to agricultural resources are significant environmental effects, lead agencies may refer to the California Agricultural Land Evaluation and Site Assessment Model (1997) prepared by the California Department of Conservation as an optional model to use in assessing impacts on agriculture and farmland. In determining whether impacts to forest resources, including timberland, are significant environmental effects, lead agencies may refer to information compiled by the California Department of Forestry and Fire Protection regarding the state's inventory of forest land, including the Forest and Range Assessment Project and the Forest Legacy Assessment Project; and forest carbon measurement methodology provided in Forest Protocols adopted by the California Air Resources Board.	Potentially Significant Impact	Less Than Significant with Mitigation Incorporated	Less Than Significant Impact	No Impact
a. Convert Prime Farmland, Unique Farmland, or Farmland of Statewide Importance (Farmland), as shown on the maps prepared pursuant to the Farmland Mapping and Monitoring Program of the California Resources Agency, to non-agricultural use?	<input type="checkbox"/>	<input type="checkbox"/>	<input type="checkbox"/>	<input checked="" type="checkbox"/>
b. Conflict with existing zoning for agricultural use, or a Williamson Act contract?	<input type="checkbox"/>	<input type="checkbox"/>	<input type="checkbox"/>	<input checked="" type="checkbox"/>
c. Conflict with existing zoning for, or cause rezoning of, forest land (as defined in Public Resources Code section 12220(g)), timberland (as defined by Public Resources Code section 4526), or timberland zoned Timberland Production (as defined by Government Code section 51104(g))?	<input type="checkbox"/>	<input type="checkbox"/>	<input type="checkbox"/>	<input checked="" type="checkbox"/>
d. Result in the loss of forest land or conversion of forest land to non-forest use?	<input type="checkbox"/>	<input type="checkbox"/>	<input type="checkbox"/>	<input checked="" type="checkbox"/>
e. Involve other changes in the existing environment which, due to their location or nature, could result in conversion of Farmland to non-agricultural use or conversion of forest land to non-forest use?	<input type="checkbox"/>	<input type="checkbox"/>	<input type="checkbox"/>	<input checked="" type="checkbox"/>

Environmental checklist established by CEQA Guidelines, Appendix G.

4.2.1 Setting

Historical information on the project site shows that it was part of a larger farmland property known as Martin Ranch dating to the late 1800s (SV1 2020b, Appendix G, Pgs. 1, 5 and 13–16; Figure 2 and historical aerial photographs). Aerial photographs and topographic maps between 1939 and 1980 indicate that most of the site was planted in orchards. Later aerial photographs show the orchards were removed and replaced by row crops or cultivated for hay. The project site is currently an undeveloped, open field that is no longer used for crop production.

Regulatory Background

Federal

No federal regulations relating to agriculture and forestry resources apply to the project.

State

Farmland Mapping and Monitoring Program. The California Department of Conservation (CDOC) established the Farmland Mapping and Monitoring Program (FMMP) in 1982 to assess the location, quantity, and quality of agricultural lands and conversion of those lands to other uses. The FMMP identifies and maps agricultural lands as Prime Farmland, Farmland of Statewide Importance, Unique Farmland, Farmland of Local Importance, and Grazing Land. The current Santa Clara County Important Farmland Map shows that the project site is classified as Farmland of Local Importance (CDOC 2018).

The FMMP also designates Urban and Built-up Land to indicate land occupied by structures with a building density of at least one unit to 1.5 acres, or approximately six structures to a 10-acre parcel. Common examples include residential, industrial, commercial, institutional facilities, cemeteries, airports, golf courses, landfills, sewage treatment, and water control structures.

Williamson Act. The California Land Conservation Act of 1965, or Williamson Act, is the principal method for encouraging the preservation of agricultural lands in California (Gov. Code, § 51200 et seq.). It enables local governments to enter into contracts with private landowners who agree to maintain specified parcels of land in agricultural or related open space use in exchange for tax benefits.

Local

City of San Jose General Plan and Zoning Ordinance. The *Envision San Jose 2040 General Plan* (General Plan) land use map shows that the eastern half of the project site is part of an area designated IP, Industrial Park; the western half is part of an area designated TEC, Transit Employment Center. The IP designation is “intended for a wide variety of industrial users such as research and development, manufacturing, assembly, testing and offices” (San Jose 2020). The TEC designation is “applied to areas planned for intensive job growth because of their importance as employment districts to the City and high degree of access to transit and other facilities and services.” Areas east and

northeast of the project site include properties that are designated Combined Industrial/Commercial. The area south of the project site, on the south side of Santa Teresa Boulevard, is designated Residential Neighborhood. The project site is in the IP, Industrial Park zoning district, which is intended for the same types of uses described for the IP General Plan designation (San Jose 2021, § 20.50.010, subd. (C)(3)).

4.2.2 Applicant Proposed Measures

None.

4.2.3 Environmental Impacts and Mitigation Measures

a. Convert Prime Farmland, Unique Farmland, or Farmland of Statewide Importance (Farmland), as shown on the maps prepared pursuant to the Farmland Mapping and Monitoring Program of the California Resources Agency, to non-agricultural use?

Construction and Operation

No Impact. The project site was in agricultural uses at least from the late 1800s through the end of the twentieth century. Staff reviewed past Important Farmland maps for Santa Clara County on the CDOC website (CDOC 2019). FMMP data leading up to and including publication of the 2000 Important Farmland map show the project site was part of an area classified as Prime Farmland, which applies to “irrigated land with the best combination of physical and chemical features able to sustain long term production of agricultural crops.”

Starting with the 2000–2002 reporting period, the Prime Farmland classification converted to Other Land, which applies to “land not included in any other mapping category.” The Other Land classification may also apply to “[v]acant and nonagricultural land surrounded on all sides by urban development and greater than 40 acres...” This classification was applied to the project site’s two parcels and the two contiguous parcels south of the site that border Santa Teresa Boulevard. These four parcels have been surrounded by land classified as Urban and Built-up Land since the 2000–2002 reporting period.

During the 2014–2016 reporting period, the Other Land classification for the four parcels converted to Farmland of Local Importance, which Santa Clara County defines to include “small orchards and vineyards primarily in the foothill areas,” as well as “land cultivated as dry cropland for grains and hay” (CDOC 2018). CDOC data show that mapping of the properties as Farmland of Local Importance was due to production of non-irrigated grain that was verified during a field visit by CDOC staff for the 2016 update (CEC 2020h). The 2016 Important Farmland map is the latest available for Santa Clara County. CDOC staff reported to CEC staff that aerial imagery since 2018 show the site to be fallow. The FMMP classification will not change until the area is shown to be fallow for three update cycles, which means that when the 2018 map for Santa Clara County is published, it will still

show the FMMP classification as Farmland of Local Importance for the four parcels, including the two parcels comprising the project site.

Under the California Environmental Quality Act (CEQA), conversion of Farmland to nonagricultural use applies only to Prime Farmland, Farmland of Statewide Importance, and Unique Farmland (CEC 2020h). These three types are primarily irrigated farmland, although small amounts of Unique Farmland can be non-irrigated orchards or vineyards. The current Santa Clara County Important Farmland Map shows that the project site is classified as Farmland of Local Importance, which a county may apply to various agricultural uses, including non-irrigated grain crops (e.g., winter wheat). CDOC staff concurred that the FMMP maps show that the site is not mapped as Prime Farmland, Farmland of Statewide Importance, or Unique Farmland. Therefore, the project would not convert Farmland to a non-agricultural use. Construction and operation activities would cause no impact on Farmland.

b. Conflict with existing zoning for agricultural use, or a Williamson Act contract?

Construction and Operation

No Impact. The project site is zoned IP, Industrial Park, which is not an agricultural zoning district. Agricultural uses on former farmland in the area ceased several years ago. In its discussion of impacts on agricultural resources, the *Draft Program Environmental Impact Report [EIR] for the Envision San Jose 2040 General Plan* states that only the “Lester Property” was under a Williamson Act contract (San Jose 2011). As of publication of the EIR, the Lester Property was planned as a future park site.

The project site is within an area designated for urban uses in the General Plan, indicating that the City is guiding a pattern of land uses to encourage a variety of industrial and commercial developments that will support job growth. Therefore, the project would not conflict with zoning for agricultural use or a Williamson Act contract, and no impact would occur.

c. Conflict with existing zoning for, or cause rezoning of, forest land (as defined in Public Resources Code section 12220(g)), timberland (as defined by Public Resources Code section 4526), or timberland zoned Timberland Production (as defined by Government Code section 51104(g))?

Construction and Operation

No Impact. The project site is in the IP, Industrial Park zoning district, which is “intended for a wide variety of industrial users such as research and development, manufacturing, assembly, testing, and offices” (San Jose 2021, § 20.50.010, subd. (C)(3)). Adjacent areas are developed with various urban uses and businesses, including industrial, commercial, product manufacturing, and technology and communications services. No

land in the area is zoned for forest land, timberland, or timberland production. Therefore, project construction and operation would cause no impact on such lands or uses.

d. Result in the loss of forest land or conversion of forest land to non-forest use?

Construction and Operation

No Impact. The project site does not contain forest land and is not in a region where forest land is present; therefore, project construction, operation, and maintenance would cause no loss of forest land, and no impact would occur.

e. Involve other changes in the existing environment which, due to their location or nature, could result in conversion of Farmland to non-agricultural use or conversion of forest land to non-forest use?

Construction and Operation

No Impact. Agricultural uses on former farmland in the project area ceased several years ago. As discussed above, the Important Farmland maps for Santa Clara County show that the classification for the project site's two parcels and the two contiguous parcels to the south converted to Farmland of Local Importance during the 2014–2016 reporting period. According to CDOC staff, the conversion was due to production of non-irrigated grain on the site that was verified by CDOC staff for the 2016 map update (CEC 2020h). CDOC staff reported to CEC staff that aerial images since 2018 show the site to be fallow. CDOC staff concurred that the site is not mapped as Prime Farmland, Farmland of Statewide Importance, or Unique Farmland. Consistent with CEC staff's conclusion, no impact relating to conversion of Farmland would occur. Project construction, operation, and maintenance would cause no changes in the existing environment that would cause conversion of Farmland to a non-agricultural use or forest land to a non-forest use. Therefore, no impact would occur.

4.2.4 References

CEC 2020h – California Energy Commission (CEC). Report of Conversation – FMMP Land Classification: Great Oaks South Backup Generating Facility (TN 233242), May 2020. Available online at: <https://efiling.energy.ca.gov/Lists/DocketLog.aspx?docketnumber=20-SPPE-01>

CDOC 2018 – California Department of Conservation (CDOC). Farmland Mapping and Monitoring Program. Santa Clara County Important Farmland 2016. County PDF Maps. Accessed on May 6, 2020. Map published September 2018. Available online at: <https://www.conservation.ca.gov/dlrp/fmmp>

CDOC 2019 – California Department of Conservation (CDOC). Farmland Mapping and Monitoring Program. Important Farmland Time Series. Accessed on May 7, 2020. Available online at: <https://www.conservation.ca.gov/dlrp/fmmp>

San Jose 2011 – City of San Jose (San Jose). Planning, Building & Code Enforcement. *Draft Program Environmental Impact Report for the Envision San Jose 2040 General Plan*. State Clearinghouse No. 2009072096. File Number PP09-011. June 2011. Pgs. 176–177. Accessed on: May 11, 2020. Available online at: <https://www.sanjoseca.gov/your-government/departments/planning-building-code-enforcement/planning-division/environmental-planning/environmental-review/completed-eirs>

San Jose 2020 – City of San Jose (San Jose). Planning, Building & Code Enforcement. *Envision San Jose 2040 General Plan*. Adopted November 1, 2011. As amended March 16, 2020. Chapter 5, pgs. 6, 8, 10, and 11. General Plan 2040 Land Use Map. Accessed on: May 6, 2020 and February 22, 2021. Available online at: <https://www.sanjoseca.gov/your-government/departments/planning-building-code-enforcement/planning-division/citywide-planning/envision-san-jos-2040-general-plan>

San Jose 2021 – City of San Jose (San Jose). Code of Ordinances. Adopted January 26, 2021. Accessed on: May 7, 2020 and February 22, 2021. Available online at: https://library.municode.com/ca/san_jose/codes/code_of_ordinances?nodeId=TI T20ZO

SV1 2020b – SV1, LLC. (SV1). Application Appendices A through K: Great Oaks South Backup Generating Facility (TN 232467-1,2,3), March 2020. Available online at: <https://efiling.energy.ca.gov/Lists/DocketLog.aspx?docketnumber=20-SPPE-01>

4.3 Air Quality

This section describes the environmental and regulatory setting and discusses impacts specific to air quality associated with the construction, readiness testing and maintenance, and the potential for emergency operation of the Great Oaks South Data Center (GOSDC) and Great Oaks South Backup Generating Facility (GOSBGF). It is important to note that intermittent and standby emitting sources, like those proposed in this project, could operate for emergency use, and such emergency operations would be infrequent and for unplanned circumstances, which are beyond the control of the project owner. Emergency operations and the impacts of air pollutants during emergencies are generally exempt from air district permitting. Emissions from emergency operation are not regular, expected, or easily quantifiable and, as such, they cannot be modeled or predicted with certainty.

AIR QUALITY Where available, the significance criteria established by the applicable air quality management district or air pollution control district may be relied upon to make the following determinations. Would the project:	Potentially Significant Impact	Less Than Significant with Mitigation Incorporated	Less Than Significant Impact	No Impact
a. Conflict with or obstruct implementation of the applicable air quality plan?	<input type="checkbox"/>	<input type="checkbox"/>	<input checked="" type="checkbox"/>	<input type="checkbox"/>
b. Result in a cumulatively considerable net increase of any criteria pollutant for which the project region is non-attainment under an applicable federal or state ambient air quality standard?	<input type="checkbox"/>	<input checked="" type="checkbox"/>	<input type="checkbox"/>	<input type="checkbox"/>
c. Expose sensitive receptors to substantial pollutant concentrations?	<input type="checkbox"/>	<input type="checkbox"/>	<input checked="" type="checkbox"/>	<input type="checkbox"/>
d. Result in other emissions (such as those leading to odors) adversely affecting a substantial number of people?	<input type="checkbox"/>	<input type="checkbox"/>	<input checked="" type="checkbox"/>	<input type="checkbox"/>

Environmental checklist established by CEQA Guidelines, Appendix G.

Background

The air quality evaluation below assesses the degree to which GOSDC and GOSBGF would potentially cause a significant impact according to the California Environmental Quality Act (CEQA) guidelines established by the State of California. The Bay Area Air Quality Management District (BAAQMD) is the local air district responsible for attainment and maintenance of the federal and state ambient air quality standards (AAQS) and associated program requirements at the project location. The analysis incorporates “thresholds of significance” from the May 2017 CEQA Air Quality Guidelines (BAAQMD 2017b) to determine the significance of the potential air quality emissions. The BAAQMD thresholds of significance are included in **Table 4.3-4**. Construction mass emissions are compared

to these thresholds of significance values in **Table 4.3-5**. Readiness testing and engine maintenance mass emissions are compared to the thresholds of significance values in **Table 4.3-6**. Worst-case mass emissions during overlapping periods between the construction and readiness testing and engine maintenance are compared with thresholds of significance values in **Table 4.3-7**.

The air quality evaluation addresses both emissions of criteria pollutants (which have health-based standards) and toxic air contaminants (which are identified as potentially harmful even at low levels and have no established safe levels or health-based ambient air quality standards). The analysis includes ambient air quality impact modeling for construction, readiness testing and maintenance, and overlapping periods between construction and readiness testing and maintenance for the proposed diesel-fueled engines to estimate the air quality impacts caused by the emissions. Construction impacts are shown in **Table 4.3-8** and readiness testing and engine maintenance impacts are shown in **Table 4.3-9**. Impacts during overlapping periods between the construction and readiness testing and engine maintenance are shown in **Table 4.3-10**.

Criteria Pollutant Evaluation

The California Air Resources Board (ARB) and US Environmental Protection Agency (US EPA) have established ambient air quality standards (AAQS) for criteria pollutants. While both state and federal AAQS apply to every location in California, typically the state standards are lower (i.e., more stringent) than federal standards. Air monitoring stations, usually operated by local air districts or ARB, measure the ambient air to determine an area's attainment status. Depending on the pollutant, the time period over which these pollutants are measured varies from 1-hour, to 3-hours, to 8-hours, to 24-hours and to annual averages. Most criteria pollutants have ambient standards with more than one averaging time. Pollutant concentrations are expressed in terms of mass of pollution per unit volume of air, typically using micrograms for the mass portion of the expression and cubic meters of air for the volume, or "micrograms per cubic meter of air, expressed as $\mu\text{g}/\text{m}^3$." The concentration can also be expressed as parts of pollution per million parts of air, or "ppm." **Table 4.3-1** lists both the state and federal AAQS.

Some forms of air pollution are primary air pollutants, which are gases and particles directly emitted from stationary and mobile sources. Other forms of air pollution are secondary air pollutants that result from complex interactions between primary pollutants, background atmospheric constituents, and other secondary pollutants. Some pollutants can be a combination of both primary and secondary formation, such as PM_{2.5} (particulate matter with an aerodynamic diameter less than 2.5 micrometer [μm]). In this case, the primary pollutant component of PM_{2.5} is directly emitted, such as from the stack of diesel-fueled engines, and the secondary pollutant component of PM_{2.5} is formed in the air by transformation of nitrogen oxide (NO_x), sulfur oxide (SO_x), and ammonia (NH₃) gases into particles. In this case, the NO_x, SO_x, and NH₃ emissions are precursors to the formation of the secondary aerosol pollutant.

Nitrogen oxide emissions are the sum of nitric oxide (NO) and nitrogen dioxide (NO₂). In the case of stack emissions from diesel-fueled engines, approximately 90 percent of the NO_x is in the form of NO while the remainder is directly emitted NO₂. The ambient standards are expressly for NO₂, not NO. Once these gases exit the stack, chemical reactions in the region downwind of the facility, meteorological conditions and sunlight interact to convert the NO into NO₂, ozone, and particulates. The ozone that exists in the ambient air is not directly emitted; it is formed in the air when the NO to NO₂ reaction occurs, followed by a set of complex reactions including interactions with volatile organic compounds (VOC). The BAAQMD uses the term Precursor Organic Compounds (POC) instead of VOC.

California is divided into 35 local air districts. Some are called "air quality management districts," while the remainder are called "air pollution control districts." ARB oversees activities within the BAAQMD and other local air districts. ARB develops guidance for these local districts, and both ARB and the local agency work together to develop rules and regulations in the district that are intended to reduce emissions to meet or maintain both the California Ambient Air Quality Standards (CAAQS) and the National Ambient Air Quality Standards (NAAQS). Areas that meet the AAQS based upon air monitoring measurements made by either the local district or ARB are classified as "attainment areas," and areas that have monitoring data that exceed ambient air quality standards are classified as "nonattainment areas." As demonstrated in **Table 4.3-2**, an area can be classified as attainment for some pollutants and nonattainment for others. Even for the same pollutant, an area can be attainment for one averaging time and nonattainment for another.

Air districts adopt rules, regulations, and attainment and maintenance plans aimed at protecting public health and reducing emissions. Air districts incorporate these requirements into State Implementation Plans (SIP) for areas that do not meet federal NAAQS. SIPs include components developed by local districts in consultation with ARB, which must approve them before sending them to the US EPA for federal approval. Once a SIP is approved by the US EPA, the requirements in the SIP become federally enforceable.

If the CEC concludes the project satisfies the requirements for an exemption from its jurisdiction, the local air district would then implement its permit review process and if the proposed facility meets local air district requirements, an operating permit would be issued by the local district.

An air quality analysis focuses upon whether the proposed project would meet local, state and federal requirements. The analysis typically follows the local district's New Source Review (NSR) program which includes several steps: (1) quantifying emissions to determine if the project requires a federal operating permit (Title V) or prevention of significant deterioration (PSD) evaluation; (2) determining if a project complies with all emissions limits established for this class of facility; (3) reviewing if the project would

trigger Best Available Control Technology (BACT) requirements; and (4) determining if the project would trigger offset requirements.

PSD evaluations are required for facilities that are considered major sources of pollutants that are in attainment in the area where the facility is proposed to be located. A project is considered a major source depending on the project's mass emission increase. PSD requirements are designed to ensure the project would not cause an attainment area to backslide to non-attainment.

Offset requirements are developed by the local air district during their evaluation of a permit application for a project.

Non-Criteria Pollutant Evaluation

Non-criteria pollutants that are typically evaluated are airborne toxic pollutants identified to have potential harmful human health impacts. Evaluations assess the potential risks from toxic air contaminants (TACs) and hazardous air pollutants (HAPs). TACs include toxic air pollutants identified by the state and HAPs include toxic air pollutants identified at the federal level. Most toxic air pollutants do not have AAQS; however, AAQS have been established for a few pollutants.

TACs are separated into "carcinogens" and "non-carcinogens" based on the nature of the physiological effects associated with exposure. There are two types of thresholds for TACs. Cancer risk is expressed as excess cancers per 1 million exposed individuals, typically over a lifetime of exposure. Acute and chronic exposure to non-carcinogens is expressed as a hazard index (HI), which is the ratio of expected exposure levels to acceptable reference exposure levels (REL) for each of the TACs associated with acute and chronic health effects.

The impact evaluation below focuses on the project's incremental impact due to diesel particulate matter (DPM) exhaust from construction equipment and from the stacks of the diesel-fueled backup engines. That is because DPM is the primary TAC of concern, as explained below. **Table 4.3-11** shows the results of construction health risk assessment (HRA) at the maximally exposed individual resident (MEIR), the maximally exposed individual worker (MEIW), and the Maximally Exposed Individual Sensitive Receptor (MEISR). **Table 4.3-12** shows the results of HRA for readiness testing and maintenance at the maximally exposed individual receptors. **Table 4.3-13** shows the results of HRA for the overlapping period between construction and readiness testing and maintenance at the maximally exposed individual receptors. If risks to these receptors are below significance thresholds, then impacts to other receptors would also be below significance thresholds. **Table 4.3-14**, **Table 4.3-15**, and **Table 4.3-16** summarize the results of the staff cumulative HRA and compares them to the BAAQMD thresholds of significance for cumulative risk and hazards.

Odor Impact Evaluation

Aside from criteria air pollutants and TACs, impacts may arise from other emissions, notably related to odor. These are listed in **Table 4.3-17**.

4.3.1 Setting

Criteria Pollutants

The US EPA and the ARB have established ambient air quality standards for several pollutants based on their adverse health effects. The US EPA has set NAAQS for ozone (O₃), carbon monoxide (CO), NO₂, particulate matter less than or equal to 10 microns (PM₁₀), fine particulate matter less than or equal to 2.5 microns (PM_{2.5}), sulfur dioxide (SO₂), and lead (Pb). These pollutants are commonly referred to as "criteria pollutants." Primary standards were set to protect public health; secondary standards were set to protect public welfare against visibility impairment, damage to animals, crops, vegetation, and buildings. In addition, ARB has established CAAQS for these pollutants, as well as for sulfate (SO₄), visibility reducing particles, hydrogen sulfide (H₂S), and vinyl chloride. California standards are generally stricter than national standards. The standards currently in effect in California and relevant to the project are shown in **Table 4.3-1**.

Attainment Status and Air Quality Plans

The US EPA, ARB, and the local air districts classify an area as attainment, unclassified, or nonattainment. The classification depends on whether the monitored ambient air quality data show compliance, insufficient data are available, or non-compliance with the ambient air quality standards, respectively. The proposed project would be located in Santa Clara County in the San Francisco Bay Area Air Basin (SFBAAB), under the jurisdiction of the Bay Area Air Quality Management District (BAAQMD). **Table 4.3-2** summarizes attainment status for the relevant criteria pollutants in the SFBAAB with both the federal and state standards.

TABLE 4.3-1 NATIONAL AND CALIFORNIA AMBIENT AIR QUALITY STANDARDS

Pollutant	Averaging Time	California Standards ^a	National Standards ^b	
			Primary	Secondary
O ₃	1-hour	0.09 ppm (180 µg/m ³)	—	Same as Primary Standard
	8-hour	0.070 ppm (137 µg/m ³)	0.070 ppm (137 µg/m ³)	
PM ₁₀	24-hour	50 µg/m ³	150 µg/m ³	Same as Primary Standard
	Annual Mean	20 µg/m ³	—	
PM _{2.5}	24-hour	—	35 µg/m ³	Same as Primary Standard
	Annual Mean	12 µg/m ³	12 µg/m ³	15 µg/m ³
CO	1-hour	20 ppm (23 mg/m ³)	35 ppm (40 mg/m ³)	—
	8-hour	9.0 ppm (10 mg/m ³)	9 ppm (10 mg/m ³)	—
NO ₂	1-hour	0.18 ppm (339 µg/m ³)	0.100 ppm (188 µg/m ³) ^c	—
	Annual Mean	0.030 ppm (57 µg/m ³)	0.053 ppm (100 µg/m ³)	Same as Primary Standard
SO ₂ ^d	1-hour	0.25 ppm (655 µg/m ³)	75 ppb (196 µg/m ³)	—
	3-hour	—	—	0.5 ppm (1,300 µg/m ³)
	24-hour	0.04 ppm (105 µg/m ³)	0.14 ppm (for certain areas) ^d	—
	Annual Mean	—	0.030 ppm (for certain areas) ^d	—

Notes: ppm=parts per million; ppb = parts per billion; µg/m³ = micrograms per cubic meter; mg/m³ = milligrams per cubic meter; “—” = no standard

^a California standards for O₃, CO (except 8-hour Lake Tahoe), SO₂ (1 and 24 hour), NO₂, and particulate matter (PM₁₀, PM_{2.5}, and visibility reducing particles), are values that are not to be exceeded. All others are not to be equaled or exceeded.

^b National standards (other than O₃, PM, NO₂ [see note c below], and those based on annual arithmetic mean) are not to be exceeded more than once a year. The 8-hour O₃ standard is attained when the fourth highest 8-hour concentration measured at each site in a year, averaged over three years, is equal to or less than the standard. The 24 hour PM₁₀ standard of 150 µg/m³ is not to be exceeded more than once per year on average over a 3-year period. The 24-hour PM_{2.5} standard is attained when the 3-year average of 98th percentile concentration is less than or equal to 35 µg/m³.

^c To attain the 1-hour national standard, the 3-year average of the annual 98th percentile of the 1-hour daily maximum concentrations at each site must not exceed 0.100 ppm.

^d On June 2, 2010, a new 1-hour SO₂ standard was established and the existing 24-hour and annual primary standards were revoked. To attain the 1-hour national standard, the 3-year average of the annual 99th percentile of the 1-hour daily maximum concentrations at each site must not exceed 75 ppb. The previous SO₂ standards (24-hour and annual) will additionally remain in effect in certain areas: (1) any area for which it is not yet 1 year since the effective date of designation under the current (2010) standards, and (2) any area for which an implementation plan providing for attainment of the current (2010) standard has not been submitted and approved and which is designated nonattainment under the previous SO₂ standards or is not meeting the requirements of a SIP call under the previous SO₂ standards (40 CFR 50.4(3)). A SIP call is a US EPA action requiring a state to resubmit all or part of its State Implementation Plan to demonstrate attainment of the required NAAQS.

Sources: BAAQMD 2020a, US EPA 2020a

TABLE 4.3-2 ATTAINMENT STATUS FOR SFBAAB

Pollutant	Averaging Time	State Designation	Federal Designation
O ₃	1-hour	Nonattainment	—
	8-hour	Nonattainment	Nonattainment
PM ₁₀	24-hour	Nonattainment	Unclassified
	Annual	Nonattainment	—
PM _{2.5}	24-hour	—	Nonattainment ^a
	Annual	Nonattainment	Unclassifiable/attainment ^b
CO	1-hour	Attainment	Attainment
	8-hour	Attainment	Attainment
NO ₂	1-hour	Attainment	Unclassifiable/Attainment
	Annual	Attainment	Attainment
SO ₂	1-hour	Attainment	Attainment/Unclassifiable ^c
	24-hour	Attainment	— ^d
	Annual	—	— ^d

Notes:

^a On January 9, 2013, US EPA issued a final rule to determine that the Bay Area attains the 24-hour PM_{2.5} national standard (US EPA 2013). This US EPA rule suspends key state implementation plan (SIP) requirements as long as monitoring data continues to show that the Bay Area attains the standard. Despite this US EPA action, the Bay Area will continue to be designated as “non-attainment” for the national 24-hour PM_{2.5} standard until such time as the BAAQMD submits a “redesignation request” and a “maintenance plan” to US EPA, and US EPA approves the proposed redesignation.

^b In December 2012, US EPA strengthened the annual PM_{2.5} NAAQS from 15.0 to 12.0 µg/m³. In December 2014, US EPA issued final area designations for the 2012 primary annual PM_{2.5} NAAQS (US EPA 2014). Areas designated “unclassifiable/attainment” must continue to take steps to prevent their air quality from deteriorating to unhealthy levels. The effective date of this standard is April 15, 2015.

^c On January 9, 2018, US EPA issued a final rule to establish the initial air quality designations for certain areas in the US for the 2010 SO₂ primary NAAQS (US EPA 2018b). This final rule designated the SFBAAB as attainment/unclassifiable for the 2010 SO₂ primary NAAQS.

^d See note d under **Table 4.3-1**.

Sources: ARB 2020a, BAAQMD 2020a, US EPA 2013, US EPA 2014, US EPA 2018b

Overall air quality in the SFBAAB is better than most other developed areas in California, including the South Coast, San Joaquin Valley, and Sacramento regions. This is due to a more favorable climate, with cooler temperatures and regional air flow patterns that transports pollutants emitted in the air basin out of the air basin. Although air quality improvements have occurred, violations and exceedances of the state ozone and PM standards continue to persist in the SFBAAB, and still pose challenges to state and local air pollution control agencies (ARB 2013). The project area’s proximity to both the Pacific Ocean and the San Francisco Bay has a moderating influence on the climate. This portion of the Santa Clara Valley is bounded by the San Francisco Bay to the north, the Santa Cruz Mountains to the southwest and west, and the Diablo Range to the northeast. The surrounding terrain greatly influences winds in the valley, resulting in a prevailing wind that flows along the valley’s northwest-southeast axis.

Pollutants in the air can cause health problems, especially for children, the elderly, and people with heart or lung problems. Healthy adults may experience symptoms during periods of intense exercise. Pollutants can also cause damage to vegetation, animals, and property.

Existing Ambient Air Quality

There are two background ambient air quality monitoring stations in San Jose: the Jackson Street station and the Knox Avenue station. The Jackson Street station is about 9.9 miles north-northwest of the project site. Ambient ozone, PM₁₀, PM_{2.5}, NO₂, CO, SO₂ data are all monitored at the Jackson Street station. The Knox Avenue station is about 7.9 miles north-northwest of the project site, which is closer than the Jackson Street station. Starting from September 2014, NO₂, CO, and PM_{2.5} with other parameters are monitored at the Knox Avenue station (BAAQMD 2018). The Knox Avenue station is located close to the intersection between US Highway 101 and Interstate 680/280. The near-road Knox Avenue station is considered micro-scale because of its distance to roadways. However, PM_{2.5} monitoring at this site is considered representative of area-wide concentrations within this major metropolitan region. NO₂ monitoring at the Knox Avenue station is considered micro-scale, while NO₂ monitoring at the Jackson Street station is considered neighborhood or larger scale (BAAQMD 2018).

Table 4.3-3 presents the air quality monitoring data from both the San Jose – Jackson Street station and the San Jose – Knox Avenue station from 2014 to 2019, the most recent years for which data are available as of April 2021. Data in this table that are marked in **bold** indicate that the most-stringent current standard was exceeded during that period. Staff recommends using PM₁₀ and SO₂ data from the Jackson Street station to represent ambient condition at the project site since they are not monitored at the Knox Avenue station. The NO₂ and CO background data at the Knox Avenue station were generally a little higher than those at the Jackson Street station. Staff recommends using CO background data at the Knox Avenue station to conservatively represent the background condition at the project site. However, for NO₂ monitoring, the near-road Knox Avenue station is considered micro-scale, while the Jackson Street station is considered neighborhood or larger scale, which would better represent the background condition at the project site. In addition, ozone is monitored together with NO₂ at the Jackson Street station, both of which are needed in the 1-hour NO₂ modeling analysis as explained below. Ozone is not monitored at the Knox Avenue station. Therefore, staff recommends using both ozone and NO₂ data at the Jackson Street station in the 1-hour NO₂ impacts analysis. For the annual NO₂ impacts analysis, staff recommends using the higher NO₂ background data from the Knox Avenue station to conservatively represent the background condition at the project site. The PM_{2.5} background concentrations at the Jackson Street station were higher than those at the Knox Avenue station in 2014, 2018, and 2019, but lower in 2015-2017. For a conservative PM_{2.5} impacts analysis, staff recommends using the PM_{2.5} background concentrations at the Jackson Street station for the most recent years (2017-2019). However, it should be noted that the difference between the background data from the Jackson Street station and those from the Knox Avenue station is small. Staff does not expect the conclusions regarding the project's impacts would change using background data from either station.

TABLE 4.3-3 AMBIENT AIR QUALITY MONITORING DATA

Pollutant	Averaging Time	2014	2015	2016	2017	2018	2019
San Jose-Jackson Street							
O ₃ (ppm)	1-hour	0.089	0.094	0.087	0.121	0.078	0.095
	8-hour	0.066	0.081	0.066	0.098	0.061	0.081
PM10 (µg/m ³)	24-hour	56	58	41	70	122	77.1
	Annual	20	22	18.5	21.6	23.1	19.2
PM2.5 (µg/m ³)	24-hour (98th percentile)	27.2	27.4	19	34.3	73.4	21
	Annual	9.3	10.6	8.4	9.5	12.9	9.1
NO ₂ (ppb)	1-hour (maximum)	58.4	49.3	51.1	68	86.1	60
	1-hour (98th percentile)	55	44	42	50	59	52
	Annual	13.07	12.81	11.26	12.24	12.04	10.63
CO (ppm)	1-hour	2.4	2.4	2	2.1	2.5	1.7
	8-hour	1.9	1.8	1.4	1.8	2.1	1.3
SO ₂ (ppb)	1-hour (maximum)	3	3.1	1.8	3.6	6.9	14.5
	1-hour (99th percentile)	2	2	2	3	3	2
	24-hour	0.9	1.1	0.8	1.1	1.1	1.5
San Jose-Knox Avenue							
PM2.5 (µg/m ³)	24-hour (98th percentile)	21	28	19.4	37	71.1	20
	Annual	7.4	8.4	9.1	10.8	12.3	7.4
NO ₂ (ppb)	1-hour (maximum)	65	61.1	52.2	77	88	65.1
	1-hour (98th percentile)	52	47.4	46	52.1	55.4	51
	Annual	19.69	17.68	15.95	17	16.69	14.47
CO (ppm)	1-hour	2.2	2.7	2.5	2.6	2.8	2
	8-hour	1.9	2	1.6	1.8	2.3	1.6

Note:

Concentrations in **bold** type are those that exceed the limiting ambient air quality standard.

Sources: ARB 2020b, US EPA 2020b, BAAQMD 2020b

The maximum concentration values listed in **Table 4.3-3** have not been screened to remove values that are designated as exceptional events. Violations that are the result of exceptional events such as wildfires are normally excluded from consideration as AAQS violations. Exceptional events undoubtedly affected many of the maximum concentration values for 2017-2019, most of which occurred from September to mid-November during a period of extensive California-wide wildfire activity. The ozone¹ and PM in 2017-2019 strongly illustrate the effect of events like the extensive northern California wild-land fires. Even though they were hundreds of miles from the monitoring stations, the blanket of smoke and adverse air quality most likely affected air monitoring stations in the urban areas surrounding the project. For a conservative analysis, staff uses the background ambient air quality concentrations from 2017 to 2019 to represent the baseline condition

¹ Wildfires also emit substantial amounts of volatile and semi-volatile organic materials and nitrogen oxides that form ozone and organic particulate matter (NOAA 2019).

at the project site, except for the refined 1-hour NO₂ impacts analysis as discussed in detail below.

Health Effects of Criteria Pollutants

Below are descriptions of the health effects of criteria pollutants that are a concern in the regional study area. The California Health and Safety Code Section 39606 requires the ARB to adopt ambient air quality standards at levels that adequately protect the health of the public, including infants and children, with an adequate margin of safety. Ambient air quality standards define clean air (ARB 2020c).

Ozone. Ozone is a respiratory irritant and an oxidant that increases susceptibility to respiratory infections and that can cause substantial damage to vegetation and other materials. Ozone is not emitted directly into the atmosphere but is a secondary air pollutant produced in the atmosphere through a complex series of photochemical reactions involving reactive organic gases (ROG) and NO_x, including NO₂. ROG and NO_x are known as precursor compounds for ozone. Significant ozone production generally requires ozone precursors to be present in a stable atmosphere with strong sunlight.

Ozone can cause the muscles in the airways to constrict, trapping air in the alveoli, potentially leading to wheezing and shortness of breath. Ozone can make it more difficult to breathe deeply and vigorously; cause shortness of breath and pain when taking a deep breath; cause coughing and sore or scratchy throat; inflame and damage the airways; aggravate lung diseases such as asthma, emphysema, and chronic bronchitis; increase the frequency of asthma attacks; make the lungs more susceptible to infection; continue to damage the lungs even when the symptoms have disappeared; and cause chronic obstructive pulmonary disease. Long-term exposure to ozone is linked to aggravation of asthma and is likely to be one of many causes of asthma development. Long-term exposures to higher concentrations of ozone may also be linked to permanent lung damage, such as abnormal lung development in children. Inhalation of ozone causes inflammation and irritation of the tissues lining human airways, causing and worsening a variety of symptoms, and exposure to ozone can reduce the volume of air that the lungs breathe in and cause shortness of breath.

People most at risk for adverse health effects from breathing air containing ozone include people with asthma, children, older adults, and people who are active outdoors, especially outdoor workers. Children are at greatest risk from exposure to ozone because their lungs are still developing and they are more likely to be active outdoors when ozone levels are high, which increases their exposure. Studies show that children are no more or less likely to suffer harmful effects than adults; however, children and teens may be more susceptible to ozone and other pollutants because they spend nearly twice as much time outdoors and engaged in vigorous activities compared to adults. Children breathe more rapidly than adults and inhale more pollution per pound of their body weight than adults and are less likely than adults to notice their own symptoms and avoid harmful exposures.

Particulate Matter. PM10 and PM2.5 represent size fractions of particulate matter that can be inhaled into air passages and the lungs and can cause adverse health effects. Very small particles of certain substances (e.g., sulfates and nitrates) can cause lung damage directly, or can contain absorbed gases (e.g., chlorides or ammonium) that may be injurious to health. Health effects of particulate matter may include cardiovascular effects such as cardiac arrhythmias and heart attacks, and respiratory effects such as asthma attacks and bronchitis. Particulates can also damage materials and reduce visibility.

Nitrogen Dioxide. Breathing air with a high concentration of NO₂ can irritate airways in the human respiratory system. Such exposures over short periods (as represented by the 1-hour standards) can aggravate respiratory diseases, particularly asthma, leading to respiratory symptoms (such as coughing, wheezing or difficulty breathing), hospital admissions and visits to emergency rooms. Longer exposures to elevated concentrations of NO₂ (as represented by the annual standards) may contribute to the development of asthma and potentially increase susceptibility to respiratory infections. People with asthma, as well as children and the elderly are generally at greater risk for the health effects of NO₂. NO_x (NO₂ and NO – nitric oxide) reacts with other chemicals in air and sunlight to form both particulate matter and ozone.

Carbon Monoxide. CO is a pollutant that is a product of incomplete combustion and is mostly associated with motor vehicle traffic. High CO concentrations develop primarily during winter when periods of light winds combine with the formation of ground level temperature inversions (typically from the evening through early morning). These conditions result in reduced dispersion of vehicle emissions. Motor vehicles also exhibit increased CO emission rates at low air temperatures. When inhaled at high concentrations, CO combines with hemoglobin in the blood and reduces the oxygen-carrying capacity of the blood. This results in reduced oxygen reaching the brain, heart, and other body tissues. This condition is especially critical for people with cardiovascular diseases, chronic lung disease, or anemia.

Sulfur Dioxide. SO₂ is produced through combustion of sulfur or sulfur-containing fuels such as coal. SO₂ is also a precursor to the formation of atmospheric sulfate and particulate matter (PM10 and PM2.5) and contributes to potential atmospheric sulfuric acid formation that could precipitate downwind as acid rain.

Lead. Lead has a range of adverse neurotoxin health effects and was predominately released into the atmosphere primarily via the combustion of leaded gasoline. The phase-out of leaded gasoline has resulted in decreasing levels of atmospheric lead.

Toxic Air Contaminants

According to section 39655 of the California Health and Safety Code, a toxic air contaminant (TAC) is "an air pollutant which may cause or contribute to an increase in mortality or an increase in serious illness, or which may pose a present or potential hazard to human health." In addition, substances which have been listed as federal hazardous air pollutants (HAPs) pursuant to section 7412 of Title 42 of the United States Code are

TACs under the state's air toxics program pursuant to section 39657 (b) of the California Health and Safety Code. ARB formally made this identification on April 8, 1993 (Title 17, California Code of Regulations, section 93001 [OEHHA 2020]). TACs, also referred to as HAPs or air toxics, are different from criteria air pollutants such as ground-level ozone, particulate matter, carbon monoxide, nitrogen dioxide, sulfur dioxide, and lead. Criteria air pollutants are regulated using national and state Ambient Air Quality Standards as noted above. However, there are no ambient standards for most TACs² so site-specific health risk assessments (HRAs) are conducted to evaluate whether risks of exposure to TACs create an adverse impact. Specific TACs have known acute, chronic, and cancer health impacts. TACs that have been identified by ARB are listed at Title 17, California Code of Regulations, sections 93000 and 93001. The nearly 200 regulated TACs include asbestos, organic, and inorganic chemical compounds and compound categories, diesel exhaust, and certain metals. The requirements of the Air Toxic "Hot Spots" Information and Assessment Act apply to facilities that emit these listed TACs above regulated threshold quantities.

Health Effects of TACs

The health effects associated with TACs are quite diverse and generally are assessed locally, rather than regionally. TACs could cause long-term health effects such as cancer, birth defects, neurological damage, asthma, bronchitis or genetic damage; or short-term effects such as eye watering, respiratory irritation (a cough), running nose, throat pain, and headaches (BAAQMD 2017b, page 5-1). Numerous other health effects also have been linked to exposure to TACs, including heart disease, Sudden Infant Death Syndrome, respiratory infections in children, lung cancer, and breast cancer (OEHHA 2015).

The primary on-site TAC emission sources for the GOSBGF would be diesel engines, including engines in vehicles and equipment used during construction and stationary standby engines during readiness testing and maintenance. Diesel exhaust is a complex mixture of thousands of gases and fine particles and contains over 40 substances listed by the US EPA as hazardous air pollutants and by ARB as toxic air contaminants. The solid material in diesel exhaust is known as diesel particulate matter (DPM [ARB 2020d]).

DPM has been the accepted surrogate for whole diesel exhaust since the late 1990's. ARB identified DPM as the surrogate compound for whole diesel exhaust in its Proposed Identification of Diesel Exhaust as a Toxic Air Contaminant staff report in April 1998 (Appendix III, Part A, Exposure Assessment [ARB 1998]). DPM is primarily composed of aggregates of spherical carbon particles coated with organic and inorganic substances. Diesel exhaust deserves particular attention mainly because of its ability to induce serious noncancerous effects and its status as a likely human carcinogen. Diesel exhaust is also characterized by ARB as "particulate matter from diesel-fueled engines." The impacts from human exposure would include both short- and long-term health effects. Short-term effects can include increased coughing, labored breathing, chest tightness, wheezing, and

² Ambient air quality standards for TACs exist for lead (federal and state standards), hydrogen sulfide (state standard), and vinyl chloride (state standard).

eye and nasal irritation. Effects from long-term exposure can include increased coughing, chronic bronchitis, reductions in lung function, and inflammation of the lung. Epidemiological studies strongly suggest a causal relationship exists between occupational diesel exhaust exposure and lung cancer. Diesel exhaust is listed by the US EPA as “likely to be carcinogenic to humans” (US EPA 2002).

Sensitive Receptors

Sensitive receptors are defined as groups of individuals that may be more susceptible to health risks due to chemical exposure. Sensitive individuals, such as infants, the aged, and people with specific illnesses or diseases, are the subpopulations which are more sensitive to the effects of toxic substance exposure. Examples of sensitive receptors include residences, schools and school yards, parks and playgrounds, daycare centers, nursing homes, and medical facilities. Residences could include houses, apartments, and senior living complexes. Medical facilities could include hospitals, convalescent homes, and health clinics. Playgrounds could be play areas associated with parks or community centers (BAAQMD 2017b, page 5-8). The potential sensitive receptor locations evaluated in the HRA for GOSDC include:

- Residential dwellings
- Schools
- Daycare centers
- Hospitals and health clinics
- Senior-care facilities

Sensitive Receptors Near the Project

BAAQMD recommends that any proposed project including the siting of a new TAC emissions source assess associated community risks and hazards impacts within 1,000 feet of the proposed project, and take into account both individual and nearby cumulative sources (that is, proposed project plus existing and foreseeable future projects). Cumulative sources represent the combined total risk values of each individual source within the 1,000-foot evaluation zone. A lead agency should enlarge the 1,000-foot radius on a case-by-case basis if an unusually large source or sources of risk or hazard emissions that may affect a proposed project is beyond the recommended radius (BAAQMD 2017b, Table 2-1, page 5-2, and page 5-3).

Staff previously used a 6-mile radius for cumulative impacts analyses of power plant cases. Based on staff’s modeling experience, beyond 6 miles there is no statistically significant concentration overlap for non-reactive pollutant concentration between two stationary emission sources. The 6-mile radius is more appropriate to be used for the turbines with tall stacks and more buoyant plumes. The diesel emergency standby engines would result in more localized impacts due to shorter stacks and less buoyant plumes. The worst-case impacts of the diesel emergency standby engines would occur at or near the fence line and decrease rapidly with distance from fence line. This also

explains why the BAAQMD recommends 1,000 feet as the boundary for the cumulative health risks assessment in the BAAQMD CEQA Guidelines.

The project site is approximately 18 acres (SV1 2020a, Page 8). **Table 4.5-17** of the SPPE application provides some sensitive receptors based on Google Earth image dated 10/7/2019 (SV1 2020a, Page 90). However, staff searched the GIS database and identified more sensitive receptors. **Figure 4.3-1** shows the map of sensitive receptors near the project.

The nearest residences (southwest of Santa Teresa Boulevard) are located to the south, southwest, and west of the site at distances starting from approximately 710 feet (ft) from the southwest most stack locations. The nearest residences to the southeast and east of the project (southeast of Bernal Road) are at distances starting from approximately 2,260 ft from the project boundary.

The nearest school, Stratford School, is about 1,800 ft southwest of the project boundary. The Santa Teresa Elementary is about 2,900 ft west of the project boundary. The Bernal Intermediate School is about 3,090 ft southwest of the project boundary. The Los Paseos Elementary is about 3,770 ft southeast of the project boundary.

Table 4.5-17 of the SPPE application identifies the nearest daycare to be 4,873 ft northwest of the project site, which is the Bright Horizons-San Jose. However, staff looked at the GIS database and identified more daycare locations (shown as aqua blue dots in **Figure 4.3-1**) around the project area. The Centro Armonia Spanish School-Santa Teresa is about 1,300 ft south-southeast of the project boundary. The daycare at the Stratford School is about 1,800 ft southwest of the project boundary. The Santa Teresa State Preschool (at the Santa Teresa Elementary) is about 2,900 ft west of the project boundary. The Genius Kids is about 3,270 ft southeast of the project boundary. The YMCA childcare at the Los Paseos Elementary is about 3,770 ft southeast of the project boundary.

Table 4.5-17 of the SPPE application identifies the nearest hospital to be 5,514 ft northwest of the project site, which is the Kaiser Foundation Hospital – San Jose. It is not shown in **Figure 4.3-1** because it is just outside of the map domain. However, staff searched the GIS database and found more health care facility locations (shown as orange dots in **Figure 4.3-1**) around the project area. Kaiser Foundation Hospital Home Health-Santa Clara is about 1,500 ft northeast of the project boundary. The RCCA – Purple Hills Drive is about 2,300 ft west of the project boundary. There are two nearby dialysis centers: the Fresenius Medical Care San Jose (about 800 ft south of the project boundary) and the Satellite Dialysis (about 1,800 ft southeast of the project boundary). While these facilities would be visited by sensitive receptors, they are not considered sensitive receptors for the cancer risk and chronic hazard index assessment of the project. The effects of DPM emissions from the project are considered chronic. Sensitive receptors using these facilities would have short exposure times near the site, therefore, would not experience chronic effects of DPM emissions from the project. But staff's acute HRA evaluates acute hazard index at these facilities.

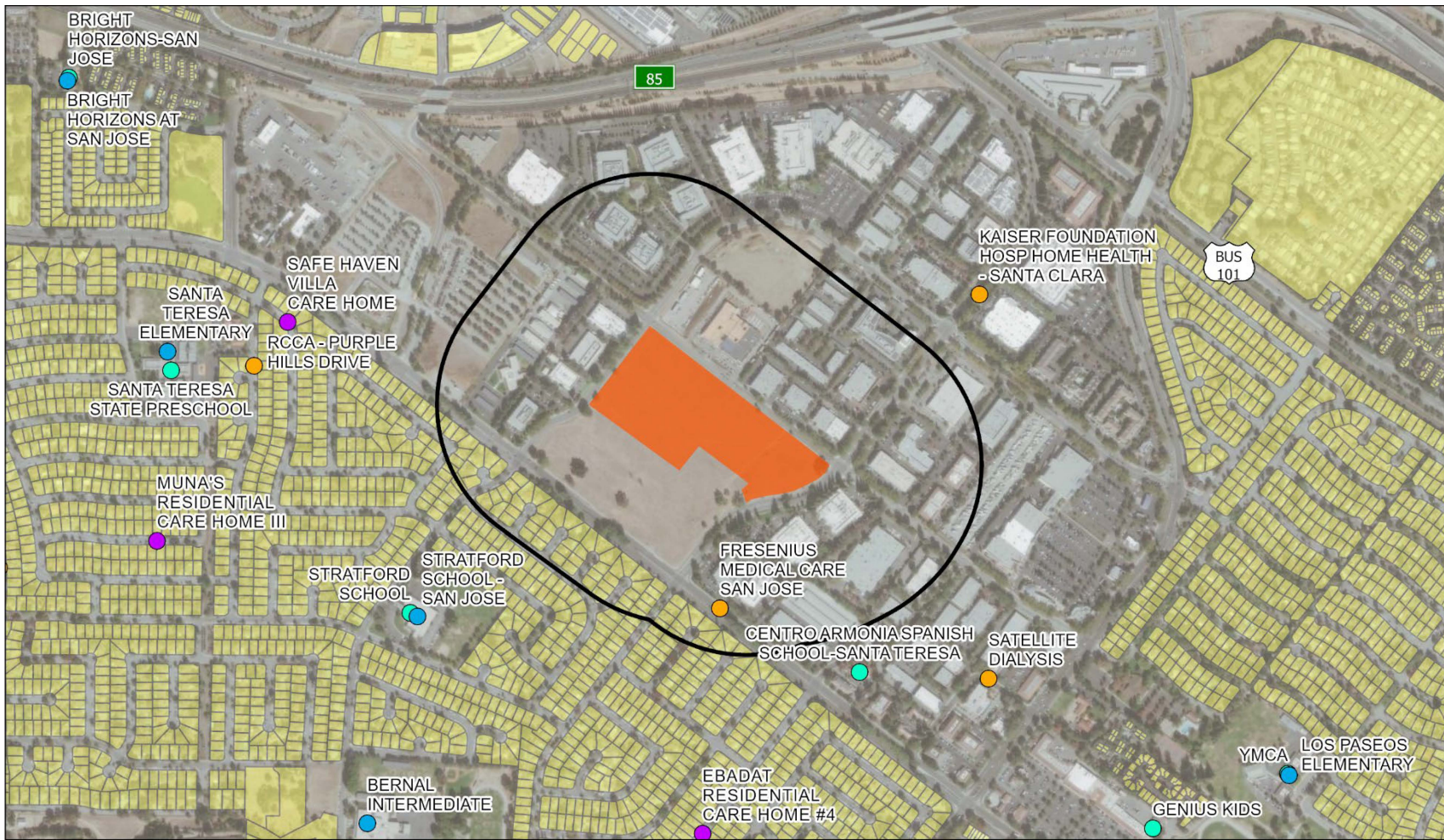

Great Oaks South Data Center

- Project Footprint
- 1,000 Ft Influence Zone
- Residential Community

Sensitive Receptors Outside
1,000 Foot Influence Zone

- Day Care Facility
- Health Care Facility
- Nursing Home
- School

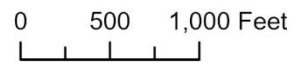

Figure 4.3-1
1,000 Foot Influence Zone

Sources: California Energy Commission,
HIFLD, USGS, CDPH, ORNL, Esri

Figure 4.3-1 shows the senior-care facilities as purple dots. The Safe Haven Villa Care Home is about 2,100 ft west-northwest of the project boundary. The Ebadat Residential Care Home #4 is about 2,330 ft south of the project boundary. The Muna's Residential Care Home III is about 3,000 ft west-southwest of the project boundary.

Regulatory Background

Federal, state, and regional agencies regulate air quality in the SFBAAB, within which the project site is located.

Federal

Clean Air Act. The federal Clean Air Act (CAA) establishes the statutory framework for regulation of air quality in the United States. Under the CAA, the US EPA oversees implementation of federal programs for permitting new and modified stationary sources, controlling toxic air contaminants, and reducing emissions from motor vehicles and other mobile sources.

Title I (Air Pollution Prevention and Control) of the federal CAA requires establishment of NAAQS, air quality designations, and plan requirements for nonattainment areas. States are required to submit a state implementation plan (SIP) to the US EPA for areas in nonattainment with NAAQS. The SIP, which is reviewed and approved by the US EPA, must demonstrate how state and local regulatory agencies will institute rules, regulations, and/or other programs to attain NAAQS.

Prevention of Significant Deterioration (PSD) is a federal program for federal attainment areas. The purpose of the federal PSD program is to ensure that attainment areas remain in attainment of NAAQS based upon a proposed facility's annual potential to emit. If annual emissions of a proposed project are less than prescribed amounts, a PSD review is not required. GOSDC is not expected to be subject to PSD, with a final determination made by the local district at the time of permitting.

National Emission Standard for Hazardous Air Pollutants. CAA section 112 (Title 42, U.S. Code section 7412) addresses emissions of hazardous air pollutants (HAPs). The CAA defines HAPs as a variety of substances that pose serious health risks. Direct exposure to HAPs has been shown to cause cancer, reproductive effects or birth defects, damage to brain and nervous system, and respiratory disorders. Categories of sources that cause HAP emissions are controlled through separate standards under CAA Section 112: National Emission Standards for Hazardous Air Pollutants (NESHAP). These standards are specifically designed to reduce the potency, persistence, or potential bioaccumulation of HAPs. New sources that emit more than ten (10) tons per year (tpy) of any specified HAP or more than 25 tpy of any combination of HAPs are required to apply Maximum Achievable Control Technology (MACT).

Asbestos is a HAP regulated under the US EPA NESHAP. The asbestos NESHAP is intended to provide protection from the release of asbestos fibers during activities involving the handling of asbestos. Air toxics regulations under the CAA specify work practices for

asbestos to be followed during operations of demolitions and renovations. The regulations require a thorough inspection of the area where the demolition or renovation operations would occur and advance notification of the appropriate delegated entity. Work practice standards that control asbestos emissions must be implemented, such as removing, wetting, and sealing in leak-tight containers all asbestos-containing materials (ACM) and disposing of the waste as expediently as practicable.

State

The Air Resources Board (ARB) is the primary administrator of California's federal CAA compliance efforts, while local air quality districts administer air rules and regulations at the local and regional levels. ARB is also responsible for California's state regulated air quality management, including establishment of CAAQS for criteria air pollutants, mobile source/off-road equipment/portable equipment emission standards, portable equipment registration, greenhouse gas (GHG) regulations, as well as oversight of local or regional air quality districts and preparation of implementation plans, including regulations for stationary sources of air pollution.

Air Toxic "Hot Spots" Information and Assessment Act. The Air Toxic "Hot Spots" Information and Assessment Act, also known as Assembly Bill (AB) 2588, identifies TAC hot spots where emissions from specific stationary sources may expose individuals to an elevated risk of adverse health effects, particularly cancer or reproductive harm. Many TACs are also classified as HAPs. AB 2588 requires that a business or other establishment identified as a significant stationary source of toxic emissions provide the affected population with information about health risks posed by their emissions.

Airborne Toxic Control Measure (ATCM) for Emergency Standby Diesel-Fueled Engines. Statewide regulations govern the use of and emissions performance standards for emergency standby diesel-fueled engines, including those of the project. As defined by the California Code of Regulations (17 CCR §93115.4), an emergency standby engine is one that provides electrical power during an emergency use and is not the source of primary power at the facility; an emergency standby engine is not operated to supply power to the electric grid. The ATCM (17 CCR §93115.6) restricts each emergency standby engine to operate no more than 50 hours per year for maintenance and testing purposes. The ATCM establishes no limit on engine operation for emergency use or for emission testing to show compliance with the ATCM's standards.

Asbestos Airborne Toxic Control Measure for Construction, Grading, Quarrying, and Surface Mining Operations. ARB has established the Asbestos ATCM for Construction, Grading, Quarrying, and Surface Mining Operations to minimize the generation of asbestos from earth disturbance or construction activities. The Asbestos ATCM applies to any project that would include sites to be disturbed in a geographic ultramafic rock unit area or an area where naturally occurring asbestos (NOA), serpentine, or ultramafic rocks are determined to be present. Based upon review of the US Geological Survey map detailing natural occurrence of asbestos in California, NOA is not expected to be present at the project site (Van Gosen and Clinkenbeard 2011).

Regional

The BAAQMD is the regional agency charged with preparing, adopting, and implementing emission control measures and standards for stationary sources of air pollution pursuant to delegated state and federal authority, for all projects located within their jurisdiction. Under the California CAA, the BAAQMD is required to develop an air quality plan to achieve and/or maintain compliance with federal and state nonattainment criteria pollutants within the air district's boundary.

Bay Area 2017 Clean Air Plan. BAAQMD adopted the Bay Area 2017 Clean Air Plan (CAP) on April 19, 2017 (BAAQMD 2017a). The 2017 CAP provides a regional strategy to protect public health and protect the climate. The 2017 CAP updates the most recent Bay Area ozone plan, the 2010 Clean Air Plan, pursuant to air quality planning requirements defined in the California Health & Safety Code. The 2017 CAP defines an integrated, multi-pollutant control strategy to reduce emissions of particulate matter, TACs, ozone and key ozone precursors, and greenhouse gases.

BAAQMD California Environmental Quality Act Guidelines. BAAQMD publishes California Environmental Quality Act (CEQA) guidelines to assist lead agencies in evaluating a project's potential impacts on air quality. The BAAQMD published the most recent version of its CEQA Guidelines in May 2017 (BAAQMD 2017b).

BAAQMD Regulation 2, Rule 2: New Source Review. This rule applies to all new or modified sources requiring an Authority to Construct and/or Permit to Operate. It requires the applicant to use the Best Available Control Technology (BACT) to control emissions if the source will have the potential to emit (PTE) a BAAQMD BACT pollutant in an amount of 10 or more pounds per day (lbs/day). Note that pollutant calculations only include those emissions from readiness testing and maintenance, as emissions from emergency operations are exempt from district permitting. Offsets are required at a 1:1 ratio if more than 10 tpy of nitrogen oxides (NO_x) or Precursor Organic Compounds (POC), or more than 100 tpy of PM_{2.5}, PM₁₀, or SO₂, are emitted. If the PTE for NO_x or POC is more than 10 tpy but less than 35 tpy, the BAAQMD needs to provide any required offsets at 1:1 ratio from the Small Facility Banking Account in the BAAQMD's Emissions Bank. If the PTE for NO_x or POC is 35 tons per year or more, the offset ratio increases to 1.15:1 and offsets can no longer be obtained through the Small Facility Banking Account.

On June 3, 2019, the BAAQMD staff issued a new policy to protect the Small Facility Banking Account from over withdrawal by new emergency backup power generator sources. The policy provides procedures, applicable to the determination of access to the Small Facility Banking Account only, for calculating a facility's PTE to determine eligibility for emission reduction credits (ERCs) from the Small Facility Banking Account for emergency backup power generators (BAAQMD 2019). When determining the PTE for a facility with emergency backup power generators, the PTE shall include as a proxy, emissions proportional to emergency operation for 100 hours per year per standby generator, in addition to the permitted limits for readiness testing and maintenance (generally 50 hours/year or less per standby or backup engine). BAAQMD would not allow

an owner/operator to accept a permit condition to limit emergency operation to less than 100 hours per year to reduce the source's PTE for purposes of qualifying for the Small Facility Banking Account.

After comparing the PTE calculated to determine the account eligibility threshold, the applicant would only be required to use permitted emissions from readiness testing and maintenance and not the emissions from emergency operation to calculate the project PTE that would be offset to comply with the regular district banking and offset procedures. Emissions offsets represent ongoing emission reductions that continue every year, year after year, in perpetuity. BAAQMD uses offsets to counterbalance increases in regular and predictable emissions, not increases in emissions occurring infrequently when emergency conditions arise. An owner/operator may reduce hours of readiness testing and maintenance to achieve a PTE for ERC mitigation purposes or by installing emissions controls (BAAQMD 2019).

The NO_x PTE of the proposed project would be greater than 10 tpy but less than 35 tpy (SV1 2021i). Therefore, the NO_x emissions need to be fully offset through the permitting process with the BAAQMD. Staff conservatively estimated the total required NO_x offsets to be 16.24 tpy using Tier 2 emission factors, as shown in **Table 4.3-6**. However, as discussed below, the 36 larger engines would be equipped with Miratech Selective Catalytic Reduction (SCR) systems to comply with Tier 4 NO_x emission standard. Staff's conservative estimation of the NO_x offsets does not account for the fact that, depending on load, the SCR would be expected to kick on within 15 minutes, providing some additional emissions control for tests that run longer than this. The exact amount and the source of the NO_x offsets required for the project to comply with the offset requirements in BAAQMD's Regulation 2, Rule 2, under District policy, would be confirmed through the permitting process with the BAAQMD.

On December 21, 2020, BAAQMD issued a letter to ARB and CEC establishing a BACT guideline for large (greater than or equal to 1,000 brake horsepower [bhp]) diesel engines used for emergency standby power that requires them to meet U.S. EPA Tier 4 emission standards. This determination applies to any new and open permit application with a diesel backup engine greater than 1,000 bhp that is deemed complete after January 1, 2020 (BAAQMD 2020z). The 36 larger engines would be equipped with Miratech SCR systems and Diesel Particulate Filters (DPF) to achieve compliance with Tier 4 emission standards. The three smaller engines would be less than 1,000 bhp and are not subject to the Tier 4 BACT. However, these smaller engines would be equipped with DPF to meet Tier 4 emission standard for PM (SV1 2020j; SV1 2021i). Staff expects the proposed generators would meet the current BAAQMD BACT requirements. However, the BAAQMD would make the final determination of BACT during the permitting process.

BAAQMD Regulation 2, Rule 5: New Source Review of Toxic Air Contaminants.

This rule provides for the review of new and modified sources of TAC emissions to evaluate potential public exposure and health risk. Under this rule, a project would be denied an Authority to Construct if it exceeds any of the specified risk limits, which are consistent with BAAQMD's CEQA significance thresholds. Best Available Control

Technology for Toxics (TBACT) would also be required for any new or modified source of TACs where the source has a cancer risk greater than 1.0 in 1 million or a chronic hazard index (HI) greater than 0.20. The specific toxicity values of each TAC, as identified by California Office of Environmental Health Hazard Assessment (OEHHA), are listed in Table 2-5-1 of this rule for use in the HRA (BAAQMD 2016).

BAAQMD Regulation 9, Rule 8: Nitrogen Oxides And Carbon Monoxide From Stationary Internal Combustion Engines. This rule limits NO_x and CO emissions from stationary internal combustion engines with an output rated by the manufacturer at more than 50 brake horsepower, including the standby engines of the project. This regulation (Rule 9-8-231) defines emergency use as “the use of an emergency standby or low usage engine during any of the following:”

- In the event of unforeseeable loss of regular natural gas supply;
- In the event of unforeseeable failure of regular electric power supply;
- Mitigation or prevention of an imminent flood;
- Mitigation of or prevention of an imminent overflow of sewage or waste water;
- Fire or prevention of an imminent fire;
- Failure or imminent failure of a primary motor or source of power, but only for such time as needed to repair or replace the primary motor or source of power; or
- Prevention of the imminent release of hazardous material.

Local

City of San Jose General Plan. *Envision San Jose 2040 General Plan* includes policies for the purpose of avoiding or mitigating impacts resulting from planned development projects within the City. The air quality policies relevant to the project include:

- MS-10.1: Assess projected air emissions from new development in conformance with the BAAQMD CEQA Guidelines and relative to state and federal standards. Identify and implement feasible air emission reduction measures.
- MS-11.2: For projects that emit toxic air contaminants, require project proponents to prepare health risk assessments in accordance with BAAQMD-recommended procedures as part of environmental review and employ effective mitigation to reduce possible health risks to a less than significant level. Alternatively, require new projects (such as, but not limited to, industrial, manufacturing, and processing facilities) that are sources of TACs to be located an adequate distance from residential areas and other sensitive receptors.
- MS-13.1: Include dust, particulate matter, and construction equipment exhaust control measures as conditions of approval for subdivision maps, site development and planned development permits, grading permits, and demolition permits. At minimum, conditions shall conform to construction mitigation measures recommended in the current BAAQMD CEQA Guidelines for the relevant project size and type.

In addition, goals and policies throughout the *Envision San Jose 2040 General Plan* encourage a reduction in vehicle miles traveled through land use, pedestrian and bicycle improvements, and parking strategies that reduce automobile travel through parking supply and pricing management.

Significance Criteria

This analysis is based upon the methodologies and related thresholds in the most recent BAAQMD CEQA Guidelines (BAAQMD 2017b). These methodologies include qualitative determinations and determination of whether project construction and readiness testing and maintenance would exceed numeric emissions and health risk thresholds (BAAQMD 2017b).

BAAQMD project-level thresholds of significance for non-attainment criteria pollutants and precursor pollutants and TAC health risks that apply during construction and operation are shown in **Table 4.3-4**. If a project exceeds the identified significance thresholds, its emissions would be cumulatively considerable, resulting in significant adverse air quality impacts to the region's existing air quality conditions.

For fugitive dust emissions during construction period, BAAQMD does not have a significance threshold. Rather, BAAQMD recommends using a current Best Management Practices (BMPs) approach, which has been a pragmatic and effective approach to the control of fugitive dust emissions.

Significance criteria also include Significant Impact Levels (SILs) for the particulate matter portions of the analysis. Regulatory agencies have traditionally applied SILs as a de minimis value, which represents the offsite concentration predicted to result from a source's emissions that does not warrant additional analysis or mitigation. If a source's modeled impact at any offsite location does not exceed the relevant SIL, the source owner would typically not need to assess multi-source or cumulative air quality analysis to determine whether or not that source's emissions would cause or contribute to a violation of the relevant NAAQS or CAAQS.

Staff evaluates project emissions against the BAAQMD emissions thresholds and also analyzes the project's potential to expose sensitive receptors to increased concentrations of criteria pollutants. The AAQS are health protective values, so staff uses these health-based regulatory standards to help define what is considered a substantial pollutant concentration. The BAAQMD thresholds of significance are an important aspect of staff's air quality analysis for GOSBGF. Therefore, staff's analysis determines whether the project would be likely to exceed any ambient air quality standard or contribute substantially to an existing or projected air quality violation, and if necessary, proposes mitigation to reduce or eliminate these pollutant exceedances or substantial contributions.

TABLE 4.3-4 BAAQMD THRESHOLDS OF SIGNIFICANCE

Pollutant	Construction	Operation	
	Average Daily Emissions (lbs/day)	Average Daily Emissions (lbs/day)	Maximum Annual Emissions (tpy)
ROG	54	54	10
NOx	54	54	10
PM10	82 (exhaust)	82	15
PM2.5	54 (exhaust)	54	10
PM10/PM2.5 (fugitive dust)	Best Management Practices	None	
Local CO	None	9.0 ppm (8-hour average), 20.0 ppm (1-hour average)	
Risk and Hazards for New Sources and Receptors (Individual Project)	Same as Operation Threshold	Compliance with Qualified Community Risk Reduction Plan OR Increased cancer risk of >10.0 in a million Increased non-cancer risk of > 1.0 Hazard Index (Chronic or Acute) Ambient PM2.5 increase: > 0.3 µg/m ³ annual average <u>Zone of Influence:</u> 1,000-foot radius from property line of source or receptor	
Risk and Hazards for New Sources and Receptors (Cumulative Threshold)	Same as Operation Threshold	Compliance with Qualified Community Risk Reduction Plan OR Cancer: > 100 in a million (from all local sources) Non-cancer: > 10.0 Hazard Index (from all local sources) (Chronic) PM2.5: > 0.8 µg/m ³ annual average (from all local sources) <u>Zone of Influence:</u> 1,000-foot radius from property line of source or receptor	

Source: BAAQMD 2017b, Table 2-1

BAAQMD does not have localized impact significance criteria for PM10, or 24-hour localized impact significance criteria for PM2.5. To determine if the project could contribute to or create a substantial pollutant concentration for the nonattainment pollutant PM10, the US EPA PM10 SILs, established in regulations for nonattainment areas [40 CFR 51.165(b)(2)], for 24-hour impacts (5 µg/m³) and for annual impacts (1 µg/m³) have been used³. The same regulation [40 CFR 51.165(b)(2)] also established the US EPA PM2.5 SILs levels for 24-hour impacts (1.2 µg/m³) and for annual impacts (0.3 µg/m³). The BAAQMD significance threshold (for a project level) of annual ambient PM2.5 increase is also 0.3 µg/m³ (as shown in **Table 4.3-4**). However, in April 2018, the US EPA issued *Guidance on Significant Impact Levels for Ozone and Fine Particles in the Prevention of Significant Deterioration Permitting Program* (US EPA 2018a), which

³ BAAQMD does not have localized impact significance criteria for PM10, or 24-hour localized impact significance criteria for PM2.5. Comparable significance criteria, for an area with greater levels of particulate pollution, would be the SCAQMD project operation localized significant concentration threshold bases for PM10 (24-hour = 2.5 µg/m³, and annual = 1.0 µg/m³) and PM2.5 (24-hour = 2.5 µg/m³).

recommends PM2.5 SILs levels for 24-hour impacts to be 1.2 $\mu\text{g}/\text{m}^3$ (same as that in [40 CFR 51.165(b)(2)]) and for annual impacts to be 0.2 $\mu\text{g}/\text{m}^3$ (lower than 0.3 $\mu\text{g}/\text{m}^3$). It should be noted that the US EPA SILs values are all based on the forms of the applicable NAAQS. For example, the 24-hour PM2.5 SILs of 1.2 $\mu\text{g}/\text{m}^3$ is based on the 98th percentile 24-hour concentrations averaged over 3 years. The annual PM2.5 SILs of 0.2 $\mu\text{g}/\text{m}^3$ is based on a 3-year average of annual average concentrations. For this analysis, staff uses the US EPA SILs as well as the BAAQMD significance threshold to determine project significance for PM2.5.

For health risk evaluation purposes, TACs are separated into carcinogens and non-carcinogens based on the nature of the physiological effects associated with exposure to the pollutant. Therefore, there are two kinds of thresholds for TACs. Cancer risk is expressed as excess cancer cases per 1 million exposed individuals, typically over a lifetime of exposure. Acute and chronic exposure to non-carcinogens is expressed as a hazard index (HI), which is the ratio of expected exposure levels to acceptable reference exposure levels (REL) for each of the TACs with acute and chronic health effects (BAAQMD 2017b). The significance thresholds for TACs and PM2.5 applied to the licensing or permitting of a new source are listed in **Table 4.3-4** and summarized in the following text (BAAQMD 2017b).

The BAAQMD significance thresholds for a single source are as follows:

- An excess lifetime cancer risk level of more than 10 in 1 million
- A non-cancer chronic HI greater than 1.0
- A non-cancer acute HI greater than 1.0
- An incremental increase in the annual average PM2.5 concentration of greater than 0.3 micrograms per cubic meter ($\mu\text{g}/\text{m}^3$)

The BAAQMD significance thresholds for cumulative impacts are also summarized below. A project would have a cumulatively considerable impact if the aggregate total of all past, present, and foreseeable future sources within a 1,000-foot distance from the fence line of a source and the contribution from the project, exceeds the following:

- An excess lifetime cancer risk level of more than 100 in 1 million
- A non-cancer chronic HI greater than 10.0
- An annual average PM2.5 concentration of greater than 0.8 $\mu\text{g}/\text{m}^3$

4.3.2 Applicant Proposed Measures

PD AQ-1: To ensure that fugitive dust impacts are less than significant, the project will implement the BAAQMD's recommended BMPs [best management practices] during the construction phase. These BMPs are incorporated into the design of the project and will include:

- All exposed surfaces (soil piles, graded areas, and unpaved access roads) shall be watered at least two times per day.

- All haul trucks transporting material offsite shall be covered.
- All track-out onto adjacent public roads shall be removed using wet power vacuum street sweepers at least once per day.
- All vehicle speeds on onsite unpaved surfaces shall be limited to 5 miles per hour.
- All roadways, driveways, and sidewalks shall be paved as soon as possible. Building pads shall be completed as soon as possible after grading unless seeding or soil binders are used.
- Equipment idling times shall be minimized to 5 minutes per the Air Toxics Control Measure (ATCM). Idling time signage shall be provided for construction workers at all access points.
- All construction equipment shall be maintained and properly tuned in accordance with manufacturer specifications. All equipment shall be checked by a certified visible emissions evaluator.
- Information on who to contact, contact phone number, and how to initiate complaints about fugitive dust problems will be posted at the site.

For the original project design approved by the City of San Jose, the applicant also incorporated PD AQ-2 to limit the testing and maintenance of the originally proposed 21 generators to no more than 356 hours in any consecutive 12-month period. The limit was to make sure the NOx emissions of the original project do not exceed the BAAQMD significance threshold of 54 lbs/day or 10 tpy. The applicant currently proposes 39 generators. With the assumed 20 hours per year per engine for testing and maintenance and 100 hours of emergency operation (per 2019 BAAQMD policy [BAAQMD 2019]), the NOx PTE would exceed 10 tpy. The NOx emissions for testing and maintenance of the standby generators need to be fully offset. The exact amount and the source of the NOx offsets would be confirmed through the permitting process with the BAAQMD. Therefore, PD AQ-2 does not apply to the currently proposed project anymore and is not included here. BAAQMD's permitting process will ensure that the project provides all necessary offsets from a location(s) sufficient to mitigate impacts, therefore it is not necessary to require a mitigation measure addressing this issue here.

4.3.3 Environmental Impacts and Mitigation Measures

a. Would the project conflict with or obstruct implementation of the applicable air quality plan?

Construction, Readiness Testing and Maintenance

Less Than Significant Impact. The BAAQMD has permit authority over stationary sources, acts as the primary reviewing agency for environmental documents, and develops regulations that must be consistent with or more stringent than federal and state air quality laws and regulations. The applicable air quality plan (AQP) is the Bay Area 2017

CAP. A project would be consistent with the AQP if that project (BAAQMD 2017b, page 9-2 and 9-3):

1) Supports the primary goals of the AQP.

The determination for this criterion, per BAAQMD, can be met through consistency with the District-approved CEQA thresholds of significance. As can be seen in the impact analysis discussions under checklist questions (b) and (c) below, the project would have less than significant impacts related to the District-approved CEQA thresholds. Therefore, the project would have a less than significant impact related to the primary goals of the AQP.

2) Includes applicable control measures from the AQP.

The project would include the implementation of applicable control measures from the AQP. The project level applicable control measures include Green Buildings (BL1) and Bicycle and Pedestrian Access and Facilities (TR9). The project would comply with these control measures through compliance with the *Envision San Jose 2040 General Plan* and the City's Greenhouse Gas Reduction Strategy (SV1 2021a), as demonstrated in more detail in **Section 4.8 Greenhouse Gas Emissions**.

3) Does not disrupt or hinder implementation of any AQP control measures.

Examples of disrupting or hindering implementation of an AQP would be proposing excessive parking or precluding the extension of public transit or bike paths. The project design as proposed is not known to hinder the implementation of any AQP control measure.

Therefore, given that the project would not exceed CEQA thresholds of significance, as discussed below under checklist criterion "b" and ambient air quality standards under checklist criterion "c", the project would be consistent with the AQP and would have less than significant impacts.

Required Mitigation Measures: None.

b. Would the project result in a cumulatively considerable net increase of any criteria pollutant for which the project region is non-attainment under an applicable federal or state ambient air quality standard?

This section focuses on whether the project's non-attainment criteria pollutant emissions exceed any of the BAAQMD construction or operation emissions significance thresholds for criteria pollutants. TAC effects are not included because they are not criteria pollutants.

Construction

Less Than Significant with Mitigation Incorporated. Project construction would include three separate phases for each of the three buildings. Onsite construction emissions from

construction of the GOSBGF would result from site preparation and grading activities, building erection and parking lot construction activities, “finish” construction activities, and the use of onsite construction equipment. Offsite construction emissions would be derived primarily from materials transport to and from the site, and worker travel. The applicant estimated the actual construction period for the buildings, parking lots, engine pad areas, and support infrastructure, would be approximately 4.3 years (52 months [SV1 2020j]). Emissions from the 52-month construction period were estimated using the California Emissions Estimator Model⁴ (CalEEMod) program. In response to staff data request, the applicant also provided construction emissions associated with the 21 kV underground feeders that PG&E would construct as well as construction emissions for a sidewalk repair and replacement project requested by the City (SV1 2020p). The total estimated criteria pollutant construction emissions are summarized in **Table 4.3-5**.

TABLE 4.3-5 CRITERIA POLLUTANT EMISSIONS FROM PROJECT CONSTRUCTION

Pollutant	Average Daily Emissions (lbs/day)^a	Maximum Annual Construction Emissions (tpy)	BAAQMD Significance Thresholds for Construction-related Average Daily Emissions (lbs/day)^c	Threshold Exceeded?
ROG/VOC	32.3	4.26	54	No
CO	33.41	4.41	None	N/A
NOx	29.77	3.93	54	No
SOx	0.065	0.0086	None	N/A
PM10 ^b	1.55 (exhaust) 2.27 (fugitive)	0.205 (exhaust) 0.294 (fugitive)	82	No
PM2.5 ^b	1.54 (exhaust) 1.14 (fugitive)	0.203 (exhaust) 0.149 (fugitive)	54	No

Notes:

^a There are no annual construction-related BAAQMD thresholds of significance. The BAAQMD’s thresholds are average daily thresholds for construction. Accordingly, the average daily emissions reported are the maximum annual construction emissions averaged over 264 workdays per year (i.e. 22 days per month for 12 months).

^b The average daily PM exhaust emissions are compared to the BAAQMD’s significance thresholds for exhaust emissions. Fugitive emissions will be controlled with best management practices (BMPs), in accordance with the significance threshold.

^c BAAQMD 2017b, Table 2-1

Source: SV1 2020j, Table 11; SV1 2020p; Energy Commission staff analysis

The average daily emissions shown in **Table 4.3-5** are the maximum annual construction emissions averaged over 264 workdays per year (i.e. 22 days per month for 12 months). Excluding fugitive dusts, these average daily construction emissions are compared to the BAAQMD’s significance thresholds for construction-related average daily emissions. The BAAQMD’s significance thresholds for PM10 and PM2.5 emissions apply to exhaust

4 CalEEMod was developed by the California Air Pollution Control Officers Association in collaboration with California Air Districts. This model is a construction and emissions estimating computer model that estimates direct criteria pollutant and direct and indirect greenhouse gas emissions for a variety of land use projects. The model calculates maximum daily and annual emissions. The model also identifies mitigation measures to reduce criteria pollutant and GHG emissions along with calculating the benefits achieved from measures.

emissions only. **Table 4.3-5** shows that the average daily construction emissions would be lower than the thresholds of significance from the BAAQMD May 2017 CEQA Guidelines.

There is no numerical threshold for fugitive dust generated during construction in BAAQMD. BAAQMD considers fugitive dust emissions to be significant without BMPs. Consequently, dust emissions generated by project construction activities would be potentially significant. The BAAQMD May 2017 CEQA Guidelines require control of fugitive dust through BMPs in order to conclude that impacts from fugitive dust emissions are less than significant. The applicant proposed to incorporate the BAAQMD's recommended construction BMPs as a project design feature (as shown in PD AQ-1). Staff determines the mitigation measures to be sufficient to reduce emissions even further than construction period emissions levels that were analyzed by staff. In addition, staff recommends mitigation measure (MM) **MM AQ-1** to minimize the exhaust emissions during construction and be consistent with the estimates provided by the applicant. The project would not conflict with or obstruct implementation of the applicable air quality plan and impacts would be less than significant with the implementation of the PD AQ-1 and **MM AQ-1** during construction.

Readiness Testing and Maintenance

Less Than Significant with Mitigation Incorporated. Primary operational emissions would result from readiness testing and maintenance of the 39 standby diesel generators, offsite vehicle trips for worker commutes and material deliveries. Secondary operational emissions would result from facility upkeep, such as architectural coatings, consumer product use, landscaping, water use, waste generation, natural gas use for comfort heating, employee vehicle trips, and electricity use (SV1 2020a, Page 71).

Each of the primary emission sources are described in more detail below.

Stationary Sources – Generator Emissions. The project would include 36 emergency generators with 3.25-MW Cummins QSK95-G9 engines and three life safety emergency generators with 0.5-MW Cummins QSX15-G9 engines. The 36 larger engines would be equipped with Miratech SCR and DPF to achieve compliance with Tier 4 emission standards. The three smaller life safety engines would be Tier 2 engines equipped with DPF to meet Tier 4 emission standard for PM (SV1 2020j; SV1 2021i).

All generators would be operated for routine maintenance and testing to ensure they would function during an emergency event. During routine readiness testing, criteria pollutants and TACs would be emitted directly from the generators. Criteria pollutant emissions from generator testing are quantified using information provided by the manufacturer. SO₂ emissions are based on the maximum sulfur content allowed in California diesel (15 parts per million by weight), and an assumed 100 percent conversion of fuel sulfur to SO₂. DPM emissions are assumed equal to PM₁₀/PM_{2.5} emissions (SV1 2020a, Page 72).

In estimating the annual emissions, the applicant assumed that testing (weekly, monthly, quarterly, annual, and special testing) would occur for no more than 20 hours per year per engine. The Airborne Toxic Control Measure for Stationary Toxic Compression Ignition Engines (Title 17, Section 93115, CCR) limits testing to 50 hours per year per engine. However, it is the applicant's experience that each engine would be operated for considerably less than 50 hours a year. The applicant is proposing an annual readiness testing and maintenance schedule not to exceed 20 hours per year per engine. Readiness testing and maintenance usually occur at different load conditions. The applicant did a screening analysis at all load ranges and determined the worst-case emissions and impacts during readiness testing and maintenance would be at full load (SV1 2020a).

Emissions that could occur in the event of a power outage or other disruption, upset, or instability that triggers emergency operations would not occur on a regular or predictable basis (BAAQMD 2019) and are not included in the quantitative calculation of emissions, but are analyzed qualitatively below.

Miscellaneous Operational Emissions. Miscellaneous emissions would occur from operational activities such as worker commute travel, deliveries, energy and fuel use for facility electrical, heating and cooling needs, periodic use of architectural coatings, landscaping, etc. The applicant estimated the miscellaneous operational emissions using CalEEMod.

The BAAQMD CEQA Guidelines state that if the project's daily average or annual emissions of operational-related criteria air pollutants or precursors do not exceed any applicable threshold of significance listed in **Table 4.3-4**, the proposed project would not result in a cumulatively significant impact (BAAQMD 2017b).

Table 4.3-6 provides the annual and average daily criteria pollutant emission estimates for project readiness testing and maintenance using the emission source assumptions noted above. The average daily emissions are based on annual emissions averaged over 365 days per year. The NO_x emissions are conservatively estimated using Tier 2 emission factors, assuming the SCRs are not effective during readiness testing and maintenance (even though, depending on load, the SCR would be expected to kick on within 15 minutes, providing some additional emissions control for tests that run longer than this). **Table 4.3-6** shows that with NO_x emissions from the readiness testing and maintenance of the standby generators fully offset through the permitting process with the BAAQMD, the project would not exceed any of the BAAQMD emissions significance thresholds.

TABLE 4.3-6 CRITERIA POLLUTANT EMISSIONS FROM PROJECT READINESS TESTING AND MAINTENANCE

Source Type	ROG/VOC	CO	NOx	SO ₂	PM10	PM2.5
	Annual Emissions (tpy)					
Miscellaneous Operational Emissions	3.65	0.63	0.66	0.004	0.048	0.048
Diesel Storage Tanks	0.02	--	--	--	--	--
Standby Generators (Testing Only) ^a	0.85	1.86	16.24 ^b	0.019	0.056	0.056
Proposed Offsets ^c	--	--	(-16.24)	--	--	--
Total Mitigated Emissions	4.52	2.49	0.66	0.023	0.1	0.1
BAAQMD Annual Significance Thresholds	10	--	10	--	15	10
Mitigated Emissions Exceed BAAQMD Threshold? (Y/N)	N	N/A	N	N/A	N	N
Average Daily Emissions (lbs/day) ^d						
Miscellaneous Operational Emissions	20.00	3.45	3.62	0.02	0.26	0.26
Diesel Storage Tanks	0.11	--	--	--	--	--
Standby Generators (Testing Only)	4.68	10.18	88.99	0.10	0.31	0.31
Proposed Offsets ^c	--	--	(-88.99)	--	--	--
Total Mitigated Emissions	24.79	13.63	3.62	0.12	0.57	0.57
BAAQMD Average Daily Significance Thresholds	54	--	54	--	82	54
Mitigated Emissions Exceed BAAQMD Threshold? (Y/N)	N	N/A	N	N/A	N	N

Notes:

^a The annual emissions of the standby generators are estimated assuming readiness testing and maintenance would occur 20 hours per year per engine.

^b The NOx emissions for readiness testing and maintenance are conservatively estimated based on Tier 2 emission factors.

^c The estimated NOx PTE of the project would be less than 35 tpy (based on 20 hours of readiness testing and maintenance per year per engine and 100 hours of emergency operation per year per engine according to BAAQMD policy [BAAQMD 2019; SV1 2021i]). Therefore, the offset ratio would be 1:1.

^d The average daily emissions and offsets are based on the annual emissions averaged over 365 days per year.

Sources: SV1 2020a, Table 4.5-23; SV1 2020d, Response to Data Request 23; SV1 2020j, Table 2; SV1 2021i, Table 1A and Table 2; Energy Commission staff analysis

Table 4.3-6 shows that the project would not be expected to result in a cumulatively considerable net increase of criteria pollutants during the lifetime of the project, including readiness testing and maintenance of the standby generators. The NOx emissions of the standby generators during readiness testing and maintenance would be fully offset through the permitting process with the BAAQMD. Emissions from miscellaneous sources are not required to be offset under BAAQMD policy, which only applies to stationary sources.

In addition to the emissions shown in **Table 4.3-6**, ammonia would also be emitted from the urea used in the SCR system. Ammonia is considered a particulate precursor but not a criteria pollutant. Reactive with sulfur and nitrogen compounds, ammonia is common in the atmosphere primarily from natural sources or as a byproduct of tailpipe controls on motor vehicles. Currently, there are no agency-recommended models or procedures for estimating secondary particulate nitrate or sulfate formation from individual sources such as the proposed project. BAAQMD CEQA Guidelines do not include a significance threshold for ammonia emissions. The primary emissions of PM from this project are well below the BAAQMD significance threshold and do not require additional mitigation or trigger the need for offsets. In addition, the applicant conservatively estimated the ammonia emissions of the project to be 0.22 tpy (440 lbs/yr), assuming the SCR is effective after 15 minutes of warm-up in a full hour testing for a total of 20 hours per year per engine (SV1 2021j). However, during low load readiness testing and maintenance, it would take more time for the SCR to warm up, therefore, less ammonia would be emitted than estimated by the applicant. Therefore, staff expects the secondary PM impacts from ammonia emissions would be less than significant and would not require additional mitigation or offsets.

The project operations would not result in a cumulatively considerable net increase of any criteria pollutant, and these impacts would be less than significant.

Construction and Readiness Testing and Maintenance Overlap

Less Than Significant with Mitigation Incorporated. The three data center buildings would be constructed in three separate phases. The applicant assumes the engines in Phase 1 (SV12) would be under normal readiness testing and maintenance prior to the start of Phase 2 construction. Similarly, the engines in Phase 1 (SV12) and Phase 2 (SV18) would be under normal readiness testing and maintenance prior to the start of Phase 3 construction (SV1 2020j). There would be an overlap of emissions from construction and readiness testing and maintenance.

There would be two overlap scenarios: 1) overlap of emissions from the Phase 1 (SV12) engines (13 total) and the construction emissions from Phase 2 (SV18); and 2) overlap of emissions from the Phase 1 and Phase 2 engines (26 total) and the construction emissions from Phase 3 (SV19). The overall emissions for the second scenario would be higher than those for the first scenario. The applicant chose the second scenario for a worst-case overlap analysis. In addition to the construction emissions for the data center, the applicant also provided construction emissions associated with the 21 kV underground feeders that PG&E will construct as well as construction emissions for a sidewalk repair and replacement project requested by the City (SV1 2020p). Construction of the Santa Teresa Route 2 for the 21 kV underground feeders and the sidewalk improvement would occur during the Phase 3 construction. Staff computed the total Phase 3 construction emissions by adding the emissions from the SV19 building construction with the emissions from construction of the Santa Teresa Route 2 and the sidewalk improvement.

Table 4.3-7 provides the annual and daily criteria pollutant emission estimates for the overlapping period between the Phase 3 construction and readiness testing and maintenance of the Phase 1 and Phase 2 engines (26 total). The applicant estimated Phase 3 construction to last 17 months (SV1 2020j). The annualized emissions for Phase 3 construction shown in **Table 4.3-7** were calculated based on the total emissions for the 17-month period prorated to 12 months. The average daily emissions for construction are calculated based on the annual emissions averaged over 264 construction workdays per year (i.e. 22 average workdays per month). **Table 4.3-7** shows both exhaust and fugitive PM10 and PM2.5 emissions for Phase 3 construction. Staff conservatively included both the exhaust and fugitive emissions in calculating the total PM10 and PM2.5 emissions.

TABLE 4.3-7 CRITERIA POLLUTANT EMISSIONS FROM PROJECT CONSTRUCTION AND READINESS TESTING AND MAINTENANCE OVERLAP

Source Type	ROG/VOC	CO	NOx	SO ₂	PM10	PM2.5
	Annual Emissions (tpy)					
Phase 3 Construction (with construction of 21 kV underground feeders and sidewalk improvement) ^a	3.11	4.44	3.51	0.0085	0.19 (exhaust) 0.20 (fugitive)	0.19 (exhaust) 0.07 (fugitive)
Miscellaneous Operational Emissions for SV12 and SV18 ^b	2.43	0.42	0.44	0.003	0.032	0.032
Diesel Storage Tanks for SV12 and SV18 ^b	0.013	--	--	--	--	--
Standby Generators in SV12 and SV18 (testing only) ^c	0.57	1.24	10.83	0.012	0.037	0.037
Proposed Offsets ^d	--	--	(-10.83)	--	--	--
Total Mitigated Emissions	6.13	6.10	3.95	0.02	0.46 ^e	0.32 ^e
BAAQMD Annual Significance Thresholds	10	--	10	--	15	10
Mitigated Emissions Exceed BAAQMD Threshold? (Y/N)	N	N/A	N	N/A	N	N
Average Daily emissions (lbs/day) ^f						
Phase 3 Construction (with construction of 21 kV underground feeders and sidewalk improvement)	23.55	33.64	26.61	0.06	1.45 (exhaust) 1.51 (fugitive)	1.44 (exhaust) 0.50 (fugitive)
Miscellaneous Operational Emissions for SV12 and SV18	13.33	2.30	2.41	0.01	0.18	0.18
Diesel Storage Tanks for SV12 and SV18	0.07	--	--	--	--	--
Standby Generators in SV12 and SV18 (testing only)	3.12	6.78	59.33	0.07	0.20	0.20
Proposed Offsets ^d	--	--	(-59.33)	--	--	--
Total Mitigated Emissions	40.08	42.73	29.02	0.15	3.33 ^e	2.32 ^e
BAAQMD Average Daily Significance Thresholds	54	--	54	--	82	54

TABLE 4.3-7 CRITERIA POLLUTANT EMISSIONS FROM PROJECT CONSTRUCTION AND READINESS TESTING AND MAINTENANCE OVERLAP

Source Type	ROG/VOC	CO	NOx	SO ₂	PM10	PM2.5
	Annual Emissions (tpy)					
Mitigated Emissions Exceed BAAQMD Threshold? (Y/N)	N	N/A	N	N/A	N	N

Notes:

^a The annualized emissions for Phase 3 construction are based on the total emissions for the 17-month period prorated to 12 months.

^b The miscellaneous operational emissions and emissions from the diesel storage tanks for SV12 and SV18 were calculated as two thirds (2/3) of those shown in **Table 4.3-6**, assuming these emissions are proportional to the number of operational buildings.

^c The annual emissions of the standby generators are estimated assuming readiness testing and maintenance would occur 20 hours per year per engine.

^d The estimated NOx PTE of the project would be less than 35 tpy (based on 20 hours of readiness testing and maintenance per year per engine and 100 hours of emergency operation per year per engine according to BAAQMD policy [BAAQMD 2019; SV1 2021i]). Therefore, the offset ratio would be 1:1.

^e Staff conservatively included both the exhaust and fugitive emissions in calculating the total PM10 and PM2.5 emissions.

^f The average daily emissions for construction are conservatively based on the annual emissions averaged over 264 construction workdays per year (i.e. 22 average workdays per month). The average daily emissions for operational sources (miscellaneous, diesel storage tanks, and standby generators) are based on the annual emissions averaged over 365 days per year.

Sources: SV1 2020a, Table 4.5-23; SV1 2020d, Response to Data Request 23; SV1 2020j, Tables 2 and 14; SV1 2020l, revised Table 13; SV1 2020p; SV1 2021i; Energy Commission staff analysis

The miscellaneous operational emissions and emissions from the diesel storage tanks for SV12 and SV18 shown in **Table 4.3-7** were calculated as two thirds (2/3) of those shown in **Table 4.3-6**, assuming these emissions are proportional to the number of operational buildings. Annual emissions of the standby generators in SV12 and SV18 (26 total) are based on 20 hours of readiness testing and maintenance per year per engine. The NOx offsets shown in **Table 4.3-7** are calculated based on the NOx emissions from the standby generators in SV12 and SV18, which is consistent with **Table 4.3-6**. The average daily emissions for operational sources (miscellaneous, diesel storage tanks, and standby generators) are calculated based on the annual emissions averaged over 365 days per year.

Table 4.3-7 shows that with NOx emissions from readiness testing and maintenance of the standby generators fully offset through the permitting process with the BAAQMD, the project would not exceed any of the BAAQMD emissions significance thresholds during the overlapping period between construction and readiness testing and maintenance. Therefore, with the implementation of the PD AQ-1 and **MM AQ-1** during construction and NOx offsets for readiness testing and maintenance, the project would not result in a cumulatively considerable net increase of any criteria pollutant, and these impacts would be less than significant during the overlapping period between construction and readiness testing and maintenance.

MM AQ-1: To minimize the exhaust emissions during construction, the project owner shall implement the following measures:

- Use diesel construction equipment that meets US EPA Tier 4 interim or Tier 4 final emission standards if commercially available.
- If Tier 4 engines are not available, all construction equipment larger than 25 horsepower used at the site for more than two continuous days or 20 hours total shall meet US EPA emission standards for Tier 3 engines. If such are not available, Tier 2 or lower Tier engines using retrofit controls verified by ARB or US EPA can be used.
- Provide line power, if available, to the site to minimize the use of diesel-powered stationary equipment, such as generators.

Required Mitigation Measures: MM AQ-1

c. Would the project expose sensitive receptors to substantial pollutant concentrations?

This impact analysis considers the potential for exposure to substantial pollutant concentrations for both criteria pollutants in an Air Quality Impact Analysis (AQIA), and toxic air contaminants in a Health Risk Assessment (HRA). This section discusses criteria pollutant impacts from construction, readiness testing and maintenance, and during the overlapping period between construction and readiness testing and maintenance. Then the section discusses HRA results of TACs for construction, readiness testing and maintenance, and during the overlapping period between construction and readiness testing and maintenance. Finally, the section discusses issues associated with potential emergency operations.

Criteria Pollutant Air Quality Impact Analysis (AQIA)

Staff considers any new AAQS exceedance and substantial contribution to any existing AAQS exceedance caused by project emissions to be substantial evidence of potentially significant impacts that would require the evaluation of potential mitigation measures.

Construction AQIA

Less than Significant Impact. In response to staff data requests, the applicant provided the modeled ambient air quality concentrations caused by the construction emissions (SV1 2020j). The applicant used the American Meteorological Society/Environmental Protection Agency Regulatory Model (AERMOD [Version 19191]) to estimate ambient air quality impacts.

Meteorological Data. The applicant used the 5-year (2013-2017) record of hourly meteorological data provided by the BAAQMD. As explained in more detail below, the 2013-2017 meteorological data is the most current data for modeling purposes formally approved by BAAQMD as of February 2021. The meteorological data were collected at the San Jose International Airport surface station, which is located approximately 11.5 miles northwest of the project site and best represents the meteorology at the project

site. The concurrent daily upper air sounding data from the Oakland International Airport station were also included. The BAAQMD preprocessed the data with AERMET (version 18081), AERMOD's meteorological data preprocessor module, for direct use in AERMOD.

Modeling Assumptions for Construction. The applicant grouped the emission sources for the construction site into two categories: exhaust emissions and dust emissions. The applicant modeled the combustion equipment exhaust emissions as thirty-nine (39) point sources placed at regular 40-meter intervals around the construction area. The applicant modeled the construction fugitive dust emissions as area sources covering the construction area with an effective plume height of 0.5 meters. The applicant's dispersion modeling assumes construction activities would be limited to 10 hours per day (7 AM to 5 PM) consistent with the expected period of onsite construction activities generating both exhaust emissions and fugitive dust.

Table 4.3-8 shows the impacts of the project during construction period. The project impact column shows the worst-case impacts of the project from modeling. The background column shows the highest (or 3-year averages for the 24-hour PM_{2.5} and federal 1-hour NO₂ and SO₂ standards according to the forms of the standards) of the background concentrations from the last three years (2017-2019) of representative data. As explained above, the background data were collected from the Jackson Street station, except for CO and annual NO₂ background data, which were collected at the Knox Avenue station. The background PM₁₀ and PM_{2.5} concentrations are shown in **bold** because they already exceeded the corresponding limiting standards. The total impact column shows the sum of the existing background condition plus the maximum impact predicted by the modeling analysis for construction. The limiting standard column combines CAAQS and NAAQS, whichever is more stringent.

Table 4.3-8 shows that the impacts from project construction would be below the limiting standards for CO, NO₂, and SO₂. **Table 4.3-8** also shows that the existing 24-hour and annual PM₁₀ background concentrations are already above the CAAQS. The project would therefore contribute to existing exceedances of the 24-hour and annual PM₁₀ CAAQS. However, the modeled 24-hour PM₁₀ concentrations from project construction are below the US EPA PM₁₀ SILs of 5 µg/m³ for 24-hour impacts. The maximum modeled annual PM₁₀ concentration of 1.3 µg/m³ would exceed the PM₁₀ SILs of 1 µg/m³ for annual impacts. However, it should be noted that the results provided in **Table 4.3-8** are the maximum modeled impacts, which would occur at the project fence line. The impacts would decrease rapidly with distance from the fence line. For example, the maximum modeled annual PM₁₀ concentration of 1.3 µg/m³ (modeled at the project fence line) would decrease to about 0.4 µg/m³ at the nearest worker building to the southeast of the project (across Great Oaks Boulevard), which is lower than the PM₁₀ annual SILs level of 1 µg/m³. The sensitive/residential receptors are further away from the fence line and the maximum annual PM₁₀ impacts at these receptors would be much lower than the PM₁₀ annual SILs level of 1 µg/m³. Therefore, the PM₁₀ impacts of the project during construction period would be less than significant with the implementation

of PD AQ-1. In addition, construction is considered short-term and the construction impacts would be further reduced with the implementation of **MM AQ-1**.

TABLE 4.3-8 GOSBGF MAXIMUM IMPACTS DURING CONSTRUCTION ($\mu\text{g}/\text{m}^3$)

Pollutant	Averaging Time	Project Impact	Background	Total Impact	Limiting Standard	Percent of Standard
PM10	24-hour	3.6	122	125.6	50	251%
	Annual	1.3	23.1	24.4	20	122%
PM2.5	24-hour	1.8	42.9	44.7	35	128%
	Annual	0.6	12.9	13.5	12	113%
CO	1-hour	25.7	3,206.6	3,232.3	23,000	14%
	8-hour	11.1	2,634.0	2,645.1	10,000	26%
NO ₂ ^a	State 1-hour	20.0	162.0	182.0	339	54%
	Federal 1-hour	20.0	101.0	120.9	188	64%
	Annual	1.5	32.0	33.5	57	59%
SO ₂	State 1-hour	0.05	38.0	38.0	655	6%
	Federal 1-hour	0.05 ^b	7.0	7.0	196	4%
	24-hour	0.01	2.9	2.9	105	3%

Notes: Concentrations in **bold** type are those that exceed the limiting ambient air quality standard.

^a 1-hour and annual NO₂ impacts are evaluated with the US EPA Ambient Ratio Method 2 (ARM2) with US EPA-default minimum/maximum NO₂/NO_x ambient ratios of 0.5/0.9. The state 1-hour NO₂ total impacts include the maximum modeled project impact combined with maximum NO₂ background value. For the federal 1-hour NO₂ standard, staff conservatively combined the maximum modeled project impact with the 3-year average of 98th percentile daily maximum 1-hour background NO₂ to compute the total NO₂ impact.

^b To compute the total impacts for the 1-hour SO₂ NAAQS, staff conservatively combined the maximum modeled 1-hour SO₂ impacts to the 3-year average of the annual 99th percentile of the 1-hour daily maximum background.

Source: SV1 2020a with modeling files; SV1 2020j, Table 7 with modeling files; Energy Commission staff analysis

Similarly, **Table 4.3-8** also shows that the existing 24-hour and annual PM2.5 background concentrations are already above the limiting standards. The project would therefore contribute to existing exceedances of the 24-hour and annual PM2.5 standards. The maximum 24-hour PM2.5 impacts of 1.8 $\mu\text{g}/\text{m}^3$ would exceed the 24-hour PM2.5 SILs of 1.2 $\mu\text{g}/\text{m}^3$. However, the maximum modeled 24-hour PM2.5 impacts would occur at the project fence line and would decrease rapidly to 0.85 $\mu\text{g}/\text{m}^3$ at the nearest worker building to the northwest of the project (across San Ignacio Avenue), which is below the 24-hour PM2.5 SILs level of 1.2 $\mu\text{g}/\text{m}^3$. **Table 4.3-8** also shows that the maximum annual PM2.5 impacts during the construction period would be approximately 0.6 $\mu\text{g}/\text{m}^3$, which would also occur at project fence line. However, the maximum annual PM2.5 impacts would decrease rapidly to about 0.21 $\mu\text{g}/\text{m}^3$ at the nearest worker building to the southeast of the project (across Great Oaks Boulevard), which is less than the BAAQMD significance threshold for a project level annual ambient PM2.5 increase of 0.3 $\mu\text{g}/\text{m}^3$. The maximum 5-year average annual PM2.5 impacts would decrease to about 0.19 $\mu\text{g}/\text{m}^3$ at the nearest worker building to the southeast of the project (across Great Oaks Boulevard), which is less than the US EPA annual PM2.5 SILs level of 0.2 $\mu\text{g}/\text{m}^3$. The sensitive/residential receptors are further away from the fence line and the maximum

annual PM_{2.5} impacts at these receptors would be much lower than the BAAQMD significance threshold of 0.3 µg/m³ and US EPA annual PM_{2.5} SILs level of 0.2 µg/m³. The PM_{2.5} impacts of the project during its construction period would be less than significant with the implementation of PD AQ-1. In addition, construction is considered short-term and the construction impacts would be further reduced with the implementation of **MM AQ-1**.

Project construction would not expose sensitive receptors to substantial pollutant concentrations, and this impact would be less than significant.

Readiness Testing and Maintenance AQIA

Less Than Significant Impact. The applicant provided an ambient air quality impact analysis to compare worst-case ground-level impacts resulting from the project's readiness testing and maintenance with established state and federal ambient air quality standards. The applicant's modeling analysis, described in more detail below, included the standby generator engines' emissions from readiness testing and maintenance. The applicant's modeling analysis did not include other on-site emission sources, such as natural gas combustion emissions for space heating.

Modeling Assumptions for Readiness Testing and Maintenance. Stack parameters (e.g., stack height, exit temperature, stack diameter, and stack exit velocity) were based on the parameters given by the manufacturer and the applicant. The engines could be tested at all load conditions. The applicant's screening analysis modeled each engine at six different load conditions from 1 percent to 100 percent to determine the worst-case scenario to include in the refined modeling analysis.

It is assumed only one engine would be tested at any one time during a single hour between 7 AM and 5 PM and that no more than six engines would be tested in any one day. Although each engine would typically only be tested individually up to one hour at any one time, the applicant assumed each larger QSK95 engine would be tested up to 6 hours per day (between 7 AM and 5 PM) to conservatively represent up to 6 different engines being tested one hour each in any one day as appropriate for 3-hour, 8-hour, and 24-hour averaging times (i.e., 3 engines for 3-hour averaging times, 6 engines for 8-hour averaging times by ratioing 8-hour emissions by [6/8], and 6 engines for 24-hour averaging times by ratioing 24-hour emissions by [6/10] for the 10 hours [7 AM to 5 PM] modeled for each day). Similarly, the applicant assumed one smaller QSX15 engine would be tested for up to 3 hours per day to conservatively represent the 3 smaller engines being tested one hour each in any one day. For annual impacts analysis, the applicant assumed readiness testing and maintenance would occur 20 hours per year per engine (SV1 2020a; SV1 2020j; SV1 2021i).

Refined Modeling Analyses. The applicant performed refined modeling analyses for comparison to the short-term NAAQS with multi-year statistical forms (1-hour NO₂ and SO₂ and 24-hour PM_{2.5}). Since the engines would each be tested far less than 100 hours per year (limited to 20 hours per year), the applicant used annual average emission rate

in the 1-hour NO₂ and SO₂ NAAQS modeling analyses per US EPA guidance due to the statistical nature of these standards (US EPA 2011). However, for the 1-hour NO₂ CAAQS and 1-hour SO₂ CAAQS impacts analyses, the applicant modeled maximum 1-hour NO₂ and SO₂ emission rates according to the forms of the standards. The applicant also performed refined modeling analyses for annual CAAQS and NAAQS to include both the larger and smaller engines, each with its own stack parameters and emission rates.

For the 1-hour NO₂ modeling analysis, the applicant used the Plume Volume Molar Ratio Method (PVMRM) in AERMOD, as described in US EPA's Guideline on Air Quality Models (US EPA 2017). The applicant used an in-stack NO₂/NO_x ratio of 0.1 (10 percent) based on a conservative assessment of this type and size of diesel engine in US EPA's Nitrogen Dioxide/Nitrogen Oxide In-Stack Ratio (ISR) database (US EPA 2020c). The applicant used hourly ozone data (concurrent with the meteorological data [2013-2017]) from the Jackson Street monitoring station in the 1-hour NO₂ modeling analysis. The NO₂ background data were also from the Jackson Street monitoring station. Consistent with guidance from California Air Pollution Control Officers Association (CAPCOA) and US EPA, the applicant obtained the NO₂ data on a contiguous seasonal basis by hour for the three consecutive years of monitoring data (December 2014-November 2017), concurrent with the last 3 years of meteorological data used for modeling. The applicant conservatively added the maximum hourly background values for the season/hour to the modeled hourly NO₂ project impacts for the 1-hour NO₂ CAAQS analysis. Consistent with US EPA 2011 guidance document (US EPA 2011), the applicant added the three-year average of the second-highest hourly background values for the season/hour to the modeled NO₂ project impacts for the 1-hour NO₂ NAAQS analysis. For both 1-hour NO₂ NAAQS and CAAQS analysis, the applicant assumed only one generator would operate at a time for readiness testing and maintenance purposes.

In October 2020, staff received informal meteorological data for 2018 and 2019 from BAAQMD. Staff processed the hourly ozone data for 2018 and 2019 and maximum seasonal hourly NO₂ background data for the most recent three years (December 2016-November 2019). Staff did an independent modeling analysis of the 1-hour NO₂ CAAQS impacts using the updated data for 2018 and 2019. The maximum total 1-hour NO₂ impact from staff's independent modeling analysis was about 1 µg/m³ less than the applicant modeled impacts using data from 2013-2017. Staff believes using the applicant modeled impacts for 2013-2017 would be more conservative than those for 2018-2019. In addition, the 2018-2019 meteorological data was provided by the BAAQMD informally for staff to complete supplemental modeling analysis for another project. As of February 2021, the 2013-2017 meteorological data is still the most current data for modeling purposes formally approved by BAAQMD. Therefore, the impacts shown in this section were modeled using data for 2013-2017.

Table 4.3-9 shows the maximum impacts from standby generator engine readiness testing and maintenance. The project impact column shows the worst-case impacts of the project from modeling using data for 2013-2017. The background concentrations (except for 1-hour NO₂ as explained above) shown in **Table 4.3-9** are the highest (or 3-

year averages for the 24-hour PM_{2.5} and federal 1-hour SO₂ standards according to the forms of the standards) from the last three years (2017-2019) of representative data. As explained above, the background data were collected from the Jackson Street station, except for CO and annual NO₂ background data, which were collected at the Knox Avenue station. The background PM₁₀ and PM_{2.5} concentrations are shown in **bold** because they already exceeded the corresponding limiting standards. Except for the 1-hour NO₂ total impacts, the total impact column shows the sum of the existing background condition plus the maximum impact predicted by the modeling analysis for readiness testing and maintenance. The 1-hour NO₂ total impacts shown in **Table 4.3-9** include project impact and a seasonal hour of day background. More details regarding how the 1-hour NO₂ impacts are modeled is explained in the text above. The limiting standard column combines CAAQS and NAAQS, whichever is more stringent.

Table 4.3-9 shows that the standby generator engine readiness testing and maintenance would not cause exceedances of the CO, NO₂, or SO₂ standards. **Table 4.3-9** also shows that the existing PM₁₀ and PM_{2.5} background concentrations are already above the limiting standards. The project would therefore contribute to existing exceedances of the PM₁₀ and PM_{2.5} standards. But the modeled PM₁₀ concentrations from project standby generator engine testing are much below the US EPA PM₁₀ SILs of 5 µg/m³ for 24-hour impacts and 1 µg/m³ for annual impacts. The modeled PM_{2.5} concentrations from project standby generator engine testing are also much below the US EPA PM_{2.5} SILs of 1.2 µg/m³ for 24-hour impacts and 0.2 µg/m³ for annual impacts. **Table 4.3-9** also shows that the annual PM_{2.5} project impacts would be much below the BAAQMD threshold for annual-average PM_{2.5} of 0.3 µg/m³, for risk and hazards.

Table 4.3-9 shows that standby generator engine readiness testing and maintenance would not expose sensitive receptors to substantial pollutant concentrations, and this impact would be less than significant.

Construction and Readiness Testing and Maintenance Overlap AQIA

Less Than Significant Impact. In response to staff data requests, the applicant provided the modeled ambient air quality concentrations during the worst-case overlapping period of Phase 3 (SV19) construction with readiness testing and maintenance of the Phase 1 and Phase 2 engines.

Similar to the construction impacts analysis, the applicant grouped the emission sources for the Phase 3 (SV19) construction site into two categories: exhaust emissions and dust emissions. The applicant modeled the combustion equipment exhaust emissions from Phase 3 (SV19) construction as 11 point sources placed at regular 30-meter intervals around the construction area of SV19. The applicant modeled the construction fugitive dust emissions as area sources covering the construction area with an effective plume height of 0.5 meters. The applicant's dispersion modeling assumes construction activities would be limited to 10 hours per day (7 AM to 5 PM) consistent with the expected period of onsite construction activities generating both exhaust emissions and fugitive dust. The modeling parameters for the readiness testing and maintenance of the Phase 1 and Phase

2 engines remain the same as those used for the modeling analysis of the readiness testing and maintenance of all engines.

TABLE 4.3-9 GOSBGF MAXIMUM IMPACTS DURING READINESS TESTING AND MAINTENANCE ($\mu\text{g}/\text{m}^3$)

Pollutant	Averaging Time	Project Impact	Background	Total Impact	Limiting Standard	Percent of Standard
PM10	24-hour	0.34	122	122.3	50	245%
	Annual	0.013	23.1	23.1	20	116%
PM2.5	24-hour ^a	0.34	42.9	43.2	35	124%
	Annual	0.013	12.9	12.9	12	108%
CO	1-hour	87.2	3,206.6	3,293.8	23,000	14%
	8-hour	37.5 ^b	2,634.0	2,671.5	10,000	27%
NO ₂ ^c	State 1-hour ^d	-	-	290.7 ^b	339	86%
	Federal 1-hour ^d	-	-	94.6	188	50%
	Annual	3.39 ^b	32.0	35.4	57	62%
SO ₂	State 1-hour ^d	0.78	38.0	38.7	655	6%
	Federal 1-hour ^d	0.003	7.0	7.0	196	4%
	24-hour	0.21	3.9	4.1	105	4%

Notes: Concentrations in **bold** type are those that exceed the limiting ambient air quality standard.

^a To compute the total impacts for the 24-hour PM2.5 NAAQS, staff conservatively combined the maximum modeled 24-hour PM2.5 impacts to the 3-year average of 98th percentile PM2.5 background.

^b Staff presents the impacts directly from modeling files. This note indicates that these modeled results are slightly higher than those presented in Table 6 in SV1 2021i. For 1-hour NO₂ state standard, the result is from staff's independent modeling analysis by re-running AERMOD for the worst-case engine. The result is slightly higher than that presented in Table 6 in SV1 2021i (290.7 $\mu\text{g}/\text{m}^3$ vs. 288.9 $\mu\text{g}/\text{m}^3$). However, the slight differences between the modeled results and those shown in Table 6 in SV1 2021i do not change the conclusions regarding the project impacts.

^c The 1-hour NO₂ impacts are evaluated using the PVMRM option in AERMOD and an in-stack NO₂/NO_x ratio of 0.10. The state 1-hour NO₂ total impacts include project impact combined with maximum seasonal hourly NO₂ background values and the federal 1-hour NO₂ total impacts include project impact combined with three-year average of the second-highest seasonal hourly NO₂ background values. Annual NO₂ impacts are evaluated with the ARM2 with US EPA-default minimum/maximum NO₂/NO_x ambient ratios of 0.5/0.9.

^d Impacts for the 1-hour statistical-based NO₂ and SO₂ NAAQS are based on the annual average emissions per US EPA guidance documents for intermittent sources like emergency generators (US EPA 2011). Impacts for the 1-hour NO₂ and SO₂ CAAQS are based on the maximum 1-hour emission rates since these CAAQS are "values that are not to be exceeded".

Sources: SV1 2021i, Table 6 with modeling files; and Energy Commission staff analysis

Table 4.3-10 shows that the impacts from project construction and readiness testing and maintenance overlap would be below the limiting standards for CO, NO₂, and SO₂. **Table 4.3-10** also shows that the existing PM10 and PM2.5 background concentrations are already above the limiting standards. The project would therefore contribute to existing exceedances of the PM10 and PM2.5 standards. The modeled worst-case PM10 concentrations from the overlapping period would exceed the PM10 SILs of 5 $\mu\text{g}/\text{m}^3$ for

24-hour impacts and $1 \mu\text{g}/\text{m}^3$ for annual impacts. However, it should be noted that the results provided in **Table 4.3-10** are the maximum impacts, which would occur at the project fence line. The impacts would decrease rapidly with distance from the fence line. The maximum modeled 24-hour PM₁₀ concentration of $6.0 \mu\text{g}/\text{m}^3$ (modeled at the project fence line) would decrease to $2.2 \mu\text{g}/\text{m}^3$ at the nearest worker building to the northwest of the project (across San Ignacio Avenue), which is lower than the PM₁₀ SILs of $5 \mu\text{g}/\text{m}^3$ for 24-hour impacts. Similarly, the maximum modeled annual PM₁₀ concentration of $1.7 \mu\text{g}/\text{m}^3$ (at the fence line) would exceed the PM₁₀ annual SILs level of $1 \mu\text{g}/\text{m}^3$. However, the maximum annual PM₁₀ concentration would decrease rapidly to $0.23 \mu\text{g}/\text{m}^3$ at the nearest worker building to the northwest of the project (across San Ignacio Avenue), which is lower than the PM₁₀ annual SILs level of $1 \mu\text{g}/\text{m}^3$. The sensitive/residential receptors are further away from the fence line and the maximum PM₁₀ impacts at these receptors would be much lower than the PM₁₀ SILs. In addition, the overlapping period between construction and readiness testing and maintenance is considered short-term and the impacts would be dominated by the construction emissions. The PM₁₀ impacts of the project during the overlapping period would be less than significant with the implementation of PD AQ-1. Impacts during the overlapping period would be further reduced with the implementation of **MM AQ-1**.

Table 4.3-10 also shows that the modeled worst-case PM_{2.5} concentrations from the overlapping period would exceed the US EPA 24-hour PM_{2.5} SILs of $1.2 \mu\text{g}/\text{m}^3$, annual PM_{2.5} SILs of $0.2 \mu\text{g}/\text{m}^3$, and BAAQMD significance threshold of $0.3 \mu\text{g}/\text{m}^3$ for annual PM_{2.5} impacts. However, the maximum PM_{2.5} impacts during the overlapping period would occur at project fence line and the impacts would decrease rapidly with distance from the fence line. The maximum 24-hour PM_{2.5} impacts would decrease to $0.87 \mu\text{g}/\text{m}^3$ at the nearest worker building to the northwest of the project (across San Ignacio Avenue), which is less than the 24-hour PM_{2.5} SILs of $1.2 \mu\text{g}/\text{m}^3$. The maximum annual PM_{2.5} impacts would decrease to about $0.1 \mu\text{g}/\text{m}^3$ at the nearest worker building to the northwest of the project (across San Ignacio Avenue), which is less than the US EPA annual PM_{2.5} SILs level of $0.2 \mu\text{g}/\text{m}^3$ and the BAAQMD significance threshold of $0.3 \mu\text{g}/\text{m}^3$ for annual impacts. The sensitive/residential receptors are further away from the fence line and the maximum annual PM_{2.5} impacts at these receptors would be much lower than the US EPA SILs levels and the BAAQMD significance threshold. In addition, the overlapping period between construction and readiness testing and maintenance is considered short-term and the impacts would be dominated by the construction emissions. The PM_{2.5} impacts of the project during the overlapping period would be less than significant with the implementation of PD AQ-1. Impacts during the overlapping period would be further reduced with the implementation of **MM AQ-1**.

The project would not expose sensitive receptors to substantial pollutant concentrations during the overlapping period of construction and readiness testing and maintenance, and this impact would be less than significant.

TABLE 4.3-10 GOSBGF MAXIMUM IMPACTS DURING CONSTRUCTION AND READINESS TESTING AND MAINTENANCE OVERLAP ($\mu\text{g}/\text{m}^3$)

Pollutant	Averaging Time	Project Impact	Background	Total Impact	Limiting Standard	Percent of Standard
PM10	24-hour	6.0	122	128.0	50	256%
	Annual	1.7	23.1	24.8	20	124%
PM2.5	24-hour ^a	2.0	42.9	44.9	35	128%
	Annual	0.6	12.9	13.5	12	113%
CO	1-hour	88.7 ^b	3,206.6	3,295.3	23,000	14%
	8-hour	45.6 ^b	2,634.0	2,679.6	10,000	27%
NO ₂ ^c	State 1-hour	-	-	289.1	339	85%
	Federal 1-hour ^d	-	-	91.7 ^b	188	49%
	Annual	3.5	32.0	35.5	57	62%
SO ₂	State 1-hour	0.9 ^b	38.0	38.8	655	6%
	Federal 1-hour	0.9 ^e	7.0	7.9	196	4%
	24-hour	0.2	3.9	4.1	105	4%

Notes: Concentrations in **bold** type are those that exceed the limiting ambient air quality standard.

^a To compute the total impacts for the 24-hour PM2.5 NAAQS, staff conservatively combined the maximum modeled 24-hour PM2.5 impacts to the 3-year average of 98th percentile PM2.5 background.

^b Staff presents the impacts directly from modeling files. This note indicates that these modeled results are slightly different from those presented in Table 15 in SV1 2021i. However, the slight differences between the modeled results and those shown in Table 15 in SV1 2021i do not change the conclusions regarding the project impacts.

^c The 1-hour NO₂ impacts are evaluated using the PVMRM option in AERMOD and an in-stack NO₂/NO_x ratio of 0.10. The state 1-hour NO₂ total impacts include project impact combined with maximum seasonal hourly NO₂ background values and the federal 1-hour NO₂ total impacts include project impact combined with three-year average of the second-highest seasonal hourly NO₂ background values. Annual NO₂ impacts are evaluated with the ARM2 with US EPA-default minimum/maximum NO₂/NO_x ambient ratios of 0.5/0.9.

^d Impacts of the engines for the 1-hour statistical-based NO₂ NAAQS are based on the annual average emissions per US EPA guidance documents for intermittent sources like emergency generators (US EPA 2011). Impacts of the engines for the 1-hour NO₂ CAAQS are based on the maximum 1-hour emission rates since these CAAQS are "values that are not to be exceeded". Construction 1-hour NO₂ impacts are based on the annual average emissions averaged over 264 workdays per year (i.e. 22 days per month for 12 months) and 10 hours per day.

^e To compute the total impacts for the 1-hour SO₂ NAAQS, staff conservatively combined the maximum modeled 1-hour SO₂ impacts to the 3-year average of the annual 99th percentile of the 1-hour daily maximum background.

Sources: SV1 2021i, Table 15 with modeling files; and Energy Commission staff analysis

Localized CO Impacts

Less Than Significant Impact. Engine exhaust may elevate localized CO concentrations, resulting in "hot spots". Receptors exposed to these CO hot spots may have a greater likelihood of developing adverse health effects. CO hot spots are typically observed at heavily congested intersections where a substantial number of vehicles idle for prolonged durations throughout the day. BAAQMD screening guidance indicates that a project would

not exceed the CO significance threshold if a project's traffic projections indicate traffic levels would not increase at any affected intersection to more than 44,000 vehicles per hour or at any affected intersections to more than 24,000 vehicles per hour where vertical and/or horizontal mixing is substantially limited.

The proposed project would generate a small number of vehicle trips to the site. These trips include workers, material, and equipment deliveries. It is unlikely that the addition of vehicle trips from the project on any roadway in the vicinity of the project site would result in an exceedance of the BAAQMD screening threshold. As a result, the additional vehicle trips associated with the project would result in a negligible effect on CO concentrations in the vicinity of the project site.

Table 4.3-8, Table 4.3-9, and Table 4.3-10 show that the CO impacts from project construction, the readiness testing and maintenance of the standby engine generators, and the overlapping period between construction and readiness testing and maintenance would be well below the limiting standards and BAAQMD significance thresholds of 20.0 ppm (23,000 $\mu\text{g}/\text{m}^3$) for 1-hour average concentrations and 9.0 ppm (10,000 $\mu\text{g}/\text{m}^3$) for 8-hour average concentrations. CO impacts would be less than significant.

Required Mitigation Measures: None

Health Risk Assessment (HRA) for Toxic Air Contaminants

The Health Risk Assessment (HRA) for the project was conducted separately for the project construction, the standby generator readiness testing and maintenance, and the overlapping period of construction and readiness testing and maintenance.

Construction HRA

Less Than Significant Impact. As mentioned above, project construction would include three separate phases for each of the three buildings. The applicant estimated the actual construction period for the buildings, parking lots, engine pad areas, and support infrastructure, would be approximately 4.3 years (52 months [SV1 2020j]). Onsite construction emissions from construction of the GOSBGF would result from site preparation and grading activities, building erection and parking lot construction activities, "finish" construction activities, and the use of onsite construction equipment. Offsite construction emissions would be derived primarily from materials transport to and from the site, and worker travel. In the HRA for construction activities, the applicant considered diesel particulate matter (DPM) as the only TAC because it is the approved surrogate for diesel exhaust. Since DPM has no acute REL, acute HI values were not calculated in applicant's HRA. Staff supplemented the HRA by evaluating the acute hazard index of speciated total organic gases (TOG) in diesel exhaust. The TACs from speciated TOG include: 1,3-butadiene, acetaldehyde, benzene, formaldehyde, methanol, methyl ethyl ketone (MEK), styrene, toluene, and xylene.

AERMOD (version 19191) dispersion modeling and the Hotspots Analysis and Reporting Program (HARP) Air Dispersion Modeling and Risk Tool (ADMRT) (version 19121) were

used to estimate carcinogenic and chronic health risks at residential, sensitive, and worker receptors. The US EPA approved AERMOD (version 19191) air dispersion modeling program was used to derive the maximum annual and hourly ground-level concentrations. The modeled output (maximum ground-level concentrations) was used by HARP (ADMRT 19121) to prepare the HRA. The applicant modeled the combustion equipment diesel exhaust emissions as thirty-nine (39) point sources covering the construction area. The applicant assumed construction to occur for 10 hours per day (7 AM to 5 PM). The AERMOD dispersion model was run using maximum annual exhaust particulate matter emission rates to get the worst-case DPM concentrations. The AERMOD results are then used in HARP to calculate the health risks. The applicant used a 5-year exposure period to conservatively represent the 4.3-year construction period (HARP does not allow fractions of years as exposure values).

The results of the construction HRA are presented in **Table 4.3-11**, which shows that the excess cancer risks, chronic HIs, and acute HIs at the Maximally Exposed Individual Resident (MEIR), Maximally Exposed Individual Worker (MEIW), and Maximally Exposed Individual Sensitive Receptor (MEISR) would be less than the BAAQMD’s significance thresholds.

TABLE 4.3-11 CONSTRUCTION -- MODELED RECEPTOR MAXIMUM HEALTH RISK

Receptor Type	Cancer Risk Impact (in one million)	Chronic Non-Cancer Hazard Index (HI)	Acute Non-Cancer Hazard Index (HI)
MEIR ¹	3.59	0.0016	0.0020
MEIW ²	3.77	0.014	0.0043
MEISR ³	2.74	0.0012	0.0020
BAAQMD Threshold	10	1	1

Notes:

¹ Maximally Exposed Individual Resident (MEIR). The MEIR for cancer risk impact and chronic HI is at the residence located about 2,398 ft southeast of the project boundary (southeast of Bernal Road). The MEIR for acute HI is at the residence about 810 ft southwest of the project boundary (west of the intersection of Santa Teresa Boulevard and San Ignacio Avenue).

² Maximally Exposed Individual Worker (MEIW). It is located about 240 ft southeast of the project boundary (southeast of Great Oaks Boulevard) for cancer risk impact, chronic HI, and acute HI.

³ Maximally Exposed Individual Sensitive Receptor (MEISR). The MEISR for cancer risk impact and chronic HI is at the Los Paseos Elementary School boundary, which is about 2,953 ft southeast of the project boundary. The MEISR for acute HI is at the Centro Armonia Spanish School-Santa Teresa, which is about 1,300 ft south-southeast of the project boundary.

Source: SV1 2020j, Table 10 with modeling files; Energy Commission staff analysis

It should be noted that the risk values shown in **Table 4.3-11** are the highest of those modeled for each type of sensitive receptors. The risk values at other locations for each type of sensitive receptors would be lower than those shown in **Table 4.3-11**. For example, the maximum cancer risk at the nearest residential area (starting from 710 ft to the south/southwest/west of the project) would be 1.6 in 1 million, which is lower than the cancer risk of 3.59 in 1 million at the MEIR (southeast of Bernal Road) shown in **Table 4.3-11**. Even though the MEIR for cancer risks is further away from the project (about 2,398 ft southeast of the project boundary), the cancer risk at the MEIR would be higher

than those at the nearest residential area to the south/southwest/west of the project because the prevailing wind blowing from northwest to southeast determines the pattern of long-term (annual) concentrations. However, the acute HI is determined by the maximum 1-hour concentrations modeled in any hour of the 5 modeling years. Therefore, the MEIR for the acute HI is at the nearest residential area (about 810 ft southwest of the project boundary).

Similarly, the cancer risk at the Centro Armonia Spanish School-Santa Teresa would be 2.5 in 1 million, which is a little lower than the cancer risk of 2.74 in 1 million estimated at the MEISR located at the Los Paseos Elementary School boundary (about 2,953 ft southeast of the project). The cancer risks at the Stratford School including daycare (about 1,800 ft southwest of the project), the Santa Teresa Elementary including preschool (about 2,900 ft west of the project), the Bernal Intermediate School (about 3,090 ft southwest of the project), and the Genius Kids (about 3,270 ft southeast of the project boundary) would be 0.6 in 1 million, 0.4 in 1 million, 0.3 in 1 million, and 1.8 in 1 million respectively, all of which are lower than the cancer risk of 2.74 in 1 million estimated at the MEISR shown in **Table 4.3-11**.

The cancer risks at Kaiser Foundation Hospital Home Health-Santa Clara and RCCA – Purple Hills Drive would be 0.8 in 1 million and 0.6 in 1 million respectively, lower than the cancer risk of 2.74 in 1 million estimated at the MEISR shown in **Table 4.3-11**. The cancer risks at the Safe Haven Villa Care Home, the Ebadat Residential Care Home #4, and the Muna’s Residential Care Home III would be 1.0 in 1 million, 0.4 in 1 million, and 0.3 in 1 million respectively, lower than the cancer risk of 2.74 in 1 million estimated at the MEISR shown in **Table 4.3-11**.

Like cancer risks, the chronic non-cancer HI and acute HI at other locations for each type of sensitive receptors would be lower than those at the maximally exposed individual receptors shown in **Table 4.3-11**. Since the chronic non-cancer HI and acute HI shown in **Table 4.3-11** are much below the significance threshold of 1, the chronic non-cancer HI and acute HI at other locations of each type of sensitive receptors would be even lower and, therefore, are not discussed in detail.

The applicant also modeled the cancer risk at the point of maximum impact (PMI) to be 36.9 in 1 million, which is higher than 10 in 1 million. However, the PMI is located on the project fence line, neither a residential nor a sensitive receptor. In addition, the chronic non-cancer hazard index at the PMI would be 0.016, which is much less than the threshold of 1.0. Staff does not expect a person to stay at the PMI location for the assumed 5-year exposure duration for construction. Additionally, the BAAQMD CEQA Air Quality Guidelines note that the health risk evaluation should be considered for the maximally exposed individual (MEI). Per BAAQMD Rule 2-5-212 and BAAQMD Rule 11-18-213, the MEI is defined as a person that may be located at the receptor location where the highest exposure to toxic air contaminants emitted from a given source or project is

predicted, as shown by an APCO-approved HRA.^{5,6} The definitions go on to specify that MEI locations consider exposure to residents, workers, and students. As such, the 10 in one million risk threshold only applies to MEI receptor locations and does not apply to the PMI, unless the PMI is co-located with a MEI. The PMI in this evaluation is not located in a MEI location and it is not appropriate to compare the health risks at the PMI to the significance thresholds for the health risk evaluation. Since the PMI is not located at a receptor location where a person may reasonably be located on a long-term basis, the 10 in 1 million cancer risk threshold is not applicable to the PMI location.

Health risks at nearby worker/residential/sensitive receptors would all be below the significance thresholds. The health risks from project construction would be less than significant with the implementation of PD AQ-1. In addition, impacts during project construction would be further reduced with the implementation of **MM AQ-1**.

Readiness Testing and Maintenance HRA

Less Than Significant Impact. Project operation would include TAC emissions from the diesel-fired emergency standby engines. The only on-site emissions included in the applicant's HRA are the TAC emissions from testing and maintenance of the diesel-fueled emergency standby engines. Offsite vehicle trips for worker commutes and material deliveries were not included in the HRA.

The applicant evaluated DPM as the only TAC in the project readiness testing and maintenance HRA. As mentioned above, DPM is the approved surrogate compound for diesel fuel combustion for purposes of health risk assessment. DPM emissions resulting from diesel stationary combustion were assumed equal to PM₁₀/PM_{2.5} emissions. The applicant estimated the PM emissions using the emission rate of 0.015 grams per brake horsepower-hour (g/bhp-hr) as confirmed by Miratech (SV1 2021I). Since DPM has no acute REL, acute HI values were not calculated in applicant's HRA. Staff supplemented the HRA by evaluating the acute hazard index of speciated TOG in diesel exhaust. The TACs from speciated TOG include: 1,3-butadiene, acetaldehyde, benzene, formaldehyde, methanol, methyl ethyl ketone (MEK), styrene, toluene, and xylene.

As mentioned above, the 36 larger engines would comply with US EPA Tier 4 emission standards using both SCR and DPF emission controls. Ammonia would be emitted from the urea used in the SCR system, increasing the health risk. However, the ammonia emissions are estimated to be 0.61 lb/hr and 440 lbs/yr, which would be much lower than the trigger levels of 7.1 lbs/hr and 7,700 lbs/yr specified in the BAAQMD Regulation 2 Rule 5 (SV1 2021j). Therefore, the resulting health risks due to ammonia emissions are not expected to cause or contribute significantly to adverse health effects. Additional

5 Per BAAQMD Regulation 2 Rule 5: New Source Review of Toxic Air Contaminants:
https://www.baaqmd.gov/~media/dotgov/files/rules/reg-2-rule-5-new-source-review-of-toxic-air-contaminants/documents/rg0205_120716-pdf.pdf?la=en

6 Per BAAQMD Regulation 11 Rule 18: Reduction of Risk from Air Toxic Emissions at Existing Facilities:
https://www.baaqmd.gov/~media/dotgov/files/rules/regulation-11-rule-18-reduction-of-risk-from-air-toxic-emissions-at-existing-facilities/documents/20171115_fr_1118-pdf.pdf?la=en

health risk assessment for the ammonia emissions is not necessary. However, for completeness, staff also included ammonia emissions in staff's supplemental HRA for acute HI.

The California Air Resources Board's Airborne Toxic Control Measures (ATCM) limits each engine to no more than 50 hours annually for reliability purposes (i.e., testing and maintenance). However, it is the applicant's experience that each engine would be operated for considerably less than 50 hours a year. The applicant is proposing an annual readiness testing and maintenance schedule not to exceed 20 hours per year per engine. However, in the HRA for readiness testing and maintenance, the applicant conservatively assumed 50 hours per year per engine to compute the DPM emissions and health risks, more than the proposed 20 hours per year per engine.

Air would be the dominant pathway for public exposure to chemical substances released by the project. Emissions to the air would consist primarily of combustion by-products produced by the diesel-fired emergency standby engines. Potential health risks from combustion emissions would occur almost entirely by direct inhalation. To be conservative, the applicant included additional pathways in the health risk modeling; however, direct inhalation is considered the most likely exposure pathway. The applicant conducted the risk assessment in accordance with guidance established by OEHHA (OEHHA 2015) and ARB (SV1 2020a, Page 89).

When the applicant updated the air quality and public health analysis in March 2021 (SV1 2021i), the HRA for readiness testing and maintenance of the standby generators was not updated because the applicant expects the overall risks would be lower than those shown in the prior analysis (SV1 2020i). Staff performed an independent HRA for readiness testing and maintenance of the standby generators based on the revised DPM concentrations provided by the applicant. The results of staff's HRA for readiness testing and maintenance of the standby generators are presented in **Table 4.3-12**. The cancer risks and chronic HIs at PMI and MEIW from staff's HRA are slightly lower than those shown in applicant's prior analysis. The cancer risks and chronic HIs at MEIR and MEISR from staff's HRA are the same as those shown in applicant's prior analysis.

Table 4.3-12 shows that the cancer risks, chronic HIs, and acute HIs at the MEIR, MEIW, and MEISR during readiness testing and maintenance would be less than the BAAQMD's significance thresholds.

It should be noted that the risk values shown in **Table 4.3-12** are the highest of those modeled for each type of sensitive receptors. The risk values at other locations for each type of sensitive receptors would be lower than those shown in **Table 4.3-12**. For example, the maximum cancer risk at the nearest residential area (starting from 710 ft to the south/southwest/west of the project) would be about 1.13 in 1 million, which is lower than the cancer risk of 2.98 in 1 million at the MEIR shown in **Table 4.3-12**. Even though the MEIR for cancer risk is further away from the project (about 2,398 ft southeast of the project boundary), the cancer risk at the MEIR would be higher than those at the nearest residential area to the south/southwest/west of the project because

the prevailing wind blowing from northwest to southeast determines the pattern of long-term (annual) concentrations. However, the acute HI is determined by the maximum 1-hour concentrations modeled in any hour of the 5 modeling years. Therefore, the MEIR for the acute HI is at the nearest residential area (about 790 ft south of the project boundary).

Similarly, the cancer risk at the Centro Armonia Spanish School-Santa Teresa, which is the closest daycare from the project (about 1,300 ft to the south-southeast), would be 2.17 in 1 million, which is a little lower than the cancer risk of 2.21 in 1 million estimated at the MEISR located at the Los Paseos Elementary School boundary (about 2,953 ft southeast of the project). The cancer risks at the Stratford School including daycare (about 1,800 ft southwest of the project), the Santa Teresa Elementary including preschool (about 2,900 ft west of the project), the Bernal Intermediate School (about 3,090 ft southwest of the project), and the Genius Kids (about 3,270 ft southeast of the project boundary) would be about 0.4 in 1 million, 0.3 in 1 million, 0.2 in 1 million, and 1.5 in 1 million respectively, all of which are lower than the cancer risk of 2.21 in 1 million estimated at the MEISR shown in **Table 4.3-12**.

TABLE 4.3-12 READINESS TESTING AND MAINTENANCE -- MODELED RECEPTOR MAXIMUM HEALTH RISK

Receptor Type	Cancer Risk Impact (in one million)	Chronic Non-Cancer Hazard Index (HI)	Acute Non-Cancer Hazard Index (HI)
MEIR ¹	2.98	0.00069	0.055
MEIW ²	4.95	0.0038	0.098
MEISR ³	2.21	0.00051	0.049
BAAQMD Threshold	10	1	1

Notes:

¹ Maximally Exposed Individual Resident (MEIR). The MEIR for cancer risk impact and chronic HI is at the residence located about 2,398 ft southeast of the project boundary (southeast of Bernal Road). The MEIR for acute HI is at the residence about 790 ft south of the project boundary (west of the intersection of Santa Teresa Boulevard and Vineyard Drive/Great Oaks Boulevard).

² Maximally Exposed Individual Worker (MEIW). The MEIW for cancer risk impact and chronic HI is located at about 240 ft southeast of the project boundary (southeast of Great Oaks Boulevard). The MEIW for acute HI is located at about 230 ft northeast of the project boundary (northeast of Vie del Oro).

³ Maximally Exposed Individual Sensitive Receptor (MEISR). The MEISR for cancer risk impact and chronic HI is at the Los Paseos Elementary School boundary, which is about 2,953 ft southeast of the project boundary. The MEISR for acute HI is at the Fresenius Medical Care San Jose, which is about 800 ft south of the project boundary.

Source: SV1 2021i, Tables 8 and 9 with modeling files; and Energy Commission staff analysis

The cancer risks at Kaiser Foundation Hospital Home Health-Santa Clara and RCCA – Purple Hills Drive would be 0.7 in 1 million and 0.4 in 1 million respectively, lower than the cancer risk of 2.21 in 1 million estimated at the MEISR shown in **Table 4.3-12**. The cancer risks at the Safe Haven Villa Care Home, the Ebadat Residential Care Home #4, and the Muna’s Residential Care Home III would be about 0.7 in 1 million, 0.3 in 1 million,

and 0.2 in 1 million respectively, lower than the cancer risk of 2.21 in 1 million estimated at the MEISR shown in **Table 4.3-12**.

Like cancer risks, the chronic non-cancer HI and acute HI at other locations for each type of sensitive receptors would be lower than those at the maximally exposed individual receptors shown in **Table 4.3-12**. Since the chronic non-cancer HI and acute HI shown in **Table 4.3-12** are much below the significance threshold of 1, the chronic non-cancer HI and acute HI at other locations of each type of sensitive receptors would be even lower and, therefore, are not discussed in detail.

Staff also modeled the cancer risk at the PMI to be 25.4 in 1 million, which is higher than 10 in 1 million. However, the PMI is located on the project fence line, neither a residential nor a sensitive receptor. In addition, the chronic non-cancer hazard index at the PMI would be 0.006, which is much less than the threshold of 1.0. Staff does not expect a person to stay at the PMI location for the duration of the assumed 30-year residential exposure or 25-year worker exposure. Additionally, the BAAQMD CEQA Air Quality Guidelines note that the health risk evaluation should be considered for the MEI, the definition of which is explained above. The PMI in this evaluation is not located in a MEI location and it is not appropriate to compare the health risks at the PMI to the significance thresholds for the health risk evaluation. Since the PMI is not located at a receptor location where a person may reasonably be located on a long-term basis, the 10 in 1 million cancer risk threshold is not applicable to the PMI location.

In addition, each of the proposed 39 generators would be equipped with DPF to control the DPM emissions (SV1 2020j). Moreover, the HRA was based on extremely conservative assumptions (i.e. 30-year residential exposure and 25-year worker exposure, 50 hours per year per engine of operation hours). Finally, the health risks at the nearby worker/residential/sensitive receptors would all be below the BAAQMD significance thresholds. Considering all these, the health risks of readiness testing and maintenance of the project would be less than significant.

Construction and Readiness Testing and Maintenance Overlap HRA

Less Than Significant Impact. In response to staff data requests, the applicant provided the HRA during the worst-case overlapping period of Phase 3 (SV19) construction with readiness testing and maintenance of the Phase 1 and Phase 2 engines. The applicant performed the HRA for diesel particulate matter (DPM) only, as DPM is the accepted surrogate compound for whole diesel exhaust. The fugitive dust emissions are not included in the HRA but were included in the AQIA shown above. The AERMOD dispersion model was run first to get the DPM concentrations. The modeling parameters remain the same as those used for the PM10 (more conservative than PM2.5) impacts analysis for the construction and readiness testing and maintenance overlapping period. The AERMOD results are then used in HARP to calculate the health risks. The applicant conservatively used a 2-year exposure period to represent the 17-month emissions overlap (HARP does not allow fractions of years as exposure values). The AQIA and HRA for the construction and readiness testing and maintenance overlapping period both

assumed each engine in SV12 and SV18 would be tested for 20 hours, consistent with the applicant proposed testing limit.

When the applicant updated the air quality and public health analysis in March 2021 (SV1 2021i), the HRA for the construction and readiness testing and maintenance overlapping period was not updated because the applicant expects the overall risks would be lower than those shown in the prior analysis (SV1 2020j and SV1 2020l). Staff performed an independent HRA for the construction and readiness testing and maintenance overlapping period based on the revised DPM concentrations provided by the applicant. Staff supplemented the HRA by evaluating the acute hazard index of speciated total organic gases (TOG) in diesel exhaust as well as the ammonia emissions due to the use of SCR. The results of staff's HRA for the construction and readiness testing and maintenance overlapping period are presented in **Table 4.3-13**. The cancer risks and chronic HIs at MEIR and MEIW from staff's HRA are the same as those shown in applicant's prior analysis. Staff noticed a typographical error in the cancer risk at PMI shown in applicant's prior analysis as well as in the March 2021 analysis. The cancer risk at PMI from staff's HRA is slightly higher than that shown in the applicant's analysis. In addition, as explained below, staff noticed the MEISR for the construction and readiness testing and maintenance overlapping period would be at the Centro Armonia Spanish School-Santa Teresa, instead of the Los Paseos Elementary School boundary, for which the health risks are presented in the applicant's analysis. Therefore, **Table 4.3-13** shows higher health risks at MEISR than those presented in the applicant's March 2021 analysis (SV1 2021i).

Table 4.3-13 shows that the cancer risks, chronic HIs, and acute HIs at the MEIR, MEIW, and MEISR during the overlapping period would be less than the BAAQMD's significance thresholds.

It should be noted that the risk values shown in **Table 4.3-13** are the highest of those modeled for each type of sensitive receptors. The risk values at other locations for each type of sensitive receptors would be lower than those shown in **Table 4.3-13**. For example, the maximum cancer risk at the nearest residential area (starting from 710 ft to the south/southwest/west of the project) would be about 1.7 in 1 million, which is lower than the cancer risk of 2.31 in 1 million at the MEIR shown in **Table 4.3-13**. Even though the MEIR for cancer risk is further away from the project (about 2,398 ft southeast of the project boundary), the cancer risk at the MEIR would be higher than those at the nearest residential area to the south/southwest/west of the project because the prevailing wind blowing from northwest to southeast determines the pattern of long-term (annual) concentrations. However, the acute HI is determined by the maximum 1-hour concentrations modeled in any hour of the 5 modeling years. Therefore, the MEIR for the acute HI is at the nearest residential area (about 790 ft south of the project boundary).

TABLE 4.3-13 CONSTRUCTION AND READINESS TESTING AND MAINTENANCE OVERLAP -- MODELED RECEPTOR MAXIMUM HEALTH RISK

Receptor Type	Cancer Risk Impact (in one million)	Chronic Non-Cancer Hazard Index (HI)	Acute Non-Cancer Hazard Index (HI)
MEIR ¹	2.31	0.0014	0.019
MEIW ²	1.02	0.0094	0.035
MEISR ³	2.59	0.0015	0.020
BAAQMD Threshold	10	1	1

Notes:

¹ Maximally Exposed Individual Resident (MEIR). The MEIR for cancer risk impact and chronic HI is at the residence located about 2,398 ft southeast of the project boundary (southeast of Bernal Road). The MEIR for acute HI is at the residence about 790 ft south of the project boundary (west of the intersection of Santa Teresa Boulevard and Vineyard Drive/Great Oaks Boulevard).

² Maximally Exposed Individual Worker (MEIW). The MEIW for cancer risk impact and chronic HI is located about 206 ft south-southeast of the project boundary (south of Great Oaks Boulevard). The MEIW for acute HI is located at about 240 ft southeast of the project boundary (southeast of Great Oaks Boulevard).

³ Maximally Exposed Individual Sensitive Receptor (MEISR). It is at the Centro Armonia Spanish School-Santa Teresa, which is about 1,300 ft to the south-southeast of the project boundary for cancer risk impact, chronic HI, and acute HI.

Sources: SV1 2021i, Table 16 with modeling files; and Energy Commission staff analysis

It also should be noted that the MEISR for cancer risk and chronic HI for the construction period and for readiness testing and maintenance evaluated separately (shown in **Tables 4.3-11** and **4.3-12**) would both be located at the Los Paseos Elementary School boundary (about 2,953 ft southeast of the project). But staff noticed that the MEISR for the construction and readiness testing and maintenance overlapping period (shown in **Table 4.3-13**) would be located at the Centro Armonia Spanish School-Santa Teresa, which is the closest daycare from the project (about 1,300 ft to the south-southeast). The MEISR location difference is probably due to different construction source locations for different periods: e.g. 11 point sources placed on the construction area of SV19 for the overlapping period vs. 39 point sources covering the whole construction area for the whole construction period. The cancer risk at the Los Paseos Elementary School boundary for the construction and readiness testing and maintenance overlapping period would be 1.91 in 1 million, lower than the cancer risk of 2.59 in 1 million estimated at the MEISR located at the Centro Armonia Spanish School-Santa Teresa. The cancer risks at the Stratford School including daycare (about 1,800 ft southwest of the project), the Santa Teresa Elementary including preschool (about 2,900 ft west of the project), the Bernal Intermediate School (about 3,090 ft southwest of the project), and the Genius Kids (about 3,270 ft southeast of the project boundary) would be about 0.5 in 1 million, 0.4 in 1 million, 0.3 in 1 million, and 1.4 in 1 million respectively, all of which are lower than the cancer risk of 2.59 in 1 million estimated at the MEISR shown in **Table 4.3-13**.

The cancer risks at Kaiser Foundation Hospital Home Health-Santa Clara and RCCA – Purple Hills Drive would both be about 0.6 in 1 million, lower than the cancer risk of 2.59 in 1 million estimated at the MEISR shown in **Table 4.3-13**. The cancer risks at the Safe Haven Villa Care Home, the Ebadat Residential Care Home #4, and the Muna’s Residential

Care Home III would be 0.9 in 1 million, 0.3 in 1 million, and 0.2 in 1 million respectively, lower than the cancer risk of 2.59 in 1 million estimated at the MEISR shown in **Table 4.3-13**.

Like cancer risks, the chronic non-cancer HI and acute HI at other locations for each type of sensitive receptors would be lower than those at the maximally exposed individual receptors shown in **Table 4.3-13**. Since the chronic non-cancer HI and acute HI shown in **Table 4.3-13** are much below the significance threshold of 1, the chronic non-cancer HI and acute HI at other locations of each type of sensitive receptors would be even lower and, therefore, are not discussed in detail.

Staff also modeled the cancer risk at PMI to be 49.8 in 1 million, which is higher than 10 in 1 million. However, the PMI is located on the project fence line, neither a residential nor a sensitive receptor. In addition, the chronic non-cancer hazard index at the PMI would be 0.029, which is much less than the threshold of 1.0. Staff does not expect a person to stay at the PMI location for the duration of the assumed 2-year exposure period. Additionally, the BAAQMD CEQA Air Quality Guidelines note that the health risk evaluation should be considered for the MEI, the definition of which is explained above. The PMI in this evaluation is not located in a MEI location and it is not appropriate to compare the health risks at the PMI to the significance thresholds for the health risk evaluation. Since the PMI is not located at a receptor location where a person may reasonably be located on a long-term basis, the 10 in 1 million cancer risk threshold is not applicable to the PMI location.

Each of the proposed 39 generators would be equipped with DPF to control the DPM emissions (SV1 2020j). Moreover, the HRA was based on conservative assumptions (i.e. 2-year exposure to represent 17-month overlapping period). And finally, the health risks at the nearby worker/residential/sensitive receptors would all be below the BAAQMD significance thresholds. Considering all these, the health risks during the construction and readiness testing and maintenance overlapping period would be less than significant with the inclusion of PD AQ-1. In addition, impacts during project construction would be further reduced with the implementation of **MM AQ-1**.

Cumulative HRA

Less Than Significant Impact. Per staff's request in Data Request 26, the applicant provided a cumulative HRA and compared results with the BAAQMD threshold of significance for cumulative risk and hazards (SV1 2020d, Pages 15-17). The applicant states that there are no major roadways or highways within 1,000 feet of the project boundary, so the applicant only included cumulative stationary sources within 1,000 feet of the project boundary. The applicant assessed the cumulative HRA impacts for the worst-case receptor location (SV1 2020d, Page 16). The applicant's cumulative HRA shows that the maximum cumulative cancer risk would be 89.78 in a million, below the threshold of 100 in a million; the maximum cumulative HI would be 0.137, below the threshold of 10; and the maximum cumulative PM_{2.5} concentration would be 0.68 µg/m³, below the threshold of 0.8 µg/m³.

Staff also conducted an independent cumulative HRA, which is an assessment of the proposed project's impact summed with the impacts of existing sources within 1,000 feet⁷ of the maximally exposed sensitive receptors. Staff also conducted an additional cumulative HRA at the nearest residences. Staff picked the midpoint (i.e. 206 Paraiso Court) of the nearest residences along the Santa Teresa Boulevard between San Ignacio Avenue and Vineyard Drive to represent the nearest residences.

The results of staff's cumulative HRA are compared to the BAAQMD CEQA cumulative thresholds of significance (BAAQMD 2017b) in **Table 4.3-14**, **Table 4.3-15**, and **Table 4.3-16**. Staff's cumulative HRA includes four major sources of impacts: (1) existing stationary sources; (2) surrounding highways, main streets, and railways; (3) the China Mobile International data center; and (4) the proposed project.

1. Existing Stationary Sources

The cumulative cancer risk, non-cancer hazard index, and PM2.5 concentrations of existing stationary sources were first retrieved from BAAQMD'S Permitted Sources Risk and Hazards Map⁸. Then the risks were calculated using BAAQMD's Health Risk Calculator⁹ to refine screen-level cancer risk, non-cancer health hazard index, and PM2.5 concentrations. The Health Risk Calculator incorporates factors such as risk associated with individual toxic air contaminants emitted from an existing stationary source and how far a stationary source is from the proposed project's maximally exposed sensitive receptor locations to calculate overall cancer risk, hazard index, and PM2.5 concentration from a stationary source.

Staff searched the risks data from existing stationary sources within 1,000 feet of the proposed project's maximally exposed sensitive receptor locations. These existing stationary sources include: Pacific Gas and Electric Company, G&I VII Westcore Santa Teresa & Great Oaks LP, Oak Grove School District, ISCS Inc, Monolithic Power Systems Inc, Bernal Shell, and APRO LLC dba United Pacific #5442. Staff also measured the distances of these stationary sources to the proposed project's maximally exposed sensitive receptor locations. Staff then applied these distances in the Health Risk Calculator to get the refined cumulative cancer risk, non-cancer hazard index, and PM2.5 concentration of the existing stationary sources at the proposed project's maximally exposed sensitive receptor locations. In addition, staff used the same approach to get the refined cumulative cancer risk, non-cancer hazard index, and PM2.5 concentration of the existing stationary sources at the nearest residences.

7 Per the BAAQMD CEQA Guidelines, the zone of influence for the cumulative threshold is 1,000 feet from the source or receptor.

8 The BAAQMD'S Permitted Sources Risk and Hazards Map can be accessed here: <https://baaqmd.maps.arcgis.com/apps/webappviewer/index.html?id=2387ae674013413f987b1071715daa65>

9The BAAQMD Health Risk Calculator Beta 4.0 can be downloaded here: https://www.baaqmd.gov/~/_/media/files/planning-and-research/ceqa/tools/baaqmd-health-risk-calculator-beta-4-0-xlsx.xlsx?la=en

2. Surrounding Highways, Main Streets, and Railways

The cancer risk and PM_{2.5} concentration from surrounding highways, major streets and railways were determined using BAAQMD raster files that incorporate annual average daily traffic (AADT) per EMFAC 2014 data for fleet mix and includes OEHHA's 2015 Guidance Methods. The raster files encompass highways, major streets and rails with greater than 30,000 AADT. Staff received the risk numbers for the surrounding highways, main streets, and railways directly from BAAQMD.

3. The China Mobile International data center

The China Mobile International data center would be located at 6320 San Ignacio Ave., San Jose, CA (CEC 2021f), which is about 560 ft to the northeast of the GOSBGF project boundary. The BAAQMD issued the Authority to Construct (ATC) for the China Mobile International data center in April 2020. The project is not operational yet. Staff considers the China Mobile International data center as a reasonably foreseeable project near the GOSBGF project. Therefore, staff includes the health risks of the China Mobile International data center in this cumulative HRA. Staff received the Engineering Evaluation and HRA memorandum from BAAQMD staff (CEC 2021f). Staff prorated the cancer risk, non-cancer hazard index, and PM_{2.5} concentration at MEIW and MEIR for the China Mobile International data center based on the HRA results shown in the BAAQMD memorandum (based on 50 hours per year per engine for reliability testing) and the permit limit of 29 hours per year per engine for reliability testing. Staff then conservatively added the prorated HRA results at the MEIW and MEIR for the China Mobile International data center to those at the MEIW and MEIR/MEISR/nearest residence for the GOSBGF project respectively, assuming the maximally exposed sensitive receptors for the two projects would locate at the same places. This is the worst-case addition for screening purposes since staff does not have more refined HRA results from the China Mobile International data center at the MEIW, MEIR, MEISR, or nearest residence for the GOSBGF. Staff does not recommend that this approach be used for future projects if more refined results are available.

4. The Proposed Project

For the proposed project, please see the result of the applicant's HRA for facility wide operation of GOSBGF presented in **Table 4.3-12**.

Table 4.3-14, Table 4.3-15, and Table 4.3-16 summarize the results of the staff cumulative HRA and compares them to the BAAQMD thresholds of significance for cumulative risk and hazards. The cumulative cancer risk, hazard index, and PM_{2.5} concentration were conservatively calculated using the maximum value in relation to the maximally exposed sensitive receptors as well as at the nearest residences. **Table 4.3-14, Table 4.3-15, and Table 4.3-16** show that the proposed project's health risks would not exceed the cumulative health risk thresholds when summed with the health risks of cumulative sources within 1,000 feet of each maximally exposed sensitive receptors or the nearest residences.

TABLE 4.3-14 CANCER RISKS (PER MILLION) FROM CUMULATIVE SOURCES

Sources of Cumulative Impacts	Cancer Risk at MEIW	Cancer Risk at MEISR	Cancer Risk at MEIR	Cancer Risk at Nearest Residence ^a
Existing Stationary Sources	0.28	0.33	1.19	18.31
Surrounding Highways, Major Streets, and Railways	8.42	8.33	8.93	6.56
China Mobile International Data Center ^b	9.86 ^c	4.93 ^d	4.93 ^d	4.93 ^d
GOSBGF ^e	4.95	2.21	2.98	1.13
Total - Cumulative Sources	23.50	15.80	18.03	30.94
Significance Threshold	100	100	100	100
Potential Significant Impact?	No	No	No	No

Notes:

^a Staff picked the midpoint (i.e. 206 Paraiso Court) of the nearest residences along the Santa Teresa Boulevard between San Ignacio Avenue and Vineyard Drive to represent the nearest residences.

^b Staff prorated the HRA results at the MEIW and MEIR for the China Mobile International data center based on the HRA results shown in the BAAQMD HRA memorandum (based on 50 hours per year per engine for reliability testing) and the permit limit of 29 hours per year per engine for reliability testing.

^c Staff conservatively added the HRA results at the MEIW for the China Mobile International data center to those at the MEIW for the GOSBGF project, assuming the maximally exposed worker receptors for the two projects would locate at the same places. This is the worst-case addition for screening purposes since staff does not have more refined HRA results from the China Mobile International data center at the MEIW for the GOSBGF. Staff does not recommend that this approach be used for future projects if more refined results are available.

^d Staff conservatively added the HRA results at the MEIR for the China Mobile International data center to those at the MEISR, MEIR, and nearest residence for the GOSBGF project, assuming the maximally exposed sensitive receptors for the two projects would locate at the same places. This is the worst-case addition for screening purposes since staff does not have more refined HRA results from the China Mobile International data center at the MEISR, MEIR, or nearest residence for the GOSBGF. Staff does not recommend that this approach be used for future projects if more refined results are available.

^e The HRA for GOSBGF conservatively assumed 50 hours per year per engine of readiness testing and maintenance to compute the DPM impacts and health risks, more than the proposed 20 hours per year per engine of readiness testing and maintenance.

Sources: CEC 2021f, Energy Commission staff analysis of data from BAAQMD

TABLE 4.3-15 CHRONIC HAZARD INDICES FROM CUMULATIVE SOURCES

Sources of Cumulative Impacts	Chronic Hazard Index at MEIW	Chronic Hazard Index at Receptor MEISR	Chronic Hazard Index at MEIR	Chronic Hazard Index at Nearest Residence ^a
Existing Stationary Sources	0	0.0015	0.0052	0.029
Surrounding Highways, Major Streets, and Railways	No Data Available ^b	No Data Available ^b	No Data Available ^b	No Data Available ^b
China Mobile International Data Center ^c	0.0075 ^d	0.0013 ^e	0.0013 ^e	0.0013 ^e
GOSBGF ^f	0.0038	0.00051	0.00069	0.00026
Total - Cumulative Sources	0.011	0.0033	0.0072	0.030
Significance Threshold	10	10	10	10
Potential Significant Impact?	No	No	No	No

Notes:

a Staff picked the midpoint (i.e. 206 Paraiso Court) of the nearest residences along the Santa Teresa Boulevard between San Ignacio Avenue and Vineyard Drive to represent the nearest residences.

b No data available — BAAQMD staff did not provide data for these sources; they indicated the following: "We did not include chronic HI because you would see an exceedance above the thresholds under risk and PM2.5 before you see a hazard exceedance since the primary pollutant is diesel PM. Diesel PM has higher chronic reference dose so that it has relatively lower chronic impact compared to its risk potency." See **Table 4.3-16** below for PM2.5 impacts.

c Staff prorated the HRA results at the MEIW and MEIR for the China Mobile International data center based on the HRA results shown in the BAAQMD HRA memorandum (based on 50 hours per year per engine for reliability testing) and the permit limit of 29 hours per year per engine for reliability testing.

d Staff conservatively added the HRA results at the MEIW for the China Mobile International data center to those at the MEIW for the GOSBGF project, assuming the maximally exposed worker receptors for the two projects would locate at the same places. This is the worst-case addition for screening purposes since staff does not have more refined HRA results from the China Mobile International data center at the MEIW for the GOSBGF. Staff does not recommend that this approach be used for future projects if more refined results are available.

e Staff conservatively added the HRA results at the MEIR for the China Mobile International data center to those at the MEISR, MEIR, and nearest residence for the GOSBGF project, assuming the maximally exposed sensitive receptors for the two projects would locate at the same places. This is the worst-case addition for screening purposes since staff does not have more refined HRA results from the China Mobile International data center at the MEISR, MEIR, or nearest residence for the GOSBGF. Staff does not recommend that this approach be used for future projects if more refined results are available.

f The HRA for GOSBGF conservatively assumed 50 hours per year per engine of readiness testing and maintenance to compute the DPM impacts and health risks, more than the proposed 20 hours per year per engine of readiness testing and maintenance.

Sources: CEC 2021f, Energy Commission staff analysis of data from BAAQMD

TABLE 4.3-16 ANNUAL DIESEL PARTICULATE MATTER (DPM/PM2.5) CONCENTRATIONS ($\mu\text{g}/\text{m}^3$) FROM CUMULATIVE SOURCES

Sources of Cumulative Impacts	Annual DPM/PM2.5 Concentration at MEIW	Annual DPM/PM2.5 Concentration at MEISR	Annual DPM/PM2.5 Concentration at MEIR	Annual DPM/PM2.5 Concentration at Nearest Residence ^a
Existing Stationary Sources	0	0	0	0.013
Surrounding Highways, Major Streets, and Railways	0.14	0.12	0.13	0.12
China Mobile International Data Center ^b	0.037 ^c	0.0064 ^d	0.0064 ^d	0.0064 ^d
GOSBGF ^e	0.019	0.0026	0.0035	0.0013
Total - Cumulative Sources	0.19	0.13	0.14	0.14
Significance Threshold	0.8	0.8	0.8	0.8
Potential Significant Impact?	No	No	No	No

Notes:

a Staff picked the midpoint (i.e. 206 Paraiso Court) of the nearest residences along the Santa Teresa Boulevard between San Ignacio Avenue and Vineyard Drive to represent the nearest residences.

b Staff prorated the HRA results at the MEIW and MEIR for the China Mobile International data center based on the HRA results shown in the BAAQMD HRA memorandum (based on 50 hours per year per engine for reliability testing) and the permit limit of 29 hours per year per engine for reliability testing.

c Staff conservatively added the HRA results at the MEIW for the China Mobile International data center to those at the MEIW for the GOSBGF project, assuming the maximally exposed worker receptors for the two projects would locate at the same places. This is the worst-case addition for screening purposes since staff does not have more refined HRA results from the China Mobile International data center at the MEIW for the GOSBGF. Staff does not recommend that this approach be used for future projects if more refined results are available.

d Staff conservatively added the HRA results at the MEIR for the China Mobile International data center to those at the MEISR, MEIR, and nearest residence for the GOSBGF project, assuming the maximally exposed sensitive receptors for the two projects would locate at the same places. This is the worst-case addition for screening purposes since staff does not have more refined HRA results from the China Mobile International data center at the MEISR, MEIR, or nearest residence for the GOSBGF. Staff does not recommend that this approach be used for future projects if more refined results are available.

e The HRA for GOSBGF conservatively assumed 50 hours per year per engine of readiness testing and maintenance to compute the DPM impacts and health risks, more than the proposed 20 hours per year per engine of readiness testing and maintenance. The AQIA for GOSBGF is based on the proposed 20 hours per year per engine of readiness testing and maintenance. Therefore, the DPM/PM2.5 impacts of 0.019 $\mu\text{g}/\text{m}^3$ at MEIW shown here is higher than the maximum annual PM2.5 impacts of 0.01 $\mu\text{g}/\text{m}^3$ (at the fence line) shown in **Table 4.3-9**.

Sources: CEC 2021f, Energy Commission staff analysis of data from BAAQMD

Evaluating Emergency Operations

This section addresses the potential for emergency situations that could trigger emergency use of the standby generator engines. The air quality impacts of standby generator operation during emergencies are not quantified below because impacts of

emergency operations are typically not evaluated during facility permitting and air districts do not normally conduct an air quality impact assessment of such impacts. Energy Commission staff assessed the likelihood of emergency events but finds that assessing the air quality impacts of emergency operations would require a host of unvalidated, unverifiable, and speculative assumptions about when and under what circumstances such a hypothetical emergency would occur. Such a speculative analysis is not required under CEQA (CEQA Guidelines § 15064(d)(3) and § 15145), and, most importantly, would not provide meaningful information by which to determine project impacts.

Staff determined that assessing air quality impacts of emergency operation of the standby generators could be speculative for the following reasons:

- Emergency use of a standby generator engine is allowed only under specific, limited, and unplanned situations. Emergency operation may occur during a failure or disruption of the regular electric power, or under other limited situations that are defined by regulations, including the California ARB ATCM and BAAQMD Rule 9-8-231. These requirements ensure that emergency use only occurs during events that pose an imminent threat or hazard to public safety or well-being.
- Grid outages, upsets and instabilities are variable and unpredictable, depending on cause and remedy. For example, some would be short enough to avoid triggering emergency operation of the standby generators. Another may be longer if equipment repair or replacement is required. Another may be avoided entirely if a redundant transmission component can be immediately switched into service. Power outages in PG&E's transmission service territory have historically been very infrequent and irregular and are expected to remain so. Regular electric service to the project site would only be disrupted during unplanned outages that are unpredictable, and when an outage occurs, PG&E takes steps to minimize the duration and the number of customers affected (see **Appendix B** for more information).
- The number of standby generators that could need to operate during an event that triggers emergency use, and the associated emissions, would be continuously variable. The number of generators operating during an emergency would depend on instantaneous power demand of the data center at the time of an outage and could vary with changing on-site demands during the outage. The number of standby generators that would need to operate during an emergency could also vary because some engines are redundant to ensure reliability should one or more of the engines fail during the emergency. As a result, the exact stack combinations and their locations within the project site are indeterminate for a specific emergency scenario. Modeling results can be highly sensitive to even minor adjustments of these variables.
- The load levels at which the standby generators would need to operate during a power outage would be variable based on the actual power demand during the outage and the level of backup power reliability required by parties contracting to use the data servers. Backup strategies vary, for example, as in how many standby backup generators might be started up to provide "backup" for the other operating backup

generators as a way to provide compound redundancy, should an occupant contract for it.

To adequately assess air quality impacts during emergency operation of the standby generators, staff would need to estimate each engine's emissions characteristics that depend on engine loading. Factors that would affect the instantaneous power demand of the data center include the data center's level of occupancy, type of occupants and their operational use of their servers, time of day, day of week, holiday or not, the rate of transactions occurring during the outage, and so forth. Data center occupants instantaneously vary the number of servers operating by turning them on or off to adjust to varying processing demand to maintain responsiveness to online customers at the lowest operational cost. For example, the data center power demand required for processing credit card transactions would be expected to be much higher on a Black Friday shopping day following a Thanksgiving holiday, than on a slower shopping day. Conversely, overnight server activity when the servers perform backup or mirroring activities could be higher than normal daytime commercial activity.

The overall electrical demand of the data center buildings also depends on the need for cooling, which would vary by season and hour of day, and how the various devices within the buildings respond to a power outage or disruption. Data servers could, for instance, immediately begin shifting their processing load to another data center site requiring high initial power demand, and then, once shifting was complete, drastically reduce demand for the remainder of the outage. Similar unpredictable power demand variability can be expected with a mix of data center users. Servers within the building may serve industries such as: banking, streaming entertainment, academic, call centers, government and public operations, email, conferencing, communications, and social media. Varying server demand, of course, influences other facility demands, such as for air conditioning to cool operating data servers.

For these reasons, emergency conditions could be expected to create irregular demands. Staff is unable to make an informed assumption of the level of facility demands that would occur, and this means that staff cannot make an informed quantification of steady emission rates from the backup generator engines during emergency use.

Appendix B provides a detailed analysis regarding the likelihood of an interruption of the electrical supply that would trigger emergency operations of the project's standby generators. In addition, scoping comments from BAAQMD provided a review of data centers that initiated operation of diesel engines for "non-testing/non-maintenance" purposes, for the purpose of informing staff's consideration of scenarios of backup power generation operations beyond routine testing and maintenance (BAAQMD 2020x; BAAQMD 2021a). **Appendix B** provides a detailed analysis of the data provided by BAAQMD. The BAAQMD review confirms that these types of events remain infrequent, irregular, and unlikely and the resulting emissions are not easily predictable or quantifiable and cannot be modeled in an informative or meaningful way. The BAAQMD review does not show that these facilities operate significantly more than staff previously analyzed in the grid reliability context in prior cases.

Air Quality Impacts During Emergency Operations

The air quality impacts of emergency operations are generally exempted from modeling by air districts in their permitting evaluations, and such is the practice of BAAQMD, in whose jurisdiction the project would be located. Guidelines from US EPA and local air districts regarding permit evaluations generally do not require air quality impact analysis of emissions that would occur infrequently, be highly intermittent and unpredictable, or be triggered by an emergency.

Permitting of emissions from routine or regularly scheduled activities such as readiness testing and maintenance of emergency engines are subject to impacts analyses. The air quality impact analysis for this project includes the proposed readiness testing and maintenance, as provided earlier in this section.

Although normally excluded from impact analysis during permit review, scoping comments from BAAQMD requested that this air quality analysis include various scenarios of backup power generation operations beyond routine testing and maintenance (BAAQMD 2020x).

The BAAQMD regulation on stationary internal combustion engines (Regulation 9, Rule 8, section 231.5) defines emergency use as “the use of an emergency standby or low usage engine in the event of [an] unforeseeable failure of [the] regular electric power supply. Emergencies are therefore, unplanned, uncontrolled, infrequent, and unlikely.” Additionally, BAAQMD Regulation 9, Rule 8, section 237 defines unforeseeable as “not able to be reasonably anticipated and demonstrated by the owner or operator to the satisfaction of the Air Pollution Control Officer to have been beyond the reasonable control of the owner or operator.”

The BAAQMD and other air districts and permitting agencies routinely conduct air quality impact analyses (called AQIAs) when evaluating projects involving stationary air pollution sources. For emergency-use-only equipment, the 35 California local air district rules typically do not require them to include emergency operations in their AQIA. Some air districts place a limit of 200 hours of emergency operation, while other agencies rely on the ARB Air Toxic Control Measure (ATCM), which allows unlimited emergency operation:

- ARB’s ATCM allows for 50 to 100 hours per year for readiness testing and maintenance and includes unlimited hours for emergency operations. The emission limitations in the ATCM are different depending on whether an engine is used as an emergency standby engine (i.e., used only during emergencies such as an electrical outage, flood, or fire) or as a prime engine. Emergency standby engines, since they typically operate no more than 20 to 50 hours a year, have different standards than prime engines, which operate hundreds to thousands of hours per year. The ATCM limits the number of hours an emergency standby engine can operate for maintenance and testing purposes to no more than 50 to 100 hours per year. The ATCM does not limit emergency use hours (ARB 2010).

- BAAQMD uses the ARB's ATCM and allows 50 hours of readiness testing and maintenance and unlimited hours of emergency operations. In some permits, the engineering evaluations resulted in fewer than 50 hours of testing following the ARB's ATCM requirements; however, the applicant requested those limitations at the time of permitting.
- South Coast Air Quality Management District (SCAQMD) Rule 1304 specifically allows their Executive Officer to exempt both AQIA modeling of emergency standby equipment and the requirement for such equipment to obtain emissions offsets, as long as this equipment does not operate more than 200 hours per year. In addition, SCAQMD Rule 1401 exempts such equipment from an evaluation of toxic air contaminants during an emergency.
- San Joaquin Valley Air Pollution Control District (SJVAPCD) Rule 2201 (Part 4.6.2) also specifically exempts emergency standby equipment that operates no more than 200 hours per year from the requirement to obtain offsets. SJVAPCD also developed guidance for evaluating emergency operations of emergency equipment located at a permitted facility. They estimated that for facilities that would operate only 50 to 200 hours per year, there was only a 0.57 to 2.34 percent chance of such unit operating precisely during the hours of maximum (peak) modeled concentration. The guidance document concluded that it is highly unlikely that intermittent operating units will cause or contribute to an exceedance of a short term (1, 3, 8, and 24 hour) CAAQS or NAAQS. Therefore, SJVAPCD concluded that there was no need to conduct an AQIA for such facilities for permitting purposes (SJVAPCD 2011).
- The U.S. Environmental Protection Agency (US EPA) provides a *Guideline on Air Quality Models* (US EPA 2017) for evaluating stationary source facility operations within the New Source Review process. The US EPA's March 1, 2011 guidance memorandum states that modeling intermittent emissions units, such as emergency generators, is a "main challenge." The guidance specifically addresses emergency generators in light of the 1-hour NO₂ NAAQS and recommends evaluating emissions scenarios that are continuous enough or frequent enough to contribute significantly to the annual distribution of daily maximum 1-hour concentrations. This document emphasizes that there is sufficient discretion within the existing guidelines for reviewing authorities to not include intermittent emissions from emergency generators in compliance demonstrations (US EPA 2011).

The federal permitting process in the PSD program generally calls for an AQIA when a new or modified stationary source causes more than 40 tons/year of NO_x [40 CFR 52.21(b)(23)]. The BAAQMD New Source Review permitting program requirements and the applicant's commitments to limit readiness testing and maintenance ensure that the emissions increases associated with this project do not trigger this requirement.

Based on staff's review of air quality agency practices summarized above, staff concludes that emergency operations are too infrequent and too irregular to be reliably evaluated for ambient air quality impacts. Staff takes into consideration: the low likelihood of emergency operation occurring and the intermittency of equipment

operating for emergency purposes; the expectation that these standby generators would run only a few hours or less during emergencies; and the unlikelihood that emissions during an emergency would occur at the same time as peak background concentrations.

For permitting purposes, air quality agencies normally do not consider emergency operations in analyzing whether a project's potential air emissions are cumulatively considerable. This is for several reasons. Primarily, emergency conditions are too infrequent and irregular to presume a steady rate of emissions from an emergency-use-only source, making modeling too imprecise to provide sufficient information on which to reach a conclusion. This is true for a facility with one emergency-use-only source, and even more true for a facility such as this project with 39 emergency generator engines and innumerable possible configurations of source operation and operating load points, that could occur in a range of meteorological conditions and background concentrations.

Due to the number of factors that need to be considered, using an air quality model to evaluate ambient air quality impacts during emergency operations would require unnecessary speculation and would render the results of any such exercise too speculative to be meaningful. This remains especially true when neither the CEC nor any other agency has established or used in practice a threshold of significance by which to interpret air quality modeling results from emergency operations. Emergency operation would be very infrequent, and emergency operations would not occur routinely during the lifetime of the facility. Accordingly, the potential for any adverse impacts to ambient air quality concentrations would be a very low probability event.

Thus, staff concludes that assessing the impacts of emergency operation of the standby generators would be speculative due to the infrequent, irregular, and unplanned nature of emergency events. Emissions and impacts during emergency operation are not easily predictable or quantifiable and cannot be modeled in an informative or meaningful way. Because of the infrequent nature of emergency conditions, and the record of highly reliable electric service available to the project (see **Electrical System Reliability** in **Appendix B** for more information), the project's emergency operation would be unlikely to expose sensitive receptors to substantial concentrations of criteria air pollutants.

Health Risk Assessment (HRA) During Emergency Operations

This assessment also addresses the health impacts of toxic air contaminants emitted as a result of emergency operations. The health risk assessment for TACs during readiness testing evaluates the project cancer risk, chronic non-cancer, and acute non-cancer health risks under non-emergency conditions, assuming up to 50 hours of operation per engine per year, more than the proposed 20 hours per year per engine of readiness testing and maintenance.

Staff's analysis of acute TAC impacts, shown in **Table 4.3-12** includes all 36 standby and 3 life safety generators operating concurrently for readiness testing and

maintenance. While concurrently operating all backup generators could approximate what might occur during an undefined emergency situation, the analysis of acute non-cancer hazards showed the acute health risks to be below the relevant significance thresholds. No additional impact analysis is required to evaluate emergency operations for acute risk because the maximum facility emissions as a result of emergency operations would not exceed those of concurrent operation of all backup generators. Therefore, the project is expected to have less than significant acute health risks as a result of emergency operations.

The chronic health risks determined for project construction, readiness testing and maintenance, and overlapping period between construction and readiness testing and maintenance, shown in **Table 4.3-11**, **Table 4.3-12**, and **Table 4.3-13**, are substantially below the significance threshold, and no reasonable emergency operation scenario would change that finding. In addition, emissions from emergency operations of standby engines are exempt from BAAQMD evaluation for TACs in Regulation 2, Rule 5 (Section 2-5-111). Therefore, the project would also have less than significant chronic health risks as a result of emergency operations.

Required Mitigation Measures: None

d. Would the project result in other emissions (such as those leading to odors) adversely affecting a substantial number of people?

The BAAQMD states that, while offensive odors rarely cause direct health impacts or any physical harm, they still can be very unpleasant and lead to considerable distress among the public, often generating citizen complaints to local governments and the BAAQMD (BAAQMD 2017b). Any project with the potential to frequently expose members of the public to objectionable odors would be deemed to have a significant impact. Odor impacts on residential areas and other sensitive receptors warrant the closest scrutiny, but consideration should also be given to other land uses where people may congregate, such as recreational facilities, worksites, and commercial areas.

Construction

Less Than Significant Impact. Potential odor sources during construction activities include diesel exhaust from heavy-duty equipment. Odors from construction activities near existing receptors would be temporary in nature and dissipate as a function of distance. Accordingly, construction of the project is not expected to result in odor impacts that would exceed BAAQMD's odor thresholds.

Fugitive dust emissions can also create a nuisance that can cause adverse effects. The project is proposing to comply with the BAAQMD construction fugitive dust control BMPs and so should not have substantial fugitive dust emissions during construction that could adversely affect a substantial number of people.

Therefore, during construction the project would not result in other emissions that could adversely affect a substantial number of people and would have less than significant impacts.

Readiness Testing and Maintenance, and Emergency Operation

Less Than Significant Impact. Potential odor sources from project testing and maintenance along with emergency operation would include diesel exhaust from standby generator readiness testing and maintenance, trash pick-up and other heavy-duty delivery vehicles, and the occasional use of architectural coatings during routine maintenance. When compared to existing odor sources near the project site, which include heavy and light industrial uses, odor impacts from project testing and maintenance along with emergency operations would be similar.

Under the BAAQMD CEQA guidelines determining the significance of potential odor impacts involves a two-step process. First, determine whether the project would result in an odor source and receptors being located within the distances indicated in **Table 4.3-17**. This table also lists types of facilities known to emit objectionable odors. Second, if the proposed project would result in an odor source and receptors being located closer than the screening level distances indicated in **Table 4.3-17**, a more detailed analysis should be conducted, as described in the BAAQMD 2017 CEQA Guidelines (BAAQMD 2017b).

TABLE 4.3-17 PROJECT SCREENING TRIGGER LEVELS FOR POTENTIAL ODOR SOURCES

Land Use/Type of Operation	Project Screening Distance
Wastewater Treatment Plant	2 miles
Wastewater Pumping Facilities	1 mile
Sanitary Landfill	2 miles
Transfer Station	1 mile
Composting Facility	1 mile
Petroleum Refinery	2 miles
Asphalt Batch Plant	2 miles
Chemical Manufacturing	2 miles
Fiberglass Manufacturing	1 mile
Painting/Coating Operations	1 mile
Rendering Plant	2 miles
Coffee Roaster	1 mile
Food Processing Facility	1 mile
Confined Animal Facility/Feed Lot/Dairy	1 mile
Green Waste and Recycling Operations	1 mile
Metal Smelting Plants	2 miles

Source: BAAQMD 2017b, Table 3-3.

The project is not an odor source listed in **Table 4.3-17** and this project type is not known to cause any significant odor impacts (SV1 2020a, Page 69). A further evaluation of this facility is not warranted by any local conditions or special circumstances. Therefore,

staff finds that the project would not likely create objectionable odors affecting a substantial number of people.

The project would have no ongoing fugitive dust emissions sources once it is built and operating. Therefore, nuisance dust impacts would not occur during readiness testing and maintenance or any emergency operation. During testing and maintenance along with emergency operation, the project would not result in other emissions that could adversely affect a substantial number of people and would have less than significant impacts.

Required Mitigation Measures: None

4.3.4 References

- ARB 1998 – California Air Resources Board (ARB). Proposed Identification of Diesel Exhaust as a Toxic Air Contaminant. Appendix III, Part A, Exposure Assessment. April 1998. Accessed June 2020. Available online at:
https://ww3.arb.ca.gov/toxics/dieseltac/part_a.pdf
- ARB 2010 – California Air Resources Board (ARB). 2010. Staff Report: Initial Statement of Reasons For Proposed Rulemaking. Accessed March 2021. Available online at:
<https://ww3.arb.ca.gov/regact/2010/atcm2010/atcmisor.pdf>
- ARB 2013 – California Air Resources Board (ARB). The California Almanac of Emissions and Air Quality -2013 Edition. Accessed January 2020. Available online at:
<https://www.arb.ca.gov/aqd/almanac/almanac13/almanac13.htm>
- ARB 2020a – California Air Resources Board (ARB). Maps of State and Federal Area Designations. Accessed June 2020. Available online at:
<https://www.arb.ca.gov/desig/adm/adm.htm>
- ARB 2020b – California Air Resources Board (ARB). Air Quality Data Statistics Top 4 Summary. Accessed October 2020. Available online at:
<https://www.arb.ca.gov/adam/topfour/topfour1.php>
- ARB 2020c – California Air Resources Board (ARB). California Ambient Air Quality Standards. Accessed June 2020. Available online at:
<https://ww2.arb.ca.gov/resources/california-ambient-air-quality-standards>
- ARB 2020d – California Air Resources Board (ARB). Accessed June 2020. Overview: Diesel Exhaust & Health. Available online at:
<https://ww2.arb.ca.gov/resources/overview-diesel-exhaust-and-health>
- BAAQMD 2016 – Bay Area Air Quality Management District (BAAQMD). Regulation 2 Rule 5: New Source Review of Toxic Air Contaminants. Dated December 7, 2016. Accessed June 2020. Available online at:
https://www.baaqmd.gov/~/media/dotgov/files/rules/reg-2-rule-5-new-source-review-of-toxic-air-contaminants/documents/rg0205_120716-pdf.pdf?la=en

- BAAQMD 2017a – Bay Area Air Quality Management District (BAAQMD). Final 2017 Clean Air Plan, Adopted April 19, 2017. Accessed June 2020. Available online at: http://www.baaqmd.gov/~media/files/planning-and-research/plans/2017-clean-air-plan/attachment-a_-proposed-final-cap-vol-1-pdf.pdf
- BAAQMD 2017b – Bay Area Air Quality Management District (BAAQMD). California Environmental Quality Act, Air Quality Guidelines. Updated May 2017. Accessed June 2020. Available online at: http://www.baaqmd.gov/~media/files/planning-and-research/ceqa/ceqa_guidelines_may2017-pdf.pdf?la=en
- BAAQMD 2018 – Bay Area Air Quality Management District (BAAQMD). 2017 Air Monitoring Network Plan. Dated July 1, 2018. Accessed June 2020. Available online at: https://www.baaqmd.gov/~media/files/technical-services/2017_network_plan_20180701-pdf.pdf?la=en
- BAAQMD 2019 – Bay Area Air Quality Management District (BAAQMD). Calculating Potential to Emit for Emergency Backup Power Generators. Dated June 3, 2019. Accessed June 2020. Available online at: http://www.baaqmd.gov/~media/files/engineering/policy_and_procedures/banking-and-offsets/calculating-pte-for-emergency-generators-06032019-pdf
- BAAQMD 2020a – Bay Area Air Quality Management District (BAAQMD). Air Quality Standards and Attainment Status. Accessed June 2020. Available online at: <https://www.baaqmd.gov/about-air-quality/research-and-data/air-quality-standards-and-attainment-status>
- BAAQMD 2020b – Bay Area Air Quality Management District (BAAQMD). Annual Bay Area Air Quality Summaries. Accessed October 2020. Available online at: <http://www.baaqmd.gov/about-air-quality/air-quality-summaries>
- BAAQMD 2020x – Bay Area Air Quality Management District (BAAQMD). BAAQMD Comment Letter for Great Oaks South Backup Generating Facility (TN 235803), November 2020. Available online at: <https://efiling.energy.ca.gov/Lists/DocketLog.aspx?docketnumber=20-SPPE-01>
- BAAQMD 2020z – Bay Area Air Quality Management District (BAAQMD). BAAQMD Letter Re: BACT Determination for Diesel Back-up Engines Greater Than or Equal to 1,000 Brake Horsepower: Great Oaks South Backup Generating Facility (TN 236091), December 2020. Available online at: <https://efiling.energy.ca.gov/Lists/DocketLog.aspx?docketnumber=20-SPPE-01>
- BAAQMD 2021a – Bay Area Air Quality Management District (BAAQMD). (TN 236946). Bay Area Air Quality Management District Comments – Comment Letter for San Jose Data Center NOP, dated March 1, 2021. Available online at: <https://efiling.energy.ca.gov/Lists/DocketLog.aspx?docketnumber=19-SPPE-04>
- CEC 2021f – California Energy Commission (CEC). ROC with Xuna Cai, BAAQMD re: China Mobile Data Center: Great Oaks South Backup Generating Facility (TN 237298), March 2021. Available online at: <https://efiling.energy.ca.gov/Lists/DocketLog.aspx?docketnumber=20-SPPE-01>

- NOAA 2019 – National Oceanic and Atmospheric Administration (NOAA). The Impact of Wildfires on Climate and Air Quality, An emerging focus of the NOAA ESRL Chemical Sciences Division. Accessed June 2020. Available online at: <https://www.esrl.noaa.gov/csd/factsheets/csdWildfiresFIREX.pdf>
- OEHHA 2015 – Office of Environmental Health Hazard Assessment (OEHHA). Air Toxics Hot Spots Program Risk Assessment Guidelines. Guidance Manual for Preparation of Health Risk Assessments, March 6, 2015. Available online at: <https://oehha.ca.gov/media/downloads/crnrr/2015guidancemanual.pdf>
- OEHHA 2020 – Office of Environmental Health Hazard Assessment (OEHHA). Toxic Air Contaminants. Accessed June 2020. Available online at: <https://oehha.ca.gov/air/toxic-air-contaminants>
- PG&E 2020a – Pacific Gas and Electric Company (PG&E). PG&E Responses to Staff Requests Concerning Interconnection of Great Oaks South Backup Generating Facility (TN 234392), August 2020. Available online at: <https://efiling.energy.ca.gov/Lists/DocketLog.aspx?docketnumber=20-SPPE-01>
- SV1 2020a – SV1, LLC. (SV1). Application for Small Power Plant Exemption: Great Oaks South Backup Generating Facility (TN 232466), March 2020. Available online at: <https://efiling.energy.ca.gov/Lists/DocketLog.aspx?docketnumber=20-SPPE-01>
- SV1 2020d – SV1, LLC. (SV1). SV1 Responses to CEC Data Request Set 2: Great Oaks South Backup Generating Facility Part 1 through Part 4 (TN 233005-1,2,3,4), May 2020. Available online at: <https://efiling.energy.ca.gov/Lists/DocketLog.aspx?docketnumber=20-SPPE-01>
- SV1 2020h – SV1, LLC. (SV1). SV1 Supplemental Responses to DR 65-69: Great Oaks South Backup Generating Facility (TN 233924), July 2020. Available online at: <https://efiling.energy.ca.gov/Lists/DocketLog.aspx?docketnumber=20-SPPE-01>
- SV1 2020j – SV1, LLC. (SV1). SV1 Revised AQ and HRA Modeling Analysis: Great Oaks South Backup Generating Facility (TN 234479), August 2020. Available online at: <https://efiling.energy.ca.gov/Lists/DocketLog.aspx?docketnumber=20-SPPE-01>
- SV1 2020l – SV1, LLC. (SV1). SV1 Supplemental Responses to Revised AQ Analysis – SPPE Application: Great Oaks South Backup Generating Facility (TN 234586), September 2020. Available online at: <https://efiling.energy.ca.gov/Lists/DocketLog.aspx?docketnumber=20-SPPE-01>
- SV1 2020p – SV, LLC. (SV1). SV1 Revised SV1 Supplemental DR-47 Response: Great Oaks South Backup Generating Facility (TN 235566), November 2020. Available online at: <https://efiling.energy.ca.gov/Lists/DocketLog.aspx?docketnumber=20-SPPE-01>
- SV1 2021a – SV, LLC. (SV1). SV1 City of San Jose GHGRS Compliance Checklist: Great Oaks South Backup Generating Facility (TN 236336), January 2021. Available online at: <https://efiling.energy.ca.gov/Lists/DocketLog.aspx?docketnumber=20-SPPE-01>

- SV1 2021i – SV, LLC. (SV1). SV 1 Revised Air Quality and Public Health Analysis: Great Oaks South Backup Generating Facility (TN 237152), March 2021. Available online at: <https://efiling.energy.ca.gov/Lists/DocketLog.aspx?docketnumber=20-SPPE-01>
- SV1 2021j – SV, LLC. (SV1). Ammonia Emission Description and Spreadsheet: Great Oaks South Backup Generating Facility (TN 237205), March 2021. Available online at: <https://efiling.energy.ca.gov/Lists/DocketLog.aspx?docketnumber=20-SPPE-01>
- SV 2021l – SV, LLC. (SV1). Miratech Emission Information: Great Oaks South Backup Generating Facility (TN 237508), April 2021. Available online at: <https://efiling.energy.ca.gov/Lists/DocketLog.aspx?docketnumber=20-SPPE-01>
- SJVAPCD 2011 – San Joaquin Valley Air Pollution Control District (SJVAPCD). Policy for Modeling Intermittent Operating Units When Evaluating for CAAQS/NAAQS, September 2011. Accessed March 2021. Available online at: http://www.valleyair.org/policies_per/Policies/APR1920.pdf
- US EPA 2002 – United States Environmental Protection Agency (US EPA). Health Assessment Document For Diesel Engine Exhaust. May 2002. Accessed June 2020. Available online at: https://cfpub.epa.gov/si/si_public_file_download.cfm?p_download_id=36319&Lab=NCEA
- US EPA 2011 – United States Environmental Protection Agency (US EPA). Additional Clarification Regarding Application of Appendix W Modeling Guidance for the 1-hour NO₂ National Ambient Air Quality Standard. March 2011. Accessed June 2020. Available online at: https://www3.epa.gov/ttn/scram/guidance/clarification/Additional_Clarifications_AppendixW_Hourly-NO2-NAAQS_FINAL_03-01-2011.pdf
- US EPA 2013 – United States Environmental Protection Agency (US EPA). Determination of Attainment for the San Francisco Bay Area Nonattainment Area for the 2006 Fine Particle Standard; California; Determination Regarding Applicability of Clean Air Act Requirements. Accessed June 2020. Available online at: <https://www.federalregister.gov/documents/2013/01/09/2013-00170/determination-of-attainment-for-the-san-francisco-bay-area-nonattainment-area-for-the-2006-fine>
- US EPA 2014 – United States Environmental Protection Agency (US EPA). EPA Finalizes Initial Area Designations for the 2012 National Air Quality Standard for Fine Particles - Dec 2014. Accessed June 2020. Available online at: <https://www.epa.gov/particle-pollution-designations/epa-finalizes-initial-area-designations-2012-national-air-quality>
- US EPA 2017 – United States Environmental Protection Agency (US EPA). 2017. Guideline on Air Quality Models. 40 Code of Federal Regulations (CFR) Part 51, Appendix W. January. Accessed June 2020. Available online at: https://www3.epa.gov/ttn/scram/appendix_w-2016.htm

- US EPA 2018a – United States Environmental Protection Agency (US EPA). Guidance on Significant Impact Levels for Ozone and Fine Particles in the Prevention of Significant Deterioration Permitting Program. Accessed October 2020. Available online at: https://www.epa.gov/sites/production/files/2018-04/documents/sils_policy_guidance_document_final_signed_4-17-18.pdf
- US EPA 2018b – United States Environmental Protection Agency (US EPA). Air Quality Designations for the 2010 Sulfur Dioxide (SO₂) Primary National Ambient Air Quality Standard—Round 3. Accessed June 2020. Available online at: <https://www.govinfo.gov/content/pkg/FR-2018-01-09/pdf/2017-28423.pdf>
- US EPA 2020a – United States Environmental Protection Agency (US EPA). NAAQS Table. Accessed June 2020. Available online at: <https://www.epa.gov/criteria-air-pollutants/naqs-table>
- US EPA 2020b – United States Environmental Protection Agency (US EPA). Outdoor Air Quality Data, Monitor Values Report. Accessed October 2020. Available online at: <https://www.epa.gov/outdoor-air-quality-data/monitor-values-report>
- US EPA 2020c – United States Environmental Protection Agency (US EPA). Nitrogen Dioxide/Nitrogen Oxide In-Stack Ratio (ISR) Database. Accessed June 2020. Available online at: <https://www.epa.gov/scram/nitrogen-dioxidenitrogen-oxide-stack-ratio-isr-database>
- Van Gosen and Clinkenbeard 2011 – Van Gosen, B.S., and Clinkenbeard, J.P. (Van Gosen and Clinkenbeard). Reported Historic Asbestos Mines, Historic Asbestos Prospects, and Other Natural Occurrences of Asbestos in California: U.S. Geological Survey Open-File Report 2011-1188. Accessed June 2020. Available online at: <http://pubs.usgs.gov/of/2011/1188/>

4.4 Biological Resources

This section describes the environmental and regulatory setting, and discusses impacts associated with the construction and operation of the project with respect to biological resources that occur in the project area.

BIOLOGICAL RESOURCES		Less Than Significant with Mitigation Incorporated	Less Than Significant Impact	No Impact
Except as provided in Public Resources Code Section 21099, would the project:	Potentially Significant Impact			
a. Have a substantial adverse effect, either directly or through habitat modifications, on any species identified as a candidate, sensitive, or special-status species in local or regional plans, policies, or regulations, or by the California Department of Fish and Wildlife or U.S. Fish and Wildlife Service?	<input type="checkbox"/>	<input checked="" type="checkbox"/>	<input type="checkbox"/>	<input type="checkbox"/>
b. Have a substantial adverse effect on any riparian habitat or other sensitive natural community identified in local or regional plans, policies, regulations or by the California Department of Fish and Wildlife or U.S. Fish and Wildlife Service?	<input type="checkbox"/>	<input checked="" type="checkbox"/>	<input type="checkbox"/>	<input type="checkbox"/>
c. Have a substantial adverse effect on state or Federally protected wetlands (including, but not limited to, marsh, vernal pool, coastal, etc.) through direct removal, filling, hydrological interruption, or other means?	<input type="checkbox"/>	<input type="checkbox"/>	<input type="checkbox"/>	<input checked="" type="checkbox"/>
d. Interfere substantially with the movement of any native resident or migratory fish or wildlife species or with established native resident or migratory wildlife corridors, or impede the use of native wildlife nursery sites?	<input type="checkbox"/>	<input type="checkbox"/>	<input type="checkbox"/>	<input checked="" type="checkbox"/>
e. Conflict with any local policies or ordinances protecting biological resources, such as a tree preservation policy or ordinance?	<input type="checkbox"/>	<input type="checkbox"/>	<input checked="" type="checkbox"/>	<input type="checkbox"/>
f. Conflict with the provisions of an adopted Habitat Conservation Plan, Natural Community Conservation Plan, or other approved local, regional, or State habitat conservation plan?	<input type="checkbox"/>	<input checked="" type="checkbox"/>	<input type="checkbox"/>	<input type="checkbox"/>

Environmental checklist established by CEQA Guidelines, Appendix G.

4.4.1 Setting

Existing Habitat

The proposed project would be located in the City of San Jose, in Santa Clara County California (SV1 2020a - TN232466). The construction of the data center buildings, backup generators, and parking and landscaped areas would occur on an approximately 18-acre site primarily surrounded by commercial buildings, residential housing, and San Ignacio

Ave (northwest), Via Del Oro (northeast), Great Oaks Boulevard (southeast), and Santa Teresa Boulevard. (southwest). The project site is located on the northeastern half of a vacant lot, which consists primarily of non-native grasses and forbs and some scattered trees.

The site provides habitat for foraging wildlife and nesting birds. Botanical and wildlife surveys including focused burrowing owl surveys and raptor nesting activity were conducted by H.T. Harvey and Associates (SV1 2020f - TN 233005-3) on October 30, 2015 and November 4, 2015. No special status species were identified in the area during field surveys (SV1 2020f, BIO DR-34 TN 233005-3). This area is regularly mowed and dominated by non-native grasses primarily wild oats (*Avena* sp.) and non-native forbs such as stinkwort (*Dittrichia graveolens*), mustard (*Brassica* sp.), and horehound (*Marrubium vulgare*). Wildlife species that were seen onsite during surveys include America crow (*Corvus brachyrhychos*), Anna's hummingbird (*Calypte anna*), cedar waxwing (*Bombycilla cedrorum*), black phoebe (*Sayornis nigricans*), Say's phoebe (*Sayornis saya*), northern mockingbird (*Mimus polygottos*), house finch (*Haemorhous mexicanus*), mourning dove (*Zenaida macroura*), western meadowlark (*Sturnella neglecta*), American pipit (*Anthus rubescens*), and a red-tailed hawk (*Buteo jamaicensis*). Multiple California ground squirrels and burrows were also observed.

There are no natural or sensitive habitats located on or adjacent to the site. There are no waterways, wetland, or other aquatic resources located on or adjacent to the site. The nearest waterway is Coyote Creek located approximately 0.98-mile northeast of the site. Commercial property, roads, and US 101 lie between Coyote Creek and the site.

The proposed project is a "covered project" under the Santa Clara Valley Habitat Plan (SCVHP) (SCVHP 2012). Fees are imposed for projects that result in nitrogen deposition, in-lieu of providing compensatory mitigation. The nitrogen deposition fee applies to all projects that create new vehicle trips (mobile emission sources) as well as backup generators (point source emissions). Currently the SCVHP nitrogen deposition fee only accounts for indirect impacts from vehicle emissions on sensitive habitats within the SCVHP permit area. While the SCVHP does not designate a nitrogen deposition fee for point source emissions, a fee will still be required. This additional fee accounts for indirect impacts from point source emissions on sensitive serpentine habitat within the SCVHP permit area.

Sensitive Habitat and Special Status Species

Aside from trees which provide suitable nesting for migratory birds, the site does not provide habitat or support any other special status plant or wildlife species. Special status species are plant and wildlife species that have been afforded special recognition by federal, state, or local resource agencies or organizations. No special status species were identified in the area during the site visit (SV1 2020d; BIO DR-34 TN 233005-3).

The closest sensitive (serpentine) habitat (SCVHP 2012; CNDDDB 2020) is approximately 0.67 mile to the southwest (Santa Teresa Hills and Santa Teresa County Park). Other

nearby locations include Tulare Hill, which is approximately 1.28 miles southeast, and Coyote Ridge which is approximately 1.17 miles northeast/east. These areas is also critical habitat (USFWS 2020) for Bay checkerspot butterfly (*Euphydryas editha bayensis*; FT¹), and known occurrences of Santa Clara Valley dudleya (*Dudleya abramsii* ssp. *setchellii*; FE and CRPR 1B.1), Metcalf Canyon jewelflower (*Streptanthus albidus* ssp. *albidus*; FE and CRPR 1B.1), fragrant fritillary (*Fritillaria liliacea*; CRPR 1B.2), smooth lessingia (*Lessingia microdenia* var. *glabrata*; CRPR 1B.2), and most beautiful jewelflower (*Streptanthus albidus* ssp. *peramoerus*; CRPR 1B.2) (CNDDDB 2021).

Landscape Trees

The site is currently vacant and undeveloped consisting primarily of ruderal grassland with seven ordinance-sized trees (SV1 2020f, BIO DR-34 & BIO DR-36 TN233005-3). A certified arborist conducted a survey and provided a report (SV1 2020f, BIO DR-34 & BIO DR-36 TN233005-3) of the trees on the proposed project site. There are seven existing trees that occur along San Ignacio Ave. and Via Del Oro, which consist of the following species: valley oak (*Quercus lobata*), shamel ash (*Fraxinus uhdei*), blue elderberry (*Sambucus nigra caerulea*), and southern magnolia (*Magnolia grandiflora*). The valley oak (*Quercus lobata*) is a City designated Heritage Tree and will be preserved on site.

Regulatory Background

Federal

Endangered Species Act (16 U.S.C., § 1530 et seq., and 50 C.F.R., part 17.1 et seq.). The Endangered Species Act (ESA) designates and provides for protection of threatened and endangered plant and animal species, and their critical habitat. Its purpose is to protect and recover imperiled species and the ecosystems for which they depend. It is administered by the United States Fish and Wildlife Service (USFWS) and the National Marine Fisheries Service (NMFS). The USFWS is responsible for terrestrial and freshwater organisms while NMFS is responsible for marine wildlife such as whales and anadromous fish (such as salmon). Species may be listed as endangered or threatened. All species are defined to include subspecies, varieties, and for vertebrates, distinct population segments. The ESA protects endangered and threatened species and their habitats by prohibiting the “take” of listed animals and the interstate or international trade in listed plants and animals, including their parts and products, except under federal permit. Take of federally listed species as defined in the Endangered Species Act is prohibited without incidental take authorization, which may be obtained through Section 7 consultation (between federal agencies) or a Section 10 Habitat Conservation Plan.

Migratory Bird Treaty Act (16 U.S.C., §§ 703-711). The Migratory Bird Treaty Act (MBTA) makes it illegal to take, possess, import, export, transport, sell, purchase, barter,

1 Status Codes: FT = Federally Threatened; CRPR = California Rare Plant Rank; 1B = Rare throughout their range with the majority of them endemic to California; 1 = Seriously threatened in California (over 80% of occurrences threatened/high degree and immediacy of threat; 2 = Moderately threatened in California (20-80% occurrences threatened/moderate degree and immediacy of threat.

or offer for sale, purchase, or barter, any migratory bird, or the parts, nests, or eggs of such a bird except under the terms of a valid federal permit. The USFWS has authority and responsibility for enforcing the MBTA.

State

California Endangered Species Act. The California Endangered Species Act (CESA) of 1984 (Fish and Game Code sections 2050-2098) states that all native species of fish, amphibians, reptiles, birds, mammals, invertebrates, and plants, and their habitats, threatened with extinction and those experiencing a significant decline which, if not halted, would lead to a threatened or endangered designation, will be protected and preserved. CESA prohibits the take of any species of wildlife designated by the California Fish and Game Commission as endangered, threatened, or candidate species. The California Department of Fish and Wildlife (CDFW) may authorize the take of any such species if certain conditions are met. These criteria are listed in Title 14 of the California Code of Regulations, section 783.4 subdivisions (a) and (b). For purposes of CESA “take” means to hunt, pursue, catch, capture, or kill, or attempt to hunt, pursue, catch, capture, or kill (Fish and G. Code, § 86).

California Fish and Game Code. The administering agency for the Fish and Game Code sections is CDFW.

- Section 3503: This section makes it unlawful to take, possess, or needlessly destroy the nest or eggs of any bird, except as otherwise provided by this code or any regulation made pursuant thereto.
- Section 3503.5: This section makes it unlawful to take, possess, or destroy any birds in the orders Falconiformes and Strigiformes or to take, possess, or destroy the nest or eggs of any such bird.
- Section 3513: This section protects California’s migratory birds by making it unlawful to take or possess any migratory nongame bird as designated in the Migratory Bird Treaty Act or any part of such migratory nongame birds.

Local

Santa Clara Valley Habitat Plan. The SCVHP primarily covers southern Santa Clara County, as well as the City of San Jose (except for the bayland areas). The SCVHP addresses listed species and species that are likely to become listed during the plan's 50-year permit term. The covered species include nine plants and nine animals. The SCVHP requires that the agencies comment on reportable interim projects and recommend mitigation measures or project alternatives that would help achieve the preliminary conservation objectives and not preclude important conservation planning options or connectivity between areas of high habitat value.

The project is considered a “covered project” under the SCVHCP. As a result, the project would be subject to conditions and fees of the SCVHCP, which will be calculated at the

time the project submits an application, which corresponds to application timing of grading and/or building permits.

City of San Jose General Plan. *Envision San Jose 2040 General Plan* aims to protect biological resources when properties are developed in San Jose. Generally, similar types of requirements occur in the General Plan as in the SCVHCP. The General Plan includes several policies with respect to biological protections that are relevant to this analysis including, but not limited to, the following (San Jose 2020):

- Policy MS-21.4: Encourage the maintenance of mature trees, especially natives, on public and private property as an integral part of the community forest. Prior to allowing the removal of any mature tree, pursue all reasonable measures to preserve it.
- Policy MS-21.5: As part of the development review process, preserve protected trees (as defined by the Municipal Code), and other significant trees. Avoid any adverse effect on the health and longevity of protected or other significant trees through appropriate design measures and construction practices. Special priority should be given to the preservation of native oaks and native sycamores. When tree preservation is not feasible, include appropriate tree replacement, both in number and spread of canopy.
- Policy MS-21.6: As a condition of new development, require, where appropriate, the planting and maintenance of both street trees and trees on private property to achieve a level of tree coverage in compliance with and that implements City laws, policies or guidelines.
- Policy ER-1.5: Preserve and protect oak woodlands, and individual oak trees. Any loss of oak woodland and/or native oak trees must be fully mitigated.
- Policy ER-4.4: Require that development projects incorporate mitigation measures to avoid and minimize impacts to individuals of special-status species.
- Policy ER-5.1: Avoid implementing activities that result in the loss of active native birds' nests, including both direct loss and indirect loss through abandonment, of native birds. Avoidance of activities that could result in impacts to nests during the breeding season or maintenance of buffers between such activities and active nests would avoid such impacts.
- Policy ER-5.2: Require that development projects incorporate measures to avoid impacts to nesting migratory birds.
- Policy ER-6.5: Prohibit use of invasive species, citywide, in required landscaping as part of the discretionary review of proposed development.
- Policy ER-6.6: Encourage the use of native plants in the landscaping of developed areas adjacent to natural lands.
- Policy ER-6.8: Design and construct development to avoid changes in drainage patterns across adjacent natural areas and for adjacent native trees, such as oaks.

4.4.2 Applicant Proposed Measures

CEC staff made some minor revisions to survey periods in PD BIO-3, and the applicant is in agreement with these changes (CEC 2020i).

PD BIO-1: In accordance with current City policies and Municipal regulations, trees removed will be replaced at the ratios identified in Table 4.6-1 [SPPE Application, pg 105].

- In the event replacement/mitigation trees cannot be accommodated on the site, tree removal shall be mitigated through a donation of \$300 per mitigation tree to Our City Forest for in-lieu off-site tree planting in the community. The species of trees to be planted shall be determined in consultation with the City Arborist and the Department of Planning, Building and Code Enforcement. Trees removed shall be replaced at these ratios, or the applicant shall pay an in-lieu fee to Our City Forest to compensate for the loss of trees on-site.

PD BIO-2: In accordance with guidelines established by the International Society for Arboriculture, the following tree protection measures will be implemented to reduce impacts to the Heritage Tree:

- Establish an area surrounding the Heritage Tree to be protected during construction as defined by a circle concentric with each tree with a radius 1-1/2 times the diameter of the tree canopy drip line. This "tree protection zone" is established to protect the tree trunk, canopy and root system from damage during construction activities and to ensure the long-term survival of the protected trees. The tree protection zone shall: (1) ensure that no structures or buildings, that might restrict sunlight relative to the existing conditions, will be constructed in close proximity to the trees; and (2) that no improvements are constructed on the ground around the tree within the tree protection zone, thus ensuring that there is sufficient undisturbed native soil surrounding the tree to provide adequate moisture, soil nutrients and oxygen for healthy root growth.
- Protect tree root systems from damage caused by (a) runoff or spillage of noxious materials while mixing, placing, or storing construction materials and (b) ponding, eroding, or excessive wetting caused by incident rainfall through use of the following measures during excavation and grading:
 - Excavation: Do not trench inside tree protection zones. Hand excavate under or around tree roots to a depth of three feet. Do not cut main lateral tree roots or taproots. Protect exposed roots from drying out before placing permanent backfill.
 - Grading: Maintain existing grades within tree protection zones. Where existing grade is two inches or less below elevation of finish grade, backfill with topsoil or native soil from the project site. Place fill soil in a single un-compacted layer and hand grade to required finish elevation.
 - Apply six-inch average thickness of wood bark mulch inside tree protection zones. Keep mulch six inches from tree trunks.

- Provide 48-inch tall orange plastic construction fencing fastened to steel T-posts, minimum six feet in length, using heavyweight plastic ratchet ties. Install fence along edges of tree protection zones before materials or equipment are brought on site and construction operations begin. Maintain fence in place until construction operations are completed and equipment has been removed from site.
- Provide temporary irrigation to all trees in protection zones using a temporary on-grade drip or bubbler irrigation system sufficient to wet the soil within tree protection zones to a depth of 30 inches per bi-weekly irrigation event.

Heritage Tree Design Requirements

- Establish the horizontal and vertical elevation of the Heritage Tree. Include the trunk location and tag number on all plans.
- Design finish grades so that no water accumulates around the base of the trunk of the Heritage Tree.
- Allow the Consulting Arborist to review all future project submittals including grading, utility, drainage, irrigation, and landscape plans.
- Maintain the tree protection zone around the Heritage Tree as depicted on the Grading and Drainage Plan prepared by Ruth and Going. The tree protection zone shall be the limit of work.
- Route underground services including utilities, sub-drains, water or sewer around the tree protection zone. Where encroachment cannot be avoided, special construction techniques such as hand digging or tunneling under roots shall be employed where necessary to minimize root injury.
- Use only herbicides safe for use around trees and labeled for that use, even below pavement.
- Design the landscape around the Heritage Tree to be compatible with the cultural requirements of native oak trees.
- Any irrigation system must be designed so that no trenching will occur within the dripline of the Heritage Tree.

Pre-construction and Demolition Treatments

The demolition contractor shall meet with the Consulting Arborist before beginning work to discuss work procedures and tree protection.

- Install protection at the tree protection zone prior to demolition, grubbing, or grading.
- No entry is permitted into a tree protection zone without permission of the project superintendent.
- The Heritage Tree should be pruned to reduce the length and weight of long, horizontal branches. Remove stubs only when there is well-developed woundwood present at the attachment. Do not remove the large stub in the center of the crown. All pruning shall be completed by an ISA Certified Arborist or Tree Worker and adhere

to the latest editions of the American National Standards for tree work (Z133 and A300) and International Society of Arboriculture Best Management Practices, Pruning.

- The Heritage Tree should also be evaluated for installation of new cables to support heavy horizontal limbs.

Tree Protection during Construction

- Any grading, construction, demolition or other work that occurs within the tree protection zone should be monitored by the Consulting Arborist.
- If injury occurs to any tree during construction, it should be evaluated as soon as possible by the Consulting Arborist so that appropriate treatments can be applied.
- Fences are to remain until all site work has been completed. Fences may not be relocated or removed without permission of the project superintendent.
- Construction trailers, traffic and storage areas must remain outside fenced areas at all times.
- No materials, equipment, soil, waste, or wash-out water may be deposited, stored, or parked within the tree protection zone (fenced area).
- Any tree pruning needed for clearance during construction must be performed by a qualified arborist and not by construction personnel.
- Any roots damaged during grading or construction shall be exposed to sound tissue and cut cleanly with a saw.

PD BIO-3: The following measure will be implemented to reduce impacts to nesting birds:

- If possible, construction should be scheduled between September and January (inclusive) to avoid the nesting season. If this is not possible, pre-construction surveys for nesting raptors and other migratory breeding birds shall be conducted by a qualified ornithologist to identify active nests that may be disturbed during project implementation onsite and within 250 feet of the site. Between February 1 and August 31 pre-construction surveys shall be conducted no more than 14 days prior to construction activities or tree relocation or removal. The surveying ornithologist shall inspect all trees in and immediately adjacent to the construction area for nests.
- If an active nest is found in or close enough to the construction area to be disturbed by these activities, the ornithologist shall, in consultation with the California Department of Fish and Wildlife (CDFW), designate a construction-free buffer zone (typically 250 feet for raptors and 100 feet for other birds) around the nest, which shall be maintained until after the breeding season has ended and/or a qualified ornithologist has determined that the younger birds have fledged.
- The applicant shall submit a report indicating the results of the survey and any designated buffer zones to the satisfaction of the Director of Planning, Building and Code Enforcement prior to the issuance of any grading or building permit.

4.4.3 Environmental Impacts and Mitigation Measures

a. Would the project have a substantial adverse effect, either directly or through habitat modifications, on any species identified as a candidate, sensitive, or special status species in local or regional plans, policies, or regulations, or by the California Department of Fish and Wildlife or U.S. Fish and Wildlife Service?

The site occurs on the northeastern half of a vacant lot, which consists primarily of non-native grasses and forbs. The site contains seven existing ordinance-sized trees, six of which will be removed (SV1 2020d, Arborist Report DR-36, TN 233005-3). The valley oak at the corner of Via Del Oro and Great Oaks Boulevard is considered a heritage tree and will be preserved. Commercial office buildings, residential housing, and city roads are present in the area around the site.

Construction

Less Than Significant Impact. Rare, threatened, endangered, and sensitive plant and wildlife species are not expected to occur on site because the site does not contain suitable habitat (e.g., vernal pools, marsh, riparian, chaparral, coastal scrub, or serpentine soils). Existing mature trees on and near the project site provide potential habitat and food sources for bird species, including raptors and other migratory birds, protected by the Migratory Bird Treaty Act (MBTA) and Sections 3503 and 3503.5 of the California Fish and Game Code.

Nesting Birds. Tree removal associated with project implementation could result in direct destruction of active nests of birds protected if tree removal occurs during the nesting season (February 1 through August 31). Project construction could also result in the indirect disturbance of nesting birds on or near the project site causing nest abandonment by the adults and mortality of chicks and eggs. Destruction of active bird nests, nest abandonment and/or loss of reproductive effort caused by disturbance are considered "take" by the CDFW, and therefore would be a significant impact.

The applicant provided a project design measure, PD BIO-3, to avoid impacts to nesting birds. For the most part this measure was adequate except for the different timing (days) and timeframes (months) to conduct surveys prior to construction during the breeding season. Birds can complete nest building within 14 days. Staff proposed changes to PD BIO-3, including conducting surveys no more than 14 days prior to construction for the entire breeding season (February 1 through August 31). The applicant accepted staff's changes (CEC 2020i).

Following PD BIO-3, the applicant would attempt to do construction outside the nesting period if possible, conduct pre-construction nesting surveys during the breeding season (February 1 Through August 31), and establish buffers to avoid disturbance of nesting birds if active nests are detected in the trees within 250 feet from construction. This design measure also requires a qualified ornithologist to conduct the pre-construction

nesting surveys and consult with CDFW regarding appropriate buffer zones. In addition, a survey report which would include recommended buffer zones would be submitted to the city's Director of Planning, Building and Code Enforcement prior to any grading or building permit. PD BIO-3 would reduce potential impacts to nesting birds during construction to a less than significant level.

Operation

Less Than Significant with Mitigation Incorporated. Operation activities, such as landscape and irrigation maintenance, are expected to result in the same level of human presence and disturbance as typical nearby landscape and irrigation maintenance activities. The only other operational impacts that could potentially affect biological resources are indirect impacts from nitrogen deposition. Staff considered these impacts as required by the SCVHP (SCVHP 2012). The SCVHP currently proposes a per vehicle trip fee on new development projects to account for mobile emission sources but not point source emissions.

Nitrogen Deposition. The proposed project is considered a "covered project" under the SCVHP. The Santa Clara Valley Habitat Agency (SCVHA) leads the implementation of the SCVHP although fees for this project are paid to the City of San Jose. The SCVHP defines measures to avoid, minimize, and mitigate impacts on covered species and their habitats. These measures are described as conditions on covered activities designed to achieve the following objectives:

- Provide avoidance of covered species during implementation of covered activities throughout the study area.
- Prevent take of individuals from covered activities as prohibited by law.
- Minimize adverse effects on natural communities and covered species where conservation actions will take place.
- Avoid and minimize impacts on jurisdictional wetlands and waters throughout the study area.

To be consistent with the SCVHP the applicant is required to pay a nitrogen deposition fee, in-lieu of providing compensatory mitigation, for projects that result in atmospheric nitrogen emissions. The fee is determined by the number of new vehicle trips for the proposed project. However, this nitrogen deposition fee is only assessed on mobile emission sources because it was not feasible to calculate impacts from point source emissions at the time the SCVHP was being prepared. The project's backup generators would also contribute (as a point source of emissions) to nitrogen deposition. Therefore, staff analyzed nitrogen deposition from the testing and maintenance of the backup generators to potential sensitive habitats.

For new daily vehicle trips, the nitrogen deposition fee is calculated by taking the number of new daily vehicle trips and multiplying it to the nitrogen deposition fee of \$4.96 (SCVHP 2012, Ch6; SV1 2020d, BIO DR-40 Exhibit 2 TN 233005-3). For permanent impacts the

applicant used 959 new daily vehicle trips (SV1 2020b, Appendix K 2017 IS/MND, TN 232467-3) multiplied by \$4.96, which results in a nitrogen deposition fee of \$4,756.64 (SV1 2020d, Exhibit 2 of DR-40, TN 233005-3). This fee was paid in full (SV1 2020d). Based on the Hexagon Consultants Transportation Analysis (SV1 2021h, TN 237150), Table 5 Project Trip Generation Estimates shows the proposed project would generate at most 515 new daily vehicle trips during operations, which is below the original 959 trips previously used to calculate and pay the nitrogen deposition fee.

Testing and maintenance of the standby backup diesel generators would result in emissions of nitrogen oxide (NO_x). Nitrogen deposition is the input of nitrogen oxide (NO_x) and ammonia (NH₃) "atmospherically derived pollutants" (ADP) primarily nitric acid (HNO₃), from the atmosphere to the biosphere. Nitrogen deposition sources are primarily vehicle, agriculture, and industrial emissions, including power plants.

Mechanisms by which nitrogen deposition can lead to impacts on sensitive species include changes in species composition among native plants and the enhancement of invasive species such as grasses (Fenn et al. 2003, Weiss 2006). The increased dominance and growth of invasive annual non-native species is especially prevalent in low biomass vegetation communities that are naturally nitrogen-limited (e.g., serpentine soils). Nitrogen deposition artificially fertilizes the soil and creates better conditions for non-native species to persist and to ultimately displace the native species, resulting in type conversion (conversion of one habitat type to another). Increased nitrogen deposition in nitrogen poor soils has allowed for the proliferation of non-native species that can crowd out native species (e.g., Metcalf Canyon jewelflower and most beautiful jewelflower).

Sensitive biological resources in the vicinity of the project occur in the areas of the Santa Teresa Hills, Tulare Hill, and Coyote Ridge. These areas contain serpentine habitats as well as USFWS designated critical habitat (USFWS 2020), for the federally threatened Bay checkerspot butterfly (USFWS 2008), which also support several special-status species.

These sensitive biological resources include serpentine bunchgrass, Bay checkerspot butterfly (federally threatened) and its designated critical habitat (USFWS 2020), Santa Clara Valley dudleya (federally endangered and rare plant rank 1B.1), Metcalf Canyon jewelflower (federally endangered and rare plant rank 1B.1), fragrant fritillary (rare plant rank 1B.2), smooth lessingia (rare plant rank 1B.2), and most beautiful jewelflower (rare plant rank 1B.2) (CNDDDB 2020; SCVHP 2012, Ch 4 and Appx D). Serpentine bunchgrass is considered a sensitive natural community by the CDFW's CNDDDB (CNDDDB 2020), and occurs on serpentine soils (serpentine habitat).

Competition from invasive non-native species affects Bay checkerspot butterfly, Santa Clara Valley dudleya, Metcalf Canyon jewelflower, fragrant fritillary, smooth lessingia, and most beautiful jewelflower (USFWS 1998; SCVHP 2012). For the Bay checkerspot butterfly, habitat degradation and loss are caused by non-native plants which displace or reduce native food plants (USFWS 1998). Serpentine habitat has a critical load of 6 kg N/ha/yr (Pardo et al. 2011). Critical load is defined as the input of a pollutant below which no detrimental ecological effects occur over the long-term. Above this critical load value,

the effects of invasive non-native species on listed and other sensitive plant species begin to occur. These effects include the proliferation of invasive non-native species.

CEC Air Quality staff modeled the potential nitrogen emissions from the testing and maintenance of the generators using AERMOD. This model included expected testing and maintenance conditions and the predominant atmospheric conditions and wind direction in sensitive habitats (serpentine) that support the Bay checkerspot butterfly and other special-status species mentioned previously. A summary analysis prepared by Air Quality staff that provides a better understanding of the nitrogen deposition modeling used for the proposed project is presented in **Appendix C**.

Staff addressed the potential for deposition of nitrogen to affect sensitive biological resources within six miles of the proposed project (**Figure 4.4.1**). It has been staff's experience that by the time the plume has traveled this distance, in-plume concentrations become indistinguishable from background concentrations. Staff then further refined affected areas to within the nitrogen deposition plume isopleth (**Figure 4.4.2**) provided by Air Quality staff. The majority of modeled annual nitrogen deposition from the proposed project at sensitive habitat would be 0.01 kg/ha/yr or less. That is, 11 percent of the nitrogen deposition would occur in the outermost ring out of the 13 percent of sensitive habitat that occurs within the nitrogen deposition plume. For a small part of the sensitive habitat to the south and southeast of the proposed project, nitrogen deposition ranges from 0.01 kg N/ha/yr to 0.08 kg N/ha/yr, with the majority occurring in the lowest range.

The Great Oaks South Backup Generating Facility (GOSBGF) would contribute to nitrogen deposition within sensitive (serpentine) habitats in the Santa Teresa Hills, Tulare Hill and Coyote Ridge areas which support populations of the Bay checkerspot butterfly, Santa Clara Valley dudleya, and Metcalf Canyon jewelflower, along with three rare plants: fragrant fritillary, smooth lessingia, and most beautiful jewelflower. This area includes USFWS designated critical habitat (USFWS 2020) for the Bay checkerspot butterfly (USFWS 2008). The proposed GOSBGF's contribution of nitrogen emission sources would add to the current proliferation of invasive weeds in serpentine habitats supporting these species. The largest threat to these species are invasive non-natives (typically grasses) and the resultant cascading effects (e.g., competition, wildfires). Invasive non-native species is facilitated by nitrogen deposition, which is a result of the NO_x emissions from many mobile and point sources within the region. Given the threats to these sensitive species from invasive weeds are exacerbated by nitrogen at this already stressed ecosystem this contribution would be a significant indirect impact.

The threat to these species from invasive non-natives and from existing non-native weed invasions in sensitive habitat (Santa Teresa Hills, Tulare Hill, and Coyote Ridge), especially related to nitrogen deposition, the GOSBGF's emissions and the resulting incremental effect to Bay checkerspot butterfly, Santa Clara Valley dudleya, Metcalf Canyon jewelflower, fragrant fritillary, smooth lessingia, and most beautiful jewelflower is a significant impact in the absence of mitigation.

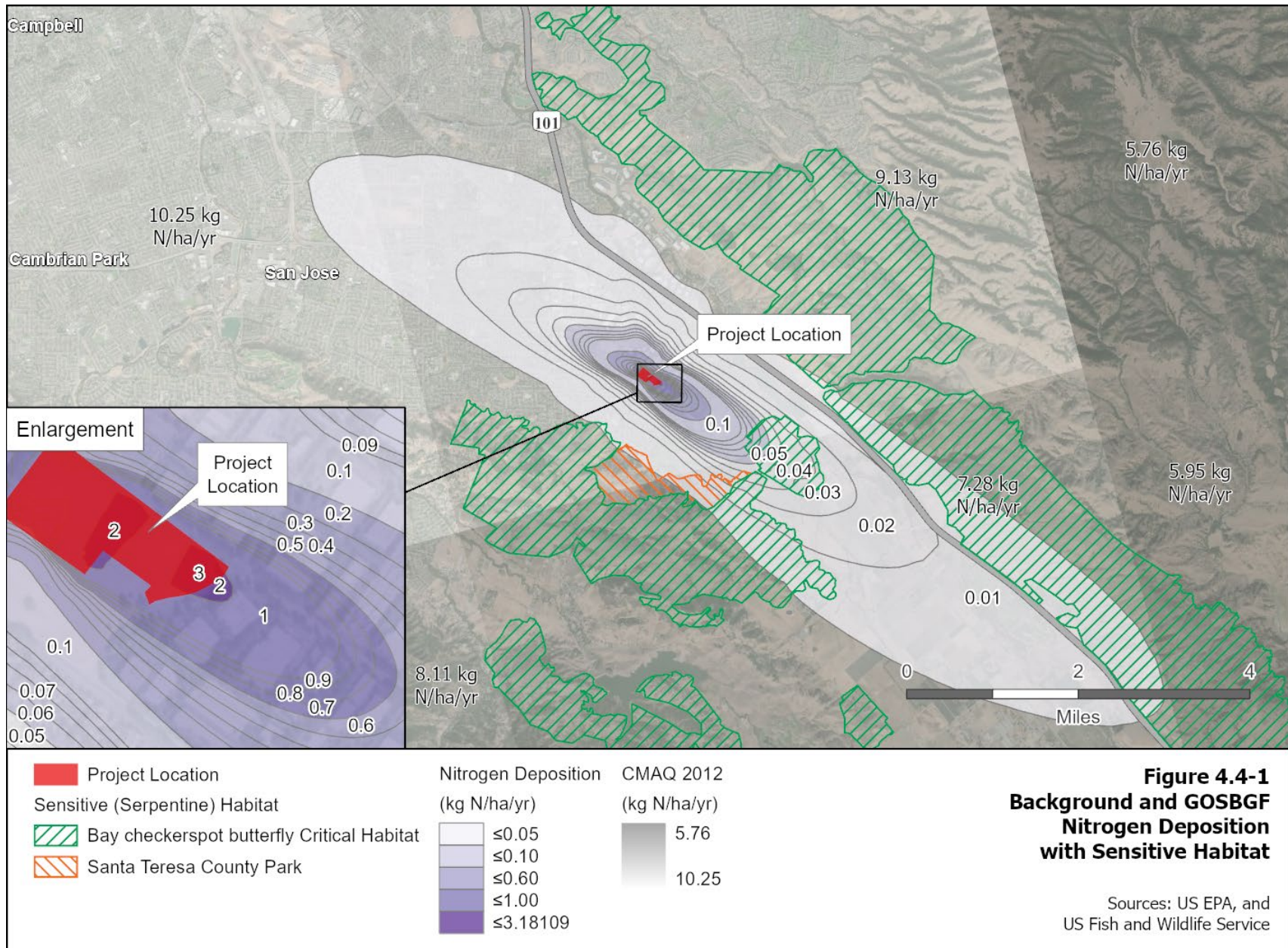

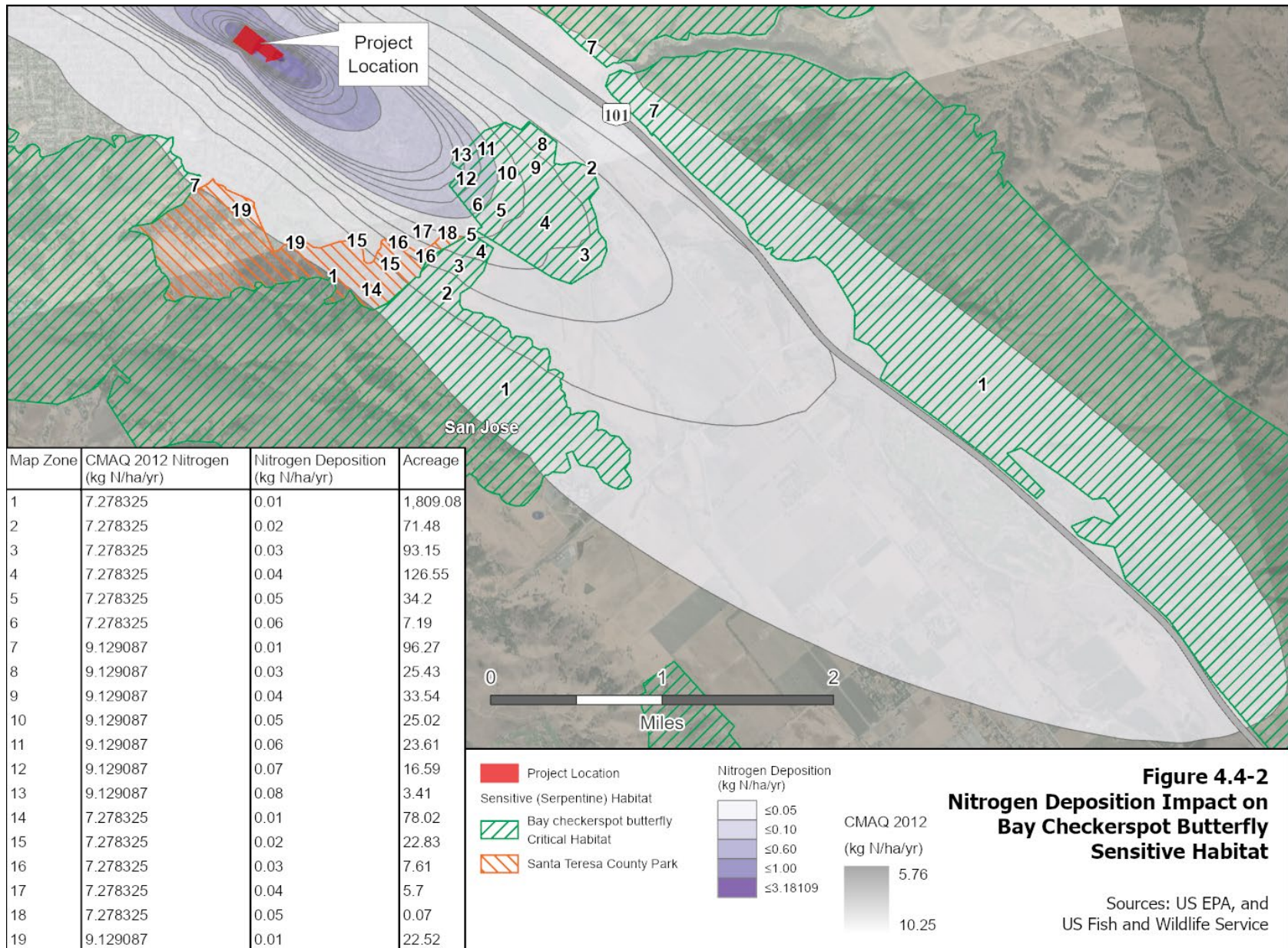

Staff worked with the Santa Clara Valley Habitat Agency (SCVHA) (which implements the SCVHP), U.S. Fish and Wildlife Service, and the California Department of Fish and Wildlife to determine appropriate mitigation for point source nitrogen deposition impacts from the proposed GOSBGF.

According to the model conducted by air quality staff, nitrogen deposition rates from GOSBGF in sensitive habitat within the Santa Teresa Hills, Tulare Hill, and Coyote Ridge areas would range from 0.01 to 0.08 kilograms of Nitrogen per hectare per year (kg N/ha/yr). Background levels of nitrogen deposition within serpentine habitat in these areas within critical habitat for Bay checkerspot butterfly range from approximately 7.28-9.13 kg N/ha/yr (CMAQ 2012). See **Figures 4.4-1 and 4.4-2** for details regarding the background nitrogen deposition levels in relation to GOSBGF emissions.

To determine how to mitigate for the nitrogen deposition from the testing and maintenance of the backup generators for point source emissions, staff contacted Gerry Haas with the SCVHA. During a conference call, Mr. Haas (CEC 2020) proposed that the applicant submit an Application for Nitrogen Deposition-Only Projects (SCVHA 2020) and for the payment of a separate fee (as a way to mitigate for future emissions) since the project is a “covered project” under the SCVHP. Determination of appropriate nitrogen deposition fees for the backup generators would require a separate fee calculation.

It is understood that emissions from the proposed GOSBGF would not be the only source of nitrogen deposition in sensitive (serpentine) habitat within Santa Teresa Hills, Tulare Hill, and Coyote Ridge areas. There are existing industrial stationary (point) sources as well as mobile sources (i.e., transportation) in the southern San Jose area that collectively contribute to elevated local and regional nitrogen deposition. Accordingly, staff proposes that the applicant’s mitigation be proportional to the proposed GOSBGF’s contribution toward the total nitrogen deposition within critical habitat (See **Figures 4.4-1 and 4.4-2**) in the Santa Teresa Hills, Tulare Hill, and Coyote Ridge areas and Santa Teresa County Park. The following equation was developed by staff to calculate habitat compensation acres from earlier CEC siting cases which include the Metcalf Energy Center, Marsh Landing Generating Station, Oakley Generating Station, and Pio Pico Energy Center.

$$\left[\frac{\text{Project n-dep within critical habitat}}{\text{background n-dep within critical habitat}} \right] \times \text{acreage of affected habitat} = \text{acres of mitigation land}$$

This earlier equation was modified in order to account for the proposed GOSBGF nitrogen deposition impacts to Bay checkerspot butterfly sensitive habitat from each level of the isopleth (plume) in relation to the total area of sensitive habitat with the addition of a cost value. In addition, the GOSBGF nitrogen deposition rate is averaged for each isopleth level. For example, the average for the first level 0.01 kg N/ha/yr to 0.02 kg N/ha/yr would be 0.015 kg N/ha/yr and so on. According to the Santa Clara Valley Habitat Plan Development Fee Nexus Study (Willdan 2012), the cost of nitrogen deposition impacts on serpentine habitats (land cover types) is \$5,310,000 (SCVHP 2012, Table 4.1) over the 50-year term of the SCVHP. This cost factors in managing serpentine reserve lands to prevent the invasion of nonnative species as a result of nitrogen deposition and other

threats. Serpentine habitat has higher per acre cost for management and maintenance, monitoring, research, and scientific review, than non-serpentine habitats. This high cost results from the large number of covered species occurring in serpentine habitat and the intensive management and monitoring required to maintain the quality of this habitat. The following equation is the result of taking these factors into consideration.

$$\begin{aligned} & [\text{Acres of sensitive habitat within each map zone} / \text{total acres of sensitive habitat}] \times \\ & [\text{Project n-dep within each map zone (sensitive habitat)} / \text{background n-dep within} \\ & \text{sensitive habitat}] \times \text{cost of nitrogen deposition impact on serpentine habitats for the 50-} \\ & \text{year term of the SCVHP} = \text{cost of additional nitrogen deposition fee} \end{aligned}$$

Since the nitrogen deposition plume extends several miles southeast of the proposed project it encompasses several different background levels of nitrogen deposition as illustrated in **Figures 4.4.1 and 4.4.2**. The GOSBGF's nitrogen deposition levels also vary across sensitive habitat areas for listed and special status species. Each area that was identified as having different nitrogen deposition backgrounds and GOSBGF emission values was identified as a "Map Zone". Refer to **Figures 4.4.1 and 4.4.2** at the end of this section for an illustration of the map zones. The values for each map zone were calculated individually using the equation above and then totaled to determine the final cost for mitigation. Each map zone calculation accounted for the acres of impacted sensitive habitat, the total acres of sensitive habitat for the Bay checkerspot butterfly, the GOSBGF's nitrogen deposition within sensitive habitat, the baseline nitrogen deposition, and the cost of nitrogen deposition impacts on serpentine habitats over the 50-year term of the SCVHP (\$5,310,000).

Following is an example of this methodology applied for two map zones of affected Bay checkerspot butterfly habitat:

$$\text{Map Zone 1 [1809.08 ac/41680 ac]} \times [0.015 \text{ kg N/ha/yr}/7.28 \text{ kg N/ha/yr}] \times \$5,310,000 = \$1058.97$$

$$\text{Map Zone 2 [71.48 ac/41680 ac]} \times [0.025 \text{ kg N/ha.yr}/7.28 \text{ kg N/ha/yr}] \times \$5,310,000 = \$69.74$$

This calculation was repeated for all 19 map zones and totaled to be \$864.01. **Table 4.4-1** presents the mitigation calculations for listed and sensitive species affected by GOSBGF point source nitrogen deposition emissions.

TABLE 4.4-1: CALCULATION FOR NITROGEN DEPOSITION FROM POINT SOURCE EMISSIONS

Map Zone	Acres of affected sensitive habitat	Total acres of sensitive habitat	GOSBGF nitrogen deposition (kg N/ha/yr)	Background nitrogen deposition (kg N/ha/yr)	Cost of nitrogen deposition in serpentine habitat	Total Cost (\$)
1	1809.08	41680	.015	7.28	5,310,000	474.88
2	71.48	"	.025	7.28	"	31.27
3	93.15	"	.035	7.28	"	57.05
4	126.55	"	.045	7.28	"	99.66
5	34.20	"	.055	7.28	"	32.92
6	7.19	"	.065	7.28	"	8.18
7	96.27	"	.015	9.13	"	20.15
8	25.43	"	.035	9.13	"	12.42
9	33.54	"	.045	9.13	"	21.06
10	25.02	"	.055	9.13	"	19.20
11	23.61	"	.065	9.13	"	21.41
12	16.59	"	.075	9.13	"	17.36
13	3.41	"	.085	9.13	"	4.04
14	78.02	"	.015	7.28	"	20.48
15	22.83	"	.025	7.28	"	9.99
16	7.61	"	.035	7.28	"	4.66
17	5.70	"	.045	7.28	"	4.49
18	0.07	"	.055	7.28	"	0.07
19	22.52	"	.015	9.13	"	4.71
Total Cost						864.01

Staff recommends **MM BIO-1** to reduce the GOSBGF's significant impact from nitrogen deposition for point source emissions. Per **MM BIO-1**, the proposed project would provide an additional nitrogen deposition fee of \$864.01 which is proportional to the GOSBGF contribution of nitrogen deposition occurring at Tulare Hill, Coyote Ridge, and Santa Teresa Hills. With the implementation of MM-BIO-1, operation of the proposed project would not result in a substantially adverse effect from nitrogen deposition, either directly or through habitat modifications, on any species identified as a candidate, sensitive, or special status. Therefore, this impact would be less than significant with mitigation.

Emergency Operations of the Backup Generators. Staff has undertaken a qualitative analysis of nitrogen deposition impacts of emergency operations of the backup generators. This type of analysis was conducted because it is difficult to determine how often and under what circumstances any potential emergency operation would occur for the purposes of modeling nitrogen deposition. For reasons why this is so difficult to predict see Evaluating Emergency Operations in **Section 4.3 Air Quality**.

The applicant states that testing and maintenance rarely exceeds 12 hours per engine per year and has agreed to a cap of 20 hours per engine per year. The nitrogen deposition modeling, which is overly conservative, considers up to 20 hours per engine per year.

This overestimates the hours run for testing and maintenance and the amount of nitrogen deposition the project contributes to sensitive habitat and associated species. This overestimation includes 8 hours per engine per year of limited use which could be applied to emergency operations of the backup generators, assuming testing and maintenance of the diesel engines is not greater than 12 hours, more so if less than 12 hours is used.

The modeling also assumes Tier 2 emission factors, instead of Tier 4 proposed by the project, since the selective catalytic reduction (SCR) is not always effective during short, low load testing. During emergency operations and depending on the load, the SCR would be expected to be more effective within 15 minutes and therefore a decrease in NOx and hence as a result less nitrogen deposition.

Mitigation required by staff for the project's cumulatively significant point source contribution of nitrogen deposition impacts from the testing and maintenance of the diesel engines, incorporates some allowance of emergency operations of the backup generators. As stated earlier, testing and maintenance of the backup generators rarely exceeds 12 hours and the nitrogen deposition modeling factors in 20 hours.

Because of the infrequent nature of emergency conditions, the record of highly reliable electric service available to the project, and the extremely conservative assumptions of the nitrogen deposition modeling, staff does not expect any significant impacts to occur from nitrogen deposition in sensitive habitat and associated species during emergency operation of the backup generators.

MM BIO-1: Additional Nitrogen Deposition Fee for Point Source Emissions.

Complete and submit an Application for Nitrogen Deposition-Only Projects to the city of San Jose and reference the original data center project. Pay the additional one-time nitrogen deposition fee of \$864.01 to the city of San Jose.

Required Mitigation Measure: MM BIO-1

b. Would the project have a substantial adverse effect on any riparian habitat or other sensitive natural community identified in local or regional plans, policies, and regulations or by the California Department of Fish and Wildlife or U.S. Fish and Wildlife Service?

Construction

No Impact. The project site consists of non-native grasses and forbs and surrounded by development (commercial office buildings and residential houses) and roads. There are no riparian habitats or other sensitive natural communities identified in local or regional plans, policies, and regulations or by the CDFW or USFWS within the project site. There would be no impact.

Operation

Less Than Significant Impact with Mitigation Incorporated. As stated above, no direct impacts would occur during operation and maintenance of the proposed project. However, staff also considered indirect impacts from nitrogen deposition. As discussed earlier the applicant has paid the required nitrogen deposition fees for mobile source emissions for the proposed project. It should be noted that the SCVHP does not include consideration of nitrogen deposition from point source emissions. Point source emissions from the project, as discussed in impact criterion "a" would be significant. However, with the implementation of **MM BIO-1**, impacts from point source emissions would be reduced to less than significant. Therefore, impacts from nitrogen deposition would be less than significant with mitigation incorporated.

Required Mitigation Measures: MM BIO-1

- c. Would the project have a substantial adverse effect on federally protected wetlands as defined by Section 404 of the Clean Water Act (including, but not limited to, marsh, vernal pool, coastal, etc.) either individually or in combination with the known or probable impacts of other activities through direct removal, filling, hydrological interruption, or other means?**

Construction and Operation

No Impact. There are no state or federally protected wetlands within or adjacent to the project site. The closest aquatic feature to the project site is Coyote Creek located approximately 0.9-mile northeast and separated from the site by development consisting of commercial buildings, residential housing, US 101, and various city roads. There would be no impact during construction, operation, or maintenance of the proposed project.

- d. Would the project interfere substantially with the movement of any native resident or migratory fish or wildlife species or with established native resident or migratory wildlife corridors, or impede the use of wildlife nursery sites?**

Construction and Operation

No Impact. There are no established wildlife corridors, such as rivers or streams, in the immediate project vicinity. Coyote Creek, located approximately 0.9-mile northeast of the proposed project, is the closest corridor where movement or migration of native resident or migratory fish or wildlife species would likely occur. There are no known wildlife nursery sites, such as a rookery, fawning area, or fish spawning habitat, in the project area. Therefore, the proposed project would have no impact during construction or operation.

e. Would the project conflict with any local policies or ordinances protecting biological resources, such as a tree preservation policy or ordinance?

Construction

Less Than Significant Impact. There are 7 trees located within the approximately 18-acre project site. All trees are ordinance-sized, one of which is considered a heritage tree (valley oak) by the City of San Jose. As part of the project, the applicant proposes to remove six of the ordinance-sized trees and protect the valley oak tree documented as occurring on site (SV1 2020d, Arborist Report BIO DR-36, TN 233005-3). The City of San Jose requires a tree removal permit for any ordinance-sized trees. The applicant's project design measure PD BIO-1 requires tree removal in accordance with current City policies and municipal regulations and to replace trees at ratios identified in Table 4.6-1 Tree Replacement Ratios (SV1 2020a, TN 232466). There is also a provision to make a donation to Our City Forest of \$300 per mitigation tree in case a tree cannot be placed on the site.

One valley oak tree (heritage tree) will remain on-site and will require protection during construction. The applicant's project design measure PD BIO-2 requires tree protection measures such as a "tree protection zone" to protect the tree and roots. It also provides design requirements that prevent water accumulation around roots and to route underground services around the "tree protection zone". It includes pre-construction and demolition treatments, along with protection during construction. PD BIO-1 and PD BIO-2 would ensure the project does not conflict with local tree preservation policies and ordinances and would reduce impacts on trees to less-than-significant levels.

Operation

No Impact. Tree removal or other activities that conflict with any local policies or ordinances protecting biological resources are not expected to occur during operation and maintenance. Therefore, no impact would occur during operation or maintenance of the proposed project.

Required Mitigation Measures: None

f. Would the project conflict with the provisions of an adopted Habitat Conservation Plan, Natural Communities Conservation Plan, or other approved local, regional, or State habitat conservation plan?

Construction and Operation

Less Than Significant with Mitigation Incorporated. As discussed previously, the proposed project is a covered project under the SCVHP and the required nitrogen deposition fee for mobile emissions has been paid (SV1 2020d). However, point source emissions have not been considered in the SCVHP. As discussed above in impact criterion "a" point source

emissions from the project would be significant without mitigation. Implementation of **MM BIO-1** would reduce the projects impacts from nitrogen deposition to less than significant.

Required Mitigation Measures: MM BIO-1

4.4.4 References

- CEC 2020i – California Energy Commission (CEC). Report of Conversation – Edits to PD BIO-3: Great Oaks South Backup Generating Facility (TN 233485), June 2020. Available online at: <https://efiling.energy.ca.gov/Lists/DocketLog.aspx?docketnumber=20-SPPE-01>
- CNDDDB 2020 – California Natural Diversity Database (CNDDDB). Rarefind 5 (Government Version, June 30, 2019) 9 quad search around the proposed project. Accessed March 1, 2020
- CMAQ 2020 – Community Multiscale Air Quality Modeling System (CMQA) Download shapefiles of CMAQ-predicted values of annual total deposition across the US for 2002 through 2012. Available online at: http://www.epa.gov/cmaq/cmaq-output#CMAS_Data_Warehouse
- Fenn et al. 2003 – Fenn, M.E., Baron, J.S., Allen, E.B., Rueth, H.M., Nydick, K.R., Geiser, L., Bowman, W.D., Sickman, J.O., Meixner, T., Johnson, D.W., P. Neitlich (Fenn et al.). 2003. Ecological effects of nitrogen deposition in the western United States. *Bioscience* 53(4): 404-420
- Pardo et al. 2011 – Pardo LH, ME Fenn, GL Goodale, LH Geiser, CT Briscoll, EB Allen, J Baron, R. Bobbink, WD Bowman, C Clark, E Emmett, FS Gillian, T Greaver, SJ Hall, EA Lilleskor, L Liu, J Lynch, K Nodelhoffer, SS Perakis, MJ Robin-Abbott, J Stoddard, K Weathers, and RL Dennis (Pardo et al.). Effects of nitrogen deposition and empirical nitrogen critical loads for ecoregions of the United States. *Ecological Applications* 21:3049-3082
- San Jose 2020 – *Envision San Jose 2040 General Plan*. Adopted November 1, 2011. As Amended on March 16, 2020. Available online at: <https://www.sanjoseca.gov/your-government/departments/planning-building-code-enforcement/planning-division/citywide-planning/envision-san-jos-2040-general-plan>
- SCVHP 2012 – Santa Clara Valley Habitat Plan (SCVHP). Final Santa Clara Valley Habitat Plan. August 2012. Available online at: <https://scv-habitatagency.org/178/Santa-Clara-Valley-Habitat-Plan>
- SV1 2020a – SV1, LLC. (SV1). Application for Small Power Plant Exemption: Great Oaks South Backup Generating Facility (TN 232466), March 2020. Available online at: <https://efiling.energy.ca.gov/Lists/DocketLog.aspx?docketnumber=20-SPPE-01>

- SV1 2020b – SV1, LLC. (SV1). Application Appendices A through K: Great Oaks South Backup Generating Facility (TN 232467-1,2,3), March 2020. Available online at: <https://efiling.energy.ca.gov/Lists/DocketLog.aspx?docketnumber=20-SPPE-01>
- SV1 2020d – SV1, LLC. (SV1). SV1 Responses to CEC Data Request Set 2: Great Oaks South Backup Generating Facility Part 1 through Part 4 (TN 233005-1,2,3,4), May 2020. Available online at: <https://efiling.energy.ca.gov/Lists/DocketLog.aspx?docketnumber=20-SPPE-01>
- SV1 2020f – SV1, LLC. (SV1). SV1 Supplemental Responses to CEC Data Requests 18 and 56: Great Oaks South Backup Generating Facility (TN 233681), June 2020. Available online at: <https://efiling.energy.ca.gov/Lists/DocketLog.aspx?docketnumber=20-SPPE-01>
- SV1 2021h – SV, LLC. (SV 1). SV 1 Hexagon Consultants Transportation Analysis: Great Oaks South Backup Generating Facility (TN 237150), March 2021. Available online at: <https://efiling.energy.ca.gov/Lists/DocketLog.aspx?docketnumber=20-SPPE-01>
- USFWS 1998 – United States Fish and Wildlife Service (USFWS). Recovery Plan for Serpentine Soil Species of the San Francisco Bay Area. Portland, Oregon. 330+ pp. Available online at: <https://ecos.fws.gov/ecp0/profile/speciesProfile?scode=I021>
- USFWS 2008 – United States Fish and Wildlife Service (USFWS). Endangered and Threatened Wildlife and Plants; Designation of Critical Habitat for the Bay Checkerspot Butterfly (*Euphydryas editha bayensis*). Final Rule. Federal Register. 73(166): 50406-50452
- USFWS 2020 – United States Fish and Wildlife Service (USFWS). Critical Habitat Mapper. Available online at: <https://fws.maps.arcgis.com/home/webmap/viewer.html?webmap=9d8de5e265ad4fe09893cf75b8dbfb77>
- Weiss 2006 – Weiss. Impacts of Nitrogen Deposition on California Ecosystems and Biodiversity. California Energy Commission, PIER Energy-Related Environmental Research. CEC-500-2005-165

4.5 Cultural and Tribal Cultural Resources

This section describes the environmental and regulatory setting and discusses the impacts associated with the construction and operation of the project with respect to cultural and tribal cultural resources.

CULTURAL RESOURCES		Potentially Significant Impact	Less Than Significant with Mitigation Incorporated	Less Than Significant Impact	No Impact
Would the project:					
a. Cause a substantial adverse change in the significance of a historical resource pursuant to §15064.5?	<input type="checkbox"/>	<input checked="" type="checkbox"/>	<input type="checkbox"/>	<input type="checkbox"/>	<input type="checkbox"/>
b. Cause a substantial adverse change in the significance of a unique archaeological resource pursuant to §15064.5?	<input type="checkbox"/>	<input checked="" type="checkbox"/>	<input type="checkbox"/>	<input type="checkbox"/>	<input type="checkbox"/>
c. Disturb any human remains, including those interred outside of dedicated cemeteries?	<input type="checkbox"/>	<input checked="" type="checkbox"/>	<input type="checkbox"/>	<input type="checkbox"/>	<input type="checkbox"/>

TRIBAL CULTURAL RESOURCES		Potentially Significant Impact	Less Than Significant with Mitigation Incorporated	Less Than Significant Impact	No Impact
Would the project cause a substantial adverse change in the significance of a tribal cultural resource, defined in Public Resources Code section 21074 as either a site, feature, place, cultural landscape that is geographically defined in terms of the size and scope of the landscape, sacred place, or object with cultural value to a California Native American tribe, and that is:					
a. Listed or eligible for listing in the California Register of Historical Resources, or in a local register of historical resources as defined in Public Resources Code section 5020.1(k), or	<input type="checkbox"/>	<input type="checkbox"/>	<input type="checkbox"/>	<input type="checkbox"/>	<input checked="" type="checkbox"/>
b. A resource determined by the lead agency, in its discretion and supported by substantial evidence, to be significant pursuant to criteria set forth in subdivision (c) of Public Resources Code Section 5024.1. In applying the criteria set forth in subdivision (c) of Public Resource Code Section 5024.1, the lead agency shall consider the significance of the resource to a California Native American tribe.	<input type="checkbox"/>	<input checked="" type="checkbox"/>	<input type="checkbox"/>	<input type="checkbox"/>	<input type="checkbox"/>

Environmental checklist established by CEQA Guidelines, Appendix G.

4.5.1 Setting

This section assesses the potential impacts of the proposed project on cultural and tribal cultural resources. The section considers four broad classes of cultural resources: prehistoric, ethnographic, historic-period, and tribal cultural resources. The next four

paragraphs briefly describe these classes of resources. Afterward, the Cultural and Tribal Cultural Resources section presents the environmental setting pertinent to these resources:

- *Prehistoric, ethnographic, and historic contexts*— generally describes who lived in the project vicinity, the timing of their occupation, and what uses they made of the area
- *Methods of analysis* — establishes what kinds of physical traces (cultural and tribal cultural resources) past peoples might have left in the project area, given the project vicinity’s prehistoric, ethnographic, and historic contexts
- *Results* ensuing from those methods — identifies the specific resources present or expectable in the project area
- *Regulatory setting* — presents the criteria for identifying *significant* cultural and tribal cultural resources under the California Environmental Quality Act (CEQA) and other applicable authorities, as well as criteria for identifying significant impacts on these resources
- *Impacts* — identifies any impacts on cultural and tribal cultural resources, along with the severity of any such impacts
- *Mitigation measures* — proposes measures to avoid, minimize, rectify, reduce or eliminate, or compensate for identified impacts

Prehistoric archaeological resources are those materials relating to Native American occupation and use of a particular environment. These resources may include sites and deposits, structures, artifacts, rock art, trails, and other traces of Native American activity. In California, the prehistoric period began more than 12,000 years ago and extended through the eighteenth century until A.D. 1769, when Europeans first settled in California.

Ethnographic resources are those materials important to the heritage of a particular ethnic or cultural group, such as Native Americans or African, European, or Asian immigrants. They may include traditional resource collecting areas, ceremonial sites, topographic features, value-imbued landscapes, cemeteries, shrines, or neighborhoods and structures. Ethnographic resources are variations of natural resources and standard cultural resource types. They are subsistence and ceremonial locales and sites, structures, objects, and rural and urban landscapes assigned cultural significance by traditional users. The decision to call resources “ethnographic” depends on whether associated peoples perceive them as traditionally meaningful to their identity as a group and the survival of their lifeways.

Historic-period resources are those materials, archaeological and architectural, usually but not necessarily associated with Euro-American exploration and settlement of an area and the beginning of a written historical record. They may include archaeological deposits, sites, structures, trail and road corridors, artifacts, or other evidence of historic human activity. Under federal and state requirements, historic period cultural resources must be 50 years or older to be considered of potential historic importance. A resource

less than 50 years of age may be historically significant if the resource is of exceptional importance. The Office of Historic Preservation (OHP 1995, page 2) endorses recording and evaluating resources 45 years or older to accommodate a five-year lag in the planning process.

Tribal cultural resources are a category of historical resources introduced into CEQA by Assembly Bill 52 (Stats. 2014). Tribal cultural resources are resources that are any of the following: sites, features, places, cultural landscapes, sacred places, or objects that are included in or determined eligible to the California Register of Historical Resources (CRHR), or are included on a local register of historical resources as defined in Public Resources Code, section 5020.1(k). Tribal cultural resources can be prehistoric, ethnographic, or historic.

Prehistoric Context

The archaeological record in the Santa Clara Valley began about 9,000 years before present (B.P., where the year 1950 is considered "present") with the Metcalf Creek Aspect, the local expression of the Millingstone cultural pattern. Archaeological deposits dating to this time contain milling slabs and handstones, and large wide-stemmed and leaf-shaped projectile points. Native people during this period were mobile foragers and burials were typically flexed (knees pulled up toward the chin) and placed beneath millingstone cairns. (Milliken et al. 2007, page 114.)

This Early Holocene culture extended until the beginning of the Early Period (about 5500 B.P.). It exhibits developments in groundstone technology (i.e., replacing millingstones with the mortar and pestle), less movement of entire communities, regional symbolic integration between cultural groups, and increased trade. Also referred to locally as the Sandhill Bluff Aspect, this cultural pattern lasted until about 2500 B.P., when the Lower Middle Period began with a "major disruption in symbolic integration systems." (Milliken et al. 2007, page 115.) Archaeological assemblages from the Lower Middle Period include more olive snail-shell saucer beads and circular abalone shell ornaments (and the disappearance of the rectangular shell beads), as well as bone tools and whistles.

The Upper Middle Period began about 1520 B.P. with a disruption of the olive snail-shell bead trade network, abandonment of some village sites, and changes in shell bead manufacture. Some South Bay burials from this period were extended rather than flexed burials, and grave goods were lacking. (Milliken et al. 2007, page 116.)

The Late Period began about 900 B.P., with groups increasingly intensifying the creation of wealth objects, as seen in burials. Smaller projectile points for use in the bow and arrow emerged during this period and some of the mortuary evidence suggests the introduction of cremation, at least among the wealthiest of individuals. (Milliken et al. 2007, page 117.)

Archaeological research in the project vicinity reveals a rich and lengthy archaeological record. Archaeologists have found numerous buried Native American sites throughout the

lower Santa Clara Valley. Coyote Creek and the Guadalupe River buried generations of Native American sites under layers of silt and clay. As a result, the surface archaeological record of Santa Clara Valley represents only the last 2,000 years of human occupation. The remaining 7,000 years of native history lay anywhere from near surface up to 30 feet below the modern ground surface. (Busby et al. 1996a, pages 2–4; Busby et al. 1996b, page 2; Jones et al. 2007, page 130; Parsons and KEMCO 1983, pages 16, 25–26, 33; Ruby et al. 1992, pages 9, 12, 17–19.)

Ethnographic Context

The Costanoans are the Native Americans who inhabited the Bay Area since time immemorial. The Costanoan designation refers to those who spoke one of eight separate but related languages (Shipley 1978, pages 84, 89). The Costanoan languages are related to Miwok and are part of the Yok-Utian language family of the Penutian stock (Golla 2007, pages 75–76). Tamyen (Santa Clara Costanoan) was spoken around the southern end of San Francisco Bay and the lower Santa Clara Valley (and was spoken by Costanoans in the project vicinity). (Milliken et al. 2007, Figure 8.1; Shipley 1978, pages 84 and 89.)

Each village was a separate and politically autonomous unit (called a “tribelet”), with about 200 people living within each. Tribelets were the basic unit of political organization, with chiefs, either women or men, descended from their patrilineal relative. In the late 1700s, there was one tribelet near the proposed project site, San Juan Bautista, presumably comprising Tamyen speakers. (Levy 1978, Figure 1.) Levy (1978, Figure 1) indicates that the settlement was located within a couple of miles of the project site on Coyote Creek.

Like most other Native Americans in California, acorns were the staple food of the Costanoan people in the Santa Clara region. Other nuts such as buckeye, California laurel, and hazelnuts were also eaten. The Costanoans set controlled fires to promote the growth of the nuts and seeds upon which they relied. The primary mammals taken by the Costanoan included the black-tailed deer, elk, antelope, grizzly bear, mountain lion, sea lion, and whale. Waterfowl, salmon, steelhead, and lampreys were also important components of the Costanoan diet. (Levy 1978, page 491.)

Thatched, domed houses were the most common type of structure for the Costanoans. Sweathouses along the banks of rivers were also constructed, in addition to dance enclosures and assembly houses. (Levy 1978, page 492.)

Bodies were either buried or cremated on the day of death. The community either buried the deceased’s property with the body or destroyed their property. (Kroeber 1976, page 469; Levy 1978, page 490.)

Trade was important for the Costanoan groups, and their primary partners in trade were the Plains Miwok, Sierra Miwok, and Yokuts. The Costanoan provided coastal resources such as mussels, abalone shell, dried abalone, and salt to the Yokuts in exchange for piñon pine nuts. The Miwok obtained olive snail shells from the Costanoans. Warfare

occurred between Costanoan tribelets as well as the Costanoans and the Esselen, Salinan, and Northern Valley Yokuts. (Davis 1961, page 19; Levy 1978, page 488.)

A common archaeological manifestation of a Costanoan village site is the shell mound deposit (Kroeber 1976, page 466). Mussels are the primary shells that constitute these mounds, in addition to other household wastes.

The Spanish established seven missions in Costanoan territory between 1770 and 1797. By 1810, the mission system subsumed the last Costanoan village. Missions in the Bay Area mixed various language and cultural groups including the Esselen, Foothill Yokuts, Plains Miwok, Saclan Miwok, Lake Miwok, Coast Miwok, and Patwin. The mission closest to the proposed project area was Santa Clara de Asís, built in 1777. The mission no longer exists, but the area is still rich in archaeological manifestations from the mission period and before. (Levy 1978, page 486.) Other missions within 30 miles of the project site were the Mission San Jose, located approximately 22 miles away in what is now Fremont and Mission San Juan Bautista, located approximately 30 miles away in San Juan Bautista.

Historic Context

To inform understanding of the potential significance of built environment resources in the project vicinity, a review of the major historical timeline markers for the project area provides context. This subsection offers a brief look at those events and trends in the history of the Santa Clara Valley and San Jose that provide that context for the project site:

- Spanish Mission Period
- Mexican Period
- American Period
 - Transportation and Railroads
 - Agriculture and Fruit Industry
 - Silicon Valley
 - Project Site History

Spanish/Mission Period (1769 to 1821)

The Spanish Period was characterized by several developments: the establishment of Spanish Colonial military outposts (presidios), pueblos, and 21 missions throughout Alta California. Nearest to the location of the proposed project were the Santa Clara de Asís Mission (1777) and El Pueblo de San Jose de Guadalupe (1777) and Mission (1797). The Spanish government also awarded land grants to soldiers and others and thus began the tradition of large land grants used for agriculture and livestock. Little remains of the cultural landscape that existed during this time aside from some modern roads that follow early transportation routes (Santa Clara 2012, pages 22–26).

Mexican Period (1821 to 1848)

Following Mexican independence from Spain in 1821, Mexican Governor Pío Pico granted lands to Mexican settlers, including the former lands of the missions, whose connection to the government was lost in the Decree of Secularization in 1834. Spanish and Mexican governors granted 43 ranchos in the Santa Clara Valley between 1802 and 1845. Local planning agencies lack detailed information on the location and integrity of these early California sites (Santa Clara 2012, pages 30–32). The County of Santa Clara’s historic context statement laments that most traces of original haciendas, adobes, and other rancho structures are not discernible in the landscape today and few records exist (Santa Clara 2012, page 32).

American Period (1848 to Present)

California became the thirty-first state in the union in 1850. The project area is located between the Santa Teresa Mountains and Coyote Creek in the Santa Clara Valley, southeast of the center of San Jose. The Project Area was a part of Rancho Santa Teresa, a 9,647-acre piece of land granted to Jose Joaquin Bernal in 1834 (D’Oro 2018, page 13).

Transportation and Railroads

In 1869, the Western Pacific Railroad completed a rail line from San Jose to Niles, California, effectively connecting San Jose with the Transcontinental Railroad. This opened new markets for the agricultural and manufactured products of the entire Santa Clara Valley. In 1982, Western Pacific merged with Union Pacific Railroad (Santa Clara 2012, page 44).

Senator James Fair, a multi-millionaire, envisioned a route from the east side of San Francisco Bay, south to San Jose, then on to Los Gatos and through the mountains to Felton, ultimately connecting to Santa Cruz. Senator Fair incorporated the South Pacific Coast Railroad in 1876 and immediately began building the segment from Dumbarton in the East Bay to Los Gatos, by way of Santa Clara and San Jose. Following that segment, the rail line extended through the Santa Cruz Mountains to connect with the narrow-gauge railroad at Felton. The Southern Pacific acquired these rail lines in 1887 and eventually converted the narrow-gauge lines to standard gauge (Lehmann 2000, pages 31–33).

The Santa Cruz Division of the Southern Pacific Railroad crossed the slough into Alviso from Niles and Newark to the north, passed adjacent to the eastern edge of the downtown grid of Santa Clara and into the heart of San Jose by 1899 (USGS 1899). The Southern Pacific Railroad Monterey Division is also on the 1899 USGS topographic map (USGS 1899), extending from San Jose to Monterey. A 1915 USGS topographic map shows the route of the entire Santa Cruz and Monterey Divisions from San Jose through the Santa Cruz Mountains to Santa Cruz and Monterey and indicating a connection to Los Angeles (USGS 1915). None of the railroads directly connected to the project site, but these connections provided freight and passenger access to the South Bay and San Jose region.

Santa Clara Valley Agriculture and Fruit Industry

Fruit orchards and vegetable farms dominated the Santa Clara Valley from the 1890s to the 1940s. Wheat and flour milling were the first major agricultural activities. In support of the fruit and vegetable industry, canning operations flourished in the northeastern portion of the county. Fruit packing companies were common in Santa Clara Valley in the first third of the twentieth century. Nearly half of the world's supply of fresh, dried, and canned fruit through the end of World War II (WWII) originated from the valley. The agricultural base economy and its support operations were gradually displaced by expanding suburban development, light industrial, and high-tech research and development operations by the 1970s (Fike 2016, page 2).

The Santa Clara Valley's current commercial and industrial operations are indicative of the shift that took place after WWII from agricultural-based businesses to light industrial and ultimately high-tech research and development facilities. Throughout the valley, residential home developments and commercial/industrial operations slowly replaced the orchards and agricultural fields. The landscape was forever transformed.

Silicon Valley

Industrial growth expanded significantly from 1960 to 1980, much of the growth in the electronics research and manufacturing sectors. The southern Silicon Valley cities of Santa Clara and San Jose are home to Adobe Systems Incorporated, Applied Materials, Cisco Systems, Intel, PayPal, Sun Microsystems, National Semiconductor, and other high technology companies.

Project Site

The project site is on land formerly located in the southern section of Rancho Santa Teresa, established during the Mexican historic period in California (1804–1848). The rancho's adobe dwellings were situated approximately ½ mile southwest of the project site. No built environment features from the Mexican period, roads, buildings, or other features have been reported in the vicinity of the project. (Basin 1997b, page 2).

The project site has historically been used for agricultural purposes. The site and adjacent property reportedly were part of a large undivided parcel owned by P. Martin (250 acres) and J. Tennant (149 acres) in the late 1870s. The Martin House, formerly on the adjacent parcel to the southeast, was constructed about 1910 (P-43-003720). The Martin house and accessory farm structures were removed in 1997. From 1919 to 1947 there were no built environment features evident on the project site itself on historical topographic maps (SV1 2020b, Appendix G, pages 12–14). Orchards occupied the site until the 1980s, when the trees were removed and replaced with row crops and/or hay cultivation. By 2019, the site was covered in grass and weeds (CEG 2019, pages 13–14). Martinvale Road, which led to the Martin House in a north to south alignment, was replaced by the curvilinear Great Oaks Boulevard 1980 and 1982 (CEG 2019, Aerial Imagery). The agricultural nature of the setting began to change in the 1970s, as properties in the area began to convert to commercial, industrial, and residential use.

The project site is bounded by streets on three sides, and on the southwest boundary by undeveloped land. San Ignacio Avenue is to the northwest, Via Del Oro to the northeast and Great Oaks Boulevard to the southeast. Review of the 1982 topographic map shows the streets in their current alignments. Santa Teresa Boulevard was built by 1968. San Ignacio Avenue, Via del Oro, and Great Oaks Boulevard were constructed between 1980 and 1982 (CEG 2019). To the northeast, northwest, and southeast, commercial buildings are located across the streets.

The project footprint, including all linears, construction laydown areas, and access routes, is located within the Santa Teresa community of San Jose. The buildings would be constructed on two parcels consisting of a total of 18 acres: APNs 706-02-057 and 706-02-060 (CEG 2019, page 3). The parcel numbers have changed numerous times over the years. The current parcel numbers came into use after the 2017 initial study/mitigated negative declaration was completed (SV1 2020a, page 158). The permit and planning history for the project site has been associated with the street address 300 Great Oaks Boulevard.

Project Linears

Storm water and sanitary sewer connections would be made to existing facilities located in the rights of way of Great Oaks Boulevard. Domestic water and fire water connections would be made to existing facilities located in the rights of way of Via Del Oro and San Ignacio Avenue. Depth of stormwater drainage pipes would be approximately 8 feet. Depth of domestic water service and fire water pipes would be 4 feet minimum. Sanitary sewer discharge lines would be at a depth of 15 feet (SV1 2020a).

The electrical supply line would be routed from the Santa Teresa Substation to the data center site by way of underground transmission lines in the rights of way of Via Del Oro and Santa Teresa Boulevard (SV1 2020d, DR Set 2, Part III, TN 233005-3, Figure CUL-DR-48).

Methods

The methods employed for the cultural resources analysis include determining a Project Area of Analysis (PAA), reviewing records and other documents provided by a literature search and other historical sources, consultation with California Native American tribes, historic architectural and archaeological surveys and archaeological presence/absence excavation.

Project Area of Analysis

The PAA defines the geographic area in which the proposed project has the potential to affect cultural or tribal cultural resources. Effects may be immediate, further removed in time, or cumulative. They may be physical, visual, audible, or olfactory in character. The PAA may or may not be one uninterrupted expanse. It could include the site of the proposed project (project site), the routes of requisite transmission lines and water and sewer pipelines, and other offsite ancillary facilities, in addition to one or several

discontiguous areas where the project could arguably affect cultural or tribal cultural resources. The PAA has archaeological, ethnographic, and historic built environment components, as described in the following paragraphs.

The archaeological component of the PAA consists of all areas in which the applicant proposes ground disturbance to construct, operate, and decommission the proposed project. This includes the proposed generator yards, data center building sites, parking, landscaping, areas to be graded, staging and laydown areas, access roads, perimeter fence, tree removal, subsurface drainage, sanitary sewer line, and domestic and fire water lines. The estimated excavation depths for the proposed project elements are:

- Concrete, drilled-pier foundations for generators and data center buildings: 50–75 feet
- Proposed data center slab foundations, 6.5 feet below ground surface
- 115-kilovolt (kV) transmission line extension from the existing Metcalf-Edenvale 115-kV transmission line to PG&E's Santa Teresa Substation
- Electrical distribution lines extending from Santa Teresa Substation on Via Del Oro and Santa Teresa Boulevard to the project site in three trenches 4 feet deep and 2 feet wide
- Sanitary sewer line interconnection to existing sewer in Great Oaks Boulevard at 15 feet below ground surface
- Domestic and fire water lines at a minimum of 4 feet below ground surface
- Storm water detention basin approximately 14.5 feet below ground surface
- Storm water tie-in to stormwater drain in Great Oaks Boulevard at about 8 feet below ground surface
- Construction entrances excavations approximately 12 inches below ground surface (D'Oro 2018, page 2; SV1 2020a, pages 19, 31; SV1 2020b, Appendix F, page 18; SV1 2020d, pages 25–26; SV1 2020p, page 2.)

Additionally, trenches for underground distribution lines from the Santa Teresa Substation would be approximately 4 feet deep and 2 feet wide. Initial power requirements would require one trench. Later phases of the project would require an additional two trenches (SV1 2020d, page 26; SV1 2020p, page 2), to accommodate five distribution lines. (SV1 2020b, Appendix K).

With PD TRA-1, additional off-site street improvements would include the addition of Class II bicycle lanes along Via Del Oro on the opposing side of the project frontage between San Ignacio Avenue and Great Oaks Boulevard. Also PD TRA-1 includes removal of the existing "pork chop islands" from the pedestrian crossing at Great Oaks Boulevard and Santa Teresa Boulevard intersection to improve pedestrian access (SV1 2021h, page 23).

For ethnographic resources, the PAA takes into account sacred sites, tribal cultural resources, traditional cultural properties (places), and larger areas such as ethnographic landscapes that can be vast and encompassing, including viewsheds that contribute to the historical significance of such resources. The Native American Heritage Commission (NAHC) assists project-specific cultural resources consultants and agency staff in identifying these resources, and consultation with Native Americans and other ethnic or community groups may contribute to defining the PAA. In the case of the proposed project, the immediate environs consist largely of office parks, industrial structures, residences, and a vacant lot. Staff therefore treats the ethnographic component of the PAA as the same as with the archaeological component.

The proposed project site consists primarily of fallow agricultural fields. Proposed linear features would pass by residential and commercial neighborhoods via underground connections within city street rights of way. The historic built environment PAA for this project includes the project site and adjacent properties within a one-parcel boundary of the project site and all linear routes.

Literature Review

The literature review for this analysis consisted of a records search at the California Historical Resources Information System, review of the application for small power plant exemption, and examination of pertinent literature concerning cultural resources in the Santa Clara Valley.

The records search was provided to the applicant's consultant by the Northwest Information Center (NWIC) on September 21, 2018 (NWIC File No. 18-0527). The records search area included the project site for resources and a 1/4-mile radius from the project site for reports. (D'Oro 2018, Appendix A). Additionally, the records search included review of the Office of Historic Preservation's (OHP's) Archaeological Determinations of Eligibility, OHP's Historic Properties Directory and California Inventory of Historic Resources (1976), historical maps and General Land Office or rancho plat maps (D'Oro 2018, Appendix A).

In addition, California Energy Commission (CEC) staff examined historic maps and aerial photographs of the PAA and vicinity to identify cultural resources (Amec Foster Wheeler 2015, Appendix D; D'Oro 2018, Figures 2–6; Edward Denny & Co. 1913; SV1 2020b, Appendix G). These sources depict the historic appearance of the PAA on a decadal basis from 1863 through 1974.

Staff also consulted the National Register of Historic Places (NRHP), CRHR, Historic American Building Survey, Historic American Engineering Record, Historic American Landscape Survey, the City of San Jose Historic Resource Inventory (San Jose 2009, pages 42–54), County of Santa Clara Historic Context Statement (Santa Clara 2012) and other repositories of documentation of historical resources, including internal CEC files.

Tribal Consultation

Applicant's Correspondence

David J. Powers & Associates, Inc., on behalf of the applicant, contacted the six following California Native American tribes on November 15, 2019 based on the recommendation of the, Native American Heritage Commission (SV1 2020a, page 114):

1. Amah Mutsun Tribal Band
2. Amah Mutsun Tribal Band of Mission San Juan Bautista
3. North Valley Yokuts Tribe
4. Muwekma Ohlone Indian Tribe
5. The Ohlone Indian Tribe
6. Indian Canyon Mutsun Band of Costanoan

CEC Consultation

The California Environmental Quality Act (CEQA) requires lead agencies to consult with all California Native American tribes that have traditional and cultural affiliation with the geographic area of a project, and that have previously requested consultation. To invoke an agency's requirement to consult under CEQA, a tribe must first send the lead agency a written request for formal notification of any projects within the geographic area with which they are traditionally and culturally affiliated. (Pub. Resources Code, § 21080.3.1(b).) The CEC has not received any requests for formal notification from tribes that have traditional and cultural affiliation with the geographic area of the proposed project. Therefore, the CEC has no obligations under CEQA's formal tribal notification or consultation requirements.

However, consistent with the CEC's tribal consultation policy (CEC 2017), CEC staff contacted the NAHC on March 23, 2020 to request a search of the Sacred Lands File and a list of California Native American tribes that might be interested in the proposed project. The NAHC responded on March 23, 2020 and provided a list of six California Native American tribes to contact; the listed tribes were the same six tribes listed above. CEC staff mailed initial consultation letters to these six tribes on April 15, 2020. Follow-up phone calls were made on May 1, 2020. See the following subsection, "Results," for tribal responses and lead agency follow-up.

Limited Subsurface Testing and Archaeological Survey

On October 5 and 8, 2018, two archaeologists conducted limited subsurface test excavations and surveyed the proposed project site. The archaeologists directed excavation of six backhoe trenches on the project site to assess the proposed project's likelihood of impacting buried cultural resources. The backhoe trenches generally measured 3 feet wide, 10 feet long, and up to 9 feet deep. Trenches targeted areas of the project site slated for deeper construction-related digging. The backhoe operator

excavated the trenches in passes or layers about 2 feet thick. The archaeologists observed the excavation's progress and screened excavated material at intervals. To identify surficial cultural resources, the archaeologists surveyed the project site by walking parallel transects spaced at 33-foot intervals and observing the ground surface. (D'Oro 2018, pages i, 1, 19–30.)

Historic Architectural Survey

The applicant did not conduct a historic architectural survey as part of the cultural resources investigation. Staff investigated the parcels adjacent to the project site and along linear routes. See results below.

Results

Literature Review

A search of records at the NWIC and the CEC's confidential cultural resources files indicates that nine cultural resource studies have been conducted within the PAA and 19 studies were conducted within 1 mile of the PAA. No previously recorded archaeological resources have been identified within the PAA and 12 previously recorded cultural resources have been recorded within 1 mile of the PAA. One previously recorded built environment resource within ¼ mile of the PAA no longer exists. (see **Tables 4.5-1** through **4.5-4.**)

TABLE 4.5-1: BUILT ENVIRONMENT RESOURCES IDENTIFIED WITHIN ¼-MILE OF THE PAA

No.	Primary Number	Resource Name	Age	Type
1.	P-43-003720	Martin House	Ca. 1910	No longer exists

TABLE 4.5-2: ARCHAEOLOGICAL RESOURCES AND CHARACTERISTICS WITHIN 1 MILE OF THE PAA

Resource	Type	Age	Discovery Context	Size (feet)	Significance	Source
P-43-000353	Flaked stone scatter, human burial, FAR	Prehistoric	Surface, buried	492 x 328	Unevaluated	Sikes et al. 2014, pp. 83, 84
P-43-000341	Unknown	Historic	Unknown	137 x 159	Unevaluated	CEC
P-43-001095	Cemetery and camp, historic buildings & refuse pit	Prehistoric (Lower Middle Period/Late Period), historic	Buried	1,882 x 788	NRHP eligible	Rosenthal 2001a, p. 2; Sikes et al. 2014, pp. 79, 80

TABLE 4.5-2: ARCHAEOLOGICAL RESOURCES AND CHARACTERISTICS WITHIN 1 MILE OF THE PAA

Resource	Type	Age	Discovery Context	Size (feet)	Significance	Source
P-43-000138	Rancho Santa Teresa Hacienda/HQ Site	Prehistoric	Unknown	748 x 1,027	NRHP eligible	Basin 1996, List 3, p. 2
P-43-000205	Burial site	Prehistoric	Buried	796 x 828	Unknown	Byrd et al. 2017, p. 239
P-43-000718	Domestic refuse dump and scatter	Historic (WWII–mid-1950s)	Unknown	186 x 100	Ineligible	Sikes et al. 2014, p. 84
P-43-000250	Stone core and flake	Prehistoric	Surface	75 x 75	Ineligible	Rosenthal 2001b, p. 2
P-43-000208	Unknown	Prehistoric	Unknown	147 x 128	Unknown	CEC
P-43-000532	Unknown	Historic	Unknown	144 x 174	Unknown	CEC
P-43-000204	Unknown	Prehistoric	Unknown	109 x 106	Unknown	CEC
P-43-000282	Unknown	Prehistoric	Unknown	90 x 131	Unknown	CEC
CA-SCL-436H	Unknown	Historic	Unknown	118 x 194	Unknown	CEC

Abbreviations and Notes: CEC = confidential cultural resources records at California Energy Commission; FAR = fire-affected rock; H = historic; HQ = headquarters; NRHP = National Register of Historic Places; P = Primary Number, California Historical Resources Information System; SCL = Santa Clara County

TABLE 4.5-3: REPORTS IDENTIFIED THE PROJECT AREA OF ANALYSIS

No.	Study Number	Author, Year	Type
1.	S-004277	Dietz 1976a	Archaeological inventory
2.	S-004277a	Dietz 1976b	Subsurface archaeological inventory
3.	S-004318	Jackson 1973	Archaeological evaluation
4.	S-023382	Basin 2000	Cultural resources inventory
5.	S-047857	Estes et al. 2014	Archaeological inventory
6.	S-021156	Basin 1997a	Archaeological inventory
7.	S-033600	Meyer and Rosenthal 2007	Literature-based review
8.	S-021156a	Basin 1997b	Historical evaluation
9.	S-005259	Hines et al. 1979	Literature review of historic built environment

TABLE 4.5-4: REPORTS IDENTIFIED WITHIN 1 MILE OF THE PROJECT AREA OF ANALYSIS

No.	Study Number	Author, Year	Type
1.	S-021543	Basin 1998	Archaeological evaluation
2.	S-013200	Garaventa et al. 1991	Cultural resources assessment (literature-based)
3.	S-011396	Anonymous 1988	Survey
4.	S-004428	Anonymous n.d.	Cultural resources analysis
5.	S-017852	Kehl and Yamane 1995	Ethnohistoric study
6.	S-008387	Anonymous 1980	Archaeological analysis
7.	S-032596	Milliken et al. 2006	Ethnohistoric study
8.	S-022819	Nelson et al. 2000	Cultural resources inventory
9.	LA-004836	Anonymous 2000	Cultural resources inventory
10.	S-045670	Kubal 2014	Cultural resources inventory
11.	S-015228	Garaventa et al. 1993	Literature review
12.	S-009583	Mayfield 1978	Ecological overview
13.	S-007483	Elsasser et al. 1985	Literature review
14.	S-016394	Basin 1994	Literature review
15.	S-004754	King and King 1973	Windshield survey
16.	S-049780	Byrd et al. 2017	Archaeological overview and research design
17.	S-047857b	Estes and Fino 2015	Archaeological testing report
18.	S-047857c	WSA 2015	Archaeological work plan
19.	S-047857d	Polanco 2015	Consultation letter

Abbreviations: n.d. = no date; WSA = William Self Associates

Staff consulted the City of San Jose's (City's) register of City Landmarks, Historic Districts, and Structures of Merit and determined there are no historical built environment resources of any category identified by the City within 1 mile of the project (San Jose 2009, Figures 7A, 10, and 11).

Tribal Consultation

David J. Powers & Associates did not receive a response from any of the six contacted tribes.

The March 23, 2020 search of the Sacred Lands File returned negative results, indicating that the NAHC did not have a record of the presence of Native American cultural resources in the search area. In response to CEC staff's letters and phone calls, one tribe requested consultation and expressed agreement with the professional recommendations of the cultural resources assessment prepared by Albion Environmental, Inc. (Albion). The recommendations were that activities in the areas should cease in the case of a cultural resources discovery and for an archaeologist to inspect and evaluate the discovery and prepare a recommendation for a further course of action (D'Oro 2018, page 33). None of the other tribes requested formal consultation, but one tribal representative expressed the need for archaeological and Native American monitors.

Archaeological Survey and Subsurface Testing

Following a review of the records search results, Albion conducted an intensive pedestrian survey and limited subsurface testing of the project site. One isolated cultural artifact (a possible flake) was noted during the surface investigation. Six trenches were mechanically

excavated to expose subsurface deposits. This investigation exposed no cultural materials other than some mixed-context modern debris. Albion spaced the trenches about 325–400 feet apart (D’Oro 2018, page i, Figure 7).

Historic Architectural Survey

The applicant did not conduct a historic architectural survey as part of the cultural resources investigation. CEC staff investigated the properties within one parcel of the project site and linear routes for the potential for historical built environment resources. Staff consulted historical maps and aerial images (CEG 2019), as well as the City’s online building permit records for each parcel (SJ Permits 2020). Of the 11 parcels investigated adjacent to the project site, none contained built environment resources that are 45 years or older. Staff also investigated properties along the linear routes (proposed underground transmission lines) and identified 19 parcels that have structures 45 years or older using online mapping and assessor’s office technology. Two buildings 45 years or older are adjacent to both transmission line routes, the Oak Grove School District Office and the PG&E Edenvale Service Center. There are 17 residences on Pemba Drive that are known to be 45 years or older. Pemba Drive parallels Santa Teresa Boulevard to the south and the residences’ backyards are adjacent to the boulevard right-of-way, separated from the boulevard by walls and fences.

The investigation characterizes the residences along Pemba Drive as a form of suburban development common in the Santa Clara Valley in the 1970s. Homes are one and two-story, mostly stucco with variant exterior trim and generally feature a two-car garage facing the street. These are not buildings that would rise to the level of inclusion in the CRHR or the San Jose Historic Register, individually or as a district.

Two of the properties were investigated further for their potential to be eligible for listing on the CRHR or the San Jose Register. These are the Oak Grove School District Office building and the PG&E Edenvale Service Center.

Oak Grove School District Office Building (6578 Santa Teresa Boulevard, APN 706-03-008)

The Oak Grove School District Office Building was constructed about 1974. The grant deed dates to 1973 according to the Santa Clara County Assessor’s records. In plan view, the building is sited at a 45-degree angle to the street and lot lines. The building is comprised of four wings radiating out from the center. The landscape elements such as secondary walkways are aligned in the same 45-degree angle pattern. The main approach walkway to the building is perpendicular to the street and the lot lines. Parking lots are located on the south, west and north sides of the building. Structures topped with solar panels cover much of the south and north parking lot areas. The landscape is dominated by parking lots and lawn areas, with a few trees on the south, west and east sides of the lot. Concrete planting beds are integrated into the main entrance and contain cobble rock and shrubs. Several elevations have bermed planters with a slanted concrete cap where it meets the building at bottom of the windows.

Due a lack of permit information online and an inquiry backlog at the City Building Department due to the COVID-19 pandemic, the actual square footage of the building is unknown. Based upon measurements available in Google Earth, the building appears to be approximately 20,000 square feet in area.

The main entrance is on the south side of the building in a wall of dark tinted glass. The building is best described as having exterior walls of concrete masonry, pierced by a regular pattern of tall narrow windows of dark glass and capped by a modified Mansard-style composition shingle roof with painted wooden fasciae.

A monument sign is located toward the southwest corner of the property. A recent aluminum sign has been added to what is likely the original engraved concrete monument sign (esignsunlimited 2020).

Contemporary Mansard roof forms were popular from 1965 to 1980 and are found on many buildings of the mid-1970s. The Mansard roof of this era is a weak nod to the Second Empire, Beaux Arts and Richardsonian Romanesque styles of earlier eras. The Mansard roof is found on residential structures as well as shopping centers, commercial and office buildings and is ubiquitous to those years (McAlester and McAlester 1997, page 487). Generally, a Mansard roof will have a pitch considerably steeper than the Oak Grove School District Building. As a single story building however, a lower pitch is understandable. Like all rooflines of this type, it is effective in hiding HVAC and other equipment located on the center of the flat roof behind the Mansard parapet.

California Register of Historical Resources Evaluation

The Oak Grove School District Office Building does not appear to be associated with events or a broad pattern of local or regional history or the cultural heritage of California (Criterion 1)³. The building or property does not appear to be associated with lives of persons important to local, California or national history (Criterion 2). While the building exhibits some common architectural characteristics of its time, it does not possess high artistic style or creative use of materials, nor does it embody the distinctive characteristics of a type, period, region or method of construction or represent the work of a master (Criterion 3). Finally, the building or the property does not manifest the ability to yield information important to the prehistory or history of the local area, California, or the nation (Criterion 4).

San Jose Historic Register Evaluation

The Oak Grove School District Office Building does not appear to meet any of the criteria established by the City of San Jose Municipal Code Title 13, Chapter 13.48, Historic

³ See Pub. Resources Code, § 5024.1, summarized below on page 4.5-19.

Preservation, Sections 13.48.010 through 13.48.660 as a structure of merit, a City Landmark or as part of a historic district⁴.

PG&E Edenvale Service Center (6402 Santa Teresa Boulevard, APN 706-03-016)

The PG&E Edenvale Service Center was constructed in 1974 and 1975 as documented in building permit #84137 found online at the City's building permit system (SJ Permits 2020). The Edenvale complex consists of three buildings, two of which were categorized as shop buildings and the other as an operations building on the original building permits. The primary operations building is a T-shape, in a perpendicular orientation to Santa Teresa Boulevard. The shop buildings are rectangular and located in the northwest corner of the lot, close to State Route 85. Large tree-shaded parking areas are to the east, south and west of the main operations building. An open work yard to the north also provides additional parking and vehicle storage.

The operations building is a single-story concrete masonry structure with few architectural embellishments. The elevations are articulated with bays of dark-tinted windows. Each window bay features a projecting eyebrow-like decorative element a few feet above the window bay. A similarly treated projecting cornice wraps around the building below the parapet. HVAC and other equipment are located on the roof in the center. The parapet mostly hides it from view from the ground level.

The shop buildings are rudimentary according to their use and have no architectural embellishment at all. They share the same concrete construction as the operations building. One is considerably taller than the other but they both feature roll-up overhead doors, bays, and personnel doors. Various other sheds are on the property.

There are landscape elements at the north and south end of the operations building. The primary entrance is from Santa Teresa Boulevard and includes a semi-circular drive and small parking area with approximately 16 parking spaces. This entrance area features some mature trees and scattered shrub plantings, which have replaced earlier lawn areas visible in historical aerial imagery. An entrance on the north side has an updated walkway and plantings. That entrance features the original straight path to the entrance bisected by a new path that is curvilinear and features a circular path surrounding a monument of some kind. Plantings appear to be scattered and an outdoor gathering area is at the northwest corner. Additional gathering areas and plantings are on the west side of the building. All these recent landscape improvements appear to date to 2016.

Several structures of unknown use had been added to the parking lot west of the operations building by 2019. This may be construction-related trailers or structures.

The Edenvale Service Center was constructed at the same time as residential subdivisions to the south were building out. It was initially in an orchard setting, which in the 1970s

⁴ See San Jose Municipal Code Chapter 13.48, summarized below on page 4.5-22.

and more so in the 1980s was completely replaced by residential, commercial, and light industrial development on all sides. The light rail line to the east and State Highway 85 to the north were completed between 1982 and 1993 (SV1 2020b; EDR Aerials).

California Register of Historical Resources Evaluation

The PG&E Edenvale Service Center does not appear to be associated with events or a broad pattern of local or regional history or the cultural heritage of California (Criterion 1). The building or property does not appear to be associated with lives of persons important to local, California or national history (Criterion 2). While the building exhibits some common architectural characteristics of its time, it does not possess high artistic style or creative use of materials, nor does it embody the distinctive characteristics of a type, period, region or method of construction or represent the work of a master (Criterion 3). Finally, the building or the property does not manifest the ability to yield information important to the prehistory or history of the local area, California, or the nation (Criterion 4).

San Jose Historic Register Evaluation

The PG&E Edenvale Service Center does not appear to meet any of the criteria established by the City of San Jose Municipal Code Title 13, Chapter 13.48, Historic Preservation, Sections 13.48.010 through 13.48.660 as a structure of merit, a City Landmark or as part of a historic district.

Archaeological Sensitivity

Archaeologists have discovered numerous archaeological resources buried under the modern ground surface within the Santa Clara Valley. Staff's literature review has identified at least 18 buried archaeological resources in the valley (Rehor and Kubal 2014, page 4-1, Table 4-1). The proposed project would be built on a Quaternary-aged alluvial fan deposit that Rehor and Kubal (2014, page 4-7) regard as highly sensitive for the presence of buried archaeological resources, owing to the alluvial fan's correlation with the age of local human occupation (about 11,000 years ago to present) and the occurrence of buried archaeological resources in Quaternary alluvial fans throughout the valley.

The applicant concludes that there is a low probability that construction activities would encounter buried archaeological resources because subsurface archaeological testing did not identify archaeological resources below ground surface (SV1 2020a, page 113). The subsurface archaeological testing program to which the applicant refers (D'Oro 2018); however, does not substantiate the conclusion that the archaeological PAA's archaeological sensitivity is low. As staff mentioned earlier in this section, the subsurface archaeological testing consisted of six backhoe-excavated trenches across the archaeological PAA. Investigators placed the trenches such that about 325 feet to 400 feet separated one trench from another. (D'Oro 2018, Figure 7.) The sampling interval is problematic from the standpoint of drawing conclusions about the presence or absence of buried archaeological resources in the archaeological PAA because the space between

trenches is too wide to expect that a given trench would intersect a buried archaeological resource. Table 5.5-2 shows that eight out of 12 (75 percent) recorded archaeological resources within 1 mile of the archaeological PAA are smaller than 325 feet in all dimensions. The interval between test trenches was too wide to have had a reasonable chance to encounter buried archaeological resources.

Regulatory Background

Federal

No federal regulations related to cultural and cultural resources apply to the project.

State

California Environmental Quality Act

Various laws apply to the evaluation and treatment of cultural resources. The California Environmental Quality Act (CEQA) requires lead agencies to evaluate cultural resources by determining whether they meet several sets of specified criteria that make such resources eligible to the CRHR. Those cultural resources eligible to the CRHR are historical resources. The evaluation then influences the analysis of potential impacts to such historical resources and the mitigation that may be required to ameliorate any such impacts.

CEQA and the CEQA Guidelines define significant cultural resources under two regulatory definitions: historical resources and unique archaeological resources. A historical resource is defined as a "resource listed in, or determined to be eligible by the State Historical Resources Commission, for listing in the California Register of Historical Resources", or "a resource included in a local register of historical resources, as defined in section 5020.1(k) of the Public Resources Code or identified as significant in an historical resource survey meeting the requirements of Section 5024.1(g) of the Public Resources Code," or "any object, building, structure, site, area, place, record, or manuscript which a lead agency determines to be historically significant or significant in the architectural, engineering, scientific, economic, agricultural, educational, social, political, military, or cultural annals of California, provided the agency's determination is supported by substantial evidence in light of the whole record." (Cal. Code Regs., tit. 14, § 15064.5(a).) Historical resources that are automatically listed in the CRHR include California historical resources listed in or formally determined eligible for the NRHP and California Registered Historical Landmarks from No. 770 onward (Pub. Resources Code, § 5024.1(d)).

Under CEQA, a resource is generally considered historically significant if it meets the criteria for listing in the CRHR. In addition to being at least 50 years old, a resource must meet one or more of the following four criteria (Pub. Resources Code, § 5024.1):

- Criterion 1, is associated with events that have made a significant contribution to the broad patterns of California's history and cultural heritage;
- Criterion 2, is associated with the lives of persons important in our past;

- Criterion 3, embodies the distinctive characteristics of a type, period, region, or method of construction, or represents the work of an important creative individual, or possesses high artistic values; or
- Criterion 4, has yielded, or may be likely to yield, information important in prehistory or history.

In addition, historical resources must also possess integrity of location, design, setting, materials, workmanship, feeling, and association (Cal. Code Regs., tit. 14, § 4852(c)).

Even if a resource is not listed or determined to be eligible for listing in the CRHR, CEQA requires the lead agency to make a determination as to whether the resource is a historical resource as defined in Public Resources Code, sections 5020.1(j) or 5024.1.

In addition to historical resources, archaeological artifacts, objects, or sites can meet CEQA's definition of a unique archaeological resource, even if the resource does not qualify as a historical resource (Cal. Code Regs., tit. 14, § 15064.5(c)(3)). Archaeological artifacts, objects, or sites are considered unique archaeological resources if it can be clearly demonstrated that, without merely adding to the current body of knowledge, there is a high probability that the resource meets any of the following criteria:

1. Contains information needed to answer important scientific research questions and that there is a demonstrable public interest in that information.
2. Has a special and particular quality such as being the oldest of its type or the best available example of its type.
3. Is directly associated with a scientifically recognized important prehistoric or historic event or person. (Pub. Resources Code, § 21083.2(g).)

To determine whether a proposed project may have a significant effect on the environment, staff analyzes the project's potential to cause a substantial adverse change in the significance of historical or unique archaeological resources. The magnitude of an impact depends on:

- the historical resource(s) affected;
- the specific historic significances of any potentially impacted historical resource(s);
- how the historical resource(s) significance is manifested physically and perceptually;
- appraisals of those aspects of any historical resource's integrity that figure importantly in the manifestation of the resource's historical significance; and
- how much the impact will change historical resource integrity appraisals.

Title 14, California Code of Regulations, section 15064.5(b) defines a "substantial adverse change" as the "physical demolition, destruction, relocation, or alteration of the resource or its immediate surroundings such that the significance of an historical resource would be materially impaired."

California Native American Tribes, Lead Agency Tribal Consultation Responsibilities, and Tribal Cultural Resources

CEQA provides definitions for California Native American tribes, lead agency responsibilities to consult with California Native American tribes, and tribal cultural resources. A "California Native American tribe" is a "Native American tribe located in California that is on the contact list maintained by the Native American Heritage Commission (NAHC) for the purposes of Chapter 905 of the Statutes of 2004" (Pub. Resources Code, § 21073). Lead agencies implementing CEQA are responsible for consultation with California Native American tribes about tribal cultural resources within specific timeframes, observant of tribal confidentiality, and if tribal cultural resources could be impacted by a CEQA project, are to exhaust the consultation to points of agreement or termination.

Tribal cultural resources are either of the following:

1. Sites, features, places, cultural landscapes, sacred places, and objects with cultural value to a California Native American tribe that are either of the following:
 - a. Included or determined to be eligible for inclusion in the CRHR
 - b. Included in a local register of historical resources as defined in the Public Resources Code, section 5020.1(k).
2. A resource determined by the lead agency, in its discretion and supported by substantial evidence, to be significant pursuant to criteria set forth in the Public Resources Code, section 5024.1(c). In applying these criteria, the lead agency shall consider the significance of the resource to a California Native American tribe. (Pub. Resources Code, § 21074(a).)

A cultural landscape that meets the criteria of Public Resources Code, section 21074(a), is a tribal cultural resource to the extent that the landscape is geographically defined in terms of its size and scope (Pub. Resources Code, § 21074(b)). Historical resources, unique archaeological resources, and non-unique archaeological resources, as defined at Public Resources Code, sections 21084.1, 21083.2(g), and 21083.2(h), may also be tribal cultural resources if they conform to the criteria of Public Resources Code, section 21074(a).

CEQA also states that a project with an impact that may cause a substantial adverse change in the significance of a tribal cultural resource is a project that may have a significant effect on the environment (Pub. Resources Code, § 21084.2).

Local

City of San Jose General Plan

Historical and cultural resources are addressed in goals LU-13 thru LU-16 in Chapter 6 of the *Envision San Jose 2040 General Plan*. The primary General Plan goal is to preserve historically and archaeologically significant structures, sites, districts, and artifacts in

order to promote a greater sense of historical awareness and community identity, contribute to a sense of place, raise public awareness, encourage sustainable practices through preservation and enhance the quality of urban living (San Jose 2020).

Chapter 3 of the General Plan also describes goals, policies, and actions to encourage the preservation of archaeology.

- Goal ER-10: This goal seeks to preserve and conserve archaeologically significant structures, sites, districts, and artifacts “to promote a greater sense of historic awareness and community identity”. (San Jose 2020, page 20.)
- Policy ER-10.1: This policy requires archaeological investigations during the planning process for development that is proposed in archaeologically sensitive areas of the city. If any such investigation finds that potentially significant archaeological resources are present and would suffer impacts, mitigation measures must be incorporated into the project design.
- Policy ER-10.2: This policy requires work to stop if potentially Native American human remains are encountered during construction. Applicable state laws concerning the treatment of human remains shall be followed.
- Policy ER-10.3: This policy advocates for the enforcement of city, state, and federal historic preservation laws, regulations, and codes to protect historic and prehistoric resources. The City also maintains a file of archaeological survey reports by location and will endeavor to make these holdings available for research over time. (San Jose 2020, page 36.)

San Jose Municipal Code Title 13, Chapter 13.48, Historic Preservation, Sections 13.48.010 through 13.48.660.

As a Certified Local Government, the City has the authority from the Office of Historic Preservation to develop and maintain its own historical preservation program. According to the City’s Historic Preservation Ordinance (Municipal Code Chapter 13.48), the City is authorized to maintain an inventory of historical resources, establish a historical landmarks commission, preserve historical properties using landmark designation process, require historical preservation permits for additions or alterations to City Landmarks or buildings within City Historic Districts, and to provide financial incentives through the Historic Property Contracts program (San Jose 2021).

The City maintains a register of City Landmarks, Historic Districts, and Structures of Merit. The City of San Jose’s Historic Preservation Ordinance defines a resource as a City Landmark if it falls into one of the following four categories of structure:

1. An individual structure or portion thereof
2. An integrated group of structures on a single lot
3. A site, or portion thereof
4. Any combination thereof (San Jose 2021, Sec. 13.48.020.C.)

The landmark designation process itself requires that findings be made that proposed landmarks have special “historical, architectural, cultural, aesthetic, or engineering interest or value of an historical nature”, and that designation as a landmark conforms to the goals and polices of the General Plan. The following eight factors can be considered to make those findings among other relevant factors:

1. Its character, interest, or value as a part of the local, regional, state, or national history, heritage, or culture
2. Its location as a site of a significant historical event
3. Its identification with a person or persons who significantly contributed to the local, regional, state, or national culture and history
4. Its exemplification of the cultural, economic, social, or historical heritage of the City of San Jose
5. Its portrayal of the environment of a group of people in an era of history characterized by a distinctive architectural style
6. Its embodiment of distinguishing characteristics of an architectural type or specimen
7. Its identification as the work of an architect or master builder whose individual work has influenced the development of the city of San Jose
8. Its embodiment of elements of architectural or engineering design, detail, materials, or craftsmanship which represents a significant architectural innovation, or which is unique (San Jose 2021, Sec. 13.48.110 H).

City of San Jose Revised Guidelines for Historic Reports

Evaluation of potential City Landmarks is conducted based on both the subjective criteria listed in the Historic Preservation Ordinance and on a numerical tally system that scores structures based on visual quality or design; history and association; environment and context; integrity; reversibility; interior quality and conditions; and NRHP/CRHR status. A points-based scoring system is used; scores over 33 suggest that the building should be evaluated for City Landmark status or the CRHR (San Jose 2010).

Special Use Permit SP15-031

A Special Use Permit (SUP) is active for the data center project. SP15-031 was approved and issued on January 25, 2017. The SUP requires mitigation measures that provide a presence absence test and resulting research design, that work shall be halted within 50 feet of any discoveries, a process for the discovery of human remains, and a summary report at the conclusion of the project (CEC 2020m).

4.5.2 Applicant Proposed Measures

PD CUL-1: The following project-specific measures shall be implemented during construction to avoid significant impacts to unknown subsurface cultural resources:

- In the event that prehistoric or historic resources are encountered during on-site construction activities, all activity within a 50-foot radius of the find shall be stopped, the Director of Community Development shall be notified, and a Secretary of the Interior-qualified archaeologist shall examine the find and record the site, including field notes, measurements, and photography for a Department of Parks and Recreation 523 Primary Record form. The archaeologist shall make a recommendation regarding eligibility for the California Register of Historical Resources, data recovery, curation, or other appropriate mitigation. Ground disturbance within the 50-foot radius can resume once these steps are taken and the Director of Planning, Building, and Code Enforcement has concurred with the recommendations. Within 30 days of the completion of construction or cultural resources monitoring, whichever comes first, a report of findings documenting any cultural resource finds, recommendations, data recovery efforts, and other pertinent information gleaned during cultural resources monitoring shall then be submitted to the Director of Planning, Building, and Code Enforcement. Once finalized, this report shall be submitted to the Northwest Information Center at Sonoma State University.
- Prior to and for the duration of ground disturbance, the project owner shall provide Worker Environmental Awareness Program training to all existing and any new employees. This training should include: a discussion of applicable laws and penalties under the laws; samples or visual aids of artifacts that could be encountered in the project vicinity, including what those artifacts may look like partially buried, or wholly buried and freshly exposed; and instructions to halt work in the vicinity of any potential cultural resources discovery, and notify the city-approved archaeologist and Native American cultural resources monitor.

PD CUL-2: The following project-specific measures shall be implemented during construction to avoid significant impacts to unknown subsurface cultural resources:

- In the event that human remains are discovered during on-site construction activities, all activity within a 50-foot radius of the find shall be stopped. The Santa Clara County Coroner shall be notified and shall make a determination as to whether the remains are of Native American origin or whether an investigation into the cause of death is required. If the remains are determined to be Native American, the Coroner shall notify the Native American Heritage Commission. All actions taken under this mitigation measure shall comply with Health and Human Safety Code § 7050.5(b).

4.5.3 Environmental Impacts and Mitigation Measures

Cultural Resources CEQA Checklist Criterion

a. Would the project cause a substantial adverse change in the significance of a historical resource as defined in §15064.5?

Construction

Less Than Significant with Mitigation Incorporated. No historic built environment resources meeting CEQA's criteria for historical resources are in the project area of analysis (PAA). No archaeological or ethnographic resources meeting CEQA's criteria for historical resources occupy the surface of the PAA. Previous studies in the project vicinity, however, indicate that the PAA could harbor buried archaeological or ethnographic resources. The PAA is located near a waterway (Coyote Creek) on the former grounds of a farm (pear orchard). Previous studies have identified no fewer than 12 archaeological sites in the project vicinity. The City of San Jose's General Plan Program Environmental Impact Report designates the Edenvale Planning Area (in which the PAA is located) as highly sensitive for the presence of buried archaeological resources (Basin 2010, Table 3.8).

The ground disturbance required to build the proposed project would extend into native soils up to 75 feet below grade. A geotechnical study and the subsurface archaeological investigation of the PAA primarily found native soils from the ground surface to the maximum extent of exploration (in excess of 10 feet deep), although the backhoe trench excavated in the southeast corner of the PAA revealed fill dirt from the surface to 1 foot below grade (D'Oro 2018, page 24, Figure 13; SV1 2020b, Appendix F). Therefore, the proposed project would involve excavation of native soils from about 1 to 75 feet below grade. Known buried archaeological sites in Santa Clara Valley are located at depths of 1.0–10.5 feet below grade (Rehor and Kubal 2014, Table 4-1). If such resources were to be damaged during construction, it would be considered a significant impact. Therefore, staff recommends that one or more qualified archaeologists and Native Americans monitor construction-related excavation in the PAA (see Proposed Mitigation Measures below).

Staff evaluated applicant-proposed design measure PD CUL-1 in the context of the potential impacts and concludes that it is insufficient to reduce impacts to buried, as-yet-undiscovered historical resources to a less than significant level. PD CUL-1 proposes that the applicant retain a qualified archaeologist to respond to inadvertent cultural resource discoveries should any occur during construction. PD CUL-1 also stipulates implementing a Worker Environmental Awareness Program prior to and during construction to foster crew members' recognition of cultural resources and the appropriate actions to take should construction expose cultural resources in the PAA. In short, PD CUL-1 would place the responsibility of cultural resources management on construction workers instead of cultural resources professionals and Native Americans, following on an incomplete

archaeological investigation of the PAA. A second problem with PD CUL-1 is its lack of qualification standards for Native American monitors. Staff proposes additional mitigation measures (**MM**) **MM CUL-1** through **CUL-4** would replace PD CUL-1. These measures are drawn from the *Initial Study/Mitigated Negative Declaration for the Equinix Data Centers (SV-12, SV-13, SV-14) and Santa Teresa Substation (SV1 2020b, Appendix K, pages 60–61)*. Staff's proposed measures would ensure the prompt identification and management of cultural and tribal cultural resource discoveries by requiring a professional archaeologist and qualified Native American monitor observe ground-disturbing activities associated with the proposed project. In addition, staff adds qualification criteria for Native American monitors. PD CUL-2 presents an appropriate procedure for responding to inadvertent discoveries of human remains.

Staff concludes that implementation of PD CUL-2 and **MM CUL-1** through **MM-CUL-4** would reduce the impacts to buried historical resources to a less than significant level.

Operation

No Impact. Ground-disturbing activities are not part of the operational or maintenance profile of the proposed project. Impacts on historical resources are therefore not expectable during operation.

MM CUL-1: An archaeologist qualified in local historical and prehistory archaeology shall augment the applicant's subsurface presence/absence program by excavating additional backhoe trenches in the archaeological PAA prior to construction. The purpose of excavating the trenches is to determine whether any intact archaeological deposits are present on-site. Based on the archaeological site dimensions presented in Table 5.5-2, a trenching interval with a reasonable chance of finding buried archaeological resources (if present) would be about 150 feet (the median value of site dimensions in Table 5.5-2 is 153 feet). Should any archaeological features or deposits be identified, a focused research design and treatment plan shall be prepared to address any potential resources exposed during construction activities followed by archaeological excavation of these features. The applicant will secure the services of a Secretary of the Interior-qualified archaeologist and a Native American monitor to observe grading of native soil once all pavement is removed from the project site. The applicant shall submit the name and qualifications of the selected archaeologist and Native American Monitor to the Director of Community Development prior to the issuance of a grading permit. Preference in selecting Native American monitors shall be given to Native Americans with:

1. Traditional ties to the area being monitored.
2. Knowledge of local historic and prehistoric Native American village sites.
3. Knowledge and understanding of Health and Safety Code, section 7050.5, and Public Resources Code, section 5097.9 et seq.
4. Ability to effectively communicate the requirements of Health and Safety Code, section 7050.5, and Public Resources Code, section 5097.9 et seq.

5. Ability to work with law enforcement officials and the Native American Heritage Commission to ensure the return of all associated grave goods taken from a Native American grave during excavation.
6. Ability to travel to project sites within traditional tribal territory.
7. Knowledge and understanding of Title 14, California Code of Regulations, section 15064.5.
8. Ability to advocate for the preservation in place of Native American cultural features through knowledge and understanding CEQA mitigation provisions.
9. Ability to read a topographical map and be able to locate site and reburial locations for future inclusions in the Native American Heritage Commission's Sacred Lands Inventory.
10. Knowledge and understanding of archaeological practices, including the phases of archaeological investigation.

MM CUL-2: Prior to and for the duration of ground disturbance, the project owner shall provide Worker Environmental Awareness Program training to all existing and any new employees. This training should include: a discussion of applicable laws and penalties under the laws; samples or visual aids of artifacts that could be encountered in the project vicinity, including what those artifacts may look like partially buried, or wholly buried and freshly exposed; and instructions to halt work in the vicinity of any potential cultural resources discovery, and notify the city-approved archaeologist and Native American cultural resources monitor. The applicant shall contract with qualified cultural resources specialists to prepare the training materials.

MM CUL-3: If prehistoric and/or historic resources are encountered during construction, all activity within a 50-foot radius of the find will be stopped and the archaeologist and Native American monitor will examine the find and record the site, including field notes, measurements, and photography for a Department of Parks and Recreation 523 Primary Record form. The archaeologist will provide recommendations regarding eligibility for the California Register of Historical Resources, data recovery, curation, or other appropriate mitigation. Ground disturbance within the 50-foot radius can resume once these steps are taken and the City of San Jose has concurred with the recommendations.

MM CUL-4: Within 30 days of the completion of construction, the applicant shall have the archaeologist/Native American monitor prepare a report of findings. The report shall document the archaeological/Native American resource finds, if any, recommendations, data recovery efforts, and other pertinent information gleaned during construction. The report shall be submitted to the City of San Jose for review and approval. The applicant shall submit the final report to the Northwest Information Center of the California Historical Resources Information System.

Required Mitigation Measures: MM CUL-1 through MM CUL-4.

b. Would the project cause a substantial adverse change in the significance of a unique archaeological resource pursuant to §15064.5?

Construction

Less Than Significant with Mitigation Incorporated. See the response to CEQA checklist criterion “a” above, which includes a discussion of historic, archaeological, and ethnographic resources. Implementation of PD CUL-2 and **MM CUL-1 through MM CUL-4** would reduce impacts on buried, unique archaeological resources to a less than significant level.

Operation

No Impact. Ground-disturbing activities are not part of the operational or maintenance profile of the proposed project. Impacts on unique archaeological resources are therefore not expectable during operation.

Required Mitigation Measures: MM CUL-1 through MM CUL-4.

c. Would the project disturb any human remains, including those interred outside of formal cemeteries?

Construction

Less Than Significant with Mitigation Incorporated. See the response to CEQA checklist criterion “a” above, which includes a discussion of historic, archaeological, and ethnographic resources (all of which could include human remains). PD CUL-2 and **MM CUL-1 through MM CUL-4** would reduce impacts on buried human remains to a less than significant level.

Operation

No Impact. Ground-disturbing activities are not part of the operational or maintenance profile of the proposed project. Impacts on human remains are therefore not expectable during operation.

Required Mitigation Measures: MM CUL-1 through MM CUL-4.

Tribal Cultural Resources CEQA Checklist Criterion

a. Would the project cause a substantial adverse change in the significance of a tribal cultural resource, defined in Public Resources Code section 21074 as either a site, feature, place, or cultural landscape that is geographically defined in terms of the size and

scope of the landscape, sacred place, or object with cultural value to a California Native American tribe, and that is listed or eligible for listing in the California Register of Historical Resources, or in a local register of historical resources as defined in Public Resources Code section 5020.1(k)?

Construction

No Impact. There will not be any impacts to tribal cultural resources listed or eligible for listing in the CRHR or other state registers, National Register of Historic Places (NRHP), or local register of historical resources.

Operation

No Impact. Ground-disturbing activities are not part of the operational or maintenance profile of the proposed project. Impacts on tribal cultural resources listed or eligible for listing in the CRHR or other state registers, NRHP, or local register of historical resources are therefore not expectable during operation.

Required Mitigation Measures: None.

b. Would the project cause a substantial adverse change in the significance of a tribal cultural resource, defined in Public Resources Code section 21074 as either a site, feature, place, or cultural landscape that is geographically defined in terms of the size and scope of the landscape, sacred place, or object with cultural value to a California Native American tribe, and that is a resource determined by the lead agency, in its discretion and supported by substantial evidence, to be significant pursuant to criteria set forth in subdivision (c) of Public Resources Code Section 5024.1? In applying the criteria set forth in subdivision (c) of Public Resource Code Section 5024.1, the lead agency shall consider the significance of the resource to a California Native American tribe.

Construction

Less Than Significant with Mitigation Incorporated. Although there are no known tribal cultural resources on or directly adjacent to the proposed site, ground disturbance associated with the proposed project could result in the exposure and destruction of buried, as-yet unknown prehistoric archaeological resources that could qualify as tribal cultural resources. If these resources were to be exposed or destroyed, it would be a significant impact. Implementation of PD CUL-2 and **MM CUL-1** through **MM CUL-4** would reduce impacts on buried, tribal cultural resources to a less than significant level.

Operation

No Impact. Ground-disturbing activities are not part of the operational or maintenance profile of the proposed project. Impacts on tribal cultural resources listed or eligible for listing in the CRHR or other state registers, NRHP, or local register of historical resources are therefore not expectable during operation.

Required Mitigation Measures: MM-CUL-1 through MM-CUL-4.

4.5.3 References

Amec Foster Wheeler 2015 — Amec Foster Wheeler Environment & Infrastructure, Inc. (Amec Foster Wheeler). *Report of Phase I Environmental Site Assessment Great Oaks Boulevard Parcels, San Jose, California*. Prepared for Equinix, Redwood City, CA. Petaluma, CA. Project No. 8415180020. February 23, 2015. Electronic document, <https://www.sanjoseca.gov/home/showdocument?id=26211>, accessed July 13, 2020

Anonymous n.d. — Anonymous (Anonymous). *E-300; HUD Community Development Block Grant: Cultural Resources*. Confidential report on file, Northwest Information Center, California Historical Resources Information System, Rohnert Park. Study S-004428

Anonymous 1980 — Anonymous (Anonymous). *Archaeological Resources Assessment for the Guadalupe Corridor Alternatives Analysis Draft Environmental Impact Statement*. Confidential report on file, Northwest Information Center, California Historical Resources Information System, Rohnert Park. Study S-008387. September 1980

Anonymous 1988 — Anonymous (Anonymous). *WTG-West, Inc. Fiber Optic Cable Project*. Confidential report on file, Northwest Information Center, California Historical Resources Information System, Rohnert Park. Study S-011396. October 1988

Anonymous 2000 — Anonymous (Anonymous). Appendix D Through G: Confidential Archaeological Site Record Search Maps and Updated Site Record Forms for the Global West Fiber Optic Cable Project. Confidential report on file, Northwest Information Center, California Historical Resources Information System, Rohnert Park

Basin 1994 — Basin Research Associates (Basin). *Recorded Archaeological Resources in Santa Clara County, California (Plotted on the BARCLAY 1993 LoCaide Atlas)*. Prepared for Environmental Analysis, Santa Clara County Transportation District, San Jose, CA. Confidential report on file, Northwest Information Center, California Historical Resources Information System, Rohnert Park. Study S-016394. San Leandro, CA. January 1994

Basin 1996 — Basin Research Associates (Basin). *Second Supplement: Recorded Archaeological Resources in Santa Clara County, California (Plotted on the*

- BARCLAY 1994 LoCaide Atlas*). Prepared for Environmental Analysis, Santa Clara County Transportation District, San Jose, CA. Confidential report on file, Northwest Information Center, California Historical Resources Information System, Rohnert Park. Study S-016394b. San Leandro, CA. April 1996
- Basin 1997a — Basin Research Associates (Basin). *Archaeological Evaluation Report: Great Oaks Business Park, Santa Teresa Hills Area, City of San Jose, Santa Clara County*. Confidential report on file, Northwest Information Center, California Historical Resources Information System, Rohnert Park. Study S-021156a. Prepared for Orchard Management Services, San Jose, CA. San Leandro, CA, May 27, 1997
- Basin 1997b — Basin Research Associates (Basin). *Historic Evaluation Report: Great Oaks Business Park, Santa Teresa Hills Area, City of San Jose, Santa Clara County*. Confidential report on file, Northwest Information Center, California Historical Resources Information System, Rohnert Park. Study S-021156a. Prepared for Orchard Management Services, San Jose, CA. San Leandro, CA, May 30, 1997
- Basin 1998—Basin Research Associates (Basin). *Archaeological Evaluation Report, Parcel at the Northwest Corner of Via Del Oro and Great Oaks Boulevard, City of San Jose, Santa Clara County, APN 706-02-32*. Confidential report on file, Northwest Information Center, California Historical Resources Information System, Rohnert Park. Study S-021543. Prepared for Balch Enterprises, Hayward, CA, and Paul R. McAllister A.I.A. & Associates, San Jose, CA. San Leandro, CA. April 1998
- Basin 2000 — Basin Research Associates, Inc. (Basin). *Cultural Resources Assessment, Historic Properties Affected or Potentially Affected by the South Bay Water Recycling Program Phase 2 Facilities, Modifications to Existing Segments SJ-1, SJ-2, SC-2, SC-5, M-1 and New Segments SJ-3, SJ-4, SJ-5, SJ-6, SJ-7, M-2, M-5, Cities of San Jose and Milpitas, Santa Clara County*. Confidential report on file, Northwest Information Center, California Historical Resources Information System, Rohnert Park. Study S-023382
- Basin 2010 — Basin Research Associates, Inc. (Basin). *Cultural Resources Impacts Envision San Jose 2040 General Plan, Santa Clara County, California*. Appendix J-2 to *Draft Program Environmental Impact Report for the Envision San Jose 2040 General Plan*. Prepared for David J. Powers & Associates, Inc., San Jose, CA. San Leandro, CA. December 2010. Electronic document, <https://www.sanjoseca.gov/home/showdocument?id=22067>, accessed October 23, 2020
- Busby et al. 1996a — Colin I. Busby, Donna M. Garaventa, Melody E. Tannam, and Stuart A. Guedon (Busby et al.). *Historic Properties Treatment Plan, South Bay Water Recycling Program*. Revised. July. Prepared by Basin Research Associates, San Leandro, CA. Prepared for Parsons Engineering Science, Alameda, CA. On

- file, Northwest Information Center, California Historical Resources Information System, Rohnert Park. Study S-019072
- Busby et al. 1996b — Colin I. Busby, Donna M. Garaventa, Melody E. Tannam, and Stuart A. Guedon (Busby et al.). *Supplemental Report: Historic Properties Affected or Potentially Affected by the South Bay Water Recycling Program*. June. Prepared for Parsons Engineering Science, Alameda, CA. On file, Northwest Information Center, California Historical Resources Information System, Rohnert Park. Study S-019072a
- Byrd et al. 2017 — Brian F. Byrd, Adrian R. Whitaker, Patricia J. Mikkelsen, and Jeffrey S. Rosenthal (Byrd et al.). *San Francisco Bay-Delta Regional Context and Research Design for Native American Archaeological Resources, Caltrans District 4*. Confidential report on file, Northwest Information Center, California Historical Resources Information System, Rohnert Park. Study S-049780. Prepared for Office of Cultural Resources Studies, District 4, California Department of Transportation, Oakland, June 2017
- CEC 2017 — California Energy Commission (CEC). California Energy Commission, *Tribal Consultation Policy*. CEC-700-2017-002-D. Sacramento, CA, revised December 2017
- CEC 2020m — California Energy Commission (CEC). Report of Conversation Between CEC Staff J. Hinde and City of San Jose Staff A. Wang: Great Oaks South Backup Generating Facility (TN 234481), August 2020. Available online at: <https://efiling.energy.ca.gov/Lists/DocketLog.aspx?docketnumber=20-SPPE-01>
- CEG 2019 — Cornerstone Earth Group (CEG). Phase I Environmental Site Assessment. 300 Great Oaks Boulevard. San Jose, California. October 8, 2019
- Davis 1961 — James T. Davis (Davis). *Trade Routes and Economic Exchange among the Indians of California*. Report No. 54. March 31. Berkeley: University of California Archaeological Survey
- Dietz 1976a — Stephen A. Dietz (Dietz). Letter Regarding a Preliminary Archaeological Reconnaissance of the Edenvale Redevelopment Project Location in San Jose, California. Confidential report on file, Northwest Information Center, California Historical Resources Information System, Rohnert Park. Study S-004277. Prepared for Office of Economic Development, San Jose, CA. Archaeological Consulting and Research Services, Inc., Mill Valley, CA. April 16, 1976
- Dietz 1976b — Stephen A. Dietz (Dietz). Letter Regarding Subsurface Archaeological Investigations in the Edenvale Redevelopment Project Area. Confidential report on file, Northwest Information Center, California Historical Resources Information System, Rohnert Park. Study S-004277a. Prepared for Office of Economic Development, San Jose, CA. Archaeological Consulting and Research Services, Inc., Mill Valley, CA. June 11, 1976

- D'Oro 2018 — Stella D'Oro (D'Oro). *Cultural Resources Assessment of Proposed Construction at APNs 706-02-053 and 706-02-054 and Portions of 706-02-055 and 706-02-056, San Jose, California*. Prepared for David J. Powers & Associates, San Jose, CA. Prepared by Albion Environmental, Inc., Santa Cruz, CA, October 2018
- Edward Denny & Co. 1913 — Edward Denny & Co. Map Publishers (Edward Denny & Co.). *Denny's Pocket Map, Santa Clara County, California*
- Elsasser et al. 1985 — Albert B. Elsasser, R. L. Anastasio, J. C. Bard, C. I. Busby, D. M. Garaventa, Stuart A. Guedon, E. L. M (Elsasser et al.). *Review of the Prehistory of the Santa Clara Valley Region as Part of the Guadalupe Transportation Corridor Compliance with 36 CFR Part 800*. Confidential report on file, Northwest Information Center, California Historical Resources Information System, Rohnert Park. Study S-007483. May 1985
- Estes et al. 2014 — Allen Estes, David Buckley, and Nazih Fino (Estes et al.). *Archaeological Survey Report, Department of Veterans Affairs Outpatient Clinic Project, Santa Clara County, California*. Confidential report on file, Northwest Information Center, California Historical Resources Information System, Rohnert Park. Study S-047857. Prepared for EMC Planning Group, Inc., Monterey, CA. Prepared by WSA, WSA Project 2014-72, WSA Report 2014-43. December 2014
- Estes and Fino 2015 — Allen Estes and Nazih Fino (Estes and Fino). *Archaeological Testing Report for the Department of Veterans Affairs Outpatient Clinic Project San Jose, Santa Clara County, California*. Confidential report on file, Northwest Information Center, California Historical Resources Information System, Rohnert Park. Study S-047857a. Prepared for EMC Planning Group, Inc., Monterey, CA. Prepared by WSA, WSA Project 2014-88, WSA Report 2015-18. May 2015
- Esignsunlimited 2020 — Signs Unlimited (Esignsunlimited). Available at: <https://esignsunlimited.com/new-monument-sign-face-oak-grove-schools/#>. Accessed September 30, 2020
- Fike 2016 — Aisha Fike (Fike). *651 Mathew Street*. California Department of Recreation Primary Record Form. October 25. ICF International. Prepared for the City of Santa Clara
- Garaventa et al. 1991 — Donna M. Garaventa, Colin I. Busby, Sondra A. Jarvis, and David G. Brittin (Garaventa et al.). *Cultural Resources Assessment for the Santa Clara County Transportation Plan - T2010 EIR*. Confidential report on file, Northwest Information Center, California Historical Resources Information System, Rohnert Park. Study S-013200. Prepared for Donaldson Associates, Albany, CA. Prepared by Basin Research Associates, Inc., San Leandro, CA. May 1991
- Garaventa et al. 1993 — Donna M. Garaventa, Stuart A. Guedon, and Colin I. Busby (Garaventa et al.). *Cultural Resources Review for the City of San Jose 2020 General Plan Update*. Confidential report on file, Northwest Information Center,

- California Historical Resources Information System, Rohnert Park. Study S-015228. April 1993
- Golla 2007—Victor Golla (Golla). Linguistic Prehistory. Chapter 6 in *California Prehistory: Colonization, Culture, and Complexity*, edited by Terry L. Jones and Kathryn A. Klar, pp. 71–82. Lanham, MD: Altamira
- Hines et al. 1979—Ann Hines, Pauline Pace, and Gail Woolley (Hines et al). *Santa Clara County Heritage Resource Inventory*. On file, Northwest Information Center, California Historical Resources Information System, Rohnert Park. Study S-005259. June 1979
- Jackson 1973—Thomas L. Jackson (Jackson). *Proposed Highway Improvements, Cochran Road to Ford Road, Santa Clara County: An Archaeological Evaluation*. Confidential report on file, Northwest Information Center, California Historical Resources Information System, Rohnert Park. Study S-004318. Prepared by San Francisco State University, San Francisco, CA. November 1973
- Jones et al. 2007—Terry L. Jones, Nathan E. Stevens, Deborah A. Jones, Richard T. Fitzgerald, and Mark G. Hylkema (Jones et al.). The Central Coast: A Midlatitude Milieu. Chapter 9 in *California Prehistory: Colonization, Culture, and Complexity*, edited by Terry L. Jones and Kathryn A. Klar, pp. 125–146. Lanham, MD: Altamira
- Kehl and Yamane 1995 — Jacquelin Jensen Kehl and Linda Yamane (Kehl and Yamane). *Ethnohistoric Genealogy Study: Tasman Corridor Light Rail Project Santa Clara County, California*. Confidential report on file, Northwest Information Center, California Historical Resources Information System, Rohnert Park. Study S-017852. Submitted to Woodward-Clyde Consultants, Oakland, CA
- King and King 1973 — Thomas F. King and Linda King (King and King). *Visual Inventory of Historic and Archaeological Sites, San Jose, California*. Confidential report on file, Northwest Information Center, California Historical Resources Information System, Rohnert Park. Study S-004754. November 1973
- Kroeber 1976 — A. L. Kroeber (Kroeber). *Handbook of the Indians of California*. Reprinted. New York, NY: Dover Publications. Originally published in 1925, Bulletin No. 78, Bureau of American Ethnology, Smithsonian Institution, Washington, D.C.
- Kubal 2014 — Kathleen Kubal (Kubal). *Historic Property Survey Report, US 101 Express Lanes Project, 04-SCL-101 PM 16.00/52.55 - 04-SCL-85 PM 23.0/24.1, Santa Clara County, California*. Confidential report on file, Northwest Information Center, California Historical Resources Information System, Rohnert Park. Study S-045670. April 2014
- Lehmann 2000 — Susan Lehmann (Lehmann). Economic Development of the City of Santa Cruz, 1850-1950. From: *Fully Developed Context Statement for the City of Santa Cruz*. Prepared for City of Santa Cruz Planning and Development Department. Chapter 3, Context I: Economic Development of the City of Santa

- Cruz 1850-1950, pp. 25-27. Electronic document, <https://history.santacruzpl.org/omeka/items/show/134510#?c=0&m=0&s=0&cv=0>. Accessed June 18, 2019
- Levy 1978 — Richard Levy (Levy). Costanoan. In *California*, edited by Robert F. Heizer, pp. 485–495. Handbook of North American Indians, vol. 8, William C. Sturtevant, ed. Washington, D.C.: Smithsonian Institution
- Mayfield 1978 — David W. Mayfield (Mayfield). Ecology of the Pre-Spanish San Francisco Bay Area. Confidential report on file, Northwest Information Center, California Historical Resources Information System, Rohnert Park. Study S-009583
- McAlester and McAlester 1997 — Virginia McAlester and Lee McAlester (McAlester and McAlester). *A Field Guide to American Houses*. New York, Alfred A. Knopf. 1997
- Meyer and Rosenthal 2007 — Jack Meyer and Jeffrey Rosenthal (Meyer and Rosenthal). *Geoarchaeological Overview of the Nine Bay Area Counties*. Submitted to District 4, California Department of Transportation, Oakland. Confidential report on file, Northwest Information Center, California Historical Resources Information System, Rohnert Park. Study S-033600. Prepared by Far Western Anthropological Research Group, Inc., Davis, CA, June 2007
- Milliken et al. 2007 — Randall Milliken, Richard T. Fitzgerald, Mark G. Hylkema, Randy Groza, Tom Origer, David G. Bieling, Alan Leventhal, Randy S. Wiberg, Andrew Gottsfield, Donna Gillette, Viviana Bellifemine, Eric Strother, Robert Cartier, and David A. Fredrickson (Milliken et al.). Punctuated Culture Change in the San Francisco Bay Area. Chapter 8 in *California Prehistory: Colonization, Culture, and Complexity*, edited by Terry L. Jones and Kathryn A. Klar, pp. 99–123. Lanham, MD: Altamira, 2007
- Milliken et al. 2006 — Randall Milliken, Jerome King, and Patricia Mikkelsen (Milliken et al.) *Central California Ethnographic Community Distribution Model, Version 2.0, with Special Attention to the San Francisco Bay Area*. Confidential report on file, Northwest Information Center, California Historical Resources Information System, Rohnert Park. Study S-032596. Prepared by Far Western Anthropological Research Group, Inc., Davis, CA, December 2006
- Nelson et al. 2000 — Wendy J. Nelson, Maureen Carpenter, and Julia G. Costello Nelson (Nelson et al.) *Cultural Resources Survey for the Level (3) Communications Long Haul Fiber Optics Project, Segment WS05: San Jose to San Luis Obispo*. Confidential report on file, Northwest Information Center, California Historical Resources Information System, Rohnert Park. Study S-022819
- OHP 1995 — Office of Historic Preservation (OHP). *Instructions for Recording Historical Resources*. Sacramento, CA: Office of Historic Preservation. March 1995
- Parsons and KEMCO 1983 — Parsons Brinckerhoff Quade & Douglas and Kobori Environmental Management Corp (Parsons and KEMCO). *Data Recovery Plan for the Guadalupe Corridor Transportation Project, Santa Clara County, California*.

- February. Prepared for Santa Clara County Transportation Agency. Confidential report on file, Northwest Information Center, California Historical Resources Information System, Rohnert Park. Study S-006066
- Polanco 2015 — Julianne Polanco (Polanco). Letter Regarding Section 106 Consultation for the Department of Veterans Affairs (VA) Outpatient Clinic Project, San Jose, CA. Confidential report on file, Northwest Information Center, California Historical Resources Information System, Rohnert Park. Study S-047857d. Submitted to Palo Alto Health Care System, Department of Veteran Affairs, Palo Alto, CA. Prepared by Office of Historic Preservation, Department of Parks and Recreation, Sacramento, CA. Reference No. VA_2015_0414_001. July 13, 2015
- Rehor and Kubal 2014 — Jay Rehor and Kathleen Kubal (Rehor and Kubal). *Extended Phase I Study: US 101 Express Lanes Project, Santa Clara County, California*. Prepared for District 4, Department of Transportation, State of California, Oakland, and Santa Clara Valley Transportation Authority, San Jose, CA. US PM 16.0/52.55, SR 85 PM 23.0/R24.1. Project No. 0412000459. EA 2G7100. Confidential report on file, Northwest Information Center, California Historical Resources Information System, Rohnert Park. Study S-045670c. URS Corporation, Oakland, CA. April 2014
- Rosenthal 2001a — J. Rosenthal (Rosenthal). Update of Department of Parks and Recreation 523 Forms for P-43-001095 (CA-SCL-732/H). Confidential record on file, Northwest Information Center, California Historical Resources Information System, Rohnert Park. Far Western Anthropological Research Group, Inc., Davis, CA, May 3, 2001
- Rosenthal 2001b — J. Rosenthal (Rosenthal). Update of Department of Parks and Recreation 523 Forms for P-43-000250 (CA-SCL-240). Confidential record on file, Northwest Information Center, California Historical Resources Information System, Rohnert Park. Far Western Anthropological Research Group, Inc., Davis, CA, May 3, 2001
- Ruby et al. 1992 — Allika Ruby, Jason Bass, and Mike Kelley (Ruby et al.) *Evaluation of Archaeological Resources for the San Jose/Santa Clara Nonpotable Water Reclamation Project*. May 11. Archaeological Resource Management, San Jose, CA. Prepared for Engineering Science, Alameda, CA. Project #60800-92-62. On file, Northwest Information Center, California Historical Resources Information System, Rohnert Park. Study S-014230
- San Jose 2009 — City of San Jose (San Jose). *Envision San Jose General Plan Appendix J-, Cultural Resources Existing Setting*. Prepared for David. J Powers & Associates, Inc. by Basin Research Associates, Inc. <https://www.sanjoseca.gov/your-government/departments/planning-building-code-enforcement/planning-division/environmental-planning/environmental-review/completed-eirs/envision-san-jose-2040-general-plan-4-year/envision-san-jos-2040-general-plan>. July 2009

- San Jose 2010 — City of San Jose (San Jose). *Revised Guidelines for Historic Reports*. February 26, 2010
- San Jose 2020 — City of San Jose (San Jose). *Envision San Jose 2040 General Plan*. November 2011, amended December 18, 2018, updated March 16, 2020. Available online at: <https://www.sanjoseca.gov/home/showpublisheddocument?id=22359>
- San Jose 2021 — City of San Jose (San Jose). City of San Jose Municipal Code. Title 13, Chapter 13.48 Historic Preservation. Codified through Ordinance No. 30336, adopted November 19, 2019. (Supp. No. 35, Update 5). Posted online March, 2021 at: https://library.municode.com/ca/san_Jose/codes/code_of_ordinances?nodeId=TI T13STSIPUPL_CH13.48HIPR/codes/code_of_ordinances?nodeId=TIT13STSIPUPL_CH13.48HIPR
- Santa Clara 2012 — County of Santa Clara Department of Planning and Development, Planning Office (Santa Clara County). County of Santa Clara Historic Context Statement. December 2004, Revised February 2012
- Shipley 1978 — William F. Shipley (Shipley). Native Languages of California. In *California*, edited by Robert F. Heizer, pp. 80–90. Handbook of North American Indians, vol. 8, William C. Sturtevant, ed. Washington, D.C.: Smithsonian Institution
- Sikes et al. 2014 — Nancy E. Sikes, Molly Valasik, and Amy Glover (Sikes et al.). *Archaeological Survey Report for the US 101 Express Lanes Project, Santa Clara County, California*. Prepared for District 4, California Department of Transportation, Oakland, and Santa Clara Valley Transportation Authority, San Jose, CA. Confidential report on file, Northwest Information Center, California Historical Resources Information System, Rohnert Park. Study S-045670b. Cogstone, Orange, CA, May 1, 2014
- SJ Permits 2020 — City of San Jose Online Permit (SJ Permits). Property or Zoning Information Search. <https://sjpermits.org/permits/general/combinedquery.asp>. Accessed July and October 2020
- SV1 2020a — SV1, LLC. (SV1). Application for Small Power Plant Exemption: Great Oaks South Backup Generating Facility (TN 232466), March 2020. Available online at: <https://efiling.energy.ca.gov/Lists/DocketLog.aspx?docketnumber=20-SPPE-01>
- SV1 2020b — SV1, LLC. (SV1). Application Appendices A through K: Great Oaks South Backup Generating Facility (TN 232467-1,2,3), March 2020. Available online at: <https://efiling.energy.ca.gov/Lists/DocketLog.aspx?docketnumber=20-SPPE-01>
- SV1 2020d — SV1, LLC. (SV1). SV1 Responses to CEC Data Request Set 2: Great Oaks South Backup Generating Facility Part 1 through Part 4 (TN 233005-1,2,3,4), May 2020. Available online at: <https://efiling.energy.ca.gov/Lists/DocketLog.aspx?docketnumber=20-SPPE-01>

- SV1 2021h — SV1, LLC, (SV1). SV 1 Hexagon Consultants Transportation Analysis: Great Oaks South Backup Generating Facility (TN 237150), March 2021. Available online at: <https://efiling.energy.ca.gov/Lists/DocketLog.aspx?docketnumber=20-SPPE-01>
- SV1 2020p — SV1, LLC. (SV1). SV1 Revised SV1 Supplemental DR-47 Response: Great Oaks South Backup Generating Facility (TN 235566), November 2020. Available online at: <https://efiling.energy.ca.gov/Lists/DocketLog.aspx?docketnumber=20-SPPE-01>
- USGS 1899 — United States Geological Survey (USGS). San Jose, California, Sheet. 15-minute Topographic Series. Surveyed 1895. March 1899
- USGS 1915 — United States Geological Survey (USGS). Geologic and Topographic Map of the Coast Route
- WSA 2015 — William Self Associates (WSA). *Archaeological Workplan for the Department of Veterans Affairs Outpatient Clinic Project, Santa Clara County, California*. Confidential report on file, Northwest Information Center, California Historical Resources Information System, Rohnert Park. Study S-047857c. Submitted to EMC Planning Group, Inc., Monterey, CA. Orinda, CA. Revised April 23, 2015

4.6 Energy and Energy Resources

This section describes the environmental and regulatory setting and discusses impacts associated with the construction and operation of the project specific to energy and energy resources¹.

ENERGY	Potentially Significant Impact	Less Than Significant with Mitigation Incorporated	Less Than Significant Impact	No Impact
Would the project:				
a. Result in potentially significant environmental impact due to wasteful, inefficient, or unnecessary consumption of energy resources, during project construction or operation?	<input type="checkbox"/>	<input type="checkbox"/>	<input checked="" type="checkbox"/>	<input type="checkbox"/>
b. Conflict with or obstruct a state or local plan for renewable energy or energy efficiency?	<input type="checkbox"/>	<input type="checkbox"/>	<input type="checkbox"/>	<input checked="" type="checkbox"/>

Environmental checklist established by CEQA Guidelines, Appendix G.

4.6.1 Setting

The project would consist of three data center buildings and a total of 39 diesel-fired standby generators (gensets). The three buildings would include 36, 3.25-megawatt (MW) gensets (12 gensets per building, of which, two gensets per building would be redundant) that would be used to provide backup power supply to support an uninterruptible power supply exclusively for the project (SV1 2020a, Section 2.2). In addition, the project would include three life safety emergency gensets (one genset per building) capable of generating 500 kilowatt (kW) each, to support fire alarm, fire pumps, general lighting, administration office space, shipping/receiving and other common building systems. The gensets would serve the data center only during times when electric service delivered by Pacific Gas & Electric Company (PG&E) is interrupted. The backup generators would be electrically isolated from the PG&E electrical transmission grid with no means to deliver electricity offsite.

The 36 standby gensets would each be a Cummins QSK95-G9 Model C3250D6e with a peak rated output capacity of 3.25 MW and a continuous steady-state output capacity of 2.5 MW, and fuel consumption rate of 222 gallons per hour (gal/hr) at full load (SV1 2020a, Section 2.2.6). The three 500 kW life safety emergency generators would each be a Cummins QSK15-G9 with fuel consumption rate of 34 gal/hr at full load. Staff has verified the output capacity and rate of fuel consumption of these generators from their product sheets (SV1 2020b, Appendix J). The maximum electrical load requirement of the data center would be 99 MW, which includes the electrical power load of the

¹ This section includes staff's analysis of the project's potential impact on Energy Resources, as required by Public Resources Code section 25541 when considering a Small Power Plant Exemption

Information Technology (IT) servers, the cooling load of the data center buildings as well as facility's ancillary loads. See **Section 3.0 Project Description** for further information. For the purposes of testing and maintenance, only one generator would run at any given time.

Regulatory Background

Federal

Energy Star and Fuel Efficiency. At the federal level, energy standards set by the Environmental Protection Agency (EPA) apply to numerous consumer products and appliances. The EPA also sets fuel efficiency standards for automobiles and other modes of transportation.

State

Title 24, California Energy Efficiency Standards for Residential and Nonresidential Buildings—California Green Building Code (2019). The California Green Building Code applies to newly constructed buildings and requires installation of energy-efficient infrastructure.

Senate Bill 100—The 100 Percent Clean Energy Act of 2018. Senate Bill (SB) 100 requires that retail sellers and local publicly owned electric utilities procure a minimum quantity of electricity products from eligible renewable energy resources so that the total kilowatt-hours of those products sold to their retail end-use customers achieve 44 percent of retail sales by December 31, 2024, 52 percent by December 31, 2027, and 60 percent by December 31, 2030. This requirement applies to San Jose Clean Energy (SJCE) program, which would be the primary source of energy supply for GOSDC. The bill also declares that the Public Utilities Commission, California Energy Commission, and State Air Resources Board should utilize programs authorized under existing statutes to meet the state policy goal of 100 percent of total retail sales of electricity in California provided by eligible renewable energy resources and zero-carbon resources by December 31, 2045.

Local

City of San Jose General Plan. *Envision San Jose 2040 General Plan* was adopted by the San Jose City Council in November 2011, amended in December 2018, and updated March 16, 2020. The city's progress towards achieving key goals are evaluated every four years (San Jose 2020a). Applicable *Envision San Jose 2040 General Plan* Policies and Actions regarding energy are detailed in Chapter 3 – Environmental Leadership guidelines of this general plan and are summarized below:

- MS-2.2: Encourage maximized use of on-site generation of renewable energy for all new and existing buildings.
- MS-2.3: Utilize solar orientation (i.e., building placement), landscaping, design, and construction techniques for new construction to minimize energy consumption.

- MS-2.4: Promote energy efficient construction practices.
- MS-2.6: Promote roofing design and surface treatments that reduce the heat island effect of new and existing development and support reduced energy use, reduced air pollution, and a healthy urban forest. Connect businesses and residents with cool roof rebate programs through the city's outreach efforts.
- MS-2.7: Encourage the installation of solar panels or other clean energy power generation sources over parking areas.
- MS-2.8: Develop policies which promote energy reduction for energy-intensive industries. For facilities such as data centers require evaluation of operational energy efficiency and inclusion of operational design measures as part of development review consistent with benchmarks such as those in EPA's Energy Star Program for new data centers.
- MS-2.9: Develop, implement, and utilize programs that help businesses and homeowners improve the energy efficiency of new and existing buildings and use of renewable energy sources, such as solar, through on-site generation or purchase of electricity from solar power programs in California.
- MS-2.10: Develop policies to encourage the use of building materials extracted and/or manufactured in California, or within 500 miles of San Jose.
- MS-2.11: Require new development to incorporate green building practices, including those required by the Green Building Ordinance. Specifically, target reduced energy use through construction techniques (e.g., design of building envelopes and systems to maximize energy performance), through architectural design (e.g., design to maximize cross ventilation and interior daylight) and through site design techniques (e.g., orienting buildings on sites to maximize the effectiveness of passive solar design).

The project would be required to comply with applicable provisions in the City's General Plan and zoning ordinance, as verified by the City's design review process.

4.6.2 Applicant Proposed Measures

None.

4.6.3 Environmental Impacts and Mitigation Measures

a. Result in potentially significant environmental impact due to wasteful, inefficient, or unnecessary consumption of energy resources, during project construction or operation?

Construction

Less Than Significant Impact. Construction activities would consume nonrenewable energy resources, primarily fossil fuels (oil, gasoline, and diesel), for construction equipment and vehicles. It is anticipated that these nonrenewable energy resources

would be used efficiently during construction activities and would not result in long-term significant depletion of these energy resources or permanently increase the project's reliance on them.

Under PD AQ-1, the project would implement measures to minimize the idling of construction equipment and would require all such equipment to be maintained and properly tuned (see **Section 4.3 Air Quality**). This would ensure that fuel consumed during construction would not be wasted through unnecessary idling or operation of poorly maintained equipment. Additionally, the project would participate in the city's Construction and Demolition Debris Recycling Program by recycling or diverting at least 50 percent of materials generated for discards by the project in order to reduce the amount of demolition and construction waste going to the landfill (SV1 2020a, Section 4.8.2). Diversion saves energy by reusing and recycling materials for other uses (instead of landfilling materials and using additional non-renewable resources).

Therefore, construction of the project would create a less-than-significant impact on local and regional energy supplies and a less-than-significant environmental impact due to wasteful, inefficient, or unnecessary consumption of energy resources.

Operation

Less Than Significant Impact. The total number of hours of operation for reliability purposes (i.e.; readiness testing and maintenance) for the generators would be limited by the data center to no more than 20 hours per generator annually (SV1 2020h). At this rate, the total quantities of diesel fuel used for all the generators operating at full load would be approximately 3,854 barrels per year (bbl/yr)². California has a diesel fuel supply of approximately 341,036,000 bbl/yr.³ The project's use of fuel constitutes a small fraction (less than 0.0011 percent) of available resources and the supply is more than sufficient to meet necessary demand. For these reasons, the project's use of fuel is less than significant.

It is important to note that maintenance and readiness testing of the gensets are crucial to the project's viability. The most important data center criterion is reliability. Crucial services such as the 911, Offices of Emergency Management, and utilities infrastructure are increasingly using data centers for their operation. Reliability and data security requirements of a data center would be compromised by limiting or reducing fuel consumption for the purpose of maintenance and readiness testing. This includes the primary gensets as well as the redundant ones. Even though the redundant gensets are purposed to provide backup service to the rest of the gensets, their operational reliability is equally important, and they are often designed to start up at the same time as the main gensets during emergency operations, with each genset running at less than full

2 Calculated as: (222 gal/hr x 20 hours per year x 36 generators) + (34 gal/hr x 20 hours per year x 3 generators) = 161,880 gallons per year = 3,854 bbl/yr.

3 This is the sum of the annual production of 141,771,000 bbl and available stocks of 199,266,000 bbl obtained from the Energy Commission's Weekly Fuels Watch Report for 2019 (latest annual report available).

capacity. If any of the primary gensets fails to operate, a redundant one must be immediately ready to run to take up the lost load. So, it is crucial that the redundant gensets be regularly tested and maintained according to the same testing and maintenance requirements as the primary ones and as prescribed by the manufacturer's warranty conditions. The use of nonrenewable fuel for the generators for readiness testing and maintenance would not be unnecessary, inefficient, or wasteful.

The standby generators would use nonrenewable resources (diesel and lubricating oils). However, the use of the standby generators for emergency purposes would be limited to times when there is an interruption of PG&E's delivery of electric service or other rare emergency that would require the facility to switch to backup generator use. Under emergency conditions, defined as the loss of electrical power to the data center, which are infrequent and short-duration events, the generators could operate and use nonrenewable resources, as necessary, to maintain data center operations. The Cummins genset models selected for this project have an efficiency rating comparable to other commercially available diesel-fueled generators of similar generating capacity.

Power Usage Effectiveness (PUE) is a metric used to compare the efficiency of facilities that house computer servers. It is a common metric for determining how effectively a data center's infrastructure systems can deliver power to the computer systems it houses. PUE was published in 2016 as a global standard under the International Organization for Standardization and the International Electrotechnical Commission as well as the European Standards (ISO 20160, European Standards 2016). It is defined as the ratio of total facility energy draw (including the facility's mechanical and electrical loads) to IT server electrical power draw ($PUE = \text{total facility source energy [including the IT source energy]} / \text{IT source energy}$). This approach to calculating a data center's energy efficiency is similar to the American Society of Heating, Refrigerating, and Air-conditioning Engineers (ASHRAE) Energy Standard for Data Centers (ASHRAE 90.4). However, there is a notable difference. ASHRAE 90.4 intends to tackle and regulate lower performers. Its method of calculating energy efficiency provides an alternative path that allows tradeoffs between mechanical and electrical loads particularly within existing, older data centers, while the PUE is a more appropriate path to determining a new data center's energy efficiency.

A PUE of 2 means that the data center must draw two watts of electricity for each watt of power consumed by the IT server equipment. While the PUE is always greater than 1, the closer it is to 1, the greater the portion of the power drawn by the facility that goes to the IT server equipment.

The PUE has been used as a guideline for assessing and comparing energy and power efficiencies associated with data centers since 2007 (ASHRAE 2016). It has to be noted that the PUE metric was designed to compare facilities of similar size and within similar climatic conditions. PUE factors started around 2.0, but values have since been migrating down to 1.25 or lower, demonstrating a significant improvement over the years. A facility with a PUE of 1.5-2.0 is considered "efficient", while one with a PUE of 1.2-1.5 is considered "very efficient". The peak PUE for GOSDC would be 1.30, and its annual

average PUE would be 1.23 (SV1 2020a, Section 4.10.2). The project's peak operation PUE estimate is based on design assumptions and represents worst case; that is, the hottest day with all server bays occupied and all servers operating at 100 percent capacity. The project's more realistic PUE, based on annual average site temperatures and less than maximum power loads, would not exceed 1.23.

The project would be constructed in accordance with the 2019 California Green Building Code and would include green building measures to reduce energy consumption (SV1 2020a, Table 2.3-1). Examples of these measures include:

- high efficiency water-cooled chilled water system with water-side economizer for the data halls and variable refrigerant flow cooling system;
- airflow management – hot aisle containment, separated ceiling plenum to provide separation of hot and cool air in data halls, and use of blanking panels and other measures to avoid bypass of cold air into hot aisles;
- utilizing lighting control and LED lighting to reduce energy usage;
- air economization⁴ integrated into the central air handling system for building cooling;
- Cool Roof, using reflective surfaces to reduce heat gains; and
- building insulation.

The GOSDC's consumption of energy resources during operation would not be inefficient or wasteful. Project operation would have a less-than-significant adverse effect on local or regional energy supplies and energy resources.

Required Mitigation Measures: None

b. Conflict with or obstruct a state or local plan for renewable energy or energy efficiency?

Construction and Operation

No Impact. During operation, GOSDC would use both nonrenewable energy resources and renewable energy resources. GOSDC would opt in to the SJCE program (SV1 2020a, Section 4.8.1.2). SJCE is the electricity provider for residents and businesses in the city of San Jose that opt into its program. SJCE sources the electricity and PG&E delivers it to customers over existing utility lines. As of February 2019, most residents and businesses were automatically enrolled in SJCE's GreenSource. GreenSource consists of 40 percent renewable, 52 percent non-renewable carbon-free, and 8 percent unspecified sources. And offers 100 percent renewable energy to its customers through its TotalGreen program (San Jose 2021). In addition, SJCE has adopted "Reach Codes," which are local

⁴ An air economizer is a ducting arrangement, including dampers, linkages, and an automatic control system that allows a cooling supply fan system to supply outside air to reduce or eliminate the need for mechanical cooling.

energy targets that “reach” beyond the state minimum requirements for energy use in building design and construction. SJCE reaches beyond state minimum requirements through its TotalGreen program.

GOSDC would receive electricity from SJCE sources, which is on track to meet the requirements of SB 100. SJCE has committed to meeting California’s Renewable Portfolio Standard through its 100 percent renewable energy program, the SJCE program (San Jose 2020b). Therefore, power usage by the project would be consistent with SB 100.

Given the project’s gensets would operate only during testing, which is limited to 20 hours per generator annually, and in the case of emergencies, and that the generated electricity would only serve the project and not the wider electric grid, the project’s use of diesel fuel would not obstruct or inhibit the state from achieving these energy related goals. Additionally, it is likely that renewable fuels could be broadly available in the future for these engines (i.e., renewable diesel) should requirements or incentives be put in place for these types of facilities to transition to more renewable sources of fuel. See **Section 5 Alternatives** for more discussion.

The project would participate in the city’s Construction and Demolition Debris Recycling Program and implement measures to promote walking, bicycling, and transit use, thereby reducing motor vehicle use. Through the city’s design review process, SJCE would be required to comply with the California Green Building Code and the city’s *Envision San Jose 2040 General Plan* Policies and Actions related to energy in Chapter 3 – Environmental Leadership guidelines, which are consistent with the EPA’s Energy Star and Fuel Efficiency program.

Through energy efficient design and increased renewable electricity use from its primary source (SJCE), the project would neither conflict with, nor obstruct state or local plans for renewable energy or energy efficiency, and therefore would have no impact on them.

4.6.4 References

ASHRAE 2016 – American Society of Heating, Refrigerating, and Air-conditioning Engineers ASHRAE Journal (ASHRAE). Article: Supercomputers, Super Efficiency, pp. 38-39. Published in January 2016. Available online at: <https://technologyportal.ashrae.org/journal/articledetail/1670>

European Standards 2016 – European Standards. CSN EN 50600-4-2 Information technology – Data centre facilities and infrastructures – Part 4-1: Power Usage Effectiveness. Released 2016. Available online at: <https://www.en-standard.eu/csn-en-50600-4-2-information-technology-data-centre-facilities-and-infrastructures-part-4-2-power-usage-effectiveness/>

ISO 2016 – ISO. ISO/IEC 30134-2:2016, Information technology – Data centres – key performance indicators – Part 2: Power usage effectiveness (PUE). Published April 2016. Available online at: <https://www.iso.org/standard/63451.html>

San Jose 2019 – City of San Jose (San Jose). Green Source Gets Cleaner In 2020, Rates Remain 1% Below PG&E. Available online at:
<https://sanjosecleanenergy.org/greensource-gets-cleaner-in-2020-rates-remain-1-below-pge/>

San Jose 2020a – City of San Jose (San Jose). Envision San Jose 2040 General Plan. Updated March 16, 2020. Available online at: <https://www.sanjoseca.gov/home/showdocument?id=22359>

San Jose 2020b – City of San Jose (San Jose). San Jose Clean Energy. Accessed on: March 30, 2020. Available online at: <https://www.sanjosecleanenergy.org/>

San Jose 2021 – City of San Jose (San Jose). San Jose Clean Energy. Accessed on: April 20, 2021. Available online at: <https://sanjosecleanenergy.org/your-choices/#greensource>

SV1 2020a – SV1, LLC. (SV1). Application for Small Power Plant Exemption: Great Oaks South Backup Generating Facility (TN 232466), March 2020. Available online at: <https://efiling.energy.ca.gov/Lists/DocketLog.aspx?docketnumber=20-SPPE-01>

SV1 2020b – SV1, LLC. (SV1). Application Appendices A through K: Great Oaks South Backup Generating Facility (TN 232467-1,2,3), March 2020. Available online at: <https://efiling.energy.ca.gov/Lists/DocketLog.aspx?docketnumber=20-SPPE-01>

SV1 2020h – SV1, LLC. (SV1). SV1 Supplemental Responses to DR 65-69: Great Oaks South Backup Generating Facility (TN 233924), July 2020. Available online at: <https://efiling.energy.ca.gov/Lists/DocketLog.aspx?docketnumber=20-SPPE-01>

4.7 Geology and Soils

This section describes the environmental and regulatory setting and discusses impacts associated with the construction and operation of the project with specific to geology and soils.

GEOLOGY AND SOILS	Potentially Significant Impact	Less Than Significant with Mitigation Incorporated	Less Than Significant Impact	No Impact
Would the project:				
a. Directly or indirectly cause potential substantial adverse effects, including the risk of loss, injury, or death involving:				
i. Rupture of a known earthquake fault, as delineated on the most recent Alquist-Priolo Earthquake Fault Zoning Map issued by the State Geologist for the area or based on other substantial evidence of a known fault? Refer to Division of Mines and Geology Special Publication 42.	<input type="checkbox"/>	<input type="checkbox"/>	<input type="checkbox"/>	<input checked="" type="checkbox"/>
ii. Strong seismic ground shaking?	<input type="checkbox"/>	<input type="checkbox"/>	<input checked="" type="checkbox"/>	<input type="checkbox"/>
iii. Seismic-related ground failure, including liquefaction?	<input type="checkbox"/>	<input type="checkbox"/>	<input checked="" type="checkbox"/>	<input type="checkbox"/>
iv. Landslides?	<input type="checkbox"/>	<input type="checkbox"/>	<input type="checkbox"/>	<input checked="" type="checkbox"/>
b. Result in substantial soil erosion or the loss of topsoil?	<input type="checkbox"/>	<input type="checkbox"/>	<input checked="" type="checkbox"/>	<input type="checkbox"/>
c. Be located on geologic units or soil that is unstable, or that would become unstable as a result of the project, and potentially result in on- or off-site landslide, lateral spreading, subsidence, liquefaction, or collapse?	<input type="checkbox"/>	<input type="checkbox"/>	<input checked="" type="checkbox"/>	<input type="checkbox"/>
d. Be located on expansive soil, as defined in Section 1803.5.3 of the California Building Code (2010), creating substantial direct or indirect risks to life or property?*	<input type="checkbox"/>	<input type="checkbox"/>	<input checked="" type="checkbox"/>	<input type="checkbox"/>
e. Have soils incapable of adequately supporting the use of septic tanks or alternative wastewater disposal systems where sewers are not available for the disposal of waste water?	<input type="checkbox"/>	<input type="checkbox"/>	<input type="checkbox"/>	<input checked="" type="checkbox"/>
f. Directly or indirectly destroy a unique paleontological resource or site or unique geologic feature?	<input type="checkbox"/>	<input checked="" type="checkbox"/>	<input type="checkbox"/>	<input type="checkbox"/>

*Geology and Soils question (d) reflects the current 2013 California Building Code (CBC), effective January 1, 2014, which is based on the International Building Code (2009).

Environmental checklist established by CEQA Guidelines, Appendix G.

4.7.1 Setting

Analysis of existing data included reviews of publicly available literature, maps, air photos, and documents presented with the application. An online database search was performed

to identify previously reported paleontological resources near the project site. The geologic map review of the project area included maps published by the U.S. Geological Survey (Helley and Wesling 1989; Wesling and Helley 1989, and Helley et al. 1994). The literature reviewed included published and unpublished scientific papers. A paleontological record search of the University of California Museum of Paleontology, Berkeley online paleontological database was conducted for the disturbed project areas, including a 10-mile buffer zone surrounding the proposed data center (UCMP 2020).

Paleontological Sensitivity

Paleontological resources are the fossilized remains of organisms from prehistoric environments found in geologic strata. They range from mammoth and dinosaur bones to impressions of ancient animals and plants, trace remains, and microfossils. These are valued for the information they yield about the history of the earth and its past ecological settings. The potential for paleontological resources to occur in the project area was evaluated using the federal Potential Fossil Yield Classification (PFYC) system developed by the Bureau of Land Management (BLM 2016). Because of its demonstrated usefulness as a resource management tool, the PFYC has been utilized for many years for projects across the country, regardless of land ownership. It is a predictive resource management tool that classifies geologic units on their likelihood to contain paleontological resources on a scale of 1 (very low potential) to 5 (very high potential) or Unknown. This system is intended to aid in predicting, assessing, and mitigating impacts to paleontological resources. The PFYC ranking system is summarized in **Table 4.7-1**.

TABLE 4.7-1: POTENTIAL FOSSIL YIELD CLASSIFICATION	
BLM PFYC Designation	Assignment Criteria Guidelines and Management Summary
1 Very Low Potential	Geologic units are not likely to contain recognizable paleontological resources.
	Units are igneous or metamorphic, excluding air-fall and reworked volcanic ash units.
	Units are Precambrian in age.
	Management concern is usually negligible, and impact mitigation is unnecessary except in rare or isolated circumstances.
2 Low	Geologic units are not likely to contain paleontological resources.
	Field surveys have verified that significant paleontological resources are not present or are very rare.
	Units are generally younger than 10,000 years before present.
	Recent aeolian deposits.
	Sediments exhibit significant physical and chemical changes (i.e., diagenetic alteration) that make fossil preservation unlikely
Management concern is generally low, and impact mitigation is usually unnecessary except in occasional or isolated circumstances.	
3 Moderate Potential	Sedimentary geologic units where fossil content varies in significance, abundance, and predictable occurrence.
	Marine in origin with sporadic known occurrences of paleontological resources.
	Paleontological resources may occur intermittently, but these occurrences are widely scattered.
	The potential for authorized land use to impact a significant paleontological resource is known to be low-to-moderate.

TABLE 4.7-1: POTENTIAL FOSSIL YIELD CLASSIFICATION

BLM PFYC Designation	Assignment Criteria Guidelines and Management Summary
	<p>Management concerns are moderate. Management options could include record searches, pre-disturbance surveys, monitoring, mitigation, or avoidance. Opportunities may exist for hobby collecting. Surface-disturbing activities may require sufficient assessment to determine whether significant paleontological resources occur in a proposed action and whether the action could affect the paleontological resources.</p>
4 High Potential	<p>Geologic units that are known to contain a high occurrence of paleontological resources.</p> <p>Significant paleontological resources have been documented but may vary in occurrence and predictability.</p> <p>Surface-disturbing activities may adversely affect paleontological resources.</p> <p>Rare or uncommon fossils, including invertebrate (such as soft body preservation) or unusual plant fossils, may be present.</p> <p>Illegal collecting activities may impact some areas.</p> <p>Management concern is moderate to high depending on the proposed action. A field survey by a qualified paleontologist is often needed to assess local conditions. On-site monitoring or spot-checking may be necessary during land disturbing activities. Avoidance of known paleontological resources may be necessary.</p>
5 Very High Potential	<p>Highly fossiliferous geologic units that consistently and predictably produce significant paleontological resources.</p> <p>Significant paleontological resources have been documented and occur consistently.</p> <p>Paleontological resources are highly susceptible to adverse impacts from surface disturbing activities.</p> <p>Unit is frequently the focus of illegal collecting activities.</p> <p>Management concern is high to very high. A field survey by a qualified paleontologist is almost always needed and on-site monitoring may be necessary during land use activities. Avoidance or resource preservation through controlled access, designation of areas of avoidance, or special management designations should be considered.</p>
U Unknown	<p>Geologic units that cannot receive an informed PFYC assignment.</p> <p>Geological units may exhibit features or preservation conditions that suggest significant paleontological resources could be present, but little information about the actual paleontological resources of the unit or area is known.</p> <p>Geologic units represented on a map are based on lithologic character or basis of origin, but have not been studied in detail.</p> <p>Scientific literature does not exist or does not reveal the nature of paleontological resources.</p> <p>Reports of paleontological resources are anecdotal or have not been verified.</p> <p>Area or geologic unit is poorly or under-studied.</p> <p>BLM staff has not yet been able to assess the nature of the geologic unit.</p> <p>Until a provisional assignment is made, geologic units with unknown potential have medium to high management concerns. Field surveys are normally necessary, especially prior to authorizing a ground-disturbing activity.</p>

Source: Summarized and modified from BLM 2016

Regional Geologic Setting

The proposed project site is situated in the Southern Coastal Ranges geomorphic province. The division between the Northern and Southern Coastal Ranges is one of convenience. Both provinces contain many elongate ridges and narrow valleys that are approximately parallel to the coast, although the coast trends slightly northward more than the ridges and valleys, except at San Francisco Bay where a pronounced gap separates the two provinces (Norris and Webb 1990). The differences between the two provinces occur because the northern ranges lie east of the San Andreas Fault zone, whereas the southern ranges predominantly lie to the west (Norris and Webb 1990). The two Ranges have dissimilar basement rocks. The Northern Range and portions of the Southern Range east of the San Andreas Fault zone are underlain by strongly deformed Franciscan subduction complex rocks, and the areas west of the San Andreas Fault zone, in both the Northern and Southern Range, are underlain by a strongly deformed granitic-metamorphic complex known as the Salinian block. The basement rock beneath the project site, which lies east of the San Andreas Fault zone consists of Franciscan Complex rocks (Norris and Webb 1990).

Local Geology

The project site is located in the Santa Clara Valley, a relatively broad and level alluvial basin, bounded by the San Francisco Bay to the north, the Santa Cruz Mountains to the west and southwest, and the Diablo Mountain Range to the east and southeast. The San Andreas Fault system, including the Monte Vista-Shannon Fault, exists within the Santa Cruz Mountains, and the Hayward and Calaveras Fault systems exist within the Diablo Range (SV1 2020a).

The Santa Clara Valley basin contains alluvial deposits derived from the Diablo Range and the Santa Cruz Mountains. Alluvial deposits are interbedded with bay and lacustrine (lake) deposits in the north-central region. The valley sediments were deposited as a series of coalescing alluvial fans by streams that drain the adjacent mountains. These alluvial sediments make up the groundwater aquifers of the area (Norris and Webb 1990).

The project site is underlain by Holocene age (less than 11,000 years old) basin deposits (Qhb). The basin deposits consist primarily of estuarine deposits of the Alameda Formation and younger alluvial fans. In addition, these sediments have low potential to yield fossil resources or to contain significant nonrenewable paleontological resources. However, these Holocene age sediments overlie older, Pleistocene age sediments that have a high potential to contain paleontological resources. These older sediments, often found at depths of ten feet or more below the ground surface in the Santa Clara Valley, have yielded the fossil remains of plants and extinct terrestrial Pleistocene vertebrates. These older sediments have the potential to yield significant fossils at the site (SV1 2020a).

There are no unique geologic features on or adjacent to the project site. The topography of the project site is relatively flat with no erosion or landslide hazards. The elevation of the site ranges from about 202 to 208 feet with a very gentle slope towards the southwest

(SV1 2020b). The average grade of the valley floor ranges from nearly horizontal to about two percent generally towards the southwest (SV1 2020b). Grades are steeper on the surrounding hillsides (Santa Clara 2011).

Groundwater

Ground water was encountered at depths ranging from approximately 50 to 70 feet below the current grade. Historic groundwater levels have been recorded at approximately 20 to 30 feet below grade (SV1 2020b). Fluctuations in groundwater levels are common due to seasonal weather patterns, underground drainage patterns, regional fluctuations, and other factors.

Seismicity and Seismic Hazards

The San Francisco Bay Area is one of the most seismically active areas in the United States. The significant earthquakes that occur in the Bay Area are generally associated with crustal movement along well-defined active fault zones of the San Andreas Fault system, which regionally trend in a northwesterly direction (**Figure 4.7-1**). Three of the major earthquake faults (the San Andreas Fault, the Hayward-Rogers Creek Fault, and the Calaveras Fault) that comprise the San Andreas Fault system extend through the Bay Area (CGS 2015).

Figure 4.7-1 identifies the regional earthquake faults in the project vicinity. Higher levels of shaking and damage would be expected for earthquakes occurring at closer distances. The faults considered capable of generating significant earthquakes in the area are generally associated with the well-defined areas of crustal movement, which trend northwesterly. The three major faults in the region are the Calaveras Fault (approximately 6 miles east of the site), the San Andreas Fault (approximately 11 miles southwest of the site), and the active segment of the Hayward-Rogers Creek Fault (approximately 19 miles north of the site) (SV1 2020a). Also, a portion of the Hayward-Rogers Creek fault that was active during the Holocene is about 3.4 miles northeast of the site. Because of the proximity of the site to these faults, any ground shaking, ground failure, or liquefaction due to an earthquake could cause damage to the structures.

Several potentially active faults have been mapped outside of the general project area, the closest being the San Jose fault, which is mapped about 1,467 feet southwest of the proposed project, and the Silver Creek fault, which is mapped approximately 8,606 feet northeast of the proposed project (**Figure 4.7-1**). While the project site is not located within an Alquist-Priolo Earthquake fault rupture hazard zone, strong ground shaking is expected to occur on-site during an earthquake (SV1 2020a). Structural design of facilities in California are required to incorporate design features to ensure public safety if a seismic event generates sufficient ground motion to impact the structural integrity of the facility in accordance with California Building Code (CBC 2019).

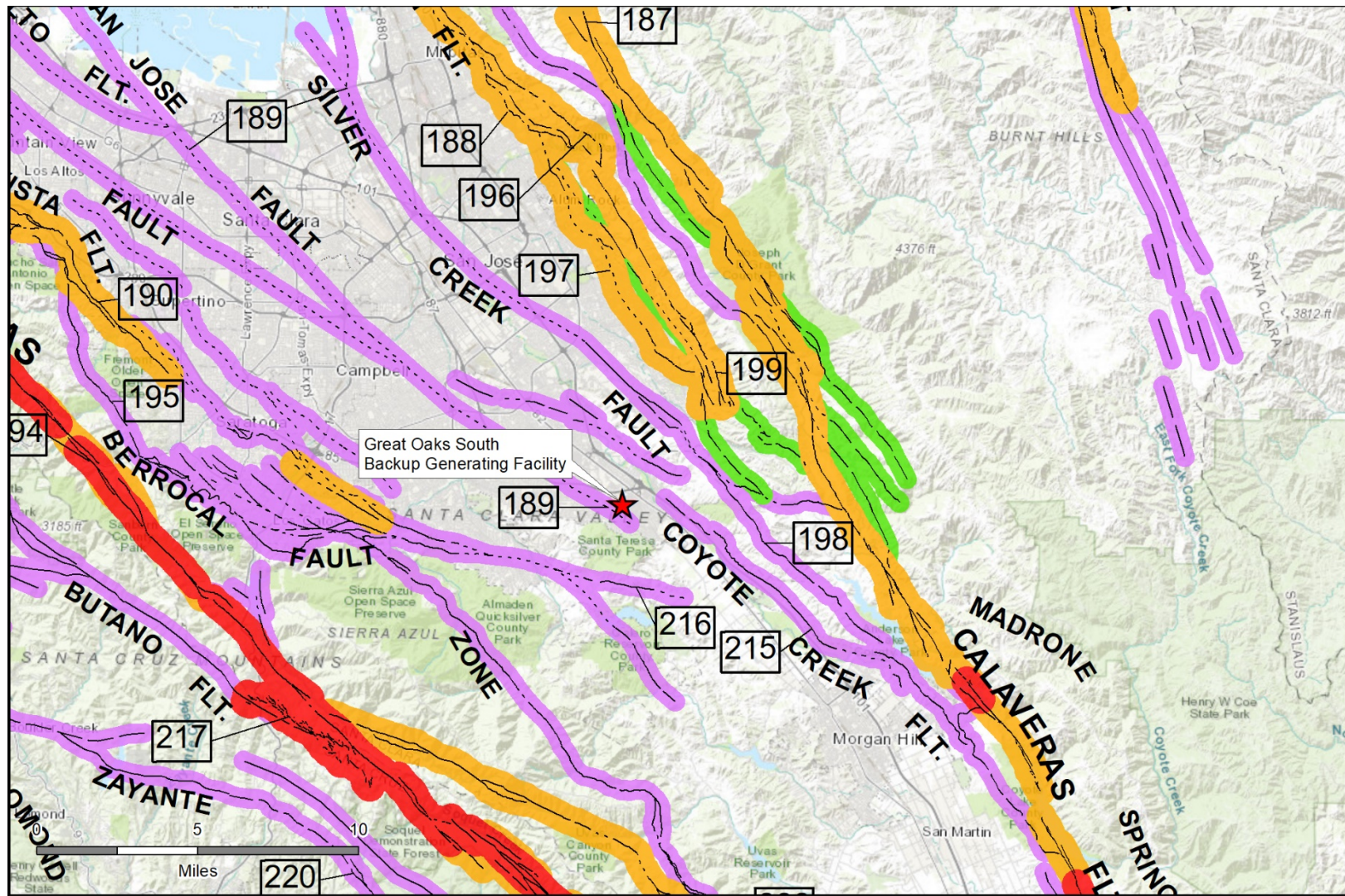

Fault Classification (based on most recent activity)

- Historic
- Holocene
- Late Quaternary
- Quaternary

Figure 4.7-1
Regional Fault Map

Source: California Department of Conservation 2010

Loose unsaturated sandy soils can settle during strong seismic shaking. However, the soils encountered below the design groundwater level at the site are predominantly clays, with some sand and gravel layers (SV1 2020a). Up to 1-inch of differential settlement could occur during an earthquake over a horizontal distance of 50 feet (SV1 2020b). Thus, the potential for significant differential seismic settlement affecting the proposed project is relatively low.

Soils

Soil types in the area include clay in the low-lying central areas, loam and gravelly loam in the upper portions of the valley and eroded rocky clay loam in the foothills. The project area is composed of an Urban land-Stevens Creek soil complex (NRCS 2019). The soil profile for this complex includes sandy loam which persists to two inches below the surface, silt loam which persists from two to nine inches below the surface, silty clay which persists from nine to 27 inches below the surface, clay loam which persists from 27 to 39 inches below the surface, and sandy clay loam which persists from 39 to 70 inches below the surface (SV1 2020a). Two medium dense to very dense sand layers were encountered throughout the project site. The upper sand layer was encountered at a depth of approximately 25 to 35 feet below ground surface (bgs) and varied in thickness from approximately 3 to 5 feet along the northern portion of the site to 30 feet on the southern portion of the site. The lower sand layer was encountered at a depth of approximately 60 to 80 feet bgs and extended to the maximum depth explored (SVE 2020b). Two percolation tests performed at the site had percolation rates of less than 0.5-inch per hour, which indicates the surface soil has very low permeability (SV1 2020b).

Construction of the Great Oaks South Data Center would require excavation to depths of up to 14.5 feet for the retention basin (SV1 2020d). Foundations would be augered piles that could be as deep as 75 feet (SV1 2020b). Although the Great Oaks South Data Center site would be graded and any excavation for deep foundations would be completed prior to installation of any of the backup generating facilities, these facilities would require trenching to install the underground cabling for the electrical interconnection between each generator yard and the data center building it serves. However, this trenching would most likely occur in previously disturbed soils shallower than 10 feet (SV1 2020a).

Expansive soil can undergo volume changes with changes in moisture content. Specifically, when wetted during the rainy season expansive soil tends to swell, and when dried during the summer months the material shrinks. These volume changes can cause heaving and cracking of slabs-on-grade, pavements, and structures founded on shallow foundations. However, expansive soil can be mitigated through removal or mixing with non-expansive soil. The project site is located on expansive soil as defined in Section 1803.5.3 of the CBC (SV1 2020a). The project site soil has a high potential for expansion and this expansion potential would be characterized in greater detail for this site as part of the design-level geotechnical investigation.

Liquefaction

During strong ground shaking, loose, saturated, cohesionless soils can experience a temporary loss of shear strength and act as a fluid. This phenomenon is known as liquefaction. Liquefaction depends on the depth to water, grain size distribution, relative soil density, degree of saturation, and intensity and duration of the earthquake. Soils most susceptible to liquefaction are loose, uniformly graded, saturated, fine-grained sands that lie close to the ground surface (Youd et al. 2001).

The potential hazard associated with liquefaction is seismically induced settlement. The data center site is mapped within a State of California Seismic Hazard Zone for liquefaction. Areas mapped for this hazard have been impacted historically by liquefaction or display geologic or groundwater conditions conducive to liquefaction. However, no significant liquefaction phenomena were observed/recorded in the site vicinity during the 1989 Loma Prieta earthquake. Because the soils on the site are mostly medium-dense to dense and the site water table is relatively deep (between 50 to 70 feet), the potential for liquefaction at the site is low to moderate (SV1 2020b). Liquefaction-induced settlement of approximately 2-inches could occur at the site (SV1 2020b). Proposed structures would be designed and constructed to account for liquefiable soils in accordance with the California Building Code (CBC 2019).

Lateral Spreading

Lateral spreading typically occurs as a form of horizontal displacement of relatively flat-lying alluvial material toward an open or "free" face such as an open body of water, channel, or excavation. In soils, this movement is generally due to failure along a weak plane and may often be associated with liquefaction. As cracks develop within the weakened material, blocks of soil displace laterally towards the open face. Cracking and lateral movement may gradually propagate away from the face as blocks continue to break free. Lateral spreading is generally the most pervasive and damaging type of liquefaction-induced ground failure induced by earthquakes. However, failure in this mode is analytically unpredictable because it is difficult to evaluate where the first tension crack would occur.

The project site is relatively flat, the potentially liquefiable soils are relatively deep, and there is no open face slope. Furthermore, lateral spreading was not reported to have occurred at the site during the 1906 or 1989 earthquakes. Therefore, lateral spreading is not likely to affect the site (SV1 2020a).

Regulatory Background

The project would be required to obtain building permits that would be issued by the city of San Jose. The issuance of the building permits and oversight provided by the city of San Jose would ensure that the project complies with the applicable building codes.

Federal

There are no federal regulations related to geology and soils and paleontological resources that apply to this project. However, the Bureau of Land Management (BLM 2016) has developed a Potential Fossil Yield Classification (PFYC) system. Because of its demonstrated usefulness as a resource management tool, the PFYC has been utilized for many years for projects across the country, regardless of land ownership. It is a predictive resource management tool that classifies geologic units on their likelihood to contain paleontological resources

State

Alquist-Priolo Earthquake Fault Zoning Act. The Alquist-Priolo Earthquake Fault Zoning Act was passed following the 1971 San Fernando earthquake. The act regulates development in California near known active faults due to hazards associated with surface fault ruptures. Alquist-Priolo maps are distributed to affected cities, counties, and state agencies for their use in planning and controlling new construction. Areas within an Alquist-Priolo Earthquake Fault Zone require special studies to evaluate the potential for surface rupture to ensure that no structures intended for human occupancy are constructed across an active fault.

Seismic Hazards Mapping Act. The Seismic Hazards Mapping Act (SHMA) was passed in 1990 following the 1989 Loma Prieta earthquake. The SHMA directs the California Geological Survey (CGS) to identify and map areas prone to liquefaction, earthquake-induced landslides, and amplified ground shaking. CGS has completed seismic hazard mapping for the portions of California most susceptible to liquefaction, landslides, and ground shaking, including the central San Francisco Bay Area. The SHMA requires that agencies only approve projects in seismic hazard zones following site-specific geotechnical investigations to determine if the seismic hazard is present and identify measures to reduce earthquake-related hazards.

California Building Standards Code. The California Building Standards Code (CBC) prescribes standards for constructing safer buildings. The CBC contains provisions for earthquake safety based on factors including occupancy type, soil and rock profile, ground strength, and distance to seismic sources. The CBC requires that a site-specific geotechnical investigation report be prepared for most development projects to evaluate seismic and geologic conditions, such as surface fault ruptures, ground shaking, liquefaction, differential settlement, lateral spreading, expansive soils, and slope stability. The CBC is updated every three years; the current version is the 2019 CBC.

California Division of Occupational Safety and Health Regulations. Excavation, shoring, and trenching activities during construction are subject to occupational safety standards for stabilization by the California Division of Occupational Safety and Health (Cal/OSHA) under Title 8 of the California Code of Regulations and Excavation Rules. These regulations minimize the potential for instability and collapse that could injure construction workers on the site.

Public Resources Code Section 5097.5. Paleontological resources are the fossilized remains of organisms from prehistoric environments found in geologic strata. They range from mammoth and dinosaur bones to impressions of ancient animals and plants, trace remains, and microfossils. These are valued for the information they yield about the history of the earth and its past ecological settings. The California Public Resources Code (Section 5097.5) specifies that unauthorized removal of a paleontological resource is a misdemeanor. Under the California Environmental Quality Act (CEQA) Guidelines, a project would have a significant impact on paleontological resources if it would disturb or destroy a unique paleontological resource or site or unique geologic feature.

CEQA encourages the protection of all aspects of the environment by requiring state and local agencies to prepare multidisciplinary analyses of the environmental impacts of a project and to make decisions based on the findings of those analyses. CEQA includes, in its definition of historical resources, any object or site that “has yielded, or may be likely to yield, information important in prehistory” (California Code Regulations, title 14, § 15064.5(a)(3)(D)), which is typically interpreted by professional scientists as including fossil materials and other paleontological resources. More specifically, destruction of a “unique paleontological resource or site or unique geologic feature” may be a significant impact under CEQA (CEQA Guidelines Appendix G.VII. (f)).

Local

City of San Jose General Plan. Staff reviewed the city of San Jose General Plan, titled *Envision San Jose 2040 General Plan* (San Jose 2020) for policies relevant to geologic and paleontological resources. Two policies in the General Plan were found to address paleontological resources. Eight policies contained in the General Plan have been adopted for the purpose of avoiding or mitigating geology and soils impacts resulting from planned development within San Jose. The following policies are applicable to the proposed project.

- ER-10.1: For proposed development sites that have been identified as archaeologically or paleontologically sensitive, require investigation during the planning process in order to determine whether potentially significant archeological or paleontological information may be affected by the project and then require, if needed, that appropriate mitigation measures be incorporated into the project design.
- ER-10.3: Ensure that City, State, and Federal historic preservation laws, regulations, and codes are enforced, including laws related to archaeological and paleontological resources, to ensure the adequate protection of historic and pre-historic resources.
- EC-3.1: Design all new or remodeled habitable structures in accordance with the most recent California Building Code and California Fire Code as amended locally and adopted by the city of San Jose, including provisions regarding lateral forces.
- EC-4.1: Design and build all new or remodeled habitat structures in accordance with the most recent California Building Code and municipal code requirements as amended and adopted by the city of San Jose, including provisions for expansive soil, and grading and stormwater controls.

- EC-4.2: Development in areas subject to soils and geologic hazards, including unengineered fill and weak soils and landslide-prone areas, only when the severity of hazards have been evaluated and if shown to be required, appropriate mitigation measures are provided. New development proposed within areas of geologic hazards shall not be endangered by, nor contribute to, the hazardous conditions on the site or on adjoining properties. The city of San Jose Geologist will review and approve geotechnical and geological investigation reports for projects within these areas as part of the project approval process.
- EC-4.4: Require all new development to conform to the city of San Jose's Geologic Hazard Ordinance.
- EC-4.5: Ensure that any development activity that requires grading does not impact adjacent properties, local creeks, and storm drainage systems by designing and building the site to drain properly and minimize erosion. An Erosion Control Plan is required for all private development projects that have a soil disturbance of one acre or more, adjacent to a creek/river, and/or are located in hillside areas. Erosion Control Plans are also required for any grading occurring between October 1 and April 30.
- ES-4.7: Consistent with the San Jose Geologic Hazard Ordinance, prepare geotechnical and geological investigation reports for projects in areas of known concern to address the implications of irrigated landscaping to slope stability and to determine if hazards can be adequately mitigated.
- ES-4.9: Permit development only in those areas where potential danger to the health, safety, and welfare of persons in that area can be mitigated to an acceptable level.
- EC-4.12: Require review and approval of grading plans and erosion control plans (if applicable) prior to issuance of a grading permit by the Director of Public Works.

City of San Jose Municipal Code. Title 24 of the San Jose Municipal Code (San Jose 2021) includes the current California Building, Plumbing, Mechanical, Electrical, Existing Building, and Historical Building Codes. Requirements for building safety and earthquake hazard reduction are also addressed in Chapter 17.40 (Dangerous Buildings) and Chapter 17.10 (Geologic Hazards Regulations) of the Municipal Code. Requirements for grading, excavation, and erosion control are included in Chapter 17.10 (Building Code, Part 6 Excavation and Grading). In accordance with the Municipal Code, the Director of Public Works must issue a Certificate of Geologic Hazard Clearance prior to the issuance of grading and building permits within defined geologic hazard zones, including State Seismic Hazard Zones for Liquefaction.

4.7.2 Applicant Proposed Mitigation Measures

PD GEO-1: In order to ensure the project design conforms to the requirements of a final geotechnical engineering investigation and California and local building standards and codes, the following is proposed as mitigation incorporated into the project. Incorporation will ensure seismic hazards are reduced to less than significant levels.

- The project shall be constructed in conformance with the recommendations of the design-level geotechnical investigation prepared for the project, as well as at [sic] the 2017 California Building Code, or subsequent adopted codes.

4.7.3 Environmental Impacts and Mitigation Measures

- a. Would the project directly or indirectly cause potential substantial adverse effects, including the risk of loss, injury, or death involving:**
- i. Rupture of a known earthquake fault, as delineated on the most recent Alquist-Priolo Earthquake Fault Zoning Map issued by the State Geologist for the area or based on other substantial evidence of a known fault? Refer to Division of Mines and Geology Special Publication 42.**

Construction and Operation

No Impact. The probability that construction of the proposed project would have an impact on the risk of loss, injury, or death involving rupture of an earthquake fault during construction is remote. The project site is located within the seismically active San Francisco Bay region, and the nearest historically active fault, the San Andreas Fault, is approximately 11 miles from the project site (**Figure 4.7-1**). However, there are no active or potentially active faults known to cross the site. The site is not located within an Earthquake Fault Zone as defined by the Alquist-Priolo Earthquake Fault Zoning Act. The project site is not located within a fault rupture zone (SV1 2020a). Several potentially active faults have been mapped outside of the general project area, the closest being the San Jose Fault, which is mapped about 1,467 feet southwest of the proposed project, and the Silver Creek Fault, which is mapped approximately 8,606 feet northeast of the proposed project (**Figure 4.7-1**). Due to the distance of faults from the site and the absence of known faults within or near the site, development of the project would not expose people or buildings to known risks of fault rupture. Additionally, operation of the project is not expected to exacerbate rupture of known earthquake faults. Therefore, no impacts related to fault rupture would occur.

ii. Strong seismic ground shaking?

Construction

Less Than Significant Impact. Earthquakes along several nearby active faults in the region could cause moderate to strong ground shaking at the site (SV1 2020a). The intensity of ground motion and the damage done by ground shaking would depend on the characteristics of the generating fault, distance to the fault and rupture zone, earthquake magnitude, earthquake duration, and site-specific geologic conditions. To avoid or minimize potential damage from seismic shaking, the project would be built using standard engineering and seismic safety design techniques. Building design and construction at the site shall be completed in conformance with the recommendations of a design-level geotechnical investigation as required by the CBC, which would be included

in a report to the city. With implementation of the seismic design guidelines per the CBC, as well as the anticipated project-specific recommendations in the final geotechnical engineering report (PD GEO-1), construction of the project would not expose people or property, directly or indirectly, to significant impacts associated with geologic or seismic ground shaking. This conclusion is consistent with the findings of the 2017 Mitigated Negative Declaration (MND) prepared for this site (SV1 2020a). Therefore, risks to people or structures from strong seismic ground-shaking or exacerbating the effects of seismic ground shaking would continue to be less than significant.

Operation

Less Than Significant Impact. During operation and maintenance of the proposed project, the project facility would be subject to moderate to strong seismic ground shaking (SV1 2020a). However, with implementation of the seismic design guidelines per the CBC, as well as the anticipated project-specific recommendations in the final geotechnical engineering report (PD GEO-1), the project would not expose people or property, directly or indirectly, to significant impacts associated with geologic or seismic ground shaking. Therefore, risks to people or structures from strong seismic ground-shaking would continue to be less than significant.

Required Mitigation Measures: None.

iii. Seismic-related ground failure, including liquefaction?

Construction

Less than Significant Impact. The site is located within a state-designated Liquefaction Hazard Zone (SV1 2020a). Because the soils on the site are mostly medium-dense to dense and the site water table is relatively deep (between 50 to 70 feet), the potential for liquefaction at the site is low to moderate (SV1 2020b). Soil tests to determine site-specific liquefaction potential would be conducted as part of the design-level geotechnical investigation. The likely consequence of potential liquefaction at the site would be settlement. As previously mentioned, the project would be constructed in compliance with the 2019 CBC, including all applicable seismic standards for structures (PD GEO-1). Compliance with the 2019 CBC reduces potential risks associated with settlement from seismically induced liquefaction. Therefore, risks to people or structures from strong seismic ground-shaking would continue to be less than significant.

Operation

Less Than Significant Impact. During operation and maintenance of the proposed project the project facility would be subject to moderate to strong seismic ground shaking (SV1 2020a). However, with implementation of seismic design guidelines per the California Building Code (CBC 2019), as well as the anticipated project-specific recommendations in the design-level geotechnical investigation, the project would not expose people or property, directly or indirectly, to significant impacts associated with geologic or seismic ground shaking, including ground failure, liquefaction, or seismically induced subsidence.

Therefore, risks to people or structures, or exacerbating ground failure, during strong seismic ground-shaking would continue to be less than significant.

Required Mitigation Measures: None.

iv. Landslides?

Construction

No Impact. The proposed project is located on very mildly sloping terrain and is not located within a landslide hazard zone (SV1 2020a). Grading of the substation expansion would not create steep slopes and construction of the proposed project would not cause a landslide. Therefore, there would be no impact from landslides.

Operation

No Impact. Operation and maintenance activities would not include construction or grading of new slopes. For these reasons, and because the project components are not located in areas subject to landslides as identified in the city of Santa Clara General Plan (Santa Clara 2010), no impact would occur.

b. Would the project result in substantial soil erosion or the loss of topsoil?

Construction

Less Than Significant Impact. As discussed in the 2017 MND, ground disturbance would be required during excavation, grading, and construction of the proposed data center buildings. Five trenches would be dug to install the five 21 kV distribution line, where two lines would be located in a single trench. Pacific Gas and Electric Company (PG&E) requires six feet of separation between trenches. The initial power requirements would be met with one trench from Santa Teresa Substation to the site containing two distribution lines. The remaining three distribution lines would be constructed as needed and would require two additional trenches. According to PG&E practices, a typical trench for the distribution lines would be 3 to 5 feet deep and approximately 18 to 30 inches wide. The trench-work would require temporary removal of existing pavement on Via Del Oro and/or Santa Teresa route, depending on the route selected by PG&E (SV1 2020d, TN 233005-1). After the installation of the underground feeders, the roadway would be repaved. Construction activities associated with the project would temporarily increase sedimentation and erosion by exposing soils to wind and runoff until construction is complete and new vegetation is established (SV1 2020a). As discussed in **Section 4.10 Hydrology and Water Quality**, the city's NPDES Municipal Permit, urban runoff policies, and the Municipal Code are the primary means of enforcing erosion control measures through the grading and building permit process. In accordance with General Plan policies, implementation of the regulatory programs and policies in place would reduce possible impacts of accelerated erosion during construction to a less than significant level.

Operation

Less Than Significant Impact. Best Management Practices for erosion and sedimentation control taken to comply with the NPDES permit would ensure the site would not include areas of exposed topsoil subject to erosion. Surface water runoff from the facility would not be expected to impact soil erosion or cause the loss of topsoil during project operation. Occasional minor surface disturbance may continue to be required during maintenance activities, but such disturbance would be temporary and likely small. Continuous operation and maintenance work would not result in increased erosion or topsoil loss and therefore, a less than significant impact would be associated with erosion or loss of topsoil.

Required Mitigation Measures: None.

c. Would the project be located on geologic units or soil that is unstable, or that would become unstable as a result of the project, and potentially result in on- or off-site landslide, lateral spreading, subsidence, liquefaction, or collapse?

Construction

Less Than Significant Impact. Lateral spreading is a type of ground failure related to liquefaction. It consists of the horizontal displacement of flat-lying alluvial material toward an open face, such as the steep bank of a stream channel or slopes. The project site is in a mapped liquefaction hazard zone. The site is not located within a landslide hazard zone, and geomorphology of the site is such that the site would not be subject to lateral spreading. There are no stream channels or other open faces on or adjacent to the site that would be subject to lateral spreading.

The project would be designed and constructed in accordance with standard engineering safety techniques and in conformance with the applicable requirements of the current CBC (SV1 2020a). Compliance with PD GEO-1 would avoid or reduce impacts related to the stability of soil on-site. The project would not change or exacerbate the geologic conditions of the project area and the project would not expose people or property, directly or indirectly, to unstable geologic or soil units. Therefore, there would be a less than significant impact.

Operation

Less Than Significant Impact. Operation and maintenance activities would not materially change the surface runoff or geotechnical characteristics of the material beneath the project facilities. Thus, operation and maintenance activities would not introduce new soil stability hazards. Occasional minor surface disturbance may continue to be required during maintenance activities, but such disturbance would be temporary and likely small. The project would not expose people or property, directly or indirectly, to unstable geologic or soil units.

Required Mitigation Measures: None.

d. Would the project be located on expansive soil, as defined in Section 1803.5.3 of the California Building Code (2010), creating substantial direct or indirect risks to life or property?

Construction

Less Than Significant Impact. As discussed above in section "4.7.1 Setting", expansive soil behavior is a condition where clay soils react to changes in moisture content by expanding or contracting. Poorly drained soils have greater shrink-swell potential. Potential causes of moisture fluctuations include drying during construction, and subsequent wetting from rain, capillary rise, landscape irrigation, and type of plant selection. If untreated, expansive soils could damage future buildings and pavements on the project site (SV1 2020b).

The project site is located on expansive soil as defined in Section 1803.5.3 of the CBC (SV1 2020a). The policies of the city of San Jose have been adopted for the purpose of avoiding or mitigating environmental effects resulting from planned development within the city. To avoid risks associated with expansive soils, foundation designs would be reviewed and approved by city engineers for compliance with the 2019 CBC general foundation design standards (PD GEO-1). San Jose policy EC-4.2 requires that new development be designed to meet current safety standards and implement appropriate building codes to reduce risk associated with geologic conditions. Also, the project would be required to adhere to the SHMA and CBC. With implementation of the anticipated project-specific recommendations in the final geotechnical engineering report (PD GEO-1) construction of the project would not expose people or property, directly or indirectly, to significant impacts associated with expansive soil. This conclusion is consistent with the findings of the 2017 MND (SV1 2020a). Therefore, risks to people or structures from expansive soil would be less than significant.

Operation

No Impact. Operation and maintenance activities would not change materially the surface runoff or geotechnical characteristics of the material beneath the project facilities. Thus, operation and maintenance activities would not introduce new soil stability hazards. Occasional minor surface disturbance may continue to be required during maintenance activities, but such disturbance would be temporary and likely small. The project would not expose people or property, directly or indirectly, to unstable geologic or soil units. After construction there would be no impact related to expansive soils.

Required Mitigation Measures: None.

e. Would the project have soils incapable of adequately supporting the use of septic tanks or alternative wastewater disposal systems where sewers are not available for the disposal of wastewater?

Construction and Operation

No Impact. Two percolation tests performed at the site had percolation rates of less than 0.5-inch per hour, which indicates the surface soil has very low permeability (SV1 2020b). However, the project would connect to an existing city-provided sanitary sewer connection, so the project site would not need to support septic tanks or alternative wastewater disposal systems (SV1 2020a). Therefore, there would be no impact to soils because of sanitary waste disposal from the project during construction or operation.

f. Directly or indirectly destroy a unique paleontological resource or site or unique geologic feature?

Construction

Less Than Significant with Mitigation Incorporated. The project site is in the Santa Clara Valley, an area known to have scientifically significant but widespread or intermittent fossil discoveries. Surficial sediment has been mapped as Holocene age (11,700 years before present) (NRCS 2019), which is generally not considered sensitive for paleontological resources, because biological remains younger than 10,000 years are not usually considered fossils. However, Pleistocene age (2.6 million to 11,700 years before present) sediments may also be present at or near the surface (Helley and Wealing 1989 and Helley et al. 1994). Five fossil sites have been found at or near the ground surface within two miles of the project site, especially along stream beds (UCMP 2020). However, the general area has been extensively developed over the last 50 years as part of the technology research and development area known as Silicon Valley.

The potential to disturb paleontological resources would occur during the construction activities requiring earth moving, such as grading, trenching for utilities, excavation for foundations, and installation of support structures where native soil would be disturbed. Construction of the Great Oaks South Data Center would require excavation to depths of up to 14.5 feet for the retention basin (SV1 2020d). Foundations would be augured piles that could be as deep as 75 feet (SV1 2020b).

Although unlikely, paleontological resources could be encountered during construction. Mitigation measure **(MM) GEO-1** would provide training to construction personnel regarding proper procedures (including identification and notification) in the event fossil materials are encountered during construction. **MM GEO-1** also provides guidance on the recovery and processing of significant paleontological finds. With the incorporation of **MM GEO-1** and the implementation of existing LORS the impact to paleontological resources from construction of this project would be less than significant.

Operation

No Impact. There is no potential to disturb paleontological resources during operations because there would be no earth-moving activities required for operations. Occasional minor surface disturbance may continue to be required during maintenance activities, but such disturbance would be temporary, small, and most likely limited to disturbance of fill. There would be no impact to paleontological resources.

MM GEO-1: To ensure impacts to paleontological resources are less than significant:

- Prior to the start of any subsurface excavations that would extend beyond previously disturbed soils, all construction forepersons and field supervisors shall receive training by a qualified professional paleontologist, as defined by the Society of Vertebrate Paleontology, who is experienced in teaching non-specialists, to ensure they can recognize fossil materials and shall follow proper notification procedures in the event any are uncovered during construction. Procedures to be conveyed to workers include halting construction within 50 feet of any potential fossil find and notifying a qualified paleontologist, who shall evaluate its significance.
- If a fossil is found and determined by the qualified paleontologist to be significant and avoidance is not feasible, the paleontologist shall develop and implement an excavation and salvage plan in accordance with Society of Vertebrate Paleontology standards. Construction work in these areas shall be halted or diverted to allow recovery of fossil remains in a timely manner. Fossil remains collected during the monitoring and salvage portion of the mitigation program shall be cleaned, repaired, sorted, and cataloged. Prepared fossils, along with copies of all pertinent field notes, photos, and maps, shall then be deposited in a scientific institution with paleontological collections. A final Paleontological Mitigation Plan Report shall be prepared that outlines the results of the mitigation program. The Director of Planning and Inspection shall be responsible for ensuring that the paleontologist's recommendations regarding treatment and reporting are implemented.

Required Mitigation Measure: MM GEO-1

4.7.3 References

- BLM 2016 – Bureau of Land Management (BLM). Potential Fossil Yield Classification System: BLM Instruction Memorandum No. 2016-124. July 8, 2016. Accessed on: July 3, 2020. Available online at: <https://edit.blm.gov/policy/im-2016-124>
- CBC 2019 – California Building Code (CBC). California Building Standard Commission. Accessed on: July 3, 2020. Available online at: <http://www.bsc.ca.gov/Codes.aspx>
- CGS 2010 – California Geological Survey (CGS), California Department of Conservation. Fault Activity Map of California. Accessed on: July 9, 2020. Available online at: <http://maps.conservation.ca.gov/cgs/fam/>

- Helley and Wealing 1989 – E.J. Helley and J.R. Wealing, 1989, Quaternary Geologic Map of the Milpitas Quadrangle, Alameda and Santa Clara Counties, California, U.S. Geological Survey Open-File Report 89-671, 1989. Accessed on: July 3, 2020. Available online at: <https://pubs.usgs.gov/of/1989/0671/report.pdf>
- Helley et al. 1994 – E. J. Helley, R.W. Graymer, G.A. Phelps, P.K. Showalter, and C.M. Wentworth. Preliminary Quaternary geologic maps of Santa Clara Valley, Santa Clara, Alameda, and San Mateo Counties, California: A Digital Database, USGS Open-File Report 94.231, 1994. Accessed on: July 3, 2020. Available online at: <https://pubs.usgs.gov/of/1994/0231/report.pdf>
- Norris and Webb 1990 – Robert M. Norris and Robert W. Webb, 1990, Geology of California, Second Edition, John Wiley and Sons. ISBN-13: 978-0471509806
- NRCS 2019 – Natural Resources Conservation Service (NRCS), U.S. Department of Agriculture, 2019, Interactive Soil Map. Accessed on: July 3, 2020. Available online at: <https://websoilsurvey.sc.egov.usda.gov/App/WebSoilSurvey.aspx>
- San Jose 2020 – City of San Jose (San Jose). *Envision San Jose 2040 General Plan*, Updated on: March 16, 2020. Accessed on: July 21, 2020. Available online at: <https://www.sanjoseca.gov/your-government/departments/planning-building-code-enforcement/planning-division/citywide-planning/envision-san-jos-2040-general-plan>
- San Jose 2021 – City of San Jose (San Jose). San Jose City Ordinances. Adopted January 26, 2021. Accessed on: July 21, 2020. Available online at: <https://www.sanjoseca.gov/your-government/departments/planning-building-code-enforcement/code-enforcement/city-ordinances>
- SV1 2020a – SV1, LLC. (SV1). Application for Small Power Plant Exemption: Great Oaks South Backup Generating Facility (TN 232466), March 2020. Available online at: <https://efiling.energy.ca.gov/Lists/DocketLog.aspx?docketnumber=20-SPPE-01>
- SV1 2020b – SV1, LLC. (SV1). Application Appendices A through K: Great Oaks South Backup Generating Facility (TN 232467-1,2,3), March 2020. Available online at: <https://efiling.energy.ca.gov/Lists/DocketLog.aspx?docketnumber=20-SPPE-01>
- SV1 2020d – SV1, LLC. (SV1). SV1 Responses to CEC Data Request Set 2: Great Oaks South Backup Generating Facility Part 1 through Part 4 (TN 233005-1,2,3,4), May 2020. Available online at: <https://efiling.energy.ca.gov/Lists/DocketLog.aspx?docketnumber=20-SPPE-01>
- UCMP 2020 – University of California Museum of Paleontology (UCMP) 2019. *UCMP database*. Accessed on: June 22, 2020. Available online at: <http://ucmpdb.berkeley.edu/>
- Wesling and Helley 1989 – J.R. Wesling and E.J. Helley, Quaternary Geologic Map of the San Jose West Quadrangle, Santa Clara County, California, U.S. Geological Survey Open-File Report 89-672, 1989. Accessed on: July 3, 2020. Available online at: <https://pubs.usgs.gov/of/1989/0672/report.pdf>

Youd et al. 2001 – T. L. Youd, I. M. Idriss, Ronald D. Andrus, Ignacio Arango, Gonzalo Castro, John T. Christian, Richardo Dobry, W. D. Liam Finn, Leslie F. Harder, Mary Ellen Hynes, Kenji Ishihara, Joseph P. Koester, Sam S.C. Liao, William F. Marcuson, Geoffrey R. Martin, James K. Mitchell, Yoshiharu Moriwaki, Maurice S. Power, Peter K. Robertson, Raymond B. Seed, and Kenneth H Stokoe
"Liquefaction Resistance of Soils: Summary Report from the 1996 NCEER and 1998 NCEER/NSF Workshops on Evaluation of Liquefaction Resistance of Soils."
ASCE Journal of Geotechnical and Geoenvironmental Engineering, Vol 127, No. 10. October

4.8 Greenhouse Gas Emissions

This section describes the environmental and regulatory setting and discusses greenhouse gas (GHG) emissions impacts associated with the construction, readiness testing and maintenance, and the potential for emergency operation of the Great Oaks South Data Center (GOSDC) and Great Oaks South Backup Generating Facility (GOSBGF), collectively called "the project" in the analysis which follows.

GREENHOUSE GAS EMISSIONS	Potentially Significant Impact	Less Than Significant with Mitigation Incorporated	Less Than Significant Impact	No Impact
Would the project:				
a. Generate greenhouse gas emissions, either directly or indirectly, that may have a significant impact on the environment?	<input type="checkbox"/>	<input type="checkbox"/>	<input checked="" type="checkbox"/>	<input type="checkbox"/>
b. Conflict with an applicable plan, policy or regulation adopted for the purpose of reducing the emissions of greenhouse gases?	<input type="checkbox"/>	<input checked="" type="checkbox"/>	<input type="checkbox"/>	<input type="checkbox"/>

Environmental checklist established CEQA Guidelines, Appendix G.

4.8.1 Setting

Unlike emissions of criteria and toxic air pollutants, which have local or regional impacts, emissions of GHGs have a much broader, global impact. Global warming associated with the "greenhouse effect" is a process whereby GHGs accumulating in the atmosphere contribute to an increase in the temperature of the earth's atmosphere. The principal GHGs that contribute to global warming and climate change include carbon dioxide (CO₂), methane (CH₄), nitrous oxide (N₂O), black carbon, and fluorinated gases (F-gases): hydrofluorocarbons (HFCs), perfluorocarbons (PFCs), and sulfur hexafluoride (SF₆). Emissions of GHGs contributing to global climate change are attributable in large part to human activities associated with the transportation, industrial/manufacturing, utility, residential, commercial, and agricultural sectors.

Each GHG has its own potency and effect upon the earth's energy balance, expressed in terms of a global warming potential (GWP), with CO₂ being assigned a value of 1. Specifically, the GWP is a measure of how much energy the emissions of 1 ton of a gas will absorb over a given period of time, relative to the emissions of 1 ton of CO₂. The larger the GWP, the more that a given gas warms the earth compared to CO₂ over that time period. The time period usually used for GWPs is 100 years.

For example, CH₄ has a GWP of 28 over 100 years from the Fifth Assessment Report (AR5) of the Intergovernmental Panel on Climate Change (IPCC 2013), which means that it has a global warming effect 28 times greater than CO₂ on an equal-mass basis. The F-gases are sometimes called high-GWP gases because, for a given amount of mass, they trap substantially more heat than CO₂. The GWPs for these gases can be in the thousands

or tens of thousands. The carbon dioxide equivalent (CO₂e) for a source is obtained by multiplying each quantity of GHG by its GWP and then adding the results together to obtain a single, combined emission rate representing all GHGs in terms of CO₂e. The Sixth Assessment Report is due in 2022 (IPCC 2017).

Regulatory Background

Federal

Endangerment Finding and Cause or Contribute Finding. In April 2007, the US Supreme Court held that GHG emissions are pollutants within the meaning of the Clean Air Act (CAA). In reaching its decision, the Court also acknowledged that climate change results, in part, from anthropogenic causes (*Massachusetts et al. v. Environmental Protection Agency*, 549 U.S. 497 [2007]). The Supreme Court's ruling paved the way for the regulation of GHG emissions by the United States Environmental Protection Agency (U.S. EPA) under the CAA.

In response to this Supreme Court decision, on December 7, 2009, the U.S. EPA Administrator signed two distinct findings regarding GHGs under the CAA, section 202(a):

- Endangerment Finding: That the current and projected concentrations of the GHGs in the atmosphere threaten the public health and welfare of current and future generations; and
- Cause or Contribute Finding: That the combined emissions of GHGs from new motor vehicles and new motor vehicle engines contribute to the GHG pollution, which threatens public health and welfare.

U.S. EPA has also enacted regulations for GHG reporting, the phase-out and banning of high global warming potential chemicals, and stationary GHG emissions source permitting. However, the project, as currently proposed, would not be subject to any of these federal regulations.

State

Global Warming Solutions Act of 2006. In 2006, the California State Legislature signed the Global Warming Solutions Act of 2006, or Assembly Bill (AB) 32, which provides the framework for regulating GHG emissions in California. This law requires the California Air Resources Board (ARB) to design and implement emission limits, regulations, and other measures such that statewide GHG emissions are reduced in a technologically feasible and cost-effective manner to 1990 levels by 2020. The statewide 2020 emissions limit is shown in the AB 32 Scoping Plan.

AB 32 Scoping Plan. Part of the Legislature's direction to ARB under AB 32 was to develop a Scoping Plan that contains the main strategies California will use to reduce GHG emissions that cause climate change. ARB first approved the AB 32 Scoping Plan in 2008 and released its first update in 2014 and another update in 2017. The Scoping Plan includes a range of GHG reduction actions, which include direct regulations, alternative

compliance mechanisms, monetary and non-monetary incentives, voluntary actions, market-based mechanisms such as a cap-and-trade system, and cost of implementation fee regulation to fund the program. In December 2007, ARB set the statewide 2020 emissions limit, defined as reducing emissions to 1990 levels, at 427 million metric tons of CO₂e (MMTCO₂e). The May 2014 First Update to the Climate Change Scoping Plan adjusted the 1990 emissions estimate and the statewide 2020 emissions limit goal to 431 MMTCO₂e (ARB 2014).

Regulation for the Mandatory Reporting of Greenhouse Gas Emissions. One key regulation resulting from AB 32 was ARB's Regulation for the Mandatory Reporting of Greenhouse Gas Emissions, which came into effect in January 2009. It requires annual GHG emissions reporting from electric power entities, fuel suppliers, CO₂ suppliers, petroleum and natural gas system operators, and industrial facilities that emit at least 10,000 metric tons of CO₂e (MTCO₂e/yr) from stationary combustion and/or process sources. The project would not be impacted by this regulation because stationary source testing and maintenance combustion GHG emissions are expected to be below the reporting threshold of 10,000 MTCO₂e/yr, as shown in **Table 4.8-2**.

Executive Order B-30-15. On April 29, 2015, Governor Brown issued Executive Order B-30-15, directing state agencies to implement measures to reduce GHG emissions 40 percent below their 1990 levels by 2030 and to make it possible to achieve the previously-stated goal of an 80 percent GHG reduction below 1990 GHG emissions by 2050. California's 2017 update to the Climate Change Scoping Plan identified strategies for achieving the 2030 goal of 40% below 1990 level on the path toward 80% below 1990 level by 2050 (ARB 2017a).

Renewable Energy Programs. In 2002, California initially established its Renewables Portfolio Standard (RPS), with the goal of increasing the percentage of renewable energy in the state's electricity mix to 20 percent by 2017. State energy agencies recommended accelerating that goal, and California Executive Order S-14-08 (November 2008) required California utilities to reach the 33 percent renewable electricity goal by 2020, consistent with the AB 32 Scoping Plan. In April 2011, Senate Bill (SB) 2 of the First Extraordinary Session (SB X1-2) was signed into law. SB X1-2 expressly applies the new 33 percent RPS by December 31, 2020, to all retail sellers of electricity and established renewable energy standards for interim years prior to 2020.

- **Senate Bill 350:** On October 7, 2015, Senate Bill (SB) 350 was signed into law, establishing new clean energy, clean air and greenhouse gas reduction goals for 2030 and beyond. SB 350 increases California's renewable electricity procurement goal from 33 percent by 2020 to 50 percent by 2030.
- **Senate Bill 100:** On September 10, 2018, SB 199 was signed into law, advancing the RPS deadlines to 50 percent renewable resources by December 31, 2026, and 60 percent by December 31, 2030. In addition, SB 100 establishes policy that renewable energy resources and zero-carbon resources supply 100 percent of all retail sales of electricity by December 31, 2045.

Mobile Source Strategy. In May 2016, ARB prepared the Mobile Source Strategy, which addresses the current and proposed programs for reducing all mobile source emissions, including GHG emissions. The Mobile Source Strategy identifies programs that the state and federal government have or will adopt, which further the goals of the AB 32 Scoping Plan. Some programs provide incentives to facilitate increased purchase of new, lower emission light-, medium-, and heavy-duty vehicles to aid the state in achieving emission reduction goals. Other programs such as the On-Road, Low-NOx and Zero-Emission Technology Program require vehicle manufacturers to offer engines that reduce NOx emissions 90 percent from current levels. This will have a co-benefit for reducing GHG emissions depending on how this goal is met (ARB 2016). These programs calling for more stringent emissions limits are required by state and federal law and monitored by ARB or U.S.EPA.

Senate Bill 32 and Assembly Bill 197. On September 8, 2016, SB 32, codified as Section 38566 of the Health and Safety Code, was enacted. It extends California's commitment to reduce GHG emissions by requiring the state to reduce statewide GHG emissions by 40 percent below 1990 levels by 2030. A companion bill, AB 197, assures that the state's implementation of its climate change policies is transparent and equitable, with the benefits reaching disadvantaged communities. AB 197 also requires ARB to update its Scoping Plan to achieve the maximum technologically feasible and cost-effective reductions in GHG and to prioritize specific emissions reduction rules and regulations. These bills implement the policy goals outlined in the Governor's Executive Order B-30-15. In response, ARB updated the AB 32 Scoping Plan in November 2017 to establish a path that will get California to its 2030 target (ARB 2017a).

Short-Lived Climate Pollutant Reduction Strategy. In an effort to best support reduction of GHG emissions consistent with AB 32, ARB released the Short-Lived Climate Pollutant (SLCP) Reduction Strategy in March 2017. This was required by SB 605, which also defined SLCPs as having lifetimes in the atmosphere ranging from "a few days to a few decades." SB 1383, adopted in 2016, requires ARB to set targets to reduce SLCP emissions 40 percent below 2013 levels by 2030 for methane and hydrofluorocarbons and 50 percent below 2013 levels by 2030 for anthropogenic black carbon (ARB 2017b). The SLCP Reduction Strategy was integrated into the 2017 update to ARB's Scoping Plan.

Executive Order B-55-18. On September 10, 2018, Governor Brown issued Executive Order B-55-18 to achieve carbon neutrality, establishing a new statewide goal. This executive order states the governor's intention "to achieve carbon neutrality as soon as possible, and no later than 2045, and achieve and maintain net negative emissions thereafter. This goal is in addition to the existing statewide targets of reducing greenhouse gas emissions." This executive order cites many steps already taken by California to reduce GHG emissions.

Regulation for Reducing SF₆ Emissions from Gas Insulated Switchgear (GIS). Title 17, California Code of Regulations, sections 95350 et. seq was enacted as an early action measure pursuant to AB 32 to reduce SF₆ emissions from the electricity sector's

transmission and distribution system. The Regulation requires GIS owners to report the SF₆ emissions annually and requires reductions of SF₆ emissions from GIS over time, setting an annual emission rate limit for each GIS owner. The maximum allowable emission rate started at ten percent in 2011 and has decreased one percent per year since then. The limit would reach one percent in 2020 and remain at that level going forward. However, data show that statewide SF₆ capacity is growing by one to five percent per year, which will increase the expected SF₆ emissions. On July 21, 2020, ARB staff proposed amendments to the SF₆ regulation, which will expand the scope to include other GHGs beyond SF₆, change the term GIS to “gas-insulated equipment” (GIE) to include more devices beyond switchgear, and accelerate the transition to technologies that do not use SF₆.

Regional

2017 Bay Area Clean Air Plan. The Bay Area Air Quality Management District (BAAQMD) adopted the 2017 Bay Area Clean Air Plan on April 19, 2017 (BAAQMD 2017a). It provides a regional strategy to protect public health and protect the climate. To protect public health, the plan describes how the BAAQMD will continue its progress toward attaining all state and federal ambient air quality standards and eliminating health risk disparities from exposure to air pollution among Bay Area communities. To protect the climate, the plan defines a vision for transitioning the region to a post-carbon economy needed to achieve ambitious GHG reduction targets for 2030 and 2050, and provides a regional climate protection strategy that will put the Bay Area on a pathway to achieve those GHG reduction targets.

BAAQMD CEQA Air Quality Guidelines. BAAQMD published CEQA guidelines to assist lead agencies in evaluating a project’s impacts on air quality (BAAQMD 2017b). This document describes the criteria that BAAQMD uses when reviewing and commenting on the adequacy of environmental documents. It recommends thresholds for use in determining whether a project would have significant adverse environmental impacts, identifies methodologies for predicting project emissions and impacts, and identifies measures that can be used to avoid or reduce air quality impacts. The BAAQMD CEQA Guidelines document includes a methodology for estimating GHG emissions. BAAQMD has begun updating their CEQA guidelines, but these are not yet available. BAAQMD has confirmed that the thresholds developed for GHG emissions are still technically effective, even though the 2020 goal to which they were targeted has passed.

Diesel Free by ‘33. In 2018, the BAAQMD established a program intended to reduce GHG and criteria pollutant emissions by eliminating petroleum use by the year 2033. Various local agencies are encouraged to adopt the Statement of Purpose of this initiative. Entities signing the Statement of Purpose pledge to develop their own individual strategies to achieve the goal of reaching zero diesel emissions in their communities. Signatories to this agreement express their intent to:

1. Collaborate and coordinate on ordinances, policies, and procurement practices that will reduce diesel emissions to zero within their jurisdictions, communities or companies;

2. Share and promote effective financing mechanisms domestically and internationally to the extent feasible that allow for the purchase of zero emissions equipment;
3. Share information and assessments regarding zero emissions technology;
4. Build capacity for action and technology adaptation through technology transfer and sharing expertise;
5. Use policies and incentives that assist the private sector as it moves to diesel-free fleets and buildings; and
6. Periodic reporting to all signers of progress towards the zero-diesel emissions goal.

Plan Bay Area 2040. Under the requirements of SB 375, all metropolitan regions in California must complete a Sustainable Communities Strategy (SCS) as part of their Regional Transportation Plan. In the Bay Area, the Metropolitan Transportation Commission (MTC) and Association of Bay Area Governments (ABAG) are jointly responsible for developing and adopting an SCS that integrates transportation, land use, and housing to meet GHG reduction targets set by ARB. In July 2017, the MTC and ABAG approved Plan Bay Area 2040, which is a strategic update to the previous plan approved in July 2013. The Bay Area GHG reduction targets established by ARB in September 2010 include a seven percent reduction in GHG emissions per capita from passenger vehicles by 2020 compared to 2005 emissions. Similarly, Plan Bay Area 2040 includes a target to reduce GHG emissions per capita from passenger vehicles 15 percent by 2035 compared to 2005 emissions (MTC & ABAG 2017).

Local

City of San Jose General Plan. The City Council adopted the *Envision San Jose 2040 General Plan* in November 2011, with amendments published in December 2018 and March 2020 (San Jose 2020a). Prior to developing this current General Plan, the City's Green Vision was adopted in October 2007, to steer economic growth while reducing GHG emissions through 2022. The *Envision San Jose 2040 General Plan* includes a major strategy of "Measurable Sustainability" to incorporate and expand on the goals established earlier by the City's Green Vision (San Jose 2020a). The General Plan also provided the basis for the City's GHG Reduction Strategy initially established in 2011 and updated in 2015 (San Jose 2015).

Climate Smart San Jose. Climate Smart San Jose is a city-wide plan adopted by the City Council in February 2018 to promote urban sustainability. Climate Smart San Jose identified nine overarching strategies to promote sustainability through actions to "transition to a renewable energy future" and "improve our commercial building stock" (San Jose 2018).

City of San Jose GHG Reduction Strategy. The City of San Jose GHG Reduction Strategy (GHGRS) is a comprehensive plan to achieve the City's share of statewide emissions reductions for the 2020 timeframe established by AB 32, while meeting the mandates outlined in the BAAQMD's CEQA Guidelines. The City's GHG Reduction Strategy

was first adopted in June 2011 and amended in December 2015 (San Jose 2015). Since the GHGRS update in 2015, the State of California has expanded on AB 32 by establishing statewide GHG reduction targets for 2030 through SB 32, followed by EO B-55-18 defining a carbon neutrality goal to be achieved by 2045. The City recently updated to 2030 GHG Reduction Strategy in response to achieving the GHG reduction targets set forth for 2030 by SB 32 (San Jose 2020). The 2030 GHG Reduction Strategy builds upon the City’s 2018 Climate Smart San Jose (San Jose 2018).

Existing Conditions

California is a substantial contributor to global GHG emissions. The total gross California GHG emissions in 2018 were 425.3 MMTCO₂e (ARB 2020). The largest category of GHG emissions in California is transportation, followed by industrial activities and electricity generation in state and out of state (ARB 2019). In 2017, total gross US greenhouse gas emissions were 6,457 MMTCO₂e (U.S. EPA 2020).

The City of San Jose recently published a city-wide inventory of GHG emissions for 2017 (San Jose 2019), as shown in **Table 4.8-1**.

End-Use Sector	Percentage of Total (%)	Carbon dioxide-equivalent emissions (MTCO₂e)
Commercial Energy	11	627,496
Residential Energy	13	763,961
Transportation and Mobile Sources	63	3,589,159
Industrial Energy	7	399,690
Solid Waste	5	271,862
Water and Wastewater	<1	29,235
Process and Fugitive Emissions	<1	30,262
Total	100	5,711,665

Source: San Jose 2019.

4.8.2 Applicant Proposed Measures

None.

4.8.3 Environmental Impacts and Mitigation Measures

Methodology

The applicant estimated GHG emissions for both construction and operation from the project construction equipment, vendor and hauling truck trips and worker vehicle trips.

Testing and maintenance GHG emissions from the project are a result of diesel fuel combustion from readiness testing and maintenance of the standby generators, offsite vehicle trips for worker commutes and material deliveries, and facility upkeep (such as architectural coatings, consumer product use, landscaping, water use, waste generation, natural gas use for comfort heating, and electricity use).

Significance Criteria

BAAQMD CEQA Guidelines include recommended thresholds for use in determining whether projects would have significant adverse environmental impacts. BAAQMD has adopted a numeric threshold of 10,000 MTCO₂e/yr for projects that require permits from the BAAQMD (BAAQMD 2017b). Given that the project would include standby generators requiring BAAQMD permits to operate, the significance threshold applicable to this project is 10,000 MTCO₂e/yr.

This BAAQMD threshold is consistent with stationary source thresholds adopted by other air quality management districts throughout the state. According to BAAQMD CEQA guidelines (BAAQMD 2017b), the 10,000 MTCO₂e/yr threshold is expected to capture 95 percent of the stationary source sector GHG emissions in the Bay Area. The five percent of emissions that are from stationary source projects below the 10,000 MTCO₂e/yr threshold account for a small portion of the Bay Area's total GHG emissions from stationary sources and these emissions come from very small projects. According to BAAQMD, such small stationary source projects would not significantly add to the global problem of climate change, and they would not hinder the Bay Area's ability to reach the AB 32 goal in any significant way, even when considered cumulatively (BAAQMD 2017b).

New permit applications to BAAQMD for stationary sources that comply with the quantitative threshold of 10,000 MTCO₂e/yr would not be considered "cumulatively considerable" because they also would not hinder the state's ability to meet greenhouse gas emissions goals pursuant to AB 32. The AB 32 Scoping Plan measures, including the cap-and-trade program, provide for necessary emissions reductions from the stationary source sector to achieve AB 32 2020 goals (BAAQMD 2017b).

GHG impacts from the project's standby generators would be considered to have a less-than-significant impact if emissions are below the BAAQMD's threshold of 10,000 MTCO₂e/yr. Other project-related emissions from mobile sources, area sources, energy use and water use, would not be included for comparison to this threshold, based on guidance in the BAAQMD's CEQA Guidelines (BAAQMD 2017b). GHG impacts from all other project-related emission sources would be considered to have a less-than-significant impact if the project is consistent with the City of San Jose GHG Reduction Strategy and applicable regulatory programs and policies adopted by ARB or other California agencies. However, it should be noted that these plans focus on the near term 2020 and 2030 GHG goals and do not address the sharp cuts that will be needed to meet the 2045 goals and beyond.

a. Would the project generate greenhouse gas emissions, either directly or indirectly, that may have a significant impact on the environment?

Construction

Less Than Significant Impact. Construction of the project would result in GHG emissions generated by on- and offsite vehicle trips (material haul truck, worker commute, and

delivery vehicle trips) and operation of construction equipment. The applicant estimated that these sources would generate approximately 3,241 MTCO₂e during the estimated 52 months (4.3 years) of construction. The GOSDC would connect to a new PG&E substation via five new 21 kilovolt (kV) distribution feeders that would extend underground along three proposed routes: Via Del Oro, Santa Teresa Route 1, and Santa Teresa Route 2 to the project site. Each route is simply a trenching project which would require minimal equipment and work staff to complete. The estimated GHG emissions for the construction of these three routes are 30.3 MTCO₂e, 50.3 MTCO₂e and 52.0 MTCO₂e respectively.

Because construction emissions would cease once construction is complete, they are considered short-term. The BAAQMD CEQA Guidelines do not identify a GHG emission threshold for construction-related emissions. Instead, BAAQMD recommends that GHG emissions from construction be quantified and disclosed. BAAQMD further recommends incorporation of Best Management Practices (BMPs) to reduce GHG emissions during construction, as feasible and applicable. BMPs may include use of alternative-fueled (for example, renewable diesel or electric) construction vehicles and equipment for at least 15 percent of the fleet, use of at least 10 percent of local building materials, and recycling or reusing at least 50 percent of construction waste (BAAQMD 2017b). The quantity of construction related GHG emissions would be limited to occur only during the construction phase, which would ensure GHG impacts are less than significant.

Readiness Testing and Maintenance

Less Than Significant Impact. GHG emissions from project readiness testing and maintenance would consist of emissions from routine readiness testing and maintenance of the standby emergency generators, offsite vehicle trips for worker commutes and material deliveries, and facility upkeep, including architectural coatings, consumer product use, landscaping, water use, waste generation, natural gas use for comfort heating, and electricity use.

Project Stationary Combustion Sources. Table 4.8-2 shows the maximum potential annual GHG emission estimates for the standby generators' routine readiness testing and maintenance. The emissions are estimated based on 20 hours of annual testing and maintenance at 100 percent load.

TABLE 4.8-2 GREENHOUSE GAS EMISSIONS FROM STANDBY GENERATORS TESTING AND MAINTENANCE

Source	Maximum Annual Emissions (MTCO ₂ e/yr)
Standby Generators – Testing and Maintenance	1,834
BAAQMD Threshold	10,000
Exceeds Threshold?	No

Source: SV1 2021i

Table 4.8-2 shows that the estimated average annual GHG emissions from the project’s stationary sources, the standby generators, for routine testing and maintenance are well below the BAAQMD GHG emissions significance threshold for stationary sources.

Data Center Electricity Usage. The proposed project would require a continuous electricity supply up to a theoretical maximum demand of 99 MW, 24 hours a day or 8,760 hours per year. Although actual electricity usage in any year would be lower than this level, staff conservatively assumes that the project could consume up to 867,240 MWh per year, based on the maximum demand of 99 MW during all 8,760 hours per year.

Electricity used by the project would be delivered by the Pacific Gas and Electric Company (PG&E). The mix of energy resources in the electricity supply changes from year to year, and in general, the carbon intensity of PG&E’s and California’s electricity supply is on a long-term downward trend. Depending on the customer type and size, PG&E offers a renewable energy content greater than the “Base Plan” mix through PG&E’s “Solar Choice” program. The PG&E Solar Choice program is available to businesses smaller than the proposed project having a peak load limited to 2 MW (PG&E 2020a). The project intends to opt into the San Jose Clean Energy (SJCE) Greensource Program (SV1 2020a). SJCE sources the electricity and PG&E delivers the power to the project. The current SJCE Greensource power generation mix includes 47 percent renewable, 36 percent large hydroelectric and 17 percent unspecified sources (Unspecified sources aren’t traceable to a specific generation facility, such as electricity traded through open-market transactions. They may also include renewables and hydroelectric (SJCE 2020). PG&E’s 2030 energy portfolio is expected to be 88.2 percent renewable or GHG-free. Per SJCE Community Choice Aggregation Implementation Plan and Statement of Intent, August 17, 2017, SJCE will exceed PG&E’s renewable and GHG-free generation by 10 percent, which would mean providing 98.2 percent renewable and GHG-free generation. However, in this analysis staff conservatively uses PG&E Carbon Intensity factor for the calculation of GHG emissions from the energy use.

TABLE 4.8-3 COMPARISON OF THE MIX OF RESOURCES THAT MAKE UP THE ELECTRICITY SUPPLIED BY PG&E AND THE STATEWIDE POWER MIX

Energy Resources	2018 PG&E "Base Plan" Power Mix	2018 California Power Mix
Renewable (Biomass, Geothermal, Eligible Hydroelectric, Solar, and Wind)	39%	31%
Coal	0%	3%
Large Hydroelectric	13%	11%
Natural Gas	15%	35%
Nuclear	34%	9%
Other	0%	< 1%
Unspecified sources of power (not traceable to specific sources)	0%	11%
Total	100%	100%

Source: 2018 Power Content Label for PG&E (CEC 2019)

Recent voluntary GHG reporting by PG&E indicates that the delivered electricity carbon intensity factors in 2016 and 2017 were 294 and 210 pounds (0.133 and 0.095 metric tons) of CO₂e per MWh, respectively (PG&E 2020b). PG&E's 2018 carbon intensity was further reduced to 206 pounds (0.093 metric tons) of CO₂e per MWh in 2018 (PG&E 2020b). See **Figure 4.8-1** for this trend. The Corporate Responsibility and Sustainability Report by PG&E notes that several factors affect PG&E's power mix and emissions from year to year. The carbon intensity factors depend on: the availability of hydroelectric power and renewable energy in the energy mix for the year, the customer electricity demand and share of customers that receives power procurement from PG&E, as well as the availability and flexibility of the power plants in the PG&E portfolio (PG&E 2020b). As with all load serving entities in California, the carbon intensity factor will continue to change as the power mix gradually increases the use of renewable resources to achieve California's GHG and renewable energy goals.

FIGURE 4.8-1 CARBON INTENSITY OF ALL ELECTRICITY SUPPLIED BY PG&E (POUNDS CO₂E/MWH)

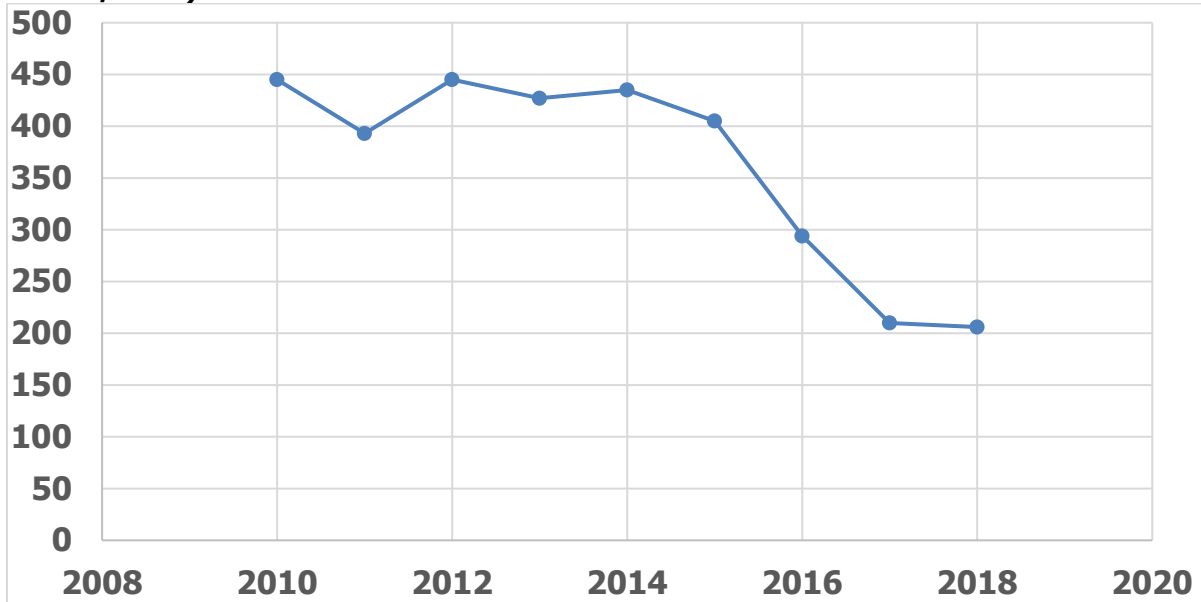

Source: PG&E 2020b

Project Mobile Emission Sources. Based on the facility’s anticipated 42 employees per day, plus thirty visitors per day, the GOSDC could generate roughly 144 daily vehicle trips (72 round trips).

Project Water Consumption and Waste Generation. Water consumption results in indirect emissions from electricity usage for water conveyance and wastewater treatment. Daily operations at the data center would also generate solid waste, which results in fugitive GHG emissions during waste decomposition.

Summary of GHG Emissions. GHG emissions from stationary combustion sources (standby generator testing and maintenance) are presented in **Table 4.8-2** above. GHG emissions from energy use, mobile sources and building operation are provided in **Table 4.8-4**.

As shown in **Table 4.8-4**, operation of the project is estimated to generate 82,729 MTCO₂e/yr from maximum possible electricity use and other non-stationary sources. The majority of emissions are from the energy use, which is estimated to be 81,035 MTCO₂e/yr. Staff calculated the energy use emissions based on 2018 PG&E carbon intensity factor of 206 pounds of CO₂e per MWh. The same calculation method has been used in previous data center projects and determined to be “...a reasonable method for estimating the indirect, non-stationary GHG emissions...” (Mission College 2020) This emissions estimate does not include efficiency measures that would be pursued as part of the project, nor does it reflect implementation of state and local measures to reduce GHG emissions associated with electricity production and California’s fuels. For example, programs to implement SB 350 and SB 100 would continue to promote renewable

resources in the power mix and ensure the ongoing substantial reductions in GHG emissions from electricity generation.

TABLE 4.8-4. MAXIMUM GHG EMISSIONS FROM ENERGY USE, MOBILE SOURCES AND BUILDING OPERATION DURING PROJECT OPERATION

Source	Annual Emissions (MTCO _{2e} /yr)
Energy Use ^a	81,035
Mobile Sources ^b	576
Area Sources ^c	775
Water Use ^d	2
Waste Generation ^e	341
Total	82,729

Source: SV1 2020j.

Notes:

^a Based on 2018 PG&E carbon intensity factor of 206 pounds of CO_{2e} per MWh.

^b Based on Institute of Transportation Engineers (ITE) trip rates for Data Center (Land Use Code 160) applied to a 547,050 square foot data center.

^c Based on CalEEMod default emission factors for General Light Industrial land uses applied to a 547,050 square foot data center. The total includes natural gas emissions, which are conservatively assumed to apply to all 547,050 square feet of the building, even though the data halls will not require natural gas.

^d CalEEMod default emissions adjusted to reflect the maximum project water demand of 1,310 acre feet per year.

^e Based on CalEEMod default emission factors for General Light Industrial land uses applied to a 547,050 square foot data center.

Conclusion

Less Than Significant Impact. The GOSDC's GHG emissions are estimated to be 3,241 MTCO_{2e} during the demolition and construction period. Post-construction estimated emissions from the emergency generators during readiness testing and maintenance are estimated to be 1,834 MTCO_{2e}/year as shown in **Table 4.8-2**.

The GHG emissions for the annual testing and maintenance emissions from the facility's stationary sources would be well below the BAAQMD significance thresholds of 10,000 MTCO_{2e}/yr as shown in **Table 4.8-2**. This, coupled with the project's compliance with the GHGRS, ensures the project's GHG emissions would not have a significant direct or indirect impact on the environment.

The GHG significance thresholds were established considering GHG emission reduction strategies in the AB 32 Scoping Plan, regional GHG reduction goals, and EO B-55-18. The GHG emissions that would be generated by the project would not be a "cumulatively considerable" contribution under CEQA because they would conform with all applicable plans, policies, and regulations adopted for the purpose of GHG reductions. Therefore, the maximum operation for GOSDC's non-stationary source GHG emissions (82,729 MTCO_{2e}/yr) are determined to have less than significant GHG impacts.

The great majority of the project's operational GHG emissions would occur during testing and maintenance. As analyzed in **Appendix B**, the project's likelihood of operating for

non-testing/non-maintenance (emergency) purposes is low and if such operation did occur it would be infrequent and of short duration. Staff concludes that these emissions would be less than significant.

Required Mitigation Measures: None.

b. Would the project conflict with an applicable plan, policy or regulation adopted for the purpose of reducing the emissions of greenhouse gases?

Construction

Less Than Significant. The project's short-term demolition and construction GHG emissions would not interfere with the state's ability to achieve long-term GHG emissions reduction goals. The vehicles and fuel supplies used during demolition and construction of the project are required to comply with the applicable GHG reduction programs for mobile sources and suppliers of transportation fuels. The project would conform to relevant programs and recommended actions detailed in the AB 32 Scoping Plan and Mobile Source Strategy. Similarly, the project components would not conflict with regulations adopted to achieve the goals of the AB 32 Scoping Plan.

Readiness Testing and Maintenance

Less Than Significant Impact with Mitigation Incorporated. The project's GHG emissions related to readiness testing and maintenance would be caused by combustion of diesel fuel in the standby generator engines and other routine operational activities.

Currently, California has adopted policy goals to lead California to a low carbon future, including Executive Order B-55-18 (see above), which calls for achieving carbon neutral statewide emissions as soon as possible and no later than 2045. However, staff is not aware of any regulations that have been adopted to meet the goal of the Executive Order that would apply to this project. Should such regulations be adopted in the future, new facilities such as this project could meet the goal in one of three ways: they could cease operations by 2045 if the facility no longer met their client's needs (SV1 2020i), there could be some new hardware developed that would not need to use backup generators, or they could convert to renewable diesel use.

Renewable diesel is currently used as a transportation fuel. There are both federal (CEC2020k) and state incentives that offset the increased cost of renewable diesel compared to petroleum diesel when used in transportation applications. However, at this time staff is not aware of any incentives that would apply to stationary sources such as GOSBGF.

The Diesel Free by '33 is a BAAQMD-sponsored initiative to encourage local communities in BAAQMD's territory to reach zero diesel emissions in their communities by replacing diesel-fueled vehicles and equipment with zero emission technologies. In 2018, the Mayor

and Vice Mayor of the City of San Jose became signatories to the initiative. However, the Commission has concluded that Diesel Free by '33 is not an applicable GHG emissions reduction strategy, program, or law that facilities must comply with.

Indirect emissions related to the electricity used by GOS and supplied by PG&E must comply with RPS and Cap-and-Trade Program requirements. Other project activities would be similar to those of other commercial or industrial projects subject to development review by the City of San Jose.

The GOSDC would comply with all applicable City and state green building measures, including Title 24, Part 6, California Energy Code baseline standard requirements for energy efficiency, based on the 2016 Energy Efficiency Standards requirements, Title 20 Appliance Efficiency Regulations, and the 2016 California Green Building Standards Code, commonly referred to as CALGreen (California Code of Regulations, Title 24, Part 11).

The project would conform to relevant programs and recommended actions detailed in the AB 32 Scoping Plan and Mobile Source Strategy. Operation of the project components would not conflict with regulations adopted to achieve the goals of the Scoping Plan. Accordingly, the project's operational activities would not interfere with the state's ability to achieve long-term GHG emissions reduction goals.

Bay Area 2017 Clean Air Plan (CAP). The Bay Area 2017 Clean Air Plan (BAAQMD 2017a) includes performance objectives, consistent with the state's climate protection goals under AB 32 and SB 375, designed to reduce GHG emissions to 1990 levels by 2030 and 80 percent below 1990 levels by 2050. Due to the relatively high electrical demand of the GOSDC, energy efficiency measures are included in the design and operation of the onsite electrical and mechanical systems. This would be consistent with the general purpose of Energy and Climate Measure (ECM)-1 – Energy Efficiency in the 2017 Bay Area Clean Air Plan.

Plan Bay Area 2040/California SB 375. Under the requirements of SB 375, the MTC and ABAG developed a Sustainable Communities Strategy (SCS) with the adopted Plan Bay Area 2040 to achieve the Bay Area's regional GHG reduction target. Plan Bay Area 2040 sets a 15 percent GHG emissions reduction per capita target from passenger vehicles by 2035 when compared to the project 2005 emissions. However, these emission reduction targets are intended for land use and transportation strategies only. The project has a low concentration of employment and would not contribute to a substantial increase in passenger vehicle travel within the region.

California SB 100. SB 100 advances the RPS renewable resources requirement to 50 percent by 2026 and 60 percent by 2030. It also requires renewable energy resources and zero-carbon resources to supply 100 percent of all retail sales of electricity by 2045. The project's GHG emissions are predominantly from electricity usage. Because all electricity supplied to the project by PG&E or SJCE would be subject to the RPS

requirements promulgated under SB 100, the project would not conflict with plans, policies, or regulations adopted pursuant to SB 100.

ARB Scoping Plan. The vast majority of the project’s GHG emissions would result from energy use. Multiple measures contained in the ARB’s Scoping Plan address GHG emissions from energy use. For example, the Cap-and-Trade Program, through the regulation of upstream electricity producers, will account for GHG emissions in the power mix and requires these emissions to be reduced by the amount needed to achieve the state’s 2030 GHG goal.

San Jose GHG Reduction Strategy. The project owner would apply for building permits from the City of San Jose. For commercial or industrial projects subject to development review by the City of San Jose, the City’s 2030 GHG Reduction Strategy (GHGRS) presents the City’s comprehensive path to reduce GHG emissions to achieve the 2030 reduction target, based on SB32, BAAQMD, and OPR. Additionally, the 2030 GHGRS leverages other important City plans and policies, including the General Plan, Climate Smart San Jose, and the City Municipal Code in identifying reductions strategies that achieve the City’s target. The City of San Jose’s 2030 GHGRS represents San Jose’s qualified climate action plan in compliance with CEQA.

The project owner would incorporate measures from the GHG Reduction Strategy, as specified by the City during the design review process to ensure compliance with applicable laws, ordinances, regulations, and standards. Conformance with the applicable design codes and policies will be enforced during the City design review process.

The compliance of the project with the City’s 2030 GHG Reduction Strategy (San Jose 2020b) is discussed in **Table 4.8-5**.

TABLE 4.8-5 PROJECT COMPLIANCE WITH CITY OF SAN JOSE 2030 GHG REDUCTION STRATEGY	
Emission Reduction Policies	Project Compliance
<i>General Plan Policy Consistency</i>	
1) Consistency with the Land Use/ Transportation Diagram (Land Use and Density).	Yes. The eastern portion of the project site is currently designated as Industrial Park and the western portion is designated as Transit Employment Center in the <i>Envision San Jose 2040 General Plan</i> . The project is consistent with the existing General Plan designations on the site.
2) Implementation of Green Building Measures	

TABLE 4.8-5 PROJECT COMPLIANCE WITH CITY OF SAN JOSE 2030 GHG REDUCTION STRATEGY

Emission Reduction Policies	Project Compliance
MS-2.2: Encourage maximized use of on-site generation of renewable energy for all new and existing buildings.	Yes. The project includes installation of solar PV array hook ups on the rooftops of each building. As part of the design process, Equinix considers all available rooftop space for installation of solar arrays. For data center buildings, much of the rooftop space is dedicated to other necessary building infrastructure equipment. The project includes installation of rooftop solar PV arrays to the extent feasible on space not designated for other building infrastructure equipment.
MS-2.3: Encourage consideration of solar orientation, including building placement, landscaping, design, and construction techniques for new construction to minimize energy consumption.	Yes. Unlike typical structures which would utilize windows to take advantage of sun exposure to reduce energy consumption, one of the primary concerns of data center structures is interior cooling. As a result, the project is designed with minimal windows and sun exposure to the data hall areas to reduce energy consumption associated with cooling.
MS-2.7: Encourage the installation of solar panels or other clean energy power generation sources over parking areas.	No. The project's parking area is not conducive to solar arrays due shading from trees and proposed buildings, as well as its limited size. Equinix would explore the use of solar over parking areas to the extent it is feasible and effective in this location.
MS-2.11: Require new development to incorporate green building practices, including those required by the Green Building Ordinance. Specifically, target reduced energy use through construction techniques (e.g., design of building envelopes and systems to maximize energy performance), through architectural design (e.g., design to maximize cross ventilation and interior daylight) and through site design techniques (e.g., orienting buildings on sites to maximize the effectiveness of passive solar design).	Yes. The GOSDC would be built in accordance with Title 24 and CalGreen, and would include green building measures to reduce energy consumption. The GOSDC would also utilize lighting control to reduce energy usage for new exterior lighting and air economization for building cooling. Water efficient landscaping and ultralow flow plumbing fixtures in the building would be implemented to limit water consumption. The GOSDC would be designed to achieve a minimum of LEED Silver certification.
MS-16.2: Promote neighborhood-based distributed clean/renewable energy generation to improve local energy security and to reduce the amount of energy wasted in transmitting electricity over long distances.	Yes. The project includes installation of solar PV array hook ups on the rooftops of each building. As part of the design process, Equinix considers all available rooftop space for installation of solar arrays. For data center buildings, much of the rooftop space is dedicated to other necessary building infrastructure equipment. The project includes installation of rooftop solar PV arrays to the extent feasible on space not designated for other building infrastructure equipment.
3) Pedestrian, Bicycle & Transit Site Design Measures	
CD-2.1: Promote the Circulation Goals and Policies in the <i>Envision San Jose 2040 General Plan</i> . Create streets that promote pedestrian and bicycle transportation by following applicable goals and policies in	Yes. The project would replace the existing meandering sidewalks along the San Ignacio, Via Del Oro and Great Oaks frontages of the site. To enhance walkability, a 10-foot-wide monolithic sidewalk with tree wells and street

TABLE 4.8-5 PROJECT COMPLIANCE WITH CITY OF SAN JOSE 2030 GHG REDUCTION STRATEGY

Emission Reduction Policies	Project Compliance
<p>the Circulation section of the Envision San José 2040 General Plan.</p>	<p>trees at the back of curb would be constructed along all street frontages. PD TRA-1 would require the following:</p> <ol style="list-style-type: none"> 1. Remove each of the pork chop islands on the north leg (Great Oaks Boulevard) at the Santa Teresa Boulevard/Great Oaks Boulevard intersection to improve pedestrian safety and access. The signal would need to be modified to implement the pork chop removal. 2. Implement Class II bike lanes along Via Del Oro on the opposing side of the project frontage between San Ignacio Avenue and Great Oaks Boulevard. 3. In-lieu of the installed ADA curb ramps at Great Oaks Boulevard/Via Del Oro intersection, the project would be required to provide contribution towards the signal improvements including pan, tilt, zoom (PTZ) cameras at the Via Del Oro/San Ignacio Avenue and Via Del Oro/Great Oaks Boulevard intersections to improve the pedestrian network in the project vicinity. <p>There are existing buffered bike lanes along the site's San Ignacio and Great Oaks frontages which allow direct bike access to the Santa Teresa LRT station. The City's "Better Bike Plan 2025" shows the addition of a bike lane along the Via Del Oro on the opposing side of the project frontage between San Ignacio Avenue and Great Oaks Boulevard. The project is conditioned to contribute \$20,000 toward traffic signal improvements at the Via Del Oro/San Ignacio Avenue and Via Del Oro/Great Oaks Boulevard intersections. No other street improvements are required by the project.</p>
<p>CD-2.5: Integrate Green Building Goals and Policies of the <i>Envision San Jose 2040 General Plan</i> into site design to create healthful environments. Consider factors such as shaded parking areas, pedestrian connections, minimization of impervious surfaces, incorporation of stormwater treatment measures, appropriate building orientations, etc.</p>	<p>Yes. The GOSDC would be built in accordance with Title 24 and CalGreen, and would include green building measures to reduce energy consumption. The GOSDC would be designed to achieve a minimum of LEED Silver certification. Stormwater treatment is implemented in various locations to treat runoff from impervious surfaces. The parking lot would include shade trees.</p>
<p>CD-2.11: Within the Downtown and Urban Village Overlay areas, consistent with the minimum density requirements of the pertaining Land Use/Transportation Diagram designation, avoid the construction of surface parking lots except as an interim use, so that long-term development of the site will result in a cohesive urban form. In these areas, whenever possible, use structured</p>	<p>Not applicable. The project is not within a Downtown or Urban Village overlay.</p>

TABLE 4.8-5 PROJECT COMPLIANCE WITH CITY OF SAN JOSE 2030 GHG REDUCTION STRATEGY

Emission Reduction Policies	Project Compliance
parking, rather than surface parking, to fulfill parking requirements. Encourage the incorporation of alternative uses, such as parks, above parking structures.	
CD-3.2: Prioritize pedestrian and bicycle connections to transit, community facilities (including schools), commercial areas, and other areas serving daily needs. Ensure that the design of new facilities can accommodate significant anticipated future increases in bicycle and pedestrian activity.	Yes. The project includes bicycle parking facilities onsite. The project would replace the existing meandering sidewalks along the San Ignacio, Via Del Oro and Great Oaks frontages of the site. To enhance walkability, a 10-foot-wide monolithic sidewalk with tree wells and street trees at the back of curb will be constructed along all street frontages. On-site sidewalks are provided connecting to the public streets. The project would provide 21 on-site spaces for bicycles.
CD-3.4: Encourage pedestrian cross-access connections between adjacent properties and require pedestrian and bicycle connections to streets and other public spaces, with particular attention and priority given to providing convenient access to transit facilities. Provide pedestrian and vehicular connections with cross-access easements within and between new and existing developments to encourage walking and minimize interruptions by parking areas and curb cuts.	Yes. The project includes bicycle parking facilities onsite. The project would replace the existing meandering sidewalks along the San Ignacio, Via Del Oro and Great Oaks frontages of the site. To enhance walkability, a 10-foot-wide monolithic sidewalk with tree wells and street trees at the back of curb will be constructed along all street frontages. On-site sidewalks are provided connecting to the public streets. The project would provide 21 on-site spaces for bicycles.
LU-3.5: Balance the need for parking to support a thriving Downtown with the need to minimize the impacts of parking upon a vibrant pedestrian and transit oriented urban environment. Provide for the needs of bicyclists and pedestrians, including adequate bicycle parking areas and design measures to promote bicyclist and pedestrian safety.	Not applicable. The project is not located in the Downtown area.
TR-2.8: Require new development to provide on-site facilities such as bicycle storage and showers, provide connections to existing and planned facilities, dedicate land to expand existing facilities or provide new facilities such as sidewalks and/or bicycle lanes/paths, or share in the cost of improvements.	Yes. The project includes bicycle parking facilities onsite. The project would replace the existing meandering sidewalks along the San Ignacio, Via Del Oro and Great Oaks frontages of the site. To enhance walkability, a 10-foot-wide monolithic sidewalk with tree wells and street trees at the back of curb will be constructed along all street frontages. On-site sidewalks are provided connecting to the public streets. The project would provide 21 on-site spaces for bicycles.
TR-7.1: Require large employers to develop TDM programs to reduce the vehicle trips and vehicle miles generated by their employees through the use of shuttles, provision for car-sharing, bicycle	Yes. The project would include 42 employees and would not be considered a large employer, which is typically defined as 50 or more employees. However, the project includes TDM measures (PD TRA-1). See Section 4.17 Transportation for more details.

TABLE 4.8-5 PROJECT COMPLIANCE WITH CITY OF SAN JOSE 2030 GHG REDUCTION STRATEGY

Emission Reduction Policies	Project Compliance
sharing, carpool, parking strategies, transit incentives and other measures.	
TR-8.5: Promote participation in car share programs to minimize the need for parking spaces in new and existing development.	Not applicable. Due to the low number of employees, a car share program is not proposed.
4) Water Conservation and Urban Forestry Measures	
MS-3.1: Require water-efficient landscaping, which conforms to the State's Model Water Efficient Landscape Ordinance, for all new commercial, institutional, industrial, and developer-installed residential development unless for recreation needs or other area functions.	Yes. The project includes water efficient landscaping.
MS-3.2: Promote the use of green building technology or techniques that can help reduce the depletion of the City's potable water supply, as building codes permit. For example, promote the use of captured rainwater, graywater, or recycled water as the preferred source for non-potable water needs such as irrigation and building cooling, consistent with Building Codes or other regulations.	Yes. The project applicant modified the cooling technology for the project by replacing the originally proposed Water-Cooled Chilled Water system with an Air-Cooled Chilled Water System with refrigerant-side economizer. This project modification reduces the total water demand per data center building from 343 acre feet per year to less than 4 acre feet per year.
MS-19.4: Require the use of recycled water wherever feasible and cost-effective to serve existing and new development.	Yes. Recycled water is not available on-site or in its vicinity.
MS-21.3: Ensure that San Jose's Community Forest is comprised of species that have low water requirements and are well adapted to its Mediterranean climate. Select and plant diverse species to prevent monocultures that are vulnerable to pest invasions. Furthermore, consider the appropriate placement of tree species and their lifespan to ensure the perpetuation of the Community Forest.	Yes. The plant species have low water requirements and are suitable for San Jose's climate.
MS-26.1: As a condition of new development, require the planting and maintenance of both street trees and trees on private property to achieve a level of tree coverage in compliance with and that implements City laws, policies or guidelines.	Yes. The project would meet conditions of approval required for street trees and trees on private property.
ER-8.7: Encourage stormwater reuse for beneficial uses in existing infrastructure and future development through the installation of rain barrels, cisterns, or other water storage and reuse facilities.	No. The project is not proposing any rain barrels, cisterns, or other water storage facilities. The designers do not believe rainwater harvesting or the use of water storage facilities is feasible in Santa Clara County. Rainfall comes in a 3- or 4-month period at a time when irrigation is at its

TABLE 4.8-5 PROJECT COMPLIANCE WITH CITY OF SAN JOSE 2030 GHG REDUCTION STRATEGY

Emission Reduction Policies	Project Compliance
	<p>minimum. Storage of water for use during the dry weather has the potential for vector problems. Storage of water for use in chillers is not applicable because the project is using air-cooled chillers.</p>
<i>2030 Greenhouse Gas Reduction Strategy Compliance</i>	
<p>Renewable Energy Development</p> <ol style="list-style-type: none"> 1. Install solar panels, solar hot water, or other clean energy power generation sources on development sites, or 2. Participate in community solar programs to support development of renewable energy in the community, or 3. Participate in San Jose Clean Energy at the Total Green level (i.e., 100% carbon-free electricity) for electricity accounts associated with the project. 	<p>No. Compliance with this policy should be demonstrated by employing one or more of the three options. The project proposed to comply with item Number 1 only as follows (excerpted from the applicant’s completed checklist TN236336).</p> <ol style="list-style-type: none"> 1. The project includes installation of solar PV array hook ups on the rooftops of each building. As part of the design process, Equinix considers all available rooftop space for installation of solar arrays. For data center buildings, much of the rooftop space is dedicated to other necessary building infrastructure equipment. The project includes installation of rooftop solar PV arrays to the extent feasible on space not designated for other building infrastructure equipment. However, staff considers this to fall short of showing the project will comply with the requirement to actually install solar panels. Additionally, given that the applicant acknowledges that much of the roof space is already reserved for equipment necessary to operate the buildings, even if some panels were ultimately installed, it would still fall far short of the amount necessary to compensate for the buildings’ large electricity load. 2. The project is not proposing to participate in community solar programs. 3. The project is not proposing to participate in the San Jose Clean Energy at the Total Green Level. However, because the project does not make a clear showing that it has satisfied option 1 of this requirement, staff is proposing to require participation in this element of the plan to ensure the project meets the requirements for renewable energy development under the 2030 Greenhouse Gas Reduction Strategy. MM GHG-1 is proposed to accomplish this.
<p>Building Retrofits – Natural Gas</p> <ol style="list-style-type: none"> 1. Replace an existing natural gas appliance with an electric alternative (e.g., space heater, water heater, clothes dryer), or 2. Replace an existing natural gas appliance with a high-efficiency model 	<p>Not Applicable. The project does not include any retrofit of existing buildings.</p>

TABLE 4.8-5 PROJECT COMPLIANCE WITH CITY OF SAN JOSE 2030 GHG REDUCTION STRATEGY

Emission Reduction Policies	Project Compliance
<p>Zero Waste Goal</p> <ol style="list-style-type: none"> 1. Provide space for organic waste (e.g., food scraps, yard waste) collection containers, and/or 2. Exceed the City’s construction & demolition waste diversion requirement. 	<p>Yes.</p> <ol style="list-style-type: none"> 1. The project would be providing organic waste container. 2. The project would exceed the City’s construction and demolition waste diversion requirements.
<p>Caltrain Modernization</p> <ol style="list-style-type: none"> 1. For projects located within ½ mile of a Caltrain station, establish a program through which to provide project tenants and/or residents with free or reduced Caltrain passes or 2. Develop a program that provides project tenants and/or residents with options to reduce their vehicle miles traveled (e.g., a TDM program), which could include transit passes, bike lockers and showers, or other strategies to reduce project related VMT. 	<p>Not Applicable.</p> <ol style="list-style-type: none"> 1. The project is not within ½ mile of a Caltrain station. 2. While the project would have a low number of employees, a Transportation Demand Management (TDM) measures are proposed (PD TRA-1).
<p>Water Conservation</p> <ol style="list-style-type: none"> 1. Install high-efficiency appliances/fixtures to reduce water use, and/or include water-sensitive landscape design, and/or 2. Provide access to reclaimed water for outdoor water use on the project site 	<p>Yes.</p> <ol style="list-style-type: none"> 1. The project would include high-efficiency fixtures to reduce water usage, consistent with the Cal Green Code requirements. Additionally, the project applicant modified the cooling technology for the project by replacing the originally proposed Water-Cooled Chilled Water system with an Air-Cooled Chilled Water System with refrigerant-side economizer. This project modification reduces the total water demand per data center building from 343 acre feet per year to less than 4 acre feet per year. 2. There is not reclaimed water available to the site. The use of reclaimed water is not applicable.
<p><i>Applicant Proposed Greenhouse Gas Reduction Measures</i></p>	
<p>Description of Proposed Measure</p>	<p>In 2015, Equinix set a goal to reach 100 percent clean and renewable energy across its global portfolio. Since 2015, Equinix’s market-based indirect carbon emissions have decreased 60 percent from 766,100 metric tons to 306,000 metric tons. In 2019, 100 percent of Equinix’s data centers in the U.S. were covered by 100 percent net-zero carbon emission energy. This is achieved through a variety of measures, including:</p> <ul style="list-style-type: none"> • Working with suppliers to buy green power through our existing electricity supply contracts. • Off-site purchases of renewables such as through Virtual Power Purchase Agreements (VPPAs) for wind

TABLE 4.8-5 PROJECT COMPLIANCE WITH CITY OF SAN JOSE 2030 GHG REDUCTION STRATEGY

Emission Reduction Policies	Project Compliance
	<p>in places where the retail purchase of renewable energy is either not available or not cost-effective.</p> <ul style="list-style-type: none"> • Purchasing of market-based instruments like Renewable Energy Certificates (RECs) and Guarantees of Origin (GoOs). • Purchasing certificates from recently built renewable installations in nascent markets like Asia. <p>Although the proposed project would utilize electricity from PG&E that is not 100 percent clean and renewable, it would be part of Equinix’s U.S. portfolio and would therefore be covered by 100 percent net-zero carbon emission energy. This would be achieved through a combination of the measures listed above.</p>
Description of GHG Reduction Estimate	Equinix’s program of covering all U.S. data centers with 100 percent net-zero carbon emission energy would offset all indirect project GHG emissions from energy use.

As shown in “Renewable Energy Development” section, part 2 of the above table, compliance with this element of the reduction strategy can be achieved in one of three ways, including the first option: by installing solar panels, solar hot water, or other clean energy power generation sources. The applicant has elected to comply with this provision out of the three, but has only proposed to install solar PV array hook ups on the building rooftops, with the future installation of PV arrays left to be determined at a later date and only to the extent feasible on space available. Since the majority of the data center building rooftop space is dedicated for necessary building infrastructure equipment, staff does not believe the project would be able to install enough clean energy generation to comply with the requirement. Though the plan does not establish a minimum size necessary to show compliance, the reduction strategy is intended to ensure the city obtains sufficient GHG reductions to meet 2030 goals. In order to do so, each new construction in the city needs to appreciably contribute to that goal. The applicant’s proposal does not show that this project will. Nor is the project proposing to comply with MS-2.7, which encourages the installation of solar panels or other clean energy power generation sources over parking areas. Therefore, the project application does not show the project will generate clean energy onsite in order to comply with the reduction strategy and help San Jose meet its GHG reduction goals. However, the project can still comply with the renewable energy development requirement by participating in San Jose Clean Energy at the TotalGreen level, (item 3). SJCE currently offers all customers the choice to participate at the TotalGreen level. Choosing to participate at the TotalGreen level is an easy and affordable way to comply with the renewable energy development requirement. Therefore, staff proposes **MM GHG-1**, which would require the project owner to participate in San Jose Clean Energy at the TotalGreen level and ensure compliance with the 2030 Greenhouse Gas Emissions Strategy.

While the project meets GHG thresholds and would not conflict with any applicable plan, policy or regulation adopted for the purpose of reducing the emissions of greenhouse gases with implementation of **MM GHG-1**, using renewable diesel would further reduce the less than significant GHG emission impacts of the proposed project. As discussed in **Section 5 Alternatives**, renewable diesel is expected to become more widely available in the near future and would further reduce the project's less than significant emissions of GHGs, therefore staff recommends the project owner consider incorporating the use of renewable diesel as the primary fuel for the backup diesel generators when it is available and feasible, and only use ultra-low sulfur diesel (ULSD) as a secondary fuel in the event of supply challenges or disruption in obtaining renewable diesel.

Conclusion

Less Than Significant with Mitigation Incorporated. With implementation of the efficiency measures to be incorporated into the project and the implementation of **MM GHG-1**, GHG emissions related to the project would be consistent with applicable plans and policies adopted to reduce GHG emissions and would comply with all regulations or requirements adopted to implement a statewide, regional, or local plan for the reduction or mitigation of GHG emissions. The potential for the project to conflict with an applicable plan, policy or regulation for GHG reductions would be less than significant with mitigation incorporated.

MM GHG-1: The project owner shall participate in the San Jose Clean Energy at the Total Green level (i.e., 100% carbon-free electricity) for electricity accounts associated with the project.

Required Mitigation Measures: MM GHG-1.

4.8.4 References

ARB 2014 – California Air Resources Board (ARB). First Update to the Climate Change Scoping Plan, dated May 2014. Accessed on: April 2021. Available online at: https://ww3.arb.ca.gov/cc/scopingplan/2013_update/first_update_climate_change_scoping_plan.pdf

ARB 2016 – California Air Resources Board (ARB). Mobile Source Strategy. Accessed on: April 2021. Available online at: <https://ww3.arb.ca.gov/planning/sip/2016sip/2016mobsrsrc.pdf>

ARB 2017a – California Air Resources Board (ARB). 2017 Climate Change Scoping Plan Update: The Strategy for Achieving California's 2030 GHG Target, November 2017. Accessed on: April 2021. Available online at: https://ww3.arb.ca.gov/cc/scopingplan/scoping_plan_2017.pdf

ARB 2017b – California Air Resources Board (ARB). Short-Lived Climate Pollutant Reduction Strategy, March 2017. Accessed on: April 2021. Available online at: https://ww2.arb.ca.gov/sites/default/files/2020-07/final_SLCP_strategy.pdf

- ARB 2020 – California Air Resources Board (ARB). California Greenhouse Gas Inventory for 2000-2018. Accessed on: April 2021. Available online at: https://ww3.arb.ca.gov/cc/inventory/data/tables/ghg_inventory_scopingplan_sum_2000-18.pdf
- BAAQMD 2017a – Bay Area Air Quality Management District (BAAQMD). Final 2017 Clean Air Plan, Adopted April 19, 2017. Accessed on: April 2021. Available online at: http://www.baaqmd.gov/~media/files/planning-and-research/plans/2017-clean-air-plan/attachment-a_-proposed-final-cap-vol-1-pdf.pdf
- BAAQMD 2017b – Bay Area Air Quality Management District (BAAQMD). California Environmental Quality Act Air Quality Guidelines, Updated May 2017. Available online at: http://www.baaqmd.gov/~media/files/planning-and-research/ceqa/ceqa_guidelines_may2017-pdf.pdf?la=en. Accessed on: April 2021
- CEC 2019 – California Energy Commission (CEC). California Energy Commission - Power Source Disclosure, 2018 Power Content Label, Pacific Gas and Electric Company. Available online at: https://www.energy.ca.gov/sites/default/files/2020-01/2018_PCL_PG_and_E.pdf. Accessed on: April 2021
- CEC 2020k – California Energy Commission (CEC). ROC with US EPA and CEC staff G. Bemis - Supersedes TN 234348 (TN 234353), August 2020. Available online at: <https://efiling.energy.ca.gov/Lists/DocketLog.aspx?docketnumber=20-SPPE-01>
- IPCC 2013 – Intergovernmental Panel on Climate Change (IPCC). Climate Change 2013: The Physical Science Basis. Contribution of Working Group I to the Fifth Assessment Report of the Intergovernmental Panel on Climate Change [Stocker, T.F., D. Qin, G.-K. Plattner, M. Tignor, S.K. Allen, J. Boschung, A. Nauels, Y. Xia, V. Bex and P.M. Midgley (eds.)]. Cambridge University Press, Cambridge, United Kingdom and New York, NY, USA, 1535 pp, doi:10.1017/CBO9781107415324. Available online at: <https://www.ipcc.ch/report/ar5/wg1/>. Accessed April 2021
- IPCC 2017 – Intergovernmental Panel on Climate Change (IPCC). Chair’s Vision Paper; AR6 Scoping Meeting. Accessed on: April 2021. Available online at: <https://www.ipcc.ch/site/assets/uploads/2018/11/AR6-Chair-Vision-Paper.pdf>
- Mission College 2020 – Mission College Final Decision (Mission College). Mission College Final Decision, August 2020. Available online at: <https://efiling.energy.ca.gov/GetDocument.aspx?tn=234401&DocumentContentId=67270>
- MTC & ABAG 2017 – Metropolitan Transportation Commission and Association of Bay Area Governments (MTC & ABAG). Plan Bay Area 2040. July. Available online at: <https://mtc.ca.gov/our-work/plans-projects/plan-bay-area-2040>. Accessed on: April 2021
- PG&E 2020a – Pacific Gas and Electric Company (PG&E). Solar Choice Program Costs, Frequently asked questions. Available online at: https://www.pge.com/en_US/small-medium-business/energy-alternatives/solar-

- and-other-clean-energy/solar-choice-rates/solar-choice-faqs.page. Accessed on: April 2021
- PG&E 2020b – Pacific Gas and Electric Company (PG&E). PG&E Corporation. Corporate Responsibility and Sustainability Report; Benchmarking Greenhouse Gas Emissions for Delivered Electricity (Pounds of CO₂ per MWh). Accessed on: April 2021. Available online at: http://www.pgecorp.com/corp_responsibility/reports/2019/en02_climate_change.html
- San Jose 2015 – City of San Jose (San Jose). Greenhouse Gas Reduction Strategy. June 2011. Updated December 2015. Available online at: <https://www.sanjoseca.gov/home/showdocument?id=28213>. Accessed on: April 2021
- San Jose 2018 – City of San Jose (San Jose). Climate Smart San Jose, A People-Centered Plan for a Low-Carbon City. February 2018. Available online at: <https://www.sanjoseca.gov/home/showdocument?id=32171>. Accessed on: April 2021
- San Jose 2019 – City of San Jose (San Jose). 2017 Inventory of Community Greenhouse Gas Emissions. Produced by ICLEI - Local Governments for Sustainability USA for City of San Jose, through the Statewide Energy Efficiency Collaborative (SEEC). Accessed on: April 2021. April 2019. Available online at: <https://www.sanjoseca.gov/home/showdocument?id=44752>
- San Jose 2020a – City of San Jose (San Jose). General Plan update. Envision San Jose 2040. Adopted November 2011. Amended March 2020. Accessed on: April 2021. Available online at: <https://www.sanjoseca.gov/home/showdocument?id=22359>
- San Jose 2020b – City of San Jose (San Jose). 2030 Greenhouse Gas Reduction Strategy. August 2020. Available at: <https://www.sanjoseca.gov/Home/ShowDocument?id=63605>
- SJCE 2020 – City of San Jose (San Jose). San Jose Clean Energy Typical Commercial Electric Rates. Available online at: https://sanjosecleanenergy.org/wp-content/uploads/2020/07/LargeCommercial_E19S_SJCE_PGE_JRM.pdf
- SV1 2020a – SV1, LLC. (SV1). Application for Small Power Plant Exemption: Great Oaks South Backup Generating Facility (TN 232466), March 2020. Available online at: <https://efiling.energy.ca.gov/Lists/DocketLog.aspx?docketnumber=20-SPPE-01>
- SV1 2020e – SV1, LLC. (SV1). SV1 Responses to CEC Data Request Set 3: Great Oaks South Backup Generating Facility (TN 233638), June 2020. Available online at: <https://efiling.energy.ca.gov/GetDocument.aspx?tn=233638&DocumentContentId=66223>
- SV1 2020i – SV1, LLC. (SV1). SV1 Responses to Data Requests Set 1 DR 1-5: Great Oaks South Backup Generating Facility (TN 233999), July 2020. Available online

at: <https://efiling.energy.ca.gov/Lists/DocketLog.aspx?docketnumber=20-SPPE-01>

SV1 2021i – SV, LLC. (SV). SV 1 Revised Air Quality and Public Health Analysis: Great Oaks South Backup Generating Facility (TN 237152), March 2021. Available online at: <https://efiling.energy.ca.gov/Lists/DocketLog.aspx?docketnumber=20-SPPE-01>

SV1 2020j – SV1, LLC. (SV1). SV1 Revised AQ and HRA Modeling Analysis: Great Oaks South Backup Generating Facility (TN 234479), August 2020. Available online at: <https://efiling.energy.ca.gov/Lists/DocketLog.aspx?docketnumber=20-SPPE-01>

US EPA 2020 – United States Environmental Protection Agency (US EPA). Inventory of U.S. Greenhouse Gas Emissions and Sinks. Accessed on: July 2020. Available online at: <https://www.epa.gov/ghgemissions/inventory-us-greenhouse-gas-emissions-and-sinks>

4.9 Hazards and Hazardous Materials

This section describes the environmental and regulatory setting and discusses impacts associated with the construction and operation of the project specific to hazards and hazardous materials.

HAZARDS AND HAZARDOUS MATERIALS	Potentially Significant Impact	Less Than Significant with Mitigation Incorporated	Less Than Significant Impact	No Impact
Would the project:				
a. Create a significant hazard to the public or the environment through the routine transport, use, or disposal of hazardous materials?	<input type="checkbox"/>	<input type="checkbox"/>	<input checked="" type="checkbox"/>	<input type="checkbox"/>
b. Create a significant hazard to the public or the environment through the routine transport, use, or disposal of hazardous materials?	<input type="checkbox"/>	<input type="checkbox"/>	<input checked="" type="checkbox"/>	<input type="checkbox"/>
c. Emit hazardous emissions or handle hazardous or acutely hazardous materials, substances, or waste within one-quarter mile of an existing or proposed school?	<input type="checkbox"/>	<input type="checkbox"/>	<input type="checkbox"/>	<input checked="" type="checkbox"/>
d. Be located on a site which is included on a list of hazardous materials sites compiled pursuant to Government Code Section 65962.5 and, as a result, would it create a significant hazard to the public or the environment?	<input type="checkbox"/>	<input type="checkbox"/>	<input checked="" type="checkbox"/>	<input type="checkbox"/>
e. For a project located within an airport land use plan or, where such a plan has not been adopted, within two miles of a public airport or public use airport, would the project result in a safety hazard or excessive noise for people residing or working in the project area?	<input type="checkbox"/>	<input type="checkbox"/>	<input type="checkbox"/>	<input checked="" type="checkbox"/>
f. Impair implementation of or physically interfere with an adopted emergency response plan or emergency evacuation plan?	<input type="checkbox"/>	<input type="checkbox"/>	<input type="checkbox"/>	<input checked="" type="checkbox"/>
g. Expose people or structures, either directly or indirectly, to a significant risk of loss, injury or death involving wildland fires?	<input type="checkbox"/>	<input type="checkbox"/>	<input type="checkbox"/>	<input checked="" type="checkbox"/>

Environmental checklist established by CEQA Guidelines, Appendix G.

4.9.1 Setting

Hazardous Waste and Substances Sites

The project owner hired Cornerstone Earth Group, Inc. (Cornerstone) to conduct a Phase 1 Environmental Site Assessment (ESA) and to determine the location of hazardous wastes and hazardous material release sites within 0.25 mile of the project. The analysis provided by Cornerstone included within the Phase 1 ESA a search through Environmental Data Resources, Inc (EDR) proprietary database related to generation, storage, handling, transportation, treatment of wastes, and the remediation of contaminated soil and

groundwater sites. Cornerstone included searches of the State Water Resources Control Board's (SWRCB), GeoTracker database, and the California Department of Toxic Substance Control's (DTSC) EnviroStor database.

The site was used for agricultural purposes, mainly orchards. A single-family residence, known as the Martin House, was constructed in 1910. In 1997, the residence and associated buildings, along with three above-ground fuel tanks and an agricultural chemical storage trailer were removed from the site. Currently, the site has been undeveloped agricultural land used for hay cultivation (SV1 2020a).

In 2012, Cornerstone conducted a limited subsurface investigation of the site that included analysis of 40 soil samples taken from the project site using a combination of hand sampling and direct push drilling equipment. The subsurface investigation focused on the potential for lead paint soil contamination around existing structures that were removed from site and pesticide contamination in agricultural fields. Organochlorine pesticides, lead, arsenic and mercury concentrations were detected in the soil samples at levels less than their residential or commercial screening levels (SV1 2020b).

In several soil samples collected off-site on the southwesterly adjacent parcel (APN 706-02-058), concentrations of organochlorine pesticides (dichlorodiphenyldichloroethane, dichlorodiphenyldichloroethylene and dichlorodiphenyltrichloroethane) and lead exceeding residential and commercial screening levels were detected. The highest concentrations were generally identified in soil near the former off-site structure locations (SV1 2020b). See **Figure 4.9-1** for project site plan and adjacent parcels.

Airports

There are no public or active private airports located within 2 miles of the project. The nearest airports are the Norman Y. Mineta San Jose International Airport and Reid-Hillview Airport. The Norman Y. Mineta San Jose International Airport is located approximately 15 miles south of the project site and the Reid-Hillview Airport is approximately 10 miles west of the project site.

Schools

There are no schools within 0.25 mile of the project site. The closest school is the Stratford Preschool, which is approximately 0.80 miles east of GOSDC.

Emergency Evacuation Routes

The Santa Clara Local Hazard Mitigation Plan (Santa Clara County 2017) and the San Jose Emergency Operations Base Plan (San Jose 2019) identifies potential hazards and provides a risk assessment for the potential natural hazards, such as a flood, wildfire, or earthquake, that could impact the city and the county. The plan does not identify any designated evacuation routes near the project site.

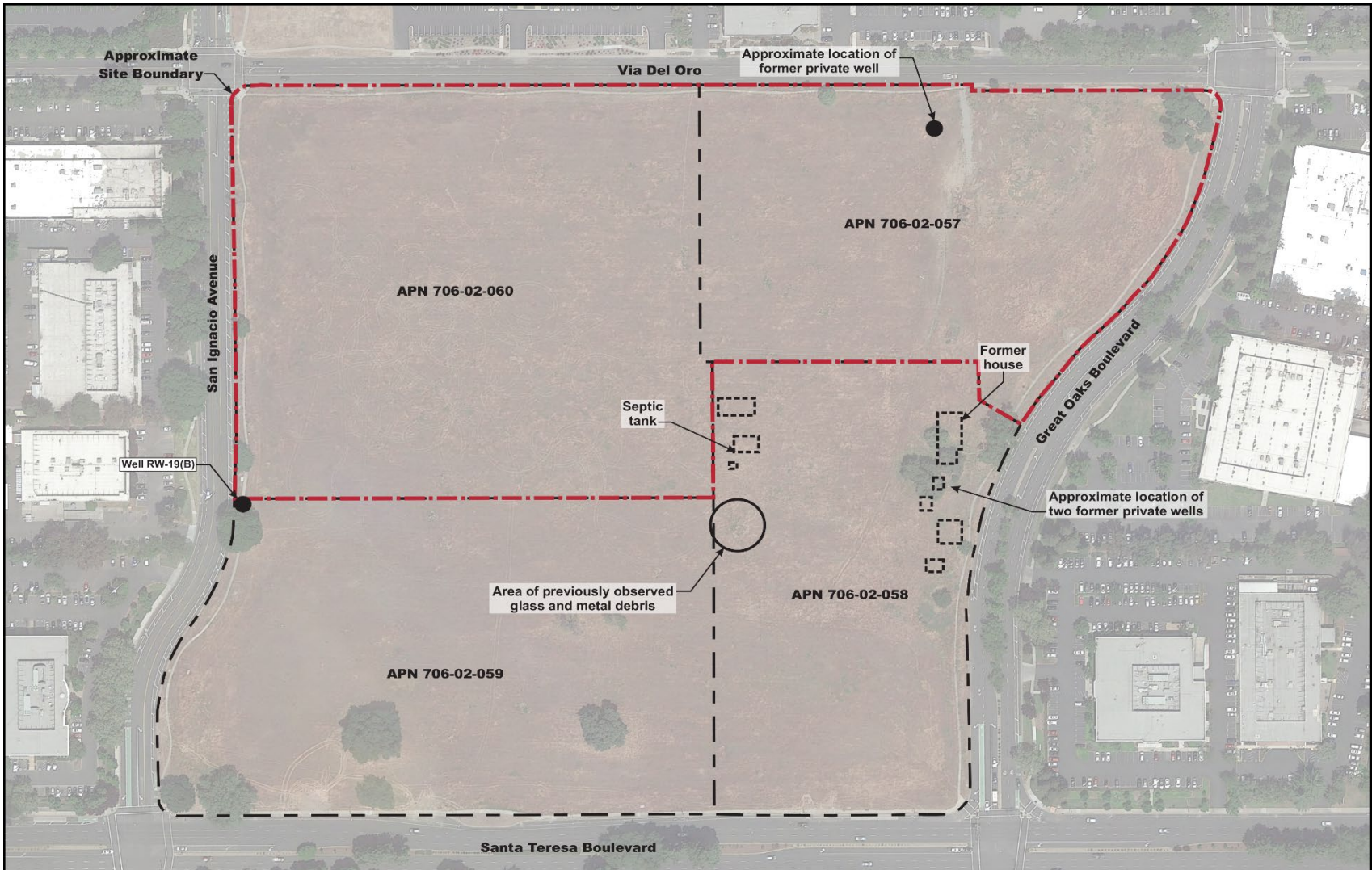

- Approximate location of well
- Approximate location of former house and associated outbuildings



Figure 4.9-1
Site Plan

Source: TN232467-2 GOSBGF SPPE Application Appendix G, Figure 2

Wildfire Hazards

The California Department of Forestry and Fire Protection (Cal Fire) identifies and maps areas of significant fire hazards based on fuels, terrain, and other relevant factors. The maps identify this information as a series of Fire Hazard Severity Zones, which are progressively ranked in severity as un-zoned, moderate, high, and very high. State responsibility areas (SRAs) are locations where the State of California is responsible for wildland fire protection. Local responsibility areas (LRAs) are locations where the responding agency is the local county or city. The new GOSDC would be located within Santa Clara County.

The Cal Fire maps for Santa Clara County (CalFire 2007) indicate that the project site is located in an LRA. Within the LRA, the project site falls within an un-zoned Fire Hazard Severity Zone that indicates that the project site has a less than moderate susceptibility to wildland fires. For more information on wildfire hazards, see **Section 4.19 Wildfire**.

Regulatory Background

Federal

Resource Conservation and Recovery Act. The federal Toxic Substances Control Act (1976) and the Resource Conservation and Recovery Act of 1976 (RCRA) established a program administered by the U.S. EPA for the regulation of the generation, transportation, treatment, storage, and disposal of hazardous waste. RCRA was amended in 1984 by the Hazardous and Solid Waste Act, which affirmed and extended the “cradle to grave” system of regulating hazardous wastes. The use of certain techniques for the disposal of some hazardous wastes was specifically prohibited by the Hazardous and Solid Waste Act.

Comprehensive Environmental Response, Compensation, and Liability Act. Congress enacted the federal CERCLA, including the Superfund program, on December 11, 1980. This law provided broad federal authority to respond directly to releases or threatened releases of hazardous substances that may endanger public health or the environment. CERCLA established requirements concerning closed and abandoned hazardous waste sites; provided for liability of persons responsible for releases of hazardous waste at these sites; and established a trust fund to provide for cleanup when no responsible party could be identified. CERCLA also enabled the revision of the National Contingency Plan. The National Contingency Plan provided the guidelines and procedures needed to respond to releases and threatened releases of hazardous substances, pollutants, and/or contaminants. The National Contingency Plan also established the National Priorities List. CERCLA was amended by the Superfund Amendments and Reauthorization Act on October 17, 1986.

Department of Transportation. The United States Department of Transportation is the primary federal agency responsible for regulating the proper handling and storage of hazardous materials during transportation (49 C.F.R. §§ 171-177 and 350-399).

Federal Aviation Administration. Title 14, Part 77.9 of the Code of Federal Regulations requires Federal Aviation Administration (FAA) notification for any construction or alteration of navigable airspace exceeding 200 feet above ground level (AGL). It also requires notification for construction or alterations within 20,000 feet of an airport with a runway more than 3,200 feet in length if the height of the construction or alteration exceeds a slope of 100 to 1 extending outward and upward from the nearest point of the nearest runway of the airport.

If a project's height exceeds 200 feet or exceeds the 100:1 surface, the project applicant must submit a copy of FAA Form 7460-1, Notice of Proposed Construction or Alteration, to the FAA.

State

California Environmental Protection Agency. The California Environmental Protection Agency (CalEPA), created in 1991, unified California's environmental authority in a single cabinet-level agency and brought the California Air Resources Board (CARB), State Water Resources Control Board (SWRCB), Regional Water Quality Control Boards (RWQCBs), Integrated Waste Management Board, DTSC, Office of Environmental Health Hazard Assessment, and Department of Pesticide Regulation under one agency. These agencies under the CalEPA "umbrella" provide protection of human health and the environment and ensure the coordinated deployment of state resources. Their mission is to restore, protect and enhance the environment, to ensure public health, environmental quality, and economic vitality.

The California Hazardous Waste Control Law. CalEPA administers the California Hazardous Waste Control Law to regulate hazardous wastes. The Hazardous Waste Control Law lists 791 chemicals and about 300 common materials that may be hazardous; establishes criteria for identifying, packaging and labeling hazardous wastes; prescribes management controls; establishes permit requirements for treatment, storage, disposal and transportation; and identifies some wastes that cannot be disposed of in landfills.

Department of Toxic Substances Control. DTSC is a department within CalEPA and is the primary agency in California that regulates hazardous waste, cleans up existing contamination, and looks for ways to reduce the hazardous waste produced in California. DTSC regulates hazardous waste in California primarily under the authority of RCRA and the California Health and Safety Code. Other laws that affect hazardous waste are specific to handling, storage, transportation, disposal, treatment, reduction, cleanup, and emergency planning.

California Occupational Safety and Health Administration. California Occupational Safety and Health Administration (Cal OSHA) is the primary agency responsible for worker safety related to the handling and use of chemicals in the workplace. Cal OSHA standards are generally more stringent than federal regulations. The employer is required to monitor worker exposure to listed hazardous substances and notify workers of exposure (Title 8, Cal. Code Regs., §§ 337 340). The regulations specify requirements for employee training,

availability of safety equipment, accident-prevention programs, and hazardous substance exposure warnings.

Department of California Highway Patrol. Department of California Highway Patrol is the primary agency responsible for enforcing the regulations related to the transport of hazardous materials on California roads and highways (Title 13, Cal. Code Regs., §§ 1160-1167).

Local

City of San Jose General Plan. *Envision San Jose 2040 General Plan* includes policies applicable to all development projects in San Jose. The following are applicable to the proposed project:

- Policy EC-7.1: For development and redevelopment projects, require evaluation of the proposed site's historical and present uses to determine if any potential environmental conditions exist that could adversely impact the community or environment.
- Policy EC-7.2: Identify existing soil, soil vapor, groundwater, and indoor air contamination and mitigation for identified human health and environmental hazards to future users and provide as part of the environmental review process for all development and redevelopment projects. Mitigation measures for soil, soil vapor, and groundwater contamination shall be designed to avoid adverse human health or environmental risk, in conformance with regional, State, and Federal laws, regulations, guidelines, and standards.
- Policy EC-7.3: Where a property is located in near proximity of known groundwater contamination with volatile organic compounds or within 1,000 feet of an active or inactive landfill, evaluate and mitigate the potential for indoor air intrusion of hazardous compounds to the satisfaction of the City's Environmental Compliance Officer and appropriate regional, state and federal agencies prior to approval of a development or redevelopment project.
- Policy EC-7.4: On redevelopment sites, determine the presence of hazardous building materials during the environmental review process or prior to project approval. Mitigation and remediation of hazardous building materials, such as lead-paint and asbestos-containing materials, shall be implemented in accordance with state and federal laws and regulations.
- Policy EC-7.5: On development and redevelopment sites, require all sources of imported fill to have adequate documentation that it is clean and free of contamination and/or acceptable for the proposed land use considering appropriate environmental screening levels for contaminants. Disposal of groundwater from excavations on construction sites shall comply with local, regional, and state requirements.

Santa Clara County Operational Area Hazard Mitigation Plan. The plan includes a risk assessment that identifies the natural hazards and risks that can impact a community based on historical experience, estimates the potential frequency and magnitude of disasters, and assesses potential losses to life and property. The plan also includes

developed mitigation goals and objectives as part of a strategy for mitigating hazard-related losses.

San Jose City Emergency Operations Base Plan. The plan establishes the foundational policies and procedures that define how San Jose will prepare for, respond to, recover from, and mitigate against natural or human-caused disasters. It provides a description of the emergency management organization and how it is activated.

4.9.2 Applicant Proposed Measures

PD HAZ-1: The project proposes to implement the following measures which will reduce the potential for tracking of impacted soil from the adjacent parcel to the project site.

- During construction activities (e.g. grading, vehicle travel, movement of equipment or materials, etc.), adjacent to APN 706-02-058, the project contractor shall fence the southwesterly adjacent parcel (APN 706-02-058) separately from the rest of the site.

4.9.3 Environmental Impacts and Mitigation Measures

a. Create a significant hazard to the public or the environment through the routine transport, use, or disposal of hazardous materials?

Construction

Less Than Significant Impact. During the construction phase of the project, the only hazardous materials used would be paints, cleaners, solvents, gasoline, motor oil, welding gases, and lubricants. When not in use, any hazardous material would be stored in designated construction staging areas in compliance with local, state, and federal requirements. Any impacts resulting from spills or other accidental releases of these materials would be limited to the site due to the small quantities involved and their infrequent use, hence reduced chances of release. Temporary containment berms would also be used to help contain any spills during the construction of the project.

During construction, all 36 diesel generator and three 500 kW standby generator fuel tanks would have to be filled. The transportation of the diesel fuel to the site would take many tanker truck trips for the initial fill. Diesel fuel has a long history of being routinely transported and used as a common motor fuel. It is appropriate to rely upon the extensive regulatory framework that applies to the shipment of hazardous materials on California highways and roads to ensure safe handling in general transportation (see Federal Hazardous Materials Transportation Law 49 USC § 5101 et seq., DOT regulations 49 CFR subpart H, §§ 172–700, and California Department of Motor Vehicles (DMV) regulations on hazardous cargo). Thus, the transportation of diesel fuel would pose a less than significant risk to the surrounding public.

The routine transport, use or disposal of hazardous materials would have a less than significant impact to the public or the environment.

Operation

Less Than Significant Impact. Diesel fuel would be used during routine testing and maintenance, and emergencies if they occurred. Each generator would be tested up to 20 hours annually with 100% load on the engine (Great Oaks 2020a). The load tests would result in the tanks being refilled approximately twice a year.

Projects with diesel-fired back up generators would use standard practice for fuel quality and maintenance of stored diesel fuel. Standard practice includes that each engine would have a fuel filtration system that would filter the fuel contents daily. The project is implementing dual fuel filters on each diesel-fired back up generator. (SV1 2020d) The fuel filters would be replaced as needed or annually which would reduce any effects of fuel degradation on engine components and operation. Commercial diesel fuels also contain biocides that prevent microbial growth and additives that help to stabilize the fuel for several months.

These Tier 4 diesel generators would use selective catalytic reduction (SCR) that injects a liquid-reductant through a special catalyst into the exhaust stream of the diesel engine. The reductant source would be called diesel exhaust fluid (DEF) which is a non-hazardous solution of 67.5 percent water and 32.5 percent automotive grade urea. The DEF consumption would vary depending upon the environment, operation, and duty cycle of equipment. On average, DEF consumption would be 3 percent to 5 percent of diesel fuel consumption. The DEF tank levels would be monitored and refilled as necessary.

With the above listed safety features and precautions, the risk to the off-site public or environment through the routine transport, use or disposal of hazardous materials would have a less than significant impact.

Required Mitigation Measures: None.

b. Create a significant hazard to the public or the environment through reasonably foreseeable upset and accident conditions involving the release of hazardous materials into the environment?

Construction

Less Than Significant Impact. As described under the discussion for impact criterion "a", project construction would require the limited use of hazardous materials, such as fuels, lubricants, and solvents. The storage and use of hazardous materials during construction could result in the accidental release of small quantities of hazardous materials typically associated with minor spills or leaks. However, as discussed in impact criterion "a", hazardous materials would be stored, handled, and used in accordance with applicable regulations. Personnel would be required to follow instructions on health and safety precautions and procedures to follow in the event of a release of hazardous materials. All equipment and materials storage would be routinely inspected for leaks. Records would be maintained for documenting compliance with the storage and handling of hazardous materials.

For the above reasons, the project impacts would be less than significant.

Operation

Less Than Significant Impact. The project would not create a significant hazard to the public or environment due to an accidental release of a hazardous material. Although a substantial quantity of diesel fuel would be stored on-site, its storage would be tanks located in a dedicated fuel tank beneath each generator. Each tank can hold 9,200 gallons of diesel fuel. The 500- kW standby generator fuel tank would have a storage capacity of 2,000 gallons respectively.

Each generator's integrated fuel tank would be of a double-walled high integrity design. The interstitial space between the inner and outer walls of each tank would be continuously monitored electronically for the presence of leaks through the inner wall. The monitoring system would be electronically linked to an alarm system in the security office that would alert personnel if a leak were detected in any of the inner tanks.

Deliveries of diesel fuel by tanker truck during the project's operation would be scheduled on an as-needed basis. However, the estimated fuel consumed during routine maintenance and testing of the generators would require the diesel fuel to be replenished on a bi-annual basis and would take approximately twenty fuel tanker truck trips per year. Diesel tanker trucks would use warning signs and/or wheel chocks in the loading/unloading areas to prevent the truck from moving before complete disconnection of the transfer lines. An emergency pump shut-off would be available in case a pump hose breaks during the fueling. In addition, a temporary spill catch basin would be located at the fill port of each generator fuel tank during refilling. For the above listed safety features and precautions, the risk to the off-site public or environment through reasonably foreseeable upset and accident conditions involving the release of hazardous materials would have a less than significant impact.

Required Mitigation Measures: None

c. Emit hazardous emissions or handle hazardous or acutely hazardous materials, substances, or waste within one-quarter mile of an existing or proposed school?

Construction and Operation

No Impact. There are no schools located or proposed within 0.25 mile of the project site. In addition, there are no hazardous materials that would be emitted from the site at rates capable of creating offsite impacts. Therefore, there would be no impact.

d. Be located on a site which is included on a list of hazardous materials sites compiled pursuant to Government Code Section 65962.5 and, as a result, would it create a significant hazard to the public or the environment?

Construction

Less Than Significant Impact. According to a review of the Envirostor and GeoTracker databases, the project site does not have any known, open cases on the hazardous materials sites compiled pursuant to Government Code section 65962.5. The project site was historically used for agricultural purposes. In Cornerstone's Phase 1 ESA, the analysis of the soil samples detected concentrations of organochlorine pesticides, lead, arsenic and mercury at levels less than their residential or commercial screening levels, and therefore poses a less than significant impact (Great Oaks 2020b).

In several soil samples collected off-site on the southwesterly adjacent parcel (APN 706-02-058), concentrations of organochlorine pesticides (DDD, DDE and DDT) and lead exceeding residential and commercial screening levels were detected. The highest concentrations were generally identified in soil near the former off-site structure locations.

With the implementation of the PD HAZ-1, the project contractor would be required to fence the southwesterly adjacent parcel (APN 706-02-058) separately from the rest of the site. The proposed measure eliminates the potential to track contaminated soil to the project site from the adjacent parcel (APN 706-02-058) during construction activities, such as grading, vehicle travel, or movement of the equipment or materials. Therefore, the construction of the project would create a less than significant impact to the public or the environment. See **Figure 4.9-1** for project site plan and adjacent parcels.

Operation

No Impact. Operation and maintenance activities would not involve excavation activities and would therefore have no impact.

Required Mitigation Measures: None

e. For a project located within an airport land use plan or, where such a plan has not been adopted, within two miles of a public airport or public use airport, would the project result in a safety hazard or excessive noise for people residing or working in the project area?

Construction

No Impact. There are no public or private airports within 2 miles of the project and the project does not fall within an airport land use plan. Therefore, the project would not pose a safety hazard and would have no impact. Project construction would not result in excessive noise impacts for people residing or working in the project area, as described in a more detailed analysis in **Section 4.13 Noise**.

Operation

No Impact. Operation and maintenance activities for the project site would be similar to those for a similarly sized industrial building and would not have an impact on people working or residing in the area. In addition, the thermal plume generated by the project would not pose a safety hazard to any aircraft near the Norman Y. Mineta San Jose International Airport or Reid-Hillview Airport. Detailed analysis of potential thermal plume impacts is contained in **Section 4.17 Transportation**.

f. Impair implementation of or physically interfere with an adopted emergency response plan or emergency evacuation plan?

Construction

No Impact. A review of the Santa Clara County Operational Area Hazard Mitigation Plan and the San Jose Emergency Operations Base Plan for the project revealed no specific mapping or delineation of emergency evacuation or access routes. The plans identified that the area police, fire department, and other emergency services would implement their emergency response or evacuation plans according to their communications protocols and hazard mitigation programs. The project site is not identified on any emergency evacuation or access routes. In addition, the construction would not require any road closures since the work would all be done onsite. During project construction, there would be no impact to an adopted response plan or emergency evacuation plan.

Operation

No Impact. After construction, no lane closures would be needed, and no impact to a response plan or emergency evacuation plan would occur.

g. Expose people or structures, either directly or indirectly, to a significant risk of loss, injury or death involving wildland fires?

Construction and Operation

No Impact. The project site is located in Santa Clara County. It is located within an un-zoned Fire Hazard Severity Zone, within an LRA, indicating that the project site has a less than moderate susceptibility to wildland fires. The project site is not adjacent to wildlands. The project site is located in an office park area and is surrounded by commercial office buildings to the west, north, and east. There are no developments south of the site. Although equipment and vehicles used during construction, as well as welding activities, have the potential to ignite dry vegetation, the project is located within an urban area surrounded by industrial and commercial zones that have very limited dry vegetation. In addition, the project is located within an un-zoned fire hazard area. Therefore, there would be no impact from wildland fires resulting from construction activities related to the project.

4.9.4 References

- CEC 2020b – California Energy Commission (CEC). Data Requests Set 2: Great Oaks South Backup Generating Facility (TN 232755), April 2020. Available online at: <https://efiling.energy.ca.gov/Lists/DocketLog.aspx?docketnumber=20-SPPE-01>
- CalFire 2007 – California Department of Forestry and Fire Protection (CalFire). 2007 Santa Clara County – Very High Fire Hazard Severity Zones in State Responsibility Area. Department of Forestry and Fire Protection. Projection Albers, NAD 1927, Scale 1: 100,000 at 32" x 27"
- DTSC 2018 – Department of Toxic Substances Control (DTSC). Envirostor Database. Accessed on: February 13, 2020. Available online at: <http://www.envirostor.dtsc.ca.gov/public/>
- San Jose 2018 – City of San Jose Emergency Management (San Jose). February 2018. City of San Jose Emergency Operations Base Plan. Available online at: <https://www.sanjoseca.gov/home/showdocument?id=42015>
- Santa Clara County 2017 – County of Santa Clara Emergency Management (Santa Clara County). October 15, 2017. Santa Clara County Operational Area Hazard Mitigation Plan Volume 1. Available online at: <https://www.sccgov.org/sites/oes/partners/Documents/Local-Hazard-Mitigation-Plan-LHMP-Vol-1.pdf>
- SCCALUC 2016 – Santa Clara County Airport Land Use Commission (SCCALUC). Mineta San Jose International Airport Comprehensive Land Use Plan for Santa Clara County. Adopted May 25, 2011. Amended November 16, 2016. Accessed on: May 12, 2020. Available online at: https://www.sccgov.org/sites/dpd/DocsForms/Documents/ALUC_SJC_CLUP.pdf
- SV1 2020a – SV1, LLC. (SV1). Application for Small Power Plant Exemption: Great Oaks South Backup Generating Facility (TN 232466), March 2020. Available online at: <https://efiling.energy.ca.gov/Lists/DocketLog.aspx?docketnumber=20-SPPE-01>
- SV1 2020b – SV1, LLC. (SV1). Application Appendices A through K: Great Oaks South Backup Generating Facility (TN 232467-1,2,3), March 2020. Available online at: <https://efiling.energy.ca.gov/Lists/DocketLog.aspx?docketnumber=20-SPPE-01>
- SV1 2020d – SV1, LLC. (SV1). SV1 Responses to CEC Data Request Set 2: Great Oaks South Backup Generating Facility Part 1 through Part 4 (TN 233005-1,2,3,4), May 2020. Available online at: <https://efiling.energy.ca.gov/Lists/DocketLog.aspx?docketnumber=20-SPPE-01>
- SWRCB 2018 – State Water Resources Control Board (SWRCB). GeoTracker Database. Accessed on: May 13, 2020. Available online at: <http://geotracker.waterboards.ca.gov>

4.10 Hydrology and Water Quality

This section describes the environmental and regulatory setting and discusses potential impacts associated with the construction and operation of the proposed project specific to hydrology and water quality.

HYDROLOGY AND WATER QUALITY	Potentially Significant Impact	Less Than Significant with Mitigation Incorporated	Less Than Significant Impact	No Impact
Would the project:				
a. Violate water quality standards or waste discharge requirements or otherwise substantially degrade surface or ground water quality?	<input type="checkbox"/>	<input type="checkbox"/>	<input checked="" type="checkbox"/>	<input type="checkbox"/>
b. Substantially decrease groundwater supplies or interfere substantially with groundwater recharge such that the project may impede sustainable groundwater management of the basin?	<input type="checkbox"/>	<input type="checkbox"/>	<input checked="" type="checkbox"/>	<input type="checkbox"/>
c. Substantially alter the existing drainage pattern of the site or area, including through the alteration of the course of a stream or river, or through the addition of impervious surfaces in a manner which would:				
i. result in substantial erosion or siltation, on- or offsite;	<input type="checkbox"/>	<input type="checkbox"/>	<input checked="" type="checkbox"/>	<input type="checkbox"/>
ii. substantially increase the rate or amount of surface runoff in a manner which would result in flooding on- or offsite;	<input type="checkbox"/>	<input type="checkbox"/>	<input checked="" type="checkbox"/>	<input type="checkbox"/>
iii. create or contribute runoff water which would exceed the capacity of existing or planned stormwater drainage systems or provide substantial additional sources of polluted runoff; or	<input type="checkbox"/>	<input type="checkbox"/>	<input checked="" type="checkbox"/>	<input type="checkbox"/>
iv. impede or redirect flood flows?	<input type="checkbox"/>	<input type="checkbox"/>	<input checked="" type="checkbox"/>	<input type="checkbox"/>
d. In flood hazard, tsunami, or seiche zones, risk release of pollutants due to project inundation?	<input type="checkbox"/>	<input type="checkbox"/>	<input checked="" type="checkbox"/>	<input type="checkbox"/>
e. Conflict with or obstruct implementation of a water quality control plan or sustainable groundwater management plan?	<input type="checkbox"/>	<input type="checkbox"/>	<input checked="" type="checkbox"/>	<input type="checkbox"/>

Environmental checklist established by CEQA Guidelines, Appendix G.

4.10.1 Setting

Storm Drainage and Water Quality

The project would be constructed in the city of San Jose within the Guadalupe Watershed, a 170-square-mile area with multiple small-creek watersheds, and storm water runoff from the project site drains into Canoas Creek. Canoas Creek is a tributary to the Guadalupe River, an alluvial stream that originates in the Santa Cruz Mountains west and south of San Jose and flows in a northerly direction to San Francisco Bay.

Under existing conditions, the site is undeveloped and the entire site is pervious to precipitation and surface flow. Runoff from the site likely contains minor amounts of sediment and plant debris. Storm drain lines serving the project area include a 48-inch storm main in San Ignacio Avenue, a 24-inch storm main in Via Del Oro, and a 48-inch storm main in Great Oaks Boulevard.

Groundwater

The Santa Clara Valley groundwater basin is divided into four interconnected subbasins that border the southern San Francisco Bay. The proposed project would be located in the Santa Clara Subbasin, which extends across the Santa Clara Valley in the region south of San Francisco Bay. The project site is within a portion of the basin where groundwater occurs under unconfined conditions. The site is located within an urbanized area of San Jose and is not within or adjacent to a Santa Clara Valley Water District (SCVWD) groundwater recharge facility, such as a SCVWD recharge pond (SV1 2020a).

Groundwater was not encountered during field explorations at the project site. According to public well data, groundwater in the project area has been found at depths between 30 feet to 70 feet below ground surface (SV1 2020a).

Flooding

The elevation of the project site is at about 200 feet above the 1988 North American Vertical Datum (NAVD88) (USGS 2018). According to the Federal Emergency Management Agency's (FEMA) Flood Insurance Rate Map (FIRM) 06085C0407H, effective May 18, 2009, the project site is located within Zone D. Zone D is defined as an area where flood hazards are undetermined, but possible. There are no city of San Jose floodplain requirements for Zone D. Also, the project site is not within an area mapped as vulnerable to sea level rise in the National Oceanic and Atmospheric Administration's Digital Coast, Sea Level Rise Viewer (NOAA 2020).

Regulatory Background

Federal

Clean Water Act and California's Porter-Cologne Water Quality Control Act.

The State Water Resources Control Board (SWRCB) and its nine Regional Water Quality Control Boards (RWQCB) are responsible for the regulation and enforcement of the water

quality protection requirements of the federal Clean Water Act (CWA) and the state's Porter-Cologne Water Quality Control Act (Porter-Cologne). The National Pollutant Discharge Elimination System (NPDES) is the permitting program that allows point source dischargers to comply with the CWA and Porter-Cologne laws. This regulatory framework protects the beneficial uses of the state's surface and groundwater resources for public benefit and from environmental degradation. Protection of water quality could be achieved by ensuring the proposed project complies with applicable NPDES permits from the SWRCB or the San Francisco Bay RWQCB.

Under Section 303(d) of the CWA, states are required to identify impaired surface water bodies and develop total maximum daily loads (TMDLs) for contaminants of concern. The TMDL is the quantity of pollutant that can be assimilated by a water body without violating water quality standards. Listing of a water body as impaired does not necessarily suggest that the water body cannot support the beneficial uses; rather, the intent is to identify the water body as requiring future development of a TMDL to maintain water quality and reduce the potential for future water quality degradation. Guadalupe River, west of the project site, is currently listed on the United States Environmental Protection Agency's Section 303(d) Listed Waters for California for diazinon, mercury, and trash.

The San Francisco Bay RWQCB issued a Municipal Regional Storm Water NPDES Permit (Permit Number CAS612008) that requires the city of San Jose to implement a storm water quality protection program. This regional permit applies to 77 Bay Area municipalities, including the city of San Jose. Under the provisions of the Municipal NPDES Permit, redevelopment projects that disturb more than 10,000 square feet are required to design and construct storm water treatment controls to treat post-construction storm water runoff. The permit requires the post-construction runoff from qualifying projects to be treated by using low impact development (LID) treatment controls, such as biotreatment facilities.

The Santa Clara Valley Urban Runoff Pollution Prevention Program (SCVURPPP) assists co-permittees, such as the city of San Jose, in the implementation of the provisions of the Municipal NPDES Permit. In addition to water quality controls, the Municipal NPDES Permit requires all new and redevelopment projects that create or replace one acre or more of impervious surface to manage development-related increases in peak runoff flow, volume, and duration, where such hydromodification is likely to cause increased erosion, silt pollutant generation, or other impacts to beneficial uses of local rivers, streams, and creeks. Projects may be deemed exempt from the permit requirements if they do not meet the size threshold, drain into tidally influenced areas or directly into the Bay (per the city of San Jose Hydromodification Management Map). The project site is located in a catchment area with imperviousness of less than 65 percent; thus, the project site is subject to the SCVURPPP hydromodification requirements.

Federal Emergency Management Agency Flood Insurance Program. The magnitude of flood used nationwide as the standard for floodplain management is a flood having a probability of occurrence of one percent in any given year. This flood is also known as the 100-year flood, or base flood. The Federal Insurance Rate Map (FIRM) is

the official map created and distributed by Federal Emergency Management Agency (FEMA) for the National Flood Insurance Program that shows areas subject to inundation by the base flood for participating communities. FIRMs contain flood risk information based on historic, meteorologic, hydrologic, and hydraulic data, as well as open-space conditions, flood control works, and development.

State

State Sustainable Groundwater Management Act. The 2014 Sustainable Groundwater Management Act (SGMA) requires local public agencies and Groundwater Sustainability Agencies (GSAs) in high- and medium-priority basins to develop and implement Groundwater Sustainability Plans (GSPs) or Alternatives to GSPs. GSPs are detailed road maps for how groundwater basins will be managed to reach long term sustainability.

The SCVWD is the exclusive GSA for the Santa Clara Valley Subbasin, which contains the proposed project. SCVWD developed a groundwater management plan for the Santa Clara and Llagas Subbasins that is intended to be functionally equivalent to a GSP.

Local

City of San Jose Municipal Code. Chapter 17.08 (special flood hazard area) of the San Jose Municipal Code promotes the public health, safety, and general welfare, to minimize public and private losses due to flood conditions in specific areas by legally enforceable regulations applied uniformly throughout the community to all publicly and privately-owned land within flood prone areas.

City of San Jose Post-Construction Urban Runoff Management. City Policy No. 6-29 implements the storm water treatment requirements of Provision C.3 of the Municipal NPDES Permit. The same policy requires all new and redevelopment projects regardless of size and land use to implement post-construction Best Management Practices (BMPs) and Treatment Control Measures (TCMs) to the maximum extent practicable. This policy also established specific design standards for post-construction TCMs for projects that create, add, or replace 10,000 square feet or more of impervious surface area to use site design and source control measures and numerically-sized LID storm water treatment measures in accordance with the strategies set forth in the policy.

City of San Jose Hydromodification Management. City Policy No. 8-14 implements the storm water treatment requirements of Provision C.3 of the Municipal NPDES Permit. Policy No. 8-14 requires all new and redevelopment projects that create or replace one acre or more of impervious surface to manage development-related increases in peak runoff flow, volume, and duration, where such hydromodification is likely to cause increased erosion, silt pollutant generation or other impacts to beneficial uses of local

rivers, streams, and creeks. The policy requires these projects to be designed to control project-related hydromodification through a Hydromodification Management Plan (HMP).

4.10.2 Applicant Proposed Measures

PD HYD-1: The project will incorporate the following into the design and these measures should be treated as mitigation incorporated into the project. The following will reduce construction-related water quality impacts:

- Burlap bags filled with drain rock shall be installed around storm drains to route sediment and other debris away from the drains.
- Earthmoving or other dust-producing activities shall be suspended during periods of high winds.
- All exposed or disturbed soil surfaces shall be watered at least twice daily to control dust as necessary.
- Stockpiles of soil or other materials that can be blown by the wind shall be watered or covered.
- All trucks hauling soil, sand, and other loose materials shall be required to be covered trucks or maintain at least two feet of freeboard.
- All paved access roads, parking areas, staging areas and residential streets adjacent to the construction site shall be swept daily (with water sweepers).
- Vegetation in disturbed areas shall be replanted as quickly as possible.
- All unpaved entrances to the site shall be filled with rock to knock mud from truck tires prior to entering City streets. A tire wash system may also be employed at the request of the City.
- The project proponent shall comply with the City of San Jose Grading Ordinance, including implementing erosion and dust control during site preparation and with the City of San Jose Zoning Ordinance requirements for keeping adjacent streets free of dirt and mud during construction.
- A Storm Water Permit shall be administered by the SWRCB. Prior to construction grading for the proposed land uses, the project proponents will file an NOI to comply with the General Permit and prepare a SWPPP which addresses measures that will be included in the project to minimize and control construction and post-construction runoff. Measures will include, but are not limited to, the aforementioned RWQCB Best Management Practices.
- The SWPPP shall be posted at the project site and shall be updated to reflect current site conditions.
- When construction is complete, a Notice of Termination for the General Permit for Construction shall be filed with the SWRCB. The Notice of Termination shall document that all elements of the SWPPP have been executed, construction

materials and waste have been properly disposed of, and a post-construction stormwater management plan is in place as described in the SWPPP for the site.

4.10.3 Environmental Impacts and Mitigation Measures

a. Would the project violate water quality standards or waste discharge requirements or otherwise substantially degrade surface or ground water quality?

Construction and Operation

Less Than Significant Impact. The proposed project would disturb about 20 acres of land in total (18 acres for the data center and 2 acres for the substation) and would be subject to construction-related storm water permit requirements of California's NPDES General Permit for Storm Water Discharges Associated with Construction and Land Disturbance Activities (Construction General Permit) administered by the SWRCB. Prior to any ground-disturbing construction activity, the applicant must comply with the Construction General Permit, which includes preparation of a construction Storm Water Pollution Prevention Plan (SWPPP). With implementation of the construction SWPPP, redevelopment of the site would not cause a substantial degradation in the quality, or an increase in the rate or volume, of storm water runoff from the site during construction. In addition, the Municipal NPDES permit, as well as the SCVURPPP, requires that redevelopment not result in a substantial net increase in storm water flow exiting the project site during operation. As a result, runoff from the project site would not be expected to exceed the capacity of the local drainage system or to significantly contribute to the degradation of storm water runoff quality.

The project could potentially excavate soil at the existing site to a maximum depth of 10 feet below grade (SV1 2020a). It is therefore unlikely that the project would encounter groundwater during excavation activities or that dewatering would be necessary during construction.

Under existing conditions, the site does not have any impervious surfaces. Implementation of the project would increase site impervious surface to about 645,983 square feet. The increase in impervious surface area would result in an increase in storm water runoff generated from the project site, which could impact water quality. The project would be required to comply with the city of San Jose's Post-Construction Urban Runoff Policy No. 6-29, Municipal NPDES Permit, and the SCVURPPP. The plans and permits work together to establish specific requirements to reduce storm water pollution from new and redevelopment projects. They also require post-construction storm water runoff to be treated by appropriately sized LID treatment controls.

The proposed property is located in a catchment or sub-watershed that is less than 65 percent impervious. Development of any property located in such a catchment area that results in more than one acre of impervious surfaces will require the incorporation of hydromodification management controls in accordance with Provision C.3.g of the

RWQCB-issued Municipal Stormwater Permit and city of San Jose Policy 8-14: Post-Construction Hydromodification Management. The project proposes to implement an underground detention basin with a storage volume of about 100,000 cubic feet, which would satisfy the identified hydromodification requirements.

Thus, the project would adequately mitigate for its proposed increase in stormwater runoff and would not be expected to violate water quality standards or waste discharge requirements during construction or operation. Therefore, impacts would be less than significant.

Required Mitigation Measures: None.

b. Would the project substantially decrease groundwater supplies or interfere substantially with groundwater recharge such that the project may impede sustainable groundwater management of the basin?

Construction and Operation

Less Than Significant Impact. The project is in the Great Oaks Water Company (GOWC) service area that serves over 20,000 customers across a 14 square mile area. Potable water supply for this area is locally produced groundwater. Recycled water is not available at the site (SV1 2020a).

The project proposes to use about 4 acre-feet (AF) of groundwater during 47 months of construction and about 4 acre-feet per year (AFY) during operations. According to the Great Oaks Water Company 2015 Urban Water Management Plan (UWMP), Table 7-4 Retail: Multiple Dry Years Supply and Demand Comparison, they would have adequate supplies between 2020 and 2040 during normal, single-dry, and multiple-dry years to serve the proposed project (GOWC 2015).

The GOWC's 2015 UWMP states that the Santa Clara Valley Subbasin is managed by the SCVWD, the local GSA. According to the SCVWD's 2015 UWMP, California Department of Water Resources (DWR) has identified the Santa Clara Valley Subbasin as a medium-priority groundwater basin, and that this subbasin is not in critical overdraft condition (SCVWD 2015). Additionally, in case of a water supply shortage, GOWC and the SCVWD have adopted water conservation policies to reduce demand such that available supplies are sufficient to meet demand (GOWC 2015 and SCVWD 2015).

The project's proposed use of 4 AF during construction and 4 AFY during operation would not substantially decrease critical groundwater supplies. The project's impact on groundwater supplies, recharge, or sustainable groundwater management during construction and operation would therefore be less than significant.

Required Mitigation Measures: None.

c. Would the project substantially alter the existing drainage pattern of the site or area, including through the alteration of the course of a stream or river, or through the addition of impervious surfaces in a manner which would:

i. Result in substantial erosion or siltation on- or off-site;

Construction and Operation

Less Than Significant Impact. The existing site is almost completely pervious. The proposed project would result in an increase of impervious areas that would result in an increase in storm water runoff from the project site. To mitigate the potential storm water increase, the project would include a new storm water collection system that would incorporate source, treatment, and hydromodification control BMPs. These BMPs would reduce the overall runoff into the city's collection system and also reduce erosion and sedimentation impacts. This post-construction design would therefore not be expected to substantially increase runoff (rate or volume) from the site. The storm water design is expected to comply with the SCVURPPP. Therefore, impacts would be less than significant.

Required Mitigation Measures: None.

ii. Substantially increase the rate or amount of surface runoff in a manner which would result in flooding on- or offsite;

Construction and Operation

Less Than Significant Impact. Surface runoff from the proposed project would be controlled as described under impact criterion "a" and "c (i)" above. Therefore, impacts would be less than significant.

Required Mitigation Measures: None.

iii. Create or contribute runoff water which would exceed the capacity of existing or planned storm water drainage systems or provide substantial additional sources of polluted runoff; or

Construction and Operation

Less Than Significant Impact. The proposed project would result in a new storm water collection system that includes BMPs to mitigate for any increases in runoff to the city's collection system. The discharge of polluted runoff from the site is not expected to be greater than what is expected under existing conditions. Therefore, impacts would be less than significant.

Required Mitigation Measures: None.

iv. Impede or redirect flood flows?

Construction and Operation

Less Than Significant Impact. According to the FEMA FIRM 06085C0407H, effective May 18, 2009, the project site is located within Zone D. Zone D is defined as an area where flood hazards are undetermined, but possible. There are no city of San Jose floodplain requirements for Zone D. The project site is also not within an area mapped as vulnerable to sea level rise in the National Oceanic and Atmospheric Administration's Digital Coast, Sea Level Rise Viewer (NOAA 2020).

The proposed project also would not be expected to add significantly to the existing potential of the site to impede or redirect flood flows. The project would be constructed on the Sana Clara Valley floor, which is broad and generally flat. The proposed structure would be expected to increase flood depths within the immediate vicinity of the new buildings but the flood water would dissipate almost immediately offsite. This localized increase in flood depth is not expected to be noticeable outside the project property. Therefore, significant obstruction of floods is not expected from the proposed project and the impacts would be less than significant.

Required Mitigation Measures: None.

d. Would the project, in flood hazard, tsunami, or seiche zones, risk release of pollutants due to project inundation?

Construction and Operation

Less Than Significant Impact. The project would not be constructed in an identified flood hazard area. Also, the project site is not within an area mapped as vulnerable to sea level rise in the National Oceanic and Atmospheric Administration's Digital Coast, Sea Level Rise Viewer (NOAA 2020).

The project site is located within the Anderson Dam failure inundation zone. The California Division of Safety of Dams is responsible for inspecting dams on an annual basis to ensure the dams are safe, perform as intended and are not prone to developing problems. As part of its comprehensive dam safety program, the SCVWD routinely monitors and studies the condition of each of its ten dams, including Anderson Dam. The city of San Jose's General Plan concludes that new development and redevelopment under the General Plan could result in placement of new development in Special Flood Hazard Areas and dam failure inundation zones; however, implementation of the city's policies and regulations would substantially reduce flooding and drainage hazards (SCVWD 2016).

The project site is not located near a large body of water, the ocean, or steep slopes. Due to the location of the proposed project site, it would not be subject to inundation by seiche, tsunami, or mudflow. Additionally, according the California Office of Emergency Services the site is not within a Tsunami Emergency Response Planning Zone (Cal OES 2020).

In the unlikely event of a flood, release of on-site pollutants would be prevented by implementation of the pollution prevention BMPs included in the SWPPP, Worker Environmental Training, a Spill Prevention, Control, and Countermeasure Plan, a Hazardous Materials Business Plan, and through an emergency spill response program. All of these measures would work together to help keep potential pollutants properly contained. Therefore, the impacts would be less than significant.

Required Mitigation Measures: None.

e. Would the project conflict with or obstruct implementation of a water quality control plan or sustainable groundwater management plan?

Construction and Operation

Less Than Significant Impact. The Water Quality Control Plan for the San Francisco Bay Basin (Basin Plan) is the local water quality control plan. The project would comply with the Basin Plan by implementing the requirements of the Construction General Permit, preparation of a construction SWPPP, and through the implementation of post-construction BMPs, as described under impact criterion "a" above. This impact would be less than significant.

The project proposes to use about 4 AF of groundwater during construction and about 4 AFY during operation. According to the Great Oaks Water Company 2015 Urban Water Management Plan (UWMP), Table 7-4 Retail: Multiple Dry Years Supply and Demand Comparison, they would have adequate supplies between 2020 and 2040 during normal, single-dry, and multiple-dry years to serve the proposed project (GOWC 2015).

The GOWC's 2015 UWMP states that the Santa Clara Valley Subbasin is managed by the SCVWD, the local GSA. According to the SCVWD's 2015 UWMP, California DWR has identified the Santa Clara Valley Subbasin as a medium-priority groundwater basin, and that this subbasin is not in critical overdraft condition (SCVWD 2015). Additionally, in case of a water supply shortage, GOWC and the SCVWD have adopted water conservation policies to reduce demand such that available supplies are sufficient to meet demand (GOWC 2015 and SCVWD 2015).

The project's proposed use of 4 AF during construction and 4 AFY during operation would not substantially decrease critical groundwater supplies. The project's impact on sustainable groundwater management during construction and operation would therefore be less than significant.

Required Mitigation Measures: None.

4.10.3 References

Cal OES 2020 – California Office of Emergency Services (Cal OES). My Hazards planning tool. Accessed on: July 12, 2020. Available online at:
<https://myhazards.caloes.ca.gov>

- GOWC 2015 – Great Oaks Water Company (GOWC). Great Oaks Water Company Urban Water Management Plan 2015. Prepared by Great Oaks Water Company in 2015. Accessed on: July 12, 2020. Available online at: <https://www.greatoakswater.com/OtherPDFs/2015UrbanWaterManagementPlan.pdf>
- NOAA 2020 – National Oceanic and Atmospheric Administration (NOAA). Digital Coast, Sea Level Rise Viewer. Accessed on: March 2, 2020. Available online at: <https://coast.noaa.gov/slr/#/layer/slr/0/-11581024.663779823/5095888.569004184/4/satellite/none/0.8/2050/interHigh/midAccretion>
- SCVWD 2015 – Santa Clara Valley Water District (SCVWD). Santa Clara Valley Water District Urban Water Management Plan 2015. Prepared by Santa Clara Valley Water District, May 2016. Accessed on: July 12, 2020. Available online at: <https://www.valleywater.org/sites/default/files/SCVWD%202015%20UWMP-Report%20Only.pdf>
- SCVWD 2016 – Santa Clara Valley Water District (SCVWD). Anderson Dam Flood Inundation Maps. Accessed on March 10, 2020. Accessed at: <https://www.valleywater.org/sites/default/files/Anderson%20Dam%20Inundation%20Maps%202016.pdf>
- SV1 2020a – SV1, LLC. (SV1). Application for Small Power Plant Exemption: Great Oaks South Backup Generating Facility (TN 232466), March 2020. Available online at: <https://efiling.energy.ca.gov/Lists/DocketLog.aspx?docketnumber=20-SPPE-01>
- SV1 2020d – SV1, LLC. (SV1). SV1 Responses to CEC Data Request Set 2: Great Oaks South Backup Generating Facility Part 1 through Part 4 (TN 233005-1,2,3,4), May 2020. Available online at: <https://efiling.energy.ca.gov/Lists/DocketLog.aspx?docketnumber=20-SPPE-01>
- USGS 2018 – United States Geological Survey (USGS). United States Geological Survey, Santa Teresa Hills, 7.5-minute series, Published 2018. Accessed on: July 6, 2020. Available online at: <https://viewer.nationalmap.gov>

4.11 Land Use and Planning

This section describes the environmental and regulatory setting and discusses impacts associated with the construction and operation of the project specific to land use and planning.

LAND USE AND PLANNING	Potentially Significant Impact	Less Than Significant with Mitigation Incorporated	Less Than Significant Impact	No Impact
Would the project:				
a. Physically divide an established community?	<input type="checkbox"/>	<input type="checkbox"/>	<input type="checkbox"/>	<input checked="" type="checkbox"/>
b. Cause a significant environmental impact due to a conflict with any land use plan, policy, or regulation adopted for the purpose of avoiding or mitigating an environmental effect?	<input type="checkbox"/>	<input type="checkbox"/>	<input checked="" type="checkbox"/>	<input type="checkbox"/>

Environmental checklist established by CEQA Guidelines, Appendix G.

4.11.1 Setting

The approximately 18-acre project site is located in the southern portion of the City of San Jose (City). The site covers two parcels; the eastern half of the site is assessor's parcel number (APN) 706-02-057, and the western half is APN 706-02-060. The project site's two parcels and the two contiguous parcels south of the site are undeveloped, open fields. The site is bordered on three sides by roadways, including Great Oaks Boulevard along the east side of the site, Via Del Oro along the north side, and San Ignacio Avenue along the west side. Adjacent areas are developed with businesses and uses that include commercial, technology and communications services, product manufacturing, light industrial, financial services, corporate offices, and health care services. Buildings in the area are typically one to three stories high. The Santa Teresa Light Rail Station is located approximately one-third mile from the project site, between Santa Teresa Boulevard and Via Del Oro. The Norman Y. Mineta San Jose International Airport is located over 10 miles northwest of the project site.

Regulatory Background

Federal

No federal regulations relating to land use and planning apply to the project.

State

No state regulations relating to land use and planning apply to the project.

Local

City of San Jose General Plan. *Envision San Jose 2040 General Plan* (General Plan) Land Use/Transportation Diagram shows that the eastern half of the project site is part of an area designated IP, Industrial Park, and the western half is part of an area designated TEC, Transit Employment Center. The IP designation is “intended for a wide variety of industrial users such as research and development, manufacturing, assembly, testing and offices” (San Jose 2020). The General Plan specifies a maximum floor area ratio (FAR) of 10.0 for properties designated IP, and the typical building height is two to 15 stories.

The TEC designation is “applied to areas planned for intensive job growth because of their importance as employment districts to the City and high degree of access to transit and other facilities and services.” “Uses allowed in the Industrial Park designation are appropriate in the Transit Employment Center designation...” (San Jose 2020). A maximum FAR of 12.0 is specified for properties designated TEC, and the typical building height is four to 25 stories.

Areas east and northeast of the project site include properties that are designated Combined Industrial/Commercial. The closest residential area is approximately 600 feet south of the site, on the south side of Santa Teresa Boulevard, a six-lane connector street. The area is designated Residential Neighborhood, which applies throughout the City to most of the established, single-family residential neighborhoods (San Jose 2020).

The General Plan contains implementation policies regarding the “City’s intent for the appropriate future land use and development character...for a designated area” (San Jose 2020). The following policy allows for flexibility in land use and permit decisions:

- IP-1.1 – Use the *Envision General Plan* Land Use/Transportation Diagram designations to indicate the general intended land use, providing flexibility to allow for a mix of land uses, intensities and development forms compatible with a wide variety of neighborhood contexts and to designate the intended roadway network to be developed over the timeframe of the *Envision General Plan*. Use the Zoning designation to indicate the appropriate type, form and height of development for particular properties.

The General Plan identifies employment areas on its Planned Growth Areas Diagram. The project site is within an employment area identified as the Old Edenvale Transit Employment Center, which is an area with access to light rail that is planned for additional job growth (San Jose 2020). The General Plan contains land use policies to focus new growth in identified Growth Areas; policy LU-2.2 supports intensification of employment activity in different parts of the City, including the Old Edenvale area.

The City adopted the Edenvale Area Development Policy (EADP) to manage traffic congestion; promote economic development, particularly high technology driven industries; and encourage a reverse commute to jobs in the EADP area (San Jose 2014). The project site is located in the Old Edenvale area, which is intended “for an

intensification of employment uses in the vicinity of the Santa Teresa Light Rail Transit Station...in accordance with the goals of the Envision San Jose 2040 General Plan.”

The General Plan contains community design policies pertaining to development design and building height, including the following:

- CD-4.9 – For development subject to design review, ensure the design of new or remodeled structures is consistent or complementary with the surrounding neighborhood fabric (including but not limited to prevalent building scale, building materials, and orientation of structures to the street).
- CD-8.1 – Ensure new development is consistent with specific height limits established within the City’s Zoning Ordinance and applied through the zoning designation for properties throughout the City. Land use designations in the Land Use/Transportation Diagram provide an indication of the typical number of stories expected for new development, however specific height limitations for buildings and structures in San Jose are not identified in the *Envision General Plan*.

City of San Jose Zoning Code. The entire project site is in the IP, Industrial Park zoning district, which is “an exclusive designation intended for a wide variety of industrial users such as research and development, manufacturing, assembly, testing, and offices. Industrial uses are consistent with this designation insofar as any functional or operational characteristics of a hazardous or nuisance nature can be mitigated through design controls” (San Jose 2021, § 20.50.010, subd. (C)(3)). Allowed uses for properties in the IP zoning district specify that a data center requires a Special Use Permit (San Jose 2021, § 20.50.100, subd. (E); Table 20-110).

The City’s development standards for the IP zoning district specify a front building setback of 15 feet to lot boundaries abutting streets (San Jose 2021, § 20.50.200, Table 20-120). Side and rear setbacks for buildings and structures to lot boundaries not abutting streets is zero unless the property abuts a residential district. The front setback for parking and circulation for passenger vehicles to lot boundaries is 25 feet. Development standards in the IP zoning district specify a maximum height of 50 feet unless a different maximum is established in Chapter 20.85, “Specific Height Restrictions,” for different geographic areas, including employment centers. For the Old Edenvale area where the project site is located, maximum allowable building height shall not exceed 250 feet (San Jose 2021, § 20.85.020, subd. (C)(2)).

Comprehensive Land Use Plan, Norman Y. Mineta San Jose International Airport. The Santa Clara County Airport Land Use Commission (ALUC) adopted the Comprehensive Land Use Plan (CLUP) for the San Jose International Airport in 2011; the ALUC approved minor amendments to the CLUP in 2016. The purpose of the CLUP is to safeguard the welfare of the inhabitants in the airport vicinity and ensure that new land uses do not affect airport operations. The project site is located over 7.0 miles from the closest boundary of the designated Airport Influence Area (AIA), which is a “composite of the areas surrounding the Airport that are affected by noise, height, and safety considerations” (Santa Clara County ALUC 2016). The project site is not located within

any of the Airport Safety Zones. The CLUP policies do not apply to the project. Therefore, the Land Use and Planning analysis contains no further discussion of the CLUP for the San Jose International Airport.

4.11.2 Applicant Proposed Measures

None.

4.11.3 Environmental Impacts and Mitigation Measures

a. Physically divide an established community?

Construction and Operation

No Impact. The project would be constructed and operated on two, undeveloped parcels of land. The project site's two parcels and the two contiguous parcels south of the site are bordered by roads and surrounded primarily by commercial, technology and communications, product manufacturing, and other similar uses. The parcel boundaries would remain the same, and the properties are privately owned and not open to public use. No changes are proposed involving construction of new facilities that could physically divide the community. Therefore, project construction and operation activities would not physically divide an established community, and no impact would occur.

b. Cause a significant environmental impact due to a conflict with any land use plan, policy, or regulation adopted for the purpose of avoiding or mitigating an environmental effect?

Construction and Operation

Less Than Significant Impact. As discussed in the subsections that follow, construction and operation of the project would not conflict with land use plans or policies such that significant environmental impacts would occur. Impacts would be less than significant.

City of San Jose General Plan. The eastern half of the project site is in an area with the land use designation IP, Industrial Park, which is "intended for a wide variety of industrial users such as research and development, manufacturing, assembly, testing and offices." Land uses in areas designated IP are limited "to those for which functional or operational characteristics of a hazardous or nuisance nature can be mitigated through design controls" (San Jose 2020). The western half of the project site is in an area with the land use designation TEC, Transit Employment Center. The TEC designation is "applied to areas planned for intensive job growth because of their importance as employment districts to the City and high degree of access to transit and other facilities and services." The General Plan specifies that uses allowed in areas with the IP designation are also appropriate in areas with the TEC designation. The project would be consistent with the description of uses allowed in areas with these land use designations, and it would not involve uses that could cause hazardous or nuisance impacts. (**Sections 4.3 Air Quality, 4.9 Hazards and Hazardous Materials, and 4.17 Transportation**

of this document evaluate the proposed project's potential effects relating to nuisance effects and hazards.)

In December 2016, the City published its initial study/mitigated negative declaration (IS/MND) for a data center on the project site (Equinix Data Centers) (File No. SP15-031). The Land Use section of the IS/MND assessed the project's compatibility with the EADP (SV1 2020b, Appendix K). In evaluating the project's ability to promote economic development and job growth in the Old Edenvale area, the analysis concluded that although "the number of employees would be lower than for office or other industrial uses, development of data center uses would promote economic development in the City of San Jose." The Land Use analysis in the 2016 IS/MND identified no conflicts with the EADP. Likewise, CEC staff concludes that the Great Oaks South Data Center project would not conflict with the EADP. Neither would the project conflict with General Plan policy LU-2.2, which supports employment activity in various parts of the City, including the Old Edenvale area. (See **Section 4.17 Transportation** of this document for an analysis of the project's consistency with the EADP pertaining to development impacts and the area's transportation system.)

On January 25, 2017, the City approved and issued the original Special Use Permit (SP15-031) for the Equinix Data Centers project (SV1 2020d). An application was submitted to the City on March 3, 2020, to amend the original permit (CEC 2020m). In its analysis of SP15-031, City staff evaluated the project's consistency with the General Plan, including the first implementation policy (IP-1.1), which states that the General Plan Land Use/Transportation Diagram designations should be used "to indicate the general intended land use, providing flexibility to allow for a mix of land uses, intensities and development forms compatible with a wide variety of neighborhood contexts..." (San Jose 2020). Regarding the City's zoning code, IP-1.1 states that zoning is to be used "to indicate the appropriate type, form and height of development for particular properties" (SV1 2020d) (see the discussion of project site zoning below under "City of San Jose Zoning Code"). A data center does not fully satisfy the City's plan to achieve the intensive job growth specified for areas designated TEC (SV1 2020d). However, City staff noted that IP-1.1 provides a basis for concluding that a data center may be determined consistent with the General Plan due to the City's intention to allow a use with a relatively low employment density in an area with the TEC land use designation. City staff confirmed that the project as amended would remain consistent with IP-1.1 (CEC 2020m). CEC staff concurs that the project would be consistent with General Plan policy IP-1.1.

Floor area ratio (FAR) is a tool for local governments to predict and limit the intensity of land uses and their resulting environmental impacts. The FAR of a development is the total square footage of a building(s) on a lot divided by the total lot area. A project with a higher than allowed FAR could cause environmental impacts relating to increased vehicle miles travelled, or VMT. The project's building square footage would be approximately 547,050 square feet (sq. ft.). The lot area is approximately 18 acres, or approximately 784,080 sq. ft. Using those values, staff calculates FAR to be 0.7, which is below the General Plan's maximum FAR of 10.0 for properties designated Industrial Park

and 12.0 for properties designated Transit Employment Center. The General Plan does not set minimum FAR requirements (CEC 2020m). Therefore, no conflict with the FAR standards in the General Plan would occur. (See **Section 4.17 Transportation** for an analysis of the project's potential impacts on transportation using the VMT metric.)

Buildings typically have two to 15 stories in areas designated IP and four to 25 stories in areas designated TEC. The project would consist of three, two-story data center buildings. As discussed above, the General Plan's community design policy CD-4.9 specifies that "[f]or development subject to design review, ensure the design of new or remodeled structures is consistent or complementary with the surrounding neighborhood fabric..." (San Jose 2020). Because the project's data center buildings would be similar in scale and height to other buildings in the area, no conflicts would occur.

City of San Jose Zoning Code. The project site is in the IP, Industrial Park zoning district. Use regulations for properties in the IP zoning district specify that a data center requires a Special Use Permit (San Jose 2021, § 20.50.100, subd. (E); Table 20-110). On January 25, 2017, the City approved and issued a Special Use Permit (SP15-031) for the Equinix Data Centers with project site boundaries similar to the Great Oaks South Data Center project. An application for an amended Special Use Permit was submitted to the City on March 3, 2020 (SPA15-031-01). The City has since provided comments to the applicant following two rounds of reviews and anticipates receiving a revised submittal to address the second round of review comments (CEC 2020m). The applicant will be required to comply with the City's development standards to complete the permit amendment application process. As stated above, the first implementation policy (IP-1.1) from the City's General Plan states that the zoning district is used "to indicate the appropriate type, form and height of development for particular properties" (SV1 2020d). As described in the paragraphs that follow, the project would be consistent with the City's development standards.

The Zoning Code specifies development regulations for industrial zoning districts. The IP zoning district requires a front building setback of 15 feet to lot boundaries abutting streets (San Jose 2021, § 20.50.200, Table 20-120). Requirements for side and rear setbacks for buildings and structures not abutting streets is zero unless the property abuts a residential district; the closest area zoned for residential use is approximately 600 feet south of the property boundary, on the south side of Santa Teresa Boulevard. The front setback requirement for parking and circulation for passenger vehicles to lot boundaries is 25 feet, and the setback for loading docks is 60 feet to lot boundaries. The project site plan shows setback distances that would meet or exceed minimum requirements (SV1 2020a). Therefore, no conflicts with the City's development standards for minimum setbacks would occur.

Development standards in the IP zoning district specify a maximum height of 50 feet unless a different maximum is established in Chapter 20.85, "Specific Height Restrictions," for different geographic areas, including employment centers. For the Old Edenvale area

where the project site is located, maximum allowable building height shall not exceed 250 feet (San Jose 2021, § 20.85.020, subd. (C)(2)). The three, two-story data center buildings would have a roof height of approximately 49 feet above ground level (AGL), and 53.25 feet to the top of the parapet. The height to the top of the screenwall for concealing mechanical equipment would be 63.25 feet AGL. The total height to the top of the stair and elevator penthouse would be 72.25 feet AGL. As discussed above, the General Plan contains community design policies pertaining to development design and building height. Policy CD-8.1 requires that new development be “consistent with specific height limits established within the City’s Zoning Ordinance and applied through the zoning designation for properties throughout the City” (San Jose 2020). The project’s buildings and rooftop equipment would conform to the height limits. City staff stated that SPA15-031-01 has included the City’s review and approval of the project’s architectural design and screening for rooftop equipment (CEC 2020m). For the reasons described above, no conflicts with development design requirements or the building height regulation would occur.

The Zoning Code specifies several “findings” that must be made by the planning director, planning commission, or city council to allow issuance of a Special Use Permit (San Jose 2021, § 20.100.820). Included in the findings is a requirement that the Special Use Permit must be consistent with the policies of the General Plan and area development policies. The proposed use must not be detrimental to public health, safety, or general welfare. The proposed site must be adequate in size and shape to accommodate the development features prescribed in the City’s Code of Ordinances. The project’s environmental impacts, “even if insignificant for purposes of the California Environmental Quality Act, will not have an unacceptable negative affect on adjacent property or properties.”

The original Special Use Permit contains an analysis of findings to substantiate its conclusion that the approved permit “is consistent with and will further the policies of the general plan and applicable specific plans and area development policies” (SV1 2020d). As described above, the City’s General Plan designates the eastern half of the project site as IP, Industrial Park, and the western half as TEC, Transit Employment Center. The findings reference IP-1.1 from the General Plan to explain the allowance for “blending of land use designations...to achieve the overall intent of the General Plan” (SV1 2020d). The findings explain that even with the site’s two land use designations, the intent of the General Plan is met “by providing the appropriate mix of uses throughout the site without rigidly adhering to the delineated lines on the Land Use/Transportation Diagram” (SV1 2020d). As described above, City staff confirmed that the project as amended would remain consistent with IP-1.1 (CEC 2020m). CEC staff concurs that the project would be consistent with General Plan policy IP-1.1.

The City is working with the applicant to ensure the project plans meet City requirements. Approval and issuance of an amendment to the Special Use Permit is contingent on the City’s decision makers determining that the findings are satisfied. Due to this requirement,

and the consistency of the project with the General Plan and the Zoning Code, the project would not cause a significant impact due to a conflict with any land use plan, policy, or regulation adopted for the purpose of avoiding or mitigating an environmental effect. Therefore, impacts would be less than significant.

Required Mitigation Measures: None.

4.11.4 References

- CEC 2020m – California Energy Commission (CEC). Report of Conversation Between CEC Staff J. Hinde and City of San Jose Staff A. Wang: Great Oaks South Backup Generating Facility (TN 234481), August 2020. Available online at: <https://efiling.energy.ca.gov/Lists/DocketLog.aspx?docketnumber=20-SPPE-01>
- San Jose 2014 – City of San Jose (San Jose). City Council Resolution No. 77220. Proposed Amendments to the Envision San Jose 2040 General Plan, including revision of the Edenvale Area Development Policy dated April 2014. Adopted on November 18, 2014. Available online at: <https://www.sanjoseca.gov/home/showdocument?id=22377>
- San Jose 2020 – City of San Jose (San Jose). Planning, Building & Code Enforcement. *Envision San Jose 2040 General Plan*. Adopted November 1, 2011. As amended March 16, 2020. Chapter 1, pgs. 27–28; Chapter 4, pgs. 19 and 24; Chapter 5, pgs. 8–11 and 14–15; Chapter 7, pg. 4; General Plan 2040 Land Use Map, Land Use/Transportation Diagram, and Planned Growth Areas Diagram. Accessed on May 22, 2020 and February 22, 2021. Available online at: <https://www.sanjoseca.gov/your-government/departments/planning-building-code-enforcement/planning-division/citywide-planning/envision-san-jos-2040-general-plan>
- San Jose 2021 – City of San Jose (San Jose). San Jose Code of Ordinances. Adopted January 26, 2021. Accessed on: May 18, 2020 and February 22, 2021. Available online at: https://library.municode.com/ca/san_jose/codes/code_of_ordinances?nodeId=TI_T20Z0
- Santa Clara County ALUC 2016 – Santa Clara County Airport Land Use Commission (Santa Clara ALUC). *Comprehensive Land Use Plan, Santa Clara County, Norman Y. Mineta San Jose International Airport*. Pg. 3-17; Figures 6, 7, and 8. Adopted by Santa Clara County Airport Land Use Commission, San Jose, CA. May 25, 2011; amended November 16, 2016. Accessed on: July 13, 2020. Available online at: <https://www.sccgov.org/sites/dpd/Commissions/ALUC/Pages/ALUC.aspx>
- SV1 2020a – SV1, LLC. (SV1). Application for Small Power Plant Exemption: Great Oaks South Backup Generating Facility (TN 232466), March 2020. Pgs. 5, 7, 8, 18, and 19; Figure 1.1-3 Aerial Photograph and Surrounding Land Uses; Figure 2.2-1 Site Plan. Available online at: <https://efiling.energy.ca.gov/Lists/DocketLog.aspx?docketnumber=20-SPPE-01>

SV1 2020b – SV1, LLC. (SV1). Application Appendices A through K: Great Oaks South Backup Generating Facility (TN 232467-1,2,3), March 2020. Appendix K. Available online at:
<https://efiling.energy.ca.gov/Lists/DocketLog.aspx?docketnumber=20-SPPE-01>

SV1 2020d – SV1, LLC. (SV1). SV1 Responses to CEC Data Request Set 2: Great Oaks South Backup Generating Facility Part 1 through Part 4 (TN 233005-1,2,3,4), May 2020. Attachment BIO DR-39, Special Use Permit. Available online at:
<https://efiling.energy.ca.gov/Lists/DocketLog.aspx?docketnumber=20-SPPE-01>

4.12 Mineral Resources

This section describes the environmental and regulatory setting, and discusses impacts associated with the construction and operation of the project specific to mineral resources.

MINERAL RESOURCES	Potentially Significant Impact	Less Than Significant with Mitigation Incorporated	Less Than Significant Impact	No Impact
Would the project:				
a. Result in the loss of availability of a known mineral resource that would be of value to the region and the residents of the State?	<input type="checkbox"/>	<input type="checkbox"/>	<input type="checkbox"/>	<input checked="" type="checkbox"/>
b. Result in the loss of availability of a locally important mineral resource recovery site delineated on a local general plan, specific plan or other land use plan?	<input type="checkbox"/>	<input type="checkbox"/>	<input type="checkbox"/>	<input checked="" type="checkbox"/>

Environmental checklist established by CEQA Guidelines, Appendix G.

4.12.1 Setting

Information on mineral resources was compiled from published literature, maps, and review of aerial photographs. Impacts to mineral resources from project construction and operational activities were evaluated qualitatively based on the area occupied by the project, site conditions, expected construction practices, anticipated materials used, and the locations and duration of project construction and operational activities.

The project site, located in the City of San Jose within Santa Clara County, is in an area identified as Mineral Resource Zone 1 (MRZ-1) for aggregate materials by the State of California (DOC 2015). MRZ-1 refers to an area where available geologic information indicates that no significant mineral deposits are present, or where it is judged that little likelihood for their presence exists (DOC 2015). The project site and surrounding area are not known to support significant mineral resources of any type. Other than the Communication Hill Area, located about 5.2 miles northwest of the project site, which contains mineral deposits that are of regional significance as a source of construction aggregate materials, the city of San Jose does not have mineral deposits subject to the California Surface Mining and Reclamation Act of 1975 (SMARA) (San Jose 2020). The Division of Mine Reclamation's list of mines, referred to as the AB 3098 List and regulated under SMARA, identifies four other facilities in Santa Clara County, the closest being the Stevens Creek Quarry located about 6.2 miles southwest of the project site (DOC 2016).

Regulatory Background

Federal

No federal regulations related to mineral resources apply to the project.

State

Surface Mining and Reclamation Act. SMARA requires that the State Geologist classify land into MRZ or Scientific Zones according to the known or inferred mineral potential of the land (Pub. Resources Code, §§ 2710-2796). MRZs are defined as the following (DOC 2015):

- MRZ-1: Areas where adequate information indicates that no significant mineral deposits are present, or where it is judged that little likelihood for their presence exists.
- MRZ-2: Areas where adequate information indicates that significant deposits are present, or where it is judged that a high likelihood for their presence exists. The guidelines set forth two requirements to be used to determine if land should be classified MRZ-2:
 - The deposit must be composed of material that is suitable as a marketable commodity.
 - The deposit must meet threshold value. The projected value (gross selling price) of the deposit, based on the value of the first marketable product, must be at least \$5 million (1978 dollars).
- MRZ-3: Areas containing mineral deposits, but their significance cannot be evaluated from available data.
- MRZ-4: Areas where available information is inadequate for assignment to any other MRZ category.
- Scientific Zones are defined as areas containing unique or rare occurrence of rocks, minerals, or fossils that are of outstanding scientific significance shall be classified in this zone.

Local

No local regulations related to mineral resources apply to the project.

4.12.2 Applicant Proposed Measures

None.

4.12.3 Environmental Impacts and Mitigation Measures

a. Result in the loss of availability of a known mineral resource that would be of value to the region and the residents of the State?

Construction and Operation

No Impact. The project site is in a developed urban area and does not contain any known or designated mineral resources. Therefore, the project would not result in the loss of availability of a known mineral resource.

b. Result in the loss of availability of a locally important mineral resource recovery site delineated on a local general plan, specific plan or other land use plan?

Construction and Operation

No Impact. The project site is in an area that does not contain any known or designated mineral resources. Therefore, the project would not result in the loss of availability of a locally important mineral resource recovery site.

4.12.4 References

DOC 2015 – California Department of Conservation (DOC). DOC - Surface Mining and Reclamation Act (SMARA) Mineral Lands Classification (MLC) data portal. Mineral Land Classification: Aggregate Materials in the San Francisco-Monterey Bay Area: Classification of Aggregate Resource Areas: South San Francisco Bay Production-Consumption Region. Author: Melvin C. Stinson, Michael W. Manson and John J. Plappert (1987) Special Report 146. Accessed on: April 20, 2020. Available online at:
<https://maps.conservation.ca.gov/cgs/informationwarehouse/index.html?map=mlc>

DOC 2016 – California Department of Conservation (DOC). DOC - AB 3098 List. This list is updated daily. Accessed on: April 21, 2020. Available online at: <ftp://ftp.consrv.ca.gov/pub/omr/AB3098%20List/AB3098List.pdf>

San Jose 2020 – City of San Jose (San Jose). Envision San Jose 2040 General Plan, Adopted November 1, 2011, as amended on December 18, 2018, and updated March 16, 2020. Accessed on: February 24, 2021. Available online at: <https://www.sanjoseca.gov/home/showdocument?id=22359>

4.13 Noise

This section describes the environmental and regulatory setting and discusses impacts associated with the construction and operation of the project related to noise.

NOISE	Potentially Significant Impact	Less Than Significant with Mitigation Incorporated	Less Than Significant Impact	No Impact
Would the project result in:				
a. Generation of a substantial temporary or permanent increase in ambient noise levels in the vicinity of the project in excess of standards established in the local general plan or noise ordinance, or applicable standards of other agencies?	<input type="checkbox"/>	<input checked="" type="checkbox"/>	<input type="checkbox"/>	<input type="checkbox"/>
b. Generation of excessive groundborne vibration or groundborne noise levels?	<input type="checkbox"/>	<input type="checkbox"/>	<input checked="" type="checkbox"/>	<input type="checkbox"/>
c. For a project located within the vicinity of a private airstrip or an airport land use plan or, where such a plan has not been adopted, within two miles of a public airport or public use airport, would the project expose people residing or working in the project area to excessive noise levels?	<input type="checkbox"/>	<input type="checkbox"/>	<input checked="" type="checkbox"/>	<input type="checkbox"/>

Environmental checklist established by CEQA Guidelines, Appendix G.

4.13.1 Setting

The project area consists of various land use designations. The Great Oaks South Data Center (GOSDC) site zoning is Industrial Park (IP) and Transit Employment Center (TEC) (SV1 2020a, Section 3.6). The eastern portion of the project site is currently designated as IP and the western portion is designated TEC in the Envision San Jose 2040 General Plan (SV1 2020a, Section 4.13). Buildings designated Combined Industrial/Commercial use lie directly to the east and southeast of the site, across Great Oaks Boulevard. The nearest residential area is located approximately 700 feet to the south and southwest of the project site boundary, across and along Santa Teresa Boulevard. The nearest airport is the Norman Y. Mineta San Jose International Airport approximately 11 miles northwest of the project site. The predominant long-term ambient noise sources are the automobile traffic on Santa Teresa Blvd to the south and southwest of the project site and on San Ignacio Ave to the east and southeast of the project site (SV1 2020a, Table 4.15-2).

Regulatory Background

Federal

No federal regulations relating to noise apply to the project.

State

The California Environmental Quality Act (CEQA) Guidelines state that a project would normally be considered to have a significant impact if noise levels conflict with adopted environmental standards or plans, or if noise levels generated by the project would substantially increase existing noise levels at noise-sensitive receivers on a permanent or temporary basis. CEQA does not define what noise level increase would be substantial. Generally, an increase of 3 A weighted decibels (dBA) is noticeable and an increase of 5 dBA is distinct. A noise level increase of more than 5 dBA would be considered potentially significant. Some local government entities, such as the city of San Jose, consider a 5-dBA increase or more as a significant impact whether the resulting noise level remains within the maximum acceptable threshold for a land use designation, or not; while a 3-dBA increase or more would be a significant impact if the resulting noise level exceeds the allowable maximum threshold for the land use zone (San Jose 2018, EC-1.2). Other factors, such as the frequency of occurrence of the noise and time of day/night it occurs, are also commonly considered in determining if such an increase is clearly significant or not.

In September 2013, the California Department of Transportation (Caltrans) released the Transportation and Construction Vibration Guidance Manual. This manual includes the Federal Transit Authority (FTA) method and findings. The Caltrans manual states that for construction activities that generate vibration, the threshold of human response begins at a peak particle velocity of 0.16 inch per second (in/sec). This is characterized by Caltrans as a “distinctly perceptible” event with an incident range of transient to continuous (Caltrans 2013). A level of 0.20 in/sec has been found to be annoying to people in buildings and can pose a risk of architectural damage to buildings.

Local

City of San Jose General Plan. *Envision San Jose General Plan 2040* describes the levels of exterior noise considered compatible for various land uses to guide land use planning decisions. The city’s General Plan considers a 5 dBA increase in ambient noise while it remains within allowable limits a significant impact under any circumstance, but if it would result in the noise level exceeding the allowable limit, then a 3 dBA increase is considered a significant impact. The General Plan includes policies applicable to all development projects in San Jose (San Jose 2020). The city’s noise and land use compatibility guidelines are shown in **Table 4.13-1**.

TABLE 4.13-1 GENERAL PLAN'S ALLOWABLE NOISE LEVEL GUIDELINES FOR LAND USE COMPATIBILITY

Land Use Category	Maximum Acceptable Day-night Composite Noise Value (L_{dn}) in Decibels (dBA)
1. Residential, Hotels and Motels, Hospitals and Residential Care	60
2. Outdoor Sports and Recreation, Neighborhood Parks and Playgrounds	65
3. Schools, Libraries, Museums, Meeting Halls, Churches	60
4. Office Buildings, Business Commercial, and Professional Offices	70
5. Sports Arena, Outdoor Spectator Sports	70
6. Public and Quasi-Public Auditoriums, Concert Halls, Amphitheaters	70 ¹

Notes: 1 Conditionally acceptable. Specified land use may be permitted only after detailed analysis of the noise reduction requirements and needed noise insulation features included in the design.

In addition, the General Plan lists the following policies to control noise and vibration pollution impacts:

- EC-1.1: Locate new development in areas where noise levels are appropriate for the proposed uses, taking into consideration federal, state and city noise standards and guidelines.
- EC-1.2: Minimize the noise impacts of new development on land uses sensitive to increased noise levels by limiting noise generation and by requiring use of noise attenuation measures such as acoustical enclosures and sound barriers, where feasible.
- EC-1.3: Mitigate noise generation of new non-residential land uses to 55 dBA L_{dn} at the property line when located adjacent to existing or planned noise sensitive residential and public/quasi-public land uses.
- EC-1.6: Regulate the effects of operational noise from existing and new industrial and commercial development on adjacent uses through noise standards in the City's Municipal Code.
- EC-2.3: Require new development to minimize vibration impacts to adjacent uses during demolition and construction. For sensitive historic structures, a vibration limit of 0.08 in/sec PPV will be used to minimize the potential for cosmetic damage to a building. A vibration limit of 0.20 in/sec PPV will be used to minimize the potential for cosmetic damage at buildings of normal conventional construction.

City of San Jose Municipal Code. Title 20 (Zoning), Section 20.50 specifies allowable uses and activities for areas zoned or used for industrial purposes. Noise limits at the property line of a project are not allowed to exceed 55 dBA (anytime) if a residential area is adjacent to any of the project boundaries; 60 dBA if adjacent uses are commercial with no residential areas; and 70 dBA if all adjacent uses are industrial.

The Municipal Code also establishes allowable hours of construction for projects within 500 feet of a residential area to the hours of 7:00 a.m. to 7:00 p.m. on Monday through Friday, unless otherwise expressly allowed in a development permit or other planning approval. No construction activities are permitted on the weekends at sites within 500 feet of a residence unless permission is granted with a development permit or other planning approval. The city's Municipal Code does not establish quantitative noise limits for demolition or construction activities occurring in the city.

4.13.2 Applicant Proposed Measures

PD NOI-1: The project proposes to implement the following measures to reduce temporary construction noise to less than significant levels.

- Construction activities within 200 feet of commercial uses shall be limited to the hours between 7:00 AM and 7:00 PM, Monday through Friday.
- Equip all internal combustion engine-driven equipment with intake and exhaust mufflers that are in good condition and appropriate for the equipment.
- Unnecessary idling of internal combustion engines within 200 feet of commercial uses is strictly prohibited. Equipment shall be turned off when not in use and the maximum idling time shall be limited to five minutes.
- Locate stationary noise-generating equipment such as air compressors or portable power generators at least 200 feet from adjacent office and commercial uses to the greatest extent feasible.
- Utilize "quiet" air compressors and other stationary noise sources where technology exists.
- Notify all adjacent business and other noise-sensitive land uses of the construction schedule, in writing, and provide a written schedule of "noisy" construction activities to the adjacent land uses.

PD NOI-2: The project applicant shall prepare a noise logistics plan, which shall be submitted for review and approval by the Supervising Planner of the Environmental Review Division of the Department of Planning, Building, and Code Enforcement prior to issuance of grading and building permits. This plan shall include, at a minimum, the following measures to reduce the exposure of adjacent office buildings to construction noise:

- All internal combustion engine-driven equipment shall use best available noise control practices and equipment (including mufflers, intake silencers, ducts, engine enclosures, and acoustically attenuating shields or shrouds). A letter from a qualified acoustic specialist shall be attached to the noise logistics plan along with a list of proposed construction equipment, certifying that the proposed construction equipment includes the best available noise attenuating technologies.

- The contractor will prepare a detailed construction plan identifying a schedule of major noise generating construction activities. This plan shall identify a noise control “disturbance coordinator” and procedure for coordination with the adjacent noise sensitive facilities so that construction activities can be scheduled to minimize noise disturbance. This plan shall be made publicly available for interested community members. The disturbance coordinator will be responsible for responding to any local complaints about construction noise. The disturbance coordinator will determine the case of the noise complaint (e.g. starting too early, bad muffler, etc.) and will require that reasonable measures warranted to correct the problem be implemented. The telephone number for the disturbance coordinator construction site shall be posted on the construction site and included in a notice sent to adjacent commercial businesses regarding the construction schedule.
- All measures in the approved noise logistics plan shall be printed on all approved plans for grading and building permits.

4.13.3 Environmental Impacts and Mitigation Measures

a. Would the project result in generation of a substantial temporary or permanent increase in ambient noise levels in the vicinity of the project in excess of standards established in the local general plan or noise ordinance, or applicable standards of other agencies?

Construction

Less Than Significant with Mitigation Incorporated. Construction activities for the project would likely utilize equipment that could generate noise levels that exceed ambient noise, such as bulldozers and jackhammers. Construction noise can be significant for short periods of time at any particular location and generates the highest noise levels during grading and excavation, with lower noise levels occurring during building construction. Large pieces of earth-moving equipment, such as graders, scrapers, and bulldozers would be used. Typical hourly average construction-generated noise levels are approximately 78 to 88 dBA measured at a distance of 50 feet from the site during busy construction periods. The loudest construction activities can elevate noise levels at the adjacent businesses by up to 15 dBA and at the nearest residences by up to 5 dBA.

The city’s Municipal Code does not establish construction noise sources in its prescribed noise level limits, but in Chapter 20.100.450, the city limits construction and demolition activities to occur during the daytime hours of 7:00 a.m. to 7:00 p.m. Monday through Friday, and prohibits construction work on weekends at sites within 500 feet of a residence unless permission is granted with a development permit or other planning approval.

Project construction may have the potential to create a significant impact at the nearby noise receptors. To ensure the impact is reduced to less than significant, the project applicant proposes to implement the project design measures included in PD NOI-1 and

PD NOI-2. While PD NOI-1 and PD NOI-2 would reduce construction noise levels emanating from the site and limit construction hours, due to the proximity of residents to the project site, their construction notification requirements need to specifically mention these residents. Mitigation measure (**MM**) **NOI-1**, discussed below, includes notification requirements to the nearby residents and a contact number. With the addition of the notification to nearby residents, impacts would be reduced to less than significant. The noise-sensitive land uses (residences) would be notified of construction schedules and activities and a designated “disturbance coordinator” would be responsible for responding to any complaints about construction noise. These are measures that have proven to effectively control noise in other construction projects and reduce annoyance to the public. With the implementation of PD NOI-1, PD NOI-2, and **MM** **NOI-1**, and recognizing the noise generated by construction activities would occur over a temporary period, the temporary increase in ambient noise levels would create a less-than-significant impact.

Operation

Less Than Significant Impact. The proposed emergency backup generators (gensets) would provide backup power to the data center buildings in the event that an equipment failure or other conditions resulting in an interruption of the electricity delivered by Pacific Gas and Electric Company (PG&E). The gensets would be enclosed in equipment yards located adjacent to the north and south sides of each building. The city’s General Plan policy (EC-1.3) along with the city’s Municipal Code (Section 20.50.300) establishes mitigation and noise level performance standards for noise generation of new nonresidential land uses to a maximum of 55 dBA DNL. Where the new land (industrial) use property line is adjacent to existing or planned noise sensitive residential and public/quasi-public land uses. Additionally, the city’s General Plan policy (EC-1.6) regulates operational noise from existing and new industrial and commercial development on adjacent uses in Section 20.50.300 of the city’s Municipal Code. Where the industrial use property is adjacent to a commercial use the maximum noise level at the property line must be 60 dBA and where it is adjacent to an industrial use the maximum noise level at the property line must be 70 dBA. However, the city’s Municipal Code does not apply to the operation of the backup generators during an emergency situation such as interruption of electricity delivered by PG&E.

The applicant would use gensets that ensure sufficient exhaust silencing and other design measures, if required, such that the project meets the city noise requirements. The project would include 39 gensets and each genset would be tested only during daytime hours. The generator yards would be surrounded on all sides by a screen wall to mitigate noise levels. Heating, ventilation and air conditioning (HVAC) equipment including, but not limited to, chiller plant modules and condensing units would be located on the rooftops of each of the data center buildings and would be surrounded by screening walls as well (SV1 2020a, Section 4.15).

The applicant modeled sources of noise for the project, using SoundPLAN, to assess the impact of its operational activities on nearby noise receptors. Noise modeling was performed for two modes of project operation: "normal" and "normal plus testing". Normal operation would primarily consist of continuous operation of the heating, ventilation, and air conditioning (HVAC) equipment and other air-handling units. The second mode of operation would be the normal mode and testing of one genset at the same time. The applicant modeled normal operation as well as a conservative scenario of operation where all generators are assumed to be tested simultaneously for a worst-case noise impact assessment (SV1 2020a, Section 4.15). Since the emergency generators would be tested one at a time, the noise generated during the conservative scenario would be substantially higher than that during normal operation. The frequency of testing the emergency generators would be low (not to exceed 17 hours per engine per year) and testing would only occur during daytime hours (SV1 2020h).

Results of the computer modeling show that during simultaneous testing of one generator under full load along with normal operational equipment, the modeled equivalent continuous sound level (L_{eq}) at the residential receptors reached a maximum of 50 dBA. This is below the city's daytime residential noise level limit of 55 dBA L_{eq} (generator testing would not occur at night), and is also below the nightly ambient noise level of 55 dBA L_{eq} at these residences¹. Noise levels at the nearest commercial receptors would be anticipated to reach a maximum of 58 dBA L_{eq} , which is below the city's commercial noise level limit of 60 dBA L_{eq} (SV1 2021f).

The modeling results also show that for the normal mode of operation (without generator testing), the noise level at the residential receptors would be anticipated to reach a maximum of 44 dBA L_{eq} (SV1 2020f - Table 9). Again, this is below the city's daytime noise limit of 55 dBA L_{eq} for residential area and below the nightly ambient levels at the nearest residences. For the nearest commercial receptors, the anticipated noise level during normal mode of operation would be 46 dBA L_{eq} , which is below the city's noise level limits of 60 dBA L_{eq} .

Humming noise from the operation of an industrial facility, such as a data center, is usually associated with either, equipment imbalance that can occur in older or poorly designed equipment, or due to the lack of noise-control features. GOSDC, on the other hand, would be a new, state of the art facility, incorporating low-noise equipment and noise-control features. The project is not expected to generate a humming noise or any other tonal noise discernable at the nearby residences.

The noise modeling has considered acoustic upgrades/measures to control operational noise. In the unlikely event that additional improvements are needed to reduce noise levels, practical and available noise-reducing measures can be considered for project operation to achieve compliance with the city's limits at the adjacent residential dwellings.

¹ Nighttime ambient noise is lower than the daytime ambient noise at this location

Consideration of any additional measures is usually determined in the final design stage of a project. Examples of such measures typically implemented at data centers are listed below.

- Low speed fans and duct and transition silencers: These are typically installed in facility yards to control noise levels at project perimeter.
- Acoustical building panels, tiles, and baffles: These are typically installed inside buildings to reduce internal noise levels.
- Sound dampening server cabinets: These are also used to reduce noise levels inside buildings.

The noise impact from project operation would be less than significant.

Noise levels from project construction and operation would not conflict with adopted environmental standards or plans.

MM NOI-1: The project shall implement the following measures to reduce temporary construction noise to less than significant levels.

- Notify the residents south of the project site immediately across Santa Teresa Boulevard of the construction schedule, in writing, and provide a written schedule of “noisy” construction activities to the adjacent land uses.
- Include the telephone number for the disturbance coordinator construction site in a notice regarding the construction schedule sent to residents south of the project site immediately across Santa Teresa Boulevard.

Required Mitigation Measures: MM NOI-1.

b. Would the project result in generation of excessive groundborne vibration or groundborne noise levels?

Construction

Less Than Significant Impact. This analysis relies on the vibration thresholds identified by Caltrans to determine the significance of vibration impacts related to adverse human reaction. These thresholds are consistent with local regulations, in particular, 0.20 in/sec PPV criterion specified by General Plan Policy EC-2.3. The threshold of human response begins at a peak particle velocity (PPV) of 0.16 in/sec. Caltrans characterizes this as a “distinctly perceptible” event (Caltrans 2013). A level of 0.20 in/sec has been found to be annoying to people in buildings and can pose a risk of architectural damage to buildings.

Impact of vibratory pile driving would not be proposed as a method of construction activity for the project, but there would be other construction activities that would generate groundbourne vibrations on the immediate vicinity of the work area.

Jackhammers can cause a groundborne vibration rate of 0.035 in/sec at 25 feet (less than the threshold of human response) and vibratory rollers can cause a groundborne vibration of 0.21 in/sec at 25 feet (Caltrans 2013). The nearest commercial/office buildings are approximately 100 feet away from project site boundaries. A vibratory roller may be used during project construction for paving of the parking lot. At the nearest noise receptors, the commercial/office buildings, 0.21 in/sec translates to approximately 0.098 in/sec; less than the threshold of human response. Construction equipment and activities would be similar to those used at similar projects and vibration impacts from project construction would be less than significant.

Operation

Less Than Significant Impact. Sources of groundborne vibration associated with project operation would include the backup generators and rooftop equipment. These pieces of equipment would be well-balanced, as they are designed to produce very low vibration levels throughout the life of a project. In most cases, even when there is an imbalance, they could contribute to ground vibration levels only in the vicinity of the equipment and would be dampened within a short distance. Furthermore, the backup generators would be equipped with specifications that ensure sufficient exhaust silencing to reduce vibration. Therefore, vibration impacts due to project operation would be less than significant.

Required Mitigation Measures: None.

c. For a project located within the vicinity of a private airstrip or an airport land use plan or, where such a plan has not been adopted, within two miles of a public airport or public use airport, would the project expose people residing or working in the project area to excessive noise levels?

Construction and Operation

Less than Significant Impact. The nearest airport to the project site is the Norman Y. Mineta San Jose International Airport, located approximately 11 miles northwest of the project site. The project site is located outside the Airport Noise Zone (the 65 CNEL² contour, as set forth by state law) as defined in the Comprehensive Land Use Plan for the airport. The project site is surrounded with mostly industrial and commercial uses and the closest residence is about 700 feet away from the project site. The project's operational noise levels would not exceed the 24-hour ambient noise levels at the nearest residential receptors. The project site is not in the vicinity of a private airport and it would

² CNEL is the average sound level over a 24-hour period, with a penalty of 5 dB added between 7 pm and 10 pm and a penalty of 10 dB added for the nighttime hours of 10 pm to 7 am. CNEL is frequently used in regulations of airport noise impact on the surrounding community.

not place sensitive land uses within the airport noise contour. Thus, the project would not combine with the airport to expose people to excessive noise levels.

Required Mitigation Measures: None.

4.13.4 References

- Caltrans 2013 – California Department of Transportation (Caltrans). Technical Noise Supplement to the Caltrans Traffic Noise Analysis Protocol, A Guide for Measuring, Modeling, and Abating Highway Operation and Construction Noise Impacts, Division of Environmental Analysis, Environmental Engineering. September 2013. Report No. CT-HWANP-RT-13069.25.3. Accessed on: April 27, 2020. Available online at: <http://website.dot.ca.gov/env/noise/docs/tens-sep2013.pdf>
- San Jose 2020 – City of San Jose (San Jose). *Envision San Jose 2040 General Plan*. Adopted November 1, 2011, amended December 18, 2018, and updated March 16, 2020. Available online at: <https://www.sanjoseca.gov/home/showdocument?id=22359>
- San Jose 2021 – City of San Jose (San Jose). City of San Jose Municipal Code, Title 20: Zoning. Adopted January 26, 2021. Available online at: https://library.municode.com/ca/san_jose/codes/code_of_ordinances?nodeId=TI_T20ZO_CH20.50INZODI
- SV1 2020a – SV1, LLC. (SV1). Application for Small Power Plant Exemption: Great Oaks South Backup Generating Facility (TN 232466), March 2020. Available online at: <https://efiling.energy.ca.gov/Lists/DocketLog.aspx?docketnumber=20-SPPE-01>
- SV1 2020d – SV1, LLC. (SV1). SV1 Responses to CEC Data Request Set 2: Great Oaks South Backup Generating Facility Part 1 through Part 4 (TN 233005-1,2,3,4), May 2020. Available online at: <https://efiling.energy.ca.gov/Lists/DocketLog.aspx?docketnumber=20-SPPE-01>
- SV1 2020f – SV1, LLC. (SV1). SV1 Supplemental Responses to CEC Data Requests 18 and 56: Great Oaks South Backup Generating Facility (TN 233681), June 2020. Available online at: <https://efiling.energy.ca.gov/Lists/DocketLog.aspx?docketnumber=20-SPPE-01>
- SV1 2020h – SV1, LLC. (SV1). SV1 Supplemental Responses to DR 65-69: Great Oaks South Backup Generating Facility (TN 233924), July 2020. Available online at: <https://efiling.energy.ca.gov/Lists/DocketLog.aspx?docketnumber=20-SPPE-01>

SV1 2021f – SV, LLC. (SV1). SV 1 Revised Noise Analysis: Great Oaks South Backup Generating Facility (TN 237148), March 2021. Available online at:
<https://efiling.energy.ca.gov/Lists/DocketLog.aspx?docketnumber=20-SPPE-01>

4.14 Population and Housing

This section describes the environmental and regulatory setting, and discusses impacts associated with the construction and operation of the project specific to population and housing.

POPULATION AND HOUSING	Potentially Significant Impact	Less Than Significant with Mitigation Incorporated	Less Than Significant Impact	No Impact
Would the project:				
a. Induce substantial unplanned population growth in an area, either directly (for example, by proposing new homes and businesses) or indirectly (for example, through extension of roads or other infrastructure)?	<input type="checkbox"/>	<input type="checkbox"/>	<input checked="" type="checkbox"/>	<input type="checkbox"/>
b. Displace substantial numbers of existing people or housing, necessitating the construction of replacement housing elsewhere?	<input type="checkbox"/>	<input type="checkbox"/>	<input checked="" type="checkbox"/>	<input type="checkbox"/>

Environmental checklist established by CEQA Guidelines, Appendix G.

4.14.1 Setting

The project is proposed in the City of San Jose in Santa Clara County. Nearby cities include Campbell, Los Gatos, and Morgan Hill. The applicant estimates the construction and operations workers would come from the greater Bay Area. Staff considers the local workers¹ from the greater Bay Area are not likely to temporarily (during construction) or permanently (during operations) move closer to the project. Staff considers the City of San Jose as the study area for population and housing-related impacts and the San Jose-Sunnyvale-Santa Clara Metropolitan Statistical Area (MSA), which covers San Benito and Santa Clara counties, as the setting for labor supply for the project.

Population Growth

The City of Santa Jose has an estimated land area of 180 square miles. The 2016 Envision San Jose 2040 General Plan Four Year Review projects that San Jose would add approximately 405,000 new residents by the year 2040 (San Jose 2016). The estimated 2020 population for the city is 1,028,210 people (ABAG 2019).

Table 4.14-1 shows the historical and projected populations for the cities within proximity of the project site, plus Santa Clara County. Population projections between 2020 and 2040 show a growth ranging from 4.5 to 33.9 percent or 0.2 to 1.7 percent per year in the cities within and around the project site.

¹ Workers with a greater commute would be considered non-local and would tend to seek lodging closer to the project site (temporarily during construction or permanently during operations).

TABLE 4.14-1 HISTORICAL AND PROJECTED POPULATIONS

Area	2010 ¹	2020 ²	2040 ²	Projected Population Change 2020-2040 Number	Projected Population Change 2020-2040 Percent (%)	Projected Population Change 2020-2040 Percent per Year (%)
Campbell	39,349	43,700	47,120	3,420	7.8	0.4
Los Gatos	29,413	31,635	33,050	1,415	4.5	0.2
San Jose	945,942	1,028,210	1,377,145	348,935	33.9	1.7
Morgan Hill	37,882	43,285	50,165	6,880	15.9	0.8
Santa Clara County	1,781,642	1,986,340	2,538,320	551,980	27.8	1.4

Sources: ¹US Census 2010; ²ABAG 2019

Housing

Table 4.14-2 presents housing supply data for the project area. Year 2020 housing estimates indicated 28,794 vacant housing units within Santa Clara County representing a vacancy rate of 4.3 percent (CA DOF 2020).

TABLE 4.14-2 HOUSING SUPPLY ESTIMATES IN THE PROJECT AREA

Housing Supply		2020 Total	2020 Vacant
Campbell	Number	18,158	1,303
	Percent	100	7.2
Los Gatos	Number	13,637	816
	Percent	100	6.0
Morgan Hill	Number	15,350	662
	Percent	100	4.3
San Jose	Number	336,507	11,815
	Percent	100	3.5
Santa Clara County	Number	674,558	28,794
	Percent	100	4.3

Source: CA DOF 2020

San Jose’s General Plan provides for the long-term ability to construct up to 120,000 new dwelling units and the development of up to 382,000 new jobs through 2040. Combined with San Jose’s current development and this additional growth capacity, San Jose could grow to 751,000 jobs and 430,000 dwelling units, supporting a residential population of 1.3 million people with a Jobs/Employed Resident Ratio of 1.1/1 (San Jose 2016). The Santa Clara County regional housing needs assessment allocation projected a county need of 58,836 new housing units by 2022. Of the 58,835 new housing units, 35,080 new housing units would be needed in the City of San Jose (ABAG 2013, page 26).

Labor Supply

Table 4.14-3 presents the California Employment Development Department 2016-2026 Occupational Employment Projections for the project’s construction occupations in the San Jose-Sunnyvale-Santa Clara MSA.

TABLE 4.14-3 PROJECTED EMPLOYMENT GROWTH

San Jose-Sunnyvale-Santa Clara MSA	Year 2016	Year 2026	Percent Change
Construction and Extraction Trades	46,900	52,430	11.8
General and Operations Managers	17,520	19,590	11.8
Security Guards	8,510	9,390	10.3
Janitors and Cleaners, Except Maids and Housekeeping Cleaners	16,520	17,910	8.4

Source: CA EDD 2019

Regulatory Background

No regulations related to population and housing apply to the project.

4.14.2 Applicant Proposed Measures

None.

4.14.3 Environmental Impacts and Mitigation Measures

- a. Induce substantial unplanned population growth in an area, either directly (for example, by proposing new homes and businesses) or indirectly (for example, through extension of roads or other infrastructure)?**

Construction

Less Than Significant Impact. The project would not directly or indirectly induce substantial unplanned growth in the City of San Jose. The project does not propose new housing or land use designation changes and it would not facilitate growth through the extension of roads, water supply pipelines, or other growth inducing infrastructure. While the project includes a backup generating facility, the electricity produced would directly serve the data center if power interruptions occurred and would not be an extension of infrastructure that would result in indirect population growth.

Site preparation activities for the project would include ground preparation and grading of the entire site. Project construction would take place in three phases for each of the project's three buildings. Construction of the first phase would last approximately 15 months. Construction of the second phase and third phase would each take approximately 18 months to complete. The total construction period would be approximately 51 months, which includes construction downtime between phases and lag times between the start and end of construction (SV1 2020d). Project construction would require an onsite construction workforce averaging 125-150 workers per month and a peak workforce of 200-225 workers for each of the three phases (SV1 2020a pg. 31).

The applicant anticipates the construction workforce for the project would be recruited from the greater Bay Area (SV1 2020a pg. 212). As shown in the "Setting" subsection of this analysis, there is a sufficient local construction workforce in the San Jose-Sunnyvale-

Santa Clara MSA to accommodate the project; thus, the construction workforce would not likely seek temporary lodging closer to the project site. Therefore, the project's construction workforce would not directly or indirectly induce substantial population growth in the project area. The impacts would be less than significant.

Operation

Less Than Significant Impact. The project would employ approximately 42 operations workers. The applicant anticipates the operations workforce would be recruited from the greater Bay Area. Based on the proximity of the supply of operations workers, they are not likely to relocate closer to the project. If some operations workers were to relocate, housing data shows a vacancy rate of 4.3 percent in Santa Clara County and 3.5 percent in the City of San Jose. A 5-percent vacancy is a largely industry-accepted minimum benchmark for a sufficient amount of housing available for occupancy (Virginia Tech 2006). While the vacancy rate in the city and county is slightly lower than the minimum benchmark, housing counts in the project area indicate a sufficient supply of available housing units for the possible few operations workers that could seek housing closer to the project. In addition, the city's general plan has accounted for population growth in the City of San Jose. If the few new operation workers were to relocate closer to the project site, it would not result in unplanned population growth. Therefore, the project's operations workforce would not directly or indirectly induce a substantial population growth in the project area. The impact would be less than significant.

Required Mitigation Measures: None.

b. Displace substantial numbers of existing people or housing, necessitating the construction of replacement housing elsewhere?

Construction

No Impact. The project site is an undeveloped vacant lot and therefore would not displace any people or housing. Construction of replacement housing elsewhere would not be necessary, no people or houses would be displaced, and thus no impact would occur.

Operation

Less Than Significant Impact. The project's 42 operations workers would be drawn from the greater Bay Area and are not expected to relocate closer to the project site. If some operations workers were to move closer to the project, there is a sufficient housing supply for these operations workers and their existing housing within the greater Bay Area would be vacated. Therefore, the project would not displace substantial numbers of people or housing, and no replacement housing would need to be constructed elsewhere. The impact would be less than significant.

Required Mitigation Measures: None.

4.14.4 References

- ABAG 2013 – Association of Bay Area Governments (ABAG). Final Regional Housing Need Allocation 2015-2023, Adopted July 18, 2013. Available online at: https://abag.ca.gov/sites/default/files/2015-23_rhna_plan.pdf
- ABAG 2019 – Association of Bay Area Governments (ABAG). Projections 2040 by Jurisdiction. Data last updated May 1, 2019. Available online at: <https://data.bayareametro.gov/Demography/Projections-2040-by-Jurisdiction/grqz-amra>
- CA DOF 2020 – California Department of Finance (CA DOF). E-5 Population and Housing Estimates for Cities, Counties and the State — January 1, 2011-2020, with 2010 Benchmark, May 2020. Available online at: <http://dof.ca.gov/Forecasting/Demographics/Estimates/E-5/>
- CA EDD 2019 – Employment Development Department, State of California (CA EDD). Labor Market Information Division, 2016-2026 Occupational Employment Projections, San Jose-Sunnyvale-Santa Clara Metropolitan Statistical Area, (San Benito and Santa Clara Counties), data last update May 28, 2019. Available online at: <https://data.edd.ca.gov/Employment-Projections/Long-Term-Occupational-Employment-Projections/4yzm-uyfq>
- San Jose 2016 – City of San Jose (San Jose). Planning Commission Staff Report, Addendum to the Envision San Jose 2040 General Plan Final Program Environmental Impact Report. December 13, 2016. Available online at: http://sanjose.granicus.com/MetaViewer.php?view_id=&event_id=2662&meta_id=604932
- SV1 2020a – SV1, LLC. (SV1). Application for Small Power Plant Exemption: Great Oaks South Backup Generating Facility (TN 232466), March 2020. Available online at: <https://efiling.energy.ca.gov/Lists/DocketLog.aspx?docketnumber=20-SPPE-01>
- SV1 2020d – SV1, LLC. (SV1). SV1 Responses to CEC Data Request Set 2: Great Oaks South Backup Generating Facility Part 1 through Part 4 (TN 233005-1,2,3,4), May 2020. Available online at: <https://efiling.energy.ca.gov/Lists/DocketLog.aspx?docketnumber=20-SPPE-01>
- US Census 2010 – United States Census Bureau (US Census). P1: TOTAL POPULATION - Universe: Total population, 2010 Census Summary File 1. Available online at: <https://data.census.gov/cedsci/>

4.15 Public Services

This section describes the environmental and regulatory setting, and discusses impacts associated with the construction and operation of the project specific to public services.

PUBLIC SERVICES	Potentially Significant Impact	Less Than Significant with Mitigation Incorporated	Less Than Significant Impact	No Impact
a. Would the project result in substantial adverse physical impacts associated with the provision of new or physically altered governmental facilities, need for new or physically altered governmental facilities, the construction of which could cause significant environmental impacts, in order to maintain acceptable service ratios, response times, or other performance objectives for any of the public services:	<input type="checkbox"/>	<input type="checkbox"/>	<input checked="" type="checkbox"/>	<input type="checkbox"/>
i. Fire protection?	<input type="checkbox"/>	<input type="checkbox"/>	<input checked="" type="checkbox"/>	<input type="checkbox"/>
ii. Police Protection?	<input type="checkbox"/>	<input type="checkbox"/>	<input checked="" type="checkbox"/>	<input type="checkbox"/>
iii. Schools?	<input type="checkbox"/>	<input type="checkbox"/>	<input checked="" type="checkbox"/>	<input type="checkbox"/>
iv. Parks?	<input type="checkbox"/>	<input type="checkbox"/>	<input checked="" type="checkbox"/>	<input type="checkbox"/>
v. Other public facilities?	<input type="checkbox"/>	<input type="checkbox"/>	<input checked="" type="checkbox"/>	<input type="checkbox"/>

Environmental checklist established by CEQA Guidelines, Appendix G.

4.15.1 Setting

The proposed project is in the City of San Jose in Santa Clara County. The project would include three 182,350 square foot, two-story data center buildings and a backup generating facility in six generation yards. Fire and police protection services are provided to the project site from departments within the City of San Jose. Recreation facilities and other public facilities like libraries are also provided by the City of Santa Jose. Therefore, the study area for public services-related impacts is the City of San Jose, with the exception of schools which is based on the school district(s) in which the project is located; within the boundaries of the Oak Grove and East Side Union school districts.

Fire Protection

The project would be located within the jurisdiction of the San Jose Fire Department (SJFD). The SJFD provides fire suppression, emergency medical services, and fire prevention services to the City of San Jose (San Jose 2020a, pg. 80). The SJFD has 33 fire stations. Station 27 is located at 6027 San Ignacio Avenue, approximately 0.5 mile east of the project site (SJFD 2020a).

The SJFD has approximately 676 fire service personnel (SJFD 2020b). In 2019-2020, SJFD responded to approximately 91,600 incidents. Of the incidents SJFD responded to, approximately 62 percent were for medical emergencies, 4 percent for fires, and 34

percent were for other incidents (rescues, good intent calls, and false alarms) (San Jose 2020a).

The SJFD's goal is to respond within eight minutes for 80 percent of Priority 1 incidents and within 13 minutes for 80 percent of Priority 2 incidents. In 2019-2020, SJFD responded to 75 percent of Priority 1 incidents within 8 minutes and 92 percent of Priority 2 incidents within 13 minutes. The SJFD disaggregates Priority 1 response time by three time targets: dispatch time, turnout time, and travel time. SJFD met its target for dispatch time and turnout time. The SFPD met its travel time standard for only 45 percent of Priority 1 incidents. (San Jose 2019). San Jose is not in a very high fire hazard severity zone in a local responsibility area (CalFire 2008).

Police Protection

Police protection would be provided by the San Jose Police Department (SJPD). The SJPD is located at 201 West Mission Street, approximately 10.5 miles northwest of the project site. The SJPD has 110 sworn authorized positions per 100,000 residents (San Jose 2020a). The SJPD is comprised of four bureaus and the Bureau of Field Operations (BFO) is the primary provider of police services for the residents of San Jose. The BFO has over 980 officers and responds to emergency and non-emergency calls for service. The BFO is divided into four divisions and the project site is located in the Southern Division (SJPD 2020).

In 2019-2020, the SJPD handled 1.2 million calls for service and responded to 212,000 Priority 1 to 4 incidents. Approximately 5 percent of the incidents SJPD responded to were Priority 1 and approximately 41 percent were Priority 2. The City of San Jose's Envision 2040 General Plan (general plan) identifies a goal to provide a response time of six minutes or less for 60 percent of all Priority 1 calls and eleven minutes or less for 60 percent of all Priority 2 calls (San Jose 2018, Chapter 4, pg. 38). The average response time for Priority 1 calls was 7 minutes and 58 percent of Priority 1 calls met the six-minute target. The average response time for Priority 2 calls was 21 minutes and 46 percent of the Priority 2 calls met the 11-minute target (San Jose 2020a).

Schools

The project would be located within the Oak Grove Elementary and East Side Union school districts. The Oak Grove Elementary School District is located in the southeastern corner of San Jose. The Santa Clara Unified School District has an approximate enrollment of 9,896 students from transitional kindergarten to 8th grade. There are 14 elementary schools and 3 intermediate schools (OGSD 2020). The East Side Union School District had an enrollment of 24,263 students in the 2017/2018 school year and has 11 high schools, 10 charter schools, 4 continuation schools, and 1 alternative school (CDE 2018). The closest schools to the project site in the Oak Grove Elementary School District are Julia Baldwin Elementary and Bernal Intermediate, located approximately 0.6 mile south and 0.7 mile southwest respectively. In the East Union High School District, the nearest school to the project site is Santa Teresa High School, located approximately 1.5 miles west of

the project site. The nearest school to the project site is the Stratford School (private) located approximately 0.4 mile west of the project site.

Parks

The City of San Jose has 199 neighborhood and 10 regional parks, 40 trail systems, and 48 community centers (San Jose 2020a). Included in the park and recreation areas are ball fields, basketball hoops, park playgrounds, swimming pools, skate parks, dog parks, courts (bocce ball, volleyball, and tennis), and a zoo (San Jose 2017).

The City of San Jose's goal is to provide 3.5 acres of neighborhood/community serving parkland per 1,000 population through a combination of 1.5 acres of public park and 2 acres of recreational school grounds open to the public. San Jose also has the goal to provide 7.5 acres of citywide/regional park and open space lands per 1,000 population and 500 square feet of community center space per 1,000 population (San Jose 2018).

Table 4.14-1 in **Section 4.14 Population and Housing** provides a population estimate of 1,028,210 for the City of San Jose. With a total 1,228 acres of neighborhood parks, San Jose has approximately 1.2 acres per 1,000 population and does not meet its park standard for neighborhood/community serving parkland. With a combined total of 1,987 acres of regional parks and open space and undeveloped land, San Jose has approximately 1.9 acres per 1,000 population and does not meet its citywide/regional park and open space standard. San Jose has 553,464 square feet of community center facilities and meets its community center facilities standard with 538 square feet per 1,000 population (San Jose 2020a).

The closest parks to the project site are George Page Park, which is located approximately 0.9 mile to the northwest, and Los Paseos Park, located approximately 0.7 mile to the southeast. George Page Park is a four-acre park with a youth playground, tennis court, and softball field. Los Paseos Park is a 10.8-acre park with a playground, tennis courts, and exercise course (San Jose 2020b).

Other Public Facilities

The San Jose City Library has 25 branches to serve the City of San Jose. The closest library to the project site is the Santa Teresa Library, which is located approximately 1.1 miles to the northwest (SJPL 2020).

Regulatory Background

No regulations related to public services apply to the project.

4.15.2 Applicant Proposed Measures

None.

4.15.3 Environmental Impacts and Mitigation Measures

a. Would the project result in substantial adverse physical impacts associated with the provision of new or physically altered governmental facilities, need for new or physically altered governmental facilities, the construction of which could cause significant environmental impacts, in order to maintain acceptable service ratios, response times, or other performance objectives for any of the public services:

i. Fire Protection?

Construction

Less Than Significant Impact. The existing project site is a vacant lot, which is already serviced by the City of San Jose Fire Department (SV1 2020a, pg. 185).

Project construction activities that could pose a risk for fire or the need for fire protection response due to heated exhaust or sparks, include the use of grinders, cranes, excavation equipment, vehicles, and bulldozers. Other construction activities with a potential fire risk due to heat sources or open flames could include the use of torches or welding.

The standard for fire protection response time for Priority 1 incidents is eight minutes, 80 percent of the time. Current data show the SJFD meets its target response time for Priority 1 incidents 75 percent of the time (San Jose 2020a). While there may be a slight increased need for fire protection response during project construction, these effects would not be sufficient to induce the construction of new or physically altered governmental facilities that could result in significant environmental impacts; therefore, impacts would be less than significant.

Operation

Less Than Significant Impact. The project would employ an estimated 42 operations workers. The applicant estimates that workers would be hired locally from the greater Bay Area (SV1 2020a). Based on the proximity of the supply of operations workers, they are not likely to relocate closer to the project. The few operations workers that may move into San Jose and within SJFD's service area would have a negligible effect on the ability of the existing fire stations to meet their emergency service and response standards.

The project would develop a vacant site, thereby increasing the demand for fire services. However, the project would be consistent with the planned growth in the general plan (see **Section 4.14 Population and Housing**) and would not result in the need to construct new fire facilities.

The project would include diesel fuel tanks located underneath each generator (SV1 2020a, pg. 10). The fuel tanks would be double-walled with leak detection (SV1 2020a, pg. 16). Diesel fuel would be delivered on an as needed basis in a compartmentalized

tanker truck with maximum capacity of 8,500 gallons. An emergency pump shut-off would be used if a pump hose breaks while fueling the tanks (SV1 2020a, pg. 17). A fire access lane along the southern boundary of the project site would provide access to emergency vehicles (SV1 2020a, pg. 195). The project facilities would be constructed to conform with current building and fire codes. The SJFD would review project plans to ensure appropriate safety measures are incorporated to reduce fire hazards (SV1 2020a, pg. 185). With all of the above elements, the impacts to the fire protection service would be less than significant.

Required Mitigation Measures: None.

ii. Police Protection?

Construction

Less Than Significant Impact. The construction workforce is not expected to relocate closer to the project site and would not increase the demand for emergency response services, including police protection. Construction of the project may result in a slight increase in the need for police services. However, the average response times for the police department would not be significantly affected by the project construction. The project would not induce construction of new or physically altered governmental facilities, such as police stations that could result in significant environmental impacts. Therefore, impacts would be less than significant.

Operation

Less Than Significant Impact. The project's 42 operations workers would be drawn from the greater Bay Area and are not expected to relocate closer to the project site. The few operations employees that may move into San Jose and within SJPD's service area would have a negligible effect on the ability of the SJPD to meet its emergency service and response standards.

The project would develop a vacant site, thereby increasing the demand for police services. However, the project would be consistent with the planned growth in the general plan. The project would have a security office and onsite security personnel. The project site's three entry points would be gated and electronically secured (SV1 2020a, pg. 19). The onsite security and gated entry points would deter criminal activity during operation. Additionally, the police department would review the final site design to ensure that the project provides adequate safety and security measures (SV1 2020a). The project would not result in substantial adverse physical environmental impacts associated with the provision of new or physically altered police service facilities in order to maintain acceptable service ratios, response times, or other performance objectives. Impacts would be less than significant.

Required Mitigation Measures: None.

iii. Schools?

Construction and Operation

Less Than Significant Impact. The project would be in the Oak Grove Elementary and East Side Union High school districts. The District Board Policy (BP 7211 Facilities: Developer Fees) for both of the school districts allows the Board of Trustees to establish, levy, and collect developer fees on residential, commercial, and industrial construction within the district. Government Code section 65995 expressly provides that “[t]he payment or satisfaction of a fee, charge, or other requirement levied or imposed pursuant to Section 17620 of the Education Code in the amount specified in Section 65995... are hereby deemed to be full and complete mitigation of the impacts of any legislative or adjudicative act, or both, involving but not limited to, the planning, use, or development of real property, or any change in governmental organization... on the provision of adequate school facilities.” The current school impact fee for the Oak Grove Elementary School District is \$0.34 per square foot of covered, enclosed commercial/industrial space (OGESD 2013). Based on the proposed size of the three buildings (combined total of 547,050 square feet), an estimated \$292,173 would be assessed. The current school impact fee for the East Side Union High School District is \$0.20 per square foot of covered, enclosed commercial/industrial space and an estimated \$190,410 would be assessed on the proposed size of the three buildings (ESUHSD 2019). These fees would be collected at the time the applicant applies for building permits from the City of San Jose; therefore, impacts would be less than significant.

Required Mitigation Measures: None.

iv. Parks?

Construction

No Impact. The project would be constructed in three separate phases; each phase would require an average 125-150 workers and a peak of 200-225 workers. The construction workforce would be drawn from the greater Bay Area and would not require an influx of new workers. Also, construction workers who may temporarily relocate closer to the project do not typically visit area parks or park facilities while working in the project area and tend to return to their primary residence for the weekends. Therefore, construction of the project would not affect park standards or increase the demand for park facilities. The project construction would have no impact on parks or park facilities.

Operation

Less Than Significant Impact. The project’s approximately 42 operations workers would be drawn from the greater Bay Area and are not likely to relocate closer to the project. If some operations workers were to relocate, the few new residents would have a negligible increase on the usage of or demand for parks or other recreational facilities. Therefore, the project would not result in substantial adverse physical environmental impacts associated with the provision of new or physically altered park facilities in order

to maintain acceptable service ratios or other performance objectives. Impacts would be less than significant.

Required Mitigation Measures: None

v. Other Public Facilities?

Construction

No Impact. The construction workforce would be drawn from the greater Bay Area and workers would not likely relocate closer to the project site. However, if some construction workers were to temporarily relocate, they are not likely to visit public facilities such as public libraries while working in the project area and tend to return to their primary residence for the weekends. There would be no impacts to public facilities during project construction.

Operation

Less Than Significant Impact. The project's approximately 42 operations workers would be drawn from the greater Bay Area and are not likely to relocate closer to the project site. However, if some operations workers were to relocate, the few new residents would likely have a negligible increase in the usage of or demand for the surrounding libraries or public facilities; therefore, the project's operations impacts would be less than significant.

Required Mitigation Measures: None.

4.15.4 References

CalFire 2008 – Cal Fire. Santa Clara County FHSZ Map in Local Responsibility Area. October 8, 2008. Accessed April 2020. Available online at: https://osfm.fire.ca.gov/media/6764/fhszl_map43.pdf

CDE 2018 – California Department of Education (CDE). California Department of Education, Data Quest, Selected District Level Data for the year 2017-2018, East Side Union (43-69427). Available online at: <https://dq.cde.ca.gov/dataquest/Cbeds3.asp?Tp=on&GradeSpan=on&NumSchls=on&Enroll=on&cSelect=4369427--East+Side+Union+High&cChoice=DstProf2&cYear=2017-18&cLevel=District&cTopic=Profile&myTimeFrame=S&submit1=Submit>

ESUHSD 2019 – East Side Union High School District (ESUHSD). East Side Union High School District Developer Fee. Effective August 11, 2019. Accessed April 2020. Available online at: <http://www.esuhd.org/Community/Facilities/Developer-Impact-Fees/index.html>

OGSD 2013 – Oak Grove School District (OGSD). Oak Grove School District Developer Fee. Effective June 26, 2013. Accessed on: April 2020. Available online at:

https://www.ogsd.net/apps/pages/index.jsp?uREC_ID=586638&type=d&pREC_ID=1551379

OGSD 2020 – Oak Grove School District. Oak Grove School District, About Us. Accessed April 2020. Available online at:

https://www.ogsd.net/apps/pages/index.jsp?uREC_ID=586020&type=d&pREC_ID=1075696

San Jose 2017 – City of San Jose (San Jose). Building Community Through Fun 2017 Community Impact Report. Accessed on April 2020. Available online at:

<https://www.sanjoseca.gov/home/showdocument?id=9657>. San Jose 2018 – City of San Jose (San Jose). Envision San Jose 2040 General Plan. Adopted November 1, 2011. Last Amended December 18, 2018. Available online at:
<https://www.sanjoseca.gov/home/showdocument?id=22359>

San Jose 2020a – City of San Jose (San Jose). City of San Jose Annual Report on City Services 2019-2020. December 2020. Accessed on: February 2021. Available online at: <https://www.sanjoseca.gov/your-government/appointees/city-auditor/services-report>

San Jose 2020b – City of San Jose (San Jose). City of San Jose website – Search Parks & Playgrounds. Accessed on: April 2020. Available online at:

<https://www.sanjoseca.gov/your-government/departments/parks-recreation-neighborhood-services/outdoor-activities/search-parks-playgrounds>

SJFD 2020a – San Jose Fire Department (SJFD). San Jose Fire Department website – Stations. Accessed on: April 2020. Available online at:

<https://www.sanjoseca.gov/your-government/departments-offices/fire/stations>

SJFD 2020b – San Jose Fire Department (SJFD). San Jose Fire Department website – San Jose Fire Fighters “Year in Review”. Accessed on: April 2020. Available online at: <https://sjff.org/sjfd>

SJPD 2020 – San Jose Police Department (SJPD). San Jose Police Department website – SJPD Central Division. Accessed on: April 2020. Available online at:

<http://www.sjpd.org/bfo/central.asp>

SJPL 2020 – San Jose Public Library (SJPL). San Jose Public Library website – Locations & Hours. Accessed on: April 2020. Available at: <https://www.sjpl.org/locations-menu>

SV1 2020a – SV1, LLC. (SV1). Application for Small Power Plant Exemption: Great Oaks South Backup Generating Facility (TN 232466), March 2020. Available online at: <https://efiling.energy.ca.gov/Lists/DocketLog.aspx?docketnumber=20-SPPE-01>

4.16 Recreation

This section describes the environmental and regulatory setting, and discusses impacts associated with the construction and operation of the project specific to recreation.

RECREATION Would the project:	Potentially Significant Impact	Less Than Significant with Mitigation Incorporated	Less Than Significant Impact	No Impact
a. Would the project increase the use of existing neighborhood and regional parks or other recreational facilities such that substantial physical deterioration of the facility would occur or be accelerated?	<input type="checkbox"/>	<input type="checkbox"/>	<input checked="" type="checkbox"/>	<input type="checkbox"/>
b. Does the project include recreational facilities or require the construction or expansion of recreational facilities, which might have an adverse physical effect on the environment?	<input type="checkbox"/>	<input type="checkbox"/>	<input checked="" type="checkbox"/>	<input type="checkbox"/>

Environmental checklist established by CEQA Guidelines, Appendix G.

4.16.1 Setting

The project is proposed in the City of San Jose in Santa Clara County. The project site is undeveloped and zoned Industrial Park. While nearby cities include Campbell, Los Gatos, and Morgan Hill, staff considers the City of San Jose as the project study area for recreation impacts. This is consistent with staff's experience that local workers are not likely to temporarily or permanently relocate closer to the project site (see **Section 4.14 Population and Housing**) and thus, not add new users to the city's recreation facilities.

Recreation Facilities

The City of San Jose has 199 neighborhood and 10 regional parks, 40 trail systems, and 48 community centers (San Jose 2020). The closest recreational facilities to the project site are George Page Park located approximately 0.9 mile northwest and Los Paseos Park located approximately 0.7 mile to the southeast. The City of San Jose maintains the parks.

Regulatory Background

No regulations related to recreation apply to the project.

4.16.2 Applicant Proposed Measures

None.

4.16.3 Environmental Impacts and Mitigation Measures

a. Would the project increase the use of existing neighborhood and regional parks or other recreational facilities such that substantial physical deterioration of the facility would occur or be accelerated?

Construction

No Impact. The project would be constructed in three separate phases, each phase requiring an average of 125-150 workers and a peak of 200-225 workers (SV1 2020a). The construction period would last 51 months, which includes downtime between phases and lag time between the start and end of construction (SV1 2020d). The applicant estimates that the construction workforce would be recruited from the greater Bay Area, thus the workforce would likely be drawn from the San Jose-Sunnyvale-Santa Clara region.¹ Based on the proximity of the available workforce to the project, construction workers from neighboring cities and counties are not likely to temporarily relocate closer to the project site or visit the nearby parks. Thus, the project would not increase the use of or accelerate the physical deterioration of parks or other recreational facilities. Therefore, the project would have no impact on the surrounding parks and recreational facilities.

Operation

Less Than Significant Impact. The project would employ 42 operations workers drawn from the greater Bay Area (see **Section 4.14 Population and Housing**). Based on the proximity of the supply of operations workers, they are not likely to relocate closer to the project. If some operations workers were to move closer to the project, they would not be in numbers where the use of existing parks or recreational facilities would be increased to the extent that substantial physical deterioration of the park or facility would result. Impacts to surrounding parks and recreational facilities would be less than significant.

Required Mitigation Measures: None.

b. Does the project include recreational facilities or require the construction or expansion of recreational facilities, which might have an adverse physical effect on the environment?

Construction

No Impact. Recreational facilities are not included as part of the project nor would the project require the construction or expansion of recreational facilities. The construction needs of the project would be supplied by the existing workforce from the greater Bay Area and would not require an influx of new workers. Construction workers would commute to the project site during construction and they are not likely to temporarily

¹ Region in this instance is the Metropolitan Statistical Area. A Metropolitan Statistical Area is a geographical region with a relatively high population density at its core and close economic ties throughout the area.

relocate closer to the project. Therefore, project construction would have no impacts to recreational facilities.

Operation

Less Than Significant Impact. The project would employ 42 operations workers drawn from the greater Bay Area. If some operations workers did move closer to the project, they would not be in numbers that would require the construction or expansion of recreational facilities. Therefore, operation of the project would have a less than significant impact on recreation facilities and would not require the construction or expansion of recreational facilities to accommodate the project.

Required Mitigation Measures: None.

4.16.4 References

San Jose 2020 – City of San Jose (San Jose). City of San Jose Annual Report on City Services 2019-2020. December 2020. Accessed on: February 2021. Available online at: <https://www.sanjoseca.gov/your-government/appointees/city-auditor/services-report>

SV1 2020a – SV1, LLC. (SV1). Application for Small Power Plant Exemption: Great Oaks South Backup Generating Facility (TN 232466), March 2020. Available online at: <https://efiling.energy.ca.gov/Lists/DocketLog.aspx?docketnumber=20-SPPE-01>

SV1 2020d – SV1, LLC. (SV1). SV1 Responses to CEC Data Request Set 2: Great Oaks South Backup Generating Facility Part 1 through Part 4 (TN 233005-1,2,3,4), May 2020. Available online at: <https://efiling.energy.ca.gov/Lists/DocketLog.aspx?docketnumber=20-SPPE-01>

4.17 Transportation

This section describes the environmental and regulatory setting and discusses impacts specific to transportation associated with the construction and operation of the project.

TRANSPORTATION	Potentially Significant Impact	Less Than Significant with Mitigation Incorporated	Less Than Significant Impact	No Impact
Would the project:				
a. Conflict with a program, plan, ordinance or policy addressing the circulation system, including transit, roadway, bicycle and pedestrian facilities?	<input type="checkbox"/>	<input type="checkbox"/>	<input checked="" type="checkbox"/>	<input type="checkbox"/>
b. Conflict or be inconsistent with CEQA Guidelines section 15064.3, subdivision (b)?	<input type="checkbox"/>	<input type="checkbox"/>	<input checked="" type="checkbox"/>	<input type="checkbox"/>
c. Substantially increase hazards due to a geometric design feature (e.g., sharp curves or dangerous intersections) or incompatible uses (e.g., farm equipment)?	<input type="checkbox"/>	<input type="checkbox"/>	<input checked="" type="checkbox"/>	<input type="checkbox"/>
d. Result in inadequate emergency access?	<input type="checkbox"/>	<input type="checkbox"/>	<input checked="" type="checkbox"/>	<input type="checkbox"/>

Environmental checklist established by CEQA Guidelines, Appendix G.

4.17.1 Setting

The project site is in the City of San Jose on an 18-acre undeveloped lot. The site is associated with three addresses: 123 Great Oaks Boulevard, 127 Great Oaks Boulevard, and 131 Great Oaks Boulevard. Numerous urban roadways and freeways, including U.S. Highway 101 (US-101) and State Route 85 (SR-85), provide regional access. Local access to the site is provided by Bernal Road and Santa Teresa Boulevard. Direct access is established via Great Oaks Boulevard, Via Del Oro, and San Ignacio Avenue.

Three site entrances would be constructed. A main passenger vehicle entrance would be provided along Great Oaks Boulevard near an existing curb cut in the boulevard median. A secondary passenger vehicle entrance would be provided on San Ignacio Avenue. A service entrance for delivery trucks would be provided mid-block on Via Del Oro. All entrances would be gated and electronically secured (SV1 2020a).

Nearby transportation infrastructure includes sidewalks, bicycle lanes, bus transit and passenger rail. Pedestrian facilities in the project area consist of sidewalks and crosswalks that provide pedestrians with safe routes to transit and the surrounding land uses. Bicycle facilities in the area consist of Class II bicycle lanes on Santa Teresa Boulevard, Great Oaks Boulevard, Bernal Road, and San Ignacio Avenue. Existing Class II bike lanes along Great Oaks Boulevard, San Ignacio Avenue, and Santa Teresa Boulevard are planned to be converted to Class IV protected bike lanes. Lastly, a Class II bicycle lane is planned for Via Del Oro, between San Ignacio Avenue and the iSTAR mixed-use development (San Jose 2009). Transit service to the project area is provided by the Santa Clara Valley Transportation Agency (VTA). The Santa Teresa Light Rail Station, which is located

approximately 0.25-mile northwest of the project site, has a park and ride lot and is served by the Santa Teresa-Baypointe Blue Line. The Santa Teresa Light Rail station is also served by bus routes: 42, 68, 102, 122, and 182. Caltrain, Altamont Commuter Express (ACE), and Amtrak's Capitol Corridor provide passenger train service approximately 1.3-miles southwest of the project site at the Blossom Hill Station (VTA 2020). The closest bus stop to the site is located at the San Ignacio Avenue and Via Del Oro intersection, approximately 100 feet north of the site, along VTA local Bus Route 42. Frequent bus route 68 runs along Santa Teresa Boulevard with the nearest stop located at the Santa Teresa Light Rail Station. The closest airport is the Reid Hill-View Airport located approximately 6.85 miles north of the project site (AirNav 2020).

Regulatory Background

Federal

Code of Federal Regulations (Title 14, Part 77.9 [a]). This regulation requires notification of the Federal Aviation Administration (FAA) for any construction or alterations exceeding 200 feet above ground level (AGL) (CFR 2020a). If a project's height, including any temporary equipment (such as cranes used during construction) or any ancillary structures (such as transmission poles), exceeds 200 feet AGL, the project applicant must submit a copy of FAA Form 7460-1, Notice of Proposed Construction or Alteration, to the FAA. This regulation also requires FAA notification of any construction or alteration of greater height than an imaginary surface extending outward and upward at a slope of 100 to 1 for a horizontal distance of 20,000 feet from the nearest point of the nearest runway of a public or military airport with at least one runway more than 3,200 feet in length.

State

California Department of Transportation. Project construction activities that require movement of oversized or excessive load vehicles on state roadways require a transportation permit issued by the California Department of Transportation (Caltrans). Caltrans may also require the applicant to prepare a Transportation Management Plan prior to construction to reduce effects on the state transportation network (Caltrans 2014).

Local

Santa Clara County Airport Land Use Commission's Comprehensive Land Use Plan for Reid-Hillview Airport. Figure 6 of the Santa Clara County Airport Land Use Commission's Comprehensive Land Use Plan (CLUP) identifies the Federal Aviation Regulations (FAR) Part 77 obstruction surfaces around the airport. Exceedance of these surfaces could result in obstruction of airspace and hazards to aircraft entering or exiting the Reid-Hillview Airport. The project site is located outside of the airport's FAR Part 77 surfaces; however, the least restrictive FAR Part 77 surface of 483 feet above mean sea level (AMSL) is shown on Figure 6 of the CLUP and is used in this analysis for discussion purposes only (Santa Clara County 2016).

City of San Jose General Plan. *Envision San Jose 2040 General Plan* includes policies for the purpose of avoiding or mitigating impacts resulting from planned development projects with the City. The following policies are specific to transportation and are applicable to the proposed project.

- Policy TR-1.1: Accommodate and encourage use of non-automobile transportation modes to achieve San Jose’s mobility goals and reduce vehicle trip generation and vehicle miles traveled (VMT).
- Policy TR-1.2: Consider impacts on overall mobility and all travel modes when evaluating transportation impacts of new developments or infrastructure projects.
- Policy TR-1.4: Through the entitlement process for new development, fund needed transportation improvements for all transportation modes, giving first consideration to improvement of bicycling, walking and transit facilities. Encourage investments that reduce vehicle travel demand.
- Policy TR- 1.5: Design, construct, operate, and maintain public streets to enable safe, comfortable, and attractive, access and travel for motorists and for pedestrians, bicyclists, and transit users of all ages, abilities, and preferences.
- Policy TR-2.8: Require new development where feasible to provide on-site facilities such as bicycle storage and showers, provide connections to existing and planned facilities, dedicate land to expand existing facilities or provide new facilities such as sidewalks and/or bicycle lanes/paths, or share in the cost of improvements.
- Policy TR-3.3: As part of the development review process, require that new development along existing and planned transit facilities consist of land use and development types and intensities that contribute towards transit ridership. In addition, require that new development is designed to accommodate and to provide direct access to transit facilities.
- Policy TR- 5.3: The minimum overall roadway performance during peak travel periods should be level of service “D” except for designated areas and specified exceptions identified in the General Plan including the Downtown Core Area. Mitigation measures for vehicular traffic should not compromise or minimize community livability by removing mature street trees, significantly reducing front or side yards, or creating other adverse neighborhood impacts.
- Policy TR-8.4: Discourage, as part of the entitlement process, the provision of parking spaces significantly above the number of spaces required by code for a given use.
- Policy TR-9.1: Enhance, expand and maintain facilities for walking and bicycling, particularly to connect with and ensure access to transit and to provide a safe and complete alternative transportation network that facilitates non-automobile trips.

City of San Jose, Transportation Analysis Policy 5-1. The City of San Jose adopted Transportation Analysis Policy 5-1 to align with SB 743. This policy replaces Transportation Impact Policy 5-3 and establishes thresholds for transportation impacts under the California Environmental Quality Act (CEQA) based on VMT instead of level of service

(LOS). The intent of this change is to shift the focus of transportation analysis under CEQA from vehicle delay and roadway auto capacity to a reduction in vehicle emissions.

According to the policy, an employment (e.g., office or research and development) project's transportation impact would be less than significant if the project VMT is 15 percent or more below the existing regional VMT per employee. For industrial projects (e.g., warehouse, manufacturing, distribution), the impact would be less than significant if the project VMT is equal to or less than existing average regional per capita VMT. Screening criteria have been established by the city to determine which projects require a detailed VMT analysis. If a project meets the relevant screening criteria, it is considered to have a less than significant VMT impact. If a project's VMT does not meet the screening criteria and established thresholds, mitigation measures would be required, where feasible.

City of San Jose, Transportation Analysis Handbook 2020. The Transportation Analysis Handbook provides transportation analysis (TA) significance criteria, screening criteria, and thresholds of significance for environmental clearance of development projects, city transportation projects, and General Plan amendments. In addition, it provides a framework for a TA based on the city's transportation policies and the *Envision San Jose 2040 General Plan*. It also provides appropriate methodologies, procedures, and process for the preparation of a TA report within the context of CEQA. Lastly, it provides the appropriate methodologies, procedures, and process for determining the effects of projects on the local transportation system.

A TA that includes an analysis of VMT and local transportation impacts related to level of service (LOS) was conducted for the project. Existing peak hour traffic volumes for four intersections in the project's immediate vicinity (Santa Teresa Boulevard and Great Oaks Boulevard, Santa Teresa Boulevard and San Ignacio Avenue, Via Del Oro and Great Oaks Boulevard, and Via Del Oro and San Ignacio Avenue) were obtained from the City of San Jose¹. The results of the LOS analysis, contained in Appendix C of the TA, show the four intersections are currently operating above the City of San Jose LOS standard "D" during both AM and PM peak hours. (SV1 2021h) The addition of project trips is not expected to reduce existing intersection LOS ("B" and "C") to a level below LOS "D". Furthermore, the project site is located within the Edenvale Area Development Area which allows LOS to temporarily degrade to a level below LOS "D".

Edenvale Area Development Policy. The policy area includes approximately 2,312 acres located in south San Jose in the vicinity of US Highway 101 and State Route 85 interchange, north of Santa Teresa Boulevard, east of Cottle Road, and west of Bernal Road/Silicon Valley Boulevard. The project is located within "Sub-Area 2" or "Old Edenvale" and is located east of Cottle Road, north of Santa Teresa Boulevard, northwest

¹ Due to the current COVID-19 pandemic a one percent compounded annual growth factor was applied to traffic counts that are older than two years to estimate traffic conditions in 2020. (SV 2021h)

of Bernal Road, and southwest of State Route 85 (San Jose 2014). Area 2 is located within Community Facilities District 6, Great Oaks- Route 85 (San Jose 2001).

The Edenvale Area Development Policy (EADP) was adopted to manage traffic congestion associated with near term development in the policy area, promote General Plan goals for economic development (particularly high technology driving industries), encourage a citywide reverse commute to jobs at southerly locations in San Jose, and provide for transit-oriented, mixed-use residential and commercial development to increase internalization of automobile trips and promote transit ridership.

The EADP accomplishes these goals by allowing certain industrial, office, and commercial developments to proceed prior to the construction and completion of traffic infrastructure improvements required by mitigation measures to address intersection LOS impacts. This will result in interim congestion at these intersections to temporarily exceed the LOS standards of the Citywide LOS Policy, with the intention that these intersections will return to a LOS standard that is better than or equivalent to background conditions prior to the adoption of the EADP once all mitigation is constructed.

A project's consistency with the EADP is determined by its consistency with the land use development and traffic assumptions described in the EADP, and its contribution to assessment and community facilities districts to finance infrastructure improvements in the EADP.

4.17.2 Applicant Proposed Measures

PD TRA-1: Prior to the issuance of any Public Works clearances, the project shall implement the following Transportation Demand Management (TDM) measures:

- Expand the Reach of Bike Access with Investment in Infrastructure (Tier 2- Bike Access Improvements): Implement bicycle facilities that close gaps in the bicycle network and/or improve the existing bicycle network (e.g. construct barrier or buffer for an existing bike lane). Improving bike access to the project promotes biking as an alternative to driving and reduces VMT. The San Jose Better Bike Plan 2025 identifies Class II bike lanes along Via Del Oro between Bernal Road and Raleigh Road. Additionally, the existing Class II bike lanes along Great Oaks Boulevard, San Ignacio Avenue, and Santa Teresa Boulevard in the project vicinity are planned to be converted to Class IV protected bike lanes. The project would be required to implement Class II bike lanes along Via Del Oro on the opposing side of the project frontage between San Ignacio Avenue and Great Oaks Boulevard. AND
- Provide Pedestrian Network Improvements for Active Transportation (Tier 2- Pedestrian Access improvements): Implement pedestrian improvements both on-site and in the surrounding area. Improving pedestrian connections encourages people to walk instead of drive and reduces vehicle miles travelled (VMT). The project would be required to remove each of the pork chop islands on the north leg (Great Oaks Boulevard) at the Santa Teresa Boulevard/Great Oaks Boulevard intersection to improve pedestrian safety and access. A signal modification will be needed for the

implementation of the pork-chop island removal at the northeast and northwest corners of Santa Teresa Boulevard/Via Del Oro intersection. In-lieu of the installed ADA curb ramps at Great Oaks Boulevard/Via Del Oro intersection, the project will be required to provide contribution towards the signal improvements including pan, tilt, zoom (PTZ) cameras at the Via Del Oro/San Ignacio Avenue and Via Del Oro/ Great Oaks Boulevard intersections to improve the pedestrian network in the project vicinity (SV1 2021h).

4.17.3 Environmental Impacts and Mitigation Measures

a. Conflict with a program, plan, ordinance or policy addressing the circulation system, including transit, roadway, bicycle and pedestrian facilities?

Construction

Less Than Significant Impact. Project construction would not significantly obstruct any transit, roadway, bicycle, or pedestrian facilities in the area. Construction activities would occur mostly onsite and not in the public right-of-way, with the exceptions of: installation of underground electrical distribution feeders at Via Del Oro; sidewalk improvements along Great Oaks Boulevard, San Ignacio Avenue, and Via Del Oro; removal of triangular raised (“pork chop”) islands at Great Oaks Boulevard and Santa Teresa Boulevard intersection; addition of a new Class II bicycle lane along Via Del Oro; and construction of project access points at Great Oaks Boulevard, San Ignacio Avenue and Via Del Oro. Project construction would not otherwise temporarily or permanently alter any public roadways or intersections. The City of San Jose, as the permitting agency, would ensure the project applicant obtains the proper permits for these activities to minimize disruption to the circulation system. Furthermore, the City of San Jose, as the permitting agency, would require the applicant to obtain all the required permits from Caltrans for the movement of oversized or excessive load vehicles on state roadways, and to submit to Caltrans a Transportation Management Plan, if required for the project, prior to construction to reduce effects on the state transportation network.

Project construction would not conflict with any program, plan, ordinance, or policy addressing the circulation system, including transit, roadway, bicycle, and pedestrian facilities, and would therefore have less than significant impacts.

Operation

Less Than Significant Impact. Operation of the project would occur fully onsite and would not obstruct pedestrian, bike, or transit facilities. Additionally, the project would not interfere with any future pedestrian, bike, or transit plans for the area. The project would be consistent with General Plan Policies TR 1.1, TR 1.2, TR 1.4, TR 1.5, TR 2.8, TR 3.3, TR 5.3 and TR 8.4 (discussed under the “Regulatory Background” heading of this section), which are intended to improve multimodal accessibility between land uses and to facilitate the use of non-vehicular travel. The project would involve the construction of a new

bicycle lane along the opposing side of Via Del Oro, the removal of pork chop islands at the intersection of Santa Teresa and Great Oaks boulevards, and the installation of PTZ cameras at two intersections to improve the pedestrian network in the project vicinity. Thus, the project would help implement pedestrian plans.

The project would also be consistent with the EADP, which was adopted to provide for the timely approval of up to five million square feet of industrial/R&D development in the development area, including the project site. Data centers are compatible with the site's existing IP – Industrial Park and TEC – Transit Employment Center General Plan land use designations. While the number of employees would be lower than for office or other industrial uses, development of data center uses would promote economic development in the City of San Jose. The proposed use is consistent with, or less employee and traffic intensive as the land development and traffic assumptions in the EADP. Additionally, the City of San Jose, as the permitting agency, would ensure the project contributes its fair share to Community Facilities District 6. To date, the project has contributed approximately \$120,083 to the Community Facilities District (CEC 2021k). Payments would continue until fiscal year 2023. Therefore, operation of the project would not conflict with the EADP.

Operation of the project would not conflict with any program, plan, ordinance, or policy addressing the circulation system, including transit, roadway, bicycle, and pedestrian facilities, and would therefore have less than significant impacts.

Required Mitigation Measures: None

b. Conflict or be inconsistent with CEQA Guidelines section 15064.3, subdivision (b)?

Construction

Less Than Significant Impact. CEQA Guidelines section 15064.3, subdivision (b), states that generally VMT is the most appropriate measure of transportation impacts. VMT refers to the amount and distance of automobile travel attributable to a project. Increased VMT exceeding an applicable threshold could constitute a significant impact. If existing models or methods are not available to estimate the VMT for a particular project being considered, a lead agency may analyze the project's VMT qualitatively, evaluating factors such as the availability of transit or proximity to other destinations. For construction traffic, a qualitative analysis of VMT impacts (instead of a more detailed quantitative analysis) is often appropriate (CANRA 2018; see also CEQA Guidelines section 15064.3, subdivision (b)(3)). The CEQA Guidelines also state that projects within 0.5 mile of either an existing major transit stop or a stop along an existing high-quality transit corridor should be regarded as having less than significant VMT impacts (CANRA, 2018).

Project construction would involve a temporary increase in vehicle trips resulting from workers commuting to the project site, and the delivery and hauling of project materials. Preparation of the site would include grading the entire site. Construction would occur in

three separate phases. One building would be constructed per phase, with construction lasting approximately 13 to 15 months per phase. The average construction workforce is estimated to be 138, with a peak estimated to be 225 for each phase (SV1 2020a). Each phase of construction is estimated to have one peak month of construction, for a total of three peak months during the construction timeline. To estimate construction worker trips the project applicant used daily trip rates for employees at a general light industrial facility and applied those rates to the anticipated number of construction workers for the average and peak workforce. The Institute of Transportation Engineers (ITE) Trip Generation Manual, Tenth Edition's trip generation rate for general light industrial land uses (land use code 110) is 3.05 daily one-way trips per employee (SV1 2020a).

Project construction would generate an average of 421 daily trips and a maximum of 686 daily trips during the approximately 47-month construction period. Many of the construction worker trips would be expected to occur prior to the morning and evening peak hours, in accordance with typical construction schedules. Truck trips would occur throughout the day and would be scheduled for off-peak hours whenever possible. All workers would be from the greater Bay Area and would not be traveling long distances. See **Section 4.3 Air Quality** for information related to exhaust emissions during construction.

The project would not conflict or be inconsistent with CEQA Guidelines section 15064.3, subdivision (b) because construction-generated traffic would be temporary and all workers would commute from the greater Bay Area, minimizing VMT impacts. Furthermore, the project is located within 0.5 mile of the Santa Teresa Light Rail Station, which provides frequent light rail and bus service during commute hours. Therefore, VMT impacts from project construction would be less than significant.

Operation

Less Than Significant Impact. Operation trips would be generated by: the 42 daily employees and 30 visitors (for a total of 72 daily round trips) who would travel to and from the project site; periodic trips by a tanker truck to supply diesel fuel for the generators on an as-needed basis; and delivery and trash-hauling trucks. It should be noted that the majority of trips would be made by the 72 employees and visitors, and as a result, the vehicle trips generated by the project would be much lower than the number calculated by the Institute of Transportation Engineers (ITE) trip generation rate for data centers (ITE #160), which estimates an average of 515 daily trips².

The project-level impact analysis under CEQA uses the VMT metric to evaluate a project's transportation impacts by comparing against the VMT thresholds of significance as established in the city's Transportation Analysis Policy 5-1. The thresholds of significance

² A five percent trip reduction was applied to the project trip generation estimates based on the location-based vehicle mode share produced from the San Jose Travel Demand Model (SV1 2021h, p. 28).

for development projects are based on the existing regional average VMT level for industrial and office employment uses.

The city's threshold of significance for industrial employment uses is 14.37 VMT per employee (San Jose 2020). Using the City of San Jose's Online VMT Evaluation Tool, the project is estimated to generate a total of 14.65 VMT per employee. Thus, VMT generated by the project, 14.65 VMT per employee before incorporation of PD TRA-1, would have exceeded the threshold of 14.37 VMT per employee. In consultation with the City of San Jose, the applicant incorporated PD TRA-1 to reduce the VMT impact. Implementation of PD TRA-1 would reduce the project VMT to 14.34 per employee which would cause the project VMT to fall below the city's industrial threshold and reduce the project impact to a less than-significant level. The City of San Jose, as the permitting agency, would ensure construction activities associated with implementation of PD TRA-1 are properly permitted to minimize disruption to project roadways. In addition, the City of San Jose would require the project applicant to prepare and submit a Transportation Demand Management (TDM) Plan for review and approval. A TDM plan includes monitoring, reporting, compliance, and funding of mitigation measures for the life the project (San Jose 2020). With incorporation of PD TRA-1, the project VMT (14.65) would be reduced to below the industrial threshold (14.37). Therefore, the project would have a less-than-significant impact on VMT.

Required Mitigation Measures: None.

c. Substantially increase hazards due to a geometric design feature (e.g., sharp curves or dangerous intersections) or incompatible uses (e.g., farm equipment)?

Construction

Less Than Significant Impact. Construction activities would occur mostly onsite and not in the public right-of-way, with the exceptions of: installation of underground distribution feeders at Via Del Oro; sidewalk improvements along Great Oaks Boulevard, San Ignacio Avenue, and Via Del Oro; removal of pork chop islands at Great Oaks Boulevard and Santa Teresa Boulevard intersection; addition of a new Class II bicycle lane along Via Del Oro; and construction of project access points at Great Oaks Boulevard, San Ignacio Avenue, and Via Del Oro. The City of San Jose, as the permitting agency, would ensure the applicant obtains the proper permits, including encroachment permits, to minimize any hazards resulting from construction equipment or activities. The City of San Jose would also require the project applicant to prepare a Traffic Control Plan to ensure localized traffic control around the project site during deliveries and construction activities would not cause hazards by obstructing roadways. Furthermore, the City of San Jose, as the permitting agency, would require the applicant to obtain all the required permits from Caltrans for the movement of oversized or excessive load vehicles on state roadways, and to submit to Caltrans a Transportation Management Plan, if required for the project, prior to construction. These actions would reduce any hazards from transportation of materials to and from the site and from construction activities affecting roadways.

As discussed under the “Regulatory Background” heading of this section, under Title 14, Part 77.9 of the Code of Federal Regulations, the threshold for the FAA notification is approximately 200 feet above ground level (AGL) at the project site. Project construction would require a crane for placement of each generator (SV1 2020a). If the crane should exceed 200 feet in height, the project applicant would be required to submit a Form 7460-1, Notice of Proposed Construction or Alteration, to the FAA. The FAA generally grants a Determination of No Hazard for temporary construction equipment. The City of San Jose, as the permitting agency for the project, would ensure consistency with this regulation and compliance with any of the FAA’s conditions. For these reasons, project construction would not increase hazards due to a geometric design feature or incompatible uses; therefore, impacts would be less than significant.

Operation

Less Than Significant Impact.

Structure Height. The project site is located approximately 6.85 miles south of the Reid-Hillview Airport. Tall structures can potentially pose a hazard to occupants of aircraft, depending on the heights of structures and their proximity to air traffic. The highest point of the proposed project, the top of the stair and elevator penthouse, would be approximately 72 feet AGL. The project’s maximum structure height of 72 feet would not exceed the FAA’s obstruction surface of 200 feet AGL at the project site. As a result, the project applicant would not be required to submit Form 7460-1, Notice of Proposed Construction or Alteration, to the FAA.

Thermal Plumes. The project’s emergency diesel generators and chillers would discharge thermal plumes, high-velocity columns of hot air, during operation. Thermal plume velocities would be greatest at the discharge points, with plume velocities decreasing with increasing altitude. Plume velocities would also be highest during certain weather conditions, such as cool temperatures and calm winds. High velocity thermal plumes have the potential to affect aviation safety, and the FAA Aeronautical Information Manual identifies thermal plumes as potential flight hazards (FAA 2017), though it should be noted that while the FAA regulates the heights of physical structures, it does not regulate plumes. Aircraft flying through thermal plumes may experience significant air disturbances, such as turbulence and vertical shear. The FAA manual advises that, when able, a pilot should fly upwind of smokestacks and cooling towers to avoid encountering thermal plumes.

CEC staff uses a peak vertical plume velocity of 10.6 meters per second (m/s) (5.3 m/s average plume velocity) as a screening threshold for potential impacts to aviation. Based on a literature search, this velocity generally defines the point at which aircraft begin to experience severe turbulence.

Based on data from past data center projects, staff estimated the project’s emergency diesel generator plumes would maintain a peak vertical velocity of 10.6 m/s up to

approximately 93 feet above the exhaust stack. The chiller plumes would maintain a peak vertical velocity of 10.6 m/s up to approximately 159 feet above the chillers.

Considering the current project site elevation of 200 feet above sea level, the height of the diesel generators and their associated exhaust stack of 43 feet (generator height of 24 feet and stack height of 19 feet), the plumes from the emergency diesel generators would maintain a peak vertical velocity of 10.6 m/s up to approximately 336 feet AMSL. The chillers would be placed on the roof of the second floor, which measures 49 feet tall; thus, the plumes from the chillers would maintain a peak vertical velocity of 10.6 m/s up to approximately 408 feet. The emergency diesel generator and chiller plumes are expected to dissipate at these approximate elevations and drop below velocities that could cause significant air disturbance to aircraft.

Aircraft would not be expected to be flying low enough over the project site to encounter potentially hazardous thermal plumes produced by the project's emergency diesel generators and chillers. Title 14, Section 91.119 of the Code of Federal Regulations states that unless necessary for takeoff or landing, the minimum safe altitudes for aircraft are 500 feet AGL for non-congested areas and 1,000 feet AGL for congested areas, such as the area around the project site (CFR 2020b). Additionally, at approximately 6.85 miles away, the project site is located well outside the airport influence area and all airport safety zones of the Reid-Hillview Airport, including the airport's FAA Part 77 airspace surface of 483 feet AMSL (Santa Clara County 2016). Due to the project's distance from the airport and the unlikely scenario of low altitude overflight of the site, the project's thermal plumes would not be a flight hazard.

As discussed above, the project would not result in hazards to aircraft from either a geometric design feature, such as structure height, or incompatible uses, including land uses or thermal plumes. The project would not increase any other hazards. For these reasons, impacts would be less than significant.

Required Mitigation Measures: None

d. Result in inadequate emergency access?

Construction and Operation

Less Than Significant Impact. A fire access lane would be constructed along the southern property boundary of the site to provide site access for emergency vehicles. The fire access lane would have a minimum turning radius of 30 feet and an outside turning radius of 50 feet and would be designed and maintained to support the load of a fire apparatus of at least 75,000 pounds (SV1 2020a). Three new entrances would be constructed to access the project site. Adequate sight distance should be provided when constructing a driveway in accordance with the American Association of State Highway Transportation Officials (AASHTO) standards. Sight distance requirements vary depending on the roadway speeds. Via Del Oro, San Ignacio Avenue and Great Oaks Boulevard have posted speed limits of 35 and 40 miles per hour (mph) along the project frontages. The AASHTO

stopping sight distance for roadways with posted speed limits of 35-40 mph are approximately 250 and 305 feet. Based on the site plan and observations in the field, vehicles exiting the project site driveways could see approaching traffic at least 250 and 305 feet away in both directions. Therefore, adequate sight distance would be provided at project driveways in accordance with the AASHTO standards (SV1 2021h). Thus, the project would not physically block any access roads or result in traffic congestion that could significantly compromise timely access to this facility or other facilities located within the project vicinity during construction and operation. Construction, operation and maintenance of the project would be consistent with regulatory requirements for emergency access. Therefore, the impact would be less than significant.

Required Mitigation Measures: None

4.17.4 References

- AirNav 2020 – AirNav (AirNav). KRHV Reid-Hillview Airport. Accessed on: June 8, 2020. Available online at: <https://www.airnav.com/airport/KRHV>
- Caltrans 2019 – California Department of Transportation (Caltrans). Comments on the Laurelwood Initial Study (19-SPPE-01, TN 229939), dated October 1, 2019
- CANRA 2018 – California Natural Resources Agency (CANRA). CEQA: The California Environmental Quality Act, 2018 Amendments and Additions to the State CEQA Guidelines, Final Adopted Text. Accessed on: March 25, 2020. Available online at: http://resources.ca.gov/ceqa/docs/2018_CEQA_FINAL_TEXT_122818.pdf
- CEC 2021k – California Energy Commission (CEC). Record of conversation with Tom Borden, City of San Jose Public Works Development Services Division: Great Oaks South Backup Generating Facility (TN 237575), April 2021. Available online at: <https://efiling.energy.ca.gov/Lists/DocketLog.aspx?docketnumber=20-SPPE-01>
- CFR 2020a – Code of Federal Regulations (CFR). Title 14, Section 77.9, Construction or Alteration Requiring Notice. Accessed on: March 25, 2020. Available online at: [https://gov.ecfr.io/cgi-bin/text-idx?SID=8a9408b6022186a8d9460c5fa676d1ff&mc=true&node=se14.2.77_19&rgn=div8" \t "_blank"](https://gov.ecfr.io/cgi-bin/text-idx?SID=8a9408b6022186a8d9460c5fa676d1ff&mc=true&node=se14.2.77_19&rgn=div8)
- CFR 2020b – Code of Federal Regulations (CFR). Title 14, Section 91.119, Minimum Safe Altitudes: General. Accessed on: March 25, 2020. Available online at: https://gov.ecfr.io/cgi-bin/text-idx?SID=1cdef684edba4fd0373ed7de0d3b1569&mc=true&node=se14.2.91_1119&rgn=div8
- FAA 2017 – Federal Aviation Administration (FAA). Aeronautical Information Manual, Chapter 7. Safety of Flight, Section 5: Potential Flight Hazards, Subsection 7-5-15: Avoid Flight in the Vicinity of Exhaust Plumes (Smoke Stacks and Cooling

- Towers), October 12, 2017. Accessed on: March 25, 2020. Available online at: https://www.faa.gov/air_traffic/publications/atpubs/aim_html/index.html
- San Jose 2001 – City of San Jose (San Jose). Community facilities District 6 (Great Oaks- Route 85) Report. Community Facilities Map. Accessed on: July 30, 2020. Available online at: Report
<https://www.sanjoseca.gov/home/showdocument?id=37255>, Map
<https://www.sanjoseca.gov/home/showdocument?id=37253>
- San Jose 2009 – City of San Jose (San Jose). Department of Transportation. *San Jose Bike Plan 2020*. Adopted November 17, 2009. Accessed on: April 10, 2020. Available online at:
http://www3.sanjoseca.gov/clerk/Agenda/20091117/20091117_0602att.pdf
- San Jose 2014 – City of San Jose (San Jose). City Council Resolution No. 77220. Proposed Amendments to the Envision San Jose 2040 General Plan, including revision of the Edenvale Area Development Policy dated April 2014. Adopted on November 18, 2014. Available online at: <https://www.sanjoseca.gov/home/showdocument?id=22377>
- San Jose 2018 – City of San Jose (San Jose). Transportation Analysis Policy 5-1. Approved: February 27, 2018. Resolution No. 78520. Accessed on: June 3, 2020. Available online at:
<https://www.sanjoseca.gov/home/showpublisheddocument?id=2516>
- San Jose 2020 – City of San Jose (San Jose). Planning, Building & Code Enforcement. *Transportation Analysis Handbook*. Adopted April 2020. Accessed on: May 18, 2020. Available online at: <https://www.sanjoseca.gov/home/showdocument?id=28461>
- Santa Clara County 2016 – Santa Clara County Airport Land Use Commission (Santa Clara County). Reid-Hillview Airport Comprehensive Land Use Plan for Santa Clara County. Accessed on: March 27, 2020. Available online at: https://www.sccgov.org/sites/dpd/DocsForms/Documents/ALUC_RHV_CLUP.pdf
- SV1 2020a – SV1, LLC. (SV1). Application for Small Power Plant Exemption: Great Oaks South Backup Generating Facility (TN 232466), March 2020. Available online at: <https://efiling.energy.ca.gov/Lists/DocketLog.aspx?docketnumber=20-SPPE-01>
- SV1 2021h – SV, LLC. (SV1). SV 1 Hexagon Consultants Transportation Analysis: Great Oaks South Backup Generating Facility (TN 237150), March 2021. Available online at: <https://efiling.energy.ca.gov/Lists/DocketLog.aspx?docketnumber=20-SPPE-01>
- VTA 2020a – Valley Transportation Authority (VTA). New Service System Map (Bus and Rail). Accessed on: April 2020. Available online at:
<https://www.vta.org/sites/default/files/2019-11/VTA%20Transit%20Map.pdf>
- VTA 2020b – Valley Transportation Authority (VTA). Bikeway Map. Accessed on: June 12, 2020. Available online at:

https://www.vta.org/sites/default/files/images/2020-07/vta%20bike%20map_web-01.jpg

4.18 Utilities and Service Systems

This section describes the environmental and regulatory setting and discusses impacts associated with the construction and operation of the project specific to utilities and service systems.

UTILITIES AND SERVICE SYSTEMS	Potentially Significant Impact	Less Than Significant with Mitigation Incorporated	Less Than Significant Impact	No Impact
Would the project:				
a. Require or result in the relocation or construction of new or expanded water, wastewater treatment or storm water drainage, electric power, natural gas, or telecommunications facilities, the construction or relocation of which could cause significant environmental effects?	<input type="checkbox"/>	<input type="checkbox"/>	<input checked="" type="checkbox"/>	<input type="checkbox"/>
b. Have sufficient water supplies available to serve the project and reasonably foreseeable future development during normal, dry and multiple dry years?	<input type="checkbox"/>	<input type="checkbox"/>	<input checked="" type="checkbox"/>	<input type="checkbox"/>
c. Result in a determination by the wastewater treatment provider which serves or may serve the project that it has inadequate capacity to serve the project's projected demand in addition to the provider's existing commitments?	<input type="checkbox"/>	<input type="checkbox"/>	<input checked="" type="checkbox"/>	<input type="checkbox"/>
d. Generate solid waste in excess of State or local standards, or in excess of the capacity of local infrastructure, or otherwise impair the attainment of solid waste reduction goals?	<input type="checkbox"/>	<input type="checkbox"/>	<input checked="" type="checkbox"/>	<input type="checkbox"/>
e. Comply with federal, state, and local management and reduction statutes and regulations related to solid waste?	<input type="checkbox"/>	<input type="checkbox"/>	<input type="checkbox"/>	<input checked="" type="checkbox"/>

Environmental checklist established by CEQA Guidelines, Appendix G.

4.18.1 Setting

Potable Water Supply

The project is in the Great Oaks Water Company (GOWC) service area that serves over 20,000 customers across a 14 square mile area. Potable water supply for this area is locally produced groundwater from the Santa Clara Valley Subbasin. The GOWC's 2015 Urban Water Management Plan (UWMP) states that the Santa Clara Valley Subbasin is managed by the Santa Clara Valley Water District (SCVWD), the local Groundwater Sustainability Agency (GSA) (GOWC 2015). According to the SCVWD's 2015 UWMP, California Department of Water Resources (DWR) has identified the Santa Clara Valley Subbasin as a medium-priority groundwater basin, and that this subbasin is not in critical overdraft condition (SCVWD 2015). Additionally, in case of a water supply shortage,

GOWC and the SCVWD have adopted water conservation policies to reduce demand such that available supplies are sufficient to meet demand (GOWC 2015, SCVWD 2015).

The project proposes to use approximately 4 acre-feet (AF) of potable water from GOWC during 24 months of construction and approximately 4 acre-feet per year (AFY) during operations. According to the GOWC's 2015 UWMP, Table 7-4 Retail: Multiple Dry Years Supply and Demand Comparison, they would have adequate supplies between 2020 and 2040 during normal, single-dry, and multiple-dry years to serve the proposed project (GOWC 2015).

Recycled Water Supply

The applicant met with the South Bay Water Recycling Program (SBWRP) who explained that the Great Oaks Water Company would have to join its program in order for the SBWRP to serve recycled water to the site. The applicant met with Great Oaks Water Company who explained that they have no plans to join the SBWRP Program and as a condition of it serving the site with potable water, no recycled water could be delivered to the site. Therefore, recycled water is not feasible for the GOSDC (SV1 2020a).

Wastewater Service

The city of San Jose's Department of Water and Sewer Utilities is responsible for the wastewater collection system within the city. Wastewater is collected by city's sewer systems and is conveyed by pipelines to the San Jose-Santa Clara Regional Wastewater Facility (RWF). Located in Alviso, the RWF is owned jointly by the cities of San Jose and Santa Clara and is operated by the city of San Jose's Department of Environmental Services. The RWF has a capacity to treat 167 million gallons per day (mgd) of wastewater and currently treats an average of 110 mgd, thus it has 57 mgd, or 35 percent of available capacity. Approximately 13 percent of the RWF's effluent undergoes advanced tertiary treatment to meet Title 22 recycled water standards, after which it flows to SBWR's adjacent pump station to be distributed to several customers in the area. The remaining effluent flows into San Francisco Bay. The RWF's current Wastewater Discharge Requirements (WDRs) were issued by the San Francisco Regional Water Quality Control Board (RWQCB) in September 2014. There are three sewer lines in the vicinity of the project site that the project could connect to: a 15-inch sewer line in San Ignacio Avenue, a 15-inch sewer line in Great Oaks Boulevard, and an eight-inch sewer line in Via Del Oro.

Storm Sewer Service

The project would be constructed in the city of San Jose within the Guadalupe Watershed, a 170-square-mile area with multiple small-creek watersheds. Storm water runoff from the project site drains into Canoas Creek. Canoas Creek is a tributary to the Guadalupe River, an alluvial stream that originates in the Santa Cruz Mountains west and south of San Jose and flows in a northerly direction to San Francisco Bay. The city of San Jose owns and maintains the municipal storm drainage system in the vicinity of the project site. Under existing conditions, the site is undeveloped and the entire site is pervious to precipitation and surface flow. Storm drain lines serving the project area include a 48-

inch storm main in San Ignacio Avenue, a 24-inch storm main in Via Del Oro, and a 48-inch storm main in Great Oaks Boulevard.

Solid Waste

Solid waste and recycling collection for businesses at commercial and institutional properties in the city of San Jose is provided by Republic Services through a contract with the city. Republic Services collects waste using a Wet/Dry system. San Jose businesses receive “Wet” collection service for organics, such as food waste, and “Dry” collection service for recyclables and everything else. All waste is sorted locally at the Newby Island Resource Recovery Park. After sorting, recyclable materials are captured for reuse, diverting them from landfill, and organic material is taken to a Zero-Waste Energy Development facility, where it is put through an anaerobic digestion process, ultimately producing electricity and compost. Newby Island Landfill, located in San Jose, provides disposal capacity to the cities of San Jose, Milpitas, Santa Clara, Cupertino, Los Altos, and Los Altos Hills. The Newby Island Landfill is permitted to accept a maximum of 3,260 tons of solid waste per day and has an available disposal capacity of 21.2 million cubic yards. The Santa Clara County Integrated Waste Management Plan estimates that there is adequate waste capacity through its planning horizon of 2024. According to the city of Santa Clara General Plan, the life of the Newby Island Landfill could be prolonged beyond 2024 as a result of the increases in recycling and reduction in waste generation measures being implemented by the landfill. Also, the landfill has been evaluating an expansion plan. If the landfill cannot operate beyond 2024 for any reason, the city of Santa Clara is planning to use property it owns outside its jurisdictional boundaries for waste disposal purposes (Santa Clara 2014). In October 2007, the San Jose City Council adopted a Zero-Waste Resolution which set a goal of 75 percent waste diversion by 2013 and zero waste by 2022.

Electric Power, Natural Gas, and Telecommunications

Electricity needed for project operation would be provided by Pacific Gas and Electric Company (PG&E). PG&E acts as the transmitter and distributor of power generated by San Jose Clean Energy (SJCE), known as a community choice energy program. PG&E is responsible for maintaining power lines. SJCE is governed by San Jose City Council, with input from a Community Advisory Commission (SJCE 2019).

Telecommunication services in the project area are provided by several fiber optics providers, such as CenturyLink, Zayo, AT&T, and others. The applicant anticipates that telecommunication services would be provided to the facility via established rights of way, as is the industry’s common practice.

Natural gas service in the project area is provided by PG&E who owns natural gas distribution facilities within the city of San Jose.

Regulatory Background

Federal

Clean Water Act and California's Porter-Cologne Water Quality Control Act. The State Water Resources Control Board (SWRCB) and its nine RWQCBs are responsible for the regulation and enforcement of the water quality protection requirements of the federal Clean Water Act (CWA) and the state's Porter-Cologne Water Quality Control Act (Porter-Cologne). The National Pollutant Discharge Elimination System (NPDES) is the permitting program that allows point source dischargers to comply with the CWA and Porter-Cologne laws. This regulatory framework provides environmental protection and protects the beneficial uses of the state's surface and groundwater resources for public benefit. Protection of water quality for the proposed project could be achieved by complying with applicable NPDES permits from the SWRCB or the San Francisco Bay RWQCB. The RWF complies with the Clean Water Act through its current NPDES WDRs, which were issued by the San Francisco RWQCB September 2014.

Under Section 303(d) of the CWA, states are required to identify impaired surface water bodies and develop total maximum daily loads (TMDLs) for contaminants of concern. The TMDL is the quantity of pollutant that can be assimilated by a water body without violating water quality standards. Listing of a water body as impaired does not necessarily suggest that the water body cannot support the beneficial uses; rather, the intent is to identify the water body as requiring future development of a TMDL to maintain water quality and reduce the potential for future water quality degradation. Guadalupe River, west of the project site, is currently listed on the United States Environmental Protection Agency's Section 303(d) Listed Waters for California for diazinon, mercury, and trash.

The San Francisco Bay RWQCB issued a Municipal Regional Storm Water NPDES Permit (Permit Number CAS612008) that requires the city of San Jose to implement a storm water quality protection program. This regional permit applies to 77 Bay Area municipalities, including the city of San Jose. Under the provisions of the Municipal NPDES Permit, redevelopment projects that disturb more than 10,000 square feet are required to design and construct storm water treatment controls to treat post-construction storm water runoff. The permit requires the post-construction runoff from qualifying projects to be treated by using low impact development treatment controls, such as biotreatment facilities.

The Santa Clara Valley Urban Runoff Pollution Prevention Program (SCVURPPP) assists co-permittees, such as the city of San Jose, in the implementation of the provisions of the Municipal NPDES Permit. In addition to water quality controls, the Municipal NPDES Permit requires all new and redevelopment projects that create or replace one acre or more of impervious surface to manage development-related increases in peak runoff flow, volume, and duration, where such hydromodification is likely to cause increased erosion, silt pollutant generation, or other impacts to beneficial uses of local rivers, streams, and creeks. Projects may be deemed exempt from the permit requirements if they do not meet the size threshold, drain into tidally influenced areas or directly into the Bay (per

the city of San Jose Hydromodification Management Map). The project site is located in a catchment area with imperviousness of less than 65 percent; thus, the project site is subject to the SCVURPPP hydromodification requirements.

State

California Water Code, Sections 10910-10915. California Water Code (Sections 10910-10915) requires water service providers to evaluate stresses to the water supply service system caused by proposed project developments. The code sections require public water systems to prepare water supply assessments (WSA) for certain defined development projects subject to the California Environmental Quality Act (CEQA).

According to Section 10912, if a "Project" meets any of the following criteria, then a detailed WSA would be required to be prepared by the water supplier:

- A proposed residential development of more than 500 dwelling units.
- A proposed shopping center or business establishment employing more than 1,000 persons or having more than 500,000 square feet of floor space.
- A proposed commercial office building employing more than 1,000 persons or having more than 250,000 square feet of floor space.
- A proposed hotel or motel, or both, having more than 500 rooms.
- A proposed industrial, manufacturing, or processing plant, or industrial park planned to house more than 1,000 persons, occupying more than 40 acres of land, or having more than 650,000 square feet of floor area.
- A mixed-use project that includes one or more of the projects specified in this subdivision.
- A project that would demand an amount of water equivalent to, or greater than, the amount of water required by a 500 dwelling unit project.

Further guidance for how to interpret these sections of the Water Code is provided in a California Department of Water Resources document titled "Guidebook for Implementation of Senate Bill 610 and Senate Bill 221 of 2001" (Guidebook) (DWR 2003). A helpful interpretive section on page 3 of the Guidebook explains how to interpret item (1) above. It states that one dwelling unit typically consumes 0.3 to 0.5 AF of water per year (DWR 2003). Therefore 500 dwelling units could be interpreted to mean 150 to 250 acre-feet per year (AFY) of potable water.

The Guidebook also provides guidance about how to interpret other items in the list, but the one central theme is that WSAs are necessary for projects that increase the demand on the local system substantially. The Guidebook also emphasizes that WSAs are necessary in areas with a poorly understood water supply, or in an area where the project would increase the demand substantially, or 10-percent (DWR 2003).

The project would be located in a well-studied service area with many service connections. The project's demand of 4 AFY is less than the amount needed for 500 dwelling units and the project does not meet the regulatory criteria of 250,000 square feet of office space. Therefore, the project does not meet Section 10912's criteria and does not require a WSA.

California Energy Efficiency Standards for Residential and Nonresidential Buildings—Green Building Code (2011), Title 24 Update (2014). The California Green Buildings Standards Code applies to planning, design, operation, construction, use, and occupancy of newly constructed buildings and requires installation of energy- and water-efficient indoor infrastructure. The related waste management plan is required to allow for diversion of 50 percent of the generated waste away from the landfill.

Integrated Waste Management Act. The Integrated Waste Management Act of 1989 requires cities and counties to reduce, by 50 percent, the amount of solid waste disposed of in landfills by the year 2000 and beyond. To comply with the Integrated Waste Management Act, counties adopt regulations and policies to fulfill the requirements of the Act.

California Senate Bill 350 (Renewable Energy Targets). Senate Bill (SB) 350, the Clean Energy and Pollution Reduction Act of 2015 calls for adoption of regulations to increase the procurement of electricity from renewable sources from 33 percent to 50 percent by 2030. SB 350 also requires establishment of annual targets for statewide energy efficiency savings and demand reduction by November 1, 2017. These energy efficiency savings and demand reductions will be designed to achieve a cumulative doubling of statewide energy efficiency savings in electricity and natural gas use by January 1, 2030.

Local

City of San Jose General Plan. *Envision San Jose 2040 General Plan* (San Jose 2020) includes numerous policies related to utilities and service systems applicable to all development projects in San Jose. These policies are designed to provide water supply, sanitary sewer, and storm drainage infrastructure facilities to meet future growth planned within the city and to assure high-quality service to existing and future residents while fulfilling regulatory requirements. The General Plan sets Measurable Environmental Sustainability (MS) goals and actions for San Jose through 2040.

- MS-2.8 - This action aims to develop policies which promote energy reduction for energy-intensive industries. For facilities such as data centers, which have high energy demand and indirect greenhouse gas emissions, it requires evaluation of operational energy efficiency and inclusion of operational design measures as part of development review consistent with benchmarks such as those in EPA's EnergyStar Program for new data centers. It also requires consideration of distributed power production for these facilities to reduce energy losses from electricity transmission over long distances and energy production methods such as waste-heat reclamation or the purchase of renewable energy to reduce greenhouse gas emissions.

- MS-5 and MS-6 - These goals (MS-5 waste diversion and MS-6 waste reduction) set policies and actions to achieve solid waste reduction and diversion of 100 percent of waste from landfills by 2022 and maintain the 100 percent diversion through 2040.

City of San Jose Municipal Code. The city's Municipal Code includes regulations associated with water conservation and water diversion (San Jose 2021). City regulations include a Green Building Ordinance (Chapter 17.84) to promote practices to minimize the use of water and other resources in the city of San Jose, Water Efficient Landscape Standards for New and Rehabilitated Landscaping (Chapter 15.10), and a Construction and Demolition Diversion Deposit Program that encourages recycling of construction and demolition materials (Chapter 9.10).

City of San Jose Zero Waste Strategic Plan. This plan sets policies to help the city of San Jose build a healthier community and achieve its Green Vision goals, including 75 percent diversion by 2013 and zero waste by 2022 (San Jose 2020). The Green Vision also includes ambitious goals for economic growth, environmental sustainability, and an enhanced quality of life for San Jose residents and businesses.

4.18.2 Applicant Proposed Measures

None.

4.18.3 Environmental Impacts and Mitigation Measures

- a. Require or result in the relocation or construction of new or expanded water, wastewater treatment or storm water drainage, electric power, natural gas, or telecommunications facilities, the construction or relocation of which could cause significant environmental effects?**

Construction and Operation

Less Than Significant Impact. The project would use potable water supplied by GOWC. GOWC serves over 20,000 customers across a 14 square mile area. Potable water supply for this area is locally produced groundwater. Recycled water is not available at the site because Great Oaks Water Company has no plans to join the SBWRP Program and as a condition of it serving the site with potable water, no recycled water could be delivered to the site. Therefore, recycled water is not feasible for the GOSDC (SV1 2020a).

The project proposes to use approximately 4 acre-feet (AF) of groundwater during 47 months of construction (SV1 2020d - TN 233005-1) and approximately 4 acre-feet per year (AFY) during operations. According to the GOWC 2015 UWMP, Table 7-4 Retail: Multiple Dry Years Supply and Demand Comparison, they would have sufficient supplies between 2020 and 2040 during normal, single-dry, and multiple-dry years to serve the proposed project (GOWC 2015). Neither construction nor operation of the project would result in relocation or construction of new water supply facilities.

The project's wastewater flow during construction and operation would be treated by the RWF, which is monitored by the San Francisco Bay RWQCB to ensure compliance with the facility's NPDES wastewater discharge permit. The RWF is permitted to treat the industrial and sanitary waste flows that would be generated by the project. Furthermore, as discussed below, the RWF has sufficient available capacity to accommodate the project's estimated wastewater flow. Therefore, the project would not cause the RWF to exceed its wastewater treatment requirements of the San Francisco Bay RWQCB for project construction and operation. The impact of the project on wastewater treatment capacity would be less than significant.

Electricity for construction and operation of the proposed project would be provided by the SJCE program through PG&E. The PG&E electrical resources available are reliable. See "Pacific Gas & Electric System Reliability" discussion in **Section 3 Project Description** for more information. SJCE has sufficient energy to serve the expected future demand of the project. Project electric demand during construction and operation would not be substantial and would not be expected to affect existing users. The project would be supported from a new Santa Teresa Substation, a 115 kV transmission line extension to the substation from the existing Metcalf-Edenvale 115 kV transmission line and five new 21 kV distribution lines extending underground along Via Del Oro and/or Santa Teresa, to connect the data centers with the Santa Teresa Substation (SV1 2020d - TN 233005-1). Refer to **Section 3 Project Description** for more information about the distribution lines. The applicant anticipates that buildout of the project would occur based on market conditions, and thus full electrical load may develop over a phased period. To serve the full electrical load of the project, a reconductoring of the existing Metcalf-Edenvale 115 kV transmission line or line re-rate, may be necessary. Before full electrical load is installed, a load study would need to be conducted to determine which transmission line improvement would be necessary. If upgrades to the PG&E system are necessary, PG&E would need seek approval by the California Public Utilities Commission, who would conduct any necessary CEQA review and require any necessary mitigation. This information cannot be obtained now, as it requires information about what the system may look like when the third phase is ready for construction, some five to seven years out. The early phases of the project would not require any changes to the transmission line and any changes necessitated by the third phase would be reviewed by the CPUC pursuant to CEQA. Therefore, potential impacts would be less than significant.

Telecommunication services for the proposed project would be provided by providers that have been serving the existing business in the project area. Those providers have adequate available capacity to accommodate the project needs during construction and operation. The impact of the project on telecommunication services would be less than significant.

Natural gas for the project would be supplied by PG&E. PG&E owns natural gas distribution facilities within the city of San Jose. PG&E has adequate natural gas supplies to supply the project and therefore, construction and operation of the project would not

require the construction of any additional off-site facilities. Therefore, there would not be a significant impact on natural gas supplies in the project area.

Required Mitigation Measures: None

b. Have sufficient water supplies available to serve the project and reasonably foreseeable future development during normal, dry and multiple dry years?

Construction and Operation

Less Than Significant Impact. The project would use potable water from GOWC both for construction and operation. According to the GOWC 2015 UWMP, GOWC would have sufficient supplies between 2020 and 2040 during normal, single-dry, and multiple-dry years to serve the proposed project and foreseeable future development (GOWC 2015). Additionally, in case of a water supply shortage, GOWC and the SCVWD have adopted water conservation policies to reduce demand such that available supplies are sufficient to meet demand (GOWC 2015, SCVWD 2015).

Required Mitigation Measures: None

c. Result in a determination by the wastewater treatment provider which serves or may serve the project that it has inadequate capacity to serve the project's projected demand in addition to the provider's existing commitments?

Construction and Operation

Less Than Significant Impact. The project would use an air-cooled chilled water system for cooling of the data center (SV1 2020f). The little amount of water the air-cooled system uses is completely evaporated. The air-cooled system does not need blowdown and thus no blowdown wastewater is generated.

When the applicant submitted the SPPE application, the project design included the use of a water-cooled chilled water system instead of the now-proposed air-cooled system. The applicant did not provide information about the revised wastewater amounts the project would generate as a result of switching the cooling system. However, the water demand for the project was revised from approximately 1,000 AFY to only approximately 4 AFY. The fact that the project's water demand went down from 1,000 AFY to approximately 4 AFY indicates that the amount of wastewater generated by the project would be substantially less. The 4 AFY consumption would be for landscaping and sanitary uses. Assuming that half of the 4 AFY is used for sanitary purposes, which is a conservative estimate since only a few employees would staff the data center most of the time, then the amount of wastewater generated by the project during operation would be approximately 2 AFY, or 650 gpd.

Wastewater in the city of San Jose is collected by the city's sewer systems and is conveyed by pipelines to the San Jose-Santa Clara RWF. Wastewater from the proposed project would flow to RWF through one of the sewer lines located in the vicinity of the project site such as the 15-inch sewer line in San Ignacio Avenue, the 15-inch sewer line in Great Oaks Boulevard, or the eight-inch sewer line in Via Del Oro. The RWF has a capacity to treat 167 million gallons per day (mgd) of wastewater and currently treats an average of 110 mgd, leaving RWF with 57 mgd of available capacity, which is substantially more than the project's discharge of approximately 650 gpd. Therefore, there is an abundance of capacity at the RWF to accommodate project flows. Additionally, the city's General Plan concludes that the sewage generated by the buildout of the General Plan would not exceed the city's allocated capacity at the RWF. Thus, the impact on wastewater treatment facilities would be less than significant.

Required Mitigation Measures: None

d. Generate solid waste in excess of State or local standards, or in excess of the capacity of local infrastructure, or otherwise impair the attainment of solid waste reduction goals?

Construction and Operation

Less Than Significant Impact. Construction activities for the project would result in minor amounts of solid waste and a temporary increase in solid waste. Operations would result in long-term generation of a small amount of solid waste. The solid waste would be disposed of at the Newby Island Landfill in San Jose. The Newby Island Landfill has a remaining capacity of 21.2 million cubic yards and would provide adequate disposal space for the solid waste associated with the project's construction, and for operations through 2024. According to the city of Santa Clara General Plan, the life of the Newby Island Landfill could be prolonged beyond 2024 as a result of the increases in recycling and reduction in waste generation as well as diversion measures being implemented by the city. Also, the landfill has been evaluating an expansion plan. If the landfill cannot operate beyond 2024 for any reason, the city of Santa Clara is planning to use property it owns outside its jurisdictional boundaries for waste disposal purposes (Santa Clara 2014). The project would not significantly increase solid waste generation and could be accommodated by existing solid waste facilities. Therefore, the impact resulting from construction and operation of the proposed project on landfill capacity would be less than significant.

Required Mitigation Measures: None

e. Comply with federal, state, and local management and reduction statutes and regulations related to solid waste?

Construction and Operation

No Impact. The California Integrated Waste Management Act of 1989 (Assembly Bill 939) requires local jurisdictions in California to reduce, by 50 percent, the amount of solid waste disposed of in landfills by the year 2000 and beyond. During construction, the

project would collect and haul construction debris off-site for recycling or disposal in local jurisdictions that comply with this state requirement and have programs in place to ensure that disposal of solid waste meets these requirements. The project would comply with these requirements pursuant to city requirements. The project would not result in an impact on solid waste collection and would comply with management and reduction regulations (SV1 2020a). Typically, data centers do not generate special or unique wastes. Likewise, the project would not generate any special or unique wastes that would make the project not comply with federal, state, and local statutes or solid waste management and reduction regulations. Management of hazardous waste and applicable federal regulations are discussed in **Section 4.9 Hazards and Hazardous Materials**

4.18.4 References

SJCE 2020 – Information about the San Jose Clean Energy program. Accessed on: July 23, 2020. Available online at: <https://sanjosecleanenergy.org/about-sjce>

Santa Clara 2014 – City of Santa Clara (Santa Clara). City of Santa Clara 2010-2035 General Plan. Approved by City Council November 16, 2010 and updated December 9, 2014. Accessed on: February 14, 2020. Available online at: <https://www.santaclaraca.gov/our-city/departments-a-f/community-development/planning-division/general-plan>

San Jose 2020 – City of San Jose (San Jose). *Envision San Jose 2040 General Plan*, Updated on: March 16, 2020. Accessed on: March 8, 2021. Available online at: <https://www.sanjoseca.gov/your-government/departments/planning-building-code-enforcement/planning-division/citywide-planning/envision-san-jos-2040-general-plan>

San Jose 2021 – City of San Jose (San Jose). San Jose City Municipal Code. Updated version: February 16, 2021. Accessed on: March 8, 2021. Available online at: <https://www.sanjoseca.gov/your-government/departments/planning-building-code-enforcement/code-enforcement/city-ordinances>

SV1 2020a – SV1, LLC. (SV1). Application for Small Power Plant Exemption: Great Oaks South Backup Generating Facility (TN 232466), March 2020. Available online at: <https://efiling.energy.ca.gov/Lists/DocketLog.aspx?docketnumber=20-SPPE-01>

SV1 2020b – SV1, LLC. (SV1). Application Appendices A through K: Great Oaks South Backup Generating Facility (TN 232467-1,2,3), March 2020. Available online at: <https://efiling.energy.ca.gov/Lists/DocketLog.aspx?docketnumber=20-SPPE-01>

SV1 2020d – SV1, LLC. (SV1). SV1 Responses to CEC Data Request Set 2: Great Oaks South Backup Generating Facility Part 1 through Part 4 (TN 233005-1,2,3,4), May 2020. Available online at: <https://efiling.energy.ca.gov/Lists/DocketLog.aspx?docketnumber=20-SPPE-01>

SV1 2020f – SV1, LLC. (SV1). SV1 Supplemental Responses to CEC Data Requests 18 and 56: Great Oaks South Backup Generating Facility (TN 233681), June 2020. Available online at: <https://efiling.energy.ca.gov/Lists/DocketLog.aspx?docketnumber=20-SPPE-01>

GOWC 2015 – Great Oaks Water Company (GOWC). Great Oaks Water Company Urban Water Management Plan 2015. Accessed July 12, 2020. Accessed at: <https://www.greatoakswater.com/OtherPDFs/2015UrbanWaterManagementPlan.pdf>

SCVWD 2015 – Santa Clara Valley Water District (SCVWD). Santa Clara Valley Water District Urban Water Management Plan 2015. Accessed July 12, 2020. Accessed at: <https://www.valleywater.org/sites/default/files/SCVWD%202015%20UWMP-Report%20Only.pdf>

4.19 Wildfire

This section describes the environmental and regulatory setting, and discusses impacts associated with the construction and operation of the project specific to wildfire.

WILDFIRE		Less Than Significant with Mitigation Incorporated	Less Than Significant Impact	No Impact
If located in or near state responsibility areas or lands classified as very high fire hazard severity zones, would the project:	Potentially Significant Impact			
a. Substantially impair an adopted emergency response plan or emergency evacuation plan?	<input type="checkbox"/>	<input type="checkbox"/>	<input type="checkbox"/>	<input checked="" type="checkbox"/>
b. Due to slope, prevailing winds, and other factors, exacerbate wildfire risks, and thereby expose project occupants to, pollutant concentrations from a wildfire or the uncontrolled spread of a wildfire?	<input type="checkbox"/>	<input type="checkbox"/>	<input type="checkbox"/>	<input checked="" type="checkbox"/>
c. Require the installation or maintenance of associated infrastructure (such as roads, fuel breaks, emergency water sources, power lines or other utilities) that may exacerbate fire risk or that may result in temporary or ongoing impacts to the environment?	<input type="checkbox"/>	<input type="checkbox"/>	<input type="checkbox"/>	<input checked="" type="checkbox"/>
d. Expose people or structures to significant risks, including downslope or downstream flooding or landslides, as a result of runoff, post-fire slope instability, or drainage changes?	<input type="checkbox"/>	<input type="checkbox"/>	<input type="checkbox"/>	<input checked="" type="checkbox"/>

Environmental checklist established by CEQA Guidelines, Appendix G.

4.19.1 Setting

The Department of Forestry and Fire Protection (Cal Fire) identifies and maps areas of significant fire hazards based on fuels, terrain, and other relevant factors. These maps categorize this information by Fire Hazard Severity Zones (FHSZ), grouped into unzoned, moderate, high, and very high zones. State Responsibility Areas (SRA) are locations where the state of California is responsible for wildfire protection and Local Responsibility Areas are locations where the responding agency is the county or city.

The California Public Utilities Commission (CPUC) categorizes fire threat areas as Tier 1, Tier 2, or Tier 3. Tier 1 (or CAL FIRE Zone 1) encompasses High Hazard Zones (HHZ) on the United States Forest Service (USFS-CAL FIRE) joint map of Tree Mortality HHZ. This tier represents areas where tree mortality directly coincides with critical infrastructure such as communities, roads, and utility lines, and are a direct threat to public safety. Tier 2 consists of areas where there is an elevated risk (including likelihood and potential impacts on people and property) from wildfires associated with overhead utility power lines or overhead utility power-line facilities also supporting communication facilities. Tier 3 consists of areas where there is an extreme risk (including likelihood and potential impacts on people and property) from wildfires associated with overhead utility power lines or overhead utility power-line facilities also supporting communication facilities.

The project site is surrounded by urban and industrial development in the city of San Jose and is not located in or near a SRA or a very high FHSZ, or land classified as having a fire threat by the CPUC (SV1 2020a). The project site is also not within a state of California FHSZ (Cal Fire 2007) at the wildland and urban interface and is not in the vicinity of wildlands.

Regulatory Background

Federal

No federal regulations related to wildfires apply to the project.

State

Fire Hazard Severity Zones (Pub. Resources Code, §§ 4201-4204). The purpose of this code section is to provide for the classification of lands within SRAs in accordance with the severity of fire hazard present and identify measures to be taken to retard the rate of spreading and to reduce the potential intensity of uncontrolled fires that threaten to destroy resources, life, or property.

Fire Hazard Severity (Cal. Code Regs, tit. 14, § 1280). FHSZs reflect the degree of severity of fire hazard.

CPUC General Order 95: Rules for Overhead Electric Line Construction. CPUC GO 95, Section 35, covers all aspects of design, construction, operation, and maintenance of overhead electrical lines and management of safety hazards. Its application would ensure adequate service and safety to persons engaged in the construction, maintenance, operation or use of overhead lines and to the public in general.

CPUC General Order 166: Standards for Operation, Reliability, and Safety during Emergencies and Disasters. CPUC GO 166 covers the standards which require all electric utilities to be prepared for emergencies and disasters in order to minimize damage and inconvenience to the public which may occur as a result of electric system failures, major outages, or hazards posed by damage to electric distribution facilities.

Local

Santa Clara County Operational Area Hazard Mitigation Plan. The plan includes risk assessment that identifies the natural hazards and risks that can impact a community based on historical experience, estimate the potential frequency and magnitude of disasters, and assess potential losses to life and property. The plan also includes developed mitigation goals and objectives as part of a strategy for mitigating hazard-related losses.

4.19.2 Applicant Proposed Measures

None.

4.19.3 Environmental Impacts and Mitigation Measures

If located in or near state responsibility areas or lands classified as very high fire hazard severity zones, would the project:

a. Substantially impair an adopted emergency response plan or emergency evacuation plan?

Construction

No Impact. During project construction, traffic levels would experience a minimal increase that is not expected to degrade traffic performance significantly. Emergency response access during construction would not be significantly impeded. The project would not involve the development of structures that could potentially impair implementation of or physically interfere with an adopted emergency response plan or emergency evacuation plan. No streets would be closed, rerouted, or substantially altered during construction (SV1 2020a).

Additionally, the project is not located in or near a SRA or a very high FHSZ, or land classified as having a fire threat by the CPUC.

Operation

No Impact. The project does not involve the addition of a large number of people to the local area who could increase emergency response demand during a potential evacuation (SV1 2020a). Thus, the project would not interfere with the coordination of the city's emergency operations plan at the emergency operations center or alternate emergency operations center, nor would the project interfere with any statewide emergency response, or evacuation routes or plans. Adequate emergency access to the project site and surrounding industrial area would be maintained.

Additionally, the project is not located in or near a SRA or a very high FHSZ, or land classified as having a fire threat by the CPUC.

b. Due to slope, prevailing winds, and other factors, exacerbate wildfire risks, and thereby expose project occupants to, pollutant concentrations from a wildfire or the uncontrolled spread of a wildfire?

Construction and Operation

No Impact. The topography of the project site is flat and the project area is currently undeveloped (SV1 2020a). Therefore, project construction would not exacerbate wildfire risk or expose occupants to pollutant concentrations from a wildfire. Additionally, the project is not located in or near a SRA or a very high FHSZ, or land classified as having a fire threat by the CPUC.

c. Require the installation or maintenance of associated infrastructure (such as roads, fuel breaks, emergency water sources, power lines or other utilities) that may exacerbate fire risk or that may result in temporary or ongoing impacts to the environment?

Construction and Operation

No Impact. The project would be supported by a new PG&E substation (Santa Teresa Substation), a 115 kilovolt (kV) transmission line extension to the substation from the existing Metcalf-Edenvale 115 kV transmission line, and five new 21 kV distribution feeders that would extend along Via Del Oro to the data center site. The construction of the proposed connections would not block access to any road or result in traffic congestion. Any large trees that would be crossed by the electrical supply line would be trimmed or removed consistent with electric reliability requirements (SV1 2020a). Therefore, the constructed electrical supply line and other project infrastructure would not constitute a possible ignition source for local vegetation, nor would it block access to any road or result in traffic congestion.

Additionally, the project is not located in or near a SRA or a very high FHSZ, or land classified as having a fire threat by the CPUC.

d. Expose people or structures to significant risks, including downslope or downstream flooding or landslides, as a result of runoff, post-fire slope instability, or drainage changes?

Construction

No Impact. The project would not substantially alter local drainage patterns. Storm water discharge during construction would be managed according to the project's Storm Water Pollution Prevention Plan, and appropriately discharged to the city of San Jose's storm drain system (SV1 2020a). The project would therefore not be expected to contribute to a flooding hazard onsite or offsite. For further discussion of the potential flooding impacts that could result from the proposed project, please see the discussion in **Section 4.10 Hydrology and Water Quality**.

As discussed in this section, the topography of the project site and surrounding area is relatively flat and generally developed. Therefore, the project would not be exposed to post-fire slope instability or drainage changes.

Additionally, the project is not located in or near a SRA or a very high FHSZ, or land classified as having a fire threat by the CPUC.

Operation

No Impact. Operation of the project would not alter the course of a drainage (stream or river) and would not substantially alter local drainage patterns. The proposed onsite storm drainage system would be designed to meet the city's storm water drainage standards

and sized adequately to convey water away from the site and to the city of San Jose's storm drain system (SV1 2020a). The project would therefore not contribute to a flooding hazard onsite or offsite.

As discussed in this section, the topography of the project site and surrounding area is relatively flat and highly developed. Therefore, the project would not be exposed to post-fire slope instability or drainage changes.

Additionally, the project is not located in or near a SRA or a very high FHSZ, or land classified as having a fire threat by the CPUC.

4.19.3 References

Cal Fire 2007 – Department of Forestry and Fire Protection (Cal Fire). *Santa Clara County FHSZ Map in Local Responsibility Area*. Accessed on: June 30, 2020. Available online at: https://osfm.fire.ca.gov/media/6766/fhszs_map43.pdf.

SV1 2020a – SV1, LLC. (SV1). Application for Small Power Plant Exemption: Great Oaks South Backup Generating Facility (TN 232466), March 2020. Available online at: <https://efiling.energy.ca.gov/Lists/DocketLog.aspx?docketnumber=20-SPPE-01>

4.20 Mandatory Findings Of Significance

This section describes the environmental and regulatory setting, and discusses impacts associated with the construction and operation of the project specific to mandatory findings of significance.

MANDATORY FINDINGS OF SIGNIFICANCE	Potentially Significant Impact	Less Than Significant with Mitigation Incorporated	Less Than Significant Impact	No Impact
a. Does the project have the potential to substantially degrade the quality of the environment, substantially reduce the habitat of a fish or wildlife species, cause a fish or wildlife population to drop below self-sustaining levels, threaten to eliminate a plant or animal community, substantially reduce the number or restrict the range of a rare or endangered plant or animal or eliminate important examples of the major periods of California history or prehistory?	<input type="checkbox"/>	<input checked="" type="checkbox"/>	<input type="checkbox"/>	<input type="checkbox"/>
b. Does the project have impacts that are individually limited, but cumulatively considerable? ("Cumulatively considerable" means that the incremental effects of an individual project are significant when viewed in connection with the effects of past projects, the effects of other current projects, and the effects of probable future projects)??	<input type="checkbox"/>	<input checked="" type="checkbox"/>	<input type="checkbox"/>	<input type="checkbox"/>
c. Does the project have environmental effects which will cause substantial adverse effects on human beings, either directly or indirectly?	<input type="checkbox"/>	<input checked="" type="checkbox"/>	<input type="checkbox"/>	<input type="checkbox"/>

Environmental checklist established by CEQA Guidelines, Appendix G.

a. Does the project have the potential to substantially degrade the quality of the environment, substantially reduce the habitat of a fish or wildlife species, cause a fish or wildlife population to drop below self-sustaining levels, threaten to eliminate a plant or animal community, substantially reduce the number or restrict the range of a rare or endangered plant or animal or eliminate important examples of the major periods of California history or prehistory?

Less Than Significant with Mitigation Incorporated

Biological Resources

Less Than Significant with Mitigation Incorporated. The project would not substantially degrade the quality of the environment, reduce the existing habitat of any fish or wildlife species, cause any fish or wildlife population to drop below self-sustaining levels, threaten

to eliminate any plant or animal community, or substantially reduce the number or restrict the range of an endangered, threatened, or rare plant or animal.

The project site consists of ruderal grassland vegetation comprised primarily of non-native grasses and forbs. The surrounding properties are developed lands consisting of commercial offices, residential housing, and city streets. However, mature landscaping trees and shrubs provide nesting opportunities for protected migratory bird species. The applicant's project design measures for tree removal (PD BIO-1), pre-construction nesting bird surveys (PD BIO-2), and heritage tree protection (PD BIO-3) would ensure that project impacts would be less than significant.

The proposed project's indirect impact from nitrogen deposition on sensitive habitats would be significant. The project's incremental effect in addition to other sources of nitrogen deposition would be cumulatively considerable. The project's significant indirect and incremental cumulative effects would be less than significant with implementation of mitigation measure **MM BIO-1** (discussed in **Section 4.4 Biological Resources**). See below for more discussion on cumulative nitrogen deposition impacts.

Cultural and Tribal Cultural Resources

Less Than Significant with Mitigation Incorporated. Important examples of the major periods of California history or prehistory represented by historical, unique archaeological, or tribal cultural resources are not known to be present in the project area. Nevertheless, the extent of proposed ground disturbance has the potential to damage unknown, buried archaeological resources in the project area. As described in **Section 4.5 Cultural and Tribal Cultural Resources**, the majority of archaeological resources aged about 5,000 years or older are buried beneath the ground surface. If these resources were to be exposed or destroyed, it would be a significant impact. Implementation of PD CUL-2 and proposed mitigation measures **MM CUL-1** through **MM CUL-4** included in **Section 4.5 Cultural and Tribal Cultural Resources** would reduce the impacts to buried cultural resources to a less-than-significant level. The proposed project therefore is unlikely to eliminate important examples of major periods of California history or prehistory, therefore the impact would be less than significant.

Geology and Soils

Less Than Significant with Mitigation Incorporated. Paleontological resources that represent important examples of the major periods of California prehistory are known to be present in the project area. The extent of proposed ground disturbance has the potential to damage unknown, buried paleontological resources in the project footprint. As described in **Section 4.7 Geology and Soils**, paleontological resources may be buried beneath the ground surface in Pleistocene age sediments. Five fossil sites have been found at or near the ground surface within several miles of the project site, particularly along stream beds (UCMP 2020). If significant paleontological resources were to be exposed or destroyed, it would be a significant impact. Adherence to the City of San Jose General Plan (San Jose 2020) policies (ER-10.1 and ER-10), and implementation of proposed mitigation measure **MM GEO-1** included in **Section 4.7 Geology and**

Soils would reduce the impacts to buried paleontological resources to a less-than-significant level. The proposed project therefore is unlikely to eliminate important examples of paleontological resources that are part of the prehistory of California, therefore the impact would be less than significant.

Required Mitigation Measures: MM BIO-1, MM CUL-1 through MM CUL-4, and MM GEO-1.

b. Does the project have impacts that are individually limited, but cumulatively considerable? (“Cumulatively considerable” means that the incremental effects of an individual project are significant when viewed in connection with the effects of past projects, the effects of other current projects, and the effects of probable future projects)?

Less Than Significant with Mitigation Incorporated. The analysis of cumulative impacts can employ one of two methods to establish the effects of other past, current, and probable future projects. A lead agency may select a list of projects, including those outside the control of the agency, or, alternatively, a summary of projections. These projections may be from an adopted general plan or related planning document, or from a prior environmental document that has been adopted or certified, and these documents may describe or evaluate the regional or area-wide conditions contributing to the cumulative impact.

General Plan Projection

This EIR evaluates cumulative impacts using the *Addendum to the Envision San Jose 2040 General Plan Final Program Environmental Impact Report and Supplemental Environmental Impact Report* for the Envision San Jose 2040 General Plan 4-Year Review (General Plan FPEIR) (San Jose 2016). The General Plan FPEIR identified that build out of the *Envision San Jose 2040 General Plan* (General Plan) would contribute to five, significant and unavoidable cumulative impacts in the areas of biological resources, land use, noise, population and housing, and transportation.

General Plan Significant Unavoidable Impacts

The General Plan FPEIR identified the following significant unavoidable environmental impacts relevant to the proposed project:

- Biological Resources – Cumulative development would result in emissions of nitrogen compounds that could affect the species composition and viability of sensitive grasslands.
- Land Use and Agricultural Resources – Build-out of the General Plan in the north Coyote Valley area in conjunction with other planned or proposed development would make a cumulatively considerable contribution to cumulative impacts to agricultural resources.

- Noise – Increased development in the South Bay Area will result in a significant increase in traffic noise levels on roadway segments throughout the region, beyond accepted noise thresholds in various communities.
- Population and Housing – Build-out of the General Plan in conjunction with other planned development would contribute cumulatively to impacts arising from a regional jobs-housing imbalance.
- Transportation – Build-out of the General Plan in conjunction with other planned development in the South Bay Area would result in a substantial contribution to cumulatively significant regional transportation impacts on roadways and highways.

With the exception of impacts to agriculture and forestry resources, the project, in combination with future development in the City of San Jose, could conceivably have a significant cumulative impact to these environmental resources; however, the following discussion demonstrates how the project's contribution to these impacts would be less than cumulatively considerable and thus less than significant with the incorporation of mitigation identified in this project EIR.

Biological Resources

Less Than Significant with Mitigation Incorporated. As previously mentioned, the City of San Jose General Plan EIR (San Jose 2011) identifies significant and unavoidable impacts on sensitive habitat from the nitrogen deposition. The Envision San Jose 2040 General Plan (San Jose 2020) includes policies to reduce the City of San Jose's contribution to regional impacts to sensitive habitat, and special status species populations from new development. Implementation of the General Plan (San Jose 2020) would reduce nitrogen oxide emissions from vehicle trips through planned multi-modal improvements, trip reduction programs, and local land use strategies. Nitrogen deposition impacts would require the establishment and implementation of managed serpentine grassland preserves.

With a projected increase in vehicle miles traveled, beyond or above the growth in population and employment, implementation of the General Plan would contribute to increased nitrogen oxide emissions in the San Francisco Bay Area Basin. Regional nitrogen deposition impacts to serpentine habitats in southern San Jose and Santa Clara County is a cumulative issue that is addressed through the SCVHP; except emissions from point sources (e.g., generators).

The Santa Teresa Hills, Tulare Hill, and Coyote Ridge areas contain serpentine habitat. These areas also support populations of the Bay checkerspot butterfly (federally threatened), Santa Clara Valley dudleya (federally endangered and rare plant rank 1B.1), along with three rare plants: fragrant fritillary, smooth lessingia, and most beautiful jewelflower (rare plant rank 1B.2) (CNDDDB 2019, USFWS 1998). These areas also contain Bay checkerspot butterfly critical habitat (USFWS 2008). All these species are vulnerable to environmental change. The largest threat is invasive non-native weeds and the resultant effects such as competition and wildfires. As described in **Section 4.4**

Biological Resources, nitrogen deposition leads to the enhancement of invasive non-native weeds, which is a result of the cumulative emissions of many sources within the region.

The emissions from the project's backup generators would contribute to the significant cumulative impacts from nitrogen deposition on serpentine habitat containing sensitive species in the Santa Teresa Hills, Tulare Hill, and Coyote Ridge areas. Given the threat to these species from invasive non-native weeds, the incremental effect of the project's stationary source emissions would be cumulatively considerable in the absence of mitigation. Staff recommends **MM BIO-1** (see **Section 4.4 Biological Resources**) to reduce the project's contribution to significant cumulative impacts.

MM BIO-1 requires a one-time fee of \$864.01, proportional to the proposed project's contribution of nitrogen deposition in sensitive habitat. Payment of this one-time nitrogen deposition fee would mitigate the proposed project's incremental contribution towards nitrogen deposition within sensitive habitat to less than cumulatively considerable.

Emergency Operations of the Backup Generators. Staff has provided an evaluation of the emergency operations of the backup generators and how it affects nitrogen deposition. See **Section 4.4 Biological Resources** under California Environmental Quality Act (CEQA) impact criterion "a" for more information.

Land Use and Agricultural Resources

No Impact. The General Plan FPEIR found that new development would be allowed on several sites classified as Prime Farmland under the California Department of Conservation (CDOC) Farmland Mapping and Monitoring Program (FMMP). The loss of Prime Farmland was determined to be a significant and unavoidable impact of the General Plan. As discussed in **Section 4.2 Agriculture and Forestry Resources**, the FMMP classification of the project site converted to Farmland of Local Importance during the 2014–2016 reporting period due to production of non-irrigated grain that was verified during a field visit by CDOC staff for the 2016 FMMP update. Former agricultural uses on the project site and adjacent properties ceased several years ago. Under CEQA, conversion of Farmland to nonagricultural use applies only to Prime Farmland, Farmland of Statewide Importance, and Unique Farmland. The project site is not mapped under any of the Farmland classifications. Therefore, the project would not convert Farmland to a non-agricultural use, and no impact would occur. Neither would it contribute to the cumulative impact of loss of Farmland, including Prime Farmland.

Noise

Less Than Significant with Mitigation Incorporated. Temporary construction activities at the project site may significantly increase the existing ambient noise levels at the residential area immediately south of the project site (depending on the activity occurring and equipment being used at the time). However, implementation of PD NOI-1 and PD NOI-2 with the proposed mitigation measure, **MM NOI-1**, noise impacts would be reduced. With the implementation of PD NOI-1, PD NOI-2, and **MM NOI-1**, the project's

contribution to cumulative noise impacts during project construction and operation would not be cumulatively considerable.

The project would contribute to vehicle trips during the construction period as construction workers commute, and trucks deliver construction materials, to the project site. These trips would be temporary in nature; therefore, they would not significantly add to regular traffic. Based on the facility's anticipated 42 operational employees and 30 visitors, the facility would generate minimal daily trips that would not substantially increase the traffic or associated traffic-related noise levels in the project area. Any noise impacts associated with construction and operation-related traffic would be less than significant and cumulatively not considerable.

Population and Housing

Less Than Significant. The General Plan FPEIR identified significant impacts from job growth allowed under the General Plan. The General Plan FPEIR concluded that substantial residential development could be required elsewhere in the region to provide adequate housing opportunities to future workers. As described in **Section 4.14 Population and Housing**, the project would not displace any people or housing, or necessitate construction of replacement housing elsewhere. Operation of the project is anticipated to require approximately 42 employees. The project's construction and operation workforce would not directly or indirectly induce substantial population growth in the project area. Therefore, the project's contribution to the jobs-housing imbalance would not be cumulatively considerable.

Transportation

Less Than Significant. The General Plan FPEIR anticipates significant traffic impacts from the build-out of the General Plan. As discussed in **Section 4.17 Transportation**, implementation of PD TRA-1 would reduce the project generated VMT to a level below the city's industrial threshold and reduce the project impact to a less than-significant level. With implementation of PD-TRA-1, the project's contribution to cumulative transportation impacts during project construction and operation would not be cumulatively considerable.

Other Technical Areas

Although the city's general plan FPEIR did not identify significant effects in the areas of air quality, cultural resources, and geology (paleontology), and did not include an analysis of impacts to tribal cultural resources as the general plan FPEIR was adopted before the passage of AB52 requiring such analysis, CEC staff concluded that the project's impacts in these areas are *less than significant with mitigation*. Thus, staff has considered whether the project would contribute to cumulatively considerable impacts in these areas. Staff has also included an analysis of potential cumulative impacts for the other technical areas where project impacts would be *less than significant*.

Air Quality

Less Than Significant with Mitigation Incorporated. The proposed project would be located in Santa Clara County in the San Francisco Bay Area Air Basin (SFBAAB), under the jurisdiction of the Bay Area Air Quality Management District (BAAQMD). The SFBAAB is designated as a nonattainment area for ozone and fine particulate matter having a diameter of less than or equal to 2.5 microns (called "PM2.5") under both California Ambient Air Quality Standards (CAAQS) and National Ambient Air Quality Standards (NAAQS). The SFBAAB is also designated as nonattainment for particulate matter having a diameter of less than or equal to 10 microns (called "PM10") under CAAQS, but not NAAQS.

SFBAAB's nonattainment status is attributed to the region's development history. Past, present, and future development projects contribute to the region's adverse air quality impacts on a cumulative basis. In developing thresholds of significance for air pollutants, BAAQMD considers the emission levels for which a project's individual emissions would be cumulatively considerable. If a project exceeds the identified significance thresholds, its emissions would be cumulatively considerable, resulting in significant adverse air quality impacts to the region's existing air quality conditions. The California Environmental Quality Act (CEQA) would then require implementation of all feasible mitigation measures.

The construction emissions of the project would be lower than the thresholds of significance from the BAAQMD CEQA Air Quality Guidelines. There is no numerical threshold for fugitive dust generated during construction in BAAQMD. BAAQMD considers fugitive dust emissions to be potentially significant without incorporation of basic construction mitigation measures, also called best management practices (BMPs). The applicant proposes to incorporate the BAAQMD's recommended BMPs as a project design feature (see PD AQ-1). In addition, staff recommends mitigation measure **MM AQ-1** to minimize the exhaust emissions during construction. Therefore, the project's construction emissions would not be cumulatively considerable.

During readiness testing and maintenance, the oxides of nitrogen (NOx) emissions of the standby generators are estimated to exceed the BAAQMD significance threshold of 10 tons per year. All other pollutants would have estimated emission rates below BAAQMD significance thresholds. The NOx emissions from the standby generator readiness testing and maintenance would be required to be fully offset through the permitting process with the BAAQMD. Therefore, the project emissions during readiness testing and maintenance would not be cumulatively considerable.

The criteria pollutant air quality impact analysis found that the concentrations from construction and readiness testing and maintenance of the standby engine generators would not cause any exceedance of ambient air quality standards. Therefore, the project's criteria air pollutant impacts from standby generator readiness testing and maintenance would be less than significant.

The health risk assessment (HRA) shows that the project's health risk impacts would not exceed BAAQMD significance thresholds during construction or standby generator readiness testing and maintenance. The project would not expose sensitive receptors to substantial toxic air contaminant (TAC) concentrations during construction or standby generator readiness testing and maintenance.

Due to the infrequent nature of emergency conditions and the record of highly reliable electric service available to the project (see **Appendix B**), the project's emergency operations would be unlikely to expose sensitive receptors to substantial concentrations of criteria air pollutants or toxic air contaminants.

Therefore, the project's air quality impacts would not be cumulatively significant.

Cultural and Tribal Cultural Resources

Less Than Significant with Mitigation Incorporated. The General Plan FPEIR does not specifically address impacts on tribal cultural resources. Historical resources and unique archaeological resources, as defined by CEQA, share several of the impact vulnerabilities that tribal cultural resources face, especially the effects of ground-disturbing activities. In addition, historical and unique archaeological resources can also qualify as tribal cultural resources. The suite of mitigation measures for cultural resources presented in the General Plan FPEIR would reduce the severity of some impacts on tribal cultural resources. No known historical resources, unique archaeological resources, or tribal cultural resources have been found on the project site, although ground disturbance associated with the proposed project could result in the exposure and destruction of buried, as-yet unknown archaeological resources that could qualify as historical resources, unique archaeological resources, or tribal cultural resources. Implementation of PD CUL-2 and proposed mitigation measures **MM CUL-1** through **MM CUL-4** would prevent, minimize, or compensate for impacts on buried, historical, unique archaeological, or tribal cultural resources. Project impacts to cultural resources and tribal cultural resources therefore would not be cumulatively considerable.

Energy and Energy Resources

Less Than Significant Impact. The total number of hours of operation for reliability purposes (i.e., readiness testing and maintenance) for the generators would be limited to no more than 20 hours per generator annually. At this rate, the total quantities of diesel fuel used for all the generators operating at full load would be approximately 3,854 barrels per year (bbl/yr). California has a diesel fuel supply of approximately 341,036,000 bbl/yr. The project's use of fuel constitutes a small fraction (less than 0.0011 percent) of available resources and the supply is more than sufficient to meet necessary demand. For these reasons, the project's use of fuel is less than significant.

The project's consumption of energy resources during operation would not be inefficient or wasteful, as discussed in **Section 4.6 Energy and Energy Resources**. Project operation would have a less-than-significant adverse effect on local or regional energy supplies and energy resources and likewise, would not be cumulatively considerable.

Geology and Soils

Less Than Significant with Mitigation Incorporated. The City of San Jose General Plan identifies two policies (ER-10.1 and ER-10.3) that specifically address impacts on paleontological resources (San Jose 2020). Paleontological resources can be impacted by the effects of ground-disturbing activities. Five fossil sites have been found at or near the ground surface within several miles of the project site, particularly along stream beds (UCMP 2020). The suite of mitigation measures for paleontological resources presented in the General Plan EIR would reduce the severity of some impacts on paleontological resources. No known paleontological resources have been found on the project site. Ground disturbance associated with the proposed project could result in the exposure and destruction of buried, as-yet unknown paleontological resources that could qualify as significant paleontological resources. Implementation of mitigation measure **MM GEO-1** would prevent, or minimize, impacts on buried paleontological resources. Project impacts to paleontological resources therefore would not be cumulatively considerable.

Greenhouse Gas Emissions

Less Than Significant with Mitigation Incorporated. The BAAQMD CEQA Air Quality Guidelines do not identify a GHG emissions threshold for construction-related emissions. Instead, BAAQMD recommends that GHG emissions from construction be quantified and disclosed and the impacts be determined in relation to meeting Assembly Bill (AB) 32 GHG reduction goals. The BAAQMD further recommends incorporation of BMPs to reduce GHG emissions during construction, as feasible and applicable. The project's construction emissions would be in conformance with state and local GHG emissions reduction goals, so impacts would be cumulatively less than significant.

For readiness testing and maintenance-related emissions, the BAAQMD CEQA Air Quality Guidelines states that for stationary-source projects, the threshold to determine the significance of an impact from GHG emissions is 10,000 metric tons per year of carbon dioxide equivalent (MTCO₂e/yr). For commercial/industrial land use development projects, BAAQMD has adopted a numeric threshold of 1,100 MTCO₂e/yr and a qualitative threshold of complying with a qualified GHG reduction strategy. The 10,000 MTCO₂e/yr threshold would apply to the proposed project, which includes stationary sources that are subject to BAAQMD permitting, and the project would not be subject to the 1,100 MTCO₂e/yr threshold recommended for commercial/industrial land use developments. Other project-related emissions from mobile sources, area sources, energy use and water use, would not be included for comparison to this threshold, based on guidance in the BAAQMD's CEQA Guidelines. GHG impacts from all other project-related emission sources would be considered to have a less-than-significant impact if the project is consistent with the *City of San Jose Greenhouse Gas Reduction Strategy* and applicable regulatory programs and policies adopted by the Air Resources Board or other California agencies, which are considered a qualified greenhouse gas reduction strategy. The City of San Jose's GHG Reduction Strategy is a Qualified Climate Action Plan under CEQA. This project would comply with the requirements of that plan with implementation of **MM GHG-1**, which would require the applicant to participate in San Jose Clean Energy at the

TotalGreen level (see **Section 4.8 Greenhouse Gas Emissions** for the proposed mitigation). Pursuant to California Code of Regulations, title 14, section 15183.5, the CEC may rely on that compliance in its analysis of GHG emissions impacts. Accordingly, staff concludes with implementation of **MM GHG-1**, the project's GHG emissions would not have a significant direct or indirect impact on the environment.

The GHG emissions of the standby generators of the project are expected to be less than the 10,000 MTCO₂e/yr threshold and would not be cumulatively significant. Additionally, the project would implement efficiency measures to meet California green building standards, and additional voluntary efficiency and use reduction measures. Indirect GHG emissions from energy used by the project and supplied by PG&E will comply with RPS and Cap-and-Trade Program requirements. As such, GHG emissions related to the project would not conflict with the City of San Jose GHG reduction Strategy or other plans, policies, or regulations adopted for the purpose of reducing the emissions of GHGs. Therefore, the project's GHG emissions would not be considered cumulatively significant.

Hazards and Hazardous Materials

Less Than Significant Impact. As discussed in **Section 4.9 Hazards and Hazardous Materials** the project would use hazardous materials in small quantities as associated with construction. These hazardous materials would be stored in designated construction staging areas in compliance with local, state, and federal requirements. Any diesel fuel transported on site would also comply with the extensive regulatory framework that applies to the shipment of hazardous materials. In addition, the applicant would implement procedures, and safety features and precautions that would reduce the risk of an accidental hazardous materials release. Therefore, the impact from the use, transport, disposal, or accidental release of hazardous materials would not be considered cumulatively significant.

Hydrology and Water Quality

Less Than Significant Impact. The project would be required to comply with the city of San Jose's Post-Construction Urban Runoff Policy No. 6-29, the Municipal NPDES Permit, and the Santa Clara Valley Urban Runoff Pollution Prevention Program. The plans and permits work together to establish specific requirements to reduce storm water pollution from new and redevelopment projects, singularly and cumulatively. If implemented as described in **Section 4.10 Hydrology and Water Quality**, these standards would protect the watershed receiving discharge from the project from a cumulatively considerable impact to the basin's hydrology. Similarly, these same plans and permits would be protective of water quality. These standards would be protective of the quality, of both surface water and groundwater bodies, receiving discharge from the project.

Public Services

Less Than Significant Impact. As discussed in **Section 4.15 Public Services**, the construction and operation of the project would not result in substantial adverse physical environmental impacts associated with the provision of new or physically altered fire and

police service facilities in order to maintain acceptable service ratios, response times, or other performance objectives. The project would be consistent with the planned growth in the general plan. The San Jose Fire Department would review project plans to ensure appropriate safety measures are incorporated to reduce fire hazards and the police department would review the final site design to ensure that the project provides adequate safety and security measures.

In accordance with California Government Code Section 65996, the project would be required to pay the appropriate school impact fees to Oak Grove Elementary and East Side Union High school districts. Operation of the project is anticipated to require approximately 42 employees, which the applicant anticipates would be drawn from the great Bay Area. Even if all of the operation workforce would relocate closer to the project site, the additional population would be consistent with growth projections and service ratios in the General Plan and thus the project would not cause significant environmental impacts associated with the provision of new or physically altered park and other public facilities in order to maintain acceptable service ratios or other performance objectives. The project's impacts to the public services would not be cumulatively considerable.

Recreation

Less Than Significant Impact. As discussed in **Section 4.16 Recreation**, the project does not require or propose the construction or expansion of recreation facilities. Operation of the project is anticipated to require approximately 42 employees. The project's operation workforce would be consistent with growth projects and service ratios in the General Plan and thus the project would not increase the use of existing parks or recreational facilities to the extent that substantial physical deterioration of the park or facility would result. The project's impacts to recreation would not be cumulatively considerable.

Utilities and Service Systems

Less Than Significant Impact. As determined in **Section 4.17 Utilities and Service Systems**, adequate water supply as well as water and wastewater treatment capacity are available to serve the project. Likewise, there are adequate telecommunication and natural gas resources in the project area to meet the project's needs.

The city of San Jose has available landfill capacity at the Newby Island Landfill through 2041. The current landfill impacts are addressed within an ongoing Santa Clara County Integrated Waste Management Plan to provide waste disposal services. The project would generate minimal operational waste as data centers typically require very little equipment turnover. Additionally, the project does not include a residential component and would not generate any increases in the supply and demand of utility services and infrastructure. Therefore, the project's contribution to this cumulative impact would not be cumulatively considerable.

Required Mitigation Measures: MM AQ-1, MM BIO-1, MM CUL-1 through MM CUL-4, MM GEO-1, and MM GHG-1.

c. Does the project have environmental effects which will cause substantial adverse effects on human beings, either directly or indirectly?

Less Than Significant with Mitigation Incorporated. The proposed project would not cause substantial adverse effects on human beings either directly or indirectly. The proposed project would result in less than significant temporary impacts to human health during construction, including changes to air quality, and exposure to geologic hazards, noise, and hazardous materials. As discussed in **Section 4.3 Air Quality**, with implementation of PD AQ-1 and **MM AQ-1** to control emissions during project construction and fully offset NOx emissions for engine testing and maintenance, the project would result in a less than significant impact related to human health. As discussed in **Section 4.8 Greenhouse Gas Emissions**, with implementation of **MM GHG-1** requiring the project to participate in the San Jose Clean Energy at the Total Green level, the project's GHG emissions would not have a significant impact on the environment. As discussed in **Section 4.7 Geology and Soils**, implementation of seismic design guidelines in the current California Building Code and project-specific recommendations in a final geotechnical engineering report, as required by PD GEO-1, would ensure the project would not expose people or property to significant impacts associated with geologic or seismic conditions onsite. The project would result in temporary noise impacts to humans during construction and intermittently during operation. As discussed in **Section 4.13 Noise**, with the implementation of **MM NOI-1**, the project's noise impacts during project construction and operation would be less than significant. As discussed in **Section 4.9 Hazards and Hazardous Materials**, with the implementation of PD HAZ-1, hazards and hazardous material impacts would be less than significant. As discussed in **Section 4.10 Hydrology and Water Quality**, water quality impacts would be less than significant. No additional impacts to human beings would occur during project operation.

Required Mitigation Measures: MM AQ-1, MM NOI-1, and MM GHG-1.

4.20.4 References

CNDDDB 2019 – California Natural Diversity Database (CNDDDB). Rarefind 5 (Government Version, June 30, 2019). 9 quad search around the proposed project. Accessed March 1, 2020

San Jose 2020 – City of San Jose (San Jose). *Envision San Jose 2040 General Plan*. Approved November 1, 2011. Updated March 16, 2020. Accessed on July 21, 2020. Available online at: <https://www.sanjoseca.gov/your-government/departments/planning-building-code-enforcement/planning-division/citywide-planning/envision-san-jos-2040-general-plan>

San Jose 2016 – City of San Jose (San Jose). *Addendum to the Envision San Jose 2040 General Plan Final Program Environmental Impact Report and Supplemental Environmental Impact Report*, Envision San Jose 2040 General Plan 4 Year

Review. November 2016. Available online
at: <https://www.sanjoseca.gov/home/showdocument?id=22025>

- San Jose 2011 – City of San Jose (San Jose). *Draft Program Environmental Impact Report for the Envision San Jose 2040 General Plan*. June 2011. State Clearinghouse Number 2009072096, File Number: PP09-011. Available online at: <https://www.sanjoseca.gov/your-government/departments/planning-building-code-enforcement/planning-division/environmental-planning/environmental-review/completed-eirs/envision-san-jose-2040-general-plan-4-year/envision-san-jos-2040-general-plan>
- SCVHP 2012 – Santa Clara Valley Habitat Plan (SCVHP). Final Santa Clara Valley Habitat Plan. August 2012. Available online at: <https://scv-habitatagency.org/178/Santa-Clara-Valley-Habitat-Plan>
- UCMP 2020 – University of California Museum of Paleontology (UCMP). *UCMP database*. Accessed on: June 22, 2020. Available online at: <http://ucmpdb.berkeley.edu/>
- USFWS 1998 – U.S. Fish and Wildlife Service (USFWS). Recovery Plan for Serpentine Soil Species of the San Francisco Bay Area. Portland, Oregon. 330+ pp. Available online at: <https://ecos.fws.gov/ecp0/profile/speciesProfile?sPCODE=I021>
- USFWS 2008 – U.S. Fish and Wildlife Service (USFWS). Endangered and Threatened Wildlife and Plants; Designation of Critical Habitat for the Bay Checkerspot Butterfly (*Euphydryas editha bayensis*). Final Rule. Federal Register. 73(166): 50406-50452
- USFWS 1998 – United States Fish and Wildlife Service (USFWS). Recovery Plan for Serpentine Soil Species of the San Francisco Bay Area. Portland, Oregon. 330+ pp. Available online at: <https://ecos.fws.gov/ecp0/profile/speciesProfile?sPCODE=I021>
- Wildan 2012 – Willdan Financial Services with Urban Economics (Wildan). Santa Clara Valley Habitat Plan Development Fee Nexus Study. June 31, 2012. 52 pp. Available online at: <https://scv-habitatagency.org/DocumentCenter/View/141/Santa-Clara-Valley-Habitat-Plan-Development-Fee-Nexus-Study>

4.21 Environmental Justice

This section describes the environmental and regulatory setting, and discusses impacts specific to environmental justice associated with the construction and operation of the project.

4.21.1 Setting

The United States Environmental Protection Agency (U.S. EPA) defines environmental justice (EJ) as, “the fair treatment and meaningful involvement of all people regardless of race, color, national origin or income with respect to the development, implementation and enforcement of environmental laws, regulations and policies” (U.S. EPA 2015, pg. 4).

The “Environmental Justice in the Energy Commission Site Certification Process” subsection immediately below describes why EJ is part of the CEC’s site certification process, the methodology used to identify an EJ population, and the consideration of data from the California Environmental Protection Agency’s (CalEPA) California Communities Environmental Health Screening Tool (CalEnviroScreen). Below that, the “Environmental Justice Project Screening” subsection presents the demographic data for those people living in a six-mile radius of the project site and a determination on presence or absence of an EJ population. When an EJ population is identified, the analysis in 10 technical areas¹ and Mandatory Findings of Significance consider the project’s impacts on this population and whether any impacts would disproportionately affect the EJ population. Lastly, the “Project Outreach” subsection discusses the CEC’s outreach program specifically as it relates to the proposed project.

Environmental Justice in the Energy Commission Site Certification Process

Executive Order 12898, “Federal Actions to Address Environmental Justice in Minority Populations and Low-Income Populations,” focuses federal attention on the environment and human health conditions of minority communities and calls on federal agencies to achieve environmental justice as part of their mission. The order requires the U.S. EPA and all other federal agencies (as well as state agencies receiving federal funds) to develop strategies to address this issue. The agencies are required to identify and address any disproportionately high and adverse human health or environmental effects of their programs, policies, and activities on minority and/or low-income populations.

The California Natural Resources Agency recognizes that EJ communities are commonly identified as those where residents are predominantly minorities or live below the poverty level; where residents have been excluded from the environmental policy setting or

¹ The 10 technical areas are Aesthetics, Air Quality, Cultural and Tribal Cultural Resources, Hazards and Hazardous Materials, Hydrology and Water Quality, Land Use and Planning, Noise, Population and Housing, Transportation, and Utilities and Service Systems. Cultural and Tribal Cultural Resources considers impacts to Native American populations.

decision-making process; where they are subject to a disproportionate impact from one or more environmental hazards; and where residents experience disparate implementation of environmental regulations, requirements, practices, and activities in their communities. Environmental justice efforts attempt to address the inequities of environmental protection in these communities.

An EJ analysis is composed of the following:

- Identification of areas potentially affected by various emissions or impacts from a proposed project;
- Providing notice in appropriate languages (when possible) of the proposed project and opportunities for participation in public meetings to EJ communities;
- A determination of whether there is a comparatively larger population of minority persons, or persons below the poverty level, living in an area potentially affected by the proposed project; and
- A determination of whether there may be a significant adverse impact on a population of minority persons or persons below the poverty level caused by the proposed project alone, or in combination with other existing and/or planned projects in the area.

California law defines EJ as “the fair treatment of people of all races, cultures and income with respect to the development, adoption, implementation, and enforcement of environmental laws, regulations, and policies” (Gov. Code, § 65040.12; Pub. Resources Code, §§ 71110-71118). All departments, boards, commissions, conservancies and special programs of the Resources Agency must consider EJ in their decision-making process if their actions have an impact on the environment, environmental laws, or policies. Such actions that require EJ consideration may include:

- adopting regulations;
- enforcing environmental laws or regulations;
- making discretionary decisions or taking actions that affect the environment;
- providing funding for activities affecting the environment; and
- interacting with the public on environmental issues.

CalEnviroScreen - More Information About an EJ Population

CalEnviroScreen is a science-based mapping tool used by CalEPA to identify disadvantaged communities² pursuant to Senate Bill (SB) 535. As required by SB 535, disadvantaged communities are identified based on geographic, socioeconomic, public health and environmental hazard criteria. CalEnviroScreen identifies communities most burdened by pollution from multiple sources and most vulnerable to its effects, taking

² The California Environmental Protection Agency, for the purposes of its Cap-and-Trade Program, has designated *disadvantaged communities* as census tracts having a CalEnviroScreen score at the top 25 percent (75th percentile) (CalEPA 2017).

into account socioeconomic and health status of people living in those communities (OEHHA 2017, pg. 1).

Using data from federal and state sources, the tool consists of four components in two broad groups. The Exposure and Environmental Effects components comprise a Pollution Burden group, and the Sensitive Populations and Socioeconomic Factors components comprise a Population Characteristic Group. The four components are made up of environmental, health, and socioeconomic data from 20 indicators.

CalEnviroScreen scores are calculated by combining the individual indicator scores within each of the four components, then multiplying the Pollution Burden and Population Characteristics groups scores to produce a final score (Pollution Burden X Population Characteristics = CalEnviroScreen Score). (CalEPA 2017, pg. 3) Each group has a maximum score of 10, thus the maximum CalEnviroScreen score is 100. Based on these scores, census tracts across California are ranked relative to one another (OEHHA 2017, pg. 6). Values for the various components are shown as percentiles, which indicate the percent of all census tracts with a lower score. A higher percentile indicates a higher potential relative burden.

Table 4.21-1 lists the indicators that go into the Pollution Burden score and the Population Characteristics score to form the final CalEnviroScreen score. These indicators are used to measure factors that affect the potential for pollution impacts in communities.

TABLE 4.21-1 COMPONENTS THAT FORM THE CALENVIROSCREEN 3.0 SCORE	
Pollution Burden	
Exposure Indicators	Environmental Effects Indicators
Diesel particulate matter (PM) emissions	Cleanup sites
Drinking water contaminants	Groundwater threats
Ozone concentrations	Hazardous waste
PM 2.5 concentrations	Impaired water bodies
Pesticide use	Solid waste sites and facilities
Toxic releases from facilities	
Traffic density	
Population Characteristics	
Sensitive Populations Indicators	Socioeconomic Factors Indicators
Asthma emergency department	Educational attainment
Cardiovascular disease (emergency department visits for heart attacks)	Housing burdened low income households
Low birth-weight infants	Linguistic isolation
	Poverty
	Unemployment

Notes: PM= particulate matter. PM 2.5= fine particulate matter 2.5 microns or less.
Source: OEHHA 2017

Part of staff’s assessment of how, or if, the project would impact an EJ population includes a review of CalEnviroScreen data for the project area. There are four technical areas that could have project impacts that could combine with the indicators in CalEnviroScreen: Air

Quality, Hydrology and Water Quality, Hazards and Hazardous Materials, and Utilities and Service Systems.

The CalEnviroScreen indicators relevant to each of the four technical areas are:

- For air quality, these indicators are asthma, cardiovascular disease, diesel PM emissions, low birth-weight infants, ozone concentrations, pesticide use, PM2.5 concentrations, toxic releases from facilities, and traffic density.
- For hydrology and water quality, these indicators are drinking water contaminants, groundwater threats, and impaired water bodies.
- For hazards and hazardous materials, the indicator is cleanup sites.
- For utilities and service systems, these indicators are cleanup sites, hazardous waste, and solid waste sites and facilities.

When these technical areas have identified a potential project impact where an EJ population is present, CalEnviroScreen is used to better understand the characteristics of the areas where the impact would occur and ensure that disadvantaged communities in the vicinity of the proposed project have not been missed when screened by race/ethnicity and low income.

There are several limitations with CalEnviroScreen that are important to note (OEHHA 2017, pgs. iii, 1-3, 6, 12). These limitations and items to note include the following:

- The core purpose of this tool is to characterize “impacts” of pollution in communities with respect to factors that are not routinely included in risk assessments, where “impacts,” for the purposes of this tool, refers broadly to stressors that can affect health and quality of life.
- The tool is a screening tool developed to conduct statewide evaluations of community-scale impacts.
- Many factors, or stressors, contribute to a community’s pollution burden and vulnerability.
- Integration of multiple stressors into a risk assessment is currently not feasible.
- The score provides a relative rather than absolute measure of pollution’s impacts and vulnerabilities in California communities.
- The score provides a broad picture of the burdens and vulnerabilities that communities confront from environmental pollutants.
- A percentile does not describe the magnitude of the difference between two tracts, rather it simply tells the percentage of tracts with lower values for that indicator.
- The score is for a given tract relative to other tracts in the state.

The tool did not/does not:

- substitute for a cumulative impact analysis under the California Environmental Quality Act (CEQA);
- restrict the authority of government agencies in permit and land use decisions;
- guide all public policy decisions; and,
- inform the implementation of many policies, programs, and activities throughout the state.

Project Outreach

- As a part of the U.S. EPA's definition of EJ, meaningful involvement is an important part of the siting process. Meaningful involvement occurs when (U.S. EPA 2019): potentially affected community residents have an appropriate opportunity to participate in decisions about a proposed activity that will affect their environment and/or health;
- the public's contribution can influence the regulatory agency's decision;
- the concerns of all participants involved will be considered in the decision-making process; and,
- the decision makers seek out and facilitate the involvement of those potentially affected.
- CEC staff and the Public Advisor's Office (PAO) coordinated closely on public outreach early in the review process. The PAO outreach consisted of emails to state and locally elected officials, environmental justice organizations, local chambers of commerce, schools and school districts, labor unions and trade associations, community centers, daycare centers, park departments, and religious organizations within a six- and twelve- mile radius of the proposed project.

In addition, PAO and CEC Siting Division and Office of Governmental Affairs management briefed San Jose City District 2 Council Member and staff and San Jose Mayor's staff on the project. Furthermore, PAO assisted interested public members on how to have meaningful participation and public engagement during an SPPE proceeding.

CEC staff docketed and mailed to the project mail list, including EJ organizations and similar interest groups, a Notice of Receipt of the Great Oaks South Data Center (or project) Small Power Plant Exemption (SPPE) Application on June 30, 2020. Based on current U.S. Census English fluency data for the population residing in the cities and communities within a six-mile radius of the project site, translation of project notices was deemed appropriate. U.S. Census data also showed that of those who report they "Speak English less than very well", the predominant language spoken was Spanish and Vietnamese. In addition, CalEnviroScreen 3.0 data for the one disadvantaged community census tract within a six mile radius of the project showed the linguistic isolation population characteristic with a percentile of 90 and above. The CalEnviroScreen data

supports the U.S. Census language fluency data, showing that the population living in this immediate project area are linguistically isolated and translation is warranted. Public notices for the project were published in local newspapers in English on July 9, 2020 and in Spanish and Vietnamese on July 10, 2020.

In accordance with the Governor's Executive Order B-10-11, the CEC's Tribal Consultation Policy, the CEC's Siting Regulations, and recent amendments to CEQA (that is, Assembly Bill 52), staff conducted outreach and consultation with regional tribal governments. Additional information regarding the outreach efforts and specific groups contacted can be found in **Section 4.5 Cultural and Tribal Cultural Resources**.

As described in **Section 2 Introduction**, staff exceeded the noticing requirements under CEQA Guidelines Section 15087 by mailing the Notice of Availability of the Draft EIR to all owners and occupants not just contiguous to the project site but also to property owners within 1,000 feet of project site and 500 feet of project linears.

Environmental Justice Project Screening

CEC staff gathers demographic data within a six mile radius of the project site and when present, considers how the project would impact an environmental justice population. Staff typically uses a six mile radius for projects of this nature because at this distance a project's air emissions (pollutants) tend to settle out of the air column and/or are dispersed to the extent where the resulting levels are not considerable for any population, including sensitive and EJ populations. Based on Air Quality staff's modeling experience, beyond six miles there is no statistically significant concentration overlap for non-reactive pollutant concentrations between two stationary emission sources. This is an extremely conservative approach as most emissions, and the majority of other project effects, are focused on an area within 1,000 feet of the project.

Figure 4.21-1 shows 2010 census blocks in a six-mile radius of the project with a minority population greater than or equal to 50 percent (U.S. Census 2010). The population in these census blocks represents an EJ population based on race and ethnicity as defined in the U.S. EPA's *Guidance on Considering Environmental Justice During the Development of Regulatory Actions* (U.S. EPA 2015).

Based on California Department of Education data in **Table 4.21-2** and presented in **Figure 4.21-2**, staff concludes that the percentage of those living in the school districts of Franklin-McKinley Elementary, Morgan Hill Unified, and San Jose Unified (in a six-mile radius of the project site) are enrolled in the free or reduced price meal program is larger than those in the reference geography, and thus are considered an EJ population based on a low income population as defined in *Guidance on Considering Environmental Justice During the Development of Regulatory Actions*.

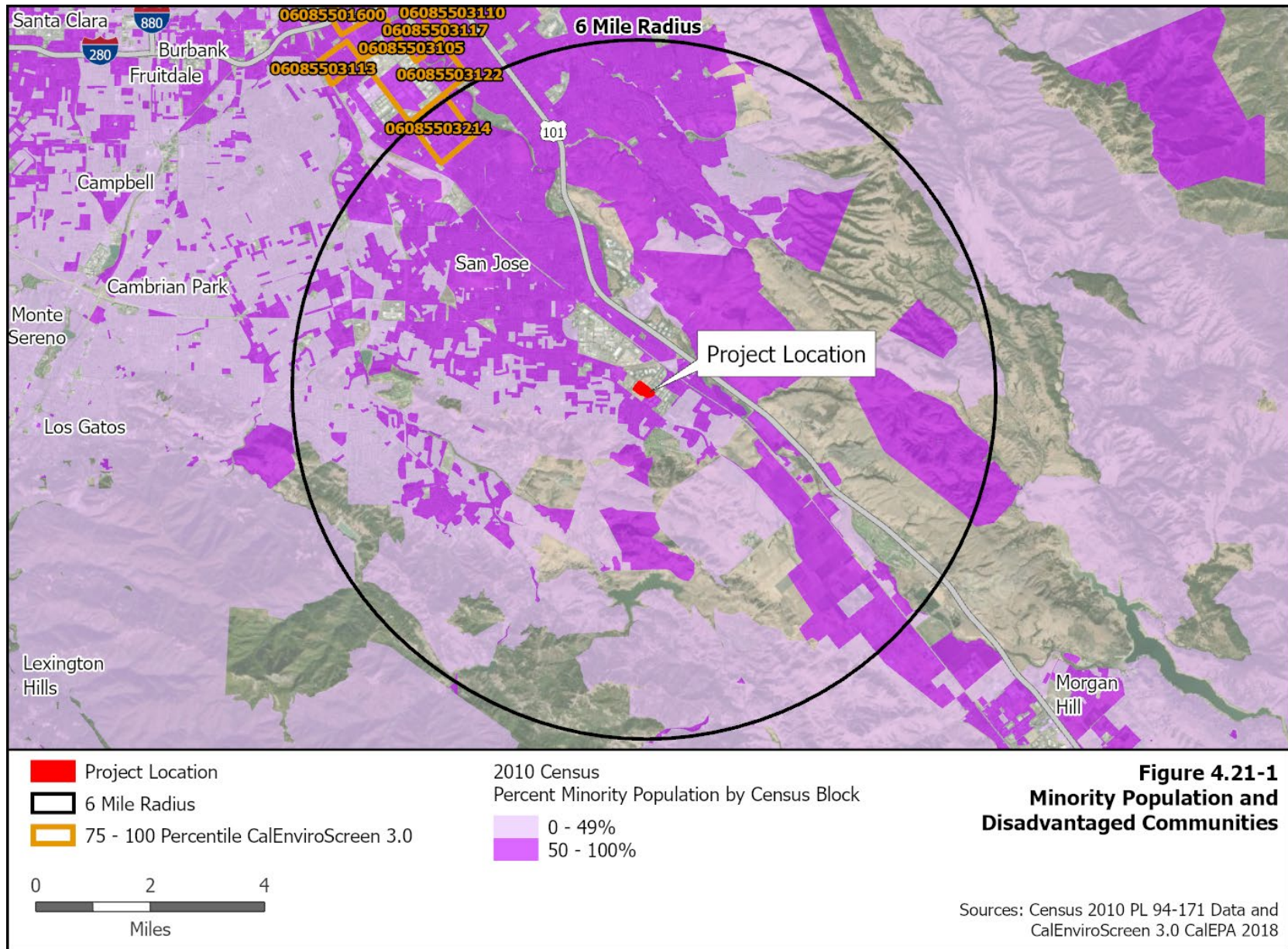

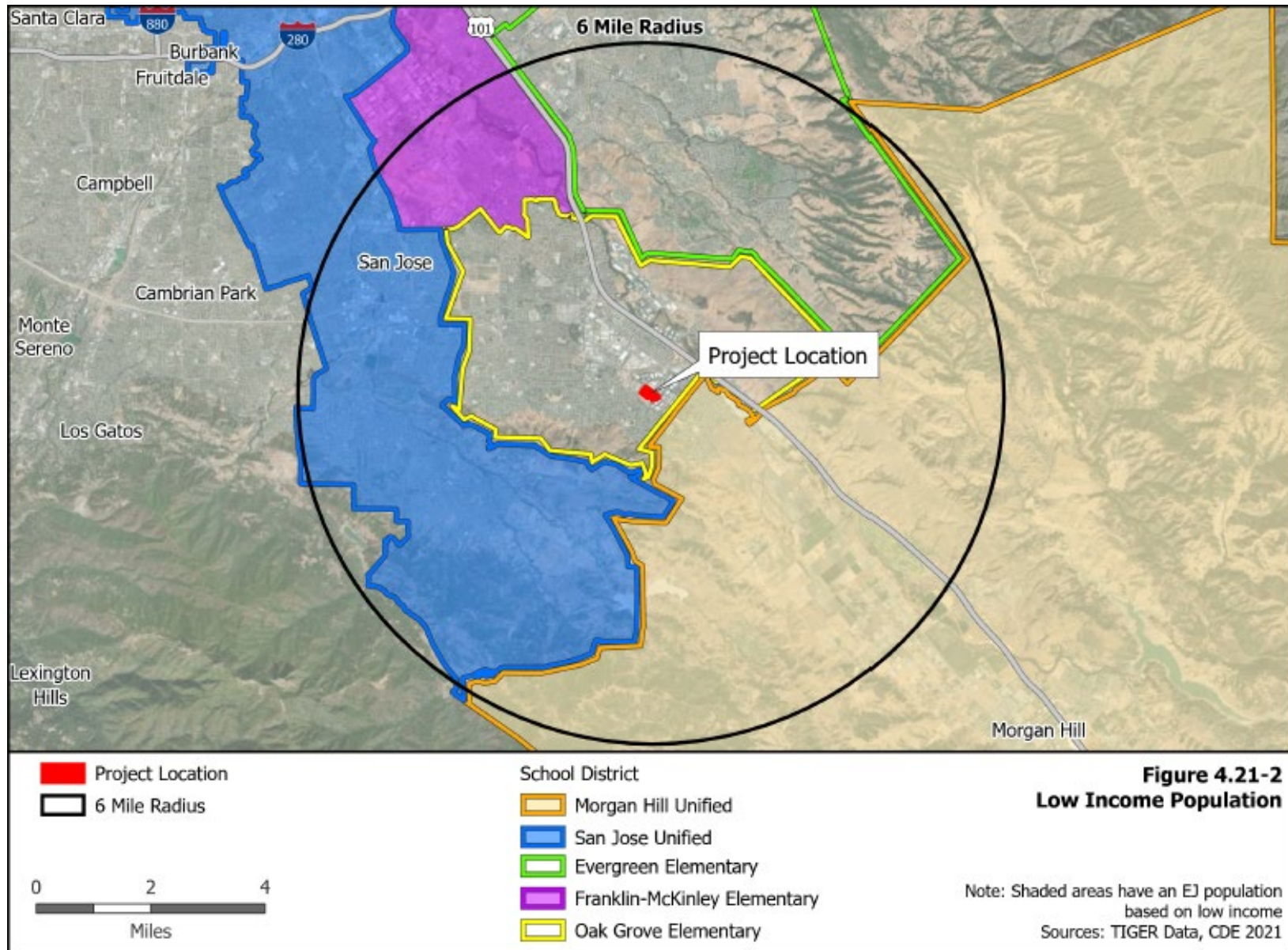

TABLE 4.21-2 LOW INCOME DATA WITHIN THE PROJECT AREA

Santa Clara County School Districts in a Six Mile Radius of the Project Site	Enrollment Used for Meals	Free or Reduced Price Meals	
Evergreen Elementary	9,789	2,411	24.6%
Franklin-McKinley Elementary	8,980	6,381	71.1%
Morgan Hill Unified	8,894	3,170	35.6%
Oak Grove Elementary	9,362	2,387	25.5%
San Jose Unified	28,710	10,622	37.0%
Reference Geography			
Santa Clara County	253,625	82,218	32.4%

Note: **Bold** indicates school districts considered having an EJ population based on low income.

Source: CDE 2021.

CalEnviroScreen - Disadvantaged Communities

CalEnviroScreen 3.0 was used to gather additional information about the population potentially impacted by the proposed project. The CalEnviroScreen indicators (see **Figure 4.21-1**) are used to measure factors that affect the potential³ for pollution impacts in communities (OEHHA 2017). Staff used CalEnviroScreen to identify disadvantaged communities⁴ in the vicinity of the proposed project (six-mile radius) and better understand the characteristics of the areas where impacts could occur. **Table 4.21-3** presents the CalEnviroScreen overall scores for the one disadvantaged community within a six-mile radius of the project site.

TABLE 4.21-3 CALENVIROSCREEN SCORES FOR DISADVANTAGED COMMUNITIES

Census Tract No.	Total Population	CES 3.0 Percentile	Pollution Burden Percentile	Population Characteristics Percentile
06085503214	7,253	82.27	62.79	86.88

Note: Disadvantaged communities by census tract in the project’s 6-mile radius. Shaded row indicates census tract where the project is located. Source: Cal/EPA 2018

Table 4.21-4 presents the CalEnviroScreen percentiles for the indicators that make up the pollution burden percentile. When percentiles for CalEnviroScreen indicators are 90 and above, shown in bold, these relatively higher percentiles could be seen as drivers for why the census tract is identified as a disadvantaged community. The one disadvantaged

³ It is important to note that CalEnviroScreen is not an expression of health risk and does not provide quantitative information on increases of impacts for specific sites or project. CalEnviroScreen uses the criteria of “proximity” to a hazardous waste site, a leaking underground tank, contaminated soil, an emission stack (industry, power plant, etc.) to determine that a population is “impacted”. It does not address general principles of toxicology: dose/response and exposure pathways. For certain toxic chemicals to pose a risk to the public, offsite mitigation pathways must exist (through ingestion, inhalation, dermal contact, etc.) and contact to a certain amount- not just any amount – must exist.

⁴ The California Environmental Protection Agency (CALEPA), for purposes of its Cap-and-Trade Program, has designated *disadvantaged communities* as census tracts having a CalEnviroScreen score at or above the 75th percentile (CalEPA 2017). As a comparative screen tool, it is not intended to be used as a health or ecological risk assessment for a specific area.

community census tract within a six mile radius of the project site does not have a combined or individual pollution burden percentile of 90 or above.

Table 4.21-5 presents the CalEnviroScreen percentiles for the indicators that make up the population characteristics. The one disadvantaged community census tract does not have a combined population characteristics percentile of 90 or above, but does have an individual population characteristics indicator, linguistic isolation, that is 90 or above.

TABLE 4.21-4 CALENVIROSCREEN INDICATOR PERCENTILES FOR POLLUTION BURDEN FOR DISADVANTAGED COMMUNITIES	
Percentiles for Census Tract 06085503214	
Pollution Burden	62.79
Ozone	22.34
PM2.5	52.61
Diesel PM	89.01
Drinking Water	51.02
Pesticides	0.00
Toxic Release	28.87
Traffic	44.40
Cleanup Sites	84.42
Groundwater Threats	86.05
Hazardous Waste	65.56
Impaired Water Bodies	29.25
Solid Waste	20.49

Notes: Disadvantaged communities by census tract in the project's 6-mile radius.
Source: OEHHA 2018

TABLE 4.21-5 CALENVIROSCREEN INDICATOR PERCENTILES FOR POPULATION CHARACTERISTICS FOR DISADVANTAGED COMMUNITIES	
Percentiles for Census Tract 06085503214	
Population Characteristics	86.88
Asthma	61.35
Low Birth Weight	80.65
Cardiovascular Disease	66.26
Education	80.14
Linguistic Isolation	97.57
Poverty	76.72
Unemployment	77.40
Housing Burden	70.20

Notes: Disadvantaged communities by census tract in the project's 6-mile radius.
Bold indicates a percentile is 90 or above. Source: OEHHA 2018

4.21.2 Environmental Impacts and Mitigation Measures

The following technical areas discuss impacts to EJ populations: Aesthetics, Air Quality⁵, Cultural and Tribal Cultural Resources, Hazards and Hazardous Materials, Hydrology and Water Quality, Land Use and Planning, Noise, Population and Housing, Transportation,

⁵ Public Health concern discussed under Air Quality.

and Utilities and Service Systems. Cumulative impacts (Mandatory Findings of Significance) to EJ populations are also discussed in the “Mandatory Findings of Significance” subsection below.

Part of staff’s assessment of how, or if, the project would impact an EJ population includes a review of CalEnviroScreen data for the project area. There are four technical areas that could have project impacts that could combine with the indicators in CalEnviroScreen: Air Quality, Hazards and Hazardous Materials, Hydrology and Water Quality, and Utilities and Service Systems. When these technical areas have identified a potential impact where an EJ population is present, CalEnviroScreen is used to better understand the characteristics of the areas where the impact would occur and ensure that disadvantaged communities in the vicinity of the proposed project have not been missed when screened by race/ethnicity and low income.

Aesthetics

Less Than Significant Impact. A disproportionate impact pertaining to Aesthetics to an EJ population may occur if a project is in proximity to an EJ population and the following:

- The project, if in an “urbanized area” per Public Resources Code section 21071, conflicts with applicable zoning and other regulations governing scenic quality.
- The project, if in a non-urbanized area, substantially degrades the existing visual character or quality of the public view of the site and its surroundings.
- The project creates a new source of substantial light and glare that adversely affects day or nighttime views in the area.

As discussed in **Section 4.1 Aesthetics**, the project is in an urbanized area and it conforms to applicable city zoning and other regulations governing scenic quality.

The project includes outdoor lighting for driveways, entrances, walkways, parking areas, and security purposes. The project design includes installing LED lighting and directional and shielded light fixtures throughout the project site to minimize light and glare.

The project would have a less than significant effect on aesthetics and would not have a disproportionate effect to an EJ population.

Air Quality

Less Than Significant Impact. **Table 4.21-4** and **Table 4.21-5** include indicators that relate to both air quality and public health. The indicators that are associated with criteria pollutants such as ozone, fine particulate matter having a diameter of less than or equal to 2.5 microns (PM_{2.5}), and NO₂ are indicators related to air quality. Indicators that are associated with protecting public health are: Diesel PM, Pesticide Use, Toxic Release from Facilities, Traffic Density, Asthma ER Visits, Low Birth Weight Infants, and Cardiovascular Disease. Each of these air quality and public health indicators are summarized under this Air Quality subsection.

Ambient air quality standards (AAQS) are established to protect the health of even the most sensitive individuals in our communities, which includes the EJ population, by defining the maximum amount of a pollutant that can be present in outdoor air without harm to the public's health. Both the California Air Resources Board and the U.S. EPA are authorized to set ambient air quality standards.

Staff identified the potential air quality impacts (i.e. ozone and PM_{2.5}) that could affect the EJ population represented in **Figures 4.21-1** and **4.21-2**. Staff also examined individual contributions of indicators in CalEnviroScreen that are relevant to air quality (see **Table 4.21-4**).

Staff identified the potential public health impacts (i.e. cancer and non-cancer health effects) that could affect the EJ population represented in **Figures 4.21-1** and **4.21-2**. These potential public health risks were evaluated quantitatively based on the most sensitive population, which includes the EJ population, by conducting a health risk assessment. The results were presented by levels of risk. The potential construction and standby generator readiness testing and maintenance risks are associated with exposure to diesel particulate matter, total organic gases in diesel exhaust, and evaporative and exhaust total organic gases from gasoline vehicles. The toxic air contaminants in total organic gases include 1,3-Butadiene, Acetaldehyde, Benzene, Ethylbenzene, Formaldehyde, n-Hexane, Methanol, Methyl Ethyl Ketone, Napthalene, Propylene, Styrene, Toluene, and Xylene.

In **Section 4.3 Air Quality**, staff concluded that construction, readiness testing and maintenance, and any emergency operation are not likely to cause significant adverse direct or indirect air quality or public health impacts. Criteria pollutants would not cause or contribute to exceedances of health-based ambient standards and the project's toxic air emissions would not exceed health risk limits. Therefore, no mitigation is required. Likewise, the project would not cause disproportionate air quality or public health impacts on sensitive populations, such as the EJ population represented in **Figures 4.21-1** and **4.21-2**.

The text below addresses each of the air quality and public health indicators included in **Tables 4.21-4** and **4.21-5**.

Ozone Impacts

Ozone is known to cause numerous health effects, which can potentially affect EJ communities as follows:

- lung irritation, inflammation and exacerbation of existing chronic conditions, even at low exposures (Alexis et al. 2010, Fann et al. 2012, Zanobetti and Schwartz 2011);
- increased risk of asthma among children under 2 years of age, young males, and African American children (Lin et al. 2008, Burnett et al. 2001); and,
- higher mortality, particularly in the elderly, women and African Americans (Medina-Ramón and Schwartz 2008).

Even though ozone is not directly emitted from emission sources such as the backup generators, precursor pollutants that create ozone, such as nitrogen oxides (NO_x) and volatile organic compounds (VOCs), would be emitted. The NO_x emissions of the standby generators during readiness testing and maintenance would be required to be fully offset through the permitting process with the Bay Area Air Quality Management District (BAAQMD). See more detailed discussion in **Section 4.3 Air Quality**.

For CalEnviroScreen, the air monitoring data used in this indicator reflect ozone measurements for the years 2011 to 2013. While the data is somewhat dated, all census tracts use the same time period to determine relative ranking and relative rankings would not change using more current data unless one region has been far more successful in achieving the ozone standards than other regions. CalEnviroScreen 3.0 uses the average daily maximum one-hour ozone concentration. According to CalEnviroScreen data, ozone concentrations in each census tract are ordered by ozone concentration values, and then are assigned a percentile based on the statewide distribution of values.

Results for ozone are included in **Table 4.21-4**. The census tract within a six-mile radius of the project site is at the 22nd percentile. This means ozone levels in the census tract are relatively low, with lower values reported for only 22 percent of all the census tracts in California. Another way to look at the data is that approximately 78 percent of all California census tracts have higher ozone levels than those near the project. For ozone, the census tract within a six-mile radius of the proposed project's site is not exposed to high ozone concentrations compared to the rest of the state.

The project would not be expected to contribute significantly to regional air quality as it relates to ozone. The project would be required to comply with air quality emission rate significance thresholds for NO_x and VOCs, which are precursor pollutants that create ozone during the construction and testing and maintenance phases. The project would use best management practices (BMPs) during construction, which would reduce NO_x and VOCs. The project's impacts would not be expected to cause exceedance of ambient air quality standards during readiness testing and maintenance. NO_x emissions resulting from readiness testing and maintenance would be high enough to trigger offset requirements due to BAAQMD Regulation 2, Rule 2. Therefore, the NO_x emissions would need to be fully offset to reduce net impacts to levels below the BAAQMD's CEQA threshold. VOC emissions would be below the BAAQMD's threshold of significance and the applicant would not be required to offset them. Therefore, the project would not contribute significantly to regional ozone concentrations, relative to baseline conditions.

The project's ozone and ozone precursor air quality impacts would be less than significant for the local EJ community and the general population. Additionally, as NO_x emissions of the standby generators would be fully offset, the project would not result in a cumulatively considerable net increase of secondary pollutants such as ozone in the air basin.

PM_{2.5} Impacts

PM is a complex mixture of aerosolized solid and liquid particles including such substances as organic chemicals, dust, allergens, and metals. These particles can come from many sources, including cars and trucks, industrial processes, wood burning, or other activities involving combustion. The composition of PM depends on the local and regional sources, time of year, location, and weather.

PM_{2.5} is known to cause numerous health effects that can potentially affect EJ communities. Particles in this size range can have adverse effects on the heart and lungs, including lung irritation, exacerbation of existing respiratory disease, and cardiovascular effects.

For CalEnviroScreen, the indicator PM_{2.5} is determined by the annual mean concentration of PM_{2.5} (average of quarterly means), averaged over three years (2011-2013). While the data is somewhat dated, all census tracts use the same time period to determine relative ranking and relative rankings would not change using more current data unless one region has been far more successful in achieving PM_{2.5} standards than other regions. According to CalEnviroScreen data, PM_{2.5} concentrations in each census tract are ordered by PM_{2.5} concentration values, and then are assigned a percentile based on the statewide distribution of values and are shown in **Table 4.21-4**. The census tract within a six-mile radius of the project site is at the 53rd percentile. This means PM_{2.5} concentrations in the census tract is about average compared to other census tracts in California.

The project would not be expected to contribute significantly to regional PM_{2.5} air quality concentrations. The project would not expose sensitive receptors to substantial pollutant concentrations of PM_{2.5} during construction or readiness testing and maintenance of the standby generators. The project would use BMPs during construction, which would reduce particulate matter emissions. The standby diesel engines would be equipped with diesel particulate matter filters, which would reduce particulate matter emissions from the engines. Therefore, the project would not contribute significantly to regional PM_{2.5} concentrations, relative to baseline conditions.

The project's PM_{2.5} air quality impacts would be less than significant for the local EJ community and the general population. Additionally, as NO_x emissions of the standby generators would be fully offset, the project would not result in cumulatively considerable net increase of secondary pollutants such as PM in the air basin.

NO₂ Impacts

Section 4.3 Air Quality includes additional assessment of other criteria pollutant impacts including NO₂ impacts. Staff's analysis indicates that the project would not cause adverse NO₂ impacts during construction or readiness testing and maintenance. The project's NO₂ air quality impacts would be less than significant for the local EJ community and the general population.

Diesel PM

This indicator represents how much diesel PM is emitted into the air within and near the census tract. The data are from 2012 California Air Resources Board's emission data from on-road vehicles (trucks and buses) and off-road sources (ships and trains, for example). This is the most recent data available with which to make the necessary comparisons. While it is several years old, all census tracts use the same time period to determine relative ranking and relative rankings would not change using more current data unless one region has been far more successful than others at implementing diesel PM controls such as replacing diesel vehicles with electric vehicles.

Table 4.21-4 shows that the percentile ranking of diesel PM for the census tract within a six-mile radius of the project site is at the 89th percentile, meaning it is higher than about 89 percent of all the census tracts in California. However, according to the results of the health risk assessment conducted for this project in **Section 4.3 Air Quality**, impacts associated with diesel PM from the proposed project construction and readiness testing and maintenance activities (diesel-fueled equipment) would be less than significant.

Therefore, the project's diesel PM impacts would be less than significant for the local EJ community and the general population.

Pesticide Use

Specific pesticides included in the pesticide use indicator were narrowed from the list of all registered pesticides in use in California to focus on a subset of 70 chemicals that are filtered for hazard and volatility for the years 2012-2014 collected by the California Department of Pesticide Regulation. This is the most recent data available with which to make the necessary comparisons. While it is several years old, all census tracts use the same time period, and it is only used to compare the census tracts to one another using similar vintage data. Significant changes in relative rankings would only occur if one area were to change from agricultural land uses to another use. Only pesticides used on agricultural commodities are included in the indicator.

For pesticide use, the census tract within a six-mile radius of the proposed project's site is ranked at the zeroth (0.00) percentile. This indicates the EJ population and the general public in this area are currently not exposed to high pesticide use compared to the rest of the state. The applicant has not indicated whether any pesticides would be used at the project site, but as there would be landscaping around the project, it is reasonable to assume that some pesticides would be used in small amounts in the maintenance of the landscaping and building housekeeping. Any pesticide use at the project site would not have a significant cumulative contribution to pesticide use in the vicinity of the project site.

The project's pesticide use would be less than significant for the local EJ community and the general population.

Toxic Releases from Facilities

This indicator represents modeled toxicity-weighted concentrations of modeled chemical releases to air from facility emissions and off-site incineration in and near a census tract. The U.S. EPA provides public information on the amount of chemicals released into the environment from many facilities. This indicator uses the modeled air concentration and toxicity of the chemical to determine the toxic release score. The data are from 2011-2013. This is the most recent data available with which to make the necessary comparisons. While it is several years old, all census tracts use the same time period, and it is only used to evaluate local census tracts and compare them to other census tracts using the same vintage data.

Table 4.21-4 shows the census tract within a six-mile radius of the project site is at the 29th percentile for the Toxic Release from Facilities indicator. This indicates that toxic release from facilities threats in this census tract is lower than the statewide average.

According to the results of the health risk assessment conducted for the project in **Section 4.3 Air Quality**, impacts associated with toxic releases from construction, and readiness testing and maintenance activities (diesel-fueled equipment) would be less than significant. The project would not have a significant cumulative contribution to toxic releases.

The project's toxics emissions would be less than significant for the local EJ community and the general population.

Traffic Density

This indicator represents the sum of traffic volumes adjusted by road segment length. It is calculated by dividing the traffic volumes by the total road length within 150 meters of the census tract boundary. It is not a measure of level of service on roadways. The data are from 2013. This is the most recent data available with which to make the necessary comparisons. While it is several years old, all census tracts use the same time period, and it is only used to evaluate local census tracts and compare them to other census tracts using the same vintage data.

The census tract within a six-mile radius of the project site is at the 44th percentile for the traffic density indicator, below the statewide average (see **Table 4.21-4**). Traffic density is related to the diesel PM emitted from diesel-fueled vehicles. However, according to the results of the health risk assessment conducted for the project in **Section 4.3 Air Quality**, impacts associated with diesel PM from construction, and readiness testing and maintenance activities (diesel-fueled equipment) would be less than significant.

The proposed project would generate a small number of vehicle trips to the site. These trips include workers, material, and equipment deliveries. It is unlikely that the addition of vehicle trips from the project would result in a significant contribution to the traffic density on any roadway in the vicinity of the project site.

The project's traffic volume impact would not have a significant cumulative contribution to the traffic density for the local EJ community and the general population.

Asthma ER Visits

This indicator is a representation of an asthma rate. It measures the number of emergency room visits for asthma per 10,000 people over the years 2011 to 2013. This is the most recent data available with which to make the necessary comparisons. While it is several years old, all census tracts use the same time period, and it is only used to evaluate local census tracts and compare them to other census tracts using the same vintage data. The information was collected by the California Office of Statewide Health Planning and Development.

The census tract within a six-mile radius of the project site is at the 61st percentile for the Asthma indicator (see **Table 4.21-5**). This indicates the number of emergency room visits for asthma per 10,000 people over the years 2011 to 2013 are higher than about 61 percent of census tracts statewide. This indicates that this census tract has an above average number of emergency room visits due to asthma compared to the rest of the state.

According to the results of the health risk assessment conducted for the project in **Section 4.3 Air Quality**, impacts associated with emissions from construction, and readiness testing and maintenance activities (diesel-fueled equipment) would be less than significant and would not have a significant cumulative contribution to asthma ER visits.

The project's emissions would not have a significant cumulative contribution to asthma ER visits for the local EJ community and the general population.

Low Birth Weight Infants

This indicator measures the percentage of babies born weighing less than 2500 grams (about 5.5 pounds) out of the total number of live births over the years 2006 to 2012. This is the most recent data available with which to make the necessary comparisons. While it is several years old, all census tracts use the same time period, and it is only used to evaluate local census tracts and compare them to other census tracts using the same vintage data. The information was collected by the California Department of Public Health.

The census tract within a six-mile radius of the project site is at the 81st percentile for the Low Birth Weight category (see **Table 4.21-5**). This means that the percent of births deemed to be associated with low birth weight is higher than about 81 percent of all census tracts in California.

Staff's health risk assessment of the project was based on a highly conservative health-protective methodology that accounts for impacts on the most sensitive individuals in a given population. According to the results of the assessment, the risks at the maximally exposed sensitive receptors (that is, Maximally Exposed Individual Sensitive Receptor

[MEISR] and Maximally Exposed Individual Resident [MEIR]) would be below health-based thresholds. Therefore, the toxic emissions from the project would not cause significant health effects for the low birth weight infants.

The project's emissions would not have a significant cumulative contribution to low birth weight infant births for the local EJ community and the general population.

Cardiovascular Disease

This indicator represents the rate of heart attacks. It measures the number of emergency medical department visits for acute myocardial infarction (or heart attack) per 10,000 people over the years 2011 to 2013. This is the most recent data available with which to make the necessary comparisons. While it is several years old, all census tracts use the same time period, and it is only used to evaluate local census tracts and compare them to other census tracts using the same vintage data.

The census tract within a six-mile radius of the project site is at the 66th percentile for the Cardiovascular Disease indicator. This means the number of emergency medical department visits for acute myocardial infarction (heart attack) per 10,000 people over the years 2011 to 2013 is above average as compared to all other census tracts in California (see **Table 4.21-5**).

According to the results of the health risk assessment conducted for the project in **Section 4.3 Air Quality**, impacts associated with emissions from construction, and readiness testing and maintenance activities (diesel-fueled equipment) would be less than significant and would not have a significant cumulative contribution to cardiovascular disease.

The project's emissions would not have a significant cumulative contribution to cardiovascular disease for the local EJ community and the general population.

Cultural and Tribal Cultural Resources

No Impact. Staff did not identify any Native American EJ populations that either reside within six miles of the project or that rely on any subsistence resources that could be impacted by the proposed project.

Hazards and Hazardous Materials

Less Than Significant Impact. An EJ population may experience disproportionate hazards and hazardous materials impacts if the storage and use of hazardous materials within or near EJ communities occur to a greater extent than within the community at large. A disproportionate impact upon the EJ population resulting from the planned storage and use of hazardous materials on the site is extremely low. Diesel fuel to run the emergency generators is the hazardous material that the project site would have in greatest quantity. The total quantity would be divided up and stored in many separate double-walled fuel tanks (one for each generator) with proper spill controls. Therefore, the likelihood of a

spill of sufficient quantity to impact the surrounding community and EJ population would be very unlikely, thus is considered less than significant.

Hydrology and Water Quality

Less Than Significant Impact. A disproportionate hydrologic or water quality impact on an EJ population could occur if the project would contribute to impairment of drinking water, exacerbate groundwater contamination threats, or contribute pollutants to impaired water bodies.

Since the overall CalEnviroScreen score reflects the collective impacts of multiple pollutants and factors, staff examined the individual contributions to indicators as they relate to hydrology and water quality. The pollutants of concern in this analysis are those from construction and operational activities. The CalEnviroScreen scores for the disadvantaged community census tract in a 6-mile radius of the project (see **Figure 4.21-1**) are presented in **Table 4.12-4** for each of the following environmental stressors that relate to hydrology and water quality: Drinking Water Contaminants, Groundwater Threat, and Impaired Water Bodies. The percentile for each disadvantaged census tract reflects its relative ranking among all of California's census tracts. A disproportionate hydrology or water quality impact on an EJ population could occur if a project introduces an additional pollutant burden to a disadvantaged community.

CalEnviroScreen-3.0 assigns a score to each type of stressor. To assess the impact of a stressor on population within a census tract, the score is assigned a weighting factor that decreases with distance from the census tract. For stationary stressors related to hydrology or water quality, the weighting factor diminishes to zero for distances greater than 1,000 meters (0.6 mile). As **Figure 4.21-1** shows, the one disadvantaged census tract within a 6-mile radius of the project site is more than 1,000 meters away from the project. Therefore, impacts to Hydrology and Water Quality would not introduce an additional burden to an EJ population and would be less than significant.

Land Use and Planning

Less Than Significant Impact. A disproportionate land use impact on an EJ population could occur if a project would physically divide the established community of an EJ population or if a project in proximity to an EJ population conflicts with applicable land use plans, policies, or regulations adopted for the purpose of avoiding or mitigating environmental impacts on a population. The primary purpose of planning is to protect the public health, safety, and welfare. Incompatible land uses may create health, safety, and welfare issues for the community. There are EJ populations south and west of the project site (see **Figure 4.21-1**).

The closest residence in an EJ area is approximately 650 feet west of the project. The EJ population that appears to be living adjacent to the project site to the east is actually approximately 0.6 mile from the project. The figure makes it appear that an EJ population is living closer to the project because the data is reported at the census block level and

the residences are located towards the eastern extent of the block boundaries, further from the project site.

Staff concludes the project would not divide an existing community, as the project is proposed on land where the eastern half of the project site is in an area with the General Plan land use designation IP, Industrial Park, which is intended for uses that include research and development, manufacturing, assembly, testing, and offices and the western half of the project site is in an area with the land use designation TEC, Transit Employment Center, which is applied to areas planned for intensive job growth.

The project site is in the IP, Industrial Park zoning district; allowed uses for properties in the IP zoning district specify that a data center requires a Special Use Permit. In 2017, the City of San Jose (City) approved and issued Special Use Permit, SP15-031, for the previously approved Equinix Data Centers with project site boundaries similar to the Great Oaks South Backup Generating Facility project. An application for an amended permit was submitted to the City on March 3, 2020 (SPA15-031-01). The City has since provided comments to the applicant and anticipates receiving a revised submittal that responds to those comments. The project's buildings and rooftop equipment would be consistent with height limits established within the City's Zoning Ordinance. The project would be consistent with the maximum floor area ratio for properties designated Industrial Park and Transit Employment Center. The applicant will be required to comply with the City's development standards to complete the permit amendment application process. As discussed in **Section 4.11 Land Use and Planning**, the project would not conflict with land use plans or policies such that significant environmental impacts would occur.

Staff in the technical areas of Noise, Air Quality (Public Health), Hydrology and Water Quality, and Transportation concludes that the project would not pose a significant individual or cumulative hazard to health and human safety with the incorporation of recommended mitigation measures (MM) (**MM AQ-1** and **MM NOI-1**) (**Sections 4.3 Air Quality, 4.9 Hazards and Hazardous Materials, and 4.17 Transportation** in this document evaluate the project's potential effects relating to nuisance effects and hazards.). Thus, the project would not create a land use incompatibility that could disproportionately affect the EJ population. Land use impacts from the project on the EJ population would be less than significant. Likewise, land use impacts would not be disproportionate.

Noise

Less Than Significant with Mitigation Incorporated. EJ populations may experience disproportionate noise impacts if the siting of unmitigated industrial facilities occurs within or near EJ communities to a greater extent than within the community at large. The project site is within an area having an EJ population. The area surrounding the site is primarily industrial and commercial uses. The nearest sensitive receptors are residences approximately 700 feet south of the project site, across from Santa Teresa Boulevard.

Demolition and construction activities would increase existing noise levels at the adjacent commercial and industrial land uses and the nearby residences identified above, but they would be temporary and intermittent. The project applicant proposes to implement the project design measures included in PD NOI-1 and PD NOI-2. While these mitigation measures would reduce construction noise levels emanating from the site and limit construction hours, due to the proximity of residents to the project site, the project's construction notification requirements need to specifically mention these residents. **MM NOI-1** includes the nearby residents in the notification. With this and PD NOI-1 and PD-NOI-2, impacts would be reduced to less than significant. In addition, demolition and construction would not occur on Sundays and holidays, in compliance with the San Jose City Code, Section 20.5.

Therefore, potential noise effects related to demolition and construction would not result in a significant noise impact on the area's population, including the EJ population.

Sources of operational noise for the project would include the backup generators, rooftop mechanical equipment including HVAC and other equipment necessary for project operation. The city's General Plan Policy EC-1.6 requires existing and new industrial development to reduce the effects of operational noise on adjacent properties through compliance with noise standards in the city's Municipal Code (Sections 20.40.600 and 20.50.300). Since the project is near a residential land use, noise reduction measures, such as mechanical equipment screening and enclosures, would be required (incorporated in the operational noise modeling). Thus, operation of the project would have a less than significant noise impact for all the area's population, including the EJ population.

Population and Housing

Less Than Significant Impact. Because the study area used in this analysis for impacts related to population influx and housing supply includes Campbell, Los Gatos, and Morgan Hill, San Jose, and Santa Clara County, staff considered the project's population and housing impacts on the EJ population living in these geographic areas.

The potential for population and housing impacts is predominantly driven by the temporary influx of non-local construction workers seeking lodging closer to a project site. For the project, the construction workers would be drawn from the greater Bay Area and thus would not likely seek temporary lodging closer to the project site. The operations workers are also anticipated to be drawn from the greater Bay Area and would not likely seek housing closer to the project site. If some operations workers were to relocate closer to the project site, there would be sufficient housing in the project area.

A population and housing impact could disproportionately affect an EJ population if the project were to displace minority or low income residents from where they live, causing them to find housing elsewhere. If this occurs, an EJ population may have a more difficult time finding replacement housing due to racial biases and possible financial constraints.

As the project would not displace any residents or remove any housing, there would be no disproportionate impact to EJ populations from this project.

Transportation

Less Than Significant Impact. Significant reductions in transportation options may significantly impact EJ populations. In particular, an impact to bus transit, pedestrian facilities, or bicycle facilities could cause disproportionate impacts to low-income communities, as low-income residents more often use these modes of transportation. However, as concluded in **Section 4.17 Transportation** all transportation impacts, including impacts to alternative transportation, would be less than significant, and therefore would cause less than significant impacts to EJ populations. Likewise, transportation impacts would not be disproportionate.

Utilities and System Services

Less Than Significant Impact. Disproportionate impacts to an EJ population could occur if the project would contribute to or exacerbate the effects of cleanup sites, hazardous waste generators and facilities, and solid waste facilities.

Since the overall CalEnviroScreen score reflects the collective impacts of multiple pollutants and factors, staff examined the individual contributions to indicators as they relate to wastes addressed under utilities and system services. The wastes of concern in this analysis are those from construction and operational activities. The handling and disposal of each type of waste depends on the hazardous ranking of its constituent materials. Existing laws, ordinances, regulations, and standards ensure the desired handling and disposal of waste materials without potential public or environmental health impacts. The CalEnviroScreen scores for the disadvantaged community census tract in a 6-mile radius of the project (see **Figure 4.21-1**) are presented in **Table 4.21-4** for each of the following environmental stressors that relate to waste management: cleanup sites, hazardous waste generators and facilities, and solid waste facilities. The percentile for each disadvantaged census tract reflects its relative ranking among all of California's census tracts. A disproportionate waste management impact on an EJ population could occur if project wastes impacted the disadvantaged community.

CalEnviroScreen assigns a score to each category of stressors. To assess the impact of a stressor on population within a census tract, the score is assigned a weighting factor that decreases with distance from the census tract. The weighting factor for stationery stressors more than 1,000 meters (0.6 mile) away from a census tract is zero. As **Figure 4.21-1** shows, the one disadvantaged census tract within a 6-mile radius of the project site is more than 1,000 meters away from the project. Therefore, no stressor is close enough under Utilities and Service Systems to create an additional burden to an EJ population and therefore the project impact on Environmental Justice communities would be less than significant.

Mandatory Findings of Significance

Less Than Significant with Mitigation Incorporated. Staff analysis (for those areas that address EJ) concluded that the incremental effects of the project would be less than cumulatively considerable with the incorporation of **MM AQ-1**, **MM CUL-1** through **MM CUL-4**, and **MM NOI-1**. Therefore, cumulative impacts would be less than significant for both the general population and the EJ population.

List of Preparers and Contributors

The following are a list of preparers and contributors to **Section 4.21 Environmental Justice**:

Ellen LeFevre	General Environmental Justice information, CalEnviroScreen information, Environmental Justice screening, public outreach, CalEnviroScreen project screening, and Population and Housing impact analysis.
Lisa Worrall, Ellen LeFevre	Mandatory Findings of Significance impact analysis
Mark Hamblin	Aesthetics impact analysis
Wenjun Qian	Air Quality (public health) impact analysis
Melissa Mourkas, Gabriel Roark, Cameron Travis	Cultural and Tribal Cultural Resources impact analysis
Ryan Casebeer	Hazards and Hazardous Materials impact analysis
Mike Conway	Hydrology and Water Quality impact analysis
Jeanine Hinde	Land Use and Planning impact analysis
Kenneth Salyphone	Noise impact analysis
Abdel-Karim Abulaban	Utilities and Service Systems impact analyses
Ashley Gutierrez	Transportation impact analysis

4.21.3 References

- Alexis NE et al. 2010 – Alexis NE, Lay JC, Hazucha M, Harris B, Hernandez ML, Bromberg PA, et al. Low-level ozone exposure induces airways inflammation and modifies cell surface phenotypes in healthy humans. *Inhal Toxicol* 22(7):593-600. Available online at: <https://www.ncbi.nlm.nih.gov/pubmed/20384440>
- Burnett RT et al. 2001 – Burnett RT, Smith-Doiron M, Stieb D, Raizenne ME, Brook JR, et al. Association between Ozone and Hospitalization for Acute Respiratory Diseases in Children Less than 2 Years of Age. *American Journal of Epidemiology* 153(5):444-452. Available online at: <https://academic.oup.com/aje/article/153/5/444/149769>

- CalEPA 2017 – California Environmental Protection Agency (Cal/EPA). *Designation of Disadvantaged Communities Pursuant to Senate Bill 535 (De Leon)*, April 2017. Available online at: <https://calepa.ca.gov/wp-content/uploads/sites/6/2017/04/SB-535-Designation-Final.pdf>
- CDE 2021 – California Department of Education (CDE). California Department of Education Educational Demographics Unit, Data Quest, Selected District Level Data - 4369674--Santa Clara Unified for the year 2020-21. Free or Reduced Price Meals. Available online at: <https://dq.cde.ca.gov/dataquest/cbeds2.asp?cYear=2020-21&FreeLunch=on&cChoice=CoProf2&TheCounty=43%2CSANTA%2525ECLARA&cLevel=County&cTopic=Profile&myTimeFrame=S&submit1=Submit>
- Fann N et al. 2012 – Fann N, Lamson AD, Anenberg SC, Wesson K, Risley D, Hubbell BJ, Estimating the National Public Health Burden Associated with Exposure to Ambient PM2.5 and Ozone. *Risk Analysis* 32(1):81- 95. Available online at: <https://www.ncbi.nlm.nih.gov/pubmed/21627672>
- Lin S et al. 2008 – Lin S, Liu X, Le, LH, Hwang, S, Chronic Exposure to Ambient Ozone and Asthma Hospital Admissions among Children. *Environ Health Perspect* 116(12):1725-1730. Available online at: <https://www.ncbi.nlm.nih.gov/pmc/articles/PMC2599770/>
- Medina-Ramón M, Schwartz J 2008 – Who is more vulnerable to die from ozone air pollution? *Epidemiology* 19(5):672-9. Available online at: <https://www.ncbi.nlm.nih.gov/pubmed/18480732>
- OEHHA 2017 – California Environmental Protection Agency’s Office of Environmental Health Hazzard and Assessment (OEHHA). California Communities Environmental Health Screening Tool, Version. 3.0 (CalEnviroScreen 3.0), Guidance and Screening Tool, January 2017. Available online at: <http://oehha.ca.gov/calenviroscreen/report/calenviroscreen-30>
- OEHHA 2018 – California Environmental Protection Agency’s Office of Environmental Health Hazzard and Assessment (OEHHA). ArcGIS Geodatabase. CEC3Gdb.zip. Updated June 2018. Accessed on: October 2020. Available online at: <https://oehha.ca.gov/calenviroscreen/report/calenviroscreen-30>
- U.S. Census 2010 – United States Census Bureau (U.S. Census). QT-PL-Race, Hispanic or Latino, Age, and Housing Occupancy: 2010 – Census Redistricting Data (Public Law 94-171) Summary File, Tables P1, P2, P3, P4, H1. Available online at: <https://data.census.gov/cedsci/>
- U.S. EPA 2015 – United States Environmental Protection Agency (U.S. EPA). Guidance on Considering Environmental Justice During the Development of Regulatory Actions, May 2015. Available online at: <https://www.epa.gov/environmentaljustice/guidance-considering-environmental-justice-during-development-action>

U. S. EPA 2019 – United States Environmental Protection Agency (U.S. EPA). EJ 2020 Glossary. Last updated: August 2, 2019. Available online at: <https://www.epa.gov/environmentaljustice/ej-2020-glossary#:~:text=Environmental%20Justice%20%28EJ%29%20-%20The%20fair%20treatment%20and,enforcement%20of%20protective%20environmental%20laws%2C%20regulations%2C%20and%20policies>

Zanobetti A, Schwartz J 2011 – Ozone and survival in four cohorts with potentially predisposing diseases. *Am J Respir Crit Care Med* 184(7):836-41. Available online at: <https://www.ncbi.nlm.nih.gov/pubmed/21700916>

Section 5

Alternatives

5 Alternatives

5.1 Introduction and Summary Conclusions

This section evaluates a reasonable range of potentially feasible alternatives to the Great Oaks South Backup Generating Facility (GOSBGF). The GOSBGF would be part of the Great Oaks South Data Center (GOSDC).¹ Alternatives selected for analysis are limited to those that could feasibly attain most of the proposed project's basic objectives while reducing or avoiding any of its significant effects. Alternatives considered but not evaluated further are discussed below, including the reasons for their dismissal from detailed consideration.

In addition to the two No Project Alternative scenarios, review and investigation of information on potentially feasible alternatives led staff to select two project alternatives for analysis and comparison to the GOSDC:

- Alternative 1a: No Project – No Build Alternative
- Alternative 1b: No Project – Development of Previously Approved Data Center Project
- Alternative 2: Alternative Fuel – Renewable Diesel
- Alternative 3: Natural Gas Internal Combustion Engines (ICEs)

Alternative 1a. Staff evaluated a No Project scenario in which no development of the project site would occur, and current conditions would continue at the site for an unknown period. Although a different project would likely be proposed at the site in the future, no development plan exists to allow a comparison with the proposed project, and it would be speculative to assume the characteristics of such an alternative. Alternative 1a would avoid the proposed project's potentially significant impacts identified in this environmental impact report (EIR) (no impact compared to the proposed project). If the project were not constructed, the applicant's project objectives would not be attained.

Alternative 1b. Staff evaluated a second No Project scenario that assumes development of the previously approved Equinix Data Center project on the GOSBGF site. The applicant would be required to change the diesel-fueled engines to meet the more stringent Tier 4 emission standards. Staff concluded that this alternative is somewhat environmentally superior to the proposed project because of the reduced number of engines and the accompanying reduction in air emissions compared to the proposed project. For biological resources, staff compared the impact of nitrogen deposition on serpentine habitat and concluded that this alternative would have a lower impact. Staff has insufficient data to

¹ References to the GOSBGF are to the diesel-fired generators and equipment appurtenant to the backup generation facilities on the project site. References to the GOSDC are to the entire project, including the three, two-story data center buildings on the project site. For the alternatives selected for analysis, the data center buildings and their massing on the site would remain the same as under the GOSDC.

reach comparative conclusions for health risks and greenhouse gas (GHG) emissions for this alternative.

Alternative 2. The Renewable Diesel Alternative would substitute renewable diesel fuel for the GOSBGF's conventional, petroleum-based diesel fuel. Air quality and public health impacts using renewable diesel during project operations would likely be less than those that would occur under the proposed project. However, the reduction would need to be confirmed with testing under controlled conditions for the engines with diesel particulate filters and selective catalytic reduction being operative. Biological resources staff compared the impact of nitrogen deposition on serpentine habitat and concluded that this alternative would have a lower impact. Staff concluded that this alternative is somewhat environmentally superior to the proposed project although further study and analysis would be needed to fully compare this alternative to the proposed project. The GHG impacts from this alternative would likely be less than those of the GOSBGF due to the reduced GHG emissions during the entire fuel cycle.

Alternative 3. The Natural Gas ICEs Alternative would replace the GOSBGF's generators with engines that would be fueled by natural gas. Criteria pollutant emissions and air quality impacts using natural gas ICEs are expected to be much less than those that would occur with the GOSBGF's diesel engines. Although no testing data has been provided for toxics emissions, these emissions are expected to be reduced due to the reductions reported for volatile organic compounds and particulate matter. Therefore, public health impacts using natural gas ICEs would likely be less than those that would occur with the GOSBGF's diesel engines. Biological resources staff compared the impact of nitrogen deposition on serpentine habitat and concluded that this alternative would have a much lower impact. The GHG impacts of this alternative would likely be less than those of the GOSBGF due to the reduced GHG emissions during the entire fuel cycle. Staff concluded that this alternative is environmentally superior to the proposed project due to its deep reductions in criteria air pollutants.

The subsection below, "5.6 Alternatives Selected for Analysis," identifies potential feasibility issues for the alternatives and discusses the extent to which the project objectives could be met.

5.2 CEQA Requirements

The California Environmental Quality Act (CEQA) Guidelines require that an EIR consider and discuss alternatives to the proposed project (Cal. Code Regs., tit. 14, § 15000 et seq.). Section 15126.6 of the CEQA Guidelines provides that the alternatives analysis must:

- describe a range of reasonable alternatives to the project, or to the location of the project, which would feasibly attain most of the basic objectives of the project;
- evaluate the comparative merits of the alternatives;
- focus on alternatives that would avoid or substantially lessen any significant effects of the project, even if these alternatives would impede to some degree attainment of the project objectives, or would be more costly; and
- describe the rationale for selecting alternatives to be discussed and identify alternatives that were initially considered but then rejected from further evaluation.

CEQA requires that an EIR “consider a reasonable range of potentially feasible alternatives that will foster informed decision making and public participation” (Cal. Code Regs., tit. 14, § 15126.6, subd. (a)). Alternatives may be eliminated from detailed consideration by the lead agency if they fail to meet most of the basic project objectives, are infeasible, or could not avoid any significant environmental effects (Cal. Code Regs., tit. 14, § 15126.6, subd. (c)). The range of potentially feasible alternatives selected for analysis is governed by a “rule of reason,” requiring evaluation of only those alternatives “necessary to permit a reasoned choice” (Cal. Code Regs., tit. 14, § 15126.6, subd. (f)).

An EIR is not required to consider alternatives that are infeasible (Cal. Code Regs., tit. 14, § 15126.6, subd. (a)). In addressing feasibility of alternatives, factors that may be taken into account are site suitability; economic viability; availability of infrastructure; general plan consistency; other plans or regulatory limitations; jurisdictional boundaries; and whether the proponent can reasonably acquire, control, or otherwise have access to the alternative site (Cal. Code Regs., tit. 14, § 15126.6, subd. (f)(1)). An EIR “need not consider an alternative whose effect cannot be reasonably ascertained and whose implementation is remote and speculative” (Cal. Code Regs., tit. 14, § 15126.6, subd. (f)(3)).

The lead agency is also required to evaluate the “no project” alternative along with its impact. Analyzing a no project alternative allows decision makers to compare the impacts of approving the proposed project with the impacts of not approving the proposed project (Cal. Code Regs., tit. 14, § 15126.6, subd. (e)(1)). “The ‘no project’ analysis shall discuss the existing conditions at the time the notice of preparation is published...as well as what would be reasonably expected to occur in the foreseeable future if the project were not approved, based on current plans and consistent with available infrastructure and community services. If the environmentally superior alternative is the ‘no project’ alternative, the EIR shall also identify an environmentally superior alternative among the other alternatives” (Cal. Code Regs., tit. 14, § 15126.6, subd. (e)(2)).

5.3 Project Objectives and Alternatives Screening

The ideal process to select alternatives to include in the analysis begins with the establishment of project objectives. Section 15124 of the CEQA Guidelines addresses the requirement for an EIR to contain a statement of objectives, as follows:

A clearly written statement of objectives will help the lead agency develop a reasonable range of alternatives to evaluate in the EIR and will aid the decision makers in preparing findings or a statement of overriding considerations, if necessary. The statement of objectives should include the underlying purpose of the project and may discuss the project benefits.

The applicant's primary goal is to develop a state-of-the-art data center that would be part of the single, largest internet hub on the west coast. The primary project objective is to reliably meet the increased demand of the digital economy and its customers (SV1 2020k).

In addition to its primary goal, the applicant has set forth these project objectives:

- Develop a state-of-the-art data center with up to 547,000 square feet.
- Develop the data center on land that has been previously approved for a similar size data center.
- Develop a data center that can be constructed in phases which can be timed to match projected customer growth.
- Meet high sustainability and green building standards by designing the data center to meet U.S. Green Building Code LEED and Cal-Green standards for new construction.
- Incorporate the most reliable and flexible form of backup electric generating technology considering the following evaluation criteria:
 - Commercial Availability and Feasibility. The selected backup electric generation technology must currently be in use and proven as an accepted industry standard for technology. It must be operational within a reasonable timeframe where permits and approvals are required.
 - Technical Feasibility. The selected backup electric generation technology must utilize systems that are compatible with one another.
 - Reliability. The selected backup electric generation technology must be extremely reliable in the case of an emergency loss of electricity from the utility.
 - Industry Standard. The selected backup electric generation technology must be considered industry standard or best practice. The customers of SV1 are informed consumers and will request SV1 to provide a detailed description of the type of backup generation that it delivers as part of the customer's due diligence. If the selected technology does not meet customers' requirements, they will not put their servers in the Great Oaks South Data Center.

5.4 Environmental Impacts of the Proposed Project

This EIR evaluates the potential environmental impacts of the proposed project. No significant and unavoidable environmental impacts have been identified.

The applicant proposes project design measures and staff recommends additional mitigation measures, which would reduce potentially significant impacts to less-than-significant levels. The applicant's project design measures and staff's recommended mitigation measures are as follows:

- **Air Quality** – The applicant proposes project design (PD) measure PD AQ-1 to reduce air quality impacts during project construction. This measure requires incorporation of the local air district's best management practices to control fugitive dust. Staff recommends mitigation measure (**MM**) **AQ-1**, which adds exhaust control measures to reduce emissions from construction equipment. During readiness testing and maintenance, the oxides of nitrogen (NO_x [as an ozone precursor]) emissions of the standby generators would be fully offset through the permitting process with the Bay Area Air Quality Management District (BAAQMD). With implementation of these measures during construction and NO_x offsets for readiness testing and maintenance through the local air district's permitting requirements, the project would not cause a cumulatively considerable net increase of any criteria pollutant, and impacts would be reduced to **less than significant with mitigation incorporated**.
- **Biological Resources** – To avoid conflict with City of San Jose (City) policies and its Municipal Code regarding tree removal and protection of the Heritage Tree at the northeast corner of the project site,, the applicant proposes project design measure PD BIO-1 specifying the tree replacement ratio and other mitigation to compensate for loss of trees on the site. The applicant proposes project design measure PD BIO-2 specifying protection measures to reduce impacts on the Heritage Tree during project construction. The applicant also proposes project design measure PD BIO-3 specifying pre-construction nesting bird surveys. Incorporation of PD BIO-1, PD BIO-2, and PD BIO-3 would reduce impacts on trees and nesting birds to **less than significant**. Staff recommends **MM BIO-1** to reduce the proposed project's significant impacts from nitrogen deposition for point source emissions on serpentine habitat to **less than significant with mitigation incorporated**. **MM BIO-1** would also mitigate the proposed project's incremental contribution towards nitrogen deposition to less than cumulatively considerable.
- **Cultural and Tribal Cultural Resources** – The applicant proposed design measure, PD CUL-2 includes procedures for the treatment of any human remains encountered during construction. Staff recommends a set of mitigation measures (**MM**) **MM CUL-1** through **MM CUL-4**, which are similar to the measures the City of San Jose included in its Special Use Permit (SP15-031) issued in 2017 for the previously approved data center on the project site (SV1 2020d). The mitigation measures for the proposed project include a supplementary presence/absence trenching program (**MM CUL-1**). **MM CUL-2** through **MM CUL-4** consist of implementing a workers' environmental awareness program during construction (**MM CUL-2**), procedures for evaluating and

mitigating any buried cultural resources encountered during construction (**MM CUL-3**) and a final report of findings from implementing **MM CUL-1** through **CUL-3 (MM CUL-4)**. With implementation of PD CUL-2 and these mitigation measures, potential impacts on cultural and tribal cultural resources would be reduced to **less than significant with mitigation incorporated**.

- **Geology and Soils** – To reduce impacts relating to seismic hazards, the applicant proposes project design measure PD GEO-1 to ensure conformance with requirements of a final geotechnical engineering investigation and California and local building standards and codes. Incorporation of this measure would reduce potential impacts from seismic hazards to **less than significant**. Earth moving during project construction has the potential to disturb paleontological resources. Staff recommends **MM GEO-1** to train construction personnel and guide recovery and processing of any significant paleontological finds; implementation of this measure would reduce the impact to **less than significant with mitigation incorporated**.
- **Greenhouse Gas Emissions** – This project would have a less than significant impact with implementation of **MM GHG-1**, which would require the applicant to participate in San Jose Clean Energy at the TotalGreen level. Participation would ensure the project complies with the San Jose Greenhouse Gas Reduction Strategy. Pursuant to California Code of Regulations, title 14, section 15183.5, the CEC may rely on that compliance in its analysis of GHG emissions impacts. Accordingly, staff concludes with implementation of **MM GHG-1**, the project's GHG emissions would not have a significant direct or indirect impact on the environment. With implementation of **MM GHG-1**, impacts related to GHG emissions would be **less than significant with mitigation incorporated**.
- **Hazards and Hazardous Materials** – Soil samples collected from the adjacent parcel south of the project site indicate concentrations of organochlorine pesticides and lead that exceeds residential and commercial screening levels (assessor parcel number 706-02-058). The applicant proposes project design measure PD HAZ-1, which requires fencing the adjacent parcel to eliminate the potential to track contaminated soil onto the project site during project construction. Implementation of this measure would reduce the impact to **less than significant**.
- **Hydrology and Water Quality** – Project construction has the potential to degrade the quality of storm water runoff during project construction. In addition to ensuring compliance with the Storm Water Pollution Prevention Plan, the applicant proposes project design measure PD HYD-1, which requires implementation of additional measures to reduce potential construction-related impacts on water quality to **less than significant**.
- **Noise and Vibration** – Construction activities would elevate noise levels at adjacent businesses and residences nearest the project site. The applicant proposes project design measures PD NOI-1 and PD NOI-2 to reduce temporary noise from construction. Staff recommends **MM NOI-1** to add nearby residents to the construction notification requirements to reduce noise impacts to **less than significant with mitigation incorporated**.

- **Transportation** – Project-generated vehicle miles traveled (VMT) per employee would exceed the City’s thresholds for industrial employment and office employment uses. The applicant proposes project design measure PD TRA-1 requiring preparation and implementation of Transportation Demand Management measures, which would cause the project VMT to fall below the thresholds, thereby reducing the impact to **less than significant**.

5.5 Alternatives Considered and Not Evaluated Further

Some of the alternatives initially considered by staff for this analysis were eliminated from detailed consideration because they could not feasibly be accomplished, would not avoid any significant impacts, or would fail to meet most of the basic project objectives (Cal. Code Regs., tit. 14, § 15126.6, subd. (c)). The following discussions provide staff’s reasons for eliminating these alternatives from further analysis and comparison to the proposed project.

5.5.1 Alternative Fuel and Technology Alternatives

Staff initially evaluated biodiesel as a potential alternative fuel and two technology alternatives: fuel cells and battery storage, as potential alternatives to the diesel-fueled reciprocating engine technology proposed by the applicant. It is assumed that the project site location would remain the same under these alternatives.

The alternatives described in the subsections that follow could not achieve the level of reliability required to ensure an uninterrupted power supply. See the subsection below, “5.7 Reliability and Risk Factors,” for further discussion and analysis.

Alternative Fuel – Biodiesel

Biodiesel is a domestically produced renewable fuel. Like renewable diesel, biodiesel can be manufactured from a variety of biomasses such as vegetable oils, animal fats, and grease. However, biodiesel is not the same as renewable diesel. Biodiesel has different fuel properties that must meet the definition of American Society for Testing and Materials (ASTM) D6751. Also, it is produced through transesterification, which is a chemical process that converts fats and oils into fatty acid methyl esters (U.S. EIA 2021). Biodiesel is generally blended with conventional diesel at a 5 percent to 20 percent ratio (Green Fleet 2021). Its physical properties are similar to conventional diesel, proposed for use by the applicant, but it is a cleaner burning fuel than conventional diesel. Biodiesel could be used as an alternative fuel for diesel-fired backup generators (gensets).

Fuel Cell Technology

Fuel cells convert chemical energy into electrical energy. There are many types of fuel cells, each of which is classified primarily by the kind of electrolyte they employ. Fuel cells vary according to the kinds of electro-chemical reactions that take place in the cells, the kinds of catalysts required, the operating temperature range, the fuel requirements, and other factors affecting the applications suitable for the fuel cells. There are several types

of fuel cells. The most promising for powering data centers are solid oxide fuel cells (SOFCs) and polymer electrolyte membrane, or PEM fuel cell technology (Microsoft 2021).

Solid Oxide Fuel Cells. SOFCs are electrochemical devices that convert the chemical energy of a fuel and oxidant directly into electrical energy. They operate at high temperatures, as high as 2,100 degrees Fahrenheit. Operating at high temperatures enables the SOFCs to use a variety of fuels to produce hydrogen but also carbon oxides. SOFCs can use natural gas, biogas and gases made from coal as fuel (U.S. DOE 2020a), but more commonly use natural gas. SOFCs are resilient and not susceptible to carbon monoxide (CO) poisoning. CO is a product of the chemical reaction created by the fuel and steam molecules. CO poisoning affects the voltage output of other types of fuel cells such as PEM fuel cells. Due to their resiliency against CO poisoning and because they operate at extremely high temperatures, SOFCs can reform fuel internally. This reduces the cost associated with adding a reformer to the system. However, because it takes time to reach critical operating temperatures, SOFCs have slow startup times and can require up to 60 minutes to start (GenCell 2021).

SOFCs are typically configured to serve as a prime base load power. To date, eBay's data center in Utah is using 30 SOFCs to provide continuous base load power to the IT load, 24 hours/day, all-year-round, with the electric grid as their backup power supply. Additionally, some data centers (i.e., Apple and Equinix) have supplemented their base load power demand (IT and cooling systems) with SOFCs but they rely on the electric grid to support other loads, while retaining traditional Uninterruptible Power Supply (UPS) and gensets for emergency power (Data Center 2021). However, SOFCs providing power for 100 percent base load demand (i.e., IT and cooling systems) are not yet industry standard for large-scale data centers.

PEM Fuel Cell Technology. A suitable fuel cell technology for backup energy generation is PEM fuel cell technology, also called Proton Exchange Membrane fuel cell technology (U.S. DOE 2020a). Currently, PEM fuel cells are available for low-power applications that require intermittent backup power. They are typically used in small applications, such as mobile services or small stationary applications as backup generators for communication towers. Their power capacity ranges between 10 and 125 kilowatts (kW). While other chemicals can be used by PEM fuel cells, the preferred fuel is pure hydrogen to deliver high power and quick start up times that a data center requires in a backup generator.

Battery Storage Technology

Batteries store chemical energy and convert it to electrical energy. Batteries come in many different shapes, sizes, and chemical properties and are used to supply power for many applications. Lithium-ion batteries in huge battery banks provide standby or emergency power and almost instantaneous start up times and are thus considered suitable for data centers.

Data centers currently use UPS systems consisting of batteries, to ensure a smooth transition from the grid to the gensets while the gensets synchronize to the data centers'

electrical busbar². The UPS system proposed for the GOSDC is designed to provide up to 6.5 minutes of backup power at 100 percent load. UPS systems are proven and reliable to support genset start up, but they are currently limited in power supply duration.

A Battery Energy Storage System, or BESS, would provide higher capacity and support longer outages for data center projects. A BESS can be designed to provide up to 99 megawatts (MW) of backup power and provides the quick start times that a data center requires.

Decision to Eliminate These Alternatives from Further Consideration

The applicant's key project objective is to reliably meet the increased demand of the digital economy and its customers. Biodiesel fuel, fuel cells, and battery storage alternatives were eliminated from further consideration as alternative technologies to the proposed project, based on their infeasibility and/or lack of a sufficient level of proven reliability. The selected backup electric generation technology must be extremely reliable in responding to the loss of power from the utility line the data center is connected to. Reliability would be measured by the technology's exposure to the risk of loss of data and rendering of critical services.

Alternative Fuel – Biodiesel

Currently, biodiesel fuel suffers from technical problems making it an unsuitable substitution for 100 percent petroleum-based, ultra-low sulfur diesel. Biodiesel fuel can be problematic for the genset's fuel system. It is harmful to rubber material, such as the hoses that transfer fuel, and the associated O-rings and seals that prevent fuel leaks. Additionally, this fuel suffers from stability issues when stored for long periods of time. Compared to conventional diesel, biodiesel is more hygroscopic (i.e., it attracts water) (Farm Energy 2021). Water can accumulate during transportation and storage. Moisture, if allowed to accumulate for a long time, will alter the fuel's chemical structure. Moreover, in cold weather conditions, the fuel thickens sooner than conventional diesel. Both conditions affect the function of the fuel filter, pump, and injectors in the fuel system. These issues would also increase maintenance cycles and cost and can be a cause to void engine warranties. Additionally, the fuel itself is expensive.

To date, the operating hours for biodiesel fuel use in data centers are minimal.

Lastly, production of biodiesel from plant material could have environmental impacts of its own; it is a water-intensive operation, as 2,500 liters of water would be needed to produce 1.0 liter of biodiesel fuel (UNESCO 2021).

Fuel Cell Technology

Solid Oxide Fuel Cells. SOFCs are slow to startup. Data centers must have a constant electricity supply, with even a momentary outage risking the loss of data; they thus

² In electric power distribution, a busbar is a metallic strip or bar used to connect high voltage equipment at electrical switchyards, and low voltage equipment in battery banks.

require fast startup for their backup power generators. SOFCs also have a slow response to electricity demand (GenCell 2021). This can pose a problem for data centers, as their IT and cooling load demands constantly fluctuate, in addition to changes in environmental conditions (ambient air temperature and humidity). The internal temperature of the data center buildings must remain steady for the IT servers' optimal performance. The rapid changes in electricity demand could outpace the SOFCs' ability to provide the needed services offered by the data center.

Durability of the fuel cells is also an important factor that cannot be ignored. The high operating temperatures place stringent durability requirements on fuel cell materials. They can be made with durable materials; however, they are costly.

SOFCs would utilize the underground natural gas pipeline system. At least one pipeline connection would be needed to supply the project with natural gas. A second, independent pipeline connection may be needed for redundancy.

A crucial hurdle facing those ambitious big potential users of SOFCs, such as data centers, is the lack of sufficient supply. According to the Clean Energy Institute there is currently a limited production of SOFC components to meet the needs of major users (ZDNet 2021). While more producers are continuously coming online, it is forecasted that production of SOFC would not be enough to meet demand until after 2030, or possibly by 2040 at the earliest.

PEM Fuel Cell Technology. PEM fuel cells operate at low temperatures and require fuels that are carbon free rich in hydrogen content, preferably pure hydrogen, for maximum voltage output. CO poisoning is an important issue for PEM. It cannot tolerate great amounts of CO (Fuel Cell 2021). Onsite fuel storage of hydrogen and the current pipeline infrastructure would challenge the project's ability to provide fuel to the fuel cell. Storing hydrogen onsite would require 13 times the volume requirements of diesel fuel. The footprint required for hydrogen storage for the project would be approximately 1.0 acre, with a height of the storage structure of 29 feet and fuel pressure of 200 bar (approximately 3,000 pounds per square inch [psi]). The volume for compressed hydrogen would be on the order of magnitude of the largest pressure vessel in the world. For large applications, such as the project, hydrogen would need to be supplied through pipelines to mitigate onsite storage challenges. However, according to U.S. Department of Energy (U.S. DOE 2020b), with approximately 1,600 miles of hydrogen pipeline currently operating in the United States, there are technical concerns related to pipeline transmission, including:

- The potential for hydrogen to embrittle the steel and welds used to fabricate the pipelines.
- The need to control hydrogen permeation and leaks.
- The need for lower cost, more reliable, and more durable hydrogen compression technology.

Alternatively, hydrogen can be produced using other methods such as reforming. Reforming is a process that uses existing fuels with hydrogen content to react with water, which produces hydrogen and carbon oxides as products.

Steam-methane reforming (SMR) is a type of reforming. It is a thermal process, combining steam with a methane source, such as natural gas, to produce hydrogen and carbon oxides. SMR would need additional equipment, and a pipeline, or possibly a second pipeline for redundancy, to supply natural gas as fuel. This would increase costs for the project. SMR is typically used in SOFCs because of the resiliency of the SOFCs' interior components to high levels of CO. SMR is the preferred method of fuel reforming for SOFCs.

In the case of PEM, the CO can poison the PEM's platinum on the electrode. This leads to lower voltage at a given electrical current density (Fuel Cell 2021). SMR could produce the desired hydrogen content for PEM should further processing to remove undesired levels of CO be performed or by using a larger PEM cell where the same amount of CO would be spread over a larger electrode.

Methanol reforming, however, is the leading reforming technology candidate for PEM fuels cells because of its high efficiency and energy density (Fuel Cell 2021). It is a liquid, like conventional diesel, and can be stored onsite. Methanol is reformed with water to produce hydrogen and carbon oxides. Additional equipment required to reform methanol would increase project costs.

Both SMR and methanol reforming produce carbon dioxide that may be released into the atmosphere.

Moreover, advances in fuel cell technology have led to increases in PEM fuel cell capacity. However, the technology has not shown proven operating hours for large-scale backup energy solutions used in data centers. At this time further testing is needed to verify the compatibility and reliability of these fuel cells. To ensure system compatibility, more test sites or hybrid power systems in current data centers should be considered.

The other fuel cell types also face technical challenges that need to be resolved before they are suitable for use in data centers.

Battery Storage Technology

A standalone BESS for a data center's load demands would require ample onsite storage space for long outage durations. To date, a 300-MW/1200 megawatt-hours (MWh) (supplying 300 MW continuously for 4 hours) is the largest battery storage system (Power Magazine 2021). The operational duration of battery systems has been limited to a range of 4 to 6 hours, not concluding that the system cannot operate longer, but that it has not been demonstrated in large-scale data center applications requiring long-duration backup power. Employment of a BESS for the GOSDC would be the first application of this technology for a project of this magnitude (supplying up to 99 MW continuously for up to 41 hours). For context, a 6-MWh battery storage container requires approximately 380

square feet of space. To supply 99 MW of uninterruptable power in case of 41 hours of grid outage, the project would need a 4,059-MWh battery system, assuming a 100-percent charging and discharging scenario. This translates to approximately 6 acres of battery storage space alone, not including the data center buildings and miscellaneous equipment and structures. This footprint could be reduced by stacking the batteries on top of each other; however, the stacked height would be limited. The stacked containers would need to be constructed such that it can be readily accessible for maintenance and potential fire response, while mitigating seismic concerns. Alternatively, the batteries could be stored in buildings to reduce footprint but would be subjected to stricter building code fire protection requirements. Reducing the footprint would increase the project cost.

Once discharged, the batteries would require power to recharge; to account for this, further design considerations would be needed. Batteries have a lifetime of about 10 years. In addition, their lifetime will be shortened if recharged above 80 percent or discharged below 20 percent. To compensate for this, additional batteries, and thus footprint would be needed. If the project lifespan is 20 years, the batteries would have to be replaced at least once, adding to the project cost.

During a project scoping meeting on February 19, 2021, a public commenter requested that staff evaluate an alternative that would involve adding a roughly 10-MW BESS to the project, which could provide the data center with backup power, in lieu of the gensets, during short power outages. Although this offers some benefits, project reliability would be reduced. A BESS in tandem with gensets would allow the batteries to act as primary backup power for short outage durations, and gensets would provide backup power when the batteries are discharged. Having a tandem system would not reduce the number of gensets for the project. Moreover, the gensets would support data center load demands for longer outages if needed. A 10-MW battery solution would not provide enough capacity for the project. The load demand of the GOSDC would be roughly 10 times that (99 MW). Much of the customers' data would be lost. The BESS must provide 99 MW of backup power. The battery system would provide primary backup power for short term outages, followed by the project's 39 gensets should the outage last longer. For a 99-MWh battery system, the project would require an additional 6,300 square feet of storage space that is not available on the project site. Also, project cost would increase immensely.

This hybrid solution would be the first of its kind for a data center application at the magnitude of the GOSDC. The electrical and electronic interface between the batteries and gensets would need to be tested to ensure system reliability. This would require a trial project before this hybrid solution is ready for deployment in a project such as the GOSDC.

As previously mentioned, once the batteries are discharged to the designed threshold, they would have to be recharged when grid service is restored. One alternative is to recharge the batteries from the grid. This would require redesign of the project's electrical connections, since the proposed gensets would not be connected to the grid. The other is to use the gensets. This method would not be preferred since it would require diesel

fuel, which would defeat the purpose of deploying batteries to reduce fossil fuel consumption.

Using the gensets to recharge the BESS during the gensets' readiness testing would compromise the purpose of the test. The purpose of this readiness testing is to verify that the equipment's electrical and mechanical systems function properly without interference from any other system, in this case, the batteries.

Furthermore, gensets are designed to maintain output voltage over a wide range of load conditions including various amounts of leading and lagging out-of-phase current. The equipment (i.e., HVAC, pumps, lighting, IT servers) used in the project generate a wide range of load conditions for the gensets. However, there is a unique problem with leading out-of-phase current. When the leading current of the load becomes too large, the voltage regulators cannot maintain the voltage output and the output voltage of the generator begins to rise in an uncontrolled way, known as overvoltage. Too much overvoltage causes the safety systems to trigger an immediate shutdown of the generator (Rasmussen 2021). Overvoltage can occur during the genset's recharging of batteries because batteries have capacitive loads, to which, the battery (load) current leads the voltage (leading current). This can be problematic for the operational reliability of, and components within, the genset.

Additional design considerations would include the battery chemistry. There are various battery storage chemistries, but they suffer from inherent fire risks. For a project of this scale, a battery chemistry with high energy density would be ideal, but would have greater risk of thermal run away, which would result in increased potential for fires and explosions. Fire risks would challenge large-scale batteries housed in buildings and alternative locations would need to be considered.

Currently, all three of the alternative generating technologies (biodiesel, fuel cell, and battery storage) are not fully developed for large-scale data center applications and their reliability is questionable. Data center customers demand the most reliable data storage service available. Also, data center insurers are willing to invest only in proven technologies with extremely low probability of operational failure. These technologies have been eliminated from detailed consideration as alternatives to the proposed project.

Additional details on the feasibility of the alternatives from the standpoint of reliability as a key project objective are discussed in the subsection below, "5.7 Reliability and Risk Factors."

5.5.2 North Coyote Valley Alternative Site

Staff conducted a screening level analysis of an area approximately 2 miles southeast of the GOSBGF site to assess whether an alternative site in this area could reduce or avoid any of the proposed project's impacts. The study area is near the Metcalf Energy Center, a natural gas-fired power plant licensed by the CEC in 2001. The area for the alternative site was generally described in a public comment submitted by a local resident (Public

2020o). Staff outlined an alternative site study area covering approximately 115 acres within the North Coyote Valley Employment Area, as identified on maps contained in the *Envision San Jose 2040 General Plan*; the land use designation is IP, Industrial Park (San Jose 2020a). The area is located between Blanchard Road and Emado Avenue. The Caltrain rail line paralleling Monterey Road borders the east side of the area. U.S. Route 101 is located approximately 2,000 feet east of the alternative site study area (**Figure 5-1**). The four parcels comprising the study area are owned by the City of San Jose (City).

The alternative site study area and the North Coyote Valley is mostly characterized by undeveloped, open fields. Aerial images show one or two residences located along the south side of Blanchard Road. A possible residence and large storage structures are located at a site along Emado Avenue near Monterey Road. Some properties in the valley appear to be used for agricultural purposes, although some of these properties may be fallow. A few residences are located on the east side of Monterey Road that are within a couple of hundred feet of the alternative site.

Biological Resources Impact

Less Than Significant with Mitigation Incorporated. Biological resources staff determined that nitrogen deposition impacts on serpentine habitat under the proposed project would be significant in the absence of mitigation; staff recommends mitigation to reduce impacts to less than significant (see the analysis in **Section 4.4 Biological Resources** in this EIR). Staff evaluated the location of serpentine habitat in the area surrounding the North Coyote Valley Alternative Site study area and determined that operation of a project similar to the GOSBGF at a site in the area would cause *greater* impacts from nitrogen deposition on serpentine habitat. Mitigation measures imposed on a project at an alternative site in this area would reduce the impact to less than significant.

Serpentine habitat includes critical habitat for the Bay checkerspot butterfly, which also contains populations for other sensitive plant species. This alternate location is much closer to serpentine habitat compared to the GOSDC.

Serpentine habitat is present at Tulare Hill, Coyote Ridge, and the Santa Teresa Hills, which surround the study area on all sides except to the southeast; the distances of serpentine habitat to the area are relatively close (approximately 320 feet to Tulare Hill; 2,400 feet to Coyote Ridge; and 1,600 feet to the Santa Teresa Hills). These habitat areas are a few thousand feet further from the GOSBGF site (approximately 6,400 feet to Tulare Hill; 6,600 feet to Coyote Ridge; and 3,400 feet to the Santa Teresa Hills). Nitrogen deposition modeling shows that nitrogen deposition is greatest at the source of the emissions and reduces as it moves out from the point source (see **Figures 4.4-1 and 4.4-2** in **Section 4.4 Biological Resources** in this EIR). Therefore, this impact would be greater at the North Coyote Valley Alternative Site due to its closer proximity to serpentine habitat compared to the GOSDC site. Imposition of mitigation would reduce this impact at an alternative site in the study area to less than significant.

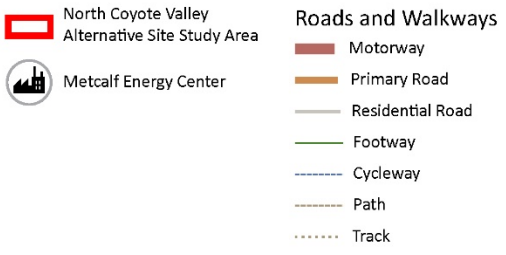

Figure 5-1
North Coyote Valley
Alternative Site

Sources: California Energy Commission,
OpenStreetMap, & Esri

Cultural and Tribal Cultural Resources Impacts

Potentially Significant and Unavoidable Impact. Staff determined that the proposed project would have a less-than-significant impact on cultural and tribal cultural resources with implementation of mitigation measures. Construction of the proposed project could unearth as-yet-unidentified cultural resources, as numerous buried archaeological resources have been found in the Santa Clara Valley. To reduce this impact to a less-than-significant level, staff recommends PD CUL-2 and four mitigation measures as a reliable contingency for inadvertent archaeological or human remains discoveries (**MMs CUL-1** through **CUL-4**; see **Section 4.5 Cultural and Tribal Cultural Resources** in this EIR).

Staff analyzed the North Coyote Valley Alternative Site by consulting the CEC's confidential records of previous cultural resource studies and known cultural resources in the site. Numerous cultural resource studies have been conducted on or adjacent to the alternative site, many of which are summarized in Basin (Basin 2007, pages 2 - 5, 25) and Basin and Hill (Basin and Hill 1999, pages 3 - 7).

CEC's literature also indicates that five previously recorded cultural resources are in or adjacent to the North Coyote Valley Alternative Site. Archaeological sites P-43-001280 (CA-SCL-000838) and Archaeological Resource 2 are among them (Calpine and Bechtel 1999, Figure 8.3-4b). P-43-001280 is a Native American occupation and burial site containing at least 28 Native American burials. Many of the artifacts, features, and human burials were found at depths of 6 to 13 feet below the ground surface. P-43-001280 extends an unknown distance into the North Coyote Valley Alternative Site. The archaeological site qualifies as a historical resource, as defined by CEQA (Pub. Resources Code § 21084.1) and the CEQA Guidelines (Cal. Code Regs., tit. 14, § 15064.5, subd. (a)) (Reinoehl 2006, pages 3–5). In addition, site P-43-001280 could qualify as a tribal cultural resource (see Pub. Resources Code, § 21074(a)), although no lead agency has specifically evaluated the site against CEQA's criteria for tribal cultural resources at the time of this writing.

There are two previously recorded farm complexes located on or adjacent to the alternative site on Emado Avenue. Located across Emado Avenue from the alternative site, P-43-001167, the Groesbeck/Puppo Farm, was evaluated as not eligible for any register (Busby 2004, page 29). Located on the alternative site, P-43-001168, the Lester Farm, was evaluated as not eligible for any register (Busby 2004, pages 29 –30). Railroad tracks are located adjacent to the eastern boundary of the site. The rail line has been evaluated in multiple sections in both Santa Clara and San Benito counties as P-43-000928/P-35-000334. The section nearest to the alternative site (at Blossom Hill Road) was evaluated as not eligible for listing on either the National Register of Historic Places or the California Register of Historical Resources (Jurich and Martinez 2008).

Development of a project similar to the GOSBGF at the North Coyote Valley Alternative Site would result in impacts on cultural and tribal cultural resources *equal to or greater than* those identified at the GOSBGF site. At least two cultural resources are in the North

Coyote Valley Alternative site, comprising both archaeological resources and historic buildings and structures. Of the archaeological resources, site P-43-001280 is a historical resource for the purposes of CEQA. Development of a data center and associated back-up generating facility at the North Coyote Valley Alternative site would damage archaeological site P-43-001280 through ground disturbance. Archaeological test excavation would be required to determine how much of the North Coyote Valley Alternative site P-43-001280 occupies—and whether a project similar to the GOSDC could be built within the North Coyote Valley Alternative Site—and still avoid damaging archaeological site P-43-001280.

Farmland Conversion Impact

Potentially Significant and Unavoidable Impact. The California Department of Conservation (CDOC) established the Farmland Mapping and Monitoring Program (FMMP) to assess the location, quantity, and quality of agricultural lands and conversion of those lands to other uses. The FMMP identifies and maps agricultural lands as Prime Farmland, Farmland of Statewide Importance, Unique Farmland, Farmland of Local Importance, and Grazing Land. Under CEQA, conversion of Farmland to nonagricultural use applies only to Prime Farmland, Farmland of Statewide Importance, and Unique Farmland (CEC 2020h). Current Important Farmland maps show that the GOSDC site is classified as Farmland of Local Importance, which Santa Clara County defines to include “small orchards and vineyards primarily in the foothill areas,” as well as “land cultivated as dry cropland for grains and hay” (CDOC 2019a, 2019b). As discussed in **Section 4.2 Agriculture and Forestry Resources** in this EIR, the GOSDC would cause no impact on Farmland.

FMMP data show that the North Coyote Valley Alternative Site is within an extensive area that is classified Prime Farmland. Of the total approximately 115 acres at the site, approximately 96 acres are classified Prime Farmland. The conversion of Prime Farmland would be a significant impact of this alternative that would not occur under the GOSDC. Mitigation for conversion of Prime Farmland could involve compensating for the loss through a conservation easement. However, it is uncertain whether feasible mitigation could be identified to reduce the impact to less than significant, and the Farmland conversion impact under this alternative could remain significant and unavoidable.

Potential Feasibility Issues and Attaining the Project Objectives

Addressing feasibility of an alternative takes several factors into account, including whether the project proponent can reasonably acquire, control, or otherwise have access to the alternative site (Cal. Code Regs., tit. 14, § 15126.6, subd. (f)(1)). The applicant does not have site control of properties in the North Coyote Valley. While studying the alternative site, staff obtained information documenting the \$93 million purchase of 937 acres of rural farmland and open space in the North Coyote Valley, including the properties comprising the alternative site study area (CEC 2021h). The City partnered with the Santa Clara Valley Open Space Authority and the Peninsula Open Space Trust (POST) to finalize the purchase in 2020 with the intent to preserve the property for wildlife, open space, and flood control. The land purchase was preceded by decades of public controversy over earlier proposals to develop technology company campuses in

the area. Public input would help to determine future uses of the preserve, which could include trails and wildlife habitat restoration. In early 2021, POST purchased an additional approximately 300 acres in the mid-Coyote Valley for permanent protection (POST 2021). Although staff does not have an accounting of all recent land purchases for open space preservation and related uses, the total acreage in and around Coyote Valley is reported to exceed 3,300 acres as of March 2021.

The applicant would have no option or opportunity to purchase or lease property in the alternative site study area. Even if the applicant could gain access to any of the properties in other parts of the valley, the process for the applicant to prepare and submit a new application to the CEC would delay the project for an indeterminable length of time. A prolonged delay could adversely affect the potential feasibility of a project at any off-site location.

The project objectives include developing a state-of-the-art data center on land that has been previously approved for a similar size data center, which is the GOSBGF site. The applicant plans to develop its proposed data center in phases to match projected customer demand. The potential feasibility issue of the applicant's ability to acquire property at a different site and plan and develop a similar project at an off-site location could result in a failure to attain any of the basic project objectives. For the reasons described above, an off-site alternative is not evaluated further in this analysis of alternatives.

Decision to Eliminate the Alternative Site Study Area from Further Consideration

Staff's analyses of the proposed project's potential environmental impacts contained in this EIR conclude that impacts would be reduced to less than significant with implementation of mitigation measures. Staff's analysis of impacts comparing the North Coyote Valley Alternative Site to the GOSBGF indicates that impacts on serpentine habitat would be greater at the alternative site. Comparable impacts on cultural and tribal cultural resources could be greater at the alternative site. Development of a site in the North Coyote Valley would convert Prime Farmland to a nonagricultural use, which is a significant unavoidable impact that would not occur at the GOSBGF site. Staff concludes that further exploration of properties beyond the project site is unlikely to yield a different location for the project that could feasibly be developed as an alternative to the GOSBGF. No other alternative locations have been identified by the City or public agencies or members of the public where environmental impacts would likely be avoided or substantially lessened compared to the GOSBGF.

5.6 Alternatives Selected for Analysis

The following alternatives are evaluated in this EIR:

- Alternative 1a: No Project – No Build Alternative
- Alternative 1b: No Project – Development of Previously Approved Data Center Project

- Alternative 2: Alternative Fuel – Renewable Diesel
- Alternative 3: Natural Gas Internal Combustion Engines

Other than the two No Project Alternatives, project alternatives were developed that could feasibly avoid or lessen the proposed project’s potentially significant impacts. The comparative impact analysis is followed by an assessment of the extent to which the alternative could meet the basic project objectives and a discussion of potential feasibility issues.

The comparative analyses that follow are centered on the topics of air quality, biological resources, public health, and greenhouse gas (GHG) emissions. **Table 5-1**, below, summarizes the environmental effects for each alternative compared to the proposed project. Staff’s comparative analyses for the other topics covered in this EIR show essentially no differences between the impacts identified under the proposed project and the alternatives evaluated below.

The alternative technologies evaluated in the subsections that follow could not achieve the level of reliability required to ensure an uninterrupted power supply. See the subsection below, “5.7 Reliability and Risk Factors,” for further discussion and analysis. It is assumed that the project site location would remain the same under the alternative fuel and technology alternatives.

5.6.1 Alternative 1a: No Project – No Build Alternative

Under the No Project – No Build Alternative, no development of the project site would occur, and current conditions would continue at the site for an unknown period. As discussed in **Section 4.11 Land Use and Planning** in this EIR, the eastern half of the project site is designated IP, Industrial Park, and the western half is designated TEC, Transit Employment Center. The IP designation allows for a variety of industrial users. The TEC designation is “applied to areas planned for intensive job growth because of their importance as employment districts to the City and high degree of access to transit and other facilities and services” (San Jose 2020a).

The site could eventually be approved for a use or uses consistent with these land use designations should the GOSBGF not move forward. Although a different project would likely be proposed at the site in the future, no development plan exists to allow a comparison with the GOSBGF, and it would be speculative to assume the characteristics of such an alternative.

The No Project – No Build Alternative would avoid the proposed project’s potentially significant impacts identified in this EIR (*no impact* compared to the proposed project). If the project were not constructed, the applicant’s primary goal to develop a state-of-the-art data center along with the basic project objectives would not be attained.

5.6.2 Alternative 1b: No Project – Development of Previously Approved Data Center Project

On January 25, 2017, the City of San Jose approved and issued the original Special Use Permit (SP15-031) for the Equinix Data Centers project (SV1 2020d). The approved project included a total of 21, 3-MW backup diesel fuel generators for a maximum load demand of 57 MW (SV1 2020d). The original project site configuration consisted of three, two-story data center buildings, which were designated SV-12, SV-13, and SV-14.

CEC staff contacted the City to inquire about steps the applicant would need to complete before proceeding with construction of the approved project at the existing site. According to City staff, one grading permit (File No. 3-05857) was issued on December 10, 2018, to allow grading for data center building SV12 (CEC 2021g). The building permit to allow construction of SV12 (File No. 2018-144961) has been on file since 2018, and the City's internal review of SV12 is complete. The building permit for SV12 has not yet been issued. Grading permits, which include satisfying any previously approved mitigation measures, are still needed for the two other data center buildings, as are building permits.

SP15-031 had a 4-year term with an expiration date of January 25, 2021. On August 25, 2020, the City adopted an ordinance extending the terms of specified land use permits by 2 years from the set expiration date (Ordinance No. 30460); the City took this action in response to the pandemic-induced recession. SP15-031 is among the permits that qualify for an extended permit expiration date; the new expiration date for the approved project is January 25, 2023 (CEC 2021g). With this land use permit term extension, the applicant has additional time to complete project approvals for this No Project Alternative scenario.

However, as explained in detail below under, "Potential Feasibility Issues and Attaining the Project Objectives," the applicant would be required to change its previously approved project to meet the more stringent Tier 4 emission standards, instead of Tier 2 emission standards, before it could be permitted by the Bay Area Air Quality Management District (BAAQMD).

Air Quality (and Public Health)

The City's approved project from 2017 included a total of 21, 3-MW backup diesel fuel generators with Tier 2 Cummins QSK95-G9 diesel-fueled engines (San Jose 2016). The currently proposed GOSBGF would include 36 generators with 3.25-MW Cummins QSK95-G9 engines and three life safety generators with 0.5-MW Cummins QSK15-G9 engines. Each of the 36 3-MW generators would be equipped with diesel particulate filters (DPF) and selective catalytic reduction (SCR) to meet Tier 4 emission standards (SV1 2021i). The three smaller life safety generators would meet Tier 2 emission standards, except for particulate matter (PM), which would be controlled by DPFs to meet Tier 4 emission standards.

The currently proposed 36 larger engines have the same model number (Cummins QSK95-G9) as those previously approved by the City. However, emissions of the proposed

project would be controlled to meet more stringent Tier 4 emission standards, rather than Tier 2 emission standards for the approved project. The currently proposed Cummins QSK95-G9 engines would provide more power than the engines approved by the City (4,631 brake horsepower [bhp] vs. 4,307 bhp at full load, a 7.5 percent increase). The City limits readiness testing and maintenance of the original 21 generators to a total of 356 hours in any consecutive 12-month period. For the current project, the applicant is proposing an annual readiness testing and maintenance schedule not to exceed 20 hours per year per engine (a total of 720 hours for the 36 larger engines and 60 hours for the three smaller life safety engines). Considering the increase in engine power, number of engines, annual readiness testing and maintenance hours, and additional emission controls, staff expects the criteria pollutant emissions from the currently proposed engines would be higher than those of the approved project's engines, except for PM as explained in detail below.

For example, the City's initial study/mitigated negative declaration (IS/MND) on the approved 2017 data center project shows the nitrogen oxide (NO_x) emissions of the approved 21 engines would be 7.9 tons per year (tpy) with 15 hours per year per engine at full load and 1 hour per year per engine at 25 percent load readiness testing and maintenance or 8.3 tpy with 16 hours per year per engine at full load readiness testing and maintenance (San Jose 2016, Table 4.3-7). For the currently proposed GOSBGF, the applicant would use SCR on the 36 3-MW engines to control the NO_x emissions to meet Tier 4 emission standards. However, the SCR might not fully control the emissions during the initial 15 minutes of startup. Therefore, the applicant conservatively estimated the total annual NO_x emissions of the engines during readiness testing and maintenance to be 16.24 tpy, based on Tier 2 emission factors (SV1 2021i). The conservatively estimated NO_x emissions from the currently proposed engines would be about twice that of the approved project's engines. In addition, as explained in detail below under, "Potential Feasibility Issues and Attaining the Project Objectives," the applicant would be required to change its previously approved project to meet the more stringent Tier 4 emission standards, instead of Tier 2 emission standards, before it could be permitted by the BAAQMD. Staff expects the NO_x emissions of the approved project with potential Tier 4 emission controls would still be lower than those for the proposed GOSBGF, assuming other aspects of the approved project did not change.

The applicant is proposing to use DPFs to control the PM emissions of the GOSBGF to meet Tier 4 emission standard. Combining the reduced PM emission factor with the increase in engine power, number of engines, and annual readiness testing and maintenance hours, staff expects the PM emissions of the currently proposed engines with DPFs would be lower than those from the previously approved engines without DPFs.

Since the approved project would also now be required to meet Tier 4 emission standards, staff expects the PM emissions of the approved project with potential Tier 4 emission controls would be similar to those for the proposed GOSBGF. However, it is assumed that the total annual emissions for the approved project would be lower since there are fewer engines that would be operated for testing and maintenance purposes.

Staff expects the short-term impacts of the approved project with potential Tier 4 emission controls would probably be similar to those for the proposed project due to the limit of testing one engine at a time. Staff expects the long-term (annual) impacts of the approved project with potential Tier 4 emission controls would likely be less than those for the proposed project due to expected lower total annual emissions. However, the conclusion would need to be confirmed with quantitative modeling. Therefore, the comparative impact for criteria pollutants is *likely less under this alternative with Tier 4 emission controls*.

Staff expects the health risks of the proposed GOSBGF with PM emission reduction by using DPFs would be lower than those for the City approved project without DPFs. However, the City's IS/MND Appendix A (San Jose 2016, Table 9) shows that the maximum cancer risk of the original data center operation would be 1.6 per million at an off-site residence south of the data center project site across Santa Teresa Boulevard. For the proposed GOSBGF, the applicant provided health risks at different types of sensitive receptors and showed higher health risks than those presented in the City's IS/MND. More details of the health risks at different types of sensitive receptors for the GOSBGF can be found in **Section 4.3 Air Quality** of this EIR. Staff verified the modeling results for the GOSBGF with a rigorous independent review, critique and testing of the analysis done by the applicant. However, staff does not have the detailed modeling files used by the City to verify the health risks for the City approved project. Therefore, staff cannot verify how the health risks impacts of the City's approved project would compare to those of the proposed project. In addition, the health risks for the City approved project would probably need to be remodeled to be consistent with the Tier 4 emission standard currently required by BAAQMD. However, staff expects the health risks of the approved project with potential Tier 4 emission controls would likely be lower than those for the proposed GOSBGF due to expected lower PM emissions. Therefore, the comparative impact for health risks is *likely less under this alternative with Tier 4 emission controls*.

Biological Resources

Nitrogen deposition is a concern in serpentine habitat (see **Section 4.4 Biological Resources** in this EIR), which contains sensitive species and critical habitat, located within 6 miles of the GOSBGF site. Nitrogen deposition causes the proliferation of invasive non-native plant species, which are primarily grasses. These non-native grasses crowd out native species, including special-status plants and common plant species that the Bay checkerspot butterfly caterpillar depends on as a food source. NOx emissions determine the amount of nitrogen deposition that would occur. The Previously Approved Data Center Project Alternative would have half the NOx emissions compared to the proposed project. Nitrogen deposition would likely be reduced to some degree because there would be less NOx emitted under this alternative.

Staff determined that nitrogen deposition impacts on serpentine habitat under the proposed project would be significant in the absence of mitigation (see **Section 4.4 Biological Resources** in this EIR). The Santa Clara Valley Habitat Plan (SCVHP) would require a nitrogen deposition fee to mitigate the impact (for point source emissions).

When the SCVHP was developed in 2012 it was not feasible to calculate impacts from point source emissions. Thus, the nitrogen deposition fee mitigation for the project's point source emissions will need approval from the Santa Clara Valley Habitat Agency (SCVHA). Approval is anticipated to occur prior to publication of the final EIR. The nitrogen deposition fee is tied directly to the amount of nitrogen deposition. Under this alternative, nitrogen deposition impacts to nearby serpentine habitat would be less compared to the proposed project. Payment of the mitigation fee would be required to reduce the impact to less than significant; however, the fee amount would be lower than under the proposed project, and the comparative impact is *likely less* under this alternative.

Greenhouse Gas Emissions

The City's 2016 IS/MND does not contain a quantitative GHG analysis for the previously approved project. However, the size of the previously approved project is less than that of the proposed GOSBGF. By reasonably assuming that similar engines would be used in both projects, the previously approved project would use fewer engines and less fuel. Therefore, staff expects the GHG emissions are *likely less* under this alternative.

Potential Feasibility Issues and Attaining the Project Objectives

For the City's approved 2017 data center project, the applicant would still need to apply for an authority to construct (ATC)/permit to operate (PTO) from the BAAQMD. On December 21, 2020, BAAQMD issued a letter to California Air Resources Board (CARB) and CEC establishing a Best Available Control Technology (BACT) guideline for large (greater than or equal to 1,000 brake horsepower [bhp]) diesel engines used for emergency standby power that requires them to meet U.S. EPA Tier 4 emission standards. This determination applies to any new and open permit application with a diesel backup engine greater than 1,000 bhp that is deemed complete after January 1, 2020 (BAAQMD 2020z). BAAQMD would not issue a permit to the applicant to allow construction and operation of the project as approved by the City unless the applicant changes the project to meet the Tier 4 emission standards.

In addition, the City limits the testing and maintenance of the original 21 generators to no more than 356 hours in any consecutive 12-month period. The limit was to make sure the NOx emissions of the original project do not exceed the BAAQMD significance threshold of 54 pounds per day (lbs/day) or 10 tpy, so that NOx offsets were not required for the original project. However, on June 3, 2019, the BAAQMD staff issued a new policy to protect the Small Facility Banking Account from over withdrawal by new emergency backup power generator sources. With the new policy, when determining the potential to emit (PTE) for a facility with emergency backup power generators, the PTE shall include as a proxy, emissions proportional to emergency operation for 100 hours per year per standby generator, in addition to the permitted limits for readiness testing and maintenance. Under this new policy, the NOx PTE for the original project would need to be re-calculated to include the emergency operation for 100 hours per year per standby generator. If the NOx PTE exceeds 10 tpy, NOx offsets would be required to mitigate the impacts. The details regarding the amount and the source of the NOx offsets would be determined through the permitting process with the BAAQMD. The applicant would be

required to change its previously approved project to meet the Tier 4 emission standards. Staff considers it unlikely that the applicant would pursue BAAQMD permitting of the original project, which would probably cause an investment loss given the work that has occurred over the past few years to redesign the project for the GOSBGF.

Development of the applicant's 2017 data center project could be infeasible, because it would not be able to match the projected customer growth for the proposed project as stated by the applicant's project objectives. Additionally, the project would need to gain necessary approvals for the earlier project and file for a small power plant exemption with the CEC. Even if this alternative was potentially feasible, changing the project back to its original design but with Tier 4 engines would at least cause a project schedule delay, and it is unknown at what point the delay would affect project viability. If the originally approved project could not feasibly be constructed and operated, it would not attain any of the project objectives.

5.6.3 Alternative 2: Alternative Fuel – Renewable Diesel

Renewable diesel fuel is an alternative to conventional, petroleum-based diesel fuel. Renewable diesel is not a fossil fuel, but instead is made of nonpetroleum renewable resources with the same chemical structure as conventional diesel. It is produced through various thermochemical processes such as hydrotreating, gasification, and pyrolysis (U.S. EIA 2021). It also meets ASTM D975 specifications for conventional diesel in the United States (U.S. DOE 2020c). This makes renewable diesel a drop-in replacement for conventional diesel. Also, renewable diesel is a cleaner burning fuel alternative to conventional diesel fuel that would be expected to meet the project objectives as a source of fuel for the standby generators.

Under this alternative the project would be developed the same as the proposed, except it would use renewable diesel as the fuel source for the generators. There would be no changes to the number, size, or placement of the generators. The number of fuel deliveries would remain the same.

Air Quality and Public Health

Limited testing done to date on engines used in motor vehicles show that renewable diesel would have lower criteria pollutant emissions than conventional, ultralow sulfur diesel (ULSD) proposed to be used for the GOSBGF. **Appendix D** provides a detailed comparison of the emissions from limited testing. For example, **Appendix D** shows that the NO_x emissions would be about 10 percent to 18 percent lower using renewable diesel than those using ULSD, depending on the type of engine and testing cycle. **Appendix D** also shows that the particulate matter (PM) emissions would be about 25 percent to 39 percent lower using renewable diesel than those using ULSD, depending on the type of engine and testing cycle. These limited data also show good potential for reducing toxics substance emissions by substituting renewable diesel for ULSD. However, the results obtained for increased acetone emissions may need further study and analysis.

The above conclusions are based on limited testing done for much smaller engines than those proposed for the GOSBGF. The reduction in emissions would need to be confirmed with testing under controlled conditions in the size of engine proposed for this facility, preferably using the same source test protocol used for engine certification.

It should also be noted that the effect of any pollution control equipment used on the tested engines may not have the same effect as the pollution controls expected to be used on the GOSBGF. Specifically, the proposed DPFs and SCR for the project may reduce PM, toxics species, and NOx emissions such that there is not a significant difference between renewable diesel and conventional petroleum diesel.

Air quality and public health impacts using renewable diesel during project operations are *likely less* than those that would occur with the project. However, the reduction in emissions would need to be confirmed with testing under controlled conditions for the proposed engines with DPFs and SCR on.

Biological Resources

As described in **Section 4.4 Biological Resources** of this EIR, serpentine habitat is sensitive to nitrogen deposition. Based on information stated above under "Air Quality and Public Health," the Renewable Diesel Alternative would result in a reduction in NOx emissions. The amount of reduction would depend on the type of engine used and testing cycle. As a result of reduced NOx emissions from renewable diesel, nitrogen deposition impacts would also be reduced. However, this reduction would need to be confirmed with more testing.

Staff determined that nitrogen deposition impacts on serpentine habitat under the proposed project would be significant in the absence of mitigation (see **Section 4.4 Biological Resources** in this EIR). As discussed above, there is a direct relationship between nitrogen deposition and the nitrogen deposition fee amount (see the "Biological Resources" analysis under the subsection, "5.6.2 Alternative 1b: No Project – Development of Previously Approved Data Center Project"). When nitrogen deposition from the proposed project decreases so does the nitrogen deposition fee. This fee is a requirement of the SCVHP to mitigate for point source emissions and is subject to approval from the SCVHA. Under this alternative, nitrogen deposition impacts to nearby serpentine habitat would be less compared to the proposed project. Payment of the mitigation fee would be required to reduce the impact to less than significant; however, the fee amount would be lower than under the proposed project, and the comparative impact is *likely less* under this alternative.

Greenhouse Gas Emissions

Compared to ULSD, renewable diesel would reduce carbon dioxide tailpipe emissions approximately 3 to 4 percent (**Appendix D, Tables D-1 to D-5**). However, renewable diesel is produced with a fuel cycle that has a far lower carbon intensity (CI) than ULSD. To have a more complete understanding of the impact of replacing ULSD with renewable

diesel, it is necessary to examine the full fuel cycle of each fuel from origin to use. This is because greenhouse gases (GHGs) have a global impact rather than a local impact.

Based on data from CARB's Low Carbon Fuel Standard (LCFS) program, staff computed the average amount of GHGs reduction per million gallons of renewable diesel and used it as a factor to compute the fuel cycle emissions that would be avoided by switching from ULSD to renewable diesel. The results show that replacing the proposed ULSD with renewable diesel would reduce GOSBGF readiness testing and maintenance GHG emissions from 1,834 metric tons of CO₂e (MTCO₂e) per year with ULSD by 1,472 MTCO₂e per year, to annual emissions of 362 MTCO₂e per year with renewable diesel.

Based on the limited information contained in **Appendix D**, using renewable diesel in place of ULSD would reduce the GOSBGF's full fuel cycle GHG emissions associated with onsite fuel consumption during the operations period. However, renewable diesel still has some carbon associated with the fuel cycle, because the CI values are not zero or negative. Therefore, additional measures would be needed before an alternative fueled by renewable diesel could be considered a carbon-free facility. The comparative impact is *likely less* under this alternative.

While the project meets GHG thresholds and would not conflict with any applicable plan, policy or regulation adopted for the purpose of reducing the emissions of greenhouse gases with the implementation of **MM GHG-1**, using renewable diesel would further reduce the less than significant GHG emission impacts of the proposed project. Therefore, staff recommends the project owner consider incorporating the use of renewable diesel as the primary fuel for the backup diesel generators when it is available and feasible, and only use ultra-low sulfur diesel (ULSD) as a secondary fuel in the event of supply challenges or disruption in obtaining renewable diesel.

Potential Feasibility Issues and Attaining the Project Objectives

Renewable diesel fuel is not new but would be considered new for large-scale stationary equipment, such as the proposed project's gensets. The fuel is currently used in heavy-duty mobile engines and trucks. The City of Oakland and other cities surrounding the San Francisco Bay Area are using renewable diesel in their transportation fleet (Green Fleet 2021). While renewable diesel has been used in such applications, at this time there is no significant data regarding its use in, at least, large stationary engines such as those for the proposed project. The majority of renewable diesel consumed in California is primarily sourced and produced from a location overseas. Single sourced production challenges the fuel supply reliability and cost. If the source could no longer produce the fuel or other production issues arise, the project could face supply shortage. Single sourced products are quite often expensive, and for renewable diesel the current cost is approximately two times that of conventional diesel. Distributors could mitigate these challenges by having large supply on hand. In addition, new fuel supplies could increase in the future as more suppliers are added, such as Exxon Mobil, Bakersfield Renewable Fuels, Marathon Petroleum, and others (Biodiesel 2021). These future suppliers have announced plans for operation as early as 2022. At this point, the availability of a second

source does not seem timely for the project. However, in the foreseeable future if and when more suppliers come online, and the supply is plentiful, the project should revisit the feasibility of renewable diesel as primary source of fuel.

Currently, there are credits available for mobile sources to use renewable diesel, making this fuel more financially viable; however, those credits are not currently available for stationary sources. Extension of credits for non-mobile sources could result in an effective decrease to fuel cost for GOSDC; currently the cost of renewable diesel is roughly twice as much as conventional diesel.

Note that data center customers demand the most reliable data storage service available. And data center insurers are willing to provide coverage only in proven technologies with extremely low probability of operational failure. In the absence of a second source of renewable diesel supply, conventional diesel fuel can be considered as the backup fuel until and when renewable diesel supply is more available, and readily accessible. Because renewable and conventional diesel have the same chemical structure, renewable diesel can be used in engines that are designed to run on conventional diesel—with no blending required (Green Fleet 2021).

This alternative could potentially attain the project objectives if a reliable fuel source could be obtained.

5.6.4 Alternative 3: Natural Gas Internal Combustion Engines

Natural gas internal combustion engines (ICEs) are fueled by natural gas, while the proposed engines for the GOSBGF would use conventional diesel. Natural gas ICEs are available up to 18 MW. Their physical dimensions range based on their MW capacity. For example, one of the natural gas engines from Power Solution International (PSI) has a capacity of 445 kW and a nominal height of 12 feet. One of the natural gas engines by Innio has a capacity of 3 MW with a height for the genset assembly of 23 feet. As a point of reference, the height of the proposed genset assembly for the project is 27 feet. It is assumed that the massing and locations of the data center buildings would be essentially the same as the GOSDC.

Data centers require a power generating solution with quick start times. The time it takes the ICE to begin carrying the data center load from its power-off position (the moment the engine synchronizes to the bus bar) varies depending on the ICE's size and capacity. In the meantime, the UPS system can provide power to the data center. The startup time for the PSI ICE, and Innio ICE generators are fast enough that the UPS system would not need to be redesigned.

The preferred method to supply fuel for the ICEs would be by pipeline through PG&E's underground natural gas transmission system. The two closest locations for independent natural gas pipeline connections are approximately 1.2 miles west of the project site at

PG&E's Blossom Hill feeder main³ and 4.3 miles east of the project site at Metcalf Motorcycle County Park⁴. The shorter pipeline would be the primary one. The other pipeline can also be installed to provide added reliability. It is assumed that new pipelines would be constructed along existing roadway rights-of-way and utility corridors. The natural gas pipeline trenches would be approximately 6 feet deep and 4 to 6 feet wide, with a minimum cover depth of 36 inches. Installation of natural gas pipelines would cause temporary impacts during construction. Staff assumes that implementation of the same mitigation and project design measures under the GOSDC would apply to pipeline construction impacts (e.g., measures to reduce impacts on air quality, water quality, noise, soil resources, and transportation) during project construction to less-than-significant levels.

In short summary, under this alternative, the footprint of the ICEs may not be the same as the proposed diesel gensets. The footprint for Innio would be approximately 5 percent larger, but the same footprint for the PSI ICEs. The number of engines and associated equipment, height, fuel delivery, and onsite fuel storage would be different.

After August 1, 2021, natural gas pipeline infrastructure in all new construction will generally be prohibited in the City of San Jose (San Jose 2020b). However, section 17.854.040 (B) of the City's Municipal Code will provide an exception. The exception will apply to facilities with physical connection to the electric grid and Distributed Energy Resource for necessary operational requirements to protect the service they provide in the event of an electric grid outage, until December 31, 2024 (San Jose 2021). As defined in section 17.824.020 (E) of the municipal code, "Distributed Energy Resource" means an electric generation or storage technology that complies with the emissions standards adopted by the State Air Resources Board. ICEs, by definition, would be a Distributed Energy Resource, and data centers have operational requirements to protect the service they provide. Thus, the use of natural gas for the ICEs and the project would fall under this exception.

Air Quality and Public Health

Enchanted Rock, LLC, recently commissioned an analysis by the Brattle Group (Enchanted Rock 2020). The analysis compared both criteria pollutant emissions and carbon dioxide emissions of natural gas ICEs against Tier 2 and Tier 4 emission standards for petroleum diesel fired engines. The proposed 36, 3-MW engines would meet Tier 4 emission standards. The three smaller life safety generators would meet Tier 2 emission standards, except for PM, which would be controlled by DPFs to meet the Tier 4 emission standard. Information for the natural gas ICE is primarily based on test data for an Enchanted Rock system. As shown in **Appendix D**, the test results from Enchanted Rock, LLC, show that NOx and volatile organic compounds (VOC) emissions would reduce by more than 99 percent using natural gas ICEs compared to diesel engines that meet Tier 2 or Tier 4 emission standards. The PM emissions would reduce by more than 95 percent using

3 Along Santa Teresa Blvd. to Ignacio Ave.

4 Along Metcalf Road, Monterey Road, Bernal Way, San Ignacio Ave to Great Oaks Blvd.

natural gas ICEs compared to diesel engines that meet Tier 4 emission standards. There would be less reduction in carbon monoxide (CO) and sulfur dioxide (SO₂) emissions (about 86 percent reduction for CO and about 56 percent reduction for SO₂). The Enchanted Rock report did not include toxics emissions testing data. However, these are expected to be reduced due to the reductions reported for VOCs and PM.

Air quality impacts using natural gas ICEs are expected to be *much less* than those that would occur with the proposed diesel engines for the GOSBGF. Public health impacts using natural gas ICEs are *likely less* than those that would occur with the proposed diesel engines for the GOSBGF.

Biological Resources

As discussed in **Section 4.4 Biological Resources** of this EIR, serpentine habitat is sensitive to nitrogen deposition. Nitrogen deposition is not only affected by NO_x emissions but also from ammonia. NO_x emissions would be reduced by more than 99 percent with natural gas ICEs compared to the GOSBGF's diesel engines. (As discussed above, nitrogen deposition impacts on sensitive habitat under the proposed project would be significant in the absence of mitigation.) Unlike the proposed project, the Natural Gas ICEs Alternative would not require the use of ammonia. Since NO_x is reduced to a greater degree, there is likely very little nitrogen deposition from this alternative. Therefore, nitrogen deposition impacts to nearby sensitive and critical habitat would be much less than the proposed project with the use of natural gas ICEs, and the comparative impact is *much less* under this alternative. Any amount of nitrogen deposition would require payment of the mitigation fee to reduce the impact to less than significant; however, the fee amount would be lower compared to the proposed project. (As mentioned above, the nitrogen deposition fee is required through the SCVHP, and the proposed point source emission mitigation requires approval from the SCVHA.)

Greenhouse Gas Emissions

As shown in **Appendix D**, the test results from Enchanted Rock, LLC, show that the natural gas fueled ICEs would reduce GHG emissions by approximately 10 percent from Tier 1 and Tier 4 petroleum diesel fired ICEs. When extending to the full fuel cycle, GHG emissions from natural gas ICEs fueled with pipeline natural gas produced from fossil feedstocks would be 20 percent lower than those from petroleum diesel as indicated by the CI values. Moreover, natural gas feedstocks from some renewable feedstocks may have a much lower CI. The CI values of most renewable feedstocks are even negative, reflecting a net reduction in fuel cycle carbon emissions. The comparative impact is *likely less* under this alternative.

Fossil natural gas and some forms of renewable natural gas still has some carbon associated with the fuel cycle. These show up in the table for those fuels with a CI that is greater than zero. In these cases, additional measures could be needed before an alternative fueled by natural gas would be considered a carbon-free facility.

Potential Feasibility Issues and Attaining the Project Objectives

Natural gas ICEs are cleaner burning due to the type of fuel; however, the technology is not without feasibility issues. The GOSBGF would employ 39 total backup gensets (including the three emergency life safety engines). Depending upon the MW size of the ICE engine, more engines may or may not be needed.

There are two potential fuel supply methods—onsite storage and pipeline connection. Onsite storage would require redesigning the project and would suffer from some feasibility issues. The project would need approximately 344 million gallons of natural gas storage to provide 41 hours of backup ICE operation, the same backup duration as the current proposal. Liquefied natural gas (LNG)⁵ would minimize the storage space, but the needed storage volume would still be substantially larger than that of diesel fuel.^{6,7}

LNG would need to be stored and distributed with specialized equipment and stored in insulated tanks to keep the fuel in a liquid state at minus 260 degrees Fahrenheit. For LNG to remain at a constant temperature and pressure, it must boil-off gas (BOG). BOG is essentially a loss of stored fuel that occurs when the ambient temperature heats the insulated tanks. LNG must release this gas to maintain its liquid state. To mitigate the loss of fuel and gas release into the atmosphere, BOG can be reliquefied and put back into the LNG tank, or used as fuel in certain marine applications, steam turbines, or in a gasification unit for creating alternative fuels. LNG would need to undergo a regasification process for the fuel to be used in ICEs. Both reliquefaction and regasification would result in additional processes, equipment, and footprint.

Fuel storage, reliquefaction, regasification equipment must comply with standards specified by the National Fire Protection Association along with San Jose City Municipal Code to protect against hazardous material release, fire, and explosions during natural disasters and as the result of accidents. Additionally, permits for the storage of hazardous materials would be needed pursuant to the City's municipal code.

The utility's underground pipeline transmission system would be the primary and preferred method of fuel supply. However, pipelines are susceptible to natural disasters (e.g., earthquakes) as well as accidents. This can potentially cut off fuel supply to the project during a grid outage. Access to a secondary pipeline would increase fuel supply reliability.

5 Natural Gas can be liquefied to 600 cubic meters times smaller than its volume in its gas state.

6 LNG calculated as: Approximate ICE Fuel Consumption 9,500 cubic feet per megawatt-hour x 118 MW (includes redundant engines) x 41 hours of backup duration = 45,961,000 cubic feet of natural gas = 344 million gallons

Conversion Cubic feet gas to liquid gallons: 45,961,000 cubic feet x 0.0283168 cubic meter gas x (1 cubic meter LNG / 600 cubic meter gas) x 264.172 liquid gallons = 573,019 gallons

7 Diesel volume for current proposal: Genset Fuel Consumption 222 gallons per hour x 39 gensets x 41 hours = 354,980 gallons

This alternative could potentially attain the project objectives if a reliable fuel source could be obtained and the technology were to become industry standard.

5.7 Reliability and Risk Factors

The most important data center criterion is reliability. Crucial services such as the 911, Offices of Emergency Management, and utilities infrastructure are increasingly using data centers for their operation. The selected backup electric generation technology must be extremely reliable in the case of an emergency loss of electricity from the utility. As described earlier, data center customers demand the most reliable data storage service available. And data center insurers are willing to invest only in proven technologies with extremely low probability of operational failure.

Any alternative backup generation technology would be measured against proven available technologies, such as the current technology proposed. Should the reliability of that technology not match that of the proposed gensets, it would not be considered a viable alternative.

Risk factors that affect the reliable operation of backup generators include the following: failure to start, failure to run due to mechanical issues, and failure to run due to lack of fuel supply (NREL 2021). Any alternative technology must have proven operational hours, a reliable source of fuel supply, and redundancy capabilities. Sufficiently mitigating these risks would ensure that data center operation is not interrupted during a power utility failure.

The ICE technology is not currently an accepted industry standard for risk-averse applications such as data centers that rely exclusively on in situ backup generation during an emergency, such as GOSDC. In addition, the project owner and PG&E would need to ensure that the fuel supply is adequate (e.g., whether redundant pipeline is needed) and that downstream and upstream impacts have been considered.

Renewable diesel, on the other hand, could provide adequate reliability guarantees and meet the reliability needs of the project should a second source of fuel supply become available or if conventional diesel were used as a secondary fuel source.

5.8 Environmentally Superior Alternative

CEQA requires that if the environmentally superior alternative is the 'no project' alternative, the EIR shall also identify an environmentally superior alternative among the other alternatives" (Cal. Code Regs., tit. 14, § 15126.6, subd. (e)(2)). Alternative 1a, the No Project – No Build Alternative, is the environmentally superior alternative because it would avoid the potentially significant impacts of the proposed project. However, Alternative 1a would not meet any of the project objectives.

Staff compared the other alternatives to the proposed project and determined that each has some advantages in terms of reducing impacts. Staff examined the potential for the alternatives to meet most of the project's basic objectives. Staff's conclusions for the

alternatives are summarized below, including discussions of whether the alternatives could attain the project objectives.

5.8.1 Alternative 1b: No Project – Development of Previously Approved Data Center Project

With the Tier 4 emission controls required by BAAQMD, staff expects the emissions of criteria pollutants of this alternative would be lower than those of the currently proposed GOSBGF, assuming other aspects of the previously approved project did not change. This conclusion is based on the same emission factors but fewer engines and fewer readiness testing and maintenance hours that would accompany this alternative compared to the proposed project. However, staff has insufficient data to reach comparative conclusions for health risks and GHG emissions.

For biological resources, staff compared the impact of nitrogen deposition on serpentine habitat and concluded that this alternative would have a lower impact compared to the proposed project because the previously approved project would have half the NO_x emissions due to fewer engines and fewer readiness testing and maintenance hours that would accompany this alternative.

This alternative could partially meet the key project objective to incorporate the most reliable and flexible form of backup electric generating technology. This alternative could meet the project objective specifying that the selected technology must be considered best practice, because it would use standard commercial gensets for data centers. Changing the project back to its original design (but with Tier 4 emission controls) could reduce its ability to fully meet the project objective of developing a data center that can be constructed in phases and timed to match projected customer growth. The previously approved alternative was smaller in MW size, and it appears that the larger data center proposed is based on increased market projected growth.

Staff considers Alternative 1B to be *somewhat environmentally superior* to the proposed project because of the reduced number of engines and the accompanying reduction in air emissions compared to the proposed project. This alternative would meet all the objectives except being able to match the projected customer growth for the proposed project as stated by the applicant's project objectives.

5.8.2 Alternative 2: Alternative Fuel – Renewable Diesel

Air quality and public health impacts using renewable diesel during project operations would likely be less than those that would occur under the proposed project. However, the reduction would need to be confirmed with testing under controlled conditions for the proposed engines with diesel particulate filters and selective catalytic reduction being operative.

This alternative would have a lower nitrogen deposition impact on serpentine habitat since renewable diesel would provide some reduction of NO_x emissions compared to the proposed project.

The GHG impacts from this alternative would likely be less than those of the GOSBGF due to the reduced GHG emissions during the entire fuel cycle.

Staff considers Alternative 2 to be *somewhat environmentally superior* to the proposed project, although further study and analysis would be needed to fully compare this alternative to the proposed project. Changing the fuel source from conventional to renewable diesel would not require a project redesign or necessarily cause a schedule delay. Currently, the lack of fuel credits for non-mobile sources results in an effective increase to the cost of fuel for projects like GOSDC.

Two options would make this alternative potentially feasible. One option is to use renewable diesel as the primary source for the project, with conventional diesel as its backup fuel. The second option is to solely use renewable diesel. To only use renewable diesel, a second renewable fuel source should be available for reliability purposes. Future renewable diesel fuel suppliers have announced plans to provide additional fuel for California as early as 2022. If these plans are implemented and the supply becomes plentiful, the project owner should revisit the feasibility of replacing conventional diesel with renewable diesel.

If one of these options were fulfilled, this alternative could potentially attain the project objectives.

5.8.3 Alternative 3: Natural Gas Internal Combustion Engines

Criteria pollutant emissions and air quality impacts using natural gas ICEs are expected to be much less than those that would occur with the GOSBGF's diesel engines. No testing data has been provided for toxics emissions, but these are expected to be reduced due to the reductions reported for volatile organic compounds and particulate matter. Therefore, public health impacts using natural gas ICEs would likely be less than those that would occur with the GOSBGF's diesel engines.

This alternative would have a much lower nitrogen deposition impact on serpentine habitat compared to the proposed project because of the reduction of NOx emissions by more than 99 percent.

The GHG impacts of this alternative would likely be less than those of the GOSBGF due to the reduced GHG emissions during the entire fuel cycle.

Staff considers Alternative 3 to be *environmentally superior* to the proposed project due to its deep reductions in criteria air pollutants. Redesigning the project with natural gas ICE technology could increase the number of engines onsite depending upon the MW sizing and physical dimensions. Onsite storage as a secondary supply source is considered potentially infeasible. Therefore, the preferred option to supply fuel would be through pipeline connection. Two independent pipelines may be needed to match the fuel supply reliability of the proposed project.

There are two PG&E feeder pipelines in the project area that could potentially connect to GOSDC. The route to the first nearby pipeline located to the west of the project site is approximately 1.2 miles long. The route of the second pipeline, which would connect to a transmission pipeline east of the project site, is approximately 4.3 miles long. Permitting and construction of the new pipelines would take time to complete.

Table 5-1 (below) summarizes the environmental effects for each alternative compared to the proposed project for the topics of air quality, biological resources, public health, and GHG emissions. As discussed above, staff's comparative analyses for the other topics covered in this EIR show essentially no differences between the impacts identified under the proposed project and the alternatives selected for analysis.

TABLE 5-1 SUMMARY COMPARISON OF IMPACTS OF THE PROPOSED PROJECT TO THE ALTERNATIVES

Environmental Topics and Impacts	Proposed Project	Alternatives			
		No Project – No Build	No Project – Development of Previously Approved Data Center	Alternative Fuel – Renewable Diesel	Natural Gas ICEs
Air Quality, Public Health, Greenhouse Gas (GHG) Emissions					
Criteria pollutants	LTS with Mitigation	No Impact	LTS with Mitigation (Likely Less if changed to Tier 4)	LTS with Mitigation (Likely Less)	LTS with/without Mitigation (Much Less)
Health risks	LTS	No Impact	LTS (Likely Less if changed to Tier 4)	LTS (Likely Less)	LTS (Likely Less)
GHG emissions	LTS	No Impact	LTS (Likely Less)	LTS (Likely Less)	LTS (Likely Less)
Biological Resources					
Nitrogen deposition (cumulative only)	LTS with Mitigation	No Impact	LTS with Mitigation (Likely Less)	LTS with Mitigation (Likely Less)	LTS with Mitigation (Much Less)

Impact conclusions for the proposed project and the alternatives in **Table 5-1** are shown using these abbreviations:

No Impact = the proposed project or an alternative has no potential to affect the resource

LTS = less-than-significant impact, no mitigation required

LTS with Mitigation = mitigation measure(s) required to reduce a potentially significant impact to less than significant

The comparisons of impacts to the proposed project in **Table 5-1** are conveyed using these abbreviations (staff identified no impacts that would be greater than the proposed project):

- Much Less
- Less
- Likely Less (conclusion that is estimated and cannot be fully verified with available data)

5.9 References

- BAAQMD 2020z – Bay Area Air Quality Management District (BAAQMD). BAAQMD Letter Re: BACT Determination for Diesel Back-up Engines Greater Than or Equal to 1,000 Brake Horsepower: Great Oaks South Backup Generating Facility (TN 236091), December 2020. Available online at:
<https://efiling.energy.ca.gov/Lists/DocketLog.aspx?docketnumber=20-SPPE-01>
- Basin 2007 – Basin Research Associates, Inc. (Basin). *Cultural Resources Report for the Metcalf Energy Center (CA-SCL-838), City of San Jose, Santa Clara County, California*. Confidential report prepared for CH2M Hill, Inc., Sacramento, CA, and Energy Facilities Siting and Environmental Protection Division, California Energy Commission, Sacramento. San Leandro, CA, May 2007
- Basin and Hill 1999 – Basin Research Associates and Ward Hill (Basin and Hill). *Cultural Resources Assessment: Coyote Research Park, City of San Jose, Santa Clara County, California*. Prepared for David J. Powers & Associates, San Jose, CA. Prepared by Basin Research Associates, Inc., San Leandro, CA, and Ward Hill, San Francisco, CA, July 1999
- Biodiesel 2021 – Biodiesel Magazine (Biodiesel). Renewable Diesel’s Rising Tide, January 2021. Accessed April 2021. Available online at:
<http://www.biodieselmagazine.com/articles/2517318/renewable-diesels-rising-tide>
- Busby 2004 – Colin I. Busby (Busby). *Cultural Resources Assessment Sanitary Sewer and Road Corridor from Metcalf Energy Center (MEC) to Santa Teresa Boulevard, City of San Jose, Santa Clara County*. Basin Research Associates, Inc. San Leandro, CA, March 25, 2004
- Calpine and Bechtel 1999 – Calpine Corporation and Bechtel Enterprises, Inc. (Calpine and Bechtel). *Application for Certification for the Metcalf Energy Center*. 2 vols. April 1999
- CEC 2020h – California Energy Commission (CEC). Report of Conversation between CEC staff J. Hinde and California Department of Conservation staff K. Kisko regarding FMMP classifications (TN 233242), April 2020. Available online at:
<https://efiling.energy.ca.gov/Lists/DocketLog.aspx?docketnumber=20-SPPE-01>
- CEC 2021g – California Energy Commission (CEC). Report of Conversation between CEC staff J. Hinde and City of San Jose staff A. Petersen regarding the status of the original Special Use Permit for the previously approved Equinix Data Centers project (TN 237308). Available online at:
<https://efiling.energy.ca.gov/Lists/DocketLog.aspx?docketnumber=20-SPPE-01>
- CEC 2021h – California Energy Commission (CEC). Report of Conversation between CEC staff J. Hinde and City of San Jose staff K. Ice regarding permitted developments in the North Coyote Valley (TN 237309). Available online at:
<https://efiling.energy.ca.gov/Lists/DocketLog.aspx?docketnumber=20-SPPE-01>

- CDOC 2019a – California Department of Conservation (CDOC). Farmland Mapping and Monitoring Program. Santa Clara County Important Farmland Data Availability; California Important Farmland Finder and Important Farmland Time Series. Accessed on November 9, 2020. Available online at: <https://www.conservation.ca.gov/dlrp/fmmp/Pages/SantaClara.aspx>
- CDOC 2019b – California Department of Conservation (CDOC). Farmland Mapping and Monitoring Program. Important Farmland Categories. Accessed on November 9, 2020. Available online at: <https://www.conservation.ca.gov/dlrp/fmmp/Pages/Important-Farmland-Categories.aspx>
- Data Center 2021 – DataCenter Knowledge (Data Center). eBay Goes Live With its Bloom Powered Data Center, September 2013. Accessed April 19, 2021. Available online at: <https://www.datacenterknowledge.com/archives/2013/09/26/ebay-goes-live-with-its-bloom-powered-data-center>
- Enchanted Rock 2020 – Enchanted Rock (Enchanted Rock). Decarbonized Resilience—Assessing Alternatives to Diesel Backup Power, June 2020. Prepared for Enchanted Rock, LLC. Prepared by the Brattle Group. Accessed October 2020. Available online at: https://brattlefiles.blob.core.windows.net/files/19026_decarbonized_resilience_white_paper_-_final.pdf
- Farm Energy 2021 – Farm Energy (Farm Energy). Biodiesel Fuel Quality, April 2019. Accessed March 31, 2021. Available online at: <https://farm-energy.extension.org/biodiesel-fuel-quality/>
- Fuel Cell 2021 – Fuel Cell Store (Fuel Cell). Processing Alternative Fuels for Fuel Cells, March 2019. Accessed April 19, 2021. Available online at: <https://www.fuelcellstore.com/blog-section/processing-alternative-fuels-for-fuel-cells>
- GenCell 2021 – GenCell (GenCell). Comparing Fuel Cell Technologies. Accessed April 19, 2021. Available online at: <https://www.gencellenergy.com/news/comparing-fuel-cell-technologies/>
- Green Fleet 2021 – Government Fleet (Green Fleet). What You Need to Know About Renewable Diesel, March 2016. Accessed March 29, 2021. Available online at: <https://www.government-fleet.com/156621/what-you-need-to-know-about-renewable-diesel>
- Hydrogen 2021 – Hydrogen Fact Sheet (Hydrogen). Hydrogen Production - SMR. Accessed April 19, 2021. Available online at: <https://web.archive.org/web/20060204211916/http://www.getenergysmart.org/Files/HydrogenEducation/6HydrogenProductionSteamMethaneReforming.pdf>
- Jurich and Martinez 2008 – Denise Jurich and Jesse Martinez, PBS&J (Jurich and Martinez). Passenger Rail Line. California Department of Parks Recreation DPR 523 form. Recorded February 25 and July 25, 2008

- NREL 2021 – National Renewable Energy Laboratory (NREL). A Comparison of Fuel Choice for Backup Generators, March 2019. Accessed January 2021. Available online at: <https://www.nrel.gov/docs/fy19osti/72509.pdf>
- Power Magazine 2021 – Power Magazine (Power Magazine). Vistra Energizes Massive 1.2-GWh Battery System at California Gas Plant. By Sonal Patel. January 14, 2021. Accessed in March 2021. Available online at: <https://www.powermag.com/vistra-energizes-massive-1-2-gwh-battery-system-at-california-gas-plant/>
- Microsoft 2021 – Microsoft. Fuel Cells for Data Centers. By Li Zhao. February 2016. Accessed in March 2021. Available online at: <https://www.microsoft.com/en-us/research/wp-content/uploads/2016/02/FCDC-TechReport.pdf>
- POST 2021 – Peninsula Open Space Trust (POST). POST Purchases 206-Acre Property in Mid-Coyote Valley. San Jose, California. March 17, 2021. Available online at: https://openspacetrust.org/post-news/post-protects-mid-coyote-valley-property/?utm_source=pardot&utm_medium=email&utm_campaign=newsletter&utm_content=headline
- Public 2020o – Public comment. Bill Dunmyer. Comments on 20-SPPE-01: Great Oaks South Backup Generating Facility (TN 234335), August 2020. Available online at: <https://efiling.energy.ca.gov/Lists/DocketLog.aspx?docketnumber=20-SPPE-01>
- Rasmussen 2021 – Schneider Electric (Rasmussen). Impact of Leading Power Factor on Data Center Generator Systems, 2014. Accessed on March 12, 2021. Available online at: https://3dfs.com/wp-content/uploads/2015/11/VAVR-9EJ262_R0_EN.pdf
- Reinoehl 2006 – Gary Reinoehl (Reinoehl). Memorandum Regarding Determination of Significance of Site CA-SCI-838. Cultural Resources Unit, California Energy Commission, Sacramento, March 2, 2006
- San Jose 2016 – City of San Jose (San Jose). Planning, Building, & Code Enforcement. *Initial Study/Mitigated Negative Declaration for the Equinix Data Centers (SV-12, SV-13, SV-14) and Santa Teresa Substation, File No. SP15-031*. Appendix A – Air Quality Assessment, June 16, 2016. Available online at: <https://www.sanjoseca.gov/your-government/departments/planning-building-code-enforcement/planning-division/environmental-planning/environmental-review/negative-declaration-initial-studies/equinix-data-centers-sv-12-sv-13-sv-14>
- San Jose 2020a – City of San Jose (San Jose). Planning, Building & Code Enforcement. *Envision San Jose 2040 General Plan*. Adopted November 1, 2011. As amended March 16, 2020. Chapter 1, pgs. 27–28; Chapter 4, pgs. 19 and 24; Chapter 5, pgs. 8–11 and 14–15; Chapter 7, pg. 4; General Plan 2040 Land Use Map, Land Use/Transportation Diagram, and Planned Growth Areas Diagram. Accessed on October 20, 2020 and February 22, 2021. Available online at: [ALTERNATIVES
5-38](https://www.sanjoseca.gov/your-government/departments/planning-building-</p></div><div data-bbox=)

code-enforcement/planning-division/citywide-planning/envision-san-jos-2040-general-plan

San Jose 2020b – City of San Jose (San Jose). San Jose Reach Code. Prohibit Natural Gas Infrastructure in Newly Constructed Buildings, January 2021. Accessed on March 2021. Available online at: <https://www.sanjoseca.gov/your-government/departments-offices/environmental-services/climate-smart-san-jos/2019-reach-code-initiative>

San Jose 2021 – City of San Jose (San Jose). San Jose Code of Ordinances. Chapter 17.845.040 - Exception for Hospitals, Attached Accessory Dwelling Units, and Facilities with a Distributed Energy Resource., March 5, 2021. Accessed on March 19, 2021. Available online at: https://library.municode.com/ca/san_jose/codes/code_of_ordinances?nodeId=TI17BUCO_CH17.845PRNAGAINNECOBU

SV1 2020b – SV1, LLC. (SV1). Application Appendices A through K: Great Oaks South Backup Generating Facility (TN 232467-1, -2, -3), March 2020. Available online at: <https://efiling.energy.ca.gov/Lists/DocketLog.aspx?docketnumber=20-SPPE-01>

SV1 2020d – SV1, LLC. (SV1). SV1 Responses to CEC Data Requests Set 2, Part III: Great Oaks South Backup Generating Facility. Attachment BIO DR-39, Special Use Permit (TN 233005-3). May 2020. Available online at: <https://efiling.energy.ca.gov/Lists/DocketLog.aspx?docketnumber=20-SPPE-01>

SV1 2020j – SV1, LLC. (SV1). SV1 Revised AQ and HRA Modeling Analysis: Great Oaks South Backup Generating Facility (TN 234479), August 2020. Available online at: <https://efiling.energy.ca.gov/Lists/DocketLog.aspx?docketnumber=20-SPPE-01>

SV1 2020k – SV1, LLC. (SV1). Small Power Plant Exemption Application: Great Oaks South Data Center. Section 5.0 Alternatives (Revised) (TN 234485), August 2020. Available online at: <https://efiling.energy.ca.gov/Lists/DocketLog.aspx?docketnumber=20-SPPE-01>

SV1 2020l – SV1, LLC. (SV1). SV1 Supplemental Responses to Revised AQ Analysis – SPPE Application: Great Oaks South Backup Generating Facility (TN 234586), September 2020. Available online at: <https://efiling.energy.ca.gov/Lists/DocketLog.aspx?docketnumber=20-SPPE-01>

SV1 2021i – SV, LLC. (SV1). SV 1 Revised Air Quality and Public Health Analysis: Great Oaks South Backup Generating Facility (TN 237152), March 2021. Available online at: <https://efiling.energy.ca.gov/Lists/DocketLog.aspx?docketnumber=20-SPPE-01>

UNESCO 2021 – United Nations Educational, Scientific, and Cultural Organization (UNESCO). World Water Assessment Programme, 2017. Accessed March 2021. Available online at: <http://www.unesco.org/new/en/natural-sciences/environment/water/wwap/facts-and-figures/all-facts-wwdr3/fact-7-water-biofuel/>

- U.S. DOE 2020a – U.S. Department of Energy (U.S. DOE). U.S. DOE Office of Energy Efficiency and Renewable Energy. Types of Fuel Cells. Accessed October 2020. Available online at: <https://www.energy.gov/eere/fuelcells/types-fuel-cells>
- U.S. DOE 2020b – U.S. Department of Energy (U.S. DOE). U.S. DOE Office of Energy Efficiency and Renewable Energy. Hydrogen Pipelines. Accessed February 2021. Available online at: <https://www.energy.gov/eere/fuelcells/hydrogen-pipelines>
- U.S. DOE 2020c – U.S. Department of Energy (U.S. DOE). U.S. DOE Office of Energy Efficiency and Renewable Energy. Alternative Fuels Data Center. Accessed February 2021. Available online at: https://afdc.energy.gov/fuels/emerging_hydrocarbon.html
- U.S. EIA 2021 – U.S. Energy Information Administration (U.S. EIA). Biofuels Explained. Accessed April 2021. Available online at: <https://www.eia.gov/energyexplained/biofuels/>
- ZDNet 2021 – ZDNet (ZDNet). Data centers want to be a lot greener. One big problem is holding them back. Accessed April 2021. Available online at: <https://www.zdnet.com/article/data-centers-want-to-be-a-lot-greener-one-big-problem-is-holding-them-back/>

Section 6

Authors and Reviewers

6 Authors and Reviewers

Lead Agency—California Energy Commission

Technical Staff / Section Authors

Mark Hamblin (Aesthetics)

Jeanine Hinde (Agriculture/Forestry, Land Use and Planning)

Wenjun Qian, Ann Chu, Tao Jiang, (Air Quality, Greenhouse Gas)

Andrea Stroud (Biology)

Melissa Mourkas, Gabriel Roark, Cameron Travis (Cultural and Tribal Cultural Resources)

Laiping Ng (Energy/Energy Resources)

Kenneth Salyphone (Energy/Energy Resources)

Garry Maurath (Geology/Soils, Minerals)

Ryan Casebeer (Hazards/Hazardous Materials)

Mike Conway (Hydrology/Water Resources, Wildfire)

Abdel-Karim Abulaban, Kenneth Salyphone (Noise)

Ellen LeFevre (Population/Housing, Public Services, Recreation, Environmental Justice, Mandatory Findings of Significance)

Ashley Gutierrez (Transportation)

Abdel-Karim Abulaban (Utilities/Service Systems)

Supervision and Management

Joseph Hughes, Air Quality Unit Supervisor

Thomas Gates, Cultural Unit Supervisor

Steve Kerr, Siting and CEQA Review Unit Supervisor

Mark Hesters, Energy Reliability Unit Supervisor, Energy Assessments Division

Eric Knight, Acting Biology Unit Supervisor, Environmental Office Manager

Geoff Lesh, Engineering Office Manager

Shawn Pittard, Deputy Director—Siting, Transmission and Environmental Protection

Project Management/Legal

Lisa Worrall, Senior Environmental Planner

Lisa DeCarlo, Staff Counsel

Kerry Willis, Senior Staff Counsel

Appendix A

Project's Jurisdictional and Generating Capacity Analysis

Appendix A: Project's Jurisdictional and Generating Capacity Analysis

The Great Oaks South Backup Generating Facility (GOSBGF) (project) would be part of the Great Oaks South Data Center (GOSDC) to be located in the City of San Jose. The GOSBGF would include 36 diesel-fired standby generators (gensets) that would provide emergency backup power supply for the GOSDC project only during interruptions of electric service delivered by Pacific Gas and Electric (PG&E). The gensets would be electrically isolated from the PG&E electrical transmission system with no means to deliver electricity offsite of GOSDC (the distribution line would only allow power to flow in one direction—from PG&E electrical transmission line to GOSDC).

Each generator would have a nameplate output capacity of 3.25 megawatts (MW) and continuous steady-state output capacity of 2.5 MW. The maximum total facility load requirements would not exceed 99 MW. This includes the critical Information Technology (IT) load of the servers and server bays, the cooling load of the IT servers and bays, and the facility's ancillary electrical and telecommunications equipment operating loads to support the data customers and campus.

The California Energy Commission is responsible for reviewing, and ultimately approving or denying, all applications for thermal electric power plants, 50 MW and greater, proposed for construction in California. (Pub. Resources Code, § 25500.) The Energy Commission has a regulatory process, referred to as the Small Power Plant Exemption (SPPE) process, which allows applicants with projects between 50 and 100 MW to obtain an exemption from the Energy Commission's jurisdiction and proceed with local approval rather than requiring an Energy Commission certificate. The Energy Commission can grant an exemption if it finds that the proposed project would not create a substantial adverse impact on the environment or energy resources. (See Pub. Resources Code, § 25541.)

Staff calculated a net deliverable or useable electricity capacity of more than 50 MW and less than 100 MW from the GOSDC backup generation facility, qualifying it for a Small Power Plant Exemption under the capacity criterion. The following provides a summary of the factors supporting this conclusion, with a more detailed discussion of these factors following after.

1. The diesel-fueled reciprocating engine generators use a thermal energy source.
2. The gensets and the associated GOSDC equipment that they would support would all be located on a common property under common ownership sharing common utilities and the 36 gensets should be aggregated and considered as one thermal power generating facility with a generation capacity of greater than 50 MW.
3. While GOSBGF has an apparent installed generation capacity greater than 100 MW (36 gensets, each with 3.25 MW peak capacity), the "extra" MW installed are

redundant. In no case would the maximum facility-wide load demand exceed 99 MW due to physical constraints built into the project.

4. Jurisdictional analyses are based on the net MWs that can be delivered for “use” (i.e., to a data center facility or the electricity grid), not the gross or nameplate rating. Unlike a traditional power plant supplying electricity to the grid, for a data center the maximum load being served is determinative and not the combined net capacity of the installed generators. Here, the maximum facility-wide GOSDC load requirement would be 99 MW.
5. The backup generators would be exclusively connected to the GOSDC buildings and would not be capable of delivering electricity to any other user or to the electrical transmission grid. The proposed redundancies built into the design of the facility are to ensure performance reliability, not to generate and supply the GOSDC facility with more than 99 MW of electricity.
6. The restriction on the facility’s load demand is hardwired through various control systems. It would be physically impossible for the gensets to generate more electricity than the buildings require. Excess electricity would damage components or at a minimum, isolate the GOSDC loads from the backup generators.

In order to make a jurisdictional recommendation, staff assessed the generating capacity of the facility, using the following:

1. GOSBGF is a thermal power plant under the Energy Commission’s definition.

The Warren-Alquist Act defines a thermal power plant “as any stationary or floating electrical generating facility using any source of thermal energy, with a generating capacity of 50 megawatts or more, and any facilities appurtenant thereto.” (Pub. Resources Code, § 25120.) The GOSBGF is made up of gensets that use diesel fossil-fueled engines to convert the thermal energy in the diesel fuel¹ into electricity from a rotating generator, thus - each genset is an electrical generating device that uses a source of thermal energy. The facility proposes to use 36 such gensets to service GOSDC.

The 36 gensets, and the associated GOSDC that they would support, would all be located on a common property under common ownership sharing common utilities. The gensets would operate to provide backup electricity to GOSDC when its connection to the grid is lost. The gensets system includes a 6-to-make-5 design configuration, meaning that for every five standby generators that would support load in the event of a utility failure, there is one redundant generator. All 36 gensets would never operate simultaneously at 100 percent capacity. However, any genset can function either as a back up if the grid goes down or a back up to the back up gensets, so there is not a functional difference in the type of engine or generator between each genset. All of the backup gensets at the

¹ Diesel fuel is composed of a mixture of hydrocarbons, containing chemical energy. When ignited, this chemical energy is converted to thermal energy.

GOSDC would share a common trigger for operation during an emergency: the transfer switch isolating the GOSDC from the grid.

2. Title 20, California Code of Regulations section 2003 does not control.

The GOSDC would be installed during the initial construction of the project by the project owner, but there is no specific timeline proposed for when the GOSDC will need the full capacity of the facility; the exact timing of individual leases that fill server bay space is subject to the market decisions of disparate customers. Therefore, it may be years before the GOSDC is at full load. Nevertheless, for purposes of this analysis, staff assumes full load will eventually be reached.

Title 20, California Code of Regulations, section 2003 specifies how the Energy Commission calculates “generating capacity” for jurisdictional determinations, including the 50 MW threshold for the definition of a thermal power plant under section 25120. However, section 2003, which uses nameplate capacity in addition to consideration of other factors, only addresses steam and combustion turbines, not diesel-fueled gensets as used by the GOSDC, and is therefore not controlling here. There are also other reasons to conclude that simply focusing on nameplate capacity here is not appropriate.

For a typical power plant, outside the factors identified in section 2003, there is almost no limit on what might be generated and provided to the grid, so the approach outlined in that provision identifies the potential maximum generating capacity and is reasonable for those facilities. This is not the case with data centers, where producing electricity in excess of what the data center requires would be economically wasteful and likely result in damage to the facility.

In traditional turbine-based power plants, parasitic loads (fans, pumps, and heaters) are external to the turbine; the generating capacity is the total net MWs at the switchyard bus; that is, gross MWs less parasitic loads. If the grid “demands” more, the power plant cannot deliver more electricity unless it burns fuel at a higher rate or reduces parasitic loads. Even then, equipment would have to have the physical capacity to burn more fuel and convert thermal energy into rotational energy, and then operate the generator at a higher output. The calculations assume normal conditions, where generation would be under average operating conditions, and assumes the onsite loads (often called parasitic loads) are also average (e.g., a filter backwash pumping load would not be included if that operation only occurs monthly or annually). Typically, at a traditional power plant, no redundant generating equipment is installed.² Generating capacity is determined based on the net capacity of all of the generators that are proposed to be installed

² At modern power plants, some equipment design includes 50 to 100 percent redundancy. The redundant equipment is generally limited to certain critical components like transformers, which are often custom items with long lead times for fabrication, or boiler water feed pumps, which are intended to protect the steam boiler components from damage from too much heat if circulating water flow is interrupted.

because they are to be connected to the grid where there is almost no limitation on the amount of MWs the grid can “take” from the facility.

Typically, backup generating facilities serving data centers are not physically able to send excess electricity to the grid and all electricity generated must be absorbed by the data center itself. Data centers are designed with precise loads, assuming full build-out, and providing electricity in excess of these loads is not only economically wasteful (burning fuel for no benefit or reason), but can result in damage to the sensitive components located inside these data centers, as well as to the heating, ventilation, air conditioning (HVAC) unit and other systems serving the buildings. Therefore, for purposes of evaluating the capacity of backup generating facilities serving data centers, it is reasonable for staff to consider that the controlling factor in how much electricity is capable of being generated is the building load.

3. Data Centers are analyzed differently than conventional power plant facilities for a number of reasons.

To determine the net generating capacity of a collection of backup gensets³ for data centers, the approach is slightly different but consistent with that used on a traditional power plant. The differences are: 1) the end user is the building and data servers, not the grid, and 2) extra gensets or generating capacity are installed to provide electricity not only for building and data server loads, but to provide redundancy that achieves a statistical reliability that can be marketed to data customers.

Staff’s approach is consistent with widely practiced standards. For example, ASHRAE’s (American Society of Heating, Refrigerating and Air-Conditioning Engineers) Energy Standards for Data Centers do not use the nameplate or gross capacity, but the net generating capacity of data centers, or the actual cooling and IT server loads.⁴ These ASHRAE standards are performance-based as opposed to prescriptive standards, advocating the position that determination of load requirements should be based on project-specific operational characteristics.

Staff’s approach to calculating generating capacity has also been devised based on the International Organization for Standardization (ISO), which sets standards for different industries including the energy industry. The ISO standards are widely accepted by, and used throughout, the energy industry. Consistent with staff’s method, the ISO specifies

³ Backup generators, by definition, generally have the following characteristics: reliable starts, fast starting to full load, cheap to maintain as they sit idle most of the time, use cheap and stable fuel as the fuel sits unused most of the time, and use high-density fuels to limit storage volumes onsite so the project can operate if “islanded.”

⁴ American National Standards Institute (ANSI)/ASHRAE Standard 90.4-2016, www.ashrae.org.

that generating capacity should be the net capacity at average annual ambient conditions.⁵

In the case of GOSDC, the load served acts as a limit to the generation levels from the gensets in the backup generating facility. This factor is not present in a capacity generation determination for a typical power plant feeding to the grid because the grid does not act in the same way the "GOSDC grid" does. If the breakers between the GOSDC building and the gensets were to trip due to excess generation, the data center would be isolated from the backup generators, the servers and building cooling would be forced to shut down. This subverts the intention of using the backup generators to maintain reliable and high-quality electricity. Excess electricity would damage components or at a minimum, isolate the load from the backup generators. If building cooling load were to increase (e.g., the day gets warmer), the genset(s) would open the engine fuel throttle to increase generation output and match demand but would still not exceed the combined 99 MW IT and building demand.

4. GOSDC's capacity will not exceed 99 MW.

The exact number of backup generators that could operate in an emergency depends on actual cooling and IT server loads, and the reliability and performance of the backup generators. In no case would the combined output of backup generators exceed the prescribed maximum load of 99 MW. As explained above, it would be physically impossible for the gensets to generate more electricity than the buildings require. Non-operating backup generators would be reserved as redundant generators, ready to start if other generators fail. For the purposes of testing and maintenance, only one generator would operate at any given time.

The maximum demand of 99 MW would be fixed by the specification and installation of electrical buses and panels, switchyard, and breakers that would have an upper electrical capacity limit. The cooling equipment's maximum demand would be fixed by the specification and installation of equipment that have an upper physical limit of cooling capacity, and would include some redundant cooling equipment. Such redundant equipment could only be operated if a primary component fails, and could not be operated in addition to the primary components, which would damage the data center. The data center would be served from the grid or from the emergency gensets with electricity that matches and does not exceed demand for operations of the data server bays and buildings.

The heat rejected by the IT servers must be removed from each server bay or else the server equipment and data would be damaged. Any attempt to add more servers to a bay would result in direct, immediate and dire consequences because the building and equipment would have been designed for an upper critical IT load. It is important to note

5 ISO 3046-1 Reciprocating Internal Combustion Engines – Performance, www.iso.org/standards.

that the maximum combined facility load of 99 MW is based on 100 percent critical IT load with maximum cooling on the hottest day. In actuality, the critical IT load and related cooling load would typically be less than this worst-case scenario.

In recent years, the power and energy industries have advanced in terms of software development and hardwired digital control to permanently limit generation capacity. The generation by the GOSBGF would be regulated by each building and each bay in that building. Software would be used to operate the gensets in a manner that meets the bay and building demand. If the demand decreases (i.e., less mechanical load for cooling, etc.), the generator sets would automatically adjust the loading and corresponding electrical output. If a generator or the software were to malfunction and attempt to generate more electricity than the building demand, individual electrical generator controllers would shut down. The GOSDC would employ physical electronic devices and software technology (automatic throw-over main breakers and building load management system) that limit the facility's electrical load.

For the maximum generating capacity to increase, the project would have to be redesigned to physically fit more servers in a server bay or add more bays. The project owner would have to address the unplanned increase in electricity demand for normal operations, because the existing electrical equipment would not be sized for the higher electricity throughput. Additionally, the project owner would have to install additional cooling equipment units to address the increased heat rejected by the server bays and buildings, and install additional redundant cooling equipment, additional uninterruptable power supply (UPS) battery units, and additional gensets to maintain the level of backup and reliability to match the new higher levels of load. This is an unlikely outcome because such changes are not trivial and would result in a cascade of design and physical changes to the facility.

When the GOSDC is at full load, its worst-case day combined IT and building load⁶ would not exceed 99 MW. The project proposes generators that total more than 99 MW for purposes of redundancy. The combined generating capacity of the installed operational gensets is autonomously determined by the electrical equipment in the GOSDC server bays and building equipment in use at the time of an emergency. The GOSDC has been designed with six generation yards, or lineups; two for each IT building. Each lineup would consist of six gensets, one of which would be redundant. The emergency operation of each lineup is fully automated. Once the GOSDC loses connection to the local grid, the transfer switch isolates the GOSDC from the local PG&E transmission grid and all non-redundant (primary) gensets assigned to a server bay set initiate startup. As the gensets start, synchronize, and take up load associated with their server bays and building equipment, the UPS system would be sized to support a 1,250 kilowatt load for up to 6.5

⁶ Based on the hottest, most humid day of the year and with all IT servers in use at their full usage rate.

minutes⁷ of power to smoothly transition the GOSDC customer's data servers from the grid to the emergency gensets (SV1 2020a, Section 2.2.5.2). If a genset or two fail to start or synchronize, the remaining genset in the 6-to-make-5 server bay initiates a startup and the other gensets in the server bay set ramp up to higher output levels. The output of the genset assigned to a server bay set match (meet but cannot exceed) the GOSDC data customer's IT demand in the respective server bay and the server bay's HVAC demand. The combined output of the server bay set is autonomously determined by the electrical equipment in the GOSDC server bays and building equipment.

Combined output would be limited by sizing the electricity handling equipment that would throttle transfer capacity to no more than 99 MW, which would prevent damage to IT servers and building equipment. Therefore, it would be physically impossible for the gensets to generate more electricity than what the data center would use, or more than 99 MW.

⁷ The gensets are expected to be on and synchronized within a minute or so, but the UPS can supply up to 6.5 minutes of power at 100 percent full-load UPS to ensure a complete transition from the grid to the gensets.

Appendix B

Pacific Gas and Electric Company Santa Teresa
Substation Details and Emergency Operations

Appendix B: Pacific Gas and Electric Company Santa Teresa Substation Details and Emergency Operation

This appendix includes a discussion of the Pacific Gas and Electric Company's (PG&E) electrical system reliability (including supporting information) and emergency operations.

Electrical System Reliability

Apart from readiness testing, the backup generators are designed to operate only when the electric system is unable to provide power to the data center. To understand the potential for the backup generators to operate during emergencies, one needs to know the conditions under which the electric system is unable to provide power to the data center. There are essentially three conditions that might result in the operation of the backup generators:

- A fault occurs (power supply interruption) or planned maintenance is required on the equipment interconnecting the data center to the PG&E grid and the data center's electricity needs cannot be met.
- An outage or fault occurs on the utility transmission system and PG&E is unable to provide power to the data center.
- A Public Safety Power Shutoff (PSPS) impacts the utility transmission system and the data center is not able to receive power from PG&E.
- An energy shortage crisis similar to the one in late Summer 2020 where the utility (e.g. PG&E) is unable to supply electricity to the data center or the data center operators voluntarily disconnect from the utility and relies on backup generators to provide the needed electricity.

Due to the design of the data center interconnection with PG&E, the design of the PG&E transmission network, and the historical and expected impacts of PSPS, staff expects the backup generators would only be used in rare events. Emergency use of standby generator engines is allowed only under specific, limited, and unplanned situations. Emergency operation may occur during a failure or disruption of the regular electric power, or under other limited situations that are defined by regulations, including the California Air Resource Board Airborne Toxic Control Measure and Bay Area Air Quality Management District Rule 9-8-231. These requirements ensure that emergency use only occurs during events that pose an imminent threat or hazard to public safety or well-being.

The proposed data center interconnection to PG&E includes redundant facilities that would allow the data center energy needs to be met even when maintenance is required on the transmission system. Thus, transformer or transmission line maintenance could be performed without interrupting the supply of electricity from PG&E.

The Santa Teresa Substation would have three transformers to meet the full GOSDC loads and other PG&E customers connected to the substation. The two existing Metcalf -

Edenvale 115 kilovolt (kV) lines would be looped into the new Santa Teresa Substation. These two lines may require reconductoring to independently supply the full data center load.

The California Independent System Operator (ISO) and PG&E are responsible for the reliability of the transmission network and are required to maintain compliance with national, regional, state, and local standards. These standards are complicated but, generally speaking, they require that no loads be dropped, (customers losing services), when any single element of the bulk electric system is forced out of service. For the GOSDC, this means that PG&E should be able to supply power whenever any single part of the transmission system is out of service, sometimes called an N-1 or single contingency condition. This is the equivalent of, at a minimum, providing a looped system for the GOSDC.

The PG&E outage data provided by PG&E shows the benefit of PG&E's redundant interconnections (PGE 2020a). The data response indicated that from 2007 to 2020 there were eighteen outages of either the Metcalf-Edenvale #1 and #2 115 kV lines and none of the outages resulted in customers losing services.

Wildfire policies could impact PG&E's ability to supply power to GOSDC if curtailments on the transmission system interrupt supplies to the Santa Teresa Substation. A PSPS essentially de-energizes power lines to prevent the lines from causing or being damaged by wildfires. The PSPS' events to date have been generally limited to high fire risk zones and only implemented under special conditions. The PG&E 115 kV transmission line interconnection points for the Santa Teresa Substation are not in high risk zones. A line de-energization in one of PG&E's high-risk fire zones to reduce the risk of lines causing a wildfire could reduce the electricity transmission access and supply to the Edenvale Substation. The future impact of safety shutoffs on the PG&E system are not currently known – to date, two broadly implemented PSPS events in PG&E service territory during fall 2020 had no impact on the Edenvale Substation. As the utilities and regulators try to balance the costs and benefits of PSPS by fine tuning and targeting the implementation, the mostly likely outcome is that future PSPS events would have even fewer potential effects on PG&E's territory.

Energy shortages, like those that occurred on two occasions in 2020, could prevent a utility from supplying the data center electricity needs and the data center would then rely on backup generators. Recently, the California Public Utilities Commission (CPUC) has adopted a new pilot program (D.21-03-056), currently in effect through 2025, which ordered PG&E, Southern California Edison and San Diego Gas and Electric to administer the Emergency Load Reduction Program (ELRP). Data centers could voluntarily participate in the ELRP and in the event of an energy shortage emergency, they would disconnect from the grid and use their on-site generators to supply electricity. The ELRP provides a mechanism for utilities to measure the load reduction and provide financial compensation to the participants. The ELRP does not affect the likelihood of emergency shortage events. The last time an energy shortage event occurred, like those in 2020, was 2001. If the

past is indicative of future shortage, they are rare events.

Still, CEC staff expects the GOSDC backup generators to be required to supply data center loads only rarely. The generators would not be used when maintenance is performed on the transmission line or substation connecting the data center to the PG&E grid. The PG&E system around the Metcalf and Edenvale substations can supply power to the data center from two 115 kV transmission lines. These interconnections make the energy supply to the data center as reliable as a looped system. Finally, PSPS events have not impacted customers directly connected to the Edenvale Substation and as staff expects the effects of PSPS events to decrease over time, staff does not think this would be an issue for the GOSDC going forward.

Emergency Operations

Historical Power Outage Frequency

This section reviews information on the likelihood of an interruption of the electrical supply that would trigger emergency operations of the project's standby generators.

Pursuant to CPUC requirements, PG&E annually publishes a review of its system reliability. In the report covering 2019¹, "major event days" contributed to extended durations of outages. Average customer outages were 1,365 minutes per customer (System Average Interruption Duration Index or SAIDI), which is the amount of time the average PG&E customer experienced a sustained outage or outages (being without power for more than five minutes). Outages were much shorter in the project area. When considering only the portion of PG&E's system within its San Jose Division, outages were 275.7 customer-minutes (SAIDI). This indicates that San Jose area customers experience outages that are shorter in duration than the system-wide average. For the frequency of PG&E's customers experiencing outages in 2019, PG&E shows, on average, outages occurred nearly twice in the year for all customer types (1.874 for the System Average Interruption Frequency Index or SAIFI). The transmission system index (0.200 SAIFI in 2019) demonstrates a much higher reliability for transmission service when compared with the combination of transmission and distribution system service.

In addition, electricity for the GOSDC would be supplied by the new PG&E Santa Teresa Substation which is designed to loop into the existing Metcalf-Edenvale 115 kV transmission lines. The PG&E system around the Metcalf and Edenvale substations can supply power to the GOSDC from two 115 kV transmission lines. These interconnections make the energy supply to the data center as reliable as a looped system. The PG&E outage data provided by PG&E shows the benefit of PG&E's redundant interconnections (PG&E 2020a). The data response indicated that from 2007 to 2020 there were eighteen

1 Pacific Gas and Electric Company, 2019 Annual Electric Reliability Report (Per Decision 16-01-008), dated July 15, 2020. Available online at: https://www.pge.com/pge_global/common/pdfs/outages/planning-and-preparedness/safety-and-preparedness/grid-reliability/electric-reliability-reports/CPUC-2019-Annual-Electric-Reliability-Report.pdf

outages of either the Metcalf-Edenvale #1 and #2 115 kV lines and none of the outages resulted in customers losing services. In addition, PSPS events have not impacted customers directly connected to the Edenvale Substation and as we expect the effects of PSPS events to decrease over time we do not think this would be an issue for the GOSDC going forward.

The above information would be indicative of historical electric system reliability but cannot be used to predict the frequency and duration of reasonably foreseeable future electrical outages that could trigger emergency operations of the standby diesel generators. The data from PG&E indicates that by receiving service from PG&E's redundant interconnections and by being located in the San Jose Division, the data center would receive a much higher level of reliable electric service than average customers served by the combination of the transmission and distribution system.

BAAQMD's Review of Data Center Diesel Engine Operations

Scoping comments from the Bay Area Air Quality Management District (BAAQMD) provided a review of data centers that initiated operation of diesel engines for "non-testing/non-maintenance" purposes, for the purpose of informing staff's consideration of scenarios of backup power generation operations beyond routine testing and maintenance (BAAQMD 2020x; BAAQMD 2021a). The BAAQMD's review covers a recent 13-month period (September 1, 2019 to September 30, 2020) that spans different types of emergency situations across California.

There are 66 data centers under the jurisdiction of the BAAQMD. Staff at BAAQMD gathered information from 45 data center facilities under its jurisdiction, and the attachment to BAAQMD's scoping comments listed 20 facilities that reported some level of "non-testing/non-maintenance" diesel engine use in the 13-month period (CEC 2021I).

The scope of BAAQMD's review can be summarized as follows:

- Period covered: 13 months (9,504 hours)
- Facilities (data centers) under BAAQMD jurisdiction: 66 data centers
- Facilities from which information was collected: 45 data centers
- Facilities responding with some "non-testing/non-maintenance" use: 20 data centers
- Permitted engines at the 20 facilities responding: 288 engines
- Installed generating capacity of engines at the 20 facilities responding: 686.5 MW
- No information was provided for the 25 facilities that did not report any non-testing/non-maintenance use or the other 21 facilities under BAAQMD's jurisdiction that were not surveyed in this data gathering effort.

The BAAQMD normally issues permits for standby diesel generator engines that require each owner or operator to maintain records of the number of operating hours for each "emergency" and the nature of the emergency. The types of events within the BAAQMD's

review period include a Governor-declared State of Emergency, other outages, power quality events, and human errors. The data shows that 75 percent of all engine-hours occurred either during the August 2020 State of Emergency or the subsequent heat event in September 2020. Staff does not consider this a typical year, and the data is probably not representative or indicative of future years.

For the 20 data centers listed in BAAQMD’s review, the total permitted and installed generating capacity of these facilities equals 686.5 MW, across 288 individual diesel engines. The total amount of “non-testing/non-maintenance” runtime of all of these 288 engines amounted to approximately 1,877 engine-hours of operation.

Table B-1 summarizes the runtimes found by BAAQMD’s review for each of the 20 data centers. The BAAQMD’s review identified one data center facility that ran diesel generators for approximately 400 hours for non-testing/non-maintenance purposes during this time period. **Table B-1** shows that this facility has over 40 individual engines permitted at the site, for an average runtime of about 10 hours per engine. The different data centers within the BAAQMD’s review showed that 9 of the 20 facilities responding had fewer than 50 hours of operating one or more diesel engines for non-testing/non-maintenance purposes.

TABLE B-1: BAAQMD’S REVIEW OF NON-TESTING/ NON-MAINTENANCE OPERATION (ENGINE-HOURS)

Data Center	# of Permitted Engines	# of Engines with Non-Testing/ Non-Maintenance Operations	Sum of Non-Testing/ Non-Maintenance Operations (Engine-Hours)	Average Hours of Operations per Engine Used
1	10	10	83	8.3
2	5	5	77	15.3
3	6	6	108	18.0
4	44	44	22	0.5
5	3	2	11	5.5
6	6	6	219	36.5
7	24	24	202	8.4
8	26	24	10	0.4
9	5	5	26	5.2
10	41	40	401	10.0
11	14	11	75	6.8
12	11	11	275	25.0
13	5	5	85	17.0
14	22	8	28	3.4
15	8	7	98	14.0
16	17	4	10	2.4
17	2	2	4	2.0
18	8	6	18	3.0
19	6	6	24	4.0
20	25	17	103	6.0
Total	288	243	1,877	Max. 36.5

Sources: BAAQMD 2020x, BAAQMD 2021a, Energy Commission staff analysis of data from BAAQMD

From the runtimes of all the engines at all facilities in the BAAQMD's review, **Table B-1** estimates that the average engine ran no more than 36.5 hours over the 13-month period. Staff also found that no single engine within the BAAQMD's review ran for more than 50 hours overall for "non-testing/non-maintenance" purposes.

Staff used the data in the BAAQMD's review (BAAQMD 2020x; BAAQMD 2021a) and a clarifying email of BAAQMD results (CEC 2021l) to estimate the power production during "non-testing/non-maintenance" diesel engine use and found that approximately 1,575 MWh was generated during this 13-month (9,504 hour) period. The power generated by these engines presumably displaced grid service for the on-site data center facility electrical demand. Based on the installed generating capacity of 686.5 MW partially operating within the 13-month record, the engines in BAAQMD's review that did operate would have an extremely low capacity factor of 0.024 percent [0.024 percent = $1,575 \text{ MWh} / (686.5 \text{ MW} * 9,504 \text{ hours})$]. This capacity factor is only considering the facilities which had engines that ran during this 13-month period. 25 of the 45 facilities reporting had zero hours of engine runtime.

Consideration of Extreme Events. California experienced different types of emergency situations within the 13-month period (September 1, 2019 to September 30, 2020) of BAAQMD's review. This period included the expansion of PG&E's PSPS program, severe wildfires, several California Independent System Operator (CAISO) -declared emergencies, and winter storms. From August 14 to 19, 2020, California experienced excessive heat. On August 16, 2020, Governor Newsom declared a State of Emergency² because of the extreme heat wave in California and surrounding western states. This was a 1 in 30 year weather event that resulted in the first system-wide power outages California had seen in 20 years. In addition to the extreme heat wave in mid-August, high temperatures and high electricity demand occurred over the 2020 Labor Day weekend, especially on Sunday, September 6 and Monday, September 7, 2020 (CAISO 2021). Thus, the data set provided is not necessarily representative of an average 13-month period from which one could extrapolate average backup facility use into the future.

Table B-2 summarizes how these extreme events influenced the runtimes found by BAAQMD's review for each of the 20 data centers.

Table B-2 shows that most "non-testing/non-maintenance" diesel engine use identified by BAAQMD's review (over 1,400 engine-hours out of 1,877 engine-hours) occurred either during the August 2020 State of Emergency or the subsequent heat event in September. Excluding these extreme events results in 473.7 engine-hours of "non-testing/non-maintenance" diesel engine use during other dates, or fewer than 2 hours per engine for all 288 engines in the review. Out of the 20 data centers that ran engines for "non-testing/non-maintenance" purposes, the 473.7 engine-hours of runtime

² <https://www.gov.ca.gov/wp-content/uploads/2020/08/8.16.20-Extreme-Heat-Event-proclamation-text.pdf>.

outside of extreme events was spread across ten data centers out of the 45 data centers covered by BAAQMD’s review.

TABLE B-2 EXTREME EVENTS: NON-TESTING/NON-MAINTENANCE OPERATION (ENGINE-HOURS)

Data Center	Operations During August 2020 State of Emergency (Engine-Hours)	Operations During September 2020 Heat Event (Engine-Hours)	Other Dates of Operations (Engine-Hours)	Sum of Non- Testing/ Non-Maintenance Operations (Engine-Hours)
1	82.7			83
2			76.6	77
3	107.8			108
4	21.6			22
5	11.0			11
6	218.8			219
7	88.2	81.2	32.5	202
8			10.3	10
9	26.0			26
10	259.7		141.1	401
11	75.0			75
12	275.3			275
13			85.0	85
14	19.9		7.6	28
15			98.0	98
16			9.6	10
17			4.0	4
18	9.0		9.0	18
19	24.0			24
20	88.4	14.3		103
Total	1,307.4	95.5	473.7	1,877

Sources: BAAQMD 2020x, BAAQMD 2021a, Energy Commission staff analysis of data from BAAQMD

Similarly, staff estimates that over 50 percent of the overall power produced by the engines in the BAAQMD’s review (at least 843 MWh of 1,575 MWh) occurred during the Governor’s State of Emergency, and another 25 percent of the power produced was attributable to unknown days in the period. Staff’s analysis of actual power produced during each day of the 13-month record appears in **Table B-3**.

Across all events, including the extreme event days within the period, Table B-3 shows that the average engine loading in the BAAQMD’s review was below 40 percent. However, the data does not establish a typical type of operation that could be reasonably expected to occur during any emergency or any typical operational characteristics that could be used in representative air quality modeling. For example, some engines in the data set ran at no load or with very low loads; one engine ran at

no load for 41.7 hours, while the highest engine load in the data set was 70 percent load. The range of engine loads and the fact that most engines operated at low loads demonstrates the difficulty in predicting the level of facility electrical demands that would need to be served by the engines during an emergency, and this also demonstrates the difficulty in making an informed prediction of the engines' emission rates, which vary depending on load, in the event of an emergency.

TABLE B-3 EXTREME EVENTS: NON-TESTING/NON-MAINTENANCE OPERATION (ENGINE LOADS)

Date of Event Start	Extreme Heat Wave Event?	Non-Testing/Non-Maintenance Operations - @ actual load (MWh - per day)	Average Engine Loading on Event Day
Unknown		418.0	45.3%
11/26/2019		1.1	13.8%
11/27/2019		5.5	17.7%
2/15/2020		0.7	7.0%
7/31/2020		2.9	17.3%
8/14/2020		39.0	48.0%
8/16/2020		25.6	38.4%
8/17/2020	Aug 2020 Emergency	843.1	34.5%
8/18/2020	Aug 2020 Emergency	112.0	31.2%
8/19/2020	Aug 2020 Emergency	14.4	40.0%
8/25/2020		5.4	30.0%
9/6/2020	Sept 2020 Event	90.0	48.6%
9/7/2020	Sept 2020 Event	16.8	39.2%
Total		1,574.7	Average 31.6%

Sources: BAAQMD 2020x, BAAQMD 2021a, Energy Commission staff analysis of data from BAAQMD

Frequency of Diesel Engine Emergency Use, Discussion: The BAAQMD scoping comment illustrates that standby generator engines were used at data centers for “non-testing/non-maintenance” purposes that could occur more frequently than utility service power outages. In staff’s review of prior data center cases that were proposed within the SVP territory, staff found that the likelihood of an outage on SVP’s looped 60 kV system that forces emergency operation of a data center’s standby generators would be “extremely rare” and a low-probability event. For the prior cases in SVP territory, staff estimated a 1.6percent probability of any given data center facility experiencing a power outage in a period of a year (e.g. CEC 2020qq; CEC 2020rr; CEC 2021).

In the BAAQMD’s review, without excluding the extreme events, 1,877 engine-hours of diesel engine use occurred at 20 data centers for “non-testing/non-maintenance” purposes (less than half of the 45 facilities included in the review, and less than a third of such facilities under BAAQMD’s jurisdiction). These runtimes occurred due to power outages, in response to the heat storm, and also for other unspecified situations categorized by the engine operators as “emergencies.” The BAAQMD’s review covered

288 individual diesel engines that operated over a 13-month record. No data was provided concerning the number of engines at the 25 facilities that did not operate under these circumstances. Because the backup generator engines were collectively available for over 2.74 million engine-hours during the 13-month period (288 engines * 9,504 hours), and they were used for emergency operations for 1,877 engine-hours, at those facilities where operation occurred, the engines entered into emergency operations during 0.07 percent of their available time (1,877 / 2.74 million). This confirms that emergency use of the engines would be very infrequent. It is important to note that this calculation only takes into consideration those engines that the BAAQMD found to run during this time period; a more comprehensive review would also include the availability of the 25 facilities that had zero hours of engine run time and also conceivably the 21 facilities that were not surveyed at all. If these facilities without engine runs were included, the estimated probability that any given engine would be likely to run would be lower.

In addition, the applicant provided data showing the generator run-time of the nearby existing Equinix data centers (SV1, SV5 and SV10) due to utility outages from 2016 to September 2020 (approximately 4.7 years [SV1 2020m]). The total generator run-time due to utility outages for the three nearby Equinix data centers was only 2 hours in the approximately 4.7 years. SV10 generators had zero hour of run-time due to utility outages during these recent years. SV1 generators ran a total of one hour (two events each running 30 minutes) due to utility outages in 2017 and did not run for the other years. SV5 generators also ran a total of one hour (two events each running 30 minutes) due to utility outages in 2019 and 2020 and did not run for the other years. There were no concurrent emergency operations of the three Equinix data centers during the recent years. SV1 and SV5 each entered into emergency operations during 0.002 percent of their available time (1 / 41,424). This further confirms that emergency use of the engines would be very infrequent.

Duration of Diesel Engine Emergency Use, Discussion: The BAAQMD scoping comment shows extended durations of standby generator engines use for “non-testing/non-maintenance” purposes, mostly due to extreme events within the 13-month record. The average runtime for each event in BAAQMD’s review was approximately 5.0 hours. This shows that the duration of diesel engine use for “non-testing/non-maintenance” purposes, without excluding the extreme events, could involve longer runtimes than for typical utility service power outages. However, again this calculation does not factor in the larger proportion of facilities that did not run at all. In staff’s review of prior data center cases, staff found an average of 2.6 hours per outage, based on only two transmission line outages in recent years affecting data centers served by SVP 60-KV lines (e.g. CEC 2020qq; CEC 2020rr; CEC 2021).

The historical outage data for the nearby existing Equinix data centers provided by the applicant shows that the generators only operated 30 minutes during each of the four outage events in the 2016 to September 2020 period (SV1 2020m).

The BAAQMD's review of diesel engine use considers more types of reasons for running the engines than solely an electric power service outage. The listed reasons include: state emergency load shedding, human error event, utility inflicted disturbance, lightning strikes to transmission line, utility outage, power outage, system-wide power quality event, equipment failure, power bump, power supplier request, power blips, UPS/board repair, utility sag event, mandatory load transfer, and substation transformer power equipment failure. Many of these explanations are simply subcategories under the general category of grid reliability analyzed for prior cases. Others like human error event, equipment failure, and UPS/board repair appear to be exceedingly rare occurrences unlikely to significantly add to the calculation of when emergency operations might occur. Lastly, the category of emergency load shedding/power supplier request/mandatory load transfer all appear related to the heat storm and State of Emergency described above and, given the State's efforts to address reliability in response to such events, are unlikely to re-occur with any frequency. The provision of these categories and sub-categories helps to explain why BAAQMD shows more instances of engines running than staff found in prior cases and longer durations of runtimes during emergency situations. Although emergency operations could be triggered for a range of situations, including extreme events like those of August and September 2020, this information confirms that regardless of triggering event, emergency operations of standby generator engines would be expected to be infrequent and of short duration.

Summary of Staff's Analysis of "Non-testing/Non-maintenance" Engine Use:

The BAAQMD's review of "non-testing/non-maintenance" engine operations expands our understanding of "when, why, and for how long" diesel engine use might occur. The BAAQMD's 13-month period of review included a Governor-declared State of Emergency, other outages, power quality events, and human errors. Accordingly, the BAAQMD's review confirms that engine use may occur for reasons other than grid outages, though the period is not representative of a typical year due to the rare heat storm events. Many engines were used for "non-testing/non-maintenance" purposes in the period reviewed by BAAQMD, but the overall number of hours of operation for the less than half of the facilities in the review that did run was 0.07 percent of the available time. Engine loading levels recorded during these times of use were low (average below 40 percent) and the capacity factor of these engines was extremely low (0.024 percent). The BAAQMD review confirms that these types of events remain infrequent, irregular, and unlikely and the resulting emissions are not easily predictable or quantifiable and cannot be modeled in an informative or meaningful way. The BAAQMD review does not show that these facilities operate significantly more than staff previously analyzed in the grid reliability context in prior cases.

CPUC Decision Directing Pacific Gas and Electric Company, Southern California Edison Company, and San Diego Gas and Electric Company To Take Actions To Prepare For Potential Extreme Weather In The Summers Of 2021 And 2022

On March 25, 2021, the CPUC adopted the Proposed Decision of ALJ Stevens in Rulemaking 20-11-003, Order Instituting Rulemaking to Establish Policies, Processes, and Rules to Ensure Reliable Electric Service in California in the Event of an Extreme Weather Event in 2021.

This decision addresses two main issues: how to decrease energy demand and increase energy supply during peak demand and net demand peak hours in the event that an extreme heat event similar to the August 2020 event occurs in the summer of 2021 or 2022. More specifically, addressed in this decision are the following scoped issues:

1. Flex Alert program authorization and design
2. Modifications to and expansion of Critical Peak Pricing (CPP) Program
3. The development of an Emergency Load Reduction Program (ELRP)
4. Modifications to existing demand response (DR) programs
5. Expedited Integrated Resource Plan (IRP) procurement
6. Modifications to the planning reserve margin (PRM)
7. Parameters for supply side capacity procurement
8. Expanded electric vehicle participation

As can be seen above, this is a pragmatic approach that employs a menu of options to ensure grid reliability. One of the options is an Emergency Load Reduction Program (ELRP). The purpose of ELRP is to allow the large electric IOUs and CAISO to access additional load reduction during times of high grid stress and emergencies involving inadequate market resources, with the goal of avoiding rotating outages while minimizing costs to ratepayers.

The decision would allow data centers to choose to participate in a program whereby they could be asked to shed load in the event that an extreme heat event similar to the August 2020 event occurs in the summer of 2021 or 2022. The initial duration of the ELRP pilot program will be five years, 2021-2025, with years 2023-2025 subject to revision in the DR application proceeding that is expected to be initiated November 2021. However, the decision lays out many options for emergency load reduction to ensure grid reliability that could be utilized before resorting to backup diesel generators. The decision explains that the ELRP design aspects that are subject to review and revision as part of the pilot program include minimizing use of diesel backup generators where there are safe, cost-effective, and feasible alternatives (CPUC 2021, Section 5.2, page 19).

However, it is not expected that the GOSDC would be operational until after the summer of 2022, based on these factors: 1) estimated construction schedule of 15 months for the

first phase of GOSDC (SV1 2021g); 2) estimated completion of CEC exemption proceeding in the summer of 2021; 3) additional time needed for the city and BAAQMD to permit the project (the applicant has not filed an application to the BAAQMD as of April 13, 2021). Thus, GOSDC would not be online in time to be part of the first phase of the ELRP. The next two summers are likely to be the most critical in terms of extra measures needed to ensure grid reliability. It is less likely that these types of measures will be necessary beyond the immediate future, as longer-term strategies for grid resilience such as battery facilities to supplement intermittent renewable generation come on-line.

Furthermore, based on the capacity factors and run times for data centers that operated during the 2020 heat events, even if it were necessary to call on data centers to shed load again, it is expected that these facilities would be called on very infrequently and would have very low capacity factors and run times in any potential future events.

Electrical Reliability Supporting Information

Energy Commission staff provided a series of questions to Pacific Gas & Electric (PG&E) designed to understand when, why, and for how long backup generators would need to operate for any purpose, including Public Safety Power Shutoff (PSPS), other than readiness testing or maintenance at the proposed data center in the PG&E service area.

This supporting information includes the following:

1. A direct written response from PG&E on August 17, 2020 to staff's questions regarding substation details (including a table listing outages between July 2008 – February 2019 of the Metcalf-Edenvale #1 and #2 115 kV lines);
2. A direct written response from PG&E on September 11, 2020 to more staff follow-up questions;
3. A direct written response from PG&E on September 25, 2020 to the last of staff's information requests;
4. A diagram showing distribution ties near Santa Teresa Substation; and
5. A one-line diagram of the proposed Santa Teresa Substation for the Great Oaks South Data Center.

PG&E Responses to Staff Data Requests Concerning Interconnection of Great Oaks South Backup Generating Facility Submitted On August 17, 2020.

Note: CEC has received responses from PG&E to staff's questions for PG&E, presented below. Staff has modified these responses by underlining PG&E's responses to staff's questions for ease of reading.

GREAT OAKS SOUTH BACKUP GENERATING FACILITY (20-SPPE-01)

Questions for PG&E

A. Santa Teresa Substation design related to the Great Oaks South Data Center and the redundancy of the PG&E 115 kV system in San Jose Division.

It appears there are three data centers, Equinix, China Mobile and Ri Cloud (China Telecom) that all propose to interconnect to the Santa Teresa substation (from PG&E Advice letter 6501-E and 5601-E-A). The Equinix Data Center is actually on the same site as the proposed Great Oaks South Data Center (GOS data center) in the application filed by SV1, LLC, a wholly owned subsidiary of Equinix, LLC (SV1) before the California Energy Commission and we think they are essentially the same project. Equinix was a 63 megawatt (MW) data center. The GOS data center before the Energy Commission is a staged data center that, if approved or exempted, could ultimately be a 99 MW data center load.

1. Information provided by the GOS data center to the Energy Commission indicated that there would be five 21 kilovolt (kV) underground cable connections between the Santa Teresa Substation and the GOS data center.
 - a. Without a "load application for the GOS project," can you confirm the above statement?

Yes, each 21 kV circuit can serve approximately 20 MW of load. 99 MW would require five 21 kV circuits, each rated 20MW.

The Email from Jennifer Goncalves to Laiping Ng from Friday July 3, 2020 included two sets of one-line diagrams, one labeled "Santa Teresa – planned" and Santa Teresa – Ultimate."

The "planned" Santa Teresa substation has two 115 kV lines connecting to a 115 kV bus and a single transformer from the 115 kV bus to the 21 kV bus (assume it is 21 kV).

There are four circuits leaving the 21 kV bus. The "ultimate" Santa Teresa substation has three 115 kV lines connected to the 115 kV bus and three transformers between

the 115 kV and 21 kV bus (assume it is 21 kV). There are twelve circuits leaving the 21 kV bus.

2. Does the "planned" Santa Teresa substation allow for the interconnection of the GOS (Equinix) data center?

No, the planned substation does not have sufficient capacity to serve the GOS, but the ultimate substation does. New banks and feeders will be added to Santa Teresa substation when load forecasts predict that the existing bank and/or feeders will be above normal capacity. Load forecasts include the impact of growth from both new applications for service and the added load of existing customers.

3. What project/projects trigger the need for the "ultimate" Santa Teresa substation?

Load forecasts include the impact of new load from applications for service. The Great Oaks South data center would submit an application for service for one or more phases of their project and PG&E would study the impact to the system from the new load. If the load forecast shows the facilities at Santa Teresa Substation above normal capacity, a project to address the capacity need would be initiated. This project may be a reconfiguration of existing circuits, the installation of new banks and feeders, or a Request for Offer from a third-party DER provider.

4. Does a new, third, 115 kV line need to be sited and developed in the area to allow growth from the "planned" to the "ultimate" Santa Teresa substation?

This is unknown at the present time and requires a complete transmission study. The ultimate design includes this third 115 kV line as a possible connection, and it should be understood that the third line could be a new 115 kV line to a future customer site in order to serve new load.

5. What are the ratings for the three 115 kV lines that connect to the Santa Teresa substation and what substations do they connect to?

- a. If one of the lines is out of service, can the loads connected to the Santa Teresa substation be supplied through the remaining line or lines?

This is unknown at this time and would require a complete transmission study. The existing Metcalf- Edenvale #1 and #2 115 kV lines are bundled 715.5- 37 Aluminum conductors on Lattice Steel towers. The scope of the section looping into the new Santa Theresa 115 kV substation is unknown at this point, but would most likely match the existing conductors and towers to main structural integrity and Right of Way requirements.

6. What are the ratings for the transformers in the Santa Teresa substation?

Each transformer will be 45 MVA.

- a. Is it correct that for the “planned” substation the loads connected to the 21 kV bus would be dropped or shut-off when maintenance was required on the 115/21 kV transformer?

No, that is not correct. Planned maintenance is done at a time of low loading and loads are moved to adjacent substations. If all loads cannot be moved to adjacent substations then temporary mobile generation is usually employed to serve the loads that cannot be moved.

- b. For the “ultimate” Santa Teresa substation would two of the 115/21 kV transformers be capable of supplying the full loads of the 21kV bus when the third transformer is undergoing maintenance or out of service?

Yes, the plan would be that two of the three transformers could serve all loads in either an emergency or a planned clearance.

7. What MW size GOS or Equinix data center does the “Ultimate” design one-line diagram accommodate?

The ultimate design could serve 45 X 3 or 135 MVA of load.

- a. Among the 12 feeders shown in the one-line diagram, are five feeders designed for GOS?

No. None of the feeders except the first four are designed for any particular customer or with any particular customer in mind.

8. How many of the feeders serving GOS could undergo maintenance simultaneously, for example to service an underground vault containing multiple feeders, without disrupting service to GOS?

This is unknown at this time because the feeders have not been designed, but it is typical to run only two feeders per trench and only two feeders into any one vault.

9. According to a California Energy Commission (CEC) map of the local area, electricity for Santa Teresa substation would come from a double circuit 115 kV line coming from the Metcalf substation located to the southeast of Santa Teresa substation and extending to the Edenvale substation. But this is the only line supplying electricity to Edenvale and it appears that Edenvale is a radial extension from Metcalf. If there is loss of power from the Metcalf substation, how would electricity be supplied to Santa Teresa substation? Are there additional lines serving Edenvale that are not on the CEC map? Can Edenvale supply the full capacity needs of Santa Teresa without Metcalf?

It should first be understood that there are two 115 kV lines that presently run between Metcalf and Edenvale. This system is not a radial system, it is part of the transmission network. One 115 kV line is planned to loop through the new Santa Teresa Substation once that substation is placed in service. Because of the network

design, the transmission line to Santa Teresa will be in service as long as either 115 kV from Metcalf to Edenvale has power.

- a. Does this Ultimate design one-line diagram for the Santa Teresa substation include interconnection for the 99 MW GOS data center (Equinix) and the other two data centers (China Mobile and Ri Cloud) mentioned in Advice Letter 5601-A?

The ultimate design will be able to serve the known loads from Equinix SV11, China Mobile, and RiCloud. At this time, and with no other customer applications in the area, it would be able to serve the proposed loads from the GOS data center.

B. Trigger need for reconductor/line re-rate

We understand from Ms. Goncalves' email that a load study would be needed to determine whether reconductoring or a line re-rate is required for the 115 kv lines to carry the full load of the data center (99 MW), independently. We have the following related questions:

10. How long does a load study take to complete?

The Large Load Study timeline to complete the Preliminary Engineering Study (PES) is 90 business days. Once the PES is signed by the customer, the project will be handed-off to the Project Manager for implementation. If there are any network upgrades like reconductoring the transmission lines, the typical duration for reconductoring can vary between 12-24 months depending on the scope of projects (reconductoring, tower replacement, additional ROW). Environmental review of the circuit may require Notice of Construction (NOC) from CPUC which could be another 6-8 months.

11. Who requests a load study be conducted?

The customer/applicant, along with payment of an Engineering Advance.

- a. Are there other ways of determining whether a reconductoring or line re-rate is necessary other than conducting a load study?

A Full Load Study must be performed to see the impacts of the proposed project to be interconnected. If a project is a phased project and if the project proponent provides an application for service for each phase of the project, then PG&E will study each phase separately and make system modifications in order to accommodate each phase.

12. If reconductoring were determined necessary, what level of detail will be known? Construction methods (like use of a helicopter), replacement of existing equipment other than the transmission line (like transmission towers).

PES provided during the study phase will identify a high-level scope, cost and duration for the reconductoring project. The scope may include conductor selection, tower replacement, ROW requirements, upgrades and limiting

equipment at the substation. Once the project is handed-off to a Project Manager and the project is initiated, the detailed scope for the load interconnection will be determined. Use of helicopter is part of construction and not identified in the PES.

- a. What is the scope of the reconductoring, if it were necessary- e.g. length of line, conductor type and rating?

A Full Load Study must be performed to see the impacts of the proposed project to be interconnected.

C. Reliability of the San Jose 115 kV system:

13. Will PG&E be able to manage future PSPS events to ensure that they would not affect the delivery of service to these substations (Santa Teresa, Metcalf, Edenvale)?

If severe weather threatens a portion of the electric system, it may be necessary for PG&E to turn off electricity in the interest of public safety. No single factor drives a PSPS, as each situation is unique. PG&E carefully reviews a combination of many criteria when determining if power should be turned off for safety.

These factors generally include, but are not limited to:

- 1) A Red Flag Warning declared by the National Weather Service
- 2) Low humidity levels, generally 20 percent and below
- 3) Forecasted sustained winds generally above 25 mph and wind gusts in excess of approximately 45 mph, depending on location and site-specific conditions such as temperature, terrain and local climate
- 4) Condition of dry material on the ground and live vegetation (moisture content)
- 5) On-the-ground, real-time observations from PG&E's Wildfire Safety Operations Center and field crews

It is important to note that while we monitor and take into consideration Red Flag Warnings issued from the National Weather Service, the issuance of a Red Flag Warning does not automatically trigger a PSPS if local conditions do not warrant activation.

While it is impossible to predict with certainty when, where and how often severe weather could occur, depending on the location, areas could experience an average of 0 to 5 events per year.

The most likely electric lines to be considered for a public safety power outage will be those that pass through areas that have been designated by the California Public Utilities Commission (CPUC) High Fire Threat District (HFTD)

map as at elevated (Tier 2) or extreme risk (Tier 3) for wildfire. Customers outside of these areas could have their power shut off, though, if their community relies upon a line that passes through a high fire-threat area or an area experiencing severe weather. Short sections of both Metcalf-Edenvale #1 and #2 115kV circuits have been designated as residing in a Tier 2 area.

PG&E knows that PSPS is very disruptive and customers need as much warning as possible. PG&E uses the contact information associated with the customers' PG&E account to reach them. So, as a first step customers are asked to please ensure that PG&E has their correct email address, landline number and mobile number.

PG&E will attempt to contact customers through automated calls, texts and emails. PG&E will do its best to give customers as much notice as possible. This year, we are updating our customer alerts about PSPS events to provide more detail earlier – including estimated time of restoration – about what to expect during PSPS events. We will also use pge.com and social media channels, and we will keep local news and radio outlets informed and updated.

Timing of notifications: If we need to turn off customers' power for safety, we aim to provide advance notifications in three phases:

- 1) Advance notification (when possible)
 - Two days before electricity is turned off
 - One day before electricity is turned off
 - Just before electricity is turned off
- 2) During the public safety outage
- 3) Once power has been restored

NOTE: Due to the focus on safety, the shutoff notification will be sent at any time, day or night. PG&E aims to send all other notifications between 8 a.m. and 9 p.m. However, severe weather threats can change quickly, and there may be some instances when notifications may be sent outside of those hours.

14. Please use the database mentioned in *PG&E's 2018 Annual Electricity Reliability Report* to the CPUC in response to D16-01-008 to develop a table similar to Table 4 in that report.

We would like the response to this request to be tailored to the capacity of the lines that would support the Santa Teresa substation. We seek to understand the reliability of the transmission line system in the division within which the Santa Teresa substation would be located (we think that is the San Jose Division).

Please provide the same parameters shown in **Table 4**.

A screen shot of **Table 4** from PG&E's 2018 Annual Electric Reliability Report to the CPUC is shown below. The indices in this table – i.e., SAIDI (system average interruption duration index), SAIFI (system average interruption frequency index) and CAIDI (customer average interruption duration index) are industry standard reliability measures based on customers served at distribution voltage levels – i.e., 4kV, 12kV or 21kV within PG&E's service territory. When an unplanned outage occurs on PG&E's electric "Transmission System", customers served at a distribution voltage level are usually unaffected. Table 4 captures all those 2018 unplanned outages when a transmission or substation "failure" resulted in a sustained event that contributed to SAIDI, SAIFI and CAIDI indices.

The electric transmission sources to the proposed Santa Teresa substation are the existing Metcalf-Edenvale #1 and Metcalf-Edenvale #2-115kV lines.

Currently, when one of these 115kV lines experiences an unplanned outage, no customers served at the distribution voltage level are affected. There is one customer (IBM) served at the transmission voltage level, but that one customer per IEEE standard 1466 is not included in SAIDI, SAIFI or CAIDI calculations.

The only time Edenvale customers would experience an outage would be if both 115kV feeds above simultaneously experienced an unplanned outage. The historical unplanned outage table below provides an outage history going back to 2007 and through July 2020 for the Metcalf-Edenvale #1 and #2 115kV circuits. This outage history table shows no such events where a simultaneous outage occurred. Hence, populating a table similar to Table 4 from the CPUC report and specific to these two circuits cannot be done. However, the historical outage table below for both these circuits clearly shows that both lines have been very reliable and available for service over the years since 2007. Assuming a similar substation bus design at Santa Teresa to that of Edenvale, the expectations for availability/ reliability would be no different moving forward.

ii. Transmission System Indices

Table 4 – Transmission System Indices (2009-2018)
 (Excludes planned outages, distribution, and generation related outages)
 (Includes substation outages)

Year	Major Events Included			Major Events Excluded		
	SAIDI	SAIFI	CAIDI	SAIDI	SAIFI	CAIDI
2009	20.6	0.165	124.8	14.9	0.144	103.4
2010	38.7	0.230	168.2	22.0	0.186	118.4
2011	39.5	0.224	176.2	16.9	0.168	100.6
2012	21.3	0.165	128.7	14.8	0.149	99.6
2013	13.1	0.168	77.7	11.7	0.160	72.6
2014	14.1	0.116	121.0	7.5	0.097	77.8
2015	32.1	0.160	201.0	7.8	0.095	82.7
2016	11.2	0.125	89.5	10.7	0.121	88.3
2017	54.9	0.191	286.9	7.3	0.085	85.4
2018	16.3	0.145	112.3	7.8	0.114	68.9

Note: PG&E defines its transmission system as line voltage 60 kilovolts (KV) and above

TABLE B-4: UNPLANNED OUTAGE HISTORY METCALF-EDENVALE # 1 AND # 2 115kV

kV	FACILITY	Date Out	MED	ET Wire Down	Auto Reclose Disabled	Durn (mins)	Cause Category	Cause Detail	Secondary Cause	Comments	Customers Affected
115	METCALF-EDENVALE #2	7/6/2008 2:22:00 PM	No	No	No	0	Unknown	Patrol found nothing	NONE	Relayed, tested OK, as did IBM BaileyAve tap (plant closed for holiday); weather clear; eventID=5809	0
115	METCALF-EDENVALE #1	11/19/2009 1:44:00 PM	No	No	No	11	Other	Safety clearance	RELY	Forced out Edenvale CB-112 to test breaker back-up relay, open ending this line	0
115	METCALF-EDENVALE #2	8/31/2010 8:04:00 PM	No	No	No	315	Equipment Failure	ccvt	AUX	Forced out due to NG CCVT at Metcalf; no customer interruption	0
115	METCALF-EDENVALE #2	11/20/2011 1:52:00 AM	No	No	No	501	Equipment Failure	Relay	RELY	Relayed, tested NG (Aware Time=0433); caused by mis-operation of a faulty line current differential relay; SUS IBM Bailey (1); rain; 0936 line manually tested OK restoring IBM Bailey; 1013 line returned to service	1
115	METCALF-EDENVALE #2	11/23/2011 8:52:00 AM	No	No	No	297	Other	Safety clearance	RELY	Open-ended after Edenvale CB-122 forced out to install temporary relay; no customers interrupted	0
115	METCALF-EDENVALE #2	11/28/2011 3:13:00 PM	No	No	No	163	Other	Safety clearance	RELY	Open ended after Metcalf CB-482 forced out to install temp line relay; no customers interrupted	0
115	METCALF-EDENVALE #2	3/16/2012 10:36:00 PM	No	No	No	0	Equipment Failure	Relay	RELY	Relayed, tested OK; MOM IBM Bailey; rain; new current differential relays recently installed @ IBM & 1 was found with H2O after rain; eventID=8316	0
115	METCALF-EDENVALE #2	7/9/2012 8:05:00 PM	No	No	No	0	Unknown	Patrol found nothing	NONE	Relayed, tested OK; MOM IBM Bailey; weather clear; ground & air patrols found no cause, no damage	1

TABLE B-4: UNPLANNED OUTAGE HISTORY METCALF-EDENVALE # 1 AND # 2 115kV

kV	FACILITY	Date Out	MED	ET Wire Down	Auto Reclose Disabled	Durn (mins)	Cause Category	Cause Detail	Secondary Cause	Comments	Customers Affected
115	METCALF-EDENVALE #1	4/16/2013 1:47:00 AM	No	No	No	0	External Contact	Vandalism	CB	Open-ended after Metcalf CB-472 tripped, reclosed by automatics; line subsequently forced out at 1322 same day to effect repairs on damaged CB	0
115	METCALF-EDENVALE #1	4/16/2013 1:22:00 PM	No	No	No	5,968	External Contact	Vandalism	CB	De-energized to force out Metcalf CB-472 due to gunshot damage (had relayed, reclosed by autos earlier in day @ 0147); no customers interrupted	0
115	METCALF-EDENVALE #2	7/13/2013 8:03:00 AM	No	No	No	673	Equipment Failure	Relay	RELY	Open ended after Edenvale CB-122 forced out to install temp line relay due to NG backup relay; no customers interrupted	0
115	METCALF-EDENVALE #1	10/16/2013 2:08:00 PM	No	No	No	1,655	Equipment Failure	ccvt	AUX	Forced out from scheduled work due to NG CCVT; 10/17/13, 1743 line returned to service following repairs	0
115	METCALF-EDENVALE #1	4/24/2014 9:15:00 AM	No	No	No	0	Animal	Bird	NONE	Relayed, tested OK; momentary IBM; weather clear; reported bird contact at tower 4/26; clearance will be scheduled to remove hawk's nest	1
115	METCALF-EDENVALE #1	7/23/2014 6:10:00 PM	No	No	No	9,917	Equipment Failure	Relay	CB	Forced out from scheduled work after CB failed to close during switching; no customers interrupted; 07/30/14, 1527 Edenvale CB-112 closed, line normal after replacing failed 52Y relay & CB close latch	0
115	METCALF-EDENVALE #2	1/4/2017 11:27:00 AM	No	No	No	0	Unknown	Patrol found nothing	NONE	While personnel in stn Metcalf-Edenvale#2 momentarily open ended after MetcalfCB-482 tripped, reclosed by autos; no customers interrupted; rain	0

TABLE B-4: UNPLANNED OUTAGE HISTORY METCALF-EDENVALE # 1 AND # 2 115kV

kV	FACILITY	Date Out	MED	ET Wire Down	Auto Reclose Disabled	Durn (mins)	Cause Category	Cause Detail	Secondary Cause	Comments	Customers Affected
115	METCALF-EDENVALE #2	6/4/2018 2:49:00 AM	No	No	No	0	Unknown	Patrol found nothing	NONE	Relayed, tested OK; momentary IBM; weather clear; B-G fault 1.0 mi from Metcalf near 000/006, +/-0.5 mi	1
115	METCALF-EDENVALE #2	1/18/2019 9:25:00 AM	No	No	No	2,090	Equipment Failure	Relay	RELY	Open-ended after Metcalf CB-482 forced out to replace NG set B relay; no customers interrupted; 01/19/19, 2015 Metcalf CB-482 returned to service	0
115	METCALF-EDENVALE #1	2/12/2019 11:57:00 PM	YES	No	No	0	Weather	Rain	NONE	Relayed, tested OK; momentary IBM; rain, wind; B-G fault 1.2 mi from Metcalf near 001/008, +/-0.5 mi; declared Major Event Day	1

September 11, 2020 PG&E

Follow Up Questions for Pacific Gas and Electric Company Regarding Great Oaks South Backup Generating Facility
Responses are underlined

16. How many megawatts is Equinix SV11 (operating data center at 7 Great Oaks Boulevard, San Jose, CA)?

By the end of 10 years, 19 megawatts (MW). Timing?- scheduled to come online early next year; Equinix did not indicate the initial MW demand beginning next year. Load ramp projected to come online over a 7-year period. Projections updated on a regular basis. Seven years is Equinix's fastest estimate. It could go more slowly.

PG&E takes the customer's ramp up schedule and using their models will run what PG&E thinks will happen and the worst-case scenario.

Redundancy for incremental design: Reliability of PG&E?

Equinix: 4 hours of unplanned run time for outage starting in 2016 and extending to just a few months ago, over 4 years, not full load.

17. Responses to question 6 stated: "Planned maintenance is done at a time of low loading and loads are moved to adjacent substations. If all loads cannot be moved to adjacent substations then temporary mobile generation is usually employed to serve the loads that cannot be moved."

a. Which adjacent substations would the data center loads be moved to?

Edenvale (nearest substation to Great Oaks South project) and offload to Percy and Hicks substations. Summer peak loads are so much larger than winter. Distribution movement. Radial, but ties to another circuit. No one set of customers are fed by one way, they are fed by other routes. Not unique way of servicing in PG&E territory.

b. How is "temporary mobile generation" provided to unmovable loads?

Fleet of diesel generators. PG&E will provide some fleet information.

Planned maintenance- use mobile generators. Outages due to failure- fix the problem instead of using mobile generators.

i. What type of mobile generation? Size? Will the temporary mobile generation be sufficient to serve the data centers?

18. Responses to question 9 stated: "It should first be understood that there are two 115 kV lines that presently run between Metcalf and Edenvale. This system is not a radial system, it is part of the transmission network. One 115 kV line is planned to loop

through the new Santa Teresa Substation once that substation is placed in service. Because of the network design, the transmission line to Santa Teresa will be in service as long as either 115 kV from Metcalf to Edenvale has power.”

In regards to the reconductoring, as stated in the applicant’s response to data request set 2, #62, “reconductoring or a line re-rate for 115 kV lines supplying the Santa Teresa Substation (Please see response to 31) may be required for each to meet the full demand of the site independently.” The PG&E response to Question 2 stated: “No, the planned substation does not have sufficient capacity to serve the GOS, but the ultimate substation does.”

- a. Why will there be only one 115 kV line looping through Santa Teresa Substation when 3 lines are shown on the Ultimate Substation design one-line diagram?

Only one 115 kV line will be looping in and out of the Santa Teresa substation, but line 1 and line 2 are interconnect through disconnect switches and breakers so either line 1 or line 2 can serve the Santa Teresa Load. Power can come in from Metcalf to Santa Teresa or from Edenvale to Santa Teresa.

- i. Is there a redundant way to serve the GOS project site?

Without load study, PG&E doesn’t know, but they must design and build the system to meeting the NERC standards. Distribution circuits are connected from other substations to the Santa Teresa substation, this interconnection of the substations will improve the reliability of the 21 kV system when contingency occurs at the 115kV grid connected system.

Line 3- not a supply line, but a line to a possible future customer. It is an additional breaker position. Could be for generation or for load.

Year 1-5 can plan a project, beyond year five, will monitor load projection.

Equinix: 4 events (30 min operation) (2 hours total) of unplanned run time for outage starting in 2016 and extending to just a few months ago, over 4 years, not full building load (occupancy).

- b. What do you mean by “the planned substation does not have sufficient capacity to serve the GOS”? Can you specify how much of the GOS data center load could be served by the planned design?

PG&E will provide information on how and when the second and third transformer will be installed to serve the anticipated Great Oaks South load.

- 19. What is the route that would be used for the underground 21 kV distribution line connecting between Santa Teresa substation and the data center? The latest information showed that the Via Del Oro route and/ or Santa Teresa route would be used.

- a. If the decision on the route has not yet been made, please estimate when the final route would be determined.

PG&E says they are likely to use both routes. Two feeders per trench, any more would result in over-heating and a need to de-rate capacity. Each feeder would be able to carry up to 20 MW of load. Trenches would be a minimum of six feet apart to avoid overheating from the adjacent trench.

21 kV distribution line constructed underground within the roadway. It is not a dedicated feeder to the Great Oaks South project. Other "take off users" could be on the 21 kV line, but would not be associated with the Great Oaks project.

Additional notes taken during the meeting:

Reliability of PG&E-

Equinix: beginning from 2016 and up until a few months ago, there have been a total of 4 hrs of backup generator run time for unplanned outages. They can give CEC some information about emergency operation.

Within each room there is some ramping (scale up of occupancy). Data centers rarely have enough occupancy to get up to 70 percent of their critical IT load.

PG&E does not re-rate as peak hour has shifted. PG&E understands that a reconductoring would be possibly needed as they don't do a line re-rate anymore.

Notice of Construction for like for like work, or for more work like replacement of towers, that would need an environmental document.

Equinix isn't sure that reconductoring will need to be done as they may not reach 99 MW load.

PG&E plans for a 10-year horizon.

Three permits- fencing, building (foundation), grading. Working with City of San Jose. Operation June 2021. Estimated start October 2020 for construction assuming permits are secured.

PG&E states that if load is so high that they can't clear the transformer for maintenance, they will install another transformer.

It is normal practice to do CEQA on an "as-needed" basis, as PG&E builds the local network.

September 25, 2020

Follow Up Informational Requests for PG&E Regarding Great Oaks South Backup Generating Facility
Responses are underlined

1. PG&E will submit a clarification on how and when the second and third transformers be installed to serve the anticipated GOS load.

The second and third transformers would be installed at Santa Teresa Substation when they are needed for additional capacity. This would likely be when one of the following occurs:

- a. PG&E's load forecasts show an overload at either Santa Teresa Substation or Edenvale Substation that cannot be mitigated by circuit reconfiguration and load transfers to another substation. These overloads could be the result of applications for service such as the GOSD or the growth of existing customers at these substations.
- b. PG&E determines that the existing transformer at Santa Teresa Substation cannot be cleared for maintenance at any time of year.

2. PG&E will submit a clarification of the power supplying the Santa Teresa Substation would come from both of the Metcalf Substation and Edenvale Substation.

Santa Teresa Substation will be looped onto Metcalf-Edenvale #1 115 kV line. Santa Teresa will have a Ring configuration. Losing either Edenvale – Santa Teresa 115 kV line or Metcalf Santa Teresa 115 kV line, Santa Teresa Transformers #1 and #2 will continue being supplied from the other source.

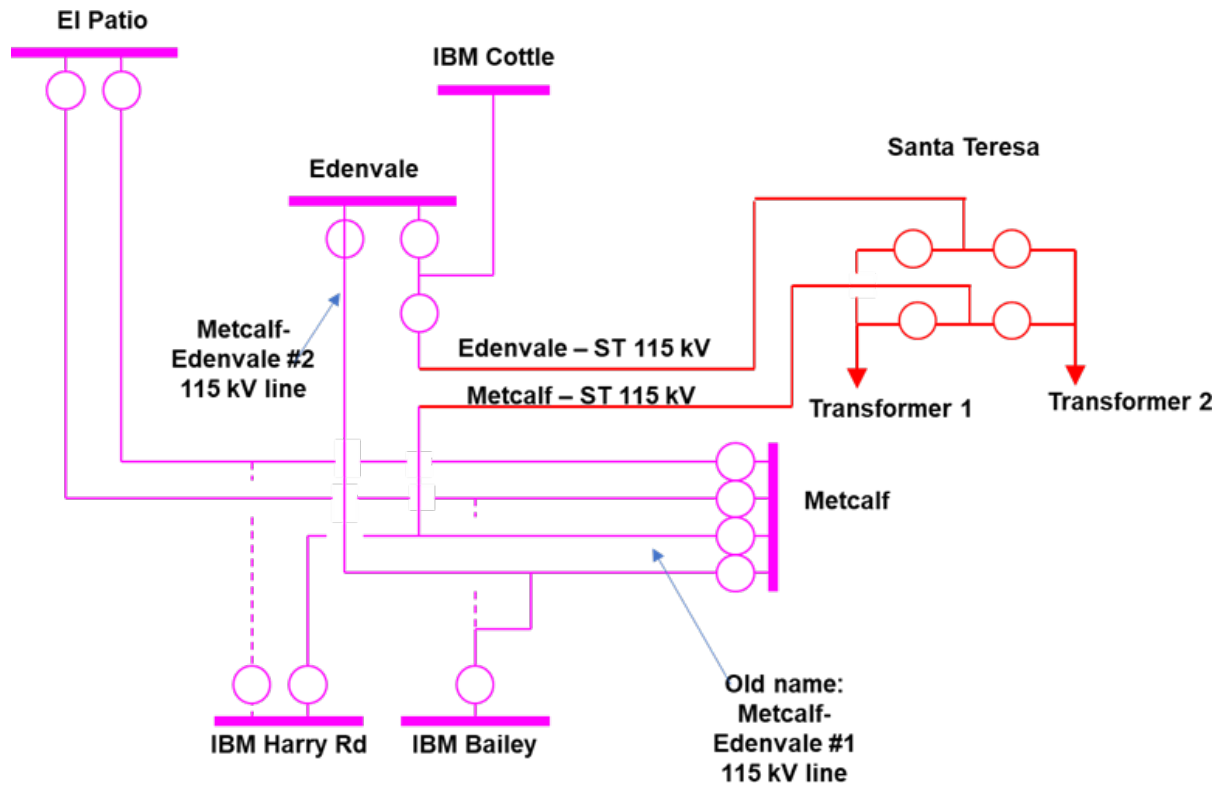

3. PG&E will provide an explanation of distribution interconnection between substations.

[See Distribution Ties near Santa Teresa Sub figure, below.](#)

4. PG&E to provide one-line diagram showing transformer ratings.

[See Santa Teresa SLD-R1 diagram, below.](#)

Distribution Ties near Santa Teresa Substation

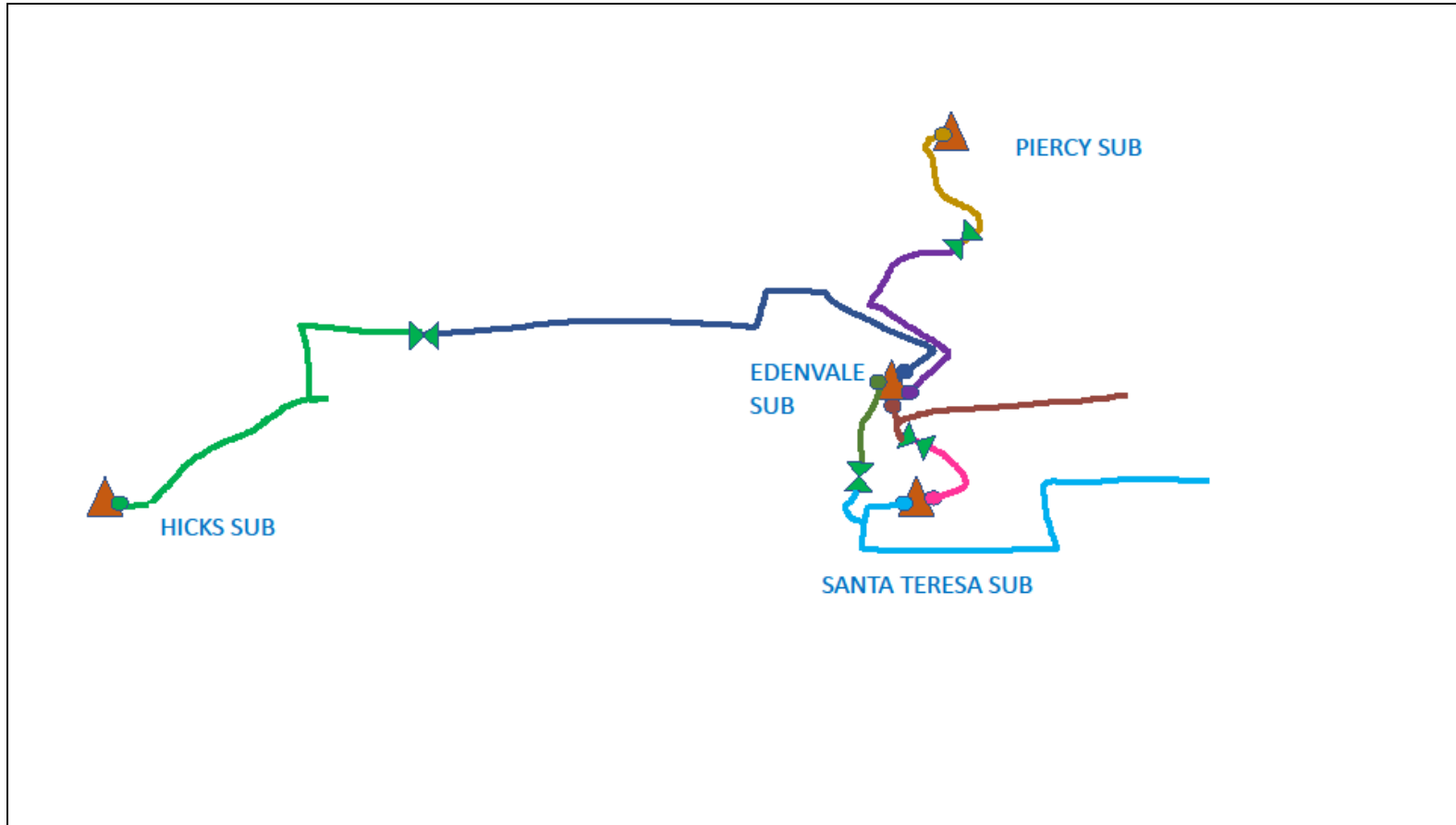

Santa Teresa One-line Diagram-R1

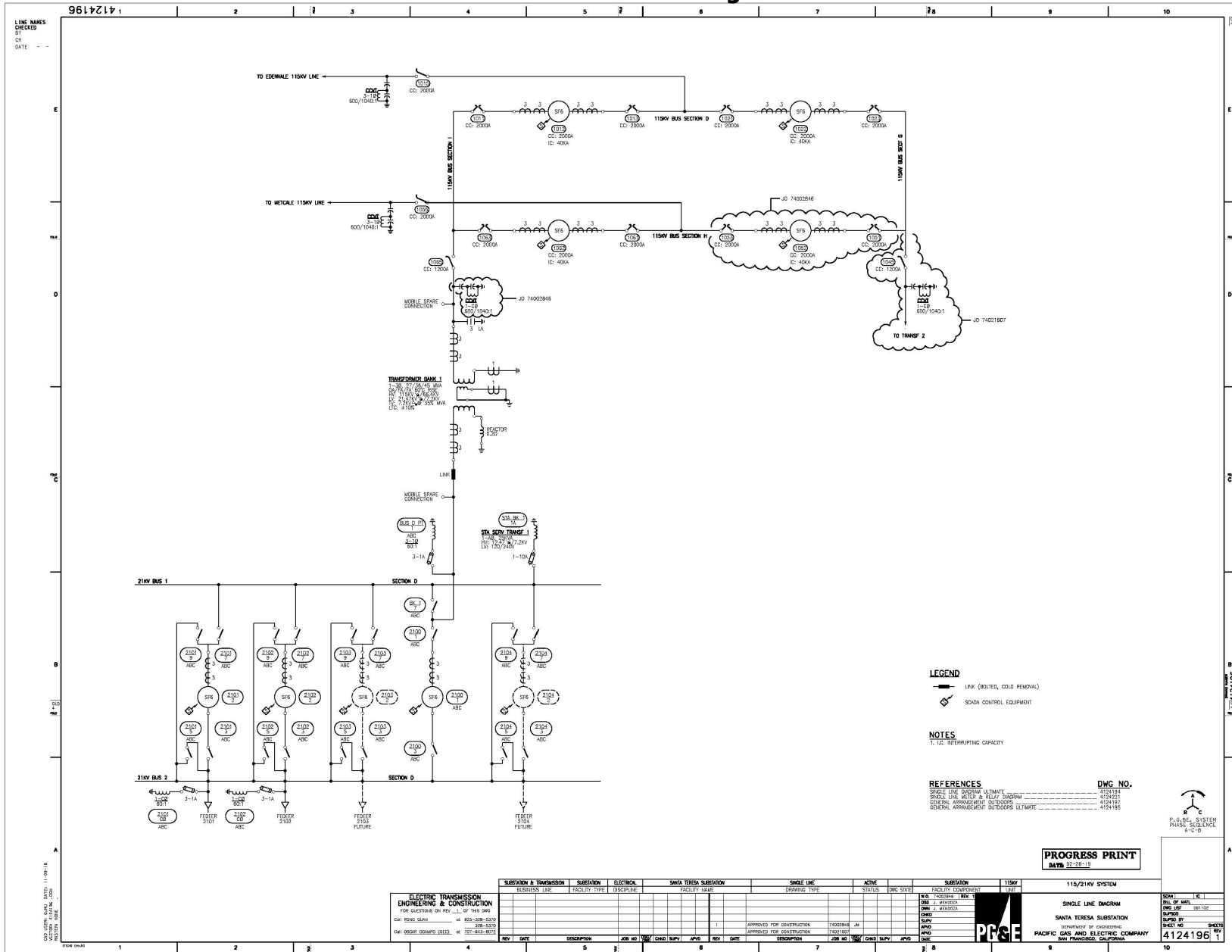

References

- BAAQMD 2020x – Bay Area Air Quality Management District (BAAQMD). BAAQMD Comment Letter for Great Oaks South Backup Generating Facility (TN 235803), November 2020. Available online at: <https://efiling.energy.ca.gov/Lists/DocketLog.aspx?docketnumber=20-SPPE-01>
- BAAQMD 2021a – Bay Area Air Quality Management District (BAAQMD). (TN 236946). Bay Area Air Quality Management District Comments – Comment Letter for San Jose Data Center NOP, dated March 1, 2021. Available online at: <https://efiling.energy.ca.gov/Lists/DocketLog.aspx?docketnumber=19-SPPE-04>
- CAISO 2021 – California Independent System Operator (CAISO). Final Root Cause Analysis Mid-August 2020 Extreme Heat Wave, dated January 13, 2021. Accessed March 2021. Available online at: <http://www.caiso.com/Documents/Final-Root-Cause-Analysis-Mid-August-2020-Extreme-Heat-Wave.pdf>
- CEC 2020qq – California Energy Commission (CEC). Walsh Data Center Initial Study and Proposed Mitigated Negative Declaration (TN 232078), February 2020. Available online at: <https://efiling.energy.ca.gov/Lists/DocketLog.aspx?docketnumber=19-SPPE-02>
- CEC 2020rr – California Energy Commission (CEC). Mission College Data Center Initial Study and Proposed Mitigated Negative Declaration (TN 232798), April 2020. Available online at: <https://efiling.energy.ca.gov/Lists/DocketLog.aspx?docketnumber=19-SPPE-05>
- CEC 2021a – California Energy Commission (CEC). Revised Initial Study and Proposed Mitigated Negative Declaration for the Sequoia Backup Generating Facility Small Power Plant Exemption (TN 236919), February 2021. Available online at: <https://efiling.energy.ca.gov/Lists/DocketLog.aspx?docketnumber=19-SPPE-03>
- CEC 2021l – California Energy Commission (CEC). Record of Conversation with J. Zielkiewicz, BAAQMD Staff Regarding Emergency Operations: Great Oaks South Backup Generating Facility (TN 237631), May 2021. Available online at: <https://efiling.energy.ca.gov/Lists/DocketLog.aspx?docketnumber=20-SPPE-01>
- CPUC 2021 – California Public Utilities Commission (CPUC). Decision Directing Pacific Gas and Electric Company, Southern California Edison Company, and San Diego Gas & Electric Company To Take Actions To Prepare For Potential Extreme Weather In The Summers Of 2021 and 2022. Decision 21-03-056 March 25, 2021. Available online at: <https://docs.cpuc.ca.gov/publisheddocs/published/g000/m373/k745/373745051.pdf>
- SV1 2020m – SV1, LLC. (SV1). SV1 Supplemental Response to DR-62 – SPPE Application: Great Oaks South Backup Generating Facility (TN 234875), September 2020. Available online at: <https://efiling.energy.ca.gov/Lists/DocketLog.aspx?docketnumber=20-SPPE-01>
- SV1 2021g – SV, LLC. (SV 1). SV 1 Revised Project Description: Great Oaks South Backup Generating Facility (TN 237149), March 2021. Available online at: <https://efiling.energy.ca.gov/Lists/DocketLog.aspx?docketnumber=20-SPPE-01>

Appendix C

Nitrogen Deposition Modeling

Appendix C: Nitrogen Deposition Modeling

Nitrogen deposition is the term used to describe the input of reactive nitrogen species from the atmosphere to the biosphere. The pollutants that contribute to nitrogen deposition derive mainly from oxides of nitrogen (NO_x) and ammonia (NH₃) emissions.

These pollutants are deposited as “atmospherically derived nitrogen” (ADN), primarily nitric acid (HNO₃). The chemical conversion from NO_x and NH₃ to ADN takes place in the atmosphere over a period of hours after the pollutants are discharged from their sources.

Staff modeled the potential nitrogen deposition impacts from readiness testing and maintenance of the proposed standby generators within a six-mile radius of the project site, including the Bay checkerspot butterfly critical habitat areas. The annual NO_x emissions were conservatively estimated based on Tier 2 emissions for 20 hours of readiness testing and maintenance per year per engine. It should be noted that the 36 larger 3-megawatt (MW) engines would be equipped with selective catalytic reduction (SCR) to reduce the NO_x emissions to meet Tier 4 emission standards. It takes time for the SCR to warm up to be fully effective. Staff’s conservative assumption of Tier 2 emissions does not consider the partial NO_x emission reduction that could be achieved during readiness testing and maintenance. In addition, assuming 20 hours of readiness testing and maintenance per year per engine is also conservative. The applicant expects that readiness testing and maintenance of each engine rarely exceeds 12 hours annually (SV1 2021g).

For the 36 larger 3-MW engines, hourly NH₃ emissions were estimated based on 45 minutes of 20 parts per million (ppm) emission, assuming initial 15-minute warmup of the SCR with no NH₃ emissions. The annual NH₃ emissions were also estimated based on 20 hours of readiness testing and maintenance per year for each 3-MW engine. No direct NH₃ emission is expected from the three life safety generators because no SCR is proposed for these smaller generators.

Staff used the American Meteorological Society/Environmental Protection Agency Regulatory Model (AERMOD) to evaluate the potential nitrogen deposition impacts of the project. The model overestimates nitrogen deposition impacts with the following assumptions:

- One hundred percent of the NO_x and NH₃ conversion to ADN within the stack rather than allowing the conversion to occur over distance and time. It ignores the fact that the conversion process requires sunlight, moisture, and time. It is unlikely that there would be sufficient time for all of the emitted NO_x or NH₃ to convert to ADN within a six-mile radius of the project.
- Maximum settling velocities derived from the parameters for HNO₃ (which, of all the depositional species, has the most affinity for soils and vegetation and the tendency to adhere to what it is deposited on) to produce maximum, or conservatively estimated, deposition rates.

As stated above, staff's analysis of nitrogen deposition impacts is overly conservative. It overestimates the nitrogen deposition impacts expected from routine readiness testing and maintenance of the standby generators. On the other hand, as staff concluded in **Section 4.3 Air Quality**, assessing impacts of emergency operation would be speculative due to the infrequent, irregular, and unplanned nature of emergency events. However, staff believes the overestimated nitrogen deposition impacts for routine readiness testing and maintenance would cover impacts from some emergency operations of the standby generators that may occur.

In addition, the NO_x emissions of the standby generators for readiness testing and maintenance would be fully offset through the permitting process with the BAAQMD. The NO_x offset would mitigate the project's effects on basin-wide nitrogen deposition.

References

SV1 2021g – SV, LLC. (SV 1). SV 1 Revised Project Description: Great Oaks South Backup Generating Facility (TN 237149), March 2021. Available online at: <https://efiling.energy.ca.gov/Lists/DocketLog.aspx?docketnumber=20-SPPE-01>

Appendix D

Renewable Diesel and Natural Gas Supplemental Information

Appendix D: Renewable Diesel and Natural Gas Supplemental Information

Renewable Diesel

Introduction

Staff has researched the difference in cost, the production, supply and emissions of renewable diesel in place of conventional, petroleum diesel for the backup generators proposed for this project. Renewable diesel fuel supply is increasing year-by-year and limited emissions data indicate that most criteria pollutants and greenhouse gas emissions would be reduced if the ultralow sulfur diesel (ULSD) fuel proposed for this facility is replaced with renewable diesel.

On July 31, 2013, the California Air Resources Board (CARB) and the Water Resources Control Board issued a joint statement to interested parties declaring that renewable diesel is fully equivalent to conventional low-sulfur diesel for sale in California.¹ Renewable diesel and CARB diesel (called ULSD below) both meet the same definition of “hydrocarbon oil” and American Society of Testing and Materials (ASTM) specification ASTM D975-12a. They state that renewable diesel is considered by these agencies to be a “drop in” fuel and fully equivalent to one another. A table attached to this joint statement showed that renewable diesel had much lower sulfur content than CARB diesel, a higher cetane number (for improved auto-ignition) and a much lower total aromatic content.

Cost Difference Between Renewable Diesel and ULSD

As explained more fully below, renewable diesel is manufactured at industrial facilities such as refineries using high pressures and temperatures to convert feedstocks to the final product. Currently, the most likely source of renewable diesel that could substitute for ULSD is the Neste facility located in Singapore.

There is very little data available comparing the unsubsidized cost of renewable diesel to ULSD. A representative of Western States Oil Company², which is a distributor of Neste renewable diesel, indicated that federal and state subsidies that are only available for transportation uses “pretty much covers the differential cost” which he estimated to be around \$2.50 to \$3.00 per gallon. In addition, transportation fuels are subject to approximately \$0.66 per gallon in road taxes, and for a stationary source to avoid these taxes, the fuel supplier must dye the fuel red to distinguish it as a non-taxed use. Staff

1 Letter from Air Resources Board, signed by Ricard Corey, Executive Officer of ARB and Tom Howard, Executive Director of SWRCB, dated July 31, 2013. Link: <https://ww2.arb.ca.gov/resources/documents/renewable-diesel-joint-statement>

2 Email exchanges of information occurred by phone and email on June 22 and June 24, 2020, between Gerry Bemis of CEC staff and Bob Brown of Western State Oil (TN 233855).

at the US Environmental Protection Agency (US EPA) confirmed that federal tax credits are only available for transportation fuel uses at this time and that it would take an act of congress to extend them to stationary source use.³ In addition, CARB staff confirmed that the state's Low Carbon Fuel Standard (LCFS) credits are only available for transportation uses.⁴

CARB initially approved the LCFS regulation in 2009 and began implementation on January 1, 2011. CARB approved some amendments to the LCFS in December 2011, which were implemented on January 1, 2013. In September 2015, the ARB approved the re-adoption of the LCFS, which became effective on January 1, 2016, to address procedural deficiencies in the way the original regulation was adopted.

Due to the complexity of the LCFS program, CARB staff have indicated that it was more likely CARB would establish a parallel program for stationary uses rather than to expand the existing LCFS Program.

The annual amount of petroleum diesel fuel needed for readiness testing and maintenance activities is approximately 161,880 gallons per year of ULSD⁵. If the cost of renewable diesel is \$3.00 per gallon more than ULSD, this equates to an annual increase in fuel cost of about \$485,000 per year.⁶ For comparison purposes, the cost of providing electricity to the Great Oaks South (GOS) data center is estimated to be about \$90 million dollars per year.⁷

Production of Renewable Diesel

Almost all renewable diesel fuel currently used in California is produced in Singapore by Neste, using a patented vegetable oil refining process⁸. Chemically, the production

3 Information exchanges occurred by email between Gerry Bemis of CEC staff and Paul Michiele, Fuel Center Director, Office of Transportation and Air Quality, US EPA. These emails were dated July 6 and 7, 2020 (TN 234353).

4 Information exchange occurred by email between Gerry Bemis of CEC staff and Rachel Connors of ARB staff on July 17, 2020 (TN 235915).

5 Application for Small Power Plant Exemption: Great Oaks South Backup Generating Facility (TN 232466), March 2020. Available online at: <https://efiling.energy.ca.gov/Lists/DocketLog.aspx?docketnumber=20-SPPE-01>

6 Computed from 161,880 gallons/yr. x \$3.00/gallon = ~\$485,000/yr.

7 Computed assuming a maximum data center occupancy and cooling load equal to 99 MW and 8,760 hours per year, or 867,240,000 kWh/yr. x \$0.173 per kWh (PG&E's E-20P rate) x 0.60 (assumed occupancy rate) = ~\$90 million per year. This is likely an overstatement of annual electricity procurement costs because the cooling portion of the electricity demand is based on the hottest day of the year.

8 Vegetable oil refining is a process to transform vegetable oil into biofuel by hydrocracking or hydrogenation. Hydrocracking breaks big molecules into smaller ones using hydrogen while

process entails direct catalytic hydrodeoxygenation⁹ of plant oils, which are triglycerides¹⁰, into the corresponding alkanes¹¹ and propane¹². The glycerol chain of the triglyceride is hydrogenated to propane.

Thus, renewable diesel is made in an industrial facility which can accommodate the high temperatures and pressures needed to manufacture it.

Adequacy of Renewable Diesel Supply

Currently, renewable diesel is used mostly in mobile source applications in California. This use is supported by both federal and state credits that are only available to transportation uses of renewable diesel. As explained above, these credits currently are high enough to cover the increased price of renewable diesel over ULSD, for those uses that qualify for these credits.

Renewable diesel produced by Neste and ULSD are both available from a terminal located near the proposed GOS facility. The distributor is Western States Oil Company, located at 1790 South Tenth Street, San Jose. A representative of this company indicated that they could easily supply one million gallons of renewable diesel per year. It is located approximately 10 miles northwest of the project's proposed location and the drive time is typically less than 20 minutes.

CARB began reporting the consumption of renewable diesel in 2011. Annual sales volumes have grown from approximately 1.8 million gallons sold in 2011 to 618 million gallons sold in 2019. The annual consumption of ULSD for Great Oaks South for readiness testing and maintenance is estimated to be about 161,880 gallons. If this were replaced with renewable diesel, this level of demand would be about 0.03 percent of renewable diesel consumption in 2019. Thus, if renewable diesel were used at GOS in place of ULSD, there would be little change in annual consumption of renewable diesel in California and the current supply should be adequate. See **Figure D-1** for annual sales of renewable diesel in California from 2011 to 2019.

hydrogenation adds hydrogen to molecules. Diesel fuel produced from these sources is known as *green diesel* or *renewable diesel*.

9 Hydrodeoxygenation (HDO) is a hydrogenolysis process for removing oxygen from oxygen containing compounds.

10 A triglyceride is an ester derived from glycerol and three fatty acids. Triglycerides are the main constituents of body fat in humans and other vertebrates, as well as vegetable fat.

11 An alkane consists of hydrogen and carbon atoms arranged in a structure in which all the carbon-carbon bonds are single.

12 Propane is a three-carbon alkane with the molecular formula C₃H₈. It is a by-product of natural gas process and petroleum refining and is commonly used as a **fuel**.

FIGURE D-1 CALIFORNIA'S ANNUAL SALES OF RENEWABLE DIESEL (MILLIONS OF GALLONS)

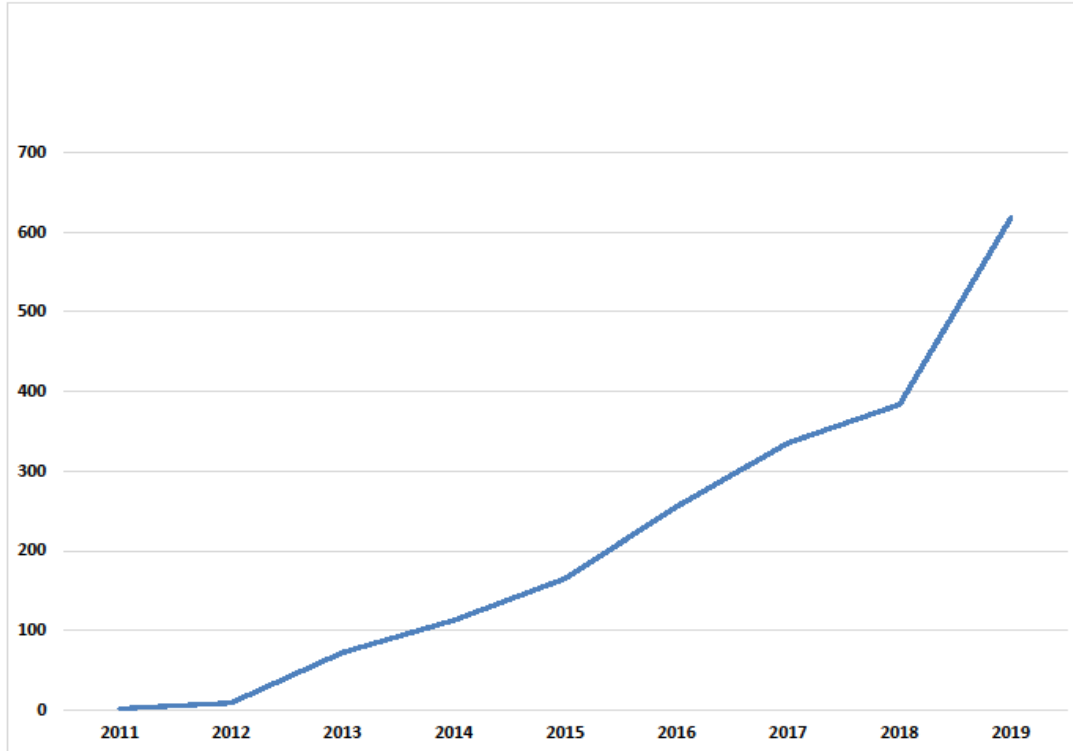

Renewable Diesel Emissions Compared to ULSD

Given the types of feedstocks and the process used to produce renewable diesel, it is expected that renewable diesel would have lower criteria pollutant emissions than conventional ULSD. Reduced emissions are expected for criteria pollutants, greenhouse gas emissions (over the full fuel cycle) and toxics substance emissions. Limited testing done to date on engines used in motor vehicles supports this conclusion. However, this should be confirmed with testing under controlled conditions in the size of engine proposed for this facility and using the same source test protocol used for engine certification.

Criteria Pollutant, Carbon Dioxide and Fuel Use Test Results

CARB has conducted a limited amount of testing using both an engine dynamometer (where results are expressed in grams/bhp-hr.) and a heavy-duty vehicle dynamometer (where results are expressed in grams/mile). Results were obtained for heavy-duty truck engines ranging in size from 385 horsepower (hp) to 475 hp. Values from additional testing on a locomotive engine are pending.

One mode of testing that was used in this series of tests is the "Urban Dynamometer Driving Schedule" or UDDS. This cycle is commonly used to collect emissions data on engines already in heavy, heavy-duty diesel (HHD) trucks. This cycle covers a distance of 5.55 miles with an average speed of 18.8 mph and maximum speed of 58 mph.

A second mode of testing is the Federal Test Procedure (FTP). It consists of a cold start phase, a cold stabilization phase and a hot start phase. The duration of the test is 31.2 minutes and cycle covers a distance of 11.04 miles at an average speed of 21.19 miles per hour.

A third mode of testing is called the "CARB Heavy Heavy-Duty Diesel Truck (HHDDT) 50 mph Cruise" schedule. It was developed for chassis dynamometer testing by the California Air Resources Board with the cooperation of West Virginia University. This cycle covers a distance of 10.5 miles with an average speed of 48.9 mph and maximum speed of 66.9 mph.

2006 Cummins ISM Engine Testing

Laboratory testing was conducted using an engine dynamometer after a 2006 Cummins ISM engine was removed from an on-road, heavy-duty vehicle. Emissions are reported in a 2011 report,¹³ with funding provided by the California Air Resources Board, the South Coast Air Quality Management District, and others. Renewable diesel used for these tests was provided by Neste. Tests were conducted under the Urban Dynamic Driving Schedule (UDDS), a Federal Test Procedure (FTP) cycle, and a 50 miles/hour cruise cycle. Renewable diesel reduced criteria pollutant and carbon dioxide emissions for all pollutants tested, except for a slight increase in carbon monoxide (CO) which may have been an artifact of the testing protocol as explained in the report. Most of the testing documented in this report are for fuels other than renewable diesel; results for renewable diesel were obtained for a 2006 Cummins ISM 370 engine with a diesel particulate filter.

The engine was rated as having a maximum rating of 385 hp and was obtained from an on-road, heavy-duty vehicle with 92,000 miles of total service. The results are shown in the tables (**Tables D-1, D-2, and D-3**) below.

Tailpipe testing was also conducted for carbon dioxide (CO₂) and results are shown below. However, as discussed later in this paper, the full fuel cycle should be evaluated for a comprehensive greenhouse gas emissions comparison. Fuel consumption is also shown, in units of brake-specific fuel consumption (BSFC). The increase in BSFC for the renewable diesel is likely due to its slightly lower energy density per gallon, around 4 to 10 percent lower than ULSD. The designation "ISM" stands for Cummins Model M, with Interact System.

TABLE D-1 2006 CUMMINS ISM—UDDS CYCLE RENEWABLE DIESEL (RD) MINUS ULSD

	Units	ULSD	RD	Difference	Percent Difference
NOx	g/bhp-hr	5.891	4.825	-1.066	-18
PM	g/bhp-hr	0.063	0.045	-0.018	-29
THC	g/bhp-hr	0.769	0.677	-0.092	-12
CO	g/bhp-hr	2.019	1.392	-0.627	-31

13 CARB Assessment of the Emissions from the Use of Biodiesel as a Motor Vehicle Fuel in California—Biodiesel Characterization and NOx Mitigation Study (October 2011); Appendix G.

TABLE D-1 2006 CUMMINS ISM—UDDS CYCLE RENEWABLE DIESEL (RD) MINUS ULSD

CO2	g/bhp-hr	838	811	-27	-3
BSFC	gal/bhp-hr	0.086	0.090	0.004	+5

TABLE D-2 2006 CUMMINS ISM—FTP CYCLE RENEWABLE DIESEL (RD) MINUS ULSD

	Units	ULSD	RD	Difference	Percent Difference
NOx	g/bhp-hr	2.088	1.882	-0.206	-10
PM	g/bhp-hr	0.073	0.048	-0.025	-34
THC	g/bhp-hr	0.294	0.284	-0.01	-3
CO	g/bhp-hr	0.701	0.614	-0.087	-12
CO2	g/bhp-hr	631	610	-21	-3
BSFC	gal/bhp-hr	0.064	0.068	0.004	+6

TABLE D-3 2006 CUMMINS ISM—50 MPH CRUISE CYCLE RENEWABLE DIESEL (RD) MINUS ULSD

	Units	ULSD	RD	Difference	Percent Difference
NOx	g/bhp-hr	1.809	1.553	-0.256	-14
PM	g/bhp-hr	0.053	0.040	-0.013	-25
THC	g/bhp-hr	0.176	0.174	-0.002	-1
CO	g/bhp-hr	0.452	0.467	+0.015	+3
CO2	g/bhp-hr	549	537	-12	-2
BSFC	gal/bhp-hr	0.056	0.059	+0.003	+5

Notes: 1 The small increase in **Table D-3** for CO was noted in the report as "possibly the result of testing conditions related to the specifics of engine operation."

2 The increase in **Tables D-1, D-2** and **D-3**, for BSFC is likely due to the lower energy content of a gallon of renewable diesel versus ULSD.

The Cummins C3250 D6e engines proposed by the applicant to be used at GOS for the backup generators are rated at a nominal 3.25 MW (~4,360 hp), much larger than the 385 hp Cummins engine tested in the report cited above. The Cummins C3250 D6e engine proposed for GOS was certified as meeting EPA Tier 2 emissions requirements using 40CFR89.¹⁴ Ideally, this test should be replicated using renewable diesel rather than ULSD to have a better understanding of the amount of reduction in emissions expected using renewable diesel in place of ULSD. However, based upon testing to date, criteria pollutant emissions should be significantly reduced when replacing ULSD with renewable diesel.

2000 Caterpillar C-15 Engine Testing

Laboratory testing was also conducted on a 14.6 liter, 475 hp year 2000 Caterpillar C-15 engine mounted on a Freightliner chassis using a heavy-duty vehicle dynamometer.¹⁵ This vehicle had approximately 34,000 miles on it. This engine was tested only for the UDDS cycle and 50 miles per hour cruising cycle. Results are presented in grams per mile

14 See: <https://www.law.cornell.edu/cfr/text/40/part-89>.

15 See note 13 above.

(g/mile) and miles per gallon (MPG) because this engine remained in the vehicle chassis during the tests.

The Caterpillar C-15 test results were shown only in charts in the CARB report. The values in **Tables D-4** and **D-5** were estimated from these charts.

TABLE D-4 2000 CATERPILLAR C-15 ENGINE TEST—UDDS CYCLE RENEWABLE DIESEL (RD) MINUS ULSD					
	Units	ULSD	RD	Difference	Percent Difference
NOx	g/mile	16	14	-2	-13
PM	g/mile	0.205	0.125	-0.08	-39
THC	g/mile	0.48	0.38	-0.1	-21
CO	g/mile	3.25	2.75	-0.5	-15
CO2	g/mile	1550	1490	-60	-4
Fuel Use	MPG	6.35	6.10	-0.25	-4

TABLE D-5 2000 CATERPILLAR C-15 ENGINE TEST—50 MPG CRUISE CYCLE RENEWABLE DIESEL (RD) MINUS ULSD					
	Units	ULSD	RD	Difference	Percent Difference
NOx	g/mile	21.5	19	-2.5	-12
PM	g/mile	0.125	0.085	-0.04	-32
THC	g/mile	0.22	0.19	-0.03	-14
CO	g/mile	1.75	0.145	-0.3	-17
CO2	g/mile	1450	1410	-40	-3
Fuel Use	MPG	6.75	6.4	-0.35	-5

The limited testing conducted to date indicates that renewable diesel is expected to reduce criterial pollutant and carbon dioxide emissions of criteria pollutants from levels expected for ULSD.

Toxics Emissions Test Results. Toxics emissions were also tested on the 2000 Caterpillar C-15 engine in the Freightliner chassis tested on a heavy-duty vehicle dynamometer. Results are expressed in units of mass emissions per mile.

TABLE D-6 2000 CATERPILLAR C-15 ENGINE ON UDDS TEST CYCLE

Toxic Substance	Units	ULSD	Renewable Diesel	Difference	Percent Difference
1,3 Butadiene	µg/mile	1.75	1.5	-0.25	-14%
Benzene	mg/mile	0.35	0.30	-0.05	-14%
Toluene	mg/mile	0.2	0.1	-0.1	-50%
Ethyl Benzene	mg/mile	0.6	0.05	-0.55	-92%
O-Xylene	mg/mile	0.1	0.07	-0.03	-30%
Formaldehyde	mg/mile	62	44	-18	-29%
Acetaldehyde	mg/mile	25.5	20.2	-5.3	-21%
Acetone	mg/mile	30.2	45	14.8	+49%
Acrolein	µg/mile	175	130 – 140	-45/-35	-26%/-20%
o,m Tolualdehyde	µg/mile	30	9 – 10	-21/-20	-30%/-67%
Particle Number	count	1.1 x 10 ¹⁵	1.1 x 10 ¹⁴	-1000	-Nil

TABLE D-7 2000 CATERPILLAR C-15 ENGINE ON 50 MPH CRUISE TEST CYCLE

Toxic Substance	Units	ULSD	Renewable Diesel	Difference	Percent Difference
1,3 Butadiene	µg/mile	--	--	--	--
Benzene	mg/mile	0.24	0.25	+0.01	+4.1%
Toluene	mg/mile	0.1	0.06	-0.04	-40%
Ethyl Benzene	mg/mile	0.4	0.15	-0.25	-62%
O-Xylene	mg/mile	0.04	0.03	-0.01	-25%
Formaldehyde	mg/mile	23	14	-9	-39%
Acetaldehyde	mg/mile	12.5	7.5	-5.0	-40%
Acetone	mg/mile	15	46	+31	+307%
Acrolein	µg/mile	--	--	--	--
O, M Tolualdehyde	µg/mile	--	--	--	--
Particle Number	count	1.9 x 10 ¹⁴	1.0 x 10 ¹⁵	+1,000	+ Nil

These limited data show good potential for reducing toxics substance emissions by substituting renewable diesel for ULSD. However, the results obtained for acetone emissions may need further study and analysis.

[Note: CARB is in the process of testing renewable diesel in a locomotive engine; this testing should be more comparable to the proposed engines than the results shown the tables above because they will be more similar in horsepower. However, these results are not yet available.]

Fuel Cycle Greenhouse Gas Emissions Comparison

As shown in Tables 1 through 6 above, renewable diesel used in place of ULSD can reduce carbon dioxide tailpipe emissions approximately 3 to 4 percent. However, renewable diesel is produced with a fuel cycle that is a far lower carbon intensity (CI) than ULSD. To have a more complete understanding of the impact of replacing ULSD with renewable diesel, it is necessary to examine the full fuel cycle of each fuel from origin to use. This is because greenhouse gases have a global impact rather than a local impact.

To compute full fuel cycle GHG emissions, a model called GREET¹⁶ is commonly used to evaluate full fuel cycle GHG emissions for transportation. Although staff has not computed fuel cycle emissions using GREET, we can estimate the relative change in GHG emissions using CI values from California’s LCFS program. Although use of renewable diesel does not qualify for obtaining credits from California’s LCFS as explained above, CI values obtained from that program¹⁷ can be used to estimate the expected GHG reductions associated with switching from ULSD to renewable diesel in this project. ARB staff use a version of GREET called CA-GREET to compute CI values for the LCFS program.¹⁸

The data shown below in Table 8 are ARB-estimated values for Neste reformulated diesel supplied from various feedstocks with the renewable diesel produced at the Neste refinery located in Singapore. These CI values include the feedstock and transport to California via oceangoing tanker. They apparently do not include consumption of the fuel. Combining the CI of the fuel cycle with the reduced tailpipe emissions from Tables 1 through 6 provides an approximate estimate of the full fuel cycle benefit of replacing ULSD with renewable diesel. For comparison purposes, the CI for LCFS produced for use in California has a value of 100.45.

Feed stock	Carbon intensity (CI)	Percent Reduction of Renewable Diesel From ULSD (%)
Asian-sourced used cooking oil	16.89	-83
Globally averaged used cooking oil	25.61	-75
Southeast Asian fish oil	33.08	-67
North American tallow	34.19	-66
New Zealand tallow	34.81	-65
Australian tallow	36.83	-63

16 Greenhouse gases, Regulated Emissions, and Energy use in Transportation. Available from Argonne National Labs. From the Arbonne web site: Analysis of transportation systems on a life-cycle basis permits us to better understand the breadth and magnitude of impacts produced when vehicle systems are operated on different fuels or energy options like electricity or hydrogen. Such detailed analysis also provides the granularity needed to investigate policy implications, set R&D goals, and perform follow-on impact and policy assessments. US Department Energy’s Office of Energy Efficiency and Renewable Energy, Systems Assessment Group in Argonne’s Energy Systems Division has been developing the GREET model to provide a common, transparent platform for lifecycle analysis (LCA) of alternative combinations of vehicle and fuel technologies.

Vehicle technologies include conventional internal combustion engines, hybrid electric systems, battery electric vehicles, and fuel cell electric vehicles. Fuel/energy options include petroleum fuels, natural gas-based fuels, biofuels, hydrogen, and electricity. LCAs conducted with the GREET platform permit consideration of a host of different fuel production, and vehicle material and production pathways, as well as alternative vehicle utilization assumptions. GREET includes all transportation modes – on-road vehicles, aircraft, marine vessels, and rail (to be added in a new GREET release). The Systems Assessment Group has conducted various LCAs of vehicle/fuel systems for DOE and other agencies. There are more than 20,000 registered GREET users.

17 <https://ww2.arb.ca.gov/resources/documents/lcfs-pathway-certified-carbon-intensities>

18 <https://ww2.arb.ca.gov/resources/documents/lcfs-pathway-certified-carbon-intensities>.

TABLE D-8 CARBON INTENSITY VALUES COMPUTED FROM CA-GREET MODEL

Feed stock	Carbon intensity (CI)	Percent Reduction of Renewable Diesel From ULSD (%)
Midwest corn oil	37.39	-63
Globally averaged tallow	39.06	-61
ULSD/CARB Diesel	100.45	0

Thus, the 61 to 83 percent reduction in CI values from Table 8 should be combined with results in Tables 1 through 5 above. However, it can be seen that using renewable diesel in place of ULSD would greatly reduce the GOS facility’s full fuel cycle greenhouse gas emissions associated with operating diesel-fueled equipment during the construction period and onsite fuel consumption during the operations period. However, renewable diesel still has some carbon associated with the fuel cycle, as evidenced by the CI values in Table 8 not being zero, so additional measures would be needed before GOS could be considered a carbon-free facility.

Natural Gas ICEs

Introduction

Staff has researched the difference in cost, supply and emissions of using natural gas fueled internal combustion engines (ICEs) in place of conventional, petroleum diesel for the backup generators proposed for this project. Currently, there is limited information available on fuel supply reliability of natural gas delivered to the site by pipeline versus the reliability of delivering liquid petroleum diesel by tanker truck to the site. However, most backup generators currently in place currently use diesel. A nationwide survey in 2016 revealed that 85 percent of the backup generation was served by diesel, while 10 percent was served by natural gas and the remainder by propane.¹⁹

Cost Difference Between Natural Gas and Petroleum Diesel Backup Generators

The reliability of a system is an important consideration when selecting a backup genset. But cost is important as well. Many factors contribute to the life-cycle costs of a backup system, such as equipment, maintenance, and fuel costs.

Both, natural gas ICEs and diesel engines are reciprocating engines. They are available in sizes up to 18 MW. The fast start-up capability of reciprocating engines allows timely resumption of the system following a maintenance procedure. In peaking or emergency power applications, reciprocating engines can quickly supply electricity on demand. The annual energy cost (\$/MMBtu) for natural gas fuel is lower than conventional diesel. But, diesel gensets generally have a lower component cost than ICEs. It is notable that

19 National Renewable Energy Laboratory report. A Comparison of Fuel Choices for Backup Generators; <https://www.nrel.gov/docs/fy19osti/72509.pdf>.

improvements in ICEs and recently promulgated air quality regulations have reduced some of the cost advantages of diesel systems.¹⁹

The size of the engines can impact operating cost. If switching from one generating technology to another requires more engines to deliver the same total MW capacity, the repair and maintenance frequency and testing requirements could increase, which may result in an increase in associated costs.

Fuel Supply Reliability

Staff contacted Pacific Gas and Electric Company (PG&E) natural gas staff to obtain a better understanding of the relative risk of supplying natural gas in an underground pipe to the site versus the reliability of using onsite liquid diesel storage tanks of 9,200 gallons for each of the 36 engines (six engines are redundant). This storage tank capacity is expected to provide service for at least 30 hours of full load operation. To date, the longest duration of electrical service outage was for 19+ hours in 2016. These tanks would need to be resupplied for longer outages and typically would be resupplied as soon as possible after any emergency use. While there would not be a need to restock the natural gas supply option, there is a risk of pipeline outage. Typically, most such outages are due to human error (for example, from excavation damage to the natural gas pipe) or due to an earthquake.

Staff was able to find only limited information that addresses the relative reliability of these two fuel supply options. Oftentimes, available information focuses on a comparison between natural gas and electricity reliability during and after a natural disaster such as a hurricane, rather than comparing the risk of natural gas pipeline delivery reliability to on-road truck delivery of petroleum diesel.

However, a 2017 white paper²⁰ by Burns McDonnell compared these two options specifically for backup generators located at data centers. As stated in the title of their white paper, they concluded that natural gas backup options can be a very reliable option, even in earthquake-prone areas. To quote from their paper: *"For data centers and other mission critical facilities, one rule is paramount: keep the power on. A desire for cleaner power has shifted backup generators from diesel to natural gas, but a common myth exists with this transition—the supposed fragility of natural gas pipelines in seismic conditions. Smart pipeline design proves the myth is not true."*

The white paper states further: *"natural gas (is) an ideal option for data center backup power. But some operators have been reluctant to rely on natural gas to maintain 24/7 service because they're concerned about the resiliency of pipeline infrastructure — especially in earthquake-prone areas."*

20 Burns McDonnell, "Natural Gas is a Smart Choice for Data Center Backup Power—Even in Earthquake-Prone Areas; <https://www.burnsmcd.com/insightsnews/tech/natural-gas-smart-choice-for-data-center-power>.

"But well-designed natural gas pipelines have performed well in seismic conditions for decades. Having successfully installed high-pressure natural gas pipelines, often in earthquake-prone regions, we have experienced the benefit of smart design. Smart design validates the resiliency and redundancy of the natural gas grid, making natural gas generators a reliable choice for data center backup power."

Enchanted Rock, LLC commissioned the National Renewable Energy Laboratory (NREL) of the U.S. Department of Energy to conduct the study referenced above in footnote 19. This report states: *"natural gas generators are less likely than diesel generators to fail during a (n electrical) power outage. The differences in likelihoods of failure between natural gas and diesel generators are small for most regions and dependent on several assumptions. This indicates that differences in fuel source security are of second-order concern."* As seen in the quote, this report suggests that natural gas pipeline delivery to the project site should be as reliable as roadway delivery of conventional petroleum diesel.

The NREL report also says: *"Generators pose the risk of being unavailable due to problems with maintenance, failing to start and support load, and failing to run for the duration of the outage. Natural gas generators pose the additional risk of a loss of gas pressure, while diesel generators pose the additional risk of running out of fuel in situations where resupply is not possible. Fuel related risks are highest for widespread, long outages. Most power outages are short duration events, but long duration outages are not uncommon."*

To develop a better understanding of local reliability natural gas pipeline supply issues in the vicinity of the proposed project, staff met with PG&E representatives. PG&E staff stated that most of the pressure in their natural gas pipes is provided by burning a small amount of the transported gas at compressor stations and that there are only two electric powered compressor stations in their entire service system, one of which is located in the City of Tracy and the other in the City of Willows. As a result, it is extremely unlikely to have insufficient pipeline pressure from loss of electricity anywhere in their system.

When PG&E must take a local line out of service for planned maintenance, they can often provide for ongoing service by temporarily provide local service using a truck loaded with compressed natural gas. This truck requires a footprint of 20 feet by 100 feet and is capable of delivering 100,000 cubic feet per hour of gas, with each truck carrying a total of 300 million BTU of gas. PG&E staff stated a loss of natural gas is very unlikely to happen but cannot be completely ruled out.

Space Needs

Diesel fueled backup generators are typically built on a rack over their fuel supply tank, requiring space between each generator and a staircase and service deck at the elevation of the diesel engine. For Great Oaks South, each generator is approximately 10 feet wide by 50 feet long. The exhaust stacks are spaced approximately 56 feet from one another.

Staff calculated the footprint of the 39 engines proposed at the GOS site as approximately 1.9 acres for 117 MW (peak power) or approximately 61.5 MW per acre.

Enchanted Rock provided a drawing showing how they would arrange their engines at a typical site. The result was an approximate capacity of 78 MW per acre.

Natural Gas ICE Emissions Compared to Petroleum Diesel

Criteria Pollutant and Carbon Dioxide Emissions Test Results

Enchanted Rock LLC also recently commissioned an analysis by the Brattle Group. Their June 2020 paper²¹ compared both criteria pollutant emissions and carbon dioxide emissions against Tier 2 and Tier 4 petroleum diesel fired engines. Results below compare a conventional petroleum fueled Tier 4 ICE to a natural gas ICE. The comparison to a petroleum fueled tier 2 engine would show even greater differences.

TABLE D-9 CRITERIA POLLUTANT EMISSIONS NATURAL GAS ICE VERSUS PETROLEUM DIESEL ICE

	Units	Petroleum Diesel Tier 4	Natural Gas ICE	Difference	Percent Difference (%)
NOx	Lbs/MWe-hr	1.48	0.004	-1.476	-99.7
PM	Lbs/MWe-hr	0.44	0.003	-0.437	-99.3
VOC	Lbs/MWe-hr	0.42	0.001	-0.419	-99.8
CO	Lbs/MWe-hr	7.72	1.09	-6.63	-85.8
SO2	Lbs/MWe-hr	0.016	0.007	-0.009	-56.2
CO2	Lbs/MWe-hr	1,555	1,395	-160	-10.3

Note: test data were from a "Nationally Recognized Testing Laboratory" that was not identified in the report.

Toxics Emissions Test Results

The Brattle report did not include toxics emissions testing. However, these are expected to be reduced due to the reductions reported above for VOCs and PM.

Fuel Cycle Greenhouse Gas Emissions Comparison

To compute full fuel cycle GHG emissions, a model called GREET²² is commonly used to evaluate full fuel cycle GHG emissions for transportation. Although staff has not computed

21 Decarbonized Resilience—Assessing Alternatives to Diesel Backup Power, June 2020; https://brattlefiles.blob.core.windows.net/files/19026_decarbonized_resilience_white_paper_-_final.pdf

22 Greenhouse gases, Regulated Emissions, and Energy use in Transportation. Available from Argonne National Labs. From the Arbonne web site: Analysis of transportation systems on a life-cycle basis permits us to better understand the breadth and magnitude of impacts produced when vehicle systems are operated on different fuels or energy options like electricity or hydrogen. Such detailed analysis also provides the granularity needed to investigate policy implications, set R&D goals, and perform follow-on impact and policy assessments. US Department Energy's Office of Energy Efficiency and Renewable Energy, Systems Assessment Group in Argonne's Energy Systems Division has been developing the GREET model to provide a

fuel cycle emissions using GREET, we can estimate the relative change in GHG emissions using carbon intensity (CI) values from California's LCFS program. GREET results should be combined with stack testing results shown above to get an understanding of the relative GHG emissions associated with both natural gas ICEs and petroleum diesel ICEs.

CI values indicate that natural gas ICEs fueled with pipeline natural gas produced from fossil feedstocks have a CI about 20 percent lower than petroleum diesel, as shown in the first three rows of Table 10, compared to petroleum diesel which is shown at the bottom of the table.

Natural gas feedstocks from renewable feedstocks have a CI which is much lower, with most of the renewable feedstocks associated with a net reduction in fuel cycle carbon emissions. In other words, these feedstock options act as a way of capturing GHG emissions that would otherwise escape. Negative values in Table 10 below reflect this outcome. Converting these feedstocks into a fuel would provide substantial societal benefits since the feedstock would otherwise be contributing directly to global warming.

A recent study done for the Water Resources Control Board by Carollo Engineers²³ and published in June 2019 illustrates how food wastes can be converted to renewable natural gas and achieve significant GHG emissions reductions. Through co-digestion of food waste diverted from landfills and processed in anaerobic digesters, municipal wastewater treatment plants can produce, capture, and make beneficial use of biogas, which is a renewable source of methane.

The Carollo report stated that landfills accounted for approximately 8,560,000 MT CO₂e emissions as methane in 2016, or about 22 percent of statewide methane emissions. They estimated that by the year 2030, approximately 3,400,000 short wet tons of food waste could be diverted from landfills to municipal wastewater treatment plants for co-digestion and processing into renewable natural gas for beneficial use. This would reduce methane emissions from landfills and reduce GHG emissions from this sector by up to 2,397,000 MT CO₂e.

common, transparent platform for lifecycle analysis (LCA) of alternative combinations of vehicle and fuel technologies.

Vehicle technologies include conventional internal combustion engines, hybrid electric systems, battery electric vehicles, and fuel cell electric vehicles. Fuel/energy options include petroleum fuels, natural gas-based fuels, biofuels, hydrogen, and electricity. LCAs conducted with the GREET platform permit consideration of a host of different fuel production, and vehicle material and production pathways, as well as alternative vehicle utilization assumptions. GREET includes all transportation modes – on-road vehicles, aircraft, marine vessels, and rail (to be added in a new GREET release). The Systems Assessment Group has conducted various LCAs of vehicle/fuel systems for DOE and other agencies. There are more than 20,000 registered GREET users.

23 WRCB, Co-Digestion Capacity In California; Co-Digestion Capacity Analysis Prepared for the California State Water Resources Control Board under Agreement #17-014-240; https://www.waterboards.ca.gov/water_issues/programs/climate/docs/co_digestion/final_co_digestion_capacity_in_california_report_only.pdf; June 2019.

TABLE D-10 CARBON INTENSITY VALUES COMPUTED FROM CA-GREET MODEL

Feedstock	Carbon intensity (CI)	Percent Reduction of Natural Gas ICES From Petroleum Diesel (%)
PG&E Gas	80.59	-19.7
Average Pipeline Gas	79.21	-21.1
SoCal Gas	78.21	-22.1
Landfill Gas	-5.28 to 62.30	-105 to -38
Food Wastes	-22.93	-122
Dairy Manure	-377.83 to -192.49	-476 to -292
Renewable Natural Gas	-630.72 to -151.41	-728 to -251
ULSD/CARB Diesel	100.45	0

While using pipeline natural gas in place of ULSD would reduce fuel cycle GHG emissions approximately 20 percent.

A 2018 report funded by the California Public Utilities Commission (CPUC) evaluated issues with injecting fuels other than natural gas into natural gas pipelines. The report was titled: *Biomethane in California Common Carrier Pipelines: Assessing Heating Value and Maximum Siloxane Specifications -- An Independent Review of Scientific and Technical Information*.²⁴ Assembly Bill 1900 (Chapter 602, Statutes of 2012) was chaptered into law by the California State Legislature in 2012. This bill required, among other things, that the CPUC review and upgrade as appropriate specifications for adding biogas to the state’s existing natural gas pipeline system.

In 2006 the CPUC adopted Decision 06-039-069, which increased the specified the minimum allowable biomethane heating value (HV) from 970 BTU/scf to 990 BTU/scf.

2014 the CPUC adopted Decision 14-01-034, which included additional gas quality specification requirements that biogas would need to meet before it could be added to natural gas pipelines, including a maximum siloxane content of 0.1 mg siloxane per cubic meter of gas (Si/m³). This level was set to protect against equipment damage and catalyst poisoning.

The 2018 CPUC report recommends that CPUC conduct further work to determine whether or not it would be acceptable to allow a HV as low as 970 British Thermal Units per standard cubic foot of gas (BTU/scf), which is the value that was allowed before the 2006 decision to increase the HV to 990 BTU/scf.

The 2018 CPUC report stated that Siloxanes are not expected to be present in dairy waste, agriculture waste, or forestry residues. It concluded that some sources are very unlikely to have siloxanes – e.g., dairies or agricultural waste and that these sources could be held to a reduced and simplified verification regime.

²⁴ See: <https://ccst.us/wp-content/uploads/2018biomethane.pdf>

Further work may be needed to integrate RNG into the existing natural gas pipeline system in a cost-effective manner.

Contracting to obtain rights for renewable gas would lead to greater GHG benefits. This can be accomplished simply by displacement if the issues identified above can be resolved, assuming that the location of the use of the renewable natural gas is different from the source of the renewable natural gas, unless they are close enough together to use a dedicated pipeline.

As shown in **Table D-10**, *fossil* natural gas and some forms of renewable natural gas still has some carbon associated with the fuel cycle. These show up in the table for those fuels with a CI that is greater than zero. In these cases, additional measures could be needed before GOS would be considered a carbon-free facility.

Appendix E

Mailing List

Appendix E: Mailing List

The following is the mailing list for the Great Oaks South Backup Generating Facility project.

The following is a list of the State agencies that received State Clearinghouse notices and documents:

- Air Resources Board
- San Francisco Bay Conservation and Development Commission
- Caltrans, District 4 - Bay Area/Oakland
- Department of Conservation
- Office of Emergency Services
- Energy Commission
- Fish and Wildlife, Region 3 - Bay Delta, Fairfield
- California Highway Patrol
- Office of Historic Preservation
- California Native American Heritage Commission
- California Natural Resources Agency
- Department of Parks and Recreation
- California Public Utilities Commission
- Regional Water Quality Control Board, Region 2 - San Francisco Bay, Oakland |
- California State Lands Commission
- State Water Resources Control Board, Division of Water Quality
- Department of Toxic Substances Control
- Department of Water Resources

Table E-1 presents the list of occupants and property owners contiguous to the project site.

Table E-2 presents the list of property owners within 1,000 feet of the project site and 500 feet of the project linears.

Table E-3 presents the list of agencies, including responsible and trustee agencies and libraries.

Table E-4 presents the list of interested parties including environmental justice and community-based organizations.

TABLE E-1 OWNERS AND OCCUPANTS OF PROPERTY CONTIGUOUS TO PROJECT SITE

Name	Address	City	State	Zip
EL CAMINO HOSPITAL	2500 GRANT ROAD	MOUNTAIN VIEW	CA	94040

TABLE E-2 PROPERTY OWNERS WITHIN 1,000 FEET OF PROJECT SITE AND 500 FEET OF LINEARS

Name	Address	City	State	ZIP
KAISER FOUNDATION HEALTH PLAN INC	1800 Harrison Street	Oakland	CA	94612
PECOTA FAMILY LLC	6190 SAN IGNACIO AVE	SAN JOSE	CA	95119
GREEN VALLEY ROSS	777 N 1ST ST #5TH	SAN JOSE	CA	95112
90 GREAT OAKS BLVD LLC	1860 EL CAMINO REAL #500	BURLINGAME	CA	94010
OCCUPANT	80 GREAT OAKS BLVD	SAN JOSE	CA	95119
IGLESIA BAUTISTA DEL SUR PRIMERA	145 MARTINVALE LN	SAN JOSE	CA	95119
JANINE N ROCHA	151 MARTINVALE LN	SAN JOSE	CA	95119
RANDY & LISA HOOKS	1755 W EDMUNDSON AVE	MORGAN HILL	CA	95037
PEDRON & ASSOCIATES INV CO	1021 BLOSSOM HILL RD #30	SAN JOSE	CA	95123
TADPOLE GROUP INC	6399 SAN IGNACIO AVE #200	SAN JOSE	CA	95119
M WEST PROPCO-SANTA TERESA, VIA DEL ORO & GREAT OAKS LLC	4350 LA JOLLA VLG DR #900	SAN DIEGO	CA	92122
VDO HOLDINGS LLC	6835 VIA DEL ORO	SAN JOSE	CA	95119
M WEST PROPCO-VIA DEL ORO	4350 LA JOLLA VLG DR #900	SAN DIEGO	CA	92122
ROBERT W & ELIZABETH A HIGGINS	5601 PERUGIA CIR	SAN JOSE	CA	95135
PG CACTUS SAN JOSE II LLC	1148 ALPINE RD #100	WALNUT CREEK	CA	94596
PREMIERONE CREDIT UNION	6640 VIA DEL ORO #120	SAN JOSE	CA	95119
OAK GROVE SCHOOL DISTRICT, ATTN: LAURA PHAN, ASST. SUPERINTENDANT, BUSINESS SERVICES	6578 SANTA TERESA BLVD	SAN JOSE	CA	95119
SANTA CLARA COUNTY TRANSIT DIST (VALLEY TRANSPORTATION AUTHORITY)	3331 NORTH FIRST STREET	SAN JOSE	CA	95134
MOBILE INTERNATIONAL CHINA	2570 N FIRST ST #440	SAN JOSE	CA	95131
ANTHONY & MARIA CANCIAMILLA	1315 HILLCREST DR	SAN JOSE	CA	95120
H N & FRANCES C BERGER FOUNDATION	PO BOX 13390	PALM DESERT	CA	92255
SI 54 LLC	599 CASTRO ST #400	MOUNTAIN VIEW	CA	94041
DANIEL F & JOAN L FALKENSTEIN	6660 VIA DEL ORO	SAN JOSE	CA	95119
AARON F COLTON	16601 REYNOLDS DR	MORGAN HILL	CA	95037
M WEST PROPCO-SAN IGNACIO CAMPUS LLC	4350 LA JOLLA VLG DR #900	SAN DIEGO	CA	92122

TABLE E-2 PROPERTY OWNERS WITHIN 1,000 FEET OF PROJECT SITE AND 500 FEET OF LINEARS

Name	Address	City	State	ZIP
RI CLOUD CORP	6580 VIA DEL ORO	SAN JOSE	CA	95119
OCCUPANT	6448 VIA DEL ORO	SAN JOSE	CA	95119
PEPPER LANE SAN IGNACIO LLC	15729 LOS GATOS BLVD #200	LOS GATOS	CA	95032
MONOLITHIC POWER SYSTEMS INC.	79 GREAT OAKS BLVD	SAN JOSE	CA	95119
KW FUND VI-VALLEY OAK LLC	151 S EL CAMINO	BEVERLY HILLS	CA	90212
SCHUENEMAN INVESTMENT GRP LLC	83 GREAT OAKS BLVD	SAN JOSE	CA	95119
WESTPAK INC	83 GREAT OAKS BLVD	SAN JOSE	CA	95119
SPAN PARTNERS LP	282 BARNARD AVE	SAN JOSE	CA	95125
SPAN PARTNERS GP	280 BARNARD AVE	SAN JOSE	CA	95125
PS DEVELOPMENT LLC	838 MALONE RD	SAN JOSE	CA	95125
AMPRO ADLINK TECHNOLOGY INC	5215 HELLYER AVE STE 110	SAN JOSE	CA	95138
KELLY M. REM, ESQ., LOZANO SMITH	2001 N. MAIL ST. STE 500	WALNUT CREEK	CA	94596
GREAT OAKS MF (FEE) OWNER LLC C/O FAIRFIELD GREAT OAKS LP	5510 MOREHOUSE DR	SAN DIEGO	CA	92121- 3722
ISTAR SAN JOSE LLC	180 GLASTONBURY BLVD	GLASTONBURY	CT	6033- 4439
CITY OF SAN JOSE	200 E Santa Clara Street	SAN JOSE	CA	95113
GREAT OAKS WATER COMPANY	PO BOX 23490	SAN JOSE	CA	95153- 3490
MENNONITE BRETHERN CHURCH PAC DIST CONF	6147 PURPLE HILLS DR	SAN JOSE	CA	95119- 1535
AHEAD MAGNETICS INC	6410 VIA DEL ORO	SAN JOSE	CA	95119- 1208
MOURI MANAGEMENT GROUP INCORPORATED	3220 FLINTDALE DR	SAN JOSE	CA	95148- 1231
OCCUPANT	6520 GAMMA WAY	SAN JOSE	CA	95119
OCCUPANT	6670 EMERGENT WAY	SAN JOSE	CA	95119
OCCUPANT	6410 VIA DEL ORO	SAN JOSE	CA	95119- 1208
OCCUPANT	6170 PURPLE HILLS DR	SAN JOSE	CA	95119- 1534
LY PHU HUU	2240 Lundy Ave	SAN JOSE	CA	95131
CHANG HUGO AND CHIU JUI CHU	4814 KIRKWALL DR	SUGAR LAND	TX	77479
DESHPANDE ANNAYYA P AND SHILAJA A (TRUSTEE)	6199 MCABEE RD	SAN JOSE	CA	95120

TABLE E-2 PROPERTY OWNERS WITHIN 1,000 FEET OF PROJECT SITE AND 500 FEET OF LINEARS

Name	Address	City	State	ZIP
BILKEY PAZ Q (TRUSTEE)	4131 MORELAND WAY	SAN JOSE	CA	95130
FENNERN LARRY EDGAR AND JANIS LEE (TRUSTEE)	208 CASTILLON WAY	SAN JOSE	CA	95119
ARYA SATYA P AND RAJ K (TRUSTEE)	4935 CRUDEN BAY CT	SAN JOSE	CA	95138
LEE UNHO PAUL AND YUNG SHIN (TRUSTEE)	5918 PORTO ALEGRE DR	SAN JOSE	CA	95120
COPELAND DIANA L	505 W OLIVE AVE	SUNNYVALE	CA	94086
CABIGAS ROBERTA A	2936 BRANDEIS CT	SAN JOSE	CA	95148
MOSHTAGH VAHID S (TRUSTEE)	4049 SAN FRANCISCO TER	FREMONT	CA	94538
TRUONG, NGOC THUY THI; TIEU, Y THIEN	PO BOX 51246	SAN JOSE	CA	95151
KEITH MICHAEL B AND RAYMONETTE K	3060 HASTINGS NEWVILLE RD	MANSFIELD	OH	44903
WHALEY DELOS D III (TRUSTEE)	PO BOX 5862	SANTA CLARA	CA	95056
TRAN NGA	47 N SKY LOOP	ROSWELL	NM	88201
LAMB, JONATHAN; JUAREZ LAMB, ELIZABETH	4529 WESSEX DR	SAN JOSE	CA	95136
SHIRSAT, RAJAS N; SHIRSAT, PAYAL R	1544 CORONACH AVE	SUNNYVALE	CA	94087
HUTCHINSON KENNETH E (TRUSTEE)	3063 WETMORE DR	SAN JOSE	CA	95148
BARRAGAN MARILU D; AGUILAR ESPERANZA	607 N WHITE RD	SAN JOSE	CA	95127
FERNANDEZ BRIAN S AND ANGELA	128 BROADWELL CIR	FRANKLIN	TN	37067
PICK JUDITH C (TRUSTEE)	6581 PEMBA DR	SAN JOSE	CA	95119
VAZQUEZ ALICIA (TRUSTEE)	535 N 13TH ST	SAN JOSE	CA	95112
VERKERK, CHRISTIAN; VERKERK, LAY HOOI	6515 KONA CT	SAN JOSE	CA	95119
CEBALLOS, SIDNEY PAUL; THE CEBALLOS LIVING TRUST,	2230 WOODSET DR	SAN JOSE	CA	95116
ULLOA ERNESTO J AND LETICIA I	212 CASTILLON WAY	SAN JOSE	CA	95119
WONG STANLEY AND LAURA (TRUSTEE)	242 LOS LAURELES ST	SOUTH PASADENA	CA	91030
KEGLEY RICHARD D AND SANDRA A	230 CASTILLON WAY	SAN JOSE	CA	95119
VALEL THOMAS P AND CHINNAMMA T	229 CASTILLON WAY	SAN JOSE	CA	95119
JORDEN SHEILA (TRUSTEE)	225 CASTILLON WAY	SAN JOSE	CA	95119
APARICIO EMMA AND ARNOLDO A	221 CASTILLON WAY	SAN JOSE	CA	95119
HO AARON AND KEELIKOLANI L (TRUSTEE)	219 CASTILLON WAY	SAN JOSE	CA	95119
LEE JAEBONG AND CHOI NURI	228 CASTILLON WAY	SAN JOSE	CA	95119
HEFLIN BARBARA A	226 CASTILLON WAY	SAN JOSE	CA	95119
DINH ANTHONY AND TRAN XUAN	217 CASTILLON WAY	SAN JOSE	CA	95119
LEE KWANGEE AND DEBORAH KRAFT	6122 PURPLE HILLS DR	SAN JOSE	CA	95119
ULLOA ERNESTO J AND LETICIA I	212 CASTILLON WAY	SAN JOSE	CA	95119
HENDERSON LANCE P AND LISA D (TRUSTEE)	213 CASTILLON WAY	SAN JOSE	CA	95119

TABLE E-2 PROPERTY OWNERS WITHIN 1,000 FEET OF PROJECT SITE AND 500 FEET OF LINEARS

Name	Address	City	State	ZIP
ESPINOZA JOSEPH L AND ROBERTA	211 CASTILLON WAY	SAN JOSE	CA	95119
SULAVER MICHAEL S AND ROSEMARY H (TRUSTEE)	6146 PURPLE HILLS DR	SAN JOSE	CA	95119
LOHR TIMOTHY J AND BEVERLY G (TRUSTEE)	6134 PURPLE HILLS DR	SAN JOSE	CA	95119
FENNERN LARRY EDGAR AND JANIS LEE (TRUSTEE)	208 CASTILLON WAY	SAN JOSE	CA	95119
JACKSON JOHN T AND NANCY K (TRUSTEE)	6158 PURPLE HILLS DR	SAN JOSE	CA	95119
FRASER GRACE A (TRUSTEE)	204 CASTILLON WAY	SAN JOSE	CA	95119
MELINE KIRK A AND VICTORIA S (TRUSTEE)	207 CASTILLON WAY	SAN JOSE	CA	95119
BIEGANSKI MICHAEL P AND JENNIFER	205 CASTILLON WAY	SAN JOSE	CA	95119
QUIJADA, BRANDON P; QUIJADA, MICHELLE	179 KONA PL	SAN JOSE	CA	95119
LECLAIR JULIA A (TRUSTEE)	183 KONA PL	SAN JOSE	CA	95119
KAUR MANJINDER	185 KONA PL	SAN JOSE	CA	95119
GAXIOLA KEITH D AND GLORIA F	184 KONA PL	SAN JOSE	CA	95119
RODIG CHRISTIAN L AND JODY R	6490 PEMBA DR	SAN JOSE	CA	95119
FUSILERO FREDERICK M AND JENNIFER	202 CASTILLON WAY	SAN JOSE	CA	95119
SANCHEZ STEVEN AND DENISE M (TRUSTEE)	200 CASTILLON WAY	SAN JOSE	CA	95119
DIGIUSEPPE, RONALD; DIGIUSEPPE, DIANE M	201 CASTILLON WAY	SAN JOSE	CA	95119
WEST ANTHONY R AND FRANCES	203 CASTILLON WAY	SAN JOSE	CA	95119
WATANABE STEVEN S AND ALYCIA D (TRUSTEE)	197 CASTILLON WAY	SAN JOSE	CA	95119
OTA PATRICK M AND DOROTHY C	199 CASTILLON WAY	SAN JOSE	CA	95119
MILLER, JOYCE S; THE JOYCE S MILLER TRUST, BUSTILLOS BRENDA	195 CASTILLON WAY	SAN JOSE	CA	95119
CHOWDARY ANNAM, SAI CHAKRAVARTHY; KAMMA, MANADA	187 KONA PL	SAN JOSE	CA	95119
SOUZA, WILLIAM; VEGA, MARGARITA	193 KONA PL	SAN JOSE	CA	95119
ESTRADA MARCO AND SAUCEDO PETTI B	6485 PEMBA DR	SAN JOSE	CA	95119
ISHAYA, RAMINA; MITCHELL, ERIK S	6508 PEMBA DR	SAN JOSE	CA	95119
MUNAWAR FAWAD AND FAWAD RABIA	6495 PEMBA DR	SAN JOSE	CA	95119
WELCH MATTHEW J AND JEAN (TRUSTEE)	199 KONA PL	SAN JOSE	CA	95119
LITTLE DEREK C AND LISA M	196 KONA PL	SAN JOSE	CA	95119
MAHE JEFFREY E AND LUCY	6504 KONA CT	SAN JOSE	CA	95119
PARRISH RICHARD G AND NAOMI F (TRUSTEE)	6514 KONA CT	SAN JOSE	CA	95119
BARYUDIN LEONID AND BELKIN LIDIA	6507 PEMBA DR	SAN JOSE	CA	95119
NASHASHIBI IMAD F AND SANEE I	6513 PEMBA DR	SAN JOSE	CA	95119
	6510 KONA CT	SAN JOSE	CA	95119

TABLE E-2 PROPERTY OWNERS WITHIN 1,000 FEET OF PROJECT SITE AND 500 FEET OF LINEARS

Name	Address	City	State	ZIP
CHAVEZ KENNETH AND LAURIE A	6518 PEMBA DR	SAN JOSE	CA	95119
SASUR JULIA	6512 PEMBA DR	SAN JOSE	CA	95119
THOMAS JESSY	6524 PEMBA DR	SAN JOSE	CA	95119
EHRHART RICHARD	6519 PEMBA DR	SAN JOSE	CA	95119
HARDING RANDY AND VENERABLE TERRI L	6528 PEMBA DR	SAN JOSE	CA	95119
SOLIS DANIEL AND SHANNON	6529 PEMBA DR	SAN JOSE	CA	95119
CURRY HAROLD J	6540 PEMBA DR	SAN JOSE	CA	95119
ASAY DOUGLAS J AND SVETLANA N; ASAY JAMES R AND PATRICIA J (TRUSTEE)	6521 KONA CT	SAN JOSE	CA	95119
EGGENBERGER MARK; EGGENBERGER ANIKO AND RONTO ANIKO M	6524 KONA CT	SAN JOSE	CA	95119
BOOTS ROGER R AND MOORE-BOOTS LA SHAUNA	207 PEMBA CT	SAN JOSE	CA	95119
NAKANISHI, NEIL I; NAKANISHI, HEATHER A	212 PEMBA CT	SAN JOSE	CA	95119
MORALES JOSE M AND HERNANDEZ GUILLERMINA	204 PEMBA CT	SAN JOSE	CA	95119
MCDANIEL STANLEY E AND MARY L	208 PEMBA CT	SAN JOSE	CA	95119
GRIFFITH LEROY E (TRUSTEE)	6587 PEMBA DR	SAN JOSE	CA	95119
CUMMINS GREGORY A AND PATRICIA A	6552 KANEKO DR	SAN JOSE	CA	95119
SUTTIE JAMES T AND CAROL A	6558 KANEKO DR	SAN JOSE	CA	95119
LEE, CHAN KOO; MO, EUNYOUNG	6570 KANEKO DR	SAN JOSE	CA	95119
ZORRILLA, HUGO; ZORRILLA, MARIA ELENA	6576 KANEKO DR	SAN JOSE	CA	95119
FULLER J T	6604 PEMBA DR	SAN JOSE	CA	95119
JACOBO MANUEL JR AND MARTHA C	6598 PEMBA DR	SAN JOSE	CA	95119
AGUIAR BRYAN KEITH AND TERRI MARIE	6592 PEMBA DR	SAN JOSE	CA	95119
HO, FRANCIS CHUNG YEUNG; LAI, NGAN YING	6443 SAN IGNACIO AVE	SAN JOSE	CA	95119
LORENZO FELIX AND RINA	6449 SAN IGNACIO AVE	SAN JOSE	CA	95119
HAMAMJY HENRY AND URHOY Z	6621 CIELITO WAY	SAN JOSE	CA	95119
VELOZ MARK A (TRUSTEE); RICKERS LISA M (TRUSTEE)	6625 CIELITO WAY	SAN JOSE	CA	95119
PEDRONAN ARNOLD R AND MARIE-LOU G (TRUSTEE)	6629 CIELITO WAY	SAN JOSE	CA	95119
MONCADA RHONY AND MEDINA-MONCADA ODILIA	6633 CIELITO WAY	SAN JOSE	CA	95119
MENDOZA REYES A AND MARGARITA F	6637 CIELITO WAY	SAN JOSE	CA	95119

TABLE E-2 PROPERTY OWNERS WITHIN 1,000 FEET OF PROJECT SITE AND 500 FEET OF LINEARS

Name	Address	City	State	ZIP
WILLIAMS THOMAS AND NANCY (TRUSTEE)	6641 CIELITO WAY	SAN JOSE	CA	95119
HARES KENNETH T (TRUSTEE)	6645 CIELITO WAY	SAN JOSE	CA	95119
KEEGAN PHILLIP M AND DEBRA L	6655 CIELITO WAY	SAN JOSE	CA	95119
BENNA, TODD STEPHEN; BENNA, TINA MARIE	6649 CIELITO WAY	SAN JOSE	CA	95119
BURNS JEFF AND LEBLEU-BURNS MICHELE (TRUSTEE)	6661 CIELITO WAY	SAN JOSE	CA	95119
DETTE ROBERT J AND TYRA	6667 CIELITO WAY	SAN JOSE	CA	95119
TSAO CHUN CHING; PENG JEFFREY	6679 CIELITO WAY	SAN JOSE	CA	95119
AMEZQUITA CHERYL D (TRUSTEE)	6685 CIELITO WAY	SAN JOSE	CA	95119
KULWIN BERNARD P AND CAROL A (TRUSTEE)	6691 CIELITO WAY	SAN JOSE	CA	95119
ORTEGA DANIEL A; CERVACIO XOCHIPILLI A	6697 CIELITO WAY	SAN JOSE	CA	95119
NWOKOLO PETER C AND HUNTER GLENYS	6703 CIELITO WAY	SAN JOSE	CA	95119
MORITA ALYCE S (TRUSTEE)	222 BAHIA CT	SAN JOSE	CA	95119
STEMM, JASON D; LE, TUYET N	215 VINEYARD DR	SAN JOSE	CA	95119
YURGAITIS TANYA BAY (TRUSTEE)	217 VINEYARD DR	SAN JOSE	CA	95119
BORN, MICHAEL C; BORN, MARY C	212 VINEYARD DR	SAN JOSE	CA	95119
GAIDE BENJAMIN AND LEAH	210 VINEYARD DR	SAN JOSE	CA	95119
VARTANIAN MARYAM C AND APREM	214 VINEYARD DR	SAN JOSE	CA	95119
MICKLESON DANA D; BURKEY NANCY L	213 SHERRY CT	SAN JOSE	CA	95119
GRANOVETTER DAVID A (TRUSTEE); CREAMER-GRANOVETTER DAWN (TRUSTEE)	209 SHERRY CT	SAN JOSE	CA	95119
OCCUPANT	231 CASTILLON WAY	SAN JOSE	CA	95119
OCCUPANT	227 CASTILLON WAY	SAN JOSE	CA	95119
OCCUPANT	6110 PURPLE HILLS DR	SAN JOSE	CA	95119
OCCUPANT	215 CASTILLON WAY	SAN JOSE	CA	95119
OCCUPANT	206 CASTILLON WAY	SAN JOSE	CA	95119
OCCUPANT	209 CASTILLON WAY	SAN JOSE	CA	95119
OCCUPANT	177 KONA PL	SAN JOSE	CA	95119
OCCUPANT	180 KONA PL	SAN JOSE	CA	95119
OCCUPANT	6496 PEMBA DR	SAN JOSE	CA	95119
OCCUPANT	191 KONA PL	SAN JOSE	CA	95119
OCCUPANT	6502 PEMBA DR	SAN JOSE	CA	95119
OCCUPANT	6503 PEMBA DR	SAN JOSE	CA	95119
OCCUPANT	197 KONA PL	SAN JOSE	CA	95119
OCCUPANT	202 KONA PL	SAN JOSE	CA	95119

TABLE E-2 PROPERTY OWNERS WITHIN 1,000 FEET OF PROJECT SITE AND 500 FEET OF LINEARS

Name	Address	City	State	ZIP
OCCUPANT	6520 KONA CT	SAN JOSE	CA	95119
OCCUPANT	6525 PEMBA DR	SAN JOSE	CA	95119
OCCUPANT	203 PEMBA CT	SAN JOSE	CA	95119
OCCUPANT	6534 PEMBA DR	SAN JOSE	CA	95119
OCCUPANT	6525 KONA CT	SAN JOSE	CA	95119
OCCUPANT	211 PEMBA CT	SAN JOSE	CA	95119
OCCUPANT	6564 KANEKO DR	SAN JOSE	CA	95119
OCCUPANT	6673 CIELITO WAY	SAN JOSE	CA	95119
OCCUPANT	6704 CIELITO WAY	SAN JOSE	CA	95119
OCCUPANT	211 SHERRY CT	SAN JOSE	CA	95119
OCCUPANT	210 SHERRY CT	SAN JOSE	CA	95119

TABLE E-3 AGENCIES AND LIBRARIES

First Name	Last Name	Title	Agency	Address	City	State	Zip
ADAM	PETERSEN	PLANNER	SAN JOSE PLANNING DIVISION	200 EAST SANTA CLARA STREET	SAN JOSE	CA	95113
DAVID	KEYON	PRINCIPAL PLANNER	SAN JOSE PLANNING, BUILDING & CODE ENFORCEMENT (PBCE)	200 EAST SANTA CLARA STREET	SAN JOSE	CA	95113
			BAY AREA AIR QUALITY MANAGEMENT DISTRICT	375 BEALE STREET, SUITE 600	SAN FRANCISCO	CA	94105
ARIANA	HUSAIN	PRINCIPAL AIR ENGINEER	BAY AREA AIR QUALITY MANAGEMENT DISTRICT	375 BEALE STREET, SUITE 600	SAN FRANCISCO	CA	94105
KATHRIN A.	TURNER	ASSISTANT ENGINEER II	SANTA CLARA VALLEY WATER DISTRICT	5750 ALMADEN EXPRESSWAY	SAN JOSE	CA	95118-3614
GREG	ERICKSON	REGIONAL MANAGER	CALIFORNIA DEPARTMENT OF FISH AND WILDLIFE	2825 CORDELIA ROAD SUITE 100	FAIRFIELD	CA	94534
GERRY	HAAS	CONSERVATION PLANNER	SANTA CLARA VALLEY HABITAT AGENCY	535 ALKIRE AVENUE	MORGAN HILL	CA	95037
RYAN	OLAH	DIVISION CHIEF	US FISH & WILDLIFE SERVICE, SACRAMENTO FISH & WILDLIFE OFFICE, COAST BAY DIVISION	2800 COTTAGE WAY, ROOM W2605	SACRAMENTO	CA	95825-1846

TABLE E-3 AGENCIES AND LIBRARIES

First Name	Last Name	Title	Agency	Address	City	State	Zip
REBECCA	FANCHER		CALIFORNIA AIR RESOURCES BOARD	1001 I ST	SACRAMENTO	CA	95814
COURTNEY	GRAHAM		CALIFORNIA AIR RESOURCES BOARD	1001 I ST	SACRAMENTO	CA	95814
SIMON	BAKER	DIRECTOR, ENERGY DIVISION	CALIFORNIA PUBLIC UTILITIES COMMISSION	505 VAN NESS AVENUE	SAN FRANCISCO	CA	94102
BINAYA	SHRESTHA	SUBJECT MATTER EXPERT, PG&E	CALIFORNIA INDEPENDENT SYSTEM OPERATOR	250 OUTCROPPING WAY	FOLSOM	CA	95630
NED	THOMAS	PLANNING DIRECTOR	CITY OF MILPITAS PLANNING AND NEIGHBORHOOD SERVICES	455 EAST CALAVERAS BLVD.	MILPITAS	CA	95035
SYLVIA	FUNG		IGR, CALTRANS, DISTRICT 4	P.O. BOX 23660	OAKLAND	CA	94623-0660
KEITH	LICHTEN	REGIONAL PROGRAM LEAD	SAN FRANCISCO BAY RWQCB	1515 CLAY SUITE 1400	OAKLAND	CA	94612
JULIE	PETTIJOHN	ACTING BRANCH CHIEF	DEPT. OF TOXIC SUBSTANCES CONTROL, REGION 2	700 HEINZ AVENUE SUITE 200	BERKELEY	CA	94710-2721
			SAN FRANCISCO BAY CONSERVATION & DEVELOPMENT COMMISSION	375 BEALE STREET, SUITE 510	SAN FRANCISCO	CA	94105
JON	CICIRELLI		SAN JOSE PARKS, RECREATION AND NEIGHBORHOOD SERVICES	200 EAST SANTA CLARA STREET	SAN JOSE	CA	95113
		FIRE CHIEF	SAN JOSE FIRE DEPARTMENT	1661 SENTER RD.	SAN JOSE	CA	95112
EDGARDO (EDDIE)	GARCIA	CHIEF OF POLICE	SAN JOSE POLICE DEPARTMENT	201 W. MISSION STREET	SAN JOSE	CA	95110
MANJIT	BANWAIT	SENIOR TRANSPORTATION SPECIALIST	SAN JOSE DEPARTMENT OF TRANSPORTATION	200 EAST SANTA CLARA STREET	SAN JOSE	CA	95113
RYAN	DO		SAN JOSE PUBLIC WORKS	200 EAST SANTA CLARA STREET	SAN JOSE	CA	95113

TABLE E-3 AGENCIES AND LIBRARIES

First Name	Last Name	Title	Agency	Address	City	State	Zip
KERRY	ROMANOW		SAN JOSE ENVIRONMENTAL SERVICES	200 EAST SANTA CLARA STREET 10TH FLOOR TOWER	SAN JOSE	CA	95113
CHERISE	ORANGE	ASSOCIATE PLANNER	COUNTY OF SANTA CLARA PARKS AND RECREATION DEPARTMENT	298 GARDEN HILL DRIVE	LOS GATOS	CA	95032-7669
KERRI	KISKO	ENVIRONMENTAL SCIENTIST	DEPARTMENT OF CONSERVATION	801 K STREET, MS 24-01	SACRAMENTO	CA	95814
WADE	CROWFOOT	SECRETARY	NATURAL RESOURCES AGENCY	1416 NINTH STREET, SUITE 1311	SACRAMENTO	CA	95814
PHILLIP	CRADER		STATE WATER RESOURCES CONTROL BOARD, WATER QUALITY DIVISION	P.O. BOX 100	SACRAMENTO	CA	95812-0100
ALYSON	AQUINO		NATURAL RESOURCES CONSERVATION SERVICES	3585 GREENVILLE ROAD SUITE 2	LIVERMORE	CA	94550-6707
KARLA	NEMETH	DIRECTOR	DEPARTMENT OF WATER RESOURCES	P.O. BOX 942836	SACRAMENTO	CA	94236-0001
			COUNTY OF SANTA CLARA, OFFICE OF THE CLERK RECORDER	70 WEST HEDDING STREET	SAN JOSE	CA	95110
LAURA	MIRANDA	COMMISSIONER	NATIVE AMERICAN HERITAGE COMMISSION	1550 HARBOR BLVD, SUITE 100	WEST SACRAMENTO	CA	95691
			CEC - ENERGY LIBRARY	1516 9TH ST, MS 10	SACRAMENTO	CA	95814-5504
GOV PUBLICATIONS			FRESNO COUNTY FREE LIBRARY	2420 MARIPOSA ST	FRESNO	CA	93721-2204
			HUMBOLDT COUNTY MAIN LIBRARY	1313 3RD STREET	EUREKA	CA	95501-0553
SERIALS DIVISION			LOS ANGELES PUBLIC LIBRARY	630 W 5TH ST	LOS ANGELES	CA	90071-2002
SCIENCE & INDUSTRY DIV			SAN DIEGO PUBLIC LIBRARY	330 PARK BLVD	SAN DIEGO	CA	92101-6478

TABLE E-3 AGENCIES AND LIBRARIES

First Name	Last Name	Title	Agency	Address	City	State	Zip
GOVERNMENT INFORMATION CENTER			SAN FRANCISCO PUBLIC LIBRARY	100 LARKIN ST	SAN FRANCISCO	CA	94102-4733
GOV PUBS			STANLEY MOSK LIBRARY & COURTS BLDG	914 CAPITOL MALL, 3 rd Floor	SACRAMENTO	CA	95814
			SANTA TERESA PUBLIC LIBRARY	290 INTERNATIONAL CIRCLE	SAN JOSE	CA	95119

TABLE E-4 INTERESTED PARTIES INCLUDING ENVIRONMENTAL JUSTICE AND COMMUNITY-BASED ORGANIZATIONS

First Name	Last Name	Organization	Address	City	State	Zip
CAROL	ZABIN	CENTER FOR LABOR RESEARCH AND EDUCATION (LABOR CENTER)	2521 CHANNING WAY #5555	BERKELEY	CA	94704
		EVERGREEN ECONOMICS	1648 MARTIN LUTHER KING JR. WAY	BERKELEY	CA	94709
		CALIFORNIANS FOR PESTICIDE REFORM (CPR)	2029 UNIVERSITY AVE., SUITE 200	BERKELEY	CA	94704
AMY D.	KYLE	UC BERKELEY, SCHOOL OF PUBLIC HEALTH	140 WARREN HALL	BERKELEY	CA	94720
		RISING SUN CENTER FOR OPPORTUNITY	111 36TH STREET	OAKLAND	CA	94608
BROOKS	ANDREW	ASSOCIATION FOR ENERGY AFFORDABILITY WEST	5900 HOLLIS STREET, SUITE R2	EMERYVILLE	CA	94608
		SAN MATEO COUNTY UNION COMMUNITY ALLIANCE (SMCUCA)	1153 CHESS DR.	FOSTER CITY	CA	94404
		COMMUNITIES FOR A BETTER ENVIRONMENT	6325 PACIFIC BLVD. STE 300	HUNTINGTON PARK	CA	90255
LEVONNE	STONE	FORT ORD ENVIRONMENTAL JUSTICE NETWORK, INC.	PO BOX 361	MARINA	CA	93933
		ASIAN PACIFIC ENVIRONMENTAL NETWORK	426 17TH ST #500	OAKLAND	CA	94612
STEPHANIE	CHEN	GREENLINING INSTITUTE	360 14TH STREET, 2ND FLOOR	OAKLAND	CA	94612

TABLE E-4 INTERESTED PARTIES INCLUDING ENVIRONMENTAL JUSTICE AND COMMUNITY-BASED ORGANIZATIONS

First Name	Last Name	Organization	Address	City	State	Zip
		LOCAL INITIATIVES SUPPORT CORPORATION (LISC) BAY AREA	1970 BROADWAY SUITE 1100	OAKLAND	CA	94612
		GRID ALTERNATIVES	1171 OCEAN AVENUE, SUITE 200	OAKLAND	CA	94608
STRELA	CERVAS	CALIFORNIA ENVIRONMENTAL JUSTICE ALLIANCE	1904 FRANKLIN STREET, STE. 250	OAKLAND	CA	94612
MIA	KITAHARA	STOPWASTE	1537 WEBSTER ST.	OAKLAND	CA	94612
		CENTER FOR BIOLOGICAL DIVERSITY (CBD)	1212 BROADWAY, ST. #800	OAKLAND	CA	94612
		THE PEOPLE'S SENATE	1999 HARRISON STREET, SUITE 650	OAKLAND	CA	94612
		CENTER ON RACE, POVERTY AND ENVIRONMENT (CRPE)	1999 HARRISON STREET, SUITE 650	OAKLAND	CA	94612
		THE EAST OAKLAND COLLECTIVE	PO BOX 5382	OAKLAND	CA	94605
BOB	ALLEN	URBAN HABITAT PROGRAM	2000 FRANKLIN STREET	OAKLAND	CA	94612
		UNION OF CONCERNED SCIENTISTS	500 12TH STREET, SUITE 340	OAKLAND	CA	94607
		PEOPLE UNITED FOR A BETTER OAKLAND (PUEBLO)	1728 FRANKLIN STREET	OAKLAND	CA	94612
SUSANNAH	CHURCHILL	VOTE SOLAR	360 22ND STREET, SUITE 730	OAKLAND	CA	94612
JAYANT	KAIRAM	ENVIRONMENTAL DEFENSE FUND	1107 9TH ST., STE 1070	SACRAMENTO	CA	95814
		ENVIRONMENTAL DEFENSE FUND	123 MISSION ST, 28TH FLOOR	SAN FRANCISCO	CA	94105
BRADLEY	ANGEL	GREENACTION	315 SUTTER STREET, 2ND FL	SAN FRANCISCO	CA	94108
		LITERACY FOR ENVIRONMENTAL JUSTICE	P.O. BOX 170039	SAN FRANCISCO	CA	94117-0039
		BLUEGREEN ALLIANCE	369 PINE STREET, SUITE 700	SAN FRANCISCO	CA	94104
MARIA	STAMAS	NATURAL RESOURCES DEFENSE COUNCIL (NRDC)	111 SUTTER STREET, 21ST FLOOR	SAN FRANCISCO	CA	94104

TABLE E-4 INTERESTED PARTIES INCLUDING ENVIRONMENTAL JUSTICE AND COMMUNITY-BASED ORGANIZATIONS

First Name	Last Name	Organization	Address	City	State	Zip
EDDIE	AHN	BRIGHTLINE DEFENSE	1028A HOWARD STREET	SAN FRANCISCO	CA	94103
JENNIFER	BERG	ASSOCIATION OF BAY AREA GOVERNMENTS (ABAG)	375 BEALE STREET, SUITE 700	SAN FRANCISCO	CA	94105-2066
IVAN	JIMENEZ	BRIGHTLINE DEFENSE	1028A HOWARD STREET	SAN FRANCISCO	CA	94103
ERICA	MCCONNELL	SHUTE, MIHALY & WEINBERGER LLP	396 HAYES ST.	SAN FRANCISCO	CA	94102
ANTONIO	DIAZ	PEOPLE ORGANIZING TO DEMAND ENVIRONMENTAL AND ECONOMIC RIGHTS (PODER)	474 VALENCIA STREET, #125	SAN FRANCISCO	CA	94103
		ENVIRONMENTAL LAW AND JUSTICE CLINIC	536 MISSION STREET	SAN FRANCISCO	CA	94105
		BAYVIEW HUNTERS POINT COMMUNITY ADVOCATES (KAREN PIERCE)	186 MADDUX AVENUE	SAN FRANCISCO	CA	94124
		SILICON VALLEY TOXICS COALITION	PO BOX 27669	SAN FRANCISCO	CA	94127
		SANTA CLARA VALLEY AUDUBON SOCIETY (SCVAS)--MCCLELLAN RANCH PRESERVE	22221 MCCLELLAN ROAD	CUPERTINO	CA	95014
		LOMA PRIETA SIERRA CLUB CHAPTER OFFICE	39821 EAST BAYSHORE ROAD, SUITE 204	PALO ALTO	CA	94303