

Appendix G

Transportation Impact Analysis



HEXAGON TRANSPORTATION CONSULTANTS, INC.



The Crosswinds Residential Development

Traffic Impact Analysis



Prepared for:

City of Morgan Hill



October 7, 2021



Hexagon Transportation Consultants, Inc.

Hexagon Office: 8070 Santa Teresa Boulevard, Suite 230

Gilroy, CA 95020

Hexagon Job Number: 20RD15

Phone: 408.846.7410



San Jose • Gilroy • Pleasanton • Phoenix

www.hextrans.com

Areawide Circulation Plans Corridor Studies Pavement Delineation Plans Traffic Handling Plans Impact Fees Interchange Analysis Parking Transportation Planning Traffic Calming Traffic Control Plans Traffic Simulation Traffic Impact Analysis Traffic Signal Design Travel Demand Forecasting



Table of Contents

Executive Summary	i
1. Introduction	1
2. Existing Transportation System	5
3. CEQA VMT Evaluation	11
4. Traffic Operations Analysis.....	14
5. Other Transportation Issues	38
6. Conclusions.....	48

Appendices

Appendix A	VTA VMT Evaluation Tool Output Sheets
Appendix B	Traffic Counts
Appendix C	Volume Summary
Appendix D	Level of Service Calculations
Appendix E	Signal Warrant Analysis
Appendix F	Intersection Queuing Calculations
Appendix G	Project Driveway Operations Analyses
Appendix H	Freeway On-Ramp and Off-Ramp Queuing Analyses

List of Tables

Table 1	Project Trip Generation Estimates	16
Table 2	General Plan 2035 Trip Generation Estimates	21
Table 3	Signalized Intersection Level of Service Definitions Based on Control Delay.....	28
Table 4	Unsignalized Intersection Level of Service Definitions Based on Control Delay.....	29
Table 5	Existing Plus Project Intersection Levels of Service and Signal Warrant Checks.....	31
Table 6	Year 2030 Cumulative Intersection Levels of Service and Signal Warrant Checks	32
Table 7	Freeway Level of Service Definitions Based on Density	36
Table 8	Freeway Segment Levels of Service	37
Table 9	Project Driveway Operations	41
Table 10	Vehicle Queuing Analysis.....	43
Table 11	Freeway Off-Ramp Vehicle Queuing Analysis	47

List of Figures

Figure 1	Site Location and Study Intersections.....	2
Figure 2	Project Site Plan.....	3
Figure 3	Existing Bicycle Facilities.....	8
Figure 4	Existing Transit Services	9
Figure 5	VMT Analysis	13
Figure 6	Project Trip Distribution	17
Figure 7	Project Trip Assignment	18
Figure 8	Existing Lane Configurations	22
Figure 9	Existing Traffic Volumes	23

Figure 10 Year 2030 Cumulative without Project Traffic Volumes 24
Figure 11 Existing Plus Project Traffic Volumes 26
Figure 12 Year 2030 Cumulative with Project Traffic Volumes 27
Figure 13 Project Trips at Site Access Points..... 39

Executive Summary

This report presents the results of the transportation analysis (TA) conducted for the proposed Crosswinds residential development in Morgan Hill, California. The 30.5-acre project site is currently vacant and is generally bounded by Half Road to the south, Mission View Drive to the east, future extension of DePaul Drive to the west, and Avenida De Los Padres to the north. The project as proposed will consist of a total of 269 residential units comprised of 149 condos, 56 detached single-family, and 64 duet units. The project would include the extension of DePaul Drive to the south with termination as a cul-de-sac just north of Half Road. Access to the project site would be provided via a full access driveway along Mission View Drive and two full access driveways along the future DePaul Drive extension.

Transportation Analysis Scope

The TA consists of a California Environmental Quality Act (CEQA) required vehicle-miles-traveled (VMT) analysis and a supplemental traffic operations analysis that demonstrates the project's consistency with the *Morgan Hill 2035 General Plan* goals and policies.

CEQA Transportation Analysis Scope

The CEQA VMT impact analysis was completed using the Valley Transportation Authority's (VTA) VMT tool. The City of Morgan Hill is currently developing the framework for new transportation policies based on VMT as the primary measure of transportation impacts. The new policies will replace the City's current transportation policies that are based on levels of service per the Morgan Hill 2035 General Plan. However, since the City has not formally adopted its own city-specific VMT policies, this study utilizes VMT analysis methodology and impact thresholds recommended in the Governor's Office of Planning and Research (OPR) *Technical Advisory on Evaluating Transportation Impacts in CEQA*, December 2018.

Traffic Operations Analysis Scope

The current General Plan, *Morgan Hill 2035 General Plan*, adopted in July 2016 uses Level of Service (LOS) as its primary metric for the evaluation of the projected operation of the City's roadway system. Therefore, a traffic operations analysis based upon peak hour intersection level of service analysis is included for consistency with the General Plan goals and policies. The traffic operations analysis supplements the CEQA required VMT analysis. However, the determination of project impacts per CEQA requirements is based solely on the VMT analysis.

CEQA VMT Analysis

The results of the VMT analysis using the VTA's VMT Evaluation Tool indicate that the existing VMT for residential uses in the project vicinity is 30.46 VMT per capita.

The results also indicate that the project is projected to generate VMT per capita (27.41), which would exceed the OPR's recommended impact threshold of 20.94 VMT per capita. Therefore, the project would result in an impact on the transportation system based on OPR's VMT impact criteria.

VMT Impacts and Mitigation

Using OPR's impact thresholds, the project would need to implement VMT reduction measures to achieve a 24% reduction (27.41 to 20.94) in its VMT per capita for the proposed residential uses to reduce its impact to less than significant levels.

OPR's recommended 15% below existing VMT impact threshold encourages developments in transit-rich, highly mixed-use areas to implement design features and trip reduction measures to take advantage of existing multi-modal infrastructure and land use mixes in reducing trip making and/or trip lengths. However, many communities such as Morgan Hill have very limited multi-modal transportation infrastructure and lack a mix of complementary land uses. The lack of employment in these communities along with minimal transit options results in a greater number and longer commute trips. Therefore, it is highly unlikely that developments like the proposed project in these cities can achieve OPR's recommended 15% reduction in VMT. Therefore, absent of the City adopting its own City-specific VMT policies and impact thresholds, the proposed project's VMT impact must be deemed significant and unavoidable.

Per its condition of approval, the City will however require that the project implement and/or incorporate in its design the following VMT reduction measures to encourage the use of multi-modal travel and reduce the number and length of vehicular trips:

1. The management entity/HOA shall provide fully (100 percent) subsidized annual VTA transit passes for all project homeowners (a maximum of one transit subsidy per residential unit, which would result in up to 269 transit passes per year). This subsidized transit program shall be approved by the City of Morgan Hill's Public Services Director prior to issuance of occupancy.
2. The project must improve the surrounding pedestrian network by including sidewalks which terminate at the common property line, allowing for connections to the adjacent property in the event there is development in the future. Continuous sidewalks are proposed along the project frontages. The proposed frontage improvements along Mission View Drive, Half Road, and De Paul Drive include sidewalk improvements; each of the street sections will be wide enough to accommodate future bicycle lanes.
3. The proposed development will include 64 bicycle parking spaces.

Traffic Operations Analysis

Project Trip Generation

Based on the recommended rates for single-family detached housing (Land Use #210) and the size of the proposed project, it is estimated that the proposed project would generate 2,539 daily trips, with 199

trips (50 inbound and 149 outbound) occurring during the AM peak hour and 266 trips (168 inbound and 98 outbound) occurring during the PM peak hour.

Intersection Operations Analyses

The results of the traffic operations analysis indicate that based on the City's operating standards, the proposed project would have an adverse effect on intersection operations at the following four study intersections under Year 2030 Cumulative with project conditions.

6. Mission View Drive and Cochrane Road (AM & PM Peak Hours)
8. Mission View Drive and Half Road (unsignalized) (AM & PM Peak Hours)
9. Condit Road and Main Avenue (PM Peak Hour)
10. Condit Road and Diana Avenue (unsignalized) (AM Peak Hour)

Adverse Intersection Operations Effects and Potential Improvements

The adverse intersection operation effects identified under Year 2030 Cumulative with project conditions are discussed below. Included are descriptions of the adverse effects on intersection operations and potential improvement measures that may be included as part of the project's Conditions of Approval. However, the identified roadway operations and improvements are not required or considered project impacts per CEQA guidelines.

6. Cochrane Road and Mission View Drive

This intersection is projected to operate at an unacceptable LOS F and E during the AM and PM peak hours, respectively, under Year 2030 Cumulative without project conditions. Traffic associated with the proposed project would cause the critical delay to increase by more than four seconds and the volume-to-capacity ratio (V/C) to increase by more than 0.01 during both the AM and PM peak hours. This constitutes an adverse effect on intersection operations based on the City of Morgan Hill's level of service standards.

The addition of a second northbound left-turn lane on Mission View Drive and a cycle length adjustment would be necessary to improve intersection operations. The addition of the second northbound left-turn lane will require lane striping and signal modification but will fit within the existing curb-to-curb pavement width on Mission View Drive. Implementation of this improvement would improve the intersection's level of service to LOS C during both the AM and PM peak hours under Year 2030 Cumulative with project conditions.

8. Mission View Drive and Half Road

This intersection is projected to operate at an unacceptable LOS F during the PM peak hour under Year 2030 Cumulative without and with project conditions. Furthermore, this intersection is projected to operate at an acceptable LOS D during the AM peak hour under Year 2030 Cumulative without conditions and degrade to LOS E with the addition of project traffic. Additionally, the peak-hour traffic signal warrant checks indicate that the intersection would have traffic volumes that meet thresholds that warrant signalization during both the AM and PM peak hours under Year 2030 Cumulative without and with project conditions. This constitutes an adverse effect on intersection operations based on the City of Morgan Hill's level of service standards.

The signalization of the intersection would be necessary to improve intersection operations. Implementation of a traffic signal at this location would improve the level of service to LOS C during both the AM and PM peak hours under Year 2030 Cumulative with project. This intersection is

under the jurisdiction of both the City of Morgan Hill and Santa Clara County. Therefore, implementation of the recommended improvements will require City and County approval.

9. Main Avenue and Condit Road

This intersection is projected to operate at an unacceptable LOS F during the PM peak hour under Year 2030 Cumulative without project conditions. Traffic associated with the proposed project would cause the critical delay to increase by more than four seconds and the volume-to-capacity ratio (V/C) to increase by more than 0.01 during the PM peak hour. This constitutes an adverse effect on intersection operations based on the City of Morgan Hill's level of service standards.

The addition of an exclusive southbound right-turn lane on Condit Road would be necessary to improve intersection operations. The addition of the right-turn lane will require signal modifications and lane striping on the southbound approach. Implementation of this improvement would improve the intersection's level of service to LOS D during the PM peak hour under Year 2030 Cumulative with project conditions. This intersection is under the jurisdiction of both the City of Morgan Hill and Santa Clara County. Therefore, implementation of the recommended improvements will require City and County approval.

10. Condit Road and Diana Avenue

This intersection is projected to operate at an unacceptable LOS E during the AM peak hour under Year 2030 Cumulative without and with project conditions. Additionally, the peak-hour traffic signal warrant checks indicate that the intersection would have traffic volumes that meet thresholds that warrant signalization during the AM peak hour under Year 2030 Cumulative without and with project conditions. This constitutes an adverse effect on intersection operations based on the City of Morgan Hill's level of service standards.

The signalization of the intersection would be necessary to improve intersection operations. Implementation of this improvement would improve the intersection's level of service to LOS B during the AM peak hour under Year 2030 Cumulative with project conditions.

Freeway Segment Level of Service Analysis

The results of the freeway segment level of service analysis indicate that ten directional mixed-flow lanes and one directional HOV lane on the freeway segments analyzed are projected to operate at an unacceptable LOS F during at least one peak hour under existing conditions and would continue to operate at LOS F conditions with the addition of traffic due to proposed project.

Improvement of freeway segment operations would require freeway widening to construct additional through lanes, thereby increasing freeway capacity. VTA's Valley Transportation Plan (VTP) 2040 identifies freeway express lane projects along US 101 between Cochrane Road and Whipple Avenue. The planned improvements consist of the conversion of the existing HOV lane to an express lane and the construction of a second express lane in each direction on US 101. These improvements would increase the capacity of the freeway and help to address the deficiency in freeway operations. However, it is not feasible for an individual development project to bear responsibility for implementing such extensive transportation system improvements due to constraints in the acquisition and cost of right-of-way.

Other Transportation Issues

Site Access

The project would include the extension of DePaul Drive to the south with termination as a cul-de-sac just north of Half Road. Access to the project site would be provided via a full access driveway along Mission View Drive and two full access driveways along the DePaul Drive extension.

On-Site Circulation

An internal private street network would provide access to each of the residential units from the proposed entrances along Mission View Drive and DePaul Drive. Most of the streets that front homes include on-street parallel parking. The internal streets would provide continuous access to each area of residential units.

Travel way on street is typically a minimum of 26 feet. The travel way on the internal streets is shown to be at least 20 feet wide. The narrower travel width will provide adequate width for two-way travel on each of the streets and will promote reduced travel speeds within the site. However, the straight nature of the internal roadways could result in drivers traveling at greater speeds than recommended. Therefore, it may be desirable to implement speed-reducing measures along the internal roadways. These measures could include the installation of speed bumps/humps along the internal roadways and/or bulb-outs at intersections and mid-block.

The project site plan shows sidewalks along the project's frontages along Mission View Drive and DePaul Drive and the internal street network on-site. However, there are no sidewalks provided along the west side of Mission View Drive between the project site and Cochrane Road. In conjunction with the existing sidewalks along the east side of Mission View Drive, the proposed sidewalks on Mission View Drive along the project frontage would provide a connection between the project site and bus stops along Mission View Drive and pedestrian destinations along Cochrane Road. There also are no sidewalks along either side of DePaul Drive between the project site and Cochrane Road. Therefore, there will be no sidewalk connection between the project site and Cochrane Road.

The project site should be designed following City of Morgan Hill design standards and provide adequate width and turn-radii at and along all drive/parking aisles to allow for two-way circulation and adequate circulation of larger vehicles (such as emergency trucks, garbage truck, and delivery trucks) throughout the project site. Adhering to the City of Morgan Hill standards and requirements, and implementing the above recommendations, the proposed site access points and layout of the surface parking areas would be adequate to accommodate the circulation of both passenger and emergency vehicles.

Emergency Vehicle Access and Circulation

The 20-foot-wide internal roadway would provide emergency vehicles (fire trucks) sufficient space to access each of the residential units on-site. There are several dead-end drive aisles that would not provide sufficient space for emergency vehicles to turn around. However, the dead-ends will be located along short segments of roadways. Thus, vehicles would be able to back out of the roadways.

Intersection Operations Analysis

The queuing analysis also indicates that the maximum vehicle queue for northbound left-turn movement at the Cochrane Road and Mission View Drive intersection currently exceeds the provided turn pocket storage space during the AM and PM peak hours under existing conditions.

The addition of project traffic is not projected to lengthen the projected queue during the AM peak hour. However, the addition of project traffic is projected to lengthen the projected queue by one vehicle or 25 feet during the PM peak hour under existing plus project conditions, which would exceed the existing storage capacity by 75 feet.

Recommendation: The northbound left-turn pocket can be lengthened by 250 feet to accommodate the projected queue during the AM peak hour. However, a second northbound left-turn lane is recommended to improve intersection operations.

Project Driveway Operations

The results of the project driveway operations analysis indicate that all three project driveways are projected to operate at acceptable levels of service (LOS D or better) during each of the peak hours analyzed and to have traffic conditions that fall below the thresholds that warrant signalization. Additionally, the 95th percentile queues at the project driveways are projected to be at most 25 feet.

Recommendation: A center-striped median is currently provided along Mission View Drive north of the project site. The current width of Mission View Drive along the project frontage is not adequate to provide a left-turn pocket into the project driveway. Mission View Drive would need to be widened along its east side, opposite the project frontage, to provide a striped left-turn pocket into the project site. Similarly, left-turn lanes should be striped at the project driveways along DePaul Drive if a center-striped median is planned.

Sight Distance

Based on Caltrans requirements, the available sight distance at the project site driveways on DePaul Drive and Mission View Drive would be adequate.

Recommendation: The site design should ensure design features, in particular, the landscaping and signage along the project site frontage and at the project site driveways, would not interfere with the sight distance at the proposed site driveway.

Parking

Based on Tables 18.72-2 and 18.72-3 of Section 18.72.030 of the Morgan Hill City Code, the project would be required to provide 2 covered parking spaces per residential unit and one guest parking space is required for every four residential units. The project would be required to provide 538 resident and 68 guest parking spaces for the proposed 269 residential units. The project is proposing to provide two covered parking spaces for each residential unit for a total of 538 parking spaces and 271 on-street parking spaces within the internal street network. Therefore, the provided number of parking spaces would satisfy the City's parking requirement.

Transit, Pedestrian, and Bicycle Analysis

The project site is served by Local Route 87 with bus stops along Mission View Drive and Half Road. In addition, Express Route 168 also provides service along Cochrane Road west of US 101. These two bus routes provide a connection to the Morgan Hill Caltrain Station. A conservative mode split in

Morgan Hill would be a three percent transit share. Assuming up to three percent transit mode share for the project equates to no more than six and eight transit riders during the AM and PM peak hours, respectively.

VTA has recommended that a new bus stop for Route 87 be installed along Mission View Drive on the project frontage just south of the project entrance. VTA also has suggested a new bus stop be installed on the northbound side of Mission View Drive if a controlled crosswalk were to be installed at the project entrance along Mission view Drive. However, this analysis showed no need for signal control at the project entrance. It is recommended that the project coordinate with VTA to identify the specific placement of a new bus stop along Mission View Drive and allow for adequate space along its frontage on Mission View to accommodate the installation of a bus stop including wider sidewalks, lighting, landscaping, and passenger pad.

Sidewalks are provided along the east side of Mission View Drive and the north side of Cochrane Road in the immediate project area. However, sidewalks along the south side of Cochrane Road are intermittent, with no sidewalk currently provided between the US 101 northbound ramps and De Paul Drive, and a short segment west of Mission View Drive. The project would provide sidewalks along its entire frontages along Mission View Drive, Half Road, and DePaul Drive and result in a continuous connection to the existing sidewalks on the east side of Mission View Drive to provide a safe connection between the project site and other surrounding land uses in the area. Controlled crossings at the intersections of Cochrane Road with Mission View Drive and DePaul Drive would provide a connection between the project area and retail uses on the north side of Cochrane Road.

Bike lanes are currently provided along the entire lengths of Cochrane Road and Main Avenue. An unpaved bike path, the Madrone Channel Trail, runs along the east side of US 101, between Tennant Avenue and Cochrane Road. It is expected that bicycle trips would comprise no more than one percent of the total project-generated trips. Thus, the project could potentially generate no more than three new bicycle trips during each of the peak hours. The demand generated by the proposed project could be accommodated by the existing bicycle facilities in the vicinity of the project site.

Freeway Ramp Analysis

Freeway On-Ramp Queuing Analysis

The analysis indicates that project traffic would not lengthen the projected 15-minute interval queue lengths at either of the subject Cochrane Road on-ramps under existing plus project conditions. Short vehicle queues, less than 10 vehicles, currently occur at the ramps, however, the queues dissipate during the 15-minute intervals because the demand volume is less than the service rate of the freeway ramp meters.

The volumes on the northbound diagonal on-ramp from westbound Cochrane Road are projected to be greater than the service rate of the ramp meter during the AM peak hour under Year 2030 Cumulative with project conditions. Therefore, queues are projected to develop on the northbound diagonal on-ramp. Trips from the proposed project will result in an increase in the projected queue by two vehicles. However, the projected queues on the metered northbound diagonal on-ramp can be accommodated entirely on the ramp.

Freeway Off-Ramp Queuing Analysis

The results of the analysis show that the 95th percentile queue lengths at each of the US 101 off-ramps to Cochrane Road are projected to be accommodated entirely on the ramps and would not extend back and disrupt the freeway mainline.

1. Introduction

This report presents the results of the Transportation Analysis (TA) conducted for the proposed Crosswinds residential development in Morgan Hill, California. The 30.5-acre project site is currently vacant and is generally bounded by Half Road to the south, Mission View Drive to the east, future extension of DePaul Drive to the west, and Avenida De Los Padres to the north. The project as proposed will consist of a total of 269 residential units comprised of 149 condos, 56 detached single-family, and 64 duet units. The project would include the extension of DePaul Drive to the south with termination as a cul-de-sac just north of Half Road. Access to the project site would be provided via a full access driveway along Mission View Drive and two full access driveways along the future DePaul Drive extension. The project site location and the surrounding study area are shown in Figure 1. The project site plan is shown in Figure 2.

Scope of Study

The TA consists of a California Environmental Quality Act (CEQA) required vehicle-miles-traveled (VMT) analysis and a supplemental traffic operations analysis that demonstrates the project's consistency with the *Morgan Hill 2035 General Plan* goals and policies.

CEQA Transportation Analysis Scope

Historically, traffic impact analysis has focused on the identification of traffic impacts and potential roadway improvements based on delay to relieve traffic congestion that may result due to proposed/planned growth. However, with the adoption of Senate Bill (SB) 743 legislation, public agencies are required (effective July 2020) to base transportation impacts on Vehicle-Miles-Traveled (VMT) rather than level of service that typically uses delay as its metric. The change in measurement is intended to better evaluate the effects on the state's goals for climate change and multi-modal transportation. Therefore, to adhere to the state's legislation, all new development projects are required to analyze transportation impacts using the VMT metric.

The CEQA VMT impact analysis was completed using the Valley Transportation Authority's (VTA) VMT tool. The City of Morgan Hill is currently developing the framework for new transportation policies based on VMT as the primary measure of transportation impacts. The new policies will replace the City's current transportation policies that are based on levels of service per the Morgan Hill 2035 General Plan. However, since the City has not formally adopted its own city-specific VMT policies, this study utilizes VMT analysis methodology and impact thresholds recommended in the Governor's Office of

Figure 1
Site Location and Study Intersections

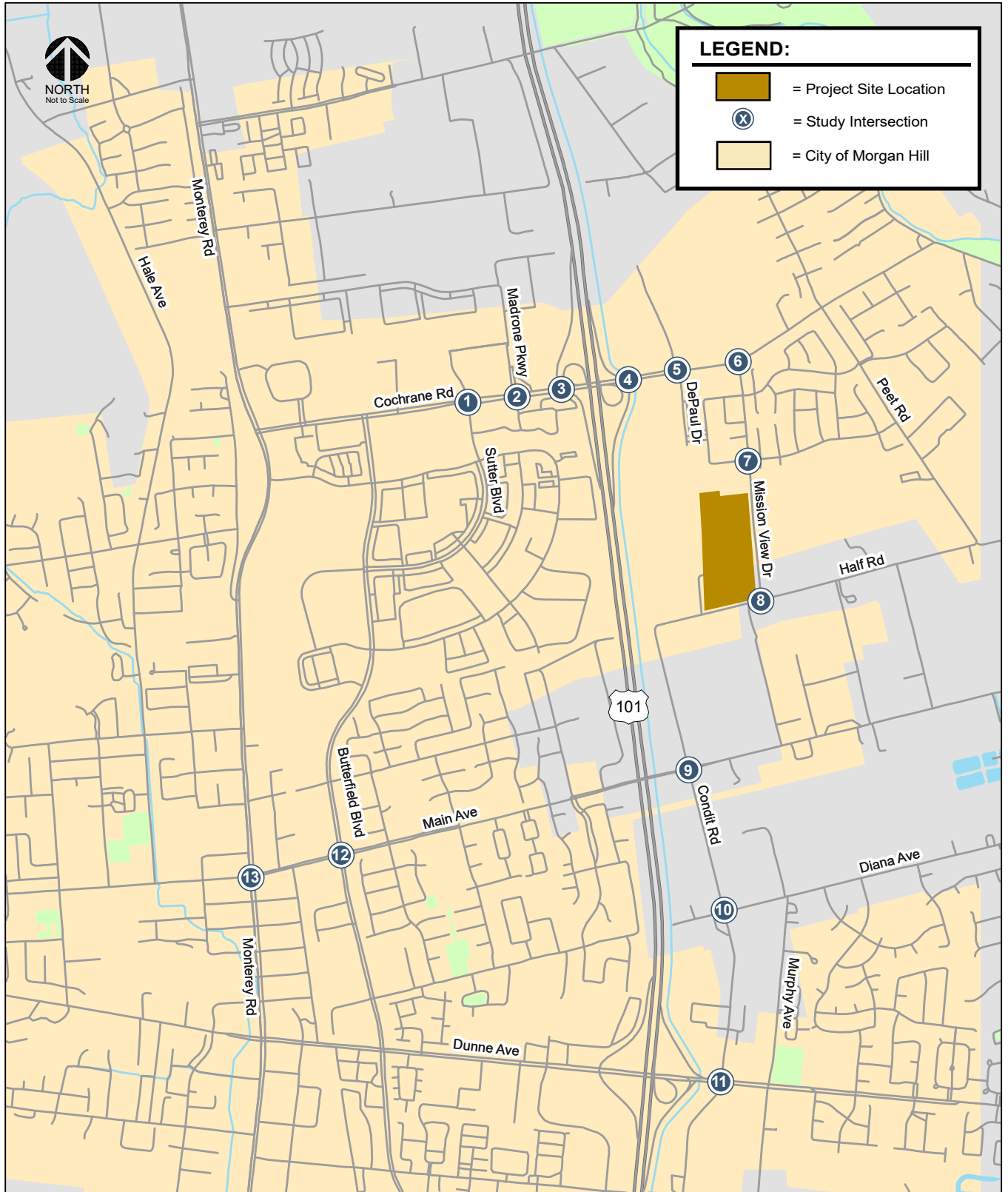

Figure 2
Project Site Plan



Planning and Research (OPR) Technical Advisory on Evaluating Transportation Impacts in CEQA, December 2018.

Traffic Operations Analysis Scope

The current General Plan, *Morgan Hill 2035 General Plan*, adopted in July 2016 uses Level of Service (LOS) as its primary metric for the evaluation of the projected operation of the City's roadway system. Therefore, a traffic operations analysis based upon peak hour intersection level of service analysis is included for consistency with the General Plan goals and policies. The traffic operations analysis supplements the CEQA required VMT analysis. However, the determination of project impacts per CEQA requirements is based solely on the VMT analysis.

The traffic operations analysis includes the evaluation of weekday AM and PM peak hour operations at selected intersections for the purpose of identifying operational issues (queuing, signal operations, and potential multi-modal issues) at intersections in the general vicinity of the project site. The traffic operations analysis also includes an evaluation of the effects of the project's on-site access, on-site circulation, and related safety elements in the immediate area of the project.

The effects of the proposed development on traffic operations on the surrounding roadway system were evaluated following the standards and methodologies set forth by the City of Morgan Hill in its *Guidelines for Preparation of Transportation Impact Reports*, February 2010, Morgan Hill 2035 General Plan, and the Santa Clara Valley Transportation Authority (VTA). The VTA administers the County Congestion Management Program (CMP).

Report Organization

The remainder of this report is divided into five chapters. Chapter 2 describes existing conditions in terms of the existing roadway network, transit service, and existing bicycle and pedestrian facilities. Chapter 3 presents the CEQA VMT analysis. Chapter 4 presents the traffic operations analysis and the project's effects on the transportation system and describes the recommended roadway improvements. Chapter 5 presents the analysis of other transportation-related issues, including site access. Chapter 6 presents the conclusions of the transportation analysis.

2. Existing Transportation System

This chapter describes the existing transportation system within the project area. It describes transportation facilities for all of the major transportation facilities in the vicinity of the site, including the roadway network, transit service, and bicycle and pedestrian facilities.

Existing Roadway Network

Regional access to the project site is provided via US 101. Local access to the site is provided by Cochrane Road, Dunne Avenue, DePaul Drive, Half Road, Mission View Drive, Main Avenue, and Condit Road. These facilities are described below.

US 101 is a north-south freeway extending northward to San Francisco and southward through Gilroy. US 101 is an eight-lane freeway (three mixed-flow lanes and one high-occupancy vehicle (HOV) lane in each direction) north of Cochrane Road. South of Cochrane Road, it is a six-lane freeway with no HOV lanes. Access to and from the project site is provided via its interchanges at Cochrane Road and Dunne Avenue.

Cochrane Road is an east-west divided roadway that runs from Monterey Road to Malaguerra Avenue, east of US 101. Currently, Cochrane Road is a four-lane road between Monterey Road and Sutter Boulevard. Between Sutter Boulevard and US 101, Cochrane Road widens to three lanes eastbound and two lanes westbound, then narrows back to four lanes east of US 101, and to two lanes east of Mission View Drive. Cochrane Road has posted speed limits of 40 and 45 miles per hour (mph). Access to the project site is provided via its intersections with DePaul Drive and Mission View Drive.

Dunne Avenue transverses the City extending from the east part of town to the west with a posted speed limit of 35 to 40 mph and sidewalks along both sides of the street. Bike lanes are found along both sides of Dunne Avenue between Peak Avenue and Gallop Drive (east of US 101). Access to the project site is provided via its intersection with Condit Road.

DePaul Drive is a north-south undivided roadway that intersects Cochrane Road approximately 700 feet east of the US-101 northbound ramps intersection and runs approximately 1,500 feet north and 1,000 feet south of Cochrane Road. DePaul Drive has a posted speed limit of 35 miles per hour (mph). The project proposes to extend DePaul Drive by approximately 2,280 feet south to provide direct

access to the project site via two full access driveways. As proposed, DePaul Drive would terminate as a cul-de-sac just north of Half Road.

Half Road is an east-west undivided roadway that runs from Condit Road to Cochrane Road. Half Road runs along the project's southern frontage and has a posted speed limit of 35 miles per hour (mph). However, Half Road would not provide direct access to the project site and would not intersect the proposed extension of DePaul Drive. Access to the project site is provided via its intersection with Mission View Drive.

Mission View Drive is a north-south two-lane undivided roadway that runs south from Eagle View Drive to Half Road. In the vicinity of the project site, Mission View Drive has a posted speed limit of 40 miles per hour (mph). Mission View Drive runs along the project's eastern frontage. Access to the project site would be provided via a full access driveway along Mission View Drive.

Main Avenue is a two-lane roadway that runs eastward from its intersection with DeWitt Avenue to Coyote Road at the base of the eastern foothills. The roadway has an overcrossing of US 101, however, no access to US 101 is provided. Access to the project site is provided via its intersection with Condit Road.

Condit Road is a two-lane north-south roadway that extends from Half Road southward to Tennant Avenue. The posted speed limit on Condit Road is 45 mph. Access to the project site is provided via its transition to Half Road.

Existing Bicycle and Pedestrian Facilities

As defined by the Valley Transportation Authority (VTA), bicycle facilities include Class I bikeways (defined as off-street bike paths, which are shared with pedestrians and excludes general motor vehicle traffic), Class II bikeways (defined as striped bike lanes on street), and rated streets. The latter refers to streets frequently used by bicyclists, sharing the roadway with motor vehicles, and includes city designated Class III bike routes. Rated streets include extreme caution (heavy traffic volumes with high traffic speeds), alert (moderate traffic volumes and speeds), and moderate (low traffic volumes and moderate to low traffic speeds). Class III bikeways only have signs to help guide bicyclists on recommended routes to certain locations.

In the project vicinity, bike lanes are currently provided along the extent of Cochrane Road and Main Avenue beginning at Live Oak High School and continuing west across US-101 to Peak Avenue. An unpaved bike path, the Madrone Channel Trail, runs along the east side of US 101, between Tennant Avenue and Cochrane Road.

The remaining bicycle facilities in the area are located west of US-101. Bike lanes are currently provided along the following roadways:

- Butterfield Boulevard, along its entire length;
- Sutter Boulevard, from Cochrane Road to Butterfield Boulevard;
- Monterey Road, nearly its entire length within City of Morgan Hill limits, with the exception of the segment that runs through downtown between Dunne Avenue and Main Avenue;
- Burnett Avenue, from Monterey Road to Bauman Court (west of US 101);
- Central Avenue, from Butterfield Boulevard to its termination point west of US 101;
- Dunne Avenue, from Peak Avenue to east of Hill Road;
- Depot Street, along its entire length;
- Peak Avenue, between Dunne Avenue and Wright Avenue;
- Murphy Avenue, between Dunne Avenue and Kelly Park Circle;

- Hale Avenue, between Main Avenue and north of the City of Morgan Hill.

Other bicycle facilities in the project vicinity include the following:

- A bike route on Monterey Road, between Dunne Avenue and Main Avenue;
- A paved bike path on the east side of Butterfield Boulevard, between San Pedro Avenue and Central Avenue.

The existing bicycle facilities in the study area are presented graphically in Figure 3.

Pedestrian facilities in the study areas consist primarily of sidewalks, pedestrian push buttons, marked crosswalks, and signal heads at signalized intersections. However, the project site is located within a primarily undeveloped area where continuous sidewalks along the surrounding streets are not available. Sidewalks are provided along at least one of the sides of the following roadways in the vicinity of the project site:

Cochrane Road – sidewalks are provided along the north side of the street between Butterfield Boulevard and White Moon Drive. Along the south side of the street, sidewalks are provided from Monterey Road to the east of Mission View Drive with the exception of the segments between Woodview Avenue and Sutter Boulevard, US 101 northbound ramps and DePaul Drive, and a short segment west of Mission View Drive.

Mission View Drive – sidewalks are provided along the east side of the street between the northern end of Mission View Drive (at Eagle View Drive) until approximately 950 feet north of its intersection with Half Road. There are no sidewalks along the west side of Mission View Drive, with the exception of curb ramps located at the northwest and southwest corners of the Mission View Drive and Cochrane Road intersection.

Sidewalks are not provided on either side of DePaul Drive south of Cochrane Road. All other streets in the immediate vicinity of the project site fronting undeveloped areas have no sidewalks.

Existing Transit Service

Existing transit service to the study area is provided by the VTA and Caltrain. The transit services are described below and shown in Figure 4.

VTA Bus Services

The study area is served directly by one local bus (Local Bus Route 87). In addition, Express Route 168 operates along Cochrane Road west of US 101.

Local Bus Route 87 operates on Cochrane Road, Mission View Drive, and Half Road in the study area. It runs from Burnett Avenue to the Civic Center (Main and Dewitt) in Morgan Hill with approximately 60-minute headways in the AM and PM commute periods. Route 87 operates between 6:30 AM and 5:45 PM. The nearest Route 87 bus stops to the project site are located near the Half Road/Elm Road and Mission View Drive/Avenida De Los Padres intersections.

Express Route 168 operates on Butterfield Boulevard and Cochrane Road on its route between the Gilroy Transit Center and the San Jose Diridon Transit Center. It operates northbound with 30- to 45-minute headways during the AM commute period only and southbound with 45-minute headways during the PM commute period only. The nearest Route 168 bus stops to the project site are located near the intersection of Cochrane Road and Sutter Boulevard, approximately $\frac{3}{4}$ miles west of the project site.

Figure 3
Existing Bicycle Facilities

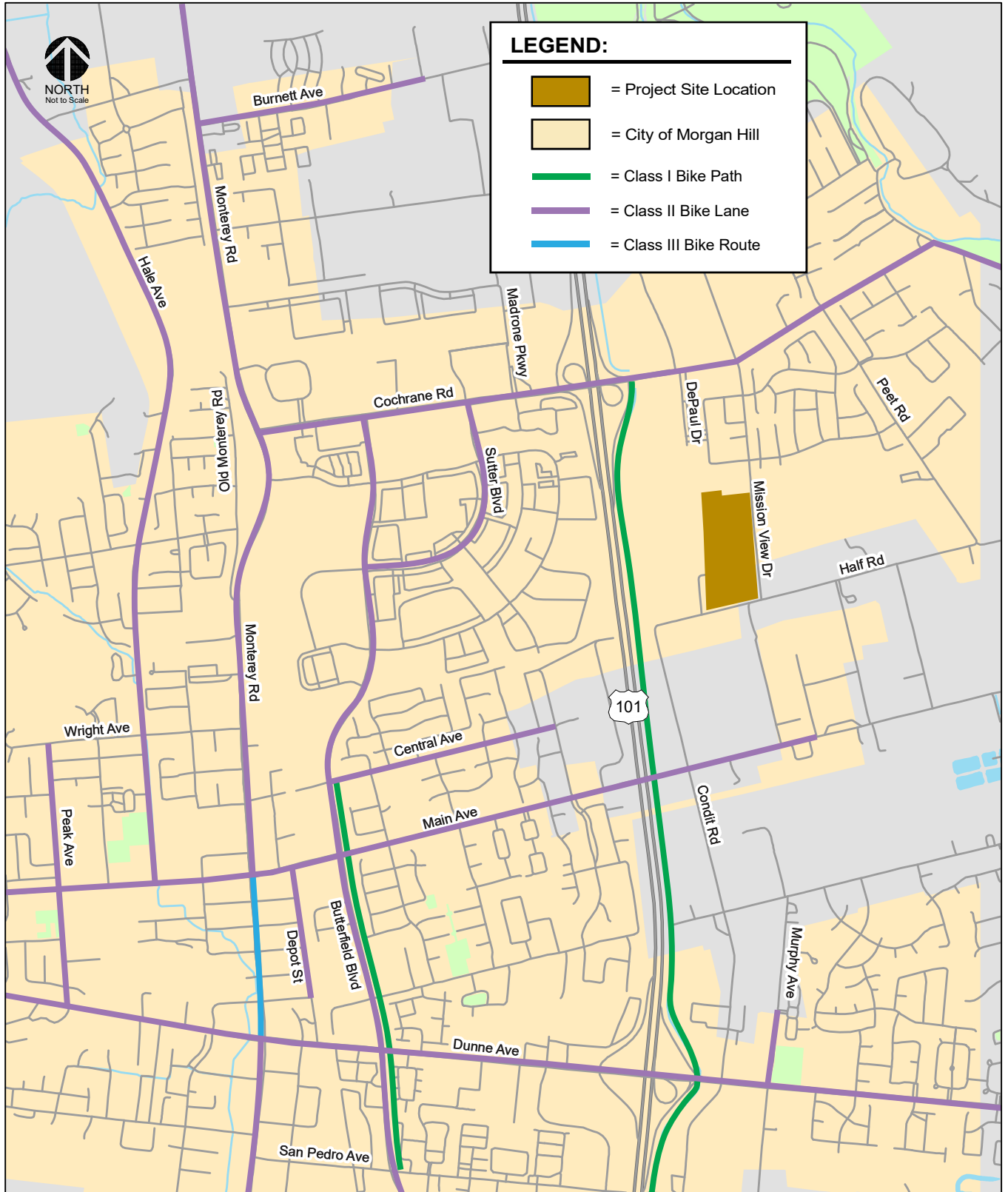
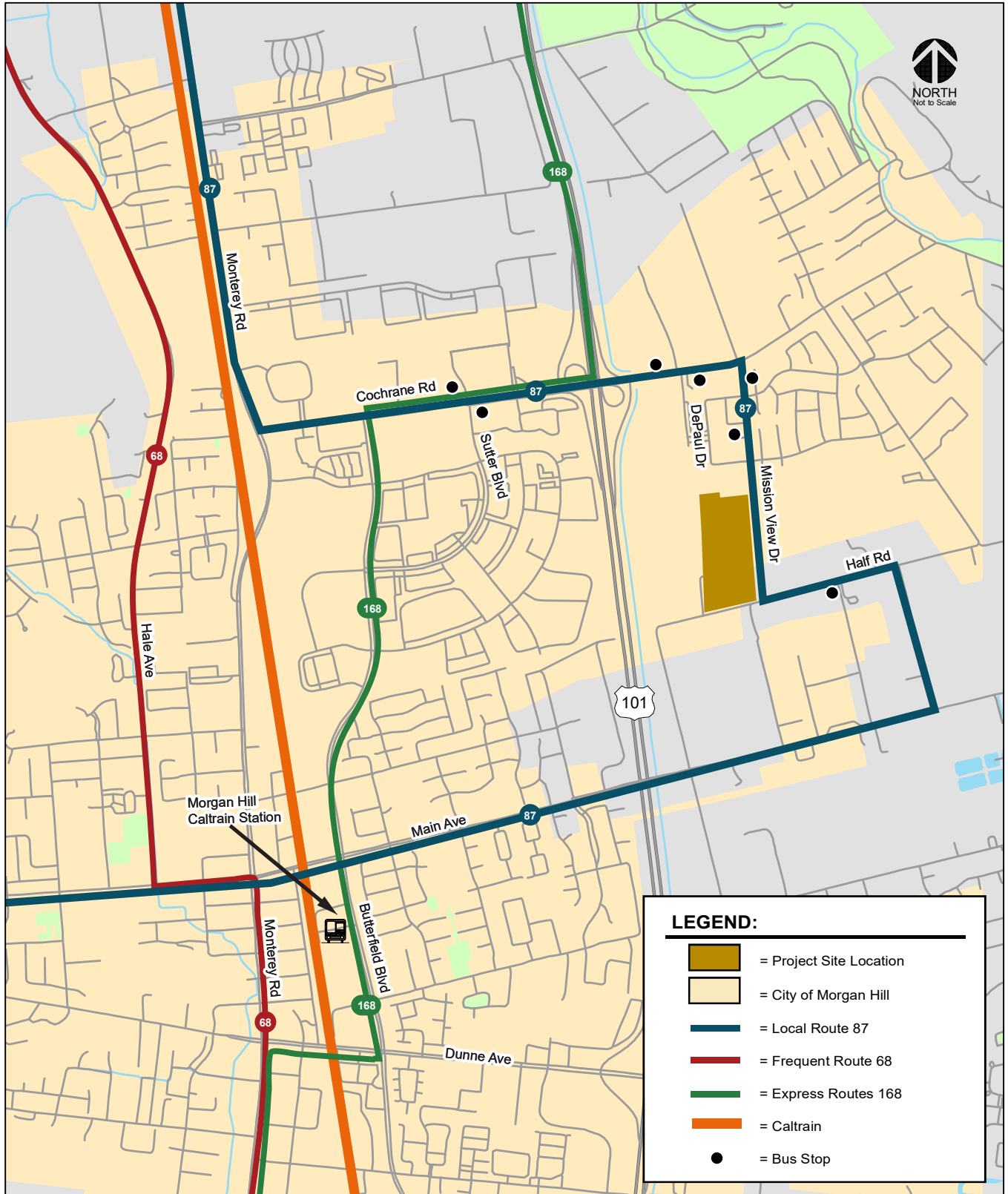

Figure 4
Existing Transit Services



Caltrain

Commuter rail service between San Francisco and Gilroy is provided by Caltrain. The Morgan Hill Caltrain Station is located along Depot Street, with main access and parking off of Butterfield Boulevard, approximately two miles from the project site. At the Morgan Hill Station, Caltrain provides service in only the northbound direction during the AM commute period with 30-minute headways and only in the southbound direction during the PM commute period with 90-minute headways.

3.

CEQA VMT Evaluation

This chapter provides an evaluation of the proposed project's effect on Vehicle Miles Traveled (VMT). Pursuant to Senate Bill (SB) 743, the California Environmental Quality Act (CEQA) 2019 Update Guidelines Section 15064.3, subdivision (b) states that VMT will be the metric in analyzing transportation impacts for land use projects for CEQA purposes.

VMT Evaluation Methodology

VMT is the total miles of travel by personal motorized vehicles a project is expected to generate in a day. VMT measures the full distance of personal motorized vehicle trips with one end within the project. Typically, development projects that are farther from other, complementary land uses (such as a business park far from housing) and in areas without transit or active transportation infrastructure (bike lanes, sidewalks, etc.) generate more driving than development near complementary land uses with more robust transportation options. Therefore, developments located in a central business district with high density and diversity of complementary land uses and frequent transit services are expected to internalize trips and generate shorter and fewer vehicle trips than developments located in a suburban area with low density of residential developments and no transit serve in the project vicinity.

The evaluation of the project's effects on VMT was completed using VTA's *VMT Evaluation Tool*. The VMT tool identifies the existing average VMT per capita and VMT per employee for the project area based on the assessor's parcel number (APN) of a project. Based on the project location, type of development, project description, and proposed trip reduction measures, the evaluation tool calculates the project VMT. Projects located in areas where the existing VMT is above the established threshold are referred to as being in "high-VMT areas". Projects in high-VMT areas are required to include a set of VMT reduction measures that would reduce the project VMT to the greatest extent possible.

VMT Policies and Impact Criteria

To adhere to the state's legislation, the City of Morgan Hill is currently developing the framework for new transportation policies based on the implementation of VMT as the primary measure of transportation impacts for CEQA purposes. The new policies will replace the City's current transportation policies that are based on levels of service. However, since the City has not formally adopted its own City-specific VMT policies, this study utilizes VMT analysis methodology and impact

thresholds recommended in the Governor's Office of Planning and Research (OPR) *Technical Advisory on Evaluating Transportation Impacts in CEQA*, December 2018.

Per OPR's technical advisory, VMT per resident (capita) is the recommended metric to evaluate CEQA-related transportation impacts for residential land uses. As stated in the technical advisory, OPR recommends an impact threshold of 15% below the existing VMT levels for residential land uses. OPR allows the existing VMT to be measured as regional or citywide VMT per capita. Therefore, 15% below the city-wide residential VMT per capita is established as the impact threshold for the residential uses of the project.

The VTA's VMT Evaluation Tool indicates that the citywide average VMT per capita is currently 24.64. Therefore, the OPR recommends an impact threshold of 15% below the citywide average VMT per capita equates to 20.94 VMT per capita.

VMT Evaluation

The results of the VMT analysis using the VTA's VMT Evaluation Tool indicate that the existing VMT for residential uses in the project vicinity is 30.46 VMT per capita.

The results also indicate that the project is projected to generate VMT per capita (27.41), which would exceed the OPR's recommended impact threshold of 20.94 VMT per capita. Therefore, the project would result in an impact on the transportation system based on OPR's VMT impact criteria.

The VTA VMT Evaluation Tool output sheets are shown in Figure 5 and also included in Appendix A.

VMT Impacts and Mitigation

Using OPR's impact thresholds, the project would need to implement VMT reduction measures to achieve a 24% reduction (27.41 to 20.94) in its VMT per capita for the proposed residential uses to reduce its impact to less than significant levels.

OPR's recommended 15% below existing VMT impact threshold encourages developments in transit-rich, highly mixed-use areas to implement design features and trip reduction measures to take advantage of existing multi-modal infrastructure and land use mixes in reducing trip making and/or trip lengths. However, many communities such as Morgan Hill have very limited multi-modal transportation infrastructure and lack a mix of complementary land uses. The lack of employment in these communities along with minimal transit options results in a greater number and longer commute trips. Therefore, it is highly unlikely that developments like the proposed project in these cities can achieve OPR's recommended 15% reduction in VMT. Therefore, absent of the City adopting its own City-specific VMT policies and impact thresholds, the proposed project's VMT impact must be deemed significant and unavoidable.

Per its condition of approval, the City will however require that the project implement and/or incorporate in its design the following VMT reduction measures to encourage the use of multi-modal travel and reduce the number and length of vehicular trips:

1. The management entity/HOA shall provide fully (100 percent) subsidized annual VTA transit passes for all project homeowners (a maximum of one transit subsidy per residential unit, which would result in up to 269 transit passes per year). This subsidized transit program shall be approved by the City of Morgan Hill's Public Services Director prior to issuance of occupancy.
2. The project must improve the surrounding pedestrian network by including sidewalks which terminate at the common property line, allowing for connections to the adjacent property in the

Figure 5
VMT Analysis

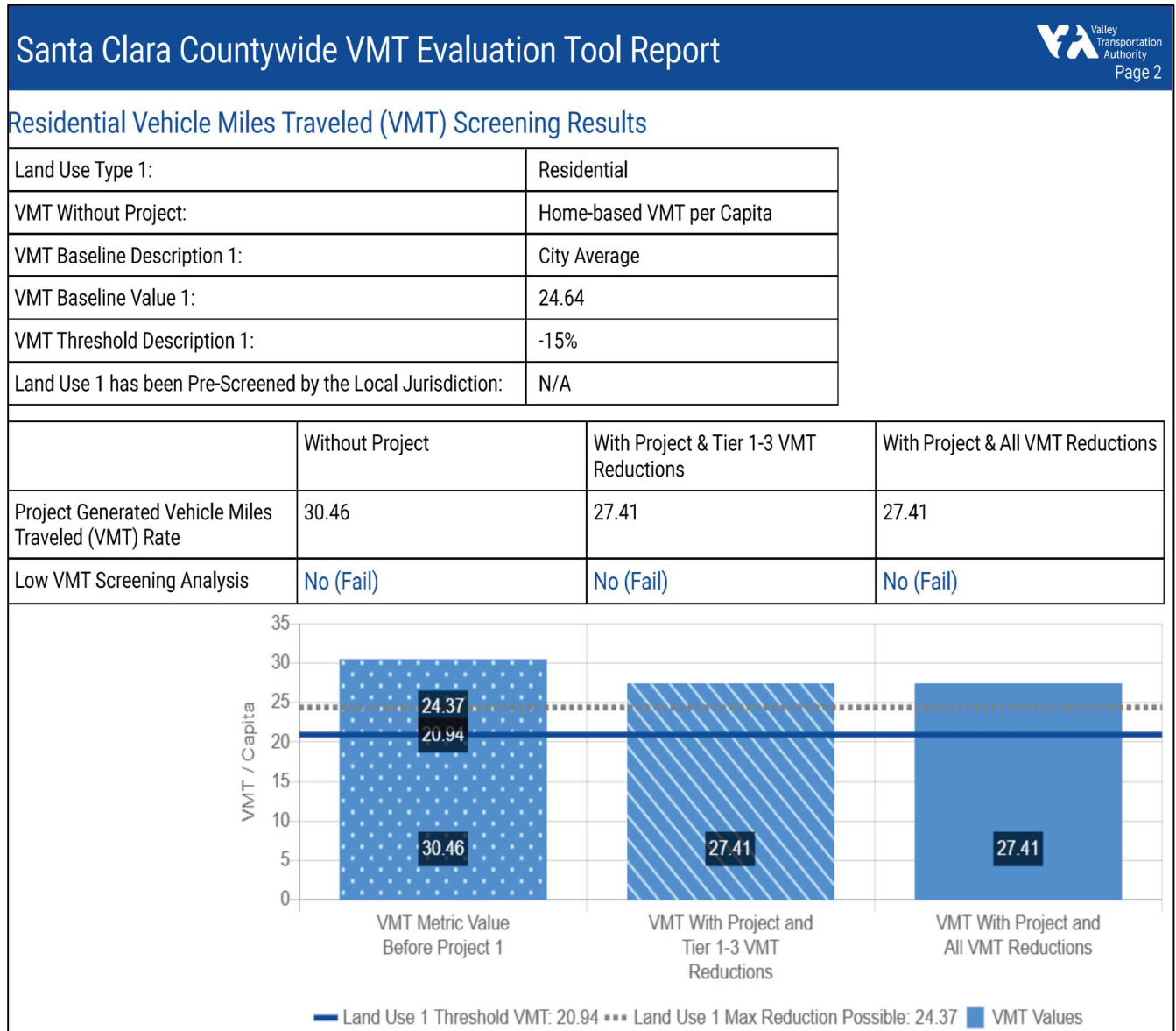

event there is development in the future. Continuous sidewalks are proposed along the project frontages. The proposed frontage improvements along Mission View Drive, Half Road, and De Paul Drive include sidewalk improvements; each of the street sections will be wide enough to accommodate future bicycle lanes.

3. The proposed development will include 64 bicycle parking spaces.

4. Traffic Operations Analysis

This chapter describes the traffic operations analysis. The traffic operations analysis provides supplemental analysis for use by the City of Morgan Hill in identifying potential improvement of the transportation system that may be included as part of the project's Conditions of Approval. However, the identified roadway operations and improvements are not required or considered project impacts per CEQA guidelines.

The chapter presents the method by which project traffic is estimated, intersection operations analysis for existing, existing plus project, Year 2030 cumulative conditions, the identification of any adverse effects on study intersections caused by project generated trips, and recommended improvements to alleviate the identified operational issues. In addition, the chapter includes an intersection vehicle queuing analysis, freeway segment capacity evaluation, site access and on-site circulation review, review of the project's effects on bicycle, pedestrian, and transit facilities, and a review of required parking.

Project Description

The 30.5-acre project site is currently vacant and is generally bounded by Half Road to the south, Mission View Drive to the east, future extension of DePaul Drive to the west, and Avenida De Los Padres to the north. The project as proposed will consist of a total of 269 residential units comprised of 149 condos, 56 detached single-family, and 64 duet units. The project would include the extension of DePaul Drive to the south with termination as a cul-de-sac just north of Half Road. Access to the project site would be provided via a full access driveway along Mission View Drive and two full access driveways along the future DePaul Drive extension.

Project Trip Estimates

The magnitude of traffic produced by a new development and the locations where that traffic would appear are estimated using a three-step process: (1) trip generation, (2) trip distribution, and (3) trip assignment. In determining project trip generation, the magnitude of traffic entering and exiting the site is estimated for the AM and PM peak hours. As part of the project trip distribution step, an estimate is made of the directions to and from which the project trips would travel. In the project trip assignment

step, the project trips are assigned to specific streets and intersections in the study area. These procedures are described further in the following sections.

Trip Generation

Through empirical research, data have been collected that correlate to common land uses their propensity for producing traffic. Thus, for the most common land uses there are standard trip generation rates that can be applied to help predict the future traffic increases that would result from a new development. Hexagon prepared trip estimates for the proposed project based on trip generation rates obtained from the Institute of Transportation Engineers' (ITE's) *Trip Generation Manual*, Tenth Edition, 2017. Single-Family Detached Housing (Land Use 210) trip generation rates were used to estimate the number of trips that would be generated by all proposed residential units because the trip-making characteristics of varying types of residential units would be similar due to the limited transit services and employment opportunities within Morgan Hill.

Based on the recommended rates for single-family detached housing (Land Use #210) and the size of the proposed project, it is estimated that the proposed project would generate 2,539 daily trips, with 199 trips (50 inbound and 149 outbound) occurring during the AM peak hour and 266 trips (168 inbound and 98 outbound) occurring during the PM peak hour. The trip generation estimates for the proposed project are shown in Table 1.

Trip Distribution and Assignment

The trip distribution patterns for project-generated traffic for the proposed land use were estimated based on existing travel patterns on the surrounding roadway system, locations of complementary land uses, and use of the City of Morgan Hill Traffic Demand Forecasting (TDF) Model. The peak-hour trips associated with the proposed project were added to the transportation network in accordance with the distribution patterns discussed above. The project trip distribution patterns are shown graphically in Figure 6. Figure 7 shows the assignment of project traffic on the local transportation network. A tabular summary of project traffic at each study intersection is contained in Appendix C.

Intersection Operations Methodology

This section presents the methods used to evaluate traffic operations at each of the study intersections for each study scenario. It includes descriptions of the data requirements, the analysis methodologies, and the applicable level of service standards, and the criteria defining adverse effects at the study intersections. The intersection operations analysis is intended to quantify the operations of intersections and to identify potential negative effects due to the addition of project traffic. However, a potential adverse effect on a study intersection is not considered a CEQA impact metric.

Study Intersections

The traffic operations analysis includes an analysis of AM and PM peak-hour traffic conditions for ten signalized intersections and three unsignalized intersections. The study intersections are identified below.

1. Cochrane Road and Sutter Boulevard
2. Cochrane Road and Madrone Parkway/Cochrane Plaza
3. Cochrane Road and US 101 Southbound Ramps
4. Cochrane Road and US 101 Northbound Ramps
5. Cochrane Road and De Paul Drive

**Table 1
Project Trip Generation Estimates**

Proposed Land Use	Size	Daily		AM Peak Hour						PM Peak Hour					
		Rate	Trip	Rate	Split		Trip			Rate	Split		Trip		
					In	Out	In	Out	Total		In	Out	Total		
Single-Family Detached Housing (ITE LU # 210) ¹	269 Dwelling Units	9.44	2,539	0.74	25%	75%	50	149	199	0.99	63%	37%	168	98	266

Notes:
¹ITE Trip Generation Manual, 10th Edition 2017

Figure 6
Project Trip Distribution

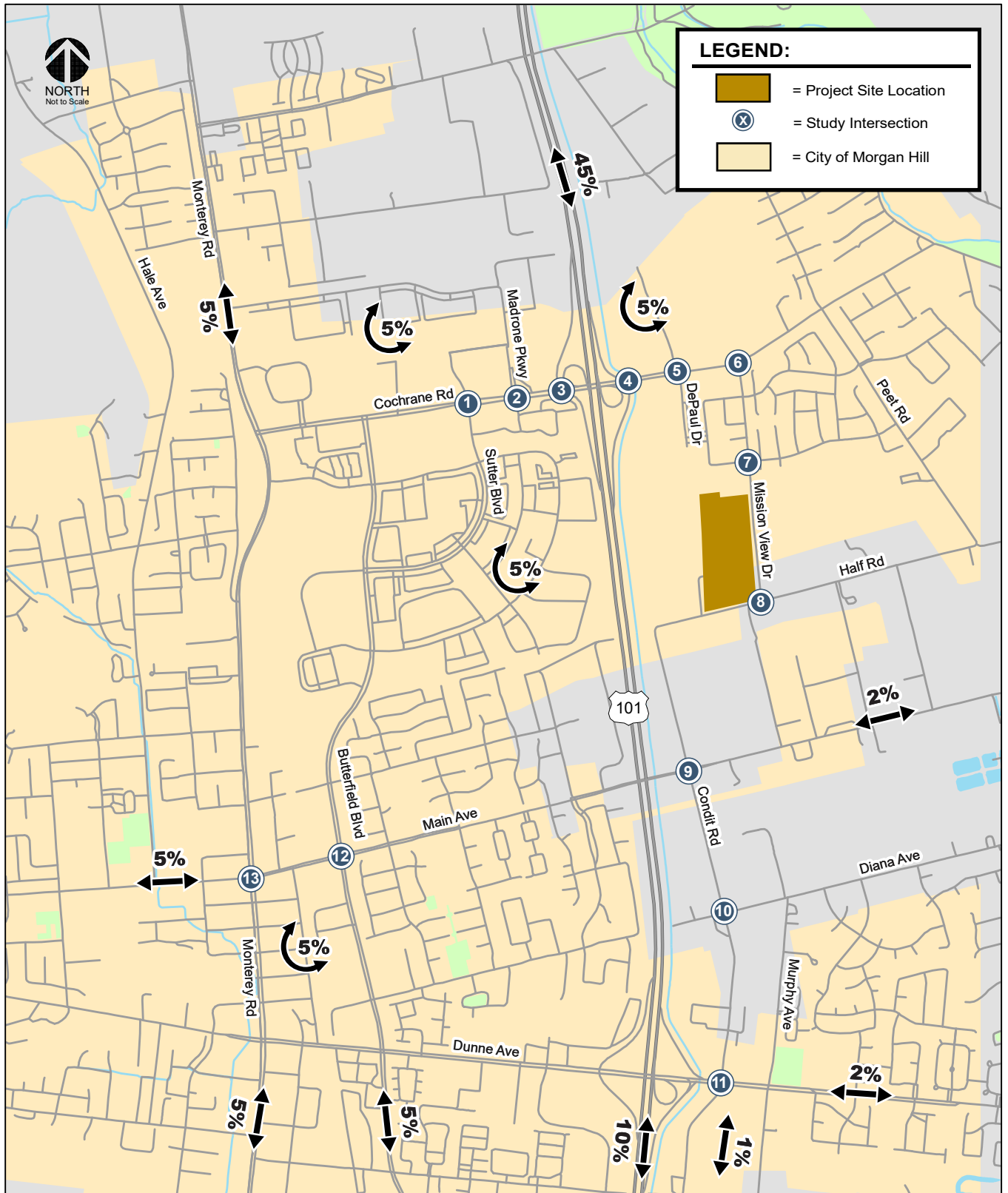

**Figure 7
Project Trip Assignment**

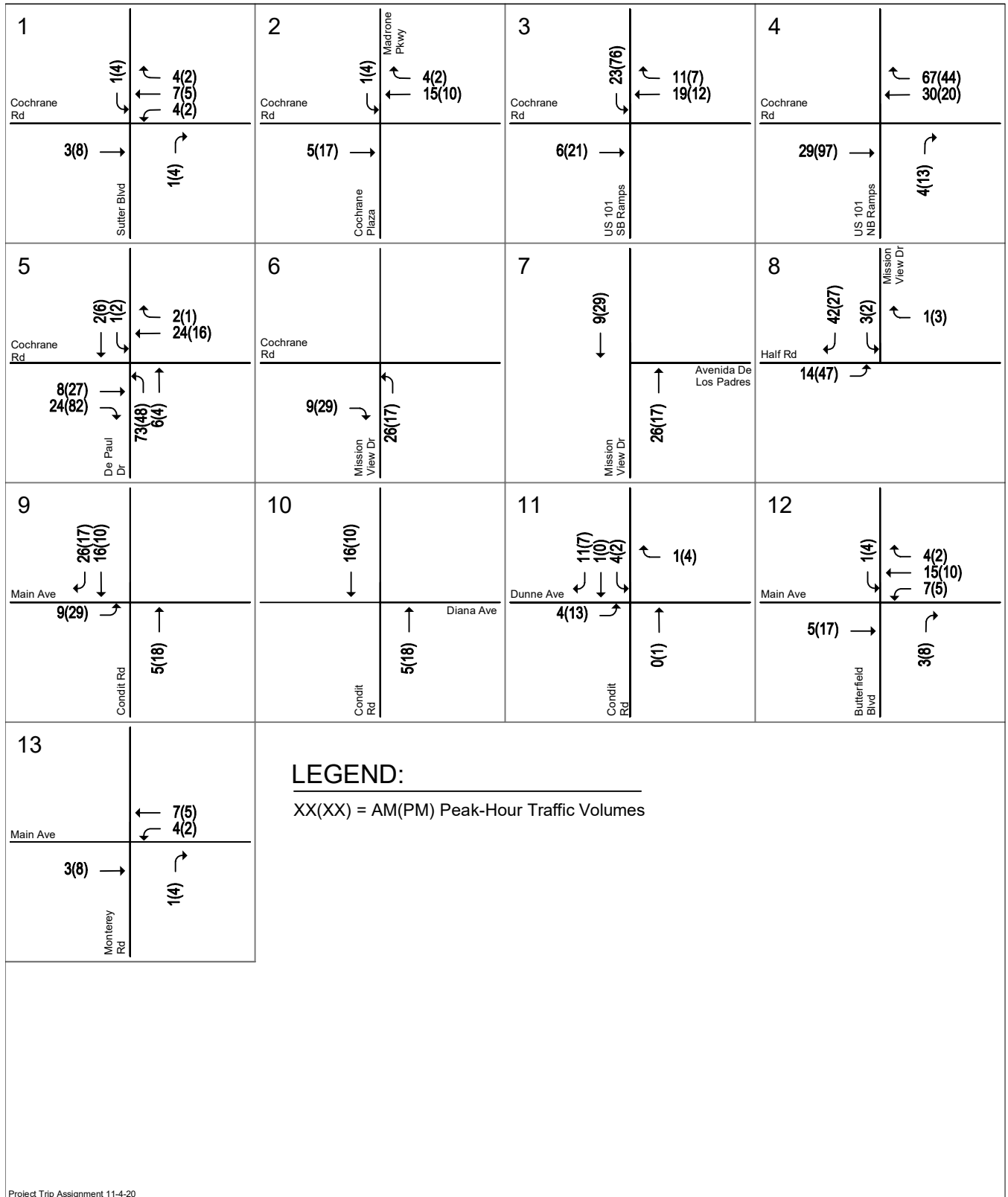

Project Trip Assignment 11-4-20

6. Cochrane Road and Mission View Drive
7. Mission View Drive and Avenida De Los Padres (*unsignalized*)
8. Mission View Drive and Half Road (*unsignalized*)
9. Main Avenue and Condit Road
10. Condit Road and Diana Avenue (*unsignalized*)
11. East Dunne Avenue and Condit Road
12. Butterfield Boulevard and Main Avenue
13. Monterey Road and Main Avenue

Traffic conditions at all of the study intersections were analyzed for the weekday AM and PM peak hours. The weekday AM peak hour of traffic is generally between 7:00 AM and 9:00 AM and the weekday PM peak hour is typically between 4:00 PM and 6:00 PM. It is during these periods that the most congested traffic conditions occur on a typical weekday. Traffic conditions were evaluated for the conditions described below:

- Scenario 1: *Existing Conditions*. Existing conditions represent existing peak-hour traffic volumes on the existing roadway network. New traffic counts could not be collected due to the current COVID-19 pandemic affecting normal travel traffic patterns. Therefore, traffic counts collected prior to the COVID-19 pandemic in 2018-2019 as part of the Morgan Hill Technology Center development project were used in this analysis.
- Scenario 2: *Existing Plus Project Conditions*. Project-generated traffic volumes were added to existing traffic volumes to estimate existing plus project conditions. Existing plus project conditions were evaluated relative to existing conditions in order to determine potential project impacts.
- Scenario 3: *Year 2030 Cumulative without Project Conditions*. Year 2030 Cumulative without project conditions represent traffic growth projected to occur in the Year 2030 without the proposed project on the existing transportation network. Projected 2030 traffic growth was developed by interpolating the projected Year 2035 traffic growth.
- Scenario 4: *Year 2030 Cumulative with Project Conditions*. Project-generated traffic volumes were added to Year 2030 Cumulative without project to estimate Year 2030 Cumulative with project conditions. Year 2030 Cumulative with project conditions were evaluated relative to Year 2030 Cumulative without project conditions in order to determine potential project impacts.

Data Requirements

The data required for the analysis were obtained from recently completed traffic studies, the City of Morgan Hill, the 2018 CMP Monitoring and Conformance Report, and field observations. The following data were collected from these sources:

- lane configurations
- existing traffic volumes
- signal timing and phasing
- average speeds on freeway segments
- Year 2035 traffic forecasts

Lane Configurations

The existing lane configurations at the study intersections were determined by observations in the field and are shown in Figure 8. It is assumed in this analysis that the roadway network and intersection configurations under existing plus project and Year 2030 cumulative conditions would be the same as described under existing conditions with the exception of the following improvements.

Extension of DePaul Drive. As part of the project, DePaul Drive is proposed to be extended by approximately 2,280 feet south to provide direct access to the project site via two full access driveways. As proposed, DePaul Drive will terminate as a cul-de-sac just north of Half Road.

Mission View Drive and Half Road. All-way stop signs installation at this intersection is planned by the County and should be completed in the near future. Therefore, this intersection is assumed to be one-way stop-controlled under existing conditions and all-way stop-controlled under Year 2030 cumulative conditions.

Traffic Volumes

Existing Traffic Volumes

Existing conditions represent existing peak-hour traffic volumes on the existing roadway network. New traffic counts could not be collected due to the current COVID-19 pandemic affecting normal travel traffic patterns. Therefore, traffic counts collected prior to the COVID-19 pandemic in 2018-2019 as part of the Morgan Hill Technology Center development project were used in this analysis. The existing peak-hour intersection volumes are shown in Figure 9. Intersection turning-movement counts conducted for this analysis are presented in Appendix B.

Year 2030 Cumulative Land Use and Traffic Forecasts

Year 2030 Cumulative traffic volumes were developed based on traffic forecasts produced for the City of Morgan Hill 2035 General Plan using the City's Traffic Demand Forecasting (TDF) model. Year 2035 General Plan traffic forecasts include land use growth and transportation improvements associated with the buildout of the City's General Plan.

The 2035 General Plan forecasts also include trips associated with 345 residential units per the adopted General Plan land use for the project site. Therefore, the trips associated with the adopted General Plan land use for the project site were removed from the projected Year 2035 traffic volumes. To develop Year 2030 Cumulative without project condition traffic volumes, Hexagon prepared trip estimates for the adopted GP land uses for comparison with the proposed project. When compared with the land use included in the City's General Plan, the proposed project would result in reductions of 56 AM and 76 PM peak hour trips for the project site. The trip generation estimates for the proposed and adopted General Plan land uses for the site are presented in Table 2.

The Year 2030 Cumulative without project traffic volumes were then estimated using a growth method that involved adding a proportion (15 Years or 75%) of the 2035 projected growth, with the removal of the trips associated with the adopted General Plan land uses for the project, to existing traffic counts at each of the study intersections. Figure 10 shows the Year 2030 Cumulative without project traffic volumes. Appendix C lists each of the components used to tabulate cumulative traffic volumes at each study intersection.

**Table 2
General Plan 2035 Trip Generation Estimates**

Proposed Land Use	Size	Daily		AM Peak Hour						PM Peak Hour					
		Rate	Trip	Rate	Split		Trip			Rate	Split		Trip		
					In	Out	In	Out	Total		In	Out	Total		
Proposed Land Use															
Single-Family Detached Housing (ITE LU # 210) ¹	269 Dwelling Units	9.44	2,539	0.74	25%	75%	50	149	199	0.99	63%	37%	168	98	266
GP Land Use															
Single-Family Detached Housing (ITE LU # 210) ¹	345 Dwelling Units	9.44	3,257	0.74	25%	75%	64	191	255	0.99	63%	37%	215	127	342
Difference (Proposed - GP Land Uses)			-718				-14	-42	-56				-47	-29	-76
Notes:															
¹ ITE Trip Generation Manual, 10 th Edition 2017															

Figure 8
Existing Lane Configurations

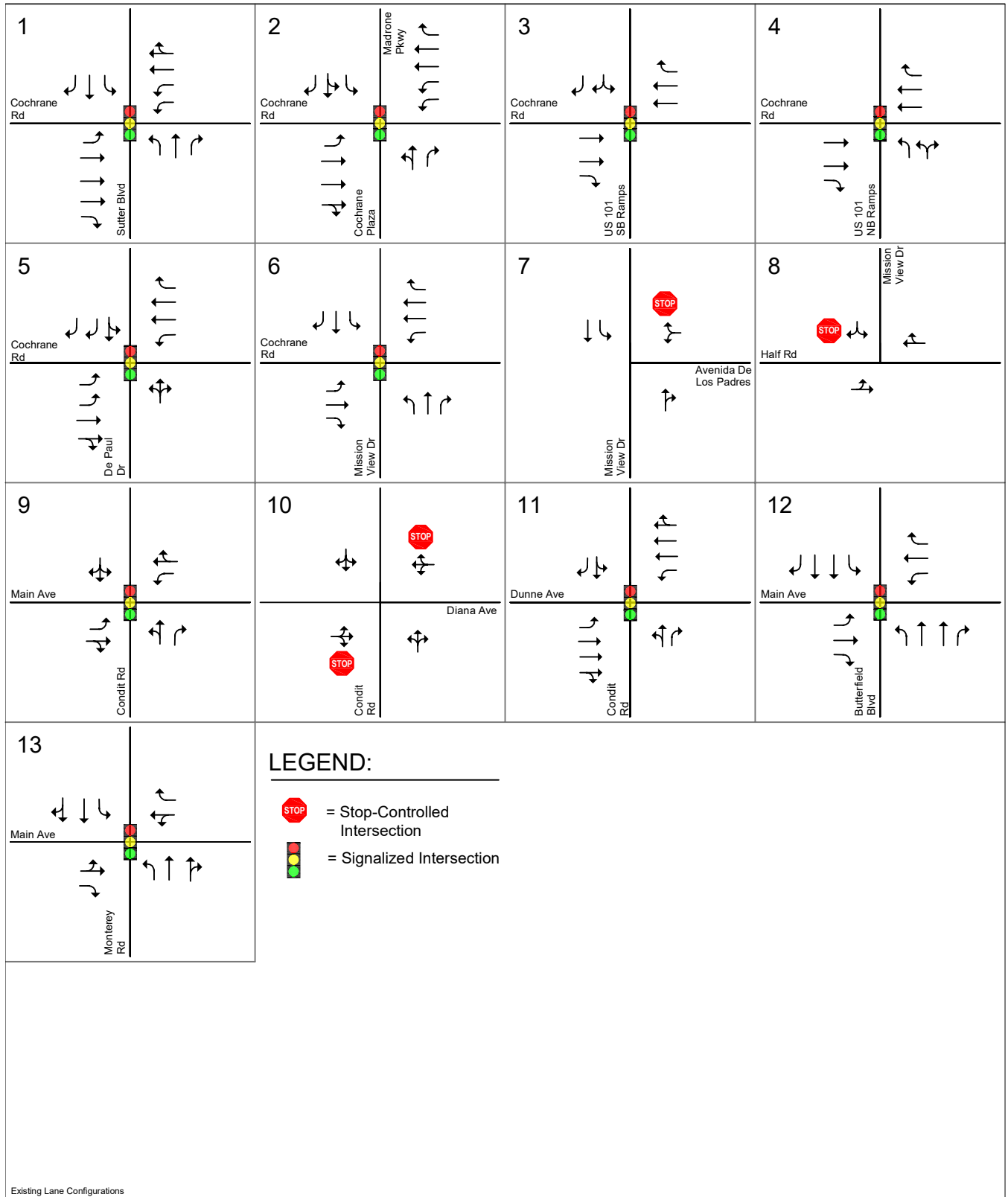

**Figure 9
Existing Traffic Volumes**

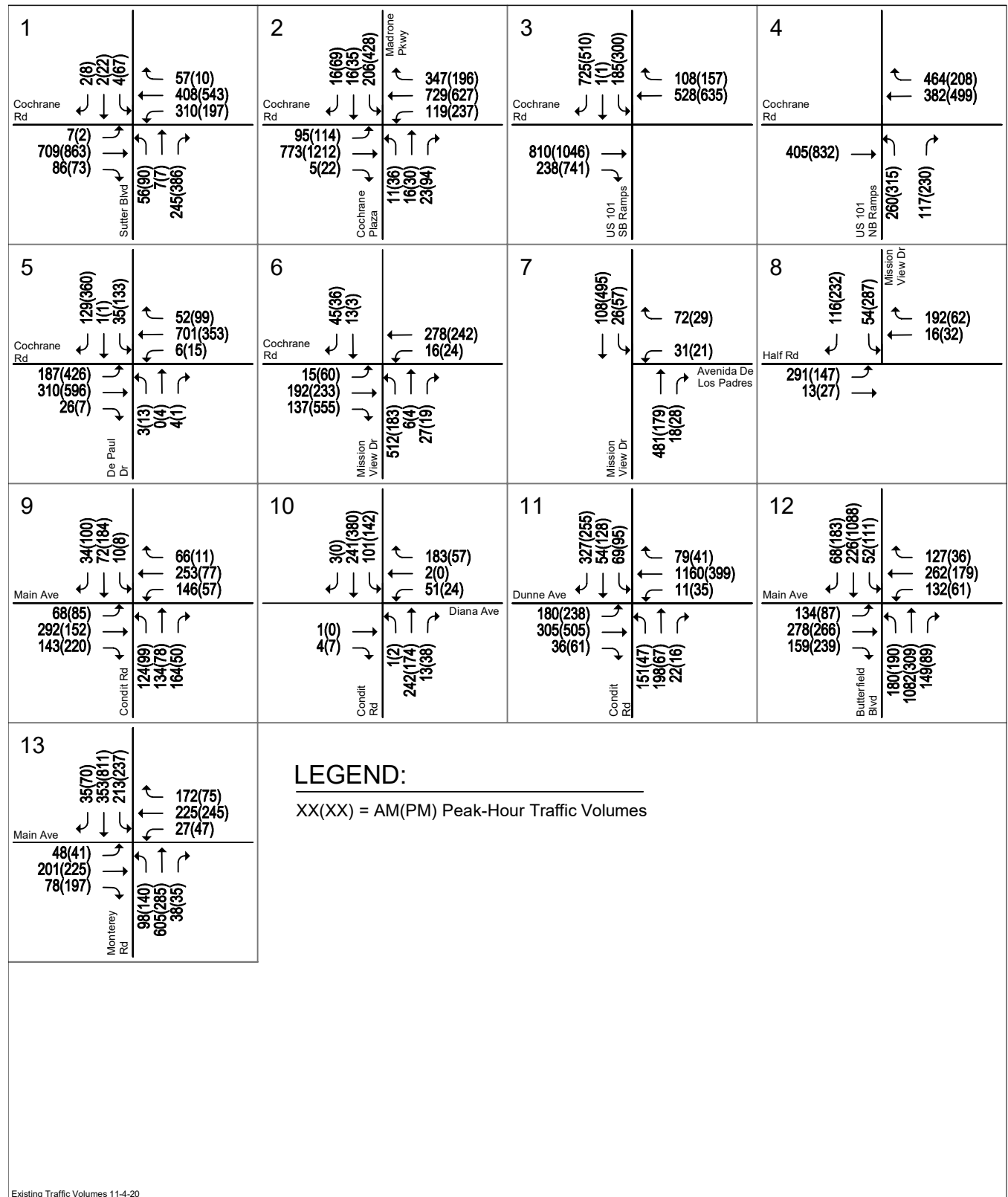
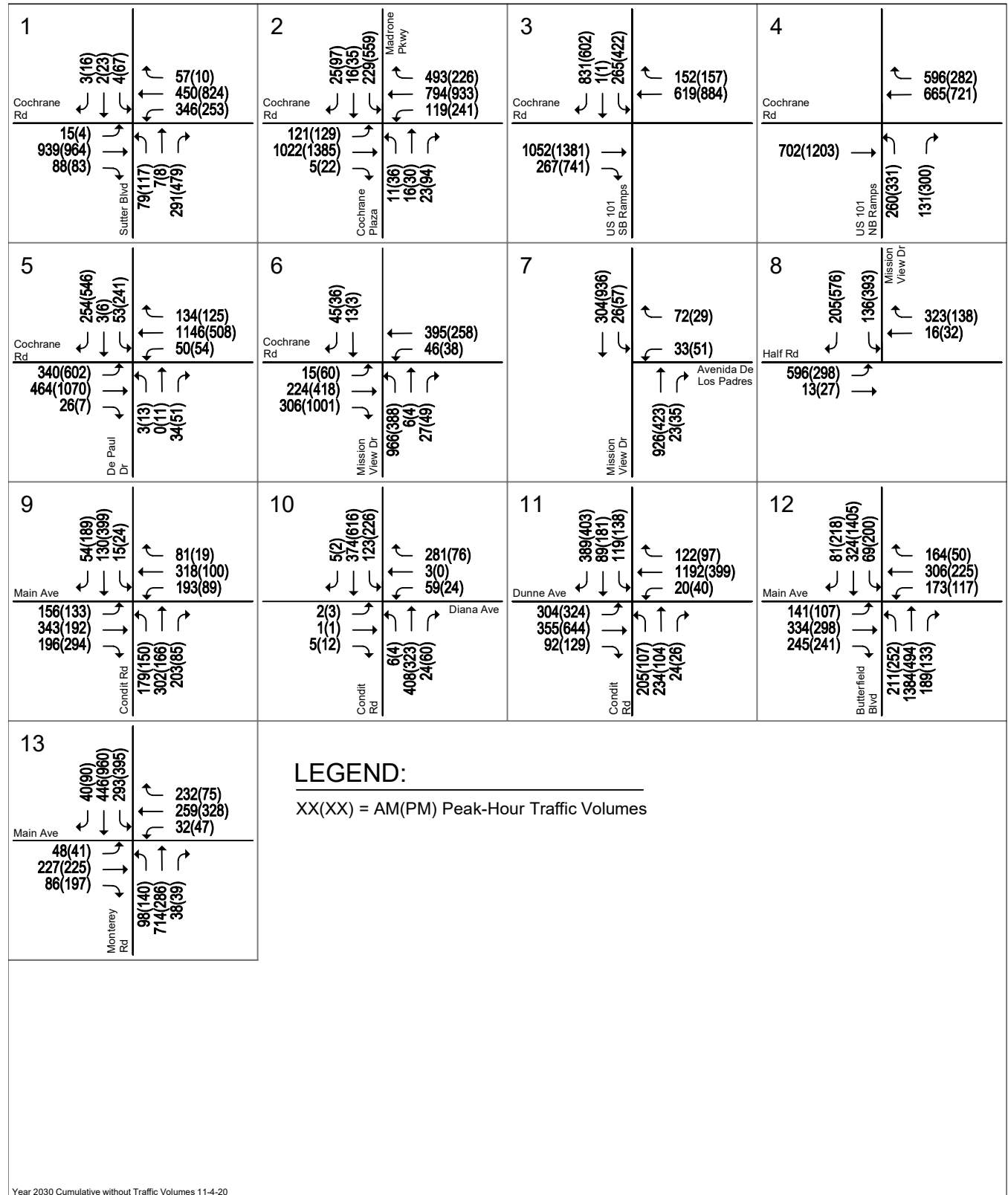

Figure 10
Year 2030 Cumulative without Project Traffic Volumes



Year 2030 Cumulative without Traffic Volumes 11-4-20

Existing and Year 2030 Cumulative Plus Project Traffic Volumes

Project trips as represented in the project trip assignment were added to the existing traffic and Year 2030 Cumulative without project traffic volumes to obtain existing and Year 2030 Cumulative with project traffic volumes. The existing plus project and Year 2030 Cumulative with project traffic volumes are shown in Figures 11 and 12, respectively.

Intersection Level of Service Standards and Analysis Methodologies

Traffic conditions at the study intersections were evaluated using level of service (LOS). *Level of Service* is a qualitative description of operating conditions ranging from LOS A, or free-flow conditions with little or no delay, to LOS F, or jammed conditions with excessive delays. The analysis methods are described below.

Signalized Intersections

Signalized study intersections are subject to the City of Morgan Hill's level of service standards. The City of Morgan Hill's level of service methodology is TRAFFIX, which is based on the 2000 *Highway Capacity Manual* (HCM) method for signalized intersections. TRAFFIX evaluates signalized intersections operations based on average delay time for all vehicles at the intersection. Since TRAFFIX is also the CMP-designated intersection level of service methodology, the City of Morgan Hill methodology employs the CMP defaults values for the analysis parameters, which include adjusted saturation flow rates to reflect conditions in Santa Clara County. All intersections within the City of Morgan Hill are required to meet the City's LOS standard of LOS D, with the exception of the following:

- **LOS F** for Downtown intersections and segments including at Main/Monterey, along Monterey Road between Main and Fifth Street, and along Depot Street at First through Fifth Street;

LOS E for the following intersections and freeway zones:

- Main Avenue and Del Monte Avenue
- Main Avenue and Depot Street
- Dunne Avenue and Del Monte Avenue
- Dunne Avenue and Monterey Avenue
- Dunne Avenue and Church Street
- Dunne Avenue and Depot Street
- Cochrane Road and Monterey Road
- Tennant Avenue and Monterey Road
- Tennant Avenue and Butterfield Boulevard
- Cochrane Road Freeway Zone: from Madrone Parkway/Cochrane Plaza to Cochrane Road/DePaul Drive
- Dunne Avenue Freeway Zone: from Walnut Grove Drive/East Dunne Avenue to Condit Road/East Dunne Avenue
- Tennant Avenue Freeway Zone: from Butterfield Boulevard/Tennant Avenue to Condit Road/Tennant Avenue

The correlation between average delay and level of service for signalized intersections is shown in Table 3.

Figure 11
Existing Plus Project Traffic Volumes

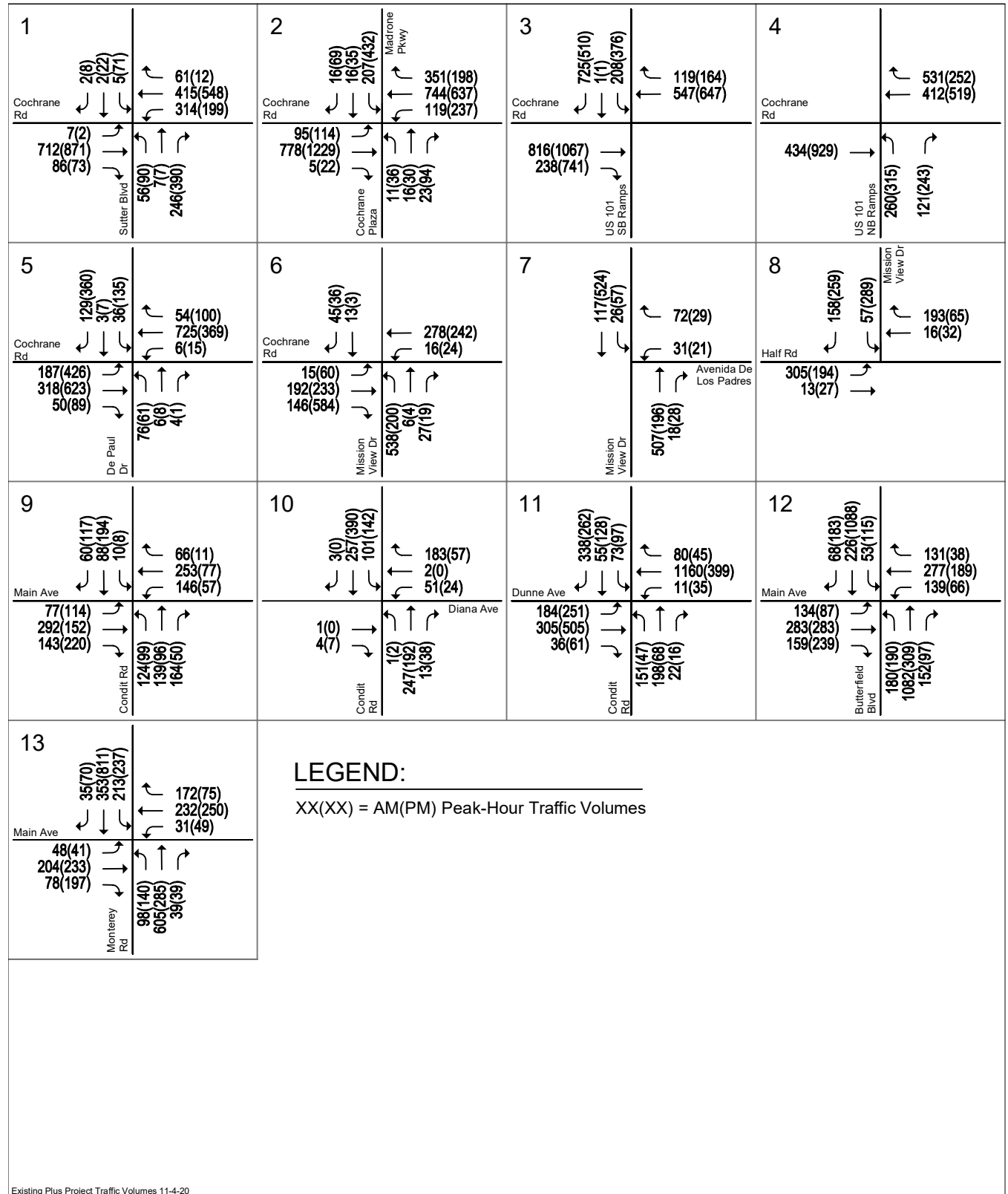

Existing Plus Project Traffic Volumes 11-4-20

Figure 12
Year 2030 Cumulative with Project Traffic Volumes

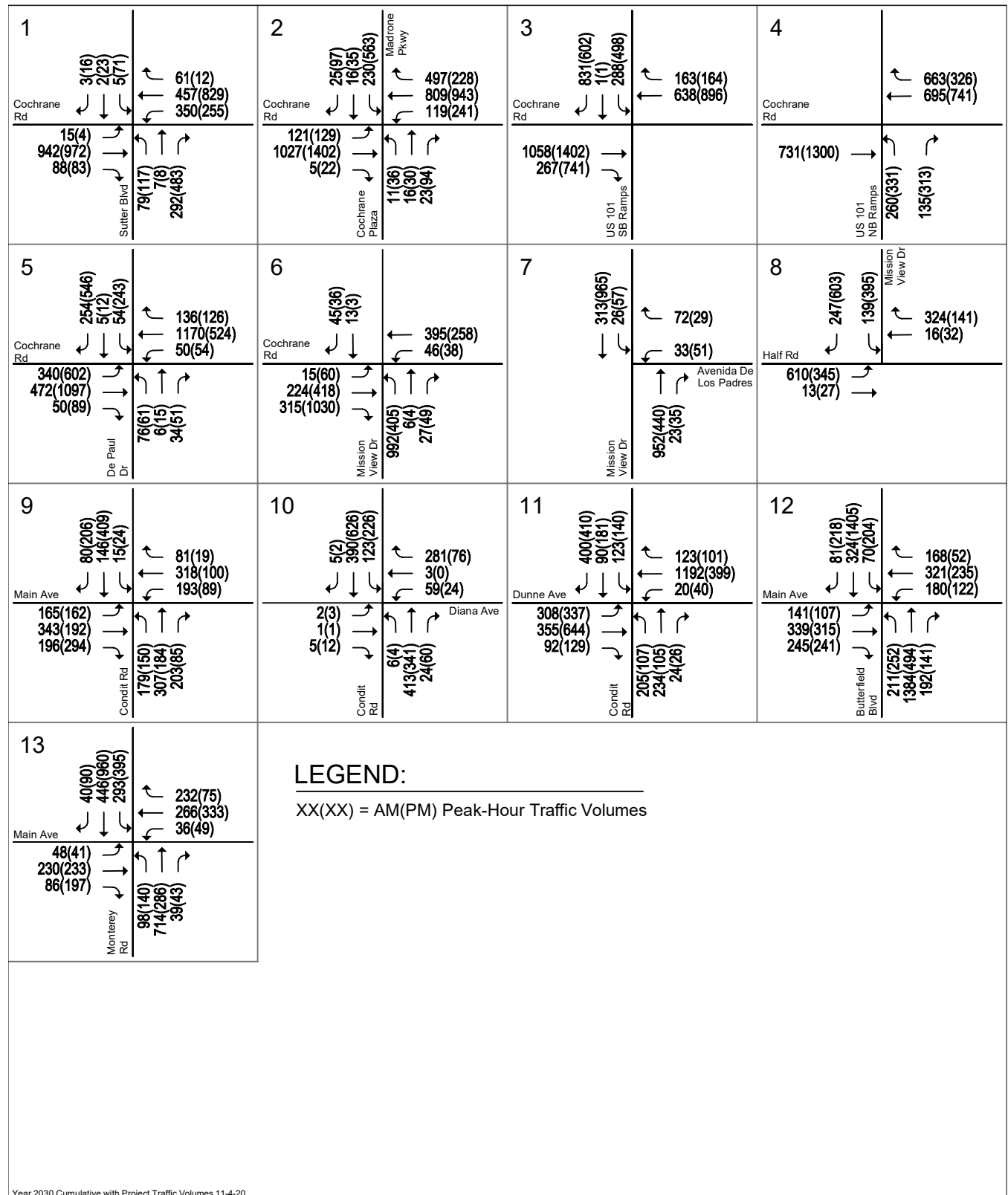

Year 2030 Cumulative with Project Traffic Volumes 11-4-20

Table 3
Signalized Intersection Level of Service Definitions Based on Control Delay

Level of Service	Description	Average Control Delay per Vehicle (sec.)
A	Operations with very low delay occurring with favorable progression and/or short cycle lengths.	up to 10.0
B	Operations with low delay occurring with good progression and/or short cycle lengths.	10.1 to 20.0
C	Operations with average delays resulting from fair progression and/or longer cycle lengths. Individual cycle failures begin to appear.	20.1 to 35.0
D	Operations with longer delays due to a combination of unfavorable progression, long cycle lengths, or high V/C ratios. Many vehicles stop and individual cycle failures are noticeable.	35.1 to 55.0
E	Operations with high delay values indicating poor progression, long cycle lengths, and high V/C ratios. Individual cycle failures are frequent occurrences. This is considered to be the limit of acceptable	55.1 to 80.0
F	Operation with delays unacceptable to most drivers occurring due to oversaturation, poor progression, or very long cycle lengths.	Greater than 80.0

Sources: Transportation Research Board, *2000 Highway Capacity Manual* (Santa Clara County and City of Gilroy adopted level of service methodology). *Traffic Level of Service Analysis Guidelines*, Santa Clara County Transportation Authority Congestion Management Program, June 2003.

Unsignalized Intersections

The methodology used to determine the level of service for unsignalized intersections is also TRAFFIX and the *2000 HCM* methodology for unsignalized intersection analysis. This method is applicable for both two-way and all-way stop-controlled intersections. For the analysis of stop-controlled intersections, the *2000 HCM* methodology evaluates intersection operations on the basis of average control delay time for all vehicles on the stop-controlled approaches. For the purpose of reporting the level of service for one- and two-way stop-controlled intersections, the delay and corresponding level of service for the stop-controlled minor street approach with the highest delay is reported. For all-way stop-controlled intersections, the reported average delay and the corresponding level of service is the average for all approaches at the intersection. The City uses a minimum acceptable level of service standard of LOS D for unsignalized intersections, in accordance with its adopted threshold of significance in its Guidelines for Preparation of Transportation Impact Reports. The correlation between average delay and level of service for unsignalized intersections is shown in Table 4.

Signal Warrants

The level of service analysis at unsignalized intersections is supplemented with an assessment of the need for signalization of the intersection. The need for signalization of unsignalized intersections is assessed based on the Peak Hour Volume Warrant (Warrant 3) described in the *California Manual on Uniform Traffic Control Devices for Streets and Highways (CA MUTCD)*, Part 4, Highway Traffic Signals, 2014. This method makes no evaluation of the intersection level of service but simply provides an indication of whether vehicular peak hour traffic volumes are, or would be, sufficient to justify the installation of a traffic signal. The decision to install a traffic signal should not be based purely on the warrants alone. Instead, the installation of a signal should be considered, and further analysis

Table 4
Unsignalized Intersection Level of Service Definitions Based on Control Delay

Level of Service	Description	Average Control Delay per Vehicle (sec.)
A	Operations with very low delays occurring with favorable progression.	up to 10.0
B	Operations with low delays occurring with good progression.	10.1 to 15.0
C	Operations with average delays resulting from fair progression.	15.1 to 25.0
D	Operation with longer delays due to a combination of unfavorable progression of high V/C ratios.	25.1 to 35.0
E	Operation with high delay values indicating poor progression and high V/C ratios. This is considered to be the limited of acceptable delay.	35.1 to 50.0
F	Operation with delays unacceptable to most drivers occurring due to oversaturation and poor progression.	Greater than 50.0

Source: Transportation Research Board, 2000 Highway Capacity Manual, (Washington, D.C., 2000).

performed when one or more of the warrants are met. Additionally, engineering judgment is exercised on a case-by-case basis to evaluate the effect a traffic signal will have on certain types of accidents and traffic conditions at the subject intersection as well as at adjacent intersections. Intersections that meet the peak hour warrant are subject to further analysis before determining that a traffic signal is necessary. Other options such as traffic control devices, signage, or geometric changes may be preferable based on existing field conditions.

Definition of Adverse Intersection Operations Effects

According to the City of Morgan Hill level of service guidelines, a development is said to create a significant adverse effect on traffic conditions at a signalized intersection if for either peak hour:

1. The level of service at the intersection degrades from an acceptable level (LOS D or LOS E as identified above) under no project conditions to an unacceptable level (LOS E or F) under project conditions, or
2. The level of service at the intersection is an unacceptable level (LOS E or F as identified above) under no project conditions and the addition of project trips causes the average critical delay to increase by four (4) or more seconds *and* the volume-to-capacity ratio (V/C) to increase by 0.01.

An exception to this rule applies when the addition of project traffic reduces the amount of average delay for critical movements (i.e., the change in average delay for critical movements is negative). In this case, the threshold of significance is an increase in the critical V/C value by 0.01 or more.

Definition of Adverse Unsignalized Intersection Operations Effects

Unsignalized intersections within the City of Morgan Hill have a minimum operating level of LOS D. According to the City of Morgan Hill level of service guidelines, a development is said to have a significant adverse effect on traffic conditions at an unsignalized intersection if for either peak hour the addition of project traffic causes the worst approach delay to degrade to LOS E or F **and** the traffic volumes at the intersection are sufficiently high to satisfy the peak hour volume warrant.

Intersection Operations Analysis

Existing Plus Project Intersection Operations Analysis

The results of the intersection level of service and signal warrant analyses under existing and existing plus project conditions are summarized in Table 5. The level of service calculation sheets are included in Appendix D. The peak-hour signal warrant sheets are contained in Appendix E.

Existing Conditions

The results of the level of service analysis indicate that, measured against the City of Morgan Hill level of service standards, all the study intersections currently operate at an acceptable level of service, LOS D or better, under existing conditions during each of the peak hours analyzed.

The results of the signal warrant analysis indicate that the existing traffic volumes at the intersection of Mission View Drive and Cochrane Road were sufficient to warrant the installation of a traffic signal during the AM and PM peak hours under existing conditions, based on counts conducted in May 2018. However, a traffic signal has since been installed at the intersection and is currently operational. Additionally, the intersection of Condit Road and Diana Avenue currently also has volumes that warrant signalization. All other unsignalized study intersections currently have traffic conditions that fall below the thresholds that warrant signalization.

Existing Plus Project Conditions

The results of the level of service analysis indicate that, when measured against the City of Morgan Hill level of service standards, all of the study intersections are projected to operate at acceptable levels of service, LOS D or better, under existing plus project conditions during each of the peak hours analyzed.

The results of signal warrant analysis indicate that the intersection of Condit Road and Diana Avenue is projected to have volumes that would warrant signalization. However, the intersection is projected to operate within the applicable level of service standards. Therefore, the project would not have an adverse effect on operations at the intersection based on the City of Morgan Hill's standards. All other unsignalized study intersections are projected to have traffic conditions that fall below the thresholds that warrant signalization.

Year 2030 Cumulative with Project Intersection Operations Analysis

The results of the intersection level of service and signal warrant analyses under Year 2030 Cumulative without and with project are summarized in Table 6.

The results of the level of service analysis indicate that the following five intersections would operate at unacceptable levels of service (LOS E or F) during Year 2030 Cumulative without and with project during at least one peak hour when measured against the City of Morgan Hill's level of service standards of LOS D:

**Table 5
Existing Plus Project Intersection Levels of Service and Signal Warrant Checks**

Int. #	Intersection	Intersection Control ¹	LOS Standard	Peak Hour	Count Date	Existing			Existing Plus Project				
						Warrant Met?	Delay ²	LOS	Warrant Met?	Delay ²	LOS	Incr. In Crit. Delay	Incr. In Crit. V/C
1	Cochrane Road and Sutter Boulevard	Signal	D	AM	05/08/18	--	17.2	B	--	17.2	B	0.0	0.002
				PM	05/08/18	--	17.9	B	--	18.0	B	0.0	0.003
2	Cochrane Road and Madrone Parkway/Cochrane Plaza	Signal	E	AM	05/08/18	--	19.1	B	--	19.2	B	-3.0	-0.003
				PM	05/08/18	--	31.4	C	--	31.4	C	0.0	0.005
3	Cochrane Road and US 101 Southbound Ramps	Signal	E	AM	05/08/18	--	12.8	B	--	13.0	B	0.2	0.016
				PM	05/08/18	--	16.5	B	--	17.6	B	1.2	0.053
4	Cochrane Road and US 101 Northbound Ramps	Signal	E	AM	05/08/18	--	8.6	A	--	8.3	A	0.0	0.043
				PM	05/08/18	--	11.3	B	--	11.2	B	0.2	0.037
5	Cochrane Road and De Paul Drive	Signal	E	AM	05/08/18	--	17.7	B	--	18.1	B	0.4	0.066
				PM	05/08/18	--	18.7	B	--	19.1	B	0.2	0.048
6	Cochrane Road and Mission View Drive	Signal	D	AM	05/08/18	--	23.0	C	--	24.8	C	3.1	0.019
				PM	05/08/18	--	15.7	B	--	16.3	B	0.9	0.021
7	Mission View Drive and Avenida De Los Padres	TWSC	D	AM	03/28/19	No	13.5	B	No	13.9	B	N/A	N/A
				PM	03/28/19	No	12.5	B	No	13.0	B	N/A	N/A
8	Mission View Drive and Half Road	OWSC	D	AM	03/28/19	No	13.6	B	No	14.0	B	N/A	N/A
				PM	03/28/19	No	22.6	C	No	34.0	D	N/A	N/A
9	Main Avenue and Condit Road	Signal	D	AM	05/08/18	--	27.6	C	--	28.9	C	1.6	0.032
				PM	05/08/18	--	26.1	C	--	27.3	C	1.4	0.031
10	Condit Road and Diana Avenue	TWSC	D	AM	06/04/19	Yes	14.7	B	Yes	14.9	B	N/A	N/A
				PM	06/04/19	No	13.6	B	No	14.0	B	N/A	N/A
11	East Dunne Avenue and Condit Road	Signal	E	AM	03/28/19	--	42.4	D	--	43.0	D	0.7	0.010
				PM	03/28/19	--	28.2	C	--	28.3	C	0.2	0.015
12	Butterfield Boulevard and Main Avenue	Signal	D	AM	05/08/18	--	27.6	C	--	27.9	C	0.1	0.001
				PM	05/08/18	--	29.8	C	--	30.3	C	0.8	0.013
13	Monterey Road and Main Avenue	Signal	F	AM	05/08/18	--	44.2	D	--	44.5	D	0.4	0.009
				PM	05/08/18	--	45.1	D	--	45.5	D	0.6	0.009

Notes:
¹OWSC = One-Way Stop-Controlled; TWSC = Two-Way Stop-Controlled
²The reported delay and corresponding level of service for signalized intersections represent the average delay for all approaches at the intersection.
The reported delay and corresponding level of service for one- and two-way stop-controlled intersections are based on the stop-controlled approach with the highest delay.
Bold indicates unacceptable level of service.

Table 6
Year 2030 Cumulative Intersection Levels of Service and Signal Warrant Checks

Int. #	Intersection	Intersection Control ¹	LOS Standard	Peak Hour	Count Date	Year 2030 Cumulative without Project			Year 2030 Cumulative with Project				
						Warrant Met?	Delay ²	LOS	Warrant Met?	Delay ²	LOS	Incr. In Crit. Delay	Incr. In Crit. V/C
1	Cochrane Road and Sutter Boulevard	Signal	D	AM	05/08/18	--	17.8	B	--	17.8	B	0.1	0.002
				PM	05/08/18	--	17.9	B	--	18.0	B	0.0	0.002
2	Cochrane Road and Madrone Parkway/Cochrane Plaza	Signal	E	AM	05/08/18	--	19.1	B	--	19.1	B	0.0	0.003
				PM	05/08/18	--	32.3	C	--	32.3	C	0.0	0.005
3	Cochrane Road and US 101 Southbound Ramps	Signal	E	AM	05/08/18	--	14.4	B	--	14.7	B	0.4	0.016
				PM	05/08/18	--	20.3	C	--	22.9	C	3.9	0.053
4	Cochrane Road and US 101 Northbound Ramps	Signal	E	AM	05/08/18	--	7.8	A	--	7.7	A	0.1	0.043
				PM	05/08/18	--	11.7	B	--	11.9	B	0.5	0.037
5	Cochrane Road and De Paul Drive	Signal	E	AM	05/08/18	--	25.1	C	--	25.8	C	0.8	0.066
				PM	05/08/18	--	22.8	C	--	25.4	C	5.0	0.080
6	Cochrane Road and Mission View Drive	Signal	D	AM	05/08/18	--	146.5	F	--	156.7	F	15.8	0.019
				PM	05/08/18	--	60.1	E	--	68.2	E	11.7	0.021
7	Mission View Drive and Avenida De Los Padres	TWSC	D	AM	03/28/19	No	28.5	D	No	30.1	D	N/A	N/A
				PM	03/28/19	No	38.5	E	No	42.1	E	N/A	N/A
8	Mission View Drive and Half Road	AWSC	D	AM	03/28/19	Yes	30.0	D	Yes	36.7	E	N/A	N/A
				PM	03/28/19	Yes	126.9	F	Yes	147.1	F	N/A	N/A
9	Main Avenue and Condit Road	Signal	D	AM	05/08/18	--	47.8	D	--	53.7	D	7.7	0.032
				PM	05/08/18	--	80.2	F	--	89.6	F	11.7	0.031
10	Condit Road and Diana Avenue	TWSC	D	AM	06/04/19	Yes	36.3	E	Yes	38.2	E	N/A	N/A
				PM	06/04/19	Yes	26.4	D	Yes	27.8	D	N/A	N/A
11	East Dunne Avenue and Condit Road	Signal	E	AM	03/28/19	--	63.6	E	--	65.7	E	2.7	0.010
				PM	03/28/19	--	32.7	C	--	33.0	C	0.7	0.015
12	Butterfield Boulevard and Main Avenue	Signal	D	AM	05/08/18	--	30.9	C	--	31.3	C	0.7	0.008
				PM	05/08/18	--	36.0	D	--	36.8	D	1.5	0.013
13	Monterey Road and Main Avenue	Signal	F	AM	05/08/18	--	47.6	D	--	48.0	D	0.6	0.009
				PM	05/08/18	--	49.1	D	--	49.8	D	0.8	0.009

Notes:
¹AWSC = All-Way Stop-Controlled; TWSC = Two-Way Stop-Controlled
²The reported delay and corresponding level of service for signalized intersections represent the average delay for all approaches at the intersection. The reported delay and corresponding level of service for one- and two-way stop-controlled intersections are based on the stop-controlled approach with the highest delay. Bold indicates unacceptable level of service or signal warrant met. Bold and boxed indicate adverse effect on operations.

6. Cochrane Road and Mission View Drive (AM and PM Peak Hours)
7. Mission View Drive and Avenida De Los Padres (unsignalized) (PM Peak Hour)
8. Mission View Drive and Half Road (unsignalized) (PM Peak Hour)
9. Main Avenue and Condit Road (PM Peak Hour)
10. Condit Road and Diana Avenue (unsignalized) (AM Peak Hour)

Additionally, the intersection of Mission View Drive and Half Road is projected to operate at LOS D during the AM peak-hour under Year 2030 cumulative conditions and degrade to LOS E with the addition of project traffic.

All of the remaining study intersections are projected to operate at acceptable levels of service under Year 2030 Cumulative without and with project, during each of the peak hours analyzed.

The results of the signal warrant analyses indicate the following two intersections are projected to have traffic volumes under Year 2030 Cumulative without and with project that would meet thresholds that warrant signalization during at least one peak hour.

8. Mission View Drive and Half Road (unsignalized) (AM & PM Peak Hours)
10. Condit Road and Diana Avenue (unsignalized) (AM & PM Peak Hour)

All other unsignalized study intersections are projected to have traffic conditions that fall below the thresholds that warrant signalization.

Based on the City's operating standards, the proposed project would have an adverse effect on intersection operations at the following four study intersections.

6. Mission View Drive and Cochrane Road (AM & PM Peak Hours)
8. Mission View Drive and Half Road (unsignalized) (AM & PM Peak Hours)
9. Condit Road and Main Avenue (PM Peak Hour)
10. Condit Road and Diana Avenue (unsignalized) (AM Peak Hour)

Adverse Intersection Operations Effects and Potential Improvements

This section discusses the adverse intersection operation effects identified under Year 2030 Cumulative with project conditions. Included are descriptions of the adverse effects on intersection operations and potential improvement measures that may be included as part of the project's Conditions of Approval. However, the identified roadway operations and improvements are not required or considered project impacts per CEQA guidelines.

6. Cochrane Road and Mission View Drive

This intersection is projected to operate at an unacceptable LOS F and E during the AM and PM peak hours, respectively, under Year 2030 Cumulative without project conditions. Traffic associated with the proposed project would cause the critical delay to increase by more than four seconds and the volume-to-capacity ratio (V/C) to increase by more than 0.01 during both the AM and PM peak hours. This constitutes an adverse effect on intersection operations based on the City of Morgan Hill's level of service standards.

The addition of a second northbound left-turn lane on Mission View Drive and a cycle length adjustment would be necessary to improve intersection operations. The addition of the second northbound left-turn lane will require lane striping and signal modification but will fit within the existing curb-to-curb pavement width on Mission View Drive. Implementation of this improvement would improve the intersection's level of service to LOS C during both the AM and PM peak hours under Year 2030 Cumulative with project conditions.

8. Mission View Drive and Half Road

This intersection is projected to operate at an unacceptable LOS F during the PM peak hour under Year 2030 Cumulative without and with project conditions. Furthermore, this intersection is projected to operate at an acceptable LOS D during the AM peak hour under Year 2030 Cumulative without conditions and degrade to LOS E with the addition of project traffic. Additionally, the peak-hour traffic signal warrant checks indicate that the intersection would have traffic volumes that meet thresholds that warrant signalization during both the AM and PM peak hours under Year 2030 Cumulative without and with project conditions. This constitutes an adverse effect on intersection operations based on the City of Morgan Hill's level of service standards.

The signalization of the intersection would be necessary to improve intersection operations. Implementation of a traffic signal at this location would improve the level of service to LOS C during both the AM and PM peak hours under Year 2030 Cumulative with project. This intersection is under the jurisdiction of both the City of Morgan Hill and Santa Clara County. Therefore, implementation of the recommended improvements will require City and County approval.

9. Main Avenue and Condit Road

This intersection is projected to operate at an unacceptable LOS F during the PM peak hour under Year 2030 Cumulative without project conditions. Traffic associated with the proposed project would cause the critical delay to increase by more than four seconds and the volume-to-capacity ratio (V/C) to increase by more than 0.01 during the PM peak hour. This constitutes an adverse effect on intersection operations based on the City of Morgan Hill's level of service standards.

The addition of an exclusive southbound right-turn lane on Condit Road would be necessary to improve intersection operations. The addition of the right-turn lane will require signal modifications and lane striping on the southbound approach. Implementation of this improvement would improve the intersection's level of service to LOS D during the PM peak hour under Year 2030 Cumulative with project conditions. This intersection is under the jurisdiction of both the City of Morgan Hill and Santa Clara County. Therefore, implementation of the recommended improvements will require City and County approval.

10. Condit Road and Diana Avenue

This intersection is projected to operate at an unacceptable LOS E during the AM peak hour under Year 2030 Cumulative without and with project conditions. Additionally, the peak-hour traffic signal warrant checks indicate that the intersection would have traffic volumes that meet thresholds that warrant signalization during the AM peak hour under Year 2030 Cumulative without and with project conditions. This constitutes an adverse effect on intersection operations based on the City of Morgan Hill's level of service standards.

The signalization of the intersection would be necessary to improve intersection operations. Implementation of this improvement would improve the intersection's level of service to LOS B during the AM peak hour under Year 2030 Cumulative with project conditions.

Freeway Segment Evaluation

The City is still required to conform to the requirements of the Valley Transit Authority (VTA) which establishes a uniform program for evaluating the transportation impacts of land use decisions on the designated CMP Roadway System. The VTA's Congestion Management Program (CMP) has yet to

adopt and implement guidelines and standards for the evaluation of the CMP roadway system using VMT. Therefore, the effects of the proposed project on freeway segments in the vicinity of the project area following the current methodologies, as outlined in the *VTA Transportation Impact Analysis Guidelines*, were completed. However, this analysis is presented for informational purposes only. The following seven freeway segments were evaluated:

Study Freeway Segments

1. US 101 between SR-85 and Bailey Avenue
2. US 101 between Bailey Avenue and Coyote Creek Golf Drive
3. US 101 between Coyote Creek Golf Drive and Cochrane Road
4. US 101 between Cochrane Road and Dunne Avenue
5. US 101 between Dunne Avenue and Tennant Avenue
6. US 101 between Tennant Avenue and San Martin Avenue
7. US 101 between San Martin Avenue and Masten Avenue

Freeway Segment Level of Service Methodology

As prescribed in the CMP technical guidelines, the level of service for freeway segments is estimated based on vehicle density. Density is calculated by the following formula:

$$D = V / S$$

Where:

D= density, in vehicles per mile per lane (vpml)

V= peak hour volume, in vehicles per hour per lane (vphpl)

S= average travel speed, in miles per hour (mph)

The vehicle density on a segment is correlated to the level of service as shown in Table 7. The CMP specifies that a capacity of 2,300 vehicles per hour per lane (vphpl) be used for mixed-flow lane segments that are three lanes or wider in one direction, and a capacity of 2,200 vphpl be used for mixed-flow lane segments that are two lanes wide in one direction. A capacity of 1,650 vphpl was used for high occupancy vehicle (HOV) lanes. The CMP defines an acceptable level of service for freeway segments as LOS E or better.

Conformance to CMP Freeway Segment Standards

Based on CMP criteria, a project would fail to meet the CMP freeway segment standard if the additional project traffic caused one of the following during either peak hour:

1. The level of service on the freeway segment is an unacceptable LOS F under existing conditions, and the number of project trips on that segment constitutes at least one percent of capacity on that segment.
2. The level of service on the freeway segment degrades from an acceptable LOS E or better under existing conditions to an unacceptable LOS F under existing plus project conditions.

A significant adverse effect by CMP standards is said to be satisfactorily addressed when measures are implemented that would restore freeway conditions to existing conditions or better.

Table 7
Freeway Level of Service Definitions Based on Density

Level of Service	Description	Density (vehicles/mile/lane)
A	Average operating speeds at the free-flow speed generally prevail. Vehicles are almost completely unimpeded in their ability to maneuver within the traffic stream.	0-11
B	Speeds at the free-flow speed are generally maintained. The ability to maneuver within the traffic stream is only slightly restricted, and the general level of physical and psychological comfort provided to drivers is still high.	>11-18
C	Speeds at or near the free-flow speed of the freeway prevail. Freedom to maneuver within the traffic stream is noticeably restricted, and lane changes require more vigilance on the part of the driver.	>18-26
D	Speeds begin to decline slightly with increased flows at this level. Freedom to maneuver within the traffic stream is more noticeably limited, and the driver experiences reduced physical and psychological comfort levels.	>26-46
E	At this level, the freeway operates at or near capacity. Operations in this level are volatile, because there are virtually no usable gaps in the traffic stream, leaving little room to maneuver within the traffic stream.	>46-58
F	Vehicular flow breakdowns occur. Large queues form behind breakdown points.	>58

Sources: Transportation Research Board, *2000 Highway Capacity Manual. Traffic Level of Service Analysis Guidelines*, Santa Clara County Transportation Authority Congestion Management Program, June 2003.

Freeway Segment Analysis

The results of the CMP freeway level of service analysis under existing plus project conditions are summarized in Table 8. Traffic volumes on the study freeway segments under existing plus project conditions were estimated by adding project trips to the existing volumes obtained from the 2018 CMP Monitoring and Conformance Report.

The results show that ten directional mixed-flow lanes and one directional HOV lane on the freeway segments analyzed are projected to operate at an unacceptable LOS F during at least one peak hour under existing conditions and would continue to operate at LOS F conditions with the addition of traffic due to proposed project. All other freeway segments analyzed operate at LOS E or better conditions during the AM and PM peak hours.

Improvement of freeway segment operations would require freeway widening to construct additional through lanes, thereby increasing freeway capacity. VTA's Valley Transportation Plan (VTP) 2040 identifies freeway express lane projects along US 101 between Cochrane Road and Whipple Avenue. The planned improvements consist of the conversion of the existing HOV lane to an express lane and the construction of a second express lane in each direction on US 101. These improvements would increase the capacity of the freeway and help to address the deficiency in freeway operations. However, it is not feasible for an individual development project to bear responsibility for implementing such extensive transportation system improvements due to constraints in the acquisition and cost of right-of-way.

**Table 8
Freeway Segment Levels of Service**

#	Freeway Segment	Dir.	Peak Hour	Existing Plus Project											Project Trips			
				Mixed-Flow Lane					HOV Lane					Mixed-Flow Lane		HOV Lane		
				Speed ¹ (mi/h)	# of Lanes	Capacity (pc/hr/ln)	Volume (pc/hr/ln)	Density (pc/hr/ln)	LOS	Speed ¹ (mi/h)	Capacity (vph)	Volume (pc/hr/ln)	Density (pc/hr/ln)	LOS	Volume (pc/hr/ln)	% of Capacity	Volume (pc/hr/ln)	% of Capacity
1	US 101 from Masten Avenue to San Martin Avenue	NB AM	34.20	3	2,300	1,809	53	E	--	--	--	--	--	2	0.1	--	--	
		NB PM	51.80	3	2,300	2,003	39	D	--	--	--	--	--	6	0.2	--	--	
2	US 101 from San Martin Avenue to Tennant Avenue	NB AM	10.40	3	2,300	866	83	F	--	--	--	--	--	2	0.1	--	--	
		NB PM	60.00	3	2,300	1,799	30	D	--	--	--	--	--	6	0.2	--	--	
3	US 101 from Tennant Avenue to East Dunne Avenue	NB AM	9.40	3	2,300	801	85	F	--	--	--	--	--	2	0.1	--	--	
		NB PM	59.80	3	2,300	1,810	30	D	--	--	--	--	--	6	0.2	--	--	
4	US 101 from East Dunne Avenue to Cochrane Road	NB AM	21.00	3	2,300	1,403	67	F	--	--	--	--	--	1	0.1	--	--	
		NB PM	61.60	3	2,300	1,687	27	D	--	--	--	--	--	4	0.2	--	--	
5	US 101 from Cochrane Road to Coyote Creek Golf Drive	NB AM	22.20	3	2,300	1,502	68	F	71.41	1,650	824	12.0	B	19	0.8	11	0.7	
		NB PM	64.20	3	2,300	1,408	22	C	72.66	1,650	628	9.0	A	13	0.6	6	0.4	
6	US 101 from Coyote Creek Golf Drive to Bailey Avenue	NB AM	32.20	3	2,300	1,824	57	E	75.29	1,650	-- ²	-- ²	A	22	1.0	0	0.0	
		NB PM	64.00	3	2,300	1,446	23	C	76.15	1,650	-- ²	-- ²	A	15	0.6	0	0.0	
7	US 101 from Bailey Avenue to SR 85	NB AM	37.60	3	2,300	1,926	51	E	65.21	1,650	1,342	21.0	C	18	0.8	13	0.8	
		NB PM	63.40	3	2,300	1,526	24	C	72.91	1,650	581	8.0	A	13	0.6	5	0.3	
8	US 101 from SR 85 to Bailey Avenue	SB AM	62.40	3	2,300	1,622	26	D	73.82	1,650	391	5.0	A	7	0.3	2	0.1	
		SB PM	16.00	3	2,300	1,227	77	F	39.99	1,650	1,777	44.0	E	17	0.7	25	1.5	
9	US 101 from Bailey Avenue to Coyote Creek Golf Drive	SB AM	64.00	3	2,300	1,423	22	C	73.79	1,650	397	5.0	A	7	0.3	2	0.1	
		SB PM	14.80	3	2,300	1,165	79	F	41.99	1,650	1,774	42.0	E	17	0.7	26	1.6	
10	US 101 from Coyote Creek Golf Drive to Cochrane Road	SB AM	62.80	3	2,300	1,577	25	C	63.14	1,650	1,426	23.0	C	6	0.3	5	0.3	
		SB PM	12.60	3	2,300	1,043	83	F	21.57	1,650	1,681	78.0	F	16	0.7	27	1.6	
11	US 101 from Cochrane Road to East Dunne Avenue	SB AM	62.00	3	2,300	1,650	27	D	--	--	--	--	--	4	0.2	--	--	
		SB PM	25.00	3	2,300	1,554	62	F	--	--	--	--	--	2	0.1	--	--	
12	US 101 from East Dunne Avenue to Tennant Avenue	SB AM	63.00	3	2,300	1,552	25	C	--	--	--	--	--	5	0.2	--	--	
		SB PM	27.00	3	2,300	1,622	60	F	--	--	--	--	--	3	0.1	--	--	
13	US 101 from Tennant Avenue to San Martin Avenue	SB AM	63.00	3	2,300	1,552	25	C	--	--	--	--	--	5	0.2	--	--	
		SB PM	25.40	3	2,300	1,571	62	F	--	--	--	--	--	3	0.1	--	--	
14	US 101 from San Martin Avenue to Masten Avenue	SB AM	60.00	3	2,300	1,797	30	D	--	--	--	--	--	5	0.2	--	--	
		SB PM	37.80	3	2,300	1,886	50	E	--	--	--	--	--	3	0.1	--	--	

Notes:

¹Santa Clara Valley Transportation Authority CMP Monitoring & Conformance Report, 2018.

²Speed exceeds the bound of the equation used to derive volume and density.

Bold indicates unacceptable LOS.

5. Other Transportation Issues

This chapter presents an analysis of other transportation issues associated with the project site, including:

- Vehicular site access
- On-site circulation
- Intersection operations analysis – vehicle queuing and left-turn pocket storage at intersections
- Potential impacts to bike, pedestrian and transit facilities

Unlike the level of service impact methodology, which is adopted by the City Council, the analyses in this chapter are based on professional judgment in accordance with the standards and methods employed by the traffic engineering community.

Site Access and Circulation

The site plan for the proposed project was reviewed performed to determine if adequate site access is provided and to identify any access and circulation issues that should be improved. This review was completed in accordance with generally accepted traffic engineering standards.

Site Access

Project trips at each of the site access points are presented in Figure 13. The project would include the extension of DePaul Drive to the south with termination as a cul-de-sac just north of Half Road. Access to the project site would be provided via a full access driveway along Mission View Drive and two full access driveways along the DePaul Drive extension.

On-Site Circulation

An internal private street network would provide access to each of the residential units from the proposed entrances along Mission View Drive and DePaul Drive. Most of the streets that front homes include on-street parallel parking. The internal streets would provide continuous access to each area of residential units.

Figure 13
Project Trips at Site Access Points



Travel way on street is typically a minimum of 26 feet. The travel way on the internal streets is shown to be at least 20 feet wide. The narrower travel width will provide adequate width for two-way travel on each of the streets and will promote reduced travel speeds within the site. However, the straight nature of the internal roadways could result in drivers traveling at greater speeds than recommended. Therefore, it may be desirable to implement speed-reducing measures along the internal roadways. These measures could include the installation of speed bumps/humps along the internal roadways and/or bulb-outs at intersections and mid-block.

The project site plan shows sidewalks along the project's frontages along Mission View Drive and DePaul Drive and the internal street network on-site. However, there are no sidewalks provided along the west side of Mission View Drive between the project site and Cochrane Road. In conjunction with the existing sidewalks along the east side of Mission View Drive, the proposed sidewalks on Mission View Drive along the project frontage would provide a connection between the project site and bus stops along Mission View Drive and pedestrian destinations along Cochrane Road. There also are no sidewalks along either side of DePaul Drive between the project site and Cochrane Road. Therefore, there will be no sidewalk connection between the project site and Cochrane Road.

The project site should be designed following City of Morgan Hill design standards and provide adequate width and turn-radii at and along all drive/parking aisles to allow for two-way circulation and adequate circulation of larger vehicles (such as emergency trucks, garbage truck, and delivery trucks) throughout the project site. Adhering to the City of Morgan Hill standards and requirements, and implementing the above recommendations, the proposed site access points and layout of the surface parking areas would be adequate to accommodate the circulation of both passenger and emergency vehicles.

Emergency Vehicle Access and Circulation

The 20-foot-wide internal roadway would provide emergency vehicles (fire trucks) sufficient space to access each of the residential units on-site. There are several dead-end drive aisles that would not provide sufficient space for emergency vehicles to turn around. However, the dead-ends will be located along short segments of roadways. Thus, vehicles would be able to back out of the roadways.

Project Driveway Operations

Based on the project trip generation and trip assignment, it is estimated that a maximum of 79 and 88 inbound trips (during the PM peak hour) and 71 and 78 outbound trips (during the AM peak hour) would enter and exit the site at the Mission View Drive driveway and the two driveways on DePaul Drive combined, respectively. As proposed, each of the three project driveways would be provided with one outbound lane and one inbound lane to serve the shared through/right-turn lane and through/left-turn lane into the site on Mission View Drive and DePaul Drive. The estimated project trips at the project site driveways are shown in Figure 13. The results of the driveway operations analyses are summarized in Table 9. The calculations for the project driveway operations analyses are included in Appendix G.

The results of the level of service analysis indicate that all three project driveways are projected to operate at acceptable levels of service (LOS D or better) during each of the peak hours analyzed.

The results of the signal warrant analysis indicate all three project driveways are projected to have traffic conditions that fall below the thresholds that warrant signalization.

The results of the queuing analysis indicate the 95th percentile queues at the project driveways are projected to be at most 25 feet.

**Table 9
Project Driveway Operations**

Intersection	Int. Control	LOS Std	Peak Hour	Existing Plus Project							Year 2030 Cumulative with Project						
				Warrant Met?	Delay ¹	Queue Length (ft.)				Warrant Met?	Delay ¹	LOS	Queue Length (ft.)				
						LOS	NBL	EB	SBL				WB	NBL	EB	SBL	WB
Mission View Drive and Project Driveway A	OWSC	D	AM	No	11.6	B	0	25	--	--	No	19.7	C	0	25	--	--
			PM	No	14.2	B	25	25	--	--	No	31.1	D	25	25	--	--
DePaul Drive and Project Driveway B	OWSC	D	AM	No	8.4	A	--	--	0	25	No	8.4	A	--	--	0	25
			PM	No	8.4	A	--	--	25	25	No	8.4	A	--	--	25	25
DePaul Drive and Project Driveway C	OWSC	D	AM	No	8.6	A	--	--	0	25	No	8.6	A	--	--	0	25
			PM	No	8.5	A	--	--	25	0	No	8.5	A	--	--	25	0

Notes:
¹The reported delay and corresponding level of service for one-way stop-controlled intersections are based on the stop-controlled approach with the highest delay.
 OWSC = one-way stop-controlled; NBL = northbound left; EB = eastbound; SBL = southbound left; WB = westbound

Recommendation: A center-striped median is currently provided along Mission View Drive north of the project site. The current width of Mission View Drive along the project frontage is not adequate to provide a left-turn pocket into the project driveway. Mission View Drive would need to be widened along its east side, opposite the project frontage, to provide a striped left-turn pocket into the project site. Similarly, left-turn lanes should be striped at the project driveways along DePaul Drive if a center-striped median is planned.

Intersection Operations Analysis

The analysis of the intersection level of service was supplemented with an analysis of intersection operations for selected intersections where the project would add a significant number of left-turning vehicles. The operations analysis is based on vehicle queuing for high demand left-turn movements at intersections. Vehicle queues were estimated using a Poisson probability distribution, which estimates the probability of “n” vehicles for a vehicle movement using the following formula:

$$P(x=n) = \frac{\lambda^n e^{-\lambda}}{n!}$$

Where:

P (x=n) = probability of “n” vehicles in queue per lane

n = number of vehicles in the queue per lane

λ = average number of vehicles in the queue per lane (vehicles per hour per lane/signal cycles per hour)

The basis of the analysis is as follows: (1) the Poisson probability distribution is used to estimate the 95th percentile number of queued vehicles per cycle for a particular movement; (2) the estimated maximum number of vehicles in the queue is translated into a queue length, assuming 25 feet per vehicle; and (3) the estimated 95th percentile queue length is compared to the existing or planned available storage capacity for the movement. This analysis thus provides a basis for estimating future left-turn storage requirements at intersections. The 95th percentile queue length value indicates that during the peak hour, a queue of this length or less would occur on 95 percent of the signal cycles. Likewise, a queue length larger than the 95th percentile queue would only occur on 5 percent of the signal cycles (about 3 cycles during the peak hour for a signal with a 60-second cycle length). Therefore, left-turn storage pocket designs based on the 95th percentile queue length would ensure that storage space would be exceeded only 5 percent of the time. The 95th percentile queue length is also known as the “design queue length”.

The vehicle queue estimates and a tabulated summary of the findings are provided in Table 10. The vehicular queuing analysis (Poisson probability calculations) is included in Appendix F.

Cochrane Road and Mission View Drive

The queuing analysis indicates that the estimated 95th vehicle queue for northbound left-turn movement at the Cochrane Road and Mission View Drive intersection currently exceeds the provided turn pocket storage space during the AM and PM peak hours under existing conditions.

The northbound left-turn pocket currently provides approximately 100 feet of vehicle storage, which can accommodate approximately 4 vehicles. The estimated 95th percentile vehicle queues for the northbound left-turn movement currently are approximately 14 and 6 vehicles during the AM and PM peak hours under existing conditions, respectively.

Table 10
Vehicle Queuing Analysis

Measurement	Cochrane Road and DePaul Drive		Mission View Drive and Cochrane Road		Mission View Drive and Half Road			
	Northbound		Northbound Left		Eastbound Left		Southbound	
	AM	PM	AM	PM	AM	PM	AM	PM
Existing Conditions								
Cycle Length/Control Delay (sec) ¹	60	60	60	60	8.3	7.6	13.6	22.6
Lanes	1	1	1	1	1	1	1	1
Volume (vph)	7	18	512	183	304	174	170	519
Volume (vphpl)	7	18	512	183	304	174	170	519
95 th %. Queue (veh/ln.)	1	1	14	6	2	2	2	7
95 th %. Queue (ft./ln) ²	25	25	350	150	50	50	50	175
Storage (ft./ ln.)	950+	950+	100	100	3500	3500	1900	1900
Adequate (Y/N)	YES	YES	NO	NO	YES	YES	YES	YES
Existing Plus Project Conditions								
Cycle Length/Control Delay (sec) ¹	60	60	60	60	8.4	7.7	14.0	34.0
Lanes	1	1	1	1	1	1	1	1
Volume (vph)	86	70	538	200	318	221	215	548
Volume (vphpl)	86	70	538	200	318	221	215	548
95 th %. Queue (veh/ln.)	4	3	14	7	2	2	2	9
95 th %. Queue (ft./ln) ²	100	75	350	175	50	50	50	225
Storage (ft./ ln.)	950+	950+	100	100	3500	3500	1900	1900
Adequate (Y/N)	YES	YES	NO	NO	YES	YES	YES	YES
Notes:								
¹ Cycle length for signalized intersections and control delay for stop-controlled intersections.								
² Assumes 25 feet per vehicle queued								

The addition of project traffic is not projected to lengthen the projected queue during the AM peak hour. However, the addition of project traffic is projected to lengthen the projected queue by one vehicle or 25 feet during the PM peak hour under existing plus project conditions, which would exceed the existing storage capacity by 75 feet.

Recommendation: The northbound left-turn pocket can be lengthened by 250 feet to accommodate the projected queue during the AM peak hour. However, a second northbound left-turn lane is recommended to improve intersection operations.

Project-generated traffic at other locations would be too low to have a measurable effect on queue lengths.

Sight Distance

Adequate sight distance (sight distance triangles) should be provided at the project site driveways in accordance with the *Caltrans Highway Design Manual*. Sight distance triangles should be measured at the driveway approximately 10 feet back from the traveled way. Providing the appropriate sight distance reduces the likelihood of a collision at a driveway or intersection and provides drivers with the ability to exit a driveway and locate sufficient gaps in traffic. The minimum acceptable sight distance is often considered the Caltrans stopping sight distance. Sight distance requirements vary depending on the roadway speeds. DePaul Drive and Mission View Drive have posted speed limits of 35 and 40 mph, respectively. The Caltrans stopping sight distance for facilities with posted speed limits of 35 and 40 mph are 250 and 300 feet, respectively. Thus, a driver exiting the project driveways on DePaul Drive and Mission View Drive must be able to see approaching traffic on DePaul Drive and Mission View Drive at minimum distances of 250 and 300 feet, respectively, to be able to stop and avoid a collision.

Based on field observations, aerial images, and the location of the project driveways, there are no existing trees or visual obstructions along DePaul Drive and Mission View Drive that would obscure sight distance to drivers exiting the project site, providing a clear view of approaching traffic on both sides of DePaul Drive and Mission View Drive beyond the minimum required distances of 250 and 300 feet, respectively. Therefore, it can be concluded that the project access driveways would meet the Caltrans minimum stopping sight distance standards.

Recommendation: The site design should ensure design features, in particular, the landscaping and signage along the project site frontage and at the project site driveways, would not interfere with the sight distance at the proposed site driveway.

Parking

Based on Tables 18.72-2 and 18.72-3 of Section 18.72.030 of the Morgan Hill City Code, the project would be required to provide 2 covered parking spaces per residential unit and one guest parking space is required for every four residential units. The project would be required to provide 538 resident and 68 guest parking spaces for the proposed 269 residential units. The project is proposing to provide two covered parking spaces for each residential unit for a total of 538 parking spaces and 271 on-street parking spaces within the internal street network. Therefore, the provided number of parking spaces would satisfy the City's parking requirement.

Transit, Pedestrian, and Bicycle Analysis

The project site is served by Local Route 87 with bus stops along Mission View Drive and Half Road. In addition, Express Route 168 also provides service along Cochrane Road west of US 101. These two bus routes provide a connection to the Morgan Hill Caltrain Station. A conservative mode split in Morgan Hill would be a three percent transit share. Assuming up to three percent transit mode share for the project equates to no more than six and eight transit riders during the AM and PM peak hours, respectively.

VTA has recommended that a new bus stop for Route 87 be installed along Mission View Drive on the project frontage just south of the project entrance. VTA also has suggested a new bus stop be installed on the northbound side of Mission View Drive if a controlled crosswalk were to be installed at the project entrance along Mission view Drive. However, this analysis showed no need for signal control at the project entrance. It is recommended that the project coordinate with VTA to identify the specific placement of a new bus stop along Mission View Drive and allow for adequate space along its frontage on Mission View to accommodate the installation of a bus stop including wider sidewalks, lighting, landscaping, and passenger pad.

Sidewalks are provided along the east side of Mission View Drive and the north side of Cochrane Road in the immediate project area. However, sidewalks along the south side of Cochrane Road are intermittent, with no sidewalk currently provided between the US 101 northbound ramps and De Paul Drive, and a short segment west of Mission View Drive. The project would provide sidewalks along its entire frontages along Mission View Drive, Half Road, and DePaul Drive and result in a continuous connection to the existing sidewalks on the east side of Mission View Drive to provide a safe connection between the project site and other surrounding land uses in the area. Controlled crossings at the intersections of Cochrane Road with Mission View Drive and DePaul Drive would provide a connection between the project area and retail uses on the north side of Cochrane Road.

Bike lanes are currently provided along the entire lengths of Cochrane Road and Main Avenue. An unpaved bike path, the Madrone Channel Trail, runs along the east side of US 101, between Tennant Avenue and Cochrane Road. It is expected that bicycle trips would comprise no more than one percent of the total project-generated trips. Thus, the project could potentially generate no more than three new bicycle trips during each of the peak hours. The demand generated by the proposed project could be accommodated by the existing bicycle facilities in the vicinity of the project site.

Freeway Ramp Analysis

Freeway On-Ramp Queuing Analysis

An analysis of metered freeway ramps providing access to the project site was performed to identify the effect of the addition of project traffic on the queues at metered study freeway on-ramps. It should be noted that the evaluation of freeway ramps is not required based on the City's transportation analysis guidelines. Nor are there adopted methodologies and impact criteria for the analysis of freeway ramps. The project is expected to add peak hour trips to only the following metered freeway on-ramps in the project vicinity:

- US 101 northbound on-ramp from westbound Cochrane Road (Active Meter – AM Peak Hour)
- US 101 southbound on-ramp from westbound Cochrane Road (Active Meter – PM Peak Hour)
- US 101 southbound on-ramp from Dunne Avenue

The project is projected to add at most four trips to the US 101 southbound on-ramp from Dunne Avenue during the AM or PM peak hour and would not lengthen the projected queues at this location. Therefore, this ramp was not included in the queuing analysis.

The analysis indicates that project traffic would not lengthen the projected 15-minute interval queue lengths at either of the subject Cochrane Road on-ramps under existing plus project conditions. Short vehicle queues, less than 10 vehicles, currently occur at the ramps, however, the queues dissipate during the 15-minute intervals because the demand volume is less than the service rate of the freeway ramp meters.

The volumes on the northbound diagonal on-ramp from westbound Cochrane Road are projected to be greater than the service rate of the ramp meter during the AM peak hour under Year 2030 Cumulative with project conditions. Therefore, queues are projected to develop on the northbound diagonal on-ramp. Trips from the proposed project will result in an increase in the projected queue by two vehicles. However, the projected queues on the metered northbound diagonal on-ramp can be accommodated entirely on the ramp. The freeway on-ramp queuing calculations are included in Appendix H.

Freeway Off-Ramp Queuing Analysis

A queuing analysis was completed for freeway off-ramps, where the project will result in the addition of peak hour trips. These freeway off-ramps are controlled by a traffic signal at their intersection with the local arterial. The project is expected to add peak hour trips to only the following freeway off-ramps in the project vicinity:

- US 101 northbound off-ramp to Cochrane Road
- US 101 southbound off-ramp to Cochrane Road
- US 101 northbound off-ramp to Dunne Avenue

The project is projected to add at most four trips to the US 101 northbound off-ramp at Dunne Avenue during the AM or PM peak hour and would not lengthen the projected queues at this location. Therefore, this ramp was not included in the queuing analysis.

The results of the analysis (see Table 11) show that the 95th percentile queue lengths at each of the US 101 off-ramps to Cochrane Road are projected to be accommodated entirely on the ramps and would not extend back and disrupt the freeway mainline. The freeway off-ramp queuing calculations are included in Appendix H.

**Table 11
Freeway Off-Ramp Vehicle Queuing Analysis**

Scenario		Queue Length ¹ (feet)			
		US 101 SB Off-Ramps and Cochrane Road		US 101 NB Off-Ramps and Cochrane Road	
		SBL/R ²	SBR ²	NBL ²	NBL/R ²
Storage		2,100	650	950	1,750
Existing	AM	375	275	150	225
	PM	525	300	150	275
Existing Plus Project	AM	400	275	150	225
	PM	600	300	150	300
Year 2030 Cumulative without Project	AM	550	350	150	250
	PM	825	375	175	400
Year 2030 Cumulative with Project	AM	575	350	150	275
	PM	975	375	175	425
Maximum		975	375	175	425
Storage - Maximum		1,125	275	775	1,325

Notes:

¹Queue lengths were obtained from Traffix assuming 25 feet per vehicle.

²SBL/R = southbound left/right; SBR = southbound right; NBL = northbound left; NBL/R = northbound left/right

6. Conclusions

The potential impacts of the project were evaluated in accordance with the California Environmental Quality Act (CEQA) guidelines and the Governor's Office of Planning and Research (OPR) *Technical Advisory on Evaluating Transportation Impacts in CEQA*, December 2018.

A supplemental traffic operations analysis also was completed to demonstrate the project's consistency with the *Morgan Hill 2035 General Plan* goals and policies. The traffic operations analysis supplements the CEQA required VMT analysis. However, the determination of project impacts per CEQA requirements is based solely on the VMT analysis.

CEQA VMT Analysis

The results of the VMT analysis using the VTA's VMT Evaluation Tool indicate that the existing VMT for residential uses in the project vicinity is 30.46 VMT per capita.

The results also indicate that the project is projected to generate VMT per capita (27.41), which would exceed the OPR's recommended impact threshold of 20.94 VMT per capita. Therefore, the project would result in an impact on the transportation system based on OPR's VMT impact criteria.

VMT Impacts and Mitigation

Using OPR's impact thresholds, the project would need to implement VMT reduction measures to achieve a 24% reduction (27.41 to 20.94) in its VMT per capita for the proposed residential uses to reduce its impact to less than significant levels.

OPR's recommended 15% below existing VMT impact threshold encourages developments in transit-rich, highly mixed-use areas to implement design features and trip reduction measures to take advantage of existing multi-modal infrastructure and land use mixes in reducing trip making and/or trip lengths. However, many communities such as Morgan Hill have very limited multi-modal transportation infrastructure and lack a mix of complementary land uses. The lack of employment in these communities along with minimal transit options results in a greater number and longer commute trips. Therefore, it is highly unlikely that developments like the proposed project in these cities can achieve OPR's recommended 15% reduction in VMT. Therefore, absent of the City adopting its own City-

specific VMT policies and impact thresholds, the proposed project's VMT impact must be deemed significant and unavoidable.

Per its condition of approval, the City will however require that the project implement and/or incorporate in its design the following VMT reduction measures to encourage the use of multi-modal travel and reduce the number and length of vehicular trips:

1. The management entity/HOA shall provide fully (100 percent) subsidized annual VTA transit passes for all project homeowners (a maximum of one transit subsidy per residential unit, which would result in up to 269 transit passes per year). This subsidized transit program shall be approved by the City of Morgan Hill's Public Services Director prior to issuance of occupancy.
2. The project must improve the surrounding pedestrian network by including sidewalks which terminate at the common property line, allowing for connections to the adjacent property in the event there is development in the future. Continuous sidewalks are proposed along the project frontages. The proposed frontage improvements along Mission View Drive, Half Road, and De Paul Drive include sidewalk improvements; each of the street sections will be wide enough to accommodate future bicycle lanes.
3. The proposed development will include 64 bicycle parking spaces.

Traffic Operations Analysis

Project Trip Generation

Based on the recommended rates for single-family detached housing (Land Use #210) and the size of the proposed project, it is estimated that the proposed project would generate 2,539 daily trips, with 199 trips (50 inbound and 149 outbound) occurring during the AM peak hour and 266 trips (168 inbound and 98 outbound) occurring during the PM peak hour.

Intersection Operations Analyses

The results of the traffic operations analysis indicate that based on the City's operating standards, the proposed project would have an adverse effect on intersection operations at the following four study intersections under Year 2030 Cumulative with project conditions.

6. Mission View Drive and Cochrane Road (AM & PM Peak Hours)
8. Mission View Drive and Half Road (unsignalized) (AM & PM Peak Hours)
9. Condit Road and Main Avenue (PM Peak Hour)
10. Condit Road and Diana Avenue (unsignalized) (AM Peak Hour)

Adverse Intersection Operations Effects and Potential Improvements

The adverse intersection operation effects identified under Year 2030 Cumulative with project conditions are discussed below. Included are descriptions of the adverse effects on intersection operations and potential improvement measures that may be included as part of the project's Conditions of Approval. However, the identified roadway operations and improvements are not required or considered project impacts per CEQA guidelines.

6. Cochrane Road and Mission View Drive

This intersection is projected to operate at an unacceptable LOS F and E during the AM and PM peak hours, respectively, under Year 2030 Cumulative without project conditions. Traffic associated with the proposed project would cause the critical delay to increase by more than four seconds and the volume-to-capacity ratio (V/C) to increase by more than 0.01 during both the AM and PM peak hours. This constitutes an adverse effect on intersection operations based on the City of Morgan Hill's level of service standards.

The addition of a second northbound left-turn lane on Mission View Drive and a cycle length adjustment would be necessary to improve intersection operations. The addition of the second northbound left-turn lane will require lane striping and signal modification but will fit within the existing curb-to-curb pavement width on Mission View Drive. Implementation of this improvement would improve the intersection's level of service to LOS C during both the AM and PM peak hours under Year 2030 Cumulative with project conditions.

8. Mission View Drive and Half Road

This intersection is projected to operate at an unacceptable LOS F during the PM peak hour under Year 2030 Cumulative without and with project conditions. Furthermore, this intersection is projected to operate at an acceptable LOS D during the AM peak hour under Year 2030 Cumulative without conditions and degrade to LOS E with the addition of project traffic. Additionally, the peak-hour traffic signal warrant checks indicate that the intersection would have traffic volumes that meet thresholds that warrant signalization during both the AM and PM peak hours under Year 2030 Cumulative without and with project conditions. This constitutes an adverse effect on intersection operations based on the City of Morgan Hill's level of service standards.

The signalization of the intersection would be necessary to improve intersection operations. Implementation of a traffic signal at this location would improve the level of service to LOS C during both the AM and PM peak hours under Year 2030 Cumulative with project. This intersection is under the jurisdiction of both the City of Morgan Hill and Santa Clara County. Therefore, implementation of the recommended improvements will require City and County approval.

9. Main Avenue and Condit Road

This intersection is projected to operate at an unacceptable LOS F during the PM peak hour under Year 2030 Cumulative without project conditions. Traffic associated with the proposed project would cause the critical delay to increase by more than four seconds and the volume-to-capacity ratio (V/C) to increase by more than 0.01 during the PM peak hour. This constitutes an adverse effect on intersection operations based on the City of Morgan Hill's level of service standards.

The addition of an exclusive southbound right-turn lane on Condit Road would be necessary to improve intersection operations. The addition of the right-turn lane will require signal modifications and lane striping on the southbound approach. Implementation of this improvement would improve the intersection's level of service to LOS D during the PM peak hour under Year 2030 Cumulative with project conditions. This intersection is under the jurisdiction of both the City of Morgan Hill and Santa Clara County. Therefore, implementation of the recommended improvements will require City and County approval.

10. Condit Road and Diana Avenue

This intersection is projected to operate at an unacceptable LOS E during the AM peak hour under Year 2030 Cumulative without and with project conditions. Additionally, the peak-hour traffic signal

warrant checks indicate that the intersection would have traffic volumes that meet thresholds that warrant signalization during the AM peak hour under Year 2030 Cumulative without and with project conditions. This constitutes an adverse effect on intersection operations based on the City of Morgan Hill's level of service standards.

The signalization of the intersection would be necessary to improve intersection operations. Implementation of this improvement would improve the intersection's level of service to LOS B during the AM peak hour under Year 2030 Cumulative with project conditions.

Freeway Segment Level of Service Analysis

The results of the freeway segment level of service analysis indicate that ten directional mixed-flow lanes and one directional HOV lane on the freeway segments analyzed are projected to operate at an unacceptable LOS F during at least one peak hour under existing conditions and would continue to operate at LOS F conditions with the addition of traffic due to proposed project.

Improvement of freeway segment operations would require freeway widening to construct additional through lanes, thereby increasing freeway capacity. VTA's Valley Transportation Plan (VTP) 2040 identifies freeway express lane projects along US 101 between Cochrane Road and Whipple Avenue. The planned improvements consist of the conversion of the existing HOV lane to an express lane and the construction of a second express lane in each direction on US 101. These improvements would increase the capacity of the freeway and help to address the deficiency in freeway operations. However, it is not feasible for an individual development project to bear responsibility for implementing such extensive transportation system improvements due to constraints in the acquisition and cost of right-of-way.

Other Transportation Issues

Site Access

The project would include the extension of DePaul Drive to the south with termination as a cul-de-sac just north of Half Road. Access to the project site would be provided via a full access driveway along Mission View Drive and two full access driveways along the DePaul Drive extension.

On-Site Circulation

An internal private street network would provide access to each of the residential units from the proposed entrances along Mission View Drive and DePaul Drive. Most of the streets that front homes include on-street parallel parking. The internal streets would provide continuous access to each area of residential units.

Travel way on street is typically a minimum of 26 feet. The travel way on the internal streets is shown to be at least 20 feet wide. The narrower travel width will provide adequate width for two-way travel on each of the streets and will promote reduced travel speeds within the site. However, the straight nature of the internal roadways could result in drivers traveling at greater speeds than recommended. Therefore, it may be desirable to implement speed-reducing measures along the internal roadways. These measures could include the installation of speed bumps/humps along the internal roadways and/or bulb-outs at intersections and mid-block.

The project site plan shows sidewalks along the project's frontages along Mission View Drive and DePaul Drive and the internal street network on-site. However, there are no sidewalks provided along

the west side of Mission View Drive between the project site and Cochrane Road. In conjunction with the existing sidewalks along the east side of Mission View Drive, the proposed sidewalks on Mission View Drive along the project frontage would provide a connection between the project site and bus stops along Mission View Drive and pedestrian destinations along Cochrane Road. There also are no sidewalks along either side of DePaul Drive between the project site and Cochrane Road. Therefore, there will be no sidewalk connection between the project site and Cochrane Road.

The project site should be designed following City of Morgan Hill design standards and provide adequate width and turn-radii at and along all drive/parking aisles to allow for two-way circulation and adequate circulation of larger vehicles (such as emergency trucks, garbage truck, and delivery trucks) throughout the project site. Adhering to the City of Morgan Hill standards and requirements, and implementing the above recommendations, the proposed site access points and layout of the surface parking areas would be adequate to accommodate the circulation of both passenger and emergency vehicles.

Emergency Vehicle Access and Circulation

The 20-foot-wide internal roadway would provide emergency vehicles (fire trucks) sufficient space to access each of the residential units on-site. There are several dead-end drive aisles that would not provide sufficient space for emergency vehicles to turn around. However, the dead-ends will be located along short segments of roadways. Thus, vehicles would be able to back out of the roadways.

Intersection Operations Analysis

The queuing analysis also indicates that the maximum vehicle queue for northbound left-turn movement at the Cochrane Road and Mission View Drive intersection currently exceeds the provided turn pocket storage space during the AM and PM peak hours under existing conditions.

The addition of project traffic is not projected to lengthen the projected queue during the AM peak hour. However, the addition of project traffic is projected to lengthen the projected queue by one vehicle or 25 feet during the PM peak hour under existing plus project conditions, which would exceed the existing storage capacity by 75 feet.

Recommendation: The northbound left-turn pocket can be lengthened by 250 feet to accommodate the projected queue during the AM peak hour. However, a second northbound left-turn lane is recommended to improve intersection operations.

Project Driveway Operations

The results of the project driveway operations analysis indicate that all three project driveways are projected to operate at acceptable levels of service (LOS D or better) during each of the peak hours analyzed and to have traffic conditions that fall below the thresholds that warrant signalization. Additionally, the 95th percentile queues at the project driveways are projected to be at most 25 feet.

Recommendation: A center-striped median is currently provided along Mission View Drive north of the project site. The current width of Mission View Drive along the project frontage is not adequate to provide a left-turn pocket into the project driveway. Mission View Drive would need to be widened along its east side, opposite the project frontage, to provide a striped left-turn pocket into the project site. Similarly, left-turn lanes should be striped at the project driveways along DePaul Drive if a center-striped median is planned.

Sight Distance

Based on Caltrans requirements, the available sight distance at the project site driveways on DePaul Drive and Mission View Drive would be adequate.

Recommendation: The site design should ensure design features, in particular, the landscaping and signage along the project site frontage and at the project site driveways, would not interfere with the sight distance at the proposed site driveway.

Parking

Based on Tables 18.72-2 and 18.72-3 of Section 18.72.030 of the Morgan Hill City Code, the project would be required to provide 2 covered parking spaces per residential unit and one guest parking space is required for every four residential units. The project would be required to provide 538 resident and 68 guest parking spaces for the proposed 269 residential units. The project is proposing to provide two covered parking spaces for each residential unit for a total of 538 parking spaces and 271 on-street parking spaces within the internal street network. Therefore, the provided number of parking spaces would satisfy the City's parking requirement.

Transit, Pedestrian, and Bicycle Analysis

The project site is served by Local Route 87 with bus stops along Mission View Drive and Half Road. In addition, Express Route 168 also provides service along Cochrane Road west of US 101. These two bus routes provide a connection to the Morgan Hill Caltrain Station. A conservative mode split in Morgan Hill would be a three percent transit share. Assuming up to three percent transit mode share for the project equates to no more than six and eight transit riders during the AM and PM peak hours, respectively.

VTA has recommended that a new bus stop for Route 87 be installed along Mission View Drive on the project frontage just south of the project entrance. VTA also has suggested a new bus stop be installed on the northbound side of Mission View Drive if a controlled crosswalk were to be installed at the project entrance along Mission View Drive. However, this analysis showed no need for signal control at the project entrance. It is recommended that the project coordinate with VTA to identify the specific placement of a new bus stop along Mission View Drive and allow for adequate space along its frontage on Mission View to accommodate the installation of a bus stop including wider sidewalks, lighting, landscaping, and passenger pad.

Sidewalks are provided along the east side of Mission View Drive and the north side of Cochrane Road in the immediate project area. However, sidewalks along the south side of Cochrane Road are intermittent, with no sidewalk currently provided between the US 101 northbound ramps and De Paul Drive, and a short segment west of Mission View Drive. The project would provide sidewalks along its entire frontages along Mission View Drive, Half Road, and DePaul Drive and result in a continuous connection to the existing sidewalks on the east side of Mission View Drive to provide a safe connection between the project site and other surrounding land uses in the area. Controlled crossings at the intersections of Cochrane Road with Mission View Drive and DePaul Drive would provide a connection between the project area and retail uses on the north side of Cochrane Road.

Bike lanes are currently provided along the entire lengths of Cochrane Road and Main Avenue. An unpaved bike path, the Madrone Channel Trail, runs along the east side of US 101, between Tennant Avenue and Cochrane Road. It is expected that bicycle trips would comprise no more than one percent of the total project-generated trips. Thus, the project could potentially generate no more than three new

bicycle trips during each of the peak hours. The demand generated by the proposed project could be accommodated by the existing bicycle facilities in the vicinity of the project site.

Freeway Ramp Analysis

Freeway On-Ramp Queuing Analysis

The analysis indicates that project traffic would not lengthen the projected 15-minute interval queue lengths at either of the subject Cochrane Road on-ramps under existing plus project conditions. Short vehicle queues, less than 10 vehicles, currently occur at the ramps, however, the queues dissipate during the 15-minute intervals because the demand volume is less than the service rate of the freeway ramp meters.

The volumes on the northbound diagonal on-ramp from westbound Cochrane Road are projected to be greater than the service rate of the ramp meter during the AM peak hour under Year 2030 Cumulative with project conditions. Therefore, queues are projected to develop on the northbound diagonal on-ramp. Trips from the proposed project will result in an increase in the projected queue by two vehicles. However, the projected queues on the metered northbound diagonal on-ramp can be accommodated entirely on the ramp.

Freeway Off-Ramp Queuing Analysis

The results of the analysis show that the 95th percentile queue lengths at each of the US 101 off-ramps to Cochrane Road are projected to be accommodated entirely on the ramps and would not extend back and disrupt the freeway mainline.

**The Crosswinds Residential Development
Technical Appendices**

October 7, 2021

Appendix A

VTA VMT Evaluation Tool Output Sheets

Project Details

Timestamp of Analysis: November 17, 2020, 04:29:27 PM

Project Name: The Crosswinds Residential Development

Project Description: 269 residential units comprised of 149 condos, 56 single-family detached, and 64 duet units

Project Location

Jurisdiction:
Morgan Hill

APN	TAZ
72830001	333
72830003	333
72830002	333
72830004	333

Inside Transit Priority Area (TPA)?
No (Fail)

Analysis Details

Santa Clara Countywide VMT Evaluation Tool Version: 1

Data Version: VTA Countywide Model December 2019

Analysis Methodology: Parcel Buffer Method

Baseline Year: 2019

Project Land Use

Residential:

Single Family DU: 269

Multifamily DU:

Total DUs: 269

Non-Residential:

Office KSF:

Local Serving Retail KSF:

Industrial KSF:

Residential Affordability (percent of all units):

Extremely Low Income: 0 %

Very Low Income: 0 %

Low Income: 15 %

Parking:

Motor Vehicle Parking:

Bicycle Parking:

Residential Vehicle Miles Traveled (VMT) Screening Results

Land Use Type 1:	Residential
VMT Without Project:	Home-based VMT per Capita
VMT Baseline Description 1:	City Average
VMT Baseline Value 1:	24.64
VMT Threshold Description 1:	-15%
Land Use 1 has been Pre-Screened by the Local Jurisdiction:	N/A

	Without Project	With Project & Tier 1-3 VMT Reductions	With Project & All VMT Reductions
Project Generated Vehicle Miles Traveled (VMT) Rate	30.46	27.41	27.41
Low VMT Screening Analysis	No (Fail)	No (Fail)	No (Fail)

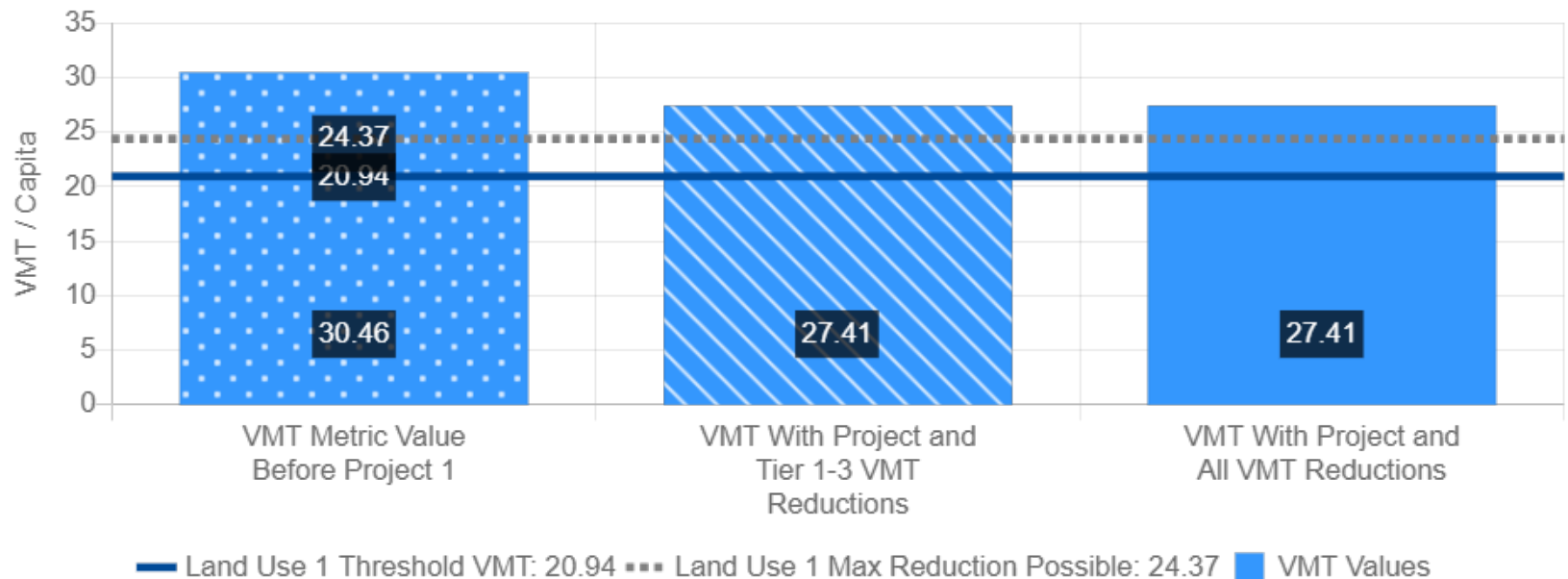

Tier 1 Project Characteristics

PC01 Increase Residential Density

Existing Residential Density:	2.28
With Project Residential Density:	4.09

PC02 Increase Residential Diversity

Existing Residential Diversity Index:	0.71
With Project Residential Diversity Index:	0.55

PC03 Affordable Housing

Low Income:	15 %
-------------	------

PC04 Increase Employment Density

Existing Employment Density:	11.62
With Project Employment Density:	11.62

Project Details

Timestamp of Analysis: December 22, 2020, 11:01:57 PM

Project Name: The Crosswinds Residential Development

Project Description: 269 residential units comprised of 149condos, 56 single-family detached, and64 duet units

Project Location

Jurisdiction:
Morgan Hill

APN	TAZ
72830001	333
72830003	333
72830002	333
72830004	333

Inside Transit Priority Area (TPA)?
No (Fail)

Analysis Details

Santa Clara Countywide VMT Evaluation Tool Version: 1

Data Version: VTA Countywide Model December 2019

Analysis Methodology: Parcel Buffer Method

Baseline Year: 2019

Project Land Use

Residential:

Single Family DU: 269

Multifamily DU:

Total DUs: 269

Non-Residential:

Office KSF:

Local Serving Retail KSF:

Industrial KSF:

Residential Affordability (percent of all units):

Extremely Low Income: 0 %

Very Low Income: 0 %

Low Income: 15 %

Parking:

Motor Vehicle Parking:

Bicycle Parking:

Appendix B

Traffic Counts



(303) 216-2439
www.alltrafficdata.net

Location: 5 SUTTER BLVD & COCHRANE RD AM
Date and Start Time: Tuesday, May 8, 2018
Peak Hour: 07:30 AM - 08:30 AM
Peak 15-Minutes: 07:45 AM - 08:00 AM

Peak Hour - All Vehicles

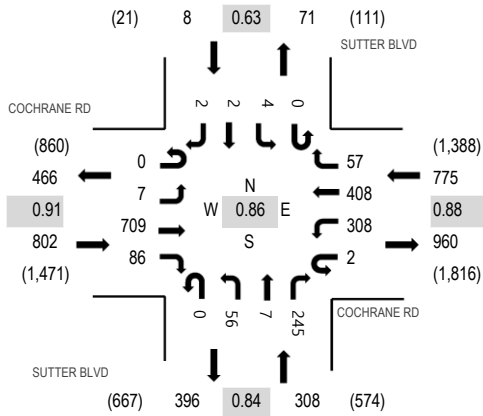

Peak Hour - Pedestrians/Bicycles in Crosswalk

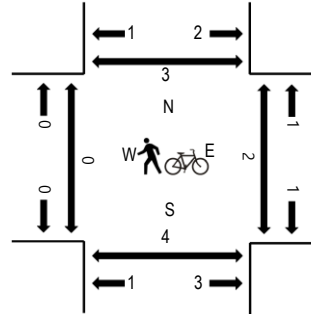

Note: Total study counts contained in parentheses.

Traffic Counts

Interval Start Time	COCHRANE RD Eastbound				COCHRANE RD Westbound				SUTTER BLVD Northbound				SUTTER BLVD Southbound				Total	Rolling Hour	Pedestrian Crossings			
	U-Turn	Left	Thru	Right	U-Turn	Left	Thru	Right	U-Turn	Left	Thru	Right	U-Turn	Left	Thru	Right			West	East	South	North
7:00 AM	0	1	207	6	0	44	66	2	0	7	1	65	0	1	1	0	401	1,818	0	0	0	0
7:15 AM	0	0	178	9	1	57	84	5	0	22	0	74	0	1	0	0	431	1,885	1	0	0	1
7:30 AM	0	0	193	14	0	71	90	6	0	7	1	54	0	0	0	1	437	1,893	0	2	0	1
7:45 AM	0	3	184	43	1	83	112	17	0	15	0	89	0	0	1	1	549	1,819	0	0	1	0
8:00 AM	0	2	183	18	1	69	92	13	0	21	0	67	0	2	0	0	468	1,636	0	0	1	2
8:15 AM	0	2	149	11	0	85	114	21	0	13	6	35	0	2	1	0	439		0	0	1	0
8:30 AM	0	2	142	6	0	58	88	10	0	10	3	38	0	2	3	1	363		0	0	0	1
8:45 AM	0	0	111	7	0	80	104	14	0	10	2	34	0	2	0	2	366		0	0	0	0

Peak Rolling Hour Flow Rates

Vehicle Type	Eastbound				Westbound				Northbound				Southbound				Total
	U-Turn	Left	Thru	Right	U-Turn	Left	Thru	Right	U-Turn	Left	Thru	Right	U-Turn	Left	Thru	Right	
Articulated Trucks	0	0	3	0	0	3	6	0	0	0	1	3	0	1	0	0	17
Lights	0	7	684	83	2	298	388	57	0	56	6	222	0	3	2	2	1,810
Mediums	0	0	22	3	0	7	14	0	0	0	0	20	0	0	0	0	66
Total	0	7	709	86	2	308	408	57	0	56	7	245	0	4	2	2	1,893



(303) 216-2439
www.alltrafficdata.net

Location: 5 SUTTER BLVD & COCHRANE RD PM

Date and Start Time: Tuesday, May 8, 2018

Peak Hour: 04:15 PM - 05:15 PM

Peak 15-Minutes: 04:30 PM - 04:45 PM

Peak Hour - All Vehicles

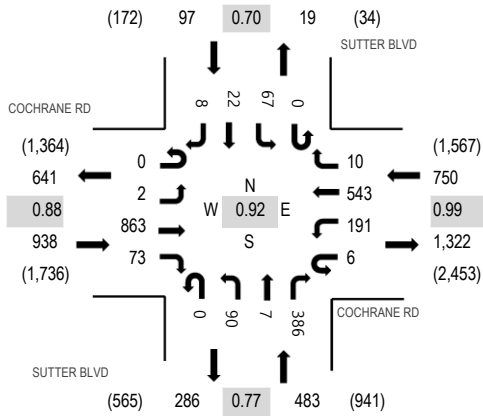

Peak Hour - Pedestrians/Bicycles in Crosswalk

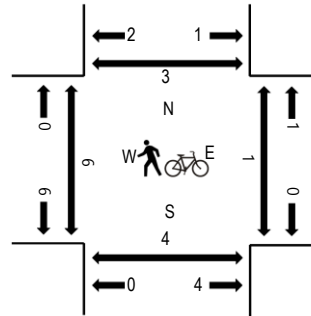

Note: Total study counts contained in parentheses.

Traffic Counts

Interval Start Time	COCHRANE RD Eastbound				COCHRANE RD Westbound				SUTTER BLVD Northbound				SUTTER BLVD Southbound				Total	Rolling Hour	Pedestrian Crossings			
	U-Turn	Left	Thru	Right	U-Turn	Left	Thru	Right	U-Turn	Left	Thru	Right	U-Turn	Left	Thru	Right			West	East	South	North
4:00 PM	0	1	208	28	0	40	141	2	0	29	5	131	0	12	2	5	604	2,258	0	0	0	2
4:15 PM	0	1	196	27	4	54	127	4	0	21	1	88	0	5	4	2	534	2,268	0	0	0	0
4:30 PM	0	1	252	17	1	43	140	2	0	26	3	106	0	21	4	3	619	2,268	2	0	2	0
4:45 PM	0	0	201	15	0	46	117	2	0	21	2	76	0	16	3	2	501	2,178	1	0	0	1
5:00 PM	0	0	214	14	1	48	159	2	0	22	1	116	0	25	11	1	614	2,158	2	1	2	2
5:15 PM	0	0	188	16	1	49	159	1	0	18	0	84	0	15	2	1	534		0	0	1	1
5:30 PM	0	0	167	16	0	46	166	2	0	34	0	76	0	16	4	2	529		3	0	2	1
5:45 PM	0	0	154	20	0	53	154	3	0	14	1	66	0	13	3	0	481		2	2	3	0

Peak Rolling Hour Flow Rates

Vehicle Type	Eastbound				Westbound				Northbound				Southbound				Total
	U-Turn	Left	Thru	Right	U-Turn	Left	Thru	Right	U-Turn	Left	Thru	Right	U-Turn	Left	Thru	Right	
Articulated Trucks	0	0	5	0	0	7	7	0	0	0	0	0	0	1	1	0	21
Lights	0	2	848	71	6	176	526	10	0	89	6	379	0	66	19	8	2,206
Mediums	0	0	10	2	0	8	10	0	0	1	1	7	0	0	2	0	41
Total	0	2	863	73	6	191	543	10	0	90	7	386	0	67	22	8	2,268



(303) 216-2439
www.alltrafficdata.net

Location: 6 COCHRANE PLAZA & COCHRANE RD AM

Date and Start Time: Tuesday, May 8, 2018

Peak Hour: 07:30 AM - 08:30 AM

Peak 15-Minutes: 07:45 AM - 08:00 AM

Peak Hour - All Vehicles

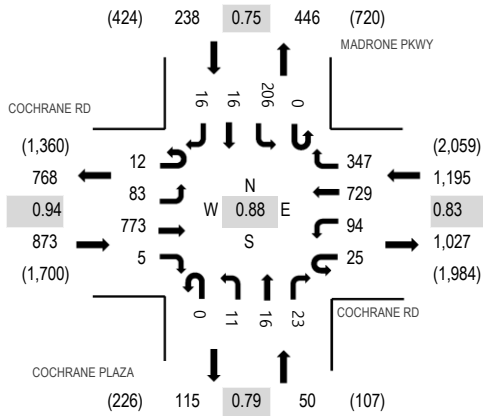

Peak Hour - Pedestrians/Bicycles in Crosswalk

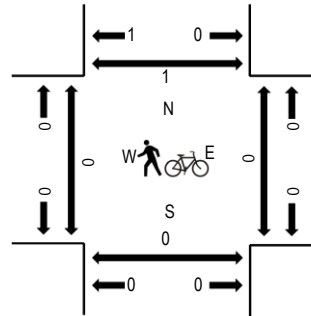

Note: Total study counts contained in parentheses.

Traffic Counts

Interval Start Time	COCHRANE RD Eastbound				COCHRANE RD Westbound				COCHRANE PLAZA Northbound				MADRONE PKWY Southbound				Total	Rolling Hour	Pedestrian Crossings			
	U-Turn	Left	Thru	Right	U-Turn	Left	Thru	Right	U-Turn	Left	Thru	Right	U-Turn	Left	Thru	Right			West	East	South	North
7:00 AM	1	23	233	4	4	23	101	43	0	2	3	9	0	32	4	3	485	2,223	0	0	0	1
7:15 AM	2	12	231	0	6	17	135	47	0	1	3	15	0	42	2	4	517	2,298	0	0	0	0
7:30 AM	2	18	210	2	5	18	159	71	0	3	3	4	0	48	5	7	555	2,356	0	0	0	0
7:45 AM	2	18	218	2	8	18	214	120	0	3	9	5	0	44	3	2	666	2,263	0	0	0	0
8:00 AM	3	24	185	1	8	27	148	72	0	3	1	9	0	75	3	1	560	2,067	0	0	0	0
8:15 AM	5	23	160	0	4	31	208	84	0	2	3	5	0	39	5	6	575		0	0	0	1
8:30 AM	5	19	155	2	8	22	136	54	0	2	2	6	0	36	4	11	462		0	0	0	0
8:45 AM	1	16	122	1	7	27	184	50	0	2	2	10	0	41	5	2	470		0	0	0	0

Peak Rolling Hour Flow Rates

Vehicle Type	Eastbound				Westbound				Northbound				Southbound				Total
	U-Turn	Left	Thru	Right	U-Turn	Left	Thru	Right	U-Turn	Left	Thru	Right	U-Turn	Left	Thru	Right	
Articulated Trucks	0	0	9	0	0	0	9	2	0	0	0	0	0	2	0	0	22
Lights	12	83	724	5	24	92	703	341	0	11	16	23	0	202	16	16	2,268
Mediums	0	0	40	0	1	2	17	4	0	0	0	0	0	2	0	0	66
Total	12	83	773	5	25	94	729	347	0	11	16	23	0	206	16	16	2,356



(303) 216-2439
www.alltrafficdata.net

Location: 6 COCHRANE PLAZA & COCHRANE RD PM

Date and Start Time: Tuesday, May 8, 2018

Peak Hour: 04:15 PM - 05:15 PM

Peak 15-Minutes: 04:30 PM - 04:45 PM

Peak Hour - All Vehicles

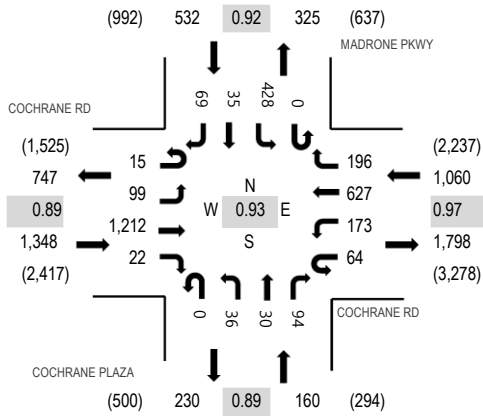

Peak Hour - Pedestrians/Bicycles in Crosswalk

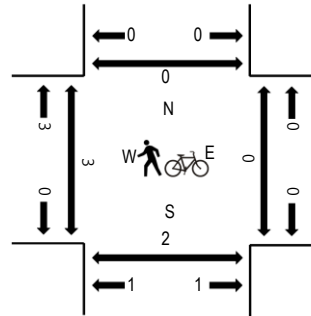

Note: Total study counts contained in parentheses.

Traffic Counts

Interval Start Time	COCHRANE RD Eastbound				COCHRANE RD Westbound				COCHRANE PLAZA Northbound				COCHRANE PLAZA Southbound				Total	Rolling Hour	Pedestrian Crossings			
	U-Turn	Left	Thru	Right	U-Turn	Left	Thru	Right	U-Turn	Left	Thru	Right	U-Turn	Left	Thru	Right			West	East	South	North
4:00 PM	4	15	305	3	24	43	135	58	0	9	7	15	1	91	11	15	736	3,044	0	0	0	0
4:15 PM	6	22	279	6	19	46	154	58	0	5	10	21	0	99	11	14	750	3,100	2	0	0	0
4:30 PM	2	24	345	6	20	43	162	40	0	12	9	25	0	117	10	18	833	3,081	0	0	0	0
4:45 PM	2	23	293	4	16	42	138	42	0	14	5	24	0	97	9	16	725	2,908	0	0	2	0
5:00 PM	5	30	295	6	9	42	173	56	0	5	6	24	0	115	5	21	792	2,896	1	0	0	0
5:15 PM	2	35	229	5	19	59	180	44	0	7	10	22	0	103	11	5	731		0	0	0	1
5:30 PM	2	18	217	5	17	49	189	54	0	4	5	17	0	61	9	13	660		1	0	0	0
5:45 PM	6	24	196	3	31	54	189	32	0	5	9	24	0	109	18	13	713		0	0	0	2

Peak Rolling Hour Flow Rates

Vehicle Type	Eastbound				Westbound				Northbound				Southbound				Total
	U-Turn	Left	Thru	Right	U-Turn	Left	Thru	Right	U-Turn	Left	Thru	Right	U-Turn	Left	Thru	Right	
Articulated Trucks	0	1	5	0	0	0	15	4	0	0	0	0	0	2	0	0	27
Lights	15	98	1,193	22	63	173	596	190	0	35	30	94	0	422	34	68	3,033
Mediums	0	0	14	0	1	0	16	2	0	1	0	0	0	4	1	1	40
Total	15	99	1,212	22	64	173	627	196	0	36	30	94	0	428	35	69	3,100



(303) 216-2439
www.alltrafficdata.net

Location: 7 US101 SB RAMPS & COCHRANE RD AM
Date and Start Time: Tuesday, May 8, 2018
Peak Hour: 07:30 AM - 08:30 AM
Peak 15-Minutes: 07:45 AM - 08:00 AM

Peak Hour - All Vehicles

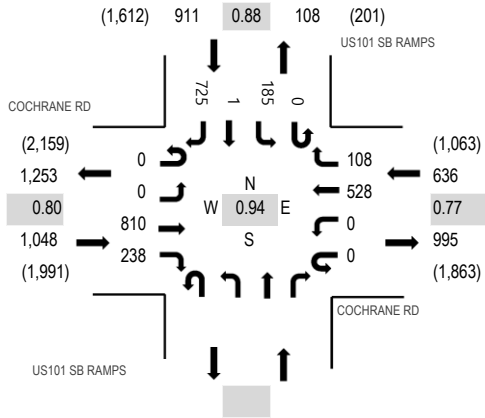

Peak Hour - Pedestrians/Bicycles in Crosswalk

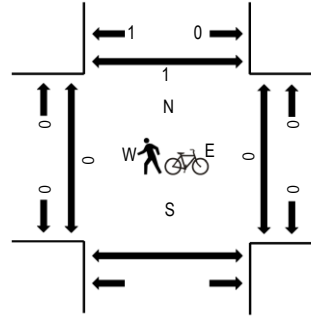

Note: Total study counts contained in parentheses.

Traffic Counts

Interval Start Time	COCHRANE RD Eastbound				COCHRANE RD Westbound				US101 SB RAMPS Northbound				US101 SB RAMPS Southbound				Total	Rolling Hour	Pedestrian Crossings			
	U-Turn	Left	Thru	Right	U-Turn	Left	Thru	Right	U-Turn	Left	Thru	Right	U-Turn	Left	Thru	Right			West	East	South	North
7:00 AM	0	0	240	42	0	0	60	11					0	30	1	109	493	2,311	0	0	0	
7:15 AM	0	0	201	40	0	0	63	28					0	26	0	159	517	2,480	0	0	0	
7:30 AM	0	0	188	64	0	0	110	39					0	45	0	162	608	2,595	0	0	0	
7:45 AM	0	0	178	50	0	0	179	27					0	61	0	198	693	2,495	0	0	0	
8:00 AM	0	0	257	71	0	0	118	18					0	36	0	162	662	2,355	0	0	1	
8:15 AM	0	0	187	53	0	0	121	24					0	43	1	203	632		0	0	0	
8:30 AM	0	0	172	54	0	0	108	23					0	33	0	118	508		0	0	0	
8:45 AM	0	0	127	67	0	0	103	31					0	39	0	186	553		0	0	0	

Peak Rolling Hour Flow Rates

Vehicle Type	Eastbound				Westbound				Northbound				Southbound				Total
	U-Turn	Left	Thru	Right	U-Turn	Left	Thru	Right	U-Turn	Left	Thru	Right	U-Turn	Left	Thru	Right	
Articulated Trucks	0	0	8	2	0	0	7	2					0	2	0	7	28
Lights	0	0	767	222	0	0	515	101					0	175	1	701	2,482
Mediums	0	0	35	14	0	0	6	5					0	8	0	17	85
Total	0	0	810	238	0	0	528	108					0	185	1	725	2,595



(303) 216-2439
www.alltrafficdata.net

Location: 7 US101 SB RAMPS & COCHRANE RD PM

Date and Start Time: Tuesday, May 8, 2018

Peak Hour: 04:30 PM - 05:30 PM

Peak 15-Minutes: 05:00 PM - 05:15 PM

Peak Hour - All Vehicles

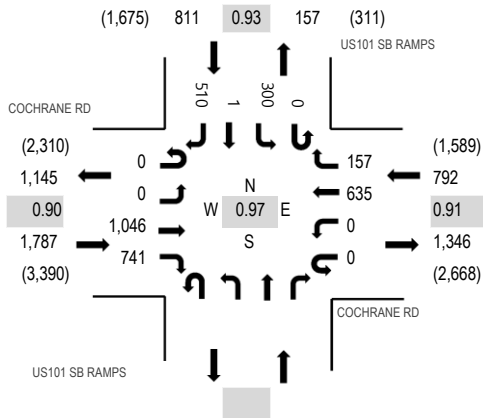

Peak Hour - Pedestrians/Bicycles in Crosswalk

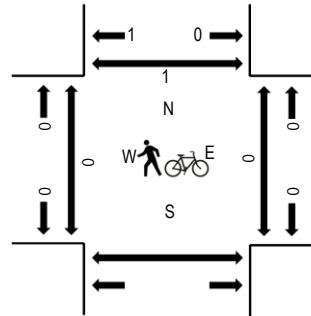

Note: Total study counts contained in parentheses.

Traffic Counts

Interval Start Time	COCHRANE RD Eastbound				COCHRANE RD Westbound				US101 SB RAMPS Northbound				US101 SB RAMPS Southbound				Total	Rolling Hour	Pedestrian Crossings			
	U-Turn	Left	Thru	Right	U-Turn	Left	Thru	Right	U-Turn	Left	Thru	Right	U-Turn	Left	Thru	Right			West	East	South	North
4:00 PM	0	0	279	188	0	0	159	37	0	55	0	113	831	3,289	0	0	0	0	0	0		
4:15 PM	0	0	228	188	0	0	167	34	0	80	0	97	794	3,335	0	0	0	0	0	0		
4:30 PM	0	0	307	193	0	0	157	35	0	56	0	122	870	3,390	0	0	0	0	0	0		
4:45 PM	0	0	219	205	0	0	149	37	0	74	1	109	794	3,350	0	0	0	0	0	0		
5:00 PM	0	0	273	177	0	0	158	38	0	87	0	144	877	3,365	0	0	0	0	0	0		
5:15 PM	0	0	247	166	0	0	171	47	0	83	0	135	849		0	0	0	0	0	1		
5:30 PM	0	0	221	122	0	0	185	44	0	113	0	145	830		0	0	0	0	0	0		
5:45 PM	0	0	252	125	0	0	132	39	0	94	0	167	809		0	0	0	0	0	1		

Peak Rolling Hour Flow Rates

Vehicle Type	Eastbound				Westbound				Northbound				Southbound				Total
	U-Turn	Left	Thru	Right	U-Turn	Left	Thru	Right	U-Turn	Left	Thru	Right	U-Turn	Left	Thru	Right	
Articulated Trucks	0	0	7	7	0	0	11	0	0	0	0	5	0	0	0	5	30
Lights	0	0	1,026	729	0	0	618	156	0	298	1	489	3,317	0	0	0	3,317
Mediums	0	0	13	5	0	0	6	1	0	2	0	16	43	0	0	0	43
Total	0	0	1,046	741	0	0	635	157	0	300	1	510	3,390	0	0	0	3,390



(303) 216-2439
www.alltrafficdata.net

Location: 8 US101 NB RAMPS & COCHRANE RD AM

Date and Start Time: Tuesday, May 8, 2018

Peak Hour: 07:30 AM - 08:30 AM

Peak 15-Minutes: 07:45 AM - 08:00 AM

Peak Hour - All Vehicles

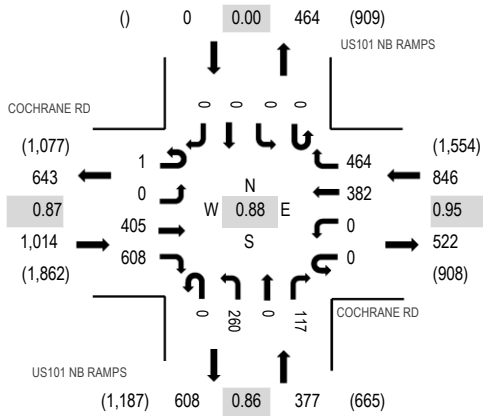

Peak Hour - Pedestrians/Bicycles in Crosswalk

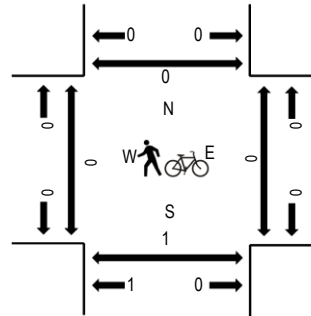

Note: Total study counts contained in parentheses.

Traffic Counts

Interval Start Time	COCHRANE RD Eastbound				COCHRANE RD Westbound				US101 NB RAMPS Northbound				US101 NB RAMPS Southbound				Total	Rolling Hour	Pedestrian Crossings			
	U-Turn	Left	Thru	Right	U-Turn	Left	Thru	Right	U-Turn	Left	Thru	Right	U-Turn	Left	Thru	Right			West	East	South	North
7:00 AM	0	0	47	211	0	0	52	144	0	22	0	17	0	0	0	0	493	2,142	0	0	1	0
7:15 AM	0	0	56	172	0	0	69	144	0	21	0	20	0	0	0	0	482	2,208	0	0	0	0
7:30 AM	0	0	73	162	0	0	101	127	0	51	0	18	0	0	0	0	532	2,237	0	0	1	0
7:45 AM	0	0	132	163	0	0	121	99	0	90	0	30	0	0	0	0	635	2,171	0	0	0	0
8:00 AM	0	0	110	157	0	0	78	124	0	54	0	36	0	0	0	0	559	1,939	0	0	0	0
8:15 AM	1	0	90	126	0	0	82	114	0	65	0	33	0	0	0	0	511		0	0	0	0
8:30 AM	0	0	83	121	0	0	67	88	0	64	0	43	0	0	0	0	466		0	0	0	0
8:45 AM	0	0	83	75	0	0	75	69	0	64	0	37	0	0	0	0	403		0	0	0	0

Peak Rolling Hour Flow Rates

Vehicle Type	Eastbound				Westbound				Northbound				Southbound				Total
	U-Turn	Left	Thru	Right	U-Turn	Left	Thru	Right	U-Turn	Left	Thru	Right	U-Turn	Left	Thru	Right	
Articulated Trucks	0	0	3	8	0	0	1	4	0	7	0	3	0	0	0	0	26
Lights	1	0	386	571	0	0	372	454	0	251	0	108	0	0	0	0	2,143
Mediums	0	0	16	29	0	0	9	6	0	2	0	6	0	0	0	0	68
Total	1	0	405	608	0	0	382	464	0	260	0	117	0	0	0	0	2,237



(303) 216-2439
www.alltrafficdata.net

Location: 8 US101 NB RAMPS & COCHRANE RD PM

Date and Start Time: Tuesday, May 8, 2018

Peak Hour: 05:00 PM - 06:00 PM

Peak 15-Minutes: 05:15 PM - 05:30 PM

Peak Hour - All Vehicles

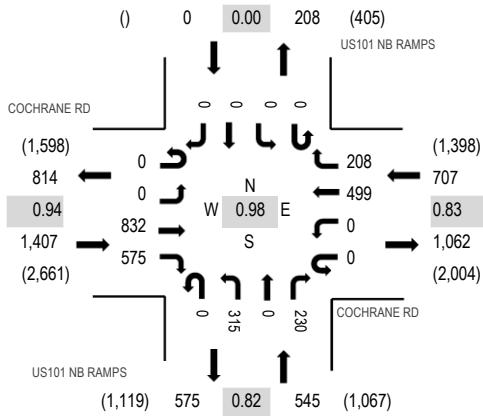

Peak Hour - Pedestrians/Bicycles in Crosswalk

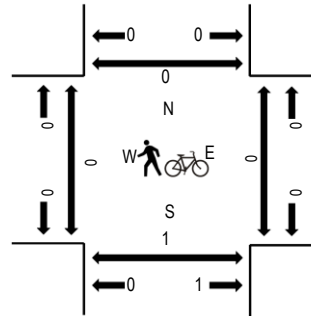

Note: Total study counts contained in parentheses.

Traffic Counts

Interval Start Time	COCHRANE RD Eastbound				COCHRANE RD Westbound				US101 NB RAMPS Northbound				US101 NB RAMPS Southbound				Total	Rolling Hour	Pedestrian Crossings			
	U-Turn	Left	Thru	Right	U-Turn	Left	Thru	Right	U-Turn	Left	Thru	Right	U-Turn	Left	Thru	Right			West	East	South	North
4:00 PM	0	0	148	145	0	0	117	54	0	74	0	61	0	0	0	0	599	2,467	0	0	0	0
4:15 PM	0	0	193	135	0	0	122	41	0	81	0	56	0	0	0	0	628	2,529	0	0	0	0
4:30 PM	0	0	186	154	0	0	132	56	0	65	0	53	0	0	0	0	646	2,582	0	0	0	0
4:45 PM	0	0	183	110	0	0	123	46	0	70	0	62	0	0	0	0	594	2,613	0	0	2	0
5:00 PM	0	0	206	162	0	0	124	47	0	75	0	47	0	0	0	0	661	2,659	0	0	0	0
5:15 PM	0	0	200	143	0	0	126	43	0	100	0	69	0	0	0	0	681		0	0	0	0
5:30 PM	0	0	205	118	0	0	144	76	0	74	0	60	0	0	0	0	677		0	0	0	0
5:45 PM	0	0	221	152	0	0	105	42	0	66	0	54	0	0	0	0	640		0	0	1	0

Peak Rolling Hour Flow Rates

Vehicle Type	Eastbound				Westbound				Northbound				Southbound				Total
	U-Turn	Left	Thru	Right	U-Turn	Left	Thru	Right	U-Turn	Left	Thru	Right	U-Turn	Left	Thru	Right	
Articulated Trucks	0	0	0	9	0	0	0	0	0	6	0	0	0	0	0	0	15
Lights	0	0	828	555	0	0	495	207	0	303	0	223	0	0	0	0	2,611
Mediums	0	0	4	11	0	0	4	1	0	6	0	7	0	0	0	0	33
Total	0	0	832	575	0	0	499	208	0	315	0	230	0	0	0	0	2,659



(303) 216-2439
www.alltrafficdata.net

Location: 9 DE PAUL DR & COCHRANE RD AM
Date and Start Time: Tuesday, May 8, 2018
Peak Hour: 07:30 AM - 08:30 AM
Peak 15-Minutes: 07:45 AM - 08:00 AM

Peak Hour - All Vehicles

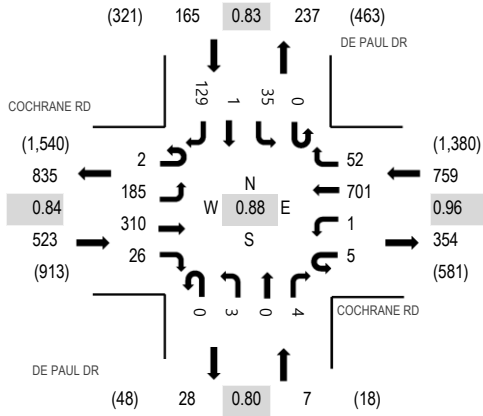

Peak Hour - Pedestrians/Bicycles in Crosswalk

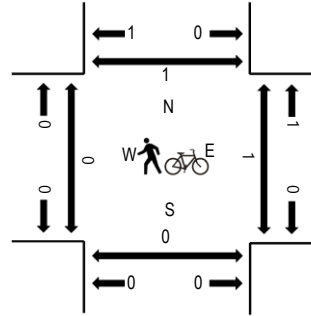

Note: Total study counts contained in parentheses.

Traffic Counts

Interval Start Time	COCHRANE RD Eastbound				COCHRANE RD Westbound				DE PAUL DR Northbound				DE PAUL DR Southbound				Total	Rolling Hour	Pedestrian Crossings				
	U-Turn	Left	Thru	Right	U-Turn	Left	Thru	Right	U-Turn	Left	Thru	Right	U-Turn	Left	Thru	Right			West	East	South	North	
7:00 AM	0	22	41	0	0	0	170	13	0	0	0	0	0	0	8	0	31	285	1,343	2	0	0	2
7:15 AM	0	32	46	3	1	0	175	20	0	0	0	1	0	5	0	0	34	317	1,442	0	0	0	0
7:30 AM	1	35	54	2	1	0	194	10	0	0	0	0	0	10	0	0	22	329	1,454	0	0	0	0
7:45 AM	0	47	109	11	2	0	191	15	0	0	0	1	0	12	0	0	24	412	1,419	0	0	0	0
8:00 AM	0	53	82	8	2	0	167	17	0	0	0	2	0	10	0	0	43	384	1,289	0	1	0	1
8:15 AM	1	50	65	5	0	1	149	10	0	3	0	1	0	3	1	0	40	329		0	0	0	0
8:30 AM	1	63	55	9	1	0	112	11	0	4	0	1	0	5	0	0	32	294		0	0	0	2
8:45 AM	0	53	57	8	2	0	106	10	0	3	2	0	0	4	0	0	37	282		0	0	0	2

Peak Rolling Hour Flow Rates

Vehicle Type	Eastbound				Westbound				Northbound				Southbound				Total
	U-Turn	Left	Thru	Right	U-Turn	Left	Thru	Right	U-Turn	Left	Thru	Right	U-Turn	Left	Thru	Right	
Articulated Trucks	0	2	4	0	0	0	3	0	0	0	0	0	0	0	0	1	10
Lights	2	178	292	26	5	1	684	52	0	3	0	4	0	33	1	126	1,407
Mediums	0	5	14	0	0	0	14	0	0	0	0	0	0	2	0	2	37
Total	2	185	310	26	5	1	701	52	0	3	0	4	0	35	1	129	1,454



(303) 216-2439
www.alltrafficdata.net

Location: 9 DE PAUL DR & COCHRANE RD PM
Date and Start Time: Tuesday, May 8, 2018
Peak Hour: 04:45 PM - 05:45 PM
Peak 15-Minutes: 05:30 PM - 05:45 PM

Peak Hour - All Vehicles

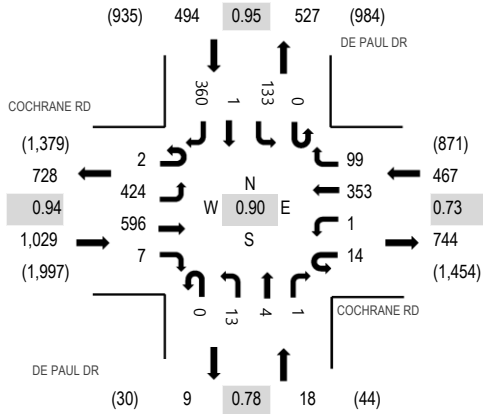

Peak Hour - Pedestrians/Bicycles in Crosswalk

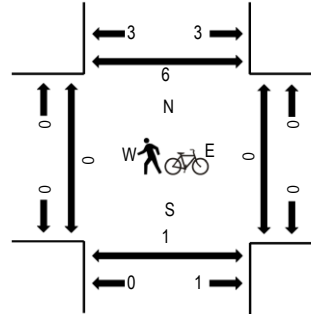

Note: Total study counts contained in parentheses.

Traffic Counts

Interval Start Time	COCHRANE RD Eastbound				COCHRANE RD Westbound				DE PAUL DR Northbound				DE PAUL DR Southbound				Total	Rolling Hour	Pedestrian Crossings				
	U-Turn	Left	Thru	Right	U-Turn	Left	Thru	Right	U-Turn	Left	Thru	Right	U-Turn	Left	Thru	Right			West	East	South	North	
4:00 PM	0	79	128	6	2	1	94	24	0	4	2	0	0	0	35	1	79	455	1,846	0	0	0	0
4:15 PM	0	88	149	3	5	0	68	18	0	4	3	2	0	27	1	87	455	1,880	0	0	0	0	
4:30 PM	1	97	130	6	2	1	93	26	0	5	0	1	0	22	0	82	466	1,916	0	0	0	0	
4:45 PM	1	101	150	2	5	1	68	16	0	4	3	0	0	25	0	94	470	2,008	0	0	1	5	
5:00 PM	0	107	148	1	2	0	82	26	0	3	1	1	0	33	1	84	489	2,001	0	0	0	1	
5:15 PM	0	105	145	2	5	0	78	24	0	5	0	0	0	41	0	86	491		0	0	0	0	
5:30 PM	1	111	153	2	2	0	125	33	0	1	0	0	0	34	0	96	558		0	0	0	0	
5:45 PM	0	107	172	2	2	0	56	12	0	4	0	1	1	32	0	74	463		0	1	0	2	

Peak Rolling Hour Flow Rates

Vehicle Type	Eastbound				Westbound				Northbound				Southbound				Total
	U-Turn	Left	Thru	Right	U-Turn	Left	Thru	Right	U-Turn	Left	Thru	Right	U-Turn	Left	Thru	Right	
Articulated Trucks	0	0	1	0	0	0	0	0	0	0	0	0	0	0	0	0	1
Lights	2	421	589	7	14	1	347	99	0	13	4	1	0	132	1	360	1,991
Mediums	0	3	6	0	0	0	6	0	0	0	0	0	0	1	0	0	16
Total	2	424	596	7	14	1	353	99	0	13	4	1	0	133	1	360	2,008



(303) 216-2439
www.alltrafficdata.net

Location: 10 MISSION VIEW DR & COCHRANE RD AM

Date and Start Time: Tuesday, May 8, 2018

Peak Hour: 07:15 AM - 08:15 AM

Peak 15-Minutes: 07:45 AM - 08:00 AM

Peak Hour - All Vehicles

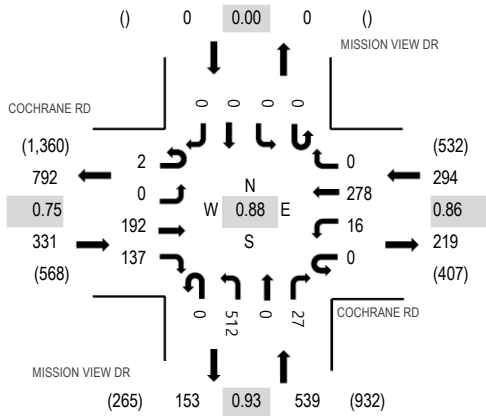

Peak Hour - Pedestrians/Bicycles in Crosswalk

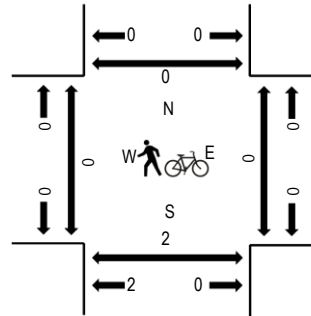

Note: Total study counts contained in parentheses.

Traffic Counts

Interval Start Time	COCHRANE RD Eastbound				COCHRANE RD Westbound				MISSION VIEW DR Northbound				MISSION VIEW DR Southbound				Total	Rolling Hour	Pedestrian Crossings					
	U-Turn	Left	Thru	Right	U-Turn	Left	Thru	Right	U-Turn	Left	Thru	Right	U-Turn	Left	Thru	Right			West	East	South	North		
7:00 AM	0	0	33	17	0	7	58	0	0	0	128	0	18	0	0	0	0	0	261	1,135	0	0	1	1
7:15 AM	1	0	31	17	0	5	70	0	0	0	123	0	10	0	0	0	0	0	257	1,164	0	0	0	0
7:30 AM	0	0	43	24	0	6	84	0	0	0	124	0	5	0	0	0	0	0	286	1,127	0	0	1	0
7:45 AM	1	0	61	55	0	4	77	0	0	0	125	0	8	0	0	0	0	0	331	1,054	0	0	0	0
8:00 AM	0	0	57	41	0	1	47	0	0	0	140	0	4	0	0	0	0	0	290	897	0	0	1	0
8:15 AM	1	0	51	16	0	3	47	0	0	0	94	0	8	0	0	0	0	0	220		0	0	0	0
8:30 AM	0	0	27	34	0	9	57	0	0	0	74	0	12	0	0	0	0	0	213		0	0	0	1
8:45 AM	2	0	32	24	0	2	55	0	0	0	52	0	7	0	0	0	0	0	174		0	0	0	1

Peak Rolling Hour Flow Rates

Vehicle Type	Eastbound				Westbound				Northbound				Southbound				Total
	U-Turn	Left	Thru	Right	U-Turn	Left	Thru	Right	U-Turn	Left	Thru	Right	U-Turn	Left	Thru	Right	
Articulated Trucks	0	0	5	0	0	0	1	0	0	1	0	0	0	0	0	0	7
Lights	2	0	176	130	0	16	276	0	0	505	0	26	0	0	0	0	1,131
Mediums	0	0	11	7	0	0	1	0	0	6	0	1	0	0	0	0	26
Total	2	0	192	137	0	16	278	0	0	512	0	27	0	0	0	0	1,164



(303) 216-2439
www.alltrafficdata.net

Location: 10 MISSION VIEW DR & COCHRANE RD PM

Date and Start Time: Tuesday, May 8, 2018

Peak Hour: 05:00 PM - 06:00 PM

Peak 15-Minutes: 05:30 PM - 05:45 PM

Peak Hour - All Vehicles

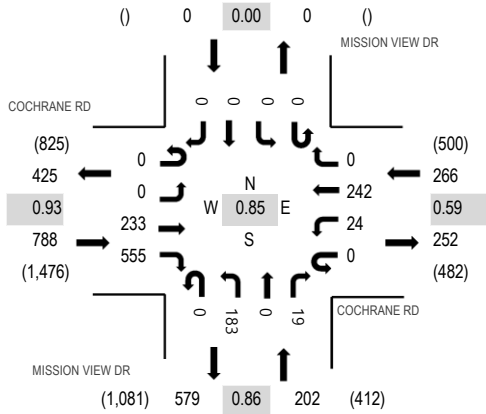

Peak Hour - Pedestrians/Bicycles in Crosswalk

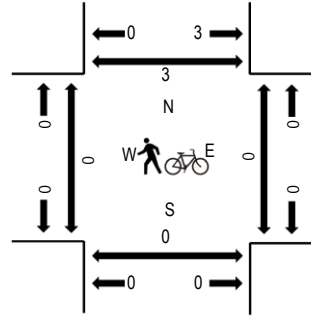

Note: Total study counts contained in parentheses.

Traffic Counts

Interval Start Time	COCHRANE RD Eastbound				COCHRANE RD Westbound				MISSION VIEW DR Northbound				MISSION VIEW DR Southbound				Total	Rolling Hour	Pedestrian Crossings			
	U-Turn	Left	Thru	Right	U-Turn	Left	Thru	Right	U-Turn	Left	Thru	Right	U-Turn	Left	Thru	Right			West	East	South	North
4:00 PM	5	0	48	114	0	14	49	0	0	70	0	3	0	0	0	0	303	1,132	0	1	0	0
4:15 PM	2	0	58	119	0	2	46	0	0	31	0	4	0	0	0	0	262	1,133	0	0	0	0
4:30 PM	2	0	53	108	0	8	59	0	0	57	0	5	0	0	0	0	292	1,174	0	1	0	2
4:45 PM	0	0	56	123	0	14	42	0	0	37	0	3	0	0	0	0	275	1,252	0	0	0	0
5:00 PM	0	0	44	140	0	9	57	0	0	49	0	5	0	0	0	0	304	1,256	0	0	0	3
5:15 PM	0	0	62	134	0	2	41	0	0	57	0	7	0	0	0	0	303		0	0	0	0
5:30 PM	0	0	59	137	0	10	113	0	0	47	0	4	0	0	0	0	370		0	0	0	0
5:45 PM	0	0	68	144	0	3	31	0	0	30	0	3	0	0	0	0	279		0	0	0	0

Peak Rolling Hour Flow Rates

Vehicle Type	Eastbound				Westbound				Northbound				Southbound				Total
	U-Turn	Left	Thru	Right	U-Turn	Left	Thru	Right	U-Turn	Left	Thru	Right	U-Turn	Left	Thru	Right	
Articulated Trucks	0	0	1	0	0	0	0	0	0	0	0	0	0	0	0	0	1
Lights	0	0	230	550	0	24	241	0	0	180	0	18	0	0	0	0	1,243
Mediums	0	0	2	5	0	0	1	0	0	3	0	1	0	0	0	0	12
Total	0	0	233	555	0	24	242	0	0	183	0	19	0	0	0	0	1,256

Traffic Data Service

San Jose, CA
 (408) 622-4787
 tdsbay@cs.com

File Name : 8AM FINAL
 Site Code : 00000008
 Start Date : 3/28/2019
 Page No : 1

Groups Printed- Vehicles

Start Time	MISSION VIEW DR Southbound					AVENIDA DE LOS PADRES Westbound					MISSION VIEW DR Northbound					AVENIDA DE LOS PADRES Eastbound					Int. Total
	Right	Thru	Left	Peds	App. Total	Right	Thru	Left	Peds	App. Total	Right	Thru	Left	Peds	App. Total	Right	Thru	Left	Peds	App. Total	
07:00 AM	0	15	0	0	15	12	0	5	0	17	3	88	0	0	91	0	0	0	0	0	123
07:15 AM	0	29	1	0	30	14	0	17	0	31	1	92	0	0	93	0	0	0	0	0	154
07:30 AM	0	40	1	0	41	20	0	18	0	38	3	129	0	0	132	0	0	0	0	0	211
07:45 AM	0	37	7	0	44	21	0	5	0	26	8	128	0	0	136	0	0	0	0	0	206
Total	0	121	9	0	130	67	0	45	0	112	15	437	0	0	452	0	0	0	0	0	694
08:00 AM	0	23	7	0	30	6	0	3	0	9	5	116	0	0	121	0	0	0	0	0	160
08:15 AM	0	8	11	0	19	25	0	5	0	30	2	108	0	0	110	0	0	0	0	0	159
08:30 AM	0	17	5	0	22	17	0	3	0	20	6	76	0	0	82	0	0	0	0	0	124
08:45 AM	0	10	2	0	12	11	0	5	0	16	3	72	0	0	75	0	0	0	0	0	103
Total	0	58	25	0	83	59	0	16	0	75	16	372	0	0	388	0	0	0	0	0	546
Grand Total	0	179	34	0	213	126	0	61	0	187	31	809	0	0	840	0	0	0	0	0	1240
Apprch %	0	84	16	0		67.4	0	32.6	0		3.7	96.3	0	0		0	0	0	0	0	
Total %	0	14.4	2.7	0	17.2	10.2	0	4.9	0	15.1	2.5	65.2	0	0	67.7	0	0	0	0	0	

Start Time	MISSION VIEW DR Southbound					AVENIDA DE LOS PADRES Westbound					MISSION VIEW DR Northbound					AVENIDA DE LOS PADRES Eastbound					Int. Total
	Right	Thru	Left	Peds	App. Total	Right	Thru	Left	Peds	App. Total	Right	Thru	Left	Peds	App. Total	Right	Thru	Left	Peds	App. Total	
07:30 AM	0	40	1		41	20	0	18		38	3	129	0		132	0	0	0	0		211
07:45 AM	0	37	7		44	21	0	5		26	8	128	0		136	0	0	0	0		206
08:00 AM	0	23	7		30	6	0	3		9	5	116	0		121	0	0	0	0		160
08:15 AM	0	8	11		19	25	0	5		30	2	108	0		110	0	0	0	0		159
Total Volume	0	108	26		134	72	0	31		103	18	481	0		499	0	0	0	0		736
% App. Total	0	80.6	19.4			69.9	0	30.1			3.6	96.4	0			0	0	0	0		
PHF	.000	.675	.591		.761	.720	.000	.431		.678	.563	.932	.000		.917	.000	.000	.000	.000		.872

Peak Hour Analysis From 07:00 AM to 08:45 AM - Peak 1 of 1
 Peak Hour for Entire Intersection Begins at 07:30 AM

Traffic Data Service

San Jose, CA
 (408) 622-4787
 tdsbay@cs.com

File Name : 8AM FINAL
 Site Code : 00000008
 Start Date : 3/28/2019
 Page No : 2

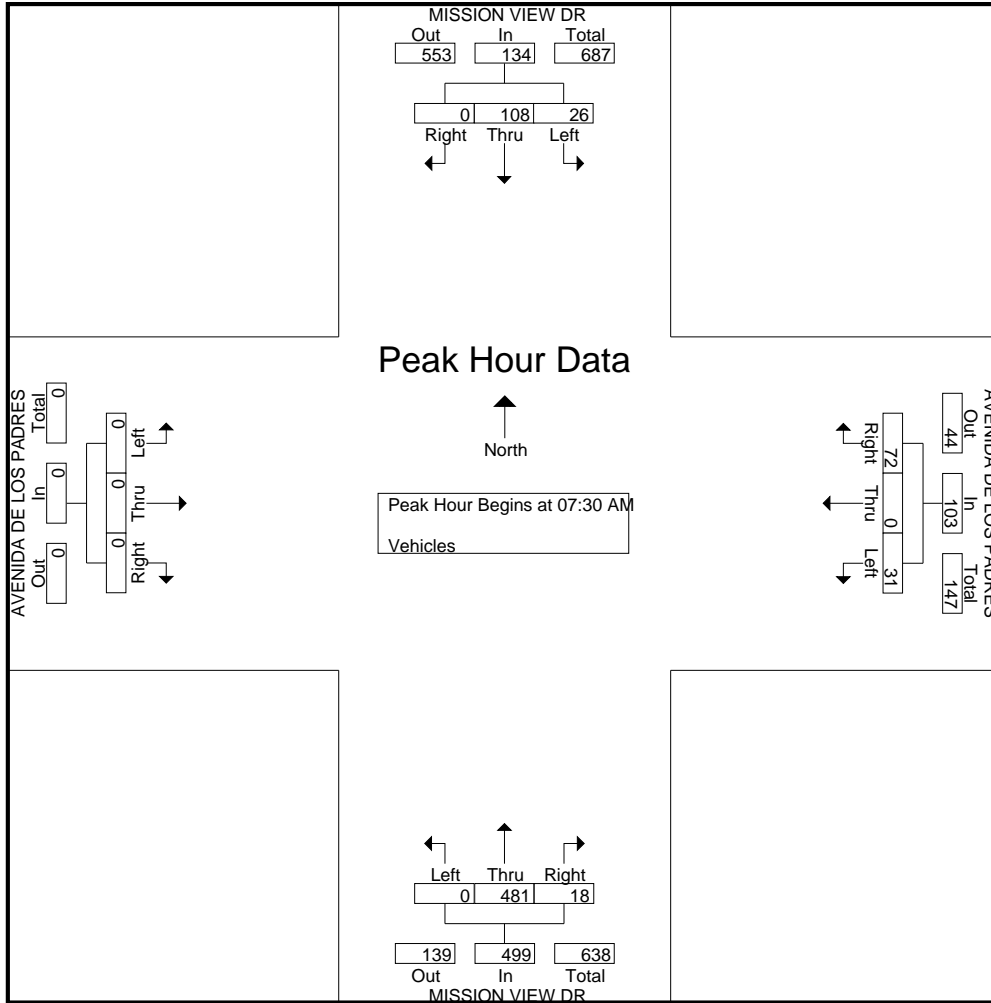

Traffic Data Service

San Jose, CA
 (408) 622-4787
 tdsbay@cs.com

File Name : 8PM FINAL
 Site Code : 00000008
 Start Date : 3/28/2019
 Page No : 1

Groups Printed- Vehicles

Start Time	MISSION VIEW DR Southbound					AVENIDA DE LOS PADRES Westbound					MISSION VIEW DR Northbound					AVENIDA DE LOS PADRES Eastbound					Int. Total
	Right	Thru	Left	Peds	App. Total	Right	Thru	Left	Peds	App. Total	Right	Thru	Left	Peds	App. Total	Right	Thru	Left	Peds	App. Total	
04:00 PM	0	80	14	0	94	6	0	6	0	12	5	40	0	0	45	0	0	0	0	0	151
04:15 PM	0	114	8	0	122	6	0	7	4	17	3	40	0	0	43	0	0	0	0	0	182
04:30 PM	0	109	19	0	128	7	0	8	1	16	3	42	0	0	45	0	0	0	0	0	189
04:45 PM	0	118	16	0	134	7	0	6	3	16	5	43	0	0	48	0	0	0	0	0	198
Total	0	421	57	0	478	26	0	27	8	61	16	165	0	0	181	0	0	0	0	0	720
05:00 PM	0	116	12	0	128	6	0	8	0	14	9	40	0	0	49	0	0	0	0	0	191
05:15 PM	0	142	13	0	155	6	0	3	1	10	9	43	0	0	52	0	0	0	0	0	217
05:30 PM	0	119	16	0	135	10	0	4	0	14	5	53	0	0	58	0	0	0	0	0	207
05:45 PM	0	93	10	0	103	10	0	8	0	18	7	34	0	0	41	0	0	0	0	0	162
Total	0	470	51	0	521	32	0	23	1	56	30	170	0	0	200	0	0	0	0	0	777
Grand Total	0	891	108	0	999	58	0	50	9	117	46	335	0	0	381	0	0	0	0	0	1497
Apprch %	0	89.2	10.8	0		49.6	0	42.7	7.7		12.1	87.9	0	0		0	0	0	0		
Total %	0	59.5	7.2	0	66.7	3.9	0	3.3	0.6	7.8	3.1	22.4	0	0	25.5	0	0	0	0	0	

Start Time	MISSION VIEW DR Southbound				AVENIDA DE LOS PADRES Westbound				MISSION VIEW DR Northbound				AVENIDA DE LOS PADRES Eastbound				Int. Total
	Right	Thru	Left	App. Total	Right	Thru	Left	App. Total	Right	Thru	Left	App. Total	Right	Thru	Left	App. Total	
Peak Hour Analysis From 04:00 PM to 05:45 PM - Peak 1 of 1																	
Peak Hour for Entire Intersection Begins at 04:45 PM																	
04:45 PM	0	118	16	134	7	0	6	13	5	43	0	48	0	0	0	0	195
05:00 PM	0	116	12	128	6	0	8	14	9	40	0	49	0	0	0	0	191
05:15 PM	0	142	13	155	6	0	3	9	9	43	0	52	0	0	0	0	216
05:30 PM	0	119	16	135	10	0	4	14	5	53	0	58	0	0	0	0	207
Total Volume	0	495	57	552	29	0	21	50	28	179	0	207	0	0	0	0	809
% App. Total	0	89.7	10.3		58	0	42		13.5	86.5	0		0	0	0		
PHF	.000	.871	.891	.890	.725	.000	.656	.893	.778	.844	.000	.892	.000	.000	.000	.000	.936

Traffic Data Service

San Jose, CA
 (408) 622-4787
 tdsbay@cs.com

File Name : 8PM FINAL
 Site Code : 00000008
 Start Date : 3/28/2019
 Page No : 2

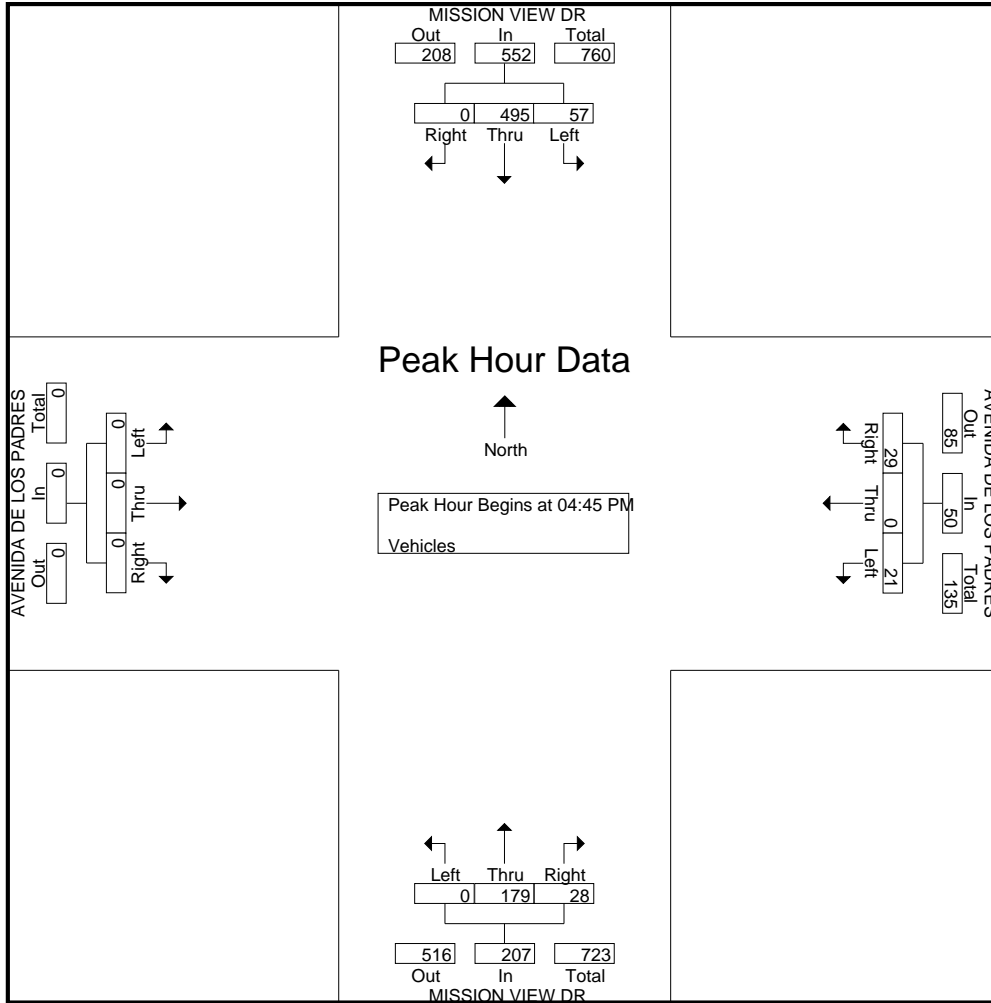

Traffic Data Service

San Jose, CA
 (408) 622-4787
 tdsbay@cs.com

File Name : 9AM FINAL
 Site Code : 00000009
 Start Date : 3/28/2019
 Page No : 1

Groups Printed- Vehicles

Start Time	MISSION VIEW DR Southbound					HALF RD Westbound					Northbound					HALF RD Eastbound					Int. Total
	Right	Thru	Left	Peds	App. Total	Right	Thru	Left	Peds	App. Total	Right	Thru	Left	Peds	App. Total	Right	Thru	Left	Peds	App. Total	
07:00 AM	16	0	4	1	21	34	2	0	1	37	0	0	0	0	0	0	2	57	1	60	118
07:15 AM	32	0	12	0	44	38	5	0	0	43	0	0	0	0	0	0	0	54	0	54	141
07:30 AM	49	0	14	0	63	63	4	0	0	67	0	0	0	0	0	0	7	72	0	79	209
07:45 AM	25	0	13	0	38	49	3	0	0	52	0	0	0	0	0	0	5	85	0	90	180
Total	122	0	43	1	166	184	14	0	1	199	0	0	0	0	0	0	14	268	1	283	648
08:00 AM	10	0	15	0	25	42	4	0	0	46	0	0	0	0	0	0	1	80	0	81	152
08:15 AM	11	0	4	0	15	28	1	0	0	29	0	0	0	0	0	0	5	83	0	88	132
08:30 AM	17	0	3	0	20	21	0	0	0	21	0	0	0	0	0	0	6	57	0	63	104
08:45 AM	10	0	5	0	15	13	4	0	0	17	0	0	0	0	0	0	7	66	0	73	105
Total	48	0	27	0	75	104	9	0	0	113	0	0	0	0	0	0	19	286	0	305	493
Grand Total	170	0	70	1	241	288	23	0	1	312	0	0	0	0	0	0	33	554	1	588	1141
Apprch %	70.5	0	29	0.4		92.3	7.4	0	0.3		0	0	0	0	0	0	5.6	94.2	0.2		
Total %	14.9	0	6.1	0.1	21.1	25.2	2	0	0.1	27.3	0	0	0	0	0	0	2.9	48.6	0.1	51.5	

Start Time	MISSION VIEW DR Southbound					HALF RD Westbound					Northbound					HALF RD Eastbound					Int. Total
	Right	Thru	Left	Peds	App. Total	Right	Thru	Left	Peds	App. Total	Right	Thru	Left	Peds	App. Total	Right	Thru	Left	Peds	App. Total	
Peak Hour Analysis From 07:00 AM to 08:45 AM - Peak 1 of 1																					
Peak Hour for Entire Intersection Begins at 07:15 AM																					
07:15 AM	32	0	12		44	38	5	0		43	0	0	0		0	0	54		54	141	
07:30 AM	49	0	14		63	63	4	0		67	0	0	0		0	0	7	72		79	209
07:45 AM	25	0	13		38	49	3	0		52	0	0	0		0	5	85		90	180	
08:00 AM	10	0	15		25	42	4	0		46	0	0	0		0	1	80		81	152	
Total Volume	116	0	54		170	192	16	0		208	0	0	0		0	13	291		304	682	
% App. Total	68.2	0	31.8			92.3	7.7	0			0	0	0		0	4.3	95.7				
PHF	.592	.000	.900		.675	.762	.800	.000		.776	.000	.000	.000		.000	.464	.856		.844	.816	

Traffic Data Service

San Jose, CA
 (408) 622-4787
 tdsbay@cs.com

File Name : 9AM FINAL
 Site Code : 00000009
 Start Date : 3/28/2019
 Page No : 2

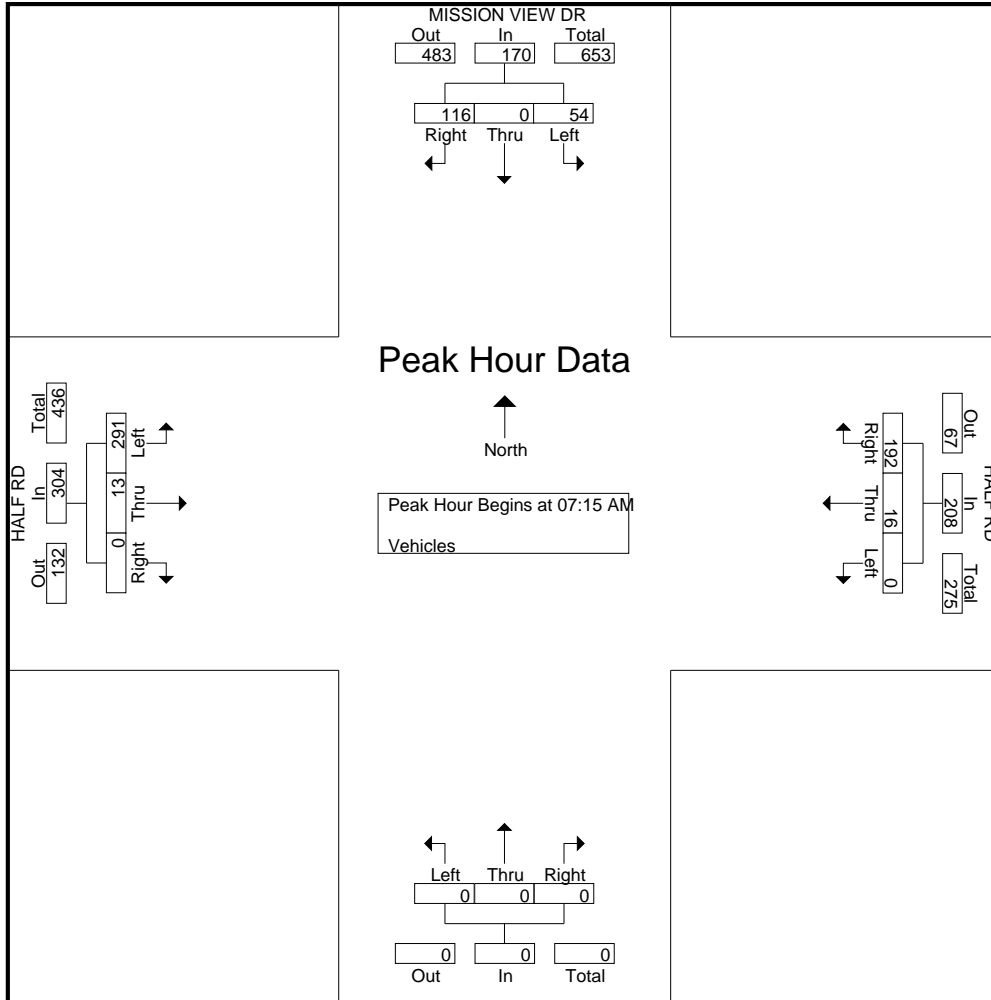

Traffic Data Service

San Jose, CA
 (408) 622-4787
 tdsbay@cs.com

File Name : 9PM FINAL
 Site Code : 00000009
 Start Date : 3/28/2019
 Page No : 1

Groups Printed- Vehicles

Start Time	MISSION VIEW DR Southbound					HALF RD Westbound					Northbound					HALF RD Eastbound					Int. Total
	Right	Thru	Left	Peds	App. Total	Right	Thru	Left	Peds	App. Total	Right	Thru	Left	Peds	App. Total	Right	Thru	Left	Peds	App. Total	
04:00 PM	39	0	55	0	94	9	4	0	0	13	0	0	0	0	0	0	4	38	0	42	149
04:15 PM	67	0	48	0	115	17	8	0	0	25	0	0	0	0	0	0	5	26	0	31	171
04:30 PM	44	0	69	1	114	15	3	0	0	18	0	0	0	0	0	0	7	28	0	35	167
04:45 PM	58	0	66	0	124	15	6	0	0	21	0	0	0	0	0	0	4	32	0	36	181
Total	208	0	238	1	447	56	21	0	0	77	0	0	0	0	0	0	20	124	0	144	668
05:00 PM	59	0	62	0	121	13	14	0	0	27	0	0	0	0	0	0	4	37	0	41	189
05:15 PM	61	0	86	0	147	16	8	0	1	25	0	0	0	0	0	0	10	38	0	48	220
05:30 PM	54	0	73	0	127	18	4	0	0	22	0	0	0	0	0	0	9	40	0	49	198
05:45 PM	49	0	54	0	103	14	10	0	0	24	0	0	0	0	0	0	5	26	0	31	158
Total	223	0	275	0	498	61	36	0	1	98	0	0	0	0	0	0	28	141	0	169	765
Grand Total	431	0	513	1	945	117	57	0	1	175	0	0	0	0	0	0	48	265	0	313	1433
Apprch %	45.6	0	54.3	0.1		66.9	32.6	0	0.6		0	0	0	0	0	0	15.3	84.7	0		
Total %	30.1	0	35.8	0.1	65.9	8.2	4	0	0.1	12.2	0	0	0	0	0	0	3.3	18.5	0	21.8	

Start Time	MISSION VIEW DR Southbound					HALF RD Westbound					Northbound					HALF RD Eastbound					Int. Total
	Right	Thru	Left	Peds	App. Total	Right	Thru	Left	Peds	App. Total	Right	Thru	Left	Peds	App. Total	Right	Thru	Left	Peds	App. Total	
Peak Hour Analysis From 04:00 PM to 05:45 PM - Peak 1 of 1																					
Peak Hour for Entire Intersection Begins at 04:45 PM																					
04:45 PM	58	0	66		124	15	6	0		21	0	0	0		0	4	32		36	181	
05:00 PM	59	0	62		121	13	14	0		27	0	0	0		0	4	37		41	189	
05:15 PM	61	0	86		147	16	8	0		24	0	0	0		0	10	38		48	219	
05:30 PM	54	0	73		127	18	4	0		22	0	0	0		0	9	40		49	198	
Total Volume	232	0	287		519	62	32	0		94	0	0	0		0	27	147		174	787	
% App. Total	44.7	0	55.3			66	34	0			0	0	0		0	15.5	84.5				
PHF	.951	.000	.834		.883	.861	.571	.000		.870	.000	.000	.000		.000	.675	.919		.888	.898	

Traffic Data Service

San Jose, CA
 (408) 622-4787
 tdsbay@cs.com

File Name : 9PM FINAL
 Site Code : 00000009
 Start Date : 3/28/2019
 Page No : 2

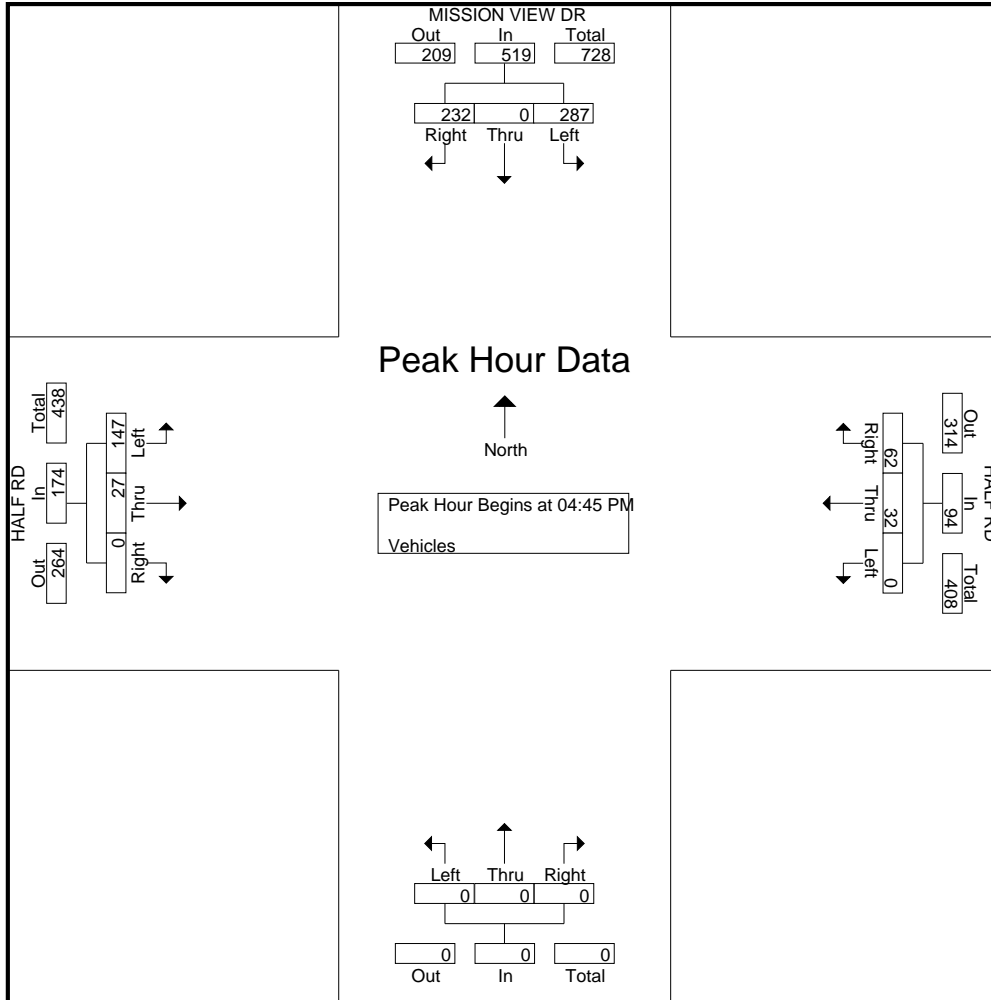



(303) 216-2439
www.alltrafficdata.net

Location: 20 CONDIT RD & MAIN AVE AM
Date and Start Time: Tuesday, May 8, 2018
Peak Hour: 07:30 AM - 08:30 AM
Peak 15-Minutes: 08:00 AM - 08:15 AM

Peak Hour - All Vehicles

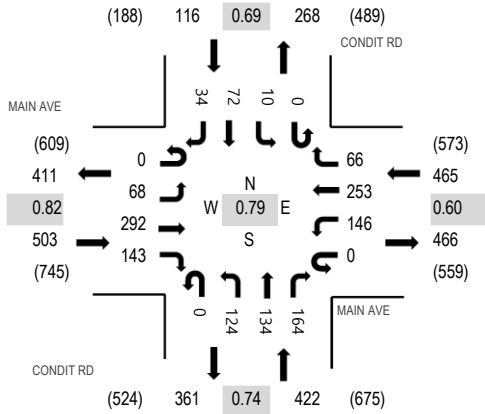

Peak Hour - Pedestrians/Bicycles in Crosswalk

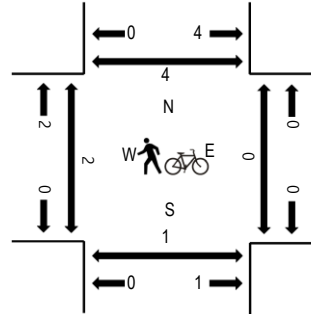

Note: Total study counts contained in parentheses.

Traffic Counts

Interval Start Time	MAIN AVE Eastbound				MAIN AVE Westbound				CONDIT RD Northbound				CONDIT RD Southbound				Total	Rolling Hour	Pedestrian Crossings			
	U-Turn	Left	Thru	Right	U-Turn	Left	Thru	Right	U-Turn	Left	Thru	Right	U-Turn	Left	Thru	Right			West	East	South	North
7:00 AM	0	24	4	16	0	3	15	2	0	18	39	8	0	0	6	7	142	1,169	0	0	0	0
7:15 AM	0	24	14	33	0	7	14	8	0	26	35	13	0	0	15	7	196	1,504	0	0	1	0
7:30 AM	0	21	62	60	0	26	48	8	0	30	37	28	0	1	36	5	362	1,506	0	0	0	0
7:45 AM	0	8	120	29	0	41	88	19	0	38	43	63	0	4	5	11	469	1,325	2	0	0	3
8:00 AM	0	20	94	28	0	71	91	32	0	27	23	61	0	2	16	12	477	1,012	0	0	0	0
8:15 AM	0	19	16	26	0	8	26	7	0	29	31	12	0	3	15	6	198		0	0	0	0
8:30 AM	0	15	20	33	0	10	17	3	0	28	32	7	0	0	8	8	181		0	0	0	0
8:45 AM	0	15	21	23	0	6	22	1	0	20	23	4	0	2	3	16	156		0	1	0	0

Peak Rolling Hour Flow Rates

Vehicle Type	Eastbound				Westbound				Northbound				Southbound				Total
	U-Turn	Left	Thru	Right	U-Turn	Left	Thru	Right	U-Turn	Left	Thru	Right	U-Turn	Left	Thru	Right	
Articulated Trucks	0	0	1	1	0	0	0	0	0	0	3	1	0	0	0	0	6
Lights	0	68	289	139	0	143	249	66	0	122	127	162	0	10	72	34	1,481
Mediums	0	0	2	3	0	3	4	0	0	2	4	1	0	0	0	0	19
Total	0	68	292	143	0	146	253	66	0	124	134	164	0	10	72	34	1,506



(303) 216-2439
www.alltrafficdata.net

Location: 20 CONDIT RD & MAIN AVE PM
Date and Start Time: Tuesday, May 8, 2018
Peak Hour: 05:00 PM - 06:00 PM
Peak 15-Minutes: 05:45 PM - 06:00 PM

Peak Hour - All Vehicles

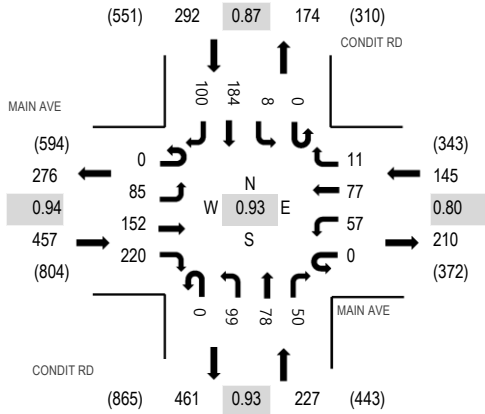

Peak Hour - Pedestrians/Bicycles in Crosswalk

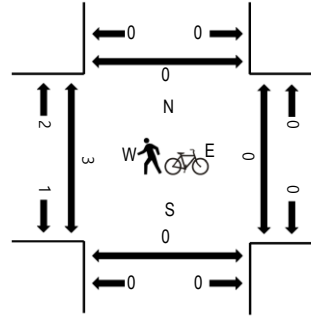

Note: Total study counts contained in parentheses.

Traffic Counts

Interval Start Time	MAIN AVE Eastbound				MAIN AVE Westbound				CONDIT RD Northbound				CONDIT RD Southbound				Total	Rolling Hour	Pedestrian Crossings			
	U-Turn	Left	Thru	Right	U-Turn	Left	Thru	Right	U-Turn	Left	Thru	Right	U-Turn	Left	Thru	Right			West	East	South	North
4:00 PM	0	16	26	35	0	23	30	5	0	25	22	12	0	1	41	23	259	1,020	0	0	0	2
4:15 PM	0	15	34	52	0	13	32	3	0	28	15	3	0	4	35	21	255	1,031	0	1	0	0
4:30 PM	0	14	31	49	0	20	37	5	0	35	18	14	0	3	33	20	279	1,049	0	0	0	0
4:45 PM	0	10	22	43	0	12	17	1	0	24	12	8	0	4	48	26	227	1,047	0	0	0	0
5:00 PM	0	22	31	57	0	6	14	0	0	25	23	7	0	1	59	25	270	1,121	0	0	0	0
5:15 PM	0	26	41	55	0	13	9	5	0	21	24	10	0	4	39	26	273		1	0	0	0
5:30 PM	0	18	39	55	0	14	27	3	0	27	17	12	0	1	41	23	277		2	0	0	0
5:45 PM	0	19	41	53	0	24	27	3	0	26	14	21	0	2	45	26	301		0	0	0	0

Peak Rolling Hour Flow Rates

Vehicle Type	Eastbound				Westbound				Northbound				Southbound				Total
	U-Turn	Left	Thru	Right	U-Turn	Left	Thru	Right	U-Turn	Left	Thru	Right	U-Turn	Left	Thru	Right	
Articulated Trucks	0	0	0	0	0	0	0	0	0	0	0	0	0	0	0	0	0
Lights	0	85	151	218	0	56	76	11	0	99	74	50	0	8	183	100	1,111
Mediums	0	0	1	2	0	1	1	0	0	0	4	0	0	0	1	0	10
Total	0	85	152	220	0	57	77	11	0	99	78	50	0	8	184	100	1,121

Traffic Data Service

San Jose, CA
 (408) 622-4787
 tdsbay@cs.com

File Name : 3AM FINAL
 Site Code : 00000003
 Start Date : 6/4/2019
 Page No : 1

Groups Printed- Vehicles

Start Time	CONDIT RD Southbound					DIANA AVE Westbound					CONDIT RD Northbound					DIANA AVE Eastbound					Int. Total
	Right	Thru	Left	Peds	App. Total	Right	Thru	Left	Peds	App. Total	Right	Thru	Left	Peds	App. Total	Right	Thru	Left	Peds	App. Total	
07:00 AM	1	18	1	0	20	9	0	13	0	22	0	28	0	0	28	1	0	0	0	1	71
07:15 AM	0	30	18	0	48	19	1	9	0	29	4	39	1	1	45	1	0	0	0	1	123
07:30 AM	1	56	61	0	118	51	0	13	0	64	1	58	0	1	60	0	0	0	0	0	242
07:45 AM	1	74	16	0	91	69	0	15	0	84	5	77	0	0	82	0	0	0	1	1	258
Total	3	178	96	0	277	148	1	50	0	199	10	202	1	2	215	2	0	0	1	3	694
08:00 AM	0	68	8	0	76	35	2	12	0	49	4	62	0	0	66	1	0	0	0	1	192
08:15 AM	1	43	16	0	60	28	0	11	0	39	3	45	1	0	49	3	1	0	0	4	152
08:30 AM	0	36	7	0	43	21	0	14	0	35	2	58	0	0	60	0	0	0	0	0	138
08:45 AM	0	34	9	0	43	30	0	9	0	39	5	46	0	1	52	1	0	0	0	1	135
Total	1	181	40	0	222	114	2	46	0	162	14	211	1	1	227	5	1	0	0	6	617
Grand Total	4	359	136	0	499	262	3	96	0	361	24	413	2	3	442	7	1	0	1	9	1311
Apprch %	0.8	71.9	27.3	0		72.6	0.8	26.6	0		5.4	93.4	0.5	0.7		77.8	11.1	0	11.1		
Total %	0.3	27.4	10.4	0	38.1	20	0.2	7.3	0	27.5	1.8	31.5	0.2	0.2	33.7	0.5	0.1	0	0.1	0.7	

Start Time	CONDIT RD Southbound					DIANA AVE Westbound					CONDIT RD Northbound					DIANA AVE Eastbound					Int. Total
	Right	Thru	Left	Peds	App. Total	Right	Thru	Left	Peds	App. Total	Right	Thru	Left	Peds	App. Total	Right	Thru	Left	Peds	App. Total	
Peak Hour Analysis From 07:00 AM to 08:45 AM - Peak 1 of 1																					
Peak Hour for Entire Intersection Begins at 07:30 AM																					
07:30 AM	1	56	61		118	51	0	13		64	1	58	0		59	0	0	0		0	241
07:45 AM	1	74	16		91	69	0	15		84	5	77	0		82	0	0	0		0	257
08:00 AM	0	68	8		76	35	2	12		49	4	62	0		66	1	0	0		1	192
08:15 AM	1	43	16		60	28	0	11		39	3	45	1		49	3	1	0		4	152
Total Volume	3	241	101		345	183	2	51		236	13	242	1		256	4	1	0		5	842
% App. Total	0.9	69.9	29.3			77.5	0.8	21.6			5.1	94.5	0.4			80	20	0			
PHF	.750	.814	.414		.731	.663	.250	.850		.702	.650	.786	.250		.780	.333	.250	.000		.313	.819

Traffic Data Service

San Jose, CA
 (408) 622-4787
 tdsbay@cs.com

File Name : 3AM FINAL
 Site Code : 00000003
 Start Date : 6/4/2019
 Page No : 2

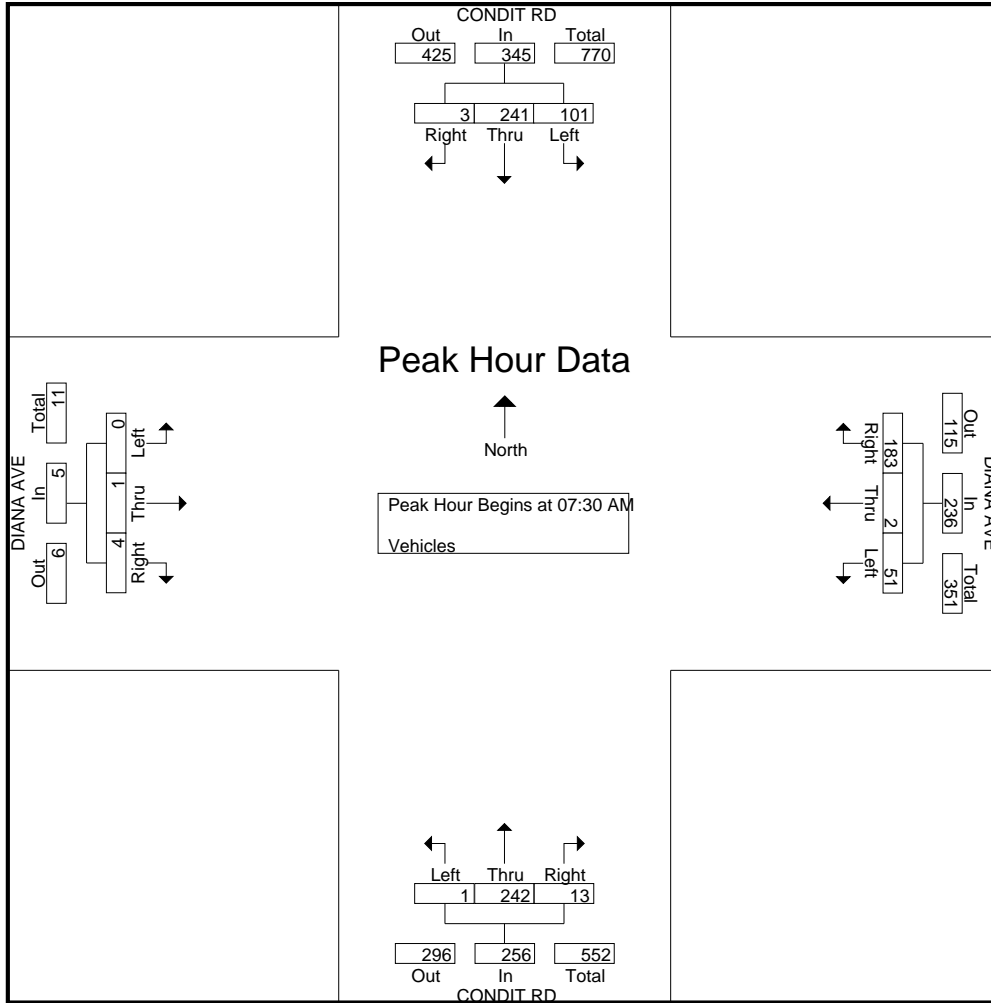

Traffic Data Service

San Jose, CA
 (408) 622-4787
 tdsbay@cs.com

File Name : 3PM FINAL
 Site Code : 00000003
 Start Date : 6/4/2019
 Page No : 1

Groups Printed- Vehicles

Start Time	CONDIT RD Southbound					DIANA AVE Westbound					CONDIT RD Northbound					DIANA AVE Eastbound					Int. Total
	Right	Thru	Left	Peds	App. Total	Right	Thru	Left	Peds	App. Total	Right	Thru	Left	Peds	App. Total	Right	Thru	Left	Peds	App. Total	
04:00 PM	1	87	27	0	115	10	0	10	0	20	3	33	0	0	36	0	0	0	0	0	171
04:15 PM	2	78	37	0	117	11	0	5	0	16	6	25	1	0	32	1	1	1	0	3	168
04:30 PM	0	86	31	0	117	14	0	6	0	20	5	32	0	0	37	0	0	0	0	0	174
04:45 PM	0	114	33	0	147	16	0	9	0	25	11	27	1	0	39	2	0	0	0	2	213
Total	3	365	128	0	496	51	0	30	0	81	25	117	2	0	144	3	1	1	0	5	726
05:00 PM	0	89	33	0	122	9	0	4	0	13	10	43	1	0	54	2	0	0	0	2	191
05:15 PM	0	83	40	0	123	16	0	7	0	23	8	49	0	0	57	3	0	0	0	3	206
05:30 PM	0	94	36	0	130	16	0	4	0	20	9	55	0	0	64	0	0	0	0	0	214
05:45 PM	0	77	32	0	109	14	0	5	0	19	6	47	2	0	55	0	0	0	0	0	183
Total	0	343	141	0	484	55	0	20	0	75	33	194	3	0	230	5	0	0	0	5	794
Grand Total	3	708	269	0	980	106	0	50	0	156	58	311	5	0	374	8	1	1	0	10	1520
Apprch %	0.3	72.2	27.4	0		67.9	0	32.1	0		15.5	83.2	1.3	0		80	10	10	0		
Total %	0.2	46.6	17.7	0	64.5	7	0	3.3	0	10.3	3.8	20.5	0.3	0	24.6	0.5	0.1	0.1	0	0.7	

Start Time	CONDIT RD Southbound					DIANA AVE Westbound					CONDIT RD Northbound					DIANA AVE Eastbound					Int. Total
	Right	Thru	Left	Peds	App. Total	Right	Thru	Left	Peds	App. Total	Right	Thru	Left	Peds	App. Total	Right	Thru	Left	Peds	App. Total	
Peak Hour Analysis From 04:00 PM to 05:45 PM - Peak 1 of 1																					
Peak Hour for Entire Intersection Begins at 04:45 PM																					
04:45 PM	0	114	33		147	16	0	9		25	11	27	1		39	2	0	0		2	213
05:00 PM	0	89	33		122	9	0	4		13	10	43	1		54	2	0	0		2	191
05:15 PM	0	83	40		123	16	0	7		23	8	49	0		57	3	0	0		3	206
05:30 PM	0	94	36		130	16	0	4		20	9	55	0		64	0	0	0		0	214
Total Volume	0	380	142		522	57	0	24		81	38	174	2		214	7	0	0		7	824
% App. Total	0	72.8	27.2			70.4	0	29.6			17.8	81.3	0.9			100	0	0			
PHF	.000	.833	.888		.888	.891	.000	.667		.810	.864	.791	.500		.836	.583	.000	.000		.583	.963

Traffic Data Service

San Jose, CA
 (408) 622-4787
 tdsbay@cs.com

File Name : 3PM FINAL
 Site Code : 00000003
 Start Date : 6/4/2019
 Page No : 2

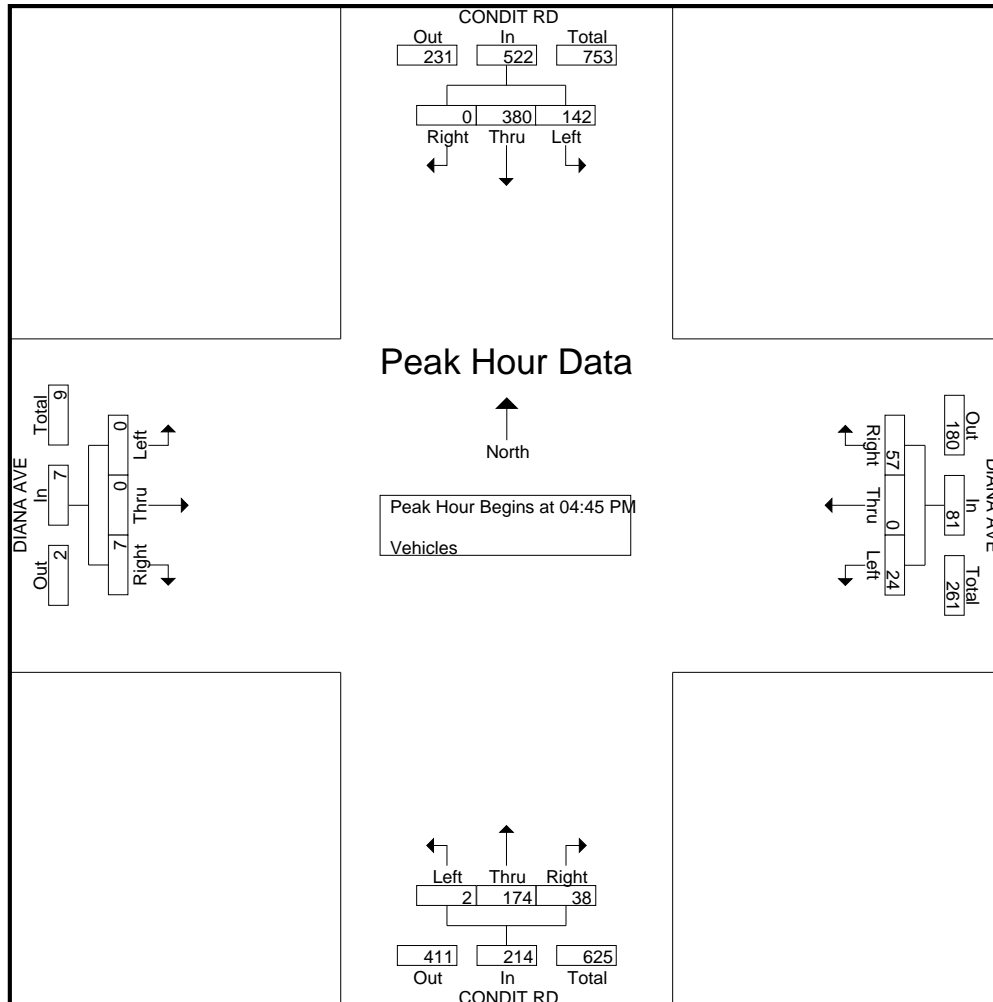

Traffic Data Service

San Jose, CA
(408) 622-4787
tdsbay@cs.com

File Name : 6AM FINAL
Site Code : 00000006
Start Date : 3/28/2019
Page No : 1

Groups Printed- Vehicles

Start Time	CONDIT RD Southbound					E DUNNE AVE Westbound					CONDIT RD Northbound					E DUNNE AVE Eastbound					Int. Total
	Right	Thru	Left	Peds	App. Total	Right	Thru	Left	Peds	App. Total	Right	Thru	Left	Peds	App. Total	Right	Thru	Left	Peds	App. Total	
07:00 AM	38	8	4	1	51	10	269	0	0	279	6	35	41	0	82	3	37	26	0	66	478
07:15 AM	60	11	14	2	87	12	270	2	0	284	7	26	46	0	79	7	81	16	2	106	556
07:30 AM	62	6	33	1	102	23	292	5	0	320	5	45	43	0	93	7	112	39	1	159	674
07:45 AM	73	17	12	0	102	20	350	1	0	371	4	60	34	0	98	8	50	54	2	114	685
Total	233	42	63	4	342	65	1181	8	0	1254	22	166	164	0	352	25	280	135	5	445	2393
08:00 AM	105	19	15	1	140	25	272	3	0	300	8	56	38	0	102	7	71	41	0	119	661
08:15 AM	87	12	9	0	108	11	246	2	0	259	5	37	36	0	78	14	72	46	0	132	577
08:30 AM	76	9	8	0	93	32	225	2	0	259	2	35	33	0	70	9	50	41	0	100	522
08:45 AM	66	6	8	0	80	15	193	3	0	211	1	36	37	0	74	9	50	50	0	109	474
Total	334	46	40	1	421	83	936	10	0	1029	16	164	144	0	324	39	243	178	0	460	2234
Grand Total	567	88	103	5	763	148	2117	18	0	2283	38	330	308	0	676	64	523	313	5	905	4627
Apprch %	74.3	11.5	13.5	0.7		6.5	92.7	0.8	0		5.6	48.8	45.6	0		7.1	57.8	34.6	0.6		
Total %	12.3	1.9	2.2	0.1	16.5	3.2	45.8	0.4	0	49.3	0.8	7.1	6.7	0	14.6	1.4	11.3	6.8	0.1	19.6	

Start Time	CONDIT RD Southbound				E DUNNE AVE Westbound				CONDIT RD Northbound				E DUNNE AVE Eastbound				Int. Total
	Right	Thru	Left	App. Total	Right	Thru	Left	App. Total	Right	Thru	Left	App. Total	Right	Thru	Left	App. Total	
Peak Hour Analysis From 07:00 AM to 08:45 AM - Peak 1 of 1																	
Peak Hour for Entire Intersection Begins at 07:30 AM																	
07:30 AM	62	6	33	101	23	292	5	320	5	45	43	93	7	112	39	158	672
07:45 AM	73	17	12	102	20	350	1	371	4	60	34	98	8	50	54	112	683
08:00 AM	105	19	15	139	25	272	3	300	8	56	38	102	7	71	41	119	660
08:15 AM	87	12	9	108	11	246	2	259	5	37	36	78	14	72	46	132	577
Total Volume	327	54	69	450	79	1160	11	1250	22	198	151	371	36	305	180	521	2592
% App. Total	72.7	12	15.3		6.3	92.8	0.9		5.9	53.4	40.7		6.9	58.5	34.5		
PHF	.779	.711	.523	.809	.790	.829	.550	.842	.688	.825	.878	.909	.643	.681	.833	.824	.949

Traffic Data Service

San Jose, CA
 (408) 622-4787
 tdsbay@cs.com

File Name : 6AM FINAL
 Site Code : 00000006
 Start Date : 3/28/2019
 Page No : 2

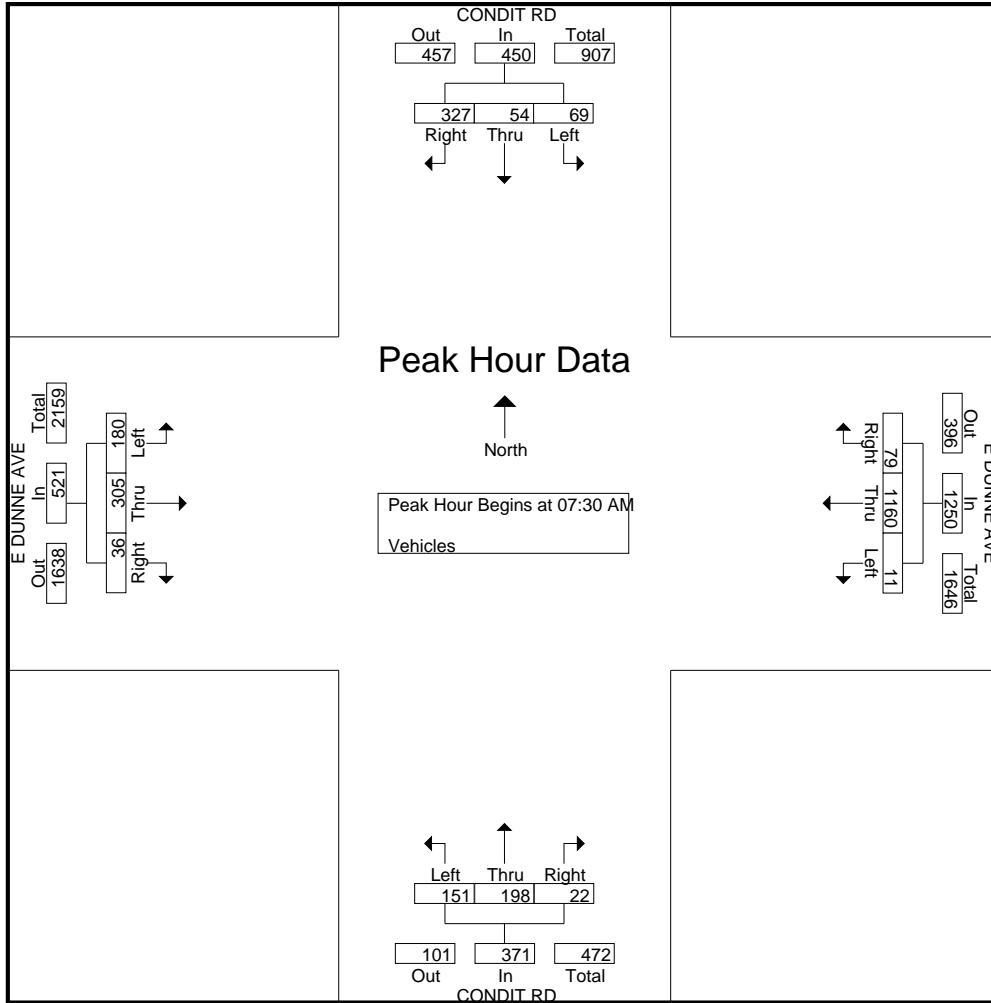

Traffic Data Service

San Jose, CA
(408) 622-4787
tdsbay@cs.com

File Name : 6PM FINAL
Site Code : 00000006
Start Date : 3/28/2019
Page No : 1

Groups Printed- Vehicles

Start Time	CONDIT RD Southbound					E DUNNE AVE Westbound					CONDIT RD Northbound					E DUNNE AVE Eastbound					Int. Total
	Right	Thru	Left	Peds	App. Total	Right	Thru	Left	Peds	App. Total	Right	Thru	Left	Peds	App. Total	Right	Thru	Left	Peds	App. Total	
04:00 PM	66	36	21	0	123	8	109	3	0	120	2	11	9	0	22	15	132	70	1	218	483
04:15 PM	68	31	30	0	129	11	99	6	0	116	5	20	11	0	36	17	124	52	0	193	474
04:30 PM	66	22	18	0	106	11	98	6	0	115	5	18	11	0	34	13	129	62	0	204	459
04:45 PM	55	39	26	0	120	11	93	20	0	124	4	18	16	0	38	16	120	54	1	191	473
Total	255	128	95	0	478	41	399	35	0	475	16	67	47	0	130	61	505	238	2	806	1889
05:00 PM	58	32	18	2	110	14	89	6	0	109	6	18	21	0	45	13	133	45	0	191	455
05:15 PM	52	25	31	0	108	9	89	9	0	107	2	12	15	0	29	17	158	67	0	242	486
05:30 PM	48	25	24	0	97	16	95	3	0	114	7	23	15	0	45	12	146	51	0	209	465
05:45 PM	54	23	20	2	99	25	80	7	0	112	4	17	15	0	36	20	151	55	0	226	473
Total	212	105	93	4	414	64	353	25	0	442	19	70	66	0	155	62	588	218	0	868	1879
Grand Total	467	233	188	4	892	105	752	60	0	917	35	137	113	0	285	123	1093	456	2	1674	3768
Apprch %	52.4	26.1	21.1	0.4		11.5	82	6.5	0		12.3	48.1	39.6	0		7.3	65.3	27.2	0.1		
Total %	12.4	6.2	5	0.1	23.7	2.8	20	1.6	0	24.3	0.9	3.6	3	0	7.6	3.3	29	12.1	0.1	44.4	

Start Time	CONDIT RD Southbound					E DUNNE AVE Westbound					CONDIT RD Northbound					E DUNNE AVE Eastbound					Int. Total
	Right	Thru	Left	Peds	App. Total	Right	Thru	Left	Peds	App. Total	Right	Thru	Left	Peds	App. Total	Right	Thru	Left	Peds	App. Total	
04:00 PM	66	36	21	0	123	8	109	3	0	120	2	11	9	0	22	15	132	70	1	217	482
04:15 PM	68	31	30	0	129	11	99	6	0	116	5	20	11	0	36	17	124	52	0	193	474
04:30 PM	66	22	18	0	106	11	98	6	0	115	5	18	11	0	34	13	129	62	0	204	459
04:45 PM	55	39	26	0	120	11	93	20	0	124	4	18	16	0	38	16	120	54	1	191	473
Total Volume	255	128	95	0	478	41	399	35	0	475	16	67	47	0	130	61	505	238	2	806	1889
% App. Total	53.3	26.8	19.9	0.0		8.6	84	7.4	0.0		12.3	51.5	36.2	0.0		7.6	62.8	29.6	0.0		
PHF	.938	.821	.792	.926		.932	.915	.438	.958		.800	.838	.734	.855		.897	.956	.850	.926		.979

Peak Hour Analysis From 04:00 PM to 05:45 PM - Peak 1 of 1

Peak Hour for Entire Intersection Begins at 04:00 PM

Traffic Data Service

San Jose, CA
 (408) 622-4787
 tdsbay@cs.com

File Name : 6PM FINAL
 Site Code : 00000006
 Start Date : 3/28/2019
 Page No : 2

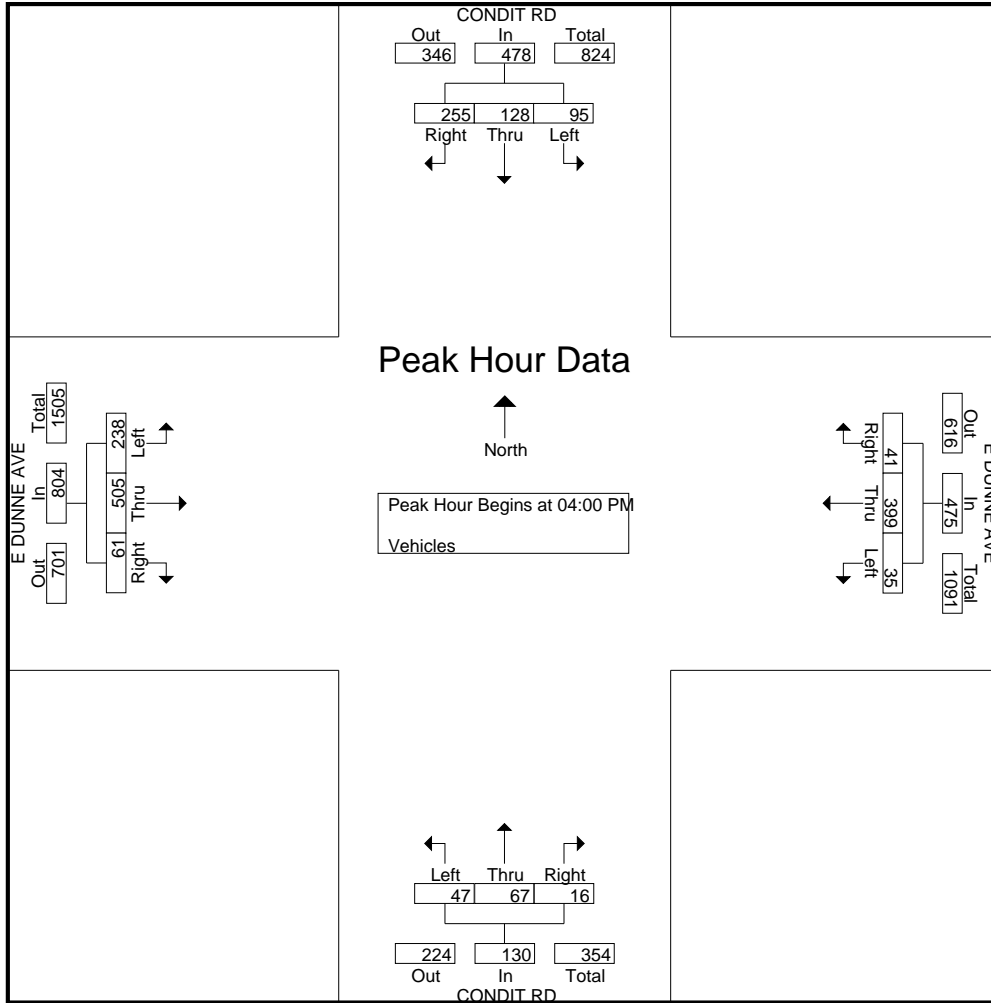



(303) 216-2439
www.alltrafficdata.net

Location: 19 BUTTERFIELD BLVD & MAIN AVE AM

Date and Start Time: Tuesday, May 8, 2018

Peak Hour: 07:15 AM - 08:15 AM

Peak 15-Minutes: 07:45 AM - 08:00 AM

Peak Hour - All Vehicles

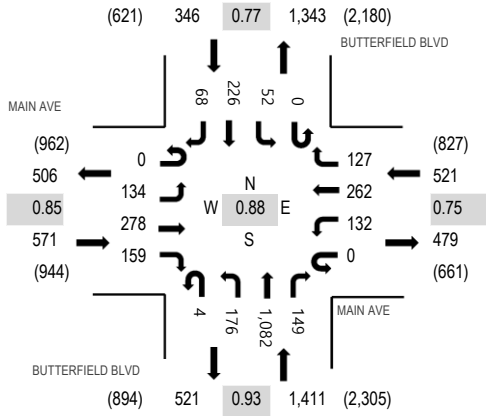

Peak Hour - Pedestrians/Bicycles in Crosswalk

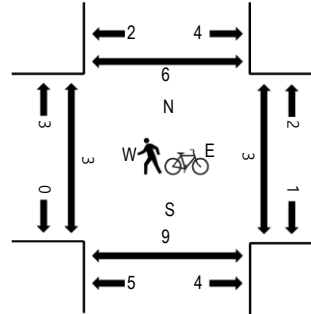

Note: Total study counts contained in parentheses.

Traffic Counts

Interval Start Time	MAIN AVE Eastbound				MAIN AVE Westbound				BUTTERFIELD BLVD Northbound				BUTTERFIELD BLVD Southbound				Total	Rolling Hour	Pedestrian Crossings			
	U-Turn	Left	Thru	Right	U-Turn	Left	Thru	Right	U-Turn	Left	Thru	Right	U-Turn	Left	Thru	Right			West	East	South	North
7:00 AM	0	18	15	23	0	18	29	25	0	16	253	10	0	3	25	7	442	2,524	1	0	3	2
7:15 AM	0	20	42	28	0	20	27	23	0	37	235	31	0	15	32	6	516	2,849	0	0	0	0
7:30 AM	0	34	73	45	0	28	64	43	1	34	296	50	0	10	60	15	753	2,825	2	3	4	3
7:45 AM	0	40	92	39	0	46	96	37	1	39	286	51	0	11	51	24	813	2,557	0	0	2	0
8:00 AM	0	40	71	47	0	38	75	24	2	66	265	17	0	16	83	23	767	2,173	1	0	3	1
8:15 AM	0	33	30	35	0	21	49	14	2	60	163	0	0	6	58	21	492		0	1	1	0
8:30 AM	0	28	46	40	0	10	53	21	0	73	140	9	0	2	39	24	485		0	3	3	0
8:45 AM	0	27	43	35	0	17	42	7	0	53	108	7	0	11	50	29	429		0	2	1	0

Peak Rolling Hour Flow Rates

Vehicle Type	Eastbound				Westbound				Northbound				Southbound				Total
	U-Turn	Left	Thru	Right	U-Turn	Left	Thru	Right	U-Turn	Left	Thru	Right	U-Turn	Left	Thru	Right	
Articulated Trucks	0	0	0	2	0	0	0	0	0	0	2	0	0	1	1	0	6
Lights	0	129	275	153	0	132	259	125	4	176	1,059	147	0	48	219	67	2,793
Mediums	0	5	3	4	0	0	3	2	0	0	21	2	0	3	6	1	50
Total	0	134	278	159	0	132	262	127	4	176	1,082	149	0	52	226	68	2,849



(303) 216-2439
www.alltrafficdata.net

Location: 19 BUTTERFIELD BLVD & MAIN AVE PM

Date and Start Time: Tuesday, May 8, 2018

Peak Hour: 04:15 PM - 05:15 PM

Peak 15-Minutes: 05:00 PM - 05:15 PM

Peak Hour - All Vehicles

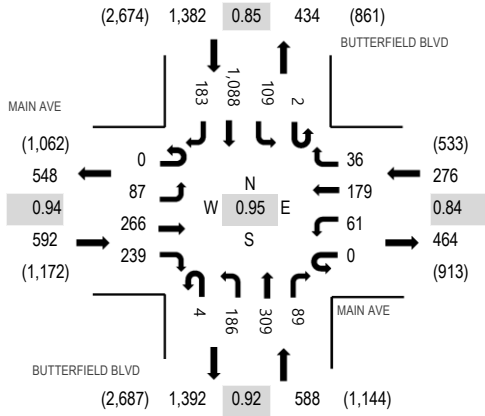

Peak Hour - Pedestrians/Bicycles in Crosswalk

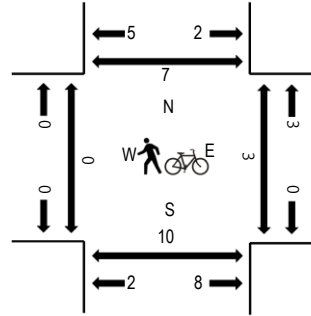

Note: Total study counts contained in parentheses.

Traffic Counts

Interval Start Time	MAIN AVE Eastbound				MAIN AVE Westbound				BUTTERFIELD BLVD Northbound				BUTTERFIELD BLVD Southbound				Total	Rolling Hour	Pedestrian Crossings			
	U-Turn	Left	Thru	Right	U-Turn	Left	Thru	Right	U-Turn	Left	Thru	Right	U-Turn	Left	Thru	Right			West	East	South	North
4:00 PM	0	31	56	57	0	16	41	10	0	45	72	23	0	14	282	48	695	2,785	0	0	2	0
4:15 PM	0	25	79	45	0	17	50	7	1	50	82	24	1	29	271	44	725	2,838	0	0	2	2
4:30 PM	0	18	77	65	0	21	53	10	1	36	70	19	0	24	253	27	674	2,825	0	0	4	2
4:45 PM	0	25	50	66	0	9	42	7	2	61	84	20	1	23	263	38	691	2,808	0	3	0	0
5:00 PM	0	19	60	63	0	14	34	12	0	39	73	26	0	33	301	74	748	2,738	0	0	1	2
5:15 PM	0	34	63	60	0	14	39	10	1	51	81	35	0	28	257	39	712		0	0	1	0
5:30 PM	0	39	59	50	0	19	37	4	2	52	67	25	0	34	234	35	657		1	0	0	1
5:45 PM	0	23	65	43	0	15	44	8	1	38	47	16	1	31	244	45	621		0	2	4	0

Peak Rolling Hour Flow Rates

Vehicle Type	Eastbound				Westbound				Northbound				Southbound				Total
	U-Turn	Left	Thru	Right	U-Turn	Left	Thru	Right	U-Turn	Left	Thru	Right	U-Turn	Left	Thru	Right	
Articulated Trucks	0	0	1	0	0	0	0	1	0	0	1	0	0	0	4	0	7
Lights	0	85	261	237	0	61	177	34	4	186	301	89	2	109	1,066	182	2,794
Mediums	0	2	4	2	0	0	2	1	0	0	7	0	0	0	18	1	37
Total	0	87	266	239	0	61	179	36	4	186	309	89	2	109	1,088	183	2,838



(303) 216-2439
www.alltrafficdata.net

Location: 18 MONTEREY RD & MAIN AVE AM
Date and Start Time: Tuesday, May 8, 2018
Peak Hour: 07:45 AM - 08:45 AM
Peak 15-Minutes: 08:00 AM - 08:15 AM

Peak Hour - All Vehicles

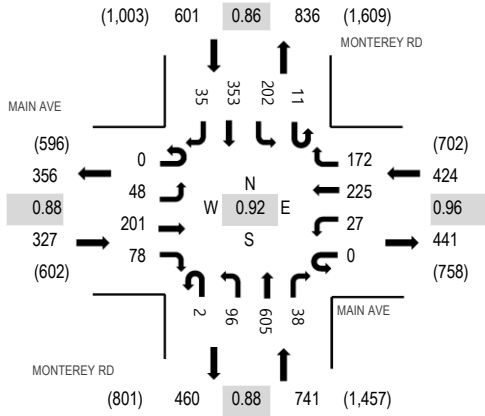

Peak Hour - Pedestrians/Bicycles in Crosswalk

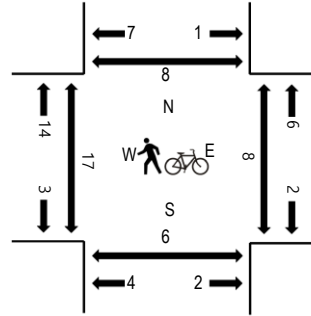

Note: Total study counts contained in parentheses.

Traffic Counts

Interval Start Time	MAIN AVE Eastbound				MAIN AVE Westbound				MONTEREY RD Northbound				MONTEREY RD Southbound				Total	Rolling Hour	Pedestrian Crossings			
	U-Turn	Left	Thru	Right	U-Turn	Left	Thru	Right	U-Turn	Left	Thru	Right	U-Turn	Left	Thru	Right			West	East	South	North
7:00 AM	0	8	22	18	0	4	28	25	1	19	153	7	1	15	34	3	338	1,760	1	0	1	0
7:15 AM	0	17	26	24	0	4	24	25	2	24	148	9	1	31	37	2	374	1,989	2	0	3	1
7:30 AM	0	13	42	22	0	6	49	33	2	20	207	14	0	44	44	5	501	2,067	0	1	0	1
7:45 AM	0	14	60	19	0	9	63	32	0	19	175	9	3	60	78	6	547	2,093	0	0	2	0
8:00 AM	0	12	59	19	0	7	57	38	1	28	181	13	2	51	90	9	567	2,004	2	3	0	1
8:15 AM	0	7	45	17	0	7	53	48	1	26	119	9	3	38	70	9	452		5	2	3	3
8:30 AM	0	15	37	23	0	4	52	54	0	23	130	7	3	53	115	11	527		8	3	1	2
8:45 AM	0	12	49	22	0	9	28	43	4	16	81	9	6	49	108	22	458		8	1	1	1

Peak Rolling Hour Flow Rates

Vehicle Type	Eastbound				Westbound				Northbound				Southbound				Total
	U-Turn	Left	Thru	Right	U-Turn	Left	Thru	Right	U-Turn	Left	Thru	Right	U-Turn	Left	Thru	Right	
Articulated Trucks	0	0	0	0	0	0	0	0	0	1	2	0	0	1	1	0	5
Lights	0	48	198	74	0	27	222	168	2	91	595	38	11	200	346	35	2,055
Mediums	0	0	3	4	0	0	3	4	0	4	8	0	0	1	6	0	33
Total	0	48	201	78	0	27	225	172	2	96	605	38	11	202	353	35	2,093



(303) 216-2439
www.alltrafficdata.net

Location: 18 MONTEREY RD & MAIN AVE PM
Date and Start Time: Tuesday, May 8, 2018
Peak Hour: 04:00 PM - 05:00 PM
Peak 15-Minutes: 04:15 PM - 04:30 PM

Peak Hour - All Vehicles

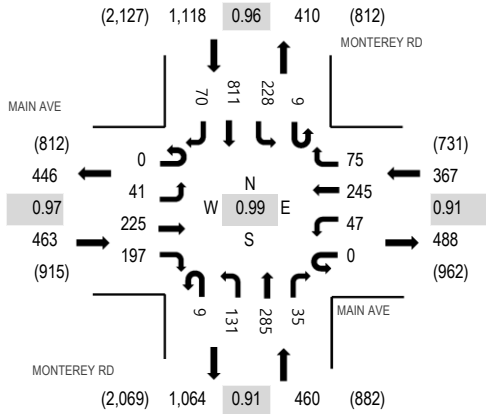

Peak Hour - Pedestrians/Bicycles in Crosswalk

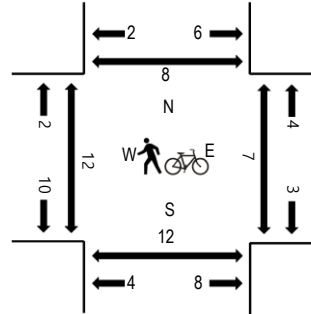

Note: Total study counts contained in parentheses.

Traffic Counts

Interval Start Time	MAIN AVE Eastbound				MAIN AVE Westbound				MONTEREY RD Northbound				MONTEREY RD Southbound				Total	Rolling Hour	Pedestrian Crossings			
	U-Turn	Left	Thru	Right	U-Turn	Left	Thru	Right	U-Turn	Left	Thru	Right	U-Turn	Left	Thru	Right			West	East	South	North
4:00 PM	0	10	54	42	0	12	57	24	6	27	76	8	2	54	204	23	599	2,408	3	0	3	0
4:15 PM	0	11	56	49	0	10	63	15	0	40	78	7	4	59	200	17	609	2,369	5	1	2	1
4:30 PM	0	9	59	51	0	10	59	16	2	45	70	9	2	61	185	16	594	2,336	4	3	4	2
4:45 PM	0	11	56	55	0	15	66	20	1	19	61	11	1	54	222	14	606	2,303	0	3	2	2
5:00 PM	0	7	63	45	0	12	59	24	1	13	71	13	2	49	185	16	560	2,247	2	3	1	2
5:15 PM	0	10	50	39	0	14	49	21	1	26	63	8	1	58	221	15	576		4	1	0	3
5:30 PM	0	11	65	45	0	12	54	19	4	27	82	12	0	44	176	10	561		3	0	2	0
5:45 PM	0	4	56	57	0	15	65	20	5	20	66	10	1	46	173	12	550		1	2	0	0

Peak Rolling Hour Flow Rates

Vehicle Type	Eastbound				Westbound				Northbound				Southbound				Total
	U-Turn	Left	Thru	Right	U-Turn	Left	Thru	Right	U-Turn	Left	Thru	Right	U-Turn	Left	Thru	Right	
Articulated Trucks	0	0	0	0	0	0	0	0	0	0	0	0	0	1	0	0	1
Lights	0	41	222	191	0	46	243	75	9	127	283	35	9	223	801	70	2,375
Mediums	0	0	3	6	0	1	2	0	0	4	2	0	0	4	10	0	32
Total	0	41	225	197	0	47	245	75	9	131	285	35	9	228	811	70	2,408

Appendix C

Volume Summary

Intersection Number: 1
 Traffix Node Number: 105
 Intersection Name: Cochrane Road and Sutter Boulevard
 Peak Hour: AM
 Count Date: 5/8/18

Scenario:	Movements												Int. Total
	North Approach			East Approach			South Approach			West Approach			
	RT	TH	LT	RT	TH	LT	RT	TH	LT	RT	TH	LT	
Existing	2	2	4	57	408	310	245	7	56	86	709	7	1,893
Project Trips	0	0	1	4	7	4	1	0	0	0	3	0	20
Existing Plus Project	2	2	5	61	415	314	246	7	56	86	712	7	1,913
2015 Model	5	1	10	32	735	278	144	1	64	102	817	22	2,211
2030 without Project Model	6	1	8	27	777	314	190	1	87	104	1047	30	2,592
2030 Cumulative without Project	3	2	4	57	450	346	291	7	79	88	939	15	2,281
2030 Cumulative with Project	3	2	5	61	457	350	292	7	79	88	942	15	2,301

Intersection Number: 2
 Traffix Node Number: 106
 Intersection Name: Cochrane Road and Madrone Parkway/Cochrane Plaza
 Peak Hour: AM
 Count Date: 5/8/18

Scenario:	Movements												Int. Total
	North Approach			East Approach			South Approach			West Approach			
	RT	TH	LT	RT	TH	LT	RT	TH	LT	RT	TH	LT	
Existing	16	16	206	347	729	119	23	16	11	5	773	95	2,356
Project Trips	0	0	1	4	15	0	0	0	0	0	5	0	25
Existing Plus Project	16	16	207	351	744	119	23	16	11	5	778	95	2,381
2015 Model	19	2	84	214	1025	174	82	2	0	0	894	78	2,574
2030 without Project Model	28	2	107	360	1090	160	80	1	0	0	1143	104	3,075
2030 Cumulative without Project	25	16	229	493	794	119	23	16	11	5	1022	121	2,874
2030 Cumulative with Project	25	16	230	497	809	119	23	16	11	5	1027	121	2,899

Intersection Number: 3
 Traffix Node Number: 107
 Intersection Name: Cochrane Road and US 101 Southbound Ramps
 Peak Hour: AM
 Count Date: 5/8/18

Scenario:	Movements												Int. Total
	North Approach			East Approach			South Approach			West Approach			
	RT	TH	LT	RT	TH	LT	RT	TH	LT	RT	TH	LT	
Existing	725	1	185	108	528	0	0	0	0	238	810	0	2,595
Project Trips	0	0	23	11	19	0	0	0	0	0	6	0	59
Existing Plus Project	725	1	208	119	547	0	0	0	0	238	816	0	2,654
2015 Model	438	0	182	157	976	0	0	0	0	234	825	0	2,812
2030 without Project Model	544	0	262	201	1067	0	0	0	0	263	1067	0	3,404
2030 Cumulative without Project	831	1	265	152	619	0	0	0	0	267	1052	0	3,187
2030 Cumulative with Project	831	1	288	163	638	0	0	0	0	267	1058	0	3,246

Intersection Number: 4
 Trafix Node Number: 108
 Intersection Name: Cochrane Road and US 101 Northbound Ramps
 Peak Hour: AM
 Count Date: 5/8/18

Scenario:	Movements												Int. Total
	North Approach			East Approach			South Approach			West Approach			
	RT	TH	LT	RT	TH	LT	RT	TH	LT	RT	TH	LT	
Existing	0	0	0	464	382	0	117	0	260	0	405	0	1,628
Project Trips	0	0	0	67	30	0	4	0	0	0	29	0	130
Existing Plus Project	0	0	0	531	412	0	121	0	260	0	434	0	1,758
2015 Model	0	0	0	427	593	0	192	0	540	0	440	0	2,192
2030 without Project Model	0	0	0	559	876	0	206	0	391	0	737	0	2,769
2030 Cumulative without Project	0	0	0	596	665	0	131	0	260	0	702	0	2,354
2030 Cumulative with Project	0	0	0	663	695	0	135	0	260	0	731	0	2,484

Intersection Number: 5
 Trafix Node Number: 109
 Intersection Name: Cochrane Road and De Paul Drive
 Peak Hour: AM
 Count Date: 5/8/18

Scenario:	Movements												Int. Total
	North Approach			East Approach			South Approach			West Approach			
	RT	TH	LT	RT	TH	LT	RT	TH	LT	RT	TH	LT	
Existing	129	1	35	52	701	6	4	0	3	26	310	187	1,454
Project Trips	0	2	1	2	24	0	0	6	73	24	8	0	140
Existing Plus Project	129	3	36	54	725	6	4	6	76	50	318	187	1,594
2015 Model	138	1	24	82	858	0	0	1	23	31	296	305	1,759
2030 without Project Model	263	3	42	164	1303	44	30	0	0	20	450	458	2,777
2030 Cumulative without Project	254	3	53	134	1146	50	34	0	3	26	464	340	2,507
2030 Cumulative with Project	254	5	54	136	1170	50	34	6	76	50	472	340	2,647

Intersection Number: 6
 Trafix Node Number: 110
 Intersection Name: Cochrane Road and Mission View Drive
 Peak Hour: AM
 Count Date: 5/8/18

Scenario:	Movements												Int. Total
	North Approach			East Approach			South Approach			West Approach			
	RT	TH	LT	RT	TH	LT	RT	TH	LT	RT	TH	LT	
Existing	45	13	0	0	278	16	27	6	512	137	192	15	1,241
Project Trips	0	0	0	0	0	0	0	0	26	9	0	0	35
Existing Plus Project	45	13	0	0	278	16	27	6	538	146	192	15	1,276
2015 Model	0	0	0	0	487	35	24	0	452	151	169	0	1,318
2030 without Project Model	0	0	0	0	604	65	20	0	906	320	201	0	2,116
2030 Cumulative without Project	45	13	0	0	395	46	27	6	966	306	224	15	2,043
2030 Cumulative with Project	45	13	0	0	395	46	27	6	992	315	224	15	2,078

Intersection Number: 7
 Traffix Node Number: 5664
 Intersection Name: Mission View Drive and Avenida De Los Padres
 Peak Hour: AM
 Count Date: 3/28/19

Scenario:	Movements												Int. Total
	North Approach			East Approach			South Approach			West Approach			
	RT	TH	LT	RT	TH	LT	RT	TH	LT	RT	TH	LT	
Existing	0	108	26	72	0	31	18	481	0	0	0	0	736
Project Trips	0	9	0	0	0	0	0	26	0	0	0	0	35
Existing Plus Project	0	117	26	72	0	31	18	507	0	0	0	0	771
2015 Model	0	84	0	0	0	77	48	182	0	0	0	0	391
2030 without Project Model	0	280	0	0	0	79	53	627	0	0	0	0	1,039
2030 Cumulative without Project	0	304	26	72	0	33	23	926	0	0	0	0	1,384
2030 Cumulative with Project	0	313	26	72	0	33	23	952	0	0	0	0	1,419

Intersection Number: 8
 Traffix Node Number: 3117
 Intersection Name: Mission View Drive and Half Road
 Peak Hour: AM
 Count Date: 3/28/19

Scenario:	Movements												Int. Total
	North Approach			East Approach			South Approach			West Approach			
	RT	TH	LT	RT	TH	LT	RT	TH	LT	RT	TH	LT	
Existing	116	0	54	192	16	0	0	0	0	0	13	291	682
Project Trips	42	0	3	1	0	0	0	0	0	0	0	14	60
Existing Plus Project	158	0	57	193	16	0	0	0	0	0	13	305	742
2015 Model	73	0	88	114	2	0	0	0	0	0	2	116	395
2030 without Project Model	162	0	170	245	0	0	0	0	0	0	0	421	998
2030 Cumulative without Project	205	0	136	323	16	0	0	0	0	0	13	596	1,289
2030 Cumulative with Project	247	0	139	324	16	0	0	0	0	0	13	610	1,349

Intersection Number: 9
 Traffix Node Number: 120
 Intersection Name: Main Avenue and Condit Road
 Peak Hour: AM
 Count Date: 5/8/18

Scenario:	Movements												Int. Total
	North Approach			East Approach			South Approach			West Approach			
	RT	TH	LT	RT	TH	LT	RT	TH	LT	RT	TH	LT	
Existing	34	72	10	66	253	146	164	134	124	143	292	68	1,506
Project Trips	26	16	0	0	0	0	0	5	0	0	0	9	56
Existing Plus Project	60	88	10	66	253	146	164	139	124	143	292	77	1,562
2015 Model	38	36	2	6	127	68	72	32	91	75	130	78	755
2030 without Project Model	58	94	7	21	192	115	111	200	146	128	181	166	1,419
2030 Cumulative without Project	54	130	15	81	318	193	203	302	179	196	343	156	2,170
2030 Cumulative with Project	80	146	15	81	318	193	203	307	179	196	343	165	2,226

Intersection Number: 10
 Trafix Node Number: 1120
 Intersection Name: Condit Road and Diana Avenue
 Peak Hour: AM
 Count Date: 6/4/19

Scenario:	Movements												Int. Total
	North Approach			East Approach			South Approach			West Approach			
	RT	TH	LT	RT	TH	LT	RT	TH	LT	RT	TH	LT	
Existing	3	241	101	183	2	51	13	242	1	4	1	0	842
Project Trips	0	16	0	0	0	0	0	5	0	0	0	0	21
Existing Plus Project	3	257	101	183	2	51	13	247	1	4	1	0	863
2015 Model	0	147	31	66	0	68	27	128	0	1	0	1	469
2030 without Project Model	2	280	53	164	1	76	38	294	5	2	0	3	918
2030 Cumulative without Project	5	374	123	281	3	59	24	408	6	5	1	2	1,291
2030 Cumulative with Project	5	390	123	281	3	59	24	413	6	5	1	2	1,312

Intersection Number: 11
 Trafix Node Number: 3115
 Intersection Name: East Dunne Avenue and Condit Road
 Peak Hour: AM
 Count Date: 3/28/19

Scenario:	Movements												Int. Total
	North Approach			East Approach			South Approach			West Approach			
	RT	TH	LT	RT	TH	LT	RT	TH	LT	RT	TH	LT	
Existing	327	54	69	79	1160	11	22	198	151	36	305	180	2,592
Project Trips	11	1	4	1	0	0	0	0	0	0	0	4	21
Existing Plus Project	338	55	73	80	1160	11	22	198	151	36	305	184	2,613
2015 Model	172	26	62	69	1197	18	4	18	66	65	471	133	2,301
2030 without Project Model	234	61	112	112	1229	27	6	54	120	121	521	257	2,854
2030 Cumulative without Project	389	89	119	122	1192	20	24	234	205	92	355	304	3,145
2030 Cumulative with Project	400	90	123	123	1192	20	24	234	205	92	355	308	3,166

Intersection Number: 12
 Trafix Node Number: 119
 Intersection Name: Butterfield Boulevard and Main Avenue
 Peak Hour: AM
 Count Date: 5/8/18

Scenario:	Movements												Int. Total
	North Approach			East Approach			South Approach			West Approach			
	RT	TH	LT	RT	TH	LT	RT	TH	LT	RT	TH	LT	
Existing	68	226	52	127	262	132	149	1082	180	159	278	134	2,849
Project Trips	0	0	1	4	15	7	3	0	0	0	5	0	35
Existing Plus Project	68	226	53	131	277	139	152	1082	180	159	283	134	2,884
2015 Model	132	190	76	226	176	172	122	846	191	225	127	219	2,702
2030 without Project Model	145	288	93	263	220	213	162	1148	222	311	183	226	3,474
2030 Cumulative without Project	81	324	69	164	306	173	189	1384	211	245	334	141	3,621
2030 Cumulative with Project	81	324	70	168	321	180	192	1384	211	245	339	141	3,656

Intersection Number: 13
 Trafix Node Number: 118
 Intersection Name: Monterey Road and Main Avenue
 Peak Hour: AM
 Count Date: 5/8/18

Scenario:	Movements												Int. Total
	North Approach			East Approach			South Approach			West Approach			
	RT	TH	LT	RT	TH	LT	RT	TH	LT	RT	TH	LT	
Existing	35	353	213	172	225	27	38	605	98	78	201	48	2,093
Project Trips	0	0	0	0	7	4	1	0	0	0	3	0	15
Existing Plus Project	35	353	213	172	232	31	39	605	98	78	204	48	2,108
2015 Model	27	273	176	32	370	43	38	19	346	92	300	8	1,724
2030 without Project Model	32	366	256	92	404	48	37	128	340	100	326	8	2,137
2030 Cumulative without Project	40	446	293	232	259	32	38	714	98	86	227	48	2,513
2030 Cumulative with Project	40	446	293	232	266	36	39	714	98	86	230	48	2,528

Intersection Number: 1
 Traffix Node Number: 105
 Intersection Name: Cochrane Road and Sutter Boulevard
 Peak Hour: PM
 Count Date: 5/8/18

Scenario:	Movements												Int. Total
	North Approach			East Approach			South Approach			West Approach			
	RT	TH	LT	RT	TH	LT	RT	TH	LT	RT	TH	LT	
Existing	8	22	67	10	543	197	386	7	90	73	863	2	2,268
Project Trips	0	0	4	2	5	2	4	0	0	0	8	0	25
Existing Plus Project	8	22	71	12	548	199	390	7	90	73	871	2	2,293
2015 Model	26	2	33	10	652	149	273	2	165	104	698	11	2,125
2030 without Project Model	34	3	28	8	933	205	366	3	192	114	799	13	2,698
2030 Cumulative without Project	16	23	67	10	824	253	479	8	117	83	964	4	2,848
2030 Cumulative with Project	16	23	71	12	829	255	483	8	117	83	972	4	2,873

Intersection Number: 2
 Traffix Node Number: 106
 Intersection Name: Cochrane Road and Madrone Parkway/Cochrane Plaza
 Peak Hour: PM
 Count Date: 5/8/18

Scenario:	Movements												Int. Total
	North Approach			East Approach			South Approach			West Approach			
	RT	TH	LT	RT	TH	LT	RT	TH	LT	RT	TH	LT	
Existing	69	35	428	196	627	237	94	30	36	22	1212	114	3,100
Project Trips	0	0	4	2	10	0	0	0	0	0	17	0	33
Existing Plus Project	69	35	432	198	637	237	94	30	36	22	1229	114	3,133
2015 Model	97	7	270	110	714	117	229	7	0	0	946	59	2,556
2030 without Project Model	125	6	401	140	1020	121	216	6	0	0	1119	74	3,228
2030 Cumulative without Project	97	35	559	226	933	241	94	30	36	22	1385	129	3,787
2030 Cumulative with Project	97	35	563	228	943	241	94	30	36	22	1402	129	3,820

Intersection Number: 3
 Traffix Node Number: 107
 Intersection Name: Cochrane Road and US 101 Southbound Ramps
 Peak Hour: PM
 Count Date: 5/8/18

Scenario:	Movements												Int. Total
	North Approach			East Approach			South Approach			West Approach			
	RT	TH	LT	RT	TH	LT	RT	TH	LT	RT	TH	LT	
Existing	510	1	300	157	635	0	0	0	0	741	1046	0	3,390
Project Trips	0	0	76	7	12	0	0	0	0	0	21	0	116
Existing Plus Project	510	1	376	164	647	0	0	0	0	741	1067	0	3,506
2015 Model	403	0	369	271	537	0	0	0	0	492	953	0	3,025
2030 without Project Model	495	0	491	259	786	0	0	0	0	449	1288	0	3,768
2030 Cumulative without Project	602	1	422	157	884	0	0	0	0	741	1381	0	4,188
2030 Cumulative with Project	602	1	498	164	896	0	0	0	0	741	1402	0	4,304

Intersection Number: 4
 Trafix Node Number: 108
 Intersection Name: Cochrane Road and US 101 Northbound Ramps
 Peak Hour: PM
 Count Date: 5/8/18

Scenario:	Movements												Int. Total
	North Approach			East Approach			South Approach			West Approach			
	RT	TH	LT	RT	TH	LT	RT	TH	LT	RT	TH	LT	
Existing	0	0	0	208	499	0	230	0	315	0	832	0	2,084
Project Trips	0	0	0	44	20	0	13	0	0	0	97	0	174
Existing Plus Project	0	0	0	252	519	0	243	0	315	0	929	0	2,258
2015 Model	0	0	0	208	563	0	219	0	245	0	877	0	2,112
2030 without Project Model	0	0	0	282	785	0	289	0	261	0	1248	0	2,865
2030 Cumulative without Project	0	0	0	282	721	0	300	0	331	0	1203	0	2,837
2030 Cumulative with Project	0	0	0	326	741	0	313	0	331	0	1300	0	3,011

Intersection Number: 5
 Trafix Node Number: 109
 Intersection Name: Cochrane Road and De Paul Drive
 Peak Hour: PM
 Count Date: 5/8/18

Scenario:	Movements												Int. Total
	North Approach			East Approach			South Approach			West Approach			
	RT	TH	LT	RT	TH	LT	RT	TH	LT	RT	TH	LT	
Existing	360	1	133	99	353	15	1	4	13	7	596	426	2,008
Project Trips	0	6	2	1	16	0	0	4	48	82	27	0	186
Existing Plus Project	360	7	135	100	369	15	1	8	61	89	623	426	2,194
2015 Model	383	4	156	47	341	0	0	4	46	40	790	265	2,076
2030 without Project Model	569	9	264	73	496	39	50	11	0	0	1264	441	3,216
2030 Cumulative without Project	546	6	241	125	508	54	51	11	13	7	1070	602	3,234
2030 Cumulative with Project	546	12	243	126	524	54	51	15	61	89	1097	602	3,420

Intersection Number: 6
 Trafix Node Number: 110
 Intersection Name: Cochrane Road and Mission View Drive
 Peak Hour: PM
 Count Date: 5/8/18

Scenario:	Movements												Int. Total
	North Approach			East Approach			South Approach			West Approach			
	RT	TH	LT	RT	TH	LT	RT	TH	LT	RT	TH	LT	
Existing	36	3	0	0	242	24	19	4	183	555	233	60	1,359
Project Trips	0	0	0	0	0	0	0	0	17	29	0	0	46
Existing Plus Project	36	3	0	0	242	24	19	4	200	584	233	60	1,405
2015 Model	0	0	0	0	202	14	14	0	187	497	450	0	1,364
2030 without Project Model	0	0	0	0	218	28	44	0	392	943	635	0	2,260
2030 Cumulative without Project	36	3	0	0	258	38	49	4	388	1001	418	60	2,255
2030 Cumulative with Project	36	3	0	0	258	38	49	4	405	1030	418	60	2,301

Intersection Number: 7
 Traffix Node Number: 5664
 Intersection Name: Mission View Drive and Avenida De Los Padres
 Peak Hour: PM
 Count Date: 3/28/19

Scenario:	Movements												Int. Total
	North Approach			East Approach			South Approach			West Approach			
	RT	TH	LT	RT	TH	LT	RT	TH	LT	RT	TH	LT	
Existing	0	495	57	29	0	21	28	179	0	0	0	0	809
Project Trips	0	29	0	0	0	0	0	17	0	0	0	0	46
Existing Plus Project	0	524	57	29	0	21	28	196	0	0	0	0	855
2015 Model	0	253	0	0	0	28	47	82	0	0	0	0	410
2030 without Project Model	0	694	0	0	0	58	54	326	0	0	0	0	1,132
2030 Cumulative without Project	0	936	57	29	0	51	35	423	0	0	0	0	1,531
2030 Cumulative with Project	0	965	57	29	0	51	35	440	0	0	0	0	1,577

Intersection Number: 8
 Traffix Node Number: 3117
 Intersection Name: Mission View Drive and Half Road
 Peak Hour: PM
 Count Date: 3/28/19

Scenario:	Movements												Int. Total
	North Approach			East Approach			South Approach			West Approach			
	RT	TH	LT	RT	TH	LT	RT	TH	LT	RT	TH	LT	
Existing	232	0	287	62	32	0	0	0	0	0	27	147	787
Project Trips	27	0	2	3	0	0	0	0	0	0	0	47	79
Existing Plus Project	259	0	289	65	32	0	0	0	0	0	27	194	866
2015 Model	190	0	92	50	2	0	0	0	0	0	2	79	415
2030 without Project Model	534	0	198	126	0	0	0	0	0	0	0	230	1,088
2030 Cumulative without Project	576	0	393	138	32	0	0	0	0	0	27	298	1,464
2030 Cumulative with Project	603	0	395	141	32	0	0	0	0	0	27	345	1,543

Intersection Number: 9
 Traffix Node Number: 120
 Intersection Name: Main Avenue and Condit Road
 Peak Hour: PM
 Count Date: 5/8/18

Scenario:	Movements												Int. Total
	North Approach			East Approach			South Approach			West Approach			
	RT	TH	LT	RT	TH	LT	RT	TH	LT	RT	TH	LT	
Existing	100	184	8	11	77	57	50	78	99	220	152	85	1,121
Project Trips	17	10	0	0	0	0	0	18	0	0	0	29	74
Existing Plus Project	117	194	8	11	77	57	50	96	99	220	152	114	1,195
2015 Model	63	123	6	2	59	62	51	30	95	82	71	49	693
2030 without Project Model	152	338	22	10	82	94	86	118	146	156	111	97	1,412
2030 Cumulative without Project	189	399	24	19	100	89	85	166	150	294	192	133	1,840
2030 Cumulative with Project	206	409	24	19	100	89	85	184	150	294	192	162	1,914

Intersection Number: 10
 Traffix Node Number: 1120
 Intersection Name: Condit Road and Diana Avenue
 Peak Hour: PM
 Count Date: 6/4/19

Scenario:	Movements												Int. Total
	North Approach			East Approach			South Approach			West Approach			
	RT	TH	LT	RT	TH	LT	RT	TH	LT	RT	TH	LT	
Existing	0	380	142	57	0	24	38	174	2	7	0	0	824
Project Trips	0	10	0	0	0	0	0	18	0	0	0	0	28
Existing Plus Project	0	390	142	57	0	24	38	192	2	7	0	0	852
2015 Model	1	198	68	16	0	46	53	160	1	1	0	0	544
2030 without Project Model	3	434	152	35	0	30	75	309	3	6	1	3	1,051
2030 Cumulative without Project	2	616	226	76	0	24	60	323	4	12	1	3	1,347
2030 Cumulative with Project	2	626	226	76	0	24	60	341	4	12	1	3	1,375

Intersection Number: 11
 Traffix Node Number: 3115
 Intersection Name: East Dunne Avenue and Condit Road
 Peak Hour: PM
 Count Date: 3/28/19

Scenario:	Movements												Int. Total
	North Approach			East Approach			South Approach			West Approach			
	RT	TH	LT	RT	TH	LT	RT	TH	LT	RT	TH	LT	
Existing	255	128	95	41	399	35	16	67	47	61	505	238	1,887
Project Trips	7	0	2	4	0	0	0	1	0	0	0	13	27
Existing Plus Project	262	128	97	45	399	35	16	68	47	61	505	251	1,914
2015 Model	197	42	96	31	572	11	23	34	104	99	1090	209	2,508
2030 without Project Model	345	95	139	87	566	16	33	71	164	167	1229	295	3,207
2030 Cumulative without Project	403	181	138	97	399	40	26	104	107	129	644	324	2,592
2030 Cumulative with Project	410	181	140	101	399	40	26	105	107	129	644	337	2,619

Intersection Number: 12
 Traffix Node Number: 119
 Intersection Name: Butterfield Boulevard and Main Avenue
 Peak Hour: PM
 Count Date: 5/8/18

Scenario:	Movements												Int. Total
	North Approach			East Approach			South Approach			West Approach			
	RT	TH	LT	RT	TH	LT	RT	TH	LT	RT	TH	LT	
Existing	183	1088	111	36	179	61	89	309	190	239	266	87	2,838
Project Trips	0	0	4	2	10	5	8	0	0	0	17	0	46
Existing Plus Project	183	1088	115	38	189	66	97	309	190	239	283	87	2,884
2015 Model	239	935	239	70	80	111	121	447	204	304	125	183	3,058
2030 without Project Model	274	1252	328	84	126	167	165	632	266	306	157	203	3,960
2030 Cumulative without Project	218	1405	200	50	225	117	133	494	252	241	298	107	3,740
2030 Cumulative with Project	218	1405	204	52	235	122	141	494	252	241	315	107	3,786

Intersection Number: 13
 Trafix Node Number: 118
 Intersection Name: Monterey Road and Main Avenue
 Peak Hour: PM
 Count Date: 5/8/18

Scenario:	Movements												Int. Total
	North Approach			East Approach			South Approach			West Approach			
	RT	TH	LT	RT	TH	LT	RT	TH	LT	RT	TH	LT	
Existing	70	811	237	75	245	47	35	285	140	197	225	41	2,408
Project Trips	0	0	0	0	5	2	4	0	0	0	8	0	19
Existing Plus Project	70	811	237	75	250	49	39	285	140	197	233	41	2,427
2015 Model	35	525	192	26	387	47	65	13	253	36	295	6	1,880
2030 without Project Model	55	674	350	24	470	38	69	14	239	17	239	4	2,193
2030 Cumulative without Project	90	960	395	75	328	47	39	286	140	197	225	41	2,823
2030 Cumulative with Project	90	960	395	75	333	49	43	286	140	197	233	41	2,842

Appendix D

Level of Service Calculations

City of Morgan Hill
The Crosswinds Residential Development

Level Of Service Computation Report
2000 HCM Operations (Future Volume Alternative)
Existing AM

Intersection #105: Sutter Boulevard and Cochrane Road

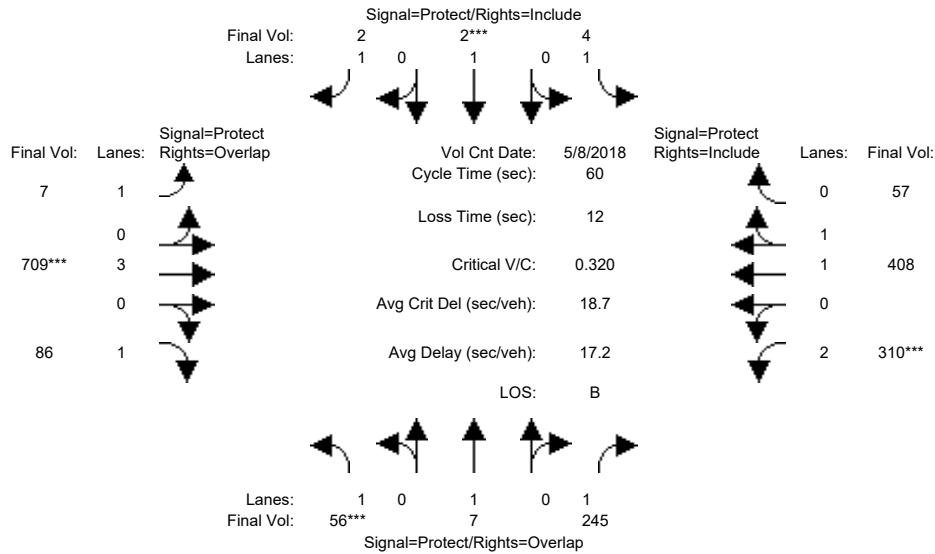

Street Name: Sutter Boulevard Cochrane Road
 Approach: North Bound South Bound East Bound West Bound
 Movement: L - T - R L - T - R L - T - R L - T - R

Min. Green:	7	10	10	7	10	10	7	10	10	7	10	10
Y+R:	4.0	4.0	4.0	4.0	4.0	4.0	4.0	4.0	4.0	4.0	4.0	4.0

Volume Module: >> Count Date: 8 May 2018 <<

Base Vol:	56	7	245	4	2	2	7	709	86	310	408	57
Growth Adj:	1.00	1.00	1.00	1.00	1.00	1.00	1.00	1.00	1.00	1.00	1.00	1.00
Initial Bse:	56	7	245	4	2	2	7	709	86	310	408	57
Added Vol:	0	0	0	0	0	0	0	0	0	0	0	0
PasserByVol:	0	0	0	0	0	0	0	0	0	0	0	0
Initial Fut:	56	7	245	4	2	2	7	709	86	310	408	57
User Adj:	1.00	1.00	1.00	1.00	1.00	1.00	1.00	1.00	1.00	1.00	1.00	1.00
PHF Adj:	1.00	1.00	1.00	1.00	1.00	1.00	1.00	1.00	1.00	1.00	1.00	1.00
PHF Volume:	56	7	245	4	2	2	7	709	86	310	408	57
Reduct Vol:	0	0	0	0	0	0	0	0	0	0	0	0
Reduced Vol:	56	7	245	4	2	2	7	709	86	310	408	57
PCE Adj:	1.00	1.00	1.00	1.00	1.00	1.00	1.00	1.00	1.00	1.00	1.00	1.00
MLF Adj:	1.00	1.00	1.00	1.00	1.00	1.00	1.00	1.00	1.00	1.00	1.00	1.00
FinalVolume:	56	7	245	4	2	2	7	709	86	310	408	57

Saturation Flow Module:

Sat/Lane:	1900	1900	1900	1900	1900	1900	1900	1900	1900	1900	1900	1900
Adjustment:	0.92	1.00	0.92	0.92	1.00	0.92	0.92	1.00	0.92	0.83	0.98	0.95
Lanes:	1.00	1.00	1.00	1.00	1.00	1.00	1.00	3.00	1.00	2.00	1.75	0.25
Final Sat.:	1750	1900	1750	1750	1900	1750	1750	5700	1750	3150	3246	454

Capacity Analysis Module:

Vol/Sat:	0.03	0.00	0.14	0.00	0.00	0.00	0.00	0.12	0.05	0.10	0.13	0.13
Crit Moves:	****			****			****			****		
Green Time:	7.0	10.0	23.7	7.0	10.0	10.0	12.8	17.3	24.3	13.7	18.2	18.2
Volume/Cap:	0.27	0.02	0.35	0.02	0.01	0.01	0.02	0.43	0.12	0.43	0.41	0.41
Delay/Veh:	24.9	20.9	13.1	23.5	20.9	20.9	18.7	17.5	11.2	20.2	16.9	16.9
User DelAdj:	1.00	1.00	1.00	1.00	1.00	1.00	1.00	1.00	1.00	1.00	1.00	1.00
AdjDel/Veh:	24.9	20.9	13.1	23.5	20.9	20.9	18.7	17.5	11.2	20.2	16.9	16.9
LOS by Move:	C	C	B	C	C	C	B	B	B	C	B	B
HCM2k95thQ:	3	0	7	0	0	0	0	7	2	6	7	7

Note: Queue reported is the number of cars per lane.

City of Morgan Hill
The Crosswinds Residential Development

Level Of Service Computation Report
2000 HCM Operations (Future Volume Alternative)
Existing Plus Project AM

Intersection #105: Sutter Boulevard and Cochrane Road

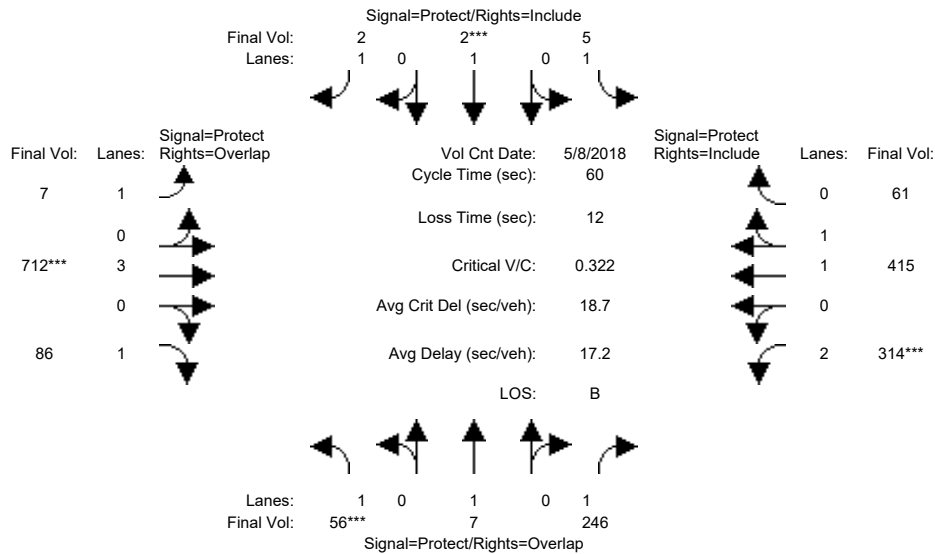

Street Name:	Sutter Boulevard						Cochrane Road					
	North Bound			South Bound			East Bound			West Bound		
Approach:	L	T	R	L	T	R	L	T	R	L	T	R
Min. Green:	7	10	10	7	10	10	7	10	10	7	10	10
Y+R:	4.0	4.0	4.0	4.0	4.0	4.0	4.0	4.0	4.0	4.0	4.0	4.0

Volume Module:	>>	Count	Date:	8 May 2018	<<							
Base Vol:	56	7	245	4	2	2	7	709	86	310	408	57
Growth Adj:	1.00	1.00	1.00	1.00	1.00	1.00	1.00	1.00	1.00	1.00	1.00	1.00
Initial Bse:	56	7	245	4	2	2	7	709	86	310	408	57
Added Vol:	0	0	1	1	0	0	0	3	0	4	7	4
PasserByVol:	0	0	0	0	0	0	0	0	0	0	0	0
Initial Fut:	56	7	246	5	2	2	7	712	86	314	415	61
User Adj:	1.00	1.00	1.00	1.00	1.00	1.00	1.00	1.00	1.00	1.00	1.00	1.00
PHF Adj:	1.00	1.00	1.00	1.00	1.00	1.00	1.00	1.00	1.00	1.00	1.00	1.00
PHF Volume:	56	7	246	5	2	2	7	712	86	314	415	61
Reduct Vol:	0	0	0	0	0	0	0	0	0	0	0	0
Reduced Vol:	56	7	246	5	2	2	7	712	86	314	415	61
PCE Adj:	1.00	1.00	1.00	1.00	1.00	1.00	1.00	1.00	1.00	1.00	1.00	1.00
MLF Adj:	1.00	1.00	1.00	1.00	1.00	1.00	1.00	1.00	1.00	1.00	1.00	1.00
Final Volume:	56	7	246	5	2	2	7	712	86	314	415	61

Saturation Flow Module:												
Sat/Lane:	1900	1900	1900	1900	1900	1900	1900	1900	1900	1900	1900	1900
Adjustment:	0.92	1.00	0.92	0.92	1.00	0.92	0.92	1.00	0.92	0.83	0.98	0.95
Lanes:	1.00	1.00	1.00	1.00	1.00	1.00	1.00	3.00	1.00	2.00	1.74	0.26
Final Sat.:	1750	1900	1750	1750	1900	1750	1750	5700	1750	3150	3225	474

Capacity Analysis Module:												
Vol/Sat:	0.03	0.00	0.14	0.00	0.00	0.00	0.00	0.12	0.05	0.10	0.13	0.13
Crit Moves:	***			****			****			****		
Green Time:	7.0	10.0	23.8	7.0	10.0	10.0	12.8	17.2	24.2	13.8	18.2	18.2
Volume/Cap:	0.27	0.02	0.35	0.02	0.01	0.01	0.02	0.43	0.12	0.43	0.42	0.42
Delay/Veh:	24.9	20.9	13.0	23.5	20.9	20.9	18.7	17.6	11.3	20.2	16.9	16.9
User DelAdj:	1.00	1.00	1.00	1.00	1.00	1.00	1.00	1.00	1.00	1.00	1.00	1.00
AdjDel/Veh:	24.9	20.9	13.0	23.5	20.9	20.9	18.7	17.6	11.3	20.2	16.9	16.9
LOS by Move:	C	C	B	C	C	C	B	B	B	C	B	B
HCM2k95thQ:	3	0	7	0	0	0	0	7	2	6	7	7

Note: Queue reported is the number of cars per lane.

City of Morgan Hill
The Crosswinds Residential Development

Level Of Service Computation Report
2000 HCM Operations (Future Volume Alternative)
Year 2030 Cumulative without Project AM

Intersection #105: Sutter Boulevard and Cochrane Road

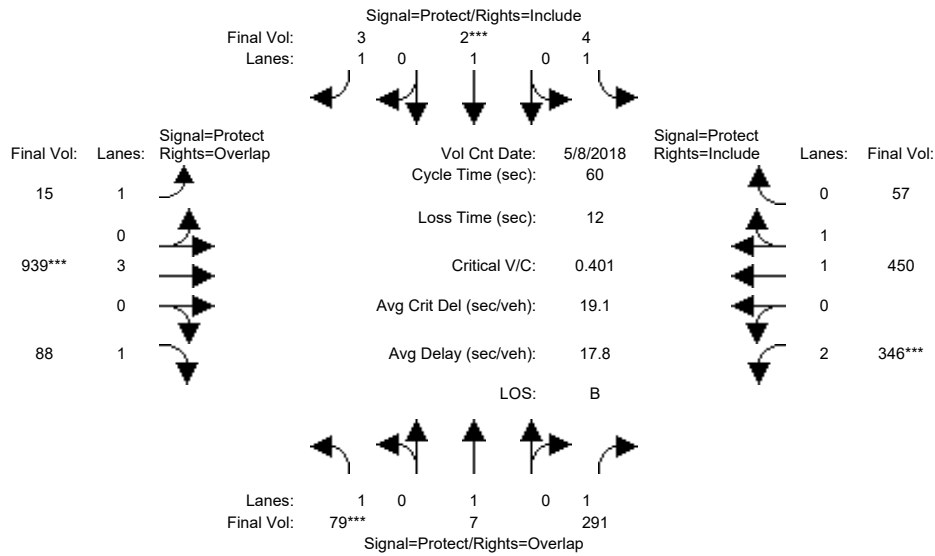

Street Name:	Sutter Boulevard						Cochrane Road					
	North Bound			South Bound			East Bound			West Bound		
Approach:	North Bound			South Bound			East Bound			West Bound		
Movement:	L	T	R	L	T	R	L	T	R	L	T	R
Min. Green:	7	10	10	7	10	10	7	10	10	7	10	10
Y+R:	4.0	4.0	4.0	4.0	4.0	4.0	4.0	4.0	4.0	4.0	4.0	4.0

Volume Module:	>>	Count	Date:	8 May 2018	<<											
Base Vol:	79	7	291	4	2	3	15	939	88	346	450	57				
Growth Adj:	1.00	1.00	1.00	1.00	1.00	1.00	1.00	1.00	1.00	1.00	1.00	1.00				
Initial Bse:	79	7	291	4	2	3	15	939	88	346	450	57				
Added Vol:	0	0	0	0	0	0	0	0	0	0	0	0				
PasserByVol:	0	0	0	0	0	0	0	0	0	0	0	0				
Initial Fut:	79	7	291	4	2	3	15	939	88	346	450	57				
User Adj:	1.00	1.00	1.00	1.00	1.00	1.00	1.00	1.00	1.00	1.00	1.00	1.00				
PHF Adj:	1.00	1.00	1.00	1.00	1.00	1.00	1.00	1.00	1.00	1.00	1.00	1.00				
PHF Volume:	79	7	291	4	2	3	15	939	88	346	450	57				
Reduct Vol:	0	0	0	0	0	0	0	0	0	0	0	0				
Reduced Vol:	79	7	291	4	2	3	15	939	88	346	450	57				
PCE Adj:	1.00	1.00	1.00	1.00	1.00	1.00	1.00	1.00	1.00	1.00	1.00	1.00				
MLF Adj:	1.00	1.00	1.00	1.00	1.00	1.00	1.00	1.00	1.00	1.00	1.00	1.00				
Final Volume:	79	7	291	4	2	3	15	939	88	346	450	57				

Saturation Flow Module:												
Sat/Lane:	1900	1900	1900	1900	1900	1900	1900	1900	1900	1900	1900	1900
Adjustment:	0.92	1.00	0.92	0.92	1.00	0.92	0.92	1.00	0.92	0.83	0.98	0.95
Lanes:	1.00	1.00	1.00	1.00	1.00	1.00	1.00	3.00	1.00	2.00	1.77	0.23
Final Sat.:	1750	1900	1750	1750	1900	1750	1750	5700	1750	3150	3284	416

Capacity Analysis Module:												
Vol/Sat:	0.05	0.00	0.17	0.00	0.00	0.00	0.01	0.16	0.05	0.11	0.14	0.14
Crit Moves:	****				****			****		****		
Green Time:	7.0	10.0	22.4	7.0	10.0	10.0	12.8	18.6	25.6	12.4	18.2	18.2
Volume/Cap:	0.39	0.02	0.45	0.02	0.01	0.01	0.04	0.53	0.12	0.53	0.45	0.45
Delay/Veh:	25.7	20.9	14.6	23.5	20.9	20.9	18.8	17.4	10.5	22.1	17.1	17.1
User DelAdj:	1.00	1.00	1.00	1.00	1.00	1.00	1.00	1.00	1.00	1.00	1.00	1.00
AdjDel/Veh:	25.7	20.9	14.6	23.5	20.9	20.9	18.8	17.4	10.5	22.1	17.1	17.1
LOS by Move:	C	C	B	C	C	C	B	B	B	C	B	B
HCM2k95thQ:	4	0	9	0	0	0	0	9	2	7	8	8

Note: Queue reported is the number of cars per lane.

City of Morgan Hill
The Crosswinds Residential Development

Level Of Service Computation Report
2000 HCM Operations (Future Volume Alternative)
Year 2030 Cumulative with Project AM

Intersection #105: Sutter Boulevard and Cochrane Road

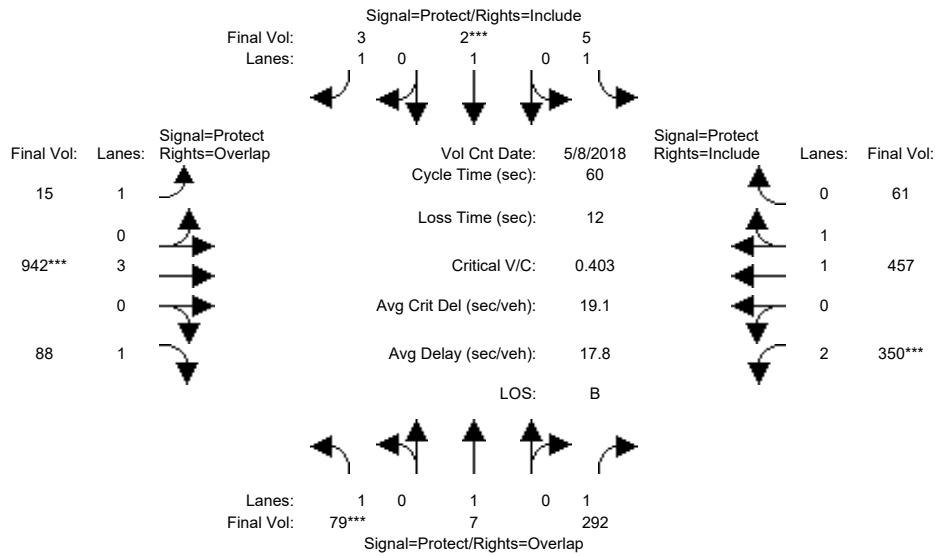

Street Name:	Sutter Boulevard						Cochrane Road					
	North Bound			South Bound			East Bound			West Bound		
Approach:	L	T	R	L	T	R	L	T	R	L	T	R
Min. Green:	7	10	10	7	10	10	7	10	10	7	10	10
Y+R:	4.0	4.0	4.0	4.0	4.0	4.0	4.0	4.0	4.0	4.0	4.0	4.0

Volume Module:	>>	Count	Date:	8 May 2018	<<							
Base Vol:	79	7	291	4	2	3	15	939	88	346	450	57
Growth Adj:	1.00	1.00	1.00	1.00	1.00	1.00	1.00	1.00	1.00	1.00	1.00	1.00
Initial Bse:	79	7	291	4	2	3	15	939	88	346	450	57
Added Vol:	0	0	1	1	0	0	0	3	0	4	7	4
PasserByVol:	0	0	0	0	0	0	0	0	0	0	0	0
Initial Fut:	79	7	292	5	2	3	15	942	88	350	457	61
User Adj:	1.00	1.00	1.00	1.00	1.00	1.00	1.00	1.00	1.00	1.00	1.00	1.00
PHF Adj:	1.00	1.00	1.00	1.00	1.00	1.00	1.00	1.00	1.00	1.00	1.00	1.00
PHF Volume:	79	7	292	5	2	3	15	942	88	350	457	61
Reduct Vol:	0	0	0	0	0	0	0	0	0	0	0	0
Reduced Vol:	79	7	292	5	2	3	15	942	88	350	457	61
PCE Adj:	1.00	1.00	1.00	1.00	1.00	1.00	1.00	1.00	1.00	1.00	1.00	1.00
MLF Adj:	1.00	1.00	1.00	1.00	1.00	1.00	1.00	1.00	1.00	1.00	1.00	1.00
Final Volume:	79	7	292	5	2	3	15	942	88	350	457	61

Saturation Flow Module:												
Sat/Lane:	1900	1900	1900	1900	1900	1900	1900	1900	1900	1900	1900	1900
Adjustment:	0.92	1.00	0.92	0.92	1.00	0.92	0.92	1.00	0.92	0.83	0.98	0.95
Lanes:	1.00	1.00	1.00	1.00	1.00	1.00	1.00	3.00	1.00	2.00	1.76	0.24
Final Sat.:	1750	1900	1750	1750	1900	1750	1750	5700	1750	3150	3264	436

Capacity Analysis Module:												
Vol/Sat:	0.05	0.00	0.17	0.00	0.00	0.00	0.01	0.17	0.05	0.11	0.14	0.14
Crit Moves:	****			****			****			****		
Green Time:	7.0	10.0	22.5	7.0	10.0	10.0	12.8	18.5	25.5	12.5	18.2	18.2
Volume/Cap:	0.39	0.02	0.45	0.02	0.01	0.01	0.04	0.53	0.12	0.53	0.46	0.46
Delay/Veh:	25.7	20.9	14.6	23.5	20.9	20.9	18.8	17.5	10.5	22.1	17.2	17.2
User DelAdj:	1.00	1.00	1.00	1.00	1.00	1.00	1.00	1.00	1.00	1.00	1.00	1.00
AdjDel/Veh:	25.7	20.9	14.6	23.5	20.9	20.9	18.8	17.5	10.5	22.1	17.2	17.2
LOS by Move:	C	C	B	C	C	C	B	B	B	C	B	B
HCM2k95thQ:	4	0	9	0	0	0	0	9	2	7	8	8

Note: Queue reported is the number of cars per lane.

City of Morgan Hill
The Crosswinds Residential Development

Level Of Service Computation Report
2000 HCM Operations (Future Volume Alternative)
Existing PM

Intersection #105: Sutter Boulevard and Cochrane Road

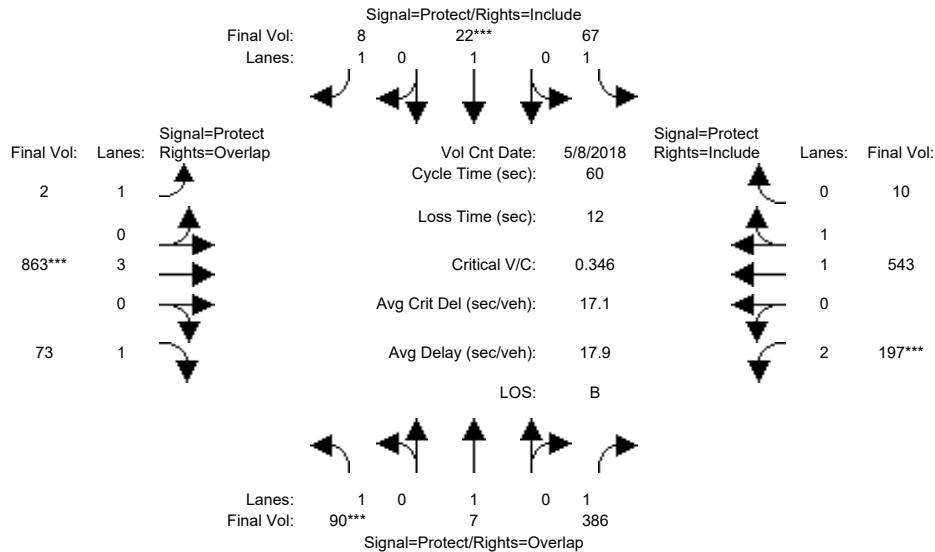

Street Name:	Sutter Boulevard						Cochrane Road					
	North Bound			South Bound			East Bound			West Bound		
Approach:	L	T	R	L	T	R	L	T	R	L	T	R
Min. Green:	7	10	10	7	10	10	7	10	10	7	10	10
Y+R:	4.0	4.0	4.0	4.0	4.0	4.0	4.0	4.0	4.0	4.0	4.0	4.0

Volume Module:	>>	Count	Date:	8 May 2018	<<												
Base Vol:	90	7	386	67	22	8	2	863	73	197	543	10					
Growth Adj:	1.00	1.00	1.00	1.00	1.00	1.00	1.00	1.00	1.00	1.00	1.00	1.00					
Initial Bse:	90	7	386	67	22	8	2	863	73	197	543	10					
Added Vol:	0	0	0	0	0	0	0	0	0	0	0	0					
PasserByVol:	0	0	0	0	0	0	0	0	0	0	0	0					
Initial Fut:	90	7	386	67	22	8	2	863	73	197	543	10					
User Adj:	1.00	1.00	1.00	1.00	1.00	1.00	1.00	1.00	1.00	1.00	1.00	1.00					
PHF Adj:	1.00	1.00	1.00	1.00	1.00	1.00	1.00	1.00	1.00	1.00	1.00	1.00					
PHF Volume:	90	7	386	67	22	8	2	863	73	197	543	10					
Reduct Vol:	0	0	0	0	0	0	0	0	0	0	0	0					
Reduced Vol:	90	7	386	67	22	8	2	863	73	197	543	10					
PCE Adj:	1.00	1.00	1.00	1.00	1.00	1.00	1.00	1.00	1.00	1.00	1.00	1.00					
MLF Adj:	1.00	1.00	1.00	1.00	1.00	1.00	1.00	1.00	1.00	1.00	1.00	1.00					
FinalVolume:	90	7	386	67	22	8	2	863	73	197	543	10					

Saturation Flow Module:												
Sat/Lane:	1900	1900	1900	1900	1900	1900	1900	1900	1900	1900	1900	1900
Adjustment:	0.92	1.00	0.92	0.92	1.00	0.92	0.92	1.00	0.92	0.83	0.97	0.95
Lanes:	1.00	1.00	1.00	1.00	1.00	1.00	1.00	3.00	1.00	2.00	1.96	0.04
Final Sat.:	1750	1900	1750	1750	1900	1750	1750	5700	1750	3150	3633	67

Capacity Analysis Module:												
Vol/Sat:	0.05	0.00	0.22	0.04	0.01	0.00	0.00	0.15	0.04	0.06	0.15	0.15
Crit Moves:	****				****			****		****		
Green Time:	7.4	10.2	19.2	7.2	10.0	10.0	12.6	21.7	29.0	9.0	18.0	18.0
Volume/Cap:	0.42	0.02	0.69	0.32	0.07	0.03	0.01	0.42	0.09	0.42	0.50	0.50
Delay/Veh:	25.7	20.8	21.5	25.1	21.2	21.0	18.7	14.6	8.4	23.8	17.6	17.6
User DelAdj:	1.00	1.00	1.00	1.00	1.00	1.00	1.00	1.00	1.00	1.00	1.00	1.00
AdjDel/Veh:	25.7	20.8	21.5	25.1	21.2	21.0	18.7	14.6	8.4	23.8	17.6	17.6
LOS by Move:	C	C	C	C	C	C	B	B	A	C	B	B
HCM2k95thQ:	4	0	15	3	1	0	0	8	2	4	8	8

Note: Queue reported is the number of cars per lane.

City of Morgan Hill
The Crosswinds Residential Development

Level Of Service Computation Report
2000 HCM Operations (Future Volume Alternative)
Existing Plus Project PM

Intersection #105: Sutter Boulevard and Cochrane Road

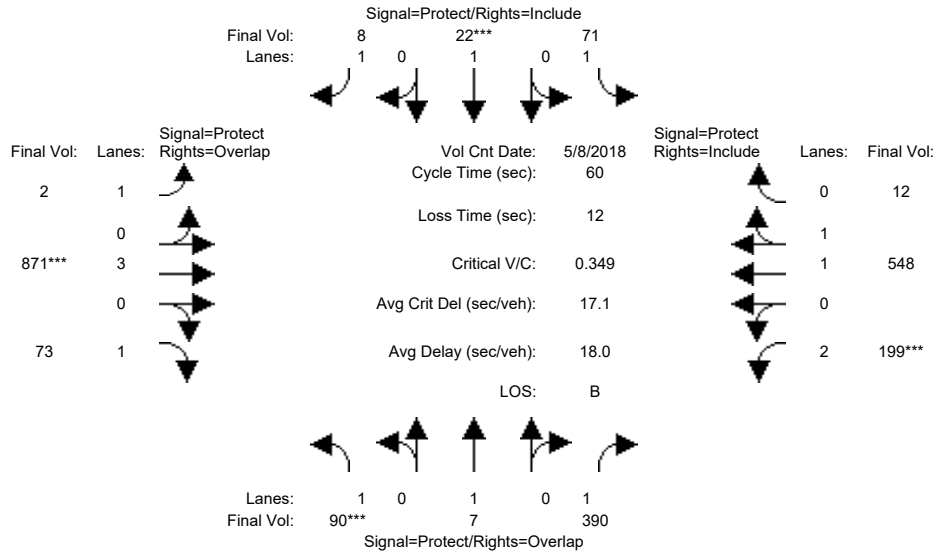

Street Name:	Sutter Boulevard						Cochrane Road					
	North Bound			South Bound			East Bound			West Bound		
Approach:	North Bound			South Bound			East Bound			West Bound		
Movement:	L	T	R	L	T	R	L	T	R	L	T	R
Min. Green:	7	10	10	7	10	10	7	10	10	7	10	10
Y+R:	4.0	4.0	4.0	4.0	4.0	4.0	4.0	4.0	4.0	4.0	4.0	4.0

Volume Module:	>>	Count	Date:	8 May 2018	<<							
Base Vol:	90	7	386	67	22	8	2	863	73	197	543	10
Growth Adj:	1.00	1.00	1.00	1.00	1.00	1.00	1.00	1.00	1.00	1.00	1.00	1.00
Initial Bse:	90	7	386	67	22	8	2	863	73	197	543	10
Added Vol:	0	0	4	4	0	0	0	8	0	2	5	2
PasserByVol:	0	0	0	0	0	0	0	0	0	0	0	0
Initial Fut:	90	7	390	71	22	8	2	871	73	199	548	12
User Adj:	1.00	1.00	1.00	1.00	1.00	1.00	1.00	1.00	1.00	1.00	1.00	1.00
PHF Adj:	1.00	1.00	1.00	1.00	1.00	1.00	1.00	1.00	1.00	1.00	1.00	1.00
PHF Volume:	90	7	390	71	22	8	2	871	73	199	548	12
Reduct Vol:	0	0	0	0	0	0	0	0	0	0	0	0
Reduced Vol:	90	7	390	71	22	8	2	871	73	199	548	12
PCE Adj:	1.00	1.00	1.00	1.00	1.00	1.00	1.00	1.00	1.00	1.00	1.00	1.00
MLF Adj:	1.00	1.00	1.00	1.00	1.00	1.00	1.00	1.00	1.00	1.00	1.00	1.00
Final Volume:	90	7	390	71	22	8	2	871	73	199	548	12

Saturation Flow Module:												
Sat/Lane:	1900	1900	1900	1900	1900	1900	1900	1900	1900	1900	1900	1900
Adjustment:	0.92	1.00	0.92	0.92	1.00	0.92	0.92	1.00	0.92	0.83	0.97	0.95
Lanes:	1.00	1.00	1.00	1.00	1.00	1.00	1.00	3.00	1.00	2.00	1.96	0.04
Final Sat.:	1750	1900	1750	1750	1900	1750	1750	5700	1750	3150	3621	79

Capacity Analysis Module:												
Vol/Sat:	0.05	0.00	0.22	0.04	0.01	0.00	0.00	0.15	0.04	0.06	0.15	0.15
Crit Moves:	****			****			****			****		
Green Time:	7.3	10.2	19.2	7.1	10.0	10.0	12.6	21.7	29.0	9.0	18.1	18.1
Volume/Cap:	0.42	0.02	0.70	0.34	0.07	0.03	0.01	0.42	0.09	0.42	0.50	0.50
Delay/Veh:	25.7	20.8	21.8	25.3	21.2	21.0	18.7	14.6	8.4	23.8	17.6	17.6
User DelAdj:	1.00	1.00	1.00	1.00	1.00	1.00	1.00	1.00	1.00	1.00	1.00	1.00
AdjDel/Veh:	25.7	20.8	21.8	25.3	21.2	21.0	18.7	14.6	8.4	23.8	17.6	17.6
LOS by Move:	C	C	C	C	C	C	B	B	A	C	B	B
HCM2k95thQ:	4	0	16	3	1	0	0	8	2	4	8	8

Note: Queue reported is the number of cars per lane.

City of Morgan Hill
The Crosswinds Residential Development

Level Of Service Computation Report
2000 HCM Operations (Future Volume Alternative)
Year 2030 Cumulative without Project PM

Intersection #105: Sutter Boulevard and Cochrane Road

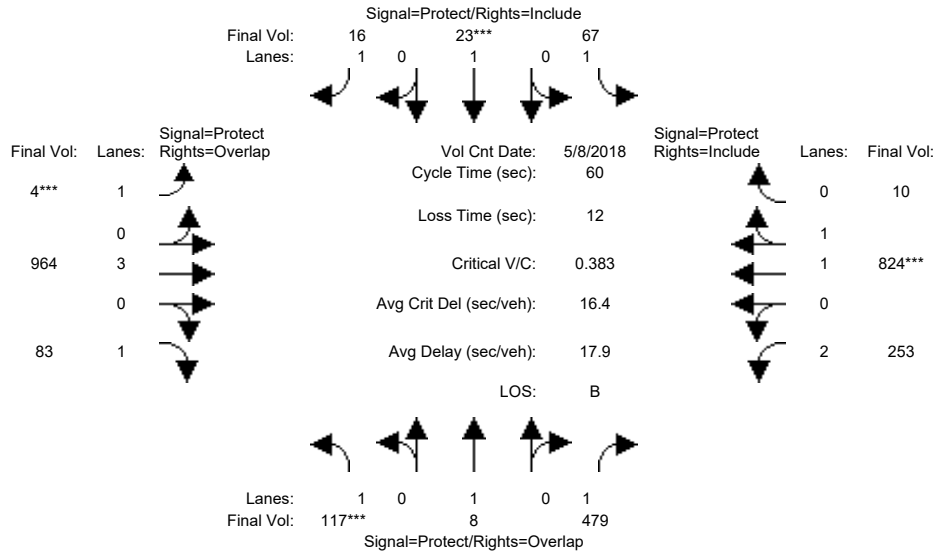

Street Name:	Sutter Boulevard						Cochrane Road					
	North Bound			South Bound			East Bound			West Bound		
Approach:	L	T	R	L	T	R	L	T	R	L	T	R
Min. Green:	7	10	10	7	10	10	7	10	10	7	10	10
Y+R:	4.0	4.0	4.0	4.0	4.0	4.0	4.0	4.0	4.0	4.0	4.0	4.0

Volume Module:	>>	Count	Date:	8 May 2018	<<												
Base Vol:	117	8	479	67	23	16	4	964	83	253	824	10					
Growth Adj:	1.00	1.00	1.00	1.00	1.00	1.00	1.00	1.00	1.00	1.00	1.00	1.00					
Initial Bse:	117	8	479	67	23	16	4	964	83	253	824	10					
Added Vol:	0	0	0	0	0	0	0	0	0	0	0	0					
PasserByVol:	0	0	0	0	0	0	0	0	0	0	0	0					
Initial Fut:	117	8	479	67	23	16	4	964	83	253	824	10					
User Adj:	1.00	1.00	1.00	1.00	1.00	1.00	1.00	1.00	1.00	1.00	1.00	1.00					
PHF Adj:	1.00	1.00	1.00	1.00	1.00	1.00	1.00	1.00	1.00	1.00	1.00	1.00					
PHF Volume:	117	8	479	67	23	16	4	964	83	253	824	10					
Reduct Vol:	0	0	0	0	0	0	0	0	0	0	0	0					
Reduced Vol:	117	8	479	67	23	16	4	964	83	253	824	10					
PCE Adj:	1.00	1.00	1.00	1.00	1.00	1.00	1.00	1.00	1.00	1.00	1.00	1.00					
MLF Adj:	1.00	1.00	1.00	1.00	1.00	1.00	1.00	1.00	1.00	1.00	1.00	1.00					
Final Volume:	117	8	479	67	23	16	4	964	83	253	824	10					

Saturation Flow Module:												
Sat/Lane:	1900	1900	1900	1900	1900	1900	1900	1900	1900	1900	1900	1900
Adjustment:	0.92	1.00	0.92	0.92	1.00	0.92	0.92	1.00	0.92	0.83	0.97	0.95
Lanes:	1.00	1.00	1.00	1.00	1.00	1.00	1.00	3.00	1.00	2.00	1.98	0.02
Final Sat.:	1750	1900	1750	1750	1900	1750	1750	5700	1750	3150	3656	44

Capacity Analysis Module:												
Vol/Sat:	0.07	0.00	0.27	0.04	0.01	0.01	0.00	0.17	0.05	0.08	0.23	0.23
Crit Moves:	***			***			***			***		
Green Time:	7.1	10.1	22.7	7.0	10.0	10.0	7.0	18.3	25.4	12.6	23.9	23.9
Volume/Cap:	0.57	0.03	0.72	0.33	0.07	0.05	0.02	0.55	0.11	0.38	0.57	0.57
Delay/Veh:	28.6	20.9	19.9	25.3	21.2	21.1	23.5	17.8	10.6	20.7	14.5	14.5
User DelAdj:	1.00	1.00	1.00	1.00	1.00	1.00	1.00	1.00	1.00	1.00	1.00	1.00
AdjDel/Veh:	28.6	20.9	19.9	25.3	21.2	21.1	23.5	17.8	10.6	20.7	14.5	14.5
LOS by Move:	C	C	B	C	C	C	C	B	B	C	B	B
HCM2k95thQ:	6	0	18	3	1	1	0	10	2	5	12	12

Note: Queue reported is the number of cars per lane.

City of Morgan Hill
The Crosswinds Residential Development

Level Of Service Computation Report
2000 HCM Operations (Future Volume Alternative)
Year 2030 Cumulative with Project PM

Intersection #105: Sutter Boulevard and Cochrane Road

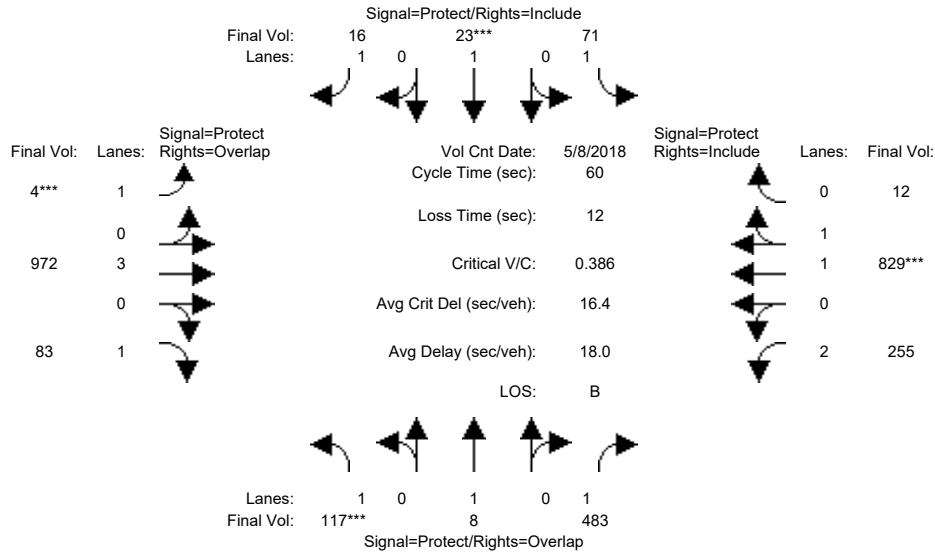

Street Name:	Sutter Boulevard						Cochrane Road					
	North Bound			South Bound			East Bound			West Bound		
Approach:	L	T	R	L	T	R	L	T	R	L	T	R
Min. Green:	7	10	10	7	10	10	7	10	10	7	10	10
Y+R:	4.0	4.0	4.0	4.0	4.0	4.0	4.0	4.0	4.0	4.0	4.0	4.0

Volume Module:	>>	Count	Date:	8 May 2018	<<							
Base Vol:	117	8	479	67	23	16	4	964	83	253	824	10
Growth Adj:	1.00	1.00	1.00	1.00	1.00	1.00	1.00	1.00	1.00	1.00	1.00	1.00
Initial Bse:	117	8	479	67	23	16	4	964	83	253	824	10
Added Vol:	0	0	4	4	0	0	0	8	0	2	5	2
PasserByVol:	0	0	0	0	0	0	0	0	0	0	0	0
Initial Fut:	117	8	483	71	23	16	4	972	83	255	829	12
User Adj:	1.00	1.00	1.00	1.00	1.00	1.00	1.00	1.00	1.00	1.00	1.00	1.00
PHF Adj:	1.00	1.00	1.00	1.00	1.00	1.00	1.00	1.00	1.00	1.00	1.00	1.00
PHF Volume:	117	8	483	71	23	16	4	972	83	255	829	12
Reduct Vol:	0	0	0	0	0	0	0	0	0	0	0	0
Reduced Vol:	117	8	483	71	23	16	4	972	83	255	829	12
PCE Adj:	1.00	1.00	1.00	1.00	1.00	1.00	1.00	1.00	1.00	1.00	1.00	1.00
MLF Adj:	1.00	1.00	1.00	1.00	1.00	1.00	1.00	1.00	1.00	1.00	1.00	1.00
Final Volume:	117	8	483	71	23	16	4	972	83	255	829	12

Saturation Flow Module:												
Sat/Lane:	1900	1900	1900	1900	1900	1900	1900	1900	1900	1900	1900	1900
Adjustment:	0.92	1.00	0.92	0.92	1.00	0.92	0.92	1.00	0.92	0.83	0.97	0.95
Lanes:	1.00	1.00	1.00	1.00	1.00	1.00	1.00	3.00	1.00	2.00	1.97	0.03
Final Sat.:	1750	1900	1750	1750	1900	1750	1750	5700	1750	3150	3647	53

Capacity Analysis Module:												
Vol/Sat:	0.07	0.00	0.28	0.04	0.01	0.01	0.00	0.17	0.05	0.08	0.23	0.23
Crit Moves:	***			****			****			****		
Green Time:	7.0	10.0	22.6	7.0	10.0	10.0	7.0	18.4	25.4	12.6	24.0	24.0
Volume/Cap:	0.57	0.03	0.73	0.35	0.07	0.05	0.02	0.56	0.11	0.39	0.57	0.57
Delay/Veh:	28.8	20.9	20.3	25.4	21.2	21.1	23.5	17.8	10.5	20.8	14.5	14.5
User DelAdj:	1.00	1.00	1.00	1.00	1.00	1.00	1.00	1.00	1.00	1.00	1.00	1.00
AdjDel/Veh:	28.8	20.9	20.3	25.4	21.2	21.1	23.5	17.8	10.5	20.8	14.5	14.5
LOS by Move:	C	C	C	C	C	C	C	B	B	C	B	B
HCM2k95thQ:	6	0	18	3	1	1	0	10	2	5	12	12

Note: Queue reported is the number of cars per lane.

City of Morgan Hill
The Crosswinds Residential Development

Level Of Service Computation Report
2000 HCM Operations (Future Volume Alternative)
Existing AM

Intersection #106: Madrone Parkway/Cochrane Plaza and Cochrane Road

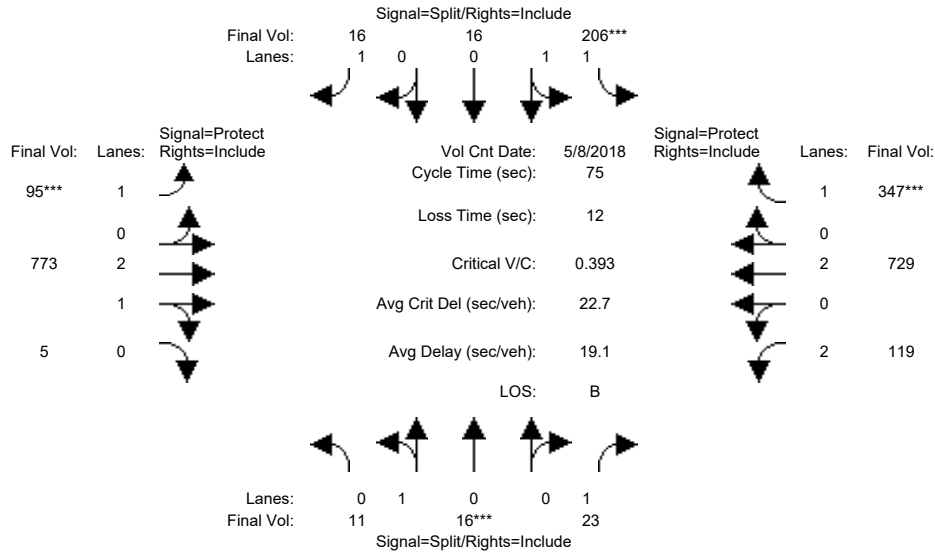

Street Name:	Madrone Parkway/Cochrane Plaza						Cochrane Road					
	North Bound			South Bound			East Bound			West Bound		
Movement:	L	T	R	L	T	R	L	T	R	L	T	R
Min. Green:	10	10	10	10	10	10	7	10	10	7	10	10
Y+R:	4.0	4.0	4.0	4.0	4.0	4.0	4.0	4.0	4.0	4.0	4.0	4.0

Volume Module:	>>	Count	Date:	8 May 2018	<<												
Base Vol:	11	16	23	206	16	16	95	773	5	119	729	347					
Growth Adj:	1.00	1.00	1.00	1.00	1.00	1.00	1.00	1.00	1.00	1.00	1.00	1.00					
Initial Bse:	11	16	23	206	16	16	95	773	5	119	729	347					
Added Vol:	0	0	0	0	0	0	0	0	0	0	0	0					
PasserByVol:	0	0	0	0	0	0	0	0	0	0	0	0					
Initial Fut:	11	16	23	206	16	16	95	773	5	119	729	347					
User Adj:	1.00	1.00	1.00	1.00	1.00	1.00	1.00	1.00	1.00	1.00	1.00	1.00					
PHF Adj:	1.00	1.00	1.00	1.00	1.00	1.00	1.00	1.00	1.00	1.00	1.00	1.00					
PHF Volume:	11	16	23	206	16	16	95	773	5	119	729	347					
Reduct Vol:	0	0	0	0	0	0	0	0	0	0	0	0					
Reduced Vol:	11	16	23	206	16	16	95	773	5	119	729	347					
PCE Adj:	1.00	1.00	1.00	1.00	1.00	1.00	1.00	1.00	1.00	1.00	1.00	1.00					
MLF Adj:	1.00	1.00	1.00	1.00	1.00	1.00	1.00	1.00	1.00	1.00	1.00	1.00					
Final Volume:	11	16	23	206	16	16	95	773	5	119	729	347					

Saturation Flow Module:												
Sat/Lane:	1900	1900	1900	1900	1900	1900	1900	1900	1900	1900	1900	1900
Adjustment:	0.95	0.95	0.92	0.93	0.95	0.92	0.92	0.98	0.95	0.83	1.00	0.92
Lanes:	0.41	0.59	1.00	1.86	0.14	1.00	1.00	2.98	0.02	2.00	2.00	1.00
Final Sat.:	733	1067	1750	3294	256	1750	1750	5564	36	3150	3800	1750

Capacity Analysis Module:												
Vol/Sat:	0.02	0.02	0.01	0.06	0.06	0.01	0.05	0.14	0.14	0.04	0.19	0.20
Crit Moves:	****			****			****			****		
Green Time:	10.0	10.0	10.0	10.5	10.5	10.5	9.1	25.4	25.4	17.1	33.4	33.4
Volume/Cap:	0.11	0.11	0.10	0.45	0.45	0.07	0.45	0.41	0.41	0.17	0.43	0.45
Delay/Veh:	28.8	28.8	28.7	30.2	30.2	28.1	32.1	19.2	19.2	23.4	14.5	14.8
User DelAdj:	1.00	1.00	1.00	1.00	1.00	1.00	1.00	1.00	1.00	1.00	1.00	1.00
AdjDel/Veh:	28.8	28.8	28.7	30.2	30.2	28.1	32.1	19.2	19.2	23.4	14.5	14.8
LOS by Move:	C	C	C	C	C	C	C	B	B	C	B	B
HCM2k95thQ:	1	1	1	6	6	1	4	9	9	3	11	11

Note: Queue reported is the number of cars per lane.

City of Morgan Hill
The Crosswinds Residential Development

Level Of Service Computation Report
2000 HCM Operations (Future Volume Alternative)
Existing Plus Project AM

Intersection #106: Madrone Parkway/Cochrane Plaza and Cochrane Road

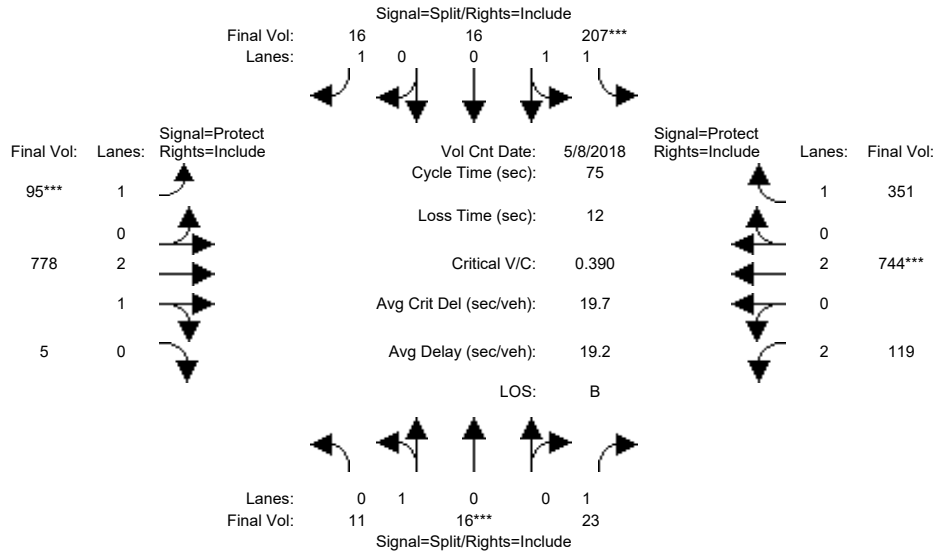

Street Name:	Madrone Parkway/Cochrane Plaza						Cochrane Road					
	North Bound			South Bound			East Bound			West Bound		
Approach:	North Bound			South Bound			East Bound			West Bound		
Movement:	L	T	R	L	T	R	L	T	R	L	T	R
Min. Green:	10	10	10	10	10	10	7	10	10	7	10	10
Y+R:	4.0	4.0	4.0	4.0	4.0	4.0	4.0	4.0	4.0	4.0	4.0	4.0

Volume Module:	>>	Count	Date:	8 May 2018	<<											
Base Vol:	11	16	23	206	16	16	95	773	5	119	729	347				
Growth Adj:	1.00	1.00	1.00	1.00	1.00	1.00	1.00	1.00	1.00	1.00	1.00	1.00				
Initial Bse:	11	16	23	206	16	16	95	773	5	119	729	347				
Added Vol:	0	0	0	1	0	0	0	5	0	0	15	4				
PasserByVol:	0	0	0	0	0	0	0	0	0	0	0	0				
Initial Fut:	11	16	23	207	16	16	95	778	5	119	744	351				
User Adj:	1.00	1.00	1.00	1.00	1.00	1.00	1.00	1.00	1.00	1.00	1.00	1.00				
PHF Adj:	1.00	1.00	1.00	1.00	1.00	1.00	1.00	1.00	1.00	1.00	1.00	1.00				
PHF Volume:	11	16	23	207	16	16	95	778	5	119	744	351				
Reduct Vol:	0	0	0	0	0	0	0	0	0	0	0	0				
Reduced Vol:	11	16	23	207	16	16	95	778	5	119	744	351				
PCE Adj:	1.00	1.00	1.00	1.00	1.00	1.00	1.00	1.00	1.00	1.00	1.00	1.00				
MLF Adj:	1.00	1.00	1.00	1.00	1.00	1.00	1.00	1.00	1.00	1.00	1.00	1.00				
Final Volume:	11	16	23	207	16	16	95	778	5	119	744	351				

Saturation Flow Module:												
Sat/Lane:	1900	1900	1900	1900	1900	1900	1900	1900	1900	1900	1900	1900
Adjustment:	0.95	0.95	0.92	0.93	0.95	0.92	0.92	0.98	0.95	0.83	1.00	0.92
Lanes:	0.41	0.59	1.00	1.86	0.14	1.00	1.00	2.98	0.02	2.00	2.00	1.00
Final Sat.:	733	1067	1750	3295	255	1750	1750	5564	36	3150	3800	1750

Capacity Analysis Module:												
Vol/Sat:	0.02	0.02	0.01	0.06	0.06	0.01	0.05	0.14	0.14	0.04	0.20	0.20
Crit Moves:	****			****			****			****		
Green Time:	10.0	10.0	10.0	10.6	10.6	10.6	9.2	25.4	25.4	17.0	33.2	33.2
Volume/Cap:	0.11	0.11	0.10	0.44	0.44	0.06	0.44	0.41	0.41	0.17	0.44	0.45
Delay/Veh:	28.8	28.8	28.7	30.1	30.1	28.0	32.0	19.2	19.2	23.5	14.7	15.0
User DelAdj:	1.00	1.00	1.00	1.00	1.00	1.00	1.00	1.00	1.00	1.00	1.00	1.00
AdjDel/Veh:	28.8	28.8	28.7	30.1	30.1	28.0	32.0	19.2	19.2	23.5	14.7	15.0
LOS by Move:	C	C	C	C	C	C	C	B	B	C	B	B
HCM2k95thQ:	1	1	1	6	6	1	4	9	9	3	11	12

Note: Queue reported is the number of cars per lane.

City of Morgan Hill
The Crosswinds Residential Development

Level Of Service Computation Report
2000 HCM Operations (Future Volume Alternative)
Year 2030 Cumulative without Project AM

Intersection #106: Madrone Parkway/Cochrane Plaza and Cochrane Road

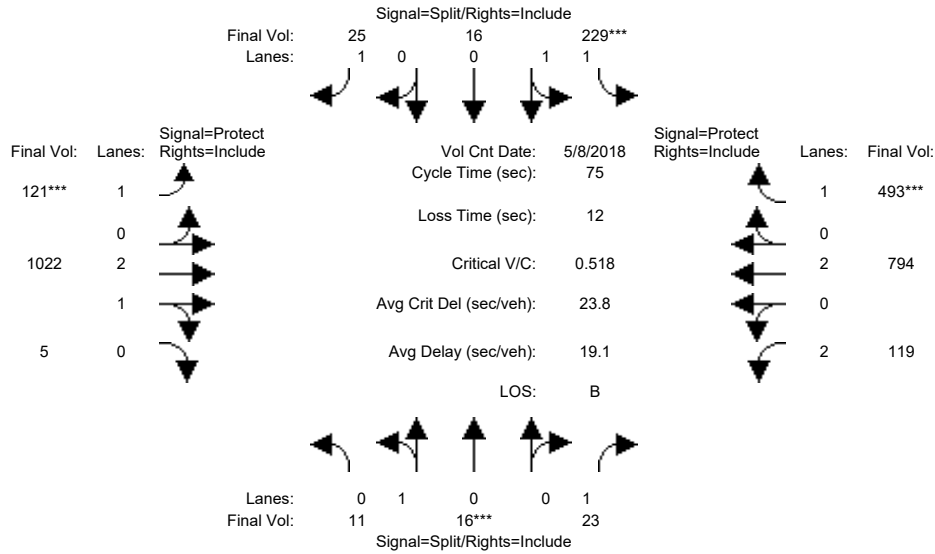

Street Name:	Madrone Parkway/Cochrane Plaza						Cochrane Road					
	North Bound			South Bound			East Bound			West Bound		
Approach:	North Bound			South Bound			East Bound			West Bound		
Movement:	L	T	R	L	T	R	L	T	R	L	T	R
Min. Green:	10	10	10	10	10	10	7	10	10	7	10	10
Y+R:	4.0	4.0	4.0	4.0	4.0	4.0	4.0	4.0	4.0	4.0	4.0	4.0

Volume Module:	>>	Count	Date:	8 May 2018	<<							
Base Vol:	11	16	23	229	16	25	121	1022	5	119	794	493
Growth Adj:	1.00	1.00	1.00	1.00	1.00	1.00	1.00	1.00	1.00	1.00	1.00	1.00
Initial Bse:	11	16	23	229	16	25	121	1022	5	119	794	493
Added Vol:	0	0	0	0	0	0	0	0	0	0	0	0
PasserByVol:	0	0	0	0	0	0	0	0	0	0	0	0
Initial Fut:	11	16	23	229	16	25	121	1022	5	119	794	493
User Adj:	1.00	1.00	1.00	1.00	1.00	1.00	1.00	1.00	1.00	1.00	1.00	1.00
PHF Adj:	1.00	1.00	1.00	1.00	1.00	1.00	1.00	1.00	1.00	1.00	1.00	1.00
PHF Volume:	11	16	23	229	16	25	121	1022	5	119	794	493
Reduct Vol:	0	0	0	0	0	0	0	0	0	0	0	0
Reduced Vol:	11	16	23	229	16	25	121	1022	5	119	794	493
PCE Adj:	1.00	1.00	1.00	1.00	1.00	1.00	1.00	1.00	1.00	1.00	1.00	1.00
MLF Adj:	1.00	1.00	1.00	1.00	1.00	1.00	1.00	1.00	1.00	1.00	1.00	1.00
Final Volume:	11	16	23	229	16	25	121	1022	5	119	794	493

Saturation Flow Module:												
Sat/Lane:	1900	1900	1900	1900	1900	1900	1900	1900	1900	1900	1900	1900
Adjustment:	0.95	0.95	0.92	0.93	0.95	0.92	0.92	0.98	0.95	0.83	1.00	0.92
Lanes:	0.41	0.59	1.00	1.87	0.13	1.00	1.00	2.98	0.02	2.00	2.00	1.00
Final Sat.:	733	1067	1750	3318	232	1750	1750	5573	27	3150	3800	1750

Capacity Analysis Module:												
Vol/Sat:	0.02	0.02	0.01	0.07	0.07	0.01	0.07	0.18	0.18	0.04	0.21	0.28
Crit Moves:	****			****			****			****		
Green Time:	10.0	10.0	10.0	10.0	10.0	10.0	8.5	28.5	28.5	14.5	34.5	34.5
Volume/Cap:	0.11	0.11	0.10	0.52	0.52	0.11	0.61	0.48	0.48	0.20	0.45	0.61
Delay/Veh:	28.8	28.8	28.7	31.3	31.3	28.8	37.3	17.8	17.8	25.5	14.0	16.6
User DelAdj:	1.00	1.00	1.00	1.00	1.00	1.00	1.00	1.00	1.00	1.00	1.00	1.00
AdjDel/Veh:	28.8	28.8	28.7	31.3	31.3	28.8	37.3	17.8	17.8	25.5	14.0	16.6
LOS by Move:	C	C	C	C	C	C	D	B	B	C	B	B
HCM2k95thQ:	1	1	1	7	7	1	6	11	11	3	12	17

Note: Queue reported is the number of cars per lane.

City of Morgan Hill
The Crosswinds Residential Development

Level Of Service Computation Report
2000 HCM Operations (Future Volume Alternative)
Year 2030 Cumulative with Project AM

Intersection #106: Madrone Parkway/Cochrane Plaza and Cochrane Road

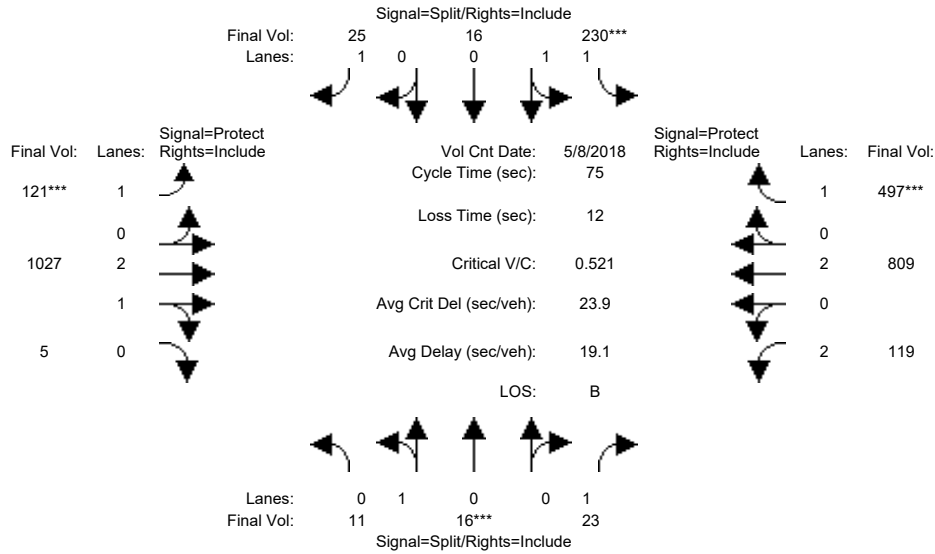

Street Name:	Madrone Parkway/Cochrane Plaza						Cochrane Road					
	North Bound			South Bound			East Bound			West Bound		
Approach:	North Bound			South Bound			East Bound			West Bound		
Movement:	L	T	R	L	T	R	L	T	R	L	T	R
Min. Green:	10	10	10	10	10	10	7	10	10	7	10	10
Y+R:	4.0	4.0	4.0	4.0	4.0	4.0	4.0	4.0	4.0	4.0	4.0	4.0

Volume Module:	>>	Count	Date:	8 May 2018	<<							
Base Vol:	11	16	23	229	16	25	121	1022	5	119	794	493
Growth Adj:	1.00	1.00	1.00	1.00	1.00	1.00	1.00	1.00	1.00	1.00	1.00	1.00
Initial Bse:	11	16	23	229	16	25	121	1022	5	119	794	493
Added Vol:	0	0	0	1	0	0	0	5	0	0	15	4
PasserByVol:	0	0	0	0	0	0	0	0	0	0	0	0
Initial Fut:	11	16	23	230	16	25	121	1027	5	119	809	497
User Adj:	1.00	1.00	1.00	1.00	1.00	1.00	1.00	1.00	1.00	1.00	1.00	1.00
PHF Adj:	1.00	1.00	1.00	1.00	1.00	1.00	1.00	1.00	1.00	1.00	1.00	1.00
PHF Volume:	11	16	23	230	16	25	121	1027	5	119	809	497
Reduct Vol:	0	0	0	0	0	0	0	0	0	0	0	0
Reduced Vol:	11	16	23	230	16	25	121	1027	5	119	809	497
PCE Adj:	1.00	1.00	1.00	1.00	1.00	1.00	1.00	1.00	1.00	1.00	1.00	1.00
MLF Adj:	1.00	1.00	1.00	1.00	1.00	1.00	1.00	1.00	1.00	1.00	1.00	1.00
Final Volume:	11	16	23	230	16	25	121	1027	5	119	809	497

Saturation Flow Module:												
Sat/Lane:	1900	1900	1900	1900	1900	1900	1900	1900	1900	1900	1900	1900
Adjustment:	0.95	0.95	0.92	0.93	0.95	0.92	0.92	0.98	0.95	0.83	1.00	0.92
Lanes:	0.41	0.59	1.00	1.87	0.13	1.00	1.00	2.98	0.02	2.00	2.00	1.00
Final Sat.:	733	1067	1750	3319	231	1750	1750	5573	27	3150	3800	1750

Capacity Analysis Module:												
Vol/Sat:	0.02	0.02	0.01	0.07	0.07	0.01	0.07	0.18	0.18	0.04	0.21	0.28
Crit Moves:	****			****			****			****		
Green Time:	10.0	10.0	10.0	10.0	10.0	10.0	8.4	28.5	28.5	14.5	34.6	34.6
Volume/Cap:	0.11	0.11	0.10	0.52	0.52	0.11	0.62	0.48	0.48	0.20	0.46	0.62
Delay/Veh:	28.8	28.8	28.7	31.3	31.3	28.8	37.5	17.8	17.8	25.6	14.0	16.7
User DelAdj:	1.00	1.00	1.00	1.00	1.00	1.00	1.00	1.00	1.00	1.00	1.00	1.00
AdjDel/Veh:	28.8	28.8	28.7	31.3	31.3	28.8	37.5	17.8	17.8	25.6	14.0	16.7
LOS by Move:	C	C	C	C	C	C	D	B	B	C	B	B
HCM2k95thQ:	1	1	1	7	7	1	6	11	11	3	12	17

Note: Queue reported is the number of cars per lane.

City of Morgan Hill
The Crosswinds Residential Development

Level Of Service Computation Report
2000 HCM Operations (Future Volume Alternative)
Existing PM

Intersection #106: Madrone Parkway/Cochrane Plaza and Cochrane Road

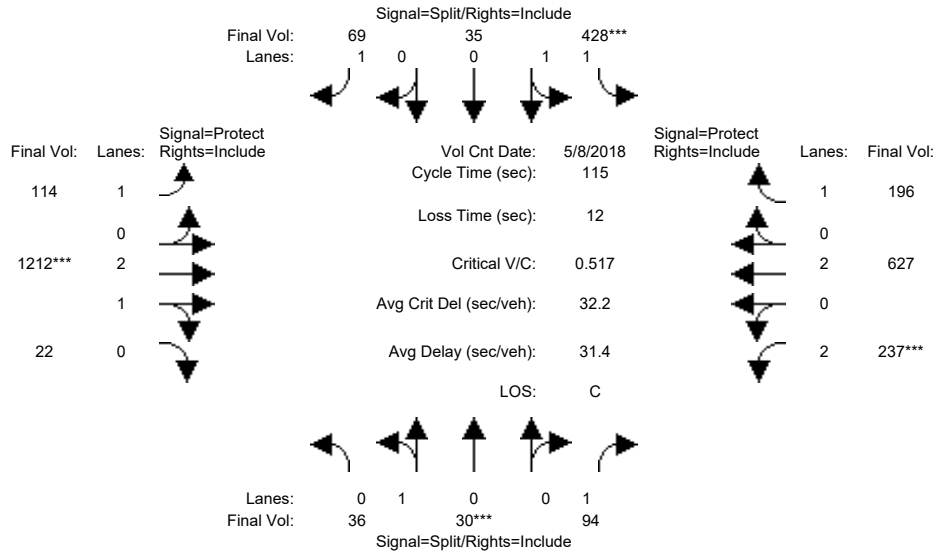

Street Name:	Madrone Parkway/Cochrane Plaza						Cochrane Road					
	North Bound			South Bound			East Bound			West Bound		
Approach:	North Bound			South Bound			East Bound			West Bound		
Movement:	L	T	R	L	T	R	L	T	R	L	T	R
Min. Green:	10	10	10	10	10	10	7	10	10	7	10	10
Y+R:	4.0	4.0	4.0	4.0	4.0	4.0	4.0	4.0	4.0	4.0	4.0	4.0

Volume Module:	>>	Count	Date:	8 May 2018	<<											
Base Vol:	36	30	94	428	35	69	114	1212	22	237	627	196				
Growth Adj:	1.00	1.00	1.00	1.00	1.00	1.00	1.00	1.00	1.00	1.00	1.00	1.00				
Initial Bse:	36	30	94	428	35	69	114	1212	22	237	627	196				
Added Vol:	0	0	0	0	0	0	0	0	0	0	0	0				
PasserByVol:	0	0	0	0	0	0	0	0	0	0	0	0				
Initial Fut:	36	30	94	428	35	69	114	1212	22	237	627	196				
User Adj:	1.00	1.00	1.00	1.00	1.00	1.00	1.00	1.00	1.00	1.00	1.00	1.00				
PHF Adj:	1.00	1.00	1.00	1.00	1.00	1.00	1.00	1.00	1.00	1.00	1.00	1.00				
PHF Volume:	36	30	94	428	35	69	114	1212	22	237	627	196				
Reduct Vol:	0	0	0	0	0	0	0	0	0	0	0	0				
Reduced Vol:	36	30	94	428	35	69	114	1212	22	237	627	196				
PCE Adj:	1.00	1.00	1.00	1.00	1.00	1.00	1.00	1.00	1.00	1.00	1.00	1.00				
MLF Adj:	1.00	1.00	1.00	1.00	1.00	1.00	1.00	1.00	1.00	1.00	1.00	1.00				
Final Volume:	36	30	94	428	35	69	114	1212	22	237	627	196				

Saturation Flow Module:												
Sat/Lane:	1900	1900	1900	1900	1900	1900	1900	1900	1900	1900	1900	1900
Adjustment:	0.95	0.95	0.92	0.93	0.95	0.92	0.92	0.98	0.95	0.83	1.00	0.92
Lanes:	0.55	0.45	1.00	1.85	0.15	1.00	1.00	2.94	0.06	2.00	2.00	1.00
Final Sat.:	982	818	1750	3282	268	1750	1750	5500	100	3150	3800	1750

Capacity Analysis Module:												
Vol/Sat:	0.04	0.04	0.05	0.13	0.13	0.04	0.07	0.22	0.22	0.08	0.17	0.11
Crit Moves:	****			****			****			****		
Green Time:	12.0	12.0	12.0	27.9	27.9	27.9	17.9	47.1	47.1	16.1	45.3	45.3
Volume/Cap:	0.35	0.35	0.52	0.54	0.54	0.16	0.42	0.54	0.54	0.54	0.42	0.28
Delay/Veh:	49.1	49.1	51.4	38.6	38.6	34.5	44.9	26.0	26.0	47.3	25.5	24.0
User DelAdj:	1.00	1.00	1.00	1.00	1.00	1.00	1.00	1.00	1.00	1.00	1.00	1.00
AdjDel/Veh:	49.1	49.1	51.4	38.6	38.6	34.5	44.9	26.0	26.0	47.3	25.5	24.0
LOS by Move:	D	D	D	D	D	C	D	C	C	D	C	C
HCM2k95thQ:	5	5	8	15	15	4	8	20	20	9	15	10

Note: Queue reported is the number of cars per lane.

City of Morgan Hill
The Crosswinds Residential Development

Level Of Service Computation Report
2000 HCM Operations (Future Volume Alternative)
Existing Plus Project PM

Intersection #106: Madrone Parkway/Cochrane Plaza and Cochrane Road

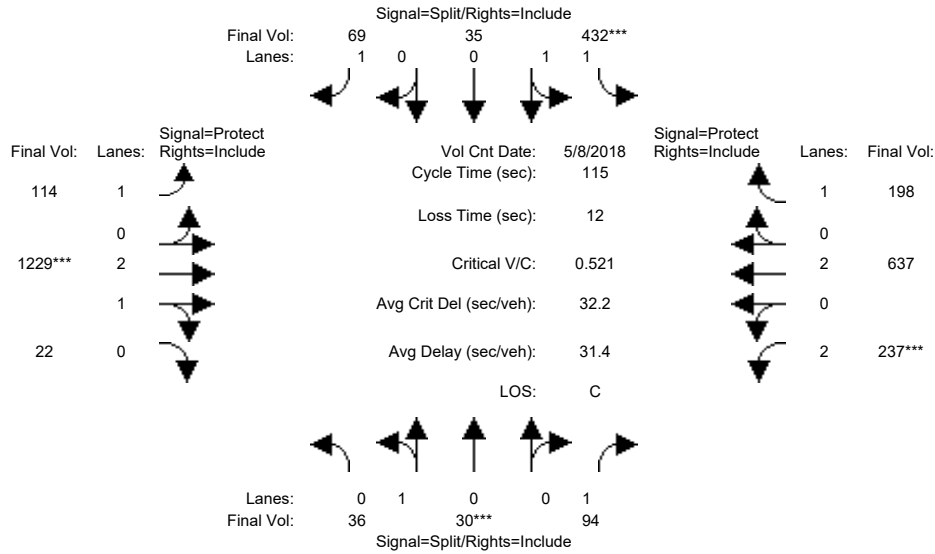

Street Name:	Madrone Parkway/Cochrane Plaza						Cochrane Road					
	North Bound			South Bound			East Bound			West Bound		
Approach:	L	T	R	L	T	R	L	T	R	L	T	R
Min. Green:	10	10	10	10	10	10	7	10	10	7	10	10
Y+R:	4.0	4.0	4.0	4.0	4.0	4.0	4.0	4.0	4.0	4.0	4.0	4.0

Volume Module:	>>	Count	Date:	8 May 2018	<<											
Base Vol:	36	30	94	428	35	69	114	1212	22	237	627	196				
Growth Adj:	1.00	1.00	1.00	1.00	1.00	1.00	1.00	1.00	1.00	1.00	1.00	1.00				
Initial Bse:	36	30	94	428	35	69	114	1212	22	237	627	196				
Added Vol:	0	0	0	4	0	0	0	17	0	0	10	2				
PasserByVol:	0	0	0	0	0	0	0	0	0	0	0	0				
Initial Fut:	36	30	94	432	35	69	114	1229	22	237	637	198				
User Adj:	1.00	1.00	1.00	1.00	1.00	1.00	1.00	1.00	1.00	1.00	1.00	1.00				
PHF Adj:	1.00	1.00	1.00	1.00	1.00	1.00	1.00	1.00	1.00	1.00	1.00	1.00				
PHF Volume:	36	30	94	432	35	69	114	1229	22	237	637	198				
Reduct Vol:	0	0	0	0	0	0	0	0	0	0	0	0				
Reduced Vol:	36	30	94	432	35	69	114	1229	22	237	637	198				
PCE Adj:	1.00	1.00	1.00	1.00	1.00	1.00	1.00	1.00	1.00	1.00	1.00	1.00				
MLF Adj:	1.00	1.00	1.00	1.00	1.00	1.00	1.00	1.00	1.00	1.00	1.00	1.00				
Final Volume:	36	30	94	432	35	69	114	1229	22	237	637	198				

Saturation Flow Module:												
Sat/Lane:	1900	1900	1900	1900	1900	1900	1900	1900	1900	1900	1900	1900
Adjustment:	0.95	0.95	0.92	0.93	0.95	0.92	0.92	0.98	0.95	0.83	1.00	0.92
Lanes:	0.55	0.45	1.00	1.85	0.15	1.00	1.00	2.95	0.05	2.00	2.00	1.00
Final Sat.:	982	818	1750	3284	266	1750	1750	5501	98	3150	3800	1750

Capacity Analysis Module:												
Vol/Sat:	0.04	0.04	0.05	0.13	0.13	0.04	0.07	0.22	0.22	0.08	0.17	0.11
Crit Moves:	****			****			****			****		
Green Time:	11.9	11.9	11.9	27.9	27.9	27.9	17.7	47.3	47.3	15.9	45.6	45.6
Volume/Cap:	0.36	0.36	0.52	0.54	0.54	0.16	0.42	0.54	0.54	0.54	0.42	0.29
Delay/Veh:	49.2	49.2	51.6	38.7	38.7	34.5	45.1	25.9	25.9	47.5	25.4	23.9
User DelAdj:	1.00	1.00	1.00	1.00	1.00	1.00	1.00	1.00	1.00	1.00	1.00	1.00
AdjDel/Veh:	49.2	49.2	51.6	38.7	38.7	34.5	45.1	25.9	25.9	47.5	25.4	23.9
LOS by Move:	D	D	D	D	D	C	D	C	C	D	C	C
HCM2k95thQ:	5	5	8	15	15	4	8	20	20	9	15	10

Note: Queue reported is the number of cars per lane.

City of Morgan Hill
The Crosswinds Residential Development

Level Of Service Computation Report
2000 HCM Operations (Future Volume Alternative)
Year 2030 Cumulative without Project PM

Intersection #106: Madrone Parkway/Cochrane Plaza and Cochrane Road

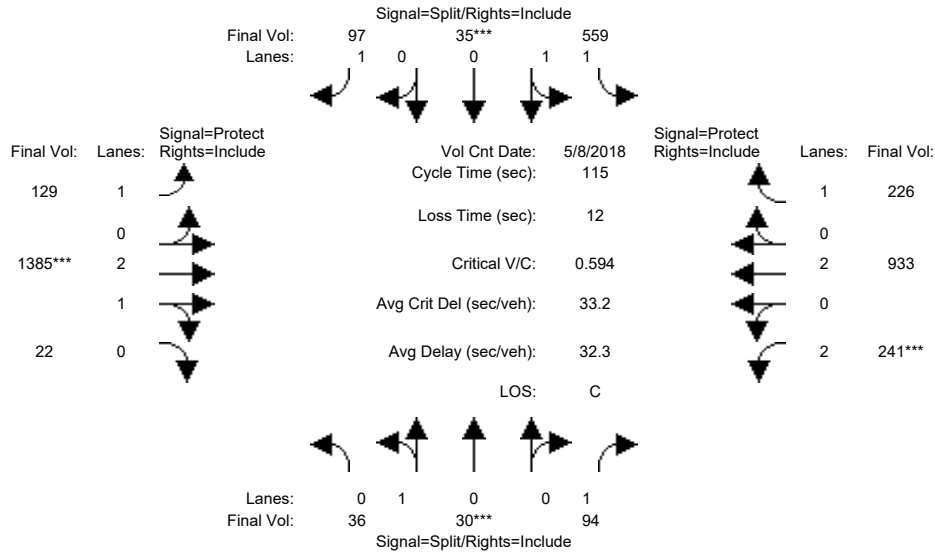

Street Name:	Madrone Parkway/Cochrane Plaza						Cochrane Road					
	North Bound			South Bound			East Bound			West Bound		
Movement:	L	T	R	L	T	R	L	T	R	L	T	R
Min. Green:	10	10	10	10	10	10	7	10	10	7	10	10
Y+R:	4.0	4.0	4.0	4.0	4.0	4.0	4.0	4.0	4.0	4.0	4.0	4.0

Volume Module:	>>	Count	Date:	8 May 2018	<<											
Base Vol:	36	30	94	559	35	97	129	1385	22	241	933	226				
Growth Adj:	1.00	1.00	1.00	1.00	1.00	1.00	1.00	1.00	1.00	1.00	1.00	1.00				
Initial Bse:	36	30	94	559	35	97	129	1385	22	241	933	226				
Added Vol:	0	0	0	0	0	0	0	0	0	0	0	0				
PasserByVol:	0	0	0	0	0	0	0	0	0	0	0	0				
Initial Fut:	36	30	94	559	35	97	129	1385	22	241	933	226				
User Adj:	1.00	1.00	1.00	1.00	1.00	1.00	1.00	1.00	1.00	1.00	1.00	1.00				
PHF Adj:	1.00	1.00	1.00	1.00	1.00	1.00	1.00	1.00	1.00	1.00	1.00	1.00				
PHF Volume:	36	30	94	559	35	97	129	1385	22	241	933	226				
Reduct Vol:	0	0	0	0	0	0	0	0	0	0	0	0				
Reduced Vol:	36	30	94	559	35	97	129	1385	22	241	933	226				
PCE Adj:	1.00	1.00	1.00	1.00	1.00	1.00	1.00	1.00	1.00	1.00	1.00	1.00				
MLF Adj:	1.00	1.00	1.00	1.00	1.00	1.00	1.00	1.00	1.00	1.00	1.00	1.00				
Final Volume:	36	30	94	559	35	97	129	1385	22	241	933	226				

Saturation Flow Module:												
Sat/Lane:	1900	1900	1900	1900	1900	1900	1900	1900	1900	1900	1900	1900
Adjustment:	0.95	0.95	0.92	0.93	0.95	0.92	0.92	0.98	0.95	0.83	1.00	0.92
Lanes:	0.55	0.45	1.00	1.88	0.12	1.00	1.00	2.95	0.05	2.00	2.00	1.00
Final Sat.:	982	818	1750	3341	209	1750	1750	5512	88	3150	3800	1750

Capacity Analysis Module:												
Vol/Sat:	0.04	0.04	0.05	0.17	0.17	0.06	0.07	0.25	0.25	0.08	0.25	0.13
Crit Moves:	****			****			****			****		
Green Time:	10.4	10.4	10.4	31.3	31.3	31.3	14.2	47.0	47.0	14.3	47.1	47.1
Volume/Cap:	0.41	0.41	0.59	0.61	0.61	0.20	0.60	0.61	0.61	0.61	0.60	0.32
Delay/Veh:	51.0	51.0	56.2	37.8	37.8	32.5	52.3	27.4	27.4	50.6	27.2	23.2
User DelAdj:	1.00	1.00	1.00	1.00	1.00	1.00	1.00	1.00	1.00	1.00	1.00	1.00
AdjDel/Veh:	51.0	51.0	56.2	37.8	37.8	32.5	52.3	27.4	27.4	50.6	27.2	23.2
LOS by Move:	D	D	E	D	D	C	D	C	C	D	C	C
HCM2k95thQ:	6	6	9	19	19	6	9	23	23	9	22	11

Note: Queue reported is the number of cars per lane.

City of Morgan Hill
The Crosswinds Residential Development

Level Of Service Computation Report
2000 HCM Operations (Future Volume Alternative)
Year 2030 Cumulative with Project PM

Intersection #106: Madrone Parkway/Cochrane Plaza and Cochrane Road

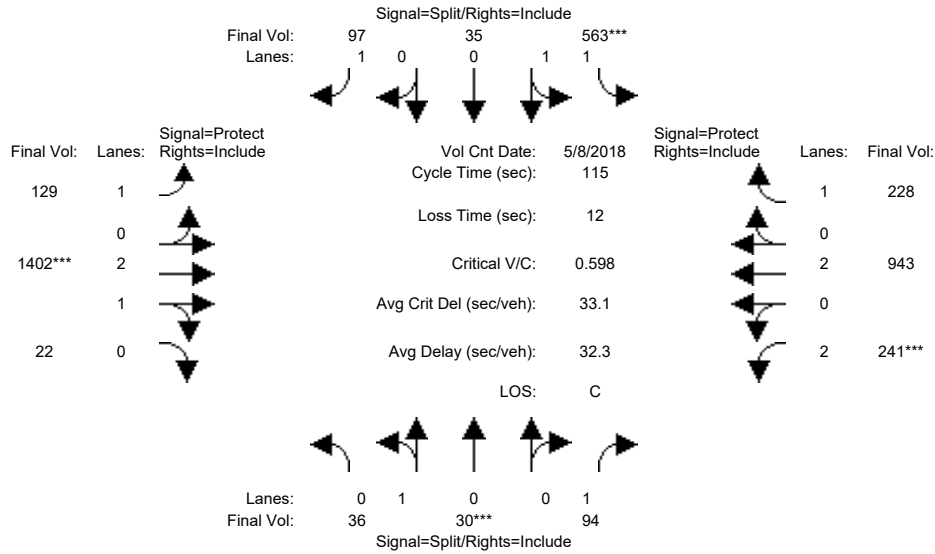

Street Name:	Madrone Parkway/Cochrane Plaza						Cochrane Road					
	North Bound			South Bound			East Bound			West Bound		
Movement:	L	T	R	L	T	R	L	T	R	L	T	R
Min. Green:	10	10	10	10	10	10	7	10	10	7	10	10
Y+R:	4.0	4.0	4.0	4.0	4.0	4.0	4.0	4.0	4.0	4.0	4.0	4.0

Volume Module:	>>	Count	Date:	8 May 2018	<<											
Base Vol:	36	30	94	559	35	97	129	1385	22	241	933	226				
Growth Adj:	1.00	1.00	1.00	1.00	1.00	1.00	1.00	1.00	1.00	1.00	1.00	1.00				
Initial Bse:	36	30	94	559	35	97	129	1385	22	241	933	226				
Added Vol:	0	0	0	4	0	0	0	17	0	0	10	2				
PasserByVol:	0	0	0	0	0	0	0	0	0	0	0	0				
Initial Fut:	36	30	94	563	35	97	129	1402	22	241	943	228				
User Adj:	1.00	1.00	1.00	1.00	1.00	1.00	1.00	1.00	1.00	1.00	1.00	1.00				
PHF Adj:	1.00	1.00	1.00	1.00	1.00	1.00	1.00	1.00	1.00	1.00	1.00	1.00				
PHF Volume:	36	30	94	563	35	97	129	1402	22	241	943	228				
Reduct Vol:	0	0	0	0	0	0	0	0	0	0	0	0				
Reduced Vol:	36	30	94	563	35	97	129	1402	22	241	943	228				
PCE Adj:	1.00	1.00	1.00	1.00	1.00	1.00	1.00	1.00	1.00	1.00	1.00	1.00				
MLF Adj:	1.00	1.00	1.00	1.00	1.00	1.00	1.00	1.00	1.00	1.00	1.00	1.00				
Final Volume:	36	30	94	563	35	97	129	1402	22	241	943	228				

Saturation Flow Module:												
Sat/Lane:	1900	1900	1900	1900	1900	1900	1900	1900	1900	1900	1900	1900
Adjustment:	0.95	0.95	0.92	0.93	0.95	0.92	0.92	0.98	0.95	0.83	1.00	0.92
Lanes:	0.55	0.45	1.00	1.88	0.12	1.00	1.00	2.95	0.05	2.00	2.00	1.00
Final Sat.:	982	818	1750	3342	208	1750	1750	5513	87	3150	3800	1750

Capacity Analysis Module:												
Vol/Sat:	0.04	0.04	0.05	0.17	0.17	0.06	0.07	0.25	0.25	0.08	0.25	0.13
Crit Moves:	****			****			****			****		
Green Time:	10.3	10.3	10.3	31.3	31.3	31.3	14.1	47.2	47.2	14.2	47.3	47.3
Volume/Cap:	0.41	0.41	0.60	0.62	0.62	0.20	0.60	0.62	0.62	0.62	0.60	0.32
Delay/Veh:	51.1	51.1	56.6	37.9	37.9	32.5	52.6	27.3	27.3	50.9	27.1	23.1
User DelAdj:	1.00	1.00	1.00	1.00	1.00	1.00	1.00	1.00	1.00	1.00	1.00	1.00
AdjDel/Veh:	51.1	51.1	56.6	37.9	37.9	32.5	52.6	27.3	27.3	50.9	27.1	23.1
LOS by Move:	D	D	E	D	D	C	D	C	C	D	C	C
HCM2k95thQ:	6	6	9	19	19	6	9	23	23	9	23	11

Note: Queue reported is the number of cars per lane.

City of Morgan Hill
The Crosswinds Residential Development

Level Of Service Computation Report
2000 HCM Operations (Future Volume Alternative)
Existing AM

Intersection #107: US 101 Southbound Ramps and Cochrane Road

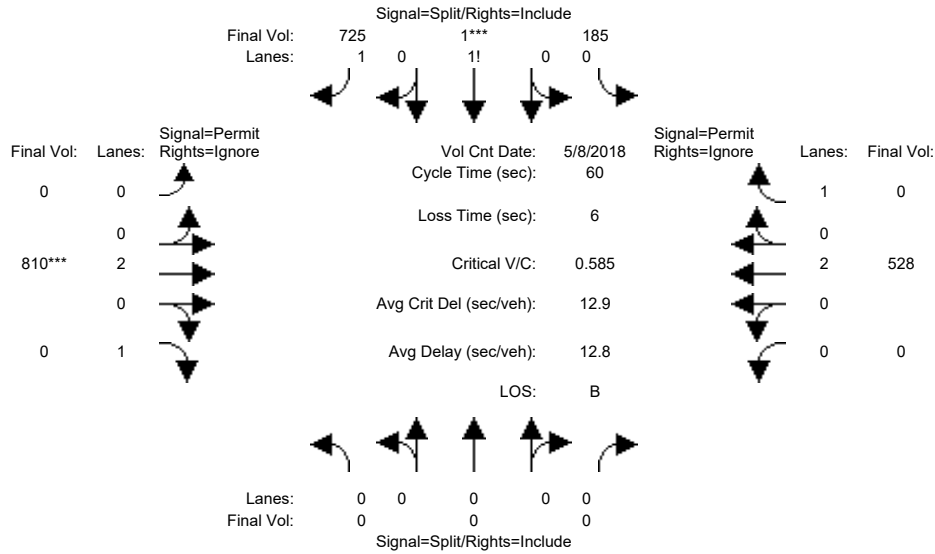

Street Name:	US 101 Southbound Ramps						Cochrane Road					
	North Bound			South Bound			East Bound			West Bound		
Movement:	L	T	R	L	T	R	L	T	R	L	T	R
Min. Green:	0	0	0	10	0	10	0	10	10	0	10	10
Y+R:	4.0	4.0	4.0	4.0	4.0	4.0	4.0	4.0	4.0	4.0	4.0	4.0

Volume Module:	>>	Count	Date:	8 May 2018	<<							
Base Vol:	0	0	0	185	1	725	0	810	238	0	528	0
Growth Adj:	1.00	1.00	1.00	1.00	1.00	1.00	1.00	1.00	1.00	1.00	1.00	1.00
Initial Bse:	0	0	0	185	1	725	0	810	238	0	528	0
Added Vol:	0	0	0	0	0	0	0	0	0	0	0	0
PasserByVol:	0	0	0	0	0	0	0	0	0	0	0	0
Initial Fut:	0	0	0	185	1	725	0	810	238	0	528	0
User Adj:	1.00	1.00	1.00	1.00	1.00	1.00	1.00	1.00	0.00	1.00	1.00	0.00
PHF Adj:	1.00	1.00	1.00	1.00	1.00	1.00	1.00	1.00	0.00	1.00	1.00	0.00
PHF Volume:	0	0	0	185	1	725	0	810	0	0	528	0
Reduct Vol:	0	0	0	0	0	0	0	0	0	0	0	0
Reduced Vol:	0	0	0	185	1	725	0	810	0	0	528	0
PCE Adj:	1.00	1.00	1.00	1.00	1.00	1.00	1.00	1.00	0.00	1.00	1.00	0.00
MLF Adj:	1.00	1.00	1.00	1.00	1.00	1.00	1.00	1.00	0.00	1.00	1.00	0.00
FinalVolume:	0	0	0	185	1	725	0	810	0	0	528	0

Saturation Flow Module:												
Sat/Lane:	1900	1900	1900	1900	1900	1900	1900	1900	1900	1900	1900	1900
Adjustment:	0.92	1.00	0.92	0.92	0.92	0.92	0.92	1.00	0.92	0.92	1.00	0.92
Lanes:	0.00	0.00	0.00	0.33	0.01	1.66	0.00	2.00	1.00	0.00	2.00	1.00
Final Sat.:	0	0	0	590	3	2907	0	3800	1750	0	3800	1750

Capacity Analysis Module:												
Vol/Sat:	0.00	0.00	0.00	0.31	0.31	0.25	0.00	0.21	0.00	0.00	0.14	0.00
Crit Moves:					****			****				
Green Time:	0.0	0.0	0.0	32.1	32.1	32.1	0.0	21.9	0.0	0.0	21.9	0.0
Volume/Cap:	0.00	0.00	0.00	0.59	0.59	0.47	0.00	0.59	0.00	0.00	0.38	0.00
Delay/Veh:	0.0	0.0	0.0	10.0	10.0	8.8	0.0	16.1	0.0	0.0	14.3	0.0
User DelAdj:	1.00	1.00	1.00	1.00	1.00	1.00	1.00	1.00	1.00	1.00	1.00	1.00
AdjDel/Veh:	0.0	0.0	0.0	10.0	10.0	8.8	0.0	16.1	0.0	0.0	14.3	0.0
LOS by Move:	A	A	A	A	A	A	A	B	A	A	B	A
HCM2k95thQ:	0	0	0	15	15	11	0	12	0	0	7	0

Note: Queue reported is the number of cars per lane.

City of Morgan Hill
The Crosswinds Residential Development

Level Of Service Computation Report
2000 HCM Operations (Future Volume Alternative)
Existing Plus Project AM

Intersection #107: US 101 Southbound Ramps and Cochrane Road

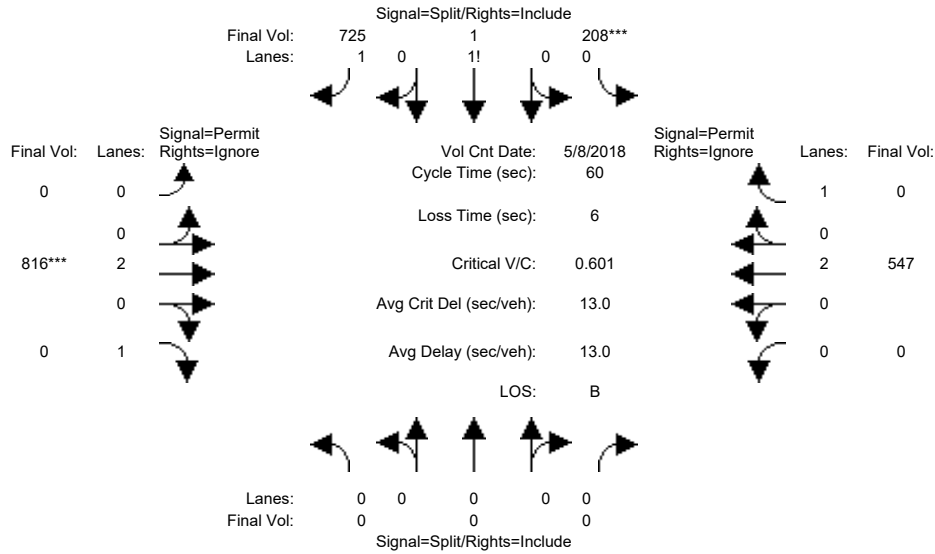

Street Name:	US 101 Southbound Ramps						Cochrane Road					
	North Bound			South Bound			East Bound			West Bound		
Movement:	L	T	R	L	T	R	L	T	R	L	T	R
Min. Green:	0	0	0	10	0	10	0	10	10	0	10	10
Y+R:	4.0	4.0	4.0	4.0	4.0	4.0	4.0	4.0	4.0	4.0	4.0	4.0

Volume Module:	>>	Count	Date:	8 May 2018	<<							
Base Vol:	0	0	0	185	1	725	0	810	238	0	528	0
Growth Adj:	1.00	1.00	1.00	1.00	1.00	1.00	1.00	1.00	1.00	1.00	1.00	1.00
Initial Bse:	0	0	0	185	1	725	0	810	238	0	528	0
Added Vol:	0	0	0	23	0	0	0	6	0	0	19	11
PasserByVol:	0	0	0	0	0	0	0	0	0	0	0	0
Initial Fut:	0	0	0	208	1	725	0	816	238	0	547	11
User Adj:	1.00	1.00	1.00	1.00	1.00	1.00	1.00	1.00	0.00	1.00	1.00	0.00
PHF Adj:	1.00	1.00	1.00	1.00	1.00	1.00	1.00	1.00	0.00	1.00	1.00	0.00
PHF Volume:	0	0	0	208	1	725	0	816	0	0	547	0
Reduct Vol:	0	0	0	0	0	0	0	0	0	0	0	0
Reduced Vol:	0	0	0	208	1	725	0	816	0	0	547	0
PCE Adj:	1.00	1.00	1.00	1.00	1.00	1.00	1.00	1.00	0.00	1.00	1.00	0.00
MLF Adj:	1.00	1.00	1.00	1.00	1.00	1.00	1.00	1.00	0.00	1.00	1.00	0.00
Final Volume:	0	0	0	208	1	725	0	816	0	0	547	0

Saturation Flow Module:												
Sat/Lane:	1900	1900	1900	1900	1900	1900	1900	1900	1900	1900	1900	1900
Adjustment:	0.92	1.00	0.92	0.92	0.92	0.92	0.92	1.00	0.92	0.92	1.00	0.92
Lanes:	0.00	0.00	0.00	0.36	0.01	1.63	0.00	2.00	1.00	0.00	2.00	1.00
Final Sat.:	0	0	0	637	3	2860	0	3800	1750	0	3800	1750

Capacity Analysis Module:												
Vol/Sat:	0.00	0.00	0.00	0.33	0.33	0.25	0.00	0.21	0.00	0.00	0.14	0.00
Crit Moves:				****				****				
Green Time:	0.0	0.0	0.0	32.6	32.6	32.6	0.0	21.4	0.0	0.0	21.4	0.0
Volume/Cap:	0.00	0.00	0.00	0.60	0.60	0.47	0.00	0.60	0.00	0.00	0.40	0.00
Delay/Veh:	0.0	0.0	0.0	10.0	10.0	8.6	0.0	16.6	0.0	0.0	14.7	0.0
User DelAdj:	1.00	1.00	1.00	1.00	1.00	1.00	1.00	1.00	1.00	1.00	1.00	1.00
AdjDel/Veh:	0.0	0.0	0.0	10.0	10.0	8.6	0.0	16.6	0.0	0.0	14.7	0.0
LOS by Move:	A	A	A	A	A	A	A	B	A	A	B	A
HCM2k95thQ:	0	0	0	16	16	11	0	12	0	0	7	0

Note: Queue reported is the number of cars per lane.

City of Morgan Hill
The Crosswinds Residential Development

Level Of Service Computation Report
2000 HCM Operations (Future Volume Alternative)
Year 2030 Cumulative without Project AM

Intersection #107: US 101 Southbound Ramps and Cochrane Road

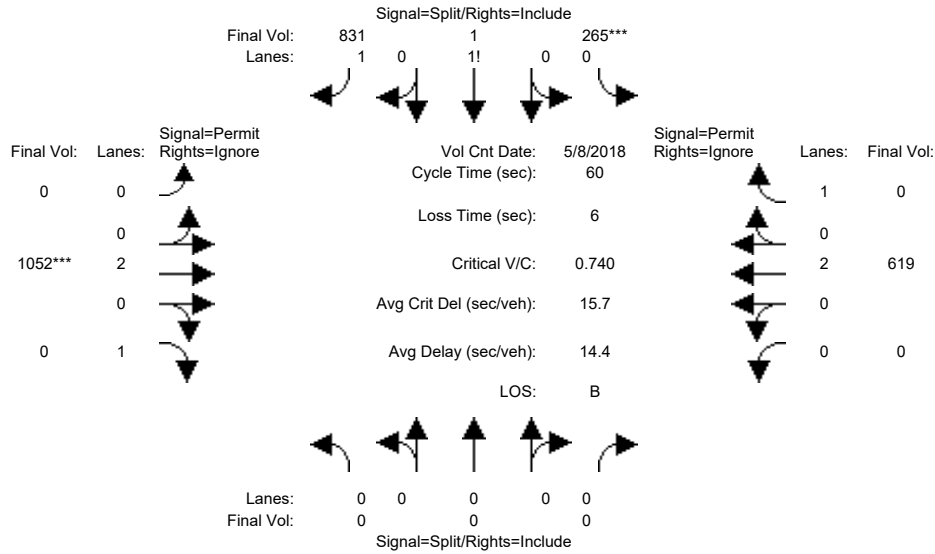

Street Name:	US 101 Southbound Ramps						Cochrane Road					
	North Bound			South Bound			East Bound			West Bound		
Movement:	L	T	R	L	T	R	L	T	R	L	T	R
Min. Green:	0	0	0	10	0	10	0	10	10	0	10	10
Y+R:	4.0	4.0	4.0	4.0	4.0	4.0	4.0	4.0	4.0	4.0	4.0	4.0

Volume Module:	>>	Count	Date:	8 May 2018	<<												
Base Vol:	0	0	0	265	1	831	0	1052	267	0	619	152					
Growth Adj:	1.00	1.00	1.00	1.00	1.00	1.00	1.00	1.00	1.00	1.00	1.00	1.00					
Initial Bse:	0	0	0	265	1	831	0	1052	267	0	619	152					
Added Vol:	0	0	0	0	0	0	0	0	0	0	0	0					
PasserByVol:	0	0	0	0	0	0	0	0	0	0	0	0					
Initial Fut:	0	0	0	265	1	831	0	1052	267	0	619	152					
User Adj:	1.00	1.00	1.00	1.00	1.00	1.00	1.00	1.00	0.00	1.00	1.00	0.00					
PHF Adj:	1.00	1.00	1.00	1.00	1.00	1.00	1.00	1.00	0.00	1.00	1.00	0.00					
PHF Volume:	0	0	0	265	1	831	0	1052	0	0	619	0					
Reduct Vol:	0	0	0	0	0	0	0	0	0	0	0	0					
Reduced Vol:	0	0	0	265	1	831	0	1052	0	0	619	0					
PCE Adj:	1.00	1.00	1.00	1.00	1.00	1.00	1.00	1.00	0.00	1.00	1.00	0.00					
MLF Adj:	1.00	1.00	1.00	1.00	1.00	1.00	1.00	1.00	0.00	1.00	1.00	0.00					
Final Volume:	0	0	0	265	1	831	0	1052	0	0	619	0					

Saturation Flow Module:												
Sat/Lane:	1900	1900	1900	1900	1900	1900	1900	1900	1900	1900	1900	1900
Adjustment:	0.92	1.00	0.92	0.92	0.92	0.92	0.92	1.00	0.92	0.92	1.00	0.92
Lanes:	0.00	0.00	0.00	0.38	0.01	1.61	0.00	2.00	1.00	0.00	2.00	1.00
Final Sat.:	0	0	0	680	3	2817	0	3800	1750	0	3800	1750

Capacity Analysis Module:													
Vol/Sat:	0.00	0.00	0.00	0.39	0.39	0.30	0.00	0.28	0.00	0.00	0.16	0.00	
Crit Moves:				****							****		
Green Time:	0.0	0.0	0.0	31.6	31.6	31.6	0.0	22.4	0.0	0.0	22.4	0.0	
Volume/Cap:	0.00	0.00	0.00	0.74	0.74	0.56	0.00	0.74	0.00	0.00	0.44	0.00	
Delay/Veh:	0.0	0.0	0.0	13.1	13.1	9.9	0.0	18.4	0.0	0.0	14.3	0.0	
User DelAdj:	1.00	1.00	1.00	1.00	1.00	1.00	1.00	1.00	1.00	1.00	1.00	1.00	
AdjDel/Veh:	0.0	0.0	0.0	13.1	13.1	9.9	0.0	18.4	0.0	0.0	14.3	0.0	
LOS by Move:	A	A	A	B	B	A	A	B	A	A	B	A	
HCM2k95thQ:	0	0	0	22	22	14	0	16	0	0	8	0	

Note: Queue reported is the number of cars per lane.

City of Morgan Hill
The Crosswinds Residential Development

Level Of Service Computation Report
2000 HCM Operations (Future Volume Alternative)
Year 2030 Cumulative with Project AM

Intersection #107: US 101 Southbound Ramps and Cochrane Road

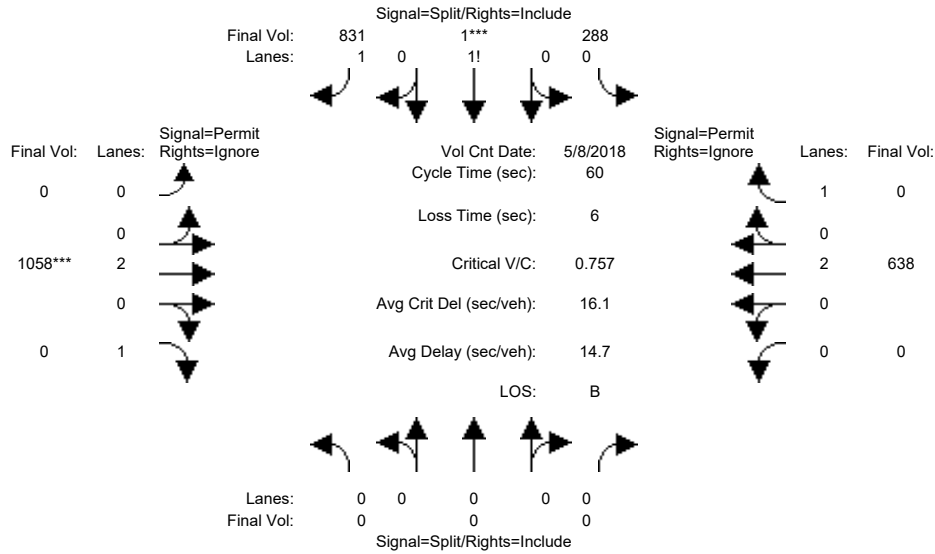

Street Name:	US 101 Southbound Ramps						Cochrane Road					
	North Bound			South Bound			East Bound			West Bound		
Movement:	L	T	R	L	T	R	L	T	R	L	T	R
Min. Green:	0	0	0	10	0	10	0	10	10	0	10	10
Y+R:	4.0	4.0	4.0	4.0	4.0	4.0	4.0	4.0	4.0	4.0	4.0	4.0

Volume Module:	>>	Count	Date:	8 May 2018	<<							
Base Vol:	0	0	0	265	1	831	0	1052	267	0	619	152
Growth Adj:	1.00	1.00	1.00	1.00	1.00	1.00	1.00	1.00	1.00	1.00	1.00	1.00
Initial Bse:	0	0	0	265	1	831	0	1052	267	0	619	152
Added Vol:	0	0	0	23	0	0	0	6	0	0	19	11
PasserByVol:	0	0	0	0	0	0	0	0	0	0	0	0
Initial Fut:	0	0	0	288	1	831	0	1058	267	0	638	163
User Adj:	1.00	1.00	1.00	1.00	1.00	1.00	1.00	1.00	0.00	1.00	1.00	0.00
PHF Adj:	1.00	1.00	1.00	1.00	1.00	1.00	1.00	1.00	0.00	1.00	1.00	0.00
PHF Volume:	0	0	0	288	1	831	0	1058	0	0	638	0
Reduct Vol:	0	0	0	0	0	0	0	0	0	0	0	0
Reduced Vol:	0	0	0	288	1	831	0	1058	0	0	638	0
PCE Adj:	1.00	1.00	1.00	1.00	1.00	1.00	1.00	1.00	0.00	1.00	1.00	0.00
MLF Adj:	1.00	1.00	1.00	1.00	1.00	1.00	1.00	1.00	0.00	1.00	1.00	0.00
Final Volume:	0	0	0	288	1	831	0	1058	0	0	638	0

Saturation Flow Module:	
Sat/Lane:	1900 1900 1900 1900 1900 1900 1900 1900 1900 1900 1900 1900
Adjustment:	0.92 1.00 0.92 0.92 0.92 0.92 0.92 1.00 0.92 0.92 1.00 0.92
Lanes:	0.00 0.00 0.00 0.40 0.01 1.59 0.00 2.00 1.00 0.00 2.00 1.00
Final Sat.:	0 0 0 715 2 2782 0 3800 1750 0 3800 1750

Capacity Analysis Module:	
Vol/Sat:	0.00 0.00 0.00 0.40 0.40 0.30 0.00 0.28 0.00 0.00 0.17 0.00
Crit Moves:	****
Green Time:	0.0 0.0 0.0 31.9 31.9 31.9 0.0 22.1 0.0 0.0 22.1 0.0
Volume/Cap:	0.00 0.00 0.00 0.76 0.76 0.56 0.00 0.76 0.00 0.00 0.46 0.00
Delay/Veh:	0.0 0.0 0.0 13.3 13.3 9.7 0.0 19.0 0.0 0.0 14.6 0.0
User DelAdj:	1.00 1.00 1.00 1.00 1.00 1.00 1.00 1.00 1.00 1.00 1.00 1.00
AdjDel/Veh:	0.0 0.0 0.0 13.3 13.3 9.7 0.0 19.0 0.0 0.0 14.6 0.0
LOS by Move:	A A A B B A A B A A B A
HCM2k95thQ:	0 0 0 23 23 14 0 17 0 0 9 0

Note: Queue reported is the number of cars per lane.

City of Morgan Hill
The Crosswinds Residential Development

Level Of Service Computation Report
2000 HCM Operations (Future Volume Alternative)
Existing PM

Intersection #107: US 101 Southbound Ramps and Cochrane Road

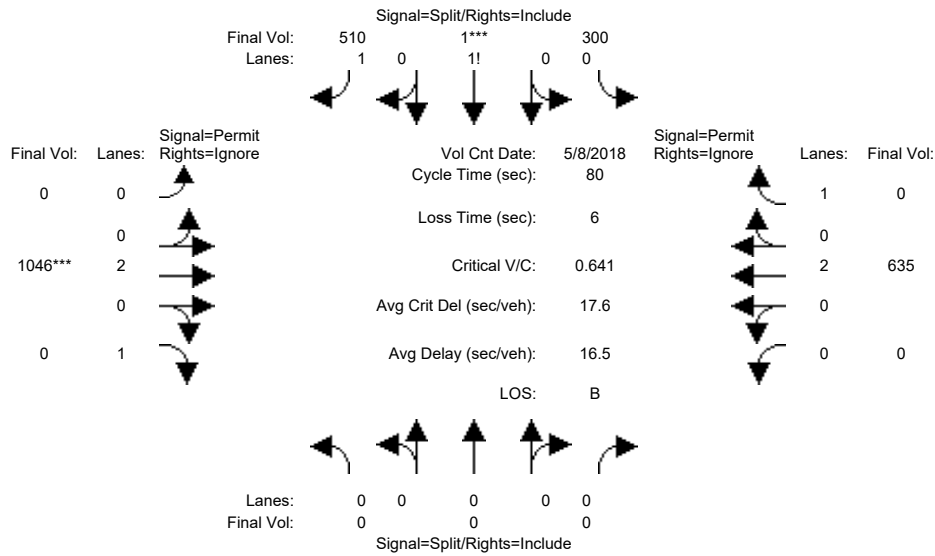

Street Name:	US 101 Southbound Ramps						Cochrane Road					
	North Bound			South Bound			East Bound			West Bound		
Movement:	L	T	R	L	T	R	L	T	R	L	T	R
Min. Green:	0	0	0	10	0	10	0	10	10	0	10	10
Y+R:	4.0	4.0	4.0	4.0	4.0	4.0	4.0	4.0	4.0	4.0	4.0	4.0

Volume Module:	>>	Count	Date:	8 May 2018	<<							
Base Vol:	0	0	0	300	1	510	0	1046	741	0	635	0
Growth Adj:	1.00	1.00	1.00	1.00	1.00	1.00	1.00	1.00	1.00	1.00	1.00	1.00
Initial Bse:	0	0	0	300	1	510	0	1046	741	0	635	0
Added Vol:	0	0	0	0	0	0	0	0	0	0	0	0
PasserByVol:	0	0	0	0	0	0	0	0	0	0	0	0
Initial Fut:	0	0	0	300	1	510	0	1046	741	0	635	0
User Adj:	1.00	1.00	1.00	1.00	1.00	1.00	1.00	1.00	0.00	1.00	1.00	0.00
PHF Adj:	1.00	1.00	1.00	1.00	1.00	1.00	1.00	1.00	0.00	1.00	1.00	0.00
PHF Volume:	0	0	0	300	1	510	0	1046	0	0	635	0
Reduct Vol:	0	0	0	0	0	0	0	0	0	0	0	0
Reduced Vol:	0	0	0	300	1	510	0	1046	0	0	635	0
PCE Adj:	1.00	1.00	1.00	1.00	1.00	1.00	1.00	1.00	0.00	1.00	1.00	0.00
MLF Adj:	1.00	1.00	1.00	1.00	1.00	1.00	1.00	1.00	0.00	1.00	1.00	0.00
FinalVolume:	0	0	0	300	1	510	0	1046	0	0	635	0

Saturation Flow Module:												
Sat/Lane:	1900	1900	1900	1900	1900	1900	1900	1900	1900	1900	1900	1900
Adjustment:	0.92	1.00	0.92	0.92	0.92	0.92	0.92	1.00	0.92	0.92	1.00	0.92
Lanes:	0.00	0.00	0.00	0.54	0.01	1.45	0.00	2.00	1.00	0.00	2.00	1.00
Final Sat.:	0	0	0	944	3	2553	0	3800	1750	0	3800	1750

Capacity Analysis Module:												
Vol/Sat:	0.00	0.00	0.00	0.32	0.32	0.20	0.00	0.28	0.00	0.00	0.17	0.00
Crit Moves:					****			****				
Green Time:	0.0	0.0	0.0	39.6	39.6	39.6	0.0	34.4	0.0	0.0	34.4	0.0
Volume/Cap:	0.00	0.00	0.00	0.64	0.64	0.40	0.00	0.64	0.00	0.00	0.39	0.00
Delay/Veh:	0.0	0.0	0.0	16.0	16.0	12.9	0.0	18.8	0.0	0.0	15.8	0.0
User DelAdj:	1.00	1.00	1.00	1.00	1.00	1.00	1.00	1.00	1.00	1.00	1.00	1.00
AdjDel/Veh:	0.0	0.0	0.0	16.0	16.0	12.9	0.0	18.8	0.0	0.0	15.8	0.0
LOS by Move:	A	A	A	B	B	B	A	B	A	A	B	A
HCM2k95thQ:	0	0	0	21	21	12	0	18	0	0	10	0

Note: Queue reported is the number of cars per lane.

City of Morgan Hill
The Crosswinds Residential Development

Level Of Service Computation Report
2000 HCM Operations (Future Volume Alternative)
Existing Plus Project PM

Intersection #107: US 101 Southbound Ramps and Cochrane Road

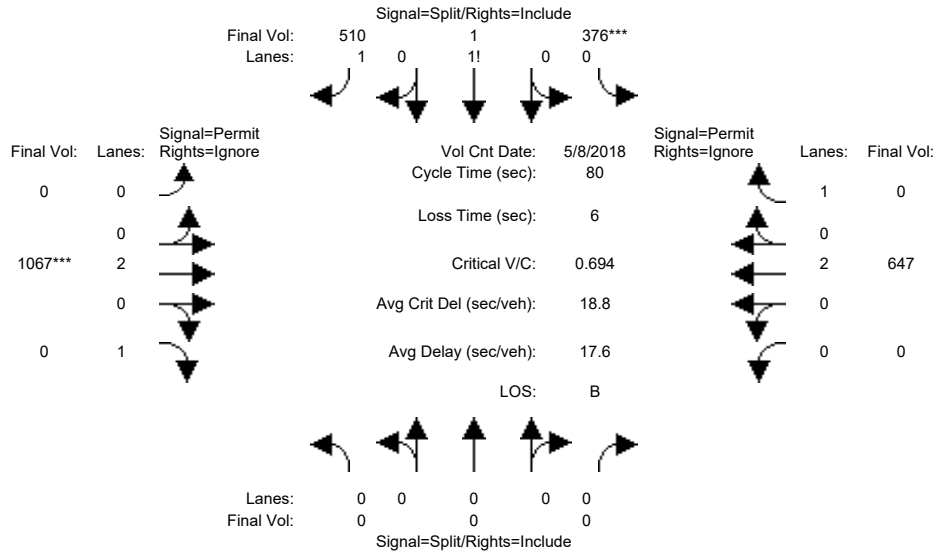

Street Name:	US 101 Southbound Ramps						Cochrane Road					
	North Bound			South Bound			East Bound			West Bound		
Movement:	L	T	R	L	T	R	L	T	R	L	T	R
Min. Green:	0	0	0	10	0	10	0	10	10	0	10	10
Y+R:	4.0	4.0	4.0	4.0	4.0	4.0	4.0	4.0	4.0	4.0	4.0	4.0

Volume Module:	>>	Count	Date:	8 May 2018	<<												
Base Vol:	0	0	0	300	1	510	0	1046	741	0	635	0					
Growth Adj:	1.00	1.00	1.00	1.00	1.00	1.00	1.00	1.00	1.00	1.00	1.00	1.00					
Initial Bse:	0	0	0	300	1	510	0	1046	741	0	635	0					
Added Vol:	0	0	0	76	0	0	0	21	0	0	12	7					
PasserByVol:	0	0	0	0	0	0	0	0	0	0	0	0					
Initial Fut:	0	0	0	376	1	510	0	1067	741	0	647	7					
User Adj:	1.00	1.00	1.00	1.00	1.00	1.00	1.00	1.00	0.00	1.00	1.00	0.00					
PHF Adj:	1.00	1.00	1.00	1.00	1.00	1.00	1.00	1.00	0.00	1.00	1.00	0.00					
PHF Volume:	0	0	0	376	1	510	0	1067	0	0	647	0					
Reduct Vol:	0	0	0	0	0	0	0	0	0	0	0	0					
Reduced Vol:	0	0	0	376	1	510	0	1067	0	0	647	0					
PCE Adj:	1.00	1.00	1.00	1.00	1.00	1.00	1.00	1.00	0.00	1.00	1.00	0.00					
MLF Adj:	1.00	1.00	1.00	1.00	1.00	1.00	1.00	1.00	0.00	1.00	1.00	0.00					
Final Volume:	0	0	0	376	1	510	0	1067	0	0	647	0					

Saturation Flow Module:												
Sat/Lane:	1900	1900	1900	1900	1900	1900	1900	1900	1900	1900	1900	1900
Adjustment:	0.92	1.00	0.92	0.92	0.92	0.92	0.92	1.00	0.92	0.92	1.00	0.92
Lanes:	0.00	0.00	0.00	0.59	0.01	1.40	0.00	2.00	1.00	0.00	2.00	1.00
Final Sat.:	0	0	0	1041	3	2456	0	3800	1750	0	3800	1750

Capacity Analysis Module:													
Vol/Sat:	0.00	0.00	0.00	0.36	0.36	0.21	0.00	0.28	0.00	0.00	0.17	0.00	
Crit Moves:				****							****		
Green Time:	0.0	0.0	0.0	41.6	41.6	41.6	0.0	32.4	0.0	0.0	32.4	0.0	
Volume/Cap:	0.00	0.00	0.00	0.69	0.69	0.40	0.00	0.69	0.00	0.00	0.42	0.00	
Delay/Veh:	0.0	0.0	0.0	16.1	16.1	11.7	0.0	21.1	0.0	0.0	17.3	0.0	
User DelAdj:	1.00	1.00	1.00	1.00	1.00	1.00	1.00	1.00	1.00	1.00	1.00	1.00	
AdjDel/Veh:	0.0	0.0	0.0	16.1	16.1	11.7	0.0	21.1	0.0	0.0	17.3	0.0	
LOS by Move:	A	A	A	B	B	B	A	C	A	A	B	A	
HCM2k95thQ:	0	0	0	24	24	12	0	20	0	0	11	0	

Note: Queue reported is the number of cars per lane.

City of Morgan Hill
The Crosswinds Residential Development

Level Of Service Computation Report
2000 HCM Operations (Future Volume Alternative)
Year 2030 Cumulative without Project PM

Intersection #107: US 101 Southbound Ramps and Cochrane Road

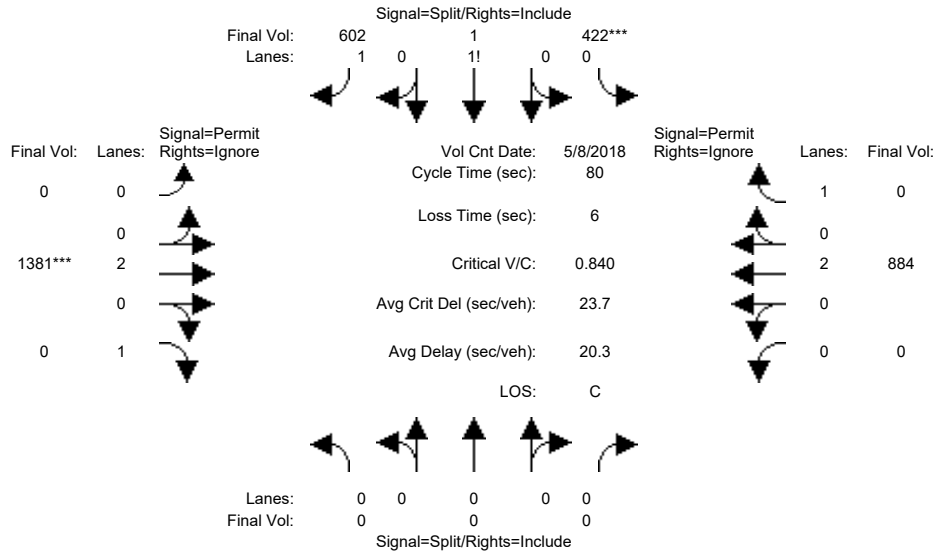

Street Name:	US 101 Southbound Ramps						Cochrane Road					
	North Bound			South Bound			East Bound			West Bound		
Movement:	L	T	R	L	T	R	L	T	R	L	T	R
Min. Green:	0	0	0	10	0	10	0	10	10	0	10	10
Y+R:	4.0	4.0	4.0	4.0	4.0	4.0	4.0	4.0	4.0	4.0	4.0	4.0

Volume Module:	>>	Count	Date:	8 May 2018	<<							
Base Vol:	0	0	0	422	1	602	0	1381	741	0	884	157
Growth Adj:	1.00	1.00	1.00	1.00	1.00	1.00	1.00	1.00	1.00	1.00	1.00	1.00
Initial Bse:	0	0	0	422	1	602	0	1381	741	0	884	157
Added Vol:	0	0	0	0	0	0	0	0	0	0	0	0
PasserByVol:	0	0	0	0	0	0	0	0	0	0	0	0
Initial Fut:	0	0	0	422	1	602	0	1381	741	0	884	157
User Adj:	1.00	1.00	1.00	1.00	1.00	1.00	1.00	1.00	0.00	1.00	1.00	0.00
PHF Adj:	1.00	1.00	1.00	1.00	1.00	1.00	1.00	1.00	0.00	1.00	1.00	0.00
PHF Volume:	0	0	0	422	1	602	0	1381	0	0	884	0
Reduct Vol:	0	0	0	0	0	0	0	0	0	0	0	0
Reduced Vol:	0	0	0	422	1	602	0	1381	0	0	884	0
PCE Adj:	1.00	1.00	1.00	1.00	1.00	1.00	1.00	1.00	0.00	1.00	1.00	0.00
MLF Adj:	1.00	1.00	1.00	1.00	1.00	1.00	1.00	1.00	0.00	1.00	1.00	0.00
Final Volume:	0	0	0	422	1	602	0	1381	0	0	884	0

Saturation Flow Module:												
Sat/Lane:	1900	1900	1900	1900	1900	1900	1900	1900	1900	1900	1900	1900
Adjustment:	0.92	1.00	0.92	0.92	0.92	0.92	0.92	1.00	0.92	0.92	1.00	0.92
Lanes:	0.00	0.00	0.00	0.58	0.01	1.41	0.00	2.00	1.00	0.00	2.00	1.00
Final Sat.:	0	0	0	1020	2	2478	0	3800	1750	0	3800	1750

Capacity Analysis Module:													
Vol/Sat:	0.00	0.00	0.00	0.41	0.41	0.24	0.00	0.36	0.00	0.00	0.23	0.00	
Crit Moves:				****				****					
Green Time:	0.0	0.0	0.0	39.4	39.4	39.4	0.0	34.6	0.0	0.0	34.6	0.0	
Volume/Cap:	0.00	0.00	0.00	0.84	0.84	0.49	0.00	0.84	0.00	0.00	0.54	0.00	
Delay/Veh:	0.0	0.0	0.0	22.9	22.9	13.8	0.0	24.3	0.0	0.0	17.1	0.0	
User DelAdj:	1.00	1.00	1.00	1.00	1.00	1.00	1.00	1.00	1.00	1.00	1.00	1.00	
AdjDel/Veh:	0.0	0.0	0.0	22.9	22.9	13.8	0.0	24.3	0.0	0.0	17.1	0.0	
LOS by Move:	A	A	A	C	C	B	A	C	A	A	B	A	
HCM2k95thQ:	0	0	0	33	33	15	0	27	0	0	15	0	

Note: Queue reported is the number of cars per lane.

City of Morgan Hill
The Crosswinds Residential Development

Level Of Service Computation Report
2000 HCM Operations (Future Volume Alternative)
Year 2030 Cumulative with Project PM

Intersection #107: US 101 Southbound Ramps and Cochrane Road

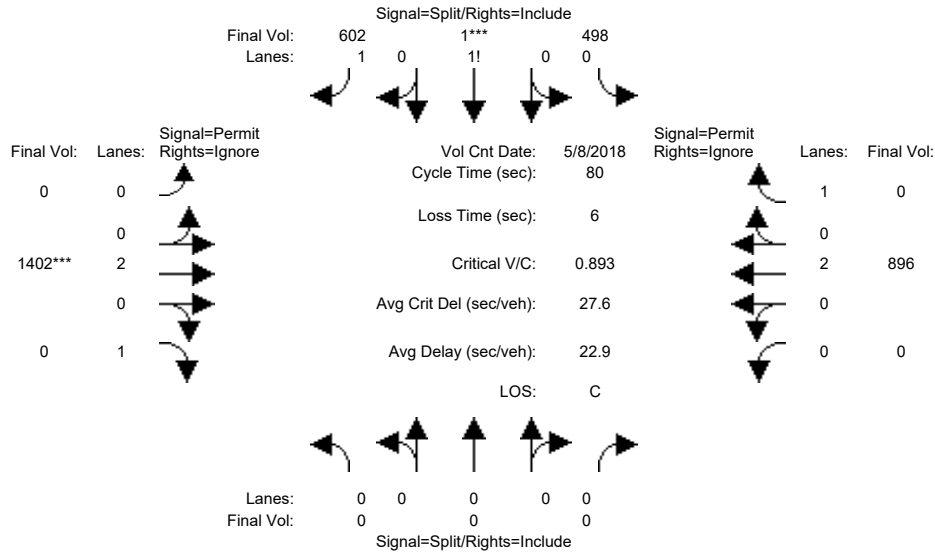

Street Name:	US 101 Southbound Ramps						Cochrane Road					
	North Bound			South Bound			East Bound			West Bound		
Movement:	L	T	R	L	T	R	L	T	R	L	T	R
Min. Green:	0	0	0	10	0	10	0	10	10	0	10	10
Y+R:	4.0	4.0	4.0	4.0	4.0	4.0	4.0	4.0	4.0	4.0	4.0	4.0

Volume Module:	>>	Count	Date:	8 May 2018	<<							
Base Vol:	0	0	0	422	1	602	0	1381	741	0	884	157
Growth Adj:	1.00	1.00	1.00	1.00	1.00	1.00	1.00	1.00	1.00	1.00	1.00	1.00
Initial Bse:	0	0	0	422	1	602	0	1381	741	0	884	157
Added Vol:	0	0	0	76	0	0	0	21	0	0	12	7
PasserByVol:	0	0	0	0	0	0	0	0	0	0	0	0
Initial Fut:	0	0	0	498	1	602	0	1402	741	0	896	164
User Adj:	1.00	1.00	1.00	1.00	1.00	1.00	1.00	1.00	0.00	1.00	1.00	0.00
PHF Adj:	1.00	1.00	1.00	1.00	1.00	1.00	1.00	1.00	0.00	1.00	1.00	0.00
PHF Volume:	0	0	0	498	1	602	0	1402	0	0	896	0
Reduct Vol:	0	0	0	0	0	0	0	0	0	0	0	0
Reduced Vol:	0	0	0	498	1	602	0	1402	0	0	896	0
PCE Adj:	1.00	1.00	1.00	1.00	1.00	1.00	1.00	1.00	0.00	1.00	1.00	0.00
MLF Adj:	1.00	1.00	1.00	1.00	1.00	1.00	1.00	1.00	0.00	1.00	1.00	0.00
Final Volume:	0	0	0	498	1	602	0	1402	0	0	896	0

Saturation Flow Module:												
Sat/Lane:	1900	1900	1900	1900	1900	1900	1900	1900	1900	1900	1900	1900
Adjustment:	0.92	1.00	0.92	0.92	0.92	0.92	0.92	1.00	0.92	0.92	1.00	0.92
Lanes:	0.00	0.00	0.00	0.62	0.01	1.37	0.00	2.00	1.00	0.00	2.00	1.00
Final Sat.:	0	0	0	1089	2	2408	0	3800	1750	0	3800	1750

Capacity Analysis Module:												
Vol/Sat:	0.00	0.00	0.00	0.46	0.46	0.25	0.00	0.37	0.00	0.00	0.24	0.00
Crit Moves:					****			****				
Green Time:	0.0	0.0	0.0	41.0	41.0	41.0	0.0	33.0	0.0	0.0	33.0	0.0
Volume/Cap:	0.00	0.00	0.00	0.89	0.89	0.49	0.00	0.89	0.00	0.00	0.57	0.00
Delay/Veh:	0.0	0.0	0.0	26.1	26.1	12.9	0.0	28.8	0.0	0.0	18.5	0.0
User DelAdj:	1.00	1.00	1.00	1.00	1.00	1.00	1.00	1.00	1.00	1.00	1.00	1.00
AdjDel/Veh:	0.0	0.0	0.0	26.1	26.1	12.9	0.0	28.8	0.0	0.0	18.5	0.0
LOS by Move:	A	A	A	C	C	B	A	C	A	A	B	A
HCM2k95thQ:	0	0	0	39	39	15	0	30	0	0	16	0

Note: Queue reported is the number of cars per lane.

City of Morgan Hill
The Crosswinds Residential Development

Level Of Service Computation Report
2000 HCM Operations (Future Volume Alternative)
Existing AM

Intersection #108: US 101 Northbound Ramps and Cochrane Road

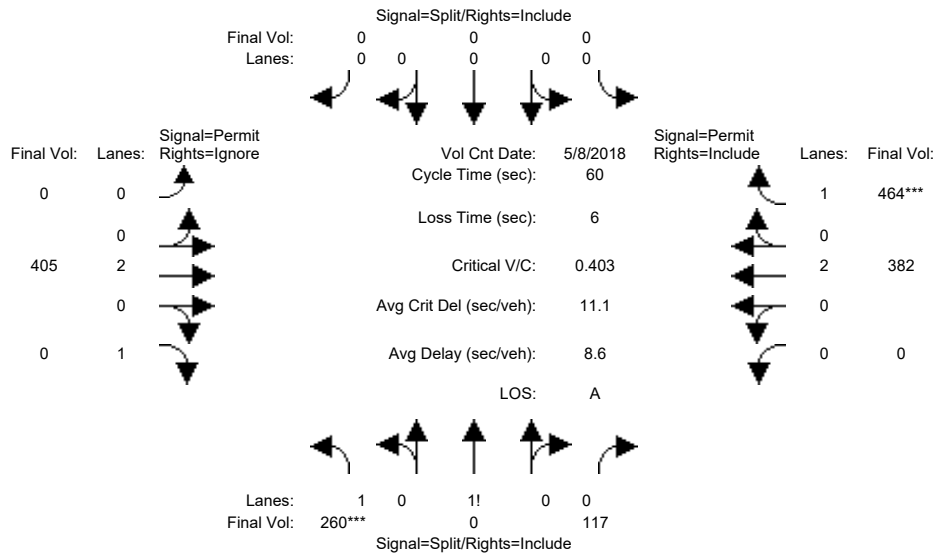

Street Name:	US 101 Northbound Ramps						Cochrane Road					
	North Bound			South Bound			East Bound			West Bound		
Movement:	L	T	R	L	T	R	L	T	R	L	T	R
Min. Green:	10	0	10	0	0	0	0	10	10	0	10	10
Y+R:	4.0	4.0	4.0	4.0	4.0	4.0	4.0	4.0	4.0	4.0	4.0	4.0

Volume Module:	>>	Count	Date:	8 May 2018	<<							
Base Vol:	260	0	117	0	0	0	0	405	0	0	382	464
Growth Adj:	1.00	1.00	1.00	1.00	1.00	1.00	1.00	1.00	1.00	1.00	1.00	1.00
Initial Bse:	260	0	117	0	0	0	0	405	0	0	382	464
Added Vol:	0	0	0	0	0	0	0	0	0	0	0	0
PasserByVol:	0	0	0	0	0	0	0	0	0	0	0	0
Initial Fut:	260	0	117	0	0	0	0	405	0	0	382	464
User Adj:	1.00	1.00	1.00	1.00	1.00	1.00	1.00	1.00	0.00	1.00	1.00	1.00
PHF Adj:	1.00	1.00	1.00	1.00	1.00	1.00	1.00	1.00	0.00	1.00	1.00	1.00
PHF Volume:	260	0	117	0	0	0	0	405	0	0	382	464
Reduct Vol:	0	0	0	0	0	0	0	0	0	0	0	0
Reduced Vol:	260	0	117	0	0	0	0	405	0	0	382	464
PCE Adj:	1.00	1.00	1.00	1.00	1.00	1.00	1.00	1.00	0.00	1.00	1.00	1.00
MLF Adj:	1.00	1.00	1.00	1.00	1.00	1.00	1.00	1.00	0.00	1.00	1.00	1.00
FinalVolume:	260	0	117	0	0	0	0	405	0	0	382	464

Saturation Flow Module:												
Sat/Lane:	1900	1900	1900	1900	1900	1900	1900	1900	1900	1900	1900	1900
Adjustment:	0.92	1.00	0.92	0.92	1.00	0.92	0.92	1.00	0.92	0.92	1.00	0.92
Lanes:	1.53	0.00	0.47	0.00	0.00	0.00	0.00	2.00	1.00	0.00	2.00	1.00
Final Sat.:	2671	0	829	0	0	0	0	3800	1750	0	3800	1750

Capacity Analysis Module:												
Vol/Sat:	0.10	0.00	0.14	0.00	0.00	0.00	0.00	0.11	0.00	0.00	0.10	0.27
Crit Moves:	****											****
Green Time:	18.8	0.0	18.8	0.0	0.0	0.0	0.0	35.2	0.0	0.0	35.2	35.2
Volume/Cap:	0.31	0.00	0.45	0.00	0.00	0.00	0.00	0.18	0.00	0.00	0.17	0.45
Delay/Veh:	15.8	0.0	16.9	0.0	0.0	0.0	0.0	5.8	0.0	0.0	5.7	7.3
User DelAdj:	1.00	1.00	1.00	1.00	1.00	1.00	1.00	1.00	1.00	1.00	1.00	1.00
AdjDel/Veh:	15.8	0.0	16.9	0.0	0.0	0.0	0.0	5.8	0.0	0.0	5.7	7.3
LOS by Move:	B	A	B	A	A	A	A	A	A	A	A	A
HCM2k95thQ:	6	0	9	0	0	0	0	3	0	0	3	11

Note: Queue reported is the number of cars per lane.

City of Morgan Hill
The Crosswinds Residential Development

Level Of Service Computation Report
2000 HCM Operations (Future Volume Alternative)
Existing Plus Project AM

Intersection #108: US 101 Northbound Ramps and Cochrane Road

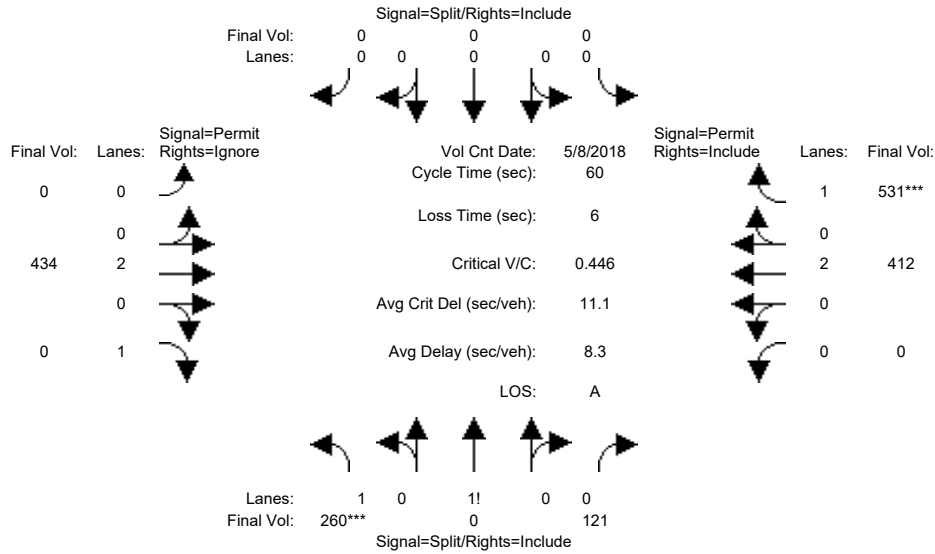

Street Name:	US 101 Northbound Ramps						Cochrane Road					
	North Bound			South Bound			East Bound			West Bound		
Movement:	L	T	R	L	T	R	L	T	R	L	T	R
Min. Green:	10	0	10	0	0	0	0	10	10	0	10	10
Y+R:	4.0	4.0	4.0	4.0	4.0	4.0	4.0	4.0	4.0	4.0	4.0	4.0

Volume Module:	>>	Count	Date:	8 May 2018	<<							
Base Vol:	260	0	117	0	0	0	0	405	0	0	382	464
Growth Adj:	1.00	1.00	1.00	1.00	1.00	1.00	1.00	1.00	1.00	1.00	1.00	1.00
Initial Bse:	260	0	117	0	0	0	0	405	0	0	382	464
Added Vol:	0	0	4	0	0	0	0	29	0	0	30	67
PasserByVol:	0	0	0	0	0	0	0	0	0	0	0	0
Initial Fut:	260	0	121	0	0	0	0	434	0	0	412	531
User Adj:	1.00	1.00	1.00	1.00	1.00	1.00	1.00	1.00	0.00	1.00	1.00	1.00
PHF Adj:	1.00	1.00	1.00	1.00	1.00	1.00	1.00	1.00	0.00	1.00	1.00	1.00
PHF Volume:	260	0	121	0	0	0	0	434	0	0	412	531
Reduct Vol:	0	0	0	0	0	0	0	0	0	0	0	0
Reduced Vol:	260	0	121	0	0	0	0	434	0	0	412	531
PCE Adj:	1.00	1.00	1.00	1.00	1.00	1.00	1.00	1.00	0.00	1.00	1.00	1.00
MLF Adj:	1.00	1.00	1.00	1.00	1.00	1.00	1.00	1.00	0.00	1.00	1.00	1.00
FinalVolume:	260	0	121	0	0	0	0	434	0	0	412	531

Saturation Flow Module:												
Sat/Lane:	1900	1900	1900	1900	1900	1900	1900	1900	1900	1900	1900	1900
Adjustment:	0.92	1.00	0.92	0.92	1.00	0.92	0.92	1.00	0.92	0.92	1.00	0.92
Lanes:	1.52	0.00	0.48	0.00	0.00	0.00	0.00	2.00	1.00	0.00	2.00	1.00
Final Sat.:	2656	0	844	0	0	0	0	3800	1750	0	3800	1750

Capacity Analysis Module:												
Vol/Sat:	0.10	0.00	0.14	0.00	0.00	0.00	0.00	0.11	0.00	0.00	0.11	0.30
Crit Moves:	****											****
Green Time:	17.3	0.0	17.3	0.0	0.0	0.0	0.0	36.7	0.0	0.0	36.7	36.7
Volume/Cap:	0.34	0.00	0.50	0.00	0.00	0.00	0.00	0.19	0.00	0.00	0.18	0.50
Delay/Veh:	17.0	0.0	18.2	0.0	0.0	0.0	0.0	5.2	0.0	0.0	5.1	6.9
User DelAdj:	1.00	1.00	1.00	1.00	1.00	1.00	1.00	1.00	1.00	1.00	1.00	1.00
AdjDel/Veh:	17.0	0.0	18.2	0.0	0.0	0.0	0.0	5.2	0.0	0.0	5.1	6.9
LOS by Move:	B	A	B	A	A	A	A	A	A	A	A	A
HCM2k95thQ:	6	0	9	0	0	0	0	3	0	0	4	12

Note: Queue reported is the number of cars per lane.

City of Morgan Hill
The Crosswinds Residential Development

Level Of Service Computation Report
2000 HCM Operations (Future Volume Alternative)
Year 2030 Cumulative without Project AM

Intersection #108: US 101 Northbound Ramps and Cochrane Road

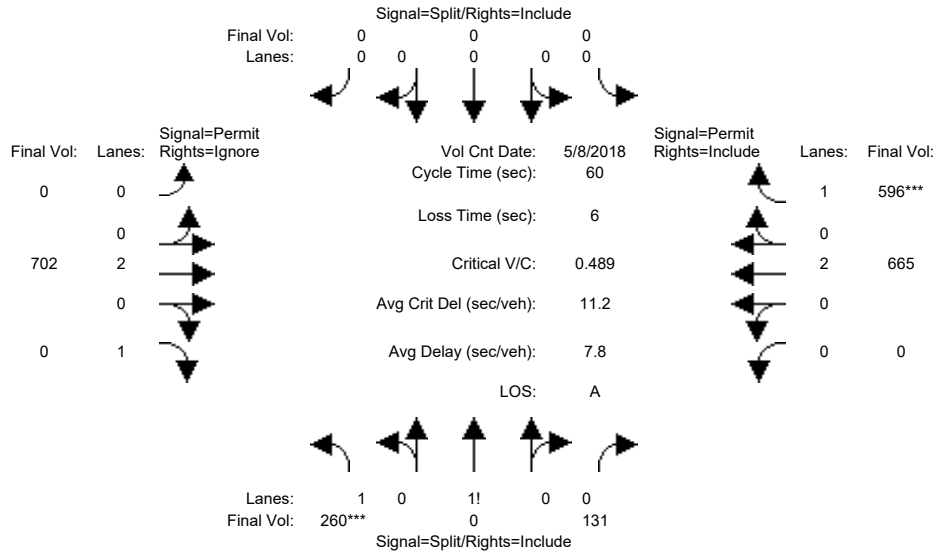

Street Name:	US 101 Northbound Ramps						Cochrane Road					
	North Bound			South Bound			East Bound			West Bound		
Movement:	L	T	R	L	T	R	L	T	R	L	T	R
Min. Green:	10	0	10	0	0	0	0	10	10	0	10	10
Y+R:	4.0	4.0	4.0	4.0	4.0	4.0	4.0	4.0	4.0	4.0	4.0	4.0

Volume Module:	>>	Count	Date:	8 May 2018	<<							
Base Vol:	260	0	131	0	0	0	0	702	0	0	665	596
Growth Adj:	1.00	1.00	1.00	1.00	1.00	1.00	1.00	1.00	1.00	1.00	1.00	1.00
Initial Bse:	260	0	131	0	0	0	0	702	0	0	665	596
Added Vol:	0	0	0	0	0	0	0	0	0	0	0	0
PasserByVol:	0	0	0	0	0	0	0	0	0	0	0	0
Initial Fut:	260	0	131	0	0	0	0	702	0	0	665	596
User Adj:	1.00	1.00	1.00	1.00	1.00	1.00	1.00	1.00	0.00	1.00	1.00	1.00
PHF Adj:	1.00	1.00	1.00	1.00	1.00	1.00	1.00	1.00	0.00	1.00	1.00	1.00
PHF Volume:	260	0	131	0	0	0	0	702	0	0	665	596
Reduct Vol:	0	0	0	0	0	0	0	0	0	0	0	0
Reduced Vol:	260	0	131	0	0	0	0	702	0	0	665	596
PCE Adj:	1.00	1.00	1.00	1.00	1.00	1.00	1.00	1.00	0.00	1.00	1.00	1.00
MLF Adj:	1.00	1.00	1.00	1.00	1.00	1.00	1.00	1.00	0.00	1.00	1.00	1.00
FinalVolume:	260	0	131	0	0	0	0	702	0	0	665	596

Saturation Flow Module:												
Sat/Lane:	1900	1900	1900	1900	1900	1900	1900	1900	1900	1900	1900	1900
Adjustment:	0.92	1.00	0.92	0.92	1.00	0.92	0.92	1.00	0.92	0.92	1.00	0.92
Lanes:	1.50	0.00	0.50	0.00	0.00	0.00	0.00	2.00	1.00	0.00	2.00	1.00
Final Sat.:	2622	0	878	0	0	0	0	3800	1750	0	3800	1750

Capacity Analysis Module:												
Vol/Sat:	0.10	0.00	0.15	0.00	0.00	0.00	0.00	0.18	0.00	0.00	0.17	0.34
Crit Moves:	****											****
Green Time:	16.4	0.0	16.4	0.0	0.0	0.0	0.0	37.6	0.0	0.0	37.6	37.6
Volume/Cap:	0.36	0.00	0.54	0.00	0.00	0.00	0.00	0.30	0.00	0.00	0.28	0.54
Delay/Veh:	17.8	0.0	19.4	0.0	0.0	0.0	0.0	5.2	0.0	0.0	5.2	6.9
User DelAdj:	1.00	1.00	1.00	1.00	1.00	1.00	1.00	1.00	1.00	1.00	1.00	1.00
AdjDel/Veh:	17.8	0.0	19.4	0.0	0.0	0.0	0.0	5.2	0.0	0.0	5.2	6.9
LOS by Move:	B	A	B	A	A	A	A	A	A	A	A	A
HCM2k95thQ:	6	0	10	0	0	0	0	6	0	0	6	14

Note: Queue reported is the number of cars per lane.

City of Morgan Hill
The Crosswinds Residential Development

Level Of Service Computation Report
2000 HCM Operations (Future Volume Alternative)
Year 2030 Cumulative with Project AM

Intersection #108: US 101 Northbound Ramps and Cochrane Road

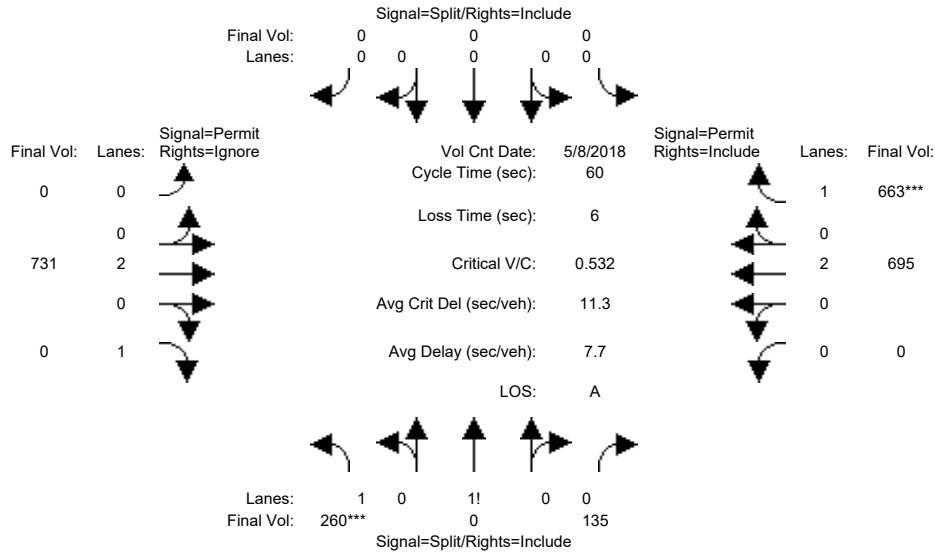

Street Name:	US 101 Northbound Ramps						Cochrane Road					
	North Bound			South Bound			East Bound			West Bound		
Movement:	L	T	R	L	T	R	L	T	R	L	T	R
Min. Green:	10	0	10	0	0	0	0	10	10	0	10	10
Y+R:	4.0	4.0	4.0	4.0	4.0	4.0	4.0	4.0	4.0	4.0	4.0	4.0

Volume Module:	>>	Count	Date:	8 May 2018	<<							
Base Vol:	260	0	131	0	0	0	0	702	0	0	665	596
Growth Adj:	1.00	1.00	1.00	1.00	1.00	1.00	1.00	1.00	1.00	1.00	1.00	1.00
Initial Bse:	260	0	131	0	0	0	0	702	0	0	665	596
Added Vol:	0	0	4	0	0	0	0	29	0	0	30	67
PasserByVol:	0	0	0	0	0	0	0	0	0	0	0	0
Initial Fut:	260	0	135	0	0	0	0	731	0	0	695	663
User Adj:	1.00	1.00	1.00	1.00	1.00	1.00	1.00	1.00	0.00	1.00	1.00	1.00
PHF Adj:	1.00	1.00	1.00	1.00	1.00	1.00	1.00	1.00	0.00	1.00	1.00	1.00
PHF Volume:	260	0	135	0	0	0	0	731	0	0	695	663
Reduct Vol:	0	0	0	0	0	0	0	0	0	0	0	0
Reduced Vol:	260	0	135	0	0	0	0	731	0	0	695	663
PCE Adj:	1.00	1.00	1.00	1.00	1.00	1.00	1.00	1.00	0.00	1.00	1.00	1.00
MLF Adj:	1.00	1.00	1.00	1.00	1.00	1.00	1.00	1.00	0.00	1.00	1.00	1.00
FinalVolume:	260	0	135	0	0	0	0	731	0	0	695	663

Saturation Flow Module:												
Sat/Lane:	1900	1900	1900	1900	1900	1900	1900	1900	1900	1900	1900	1900
Adjustment:	0.92	1.00	0.92	0.92	1.00	0.92	0.92	1.00	0.92	0.92	1.00	0.92
Lanes:	1.49	0.00	0.51	0.00	0.00	0.00	0.00	2.00	1.00	0.00	2.00	1.00
Final Sat.:	2608	0	892	0	0	0	0	3800	1750	0	3800	1750

Capacity Analysis Module:												
Vol/Sat:	0.10	0.00	0.15	0.00	0.00	0.00	0.00	0.19	0.00	0.00	0.18	0.38
Crit Moves:	****											****
Green Time:	15.4	0.0	15.4	0.0	0.0	0.0	0.0	38.6	0.0	0.0	38.6	38.6
Volume/Cap:	0.39	0.00	0.59	0.00	0.00	0.00	0.00	0.30	0.00	0.00	0.28	0.59
Delay/Veh:	18.6	0.0	20.9	0.0	0.0	0.0	0.0	4.8	0.0	0.0	4.7	7.0
User DelAdj:	1.00	1.00	1.00	1.00	1.00	1.00	1.00	1.00	1.00	1.00	1.00	1.00
AdjDel/Veh:	18.6	0.0	20.9	0.0	0.0	0.0	0.0	4.8	0.0	0.0	4.7	7.0
LOS by Move:	B	A	C	A	A	A	A	A	A	A	A	A
HCM2k95thQ:	6	0	11	0	0	0	0	6	0	0	6	16

Note: Queue reported is the number of cars per lane.

City of Morgan Hill
The Crosswinds Residential Development

Level Of Service Computation Report
2000 HCM Operations (Future Volume Alternative)
Existing PM

Intersection #108: US 101 Northbound Ramps and Cochrane Road

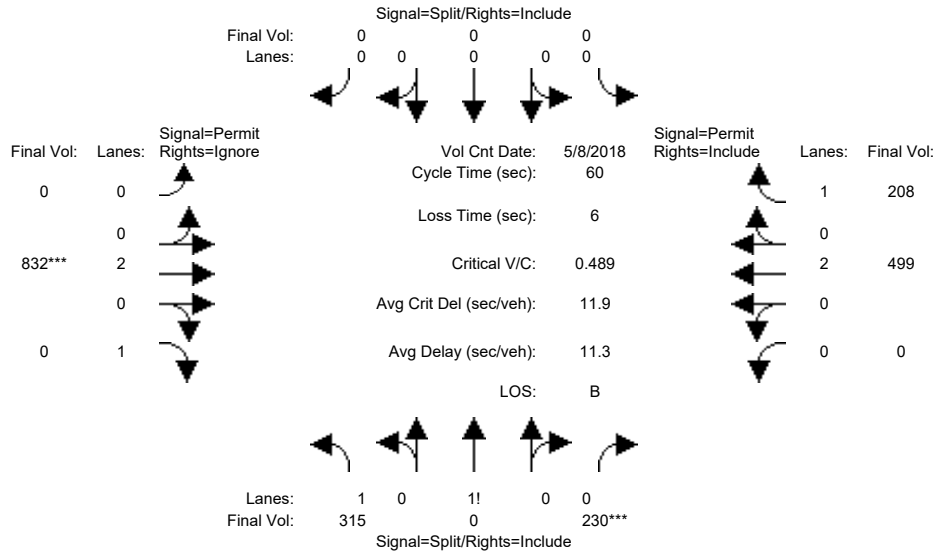

Street Name:	US 101 Northbound Ramps						Cochrane Road					
	North Bound			South Bound			East Bound			West Bound		
Movement:	L	T	R	L	T	R	L	T	R	L	T	R
Min. Green:	10	0	10	0	0	0	0	10	10	0	10	10
Y+R:	4.0	4.0	4.0	4.0	4.0	4.0	4.0	4.0	4.0	4.0	4.0	4.0

Volume Module:	>>	Count	Date:	8 May 2018	<<							
Base Vol:	315	0	230	0	0	0	0	832	0	0	499	208
Growth Adj:	1.00	1.00	1.00	1.00	1.00	1.00	1.00	1.00	1.00	1.00	1.00	1.00
Initial Bse:	315	0	230	0	0	0	0	832	0	0	499	208
Added Vol:	0	0	0	0	0	0	0	0	0	0	0	0
PasserByVol:	0	0	0	0	0	0	0	0	0	0	0	0
Initial Fut:	315	0	230	0	0	0	0	832	0	0	499	208
User Adj:	1.00	1.00	1.00	1.00	1.00	1.00	1.00	1.00	0.00	1.00	1.00	1.00
PHF Adj:	1.00	1.00	1.00	1.00	1.00	1.00	1.00	1.00	0.00	1.00	1.00	1.00
PHF Volume:	315	0	230	0	0	0	0	832	0	0	499	208
Reduct Vol:	0	0	0	0	0	0	0	0	0	0	0	0
Reduced Vol:	315	0	230	0	0	0	0	832	0	0	499	208
PCE Adj:	1.00	1.00	1.00	1.00	1.00	1.00	1.00	1.00	0.00	1.00	1.00	1.00
MLF Adj:	1.00	1.00	1.00	1.00	1.00	1.00	1.00	1.00	0.00	1.00	1.00	1.00
FinalVolume:	315	0	230	0	0	0	0	832	0	0	499	208

Saturation Flow Module:												
Sat/Lane:	1900	1900	1900	1900	1900	1900	1900	1900	1900	1900	1900	1900
Adjustment:	0.92	1.00	0.92	0.92	1.00	0.92	0.92	1.00	0.92	0.92	1.00	0.92
Lanes:	1.41	0.00	0.59	0.00	0.00	0.00	0.00	2.00	1.00	0.00	2.00	1.00
Final Sat.:	2461	0	1039	0	0	0	0	3800	1750	0	3800	1750

Capacity Analysis Module:												
Vol/Sat:	0.13	0.00	0.22	0.00	0.00	0.00	0.00	0.22	0.00	0.00	0.13	0.12
Crit Moves:	****									****		
Green Time:	27.2	0.0	27.2	0.0	0.0	0.0	0.0	26.8	0.0	0.0	26.8	26.8
Volume/Cap:	0.28	0.00	0.49	0.00	0.00	0.00	0.00	0.49	0.00	0.00	0.29	0.27
Delay/Veh:	10.4	0.0	11.9	0.0	0.0	0.0	0.0	11.9	0.0	0.0	10.6	10.6
User DelAdj:	1.00	1.00	1.00	1.00	1.00	1.00	1.00	1.00	1.00	1.00	1.00	1.00
AdjDel/Veh:	10.4	0.0	11.9	0.0	0.0	0.0	0.0	11.9	0.0	0.0	10.6	10.6
LOS by Move:	B	A	B	A	A	A	A	B	A	A	B	B
HCM2k95thQ:	6	0	11	0	0	0	0	10	0	0	6	5

Note: Queue reported is the number of cars per lane.

City of Morgan Hill
The Crosswinds Residential Development

Level Of Service Computation Report
2000 HCM Operations (Future Volume Alternative)
Existing Plus Project PM

Intersection #108: US 101 Northbound Ramps and Cochrane Road

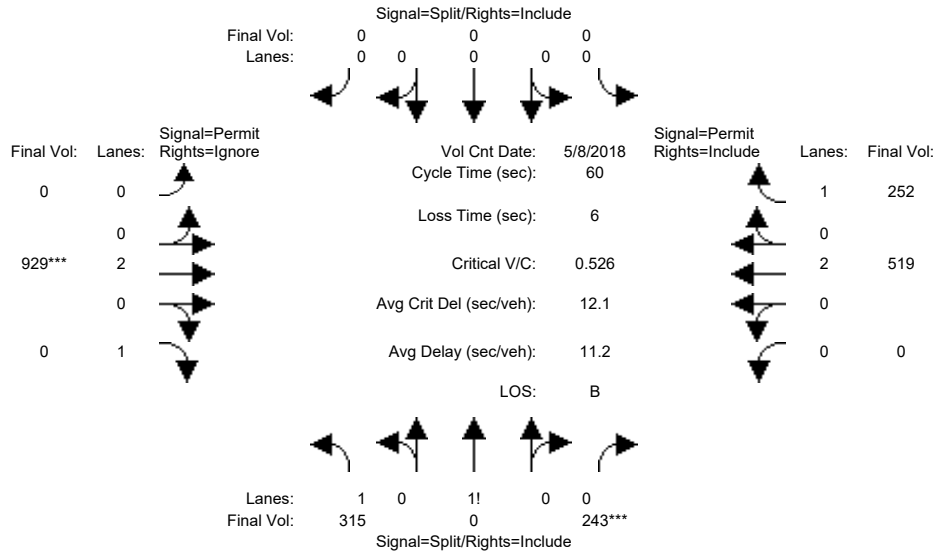

Street Name:	US 101 Northbound Ramps						Cochrane Road					
	North Bound			South Bound			East Bound			West Bound		
Movement:	L	T	R	L	T	R	L	T	R	L	T	R
Min. Green:	10	0	10	0	0	0	0	10	10	0	10	10
Y+R:	4.0	4.0	4.0	4.0	4.0	4.0	4.0	4.0	4.0	4.0	4.0	4.0

Volume Module:	>>	Count	Date:	8 May 2018	<<							
Base Vol:	315	0	230	0	0	0	0	832	0	0	499	208
Growth Adj:	1.00	1.00	1.00	1.00	1.00	1.00	1.00	1.00	1.00	1.00	1.00	1.00
Initial Bse:	315	0	230	0	0	0	0	832	0	0	499	208
Added Vol:	0	0	13	0	0	0	0	97	0	0	20	44
PasserByVol:	0	0	0	0	0	0	0	0	0	0	0	0
Initial Fut:	315	0	243	0	0	0	0	929	0	0	519	252
User Adj:	1.00	1.00	1.00	1.00	1.00	1.00	1.00	1.00	0.00	1.00	1.00	1.00
PHF Adj:	1.00	1.00	1.00	1.00	1.00	1.00	1.00	1.00	0.00	1.00	1.00	1.00
PHF Volume:	315	0	243	0	0	0	0	929	0	0	519	252
Reduct Vol:	0	0	0	0	0	0	0	0	0	0	0	0
Reduced Vol:	315	0	243	0	0	0	0	929	0	0	519	252
PCE Adj:	1.00	1.00	1.00	1.00	1.00	1.00	1.00	1.00	0.00	1.00	1.00	1.00
MLF Adj:	1.00	1.00	1.00	1.00	1.00	1.00	1.00	1.00	0.00	1.00	1.00	1.00
Final Volume:	315	0	243	0	0	0	0	929	0	0	519	252

Saturation Flow Module:												
Sat/Lane:	1900	1900	1900	1900	1900	1900	1900	1900	1900	1900	1900	1900
Adjustment:	0.92	1.00	0.92	0.92	1.00	0.92	0.92	1.00	0.92	0.92	1.00	0.92
Lanes:	1.39	0.00	0.61	0.00	0.00	0.00	0.00	2.00	1.00	0.00	2.00	1.00
Final Sat.:	2438	0	1062	0	0	0	0	3800	1750	0	3800	1750

Capacity Analysis Module:												
Vol/Sat:	0.13	0.00	0.23	0.00	0.00	0.00	0.00	0.24	0.00	0.00	0.14	0.14
Crit Moves:	****			****								
Green Time:	26.1	0.0	26.1	0.0	0.0	0.0	0.0	27.9	0.0	0.0	27.9	27.9
Volume/Cap:	0.30	0.00	0.53	0.00	0.00	0.00	0.00	0.53	0.00	0.00	0.29	0.31
Delay/Veh:	11.1	0.0	12.9	0.0	0.0	0.0	0.0	11.7	0.0	0.0	10.0	10.3
User DelAdj:	1.00	1.00	1.00	1.00	1.00	1.00	1.00	1.00	1.00	1.00	1.00	1.00
AdjDel/Veh:	11.1	0.0	12.9	0.0	0.0	0.0	0.0	11.7	0.0	0.0	10.0	10.3
LOS by Move:	B	A	B	A	A	A	A	B	A	A	B	B
HCM2k95thQ:	6	0	12	0	0	0	0	11	0	0	6	7

Note: Queue reported is the number of cars per lane.

City of Morgan Hill
The Crosswinds Residential Development

Level Of Service Computation Report
2000 HCM Operations (Future Volume Alternative)
Year 2030 Cumulative without Project PM

Intersection #108: US 101 Northbound Ramps and Cochrane Road

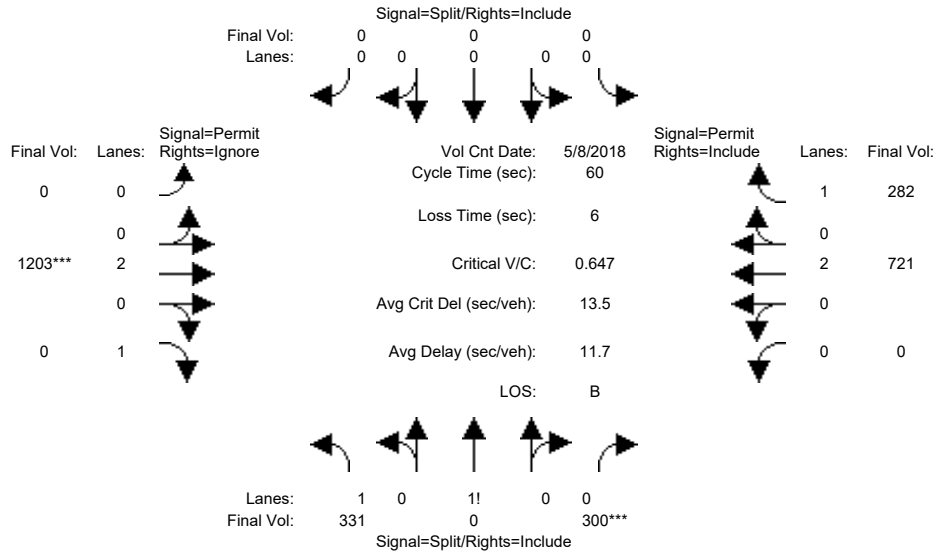

Street Name:	US 101 Northbound Ramps						Cochrane Road					
	North Bound			South Bound			East Bound			West Bound		
Movement:	L	T	R	L	T	R	L	T	R	L	T	R
Min. Green:	10	0	10	0	0	0	0	10	10	0	10	10
Y+R:	4.0	4.0	4.0	4.0	4.0	4.0	4.0	4.0	4.0	4.0	4.0	4.0

Volume Module:	>>	Count	Date:	8 May 2018	<<							
Base Vol:	331	0	300	0	0	0	0	1203	0	0	721	282
Growth Adj:	1.00	1.00	1.00	1.00	1.00	1.00	1.00	1.00	1.00	1.00	1.00	1.00
Initial Bse:	331	0	300	0	0	0	0	1203	0	0	721	282
Added Vol:	0	0	0	0	0	0	0	0	0	0	0	0
PasserByVol:	0	0	0	0	0	0	0	0	0	0	0	0
Initial Fut:	331	0	300	0	0	0	0	1203	0	0	721	282
User Adj:	1.00	1.00	1.00	1.00	1.00	1.00	1.00	1.00	0.00	1.00	1.00	1.00
PHF Adj:	1.00	1.00	1.00	1.00	1.00	1.00	1.00	1.00	0.00	1.00	1.00	1.00
PHF Volume:	331	0	300	0	0	0	0	1203	0	0	721	282
Reduct Vol:	0	0	0	0	0	0	0	0	0	0	0	0
Reduced Vol:	331	0	300	0	0	0	0	1203	0	0	721	282
PCE Adj:	1.00	1.00	1.00	1.00	1.00	1.00	1.00	1.00	0.00	1.00	1.00	1.00
MLF Adj:	1.00	1.00	1.00	1.00	1.00	1.00	1.00	1.00	0.00	1.00	1.00	1.00
FinalVolume:	331	0	300	0	0	0	0	1203	0	0	721	282

Saturation Flow Module:												
Sat/Lane:	1900	1900	1900	1900	1900	1900	1900	1900	1900	1900	1900	1900
Adjustment:	0.92	1.00	0.92	0.92	1.00	0.92	0.92	1.00	0.92	0.92	1.00	0.92
Lanes:	1.36	0.00	0.64	0.00	0.00	0.00	0.00	2.00	1.00	0.00	2.00	1.00
Final Sat.:	2372	0	1128	0	0	0	0	3800	1750	0	3800	1750

Capacity Analysis Module:												
Vol/Sat:	0.14	0.00	0.27	0.00	0.00	0.00	0.00	0.32	0.00	0.00	0.19	0.16
Crit Moves:	****						****					
Green Time:	24.7	0.0	24.7	0.0	0.0	0.0	0.0	29.3	0.0	0.0	29.3	29.3
Volume/Cap:	0.34	0.00	0.65	0.00	0.00	0.00	0.00	0.65	0.00	0.00	0.39	0.33
Delay/Veh:	12.2	0.0	15.7	0.0	0.0	0.0	0.0	12.3	0.0	0.0	9.8	9.6
User DelAdj:	1.00	1.00	1.00	1.00	1.00	1.00	1.00	1.00	1.00	1.00	1.00	1.00
AdjDel/Veh:	12.2	0.0	15.7	0.0	0.0	0.0	0.0	12.3	0.0	0.0	9.8	9.6
LOS by Move:	B	A	B	A	A	A	A	B	A	A	A	A
HCM2k95thQ:	7	0	16	0	0	0	0	15	0	0	9	7

Note: Queue reported is the number of cars per lane.

City of Morgan Hill
The Crosswinds Residential Development

Level Of Service Computation Report
2000 HCM Operations (Future Volume Alternative)
Year 2030 Cumulative with Project PM

Intersection #108: US 101 Northbound Ramps and Cochrane Road

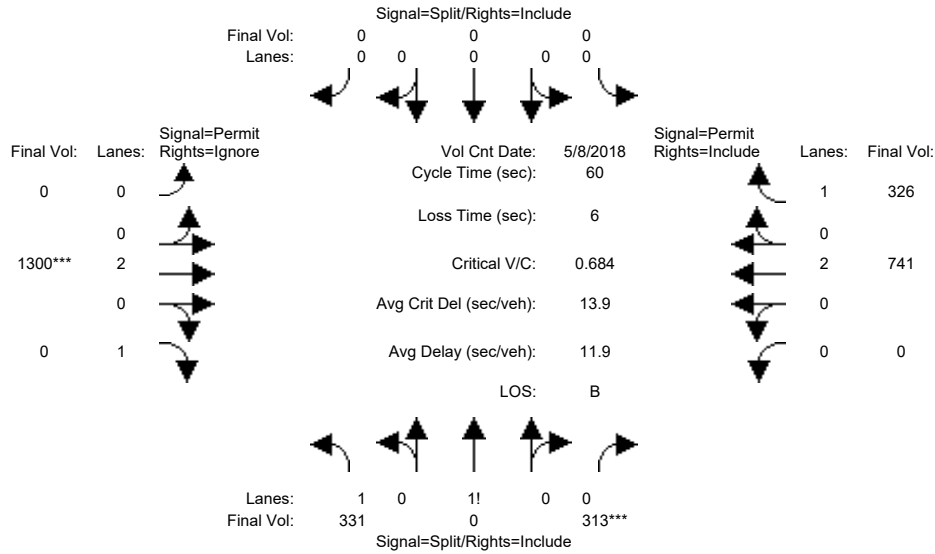

Street Name:	US 101 Northbound Ramps						Cochrane Road					
	North Bound			South Bound			East Bound			West Bound		
Movement:	L	T	R	L	T	R	L	T	R	L	T	R
Min. Green:	10	0	10	0	0	0	0	10	10	0	10	10
Y+R:	4.0	4.0	4.0	4.0	4.0	4.0	4.0	4.0	4.0	4.0	4.0	4.0

Volume Module:	>>	Count	Date:	8 May 2018	<<							
Base Vol:	331	0	300	0	0	0	0	1203	0	0	721	282
Growth Adj:	1.00	1.00	1.00	1.00	1.00	1.00	1.00	1.00	1.00	1.00	1.00	1.00
Initial Bse:	331	0	300	0	0	0	0	1203	0	0	721	282
Added Vol:	0	0	13	0	0	0	0	97	0	0	20	44
PasserByVol:	0	0	0	0	0	0	0	0	0	0	0	0
Initial Fut:	331	0	313	0	0	0	0	1300	0	0	741	326
User Adj:	1.00	1.00	1.00	1.00	1.00	1.00	1.00	1.00	0.00	1.00	1.00	1.00
PHF Adj:	1.00	1.00	1.00	1.00	1.00	1.00	1.00	1.00	0.00	1.00	1.00	1.00
PHF Volume:	331	0	313	0	0	0	0	1300	0	0	741	326
Reduct Vol:	0	0	0	0	0	0	0	0	0	0	0	0
Reduced Vol:	331	0	313	0	0	0	0	1300	0	0	741	326
PCE Adj:	1.00	1.00	1.00	1.00	1.00	1.00	1.00	1.00	0.00	1.00	1.00	1.00
MLF Adj:	1.00	1.00	1.00	1.00	1.00	1.00	1.00	1.00	0.00	1.00	1.00	1.00
FinalVolume:	331	0	313	0	0	0	0	1300	0	0	741	326

Saturation Flow Module:												
Sat/Lane:	1900	1900	1900	1900	1900	1900	1900	1900	1900	1900	1900	1900
Adjustment:	0.92	1.00	0.92	0.92	1.00	0.92	0.92	1.00	0.92	0.92	1.00	0.92
Lanes:	1.35	0.00	0.65	0.00	0.00	0.00	0.00	2.00	1.00	0.00	2.00	1.00
Final Sat.:	2355	0	1145	0	0	0	0	3800	1750	0	3800	1750

Capacity Analysis Module:												
Vol/Sat:	0.14	0.00	0.27	0.00	0.00	0.00	0.00	0.34	0.00	0.00	0.20	0.19
Crit Moves:	****						****					
Green Time:	24.0	0.0	24.0	0.0	0.0	0.0	0.0	30.0	0.0	0.0	30.0	30.0
Volume/Cap:	0.35	0.00	0.68	0.00	0.00	0.00	0.00	0.68	0.00	0.00	0.39	0.37
Delay/Veh:	12.7	0.0	17.0	0.0	0.0	0.0	0.0	12.4	0.0	0.0	9.4	9.5
User DelAdj:	1.00	1.00	1.00	1.00	1.00	1.00	1.00	1.00	1.00	1.00	1.00	1.00
AdjDel/Veh:	12.7	0.0	17.0	0.0	0.0	0.0	0.0	12.4	0.0	0.0	9.4	9.5
LOS by Move:	B	A	B	A	A	A	A	B	A	A	A	A
HCM2k95thQ:	7	0	17	0	0	0	0	16	0	0	9	8

Note: Queue reported is the number of cars per lane.

City of Morgan Hill
The Crosswinds Residential Development

Level Of Service Computation Report
2000 HCM Operations (Future Volume Alternative)
Existing AM

Intersection #109: De Paul Drive and Cochrane Road

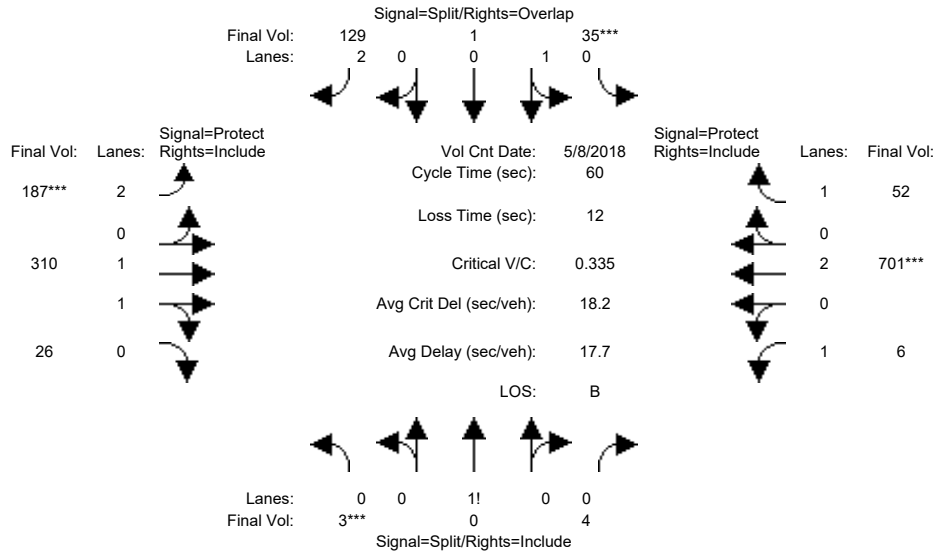

Street Name:	De Paul Drive						Cochrane Road					
	North Bound			South Bound			East Bound			West Bound		
Approach:	North Bound			South Bound			East Bound			West Bound		
Movement:	L	T	R	L	T	R	L	T	R	L	T	R
Min. Green:	10	10	10	10	10	10	7	10	10	7	10	10
Y+R:	4.0	4.0	4.0	4.0	4.0	4.0	4.0	4.0	4.0	4.0	4.0	4.0

Volume Module:	>>	Count	Date:	8 May 2018	<<							
Base Vol:	3	0	4	35	1	129	187	310	26	6	701	52
Growth Adj:	1.00	1.00	1.00	1.00	1.00	1.00	1.00	1.00	1.00	1.00	1.00	1.00
Initial Bse:	3	0	4	35	1	129	187	310	26	6	701	52
Added Vol:	0	0	0	0	0	0	0	0	0	0	0	0
PasserByVol:	0	0	0	0	0	0	0	0	0	0	0	0
Initial Fut:	3	0	4	35	1	129	187	310	26	6	701	52
User Adj:	1.00	1.00	1.00	1.00	1.00	1.00	1.00	1.00	1.00	1.00	1.00	1.00
PHF Adj:	1.00	1.00	1.00	1.00	1.00	1.00	1.00	1.00	1.00	1.00	1.00	1.00
PHF Volume:	3	0	4	35	1	129	187	310	26	6	701	52
Reduct Vol:	0	0	0	0	0	0	0	0	0	0	0	0
Reduced Vol:	3	0	4	35	1	129	187	310	26	6	701	52
PCE Adj:	1.00	1.00	1.00	1.00	1.00	1.00	1.00	1.00	1.00	1.00	1.00	1.00
MLF Adj:	1.00	1.00	1.00	1.00	1.00	1.00	1.00	1.00	1.00	1.00	1.00	1.00
Final Volume:	3	0	4	35	1	129	187	310	26	6	701	52

Saturation Flow Module:												
Sat/Lane:	1900	1900	1900	1900	1900	1900	1900	1900	1900	1900	1900	1900
Adjustment:	0.92	0.92	0.92	0.95	0.95	0.83	0.83	0.98	0.95	0.92	1.00	0.92
Lanes:	0.43	0.00	0.57	0.97	0.03	2.00	2.00	1.84	0.16	1.00	2.00	1.00
Final Sat.:	750	0	1000	1750	50	3150	3150	3413	286	1750	3800	1750

Capacity Analysis Module:												
Vol/Sat:	0.00	0.00	0.00	0.02	0.02	0.04	0.06	0.09	0.09	0.00	0.18	0.03
Crit Moves:	***			***			***			***		
Green Time:	10.0	0.0	10.0	10.0	10.0	17.0	7.0	16.5	16.5	11.5	21.0	21.0
Volume/Cap:	0.02	0.00	0.02	0.12	0.12	0.14	0.51	0.33	0.33	0.02	0.53	0.08
Delay/Veh:	21.0	0.0	21.0	21.4	21.4	16.1	26.1	17.6	17.6	19.7	15.9	13.1
User DelAdj:	1.00	1.00	1.00	1.00	1.00	1.00	1.00	1.00	1.00	1.00	1.00	1.00
AdjDel/Veh:	21.0	0.0	21.0	21.4	21.4	16.1	26.1	17.6	17.6	19.7	15.9	13.1
LOS by Move:	C	A	C	C	C	B	C	B	B	B	B	B
HCM2k95thQ:	0	0	0	1	1	2	6	6	6	0	11	2

Note: Queue reported is the number of cars per lane.

City of Morgan Hill
The Crosswinds Residential Development

Level Of Service Computation Report
2000 HCM Operations (Future Volume Alternative)
Existing Plus Project AM

Intersection #109: De Paul Drive and Cochrane Road

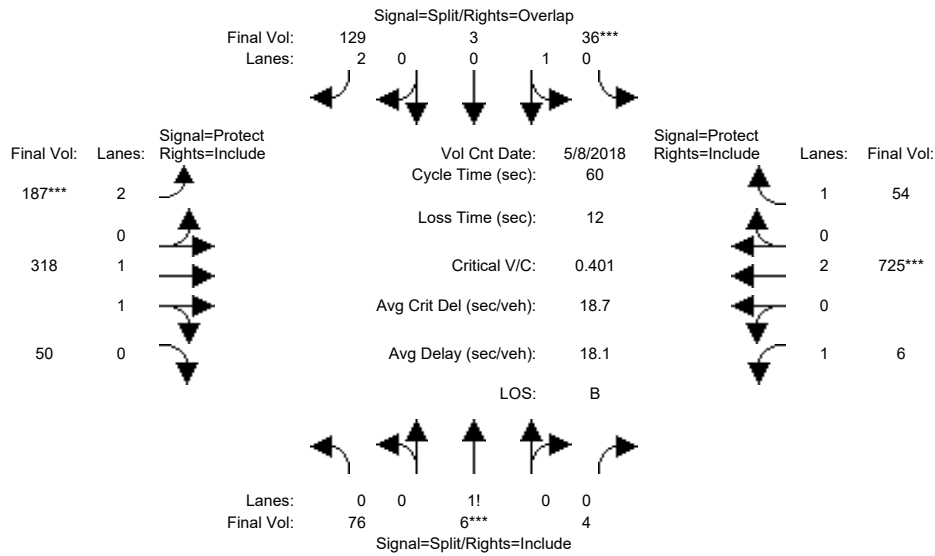

Street Name:	De Paul Drive						Cochrane Road					
	North Bound			South Bound			East Bound			West Bound		
Approach:	North Bound			South Bound			East Bound			West Bound		
Movement:	L	T	R	L	T	R	L	T	R	L	T	R
Min. Green:	10	10	10	10	10	10	7	10	10	7	10	10
Y+R:	4.0	4.0	4.0	4.0	4.0	4.0	4.0	4.0	4.0	4.0	4.0	4.0

Volume Module:	>>	Count	Date:	8 May 2018	<<												
Base Vol:	3	0	4	35	1	129	187	310	26	6	701	52					
Growth Adj:	1.00	1.00	1.00	1.00	1.00	1.00	1.00	1.00	1.00	1.00	1.00	1.00					
Initial Bse:	3	0	4	35	1	129	187	310	26	6	701	52					
Added Vol:	73	6	0	1	2	0	0	8	24	0	24	2					
PasserByVol:	0	0	0	0	0	0	0	0	0	0	0	0					
Initial Fut:	76	6	4	36	3	129	187	318	50	6	725	54					
User Adj:	1.00	1.00	1.00	1.00	1.00	1.00	1.00	1.00	1.00	1.00	1.00	1.00					
PHF Adj:	1.00	1.00	1.00	1.00	1.00	1.00	1.00	1.00	1.00	1.00	1.00	1.00					
PHF Volume:	76	6	4	36	3	129	187	318	50	6	725	54					
Reduct Vol:	0	0	0	0	0	0	0	0	0	0	0	0					
Reduced Vol:	76	6	4	36	3	129	187	318	50	6	725	54					
PCE Adj:	1.00	1.00	1.00	1.00	1.00	1.00	1.00	1.00	1.00	1.00	1.00	1.00					
MLF Adj:	1.00	1.00	1.00	1.00	1.00	1.00	1.00	1.00	1.00	1.00	1.00	1.00					
Final Volume:	76	6	4	36	3	129	187	318	50	6	725	54					

Saturation Flow Module:												
Sat/Lane:	1900	1900	1900	1900	1900	1900	1900	1900	1900	1900	1900	1900
Adjustment:	0.92	0.92	0.92	0.95	0.95	0.83	0.83	0.98	0.95	0.92	1.00	0.92
Lanes:	0.88	0.07	0.05	0.92	0.08	2.00	2.00	1.72	0.28	1.00	2.00	1.00
Final Sat.:	1547	122	81	1662	138	3150	3150	3197	503	1750	3800	1750

Capacity Analysis Module:												
Vol/Sat:	0.05	0.05	0.05	0.02	0.02	0.04	0.06	0.10	0.10	0.00	0.19	0.03
Crit Moves:	****			****			****			****		
Green Time:	10.0	10.0	10.0	10.0	10.0	17.0	7.0	16.5	16.5	11.5	21.0	21.0
Volume/Cap:	0.29	0.29	0.29	0.13	0.13	0.14	0.51	0.36	0.36	0.02	0.55	0.09
Delay/Veh:	22.5	22.5	22.5	21.5	21.5	16.1	26.1	17.8	17.8	19.7	16.1	13.1
User DelAdj:	1.00	1.00	1.00	1.00	1.00	1.00	1.00	1.00	1.00	1.00	1.00	1.00
AdjDel/Veh:	22.5	22.5	22.5	21.5	21.5	16.1	26.1	17.8	17.8	19.7	16.1	13.1
LOS by Move:	C	C	C	C	C	B	C	B	B	B	B	B
HCM2k95thQ:	4	4	4	2	2	2	6	6	6	0	12	2

Note: Queue reported is the number of cars per lane.

City of Morgan Hill
The Crosswinds Residential Development

Level Of Service Computation Report
2000 HCM Operations (Future Volume Alternative)
Year 2030 Cumulative without Project AM

Intersection #109: De Paul Drive and Cochrane Road

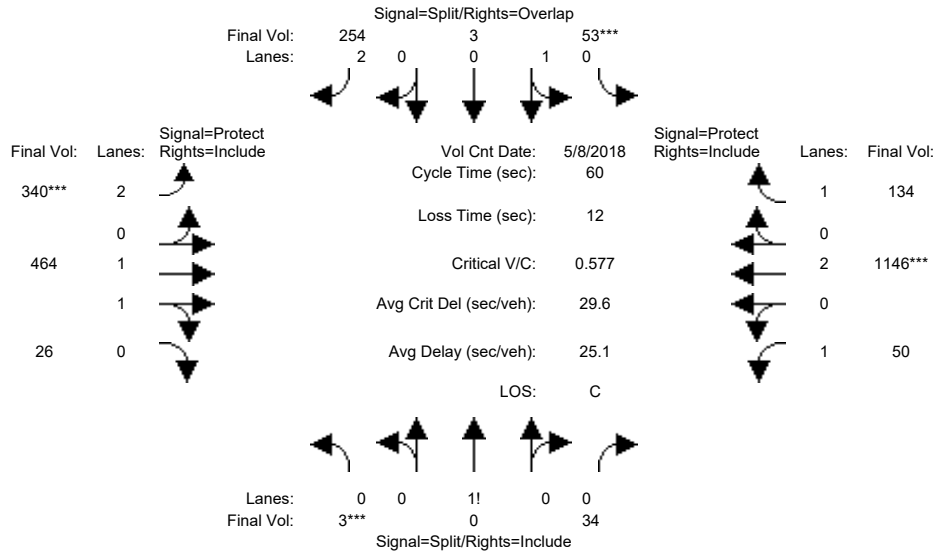

Street Name:	De Paul Drive						Cochrane Road					
	North Bound			South Bound			East Bound			West Bound		
Approach:												
Movement:	L	T	R	L	T	R	L	T	R	L	T	R
Min. Green:	10	10	10	10	10	10	7	10	10	7	10	10
Y+R:	4.0	4.0	4.0	4.0	4.0	4.0	4.0	4.0	4.0	4.0	4.0	4.0

Volume Module:	>>	Count	Date:	8 May 2018	<<											
Base Vol:	3	0	34	53	3	254	340	464	26	50	1146	134				
Growth Adj:	1.00	1.00	1.00	1.00	1.00	1.00	1.00	1.00	1.00	1.00	1.00	1.00				
Initial Bse:	3	0	34	53	3	254	340	464	26	50	1146	134				
Added Vol:	0	0	0	0	0	0	0	0	0	0	0	0				
PasserByVol:	0	0	0	0	0	0	0	0	0	0	0	0				
Initial Fut:	3	0	34	53	3	254	340	464	26	50	1146	134				
User Adj:	1.00	1.00	1.00	1.00	1.00	1.00	1.00	1.00	1.00	1.00	1.00	1.00				
PHF Adj:	1.00	1.00	1.00	1.00	1.00	1.00	1.00	1.00	1.00	1.00	1.00	1.00				
PHF Volume:	3	0	34	53	3	254	340	464	26	50	1146	134				
Reduct Vol:	0	0	0	0	0	0	0	0	0	0	0	0				
Reduced Vol:	3	0	34	53	3	254	340	464	26	50	1146	134				
PCE Adj:	1.00	1.00	1.00	1.00	1.00	1.00	1.00	1.00	1.00	1.00	1.00	1.00				
MLF Adj:	1.00	1.00	1.00	1.00	1.00	1.00	1.00	1.00	1.00	1.00	1.00	1.00				
Final Volume:	3	0	34	53	3	254	340	464	26	50	1146	134				

Saturation Flow Module:												
Sat/Lane:	1900	1900	1900	1900	1900	1900	1900	1900	1900	1900	1900	1900
Adjustment:	0.92	0.92	0.92	0.95	0.95	0.83	0.83	0.98	0.95	0.92	1.00	0.92
Lanes:	0.08	0.00	0.92	0.95	0.05	2.00	2.00	1.89	0.11	1.00	2.00	1.00
Final Sat.:	142	0	1608	1704	96	3150	3150	3504	196	1750	3800	1750

Capacity Analysis Module:												
Vol/Sat:	0.02	0.00	0.02	0.03	0.03	0.08	0.11	0.13	0.13	0.03	0.30	0.08
Crit Moves:	***			***			***			***		
Green Time:	10.0	0.0	10.0	10.0	10.0	17.4	7.4	16.5	16.5	11.5	20.6	20.6
Volume/Cap:	0.13	0.00	0.13	0.19	0.19	0.28	0.88	0.48	0.48	0.15	0.88	0.22
Delay/Veh:	21.5	0.0	21.5	21.8	21.8	16.6	45.6	18.6	18.6	20.4	25.5	14.2
User DelAdj:	1.00	1.00	1.00	1.00	1.00	1.00	1.00	1.00	1.00	1.00	1.00	1.00
AdjDel/Veh:	21.5	0.0	21.5	21.8	21.8	16.6	45.6	18.6	18.6	20.4	25.5	14.2
LOS by Move:	C	A	C	C	C	B	D	B	B	C	C	B
HCM2k95thQ:	1	0	1	2	2	5	13	9	9	2	25	4

Note: Queue reported is the number of cars per lane.

City of Morgan Hill
The Crosswinds Residential Development

Level Of Service Computation Report
2000 HCM Operations (Future Volume Alternative)
Year 2030 Cumulative with Project AM

Intersection #109: De Paul Drive and Cochrane Road

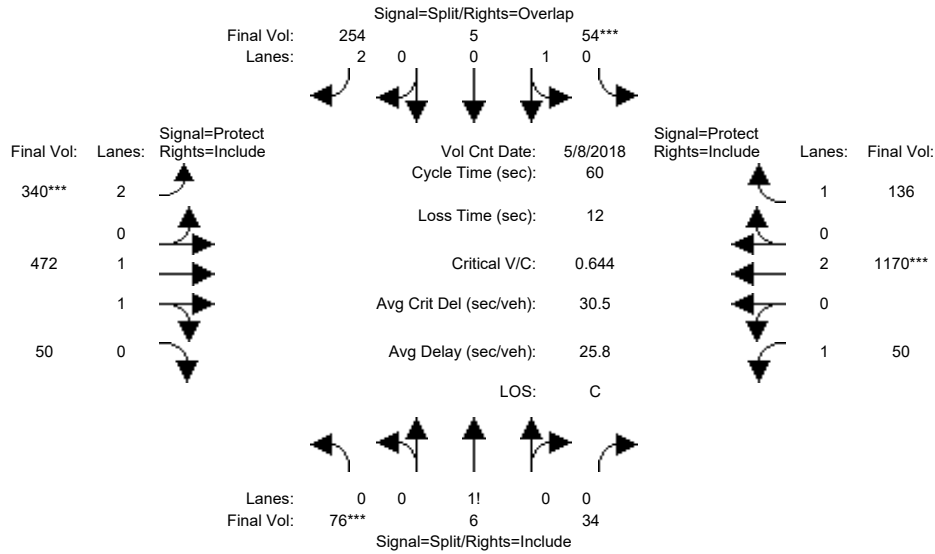

Street Name:	De Paul Drive						Cochrane Road					
	North Bound			South Bound			East Bound			West Bound		
Approach:	L	T	R	L	T	R	L	T	R	L	T	R
Min. Green:	10	10	10	10	10	10	7	10	10	7	10	10
Y+R:	4.0	4.0	4.0	4.0	4.0	4.0	4.0	4.0	4.0	4.0	4.0	4.0

Volume Module:	>>	Count	Date:	8 May 2018	<<							
Base Vol:	3	0	34	53	3	254	340	464	26	50	1146	134
Growth Adj:	1.00	1.00	1.00	1.00	1.00	1.00	1.00	1.00	1.00	1.00	1.00	1.00
Initial Bse:	3	0	34	53	3	254	340	464	26	50	1146	134
Added Vol:	73	6	0	1	2	0	0	8	24	0	24	2
PasserByVol:	0	0	0	0	0	0	0	0	0	0	0	0
Initial Fut:	76	6	34	54	5	254	340	472	50	50	1170	136
User Adj:	1.00	1.00	1.00	1.00	1.00	1.00	1.00	1.00	1.00	1.00	1.00	1.00
PHF Adj:	1.00	1.00	1.00	1.00	1.00	1.00	1.00	1.00	1.00	1.00	1.00	1.00
PHF Volume:	76	6	34	54	5	254	340	472	50	50	1170	136
Reduct Vol:	0	0	0	0	0	0	0	0	0	0	0	0
Reduced Vol:	76	6	34	54	5	254	340	472	50	50	1170	136
PCE Adj:	1.00	1.00	1.00	1.00	1.00	1.00	1.00	1.00	1.00	1.00	1.00	1.00
MLF Adj:	1.00	1.00	1.00	1.00	1.00	1.00	1.00	1.00	1.00	1.00	1.00	1.00
Final Volume:	76	6	34	54	5	254	340	472	50	50	1170	136

Saturation Flow Module:												
Sat/Lane:	1900	1900	1900	1900	1900	1900	1900	1900	1900	1900	1900	1900
Adjustment:	0.92	0.92	0.92	0.95	0.95	0.83	0.83	0.98	0.95	0.92	1.00	0.92
Lanes:	0.66	0.05	0.29	0.92	0.08	2.00	2.00	1.80	0.20	1.00	2.00	1.00
Final Sat.:	1147	91	513	1647	153	3150	3150	3345	354	1750	3800	1750

Capacity Analysis Module:												
Vol/Sat:	0.07	0.07	0.07	0.03	0.03	0.08	0.11	0.14	0.14	0.03	0.31	0.08
Crit Moves:	***			***			***			***		
Green Time:	10.0	10.0	10.0	10.0	10.0	17.3	7.3	16.5	16.5	11.5	20.7	20.7
Volume/Cap:	0.40	0.40	0.40	0.20	0.20	0.28	0.89	0.51	0.51	0.15	0.89	0.22
Delay/Veh:	23.2	23.2	23.2	21.9	21.9	16.7	48.0	18.8	18.8	20.4	26.5	14.1
User DelAdj:	1.00	1.00	1.00	1.00	1.00	1.00	1.00	1.00	1.00	1.00	1.00	1.00
AdjDel/Veh:	23.2	23.2	23.2	21.9	21.9	16.7	48.0	18.8	18.8	20.4	26.5	14.1
LOS by Move:	C	C	C	C	C	B	D	B	B	C	C	B
HCM2k95thQ:	5	5	5	2	2	5	14	9	9	2	25	4

Note: Queue reported is the number of cars per lane.

City of Morgan Hill
The Crosswinds Residential Development

Level Of Service Computation Report
2000 HCM Operations (Future Volume Alternative)
Existing PM

Intersection #109: De Paul Drive and Cochrane Road

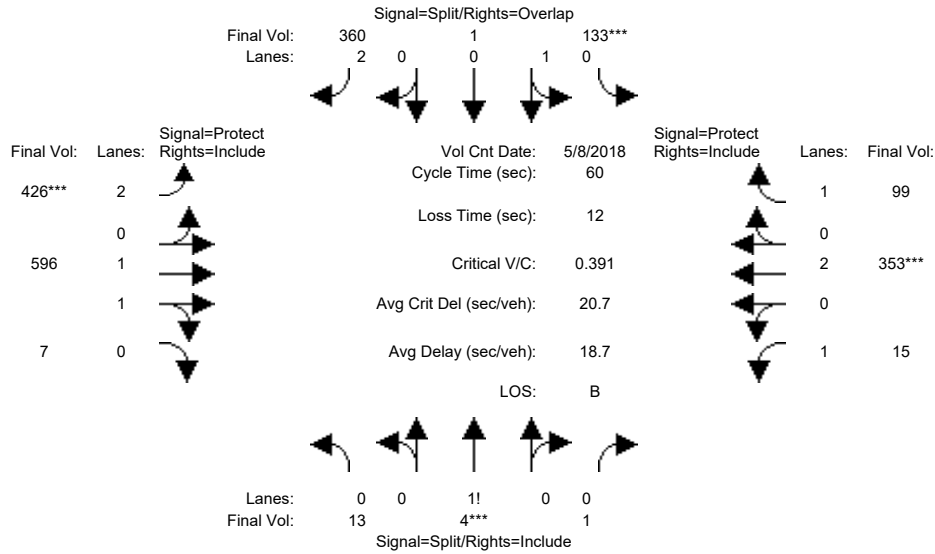

Street Name:	De Paul Drive						Cochrane Road					
	North Bound			South Bound			East Bound			West Bound		
Approach:	L	T	R	L	T	R	L	T	R	L	T	R
Min. Green:	10	10	10	10	10	10	7	10	10	7	10	10
Y+R:	4.0	4.0	4.0	4.0	4.0	4.0	4.0	4.0	4.0	4.0	4.0	4.0

Volume Module:	>>	Count	Date:	8 May 2018	<<							
Base Vol:	13	4	1	133	1	360	426	596	7	15	353	99
Growth Adj:	1.00	1.00	1.00	1.00	1.00	1.00	1.00	1.00	1.00	1.00	1.00	1.00
Initial Bse:	13	4	1	133	1	360	426	596	7	15	353	99
Added Vol:	0	0	0	0	0	0	0	0	0	0	0	0
PasserByVol:	0	0	0	0	0	0	0	0	0	0	0	0
Initial Fut:	13	4	1	133	1	360	426	596	7	15	353	99
User Adj:	1.00	1.00	1.00	1.00	1.00	1.00	1.00	1.00	1.00	1.00	1.00	1.00
PHF Adj:	1.00	1.00	1.00	1.00	1.00	1.00	1.00	1.00	1.00	1.00	1.00	1.00
PHF Volume:	13	4	1	133	1	360	426	596	7	15	353	99
Reduct Vol:	0	0	0	0	0	0	0	0	0	0	0	0
Reduced Vol:	13	4	1	133	1	360	426	596	7	15	353	99
PCE Adj:	1.00	1.00	1.00	1.00	1.00	1.00	1.00	1.00	1.00	1.00	1.00	1.00
MLF Adj:	1.00	1.00	1.00	1.00	1.00	1.00	1.00	1.00	1.00	1.00	1.00	1.00
Final Volume:	13	4	1	133	1	360	426	596	7	15	353	99

Saturation Flow Module:												
Sat/Lane:	1900	1900	1900	1900	1900	1900	1900	1900	1900	1900	1900	1900
Adjustment:	0.92	0.92	0.92	0.95	0.95	0.83	0.83	0.97	0.95	0.92	1.00	0.92
Lanes:	0.72	0.22	0.06	0.99	0.01	2.00	2.00	1.98	0.02	1.00	2.00	1.00
Final Sat.:	1264	389	97	1787	13	3150	3150	3657	43	1750	3800	1750

Capacity Analysis Module:												
Vol/Sat:	0.01	0.01	0.01	0.07	0.07	0.11	0.14	0.16	0.16	0.01	0.09	0.06
Crit Moves:	****			****			****			****		
Green Time:	10.0	10.0	10.0	10.0	10.0	26.6	16.6	16.5	16.5	11.5	11.4	11.4
Volume/Cap:	0.06	0.06	0.06	0.45	0.45	0.26	0.49	0.59	0.59	0.04	0.49	0.30
Delay/Veh:	21.1	21.1	21.1	23.6	23.6	10.6	18.6	19.8	19.8	19.8	22.2	21.4
User DelAdj:	1.00	1.00	1.00	1.00	1.00	1.00	1.00	1.00	1.00	1.00	1.00	1.00
AdjDel/Veh:	21.1	21.1	21.1	23.6	23.6	10.6	18.6	19.8	19.8	19.8	22.2	21.4
LOS by Move:	C	C	C	C	C	B	B	B	B	B	C	C
HCM2k95thQ:	1	1	1	6	6	5	9	11	11	1	7	4

Note: Queue reported is the number of cars per lane.

City of Morgan Hill
The Crosswinds Residential Development

Level Of Service Computation Report
2000 HCM Operations (Future Volume Alternative)
Existing Plus Project PM

Intersection #109: De Paul Drive and Cochrane Road

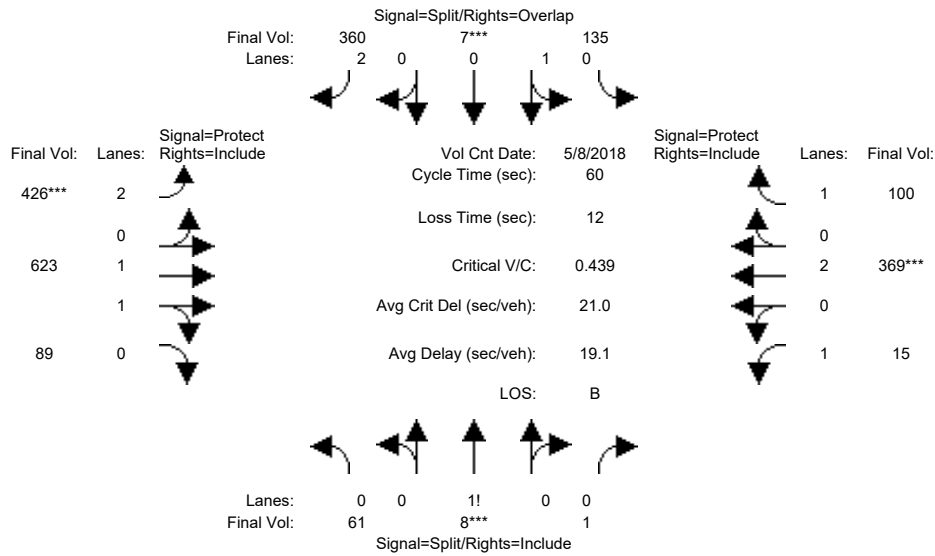

Street Name:	De Paul Drive						Cochrane Road					
	North Bound			South Bound			East Bound			West Bound		
Approach:	North Bound			South Bound			East Bound			West Bound		
Movement:	L	T	R	L	T	R	L	T	R	L	T	R
Min. Green:	10	10	10	10	10	10	7	10	10	7	10	10
Y+R:	4.0	4.0	4.0	4.0	4.0	4.0	4.0	4.0	4.0	4.0	4.0	4.0

Volume Module:	>>	Count	Date:	8 May 2018	<<							
Base Vol:	13	4	1	133	1	360	426	596	7	15	353	99
Growth Adj:	1.00	1.00	1.00	1.00	1.00	1.00	1.00	1.00	1.00	1.00	1.00	1.00
Initial Bse:	13	4	1	133	1	360	426	596	7	15	353	99
Added Vol:	48	4	0	2	6	0	0	27	82	0	16	1
PasserByVol:	0	0	0	0	0	0	0	0	0	0	0	0
Initial Fut:	61	8	1	135	7	360	426	623	89	15	369	100
User Adj:	1.00	1.00	1.00	1.00	1.00	1.00	1.00	1.00	1.00	1.00	1.00	1.00
PHF Adj:	1.00	1.00	1.00	1.00	1.00	1.00	1.00	1.00	1.00	1.00	1.00	1.00
PHF Volume:	61	8	1	135	7	360	426	623	89	15	369	100
Reduct Vol:	0	0	0	0	0	0	0	0	0	0	0	0
Reduced Vol:	61	8	1	135	7	360	426	623	89	15	369	100
PCE Adj:	1.00	1.00	1.00	1.00	1.00	1.00	1.00	1.00	1.00	1.00	1.00	1.00
MLF Adj:	1.00	1.00	1.00	1.00	1.00	1.00	1.00	1.00	1.00	1.00	1.00	1.00
Final Volume:	61	8	1	135	7	360	426	623	89	15	369	100

Saturation Flow Module:												
Sat/Lane:	1900	1900	1900	1900	1900	1900	1900	1900	1900	1900	1900	1900
Adjustment:	0.92	0.92	0.92	0.95	0.95	0.83	0.83	0.98	0.95	0.92	1.00	0.92
Lanes:	0.88	0.11	0.01	0.95	0.05	2.00	2.00	1.74	0.26	1.00	2.00	1.00
Final Sat.:	1525	200	25	1711	89	3150	3150	3237	462	1750	3800	1750

Capacity Analysis Module:												
Vol/Sat:	0.04	0.04	0.04	0.08	0.08	0.11	0.14	0.19	0.19	0.01	0.10	0.06
Crit Moves:	****			****			****			****		
Green Time:	10.0	10.0	10.0	10.0	10.0	26.3	16.3	17.4	17.4	10.6	11.7	11.7
Volume/Cap:	0.24	0.24	0.24	0.47	0.47	0.26	0.50	0.66	0.66	0.05	0.50	0.29
Delay/Veh:	22.1	22.1	22.1	23.8	23.8	10.8	18.9	20.3	20.3	20.6	22.1	21.1
User DelAdj:	1.00	1.00	1.00	1.00	1.00	1.00	1.00	1.00	1.00	1.00	1.00	1.00
AdjDel/Veh:	22.1	22.1	22.1	23.8	23.8	10.8	18.9	20.3	20.3	20.6	22.1	21.1
LOS by Move:	C	C	C	C	C	B	B	C	C	C	C	C
HCM2k95thQ:	3	3	3	6	6	5	9	14	14	1	7	4

Note: Queue reported is the number of cars per lane.

City of Morgan Hill
The Crosswinds Residential Development

Level Of Service Computation Report
2000 HCM Operations (Future Volume Alternative)
Year 2030 Cumulative without Project PM

Intersection #109: De Paul Drive and Cochrane Road

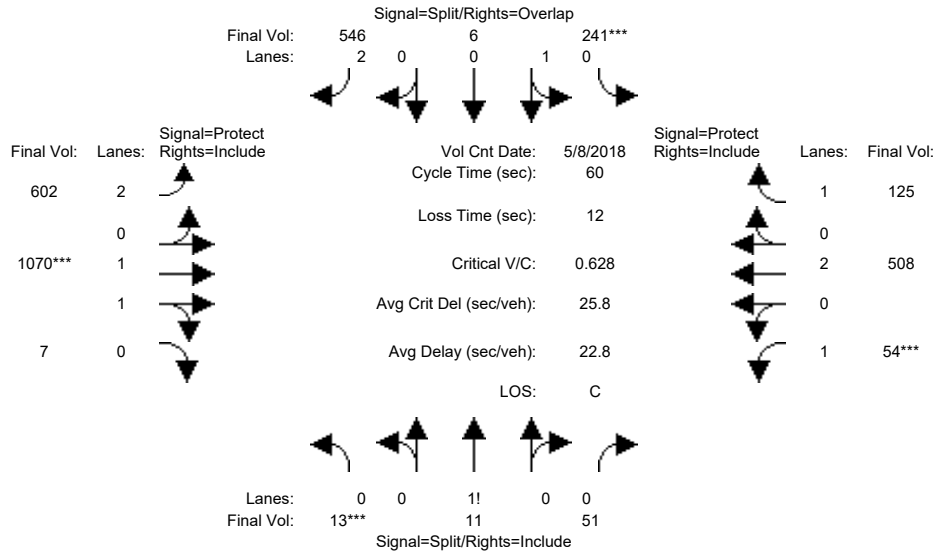

Street Name:	De Paul Drive						Cochrane Road					
	North Bound			South Bound			East Bound			West Bound		
Approach:	L	T	R	L	T	R	L	T	R	L	T	R
Min. Green:	10	10	10	10	10	10	7	10	10	7	10	10
Y+R:	4.0	4.0	4.0	4.0	4.0	4.0	4.0	4.0	4.0	4.0	4.0	4.0

Volume Module:	>>	Count	Date:	8 May 2018	<<							
Base Vol:	13	11	51	241	6	546	602	1070	7	54	508	125
Growth Adj:	1.00	1.00	1.00	1.00	1.00	1.00	1.00	1.00	1.00	1.00	1.00	1.00
Initial Bse:	13	11	51	241	6	546	602	1070	7	54	508	125
Added Vol:	0	0	0	0	0	0	0	0	0	0	0	0
PasserByVol:	0	0	0	0	0	0	0	0	0	0	0	0
Initial Fut:	13	11	51	241	6	546	602	1070	7	54	508	125
User Adj:	1.00	1.00	1.00	1.00	1.00	1.00	1.00	1.00	1.00	1.00	1.00	1.00
PHF Adj:	1.00	1.00	1.00	1.00	1.00	1.00	1.00	1.00	1.00	1.00	1.00	1.00
PHF Volume:	13	11	51	241	6	546	602	1070	7	54	508	125
Reduct Vol:	0	0	0	0	0	0	0	0	0	0	0	0
Reduced Vol:	13	11	51	241	6	546	602	1070	7	54	508	125
PCE Adj:	1.00	1.00	1.00	1.00	1.00	1.00	1.00	1.00	1.00	1.00	1.00	1.00
MLF Adj:	1.00	1.00	1.00	1.00	1.00	1.00	1.00	1.00	1.00	1.00	1.00	1.00
Final Volume:	13	11	51	241	6	546	602	1070	7	54	508	125

Saturation Flow Module:												
Sat/Lane:	1900	1900	1900	1900	1900	1900	1900	1900	1900	1900	1900	1900
Adjustment:	0.92	0.92	0.92	0.95	0.95	0.83	0.83	0.97	0.95	0.92	1.00	0.92
Lanes:	0.17	0.15	0.68	0.98	0.02	2.00	2.00	1.99	0.01	1.00	2.00	1.00
Final Sat.:	303	257	1190	1756	44	3150	3150	3676	24	1750	3800	1750

Capacity Analysis Module:												
Vol/Sat:	0.04	0.04	0.04	0.14	0.14	0.17	0.19	0.29	0.29	0.03	0.13	0.07
Crit Moves:	***			***			***			***		
Green Time:	10.0	10.0	10.0	10.0	10.0	25.0	15.0	21.0	21.0	7.0	13.0	13.0
Volume/Cap:	0.26	0.26	0.26	0.82	0.82	0.42	0.77	0.83	0.83	0.26	0.61	0.33
Delay/Veh:	22.2	22.2	22.2	40.7	40.7	12.6	25.5	22.6	22.6	24.8	22.6	20.3
User DelAdj:	1.00	1.00	1.00	1.00	1.00	1.00	1.00	1.00	1.00	1.00	1.00	1.00
AdjDel/Veh:	22.2	22.2	22.2	40.7	40.7	12.6	25.5	22.6	22.6	24.8	22.6	20.3
LOS by Move:	C	C	C	D	D	B	C	C	C	C	C	C
HCM2k95thQ:	3	3	3	14	14	9	16	22	22	3	10	5

Note: Queue reported is the number of cars per lane.

City of Morgan Hill
The Crosswinds Residential Development

Level Of Service Computation Report
2000 HCM Operations (Future Volume Alternative)
Year 2030 Cumulative with Project PM

Intersection #109: De Paul Drive and Cochrane Road

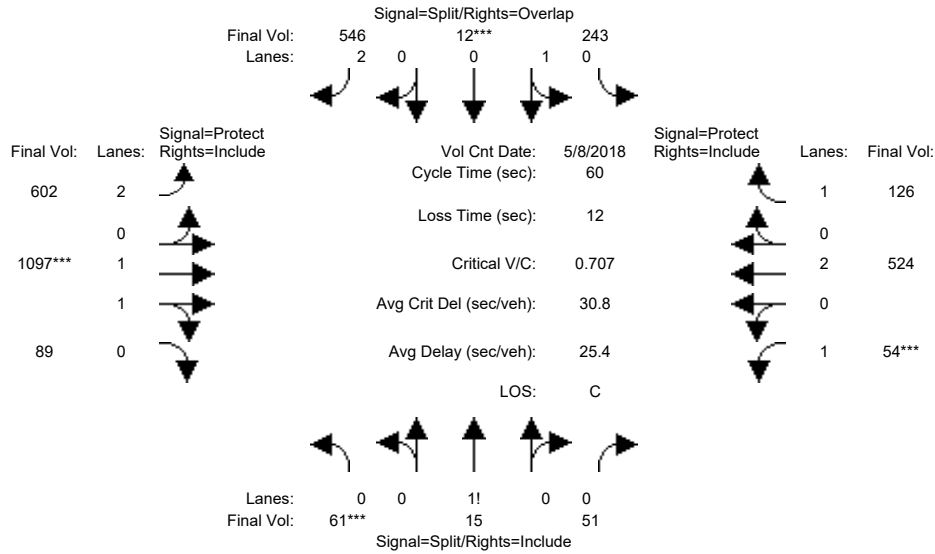

Street Name:	De Paul Drive						Cochrane Road					
	North Bound			South Bound			East Bound			West Bound		
Approach:	L	T	R	L	T	R	L	T	R	L	T	R
Min. Green:	10	10	10	10	10	10	7	10	10	7	10	10
Y+R:	4.0	4.0	4.0	4.0	4.0	4.0	4.0	4.0	4.0	4.0	4.0	4.0

Volume Module:	>>	Count	Date:	8 May 2018	<<							
Base Vol:	13	11	51	241	6	546	602	1070	7	54	508	125
Growth Adj:	1.00	1.00	1.00	1.00	1.00	1.00	1.00	1.00	1.00	1.00	1.00	1.00
Initial Bse:	13	11	51	241	6	546	602	1070	7	54	508	125
Added Vol:	48	4	0	2	6	0	0	27	82	0	16	1
PasserByVol:	0	0	0	0	0	0	0	0	0	0	0	0
Initial Fut:	61	15	51	243	12	546	602	1097	89	54	524	126
User Adj:	1.00	1.00	1.00	1.00	1.00	1.00	1.00	1.00	1.00	1.00	1.00	1.00
PHF Adj:	1.00	1.00	1.00	1.00	1.00	1.00	1.00	1.00	1.00	1.00	1.00	1.00
PHF Volume:	61	15	51	243	12	546	602	1097	89	54	524	126
Reduct Vol:	0	0	0	0	0	0	0	0	0	0	0	0
Reduced Vol:	61	15	51	243	12	546	602	1097	89	54	524	126
PCE Adj:	1.00	1.00	1.00	1.00	1.00	1.00	1.00	1.00	1.00	1.00	1.00	1.00
MLF Adj:	1.00	1.00	1.00	1.00	1.00	1.00	1.00	1.00	1.00	1.00	1.00	1.00
Final Volume:	61	15	51	243	12	546	602	1097	89	54	524	126

Saturation Flow Module:												
Sat/Lane:	1900	1900	1900	1900	1900	1900	1900	1900	1900	1900	1900	1900
Adjustment:	0.92	0.92	0.92	0.95	0.95	0.83	0.83	0.98	0.95	0.92	1.00	0.92
Lanes:	0.48	0.12	0.40	0.95	0.05	2.00	2.00	1.85	0.15	1.00	2.00	1.00
Final Sat.:	841	207	703	1715	85	3150	3150	3422	278	1750	3800	1750

Capacity Analysis Module:												
Vol/Sat:	0.07	0.07	0.07	0.14	0.14	0.17	0.19	0.32	0.32	0.03	0.14	0.07
Crit Moves:	***				***			***		***		
Green Time:	10.0	10.0	10.0	10.0	10.0	25.0	15.0	21.0	21.0	7.0	13.0	13.0
Volume/Cap:	0.44	0.44	0.44	0.85	0.85	0.42	0.77	0.92	0.92	0.26	0.63	0.33
Delay/Veh:	23.5	23.5	23.5	44.2	44.2	12.6	25.5	29.0	29.0	24.8	22.9	20.3
User DelAdj:	1.00	1.00	1.00	1.00	1.00	1.00	1.00	1.00	1.00	1.00	1.00	1.00
AdjDel/Veh:	23.5	23.5	23.5	44.2	44.2	12.6	25.5	29.0	29.0	24.8	22.9	20.3
LOS by Move:	C	C	C	C	D	B	C	C	C	C	C	C
HCM2k95thQ:	6	6	6	15	15	9	16	27	27	3	11	5

Note: Queue reported is the number of cars per lane.

City of Morgan Hill
The Crosswinds Residential Development

Level Of Service Computation Report
2000 HCM Operations (Future Volume Alternative)
Existing AM

Intersection #110: Mission View Drive and Cochrane Road

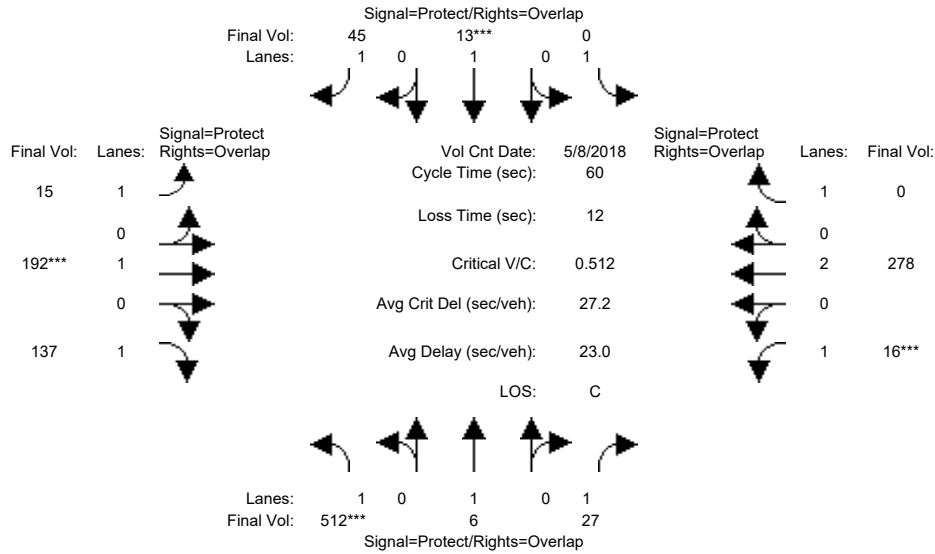

Street Name:	Mission View Drive						Cochrane Road					
	North Bound			South Bound			East Bound			West Bound		
Approach:	L	T	R	L	T	R	L	T	R	L	T	R
Min. Green:	7	10	10	7	10	10	7	10	10	7	10	10
Y+R:	4.0	4.0	4.0	4.0	4.0	4.0	4.0	4.0	4.0	4.0	4.0	4.0

Volume Module:	>>	Count	Date:	8 May 2018	<<							
Base Vol:	512	6	27	0	13	45	15	192	137	16	278	0
Growth Adj:	1.00	1.00	1.00	1.00	1.00	1.00	1.00	1.00	1.00	1.00	1.00	1.00
Initial Bse:	512	6	27	0	13	45	15	192	137	16	278	0
Added Vol:	0	0	0	0	0	0	0	0	0	0	0	0
PasserByVol:	0	0	0	0	0	0	0	0	0	0	0	0
Initial Fut:	512	6	27	0	13	45	15	192	137	16	278	0
User Adj:	1.00	1.00	1.00	1.00	1.00	1.00	1.00	1.00	1.00	1.00	1.00	1.00
PHF Adj:	1.00	1.00	1.00	1.00	1.00	1.00	1.00	1.00	1.00	1.00	1.00	1.00
PHF Volume:	512	6	27	0	13	45	15	192	137	16	278	0
Reduct Vol:	0	0	0	0	0	0	0	0	0	0	0	0
Reduced Vol:	512	6	27	0	13	45	15	192	137	16	278	0
PCE Adj:	1.00	1.00	1.00	1.00	1.00	1.00	1.00	1.00	1.00	1.00	1.00	1.00
MLF Adj:	1.00	1.00	1.00	1.00	1.00	1.00	1.00	1.00	1.00	1.00	1.00	1.00
Final Volume:	512	6	27	0	13	45	15	192	137	16	278	0

Saturation Flow Module:	
Sat/Lane:	1900 1900 1900 1900 1900 1900 1900 1900 1900 1900 1900 1900
Adjustment:	0.92 1.00 0.92 0.92 1.00 0.92 0.92 1.00 0.92 0.92 1.00 0.92
Lanes:	1.00 1.00 1.00 1.00 1.00 1.00 1.00 1.00 1.00 1.00 2.00 1.00
Final Sat.:	1750 1900 1750 1750 1900 1750 1750 1900 1750 1750 3800 1750

Capacity Analysis Module:	
Vol/Sat:	0.29 0.00 0.02 0.00 0.01 0.03 0.01 0.10 0.08 0.01 0.07 0.00
Crit Moves:	**** * 0.01 0.03 0.01 0.10 0.08 0.01 0.07 0.00
Green Time:	21.0 31.0 38.0 0.0 10.0 17.0 7.0 10.0 31.0 7.0 10.0 0.0
Volume/Cap:	0.84 0.01 0.02 0.00 0.04 0.09 0.07 0.61 0.15 0.08 0.44 0.00
Delay/Veh:	27.7 7.0 4.1 0.0 21.0 15.9 23.8 26.5 7.7 23.8 23.0 0.0
User DelAdj:	1.00 1.00 1.00 1.00 1.00 1.00 1.00 1.00 1.00 1.00 1.00 1.00
AdjDel/Veh:	27.7 7.0 4.1 0.0 21.0 15.9 23.8 26.5 7.7 23.8 23.0 0.0
LOS by Move:	C A A A C B C C A C C A
HCM2k95thQ:	22 0 0 0 0 1 1 9 3 1 6 0

Note: Queue reported is the number of cars per lane.

City of Morgan Hill
The Crosswinds Residential Development

Level Of Service Computation Report
2000 HCM Operations (Future Volume Alternative)
Existing Plus Project AM

Intersection #110: Mission View Drive and Cochrane Road

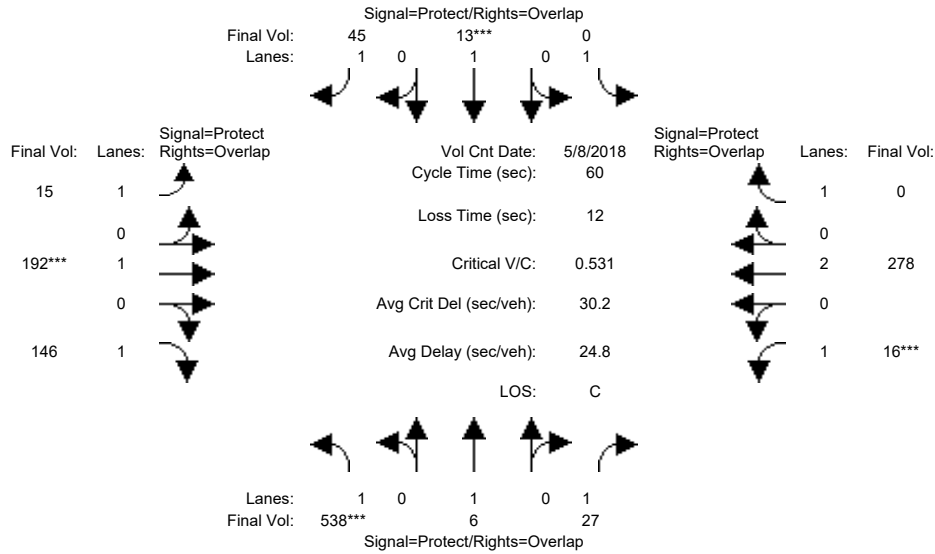

Street Name:	Mission View Drive						Cochrane Road					
	North Bound			South Bound			East Bound			West Bound		
Movement:	L	T	R	L	T	R	L	T	R	L	T	R
Min. Green:	7	10	10	7	10	10	7	10	10	7	10	10
Y+R:	4.0	4.0	4.0	4.0	4.0	4.0	4.0	4.0	4.0	4.0	4.0	4.0

Volume Module:	>>	Count	Date:	8 May 2018	<<											
Base Vol:	512	6	27	0	13	45	15	192	137	16	278	0				
Growth Adj:	1.00	1.00	1.00	1.00	1.00	1.00	1.00	1.00	1.00	1.00	1.00	1.00				
Initial Bse:	512	6	27	0	13	45	15	192	137	16	278	0				
Added Vol:	26	0	0	0	0	0	0	0	9	0	0	0				
PasserByVol:	0	0	0	0	0	0	0	0	0	0	0	0				
Initial Fut:	538	6	27	0	13	45	15	192	146	16	278	0				
User Adj:	1.00	1.00	1.00	1.00	1.00	1.00	1.00	1.00	1.00	1.00	1.00	1.00				
PHF Adj:	1.00	1.00	1.00	1.00	1.00	1.00	1.00	1.00	1.00	1.00	1.00	1.00				
PHF Volume:	538	6	27	0	13	45	15	192	146	16	278	0				
Reduct Vol:	0	0	0	0	0	0	0	0	0	0	0	0				
Reduced Vol:	538	6	27	0	13	45	15	192	146	16	278	0				
PCE Adj:	1.00	1.00	1.00	1.00	1.00	1.00	1.00	1.00	1.00	1.00	1.00	1.00				
MLF Adj:	1.00	1.00	1.00	1.00	1.00	1.00	1.00	1.00	1.00	1.00	1.00	1.00				
Final Volume:	538	6	27	0	13	45	15	192	146	16	278	0				

Saturation Flow Module:												
Sat/Lane:	1900	1900	1900	1900	1900	1900	1900	1900	1900	1900	1900	1900
Adjustment:	0.92	1.00	0.92	0.92	1.00	0.92	0.92	1.00	0.92	0.92	1.00	0.92
Lanes:	1.00	1.00	1.00	1.00	1.00	1.00	1.00	1.00	1.00	1.00	2.00	1.00
Final Sat.:	1750	1900	1750	1750	1900	1750	1750	1900	1750	1750	3800	1750

Capacity Analysis Module:												
Vol/Sat:	0.31	0.00	0.02	0.00	0.01	0.03	0.01	0.10	0.08	0.01	0.07	0.00
Crit Moves:	***				***			***		***		
Green Time:	21.0	31.0	38.0	0.0	10.0	17.0	7.0	10.0	31.0	7.0	10.0	0.0
Volume/Cap:	0.88	0.01	0.02	0.00	0.04	0.09	0.07	0.61	0.16	0.08	0.44	0.00
Delay/Veh:	32.0	7.0	4.1	0.0	21.0	15.9	23.8	26.5	7.7	23.8	23.0	0.0
User DelAdj:	1.00	1.00	1.00	1.00	1.00	1.00	1.00	1.00	1.00	1.00	1.00	1.00
AdjDel/Veh:	32.0	7.0	4.1	0.0	21.0	15.9	23.8	26.5	7.7	23.8	23.0	0.0
LOS by Move:	C	A	A	A	C	B	C	C	A	C	C	A
HCM2k95thQ:	25	0	0	0	0	1	1	9	3	1	6	0

Note: Queue reported is the number of cars per lane.

City of Morgan Hill
The Crosswinds Residential Development

Level Of Service Computation Report
2000 HCM Operations (Future Volume Alternative)
Year 2030 Cumulative without Project AM

Intersection #110: Mission View Drive and Cochrane Road

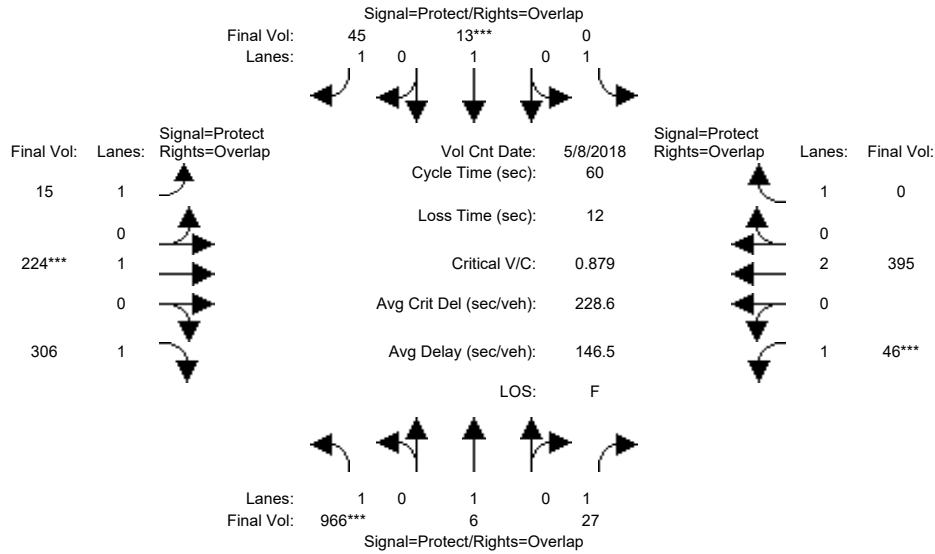

Street Name:	Mission View Drive						Cochrane Road					
	North Bound			South Bound			East Bound			West Bound		
Approach:	L - T - R			L - T - R			L - T - R			L - T - R		
Min. Green:	7	10	10	7	10	10	7	10	10	7	10	10
Y+R:	4.0	4.0	4.0	4.0	4.0	4.0	4.0	4.0	4.0	4.0	4.0	4.0

Volume Module:	>>	Count	Date:	8 May 2018	<<											
Base Vol:	966	6	27	0	13	45	15	224	306	46	395	0				
Growth Adj:	1.00	1.00	1.00	1.00	1.00	1.00	1.00	1.00	1.00	1.00	1.00	1.00				
Initial Bse:	966	6	27	0	13	45	15	224	306	46	395	0				
Added Vol:	0	0	0	0	0	0	0	0	0	0	0	0				
PasserByVol:	0	0	0	0	0	0	0	0	0	0	0	0				
Initial Fut:	966	6	27	0	13	45	15	224	306	46	395	0				
User Adj:	1.00	1.00	1.00	1.00	1.00	1.00	1.00	1.00	1.00	1.00	1.00	1.00				
PHF Adj:	1.00	1.00	1.00	1.00	1.00	1.00	1.00	1.00	1.00	1.00	1.00	1.00				
PHF Volume:	966	6	27	0	13	45	15	224	306	46	395	0				
Reduct Vol:	0	0	0	0	0	0	0	0	0	0	0	0				
Reduced Vol:	966	6	27	0	13	45	15	224	306	46	395	0				
PCE Adj:	1.00	1.00	1.00	1.00	1.00	1.00	1.00	1.00	1.00	1.00	1.00	1.00				
MLF Adj:	1.00	1.00	1.00	1.00	1.00	1.00	1.00	1.00	1.00	1.00	1.00	1.00				
Final Volume:	966	6	27	0	13	45	15	224	306	46	395	0				

Saturation Flow Module:												
Sat/Lane:	1900	1900	1900	1900	1900	1900	1900	1900	1900	1900	1900	1900
Adjustment:	0.92	1.00	0.92	0.92	1.00	0.92	0.92	1.00	0.92	0.92	1.00	0.92
Lanes:	1.00	1.00	1.00	1.00	1.00	1.00	1.00	1.00	1.00	1.00	2.00	1.00
Final Sat.:	1750	1900	1750	1750	1900	1750	1750	1900	1750	1750	3800	1750

Capacity Analysis Module:												
Vol/Sat:	0.55	0.00	0.02	0.00	0.01	0.03	0.01	0.12	0.17	0.03	0.10	0.00
Crit Moves:	***				***			***		***		
Green Time:	21.0	31.0	38.0	0.0	10.0	17.0	7.0	10.0	31.0	7.0	10.0	0.0
Volume/Cap:	1.58	0.01	0.02	0.00	0.04	0.09	0.07	0.71	0.34	0.23	0.62	0.00
Delay/Veh:	287.0	7.0	4.1	0.0	21.0	15.9	23.8	30.8	8.7	24.6	25.2	0.0
User DelAdj:	1.00	1.00	1.00	1.00	1.00	1.00	1.00	1.00	1.00	1.00	1.00	1.00
AdjDel/Veh:	287.0	7.0	4.1	0.0	21.0	15.9	23.8	30.8	8.7	24.6	25.2	0.0
LOS by Move:	F	A	A	A	C	B	C	C	A	C	C	A
HCM2k95thQ:	103	0	0	0	0	1	1	11	7	2	9	0

Note: Queue reported is the number of cars per lane.

City of Morgan Hill
The Crosswinds Residential Development

Level Of Service Computation Report
2000 HCM Operations (Future Volume Alternative)
Year 2030 Cumulative with Project AM

Intersection #110: Mission View Drive and Cochrane Road

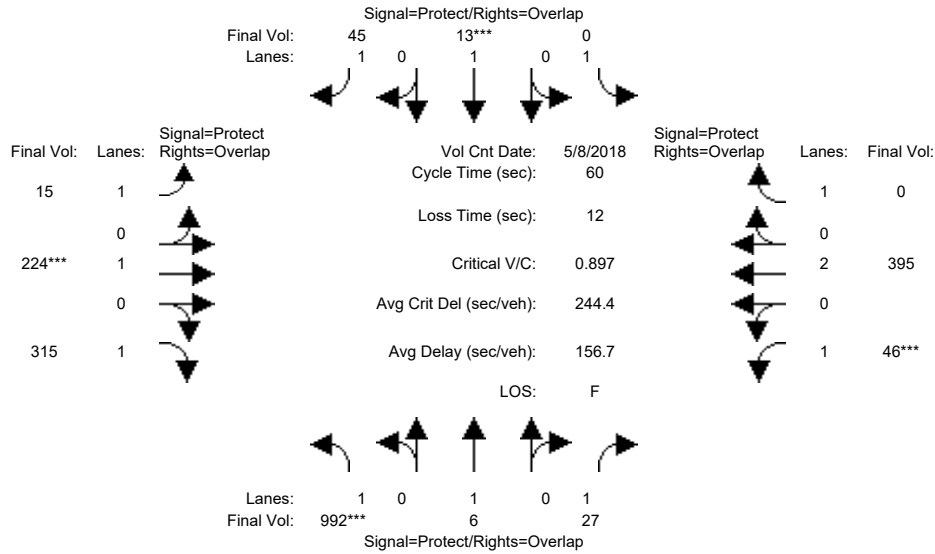

Street Name:	Mission View Drive						Cochrane Road					
	North Bound			South Bound			East Bound			West Bound		
Approach:	L	T	R	L	T	R	L	T	R	L	T	R
Min. Green:	7	10	10	7	10	10	7	10	10	7	10	10
Y+R:	4.0	4.0	4.0	4.0	4.0	4.0	4.0	4.0	4.0	4.0	4.0	4.0

Volume Module:	>>	Count	Date:	8 May 2018	<<							
Base Vol:	966	6	27	0	13	45	15	224	306	46	395	0
Growth Adj:	1.00	1.00	1.00	1.00	1.00	1.00	1.00	1.00	1.00	1.00	1.00	1.00
Initial Bse:	966	6	27	0	13	45	15	224	306	46	395	0
Added Vol:	26	0	0	0	0	0	0	0	9	0	0	0
PasserByVol:	0	0	0	0	0	0	0	0	0	0	0	0
Initial Fut:	992	6	27	0	13	45	15	224	315	46	395	0
User Adj:	1.00	1.00	1.00	1.00	1.00	1.00	1.00	1.00	1.00	1.00	1.00	1.00
PHF Adj:	1.00	1.00	1.00	1.00	1.00	1.00	1.00	1.00	1.00	1.00	1.00	1.00
PHF Volume:	992	6	27	0	13	45	15	224	315	46	395	0
Reduct Vol:	0	0	0	0	0	0	0	0	0	0	0	0
Reduced Vol:	992	6	27	0	13	45	15	224	315	46	395	0
PCE Adj:	1.00	1.00	1.00	1.00	1.00	1.00	1.00	1.00	1.00	1.00	1.00	1.00
MLF Adj:	1.00	1.00	1.00	1.00	1.00	1.00	1.00	1.00	1.00	1.00	1.00	1.00
Final Volume:	992	6	27	0	13	45	15	224	315	46	395	0

Saturation Flow Module:												
Sat/Lane:	1900	1900	1900	1900	1900	1900	1900	1900	1900	1900	1900	1900
Adjustment:	0.92	1.00	0.92	0.92	1.00	0.92	0.92	1.00	0.92	0.92	1.00	0.92
Lanes:	1.00	1.00	1.00	1.00	1.00	1.00	1.00	1.00	1.00	1.00	2.00	1.00
Final Sat.:	1750	1900	1750	1750	1900	1750	1750	1900	1750	1750	3800	1750

Capacity Analysis Module:												
Vol/Sat:	0.57	0.00	0.02	0.00	0.01	0.03	0.01	0.12	0.18	0.03	0.10	0.00
Crit Moves:	***			***			***			***		
Green Time:	21.0	31.0	38.0	0.0	10.0	17.0	7.0	10.0	31.0	7.0	10.0	0.0
Volume/Cap:	1.62	0.01	0.02	0.00	0.04	0.09	0.07	0.71	0.35	0.23	0.62	0.00
Delay/Veh:	305.8	7.0	4.1	0.0	21.0	15.9	23.8	30.8	8.8	24.6	25.2	0.0
User DelAdj:	1.00	1.00	1.00	1.00	1.00	1.00	1.00	1.00	1.00	1.00	1.00	1.00
AdjDel/Veh:	305.8	7.0	4.1	0.0	21.0	15.9	23.8	30.8	8.8	24.6	25.2	0.0
LOS by Move:	F	A	A	A	C	B	C	C	A	C	C	A
HCM2k95thQ:	109	0	0	0	0	1	1	11	8	2	9	0

Note: Queue reported is the number of cars per lane.

City of Morgan Hill
The Crosswinds Residential Development

Level Of Service Computation Report
2000 HCM Operations (Future Volume Alternative)
Year 2030 Cumulative with Project AM (with Mitigations)

Intersection #110: Mission View Drive and Cochrane Road

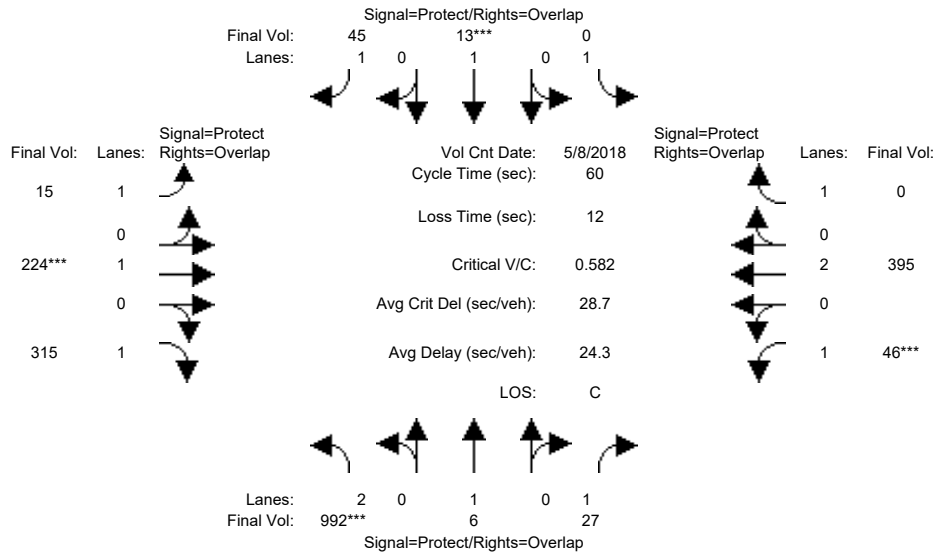

Street Name:	Mission View Drive						Cochrane Road					
	North Bound			South Bound			East Bound			West Bound		
Approach:	L	T	R	L	T	R	L	T	R	L	T	R
Min. Green:	7	10	10	7	10	10	7	10	10	7	10	10
Y+R:	4.0	4.0	4.0	4.0	4.0	4.0	4.0	4.0	4.0	4.0	4.0	4.0

Volume Module:	>>	Count	Date:	8 May 2018	<<							
Base Vol:	966	6	27	0	13	45	15	224	306	46	395	0
Growth Adj:	1.00	1.00	1.00	1.00	1.00	1.00	1.00	1.00	1.00	1.00	1.00	1.00
Initial Bse:	966	6	27	0	13	45	15	224	306	46	395	0
Added Vol:	26	0	0	0	0	0	0	0	9	0	0	0
PasserByVol:	0	0	0	0	0	0	0	0	0	0	0	0
Initial Fut:	992	6	27	0	13	45	15	224	315	46	395	0
User Adj:	1.00	1.00	1.00	1.00	1.00	1.00	1.00	1.00	1.00	1.00	1.00	1.00
PHF Adj:	1.00	1.00	1.00	1.00	1.00	1.00	1.00	1.00	1.00	1.00	1.00	1.00
PHF Volume:	992	6	27	0	13	45	15	224	315	46	395	0
Reduct Vol:	0	0	0	0	0	0	0	0	0	0	0	0
Reduced Vol:	992	6	27	0	13	45	15	224	315	46	395	0
PCE Adj:	1.00	1.00	1.00	1.00	1.00	1.00	1.00	1.00	1.00	1.00	1.00	1.00
MLF Adj:	1.00	1.00	1.00	1.00	1.00	1.00	1.00	1.00	1.00	1.00	1.00	1.00
FinalVolume:	992	6	27	0	13	45	15	224	315	46	395	0

Saturation Flow Module:	
Sat/Lane:	1900 1900 1900 1900 1900 1900 1900 1900 1900 1900 1900 1900
Adjustment:	0.83 1.00 0.92 0.92 1.00 0.92 0.92 1.00 0.92 0.92 1.00 0.92
Lanes:	2.00 1.00 1.00 1.00 1.00 1.00 1.00 1.00 1.00 1.00 2.00 1.00
Final Sat.:	3150 1900 1750 1750 1900 1750 1750 1900 1750 1750 3800 1750

Capacity Analysis Module:	
Vol/Sat:	0.31 0.00 0.02 0.00 0.01 0.03 0.01 0.12 0.18 0.03 0.10 0.00
Crit Moves:	**** **** **** ****
Green Time:	21.0 31.0 38.0 0.0 10.0 17.0 7.0 10.0 31.0 7.0 10.0 0.0
Volume/Cap:	0.90 0.01 0.02 0.00 0.04 0.09 0.07 0.71 0.35 0.23 0.62 0.00
Delay/Veh:	28.6 7.0 4.1 0.0 21.0 15.9 23.8 30.8 8.8 24.6 25.2 0.0
User DelAdj:	1.00 1.00 1.00 1.00 1.00 1.00 1.00 1.00 1.00 1.00 1.00 1.00
AdjDel/Veh:	28.6 7.0 4.1 0.0 21.0 15.9 23.8 30.8 8.8 24.6 25.2 0.0
LOS by Move:	C A A A C B C C A C C A
HCM2k95thQ:	26 0 0 0 0 1 1 11 8 2 9 0

Note: Queue reported is the number of cars per lane.

City of Morgan Hill
The Crosswinds Residential Development

Level Of Service Computation Report
2000 HCM Operations (Future Volume Alternative)
Existing PM

Intersection #110: Mission View Drive and Cochrane Road

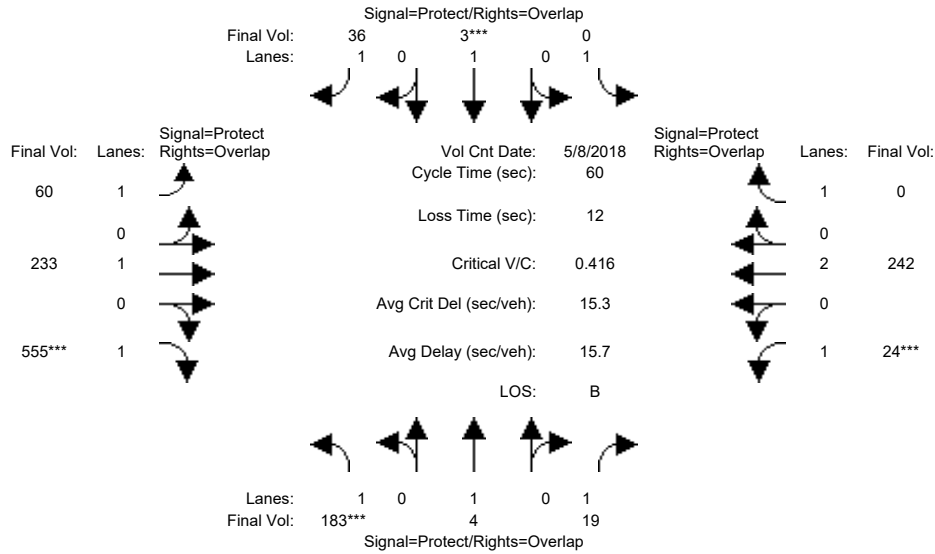

Street Name:	Mission View Drive						Cochrane Road					
	North Bound			South Bound			East Bound			West Bound		
Approach:	L	T	R	L	T	R	L	T	R	L	T	R
Min. Green:	7	10	10	7	10	10	7	10	10	7	10	10
Y+R:	4.0	4.0	4.0	4.0	4.0	4.0	4.0	4.0	4.0	4.0	4.0	4.0

Volume Module:	>>	Count	Date:	8 May 2018	<<							
Base Vol:	183	4	19	0	3	36	60	233	555	24	242	0
Growth Adj:	1.00	1.00	1.00	1.00	1.00	1.00	1.00	1.00	1.00	1.00	1.00	1.00
Initial Bse:	183	4	19	0	3	36	60	233	555	24	242	0
Added Vol:	0	0	0	0	0	0	0	0	0	0	0	0
PasserByVol:	0	0	0	0	0	0	0	0	0	0	0	0
Initial Fut:	183	4	19	0	3	36	60	233	555	24	242	0
User Adj:	1.00	1.00	1.00	1.00	1.00	1.00	1.00	1.00	1.00	1.00	1.00	1.00
PHF Adj:	1.00	1.00	1.00	1.00	1.00	1.00	1.00	1.00	1.00	1.00	1.00	1.00
PHF Volume:	183	4	19	0	3	36	60	233	555	24	242	0
Reduct Vol:	0	0	0	0	0	0	0	0	0	0	0	0
Reduced Vol:	183	4	19	0	3	36	60	233	555	24	242	0
PCE Adj:	1.00	1.00	1.00	1.00	1.00	1.00	1.00	1.00	1.00	1.00	1.00	1.00
MLF Adj:	1.00	1.00	1.00	1.00	1.00	1.00	1.00	1.00	1.00	1.00	1.00	1.00
Final Volume:	183	4	19	0	3	36	60	233	555	24	242	0

Saturation Flow Module:												
Sat/Lane:	1900	1900	1900	1900	1900	1900	1900	1900	1900	1900	1900	1900
Adjustment:	0.92	1.00	0.92	0.92	1.00	0.92	0.92	1.00	0.92	0.92	1.00	0.92
Lanes:	1.00	1.00	1.00	1.00	1.00	1.00	1.00	1.00	1.00	1.00	2.00	1.00
Final Sat.:	1750	1900	1750	1750	1900	1750	1750	1900	1750	1750	3800	1750

Capacity Analysis Module:												
Vol/Sat:	0.10	0.00	0.01	0.00	0.00	0.02	0.03	0.12	0.32	0.01	0.06	0.00
Crit Moves:	****				****				****	****		
Green Time:	10.6	20.6	27.6	0.0	10.0	21.3	11.3	20.4	31.0	7.0	16.1	0.0
Volume/Cap:	0.59	0.01	0.02	0.00	0.01	0.06	0.18	0.36	0.61	0.12	0.24	0.00
Delay/Veh:	25.7	12.9	8.8	0.0	20.9	12.8	20.8	15.3	11.5	24.0	17.3	0.0
User DelAdj:	1.00	1.00	1.00	1.00	1.00	1.00	1.00	1.00	1.00	1.00	1.00	1.00
AdjDel/Veh:	25.7	12.9	8.8	0.0	20.9	12.8	20.8	15.3	11.5	24.0	17.3	0.0
LOS by Move:	C	B	A	A	C	B	C	B	B	C	B	A
HCM2k95thQ:	9	0	0	0	0	1	2	7	16	1	4	0

Note: Queue reported is the number of cars per lane.

City of Morgan Hill
The Crosswinds Residential Development

Level Of Service Computation Report
2000 HCM Operations (Future Volume Alternative)
Existing Plus Project PM

Intersection #110: Mission View Drive and Cochrane Road

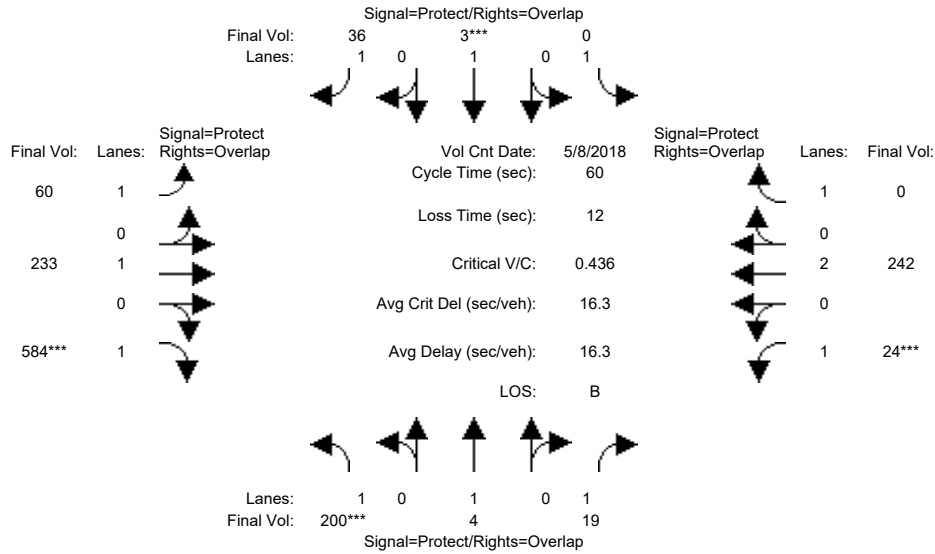

Street Name:	Mission View Drive						Cochrane Road					
	North Bound			South Bound			East Bound			West Bound		
Movement:	L	T	R	L	T	R	L	T	R	L	T	R
Min. Green:	7	10	10	7	10	10	7	10	10	7	10	10
Y+R:	4.0	4.0	4.0	4.0	4.0	4.0	4.0	4.0	4.0	4.0	4.0	4.0

Volume Module:	>>	Count	Date:	8 May 2018	<<							
Base Vol:	183	4	19	0	3	36	60	233	555	24	242	0
Growth Adj:	1.00	1.00	1.00	1.00	1.00	1.00	1.00	1.00	1.00	1.00	1.00	1.00
Initial Bse:	183	4	19	0	3	36	60	233	555	24	242	0
Added Vol:	17	0	0	0	0	0	0	0	29	0	0	0
PasserByVol:	0	0	0	0	0	0	0	0	0	0	0	0
Initial Fut:	200	4	19	0	3	36	60	233	584	24	242	0
User Adj:	1.00	1.00	1.00	1.00	1.00	1.00	1.00	1.00	1.00	1.00	1.00	1.00
PHF Adj:	1.00	1.00	1.00	1.00	1.00	1.00	1.00	1.00	1.00	1.00	1.00	1.00
PHF Volume:	200	4	19	0	3	36	60	233	584	24	242	0
Reduct Vol:	0	0	0	0	0	0	0	0	0	0	0	0
Reduced Vol:	200	4	19	0	3	36	60	233	584	24	242	0
PCE Adj:	1.00	1.00	1.00	1.00	1.00	1.00	1.00	1.00	1.00	1.00	1.00	1.00
MLF Adj:	1.00	1.00	1.00	1.00	1.00	1.00	1.00	1.00	1.00	1.00	1.00	1.00
Final Volume:	200	4	19	0	3	36	60	233	584	24	242	0

Saturation Flow Module:												
Sat/Lane:	1900	1900	1900	1900	1900	1900	1900	1900	1900	1900	1900	1900
Adjustment:	0.92	1.00	0.92	0.92	1.00	0.92	0.92	1.00	0.92	0.92	1.00	0.92
Lanes:	1.00	1.00	1.00	1.00	1.00	1.00	1.00	1.00	1.00	1.00	2.00	1.00
Final Sat.:	1750	1900	1750	1750	1900	1750	1750	1900	1750	1750	3800	1750

Capacity Analysis Module:												
Vol/Sat:	0.11	0.00	0.01	0.00	0.00	0.02	0.03	0.12	0.33	0.01	0.06	0.00
Crit Moves:	****				****				****	****		
Green Time:	10.7	20.7	27.7	0.0	10.0	21.2	11.2	20.3	31.0	7.0	16.1	0.0
Volume/Cap:	0.64	0.01	0.02	0.00	0.01	0.06	0.18	0.36	0.65	0.12	0.24	0.00
Delay/Veh:	27.4	12.9	8.8	0.0	20.9	12.8	20.8	15.3	12.1	24.0	17.3	0.0
User DelAdj:	1.00	1.00	1.00	1.00	1.00	1.00	1.00	1.00	1.00	1.00	1.00	1.00
AdjDel/Veh:	27.4	12.9	8.8	0.0	20.9	12.8	20.8	15.3	12.1	24.0	17.3	0.0
LOS by Move:	C	B	A	A	C	B	C	B	B	C	B	A
HCM2k95thQ:	10	0	0	0	0	1	2	7	17	1	4	0

Note: Queue reported is the number of cars per lane.

City of Morgan Hill
The Crosswinds Residential Development

Level Of Service Computation Report
2000 HCM Operations (Future Volume Alternative)
Year 2030 Cumulative without Project PM

Intersection #110: Mission View Drive and Cochrane Road

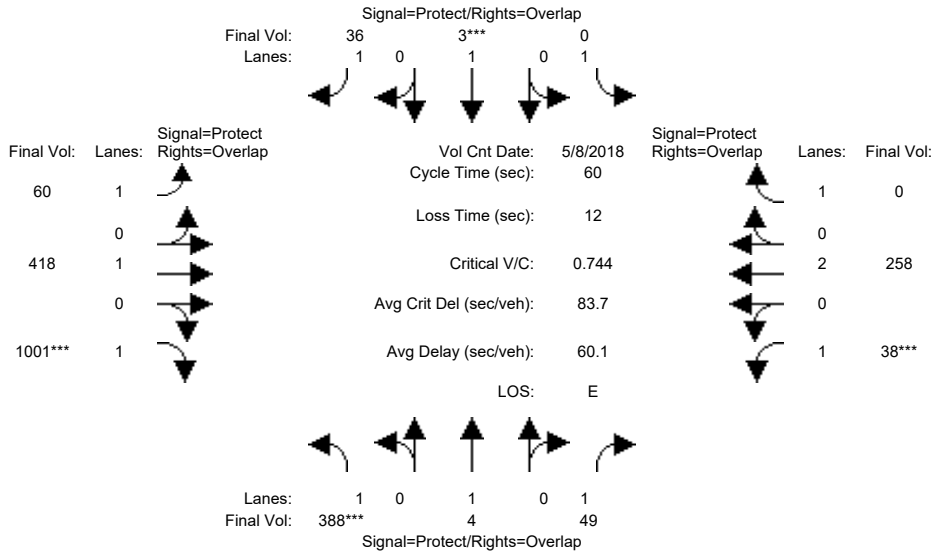

Street Name:	Mission View Drive						Cochrane Road					
	North Bound			South Bound			East Bound			West Bound		
Approach:	L	T	R	L	T	R	L	T	R	L	T	R
Min. Green:	7	10	10	7	10	10	7	10	10	7	10	10
Y+R:	4.0	4.0	4.0	4.0	4.0	4.0	4.0	4.0	4.0	4.0	4.0	4.0

Volume Module:	>>	Count	Date:	8 May 2018	<<							
Base Vol:	388	4	49	0	3	36	60	418	1001	38	258	0
Growth Adj:	1.00	1.00	1.00	1.00	1.00	1.00	1.00	1.00	1.00	1.00	1.00	1.00
Initial Bse:	388	4	49	0	3	36	60	418	1001	38	258	0
Added Vol:	0	0	0	0	0	0	0	0	0	0	0	0
PasserByVol:	0	0	0	0	0	0	0	0	0	0	0	0
Initial Fut:	388	4	49	0	3	36	60	418	1001	38	258	0
User Adj:	1.00	1.00	1.00	1.00	1.00	1.00	1.00	1.00	1.00	1.00	1.00	1.00
PHF Adj:	1.00	1.00	1.00	1.00	1.00	1.00	1.00	1.00	1.00	1.00	1.00	1.00
PHF Volume:	388	4	49	0	3	36	60	418	1001	38	258	0
Reduct Vol:	0	0	0	0	0	0	0	0	0	0	0	0
Reduced Vol:	388	4	49	0	3	36	60	418	1001	38	258	0
PCE Adj:	1.00	1.00	1.00	1.00	1.00	1.00	1.00	1.00	1.00	1.00	1.00	1.00
MLF Adj:	1.00	1.00	1.00	1.00	1.00	1.00	1.00	1.00	1.00	1.00	1.00	1.00
Final Volume:	388	4	49	0	3	36	60	418	1001	38	258	0

Saturation Flow Module:												
Sat/Lane:	1900	1900	1900	1900	1900	1900	1900	1900	1900	1900	1900	1900
Adjustment:	0.92	1.00	0.92	0.92	1.00	0.92	0.92	1.00	0.92	0.92	1.00	0.92
Lanes:	1.00	1.00	1.00	1.00	1.00	1.00	1.00	1.00	1.00	1.00	2.00	1.00
Final Sat.:	1750	1900	1750	1750	1900	1750	1750	1900	1750	1750	3800	1750

Capacity Analysis Module:												
Vol/Sat:	0.22	0.00	0.03	0.00	0.00	0.02	0.03	0.22	0.57	0.02	0.07	0.00
Crit Moves:	****				****				****	****		
Green Time:	12.0	22.0	29.0	0.0	10.0	20.7	10.7	19.0	31.0	7.0	15.3	0.0
Volume/Cap:	1.11	0.01	0.06	0.00	0.01	0.06	0.19	0.70	1.11	0.19	0.27	0.00
Delay/Veh:	104.1	12.1	8.3	0.0	20.9	13.2	21.3	21.5	78.3	24.4	18.0	0.0
User DelAdj:	1.00	1.00	1.00	1.00	1.00	1.00	1.00	1.00	1.00	1.00	1.00	1.00
AdjDel/Veh:	104.1	12.1	8.3	0.0	20.9	13.2	21.3	21.5	78.3	24.4	18.0	0.0
LOS by Move:	F	B	A	A	C	B	C	C	E	C	B	A
HCM2k95thQ:	30	0	1	0	0	1	2	15	60	2	4	0

Note: Queue reported is the number of cars per lane.

City of Morgan Hill
The Crosswinds Residential Development

Level Of Service Computation Report
2000 HCM Operations (Future Volume Alternative)
Year 2030 Cumulative with Project PM

Intersection #110: Mission View Drive and Cochrane Road

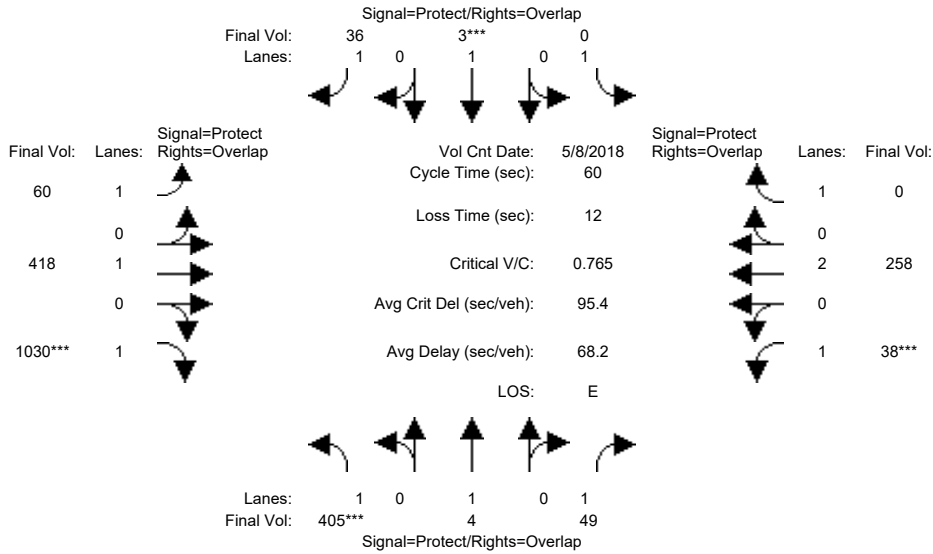

Street Name:	Mission View Drive						Cochrane Road					
	North Bound			South Bound			East Bound			West Bound		
Approach:	L	T	R	L	T	R	L	T	R	L	T	R
Min. Green:	7	10	10	7	10	10	7	10	10	7	10	10
Y+R:	4.0	4.0	4.0	4.0	4.0	4.0	4.0	4.0	4.0	4.0	4.0	4.0

Volume Module:	>>	Count	Date:	8 May 2018	<<												
Base Vol:	388	4	49	0	3	36	60	418	1001	38	258	0					
Growth Adj:	1.00	1.00	1.00	1.00	1.00	1.00	1.00	1.00	1.00	1.00	1.00	1.00					
Initial Bse:	388	4	49	0	3	36	60	418	1001	38	258	0					
Added Vol:	17	0	0	0	0	0	0	0	29	0	0	0					
PasserByVol:	0	0	0	0	0	0	0	0	0	0	0	0					
Initial Fut:	405	4	49	0	3	36	60	418	1030	38	258	0					
User Adj:	1.00	1.00	1.00	1.00	1.00	1.00	1.00	1.00	1.00	1.00	1.00	1.00					
PHF Adj:	1.00	1.00	1.00	1.00	1.00	1.00	1.00	1.00	1.00	1.00	1.00	1.00					
PHF Volume:	405	4	49	0	3	36	60	418	1030	38	258	0					
Reduct Vol:	0	0	0	0	0	0	0	0	0	0	0	0					
Reduced Vol:	405	4	49	0	3	36	60	418	1030	38	258	0					
PCE Adj:	1.00	1.00	1.00	1.00	1.00	1.00	1.00	1.00	1.00	1.00	1.00	1.00					
MLF Adj:	1.00	1.00	1.00	1.00	1.00	1.00	1.00	1.00	1.00	1.00	1.00	1.00					
Final Volume:	405	4	49	0	3	36	60	418	1030	38	258	0					

Saturation Flow Module:												
Sat/Lane:	1900	1900	1900	1900	1900	1900	1900	1900	1900	1900	1900	1900
Adjustment:	0.92	1.00	0.92	0.92	1.00	0.92	0.92	1.00	0.92	0.92	1.00	0.92
Lanes:	1.00	1.00	1.00	1.00	1.00	1.00	1.00	1.00	1.00	1.00	2.00	1.00
Final Sat.:	1750	1900	1750	1750	1900	1750	1750	1900	1750	1750	3800	1750

Capacity Analysis Module:												
Vol/Sat:	0.23	0.00	0.03	0.00	0.00	0.02	0.03	0.22	0.59	0.02	0.07	0.00
Crit Moves:	****				****				****	****		
Green Time:	12.2	22.2	29.2	0.0	10.0	20.6	10.6	18.8	31.0	7.0	15.2	0.0
Volume/Cap:	1.14	0.01	0.06	0.00	0.01	0.06	0.19	0.70	1.14	0.19	0.27	0.00
Delay/Veh:	115.0	11.9	8.2	0.0	20.9	13.2	21.3	21.9	90.5	24.4	18.1	0.0
User DelAdj:	1.00	1.00	1.00	1.00	1.00	1.00	1.00	1.00	1.00	1.00	1.00	1.00
AdjDel/Veh:	115.0	11.9	8.2	0.0	20.9	13.2	21.3	21.9	90.5	24.4	18.1	0.0
LOS by Move:	F	B	A	A	C	B	C	C	F	C	B	A
HCM2k95thQ:	32	0	1	0	0	1	2	16	65	2	4	0

Note: Queue reported is the number of cars per lane.

City of Morgan Hill
The Crosswinds Residential Development

Level Of Service Computation Report
2000 HCM Operations (Future Volume Alternative)
Year 2030 Cumulative with Project PM (with Mitigations)

Intersection #110: Mission View Drive and Cochrane Road

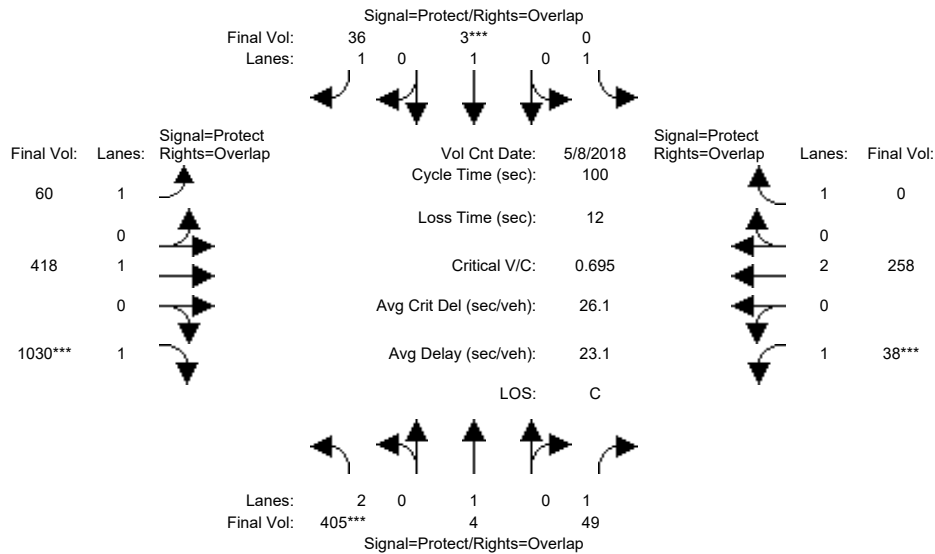

Street Name:	Mission View Drive						Cochrane Road					
	North Bound			South Bound			East Bound			West Bound		
Approach:	L	T	R	L	T	R	L	T	R	L	T	R
Min. Green:	7	10	10	7	10	10	7	10	10	7	10	10
Y+R:	4.0	4.0	4.0	4.0	4.0	4.0	4.0	4.0	4.0	4.0	4.0	4.0

Volume Module:	>>	Count	Date:	8 May 2018	<<												
Base Vol:	388	4	49	0	3	36	60	418	1001	38	258	0					
Growth Adj:	1.00	1.00	1.00	1.00	1.00	1.00	1.00	1.00	1.00	1.00	1.00	1.00					
Initial Bse:	388	4	49	0	3	36	60	418	1001	38	258	0					
Added Vol:	17	0	0	0	0	0	0	0	29	0	0	0					
PasserByVol:	0	0	0	0	0	0	0	0	0	0	0	0					
Initial Fut:	405	4	49	0	3	36	60	418	1030	38	258	0					
User Adj:	1.00	1.00	1.00	1.00	1.00	1.00	1.00	1.00	1.00	1.00	1.00	1.00					
PHF Adj:	1.00	1.00	1.00	1.00	1.00	1.00	1.00	1.00	1.00	1.00	1.00	1.00					
PHF Volume:	405	4	49	0	3	36	60	418	1030	38	258	0					
Reduct Vol:	0	0	0	0	0	0	0	0	0	0	0	0					
Reduced Vol:	405	4	49	0	3	36	60	418	1030	38	258	0					
PCE Adj:	1.00	1.00	1.00	1.00	1.00	1.00	1.00	1.00	1.00	1.00	1.00	1.00					
MLF Adj:	1.00	1.00	1.00	1.00	1.00	1.00	1.00	1.00	1.00	1.00	1.00	1.00					
Final Volume:	405	4	49	0	3	36	60	418	1030	38	258	0					

Saturation Flow Module:												
Sat/Lane:	1900	1900	1900	1900	1900	1900	1900	1900	1900	1900	1900	1900
Adjustment:	0.83	1.00	0.92	0.92	1.00	0.92	0.92	1.00	0.92	0.92	1.00	0.92
Lanes:	2.00	1.00	1.00	1.00	1.00	1.00	1.00	1.00	1.00	1.00	2.00	1.00
Final Sat.:	3150	1900	1750	1750	1900	1750	1750	1900	1750	1750	3800	1750

Capacity Analysis Module:												
Vol/Sat:	0.13	0.00	0.03	0.00	0.00	0.02	0.03	0.22	0.59	0.02	0.07	0.00
Crit Moves:	****				****				****	****		
Green Time:	15.5	25.5	32.5	0.0	10.0	35.7	25.7	55.5	71.0	7.0	36.8	0.0
Volume/Cap:	0.83	0.01	0.09	0.00	0.02	0.06	0.13	0.40	0.83	0.31	0.18	0.00
Delay/Veh:	52.3	27.8	23.5	0.0	40.6	21.1	28.7	12.9	15.0	45.7	21.5	0.0
User DelAdj:	1.00	1.00	1.00	1.00	1.00	1.00	1.00	1.00	1.00	1.00	1.00	1.00
AdjDel/Veh:	52.3	27.8	23.5	0.0	40.6	21.1	28.7	12.9	15.0	45.7	21.5	0.0
LOS by Move:	D	C	C	A	D	C	C	B	B	D	C	A
HCM2k95thQ:	18	0	2	0	0	2	3	14	43	3	5	0

Note: Queue reported is the number of cars per lane.

City of Morgan Hill
The Crosswinds Residential Development

Level Of Service Computation Report
2000 HCM Unsignalized (Future Volume Alternative)
Existing AM

Intersection #5664: Mission View Drive and Avenida De Los Padres

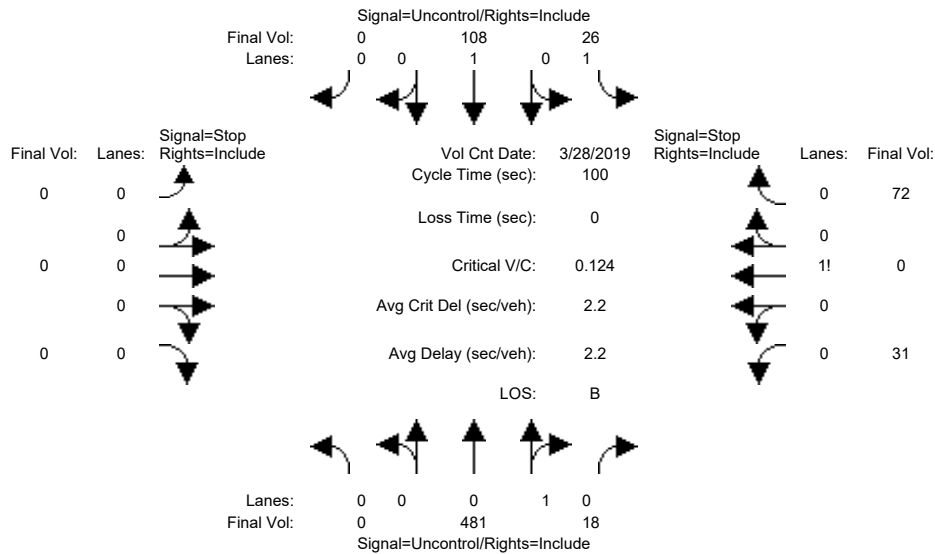

Street Name: Mission View Drive Avenida De Los Padres
 Approach: North Bound South Bound East Bound West Bound
 Movement: L - T - R L - T - R L - T - R L - T - R

Volume Module:	>>	Count	Date:	28 Mar 2019	<<							
Base Vol:	0	481	18	26	108	0	0	0	0	31	0	72
Growth Adj:	1.00	1.00	1.00	1.00	1.00	1.00	1.00	1.00	1.00	1.00	1.00	1.00
Initial Bse:	0	481	18	26	108	0	0	0	0	31	0	72
Added Vol:	0	0	0	0	0	0	0	0	0	0	0	0
PasserByVol:	0	0	0	0	0	0	0	0	0	0	0	0
Initial Fut:	0	481	18	26	108	0	0	0	0	31	0	72
User Adj:	1.00	1.00	1.00	1.00	1.00	1.00	1.00	1.00	1.00	1.00	1.00	1.00
PHF Adj:	1.00	1.00	1.00	1.00	1.00	1.00	1.00	1.00	1.00	1.00	1.00	1.00
PHF Volume:	0	481	18	26	108	0	0	0	0	31	0	72
Reduct Vol:	0	0	0	0	0	0	0	0	0	0	0	0
FinalVolume:	0	481	18	26	108	0	0	0	0	31	0	72

Critical Gap Module:							4.1	xxxx	xxxxxx	xxxxxx	xxxx	xxxx	xxxxxx	6.4	6.5	6.2	
Critical Gp:xxxxxx	xxxx	xxxxxx	xxxxxx	xxxxxx	xxxxxx	xxxxxx	xxxxxx	xxxxxx	xxxxxx	xxxxxx	xxxxxx	xxxxxx	xxxxxx	xxxxxx	xxxxxx	xxxxxx	xxxxxx
FollowUpTim:xxxxxx	xxxxxx	xxxxxx	xxxxxx	xxxxxx	xxxxxx	xxxxxx	xxxxxx	xxxxxx	xxxxxx	xxxxxx	xxxxxx	xxxxxx	xxxxxx	xxxxxx	xxxxxx	xxxxxx	xxxxxx

Capacity Module:							499	xxxx	xxxxxx	xxxxxx	xxxx	xxxx	xxxxxx	650	650	490	
Cnflct Vol:xxxxxx	xxxxxx	xxxxxx	xxxxxx	xxxxxx	xxxxxx	xxxxxx	xxxxxx	xxxxxx	xxxxxx	xxxxxx	xxxxxx	xxxxxx	xxxxxx	xxxxxx	xxxxxx	xxxxxx	xxxxxx
Potent Cap.:xxxxxx	xxxxxx	xxxxxx	xxxxxx	xxxxxx	xxxxxx	xxxxxx	xxxxxx	xxxxxx	xxxxxx	xxxxxx	xxxxxx	xxxxxx	xxxxxx	xxxxxx	xxxxxx	xxxxxx	xxxxxx
Move Cap.:xxxxxx	xxxxxx	xxxxxx	xxxxxx	xxxxxx	xxxxxx	xxxxxx	xxxxxx	xxxxxx	xxxxxx	xxxxxx	xxxxxx	xxxxxx	xxxxxx	xxxxxx	xxxxxx	xxxxxx	xxxxxx
Volume/Cap:xxxxxx	xxxxxx	xxxxxx	xxxxxx	xxxxxx	xxxxxx	xxxxxx	xxxxxx	xxxxxx	xxxxxx	xxxxxx	xxxxxx	xxxxxx	xxxxxx	xxxxxx	xxxxxx	xxxxxx	xxxxxx

Level Of Service Module:							0.1	xxxx	xxxxxx	xxxxxx	xxxx	xxxx	xxxxxx	xxxxxx	xxxx	xxxx	xxxxxx
2Way95thQ:xxxxxx	xxxxxx	xxxxxx	xxxxxx	xxxxxx	xxxxxx	xxxxxx	xxxxxx	xxxxxx	xxxxxx	xxxxxx	xxxxxx	xxxxxx	xxxxxx	xxxxxx	xxxxxx	xxxxxx	xxxxxx
Control Del:xxxxxx	xxxxxx	xxxxxx	xxxxxx	xxxxxx	xxxxxx	xxxxxx	xxxxxx	xxxxxx	xxxxxx	xxxxxx	xxxxxx	xxxxxx	xxxxxx	xxxxxx	xxxxxx	xxxxxx	xxxxxx
LOS by Move:	*	*	*	A	*	*	*	*	*	*	*	*	*	*	*	*	*
Movement:	LT - LTR - RT	LT - LTR - RT	LT - LTR - RT	LT - LTR - RT	LT - LTR - RT	LT - LTR - RT	LT - LTR - RT	LT - LTR - RT	LT - LTR - RT	LT - LTR - RT	LT - LTR - RT	LT - LTR - RT	LT - LTR - RT	LT - LTR - RT	LT - LTR - RT	LT - LTR - RT	LT - LTR - RT
Shared Cap.:xxxxxx	xxxxxx	xxxxxx	xxxxxx	xxxxxx	xxxxxx	xxxxxx	xxxxxx	xxxxxx	xxxxxx	xxxxxx	xxxxxx	xxxxxx	xxxxxx	xxxxxx	526	xxxxxx	xxxxxx
SharedQueue:xxxxxx	xxxxxx	xxxxxx	xxxxxx	xxxxxx	xxxxxx	xxxxxx	xxxxxx	xxxxxx	xxxxxx	xxxxxx	xxxxxx	xxxxxx	xxxxxx	xxxxxx	0.7	xxxxxx	xxxxxx
Shrd ConDel:xxxxxx	xxxxxx	xxxxxx	xxxxxx	xxxxxx	xxxxxx	xxxxxx	xxxxxx	xxxxxx	xxxxxx	xxxxxx	xxxxxx	xxxxxx	xxxxxx	xxxxxx	13.5	xxxxxx	xxxxxx
Shared LOS:	*	*	*	*	*	*	*	*	*	*	*	*	*	B	*	*	*
ApproachDel:xxxxxx	xxxxxx	xxxxxx	xxxxxx	xxxxxx	xxxxxx	xxxxxx	xxxxxx	xxxxxx	xxxxxx	xxxxxx	xxxxxx	xxxxxx	xxxxxx	13.5	xxxxxx	xxxxxx	xxxxxx
ApproachLOS:	*	*	*	*	*	*	*	*	*	*	*	*	*	B	*	*	*

Note: Queue reported is the number of cars per lane.

City of Morgan Hill
The Crosswinds Residential Development

Level Of Service Computation Report
2000 HCM Unsignalized (Future Volume Alternative)
Existing Plus Project AM

Intersection #5664: Mission View Drive and Avenida De Los Padres

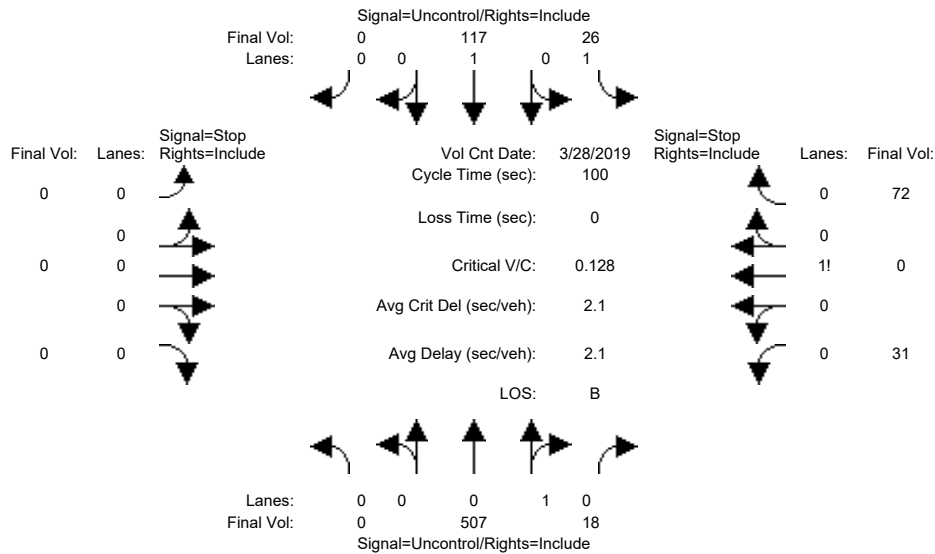

Street Name: Mission View Drive Avenida De Los Padres
 Approach: North Bound South Bound East Bound West Bound
 Movement: L - T - R L - T - R L - T - R L - T - R

Volume Module:	>>	Count	Date:	28 Mar 2019	<<							
Base Vol:	0	481	18	26	108	0	0	0	0	31	0	72
Growth Adj:	1.00	1.00	1.00	1.00	1.00	1.00	1.00	1.00	1.00	1.00	1.00	1.00
Initial Bse:	0	481	18	26	108	0	0	0	0	31	0	72
Added Vol:	0	26	0	0	9	0	0	0	0	0	0	0
PasserByVol:	0	0	0	0	0	0	0	0	0	0	0	0
Initial Fut:	0	507	18	26	117	0	0	0	0	31	0	72
User Adj:	1.00	1.00	1.00	1.00	1.00	1.00	1.00	1.00	1.00	1.00	1.00	1.00
PHF Adj:	1.00	1.00	1.00	1.00	1.00	1.00	1.00	1.00	1.00	1.00	1.00	1.00
PHF Volume:	0	507	18	26	117	0	0	0	0	31	0	72
Reduct Vol:	0	0	0	0	0	0	0	0	0	0	0	0
FinalVolume:	0	507	18	26	117	0	0	0	0	31	0	72

Critical Gap Module:

Critical Gp:	xxxxx	xxxx	xxxxxx	4.1	xxxx	xxxxxx	xxxxxx	xxxx	xxxxxx	6.4	6.5	6.2
FollowUpTim:	xxxxx	xxxx	xxxxxx	2.2	xxxx	xxxxxx	xxxxxx	xxxx	xxxxxx	3.5	4.0	3.3

Capacity Module:

Cnflct Vol:	xxxx	xxxx	xxxxxx	525	xxxx	xxxxxx	xxxx	xxxx	xxxxxx	685	685	516
Potent Cap.:	xxxx	xxxx	xxxxxx	1052	xxxx	xxxxxx	xxxx	xxxx	xxxxxx	417	373	563
Move Cap.:	xxxx	xxxx	xxxxxx	1052	xxxx	xxxxxx	xxxx	xxxx	xxxxxx	409	364	563
Volume/Cap:	xxxx	xxxx	xxxx	0.02	xxxx	xxxx	xxxx	xxxx	xxxx	0.08	0.00	0.13

Level Of Service Module:

2Way95thQ:	xxxx	xxxx	xxxxxx	0.1	xxxx	xxxxxx	xxxx	xxxx	xxxxxx	xxxx	xxxx	xxxxxx
Control Del:	xxxxx	xxxx	xxxxxx	8.5	xxxxx	xxxxxx	xxxxxx	xxxx	xxxxxx	xxxxxx	xxxx	xxxxxx
LOS by Move:	*	*	*	A	*	*	*	*	*	*	*	*
Movement:	LT - LTR - RT	LT - LTR - RT	LT - LTR - RT		LT - LTR - RT	LT - LTR - RT	LT - LTR - RT		LT - LTR - RT			
Shared Cap.:	xxxx	xxxx	xxxxxx	xxxx	xxxx	xxxxxx	xxxx	xxxx	xxxxxx	xxxx	506	xxxxxx
SharedQueue:	xxxxx	xxxx	xxxxxx	xxxxxx	xxxx	xxxxxx	xxxxxx	xxxx	xxxxxx	xxxxxx	0.8	xxxxxx
Shrd ConDel:	xxxxx	xxxx	xxxxxx	xxxxxx	xxxx	xxxxxx	xxxxxx	xxxx	xxxxxx	xxxxxx	13.9	xxxxxx
Shared LOS:	*	*	*	*	*	*	*	*	*	*	B	*
ApproachDel:	xxxxxxx			xxxxxxx			xxxxxxx			13.9		
ApproachLOS:	*			*			*			*	B	

Note: Queue reported is the number of cars per lane.

City of Morgan Hill
The Crosswinds Residential Development

Level Of Service Computation Report
2000 HCM Unsignalized (Future Volume Alternative)
Year 2030 Cumulative without Project AM

Intersection #5664: Mission View Drive and Avenida De Los Padres

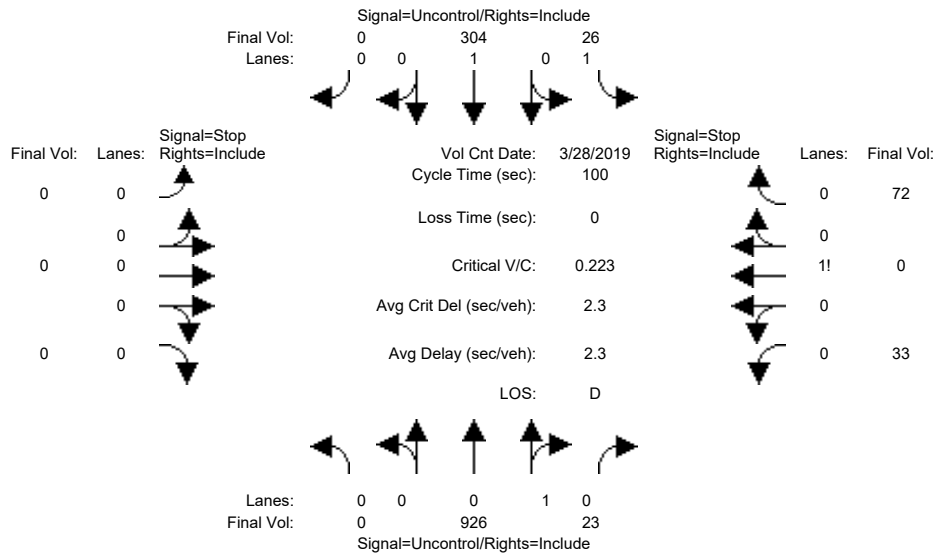

Street Name: Mission View Drive Avenida De Los Padres
 Approach: North Bound South Bound East Bound West Bound
 Movement: L - T - R L - T - R L - T - R L - T - R

Volume Module:	>>	Count	Date:	28 Mar 2019	<<							
Base Vol:	0	926	23	26	304	0	0	0	0	33	0	72
Growth Adj:	1.00	1.00	1.00	1.00	1.00	1.00	1.00	1.00	1.00	1.00	1.00	1.00
Initial Bse:	0	926	23	26	304	0	0	0	0	33	0	72
Added Vol:	0	0	0	0	0	0	0	0	0	0	0	0
PasserByVol:	0	0	0	0	0	0	0	0	0	0	0	0
Initial Fut:	0	926	23	26	304	0	0	0	0	33	0	72
User Adj:	1.00	1.00	1.00	1.00	1.00	1.00	1.00	1.00	1.00	1.00	1.00	1.00
PHF Adj:	1.00	1.00	1.00	1.00	1.00	1.00	1.00	1.00	1.00	1.00	1.00	1.00
PHF Volume:	0	926	23	26	304	0	0	0	0	33	0	72
Reduct Vol:	0	0	0	0	0	0	0	0	0	0	0	0
FinalVolume:	0	926	23	26	304	0	0	0	0	33	0	72

Critical Gap Module:												
Critical Gp:	xxxxx	xxxx	xxxxx	4.1	xxxx	xxxxx	xxxxx	xxxx	xxxxx	6.4	6.5	6.2
FollowUpTim:	xxxxx	xxxx	xxxxx	2.2	xxxx	xxxxx	xxxxx	xxxx	xxxxx	3.5	4.0	3.3

Capacity Module:												
Cnflct Vol:	xxxx	xxxx	xxxxx	949	xxxx	xxxxx	xxxx	xxxx	xxxxx	1294	1294	938
Potent Cap.:	xxxx	xxxx	xxxxx	732	xxxx	xxxxx	xxxx	xxxx	xxxxx	181	164	324
Move Cap.:	xxxx	xxxx	xxxxx	732	xxxx	xxxxx	xxxx	xxxx	xxxxx	176	158	324
Volume/Cap:	xxxx	xxxx	xxxx	0.04	xxxx	xxxx	xxxx	xxxx	xxxx	0.19	0.00	0.22

Level Of Service Module:												
2Way95thQ:	xxxx	xxxx	xxxxx	0.1	xxxx	xxxxx	xxxx	xxxx	xxxxx	xxxx	xxxx	xxxxx
Control Del:	xxxxx	xxxx	xxxxx	10.1	xxxx	xxxxx	xxxxx	xxxx	xxxxx	xxxxx	xxxx	xxxxx
LOS by Move:	*	*	*	B	*	*	*	*	*	*	*	*
Movement:	LT - LTR - RT	LT - LTR - RT	LT - LTR - RT	LT - LTR - RT	LT - LTR - RT	LT - LTR - RT	LT - LTR - RT	LT - LTR - RT	LT - LTR - RT	LT - LTR - RT	LT - LTR - RT	LT - LTR - RT
Shared Cap.:	xxxx	xxxx	xxxxx	xxxx	xxxx	xxxxx	xxxx	xxxx	xxxxx	xxxx	256	xxxxx
SharedQueue:	xxxxx	xxxx	xxxxx	xxxxx	xxxx	xxxxx	xxxxx	xxxx	xxxxx	xxxxx	1.9	xxxxx
Shrd ConDel:	xxxxx	xxxx	xxxxx	xxxxx	xxxx	xxxxx	xxxxx	xxxx	xxxxx	xxxxx	28.5	xxxxx
Shared LOS:	*	*	*	*	*	*	*	*	*	*	D	*
ApproachDel:	xxxxxxx		xxxxxxx		xxxxxxx		xxxxxxx		xxxxxxx		28.5	
ApproachLOS:	*		*		*		*		*		D	

Note: Queue reported is the number of cars per lane.

City of Morgan Hill
The Crosswinds Residential Development

Level Of Service Computation Report
2000 HCM Unsignalized (Future Volume Alternative)
Year 2030 Cumulative with Project AM

Intersection #5664: Mission View Drive and Avenida De Los Padres

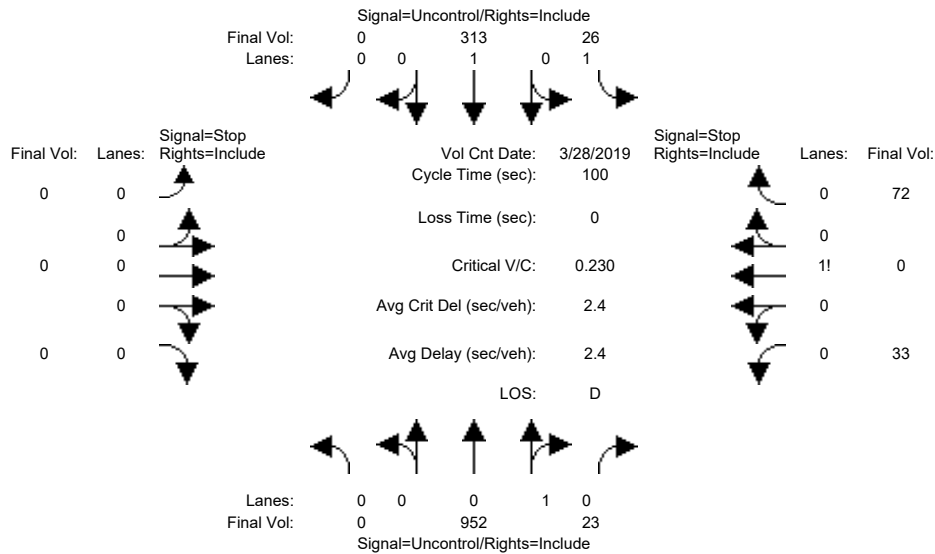

Street Name: Mission View Drive Avenida De Los Padres
 Approach: North Bound South Bound East Bound West Bound
 Movement: L - T - R L - T - R L - T - R L - T - R

Volume Module:	>>	Count	Date:	28 Mar 2019	<<							
Base Vol:	0	926	23	26	304	0	0	0	0	33	0	72
Growth Adj:	1.00	1.00	1.00	1.00	1.00	1.00	1.00	1.00	1.00	1.00	1.00	1.00
Initial Bse:	0	926	23	26	304	0	0	0	0	33	0	72
Added Vol:	0	26	0	0	9	0	0	0	0	0	0	0
PasserByVol:	0	0	0	0	0	0	0	0	0	0	0	0
Initial Fut:	0	952	23	26	313	0	0	0	0	33	0	72
User Adj:	1.00	1.00	1.00	1.00	1.00	1.00	1.00	1.00	1.00	1.00	1.00	1.00
PHF Adj:	1.00	1.00	1.00	1.00	1.00	1.00	1.00	1.00	1.00	1.00	1.00	1.00
PHF Volume:	0	952	23	26	313	0	0	0	0	33	0	72
Reduct Vol:	0	0	0	0	0	0	0	0	0	0	0	0
FinalVolume:	0	952	23	26	313	0	0	0	0	33	0	72

Critical Gap Module:												
Critical Gp:	xxxxx	xxxx	xxxxx	4.1	xxxx	xxxxx	xxxxx	xxxx	xxxxx	6.4	6.5	6.2
FollowUpTim:	xxxxx	xxxx	xxxxx	2.2	xxxx	xxxxx	xxxxx	xxxx	xxxxx	3.5	4.0	3.3

Capacity Module:												
Cnflct Vol:	xxxx	xxxx	xxxxx	975	xxxx	xxxxx	xxxx	xxxx	xxxxx	1329	1329	964
Potent Cap.:	xxxx	xxxx	xxxxx	716	xxxx	xxxxx	xxxx	xxxx	xxxxx	173	156	313
Move Cap.:	xxxx	xxxx	xxxxx	716	xxxx	xxxxx	xxxx	xxxx	xxxxx	168	151	313
Volume/Cap:	xxxx	xxxx	xxxx	0.04	xxxx	xxxx	xxxx	xxxx	xxxx	0.20	0.00	0.23

Level Of Service Module:												
2Way95thQ:	xxxx	xxxx	xxxxx	0.1	xxxx	xxxxx	xxxx	xxxx	xxxxx	xxxx	xxxx	xxxxx
Control Del:	xxxxx	xxxx	xxxxx	10.2	xxxx	xxxxx	xxxxx	xxxx	xxxxx	xxxxx	xxxx	xxxxx
LOS by Move:	*	*	*	B	*	*	*	*	*	*	*	*
Movement:	LT - LTR - RT	LT - LTR - RT	LT - LTR - RT	LT - LTR - RT	LT - LTR - RT	LT - LTR - RT	LT - LTR - RT	LT - LTR - RT	LT - LTR - RT	LT - LTR - RT	LT - LTR - RT	LT - LTR - RT
Shared Cap.:	xxxx	xxxx	xxxxx	xxxx	xxxx	xxxxx	xxxx	xxxx	xxxxx	xxxx	246	xxxxx
SharedQueue:	xxxxx	xxxx	xxxxx	xxxxx	xxxx	xxxxx	xxxxx	xxxx	xxxxx	xxxxx	2.0	xxxxx
Shrd ConDel:	xxxxx	xxxx	xxxxx	xxxxx	xxxx	xxxxx	xxxxx	xxxx	xxxxx	xxxxx	30.1	xxxxx
Shared LOS:	*	*	*	*	*	*	*	*	*	*	D	*
ApproachDel:	xxxxxxx		xxxxxxx		xxxxxxx		xxxxxxx		xxxxxxx		30.1	
ApproachLOS:	*		*		*		*		*		D	

Note: Queue reported is the number of cars per lane.

City of Morgan Hill
The Crosswinds Residential Development

Level Of Service Computation Report
2000 HCM Unsignalized (Future Volume Alternative)
Existing PM

Intersection #5664: Mission View Drive and Avenida De Los Padres

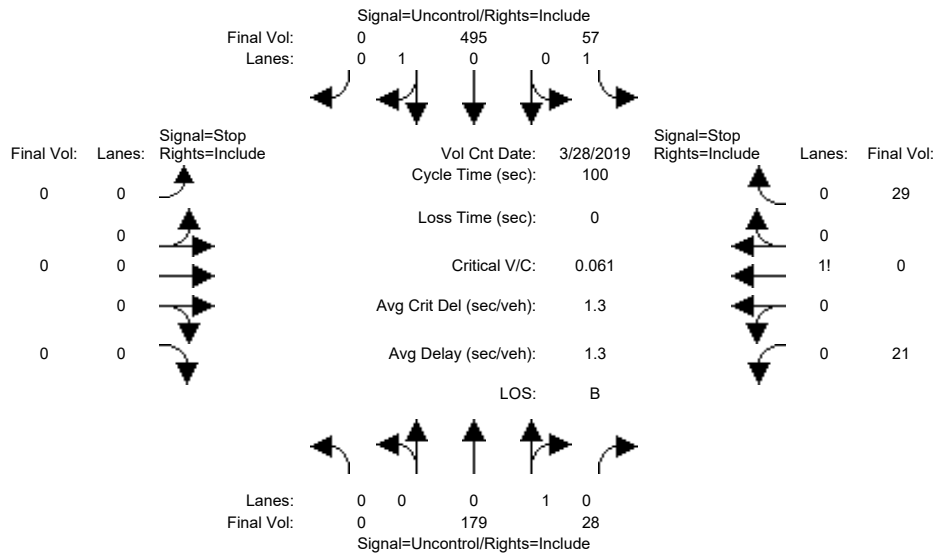

Street Name: Mission View Drive Avenida De Los Padres
 Approach: North Bound South Bound East Bound West Bound
 Movement: L - T - R L - T - R L - T - R L - T - R

Volume Module:	>>	Count	Date:	28 Mar 2019	<<							
Base Vol:	0	179	28	57	495	0	0	0	0	21	0	29
Growth Adj:	1.00	1.00	1.00	1.00	1.00	1.00	1.00	1.00	1.00	1.00	1.00	1.00
Initial Bse:	0	179	28	57	495	0	0	0	0	21	0	29
Added Vol:	0	0	0	0	0	0	0	0	0	0	0	0
PasserByVol:	0	0	0	0	0	0	0	0	0	0	0	0
Initial Fut:	0	179	28	57	495	0	0	0	0	21	0	29
User Adj:	1.00	1.00	1.00	1.00	1.00	1.00	1.00	1.00	1.00	1.00	1.00	1.00
PHF Adj:	1.00	1.00	1.00	1.00	1.00	1.00	1.00	1.00	1.00	1.00	1.00	1.00
PHF Volume:	0	179	28	57	495	0	0	0	0	21	0	29
Reduct Vol:	0	0	0	0	0	0	0	0	0	0	0	0
FinalVolume:	0	179	28	57	495	0	0	0	0	21	0	29

Critical Gap Module:

Critical Gp:	xxxxx	xxxx	xxxxx	4.1	xxxx	xxxxx	xxxxx	xxxx	xxxxx	6.4	6.5	6.2
FollowUpTim:	xxxxx	xxxx	xxxxx	2.2	xxxx	xxxxx	xxxxx	xxxx	xxxxx	3.5	4.0	3.3

Capacity Module:

Cnflct Vol:	xxxx	xxxx	xxxxx	207	xxxx	xxxxx	xxxx	xxxx	xxxxx	802	802	193
Potent Cap.:	xxxx	xxxx	xxxxx	1376	xxxx	xxxxx	xxxx	xxxx	xxxxx	356	320	854
Move Cap.:	xxxx	xxxx	xxxxx	1376	xxxx	xxxxx	xxxx	xxxx	xxxxx	345	306	854
Volume/Cap:	xxxx	xxxx	xxxx	0.04	xxxx	xxxxx	xxxx	xxxx	xxxxx	0.06	0.00	0.03

Level Of Service Module:

2Way95thQ:	xxxx	xxxx	xxxxx	0.1	xxxx	xxxxx	xxxx	xxxx	xxxxx	xxxx	xxxx	xxxxx
Control Del:	xxxxx	xxxx	xxxxx	7.7	xxxx	xxxxx	xxxxx	xxxx	xxxxx	xxxxx	xxxx	xxxxx
LOS by Move:	*	*	*	A	*	*	*	*	*	*	*	*
Movement:	LT - LTR - RT	LT - LTR - RT	LT - LTR - RT		LT - LTR - RT	LT - LTR - RT	LT - LTR - RT	LT - LTR - RT		LT - LTR - RT		
Shared Cap.:	xxxx	xxxx	xxxxx	xxxx	xxxx	xxxxx	xxxx	xxxx	xxxxx	xxxx	527	xxxxx
SharedQueue:	xxxxx	xxxx	xxxxx	xxxxx	xxxx	xxxxx	xxxxx	xxxx	xxxxx	xxxxx	0.3	xxxxx
Shrd ConDel:	xxxxx	xxxx	xxxxx	xxxxx	xxxx	xxxxx	xxxxx	xxxx	xxxxx	xxxxx	12.5	xxxxx
Shared LOS:	*	*	*	*	*	*	*	*	*	*	B	*
ApproachDel:	xxxxxxx			xxxxxxx			xxxxxxx			12.5		
ApproachLOS:	*			*			*			*	B	

Note: Queue reported is the number of cars per lane.

City of Morgan Hill
The Crosswinds Residential Development

Level Of Service Computation Report
2000 HCM Unsignalized (Future Volume Alternative)
Existing Plus Project PM

Intersection #5664: Mission View Drive and Avenida De Los Padres

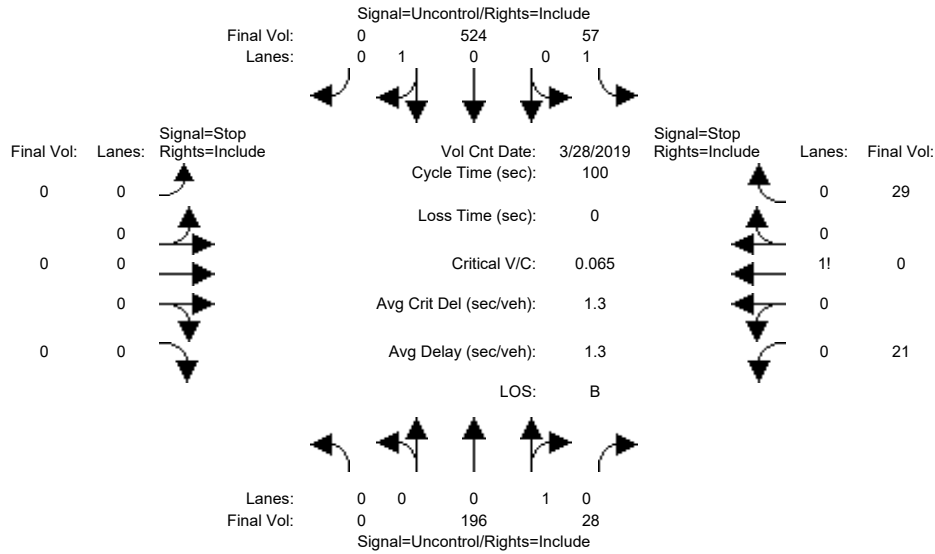

Street Name: Mission View Drive Avenida De Los Padres
 Approach: North Bound South Bound East Bound West Bound
 Movement: L - T - R L - T - R L - T - R L - T - R

Volume Module:	>>	Count	Date:	28 Mar 2019	<<							
Base Vol:	0	179	28	57	495	0	0	0	0	21	0	29
Growth Adj:	1.00	1.00	1.00	1.00	1.00	1.00	1.00	1.00	1.00	1.00	1.00	1.00
Initial Bse:	0	179	28	57	495	0	0	0	0	21	0	29
Added Vol:	0	17	0	0	29	0	0	0	0	0	0	0
PasserByVol:	0	0	0	0	0	0	0	0	0	0	0	0
Initial Fut:	0	196	28	57	524	0	0	0	0	21	0	29
User Adj:	1.00	1.00	1.00	1.00	1.00	1.00	1.00	1.00	1.00	1.00	1.00	1.00
PHF Adj:	1.00	1.00	1.00	1.00	1.00	1.00	1.00	1.00	1.00	1.00	1.00	1.00
PHF Volume:	0	196	28	57	524	0	0	0	0	21	0	29
Reduct Vol:	0	0	0	0	0	0	0	0	0	0	0	0
FinalVolume:	0	196	28	57	524	0	0	0	0	21	0	29

Critical Gap Module:												
Critical Gp:	xxxxx	xxxx	xxxxxx	4.1	xxxx	xxxxxx	xxxxxx	xxxx	xxxxxx	6.4	6.5	6.2
FollowUpTim:	xxxxx	xxxx	xxxxxx	2.2	xxxx	xxxxxx	xxxxxx	xxxx	xxxxxx	3.5	4.0	3.3

Capacity Module:												
Cnflct Vol:	xxxx	xxxx	xxxxxx	224	xxxx	xxxxxx	xxxx	xxxx	xxxxxx	848	848	210
Potent Cap.:	xxxx	xxxx	xxxxxx	1357	xxxx	xxxxxx	xxxx	xxxx	xxxxxx	334	301	835
Move Cap.:	xxxx	xxxx	xxxxxx	1357	xxxx	xxxxxx	xxxx	xxxx	xxxxxx	324	288	835
Volume/Cap:	xxxx	xxxx	xxxx	0.04	xxxx	xxxx	xxxx	xxxx	xxxx	0.06	0.00	0.03

Level Of Service Module:												
2Way95thQ:	xxxx	xxxx	xxxxxx	0.1	xxxx	xxxxxx	xxxx	xxxx	xxxxxx	xxxx	xxxx	xxxxxx
Control Del:	xxxxx	xxxx	xxxxxx	7.8	xxxxx	xxxxxx	xxxxxx	xxxx	xxxxxx	xxxxxx	xxxx	xxxxxx
LOS by Move:	*	*	*	A	*	*	*	*	*	*	*	*
Movement:	LT - LTR - RT	LT - LTR - RT	LT - LTR - RT	LT - LTR - RT	LT - LTR - RT	LT - LTR - RT	LT - LTR - RT	LT - LTR - RT	LT - LTR - RT	LT - LTR - RT	LT - LTR - RT	LT - LTR - RT
Shared Cap.:	xxxx	xxxx	xxxxxx	xxxx	xxxx	xxxxxx	xxxx	xxxx	xxxxxx	xxxx	502	xxxxxx
SharedQueue:	xxxxx	xxxx	xxxxxx	xxxxxx	xxxx	xxxxxx	xxxxxx	xxxx	xxxxxx	xxxxxx	0.3	xxxxxx
Shrd ConDel:	xxxxx	xxxx	xxxxxx	xxxxxx	xxxx	xxxxxx	xxxxxx	xxxx	xxxxxx	xxxxxx	13.0	xxxxxx
Shared LOS:	*	*	*	*	*	*	*	*	*	*	B	*
ApproachDel:	xxxxxxx			xxxxxxx			xxxxxxx			13.0		
ApproachLOS:	*			*			*			*	B	*

Note: Queue reported is the number of cars per lane.

City of Morgan Hill
The Crosswinds Residential Development

Level Of Service Computation Report
2000 HCM Unsignalized (Future Volume Alternative)
Year 2030 Cumulative without Project PM

Intersection #5664: Mission View Drive and Avenida De Los Padres

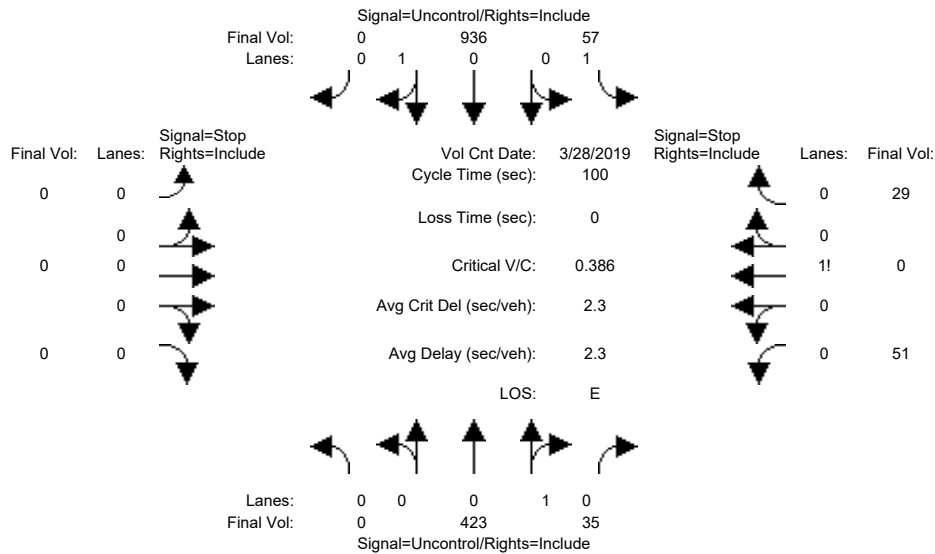

Street Name: Mission View Drive Avenida De Los Padres
Approach: North Bound South Bound East Bound West Bound
Movement: L - T - R L - T - R L - T - R L - T - R

Volume Module:	>>	Count	Date:	28 Mar 2019	<<							
Base Vol:	0	423	35	57	936	0	0	0	0	51	0	29
Growth Adj:	1.00	1.00	1.00	1.00	1.00	1.00	1.00	1.00	1.00	1.00	1.00	1.00
Initial Bse:	0	423	35	57	936	0	0	0	0	51	0	29
Added Vol:	0	0	0	0	0	0	0	0	0	0	0	0
PasserByVol:	0	0	0	0	0	0	0	0	0	0	0	0
Initial Fut:	0	423	35	57	936	0	0	0	0	51	0	29
User Adj:	1.00	1.00	1.00	1.00	1.00	1.00	1.00	1.00	1.00	1.00	1.00	1.00
PHF Adj:	1.00	1.00	1.00	1.00	1.00	1.00	1.00	1.00	1.00	1.00	1.00	1.00
PHF Volume:	0	423	35	57	936	0	0	0	0	51	0	29
Reduct Vol:	0	0	0	0	0	0	0	0	0	0	0	0
FinalVolume:	0	423	35	57	936	0	0	0	0	51	0	29

Critical Gap Module:

Critical Gp:	xxxxx	xxxx	xxxxxx	4.1	xxxx	xxxxxx	xxxxxx	xxxx	xxxxxx	6.4	6.5	6.2
FollowUpTim:	xxxxx	xxxx	xxxxxx	2.2	xxxx	xxxxxx	xxxxxx	xxxx	xxxxxx	3.5	4.0	3.3

Capacity Module:

Cnflct Vol:	xxxx	xxxx	xxxxxx	458	xxxx	xxxxxx	xxxx	xxxx	xxxxxx	1491	1491	441
Potent Cap.:	xxxx	xxxx	xxxxxx	1114	xxxx	xxxxxx	xxxx	xxxx	xxxxxx	138	125	621
Move Cap.:	xxxx	xxxx	xxxxxx	1114	xxxx	xxxxxx	xxxx	xxxx	xxxxxx	132	119	621
Volume/Cap:	xxxx	xxxx	xxxx	0.05	xxxx	xxxx	xxxx	xxxx	xxxx	0.39	0.00	0.05

Level Of Service Module:

2Way95thQ:	xxxx	xxxx	xxxxxx	0.2	xxxx	xxxxxx	xxxx	xxxx	xxxxxx	xxxx	xxxx	xxxxxx
Control Del:	xxxxx	xxxx	xxxxxx	8.4	xxxxx	xxxxxx	xxxxxx	xxxx	xxxxxx	xxxxxx	xxxx	xxxxxx
LOS by Move:	*	*	*	A	*	*	*	*	*	*	*	*
Movement:	LT - LTR - RT	LT - LTR - RT	LT - LTR - RT		LT - LTR - RT	LT - LTR - RT	LT - LTR - RT	LT - LTR - RT				
Shared Cap.:	xxxx	xxxx	xxxxxx	xxxx	xxxx	xxxxxx	xxxx	xxxx	xxxxxx	xxxx	185	xxxxxx
SharedQueue:	xxxxx	xxxx	xxxxxx	xxxxxx	xxxx	xxxxxx	xxxxxx	xxxx	xxxxxx	xxxxxx	2.0	xxxxxx
Shrd ConDel:	xxxxx	xxxx	xxxxxx	xxxxxx	xxxx	xxxxxx	xxxxxx	xxxx	xxxxxx	xxxxxx	38.5	xxxxxx
Shared LOS:	*	*	*	*	*	*	*	*	*	*	E	*
ApproachDel:	xxxxxxx			xxxxxxx			xxxxxxx			38.5		
ApproachLOS:	*			*			*			*	E	

Note: Queue reported is the number of cars per lane.

City of Morgan Hill
The Crosswinds Residential Development

Level Of Service Computation Report
2000 HCM Unsignalized (Future Volume Alternative)
Year 2030 Cumulative with Project PM

Intersection #5664: Mission View Drive and Avenida De Los Padres

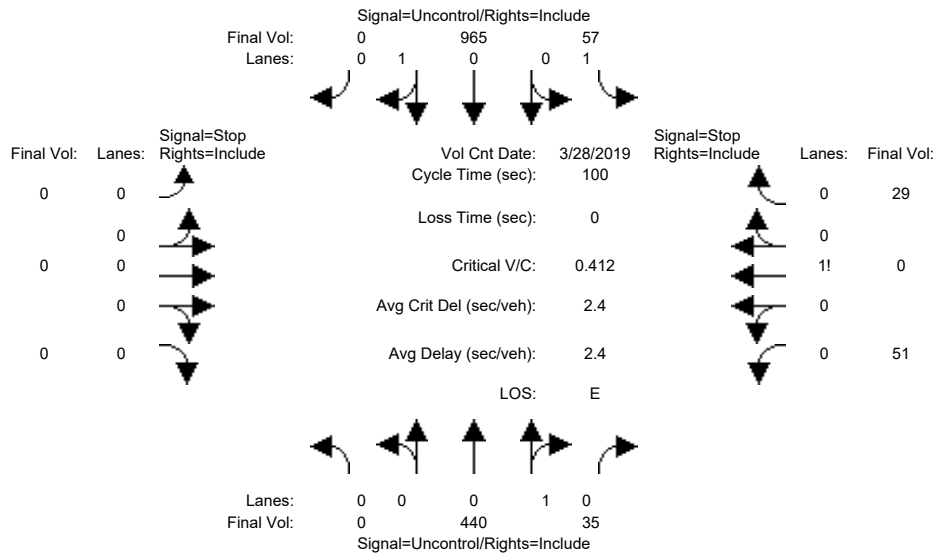

Street Name: Mission View Drive Avenida De Los Padres
Approach: North Bound South Bound East Bound West Bound
Movement: L - T - R L - T - R L - T - R L - T - R

Volume Module:	>>	Count	Date:	28 Mar 2019	<<							
Base Vol:	0	423	35	57	936	0	0	0	0	51	0	29
Growth Adj:	1.00	1.00	1.00	1.00	1.00	1.00	1.00	1.00	1.00	1.00	1.00	1.00
Initial Bse:	0	423	35	57	936	0	0	0	0	51	0	29
Added Vol:	0	17	0	0	29	0	0	0	0	0	0	0
PasserByVol:	0	0	0	0	0	0	0	0	0	0	0	0
Initial Fut:	0	440	35	57	965	0	0	0	0	51	0	29
User Adj:	1.00	1.00	1.00	1.00	1.00	1.00	1.00	1.00	1.00	1.00	1.00	1.00
PHF Adj:	1.00	1.00	1.00	1.00	1.00	1.00	1.00	1.00	1.00	1.00	1.00	1.00
PHF Volume:	0	440	35	57	965	0	0	0	0	51	0	29
Reduct Vol:	0	0	0	0	0	0	0	0	0	0	0	0
FinalVolume:	0	440	35	57	965	0	0	0	0	51	0	29

Critical Gap Module:

Critical Gp:	xxxxx	xxxx	xxxxxx	4.1	xxxx	xxxxxx	xxxxxx	xxxx	xxxxxx	6.4	6.5	6.2
FollowUpTim:	xxxxx	xxxx	xxxxxx	2.2	xxxx	xxxxxx	xxxxxx	xxxx	xxxxxx	3.5	4.0	3.3

Capacity Module:

Cnflict Vol:	xxxx	xxxx	xxxxxx	475	xxxx	xxxxxx	xxxx	xxxx	xxxxxx	1537	1537	458
Potent Cap.:	xxxx	xxxx	xxxxxx	1098	xxxx	xxxxxx	xxxx	xxxx	xxxxxx	129	117	607
Move Cap.:	xxxx	xxxx	xxxxxx	1098	xxxx	xxxxxx	xxxx	xxxx	xxxxxx	124	111	607
Volume/Cap:	xxxx	xxxx	xxxx	0.05	xxxx	xxxx	xxxx	xxxx	xxxx	0.41	0.00	0.05

Level Of Service Module:

2Way95thQ:	xxxx	xxxx	xxxxxx	0.2	xxxx	xxxxxx	xxxx	xxxx	xxxxxx	xxxx	xxxx	xxxxxx
Control Del:	xxxxx	xxxx	xxxxxx	8.5	xxxxx	xxxxxx	xxxxxx	xxxx	xxxxxx	xxxxxx	xxxx	xxxxxx
LOS by Move:	*	*	*	A	*	*	*	*	*	*	*	*
Movement:	LT - LTR - RT	LT - LTR - RT	LT - LTR - RT		LT - LTR - RT	LT - LTR - RT	LT - LTR - RT	LT - LTR - RT		LT - LTR - RT		
Shared Cap.:	xxxx	xxxx	xxxxxx	xxxx	xxxx	xxxxxx	xxxx	xxxx	xxxxxx	xxxx	174	xxxxxx
SharedQueue:	xxxxx	xxxx	xxxxxx	xxxxxx	xxxx	xxxxxx	xxxxxx	xxxx	xxxxxx	xxxxxx	2.2	xxxxxx
Shrd ConDel:	xxxxx	xxxx	xxxxxx	xxxxxx	xxxx	xxxxxx	xxxxxx	xxxx	xxxxxx	xxxxxx	42.1	xxxxxx
Shared LOS:	*	*	*	*	*	*	*	*	*	*	E	*
ApproachDel:	xxxxxxx			xxxxxxx			xxxxxxx			42.1		
ApproachLOS:	*			*			*			E		

Note: Queue reported is the number of cars per lane.

City of Morgan Hill
The Crosswinds Residential Development

Level Of Service Computation Report
2000 HCM Unsignalized (Future Volume Alternative)
Existing AM

Intersection #3117: Mission View Drive and Half Road

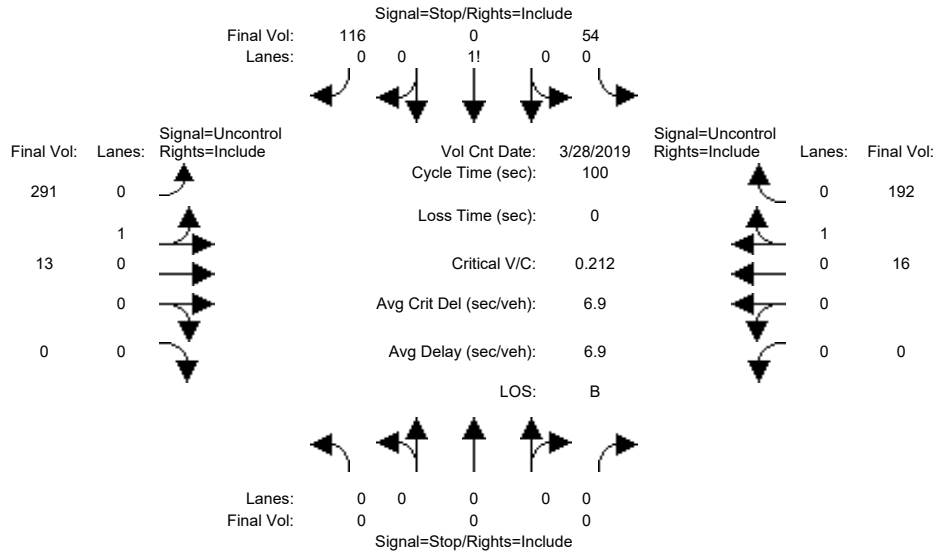

Street Name: Mission View Drive Half Road
 Approach: North Bound South Bound East Bound West Bound
 Movement: L - T - R L - T - R L - T - R L - T - R

Volume Module:	>>	Count	Date:	28 Mar 2019	<<												
Base Vol:	0	0	0	54	0	116	291	13	0	0	16	192					
Growth Adj:	1.00	1.00	1.00	1.00	1.00	1.00	1.00	1.00	1.00	1.00	1.00	1.00	1.00	1.00	1.00		
Initial Bse:	0	0	0	54	0	116	291	13	0	0	16	192					
Added Vol:	0	0	0	0	0	0	0	0	0	0	0	0					
PasserByVol:	0	0	0	0	0	0	0	0	0	0	0	0					
Initial Fut:	0	0	0	54	0	116	291	13	0	0	16	192					
User Adj:	1.00	1.00	1.00	1.00	1.00	1.00	1.00	1.00	1.00	1.00	1.00	1.00	1.00	1.00	1.00		
PHF Adj:	1.00	1.00	1.00	1.00	1.00	1.00	1.00	1.00	1.00	1.00	1.00	1.00	1.00	1.00	1.00		
PHF Volume:	0	0	0	54	0	116	291	13	0	0	16	192					
Reduct Vol:	0	0	0	0	0	0	0	0	0	0	0	0					
FinalVolume:	0	0	0	54	0	116	291	13	0	0	16	192					

Critical Gap Module:

Critical Gp:	xxxxx	xxxx	xxxxx	6.4	6.5	6.2	4.1	xxxx	xxxxx	xxxxx	xxxx	xxxxx				
FollowUpTim:	xxxxx	xxxx	xxxxx	3.5	4.0	3.3	2.2	xxxx	xxxxx	xxxxx	xxxx	xxxxx				

Capacity Module:

Cnflct Vol:	xxxx	xxxx	xxxxx	707	707	112	208	xxxx	xxxxx	xxxx	xxxx	xxxxx				
Potent Cap.:	xxxx	xxxx	xxxxx	405	363	947	1375	xxxx	xxxxx	xxxx	xxxx	xxxxx				
Move Cap.:	xxxx	xxxx	xxxxx	326	271	947	1375	xxxx	xxxxx	xxxx	xxxx	xxxxx				
Volume/Cap:	xxxx	xxxx	xxxx	0.17	0.00	0.12	0.21	xxxx	xxxx	xxxx	xxxx	xxxx				

Level Of Service Module:

2Way95thQ:	xxxx	xxxx	xxxxx	xxxx	xxxx	xxxxx	0.8	xxxx	xxxxx	xxxx	xxxx	xxxxx				
Control Del:	xxxxx	xxxx	xxxxx	xxxxx	xxxx	xxxxx	8.3	xxxx	xxxxx	xxxxx	xxxx	xxxxx				
LOS by Move:	*	*	*	*	*	*	A	*	*	*	*	*				
Movement:	LT - LTR - RT	LT - LTR - RT	LT - LTR - RT	LT - LTR - RT	LT - LTR - RT	LT - LTR - RT	LT - LTR - RT	LT - LTR - RT	LT - LTR - RT	LT - LTR - RT	LT - LTR - RT	LT - LTR - RT				
Shared Cap.:	xxxx	xxxx	xxxxx	xxxx	590	xxxxx	xxxx	xxxx	xxxxx	xxxx	xxxx	xxxxx				
SharedQueue:	xxxxx	xxxx	xxxxx	xxxxx	1.2	xxxxx	0.8	xxxx	xxxxx	xxxxx	xxxx	xxxxx				
Shrd ConDel:	xxxxx	xxxx	xxxxx	xxxxx	13.6	xxxxx	8.3	xxxx	xxxxx	xxxxx	xxxx	xxxxx				
Shared LOS:	*	*	*	*	B	*	A	*	*	*	*	*				
ApproachDel:	xxxxxxx			13.6			xxxxxxx			xxxxxxx						
ApproachLOS:	*			B			*			*		*				

Note: Queue reported is the number of cars per lane.

City of Morgan Hill
The Crosswinds Residential Development

Level Of Service Computation Report
2000 HCM Unsignalized (Future Volume Alternative)
Existing Plus Project AM

Intersection #3117: Mission View Drive and Half Road

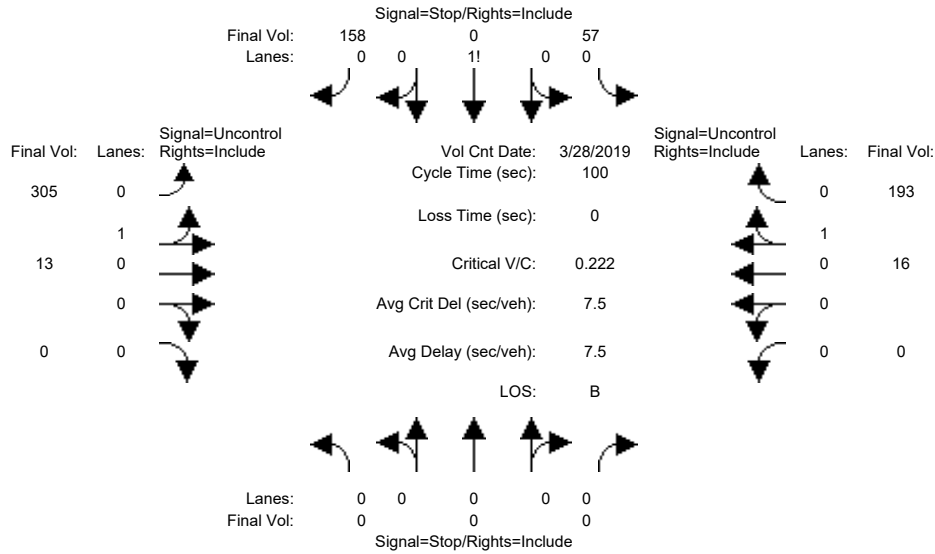

Street Name: Mission View Drive Half Road
 Approach: North Bound South Bound East Bound West Bound
 Movement: L - T - R L - T - R L - T - R L - T - R

Volume Module:	>>	Count	Date:	28 Mar 2019	<<								
Base Vol:	0	0	0	54	0	116	291	13	0	0	16	192	
Growth Adj:	1.00	1.00	1.00	1.00	1.00	1.00	1.00	1.00	1.00	1.00	1.00	1.00	
Initial Bse:	0	0	0	54	0	116	291	13	0	0	16	192	
Added Vol:	0	0	0	3	0	42	14	0	0	0	0	1	
PasserByVol:	0	0	0	0	0	0	0	0	0	0	0	0	
Initial Fut:	0	0	0	57	0	158	305	13	0	0	16	193	
User Adj:	1.00	1.00	1.00	1.00	1.00	1.00	1.00	1.00	1.00	1.00	1.00	1.00	
PHF Adj:	1.00	1.00	1.00	1.00	1.00	1.00	1.00	1.00	1.00	1.00	1.00	1.00	
PHF Volume:	0	0	0	57	0	158	305	13	0	0	16	193	
Reduct Vol:	0	0	0	0	0	0	0	0	0	0	0	0	
FinalVolume:	0	0	0	57	0	158	305	13	0	0	16	193	

Critical Gap Module:

Critical Gp:	xxxxx	xxxx	xxxxx	6.4	6.5	6.2	4.1	xxxx	xxxxx	xxxxx	xxxx	xxxxx
FollowUpTim:	xxxxx	xxxx	xxxxx	3.5	4.0	3.3	2.2	xxxx	xxxxx	xxxxx	xxxx	xxxxx

Capacity Module:

Cnflct Vol:	xxxx	xxxx	xxxxx	736	736	113	209	xxxx	xxxxx	xxxx	xxxx	xxxxx
Potent Cap.:	xxxx	xxxx	xxxxx	389	349	946	1374	xxxx	xxxxx	xxxx	xxxx	xxxxx
Move Cap.:	xxxx	xxxx	xxxxx	309	256	946	1374	xxxx	xxxxx	xxxx	xxxx	xxxxx
Volume/Cap:	xxxx	xxxx	xxxx	0.18	0.00	0.17	0.22	xxxx	xxxx	xxxx	xxxx	xxxx

Level Of Service Module:

2Way95thQ:	xxxx	xxxx	xxxxx	xxxx	xxxx	xxxxx	0.9	xxxx	xxxxx	xxxx	xxxx	xxxxx
Control Del:	xxxxx	xxxx	xxxxx	xxxxx	xxxx	xxxxx	8.4	xxxx	xxxxx	xxxxx	xxxx	xxxxx
LOS by Move:	*	*	*	*	*	*	A	*	*	*	*	*
Movement:	LT - LTR - RT	LT - LTR - RT	LT - LTR - RT	LT - LTR - RT	LT - LTR - RT	LT - LTR - RT	LT - LTR - RT	LT - LTR - RT	LT - LTR - RT	LT - LTR - RT	LT - LTR - RT	LT - LTR - RT
Shared Cap.:	xxxx	xxxx	xxxxx	xxxx	612	xxxxx	xxxx	xxxx	xxxxx	xxxx	xxxx	xxxxx
SharedQueue:	xxxxx	xxxx	xxxxx	xxxxx	1.6	xxxxx	0.9	xxxx	xxxxx	xxxxx	xxxx	xxxxx
Shrd ConDel:	xxxxx	xxxx	xxxxx	xxxxx	14.0	xxxxx	8.4	xxxx	xxxxx	xxxxx	xxxx	xxxxx
Shared LOS:	*	*	*	*	B	*	A	*	*	*	*	*
ApproachDel:	xxxxxxx			14.0			xxxxxxx			xxxxxxx		
ApproachLOS:	*			B			*			*		*

Note: Queue reported is the number of cars per lane.

City of Morgan Hill
The Crosswinds Residential Development

Level Of Service Computation Report
2000 HCM 4-Way Stop (Future Volume Alternative)
Year 2030 Cumulative without Project AM

Intersection #3117: Mission View Drive and Half Road

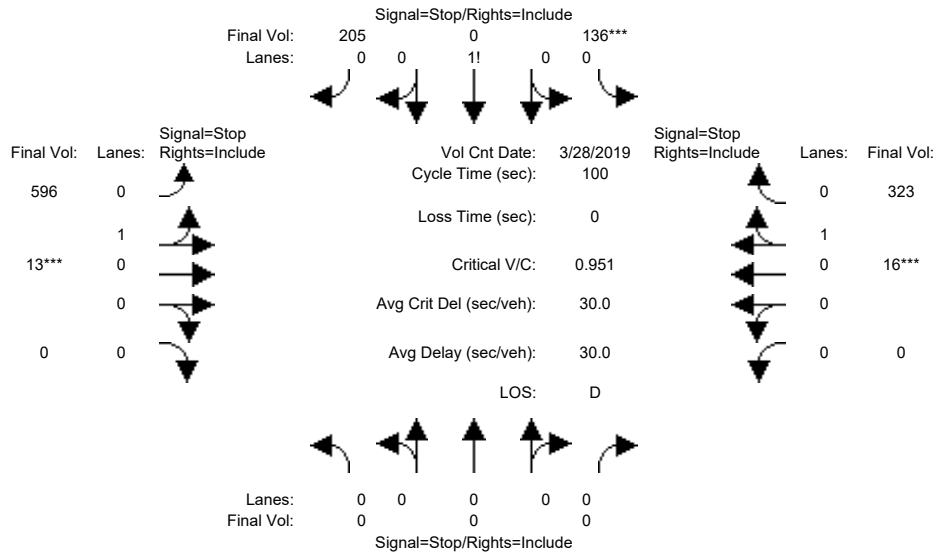

Street Name: Mission View Drive Half Road
Approach: North Bound South Bound East Bound West Bound
Movement: L - T - R L - T - R L - T - R L - T - R

Min. Green: 0 0 0 0 0 0 0 0 0 0 0 0

Volume Module: >> Count Date: 28 Mar 2019 <<

Base Vol:	0	0	0	136	0	205	596	13	0	0	16	323
Growth Adj:	1.00	1.00	1.00	1.00	1.00	1.00	1.00	1.00	1.00	1.00	1.00	1.00
Initial Bse:	0	0	0	136	0	205	596	13	0	0	16	323
Added Vol:	0	0	0	0	0	0	0	0	0	0	0	0
PasserByVol:	0	0	0	0	0	0	0	0	0	0	0	0
Initial Fut:	0	0	0	136	0	205	596	13	0	0	16	323
User Adj:	1.00	1.00	1.00	1.00	1.00	1.00	1.00	1.00	1.00	1.00	1.00	1.00
PHF Adj:	1.00	1.00	1.00	1.00	1.00	1.00	1.00	1.00	1.00	1.00	1.00	1.00
PHF Volume:	0	0	0	136	0	205	596	13	0	0	16	323
Reduct Vol:	0	0	0	0	0	0	0	0	0	0	0	0
Reduced Vol:	0	0	0	136	0	205	596	13	0	0	16	323
PCE Adj:	1.00	1.00	1.00	1.00	1.00	1.00	1.00	1.00	1.00	1.00	1.00	1.00
MLF Adj:	1.00	1.00	1.00	1.00	1.00	1.00	1.00	1.00	1.00	1.00	1.00	1.00
Final Volume:	0	0	0	136	0	205	596	13	0	0	16	323

Saturation Flow Module:

Adjustment:	1.00	1.00	1.00	1.00	1.00	1.00	1.00	1.00	1.00	1.00	1.00	1.00
Lanes:	0.00	0.00	0.00	0.40	0.00	0.60	0.98	0.02	0.00	0.00	0.05	0.95
Final Sat.:	0	0	0	237	0	358	627	14	0	0	31	631

Capacity Analysis Module:

Vol/Sat:	xxxx	xxxx	xxxx	0.57	xxxx	0.57	0.95	0.95	xxxx	xxxx	0.51	0.51
Crit Moves:				****				****			****	
Delay/Veh:	0.0	0.0	0.0	16.0	0.0	16.0	47.0	47.0	0.0	0.0	13.3	13.3
Delay Adj:	1.00	1.00	1.00	1.00	1.00	1.00	1.00	1.00	1.00	1.00	1.00	1.00
AdjDel/Veh:	0.0	0.0	0.0	16.0	0.0	16.0	47.0	47.0	0.0	0.0	13.3	13.3
LOS by Move:	*	*	*	C	*	C	E	E	*	*	B	B
ApproachDel:	xxxxxx			16.0			47.0			13.3		
Delay Adj:	xxxxxx			1.00			1.00			1.00		
ApprAdjDel:	xxxxxx			16.0			47.0			13.3		
LOS by Appr:	*			C			E			B		
AllWayAvgQ:	0.0	0.0	0.0	1.2	1.2	1.2	6.8	6.8	6.8	0.9	0.9	0.9

Note: Queue reported is the number of cars per lane.

City of Morgan Hill
The Crosswinds Residential Development

Level Of Service Computation Report
2000 HCM 4-Way Stop (Future Volume Alternative)
Year 2030 Cumulative with Project AM

Intersection #3117: Mission View Drive and Half Road

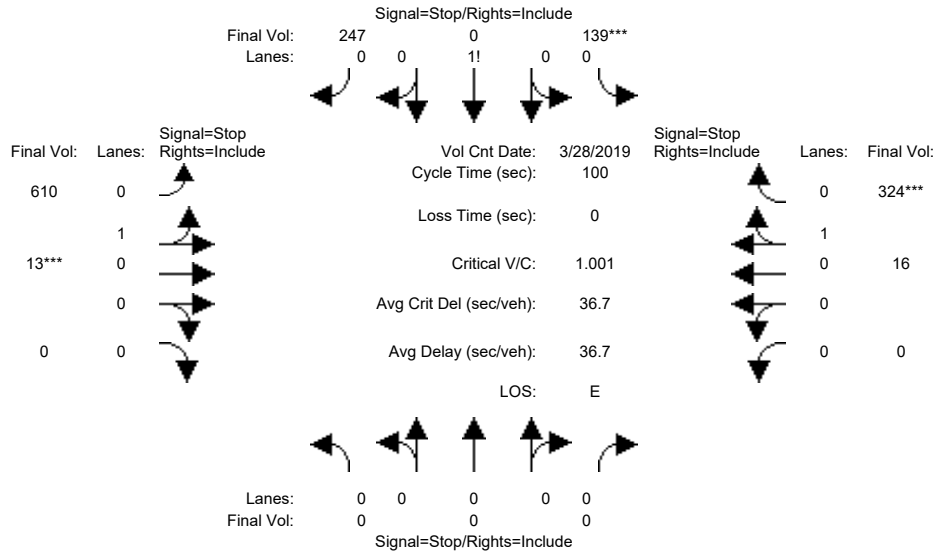

Street Name:	Mission View Drive						Half Road					
Approach:	North Bound			South Bound			East Bound			West Bound		
Movement:	L	T	R	L	T	R	L	T	R	L	T	R

Min. Green:	0	0	0	0	0	0	0	0	0	0	0	0
-------------	---	---	---	---	---	---	---	---	---	---	---	---

Volume Module:	>>	Count	Date:	28 Mar 2019	<<							
Base Vol:	0	0	0	136	0	205	596	13	0	0	16	323
Growth Adj:	1.00	1.00	1.00	1.00	1.00	1.00	1.00	1.00	1.00	1.00	1.00	1.00
Initial Bse:	0	0	0	136	0	205	596	13	0	0	16	323
Added Vol:	0	0	0	3	0	42	14	0	0	0	0	1
PasserByVol:	0	0	0	0	0	0	0	0	0	0	0	0
Initial Fut:	0	0	0	139	0	247	610	13	0	0	16	324
User Adj:	1.00	1.00	1.00	1.00	1.00	1.00	1.00	1.00	1.00	1.00	1.00	1.00
PHF Adj:	1.00	1.00	1.00	1.00	1.00	1.00	1.00	1.00	1.00	1.00	1.00	1.00
PHF Volume:	0	0	0	139	0	247	610	13	0	0	16	324
Reduct Vol:	0	0	0	0	0	0	0	0	0	0	0	0
Reduced Vol:	0	0	0	139	0	247	610	13	0	0	16	324
PCE Adj:	1.00	1.00	1.00	1.00	1.00	1.00	1.00	1.00	1.00	1.00	1.00	1.00
MLF Adj:	1.00	1.00	1.00	1.00	1.00	1.00	1.00	1.00	1.00	1.00	1.00	1.00
FinalVolume:	0	0	0	139	0	247	610	13	0	0	16	324

Saturation Flow Module:												
Adjustment:	1.00	1.00	1.00	1.00	1.00	1.00	1.00	1.00	1.00	1.00	1.00	1.00
Lanes:	0.00	0.00	0.00	0.36	0.00	0.64	0.98	0.02	0.00	0.00	0.05	0.95
Final Sat.:	0	0	0	215	0	383	609	13	0	0	30	612

Capacity Analysis Module:												
Vol/Sat:	xxxx	xxxx	xxxx	0.65	xxxx	0.65	1.00	1.00	xxxx	xxxx	0.53	0.53
Crit Moves:				****					****			****
Delay/Veh:	0.0	0.0	0.0	18.8	0.0	18.8	60.0	60.0	0.0	0.0	14.3	14.3
Delay Adj:	1.00	1.00	1.00	1.00	1.00	1.00	1.00	1.00	1.00	1.00	1.00	1.00
AdjDel/Veh:	0.0	0.0	0.0	18.8	0.0	18.8	60.0	60.0	0.0	0.0	14.3	14.3
LOS by Move:	*	*	*	C	*	C	F	F	*	*	B	B
ApproachDel:	xxxxxx			18.8			60.0			14.3		
Delay Adj:	xxxxxx			1.00			1.00			1.00		
ApprAdjDel:	xxxxxx			18.8			60.0			14.3		
LOS by Appr:	*			C			F			B		
AllWayAvgQ:	0.0	0.0	0.0	1.6	1.6	1.6	8.9	8.9	8.9	1.0	1.0	1.0

Note: Queue reported is the number of cars per lane.

City of Morgan Hill
The Crosswinds Residential Development

Level Of Service Computation Report
2000 HCM Operations (Future Volume Alternative)
Year 2030 Cumulative with Project AM (with Mitigations)

Intersection #3117: Mission View Drive and Half Road

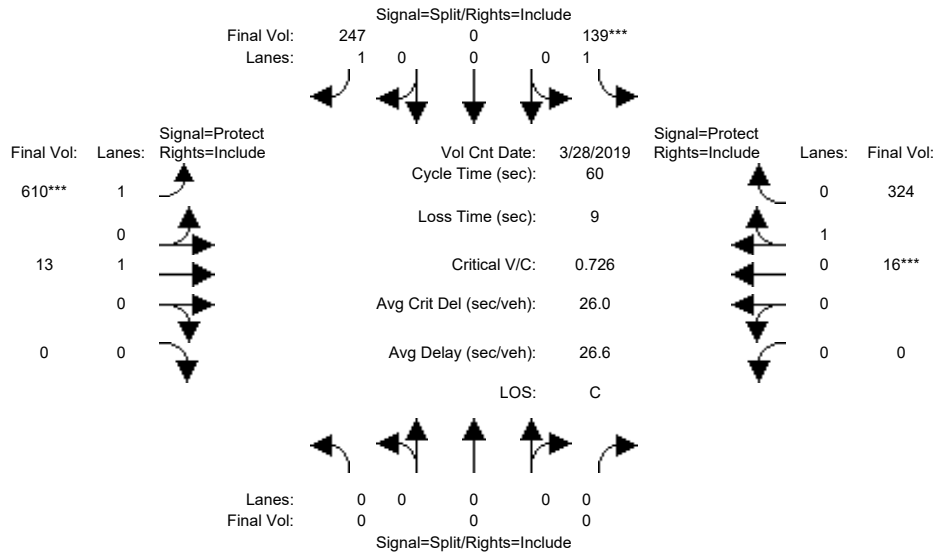

Street Name:	Mission View Drive						Half Road					
	North Bound			South Bound			East Bound			West Bound		
Approach:	L	T	R	L	T	R	L	T	R	L	T	R
Min. Green:	0	0	0	10	0	10	7	10	0	0	10	10
Y+R:	4.0	4.0	4.0	4.0	4.0	4.0	4.0	4.0	4.0	4.0	4.0	4.0

Volume Module:	>>	Count	Date:	28 Mar 2019	<<												
Base Vol:	0	0	0	136	0	205	596	13	0	0	16	323					
Growth Adj:	1.00	1.00	1.00	1.00	1.00	1.00	1.00	1.00	1.00	1.00	1.00	1.00					
Initial Bse:	0	0	0	136	0	205	596	13	0	0	16	323					
Added Vol:	0	0	0	3	0	42	14	0	0	0	0	1					
PasserByVol:	0	0	0	0	0	0	0	0	0	0	0	0					
Initial Fut:	0	0	0	139	0	247	610	13	0	0	16	324					
User Adj:	1.00	1.00	1.00	1.00	1.00	1.00	1.00	1.00	1.00	1.00	1.00	1.00					
PHF Adj:	1.00	1.00	1.00	1.00	1.00	1.00	1.00	1.00	1.00	1.00	1.00	1.00					
PHF Volume:	0	0	0	139	0	247	610	13	0	0	16	324					
Reduct Vol:	0	0	0	0	0	0	0	0	0	0	0	0					
Reduced Vol:	0	0	0	139	0	247	610	13	0	0	16	324					
PCE Adj:	1.00	1.00	1.00	1.00	1.00	1.00	1.00	1.00	1.00	1.00	1.00	1.00					
MLF Adj:	1.00	1.00	1.00	1.00	1.00	1.00	1.00	1.00	1.00	1.00	1.00	1.00					
FinalVolume:	0	0	0	139	0	247	610	13	0	0	16	324					

Saturation Flow Module:												
Sat/Lane:	1900	1900	1900	1900	1900	1900	1900	1900	1900	1900	1900	1900
Adjustment:	0.92	1.00	0.92	0.92	1.00	0.92	0.92	1.00	0.92	0.92	0.95	0.95
Lanes:	0.00	0.00	0.00	1.00	0.00	1.00	1.00	1.00	0.00	0.00	0.05	0.95
Final Sat.:	0	0	0	1750	0	1750	1750	1900	0	0	85	1715

Capacity Analysis Module:												
Vol/Sat:	0.00	0.00	0.00	0.08	0.00	0.14	0.35	0.01	0.00	0.00	0.19	0.19
Crit Moves:				****			****			****		
Green Time:	0.0	0.0	0.0	11.7	0.0	11.7	25.5	39.3	0.0	0.0	13.8	13.8
Volume/Cap:	0.00	0.00	0.00	0.41	0.00	0.73	0.82	0.01	0.00	0.00	0.82	0.82
Delay/Veh:	0.0	0.0	0.0	21.9	0.0	30.3	22.4	3.6	0.0	0.0	34.1	34.1
User DelAdj:	1.00	1.00	1.00	1.00	1.00	1.00	1.00	1.00	1.00	1.00	1.00	1.00
AdjDel/Veh:	0.0	0.0	0.0	21.9	0.0	30.3	22.4	3.6	0.0	0.0	34.1	34.1
LOS by Move:	A	A	A	C	A	C	C	A	A	A	C	C
HCM2k95thQ:	0	0	0	6	0	12	24	0	0	0	17	17

Note: Queue reported is the number of cars per lane.

City of Morgan Hill
The Crosswinds Residential Development

Level Of Service Computation Report
2000 HCM Unsignalized (Future Volume Alternative)
Existing PM

Intersection #3117: Mission View Drive and Half Road

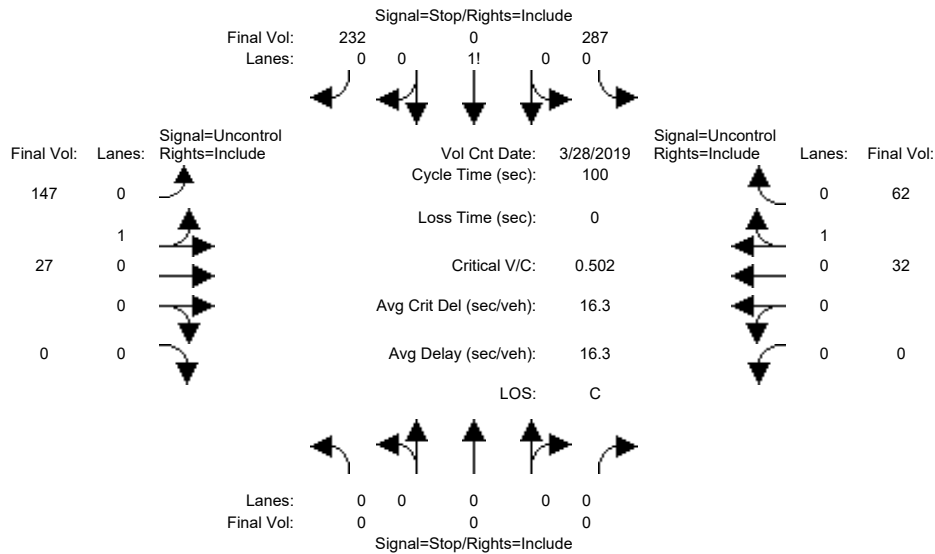

Street Name: Mission View Drive Half Road
Approach: North Bound South Bound East Bound West Bound
Movement: L - T - R L - T - R L - T - R L - T - R

Volume Module:	>>	Count	Date:	28 Mar 2019	<<								
Base Vol:	0	0	0	287	0	232	147	27	0	0	32	62	
Growth Adj:	1.00	1.00	1.00	1.00	1.00	1.00	1.00	1.00	1.00	1.00	1.00	1.00	
Initial Bse:	0	0	0	287	0	232	147	27	0	0	32	62	
Added Vol:	0	0	0	0	0	0	0	0	0	0	0	0	
PasserByVol:	0	0	0	0	0	0	0	0	0	0	0	0	
Initial Fut:	0	0	0	287	0	232	147	27	0	0	32	62	
User Adj:	1.00	1.00	1.00	1.00	1.00	1.00	1.00	1.00	1.00	1.00	1.00	1.00	
PHF Adj:	1.00	1.00	1.00	1.00	1.00	1.00	1.00	1.00	1.00	1.00	1.00	1.00	
PHF Volume:	0	0	0	287	0	232	147	27	0	0	32	62	
Reduct Vol:	0	0	0	0	0	0	0	0	0	0	0	0	
FinalVolume:	0	0	0	287	0	232	147	27	0	0	32	62	

Critical Gap Module:

Critical Gp:	xxxxx	xxxx	xxxxx	6.4	6.5	6.2	4.1	xxxx	xxxxx	xxxxx	xxxx	xxxxx
FollowUpTim:	xxxxx	xxxx	xxxxx	3.5	4.0	3.3	2.2	xxxx	xxxxx	xxxxx	xxxx	xxxxx

Capacity Module:

Cnflct Vol:	xxxx	xxxx	xxxxx	384	384	63	94	xxxx	xxxxx	xxxx	xxxx	xxxxx
Potent Cap.:	xxxx	xxxx	xxxxx	623	553	1007	1513	xxxx	xxxxx	xxxx	xxxx	xxxxx
Move Cap.:	xxxx	xxxx	xxxxx	572	494	1007	1513	xxxx	xxxxx	xxxx	xxxx	xxxxx
Volume/Cap:	xxxx	xxxx	xxxx	0.50	0.00	0.23	0.10	xxxx	xxxx	xxxx	xxxx	xxxx

Level Of Service Module:

2Way95thQ:	xxxx	xxxx	xxxxx	xxxx	xxxx	xxxxx	0.3	xxxx	xxxxx	xxxx	xxxx	xxxxx
Control Del:	xxxxx	xxxx	xxxxx	xxxxx	xxxx	xxxxx	7.6	xxxx	xxxxx	xxxxx	xxxx	xxxxx
LOS by Move:	*	*	*	*	*	*	A	*	*	*	*	*
Movement:	LT - LTR - RT	LT - LTR - RT	LT - LTR - RT	LT - LTR - RT	LT - LTR - RT	LT - LTR - RT	LT - LTR - RT	LT - LTR - RT	LT - LTR - RT	LT - LTR - RT	LT - LTR - RT	LT - LTR - RT
Shared Cap.:	xxxx	xxxx	xxxxx	xxxx	709	xxxxx	xxxx	xxxx	xxxxx	xxxx	xxxx	xxxxx
SharedQueue:	xxxxx	xxxx	xxxxx	xxxxx	6.4	xxxxx	0.3	xxxx	xxxxx	xxxxx	xxxx	xxxxx
Shrd ConDel:	xxxxx	xxxx	xxxxx	xxxxx	22.6	xxxxx	7.6	xxxx	xxxxx	xxxxx	xxxx	xxxxx
Shared LOS:	*	*	*	*	C	*	A	*	*	*	*	*
ApproachDel:	xxxxxxx				22.6		xxxxxxx			xxxxxxx		
ApproachLOS:	*				C		*			*		*

Note: Queue reported is the number of cars per lane.

City of Morgan Hill
The Crosswinds Residential Development

Level Of Service Computation Report
2000 HCM Unsignalized (Future Volume Alternative)
Existing Plus Project PM

Intersection #3117: Mission View Drive and Half Road

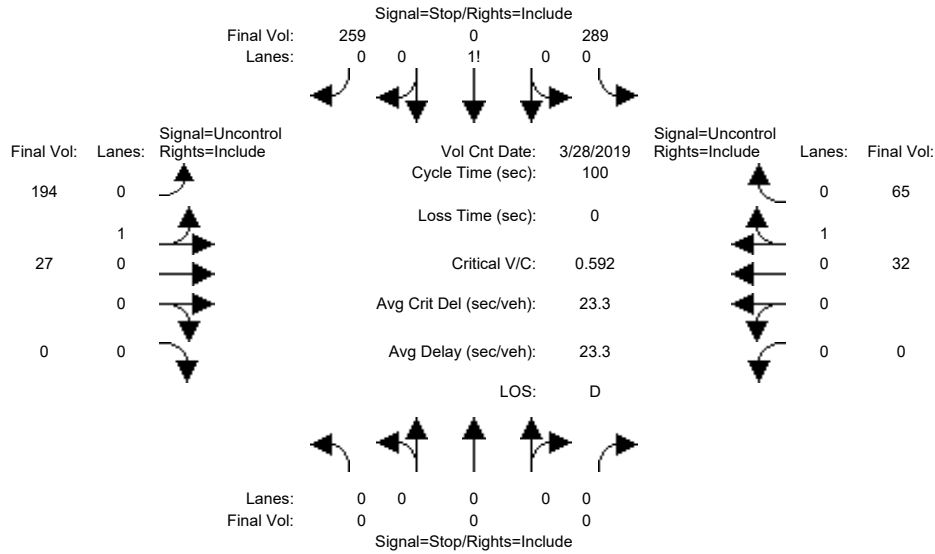

Street Name: Mission View Drive Half Road
 Approach: North Bound South Bound East Bound West Bound
 Movement: L - T - R L - T - R L - T - R L - T - R

Volume Module:	>>	Count	Date:	28 Mar 2019	<<												
Base Vol:	0	0	0	287	0	232	147	27	0	0	32	62					
Growth Adj:	1.00	1.00	1.00	1.00	1.00	1.00	1.00	1.00	1.00	1.00	1.00	1.00					
Initial Bse:	0	0	0	287	0	232	147	27	0	0	32	62					
Added Vol:	0	0	0	2	0	27	47	0	0	0	0	3					
PasserByVol:	0	0	0	0	0	0	0	0	0	0	0	0					
Initial Fut:	0	0	0	289	0	259	194	27	0	0	32	65					
User Adj:	1.00	1.00	1.00	1.00	1.00	1.00	1.00	1.00	1.00	1.00	1.00	1.00					
PHF Adj:	1.00	1.00	1.00	1.00	1.00	1.00	1.00	1.00	1.00	1.00	1.00	1.00					
PHF Volume:	0	0	0	289	0	259	194	27	0	0	32	65					
Reduct Vol:	0	0	0	0	0	0	0	0	0	0	0	0					
FinalVolume:	0	0	0	289	0	259	194	27	0	0	32	65					

Critical Gap Module:

Critical Gp:	xxxxx	xxxx	xxxxx	6.4	6.5	6.2	4.1	xxxx	xxxxx	xxxxx	xxxx	xxxxx				
FollowUpTim:	xxxxx	xxxx	xxxxx	3.5	4.0	3.3	2.2	xxxx	xxxxx	xxxxx	xxxx	xxxxx				

Capacity Module:

Cnflct Vol:	xxxx	xxxx	xxxxx	480	480	65	97	xxxx	xxxxx	xxxx	xxxx	xxxxx				
Potent Cap.:	xxxx	xxxx	xxxxx	549	488	1005	1509	xxxx	xxxxx	xxxx	xxxx	xxxxx				
Move Cap.:	xxxx	xxxx	xxxxx	488	418	1005	1509	xxxx	xxxxx	xxxx	xxxx	xxxxx				
Volume/Cap:	xxxx	xxxx	xxxx	0.59	0.00	0.26	0.13	xxxx	xxxx	xxxx	xxxx	xxxx				

Level Of Service Module:

2Way95thQ:	xxxx	xxxx	xxxxx	xxxx	xxxx	xxxxx	0.4	xxxx	xxxxx	xxxx	xxxx	xxxxx				
Control Del:	xxxxx	xxxx	xxxxx	xxxxx	xxxx	xxxxx	7.7	xxxx	xxxxx	xxxxx	xxxx	xxxxx				
LOS by Move:	*	*	*	*	*	*	A	*	*	*	*	*				
Movement:	LT - LTR - RT	LT - LTR - RT	LT - LTR - RT	LT - LTR - RT	LT - LTR - RT	LT - LTR - RT	LT - LTR - RT	LT - LTR - RT	LT - LTR - RT	LT - LTR - RT	LT - LTR - RT	LT - LTR - RT				
Shared Cap.:	xxxx	xxxx	xxxxx	xxxx	645	xxxxx	xxxx	xxxx	xxxxx	xxxx	xxxx	xxxxx				
SharedQueue:	xxxxx	xxxx	xxxxx	xxxxx	9.5	xxxxx	0.4	xxxx	xxxxx	xxxxx	xxxx	xxxxx				
Shrd ConDel:	xxxxx	xxxx	xxxxx	xxxxx	34.0	xxxxx	7.7	xxxx	xxxxx	xxxxx	xxxx	xxxxx				
Shared LOS:	*	*	*	*	D	*	A	*	*	*	*	*				
ApproachDel:	xxxxxxx			34.0			xxxxxxx			xxxxxxx						
ApproachLOS:	*			D			*			*		*				

Note: Queue reported is the number of cars per lane.

City of Morgan Hill
The Crosswinds Residential Development

Level Of Service Computation Report
2000 HCM 4-Way Stop (Future Volume Alternative)
Year 2030 Cumulative without Project PM

Intersection #3117: Mission View Drive and Half Road

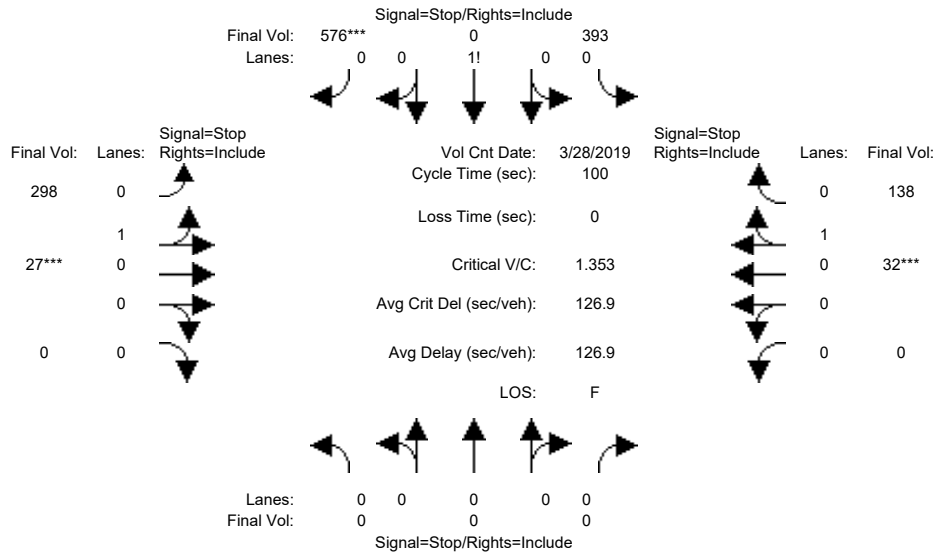

Street Name: Mission View Drive Half Road
 Approach: North Bound South Bound East Bound West Bound
 Movement: L - T - R L - T - R L - T - R L - T - R

Min. Green: 0 0 0 0 0 0 0 0 0 0 0 0

Volume Module: >> Count Date: 28 Mar 2019 <<

Base Vol:	0	0	0	393	0	576	298	27	0	0	32	138
Growth Adj:	1.00	1.00	1.00	1.00	1.00	1.00	1.00	1.00	1.00	1.00	1.00	1.00
Initial Bse:	0	0	0	393	0	576	298	27	0	0	32	138
Added Vol:	0	0	0	0	0	0	0	0	0	0	0	0
PasserByVol:	0	0	0	0	0	0	0	0	0	0	0	0
Initial Fut:	0	0	0	393	0	576	298	27	0	0	32	138
User Adj:	1.00	1.00	1.00	1.00	1.00	1.00	1.00	1.00	1.00	1.00	1.00	1.00
PHF Adj:	1.00	1.00	1.00	1.00	1.00	1.00	1.00	1.00	1.00	1.00	1.00	1.00
PHF Volume:	0	0	0	393	0	576	298	27	0	0	32	138
Reduct Vol:	0	0	0	0	0	0	0	0	0	0	0	0
Reduced Vol:	0	0	0	393	0	576	298	27	0	0	32	138
PCE Adj:	1.00	1.00	1.00	1.00	1.00	1.00	1.00	1.00	1.00	1.00	1.00	1.00
MLF Adj:	1.00	1.00	1.00	1.00	1.00	1.00	1.00	1.00	1.00	1.00	1.00	1.00
Final Volume:	0	0	0	393	0	576	298	27	0	0	32	138

Saturation Flow Module:

Adjustment:	1.00	1.00	1.00	1.00	1.00	1.00	1.00	1.00	1.00	1.00	1.00	1.00
Lanes:	0.00	0.00	0.00	0.41	0.00	0.59	0.92	0.08	0.00	0.00	0.19	0.81
Final Sat.:	0	0	0	291	0	426	527	48	0	0	114	490

Capacity Analysis Module:

Vol/Sat:	xxxx	xxxx	xxxx	1.35	xxxx	1.35	0.57	0.57	xxxx	xxxx	0.28	0.28
Crit Moves:						****		****			****	
Delay/Veh:	0.0	0.0	0.0	184.1	0.0	184.1	17.0	17.0	0.0	0.0	11.1	11.1
Delay Adj:	1.00	1.00	1.00	1.00	1.00	1.00	1.00	1.00	1.00	1.00	1.00	1.00
AdjDel/Veh:	0.0	0.0	0.0	184.1	0.0	184.1	17.0	17.0	0.0	0.0	11.1	11.1
LOS by Move:	*	*	*	F	*	F	C	C	*	*	B	B
ApproachDel:	xxxxxxx			184.1			17.0				11.1	
Delay Adj:	xxxxxx			1.00			1.00				1.00	
ApprAdjDel:	xxxxxxx			184.1			17.0				11.1	
LOS by Appr:	*			F			C				B	
AllWayAvgQ:	0.0	0.0	0.0	35.0	35.0	35.0	1.2	1.2	1.2	0.4	0.4	0.4

Note: Queue reported is the number of cars per lane.

City of Morgan Hill
The Crosswinds Residential Development

Level Of Service Computation Report
2000 HCM 4-Way Stop (Future Volume Alternative)
Year 2030 Cumulative with Project PM

Intersection #3117: Mission View Drive and Half Road

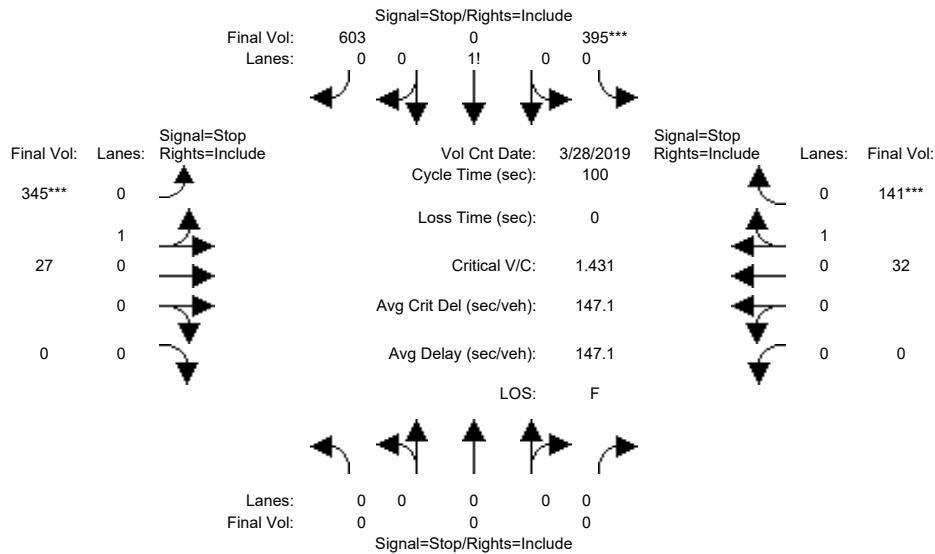

Street Name: Mission View Drive Half Road
Approach: North Bound South Bound East Bound West Bound
Movement: L - T - R L - T - R L - T - R L - T - R

Min. Green: 0 0 0 0 0 0 0 0 0 0 0 0

Volume Module: >> Count Date: 28 Mar 2019 <<

Base Vol:	0	0	0	393	0	576	298	27	0	0	32	138
Growth Adj:	1.00	1.00	1.00	1.00	1.00	1.00	1.00	1.00	1.00	1.00	1.00	1.00
Initial Bse:	0	0	0	393	0	576	298	27	0	0	32	138
Added Vol:	0	0	0	2	0	27	47	0	0	0	0	3
PasserByVol:	0	0	0	0	0	0	0	0	0	0	0	0
Initial Fut:	0	0	0	395	0	603	345	27	0	0	32	141
User Adj:	1.00	1.00	1.00	1.00	1.00	1.00	1.00	1.00	1.00	1.00	1.00	1.00
PHF Adj:	1.00	1.00	1.00	1.00	1.00	1.00	1.00	1.00	1.00	1.00	1.00	1.00
PHF Volume:	0	0	0	395	0	603	345	27	0	0	32	141
Reduct Vol:	0	0	0	0	0	0	0	0	0	0	0	0
Reduced Vol:	0	0	0	395	0	603	345	27	0	0	32	141
PCE Adj:	1.00	1.00	1.00	1.00	1.00	1.00	1.00	1.00	1.00	1.00	1.00	1.00
MLF Adj:	1.00	1.00	1.00	1.00	1.00	1.00	1.00	1.00	1.00	1.00	1.00	1.00
FinalVolume:	0	0	0	395	0	603	345	27	0	0	32	141

Saturation Flow Module:

Adjustment:	1.00	1.00	1.00	1.00	1.00	1.00	1.00	1.00	1.00	1.00	1.00	1.00
Lanes:	0.00	0.00	0.00	0.40	0.00	0.60	0.93	0.07	0.00	0.00	0.18	0.82
Final Sat.:	0	0	0	276	0	421	533	42	0	0	110	485

Capacity Analysis Module:

Vol/Sat:	xxxx	xxxx	xxxx	1.43	xxxx	1.43	0.65	0.65	xxxx	xxxx	0.29	0.29
Crit Moves:				****			****					****
Delay/Veh:	0.0	0.0	0.0	218.0	0.0	218.0	19.9	19.9	0.0	0.0	11.4	11.4
Delay Adj:	1.00	1.00	1.00	1.00	1.00	1.00	1.00	1.00	1.00	1.00	1.00	1.00
AdjDel/Veh:	0.0	0.0	0.0	218.0	0.0	218.0	19.9	19.9	0.0	0.0	11.4	11.4
LOS by Move:	*	*	*	F	*	F	C	C	*	*	B	B
ApproachDel:	xxxxxx			218.0			19.9				11.4	
Delay Adj:	xxxxxx			1.00			1.00				1.00	
ApprAdjDel:	xxxxxx			218.0			19.9				11.4	
LOS by Appr:	*			F			C				B	
AllWayAvgQ:	0.0	0.0	0.0	40.6	40.6	40.6	1.7	1.7	1.7	0.4	0.4	0.4

Note: Queue reported is the number of cars per lane.

City of Morgan Hill
The Crosswinds Residential Development

Level Of Service Computation Report
2000 HCM Operations (Future Volume Alternative)
Year 2030 Cumulative with Project PM (with Mitigations)

Intersection #3117: Mission View Drive and Half Road

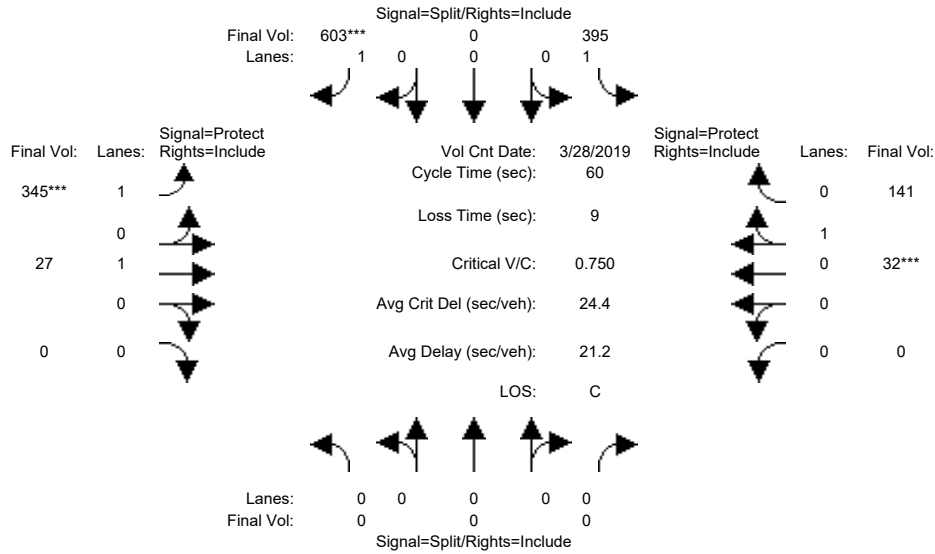

Street Name:	Mission View Drive						Half Road					
Approach:	North Bound			South Bound			East Bound			West Bound		
Movement:	L	T	R	L	T	R	L	T	R	L	T	R
Min. Green:	0	0	0	10	0	10	7	10	0	0	10	10
Y+R:	4.0	4.0	4.0	4.0	4.0	4.0	4.0	4.0	4.0	4.0	4.0	4.0

Volume Module:	>>	Count	Date:	28 Mar 2019	<<							
Base Vol:	0	0	0	393	0	576	298	27	0	0	32	138
Growth Adj:	1.00	1.00	1.00	1.00	1.00	1.00	1.00	1.00	1.00	1.00	1.00	1.00
Initial Bse:	0	0	0	393	0	576	298	27	0	0	32	138
Added Vol:	0	0	0	2	0	27	47	0	0	0	0	3
PasserByVol:	0	0	0	0	0	0	0	0	0	0	0	0
Initial Fut:	0	0	0	395	0	603	345	27	0	0	32	141
User Adj:	1.00	1.00	1.00	1.00	1.00	1.00	1.00	1.00	1.00	1.00	1.00	1.00
PHF Adj:	1.00	1.00	1.00	1.00	1.00	1.00	1.00	1.00	1.00	1.00	1.00	1.00
PHF Volume:	0	0	0	395	0	603	345	27	0	0	32	141
Reduct Vol:	0	0	0	0	0	0	0	0	0	0	0	0
Reduced Vol:	0	0	0	395	0	603	345	27	0	0	32	141
PCE Adj:	1.00	1.00	1.00	1.00	1.00	1.00	1.00	1.00	1.00	1.00	1.00	1.00
MLF Adj:	1.00	1.00	1.00	1.00	1.00	1.00	1.00	1.00	1.00	1.00	1.00	1.00
Final Volume:	0	0	0	395	0	603	345	27	0	0	32	141

Saturation Flow Module:												
Sat/Lane:	1900	1900	1900	1900	1900	1900	1900	1900	1900	1900	1900	1900
Adjustment:	0.92	1.00	0.92	0.92	1.00	0.92	0.92	1.00	0.92	0.92	0.95	0.95
Lanes:	0.00	0.00	0.00	1.00	0.00	1.00	1.00	1.00	0.00	0.00	0.18	0.82
Final Sat.:	0	0	0	1750	0	1750	1750	1900	0	0	333	1467

Capacity Analysis Module:												
Vol/Sat:	0.00	0.00	0.00	0.23	0.00	0.34	0.20	0.01	0.00	0.00	0.10	0.10
Crit Moves:						****	****				****	
Green Time:	0.0	0.0	0.0	26.1	0.0	26.1	14.9	24.9	0.0	0.0	10.0	10.0
Volume/Cap:	0.00	0.00	0.00	0.52	0.00	0.79	0.79	0.03	0.00	0.00	0.58	0.58
Delay/Veh:	0.0	0.0	0.0	13.0	0.0	20.3	30.7	10.4	0.0	0.0	25.8	25.8
User DelAdj:	1.00	1.00	1.00	1.00	1.00	1.00	1.00	1.00	1.00	1.00	1.00	1.00
AdjDel/Veh:	0.0	0.0	0.0	13.0	0.0	20.3	30.7	10.4	0.0	0.0	25.8	25.8
LOS by Move:	A	A	A	B	A	C	C	B	A	A	C	C
HCM2k95thQ:	0	0	0	12	0	23	17	1	0	0	8	8

Note: Queue reported is the number of cars per lane.

City of Morgan Hill
The Crosswinds Residential Development

Level Of Service Computation Report
2000 HCM Operations (Future Volume Alternative)
Existing AM

Intersection #120: Condit Road and Main Avenue

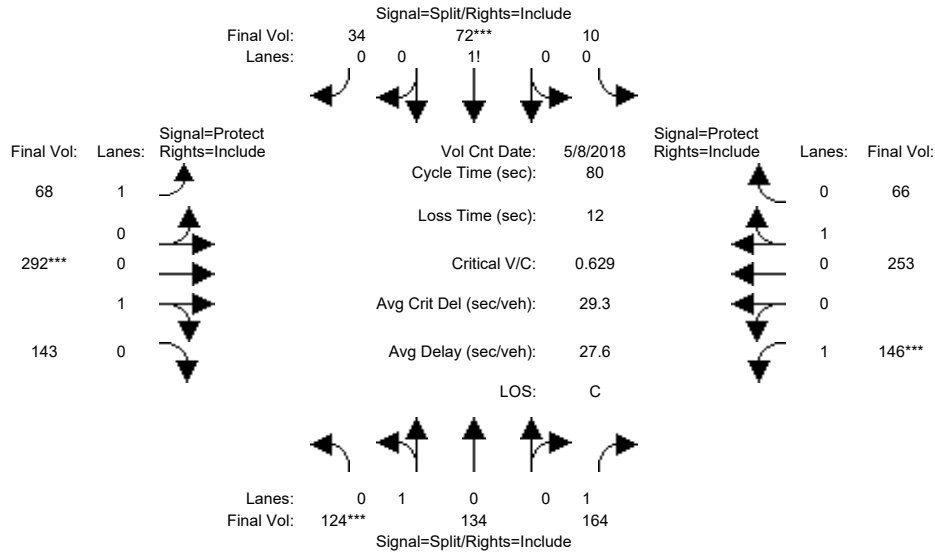

Street Name:	Condit Road						Main Avenue					
	North Bound			South Bound			East Bound			West Bound		
Approach:	L	T	R	L	T	R	L	T	R	L	T	R
Min. Green:	10	10	10	10	10	10	7	10	10	7	10	10
Y+R:	4.0	4.0	4.0	4.0	4.0	4.0	4.0	4.0	4.0	4.0	4.0	4.0

Volume Module:	>>	Count	Date:	8 May 2018	<<							
Base Vol:	124	134	164	10	72	34	68	292	143	146	253	66
Growth Adj:	1.00	1.00	1.00	1.00	1.00	1.00	1.00	1.00	1.00	1.00	1.00	1.00
Initial Bse:	124	134	164	10	72	34	68	292	143	146	253	66
Added Vol:	0	0	0	0	0	0	0	0	0	0	0	0
PasserByVol:	0	0	0	0	0	0	0	0	0	0	0	0
Initial Fut:	124	134	164	10	72	34	68	292	143	146	253	66
User Adj:	1.00	1.00	1.00	1.00	1.00	1.00	1.00	1.00	1.00	1.00	1.00	1.00
PHF Adj:	1.00	1.00	1.00	1.00	1.00	1.00	1.00	1.00	1.00	1.00	1.00	1.00
PHF Volume:	124	134	164	10	72	34	68	292	143	146	253	66
Reduct Vol:	0	0	0	0	0	0	0	0	0	0	0	0
Reduced Vol:	124	134	164	10	72	34	68	292	143	146	253	66
PCE Adj:	1.00	1.00	1.00	1.00	1.00	1.00	1.00	1.00	1.00	1.00	1.00	1.00
MLF Adj:	1.00	1.00	1.00	1.00	1.00	1.00	1.00	1.00	1.00	1.00	1.00	1.00
Final Volume:	124	134	164	10	72	34	68	292	143	146	253	66

Saturation Flow Module:												
Sat/Lane:	1900	1900	1900	1900	1900	1900	1900	1900	1900	1900	1900	1900
Adjustment:	0.95	0.95	0.92	0.92	0.92	0.92	0.92	0.95	0.95	0.92	0.95	0.95
Lanes:	0.48	0.52	1.00	0.09	0.62	0.29	1.00	0.67	0.33	1.00	0.79	0.21
Final Sat.:	865	935	1750	151	1086	513	1750	1208	592	1750	1428	372

Capacity Analysis Module:												
Vol/Sat:	0.14	0.14	0.09	0.07	0.07	0.07	0.04	0.24	0.24	0.08	0.18	0.18
Crit Moves:	***				***			***		***		
Green Time:	17.7	17.7	17.7	10.0	10.0	10.0	13.3	29.9	29.9	10.3	26.9	26.9
Volume/Cap:	0.65	0.65	0.42	0.53	0.53	0.53	0.23	0.65	0.65	0.65	0.53	0.53
Delay/Veh:	31.9	31.9	27.5	35.3	35.3	35.3	29.3	22.9	22.9	39.4	22.2	22.2
User DelAdj:	1.00	1.00	1.00	1.00	1.00	1.00	1.00	1.00	1.00	1.00	1.00	1.00
AdjDel/Veh:	31.9	31.9	27.5	35.3	35.3	35.3	29.3	22.9	22.9	39.4	22.2	22.2
LOS by Move:	C	C	C	D	D	D	C	C	C	D	C	C
HCM2k95thQ:	14	14	8	7	7	7	4	19	19	10	14	14

Note: Queue reported is the number of cars per lane.

City of Morgan Hill
The Crosswinds Residential Development

Level Of Service Computation Report
2000 HCM Operations (Future Volume Alternative)
Existing Plus Project AM

Intersection #120: Condit Road and Main Avenue

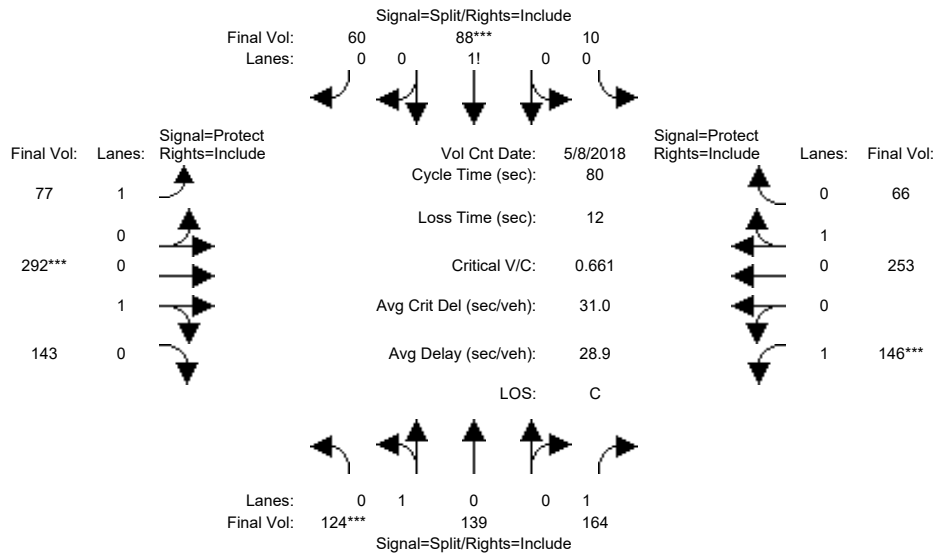

Street Name:	Condit Road						Main Avenue					
Approach:	North Bound			South Bound			East Bound			West Bound		
Movement:	L	T	R	L	T	R	L	T	R	L	T	R
Min. Green:	10	10	10	10	10	10	7	10	10	7	10	10
Y+R:	4.0	4.0	4.0	4.0	4.0	4.0	4.0	4.0	4.0	4.0	4.0	4.0

Volume Module:	>>	Count	Date:	8 May 2018	<<												
Base Vol:	124	134	164	10	72	34	68	292	143	146	253	66					
Growth Adj:	1.00	1.00	1.00	1.00	1.00	1.00	1.00	1.00	1.00	1.00	1.00	1.00					
Initial Bse:	124	134	164	10	72	34	68	292	143	146	253	66					
Added Vol:	0	5	0	0	16	26	9	0	0	0	0	0					
PasserByVol:	0	0	0	0	0	0	0	0	0	0	0	0					
Initial Fut:	124	139	164	10	88	60	77	292	143	146	253	66					
User Adj:	1.00	1.00	1.00	1.00	1.00	1.00	1.00	1.00	1.00	1.00	1.00	1.00					
PHF Adj:	1.00	1.00	1.00	1.00	1.00	1.00	1.00	1.00	1.00	1.00	1.00	1.00					
PHF Volume:	124	139	164	10	88	60	77	292	143	146	253	66					
Reduct Vol:	0	0	0	0	0	0	0	0	0	0	0	0					
Reduced Vol:	124	139	164	10	88	60	77	292	143	146	253	66					
PCE Adj:	1.00	1.00	1.00	1.00	1.00	1.00	1.00	1.00	1.00	1.00	1.00	1.00					
MLF Adj:	1.00	1.00	1.00	1.00	1.00	1.00	1.00	1.00	1.00	1.00	1.00	1.00					
Final Volume:	124	139	164	10	88	60	77	292	143	146	253	66					

Saturation Flow Module:												
Sat/Lane:	1900	1900	1900	1900	1900	1900	1900	1900	1900	1900	1900	1900
Adjustment:	0.95	0.95	0.92	0.92	0.92	0.92	0.92	0.95	0.95	0.92	0.95	0.95
Lanes:	0.47	0.53	1.00	0.06	0.56	0.38	1.00	0.67	0.33	1.00	0.79	0.21
Final Sat.:	849	951	1750	111	975	665	1750	1208	592	1750	1428	372

Capacity Analysis Module:												
Vol/Sat:	0.15	0.15	0.09	0.09	0.09	0.09	0.04	0.24	0.24	0.08	0.18	0.18
Crit Moves:	***				***			***		***		
Green Time:	17.7	17.7	17.7	10.9	10.9	10.9	13.0	29.3	29.3	10.1	26.4	26.4
Volume/Cap:	0.66	0.66	0.42	0.66	0.66	0.66	0.27	0.66	0.66	0.66	0.54	0.54
Delay/Veh:	32.5	32.5	27.5	39.5	39.5	39.5	29.9	23.7	23.7	40.5	22.8	22.8
User DelAdj:	1.00	1.00	1.00	1.00	1.00	1.00	1.00	1.00	1.00	1.00	1.00	1.00
AdjDel/Veh:	32.5	32.5	27.5	39.5	39.5	39.5	29.9	23.7	23.7	40.5	22.8	22.8
LOS by Move:	C	C	C	C	D	D	C	C	C	D	C	C
HCM2k95thQ:	14	14	8	10	10	10	4	19	19	10	14	14

Note: Queue reported is the number of cars per lane.

City of Morgan Hill
The Crosswinds Residential Development

Level Of Service Computation Report
2000 HCM Operations (Future Volume Alternative)
Year 2030 Cumulative without Project AM

Intersection #120: Condit Road and Main Avenue

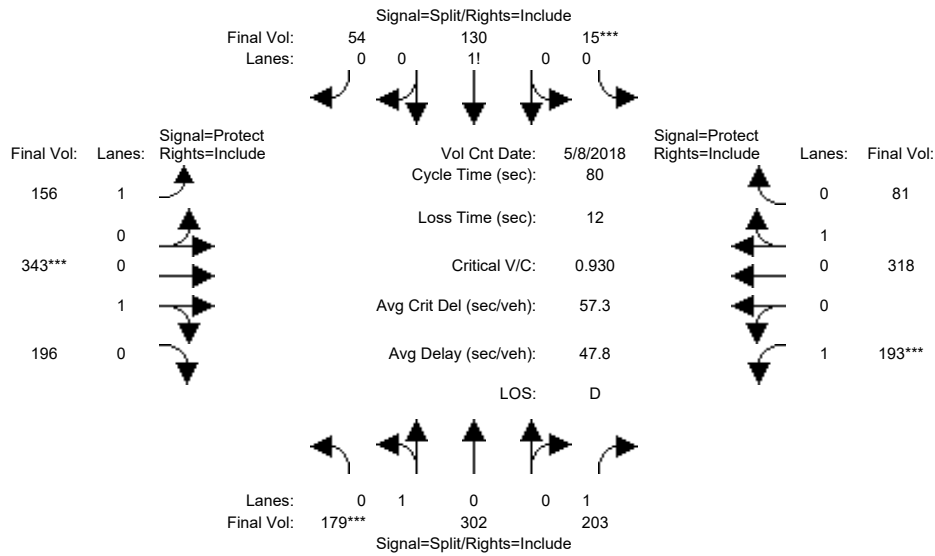

Street Name:	Condit Road						Main Avenue					
Approach:	North Bound			South Bound			East Bound			West Bound		
Movement:	L	T	R	L	T	R	L	T	R	L	T	R
Min. Green:	10	10	10	10	10	10	7	10	10	7	10	10
Y+R:	4.0	4.0	4.0	4.0	4.0	4.0	4.0	4.0	4.0	4.0	4.0	4.0

Volume Module:	>>	Count	Date:	8 May 2018	<<							
Base Vol:	179	302	203	15	130	54	156	343	196	193	318	81
Growth Adj:	1.00	1.00	1.00	1.00	1.00	1.00	1.00	1.00	1.00	1.00	1.00	1.00
Initial Bse:	179	302	203	15	130	54	156	343	196	193	318	81
Added Vol:	0	0	0	0	0	0	0	0	0	0	0	0
PasserByVol:	0	0	0	0	0	0	0	0	0	0	0	0
Initial Fut:	179	302	203	15	130	54	156	343	196	193	318	81
User Adj:	1.00	1.00	1.00	1.00	1.00	1.00	1.00	1.00	1.00	1.00	1.00	1.00
PHF Adj:	1.00	1.00	1.00	1.00	1.00	1.00	1.00	1.00	1.00	1.00	1.00	1.00
PHF Volume:	179	302	203	15	130	54	156	343	196	193	318	81
Reduct Vol:	0	0	0	0	0	0	0	0	0	0	0	0
Reduced Vol:	179	302	203	15	130	54	156	343	196	193	318	81
PCE Adj:	1.00	1.00	1.00	1.00	1.00	1.00	1.00	1.00	1.00	1.00	1.00	1.00
MLF Adj:	1.00	1.00	1.00	1.00	1.00	1.00	1.00	1.00	1.00	1.00	1.00	1.00
Final Volume:	179	302	203	15	130	54	156	343	196	193	318	81

Saturation Flow Module:	
Sat/Lane:	1900 1900 1900 1900 1900 1900 1900 1900 1900 1900 1900 1900
Adjustment:	0.95 0.95 0.92 0.92 0.92 0.92 0.92 0.95 0.95 0.92 0.95 0.95
Lanes:	0.37 0.63 1.00 0.08 0.65 0.27 1.00 0.64 0.36 1.00 0.80 0.20
Final Sat.:	670 1130 1750 132 1143 475 1750 1145 655 1750 1435 365

Capacity Analysis Module:	
Vol/Sat:	0.27 0.27 0.12 0.11 0.11 0.11 0.09 0.30 0.30 0.11 0.22 0.22
Crit Moves:	**** ****
Green Time:	22.9 22.9 22.9 10.0 10.0 10.0 10.1 25.7 25.7 9.4 25.0 25.0
Volume/Cap:	0.93 0.93 0.41 0.91 0.91 0.91 0.71 0.93 0.93 0.93 0.71 0.71
Delay/Veh:	52.1 52.1 23.6 71.6 71.6 71.6 43.7 48.8 48.8 79.2 28.4 28.4
User DelAdj:	1.00 1.00 1.00 1.00 1.00 1.00 1.00 1.00 1.00 1.00 1.00 1.00
AdjDel/Veh:	52.1 52.1 23.6 71.6 71.6 71.6 43.7 48.8 48.8 79.2 28.4 28.4
LOS by Move:	D D C E E E D D D E C C
HCM2k95thQ:	29 29 9 16 16 16 11 32 32 17 19 19

Note: Queue reported is the number of cars per lane.

City of Morgan Hill
The Crosswinds Residential Development

Level Of Service Computation Report
2000 HCM Operations (Future Volume Alternative)
Year 2030 Cumulative with Project AM

Intersection #120: Condit Road and Main Avenue

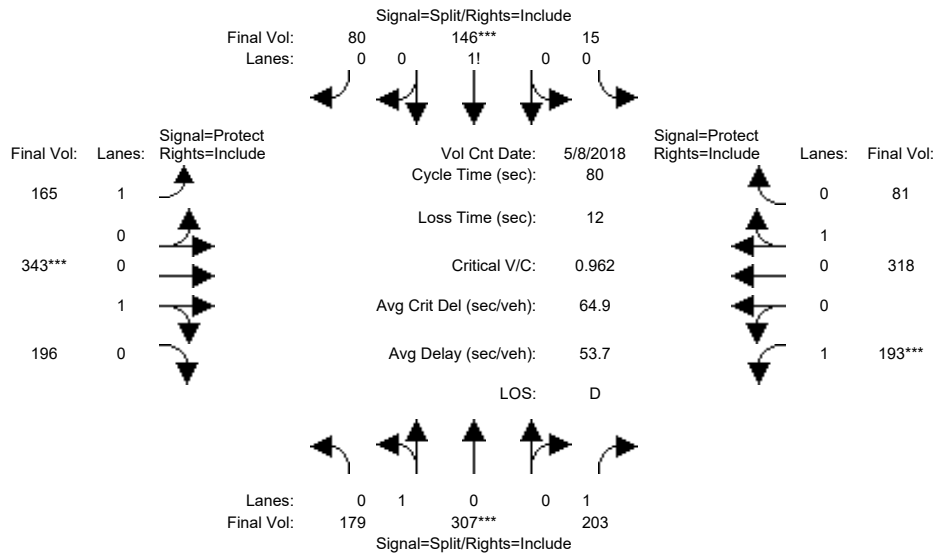

Street Name:	Condit Road						Main Avenue					
	North Bound			South Bound			East Bound			West Bound		
Approach:	L	T	R	L	T	R	L	T	R	L	T	R
Min. Green:	10	10	10	10	10	10	7	10	10	7	10	10
Y+R:	4.0	4.0	4.0	4.0	4.0	4.0	4.0	4.0	4.0	4.0	4.0	4.0

Volume Module:	>>	Count	Date:	8 May 2018	<<							
Base Vol:	179	302	203	15	130	54	156	343	196	193	318	81
Growth Adj:	1.00	1.00	1.00	1.00	1.00	1.00	1.00	1.00	1.00	1.00	1.00	1.00
Initial Bse:	179	302	203	15	130	54	156	343	196	193	318	81
Added Vol:	0	5	0	0	16	26	9	0	0	0	0	0
PasserByVol:	0	0	0	0	0	0	0	0	0	0	0	0
Initial Fut:	179	307	203	15	146	80	165	343	196	193	318	81
User Adj:	1.00	1.00	1.00	1.00	1.00	1.00	1.00	1.00	1.00	1.00	1.00	1.00
PHF Adj:	1.00	1.00	1.00	1.00	1.00	1.00	1.00	1.00	1.00	1.00	1.00	1.00
PHF Volume:	179	307	203	15	146	80	165	343	196	193	318	81
Reduct Vol:	0	0	0	0	0	0	0	0	0	0	0	0
Reduced Vol:	179	307	203	15	146	80	165	343	196	193	318	81
PCE Adj:	1.00	1.00	1.00	1.00	1.00	1.00	1.00	1.00	1.00	1.00	1.00	1.00
MLF Adj:	1.00	1.00	1.00	1.00	1.00	1.00	1.00	1.00	1.00	1.00	1.00	1.00
Final Volume:	179	307	203	15	146	80	165	343	196	193	318	81

Saturation Flow Module:												
Sat/Lane:	1900	1900	1900	1900	1900	1900	1900	1900	1900	1900	1900	1900
Adjustment:	0.95	0.95	0.92	0.92	0.92	0.92	0.92	0.95	0.95	0.92	0.95	0.95
Lanes:	0.37	0.63	1.00	0.06	0.61	0.33	1.00	0.64	0.36	1.00	0.80	0.20
Final Sat.:	663	1137	1750	109	1060	581	1750	1145	655	1750	1435	365

Capacity Analysis Module:												
Vol/Sat:	0.27	0.27	0.12	0.14	0.14	0.14	0.09	0.30	0.30	0.11	0.22	0.22
Crit Moves:	****			****			****			****		
Green Time:	22.5	22.5	22.5	11.5	11.5	11.5	10.2	24.9	24.9	9.2	23.9	23.9
Volume/Cap:	0.96	0.96	0.41	0.96	0.96	0.96	0.74	0.96	0.96	0.96	0.74	0.74
Delay/Veh:	58.7	58.7	24.0	80.1	80.1	80.1	46.2	55.6	55.6	87.6	30.7	30.7
User DelAdj:	1.00	1.00	1.00	1.00	1.00	1.00	1.00	1.00	1.00	1.00	1.00	1.00
AdjDel/Veh:	58.7	58.7	24.0	80.1	80.1	80.1	46.2	55.6	55.6	87.6	30.7	30.7
LOS by Move:	E	E	C	F	F	F	D	E	E	F	C	C
HCM2k95thQ:	31	31	9	20	20	20	12	33	33	17	20	20

Note: Queue reported is the number of cars per lane.

City of Morgan Hill
The Crosswinds Residential Development

Level Of Service Computation Report
2000 HCM Operations (Future Volume Alternative)
Existing PM

Intersection #120: Condit Road and Main Avenue

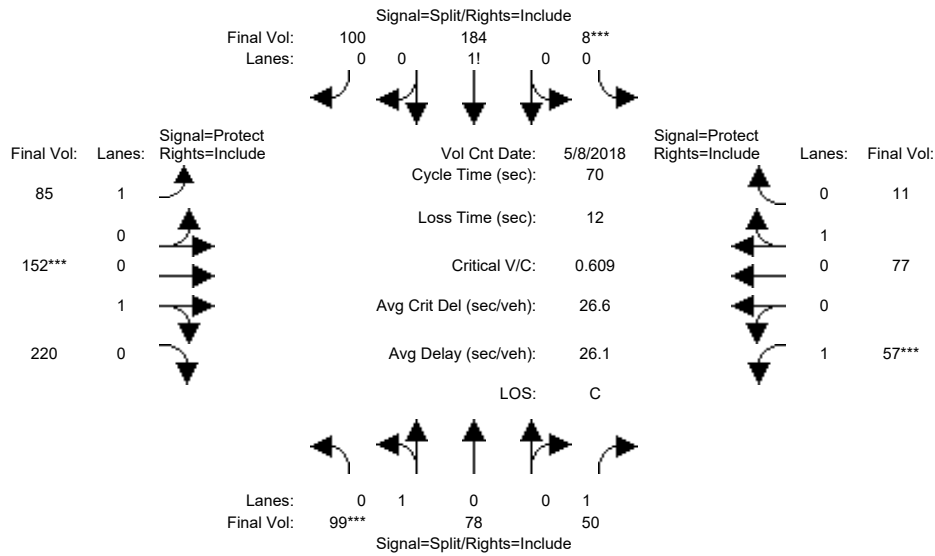

Street Name:	Condit Road						Main Avenue					
Approach:	North Bound			South Bound			East Bound			West Bound		
Movement:	L	T	R	L	T	R	L	T	R	L	T	R
Min. Green:	10	10	10	10	10	10	7	10	10	7	10	10
Y+R:	4.0	4.0	4.0	4.0	4.0	4.0	4.0	4.0	4.0	4.0	4.0	4.0

Volume Module:	>>	Count	Date:	8 May 2018	<<											
Base Vol:	99	78	50	8	184	100	85	152	220	57	77	11				
Growth Adj:	1.00	1.00	1.00	1.00	1.00	1.00	1.00	1.00	1.00	1.00	1.00	1.00				
Initial Bse:	99	78	50	8	184	100	85	152	220	57	77	11				
Added Vol:	0	0	0	0	0	0	0	0	0	0	0	0				
PasserByVol:	0	0	0	0	0	0	0	0	0	0	0	0				
Initial Fut:	99	78	50	8	184	100	85	152	220	57	77	11				
User Adj:	1.00	1.00	1.00	1.00	1.00	1.00	1.00	1.00	1.00	1.00	1.00	1.00				
PHF Adj:	1.00	1.00	1.00	1.00	1.00	1.00	1.00	1.00	1.00	1.00	1.00	1.00				
PHF Volume:	99	78	50	8	184	100	85	152	220	57	77	11				
Reduct Vol:	0	0	0	0	0	0	0	0	0	0	0	0				
Reduced Vol:	99	78	50	8	184	100	85	152	220	57	77	11				
PCE Adj:	1.00	1.00	1.00	1.00	1.00	1.00	1.00	1.00	1.00	1.00	1.00	1.00				
MLF Adj:	1.00	1.00	1.00	1.00	1.00	1.00	1.00	1.00	1.00	1.00	1.00	1.00				
Final Volume:	99	78	50	8	184	100	85	152	220	57	77	11				

Saturation Flow Module:												
Sat/Lane:	1900	1900	1900	1900	1900	1900	1900	1900	1900	1900	1900	1900
Adjustment:	0.95	0.95	0.92	0.92	0.92	0.92	0.92	0.95	0.95	0.92	0.95	0.95
Lanes:	0.56	0.44	1.00	0.03	0.63	0.34	1.00	0.41	0.59	1.00	0.87	0.13
Final Sat.:	1007	793	1750	48	1103	599	1750	735	1065	1750	1575	225

Capacity Analysis Module:												
Vol/Sat:	0.10	0.10	0.03	0.17	0.17	0.17	0.05	0.21	0.21	0.03	0.05	0.05
Crit Moves:	****			****			****			****		
Green Time:	10.6	10.6	10.6	18.0	18.0	18.0	12.1	22.3	22.3	7.0	17.3	17.3
Volume/Cap:	0.65	0.65	0.19	0.65	0.65	0.65	0.28	0.65	0.65	0.33	0.20	0.20
Delay/Veh:	33.3	33.3	26.3	26.4	26.4	26.4	25.7	23.0	23.0	30.4	21.1	21.1
User DelAdj:	1.00	1.00	1.00	1.00	1.00	1.00	1.00	1.00	1.00	1.00	1.00	1.00
AdjDel/Veh:	33.3	33.3	26.3	26.4	26.4	26.4	25.7	23.0	23.0	30.4	21.1	21.1
LOS by Move:	C	C	C	C	C	C	C	C	C	C	C	C
HCM2k95thQ:	10	10	2	14	14	14	4	16	16	3	3	3

Note: Queue reported is the number of cars per lane.

City of Morgan Hill
The Crosswinds Residential Development

Level Of Service Computation Report
2000 HCM Operations (Future Volume Alternative)
Existing Plus Project PM

Intersection #120: Condit Road and Main Avenue

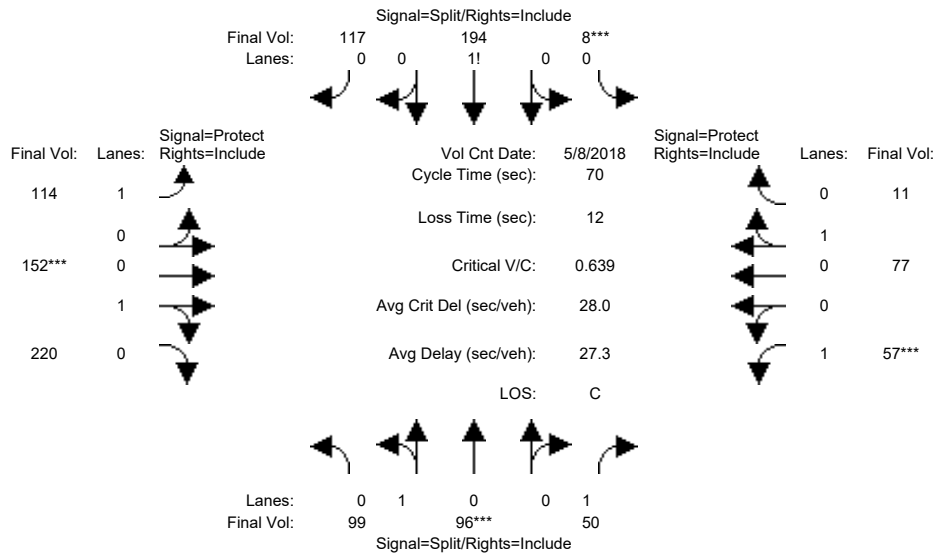

Street Name:	Condit Road						Main Avenue					
	North Bound			South Bound			East Bound			West Bound		
Approach:	L	T	R	L	T	R	L	T	R	L	T	R
Min. Green:	10	10	10	10	10	10	7	10	10	7	10	10
Y+R:	4.0	4.0	4.0	4.0	4.0	4.0	4.0	4.0	4.0	4.0	4.0	4.0

Volume Module:	>>	Count	Date:	8 May 2018	<<							
Base Vol:	99	78	50	8	184	100	85	152	220	57	77	11
Growth Adj:	1.00	1.00	1.00	1.00	1.00	1.00	1.00	1.00	1.00	1.00	1.00	1.00
Initial Bse:	99	78	50	8	184	100	85	152	220	57	77	11
Added Vol:	0	18	0	0	10	17	29	0	0	0	0	0
PasserByVol:	0	0	0	0	0	0	0	0	0	0	0	0
Initial Fut:	99	96	50	8	194	117	114	152	220	57	77	11
User Adj:	1.00	1.00	1.00	1.00	1.00	1.00	1.00	1.00	1.00	1.00	1.00	1.00
PHF Adj:	1.00	1.00	1.00	1.00	1.00	1.00	1.00	1.00	1.00	1.00	1.00	1.00
PHF Volume:	99	96	50	8	194	117	114	152	220	57	77	11
Reduct Vol:	0	0	0	0	0	0	0	0	0	0	0	0
Reduced Vol:	99	96	50	8	194	117	114	152	220	57	77	11
PCE Adj:	1.00	1.00	1.00	1.00	1.00	1.00	1.00	1.00	1.00	1.00	1.00	1.00
MLF Adj:	1.00	1.00	1.00	1.00	1.00	1.00	1.00	1.00	1.00	1.00	1.00	1.00
Final Volume:	99	96	50	8	194	117	114	152	220	57	77	11

Saturation Flow Module:												
Sat/Lane:	1900	1900	1900	1900	1900	1900	1900	1900	1900	1900	1900	1900
Adjustment:	0.95	0.95	0.92	0.92	0.92	0.92	0.92	0.95	0.95	0.92	0.95	0.95
Lanes:	0.51	0.49	1.00	0.02	0.61	0.37	1.00	0.41	0.59	1.00	0.87	0.13
Final Sat.:	914	886	1750	44	1064	642	1750	735	1065	1750	1575	225

Capacity Analysis Module:												
Vol/Sat:	0.11	0.11	0.03	0.18	0.18	0.18	0.07	0.21	0.21	0.03	0.05	0.05
Crit Moves:	****			****			****			****		
Green Time:	11.1	11.1	11.1	18.7	18.7	18.7	11.6	21.2	21.2	7.0	16.6	16.6
Volume/Cap:	0.68	0.68	0.18	0.68	0.68	0.68	0.39	0.68	0.68	0.33	0.21	0.21
Delay/Veh:	34.4	34.4	25.8	27.1	27.1	27.1	26.9	25.0	25.0	30.4	21.7	21.7
User DelAdj:	1.00	1.00	1.00	1.00	1.00	1.00	1.00	1.00	1.00	1.00	1.00	1.00
AdjDel/Veh:	34.4	34.4	25.8	27.1	27.1	27.1	26.9	25.0	25.0	30.4	21.7	21.7
LOS by Move:	C	C	C	C	C	C	C	C	C	C	C	C
HCM2k95thQ:	11	11	2	15	15	15	6	16	16	3	3	3

Note: Queue reported is the number of cars per lane.

City of Morgan Hill
The Crosswinds Residential Development

Level Of Service Computation Report
2000 HCM Operations (Future Volume Alternative)
Year 2030 Cumulative without Project PM

Intersection #120: Condit Road and Main Avenue

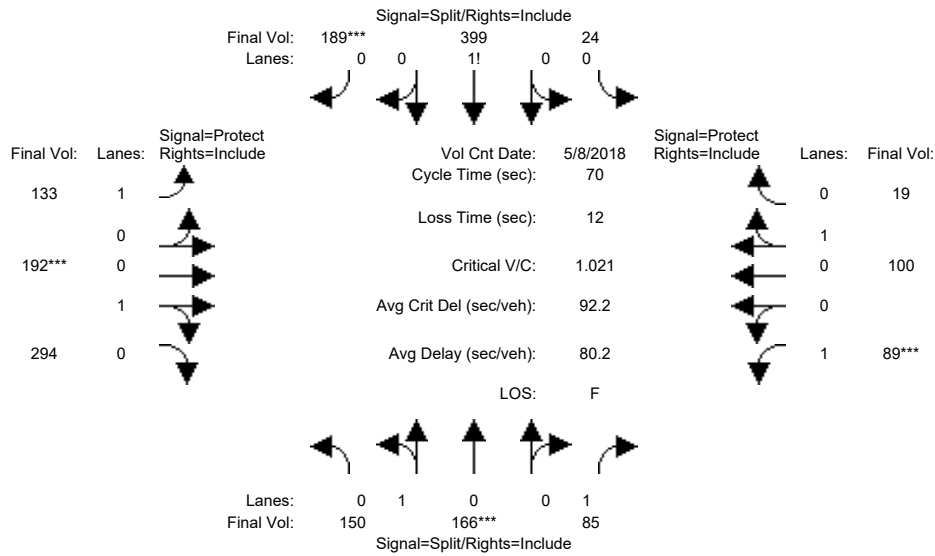

Street Name:	Condit Road						Main Avenue					
	North Bound			South Bound			East Bound			West Bound		
Approach:	North Bound			South Bound			East Bound			West Bound		
Movement:	L	T	R	L	T	R	L	T	R	L	T	R
Min. Green:	10	10	10	10	10	10	7	10	10	7	10	10
Y+R:	4.0	4.0	4.0	4.0	4.0	4.0	4.0	4.0	4.0	4.0	4.0	4.0

Volume Module:	>>	Count	Date:	8 May 2018	<<							
Base Vol:	150	166	85	24	399	189	133	192	294	89	100	19
Growth Adj:	1.00	1.00	1.00	1.00	1.00	1.00	1.00	1.00	1.00	1.00	1.00	1.00
Initial Bse:	150	166	85	24	399	189	133	192	294	89	100	19
Added Vol:	0	0	0	0	0	0	0	0	0	0	0	0
PasserByVol:	0	0	0	0	0	0	0	0	0	0	0	0
Initial Fut:	150	166	85	24	399	189	133	192	294	89	100	19
User Adj:	1.00	1.00	1.00	1.00	1.00	1.00	1.00	1.00	1.00	1.00	1.00	1.00
PHF Adj:	1.00	1.00	1.00	1.00	1.00	1.00	1.00	1.00	1.00	1.00	1.00	1.00
PHF Volume:	150	166	85	24	399	189	133	192	294	89	100	19
Reduct Vol:	0	0	0	0	0	0	0	0	0	0	0	0
Reduced Vol:	150	166	85	24	399	189	133	192	294	89	100	19
PCE Adj:	1.00	1.00	1.00	1.00	1.00	1.00	1.00	1.00	1.00	1.00	1.00	1.00
MLF Adj:	1.00	1.00	1.00	1.00	1.00	1.00	1.00	1.00	1.00	1.00	1.00	1.00
Final Volume:	150	166	85	24	399	189	133	192	294	89	100	19

Saturation Flow Module:												
Sat/Lane:	1900	1900	1900	1900	1900	1900	1900	1900	1900	1900	1900	1900
Adjustment:	0.95	0.95	0.92	0.92	0.92	0.92	0.92	0.95	0.95	0.92	0.95	0.95
Lanes:	0.47	0.53	1.00	0.04	0.65	0.31	1.00	0.40	0.60	1.00	0.84	0.16
Final Sat.:	854	946	1750	69	1141	540	1750	711	1089	1750	1513	287

Capacity Analysis Module:												
Vol/Sat:	0.18	0.18	0.05	0.35	0.35	0.35	0.08	0.27	0.27	0.05	0.07	0.07
Crit Moves:	****			****			****			****		
Green Time:	11.3	11.3	11.3	22.4	22.4	22.4	10.0	17.3	17.3	7.0	14.3	14.3
Volume/Cap:	1.09	1.09	0.30	1.09	1.09	1.09	0.53	1.09	1.09	0.51	0.32	0.32
Delay/Veh:	108.9	109	26.5	89.1	89.1	89.1	30.0	96.0	96.0	32.3	24.2	24.2
User DelAdj:	1.00	1.00	1.00	1.00	1.00	1.00	1.00	1.00	1.00	1.00	1.00	1.00
AdjDel/Veh:	108.9	109	26.5	89.1	89.1	89.1	30.0	96.0	96.0	32.3	24.2	24.2
LOS by Move:	F	F	C	F	F	F	C	F	F	C	C	C
HCM2k95thQ:	26	26	4	43	43	43	7	36	36	6	5	5

Note: Queue reported is the number of cars per lane.

City of Morgan Hill
The Crosswinds Residential Development

Level Of Service Computation Report
2000 HCM Operations (Future Volume Alternative)
Year 2030 Cumulative with Project PM

Intersection #120: Condit Road and Main Avenue

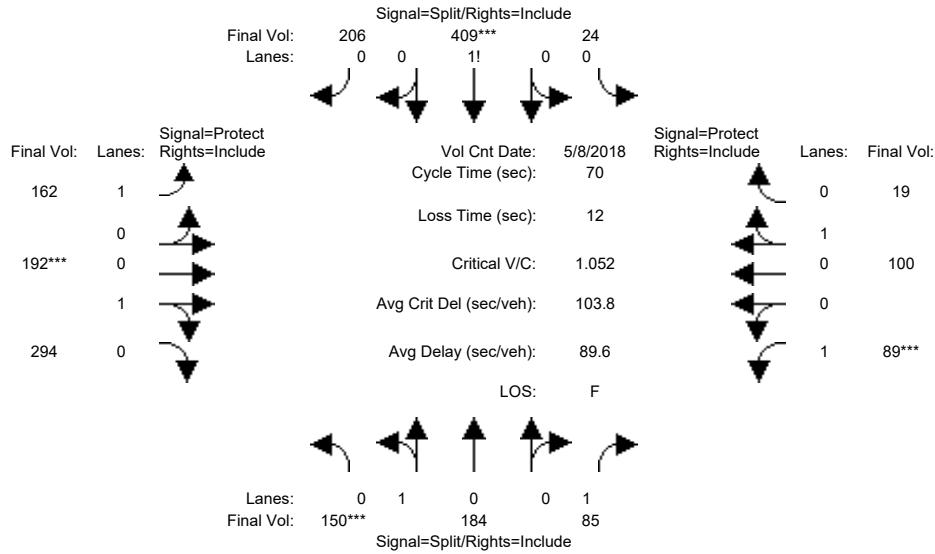

Street Name:	Condit Road						Main Avenue					
	North Bound			South Bound			East Bound			West Bound		
Approach:	L	T	R	L	T	R	L	T	R	L	T	R
Min. Green:	10	10	10	10	10	10	7	10	10	7	10	10
Y+R:	4.0	4.0	4.0	4.0	4.0	4.0	4.0	4.0	4.0	4.0	4.0	4.0

Volume Module:	>>	Count	Date:	8 May 2018	<<							
Base Vol:	150	166	85	24	399	189	133	192	294	89	100	19
Growth Adj:	1.00	1.00	1.00	1.00	1.00	1.00	1.00	1.00	1.00	1.00	1.00	1.00
Initial Bse:	150	166	85	24	399	189	133	192	294	89	100	19
Added Vol:	0	18	0	0	10	17	29	0	0	0	0	0
PasserByVol:	0	0	0	0	0	0	0	0	0	0	0	0
Initial Fut:	150	184	85	24	409	206	162	192	294	89	100	19
User Adj:	1.00	1.00	1.00	1.00	1.00	1.00	1.00	1.00	1.00	1.00	1.00	1.00
PHF Adj:	1.00	1.00	1.00	1.00	1.00	1.00	1.00	1.00	1.00	1.00	1.00	1.00
PHF Volume:	150	184	85	24	409	206	162	192	294	89	100	19
Reduct Vol:	0	0	0	0	0	0	0	0	0	0	0	0
Reduced Vol:	150	184	85	24	409	206	162	192	294	89	100	19
PCE Adj:	1.00	1.00	1.00	1.00	1.00	1.00	1.00	1.00	1.00	1.00	1.00	1.00
MLF Adj:	1.00	1.00	1.00	1.00	1.00	1.00	1.00	1.00	1.00	1.00	1.00	1.00
Final Volume:	150	184	85	24	409	206	162	192	294	89	100	19

Saturation Flow Module:												
Sat/Lane:	1900	1900	1900	1900	1900	1900	1900	1900	1900	1900	1900	1900
Adjustment:	0.95	0.95	0.92	0.92	0.92	0.92	0.92	0.95	0.95	0.92	0.95	0.95
Lanes:	0.45	0.55	1.00	0.04	0.64	0.32	1.00	0.40	0.60	1.00	0.84	0.16
Final Sat.:	808	992	1750	66	1120	564	1750	711	1089	1750	1513	287

Capacity Analysis Module:												
Vol/Sat:	0.19	0.19	0.05	0.37	0.37	0.37	0.09	0.27	0.27	0.05	0.07	0.07
Crit Moves:	***			***			***			***		
Green Time:	11.5	11.5	11.5	22.7	22.7	22.7	9.8	16.8	16.8	7.0	14.0	14.0
Volume/Cap:	1.13	1.13	0.29	1.13	1.13	1.13	0.66	1.13	1.13	0.51	0.33	0.33
Delay/Veh:	120.0	120	26.2	101.3	101	101.3	35.1	109	109.1	32.3	24.5	24.5
User DelAdj:	1.00	1.00	1.00	1.00	1.00	1.00	1.00	1.00	1.00	1.00	1.00	1.00
AdjDel/Veh:	120.0	120	26.2	101.3	101	101.3	35.1	109	109.1	32.3	24.5	24.5
LOS by Move:	F	F	C	F	F	F	D	F	F	C	C	C
HCM2k95thQ:	29	29	4	47	47	47	10	37	37	6	5	5

Note: Queue reported is the number of cars per lane.

City of Morgan Hill
The Crosswinds Residential Development

Level Of Service Computation Report
2000 HCM Operations (Future Volume Alternative)
Year 2030 Cumulative with Project PM (with Mitigations)

Intersection #120: Condit Road and Main Avenue

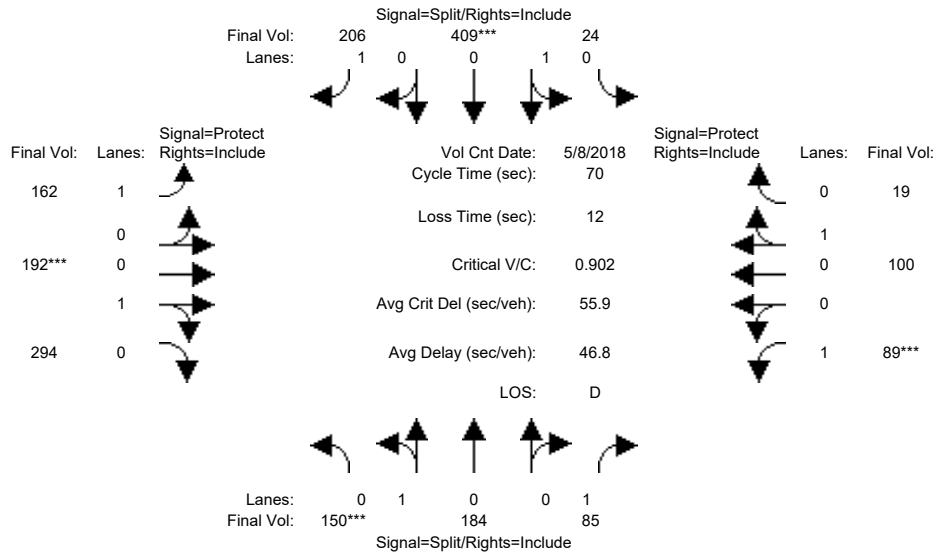

Street Name:	Condit Road						Main Avenue					
Approach:	North Bound			South Bound			East Bound			West Bound		
Movement:	L	T	R	L	T	R	L	T	R	L	T	R

Min. Green:	10	10	10	10	10	10	7	10	10	7	10	10
Y+R:	4.0	4.0	4.0	4.0	4.0	4.0	4.0	4.0	4.0	4.0	4.0	4.0

Volume Module:	>>	Count	Date:	8 May 2018	<<											
Base Vol:	150	166	85	24	399	189	133	192	294	89	100	19				
Growth Adj:	1.00	1.00	1.00	1.00	1.00	1.00	1.00	1.00	1.00	1.00	1.00	1.00				
Initial Bse:	150	166	85	24	399	189	133	192	294	89	100	19				
Added Vol:	0	18	0	0	10	17	29	0	0	0	0	0				
PasserByVol:	0	0	0	0	0	0	0	0	0	0	0	0				
Initial Fut:	150	184	85	24	409	206	162	192	294	89	100	19				
User Adj:	1.00	1.00	1.00	1.00	1.00	1.00	1.00	1.00	1.00	1.00	1.00	1.00				
PHF Adj:	1.00	1.00	1.00	1.00	1.00	1.00	1.00	1.00	1.00	1.00	1.00	1.00				
PHF Volume:	150	184	85	24	409	206	162	192	294	89	100	19				
Reduct Vol:	0	0	0	0	0	0	0	0	0	0	0	0				
Reduced Vol:	150	184	85	24	409	206	162	192	294	89	100	19				
PCE Adj:	1.00	1.00	1.00	1.00	1.00	1.00	1.00	1.00	1.00	1.00	1.00	1.00				
MLF Adj:	1.00	1.00	1.00	1.00	1.00	1.00	1.00	1.00	1.00	1.00	1.00	1.00				
FinalVolume:	150	184	85	24	409	206	162	192	294	89	100	19				

Saturation Flow Module:												
Sat/Lane:	1900	1900	1900	1900	1900	1900	1900	1900	1900	1900	1900	1900
Adjustment:	0.95	0.95	0.92	0.95	0.95	0.92	0.92	0.95	0.95	0.92	0.95	0.95
Lanes:	0.45	0.55	1.00	0.06	0.94	1.00	1.00	0.40	0.60	1.00	0.84	0.16
Final Sat.:	808	992	1750	100	1700	1750	1750	711	1089	1750	1513	287

Capacity Analysis Module:												
Vol/Sat:	0.19	0.19	0.05	0.24	0.24	0.12	0.09	0.27	0.27	0.05	0.07	0.07
Crit Moves:	****				****			****		****		
Green Time:	13.6	13.6	13.6	17.6	17.6	17.6	11.0	19.8	19.8	7.0	15.8	15.8
Volume/Cap:	0.96	0.96	0.25	0.96	0.96	0.47	0.59	0.96	0.96	0.51	0.29	0.29
Delay/Veh:	64.3	64.3	24.3	56.8	56.8	23.0	30.7	53.6	53.6	32.3	22.9	22.9
User DelAdj:	1.00	1.00	1.00	1.00	1.00	1.00	1.00	1.00	1.00	1.00	1.00	1.00
AdjDel/Veh:	64.3	64.3	24.3	56.8	56.8	23.0	30.7	53.6	53.6	32.3	22.9	22.9
LOS by Move:	E	E	C	E	E	C	C	D	D	C	C	C
HCM2k95thQ:	22	22	4	27	27	9	9	29	29	6	5	5

Note: Queue reported is the number of cars per lane.

City of Morgan Hill
The Crosswinds Residential Development

Level Of Service Computation Report
2000 HCM Unsignalized (Future Volume Alternative)
Existing AM

Intersection #1120: Condit Road and Diana Avenue

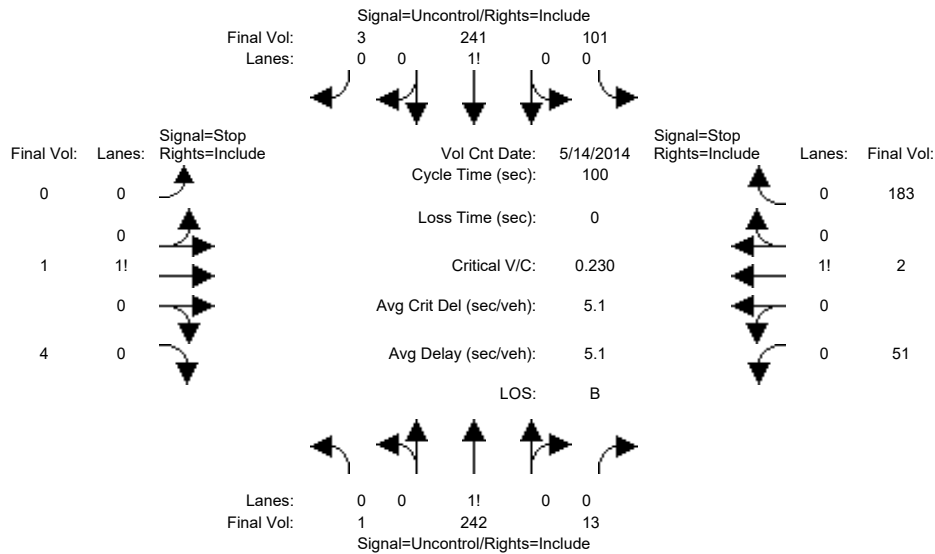

Street Name: Condit Road Diana Avenue
 Approach: North Bound South Bound East Bound West Bound
 Movement: L - T - R L - T - R L - T - R L - T - R

Volume Module:	>> Count Date: 14 May 2014 <<											
Base Vol:	1	242	13	101	241	3	0	1	4	51	2	183
Growth Adj:	1.00	1.00	1.00	1.00	1.00	1.00	1.00	1.00	1.00	1.00	1.00	1.00
Initial Bse:	1	242	13	101	241	3	0	1	4	51	2	183
Added Vol:	0	0	0	0	0	0	0	0	0	0	0	0
PasserByVol:	0	0	0	0	0	0	0	0	0	0	0	0
Initial Fut:	1	242	13	101	241	3	0	1	4	51	2	183
User Adj:	1.00	1.00	1.00	1.00	1.00	1.00	1.00	1.00	1.00	1.00	1.00	1.00
PHF Adj:	1.00	1.00	1.00	1.00	1.00	1.00	1.00	1.00	1.00	1.00	1.00	1.00
PHF Volume:	1	242	13	101	241	3	0	1	4	51	2	183
Reduct Vol:	0	0	0	0	0	0	0	0	0	0	0	0
FinalVolume:	1	242	13	101	241	3	0	1	4	51	2	183

Critical Gap Module:												
Critical Gp:	4.1	xxxx	xxxxx	4.1	xxxx	xxxxx	xxxxx	6.5	6.2	7.1	6.5	6.2
FollowUpTim:	2.2	xxxx	xxxxx	2.2	xxxx	xxxxx	xxxxx	4.0	3.3	3.5	4.0	3.3

Capacity Module:												
Cnflct Vol:	244	xxxx	xxxxx	255	xxxx	xxxxx	xxxx	702	243	698	697	249
Potent Cap.:	1334	xxxx	xxxxx	1322	xxxx	xxxxx	xxxx	365	801	358	368	795
Move Cap.:	1334	xxxx	xxxxx	1322	xxxx	xxxxx	xxxx	335	801	333	338	795
Volume/Cap:	0.00	xxxx	xxxx	0.08	xxxx	xxxx	xxxx	0.00	0.00	0.15	0.01	0.23

Level Of Service Module:												
2Way95thQ:	0.0	xxxx	xxxxx	0.2	xxxx	xxxxx	xxxx	xxxx	xxxxx	xxxx	xxxx	xxxxx
Control Del:	7.7	xxxx	xxxxx	7.9	xxxx	xxxxx	xxxxx	xxxx	xxxxx	xxxxx	xxxx	xxxxx
LOS by Move:	A	*	*	A	*	*	*	*	*	*	*	*
Movement:	LT - LTR - RT	LT - LTR - RT	LT - LTR - RT	LT - LTR - RT	LT - LTR - RT	LT - LTR - RT	LT - LTR - RT	LT - LTR - RT	LT - LTR - RT	LT - LTR - RT	LT - LTR - RT	LT - LTR - RT
Shared Cap.:	xxxx	xxxx	xxxxx	xxxx	xxxx	xxxxx	xxxx	xxxx	627	xxxx	606	xxxxx
SharedQueue:	xxxxx	xxxx	xxxxx	xxxxx	xxxx	xxxxx	xxxxx	xxxx	0.0	xxxxx	1.8	xxxxx
Shrd ConDel:	xxxxx	xxxx	xxxxx	xxxxx	xxxx	xxxxx	xxxxx	xxxx	10.8	xxxxx	14.7	xxxxx
Shared LOS:	*	*	*	*	*	*	*	*	B	*	B	*
ApproachDel:	xxxxxxx	xxxxxxx	xxxxxxx	xxxxxxx	xxxxxxx	xxxxxxx	xxxxxxx	10.8	xxxxxxx	14.7	xxxxxxx	xxxxxxx
ApproachLOS:	*	*	*	*	*	*	*	*	B	*	B	*

Note: Queue reported is the number of cars per lane.

City of Morgan Hill
The Crosswinds Residential Development

Level Of Service Computation Report
2000 HCM Unsignalized (Future Volume Alternative)
Existing Plus Project AM

Intersection #1120: Condit Road and Diana Avenue

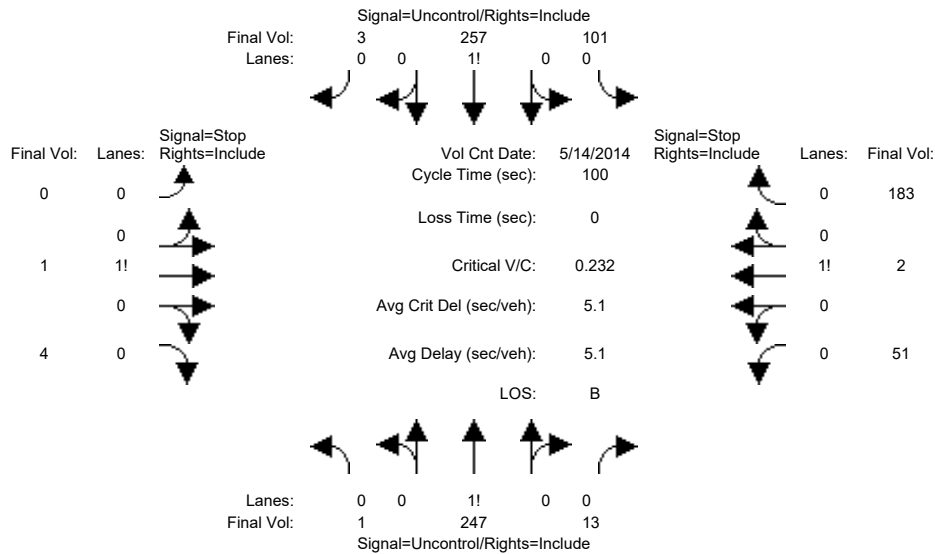

Street Name: Condit Road Diana Avenue
Approach: North Bound South Bound East Bound West Bound
Movement: L - T - R L - T - R L - T - R L - T - R

Volume Module:	>> Count Date: 14 May 2014 <<											
Base Vol:	1	242	13	101	241	3	0	1	4	51	2	183
Growth Adj:	1.00	1.00	1.00	1.00	1.00	1.00	1.00	1.00	1.00	1.00	1.00	1.00
Initial Bse:	1	242	13	101	241	3	0	1	4	51	2	183
Added Vol:	0	5	0	0	16	0	0	0	0	0	0	0
PasserByVol:	0	0	0	0	0	0	0	0	0	0	0	0
Initial Fut:	1	247	13	101	257	3	0	1	4	51	2	183
User Adj:	1.00	1.00	1.00	1.00	1.00	1.00	1.00	1.00	1.00	1.00	1.00	1.00
PHF Adj:	1.00	1.00	1.00	1.00	1.00	1.00	1.00	1.00	1.00	1.00	1.00	1.00
PHF Volume:	1	247	13	101	257	3	0	1	4	51	2	183
Reduct Vol:	0	0	0	0	0	0	0	0	0	0	0	0
FinalVolume:	1	247	13	101	257	3	0	1	4	51	2	183

Critical Gap Module:												
Critical Gp:	4.1	xxxx	xxxxx	4.1	xxxx	xxxxx	xxxxx	6.5	6.2	7.1	6.5	6.2
FollowUpTim:	2.2	xxxx	xxxxx	2.2	xxxx	xxxxx	xxxxx	4.0	3.3	3.5	4.0	3.3

Capacity Module:												
Cnflct Vol:	260	xxxx	xxxxx	260	xxxx	xxxxx	xxxx	723	259	719	718	254
Potent Cap.:	1316	xxxx	xxxxx	1316	xxxx	xxxxx	xxxx	355	785	347	358	790
Move Cap.:	1316	xxxx	xxxxx	1316	xxxx	xxxxx	xxxx	326	785	322	328	790
Volume/Cap:	0.00	xxxx	xxxx	0.08	xxxx	xxxx	xxxx	0.00	0.01	0.16	0.01	0.23

Level Of Service Module:												
2Way95thQ:	0.0	xxxx	xxxxx	0.2	xxxx	xxxxx	xxxx	xxxx	xxxxx	xxxx	xxxx	xxxxx
Control Del:	7.7	xxxx	xxxxx	8.0	xxxx	xxxxx	xxxxx	xxxx	xxxxx	xxxxx	xxxx	xxxxx
LOS by Move:	A	*	*	A	*	*	*	*	*	*	*	*
Movement:	LT - LTR - RT	LT - LTR - RT	LT - LTR - RT	LT - LTR - RT	LT - LTR - RT	LT - LTR - RT	LT - LTR - RT	LT - LTR - RT	LT - LTR - RT	LT - LTR - RT	LT - LTR - RT	LT - LTR - RT
Shared Cap.:	xxxx	xxxx	xxxxx	xxxx	xxxx	xxxxx	xxxx	xxxx	613	xxxx	596	xxxxx
SharedQueue:	xxxxx	xxxx	xxxxx	xxxxx	xxxx	xxxxx	xxxxx	xxxx	0.0	xxxxx	1.9	xxxxx
Shrd ConDel:	xxxxx	xxxx	xxxxx	xxxxx	xxxx	xxxxx	xxxxx	xxxx	10.9	xxxxx	14.9	xxxxx
Shared LOS:	*	*	*	*	*	*	*	*	B	*	B	*
ApproachDel:	xxxxxxx	xxxxxxx	xxxxxxx	xxxxxxx	xxxxxxx	xxxxxxx	xxxxxxx	10.9	xxxxxxx	14.9	xxxxxxx	xxxxxxx
ApproachLOS:	*	*	*	*	*	*	*	*	B	*	B	*

Note: Queue reported is the number of cars per lane.

City of Morgan Hill
The Crosswinds Residential Development

Level Of Service Computation Report
2000 HCM Unsignalized (Future Volume Alternative)
Year 2030 Cumulative without Project AM

Intersection #1120: Condit Road and Diana Avenue

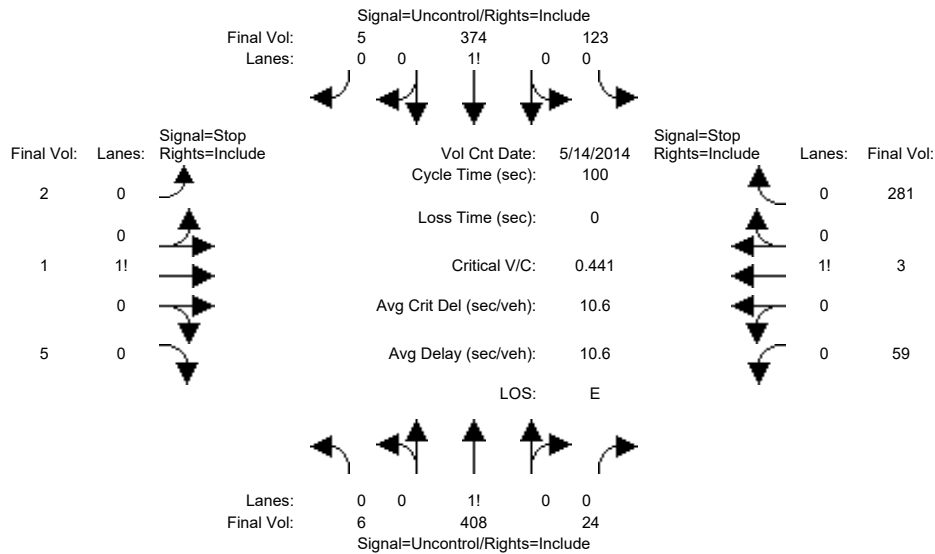

Street Name: Condit Road Diana Avenue
Approach: North Bound South Bound East Bound West Bound
Movement: L - T - R L - T - R L - T - R L - T - R

Volume Module:	Count Date: 14 May 2014 <<											
Base Vol:	6	408	24	123	374	5	2	1	5	59	3	281
Growth Adj:	1.00	1.00	1.00	1.00	1.00	1.00	1.00	1.00	1.00	1.00	1.00	1.00
Initial Bse:	6	408	24	123	374	5	2	1	5	59	3	281
Added Vol:	0	0	0	0	0	0	0	0	0	0	0	0
PasserByVol:	0	0	0	0	0	0	0	0	0	0	0	0
Initial Fut:	6	408	24	123	374	5	2	1	5	59	3	281
User Adj:	1.00	1.00	1.00	1.00	1.00	1.00	1.00	1.00	1.00	1.00	1.00	1.00
PHF Adj:	1.00	1.00	1.00	1.00	1.00	1.00	1.00	1.00	1.00	1.00	1.00	1.00
PHF Volume:	6	408	24	123	374	5	2	1	5	59	3	281
Reduct Vol:	0	0	0	0	0	0	0	0	0	0	0	0
FinalVolume:	6	408	24	123	374	5	2	1	5	59	3	281

Critical Gap Module:	Critical Gap											
Critical Gp:	4.1	xxxx	xxxxxx	4.1	xxxx	xxxxxx	7.1	6.5	6.2	7.1	6.5	6.2
FollowUpTim:	2.2	xxxx	xxxxxx	2.2	xxxx	xxxxxx	3.5	4.0	3.3	3.5	4.0	3.3

Capacity Module:	Capacity											
Cnflct Vol:	379	xxxx	xxxxxx	432	xxxx	xxxxxx	1197	1067	377	1058	1057	420
Potent Cap.:	1191	xxxx	xxxxxx	1138	xxxx	xxxxxx	164	224	674	205	227	638
Move Cap.:	1191	xxxx	xxxxxx	1138	xxxx	xxxxxx	83	197	674	184	200	638
Volume/Cap:	0.01	xxxx	xxxx	0.11	xxxx	xxxx	0.02	0.01	0.01	0.32	0.02	0.44

Level Of Service Module:	Level of Service											
2Way95thQ:	0.0	xxxx	xxxxxx	0.4	xxxx	xxxxxx	xxxx	xxxx	xxxxxx	xxxx	xxxx	xxxxxx
Control Del:	8.0	xxxx	xxxxxx	8.5	xxxx	xxxxxx	xxxxxx	xxxx	xxxxxx	xxxxxx	xxxx	xxxxxx
LOS by Move:	A	*	*	A	*	*	*	*	*	*	*	*
Movement:	LT - LTR - RT	LT - LTR - RT	LT - LTR - RT	LT - LTR - RT	LT - LTR - RT	LT - LTR - RT	LT - LTR - RT	LT - LTR - RT	LT - LTR - RT	LT - LTR - RT	LT - LTR - RT	
Shared Cap.:	xxxx	xxxx	xxxxxx	xxxx	xxxx	xxxxxx	xxxx	218	xxxxxx	xxxx	441	xxxxxx
SharedQueue:	xxxxxx	xxxx	xxxxxx	xxxxxx	xxxx	xxxxxx	xxxxxx	0.1	xxxxxx	xxxxxx	6.8	xxxxxx
Shrd ConDel:	xxxxxx	xxxx	xxxxxx	xxxxxx	xxxx	xxxxxx	xxxxxx	22.2	xxxxxx	xxxxxx	36.3	xxxxxx
Shared LOS:	*	*	*	*	*	*	*	C	*	*	E	*
ApproachDel:	xxxxxxx	xxxxxxx	xxxxxxx	xxxxxxx	xxxxxxx	xxxxxxx	22.2	xxxxxxx	xxxxxxx	36.3	xxxxxxx	
ApproachLOS:	*	*	*	*	*	*	C	*	*	E	*	

Note: Queue reported is the number of cars per lane.

City of Morgan Hill
The Crosswinds Residential Development

Level Of Service Computation Report
2000 HCM Unsignalized (Future Volume Alternative)
Year 2030 Cumulative with Project AM

Intersection #1120: Condit Road and Diana Avenue

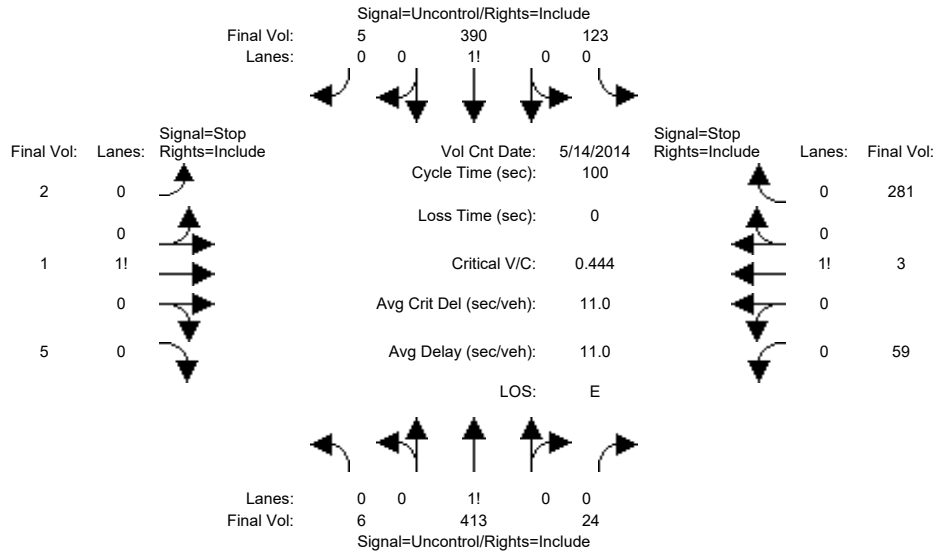

Street Name: Condit Road Diana Avenue
Approach: North Bound South Bound East Bound West Bound
Movement: L - T - R L - T - R L - T - R L - T - R

Volume Module:	>>	Count	Date:	14 May 2014	<<												
Base Vol:	6	408	24	123	374	5	2	1	5	59	3	281					
Growth Adj:	1.00	1.00	1.00	1.00	1.00	1.00	1.00	1.00	1.00	1.00	1.00	1.00					
Initial Bse:	6	408	24	123	374	5	2	1	5	59	3	281					
Added Vol:	0	5	0	0	16	0	0	0	0	0	0	0					
PasserByVol:	0	0	0	0	0	0	0	0	0	0	0	0					
Initial Fut:	6	413	24	123	390	5	2	1	5	59	3	281					
User Adj:	1.00	1.00	1.00	1.00	1.00	1.00	1.00	1.00	1.00	1.00	1.00	1.00					
PHF Adj:	1.00	1.00	1.00	1.00	1.00	1.00	1.00	1.00	1.00	1.00	1.00	1.00					
PHF Volume:	6	413	24	123	390	5	2	1	5	59	3	281					
Reduct Vol:	0	0	0	0	0	0	0	0	0	0	0	0					
FinalVolume:	6	413	24	123	390	5	2	1	5	59	3	281					

Critical Gap Module:															
Critical Gp:	4.1	xxxx	xxxxxx	4.1	xxxx	xxxxxx	7.1	6.5	6.2	7.1	6.5	6.2			
FollowUpTim:	2.2	xxxx	xxxxxx	2.2	xxxx	xxxxxx	3.5	4.0	3.3	3.5	4.0	3.3			

Capacity Module:															
Cnflct Vol:	395	xxxx	xxxxxx	437	xxxx	xxxxxx	1218	1088	393	1079	1078	425			
Potent Cap.:	1175	xxxx	xxxxxx	1134	xxxx	xxxxxx	159	218	661	198	220	634			
Move Cap.:	1175	xxxx	xxxxxx	1134	xxxx	xxxxxx	79	191	661	177	194	634			
Volume/Cap:	0.01	xxxx	xxxx	0.11	xxxx	xxxx	0.03	0.01	0.01	0.33	0.02	0.44			

Level Of Service Module:																			
2Way95thQ:	0.0	xxxx	xxxxxx	0.4	xxxx	xxxxxx	xxxx	xxxx	xxxxxx	xxxx	xxxx	xxxxxx							
Control Del:	8.1	xxxx	xxxxxx	8.6	xxxx	xxxxxx	xxxxxx	xxxx	xxxxxx	xxxxxx	xxxx	xxxxxx							
LOS by Move:	A	*	*	A	*	*	*	*	*	*	*	*							
Movement:	LT	-	LTR	-	RT	LT	-	LTR	-	RT	LT	-	LTR	-	RT				
Shared Cap.:	xxxx	xxxx	xxxxxx	xxxx	xxxx	xxxxxx	xxxx	211	xxxxxx	xxxx	433	xxxxxx							
SharedQueue:	xxxxxx	xxxx	xxxxxx	xxxxxx	xxxx	xxxxxx	xxxxxx	0.1	xxxxxx	xxxxxx	7.0	xxxxxx							
Shrd ConDel:	xxxxxx	xxxx	xxxxxx	xxxxxx	xxxx	xxxxxx	xxxxxx	22.8	xxxxxx	xxxxxx	38.2	xxxxxx							
Shared LOS:	*	*	*	*	*	*	*	C	*	*	E	*							
ApproachDel:	xxxxxxx						xxxxxxx						22.8						38.2
ApproachLOS:	*						*						C						E

Note: Queue reported is the number of cars per lane.

City of Morgan Hill
The Crosswinds Residential Development

Level Of Service Computation Report
2000 HCM Operations (Future Volume Alternative)
Year 2030 Cumulative with Project AM (with Mitigations)

Intersection #1120: Condit Road and Diana Avenue

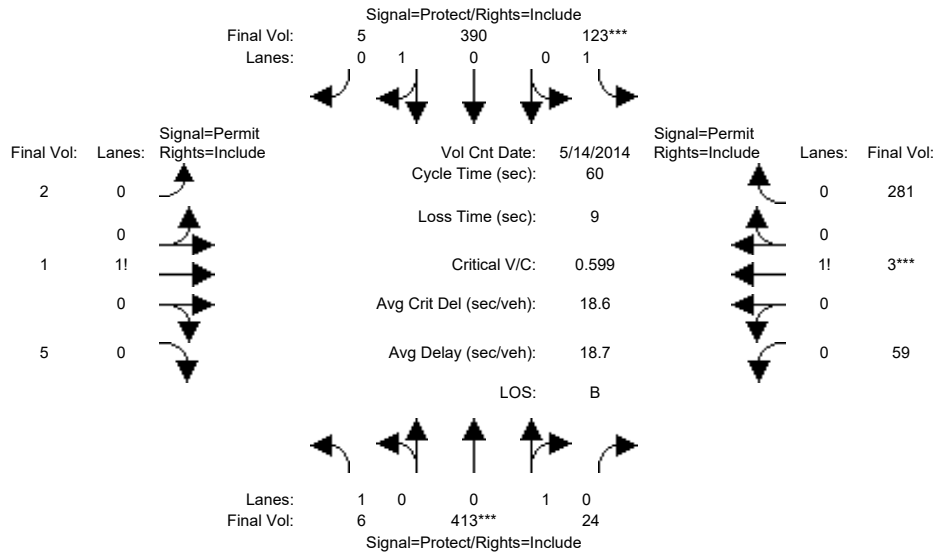

Street Name:	Condit Road						Diana Avenue					
Approach:	North Bound			South Bound			East Bound			West Bound		
Movement:	L	T	R	L	T	R	L	T	R	L	T	R
Min. Green:	7	10	10	7	10	10	10	10	10	10	10	10
Y+R:	4.0	4.0	4.0	4.0	4.0	4.0	4.0	4.0	4.0	4.0	4.0	4.0

Volume Module:	>>	Count	Date:	14 May 2014	<<							
Base Vol:	6	408	24	123	374	5	2	1	5	59	3	281
Growth Adj:	1.00	1.00	1.00	1.00	1.00	1.00	1.00	1.00	1.00	1.00	1.00	1.00
Initial Bse:	6	408	24	123	374	5	2	1	5	59	3	281
Added Vol:	0	5	0	0	16	0	0	0	0	0	0	0
PasserByVol:	0	0	0	0	0	0	0	0	0	0	0	0
Initial Fut:	6	413	24	123	390	5	2	1	5	59	3	281
User Adj:	1.00	1.00	1.00	1.00	1.00	1.00	1.00	1.00	1.00	1.00	1.00	1.00
PHF Adj:	1.00	1.00	1.00	1.00	1.00	1.00	1.00	1.00	1.00	1.00	1.00	1.00
PHF Volume:	6	413	24	123	390	5	2	1	5	59	3	281
Reduct Vol:	0	0	0	0	0	0	0	0	0	0	0	0
Reduced Vol:	6	413	24	123	390	5	2	1	5	59	3	281
PCE Adj:	1.00	1.00	1.00	1.00	1.00	1.00	1.00	1.00	1.00	1.00	1.00	1.00
MLF Adj:	1.00	1.00	1.00	1.00	1.00	1.00	1.00	1.00	1.00	1.00	1.00	1.00
FinalVolume:	6	413	24	123	390	5	2	1	5	59	3	281

Saturation Flow Module:	
Sat/Lane:	1900 1900 1900 1900 1900 1900 1900 1900 1900 1900 1900 1900
Adjustment:	0.92 0.95 0.95 0.92 0.95 0.95 0.92 0.92 0.92 0.92 0.92 0.92
Lanes:	1.00 0.95 0.05 1.00 0.99 0.01 0.25 0.12 0.63 0.17 0.01 0.82
Final Sat.:	1750 1701 99 1750 1777 23 438 219 1094 301 15 1434

Capacity Analysis Module:	
Vol/Sat:	0.00 0.24 0.24 0.07 0.22 0.22 0.00 0.00 0.00 0.20 0.20 0.20
Crit Moves:	**** **** ****
Green Time:	10.9 24.3 24.3 7.0 20.5 20.5 19.6 19.6 19.6 19.6 19.6 19.6
Volume/Cap:	0.02 0.60 0.60 0.60 0.64 0.64 0.01 0.01 0.01 0.60 0.60 0.60
Delay/Veh:	20.2 15.4 15.4 30.0 19.0 19.0 13.6 13.6 13.6 18.6 18.6 18.6
User DelAdj:	1.00 1.00 1.00 1.00 1.00 1.00 1.00 1.00 1.00 1.00 1.00 1.00
AdjDel/Veh:	20.2 15.4 15.4 30.0 19.0 19.0 13.6 13.6 13.6 18.6 18.6 18.6
LOS by Move:	C B B C B B B B B B B B
HCM2k95thQ:	0 12 12 7 14 14 0 0 0 13 13 13

Note: Queue reported is the number of cars per lane.

City of Morgan Hill
The Crosswinds Residential Development

Level Of Service Computation Report
2000 HCM Unsignalized (Future Volume Alternative)
Existing PM

Intersection #1120: Condit Road and Diana Avenue

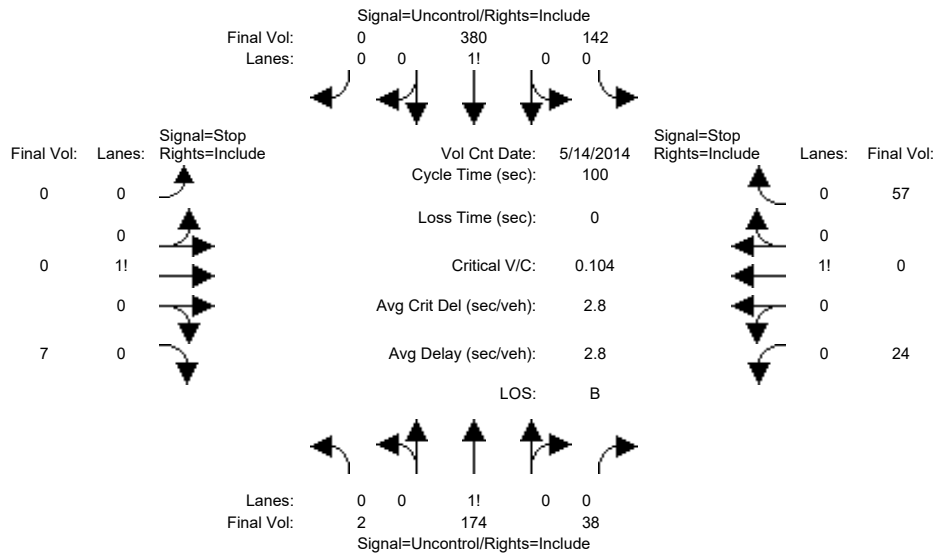

Street Name: Condit Road Diana Avenue
Approach: North Bound South Bound East Bound West Bound
Movement: L - T - R L - T - R L - T - R L - T - R

Volume Module:	>> Count Date: 14 May 2014 <<											
Base Vol:	2	174	38	142	380	0	0	0	7	24	0	57
Growth Adj:	1.00	1.00	1.00	1.00	1.00	1.00	1.00	1.00	1.00	1.00	1.00	1.00
Initial Bse:	2	174	38	142	380	0	0	0	7	24	0	57
Added Vol:	0	0	0	0	0	0	0	0	0	0	0	0
PasserByVol:	0	0	0	0	0	0	0	0	0	0	0	0
Initial Fut:	2	174	38	142	380	0	0	0	7	24	0	57
User Adj:	1.00	1.00	1.00	1.00	1.00	1.00	1.00	1.00	1.00	1.00	1.00	1.00
PHF Adj:	1.00	1.00	1.00	1.00	1.00	1.00	1.00	1.00	1.00	1.00	1.00	1.00
PHF Volume:	2	174	38	142	380	0	0	0	7	24	0	57
Reduct Vol:	0	0	0	0	0	0	0	0	0	0	0	0
FinalVolume:	2	174	38	142	380	0	0	0	7	24	0	57

Critical Gap Module:												
Critical Gp:	4.1	xxxx	xxxxx	4.1	xxxx	xxxxx	xxxxx	xxxx	6.2	7.1	6.5	6.2
FollowUpTim:	2.2	xxxx	xxxxx	2.2	xxxx	xxxxx	xxxxx	xxxx	3.3	3.5	4.0	3.3

Capacity Module:												
Cnflct Vol:	380	xxxx	xxxxx	212	xxxx	xxxxx	xxxx	xxxx	380	865	861	193
Potent Cap.:	1190	xxxx	xxxxx	1370	xxxx	xxxxx	xxxx	xxxx	671	276	295	854
Move Cap.:	1190	xxxx	xxxxx	1370	xxxx	xxxxx	xxxx	xxxx	671	250	262	854
Volume/Cap:	0.00	xxxx	xxxx	0.10	xxxx	xxxx	xxxx	xxxx	0.01	0.10	0.00	0.07

Level Of Service Module:												
2Way95thQ:	0.0	xxxx	xxxxx	0.3	xxxx	xxxxx	xxxx	xxxx	0.0	xxxx	xxxx	xxxxx
Control Del:	8.0	xxxx	xxxxx	7.9	xxxx	xxxxx	xxxxx	xxxx	10.4	xxxxx	xxxx	xxxxx
LOS by Move:	A	*	*	A	*	*	*	*	B	*	*	*
Movement:	LT - LTR - RT	LT - LTR - RT	LT - LTR - RT	LT - LTR - RT	LT - LTR - RT	LT - LTR - RT	LT - LTR - RT	LT - LTR - RT	LT - LTR - RT	LT - LTR - RT	LT - LTR - RT	LT - LTR - RT
Shared Cap.:	xxxx	xxxx	xxxxx	xxxx	xxxx	xxxxx	xxxx	xxxx	xxxxx	xxxx	497	xxxxx
SharedQueue:	xxxxx	xxxx	xxxxx	0.3	xxxx	xxxxx	xxxxx	xxxx	xxxxx	xxxxx	0.6	xxxxx
Shrd ConDel:	xxxxx	xxxx	xxxxx	7.9	xxxx	xxxxx	xxxxx	xxxx	xxxxx	xxxxx	13.6	xxxxx
Shared LOS:	*	*	*	A	*	*	*	*	*	*	B	*
ApproachDel:	xxxxxxx	xxxxxxx	xxxxxxx	xxxxxxx	xxxxxxx	xxxxxxx	10.4	xxxxxxx	xxxxxxx	13.6	xxxxxxx	xxxxxxx
ApproachLOS:	*	*	*	A	*	*	*	*	B	*	*	B

Note: Queue reported is the number of cars per lane.

City of Morgan Hill
The Crosswinds Residential Development

Level Of Service Computation Report
2000 HCM Unsignalized (Future Volume Alternative)
Existing Plus Project PM

Intersection #1120: Condit Road and Diana Avenue

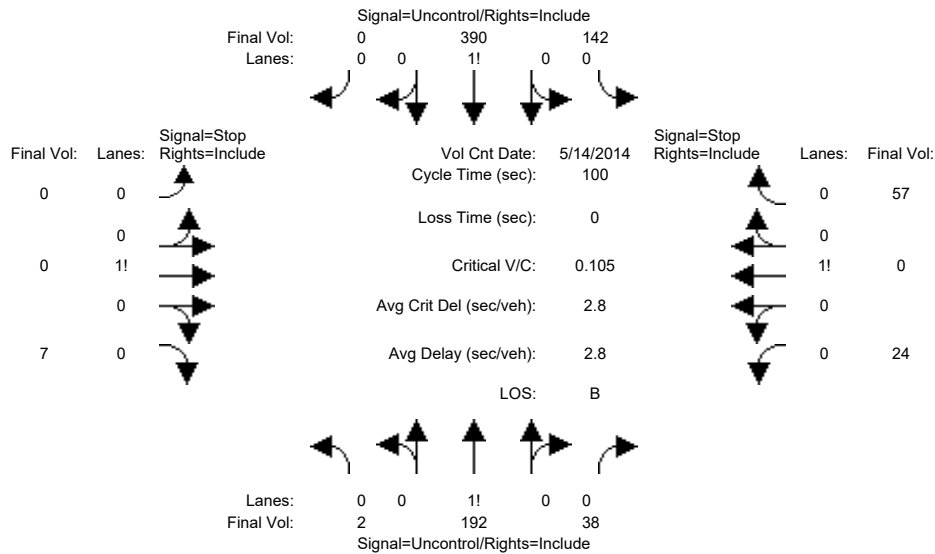

Street Name: Condit Road Diana Avenue
Approach: North Bound South Bound East Bound West Bound
Movement: L - T - R L - T - R L - T - R L - T - R

Volume Module:	>> Count Date: 14 May 2014 <<											
Base Vol:	2	174	38	142	380	0	0	0	7	24	0	57
Growth Adj:	1.00	1.00	1.00	1.00	1.00	1.00	1.00	1.00	1.00	1.00	1.00	1.00
Initial Bse:	2	174	38	142	380	0	0	0	7	24	0	57
Added Vol:	0	18	0	0	10	0	0	0	0	0	0	0
PasserByVol:	0	0	0	0	0	0	0	0	0	0	0	0
Initial Fut:	2	192	38	142	390	0	0	0	7	24	0	57
User Adj:	1.00	1.00	1.00	1.00	1.00	1.00	1.00	1.00	1.00	1.00	1.00	1.00
PHF Adj:	1.00	1.00	1.00	1.00	1.00	1.00	1.00	1.00	1.00	1.00	1.00	1.00
PHF Volume:	2	192	38	142	390	0	0	0	7	24	0	57
Reduct Vol:	0	0	0	0	0	0	0	0	0	0	0	0
FinalVolume:	2	192	38	142	390	0	0	0	7	24	0	57

Critical Gap Module:												
Critical Gp:	4.1	xxxx	xxxxx	4.1	xxxx	xxxxx	xxxxx	xxxx	6.2	7.1	6.5	6.2
FollowUpTim:	2.2	xxxx	xxxxx	2.2	xxxx	xxxxx	xxxxx	xxxx	3.3	3.5	4.0	3.3

Capacity Module:												
Cnflct Vol:	390	xxxx	xxxxx	230	xxxx	xxxxx	xxxx	xxxx	390	893	889	211
Potent Cap.:	1180	xxxx	xxxxx	1350	xxxx	xxxxx	xxxx	xxxx	663	265	285	834
Move Cap.:	1180	xxxx	xxxxx	1350	xxxx	xxxxx	xxxx	xxxx	663	239	252	834
Volume/Cap:	0.00	xxxx	xxxx	0.11	xxxx	xxxx	xxxx	xxxx	0.01	0.10	0.00	0.07

Level Of Service Module:												
2Way95thQ:	0.0	xxxx	xxxxx	0.4	xxxx	xxxxx	xxxx	xxxx	0.0	xxxx	xxxx	xxxxx
Control Del:	8.1	xxxx	xxxxx	8.0	xxxx	xxxxx	xxxxx	xxxx	10.5	xxxxx	xxxx	xxxxx
LOS by Move:	A	*	*	A	*	*	*	*	B	*	*	*
Movement:	LT - LTR - RT	LT - LTR - RT	LT - LTR - RT	LT - LTR - RT	LT - LTR - RT	LT - LTR - RT	LT - LTR - RT	LT - LTR - RT	LT - LTR - RT	LT - LTR - RT	LT - LTR - RT	LT - LTR - RT
Shared Cap.:	xxxx	xxxx	xxxxx	xxxx	xxxx	xxxxx	xxxx	xxxx	xxxxx	xxxx	480	xxxxx
SharedQueue:	xxxxx	xxxx	xxxxx	0.4	xxxx	xxxxx	xxxxx	xxxx	xxxxx	xxxxx	0.6	xxxxx
Shrd ConDel:	xxxxx	xxxx	xxxxx	8.0	xxxx	xxxxx	xxxxx	xxxx	xxxxx	xxxxx	14.0	xxxxx
Shared LOS:	*	*	*	A	*	*	*	*	*	*	B	*
ApproachDel:	xxxxxxx	xxxxxxx	xxxxxxx	xxxxxxx	xxxxxxx	xxxxxxx	10.5	xxxxxxx	xxxxxxx	14.0	xxxxxxx	xxxxxxx
ApproachLOS:	*	*	*	A	*	*	*	*	B	*	*	B

Note: Queue reported is the number of cars per lane.

City of Morgan Hill
The Crosswinds Residential Development

Level Of Service Computation Report
2000 HCM Unsignalized (Future Volume Alternative)
Year 2030 Cumulative without Project PM

Intersection #1120: Condit Road and Diana Avenue

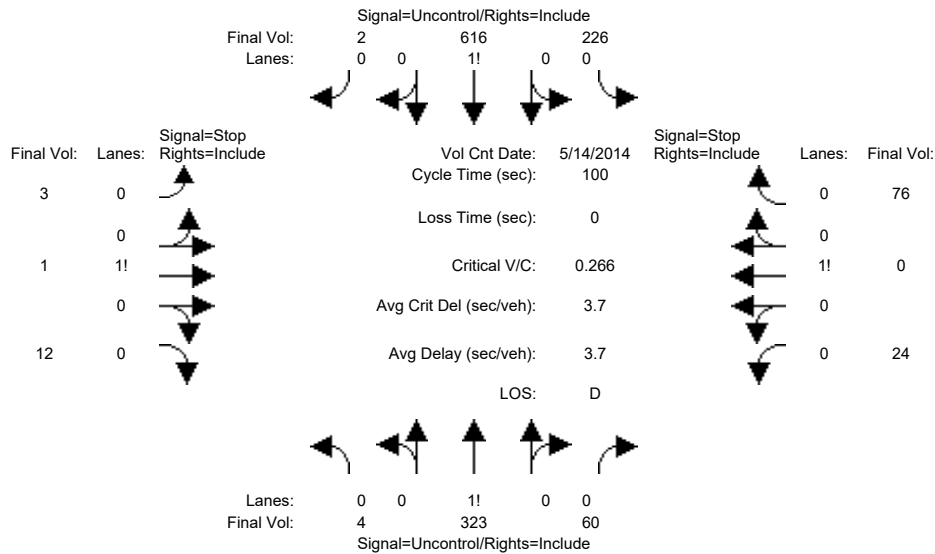

Street Name: Condit Road Diana Avenue
 Approach: North Bound South Bound East Bound West Bound
 Movement: L - T - R L - T - R L - T - R L - T - R

Volume Module:	>> Count Date: 14 May 2014 <<											
Base Vol:	4	323	60	226	616	2	3	1	12	24	0	76
Growth Adj:	1.00	1.00	1.00	1.00	1.00	1.00	1.00	1.00	1.00	1.00	1.00	1.00
Initial Bse:	4	323	60	226	616	2	3	1	12	24	0	76
Added Vol:	0	0	0	0	0	0	0	0	0	0	0	0
PasserByVol:	0	0	0	0	0	0	0	0	0	0	0	0
Initial Fut:	4	323	60	226	616	2	3	1	12	24	0	76
User Adj:	1.00	1.00	1.00	1.00	1.00	1.00	1.00	1.00	1.00	1.00	1.00	1.00
PHF Adj:	1.00	1.00	1.00	1.00	1.00	1.00	1.00	1.00	1.00	1.00	1.00	1.00
PHF Volume:	4	323	60	226	616	2	3	1	12	24	0	76
Reduct Vol:	0	0	0	0	0	0	0	0	0	0	0	0
FinalVolume:	4	323	60	226	616	2	3	1	12	24	0	76

Critical Gap Module:												
Critical Gp:	4.1	xxxx	xxxxx	4.1	xxxx	xxxxx	7.1	6.5	6.2	7.1	6.5	6.2
FollowUpTim:	2.2	xxxx	xxxxx	2.2	xxxx	xxxxx	3.5	4.0	3.3	3.5	4.0	3.3

Capacity Module:												
Cnflct Vol:	618	xxxx	xxxxx	383	xxxx	xxxxx	1468	1460	617	1437	1431	353
Potent Cap.:	972	xxxx	xxxxx	1187	xxxx	xxxxx	107	130	494	112	136	695
Move Cap.:	972	xxxx	xxxxx	1187	xxxx	xxxxx	79	102	494	90	106	695
Volume/Cap:	0.00	xxxx	xxxx	0.19	xxxx	xxxx	0.04	0.01	0.02	0.27	0.00	0.11

Level Of Service Module:												
2Way95thQ:	0.0	xxxx	xxxxx	0.7	xxxx	xxxxx	xxxx	xxxx	xxxxx	xxxx	xxxx	xxxxx
Control Del:	8.7	xxxx	xxxxx	8.7	xxxx	xxxxx	xxxxx	xxxx	xxxxx	xxxxx	xxxx	xxxxx
LOS by Move:	A	*	*	A	*	*	*	*	*	*	*	*
Movement:	LT - LTR - RT	LT - LTR - RT	LT - LTR - RT	LT - LTR - RT	LT - LTR - RT	LT - LTR - RT	LT - LTR - RT	LT - LTR - RT	LT - LTR - RT	LT - LTR - RT	LT - LTR - RT	LT - LTR - RT
Shared Cap.:	xxxx	xxxx	xxxxx	xxxx	xxxx	xxxxx	xxxx	222	xxxxx	xxxx	267	xxxxx
SharedQueue:	xxxxx	xxxx	xxxxx	xxxxx	xxxx	xxxxx	xxxxx	0.2	xxxxx	xxxxx	1.7	xxxxx
Shrd ConDel:	xxxxx	xxxx	xxxxx	xxxxx	xxxx	xxxxx	xxxxx	22.5	xxxxx	xxxxx	26.4	xxxxx
Shared LOS:	*	*	*	*	*	*	*	C	*	*	D	*
ApproachDel:	xxxxxxx	xxxxxxx		xxxxxxx	xxxxxxx		22.5		26.4			
ApproachLOS:	*	*		*	*		C		D			

Note: Queue reported is the number of cars per lane.

City of Morgan Hill
The Crosswinds Residential Development

Level Of Service Computation Report
2000 HCM Unsignalized (Future Volume Alternative)
Year 2030 Cumulative with Project PM

Intersection #1120: Condit Road and Diana Avenue

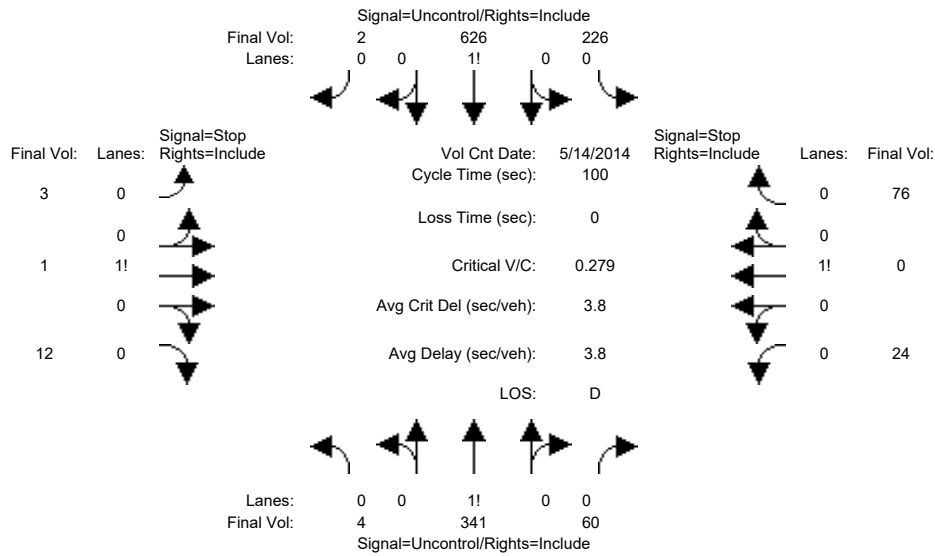

Street Name: Condit Road Diana Avenue
Approach: North Bound South Bound East Bound West Bound
Movement: L - T - R L - T - R L - T - R L - T - R

Volume Module:	>>	Count	Date:	14 May 2014	<<												
Base Vol:	4	323	60	226	616	2	3	1	12	24	0	76					
Growth Adj:	1.00	1.00	1.00	1.00	1.00	1.00	1.00	1.00	1.00	1.00	1.00	1.00					
Initial Bse:	4	323	60	226	616	2	3	1	12	24	0	76					
Added Vol:	0	18	0	0	10	0	0	0	0	0	0	0					
PasserByVol:	0	0	0	0	0	0	0	0	0	0	0	0					
Initial Fut:	4	341	60	226	626	2	3	1	12	24	0	76					
User Adj:	1.00	1.00	1.00	1.00	1.00	1.00	1.00	1.00	1.00	1.00	1.00	1.00					
PHF Adj:	1.00	1.00	1.00	1.00	1.00	1.00	1.00	1.00	1.00	1.00	1.00	1.00					
PHF Volume:	4	341	60	226	626	2	3	1	12	24	0	76					
Reduct Vol:	0	0	0	0	0	0	0	0	0	0	0	0					
FinalVolume:	4	341	60	226	626	2	3	1	12	24	0	76					

Critical Gap Module:															
Critical Gp:	4.1	xxxx	xxxxxx	4.1	xxxx	xxxxxx	7.1	6.5	6.2	7.1	6.5	6.2			
FollowUpTim:	2.2	xxxx	xxxxxx	2.2	xxxx	xxxxxx	3.5	4.0	3.3	3.5	4.0	3.3			

Capacity Module:															
Cnflct Vol:	628	xxxx	xxxxxx	401	xxxx	xxxxxx	1496	1488	627	1465	1459	371			
Potent Cap.:	964	xxxx	xxxxxx	1169	xxxx	xxxxxx	102	125	487	107	131	679			
Move Cap.:	964	xxxx	xxxxxx	1169	xxxx	xxxxxx	75	97	487	86	101	679			
Volume/Cap:	0.00	xxxx	xxxx	0.19	xxxx	xxxx	0.04	0.01	0.02	0.28	0.00	0.11			

Level Of Service Module:															
2Way95thQ:	0.0	xxxx	xxxxxx	0.7	xxxx	xxxxxx	xxxx	xxxx	xxxxxx	xxxx	xxxx	xxxxxx			
Control Del:	8.8	xxxx	xxxxxx	8.8	xxxx	xxxxxx	xxxxxx	xxxx	xxxxxx	xxxxxx	xxxx	xxxxxx			
LOS by Move:	A	*	*	A	*	*	*	*	*	*	*	*			
Movement:	LT - LTR - RT	LT - LTR - RT			LT - LTR - RT			LT - LTR - RT			LT - LTR - RT				
Shared Cap.:	xxxx	xxxx	xxxxxx	xxxx	xxxx	xxxxxx	xxxx	214	xxxxxx	xxxx	256	xxxxxx			
SharedQueue:	xxxxxx	xxxx	xxxxxx	xxxxxx	xxxx	xxxxxx	xxxxxx	0.2	xxxxxx	xxxxxx	1.8	xxxxxx			
Shrd ConDel:	xxxxxx	xxxx	xxxxxx	xxxxxx	xxxx	xxxxxx	xxxxxx	23.2	xxxxxx	xxxxxx	27.8	xxxxxx			
Shared LOS:	*	*	*	*	*	*	*	C	*	*	D	*			
ApproachDel:	xxxxxxx	xxxxxxx			23.2			27.8							
ApproachLOS:	*	*			C			D							

Note: Queue reported is the number of cars per lane.

City of Morgan Hill
The Crosswinds Residential Development

Level Of Service Computation Report
2000 HCM Operations (Future Volume Alternative)
Existing AM

Intersection #3115: Condit Road and Dunne Avenue

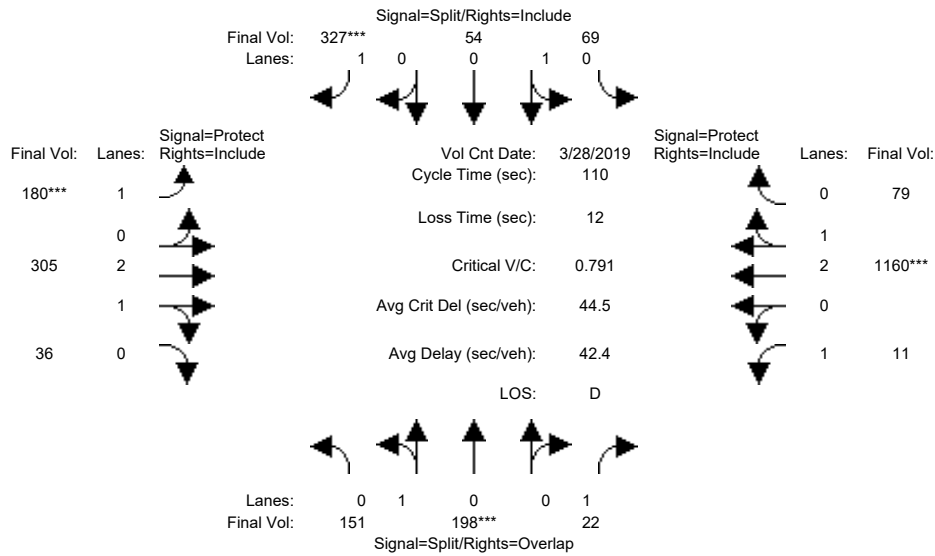

Street Name:	Condit Road						Dunne Avenue					
Approach:	North Bound			South Bound			East Bound			West Bound		
Movement:	L	T	R	L	T	R	L	T	R	L	T	R
Min. Green:	10	10	10	10	10	10	7	10	10	7	10	10
Y+R:	4.0	4.0	4.0	4.0	4.0	4.0	4.0	4.0	4.0	4.0	4.0	4.0

Volume Module:	>>	Count	Date:	28 Mar 2019	<<							
Base Vol:	151	198	22	69	54	327	180	305	36	11	1160	79
Growth Adj:	1.00	1.00	1.00	1.00	1.00	1.00	1.00	1.00	1.00	1.00	1.00	1.00
Initial Bse:	151	198	22	69	54	327	180	305	36	11	1160	79
Added Vol:	0	0	0	0	0	0	0	0	0	0	0	0
PasserByVol:	0	0	0	0	0	0	0	0	0	0	0	0
Initial Fut:	151	198	22	69	54	327	180	305	36	11	1160	79
User Adj:	1.00	1.00	1.00	1.00	1.00	1.00	1.00	1.00	1.00	1.00	1.00	1.00
PHF Adj:	1.00	1.00	1.00	1.00	1.00	1.00	1.00	1.00	1.00	1.00	1.00	1.00
PHF Volume:	151	198	22	69	54	327	180	305	36	11	1160	79
Reduct Vol:	0	0	0	0	0	0	0	0	0	0	0	0
Reduced Vol:	151	198	22	69	54	327	180	305	36	11	1160	79
PCE Adj:	1.00	1.00	1.00	1.00	1.00	1.00	1.00	1.00	1.00	1.00	1.00	1.00
MLF Adj:	1.00	1.00	1.00	1.00	1.00	1.00	1.00	1.00	1.00	1.00	1.00	1.00
Final Volume:	151	198	22	69	54	327	180	305	36	11	1160	79

Saturation Flow Module:												
Sat/Lane:	1900	1900	1900	1900	1900	1900	1900	1900	1900	1900	1900	1900
Adjustment:	0.95	0.95	0.92	0.95	0.95	0.92	0.92	0.99	0.95	0.92	0.98	0.95
Lanes:	0.43	0.57	1.00	0.56	0.44	1.00	1.00	2.67	0.33	1.00	2.80	0.20
Final Sat.:	779	1021	1750	1010	790	1750	1750	5008	591	1750	5242	357

Capacity Analysis Module:												
Vol/Sat:	0.19	0.19	0.01	0.07	0.07	0.19	0.10	0.06	0.06	0.01	0.22	0.22
Crit Moves:	****			****			****			****		
Green Time:	27.0	27.0	45.5	26.0	26.0	26.0	14.3	26.5	26.5	18.6	30.8	30.8
Volume/Cap:	0.79	0.79	0.03	0.29	0.29	0.79	0.79	0.25	0.25	0.04	0.79	0.79
Delay/Veh:	48.3	48.3	19.2	34.8	34.8	49.4	63.4	33.8	33.8	38.3	39.5	39.5
User DelAdj:	1.00	1.00	1.00	1.00	1.00	1.00	1.00	1.00	1.00	1.00	1.00	1.00
AdjDel/Veh:	48.3	48.3	19.2	34.8	34.8	49.4	63.4	33.8	33.8	38.3	39.5	39.5
LOS by Move:	D	D	B	C	C	D	E	C	C	D	D	D
HCM2k95thQ:	24	24	1	7	7	24	13	6	6	1	24	24

Note: Queue reported is the number of cars per lane.

City of Morgan Hill
The Crosswinds Residential Development

Level Of Service Computation Report
2000 HCM Operations (Future Volume Alternative)
Existing Plus Project AM

Intersection #3115: Condit Road and Dunne Avenue

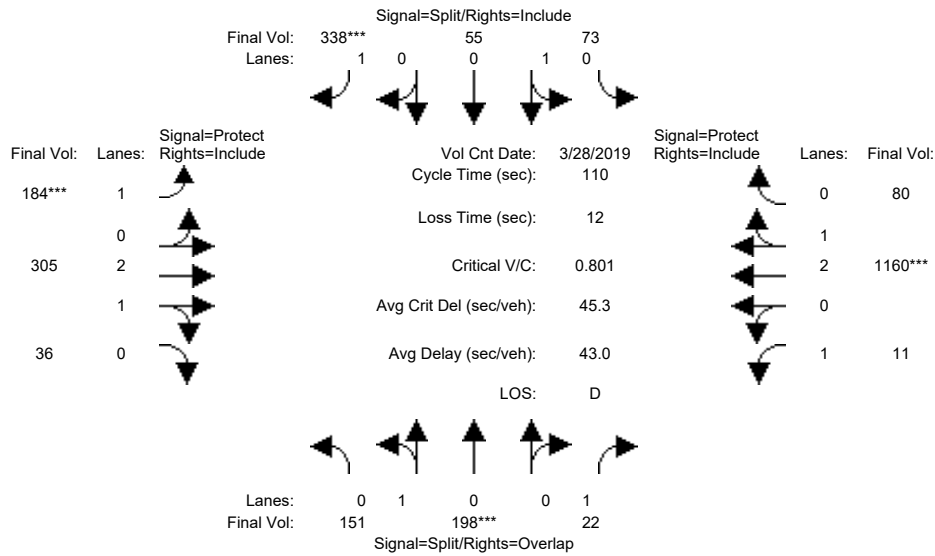

Street Name:	Condit Road						Dunne Avenue					
	North Bound			South Bound			East Bound			West Bound		
Approach:	L	T	R	L	T	R	L	T	R	L	T	R
Min. Green:	10	10	10	10	10	10	7	10	10	7	10	10
Y+R:	4.0	4.0	4.0	4.0	4.0	4.0	4.0	4.0	4.0	4.0	4.0	4.0

Volume Module:	>>	Count	Date:	28 Mar 2019	<<							
Base Vol:	151	198	22	69	54	327	180	305	36	11	1160	79
Growth Adj:	1.00	1.00	1.00	1.00	1.00	1.00	1.00	1.00	1.00	1.00	1.00	1.00
Initial Bse:	151	198	22	69	54	327	180	305	36	11	1160	79
Added Vol:	0	0	0	4	1	11	4	0	0	0	0	1
PasserByVol:	0	0	0	0	0	0	0	0	0	0	0	0
Initial Fut:	151	198	22	73	55	338	184	305	36	11	1160	80
User Adj:	1.00	1.00	1.00	1.00	1.00	1.00	1.00	1.00	1.00	1.00	1.00	1.00
PHF Adj:	1.00	1.00	1.00	1.00	1.00	1.00	1.00	1.00	1.00	1.00	1.00	1.00
PHF Volume:	151	198	22	73	55	338	184	305	36	11	1160	80
Reduct Vol:	0	0	0	0	0	0	0	0	0	0	0	0
Reduced Vol:	151	198	22	73	55	338	184	305	36	11	1160	80
PCE Adj:	1.00	1.00	1.00	1.00	1.00	1.00	1.00	1.00	1.00	1.00	1.00	1.00
MLF Adj:	1.00	1.00	1.00	1.00	1.00	1.00	1.00	1.00	1.00	1.00	1.00	1.00
Final Volume:	151	198	22	73	55	338	184	305	36	11	1160	80

Saturation Flow Module:												
Sat/Lane:	1900	1900	1900	1900	1900	1900	1900	1900	1900	1900	1900	1900
Adjustment:	0.95	0.95	0.92	0.95	0.95	0.92	0.92	0.99	0.95	0.92	0.98	0.95
Lanes:	0.43	0.57	1.00	0.57	0.43	1.00	1.00	2.67	0.33	1.00	2.80	0.20
Final Sat.:	779	1021	1750	1027	773	1750	1750	5008	591	1750	5238	361

Capacity Analysis Module:												
Vol/Sat:	0.19	0.19	0.01	0.07	0.07	0.19	0.11	0.06	0.06	0.01	0.22	0.22
Crit Moves:	****			****			****			****		
Green Time:	26.6	26.6	45.1	26.5	26.5	26.5	14.4	26.4	26.4	18.5	30.4	30.4
Volume/Cap:	0.80	0.80	0.03	0.29	0.29	0.80	0.80	0.25	0.25	0.04	0.80	0.80
Delay/Veh:	49.4	49.4	19.4	34.5	34.5	49.7	64.3	33.9	33.9	38.4	40.1	40.1
User DelAdj:	1.00	1.00	1.00	1.00	1.00	1.00	1.00	1.00	1.00	1.00	1.00	1.00
AdjDel/Veh:	49.4	49.4	19.4	34.5	34.5	49.7	64.3	33.9	33.9	38.4	40.1	40.1
LOS by Move:	D	D	B	C	C	D	E	C	C	D	D	D
HCM2k95thQ:	24	24	1	8	8	24	13	6	6	1	24	24

Note: Queue reported is the number of cars per lane.

City of Morgan Hill
The Crosswinds Residential Development

Level Of Service Computation Report
2000 HCM Operations (Future Volume Alternative)
Year 2030 Cumulative without Project AM

Intersection #3115: Condit Road and Dunne Avenue

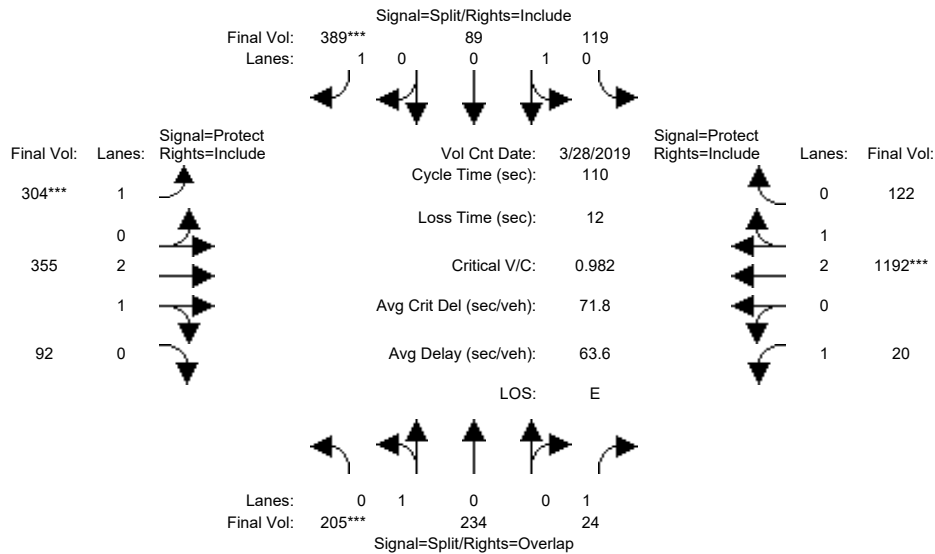

Street Name:	Condit Road						Dunne Avenue					
	North Bound			South Bound			East Bound			West Bound		
Approach:	L	T	R	L	T	R	L	T	R	L	T	R
Min. Green:	10	10	10	10	10	10	7	10	10	7	10	10
Y+R:	4.0	4.0	4.0	4.0	4.0	4.0	4.0	4.0	4.0	4.0	4.0	4.0

Volume Module:	>>	Count	Date:	28 Mar 2019	<<												
Base Vol:	205	234	24	119	89	389	304	355	92	20	1192	122					
Growth Adj:	1.00	1.00	1.00	1.00	1.00	1.00	1.00	1.00	1.00	1.00	1.00	1.00					
Initial Bse:	205	234	24	119	89	389	304	355	92	20	1192	122					
Added Vol:	0	0	0	0	0	0	0	0	0	0	0	0					
PasserByVol:	0	0	0	0	0	0	0	0	0	0	0	0					
Initial Fut:	205	234	24	119	89	389	304	355	92	20	1192	122					
User Adj:	1.00	1.00	1.00	1.00	1.00	1.00	1.00	1.00	1.00	1.00	1.00	1.00					
PHF Adj:	1.00	1.00	1.00	1.00	1.00	1.00	1.00	1.00	1.00	1.00	1.00	1.00					
PHF Volume:	205	234	24	119	89	389	304	355	92	20	1192	122					
Reduct Vol:	0	0	0	0	0	0	0	0	0	0	0	0					
Reduced Vol:	205	234	24	119	89	389	304	355	92	20	1192	122					
PCE Adj:	1.00	1.00	1.00	1.00	1.00	1.00	1.00	1.00	1.00	1.00	1.00	1.00					
MLF Adj:	1.00	1.00	1.00	1.00	1.00	1.00	1.00	1.00	1.00	1.00	1.00	1.00					
Final Volume:	205	234	24	119	89	389	304	355	92	20	1192	122					

Saturation Flow Module:												
Sat/Lane:	1900	1900	1900	1900	1900	1900	1900	1900	1900	1900	1900	1900
Adjustment:	0.95	0.95	0.92	0.95	0.95	0.92	0.92	0.99	0.95	0.92	0.99	0.95
Lanes:	0.47	0.53	1.00	0.57	0.43	1.00	1.00	2.36	0.64	1.00	2.71	0.29
Final Sat.:	841	959	1750	1030	770	1750	1750	4446	1152	1750	5079	520

Capacity Analysis Module:												
Vol/Sat:	0.24	0.24	0.01	0.12	0.12	0.22	0.17	0.08	0.08	0.01	0.23	0.23
Crit Moves:	****					****	****				****	
Green Time:	27.3	27.3	46.2	24.9	24.9	24.9	19.5	26.9	26.9	18.8	26.3	26.3
Volume/Cap:	0.98	0.98	0.03	0.51	0.51	0.98	0.98	0.33	0.33	0.07	0.98	0.98
Delay/Veh:	78.7	78.7	18.8	38.3	38.3	82.5	91.1	34.2	34.2	38.3	61.8	61.8
User DelAdj:	1.00	1.00	1.00	1.00	1.00	1.00	1.00	1.00	1.00	1.00	1.00	1.00
AdjDel/Veh:	78.7	78.7	18.8	38.3	38.3	82.5	91.1	34.2	34.2	38.3	61.8	61.8
LOS by Move:	E	E	B	D	D	F	F	C	C	D	E	E
HCM2k95thQ:	36	36	1	13	13	33	24	8	8	1	30	30

Note: Queue reported is the number of cars per lane.

City of Morgan Hill
The Crosswinds Residential Development

Level Of Service Computation Report
2000 HCM Operations (Future Volume Alternative)
Year 2030 Cumulative with Project AM

Intersection #3115: Condit Road and Dunne Avenue

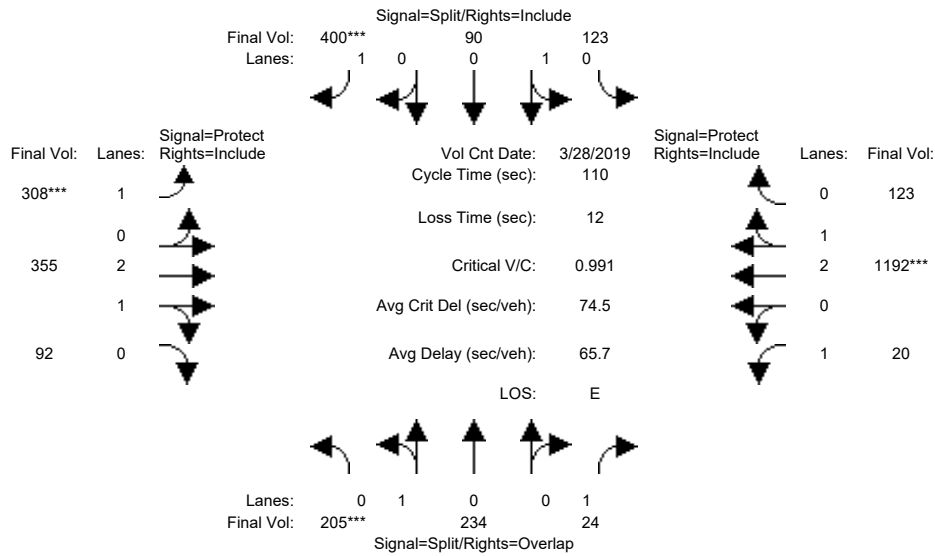

Street Name:	Condit Road						Dunne Avenue					
Approach:	North Bound			South Bound			East Bound			West Bound		
Movement:	L	T	R	L	T	R	L	T	R	L	T	R
Min. Green:	10	10	10	10	10	10	7	10	10	7	10	10
Y+R:	4.0	4.0	4.0	4.0	4.0	4.0	4.0	4.0	4.0	4.0	4.0	4.0

Volume Module:	>>	Count	Date:	28 Mar 2019	<<											
Base Vol:	205	234	24	119	89	389	304	355	92	20	1192	122				
Growth Adj:	1.00	1.00	1.00	1.00	1.00	1.00	1.00	1.00	1.00	1.00	1.00	1.00				
Initial Bse:	205	234	24	119	89	389	304	355	92	20	1192	122				
Added Vol:	0	0	0	4	1	11	4	0	0	0	0	1				
PasserByVol:	0	0	0	0	0	0	0	0	0	0	0	0				
Initial Fut:	205	234	24	123	90	400	308	355	92	20	1192	123				
User Adj:	1.00	1.00	1.00	1.00	1.00	1.00	1.00	1.00	1.00	1.00	1.00	1.00				
PHF Adj:	1.00	1.00	1.00	1.00	1.00	1.00	1.00	1.00	1.00	1.00	1.00	1.00				
PHF Volume:	205	234	24	123	90	400	308	355	92	20	1192	123				
Reduct Vol:	0	0	0	0	0	0	0	0	0	0	0	0				
Reduced Vol:	205	234	24	123	90	400	308	355	92	20	1192	123				
PCE Adj:	1.00	1.00	1.00	1.00	1.00	1.00	1.00	1.00	1.00	1.00	1.00	1.00				
MLF Adj:	1.00	1.00	1.00	1.00	1.00	1.00	1.00	1.00	1.00	1.00	1.00	1.00				
Final Volume:	205	234	24	123	90	400	308	355	92	20	1192	123				

Saturation Flow Module:												
Sat/Lane:	1900	1900	1900	1900	1900	1900	1900	1900	1900	1900	1900	1900
Adjustment:	0.95	0.95	0.92	0.95	0.95	0.92	0.92	0.99	0.95	0.92	0.99	0.95
Lanes:	0.47	0.53	1.00	0.58	0.42	1.00	1.00	2.36	0.64	1.00	2.71	0.29
Final Sat.:	841	959	1750	1039	761	1750	1750	4446	1152	1750	5076	524

Capacity Analysis Module:												
Vol/Sat:	0.24	0.24	0.01	0.12	0.12	0.23	0.18	0.08	0.08	0.01	0.23	0.23
Crit Moves:	****					****	****				****	
Green Time:	27.1	27.1	45.8	25.4	25.4	25.4	19.5	26.8	26.8	18.8	26.1	26.1
Volume/Cap:	0.99	0.99	0.03	0.51	0.51	0.99	0.99	0.33	0.33	0.07	0.99	0.99
Delay/Veh:	81.8	81.8	19.0	38.0	38.0	84.6	93.8	34.3	34.3	38.4	64.5	64.5
User DelAdj:	1.00	1.00	1.00	1.00	1.00	1.00	1.00	1.00	1.00	1.00	1.00	1.00
AdjDel/Veh:	81.8	81.8	19.0	38.0	38.0	84.6	93.8	34.3	34.3	38.4	64.5	64.5
LOS by Move:	F	F	B	D	D	F	F	C	C	D	E	E
HCM2k95thQ:	36	36	1	13	13	35	25	8	8	1	30	30

Note: Queue reported is the number of cars per lane.

City of Morgan Hill
The Crosswinds Residential Development

Level Of Service Computation Report
2000 HCM Operations (Future Volume Alternative)
Existing PM

Intersection #3115: Condit Road and Dunne Avenue

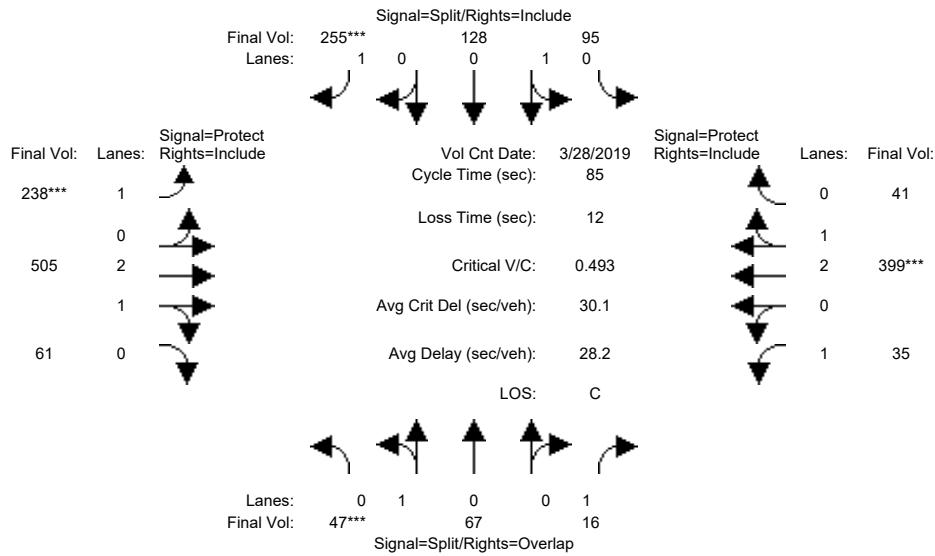

Street Name:	Condit Road						Dunne Avenue					
	North Bound			South Bound			East Bound			West Bound		
Approach:	L	T	R	L	T	R	L	T	R	L	T	R
Min. Green:	10	10	10	10	10	10	7	10	10	7	10	10
Y+R:	4.0	4.0	4.0	4.0	4.0	4.0	4.0	4.0	4.0	4.0	4.0	4.0

Volume Module:	>>	Count	Date:	28 Mar 2019	<<							
Base Vol:	47	67	16	95	128	255	238	505	61	35	399	41
Growth Adj:	1.00	1.00	1.00	1.00	1.00	1.00	1.00	1.00	1.00	1.00	1.00	1.00
Initial Bse:	47	67	16	95	128	255	238	505	61	35	399	41
Added Vol:	0	0	0	0	0	0	0	0	0	0	0	0
PasserByVol:	0	0	0	0	0	0	0	0	0	0	0	0
Initial Fut:	47	67	16	95	128	255	238	505	61	35	399	41
User Adj:	1.00	1.00	1.00	1.00	1.00	1.00	1.00	1.00	1.00	1.00	1.00	1.00
PHF Adj:	1.00	1.00	1.00	1.00	1.00	1.00	1.00	1.00	1.00	1.00	1.00	1.00
PHF Volume:	47	67	16	95	128	255	238	505	61	35	399	41
Reduct Vol:	0	0	0	0	0	0	0	0	0	0	0	0
Reduced Vol:	47	67	16	95	128	255	238	505	61	35	399	41
PCE Adj:	1.00	1.00	1.00	1.00	1.00	1.00	1.00	1.00	1.00	1.00	1.00	1.00
MLF Adj:	1.00	1.00	1.00	1.00	1.00	1.00	1.00	1.00	1.00	1.00	1.00	1.00
Final Volume:	47	67	16	95	128	255	238	505	61	35	399	41

Saturation Flow Module:												
Sat/Lane:	1900	1900	1900	1900	1900	1900	1900	1900	1900	1900	1900	1900
Adjustment:	0.95	0.95	0.92	0.95	0.95	0.92	0.92	0.99	0.95	0.92	0.99	0.95
Lanes:	0.41	0.59	1.00	0.43	0.57	1.00	1.00	2.66	0.34	1.00	2.71	0.29
Final Sat.:	742	1058	1750	767	1033	1750	1750	4996	603	1750	5077	522

Capacity Analysis Module:												
Vol/Sat:	0.06	0.06	0.01	0.12	0.12	0.15	0.14	0.10	0.10	0.02	0.08	0.08
Crit Moves:	***					****	****				****	
Green Time:	10.9	10.9	26.1	25.1	25.1	25.1	23.4	21.8	21.8	15.2	13.5	13.5
Volume/Cap:	0.49	0.49	0.03	0.42	0.42	0.49	0.49	0.40	0.40	0.11	0.49	0.49
Delay/Veh:	36.1	36.1	20.6	24.6	24.6	25.4	26.6	26.4	26.4	29.4	33.0	33.0
User DelAdj:	1.00	1.00	1.00	1.00	1.00	1.00	1.00	1.00	1.00	1.00	1.00	1.00
AdjDel/Veh:	36.1	36.1	20.6	24.6	24.6	25.4	26.6	26.4	26.4	29.4	33.0	33.0
LOS by Move:	D	D	C	C	C	C	C	C	C	C	C	C
HCM2k95thQ:	7	7	1	10	10	12	11	8	8	2	7	7

Note: Queue reported is the number of cars per lane.

City of Morgan Hill
The Crosswinds Residential Development

Level Of Service Computation Report
2000 HCM Operations (Future Volume Alternative)
Existing Plus Project PM

Intersection #3115: Condit Road and Dunne Avenue

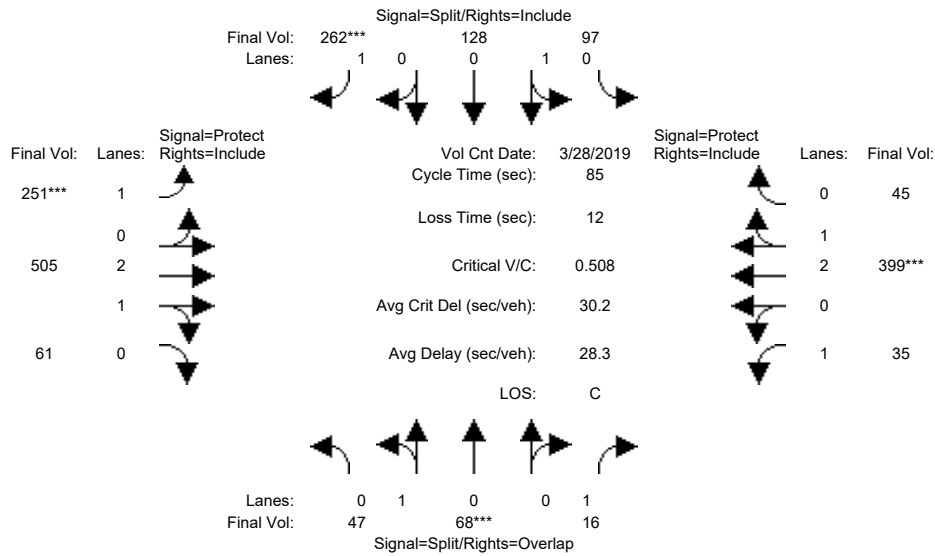

Street Name:	Condit Road						Dunne Avenue					
	North Bound			South Bound			East Bound			West Bound		
Approach:	L	T	R	L	T	R	L	T	R	L	T	R
Min. Green:	10	10	10	10	10	10	7	10	10	7	10	10
Y+R:	4.0	4.0	4.0	4.0	4.0	4.0	4.0	4.0	4.0	4.0	4.0	4.0

Volume Module:	>>	Count	Date:	28 Mar 2019	<<												
Base Vol:	47	67	16	95	128	255	238	505	61	35	399	41					
Growth Adj:	1.00	1.00	1.00	1.00	1.00	1.00	1.00	1.00	1.00	1.00	1.00	1.00					
Initial Bse:	47	67	16	95	128	255	238	505	61	35	399	41					
Added Vol:	0	1	0	2	0	7	13	0	0	0	0	4					
PasserByVol:	0	0	0	0	0	0	0	0	0	0	0	0					
Initial Fut:	47	68	16	97	128	262	251	505	61	35	399	45					
User Adj:	1.00	1.00	1.00	1.00	1.00	1.00	1.00	1.00	1.00	1.00	1.00	1.00					
PHF Adj:	1.00	1.00	1.00	1.00	1.00	1.00	1.00	1.00	1.00	1.00	1.00	1.00					
PHF Volume:	47	68	16	97	128	262	251	505	61	35	399	45					
Reduct Vol:	0	0	0	0	0	0	0	0	0	0	0	0					
Reduced Vol:	47	68	16	97	128	262	251	505	61	35	399	45					
PCE Adj:	1.00	1.00	1.00	1.00	1.00	1.00	1.00	1.00	1.00	1.00	1.00	1.00					
MLF Adj:	1.00	1.00	1.00	1.00	1.00	1.00	1.00	1.00	1.00	1.00	1.00	1.00					
Final Volume:	47	68	16	97	128	262	251	505	61	35	399	45					

Saturation Flow Module:												
Sat/Lane:	1900	1900	1900	1900	1900	1900	1900	1900	1900	1900	1900	1900
Adjustment:	0.95	0.95	0.92	0.95	0.95	0.92	0.92	0.99	0.95	0.92	0.99	0.95
Lanes:	0.41	0.59	1.00	0.43	0.57	1.00	1.00	2.66	0.34	1.00	2.68	0.32
Final Sat.:	736	1064	1750	776	1024	1750	1750	4996	603	1750	5032	567

Capacity Analysis Module:												
Vol/Sat:	0.06	0.06	0.01	0.13	0.13	0.15	0.14	0.10	0.10	0.02	0.08	0.08
Crit Moves:	****			****			****			****		
Green Time:	10.7	10.7	26.0	25.0	25.0	25.0	24.0	21.9	21.9	15.3	13.3	13.3
Volume/Cap:	0.51	0.51	0.03	0.42	0.42	0.51	0.51	0.39	0.39	0.11	0.51	0.51
Delay/Veh:	36.6	36.6	20.7	24.7	24.7	25.7	26.4	26.2	26.2	29.3	33.4	33.4
User DelAdj:	1.00	1.00	1.00	1.00	1.00	1.00	1.00	1.00	1.00	1.00	1.00	1.00
AdjDel/Veh:	36.6	36.6	20.7	24.7	24.7	25.7	26.4	26.2	26.2	29.3	33.4	33.4
LOS by Move:	D	D	C	C	C	C	C	C	C	C	C	C
HCM2k95thQ:	7	7	1	10	10	13	11	8	8	2	7	7

Note: Queue reported is the number of cars per lane.

City of Morgan Hill
The Crosswinds Residential Development

Level Of Service Computation Report
2000 HCM Operations (Future Volume Alternative)
Year 2030 Cumulative without Project PM

Intersection #3115: Condit Road and Dunne Avenue

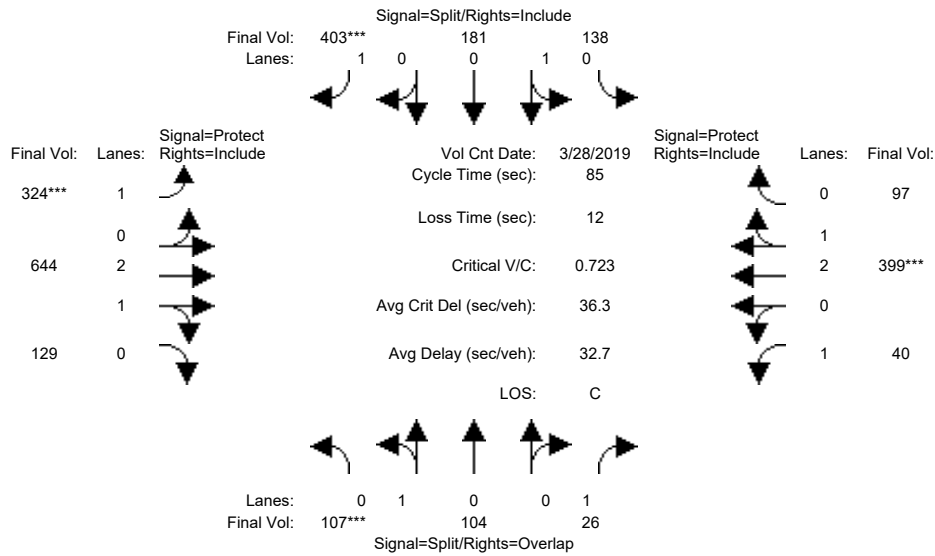

Street Name:	Condit Road						Dunne Avenue					
	North Bound			South Bound			East Bound			West Bound		
Approach:	L	T	R	L	T	R	L	T	R	L	T	R
Min. Green:	10	10	10	10	10	10	7	10	10	7	10	10
Y+R:	4.0	4.0	4.0	4.0	4.0	4.0	4.0	4.0	4.0	4.0	4.0	4.0

Volume Module:	>>	Count	Date:	28 Mar 2019	<<							
Base Vol:	107	104	26	138	181	403	324	644	129	40	399	97
Growth Adj:	1.00	1.00	1.00	1.00	1.00	1.00	1.00	1.00	1.00	1.00	1.00	1.00
Initial Bse:	107	104	26	138	181	403	324	644	129	40	399	97
Added Vol:	0	0	0	0	0	0	0	0	0	0	0	0
PasserByVol:	0	0	0	0	0	0	0	0	0	0	0	0
Initial Fut:	107	104	26	138	181	403	324	644	129	40	399	97
User Adj:	1.00	1.00	1.00	1.00	1.00	1.00	1.00	1.00	1.00	1.00	1.00	1.00
PHF Adj:	1.00	1.00	1.00	1.00	1.00	1.00	1.00	1.00	1.00	1.00	1.00	1.00
PHF Volume:	107	104	26	138	181	403	324	644	129	40	399	97
Reduct Vol:	0	0	0	0	0	0	0	0	0	0	0	0
Reduced Vol:	107	104	26	138	181	403	324	644	129	40	399	97
PCE Adj:	1.00	1.00	1.00	1.00	1.00	1.00	1.00	1.00	1.00	1.00	1.00	1.00
MLF Adj:	1.00	1.00	1.00	1.00	1.00	1.00	1.00	1.00	1.00	1.00	1.00	1.00
Final Volume:	107	104	26	138	181	403	324	644	129	40	399	97

Saturation Flow Module:												
Sat/Lane:	1900	1900	1900	1900	1900	1900	1900	1900	1900	1900	1900	1900
Adjustment:	0.95	0.95	0.92	0.95	0.95	0.92	0.92	0.99	0.95	0.92	0.99	0.95
Lanes:	0.51	0.49	1.00	0.43	0.57	1.00	1.00	2.48	0.52	1.00	2.39	0.61
Final Sat.:	913	887	1750	779	1021	1750	1750	4664	934	1750	4503	1095

Capacity Analysis Module:												
Vol/Sat:	0.12	0.12	0.01	0.18	0.18	0.23	0.19	0.14	0.14	0.02	0.09	0.09
Crit Moves:	***					***	***				***	
Green Time:	13.8	13.8	25.8	27.1	27.1	27.1	21.8	20.1	20.1	12.0	10.4	10.4
Volume/Cap:	0.72	0.72	0.05	0.56	0.56	0.72	0.72	0.58	0.58	0.16	0.72	0.72
Delay/Veh:	42.4	42.4	21.0	25.2	25.2	30.3	34.6	29.4	29.4	32.4	39.7	39.7
User DelAdj:	1.00	1.00	1.00	1.00	1.00	1.00	1.00	1.00	1.00	1.00	1.00	1.00
AdjDel/Veh:	42.4	42.4	21.0	25.2	25.2	30.3	34.6	29.4	29.4	32.4	39.7	39.7
LOS by Move:	D	D	C	C	C	C	C	C	C	C	D	D
HCM2k95thQ:	14	14	1	15	15	21	16	12	12	2	9	9

Note: Queue reported is the number of cars per lane.

City of Morgan Hill
The Crosswinds Residential Development

Level Of Service Computation Report
2000 HCM Operations (Future Volume Alternative)
Year 2030 Cumulative with Project PM

Intersection #3115: Condit Road and Dunne Avenue

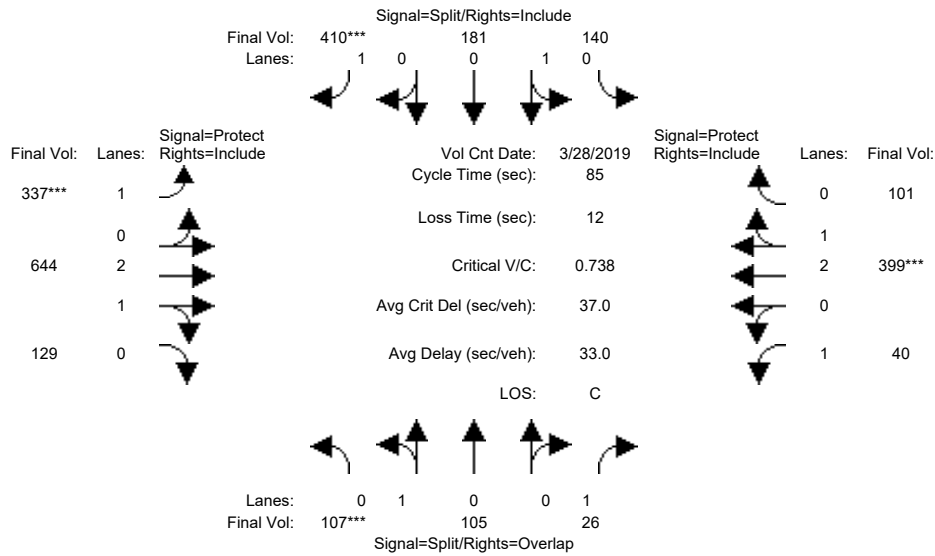

Street Name:	Condit Road						Dunne Avenue					
	North Bound			South Bound			East Bound			West Bound		
Approach:	L	T	R	L	T	R	L	T	R	L	T	R
Min. Green:	10	10	10	10	10	10	7	10	10	7	10	10
Y+R:	4.0	4.0	4.0	4.0	4.0	4.0	4.0	4.0	4.0	4.0	4.0	4.0

Volume Module:	>>	Count	Date:	28 Mar 2019	<<							
Base Vol:	107	104	26	138	181	403	324	644	129	40	399	97
Growth Adj:	1.00	1.00	1.00	1.00	1.00	1.00	1.00	1.00	1.00	1.00	1.00	1.00
Initial Bse:	107	104	26	138	181	403	324	644	129	40	399	97
Added Vol:	0	1	0	2	0	7	13	0	0	0	0	4
PasserByVol:	0	0	0	0	0	0	0	0	0	0	0	0
Initial Fut:	107	105	26	140	181	410	337	644	129	40	399	101
User Adj:	1.00	1.00	1.00	1.00	1.00	1.00	1.00	1.00	1.00	1.00	1.00	1.00
PHF Adj:	1.00	1.00	1.00	1.00	1.00	1.00	1.00	1.00	1.00	1.00	1.00	1.00
PHF Volume:	107	105	26	140	181	410	337	644	129	40	399	101
Reduct Vol:	0	0	0	0	0	0	0	0	0	0	0	0
Reduced Vol:	107	105	26	140	181	410	337	644	129	40	399	101
PCE Adj:	1.00	1.00	1.00	1.00	1.00	1.00	1.00	1.00	1.00	1.00	1.00	1.00
MLF Adj:	1.00	1.00	1.00	1.00	1.00	1.00	1.00	1.00	1.00	1.00	1.00	1.00
Final Volume:	107	105	26	140	181	410	337	644	129	40	399	101

Saturation Flow Module:												
Sat/Lane:	1900	1900	1900	1900	1900	1900	1900	1900	1900	1900	1900	1900
Adjustment:	0.95	0.95	0.92	0.95	0.95	0.92	0.92	0.99	0.95	0.92	0.99	0.95
Lanes:	0.50	0.50	1.00	0.44	0.56	1.00	1.00	2.48	0.52	1.00	2.37	0.63
Final Sat.:	908	892	1750	785	1015	1750	1750	4664	934	1750	4467	1131

Capacity Analysis Module:												
Vol/Sat:	0.12	0.12	0.01	0.18	0.18	0.23	0.19	0.14	0.14	0.02	0.09	0.09
Crit Moves:	***					***	***				***	
Green Time:	13.6	13.6	25.7	27.0	27.0	27.0	22.2	20.3	20.3	12.1	10.3	10.3
Volume/Cap:	0.74	0.74	0.05	0.56	0.56	0.74	0.74	0.58	0.58	0.16	0.74	0.74
Delay/Veh:	43.7	43.7	21.0	25.4	25.4	31.1	35.0	29.2	29.2	32.3	40.3	40.3
User DelAdj:	1.00	1.00	1.00	1.00	1.00	1.00	1.00	1.00	1.00	1.00	1.00	1.00
AdjDel/Veh:	43.7	43.7	21.0	25.4	25.4	31.1	35.0	29.2	29.2	32.3	40.3	40.3
LOS by Move:	D	D	C	C	C	C	D	C	C	C	D	D
HCM2k95thQ:	14	14	1	15	15	21	17	12	12	2	9	9

Note: Queue reported is the number of cars per lane.

City of Morgan Hill
The Crosswinds Residential Development

Level Of Service Computation Report
2000 HCM Operations (Future Volume Alternative)
Existing AM

Intersection #119: Butterfield Boulevard and Main Avenue

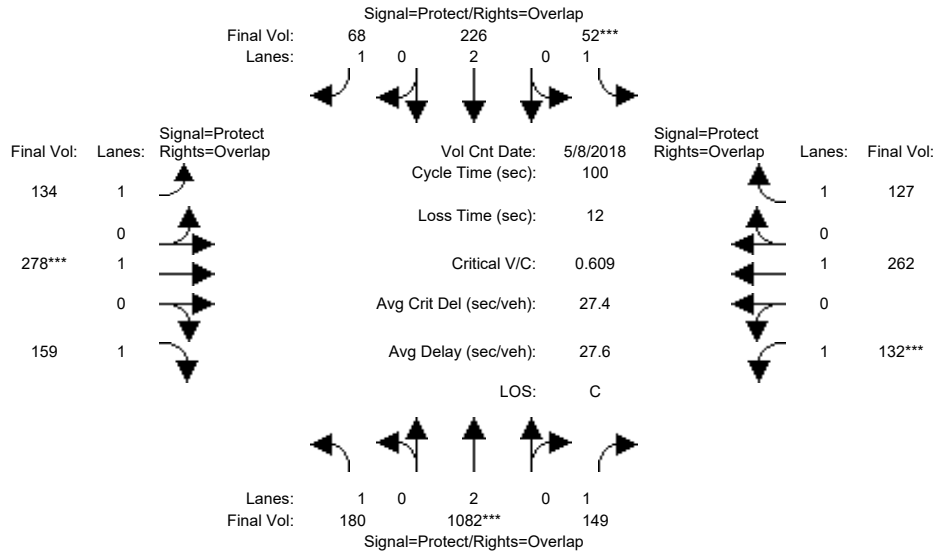

Street Name:	Butterfield Boulevard						Main Avenue					
	North Bound			South Bound			East Bound			West Bound		
Approach:	L	T	R	L	T	R	L	T	R	L	T	R
Min. Green:	7	10	10	7	10	10	7	10	10	7	10	10
Y+R:	4.0	4.0	4.0	4.0	4.0	4.0	4.0	4.0	4.0	4.0	4.0	4.0

Volume Module:	>>	Count	Date:	8 May 2018	<<											
Base Vol:	180	1082	149	52	226	68	134	278	159	132	262	127				
Growth Adj:	1.00	1.00	1.00	1.00	1.00	1.00	1.00	1.00	1.00	1.00	1.00	1.00				
Initial Bse:	180	1082	149	52	226	68	134	278	159	132	262	127				
Added Vol:	0	0	0	0	0	0	0	0	0	0	0	0				
PasserByVol:	0	0	0	0	0	0	0	0	0	0	0	0				
Initial Fut:	180	1082	149	52	226	68	134	278	159	132	262	127				
User Adj:	1.00	1.00	1.00	1.00	1.00	1.00	1.00	1.00	1.00	1.00	1.00	1.00				
PHF Adj:	1.00	1.00	1.00	1.00	1.00	1.00	1.00	1.00	1.00	1.00	1.00	1.00				
PHF Volume:	180	1082	149	52	226	68	134	278	159	132	262	127				
Reduct Vol:	0	0	0	0	0	0	0	0	0	0	0	0				
Reduced Vol:	180	1082	149	52	226	68	134	278	159	132	262	127				
PCE Adj:	1.00	1.00	1.00	1.00	1.00	1.00	1.00	1.00	1.00	1.00	1.00	1.00				
MLF Adj:	1.00	1.00	1.00	1.00	1.00	1.00	1.00	1.00	1.00	1.00	1.00	1.00				
Final Volume:	180	1082	149	52	226	68	134	278	159	132	262	127				

Saturation Flow Module:												
Sat/Lane:	1900	1900	1900	1900	1900	1900	1900	1900	1900	1900	1900	1900
Adjustment:	0.92	1.00	0.92	0.92	1.00	0.92	0.92	1.00	0.92	0.92	1.00	0.92
Lanes:	1.00	2.00	1.00	1.00	2.00	1.00	1.00	1.00	1.00	1.00	1.00	1.00
Final Sat.:	1750	3800	1750	1750	3800	1750	1750	1900	1750	1750	1900	1750

Capacity Analysis Module:												
Vol/Sat:	0.10	0.28	0.09	0.03	0.06	0.04	0.08	0.15	0.09	0.08	0.14	0.07
Crit Moves:	****			****			****			****		
Green Time:	26.6	45.5	57.6	7.0	25.9	38.6	12.7	23.4	50.0	12.1	22.8	29.8
Volume/Cap:	0.39	0.63	0.15	0.42	0.23	0.10	0.60	0.63	0.18	0.63	0.60	0.24
Delay/Veh:	30.5	21.5	9.9	46.9	29.3	19.7	46.0	37.2	13.8	47.6	37.0	26.8
User DelAdj:	1.00	1.00	1.00	1.00	1.00	1.00	1.00	1.00	1.00	1.00	1.00	1.00
AdjDel/Veh:	30.5	21.5	9.9	46.9	29.3	19.7	46.0	37.2	13.8	47.6	37.0	26.8
LOS by Move:	C	C	A	D	C	B	D	D	B	D	D	C
HCM2k95thQ:	9	22	4	3	5	3	8	14	6	10	15	6

Note: Queue reported is the number of cars per lane.

City of Morgan Hill
The Crosswinds Residential Development

Level Of Service Computation Report
2000 HCM Operations (Future Volume Alternative)
Existing Plus Project AM

Intersection #119: Butterfield Boulevard and Main Avenue

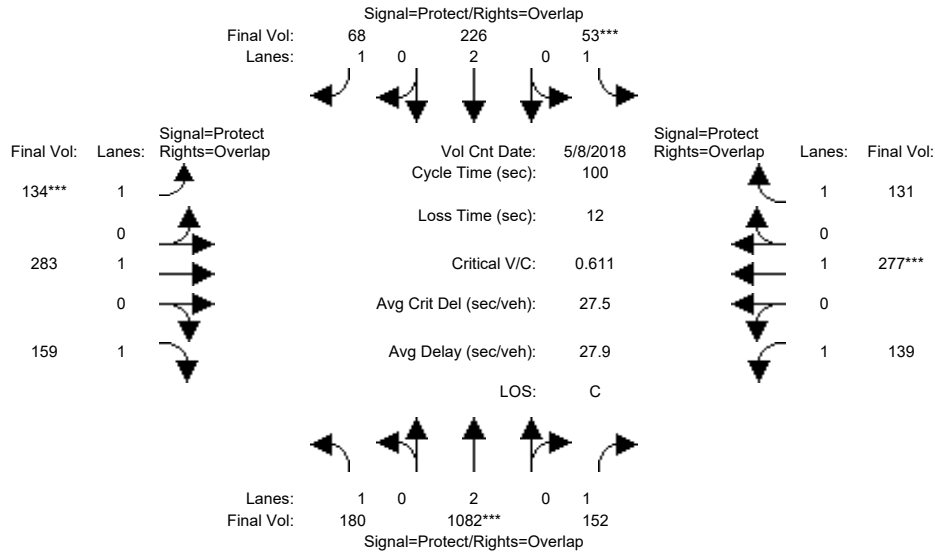

Street Name:	Butterfield Boulevard						Main Avenue					
	North Bound			South Bound			East Bound			West Bound		
Approach:	L	T	R	L	T	R	L	T	R	L	T	R
Min. Green:	7	10	10	7	10	10	7	10	10	7	10	10
Y+R:	4.0	4.0	4.0	4.0	4.0	4.0	4.0	4.0	4.0	4.0	4.0	4.0

Volume Module:	>>	Count	Date:	8 May 2018	<<											
Base Vol:	180	1082	149	52	226	68	134	278	159	132	262	127				
Growth Adj:	1.00	1.00	1.00	1.00	1.00	1.00	1.00	1.00	1.00	1.00	1.00	1.00				
Initial Bse:	180	1082	149	52	226	68	134	278	159	132	262	127				
Added Vol:	0	0	3	1	0	0	0	5	0	7	15	4				
PasserByVol:	0	0	0	0	0	0	0	0	0	0	0	0				
Initial Fut:	180	1082	152	53	226	68	134	283	159	139	277	131				
User Adj:	1.00	1.00	1.00	1.00	1.00	1.00	1.00	1.00	1.00	1.00	1.00	1.00				
PHF Adj:	1.00	1.00	1.00	1.00	1.00	1.00	1.00	1.00	1.00	1.00	1.00	1.00				
PHF Volume:	180	1082	152	53	226	68	134	283	159	139	277	131				
Reduct Vol:	0	0	0	0	0	0	0	0	0	0	0	0				
Reduced Vol:	180	1082	152	53	226	68	134	283	159	139	277	131				
PCE Adj:	1.00	1.00	1.00	1.00	1.00	1.00	1.00	1.00	1.00	1.00	1.00	1.00				
MLF Adj:	1.00	1.00	1.00	1.00	1.00	1.00	1.00	1.00	1.00	1.00	1.00	1.00				
Final Volume:	180	1082	152	53	226	68	134	283	159	139	277	131				

Saturation Flow Module:												
Sat/Lane:	1900	1900	1900	1900	1900	1900	1900	1900	1900	1900	1900	1900
Adjustment:	0.92	1.00	0.92	0.92	1.00	0.92	0.92	1.00	0.92	0.92	1.00	0.92
Lanes:	1.00	2.00	1.00	1.00	2.00	1.00	1.00	1.00	1.00	1.00	1.00	1.00
Final Sat.:	1750	3800	1750	1750	3800	1750	1750	1900	1750	1750	1900	1750

Capacity Analysis Module:												
Vol/Sat:	0.10	0.28	0.09	0.03	0.06	0.04	0.08	0.15	0.09	0.08	0.15	0.07
Crit Moves:	****		****				****			****		
Green Time:	26.6	45.5	57.8	7.0	25.9	38.1	12.2	23.2	49.8	12.4	23.3	30.3
Volume/Cap:	0.39	0.63	0.15	0.43	0.23	0.10	0.63	0.64	0.18	0.64	0.63	0.25
Delay/Veh:	30.6	21.5	9.8	47.0	29.3	20.0	47.5	37.9	14.0	48.2	37.3	26.5
User DelAdj:	1.00	1.00	1.00	1.00	1.00	1.00	1.00	1.00	1.00	1.00	1.00	1.00
AdjDel/Veh:	30.6	21.5	9.8	47.0	29.3	20.0	47.5	37.9	14.0	48.2	37.3	26.5
LOS by Move:	C	C	A	D	C	B	D	D	B	D	D	C
HCM2k95thQ:	9	22	4	3	5	3	8	15	6	11	16	7

Note: Queue reported is the number of cars per lane.

City of Morgan Hill
The Crosswinds Residential Development

Level Of Service Computation Report
2000 HCM Operations (Future Volume Alternative)
Year 2030 Cumulative without Project AM

Intersection #119: Butterfield Boulevard and Main Avenue

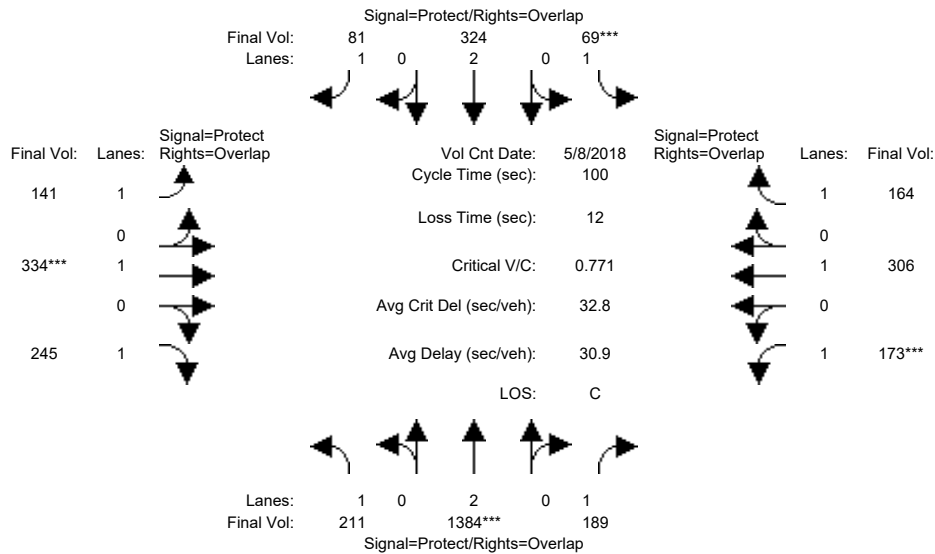

Street Name:	Butterfield Boulevard						Main Avenue					
Approach:	North Bound			South Bound			East Bound			West Bound		
Movement:	L	T	R	L	T	R	L	T	R	L	T	R
Min. Green:	7	10	10	7	10	10	7	10	10	7	10	10
Y+R:	4.0	4.0	4.0	4.0	4.0	4.0	4.0	4.0	4.0	4.0	4.0	4.0

Volume Module:	>>	Count	Date:	8 May 2018	<<											
Base Vol:	211	1384	189	69	324	81	141	334	245	173	306	164				
Growth Adj:	1.00	1.00	1.00	1.00	1.00	1.00	1.00	1.00	1.00	1.00	1.00	1.00				
Initial Bse:	211	1384	189	69	324	81	141	334	245	173	306	164				
Added Vol:	0	0	0	0	0	0	0	0	0	0	0	0				
PasserByVol:	0	0	0	0	0	0	0	0	0	0	0	0				
Initial Fut:	211	1384	189	69	324	81	141	334	245	173	306	164				
User Adj:	1.00	1.00	1.00	1.00	1.00	1.00	1.00	1.00	1.00	1.00	1.00	1.00				
PHF Adj:	1.00	1.00	1.00	1.00	1.00	1.00	1.00	1.00	1.00	1.00	1.00	1.00				
PHF Volume:	211	1384	189	69	324	81	141	334	245	173	306	164				
Reduct Vol:	0	0	0	0	0	0	0	0	0	0	0	0				
Reduced Vol:	211	1384	189	69	324	81	141	334	245	173	306	164				
PCE Adj:	1.00	1.00	1.00	1.00	1.00	1.00	1.00	1.00	1.00	1.00	1.00	1.00				
MLF Adj:	1.00	1.00	1.00	1.00	1.00	1.00	1.00	1.00	1.00	1.00	1.00	1.00				
FinalVolume:	211	1384	189	69	324	81	141	334	245	173	306	164				

Saturation Flow Module:												
Sat/Lane:	1900	1900	1900	1900	1900	1900	1900	1900	1900	1900	1900	1900
Adjustment:	0.92	1.00	0.92	0.92	1.00	0.92	0.92	1.00	0.92	0.92	1.00	0.92
Lanes:	1.00	2.00	1.00	1.00	2.00	1.00	1.00	1.00	1.00	1.00	1.00	1.00
Final Sat.:	1750	3800	1750	1750	3800	1750	1750	1900	1750	1750	1900	1750

Capacity Analysis Module:												
Vol/Sat:	0.12	0.36	0.11	0.04	0.09	0.05	0.08	0.18	0.14	0.10	0.16	0.09
Crit Moves:	****			****			****			****		
Green Time:	29.1	46.2	58.7	7.0	24.1	35.7	11.6	22.3	51.4	12.5	23.2	30.2
Volume/Cap:	0.41	0.79	0.18	0.56	0.35	0.13	0.69	0.79	0.27	0.79	0.69	0.31
Delay/Veh:	29.2	25.3	9.6	50.9	31.7	21.8	52.4	46.2	13.9	59.7	39.9	27.2
User DelAdj:	1.00	1.00	1.00	1.00	1.00	1.00	1.00	1.00	1.00	1.00	1.00	1.00
AdjDel/Veh:	29.2	25.3	9.6	50.9	31.7	21.8	52.4	46.2	13.9	59.7	39.9	27.2
LOS by Move:	C	C	A	D	C	C	D	D	B	E	D	C
HCM2k95thQ:	10	29	5	5	8	4	9	18	9	15	18	8

Note: Queue reported is the number of cars per lane.

City of Morgan Hill
The Crosswinds Residential Development

Level Of Service Computation Report
2000 HCM Operations (Future Volume Alternative)
Year 2030 Cumulative with Project AM

Intersection #119: Butterfield Boulevard and Main Avenue

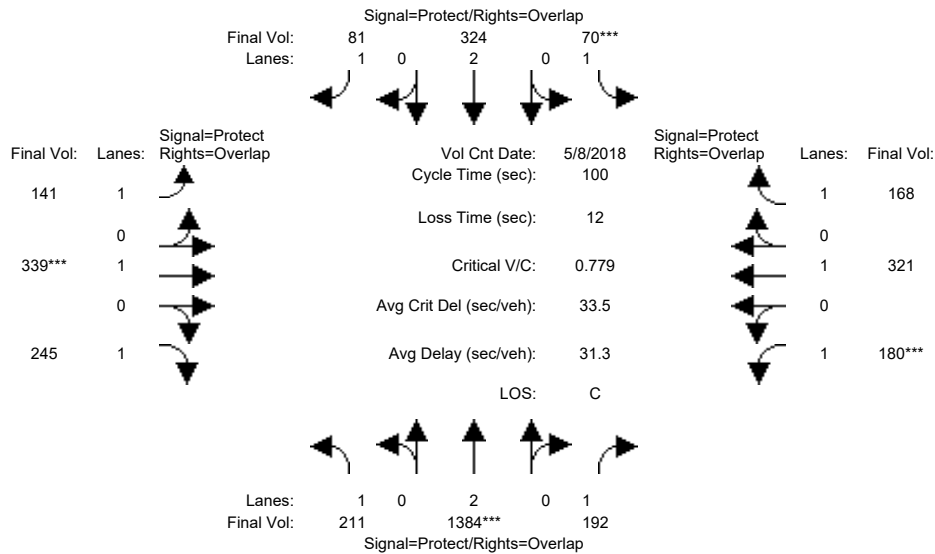

Street Name:	Butterfield Boulevard						Main Avenue					
	North Bound			South Bound			East Bound			West Bound		
Approach:	North Bound			South Bound			East Bound			West Bound		
Movement:	L	T	R	L	T	R	L	T	R	L	T	R
Min. Green:	7	10	10	7	10	10	7	10	10	7	10	10
Y+R:	4.0	4.0	4.0	4.0	4.0	4.0	4.0	4.0	4.0	4.0	4.0	4.0

Volume Module:	>>	Count	Date:	8 May 2018	<<							
Base Vol:	211	1384	189	69	324	81	141	334	245	173	306	164
Growth Adj:	1.00	1.00	1.00	1.00	1.00	1.00	1.00	1.00	1.00	1.00	1.00	1.00
Initial Bse:	211	1384	189	69	324	81	141	334	245	173	306	164
Added Vol:	0	0	3	1	0	0	0	5	0	7	15	4
PasserByVol:	0	0	0	0	0	0	0	0	0	0	0	0
Initial Fut:	211	1384	192	70	324	81	141	339	245	180	321	168
User Adj:	1.00	1.00	1.00	1.00	1.00	1.00	1.00	1.00	1.00	1.00	1.00	1.00
PHF Adj:	1.00	1.00	1.00	1.00	1.00	1.00	1.00	1.00	1.00	1.00	1.00	1.00
PHF Volume:	211	1384	192	70	324	81	141	339	245	180	321	168
Reduct Vol:	0	0	0	0	0	0	0	0	0	0	0	0
Reduced Vol:	211	1384	192	70	324	81	141	339	245	180	321	168
PCE Adj:	1.00	1.00	1.00	1.00	1.00	1.00	1.00	1.00	1.00	1.00	1.00	1.00
MLF Adj:	1.00	1.00	1.00	1.00	1.00	1.00	1.00	1.00	1.00	1.00	1.00	1.00
Final Volume:	211	1384	192	70	324	81	141	339	245	180	321	168

Saturation Flow Module:	
Sat/Lane:	1900 1900 1900 1900 1900 1900 1900 1900 1900 1900 1900 1900
Adjustment:	0.92 1.00 0.92 0.92 1.00 0.92 0.92 1.00 0.92 0.92 1.00 0.92
Lanes:	1.00 2.00 1.00 1.00 2.00 1.00 1.00 1.00 1.00 1.00 1.00 1.00
Final Sat.:	1750 3800 1750 1750 3800 1750 1750 1900 1750 1750 1900 1750

Capacity Analysis Module:	
Vol/Sat:	0.12 0.36 0.11 0.04 0.09 0.05 0.08 0.18 0.14 0.10 0.17 0.10
Crit Moves:	**** **** ****
Green Time:	28.8 45.7 58.6 7.0 23.9 35.3 11.4 22.4 51.2 12.9 23.9 30.9
Volume/Cap:	0.42 0.80 0.19 0.57 0.36 0.13 0.71 0.80 0.27 0.80 0.71 0.31
Delay/Veh:	29.4 25.9 9.7 51.4 31.9 22.0 53.7 46.8 14.0 60.0 39.9 26.7
User DelAdj:	1.00 1.00 1.00 1.00 1.00 1.00 1.00 1.00 1.00 1.00 1.00 1.00
AdjDel/Veh:	29.4 25.9 9.7 51.4 31.9 22.0 53.7 46.8 14.0 60.0 39.9 26.7
LOS by Move:	C C A D C C D D B E D C
HCM2k95thQ:	10 29 5 5 8 4 9 18 9 15 19 9

Note: Queue reported is the number of cars per lane.

City of Morgan Hill
The Crosswinds Residential Development

Level Of Service Computation Report
2000 HCM Operations (Future Volume Alternative)
Existing PM

Intersection #119: Butterfield Boulevard and Main Avenue

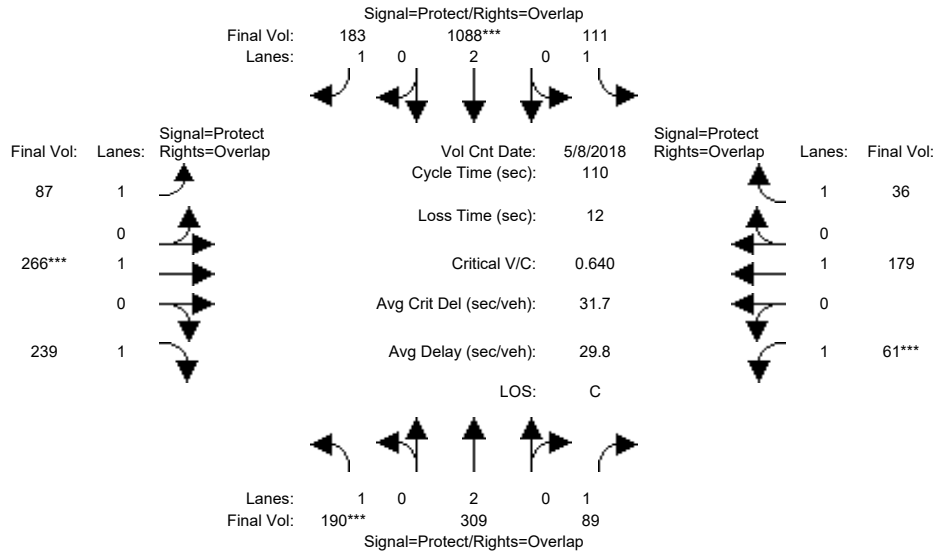

Street Name:	Butterfield Boulevard						Main Avenue					
Approach:	North Bound			South Bound			East Bound			West Bound		
Movement:	L	T	R	L	T	R	L	T	R	L	T	R
Min. Green:	7	10	10	7	10	10	7	10	10	7	10	10
Y+R:	4.0	4.0	4.0	4.0	4.0	4.0	4.0	4.0	4.0	4.0	4.0	4.0

Volume Module:	>>	Count	Date:	8 May 2018	<<							
Base Vol:	190	309	89	111	1088	183	87	266	239	61	179	36
Growth Adj:	1.00	1.00	1.00	1.00	1.00	1.00	1.00	1.00	1.00	1.00	1.00	1.00
Initial Bse:	190	309	89	111	1088	183	87	266	239	61	179	36
Added Vol:	0	0	0	0	0	0	0	0	0	0	0	0
PasserByVol:	0	0	0	0	0	0	0	0	0	0	0	0
Initial Fut:	190	309	89	111	1088	183	87	266	239	61	179	36
User Adj:	1.00	1.00	1.00	1.00	1.00	1.00	1.00	1.00	1.00	1.00	1.00	1.00
PHF Adj:	1.00	1.00	1.00	1.00	1.00	1.00	1.00	1.00	1.00	1.00	1.00	1.00
PHF Volume:	190	309	89	111	1088	183	87	266	239	61	179	36
Reduct Vol:	0	0	0	0	0	0	0	0	0	0	0	0
Reduced Vol:	190	309	89	111	1088	183	87	266	239	61	179	36
PCE Adj:	1.00	1.00	1.00	1.00	1.00	1.00	1.00	1.00	1.00	1.00	1.00	1.00
MLF Adj:	1.00	1.00	1.00	1.00	1.00	1.00	1.00	1.00	1.00	1.00	1.00	1.00
Final Volume:	190	309	89	111	1088	183	87	266	239	61	179	36

Saturation Flow Module:												
Sat/Lane:	1900	1900	1900	1900	1900	1900	1900	1900	1900	1900	1900	1900
Adjustment:	0.92	1.00	0.92	0.92	1.00	0.92	0.92	1.00	0.92	0.92	1.00	0.92
Lanes:	1.00	2.00	1.00	1.00	2.00	1.00	1.00	1.00	1.00	1.00	1.00	1.00
Final Sat.:	1750	3800	1750	1750	3800	1750	1750	1900	1750	1750	1900	1750

Capacity Analysis Module:												
Vol/Sat:	0.11	0.08	0.05	0.06	0.29	0.10	0.05	0.14	0.14	0.03	0.09	0.02
Crit Moves:	***				***			***		***		
Green Time:	18.5	39.5	46.5	27.7	48.7	61.1	12.4	23.8	42.3	7.0	18.4	46.1
Volume/Cap:	0.65	0.23	0.12	0.25	0.65	0.19	0.44	0.65	0.36	0.55	0.56	0.05
Delay/Veh:	47.7	24.7	19.4	33.2	24.8	12.2	47.1	42.8	24.5	55.6	44.4	19.0
User DelAdj:	1.00	1.00	1.00	1.00	1.00	1.00	1.00	1.00	1.00	1.00	1.00	1.00
AdjDel/Veh:	47.7	24.7	19.4	33.2	24.8	12.2	47.1	42.8	24.5	55.6	44.4	19.0
LOS by Move:	D	C	B	C	C	B	D	D	C	E	D	B
HCM2k95thQ:	12	7	4	6	25	6	6	15	11	6	12	2

Note: Queue reported is the number of cars per lane.

City of Morgan Hill
The Crosswinds Residential Development

Level Of Service Computation Report
2000 HCM Operations (Future Volume Alternative)
Existing Plus Project PM

Intersection #119: Butterfield Boulevard and Main Avenue

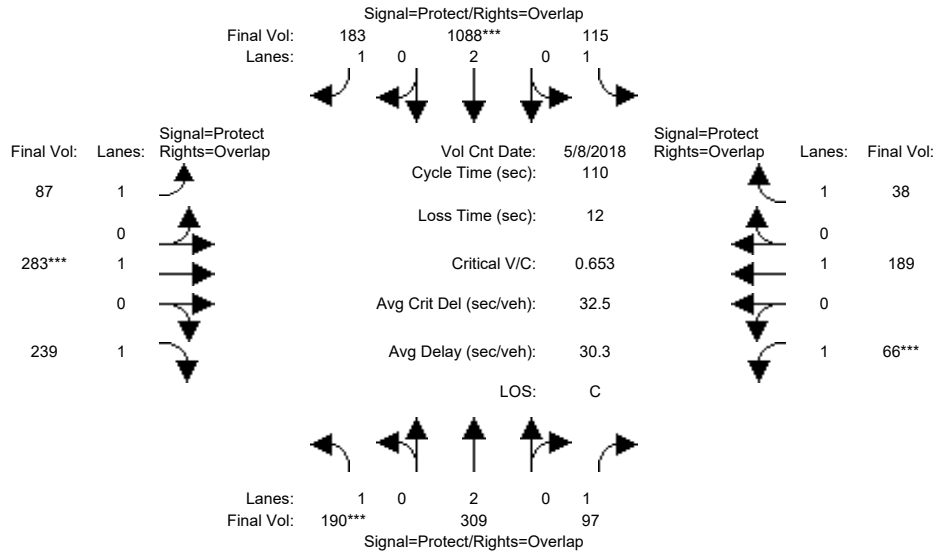

Street Name:	Butterfield Boulevard						Main Avenue					
	North Bound			South Bound			East Bound			West Bound		
Approach:	L	T	R	L	T	R	L	T	R	L	T	R
Min. Green:	7	10	10	7	10	10	7	10	10	7	10	10
Y+R:	4.0	4.0	4.0	4.0	4.0	4.0	4.0	4.0	4.0	4.0	4.0	4.0

Volume Module:	>>	Count	Date:	8 May 2018	<<							
Base Vol:	190	309	89	111	1088	183	87	266	239	61	179	36
Growth Adj:	1.00	1.00	1.00	1.00	1.00	1.00	1.00	1.00	1.00	1.00	1.00	1.00
Initial Bse:	190	309	89	111	1088	183	87	266	239	61	179	36
Added Vol:	0	0	8	4	0	0	0	17	0	5	10	2
PasserByVol:	0	0	0	0	0	0	0	0	0	0	0	0
Initial Fut:	190	309	97	115	1088	183	87	283	239	66	189	38
User Adj:	1.00	1.00	1.00	1.00	1.00	1.00	1.00	1.00	1.00	1.00	1.00	1.00
PHF Adj:	1.00	1.00	1.00	1.00	1.00	1.00	1.00	1.00	1.00	1.00	1.00	1.00
PHF Volume:	190	309	97	115	1088	183	87	283	239	66	189	38
Reduct Vol:	0	0	0	0	0	0	0	0	0	0	0	0
Reduced Vol:	190	309	97	115	1088	183	87	283	239	66	189	38
PCE Adj:	1.00	1.00	1.00	1.00	1.00	1.00	1.00	1.00	1.00	1.00	1.00	1.00
MLF Adj:	1.00	1.00	1.00	1.00	1.00	1.00	1.00	1.00	1.00	1.00	1.00	1.00
Final Volume:	190	309	97	115	1088	183	87	283	239	66	189	38

Saturation Flow Module:												
Sat/Lane:	1900	1900	1900	1900	1900	1900	1900	1900	1900	1900	1900	1900
Adjustment:	0.92	1.00	0.92	0.92	1.00	0.92	0.92	1.00	0.92	0.92	1.00	0.92
Lanes:	1.00	2.00	1.00	1.00	2.00	1.00	1.00	1.00	1.00	1.00	1.00	1.00
Final Sat.:	1750	3800	1750	1750	3800	1750	1750	1900	1750	1750	1900	1750

Capacity Analysis Module:												
Vol/Sat:	0.11	0.08	0.06	0.07	0.29	0.10	0.05	0.15	0.14	0.04	0.10	0.02
Crit Moves:	****				****			****		****		
Green Time:	18.2	38.4	45.4	27.7	47.9	60.4	12.5	24.9	43.1	7.0	19.5	47.2
Volume/Cap:	0.66	0.23	0.13	0.26	0.66	0.19	0.44	0.66	0.35	0.59	0.56	0.05
Delay/Veh:	48.4	25.5	20.2	33.3	25.5	12.6	47.1	42.4	23.9	58.4	43.5	18.4
User DelAdj:	1.00	1.00	1.00	1.00	1.00	1.00	1.00	1.00	1.00	1.00	1.00	1.00
AdjDel/Veh:	48.4	25.5	20.2	33.3	25.5	12.6	47.1	42.4	23.9	58.4	43.5	18.4
LOS by Move:	D	C	C	C	C	B	D	D	C	E	D	B
HCM2k95thQ:	13	7	4	6	25	6	6	16	11	7	12	2

Note: Queue reported is the number of cars per lane.

City of Morgan Hill
The Crosswinds Residential Development

Level Of Service Computation Report
2000 HCM Operations (Future Volume Alternative)
Year 2030 Cumulative without Project PM

Intersection #119: Butterfield Boulevard and Main Avenue

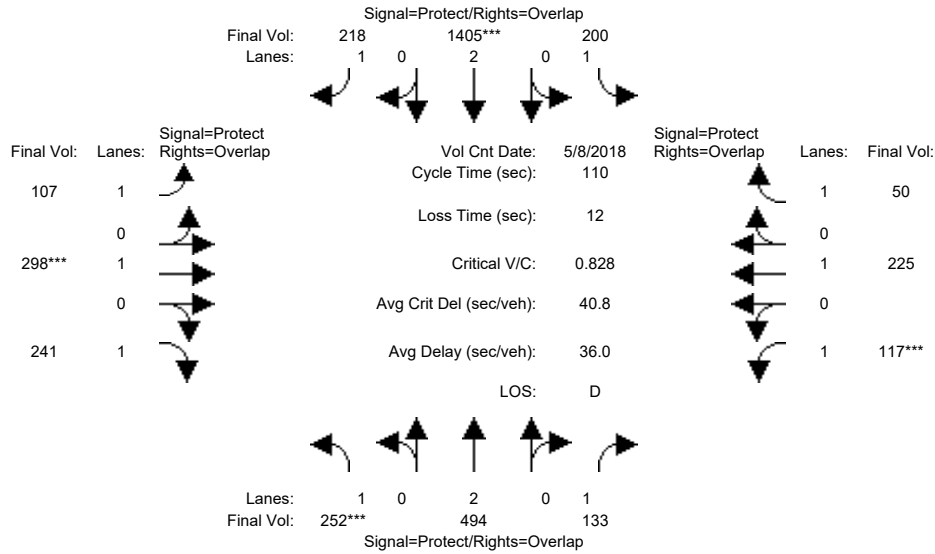

Street Name:	Butterfield Boulevard						Main Avenue					
	North Bound			South Bound			East Bound			West Bound		
Approach:	L	T	R	L	T	R	L	T	R	L	T	R
Min. Green:	7	10	10	7	10	10	7	10	10	7	10	10
Y+R:	4.0	4.0	4.0	4.0	4.0	4.0	4.0	4.0	4.0	4.0	4.0	4.0

Volume Module:	>>	Count	Date:	8 May 2018	<<							
Base Vol:	252	494	133	200	1405	218	107	298	241	117	225	50
Growth Adj:	1.00	1.00	1.00	1.00	1.00	1.00	1.00	1.00	1.00	1.00	1.00	1.00
Initial Bse:	252	494	133	200	1405	218	107	298	241	117	225	50
Added Vol:	0	0	0	0	0	0	0	0	0	0	0	0
PasserByVol:	0	0	0	0	0	0	0	0	0	0	0	0
Initial Fut:	252	494	133	200	1405	218	107	298	241	117	225	50
User Adj:	1.00	1.00	1.00	1.00	1.00	1.00	1.00	1.00	1.00	1.00	1.00	1.00
PHF Adj:	1.00	1.00	1.00	1.00	1.00	1.00	1.00	1.00	1.00	1.00	1.00	1.00
PHF Volume:	252	494	133	200	1405	218	107	298	241	117	225	50
Reduct Vol:	0	0	0	0	0	0	0	0	0	0	0	0
Reduced Vol:	252	494	133	200	1405	218	107	298	241	117	225	50
PCE Adj:	1.00	1.00	1.00	1.00	1.00	1.00	1.00	1.00	1.00	1.00	1.00	1.00
MLF Adj:	1.00	1.00	1.00	1.00	1.00	1.00	1.00	1.00	1.00	1.00	1.00	1.00
Final Volume:	252	494	133	200	1405	218	107	298	241	117	225	50

Saturation Flow Module:												
Sat/Lane:	1900	1900	1900	1900	1900	1900	1900	1900	1900	1900	1900	1900
Adjustment:	0.92	1.00	0.92	0.92	1.00	0.92	0.92	1.00	0.92	0.92	1.00	0.92
Lanes:	1.00	2.00	1.00	1.00	2.00	1.00	1.00	1.00	1.00	1.00	1.00	1.00
Final Sat.:	1750	3800	1750	1750	3800	1750	1750	1900	1750	1750	1900	1750

Capacity Analysis Module:												
Vol/Sat:	0.14	0.13	0.08	0.11	0.37	0.12	0.06	0.16	0.14	0.07	0.12	0.03
Crit Moves:	****				****			****			****	
Green Time:	19.1	36.3	45.2	31.9	49.1	59.5	10.4	20.8	40.0	8.9	19.3	51.3
Volume/Cap:	0.83	0.39	0.18	0.39	0.83	0.23	0.65	0.83	0.38	0.83	0.67	0.06
Delay/Veh:	60.7	28.6	20.8	31.8	30.2	13.4	56.7	57.5	26.2	81.3	47.7	16.2
User DelAdj:	1.00	1.00	1.00	1.00	1.00	1.00	1.00	1.00	1.00	1.00	1.00	1.00
AdjDel/Veh:	60.7	28.6	20.8	31.8	30.2	13.4	56.7	57.5	26.2	81.3	47.7	16.2
LOS by Move:	E	C	C	C	C	B	E	E	C	F	D	B
HCM2k95thQ:	17	12	6	11	35	8	7	18	12	12	16	2

Note: Queue reported is the number of cars per lane.

City of Morgan Hill
The Crosswinds Residential Development

Level Of Service Computation Report
2000 HCM Operations (Future Volume Alternative)
Year 2030 Cumulative with Project PM

Intersection #119: Butterfield Boulevard and Main Avenue

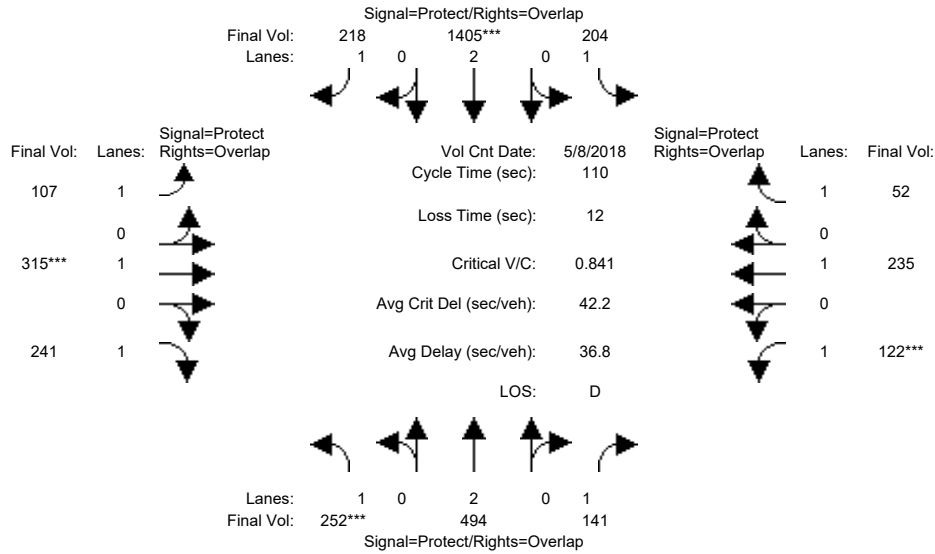

Street Name:	Butterfield Boulevard						Main Avenue					
	North Bound			South Bound			East Bound			West Bound		
Approach:	L	T	R	L	T	R	L	T	R	L	T	R
Min. Green:	7	10	10	7	10	10	7	10	10	7	10	10
Y+R:	4.0	4.0	4.0	4.0	4.0	4.0	4.0	4.0	4.0	4.0	4.0	4.0

Volume Module:	>>	Count	Date:	8 May 2018	<<							
Base Vol:	252	494	133	200	1405	218	107	298	241	117	225	50
Growth Adj:	1.00	1.00	1.00	1.00	1.00	1.00	1.00	1.00	1.00	1.00	1.00	1.00
Initial Bse:	252	494	133	200	1405	218	107	298	241	117	225	50
Added Vol:	0	0	8	4	0	0	0	17	0	5	10	2
PasserByVol:	0	0	0	0	0	0	0	0	0	0	0	0
Initial Fut:	252	494	141	204	1405	218	107	315	241	122	235	52
User Adj:	1.00	1.00	1.00	1.00	1.00	1.00	1.00	1.00	1.00	1.00	1.00	1.00
PHF Adj:	1.00	1.00	1.00	1.00	1.00	1.00	1.00	1.00	1.00	1.00	1.00	1.00
PHF Volume:	252	494	141	204	1405	218	107	315	241	122	235	52
Reduct Vol:	0	0	0	0	0	0	0	0	0	0	0	0
Reduced Vol:	252	494	141	204	1405	218	107	315	241	122	235	52
PCE Adj:	1.00	1.00	1.00	1.00	1.00	1.00	1.00	1.00	1.00	1.00	1.00	1.00
MLF Adj:	1.00	1.00	1.00	1.00	1.00	1.00	1.00	1.00	1.00	1.00	1.00	1.00
Final Volume:	252	494	141	204	1405	218	107	315	241	122	235	52

Saturation Flow Module:												
Sat/Lane:	1900	1900	1900	1900	1900	1900	1900	1900	1900	1900	1900	1900
Adjustment:	0.92	1.00	0.92	0.92	1.00	0.92	0.92	1.00	0.92	0.92	1.00	0.92
Lanes:	1.00	2.00	1.00	1.00	2.00	1.00	1.00	1.00	1.00	1.00	1.00	1.00
Final Sat.:	1750	3800	1750	1750	3800	1750	1750	1900	1750	1750	1900	1750

Capacity Analysis Module:												
Vol/Sat:	0.14	0.13	0.08	0.12	0.37	0.12	0.06	0.17	0.14	0.07	0.12	0.03
Crit Moves:	****				****			****		****		
Green Time:	18.8	35.4	44.5	31.8	48.4	58.8	10.5	21.7	40.5	9.1	20.3	52.1
Volume/Cap:	0.84	0.40	0.20	0.40	0.84	0.23	0.64	0.84	0.37	0.84	0.67	0.06
Delay/Veh:	62.9	29.3	21.3	32.0	31.4	13.7	56.3	58.1	25.8	83.1	46.6	15.7
User DelAdj:	1.00	1.00	1.00	1.00	1.00	1.00	1.00	1.00	1.00	1.00	1.00	1.00
AdjDel/Veh:	62.9	29.3	21.3	32.0	31.4	13.7	56.3	58.1	25.8	83.1	46.6	15.7
LOS by Move:	E	C	C	C	C	B	E	E	C	F	D	B
HCM2k95thQ:	17	12	6	11	36	8	7	19	12	13	16	2

Note: Queue reported is the number of cars per lane.

City of Morgan Hill
The Crosswinds Residential Development

Level Of Service Computation Report
2000 HCM Operations (Future Volume Alternative)
Existing AM

Intersection #118: Monterey Road and Main Avenue

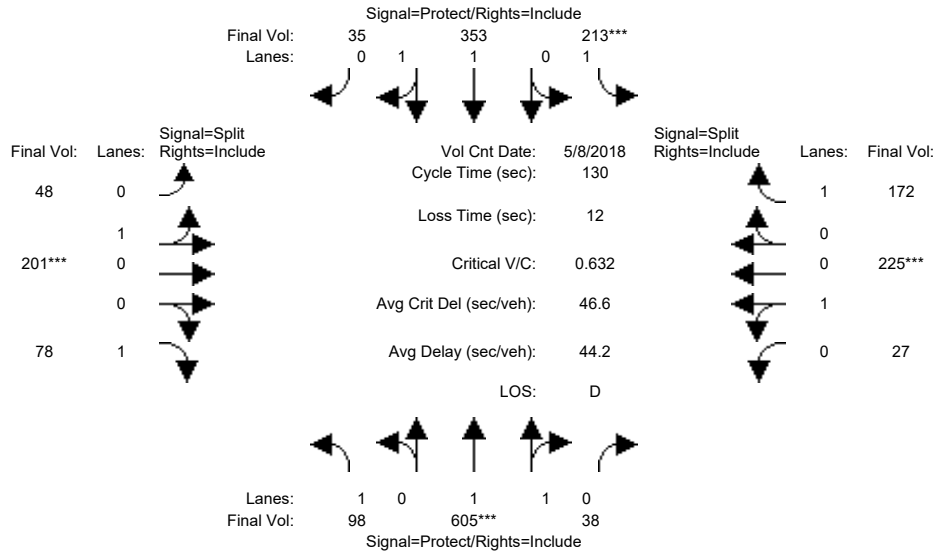

Street Name:	Monterey Road						Main Avenue					
	North Bound			South Bound			East Bound			West Bound		
Approach:	L	T	R	L	T	R	L	T	R	L	T	R
Min. Green:	7	10	10	7	10	10	10	10	10	10	10	10
Y+R:	4.0	4.0	4.0	4.0	4.0	4.0	4.0	4.0	4.0	4.0	4.0	4.0

Volume Module:	>>	Count	Date:	8 May 2018	<<							
Base Vol:	98	605	38	213	353	35	48	201	78	27	225	172
Growth Adj:	1.00	1.00	1.00	1.00	1.00	1.00	1.00	1.00	1.00	1.00	1.00	1.00
Initial Bse:	98	605	38	213	353	35	48	201	78	27	225	172
Added Vol:	0	0	0	0	0	0	0	0	0	0	0	0
PasserByVol:	0	0	0	0	0	0	0	0	0	0	0	0
Initial Fut:	98	605	38	213	353	35	48	201	78	27	225	172
User Adj:	1.00	1.00	1.00	1.00	1.00	1.00	1.00	1.00	1.00	1.00	1.00	1.00
PHF Adj:	1.00	1.00	1.00	1.00	1.00	1.00	1.00	1.00	1.00	1.00	1.00	1.00
PHF Volume:	98	605	38	213	353	35	48	201	78	27	225	172
Reduct Vol:	0	0	0	0	0	0	0	0	0	0	0	0
Reduced Vol:	98	605	38	213	353	35	48	201	78	27	225	172
PCE Adj:	1.00	1.00	1.00	1.00	1.00	1.00	1.00	1.00	1.00	1.00	1.00	1.00
MLF Adj:	1.00	1.00	1.00	1.00	1.00	1.00	1.00	1.00	1.00	1.00	1.00	1.00
Final Volume:	98	605	38	213	353	35	48	201	78	27	225	172

Saturation Flow Module:												
Sat/Lane:	1900	1900	1900	1900	1900	1900	1900	1900	1900	1900	1900	1900
Adjustment:	0.92	0.98	0.95	0.92	0.98	0.95	0.95	0.95	0.92	0.95	0.95	0.92
Lanes:	1.00	1.88	0.12	1.00	1.81	0.19	0.19	0.81	1.00	0.11	0.89	1.00
Final Sat.:	1750	3481	219	1750	3366	334	347	1453	1750	193	1607	1750

Capacity Analysis Module:												
Vol/Sat:	0.06	0.17	0.17	0.12	0.10	0.10	0.14	0.14	0.04	0.14	0.14	0.10
Crit Moves:	****			****			****			****		
Green Time:	21.2	35.7	35.7	25.0	39.6	39.6	28.4	28.4	28.4	28.8	28.8	28.8
Volume/Cap:	0.34	0.63	0.63	0.63	0.34	0.34	0.63	0.63	0.20	0.63	0.63	0.44
Delay/Veh:	49.0	42.7	42.7	52.1	35.3	35.3	49.4	49.4	41.8	49.1	49.1	44.5
User DelAdj:	1.00	1.00	1.00	1.00	1.00	1.00	1.00	1.00	1.00	1.00	1.00	1.00
AdjDel/Veh:	49.0	42.7	42.7	52.1	35.3	35.3	49.4	49.4	41.8	49.1	49.1	44.5
LOS by Move:	D	D	D	D	D	D	D	D	D	D	D	D
HCM2k95thQ:	7	21	21	16	11	11	19	19	6	17	17	12

Note: Queue reported is the number of cars per lane.

City of Morgan Hill
The Crosswinds Residential Development

Level Of Service Computation Report
2000 HCM Operations (Future Volume Alternative)
Existing Plus Project AM

Intersection #118: Monterey Road and Main Avenue

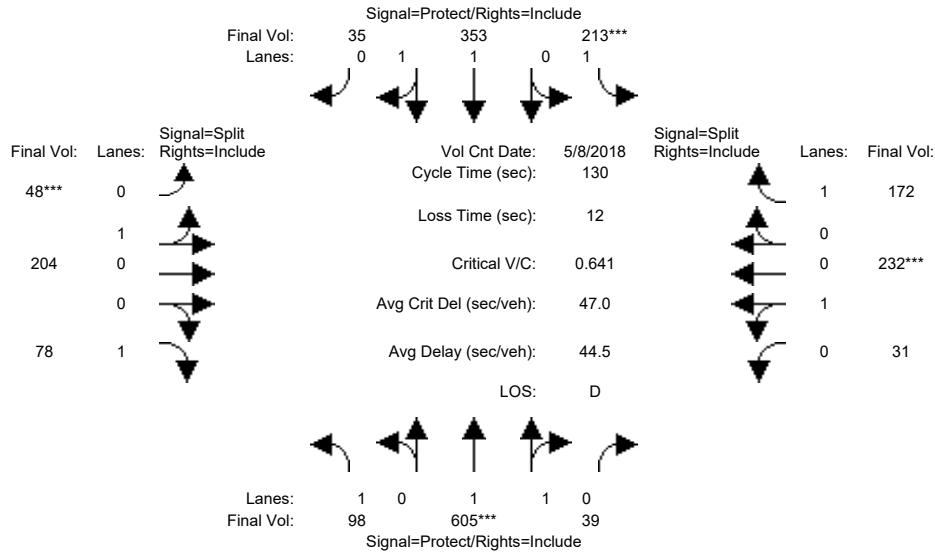

Street Name:	Monterey Road						Main Avenue					
	North Bound			South Bound			East Bound			West Bound		
Approach:	North Bound			South Bound			East Bound			West Bound		
Movement:	L	T	R	L	T	R	L	T	R	L	T	R
Min. Green:	7	10	10	7	10	10	10	10	10	10	10	10
Y+R:	4.0	4.0	4.0	4.0	4.0	4.0	4.0	4.0	4.0	4.0	4.0	4.0

Volume Module:	>>	Count	Date:	8 May 2018	<<							
Base Vol:	98	605	38	213	353	35	48	201	78	27	225	172
Growth Adj:	1.00	1.00	1.00	1.00	1.00	1.00	1.00	1.00	1.00	1.00	1.00	1.00
Initial Bse:	98	605	38	213	353	35	48	201	78	27	225	172
Added Vol:	0	0	1	0	0	0	0	3	0	4	7	0
PasserByVol:	0	0	0	0	0	0	0	0	0	0	0	0
Initial Fut:	98	605	39	213	353	35	48	204	78	31	232	172
User Adj:	1.00	1.00	1.00	1.00	1.00	1.00	1.00	1.00	1.00	1.00	1.00	1.00
PHF Adj:	1.00	1.00	1.00	1.00	1.00	1.00	1.00	1.00	1.00	1.00	1.00	1.00
PHF Volume:	98	605	39	213	353	35	48	204	78	31	232	172
Reduct Vol:	0	0	0	0	0	0	0	0	0	0	0	0
Reduced Vol:	98	605	39	213	353	35	48	204	78	31	232	172
PCE Adj:	1.00	1.00	1.00	1.00	1.00	1.00	1.00	1.00	1.00	1.00	1.00	1.00
MLF Adj:	1.00	1.00	1.00	1.00	1.00	1.00	1.00	1.00	1.00	1.00	1.00	1.00
FinalVolume:	98	605	39	213	353	35	48	204	78	31	232	172

Saturation Flow Module:												
Sat/Lane:	1900	1900	1900	1900	1900	1900	1900	1900	1900	1900	1900	1900
Adjustment:	0.92	0.98	0.95	0.92	0.98	0.95	0.95	0.95	0.92	0.95	0.95	0.92
Lanes:	1.00	1.88	0.12	1.00	1.81	0.19	0.19	0.81	1.00	0.12	0.88	1.00
Final Sat.:	1750	3476	224	1750	3366	334	343	1457	1750	212	1588	1750

Capacity Analysis Module:												
Vol/Sat:	0.06	0.17	0.17	0.12	0.10	0.10	0.14	0.14	0.04	0.15	0.15	0.10
Crit Moves:	****			****			****			****		
Green Time:	20.9	35.3	35.3	24.7	39.1	39.1	28.4	28.4	28.4	29.6	29.6	29.6
Volume/Cap:	0.35	0.64	0.64	0.64	0.35	0.35	0.64	0.64	0.20	0.64	0.64	0.43
Delay/Veh:	49.3	43.2	43.2	52.8	35.7	35.7	49.7	49.7	41.8	48.8	48.8	43.7
User DelAdj:	1.00	1.00	1.00	1.00	1.00	1.00	1.00	1.00	1.00	1.00	1.00	1.00
AdjDel/Veh:	49.3	43.2	43.2	52.8	35.7	35.7	49.7	49.7	41.8	48.8	48.8	43.7
LOS by Move:	D	D	D	D	D	D	D	D	D	D	D	D
HCM2k95thQ:	7	21	21	16	11	11	19	19	6	18	18	12

Note: Queue reported is the number of cars per lane.

City of Morgan Hill
The Crosswinds Residential Development

Level Of Service Computation Report
2000 HCM Operations (Future Volume Alternative)
Year 2030 Cumulative without Project AM

Intersection #118: Monterey Road and Main Avenue

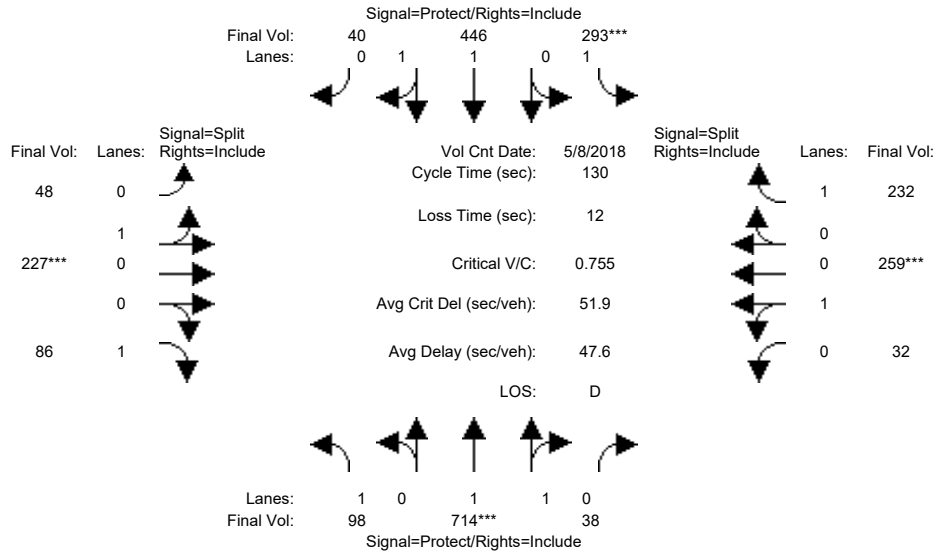

Street Name:	Monterey Road						Main Avenue					
	North Bound			South Bound			East Bound			West Bound		
Approach:												
Movement:	L	T	R	L	T	R	L	T	R	L	T	R
Min. Green:	7	10	10	7	10	10	10	10	10	10	10	10
Y+R:	4.0	4.0	4.0	4.0	4.0	4.0	4.0	4.0	4.0	4.0	4.0	4.0

Volume Module:	>>	Count	Date:	8 May 2018	<<											
Base Vol:	98	714	38	293	446	40	48	227	86	32	259	232				
Growth Adj:	1.00	1.00	1.00	1.00	1.00	1.00	1.00	1.00	1.00	1.00	1.00	1.00				
Initial Bse:	98	714	38	293	446	40	48	227	86	32	259	232				
Added Vol:	0	0	0	0	0	0	0	0	0	0	0	0				
PasserByVol:	0	0	0	0	0	0	0	0	0	0	0	0				
Initial Fut:	98	714	38	293	446	40	48	227	86	32	259	232				
User Adj:	1.00	1.00	1.00	1.00	1.00	1.00	1.00	1.00	1.00	1.00	1.00	1.00				
PHF Adj:	1.00	1.00	1.00	1.00	1.00	1.00	1.00	1.00	1.00	1.00	1.00	1.00				
PHF Volume:	98	714	38	293	446	40	48	227	86	32	259	232				
Reduct Vol:	0	0	0	0	0	0	0	0	0	0	0	0				
Reduced Vol:	98	714	38	293	446	40	48	227	86	32	259	232				
PCE Adj:	1.00	1.00	1.00	1.00	1.00	1.00	1.00	1.00	1.00	1.00	1.00	1.00				
MLF Adj:	1.00	1.00	1.00	1.00	1.00	1.00	1.00	1.00	1.00	1.00	1.00	1.00				
Final Volume:	98	714	38	293	446	40	48	227	86	32	259	232				

Saturation Flow Module:												
Sat/Lane:	1900	1900	1900	1900	1900	1900	1900	1900	1900	1900	1900	1900
Adjustment:	0.92	0.98	0.95	0.92	0.98	0.95	0.95	0.95	0.92	0.95	0.95	0.92
Lanes:	1.00	1.90	0.10	1.00	1.83	0.17	0.17	0.83	1.00	0.11	0.89	1.00
Final Sat.:	1750	3513	187	1750	3395	305	314	1486	1750	198	1602	1750

Capacity Analysis Module:												
Vol/Sat:	0.06	0.20	0.20	0.17	0.13	0.13	0.15	0.15	0.05	0.16	0.16	0.13
Crit Moves:	****			****			****			****		
Green Time:	19.1	35.0	35.0	28.8	44.8	44.8	26.3	26.3	26.3	27.8	27.8	27.8
Volume/Cap:	0.38	0.75	0.75	0.75	0.38	0.38	0.75	0.75	0.24	0.75	0.75	0.62
Delay/Veh:	51.1	46.9	46.9	55.5	32.4	32.4	57.5	57.5	43.8	56.1	56.1	49.4
User DelAdj:	1.00	1.00	1.00	1.00	1.00	1.00	1.00	1.00	1.00	1.00	1.00	1.00
AdjDel/Veh:	51.1	46.9	46.9	55.5	32.4	32.4	57.5	57.5	43.8	56.1	56.1	49.4
LOS by Move:	D	D	D	E	C	C	E	E	D	E	E	D
HCM2k95thQ:	7	25	25	21	14	14	22	22	6	21	21	16

Note: Queue reported is the number of cars per lane.

City of Morgan Hill
The Crosswinds Residential Development

Level Of Service Computation Report
2000 HCM Operations (Future Volume Alternative)
Year 2030 Cumulative with Project AM

Intersection #118: Monterey Road and Main Avenue

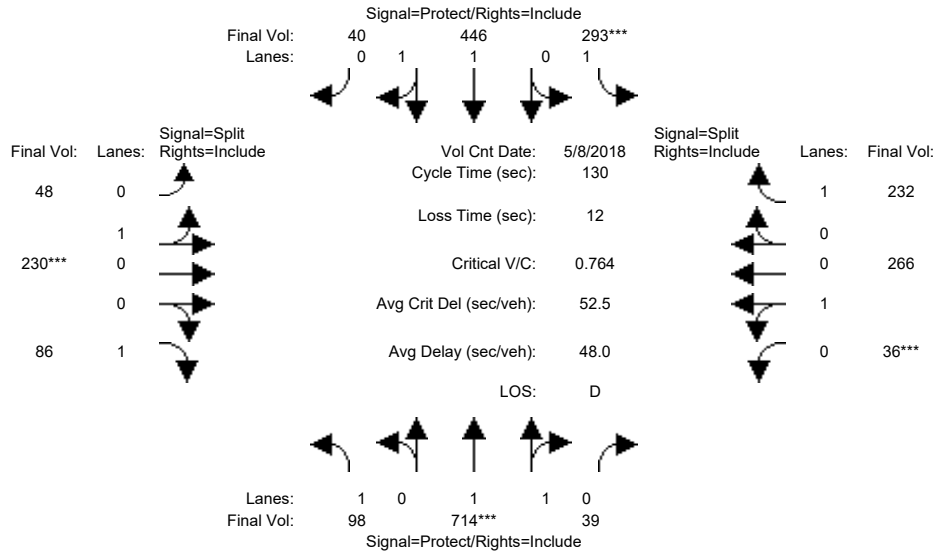

Street Name:	Monterey Road						Main Avenue					
	North Bound			South Bound			East Bound			West Bound		
Approach:	North Bound			South Bound			East Bound			West Bound		
Movement:	L	T	R	L	T	R	L	T	R	L	T	R
Min. Green:	7	10	10	7	10	10	10	10	10	10	10	10
Y+R:	4.0	4.0	4.0	4.0	4.0	4.0	4.0	4.0	4.0	4.0	4.0	4.0

Volume Module:	>>	Count	Date:	8 May 2018	<<							
Base Vol:	98	714	38	293	446	40	48	227	86	32	259	232
Growth Adj:	1.00	1.00	1.00	1.00	1.00	1.00	1.00	1.00	1.00	1.00	1.00	1.00
Initial Bse:	98	714	38	293	446	40	48	227	86	32	259	232
Added Vol:	0	0	1	0	0	0	0	3	0	4	7	0
PasserByVol:	0	0	0	0	0	0	0	0	0	0	0	0
Initial Fut:	98	714	39	293	446	40	48	230	86	36	266	232
User Adj:	1.00	1.00	1.00	1.00	1.00	1.00	1.00	1.00	1.00	1.00	1.00	1.00
PHF Adj:	1.00	1.00	1.00	1.00	1.00	1.00	1.00	1.00	1.00	1.00	1.00	1.00
PHF Volume:	98	714	39	293	446	40	48	230	86	36	266	232
Reduct Vol:	0	0	0	0	0	0	0	0	0	0	0	0
Reduced Vol:	98	714	39	293	446	40	48	230	86	36	266	232
PCE Adj:	1.00	1.00	1.00	1.00	1.00	1.00	1.00	1.00	1.00	1.00	1.00	1.00
MLF Adj:	1.00	1.00	1.00	1.00	1.00	1.00	1.00	1.00	1.00	1.00	1.00	1.00
Final Volume:	98	714	39	293	446	40	48	230	86	36	266	232

Saturation Flow Module:												
Sat/Lane:	1900	1900	1900	1900	1900	1900	1900	1900	1900	1900	1900	1900
Adjustment:	0.92	0.98	0.95	0.92	0.98	0.95	0.95	0.95	0.92	0.95	0.95	0.92
Lanes:	1.00	1.89	0.11	1.00	1.83	0.17	0.17	0.83	1.00	0.12	0.88	1.00
Final Sat.:	1750	3508	192	1750	3395	305	311	1489	1750	215	1585	1750

Capacity Analysis Module:												
Vol/Sat:	0.06	0.20	0.20	0.17	0.13	0.13	0.15	0.15	0.05	0.17	0.17	0.13
Crit Moves:	****			****			****			****		
Green Time:	18.9	34.6	34.6	28.5	44.3	44.3	26.3	26.3	26.3	28.6	28.6	28.6
Volume/Cap:	0.39	0.76	0.76	0.76	0.39	0.39	0.76	0.76	0.24	0.76	0.76	0.60
Delay/Veh:	51.3	47.5	47.5	56.4	32.7	32.7	58.2	58.2	43.9	56.1	56.1	48.3
User DelAdj:	1.00	1.00	1.00	1.00	1.00	1.00	1.00	1.00	1.00	1.00	1.00	1.00
AdjDel/Veh:	51.3	47.5	47.5	56.4	32.7	32.7	58.2	58.2	43.9	56.1	56.1	48.3
LOS by Move:	D	D	D	E	C	C	E	E	D	E	E	D
HCM2k95thQ:	7	26	26	21	14	14	23	23	6	21	21	16

Note: Queue reported is the number of cars per lane.

City of Morgan Hill
The Crosswinds Residential Development

Level Of Service Computation Report
2000 HCM Operations (Future Volume Alternative)
Existing PM

Intersection #118: Monterey Road and Main Avenue

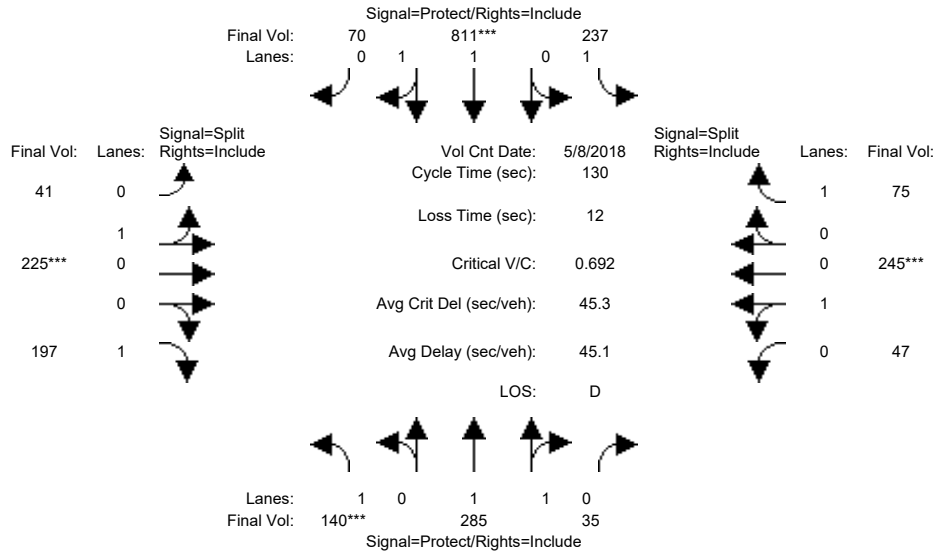

Street Name:	Monterey Road						Main Avenue					
	North Bound			South Bound			East Bound			West Bound		
Approach:	L	T	R	L	T	R	L	T	R	L	T	R
Min. Green:	7	10	10	7	10	10	10	10	10	10	10	10
Y+R:	4.0	4.0	4.0	4.0	4.0	4.0	4.0	4.0	4.0	4.0	4.0	4.0

Volume Module:	>>	Count	Date:	8 May 2018	<<							
Base Vol:	140	285	35	237	811	70	41	225	197	47	245	75
Growth Adj:	1.00	1.00	1.00	1.00	1.00	1.00	1.00	1.00	1.00	1.00	1.00	1.00
Initial Bse:	140	285	35	237	811	70	41	225	197	47	245	75
Added Vol:	0	0	0	0	0	0	0	0	0	0	0	0
PasserByVol:	0	0	0	0	0	0	0	0	0	0	0	0
Initial Fut:	140	285	35	237	811	70	41	225	197	47	245	75
User Adj:	1.00	1.00	1.00	1.00	1.00	1.00	1.00	1.00	1.00	1.00	1.00	1.00
PHF Adj:	1.00	1.00	1.00	1.00	1.00	1.00	1.00	1.00	1.00	1.00	1.00	1.00
PHF Volume:	140	285	35	237	811	70	41	225	197	47	245	75
Reduct Vol:	0	0	0	0	0	0	0	0	0	0	0	0
Reduced Vol:	140	285	35	237	811	70	41	225	197	47	245	75
PCE Adj:	1.00	1.00	1.00	1.00	1.00	1.00	1.00	1.00	1.00	1.00	1.00	1.00
MLF Adj:	1.00	1.00	1.00	1.00	1.00	1.00	1.00	1.00	1.00	1.00	1.00	1.00
Final Volume:	140	285	35	237	811	70	41	225	197	47	245	75

Saturation Flow Module:												
Sat/Lane:	1900	1900	1900	1900	1900	1900	1900	1900	1900	1900	1900	1900
Adjustment:	0.92	0.98	0.95	0.92	0.98	0.95	0.95	0.95	0.92	0.95	0.95	0.92
Lanes:	1.00	1.78	0.22	1.00	1.84	0.16	0.15	0.85	1.00	0.16	0.84	1.00
Final Sat.:	1750	3295	405	1750	3406	294	277	1523	1750	290	1510	1750

Capacity Analysis Module:												
Vol/Sat:	0.08	0.09	0.09	0.14	0.24	0.24	0.15	0.15	0.11	0.16	0.16	0.04
Crit Moves:	****				****		****			****		
Green Time:	15.0	23.3	23.3	36.5	44.7	44.7	27.8	27.8	27.8	30.5	30.5	30.5
Volume/Cap:	0.69	0.48	0.48	0.48	0.69	0.69	0.69	0.69	0.53	0.69	0.69	0.18
Delay/Veh:	65.1	48.5	48.5	39.7	38.4	38.4	52.5	52.5	46.7	50.4	50.4	40.0
User DelAdj:	1.00	1.00	1.00	1.00	1.00	1.00	1.00	1.00	1.00	1.00	1.00	1.00
AdjDel/Veh:	65.1	48.5	48.5	39.7	38.4	38.4	52.5	52.5	46.7	50.4	50.4	40.0
LOS by Move:	E	D	D	D	D	D	D	D	D	D	D	D
HCM2k95thQ:	12	11	11	15	27	27	21	21	15	20	20	5

Note: Queue reported is the number of cars per lane.

City of Morgan Hill
The Crosswinds Residential Development

Level Of Service Computation Report
2000 HCM Operations (Future Volume Alternative)
Existing Plus Project PM

Intersection #118: Monterey Road and Main Avenue

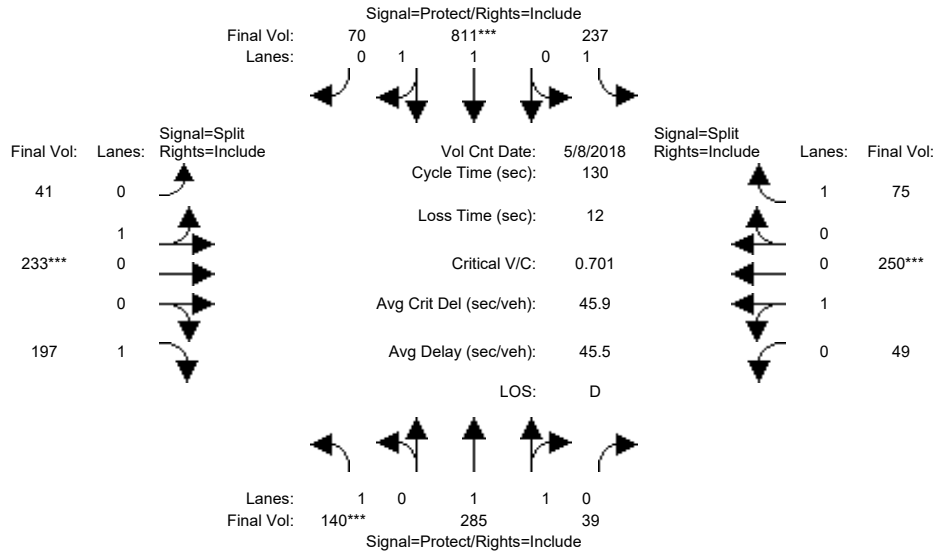

Street Name:	Monterey Road						Main Avenue					
	North Bound			South Bound			East Bound			West Bound		
Approach:												
Movement:	L	T	R	L	T	R	L	T	R	L	T	R
Min. Green:	7	10	10	7	10	10	10	10	10	10	10	10
Y+R:	4.0	4.0	4.0	4.0	4.0	4.0	4.0	4.0	4.0	4.0	4.0	4.0

Volume Module:	>>	Count	Date:	8 May 2018	<<							
Base Vol:	140	285	35	237	811	70	41	225	197	47	245	75
Growth Adj:	1.00	1.00	1.00	1.00	1.00	1.00	1.00	1.00	1.00	1.00	1.00	1.00
Initial Bse:	140	285	35	237	811	70	41	225	197	47	245	75
Added Vol:	0	0	4	0	0	0	0	8	0	2	5	0
PasserByVol:	0	0	0	0	0	0	0	0	0	0	0	0
Initial Fut:	140	285	39	237	811	70	41	233	197	49	250	75
User Adj:	1.00	1.00	1.00	1.00	1.00	1.00	1.00	1.00	1.00	1.00	1.00	1.00
PHF Adj:	1.00	1.00	1.00	1.00	1.00	1.00	1.00	1.00	1.00	1.00	1.00	1.00
PHF Volume:	140	285	39	237	811	70	41	233	197	49	250	75
Reduct Vol:	0	0	0	0	0	0	0	0	0	0	0	0
Reduced Vol:	140	285	39	237	811	70	41	233	197	49	250	75
PCE Adj:	1.00	1.00	1.00	1.00	1.00	1.00	1.00	1.00	1.00	1.00	1.00	1.00
MLF Adj:	1.00	1.00	1.00	1.00	1.00	1.00	1.00	1.00	1.00	1.00	1.00	1.00
Final Volume:	140	285	39	237	811	70	41	233	197	49	250	75

Saturation Flow Module:												
Sat/Lane:	1900	1900	1900	1900	1900	1900	1900	1900	1900	1900	1900	1900
Adjustment:	0.92	0.98	0.95	0.92	0.98	0.95	0.95	0.95	0.92	0.95	0.95	0.92
Lanes:	1.00	1.75	0.25	1.00	1.84	0.16	0.15	0.85	1.00	0.16	0.84	1.00
Final Sat.:	1750	3254	445	1750	3406	294	269	1531	1750	295	1505	1750

Capacity Analysis Module:												
Vol/Sat:	0.08	0.09	0.09	0.14	0.24	0.24	0.15	0.15	0.11	0.17	0.17	0.04
Crit Moves:	****				****			****			****	
Green Time:	14.8	23.2	23.2	35.8	44.1	44.1	28.2	28.2	28.2	30.8	30.8	30.8
Volume/Cap:	0.70	0.49	0.49	0.49	0.70	0.70	0.70	0.70	0.52	0.70	0.70	0.18
Delay/Veh:	66.1	48.7	48.7	40.3	39.0	39.0	52.6	52.6	46.2	50.6	50.6	39.8
User DelAdj:	1.00	1.00	1.00	1.00	1.00	1.00	1.00	1.00	1.00	1.00	1.00	1.00
AdjDel/Veh:	66.1	48.7	48.7	40.3	39.0	39.0	52.6	52.6	46.2	50.6	50.6	39.8
LOS by Move:	E	D	D	D	D	D	D	D	D	D	D	D
HCM2k95thQ:	12	11	11	15	27	27	21	21	15	21	21	5

Note: Queue reported is the number of cars per lane.

City of Morgan Hill
The Crosswinds Residential Development

Level Of Service Computation Report
2000 HCM Operations (Future Volume Alternative)
Year 2030 Cumulative without Project PM

Intersection #118: Monterey Road and Main Avenue

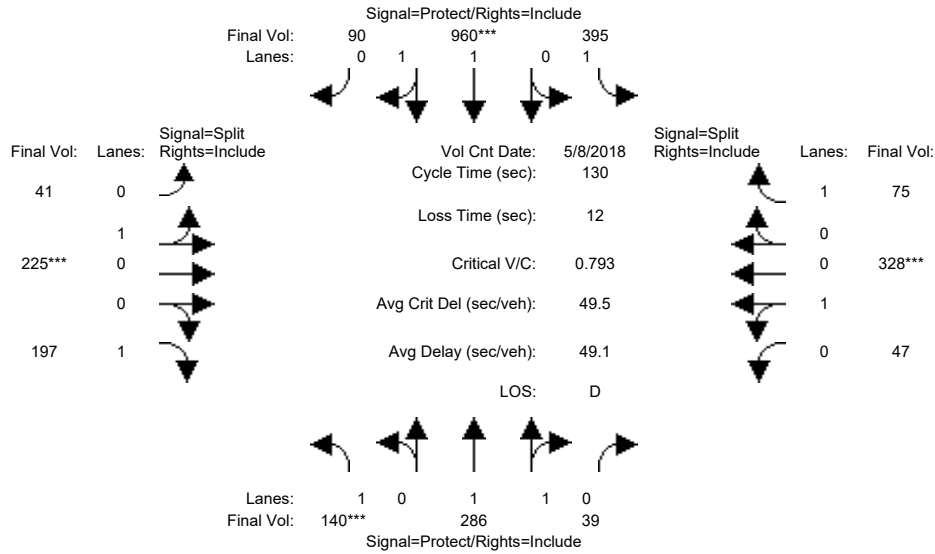

Street Name:	Monterey Road						Main Avenue					
	North Bound			South Bound			East Bound			West Bound		
Approach:	L	T	R	L	T	R	L	T	R	L	T	R
Min. Green:	7	10	10	7	10	10	10	10	10	10	10	10
Y+R:	4.0	4.0	4.0	4.0	4.0	4.0	4.0	4.0	4.0	4.0	4.0	4.0

Volume Module:	>>	Count	Date:	8 May 2018	<<							
Base Vol:	140	286	39	395	960	90	41	225	197	47	328	75
Growth Adj:	1.00	1.00	1.00	1.00	1.00	1.00	1.00	1.00	1.00	1.00	1.00	1.00
Initial Bse:	140	286	39	395	960	90	41	225	197	47	328	75
Added Vol:	0	0	0	0	0	0	0	0	0	0	0	0
PasserByVol:	0	0	0	0	0	0	0	0	0	0	0	0
Initial Fut:	140	286	39	395	960	90	41	225	197	47	328	75
User Adj:	1.00	1.00	1.00	1.00	1.00	1.00	1.00	1.00	1.00	1.00	1.00	1.00
PHF Adj:	1.00	1.00	1.00	1.00	1.00	1.00	1.00	1.00	1.00	1.00	1.00	1.00
PHF Volume:	140	286	39	395	960	90	41	225	197	47	328	75
Reduct Vol:	0	0	0	0	0	0	0	0	0	0	0	0
Reduced Vol:	140	286	39	395	960	90	41	225	197	47	328	75
PCE Adj:	1.00	1.00	1.00	1.00	1.00	1.00	1.00	1.00	1.00	1.00	1.00	1.00
MLF Adj:	1.00	1.00	1.00	1.00	1.00	1.00	1.00	1.00	1.00	1.00	1.00	1.00
Final Volume:	140	286	39	395	960	90	41	225	197	47	328	75

Saturation Flow Module:												
Sat/Lane:	1900	1900	1900	1900	1900	1900	1900	1900	1900	1900	1900	1900
Adjustment:	0.92	0.98	0.95	0.92	0.98	0.95	0.95	0.95	0.92	0.95	0.95	0.92
Lanes:	1.00	1.75	0.25	1.00	1.82	0.18	0.15	0.85	1.00	0.13	0.87	1.00
Final Sat.:	1750	3256	444	1750	3383	317	277	1523	1750	226	1574	1750

Capacity Analysis Module:												
Vol/Sat:	0.08	0.09	0.09	0.23	0.28	0.28	0.15	0.15	0.11	0.21	0.21	0.04
Crit Moves:	****				****		****			****		
Green Time:	13.1	16.7	16.7	42.9	46.5	46.5	24.2	24.2	24.2	34.1	34.1	34.1
Volume/Cap:	0.79	0.68	0.68	0.68	0.79	0.79	0.79	0.79	0.60	0.79	0.79	0.16
Delay/Veh:	78.4	58.2	58.2	41.0	40.8	40.8	62.7	62.7	51.7	53.6	53.6	37.1
User DelAdj:	1.00	1.00	1.00	1.00	1.00	1.00	1.00	1.00	1.00	1.00	1.00	1.00
AdjDel/Veh:	78.4	58.2	58.2	41.0	40.8	40.8	62.7	62.7	51.7	53.6	53.6	37.1
LOS by Move:	E	E	E	D	D	D	E	E	D	D	D	D
HCM2k95thQ:	12	12	12	25	32	32	23	23	16	26	26	5

Note: Queue reported is the number of cars per lane.

City of Morgan Hill
The Crosswinds Residential Development

Level Of Service Computation Report
2000 HCM Operations (Future Volume Alternative)
Year 2030 Cumulative with Project PM

Intersection #118: Monterey Road and Main Avenue

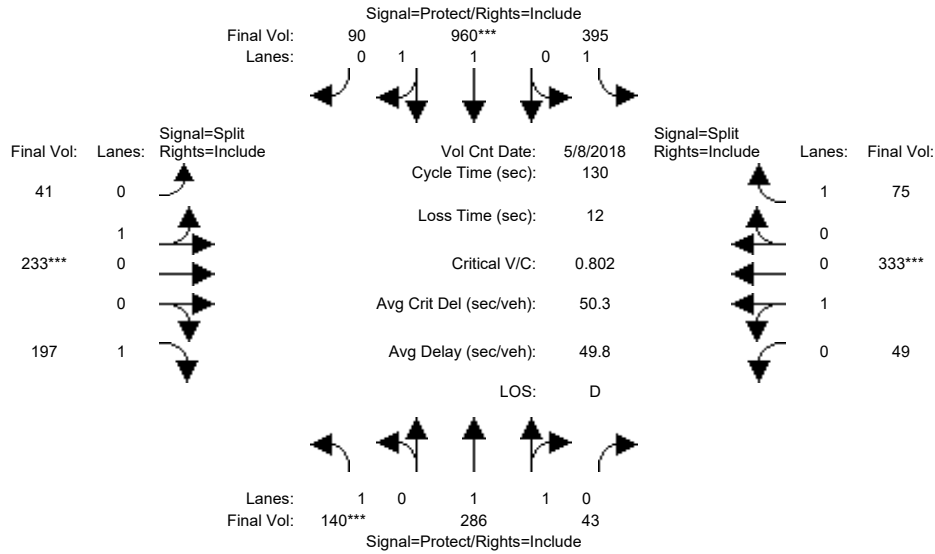

Street Name:	Monterey Road						Main Avenue					
Approach:	North Bound			South Bound			East Bound			West Bound		
Movement:	L	T	R	L	T	R	L	T	R	L	T	R
Min. Green:	7	10	10	7	10	10	10	10	10	10	10	10
Y+R:	4.0	4.0	4.0	4.0	4.0	4.0	4.0	4.0	4.0	4.0	4.0	4.0

Volume Module:	>>	Count	Date:	8 May 2018	<<							
Base Vol:	140	286	39	395	960	90	41	225	197	47	328	75
Growth Adj:	1.00	1.00	1.00	1.00	1.00	1.00	1.00	1.00	1.00	1.00	1.00	1.00
Initial Bse:	140	286	39	395	960	90	41	225	197	47	328	75
Added Vol:	0	0	4	0	0	0	0	8	0	2	5	0
PasserByVol:	0	0	0	0	0	0	0	0	0	0	0	0
Initial Fut:	140	286	43	395	960	90	41	233	197	49	333	75
User Adj:	1.00	1.00	1.00	1.00	1.00	1.00	1.00	1.00	1.00	1.00	1.00	1.00
PHF Adj:	1.00	1.00	1.00	1.00	1.00	1.00	1.00	1.00	1.00	1.00	1.00	1.00
PHF Volume:	140	286	43	395	960	90	41	233	197	49	333	75
Reduct Vol:	0	0	0	0	0	0	0	0	0	0	0	0
Reduced Vol:	140	286	43	395	960	90	41	233	197	49	333	75
PCE Adj:	1.00	1.00	1.00	1.00	1.00	1.00	1.00	1.00	1.00	1.00	1.00	1.00
MLF Adj:	1.00	1.00	1.00	1.00	1.00	1.00	1.00	1.00	1.00	1.00	1.00	1.00
Final Volume:	140	286	43	395	960	90	41	233	197	49	333	75

Saturation Flow Module:												
Sat/Lane:	1900	1900	1900	1900	1900	1900	1900	1900	1900	1900	1900	1900
Adjustment:	0.92	0.98	0.95	0.92	0.98	0.95	0.95	0.95	0.92	0.95	0.95	0.92
Lanes:	1.00	1.73	0.27	1.00	1.82	0.18	0.15	0.85	1.00	0.13	0.87	1.00
Final Sat.:	1750	3216	484	1750	3383	317	269	1531	1750	231	1569	1750

Capacity Analysis Module:												
Vol/Sat:	0.08	0.09	0.09	0.23	0.28	0.28	0.15	0.15	0.11	0.21	0.21	0.04
Crit Moves:	****				****			****			****	
Green Time:	13.0	16.7	16.7	42.3	46.0	46.0	24.7	24.7	24.7	34.4	34.4	34.4
Volume/Cap:	0.80	0.69	0.69	0.69	0.80	0.80	0.80	0.80	0.59	0.80	0.80	0.16
Delay/Veh:	80.1	58.7	58.7	41.9	41.6	41.6	63.1	63.1	51.0	54.1	54.1	36.9
User DelAdj:	1.00	1.00	1.00	1.00	1.00	1.00	1.00	1.00	1.00	1.00	1.00	1.00
AdjDel/Veh:	80.1	58.7	58.7	41.9	41.6	41.6	63.1	63.1	51.0	54.1	54.1	36.9
LOS by Move:	F	E	E	D	D	D	E	E	D	D	D	D
HCM2k95thQ:	12	13	13	25	32	32	23	23	16	26	26	5

Note: Queue reported is the number of cars per lane.

Appendix E

Signal Warrant Analysis

The Crosswinds Residential Development

7 . Mission View Drive and Avenida De Los Padres

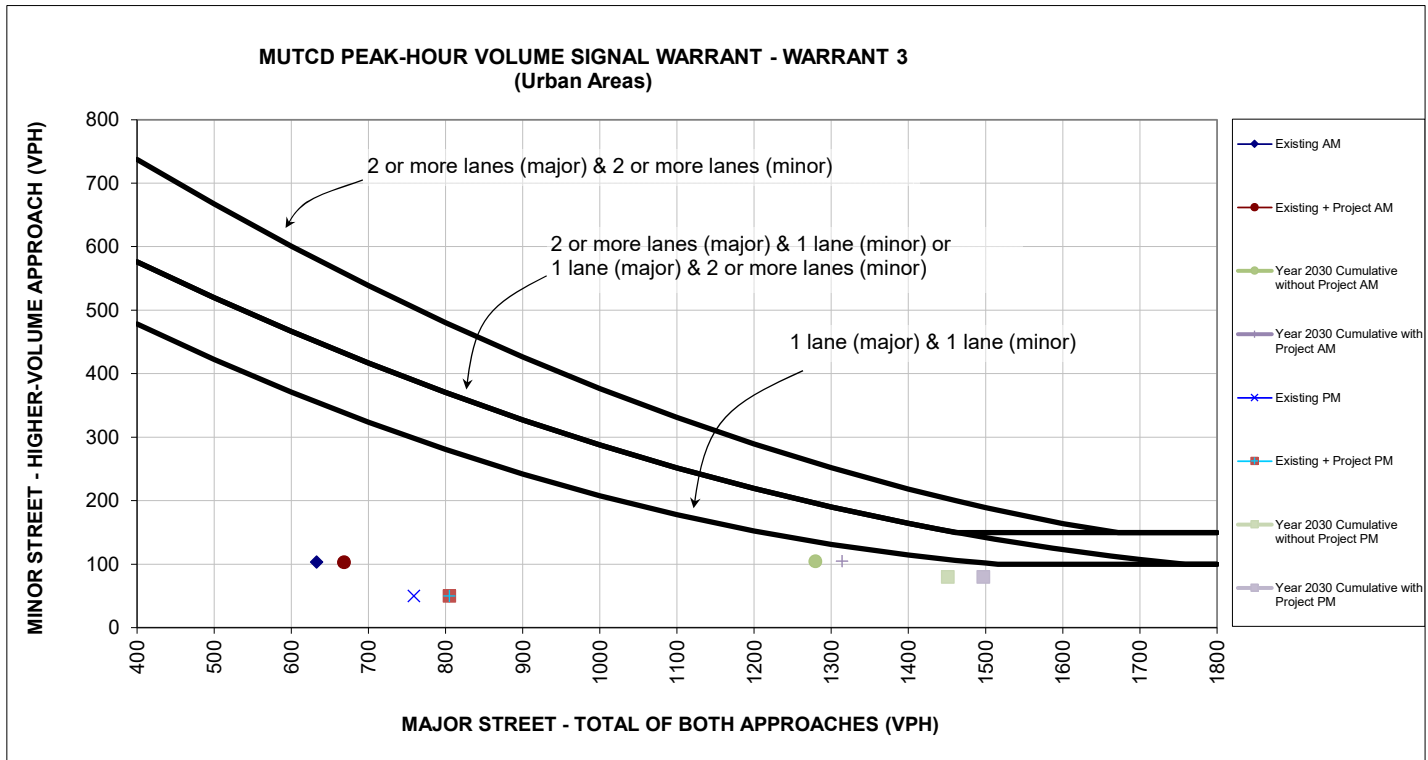

Source: Figure 4C-3 of the Manual on Uniform Traffic Control and Devices (MUTCD) from California Department of Transportation (Caltrans).

* 150 vph applies as the lower threshold volume for a minor-street approach with two or more lanes and 100 vph applies as the lower threshold volume for a minor-street approach with one lane.

		Approach Lanes		Existing AM	Existing + Project AM	Year 2030 Cumulative without Project AM	Year 2030 Cumulative with Project AM
		2 or One	More				
Major Street - Both Approaches	Avenida De Los Padres	X		633	668	1279	1314
Minor Street - Highest Approach	Mission View Drive	X		103	103	105	105
Maximum warrant threshold for minor street volume				355	338	135	128
Difference between warrant threshold & minor street volume				252	235	30	23
Warrant Met?				No	No	No	No

		Approach Lanes		Existing PM	Existing + Project PM	Year 2030 Cumulative without Project PM	Year 2030 Cumulative with Project PM
		2 or One	More				
Major Street - Both Approaches	Avenida De Los Padres	X		759	805	1451	1497
Minor Street - Highest Approach	Mission View Drive	X		50	50	80	80
Maximum warrant threshold for minor street volume				298	279	107	102
Difference between warrant threshold & minor street volume				248	229	27	22
Warrant Met?				No	No	No	No

The Crosswinds Residential Development

8 . Mission View Drive and Half Road

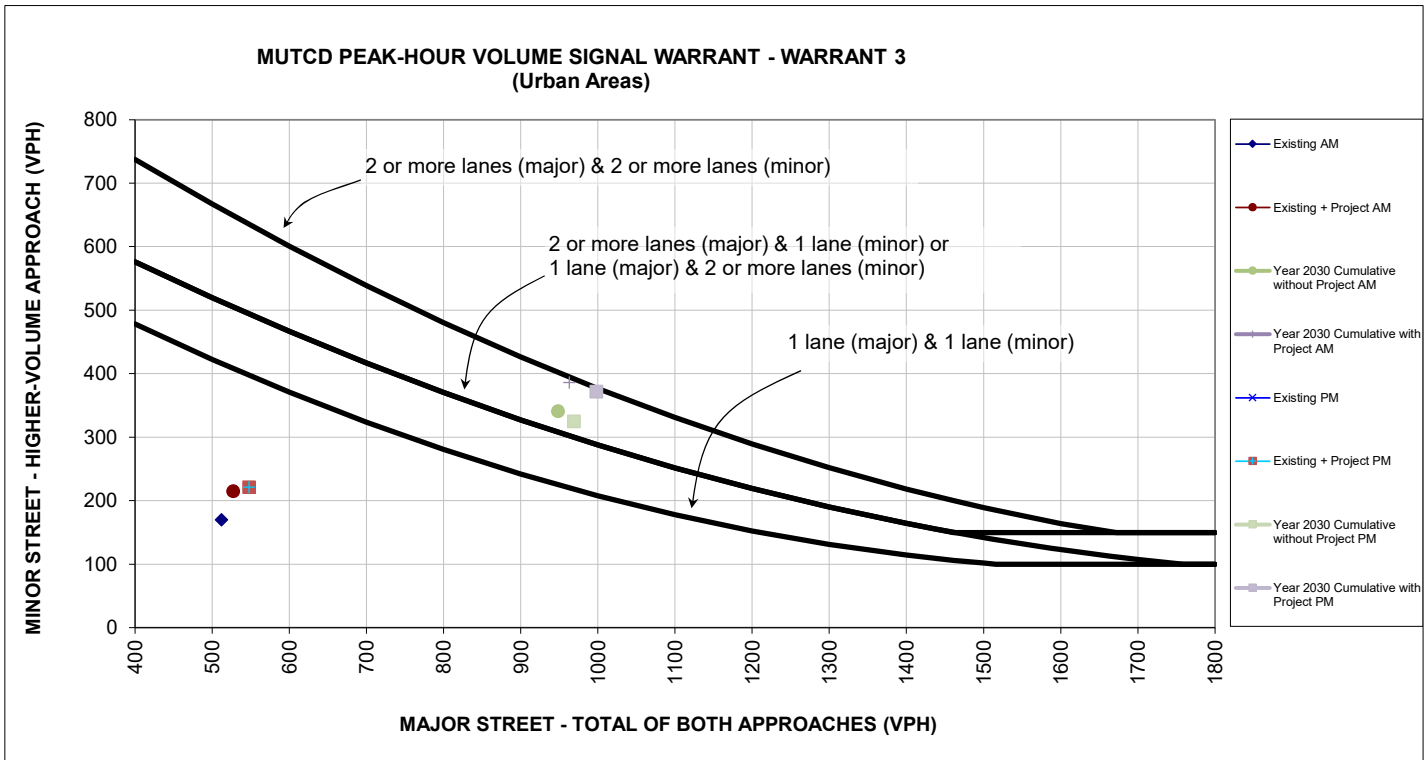

Source: Figure 4C-3 of the Manual on Uniform Traffic Control and Devices (MUTCD) from California Department of Transportation (Caltrans).

* 150 vph applies as the lower threshold volume for a minor-street approach with two or more lanes and 100 vph applies as the lower threshold volume for a minor-street approach with one lane.

		Approach Lanes		Existing AM	Existing + Project AM	Year 2030 Cumulative without Project AM	Year 2030 Cumulative with Project AM
		One	Two or More				
Major Street - Both Approaches	Mission View Drive	X		512	527	948	963
Minor Street - Highest Approach	Half Road	X		170	215	341	386
Maximum warrant threshold for minor street volume				416	408	225	220
Difference between warrant threshold & minor street volume				246	193	116	166
Warrant Met?				No	No	Yes	Yes

		Approach Lanes		Existing PM	Existing + Project PM	Year 2030 Cumulative without Project PM	Year 2030 Cumulative with Project PM
		One	Two or More				
Major Street - Both Approaches	Mission View Drive	X		268	548	969	998
Minor Street - Highest Approach	Half Road	X		519	221	325	372
Maximum warrant threshold for minor street volume				559	397	218	208
Difference between warrant threshold & minor street volume				40	176	107	164
Warrant Met?				No	No	Yes	Yes

The Crosswinds Residential Development

10 . Condit Road and Diana Avenue

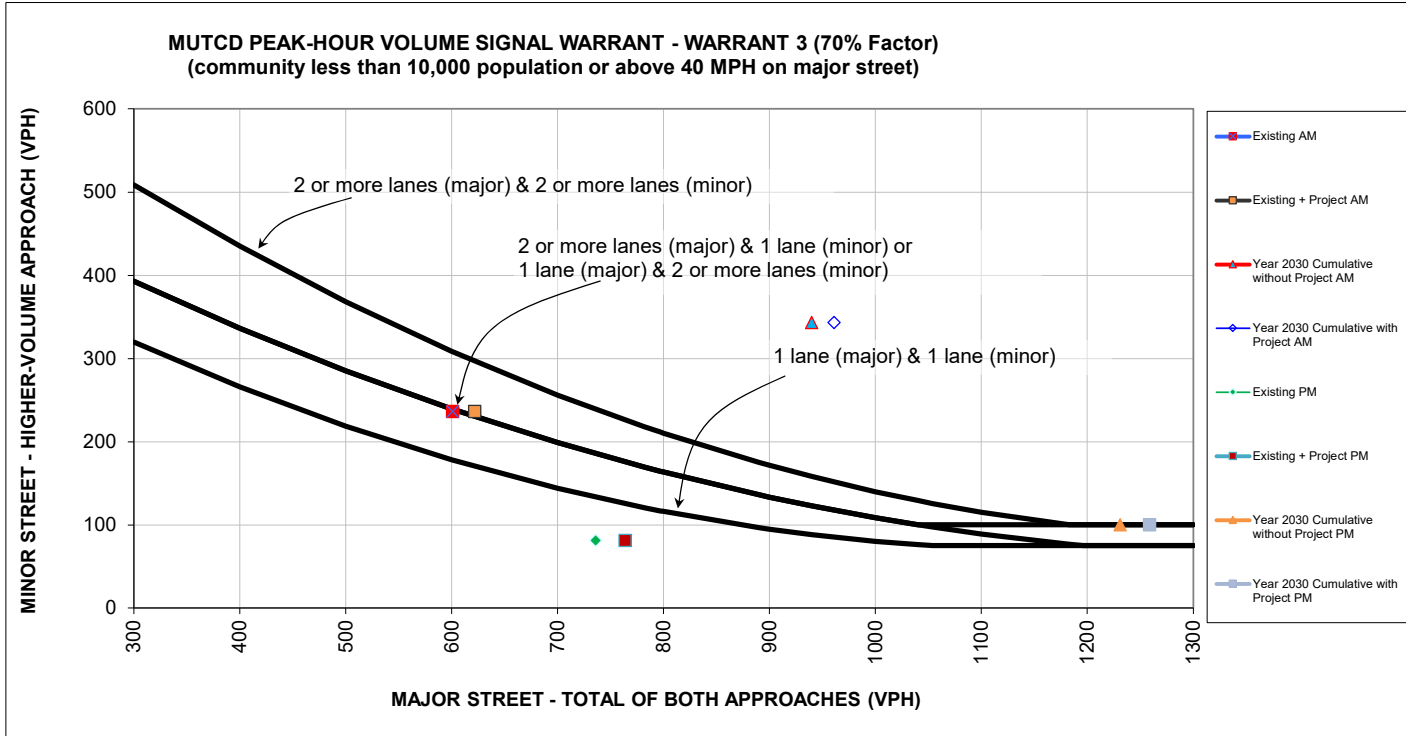

Source: Figure 4C-4 of the Manual on Uniform Traffic Control and Devices (MUTCD) from California Department of Transportation (Caltrans).

* 100 vph applies as the lower threshold volume for a minor-street approach with two or more lanes and 75 vph applies as the lower threshold volume for a minor-street approach with one lane.

		Approach Lanes		Existing AM	Existing + Project AM	Year 2030 Cumulative without Project AM	Year 2030 Cumulative with Project AM
		One	Two or More				
Major Street - Both Approaches	Diana Avenue	X		601	622	940	961
Minor Street - Highest Approach	Condit Road	X		236	236	343	343
Maximum warrant threshold for minor street volume				178	170	88	85
Difference between warrant threshold & minor street volume				58	66	255	258
Warrant Met?				Yes	Yes	Yes	Yes

		Approach Lanes		Existing PM	Existing + Project PM	Year 2030 Cumulative without Project PM	Year 2030 Cumulative with Project PM
		One	Two or More				
Major Street - Both Approaches	Diana Avenue	X		736	764	1231	1259
Minor Street - Highest Approach	Condit Road	X		81	81	100	100
Maximum warrant threshold for minor street volume				133	125	75	75
Difference between warrant threshold & minor street volume				52	44	25	25
Warrant Met?				No	No	Yes	Yes

Appendix F

Intersection Queuing Calculations

DePaul/Cochrane
 NB
 AM
 Existing Conditions
 Avg. Queue Per Lane in Veh= 0.1
 Percentile = 95% 1

DePaul/Cochrane
 NB
 AM
 Existing Plus Project Conditions
 Avg. Queue Per Lane in Veh= 1.4
 Percentile = 95% 4

Individual Probability	Cumulative Probability	Number of Queued Vehicles
0.9048	0.9048	0
0.0905	0.9953	1
0.0045	0.9998	2
0.0002	1.0000	3
0.0000	1.0000	4
0.0000	1.0000	5
0.0000	1.0000	6
0.0000	1.0000	7
0.0000	1.0000	8
0.0000	1.0000	9
0.0000	1.0000	10
0.0000	1.0000	11
0.0000	1.0000	12
0.0000	1.0000	13
0.0000	1.0000	14
0.0000	1.0000	15
0.0000	1.0000	16
0.0000	1.0000	17
0.0000	1.0000	18
0.0000	1.0000	19
0.0000	1.0000	20
0.0000	1.0000	21
0.0000	1.0000	22
0.0000	1.0000	23
0.0000	1.0000	24
0.0000	1.0000	25
0.0000	1.0000	26
0.0000	1.0000	27
0.0000	1.0000	28
0.0000	1.0000	29
0.0000	1.0000	30
0.0000	1.0000	31
0.0000	1.0000	32
0.0000	1.0000	33
0.0000	1.0000	34
0.0000	1.0000	35
0.0000	1.0000	36
0.0000	1.0000	37
0.0000	1.0000	38
0.0000	1.0000	39
0.0000	1.0000	40
0.0000	1.0000	41
0.0000	1.0000	42
0.0000	1.0000	43
0.0000	1.0000	44
0.0000	1.0000	45
0.0000	1.0000	46
0.0000	1.0000	47
0.0000	1.0000	48
0.0000	1.0000	49
0.0000	1.0000	50
0.0000	1.0000	51
0.0000	1.0000	52
0.0000	1.0000	53
0.0000	1.0000	54
0.0000	1.0000	55
0.0000	1.0000	56
0.0000	1.0000	57
0.0000	1.0000	58
0.0000	1.0000	59
0.0000	1.0000	60
0.0000	1.0000	61
0.0000	1.0000	62
0.0000	1.0000	63
0.0000	1.0000	64
0.0000	1.0000	65

Individual Probability	Cumulative Probability	Number of Queued Vehicles
0.2466	0.2466	0
0.3452	0.5918	1
0.2417	0.8335	2
0.1128	0.9463	3
0.0395	0.9857	4
0.0111	0.9968	5
0.0026	0.9994	6
0.0005	0.9999	7
0.0001	1.0000	8
0.0000	1.0000	9
0.0000	1.0000	10
0.0000	1.0000	11
0.0000	1.0000	12
0.0000	1.0000	13
0.0000	1.0000	14
0.0000	1.0000	15
0.0000	1.0000	16
0.0000	1.0000	17
0.0000	1.0000	18
0.0000	1.0000	19
0.0000	1.0000	20
0.0000	1.0000	21
0.0000	1.0000	22
0.0000	1.0000	23
0.0000	1.0000	24
0.0000	1.0000	25
0.0000	1.0000	26
0.0000	1.0000	27
0.0000	1.0000	28
0.0000	1.0000	29
0.0000	1.0000	30
0.0000	1.0000	31
0.0000	1.0000	32
0.0000	1.0000	33
0.0000	1.0000	34
0.0000	1.0000	35
0.0000	1.0000	36
0.0000	1.0000	37
0.0000	1.0000	38
0.0000	1.0000	39
0.0000	1.0000	40
0.0000	1.0000	41
0.0000	1.0000	42
0.0000	1.0000	43
0.0000	1.0000	44
0.0000	1.0000	45
0.0000	1.0000	46
0.0000	1.0000	47
0.0000	1.0000	48
0.0000	1.0000	49
0.0000	1.0000	50
0.0000	1.0000	51
0.0000	1.0000	52
0.0000	1.0000	53
0.0000	1.0000	54
0.0000	1.0000	55
0.0000	1.0000	56
0.0000	1.0000	57
0.0000	1.0000	58
0.0000	1.0000	59
0.0000	1.0000	60
0.0000	1.0000	61
0.0000	1.0000	62
0.0000	1.0000	63
0.0000	1.0000	64
0.0000	1.0000	65

DePaul/Cochrane
 NB
 PM
 Existing Conditions
 Avg. Queue Per Lane in Veh= 0.3
 Percentile = 95% 1

DePaul/Cochrane
 NB
 PM
 Existing Plus Project Conditions
 Avg. Queue Per Lane in Veh= 1.2
 Percentile = 95% 3

Individual Probability	Cumulative Probability	Number of Queued Vehicles
0.7408	0.7408	0
0.2222	0.9631	1
0.0333	0.9964	2
0.0033	0.9997	3
0.0003	1.0000	4
0.0000	1.0000	5
0.0000	1.0000	6
0.0000	1.0000	7
0.0000	1.0000	8
0.0000	1.0000	9
0.0000	1.0000	10
0.0000	1.0000	11
0.0000	1.0000	12
0.0000	1.0000	13
0.0000	1.0000	14
0.0000	1.0000	15
0.0000	1.0000	16
0.0000	1.0000	17
0.0000	1.0000	18
0.0000	1.0000	19
0.0000	1.0000	20
0.0000	1.0000	21
0.0000	1.0000	22
0.0000	1.0000	23
0.0000	1.0000	24
0.0000	1.0000	25
0.0000	1.0000	26
0.0000	1.0000	27
0.0000	1.0000	28
0.0000	1.0000	29
0.0000	1.0000	30
0.0000	1.0000	31
0.0000	1.0000	32
0.0000	1.0000	33
0.0000	1.0000	34
0.0000	1.0000	35
0.0000	1.0000	36
0.0000	1.0000	37
0.0000	1.0000	38
0.0000	1.0000	39
0.0000	1.0000	40
0.0000	1.0000	41
0.0000	1.0000	42
0.0000	1.0000	43
0.0000	1.0000	44
0.0000	1.0000	45
0.0000	1.0000	46
0.0000	1.0000	47
0.0000	1.0000	48
0.0000	1.0000	49
0.0000	1.0000	50
0.0000	1.0000	51
0.0000	1.0000	52
0.0000	1.0000	53
0.0000	1.0000	54
0.0000	1.0000	55
0.0000	1.0000	56
0.0000	1.0000	57
0.0000	1.0000	58
0.0000	1.0000	59
0.0000	1.0000	60
0.0000	1.0000	61
0.0000	1.0000	62
0.0000	1.0000	63
0.0000	1.0000	64
0.0000	1.0000	65

Individual Probability	Cumulative Probability	Number of Queued Vehicles
0.3012	0.3012	0
0.3614	0.6626	1
0.2169	0.8795	2
0.0867	0.9662	3
0.0260	0.9923	4
0.0062	0.9985	5
0.0012	0.9997	6
0.0002	1.0000	7
0.0000	1.0000	8
0.0000	1.0000	9
0.0000	1.0000	10
0.0000	1.0000	11
0.0000	1.0000	12
0.0000	1.0000	13
0.0000	1.0000	14
0.0000	1.0000	15
0.0000	1.0000	16
0.0000	1.0000	17
0.0000	1.0000	18
0.0000	1.0000	19
0.0000	1.0000	20
0.0000	1.0000	21
0.0000	1.0000	22
0.0000	1.0000	23
0.0000	1.0000	24
0.0000	1.0000	25
0.0000	1.0000	26
0.0000	1.0000	27
0.0000	1.0000	28
0.0000	1.0000	29
0.0000	1.0000	30
0.0000	1.0000	31
0.0000	1.0000	32
0.0000	1.0000	33
0.0000	1.0000	34
0.0000	1.0000	35
0.0000	1.0000	36
0.0000	1.0000	37
0.0000	1.0000	38
0.0000	1.0000	39
0.0000	1.0000	40
0.0000	1.0000	41
0.0000	1.0000	42
0.0000	1.0000	43
0.0000	1.0000	44
0.0000	1.0000	45
0.0000	1.0000	46
0.0000	1.0000	47
0.0000	1.0000	48
0.0000	1.0000	49
0.0000	1.0000	50
0.0000	1.0000	51
0.0000	1.0000	52
0.0000	1.0000	53
0.0000	1.0000	54
0.0000	1.0000	55
0.0000	1.0000	56
0.0000	1.0000	57
0.0000	1.0000	58
0.0000	1.0000	59
0.0000	1.0000	60
0.0000	1.0000	61
0.0000	1.0000	62
0.0000	1.0000	63
0.0000	1.0000	64
0.0000	1.0000	65

Mission View/Cochrane
 NBL
 AM
 Existing Conditions
 Avg. Queue Per Lane in Veh= 8.5
 Percentile = 95% 14

Mission View/Cochrane
 NBL
 AM
 Existing Plus Project Conditions
 Avg. Queue Per Lane in Veh= 9.0
 Percentile = 95% 14

Individual Probability	Cumulative Probability	Number of Queued Vehicles
0.0002	0.0002	0
0.0017	0.0019	1
0.0074	0.0093	2
0.0208	0.0301	3
0.0443	0.0744	4
0.0752	0.1496	5
0.1066	0.2562	6
0.1294	0.3856	7
0.1375	0.5231	8
0.1299	0.6530	9
0.1104	0.7634	10
0.0853	0.8487	11
0.0604	0.9091	12
0.0395	0.9486	13
0.0240	0.9726	14
0.0136	0.9862	15
0.0072	0.9934	16
0.0036	0.9970	17
0.0017	0.9987	18
0.0008	0.9995	19
0.0003	0.9998	20
0.0001	0.9999	21
0.0001	1.0000	22
0.0000	1.0000	23
0.0000	1.0000	24
0.0000	1.0000	25
0.0000	1.0000	26
0.0000	1.0000	27
0.0000	1.0000	28
0.0000	1.0000	29
0.0000	1.0000	30
0.0000	1.0000	31
0.0000	1.0000	32
0.0000	1.0000	33
0.0000	1.0000	34
0.0000	1.0000	35
0.0000	1.0000	36
0.0000	1.0000	37
0.0000	1.0000	38
0.0000	1.0000	39
0.0000	1.0000	40
0.0000	1.0000	41
0.0000	1.0000	42
0.0000	1.0000	43
0.0000	1.0000	44
0.0000	1.0000	45
0.0000	1.0000	46
0.0000	1.0000	47
0.0000	1.0000	48
0.0000	1.0000	49
0.0000	1.0000	50
0.0000	1.0000	51
0.0000	1.0000	52
0.0000	1.0000	53
0.0000	1.0000	54
0.0000	1.0000	55
0.0000	1.0000	56
0.0000	1.0000	57
0.0000	1.0000	58
0.0000	1.0000	59
0.0000	1.0000	60
0.0000	1.0000	61
0.0000	1.0000	62
0.0000	1.0000	63
0.0000	1.0000	64
0.0000	1.0000	65

Individual Probability	Cumulative Probability	Number of Queued Vehicles
0.0001	0.0001	0
0.0011	0.0012	1
0.0050	0.0062	2
0.0150	0.0212	3
0.0337	0.0550	4
0.0607	0.1157	5
0.0911	0.2068	6
0.1171	0.3239	7
0.1318	0.4557	8
0.1318	0.5874	9
0.1186	0.7060	10
0.0970	0.8030	11
0.0728	0.8758	12
0.0504	0.9261	13
0.0324	0.9585	14
0.0194	0.9780	15
0.0109	0.9889	16
0.0058	0.9947	17
0.0029	0.9976	18
0.0014	0.9989	19
0.0006	0.9996	20
0.0003	0.9998	21
0.0001	0.9999	22
0.0000	1.0000	23
0.0000	1.0000	24
0.0000	1.0000	25
0.0000	1.0000	26
0.0000	1.0000	27
0.0000	1.0000	28
0.0000	1.0000	29
0.0000	1.0000	30
0.0000	1.0000	31
0.0000	1.0000	32
0.0000	1.0000	33
0.0000	1.0000	34
0.0000	1.0000	35
0.0000	1.0000	36
0.0000	1.0000	37
0.0000	1.0000	38
0.0000	1.0000	39
0.0000	1.0000	40
0.0000	1.0000	41
0.0000	1.0000	42
0.0000	1.0000	43
0.0000	1.0000	44
0.0000	1.0000	45
0.0000	1.0000	46
0.0000	1.0000	47
0.0000	1.0000	48
0.0000	1.0000	49
0.0000	1.0000	50
0.0000	1.0000	51
0.0000	1.0000	52
0.0000	1.0000	53
0.0000	1.0000	54
0.0000	1.0000	55
0.0000	1.0000	56
0.0000	1.0000	57
0.0000	1.0000	58
0.0000	1.0000	59
0.0000	1.0000	60
0.0000	1.0000	61
0.0000	1.0000	62
0.0000	1.0000	63
0.0000	1.0000	64
0.0000	1.0000	65

Mission View/Cochrane
 NBL
 PM
 Existing Conditions
 Avg. Queue Per Lane in Veh= 3.1
 Percentile = 95% 6

Mission View/Cochrane
 NBL
 PM
 Existing Plus Project Conditions
 Avg. Queue Per Lane in Veh= 3.3
 Percentile = 95% 7

Individual Probability	Cumulative Probability	Number of Queued Vehicles
0.0450	0.0450	0
0.1397	0.1847	1
0.2165	0.4012	2
0.2237	0.6248	3
0.1733	0.7982	4
0.1075	0.9057	5
0.0555	0.9612	6
0.0246	0.9858	7
0.0095	0.9953	8
0.0033	0.9986	9
0.0010	0.9996	10
0.0003	0.9999	11
0.0001	1.0000	12
0.0000	1.0000	13
0.0000	1.0000	14
0.0000	1.0000	15
0.0000	1.0000	16
0.0000	1.0000	17
0.0000	1.0000	18
0.0000	1.0000	19
0.0000	1.0000	20
0.0000	1.0000	21
0.0000	1.0000	22
0.0000	1.0000	23
0.0000	1.0000	24
0.0000	1.0000	25
0.0000	1.0000	26
0.0000	1.0000	27
0.0000	1.0000	28
0.0000	1.0000	29
0.0000	1.0000	30
0.0000	1.0000	31
0.0000	1.0000	32
0.0000	1.0000	33
0.0000	1.0000	34
0.0000	1.0000	35
0.0000	1.0000	36
0.0000	1.0000	37
0.0000	1.0000	38
0.0000	1.0000	39
0.0000	1.0000	40
0.0000	1.0000	41
0.0000	1.0000	42
0.0000	1.0000	43
0.0000	1.0000	44
0.0000	1.0000	45
0.0000	1.0000	46
0.0000	1.0000	47
0.0000	1.0000	48
0.0000	1.0000	49
0.0000	1.0000	50
0.0000	1.0000	51
0.0000	1.0000	52
0.0000	1.0000	53
0.0000	1.0000	54
0.0000	1.0000	55
0.0000	1.0000	56
0.0000	1.0000	57
0.0000	1.0000	58
0.0000	1.0000	59
0.0000	1.0000	60
0.0000	1.0000	61
0.0000	1.0000	62
0.0000	1.0000	63
0.0000	1.0000	64
0.0000	1.0000	65

Individual Probability	Cumulative Probability	Number of Queued Vehicles
0.0369	0.0369	0
0.1217	0.1586	1
0.2008	0.3594	2
0.2209	0.5803	3
0.1823	0.7626	4
0.1203	0.8829	5
0.0662	0.9490	6
0.0312	0.9802	7
0.0129	0.9931	8
0.0047	0.9978	9
0.0016	0.9994	10
0.0005	0.9998	11
0.0001	1.0000	12
0.0000	1.0000	13
0.0000	1.0000	14
0.0000	1.0000	15
0.0000	1.0000	16
0.0000	1.0000	17
0.0000	1.0000	18
0.0000	1.0000	19
0.0000	1.0000	20
0.0000	1.0000	21
0.0000	1.0000	22
0.0000	1.0000	23
0.0000	1.0000	24
0.0000	1.0000	25
0.0000	1.0000	26
0.0000	1.0000	27
0.0000	1.0000	28
0.0000	1.0000	29
0.0000	1.0000	30
0.0000	1.0000	31
0.0000	1.0000	32
0.0000	1.0000	33
0.0000	1.0000	34
0.0000	1.0000	35
0.0000	1.0000	36
0.0000	1.0000	37
0.0000	1.0000	38
0.0000	1.0000	39
0.0000	1.0000	40
0.0000	1.0000	41
0.0000	1.0000	42
0.0000	1.0000	43
0.0000	1.0000	44
0.0000	1.0000	45
0.0000	1.0000	46
0.0000	1.0000	47
0.0000	1.0000	48
0.0000	1.0000	49
0.0000	1.0000	50
0.0000	1.0000	51
0.0000	1.0000	52
0.0000	1.0000	53
0.0000	1.0000	54
0.0000	1.0000	55
0.0000	1.0000	56
0.0000	1.0000	57
0.0000	1.0000	58
0.0000	1.0000	59
0.0000	1.0000	60
0.0000	1.0000	61
0.0000	1.0000	62
0.0000	1.0000	63
0.0000	1.0000	64
0.0000	1.0000	65

Mission View/Half
EBT/L
AM
Existing Conditions
Avg. Queue Per Lane in Veh= 0.7
Percentile = 95% 2

Mission View/Half
EBT/L
AM
Existing Plus Project Conditions
Avg. Queue Per Lane in Veh= 0.7
Percentile = 95% 2

Individual Probability	Cumulative Probability	Number of Queued Vehicles
0.4966	0.4966	0
0.3476	0.8442	1
0.1217	0.9659	2
0.0284	0.9942	3
0.0050	0.9992	4
0.0007	0.9999	5
0.0001	1.0000	6
0.0000	1.0000	7
0.0000	1.0000	8
0.0000	1.0000	9
0.0000	1.0000	10
0.0000	1.0000	11
0.0000	1.0000	12
0.0000	1.0000	13
0.0000	1.0000	14
0.0000	1.0000	15
0.0000	1.0000	16
0.0000	1.0000	17
0.0000	1.0000	18
0.0000	1.0000	19
0.0000	1.0000	20
0.0000	1.0000	21
0.0000	1.0000	22
0.0000	1.0000	23
0.0000	1.0000	24
0.0000	1.0000	25
0.0000	1.0000	26
0.0000	1.0000	27
0.0000	1.0000	28
0.0000	1.0000	29
0.0000	1.0000	30
0.0000	1.0000	31
0.0000	1.0000	32
0.0000	1.0000	33
0.0000	1.0000	34
0.0000	1.0000	35
0.0000	1.0000	36
0.0000	1.0000	37
0.0000	1.0000	38
0.0000	1.0000	39
0.0000	1.0000	40
0.0000	1.0000	41
0.0000	1.0000	42
0.0000	1.0000	43
0.0000	1.0000	44
0.0000	1.0000	45
0.0000	1.0000	46
0.0000	1.0000	47
0.0000	1.0000	48
0.0000	1.0000	49
0.0000	1.0000	50
0.0000	1.0000	51
0.0000	1.0000	52
0.0000	1.0000	53
0.0000	1.0000	54
0.0000	1.0000	55
0.0000	1.0000	56
0.0000	1.0000	57
0.0000	1.0000	58
0.0000	1.0000	59
0.0000	1.0000	60
0.0000	1.0000	61
0.0000	1.0000	62
0.0000	1.0000	63
0.0000	1.0000	64
0.0000	1.0000	65

Individual Probability	Cumulative Probability	Number of Queued Vehicles
0.4966	0.4966	0
0.3476	0.8442	1
0.1217	0.9659	2
0.0284	0.9942	3
0.0050	0.9992	4
0.0007	0.9999	5
0.0001	1.0000	6
0.0000	1.0000	7
0.0000	1.0000	8
0.0000	1.0000	9
0.0000	1.0000	10
0.0000	1.0000	11
0.0000	1.0000	12
0.0000	1.0000	13
0.0000	1.0000	14
0.0000	1.0000	15
0.0000	1.0000	16
0.0000	1.0000	17
0.0000	1.0000	18
0.0000	1.0000	19
0.0000	1.0000	20
0.0000	1.0000	21
0.0000	1.0000	22
0.0000	1.0000	23
0.0000	1.0000	24
0.0000	1.0000	25
0.0000	1.0000	26
0.0000	1.0000	27
0.0000	1.0000	28
0.0000	1.0000	29
0.0000	1.0000	30
0.0000	1.0000	31
0.0000	1.0000	32
0.0000	1.0000	33
0.0000	1.0000	34
0.0000	1.0000	35
0.0000	1.0000	36
0.0000	1.0000	37
0.0000	1.0000	38
0.0000	1.0000	39
0.0000	1.0000	40
0.0000	1.0000	41
0.0000	1.0000	42
0.0000	1.0000	43
0.0000	1.0000	44
0.0000	1.0000	45
0.0000	1.0000	46
0.0000	1.0000	47
0.0000	1.0000	48
0.0000	1.0000	49
0.0000	1.0000	50
0.0000	1.0000	51
0.0000	1.0000	52
0.0000	1.0000	53
0.0000	1.0000	54
0.0000	1.0000	55
0.0000	1.0000	56
0.0000	1.0000	57
0.0000	1.0000	58
0.0000	1.0000	59
0.0000	1.0000	60
0.0000	1.0000	61
0.0000	1.0000	62
0.0000	1.0000	63
0.0000	1.0000	64
0.0000	1.0000	65

Mission View/Half
EBT/L
PM
Existing Conditions
Avg. Queue Per Lane in Veh= 0.4
Percentile = 95% 2

Mission View/Half
EBT/L
PM
Existing Plus Project Conditions
Avg. Queue Per Lane in Veh= 0.5
Percentile = 95% 2

Individual Probability	Cumulative Probability	Number of Queued Vehicles
0.6703	0.6703	0
0.2681	0.9384	1
0.0536	0.9921	2
0.0072	0.9992	3
0.0007	0.9999	4
0.0001	1.0000	5
0.0000	1.0000	6
0.0000	1.0000	7
0.0000	1.0000	8
0.0000	1.0000	9
0.0000	1.0000	10
0.0000	1.0000	11
0.0000	1.0000	12
0.0000	1.0000	13
0.0000	1.0000	14
0.0000	1.0000	15
0.0000	1.0000	16
0.0000	1.0000	17
0.0000	1.0000	18
0.0000	1.0000	19
0.0000	1.0000	20
0.0000	1.0000	21
0.0000	1.0000	22
0.0000	1.0000	23
0.0000	1.0000	24
0.0000	1.0000	25
0.0000	1.0000	26
0.0000	1.0000	27
0.0000	1.0000	28
0.0000	1.0000	29
0.0000	1.0000	30
0.0000	1.0000	31
0.0000	1.0000	32
0.0000	1.0000	33
0.0000	1.0000	34
0.0000	1.0000	35
0.0000	1.0000	36
0.0000	1.0000	37
0.0000	1.0000	38
0.0000	1.0000	39
0.0000	1.0000	40
0.0000	1.0000	41
0.0000	1.0000	42
0.0000	1.0000	43
0.0000	1.0000	44
0.0000	1.0000	45
0.0000	1.0000	46
0.0000	1.0000	47
0.0000	1.0000	48
0.0000	1.0000	49
0.0000	1.0000	50
0.0000	1.0000	51
0.0000	1.0000	52
0.0000	1.0000	53
0.0000	1.0000	54
0.0000	1.0000	55
0.0000	1.0000	56
0.0000	1.0000	57
0.0000	1.0000	58
0.0000	1.0000	59
0.0000	1.0000	60
0.0000	1.0000	61
0.0000	1.0000	62
0.0000	1.0000	63
0.0000	1.0000	64
0.0000	1.0000	65

Individual Probability	Cumulative Probability	Number of Queued Vehicles
0.6065	0.6065	0
0.3033	0.9098	1
0.0758	0.9856	2
0.0126	0.9982	3
0.0016	0.9998	4
0.0002	1.0000	5
0.0000	1.0000	6
0.0000	1.0000	7
0.0000	1.0000	8
0.0000	1.0000	9
0.0000	1.0000	10
0.0000	1.0000	11
0.0000	1.0000	12
0.0000	1.0000	13
0.0000	1.0000	14
0.0000	1.0000	15
0.0000	1.0000	16
0.0000	1.0000	17
0.0000	1.0000	18
0.0000	1.0000	19
0.0000	1.0000	20
0.0000	1.0000	21
0.0000	1.0000	22
0.0000	1.0000	23
0.0000	1.0000	24
0.0000	1.0000	25
0.0000	1.0000	26
0.0000	1.0000	27
0.0000	1.0000	28
0.0000	1.0000	29
0.0000	1.0000	30
0.0000	1.0000	31
0.0000	1.0000	32
0.0000	1.0000	33
0.0000	1.0000	34
0.0000	1.0000	35
0.0000	1.0000	36
0.0000	1.0000	37
0.0000	1.0000	38
0.0000	1.0000	39
0.0000	1.0000	40
0.0000	1.0000	41
0.0000	1.0000	42
0.0000	1.0000	43
0.0000	1.0000	44
0.0000	1.0000	45
0.0000	1.0000	46
0.0000	1.0000	47
0.0000	1.0000	48
0.0000	1.0000	49
0.0000	1.0000	50
0.0000	1.0000	51
0.0000	1.0000	52
0.0000	1.0000	53
0.0000	1.0000	54
0.0000	1.0000	55
0.0000	1.0000	56
0.0000	1.0000	57
0.0000	1.0000	58
0.0000	1.0000	59
0.0000	1.0000	60
0.0000	1.0000	61
0.0000	1.0000	62
0.0000	1.0000	63
0.0000	1.0000	64
0.0000	1.0000	65

Mission View/Half
 SB
 AM
 Existing Conditions
 Avg. Queue Per Lane in Veh= 0.6
 Percentile = 95% 2

Mission View/Half
 SB
 AM
 Existing Plus Project Conditions
 Avg. Queue Per Lane in Veh= 0.8
 Percentile = 95% 2

Individual Probability	Cumulative Probability	Number of Queued Vehicles
0.5488	0.5488	0
0.3293	0.8781	1
0.0988	0.9769	2
0.0198	0.9966	3
0.0030	0.9996	4
0.0004	1.0000	5
0.0000	1.0000	6
0.0000	1.0000	7
0.0000	1.0000	8
0.0000	1.0000	9
0.0000	1.0000	10
0.0000	1.0000	11
0.0000	1.0000	12
0.0000	1.0000	13
0.0000	1.0000	14
0.0000	1.0000	15
0.0000	1.0000	16
0.0000	1.0000	17
0.0000	1.0000	18
0.0000	1.0000	19
0.0000	1.0000	20
0.0000	1.0000	21
0.0000	1.0000	22
0.0000	1.0000	23
0.0000	1.0000	24
0.0000	1.0000	25
0.0000	1.0000	26
0.0000	1.0000	27
0.0000	1.0000	28
0.0000	1.0000	29
0.0000	1.0000	30
0.0000	1.0000	31
0.0000	1.0000	32
0.0000	1.0000	33
0.0000	1.0000	34
0.0000	1.0000	35
0.0000	1.0000	36
0.0000	1.0000	37
0.0000	1.0000	38
0.0000	1.0000	39
0.0000	1.0000	40
0.0000	1.0000	41
0.0000	1.0000	42
0.0000	1.0000	43
0.0000	1.0000	44
0.0000	1.0000	45
0.0000	1.0000	46
0.0000	1.0000	47
0.0000	1.0000	48
0.0000	1.0000	49
0.0000	1.0000	50
0.0000	1.0000	51
0.0000	1.0000	52
0.0000	1.0000	53
0.0000	1.0000	54
0.0000	1.0000	55
0.0000	1.0000	56
0.0000	1.0000	57
0.0000	1.0000	58
0.0000	1.0000	59
0.0000	1.0000	60
0.0000	1.0000	61
0.0000	1.0000	62
0.0000	1.0000	63
0.0000	1.0000	64
0.0000	1.0000	65

Individual Probability	Cumulative Probability	Number of Queued Vehicles
0.4493	0.4493	0
0.3595	0.8088	1
0.1438	0.9526	2
0.0383	0.9909	3
0.0077	0.9986	4
0.0012	0.9998	5
0.0002	1.0000	6
0.0000	1.0000	7
0.0000	1.0000	8
0.0000	1.0000	9
0.0000	1.0000	10
0.0000	1.0000	11
0.0000	1.0000	12
0.0000	1.0000	13
0.0000	1.0000	14
0.0000	1.0000	15
0.0000	1.0000	16
0.0000	1.0000	17
0.0000	1.0000	18
0.0000	1.0000	19
0.0000	1.0000	20
0.0000	1.0000	21
0.0000	1.0000	22
0.0000	1.0000	23
0.0000	1.0000	24
0.0000	1.0000	25
0.0000	1.0000	26
0.0000	1.0000	27
0.0000	1.0000	28
0.0000	1.0000	29
0.0000	1.0000	30
0.0000	1.0000	31
0.0000	1.0000	32
0.0000	1.0000	33
0.0000	1.0000	34
0.0000	1.0000	35
0.0000	1.0000	36
0.0000	1.0000	37
0.0000	1.0000	38
0.0000	1.0000	39
0.0000	1.0000	40
0.0000	1.0000	41
0.0000	1.0000	42
0.0000	1.0000	43
0.0000	1.0000	44
0.0000	1.0000	45
0.0000	1.0000	46
0.0000	1.0000	47
0.0000	1.0000	48
0.0000	1.0000	49
0.0000	1.0000	50
0.0000	1.0000	51
0.0000	1.0000	52
0.0000	1.0000	53
0.0000	1.0000	54
0.0000	1.0000	55
0.0000	1.0000	56
0.0000	1.0000	57
0.0000	1.0000	58
0.0000	1.0000	59
0.0000	1.0000	60
0.0000	1.0000	61
0.0000	1.0000	62
0.0000	1.0000	63
0.0000	1.0000	64
0.0000	1.0000	65

Mission View/Half
 SB
 PM
 Existing Conditions
 Avg. Queue Per Lane in Veh= 3.3
 Percentile = 95% 7

Mission View/Half
 SB
 PM
 Existing Plus Project Conditions
 Avg. Queue Per Lane in Veh= 5.2
 Percentile = 95% 9

Individual Probability	Cumulative Probability	Number of Queued Vehicles
0.0369	0.0369	0
0.1217	0.1586	1
0.2008	0.3594	2
0.2209	0.5803	3
0.1823	0.7626	4
0.1203	0.8829	5
0.0662	0.9490	6
0.0312	0.9802	7
0.0129	0.9931	8
0.0047	0.9978	9
0.0016	0.9994	10
0.0005	0.9998	11
0.0001	1.0000	12
0.0000	1.0000	13
0.0000	1.0000	14
0.0000	1.0000	15
0.0000	1.0000	16
0.0000	1.0000	17
0.0000	1.0000	18
0.0000	1.0000	19
0.0000	1.0000	20
0.0000	1.0000	21
0.0000	1.0000	22
0.0000	1.0000	23
0.0000	1.0000	24
0.0000	1.0000	25
0.0000	1.0000	26
0.0000	1.0000	27
0.0000	1.0000	28
0.0000	1.0000	29
0.0000	1.0000	30
0.0000	1.0000	31
0.0000	1.0000	32
0.0000	1.0000	33
0.0000	1.0000	34
0.0000	1.0000	35
0.0000	1.0000	36
0.0000	1.0000	37
0.0000	1.0000	38
0.0000	1.0000	39
0.0000	1.0000	40
0.0000	1.0000	41
0.0000	1.0000	42
0.0000	1.0000	43
0.0000	1.0000	44
0.0000	1.0000	45
0.0000	1.0000	46
0.0000	1.0000	47
0.0000	1.0000	48
0.0000	1.0000	49
0.0000	1.0000	50
0.0000	1.0000	51
0.0000	1.0000	52
0.0000	1.0000	53
0.0000	1.0000	54
0.0000	1.0000	55
0.0000	1.0000	56
0.0000	1.0000	57
0.0000	1.0000	58
0.0000	1.0000	59
0.0000	1.0000	60
0.0000	1.0000	61
0.0000	1.0000	62
0.0000	1.0000	63
0.0000	1.0000	64
0.0000	1.0000	65

Individual Probability	Cumulative Probability	Number of Queued Vehicles
0.0055	0.0055	0
0.0287	0.0342	1
0.0746	0.1088	2
0.1293	0.2381	3
0.1681	0.4061	4
0.1748	0.5809	5
0.1515	0.7324	6
0.1125	0.8449	7
0.0731	0.9181	8
0.0423	0.9603	9
0.0220	0.9823	10
0.0104	0.9927	11
0.0045	0.9972	12
0.0018	0.9990	13
0.0007	0.9997	14
0.0002	0.9999	15
0.0001	1.0000	16
0.0000	1.0000	17
0.0000	1.0000	18
0.0000	1.0000	19
0.0000	1.0000	20
0.0000	1.0000	21
0.0000	1.0000	22
0.0000	1.0000	23
0.0000	1.0000	24
0.0000	1.0000	25
0.0000	1.0000	26
0.0000	1.0000	27
0.0000	1.0000	28
0.0000	1.0000	29
0.0000	1.0000	30
0.0000	1.0000	31
0.0000	1.0000	32
0.0000	1.0000	33
0.0000	1.0000	34
0.0000	1.0000	35
0.0000	1.0000	36
0.0000	1.0000	37
0.0000	1.0000	38
0.0000	1.0000	39
0.0000	1.0000	40
0.0000	1.0000	41
0.0000	1.0000	42
0.0000	1.0000	43
0.0000	1.0000	44
0.0000	1.0000	45
0.0000	1.0000	46
0.0000	1.0000	47
0.0000	1.0000	48
0.0000	1.0000	49
0.0000	1.0000	50
0.0000	1.0000	51
0.0000	1.0000	52
0.0000	1.0000	53
0.0000	1.0000	54
0.0000	1.0000	55
0.0000	1.0000	56
0.0000	1.0000	57
0.0000	1.0000	58
0.0000	1.0000	59
0.0000	1.0000	60
0.0000	1.0000	61
0.0000	1.0000	62
0.0000	1.0000	63
0.0000	1.0000	64
0.0000	1.0000	65

Appendix G

Project Driveway Operations Analyses

City of Morgan Hill
The Crosswinds Residential Development

Level of Service Computation Report
2000 HCM Unsignalized (Future Volume Alternative)
Existing Plus Project AM

Intersection #11592: Mission View Drive and Project Driveway A

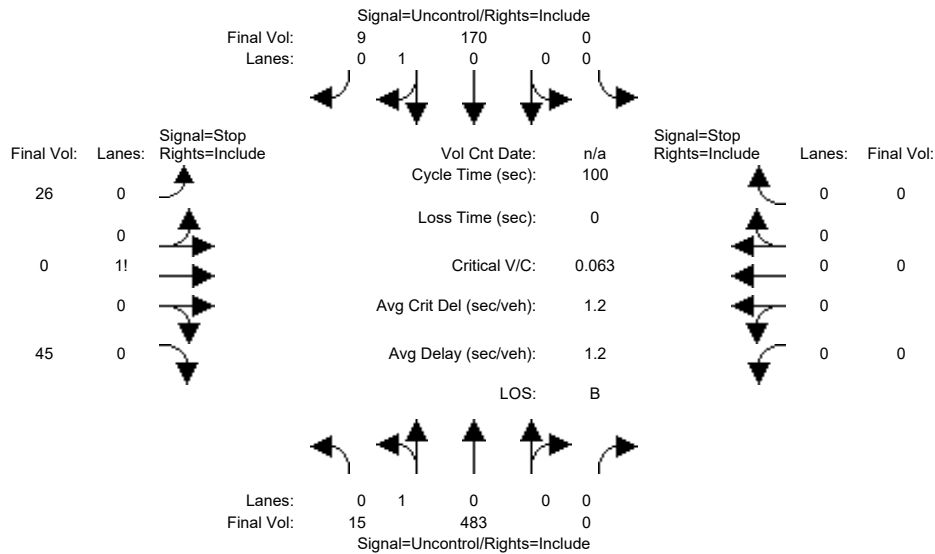

Approach: North Bound South Bound East Bound West Bound
Movement: L - T - R L - T - R L - T - R L - T - R

Volume Module:

Base Vol:	0	483	0	0	170	0	0	0	0	0	0	0
Growth Adj:	1.00	1.00	1.00	1.00	1.00	1.00	1.00	1.00	1.00	1.00	1.00	1.00
Initial Bse:	0	483	0	0	170	0	0	0	0	0	0	0
Added Vol:	15	0	0	0	0	9	26	0	45	0	0	0
PasserByVol:	0	0	0	0	0	0	0	0	0	0	0	0
Initial Fut:	15	483	0	0	170	9	26	0	45	0	0	0
User Adj:	1.00	1.00	1.00	1.00	1.00	1.00	1.00	1.00	1.00	1.00	1.00	1.00
PHF Adj:	1.00	1.00	1.00	1.00	1.00	1.00	1.00	1.00	1.00	1.00	1.00	1.00
PHF Volume:	15	483	0	0	170	9	26	0	45	0	0	0
Reduct Vol:	0	0	0	0	0	0	0	0	0	0	0	0
FinalVolume:	15	483	0	0	170	9	26	0	45	0	0	0

Critical Gap Module:

Critical Gp:	4.1	xxxx	xxxxxx	xxxxxx	xxxx	xxxxxx	6.4	6.5	6.2	xxxxxx	xxxx	xxxxxx
FollowUpTim:	2.2	xxxx	xxxxxx	xxxxxx	xxxx	xxxxxx	3.5	4.0	3.3	xxxxxx	xxxx	xxxxxx

Capacity Module:

Cnflct Vol:	179	xxxx	xxxxxx	xxxxxx	xxxx	xxxxxx	688	688	175	xxxx	xxxx	xxxxxx
Potent Cap.:	1409	xxxx	xxxxxx	xxxxxx	xxxx	xxxxxx	415	372	874	xxxx	xxxx	xxxxxx
Move Cap.:	1409	xxxx	xxxxxx	xxxxxx	xxxx	xxxxxx	412	368	874	xxxx	xxxx	xxxxxx
Volume/Cap:	0.01	xxxx	xxxx	xxxx	xxxx	xxxx	0.06	0.00	0.05	xxxx	xxxx	xxxx

Level of Service Module:

2Way95thQ:	0.0	xxxx	xxxxxx	xxxxxx	xxxx	xxxxxx	xxxx	xxxx	xxxxxx	xxxx	xxxx	xxxxxx
Control Del:	7.6	xxxx	xxxxxx	xxxxxx	xxxx	xxxxxx	xxxxxx	xxxx	xxxxxx	xxxxxx	xxxx	xxxxxx
LOS by Move:	A	*	*	*	*	*	*	*	*	*	*	*
Movement:	LT - LTR - RT	LT - LTR - RT	LT - LTR - RT	LT - LTR - RT	LT - LTR - RT	LT - LTR - RT	LT - LTR - RT	LT - LTR - RT	LT - LTR - RT	LT - LTR - RT	LT - LTR - RT	LT - LTR - RT
Shared Cap.:	xxxx	xxxx	xxxxxx	xxxxxx	xxxx	xxxxxx	xxxx	620	xxxxxx	xxxx	xxxx	xxxxxx
SharedQueue:	0.0	xxxx	xxxxxx	xxxxxx	xxxx	xxxxxx	xxxxxx	0.4	xxxxxx	xxxxxx	xxxx	xxxxxx
Shrd ConDel:	7.6	xxxx	xxxxxx	xxxxxx	xxxx	xxxxxx	xxxxxx	11.6	xxxxxx	xxxxxx	xxxx	xxxxxx
Shared LOS:	A	*	*	*	*	*	*	B	*	*	*	*
ApproachDel:	xxxxxx			xxxxxx			11.6		xxxxxx			
ApproachLOS:	*			*			B		*			*

Note: Queue reported is the number of cars per lane.

City of Morgan Hill
The Crosswinds Residential Development

Level of Service Computation Report
2000 HCM Unsignalized (Future Volume Alternative)
Existing Plus Project PM

Intersection #11592: Mission View Drive and Project Driveway A

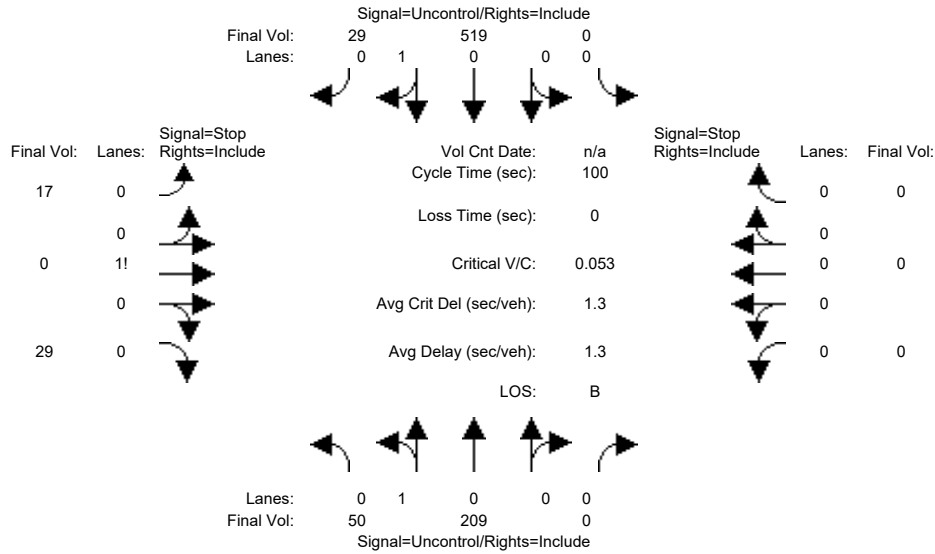

Approach: North Bound South Bound East Bound West Bound
Movement: L - T - R L - T - R L - T - R L - T - R

Volume Module:

Base Vol:	0	209	0	0	519	0	0	0	0	0	0	0
Growth Adj:	1.00	1.00	1.00	1.00	1.00	1.00	1.00	1.00	1.00	1.00	1.00	1.00
Initial Bse:	0	209	0	0	519	0	0	0	0	0	0	0
Added Vol:	50	0	0	0	0	29	17	0	29	0	0	0
PasserByVol:	0	0	0	0	0	0	0	0	0	0	0	0
Initial Fut:	50	209	0	0	519	29	17	0	29	0	0	0
User Adj:	1.00	1.00	1.00	1.00	1.00	1.00	1.00	1.00	1.00	1.00	1.00	1.00
PHF Adj:	1.00	1.00	1.00	1.00	1.00	1.00	1.00	1.00	1.00	1.00	1.00	1.00
PHF Volume:	50	209	0	0	519	29	17	0	29	0	0	0
Reduct Vol:	0	0	0	0	0	0	0	0	0	0	0	0
FinalVolume:	50	209	0	0	519	29	17	0	29	0	0	0

Critical Gap Module:

Critical Gp:	4.1	xxxx	xxxxxx	xxxxxx	xxxx	xxxxxx	6.4	6.5	6.2	xxxxxx	xxxx	xxxxxx
FollowUpTim:	2.2	xxxx	xxxxxx	xxxxxx	xxxx	xxxxxx	3.5	4.0	3.3	xxxxxx	xxxx	xxxxxx

Capacity Module:

Cnflct Vol:	548	xxxx	xxxxxx	xxxxxx	xxxx	xxxxxx	843	843	534	xxxx	xxxx	xxxxxx
Potent Cap.:	1032	xxxx	xxxxxx	xxxxxx	xxxx	xxxxxx	337	303	550	xxxx	xxxx	xxxxxx
Move Cap.:	1032	xxxx	xxxxxx	xxxxxx	xxxx	xxxxxx	324	288	550	xxxx	xxxx	xxxxxx
Volume/Cap:	0.05	xxxx	xxxx	xxxx	xxxx	xxxx	0.05	0.00	0.05	xxxx	xxxx	xxxx

Level of Service Module:

2Way95thQ:	0.2	xxxx	xxxxxx	xxxxxx	xxxx	xxxxxx	xxxx	xxxx	xxxxxx	xxxx	xxxx	xxxxxx
Control Del:	8.7	xxxx	xxxxxx	xxxxxx	xxxx	xxxxxx	xxxxxx	xxxx	xxxxxx	xxxxxx	xxxx	xxxxxx
LOS by Move:	A	*	*	*	*	*	*	*	*	*	*	*
Movement:	LT - LTR - RT	LT - LTR - RT	LT - LTR - RT	LT - LTR - RT	LT - LTR - RT	LT - LTR - RT	LT - LTR - RT	LT - LTR - RT	LT - LTR - RT	LT - LTR - RT	LT - LTR - RT	LT - LTR - RT
Shared Cap.:	xxxx	xxxx	xxxxxx	xxxxxx	xxxx	xxxxxx	xxxx	437	xxxxxx	xxxx	xxxx	xxxxxx
SharedQueue:	0.2	xxxx	xxxxxx	xxxxxx	xxxx	xxxxxx	xxxxxx	0.4	xxxxxx	xxxxxx	xxxx	xxxxxx
Shrd ConDel:	8.7	xxxx	xxxxxx	xxxxxx	xxxx	xxxxxx	xxxxxx	14.2	xxxxxx	xxxxxx	xxxx	xxxxxx
Shared LOS:	A	*	*	*	*	*	*	B	*	*	*	*
ApproachDel:	xxxxxx			xxxxxx			14.2		xxxxxx			
ApproachLOS:	*			*			B		*			*

Note: Queue reported is the number of cars per lane.

City of Morgan Hill
The Crosswinds Residential Development

Level of Service Computation Report
2000 HCM Unsignalized (Future Volume Alternative)
Year 2030 Cumulative with Project AM

Intersection #11592: Mission View Drive and Project Driveway A

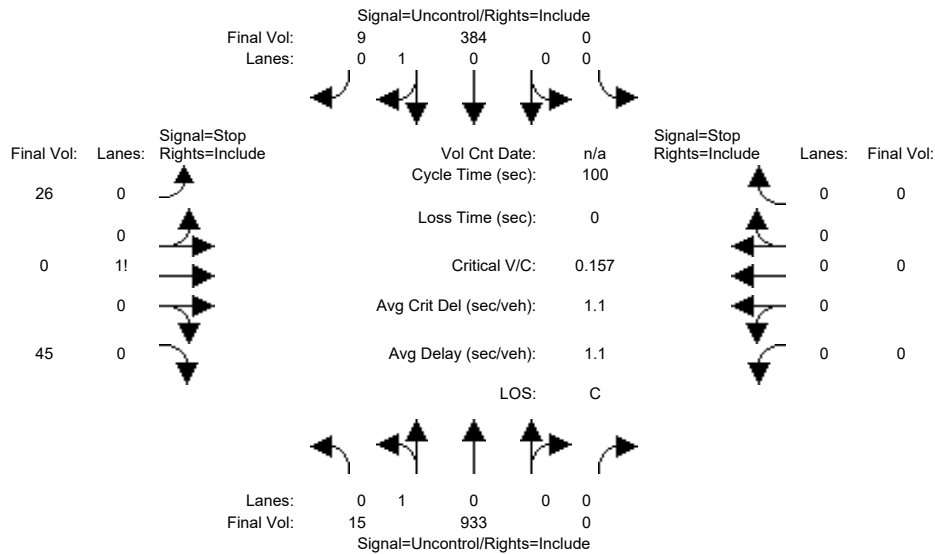

Approach: North Bound South Bound East Bound West Bound
Movement: L - T - R L - T - R L - T - R L - T - R

Volume Module:

Base Vol:	0	933	0	0	384	0	0	0	0	0	0	0
Growth Adj:	1.00	1.00	1.00	1.00	1.00	1.00	1.00	1.00	1.00	1.00	1.00	1.00
Initial Bse:	0	933	0	0	384	0	0	0	0	0	0	0
Added Vol:	15	0	0	0	0	9	26	0	45	0	0	0
PasserByVol:	0	0	0	0	0	0	0	0	0	0	0	0
Initial Fut:	15	933	0	0	384	9	26	0	45	0	0	0
User Adj:	1.00	1.00	1.00	1.00	1.00	1.00	1.00	1.00	1.00	1.00	1.00	1.00
PHF Adj:	1.00	1.00	1.00	1.00	1.00	1.00	1.00	1.00	1.00	1.00	1.00	1.00
PHF Volume:	15	933	0	0	384	9	26	0	45	0	0	0
Reduct Vol:	0	0	0	0	0	0	0	0	0	0	0	0
FinalVolume:	15	933	0	0	384	9	26	0	45	0	0	0

Critical Gap Module:

Critical Gp:	4.1	xxxx	xxxxxx	xxxxxx	xxxx	xxxxxx	6.4	6.5	6.2	xxxxxx	xxxx	xxxxxx
FollowUpTim:	2.2	xxxx	xxxxxx	xxxxxx	xxxx	xxxxxx	3.5	4.0	3.3	xxxxxx	xxxx	xxxxxx

Capacity Module:

Cnflct Vol:	393	xxxx	xxxxxx	xxxxxx	xxxx	xxxxxx	1352	1352	389	xxxx	xxxx	xxxxxx
Potent Cap.:	1177	xxxx	xxxxxx	xxxxxx	xxxx	xxxxxx	167	152	664	xxxx	xxxx	xxxxxx
Move Cap.:	1177	xxxx	xxxxxx	xxxxxx	xxxx	xxxxxx	166	150	664	xxxx	xxxx	xxxxxx
Volume/Cap:	0.01	xxxx	xxxx	xxxx	xxxx	xxxx	0.16	0.00	0.07	xxxx	xxxx	xxxx

Level of Service Module:

2Way95thQ:	0.0	xxxx	xxxxxx	xxxxxx	xxxx	xxxxxx	xxxx	xxxx	xxxxxx	xxxx	xxxx	xxxxxx
Control Del:	8.1	xxxx	xxxxxx	xxxxxx	xxxx	xxxxxx	xxxxxx	xxxx	xxxxxx	xxxxxx	xxxx	xxxxxx
LOS by Move:	A	*	*	*	*	*	*	*	*	*	*	*
Movement:	LT - LTR - RT	LT - LTR - RT	LT - LTR - RT	LT - LTR - RT	LT - LTR - RT	LT - LTR - RT	LT - LTR - RT	LT - LTR - RT	LT - LTR - RT	LT - LTR - RT	LT - LTR - RT	LT - LTR - RT
Shared Cap.:	xxxx	xxxx	xxxxxx	xxxxxx	xxxx	xxxxxx	xxxx	316	xxxxxx	xxxx	xxxx	xxxxxx
SharedQueue:	0.0	xxxx	xxxxxx	xxxxxx	xxxx	xxxxxx	xxxxxx	0.8	xxxxxx	xxxxxx	xxxx	xxxxxx
Shrd ConDel:	8.1	xxxx	xxxxxx	xxxxxx	xxxx	xxxxxx	xxxxxx	19.7	xxxxxx	xxxxxx	xxxx	xxxxxx
Shared LOS:	A	*	*	*	*	*	*	C	*	*	*	*
ApproachDel:	xxxxxx			xxxxxx			19.7		xxxxxx			
ApproachLOS:	*			*			C		*			*

Note: Queue reported is the number of cars per lane.

City of Morgan Hill
The Crosswinds Residential Development

Level of Service Computation Report
2000 HCM Unsignalized (Future Volume Alternative)
Year 2030 Cumulative with Project PM

Intersection #11592: Mission View Drive and Project Driveway A

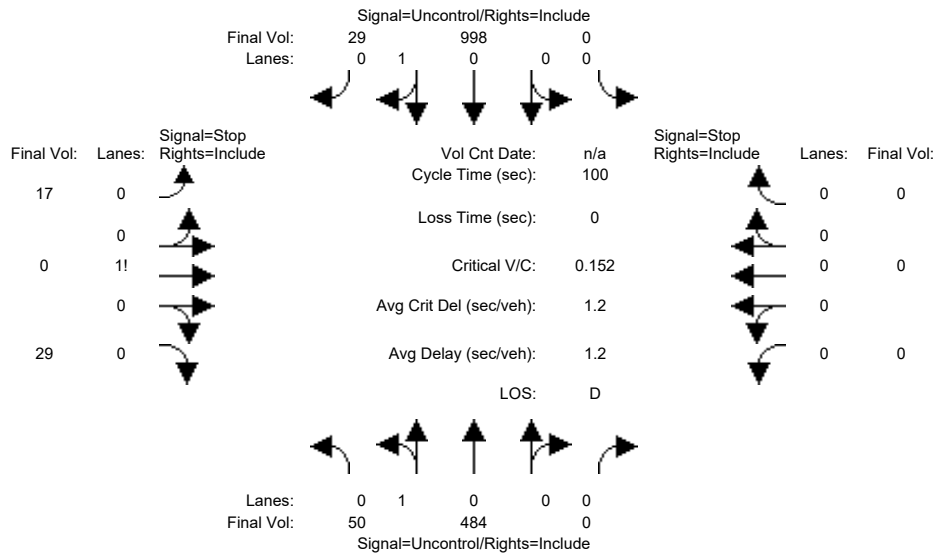

Approach: North Bound South Bound East Bound West Bound
Movement: L - T - R L - T - R L - T - R L - T - R

Volume Module:

Base Vol:	0	484	0	0	998	0	0	0	0	0	0	0
Growth Adj:	1.00	1.00	1.00	1.00	1.00	1.00	1.00	1.00	1.00	1.00	1.00	1.00
Initial Bse:	0	484	0	0	998	0	0	0	0	0	0	0
Added Vol:	50	0	0	0	0	29	17	0	29	0	0	0
PasserByVol:	0	0	0	0	0	0	0	0	0	0	0	0
Initial Fut:	50	484	0	0	998	29	17	0	29	0	0	0
User Adj:	1.00	1.00	1.00	1.00	1.00	1.00	1.00	1.00	1.00	1.00	1.00	1.00
PHF Adj:	1.00	1.00	1.00	1.00	1.00	1.00	1.00	1.00	1.00	1.00	1.00	1.00
PHF Volume:	50	484	0	0	998	29	17	0	29	0	0	0
Reduct Vol:	0	0	0	0	0	0	0	0	0	0	0	0
FinalVolume:	50	484	0	0	998	29	17	0	29	0	0	0

Critical Gap Module:

Critical Gp:	4.1	xxxx	xxxxxx	xxxxxx	xxxx	xxxxxx	6.4	6.5	6.2	xxxxxx	xxxx	xxxxxx
FollowUpTim:	2.2	xxxx	xxxxxx	xxxxxx	xxxx	xxxxxx	3.5	4.0	3.3	xxxxxx	xxxx	xxxxxx

Capacity Module:

Cnflct Vol:	1027	xxxx	xxxxxx	xxxxxx	xxxx	xxxxxx	1597	1597	1013	xxxx	xxxx	xxxxxx
Potent Cap.:	684	xxxx	xxxxxx	xxxxxx	xxxx	xxxxxx	119	108	293	xxxx	xxxx	xxxxxx
Move Cap.:	684	xxxx	xxxxxx	xxxxxx	xxxx	xxxxxx	112	100	293	xxxx	xxxx	xxxxxx
Volume/Cap:	0.07	xxxx	xxxx	xxxx	xxxx	xxxx	0.15	0.00	0.10	xxxx	xxxx	xxxx

Level of Service Module:

2Way95thQ:	0.2	xxxx	xxxxxx	xxxxxx	xxxx	xxxxxx	xxxx	xxxx	xxxxxx	xxxx	xxxx	xxxxxx
Control Del:	10.7	xxxx	xxxxxx	xxxxxx	xxxx	xxxxxx	xxxxxx	xxxx	xxxxxx	xxxxxx	xxxx	xxxxxx
LOS by Move:	B	*	*	*	*	*	*	*	*	*	*	*
Movement:	LT - LTR - RT	LT - LTR - RT	LT - LTR - RT	LT - LTR - RT	LT - LTR - RT	LT - LTR - RT	LT - LTR - RT	LT - LTR - RT	LT - LTR - RT	LT - LTR - RT	LT - LTR - RT	LT - LTR - RT
Shared Cap.:	xxxx	xxxx	xxxxxx	xxxxxx	xxxx	xxxxxx	xxxx	183	xxxxxx	xxxx	xxxx	xxxxxx
SharedQueue:	0.2	xxxx	xxxxxx	xxxxxx	xxxx	xxxxxx	xxxxxx	1.0	xxxxxx	xxxxxx	xxxx	xxxxxx
Shrd ConDel:	10.7	xxxx	xxxxxx	xxxxxx	xxxx	xxxxxx	xxxxxx	31.1	xxxxxx	xxxxxx	xxxx	xxxxxx
Shared LOS:	B	*	*	*	*	*	*	D	*	*	*	*
ApproachDel:	xxxxxx	xxxxxx	xxxxxx	xxxxxx	xxxxxx	xxxxxx	31.1	xxxxxx	xxxxxx	xxxxxx	xxxxxx	xxxxxx
ApproachLOS:	*	*	*	*	*	*	*	D	*	*	*	*

Note: Queue reported is the number of cars per lane.

City of Morgan Hill
The Crosswinds Residential Development

Level Of Service Computation Report
2000 HCM Unsignalized (Future Volume Alternative)
Existing Plus Project AM

Intersection #11591: DePaul Drive and Project Driveway B

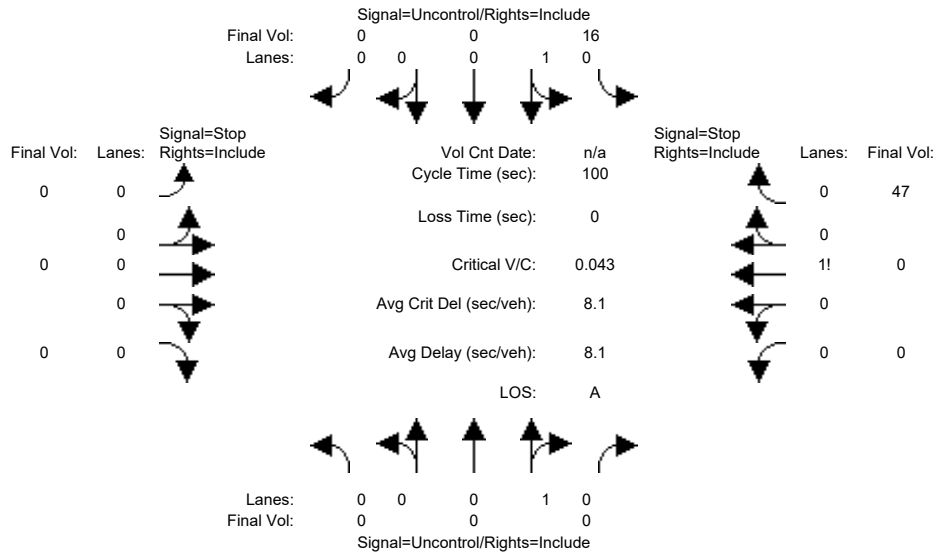

Approach:	North Bound			South Bound			East Bound			West Bound		
Movement:	L	T	R	L	T	R	L	T	R	L	T	R
Volume Module:												
Base Vol:	0	0	0	0	0	0	0	0	0	0	0	0
Growth Adj:	1.00	1.00	1.00	1.00	1.00	1.00	1.00	1.00	1.00	1.00	1.00	1.00
Initial Bse:	0	0	0	0	0	0	0	0	0	0	0	0
Added Vol:	0	0	0	16	0	0	0	0	0	0	0	47
PasserByVol:	0	0	0	0	0	0	0	0	0	0	0	0
Initial Fut:	0	0	0	16	0	0	0	0	0	0	0	47
User Adj:	1.00	1.00	1.00	1.00	1.00	1.00	1.00	1.00	1.00	1.00	1.00	1.00
PHF Adj:	1.00	1.00	1.00	1.00	1.00	1.00	1.00	1.00	1.00	1.00	1.00	1.00
PHF Volume:	0	0	0	16	0	0	0	0	0	0	0	47
Reduct Vol:	0	0	0	0	0	0	0	0	0	0	0	0
FinalVolume:	0	0	0	16	0	0	0	0	0	0	0	47
Critical Gap Module:												
Critical Gp:	xxxxx	xxxx	xxxxx	4.1	xxxx	xxxxx	xxxxx	xxxx	xxxxx	xxxxx	xxxx	6.2
FollowUpTim:	xxxxx	xxxx	xxxxx	2.2	xxxx	xxxxx	xxxxx	xxxx	xxxxx	xxxxx	xxxx	3.3
Capacity Module:												
Cnflct Vol:	xxxx	xxxx	xxxxx	0	xxxx	xxxxx	xxxx	xxxx	xxxxx	xxxx	xxxx	0
Potent Cap.:	xxxx	xxxx	xxxxx	1636	xxxx	xxxxx	xxxx	xxxx	xxxxx	xxxx	xxxx	1091
Move Cap.:	xxxx	xxxx	xxxxx	1636	xxxx	xxxxx	xxxx	xxxx	xxxxx	xxxx	xxxx	1091
Volume/Cap:	xxxx	xxxx	xxxx	0.01	xxxx	xxxx	xxxx	xxxx	xxxx	xxxx	xxxx	0.04
Level Of Service Module:												
2Way95thQ:	xxxx	xxxx	xxxxx	0.0	xxxx	xxxxx	xxxx	xxxx	xxxxx	xxxx	xxxx	0.1
Control Del:	xxxxx	xxxx	xxxxx	7.2	xxxx	xxxxx	xxxxx	xxxx	xxxxx	xxxxx	xxxx	8.4
LOS by Move:	*	*	*	A	*	*	*	*	*	*	*	A
Movement:	LT	LTR	RT	LT	LTR	RT	LT	LTR	RT	LT	LTR	RT
Shared Cap.:	xxxx	xxxx	xxxxx	xxxx	xxxx	xxxxx	xxxx	xxxx	xxxxx	xxxx	xxxx	xxxxx
SharedQueue:	xxxxx	xxxx	xxxxx	xxxxx	xxxx	xxxxx	xxxxx	xxxx	xxxxx	xxxxx	xxxx	xxxxx
Shrd ConDel:	xxxxx	xxxx	xxxxx	xxxxx	xxxx	xxxxx	xxxxx	xxxx	xxxxx	xxxxx	xxxx	xxxxx
Shared LOS:	*	*	*	*	*	*	*	*	*	*	*	*
ApproachDel:	xxxxxxx			xxxxxxx			xxxxxxx			8.4		
ApproachLOS:	*			*			*			A		

Note: Queue reported is the number of cars per lane.

City of Morgan Hill
The Crosswinds Residential Development

Level Of Service Computation Report
2000 HCM Unsignalized (Future Volume Alternative)
Existing Plus Project PM

Intersection #11591: DePaul Drive and Project Driveway B

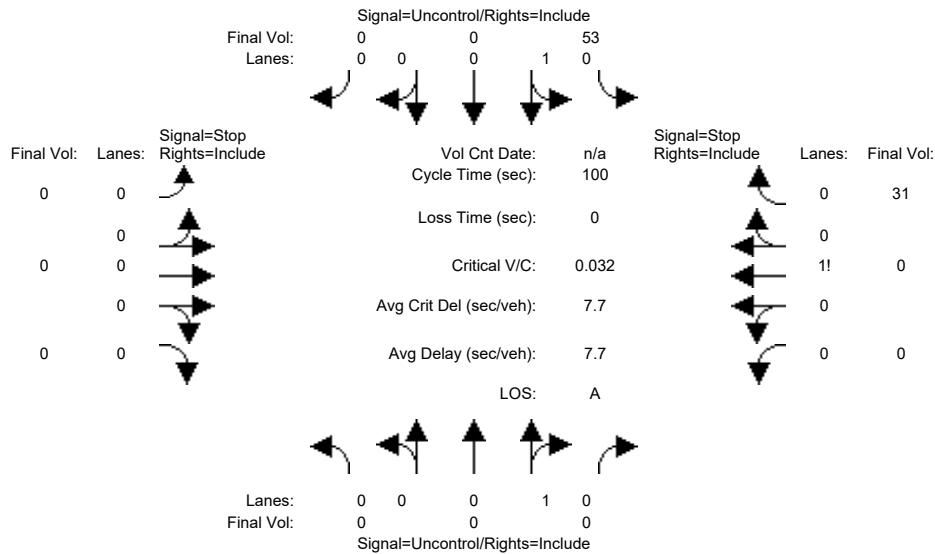

Approach: North Bound South Bound East Bound West Bound
Movement: L - T - R L - T - R L - T - R L - T - R

Volume Module:

Base Vol:	0	0	0	0	0	0	0	0	0	0	0	0
Growth Adj:	1.00	1.00	1.00	1.00	1.00	1.00	1.00	1.00	1.00	1.00	1.00	1.00
Initial Bse:	0	0	0	0	0	0	0	0	0	0	0	0
Added Vol:	0	0	0	53	0	0	0	0	0	0	0	31
PasserByVol:	0	0	0	0	0	0	0	0	0	0	0	0
Initial Fut:	0	0	0	53	0	0	0	0	0	0	0	31
User Adj:	1.00	1.00	1.00	1.00	1.00	1.00	1.00	1.00	1.00	1.00	1.00	1.00
PHF Adj:	1.00	1.00	1.00	1.00	1.00	1.00	1.00	1.00	1.00	1.00	1.00	1.00
PHF Volume:	0	0	0	53	0	0	0	0	0	0	0	31
Reduct Vol:	0	0	0	0	0	0	0	0	0	0	0	0
FinalVolume:	0	0	0	53	0	0	0	0	0	0	0	31

Critical Gap Module:

Critical Gp:	xxxx	xxxx	xxxx	4.1	xxxx	xxxx	xxxx	xxxx	xxxx	xxxx	xxxx	6.2
FollowUpTim:	xxxx	xxxx	xxxx	2.2	xxxx	xxxx	xxxx	xxxx	xxxx	xxxx	xxxx	3.3

Capacity Module:

Cnflct Vol:	xxxx	xxxx	xxxx	0	xxxx	xxxx	xxxx	xxxx	xxxx	xxxx	xxxx	0
Potent Cap.:	xxxx	xxxx	xxxx	1636	xxxx	xxxx	xxxx	xxxx	xxxx	xxxx	xxxx	1091
Move Cap.:	xxxx	xxxx	xxxx	1636	xxxx	xxxx	xxxx	xxxx	xxxx	xxxx	xxxx	1091
Volume/Cap:	xxxx	xxxx	xxxx	0.03	xxxx	xxxx	xxxx	xxxx	xxxx	xxxx	xxxx	0.03

Level Of Service Module:

2Way95thQ:	xxxx	xxxx	xxxx	0.1	xxxx	xxxx	xxxx	xxxx	xxxx	xxxx	xxxx	0.1
Control Del:	xxxx	xxxx	xxxx	7.3	xxxx	xxxx	xxxx	xxxx	xxxx	xxxx	xxxx	8.4
LOS by Move:	*	*	*	A	*	*	*	*	*	*	*	A
Movement:	LT - LTR - RT	LT - LTR - RT	LT - LTR - RT	LT - LTR - RT	LT - LTR - RT	LT - LTR - RT	LT - LTR - RT	LT - LTR - RT	LT - LTR - RT	LT - LTR - RT	LT - LTR - RT	LT - LTR - RT
Shared Cap.:	xxxx	xxxx	xxxx	xxxx	xxxx	xxxx	xxxx	xxxx	xxxx	xxxx	xxxx	xxxx
SharedQueue:	xxxx	xxxx	xxxx	xxxx	xxxx	xxxx	xxxx	xxxx	xxxx	xxxx	xxxx	xxxx
Shrd ConDel:	xxxx	xxxx	xxxx	xxxx	xxxx	xxxx	xxxx	xxxx	xxxx	xxxx	xxxx	xxxx
Shared LOS:	*	*	*	*	*	*	*	*	*	*	*	*
ApproachDel:	xxxxxx	xxxxxx	xxxxxx	xxxxxx	xxxxxx	xxxxxx	xxxxxx	xxxxxx	xxxxxx	xxxxxx	xxxxxx	8.4
ApproachLOS:	*	*	*	*	*	*	*	*	*	*	*	A

Note: Queue reported is the number of cars per lane.

City of Morgan Hill
The Crosswinds Residential Development

Level Of Service Computation Report
2000 HCM Unsignalized (Future Volume Alternative)
Year 2030 Cumulative with Project AM

Intersection #11591: DePaul Drive and Project Driveway B

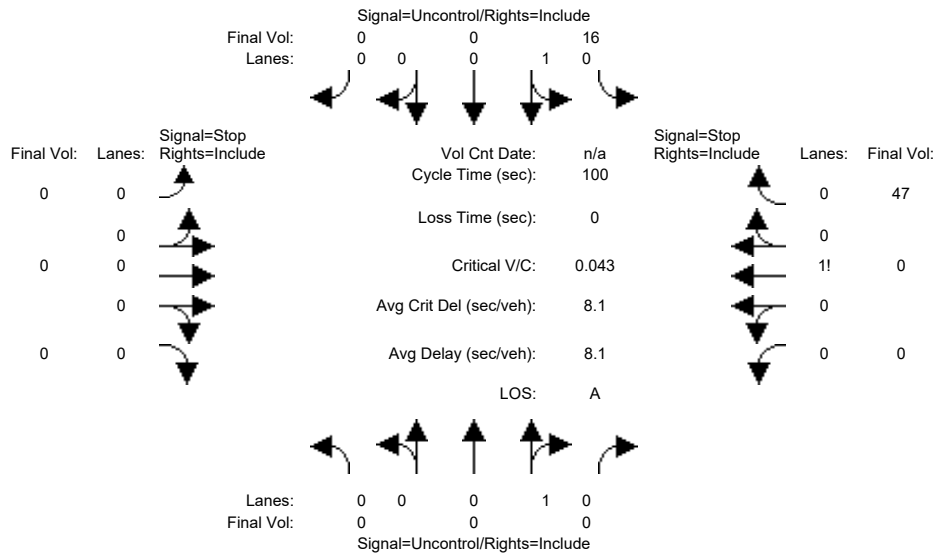

Approach: North Bound South Bound East Bound West Bound
Movement: L - T - R L - T - R L - T - R L - T - R

Volume Module:

Base Vol:	0	0	0	0	0	0	0	0	0	0	0	0
Growth Adj:	1.00	1.00	1.00	1.00	1.00	1.00	1.00	1.00	1.00	1.00	1.00	1.00
Initial Bse:	0	0	0	0	0	0	0	0	0	0	0	0
Added Vol:	0	0	0	16	0	0	0	0	0	0	0	47
PasserByVol:	0	0	0	0	0	0	0	0	0	0	0	0
Initial Fut:	0	0	0	16	0	0	0	0	0	0	0	47
User Adj:	1.00	1.00	1.00	1.00	1.00	1.00	1.00	1.00	1.00	1.00	1.00	1.00
PHF Adj:	1.00	1.00	1.00	1.00	1.00	1.00	1.00	1.00	1.00	1.00	1.00	1.00
PHF Volume:	0	0	0	16	0	0	0	0	0	0	0	47
Reduct Vol:	0	0	0	0	0	0	0	0	0	0	0	0
FinalVolume:	0	0	0	16	0	0	0	0	0	0	0	47

Critical Gap Module:

Critical Gp:	xxxxx	xxxx	xxxxx	4.1	xxxx	xxxxx	xxxxxx	xxxx	xxxxxx	xxxxxx	xxxx	6.2
FollowUpTim:	xxxxxx	xxxx	xxxxxx	2.2	xxxx	xxxxxx	xxxxxx	xxxx	xxxxxx	xxxxxx	xxxx	3.3

Capacity Module:

Cnflct Vol:	xxxx	xxxx	xxxxx	0	xxxx	xxxxxx	xxxx	xxxx	xxxxxx	xxxx	xxxx	0
Potent Cap.:	xxxx	xxxx	xxxxxx	1636	xxxx	xxxxxx	xxxx	xxxx	xxxxxx	xxxx	xxxx	1091
Move Cap.:	xxxx	xxxx	xxxxxx	1636	xxxx	xxxxxx	xxxx	xxxx	xxxxxx	xxxx	xxxx	1091
Volume/Cap:	xxxx	xxxx	xxxx	0.01	xxxx	xxxx	xxxx	xxxx	xxxx	xxxx	xxxx	0.04

Level Of Service Module:

2Way95thQ:	xxxx	xxxx	xxxxxx	0.0	xxxx	xxxxxx	xxxx	xxxx	xxxxxx	xxxx	xxxx	0.1
Control Del:	xxxxxx	xxxx	xxxxxx	7.2	xxxx	xxxxxx	xxxxxx	xxxx	xxxxxx	xxxxxx	xxxx	8.4
LOS by Move:	*	*	*	A	*	*	*	*	*	*	*	A
Movement:	LT - LTR - RT	LT - LTR - RT	LT - LTR - RT	LT - LTR - RT	LT - LTR - RT	LT - LTR - RT	LT - LTR - RT	LT - LTR - RT	LT - LTR - RT	LT - LTR - RT	LT - LTR - RT	LT - LTR - RT
Shared Cap.:	xxxx	xxxx	xxxxxx	xxxx	xxxx	xxxxxx	xxxx	xxxx	xxxxxx	xxxx	xxxx	xxxxxx
SharedQueue:	xxxxxx	xxxx	xxxxxx	xxxxxx	xxxx	xxxxxx	xxxxxx	xxxx	xxxxxx	xxxxxx	xxxx	xxxxxx
Shrd ConDel:	xxxxxx	xxxx	xxxxxx	xxxxxx	xxxx	xxxxxx	xxxxxx	xxxx	xxxxxx	xxxxxx	xxxx	xxxxxx
Shared LOS:	*	*	*	*	*	*	*	*	*	*	*	*
ApproachDel:	xxxxxx	xxxxxx	xxxxxx	xxxxxx	xxxxxx	xxxxxx	xxxxxx	xxxxxx	xxxxxx	xxxxxx	xxxxxx	8.4
ApproachLOS:	*	*	*	*	*	*	*	*	*	*	*	A

Note: Queue reported is the number of cars per lane.

City of Morgan Hill
The Crosswinds Residential Development

Level Of Service Computation Report
2000 HCM Unsignalized (Future Volume Alternative)
Year 2030 Cumulative with Project PM

Intersection #11591: DePaul Drive and Project Driveway B

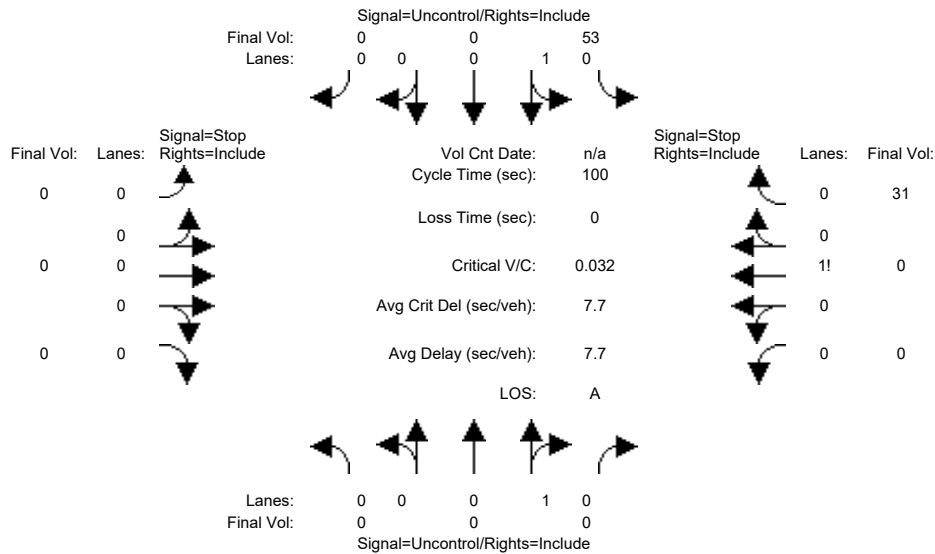

Approach: North Bound South Bound East Bound West Bound
Movement: L - T - R L - T - R L - T - R L - T - R

Volume Module:

Base Vol:	0	0	0	0	0	0	0	0	0	0	0	0
Growth Adj:	1.00	1.00	1.00	1.00	1.00	1.00	1.00	1.00	1.00	1.00	1.00	1.00
Initial Bse:	0	0	0	0	0	0	0	0	0	0	0	0
Added Vol:	0	0	0	53	0	0	0	0	0	0	0	31
PasserByVol:	0	0	0	0	0	0	0	0	0	0	0	0
Initial Fut:	0	0	0	53	0	0	0	0	0	0	0	31
User Adj:	1.00	1.00	1.00	1.00	1.00	1.00	1.00	1.00	1.00	1.00	1.00	1.00
PHF Adj:	1.00	1.00	1.00	1.00	1.00	1.00	1.00	1.00	1.00	1.00	1.00	1.00
PHF Volume:	0	0	0	53	0	0	0	0	0	0	0	31
Reduct Vol:	0	0	0	0	0	0	0	0	0	0	0	0
FinalVolume:	0	0	0	53	0	0	0	0	0	0	0	31

Critical Gap Module:

Critical Gp:	xxxx	xxxx	xxxx	4.1	xxxx	xxxx	xxxx	xxxx	xxxx	xxxx	xxxx	6.2
FollowUpTim:	xxxx	xxxx	xxxx	2.2	xxxx	xxxx	xxxx	xxxx	xxxx	xxxx	xxxx	3.3

Capacity Module:

Cnflct Vol:	xxxx	xxxx	xxxx	0	xxxx	xxxx	xxxx	xxxx	xxxx	xxxx	xxxx	0
Potent Cap.:	xxxx	xxxx	xxxx	1636	xxxx	xxxx	xxxx	xxxx	xxxx	xxxx	xxxx	1091
Move Cap.:	xxxx	xxxx	xxxx	1636	xxxx	xxxx	xxxx	xxxx	xxxx	xxxx	xxxx	1091
Volume/Cap:	xxxx	xxxx	xxxx	0.03	xxxx	xxxx	xxxx	xxxx	xxxx	xxxx	xxxx	0.03

Level Of Service Module:

2Way95thQ:	xxxx	xxxx	xxxx	0.1	xxxx	xxxx	xxxx	xxxx	xxxx	xxxx	xxxx	0.1
Control Del:	xxxx	xxxx	xxxx	7.3	xxxx	xxxx	xxxx	xxxx	xxxx	xxxx	xxxx	8.4
LOS by Move:	*	*	*	A	*	*	*	*	*	*	*	A
Movement:	LT - LTR - RT	LT - LTR - RT	LT - LTR - RT	LT - LTR - RT	LT - LTR - RT	LT - LTR - RT	LT - LTR - RT	LT - LTR - RT	LT - LTR - RT	LT - LTR - RT	LT - LTR - RT	LT - LTR - RT
Shared Cap.:	xxxx	xxxx	xxxx	xxxx	xxxx	xxxx	xxxx	xxxx	xxxx	xxxx	xxxx	xxxx
SharedQueue:	xxxx	xxxx	xxxx	xxxx	xxxx	xxxx	xxxx	xxxx	xxxx	xxxx	xxxx	xxxx
Shrd ConDel:	xxxx	xxxx	xxxx	xxxx	xxxx	xxxx	xxxx	xxxx	xxxx	xxxx	xxxx	xxxx
Shared LOS:	*	*	*	*	*	*	*	*	*	*	*	*
ApproachDel:	xxxxxx	xxxxxx	xxxxxx	xxxxxx	xxxxxx	xxxxxx	xxxxxx	xxxxxx	xxxxxx	xxxxxx	xxxxxx	8.4
ApproachLOS:	*	*	*	*	*	*	*	*	*	*	*	A

Note: Queue reported is the number of cars per lane.

City of Morgan Hill
The Crosswinds Residential Development

Level Of Service Computation Report
2000 HCM Unsignalized (Future Volume Alternative)
Existing Plus Project AM

Intersection #11620: DePaul Drive and Project Driveway C

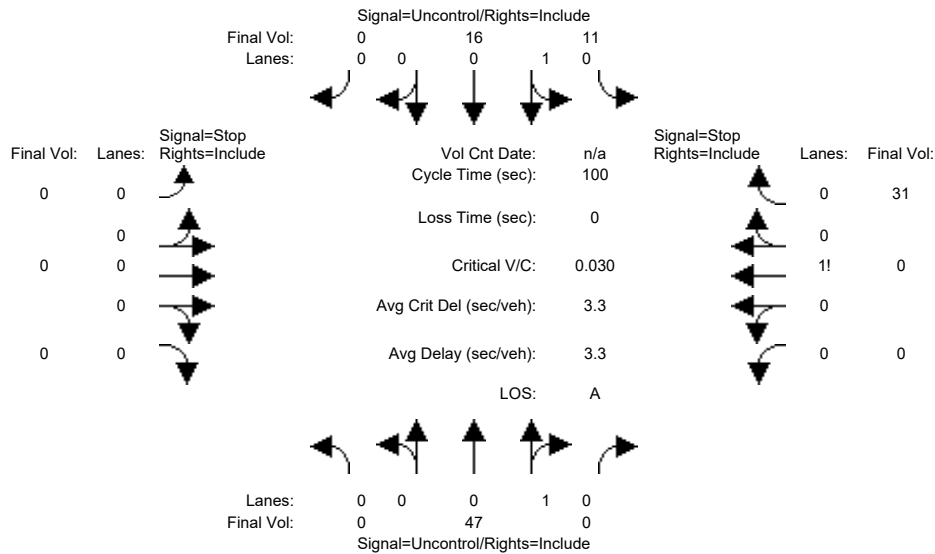

Approach:	North Bound			South Bound			East Bound			West Bound		
Movement:	L	T	R	L	T	R	L	T	R	L	T	R
Volume Module:												
Base Vol:	0	0	0	0	0	0	0	0	0	0	0	0
Growth Adj:	1.00	1.00	1.00	1.00	1.00	1.00	1.00	1.00	1.00	1.00	1.00	1.00
Initial Bse:	0	0	0	0	0	0	0	0	0	0	0	0
Added Vol:	0	47	0	11	16	0	0	0	0	0	0	31
PasserByVol:	0	0	0	0	0	0	0	0	0	0	0	0
Initial Fut:	0	47	0	11	16	0	0	0	0	0	0	31
User Adj:	1.00	1.00	1.00	1.00	1.00	1.00	1.00	1.00	1.00	1.00	1.00	1.00
PHF Adj:	1.00	1.00	1.00	1.00	1.00	1.00	1.00	1.00	1.00	1.00	1.00	1.00
PHF Volume:	0	47	0	11	16	0	0	0	0	0	0	31
Reduct Vol:	0	0	0	0	0	0	0	0	0	0	0	0
FinalVolume:	0	47	0	11	16	0	0	0	0	0	0	31
Critical Gap Module:												
Critical Gp:	xxxx	xxxx	xxxx	4.1	xxxx	xxxx	xxxx	xxxx	xxxx	xxxx	xxxx	6.2
FollowUpTim:	xxxx	xxxx	xxxx	2.2	xxxx	xxxx	xxxx	xxxx	xxxx	xxxx	xxxx	3.3
Capacity Module:												
Cnflct Vol:	xxxx	xxxx	xxxx	47	xxxx	xxxx	xxxx	xxxx	xxxx	xxxx	xxxx	47
Potent Cap.:	xxxx	xxxx	xxxx	1573	xxxx	xxxx	xxxx	xxxx	xxxx	xxxx	xxxx	1028
Move Cap.:	xxxx	xxxx	xxxx	1573	xxxx	xxxx	xxxx	xxxx	xxxx	xxxx	xxxx	1028
Volume/Cap:	xxxx	xxxx	xxxx	0.01	xxxx	xxxx	xxxx	xxxx	xxxx	xxxx	xxxx	0.03
Level Of Service Module:												
2Way95thQ:	xxxx	xxxx	xxxx	0.0	xxxx	xxxx	xxxx	xxxx	xxxx	xxxx	xxxx	0.1
Control Del:	xxxx	xxxx	xxxx	7.3	xxxx	xxxx	xxxx	xxxx	xxxx	xxxx	xxxx	8.6
LOS by Move:	*	*	*	A	*	*	*	*	*	*	*	A
Movement:	LT	LTR	RT	LT	LTR	RT	LT	LTR	RT	LT	LTR	RT
Shared Cap.:	xxxx	xxxx	xxxx	xxxx	xxxx	xxxx	xxxx	xxxx	xxxx	xxxx	xxxx	xxxx
SharedQueue:	xxxx	xxxx	xxxx	0.0	xxxx	xxxx	xxxx	xxxx	xxxx	xxxx	xxxx	xxxx
Shrd ConDel:	xxxx	xxxx	xxxx	7.3	xxxx	xxxx	xxxx	xxxx	xxxx	xxxx	xxxx	xxxx
Shared LOS:	*	*	*	A	*	*	*	*	*	*	*	*
ApproachDel:	xxxxxx			xxxxxx			xxxxxx					8.6
ApproachLOS:	*			*			*					A

Note: Queue reported is the number of cars per lane.

City of Morgan Hill
The Crosswinds Residential Development

Level Of Service Computation Report
2000 HCM Unsignalized (Future Volume Alternative)
Existing Plus Project PM

Intersection #11620: DePaul Drive and Project Driveway C

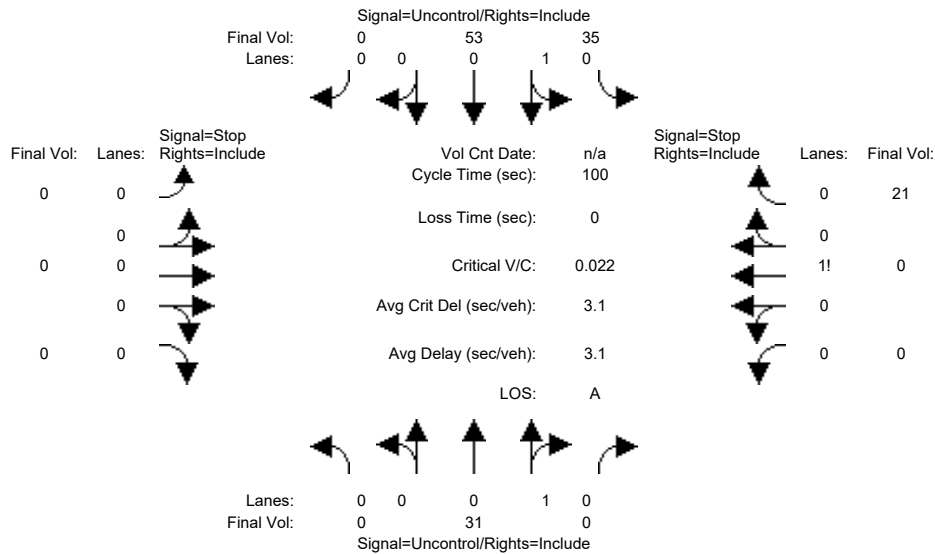

Approach: North Bound South Bound East Bound West Bound
Movement: L - T - R L - T - R L - T - R L - T - R

Volume Module:

Base Vol:	0	0	0	0	0	0	0	0	0	0	0	0
Growth Adj:	1.00	1.00	1.00	1.00	1.00	1.00	1.00	1.00	1.00	1.00	1.00	1.00
Initial Bse:	0	0	0	0	0	0	0	0	0	0	0	0
Added Vol:	0	31	0	35	53	0	0	0	0	0	0	21
PasserByVol:	0	0	0	0	0	0	0	0	0	0	0	0
Initial Fut:	0	31	0	35	53	0	0	0	0	0	0	21
User Adj:	1.00	1.00	1.00	1.00	1.00	1.00	1.00	1.00	1.00	1.00	1.00	1.00
PHF Adj:	1.00	1.00	1.00	1.00	1.00	1.00	1.00	1.00	1.00	1.00	1.00	1.00
PHF Volume:	0	31	0	35	53	0	0	0	0	0	0	21
Reduct Vol:	0	0	0	0	0	0	0	0	0	0	0	0
FinalVolume:	0	31	0	35	53	0	0	0	0	0	0	21

Critical Gap Module:

Critical Gp:	xxxx	xxxx	xxxx	4.1	xxxx	xxxx	xxxx	xxxx	xxxx	xxxx	xxxx	6.2
FollowUpTim:	xxxx	xxxx	xxxx	2.2	xxxx	xxxx	xxxx	xxxx	xxxx	xxxx	xxxx	3.3

Capacity Module:

Cnflct Vol:	xxxx	xxxx	xxxx	31	xxxx	xxxx	xxxx	xxxx	xxxx	xxxx	xxxx	31
Potent Cap.:	xxxx	xxxx	xxxx	1595	xxxx	xxxx	xxxx	xxxx	xxxx	xxxx	xxxx	1049
Move Cap.:	xxxx	xxxx	xxxx	1595	xxxx	xxxx	xxxx	xxxx	xxxx	xxxx	xxxx	1049
Volume/Cap:	xxxx	xxxx	xxxx	0.02	xxxx	xxxx	xxxx	xxxx	xxxx	xxxx	xxxx	0.02

Level Of Service Module:

2Way95thQ:	xxxx	xxxx	xxxx	0.1	xxxx	xxxx	xxxx	xxxx	xxxx	xxxx	xxxx	0.1
Control Del:	xxxx	xxxx	xxxx	7.3	xxxx	xxxx	xxxx	xxxx	xxxx	xxxx	xxxx	8.5
LOS by Move:	*	*	*	A	*	*	*	*	*	*	*	A
Movement:	LT - LTR - RT	LT - LTR - RT	LT - LTR - RT	LT - LTR - RT	LT - LTR - RT	LT - LTR - RT	LT - LTR - RT	LT - LTR - RT	LT - LTR - RT	LT - LTR - RT	LT - LTR - RT	LT - LTR - RT
Shared Cap.:	xxxx	xxxx	xxxx	xxxx	xxxx	xxxx	xxxx	xxxx	xxxx	xxxx	xxxx	xxxx
SharedQueue:	xxxx	xxxx	xxxx	0.1	xxxx	xxxx	xxxx	xxxx	xxxx	xxxx	xxxx	xxxx
Shrd ConDel:	xxxx	xxxx	xxxx	7.3	xxxx	xxxx	xxxx	xxxx	xxxx	xxxx	xxxx	xxxx
Shared LOS:	*	*	*	A	*	*	*	*	*	*	*	*
ApproachDel:	xxxxxx	xxxxxx	xxxxxx	xxxxxx	xxxxxx	xxxxxx	xxxxxx	xxxxxx	xxxxxx	xxxxxx	xxxxxx	8.5
ApproachLOS:	*	*	*	A	*	*	*	*	*	*	*	A

Note: Queue reported is the number of cars per lane.

City of Morgan Hill
The Crosswinds Residential Development

Level Of Service Computation Report
2000 HCM Unsignalized (Future Volume Alternative)
Year 2030 Cumulative with Project AM

Intersection #11620: DePaul Drive and Project Driveway C

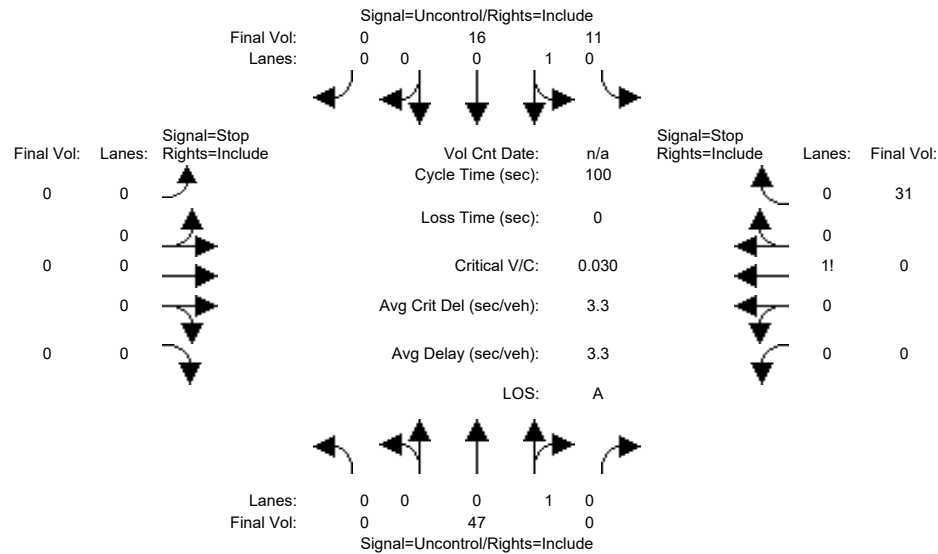

Approach: North Bound South Bound East Bound West Bound
Movement: L - T - R L - T - R L - T - R L - T - R

Volume Module:												
Base Vol:	0	0	0	0	0	0	0	0	0	0	0	0
Growth Adj:	1.00	1.00	1.00	1.00	1.00	1.00	1.00	1.00	1.00	1.00	1.00	1.00
Initial Bse:	0	0	0	0	0	0	0	0	0	0	0	0
Added Vol:	0	47	0	11	16	0	0	0	0	0	0	31
PasserByVol:	0	0	0	0	0	0	0	0	0	0	0	0
Initial Fut:	0	47	0	11	16	0	0	0	0	0	0	31
User Adj:	1.00	1.00	1.00	1.00	1.00	1.00	1.00	1.00	1.00	1.00	1.00	1.00
PHF Adj:	1.00	1.00	1.00	1.00	1.00	1.00	1.00	1.00	1.00	1.00	1.00	1.00
PHF Volume:	0	47	0	11	16	0	0	0	0	0	0	31
Reduct Vol:	0	0	0	0	0	0	0	0	0	0	0	0
FinalVolume:	0	47	0	11	16	0	0	0	0	0	0	31

Critical Gap Module:												
Critical Gp:	xxxx	xxxx	xxxx	4.1	xxxx	xxxx	xxxx	xxxx	xxxx	xxxx	xxxx	6.2
FollowUpTim:	xxxx	xxxx	xxxx	2.2	xxxx	xxxx	xxxx	xxxx	xxxx	xxxx	xxxx	3.3

Capacity Module:												
Cnflct Vol:	xxxx	xxxx	xxxx	47	xxxx	xxxx	xxxx	xxxx	xxxx	xxxx	xxxx	47
Potent Cap.:	xxxx	xxxx	xxxx	1573	xxxx	xxxx	xxxx	xxxx	xxxx	xxxx	xxxx	1028
Move Cap.:	xxxx	xxxx	xxxx	1573	xxxx	xxxx	xxxx	xxxx	xxxx	xxxx	xxxx	1028
Volume/Cap:	xxxx	xxxx	xxxx	0.01	xxxx	xxxx	xxxx	xxxx	xxxx	xxxx	xxxx	0.03

Level Of Service Module:												
2Way95thQ:	xxxx	xxxx	xxxx	0.0	xxxx	xxxx	xxxx	xxxx	xxxx	xxxx	xxxx	0.1
Control Del:	xxxx	xxxx	xxxx	7.3	xxxx	xxxx	xxxx	xxxx	xxxx	xxxx	xxxx	8.6
LOS by Move:	*	*	*	A	*	*	*	*	*	*	*	A
Movement:	LT - LTR - RT	LT - LTR - RT	LT - LTR - RT	LT - LTR - RT	LT - LTR - RT	LT - LTR - RT	LT - LTR - RT	LT - LTR - RT	LT - LTR - RT	LT - LTR - RT	LT - LTR - RT	LT - LTR - RT
Shared Cap.:	xxxx	xxxx	xxxx	xxxx	xxxx	xxxx	xxxx	xxxx	xxxx	xxxx	xxxx	xxxx
SharedQueue:	xxxx	xxxx	xxxx	0.0	xxxx	xxxx	xxxx	xxxx	xxxx	xxxx	xxxx	xxxx
Shrd ConDel:	xxxx	xxxx	xxxx	7.3	xxxx	xxxx	xxxx	xxxx	xxxx	xxxx	xxxx	xxxx
Shared LOS:	*	*	*	A	*	*	*	*	*	*	*	*
ApproachDel:	xxxxxx	xxxxxx	xxxxxx	xxxxxx	xxxxxx	xxxxxx	xxxxxx	xxxxxx	xxxxxx	xxxxxx	xxxxxx	8.6
ApproachLOS:	*	*	*	A	*	*	*	*	*	*	*	A

Note: Queue reported is the number of cars per lane.

City of Morgan Hill
The Crosswinds Residential Development

Level Of Service Computation Report
2000 HCM Unsignalized (Future Volume Alternative)
Year 2030 Cumulative with Project PM

Intersection #11620: DePaul Drive and Project Driveway C

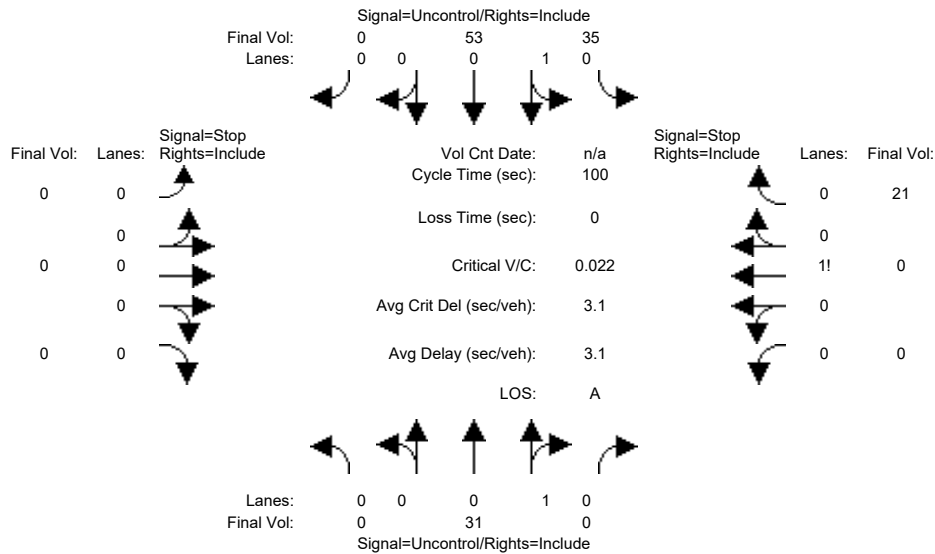

Approach: North Bound South Bound East Bound West Bound
Movement: L - T - R L - T - R L - T - R L - T - R

Volume Module:

Base Vol:	0	0	0	0	0	0	0	0	0	0	0	0
Growth Adj:	1.00	1.00	1.00	1.00	1.00	1.00	1.00	1.00	1.00	1.00	1.00	1.00
Initial Bse:	0	0	0	0	0	0	0	0	0	0	0	0
Added Vol:	0	31	0	35	53	0	0	0	0	0	0	21
PasserByVol:	0	0	0	0	0	0	0	0	0	0	0	0
Initial Fut:	0	31	0	35	53	0	0	0	0	0	0	21
User Adj:	1.00	1.00	1.00	1.00	1.00	1.00	1.00	1.00	1.00	1.00	1.00	1.00
PHF Adj:	1.00	1.00	1.00	1.00	1.00	1.00	1.00	1.00	1.00	1.00	1.00	1.00
PHF Volume:	0	31	0	35	53	0	0	0	0	0	0	21
Reduct Vol:	0	0	0	0	0	0	0	0	0	0	0	0
FinalVolume:	0	31	0	35	53	0	0	0	0	0	0	21

Critical Gap Module:

Critical Gp:	xxxx	xxxx	xxxx	4.1	xxxx	xxxx	xxxx	xxxx	xxxx	xxxx	xxxx	6.2
FollowUpTim:	xxxx	xxxx	xxxx	2.2	xxxx	xxxx	xxxx	xxxx	xxxx	xxxx	xxxx	3.3

Capacity Module:

Cnflct Vol:	xxxx	xxxx	xxxx	31	xxxx	xxxx	xxxx	xxxx	xxxx	xxxx	xxxx	31
Potent Cap.:	xxxx	xxxx	xxxx	1595	xxxx	xxxx	xxxx	xxxx	xxxx	xxxx	xxxx	1049
Move Cap.:	xxxx	xxxx	xxxx	1595	xxxx	xxxx	xxxx	xxxx	xxxx	xxxx	xxxx	1049
Volume/Cap:	xxxx	xxxx	xxxx	0.02	xxxx	xxxx	xxxx	xxxx	xxxx	xxxx	xxxx	0.02

Level Of Service Module:

2Way95thQ:	xxxx	xxxx	xxxx	0.1	xxxx	xxxx	xxxx	xxxx	xxxx	xxxx	xxxx	0.1
Control Del:	xxxx	xxxx	xxxx	7.3	xxxx	xxxx	xxxx	xxxx	xxxx	xxxx	xxxx	8.5
LOS by Move:	*	*	*	A	*	*	*	*	*	*	*	A
Movement:	LT - LTR - RT	LT - LTR - RT	LT - LTR - RT	LT - LTR - RT	LT - LTR - RT	LT - LTR - RT	LT - LTR - RT	LT - LTR - RT	LT - LTR - RT	LT - LTR - RT	LT - LTR - RT	LT - LTR - RT
Shared Cap.:	xxxx	xxxx	xxxx	xxxx	xxxx	xxxx	xxxx	xxxx	xxxx	xxxx	xxxx	xxxx
SharedQueue:	xxxx	xxxx	xxxx	0.1	xxxx	xxxx	xxxx	xxxx	xxxx	xxxx	xxxx	xxxx
Shrd ConDel:	xxxx	xxxx	xxxx	7.3	xxxx	xxxx	xxxx	xxxx	xxxx	xxxx	xxxx	xxxx
Shared LOS:	*	*	*	A	*	*	*	*	*	*	*	*
ApproachDel:	xxxxxx	xxxxxx	xxxxxx	xxxxxx	xxxxxx	xxxxxx	xxxxxx	xxxxxx	xxxxxx	xxxxxx	xxxxxx	8.5
ApproachLOS:	*	*	*	A	*	*	*	*	*	*	*	A

Note: Queue reported is the number of cars per lane.

The Crosswinds Residential Development

14 . Mission View Drive and Project Driveway A

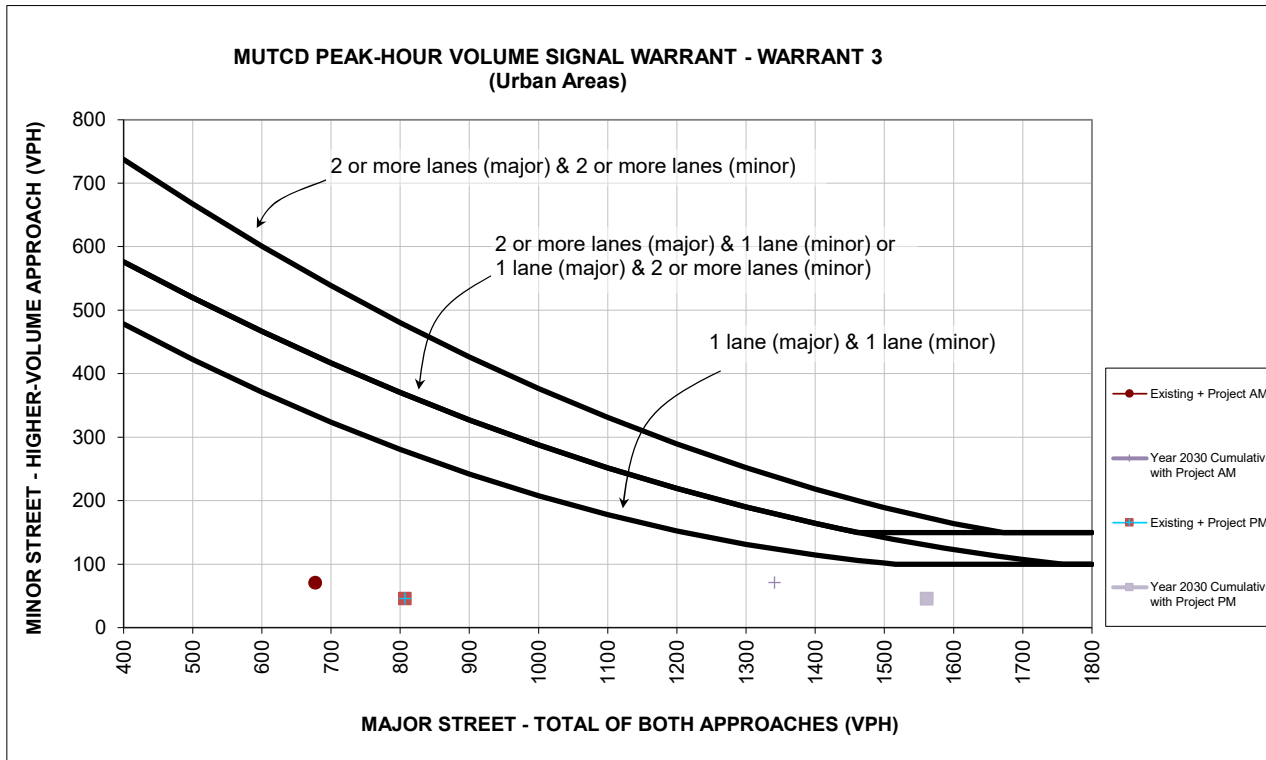

Source: Figure 4C-3 of the Manual on Uniform Traffic Control and Devices (MUTCD) from California Department of Transportation (Caltrans).

* 150 vph applies as the lower threshold volume for a minor-street approach with two or more lanes and 100 vph applies as the lower threshold volume for a minor-street approach with one lane.

		Approach Lanes		Existing + Project AM	Year 2030 Cumulative with Project AM
		One	More		
Major Street - Both Approaches	Project Driveway A	X		677	1341
Minor Street - Highest Approach	Mission View Drive	X		71	71
Maximum warrant threshold for minor street volume				334	124
Difference between warrant threshold & minor street volume				263	53
Warrant Met?				No	No

		Approach Lanes		Existing + Project PM	Year 2030 Cumulative with Project PM
		One	More		
Major Street - Both Approaches	Project Driveway A	X		807	1561
Minor Street - Highest Approach	Mission View Drive	X		46	46
Maximum warrant threshold for minor street volume				278	100
Difference between warrant threshold & minor street volume				232	54
Warrant Met?				No	No

The Crosswinds Residential Development

15 . DePaul Drive and Project Driveway B

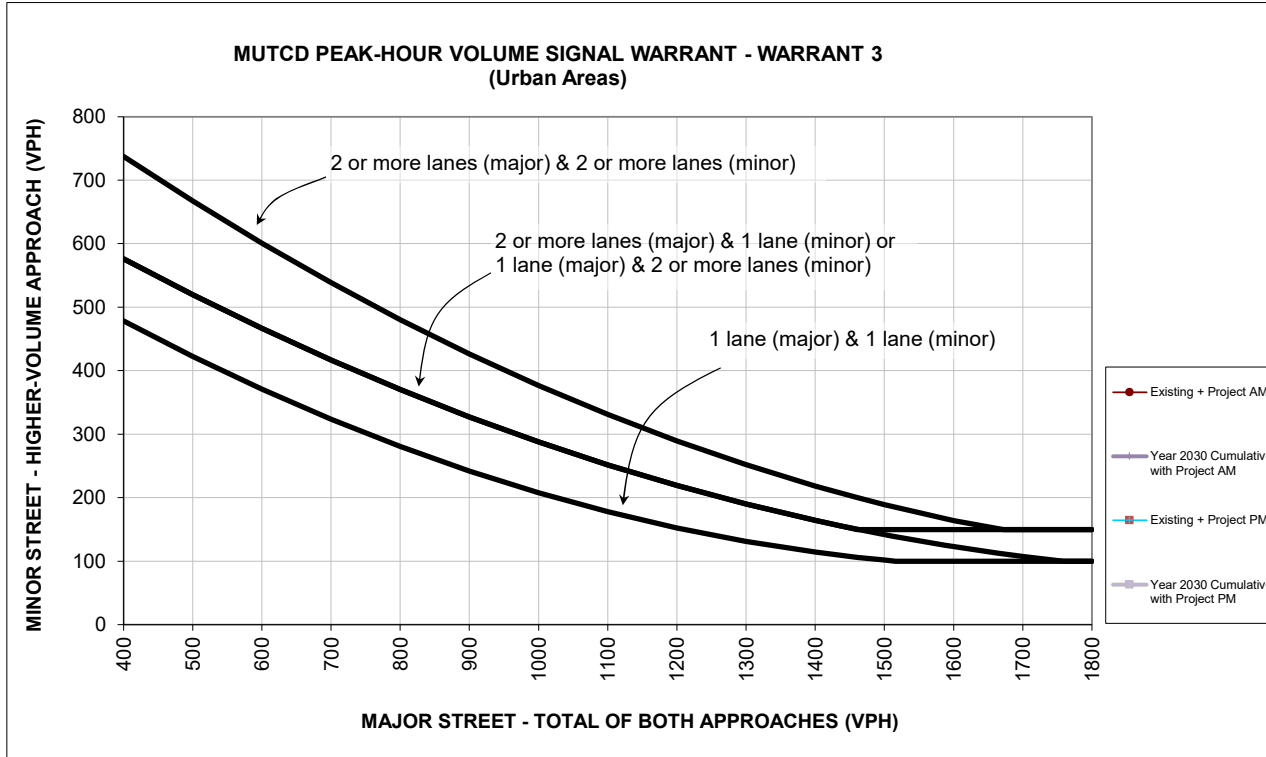

Source: Figure 4C-3 of the Manual on Uniform Traffic Control and Devices (MUTCD) from California Department of Transportation (Caltrans).

* 150 vph applies as the lower threshold volume for a minor-street approach with two or more lanes and 100 vph applies as the lower threshold volume for a minor-street approach with one lane.

		Approach Lanes		Existing + Project AM	Year 2030 Cumulative with Project AM
		One	More		
Major Street - Both Approaches	DePaul Drive	X		47	47
Minor Street - Highest Approach	Project Driveway B	X		16	16
Maximum warrant threshold for minor street volume				711	711
Difference between warrant threshold & minor street volume				695	695
Warrant Met?				No	No

		Approach Lanes		Existing + Project PM	Year 2030 Cumulative with Project PM
		One	More		
Major Street - Both Approaches	DePaul Drive	X		53	53
Minor Street - Highest Approach	Project Driveway B	X		31	31
Maximum warrant threshold for minor street volume				706	706
Difference between warrant threshold & minor street volume				675	675
Warrant Met?				No	No

The Crosswinds Residential Development

16 . DePaul Drive and Project Driveway C

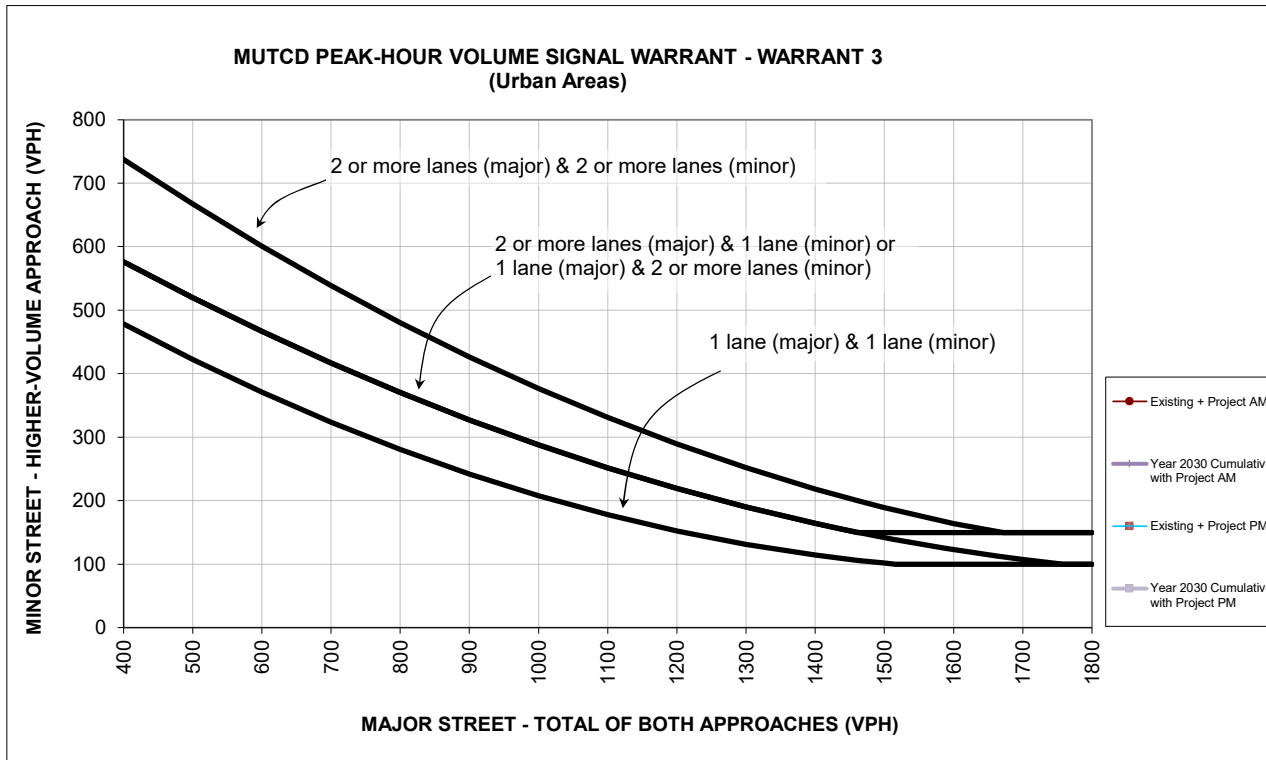

Source: Figure 4C-3 of the Manual on Uniform Traffic Control and Devices (MUTCD) from California Department of Transportation (Caltrans).

* 150 vph applies as the lower threshold volume for a minor-street approach with two or more lanes and 100 vph applies as the lower threshold volume for a minor-street approach with one lane.

		Approach Lanes		Existing + Project AM	Year 2030 Cumulative with Project AM
		One	More		
Major Street - Both Approaches	DePaul Drive	X		74	74
Minor Street - Highest Approach	Project Driveway C	X		31	31
Maximum warrant threshold for minor street volume				691	691
Difference between warrant threshold & minor street volume				660	660
Warrant Met?				No	No

		Approach Lanes		Existing + Project PM	Year 2030 Cumulative with Project PM
		One	More		
Major Street - Both Approaches	DePaul Drive	X		119	119
Minor Street - Highest Approach	Project Driveway C	X		21	21
Maximum warrant threshold for minor street volume				659	659
Difference between warrant threshold & minor street volume				638	638
Warrant Met?				No	No

Vehicle Queuing Analysis Summary

Measurement	Mission View Drive and Project Driveway A				DePaul Drive and Project Driveway B				DePaul Drive and Project Driveway C			
	Northbound Left		Eastbound		Southbound Left		Westbound		Southbound Left		Westbound	
	AM	PM	AM	PM	AM	PM	AM	PM	AM	PM	AM	PM
Existing plus Project Conditions												
Cycle Length/Control Delay (sec) ¹	7.6	8.7	11.6	14.2	7.2	7.3	8.4	8.4	7.3	7.3	8.6	8.5
Lanes	1	1	2	2	1	1	1	1	1	1	1	1
Volume (vph)	15	50	71	46	16	53	47	31	11	35	31	21
Volume (vphpl)	15	50	36	23	16	53	47	31	11	35	31	21
Avg. Queue (veh./ln.)	0.0	0.1	0.1	0.1	0.0	0.1	0.1	0.1	0.0	0.1	0.1	0.0
Avg. Queue ¹ (ft./ln)	0	3	3	3	0	3	3	3	0	3	3	0
95 th % Queue (veh./ln.)	0	1	1	1	0	1	1	1	0	1	1	0
95 th % Queue (ft./ln) ²	0	25	25	25	0	25	25	25	0	25	25	0
Year 2030 Cumulative with Project Conditions												
Control Delay (sec)	8.1	10.7	19.7	31.1	7.2	7.3	8.4	8.4	7.3	7.3	8.6	8.5
Lanes	1	1	2	2	1	1	1	1	1	1	1	1
Volume (vph)	15	50	71	46	16	53	47	31	11	35	31	21
Volume (vphpl)	15	50	36	23	16	53	47	31	11	35	31	21
95 th % Queue (veh./ln.)	0	1	1	1	0	1	1	1	0	1	1	0
95 th % Queue (ft./ln) ¹	0	25	25	25	0	25	25	25	0	25	25	0
Notes:												
¹ Assumes 25 feet per vehicle queued												

Mission View/Project Driveway A
 NBL
 AM
 Existing plus Project Conditions
 Avg. Queue Per Lane in Veh= 0.0
 Percentile = 95% 0

Mission View/Project Driveway A
 NBL
 AM
 Year 2030 Cumulative with Project Conditions
 Avg. Queue Per Lane in Veh= 0.0
 Percentile = 95% 0

Individual Probability	Cumulative Probability	Number of Queued Vehicles
#NUM!	#NUM!	0
0.0000	#NUM!	1
0.0000	#NUM!	2
0.0000	#NUM!	3
0.0000	#NUM!	4
0.0000	#NUM!	5
0.0000	#NUM!	6
0.0000	#NUM!	7
0.0000	#NUM!	8
0.0000	#NUM!	9
0.0000	#NUM!	10
0.0000	#NUM!	11
0.0000	#NUM!	12
0.0000	#NUM!	13
0.0000	#NUM!	14
0.0000	#NUM!	15
0.0000	#NUM!	16
0.0000	#NUM!	17
0.0000	#NUM!	18
0.0000	#NUM!	19
0.0000	#NUM!	20
0.0000	#NUM!	21
0.0000	#NUM!	22
0.0000	#NUM!	23
0.0000	#NUM!	24
0.0000	#NUM!	25
0.0000	#NUM!	26
0.0000	#NUM!	27
0.0000	#NUM!	28
0.0000	#NUM!	29
0.0000	#NUM!	30
0.0000	#NUM!	31
0.0000	#NUM!	32
0.0000	#NUM!	33
0.0000	#NUM!	34
0.0000	#NUM!	35
0.0000	#NUM!	36
0.0000	#NUM!	37
0.0000	#NUM!	38
0.0000	#NUM!	39
0.0000	#NUM!	40
0.0000	#NUM!	41
0.0000	#NUM!	42
0.0000	#NUM!	43
0.0000	#NUM!	44
0.0000	#NUM!	45
0.0000	#NUM!	46
0.0000	#NUM!	47
0.0000	#NUM!	48
0.0000	#NUM!	49
0.0000	#NUM!	50
0.0000	#NUM!	51
0.0000	#NUM!	52
0.0000	#NUM!	53
0.0000	#NUM!	54
0.0000	#NUM!	55
0.0000	#NUM!	56
0.0000	#NUM!	57
0.0000	#NUM!	58
0.0000	#NUM!	59
0.0000	#NUM!	60
0.0000	#NUM!	61
0.0000	#NUM!	62
0.0000	#NUM!	63
0.0000	#NUM!	64
0.0000	#NUM!	65

Individual Probability	Cumulative Probability	Number of Queued Vehicles
#NUM!	#NUM!	0
0.0000	#NUM!	1
0.0000	#NUM!	2
0.0000	#NUM!	3
0.0000	#NUM!	4
0.0000	#NUM!	5
0.0000	#NUM!	6
0.0000	#NUM!	7
0.0000	#NUM!	8
0.0000	#NUM!	9
0.0000	#NUM!	10
0.0000	#NUM!	11
0.0000	#NUM!	12
0.0000	#NUM!	13
0.0000	#NUM!	14
0.0000	#NUM!	15
0.0000	#NUM!	16
0.0000	#NUM!	17
0.0000	#NUM!	18
0.0000	#NUM!	19
0.0000	#NUM!	20
0.0000	#NUM!	21
0.0000	#NUM!	22
0.0000	#NUM!	23
0.0000	#NUM!	24
0.0000	#NUM!	25
0.0000	#NUM!	26
0.0000	#NUM!	27
0.0000	#NUM!	28
0.0000	#NUM!	29
0.0000	#NUM!	30
0.0000	#NUM!	31
0.0000	#NUM!	32
0.0000	#NUM!	33
0.0000	#NUM!	34
0.0000	#NUM!	35
0.0000	#NUM!	36
0.0000	#NUM!	37
0.0000	#NUM!	38
0.0000	#NUM!	39
0.0000	#NUM!	40
0.0000	#NUM!	41
0.0000	#NUM!	42
0.0000	#NUM!	43
0.0000	#NUM!	44
0.0000	#NUM!	45
0.0000	#NUM!	46
0.0000	#NUM!	47
0.0000	#NUM!	48
0.0000	#NUM!	49
0.0000	#NUM!	50
0.0000	#NUM!	51
0.0000	#NUM!	52
0.0000	#NUM!	53
0.0000	#NUM!	54
0.0000	#NUM!	55
0.0000	#NUM!	56
0.0000	#NUM!	57
0.0000	#NUM!	58
0.0000	#NUM!	59
0.0000	#NUM!	60
0.0000	#NUM!	61
0.0000	#NUM!	62
0.0000	#NUM!	63
0.0000	#NUM!	64
0.0000	#NUM!	65

Mission View/Project Driveway A
 NBL
 PM
 Existing plus Project Conditions
 Avg. Queue Per Lane in Veh= 0.1
 Percentile = 95% 1

Mission View/Project Driveway A
 NBL
 PM
 Year 2030 Cumulative with Project Conditions
 Avg. Queue Per Lane in Veh= 0.1
 Percentile = 95% 1

Individual Probability	Cumulative Probability	Number of Queued Vehicles
0.9048	0.9048	0
0.0905	0.9953	1
0.0045	0.9998	2
0.0002	1.0000	3
0.0000	1.0000	4
0.0000	1.0000	5
0.0000	1.0000	6
0.0000	1.0000	7
0.0000	1.0000	8
0.0000	1.0000	9
0.0000	1.0000	10
0.0000	1.0000	11
0.0000	1.0000	12
0.0000	1.0000	13
0.0000	1.0000	14
0.0000	1.0000	15
0.0000	1.0000	16
0.0000	1.0000	17
0.0000	1.0000	18
0.0000	1.0000	19
0.0000	1.0000	20
0.0000	1.0000	21
0.0000	1.0000	22
0.0000	1.0000	23
0.0000	1.0000	24
0.0000	1.0000	25
0.0000	1.0000	26
0.0000	1.0000	27
0.0000	1.0000	28
0.0000	1.0000	29
0.0000	1.0000	30
0.0000	1.0000	31
0.0000	1.0000	32
0.0000	1.0000	33
0.0000	1.0000	34
0.0000	1.0000	35
0.0000	1.0000	36
0.0000	1.0000	37
0.0000	1.0000	38
0.0000	1.0000	39
0.0000	1.0000	40
0.0000	1.0000	41
0.0000	1.0000	42
0.0000	1.0000	43
0.0000	1.0000	44
0.0000	1.0000	45
0.0000	1.0000	46
0.0000	1.0000	47
0.0000	1.0000	48
0.0000	1.0000	49
0.0000	1.0000	50
0.0000	1.0000	51
0.0000	1.0000	52
0.0000	1.0000	53
0.0000	1.0000	54
0.0000	1.0000	55
0.0000	1.0000	56
0.0000	1.0000	57
0.0000	1.0000	58
0.0000	1.0000	59
0.0000	1.0000	60
0.0000	1.0000	61
0.0000	1.0000	62
0.0000	1.0000	63
0.0000	1.0000	64
0.0000	1.0000	65

Individual Probability	Cumulative Probability	Number of Queued Vehicles
0.9048	0.9048	0
0.0905	0.9953	1
0.0045	0.9998	2
0.0002	1.0000	3
0.0000	1.0000	4
0.0000	1.0000	5
0.0000	1.0000	6
0.0000	1.0000	7
0.0000	1.0000	8
0.0000	1.0000	9
0.0000	1.0000	10
0.0000	1.0000	11
0.0000	1.0000	12
0.0000	1.0000	13
0.0000	1.0000	14
0.0000	1.0000	15
0.0000	1.0000	16
0.0000	1.0000	17
0.0000	1.0000	18
0.0000	1.0000	19
0.0000	1.0000	20
0.0000	1.0000	21
0.0000	1.0000	22
0.0000	1.0000	23
0.0000	1.0000	24
0.0000	1.0000	25
0.0000	1.0000	26
0.0000	1.0000	27
0.0000	1.0000	28
0.0000	1.0000	29
0.0000	1.0000	30
0.0000	1.0000	31
0.0000	1.0000	32
0.0000	1.0000	33
0.0000	1.0000	34
0.0000	1.0000	35
0.0000	1.0000	36
0.0000	1.0000	37
0.0000	1.0000	38
0.0000	1.0000	39
0.0000	1.0000	40
0.0000	1.0000	41
0.0000	1.0000	42
0.0000	1.0000	43
0.0000	1.0000	44
0.0000	1.0000	45
0.0000	1.0000	46
0.0000	1.0000	47
0.0000	1.0000	48
0.0000	1.0000	49
0.0000	1.0000	50
0.0000	1.0000	51
0.0000	1.0000	52
0.0000	1.0000	53
0.0000	1.0000	54
0.0000	1.0000	55
0.0000	1.0000	56
0.0000	1.0000	57
0.0000	1.0000	58
0.0000	1.0000	59
0.0000	1.0000	60
0.0000	1.0000	61
0.0000	1.0000	62
0.0000	1.0000	63
0.0000	1.0000	64
0.0000	1.0000	65

Mission View/Project Driveway A
 EB
 AM
 Existing plus Project Conditions
 Avg. Queue Per Lane in Veh= 0.1
 Percentile = 95% 1

Mission View/Project Driveway A
 EB
 AM
 Year 2030 Cumulative with Project Conditions
 Avg. Queue Per Lane in Veh= 0.2
 Percentile = 95% 1

Individual Probability	Cumulative Probability	Number of Queued Vehicles
0.9048	0.9048	0
0.0905	0.9953	1
0.0045	0.9998	2
0.0002	1.0000	3
0.0000	1.0000	4
0.0000	1.0000	5
0.0000	1.0000	6
0.0000	1.0000	7
0.0000	1.0000	8
0.0000	1.0000	9
0.0000	1.0000	10
0.0000	1.0000	11
0.0000	1.0000	12
0.0000	1.0000	13
0.0000	1.0000	14
0.0000	1.0000	15
0.0000	1.0000	16
0.0000	1.0000	17
0.0000	1.0000	18
0.0000	1.0000	19
0.0000	1.0000	20
0.0000	1.0000	21
0.0000	1.0000	22
0.0000	1.0000	23
0.0000	1.0000	24
0.0000	1.0000	25
0.0000	1.0000	26
0.0000	1.0000	27
0.0000	1.0000	28
0.0000	1.0000	29
0.0000	1.0000	30
0.0000	1.0000	31
0.0000	1.0000	32
0.0000	1.0000	33
0.0000	1.0000	34
0.0000	1.0000	35
0.0000	1.0000	36
0.0000	1.0000	37
0.0000	1.0000	38
0.0000	1.0000	39
0.0000	1.0000	40
0.0000	1.0000	41
0.0000	1.0000	42
0.0000	1.0000	43
0.0000	1.0000	44
0.0000	1.0000	45
0.0000	1.0000	46
0.0000	1.0000	47
0.0000	1.0000	48
0.0000	1.0000	49
0.0000	1.0000	50
0.0000	1.0000	51
0.0000	1.0000	52
0.0000	1.0000	53
0.0000	1.0000	54
0.0000	1.0000	55
0.0000	1.0000	56
0.0000	1.0000	57
0.0000	1.0000	58
0.0000	1.0000	59
0.0000	1.0000	60
0.0000	1.0000	61
0.0000	1.0000	62
0.0000	1.0000	63
0.0000	1.0000	64
0.0000	1.0000	65

Individual Probability	Cumulative Probability	Number of Queued Vehicles
0.8187	0.8187	0
0.1637	0.9825	1
0.0164	0.9989	2
0.0011	0.9999	3
0.0001	1.0000	4
0.0000	1.0000	5
0.0000	1.0000	6
0.0000	1.0000	7
0.0000	1.0000	8
0.0000	1.0000	9
0.0000	1.0000	10
0.0000	1.0000	11
0.0000	1.0000	12
0.0000	1.0000	13
0.0000	1.0000	14
0.0000	1.0000	15
0.0000	1.0000	16
0.0000	1.0000	17
0.0000	1.0000	18
0.0000	1.0000	19
0.0000	1.0000	20
0.0000	1.0000	21
0.0000	1.0000	22
0.0000	1.0000	23
0.0000	1.0000	24
0.0000	1.0000	25
0.0000	1.0000	26
0.0000	1.0000	27
0.0000	1.0000	28
0.0000	1.0000	29
0.0000	1.0000	30
0.0000	1.0000	31
0.0000	1.0000	32
0.0000	1.0000	33
0.0000	1.0000	34
0.0000	1.0000	35
0.0000	1.0000	36
0.0000	1.0000	37
0.0000	1.0000	38
0.0000	1.0000	39
0.0000	1.0000	40
0.0000	1.0000	41
0.0000	1.0000	42
0.0000	1.0000	43
0.0000	1.0000	44
0.0000	1.0000	45
0.0000	1.0000	46
0.0000	1.0000	47
0.0000	1.0000	48
0.0000	1.0000	49
0.0000	1.0000	50
0.0000	1.0000	51
0.0000	1.0000	52
0.0000	1.0000	53
0.0000	1.0000	54
0.0000	1.0000	55
0.0000	1.0000	56
0.0000	1.0000	57
0.0000	1.0000	58
0.0000	1.0000	59
0.0000	1.0000	60
0.0000	1.0000	61
0.0000	1.0000	62
0.0000	1.0000	63
0.0000	1.0000	64
0.0000	1.0000	65

Mission View/Project Driveway A
 EB
 PM
 Existing plus Project Conditions
 Avg. Queue Per Lane in Veh= 0.1
 Percentile = 95% 1

Mission View/Project Driveway A
 EB
 PM
 Year 2030 Cumulative with Project Conditions
 Avg. Queue Per Lane in Veh= 0.2
 Percentile = 95% 1

Individual Probability	Cumulative Probability	Number of Queued Vehicles
0.9048	0.9048	0
0.0905	0.9953	1
0.0045	0.9998	2
0.0002	1.0000	3
0.0000	1.0000	4
0.0000	1.0000	5
0.0000	1.0000	6
0.0000	1.0000	7
0.0000	1.0000	8
0.0000	1.0000	9
0.0000	1.0000	10
0.0000	1.0000	11
0.0000	1.0000	12
0.0000	1.0000	13
0.0000	1.0000	14
0.0000	1.0000	15
0.0000	1.0000	16
0.0000	1.0000	17
0.0000	1.0000	18
0.0000	1.0000	19
0.0000	1.0000	20
0.0000	1.0000	21
0.0000	1.0000	22
0.0000	1.0000	23
0.0000	1.0000	24
0.0000	1.0000	25
0.0000	1.0000	26
0.0000	1.0000	27
0.0000	1.0000	28
0.0000	1.0000	29
0.0000	1.0000	30
0.0000	1.0000	31
0.0000	1.0000	32
0.0000	1.0000	33
0.0000	1.0000	34
0.0000	1.0000	35
0.0000	1.0000	36
0.0000	1.0000	37
0.0000	1.0000	38
0.0000	1.0000	39
0.0000	1.0000	40
0.0000	1.0000	41
0.0000	1.0000	42
0.0000	1.0000	43
0.0000	1.0000	44
0.0000	1.0000	45
0.0000	1.0000	46
0.0000	1.0000	47
0.0000	1.0000	48
0.0000	1.0000	49
0.0000	1.0000	50
0.0000	1.0000	51
0.0000	1.0000	52
0.0000	1.0000	53
0.0000	1.0000	54
0.0000	1.0000	55
0.0000	1.0000	56
0.0000	1.0000	57
0.0000	1.0000	58
0.0000	1.0000	59
0.0000	1.0000	60
0.0000	1.0000	61
0.0000	1.0000	62
0.0000	1.0000	63
0.0000	1.0000	64
0.0000	1.0000	65

Individual Probability	Cumulative Probability	Number of Queued Vehicles
0.8187	0.8187	0
0.1637	0.9825	1
0.0164	0.9989	2
0.0011	0.9999	3
0.0001	1.0000	4
0.0000	1.0000	5
0.0000	1.0000	6
0.0000	1.0000	7
0.0000	1.0000	8
0.0000	1.0000	9
0.0000	1.0000	10
0.0000	1.0000	11
0.0000	1.0000	12
0.0000	1.0000	13
0.0000	1.0000	14
0.0000	1.0000	15
0.0000	1.0000	16
0.0000	1.0000	17
0.0000	1.0000	18
0.0000	1.0000	19
0.0000	1.0000	20
0.0000	1.0000	21
0.0000	1.0000	22
0.0000	1.0000	23
0.0000	1.0000	24
0.0000	1.0000	25
0.0000	1.0000	26
0.0000	1.0000	27
0.0000	1.0000	28
0.0000	1.0000	29
0.0000	1.0000	30
0.0000	1.0000	31
0.0000	1.0000	32
0.0000	1.0000	33
0.0000	1.0000	34
0.0000	1.0000	35
0.0000	1.0000	36
0.0000	1.0000	37
0.0000	1.0000	38
0.0000	1.0000	39
0.0000	1.0000	40
0.0000	1.0000	41
0.0000	1.0000	42
0.0000	1.0000	43
0.0000	1.0000	44
0.0000	1.0000	45
0.0000	1.0000	46
0.0000	1.0000	47
0.0000	1.0000	48
0.0000	1.0000	49
0.0000	1.0000	50
0.0000	1.0000	51
0.0000	1.0000	52
0.0000	1.0000	53
0.0000	1.0000	54
0.0000	1.0000	55
0.0000	1.0000	56
0.0000	1.0000	57
0.0000	1.0000	58
0.0000	1.0000	59
0.0000	1.0000	60
0.0000	1.0000	61
0.0000	1.0000	62
0.0000	1.0000	63
0.0000	1.0000	64
0.0000	1.0000	65

DePaul/Project Driveway B
 SBL
 AM
 Existing plus Project Conditions
 Avg. Queue Per Lane in Veh= 0.0
 Percentile = 95% 0

DePaul/Project Driveway B
 SBL
 AM
 Year 2030 Cumulative with Project Conditions
 Avg. Queue Per Lane in Veh= 0.0
 Percentile = 95% 0

Individual Probability	Cumulative Probability	Number of Queued Vehicles
#NUM!	#NUM!	0
0.0000	#NUM!	1
0.0000	#NUM!	2
0.0000	#NUM!	3
0.0000	#NUM!	4
0.0000	#NUM!	5
0.0000	#NUM!	6
0.0000	#NUM!	7
0.0000	#NUM!	8
0.0000	#NUM!	9
0.0000	#NUM!	10
0.0000	#NUM!	11
0.0000	#NUM!	12
0.0000	#NUM!	13
0.0000	#NUM!	14
0.0000	#NUM!	15
0.0000	#NUM!	16
0.0000	#NUM!	17
0.0000	#NUM!	18
0.0000	#NUM!	19
0.0000	#NUM!	20
0.0000	#NUM!	21
0.0000	#NUM!	22
0.0000	#NUM!	23
0.0000	#NUM!	24
0.0000	#NUM!	25
0.0000	#NUM!	26
0.0000	#NUM!	27
0.0000	#NUM!	28
0.0000	#NUM!	29
0.0000	#NUM!	30
0.0000	#NUM!	31
0.0000	#NUM!	32
0.0000	#NUM!	33
0.0000	#NUM!	34
0.0000	#NUM!	35
0.0000	#NUM!	36
0.0000	#NUM!	37
0.0000	#NUM!	38
0.0000	#NUM!	39
0.0000	#NUM!	40
0.0000	#NUM!	41
0.0000	#NUM!	42
0.0000	#NUM!	43
0.0000	#NUM!	44
0.0000	#NUM!	45
0.0000	#NUM!	46
0.0000	#NUM!	47
0.0000	#NUM!	48
0.0000	#NUM!	49
0.0000	#NUM!	50
0.0000	#NUM!	51
0.0000	#NUM!	52
0.0000	#NUM!	53
0.0000	#NUM!	54
0.0000	#NUM!	55
0.0000	#NUM!	56
0.0000	#NUM!	57
0.0000	#NUM!	58
0.0000	#NUM!	59
0.0000	#NUM!	60
0.0000	#NUM!	61
0.0000	#NUM!	62
0.0000	#NUM!	63
0.0000	#NUM!	64
0.0000	#NUM!	65

Individual Probability	Cumulative Probability	Number of Queued Vehicles
#NUM!	#NUM!	0
0.0000	#NUM!	1
0.0000	#NUM!	2
0.0000	#NUM!	3
0.0000	#NUM!	4
0.0000	#NUM!	5
0.0000	#NUM!	6
0.0000	#NUM!	7
0.0000	#NUM!	8
0.0000	#NUM!	9
0.0000	#NUM!	10
0.0000	#NUM!	11
0.0000	#NUM!	12
0.0000	#NUM!	13
0.0000	#NUM!	14
0.0000	#NUM!	15
0.0000	#NUM!	16
0.0000	#NUM!	17
0.0000	#NUM!	18
0.0000	#NUM!	19
0.0000	#NUM!	20
0.0000	#NUM!	21
0.0000	#NUM!	22
0.0000	#NUM!	23
0.0000	#NUM!	24
0.0000	#NUM!	25
0.0000	#NUM!	26
0.0000	#NUM!	27
0.0000	#NUM!	28
0.0000	#NUM!	29
0.0000	#NUM!	30
0.0000	#NUM!	31
0.0000	#NUM!	32
0.0000	#NUM!	33
0.0000	#NUM!	34
0.0000	#NUM!	35
0.0000	#NUM!	36
0.0000	#NUM!	37
0.0000	#NUM!	38
0.0000	#NUM!	39
0.0000	#NUM!	40
0.0000	#NUM!	41
0.0000	#NUM!	42
0.0000	#NUM!	43
0.0000	#NUM!	44
0.0000	#NUM!	45
0.0000	#NUM!	46
0.0000	#NUM!	47
0.0000	#NUM!	48
0.0000	#NUM!	49
0.0000	#NUM!	50
0.0000	#NUM!	51
0.0000	#NUM!	52
0.0000	#NUM!	53
0.0000	#NUM!	54
0.0000	#NUM!	55
0.0000	#NUM!	56
0.0000	#NUM!	57
0.0000	#NUM!	58
0.0000	#NUM!	59
0.0000	#NUM!	60
0.0000	#NUM!	61
0.0000	#NUM!	62
0.0000	#NUM!	63
0.0000	#NUM!	64
0.0000	#NUM!	65

DePaul/Project Driveway B
 SBL
 PM
 Existing plus Project Conditions
 Avg. Queue Per Lane in Veh= 0.1
 Percentile = 95% 1

DePaul/Project Driveway B
 SBL
 PM
 Year 2030 Cumulative with Project Conditions
 Avg. Queue Per Lane in Veh= 0.1
 Percentile = 95% 1

Individual Probability	Cumulative Probability	Number of Queued Vehicles
0.9048	0.9048	0
0.0905	0.9953	1
0.0045	0.9998	2
0.0002	1.0000	3
0.0000	1.0000	4
0.0000	1.0000	5
0.0000	1.0000	6
0.0000	1.0000	7
0.0000	1.0000	8
0.0000	1.0000	9
0.0000	1.0000	10
0.0000	1.0000	11
0.0000	1.0000	12
0.0000	1.0000	13
0.0000	1.0000	14
0.0000	1.0000	15
0.0000	1.0000	16
0.0000	1.0000	17
0.0000	1.0000	18
0.0000	1.0000	19
0.0000	1.0000	20
0.0000	1.0000	21
0.0000	1.0000	22
0.0000	1.0000	23
0.0000	1.0000	24
0.0000	1.0000	25
0.0000	1.0000	26
0.0000	1.0000	27
0.0000	1.0000	28
0.0000	1.0000	29
0.0000	1.0000	30
0.0000	1.0000	31
0.0000	1.0000	32
0.0000	1.0000	33
0.0000	1.0000	34
0.0000	1.0000	35
0.0000	1.0000	36
0.0000	1.0000	37
0.0000	1.0000	38
0.0000	1.0000	39
0.0000	1.0000	40
0.0000	1.0000	41
0.0000	1.0000	42
0.0000	1.0000	43
0.0000	1.0000	44
0.0000	1.0000	45
0.0000	1.0000	46
0.0000	1.0000	47
0.0000	1.0000	48
0.0000	1.0000	49
0.0000	1.0000	50
0.0000	1.0000	51
0.0000	1.0000	52
0.0000	1.0000	53
0.0000	1.0000	54
0.0000	1.0000	55
0.0000	1.0000	56
0.0000	1.0000	57
0.0000	1.0000	58
0.0000	1.0000	59
0.0000	1.0000	60
0.0000	1.0000	61
0.0000	1.0000	62
0.0000	1.0000	63
0.0000	1.0000	64
0.0000	1.0000	65

Individual Probability	Cumulative Probability	Number of Queued Vehicles
0.9048	0.9048	0
0.0905	0.9953	1
0.0045	0.9998	2
0.0002	1.0000	3
0.0000	1.0000	4
0.0000	1.0000	5
0.0000	1.0000	6
0.0000	1.0000	7
0.0000	1.0000	8
0.0000	1.0000	9
0.0000	1.0000	10
0.0000	1.0000	11
0.0000	1.0000	12
0.0000	1.0000	13
0.0000	1.0000	14
0.0000	1.0000	15
0.0000	1.0000	16
0.0000	1.0000	17
0.0000	1.0000	18
0.0000	1.0000	19
0.0000	1.0000	20
0.0000	1.0000	21
0.0000	1.0000	22
0.0000	1.0000	23
0.0000	1.0000	24
0.0000	1.0000	25
0.0000	1.0000	26
0.0000	1.0000	27
0.0000	1.0000	28
0.0000	1.0000	29
0.0000	1.0000	30
0.0000	1.0000	31
0.0000	1.0000	32
0.0000	1.0000	33
0.0000	1.0000	34
0.0000	1.0000	35
0.0000	1.0000	36
0.0000	1.0000	37
0.0000	1.0000	38
0.0000	1.0000	39
0.0000	1.0000	40
0.0000	1.0000	41
0.0000	1.0000	42
0.0000	1.0000	43
0.0000	1.0000	44
0.0000	1.0000	45
0.0000	1.0000	46
0.0000	1.0000	47
0.0000	1.0000	48
0.0000	1.0000	49
0.0000	1.0000	50
0.0000	1.0000	51
0.0000	1.0000	52
0.0000	1.0000	53
0.0000	1.0000	54
0.0000	1.0000	55
0.0000	1.0000	56
0.0000	1.0000	57
0.0000	1.0000	58
0.0000	1.0000	59
0.0000	1.0000	60
0.0000	1.0000	61
0.0000	1.0000	62
0.0000	1.0000	63
0.0000	1.0000	64
0.0000	1.0000	65

DePaul/Project Driveway B
 WB
 AM
 Existing plus Project Conditions
 Avg. Queue Per Lane in Veh= 0.1
 Percentile = 95% 1

DePaul/Project Driveway B
 WB
 AM
 Year 2030 Cumulative with Project Conditions
 Avg. Queue Per Lane in Veh= 0.1
 Percentile = 95% 1

Individual Probability	Cumulative Probability	Number of Queued Vehicles
0.9048	0.9048	0
0.0905	0.9953	1
0.0045	0.9998	2
0.0002	1.0000	3
0.0000	1.0000	4
0.0000	1.0000	5
0.0000	1.0000	6
0.0000	1.0000	7
0.0000	1.0000	8
0.0000	1.0000	9
0.0000	1.0000	10
0.0000	1.0000	11
0.0000	1.0000	12
0.0000	1.0000	13
0.0000	1.0000	14
0.0000	1.0000	15
0.0000	1.0000	16
0.0000	1.0000	17
0.0000	1.0000	18
0.0000	1.0000	19
0.0000	1.0000	20
0.0000	1.0000	21
0.0000	1.0000	22
0.0000	1.0000	23
0.0000	1.0000	24
0.0000	1.0000	25
0.0000	1.0000	26
0.0000	1.0000	27
0.0000	1.0000	28
0.0000	1.0000	29
0.0000	1.0000	30
0.0000	1.0000	31
0.0000	1.0000	32
0.0000	1.0000	33
0.0000	1.0000	34
0.0000	1.0000	35
0.0000	1.0000	36
0.0000	1.0000	37
0.0000	1.0000	38
0.0000	1.0000	39
0.0000	1.0000	40
0.0000	1.0000	41
0.0000	1.0000	42
0.0000	1.0000	43
0.0000	1.0000	44
0.0000	1.0000	45
0.0000	1.0000	46
0.0000	1.0000	47
0.0000	1.0000	48
0.0000	1.0000	49
0.0000	1.0000	50
0.0000	1.0000	51
0.0000	1.0000	52
0.0000	1.0000	53
0.0000	1.0000	54
0.0000	1.0000	55
0.0000	1.0000	56
0.0000	1.0000	57
0.0000	1.0000	58
0.0000	1.0000	59
0.0000	1.0000	60
0.0000	1.0000	61
0.0000	1.0000	62
0.0000	1.0000	63
0.0000	1.0000	64
0.0000	1.0000	65

Individual Probability	Cumulative Probability	Number of Queued Vehicles
0.9048	0.9048	0
0.0905	0.9953	1
0.0045	0.9998	2
0.0002	1.0000	3
0.0000	1.0000	4
0.0000	1.0000	5
0.0000	1.0000	6
0.0000	1.0000	7
0.0000	1.0000	8
0.0000	1.0000	9
0.0000	1.0000	10
0.0000	1.0000	11
0.0000	1.0000	12
0.0000	1.0000	13
0.0000	1.0000	14
0.0000	1.0000	15
0.0000	1.0000	16
0.0000	1.0000	17
0.0000	1.0000	18
0.0000	1.0000	19
0.0000	1.0000	20
0.0000	1.0000	21
0.0000	1.0000	22
0.0000	1.0000	23
0.0000	1.0000	24
0.0000	1.0000	25
0.0000	1.0000	26
0.0000	1.0000	27
0.0000	1.0000	28
0.0000	1.0000	29
0.0000	1.0000	30
0.0000	1.0000	31
0.0000	1.0000	32
0.0000	1.0000	33
0.0000	1.0000	34
0.0000	1.0000	35
0.0000	1.0000	36
0.0000	1.0000	37
0.0000	1.0000	38
0.0000	1.0000	39
0.0000	1.0000	40
0.0000	1.0000	41
0.0000	1.0000	42
0.0000	1.0000	43
0.0000	1.0000	44
0.0000	1.0000	45
0.0000	1.0000	46
0.0000	1.0000	47
0.0000	1.0000	48
0.0000	1.0000	49
0.0000	1.0000	50
0.0000	1.0000	51
0.0000	1.0000	52
0.0000	1.0000	53
0.0000	1.0000	54
0.0000	1.0000	55
0.0000	1.0000	56
0.0000	1.0000	57
0.0000	1.0000	58
0.0000	1.0000	59
0.0000	1.0000	60
0.0000	1.0000	61
0.0000	1.0000	62
0.0000	1.0000	63
0.0000	1.0000	64
0.0000	1.0000	65

DePaul/Project Driveway B
 WB
 PM
 Existing plus Project Conditions
 Avg. Queue Per Lane in Veh= 0.1
 Percentile = 95% 1

DePaul/Project Driveway B
 WB
 PM
 Year 2030 Cumulative with Project Conditions
 Avg. Queue Per Lane in Veh= 0.1
 Percentile = 95% 1

Individual Probability	Cumulative Probability	Number of Queued Vehicles
0.9048	0.9048	0
0.0905	0.9953	1
0.0045	0.9998	2
0.0002	1.0000	3
0.0000	1.0000	4
0.0000	1.0000	5
0.0000	1.0000	6
0.0000	1.0000	7
0.0000	1.0000	8
0.0000	1.0000	9
0.0000	1.0000	10
0.0000	1.0000	11
0.0000	1.0000	12
0.0000	1.0000	13
0.0000	1.0000	14
0.0000	1.0000	15
0.0000	1.0000	16
0.0000	1.0000	17
0.0000	1.0000	18
0.0000	1.0000	19
0.0000	1.0000	20
0.0000	1.0000	21
0.0000	1.0000	22
0.0000	1.0000	23
0.0000	1.0000	24
0.0000	1.0000	25
0.0000	1.0000	26
0.0000	1.0000	27
0.0000	1.0000	28
0.0000	1.0000	29
0.0000	1.0000	30
0.0000	1.0000	31
0.0000	1.0000	32
0.0000	1.0000	33
0.0000	1.0000	34
0.0000	1.0000	35
0.0000	1.0000	36
0.0000	1.0000	37
0.0000	1.0000	38
0.0000	1.0000	39
0.0000	1.0000	40
0.0000	1.0000	41
0.0000	1.0000	42
0.0000	1.0000	43
0.0000	1.0000	44
0.0000	1.0000	45
0.0000	1.0000	46
0.0000	1.0000	47
0.0000	1.0000	48
0.0000	1.0000	49
0.0000	1.0000	50
0.0000	1.0000	51
0.0000	1.0000	52
0.0000	1.0000	53
0.0000	1.0000	54
0.0000	1.0000	55
0.0000	1.0000	56
0.0000	1.0000	57
0.0000	1.0000	58
0.0000	1.0000	59
0.0000	1.0000	60
0.0000	1.0000	61
0.0000	1.0000	62
0.0000	1.0000	63
0.0000	1.0000	64
0.0000	1.0000	65

Individual Probability	Cumulative Probability	Number of Queued Vehicles
0.9048	0.9048	0
0.0905	0.9953	1
0.0045	0.9998	2
0.0002	1.0000	3
0.0000	1.0000	4
0.0000	1.0000	5
0.0000	1.0000	6
0.0000	1.0000	7
0.0000	1.0000	8
0.0000	1.0000	9
0.0000	1.0000	10
0.0000	1.0000	11
0.0000	1.0000	12
0.0000	1.0000	13
0.0000	1.0000	14
0.0000	1.0000	15
0.0000	1.0000	16
0.0000	1.0000	17
0.0000	1.0000	18
0.0000	1.0000	19
0.0000	1.0000	20
0.0000	1.0000	21
0.0000	1.0000	22
0.0000	1.0000	23
0.0000	1.0000	24
0.0000	1.0000	25
0.0000	1.0000	26
0.0000	1.0000	27
0.0000	1.0000	28
0.0000	1.0000	29
0.0000	1.0000	30
0.0000	1.0000	31
0.0000	1.0000	32
0.0000	1.0000	33
0.0000	1.0000	34
0.0000	1.0000	35
0.0000	1.0000	36
0.0000	1.0000	37
0.0000	1.0000	38
0.0000	1.0000	39
0.0000	1.0000	40
0.0000	1.0000	41
0.0000	1.0000	42
0.0000	1.0000	43
0.0000	1.0000	44
0.0000	1.0000	45
0.0000	1.0000	46
0.0000	1.0000	47
0.0000	1.0000	48
0.0000	1.0000	49
0.0000	1.0000	50
0.0000	1.0000	51
0.0000	1.0000	52
0.0000	1.0000	53
0.0000	1.0000	54
0.0000	1.0000	55
0.0000	1.0000	56
0.0000	1.0000	57
0.0000	1.0000	58
0.0000	1.0000	59
0.0000	1.0000	60
0.0000	1.0000	61
0.0000	1.0000	62
0.0000	1.0000	63
0.0000	1.0000	64
0.0000	1.0000	65

DePaul/Project Driveway C
 SBL
 AM
 Existing plus Project Conditions
 Avg. Queue Per Lane in Veh= 0.0
 Percentile = 95% 0

DePaul/Project Driveway C
 SBL
 AM
 Year 2030 Cumulative with Project Conditions
 Avg. Queue Per Lane in Veh= 0.0
 Percentile = 95% 0

Individual Probability	Cumulative Probability	Number of Queued Vehicles
#NUM!	#NUM!	0
0.0000	#NUM!	1
0.0000	#NUM!	2
0.0000	#NUM!	3
0.0000	#NUM!	4
0.0000	#NUM!	5
0.0000	#NUM!	6
0.0000	#NUM!	7
0.0000	#NUM!	8
0.0000	#NUM!	9
0.0000	#NUM!	10
0.0000	#NUM!	11
0.0000	#NUM!	12
0.0000	#NUM!	13
0.0000	#NUM!	14
0.0000	#NUM!	15
0.0000	#NUM!	16
0.0000	#NUM!	17
0.0000	#NUM!	18
0.0000	#NUM!	19
0.0000	#NUM!	20
0.0000	#NUM!	21
0.0000	#NUM!	22
0.0000	#NUM!	23
0.0000	#NUM!	24
0.0000	#NUM!	25
0.0000	#NUM!	26
0.0000	#NUM!	27
0.0000	#NUM!	28
0.0000	#NUM!	29
0.0000	#NUM!	30
0.0000	#NUM!	31
0.0000	#NUM!	32
0.0000	#NUM!	33
0.0000	#NUM!	34
0.0000	#NUM!	35
0.0000	#NUM!	36
0.0000	#NUM!	37
0.0000	#NUM!	38
0.0000	#NUM!	39
0.0000	#NUM!	40
0.0000	#NUM!	41
0.0000	#NUM!	42
0.0000	#NUM!	43
0.0000	#NUM!	44
0.0000	#NUM!	45
0.0000	#NUM!	46
0.0000	#NUM!	47
0.0000	#NUM!	48
0.0000	#NUM!	49
0.0000	#NUM!	50
0.0000	#NUM!	51
0.0000	#NUM!	52
0.0000	#NUM!	53
0.0000	#NUM!	54
0.0000	#NUM!	55
0.0000	#NUM!	56
0.0000	#NUM!	57
0.0000	#NUM!	58
0.0000	#NUM!	59
0.0000	#NUM!	60
0.0000	#NUM!	61
0.0000	#NUM!	62
0.0000	#NUM!	63
0.0000	#NUM!	64
0.0000	#NUM!	65

Individual Probability	Cumulative Probability	Number of Queued Vehicles
#NUM!	#NUM!	0
0.0000	#NUM!	1
0.0000	#NUM!	2
0.0000	#NUM!	3
0.0000	#NUM!	4
0.0000	#NUM!	5
0.0000	#NUM!	6
0.0000	#NUM!	7
0.0000	#NUM!	8
0.0000	#NUM!	9
0.0000	#NUM!	10
0.0000	#NUM!	11
0.0000	#NUM!	12
0.0000	#NUM!	13
0.0000	#NUM!	14
0.0000	#NUM!	15
0.0000	#NUM!	16
0.0000	#NUM!	17
0.0000	#NUM!	18
0.0000	#NUM!	19
0.0000	#NUM!	20
0.0000	#NUM!	21
0.0000	#NUM!	22
0.0000	#NUM!	23
0.0000	#NUM!	24
0.0000	#NUM!	25
0.0000	#NUM!	26
0.0000	#NUM!	27
0.0000	#NUM!	28
0.0000	#NUM!	29
0.0000	#NUM!	30
0.0000	#NUM!	31
0.0000	#NUM!	32
0.0000	#NUM!	33
0.0000	#NUM!	34
0.0000	#NUM!	35
0.0000	#NUM!	36
0.0000	#NUM!	37
0.0000	#NUM!	38
0.0000	#NUM!	39
0.0000	#NUM!	40
0.0000	#NUM!	41
0.0000	#NUM!	42
0.0000	#NUM!	43
0.0000	#NUM!	44
0.0000	#NUM!	45
0.0000	#NUM!	46
0.0000	#NUM!	47
0.0000	#NUM!	48
0.0000	#NUM!	49
0.0000	#NUM!	50
0.0000	#NUM!	51
0.0000	#NUM!	52
0.0000	#NUM!	53
0.0000	#NUM!	54
0.0000	#NUM!	55
0.0000	#NUM!	56
0.0000	#NUM!	57
0.0000	#NUM!	58
0.0000	#NUM!	59
0.0000	#NUM!	60
0.0000	#NUM!	61
0.0000	#NUM!	62
0.0000	#NUM!	63
0.0000	#NUM!	64
0.0000	#NUM!	65

DePaul/Project Driveway C
 SBL
 PM
 Existing plus Project Conditions
 Avg. Queue Per Lane in Veh= 0.1
 Percentile = 95% 1

DePaul/Project Driveway C
 SBL
 PM
 Year 2030 Cumulative with Project Conditions
 Avg. Queue Per Lane in Veh= 0.1
 Percentile = 95% 1

Individual Probability	Cumulative Probability	Number of Queued Vehicles
0.9048	0.9048	0
0.0905	0.9953	1
0.0045	0.9998	2
0.0002	1.0000	3
0.0000	1.0000	4
0.0000	1.0000	5
0.0000	1.0000	6
0.0000	1.0000	7
0.0000	1.0000	8
0.0000	1.0000	9
0.0000	1.0000	10
0.0000	1.0000	11
0.0000	1.0000	12
0.0000	1.0000	13
0.0000	1.0000	14
0.0000	1.0000	15
0.0000	1.0000	16
0.0000	1.0000	17
0.0000	1.0000	18
0.0000	1.0000	19
0.0000	1.0000	20
0.0000	1.0000	21
0.0000	1.0000	22
0.0000	1.0000	23
0.0000	1.0000	24
0.0000	1.0000	25
0.0000	1.0000	26
0.0000	1.0000	27
0.0000	1.0000	28
0.0000	1.0000	29
0.0000	1.0000	30
0.0000	1.0000	31
0.0000	1.0000	32
0.0000	1.0000	33
0.0000	1.0000	34
0.0000	1.0000	35
0.0000	1.0000	36
0.0000	1.0000	37
0.0000	1.0000	38
0.0000	1.0000	39
0.0000	1.0000	40
0.0000	1.0000	41
0.0000	1.0000	42
0.0000	1.0000	43
0.0000	1.0000	44
0.0000	1.0000	45
0.0000	1.0000	46
0.0000	1.0000	47
0.0000	1.0000	48
0.0000	1.0000	49
0.0000	1.0000	50
0.0000	1.0000	51
0.0000	1.0000	52
0.0000	1.0000	53
0.0000	1.0000	54
0.0000	1.0000	55
0.0000	1.0000	56
0.0000	1.0000	57
0.0000	1.0000	58
0.0000	1.0000	59
0.0000	1.0000	60
0.0000	1.0000	61
0.0000	1.0000	62
0.0000	1.0000	63
0.0000	1.0000	64
0.0000	1.0000	65

Individual Probability	Cumulative Probability	Number of Queued Vehicles
0.9048	0.9048	0
0.0905	0.9953	1
0.0045	0.9998	2
0.0002	1.0000	3
0.0000	1.0000	4
0.0000	1.0000	5
0.0000	1.0000	6
0.0000	1.0000	7
0.0000	1.0000	8
0.0000	1.0000	9
0.0000	1.0000	10
0.0000	1.0000	11
0.0000	1.0000	12
0.0000	1.0000	13
0.0000	1.0000	14
0.0000	1.0000	15
0.0000	1.0000	16
0.0000	1.0000	17
0.0000	1.0000	18
0.0000	1.0000	19
0.0000	1.0000	20
0.0000	1.0000	21
0.0000	1.0000	22
0.0000	1.0000	23
0.0000	1.0000	24
0.0000	1.0000	25
0.0000	1.0000	26
0.0000	1.0000	27
0.0000	1.0000	28
0.0000	1.0000	29
0.0000	1.0000	30
0.0000	1.0000	31
0.0000	1.0000	32
0.0000	1.0000	33
0.0000	1.0000	34
0.0000	1.0000	35
0.0000	1.0000	36
0.0000	1.0000	37
0.0000	1.0000	38
0.0000	1.0000	39
0.0000	1.0000	40
0.0000	1.0000	41
0.0000	1.0000	42
0.0000	1.0000	43
0.0000	1.0000	44
0.0000	1.0000	45
0.0000	1.0000	46
0.0000	1.0000	47
0.0000	1.0000	48
0.0000	1.0000	49
0.0000	1.0000	50
0.0000	1.0000	51
0.0000	1.0000	52
0.0000	1.0000	53
0.0000	1.0000	54
0.0000	1.0000	55
0.0000	1.0000	56
0.0000	1.0000	57
0.0000	1.0000	58
0.0000	1.0000	59
0.0000	1.0000	60
0.0000	1.0000	61
0.0000	1.0000	62
0.0000	1.0000	63
0.0000	1.0000	64
0.0000	1.0000	65

DePaul/Project Driveway C
 WB
 AM
 Existing plus Project Conditions
 Avg. Queue Per Lane in Veh= 0.1
 Percentile = 95% 1

DePaul/Project Driveway C
 WB
 AM
 Year 2030 Cumulative with Project Conditions
 Avg. Queue Per Lane in Veh= 0.1
 Percentile = 95% 1

Individual Probability	Cumulative Probability	Number of Queued Vehicles
0.9048	0.9048	0
0.0905	0.9953	1
0.0045	0.9998	2
0.0002	1.0000	3
0.0000	1.0000	4
0.0000	1.0000	5
0.0000	1.0000	6
0.0000	1.0000	7
0.0000	1.0000	8
0.0000	1.0000	9
0.0000	1.0000	10
0.0000	1.0000	11
0.0000	1.0000	12
0.0000	1.0000	13
0.0000	1.0000	14
0.0000	1.0000	15
0.0000	1.0000	16
0.0000	1.0000	17
0.0000	1.0000	18
0.0000	1.0000	19
0.0000	1.0000	20
0.0000	1.0000	21
0.0000	1.0000	22
0.0000	1.0000	23
0.0000	1.0000	24
0.0000	1.0000	25
0.0000	1.0000	26
0.0000	1.0000	27
0.0000	1.0000	28
0.0000	1.0000	29
0.0000	1.0000	30
0.0000	1.0000	31
0.0000	1.0000	32
0.0000	1.0000	33
0.0000	1.0000	34
0.0000	1.0000	35
0.0000	1.0000	36
0.0000	1.0000	37
0.0000	1.0000	38
0.0000	1.0000	39
0.0000	1.0000	40
0.0000	1.0000	41
0.0000	1.0000	42
0.0000	1.0000	43
0.0000	1.0000	44
0.0000	1.0000	45
0.0000	1.0000	46
0.0000	1.0000	47
0.0000	1.0000	48
0.0000	1.0000	49
0.0000	1.0000	50
0.0000	1.0000	51
0.0000	1.0000	52
0.0000	1.0000	53
0.0000	1.0000	54
0.0000	1.0000	55
0.0000	1.0000	56
0.0000	1.0000	57
0.0000	1.0000	58
0.0000	1.0000	59
0.0000	1.0000	60
0.0000	1.0000	61
0.0000	1.0000	62
0.0000	1.0000	63
0.0000	1.0000	64
0.0000	1.0000	65

Individual Probability	Cumulative Probability	Number of Queued Vehicles
0.9048	0.9048	0
0.0905	0.9953	1
0.0045	0.9998	2
0.0002	1.0000	3
0.0000	1.0000	4
0.0000	1.0000	5
0.0000	1.0000	6
0.0000	1.0000	7
0.0000	1.0000	8
0.0000	1.0000	9
0.0000	1.0000	10
0.0000	1.0000	11
0.0000	1.0000	12
0.0000	1.0000	13
0.0000	1.0000	14
0.0000	1.0000	15
0.0000	1.0000	16
0.0000	1.0000	17
0.0000	1.0000	18
0.0000	1.0000	19
0.0000	1.0000	20
0.0000	1.0000	21
0.0000	1.0000	22
0.0000	1.0000	23
0.0000	1.0000	24
0.0000	1.0000	25
0.0000	1.0000	26
0.0000	1.0000	27
0.0000	1.0000	28
0.0000	1.0000	29
0.0000	1.0000	30
0.0000	1.0000	31
0.0000	1.0000	32
0.0000	1.0000	33
0.0000	1.0000	34
0.0000	1.0000	35
0.0000	1.0000	36
0.0000	1.0000	37
0.0000	1.0000	38
0.0000	1.0000	39
0.0000	1.0000	40
0.0000	1.0000	41
0.0000	1.0000	42
0.0000	1.0000	43
0.0000	1.0000	44
0.0000	1.0000	45
0.0000	1.0000	46
0.0000	1.0000	47
0.0000	1.0000	48
0.0000	1.0000	49
0.0000	1.0000	50
0.0000	1.0000	51
0.0000	1.0000	52
0.0000	1.0000	53
0.0000	1.0000	54
0.0000	1.0000	55
0.0000	1.0000	56
0.0000	1.0000	57
0.0000	1.0000	58
0.0000	1.0000	59
0.0000	1.0000	60
0.0000	1.0000	61
0.0000	1.0000	62
0.0000	1.0000	63
0.0000	1.0000	64
0.0000	1.0000	65

DePaul/Project Driveway C
 WB
 PM
 Existing plus Project Conditions
 Avg. Queue Per Lane in Veh= 0.0
 Percentile = 95% 0

DePaul/Project Driveway C
 WB
 PM
 Year 2030 Cumulative with Project Conditions
 Avg. Queue Per Lane in Veh= 0.0
 Percentile = 95% 0

Individual Probability	Cumulative Probability	Number of Queued Vehicles
#NUM!	#NUM!	0
0.0000	#NUM!	1
0.0000	#NUM!	2
0.0000	#NUM!	3
0.0000	#NUM!	4
0.0000	#NUM!	5
0.0000	#NUM!	6
0.0000	#NUM!	7
0.0000	#NUM!	8
0.0000	#NUM!	9
0.0000	#NUM!	10
0.0000	#NUM!	11
0.0000	#NUM!	12
0.0000	#NUM!	13
0.0000	#NUM!	14
0.0000	#NUM!	15
0.0000	#NUM!	16
0.0000	#NUM!	17
0.0000	#NUM!	18
0.0000	#NUM!	19
0.0000	#NUM!	20
0.0000	#NUM!	21
0.0000	#NUM!	22
0.0000	#NUM!	23
0.0000	#NUM!	24
0.0000	#NUM!	25
0.0000	#NUM!	26
0.0000	#NUM!	27
0.0000	#NUM!	28
0.0000	#NUM!	29
0.0000	#NUM!	30
0.0000	#NUM!	31
0.0000	#NUM!	32
0.0000	#NUM!	33
0.0000	#NUM!	34
0.0000	#NUM!	35
0.0000	#NUM!	36
0.0000	#NUM!	37
0.0000	#NUM!	38
0.0000	#NUM!	39
0.0000	#NUM!	40
0.0000	#NUM!	41
0.0000	#NUM!	42
0.0000	#NUM!	43
0.0000	#NUM!	44
0.0000	#NUM!	45
0.0000	#NUM!	46
0.0000	#NUM!	47
0.0000	#NUM!	48
0.0000	#NUM!	49
0.0000	#NUM!	50
0.0000	#NUM!	51
0.0000	#NUM!	52
0.0000	#NUM!	53
0.0000	#NUM!	54
0.0000	#NUM!	55
0.0000	#NUM!	56
0.0000	#NUM!	57
0.0000	#NUM!	58
0.0000	#NUM!	59
0.0000	#NUM!	60
0.0000	#NUM!	61
0.0000	#NUM!	62
0.0000	#NUM!	63
0.0000	#NUM!	64
0.0000	#NUM!	65

Individual Probability	Cumulative Probability	Number of Queued Vehicles
#NUM!	#NUM!	0
0.0000	#NUM!	1
0.0000	#NUM!	2
0.0000	#NUM!	3
0.0000	#NUM!	4
0.0000	#NUM!	5
0.0000	#NUM!	6
0.0000	#NUM!	7
0.0000	#NUM!	8
0.0000	#NUM!	9
0.0000	#NUM!	10
0.0000	#NUM!	11
0.0000	#NUM!	12
0.0000	#NUM!	13
0.0000	#NUM!	14
0.0000	#NUM!	15
0.0000	#NUM!	16
0.0000	#NUM!	17
0.0000	#NUM!	18
0.0000	#NUM!	19
0.0000	#NUM!	20
0.0000	#NUM!	21
0.0000	#NUM!	22
0.0000	#NUM!	23
0.0000	#NUM!	24
0.0000	#NUM!	25
0.0000	#NUM!	26
0.0000	#NUM!	27
0.0000	#NUM!	28
0.0000	#NUM!	29
0.0000	#NUM!	30
0.0000	#NUM!	31
0.0000	#NUM!	32
0.0000	#NUM!	33
0.0000	#NUM!	34
0.0000	#NUM!	35
0.0000	#NUM!	36
0.0000	#NUM!	37
0.0000	#NUM!	38
0.0000	#NUM!	39
0.0000	#NUM!	40
0.0000	#NUM!	41
0.0000	#NUM!	42
0.0000	#NUM!	43
0.0000	#NUM!	44
0.0000	#NUM!	45
0.0000	#NUM!	46
0.0000	#NUM!	47
0.0000	#NUM!	48
0.0000	#NUM!	49
0.0000	#NUM!	50
0.0000	#NUM!	51
0.0000	#NUM!	52
0.0000	#NUM!	53
0.0000	#NUM!	54
0.0000	#NUM!	55
0.0000	#NUM!	56
0.0000	#NUM!	57
0.0000	#NUM!	58
0.0000	#NUM!	59
0.0000	#NUM!	60
0.0000	#NUM!	61
0.0000	#NUM!	62
0.0000	#NUM!	63
0.0000	#NUM!	64
0.0000	#NUM!	65

Appendix H

Freeway On-Ramp and Off-Ramp Queuing Analyses

City of Morgan Hill
The Crosswinds Residential Development

Level Of Service Computation Report
2000 HCM Operations (Future Volume Alternative)
Existing AM

Intersection #107: US 101 Southbound Ramps and Cochrane Road

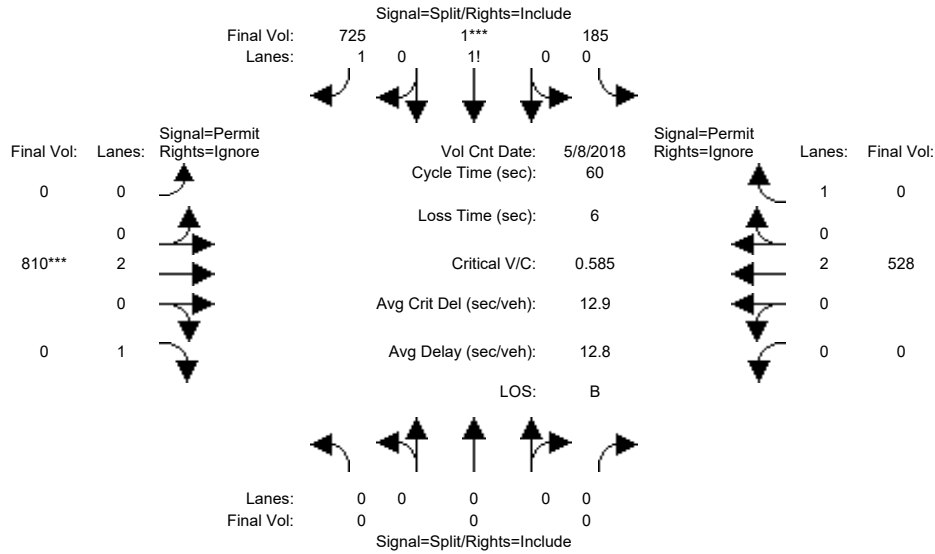

Street Name:	US 101 Southbound Ramps						Cochrane Road					
	North Bound			South Bound			East Bound			West Bound		
Movement:	L	T	R	L	T	R	L	T	R	L	T	R
Min. Green:	0	0	0	10	0	10	0	10	10	0	10	10
Y+R:	4.0	4.0	4.0	4.0	4.0	4.0	4.0	4.0	4.0	4.0	4.0	4.0

Volume Module:	>>	Count	Date:	8 May 2018	<<							
Base Vol:	0	0	0	185	1	725	0	810	238	0	528	0
Growth Adj:	1.00	1.00	1.00	1.00	1.00	1.00	1.00	1.00	1.00	1.00	1.00	1.00
Initial Bse:	0	0	0	185	1	725	0	810	238	0	528	0
Added Vol:	0	0	0	0	0	0	0	0	0	0	0	0
PasserByVol:	0	0	0	0	0	0	0	0	0	0	0	0
Initial Fut:	0	0	0	185	1	725	0	810	238	0	528	0
User Adj:	1.00	1.00	1.00	1.00	1.00	1.00	1.00	1.00	0.00	1.00	1.00	0.00
PHF Adj:	1.00	1.00	1.00	1.00	1.00	1.00	1.00	1.00	0.00	1.00	1.00	0.00
PHF Volume:	0	0	0	185	1	725	0	810	0	0	528	0
Reduct Vol:	0	0	0	0	0	0	0	0	0	0	0	0
Reduced Vol:	0	0	0	185	1	725	0	810	0	0	528	0
PCE Adj:	1.00	1.00	1.00	1.00	1.00	1.00	1.00	1.00	0.00	1.00	1.00	0.00
MLF Adj:	1.00	1.00	1.00	1.00	1.00	1.00	1.00	1.00	0.00	1.00	1.00	0.00
Final Volume:	0	0	0	185	1	725	0	810	0	0	528	0

Saturation Flow Module:	
Sat/Lane:	1900 1900 1900 1900 1900 1900 1900 1900 1900 1900 1900 1900
Adjustment:	0.92 1.00 0.92 0.92 0.92 0.92 0.92 1.00 0.92 0.92 1.00 0.92
Lanes:	0.00 0.00 0.00 0.33 0.01 1.66 0.00 2.00 1.00 0.00 2.00 1.00
Final Sat.:	0 0 0 590 3 2907 0 3800 1750 0 3800 1750

Capacity Analysis Module:	
Vol/Sat:	0.00 0.00 0.00 0.31 0.31 0.25 0.00 0.21 0.00 0.00 0.14 0.00
Crit Moves:	****
Green Time:	0.0 0.0 0.0 32.1 32.1 32.1 0.0 21.9 0.0 0.0 21.9 0.0
Volume/Cap:	0.00 0.00 0.00 0.59 0.59 0.47 0.00 0.59 0.00 0.00 0.38 0.00
Delay/Veh:	0.0 0.0 0.0 10.0 10.0 8.8 0.0 16.1 0.0 0.0 14.3 0.0
User DelAdj:	1.00 1.00 1.00 1.00 1.00 1.00 1.00 1.00 1.00 1.00 1.00 1.00
AdjDel/Veh:	0.0 0.0 0.0 10.0 10.0 8.8 0.0 16.1 0.0 0.0 14.3 0.0
LOS by Move:	A A A A A A A B A A B A
HCM2k95thQ:	0 0 0 15 15 11 0 12 0 0 7 0

Note: Queue reported is the number of cars per lane.

City of Morgan Hill
The Crosswinds Residential Development

Level Of Service Computation Report
2000 HCM Operations (Future Volume Alternative)
Existing Plus Project AM

Intersection #107: US 101 Southbound Ramps and Cochrane Road

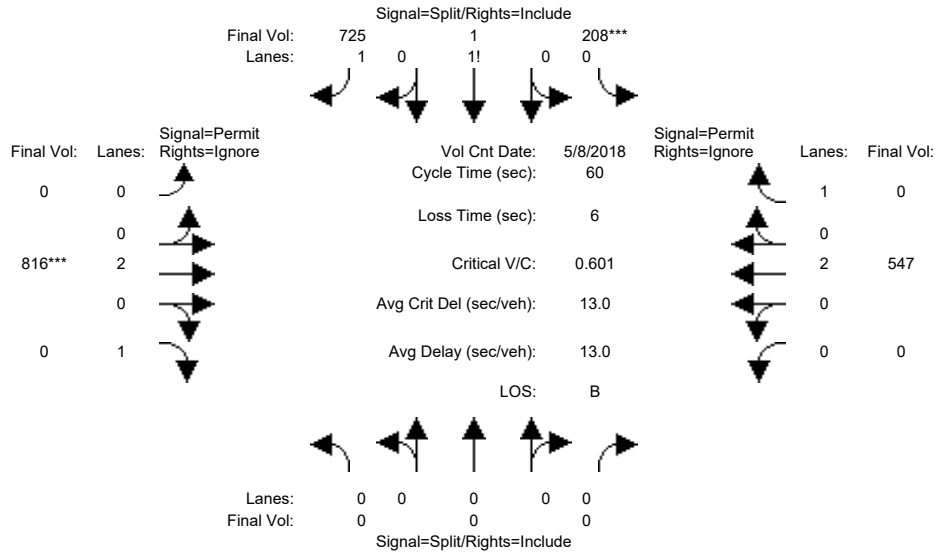

Street Name:	US 101 Southbound Ramps						Cochrane Road					
	North Bound			South Bound			East Bound			West Bound		
Movement:	L	T	R	L	T	R	L	T	R	L	T	R
Min. Green:	0	0	0	10	0	10	0	10	10	0	10	10
Y+R:	4.0	4.0	4.0	4.0	4.0	4.0	4.0	4.0	4.0	4.0	4.0	4.0

Volume Module:	>>	Count	Date:	8 May 2018	<<							
Base Vol:	0	0	0	185	1	725	0	810	238	0	528	0
Growth Adj:	1.00	1.00	1.00	1.00	1.00	1.00	1.00	1.00	1.00	1.00	1.00	1.00
Initial Bse:	0	0	0	185	1	725	0	810	238	0	528	0
Added Vol:	0	0	0	23	0	0	0	6	0	0	19	11
PasserByVol:	0	0	0	0	0	0	0	0	0	0	0	0
Initial Fut:	0	0	0	208	1	725	0	816	238	0	547	11
User Adj:	1.00	1.00	1.00	1.00	1.00	1.00	1.00	1.00	0.00	1.00	1.00	0.00
PHF Adj:	1.00	1.00	1.00	1.00	1.00	1.00	1.00	1.00	0.00	1.00	1.00	0.00
PHF Volume:	0	0	0	208	1	725	0	816	0	0	547	0
Reduct Vol:	0	0	0	0	0	0	0	0	0	0	0	0
Reduced Vol:	0	0	0	208	1	725	0	816	0	0	547	0
PCE Adj:	1.00	1.00	1.00	1.00	1.00	1.00	1.00	1.00	0.00	1.00	1.00	0.00
MLF Adj:	1.00	1.00	1.00	1.00	1.00	1.00	1.00	1.00	0.00	1.00	1.00	0.00
FinalVolume:	0	0	0	208	1	725	0	816	0	0	547	0

Saturation Flow Module:												
Sat/Lane:	1900	1900	1900	1900	1900	1900	1900	1900	1900	1900	1900	1900
Adjustment:	0.92	1.00	0.92	0.92	0.92	0.92	0.92	1.00	0.92	0.92	1.00	0.92
Lanes:	0.00	0.00	0.00	0.36	0.01	1.63	0.00	2.00	1.00	0.00	2.00	1.00
Final Sat.:	0	0	0	637	3	2860	0	3800	1750	0	3800	1750

Capacity Analysis Module:													
Vol/Sat:	0.00	0.00	0.00	0.33	0.33	0.25	0.00	0.21	0.00	0.00	0.14	0.00	
Crit Moves:				****				****					
Green Time:	0.0	0.0	0.0	32.6	32.6	32.6	0.0	21.4	0.0	0.0	21.4	0.0	
Volume/Cap:	0.00	0.00	0.00	0.60	0.60	0.47	0.00	0.60	0.00	0.00	0.40	0.00	
Delay/Veh:	0.0	0.0	0.0	10.0	10.0	8.6	0.0	16.6	0.0	0.0	14.7	0.0	
User DelAdj:	1.00	1.00	1.00	1.00	1.00	1.00	1.00	1.00	1.00	1.00	1.00	1.00	
AdjDel/Veh:	0.0	0.0	0.0	10.0	10.0	8.6	0.0	16.6	0.0	0.0	14.7	0.0	
LOS by Move:	A	A	A	A	A	A	A	B	A	A	B	A	
HCM2k95thQ:	0	0	0	16	16	11	0	12	0	0	7	0	

Note: Queue reported is the number of cars per lane.

City of Morgan Hill
The Crosswinds Residential Development

Level Of Service Computation Report
2000 HCM Operations (Future Volume Alternative)
Year 2030 Cumulative without Project AM

Intersection #107: US 101 Southbound Ramps and Cochrane Road

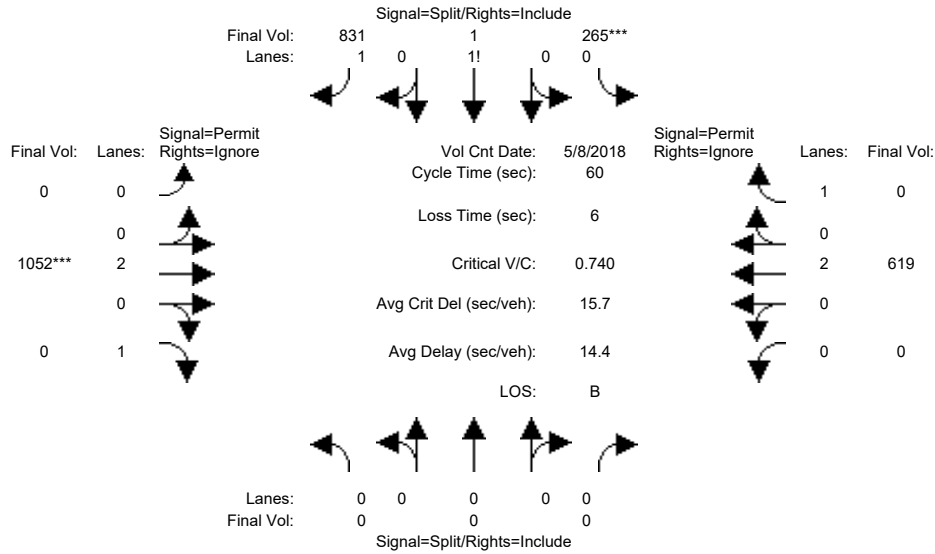

Street Name:	US 101 Southbound Ramps						Cochrane Road					
	North Bound			South Bound			East Bound			West Bound		
Movement:	L	T	R	L	T	R	L	T	R	L	T	R
Min. Green:	0	0	0	10	0	10	0	10	10	0	10	10
Y+R:	4.0	4.0	4.0	4.0	4.0	4.0	4.0	4.0	4.0	4.0	4.0	4.0

Volume Module:	>>	Count	Date:	8 May 2018	<<							
Base Vol:	0	0	0	265	1	831	0	1052	267	0	619	152
Growth Adj:	1.00	1.00	1.00	1.00	1.00	1.00	1.00	1.00	1.00	1.00	1.00	1.00
Initial Bse:	0	0	0	265	1	831	0	1052	267	0	619	152
Added Vol:	0	0	0	0	0	0	0	0	0	0	0	0
PasserByVol:	0	0	0	0	0	0	0	0	0	0	0	0
Initial Fut:	0	0	0	265	1	831	0	1052	267	0	619	152
User Adj:	1.00	1.00	1.00	1.00	1.00	1.00	1.00	1.00	0.00	1.00	1.00	0.00
PHF Adj:	1.00	1.00	1.00	1.00	1.00	1.00	1.00	1.00	0.00	1.00	1.00	0.00
PHF Volume:	0	0	0	265	1	831	0	1052	0	0	619	0
Reduct Vol:	0	0	0	0	0	0	0	0	0	0	0	0
Reduced Vol:	0	0	0	265	1	831	0	1052	0	0	619	0
PCE Adj:	1.00	1.00	1.00	1.00	1.00	1.00	1.00	1.00	0.00	1.00	1.00	0.00
MLF Adj:	1.00	1.00	1.00	1.00	1.00	1.00	1.00	1.00	0.00	1.00	1.00	0.00
Final Volume:	0	0	0	265	1	831	0	1052	0	0	619	0

Saturation Flow Module:												
Sat/Lane:	1900	1900	1900	1900	1900	1900	1900	1900	1900	1900	1900	1900
Adjustment:	0.92	1.00	0.92	0.92	0.92	0.92	0.92	1.00	0.92	0.92	1.00	0.92
Lanes:	0.00	0.00	0.00	0.38	0.01	1.61	0.00	2.00	1.00	0.00	2.00	1.00
Final Sat.:	0	0	0	680	3	2817	0	3800	1750	0	3800	1750

Capacity Analysis Module:												
Vol/Sat:	0.00	0.00	0.00	0.39	0.39	0.30	0.00	0.28	0.00	0.00	0.16	0.00
Crit Moves:				****			****					
Green Time:	0.0	0.0	0.0	31.6	31.6	31.6	0.0	22.4	0.0	0.0	22.4	0.0
Volume/Cap:	0.00	0.00	0.00	0.74	0.74	0.56	0.00	0.74	0.00	0.00	0.44	0.00
Delay/Veh:	0.0	0.0	0.0	13.1	13.1	9.9	0.0	18.4	0.0	0.0	14.3	0.0
User DelAdj:	1.00	1.00	1.00	1.00	1.00	1.00	1.00	1.00	1.00	1.00	1.00	1.00
AdjDel/Veh:	0.0	0.0	0.0	13.1	13.1	9.9	0.0	18.4	0.0	0.0	14.3	0.0
LOS by Move:	A	A	A	B	B	A	A	B	A	A	B	A
HCM2k95thQ:	0	0	0	22	22	14	0	16	0	0	8	0

Note: Queue reported is the number of cars per lane.

City of Morgan Hill
The Crosswinds Residential Development

Level Of Service Computation Report
2000 HCM Operations (Future Volume Alternative)
Year 2030 Cumulative with Project AM

Intersection #107: US 101 Southbound Ramps and Cochrane Road

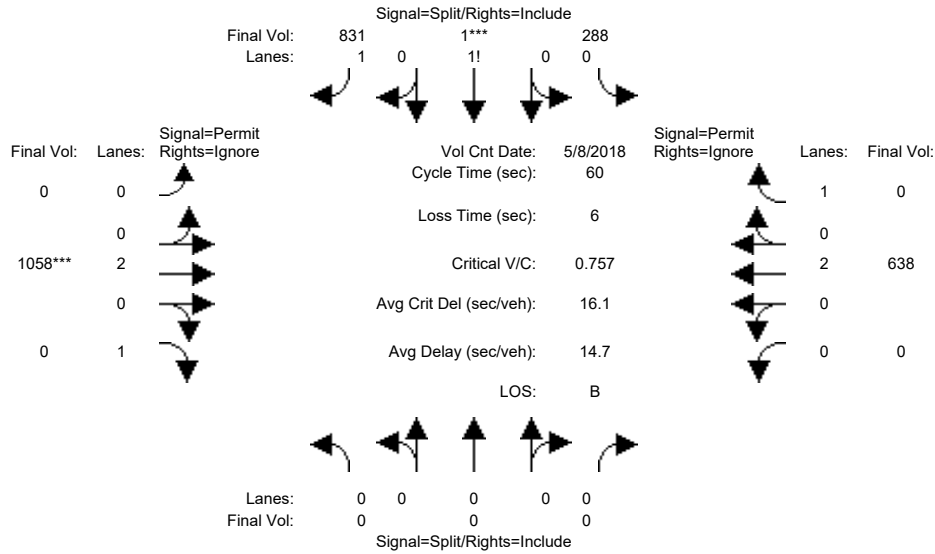

Street Name:	US 101 Southbound Ramps						Cochrane Road					
	North Bound			South Bound			East Bound			West Bound		
Movement:	L	T	R	L	T	R	L	T	R	L	T	R
Min. Green:	0	0	0	10	0	10	0	10	10	0	10	10
Y+R:	4.0	4.0	4.0	4.0	4.0	4.0	4.0	4.0	4.0	4.0	4.0	4.0

Volume Module:	>>	Count	Date:	8 May 2018	<<							
Base Vol:	0	0	0	265	1	831	0	1052	267	0	619	152
Growth Adj:	1.00	1.00	1.00	1.00	1.00	1.00	1.00	1.00	1.00	1.00	1.00	1.00
Initial Bse:	0	0	0	265	1	831	0	1052	267	0	619	152
Added Vol:	0	0	0	23	0	0	0	6	0	0	19	11
PasserByVol:	0	0	0	0	0	0	0	0	0	0	0	0
Initial Fut:	0	0	0	288	1	831	0	1058	267	0	638	163
User Adj:	1.00	1.00	1.00	1.00	1.00	1.00	1.00	1.00	0.00	1.00	1.00	0.00
PHF Adj:	1.00	1.00	1.00	1.00	1.00	1.00	1.00	1.00	0.00	1.00	1.00	0.00
PHF Volume:	0	0	0	288	1	831	0	1058	0	0	638	0
Reduct Vol:	0	0	0	0	0	0	0	0	0	0	0	0
Reduced Vol:	0	0	0	288	1	831	0	1058	0	0	638	0
PCE Adj:	1.00	1.00	1.00	1.00	1.00	1.00	1.00	1.00	0.00	1.00	1.00	0.00
MLF Adj:	1.00	1.00	1.00	1.00	1.00	1.00	1.00	1.00	0.00	1.00	1.00	0.00
FinalVolume:	0	0	0	288	1	831	0	1058	0	0	638	0

Saturation Flow Module:												
Sat/Lane:	1900	1900	1900	1900	1900	1900	1900	1900	1900	1900	1900	1900
Adjustment:	0.92	1.00	0.92	0.92	0.92	0.92	0.92	1.00	0.92	0.92	1.00	0.92
Lanes:	0.00	0.00	0.00	0.40	0.01	1.59	0.00	2.00	1.00	0.00	2.00	1.00
Final Sat.:	0	0	0	715	2	2782	0	3800	1750	0	3800	1750

Capacity Analysis Module:												
Vol/Sat:	0.00	0.00	0.00	0.40	0.40	0.30	0.00	0.28	0.00	0.00	0.17	0.00
Crit Moves:					****			****				
Green Time:	0.0	0.0	0.0	31.9	31.9	31.9	0.0	22.1	0.0	0.0	22.1	0.0
Volume/Cap:	0.00	0.00	0.00	0.76	0.76	0.56	0.00	0.76	0.00	0.00	0.46	0.00
Delay/Veh:	0.0	0.0	0.0	13.3	13.3	9.7	0.0	19.0	0.0	0.0	14.6	0.0
User DelAdj:	1.00	1.00	1.00	1.00	1.00	1.00	1.00	1.00	1.00	1.00	1.00	1.00
AdjDel/Veh:	0.0	0.0	0.0	13.3	13.3	9.7	0.0	19.0	0.0	0.0	14.6	0.0
LOS by Move:	A	A	A	B	B	A	A	B	A	A	B	A
HCM2k95thQ:	0	0	0	23	23	14	0	17	0	0	9	0

Note: Queue reported is the number of cars per lane.

City of Morgan Hill
The Crosswinds Residential Development

Level Of Service Computation Report
2000 HCM Operations (Future Volume Alternative)
Existing PM

Intersection #107: US 101 Southbound Ramps and Cochrane Road

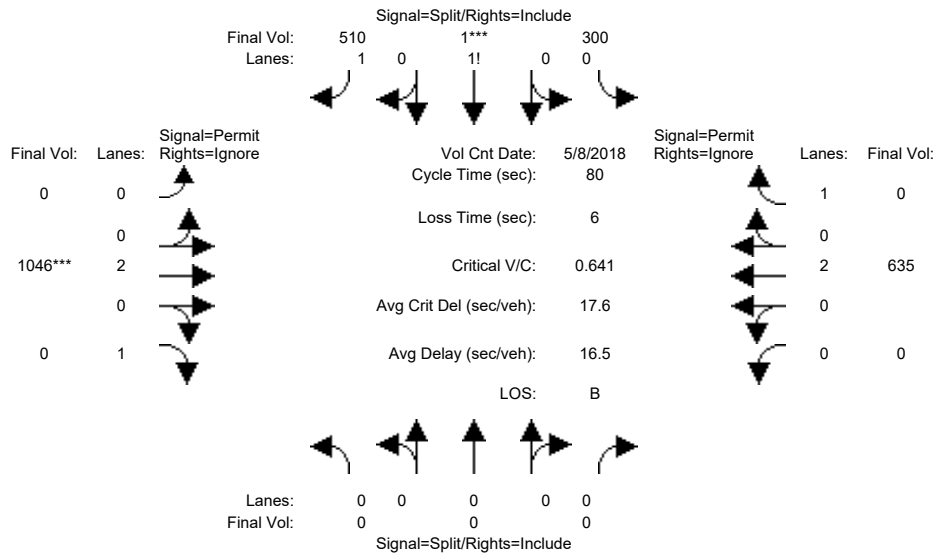

Street Name:	US 101 Southbound Ramps						Cochrane Road					
	North Bound			South Bound			East Bound			West Bound		
Movement:	L	T	R	L	T	R	L	T	R	L	T	R
Min. Green:	0	0	0	10	0	10	0	10	10	0	10	10
Y+R:	4.0	4.0	4.0	4.0	4.0	4.0	4.0	4.0	4.0	4.0	4.0	4.0

Volume Module:	>>	Count	Date:	8 May 2018	<<							
Base Vol:	0	0	0	300	1	510	0	1046	741	0	635	0
Growth Adj:	1.00	1.00	1.00	1.00	1.00	1.00	1.00	1.00	1.00	1.00	1.00	1.00
Initial Bse:	0	0	0	300	1	510	0	1046	741	0	635	0
Added Vol:	0	0	0	0	0	0	0	0	0	0	0	0
PasserByVol:	0	0	0	0	0	0	0	0	0	0	0	0
Initial Fut:	0	0	0	300	1	510	0	1046	741	0	635	0
User Adj:	1.00	1.00	1.00	1.00	1.00	1.00	1.00	1.00	0.00	1.00	1.00	0.00
PHF Adj:	1.00	1.00	1.00	1.00	1.00	1.00	1.00	1.00	0.00	1.00	1.00	0.00
PHF Volume:	0	0	0	300	1	510	0	1046	0	0	635	0
Reduct Vol:	0	0	0	0	0	0	0	0	0	0	0	0
Reduced Vol:	0	0	0	300	1	510	0	1046	0	0	635	0
PCE Adj:	1.00	1.00	1.00	1.00	1.00	1.00	1.00	1.00	0.00	1.00	1.00	0.00
MLF Adj:	1.00	1.00	1.00	1.00	1.00	1.00	1.00	1.00	0.00	1.00	1.00	0.00
FinalVolume:	0	0	0	300	1	510	0	1046	0	0	635	0

Saturation Flow Module:												
Sat/Lane:	1900	1900	1900	1900	1900	1900	1900	1900	1900	1900	1900	1900
Adjustment:	0.92	1.00	0.92	0.92	0.92	0.92	0.92	1.00	0.92	0.92	1.00	0.92
Lanes:	0.00	0.00	0.00	0.54	0.01	1.45	0.00	2.00	1.00	0.00	2.00	1.00
Final Sat.:	0	0	0	944	3	2553	0	3800	1750	0	3800	1750

Capacity Analysis Module:												
Vol/Sat:	0.00	0.00	0.00	0.32	0.32	0.20	0.00	0.28	0.00	0.00	0.17	0.00
Crit Moves:					****			****				
Green Time:	0.0	0.0	0.0	39.6	39.6	39.6	0.0	34.4	0.0	0.0	34.4	0.0
Volume/Cap:	0.00	0.00	0.00	0.64	0.64	0.40	0.00	0.64	0.00	0.00	0.39	0.00
Delay/Veh:	0.0	0.0	0.0	16.0	16.0	12.9	0.0	18.8	0.0	0.0	15.8	0.0
User DelAdj:	1.00	1.00	1.00	1.00	1.00	1.00	1.00	1.00	1.00	1.00	1.00	1.00
AdjDel/Veh:	0.0	0.0	0.0	16.0	16.0	12.9	0.0	18.8	0.0	0.0	15.8	0.0
LOS by Move:	A	A	A	B	B	B	A	B	A	A	B	A
HCM2k95thQ:	0	0	0	21	21	12	0	18	0	0	10	0

Note: Queue reported is the number of cars per lane.

City of Morgan Hill
The Crosswinds Residential Development

Level Of Service Computation Report
2000 HCM Operations (Future Volume Alternative)
Existing Plus Project PM

Intersection #107: US 101 Southbound Ramps and Cochrane Road

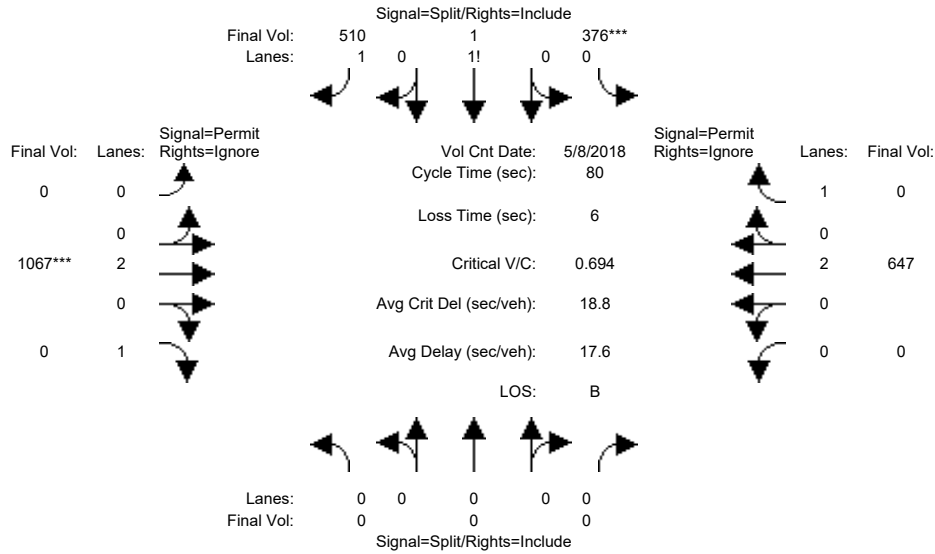

Street Name:	US 101 Southbound Ramps						Cochrane Road					
	North Bound			South Bound			East Bound			West Bound		
Movement:	L	T	R	L	T	R	L	T	R	L	T	R
Min. Green:	0	0	0	10	0	10	0	10	10	0	10	10
Y+R:	4.0	4.0	4.0	4.0	4.0	4.0	4.0	4.0	4.0	4.0	4.0	4.0

Volume Module:	>>	Count	Date:	8 May 2018	<<							
Base Vol:	0	0	0	300	1	510	0	1046	741	0	635	0
Growth Adj:	1.00	1.00	1.00	1.00	1.00	1.00	1.00	1.00	1.00	1.00	1.00	1.00
Initial Bse:	0	0	0	300	1	510	0	1046	741	0	635	0
Added Vol:	0	0	0	76	0	0	0	21	0	0	12	7
PasserByVol:	0	0	0	0	0	0	0	0	0	0	0	0
Initial Fut:	0	0	0	376	1	510	0	1067	741	0	647	7
User Adj:	1.00	1.00	1.00	1.00	1.00	1.00	1.00	1.00	0.00	1.00	1.00	0.00
PHF Adj:	1.00	1.00	1.00	1.00	1.00	1.00	1.00	1.00	0.00	1.00	1.00	0.00
PHF Volume:	0	0	0	376	1	510	0	1067	0	0	647	0
Reduct Vol:	0	0	0	0	0	0	0	0	0	0	0	0
Reduced Vol:	0	0	0	376	1	510	0	1067	0	0	647	0
PCE Adj:	1.00	1.00	1.00	1.00	1.00	1.00	1.00	1.00	0.00	1.00	1.00	0.00
MLF Adj:	1.00	1.00	1.00	1.00	1.00	1.00	1.00	1.00	0.00	1.00	1.00	0.00
Final Volume:	0	0	0	376	1	510	0	1067	0	0	647	0

Saturation Flow Module:												
Sat/Lane:	1900	1900	1900	1900	1900	1900	1900	1900	1900	1900	1900	1900
Adjustment:	0.92	1.00	0.92	0.92	0.92	0.92	0.92	1.00	0.92	0.92	1.00	0.92
Lanes:	0.00	0.00	0.00	0.59	0.01	1.40	0.00	2.00	1.00	0.00	2.00	1.00
Final Sat.:	0	0	0	1041	3	2456	0	3800	1750	0	3800	1750

Capacity Analysis Module:													
Vol/Sat:	0.00	0.00	0.00	0.36	0.36	0.21	0.00	0.28	0.00	0.00	0.17	0.00	
Crit Moves:				****							****		
Green Time:	0.0	0.0	0.0	41.6	41.6	41.6	0.0	32.4	0.0	0.0	32.4	0.0	
Volume/Cap:	0.00	0.00	0.00	0.69	0.69	0.40	0.00	0.69	0.00	0.00	0.42	0.00	
Delay/Veh:	0.0	0.0	0.0	16.1	16.1	11.7	0.0	21.1	0.0	0.0	17.3	0.0	
User DelAdj:	1.00	1.00	1.00	1.00	1.00	1.00	1.00	1.00	1.00	1.00	1.00	1.00	
AdjDel/Veh:	0.0	0.0	0.0	16.1	16.1	11.7	0.0	21.1	0.0	0.0	17.3	0.0	
LOS by Move:	A	A	A	B	B	B	A	C	A	A	B	A	
HCM2k95thQ:	0	0	0	24	24	12	0	20	0	0	11	0	

Note: Queue reported is the number of cars per lane.

City of Morgan Hill
The Crosswinds Residential Development

Level Of Service Computation Report
2000 HCM Operations (Future Volume Alternative)
Year 2030 Cumulative without Project PM

Intersection #107: US 101 Southbound Ramps and Cochrane Road

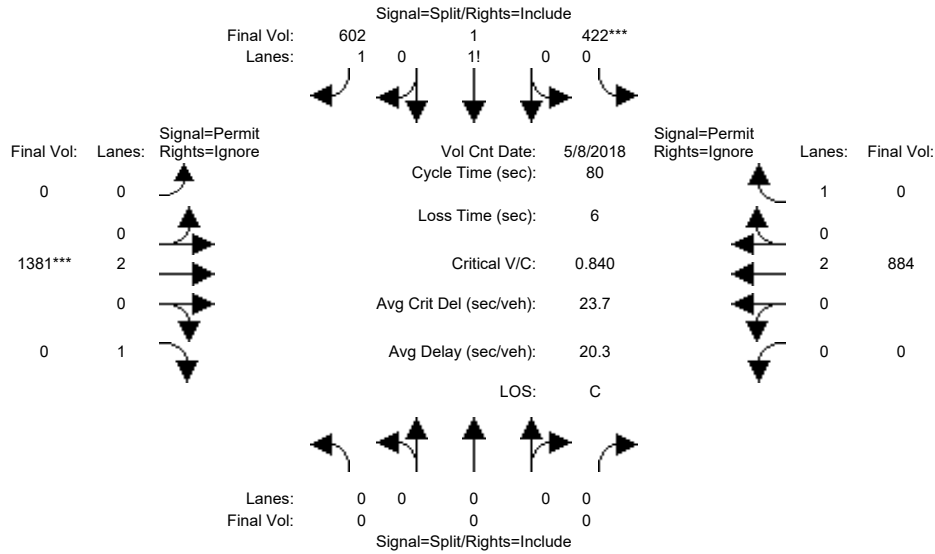

Street Name:	US 101 Southbound Ramps						Cochrane Road					
	North Bound			South Bound			East Bound			West Bound		
Movement:	L	T	R	L	T	R	L	T	R	L	T	R
Min. Green:	0	0	0	10	0	10	0	10	10	0	10	10
Y+R:	4.0	4.0	4.0	4.0	4.0	4.0	4.0	4.0	4.0	4.0	4.0	4.0

Volume Module:	>>	Count	Date:	8 May 2018	<<							
Base Vol:	0	0	0	422	1	602	0	1381	741	0	884	157
Growth Adj:	1.00	1.00	1.00	1.00	1.00	1.00	1.00	1.00	1.00	1.00	1.00	1.00
Initial Bse:	0	0	0	422	1	602	0	1381	741	0	884	157
Added Vol:	0	0	0	0	0	0	0	0	0	0	0	0
PasserByVol:	0	0	0	0	0	0	0	0	0	0	0	0
Initial Fut:	0	0	0	422	1	602	0	1381	741	0	884	157
User Adj:	1.00	1.00	1.00	1.00	1.00	1.00	1.00	1.00	0.00	1.00	1.00	0.00
PHF Adj:	1.00	1.00	1.00	1.00	1.00	1.00	1.00	1.00	0.00	1.00	1.00	0.00
PHF Volume:	0	0	0	422	1	602	0	1381	0	0	884	0
Reduct Vol:	0	0	0	0	0	0	0	0	0	0	0	0
Reduced Vol:	0	0	0	422	1	602	0	1381	0	0	884	0
PCE Adj:	1.00	1.00	1.00	1.00	1.00	1.00	1.00	1.00	0.00	1.00	1.00	0.00
MLF Adj:	1.00	1.00	1.00	1.00	1.00	1.00	1.00	1.00	0.00	1.00	1.00	0.00
Final Volume:	0	0	0	422	1	602	0	1381	0	0	884	0

Saturation Flow Module:												
Sat/Lane:	1900	1900	1900	1900	1900	1900	1900	1900	1900	1900	1900	1900
Adjustment:	0.92	1.00	0.92	0.92	0.92	0.92	0.92	1.00	0.92	0.92	1.00	0.92
Lanes:	0.00	0.00	0.00	0.58	0.01	1.41	0.00	2.00	1.00	0.00	2.00	1.00
Final Sat.:	0	0	0	1020	2	2478	0	3800	1750	0	3800	1750

Capacity Analysis Module:												
Vol/Sat:	0.00	0.00	0.00	0.41	0.41	0.24	0.00	0.36	0.00	0.00	0.23	0.00
Crit Moves:				****			****					
Green Time:	0.0	0.0	0.0	39.4	39.4	39.4	0.0	34.6	0.0	0.0	34.6	0.0
Volume/Cap:	0.00	0.00	0.00	0.84	0.84	0.49	0.00	0.84	0.00	0.00	0.54	0.00
Delay/Veh:	0.0	0.0	0.0	22.9	22.9	13.8	0.0	24.3	0.0	0.0	17.1	0.0
User DelAdj:	1.00	1.00	1.00	1.00	1.00	1.00	1.00	1.00	1.00	1.00	1.00	1.00
AdjDel/Veh:	0.0	0.0	0.0	22.9	22.9	13.8	0.0	24.3	0.0	0.0	17.1	0.0
LOS by Move:	A	A	A	C	C	B	A	C	A	A	B	A
HCM2k95thQ:	0	0	0	33	33	15	0	27	0	0	15	0

Note: Queue reported is the number of cars per lane.

City of Morgan Hill
The Crosswinds Residential Development

Level Of Service Computation Report
2000 HCM Operations (Future Volume Alternative)
Year 2030 Cumulative with Project PM

Intersection #107: US 101 Southbound Ramps and Cochrane Road

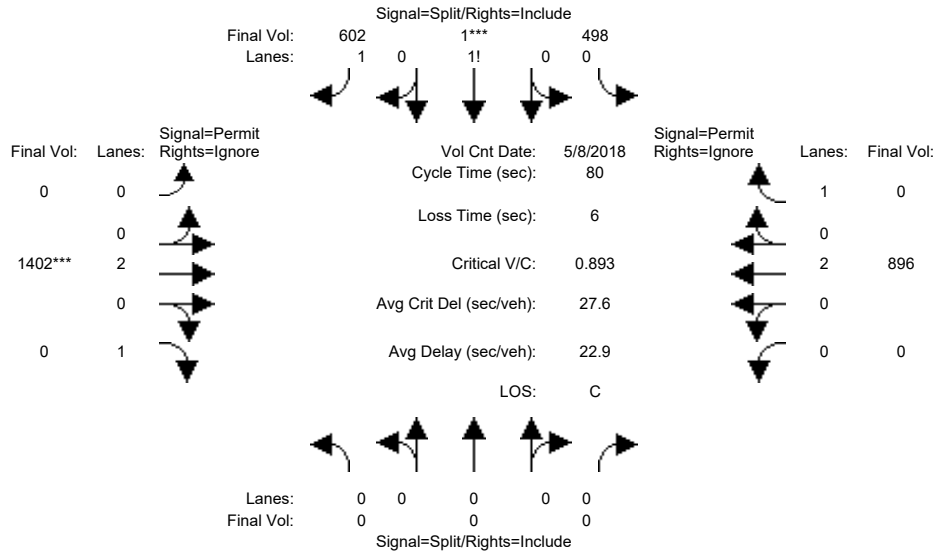

Street Name:	US 101 Southbound Ramps						Cochrane Road					
	North Bound			South Bound			East Bound			West Bound		
Movement:	L	T	R	L	T	R	L	T	R	L	T	R
Min. Green:	0	0	0	10	0	10	0	10	10	0	10	10
Y+R:	4.0	4.0	4.0	4.0	4.0	4.0	4.0	4.0	4.0	4.0	4.0	4.0

Volume Module:	>>	Count	Date:	8 May 2018	<<							
Base Vol:	0	0	0	422	1	602	0	1381	741	0	884	157
Growth Adj:	1.00	1.00	1.00	1.00	1.00	1.00	1.00	1.00	1.00	1.00	1.00	1.00
Initial Bse:	0	0	0	422	1	602	0	1381	741	0	884	157
Added Vol:	0	0	0	76	0	0	0	21	0	0	12	7
PasserByVol:	0	0	0	0	0	0	0	0	0	0	0	0
Initial Fut:	0	0	0	498	1	602	0	1402	741	0	896	164
User Adj:	1.00	1.00	1.00	1.00	1.00	1.00	1.00	1.00	0.00	1.00	1.00	0.00
PHF Adj:	1.00	1.00	1.00	1.00	1.00	1.00	1.00	1.00	0.00	1.00	1.00	0.00
PHF Volume:	0	0	0	498	1	602	0	1402	0	0	896	0
Reduct Vol:	0	0	0	0	0	0	0	0	0	0	0	0
Reduced Vol:	0	0	0	498	1	602	0	1402	0	0	896	0
PCE Adj:	1.00	1.00	1.00	1.00	1.00	1.00	1.00	1.00	0.00	1.00	1.00	0.00
MLF Adj:	1.00	1.00	1.00	1.00	1.00	1.00	1.00	1.00	0.00	1.00	1.00	0.00
Final Volume:	0	0	0	498	1	602	0	1402	0	0	896	0

Saturation Flow Module:												
Sat/Lane:	1900	1900	1900	1900	1900	1900	1900	1900	1900	1900	1900	1900
Adjustment:	0.92	1.00	0.92	0.92	0.92	0.92	0.92	1.00	0.92	0.92	1.00	0.92
Lanes:	0.00	0.00	0.00	0.62	0.01	1.37	0.00	2.00	1.00	0.00	2.00	1.00
Final Sat.:	0	0	0	1089	2	2408	0	3800	1750	0	3800	1750

Capacity Analysis Module:												
Vol/Sat:	0.00	0.00	0.00	0.46	0.46	0.25	0.00	0.37	0.00	0.00	0.24	0.00
Crit Moves:					****			****				
Green Time:	0.0	0.0	0.0	41.0	41.0	41.0	0.0	33.0	0.0	0.0	33.0	0.0
Volume/Cap:	0.00	0.00	0.00	0.89	0.89	0.49	0.00	0.89	0.00	0.00	0.57	0.00
Delay/Veh:	0.0	0.0	0.0	26.1	26.1	12.9	0.0	28.8	0.0	0.0	18.5	0.0
User DelAdj:	1.00	1.00	1.00	1.00	1.00	1.00	1.00	1.00	1.00	1.00	1.00	1.00
AdjDel/Veh:	0.0	0.0	0.0	26.1	26.1	12.9	0.0	28.8	0.0	0.0	18.5	0.0
LOS by Move:	A	A	A	C	C	B	A	C	A	A	B	A
HCM2k95thQ:	0	0	0	39	39	15	0	30	0	0	16	0

Note: Queue reported is the number of cars per lane.

City of Morgan Hill
The Crosswinds Residential Development

Level Of Service Computation Report
2000 HCM Operations (Future Volume Alternative)
Existing AM

Intersection #108: US 101 Northbound Ramps and Cochrane Road

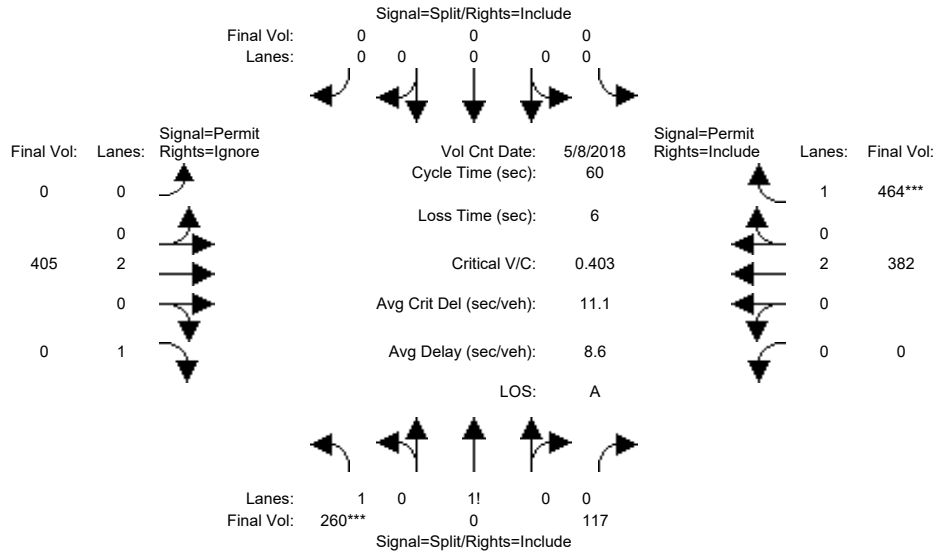

Street Name:	US 101 Northbound Ramps						Cochrane Road					
	North Bound			South Bound			East Bound			West Bound		
Movement:	L	T	R	L	T	R	L	T	R	L	T	R
Min. Green:	10	0	10	0	0	0	0	10	10	0	10	10
Y+R:	4.0	4.0	4.0	4.0	4.0	4.0	4.0	4.0	4.0	4.0	4.0	4.0

Volume Module:	>>	Count	Date:	8 May 2018	<<							
Base Vol:	260	0	117	0	0	0	0	405	0	0	382	464
Growth Adj:	1.00	1.00	1.00	1.00	1.00	1.00	1.00	1.00	1.00	1.00	1.00	1.00
Initial Bse:	260	0	117	0	0	0	0	405	0	0	382	464
Added Vol:	0	0	0	0	0	0	0	0	0	0	0	0
PasserByVol:	0	0	0	0	0	0	0	0	0	0	0	0
Initial Fut:	260	0	117	0	0	0	0	405	0	0	382	464
User Adj:	1.00	1.00	1.00	1.00	1.00	1.00	1.00	1.00	0.00	1.00	1.00	1.00
PHF Adj:	1.00	1.00	1.00	1.00	1.00	1.00	1.00	1.00	0.00	1.00	1.00	1.00
PHF Volume:	260	0	117	0	0	0	0	405	0	0	382	464
Reduct Vol:	0	0	0	0	0	0	0	0	0	0	0	0
Reduced Vol:	260	0	117	0	0	0	0	405	0	0	382	464
PCE Adj:	1.00	1.00	1.00	1.00	1.00	1.00	1.00	1.00	0.00	1.00	1.00	1.00
MLF Adj:	1.00	1.00	1.00	1.00	1.00	1.00	1.00	1.00	0.00	1.00	1.00	1.00
FinalVolume:	260	0	117	0	0	0	0	405	0	0	382	464

Saturation Flow Module:												
Sat/Lane:	1900	1900	1900	1900	1900	1900	1900	1900	1900	1900	1900	1900
Adjustment:	0.92	1.00	0.92	0.92	1.00	0.92	0.92	1.00	0.92	0.92	1.00	0.92
Lanes:	1.53	0.00	0.47	0.00	0.00	0.00	0.00	2.00	1.00	0.00	2.00	1.00
Final Sat.:	2671	0	829	0	0	0	0	3800	1750	0	3800	1750

Capacity Analysis Module:												
Vol/Sat:	0.10	0.00	0.14	0.00	0.00	0.00	0.00	0.11	0.00	0.00	0.10	0.27
Crit Moves:	****											****
Green Time:	18.8	0.0	18.8	0.0	0.0	0.0	0.0	35.2	0.0	0.0	35.2	35.2
Volume/Cap:	0.31	0.00	0.45	0.00	0.00	0.00	0.00	0.18	0.00	0.00	0.17	0.45
Delay/Veh:	15.8	0.0	16.9	0.0	0.0	0.0	0.0	5.8	0.0	0.0	5.7	7.3
User DelAdj:	1.00	1.00	1.00	1.00	1.00	1.00	1.00	1.00	1.00	1.00	1.00	1.00
AdjDel/Veh:	15.8	0.0	16.9	0.0	0.0	0.0	0.0	5.8	0.0	0.0	5.7	7.3
LOS by Move:	B	A	B	A	A	A	A	A	A	A	A	A
HCM2k95thQ:	6	0	9	0	0	0	0	3	0	0	3	11

Note: Queue reported is the number of cars per lane.

City of Morgan Hill
The Crosswinds Residential Development

Level Of Service Computation Report
2000 HCM Operations (Future Volume Alternative)
Existing Plus Project AM

Intersection #108: US 101 Northbound Ramps and Cochrane Road

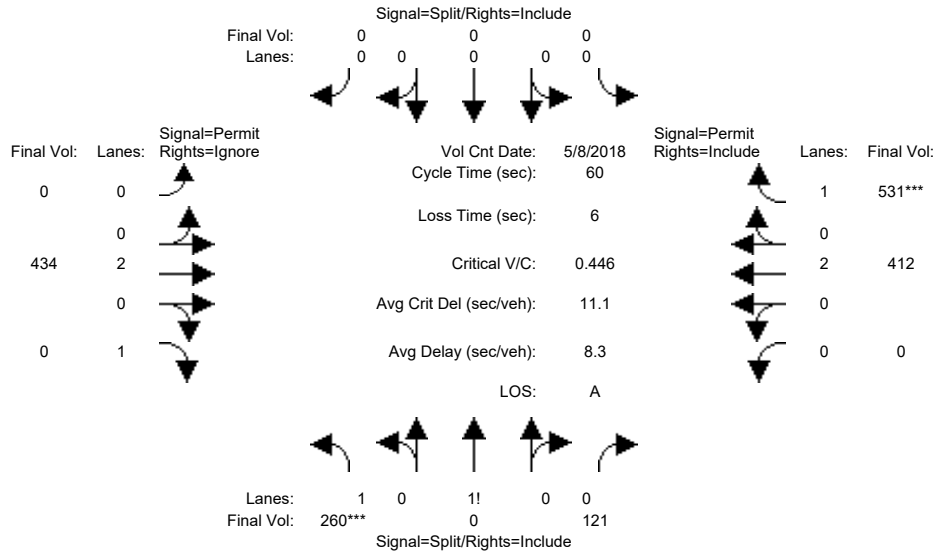

Street Name:	US 101 Northbound Ramps						Cochrane Road					
	North Bound			South Bound			East Bound			West Bound		
Movement:	L	T	R	L	T	R	L	T	R	L	T	R
Min. Green:	10	0	10	0	0	0	0	10	10	0	10	10
Y+R:	4.0	4.0	4.0	4.0	4.0	4.0	4.0	4.0	4.0	4.0	4.0	4.0

Volume Module:	>>	Count	Date:	8 May 2018	<<							
Base Vol:	260	0	117	0	0	0	0	405	0	0	382	464
Growth Adj:	1.00	1.00	1.00	1.00	1.00	1.00	1.00	1.00	1.00	1.00	1.00	1.00
Initial Bse:	260	0	117	0	0	0	0	405	0	0	382	464
Added Vol:	0	0	4	0	0	0	0	29	0	0	30	67
PasserByVol:	0	0	0	0	0	0	0	0	0	0	0	0
Initial Fut:	260	0	121	0	0	0	0	434	0	0	412	531
User Adj:	1.00	1.00	1.00	1.00	1.00	1.00	1.00	1.00	0.00	1.00	1.00	1.00
PHF Adj:	1.00	1.00	1.00	1.00	1.00	1.00	1.00	1.00	0.00	1.00	1.00	1.00
PHF Volume:	260	0	121	0	0	0	0	434	0	0	412	531
Reduct Vol:	0	0	0	0	0	0	0	0	0	0	0	0
Reduced Vol:	260	0	121	0	0	0	0	434	0	0	412	531
PCE Adj:	1.00	1.00	1.00	1.00	1.00	1.00	1.00	1.00	0.00	1.00	1.00	1.00
MLF Adj:	1.00	1.00	1.00	1.00	1.00	1.00	1.00	1.00	0.00	1.00	1.00	1.00
FinalVolume:	260	0	121	0	0	0	0	434	0	0	412	531

Saturation Flow Module:												
Sat/Lane:	1900	1900	1900	1900	1900	1900	1900	1900	1900	1900	1900	1900
Adjustment:	0.92	1.00	0.92	0.92	1.00	0.92	0.92	1.00	0.92	0.92	1.00	0.92
Lanes:	1.52	0.00	0.48	0.00	0.00	0.00	0.00	2.00	1.00	0.00	2.00	1.00
Final Sat.:	2656	0	844	0	0	0	0	3800	1750	0	3800	1750

Capacity Analysis Module:												
Vol/Sat:	0.10	0.00	0.14	0.00	0.00	0.00	0.00	0.11	0.00	0.00	0.11	0.30
Crit Moves:	****											****
Green Time:	17.3	0.0	17.3	0.0	0.0	0.0	0.0	36.7	0.0	0.0	36.7	36.7
Volume/Cap:	0.34	0.00	0.50	0.00	0.00	0.00	0.00	0.19	0.00	0.00	0.18	0.50
Delay/Veh:	17.0	0.0	18.2	0.0	0.0	0.0	0.0	5.2	0.0	0.0	5.1	6.9
User DelAdj:	1.00	1.00	1.00	1.00	1.00	1.00	1.00	1.00	1.00	1.00	1.00	1.00
AdjDel/Veh:	17.0	0.0	18.2	0.0	0.0	0.0	0.0	5.2	0.0	0.0	5.1	6.9
LOS by Move:	B	A	B	A	A	A	A	A	A	A	A	A
HCM2k95thQ:	6	0	9	0	0	0	0	3	0	0	4	12

Note: Queue reported is the number of cars per lane.

City of Morgan Hill
The Crosswinds Residential Development

Level Of Service Computation Report
2000 HCM Operations (Future Volume Alternative)
Year 2030 Cumulative without Project AM

Intersection #108: US 101 Northbound Ramps and Cochrane Road

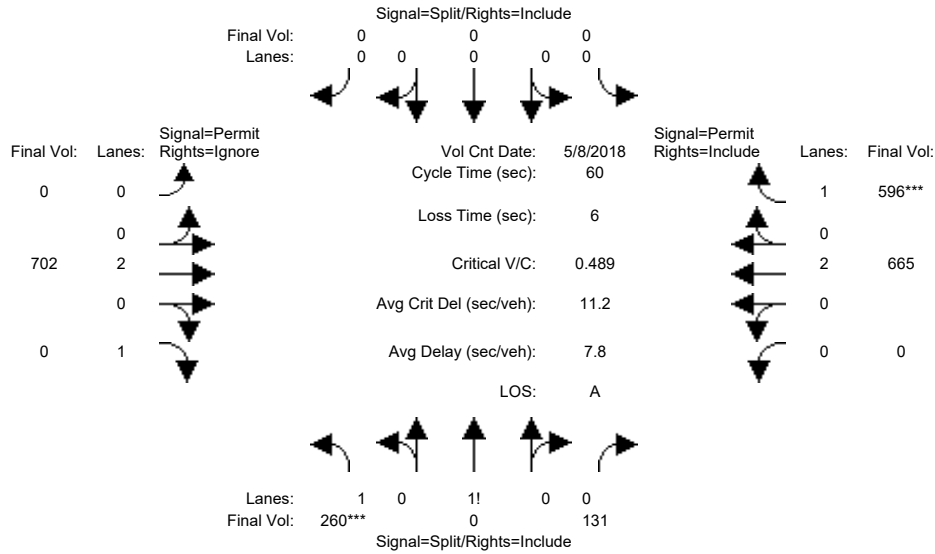

Street Name:	US 101 Northbound Ramps						Cochrane Road					
	North Bound			South Bound			East Bound			West Bound		
Movement:	L	T	R	L	T	R	L	T	R	L	T	R
Min. Green:	10	0	10	0	0	0	0	10	10	0	10	10
Y+R:	4.0	4.0	4.0	4.0	4.0	4.0	4.0	4.0	4.0	4.0	4.0	4.0

Volume Module:	>>	Count	Date:	8 May 2018	<<							
Base Vol:	260	0	131	0	0	0	0	702	0	0	665	596
Growth Adj:	1.00	1.00	1.00	1.00	1.00	1.00	1.00	1.00	1.00	1.00	1.00	1.00
Initial Bse:	260	0	131	0	0	0	0	702	0	0	665	596
Added Vol:	0	0	0	0	0	0	0	0	0	0	0	0
PasserByVol:	0	0	0	0	0	0	0	0	0	0	0	0
Initial Fut:	260	0	131	0	0	0	0	702	0	0	665	596
User Adj:	1.00	1.00	1.00	1.00	1.00	1.00	1.00	1.00	0.00	1.00	1.00	1.00
PHF Adj:	1.00	1.00	1.00	1.00	1.00	1.00	1.00	1.00	0.00	1.00	1.00	1.00
PHF Volume:	260	0	131	0	0	0	0	702	0	0	665	596
Reduct Vol:	0	0	0	0	0	0	0	0	0	0	0	0
Reduced Vol:	260	0	131	0	0	0	0	702	0	0	665	596
PCE Adj:	1.00	1.00	1.00	1.00	1.00	1.00	1.00	1.00	0.00	1.00	1.00	1.00
MLF Adj:	1.00	1.00	1.00	1.00	1.00	1.00	1.00	1.00	0.00	1.00	1.00	1.00
FinalVolume:	260	0	131	0	0	0	0	702	0	0	665	596

Saturation Flow Module:												
Sat/Lane:	1900	1900	1900	1900	1900	1900	1900	1900	1900	1900	1900	1900
Adjustment:	0.92	1.00	0.92	0.92	1.00	0.92	0.92	1.00	0.92	0.92	1.00	0.92
Lanes:	1.50	0.00	0.50	0.00	0.00	0.00	0.00	2.00	1.00	0.00	2.00	1.00
Final Sat.:	2622	0	878	0	0	0	0	3800	1750	0	3800	1750

Capacity Analysis Module:												
Vol/Sat:	0.10	0.00	0.15	0.00	0.00	0.00	0.00	0.18	0.00	0.00	0.17	0.34
Crit Moves:	****											****
Green Time:	16.4	0.0	16.4	0.0	0.0	0.0	0.0	37.6	0.0	0.0	37.6	37.6
Volume/Cap:	0.36	0.00	0.54	0.00	0.00	0.00	0.00	0.30	0.00	0.00	0.28	0.54
Delay/Veh:	17.8	0.0	19.4	0.0	0.0	0.0	0.0	5.2	0.0	0.0	5.2	6.9
User DelAdj:	1.00	1.00	1.00	1.00	1.00	1.00	1.00	1.00	1.00	1.00	1.00	1.00
AdjDel/Veh:	17.8	0.0	19.4	0.0	0.0	0.0	0.0	5.2	0.0	0.0	5.2	6.9
LOS by Move:	B	A	B	A	A	A	A	A	A	A	A	A
HCM2k95thQ:	6	0	10	0	0	0	0	6	0	0	6	14

Note: Queue reported is the number of cars per lane.

City of Morgan Hill
The Crosswinds Residential Development

Level Of Service Computation Report
2000 HCM Operations (Future Volume Alternative)
Year 2030 Cumulative with Project AM

Intersection #108: US 101 Northbound Ramps and Cochrane Road

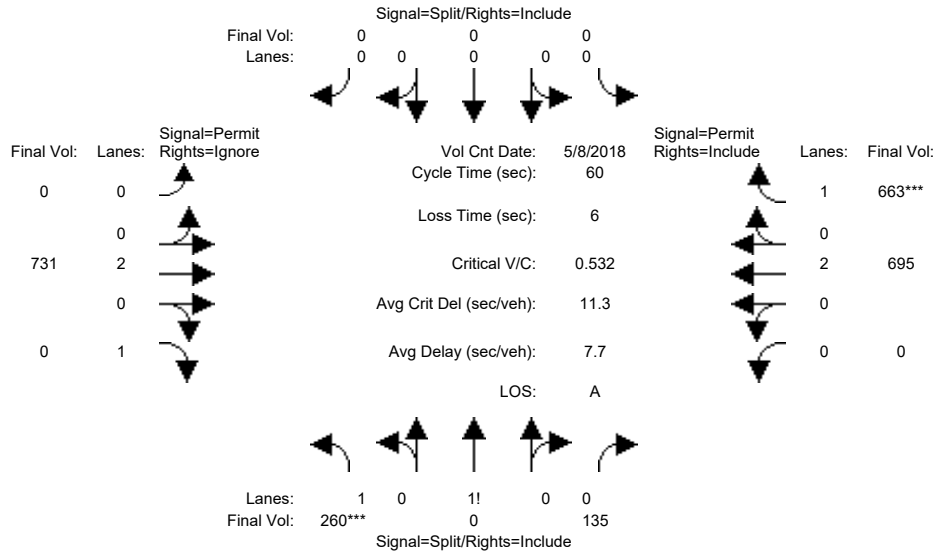

Street Name:	US 101 Northbound Ramps						Cochrane Road					
	North Bound			South Bound			East Bound			West Bound		
Movement:	L	T	R	L	T	R	L	T	R	L	T	R
Min. Green:	10	0	10	0	0	0	0	10	10	0	10	10
Y+R:	4.0	4.0	4.0	4.0	4.0	4.0	4.0	4.0	4.0	4.0	4.0	4.0

Volume Module:	>>	Count	Date:	8 May 2018	<<							
Base Vol:	260	0	131	0	0	0	0	702	0	0	665	596
Growth Adj:	1.00	1.00	1.00	1.00	1.00	1.00	1.00	1.00	1.00	1.00	1.00	1.00
Initial Bse:	260	0	131	0	0	0	0	702	0	0	665	596
Added Vol:	0	0	4	0	0	0	0	29	0	0	30	67
PasserByVol:	0	0	0	0	0	0	0	0	0	0	0	0
Initial Fut:	260	0	135	0	0	0	0	731	0	0	695	663
User Adj:	1.00	1.00	1.00	1.00	1.00	1.00	1.00	1.00	0.00	1.00	1.00	1.00
PHF Adj:	1.00	1.00	1.00	1.00	1.00	1.00	1.00	1.00	0.00	1.00	1.00	1.00
PHF Volume:	260	0	135	0	0	0	0	731	0	0	695	663
Reduct Vol:	0	0	0	0	0	0	0	0	0	0	0	0
Reduced Vol:	260	0	135	0	0	0	0	731	0	0	695	663
PCE Adj:	1.00	1.00	1.00	1.00	1.00	1.00	1.00	1.00	0.00	1.00	1.00	1.00
MLF Adj:	1.00	1.00	1.00	1.00	1.00	1.00	1.00	1.00	0.00	1.00	1.00	1.00
Final Volume:	260	0	135	0	0	0	0	731	0	0	695	663

Saturation Flow Module:												
Sat/Lane:	1900	1900	1900	1900	1900	1900	1900	1900	1900	1900	1900	1900
Adjustment:	0.92	1.00	0.92	0.92	1.00	0.92	0.92	1.00	0.92	0.92	1.00	0.92
Lanes:	1.49	0.00	0.51	0.00	0.00	0.00	0.00	2.00	1.00	0.00	2.00	1.00
Final Sat.:	2608	0	892	0	0	0	0	3800	1750	0	3800	1750

Capacity Analysis Module:												
Vol/Sat:	0.10	0.00	0.15	0.00	0.00	0.00	0.00	0.19	0.00	0.00	0.18	0.38
Crit Moves:	****											****
Green Time:	15.4	0.0	15.4	0.0	0.0	0.0	0.0	38.6	0.0	0.0	38.6	38.6
Volume/Cap:	0.39	0.00	0.59	0.00	0.00	0.00	0.00	0.30	0.00	0.00	0.28	0.59
Delay/Veh:	18.6	0.0	20.9	0.0	0.0	0.0	0.0	4.8	0.0	0.0	4.7	7.0
User DelAdj:	1.00	1.00	1.00	1.00	1.00	1.00	1.00	1.00	1.00	1.00	1.00	1.00
AdjDel/Veh:	18.6	0.0	20.9	0.0	0.0	0.0	0.0	4.8	0.0	0.0	4.7	7.0
LOS by Move:	B	A	C	A	A	A	A	A	A	A	A	A
HCM2k95thQ:	6	0	11	0	0	0	0	6	0	0	6	16

Note: Queue reported is the number of cars per lane.

City of Morgan Hill
The Crosswinds Residential Development

Level Of Service Computation Report
2000 HCM Operations (Future Volume Alternative)
Existing PM

Intersection #108: US 101 Northbound Ramps and Cochrane Road

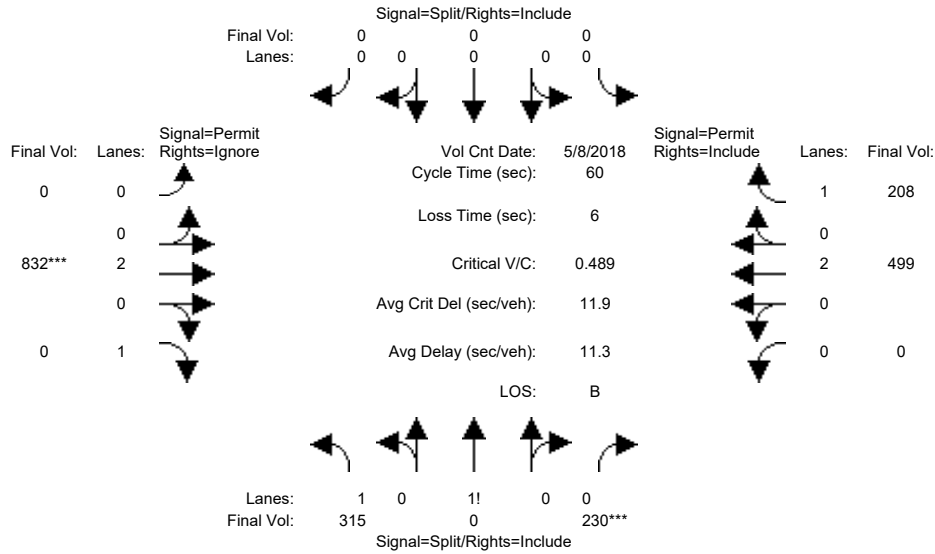

Street Name:	US 101 Northbound Ramps						Cochrane Road					
	North Bound			South Bound			East Bound			West Bound		
Movement:	L	T	R	L	T	R	L	T	R	L	T	R
Min. Green:	10	0	10	0	0	0	0	10	10	0	10	10
Y+R:	4.0	4.0	4.0	4.0	4.0	4.0	4.0	4.0	4.0	4.0	4.0	4.0

Volume Module:	>>	Count	Date:	8 May 2018	<<							
Base Vol:	315	0	230	0	0	0	0	832	0	0	499	208
Growth Adj:	1.00	1.00	1.00	1.00	1.00	1.00	1.00	1.00	1.00	1.00	1.00	1.00
Initial Bse:	315	0	230	0	0	0	0	832	0	0	499	208
Added Vol:	0	0	0	0	0	0	0	0	0	0	0	0
PasserByVol:	0	0	0	0	0	0	0	0	0	0	0	0
Initial Fut:	315	0	230	0	0	0	0	832	0	0	499	208
User Adj:	1.00	1.00	1.00	1.00	1.00	1.00	1.00	1.00	0.00	1.00	1.00	1.00
PHF Adj:	1.00	1.00	1.00	1.00	1.00	1.00	1.00	1.00	0.00	1.00	1.00	1.00
PHF Volume:	315	0	230	0	0	0	0	832	0	0	499	208
Reduct Vol:	0	0	0	0	0	0	0	0	0	0	0	0
Reduced Vol:	315	0	230	0	0	0	0	832	0	0	499	208
PCE Adj:	1.00	1.00	1.00	1.00	1.00	1.00	1.00	1.00	0.00	1.00	1.00	1.00
MLF Adj:	1.00	1.00	1.00	1.00	1.00	1.00	1.00	1.00	0.00	1.00	1.00	1.00
FinalVolume:	315	0	230	0	0	0	0	832	0	0	499	208

Saturation Flow Module:												
Sat/Lane:	1900	1900	1900	1900	1900	1900	1900	1900	1900	1900	1900	1900
Adjustment:	0.92	1.00	0.92	0.92	1.00	0.92	0.92	1.00	0.92	0.92	1.00	0.92
Lanes:	1.41	0.00	0.59	0.00	0.00	0.00	0.00	2.00	1.00	0.00	2.00	1.00
Final Sat.:	2461	0	1039	0	0	0	0	3800	1750	0	3800	1750

Capacity Analysis Module:												
Vol/Sat:	0.13	0.00	0.22	0.00	0.00	0.00	0.00	0.22	0.00	0.00	0.13	0.12
Crit Moves:	****									****		
Green Time:	27.2	0.0	27.2	0.0	0.0	0.0	0.0	26.8	0.0	0.0	26.8	26.8
Volume/Cap:	0.28	0.00	0.49	0.00	0.00	0.00	0.00	0.49	0.00	0.00	0.29	0.27
Delay/Veh:	10.4	0.0	11.9	0.0	0.0	0.0	0.0	11.9	0.0	0.0	10.6	10.6
User DelAdj:	1.00	1.00	1.00	1.00	1.00	1.00	1.00	1.00	1.00	1.00	1.00	1.00
AdjDel/Veh:	10.4	0.0	11.9	0.0	0.0	0.0	0.0	11.9	0.0	0.0	10.6	10.6
LOS by Move:	B	A	B	A	A	A	A	B	A	A	B	B
HCM2k95thQ:	6	0	11	0	0	0	0	10	0	0	6	5

Note: Queue reported is the number of cars per lane.

City of Morgan Hill
The Crosswinds Residential Development

Level Of Service Computation Report
2000 HCM Operations (Future Volume Alternative)
Existing Plus Project PM

Intersection #108: US 101 Northbound Ramps and Cochrane Road

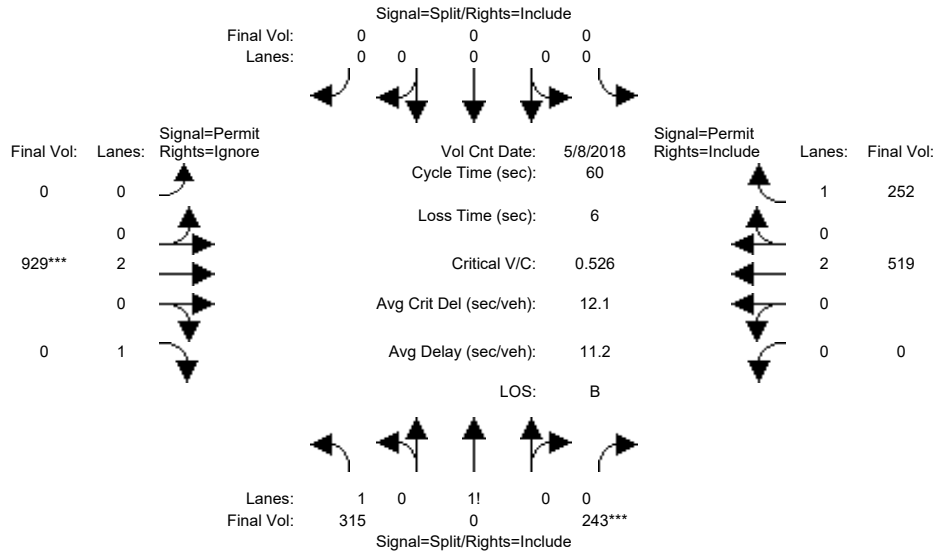

Street Name:	US 101 Northbound Ramps						Cochrane Road					
	North Bound			South Bound			East Bound			West Bound		
Movement:	L	T	R	L	T	R	L	T	R	L	T	R
Min. Green:	10	0	10	0	0	0	0	10	10	0	10	10
Y+R:	4.0	4.0	4.0	4.0	4.0	4.0	4.0	4.0	4.0	4.0	4.0	4.0

Volume Module:	>>	Count	Date:	8 May 2018	<<							
Base Vol:	315	0	230	0	0	0	0	832	0	0	499	208
Growth Adj:	1.00	1.00	1.00	1.00	1.00	1.00	1.00	1.00	1.00	1.00	1.00	1.00
Initial Bse:	315	0	230	0	0	0	0	832	0	0	499	208
Added Vol:	0	0	13	0	0	0	0	97	0	0	20	44
PasserByVol:	0	0	0	0	0	0	0	0	0	0	0	0
Initial Fut:	315	0	243	0	0	0	0	929	0	0	519	252
User Adj:	1.00	1.00	1.00	1.00	1.00	1.00	1.00	1.00	0.00	1.00	1.00	1.00
PHF Adj:	1.00	1.00	1.00	1.00	1.00	1.00	1.00	1.00	0.00	1.00	1.00	1.00
PHF Volume:	315	0	243	0	0	0	0	929	0	0	519	252
Reduct Vol:	0	0	0	0	0	0	0	0	0	0	0	0
Reduced Vol:	315	0	243	0	0	0	0	929	0	0	519	252
PCE Adj:	1.00	1.00	1.00	1.00	1.00	1.00	1.00	1.00	0.00	1.00	1.00	1.00
MLF Adj:	1.00	1.00	1.00	1.00	1.00	1.00	1.00	1.00	0.00	1.00	1.00	1.00
FinalVolume:	315	0	243	0	0	0	0	929	0	0	519	252

Saturation Flow Module:												
Sat/Lane:	1900	1900	1900	1900	1900	1900	1900	1900	1900	1900	1900	1900
Adjustment:	0.92	1.00	0.92	0.92	1.00	0.92	0.92	1.00	0.92	0.92	1.00	0.92
Lanes:	1.39	0.00	0.61	0.00	0.00	0.00	0.00	2.00	1.00	0.00	2.00	1.00
Final Sat.:	2438	0	1062	0	0	0	0	3800	1750	0	3800	1750

Capacity Analysis Module:												
Vol/Sat:	0.13	0.00	0.23	0.00	0.00	0.00	0.00	0.24	0.00	0.00	0.14	0.14
Crit Moves:	****			****								
Green Time:	26.1	0.0	26.1	0.0	0.0	0.0	0.0	27.9	0.0	0.0	27.9	27.9
Volume/Cap:	0.30	0.00	0.53	0.00	0.00	0.00	0.00	0.53	0.00	0.00	0.29	0.31
Delay/Veh:	11.1	0.0	12.9	0.0	0.0	0.0	0.0	11.7	0.0	0.0	10.0	10.3
User DelAdj:	1.00	1.00	1.00	1.00	1.00	1.00	1.00	1.00	1.00	1.00	1.00	1.00
AdjDel/Veh:	11.1	0.0	12.9	0.0	0.0	0.0	0.0	11.7	0.0	0.0	10.0	10.3
LOS by Move:	B	A	B	A	A	A	A	B	A	A	B	B
HCM2k95thQ:	6	0	12	0	0	0	0	11	0	0	6	7

Note: Queue reported is the number of cars per lane.

City of Morgan Hill
The Crosswinds Residential Development

Level Of Service Computation Report
2000 HCM Operations (Future Volume Alternative)
Year 2030 Cumulative without Project PM

Intersection #108: US 101 Northbound Ramps and Cochrane Road

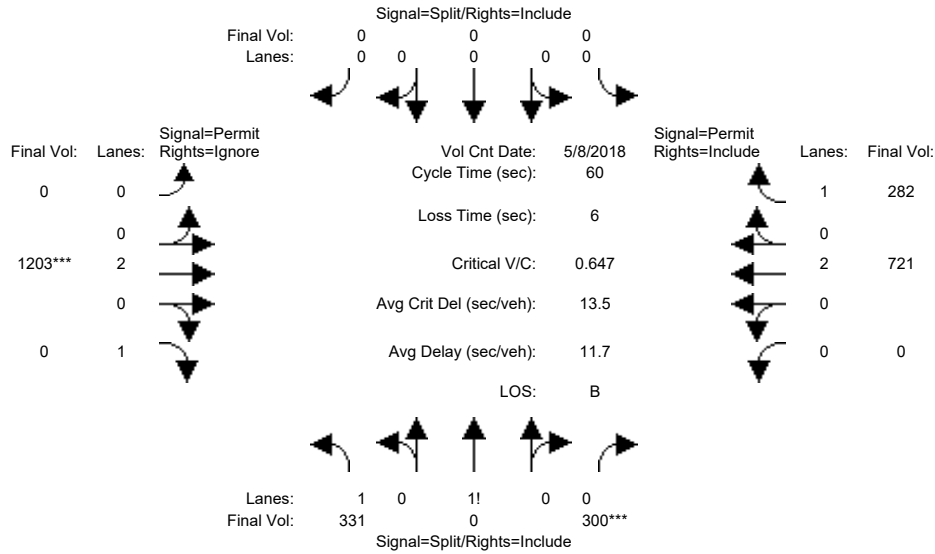

Street Name:	US 101 Northbound Ramps						Cochrane Road					
	North Bound			South Bound			East Bound			West Bound		
Movement:	L	T	R	L	T	R	L	T	R	L	T	R
Min. Green:	10	0	10	0	0	0	0	10	10	0	10	10
Y+R:	4.0	4.0	4.0	4.0	4.0	4.0	4.0	4.0	4.0	4.0	4.0	4.0

Volume Module:	>>	Count	Date:	8 May 2018	<<							
Base Vol:	331	0	300	0	0	0	0	1203	0	0	721	282
Growth Adj:	1.00	1.00	1.00	1.00	1.00	1.00	1.00	1.00	1.00	1.00	1.00	1.00
Initial Bse:	331	0	300	0	0	0	0	1203	0	0	721	282
Added Vol:	0	0	0	0	0	0	0	0	0	0	0	0
PasserByVol:	0	0	0	0	0	0	0	0	0	0	0	0
Initial Fut:	331	0	300	0	0	0	0	1203	0	0	721	282
User Adj:	1.00	1.00	1.00	1.00	1.00	1.00	1.00	1.00	0.00	1.00	1.00	1.00
PHF Adj:	1.00	1.00	1.00	1.00	1.00	1.00	1.00	1.00	0.00	1.00	1.00	1.00
PHF Volume:	331	0	300	0	0	0	0	1203	0	0	721	282
Reduct Vol:	0	0	0	0	0	0	0	0	0	0	0	0
Reduced Vol:	331	0	300	0	0	0	0	1203	0	0	721	282
PCE Adj:	1.00	1.00	1.00	1.00	1.00	1.00	1.00	1.00	0.00	1.00	1.00	1.00
MLF Adj:	1.00	1.00	1.00	1.00	1.00	1.00	1.00	1.00	0.00	1.00	1.00	1.00
FinalVolume:	331	0	300	0	0	0	0	1203	0	0	721	282

Saturation Flow Module:												
Sat/Lane:	1900	1900	1900	1900	1900	1900	1900	1900	1900	1900	1900	1900
Adjustment:	0.92	1.00	0.92	0.92	1.00	0.92	0.92	1.00	0.92	0.92	1.00	0.92
Lanes:	1.36	0.00	0.64	0.00	0.00	0.00	0.00	2.00	1.00	0.00	2.00	1.00
Final Sat.:	2372	0	1128	0	0	0	0	3800	1750	0	3800	1750

Capacity Analysis Module:												
Vol/Sat:	0.14	0.00	0.27	0.00	0.00	0.00	0.00	0.32	0.00	0.00	0.19	0.16
Crit Moves:	****						****					
Green Time:	24.7	0.0	24.7	0.0	0.0	0.0	0.0	29.3	0.0	0.0	29.3	29.3
Volume/Cap:	0.34	0.00	0.65	0.00	0.00	0.00	0.00	0.65	0.00	0.00	0.39	0.33
Delay/Veh:	12.2	0.0	15.7	0.0	0.0	0.0	0.0	12.3	0.0	0.0	9.8	9.6
User DelAdj:	1.00	1.00	1.00	1.00	1.00	1.00	1.00	1.00	1.00	1.00	1.00	1.00
AdjDel/Veh:	12.2	0.0	15.7	0.0	0.0	0.0	0.0	12.3	0.0	0.0	9.8	9.6
LOS by Move:	B	A	B	A	A	A	A	B	A	A	A	A
HCM2k95thQ:	7	0	16	0	0	0	0	15	0	0	9	7

Note: Queue reported is the number of cars per lane.

City of Morgan Hill
The Crosswinds Residential Development

Level Of Service Computation Report
2000 HCM Operations (Future Volume Alternative)
Year 2030 Cumulative with Project PM

Intersection #108: US 101 Northbound Ramps and Cochrane Road

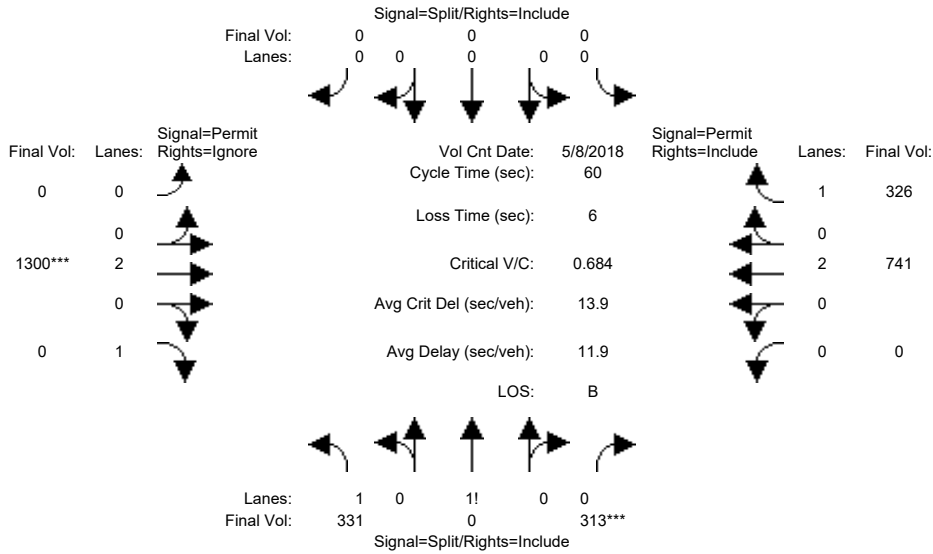

Street Name:	US 101 Northbound Ramps						Cochrane Road					
Approach:	North Bound			South Bound			East Bound			West Bound		
Movement:	L	T	R	L	T	R	L	T	R	L	T	R
Min. Green:	10	0	10	0	0	0	0	10	10	0	10	10
Y+R:	4.0	4.0	4.0	4.0	4.0	4.0	4.0	4.0	4.0	4.0	4.0	4.0

Volume Module:	>>	Count	Date:	8 May 2018	<<							
Base Vol:	331	0	300	0	0	0	0	1203	0	0	721	282
Growth Adj:	1.00	1.00	1.00	1.00	1.00	1.00	1.00	1.00	1.00	1.00	1.00	1.00
Initial Bse:	331	0	300	0	0	0	0	1203	0	0	721	282
Added Vol:	0	0	13	0	0	0	0	97	0	0	20	44
PasserByVol:	0	0	0	0	0	0	0	0	0	0	0	0
Initial Fut:	331	0	313	0	0	0	0	1300	0	0	741	326
User Adj:	1.00	1.00	1.00	1.00	1.00	1.00	1.00	1.00	0.00	1.00	1.00	1.00
PHF Adj:	1.00	1.00	1.00	1.00	1.00	1.00	1.00	1.00	0.00	1.00	1.00	1.00
PHF Volume:	331	0	313	0	0	0	0	1300	0	0	741	326
Reduct Vol:	0	0	0	0	0	0	0	0	0	0	0	0
Reduced Vol:	331	0	313	0	0	0	0	1300	0	0	741	326
PCE Adj:	1.00	1.00	1.00	1.00	1.00	1.00	1.00	1.00	0.00	1.00	1.00	1.00
MLF Adj:	1.00	1.00	1.00	1.00	1.00	1.00	1.00	1.00	0.00	1.00	1.00	1.00
FinalVolume:	331	0	313	0	0	0	0	1300	0	0	741	326

Saturation Flow Module:												
Sat/Lane:	1900	1900	1900	1900	1900	1900	1900	1900	1900	1900	1900	1900
Adjustment:	0.92	1.00	0.92	0.92	1.00	0.92	0.92	1.00	0.92	0.92	1.00	0.92
Lanes:	1.35	0.00	0.65	0.00	0.00	0.00	0.00	2.00	1.00	0.00	2.00	1.00
Final Sat.:	2355	0	1145	0	0	0	0	3800	1750	0	3800	1750

Capacity Analysis Module:												
Vol/Sat:	0.14	0.00	0.27	0.00	0.00	0.00	0.00	0.34	0.00	0.00	0.20	0.19
Crit Moves:	****						****					
Green Time:	24.0	0.0	24.0	0.0	0.0	0.0	0.0	30.0	0.0	0.0	30.0	30.0
Volume/Cap:	0.35	0.00	0.68	0.00	0.00	0.00	0.00	0.68	0.00	0.00	0.39	0.37
Delay/Veh:	12.7	0.0	17.0	0.0	0.0	0.0	0.0	12.4	0.0	0.0	9.4	9.5
User DelAdj:	1.00	1.00	1.00	1.00	1.00	1.00	1.00	1.00	1.00	1.00	1.00	1.00
AdjDel/Veh:	12.7	0.0	17.0	0.0	0.0	0.0	0.0	12.4	0.0	0.0	9.4	9.5
LOS by Move:	B	A	B	A	A	A	A	B	A	A	A	A
HCM2k95thQ:	7	0	17	0	0	0	0	16	0	0	9	8

Note: Queue reported is the number of cars per lane.

Freeway On-Ramp Queuing Analysis						
Existing Conditions						
	Ramp		16%			
Time	Meter	Arrival	HOV			Queue
Interval	Rate	Distribution	Bypass	Mixed-Flow	Total	Length
US 101 NB Diagonal On-Ramp from WB Cochrane Road						
7:30-7:45	150	27%	20	107	127	0
7:45-8:00	150	21%	16	83	99	0
8:00-8:15	150	27%	20	104	124	0
8:15-8:30	150	25%	18	96	114	0
	600	100%	74	390	464	0
	Ramp		0%			
Time	Meter	Arrival	HOV			Queue
Interval	Rate	Distribution	Bypass	Mixed-Flow	Total	Length
US 101 SB Loop On-Ramp from WB Cochrane Road						
4:30-4:45	150	22%	0	35	35	0
4:45-5:00	150	24%	0	37	37	0
5:00-5:15	150	24%	0	38	38	0
5:15-5:30	150	30%	0	47	47	0
	600	100%	0	157	157	0

Freeway On-Ramp Queuing Analysis						
Existing Plus Project Conditions						
	Ramp		16%			
Time	Meter	Arrival	HOV			Queue
Interval	Rate	Distribution	Bypass	Mixed-Flow	Total	Length
US 101 NB Diagonal On-Ramp from WB Cochrane Road						
7:30-7:45	150	27%	23	122	145	0
7:45-8:00	150	21%	18	95	113	0
8:00-8:15	150	27%	23	119	142	0
8:15-8:30	150	25%	21	110	130	0
	600	100%	85	446	531	0
	Ramp		0%			
Time	Meter	Arrival	HOV			Queue
Interval	Rate	Distribution	Bypass	Mixed-Flow	Total	Length
US 101 SB Loop On-Ramp from WB Cochrane Road						
4:30-4:45	150	22%	0	37	37	0
4:45-5:00	150	24%	0	39	39	0
5:00-5:15	150	24%	0	40	40	0
5:15-5:30	150	30%	0	49	49	0
	600	100%	0	164	164	0

Freeway On-Ramp Queuing Analysis						
<u>Year 2030 Cumulative without Project Conditions</u>						
	Ramp		16%			
Time	Meter	Arrival	HOV			Queue
Interval	Rate	Distribution	Bypass	Mixed-Flow	Total	Length
<u>US 101 NB Diagonal On-Ramp from WB Cochrane Road</u>						
7:30-7:45	150	27%	26	137	163	0
7:45-8:00	150	21%	20	107	127	0
8:00-8:15	150	27%	25	134	159	0
8:15-8:30	150	25%	23	123	146	0
	600	100%	95	501	596	0
	Ramp		0%			
Time	Meter	Arrival	HOV			Queue
Interval	Rate	Distribution	Bypass	Mixed-Flow	Total	Length
<u>US 101 SB Loop On-Ramp from WB Cochrane Road</u>						
4:30-4:45	150	22%	0	35	35	0
4:45-5:00	150	24%	0	37	37	0
5:00-5:15	150	24%	0	38	38	0
5:15-5:30	150	30%	0	47	47	0
	600	100%	0	157	157	0

Freeway On-Ramp Queuing Analysis						
Year 2030 Cumulative with Project Conditions						
	Ramp		16%			
Time	Meter	Arrival	HOV			Queue
Interval	Rate	Distribution	Bypass	Mixed-Flow	Total	Length
US 101 NB Diagonal On-Ramp from WB Cochrane Road						
7:30-7:45	150	27%	29	152	181	2
7:45-8:00	150	21%	23	119	141	0
8:00-8:15	150	27%	28	149	177	0
8:15-8:30	150	25%	26	137	163	0
	600	100%	106	557	663	2
	Ramp		0%			
Time	Meter	Arrival	HOV			Queue
Interval	Rate	Distribution	Bypass	Mixed-Flow	Total	Length
US 101 SB Loop On-Ramp from WB Cochrane Road						
4:30-4:45	150	22%	0	37	37	0
4:45-5:00	150	24%	0	39	39	0
5:00-5:15	150	24%	0	40	40	0
5:15-5:30	150	30%	0	49	49	0
	600	100%	0	164	164	0