

APPENDIX F
HYDROLOGY / WATER QUALITY TECHNICAL MEMORANDUM

This page is intentionally blank.

Technical Memorandum

TO: County of San Diego
FROM: Michael Baker International
DATE: September 28th, 2020
SUBJECT: CASA DE ORO BRANCH LIBRARY HYDROLOGY & WATER QUALITY

This technical memorandum assesses whether the project as currently designed and planned, could result in hydrology or water quality impacts per the California Environmental Quality Act (CEQA). Final project design will meet performance standards including but not limited to, the Municipal Separate Storm Sewer System (MS4) Permit Requirements, the San Diego County Hydrology Manual, and the County of San Diego BMP Design Manual.

All conceptual sizes and calculations presented in this technical memorandum are subject to change with forthcoming final design. Michael Baker has made conservative development assumptions that are described in the applicable sections of this document.

Project Information

The project is located in the Spring Valley community of unincorporated San Diego County in California. A vicinity map is provided as Attachment A.1 Vicinity Map. Based on conceptual design, the project consists of an approximately 13,000 square-foot (SF) library facility with access off Campo Road, 52 parking spaces, landscaping, and fencing. No improvement drawings are available; however, a conceptual site plan is included as Attachment A.2 Conceptual Site Plan.

This technical memorandum is based on proposed project information and details given under another title, "Casa De Oro Branch Library Project Description" (August 19, 2020. Rev. September 15, 2020), included as Attachment A.3 Project Description.

The project is not located in a FEMA flood zone, a FIRM Panel and FIRMette for the project site can be found as Attachment A.4 FIRM and A.5 FIRMette, respectively.

Soils information has been taken from a National Resource Conservation Service (NRCS) Web Soil Survey, found as Attachment A.6 Soils Survey. The calculations use Hydrologic Soil Group A, which is representative of the study area.

Existing Conditions

The project site consists of 2.24 acres of currently disturbed and/or developed land. The site is relatively flat, gently sloping from north to south. An existing culvert is present in the southwestern portion of the site which presently accommodates stormwater flows from the north/northeast that sheet flow across the subject property. Stormwater runoff from properties located to the north of the site are accommodated by an existing 48-inch RCP storm drain that extends north-south across the property.

This pipe collects school district water runoff as well as off-site runoff waters. The 48-inch storm drain outlets into the culvert at the southwest portion of the site. Well-established vegetation abuts the culvert and generally obscures it from view. Runoff from the existing surface parking area and school sheet flows into an on-site brow ditch that leaves the project Discharge Point 1 and flows to Conrad Drive.

Hardline conveyance at Conrad Drive directs runoff south and then west on Campo Road to existing County of San Diego storm drain inlets. Runoff from the southern portion currently sheet flows to Campo Road and leaves the project at Discharge Point 2. Hardline conveyance along Campo Road intercepts the sheet flow through curb and gutter to existing County of San Diego storm drain inlets southwest of the site on Campo Road. The existing drainage conditions can be found as Attachment B.1 Existing Hydrology Map.

Proposed Conditions

In the proposed conditions, impervious area is expected to increase. A conceptual proposed hydrology map is included as Attachment B.4 Conceptual Proposed Hydrology Map and is based on assumptions made on the potential design of the project. For purposes of this technical memorandum, the proposed impervious area is 44,600 square feet. The proposed impervious area was calculated using the Conceptual Site Plan found in the "Casa De Oro Branch Library Project Description" (August 19, 2020. Rev. September 15, 2020), included as Attachment A.3 Project Description. For conservatism, the proposed impervious area outlines the furthest extents of proposed impervious areas on the conceptual site plan layout outline. The increase in impervious area will cause an increase in runoff from the site.

The project design will include a drainage network designed to control and filter stormwater runoff in conformance with requirements of the San Diego Regional Water Quality Control Board and County of San Diego. The proposed stormwater system may include the use of biofilters, on-site storage of stormwater in basins with outlets to regulate the flow rate and duration of stormwater released, and/or the use of both retention and detention basins to slow and sequester stormwater runoff to the existing conditions or lesser.

Runoff from the project site will not be permitted to confluence with the existing 48-inch culvert.

It is anticipated that stormwater runoff from the site will connect to the existing public storm drain system through the same discharge points in Conrad Drive and Campo Road, as occurs under existing conditions. The project will not comingle stormwater flows from the project site in its improved condition with flows that are currently accommodated by the existing storm drain system serving the site.

Through drainage design, the project will not result in a change in stormwater volume, rate, or direction of flow from the site following project implementation. No upgrades or other improvements to the existing storm drain system are anticipated or proposed as part of the project.

Hydrology

Methodology

Hydrologic parameters have been developed using the Rational Method procedures according to 2003 San Diego County Hydrology Manual (SDCHM), excerpts are provided in Attachment C SDCHM Excerpts.

Runoff Coefficient (C)

For proposed and existing calculations, runoff coefficient values (C) were determined by composite weighted C values. A summary of these values for existing and proposed can be found as Attachment B.2 Existing Composite C Calculations and Attachment B.5 Proposed Composite C Calculations.

Intensity (I)

The rainfall intensity (I) is calculated using the following formula:

$$I = 7.44 \times P_6 \times D^{-0.645}$$

Where:

P_6 – adjusted 6-hour storm rainfall

D - duration in minutes (T_c)

P_6 is determined based on Isopluvial Maps from the SDCHM. For this project location, the 100-yr P_6 value was determined to be 2.75 inches.

For existing and proposed project site hydrology, time of concentration (T_c) was determined using the sum of initial travel time and time for shallow concentrated flow. Initial travel time is found per Table 3-2 and shallow concentrated flow using TR-55 Figure 3-1, both included in Attachment C SDCHM Excerpts. For Drainage Area 2, a conservative T_c of 5 minutes was used to account for the small size of the drainage area.

Area (A)

Drainage areas (A) were delineated from a combination of site-specific topographic survey (site survey), regional topography from SanGIS, and aerial photography. Drainage area delineations are included in the hydrology maps.

Conceptual Results

Existing conditions show a 100-year flowrate of 2.88 CFS for Drainage Area 1 at Discharge Point 1 and 1.26 CFS for Drainage Area 2 at Discharge Point 2.

TABLE 1- HYDROLOGY SUMMARY 100 YEAR– EXISTING

Drainage Areas	Area (ac)	C	Tc (min)	100 Year		
				P ₆ (in)	I (in/hr)	Q ₁₀₀ (cfs)
1	1.93	0.37	8.8	2.75	4.03	2.88
2	0.31	0.56	5	2.75	7.25	1.26

Proposed conditions show a 100-year flowrate of 4.19 CFS for Drainage Area 1 at Discharge Point 1 and 0.90 CFS for Drainage Area 2 at Discharge Point 2.

TABLE 2- HYDROLOGY SUMMARY 100 YEAR– PROPOSED CONCEPT

Drainage Areas	Area (ac)	C	Tc (min)	100 Year		
				P ₆ (in)	I (in/hr)	Q ₁₀₀ (cfs)
1	1.93	0.54	8.8	2.75	4.03	4.19
2	0.31	0.40	5	2.75	7.25	0.90

Full conceptual proposed hydrology calculations can be found as Attachment B.6 Proposed Hydrology Calculations. All conceptual sizes and calculations presented in this technical memorandum are subject to change with forthcoming design.

Water Quality

Methodology

Water quality parameters will be developed using procedures according to the most current County of San Diego BMP Design Manual (BMP DM) and the San Diego Regional Water Quality Control Board requirements. The project will require a Storm Water Quality Management Plan (SWQMP) that complies with local (San Diego County) and Municipal Separate Storm Sewer System (MS4) Permit Requirements.

Based on the Conceptual Site Plan found in the “Casa De Oro Branch Library Project Description” (August 19, 2020. Rev. September 15, 2020), found as Attachment A.3 Project Description, the project will be a Priority Development Project (PDP). Both Pollutant Control and Hydromodification Management Requirements apply.

The BMP DM proposes many strategies that can be used during project design to fulfill the performance standards. Applicable BMPs include, but not limited to, baseline, source control, site design, design capture reduction, pollutant control, hydromodification management and avoidance and bypass of critical coarse sediment.

The strategy for this project may include biofilters, Significant Site Design BMPs, on-site storage of stormwater in basins with outlets to regulate the flow rate and duration of stormwater released, and/or the use of both retention and detention basins to slow and sequester stormwater runoff to the existing conditions or lesser. The Appendices of the BMP DM provide guidance on BMP selection to meet performance standards and is included as Attachment D.4 BMP DM Appendices of this memorandum.

The sizing provided in this technical memorandum is based on the project site in its entirety. This is a strategy used in preliminary design at the conceptual phase to aid in finding the minimum required treatment BMP for the whole project. BMP sizing and selection will occur during final design, as informed by this memorandum.

Baseline BMP Implementation – Source Control and Site Design

Baseline BMP requirements include conservation of existing natural site features, minimization of outdoor impervious areas, rooftop dispersion, landscape sustainability, protection of work and storage areas, management of stormwater discharges, and management of non-stormwater discharges.

Per the BMP DM, “Source control BMPs avoid and reduce pollutants in storm water runoff. Everyday activities, such as recycling, trash disposal, and irrigation generate potential storm water pollutants.

Source control BMPs are defined as activities or features that reduce the potential for storm water runoff to come into contact with pollutants.”

The project will be designed to implement all source control BMP requirements. Source control BMPs are found in Appendix C of the BMP DM. The BMP DM Appendices are included in this memorandum as Attachment D.4 BMP DM Appendices.

Per the BMP DM, “Site design BMPs (also referred to as low impact design (LID) BMPs) are intended to reduce the rate and volume of storm water runoff and associated pollutant loads by minimizing surface soil compaction, reducing impervious surfaces, or providing flow pathways that are “disconnected” from the storm drain system, such as by routing flow over pervious surfaces. Site design BMPs may incorporate interception, storage, evaporation, evapotranspiration, infiltration, and/or filtration processes to retain and/or treat pollutants in storm water before it is discharged from a site.”

The project will be designed to implement all site design BMPs required by performance standards. Site design BMPs are found in Appendix C of the BMP DM. The BMP DM Appendices are included in this memorandum as Attachment D.4 BMP DM Appendices.

The quantity and quality of runoff leaving the site will not be altered adversely through the implementation of site design and source control BMPs.

Storm Water Pollutant BMPs

The project will implement stormwater pollutant control BMPs to maximize retention of stormwater and reduce the quantity of pollutants in storm water discharges. The BMP DM outlines steps for selecting and designing storm water pollutant control BMPs in Appendix B. The BMP DM Appendices are included in this memorandum as Attachment D.4 BMP DM Appendices. Examples of storm water pollutant control BMPs include amended soils, tree wells, and biofilters.

For the purpose of this technical memorandum, the BMP design capture volume, retention requirements and performance are calculated using the 2.24-acre site in entirety. The proposed impervious area presented in the conceptual site plan is 44,600 square feet and used in analysis. Attachment D.1 Water Quality Sizing Spreadsheet is a high-level conceptual BMP sizing spreadsheet that shows a biofiltration basin adequately sized per the conceptual site plan. The sizing worksheets are provided for feasibility only and not for design purposes. Further strategy design will be required.

Hydromodification Management BMPs

Hydromodification management requirements are required to minimize the potential of storm water discharges from the MS4 from causing altered flow regimes and excessive downstream erosion in receiving waters. The current standard for storm water pollutant control is retention of the 24-hour 85th percentile storm volume. Examples of BMPs for hydromodification include retention basins, and Significant Site Design BMPs such as amended soils and self-retaining areas.

Critical Coarse Sediment Yield Areas (CCYSA) do not exist on, nor upstream of the project site and therefore will not be disturbed by the project. See Attachment D.3 CCYSA Exhibit for the CCYSA Exhibit.

The conceptual BMP sized for storm water pollutant control will also be sized for hydromodification purposes. The depth and storage will be designed to implement all requirements and modeling will be required to ensure compliance. The conceptual sizing worksheets are included as Attachment D.2 Hydromodification Sizing Spreadsheet.

Results and Discussion

To summarize, the project will be designed to meet all required County performance standards and MS4 requirements. The performance standards are set to provide assurance that the project will not alter the quality or quantity of runoff leaving the project site in an adverse way.

All conceptual sizes and calculations presented in this technical memorandum are subject to change during final design.

Hydrology

The existing drainage patterns will not be altered with the implementation of the project. The increase in impervious area will increase the runoff at the site. Project design will include BMPs that will reduce the increase in runoff volume and peak flow to existing conditions to comply with MS4 permits.

The project will not combine stormwater flows from the project site in its improved condition with flows that are currently accommodated by the existing storm drain system serving the site. No runoff from the project will be permitted to confluence with the existing 48-inch culvert. Through drainage design, the project will not result in a change in stormwater volume, rate, or direction of flow from the site following project implementation. No upgrades or other improvements to the existing storm drain system are anticipated or proposed as part of the project.

Water Quality

The project will comply to all requirements in the BMP DM for both Pollutant Control and Hydromodification Management Requirements. Site design, source control, storm water pollutant and hydromodification standards will all be required and met through BMP selection and strategy.

The project design will include a drainage network designed to control and filter stormwater runoff in conformance with requirements of the San Diego Regional Water Quality Control Board and County of San Diego. The proposed stormwater system may include the use of biofilters, on-site storage of stormwater in basins with outlets to regulate the flow rate and duration of stormwater released, and/or the use of both retention and detention basins to slow and sequester stormwater runoff to the existing conditions or lesser.

Through drainage design, the project will not result in a change in stormwater volume, rate, or direction of flow from the site following project implementation.

CEQA – Threshold of Significance

1. Will the project violate any water quality standards or waste discharge requirements or otherwise substantially degrade surface or groundwater quality?

The project will not violate any water quality standards or waste discharge requirements or otherwise substantially degrade surface or groundwater quality. The project will be designed in accordance to current MS4 requirements, the San Diego County Hydrology Manual and the County of San Diego BMP Design Manual. The project will not decrease the quality or increase the quantity of surface or groundwater since BMPs will be designed and implemented to mitigate for the increase in runoff and peak flow and any adverse impacts on water quality. These may include biofilters, Significant Site Design BMPs, on-site storage of stormwater in basins with outlets to regulate the flow rate and duration of stormwater released, and/or the use of both retention and detention basins to slow and sequester stormwater runoff to the existing conditions or lesser. The BMP DM appendices provide guidance on BMP selection to meet performance standards and is included as Attachment D.4 BMP DM Appendices.

2. Will the project substantially decrease groundwater supplies or interfere substantially with groundwater recharge such that the project may impede sustainable groundwater management of the basin?

The project will not substantially decrease groundwater supplies or interfere substantially with groundwater recharge such that the project may impede sustainable groundwater management of the basin. The project is not located in one of the three Sustainable Groundwater Management Act (SGMA)-mandated basins in San Diego County. The Helix Water District will provide water for the project and the project will not use well water.

3. Will the project substantially alter the existing drainage pattern of the site or area, including through the alteration of the course of a stream or river or through the addition of impervious surfaces, in a manner which would:
 - i. Result in substantial erosion or siltation on- or off-site?
 - ii. Substantially increase the rate or amount of surface runoff in a manner which would result in flooding on- or off-site;
 - iii. Create or contribute runoff water which would exceed the capacity of existing or planned stormwater drainage systems or provide substantial additional sources of polluted runoff; or
 - iv. Impede or redirect flood flows?

The project will not result in a substantial alteration to the existing drainage pattern across the site. The project will be designed in accordance to current MS4 requirements, the San Diego County Hydrology Manual and the County of San Diego BMP Design Manual. The project will not decrease the quality or increase the quantity of runoff discharging from the project site compared to existing conditions. The project will not cause flooding downstream, nor will it hydraulically impact on-site or downstream storm water infrastructure.

- i. The project will not result in substantial erosion or siltation on- or off-site. The project will be designed to the most current hydromodification standards. The current standard for storm water pollutant control is retention of the 24-hour 85th percentile storm volume.
- ii. The project will not substantially increase the rate or amount of surface runoff in a manner which would result in flooding on- or off-site since BMPs such as bioretention basins, or Significant Site Design BMPs, will be designed and implemented to mitigate for the increase in runoff and peak flow. The project will not increase the quantity or velocity of surface runoff.
- iii. The project will not create or contribute runoff water which would exceed the capacity or planned stormwater drainage systems or provide substantial additional sources of polluted runoff. The project will not decrease the quality or increase the quantity of runoff discharging from the project site compared to existing conditions.
- iv. The project will not impede or redirect flood flows. The project does not lay in a Special Flood Hazard Area (SFHA) shown on the Flood Insurance Rate Map (FIRM).

4. Will the project in flood hazard, tsunami, seiche zones, risk release of pollutants due to project inundation?

Based on project location it is unlikely that the project is subject to inundation by flood hazard, seiche, tsunami or mudflow. The project does not lay in a Special Flood Hazard Area (SFHA) shown on the Flood Insurance Rate Map (FIRM).

5. Will the project conflict with or obstruct implementation of a water quality control plan or sustainable groundwater management plan?

The project will not conflict with or obstruct implementation of a water quality control plan or sustainable groundwater management plan. The project will be designed in accordance to current MS4 requirements, the San Diego County Hydrology Manual and the County of San Diego BMP Design Manual. The project will not decrease the quality or increase the quantity of runoff discharging from the project site compared to existing conditions. The project is not located in one of the three Sustainable Groundwater Management Act (SGMA)-mandated basins in San Diego County.

Attachment A- Project Information

A.1 Vicinity Map

A.2 Conceptual Site Plan

A.3 Project Description

A.4 FEMA FIRM

A.5 FEMA FIRMette

A.6 Soils Survey



9/14/2020 JN C:\Working\CDO\Vicinity Map.mxd



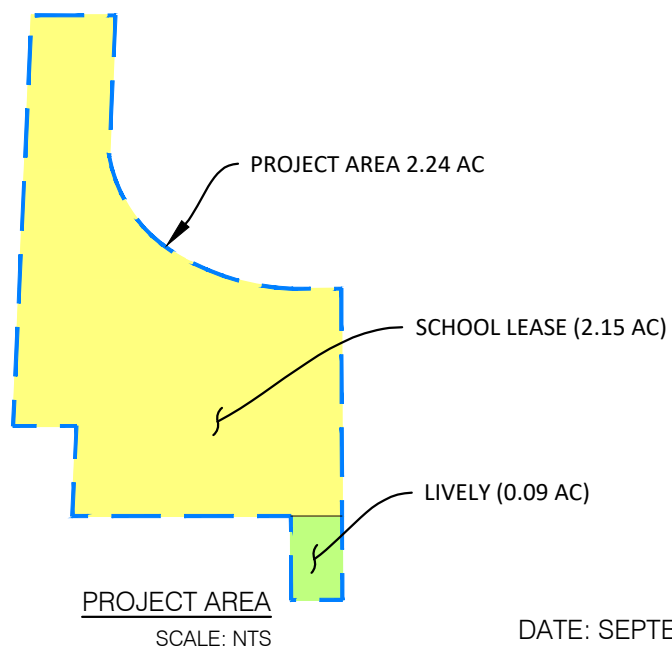
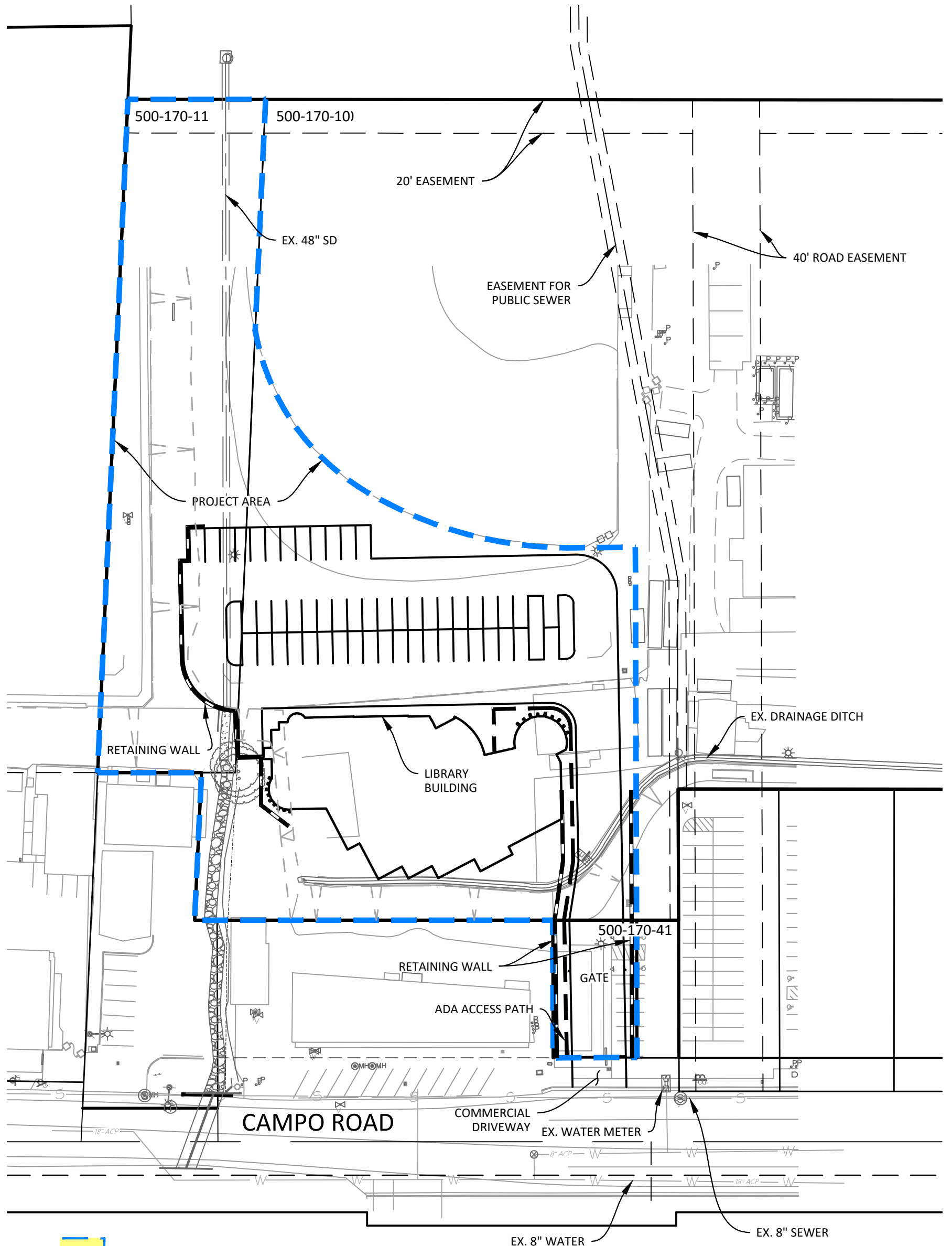

CASA DE ORO LIBRARY

SITE PLAN EXHIBIT

Michael Baker
INTERNATIONAL

9755 Clairemont Mesa Blvd.
San Diego, CA 92124
Phone: (858) 614-5000
MBAKERINTL.COM

DATE: SEPTEMBER 4, 2020

Casa De Oro Branch Library

Project Description

Spring Valley, Unincorporated San Diego County, California

August 19, 2020; Revised September 15, 2020

The Casa de Oro Branch Library Project (proposed project) would result in replacement of the existing County of San Diego (County) Casa de Oro branch library facility in the community of Spring Valley with a new branch library facility at a different location. The proposed project consists of an approximately 13,000 square-foot (SF) library facility that aims to achieve “zero net energy,” with access off Campo Road, 52 parking spaces, landscaping, and fencing. The existing library is currently located at 9805 Campo Road within an existing retail commercial shopping center, just to the southeast of the proposed project site. The proposed project is intended to enhance the County’s regional library system and provide expanded services to its patrons within the Spring Valley community and surrounding areas. The proposed project would be processed through the County’s Department of General Services (DGS).

PROJECT LOCATION

The proposed project site is located in the community of Spring Valley in southeastern unincorporated San Diego County, California. The site is within the Valle de Oro Community Plan Area. The affected County Assessor Parcel Numbers (APNs) include portions of APNs 500-170-10, -11, and -41.

Regional access to the project vicinity is provided via State Route (SR) 94 located approximately 480 feet to the south/southwest of the site at its closest point; refer to [Figure 1, Regional Map](#). Direct access to the project site would be provided from Campo Road, between Conrad Drive and Rodgers Road.

PROJECT SETTING AND EXISTING CONDITIONS

The proposed project site is located in a highly urbanized area, adjacent to the commercial corridor of Campo Road. The area surrounding the project site is highly developed with a variety of land uses including commercial, general office, and multi-family and (limited) single-family residential uses.

Adjacent to the north and west of the site is the Spring Valley Academy, a middle school serving grades 5 to 8, that is overseen by the La Mesa Spring Valley School District. To the east is the La Mesa Spring Valley School District maintenance yard. Sports fields owned and maintained by the

school abut the project site to the north and west. A small-scale restaurant fronting directly onto Campo Road is located in the southern portion of the proposed site; refer to [Figure 2, Local Vicinity Map/Project Site](#). This restaurant would be demolished to provide access to the subject property. Commercial uses are located directly to the south, along with single-family and multi-family uses to the south/southwest of the site. Single-family rural residential uses are present in the distance along the hillsides to the north and south. The Campo Road commercial corridor trends east-west through the community and forms the southern boundary of the proposed site.

The land where the library would be constructed is currently disturbed and/or developed. The majority of the property is currently surfaced with asphaltic pavement. The site would also include a portion of an existing sports field associated with the school and the removal of a modular office structure located on the school site; refer to [Figure 2, Local Vicinity Map](#).

The site is relatively flat, gently sloping from north to south. On-site elevations range from approximately 422 feet above mean sea level (amsl) in the southern portion of the site near Campo Road to approximately 443 feet amsl in the northwestern portion of the site.

An existing culvert is present in the southwestern portion of the site which presently accommodates stormwater flows from the north/northeast that sheet flow across the subject property. A 48-inch storm drain collects runoff from north of the site and outlets into this culvert. Under current conditions, well-established vegetation abuts the culvert and generally obscures it from view. Runoff from the existing surface parking area and school sheet flows into an on-site brow ditch that flows to Conrad Drive under current conditions. Runoff from the restaurant parcel currently sheet flows to Campo Road.

The western portion of the Valle de Oro Community Planning Area is drained by Spring Valley Creek with two of its tributaries in the Valle de Oro Plan Area which include the Casa de Oro and Mt. Helix creeks.

GENERAL LAND USE AND ZONING

[Table 1, Existing General Plan Land Use and Zoning](#), identifies the existing County General Plan land use designations and zoning classifications for the affected properties. No change in the existing General Plan or zoning is required or proposed with project implementation.

TABLE 1: EXISTING GENERAL PLAN LAND USE AND ZONING

Assessor Parcel Number	Regional Category	General Plan Land Use	Zoning
500-170-10 (Portion of)	Not Applicable	Public/Semi-Public Facilities	Rural Residential Single (RS)
500-170-11 (Portion of)	Not Applicable	Public/Semi-Public Facilities	Rural Residential Single (RS)
500-170-41 (Portion of)	Village	General Commercial	General Commercial (C36)

ACTIONS

As mentioned, the project would be processed through the County Department of General Services who would act as the Lead Agency under the California Environmental Quality Act (CEQA) for approval of a Mitigated Negative Declaration, which would be required to satisfy CEQA requirements. The proposed project would not be subject to discretionary review by the County. Improvement plans for the proposed project would be subject to review by the California Division of the State Architect (DSA) to ensure design conformance with current American Disability Acts (ADA) Guidelines, including for such components as parking, stairs, ramps, hazards, restrooms, casework, and signage. County’s Department of Planning and Development Services (PDS) would be responsible for inspecting construction of the library facility. All required permits (i.e., building and grading permits) for the proposed project would be issued by the County’s Department of Planning and Development Services (PDS); refer to [Table 2, Anticipated Permits and Approvals](#).

Additional approvals would also be required from other agencies. [Table 2](#) identifies the anticipated permits and approvals required for the proposed improvements. For the purposes of CEQA, the term responsible agency includes public agencies other than the lead agency that may have discretionary actions associated with implementation of the proposed project or an aspect of subsequent implementation of the proposed project.

TABLE 2: ANTICIPATED PERMITS AND APPROVALS

Permit/Approval	Affected Agency	Lead/Trustee/ Responsible Agency
Mitigated Negative Declaration (MND)	County of San Diego (County)	Lead Agency
Construction Permit	County [in lieu of Division of the State Architect (DSA)]	Lead Agency
Grading Permit	County in lieu of DSA	Lead Agency
Building Permit	County in lieu of DSA	Lead Agency
Improvement Plans	County in lieu of DSA	Lead Agency
Landscape Plan	County in lieu of DSA	Lead Agency
Stormwater Quality Management Plan/Drainage Plan	County in lieu of DSA	Lead Agency
General Construction Stormwater Permit	San Diego Regional Water Quality Control Board (RWQCB)	Responsible Agency
National Pollution Elimination System Permit (NPDES)	RWQCB	Responsible Agency

PROJECT CHARACTERISTICS

The library building would total approximately 13,000 SF in size and would house a number of rooms in order to accommodate internal library operations, as well as to provide a variety of services to the public. The proposed library would consist of the components identified in [Table 3](#). Refer also to [Figure 3, Conceptual Site Plan](#); [Figure 4A, Conceptual Layout \(Alpine Library\)](#); and [Figure 4B, Adjacency Diagram](#). In addition, [Figures 5A](#) and [5B](#) provide illustrative examples of other existing County libraries upon which the ultimate architectural style for the Casa de Oro library may be based.

TABLE 3: PROJECT COMPONENTS

Proposed Use	
Entry plaza	Entry lobby
Restroom facilities (including staff-only)	Circulation desk
Public multi-media room (computers/copy machines)	Manager's office/work room/sorter/storage/break room/staff restroom
Adult (study rooms/seating/book stacks)	Great room (reading area and magazine stacks)
Children (story-time area/discovery zone/book stacks/reading room/study area/crafts and children's restrooms)	Teens (study rooms/seating/book stacks)
Community room	Conference room
Audio/visual storage	Marketplace (popular books/ holds and self-checkouts)
Homework center	Friends of Library bookstore
Outdoor patio	

Source: County DGS 2020

Project implementation would require acquisition of Real Property from an adjoining private party to the south. The County would lease the affected property from the La Mesa Spring Valley School District; no lands would be purchased from the school. Refer also to the discussion under Demolition below.

Access

Direct access to the project site would be from Campo Drive. It is anticipated that a minimum 24-foot wide access drive would be constructed from the street up to the surface parking area proposed with the project. Construction of this access drive would require a new curb cut within the right-of-way on Campo Road and installation of a commercial driveway.

Parking

Table 4, County of San Diego Parking Requirements, shows the minimum required parking for the proposed project based on the County's Parking Ordinance. As shown in Table 4, a total of 39 parking spaces are required based upon the County's requirements for a library use. The proposed library would provide a total of 52 surface parking spaces which would exceed the County's minimum parking requirements. This would accommodate daily library parking requirements as well as after-hours use of the community room. All employees would park on-site; off-site parking would not be required to accommodate library staff.

Two dedicated parking spaces would be provided on-site for library delivery vans. These parking spaces would be provided directly adjacent to the library staff service entry for ease of loading/unloading.

On-site bike racks to accommodate 6 bikes (minimum) would also be provided. Additionally, it is anticipated that two electric vehicle (EV) charging stations would be provided on-site within the surface parking lot. The number of EV stations provided would be in conformance with CalGreen standards.

TABLE 4: COUNTY OF SAN DIEGO PARKING REQUIREMENTS

Required Parking per Square Feet (SF)	Proposed Land Use	# Parking Stalls Required	# of Parking Stalls Proposed
3.0 spaces / 1,000 SF (1 space / 333 SF)	Proposed 13,000 SF Library	39	52

Landscaping and Outdoor Seating

All plants and trees would be selected for their appropriateness to the architectural design, local climate tolerance, soil conditions, and level of maintenance intensity. No non-native invasive plant species shall be used. All trees and plant species would be consistent with County landscape guidelines.

Shaded seating for a minimum of 30 people would also be provided. The seating would be provided near the main entry area as well as at the outdoor patio. Built-in seating is preferred in lieu of providing site furniture.

Signage

The project proposes a monument sign located at the primary entrance on Campo Road as a feature of the landscape and architectural design. It is anticipated that such signage would incorporate materials compatible with the proposed landscape design. Accent lighting would be installed to illuminate the sign, while minimizing uplighting to avoid any adverse nighttime lighting effects.

Lighting

Nighttime lighting would be installed in the surface parking lot, at the entry drive, and on the exterior of the building for public safety purposes and to allow for safe pedestrian and vehicular circulation and access. Limited lighting may also be installed at the monument sign (see Signage, above) on Campo Road for identification purposes. All project lighting would be shielded and directed downward to avoid spillover onto adjacent properties and/or adverse effects on nighttime skies (i.e., sky glow). All nighttime lighting would be designed and installed in conformance with the County's Lighting Ordinance.

Fencing and Gates

A 12-foot high perimeter fence would be installed along the project's boundary with the school district property for security purposes. Chain-link fencing is likely to be used, but slats or mesh may be added to the chain-link fence, as appropriate, for screening purposes. In addition, it is anticipated that remote-controlled cameras or other security devices may be installed along the perimeter fence for security purposes.

It is anticipated that the fence would include a manually-operated gate along the northerly boundary that would provide occupants of the Spring Valley Academy with direct access to the library site during operating hours. The gate would otherwise be locked to prevent access during hours when the library was not in operation. Use of the library by students and faculty of the school will be part of the lease agreement between the County and the La Mesa Spring Valley School District. A gate with fire department approved Knox-box entry system would be located at the project entrance off of Campo Road to limit vehicle access to the site after hours.

Pedestrian, Bicycle, and Transit Access

Existing sidewalks are located along both the northern and southern sides of Campo Road, including along the proposed project frontage. These sidewalks would provide pedestrian access to the site. Additionally, bike lanes are present along both sides of Campo Road within the project vicinity. An ADA accessible ramp would be constructed from Campo Road to provide access to the library building.

The San Diego Metropolitan Transit System (MTS) provides bus service within the project area. Route 855 runs along Campo Road. An existing bus stop for westbound travel is located approximately 320 feet to the east of the project site; a bus stop for eastbound travel is located approximately 425 feet to the west of the project site.

Sustainability and Energy-Saving Features

Additionally, the library building would achieve a minimum Leadership in Energy and Environmental Design (LEED) Gold designation, while also reaching a higher level of sustainability

with a zero-net energy performance by surpassing California Green Building Standards 2016 (CCR, Title 24, Part 11 – CalGreen) by 15 percent. Zero net energy means that the project would incorporate energy saving features to offset the energy used during operations. Additionally, the facility would be subject to County of San Diego’s Zero Net Waste Guidelines which address solid waste disposal and recycling.

Anticipated energy-savings features may include low-flow fixtures; energy-efficient LED indoor and outdoor lighting; on-site recycling containers; energy-efficient water heaters; water efficient/drought tolerant landscaping, use of reclaimed water, and limiting use of conventional turf; high-efficiency heating, ventilating, and air conditioning (HVAC) systems; and/or other features. Installation of solar photovoltaic panels is not proposed with the project. As stated above, it is anticipated that several EV charging stations would be provided on-site to further offset project-related vehicle trip emissions.

PROJECT CONSTRUCTION

Schedule

It is anticipated that project construction would occur over a period of approximately 12 to 14 months from the onset of demolition through final construction. It is anticipated that the work would be completed in 8- or 10-hour shifts, with a total of five shifts per week (Monday to Friday). Overtime and weekend work would occur as necessary to meet scheduled milestones or accelerate the schedule and would comply with all applicable California labor laws and County regulations.

Demolition

An existing modular building located on the La Mesa Spring Valley School District property would be removed to accommodate the parking lot for the library. Additionally, an existing restaurant fronting onto Campo Road would be demolished to allow for site access. The existing asphaltic surface in the southern portion of the site would also be broken up and removed. Removal of a portion of the existing sports fields abutting the site to the north would also occur with project grading. Refer to [Figure 2, Local Vicinity Map/Project Site](#), which shows the existing on-site and off-site conditions.

All resulting construction debris would be trucked off-site for disposal at an approved landfill and/or diverted consistent with requirements of California Assembly Bill (AB) 939. AB 939 established the California Integrated Waste Management Act of 1989 (Public Resources Code Sections 42900-42927) which requires all California cities and counties to reduce the volume of solid waste deposited in landfills by 50 percent by the year 2000. It also requires that cities and counties continue to remain at 50 percent or higher for each subsequent year. The County of San

Diego requires a minimum of 65 percent of construction waste to be diverted from local landfills, thereby exceeding the state requirement.

Demolition would be accomplished with dozers and other heavy equipment. Waste materials would be uploaded onto large trucks using small cranes, forklifts, and/or other construction equipment as needed. Demolition equipment would be delivered to the site on low-bed trucks.

Grading and Site Preparation

The site would anticipate minor grading, 4,000 cubic yards (import), to accommodate the proposed library pad, surface parking area, and driveway. This includes preparation of and/or back filling of the site's retaining walls and ADA and driveway ramping, plus removal and recompaction (12-inch) of foundation and parking areas. Existing on-site vegetation (i.e., on the sports fields) would be removed. Grading would be accomplished with scrapers, motor graders, water trucks, dozers, and compaction equipment.

PROJECT OPERATIONS

Hours of Operation and Staffing

It is anticipated that the library would be staffed by a maximum of 6 to 8 part- and/or full-time employees on a daily basis. Consistent with current operating hours for other libraries within the County's system, it is anticipated that the Casa de Oro library would operate during the following hours:

- Monday and Wednesday: 9:30 a.m. to 6:00 p.m.
- Tuesday and Thursday: 9:30 a.m. to 8:00 p.m.
- Friday and Saturday: 9:30 a.m. to 5:00 p.m.
- Sunday: Closed

Community room hours of operation are anticipated as follows:

- Monday to Saturday: 8:00 a.m. to 8:00 p.m.
- Sunday: 8:00 a.m. to 8:00 p.m. (minimal to no use anticipated)

All project operations would be required to conform to and certified through the Living Building Challenge Net Zero Energy Guidelines. As part of ensuring project conformance with these guidelines, the following project operational activities (in addition to the operating hours identified above) would also be required and would ensure that conformance with such guidelines is achieved:

- Staff to arrive ½ hour early for daily set-up (3 additional hours/week)
- Two hours janitorial service, 3 times/week (6 additional hours/week)

- Minimum 2 hours per day for use of community room, lobby, conference room, and restrooms (10 additional hours/week = community room, conference room, lobby, and restrooms would be open an additional 2 hours on Monday/Wednesday and 3 additional hours on Friday/Saturday)

UTILITIES

Water

Public water service would be provided by the Helix Water District. The project would connect to an existing 8-inch water main located in Campo Road. No upgrades to the existing public water system are anticipated to accommodate water demands of the proposed library use. The County would obtain a service availability letter from the Helix Water District as part of the construction process to ensure that adequate water supplies are available to serve the proposed use.

Sewer

The project site is located within the boundaries of the Spring Valley Sanitation District. The project would connect to an existing 8-inch sewer line located in Campo Road. No upgrades to the existing public sewer system are anticipated to accommodate wastewater flows generated by the proposed project. The County would obtain a service availability letter from the Spring Valley Sanitation District as part of the construction process to ensure that adequate sewer services are available to serve the proposed use.

Stormwater

Stormwater runoff from properties located to the north of the site are accommodated by an existing 48-inch RCP storm drain that extends north-south across the property. This pipe collects school district water runoff as well as off-site runoff waters. Additionally, runoff from the existing surface parking area and school sheet flows into an on-site brow ditch that flows to Conrad Drive under current conditions. Runoff from the southernmost parcel currently flows to Campo Road.

The project design would include a drainage network designed to control and filter stormwater runoff in conformance with requirements of the San Diego Regional Water Quality Control Board and County of San Diego. The proposed stormwater system may include the use of biofilters, on-site storage of stormwater in basins with outlets to regulate the flow rate and duration of stormwater released, and/or the use of both retention and detention basins to slow and sequester stormwater runoff. It is anticipated that stormwater runoff from the site would connect to the existing public storm drain system in Conrad Drive, as occurs under existing conditions. The project would not comingle stormwater flows from the project site in its improved condition with flows that are currently accommodated by the existing storm drain system serving the site. Further, drainage design for the project would not result in an change in

stormwater volume, rate, or direction of flow from the site following project implementation. No upgrades or other improvements to the existing storm drain system are anticipated or proposed as part of the project.

Electricity

Electricity would be provided by San Diego Gas and Electric (SDG&E). Adjoining lands are currently served by SDG&E and the project would connect to the existing system for service.

Fire

The project site is located in the San Miguel Consolidated Fire Protection District. The nearest fire station to the project site is Station No. 14, located at 3255 Helix Street in Spring Valley, approximately 0.6 miles to the southwest of the project site.

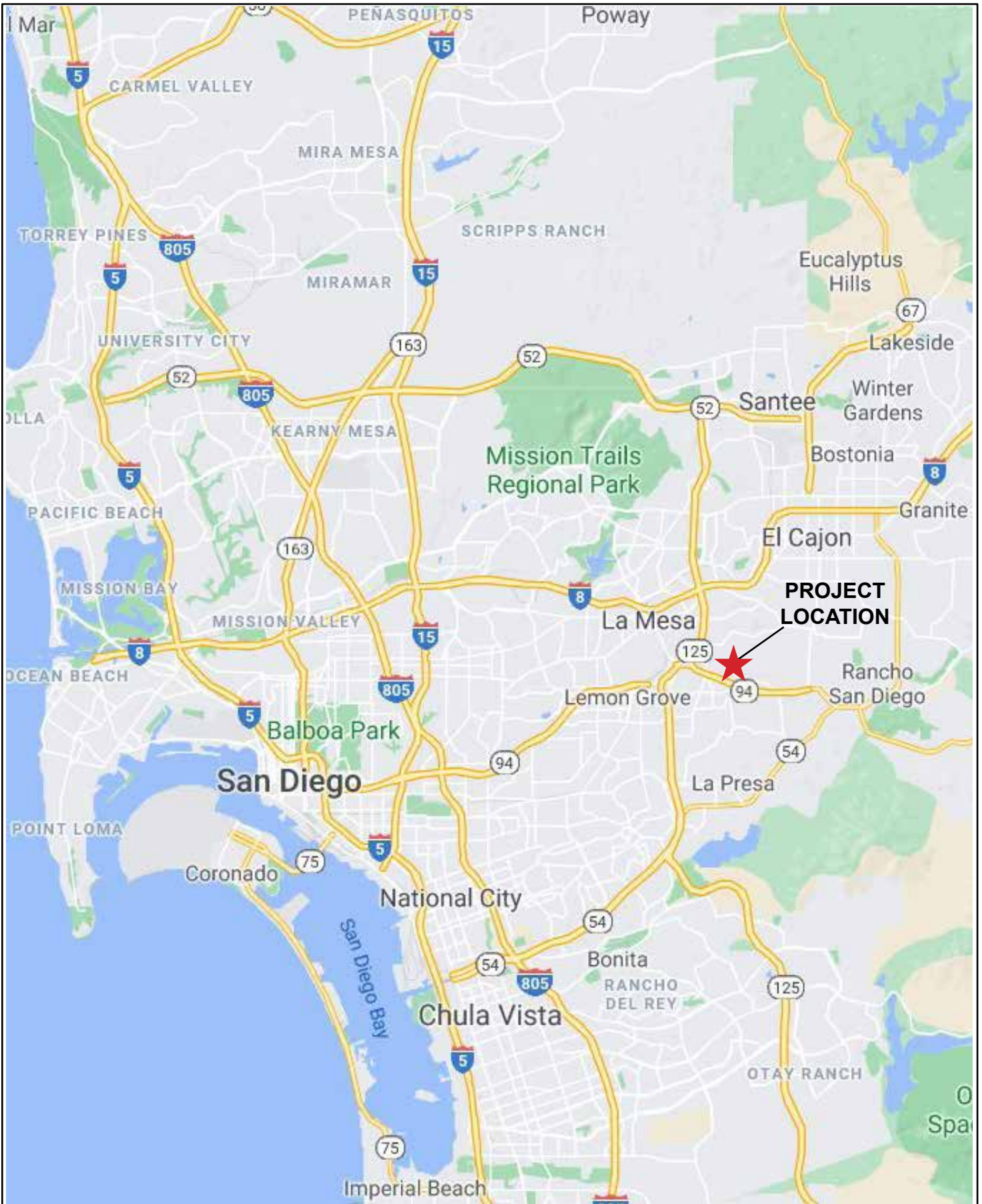

COUNTY OF SAN DIEGO
 CASA DE ORO BRANCH LIBRARY
Regional Map

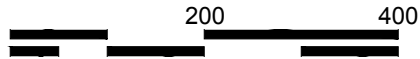

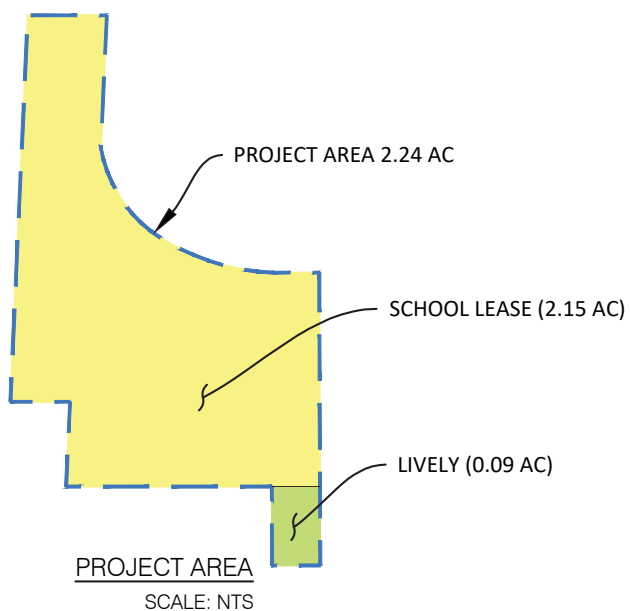
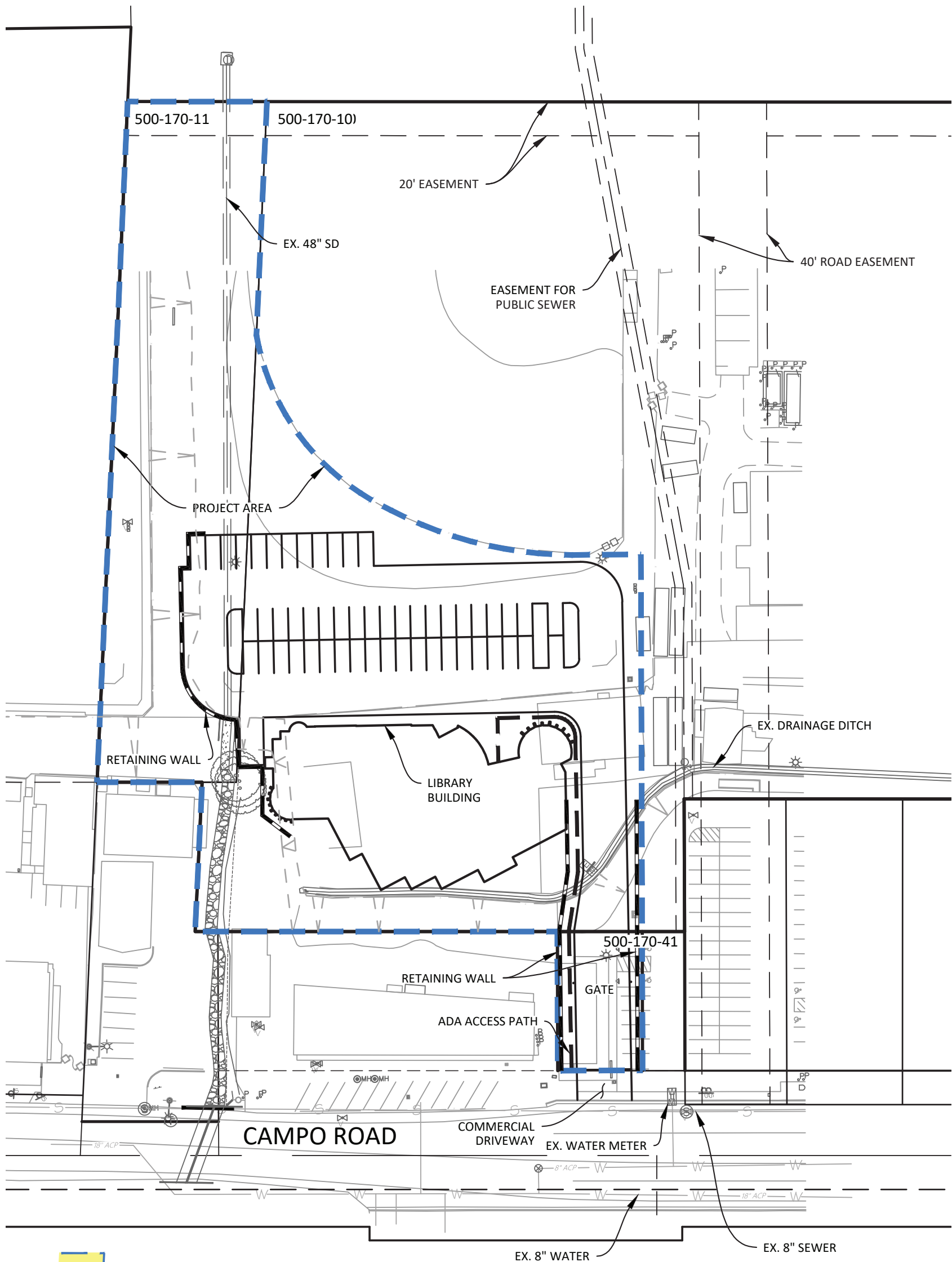

FOR SUBTERRANEAN SDG&E ROOM, REFER TO A 2.1.2

PLUMBING FIXTURE COUNT AREA CALCULATION (ACCESSORY AREAS EXCLUDED)

TOTAL AREA PER OCCUPANCY	AREA	OCC. FACTOR	TOTAL OCC.	MALE	FEMALE
A-3 (INC. EXT. READING AREAS)	11,537 SF	30	384.57	192	192
B	732 SF	200	3.66	2	2
TOTAL				194	194

REQUIRED PLUMBING FIXTURE COUNT CALCULATION

TABLE 422.1 CPC 2013	WATER CLOSETS			URINALS		LAVATORIES		DF
	MALE	FEMALE	UNISEX	MALE	MALE	FEMALE		
A-3	2	4	-	2	1	2	1	
B	0	0	0	0	0	0	0	
TOTALS	2	4	-	2	1	2	1	

PROVIDED PLUMBING FIXTURE COUNT CALCULATION

PROVIDED	WATER CLOSETS			URINALS		LAVATORIES		DF
	MALE	FEMALE	UNISEX	MALE	MALE	FEMALE		
PROVIDED	3	5	2	2	2	2	2	
SURPLUS	1	1	2	0	1	0	0	

- KEYNOTES**
- 3.2 ARCHITECTURAL CONCRETE SHADE FINIS PER STRUCTURAL FINISH PER SPECS.
 - 4.2 SPLIT FACE CONCRETE MASONRY UNIT PLANTER BOXES AND TERRACE SEAT WALL, PER LANDSCAPE.
 - 5.11 PREFINISHED SHEET METAL DOWNSPOUT PER SPECIFICATIONS. COLOR TO MATCH FIBER CEMENT SIDING, FCS-1.
 - 5.16 PREFINISHED SHEET METAL DOWNSPOUT PER SPECIFICATIONS. COLOR TO MATCH FIBER CEMENT SIDING, FCS-2.
 - 5.17 PREFINISHED SHEET METAL DOWNSPOUT PER SPECIFICATIONS. COLOR TO MATCH STUCCO.
 - 5.18 PREFINISHED SHEET METAL DOWNSPOUT PER SPECIFICATIONS. COLOR TO MATCH STOREFRONT MULLIONS.
 - 5.27 CURVED METAL FRAMING TYP UON
 - 6.1 TREX TRANSCEND, COMPLYING WITH WILDLAND URBAN-INTERFACE (WUI) REQUIREMENTS PER COUNTY AMENDMENT TO THE FIRE CODE CHAPTER 7.2.1.704.A.1.1.
 - 6.5 CUSTOM BUILT-IN MAGAZINE AND NEWSPAPER SHELVING, PER DETAIL 586A9.9
 - 6.7 BUILT-IN UNPLESTERED WINDOW SEAT, PER DETAIL 4A9.6
 - 6.8 BUILT-IN SEATING AT HOMEWORK CENTER, CHILDREN'S HEIGHT, PER DETAIL 3A9.6
 - 6.9 BUILT-IN LAPTOP COUNTER
 - 6.11 BUILT-IN SEATING AT FIRST 5, CHILDREN'S HEIGHT, PER DETAIL 7A9.6
 - 8.2 OPERABLE PARTITION AT STUDY ROOMS, PER DETAIL 14A4.4
 - 8.3 COUNTER HEIGHT PASS THROUGH WINDOW TO LIBRARY RESOURCE ROOM
 - 8.4 OVERHEAD SECTIONAL DOOR, PER SPECS.
 - 8.5 AFTER HOURS SECURITY GRILLE
 - 8.15 OPERABLE PARTITION AT LRR, PER DETAIL 11A9.4
 - 9.11 WALK-OFF GRILLE INSET IN CONCRETE.
 - 10.9 PROVIDE WALL-MOUNTED ENHANCED DIMENSIONAL LIBRARY MISSION STATEMENT SIGNAGE ABOVE STOREFRONTS ON THIS WALL PER LIBRARY STANDARDS.
 - 10.10 PROVIDE NO SMOKING SIGNAGE POSTED AT EVERY EXTERIOR ENTRY DOOR.
 - 10.11 FULLY RECESSED FIRE EXTINGUISHER CABINET, PER DETAIL 6A9.2. PROVIDE 2-A-10-B-C FIRE EXTINGUISHER.
 - 10.12 SEMI-RECESSED FIRE EXTINGUISHER CABINET, PER DETAIL 6A9.2. PROVIDE 2-A-10-B-C FIRE EXTINGUISHER.
 - 10.15 PROVIDE TACTILE ROOM SIGNAGE PER DETAILS 163A2.5 AND ROOM SIGNAGE VERBIAGE LISTED IN DOOR SCHEDULE. SIGNS ON STRIKE SIDE OF DOOR U.O.N. DOOR 104 JANITOR, DOOR 105A ALFA, DOOR 113 FIRE RISER ROOM, LIVING ROOM (ON WALL BEHIND DOOR 140A).
 - 10.21 WALL-MOUNTED ENHANCED TEEN AREA SIGNAGE PER LIBRARY STANDARDS.
 - 10.22 WALL-MOUNTED ENHANCED SELF-CHECKOUT SIGNAGE PER LIBRARY STANDARDS.
 - 10.23 WALL-MOUNTED ENHANCED HOLDS AREA SIGNAGE PER LIBRARY STANDARDS.
 - 10.26 STORAGE POCKET DOOR FOR FOLDABLE PARTITION PANELS PER SPECIFICATIONS.
 - 11.4 STEEL BOOK SHELVING WITH PLASTIC LAMINATE COUNTERTOP AND MDO END PANELS PROVIDED BY LIBRARY SHELVING VENDOR. EXACT WIDTH OF COUNTERTOP TO BE COORDINATED WITH VENDOR.
 - 11.6 FIRE DEPARTMENT KNOX BOX.
 - 12.1 PROFILE OF LARGE "WOW" ABOVE STORYTELLING CIRCLE. CONSTRUCTED OF NON-COMBUSTIBLE MATERIALS.
 - 12.2 PROFILE OF SMALL "WOW" ABOVE TWEEN AREA. CONSTRUCTED OF NON-COMBUSTIBLE MATERIALS.
 - 12.6 OAK TREE THEMING.
 - 12.10 BOOK SORTER LOCATION WITH BOOK DROP.
 - 22.1 HI-LOW DRINKING FOUNTAIN PER 19A9.5
 - 26.3 SECURITY SYSTEM ANNUNCIATOR, CARD READER AND KEYPAD PER ELECTRICAL.

WALL TYPE SCHEDULE

REFER TO EXPANSION ANCHOR SCHEDULE FOR POWDER DRIVEN FASTENERS AND WEDGE EXPANSION ANCHOR REQUIREMENTS. SEE DETAIL: 19 A8.1

REFER TO FRAMING NOTES AND REQUIREMENTS SHOWN ON DETAIL: 20 A9.1

WALL TYPE SERIES	DESCRIPTION	DETAIL REF.
A	NON-RATED FULL HEIGHT PARTITION WALL - FOR WALL REQUIREMENTS & VARIATIONS, REFER TO DETAIL.	2 A8.1
B	NON-RATED PARTIAL HEIGHT PARTITION WALL - FOR WALL REQUIREMENTS & VARIATIONS, REFER TO DETAIL.	6 A8.1
D	NON-RATED PLUMBING PARTITION - FOR WALL REQUIREMENTS & VARIATIONS, REFER TO DETAIL.	13 A8.1
E	NON-RATED SOUND ATTENUATION PARTITION - FOR WALL REQUIREMENTS & VARIATIONS, REFER TO DETAIL.	3 A8.1

FLOOR PLAN LEGEND

- PARTITION WALL
- 1-HR FIRE RATED WALL PER UL #419
- INTERIOR STOREFRONT PARTITION WALL
- CMU WALL, SPLITFACE
- CMU WALL, SHOTBLAST
- COMPOSITE WOOD DECK
- DOOR, HARDWARE, AND FRAME
- F.E.C. FIRE EXTINGUISHER CABINET, REFER TO DETAIL 6A9.2
- F.D. FLOOR DRAIN PER PLUMBING
- GLAZING PER SHEET A2.6-A2.7
- 101 DOOR PER SCHEDULE ON A2.5

FLOOR PLAN NOTES

- GENERAL:**
1. LOCATE ALL NEW DOOR FRAMES OR CASSED OPENINGS SO HINGED SIDE IS 4-INCHES FROM FACE OF THE DOOR JAMB TO THE FACE OF WALL, EXCEPT WHERE SPECIFICALLY DIMENSIONED OR SHOWN OTHERWISE. FOR LOCATION OF STOREFRONT DOORS, REFER TO WINDOW SCHEDULES.
 2. ALL ELECTRONIC SECURITY CARD READER DOOR LOCKS MUST OPERATE MANUALLY FOR EXITING UNDER ANY CIRCUMSTANCES, INCLUDING A POWER OUTAGE.
 3. REFER ALSO TO DRAWINGS T1.2 FOR PROJECT REQUIREMENTS, DRAWING T1.3 FOR ACCESSIBILITY REQUIREMENTS AND DRAWING T1.4 FOR EXITING PLAN.
 4. "PROVIDE" SHALL MEAN THAT THE CONTRACTOR, AT HIS/HER EXPENSE, SHALL FURNISH AND INSTALL THE WORK, COMPLETE IN PLACE AND READY FOR USE, INCLUDING FURNISHINGS OF NECESSARY LABOR, MATERIALS, TOOLS, EQUIPMENT AND TRANSPORTATION.

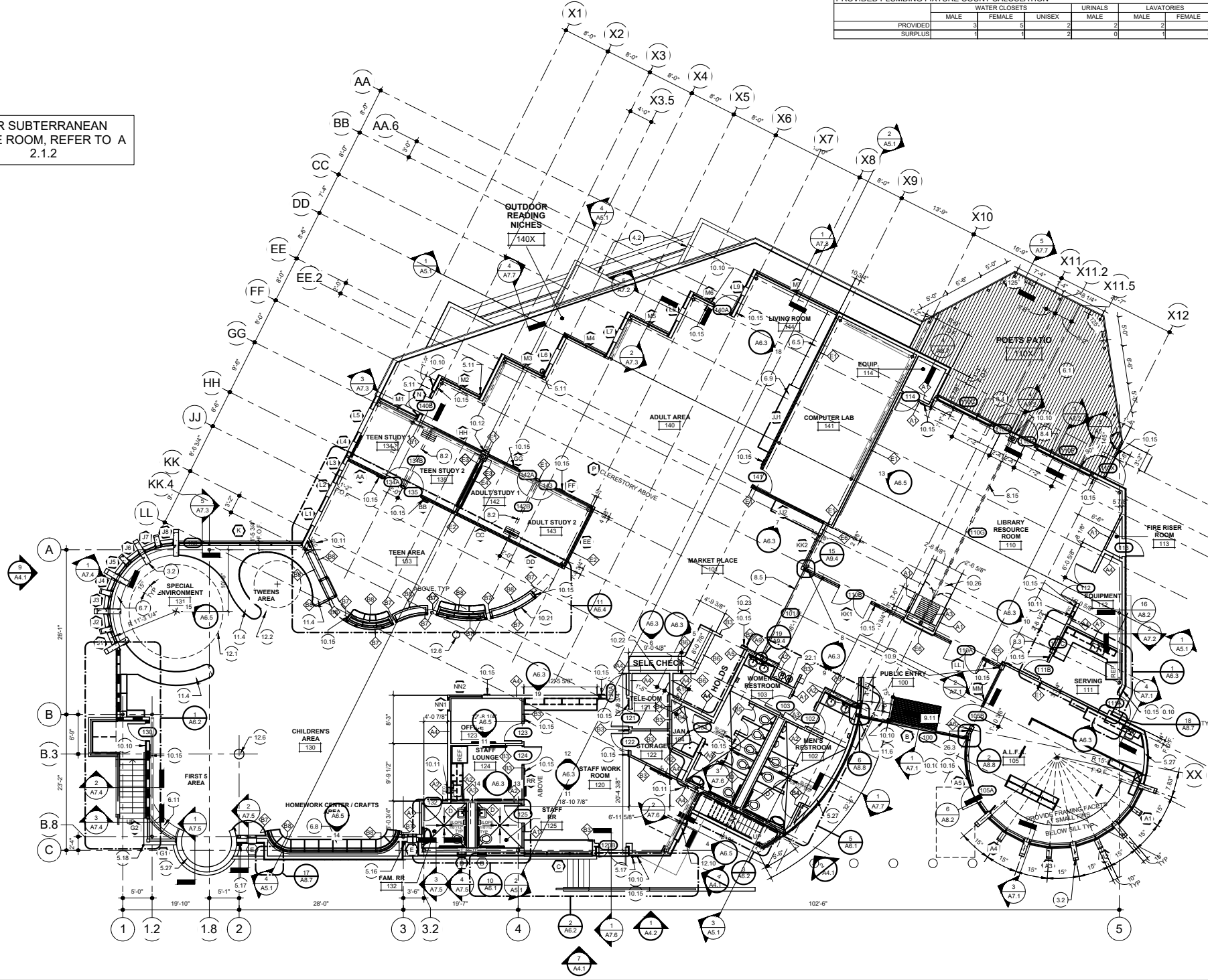

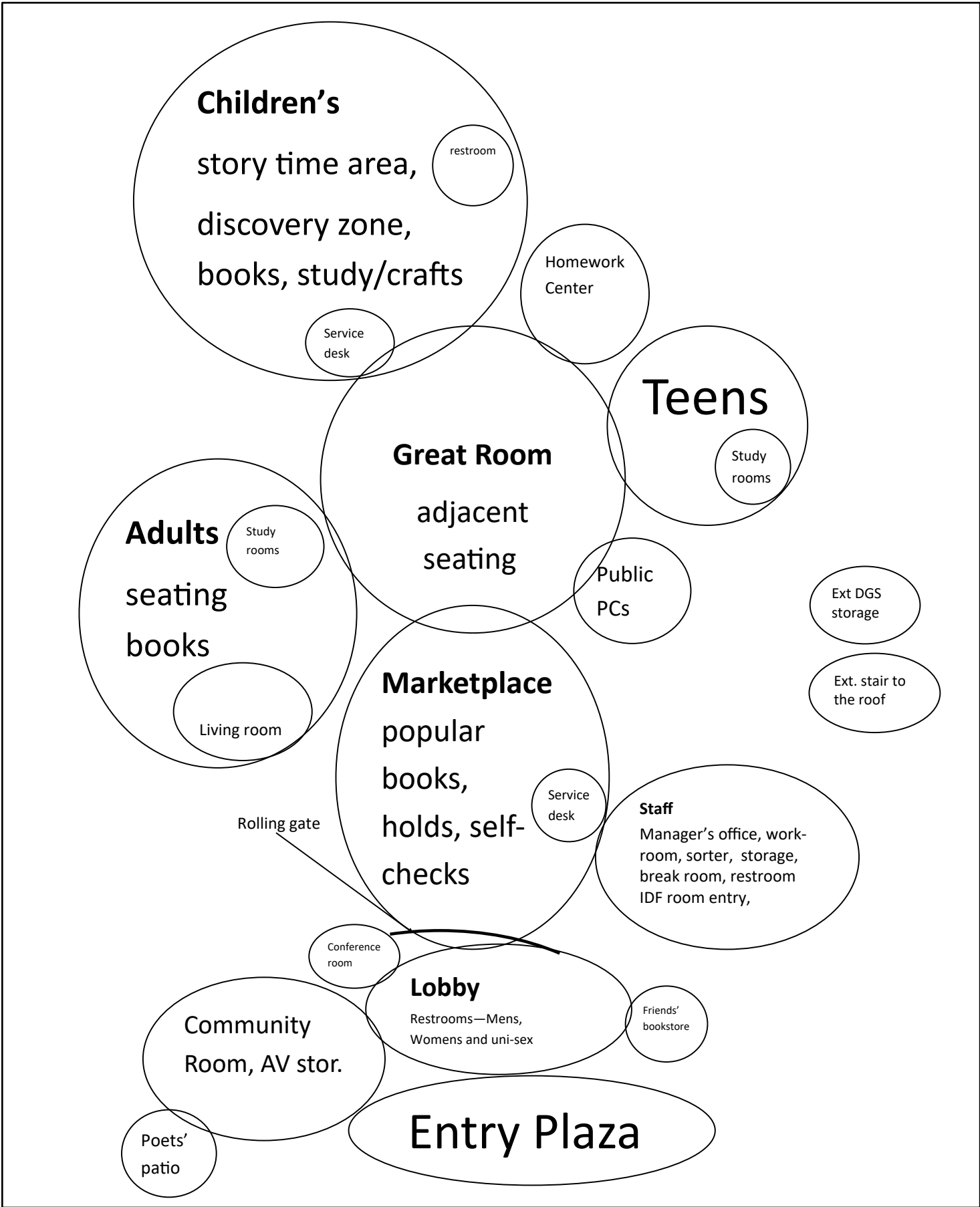

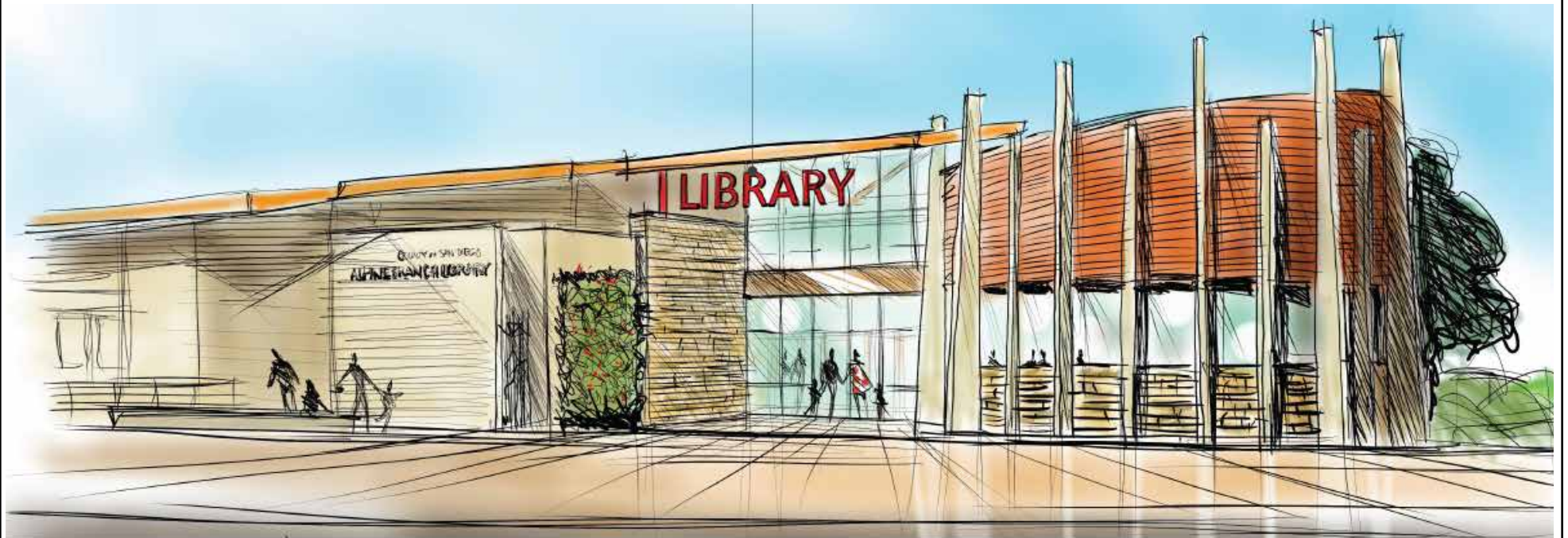





USGS The National Map: Orthoimagery. Data refreshed April 2020

FLOOD HAZARD INFORMATION

SEE FIS REPORT FOR DETAILED LEGEND AND INDEX MAP FOR FIRM PANEL LAYOUT

SPECIAL FLOOD HAZARD AREAS	Without Base Flood Elevation (BFE) Zone A, V, A99
	With BFE or Depth Zone AE, AO, AH, VE, AR
	Regulatory Floodway
OTHER AREAS OF FLOOD HAZARD	0.2% Annual Chance Flood Hazard, Areas of 1% Annual Chance Flood with average depth less than one foot or with drainage areas of less than one square mile Zone X
	Future Conditions 1% Annual Chance Flood Hazard Zone X
	Area with Reduced Flood Risk due to Levee See Notes Zone X
	Area with Flood Risk due to Levee Zone D
OTHER AREAS	NO SCREEN Area of Minimal Flood Hazard Zone X
	Effective LOMRs
	Area of Undetermined Flood Hazard Zone D
GENERAL STRUCTURES	Channel, Culvert, or Storm Sewer
	Levee, Dike, or Floodwall
	20.2 Cross Sections with 1% Annual Chance
	17.5 Water Surface Elevation
	Coastal Transect
	Coastal Transect Baseline
	Profile Baseline
	Hydrographic Feature
OTHER FEATURES	Base Flood Elevation Line (BFE)
	Limit of Study
	Jurisdiction Boundary

NOTES TO USERS

For information and questions about this Flood Insurance Rate Map (FIRM), available products associated with this FIRM, including historic versions, the current map date for each FIRM panel, how to order products, or the National Flood Insurance Program (NFIP) in general, please call the FEMA Map Information eXchange at 1-877-FEMA-MAP (1-877-336-6627) or visit the FEMA Flood Map Service Center website at <https://msc.fema.gov>. Available products may include previously issued Letters of Map Change, a Flood Insurance Study Report, and/or digital versions of this map. Many of these products can be ordered or obtained directly from the website.

Communities annexing land on adjacent FIRM panels must obtain a current copy of the adjacent panel as well as the current FIRM Index. These may be ordered directly from the Flood Map Service Center at the number listed above.

For community and countywide map dates, refer to the Flood Insurance Study Report for this jurisdiction.

To determine if flood insurance is available in this community, contact your Insurance agent or call the National Flood Insurance Program at 1-800-638-6620.

Basemap information shown on this FIRM was provided in digital format by USDA, Farm Service Agency (FSA). This information was derived from NAIP, dated April 11, 2018.

This map was exported from FEMA's National Flood Hazard Layer (NFHL) on 9/14/2020 6:28 PM and does not reflect changes or amendments subsequent to this date and time. The NFHL and effective information may change or become superseded by new data over time. For additional information, please see the Flood Hazard Mapping Updates Overview Fact Sheet at <https://www.fema.gov/media-library/assets/documents/118418>

This map complies with FEMA's standards for the use of digital flood maps if it is not void as described below. The basemap shown complies with FEMA's basemap accuracy standards. This map image is void if the one or more of the following map elements do not appear: basemap imagery, flood zone labels, legend, scale bar, map creation date, community identifiers, FIRM panel number, and FIRM effective date.

SCALE

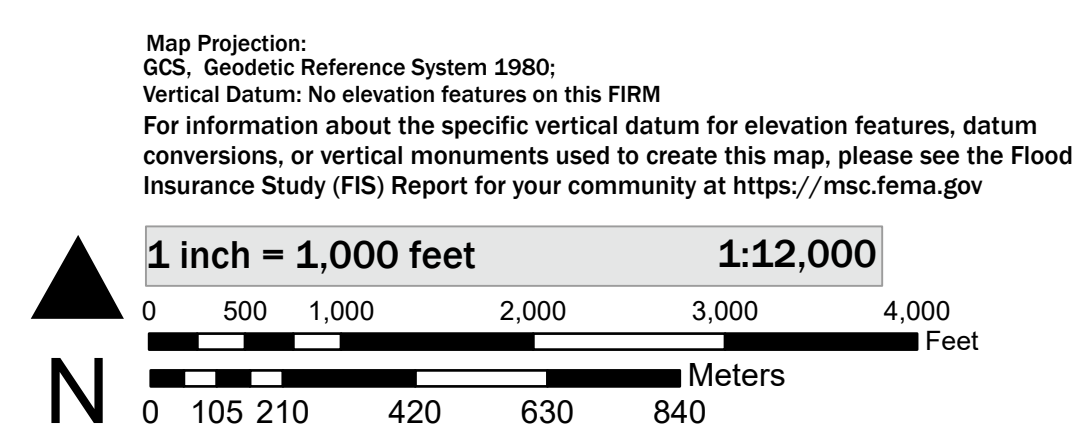

NATIONAL FLOOD INSURANCE PROGRAM
FLOOD INSURANCE RATE MAP

SAN DIEGO COUNTY, CALIFORNIA
AND INCORPORATED AREAS
PANEL 1930 OF 2300

Panel Contains:

COMMUNITY	NUMBER	PANEL
SAN DIEGO COUNTY	060284	1930

National Flood Hazard Layer FIRMette



116°59'43"W 32°45'10"N

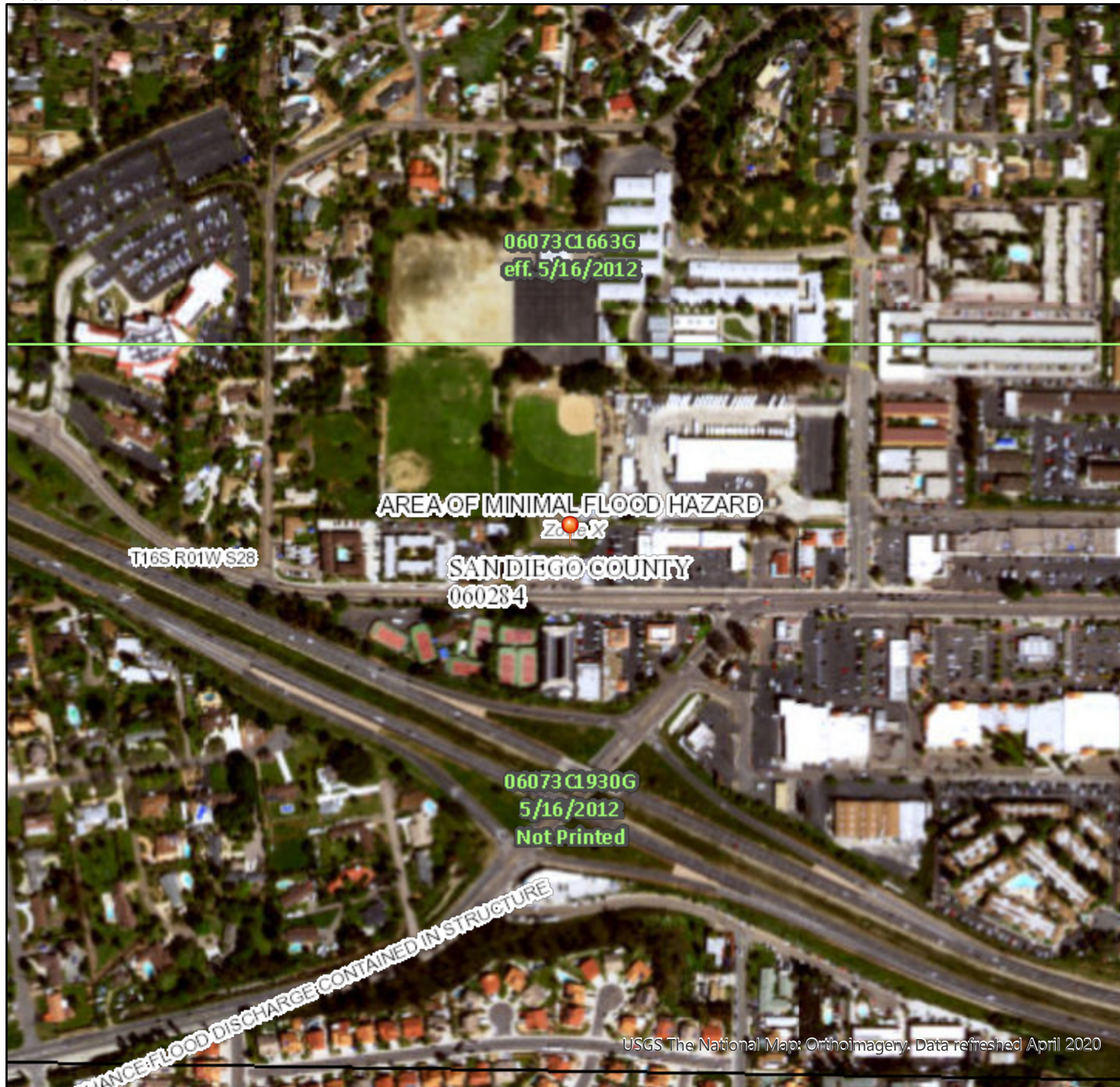

Legend

SEE FIS REPORT FOR DETAILED LEGEND AND INDEX MAP FOR FIRM PANEL LAYOUT

SPECIAL FLOOD HAZARD AREAS		Without Base Flood Elevation (BFE) <i>Zone A, V, A99</i>
		With BFE or Depth <i>Zone AE, AO, AH, VE, AR</i>
		Regulatory Floodway
OTHER AREAS OF FLOOD HAZARD		0.2% Annual Chance Flood Hazard, Areas of 1% annual chance flood with average depth less than one foot or with drainage areas of less than one square mile <i>Zone X</i>
		Future Conditions 1% Annual Chance Flood Hazard <i>Zone X</i>
		Area with Reduced Flood Risk due to Levee. See Notes. <i>Zone X</i>
		Area with Flood Risk due to Levee <i>Zone D</i>
OTHER AREAS		NO SCREEN Area of Minimal Flood Hazard <i>Zone X</i>
		Effective LOMRs
GENERAL STRUCTURES		Area of Undetermined Flood Hazard <i>Zone D</i>
		Channel, Culvert, or Storm Sewer
		Levee, Dike, or Floodwall
OTHER FEATURES		20.2 Cross Sections with 1% Annual Chance
		17.5 Water Surface Elevation
		Coastal Transect
		Base Flood Elevation Line (BFE)
		Limit of Study
MAP PANELS		Jurisdiction Boundary
		Coastal Transect Baseline
		Profile Baseline
		Hydrographic Feature
		Digital Data Available
		No Digital Data Available
		Unmapped



The pin displayed on the map is an approximate point selected by the user and does not represent an authoritative property location.

This map complies with FEMA's standards for the use of digital flood maps if it is not void as described below. The basemap shown complies with FEMA's basemap accuracy standards

The flood hazard information is derived directly from the authoritative NFHL web services provided by FEMA. This map was exported on 9/14/2020 at 6:30 PM and does not reflect changes or amendments subsequent to this date and time. The NFHL and effective information may change or become superseded by new data over time.

This map image is void if the one or more of the following map elements do not appear: basemap imagery, flood zone labels, legend, scale bar, map creation date, community identifiers, FIRM panel number, and FIRM effective date. Map images for unmapped and unmodernized areas cannot be used for regulatory purposes.

USGS The National Map: Orthoimagery. Data refreshed April 2020

0 250 500 1,000 1,500 2,000 Feet 1:6,000

116°59'5"W 32°44'39"N

Attachment A.6

Hydrologic Soil Group—San Diego County Area, California

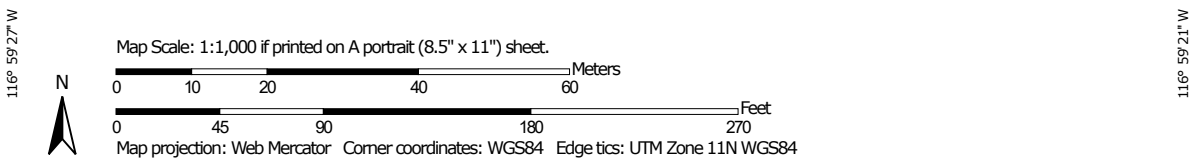
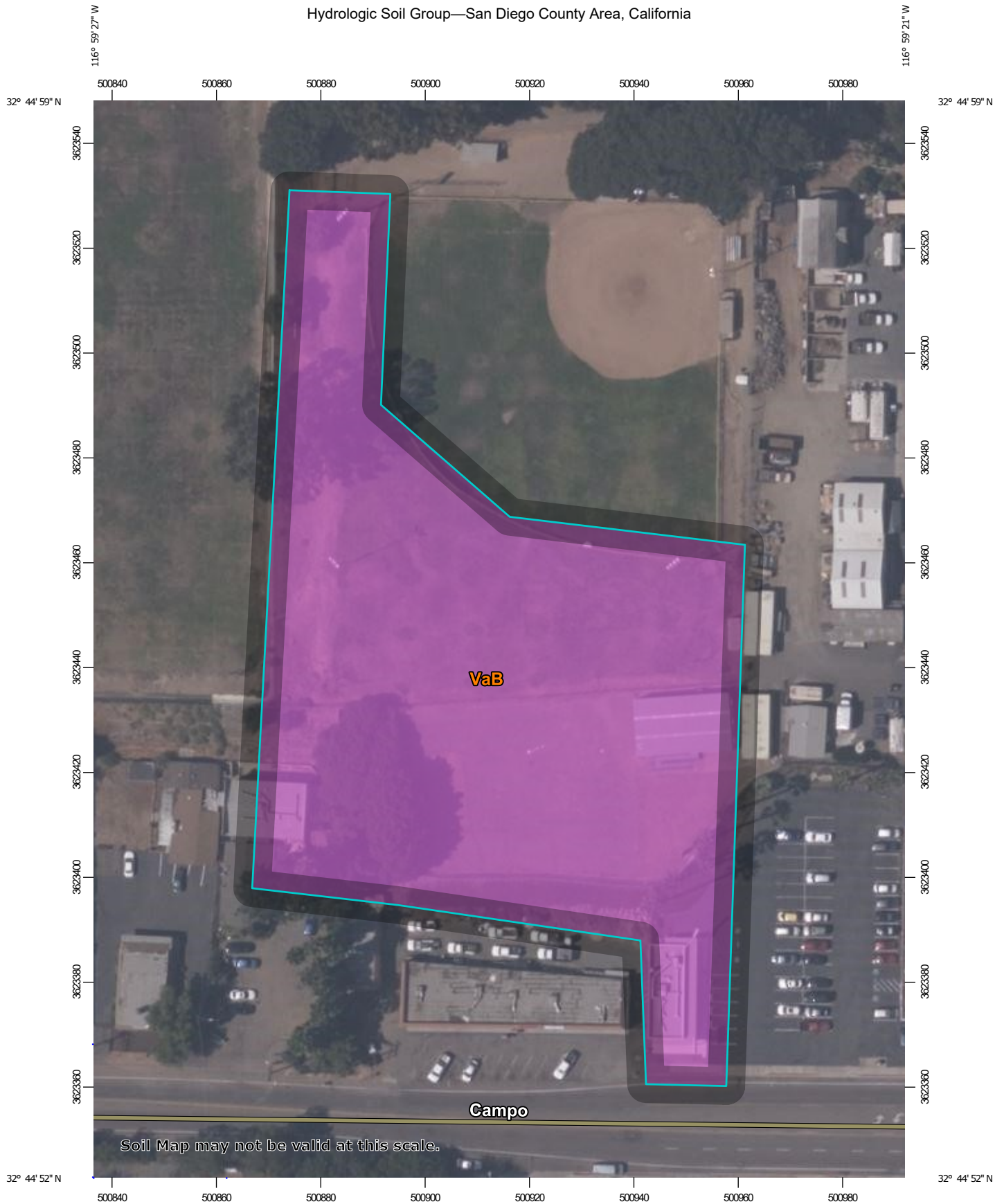

Attachment A.6

Hydrologic Soil Group—San Diego County Area, California

MAP LEGEND

Area of Interest (AOI)









 Area of Interest (AOI)

Soils

Soil Rating Polygons





 A
 A/D
 B
 B/D
 C
 C/D
 D
 Not rated or not available

Soil Rating Lines

 A
 A/D
 B
 B/D
 C
 C/D
 D
 Not rated or not available

Soil Rating Points





 A
 A/D
 B
 B/D

 C
 C/D
 D
 Not rated or not available

Water Features

 Streams and Canals

Transportation

 Rails
 Interstate Highways
 US Routes
 Major Roads
 Local Roads

Background

 Aerial Photography

MAP INFORMATION

The soil surveys that comprise your AOI were mapped at 1:24,000.

Warning: Soil Map may not be valid at this scale.

Enlargement of maps beyond the scale of mapping can cause misunderstanding of the detail of mapping and accuracy of soil line placement. The maps do not show the small areas of contrasting soils that could have been shown at a more detailed scale.

Please rely on the bar scale on each map sheet for map measurements.

Source of Map: Natural Resources Conservation Service
 Web Soil Survey URL:
 Coordinate System: Web Mercator (EPSG:3857)

Maps from the Web Soil Survey are based on the Web Mercator projection, which preserves direction and shape but distorts distance and area. A projection that preserves area, such as the Albers equal-area conic projection, should be used if more accurate calculations of distance or area are required.

This product is generated from the USDA-NRCS certified data as of the version date(s) listed below.

Soil Survey Area: San Diego County Area, California
 Survey Area Data: Version 15, May 27, 2020

Soil map units are labeled (as space allows) for map scales 1:50,000 or larger.

Date(s) aerial images were photographed: Aug 18, 2018—Aug 22, 2018

The orthophoto or other base map on which the soil lines were compiled and digitized probably differs from the background imagery displayed on these maps. As a result, some minor shifting of map unit boundaries may be evident.

Hydrologic Soil Group

Map unit symbol	Map unit name	Rating	Acres in AOI	Percent of AOI
VaB	Visalia sandy loam, 2 to 5 percent slopes	A	2.2	100.0%
Totals for Area of Interest			2.2	100.0%

Description

Hydrologic soil groups are based on estimates of runoff potential. Soils are assigned to one of four groups according to the rate of water infiltration when the soils are not protected by vegetation, are thoroughly wet, and receive precipitation from long-duration storms.

The soils in the United States are assigned to four groups (A, B, C, and D) and three dual classes (A/D, B/D, and C/D). The groups are defined as follows:

Group A. Soils having a high infiltration rate (low runoff potential) when thoroughly wet. These consist mainly of deep, well drained to excessively drained sands or gravelly sands. These soils have a high rate of water transmission.

Group B. Soils having a moderate infiltration rate when thoroughly wet. These consist chiefly of moderately deep or deep, moderately well drained or well drained soils that have moderately fine texture to moderately coarse texture. These soils have a moderate rate of water transmission.

Group C. Soils having a slow infiltration rate when thoroughly wet. These consist chiefly of soils having a layer that impedes the downward movement of water or soils of moderately fine texture or fine texture. These soils have a slow rate of water transmission.

Group D. Soils having a very slow infiltration rate (high runoff potential) when thoroughly wet. These consist chiefly of clays that have a high shrink-swell potential, soils that have a high water table, soils that have a claypan or clay layer at or near the surface, and soils that are shallow over nearly impervious material. These soils have a very slow rate of water transmission.

If a soil is assigned to a dual hydrologic group (A/D, B/D, or C/D), the first letter is for drained areas and the second is for undrained areas. Only the soils that in their natural condition are in group D are assigned to dual classes.

Rating Options

Aggregation Method: Dominant Condition

Component Percent Cutoff: None Specified

Tie-break Rule: Higher

Attachment B - Hydrology

B.1 Existing Hydrology Map

B.2 Existing Composite C Calculations

B.3 Existing Hydrology Calculations

B.4 Conceptual Proposed Hydrology Map

B.5 Proposed Composite C Calculations

B.6 Proposed Hydrology Calculations

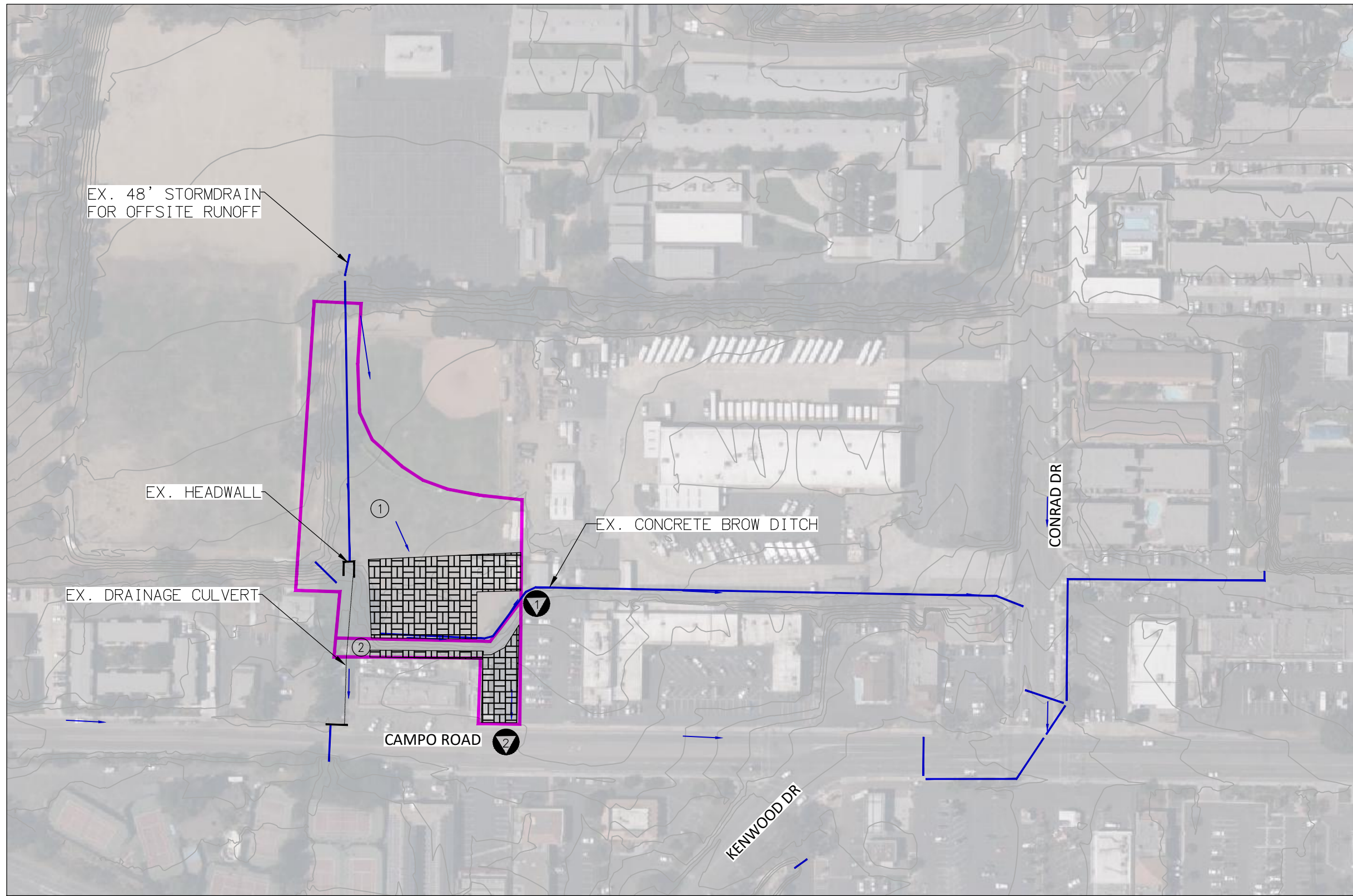

LEGEND

- DRAINAGE AREA ①
- DRAINAGE AREA BOUNDARY —
- FLOWLINE →
- EXISTING STORMDRAIN —
- DISCHARGE POINT ①
- IMPERVIOUS [Hatched Box]

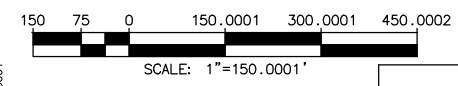

DRAINAGE AREAS					
DRAINAGE AREA	AREA (AC)	IMPERVIOUS(AC)	DISCHARGE POINT	C VALUE	Q100 (CFS)
1	1.93	0.47	1	0.37	2.88
2	0.31	0.16	2	0.56	1.26

Attachment B.1

**CASA DE ORO LIBRARY BRANCH
EXISTING HYDROLOGY**



9755 Clairemont Mesa Blvd.
San Diego, CA 92124
Phone: (858) 614-5000
MBAKERINTL.COM

FILE NAME: C:\Working\OOD\Existing Hydrology LAYOUT NAME: 11x17 10bScale PLOTTED: Monday, September 21, 2020 - 3:23pm USER: Kristin Warner

Attachment B.2

Existing Composite Weighted C

County of San Diego Hydrology Manual (June 2003)

Per Table 3-1, Soil Type A

Impervious C=0.9

Pervious C=0.2

On-Site Drainage	Area (ac)	Area (sf)	Pervious (sf)	Impervious (sf)	% Impervious	Composite C Weighted
1	1.93	84,004	63,504	20500	24%	0.37
2	0.31	13,570	6,540	7030	52%	0.56
Total	2.24			27,530		

Attachment B.3

Casa de Oro - Existing Hydrology Summary Table

Drainage Area	Area (ac)	Soil Group	C	Total Flow Length (ft)	Up-St Elevation	Downs-St Elevation	Initial Travel Time (Per Table 3-2)			Travel Time (Shallow Concentrated Flow)				Total Tt (min)	Tc (min)	2 Year			10 Year			100 Year		
							Slope (%)	Lm (ft)	Ti (min)	Slope (%)	L (ft)	V (ft/s)**	Tt (min)			P ₆ (in)	I (in/hr)	Q ₂ (cfs)	P ₆ (in)	I (in/hr)	Q ₁₀ (cfs)	P ₆ (in)	I (in/hr)	Q ₁₀₀ (cfs)
1	1.93	A	0.37	575	450	438	2%	85	8.8	2%	490	2.3	3.6	12.4	-	1.3	1.90	1.4	1.85	2.71	1.9	2.75	4.03	2.88
2	0.31	A	0.56	-	-	-	-	-	-	-	-	-	-	-	5.0	1.3	3.43	0.6	1.85	4.87	0.9	2.75	7.25	1.26

*Based on County of San Diego Hydrology Manual (June 2003) Table 3-1

**Based on TR-55 Figure 3-1 for Shallow Concentrated Flow

County of San Diego Hydrology Manual (June 2003)

Q=CIA

Q = Flow Rate (cfs)

C = Runoff Coefficient Weighted Composite - Calculations found in Appendix C

I = Intensity (in/hr)

A = Area (acres)

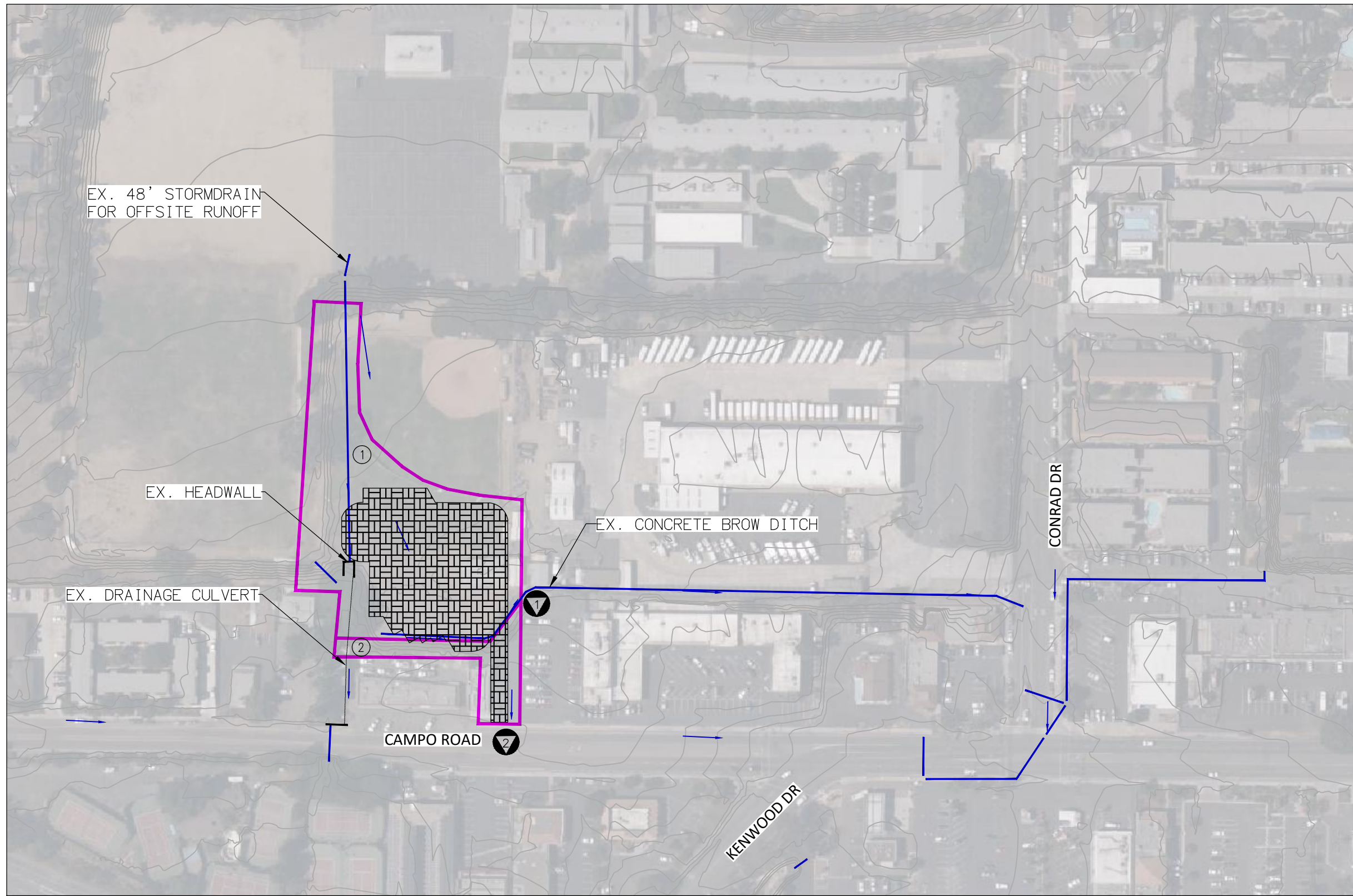

LEGEND

- DRAINAGE AREA ①
- DRAINAGE AREA BOUNDARY —
- FLOWLINE →
- EXISTING STORMDRAIN —
- DISCHARGE POINT ①
- IMPERVIOUS [Grid Pattern]

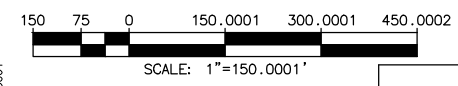

DRAINAGE AREAS					
DRAINAGE AREA	AREA (AC)	IMPERVIOUS(AC)	DISCHARGE POINT	C VALUE	Q100 (CFS)
1	1.93	0.93	1	0.54	4.19
2	0.31	0.09	2	0.40	0.90

Attachment B.4

**CASA DE ORO LIBRARY BRANCH
PROPOSED HYDROLOGY CONCEPT**



9755 Clairemont Mesa Blvd.
San Diego, CA 92124
Phone: (858) 614-5000
MBAKERINTL.COM

FILE NAME: C:\Working\OOD\Pro_Hydrology_LAYOUT NAME: 11x17 100scale PLOTTED: Monday, September 21, 2020 - 3:21pm USER: Kristin.Werner

Attachment B.5

Proposed Composite Weighted C

County of San Diego Hydrology Manual (June 2003)

Per Table 3-1, Soil Type A

Impervious C=0.9

Pervious C=0.2

On-Site Drainage	Area (ac)	Area (sf)	Pervious (sf)	Impervious (sf)	% Impervious	Composite C Weighted
1	1.93	84,004	43,332	40,672	48%	0.54
2	0.31	13,570	9,642	3,928	29%	0.40
Total	2.24			44,600		

Attachment B.6

Casa De Oro- Proposed Hydrology Summary Table

Drainage Area	Area (ac)	Soil Group	C	Total Flow Length (ft)	Up-St Elevation	Downs-St Elevation	Initial Travel Time (Per Table 3-2)			Travel Time (Shallow Concentrated Flow)				Total Tt (min)	Tc (min)	2 Year			10 Year			100 Year		
							Slope (%)	Lm (ft)	Ti (min)	Slope (%)	L (ft)	V (ft/s)**	Tt (min)			P ₆ (in)	I (in/hr)	Q ₂ (cfs)	P ₆ (in)	I (in/hr)	Q ₁₀ (cfs)	P ₆ (in)	I (in/hr)	Q ₁₀₀ (cfs)
1	1.93	A	0.54	575	450	438	2%	85	8.8	2%	490	2.3	3.6	12.4	-	1.3	1.90	2.0	1.85	2.71	2.8	2.75	4.03	4.19
2	0.31	A	0.40	-	-	-	-	-	-	-	-	-	-	-	5.0	1.3	3.43	0.4	1.85	4.87	0.6	2.75	7.25	0.90

County of San Diego Hydrology Manual (June 2003)
Q=CIA

Q = Flow Rate (cfs)
C = Runoff Coefficient Weighted Composite - Calculations found in Appendix D
I = Intensity (in/hr)
A = Area (acres)

*Hydrology and Water Quality Technical Memorandum
Casa De Oro Branch Library
9/28/2020*

Attachment C- Hydrology Excerpts

Attachment C

**Table 3-1
RUNOFF COEFFICIENTS FOR URBAN AREAS**

Land Use		Runoff Coefficient "C"				
NRCS Elements	County Elements	% IMPER.	Soil Type			
			A	B	C	D
Undisturbed Natural Terrain (Natural)	Permanent Open Space	0*	0.20	0.25	0.30	0.35
Low Density Residential (LDR)	Residential, 1.0 DU/A or less	10	0.27	0.32	0.36	0.41
Low Density Residential (LDR)	Residential, 2.0 DU/A or less	20	0.34	0.38	0.42	0.46
Low Density Residential (LDR)	Residential, 2.9 DU/A or less	25	0.38	0.41	0.45	0.49
Medium Density Residential (MDR)	Residential, 4.3 DU/A or less	30	0.41	0.45	0.48	0.52
Medium Density Residential (MDR)	Residential, 7.3 DU/A or less	40	0.48	0.51	0.54	0.57
Medium Density Residential (MDR)	Residential, 10.9 DU/A or less	45	0.52	0.54	0.57	0.60
Medium Density Residential (MDR)	Residential, 14.5 DU/A or less	50	0.55	0.58	0.60	0.63
High Density Residential (HDR)	Residential, 24.0 DU/A or less	65	0.66	0.67	0.69	0.71
High Density Residential (HDR)	Residential, 43.0 DU/A or less	80	0.76	0.77	0.78	0.79
Commercial/Industrial (N. Com)	Neighborhood Commercial	80	0.76	0.77	0.78	0.79
Commercial/Industrial (G. Com)	General Commercial	85	0.80	0.80	0.81	0.82
Commercial/Industrial (O.P. Com)	Office Professional/Commercial	90	0.83	0.84	0.84	0.85
Commercial/Industrial (Limited I.)	Limited Industrial	90	0.83	0.84	0.84	0.85
Commercial/Industrial (General I.)	General Industrial	95	0.87	0.87	0.87	0.87

*The values associated with 0% impervious may be used for direct calculation of the runoff coefficient as described in Section 3.1.2 (representing the pervious runoff coefficient, Cp, for the soil type), or for areas that will remain undisturbed in perpetuity. Justification must be given that the area will remain natural forever (e.g., the area is located in Cleveland National Forest).

DU/A = dwelling units per acre

NRCS = National Resources Conservation Service

Note that the Initial Time of Concentration should be reflective of the general land-use at the upstream end of a drainage basin. A single lot with an area of two or less acres does not have a significant effect where the drainage basin area is 20 to 600 acres.

Table 3-2 provides limits of the length (Maximum Length (L_M)) of sheet flow to be used in hydrology studies. Initial T_i values based on average C values for the Land Use Element are also included. These values can be used in planning and design applications as described below. Exceptions may be approved by the "Regulating Agency" when submitted with a detailed study.

Table 3-2

**MAXIMUM OVERLAND FLOW LENGTH (L_M)
& INITIAL TIME OF CONCENTRATION (T_i)**

Element*	DU/ Acre	.5%		1%		2%		3%		5%		10%	
		L_M	T_i	L_M	T_i	L_M	T_i	L_M	T_i	L_M	T_i	L_M	T_i
Natural		50	13.2	70	12.5	85	10.9	100	10.3	100	8.7	100	6.9
LDR	1	50	12.2	70	11.5	85	10.0	100	9.5	100	8.0	100	6.4
LDR	2	50	11.3	70	10.5	85	9.2	100	8.8	100	7.4	100	5.8
LDR	2.9	50	10.7	70	10.0	85	8.8	95	8.1	100	7.0	100	5.6
MDR	4.3	50	10.2	70	9.6	80	8.1	95	7.8	100	6.7	100	5.3
MDR	7.3	50	9.2	65	8.4	80	7.4	95	7.0	100	6.0	100	4.8
MDR	10.9	50	8.7	65	7.9	80	6.9	90	6.4	100	5.7	100	4.5
MDR	14.5	50	8.2	65	7.4	80	6.5	90	6.0	100	5.4	100	4.3
HDR	24	50	6.7	65	6.1	75	5.1	90	4.9	95	4.3	100	3.5
HDR	43	50	5.3	65	4.7	75	4.0	85	3.8	95	3.4	100	2.7
N. Com		50	5.3	60	4.5	75	4.0	85	3.8	95	3.4	100	2.7
G. Com		50	4.7	60	4.1	75	3.6	85	3.4	90	2.9	100	2.4
O.P./Com		50	4.2	60	3.7	70	3.1	80	2.9	90	2.6	100	2.2
Limited I.		50	4.2	60	3.7	70	3.1	80	2.9	90	2.6	100	2.2
General I.		50	3.7	60	3.2	70	2.7	80	2.6	90	2.3	100	1.9

*See Table 3-1 for more detailed description

Chosen for 25%
impervious.

Figure 3-1 Average velocities for estimating travel time for shallow concentrated flow

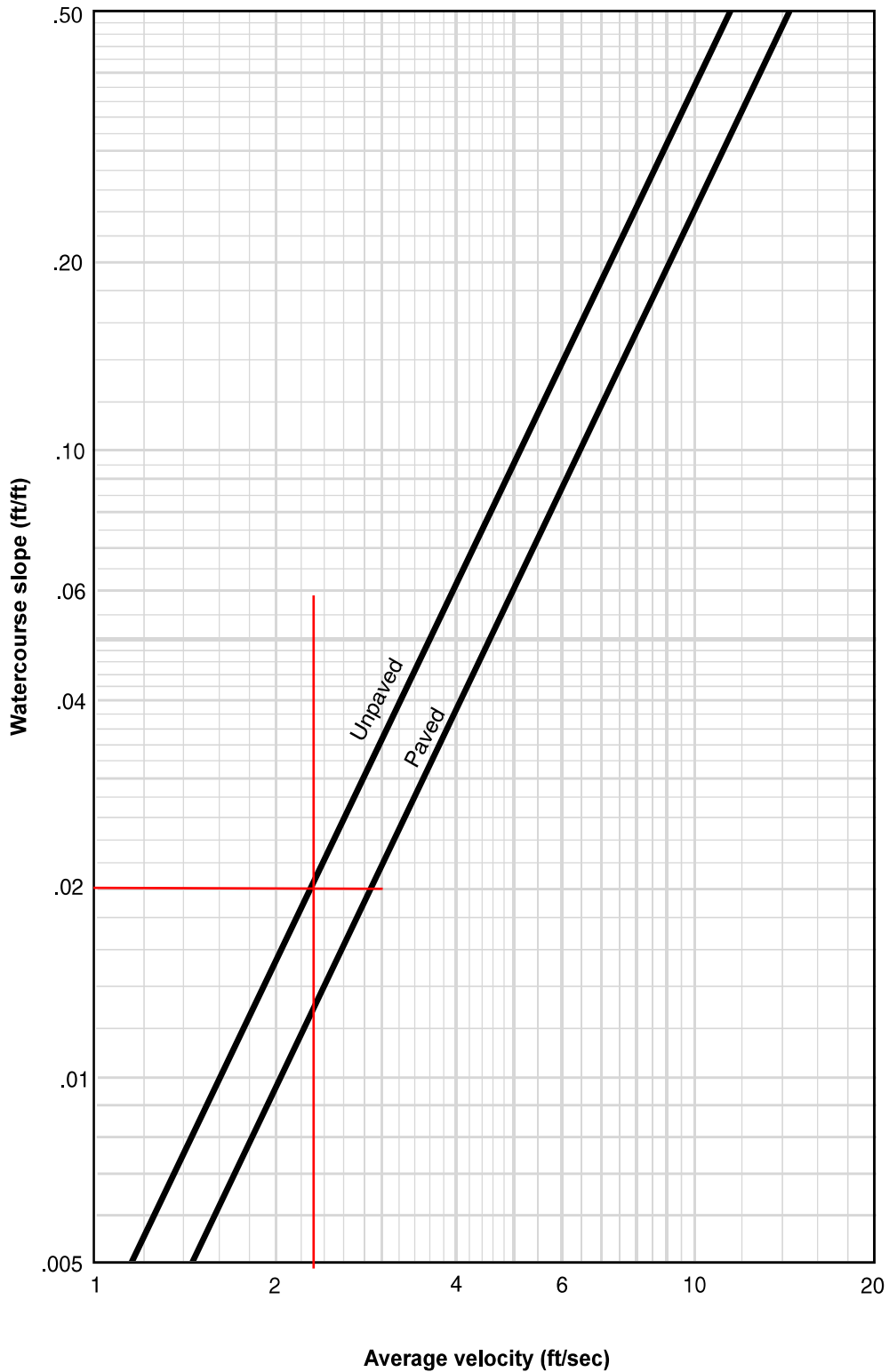

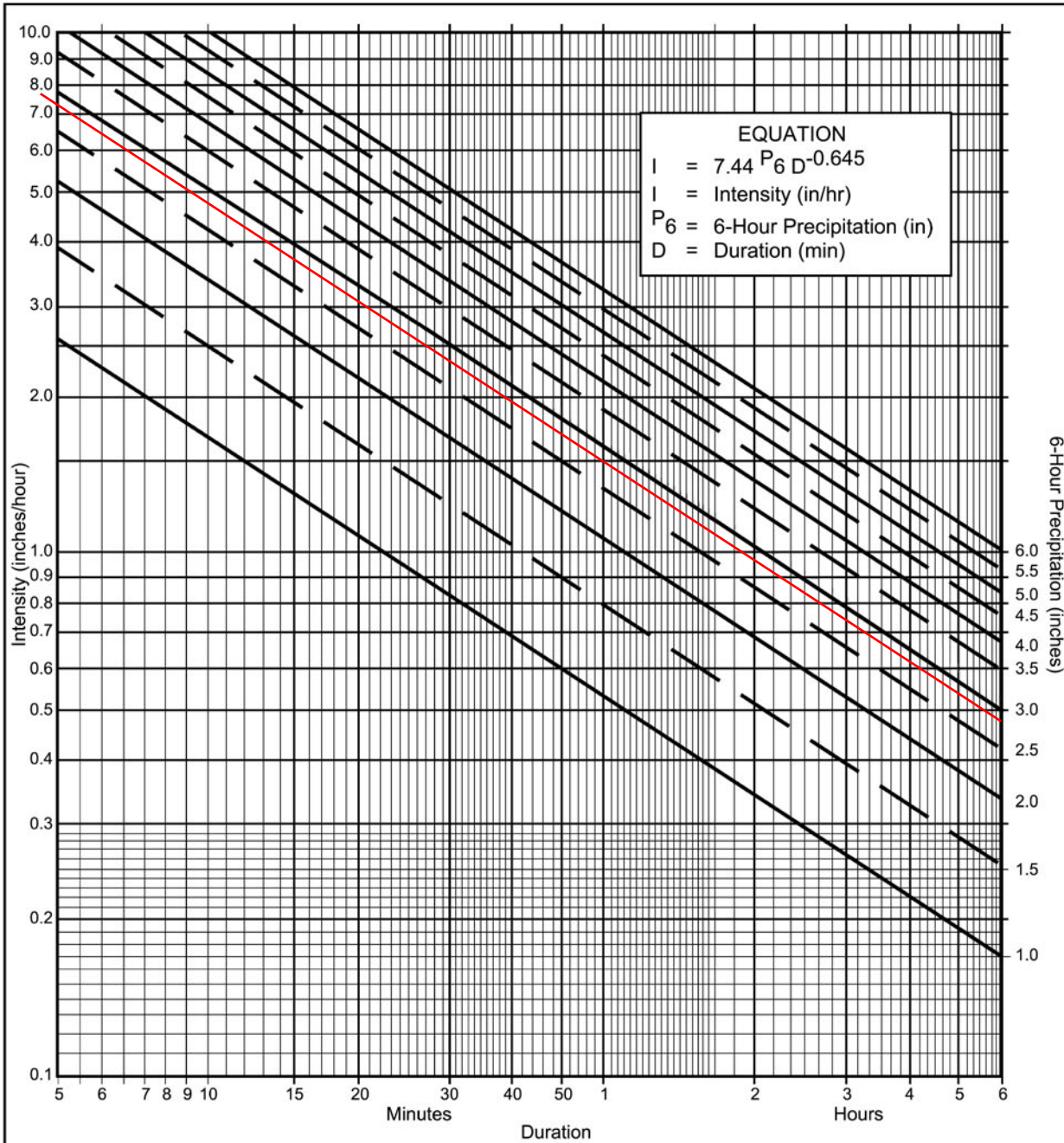

Directions for Application:

- (1) From precipitation maps determine 6 hr and 24 hr amounts for the selected frequency. These maps are included in the County Hydrology Manual (10, 50, and 100 yr maps included in the Design and Procedure Manual).
- (2) Adjust 6 hr precipitation (if necessary) so that it is within the range of 45% to 65% of the 24 hr precipitation (not applicable to Desert).
- (3) Plot 6 hr precipitation on the right side of the chart.
- (4) Draw a line through the point parallel to the plotted lines.
- (5) This line is the intensity-duration curve for the location being analyzed.

Application Form:

- (a) Selected frequency 100 year
- (b) $P_6 = \underline{2.75}$ in., $P_{24} = \underline{6.0}$, $\frac{P_6}{P_{24}} = \underline{46}$ %⁽²⁾
- (c) Adjusted $P_6^{(2)} = \underline{\hspace{2cm}}$ in.
- (d) $t_x = \underline{\hspace{2cm}}$ min.
- (e) $I = \underline{7.75}$ in./hr.

Note: This chart replaces the Intensity-Duration-Frequency curves used since 1965.

P6	1	1.5	2	2.5	3	3.5	4	4.5	5	5.5	6
Duration											
5	2.63	3.95	5.27	6.59	7.90	9.22	10.54	11.86	13.17	14.49	15.81
7	2.12	3.18	4.24	5.30	6.36	7.42	8.48	9.54	10.60	11.66	12.72
10	1.68	2.53	3.37	4.21	5.05	5.90	6.74	7.58	8.42	9.27	10.11
15	1.30	1.95	2.59	3.24	3.89	4.54	5.19	5.84	6.49	7.13	7.78
20	1.08	1.62	2.15	2.69	3.23	3.77	4.31	4.85	5.39	5.93	6.46
25	0.93	1.40	1.87	2.33	2.80	3.27	3.73	4.20	4.67	5.13	5.60
30	0.83	1.24	1.66	2.07	2.49	2.90	3.32	3.73	4.15	4.56	4.98
40	0.69	1.03	1.38	1.72	2.07	2.41	2.76	3.10	3.45	3.79	4.13
50	0.60	0.90	1.19	1.49	1.79	2.09	2.39	2.69	2.98	3.28	3.58
60	0.53	0.80	1.06	1.33	1.59	1.86	2.12	2.39	2.65	2.92	3.18
90	0.41	0.61	0.82	1.02	1.23	1.43	1.63	1.84	2.04	2.25	2.45
120	0.34	0.51	0.68	0.85	1.02	1.19	1.36	1.53	1.70	1.87	2.04
150	0.29	0.44	0.59	0.73	0.88	1.03	1.18	1.32	1.47	1.62	1.76
180	0.26	0.39	0.52	0.65	0.78	0.91	1.04	1.18	1.31	1.44	1.57
240	0.22	0.33	0.43	0.54	0.65	0.76	0.87	0.98	1.08	1.19	1.30
300	0.19	0.28	0.38	0.47	0.56	0.66	0.75	0.85	0.94	1.03	1.13
360	0.17	0.25	0.33	0.42	0.50	0.58	0.67	0.75	0.84	0.92	1.00

Intensity-Duration Design Chart - Template

FIGURE

3-1

Attachment C

County of San Diego Hydrology Manual



Rainfall Isophivials

2 Year Rainfall Event - 6 Hours

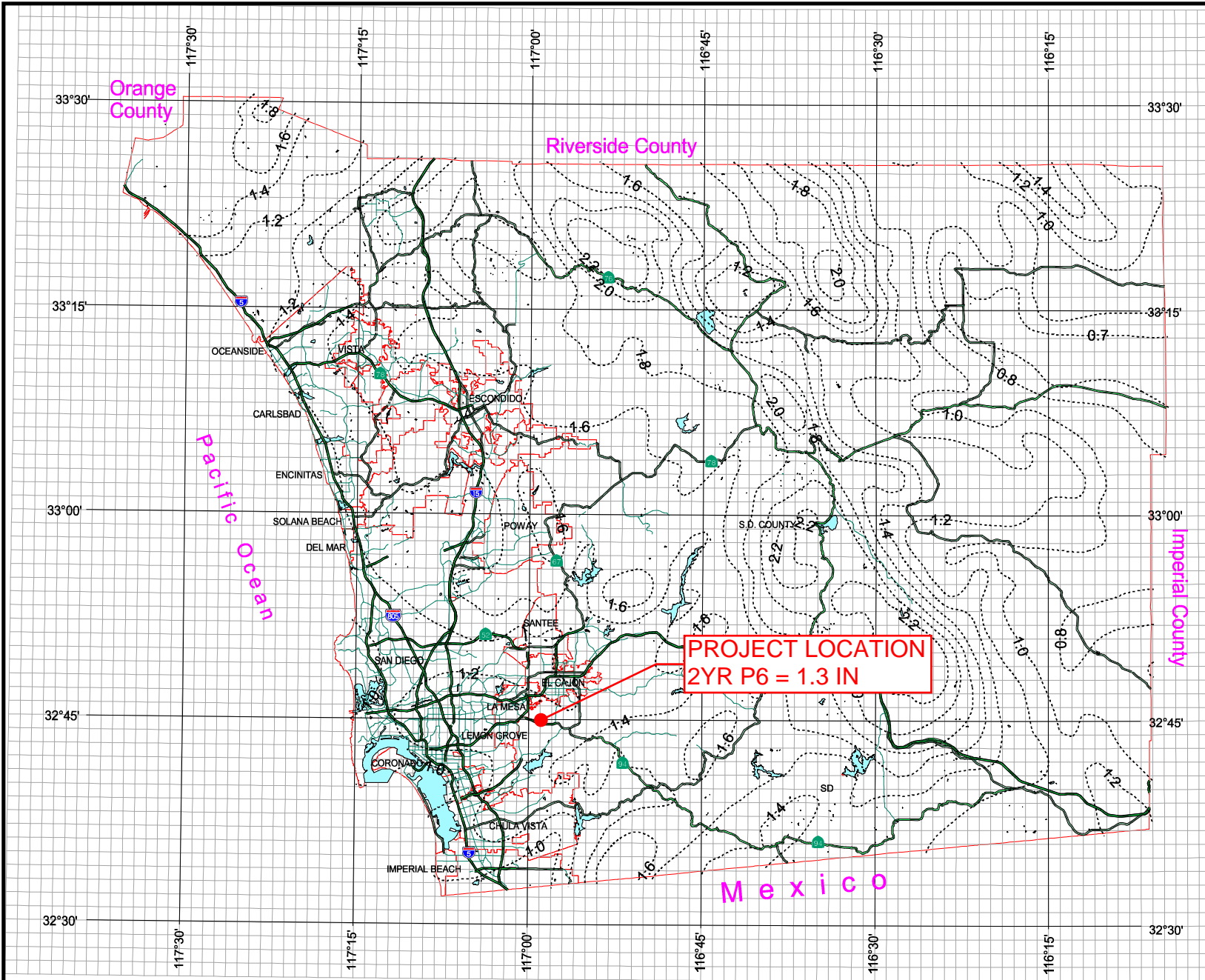
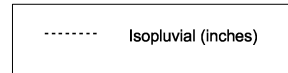

Department of Public Works
Geographic Information Services

We Have San Diego Covered!

THIS MAP IS PROVIDED WITHOUT WARRANTY OF ANY KIND, EITHER EXPRESS OR IMPLIED, INCLUDING, BUT NOT LIMITED TO, THE IMPLIED WARRANTIES OF MERCHANTABILITY AND FITNESS FOR A PARTICULAR PURPOSE. Copyright SanGIS. All Rights Reserved.

This product may contain information from the SANDAG Regional Information System which cannot be reproduced without the written permission of SANDAG.

This product may contain information which has been reproduced with permission granted by Thomas Brothers Maps.

3 0 3 Miles

County of San Diego Hydrology Manual



Rainfall Isopleths

10 Year Rainfall Event - 6 Hours

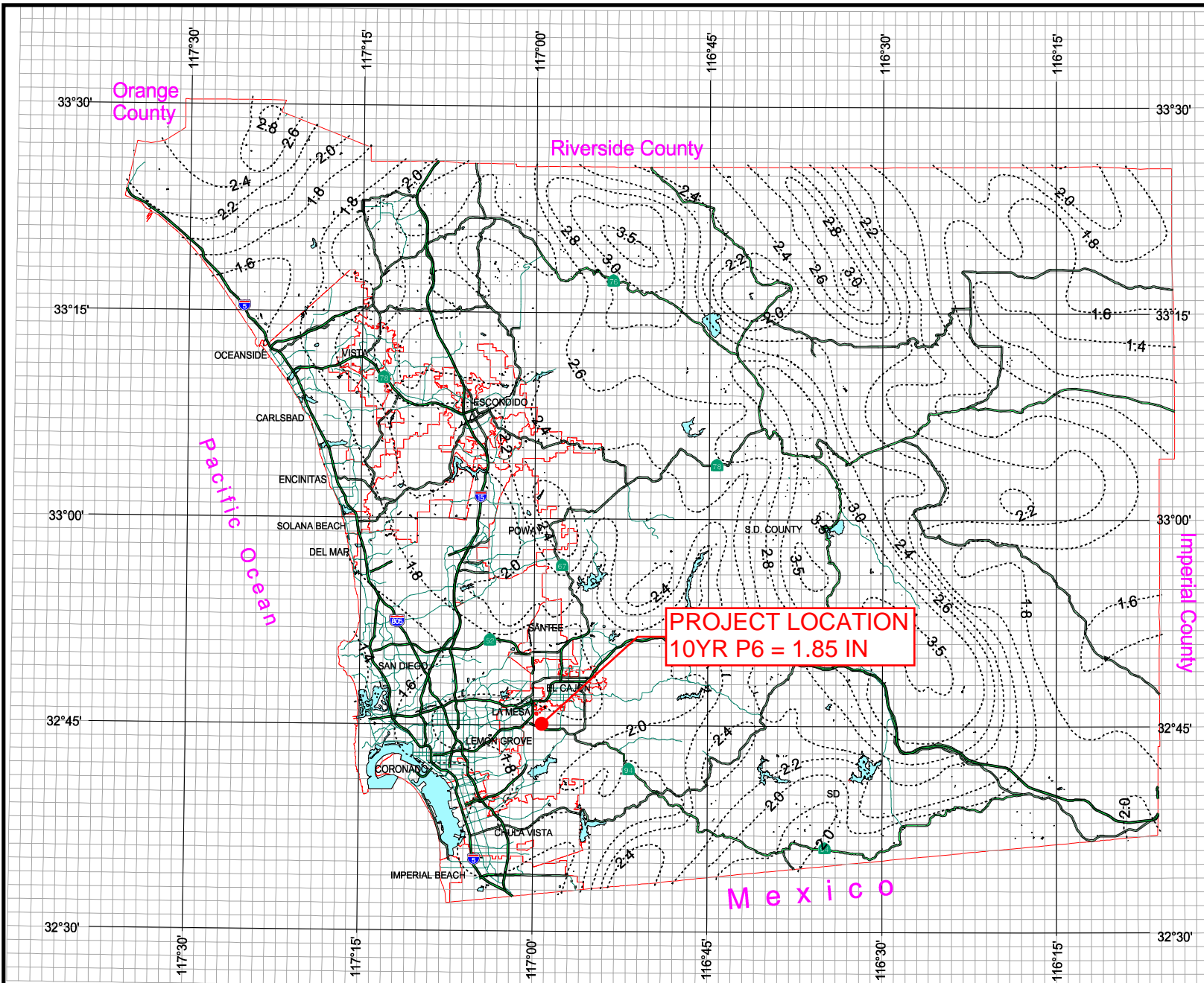
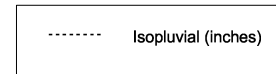

Department of Public Works
Geographic Information Services

We Have San Diego Covered!

THIS MAP IS PROVIDED WITHOUT WARRANTY OF ANY KIND, EITHER EXPRESS OR IMPLIED, INCLUDING, BUT NOT LIMITED TO, THE IMPLIED WARRANTIES OF MERCHANTABILITY AND FITNESS FOR A PARTICULAR PURPOSE. Copyright SanGIS. All Rights Reserved.

This product may contain information from the SANDAG Regional Information System which cannot be reproduced without the written permission of SANDAG.

This product may contain information which has been reproduced with permission granted by Thomas Brothers Maps.

3 0 3 Miles

County of San Diego Hydrology Manual



Rainfall Isopleths

100 Year Rainfall Event - 6 Hours

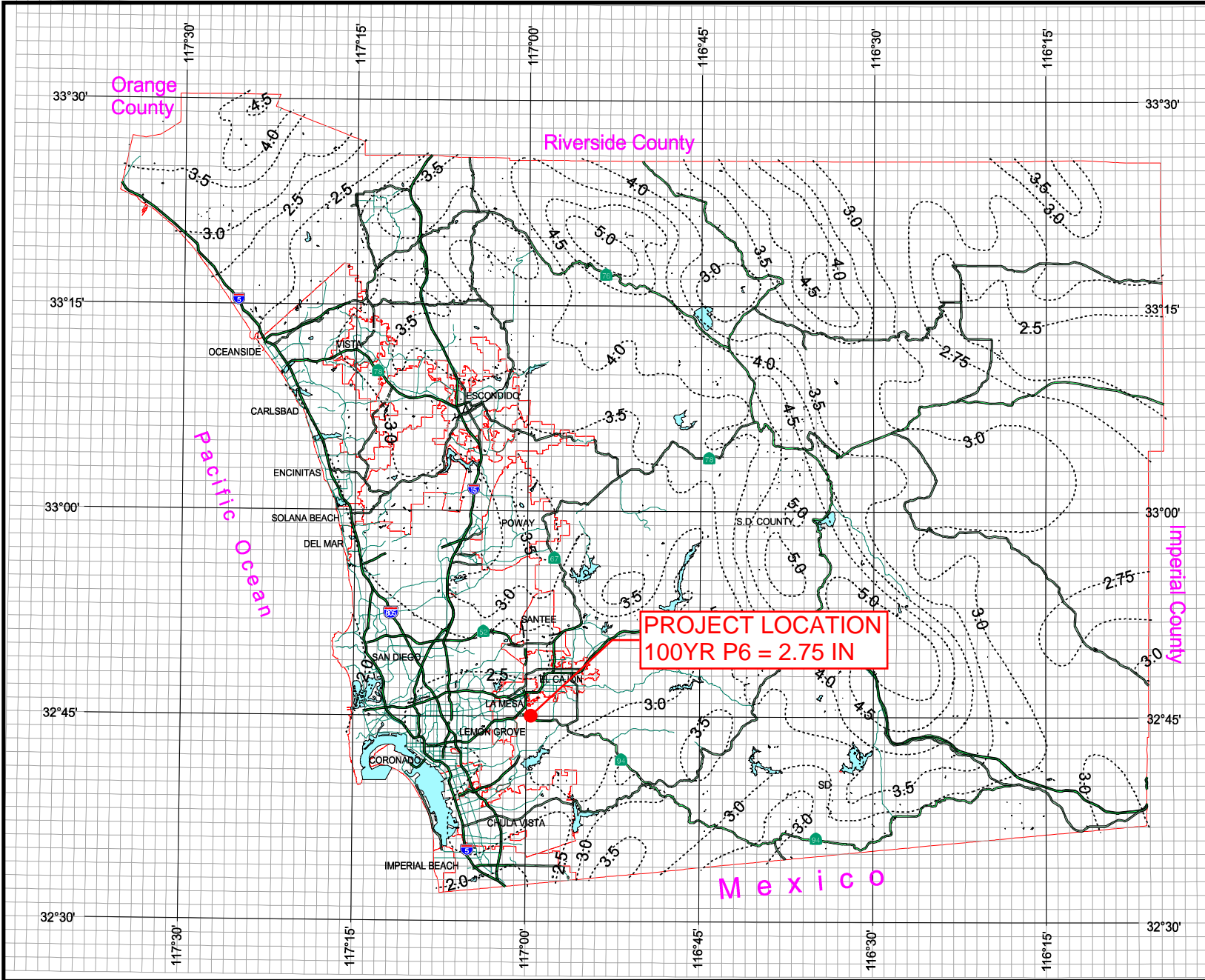
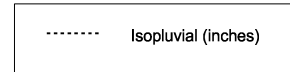

Department of Public Works
Geographic Information Services

We Have San Diego Covered!

THIS MAP IS PROVIDED WITHOUT WARRANTY OF ANY KIND, EITHER EXPRESS OR IMPLIED, INCLUDING, BUT NOT LIMITED TO, THE IMPLIED WARRANTIES OF MERCHANTABILITY AND FITNESS FOR A PARTICULAR PURPOSE. Copyright SanGIS. All Rights Reserved.

This product may contain information from the SANDAG Regional Information System which cannot be reproduced without the written permission of SANDAG.

This product may contain information which has been reproduced with permission granted by Thomas Brothers Maps.

3 0 3 Miles

County of San Diego Hydrology Manual



Rainfall Isopleths

100 Year Rainfall Event - 24 Hours

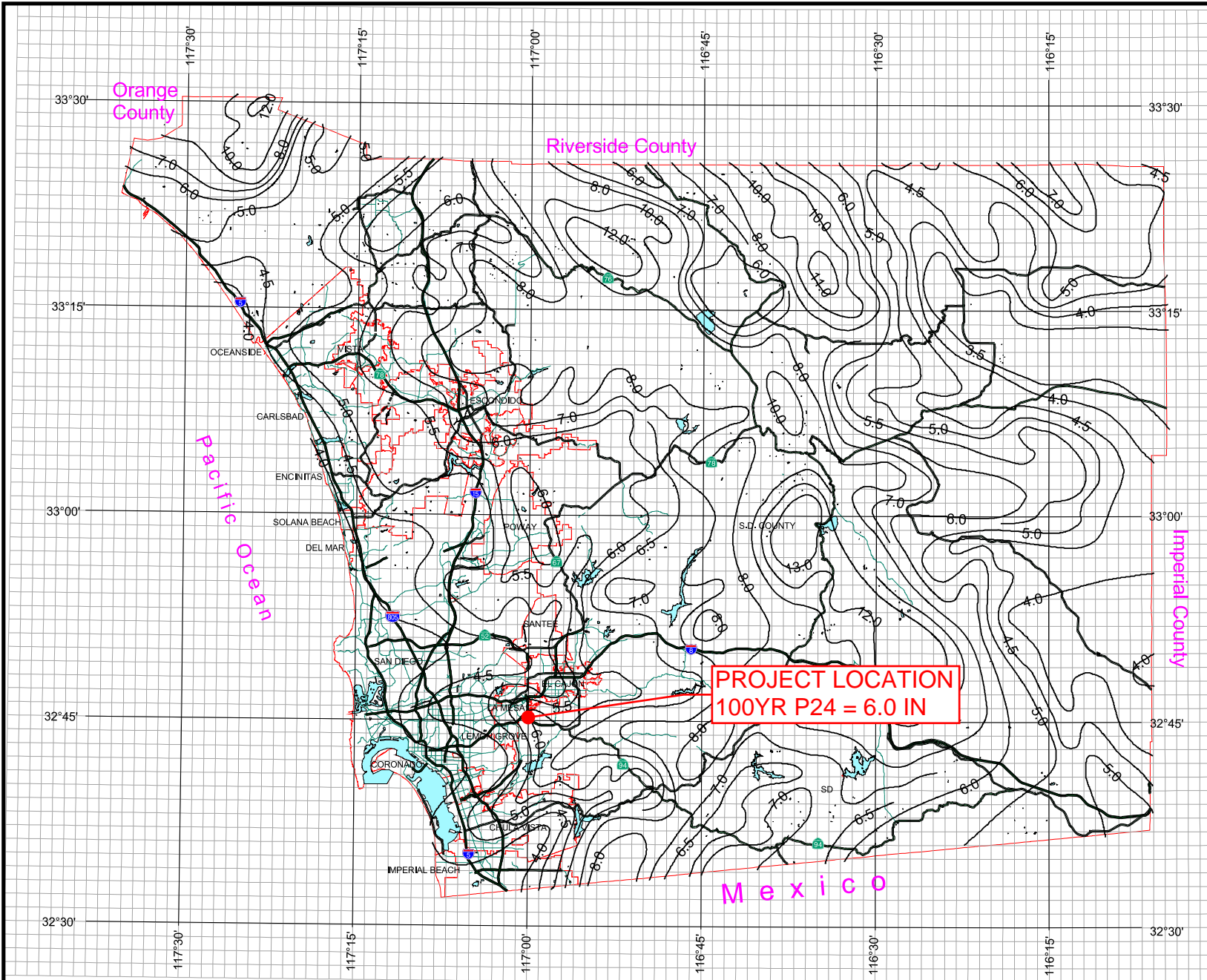
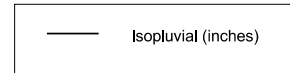

Department of Public Works
Geographic Information Services

We Have San Diego Covered!

THIS MAP IS PROVIDED WITHOUT WARRANTY OF ANY KIND, EITHER EXPRESS OR IMPLIED, INCLUDING, BUT NOT LIMITED TO, THE IMPLIED WARRANTIES OF MERCHANTABILITY AND FITNESS FOR A PARTICULAR PURPOSE. Copyright SanGIS. All Rights Reserved.

This product may contain information from the SANDAG Regional Information System which cannot be reproduced without the written permission of SANDAG.

This product may contain information which has been reproduced with permission granted by Thomas Brothers Maps.

3 0 3 Miles

San Diego County 85th Percentile Isopluvials

- 85th Percentile Rainfall in Inches
- Freeway
- Highway
- Major Road
- Street
- Municipal Boundary
- Water Body

Note:
The 85th percentile is a 24-hour rainfall total.
It represents a value such that 85% of the
observed 24-hour rainfall totals will be less
than that value.

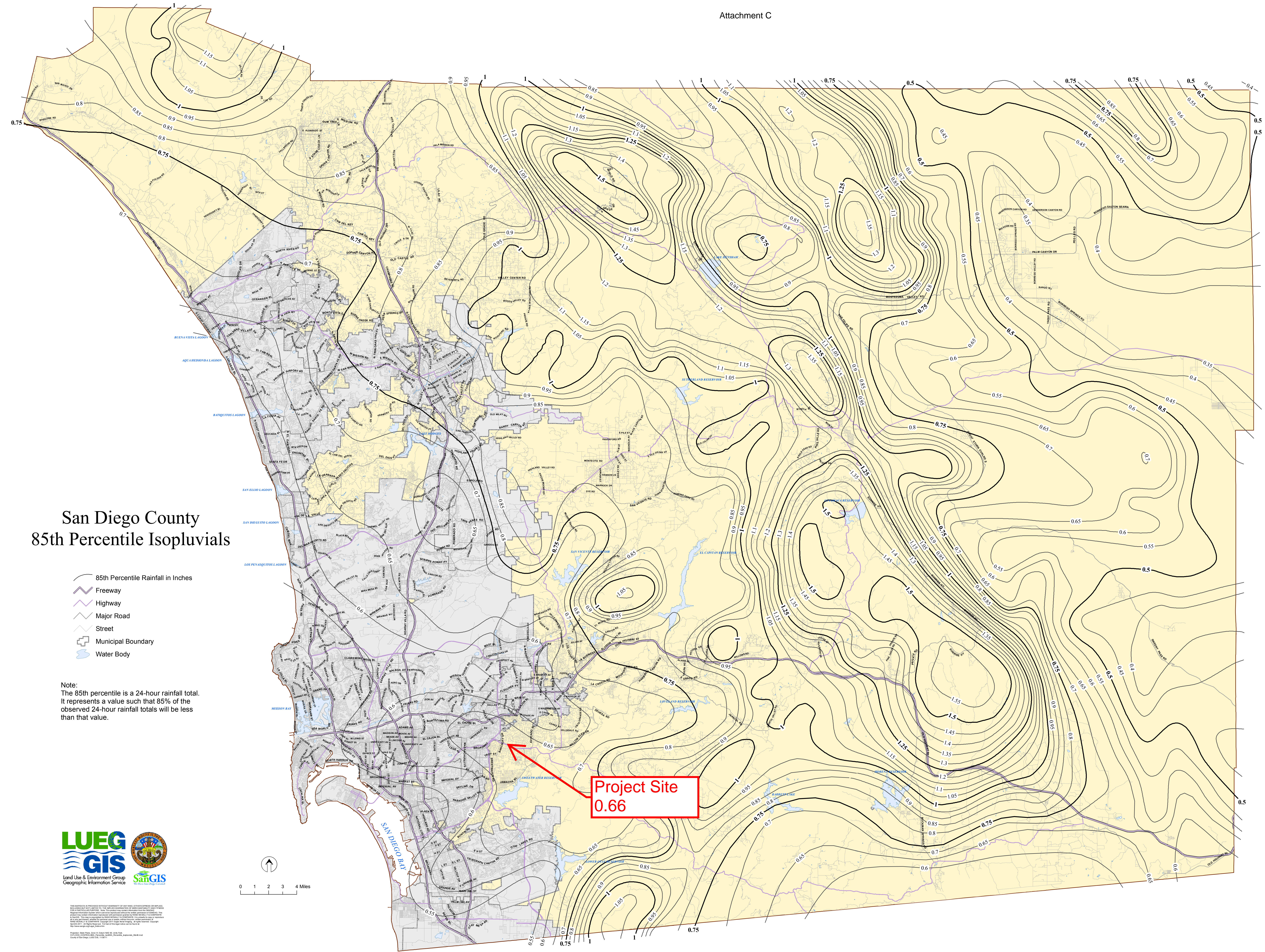

Project Site
0.66

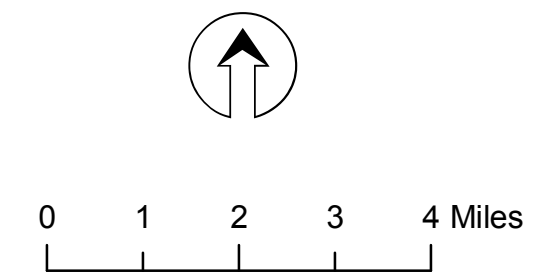

THIS MAP AND ITS PRODUCTS ARE PREPARED BY OR FOR THE USE OF THE COUNTY OF SAN DIEGO. THE COUNTY OF SAN DIEGO IS NOT RESPONSIBLE FOR ANY ERRORS OR OMISSIONS. THE USER OF THIS MAP AND ITS PRODUCTS SHALL BE RESPONSIBLE FOR OBTAINING NECESSARY PERMITS AND FOR VERIFYING THE ACCURACY OF THE DATA. THE COUNTY OF SAN DIEGO IS NOT RESPONSIBLE FOR ANY DAMAGES, INCLUDING CONSEQUENTIAL DAMAGES, ARISING FROM THE USE OF THIS MAP AND ITS PRODUCTS. THE COUNTY OF SAN DIEGO IS NOT RESPONSIBLE FOR ANY DAMAGES, INCLUDING CONSEQUENTIAL DAMAGES, ARISING FROM THE USE OF THIS MAP AND ITS PRODUCTS.

Attachment D- Water Quality

D. 1 Water Quality Sizing Spreadsheet

D. 2 Hydromodification Sizing Spreadsheet

D. 3 CCYSA Exhibit

D. 4 BMP DM Appendices

Automated Worksheet B.1: Calculation of Design Capture Volume (V2.0)

Category	#	Description	<i>i</i>	Units
Standard Drainage Basin Inputs	1	Drainage Basin ID or Name	DMA 1	unitless
	2	85th Percentile 24-hr Storm Depth	0.66	inches
	3	Impervious Surfaces <u>Not Directed to Dispersion Area</u> (C=0.90)	44,600	sq-ft
	4	Semi-Pervious Surfaces <u>Not Serving as Dispersion Area</u> (C=0.30)		sq-ft
	5	Engineered Pervious Surfaces <u>Not Serving as Dispersion Area</u> (C=0.10)		sq-ft
	6	Natural Type A Soil <u>Not Serving as Dispersion Area</u> (C=0.10)	52,974	sq-ft
	7	Natural Type B Soil <u>Not Serving as Dispersion Area</u> (C=0.14)		sq-ft
	8	Natural Type C Soil <u>Not Serving as Dispersion Area</u> (C=0.23)		sq-ft
	9	Natural Type D Soil <u>Not Serving as Dispersion Area</u> (C=0.30)		sq-ft
Dispersion Area, Tree Well & Rain Barrel Inputs (Optional)	10	Does Tributary Incorporate Dispersion, Tree Wells, and/or Rain Barrels?	No	yes/no
	11	Impervious Surfaces Directed to Dispersion Area per SD-B (Ci=0.90)		sq-ft
	12	Semi-Pervious Surfaces Serving as Dispersion Area per SD-B (Ci=0.30)		sq-ft
	13	Engineered Pervious Surfaces Serving as Dispersion Area per SD-B (Ci=0.10)		sq-ft
	14	Natural Type A Soil Serving as Dispersion Area per SD-B (Ci=0.10)		sq-ft
	15	Natural Type B Soil Serving as Dispersion Area per SD-B (Ci=0.14)		sq-ft
	16	Natural Type C Soil Serving as Dispersion Area per SD-B (Ci=0.23)		sq-ft
	17	Natural Type D Soil Serving as Dispersion Area per SD-B (Ci=0.30)		sq-ft
	18	Number of Tree Wells Proposed per SD-A		#
	19	Average Mature Tree Canopy Diameter		ft
	20	Number of Rain Barrels Proposed per SD-E		#
Initial Runoff Factor Calculation	21	Average Rain Barrel Size		gal
	22	Total Tributary Area	97,574	sq-ft
	23	Initial Runoff Factor for Standard Drainage Areas	0.47	unitless
	24	Initial Runoff Factor for Dispersed & Dispersion Areas	0.00	unitless
	25	Initial Weighted Runoff Factor	0.47	unitless
	26	Initial Design Capture Volume	2,522	cubic-feet
Dispersion Area Adjustments	27	Total Impervious Area Dispersed to Pervious Surface	0	sq-ft
	28	Total Pervious Dispersion Area	0	sq-ft
	29	Ratio of Dispersed Impervious Area to Pervious Dispersion Area	n/a	ratio
	30	Adjustment Factor for Dispersed & Dispersion Areas	1.00	ratio
	31	Runoff Factor After Dispersion Techniques	0.47	unitless
	32	Design Capture Volume After Dispersion Techniques	2,522	cubic-feet
Tree & Barrel Adjustments	33	Total Tree Well Volume Reduction	0	cubic-feet
	34	Total Rain Barrel Volume Reduction	0	cubic-feet
Results	35	Final Adjusted Runoff Factor	0.47	unitless
	36	Final Effective Tributary Area	45,860	sq-ft
	37	Initial Design Capture Volume Retained by Site Design Elements	0	cubic-feet
	38	Final Design Capture Volume Tributary to BMP	2,522	cubic-feet
No Warning Messages				

Attachment D.1

Automated Worksheet B.2: Retention Requirements (V2.0)

Category	#	Description	<i>i</i>	Units
Basic Analysis	1	Drainage Basin ID or Name	DMA 1	unitless
	2	85th Percentile Rainfall Depth	0.66	inches
	3	Predominant NRCS Soil Type Within BMP Location	A	unitless
	4	Is proposed BMP location Restricted or Unrestricted for Infiltration Activities?	Unrestricted	unitless
	5	Nature of Restriction	n/a	unitless
	6	Do Minimum Retention Requirements Apply to this Project?	Yes	yes/no
	7	Are Habitable Structures Greater than 9 Stories Proposed?	No	yes/no
Advanced Analysis	8	Has Geotechnical Engineer Performed an Infiltration Analysis?	No	yes/no
	9	Design Infiltration Rate Recommended by Geotechnical Engineer		in/hr
Result	10	Design Infiltration Rate Used To Determine Retention Requirements	0.300	in/hr
	11	Percent of Average Annual Runoff that Must be Retained within DMA	36.0%	percentage
	12	Fraction of DCV Requiring Retention	0.28	ratio
	13	Required Retention Volume	706	cubic-feet
<u>No Warning Messages</u>				

Attachment D.1

Automated Worksheet B.3: BMP Performance (V2.0)

Category	#	Description	<i>i</i>	Units
BMP Inputs	1	Drainage Basin ID or Name	DMA 1	sq-ft
	2	Design Infiltration Rate Recommended	0.300	in/hr
	3	Design Capture Volume Tributary to BMP	2,522	cubic-feet
	4	Is BMP Vegetated or Unvegetated?	Unvegetated	unitless
	5	Is BMP Impermeably Lined or Unlined?	Lined	unitless
	6	Does BMP Have an Underdrain?	Underdrain	unitless
	7	Does BMP Utilize Standard or Specialized Media?	Standard	unitless
	8	Provided Surface Area	7,485	sq-ft
	9	Provided Surface Ponding Depth	12	inches
	10	Provided Soil Media Thickness	24	inches
	11	Provided Gravel Thickness (Total Thickness)	12	inches
	12	Underdrain Offset	3	inches
	13	Diameter of Underdrain or Hydromod Orifice (Select Smallest)	1.00	inches
	14	Specialized Soil Media Filtration Rate		in/hr
	15	Specialized Soil Media Pore Space for Retention		unitless
	16	Specialized Soil Media Pore Space for Biofiltration		unitless
	17	Specialized Gravel Media Pore Space		unitless
Retention Calculations	18	Volume Infiltrated Over 6 Hour Storm	0	cubic-feet
	19	Ponding Pore Space Available for Retention	0.00	unitless
	20	Soil Media Pore Space Available for Retention	0.05	unitless
	21	Gravel Pore Space Available for Retention (Above Underdrain)	0.00	unitless
	22	Gravel Pore Space Available for Retention (Below Underdrain)	0.40	unitless
	23	Effective Retention Depth	2.40	inches
	24	Fraction of DCV Retained (Independent of Drawdown Time)	0.59	ratio
	25	Calculated Retention Storage Drawdown Time	120	hours
	26	Efficacy of Retention Processes	0.53	ratio
	27	Volume Retained by BMP (Considering Drawdown Time)	1,328	cubic-feet
28	Design Capture Volume Remaining for Biofiltration	1,194	cubic-feet	
Biofiltration Calculations	29	Max Hydromod Flow Rate through Underdrain	0.0506	cfs
	30	Max Soil Filtration Rate Allowed by Underdrain Orifice	0.29	in/hr
	31	Soil Media Filtration Rate per Specifications	5.00	in/hr
	32	Soil Media Filtration Rate to be used for Sizing	0.29	in/hr
	33	Depth Biofiltered Over 6 Hour Storm	1.75	inches
	34	Ponding Pore Space Available for Biofiltration	1.00	unitless
	35	Soil Media Pore Space Available for Biofiltration	0.35	unitless
	36	Gravel Pore Space Available for Biofiltration (Above Underdrain)	0.40	unitless
	37	Effective Depth of Biofiltration Storage	24.00	inches
	38	Drawdown Time for Surface Ponding	41	hours
	39	Drawdown Time for Effective Biofiltration Depth	82	hours
	40	Total Depth Biofiltered	25.75	inches
	41	Option 1 - Biofilter 1.50 DCV: Target Volume	1,790	cubic-feet
	42	Option 1 - Provided Biofiltration Volume	1,790	cubic-feet
	43	Option 2 - Store 0.75 DCV: Target Volume	895	cubic-feet
	44	Option 2 - Provided Storage Volume	895	cubic-feet
	45	Portion of Biofiltration Performance Standard Satisfied	1.00	ratio
Result	46	Do Site Design Elements and BMPs Satisfy Annual Retention Requirements?	Yes	yes/no
	47	Overall Portion of Performance Standard Satisfied (BMP Efficacy Factor)	1.00	ratio
	48	Deficit of Effectively Treated Stormwater	0	cubic-feet

Attention!

-Vegetated BMPs with surface ponding drawdown times over 24 hours must be certified by a landscape architect or agronomist. All BMPs must

Attachment D.2

BMP Sizing Spreadsheet V3.1

Project Name:	Casa De Oro Library Branch
Project Applicant:	MBI
Jurisdiction:	County of San Diego
Parcel (APN):	500-170-40, -10, -11
Hydrologic Unit:	Sweetwater
Rain Gauge:	Oceanside
Total Project Area (sf):	97,574
Channel Susceptibility:	High

Attachment D.2

BMP Sizing Spreadsheet V3.1			
Project Name:	Casa De Oro Library Branch	Hydrologic Unit:	Sweetwater
Project Applicant:	MBI	Rain Gauge:	Oceanside
Jurisdiction:	County of San Diego	Total Project Area:	97,574
Parcel (APN):	500-170-40, -10, -11	Low Flow Threshold:	0.1Q2
BMP Name:	BF-1	BMP Type:	Biofiltration
BMP Native Soil Type:	N/A - Impervious Liner	BMP Infiltration Rate (in/hr):	N/A

Areas Draining to BMP						HMP Sizing Factors	Minimum BMP Size
DMA Name	Area (sf)	Pre Project Soil Type	Pre-Project Slope	Post Project Surface Type	Area Weighted Runoff Factor (Table G.2-1) ¹	Surface Area	Surface Area (SF)
Impervious	44,600	A	Flat	Roofs	1.00	0.15	6690
Pervious	52,974	A	Flat	Landscape	0.1	0.15	795
						0	0
						0	0
						0	0
						0	0
						0	0
						0	0
						0	0
						0	0
						0	0
						0	0
						0	0
						0	0
BMP Tributary Area	97,574					Minimum BMP Size	7485
						Proposed BMP Size*	7485

Surface Ponding Depth	12.00	in
Bioretention Soil Media Depth	18.00	in
Filter Coarse	6.00	in
Gravel Storage Layer Depth	12	in
Underdrain Offset	3.0	in

Attachment D.2

BMP Sizing Spreadsheet V3.1			
Project Name:	Casa De Oro Library Branch	Hydrologic Unit:	Sweetwater
Project Applicant:	MBI	Rain Gauge:	Oceanside
Jurisdiction:	County of San Diego	Total Project Area:	97,574
Parcel (APN):	500-170-40, -10, -11	Low Flow Threshold:	0.1Q2
BMP Name	BF-1	BMP Type:	Biofiltration

DMA Name	Rain Gauge	Pre-developed Condition		Unit Runoff Ratio (cfs/ac)	DMA Area (ac)	Orifice Flow - %Q ₂ (cfs)	Orifice Area (in ²)
		Soil Type	Slope				
Impervious	Oceanside	A	Flat	0.256	1.024	0.026	0.37
Pervious	Oceanside	A	Flat	0.256	1.216	0.031	0.44

3.75	0.057	0.82	1.02
Max Orifice Head	Max Tot. Allowable Orifice Flow	Max Tot. Allowable Orifice Area	Max Orifice Diameter
(feet)	(cfs)	(in²)	(in)

0.051	0.055	0.79	1.000
Average outflow during surface drawdown	Max Orifice Outflow	Actual Orifice Area	Selected Orifice Diameter
(cfs)	(cfs)	(in²)	(in)

Drawdown (Hrs)	40.5
-----------------------	-------------

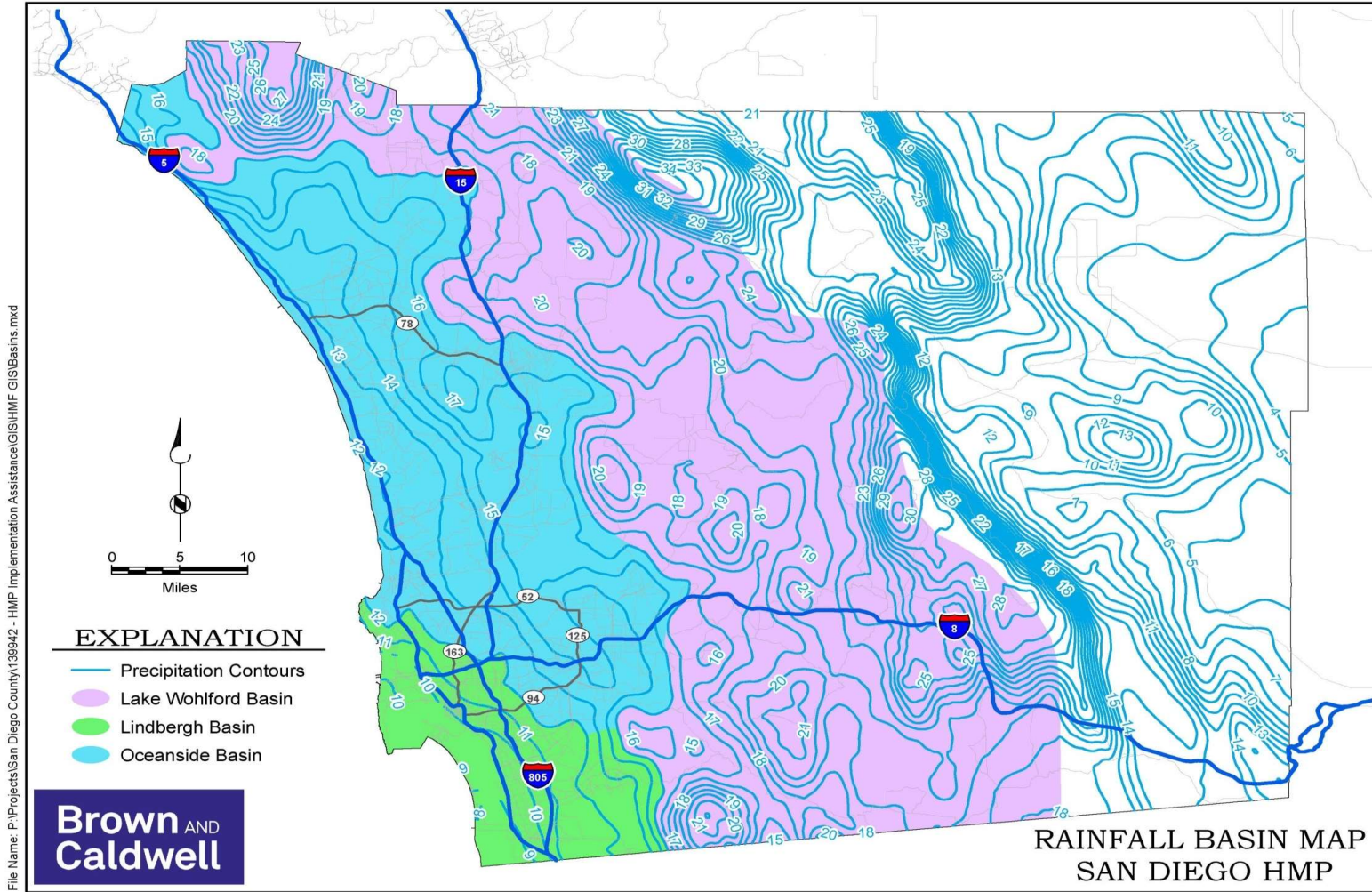



File Name: P:\Projects\San Diego County\139942 - HMP Implementation Assistance\GIS\HMF GIS\Basins.mxd

9/28/2020 JN C:\Working\CDO\Vicinity Map.mxd



Legend

-  CCYSA
-  Project Site

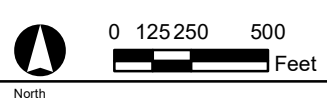



County of San Diego BMP Design Manual Appendices

September 15, 2020



This page was intentionally left blank.

Table of Contents

TABLE OF CONTENTS..... I

Appendix A Submittal Templates A-1

Appendix B Storm Water Pollutant Control Hydrologic Calculations and Sizing Methods for Structural BMPs B-1

 B.1 Step 1 - Determine DCV B-2

 B.1.1 Step 1A - Rainfall Depth B-5

 B.1.2 Step 1B - Tributary Area B-9

 B.1.3 Step 1C - Runoff Factor B-9

 B.1.4 Step 1D - Site Design Volume Reductions B-10

 B.2 Step 2 - Determine Retention Requirements B-12

 B.2.1 Step 2A - Capture and Use Analysis B-12

 B.2.2 Step 2B – Infiltration Restrictions B-13

 B.2.3 Step 2C – Design Infiltration Rate B-14

 B.2.4 Step 2D - Retention Requirements B-14

 B.3 Step 3 - Determine BMP Performance B-19

 B.3.1 Step 3A - BMP Characteristics B-22

 B.3.2 Step 3B - Retention Processes B-22

 B.3.3 Step 3C - Biofiltration Processes B-25

 B.3.4 Step 3D - Satisfaction of Pollutant Control Requirements B-27

 B.3.5 Step 3E - Satisfaction of Minimum Retention Requirements B-28

 B.4 Less Common Pollutant Control Calculations B-29

 B.4.1 Major Maintenance Intervals for Reduced Size BMPs B-29

 B.4.2 Capture and Use Evaluation B-33

 B.4.3 BMPs Downstream of a Storage Unit B-35

 B.4.4 Onsite Alternative Compliance B-35

 B.4.5 Offline BMPs B-36

 B.5 Backup Information on Pollutant Control Standards B-37

 B.5.1 Pollutant Control Performance Standard Backup B-37

 B.5.2 Retention Requirement Backup B-38

 B.5.3 Rainfall Depth Backup B-38

 B.5.4 Tree Well Backup B-39

 B.5.5 Sediment Clogging Backup B-39

Appendix C Baseline BMP Fact Sheets for Site Design and Source Control..... C-1

BL-1: Existing Natural Site FeaturesC-2

BL-2: Outdoor Impervious Area..... C-8

BL-3: Rooftop AreasC-13

BL-4: Landscaped AreasC-16

BL-5: Work and Storage AreasC-19

BL-6: Management of Storm Water Discharges.....C-28

BL-7: Management of Non-Storm Water DischargesC-35

Appendix D Geotechnical Engineer AnalysisD-1

D.1 Analysis of Infiltration Restrictions D-1

D.2 Determination of Design Infiltration Rates..... D-2

 D.2.1 Initial Infiltration Rate D-2

 D.2.2 Corrected Infiltration Rate..... D-6

 D.2.3 Safety Factors D-8

D.3 Geotechnical Reporting Requirements D-10

Appendix E Fact Sheets for Enhanced Site Design, Structural and Flow-thru BMPs..... E-1

E.1 Fact Sheet Quick Guide..... E-3

E.2 SD-A Tree WellsE-4

E.3 SD-B Impervious Area Dispersion (Dispersion Areas)E-15

E.4 SD-C: Green RoofsE-23

E.5 SD-D Permeable Pavement (Site Design BMP).....E-31

E.6 SD-E Rain Barrels.....E-41

E.7 SD-F Amended SoilE-45

E.8 HU-1 CisternE-49

E.9 INF-1 Infiltration Basin.....E-59

E.10 INF-2 Bioretention.....E-69

E.11 INF-3 Permeable Pavement (Pollutant Control).....E-83

E.12 INF-4 Dry WellsE-99

E.13 PR-1 Biofiltration with Partial Retention..... E-101

E.14 BF-1 Biofiltration..... E-115

E.15 BF-2 Nutrient Sensitive Media Design..... E-129

E.16 BF-3 Proprietary Biofiltration Systems E-133

E.17 FT-1 Vegetated Swales..... E-135

E.18 FT-2 Media Filters E-147

E.19 FT-3 Sand Filters E-155

E.20 FT-4 Dry Extended Detention Basin E-163

E.21 FT-5 Proprietary Flow-Thru Treatment Control BMPs E-173

Appendix F General Standards for Bioretention/Biofiltration BMPs F-1

F.1 Biofiltration Standards and Checklist F-1

 F.1.1 Pollutant Treatment Performance Standard F-6

 F.1.2 Guidance on Sizing and Design of Non-Standard Biofiltration BMPs F-9

F.2 Biofiltration Soil Media Composition, Testing, and Installation F-11

F.3 Plant List for Bioretention Facilities F-21

Appendix G Guidance for Continuous Simulation and Hydromodification Management Sizing Factors G-1

G.1 Guidance for Continuous Simulation Hydrologic Modeling for Hydromodification Management Studies in San Diego County Region 9 G-1

 G.1.1 Introduction G-1

 G.1.2 Software for Continuous Simulation Hydrologic Modeling G-2

 G.1.3 Climatology Parameters G-2

 G.1.4 Land Characteristics and Loss Parameters G-7

 G.1.5 Modeling Structural BMPs (Ponds and LID Features) G-18

 G.1.6 Flow Frequency and Duration G-26

G.2 Sizing Factors for Hydromodification Management BMPs G-30

 G.2.1 Unit Runoff Ratios and Low Flow Control Orifice Design G-37

 G.2.2 Sizing Factors for "Infiltration" BMP G-39

 G.2.3 Sizing Factors for Biofiltration with Partial Retention G-41

 G.2.4 Sizing Factors for Biofiltration G-45

 G.2.5 Sizing Factors for "Cistern" BMP G-48

Appendix H Guidance for Investigating Potential Critical Coarse Sediment Yield Areas H-1

H.1 Step 1: Identify CCSYAs H-2

 H.1.1 Identification Methods H-2

 H.1.2 Refinement Options H-4

H.2 Step 2: Avoidance of Onsite CCSYAs H-5

 H.2.1 Avoidance Metrics H-5

H.3 Step 3: Bypass Onsite and Upstream CCSYAs H-7

 H.3.1 Bypass CCSYAs from Hillslopes H-7

 H.3.2 Bypass CCSYAs from Channels H-8

H.3.3 De Minimis Upstream CCSYA	H-8
H.4 Step 4: Demonstrate No Net Impact	H-9
H.4.1 Background	H-9
H.4.2 Management Standard	H-11
H.4.3 Types of Mitigation Measures	H-12
H.5 References	H-14
H.5.1 Terms of Reference.....	H-16
H.6 PCCSYAs: Regional WMAA Maps	H-17
H.6.1 Site-Specific GLU Analysis	H-18
H.6.2 Assumptions for Regional WMAA PCCSYA Maps.....	H-31
H.6.3 Encroachment Allowance for Regional PCCSYA WMAA Map.....	H-32
H.7 PCCSYAs: Refinement Options.....	H-33
H.7.1 Depositional Analysis	H-33
H.7.2 Threshold Channel Analysis	H-34
H.7.3 Coarse Sediment Source Area Verification	H-39
H.8 Calculation Methodology for Ep and Sp	H-42
H.8.1 Calculation of Ep.....	H-42
H.8.2 Calculation of Sp	H-56
H.9 Mitigation Measures Fact Sheets	H-63
H.9.1 Additional Flow Control	H-63
H.9.2 Stream Rehabilitation.....	H-67
Appendix I Significant Site Design BMP (SSD-BMP) Sizing Methods and Calculations I-1	
I.1 Significant Site Design BMPs (SSD-BMPs)	I-2
I.2 Step 1: Determine DCV.....	I-2
I.3 Step 2: Dispersion Areas.....	I-5
I.4 Step 3: Tree Wells	I-8
I.4.1 Step 3.1: Determine DCV or RRV as applicable	I-12
I.4.2 Step 3.2: Select a tree species and tree well soil depth.....	I-13
I.4.3 Step 3.3: Determine the minimum soil volume required in the tree well.....	I-13
I.4.4 Step 3.4: Determine tree well soil installation area and show on plans	I-13
Appendix J Offsite Alternative Compliance Requirements and Guidance	J-1
J.1 Background.....	J-1
J.2 Key Concepts	J-2
J.3 Requirements for ACPs in the County of San Diego	J-4

J.4 Submittal Requirements for Offsite Alternative Compliance Projects J-6

J.5 Flow-Thru Treatment Control BMPs (for use with Alternative Compliance) J-6

 J.5.1 PDP Most Significant Pollutants of Concern..... J-6

 J.5.2 Selection of Flow-Thru Treatment Control BMPs..... J-8

 J.5.3 Sizing Flow-Thru Treatment Control BMPs: J-14

Appendix K Guidance on Green Infrastructure K-1

 K.1 Guidance on Green Infrastructure..... K-2

 K.2 Green Streets K-7

 K.2.1 Green Streets Performance Standard..... K-8

 K.2.2 Green Streets Guidelines..... K-19

 K.3 Green Parking Lots K-73

 K.3.1 Green Parking Lots Guidelines..... K-74

Appendix L Prior Lawful Approval Requirements and Guidance..... L-1

 L.1 Applicability of MS4 Permit Provisions L-1

 L.2 Applicant Responsibilities L-3

 L.3 PLA Option 1 (Vested Rights; WPO Section 67.811(c)(1)) L-3

 L.4 PLA Option 2 (Exception Under the 2013 MS4 Permit; WPO Section 67.811(c) (2)) L-5

Glossary of Key Terms..... i

This page was intentionally left blank.

Appendix

A

COUNTY OF SAN DIEGO BMP DESIGN MANUAL

Submittal Templates

Appendix A: Submittal Templates

This page was intentionally left blank.

Appendix A Submittal Templates

Submittal templates can be found on the County's Watershed Protection Program website under the Development Resources tab:

<https://www.sandiegocounty.gov/stormwater>

Appendix A: Submittal Templates

This page was intentionally left blank.

Appendix

B

COUNTY OF SAN DIEGO BMP DESIGN MANUAL

Storm Water Pollutant Control Hydrologic Calculations and Sizing Methods for Structural BMPs

**Appendix B: Storm Water Pollutant Control Hydrologic Calculations
and Sizing Methods for Structural BMPs**

This page was intentionally left blank.

Appendix B Storm Water Pollutant Control Hydrologic Calculations and Sizing Methods for Structural BMPs

Table of Contents:

- B.1. Step 1: Determine DCV
- B.2. Step 2: Determine Retention Requirements
- B.3. Step 3: Determine BMP Performance
- B.4. Less Common Pollutant Control Calculations
- B.5. Backup Information on Pollutant Control Standards

Appendix B: Storm Water Pollutant Control Hydrologic Calculations and Sizing Methods for Structural BMPs

B.1 Step 1 - Determine DCV

The first step in performing storm water pollutant control calculations is to calculate the Design Capture Volume (DCV). The DCV represents the volume of storm water runoff that must be retained and/or biofiltered in order to satisfy pollutant control requirements. The DCV can be calculated through use of automated Worksheet B.1 depicted on the following page, or can be calculated manually by following Steps 1A through 1D presented in this section.

$$DCV = \frac{D}{12} \times A \times C - R$$

Where:

DCV: Design Capture Volume (ft³)

D: Rainfall Depth (inches), refer to section B.1.1.

A: Tributary Area (ft²), refer to Section B.1.2.

C: Runoff Factor (unitless), refer to section B.1.3.

R: Site Design Volume Reductions (ft³), refer to Section B.1.4.

**Appendix B: Storm Water Pollutant Control Hydrologic Calculations
and Sizing Methods for Structural BMPs**

Worksheet B.1 Calculation of Design Capture Volume

Category	#	Description	<i>i</i>	Units
Standard Drainage Basin Inputs	1	Drainage Basin ID or Name		unitless
	2	85th Percentile 24-hr Storm Depth		inches
	3	Impervious Surfaces <u>Not Directed to Dispersion Area</u> (C=0.90)		sq-ft
	4	Semi-Pervious Surfaces <u>Not Serving as Dispersion Area</u> (C=0.30)		sq-ft
	5	Engineered Pervious Surfaces <u>Not Serving as Dispersion Area</u> (C=0.10)		sq-ft
	6	Natural Type A Soil <u>Not Serving as Dispersion Area</u> (C=0.10)		sq-ft
	7	Natural Type B Soil <u>Not Serving as Dispersion Area</u> (C=0.14)		sq-ft
	8	Natural Type C Soil <u>Not Serving as Dispersion Area</u> (C=0.23)		sq-ft
	9	Natural Type D Soil <u>Not Serving as Dispersion Area</u> (C=0.30)		sq-ft
Dispersion Area, Tree Well & Rain Barrel Inputs (Optional)	10	Does Tributary Incorporate Dispersion, Tree Wells, and/or Rain Barrels?		yes/no
	11	Impervious Surfaces Directed to Dispersion Area per SD-B (Ci=0.90)		sq-ft
	12	Semi-Pervious Surfaces Serving as Dispersion Area per SD-B (Ci=0.30)		sq-ft
	13	Engineered Pervious Surfaces Serving as Dispersion Area per SD-B (Ci=0.10)		sq-ft
	14	Natural Type A Soil Serving as Dispersion Area per SD-B (Ci=0.10)		sq-ft
	15	Natural Type B Soil Serving as Dispersion Area per SD-B (Ci=0.14)		sq-ft
	16	Natural Type C Soil Serving as Dispersion Area per SD-B (Ci=0.23)		sq-ft
	17	Natural Type D Soil Serving as Dispersion Area per SD-B (Ci=0.30)		sq-ft
	18	Number of Tree Wells Proposed per SD-A		#
	19	Average Mature Tree Canopy Diameter		ft
	20	Number of Rain Barrels Proposed per SD-E		#
21	Average Rain Barrel Size		gal	
Initial Runoff Factor Calculation	22	Total Tributary Area		sq-ft
	23	Initial Runoff Factor for Standard Drainage Areas		unitless
	24	Initial Runoff Factor for Dispersed & Dispersion Areas		unitless
	25	Initial Weighted Runoff Factor		unitless
	26	Initial Design Capture Volume		cubic-feet
Dispersion Area Adjustments	27	Total Impervious Area Dispersed to Pervious Surface		sq-ft
	28	Total Pervious Dispersion Area		sq-ft
	29	Ratio of Dispersed Impervious Area to Pervious Dispersion Area		ratio
	30	Adjustment Factor for Dispersed & Dispersion Areas		ratio
	31	Runoff Factor After Dispersion Techniques		unitless
	32	Design Capture Volume After Dispersion Techniques		cubic-feet
Tree & Barrel Adjustments	33	Total Tree Well Volume Reduction		cubic-feet
	34	Total Rain Barrel Volume Reduction		cubic-feet
Results	35	Final Adjusted Runoff Factor		unitless
	36	Final Effective Tributary Area		sq-ft
	37	Initial Design Capture Volume Retained by Site Design Elements		cubic-feet
	38	Final Design Capture Volume Tributary to BMP		cubic-feet

Appendix B: Storm Water Pollutant Control Hydrologic Calculations and Sizing Methods for Structural BMPs

Worksheet B.1 Line Item Notes
1. User Input from stormwater plans.
2. User input from BMPDM Figure B.1-1.
3. User Input from stormwater plans.
4. User Input from stormwater plans.
5. User Input from stormwater plans.
6. User Input from stormwater plans.
7. User Input from stormwater plans.
8. User Input from stormwater plans.
9. User Input from stormwater plans.
10. User Input. Default is "No". Select Yes if any of the referenced elements are proposed.
11. User Input from stormwater plans. Must satisfy criteria from Fact Sheet SD-B.
12. User Input from stormwater plans. Must satisfy criteria from Fact Sheet SD-B.
13. User Input from stormwater plans. Must satisfy criteria from Fact Sheet SD-B.
14. User Input from stormwater plans. Must satisfy criteria from Fact Sheet SD-B.
15. User Input from stormwater plans. Must satisfy criteria from Fact Sheet SD-B.
16. User Input from stormwater plans. Must satisfy criteria from Fact Sheet SD-B.
17. User Input from stormwater plans. Must satisfy criteria from Fact Sheet SD-B.
18. User Input. Must satisfy criteria from Fact Sheet SD-A.
19. User Input. Must satisfy criteria from Fact Sheet SD-A. Acceptable range from 0-30 feet.
20. User Input. Must satisfy criteria from Fact Sheet SD-E. Cannot provide more than a 25% reduction to initial DCV.
21. User Input. Must satisfy criteria from Fact Sheet SD-E. Acceptable range 0-100 gallons for generic volume reductions.
22. Sum of Lines 3 through 17.
23. $[0.9(\text{Line } 3) + 0.3(\text{Line } 4 + \text{Line } 9) + 0.1(\text{Line } 5 + \text{Line } 6) + 0.14(\text{Line } 7) + 0.23(\text{Line } 8)] / (\text{Sum of Lines } 3 \text{ through Line } 9)$
24. $[0.9(\text{Line } 11) + 0.3(\text{Line } 12 + \text{Line } 17) + 0.1(\text{Line } 13 + \text{Line } 14) + 0.14(\text{Line } 15) + 0.23(\text{Line } 16)] / (\text{Sum of Lines } 11 \text{ through Line } 17)$
25. $[(\text{Line } 23 \times (\text{Sum of Lines } 3 \text{ through } 9) + \text{Line } 24 \times (\text{Sum of Lines } 11 \text{ through } 17))] / \text{Line } 22]$
26. $(\text{Line } 2/12) \times \text{Line } 22 \times \text{Line } 25$
27. Line 11
28. Summation of Lines 12-17.
29. $[\text{Line } 27 / \text{Line } 28]$. If greater than 4.0 dispersion benefits are not quantified.
30. Lookup values from Table B.1-1 weighted with respect to distribution of dispersion areas specified in Lines 12-17.
31. $[\text{Line } 23 \times (\text{Sum of Lines } 3 \text{ through Line } 9) + \text{Line } 24 \times \text{Line } 30 \times (\text{Sum of Lines } 11 \text{ through Line } 17)] / \text{Line } 22$
32. $(\text{Line } 2/12) \times \text{Line } 22 \times \text{Line } 31$
33. $[\text{Line } 18 \times \text{Lookup value from Section B.1.4 of BMP Design Manual}]$
34. $[\text{Line } 20 \times \text{Line } 21/7.48]$. If Line 21 > 100 or Line 10 is "n/a" or "no", then this value must be zero.
35. $\text{Line } 31 \times [1 - ((\text{Line } 33 + \text{Line } 34)/(\text{Line } 32))]$. Value must be between zero and one.
36. $\text{Line } 22 \times \text{Line } 35$
37. $[(\text{Line } 26 - \text{Line } 32) + \text{Line } 33 + \text{Line } 34]$
38. $[\text{Line } 26 - \text{Line } 37]$. Minimum result of 0.

Appendix B: Storm Water Pollutant Control Hydrologic Calculations and Sizing Methods for Structural BMPs

B.1.1 Step 1A - Rainfall Depth

The rainfall depth (D) used to calculate the DCV is determined through examination of the 85th percentile, 24-hour isopluvial map provided in Figure B.1-1. The isopluvial map represents rainfall depths as blue line work provided at 0.02” intervals. Appropriate rainfall depths should be determined by plotting the project location on the map, examining adjacent rainfall depths, and interpolating an appropriate depth to the nearest hundredth of an inch (i.e. 0.71 inch). GIS versions of the map are also available for download at the following links.

GIS Shapefile: (Under Ecology category)

<http://www.sangis.org/download/index.html>

GIS Viewer:

<http://sdcounty.maps.arcgis.com/home/webmap/viewer.html?webmap=89523b7ae5db4e44a6569062ad9933e5>

**Appendix B: Storm Water Pollutant Control Hydrologic Calculations
and Sizing Methods for Structural BMPs**

This page was intentionally left blank.

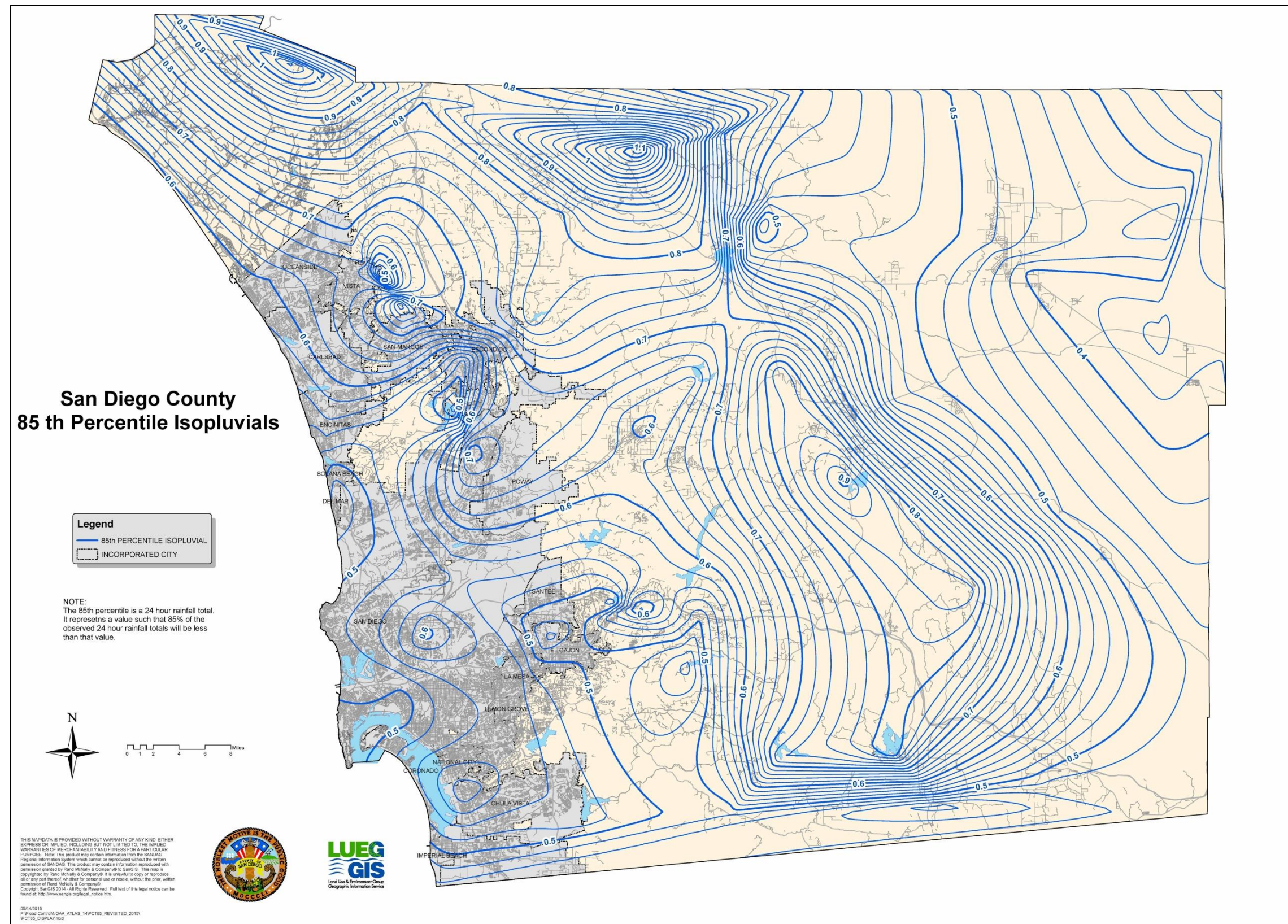

Figure B.1-1: 85th Percentile 24-hour Isopluvial Map

This page was intentionally left blank.

**Appendix B: Storm Water Pollutant Control Hydrologic Calculations
and Sizing Methods for Structural BMPs**

B.1.2 Step 1B - Tributary Area

Determine the total tributary area through evaluation of the drainage area delineations performed as outlined in Section 3. These areas will be analyzed in additional detail in Step 1C below.

B.1.3 Step 1C - Runoff Factor

Runoff factors (C) represent the ratio of storm water runoff over rainfall that is anticipated for a particular surface type. Impervious surfaces typically have high runoff factors (0.90) as nearly all rainfall is converted into runoff. Pervious surfaces typically have low runoff factors (0.10) as much of the rainfall is retained in natural surface features. Applicants should evaluate all of the surface coverages within a drainage area and assign runoff factors consistent with the values in Table B.1-1.

Table B.1-1: Runoff factors for surfaces draining to BMPs – Pollutant Control BMPs

Category	Surface Type	Runoff Factor (C)
Impervious Surfaces	Roofs, Concrete, Asphalt, Unit Pavers (grouted)	0.90
Semi-Pervious Surfaces	Decomposed Granite, Cobbles, Crushed Aggregate, Compacted soil (unpaved parking)	0.30
Engineered Pervious Surfaces	Green Roofs per SD-C Permeable Pavement per SD-D, Amended Soils per SD-F, Landscaped/Mulched Soils, Permeable Pavement per INF-3	0.10
Natural Pervious Surfaces	Type A Soil	0.10
	Type B Soil	0.14
	Type C Soil	0.23
	Type D Soil	0.30
Impoundments	Swimming pools, fountains, ponds, etc.	0.00
Dispersion Areas	Areas <u>routed to</u> or <u>serving as</u> a dispersion area per SD-B	See Dispersion Area Text Below

If a drainage area is comprised of more than one surface type, an area-weighted runoff factor must be calculated per the following equation where C represents the runoff coefficient and A represents the area of each surface.

$$C_{area-weighted} = \frac{\sum C_{surface\ 1} A_{surface\ 1} + C_{surface\ 2} A_{surface\ 2} + C_{surface\ x} A_{surface\ x}}{\sum A_{all\ surfaces}}$$

Appendix B: Storm Water Pollutant Control Hydrologic Calculations and Sizing Methods for Structural BMPs

Dispersion Area Runoff Factor Adjustments

Adjustment to runoff factors may be permitted when storm water runoff from impervious surfaces is dispersed through pervious dispersion areas in accordance with the SD-B fact sheet located in Appendix E. Note that pervious dispersion areas may be used to eliminate the DCV requiring treatment and thereby fully satisfy pollutant control requirements when designed as significant site design BMPs (SSD-BMPs). Refer to Appendix I for sizing methods and criteria to use dispersion areas as SSD-BMPs.

Runoff factor adjustments may be applied to drainage areas with a 4:1 maximum ratio of impervious to pervious area. In order to be eligible for runoff factor adjustments, impervious areas must have a runoff factor of 0.90 and must be directed towards a pervious dispersion area with a runoff factor of 0.30 or less.

Table B.1-2 presents runoff factor adjustments as a function of the ratio of impervious to pervious area and the hydrologic soil group of the pervious dispersion area. Applicants applying runoff factor adjustments must identify appropriate factors in the table below and multiply that factor by the original composite runoff factor of the impervious area and the dispersion area.

Table B.1-2: Impervious area adjustment factors that account for dispersion

Characteristics of Pervious Area	Ratio = Impervious area/Pervious area			
	<=1	2	3	4
Type A or Amended Soils	0.00	0.00	0.21	0.32
Type B Soils	0.00	0.24	0.38	0.48
Type C Soils	0.31	0.50	0.60	0.67
Type D Soils	0.77	0.84	0.87	0.90

When using adjustment factors from Table B.1-2:

- a) The underlying soil group need not be considered if amended soils implemented per SD-F.
- b) Linear interpolation must be performed if the impervious to pervious area ratio of the site is in between one of ratios for which an adjustment factor was developed;
- c) Use adjustment factor for a ratio of 1 when the impervious to pervious area ratio is less than 1

B.1.4 Step 1D - Site Design Volume Reductions

Site design volume reductions (R) account for the effects of incorporating non-structural BMPs such as tree wells and rain barrels into the site design. Effective use of these site design elements can significantly reduce the DCV requiring treatment through structural BMP strategies. Note that tree wells may be used to eliminate the DCV requiring treatment and thereby fully satisfy pollutant control requirements when designed as significant site design BMPs (SSD-BMPs). Refer to Appendix I for sizing methods and criteria to use tree wells as SSD-BMPs.

Tree wells designed per the SD-A fact sheet provide the following volume reductions to the DCV. The maximum volume reduction for any individual tree is 420 cubic feet.

**Appendix B: Storm Water Pollutant Control Hydrologic Calculations
and Sizing Methods for Structural BMPs**

Table B.1-3: Tree Well Volume Reductions

Mature Tree Canopy Diameter (ft)	Volume Reduction (cubic feet/tree)
0	0
5	10
10	40
15	100
20	180
25	290
30	420

Rain barrels designed per SD-E fact sheet can also provide limited volume reductions to the DCV. The effects of rain barrels are typically less substantial than tree wells and are subject to the following restrictions: 1) individual rain barrel volumes are no greater than 100 gallons, 2) the total rain barrel volume is no greater than 0.25 DCV, and 3) the site must have landscape areas of at least 30% of the project footprint. If the proposed rain barrels do not meet these criteria, design volume reductions may still be achieved through Cistern criteria presented in fact sheet HU-1.

Table B.1-4: Rain Barrel Volume Reductions

Rain Barrel Size (gallon)	Volume Reduction (cubic feet)
0	0.0
20	2.7
40	5.3
60	8.0
80	10.7
100	13.4

Appendix B: Storm Water Pollutant Control Hydrologic Calculations and Sizing Methods for Structural BMPs

B.2 Step 2 - Determine Retention Requirements

The second step in performing storm water pollutant control calculations is to determine the retention requirements for each drainage area. Retention requirements can be calculated through use of the automated Worksheet B.2 depicted below, or can be calculated manually by following Steps 2A through 2D presented in this section.

Worksheet B.2 Retention Requirements

Category	#	Description	<i>i</i>	Units
Basic Analysis	1	Drainage Basin ID or Name		unitless
	2	85th Percentile Rainfall Depth		inches
	3	Predominant NRCS Soil Type Within BMP Location		unitless
	4	Is proposed BMP location Restricted or Unrestricted for Infiltration Activities?		unitless
	5	Nature of Restriction		unitless
	6	Do Minimum Retention Requirements Apply to this Project?		yes/no
	7	Are Habitable Structures Greater than 9 Stories Proposed?		yes/no
Advanced Analysis	8	Has Geotechnical Engineer Performed an Infiltration Analysis?		yes/no
	9	Design Infiltration Rate Recommended by Geotechnical Engineer		in/hr
Result	10	Design Infiltration Rate Used To Determine Retention Requirements		in/hr
	11	Percent of Average Annual Runoff that Must be Retained within DMA		percentage
	12	Fraction of DCV Requiring Retention		ratio
	13	Required Retention Volume		cubic-feet

Worksheet B.2 Line Item Notes				
1. User input from stormwater plans.				
2. User input from BMPDM Figure B.1-1.				
3. User input from stormwater plans.				
4. User input from BMPDM Section B.2.2.				
5. User input from BMPDM Section B.2.2.				
6. Default value of "Yes" for Priority Development Projects.				
7. User input from BMPDM Section B.2.1. If "Yes", separate capture and use evaluation must be provided.				
8. User input from BMPDM Section B.2.3. If "Yes", geotechnical report excerpts must be provided.				
9. User input from BMPDM Section B.2.3.				
10. Rates of 0.300, 0.200, 0.100, 0.025, or 0.000 for A, B, C, D, or Restricted soils respectively. Or rate from Geotechnical Engineer.				
11. Determined Per BMPDM Section B.2.4.				
12. Determined Per BMPDM Section B.2.4.				
13. Determined Per BMPDM Section B.2.4.				

B.2.1 Step 2A - Capture and Use Analysis

Projects that **do not** propose habitable structures over 9 stories tall may skip this step (proceed to Step 2B).

Projects that propose habitable structures over 9 stories tall are required to perform a capture and use analysis to identify whether the DCV from the project site can be utilized for onsite toilet flushing and/or irrigation within 36 hours of the storm. If the results indicate capture and use is possible, then

Appendix B: Storm Water Pollutant Control Hydrologic Calculations and Sizing Methods for Structural BMPs

the project is required to implement capture and use. Guidance for performing this analysis is provided in B.3.8.

B.2.2 Step 2B – Infiltration Restrictions

The SWQMP Preparer is responsible for evaluating the infiltration restrictions in Table B.2-1 below and characterizing each drainage area as Restricted or Unrestricted for infiltration.

Restriction elements are divided into Mandatory Considerations and Optional Considerations. Mandatory Considerations include elements that may pose a significant risk to human health and safety. These elements must always be evaluated and discretion regarding the setbacks is not permitted. Optional Considerations include elements that are not necessarily associated with human health and safety, so analysis is not mandated through this guidance document.

Analysis of these elements is outside of the scope of typical geotechnical engineering investigations; therefore, it is the responsibility of the SWQMP Preparer to perform this evaluation. If a geotechnical engineer is consulted to complete this portion of the analysis, additional discretion on the mandatory considerations may be permitted if supported by the geotechnical reporting.

Table B.2-1: Infiltration Restrictions

Restriction Element		Is Element Applicable? (Yes/No)
Mandatory Considerations	BMP is within 100' of Contaminated Soils	
	BMP is within 100' of Industrial Activities Lacking Source Control	
	BMP is within 100' of Well/Groundwater Basin	
	BMP is within 50' of Septic Tanks/Leach Fields	
	BMP is within 10' of Structures/Tanks/Walls	
	BMP is within 10' of Sewer Utilities	
	BMP is within 10' of Groundwater Table	
	BMP is within Hydric Soils	
	BMP is within Highly Liquefiable Soils and has Connectivity to Structures	
	BMP is within 1.5 Times the Height of Adjacent Steep Slopes ($\geq 25\%$)	
	County Staff has Assigned "Restricted" Infiltration Category	
Optional Considerations	BMP is within Predominantly Type D Soil	
	BMP is within 10' of Property Line	
	BMP is within Fill Depths of $\geq 5'$ (Existing or Proposed)	
	BMP is within 10' of Underground Utilities	
	BMP is within 250' of Ephemeral Stream	
	Other (Provide detailed geotechnical support)	
Result	Unrestricted. None of the restriction elements above are applicable.	
	Restricted. One or more of the restriction elements above are applicable.	

Appendix B: Storm Water Pollutant Control Hydrologic Calculations and Sizing Methods for Structural BMPs

The following table summarizes public data sources available for the infiltration restriction analysis.

Table B.2-2: Public Data Sources for Infiltration Restriction Analysis

Resources	Description
Geotracker	Website: geotracker.waterboards.ca.gov Reference Layers: Groundwater Depths, Contaminated Sites/Soils
SANGIS	Website: sangis.org Reference Layers: Land Use Current, Gas Stations, Wells, Groundwater Basins, Flowlines, Liquefaction, Soils, Steep Slopes, Sewer, Topography, Elevation Grids
Web Soil Survey (NRCS Soil Type)	Website: websoilsurvey.sc.egov.usda.gov/App Reference Layers: Hydrologic Soil Group, Map Unit Names
Watershed Management Area Analysis	Website: projectcleanwater.org/watershed-management-area-analysis-wmaa Reference Layers: Electronic Data from Appendix C of WMAA
Survey Records System	Website: srs.sandiegocounty.gov Reference Layers: Grading Plans, Surveys, Drainage Plans, Topography Maps, Tentative Parcel Maps
Applicant Plans	Website: n/a Reference Layers: Utility Plans, Grading Plans, Existing Site Conditions, Proposed Site Conditions, Nearby geotechnical reports.
Geotechnical Engineer	Website: n/a Reference Layers: At discretion of Geotechnical Engineer

B.2.3 Step 2C – Design Infiltration Rate

The design infiltration rate for each drainage area must be determined through either a basic or advanced analysis. The basic analysis allows the SWQMP Preparer to assign a default design infiltration rate based on the predominant NRCS soil type present within the proposed BMP footprint. The advanced analysis allows for a geotechnical engineer to assign a more specific design infiltration rate based on field testing outlined in Appendix D. Table B.2-3 below identifies the design infiltration rates that can be used for each analysis. Please note that the basic analysis is not permitted for BMPs that lack an underdrain.

Table B.2-3: Design Infiltration Rate

Infiltration Restrictions	Design Infiltration Rate (in/hr)	
	Option 1: Basic Analysis	Option 2: Advanced Analysis
Unrestricted	Type A Soil = 0.300	Rate recommended by geotechnical engineer (Reference Appendix D)
Unrestricted	Type B Soil = 0.200	
Unrestricted	Type C Soil = 0.100	
Unrestricted	Type D Soil = 0.025	
Restricted	Any Soil = 0.000	0.000

B.2.4 Step 2D - Retention Requirements

Using information determined in previous steps, the retention requirements for each drainage area can now be determined. Retention requirements can be expressed as a function of the DCV or as a percentage of annual runoff that must be retained within the drainage area.

Appendix B: Storm Water Pollutant Control Hydrologic Calculations and Sizing Methods for Structural BMPs

Part 1) Using Figure B.2-1, locate the applicable Design Infiltration Rate (determined in Step 2A) along the x-axis. Trace vertically from the x-axis result to the intersect with the plot representing the project's 85th Percentile Rainfall Depth (determined in Step 1A).

Note: Data presented in Figure B.2-1 represents ranges of rainfall depth. Users should choose the range that includes their specific rainfall depth rather than interpolating or extrapolating discrete values between the plotted lines.

Part 2) Trace horizontally from the intersect result to the right hand y-axis to identify the fraction of the DCV that must be retained to satisfy retention requirements (F).

Note: Retention requirements can also be expressed as a fraction of annual runoff by tracing horizontally from the intersect result to the left hand y-axis. This method is appropriate if the proposed retention elements have drawdown times significantly different than 36-hours.

Part 3) Determine the total volume required to be retained for the drainage as follows.

$$V_{REQ} = DCV \times F_{DCV}$$

Where:

V_{REQ} : Total volume that must be retained within the drainage area (ft³)

DCV: Design capture volume (ft³)

F_{DCV} : Fraction of DCV requiring retention (unitless)

Retention requirements can be satisfied at the project-scale if DMA scale is not achieved.

**Appendix B: Storm Water Pollutant Control Hydrologic Calculations
and Sizing Methods for Structural BMPs**

This page was intentionally left blank.

Figure B.2-1: Retention Requirements

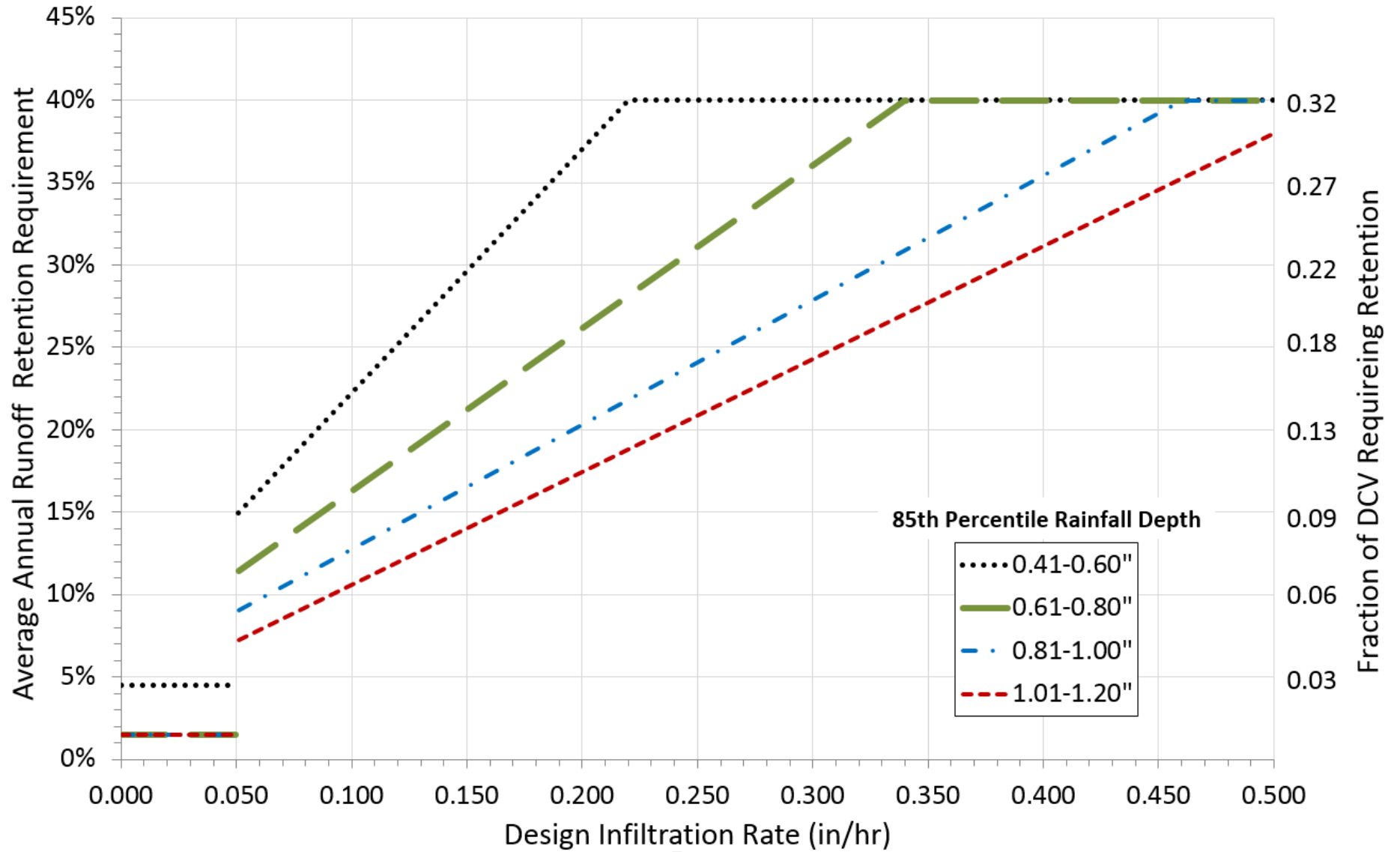

**Appendix B: Storm Water Pollutant Control Hydrologic Calculations
and Sizing Methods for Structural BMPs**

This page was intentionally left blank.

Appendix B: Storm Water Pollutant Control Hydrologic Calculations and Sizing Methods for Structural BMPs

B.3 Step 3 - Determine BMP Performance

The third step in performing stormwater pollutant control calculations is to design a structural BMP with the characteristics that provide stormwater treatment for the DCV and meet the minimum retention requirements for the drainage area. Demonstration of appropriate BMP design can be calculated through use of automated Worksheet B.3 on the next page, or can be calculated manually by following Steps 3A through 3E presented in this section.

Appendix B: Storm Water Pollutant Control Hydrologic Calculations and Sizing Methods for Structural BMPs

Worksheet B.3: BMP Performance

Category	#	Description	<i>i</i>	Units
BMP Inputs	1	Drainage Basin ID or Name		sq-ft
	2	Design Infiltration Rate Recommended		in/hr
	3	Design Capture Volume Tributary to BMP		cubic-feet
	4	Is BMP Vegetated or Unvegetated?		unitless
	5	Is BMP Impermeably Lined or Unlined?		unitless
	6	Does BMP Have an Underdrain?		unitless
	7	Does BMP Utilize Standard or Specialized Media?		unitless
	8	Provided Surface Area		sq-ft
	9	Provided Surface Ponding Depth		inches
	10	Provided Soil Media Thickness		inches
	11	Provided Gravel Thickness (Total Thickness)		inches
	12	Underdrain Offset		inches
	13	Diameter of Underdrain or Hydromod Orifice (Select Smallest)		inches
	14	Specialized Soil Media Filtration Rate		in/hr
	15	Specialized Soil Media Pore Space for Retention		unitless
	16	Specialized Soil Media Pore Space for Biofiltration		unitless
	17	Specialized Gravel Media Pore Space		unitless
Retention Calculations	18	Volume Infiltrated Over 6 Hour Storm		cubic-feet
	19	Ponding Pore Space Available for Retention		unitless
	20	Soil Media Pore Space Available for Retention		unitless
	21	Gravel Pore Space Available for Retention (Above Underdrain)		unitless
	22	Gravel Pore Space Available for Retention (Below Underdrain)		unitless
	23	Effective Retention Depth		inches
	24	Fraction of DCV Retained (Independent of Drawdown Time)		ratio
	25	Calculated Retention Storage Drawdown Time		hours
	26	Efficacy of Retention Processes		ratio
	27	Volume Retained by BMP (Considering Drawdown Time)		ratio
	28	Design Capture Volume Remaining for Biofiltration		cubic-feet
Biofiltration Calculations	29	Max Hydromod Flow Rate through Underdrain		CFS
	30	Max Soil Filtration Rate Allowed by Underdrain Orifice		in/hr
	31	Soil Media Filtration Rate per Specifications		in/hr
	32	Soil Media Filtration Rate to be used for Sizing		in/hr
	33	Depth Biofiltered Over 6 Hour Storm		inches
	34	Ponding Pore Space Available for Biofiltration		unitless
	35	Soil Media Pore Space Available for Biofiltration		unitless
	36	Gravel Pore Space Available for Biofiltration (Above Underdrain)		unitless
	37	Effective Depth of Biofiltration Storage		inches
	38	Drawdown Time for Surface Ponding		hours
	39	Drawdown Time for Effective Biofiltration Depth		hours
	40	Total Depth Biofiltered		inches
	41	Option 1 - Biofilter 1.50 DCV: Target Volume		cubic-feet
	42	Option 1 - Provided Biofiltration Volume		cubic-feet
	43	Option 2 - Store 0.75 DCV: Target Volume		cubic-feet
	44	Option 2 - Provided Storage Volume		cubic-feet
	45	Portion of Biofiltration Performance Standard Satisfied		ratio
Result	46	Do Site Design Elements and BMPs Satisfy Annual Retention Requirements?		yes/no
	47	Overall Portion of Performance Standard Satisfied (BMP Efficacy Factor)		ratio
	48	Deficit of Effectively Treated Stormwater		cubic-feet

Appendix B: Storm Water Pollutant Control Hydrologic Calculations and Sizing Methods for Structural BMPs

Worksheet B.3 Line Item Notes

1. Populated per user input from Worksheet B.1.
2. Populated per user input from Worksheet B.1.
3. Populated per result of Worksheet B.1.
4. User input. Unvegetated may be permitted in full infiltration conditions and/or Green Infrastructure Projects.
5. User input in reference to the bottom of the BMP.
6. User input.
7. User input. Default is "Standard" If specialized media is proposed, refer to BMPDM Sections F.1 - F.3 for guidance.
8. User input.
9. User input.
10. User input, 18 inches minimum.
11. User input. Value represents the total gravel thickness above and below the underdrain.
12. User input. Offset represents the distance between the bottom of the gravel layer to the invert of the underdrain.
13. User input. Select underdrain diameter or hydromod orifice diameter, whatever is smallest.
14. User input. If specialized media is proposed, refer to BMPDM Sections F.1 - F.3 for guidance.
15. User input. If specialized media is proposed, refer to BMPDM Sections F.1 - F.3 for guidance.
16. User input. If specialized media is proposed, refer to BMPDM Sections F.1 - F.3 for guidance.
17. User input. If specialized media is proposed, refer to BMPDM Sections F.1 - F.3 for guidance.
18. For unlined BMPs: Minimum of Line 3 or $[\text{Line } 8 \times (\text{Line } 2/12) \times 6.00]$. For Lined BMPs use zero.
19. Populated per Table B.3-1 of BMPDM. Values vary with respect to BMP elements such as vegetation, underdrain, liners.
20. Populated per Table B.3-1 of BMPDM. Values vary with respect to BMP elements such as vegetation, underdrain, liners.
21. Populated per Table B.3-1 of BMPDM. Values vary with respect to BMP elements such as vegetation, underdrain, liners.
22. Populated per Table B.3-1 of BMPDM. Values vary with respect to BMP elements such as vegetation, underdrain, liners.
23. $(\text{Line } 9 \times \text{Line } 19) + (\text{Line } 10 \times \text{Line } 20) + ((\text{Line } 11 - \text{Line } 12) \times \text{Line } 21) + (\text{Line } 12 \times \text{Line } 22)$
24. $[(\text{Line } 23/12) \times \text{Line } 8 + \text{Line } 18 / \text{Line } 3]$. Maximum value of 1.
25. $[\text{Line } 23 / \text{Line } 2]$. Assume 120 hours for all lined biofiltration BMPs.
26. Look up value from Retention Percent Capture Curves, and divide by 0.80. Maximum of 1.00.
27. $\text{Line } 26 \times \text{Line } 3$
28. $\text{Line } 3 - \text{Line } 27$
29. If flow controls are provided, calculate per orifice equation: $Q = CA\sqrt{2gh}$
30. If flow controls are provided, calculate as $[(\text{Line } 29 \times 12 \times 3600) / \text{Line } 8]$
31. Default = 5.00. If specialized media is proposed, refer to BMPDM Section Sections F.1 - F.3 for guidance.
32. Minimum of Line 30 or Line 31
33. $[\text{Line } 32 \times 6]$
34. Populated per Table B.3-2 of BMPDM. Values vary with respect to BMP elements such as vegetation, underdrain, liners.
35. Populated per Table B.3-2 of BMPDM. Values vary with respect to BMP elements such as vegetation, underdrain, liners.
36. Populated per Table B.3-2 of BMPDM. Values vary with respect to BMP elements such as vegetation, underdrain, liners.
37. $[(\text{Line } 9 \times \text{Line } 34) + (\text{Line } 10 \times \text{Line } 35) + ((\text{Line } 11 - \text{Line } 12) \times \text{Line } 36)]$
38. For lined basins use $[\text{Line } 9 / \text{Line } 32]$. For unlined basins use $[\text{Line } 9 / (\text{Line } 32 + \text{Line } 2)]$
39. For lined basins use $[\text{Line } 37 / \text{Line } 32]$. For unlined basins use $[\text{Line } 37 / (\text{Line } 32 + \text{Line } 2)]$
40. $[\text{Line } 33 + \text{Line } 37]$
41. $[1.50 \times \text{Line } 28]$
42. $[\text{Minimum of Line } 41 \text{ or } ((\text{Line } 40/12) \times \text{Line } 8)]$
43. $[0.75 \times \text{Line } 28]$
44. $[\text{Minimum of Line } 43 \text{ or } ((\text{Line } 37/12) \times \text{Line } 8)]$
45. $[\text{Maximum of } (\text{Line } 42 / \text{Line } 41) \text{ or } (\text{Line } 44 / \text{Line } 43)]$
46. Yes/No. Determined per BMPDM Section B.3.5.
47. $[\text{Line } 26 + \text{Line } 45]$. Maximum of 1.00.
48. $[\text{Line } 47 \times \text{Line } 3] - \text{Line } 3$

Appendix B: Storm Water Pollutant Control Hydrologic Calculations and Sizing Methods for Structural BMPs

B.3.1 Step 3A - BMP Characteristics

The performance of a BMP is a function of its retention and biofiltration processes, which are directly related to the proposed BMP geometry and design components. The SWQMP Preparer should design the BMP characteristics summarized below to satisfy pollutant control performances standards for treatment of the DCV and minimum retention requirements.

- BMP geometries identify the area and depth over which retention and/or biofiltration processes occur. Critical BMP geometries include: BMP surface area, surface ponding depth, biofiltration soil media depth, gravel depth, underdrain depth, and underdrain diameter.
- BMP components dictate how retention and biofiltration processes occur over the BMP footprint. Critical BMP components include: vegetation vs no vegetation, standard biofiltration soil media vs non-standard biofiltration soil media, impermeable liner vs no impermeable liner, underdrain vs no underdrain, and design infiltration rates.

The most common BMPs proposed for storm water compliance are infiltration BMPs, bioretention BMPs, and biofiltration BMPs. By default, these BMPs must be sized to provide a surface area that is equal to at least 3% of the tributary effective impervious area. If a smaller BMP surface area is desired, the applicant must complete Major Maintenance Interval calculations presented in Appendix B.4.1.

B.3.2 Step 3B - Retention Processes

BMP retention processes include infiltration and evapotranspiration occurring within the BMP. This section presents how to calculate the retention processes.

Part 1) Determine the volume of infiltration occurring within the BMP during a 6 hour storm event. This volume is a function of the design infiltration rate, BMP surface area, and duration of the storm event as shown below.

$$V_{R6} = \frac{I}{12} \times B \times 6 \text{ hours}$$

Where:

V_{R6} : Volume infiltrated during a 6 hour storm event (ft³)

I: Design infiltration rate (in/hr)

B: BMP surface area (ft²)

Part 2) Determine the static retention capacity of the BMP assuming it is entirely full. This volume is a function of the BMP surface area and the effective retention depth as shown below.

$$V_{RS} = B \times E_D$$

Where:

V_{RS} : Static retention capacity of the BMP (ft³)

B: BMP surface area (ft²)

E_D : The effective retention depth within all layers of the BMP (ft). This depth is calculated by multiplying the geometric depth (ft) of each BMP layer by the appropriate retention pore space factor in Table B.3-1 below and summing all of the layers.

**Appendix B: Storm Water Pollutant Control Hydrologic Calculations
and Sizing Methods for Structural BMPs**

Table B.3-1: Retention Pore Space Factors

BMP Characteristics	Unlined BMPs Without Underdrain	All Other Biofiltration/Retention BMPs
Ponding Pore Space	1.00	0.00
Media Pore Space	0.25 vegetated 0.40 non-vegetated	0.05
Gravel Pore Space Above Underdrain	0.40	0.00
Gravel Pore Space Below Underdrain	n/a	0.40*

*BMPs with an impermeable liner, must provide 3” of gravel beneath the underdrain invert (no more or no less is permitted in this case).

Part 3) Determine the fraction of the DCV retained by the BMP. This value is a function of the DCV, volume infiltrated during the 6 hour storm event, and static retention capacity of the BMP as shown below.

$$F_{DCV} = \frac{V_{R6} + V_{RS}}{DCV}$$

Where:

F_{DCV} : Fraction of the DCV retained by the BMP (decimal)

V_{R6} : Volume infiltrated during a 6 hour storm event (ft³)

V_{RS} : Static retention capacity of the BMP (ft³)

DCV: Design Capture Volume (ft³)

Part 4) Determine the drawdown time for the effective retention depth. This value is a function of the effective retention depth and the design infiltration rate of the BMP as shown below.

$$T_R = \frac{E_D}{I/12}$$

Where:

T_R : Drawdown time for effective retention depth (hrs)

E_D : The effective retention depth within all layers of the BMP (ft).

I: Design infiltration rate (in/hr). If this rate is 0.000 (i.e. lined BMP), a 120 hour drawdown time for the effective retention depth may be assumed.

Part 5) Determine the average annual percent capture provided by the BMP using Figure B.3-1 on the next page.

- a) Identify the fraction of the DCV retained by the BMP (F_{DCV}) on the x axis.
- b) Trace vertically from the x-axis result to the intersect with the plot representing the drawdown time for the effective retention depth (T_R). Interpolation between the plotted drawdown times may be necessary.
- c) Trace horizontally from the intersect result to identify the average annual percent capture of the proposed BMP.

**Appendix B: Storm Water Pollutant Control Hydrologic Calculations
and Sizing Methods for Structural BMPs**

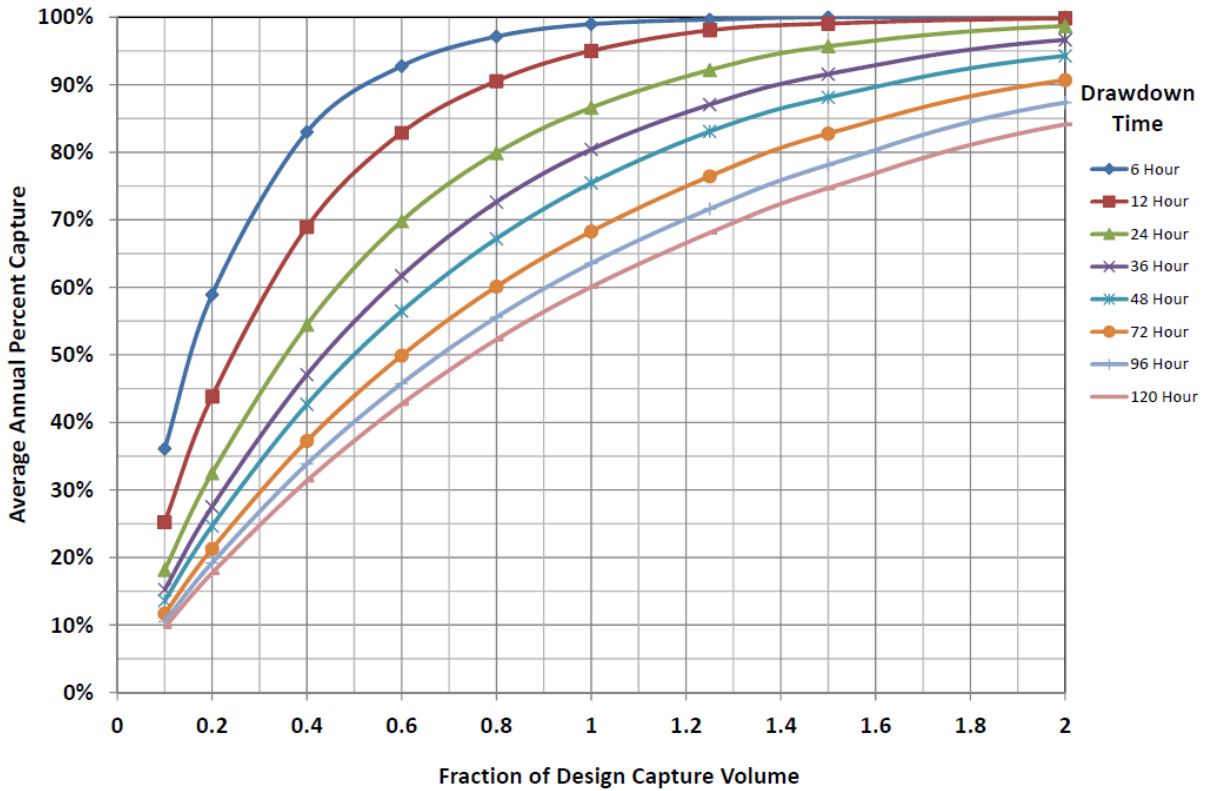

Figure B.3-1: Percent Capture Nomograph

Part 6) Determine the efficacy of the retention processes provided by the BMP. This value represents the portion of the pollutant control performance standard that is satisfied through retention processes of the BMP and is calculated as follows.

$$E_R = \frac{P_C}{80\%}$$

Where:

E_R : Efficacy of retention processes (decimal)

P_C : Average Annual Percent Capture (%)

Part 7) Determine the total volume retained by the proposed BMP.

$$V_{RBMP} = DCV \times E_R$$

Where:

V_{RBMP} : Total volume retained by BMP (ft³)

DCV: Design capture volume (ft³)

E_R : Efficacy of retention processes (decimal)

Appendix B: Storm Water Pollutant Control Hydrologic Calculations and Sizing Methods for Structural BMPs

Part 8) Determine the volume of storm water runoff still available for biofiltration treatment as shown below. If the entire volume is retained, then consideration of biofiltration processes in the next step are not required.

$$V_A = DCV - V_{RBMP}$$

Where:

V_A : Volume of storm water runoff still available for biofiltration treatment (ft³)

DCV: Design capture volume (ft³)

V_{RBMP} : Total volume retained by BMP (ft³)

B.3.3 Step 3C - Biofiltration Processes

Any portion of the DCV that has not been retained within site design or structural BMP elements must be biofiltered. BMP biofiltration processes include filtration, sedimentation, sorption, biochemical processes and/or vegetative uptake. This section presents how to calculate the biofiltration processes occurring within the proposed BMP.

Part 1) Determine the filtration rate (in/hr) of the proposed BMP. This is the rate in which storm water biofilters through the BMP and exits through the underdrain. Filtration rates can be governed by characteristics of the biofiltration soil media or by flow restrictions experienced due to the design of the BMP underdrain/orifice. Applicants must evaluate the rates associated with each of these components per the equations below and then select the lowest filtration rate for use in determining the BMP performance.

$$F_{underdrain} = (43,200CA_0\sqrt{2GH})/B$$

$$F_{soil} = 5 \text{ in/hr}$$

$$F_{BMP} = \text{Minimum}(F_{underdrain}, F_{soil})$$

Where:

$F_{underdrain}$: The filtration rate (in/hr) accommodated by the proposed BMP underdrain/orifice.

C: Orifice Coefficient (default 0.60)

A_o : Area of Underdrain/Orifice (ft²)

G: Gravitational acceleration (32.2 ft/sec²)

H: Height of water from underdrain invert to top of surface ponding (ft)

B: BMP Surface Area (ft²)

F_{soil} : The filtration rate (in/hr) accommodated by the proposed biofiltration soil media in typical conditions. The default soil media filtration rate is 5 in/hr; however, a higher rate may be used if supported per criteria in Section F.2.

F_{BMP} : The filtration rate (in/hr) of the proposed BMP

**Appendix B: Storm Water Pollutant Control Hydrologic Calculations
and Sizing Methods for Structural BMPs**

Part 2) Determine the volume of biofiltration occurring within the BMP during a 6 hour storm event. This volume is a function of the BMP filtration rate, BMP surface area, and the rainfall duration as shown below.

$$V_{B6} = \frac{F_{BMP}}{12} \times B \times 6 \text{ hours}$$

Where:

V_{B6} : Volume of water (ft³) biofiltered during a 6 hour storm event.

F_{BMP} : Filtration rate (in/hr) of the proposed BMP.

B : BMP surface area (ft²)

Part 3) Determine the static biofiltration capacity of the BMP assuming it is entirely full. This volume is a function of the BMP surface area and the effective biofiltration depth as shown below.

$$V_{BS} = B \times E_{DB}$$

Where:

V_{BS} : Static biofiltration capacity of the BMP (ft³)

B : BMP surface area (ft²)

E_{DB} : The effective biofiltration depth within all layers of the BMP (ft). This depth is calculated by multiplying the geometric depth (ft) of each BMP layer by the appropriate biofiltration pore space factor in Table B.3-2 below and summing all of the layers.

Table B.3-2: Biofiltration Pore Space Factors

BMP Characteristics	Unlined BMPs Without Underdrain	All Other Biofiltration/Retention BMPs
Ponding Pore Space	n/a	1.00
Media Pore Space	n/a	0.20 vegetated; 0.35 non-vegetated
Gravel Pore Space Above Underdrain	n/a	0.40
Gravel Pore Space Below Underdrain	n/a	0.00

Part 4) Determine the drawdown time (hours) for surface ponding. This is the ponding depth divided by the sum of the design infiltration rate and BMP filtration rate. Surface ponding depths of 24 hours or less are typically required; however, longer drawdown times up to 96 hours may be proposed if supported by a landscape architect/agronomist and no safety hazards are anticipated due to excessive ponding. Surface ponding drawdown times over 96 hours are not permitted due to vector concerns.

$$T_P = \frac{D_P}{I + F_{BMP}}$$

Where:

T_P : Time (hours) for the BMP surface ponding depth to draw down.

D_P : Surface ponding depth (inches) of the proposed BMP.

I : Design infiltration rate (in/hr)

F_{BMP} : BMP filtration rate (in/hr)

Part 5) Determine the efficacy of the biofiltration processes provided by the BMP. This value represents the portion of the pollutant control standard that is satisfied through the biofiltration processes of the BMP. There are two options available for establishing the biofiltration performance standard. Applicants may select the option of their choice. Option 1 requires that the BMP treat 1.5

Appendix B: Storm Water Pollutant Control Hydrologic Calculations and Sizing Methods for Structural BMPs

times the portion of the DCV not reliably retained onsite (assuming a 6 hour routing period). Option 2 requires that the BMP treat 1.0 times the portion of the DCV not reliably retained onsite; and additionally check that the system has a total static (i.e., non-routed) storage volume, including pore spaces and pre-filter detention volume, equal to at least 0.75 times the portion of the DCV not reliably retained onsite.

$$E_{B1} = \frac{V_{B6} + V_{BS}}{1.50 DCV - V_{RT}}$$

$$E_{B2} = \frac{V_{BS}}{0.75 DCV - V_{RT}}$$

$$E_B = \text{Maximum}(E_{B1}, E_{B2})$$

Where:

E_{B1} : Efficacy of biofiltration processes under option 1 (decimal).

V_{B6} : The volume biofiltered (ft³) during the 6 hour storm event.

V_{BS} : The static biofiltration capacity (ft³) of the BMP.

DCV: Design capture volume (ft³) delivered to BMP.

V_{RT} : The volume retained (ft³) within the BMP.

E_{B2} : Efficacy of biofiltration processes under option 2 (decimal).

E_B : Efficacy of biofiltration processes provided by the BMP (decimal).

B.3.4 Step 3D - Satisfaction of Pollutant Control Requirements

The performance of a BMP with respect to the pollutant control performance standards is referred to as the BMP efficacy. The total BMP efficacy is a function of the previously calculated retention efficacy and biofiltration efficacy as shown below.

$$E_T = E_R + (1.00 - E_R) \times E_B$$

Where:

E_T : Total BMP Efficacy (decimal)

E_R : Efficacy of retention processes (decimal)

E_B : Efficacy of biofiltration processes (decimal)

To satisfy pollutant control performance standards, the total BMP efficacy must be 100%. If this level of efficacy is not achieved, applicants should consider reconfiguring drainage layout and/or BMP designs as needed. If this level of efficacy still can't be achieved, applicants may elect to implement flow-thru treatment control at the project site and also participate in the County's Offsite Alternative Compliance Program outlined in Appendix J.

**Appendix B: Storm Water Pollutant Control Hydrologic Calculations
and Sizing Methods for Structural BMPs**

B.3.5 Step 3E - Satisfaction of Minimum Retention Requirements

Minimum retention requirements can be satisfied by demonstrating that all of the retention elements incorporated within a drainage area (rain barrels, tree wells, dispersion areas, and BMPs) retain a volume of water that is greater than or equal to what is required.

Part 1) Determine the total volume retained through site design and structural BMP elements as follows.

$$V_{RT} = V_{RRB} + V_{RTW} + V_{RD} + V_{RBMP}$$

Where:

V_{RT} : Total volume retained within the drainage area (ft³)

V_{RRB} : Volume retained by rain barrels (ft³)

V_{RTW} : Volume retained by tree wells (ft³)

V_{RD} : Volume retained by dispersion areas (ft³)

V_{RBMP} : Volume retained by the BMP (ft³)

Part 2) Demonstrate that the total volume retained through site design and structural BMP elements meets retention requirements.

$$V_{RT} \geq V_{REQ}$$

Where:

V_{RT} : Total volume retained within the drainage area (ft³)

V_{REQ} : Total volume that must be retained within the drainage area (ft³)

**Appendix B: Storm Water Pollutant Control Hydrologic Calculations
and Sizing Methods for Structural BMPs**

B.4 Less Common Pollutant Control Calculations

This section presents methodologies for performing less common pollutant control calculations including: determination of BMP major maintenance intervals, capture and use evaluation, use of offline BMPs, and BMPs located downstream of a storage unit.

B.4.1 Major Maintenance Intervals for Reduced Size BMPs

BMPs with a surface area sized at less than 3% of the tributary effective impervious area must perform additional calculations to determine the anticipated major maintenance intervals.

Major maintenance activities include items such as rehabilitation and/or replacement of the entire BMP or BMP components, which are independent of regularly scheduled annual maintenance. BMP major maintenance intervals can be calculated through use of automated Worksheet B.4 below, or can be calculated manually by following Steps 4A-4C presented in this section.

Worksheet B.4: Major Maintenance Intervals for Reduced Size BMPs

Category	#	Description	<i>i</i>	Units
Drainage Basin Info	1	Drainage Basin ID or Name		unitless
	2	Final Effective Tributary Area		sq-ft
	3	Provided BMP Surface Area		sq-ft
Biofiltration Clogging Inputs	4	Average Annual Precipitation		inches
	5	Load to Clog (default =2.0)		lb/sq-ft
	6	TSS Pretreatment Efficacy		ratio
	7	Percentage "Commercial"		percentage
	8	Percentage "Education"		percentage
	9	Percentage "Industrial"		percentage
	10	Percentage "Low Traffic Areas"		percentage
	11	Percentage "Multi-Family Residential"		percentage
	12	Percentage "Roof Areas"		percentage
	13	Percentage "Single Family Residential"		percentage
	14	Percentage "Transportation"		percentage
	15	Percentage "Vacant/Open Space"		percentage
	16	Percentage "Steep Hillslopes"		percentage
	Minimum Footprint Calculations	17	Total Percentage of Above Land Uses	0%
18		Average TSS Concentration for Tributary After Pretreatment	0	mg/L
19		Average Annual Runoff Volume	0	cubic-feet
20		Average Annual TSS Load	0	lb/yr
21		Available Sediment Storage within BMP	0	lb
Result	22	Anticipated Major Maintenance Frequency	-	years

Appendix B: Storm Water Pollutant Control Hydrologic Calculations and Sizing Methods for Structural BMPs

Worksheet B.4 Line Item Notes
1. Populated per user input from Worksheet B.1.
2. Populated per result of Worksheet B.1.
3. Populated per user input from Worksheet B.3.
4. User Input
5. User Input, Default=2.0. See BMPDM Table B.4-2 for guidance on revisions.
6. User Input. Default=0.00. See BMPDM Section B.4.1.1 for guidance on revisions.
7. User Input. (Commercial TSS Loading TSS = 128 mg/L, C=0.80)
8. User Input. (Education TSS Loading TSS = 132 mg/L, C=0.50)
9. User Input. (Industrial TSS Loading TSS = 125 mg/L, C=0.90)
10. User Input. (Low Traffic Areas TSS Loading TSS = 50 mg/L, C=0.50)
11. User Input. (Multi-Family Residential TSS Loading TSS = 40 mg/L, C=0.60)
12. User Input. (Roof Areas TSS Loading TSS = 14 mg/L, C=0.90)
13. User Input. (Single Family Residential TSS Loading TSS = 123 mg/L, C=0.40)
14. User Input. (Transportation TSS Loading TSS = 78 mg/L, C=0.90)
15. User Input. (Vacant/Open Space TSS Loading TSS = 216 mg/L, C=0.10)
16. User Input. (Steep Hillslopes TSS Loading TSS = 797 mg/L, C=0.30)
17. $\sum_{\text{Lines 7-16}}$
18. $[(\sum_{\text{Lines 7-16}} \text{Land Use Percentage} \times \text{Runoff Coefficient} \times \text{TSS Concentration}) / \text{Line 17}] \times (1 - \text{Line 6})$
19. $[(\text{Line 4}/12) \times \text{Line 2}]$
20. $\text{Line 18} \times 0.000062428 \times \text{Line 19}$
21. $\text{Line 3} \times \text{Line 5}$
22. $\text{Line 21} / \text{Line 20}$

B.4.1.1 Annual Sediment Load Delivered to BMP

The annual sediment load delivered to a BMP is a function of the average annual storm water runoff, land use characteristics, and pretreatment elements applicable to the drainage area.

Part 1) Determine the average sediment concentration in storm water runoff from the land uses present within the drainage area by referring to the total suspended solid (TSS) concentrations listed for various land uses in Table B.4-1 below.

Table B.4-1: TSS Concentrations by Land Use

Land Use	TSS Concentration (mg/L)	C	Source
Single Family Residential	123	0.40	San Diego SBPAT EMC Dataset
Commercial	128	0.80	
Industrial	125	0.90	
Education (Municipal)	132	0.50	
Multi-family Residential	40	0.60	
Open Space	216	0.10	
Transportation/Pavement	78	0.90	LA SBPAT EMC Dataset
Roof Runoff	14	0.90	Charters et al. (2015)
Low Traffic Areas/Sidewalk	50	0.50	Davis and McCuen (2005)
Steep Hillslopes	797	0.30	Model BMPDM

Appendix B: Storm Water Pollutant Control Hydrologic Calculations and Sizing Methods for Structural BMPs

If a drainage area is comprised of more than one land use type, a runoff-weighted TSS concentration must be calculated per the following equation.

$$TSS_{AVG} = \frac{\sum TSS_1 F_1 + TSS_2 F_2 + TSS_x F_x}{\sum F_1 + F_2 + F_x}$$

Where:

TSS_{AVG}: Average sediment concentration in storm water from all tributary land uses (mg/L)

TSS₁: TSS concentration from land use 1 (mg/L)

F₁: Fraction of total DCV from land use 1 (%)

TSS₂: TSS concentration from land use 2 (mg/L)

F₂: Fraction of total DCV from land use 2 (%)

TSS_x: TSS concentration from land use x (mg/L)

F_x: Fraction of total DCV from land use x (%)

Part 2) Determine the average sediment concentration in storm water runoff as it enters the BMP. This is the concentration of TSS determined in part 1 after consideration of any “pretreatment” elements incorporated as shown below.

$$TSS_{BMP} = TSS_{AVG} \times (1 - P)$$

Where:

TSS_{BMP}: Average sediment concentration in runoff entering the BMP (mg/L)

TSS_{AVG}: Average sediment concentration in storm water from all tributary land uses (mg/L)

P: Pretreatment removal efficiency (%).

- P value of 0.00 should be used if there is no pretreatment.
- P value of 0.25 should be used when pretreatment is included.
- P value of 0.50 should be used if pretreatment consistent with Washington TAPE “Pretreatment” BMP performance criteria are satisfied (>50% TSS removal)
- P value of 0.80 should be used if pretreatment consistent with Washington TAPE “Basic Treatment” performance criteria are satisfied (>80% TSS removal)

Part 3) Determine the average annual runoff volume entering the BMP. This is a function of the average annual precipitation, runoff factor, and drainage area as shown below.

$$V_{annual} = \frac{D_{annual}}{12} \times A \times C$$

Where:

V_{annual}: Average annual runoff volume entering the BMP (ft³/year)

D_{annual}: Average annual precipitation (inches/year)

A: Tributary Area (ft²)

C: Runoff factor (unitless)

Appendix B: Storm Water Pollutant Control Hydrologic Calculations and Sizing Methods for Structural BMPs

Part 4) Determine the annual sediment load delivered to the BMP. This is a function of the average annual runoff volume and the average sediment concentration in stormwater from all tributary land uses as shown below.

$$L_{annual} = TSS_{BMP} \times V_{annual} \times 0.0000624$$

Where:

L_{annual} : Annual sediment load delivered to the BMP (lbs/year)

TSS_{BMP} : Average sediment concentration in runoff entering the BMP (mg/L)

V_{annual} : Average annual runoff volume entering the BMP (ft³)

B.4.1.2 BMP Sediment Capacity

The BMP sediment capacity is the weight of sediment (lbs) that can be stored within the BMP before significant clogging impacts begin to occur. The BMP sediment capacity can be determined as follows.

Part 1) Determine the appropriate load to clog value by referencing Table B.4-2 below and identifying the BMP configuration that best characterizes the proposed BMP design.

Table B.4-2: Guidance for Selecting Load to Clog (L_c)

BMP Configuration	Load to Clog, L_c , lb/sq-ft
Default Load to Clog Value	2
≥75% vegetative cover	3
≥20 in/hr media permeability and outlet flow control	3
≥75% vegetative cover, ≥30 in/hr media permeability, and outlet control	4

Part 2) Determine the BMP Sediment Capacity (lbs) by multiplying the BMP Load to Clog by the BMP surface area.

$$C_{BMP} = B \times L_c$$

Where:

C_{BMP} : BMP sediment capacity (lbs)

B : BMP Surface Area (ft²)

L_c : BMP load to clog value (lbs/ft²)

B.4.1.3 Major Maintenance Frequency

The major maintenance frequency can be calculated by dividing the BMP sediment capacity by the annual sediment load delivered to the BMP as shown below.

$$M_{BMP} = \frac{C_{BMP}}{L_{annual}}$$

Where:

M_{BMP} : Major maintenance frequency for BMP (years)

C_{BMP} : BMP sediment capacity (lbs)

L_{annual} : Annual sediment load delivered to the BMP (lbs/yr)

Appendix B: Storm Water Pollutant Control Hydrologic Calculations and Sizing Methods for Structural BMPs

The calculated major maintenance frequency must be 10 years or greater. If the calculated major maintenance frequency is less than 10 years, the applicant must take steps to increase the BMP sediment capacity and/or reduce the annual sediment load delivered to the BMP. In limited circumstances, frequencies of less than 10 years may be acceptable if supported to the satisfaction of the County plan reviewer.

B.4.2 Capture and Use Evaluation

If the proposed project includes habitable structures over 9 stories in height, the applicant must perform a capture and use evaluation as outlined herein.

The capture and use evaluation should be performed at the project-scale, and not be limited to a single DMA. This evaluation must identify the potential demand for using stormwater for indoor toilets and outdoor irrigation use and determine if this demand is sufficient to drawdown the DCV within a 36 hour time period.

B.4.2.1 Toilet and Urinal Flushing Demand Calculations*

The following guidelines should be followed for computing harvested water demand from toilet and urinal flushing:

- If reclaimed water is planned for use for toilet and urinal flushing, then the demand for harvested storm water is equivalent to the total demand minus the reclaimed water supplied, and should be reduced by the amount of reclaimed water that is available during the wet season.
- Demand calculations for toilet and urinal flushing should be based on the average rate of use during the wet season for a typical year.
- Demand calculations should include changes in occupancy over weekends and around holidays and changes in attendance/enrollment over school vacation periods.
- For facilities with generally high demand, but periodic shut downs (e.g., for vacations, maintenance, or other reasons), a project specific analysis should be conducted to determine whether the long term storm water capture performance of the system can be maintained despite shut downs.
- Such an analysis should consider the statistical distributions of precipitation and demand, most importantly the relationship of demand to the wet seasons of the year.

Table B.4-3 provides planning level demand estimates for toilet and urinal flushing per resident, or employee, for a variety of project types. The per capita use per day is based on daily employee or resident usage. For non-residential types of development, the “visitor factor” and “student factor” (for schools) should be multiplied by the employee use to account for toilet and urinal usage for non-employees using facilities.

Note: At the time of publication of this document, there is not a program in place to permit the use of storm water for indoor use. Check with PDS prior to calculating indoor water use.

Appendix B: Storm Water Pollutant Control Hydrologic Calculations and Sizing Methods for Structural BMPs

Table B.4-3: Toilet and Urinal Water Usage per Resident or Employee

Land Use Type	Toilet User Unit of Normalization	Per Capita Use per Day		Visitor Factor ⁴	Water Efficiency Factor	Total Use per Resident or Employee
		Toilet Flushing ^{1, 2}	Urinals ³			
Residential	Resident	18.5	NA	NA	0.5	9.3
Office	Employee (non-visitor)	9.0	2.27	1.1	0.5	7 (avg)
Retail	Employee (non-visitor)	9.0	2.11	1.4	0.5	
Schools	Employee (non-student)	6.7	3.5	6.4	0.5	33
Various Industrial Uses (excludes process water)	Employee (non-visitor)	9.0	2	1	0.5	5.5

1 - Based on American Waterworks Association Research Foundation, 1999. Residential End Uses of Water. Denver, CO: AWWARF

2 - Based on use of 3.45 gallons per flush and average number of per employee flushes per subsector, Table D-1 for MWD (Pacific Institute, 2003)

3 - Based on use of 1.6 gallons per flush, Table D-4 and average number of per employee flushes per subsector, Appendix D (Pacific Institute, 2003)

4 - Multiplied by the demand for toilet and urinal flushing for the project to account for visitors. Based on proportion of annual use allocated to visitors and others (includes students for schools; about 5 students per employee) for each subsector in Table D-1 and D-4 (Pacific Institute, 2003)

5 - Accounts for requirements to use ultra low flush toilets in new development projects; assumed that requirements will reduce toilet and urinal flushing demand by half on average compared to literature estimates. Ultra low flush toilets are required in all new construction in California as of January 1, 1992. Ultra low flush toilets must use no more than 1.6 gallons per flush and Ultra low flush urinals must use no more than 1 gallon per flush. Note: If zero flush urinals are being used, adjust accordingly.

B.4.2.2 Planning Level Irrigation Demands

To simplify the planning process, the method described above has been used to develop daily average wet season demands for a one-acre irrigated area based on the plant/landscape type. These demand estimates can be used to calculate the drawdown of harvest and use systems for the purpose of LID BMP sizing calculations.

Table B.4-4: Planning Level Irrigation Demand by Plant Factor and Landscape Type

General Landscape Type	36-Hour Planning Level Irrigation Demand (gallons per irrigated acre per 36 hour period)
Hydrozone – Low Plant Water Use	390
Hydrozone – Moderate Plant Water Use	1,470
Hydrozone – High Plant Water Use	2,640
Special Landscape Area	2,640

B.4.3 BMPs Downstream of a Storage Unit

Incorporation of upstream storage units (cisterns, vaults, etc) into a project's design can regulate flows to downstream biofiltration BMPs and potentially optimize the required BMP footprints. Use of this approach is not supported by County automated worksheets, but compliance with stormwater pollutant control requirements can be demonstrated through the following steps.

- Step 1) Determine the flow rate from the upstream storage unit
 - Use the orifice equation to determine outflow from the storage unit when it is filled to the depth associated with the DCV.
- Step 2) Demonstrate that the proposed BMP can accommodate flows from the storage unit
 - Multiply the BMP surface area (ft²) by the filtration rate of the biofiltration soil media (in/hr) and divide by 43,200 to convert the units into CFS. For proprietary BMPs, this rate should correspond with the rates from certified testing the manufacturer has performed.
- Step 3) Demonstrate that the proposed BMP biofilters 92% of the annual runoff volume
 - If continuous simulation modeling has been performed, provide output reports from SWMM or SDHM modeling.
 - If continuous simulation modeling has not been performed, reference the percent capture nomographs in Figure B.3-1 to determine the percentage of annual runoff that is biofiltered. To use the nomographs, applicants must represent the BMP storage capacity as a fraction of the DCV along the x-axis, trace a line vertically to the colored line representing the drawdown time of the system, and then determine the percentage of annual runoff biofiltered by tracing horizontally to the y-axis.
- Step 4) If the downstream biofiltration BMP is <3% of the effective tributary area, provide information supporting use of compact biofiltration as generally outlined below.
 - Retention Requirements: Demonstrate that minimum retention requirements from Section B.2 are satisfied.
 - Maintenance Requirements: Demonstrate that the BMP design is expected to last 10 years before major maintenance is anticipated per Appendix B.4.1.
 - Proprietary Requirements (if applicable): Provide proprietary information demonstrating that the device meets biofiltration criteria outlined in Appendices F.1-F.2.

B.4.4 Onsite Alternative Compliance

If desired, a PDP applicant may generate stormwater pollutant control and/or hydromodification flow control benefits by managing stormwater flows from “excess areas” that are conveyed to the site. Management of flows from these excess areas may be used to offset flows from “required areas” that lack management.

Appendix B: Storm Water Pollutant Control Hydrologic Calculations and Sizing Methods for Structural BMPs

Required areas are the areas of a project for which the Permit mandates pollutant control and/or HMP flow control requirements. Excess areas are the areas of a project for which the Permit does not mandate pollutant control and/or HMP flow control requirements. Areas of offsite run-on to the PDP site may always be considered excess areas. Additionally, for redevelopment projects falling under the 50% redevelopment threshold, onsite areas that are not being redeveloped may also be considered excess areas.

Compliance with stormwater pollutant control requirements using this onsite alternative compliance approach can be demonstrated as outlined below.

- Step 1) Determine the untreated DCV from the required area
- Step 2) Determine the treated DCV from the excess area
 - If required areas and excess areas contain different land uses, a land use factor must be applied to account for variations in pollutant concentrations. In most cases, this factor results in a lower treatment volume being credited. Refer to the Water Quality Equivalency (WQE) document for guidance on determining a land use factor and note that the WQE terms “ACP tributary” and “reference tributary” correlate with “excess areas” and “required areas” respectively.
- Step 3) Demonstrate compliance
 - Show that the treated DCV from the excess area is greater than or equal to the untreated DCV from the required area (Step 2 ≥ Step 1).
 - Use of this onsite alternative compliance approach does not mandate flow-thru treatment of untreated flows from required areas; however, applicants are encouraged to do so where feasible.

B.4.5 Offline BMPs

Diversion flow rates for offline BMPs must be sized to convey the maximum flow rate of runoff produced from a rainfall intensity of 0.2 inch of rainfall per hour, for each hour of every storm event. The following hydrologic method must be used to calculate the diversion flow rate for off-line BMPs:

$$Q = C \times i \times A$$

Where:

Q = Diversion flow rate in cubic feet per second

C = Runoff factor, area weighted estimate using Table B.1-1

i = Rainfall intensity of 0.2 in/hr

A = Tributary area (acres)

B.5 Backup Information on Pollutant Control Standards

This sections presents backup information describing the rationale for the following elements relating to pollutant control: establishment of the pollutant control performance standard, establishment of retention requirements, establishment of 85th percentile rainfall depths, backup information on tree well retention values, and backup information on BMP major maintenance frequency calculations.

B.5.1 Pollutant Control Performance Standard Backup

Storm water BMPs can be conceptualized as having a storage volume and a treatment rate, in various proportions. Both are important in the long-term performance of the BMP under a range of actual storm patterns, depths, and inter-event times. Long-term performance is measured by the operation of a BMP over the course of multiple years, and provides a more complete metric than the performance of a BMP during a single event, which does not take into account antecedent conditions, including multiple storms arriving in short timeframes. A BMP that draws down more quickly would be expected to capture a greater fraction of overall runoff (i.e., long-term runoff) than an identically sized BMP that draws down more slowly. This is because storage is made available more quickly, so subsequent storms are more likely to be captured by the BMP. In contrast a BMP with a long drawdown time would stay mostly full, after initial filling, during periods of sequential storms. The volume in the BMP that draws down more quickly is more “valuable” in terms of long term performance than the volume in the one that draws down more slowly. The MS4 permit definition of the DCV does not specify a drawdown time, therefore the definition is not a complete indicator of a BMP's level of performance. An accompanying performance-based expression of the BMP sizing standard is essential to ensure uniformity of performance across a broad range of BMPs and helps prevents BMP designs from being used that would not be effective.

An evaluation of the relationships between BMP design parameters and expected long term capture efficiency has been conducted to address the needs identified above. Relationships have been developed through a simplified continuous simulation analysis of precipitation, runoff, and routing, that relate BMP design volume and storage recovery rate (i.e., drawdown time) to an estimated long term level of performance using United States Environmental Protection Agency (USEPA) SWMM and parameters listed in Appendix G for Lake Wohlford, Lindbergh, and Oceanside rain gages. Comparison of the relationships developed using the three gages indicated that the differences in relative capture estimates are within the uncertainties in factors used to develop the relationships. For example, the estimated average annual capture for the BMP sized for the DCV and 36 hour drawdown using Lake Wohlford, Lindbergh, and Oceanside are 80%, 76% and 83% respectively. In an effort to reduce the number of curves that are made available, relationships developed using Lake Wohlford are included in this manual for use in the whole San Diego County region.

Figure B.4-1 demonstrated that a BMP sized for the runoff volume from the 85th percentile, 24-hour storm event (i.e., the DCV), which draws down in 36 hours is capable of managing approximately 80 percent of the average annual. There is long precedent for 80 percent capture of average annual runoff as approximately the point at which larger BMPs provide decreasing capture efficiency benefit (also known as the “knee of the curve”) for BMP sizing. The characteristic shape of the plot of capture efficiency versus storage volume in Figure B.3-1 illustrates this concept.

Appendix B: Storm Water Pollutant Control Hydrologic Calculations and Sizing Methods for Structural BMPs

As such, this equivalency (between DCV draw down in 36-hours and 80 percent capture) has been utilized to provide a common currency between volume-based BMPs with a wide range of drawdown rates. This approach allows flexibility in the design of BMPs while ensuring consistent performance.

B.5.2 Retention Requirement Backup

In May 2016, the RWQCB provided clarification on the 2013 MS4 Permit requirement for the BMPDM to "...provide guidance for hydraulic loading rates and other biofiltration design criteria necessary to maximize the storm water retention and pollutant removal of treatment control BMPs." Through coordination with the RWQCB, a quantifiable minimum retention requirement for treatment control BMPs was established based on the assumption that BMPs would be sized at 3% of the effective tributary area and be unlined where feasible.

The retention curves presented in Figure B.2-1 were developed using Version 1.4 automated pollutant control worksheets assuming various rainfall depths (0.60 to 1.20 inches) and design infiltration rates (0.000 to 0.500 in/hr). BMPs were sized at 3% of the effective impervious tributary area, provided 18" soil media depth, 3" of gravel above the underdrain, 6" underdrains with no hydromodification management orifices, 3" of gravel beneath the underdrain, and varied surface ponding depths as needed to fully satisfy pollutant removal standards.

B.5.3 Rainfall Depth Backup

The method of calculating the 85th percentile is to produce a list of values, order them from smallest to largest, and then pick the value that is 85 percent of the way through the list. Only values that are capable of producing run off are of interest for this purpose. Lacking a legislative definition of rainfall values capable of producing runoff, Flood Control staff in San Diego County have observed that the point at which significant runoff begins is rather subjective, and is affected by land use type and soil moisture. In highly-urbanized areas, the soil has a high impermeability and runoff can begin with as little as 0.02" of rainfall. In rural areas, soil impermeability is significantly lower and even 0.30" of rain on dry soil will frequently not produce significant runoff. For this reason, San Diego County has chosen to use the more objective method of including all non-zero 24-hour rainfall totals when calculating the 85th percentile. To produce a statistically significant number, only stations with 30 years or greater of daily rainfall records are used.

A collection of 56 precipitation gage points was developed with 85th percentile precipitation values based on multiple years of gage data. A raster surface (grid of cells with values) was interpolated from that set of points. The surface initially did not cover the County's entire jurisdiction. A total of 13 dummy points were added. Most of those were just outside the County boundary to enable the software to generate a surface that covered the entire County. A handful of points were added to enforce a plausible surface. In particular, one point was added in the desert east of Julian, to enforce a gradient from high precipitation in the mountains to low precipitation in the desert. Three points were added near the northern boundary of the County to adjust the surface to reflect the effect of elevation in areas lacking sufficient operating gages.

Several methods of interpolation were considered. The method chosen is named by Environmental Systems Research Institute as the Natural Neighbor technique. This method produces a surface that is highly empirical, with the value of the surface being a product of the values of the data points nearest

Appendix B: Storm Water Pollutant Control Hydrologic Calculations and Sizing Methods for Structural BMPs

each cell. It does not produce peaks or valleys of surface based on larger area trends, and is free of artifacts that appeared with other methods.

B.5.4 Tree Well Backup

Tree Well credit volume is estimated based on typical characteristics of Tree Wells as follows:

It is assumed that each tree is considered a single BMP, with calculations based on the soil media reservoir volume and/or the individual tree within the tree BMP as appropriate. Tree Well credit volume is calculated as:

$$TWCV = TIV + TCIV + TETV$$

Where:

$TWCV$ = Tree Well credit volume (ft³)

TIV = Total infiltration volume of all storage layers within tree BMPs (ft³)

$TCIV$ = Total canopy interception volume of tree BMPs (ft³)

$TETV$ = Total evapotranspiration volume, sums the media evapotranspiration storage within each tree BMP (ft³)

Total infiltration volume is calculated as the total volume stored within the tree BMP soil media reservoir. Infiltration volume was assumed to be 20% of the total BMP soil media reservoir volume, the available pore space in the soil media reservoir (porosity – field capacity).

Total canopy interception volume was calculated as the average interception capacity for the entire mature tree canopy projection area. Interception capacity was determined to be 0.04 inches per square foot for all tree sizes, an average from the findings published by Breuer et al (2003) for coniferous and deciduous trees.

Total evapotranspiration volume is the available evapotranspiration storage volume (field capacity – wilting point) within the BMP storage layer media. TEVT is assumed to be 10% of the minimum soil volume. The minimum soil volume as required by SD-A fact sheet of 2 cubic feet per unit canopy projection area was assumed for estimating reduction in DCV.

There may be rain events that generate more runoff than the tree well can handle. Installing an overflow above the design storm water retention level of the reservoir can prevent system failure during extreme weather events. Placement of the overflow should be determined based on the infiltration rate of the subsoil. If infiltration is not adequate to remove water from the rooting zone (the top 18 to 24 inches of soil media reservoir) within 48 hours, the depth of the soil media reservoir may be increased, and the overflow should be placed such that if water rises to the level of the rooting zone it will drain in less than 48 hours.

B.5.5 Sediment Clogging Backup

Under the 2011 Model SUSMP, a sizing factor of 4 percent was used for sizing biofiltration BMPs. This value was derived based on the goal of treating the runoff from a 0.2 inch per hour uniform precipitation intensity at a constant media flow rate of 5 inches per hour. While this method was simple, it was considered to be conservative as it did not account for significant transient storage present in biofiltration BMPs (i.e., volume in surface storage and subsurface storage that would need to fill before overflow occurred). Under this manual, biofiltration BMPs will typically provide

Appendix B: Storm Water Pollutant Control Hydrologic Calculations and Sizing Methods for Structural BMPs

subsurface storage to promote infiltration losses; therefore typical BMP profiles will tend to be somewhat deeper than those provided under the 2011 Model SUSMP. A deeper profile will tend to provide more transient storage and allow smaller footprint sizing factors while still providing similar or better treatment capacity and pollutant removal. Therefore a reduction in the minimum sizing factor from the factor used in the 2011 Model SUSMP is supportable. However, as footprint decreases, issues related to potential performance, operations, and/or maintenance can increase for a number of reasons:

- 1) As the surface area of the media bed decreases, the sediment loading per unit area increases, increasing the risk of clogging. While vigorous plant growth can help maintain permeability of soil, there is a conceptual limit above which plants may not be able to mitigate for the sediment loading. Scientific knowledge is not conclusive in this area.
- 2) With smaller surface areas and greater potential for clogging, water may be more likely to bypass the system via overflow before filling up the profile of the BMP.
- 3) As the footprint of the system decreases, the amount of water that can be infiltrated from subsurface storage layers and evapotranspire from plants and soils tends to decrease.
- 4) With smaller sizing factors, the hydraulic loading per unit area increases, potentially reducing the average contact time of water in the soil media and diminishing treatment performance.

The MS4 Permit requires that volume and pollutant retention be maximized. Therefore, a minimum sizing factor was determined to be needed. This minimum sizing factor does not replace the need to conduct sizing calculations as described in this manual; rather it establishes a lower limit on required size of biofiltration BMPs as the last step in these calculations. Additionally, it does not apply to alternative biofiltration designs that utilize the checklist in Appendix F (Biofiltration Standard and Checklist). Acceptable alternative designs (such as proprietary systems meeting Appendix F criteria) typically include design features intended to allow acceptable performance with a smaller footprint and have undergone field scale testing to evaluate performance and required O&M frequency.

Sediment Clogging Calculations

As sediment accumulates in a filter, the permeability of the filter tends to decline. The lifespan of the filter bed can be estimated by determining the rate of sediment loading per unit area of the filter bed. To determine the media bed surface area sizing factor needed to provide a target lifespan, simple sediment loading calculations were conducted based on typical urban conditions. The inputs and results of this calculation are summarized in Table B.5-1.

Table B.5-1: Inputs and Results of Clogging Calculation

Parameter	Value	Source
Representative TSS Event Mean Concentration, mg/L	100	Approximate average of San Diego Land Use Event Mean Concentrations from San Diego River and San Luis Rey River WQIP
Runoff Coefficient of Impervious Surface	0.90	Table B.1-1
Runoff Coefficient of Pervious Surface	0.10	Table B.1-1 for landscape areas
Imperviousness	40% to 90%	Planning level assumption, covers typical range of single family to commercial land uses
Average Annual Precipitation, inches	11 to 13	Typical range for much of urbanized San Diego County

Appendix B: Storm Water Pollutant Control Hydrologic Calculations and Sizing Methods for Structural BMPs

Parameter	Value	Source
Load to Initial Maintenance, kg/m ²	10	Pitt, R. and S. Clark, 2010. Evaluation of Biofiltration Media for Engineered Natural Treatment Systems.
Allowable period to initial clogging, yr	10	Planning-level assumption
Estimated BMP Footprint Needed for 10-Year Design Life	2.8 to 3.3%	Calculated

This analysis suggests that a 3 percent sizing factor, coupled with sediment source controls and careful system design, should provide reasonable protection against premature clogging. However, there is substantial uncertainty in sediment loading and the actual load to clog that will be observed under field conditions in the San Diego climate. Additionally this analysis did not account for the effect of plants on maintaining soil permeability. Therefore this line of evidence should be considered provisional, subject to refinement based on field scale experience. As field scale experience is gained about the lifespan of biofiltration BMPs in San Diego and the mitigating effects of plants on long term clogging, it may be possible to justify lower factors of safety and therefore smaller design sizes in some cases. If a longer lifespan is desired and/or greater sediment load is expected, then a larger sizing factor may be justified.

Generally, the purpose of a minimum sizing factor is to help improve the performance and reliability of standard biofiltration systems and limit the use of sizing methods and assumptions that may lead to designs that are less consistent with the intent of the MS4 Permit.

Ultimately, this factor is a surrogate for a variety of design considerations, including clogging and associated hydraulic capacity, volume reduction potential, and treatment contact time. A prudent design approach should consider each of these factors on a project-specific basis and identify whether site conditions warrant a larger or smaller factor. For example a system treating only rooftop runoff in an area without any allowable infiltration may have negligible clogging risk and negligible volume reduction potential – a smaller sizing factor may not substantially reduce performance in either of these areas. Alternatively, for a site with high sediment load and limited pre-treatment potential, a larger sizing factor may be warranted to help mitigate potential clogging risks. County staff has discretion to accept alternative sizing factor(s) based on project-specific or jurisdiction-specific considerations. Additionally, the recommended minimum sizing factor may change over time as more experience with biofiltration is obtained.

**Appendix B: Storm Water Pollutant Control Hydrologic Calculations
and Sizing Methods for Structural BMPs**

This page was intentionally left blank.

Appendix

C

COUNTY OF SAN DIEGO BMP DESIGN MANUAL

Baseline BMP Fact Sheets for Site Design and Source Control

Appendix C: Baseline BMP Fact Sheets for Site Design and Source Control

This page was intentionally left blank.

Appendix C Baseline BMP Fact Sheets for Site Design and Source Control

The following fact sheets were developed to assist the project applicants with designing BMPs to meet Site Design and Source Control MS4 Permit requirements.

MS4 Category	Baseline BMP Fact Sheet	BMP ID	Page
Site Design	BL-1: Existing Natural Site Features	SD-G: Conserve Natural Features SD-H: Buffers	C-2
Site Design	BL-2: Outdoor Impervious Areas	SD-B: <i>Impervious Area Dispersion</i> SD-I: Permeable Surfaces	C-8
Site Design	BL-3: Rooftop Areas	SD-B: <i>Impervious Area Dispersion</i> SD-C: <i>Green Roofs</i> SD-E: <i>Rain Barrels</i>	C-13
Site Design	BL-4: Landscaped Areas	SD-K: Sustainable Landscaping	C-16
Source Control	BL-5: Work and Storage Areas	SC-A: Overhead Covering SC-B: Berms and Grade Breaks SC-C: Wind Protection	C-19
Source Control	BL-6: Mgt of Storm Water Discharges	SC-D: Sanitary Sewer SC-E: Containment Areas	C-28
Source Control	BL-7: Mgt of Non-Storm Water Discharges	SC-F: Storm Drain Signage SC-G: Educational BMP Signage	C-35

*BMP IDs *in italics* have a standalone fact sheet in Appendix E

BL-1: Existing Natural Site Features

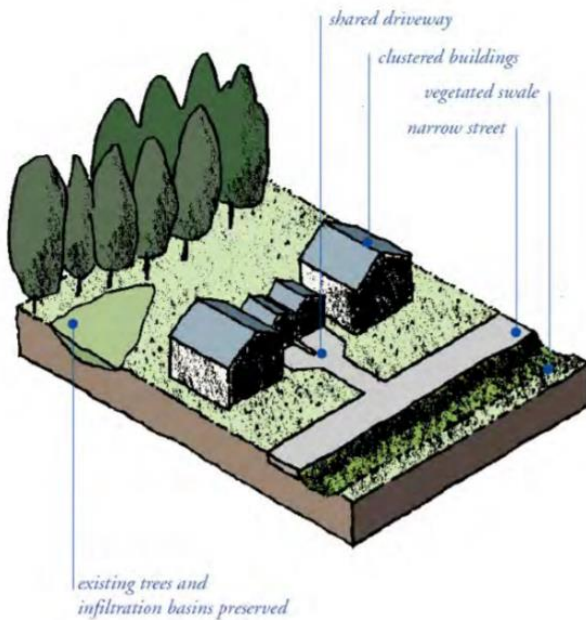

MS4 Permit Category

Site Design

BMP IDs

SD-G: Conserve Natural

Features

SD-H: Buffers

Applicable Site Features

County Watershed Protection Ordinance (WPO) Section 67.811(a)(5) requires baseline BMPs where feasible and applicable for the following types of natural site features:

- **Natural waterbodies¹** can include any significant accumulation of water on a project site. This includes both larger bodies, such as lakes and rivers, and smaller features such as intermittent and ephemeral streams, creeks, swales, springs, ponds, and wetlands. Applicants should account for any feature containing water for any portion of the year -- even if the feature is usually dry.

Note: If existing waterbodies can't be avoided, consultations with the US Army Corps of Engineers, Regional Water Quality Control Board, and California Department of Fish and Wildlife may be required along with their respective permits. Development in or near Waters of the U.S. may be subject to Clean Water Act Section 401 Water Quality Certification requirements. Consult the Army Corps of Engineers regarding any work potentially impacting Waters of the U.S. or for determining if a waterbody is a Water of the U.S.

- **Natural storage reservoirs and drainage corridors.** *Storage reservoirs* are areas where rainfall and runoff flow downhill and collect in low points such as valleys, basins, and other depressions in the landscape. Storage reservoirs can also include areas of permeable soils in topographic depressions. These features may or may not also be waterbodies. *Drainage corridors*

¹ For PDPs, Structural BMPs may not be located within a waterbody.

Appendix C: Baseline BMP Fact Sheets for Site Design and Source Control

are areas where concentrated or channelized runoff flows from higher elevation to lower elevation on the site. Examples include channels, creeks, swales and gullies. Flows can also concentrate around grade breaks (steep changes in elevation) such as banks and hillsides.

- **Natural areas, soils, and vegetation (including trees)** include undisturbed areas with beneficial soils and vegetation such as undeveloped hillsides, meadows, other non-agricultural vegetated areas, or riparian habitat. Preserving natural features such as existing trees, other vegetation, and soils will decrease the amount of storm water that leaves the project site and reduce its long-term impacts.

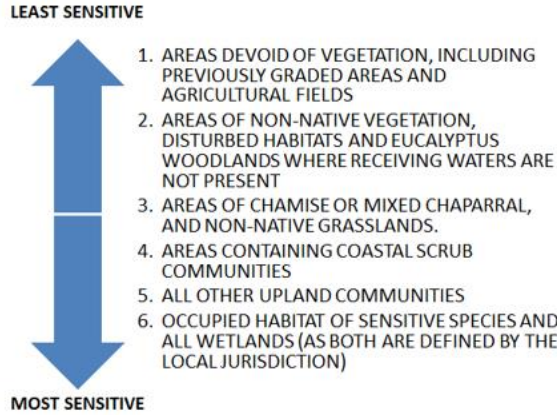

SWQMP Baseline BMP Requirements

The following baseline BMPs are required where applicable and feasible for the features described above:

- SD-G: Conserve natural features
- SD-H: Buffers

These baseline BMPs are documented in Table 1, Section A of the PDP and Standard SWQMP Templates as shown below.

A. BMPs for Existing Natural Site Features (See Fact Sheet BL-1)		
<i>1. Check the boxes below for each existing feature on the site.</i>	<i>2. Select the BMPs to be implemented for each identified feature. Explain why any BMP not selected is infeasible in Table 3.</i>	
	Conserve natural features (SD-G)	Provide buffers around waterbodies (SD-H)
<input type="checkbox"/> Natural waterbodies	<input type="checkbox"/>	<input type="checkbox"/>
<input type="checkbox"/> Natural storage reservoirs & drainage corridors	<input type="checkbox"/>	---
<input type="checkbox"/> Natural areas, soils, & vegetation (incl. trees)	<input type="checkbox"/>	---

SD-G: CONSERVE NATURAL AREAS

Description

Conservation means preserving, maintaining, or enhancing existing natural areas and features. For example, avoiding the removal of trees, or incorporating an existing stream or other open space area(s) into the project design. Leaving soil, vegetation, and other natural features in place promotes natural processes that help reduce runoff and aid in pollutant uptake. Natural areas are often well suited to retain rainwater through infiltration and evapotranspiration, allowing the project to maintain the predevelopment time of concentration and peak flow rate of runoff. Designs that emphasize natural features are often environmentally preferable and can be more appealing to buyers.

Design Considerations

- **Identify and avoid natural features:** Identify features as early as possible to allow the development to be designed around them. This limits overall impacts during and after construction and can avoid unnecessary redesign costs.

Natural features have formed over time in response to existing conditions (location, climate, soil type, etc.). Allow them to function naturally by avoiding removal or modification.

- Locate buildings, driveways, and other impervious features away from natural features. Where possible concentrate development in the least sensitive portions of the site.
- Avoid areas containing sensitive plant or animal species. Areas such as wetlands, biological open space areas, biological mitigation sites, streams, floodplains, and vegetation communities (coastal sage scrub, intact forest, etc.) may require additional regulatory protections.

Where possible, conserve areas with the highest ecological or water quality value. Avoid development in areas with thick, undisturbed vegetation because these areas tend to foster ecological diversity and protect water quality. Likewise, native trees and shrubs provide aesthetic, recreational, and air quality benefits.

- **Maintain existing site drainage and hydrology:** Maintain existing drainage patterns and pathways, topographical depressions, and potential storage areas to maximize natural infiltration and preserve the predevelopment hydrologic characteristics of the site. Avoid creating new concentrated discharge points on hillsides or other locations where drainage is not naturally concentrated. Diversion (changing the discharge location of stormwater runoff from a given land area from one concentration point to another, thereby increasing the area draining to an existing feature) can significantly impact drainage, even without the addition of new impervious area. Even small modifications can significantly impact drainage. Pay special attention to changes in the rates, duration, and volume of flows directed to storage reservoirs and drainage corridors. Increased flows can overwhelm existing natural features, potentially causing flooding, oversaturation, or other unintended consequences in downstream areas.
- **Restore or improve impacted features:** In some cases, existing features are impacted or degraded prior to development of the site. For example, previous use of the site may have caused a loss of vegetation and subsequent erosion of open space areas. Even if these areas

Appendix C: Baseline BMP Fact Sheets for Site Design and Source Control

are conserved in the final design, replanting or restoration may be necessary to ensure they function properly.

- **Prevent construction phase impacts to soils:** Natural site features can be particularly vulnerable during grading and construction. Isolate these features as necessary to prevent access by construction equipment and personnel (e.g., by staking or fencing off areas). Also consider minimizing grading as practicable.

Plan Requirements

For each required construction plan, provide the information indicated below for each applicable feature or BMP.

SD-G: Conserve Natural Areas
Plan View Requirements
<ul style="list-style-type: none"> • Show locations and boundaries of the features (or portions of features) to be conserved • Label features with BMP ID: SD-G
Detail Sheets
N/A
Typical Construction Notes
<ul style="list-style-type: none"> • USE A CONSTRUCTION FENCE OR SILT FENCE AROUND THE CONSERVED AREAS TO PREVENT CONSTRUCTION EQUIPMENT FROM ENTERING.

Maintenance Considerations

During construction of the project, fences that have been placed to prevent construction equipment from entering conserved areas must be maintained. After construction of the project is complete, generally conservation and protection of natural features does not require routine maintenance because the features are intended to remain in their natural condition. The following may be required in accordance with applicable maintenance plans or observations:

- Removal of trash and debris;
- Landscaping only when necessary to restore or improve impacted features; and
- Other maintenance activities indicated in applicable maintenance plans or in accordance with observations.

Also consider the following:

- Maintenance of areas with sensitive plants and animals may be subject to restrictions or requirements imposed by federal, state, and local laws

SD-H: BUFFERS

Description

Buffers are measures to limit access or prevent impacts to natural features. They are encouraged for all features but required for conserved waterbodies where feasible. Buffers can be effective in protecting resources from pollutants; increased runoff flows; physical disturbances from pedestrian use; vehicle parking; or equipment storage; or other potential stressors. Depending on site characteristics and the project layout, the following options should be considered.

Design Considerations

- **Buffer zones** provide physical separation between natural features and adjacent land uses or pollutant sources. Buffer zones such as a strip of landscape between a development and protected feature can effectively retain or transform pollutants and flows to produce a more favorable environment for natural systems. Buffer zones must be provided for natural water bodies whenever technically feasible. When buffer zones are not technically feasible, other types of buffers, such as access restrictions must be considered.
- **Setbacks** are buffer zones that establish minimum distances between pollutant sources and resources. For example, Waters of the U.S. typically require from 50 to 200 feet of separation from potential sources. Setbacks can be maintained landscaping or vegetated areas that provide passive treatment of runoff from a development before it reaches the protected feature.
- **Access restrictions** are buffers that protect an area from intrusion or activity (walking, driving, parking, etc.) either through physical barriers such as fences, walls, or vegetation (trees, etc.), or through legal restrictions such as easements or covenants. Physical barriers can be styled to suit the development architecture while providing the desired level of restriction.
- **Hydraulic disconnection** uses curbs, berms, grading, etc. to prevent natural areas from receiving storm water or non-storm water flows from upgradient sources. However, stormwater runoff that has been redirected from a natural area via hydraulic disconnection must ultimately be returned to the system in a safe, non-erosive manner, such as an outfall placed downstream of the protected area in a location that the runoff would have naturally arrived at without redirection. The design of these features should be part of the site drainage plan, with structures appropriately sized for the anticipated runoff.
- **Different buffer types** or combinations of those listed above may be proposed.

Plan Requirements

For each required construction plan, provide the information indicated below for each applicable feature or BMP.

SD-H: Buffers
Plan View Requirements
<ul style="list-style-type: none"> • Show locations and boundaries of buffers • Label features with BMP ID: SD-H

Appendix C: Baseline BMP Fact Sheets for Site Design and Source Control

Detail Sheets
N/A
Typical Construction Notes
<ul style="list-style-type: none">• A SETBACK OF 50 TO 200 FEET IS REQUIRED FOR DEVELOPMENT ADJACENT TO WATERS OF THE U.S.. NO STRUCTURAL BMPs ARE TO BE PLACED IN BUFFER AREAS.• USE A CONSTRUCTION FENCE OR SILT FENCE AROUND THE BUFFER ZONE TO PREVENT CONSTRUCTION EQUIPMENT FROM ENTERING.

Maintenance Considerations

During construction of the project, fences that have been placed to prevent construction equipment from entering buffer zones must be maintained. After construction of the project is complete, the following may be required in accordance with applicable maintenance plans or observations:

- Removal of trash and debris;
- Landscaping; and
- Other maintenance activities indicated in applicable maintenance plans or in accordance with observations.

Also consider the following:

- Maintenance of areas with sensitive plants and animals may be subject to restrictions or requirements imposed by federal, state, and local laws;
- Buffer areas may be maintained as part of normal landscaping practices unless other requirements apply;
- Maintenance of physical structures associated with buffers (fences, walls, curbs, berms, etc.) can be addressed as part of the normal facilities maintenance.

BL-2: Outdoor Impervious Area



Source: County of San Diego's Green Street Guidelines

MS4 Permit Category

Site Design

BMP IDs

SD-B: Impervious Area

Dispersion

SD-I: Permeable Surfaces

Applicable Site Features

County Watershed Protection Ordinance (WPO) Section 67.811(a)(5) requires baseline BMPs to minimize impervious areas where applicable and feasible for the following common types of outdoor impervious features.

- **Streets and roads** include public or private access routes used to transport automobiles, trucks, motorcycles, bicycles, and other vehicles. Surfaces in this category include alleys and street parking, but not driveways. They are traditionally paved with concrete or asphalt.
- **Sidewalks & walkways** include surfaces intended for pedestrian uses (walking, wheelchairs, etc.). Sidewalks are often at the side of a street, road, or structure, while walkways (including paved footpaths and trails) may occur throughout a property.
- **Parking areas & lots** includes any area, space, or lot designated for the temporary or long-term parking or storage of automobiles or other vehicles. They do not include parking areas within streets or roads.
- **Driveways** are surfaces that provide vehicles access from offsite to a building or other portion of the property. Unlike streets and roads, driveways normally serve a single property and are privately owned.
- **Patios, decks, & courtyards** are outdoor areas, typically unroofed, associated with a building, and supporting outdoor use (walking, gathering, leisure, etc.). They may be adjacent to or independent of other structures. They are normally exposed to the elements
- **Hardcourt recreation areas** are impermeable surfaces intended primarily for sports or recreation. Examples include basketball, tennis, or volleyball courts, and playgrounds.
- **Other proposed outdoor impervious features not otherwise listed.**

Appendix C: Baseline BMP Fact Sheets for Site Design and Source Control

SWQMP Baseline BMP Requirements

The following baseline BMPs are required where applicable and feasible for the features described above:

- SD-B: Impervious Area Dispersion
- SD-I: Permeable Surfaces

These baseline BMPs are documented in Table 1, Section B of the PDP and Standard SWQMP Templates as shown below.

B. BMPs for Common Impervious Outdoor Site Features (See Fact Sheet BL-2)			
<i>1. Check the boxes below for each proposed feature.</i>	<i>2. Select the BMPs to be implemented for each proposed feature. If neither BMP SD-B nor SD-I is selected for a feature, explain why both BMPs are infeasible in Table 3.</i>		
	Direct runoff to pervious areas (SD-B)	Construct surfaces from permeable materials (SD-I)	Minimize the size of impervious areas
<input type="checkbox"/> Streets and roads	<input type="checkbox"/>	<input type="checkbox"/>	<input type="checkbox"/> <i>Check this box to confirm that all impervious areas on the site will be minimized where feasible.</i> <i>If this box is not checked, identify the surfaces that cannot be minimized in Table 3, and explain why it is infeasible to do so.</i>
<input type="checkbox"/> Sidewalks & walkways	<input type="checkbox"/>	<input type="checkbox"/>	
<input type="checkbox"/> Parking areas & lots	<input type="checkbox"/>	<input type="checkbox"/>	
<input type="checkbox"/> Driveways	<input type="checkbox"/>	<input type="checkbox"/>	
<input type="checkbox"/> Patios, decks, & courtyards	<input type="checkbox"/>	<input type="checkbox"/>	
<input type="checkbox"/> Hardcourt recreation areas	<input type="checkbox"/>	<input type="checkbox"/>	
<input type="checkbox"/> Other:	<input type="checkbox"/>	<input type="checkbox"/>	

a. Direct runoff to pervious areas (SD-B)

For impervious surfaces covered in this Fact Sheet, impervious area dispersion refers to the practice of effectively disconnecting impervious areas from directly draining to the storm drain system by routing runoff from impervious areas such as walkways, and driveways onto the surface of adjacent pervious areas. The intent is to slow runoff discharges and reduce volumes and sources of pollutants. Dispersion with partial or full infiltration results in significant volume reduction by means of infiltration, retention and evapotranspiration. PDPs may claim Design Capture Volume (DCV) reductions if dispersion areas meet specific design criteria described in Fact Sheet SD-B. However, dispersion should still be implemented where applicable and feasible even when the area available for dispersion does not meet the criteria to claim DVC reduction.

Typical dispersion components include:

- An impervious surface from which runoff flows will be routed with minimal piping to limit concentrated inflows;
- Splash blocks, flow spreaders, or other means of dispersing concentrated flows and providing energy dissipation as needed;
- Dedicated pervious area, typically vegetated, with soil infiltration capacity for partial or full infiltration;
- Mulch, compost and/or soil amendments to improve water retention, vegetation support, maintain infiltration rates and enhance treatment of routed flows; and

Appendix C: Baseline BMP Fact Sheets for Site Design and Source Control

- Overflow route for excess flows to be conveyed from dispersion area to the storm drain.

Impervious area dispersion primarily functions as a site design BMP for reducing the effective imperviousness of a site by providing partial or full infiltration of the flows that are routed to pervious dispersion areas and otherwise slowing down excess flows that eventually reach the storm drain system. For PDPs, this can significantly reduce the DCV and flow control requirements for the site.

b. Construct surfaces from permeable materials (SD-I)

See BMP ID SD-I Permeable Surfaces below.

c. Minimize the size of impervious areas

Minimizing the overall impervious area created by a development project can reduce the impacts of environmental degradation on receiving waterbodies. Implementing this practice limits the potential for both transportation of pollutants in runoff and increased risk of erosion due to increased flows associated with impervious development.

This BMP applies broadly to any traditionally impervious areas associated with land development including streets and roads, sidewalks and walkways, parking lots, driveways, patios, decks, courtyards, hardcourt recreation areas, and the building footprints.

SD-I: PERMEABLE SURFACES

Description

This BMP consists of substituting permeable (or pervious) materials in the place of traditionally impervious materials in a development. Using permeable materials on a development site helps reduce the overall effective impervious area, thereby decreasing total runoff volume and better mimicking predevelopment hydrologic characteristics when compared to the same development using traditional impervious materials. Limiting the total runoff volume from a site has a significant impact on storm water quality by limiting the total amount of pollutants transported offsite to receiving waterbodies.

Design Considerations

Features constructed of materials like concrete, asphalt, and grouted pavers have higher runoff factors (C) causing a higher percentage of rain falling on them to become runoff. Substituting other more porous materials such as decomposed granite, cobbles, crushed aggregate, and soils (natural, compacted, or amended), which have lower runoff factors than impervious materials, can greatly reduce the amount of runoff from a project. See Appendix B, Section B.1.3 for runoff factors (C) for a variety of different construction materials. For PDPs, use of more porous materials with lower runoff factors where feasible within the project can reduce the total design capture volume (DCV) for the project.

Permeable materials should be used for outdoor hard surfaces wherever it is feasible to do so.

Applicants should consider the feasibility of using permeable materials for all impervious surfaces proposed as part of the project. All permeable surfaces that have potential traffic loading shall be designed by a civil engineer.

Typical non-engineered permeable surfaces that shall be designed and labeled with SD-I are the following:

- Decomposed Granite
- Cobbles
- Crushed Aggregate
- Reinforced Geotextile Features

Typical engineered permeable surfaces that shall be designed and labeled with SD-D (*Existing Fact Sheet in Appendix E*) are the following:

- Modular Paver Units or Paver Blocks
- Pervious Concrete
- Porous Asphalt
- Turf Pavers

Appendix C: Baseline BMP Fact Sheets for Site Design and Source Control

Plan Requirements

For each required construction plan, provide the information indicated below for each applicable feature or BMP.

SD-I: Permeable Surfaces
Plan View Requirements
<ul style="list-style-type: none">• Show locations and boundaries of the features (or portions of features) constructed of permeable material.• Label non-engineered permeable surfaces with BMP ID: SD-I• Label engineered permeable surfaces with BMP ID: SD-D
Detail Sheets
<ul style="list-style-type: none">• Varies depending on permeable surface.• Engineered permeable surfaces must include a cross section showing and clearly labeling all required layers (e.g., paver blocks, bedding, filter course, etc.) from pavement surface to subgrade; and include specifications for each material layer that is required as part of the engineered permeable surface.
Typical Construction Notes
<ul style="list-style-type: none">• Varies depending on permeable surface

Maintenance Considerations

Routine maintenance of permeable surfaces includes: removal of materials such as trash and debris accumulated on the surface, inspect tributary area for exposed soil or other sources of sediment and apply stabilization measures to sediment source areas. Apply source control measures as applicable to sources of litter or debris. Engineered permeable pavement surfaces (SD-D) require routine preventive vacuum/regenerative air sweeping.

BL-3: Rooftop Areas



Source: County of San Diego's Climate Action Plan

MS4 Permit Category

Site Design (SD)

BMP IDs

SD-B: Impervious Area

Dispersion

SD-C: Green Roofs

SD-E: Rain Barrels

Applicable Site Features

County Watershed Protection Ordinance (WPO) Section 67.811(a)(5) requires baseline BMPs for common outdoor impervious features. **Rooftop Areas** include all permanent, impervious coverings on buildings or other structures (e.g., patios or decks) within the project footprint. Rooftops normally account for much of the runoff generated on a typical project. Coverings need only be counted as rooftops if rainfall will flow over or across them rather than passing through to the ground (e.g., permeable shade coverings need not be considered as rooftops).

SWQMP Baseline BMP Requirements

The following baseline BMPs are required where applicable and feasible for the features described above:

- SD-B: Impervious Area Dispersion
- SD-C: Green Roofs
- SD-E: Rain Barrels

These baseline BMPs are documented in Table 1, Section C of the PDP and Standard SWQMP template as shown below:

C.	<input type="checkbox"/> BMPs for Rooftop Areas: Check this box if rooftop areas are proposed and select at least one BMP below. If none of the BMPs is selected, explain why all are infeasible in Table 3.	(See Fact Sheet BL-3)
1. Direct runoff to pervious areas (SD-B) <input type="checkbox"/>	2. Install green roofs (SD-C) <input type="checkbox"/>	3. Install rain barrels (SD-E) <input type="checkbox"/>

Appendix C: Baseline BMP Fact Sheets for Site Design and Source Control

a. Direct Runoff to Pervious Areas (SD-B)

For rooftop areas, impervious area dispersion refers to the practice of effectively disconnecting the rooftop from directly draining to the storm drain system by routing runoff onto the surface of adjacent pervious areas. The intent is to slow runoff discharges and reduce volumes. Dispersion with partial or full infiltration results in significant volume reduction by means of infiltration, retention and evapotranspiration. Priority Development Projects (PDPs) may claim Design Capture Volume (DCV) reductions if dispersion areas meet specific design criteria described in Fact Sheet SD-B. However, dispersion should still be implemented where applicable and feasible even when the area available for dispersion does not meet the criteria to claim DCV reduction.

Typical dispersion components for rooftop areas include:

- A rooftop surface from which runoff flows will be routed using downspout disconnection to limit concentrated inflows;
- Splash blocks, flow spreaders, or other means of dispersing concentrated flows and providing energy dissipation as needed;
- Dedicated pervious area, typically vegetated, with soil infiltration capacity for partial or full infiltration;
- Optional mulch, compost and/or soil amendments to improve water retention, vegetation support, maintain infiltration rates and enhance treatment of routed flows; and
- Overflow route for excess flows to be conveyed from dispersion area to the storm drain.

Impervious area dispersion primarily functions as a site design BMP for reducing the effective imperviousness of a site by providing partial or full infiltration of the flows that are routed to pervious dispersion areas and otherwise slowing down excess flows that eventually reach the storm drain system. For PDPs, this can significantly reduce the DCV and flow control requirements for the site.

b. Install Green Roofs (SD-C)

Green Roofs are rooftops covered with vegetation and a growing medium over a waterproofing membrane. They reduce runoff volumes and rates, treat storm water pollutants through filtration and plant uptake, provide additional landscape amenity, and create wildlife habitat. Additionally, green roofs reduce the heat island effect and provide acoustical control, air filtration and oxygen production. In terms of building design, they can protect against ultraviolet rays and extend the roof lifetime, as well as increase the building insulation, thereby decreasing heating and cooling costs.

Typical green roof components include, from top to bottom:

- Vegetation that is appropriate to the type of green roof system, climate, and watering conditions;
- Media layer (planting mix or engineered media) capable of supporting vegetation growth;
- Filter fabric to prevent migration of fines (soils) into the drainage layer;
- Optional drainage layer to convey excess runoff;
- Optional root barrier;

Appendix C: Baseline BMP Fact Sheets for Site Design and Source Control

- Optional insulation layer;
- Waterproof membrane; and
- Structural roof support capable of withstanding the additional weight of a green roof.

See **Fact Sheet SD-C** for additional detailed information on Green Roofs.

c. Install Rain Barrels (SD-E)

Rain barrels are containers that can capture rooftop runoff and store it for future use. With controlled timing and volume release, the captured rainwater can be used for irrigation or alternative grey water between storm events, thereby reducing runoff volumes and associated pollutants to downstream waterbodies. Rain barrels tend to be smaller systems, less than 100 gallons, and have low installation costs. Treatment can be achieved when rain barrels are used as part of a treatment train along with other BMPs that use captured flows in applications that do not result in discharges into the storm drain system. Rooftops are the ideal tributary areas for rain barrels.

Rain barrels can be used as a site design feature to reduce the effective impervious area of the site by removing roof runoff from the site discharge. This can reduce the DCV and flow control requirements for the site.

See **Fact Sheet SD-E** for additional detailed information on Rain Barrels.

BL-4: Landscaped Areas



Source: San Diego Sustainable Landscapes Guidelines

MS4 Permit Category

Site Design (SD)

BMP IDs

SD-K: Sustainable Landscaping

Applicable Site Features

County Watershed Protection Ordinance (WPO) Section 67.811(a)(5) requires baseline BMPs for landscaped areas. A landscape includes all planting areas, turf areas (artificial or natural), and water features in a landscape design. The landscape area does not include footprints of buildings or structures, sidewalks, driveways, parking lots, decks, patios, gravel or stone walks, other pervious or non-pervious hardscapes and other non-irrigated areas designated for non-development (e.g., open spaces and existing native vegetation).

Landscaped Areas includes SWQMP Baseline BMP Requirements

The following baseline BMPs are required where applicable and feasible for the features described above:

SD-K: Sustainable Landscaping

These baseline BMPs are documented in Table 1, Section D of the PDP and Standard SWQMP template as shown below:

D. **BMPs for Landscaped Areas:** Check this box if landscaping is proposed. Both BMPs are required where applicable. Explain inapplicability or infeasibility for BMPs not selected in Table 3. **(See Fact Sheet BL-4)**

2. Sustainable Landscaping (SD-K)

SD-K: SUSTAINABLE LANDSCAPING

Description

Sustainable landscaping uses native and drought tolerant plant species to limit the total water demand of landscaped areas and create a living sponge to soak up rainfall. Native and drought tolerant plants are well suited to the long-term climate in San Diego County; able to withstand extended dry periods and typically require less water to remain healthy compared to non-native alternatives. An additional benefit is reduced need for fertilizer and/or pesticides.

Sustainable landscaping must be evaluated for all landscaped areas of a project to meet Storm Water Quality Management Plan (SWQMP) requirements and should also be considered for any plantings associated with natural areas or areas identified for revegetation.

Design Considerations

The [San Diego Sustainable Landscape Guidelines](#) provide a detailed watershed friendly approach to landscaping. These guidelines will guide you through important principles such as:

- Selecting drought tolerant and native plants for San Diego County.
- Creating healthy soils to encourage moisture retention.
- Designing water efficient irrigation systems that reduce the likelihood of irrigation runoff.

The [County’s Landscape Ordinance](#) generally applies to any new construction for which the County issues a building permit or a discretionary review where the aggregate landscaped area is 500 square feet or more to obtain outdoor water use authorization. The [Water Efficient Landscape Design Manual](#) explains how people can comply with the County’s Landscape Ordinance by detailing water efficient irrigation systems, drought tolerant plant selection, fire-resistant designs, and other considerations.

Plan Requirements

For each required construction plan, provide the information indicated below for each applicable feature or BMP.

SD-K: Sustainable Landscaping
Plan View Requirements
<ul style="list-style-type: none"> • Show locations and boundaries of the features (or portions of features) designed as Sustainable Landscaping. • Label Sustainable Landscaping with BMP ID: SD-K
Detail Sheets
<ul style="list-style-type: none"> • Shall be shown on Landscape Plans if applicable.
Typical Construction Notes
<ul style="list-style-type: none"> • Grading plans need to refer to the approved landscape plan for construction notes.

Maintenance Considerations

Routine maintenance of the landscaped areas is essential to making them sustainable. The following are some maintenance considerations after installation:

- Maintain 2” – 4” of mulch and/or compost add more annually
- Practice Integrated Pest Management
- Check and adjust irrigation to eliminate runoff
- Regularly flush drip irrigation lines.
- Move drip irrigation and add emitters as tree growth occurs in order to maintain the wetting zone at outside edge of tree canopy (Dripline)

BL-5: Work and Storage Areas



MS4 Permit Category

Source Control (SC)

BMP IDs

SC-A: Overhead Covering

SC-B: Berms and Grade Breaks

SC-C: Wind Protection

Applicable Site Features

County Watershed Protection Ordinance (WPO) Section 67.811(a)(4) requires baseline BMPs for the following common types of outdoor work areas.

- Trash and refuse storage,
- Materials and equipment storage,
- Loading and unloading,
- Fueling,
- Maintenance and repair,
- Vehicle and equipment cleaning, and
- Other areas, not identified above, that have the potential to generate pollutants.

SWQMP Baseline BMP Requirements

The following baseline BMPs are required where applicable and feasible for the features described above. All three of these BMPs should be implemented together in all areas where storage of materials and trash will be located:

- SC-A: Overhead Covering
- SC-B: Berm and Grade Breaks
- SC-C: Wind Protection

Appendix C: Baseline BMP Fact Sheets for Site Design and Source Control

These baseline BMPs are documented in Table 2, Section A of the PDP and Standard SWQMP templates as shown below:

Table 2 – Baseline BMPs for Pollutant-generating Sources

<input type="checkbox"/> If this is a Small Residential Project, check this box and skip the rest of this table.							
A. Management of Stormwater Discharges							
1. Identify all proposed outdoor work areas below <i>(☐ Check here if none are proposed)</i>	2. Which BMPs will be used to prevent materials from contacting rainfall or runoff? <i>(See Fact Sheet BL-5)</i> <i>(Select all feasible BMPs for each work area²)</i>			3. Where will runoff from the work area be routed? <i>(See Fact Sheet BL-6)</i> <i>(Select one or more option for each work area)</i>			
	Overhead covering (rooftops, etc.) (SC-A)	Berms and grade breaks (SC-B)	Wind protection (screens, etc.) (SC-C)	Sanitary sewer³ (SC-D)	Containment Areas (SC-E)	Stormwater S-BMP or SSD-BMP⁴	Other⁵
<input type="checkbox"/> Trash & Refuse Storage	<input type="checkbox"/>	<input type="checkbox"/>	<input type="checkbox"/>	<input type="checkbox"/>	<input type="checkbox"/>	<input type="checkbox"/>	<input type="checkbox"/>
<input type="checkbox"/> Materials & Equipment Storage	<input type="checkbox"/>	<input type="checkbox"/>	<input type="checkbox"/>	<input type="checkbox"/>	<input type="checkbox"/>	<input type="checkbox"/>	<input type="checkbox"/>
<input type="checkbox"/> Loading & Unloading	<input type="checkbox"/>	<input type="checkbox"/>	---	<input type="checkbox"/>	<input type="checkbox"/>	<input type="checkbox"/>	<input type="checkbox"/>
<input type="checkbox"/> Fueling	<input type="checkbox"/>	<input type="checkbox"/>	---	<input type="checkbox"/>	<input type="checkbox"/>	<input type="checkbox"/>	<input type="checkbox"/>
<input type="checkbox"/> Maintenance & Repair	<input type="checkbox"/>	<input type="checkbox"/>	---	<input type="checkbox"/>	<input type="checkbox"/>	<input type="checkbox"/>	<input type="checkbox"/>
<input type="checkbox"/> Vehicle & Equipment Cleaning	<input type="checkbox"/>	<input type="checkbox"/>	---	<input type="checkbox"/>	<input type="checkbox"/>	<input type="checkbox"/>	<input type="checkbox"/>
<input type="checkbox"/> Other:	<input type="checkbox"/>	<input type="checkbox"/>	---	<input type="checkbox"/>	<input type="checkbox"/>	<input type="checkbox"/>	<input type="checkbox"/>

A typical isometric and plan view of a trash enclosure is shown on the next page.

Appendix C: Baseline BMP Fact Sheets for Site Design and Source Control

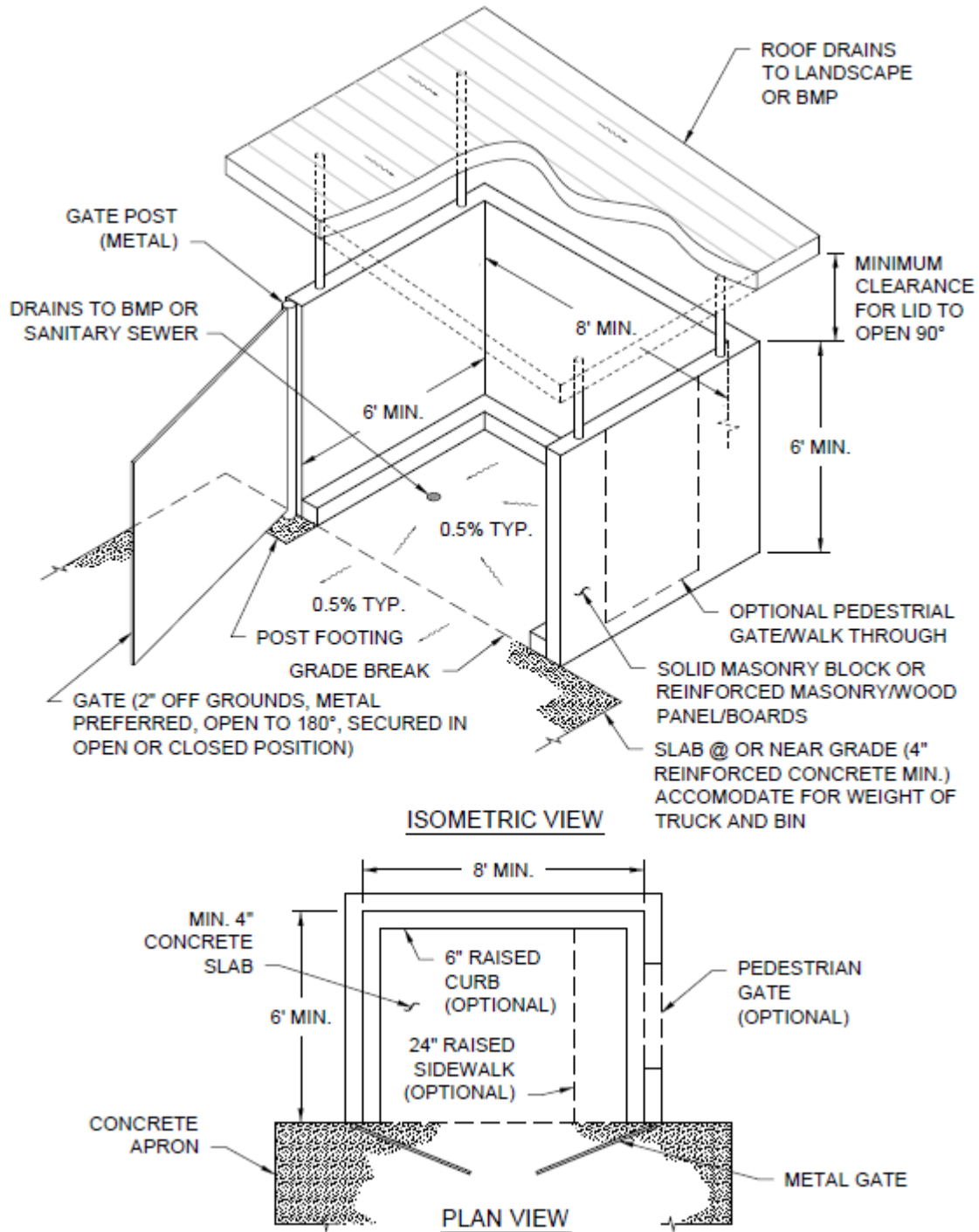

Typical Isometric and Plan View of a Trash Enclosure BMP

SC-A: OVERHEAD COVERING

Description

The Roofs or other permanent covers can be constructed over outdoor areas where pollutant-generating materials or activities are concentrated. This helps prevent rainfall from contacting materials and carrying pollutants with it into the storm drain system.

This BMP can be applied to any material or activity that will regularly be located in the same place on a site and contact with rainfall would result in pollutants being transported by storm water.

Temporary covers, such as tarps, are not considered part of this BMP but may also be an effective solution for preventing contact with rainwater when permanent covers are not feasible. For example, for pollutant-generating materials or activities that are not regularly located in the same place on a site.

Note: Permanent overhead structures must comply with the County of San Diego Consolidated Fire Code.

Design Considerations

- When initially planning a site, identify any area on the site where a pollutant-generating activity will regularly be occurring in a specific location or where pollutant-generating materials will be stored in a designated area. Consider constructing permanent overhead coverage for these areas, if feasible.
- Typical structures include roofs, awnings, and permanent canopies. Design covers with sufficient overhang to help prevent rain from contacting materials even when there are moderate winds.
- When designing permanent overhead coverage for these areas, the cover must extend at least to the edge of the berm or grade break and ideally will extend slightly beyond it.
- Projects are required to construct trash enclosures meeting various design requirements, one of which is a roof that fully covers the enclosure and is sufficiently high to allow dumpster lids to open to the full 90-degree position.
- If a downspout is used to drain a rooftop or cover over a designated washing, fueling, or trash area, it should be routed away from the designated area to avoid run-on.

Many food service facilities have storage bins for used cooking oil (i.e. “grease bins”). Storing these bins indoors, when done in accordance with County Health Department regulations, is preferable from a storm water pollution perspective. When grease bins must be stored outdoors, permanent roofs or awnings may be used when compliant with the fire code. Outdoor cooking areas may be designed with fire code compliant roofs or awnings as well.

Plan Requirements

SC-A: Overhead Covering

Plan View Requirements

- Show locations and boundaries of the features (or portions of features) designed with overhead covering
- Label with BMP ID: SC-A

Appendix C: Baseline BMP Fact Sheets for Site Design and Source Control

Detail Sheets
<ul style="list-style-type: none">• Provide details in the applicable plan set where the feature is being designed and constructed.
Typical Construction Notes
<ul style="list-style-type: none">• Storage of non-hazardous liquids must be covered by a roof and be contained by berms, dikes, liners, or vaults.• Storage of hazardous materials and wastes must be in compliance with local, state and federal hazardous materials regulations, ordinances and hazardous materials management plan for the site.

Maintenance Considerations

Repair permanent covers as needed should any damage occur.

SC-B: BERMS AND GRADE BREAKS

Description

Berms and grade breaks can be used to physically separate designated storage and activity areas and prevent storm water surface flows from transporting pollutants from these areas to the storm drain system. A berm or grade break can prevent run-on from flowing through a pollutant generating area and becoming contaminated. Additionally, berms and grade breaks can effectively prevent contaminated water or spilled liquids from leaving a designated pollutant-generating area when the area is designed with a sump or sewer connection; reducing the likelihood of an illicit discharge of pollutants.

This BMP can be applied to any material or activity that will regularly be located in the same place on a site and where storm water surface flows would be likely to pick up pollutants from the work or storage area and transport them to the storm drain system.

Areas for activities, such as washing or fueling, must be designed with berms or grade breaks around their perimeters to ensure that runoff from these activities does not drain to the storm drain system or receiving waters.

Design Considerations

When initially planning a site, identify any area on the site where a pollutant generating activity will regularly be occurring in a specific location or where pollutant-generating materials will be stored in a designated area. If storm water run-on flowing through this area would be likely to pick up pollutants and carry them to a storm drain, consider modifying the site grading or construct a berm around the area to route run-on around the area.

Constructing concrete slab and curbing around an area is often an effective way to prevent run-on from contacting materials. Lower, rounded berms can also be constructed and are often better suited for areas where vehicular access is needed. Alternatively, strategic grading of a site may achieve the same benefits without requiring construction of berms. For example, locating an activity or storage area on an elevated pad or other high point can prevent run-on from entering the area. Whether using berming or grading, the feature should be designed with sufficient height to be able to redirect anticipated flows at the site. Strategically designing surface drainage features, such as ribbon gutters, in conjunction with the planned berms and/or grade breaks can help minimize the risk of breaching.

Berms and grade breaks should also be considered for areas where water or other liquids are meant to be contained within a designated space. Designing a berm or grade break around such an area is important not only for keeping run-on out of the area, but also for ensuring that any water within the area flows to the designated sewer drain or sump rather than flowing to a storm drain outside the area. When designing washing areas, ensure that the berm or grade break has sufficient height to contain the anticipated volumes of wash water. Also ensure that the berm or grade break is positioned far enough away from the anticipated wash area so that all incidental sprays fall within the designated area. For drive-thru style car washes, consider that incidental sprays and drips are likely to fall on the areas immediately adjacent to the car wash entrance and exit. Design the car wash entrance and exit areas with grade breaks or berms to ensure that incidental drips and spills are directed back to the car wash clarifier rather than flowing to nearby storm drains. Berms can also be used around designated

Appendix C: Baseline BMP Fact Sheets for Site Design and Source Control

liquid storage areas. These berms should be constructed with sufficient height to contain the volume of liquids that could potentially be spilled in the area.

Plan Requirements

SC-B: Berms and Grade Breaks
Plan View Requirements
<ul style="list-style-type: none">• Show locations and boundaries of the features (or portions of features) designed with Berm and Grade Breaks• Label with BMP ID: SC-B
Detail Sheets
<ul style="list-style-type: none">• Provide details in the applicable plan set where the feature is being designed and constructed.
Typical Construction Notes
<ul style="list-style-type: none">• [Related to Berms]: Varies depending on type of berm.• [Related to Grade Breaks]: Where designated on plan, grade breaks shall be provided around activity areas to prevent storm water run-on.

Maintenance Considerations

Minimal maintenance is typically required for berms and grade breaks.

- Periodically clean bermed areas to reduce the chance of contaminated storm water discharges.
- Inspect and repair or reconstruct berms if they are damaged or begin to deteriorate.

SC-C: WIND PROTECTION

Description

Windbreaks are physical barriers that block wind, preventing it from impacting designated areas. They can be used to protect storage or collection areas where materials might be transported by wind. This prevents wind from blowing lightweight materials out of the designated storage area to adjacent areas where they would be more likely to be washed into a storm drain.

This BMP can be implemented wherever there is a designated area for storage of a material that is light enough to be blown away by wind. Trash storage areas are the most common areas for implementation of this BMP, as litter around trash receptacles can easily be transported by wind. Windbreaks should also be considered for protecting material storage areas whenever the stored material is lightweight. Windbreaks can also be used around outdoor work areas where work activities may generate powders or dust or where extremely lightweight materials, such as expanded polystyrene foam may be present.

Design Considerations

Identify whether the materials anticipated to be on the site can be transported by wind. If these materials will be used or stored in a designated outdoor location, consider building windbreaks to protect the area. Windbreaks can be solid walls that completely block wind, or they may be semi-solid barriers such as fences or screens that allow airflow but still trap and prevent transport of materials when used to create an enclosure around the materials. Privacy windscreens can be added to chain link fences to provide wind protection. Solid walls can also serve a dual purpose as both a windbreak and as protection against run-on. All areas shall have secured lids and/or coverings to close when not in use.

Since wind may come from different directions, it is optimal to place wind breaks on all sides of a storage area. This can be accomplished by placing fixed walls on three sides and having a gate on the fourth side. Where it is not feasible to place windbreaks on all sides of a storage area, it is often still possible to place them on three sides, leaving one side open to allow access. For example, designated stockpile storage areas may be designed with walls on three sides and one open side to allow clear access for vehicles or equipment.

At large trash-generating facilities, trash areas should be designed with three solid-sided walls and a solid gate on the fourth side.

Plan Requirements

SC-C: Wind Protection
Plan View Requirements
<ul style="list-style-type: none"> • Show locations and boundaries of the features (or portions of features) designed with Wind Protection • Label Wind Protection with BMP ID: SC-C
Detail Sheets
<ul style="list-style-type: none"> • Provide details in the applicable plan set where the feature is being designed and constructed.

Appendix C: Baseline BMP Fact Sheets for Site Design and Source Control

Typical Construction Notes
<ul style="list-style-type: none">• Varies depending on type of enclosure.

Maintenance Considerations

Windbreaks should be repaired or reconstructed if they are damaged or begin to deteriorate.

BL-6: Management of Storm Water Discharges

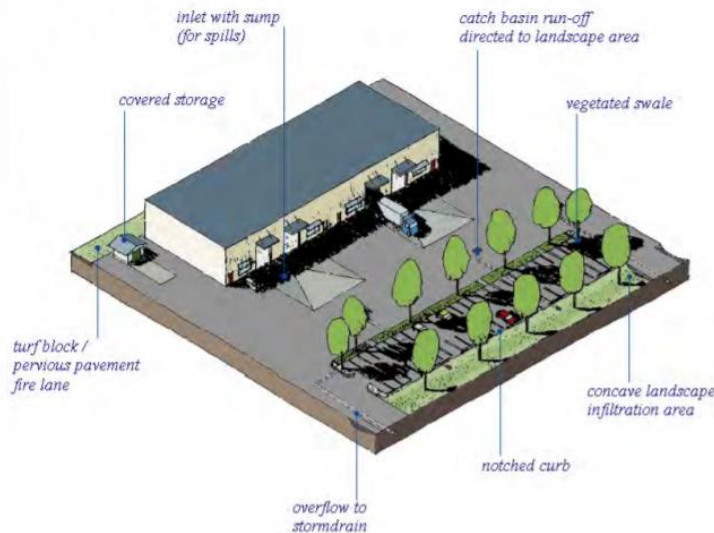

MS4 Permit Category

Source Control (SC)

BMP IDs

SC-D: Sanitary Sewer

SC-E: Containment Areas

Applicable Site Features

County Watershed Protection Ordinance (WPO) Section 67.811(a)(4) requires baseline BMPs to prevent illicit discharge into the storm drain system. This Fact Sheet describes baseline Best Management Practices (BMPs) for managing storm water discharges originating from outdoor work areas. While the baseline BMPs described in Fact Sheet BL-5, Work and Storage Areas (Baseline BMPs for Outdoor Work Areas) are intended to effectively minimize pollutant generation from work areas, projects must also be designed to ensure that storm water runoff generated from these areas is properly managed.

The discharge options described below apply to the following types of outdoor work areas:

- Trash and refuse storage,
- Materials and equipment storage,
- Loading and unloading,
- Fueling,
- Maintenance and repair,
- Vehicle and equipment cleaning, and
- Other areas, not identified above, that have the potential to generate pollutants.

SWQMP Baseline BMP Requirements

The following baseline BMPs are required where applicable and feasible for the features described above:

SC-D: Sanitary Sewers
 SC-E: Containment Areas
 Storm Water S-BMP or SSD-BMP

Appendix C: Baseline BMP Fact Sheets for Site Design and Source Control

These baseline BMPs are documented in Table 2, Section A.3 of the PDP and Standard SWQMP template:

Table 2 – Baseline BMPs for Pollutant-generating Sources

<input type="checkbox"/> If this is a Small Residential Project, check this box and skip the rest of this table.							
A. Management of Stormwater Discharges							
1. Identify all proposed outdoor work areas below <i>(☐ Check here if none are proposed)</i>	2. Which BMPs will be used to prevent materials from contacting rainfall or runoff? <i>(See Fact Sheet BL-5)</i> <i>(Select all feasible BMPs for each work area²)</i>			3. Where will runoff from the work area be routed? <i>(See Fact Sheet BL-6)</i> <i>(Select one or more option for each work area)</i>			
	Overhead covering (rooftops, etc.) (SC-A)	Berms and grade breaks (SC-B)	Wind protection (screens, etc.) (SC-C)	Sanitary sewer³ (SC-D)	Containment Areas (SC-E)	Stormwater S-BMP or SSD-BMP⁴	Other⁵
<input type="checkbox"/> Trash & Refuse Storage <input type="checkbox"/> Materials & Equipment Storage <input type="checkbox"/> Loading & Unloading <input type="checkbox"/> Fueling <input type="checkbox"/> Maintenance & Repair <input type="checkbox"/> Vehicle & Equipment Cleaning <input type="checkbox"/> Other:	<input type="checkbox"/> <input type="checkbox"/> <input type="checkbox"/> <input type="checkbox"/> <input type="checkbox"/> <input type="checkbox"/> <input type="checkbox"/>	<input type="checkbox"/> <input type="checkbox"/> <input type="checkbox"/> <input type="checkbox"/> <input type="checkbox"/> <input type="checkbox"/>	<input type="checkbox"/> <input type="checkbox"/> <input type="checkbox"/> <input type="checkbox"/> <input type="checkbox"/> <input type="checkbox"/>	<input type="checkbox"/> <input type="checkbox"/> <input type="checkbox"/> <input type="checkbox"/> <input type="checkbox"/> <input type="checkbox"/>	<input type="checkbox"/> <input type="checkbox"/> <input type="checkbox"/> <input type="checkbox"/> <input type="checkbox"/> <input type="checkbox"/>	<input type="checkbox"/> <input type="checkbox"/> <input type="checkbox"/> <input type="checkbox"/> <input type="checkbox"/> <input type="checkbox"/>	<input type="checkbox"/> <input type="checkbox"/> <input type="checkbox"/> <input type="checkbox"/> <input type="checkbox"/> <input type="checkbox"/>

SC-D: SANITARY SEWER

Description

One option for eliminating pollutant discharges to the MS4 or receiving waters is to route storm water flows from the work area to the sanitary sewer. Discharges to the sanitary sewer are treated at a publicly owned treatment facility.

This option should be considered for any pollutant source (e.g., material storage area or activity) that has the potential to routinely generate liquid waste with a high concentration of storm water pollutants.

Connections to sanitary sewer may only be allowed with approval by Sanitary Sewer Agency with authority over the proposed receiving sanitary sewer. See additional information below.

Design Considerations

Unless otherwise noted, the following guidelines assume that discharges to the sanitary sewer are approved.

- Pollutant sources with piping and/or collection systems designed to convey waste, waste byproducts, or wash water, or with a defined discharge point, should be connected to sanitary sewer through a direct connection to the facility sanitary plumbing.
- Pollutant sources that are permanent with passive discharge systems, such as interior floor drains and sumps, drain lines, and water feature overflows should be connected to sanitary sewer through a direct connection to the facility sanitary plumbing.
- Pollutant sources occupying a defined area, such as trash and refuse areas, material and equipment storage, loading and unloading areas, fueling, maintenance and repair, vehicle and equipment cleaning, and outdoor food preparation areas may drain to a sump within the area that is connected to sanitary sewer through a direct connection to the facility sanitary plumbing. Every effort should be made to prevent discharges of storm water to the sanitary sewer. Therefore, outdoor areas connected to sewer should be protected from direct rainfall and from storm water run-on.

Note: Work areas should not be discharged to an onsite wastewater treatment system (e.g. septic) unless the system is specifically designed to accommodate them. This includes being designed to handle the increased flow volumes and rates as well as being designed to process the particular type of pollutant in its anticipated concentrations. These systems are typically designed specifically for household waste. Introduction of additional flows or pollutant types outside the originally intended design can result in failure of the onsite wastewater treatments system and lead to significant public health issues.

All approved connections are subject to the design and pretreatment requirements (e.g. clarifiers or oil-water separators for wash racks and interior floor drains) of the applicable approving agency. A list of agencies is provided below for reference.

Appendix C: Baseline BMP Fact Sheets for Site Design and Source Control

County of San Diego Sanitary Sewer Agencies

Water District and Address	Telephone and Website
Borrego Water District 806 Palm Canyon Dr. Borrego Springs, CA 92004	(760)-767-5806 www.borregowd.org
City of Vista (Including Buena Sanitation District and Shadowridge) 200 Civic Center Dr. Vista, CA 92084	(760)-643-2804 www.cityofvista.com
Fallbrook Public Utility District 990 East Mission Rd. Fallbrook, CA 92028	(760)-728-1125 www.fpud.com
Leucadia Wastewater District 1960 La Costa Ave. Carlsbad, CA 92009	(760)-728-1125 www.lwwd.org
Olivenhain Municipal Water District (Including 4S Ranch and Rancho Cielo) 1966 Olivenhain Rd. Encinitas, CA 92024	(760)-753-6466 www.olivenhain.com
Otay Water District 2554 Sweetwater Springs Blvd. Spring Valley, CA 91978	(619)-670-2222 www.otaywater.gov
Padre Dam Municipal Water District 9300 Fanita Pkwy. Santee, CA 92072	(619)-258-4635 www.padredam.org
Pauma Valley Community Services District 33129 Cole Grade Rd. Pauma Valley, CA 92061	(760)-742-1909 www.yuimamwd.com
Rainbow Municipal Water District 3707 Old Highway 395 Fallbrook, CA 92028	(760)-728-1178 www.rainbowmwd.com
Ramona Municipal Water District 105 Earlham St. Ramona, CA 92065	(760)-789-1330 www.rmwd.org
Vallecitos Water District 201 Vallecitos de Oro San Marcos, CA 92069	(760)-744-0460 www.vwd.org
Valley Center Municipal Water District 29300 Valley Center Valley Center, CA 92082	(760)-749-1600 www.vcmwd.org
County Sanitation Districts Alpine/Julian/Lakeside/Pine Valley Spring Valley/Winter Gardens	(858)-514-4990 https://www.sandiegocounty.gov/dpw
Private Sewer Districts (Dudek & Associates) Fairbanks Ranch Rancho/Santa Fe CSD Whispering Palms	(760)-942-5147 www.dudek.com

Appendix C: Baseline BMP Fact Sheets for Site Design and Source Control

Plan Requirements

SC-D: Sanitary Sewer
Plan View Requirements
<ul style="list-style-type: none">• Show locations and boundaries of the features (or portions of features) discharging to Sanitary Sewer• Label with BMP ID: SC-D
Detail Sheets
<ul style="list-style-type: none">• Provide details in the applicable plan set where the feature is being designed and construction. Typically shown on utility sheet on building plan
Typical Construction Notes
<ul style="list-style-type: none">• “FEATURE (E.G. FUELING AREA, ETC)” SHALL BE PLUMBED TO SANITARY SEWER WITH APPROVAL FROM LOCAL SANITARY SEWER AGENCY [INSERT NAME OF LOCAL SANITARY SEWER AGENCY].

Maintenance Considerations

All approved connections are subject to the design, pretreatment and maintenance requirements (e.g. clarifiers or oil-water separators for wash racks and interior floor drains) of the applicable approving agency.

SC-E: CONTAINMENT AREAS

Description

Containment areas are specifically designed storage or activity areas that prevent spills, leaks, and other discharges, that would otherwise pollute storm water, from leaving the designated area. Spills leaks and other discharges from storage and activity areas can have high concentrations of pollutants that will contaminate storm water and impact receiving waterbodies if allowed to discharge from the site.

This BMP can be applied to any material or activity that will regularly be located in the same place on a site that could reasonably experience or result in spills, leaks, or other discharges.

Design Considerations

When initially planning a site, identify any area on the site where a pollutant generating activity will regularly be occurring in a specific location or where pollutant-generating materials will be stored in a designated area. If these pollutant-generating activities or materials could result in spills, leaks, or other discharges consider constructing or providing containment for the area.

Containment areas should be designed to hold the entire volume of spilled, leaked, or discharged material without overflowing.

Containment of a pollutant-generating activity can be accomplished by berming the area with a concrete curb, or other sealed linear barrier that prevents all material from flowing out of the area. Individual liquid storage containers can be effectively contained using manufactured containment pallets or sheds.

Containment areas should be completely isolated from storm drains. Do not construct storm drain inlets within containment areas, and do not allow site drainage to be directed through a containment area. If approved by the permitting sanitary sewer agency (refer to SC-D: Discharge to Sanitary Sewer), a containment area may be drained to the facility sanitary sewer plumbing. Designing containment around a pollutant-generating area is important for ensuring that any water within the area flows to the designated sewer drain rather than flowing to a storm drain outside the area.

Design of washing areas should ensure that containment has sufficient height to accommodate the anticipated volumes of wash water. Also ensure that the containment barrier is positioned far enough away from the anticipated wash area so that all incidental sprays fall within the designated area. For drive-thru style car washes, consider that incidental sprays and drips are likely to fall on the areas immediately adjacent to the car wash entrance and exit. Design the car wash entrance and exit with grade breaks or berms to ensure that incidental drips and spills are directed back to the car wash clarifier rather than flowing to nearby storm drains.

Plan Requirements

SC-E: Containment Areas

Plan View Requirements

- Show locations and boundaries of the features (or portions of features) that discharge to containment areas.
- Label with BMP ID: SC-E

Appendix C: Baseline BMP Fact Sheets for Site Design and Source Control

Detail Sheets
<ul style="list-style-type: none">• Provide details in the applicable plan set where the feature is being designed and constructed.
Typical Construction Notes
<ul style="list-style-type: none">• VARIES DEPENDING ON TYPE OF CONTAINMENT.

Maintenance Considerations

Containment areas should be kept clean of spills, leaks and debris as they occur and repaired or reconstructed if they are damaged or begin to deteriorate.

BL-7: Management of Non-Storm Water Discharges



MS4 Permit Category

Source Control (SC)

BMP IDs

SC-F: Storm Drain Signage

SC-G: Educational BMP Signage

TYPICAL STORM DRAIN SIGNAGE

Applicable Site Features

County Watershed Protection Ordinance (WPO) Section 67.811(a)(4) requires baseline BMPs for the management of non-storm water discharges to prevent illicit discharges from entering the storm drain system. This Fact Sheet describes baseline BMPs for the labeling of all storm drain inlets and catch basins; educational signage; and practices for interior work surfaces, floor drains and sumps, drain lines, and fire sprinkler test water.

SWQMP Baseline BMP Requirements

The following baseline BMPs are required where applicable and feasible for the features described above:

a. Storm Drain Inlets and Catch Basins (SC-F)

See BMP ID SC-F: Storm Drain Signage (SC-F) below.

b. Educational BMP signage (SC-G)

See BMP ID SC-G: Educational BMP Signage (SC-G) below.

c. Interior work surfaces, floor drains & sumps

All interior work surfaces, floor drains and sumps shall not be directly connected to the MS4 or receiving waters. All discharges should be directed to sanitary sewer, if feasible, and with approvals by the Sanitary Sewer Agency with authority over the proposed receiving sanitary sewer.

Appendix C: Baseline BMP Fact Sheets for Site Design and Source Control

d. Drain lines (e.g., air conditioning, boiler, etc.)

All drain lines shall not be directly connected to the MS4 or receiving waters. All discharges should be directed to sanitary sewer, if feasible, and with approvals by the Sanitary Sewer Agency with authority over the proposed receiving sanitary sewer, or discharge to landscaped areas on site.

e. Fire sprinkler test water

Fire sprinkler test water shall not be directly connected to the MS4 or receiving waters. Please click on the following fact sheet for additional information:



[https://www.sandiegocounty.gov/content/dam/sdc/dpw/WATERSHED PROTECTION PROGRAM/watershedpdf/IndustComm/English/Fire Sprinkler Maintenance.pdf](https://www.sandiegocounty.gov/content/dam/sdc/dpw/WATERSHED_PROTECTION_PROGRAM/watershedpdf/IndustComm/English/Fire_Sprinkler_Maintenance.pdf)

These baseline BMPs are documented in Table 2, Section B of the PDP and Standard SWQMP template as shown below:

B. Prevention of Non-stormwater Discharges (See Fact Sheet BL-7)		
Select one option for each feature below:		
• Storm drain inlets and catch basins ...	<input type="checkbox"/> are not proposed	<input type="checkbox"/> will be labeled with stenciling or signage to discourage dumping (SC-F)
• Educational BMP Signage...	<input type="checkbox"/> are not proposed	<input type="checkbox"/> will be labeled with educational signage for BMP (SC-G)
• Interior work surfaces, floor drains, & sumps ...	<input type="checkbox"/> are not proposed	<input type="checkbox"/> will not discharge directly or indirectly to the MS4 or receiving waters
• Drain lines (e.g., air conditioning, boiler, etc.) ...	<input type="checkbox"/> are not proposed	<input type="checkbox"/> will not discharge directly or indirectly to the MS4 or receiving waters
• Fire sprinkler test water ...	<input type="checkbox"/> are not proposed	<input type="checkbox"/> will not discharge directly or indirectly to the MS4 or receiving waters

SC-F: STORM DRAIN SIGNAGE

Description

Storm drain signs and stencils are visible source controls typically placed adjacent to inlets. Posting notices regarding discharge prohibitions at storm drain inlets can prevent waste dumping. Storm drain signage must be provided for all storm water conveyance system inlets and catch basins within the project area. Storm drain signage may include concrete stamping, concrete painting, placards, or other methods approved by the County. These may be modified and used as educational pieces promoting improved water quality. In addition to storm drain signage at storm water conveyance system inlets and catch basins, applicants are encouraged to post signs and prohibitive language (with graphical icons) which prohibit illegal dumping at trailheads, parks, building entrances, and public access points along channels and creeks within the project area.

Design Considerations

Storm drain stenciling and signage may be implemented using a painted stencil or a sign or placard affixed to the structure. Signage should be located in plain sight of someone observing a storm drain inlet. The signage may include a combination of graphics and prohibitive language that identifies the inlet as a storm drain, prohibits dumping, and explains that storm drains discharge directly to receiving waterbodies.

Stencils and placards can be purchased from a number of suppliers. In the San Diego area, the non-profit organization, I Love A Clean San Diego, loans out stencil sets for labeling storm drains. They can be contacted at (619) 291-0103 or found online at <https://ilacsd.org>.

Plan Requirements

SC-F: STORM DRAIN SIGNAGE
Plan View Requirements
<ul style="list-style-type: none"> • Label each storm drain with BMP ID: SC-F
Detail Sheets
<ul style="list-style-type: none"> • Provide details on grading or improvement plans associated with the construction of applicable inlet or drainage feature.
Typical Construction Notes
<ul style="list-style-type: none"> • MARK ALL INLETS WITH THE WORDS “NO DUMPING DRAINS TO WATERWAYS” OR SIMILAR. SEE STENCIL TEMPLATE PROVIDED ON THE SHEET.

Maintenance Considerations

Signage should be repainted or replaced if it is damaged or begins to deteriorate.

SC-G: EDUCATIONAL BMP SIGNAGE

Description

Educational BMP Signage are visible source controls typically placed adjacent to a source control, site design, or structural BMP. Signage educates workers, homeowners and/or the public to raise awareness of storm water issues and educate about the benefits of these watershed protection measures.

Educational BMP Signage is an effective source control BMP to alert the public of the function and maintenance requirements of the BMPs. Below are some typical types of Educational BMP Signage:

1. **Temporary BMP Signage:** The purpose of temporary BMP signage is to alert contractors during construction that this permanent BMP has been completed and to ensure this BMP does not get disturbed during subsequent grading and building construction activities. It is good practice to divert sediment-laden water to temporary construction BMPs (e.g., sediment traps, etc.) around the permanent structural BMP until all drainage areas have been stabilized. If sediment and/or construction activities infringe on the permanent BMP, the facility will most likely need to be rehabilitated prior to project close-out. Figure 1 below provides a typical temporary BMP signage for use during the construction process that reads “Boundary of Structural Best Management Practice: Bioretention Basin. DO NOT DISTURB”
2. **Model Home BMP Signage:** Educational BMP Signage for model homes provides future homeowners a description of the benefits and responsibilities of the BMPs constructed on their property. It also provides the maintenance requirements to ensure long-term function of the BMP. Educational BMP Signage for permanent BMPs should include the following; vegetation type, maintenance requirements, design components and link to the County website with resources on maintenance for permanent BMPs. For additional guidance please refer to the County’s Landscape Ordinance Section 86.718(b).
3. **Interpretive BMP Signage:** This type of signage provides permanent Educational BMP Signage for the public to detail how BMPs benefit the local waterways. Figure 2 below provides an example of this type of interpretative BMP signage for a permanent BMP. This type of signage would be typically beneficial in public areas and applicable to municipal facilities (such as parks and public buildings), as well as commercial and industrial facilities to educate the public.

Figure 1: Temporary Structural BMP Signage



Figure 2: Permanent Interpretive BMP Signage

Design Considerations

Temporary BMP Signage should be designed to be highly visible to construction crews. Materials should ensure the sign is effective through planned construction activities within the drainage area to the permanent BMP.

Model Home Signage would typically be designed by the homebuilder to incorporate the characteristics of the development project. Signs should clearly provide the function of the permanent BMP and maintenance requirements of the prospective buyers of the property.

Interpretive BMP Signage should be constructed of materials that can withstand long-term placement for the lifecycle of the permanent BMP. Language should emphasize the positive impacts these facilities have to local receiving waters along with design renderings of the facility. Local partnerships and owner information are also important design considerations for this type of signage.

Signage should alert the private owner or public of the function of the permanent BMP, indicate prohibited activities that cause premature clogging, and provide typical maintenance requirements.

Plan Requirements

SC-G: PERMANENT BMP SIGNAGE
Plan View Requirements
<ul style="list-style-type: none"> • Label with BMP ID: SC-G
Detail Sheets
<ul style="list-style-type: none"> • Provide details in the applicable plan set of signage design and language.

Appendix C: Baseline BMP Fact Sheets for Site Design and Source Control

Typical Construction Notes

- TEMPORARY BMP SIGNAGE SHALL BE INSTALLED WITH THE WORDS “ BOUNDARY OF STRUCTURAL BEST MANAGEMENT PRACTICE. DO NOT DISTURB” OR SIMILAR. SEE SIGNAGE TEMPLATE PROVIDED ON SHEET [INSERT SHEET NUMBER]
- MODEL HOME BMP SIGNAGE SHALL BE INSTALLED WITH THE WORDS “A STRUCTURAL BMP IS A PERMANENT STORM WATER QUALITY FEATURE OF THIS PROPERTY THAT REQUIRES MAINTENANCE AND ANNUAL REPORTING REQUIREMENTS WITH THE COUNTY OF SAN DIEGO” OR SIMILAR. SEE SIGNAGE TEMPLATE PROVIDED ON SHEET [INSERT SHEET NUMBER]
- INTERPRETIVE BMP SIGNAGE REQUIRES APPROVAL BY OWNER PRIOR TO INSTALLATION.

Maintenance Considerations

Signage should be repainted or replaced if it is damaged or begins to deteriorate.

Temporary BMP Signage may be removed once all contributing drainage areas have been completed and stabilized and all permits within the drainage area have been closed out. Signage should only be removed with the approval of County staff.

Model Home BMP Signage may be removed once occupancy of model homes have been granted by PDS Building. Signage shall only be removed with the approval of County staff.

Geotechnical Engineer Analysis

D.1 Analysis of Infiltration Restrictions

D.2 Determination of Design Infiltration Rates

D.3 Geotechnical Reporting Requirements

Appendix D: Approved Infiltration Rate Assessment Methods

This page was intentionally left blank.

Appendix D Geotechnical Engineer Analysis

D.1 Analysis of Infiltration Restrictions

This section is only applicable if the analysis of infiltration restrictions is performed by a licensed engineer practicing in geotechnical engineering. The SWQMP Preparer and Geotechnical Engineer must work collaboratively to identify any infiltration restrictions identified in Table D.1-1 below. Upon completion of this section, the Geotechnical Engineer must characterize each DMA as Restricted or Unrestricted for infiltration and provide adequate support/discussion in the geotechnical report. A DMA is considered restricted when one or more restrictions exist which cannot be reasonably resolved through site design changes.

Table D.1-1: Considerations for Geotechnical Analysis of Infiltration Restrictions

Restriction Element		Is Element Applicable? (Yes/No)
Mandatory Considerations	BMP is within 100' of Contaminated Soils	
	BMP is within 100' of Industrial Activities Lacking Source Control	
	BMP is within 100' of Well/Groundwater Basin	
	BMP is within 50' of Septic Tanks/Leach Fields	
	BMP is within 10' of Structures/Tanks/Walls	
	BMP is within 10' of Sewer Utilities	
	BMP is within 10' of Groundwater Table	
	BMP is within Hydric Soils	
	BMP is within Highly Liquefiable Soils and has Connectivity to Structures	
	BMP is within 1.5 Times the Height of Adjacent Steep Slopes (≥25%)	
	County Staff has Assigned "Restricted" Infiltration Category	
Optional Considerations	BMP is within Predominantly Type D Soil	
	BMP is within 10' of Property Line	
	BMP is within Fill Depths of ≥5' (Existing or Proposed)	
	BMP is within 10' of Underground Utilities	
	BMP is within 250' of Ephemeral Stream	
	Other (Provide detailed geotechnical support)	
Result	Based on examination of the best available information, I have not identified any restrictions above.	<input type="checkbox"/> Unrestricted
	Based on examination of the best available information, I have identified one or more restrictions above.	<input type="checkbox"/> Restricted

Table D.1-1 is divided into Mandatory Considerations and Optional Considerations. Mandatory Considerations include elements that may pose a significant risk to human health and safety and must always be evaluated. Optional Considerations include elements that are not necessarily associated with human health and safety, so analysis is not mandated through this guidance document. All elements presented in this table are subject to the discretion of the Geotechnical Engineer if adequate supporting information is provided.

Applicants must evaluate infiltration restrictions through use of the best available data. A list of resources available for evaluation is provided in Section B.2

D.2 Determination of Design Infiltration Rates

This section is only applicable if the determination of design infiltration rates is performed by a licensed engineer practicing in geotechnical engineering. The guidance in this section identifies methods for identifying observed infiltration rates, corrected infiltration rates, safety factors, and design infiltration rates for use in structural BMP design. Upon completion of this section, the Geotechnical Engineer must recommend a design infiltration rate for each DMA and provide adequate support/discussion in the geotechnical report.

Table D.2-1: Elements for Determination of Design Infiltration Rates

Item	Value	Unit
Initial Infiltration Rate: Identify per Section D.2.1		in/hr
Corrected Infiltration Rate: Identify per Section D.2.2		in/hr
Safety Factor: Identify per Section D.2.3		unitless
Design Infiltration Rate: Corrected Infiltration Rate ÷ Safety Factor		in/hr

D.2.1 Initial Infiltration Rate

For purposes of this manual, the initial infiltration rate is the infiltration rate that has been identified based on the initial testing methods. Some of the acceptable methods for determining initial infiltration rates are presented in Table D.2-2 below, though other testing methods may be acceptable as evaluated by the geotechnical engineer. This table identifies what methods require application of correction factors, safety factors, and what BMPs types are ultimately acceptable for each testing method. The geotechnical engineer should use professional discretion when selecting a testing method as it may ultimately impact the types of BMPs that are permitted.

Table D.2-2: Acceptable Initial Infiltration Rate Methods

Category	Test	Correction Factor	Safety Factor	Suitable for Following BMPs
Desktop Methods*	NRCS Soil Survey Maps	Not Applicable	Not Applicable	BMPs with Underdrains
Correlation Methods	Grain Size Analysis	Not Applicable	Required (See Section D.2.3)	BMPs with Underdrains
	Cone Penetrometer Testing			
	Laboratory Permeability Tests			
Percolation Tests	Simple Open Pit Test	Required (See Section D.2.2)	Required (See Section D.2.3)	Any BMP Type
	Open Pit Falling Head Test			
	Well Permeameter Method			
	Borehole Percolation Tests			
Infiltration Tests	Double Ring Infiltrometer Test	Not Applicable	Required (See Section D.2.3)	Any BMP Type
	Single Ring Infiltrometer Test			
	Large-scale Pilot Infiltration Test			
	Smaller-scale Pilot Infiltration Test			

*Desktop methods may be performed without a geotechnical engineer. Refer to Basic Infiltration Analysis guidance in Section B.2.3 for more information.

Appendix D: Approved Infiltration Rate Assessment Methods

NRCS Soil Survey Maps: NRCS Soil Survey maps can be used to establish approximate infiltration rates for use in BMP design. Under this method, default design infiltration rates may be applied based on the predominant NRCS soil type present within a proposed BMP location. Default design infiltration rates (in/hr) for each NRCS soil type are: A=0.300, B=0.200, C=0.100, D=0.025, Restricted=0.000. Use of these default design infiltration rates does not require application of any correction factors or safety factors.

Grain Size Analysis Testing: Hydraulic conductivity can be estimated indirectly from correlations with soil grain-size distributions. While this method is approximate, correlations have been relatively well established for some soil conditions. One of the most commonly used correlations between grain size parameters and hydraulic conductivity is the Hazen (1892, 1911) empirical formula (Philips and Kitch, 2011), but a variety of others have been developed. Correlations must be developed based on testing of site-specific soils. For purposes of this manual, saturated hydraulic conductivity and infiltration rate can be assumed to be equal.

Cone Penetrometer Testing: Hydraulic conductivity can be estimated indirectly from cone penetrometer testing (CPT). A cone penetrometer test involves advancing a small probe into the soil and measuring the relative resistance encountered by the probe as it is advanced. The signal returned from this test can be interpreted to yield estimated soil types and the location of key transitions between soil layers. If this method is used, correlations must be developed based on testing of site-specific soils. For purposes of this manual, saturated hydraulic conductivity and infiltration rate can be assumed to be equal.

Laboratory Permeability Testing: Laboratory testing can be performed to help evaluate the infiltration rates. The laboratory tests should be in accordance with ASTM or other approved procedures (e.g. ASTM D 5084 or D 5856). Several tests may be required from samples at different elevations to help evaluate the permeability characteristics of the soil strata.

Simple Open Pit Test: The Simple Open Pit Test is a falling head test in which a hole at least two feet in diameter is filled with water to a level of 6" above the bottom. Water level is checked and recorded regularly until either an hour has passed or the entire volume has infiltrated. The test is repeated two more times in succession and the rate at which the water level falls in the third test is used as the infiltration rate. This test identifies a percolation rate that should be converted to an infiltration rate using the Porchet method.

Open Pit Falling Head Test: This test is similar to the Simple Open Pit Test, but covers a larger footprint, includes more specific instructions, returns more precise measurements, and generally should be overseen by a geotechnical professional. Nonetheless, it remains a relatively simple test.

To perform this test, a hole is excavated at least 2 feet wide by 4 feet long (larger is preferred) and to a depth of at least 12 inches. The bottom of the hole should be approximately at the depth of the proposed infiltrating surface of the BMP. The hole is pre-soaked by filling it with water at least a foot above the soil to be tested and leaving it at least 4 hours (or overnight if clays are present). After pre-soaking, the hole is refilled to a depth of 12 inches and allow it to drain for one hour (2 hours for slower soils), measuring the rate at which the water level drops. The test is then repeated until successive trials yield a result with less than 10 percent change.

Well Permeameter Method (USB 7300-89): Well permeameter methods were originally developed for purposes of assessing aquifer permeability and associated yield of drinking water wells.

Appendix D: Approved Infiltration Rate Assessment Methods

This family of tests is most applicable in situations in which infiltration facilities will be placed substantially below existing grade, which limits the use of surface testing methods.

In general, this test involves drilling a 6 inch to 8 inch test well to the depth of interest and maintaining a constant head until a constant flow rate has been achieved. Water level is maintained with down-hole floats. A smaller diameter boring may be adequate, however this then requires a different correction factor to account for the increased variability expected. The Porchet method or the nomographs provided in the USBR Drainage Manual (United States Department of the Interior, Bureau of Reclamation, 1993) are used to convert the measured rate of percolation to an estimate of vertical hydraulic conductivity.

While these tests have applicability in screening level analysis, considerable uncertainty is introduced in the step of converting direct percolation measurements to estimates of vertical infiltration. Additionally, this testing method is prone to yielding erroneous results cases where the vertical horizon of the test intersects with minor lenses of sandy soils that allow water to dissipate laterally at a much greater rate than would be expected in a full-scale facility. To improve the interpretation of this test method, a continuous bore log should be inspected to determine whether thin lenses of material may be biasing results at the strata where testing is conducted. Consult USBR procedure 7300-89 for more details.

Source: (United States Department of the Interior, Bureau of Reclamation, 1990, 1993)

Borehole Percolation Tests: Borehole percolation tests were originally developed as empirical tests to estimate the capacity of onsite sewage disposal systems (septic system leach fields), but have more recently been adopted into use for evaluating storm water infiltration. Similar to the well permeameter method, borehole percolation methods primarily measure lateral infiltration into the walls of the boring and are designed for situations in which infiltration facilities will be placed well below current grade. The percolation rate obtained in this test should be converted to an infiltration rate using a technique such as the Porchet method.

This test is generally implemented similarly to the USBR Well Permeameter Method. Per the Riverside County Borehole Percolation method, a hole is bored to a depth at least 5 times the borehole radius. The hole is presoaked for 24 hours (or at least 2 hours if sandy soils with no clay). The hole is filled to approximately the anticipated top of the proposed infiltration basin. Rates of fall are measured for six hours, refilling each half hour (or 10 minutes for sand). Tests are generally repeated until consistent results are obtained.

The same limitations described for the well permeameter method apply to borehole percolation tests, and their applicability is generally limited to initial screening. To improve the interpretation of this test method, a continuous soil core can be extracted from the hole and below the test depth, following testing, to determine whether thin lenses of material may be biasing results at the strata where testing is conducted.

Sources: Riverside County Percolation Test (2011), California Test 750 (Caltrans, 1986), San Bernardino County Percolation Test (1992); USEPA Falling Head Test (USEPA, 1980).

In comparison to a double-ring infiltrometer, this test has the advantage of measuring infiltration over a larger area and better resembles the dimensionality of a typical small scale BMP. This test identifies a percolation rate that should be converted to an infiltration rate using the Porchet method. However, if this method is used to identify rates for a drywell BMP, the correction factor can be omitted at the discretion of the geotechnical engineer.

Appendix D: Approved Infiltration Rate Assessment Methods

Double Ring Infiltrometer Test (ASTM 3385): The Double Ring Infiltrometer was originally developed to estimate the saturated hydraulic conductivity of low permeability materials, such as clay liners for ponds, but has seen significant use in storm water applications. The most recent revision of this method from 2009 is known as ASTM 3385-09. The testing apparatus is designed with concentric rings that form an inner ring and an annulus between the inner and outer rings. Infiltration from the annulus between the two rings is intended to saturate the soil outside of the inner ring such that infiltration from the inner ring is restricted primarily to the vertical direction.

To conduct this test, both the center ring and annulus between the rings are filled with water. There is no pre-wetting of the soil in this test. However, a constant head of 1 to 6 inches is maintained for 6 hours, or until a constant flow rate is established. Both the inner flow rate and annular flow rate are recorded, but if they are different, the inner flow rate should be used. There are a variety of approaches that are used to maintain a constant head on the system, including use of a Mariotte tube, constant level float valves, or manual observation and filling. This test must be conducted at the elevation of the proposed infiltrating surface; therefore application of this test is limited in cases where the infiltration surface is a significant distance below existing grade at the time of testing.

This test is generally considered to provide a direct estimate of vertical infiltration rate for the specific point tested and is highly replicable. However, given the small diameter of the inner ring (standard diameter is 12 inches, but it can be larger), this test only measures infiltration rate in a small area. Additionally, given the small quantity of water used in this test compared to larger scale tests, this test may be biased high in cases where the long term infiltration rate is governed by groundwater mounding and the rate at which mounding dissipates (i.e., the capacity of the infiltration receptor). Finally, the added effort and cost of isolating vertical infiltration rate may not necessarily be warranted considering that BMPs typically have a lateral component of infiltration as well. Therefore, while this method has the advantages of being technical rigorous and well standardized, it should not necessarily be assumed to be the most representative test for estimating full-scale infiltration rates. Source: American Society for Testing and Materials (ASTM) International (2009).

Single Ring Infiltrometer Test: The single ring infiltrometer test is not a standardized ASTM test, however it is a relatively well-controlled test and shares many similarities with the ASTM standard double ring infiltrometer test (ASTM 3385-09). This test is a constant head test using a large ring (preferably greater than 40 inches in diameter) usually driven 12 inches into the soil. Water is ponded above the surface. The rate of water addition is recorded and infiltration rate is determined after the flow rate has stabilized. Water can be added either manually or automatically.

The single ring used in this test tends to be larger than the inner ring used in the double ring test. Driving the ring into the ground limits lateral infiltration; however some lateral infiltration is generally considered to occur. Experience in Riverside County (CA) has shown that this test gives results that are close to full-scale infiltration facilities. The primary advantages of this test are that it is relatively simple to conduct and has a larger footprint (compared to the double-ring method) and restricts horizontal infiltration and is more standardized (compared to open pit methods). However, it is still a relatively small scale test and can only be reasonably conducted near the existing ground surface.

Large Scale Pilot Infiltration Test: As its name implies, this test is closer in scale to a full-scale infiltration facility. This test was developed by Washington State Department of Ecology specifically for storm water applications.

To perform this test, a test pit is excavated with a horizontal surface area of roughly 100 square feet to a depth that allows 3 to 4 feet of ponding above the expected bottom of the infiltration facility.

Appendix D: Approved Infiltration Rate Assessment Methods

Water is continually pumped into the system to maintain a constant water level (between 3 and 4 feet about the bottom of the pit, but not more than the estimated water depth in the proposed facility) and the flow rate is recorded. The test is continued until the flow rate stabilizes. Infiltration rate is calculated by dividing the flow rate by the surface area of the pit.

This test has the advantage of being more resistant to bias from localized soil variability and being more similar to the dimensionality and scale of full scale BMPs. It is also more likely to detect long term decline in infiltration rates associated with groundwater mounding. As such, it remains the preferred test for establishing design infiltration rates in Western Washington (Washington State Department of Ecology, 2012). In a comparative evaluation of test methods, this method was found to provide a more reliable estimate of full-scale infiltration rate than double ring infiltrometer and borehole percolation tests (Philips and Kitch 2011).

The difficulty encountered in this method is that it requires a larger area be excavated than the other methods, and this in turn requires larger equipment for excavation and a greater supply of water. However, this method should be strongly considered when less information is known about spatial variability of soils and/or a higher degree of certainty in estimated infiltration rates is desired.

Smaller-Scale Pilot Infiltration Test: The smaller-scale PIT is conducted similarly to the large-scale PIT but involves a smaller excavation, ranging from 20 to 32 square feet instead of 100 square feet for the large-scale PIT, with similar depths. The primary advantage of this test compared to the full-scale PIT is that it requires less excavation volume and less water. It may be more suitable for small-scale distributed infiltration controls where the need to conduct a greater number of tests outweighs the accuracy that must be obtained in each test, and where groundwater mounding is not as likely to be an issue.

D.2.2 Corrected Infiltration Rate

For purposes of this manual, the corrected infiltration rate is the initial infiltration rate as modified by appropriate correction factors needed to convert from percolation to infiltration or to correct for effects of water temperature. The sections below present discussion on correction factors that should be considered by the Geotechnical Engineer.

D.2.2.1 Percolation Rate Correction Factor

A common misunderstanding is that the “percolation rate” obtained from a percolation test is equivalent to the “infiltration rate” obtained from tests such as a single or double ring infiltrometer test which is equivalent to the “saturated hydraulic conductivity”. In fact, these terms have different meanings. Saturated hydraulic conductivity is an intrinsic property of a specific soil sample under a given density. It is a coefficient in Darcy’s equation (Darcy 1856) that characterizes the flux of water that will occur under a given gradient. The measurement of saturated hydraulic conductivity in a laboratory test is typically referred to as “permeability”, which is a function of the density, structure, stratification, fines, and discontinuities of a given sample under given controlled conditions. In contrast, infiltration is the downward entry of water into the soil. The velocity at which water enters the soil is infiltration rate. Infiltration rate is typically expressed in inches per hour. For the purposes of this manual, saturated hydraulic conductivity and infiltration rate can be assumed to be equal. Similarly, to permeability, infiltration rate can be limited by a number of factors including the layering of soil, density, discontinuities, and initial moisture content. These factors control how quickly water can move through a soil. However, infiltration rate can also be influenced by mounding of

Appendix D: Approved Infiltration Rate Assessment Methods

groundwater, and the rate at which water dissipates horizontally below a BMP – both of which describe the “capacity” of the “infiltration receptor” to accept this water over an extended period. For this reason, an infiltration test should ideally be conducted for a relatively long duration resembling a series of storm events so that the capacity of the infiltration receptor is evaluated as well as the rate at which water can enter the system. Infiltration rates are generally tested with larger diameter holes, pits, or apparatuses intended to enforce a primarily vertical direction of flux.

In contrast, percolation is tested with small diameter holes, and it is mostly a lateral phenomenon. The direct measurement yielded by a percolation test tends to overestimate the infiltration rate, except perhaps in cases in which a BMP has similar dimensionality to the borehole, such as a dry well. Adjustment of percolation rates may be made to an infiltration rate using a technique such as the Porchet Method. For drywell BMPs this adjustment may be determined per other methods, (i.e. USBR 7300-89), or may be omitted entirely at the discretion of the geotechnical engineer.

Percolation Rate Conversion Example

Problem:

Apply the Porchet Method (Inverse Borehole Method) to determine the corrected infiltration rate from the following inputs:

- Total depth of test hole, $D_T = 60$ inches
- Initial depth to water, $D_O = 12.25$ inches
- Final depth to water, $D_f = 13.75$ inches
- Test hole radius, $r = 4$ inches
- Time interval, $\Delta t = 10$ minutes

Solution:

1. Solve for the height of water at the beginning of the selected time interval, H_O :

$$H_O = D_T - D_O = 60 - 12.25 = 47.75 \text{ inches}$$

2. Solve for the height of water at the end of the selected time interval, H_f :

$$H_f = D_T - D_f = 60 - 13.75 = 46.25 \text{ inches}$$

3. Solve for the change in height of water over the selected time interval, ΔH :

$$\Delta H = H_O - H_f = 47.75 - 46.25 = 1.50 \text{ inches}$$

4. Calculate the average head over the selected time interval, H_{avg} :

$$H_{avg} = (H_O + H_f)/2 = (47.75 + 46.25)/2 = 47.00 \text{ inches}$$

5. Calculate the tested infiltration rate, I_t , using the following equation:

$$I_t = (\Delta H * 60 * r) / (\Delta t * (r + 2H_{avg}))$$

$$I_t = (1.50 \text{ in} * 60 \text{ min/hr} * 4 \text{ in}) / (10 \text{ min} * (4 \text{ inch} + (2 * 47 \text{ in}))) = 0.37 \text{ in/hr}$$

D.2.2.2 Temperature Correction Factor

The rate of infiltration through soil is affected by the viscosity of water, which in turn is affected by the temperature of water. As such, infiltration rate is strongly dependent on the temperature of the infiltrating water (Cedergren, 1997). For example, Emerson (2008) found that wintertime infiltration rates below a BMP in Pennsylvania were approximately half their peak summertime rates. As such, it is important to consider the effects of temperature when planning tests and interpreting results.

If possible, testing should be conducted at a temperature that approximates the typical runoff temperatures for the site during the times when rainfall occurs. If this is not possible, then the results of infiltration tests should be adjusted to account for the difference between the temperature at the time of testing and the typical temperature of runoff when rainfall occurs. The measured infiltration can be adjusted by the ratio of the viscosity at the test temperature versus the typical temperature when rainfall occurs (Cedergren, 1997), per the following formula:

$$K_{\text{Typical}} = K_{\text{Test}} \times \left(\frac{\mu_{\text{Test}}}{\mu_{\text{Typical}}} \right)$$

Where:

K_{Typical} = the typical infiltration rate expected at typical temperatures when rainfall occurs

K_{Test} = the infiltration rate measured or estimated under the conditions of the test

μ_{Typical} = the viscosity of water at the typical temperature expected when rainfall occurs

μ_{Test} = the viscosity of water at the temperature at which the test was conducted

D.2.3 Safety Factors

A safety factor between 2.0 and 9.0 must be applied to the infiltration rates determined above². Application of a safety factor reduces initial or corrected infiltration rates in order to account for various considerations that can impact infiltration rates measured rates over time. In order to minimize safety factor impacts, applicants should consider performing rigorous site investigation, incorporating pretreatment and resiliency into the site design, and taking steps to reduce incidental compaction within BMP footprints.

If the proposed BMP utilizes an underdrain, a default safety factor of 2.0 may be applied or a more detailed safety factor may be determined per Table D.2-3. If the proposed BMP does not utilize an underdrain, then the safety factor must be determined through completion of Table D.2-3.

² Use of default design infiltration rates based on NRCS soil type does not require application of safety factor.

Appendix D: Approved Infiltration Rate Assessment Methods

Table D.2-3: Determination of Safety Factor

Consideration		Assigned Weight (w)	Factor Value (v)	Product (p) $p = w \times v$
Suitability Assessment (A)	Infiltration Testing Method	0.25	Refer to Table D.2-4	
	Soil Texture Class	0.25		
	Soil Variability	0.25		
	Depth to Groundwater/Obstruction	0.25		
	Suitability Assessment Safety Factor, $S_A = \Sigma p$			
Design (B)	Pretreatment	0.50	Refer to Table D.2-4	
	Resiliency	0.25		
	Compaction	0.25		
	Design Safety Factor, $S_B = \Sigma p$			
Safety Factor, $S = S_A \times S_B$ (Must be always greater than or equal to 2)				

The geotechnical engineer should reference Table D.2-4 below in order to determine appropriate factor values for use in the table above. The values in the table below are subjective in nature and the geotechnical engineer may use professional discretion in how the points are assigned.

Table D.2-4: Guidance for Determining Individual Factor Values

Consideration	High Concern (3 points)	Medium Concern (2 points)	Low Concern (1 point)
Infiltration Testing Method	Any	At least 2 tests of any kind within 50' of BMP.	At least 4 tests within BMP footprint, OR Large/Small Scale Pilot Infiltration Testing over at least 5% of BMP footprint.
Soil Texture Class	Unknown, Silty, or Clayey	Loamy	Granular/Slightly Loamy
Soil Variability	Unknown or High	Moderately Homogeneous	Significantly Homogeneous
Depth to Groundwater/Obstruction	<5' below BMP	5-15' below BMP	>15' below BMP
Pretreatment	None/Minimal	Provides good pretreatment OR does not receive significant runoff from unpaved areas	Provides excellent pretreatment OR only receives runoff from rooftops and road surfaces.
Resiliency	None/Minimal	Includes underdrain/backup drainage that ensures ponding draws down in <96 hours	Includes underdrain/backup drainage AND supports easy restoration of impacted infiltration rates.
Compaction	Moderate Likelihood	Low Likelihood	Very Low Likelihood

D.3 Geotechnical Reporting Requirements

This section is only applicable if a licensed engineer practicing in geotechnical engineering has performed the determination of infiltration restrictions and/or design infiltration rates. The geotechnical report must document the following items in the geotechnical report.

- **Date of site analysis**
- **Scope and results of testing**
- **Public health and safety requirements that affect infiltration locations**
 - Must address Mandatory Considerations presented in Appendix D.1
- **Conclusions**
 - Characterize DMAs as Restricted or Unrestricted for Infiltration
 - Identify Design Infiltration Rates for DMAs
- **Correspondence between County Staff and Geotechnical Engineer (if applicable)**
 - Development status of site prior to the project application (i.e. new development with raw ungraded land, or redevelopment with existing graded conditions)
 - The history of design discussions for the site proposed project
 - Site design alternatives considered to achieve infiltration or partial infiltration on site
 - Physical impairments and public safety concerns (i.e. fire road egress, sewer lines, etc)
 - The extent low impact development BMP requirements were included in the project design

It is ultimately the responsibility of the SWQMP Preparer (not the geotechnical engineer) to interpret the conclusions made in the geotechnical report and ensure they are appropriately supported/reflected in associated SWQMP submittal materials such as checklists, narratives, calculations, exhibits, and supplemental reports.

Appendix



COUNTY OF SAN DIEGO BMP DESIGN MANUAL

Fact Sheets for Enhanced Site Design, Structural and Flow-thru BMPs

Appendix E: Fact Sheets for Enhanced Site Design, Structural and Flow-thru BMPs

This page was intentionally left blank.

Appendix E Fact Sheets for Enhanced Site Design, Structural and Flow-thru BMPs



The following fact sheets were developed to assist the project applicants with designing BMPs to meet the storm water obligations. The Fact Sheet Quick Guide on the next page summarizes the layout and type of information contained in each fact sheet.

	MS4 Category	Manual Category	Design Fact Sheet	Page
Enhanced Site Design BMPs	Site Design	Site Design	SD-A Tree Wells*	E-28
			SD-B: Impervious Area Dispersion*	E-42
			SD-C: Green Roofs	E-50
			SD-D: Permeable Pavement (Site Design BMP)	E-58
			SD-E: Rain Barrels	E-68
			SD-F: Amended Soil	E-74
Structural BMPs	Retention	Harvest and Use	HU-1: Cistern	E-78
		Infiltration	INF-1: Infiltration Basins INF-2: Bioretention INF-3: Permeable Pavement (Pollutant Control) INF-4: Dry Wells	E-88 E-100 E-114 E-132
		Partial Retention	PR-1: Biofiltration with Partial Retention	E-136
	Biofiltration	Biofiltration	BF-1: Biofiltration BF-2: Nutrient Sensitive Media Design BF-3: Proprietary Biofiltration	E-150 E-164 E-168
	Flow-thru Treatment Control	Flow-thru Treatment Control with Alternative Compliance	FT-1: Vegetated Swales FT-2: Media Filters FT-3: Sand Filters FT-4: Dry Extended Detention Basin FT-5: Proprietary Flow-thru Treatment Control	E-170 E-182 E-190 E-200 E-210

*SD-A Tree Wells and SD-B Impervious Area Dispersion can function as Significant Site Design BMPs when sized according to Section 5.2.3.

Appendix E: Fact Sheets for Enhanced Site Design, Structural and Flow-thru BMPs

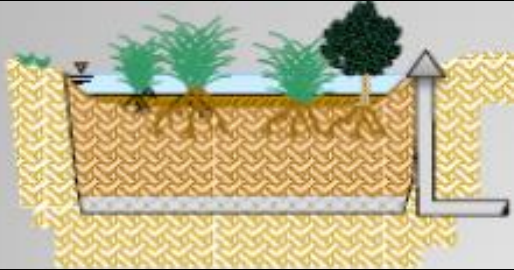
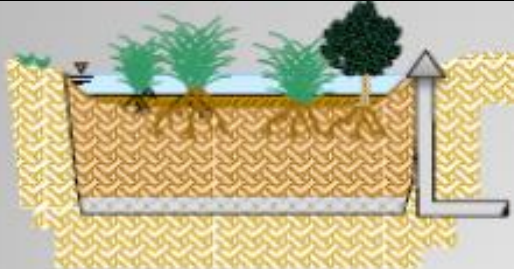
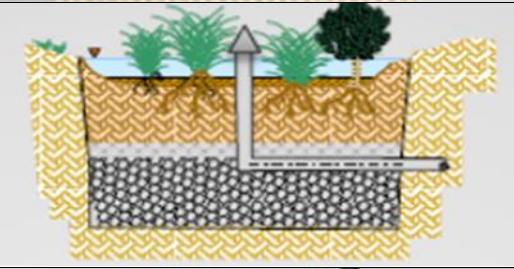
BMP Comparison Table

BMP Type	Soil Media	Underdrain present?	Bottom Liner Present ?	Typical Design
Infiltration (INF-1)	Optional	No	No	
Bioretention (INF-2)	BSM	No	No	
Biofiltration with Partial Retention (PR-1)	BSM	Yes-Optional	No	
Biofiltration (BF-1)	BSM	Yes	Yes	

E.1 Fact Sheet Quick Guide

BF-1 Biofiltration	1																		
 <p data-bbox="181 835 846 869"><i>Location: 43rd Street and Logan Avenue, San Diego, California</i></p>	<table border="1"> <tr> <td data-bbox="959 342 1370 401">MS4 Permit Category</td> <td data-bbox="1370 342 1445 401">2</td> </tr> <tr> <td data-bbox="959 401 1370 464">Biofiltration</td> <td data-bbox="1370 401 1445 464"></td> </tr> <tr> <td data-bbox="959 464 1370 527">Manual Category</td> <td data-bbox="1370 464 1445 527"></td> </tr> <tr> <td data-bbox="959 527 1370 590">Biofiltration</td> <td data-bbox="1370 527 1445 590"></td> </tr> <tr> <td data-bbox="959 590 1370 653">Applicable Performance Standard</td> <td data-bbox="1370 590 1445 653"></td> </tr> <tr> <td data-bbox="959 653 1370 716">Pollutant Control</td> <td data-bbox="1370 653 1445 716"></td> </tr> <tr> <td data-bbox="959 716 1370 779">Flow Control</td> <td data-bbox="1370 716 1445 779"></td> </tr> <tr> <td data-bbox="959 779 1370 842">Primary Benefits</td> <td data-bbox="1370 779 1445 842"></td> </tr> <tr> <td data-bbox="959 842 1370 898">Treatment</td> <td data-bbox="1370 842 1445 898"></td> </tr> </table>	MS4 Permit Category	2	Biofiltration		Manual Category		Biofiltration		Applicable Performance Standard		Pollutant Control		Flow Control		Primary Benefits		Treatment	
MS4 Permit Category	2																		
Biofiltration																			
Manual Category																			
Biofiltration																			
Applicable Performance Standard																			
Pollutant Control																			
Flow Control																			
Primary Benefits																			
Treatment																			
Description		4																	
<p>Biofiltration (Bioretention with underdrain) facilities are vegetated surface water systems that filter water through vegetation, and soil or engineered media prior to discharge via underdrain or overflow to the downstream conveyance system.</p>																			

Fact Sheet Key	
1	Best Management Practice (BMP) Title
2	Categories, Standards, and Benefits
3	BMP Image
4	<p>Main Content; Categories Include:</p> <ul style="list-style-type: none"> •Description •Design Adaptations for Project Goals •Recommended Siting Criteria •Recommended BMP Component Dimensions •Design Criteria and Considerations •Conceptual Design and Sizing Approach for <ul style="list-style-type: none"> ○ Site Design ○ Storm Water Pollutant Control Only ○ Integrated Storm Water Pollutant Control and Flow Control •Maintenance Overview •Summary of Standard Inspection and Maintenance

E.2 SD-A Tree Wells



Tree Wells (Source: County of San Diego LID Manual – EOA, Inc.)

MS4 Permit Category

Site Design
Retention

Manual Category

Site Design
Infiltration

Applicable Performance Standard

Site Design
Pollutant Control
Flow Control

Primary Benefits

Volume Reduction

Description

Trees planted to intercept rainfall and runoff as described in this fact sheet may be used as storm water management measures to provide runoff reduction of the DCV per Appendix B.1.4. Additional benefits associated with tree wells, include energy conservation, air quality improvement, and aesthetic enhancement. In addition to the requirements provided in this fact sheet, tree wells located in the County Right-of-Way shall follow requirements in Appendix K of this manual. Deviations from the outlined criteria may be approved at the discretion of County staff. Typical storm water management benefits associated with trees include:

- **Interception of rainfall** – tree surfaces (roots, foliage, bark, and branches) intercept, evaporate, store, or convey precipitation to the soil before it reaches surrounding impervious surfaces
- **Reduced erosion** – trees protect denuded area by intercepting or reducing the velocity of rain drops as they fall through the tree canopy
- **Increased infiltration** – soil conditions created by roots and fallen leaves promote infiltration
- **Treatment of storm water** – trees provide treatment through uptake of nutrients and other storm water pollutants (phytoremediation) and support of other biological processes that break down pollutants

Typical tree well system components include:

- Trees of the appropriate species for site conditions and constraints. Refer to the Plant List in this fact sheet.
- Available soil media reservoir volume based on mature tree size, soil type, water availability, surrounding land uses, and project goals
- Optional suspended pavement design to provide structural support for adjacent pavement without requiring compaction of underlying layers
- Optional root barrier devices as needed; a root barrier is a device installed in the ground, between a tree and the sidewalk, intended to guide roots down and away from the sidewalk in order to prevent sidewalk lifting from tree roots.
- Optional tree grates; to be considered to maximize available space for pedestrian circulation and to protect tree roots from compaction related to pedestrian circulation; tree grates are typically made up of porous material that will allow the runoff to soak through.
- Optional shallow surface depression for ponding of excess runoff
- Optional planter box drain

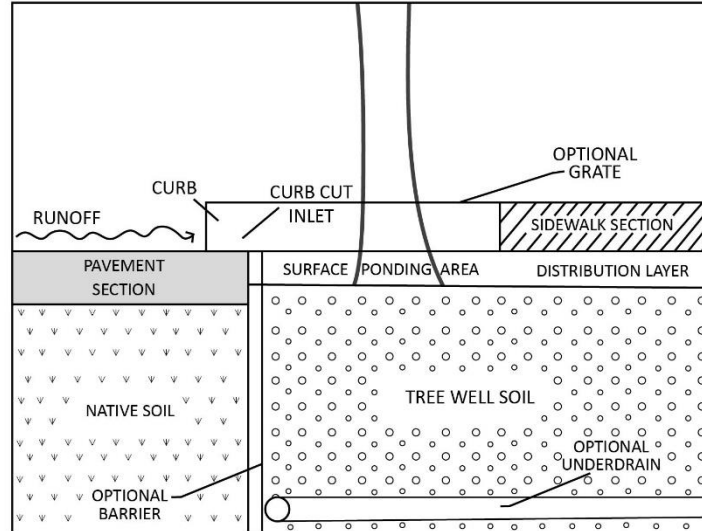

Schematic of Tree Well

Design Adaptations for Project Goals

Site design BMP to provide incidental treatment. Tree wells primarily function as site design BMPs for incidental treatment.

Pollutant Control BMP to provide treatment. Project proponents are allowed to design trees to reduce the volume of stormwater runoff that requires treatment, (the Design Capture Volume [DCV]), or completely fulfill the pollutant control BMP requirements by retaining the entire DCV. Benefits from tree wells are accounted for by using the volume reduction values in Table B.1-3 presented in Appendix B. This credit can apply to other trees that are used for landscaping purposes that meet the same criteria. Project proponents are required to provide calculations supporting the amount of credit claimed from implementing trees within the project footprint.

Flow Control BMP to meet hydromodification requirements. Project proponents are also allowed to design tree wells as a flow control BMP. Benefits from tree wells are accounted for by using the DCV multipliers listed below. Project proponents are required to provide calculations showing that the entire DCV including the DCV multiplier is retained.

Design Criteria and Considerations

Tree Wells, whether designed as Site Design BMPs, as Stormwater Pollutant Control BMP, or as a Flow Control BMP must meet the following design criteria and considerations, and if placed in the right-of-way must be consistent with the County of San Diego Green Streets Design Criteria and Green Streets Standard Drawings in Appendix K. Deviations from the below criteria may be approved at the discretion of the County staff if it is determined to be appropriate:

<i>Siting and Design</i>	<i>Intent/Rationale</i>														
<input type="checkbox"/> Tree species is appropriately chosen for the development (private or public). For public rights-of-ways, local planning guidelines and zoning provisions for the permissible species and placement of trees are consulted. A list of trees appropriate for site design that can be used by all county municipalities are provided in this fact sheet.	Proper tree placement and species selection minimizes problems such as pavement damage by surface roots and poor growth.														
<input type="checkbox"/> Tree well placement: ensure area is graded; and the well is located so that full amount of DCV reduction drains to the well.	Minimizes short-circuiting of run off and assures DCV reductions are retained onsite.														
<p>Location of trees planted along public streets follows guidance on green infrastructure (Appendix K). Vehicle and pedestrian line of sight and clear recovery zones are considered in tree selection and placement.</p> <p>Unless exemption is granted by County staff the following minimum tree separation distance is followed</p> <table border="1" style="width: 100%; border-collapse: collapse;"> <thead> <tr> <th style="width: 50%;">Improvement</th> <th style="width: 50%;">Minimum distance to tree well</th> </tr> </thead> <tbody> <tr> <td>Traffic Signal, Stop sign</td> <td>20 feet</td> </tr> <tr> <td>Underground Utility lines (except sewer)</td> <td>5 feet</td> </tr> <tr> <td>Sewer Lines</td> <td>10 feet</td> </tr> <tr> <td>Above ground utility structures (Transformers, Hydrants, Utility poles, etc.)</td> <td>10 feet</td> </tr> <tr> <td>Driveways</td> <td>10 feet</td> </tr> <tr> <td>Intersections (intersecting curb lines of two streets)</td> <td>25 feet</td> </tr> </tbody> </table>	Improvement	Minimum distance to tree well	Traffic Signal, Stop sign	20 feet	Underground Utility lines (except sewer)	5 feet	Sewer Lines	10 feet	Above ground utility structures (Transformers, Hydrants, Utility poles, etc.)	10 feet	Driveways	10 feet	Intersections (intersecting curb lines of two streets)	25 feet	Roadway safety for both vehicular and pedestrian traffic is a key consideration for placement along public streets.
Improvement	Minimum distance to tree well														
Traffic Signal, Stop sign	20 feet														
Underground Utility lines (except sewer)	5 feet														
Sewer Lines	10 feet														
Above ground utility structures (Transformers, Hydrants, Utility poles, etc.)	10 feet														
Driveways	10 feet														
Intersections (intersecting curb lines of two streets)	25 feet														

<i>Siting and Design</i>	<i>Intent/Rationale</i>
<p><input type="checkbox"/> Underground utilities and overhead wires are considered in the design and avoided or circumvented. Underground utilities are routed around or through the planter in suspended pavement applications. All underground utilities are protected from water and root penetration.</p>	<p>Tree growth can damage utilities and overhead wires resulting in service interruptions. Protecting utilities routed through the planter prevents damage and service interruptions. Refer to Section 6.6 of the Green Streets Design Criteria in Appendix K for guidelines regarding utility placement and potential conflict with BMP facilities.</p>
<p><input type="checkbox"/> Suspended pavement was used for confined Tree Well soil volume. Suspended pavement design was developed where appropriate to minimize soil compaction and improve infiltration and filtration capabilities.</p> <p>Suspended pavement was constructed with an approved structural cell.</p>	<p>Suspended pavement designs as shown in Page 7 of the Green Streets Guidelines in Appendix K provide structural support without compaction of the underlying layers, thereby promoting tree growth.</p> <p>Recommended structural cells include poured in place concrete columns, Silva Cells manufactured by Deeproot Green Infrastructures and Stratacell and Stratavault systems manufactured by Citygreen Systems.</p>
<p><input type="checkbox"/> A minimum soil volume of 2 cubic feet per square foot of mature tree canopy projection area is provided for each tree. Canopy projection area is the ground area beneath the mature tree, measured at the drip line. Soil volume must be within 1.5 times the mature tree canopy radius. Soil depth shall be a minimum of 30 inches deep, preferably 36 inches deep. When placing tree well next to curb use Structural Soil as outlined in the section below titled “Confined Tree Well Soil Volume” and use Specifications in Appendix K Use Amended Soil per Fact Sheet SD-F in all other cases.</p>	<p>The minimum soil volume ensures that there is adequate storage volume to allow for unrestricted evapotranspiration and infiltration.</p>

<i>Siting and Design</i>	<i>Intent/Rationale</i>
<p>To claim credit for existing trees, the root structure of existing tree shall be protected and additional soil volumes provided to meet the above requirements.</p> <p><input type="checkbox"/> A berm or well must be constructed around the perimeter of the soil volume to be credited and an inlet structure must be of the appropriate size to allow runoff to enter the well.</p> <p>Considerations should be made to prevent root and water intrusion damage to surrounding infrastructure.</p>	<p>The minimum soil volume ensures that there is adequate storage volume to allow for unrestricted storage, evapotranspiration, and infiltration.</p>
<p><input type="checkbox"/> DCV from the tributary area draining to the tree is equal to or greater than the tree credit volume</p>	<p>The minimum tributary area ensures that the tree receives enough runoff to fully utilize the infiltration and evapotranspiration potential provided. In cases where the minimum tributary area is not provided, the tree credit volume must be reduced proportionately to the actual tributary area.</p>
<p><input type="checkbox"/> Inlet opening to the tree that is at least 18 inches wide.</p> <p>A minimum 2 inch drop in grade from the inlet to the finish grade of the tree.</p> <p>Grated inlets are allowed for pedestrian circulation. Grates need to be ADA compliant and have sufficient slip resistance.</p>	<p>Design requirement to ensure that the runoff from the tributary area does not bypass the BMP.</p> <p>Different inlet openings and drops in grade may be allowed at the discretion of County staff if calculations are shown that the diversion flow rate (Appendix B.) from the tributary area can be conveyed to the tree. In cases where the inlet capacity is limiting the amount of runoff draining to the tree, the tree credit volume must be reduced proportionately.</p>

Conceptual Design and Sizing Approach for Site Design

Determine the areas where tree wells can be used in the site design to achieve incidental treatment. Tree wells reduce runoff volumes from the site. Refer to Appendix B.2. Document the proposed tree locations in the SWQMP.

Conceptual Design and Sizing Approach for Pollutant Control

When trees are proposed as a storm water pollutant control BMP, the project proponent must submit detailed calculations for the DCV treated by trees. Document the proposed tree locations on the BMP Plan & DMA Map, and provide sizing calculations in the SWQMP Attachment following the steps in Appendix B.

Conceptual Design and Sizing Approach for Flow Control

When trees are proposed as a flow control BMP, the project proponent must submit detailed calculations for the Required Retention Volume (RRV) treated by trees. Document the proposed tree locations on the BMP Plan & DMA Map, and provide sizing calculations in the SWQMP Attachment. Tree Wells that are designed to meet flow control requirements are designated as SSD BMPs.

1. **Determine how much volume you need.** The Required Retention Volume (RRV) is the volume of rainfall that must be retained by the tree wells in the DMA to meet flow control requirements. It is calculated by multiplying the DCV by a DCV multiplier.
 - a. Determine the DCV. See Appendix B.
 - b. Determine the DCV Multiplier. The DCV Multiplier is based on two factors: (1) The tree well soil depth and, (2) The Hydrologic Soil Group. Once you know both values, determine the DCV Multiplier using this table:
 - c. Calculate the Required Retention Volume (DCV x DCV Multiplier). Calculate the RRV by multiplying the DCV by the DCV Multiplier. This is the volume of runoff that must be offset by the Tree Well Credit Volume. Repeat this process for each DMA.

Minimum Tree Well Soil Depth (inches)	Hydrologic Soil Group				DCV Multiplier
	A	B	C	D (Default)	
30"	1.60	2.20	2.50	2.90	
36"	1.80	2.47	2.83	3.17	
42"	2.00	2.73	3.17	3.43	
48"	2.20	3.00	3.50	3.70	

DCV Multiplier Table

Tree Well Soil Depth is the vertical distance from the top to the bottom of the soil layer in the tree well. **Hydrologic Soil Group** describes the native soil surrounding the tree well. Soil type affects how well water can infiltrate into the area surrounding the tree well. Group A soils provide the most infiltration and Group D the least. If your soil type is unknown, you can assume Group D. But this will result in larger DCV Multipliers, and in turn increase the size or number of tree wells needed.

Alternative Proposals: You can also propose RRV values or use methods and assumptions different than those described here. Proposals must be based on SWMM modeling or other methods acceptable to the County.

2. **Determine how much volume you have.** The Tree Well Credit Volume is the volume of runoff retention in cubic feet per tree (ft³/tree) to be provided by each tree well (or group) in the DMA. Together retain a volume that is equal to or greater than the RRV for the DMA.

The volume credited for each tree well is based on the mature canopy diameter of the tree species selected. Any species listed below can be used in a tree well so long as it meets all other applicable restrictions and requirements for the project area. Native and drought tolerant species are required where feasible.

	Botanical Name	Common Name	Mature Height (ft)	Mature Canopy Diameter (ft)	Credit Volume per Tree (ft ³)
1	<i>Ceanothus 'Ray Hartman'</i>	California Mountain Lillac	30	10	40
2	<i>Pittosporum Phylliracoides</i>	Willow Pittosporum	25	15	100
3	<i>Salix Lasiolepis</i>	Arroyo Willow	25		
4	<i>Arbutus Unedo</i>	Strawberry Tree	30	20	180
5	<i>Prunus Ilicifolia</i>	Hollyleaf Cherry	30		
6	<i>Prunus Lynoii</i>	Catalina Cherry	40		
7	<i>Cercis Occidentalis</i>	Western Redbud	25	25	290
8	<i>Heteromeles Arbutifolia</i>	Toyon, Christmas Berry	25		
9	<i>Alnus Rhombifolia</i>	White Elder	75		
10	<i>Arbutus 'Marina'</i>	Hybrid Strawberry Tree	35		
11	<i>Chilopsis Linearis</i>	Desert Willow	30		
12	<i>Lyonothamnus Floribundus</i>	Catalina Ironwood	50		
13	<i>Magnolia Grandiflora</i>	Southern Magnolia	40		
14	<i>Pinus Torreyana</i>	Torrey Pines	80	30	420
15	<i>Platanus Racemosa</i>	California sycamore	60		
16	<i>Quercus Agrifolia</i>	Coast Live Oak	70		
17	<i>Quercus Engelmannii</i>	Engelmann Oak	50		
18	<i>Quercus Suber</i>	Cork Oak	40		
19	<i>Sambucus Mexicana</i>	Blue Elderberry	30		

Tree Palette Table

Below are sources for Tree Palette Mature Height and Mature Canopy Diameter:

- Water Efficient Landscape Design Manual, County of San Diego, 2016
- Sustainable Landscapes Guidelines, San Diego County Water Authority, 2015
- Low Impact Development Handbook, County of San Diego, 2014
- Low Impact Development Design Manual, City of San Diego, 2011
- Street Tree Selection Guide, City of San Diego, 2013
- Environmentally Friendly Garden Plant List, City of San Diego, 2004
- BMP Design Manual, County of San Diego, 2016
- California Native Plant Society. 2017

Alternative Species. Tree species other than those listed are allowable, but must be approved by the County. If you know the mature canopy diameter of the species you want to propose, use the values in the table to determine its credit volume. Note that even if you select a species with a canopy diameter greater than **30 feet**, the maximum credit any tree can generate is **420 ft³**.

3. **Determine if you have enough volume.** Compare your total Tree Well Credit Volume from Step 2 to the RRV you calculated in Step 1. Once your Credit Volume is equal to or greater than

your RRV, this requirement is satisfied. If your Credit Volume is initially too low, adjust your design either to (1) increase it with more or bigger trees, or (2) decrease the RRV through DCV reductions.

Tree wells will normally be placed at the **discharge point** of the DMA, either individually or in groups. If some of them will retain runoff from different areas in the DMA, RRV and DCV calculations must be specific to each subarea.

If an **underdrain** is proposed for the Tree Well, the sizing factors shown in the DCV Multiplier Table cannot be used, and instead continuous simulation modeling should be performed. This would allow to obtain credit for soil volume underneath the underdrain.

Tree Planting Design in New or Reconstructed Streetscapes

1. Maximized open soil area for tree planting is the most cost effective method of achieving the required soil volume.
2. Tree wells within sidewalks shall have a minimum open area of four feet wide by six feet long. Larger areas may be required to accommodate large root balls.
3. Tree well soil characteristics shall meet the requirements of SD-F Amended Soil.

Structural Requirements for Confined Tree Well Soil Volume

In order to provide adequate soil volume for tree wells, soils may be placed confined beneath adjacent paved surfaces. Acceptable soil systems capable of carrying D-50 loading include structural soils, structural slabs, and structural cells:

1. Structural soil systems include CU-StructuralSoil™, Stalite Structural Soil, or equivalent.
2. Suspended pavements that allow uncompacted growing soil beneath the sidewalk include; structural slabs that span between structural supports, structural cells, and other commercially available structural systems. See Page 7 of the Green Streets Guidelines in Appendix K for illustrations. Manufacturer details and certification must be provided for commercial systems. Structural calculations and details must be provided for structural slab installations. Structural cells are commercially-available structural systems placed subsurface that support the sidewalk and are filled with amended soil (SD-F). Manufacturer details and certification must be provided for commercial systems.

Stormwater Retention and Treatment Volume

Tree wells with expanded soil volume will serve as a method of capturing and retaining the required volume of stormwater in accordance with County requirements in Appendix B of this manual. These facilities can be designed to meet the County requirements when surface ponding volume is provided, whether designed as an enclosed plant bed with covered soil volume, or a continuous open area (either mulched or with turf) with soil volume under the adjacent sidewalk.

Maintenance Overview

Normal Expected Maintenance. Tree health shall be maintained as part of normal landscape maintenance. Additionally, ensure that storm water runoff can be conveyed into the tree well as

designed. That is, the opening that allows storm water runoff to flow into the tree well (e.g., a curb opening, tree grate, or surface depression) shall not be blocked, filled, re-graded, or otherwise changed in a manner that prevents storm water from draining into the tree well. A summary table of standard inspection and maintenance indicators is provided within this Fact Sheet.

Non-Standard Maintenance or BMP Failure. Trees wells are site design BMPs that normally do not require maintenance actions beyond routine landscape maintenance. The normal expected maintenance described above ensures the BMP functionality. If changes have been made to the tree well entrance / opening such that runoff is prevented from draining into the tree well (e.g., a curb inlet opening is blocked by debris or a grate is clogged causing runoff to flow around instead of into the tree well, or a surface depression has been filled so runoff flows away from the tree well), the BMP is not performing as intended to protect downstream waterways from pollution and/or erosion. Corrective maintenance will be required to restore drainage into the tree well as designed.

Surface ponding of runoff directed into tree wells is expected to infiltrate/evapotranspire within 24-96 hours following a storm event. Surface ponding longer than approximately 24 hours following a storm event may be detrimental to vegetation health, and surface ponding longer than approximately 96 hours following a storm event poses a risk of vector (mosquito) breeding. Poor drainage can result from clogging or compaction of the soils surrounding the tree. Loosen or replace the soils to restore drainage.

Other Special Considerations. Site design BMPs, such as tree wells, installed within a new development or redevelopment project are components of an overall storm water management strategy for the project. The presence of site design BMPs within a project is usually a factor in the determination of the amount of runoff to be managed with structural BMPs (i.e., the amount of runoff expected to reach downstream retention or biofiltration basins that process storm water runoff from the project as a whole). When site design BMPs are not maintained or are removed, this can lead to clogging or failure of downstream structural BMPs due to greater delivery of runoff and pollutants than intended for the structural BMP. Therefore, the County Engineer may require confirmation of maintenance of site design BMPs as part of their structural BMP maintenance documentation requirements. Site design BMPs that have been installed as part of the project should not be removed, nor should they be bypassed by re-routing roof drains or re-grading surfaces within the project. If changes are necessary, consult the County Engineer to determine requirements.

Summary of Standard Inspection and Maintenance

The property owner is responsible to ensure inspection, operation and maintenance of permanent BMPs on their property unless responsibility has been formally transferred to an agency, community facilities district, homeowners association, property owners association, or other special district.

Maintenance frequencies listed in this table are average/typical frequencies. Actual maintenance needs are site-specific, and maintenance may be required more frequently. Maintenance must be performed whenever needed, based on maintenance indicators presented in this table. The BMP owner is responsible for conducting regular inspections to see when maintenance is needed based on the maintenance indicators. During the first year of operation of a structural BMP, inspection is recommended at least once prior to August 31 and then monthly from September through May. Inspection during a storm event is also recommended. After the initial period of frequent inspections, the minimum inspection and maintenance frequency can be determined based on the results of the first year inspections.

Threshold/Indicator	Maintenance Action	Inspection and Maintenance Frequency
Tree health	Routine actions as necessary to maintain tree health.	<ul style="list-style-type: none"> • Inspect monthly. • Maintain when needed.
Dead or diseased tree	Remove dead or diseased tree. Replace per original plans.	<ul style="list-style-type: none"> • Inspect monthly. • Maintain when needed.
Standing water in tree well for longer than 24 hours following a storm event Surface ponding longer than approximately 24 hours following a storm event may be detrimental to tree health	Loosen or replace soils surrounding the tree to restore drainage.	<ul style="list-style-type: none"> • Inspect monthly and after every 0.5-inch or larger storm event. If standing water is observed, increase inspection frequency to after every 0.1-inch or larger storm event. • Maintain when needed.
Presence of mosquitos/larvae For images of egg rafts, larva, pupa, and adult mosquitos, see http://www.mosquito.org/biology	Disperse any standing water from the tree well to nearby landscaping. Loosen or replace soils surrounding the tree to restore drainage (and prevent standing water).	<ul style="list-style-type: none"> • Inspect monthly and after every 0.5-inch or larger storm event. If mosquitos are observed, increase inspection frequency to after every 0.1-inch or larger storm event. • Maintain when needed

Threshold/Indicator	Maintenance Action	Inspection and Maintenance Frequency
<p>Entrance / opening to the tree well is blocked such that storm water will not drain into the tree well (e.g., a curb inlet opening is blocked by debris or a grate is clogged causing runoff to flow around instead of into the tree well; or a surface depression is filled such that runoff drains away from the tree well)</p>	<p>Make repairs as appropriate to restore drainage into the tree well.</p>	<ul style="list-style-type: none"> • Inspect monthly. • Maintain when needed.

E.3 SD-B Impervious Area Dispersion (Dispersion Areas)



Photo Credit: Orange County Technical Guidance Document

Description

Impervious area dispersion (dispersion) refers to the practice of effectively disconnecting impervious areas from directly draining to the storm drain system by routing runoff from impervious areas such as rooftops (through downspout disconnection), walkways, and driveways onto the surface of adjacent pervious areas. The intent is to slow runoff discharges, and reduce volumes. Dispersion with partial or full infiltration results in significant volume reduction by means of infiltration and evapotranspiration.

Typical dispersion components include:

- An impervious surface from which runoff flows will be routed with minimal piping to limit concentrated inflows
- Splash blocks, flow spreaders, or other means of dispersing concentrated flows and providing energy dissipation as needed
- Dedicated pervious area, typically vegetated, with in-situ soil infiltration capacity for partial or full infiltration
- Optional soil amendments to improve vegetation support, maintain infiltration rates and enhance treatment of routed flows
- Overflow route for excess flows to be conveyed from dispersion area to the storm drain system or discharge point

MS4 Permit Category

Site Design

Retention

Manual Category

Site Design

Infiltration

Applicable Performance Criteria

Site Design

Pollutant Control

Flow Control

Primary Benefits

Volume Reduction

Peak Flow Attenuation

SD-B Impervious Area Dispersion (Dispersion Areas)

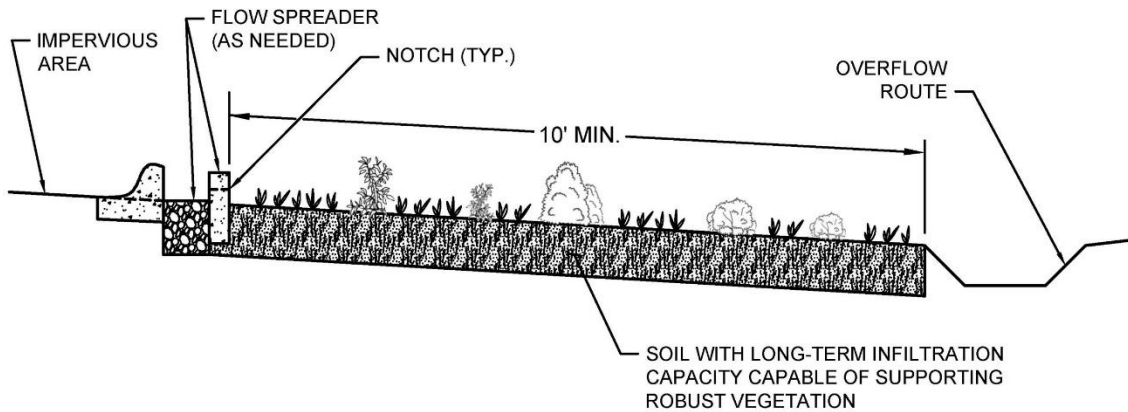
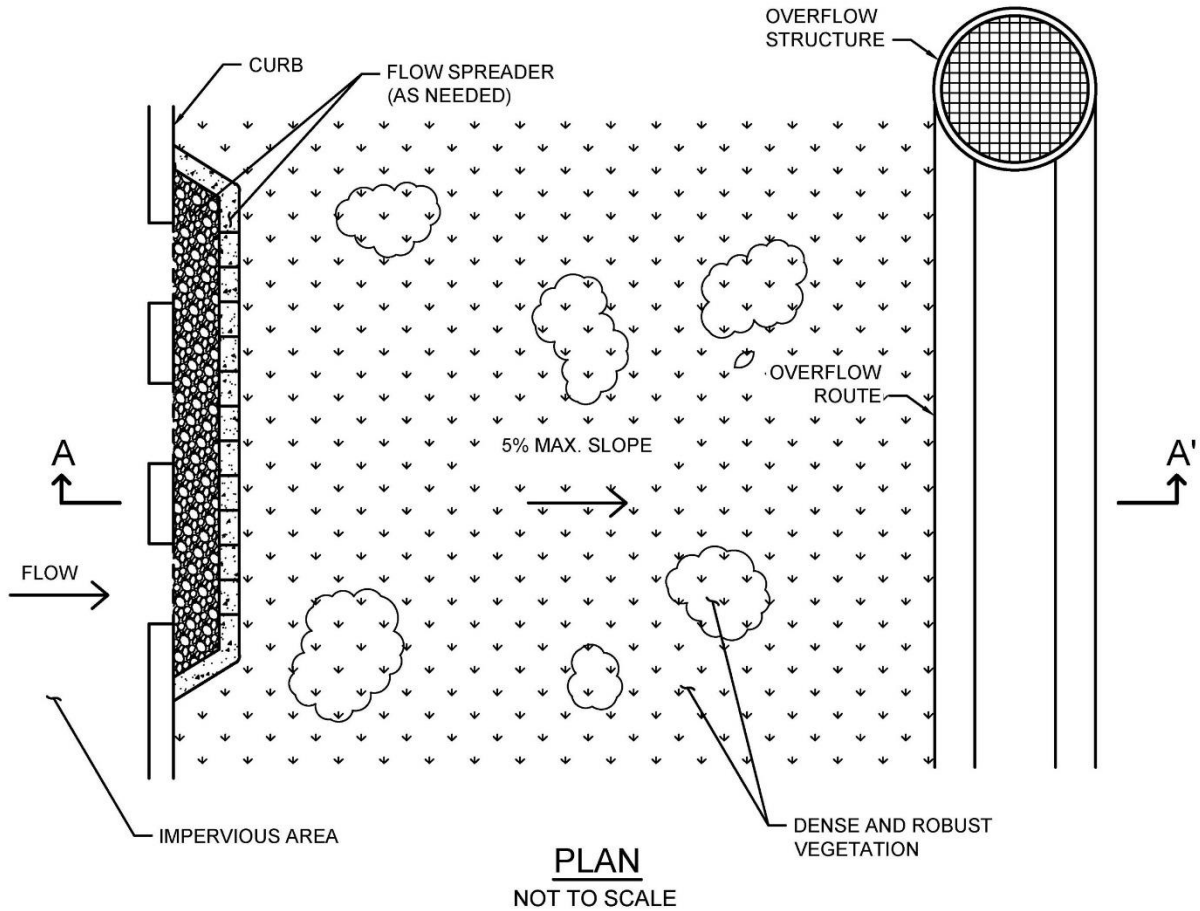

SECTION A-A'
NOT TO SCALE

Typical plan and section view of an Impervious Area Dispersion BMP

Design Adaptations for Project Goals

Site design BMP to reduce impervious area and DCV. Impervious area dispersion primarily functions as a site design BMP for reducing the effective imperviousness of a site by providing partial or full infiltration of the flows that are routed to pervious dispersion areas and otherwise slowing down excess flows that eventually reach the storm drain system. This can significantly reduce the DCV for the site.

Design Criteria and Considerations

Dispersion must meet the following design criteria. Deviations from the below criteria may be approved at the discretion of County Staff if it is determined to be appropriate:

<i>Siting and Design</i>	<i>Intent/Rationale</i>
<p><input type="checkbox"/> Impervious area dispersion Placement: ensure area is graded; and located so that full DCV water drains to the area of dispersion</p>	<p>Minimizes short-circuiting of run off</p>
<p><input type="checkbox"/> Dispersion is over areas with soil types capable of supporting or being amended (e.g., with sand or compost) to support vegetation. Media amendments must be tested to verify that they are not a source of pollutants.</p>	<p>Soil must have long-term infiltration capacity for partial or full infiltration and be able to support vegetation to provide runoff treatment. Amendments to improve plant growth must not have negative impact on water quality.</p>
<p><input type="checkbox"/> Dispersion has vegetated sheet flow over a relatively large distance (minimum 10 feet) from inflow to overflow route.</p>	<p>Full or partial infiltration requires relatively large areas to be effective depending on the permeability of the underlying soils.</p>
<p><input type="checkbox"/> Pervious areas should be flat (with less than 5% slopes) and vegetated.</p>	<p>Flat slopes facilitate sheet flows and minimize velocities, thereby improving treatment and reducing the likelihood of erosion.</p>
<i>Inflow velocities</i>	
<p><input type="checkbox"/> Inflow velocities are limited to 3 ft/s or less or use energy dissipation methods (e.g., riprap, level spreader) for concentrated inflows.</p>	<p>High inflow velocities can cause erosion, scour and/or channeling.</p>
<i>Dedication</i>	
<p><input type="checkbox"/> Dispersion areas must be owned by the project owner and be dedicated for the purposes of dispersion to the exclusion of other future uses that might reduce the effectiveness of the dispersion area.</p>	<p>Dedicated dispersion areas prevent future conversion to alternate uses and facilitate continued full and partial infiltration benefits.</p>

<i>Siting and Design</i>	<i>Intent/Rationale</i>
<i>Vegetation</i>	
<input type="checkbox"/> Dispersion typically requires dense and robust vegetation for proper function. Drought tolerant species should be selected to minimize irrigation needs. A plant list to aid in selection can be found in Appendix F.	Vegetation improves resistance to erosion and aids in runoff treatment.

Conceptual Design and Sizing Approach for Site Design

1. Determine the areas where dispersion can be used in the site design to reduce the DCV for pollutant control sizing.
2. Calculate the DCV for storm water pollutant control per Appendix B.2, taking into account reduced runoff from dispersion.
3. Determine if a DMA is considered “Self-retaining” if the impervious to pervious ratio is:
 - a. 2:1 when the pervious area is composed of Hydrologic Soil Group A
 - b. 1:1 when the pervious area is composed of Hydrologic Soil Group B

Conceptual Design and Sizing Approach for Storm Water Pollutant Treatment and Flow Control

DMA's using impervious area dispersion are considered to meet both pollutant control and hydromodification flow control requirements if ALL of the following criteria are met:

1. All impervious area within the DMA discharges to the pervious area before the runoff discharges from the DMA.
2. As a minimum, the top 11 inches of the pervious area uses amended soils in accordance with the SD-F fact sheet and the pervious area also meets the requirements for dispersion (e.g. slope, inflow velocities, etc.) in the SD-B fact sheet.
3. The impervious to pervious area ratio is 1:1 or less.

Impervious Area Dispersion designed to meet both pollutant control and flow control requirements are designated as SSD BMPs.

Maintenance Overview

Normal Expected Maintenance. Vegetated area shall be maintained as part of normal landscape maintenance. Additionally, ensure that storm water runoff can be conveyed into the vegetated area as designed. That is, the mechanism that allows storm water runoff from impervious area to flow into the pervious area (e.g., a curb cut allows runoff from a parking lot to drain onto adjacent landscaping area, or a roof drain outlet is directed to a lawn) shall not be removed, blocked, filled, or otherwise changed in a manner that prevents storm water from draining into the pervious area. A summary table of standard inspection and maintenance indicators is provided within this Fact Sheet.

SD-B Impervious Area Dispersion (Dispersion Areas)

Non-Standard Maintenance or BMP Failure. Impervious area dispersion is a site design BMP that normally does not require maintenance actions beyond routine landscape maintenance. If changes have been made to the area, such as the vegetated area has been replaced with impervious area, or the mechanism that allows storm water runoff from impervious area to flow into the pervious area has been removed (e.g., roof drains previously directed to vegetated area have been directly connected to the street or storm drain system), the BMP is not performing as intended to protect downstream waterways from pollution and/or erosion. Corrective maintenance will be required to restore drainage into the pervious area as designed. If the pervious area has been removed, contact the County reviewer to determine a solution.

Runoff directed into vegetated areas is expected to be drained within 24-96 hours following a storm event. Surface ponding longer than approximately 24 hours following a storm event may be detrimental to vegetation health, and surface ponding longer than approximately 96 hours following a storm event poses a risk of vector (mosquito) breeding. Poor drainage can result from clogging or compaction of the soils. Loosen or replace the soils to restore drainage.

Other Special Considerations. Site design BMPs, such as impervious area dispersion, installed within a new development or redevelopment project are components of an overall storm water management strategy for the project. The presence of site design BMPs within a project is usually a factor in the determination of the amount of runoff to be managed with structural BMPs (i.e., the amount of runoff expected to reach downstream retention or biofiltration basins that process storm water runoff from the project as a whole). When site design BMPs are not maintained or are removed, this can lead to clogging or failure of downstream structural BMPs due to greater delivery of runoff and pollutants than intended for the structural BMP. Therefore, the County reviewer may require confirmation of maintenance of site design BMPs as part of their structural BMP maintenance documentation requirements. Site design BMPs that have been installed as part of the project should not be removed, nor should they be bypassed by re-routing roof drains or re-grading surfaces within the project. If changes are necessary, consult the County reviewer to determine requirements.

SD-B Impervious Area Dispersion (Dispersion Areas)

This page was intentionally left blank.

Summary of Standard Inspection and Maintenance

The property owner is responsible to ensure inspection, operation and maintenance of permanent BMPs on their property unless responsibility has been formally transferred to an agency, community facilities district, homeowners association, property owners association, or other special district.

Maintenance frequencies listed in this table are average/typical frequencies. Actual maintenance needs are site-specific, and maintenance may be required more frequently. Maintenance must be performed whenever needed, based on maintenance indicators presented in this table. The BMP owner is responsible for conducting regular inspections to see when maintenance is needed based on the maintenance indicators. During the first year of operation of a structural BMP, inspection is recommended at least once prior to August 31 and then monthly from September through May. Inspection during a storm event is also recommended. After the initial period of frequent inspections, the minimum inspection and maintenance frequency can be determined based on the results of the first year inspections.

Threshold/Indicator	Maintenance Action	Inspection and Maintenance Frequency
Poor vegetation establishment	Re-seed, re-plant, or re-establish vegetation per original plans.	<ul style="list-style-type: none"> • Inspect monthly. • Maintain when needed.
Dead or diseased vegetation	Remove dead or diseased vegetation, re-seed, re-plant, or re-establish vegetation per original plans.	<ul style="list-style-type: none"> • Inspect monthly. • Maintain when needed.
Overgrown vegetation	Mow or trim as appropriate.	<ul style="list-style-type: none"> • Inspect monthly. • Maintain when needed.
Standing water in vegetated pervious area for longer than 24 hours following a storm event Surface ponding longer than approximately 24 hours following a storm event may be detrimental to vegetation health	Disperse any areas of standing water to nearby landscaping (i.e., spread it out to another portion of the pervious area so it drains into the soil). Make appropriate corrective measures such as adjusting irrigation system, or repairing/replacing clogged or compacted soils.	<ul style="list-style-type: none"> • Inspect monthly and after every 0.5-inch or larger storm event. If standing water is observed, increase inspection frequency to after every 0.1-inch or larger storm event. • Maintain when needed.

SD-B Impervious Area Dispersion (Dispersion Areas)

Threshold/Indicator	Maintenance Action	Inspection and Maintenance Frequency
<p>Presence of mosquitos/larvae</p> <p>For images of egg rafts, larva, pupa, and adult mosquitos, see http://www.mosquito.org/biology</p>	<p>Disperse any areas of standing water to nearby landscaping (i.e., spread it out to another portion of the pervious area so it drains into the soil). Loosen or replace soils to restore drainage (and prevent standing water)</p>	<ul style="list-style-type: none"> • Inspect monthly and after every 0.5-inch or larger storm event. If mosquitos are observed, increase inspection frequency to after every 0.1-inch or larger storm event. • Maintain when needed
<p>Entrance / opening to the vegetated pervious area is blocked such that storm water from impervious area will not drain into the pervious area (e.g., a curb cut opening is blocked by debris or a roof drain outlet has been directly connected to the storm drain system)</p>	<p>Make repairs as appropriate to restore drainage into the vegetated pervious area.</p>	<ul style="list-style-type: none"> • Inspect monthly. • Maintain when needed.

E.4 SD-C: Green Roofs



Location: County of San Diego Operations Center, San Diego, California

MS4 Permit Category

Site Design

Manual Category

Site Design

Applicable Performance Standard

Site Design

Primary Benefits

Volume Reduction
Peak Flow Attenuation

Description

Green roofs are vegetated rooftop systems that reduce runoff volumes and rates, treat storm water pollutants through filtration and plant uptake, provide additional landscape amenity, and create wildlife habitat. Additionally, green roofs reduce the heat island effect and provide acoustical control, air filtration and oxygen production. In terms of building design, they can protect against ultraviolet rays and extend the roof lifetime, as well as increase the building insulation, thereby decreasing heating and cooling costs. There are two primary types of green roofs:

- **Extensive** – lightweight, low maintenance system with low-profile, drought tolerant type groundcover in shallow growing medium (6 inches or less)
- **Intensive** – heavyweight, high maintenance system with a more garden-like configuration and diverse plantings that may include shrubs or trees in a thicker growing medium (greater than 6 inches)

Typical green roof components include, from top to bottom:

- Vegetation that is appropriate to the type of green roof system, climate, and watering conditions
- Media layer (planting mix or engineered media) capable of supporting vegetation growth
- Filter fabric to prevent migration of fines (soils) into the drainage layer
- Optional drainage layer to convey excess runoff

- Optional root barrier
- Optional insulation layer
- Waterproof membrane
- Structural roof support capable of withstanding the additional weight of a green roof

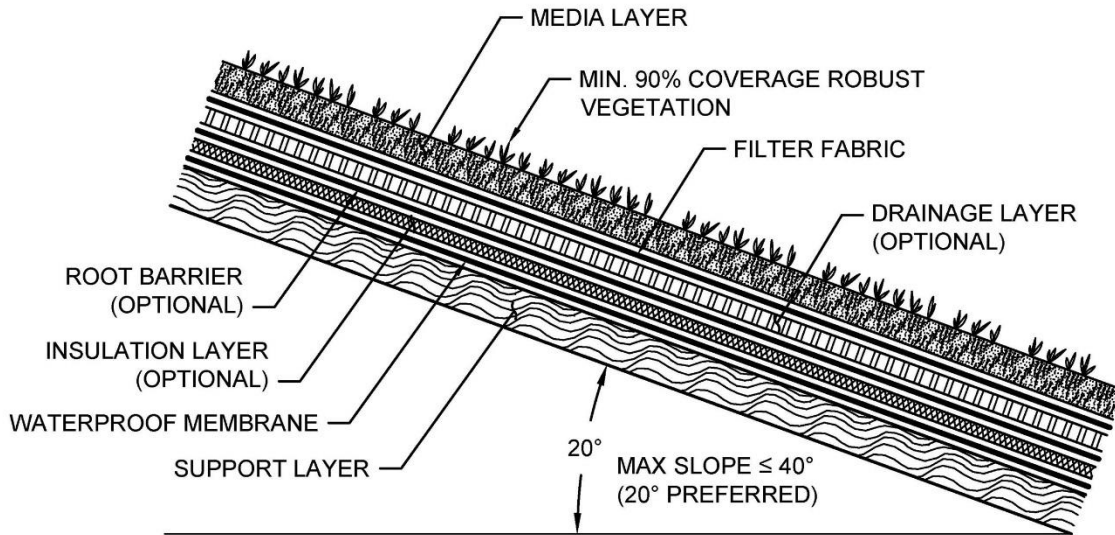

PROFILE
NOT TO SCALE

Typical profile of a Green Roof BMP

Design Adaptations for Project Goals

Site design BMP to provide incidental treatment. Green roofs can be used as a site design feature to reduce the runoff generated from the site through replacing conventional roofing. This can reduce the DCV and flow control requirements for the site.

Design Criteria and Considerations

Green roofs must meet the following design criteria. Deviations from the below criteria may be approved at the discretion of County staff if it is determined to be appropriate:

<i>Siting and Design</i>	<i>Intent/Rationale</i>
<input type="checkbox"/> Roof slope is $\leq 40\%$ (Roofs that are $\leq 20\%$ are preferred).	Steep roof slopes increase project complexity and requires supplemental anchoring.

<i>Siting and Design</i>	<i>Intent/Rationale</i>
<input type="checkbox"/> Structural roof capacity design supports the calculated additional load (lbs/sq. ft) of the vegetation growing medium and additional drainage and barrier layers.	Inadequate structural capacity increases the risk for roof failure and harm to the building and occupants.
<input type="checkbox"/> Design and construction is planned to be completed by an experienced green roof specialist.	A green roof specialist will minimize complications in implementation and potential structural issues that are critical to green roof success.
<input type="checkbox"/> Green roof location and extent must meet fire safety provisions.	Green roof design must not negatively impact fire safety.
<input type="checkbox"/> Maintenance access is included in the green roof design.	Maintenance will facilitate proper functioning of drainage and irrigation components and allow for removal of undesirable vegetation and soil testing, as needed.
<i>Vegetation</i>	
<input type="checkbox"/> Vegetation is suitable for the green roof type, climate and expected watering conditions. Perennial, self-sowing plants that are drought-tolerant (e.g., sedums, succulents) and require little to no fertilizer, pesticides or herbicides are recommended. Vegetation pre-grown at grade may allow plants to establish prior to facing harsh roof conditions.	Plants suited to the design and expected growing environment are more likely to survive.
<input type="checkbox"/> Vegetation is capable of covering $\geq 90\%$ the roof surface.	Benefits of green roofs are greater with more surface vegetation.
<input type="checkbox"/> Vegetation is robust and erosion-resistant in order to withstand the anticipated rooftop environment (e.g., heat, cold, high winds).	Weak plants will not survive in extreme rooftop environments.
<input type="checkbox"/> Vegetation is fire resistant.	Vegetation that will not burn easily decreases the chance for fire and harm to the building and occupants.
<input type="checkbox"/> Vegetation considers roof sun exposure and shaded areas based on roof slope and location.	The amount of sunlight the vegetation receives can inhibit growth therefore the beneficial effects of a vegetated roof.
<input type="checkbox"/> An irrigation system (e.g., drip irrigation system) is included as necessary to maintain vegetation.	Proper watering will increase plant survival, especially for new plantings.

<i>Siting and Design</i>	<i>Intent/Rationale</i>
<input type="checkbox"/> Media is well-drained and is the appropriate depth required for the green roof type and vegetation supported.	Unnecessary water retention increases structural loading. An adequate media depth increases plant survival.
<input type="checkbox"/> A filter fabric is used to prevent migration of media fines through the system.	Migration of media can cause clogging of the drainage layer.
<input type="checkbox"/> A drainage layer is provided if needed to convey runoff safely from the roof. The drainage layer can be comprised of gravel, perforated sheeting, or other drainage materials.	Inadequate drainage increases structural loading and the risk of harm to the building and occupants.
<input type="checkbox"/> A root barrier comprised of dense material to inhibit root penetration is used if the waterproof membrane will not provide root penetration protection.	Root penetration can decrease the integrity of the underlying structural roof components and increase the risk of harm to the building and occupants.
<input type="checkbox"/> An insulation layer is included as needed to protect against the water in the drainage layer from extracting building heat in the winter and cool air in the summer.	Regulating thermal impacts of green roofs will aid in controlling building heating and cooling costs.
<input type="checkbox"/> A waterproof membrane is used to prevent the roof runoff from vertically migrating and damaging the roofing material. A root barrier may be required to prevent roots from compromising the integrity of the membrane.	Water-damaged roof materials increase the risk of harm to the building and occupants.

Conceptual Design and Sizing Approach for Site Design

1. Determine the areas where green roofs can be used in the site design to replace conventional roofing to reduce the DCV. These green roof areas can be credited toward reducing runoff generated through representation in storm water calculations as pervious, not impervious, areas but are not credited for storm water pollutant control.
2. Calculate the DCV per Appendix B.

Maintenance Overview

Normal Expected Maintenance. A green roof requires routine maintenance to: maintain vegetation health; and maintain integrity of the roof drainage system. A summary table of standard inspection and maintenance indicators is provided within this Fact Sheet.

Non-Standard Maintenance or BMP Failure. Green roofs are site design BMPs that normally do not require maintenance actions beyond the normal maintenance described above. If a roof leak is discovered, it may be an indicator that the waterproof membrane has failed. The waterproof membrane (roof liner) shall be inspected and repaired or replaced as necessary.

Green roof systems normally receive only direct rainfall (not runoff from additional tributary area directed into the system). It is expected to be drained within 24-96 hours following a storm event. Surface ponding longer than approximately 24 hours following a storm event may be detrimental to vegetation health, and surface ponding longer than approximately 96 hours following a storm event poses a risk of vector (mosquito) breeding, as well as risk of damage to the roof. Poor drainage can result from clogging or compaction of the media, optional drainage layer, or drainage system. The specific cause of the drainage issue must be determined and corrected.

Other Special Considerations. Site design BMPs, such as green roofs, installed within a new development or redevelopment project are components of an overall storm water management strategy for the project. The presence of site design BMPs within a project is usually a factor in the determination of the amount of runoff to be managed with structural BMPs (i.e., the amount of runoff expected to reach downstream retention or biofiltration basins that process storm water runoff from the project as a whole). When site design BMPs are not maintained or are removed, this can lead to clogging or failure of downstream structural BMPs due to greater delivery of runoff and pollutants than intended for the structural BMP. Therefore, the County reviewer may require confirmation of maintenance of site design BMPs as part of their structural BMP maintenance documentation requirements. Site design BMPs that have been installed as part of the project should not be removed, nor should they be bypassed by re-routing roof drains or re-grading surfaces within the project. If changes are necessary, consult the County reviewer to determine requirements.

This page was intentionally left blank

Summary of Standard Inspection and Maintenance

The property owner is responsible to ensure inspection, operation and maintenance of permanent BMPs on their property unless responsibility has been formally transferred to an agency, community facilities district, homeowners association, property owners association, or other special district.

Maintenance frequencies listed in this table are average/typical frequencies. Actual maintenance needs are site-specific, and maintenance may be required more frequently. Maintenance must be performed whenever needed, based on maintenance indicators presented in this table. The BMP owner is responsible for conducting regular inspections to see when maintenance is needed based on the maintenance indicators. During the first year of operation of a structural BMP, inspection is recommended at least once prior to August 31 and then monthly from September through May. Inspection during a storm event is also recommended. After the initial period of frequent inspections, the minimum inspection and maintenance frequency can be determined based on the results of the first year inspections.

Threshold/Indicator	Maintenance Action	Inspection and Maintenance Frequency
Poor vegetation establishment	Re-seed, re-plant, or re-establish vegetation per original plans.	<ul style="list-style-type: none"> • Inspect monthly. • Maintain when needed.
Dead or diseased vegetation	Remove dead or diseased vegetation, re-seed, re-plant, or re-establish vegetation per original plans.	<ul style="list-style-type: none"> • Inspect monthly. • Maintain when needed.
Overgrown vegetation	Mow or trim as appropriate.	<ul style="list-style-type: none"> • Inspect monthly. • Maintain when needed.
Standing water in BMP for longer than 24 hours following a storm event Surface ponding longer than approximately 24 hours following a storm event may be detrimental to vegetation health	Disperse any areas of standing water to nearby landscaping (i.e., spread it out to another portion of the green roof so it drains into the soil). Make appropriate corrective measures such as adjusting irrigation system, clearing underdrains, or repairing/replacing clogged or compacted soils.	<ul style="list-style-type: none"> • Inspect monthly and after every 0.5-inch or larger storm event. If standing water is observed, increase inspection frequency to after every 0.1-inch or larger storm event. • Maintain when needed.

Threshold/Indicator	Maintenance Action	Inspection and Maintenance Frequency
<p>Presence of mosquitos/larvae</p> <p>For images of egg rafts, larva, pupa, and adult mosquitos, see http://www.mosquito.org/biology</p>	<p>Disperse any areas of standing water to nearby landscaping (i.e., spread it out to another portion of the green roof so it drains into the soil). Loosen or replace soils to restore drainage (and prevent standing water).</p>	<ul style="list-style-type: none"> • Inspect monthly and after every 0.5-inch or larger storm event. If mosquitos are observed, increase inspection frequency to after every 0.1-inch or larger storm event. • Maintain when needed
<p>Leaks or other damage to waterproof membrane</p>	<p>Repair or replace as applicable.</p>	<ul style="list-style-type: none"> • Inspect membrane if leak is observed. • Maintain when needed.

E.5 SD-D Permeable Pavement (Site Design BMP)



Photo Credit: San Diego Low Impact Development Design Manual

MS4 Permit Category

Site Design

Manual Category

Site Design

Applicable Performance Standard

Site Design

Primary Benefits

Description

Permeable pavement is pavement that allows for percolation through void spaces in the pavement surface into subsurface layers. Permeable pavements reduce runoff volumes and rates and can provide pollutant control via infiltration, filtration, sorption, sedimentation, and biodegradation processes. When used as a site design BMP, the subsurface layers are designed to provide storage of storm water runoff so that outflow rates can be controlled via infiltration into subgrade soils. Varying levels of storm water treatment and flow control can be provided depending on the size of the permeable pavement system relative to its drainage area and the underlying infiltration rates. As a site design BMP permeable pavement areas are designed to be self-retaining and are designed primarily for direct rainfall. Self-retaining permeable pavement areas have a ratio of total drainage area (including permeable pavement) to area of permeable pavement of 1.5:1 or less. Permeable pavement surfaces can be constructed from modular paver units or paver blocks, pervious concrete, porous asphalt, and turf pavers. Sites designed with permeable pavements can significantly reduce the impervious area of the project. Reduction in impervious surfaces decreases the DCV and can reduce the footprint of treatment control and flow control BMPs.

Typical Permeable Pavement Components (Top to Bottom)

Permeable surface layer
Bedding layer for permeable surface
Aggregate storage layer with optional underdrain(s)
Optional final filter course layer over uncompacted existing subgrade

Design Adaptations for Project Goals

Site design BMP to reduce impervious area. Permeable pavement without an underdrain can be used as a site design feature to reduce the impervious area of the site by replacing traditional pavements, including roadways, parking lots, emergency access lanes, sidewalks, trails and driveways.

Design Criteria and Considerations

Permeable Pavement (Site Design BMP) must meet the following design criteria and be consistent with the County of San Diego Green Streets Design Criteria and Green Street Standard Drawings in Appendix K. Deviations from the below criteria may be approved at the discretion of County Staff if it is determined to be appropriate:

<i>Siting and Design</i>	<i>Intent/Rationale</i>
<input type="checkbox"/> For site design permeable pavement, the ratio of the total drainage area (including the permeable pavement) to the permeable pavement should not exceed 1.5:1.	Higher ratios increase the potential for clogging.
<input type="checkbox"/> The structural section is in accordance with the manufacturer’s guidance and project soils engineering’s recommendations. Overflows and storm drain lines may still be required.	Ensures that the permeable pavement facility can be designed to provide adequate drainage system.
<input type="checkbox"/> Use appropriate thickness for permeable surface layer for vehicular loading.	<p>Permeable concrete requires a 6-inch minimum surface layer of permeable concrete.</p> <p>Permeable asphalt requires a 1 ½ -inch minimum surface layer of permeable asphalt.</p> <p>Permeable pavers require a 2 3/8-inch minimum surface layer of permeable pavers or the manufacturer’s recommendations.</p>
<input type="checkbox"/> Use appropriate thickness and material for bedding layer for vehicular loading.	<p>Permeable concrete requires 4 inches of crushed rock as a choker layer.</p> <p>Permeable asphalt requires a 3-inch minimum layer of crushed rock as a base course, and 4 inches of crushed rock as a choker layer</p> <p>Permeable pavers require a 2-inch layer of crushed rock as a base course, and 4 inches of crushed rock as a choker layer.</p>
<input type="checkbox"/> No erodible areas drain on to permeable pavement. In addition, permeable pavement shall not be placed in an area with significant overhanging trees or other vegetation.	Minimizes clogging. Sediment, leaves and organic debris can clog the pavement surface.

<i>Siting and Design</i>	<i>Intent/Rationale</i>
<input type="checkbox"/> Show system slope and direction of slope on plans.	Ensures the system functions properly. Typically, the system is only suitable on flat slope.
<input type="checkbox"/> Show cross-section of system assembly with complete dimensions and detailing on plans.	Ensures that the system gets constructed and functions properly.
<input type="checkbox"/> Specific maintenance program on plans – e.g., debris removal, vacuum sweeping twice per year, resetting pavers as needed.	Ensures system remains permeable.
<input type="checkbox"/> Note on plans: “No sealant shall be applied to constructed Permeable surfaces.”	The purpose is to allow stormwater to percolate through the permeable surfaces.
<input type="checkbox"/> When finish grade of the permeable pavement has a slope of 10% or less, bench subgrade to have a slope of 0% per Standard Drawing for Permeable Pavements Elevation (Terraced Slope) in Appendix K. Distance between steps is determined by the slope of the pavement to achieve a step no more than 12” tall. The manufacturer’s recommendations for permeable pavers may supersede the benching described above.	Avoids concentrated flows downstream.
<input type="checkbox"/> When Finish grade of the permeable pavement has a slope of 10% or more, bench subgrade to have a slope of 0% per Standard Drawing for Permeable Pavements Elevation (Terraced Slope) in Appendix K. Distance between steps is determined by the slope of the pavement to achieve a step no more than 12” tall. The manufacturer’s recommendations for permeable pavers may supersede the benching described above. Consult with the appropriate fire jurisdiction for surfacing requirements.	Avoids concentrated flows downstream.
<input type="checkbox"/> Geotextile or filter course layer may be provided along perimeter.	Geotextile or filter course layer can prevent natural soil from clogging aggregate voids.

<i>Siting and Design</i>	<i>Intent/Rationale</i>
<input type="checkbox"/> No impervious liners or moisture barriers.	Infiltration of stormwater into native soils, if allowable, can aid in pollutant removal and groundwater recharge, mimicking natural drainage characteristics as similar to pervious surface.
<input type="checkbox"/> Natural soil beneath shall be well-draining with minimal compaction; no underdrains allowed.	Infiltration of stormwater into native soils, if allowable, can aid in pollutant removal and groundwater recharge, mimicking natural drainage characteristics as similar to pervious surface.
<input type="checkbox"/> Concrete divider strip shall be provided between system and adjacent impervious materials and as edge restraints.	Provides structural stability.
<input type="checkbox"/> Fire district must verify system is acceptable to support fire apparatus.	Allows for a safe access in case of an emergency
<input type="checkbox"/> System may not disturb underground utilities.	Underground utilities have specific requirements and guidelines for clearances.
<input type="checkbox"/> Paver gaps, changes in elevation, and slopes must meet accessibility requirements if applicable.	Provides accessibility and complies with ADA requirements if applicable.
<input type="checkbox"/> Permeable pavers are not to be used in areas of high traffic volume.	Pavers are not intended to be used in areas of high traffic volume and areas where vehicular speed is excessive. Parking areas and low-speed access roads are examples of ideal applications.

Conceptual Design and Sizing Approach for Site Design

1. Determine the areas where permeable pavements can be used in the site design to replace conventional pavements.
2. Stormwater runoff from pervious areas often contribute sediment and lead to clogging and increased maintenance requirements for pervious pavement, and should be avoided to the extent possible. Ideally, at least 90-percent of the area draining to pervious pavement shall be impervious, not including the permeable pavement area itself. Pretreatment, drainage area stabilization, and specific maintenance program are options that County staff will consider for implementation where contributing drainage area is less than 90-percent impervious.

3. The wearing surface shall meet the latest ADA requirements. The wearing surface is the pavement material plus any required bedding layers under the surface and inside of the joints, in accordance with all applicable standard details, specifications and manufacturer recommendations as applicable.
4. Stormwater conveyance from all impervious areas including standard pavement shall, to the extent feasible, drain to permeable pavement as sheet flow. Otherwise pre-treatment for energy dissipation and sediment control may be required where any concentrated flow is directed onto pervious pavement. Level spreaders may be designed to convert concentrated flow to sheet flow into the pervious pavement facility.
5. When the ratio of total drainage area (including permeable pavement) to area of permeable pavement is 1.5:1 or less and all other design requirements of this Fact Sheet are satisfied, a DMA is considered self-retaining for pollutant control only. A DMA cannot satisfy hydromodification management performance standards using permeable pavement as a Site Design BMP.

Maintenance Overview

Normal Expected Maintenance. Routine maintenance of permeable pavement includes: removal of materials such as trash and debris accumulated on the paving surface; vacuuming of the paving surface to prevent clogging; and flushing paving and subsurface gravel to remove fine sediment. If the BMP includes underdrains, check and clear underdrains. A summary table of standard inspection and maintenance indicators is provided within this Fact Sheet.

Non-Standard Maintenance or BMP Failure. If the permeable pavement area is not drained between storm events, or if runoff sheet flows across the permeable pavement area and flows off the permeable pavement area during storm events, the BMP is not performing as intended to protect downstream waterways from pollution and/or erosion. During storm events up to the 85th percentile storm event (approximately 0.5 to 1 inch of rainfall in San Diego County), runoff should not flow off the permeable pavement area. The permeable pavement area is expected to have adequate hydraulic conductivity and storage such that rainfall landing on the permeable pavement and runoff from the surrounding drainage area will go directly into the pavement without ponding or overflow (in properly designed systems, the surrounding drainage area is not more than half as large as the permeable pavement area). Following the storm event, there should be no standing water (puddles) on the permeable pavement area.

If storm water is flowing off the permeable pavement during a storm event, or if there is standing water on the permeable pavement surface following a storm event, this is an indicator of clogging somewhere within the system. Poor drainage can result from clogging of the permeable surface layer, any of the subsurface components, or the subgrade soils. The specific cause of the drainage issue must be determined and corrected. Surface or subsurface ponding longer than approximately 96 hours following a storm event poses a risk of vector (mosquito) breeding. Corrective maintenance, increased inspection and maintenance, BMP replacement, or a different BMP type will be required. If poor drainage persists after flushing of the paving, subsurface gravel, and/or underdrain(s) when applicable, or if it is determined that the underlying soils do not have the infiltration capacity expected, County staff shall be contacted prior to any additional repairs or reconstruction.

Other Special Considerations. Site design BMPs, such as permeable pavement, installed within a new development or redevelopment project are components of an overall storm water management strategy for the project. The presence of site design BMPs within a project is usually a factor in the determination of the amount of runoff to be managed with structural BMPs (i.e., the amount of runoff expected to reach downstream retention or biofiltration basins that process storm water runoff from the project as a whole). When site design BMPs are not maintained or are removed, this can lead to clogging or failure of downstream structural BMPs due to greater delivery of runoff and pollutants than intended for the structural BMP. Therefore, County staff may require confirmation of maintenance of site design BMPs as part of their structural BMP maintenance documentation requirements. Site design BMPs that have been installed as part of the project should not be removed, nor should they be bypassed by re-routing roof drains or re-grading surfaces within the project. If changes are necessary, consult County staff to determine requirements.

The runoff storage and infiltration surface area in this BMP are not readily accessible because they are subsurface. This means that clogging and poor drainage are not easily corrected. If the tributary area draining to the BMP includes unpaved areas, the sediment load from the tributary drainage area can be too high, reducing BMP function or clogging the BMP. All unpaved areas within the tributary drainage area should be stabilized with vegetation. Other pretreatment components to prevent transport of sediment to the paving surface, such as grass buffer strips, will extend the life of the subsurface components and infiltration surface. Along with proper stabilization measures and pretreatment within the tributary area, routine maintenance including preventive vacuum/regenerative air street sweeping, is key to preventing clogging.

Summary of Standard Inspection and Maintenance

The property owner is responsible to ensure inspection, operation and maintenance of permanent BMPs on their property unless responsibility has been formally transferred to an agency, community facilities district, homeowners association, property owners association, or other special district.

Maintenance frequencies listed in this table are average/typical frequencies. Actual maintenance needs are site-specific, and maintenance may be required more frequently. Maintenance must be performed whenever needed, based on maintenance indicators presented in this table. The BMP owner is responsible for conducting regular inspections to see when maintenance is needed based on the maintenance indicators. During the first year of operation of a structural BMP, inspection is recommended at least once prior to August 31 and then monthly from September through May. Inspection during a storm event is also recommended. After the initial period of frequent inspections, the minimum inspection and maintenance frequency can be determined based on the results of the first year inspections.

Threshold/Indicator	Maintenance Action	Inspection and Maintenance Frequency
Preventive vacuum/regenerative air street sweeping	Pavement should be swept with a vacuum power or regenerative air street sweeper to maintain infiltration through paving surface	<ul style="list-style-type: none"> • Schedule/perform this preventive action at least twice per year.
Accumulation of sediment, litter, or debris on permeable pavement surface	Remove and properly dispose of accumulated materials. Inspect tributary area for exposed soil or other sources of sediment and apply stabilization measures to sediment source areas. Apply source control measures as applicable to sources of litter or debris.	<ul style="list-style-type: none"> • Inspect monthly and after every 0.5-inch or larger storm event. • Remove any accumulated materials found at each inspection.

SD-D Permeable Pavement (Site Design BMP)

Threshold/Indicator	Maintenance Action	Inspection and Maintenance Frequency
Weeds growing on/through the permeable pavement surface	Remove weeds and add features as necessary to prevent weed intrusion. Use non-chemical methods (e.g., instead of pesticides, control weeds using mechanical removal, physical barriers, and/or physical changes in the surrounding area adjacent to pavement that will preclude weed intrusion into the pavement).	<ul style="list-style-type: none"> • Inspect monthly. • Remove any weeds found at each inspection.
Standing water in permeable paving area following a storm event, or runoff is observed overflowing off the permeable paving surface during a storm event	This condition requires investigation of why infiltration is not occurring. If feasible, corrective action shall be taken to restore infiltration (e.g., pavement should be swept with a vacuum power or regenerative air street sweeper to restore infiltration rates, clear underdrains if underdrains are present). BMP may require retrofit if infiltration cannot be restored. The County reviewer shall be contacted prior to any repairs or reconstruction.	<ul style="list-style-type: none"> • Inspect monthly and after every 0.5-inch or larger storm event. If standing water is observed, increase inspection frequency to after every 0.1-inch or larger storm event. • Maintain when needed.

SD-D Permeable Pavement (Site Design BMP)

Threshold/Indicator	Maintenance Action	Inspection and Maintenance Frequency
<p>Presence of mosquitos/larvae</p> <p>For images of egg rafts, larva, pupa, and adult mosquitos, see http://www.mosquito.org/biology</p>	<p>If mosquitos/larvae are observed: first, immediately remove any standing water by dispersing to nearby landscaping; second, make corrective measures as applicable to restore BMP drainage to prevent standing water.</p> <p>If mosquitos persist following corrective measures to remove standing water, or if the BMP design does not meet the 96-hour drawdown criteria because the underlying soils do not have the infiltration capacity expected, the County reviewer shall be contacted to determine a solution. A different BMP type, or a Vector Management Plan prepared with concurrence from the County of San Diego Department of Environmental Health, may be required.</p>	<ul style="list-style-type: none"> • Inspect monthly and after every 0.5-inch or larger storm event. If mosquitos are observed, increase inspection frequency to after every 0.1-inch or larger storm event. • Maintain when needed.
<p>Damage to permeable paving surface (e.g., cracks, settlement, misaligned paver blocks, void spaces between paver blocks need fill materials replenished)</p>	<p>Repair or replace damaged surface as appropriate.</p>	<ul style="list-style-type: none"> • Inspect annually. • Maintain when needed.

This page was intentionally left blank

E.6 SD-E Rain Barrels



Photo Credit: San Diego Low Impact Development Design Manual

MS4 Permit Category

Site Design

Manual Category

Site Design

Applicable Performance Standard

Site Design

Primary Benefits

Description

Rain barrels are containers that can capture rooftop runoff and store it for future use. With controlled timing and volume release, the captured rainwater can be used for irrigation or alternative grey water between storm events, thereby reducing runoff volumes and associated pollutants to downstream waterbodies. Rain barrels tend to be smaller systems, less than 100 gallons, and have low installation costs. Treatment can be achieved when rain barrels are used as part of a treatment train along with other BMPs that use captured flows in applications that do not result in discharges into the storm drain system. Rooftops are the ideal tributary areas for rain barrels. Due to San Diego's arid climate, some rain barrels may fill only a few times each year.

Typical Rain Barrel Components
Storage container, barrel or tank for holding captured flows
Inlet and associated valves and piping
Outlet and associated valves and piping
Overflow outlet
Optional pump
Optional first flush diverters
Optional roof, supports, foundation, level indicator, and other accessories

Design Adaptations for Project Goals

Site design BMP to reduce effective impervious area and DCV. Barrels can be used as a site design feature to reduce the effective impervious area of the site by removing roof runoff from the site discharge. This can reduce the DCV and flow control requirements for the site.

Conceptual Design and Sizing Approach for Site Design

1. Determine the areas where rain barrels can be used in the site design to capture roof runoff to reduce the DCV. Rain barrels reduce the effective impervious area of the site by removing roof runoff from the site discharge.

2. Calculate the DCV per Appendix B.2, taking into account reduced runoff from permeable pavement areas. Credit can be taken for the full rain barrel volume when each barrel volume is smaller than 100 gallons, and meet the following criteria: total rain barrel volume is less than 0.25 DCV and landscape areas are greater than 30 percent of the project footprint. Credit for harvest and use systems that do not meet the above criteria must be based on the criteria in Appendix B.3 and HU-1 fact sheet.

Maintenance Overview

Normal Expected Maintenance. Rain barrels can be expected to accumulate some debris that is small enough to pass through the inlet into the storage container. Leaves may accumulate at the inlet. Ancillary parts including valves, piping, screens, level indicators, and other accessories will wear and require occasional replacement. Maintenance of a rain barrel generally involves: removing accumulated debris from the inlet and storage container on a routine basis; and replacement of ancillary parts on an as-needed basis. A summary table of standard inspection and maintenance indicators is provided within this Fact Sheet. If the system includes a pump, maintenance of the pump shall be based on the manufacturer's recommended maintenance plan.

Non-Standard Maintenance or BMP Failure. If any of the following scenarios are observed, the BMP is not performing as intended to protect downstream waterways from pollution and/or erosion. Corrective maintenance, increased inspection and maintenance, BMP replacement, or a different BMP type will be required.

- The inlet is found to be obstructed at every inspection such that storm water bypasses the rain barrel. The rain barrel is not functioning properly if it is not capturing storm water. This would require addition of ancillary features to protect the inlet, such as screens on roof gutters.
- The rain barrel is not drained between storm events. If the rain barrel is not drained between storm events, the storage volume will be diminished and the rain barrel will not capture the required volume of storm water from subsequent storms. This would require implementation of practices onsite to drain and use the stored water, or a different BMP if onsite use cannot be reliably sustained.

Other Special Considerations. Site design BMPs, such as rain barrels, installed within a new development or redevelopment project are components of an overall storm water management strategy for the project. The presence of site design BMPs within a project is usually a factor in the determination of the amount of runoff to be managed with structural BMPs (i.e., the amount of runoff expected to reach downstream retention or biofiltration basins that process storm water runoff from the project as a whole). When site design BMPs are not maintained or are removed, this can lead to clogging or failure of downstream structural BMPs due to greater delivery of runoff and pollutants than intended for the structural BMP. Therefore, the County reviewer may require confirmation of maintenance of site design BMPs as part of their structural BMP maintenance documentation requirements. Site design BMPs that have been installed as part of the project should not be removed, nor should they be bypassed by re-routing roof drains or re-grading surfaces within the project. If changes are necessary, consult the County reviewer to determine requirements.

Summary of Standard Inspection and Maintenance

The property owner is responsible to ensure inspection, operation and maintenance of permanent BMPs on their property unless responsibility has been formally transferred to an agency, community facilities district, homeowners association, property owners association, or other special district.

Maintenance frequencies listed in this table are average/typical frequencies. Actual maintenance needs are site-specific, and maintenance may be required more frequently. Maintenance must be performed whenever needed, based on maintenance indicators presented in this table. The BMP owner is responsible for conducting regular inspections to see when maintenance is needed based on the maintenance indicators. During the first year of operation of a structural BMP, inspection is recommended at least once prior to August 31 and then monthly from September through May. Inspection during a storm event is also recommended. After the initial period of frequent inspections, the minimum inspection and maintenance frequency can be determined based on the results of the first year inspections.

Threshold/Indicator	Maintenance Action	Inspection and Maintenance Frequency
Accumulation of debris at the inlet	Remove and properly dispose of accumulated materials.	<ul style="list-style-type: none"> • Inspect monthly and after every 0.5-inch or larger storm event. • Remove any accumulated materials found at each inspection.
Outlet blocked	Clear blockage.	<ul style="list-style-type: none"> • Inspect monthly and after every 0.5-inch or larger storm event. • Remove any accumulated materials found at each inspection.
Accumulation of debris in the storage container	Remove and properly dispose of accumulated materials.	<ul style="list-style-type: none"> • Inspect twice per year. • Maintain when needed.
Leaks or other damage to storage container	Repair or replace as applicable.	<ul style="list-style-type: none"> • Inspect twice per year. • Maintain when needed.
Standing water in storage container between storm events outside of normal use timeframe for the stored water. Normal use timeframe is 36 to 96 hours following a storm event.	Use the water as intended, or disperse to landscaping.	<ul style="list-style-type: none"> • Inspect monthly and after every 0.5-inch or larger storm event. If standing water is observed, increase inspection frequency to after every 0.1-inch or larger storm event. • Maintain when needed.

Threshold/Indicator	Maintenance Action	Inspection and Maintenance Frequency
<p>Presence of mosquitos/larvae</p> <p>For images of egg rafts, larva, pupa, and adult mosquitos, see http://www.mosquito.org/biology</p>	<p>If mosquitos/larvae are observed: first, immediately remove any standing water by using the water as intended for irrigation or alternative grey water, or by dispersing to landscaping; second, check outlet for blockage and clear blockage if applicable to restore drainage; third, install barriers such as screens that prevent mosquito access to the storage container.</p>	<ul style="list-style-type: none"> • Inspect monthly and after every 0.5-inch or larger storm event. If mosquitos are observed, increase inspection frequency to after every 0.1-inch or larger storm event. • Maintain when needed.
<p>Leaks or other damage to ancillary parts including valves, piping, screens, level indicators, and other accessories</p>	<p>Repair or replace as applicable.</p>	<ul style="list-style-type: none"> • Inspect twice per year. • Maintain when needed.
<p>Rain barrel leaning or unstable, damage to roof, supports, anchors, or foundation</p>	<p>Make repairs as appropriate to correct the problem and stabilize the system.</p>	<ul style="list-style-type: none"> • Inspect twice per year. • Maintain when needed.

E.7 SD-F Amended Soil

Image Credit: WDOE Guidelines and Resources for Implementing Amended Soil BMP T5.13

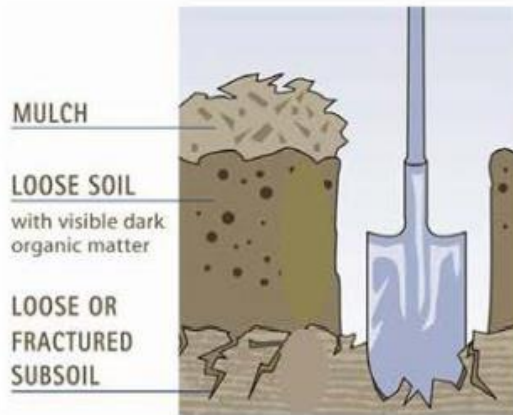

MS4 Permit Category

Site Design

Manual Category

Site Design

Applicable Performance Standard

Site Design

Primary Benefits

Volume Reduction

Peak Flow Attenuation

Description

Amended soils are soils whose physical, chemical, and biological characteristics have been altered from the natural condition to promote beneficial storm water characteristics. Amended soils shall be used as part of SD-B Impervious Area Dispersion, where applicable. Typical storm water management benefits associated with amended soils include:

- **Improved hydrologic characteristics**—amended soils can promote infiltration, decrease runoff rates and volumes, and more effectively filter pollutants from storm water runoff
- **Improved vegetation health**—amended soils provide greater moisture retention, and altered chemical and biological characteristics that can result in healthier plant growth, reduced irrigation demands, and reduced need for fertilization and maintenance
- **Reduced erosion**—amended soils produce healthier plant growth and reduced runoff which results in reduced soil erosion

Not all amended soils have the same storm water benefits, the soil amendment used should be suited for the design purpose and design period of the amended area.

Design Adaptations for Project Goals

Amended soil primarily functions as a site design BMP for reducing the effective imperviousness of a site by providing partial or full infiltration of the flows that are routed to amended soil areas and otherwise slowing down excess flows that eventually reach the storm drain system. Amended soil is used in conjunction with SD-B Impervious Area Dispersion.

Varying categories of soil amendments have different benefits and applications. Mulch is a soil amendment that is added at grade, rather than mixed into the soil. Mulch reduces evaporation and improves retention. Shavings and compost are common soil amendments that improve biological and chemical properties of the soil. Sand can be used as an amendment to improve the drainage rates of amended soils. Native soil samples may need to be analyzed by a lab to determine the specific soil amendments needed to achieve the desired infiltration, retention, and/or filtration rates.

Amending soil per these guidelines is not the same as preservation of naturally occurring topsoil and vegetation. However, amending soil will improve on-site management of storm water flow and water quality.

Design Criteria and Considerations

Soil amendments must meet the following design criteria and considerations. Deviations from the below criteria may be approved at the discretion of the County reviewer if appropriate:

<i>Siting and Design</i>	<i>Intent/Rationale</i>
<input type="checkbox"/> Mulch is applied at grade over all planting areas to a depth of 3”.	Mulch should be applied on top and not mixed into underlying soils
<input type="checkbox"/> Shavings or compost are rototilled into the native soil to a minimum depth of 6” (12 inches preferred).	If soil is not completely mixed the overall benefit will be reduced.
<input type="checkbox"/> Compost meets the criteria in Appendix F.2 Section 803-5.1	If poor quality compost is used, it will have negative impact to water quality.
<input type="checkbox"/> Soil amendments are free of stones, stumps, roots, glass, plastic, metal, and other deleterious materials.	Large debris in amended soils can cause localized erosion. Trash/harmful materials can result in personal injury or contamination.
<input type="checkbox"/> Mixing of soils are done prior to planting	Soil mixing before planting results in a more homogeneous mixing and will reduce the stress on plants.
<input type="checkbox"/> Care is taken around existing trees and shrubs to prevent root damage during construction and soil amendment application.	Preservation of existing established vegetation is an important part of site design and erosion control.
<input type="checkbox"/> Soil amendments are applied at the end of construction	Soil amendments applied too soon in the construction process may become over compacted reducing effectiveness.
<input type="checkbox"/> Soil amendments are compatible with planned vegetation	The soil amendments impact the pH and salinity of the soil. Some plants have sensitive pH and/or salinity tolerance ranges.

Conceptual Design and Sizing Approach for Site Design

- When soil amendments are used a runoff factor of 0.1 can be used for DCV calculation for the amended area.
- Amended soils should be used as part of SD-B Impervious Area Dispersion, and to increase the retention volume in other BMPs.

Maintenance

Annual maintenance may be required to determine reapplication requirements of amended soils. Amended soils should be regularly inspected for signs of compaction, waterlogging, and unhealthy vegetation.

This page was intentionally left blank

E.8 HU-1 Cistern



Photo Credit: Water Environment Research Foundation: WERF.org

MS4 Permit Category

Retention

Manual Category

Harvest and Use

Applicable Performance Standards

Pollutant Control

Flow Control

Primary Benefits

Volume Reduction

Peak Flow Attenuation

Description

Cisterns are containers that can capture rooftop runoff and store it for future use. With controlled timing and volume release, the captured rainwater can be used for irrigation or alternative grey water between storm events, thereby reducing runoff volumes and associated pollutants to downstream water bodies. Cisterns are larger systems (generally >100 gallons) that can be self-contained aboveground or below ground systems. Treatment can be achieved when cisterns are used as part of a treatment train along with other BMPs that use captured flows in applications that do not result in discharges into the storm drain system. Rooftops are the ideal tributary areas for cisterns.

Typical cistern components include:

- Storage container, barrel or tank for holding captured flows
- Inlet and associated valves and piping
- Outlet and associated valves and piping
- Overflow outlet
- Optional pump
- Optional first flush diverters
- Optional roof, supports, foundation, level indicator, and other accessories

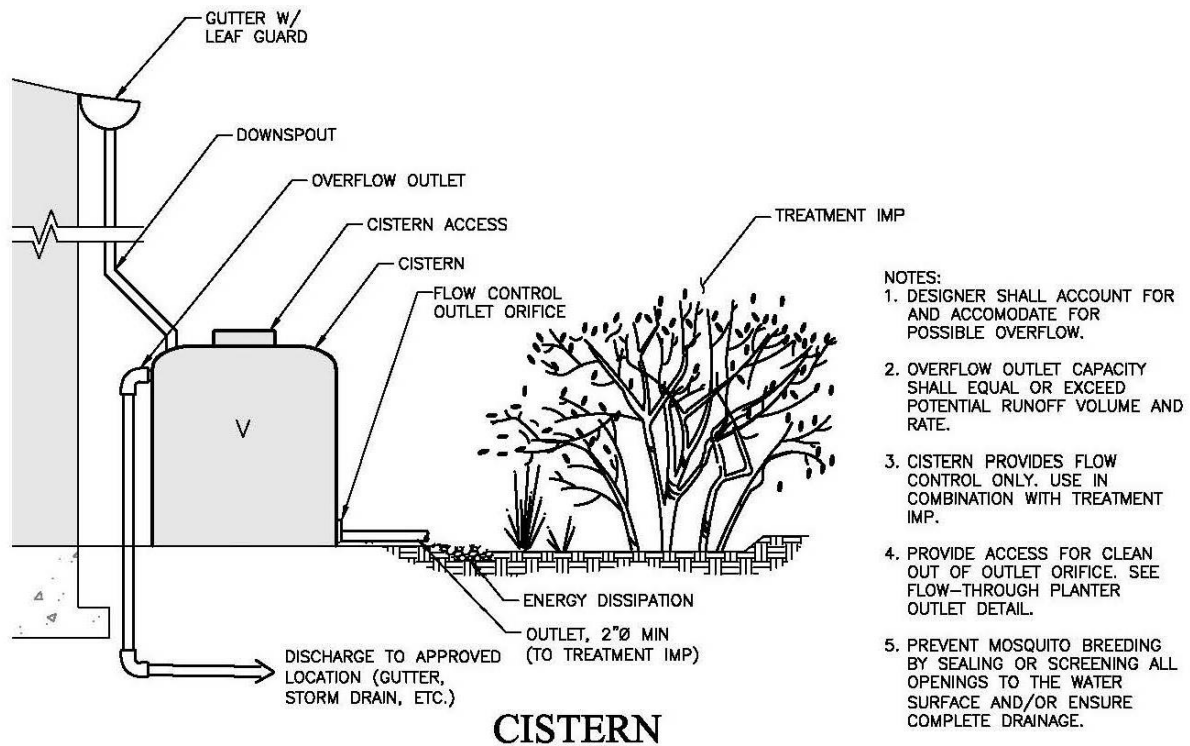

Source: City of San Diego Storm Water Standards

Design Adaptations for Project Goals

Site design BMP to reduce effective impervious area and DCV. Cisterns can be used as a site design feature to reduce the effective impervious area of the site by removing roof runoff from the site discharge. This can reduce the DCV and flow control requirements for the site.

Harvest and use for storm water pollutant control. Typical uses for captured flows include irrigation, toilet flushing, cooling system makeup, and vehicle and equipment washing.

Integrated storm water flow control and pollutant control configuration. Cisterns provide flow control in the form of volume reduction and/or peak flow attenuation and storm water treatment through elimination of discharges of pollutants. Additional flow control can be achieved by sizing the cistern to include additional detention storage and/or real-time automated flow release controls.

Design Criteria and Considerations

Cisterns must meet the following design criteria. Deviations from the below criteria may be approved at the discretion of County staff if it is determined to be appropriate:

<i>Siting and Design</i>	<i>Intent/Rationale</i>
<input type="checkbox"/> Cisterns are sized to detain the full DCV of contributing area and empty within 36 hours.	<p>Draining the cistern makes the storage volume available to capture the next storm.</p> <p>The applicant has an option to use a different drawdown time up to 120 hours if the volume of the facility is adjusted using the percent capture method in Appendix B.4.1.</p>
<input type="checkbox"/> Cisterns are fitted with a flow control device such as an orifice or a valve to limit outflow in accordance with drawdown time requirements.	<p>Flow control provides flow attenuation benefits and limits cistern discharge to downstream facilities during storm events.</p>
<input type="checkbox"/> Cisterns are designed to drain completely, leaving no standing water, and all entry points are fitted with traps or screens, or sealed.	<p>Complete drainage and restricted entry prevents mosquito habitat.</p>
<input type="checkbox"/> Leaf guards and/or screens are provided to prevent debris from accumulating in the cistern.	<p>Leaves and organic debris can clog the outlet of the cistern.</p>
<input type="checkbox"/> Access is provided for maintenance and the cistern outlets are accessible and designed to allow easy cleaning.	<p>Properly functioning outlets are needed to maintain proper flow control in accordance with drawdown time requirements.</p>
<input type="checkbox"/> Cisterns must be designed and sited such that overflow will be conveyed safely overland to the storm drain system or discharge point.	<p>Safe overflow conveyance prevents flooding and damage of property.</p>

Conceptual Design and Sizing Approach for Site Design and Storm Water Pollutant Control

1. Calculate the DCV for site design per Appendix B.
2. Determine the locations on the site where cisterns can be located to capture and detain the DCV from roof areas without subsequent discharge to the storm drain system. Cisterns are best located in close proximity to building and other roofed structures to minimize piping. Cisterns can also be used as part of a treatment train upstream by increasing pollutant control through delayed runoff to infiltration BMPs such as bioretention without underdrain facilities.
3. Use the sizing worksheet in Appendix B.3 to determine if full or partial capture of the DCV is achievable.
4. The remaining DCV to be treated should be calculated for use in sizing downstream BMP(s).

Conceptual Design and Sizing Approach when Storm Water Flow Control is Applicable

Control of flow rates and/or duration will typically require significant cistern volumes, and therefore the following steps should be taken prior to determination of site design and storm water pollutant control. Pre-development and allowable post-project flow rates and durations should be determined as discussed in Chapter 6 of the manual.

1. Verify that cistern siting and design criteria have been met. Design for flow control can be achieved using various design configurations, shapes, and quantities of cisterns.
2. Iteratively determine the cistern storage volume required to provide detention storage to reduce flow rates and durations to allowable limits. Flow rates and durations can be controlled from detention storage by altering outlet structure orifice size(s) and/or water control valve operation.
3. Verify that the cistern is drawdown within 36 hours. The drawdown time can be estimated by dividing the storage volume by the rate of use of harvested water.
4. If the cistern cannot fully provide the flow rate and duration control required by this manual, a downstream structure with additional storage volume or infiltration capacity such as a biofiltration can be used to provide remaining flow control.

Maintenance Overview

Normal Expected Maintenance. Cisterns can be expected to accumulate sediment and debris that is small enough to pass through the inlet into the storage container. Larger debris such as leaves or trash may accumulate at the inlet. While the storage container is generally a permanent structure, ancillary parts including valves, piping, screens, level indicators, and other accessories will wear and require occasional replacement. Maintenance of a cistern generally involves: removing accumulated sediment and debris from the inlet and storage container on a routine basis; and replacement of ancillary parts on an as-needed basis. A summary table of standard inspection and maintenance indicators is provided within this Fact Sheet. If the system as a whole includes a pump or other electrical equipment, maintenance of the equipment shall be based on the manufacturer's recommended maintenance plan.

Non-Standard Maintenance or BMP Failure. If any of the following scenarios are observed, the BMP is not performing as intended to protect downstream waterways from pollution and/or erosion. Corrective maintenance, increased inspection and maintenance, BMP replacement, or a different BMP type will be required.

- The inlet is found to be obstructed at every inspection such that storm water bypasses the cistern. The cistern is not functioning properly if it is not capturing storm water. This would require addition of ancillary features to protect the inlet, or pretreatment measures within the watershed draining to the cistern to intercept larger debris, such as screens on roof gutters, or drainage inserts within catch basins. Increase the frequency of inspection until the issue is resolved.

- Accumulation of sediment within one year is greater than 25% of the volume of the cistern. This means the sediment load from the tributary drainage area has diminished the storage volume of the cistern and the cistern will not capture the required volume of storm water. This would require pretreatment measures within the tributary area draining to the cistern to intercept sediment.
- The cistern is not drained between storm events. If the cistern is not drained between storm events, the storage volume will be diminished and the cistern will not capture the required volume of storm water from subsequent storms. This would require implementation of practices onsite to drain and use the stored water, or a different BMP if onsite use cannot be reliably sustained.

This page was intentionally left blank

Summary of Standard Inspection and Maintenance

The property owner is responsible to ensure inspection, operation and maintenance of permanent BMPs on their property unless responsibility has been formally transferred to an agency, community facilities district, homeowners association, property owners association, or other special district.

Maintenance frequencies listed in this table are average/typical frequencies. Actual maintenance needs are site-specific, and maintenance may be required more frequently. Maintenance must be performed whenever needed, based on maintenance indicators presented in this table. The BMP owner is responsible for conducting regular inspections to see when maintenance is needed based on the maintenance indicators. During the first year of operation of a structural BMP, inspection is recommended at least once prior to August 31 and then monthly from September through May. Inspection during a storm event is also recommended. After the initial period of frequent inspections, the minimum inspection and maintenance frequency can be determined based on the results of the first year inspections.

Threshold/Indicator	Maintenance Action	Inspection and Maintenance Frequency
Accumulation of sediment, litter, or debris at the inlet	Remove and properly dispose of accumulated materials.	<ul style="list-style-type: none"> • Inspect monthly and after every 0.5-inch or larger storm event. • Remove any accumulated materials found at each inspection.
Outlet blocked	Clear blockage. Remove any accumulated materials	<ul style="list-style-type: none"> • Inspect monthly and after every 0.5-inch or larger storm event. • Remove any accumulated materials found at each inspection.

Threshold/Indicator	Maintenance Action	Inspection and Maintenance Frequency
<p>Accumulation of sediment, litter, or debris in the storage container</p>	<p>Remove and properly dispose of accumulated materials.</p>	<ul style="list-style-type: none"> ● Inspect monthly. If the BMP is 25% full* or more in one month, increase inspection frequency to monthly plus after every 0.1-inch or larger storm event. ● Remove materials annually (minimum), or more frequently when BMP is 25% full* (or at manufacturer threshold if manufacturer threshold is less than 25% full*) in less than one year, or if accumulation blocks outlet
<p>Standing water in storage container between storm events outside of normal use timeframe for the stored water. Normal use timeframe is 36 to 96 hours following a storm event depending on the purpose and design of the cistern.</p>	<p>Use the water as intended, or disperse to landscaping.</p> <p>Implement practices onsite to drain and use the stored water.</p> <p>Contact the County reviewer to determine a solution if onsite use cannot be reliably sustained.</p>	<ul style="list-style-type: none"> ● Inspect monthly and after every 0.5-inch or larger storm event. If standing water is observed, increase inspection frequency to after every 0.1-inch or larger storm event. ● Maintain when needed.
<p>Presence of mosquitos/larvae</p> <p>For images of egg rafts, larva, pupa, and adult mosquitos, see http://www.mosquito.org/biology</p>	<p>If mosquitos/larvae are observed: first, immediately remove any standing water by using the water as intended for irrigation or alternative grey water, or by dispersing to landscaping; second, check cistern outlet for blockage and clear blockage if applicable to restore drainage; third, install barriers such as screens that prevent mosquito access to the storage container.</p>	<ul style="list-style-type: none"> ● Inspect monthly and after every 0.5-inch or larger storm event. If mosquitos are observed, increase inspection frequency to after every 0.1-inch or larger storm event. ● Maintain when needed.

Threshold/Indicator	Maintenance Action	Inspection and Maintenance Frequency
Leaks or other damage to ancillary parts including valves, piping, screens, level indicators, and other accessories	Repair or replace as applicable.	<ul style="list-style-type: none"> • Inspect twice per year. • Maintain when needed.
Leaks or other damage to storage container	Repair or replace as applicable.	<ul style="list-style-type: none"> • Inspect twice per year. • Maintain when needed.
Cistern leaning or unstable, damage to roof, supports, anchors, or foundation	Make repairs as appropriate to correct the problem and stabilize the system.	<ul style="list-style-type: none"> • Inspect twice per year. • Maintain when needed.

This page was intentionally left blank

E.9 INF-1 Infiltration Basin



Photo Credit: <http://www.stormwaterpartners.com/facilities/basin.html>

MS4 Permit Category

Retention

Manual Category

Infiltration

Applicable Performance Standard

Pollutant Control
Flow Control

Primary Benefits

Volume Reduction
Peak Flow Attenuation

Description

An infiltration basin typically consists of an earthen basin with a flat bottom constructed in naturally pervious soils. An infiltration basin retains storm water and allows it to evaporate and/or percolate into the underlying soils. The bottom of an infiltration basin is typically vegetated with native grasses or turf grass; however other types of vegetation can be used if they can survive periodic inundation and long inter-event dry periods. Treatment is achieved primarily through infiltration, filtration, sedimentation, biochemical processes and plant uptake. Infiltration basins can be constructed as linear **trenches** or as **underground infiltration galleries**.

Typical infiltration basin components include:

- Inflow distribution mechanisms (e.g., perimeter flow spreader or filter strips)
- Energy dissipation mechanism for concentrated inflows (e.g., splash blocks or riprap)
- Forebay to provide pretreatment surface ponding for captured flows, other pretreatment mechanisms may be used if they meet the requirements included in Appendix J.5.
- Vegetation selected based on basin use, climate, and ponding depth
- Uncompacted native soils at the bottom of the facility
- Overflow structure

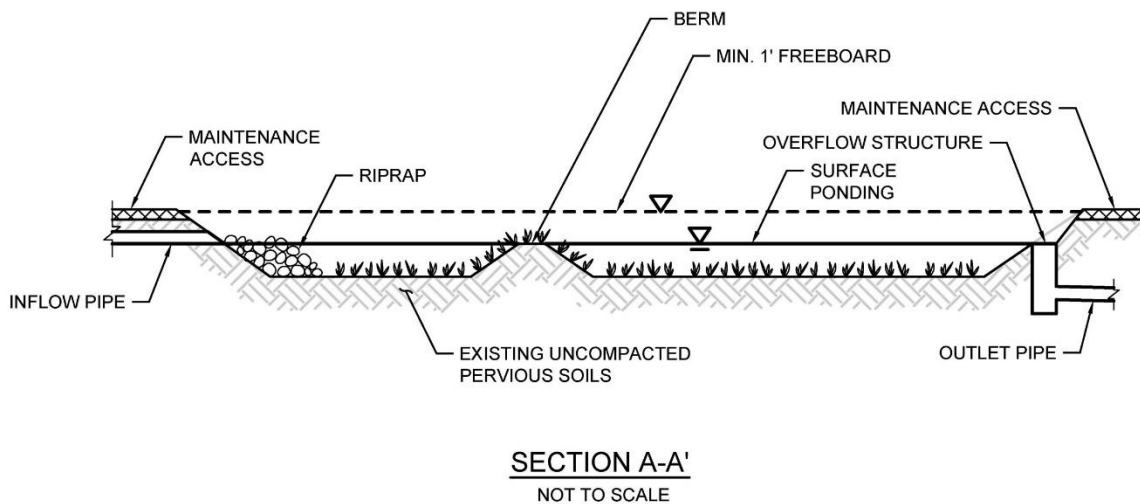
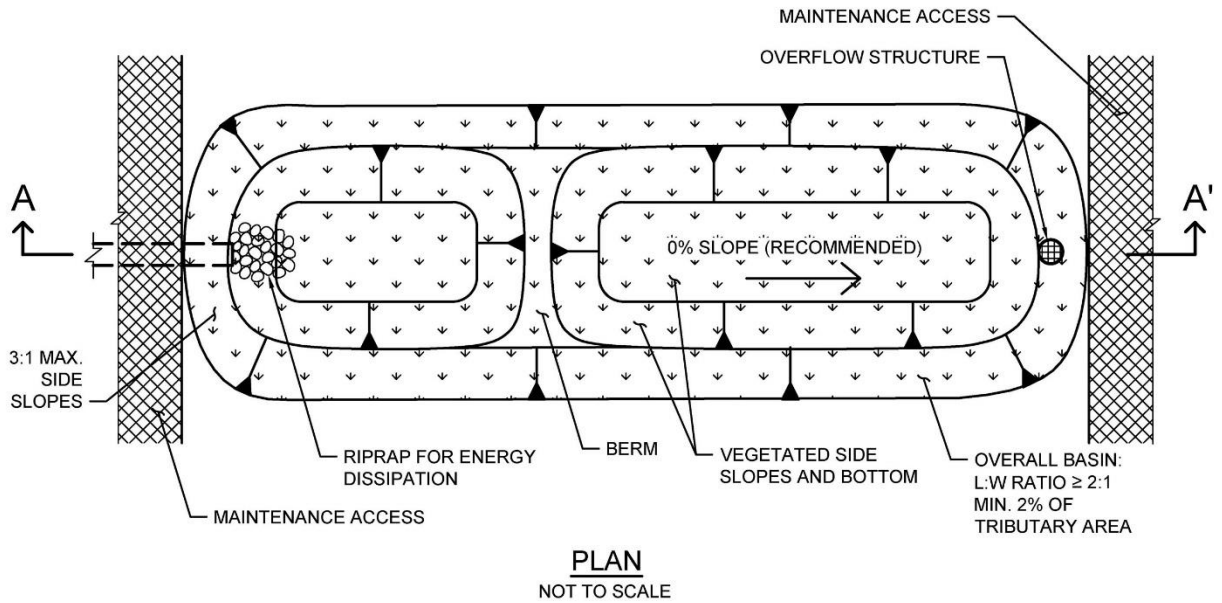

Typical plan and section view of an Infiltration BMP

Design Adaptations for Project Goals

Full infiltration BMP for storm water pollutant control. Infiltration basins can be used as a pollutant control BMP, designed to infiltrate runoff from direct rainfall as well as runoff from adjacent areas that are tributary to the BMP. Infiltration basins must be designed with an infiltration storage volume (a function of the surface ponding volume) equal to the full DCV and able to meet drawdown time limitations.

Integrated storm water flow control and pollutant control configuration. Infiltration basins can also be designed for flow rate and duration control by providing additional infiltration storage through increasing the surface ponding volume.

Design Criteria and Considerations

Infiltration basins must meet the following design criteria. Deviations from the below criteria may be approved at the discretion of County staff if it is determined to be appropriate:

<i>Siting and Design</i>	<i>Intent/Rationale</i>
<input type="checkbox"/> Placement observes geotechnical recommendations regarding potential hazards (e.g., slope stability, landslides, liquefaction zones) and setbacks (e.g., slopes, foundations, utilities).	Must not negatively impact existing site geotechnical concerns.
<input type="checkbox"/> Selection and design of basin is based on infiltration feasibility criteria and appropriate design infiltration rate (See Appendix B and D).	Must operate as a full infiltration design and must be supported by drainage area and in-situ infiltration rate feasibility findings.
<input type="checkbox"/> Finish grade of the facility is $\leq 2\%$ (0% recommended).	Flatter surfaces reduce erosion and channelization with the facility.
<input type="checkbox"/> Settling forebay has a volume $\geq 25\%$ of facility volume below the forebay overflow.	A forebay to trap sediment can decrease frequency of required maintenance.
<input type="checkbox"/> Infiltration of surface ponding is limited to a 36-hour drawdown time.	Prolonged surface ponding reduces volume available to capture subsequent storms. The applicant has an option to use a surface drawdown time of up to 96 hours if the volume of the facility is adjusted using the percent capture method in Appendix B.4.1.
<input type="checkbox"/> Minimum freeboard provided is ≥ 1 foot.	Freeboard minimizes risk of uncontrolled surface discharge.
<input type="checkbox"/> Side slopes are = 3H:1V or shallower.	Gentler side slopes are safer, less prone to erosion, able to establish vegetation more quickly and easier to maintain.

Inflow and Overflow Structures

<input type="checkbox"/> Inflow and outflow structures are accessible by required equipment (e.g., vactor truck) for inspection and maintenance.	Maintenance will prevent clogging and ensure proper operation of the flow control structures.
--	---

<i>Siting and Design</i>	<i>Intent/Rationale</i>
<input type="checkbox"/> Inflow velocities are limited to 3 ft/s or less or use energy dissipation methods (e.g., riprap, level spreader) for concentrated inflows.	High inflow velocities can cause erosion, scour and/or channeling.
<input type="checkbox"/> Overflow is safely conveyed to a downstream storm drain system or discharge point. Size overflow structure to pass 100-year peak flow for on-line basins and water quality peak flow for off-line basins.	Planning for overflow lessens the risk of property damage due to flooding.

Conceptual Design and Sizing Approach for Storm Water Pollutant Control

To design infiltration basins for storm water pollutant control only (no flow control required), the following steps should be taken:

1. Verify that siting and design criteria have been met, including placement and basin area requirements, forebay volume (not included in infiltration footprint for sizing), and maximum slopes for basin sides and bottom.
2. Calculate the DCV per Appendix B based on expected site design runoff for tributary areas.
3. Use the sizing worksheet (Appendix B.4) to determine if full infiltration of the DCV is achievable based on the infiltration storage volume calculated from the surface ponding area and depth for a maximum 36-hour drawdown time. The drawdown time can be estimated by dividing the average depth of the basin by the design infiltration rate. Appendix D provides guidance on evaluating a site’s infiltration rate.

Conceptual Design and Sizing Approach for Storm Water Pollutant Treatment and Flow Control

Control of flow rates and/or durations will typically require significant surface ponding volume, and therefore the following steps should be taken prior to determination of storm water pollutant control design. Pre-development and allowable post-project flow rates and durations should be determined as discussed in Chapter 6 of the manual.

1. Verify that siting and design criteria have been met, including placement and basin area requirements, forebay volume (not included in infiltration footprint for sizing), and maximum slopes for basin sides and bottom.
2. Iteratively determine the surface ponding required to provide infiltration storage to reduce flow rates and durations to allowable limits while adhering to the maximum 36-hour drawdown time. Flow rates and durations can be controlled using flow splitters that route the appropriate inflow amounts to the infiltration basin and bypass excess flows to the

- downstream storm drain system or discharge point.
3. If an infiltration basin cannot fully provide the flow rate and duration control required by this manual, an upstream or downstream structure with appropriate storage volume such as an underground vault can be used to provide additional control.
 4. After the infiltration basin has been designed to meet flow control requirements, calculations must be completed to verify if storm water pollutant control requirements to treat the DCV have been met.

Maintenance Overview

Normal Expected Maintenance. Infiltration basins require routine maintenance to: remove accumulated materials such as sediment, trash or debris from the forebay and the basin; maintain vegetation health if the BMP includes vegetation; and maintain integrity of side slopes, inlets, energy dissipators, and outlets. A summary table of standard inspection and maintenance indicators is provided within this Fact Sheet.

Non-Standard Maintenance or BMP Failure. If any of the following scenarios are observed, the BMP is not performing as intended to protect downstream waterways from pollution and/or erosion. Corrective maintenance, increased inspection and maintenance, BMP replacement, or a different BMP type will be required.

- The BMP is not drained between storm events. Surface ponding longer than approximately 24 hours following a storm event may be detrimental to vegetation health, and surface or subsurface ponding longer than approximately 96 hours following a storm event poses a risk of vector (mosquito) breeding. Poor drainage can result from clogging of the underlying native soils, or clogging of covers applied at the basin surface such as topsoil, mulch, or rock layer. The specific cause of the drainage issue must be determined and corrected. For surface-level basins (i.e., not underground infiltration galleries), surface cover materials can be removed and replaced, and/or native soils can be scarified or tilled to help reestablish infiltration. If it is determined that the underlying native soils have been compacted or do not have the infiltration capacity expected, or if the infiltration surface area is not accessible (e.g., an underground infiltration gallery) the County reviewer shall be contacted prior to any additional repairs or reconstruction.
- Sediment, trash, or debris accumulation has filled the forebay or other pretreatment device within one month, or if no forebay or other pretreatment device is present, has filled greater than 25% of the surface ponding volume within one maintenance cycle. This means the load from the tributary drainage area is too high, reducing BMP function or clogging the BMP. This would require adding a forebay or other pretreatment measures within the tributary area draining to the BMP to intercept the materials if no pretreatment component is present, or increased maintenance frequency for an existing forebay or other pretreatment device. Pretreatment components, especially for sediment, will extend the life of the infiltration basin.
- Erosion due to concentrated storm water runoff flow that is not readily corrected by adding

erosion control blankets, adding stone at flow entry points, or minor re-grading to restore proper drainage according to the original plan. If the issue is not corrected by restoring the BMP to the original plan and grade, the County reviewer shall be contacted prior to any additional repairs or reconstruction.

Other Special Considerations. If the infiltration basin is vegetated: Vegetated structural BMPs that are constructed in the vicinity of, or connected to, an existing jurisdictional water or wetland could inadvertently result in creation of expanded waters or wetlands. As such, vegetated structural BMPs have the potential to come under the jurisdiction of the United States Army Corps of Engineers, SDRWQCB, California Department of Fish and Wildlife, or the United States Fish and Wildlife Service. This could result in the need for specific resource agency permits and costly mitigation to perform maintenance of the structural BMP. Along with proper placement of a structural BMP, routine maintenance is key to preventing this scenario

Summary of Standard Inspection and Maintenance

The property owner is responsible to ensure inspection, operation and maintenance of permanent BMPs on their property unless responsibility has been formally transferred to an agency, community facilities district, homeowners association, property owners association, or other special district.

Maintenance frequencies listed in this table are average/typical frequencies. Actual maintenance needs are site-specific, and maintenance may be required more frequently. Maintenance must be performed whenever needed, based on maintenance indicators presented in this table. The BMP owner is responsible for conducting regular inspections to see when maintenance is needed based on the maintenance indicators. During the first year of operation of a structural BMP, inspection is recommended at least once prior to August 31 and then monthly from September through May. Inspection during a storm event is also recommended. After the initial period of frequent inspections, the minimum inspection and maintenance frequency can be determined based on the results of the first year inspections.

Threshold/Indicator	Maintenance Action	Inspection and Maintenance Frequency
Accumulation of sediment, litter, or debris in forebay and/or basin	Remove and properly dispose of accumulated materials, (without damage to vegetation when applicable).	<ul style="list-style-type: none"> • Inspect monthly. If the forebay is 25% full* or more in one month, increase inspection frequency to monthly plus after every 0.1-inch or larger storm event. • Remove any accumulated materials found within the infiltration area at each inspection. • When the BMP includes a forebay, materials must be removed from the forebay when the forebay is 25% full*, or if accumulation within the forebay blocks flow to the infiltration area.
Obstructed inlet or outlet structure	Clear blockage.	<ul style="list-style-type: none"> • Inspect monthly and after every 0.5-inch or larger storm event. • Remove any accumulated materials found at each inspection.

Threshold/Indicator	Maintenance Action	Inspection and Maintenance Frequency
Poor vegetation establishment (when the BMP includes vegetated surface by design)	Re-seed, re-plant, or re-establish vegetation per original plans.	<ul style="list-style-type: none"> • Inspect monthly. • Maintain when needed.
Dead or diseased vegetation (when the BMP includes vegetated surface by design)	Remove dead or diseased vegetation, re-seed, re-plant, or re-establish vegetation per original plans.	<ul style="list-style-type: none"> • Inspect monthly. • Maintain when needed.
Overgrown vegetation (when the BMP includes vegetated surface by design)	Mow or trim as appropriate.	<ul style="list-style-type: none"> • Inspect monthly. • Maintain when needed.
Erosion due to concentrated irrigation flow	Repair/re-seed/re-plant eroded areas and adjust the irrigation system.	<ul style="list-style-type: none"> • Inspect monthly. • Maintain when needed.
Erosion due to concentrated storm water runoff flow	Repair/re-seed/re-plant eroded areas, and make appropriate corrective measures such as adding erosion control blankets, adding stone at flow entry points, or minor re-grading to restore proper drainage according to the original plan. If the issue is not corrected by restoring the BMP to the original plan and grade, the County reviewer shall be contacted prior to any additional repairs or reconstruction.	<ul style="list-style-type: none"> • Inspect after every 0.5-inch or larger storm event. If erosion due to storm water flow has been observed, increase inspection frequency to after every 0.1-inch or larger storm event. • Maintain when needed. If the issue is not corrected by restoring the BMP to the original plan and grade, the County reviewer shall be contacted prior to any additional repairs or reconstruction.

Threshold/Indicator	Maintenance Action	Inspection and Maintenance Frequency
<p>Standing water in infiltration basin without subsurface infiltration gallery for longer than 24-96 hours following a storm event</p>	<p>Make appropriate corrective measures such as adjusting irrigation system, removing obstructions of debris or invasive vegetation, or removing/replacing clogged or compacted surface treatments and/or scarifying or tilling native soils. Always remove deposited sediments before scarification, and use a hand-guided rotary tiller. If it is determined that the underlying native soils have been compacted or do not have the infiltration capacity expected, the County reviewer shall be contacted prior to any additional repairs or reconstruction.</p>	<ul style="list-style-type: none"> • Inspect monthly and after every 0.5-inch or larger storm event. If standing water is observed, increase inspection frequency to after every 0.1-inch or larger storm event. • Maintain when needed.
<p>Standing water in subsurface infiltration gallery for longer than 24-96 hours following a storm event</p>	<p>This condition requires investigation of why infiltration is not occurring. If feasible, corrective action shall be taken to restore infiltration (e.g., flush fine sediment or remove and replace clogged soils). BMP may require retrofit if infiltration cannot be restored. The County reviewer shall be contacted prior to any repairs or reconstruction.</p>	<ul style="list-style-type: none"> • Inspect monthly and after every 0.5-inch or larger storm event. If standing water is observed, increase inspection frequency to after every 0.1-inch or larger storm event. • Maintain when needed.

Threshold/Indicator	Maintenance Action	Inspection and Maintenance Frequency
<p>Presence of mosquitos/larvae</p> <p>For images of egg rafts, larva, pupa, and adult mosquitos, see http://www.mosquito.org/biology</p>	<p>If mosquitos/larvae are observed: first, immediately remove any standing water by dispersing to nearby landscaping; second, make corrective measures as applicable to restore BMP drainage to prevent standing water. For subsurface infiltration galleries, ensure access covers are tight fitting, with gaps or holes no greater than 1/16 inch, and/or install barriers such as inserts or screens that prevent mosquito access to the subsurface storage.</p> <p>If mosquitos persist following corrective measures to remove standing water, or if the BMP design does not meet the 96-hour drawdown criteria because the underlying native soils have been compacted or do not have the infiltration capacity expected, the County reviewer shall be contacted to determine a solution. A different BMP type, or a Vector Management Plan prepared with concurrence from the County of San Diego Department of Environmental Health, may be required.</p>	<ul style="list-style-type: none"> • Inspect monthly and after every 0.5-inch or larger storm event. If mosquitos are observed, increase inspection frequency to after every 0.1-inch or larger storm event. • Maintain when needed
<p>Damage to structural components such as weirs, inlet or outlet structures</p>	<p>Repair or replace as applicable.</p>	<ul style="list-style-type: none"> • Inspect annually. • Maintain when needed.

“25% full” is defined as ¼ of the depth from the design bottom elevation to the crest of the outflow structure (e.g., if the height to the outflow opening is 12 inches from the bottom elevation, then the materials must be removed when there is 3 inches of accumulation – this should be marked on the outflow structure).

E.10 INF-2 Bioretention



Photo Credit: Ventura County Technical Guidance Document

MS4 Permit Category

Retention

Manual Category

Infiltration

Applicable Performance Standard

Pollutant Control
Flow Control

Primary Benefits

Volume Reduction
Treatment
Peak Flow Attenuation

Description

Bioretention (bioretention without underdrain) facilities are vegetated surface water systems that filter water through vegetation and soil, or engineered media prior to infiltrating into native soils. These facilities are designed to infiltrate the full DCV. Bioretention facilities are commonly incorporated into the site within parking lot landscaping, along roadsides, and in open spaces. They can be constructed inground or partially aboveground, such as planter boxes with open bottoms (no impermeable liner at the bottom) to allow infiltration. Treatment is achieved through filtration, sedimentation, sorption, infiltration, biochemical processes and plant uptake.

Typical bioretention without underdrain components include:

- Inflow distribution mechanisms (e.g, perimeter flow spreader or filter strips)
- Energy dissipation mechanism for concentrated inflows (e.g., splash blocks or riprap)
- Shallow surface ponding for captured flows
- Side slope and basin bottom vegetation selected based on expected climate and ponding depth
- Non-floating mulch layer
- Media layer (planting mix or engineered media) capable of supporting vegetation growth
- Filter course layer consisting of aggregate to prevent the migration of fines into uncompacted native soils or the optional aggregate storage layer
- Optional aggregate storage layer for additional infiltration storage
- Uncompacted native soils at the bottom of the facility
- Overflow structure

Design Adaptations for Project Goals

- **Full infiltration BMP for storm water pollutant control.** Bioretention can be used as a pollutant control BMP designed to infiltrate runoff from direct rainfall as well as runoff from adjacent tributary areas. Bioretention facilities must be designed with an infiltration storage volume (a function of the ponding, media and aggregate storage volumes) equal to the full DCV and able to meet drawdown time limitations.
- **Integrated storm water flow control and pollutant control configuration.** Bioretention facilities can be designed to provide flow rate and duration control. This may be accomplished by providing greater infiltration storage with increased surface ponding and/or aggregate storage volume for storm water flow control.

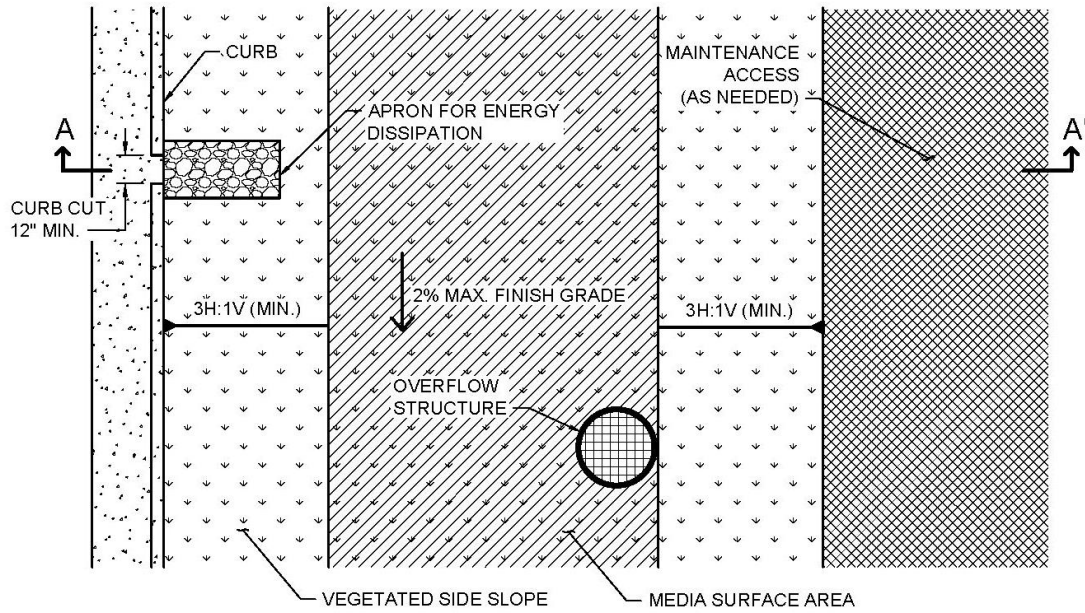

PLAN
NOT TO SCALE

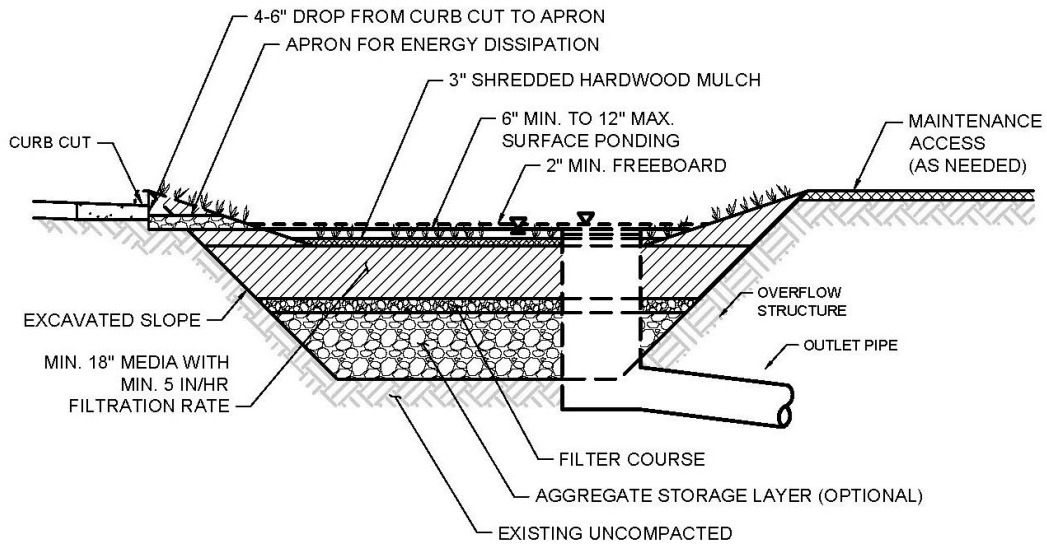

SECTION A-A'
NOT TO SCALE

Typical plan and section view of a Bioretention BMP

Recommended Siting Criteria

Bioretention must meet the following design criteria. Deviations from the below criteria may be approved at the discretion of County staff if it is determined to be appropriate:

<i>Siting Criteria</i>		<i>Intent/Rationale</i>
<input type="checkbox"/>	Placement observes geotechnical recommendations regarding potential hazards (e.g., slope stability, landslides, liquefaction zones) and setbacks (e.g., slopes, foundations, utilities).	Must not negatively impact existing site geotechnical concerns.
<input type="checkbox"/>	Selection and design of BMP is based on infiltration feasibility criteria and appropriate design infiltration rate presented in Appendix B and D.	Must operate as a full infiltration design and must be supported by drainage area and in-situ infiltration rate feasibility findings.
<input type="checkbox"/>	Contributing tributary area is ≤ 5 acres (≤ 1 acre preferred).	Bigger BMPs require additional design features for proper performance. Contributing tributary area greater than 5 acres may be allowed at the discretion of County staff if the following conditions are met: 1) incorporate design features (e.g. flow spreaders) to minimize short circuiting of flows in the BMP and 2) incorporate additional design features requested by County staff for proper performance of the regional BMP.
<input type="checkbox"/>	Finish grade of the facility is $\leq 2\%$. In long bioretention facilities where the potential for internal erosion and channelization exists, the use of check dams is required.	Flatter surfaces reduce erosion and channelization within the facility. Internal check dams reduce velocity and dissipate energy.

Design Criteria and Considerations

Bioretention must meet the following design criteria. Deviations from the below criteria may be approved at the discretion of County staff if it is determined to be appropriate:

<i>Siting and Design</i>		<i>Intent/Rationale</i>
<i>Surface Ponding</i>		
<input type="checkbox"/>	Surface ponding is limited to a 24-hour drawdown time.	24-hour drawdown time is recommended for plant health. Surface ponding drawdown time greater than 24-hours but less than 96 hours may be allowed at the discretion of County staff if certified by a landscape architect or agronomist.

<i>Siting and Design</i>	<i>Intent/Rationale</i>
<input type="checkbox"/> Surface ponding depth is ≥ 6 and ≤ 12 inches.	<p>Surface ponding capacity lowers subsurface storage requirements. Deep surface ponding raises safety concerns.</p> <p>Surface ponding depth greater than 12 inches (for additional pollutant control or surface outlet structures or flow-control orifices) may be allowed at the discretion of County staff if the following conditions are met: 1) surface ponding depth drawdown time is less than 24 hours; and 2) safety issues and fencing requirements are considered (typically ponding greater than 18" will require a fence and/or flatter side slopes) and 3) potential for elevated clogging risk is considered.</p>
<input type="checkbox"/> A minimum of 2 inches of freeboard is provided.	<p>Freeboard provides room for head over overflow structures and minimizes risk of uncontrolled surface discharge.</p>
<input type="checkbox"/> Side slopes are stabilized with vegetation and are $\geq 3H: 1V$.	<p>Gentler side slopes are safer, less prone to erosion, able to establish vegetation more quickly and easier to maintain.</p>
<i>Vegetation</i>	
<input type="checkbox"/> Plantings are suitable for the climate and expected ponding depth. A plant list to aid in selection can be found in Appendix F.	<p>Plants suited to the climate and ponding depth are more likely to survive.</p>
<input type="checkbox"/> An irrigation system with a connection to water supply is provided as needed.	<p>Seasonal irrigation might be needed to keep plants healthy.</p>
<i>Mulch (Mandatory)</i>	
<input type="checkbox"/> 3 inches of shredded hardwood mulch. Mulch must be non-floating to avoid clogging of overflow structure.	<p>Mulch will suppress weeds and maintain moisture for plant growth.</p>

<i>Siting and Design</i>		<i>Intent/Rationale</i>
Media Layer		
<input type="checkbox"/>	Media maintains a minimum filtration rate of 5 in/hr over lifetime of facility. A minimum initial filtration rate of 10 in/hr is recommended.	A high filtration rate through the soil mix minimizes clogging potential and allows flows to quickly enter the aggregate storage layer, thereby minimizing bypass.
<input type="checkbox"/>	Media is a minimum 18 inches deep, meeting either of these two media specifications: Media Specifications listed in Appendix F-3 Biofiltration Soil Media (BSM) or County of San Diego Low Impact Development Handbook: Appendix G - Bioretention Soil Specification (June 2014, unless superseded by more recent edition).	A deep media layer provides additional filtration and supports plants with deeper roots. Standard specifications must be followed.
<input type="checkbox"/>	Alternatively, for proprietary designs and custom media mixes not meeting the media specifications contained in the County LID Handbook, the media meets the pollutant treatment performance criteria in Section F.1.1.	For non-standard or proprietary designs, compliance with F.1.1 ensures that adequate treatment performance will be provided.
<input type="checkbox"/>	Media surface area is 3% of contributing area times adjusted runoff factor or greater.	Greater surface area to tributary area ratios decrease loading rates per square foot and therefore increase longevity. Adjusted runoff factor is to account for site design BMPs implemented upstream of the BMP (such as rain barrels, impervious area dispersion, etc.). Refer to Appendix B guidance. If media surface area is under 3% of contributing area, refer to Sediment Loading calculations in Appendix B.
Filter Course Layer (Optional)		
<input type="checkbox"/>	A filter course is used to prevent migration of fines through layers of the facility. Filter fabric is not used.	Migration of media can cause clogging of the aggregate storage layer void spaces or subgrade. Filter fabric is more likely to clog.

<i>Siting and Design</i>	<i>Intent/Rationale</i>	
<input type="checkbox"/>	<p>Filter course is a minimum of 6 inches thick provided in two separate 3 inch layers. The top layer shall be made of ASTM C33 choker sand and the bottom layer shall be of ASTM No. 8 aggregate. Marker stakes shall be used to ensure uniform lift thickness.</p>	<p>To prevent reduction of the available storage volume that would lead to clogging of the underdrain and native soil beneath the BMP.</p>
<input type="checkbox"/>	<p>Filter course is washed and free of fines.</p>	<p>Washing aggregate will help eliminate fines that could clog the facility and impede infiltration.</p>
<input type="checkbox"/>	<p>Filter course calculations assessing suitability for particle migration prevention have been completed.</p>	<p>Gradation relationship between layers can evaluate factors (e.g., bridging, permeability, and uniformity) to determine if particle sizing is appropriate or if an intermediate layer is needed.</p>
<i>Aggregate Storage Layer (Optional)</i>		
<input type="checkbox"/>	<p>Class 2 Permeable per Caltrans specification 68-1.025 is recommended for the storage layer. Washed, open-graded crushed rock may be used, however a 4-6 inch washed pea gravel filter course layer at the top of the crushed rock is required.</p>	<p>Washing aggregate will help eliminate fines that could clog the aggregate storage layer void spaces or subgrade.</p>
<input type="checkbox"/>	<p>Maximum aggregate storage layer depth is determined based on the infiltration storage volume that will infiltrate within a 36-hour drawdown time.</p>	<p>A maximum drawdown time to facilitate provision of adequate storm water storage for the next storm event. The applicant has an option to use a different drawdown time of up to 120 hours if the volume of the facility is adjusted using the percent capture method in Appendix B.4.1.</p>
<i>Inflow and Overflow Structures</i>		
<input type="checkbox"/>	<p>Inflow and overflow structures are accessible for inspection and maintenance. Overflow structures must be connected to downstream storm drain system or appropriate discharge point.</p>	<p>Maintenance will prevent clogging and ensure proper operation of the flow control structures.</p>

<i>Siting and Design</i>	<i>Intent/Rationale</i>	
☐	Inflow velocities are limited to 3 ft/s or less or use energy dissipation methods (e.g., riprap, level spreader) for concentrated inflows.	High inflow velocities can cause erosion, scour and/or channeling.
☐	Curb cut inlets are at least 12 inches wide, have a 4-6 inch reveal (drop) and an apron and energy dissipation as needed.	Inlets must not restrict flow and apron prevents blockage from vegetation as it grows in. Energy dissipation prevents erosion.
☐	Overflow is safely conveyed to a downstream storm drain system or discharge point. Size overflow structure to pass 100-year peak flow for on-line basins and water quality peak flow for off-line basins.	Planning for overflow lessens the risk of property damage due to flooding.

Conceptual Design and Sizing Approach for Storm Water Pollutant Control Only

To design bioretention for storm water pollutant control only (no flow control required), the following steps should be taken:

1. Verify that siting and design criteria have been met, including placement and basin area requirements, maximum side and finish grade slope, and the recommended media surface area tributary ratio.
2. Calculate the DCV per Appendix B based on expected site design runoff for tributary areas.
3. Use the sizing worksheet to determine if full infiltration of the DCV is achievable based on the available infiltration storage volume calculated from the bioretention without underdrain footprint area, effective depths for surface ponding, media and aggregate storage layers, and in-situ soil design infiltration rate for a maximum 36-hour drawdown time for the aggregate storage layer (unless percent capture method is used), with surface ponding no greater than a maximum 24-hour drawdown. The drawdown time can be estimated by dividing the average depth of the basin by the design infiltration rate of the underlying soil. Appendix D provides guidance on evaluating a site's infiltration rate. A generic sizing worksheet is provided in Appendix B.4.
4. Where the DCV cannot be fully infiltrated based on the site or bioretention constraints, an underdrain can be added to the design (use biofiltration with partial retention factsheet).

Conceptual Design and Sizing Approach when Storm Water Flow Control is Applicable

Control of flow rates and/or durations will typically require significant surface ponding and/or aggregate storage volumes, and therefore the following steps should be taken prior to determination of storm water pollutant control design. Pre-development and allowable post-project flow rates and durations must be determined as discussed in Chapter 6 of the manual.

1. Verify that siting and design criteria have been met, including placement requirements, maximum side and finish grade slopes, and the recommended media surface area tributary area ratio. Design for flow control can be achieved using various design configurations.
2. Iteratively determine the facility footprint area, surface ponding and/or aggregate storage layer depth required to provide infiltration storage to reduce flow rates and durations to allowable limits while adhering to the maximum drawdown times for surface ponding and aggregate storage. Flow rates and durations can be controlled using flow splitters that route the appropriate inflow amounts to the bioretention facility and bypass excess flows to the downstream storm drain system or discharge point.
3. If bioretention without underdrain facility cannot fully provide the flow rate and duration control required by the MS4 permit, an upstream or downstream structure with appropriate storage volume such as an underground vault can be used to provide additional control.
4. After bioretention without underdrain BMPs have been designed to meet flow control requirements, calculations must be completed to verify if storm water pollutant control requirements to treat the DCV have been met.

Maintenance Overview

Normal Expected Maintenance. Bioretention requires routine maintenance to: remove accumulated materials such as sediment, trash or debris; maintain vegetation health; maintain infiltration capacity of the media layer; replenish mulch; and maintain integrity of side slopes, inlets, energy dissipators, and outlets. A summary table of standard inspection and maintenance indicators is provided within this Fact Sheet.

Non-Standard Maintenance or BMP Failure. If any of the following scenarios are observed, the BMP is not performing as intended to protect downstream waterways from pollution and/or erosion. Corrective maintenance, increased inspection and maintenance, BMP replacement, or a different BMP type will be required.

- The BMP is not drained between storm events. Surface ponding longer than approximately 24 hours following a storm event may be detrimental to vegetation health, and surface ponding longer than approximately 96 hours following a storm event poses a risk of vector (mosquito) breeding. Poor drainage can result from clogging of the media layer, filter course, aggregate storage layer, underlying native soils, or outlet structure. The specific cause of the drainage issue must be determined and corrected. If it is determined that the underlying native soils have been compacted or do not have the infiltration capacity expected, the County reviewer shall be contacted prior to any additional repairs or reconstruction.
- Sediment, trash, or debris accumulation greater than 25% of the surface ponding volume within one month. This means the load from the tributary drainage area is too high, reducing BMP function or clogging the BMP. This would require pretreatment measures within the tributary area draining to the BMP to intercept the materials. Pretreatment components, especially for sediment, will extend the life of components that are more expensive to replace

such as media, filter course, and aggregate layers.

- Erosion due to concentrated storm water runoff flow that is not readily corrected by adding erosion control blankets, adding stone at flow entry points, or minor re-grading to restore proper drainage according to the original plan. If the issue is not corrected by restoring the BMP to the original plan and grade, the County reviewer shall be contacted prior to any additional repairs or reconstruction.

Other Special Considerations. Bioretention is a vegetated structural BMP. Vegetated structural BMPs that are constructed in the vicinity of, or connected to, an existing jurisdictional water or wetland could inadvertently result in creation of expanded waters or wetlands. As such, vegetated structural BMPs have the **potential** to come under the jurisdiction of the United States Army Corps of Engineers, SDRWQCB, California Department of Fish and Wildlife, or the United States Fish and Wildlife Service. This could result in the need for specific resource agency permits and costly mitigation to perform maintenance of the structural BMP. Along with proper placement of a structural BMP, routine maintenance is key to preventing this scenario.

Summary of Standard Inspection and Maintenance

The property owner is responsible to ensure inspection, operation and maintenance of permanent BMPs on their property unless responsibility has been formally transferred to an agency, community facilities district, homeowners association, property owners association, or other special district.

Maintenance frequencies listed in this table are average/typical frequencies. Actual maintenance needs are site-specific, and maintenance may be required more frequently. Maintenance must be performed whenever needed, based on maintenance indicators presented in this table. The BMP owner is responsible for conducting regular inspections to see when maintenance is needed based on the maintenance indicators. During the first year of operation of a structural BMP, inspection is recommended at least once prior to August 31 and then monthly from September through May. Inspection during a storm event is also recommended. After the initial period of frequent inspections, the minimum inspection and maintenance frequency can be determined based on the results of the first year inspections.

Threshold/Indicator	Maintenance Action	Inspection and Maintenance Frequency
Accumulation of sediment, litter, or debris	Remove and properly dispose of accumulated materials, without damage to the vegetation or compaction of the media layer.	<ul style="list-style-type: none"> • Inspect monthly. If the BMP is 25% full* or more in one month, increase inspection frequency to monthly plus after every 0.1-inch or larger storm event. • Remove any accumulated materials found at each inspection.
Obstructed inlet or outlet structure	Clear blockage.	<ul style="list-style-type: none"> • Inspect monthly and after every 0.5-inch or larger storm event. • Remove any accumulated materials found at each inspection.
Damage to structural components such as weirs, inlet or outlet structures	Repair or replace as applicable.	<ul style="list-style-type: none"> • Inspect annually. • Maintain when needed.
Poor vegetation establishment	Re-seed, re-plant, or re-establish vegetation per original plans.	<ul style="list-style-type: none"> • Inspect monthly. • Maintain when needed.

Threshold/Indicator	Maintenance Action	Inspection and Maintenance Frequency
Dead or diseased vegetation	Remove dead or diseased vegetation, re-seed, re-plant, or re-establish vegetation per original plans.	<ul style="list-style-type: none"> • Inspect monthly. • Maintain when needed.
Overgrown vegetation	Mow or trim as appropriate.	<ul style="list-style-type: none"> • Inspect monthly. • Maintain when needed.
2/3 of mulch has decomposed, or mulch has been removed	Remove decomposed fraction and top off with fresh mulch to a total depth of 3 inches.	<ul style="list-style-type: none"> • Inspect monthly. • Replenish mulch annually, or more frequently when needed based on inspection.
Erosion due to concentrated irrigation flow	Repair/re-seed/re-plant eroded areas and adjust the irrigation system.	<ul style="list-style-type: none"> • Inspect monthly. • Maintain when needed.
Erosion due to concentrated storm water runoff flow	Repair/re-seed/re-plant eroded areas, and make appropriate corrective measures such as adding erosion control blankets, adding stone at flow entry points, or minor re-grading to restore proper drainage according to the original plan. If the issue is not corrected by restoring the BMP to the original plan and grade, the County reviewer shall be contacted prior to any additional repairs or reconstruction.	<ul style="list-style-type: none"> • Inspect after every 0.5-inch or larger storm event. If erosion due to storm water flow has been observed, increase inspection frequency to after every 0.1-inch or larger storm event. • Maintain when needed. If the issue is not corrected by restoring the BMP to the original plan and grade, the County reviewer shall be contacted prior to any additional repairs or reconstruction.
<p>Standing water in BMP for longer than 24 hours following a storm event</p> <p>Surface ponding longer than approximately 24 hours following a storm event may be detrimental to vegetation health</p>	Make appropriate corrective measures such as adjusting irrigation system, removing obstructions of debris or invasive vegetation, or repairing/replacing clogged or compacted soils. If it is determined that the underlying native soils have been compacted or do not have the infiltration capacity expected, the County reviewer shall be contacted prior to any additional repairs or reconstruction.	<ul style="list-style-type: none"> • Inspect monthly and after every 0.5-inch or larger storm event. If standing water is observed, increase inspection frequency to after every 0.1-inch or larger storm event. • Maintain when needed.

Threshold/Indicator	Maintenance Action	Inspection and Maintenance Frequency
<p>Presence of mosquitos/larvae</p> <p>For images of egg rafts, larva, pupa, and adult mosquitos, see http://www.mosquito.org/biology</p>	<p>If mosquitos/larvae are observed: first, immediately remove any standing water by dispersing to nearby landscaping; second, make corrective measures as applicable to restore BMP drainage to prevent standing water.</p> <p>If mosquitos persist following corrective measures to remove standing water, or if the BMP design does not meet the 96-hour drawdown criteria because the underlying native soils have been compacted or do not have the infiltration capacity expected, the County reviewer shall be contacted to determine a solution. A different BMP type, or a Vector Management Plan prepared with concurrence from the County of San Diego Department of Environmental Health, may be required.</p>	<ul style="list-style-type: none"> • Inspect monthly and after every 0.5-inch or larger storm event. If mosquitos are observed, increase inspection frequency to after every 0.1-inch or larger storm event. • Maintain when needed.

“25% full” is defined as ¼ of the depth from the design bottom elevation to the crest of the outflow structure (e.g., if the height to the outflow opening is 12 inches from the bottom elevation, then the materials must be removed when there is 3 inches of accumulation – this should be marked on the outflow structure).

This page was intentionally left blank.

E.11 INF-3 Permeable Pavement (Pollutant Control)



Location: Kellogg Park, San Diego, California

MS4 Permit Category

Retention
Flow-thru Treatment
Control

Manual Category

Infiltration
Flow-thru Treatment
Control

Applicable Performance Standard

Pollutant Control
Flow Control

Primary Benefits

Volume Reduction
Peak Flow Attenuation

Description

Permeable pavement is pavement that allows for percolation through void spaces in the pavement surface into subsurface layers. The subsurface layers are designed to provide storage of storm water runoff so that outflows, primarily via infiltration into subgrade soils or release to the downstream conveyance system, can be at controlled rates. Varying levels of storm water treatment and flow control can be provided depending on the size of the permeable pavement system relative to its drainage area, the underlying infiltration rates, and the configuration of outflow controls. Pollutant control permeable pavement is designed to receive runoff from a larger tributary area than site design permeable pavement (see SD-D). Pollutant control is provided via infiltration, filtration, sorption, sedimentation, and biodegradation processes. Permeable pavements proposed as a retention or partial retention BMP should not have an impermeable liner.

Typical permeable pavement components include, from top to bottom:

- Permeable surface layer
- Bedding layer for permeable surface
- Aggregate storage layer with optional underdrain(s)
- Optional final filter course layer over uncompacted existing subgrade

INF-3 Permeable Pavement (Pollutant Control)

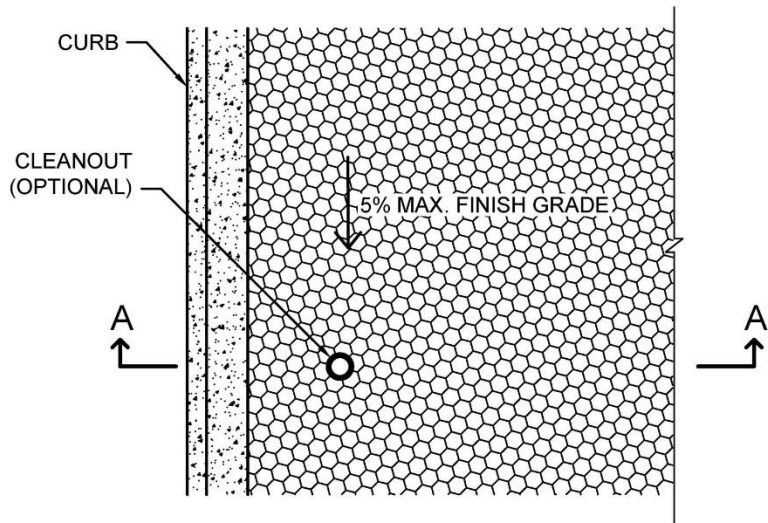

PLAN
NOT TO SCALE

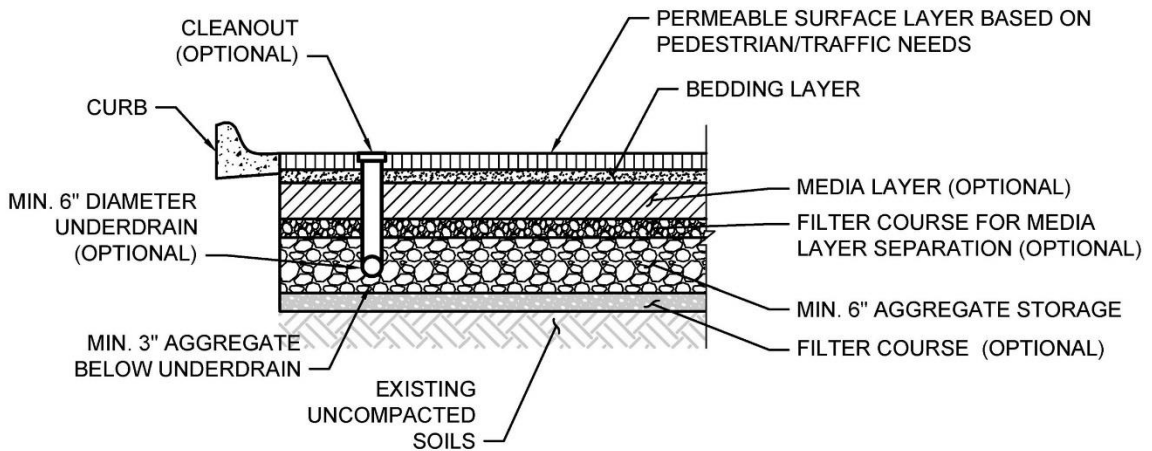

SECTION A-A'
NOT TO SCALE

Typical plan and Section view of a Permeable Pavement BMP

Subcategories of permeable pavement include modular paver units or paver blocks, pervious concrete, porous asphalt, and turf pavers. These subcategory variations differ in the material used for the permeable surface layer but have similar functions and characteristics below this layer.

Design Adaptations for Project Goals

Site design BMP to reduce impervious area and DCV. See site design option SD-D.

Full infiltration BMP for storm water pollutant control. Permeable pavement without an underdrain and without impermeable liners can be used as a pollutant control BMP, designed to infiltrate runoff from direct rainfall as well as runoff from adjacent areas that are tributary to the pavement. The system must be designed with an infiltration storage volume (a function of the aggregate storage volume) equal to the full DCV and able to meet drawdown time limitations.

Partial infiltration BMP with flow-thru treatment for storm water pollutant control. Permeable pavement can be designed so that a portion of the DCV is infiltrated by providing an underdrain with infiltration storage below the underdrain invert. The infiltration storage depth should be determined by the volume that can be reliably infiltrated within drawdown time limitations. Water discharged through the underdrain is considered flow-thru treatment and is not considered biofiltration treatment. Storage provided above the underdrain invert is included in the flow-thru treatment volume.

Flow-thru treatment BMP for storm water pollutant control. The system may be lined and/or installed over impermeable native soils with an underdrain provided at the bottom to carry away filtered runoff. Water quality treatment is provided via unit treatment processes other than infiltration. This configuration is considered to provide flow-thru treatment, not biofiltration treatment. Significant aggregate storage provided above the underdrain invert can provide detention storage, which can be controlled via inclusion of an orifice in an outlet structure at the downstream end of the underdrain. **PDPs have the option to add saturated storage to the flow-thru configuration in order to reduce the DCV that the BMP is required to treat.** Saturated storage can be added to this design by including an upturned elbow installed at the downstream end of the underdrain or via an internal weir structure designed to maintain a specific water level elevation. The DCV can be reduced by the amount of saturated storage provided.

Integrated storm water flow control and pollutant control configuration. With any of the above configurations, the system can be designed to provide flow rate and duration control. This may include having a deeper aggregate storage layer that allows for significant detention storage above the underdrain, which can be further controlled via inclusion of an outlet structure at the downstream end of the underdrain.

Design Criteria and Considerations

Permeable Pavement (Pollutant Control BMP) must meet the following design criteria and be consistent with the County of San Diego Green Streets Design Criteria and Green Streets Standard Drawings in Appendix K. Deviations. Deviations from the below criteria may be approved at the discretion of County staff if it is determined to be appropriate:

INF-3 Permeable Pavement (Pollutant Control)

<i>Siting and Design</i>	<i>Intent/Rationale</i>
<input type="checkbox"/> The structural section is in accordance with the manufacturer’s guidance and project soils engineering’s recommendations. Overflow and storm drain lines may still be required.	Ensures that the permeable pavement facility can be designed to provide adequate drainage system.
<input type="checkbox"/> No erodible areas drain on to permeable pavement. In addition, permeable pavement shall not be placed in an area with significant overhanging trees or other vegetation.	Minimizes clogging. Sediment, leaves and organic debris can clog the pavement surface.
<input type="checkbox"/> Show system slope and direction of slope on plans.	Ensures the system functions properly. Typically, the system is only suitable on flat slope.
<input type="checkbox"/> Show cross section of system assembly with complete dimensions and detailing on plans.	Ensures that the system gets constructed and functions properly.
<input type="checkbox"/> Specify maintenance programs on plans ~ e.g., debris removal, vacuum sweeping twice per year, resetting pavers as needed.	Ensures system remains permeable.
<input type="checkbox"/> Note on plans: “No sealant shall be applied to constructed Permeable surfaces”.	The purpose is to allow stormwater to percolate through the permeable surfaces.
<input type="checkbox"/> Geotextile or filter course layer may be provided along perimeter	Geotextile or filter course layer can prevent natural soil from clogging aggregate voids.
<input type="checkbox"/> Concrete divider strip shall be provided between system and adjacent impervious materials and as edge restraints.	Provides structural stability.
<input type="checkbox"/> Fire district must verify system is acceptable to support fire apparatus	Allows for a safe access in case of an emergency.
<input type="checkbox"/> System may not disturb underground utilities.	Underground utilities have specific requirements and guidelines for clearance.
<input type="checkbox"/> Paver gaps, changes in elevation, and slopes, must meet accessibility requirements if applicable.	Provides accessibility and complies with ADA requirements if applicable.

INF-3 Permeable Pavement (Pollutant Control)

<i>Siting and Design</i>	<i>Intent/Rationale</i>
<input type="checkbox"/> Placement observes geotechnical recommendations regarding potential hazards (e.g., slope stability, landslides, liquefaction zones) and setbacks (e.g., slopes, foundations, utilities).	Must not negatively impact existing site geotechnical concerns.
<input type="checkbox"/> Selection must be based on infiltration feasibility criteria.	Full or partial infiltration designs must be supported by drainage area feasibility findings.
<input type="checkbox"/> For pollutant control permeable pavement, the ratio of the total drainage area (including the permeable pavement) to the permeable pavement should not exceed 4:1.	Higher ratios increase the potential for clogging but may be acceptable for relatively clean tributary areas.
<input type="checkbox"/> Finish grade of the permeable pavement has a slope $\leq 2\%$.	Flatter surfaces facilitate increased runoff capture.
<input type="checkbox"/> Contributing tributary area includes effective sediment source control and/or pretreatment measures such as raised curbed or grass filter strips	Sediment can clog the pavement surface.
<input type="checkbox"/> Observation wells are required for facilities without an underdrain and shall be shown on design plans. Observation wells shall be installed at the downstream end and spaced at 100 foot maximum intervals. An observation well consists of a well-anchored, perforated 6 inch (diameter) PVC pipe that extends vertically to the bottom of the reservoir layer. The observation well should be fitted with a lockable cap installed flush with the ground surface (or under the pavers) to facilitate periodic inspection and maintenance.	The observation well is used to observe the rate of drawdown within the reservoir layer following a storm event
<input type="checkbox"/> Overflow conveyance shall be designed to convey larger storms to existing or new storm drain systems adjacent to the permeable pavement.	Flood prevention.
<input type="checkbox"/> Direct discharges to permeable pavement are only from downspouts carrying “clean” roof runoff that are equipped with filters to remove gross solids.	Roof runoff typically carries less sediment than runoff from other impervious surfaces and is less likely to clog the pavement surface.

<i>Siting and Design</i>	<i>Intent/Rationale</i>
<i>Permeable Surface Layer</i>	
<input type="checkbox"/> Permeable surface layer type is appropriately chosen based on pavement use and expected vehicular loading.	Pavement may wear more quickly if not durable for expected loads or frequencies.
<input type="checkbox"/> Permeable pavers are not to be used in areas of high traffic volume.	Pavers are not intended to be used in areas of high traffic volume and areas where vehicular speed is excessive. Parking areas and low-speed access roads are examples of ideal applications.
<input type="checkbox"/> Use appropriate thickness for permeable surface layer for vehicular loading.	Permeable concrete requires a 6-inch minimum surface layer of permeable concrete. Permeable asphalt requires a 1 ½ - inch minimum surface layer of permeable asphalt Permeable pavers require a 2 3/8-inch minimum surface layer of permeable pavers.
<input type="checkbox"/> Permeable surface layer type is appropriate for expected pedestrian traffic.	Expected demographic and accessibility needs (e.g., adults, children, seniors, runners, high-heeled shoes, wheelchairs, strollers, bikes) requires selection of appropriate surface layer type that will not impede pedestrian needs.
<input type="checkbox"/> When finish grade of the permeable pavement has a slope of 2% or less, bench subgrade to have a slope of 0% per Standard Drawing for Permeable Pavements Elevation (Terraced Slope) in Appendix K. Distance between steps is determined by the slope of the pavement to achieve a step no more than 12” tall.	Avoids concentrated flows downstream while helping achieve DCV requirements.
<input type="checkbox"/> When finish grade of the permeable pavement has a slope of more than 2% but less than 10%, add check dams within the reservoir/aggregate layer per Standard Drawing for Permeable Pavements Elevation (Terraced slope with Check Dams) in Appendix K.	Avoids concentrated flows downstream while helping achieve DCV requirements.

<i>Siting and Design</i>	<i>Intent/Rationale</i>
<input type="checkbox"/> When Finish grade of the permeable pavement has a slope of 10% or more, add check dams within the reservoir/aggregate layer per Standard Drawing for Permeable Pavements Elevation (Terraced Slope with Check Dams) in Appendix K. Consult with the appropriate fire jurisdiction for surfacing requirements.	Avoids concentrated flows downstream while helping achieve DCV requirements.
<input type="checkbox"/> Minimum depth to groundwater and bedrock \geq 10 ft.	A minimum separation facilitates infiltration and lessens the risk of negative groundwater impacts.
<i>Bedding Layer for Permeable Surface</i>	
<input type="checkbox"/> Use appropriate thickness and material for bedding layer for vehicular loading.	<p>Permeable concrete requires 4 inches of crushed rock as a choker layer.</p> <p>Permeable asphalt requires a 3-inch minimum layer of crushed rock as a base course, and 4 inches of crushed rock as a choker layer</p> <p>Permeable pavers require a 2-inch layer of crushed rock as a base course, and 4 inches of crushed rock as a choker layer or the manufacturer’s recommendations.</p>
<input type="checkbox"/> Aggregate used for bedding layer is washed prior to placement.	Washing aggregate will help eliminate fines that could clog the permeable pavement system aggregate storage layer void spaces or underdrain.
<i>Media Layer (Optional) –used between bedding layer and aggregate storage layer to provide pollutant treatment control</i>	
<input type="checkbox"/> The pollutant removal performance of the media layer is documented by the project proponent.	Media used for BMP design should be shown via research or testing to be appropriate for expected pollutants of concern and flow rates.
<input type="checkbox"/> A filter course is provided to separate the media layer from the aggregate storage layer.	Migration of media can cause clogging of the aggregate storage layer void spaces or underdrain.

<i>Siting and Design</i>		<i>Intent/Rationale</i>
<input type="checkbox"/>	If a filter course is used, calculations assessing suitability for particle migration prevention have been completed.	Gradation relationship between layers can evaluate factors (e.g., bridging, permeability, and uniformity) to determine if particle sizing is appropriate or if an intermediate layer is needed.
<input type="checkbox"/>	Consult permeable pavement manufacturer to verify that media layer provides required structural support.	Media must not compromise the structural integrity or intended uses of the permeable pavement surface.
<i>Aggregate Storage Layer</i>		
<input type="checkbox"/>	Minimum layer depth is 6 inches and for infiltration designs, the maximum depth is determined based on the infiltration storage volume that will infiltrate within a 36-hour drawdown time.	A minimum depth of aggregate provides structural stability for expected pavement loads. The applicant has an option to use a different drawdown time of up to 120 hours if the volume of the facility is adjusted using the percent capture method in Appendix B.4.1
<input type="checkbox"/>	When finish grade is less than 2%, bench subgrade to have a slope of 0%. Distance between steps is determined by the slope of the pavement to achieve a step no more than 12" tall.	Avoids concentrated flows downstream.
<input type="checkbox"/>	When finish grade is more than 2%, use check dams within the aggregate/storage layer. Check dam material options include waterproof membrane, PVC sheeting, and concrete. A transverse underdrain may be needed due to the width of the permeable pavement facility.	Use of membranes and sheeting are the most cost effective and generally preferred options
<input type="checkbox"/>	Aggregate used for the aggregate storage layer is washed and free of fines.	Washing aggregate will help eliminate fines that could clog aggregate storage layer void spaces or underdrain
<i>Underdrain and Outflow Structures</i>		
<input type="checkbox"/>	Underdrains and outflow structures, if used, are accessible for inspection and maintenance.	Maintenance will improve the performance and extend the life of the permeable pavement system.

<i>Siting and Design</i>		<i>Intent/Rationale</i>
<input type="checkbox"/>	Underdrain outlet elevation should be a minimum of 3 inches above the bottom elevation of the aggregate storage layer.	A minimal separation from subgrade or the liner lessens the risk of fines entering the underdrain and can improve hydraulic performance by allowing perforations to remain unblocked.
<input type="checkbox"/>	Minimum underdrain diameter is 6 inches.	Smaller diameter underdrains are prone to clogging. Subsurface drainage is recommended beneath all vehicular use permeable pavement installations unless elimination of the underdrain is expressly approved by County staff. Permeable pavement may be installed without underdrain in areas with no traffic volume if infiltration results are good and underdrain connections are not feasible.
<input type="checkbox"/>	Underdrains are made of slotted, PVC pipe conforming to ASTM D 3034 or equivalent or corrugated, HDPE pipe conforming to AASHTO 252M or equivalent.	Slotted underdrains provide greater intake capacity, clog resistant drainage, and reduced entrance velocity into the pipe, thereby reducing the chances of solids migration.
<input type="checkbox"/>	For sites where the native soil design infiltration rate is sufficient to drain the DCV within 36 hours, elevate the underdrain to be above the DCV.	Use of a raised underdrain is encouraged and provides enhanced retention. An alternative approach to a raised underdrain is an underdrain with an up-turned elbow outlet.
<input type="checkbox"/>	Clean-outs are required for all permeable pavement facilities with underdrains. Clean-outs shall be spaced at 100 foot maximum intervals. Where a storm drain structure such as a catch basin, manhole, or overflow structure is within 100 feet of a clean-out, it will serve the same function as a clean-out.	Clean-outs provide ease of maintenance thus prolonging the life of the facility and reducing the frequency of more intensive maintenance procedures.
<i>Filter Course (Optional)</i>		
<input type="checkbox"/>	Filter course is washed and free of fines.	Washing aggregate will help eliminate fines that could clog subgrade and impede infiltration.

Conceptual Design and Sizing Approach for Site Design

1. Determine the areas where permeable pavement can be used in the site design to replace traditional pavement to reduce the impervious area and DCV. These permeable pavement areas can be credited toward reducing runoff generated through representation in storm water calculations as pervious, not impervious, areas but are not credited for storm water pollutant control. These permeable pavement areas should be designed as self-retaining with the appropriate tributary area ratio identified in the design criteria.
2. Calculate the DCV per Appendix B, taking into account reduced runoff from self-retaining permeable pavement areas.
3. Stormwater runoff from pervious areas often contribute sediment and lead to clogging and increased maintenance requirements for pervious pavement, and should be avoided to the extent possible. Ideally, at least 90-percent of the area draining to pervious pavement shall be impervious, not including the permeable pavement area itself. Pretreatment, drainage area stabilization, and specific maintenance program are options that County staff will consider for implementation where contributing drainage area is less than 90-percent impervious.
4. The wearing surface shall meet the latest ADA requirements. The wearing surface is the pavement material plus any required bedding layers under the surface and inside of the joints, in accordance with all applicable standard details, specifications and manufacturer recommendations as applicable.
5. Stormwater conveyance from all impervious areas including standard pavement shall, to the extent feasible, drain to permeable pavement as sheet flow. Otherwise pre-treatment for energy dissipation and sediment control may be required where any concentrated flow is directed onto pervious pavement. Level spreaders may be designed to convert concentrated flow to sheet flow into the pervious pavement facility.

Conceptual Design and Sizing Approach for Storm Water Pollutant Control Only

To design permeable pavement for storm water pollutant control only (no flow control required), the following steps should be taken:

1. Verify that siting and design criteria have been met, including placement requirements, maximum finish grade slope, and the recommended tributary area ratio for non-self-retaining permeable pavement. If infiltration is infeasible, the permeable pavement can be designed as flow-thru treatment per the sizing worksheet. If infiltration is feasible, calculations should follow the remaining design steps.
2. Calculate the DCV per Appendix B based on expected site design runoff for tributary areas.
3. Use the sizing worksheet to determine if full or partial infiltration of the DCV is achievable based on the available infiltration storage volume calculated from the permeable pavement footprint, aggregate storage layer depth, and in-situ soil design infiltration rate for a maximum 36-hour drawdown time. The applicant has an option to use a different drawdown time up to

INF-3 Permeable Pavement (Pollutant Control)

120 hours if the volume of the facility is adjusted using the percent capture method in Appendix B.4.1.

4. Where the DCV cannot be fully infiltrated based on the site or permeable pavement constraints, an underdrain must be incorporated above the infiltration storage to carry away runoff that exceeds the infiltration storage capacity.
5. The remaining DCV to be treated should be calculated for use in sizing downstream BMP(s).

Conceptual Design and Sizing Approach when Storm Water Flow Control is Applicable

Control of flow rates and/or durations will typically require significant aggregate storage volumes, and therefore the following steps should be taken prior to determination of storm water pollutant control design. Pre-development and allowable post-project flow rates and durations should be determined as discussed in Chapter 6 of the manual.

1. Verify that siting and design criteria have been met, including placement requirements, maximum finish grade slope, and the recommended tributary area ratio for non-self-retaining permeable pavement. Design for flow control can be achieved using various design configurations, but a flow-thru treatment design will typically require a greater aggregate storage layer volume than designs which allow for full or partial infiltration of the DCV.
2. Iteratively determine the area and aggregate storage layer depth required to provide infiltration and/or detention storage to reduce flow rates and durations to allowable limits. Flow rates and durations can be controlled from detention storage by altering outlet structure orifice size(s) and/or water control levels. Multi-level orifices can be used within an outlet structure to control the full range of flows.
3. If the permeable pavement system cannot fully provide the flow rate and duration control required by this manual, a downstream structure with sufficient storage volume such as an underground vault can be used to provide remaining controls.
4. Designs with a liner on the bottom as required by the Geotechnical Engineer, the minimum slope of the underdrain shall be 0.5 percent. After permeable pavement has been designed to meet flow control requirements, calculations must be completed to verify if storm water pollutant control requirements to treat the DCV have been met.

Maintenance Overview

Normal Expected Maintenance. Routine maintenance of permeable pavement includes: removal of materials such as trash and debris accumulated on the paving surface; vacuuming of the paving surface to prevent clogging; and flushing paving and subsurface gravel to remove fine sediment. If the BMP includes underdrains and/or an outflow control structure, check and clear these features.

Non-Standard Maintenance or BMP Failure. If the permeable pavement area is not drained between storm events, or if runoff sheet flows across the permeable pavement area and flows off the permeable pavement area during storm events, the BMP is not performing as intended to protect

INF-3 Permeable Pavement (Pollutant Control)

downstream waterways from pollution and/or erosion. During storm events up to the 85th percentile storm event (approximately 0.5 to 1 inch of rainfall in San Diego County), runoff should not flow off the permeable pavement area. The permeable pavement area is expected to have adequate hydraulic conductivity and storage such that rainfall landing on the permeable pavement and runoff from the surrounding drainage area will go directly into the pavement without ponding or overflow (in properly designed systems, the surrounding drainage area is not more than half as large as the permeable pavement area). Following the storm event, there should be no standing water (puddles) on the permeable pavement area.

If storm water is flowing off the permeable pavement during a storm event, or if there is standing water on the permeable pavement surface following a storm event, this is an indicator of clogging somewhere within the system. Poor drainage can result from clogging of the permeable surface layer, any of the subsurface components, or the subgrade soils. The specific cause of the drainage issue must be determined and corrected. Surface or subsurface ponding longer than approximately 96 hours following a storm event poses a risk of vector (mosquito) breeding. Corrective maintenance, increased inspection and maintenance, BMP replacement, or a different BMP type will be required. If poor drainage persists after flushing of the paving, subsurface gravel, and/or underdrain(s) when applicable, or if it is determined that the underlying soils do not have the infiltration capacity expected, County staff shall be contacted prior to any additional repairs or reconstruction.

Other Special Considerations. The runoff storage and infiltration surface area in this BMP are not readily accessible because they are subsurface. This means that clogging and poor drainage are not easily corrected. If the tributary area draining to the BMP includes unpaved areas, the sediment load from the tributary drainage area can be too high, reducing BMP function or clogging the BMP. All unpaved areas within the tributary drainage area should be stabilized with vegetation. Other pretreatment components to prevent transport of sediment to the paving surface, such as grass buffer strips, will extend the life of the subsurface components and infiltration surface. Along with proper stabilization measures and pretreatment within the tributary area, routine maintenance, including preventive vacuum/regenerative air street sweeping, is key to preventing clogging.

Summary of Standard Inspection and Maintenance

The property owner is responsible to ensure inspection, operation and maintenance of permanent BMPs on their property unless responsibility has been formally transferred to an agency, community facilities district, homeowners association, property owners association, or other special district.

Maintenance frequencies listed in this table are average/typical frequencies. Actual maintenance needs are site-specific, and maintenance may be required more frequently. Maintenance must be performed whenever needed, based on maintenance indicators presented in this table. The BMP owner is responsible for conducting regular inspections to see when maintenance is needed based on the maintenance indicators. During the first year of operation of a structural BMP, inspection is recommended at least once prior to August 31 and then monthly from September through May. Inspection during a storm event is also recommended. After the initial period of frequent inspections, the minimum inspection and maintenance frequency can be determined based on the results of the first year inspections.

Threshold/Indicator	Maintenance Action	Inspection and Maintenance Frequency
Preventive vacuum/regenerative air street sweeping	Pavement should be swept with a vacuum power or regenerative air street sweeper to maintain infiltration through paving surface	<ul style="list-style-type: none"> • Schedule/perform this preventive action at least twice per year.
Accumulation of sediment, litter, or debris on permeable pavement surface	Remove and properly dispose of accumulated materials. Inspect tributary area for exposed soil or other sources of sediment and apply stabilization measures to sediment source areas. Apply source control measures as applicable to sources of litter or debris.	<ul style="list-style-type: none"> • Inspect monthly and after every 0.5-inch or larger storm event. • Remove any accumulated materials found at each inspection.
Weeds growing on/through the permeable pavement surface	Remove weeds and add features as necessary to prevent weed intrusion. Use non-chemical methods (e.g., instead of pesticides, control weeds using mechanical removal, physical barriers, and/or physical changes in the surrounding area adjacent to pavement that will preclude weed intrusion into the pavement).	<ul style="list-style-type: none"> • Inspect monthly. • Remove any weeds found at each inspection.

INF-3 Permeable Pavement (Pollutant Control)

Threshold/Indicator	Maintenance Action	Inspection and Maintenance Frequency
<p>Standing water in permeable paving area or subsurface infiltration gallery for longer than 24-96 hours following a storm event</p>	<p>This condition requires investigation of why infiltration is not occurring. If feasible, corrective action shall be taken to restore infiltration (e.g., pavement should be swept with a vacuum power or regenerative air street sweeper to restore infiltration rates, clear underdrains if underdrains are present). BMP may require retrofit if infiltration cannot be restored. The County reviewer shall be contacted prior to any repairs or reconstruction.</p>	<ul style="list-style-type: none"> ● Inspect monthly and after every 0.5-inch or larger storm event. If standing water is observed, increase inspection frequency to after every 0.1-inch or larger storm event. ● Maintain when needed.
<p>Presence of mosquitos/larvae</p> <p>For images of egg rafts, larva, pupa, and adult mosquitos, see http://www.mosquito.org/biology</p>	<p>If mosquitos/larvae are observed: first, immediately remove any standing water by dispersing to nearby landscaping; second, make corrective measures as applicable to restore BMP drainage to prevent standing water.</p> <p>If mosquitos persist following corrective measures to remove standing water, or if the BMP design does not meet the 96-hour drawdown criteria because the underlying native soils have been compacted or do not have the infiltration capacity expected, the County reviewer shall be contacted to determine a solution. A different BMP type, or a Vector Management Plan prepared with concurrence from the County of San Diego Department of Environmental Health, may be required.</p>	<ul style="list-style-type: none"> ● Inspect monthly and after every 0.5-inch or larger storm event. If mosquitos are observed, increase inspection frequency to after every 0.1-inch or larger storm event. ● Maintain when needed.

INF-3 Permeable Pavement (Pollutant Control)

Threshold/Indicator	Maintenance Action	Inspection and Maintenance Frequency
Obstructed underdrain or outlet structure (when the BMP includes outflow control structure for runoff released from subsurface storage via underdrain(s))	Clear blockage.	<ul style="list-style-type: none"> • Inspect if standing water is observed for longer than 24-96 hours following a storm event. • Maintain when needed.
Damage to structural components of subsurface infiltration gallery such as weirs or outlet structures	Repair or replace as applicable.	<ul style="list-style-type: none"> • Inspect annually. • Maintain when needed.
Damage to permeable paving surface (e.g., cracks, settlement, misaligned paver blocks, void spaces between paver blocks need fill materials replenished)	Repair or replace damaged surface as appropriate.	<ul style="list-style-type: none"> • Inspect annually. • Maintain when needed.

This page was intentionally left blank

E.12 INF-4 Dry Wells

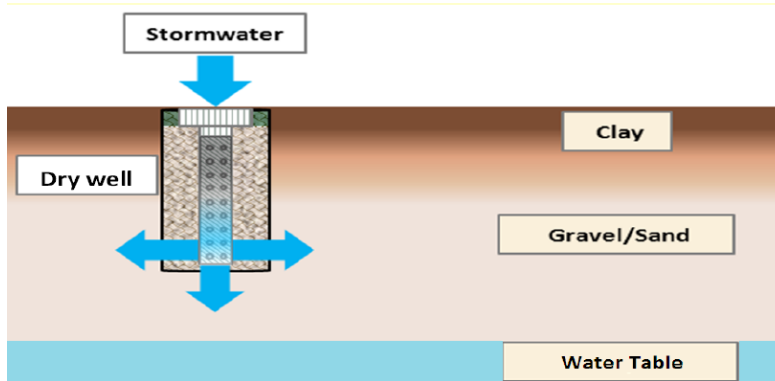

Source: Cal/EPA Fact Sheet on Dry Wells

MS4 Permit Category

Retention

Manual Category

Infiltration

Applicable Performance Standard

Pollutant Control

Flow Control

Primary Benefits

Volume Reduction

Description

Dry wells are typically designed as gravity-fed pits lined with perforated casing and often backfilled with gravel or stone. Dry wells are intended to penetrate layers of poorly infiltrating soils, such as clays, allowing infiltration into deeper permeable layers. Dry wells can reduce storm water runoff while increasing groundwater recharge. It is recommended that dry wells be used in conjunction with low impact development (LID) practices (or pretreatment) to help reduce potential contaminants to groundwater and aquatic ecosystem. Pretreatment effectiveness is contingent upon proper maintenance. With proper design and maintenance, dry wells not only aid in stormwater runoff reduction, but they can also increase groundwater recharge.

Design Adaptations for Project Goals

Full infiltration BMP for storm water pollutant control. Dry wells can be used as a pollutant control BMP, designed to infiltrate runoff from direct rainfall as well as runoff from adjacent areas that are tributary to the pavement. Dry wells must be designed with an infiltration storage volume equal to the full DCV and able to meet drawdown time limitations.

Integrated storm water flow control and pollutant control configuration. Dry wells can be designed to provide flow rate and duration control. This may be accomplished by providing greater infiltration storage

Criteria and Considerations for Use of a Dry Well as Infiltration BMP

In general, a careful site evaluation conducted by a registered civil engineer and a geologist/geotechnical engineer should be made to determine if the use of a dry well is suitable at any particular location

A dry well may be acceptable as an “infiltration BMP” if it meets **ALL** the following criteria:

- The BMP meets the minimum geotechnical and groundwater investigation requirements listed in Appendix B; and
- The BMP is evaluated by approved infiltration rate assessment methods presented in Appendix D; and
- Implements an appropriate Low Impact Development (LID) practice / pretreatment BMP (refer to Appendix J.5.2 for selection); and
- Dry wells serving lots other than single-family homes are registered with the US EPA. (additional information and registration forms can be found at: <https://www.epa.gov/uic>).

In designing a dry well, the following items should be considered:

- Depth of dry well – The EPA currently encourages that the well “should not be constructed deeper than the seasonal high water table”. As water begins to percolate into an aquifer, it requires a certain holding time in order to filter out contaminants before reaching the water table. This would need to be addressed by a professional geologist/geotechnical engineer.
- Geology – Theoretically the well would be dug through an area of low permeability and into an area that would allow the movement of water into the aquifer. Also, the type of geology and its ability to act as a conduit to the aquifer system would need to be addressed. This assessment would need to be made by a professional geologist/geotechnical engineer (Note: While some areas are conducive to this, vast areas of the County of San Diego have geological conditions not conducive for dry wells).
- Grading – The use of a dry well without the proper grading and back up storm drain system might pose a problem with the ponding of runoff due to the dry well’s limited storage capacity and the time it would take to discharge water into the aquifer system. This assessment would need to be made by a professional civil engineer.
- Routine maintenance – Pretreatment effectiveness is contingent upon proper maintenance. Routine maintenance should be provided in order to keep a dry well free of trash/debris, sediments, oil and grease, etc.
- Potential contamination – It is recommended that dry wells be used in conjunction with low impact development (LID) practices (or pretreatment BMPs) to help reduce potential contaminants to groundwater and aquatic ecosystem. Note: The County of San Diego Department of Environmental Health may be able to provide further input.

Note: As indicated on the Cal/EPA Fact Sheet on Dry Wells, there are currently no uniform state regulations or guidelines on dry wells in California. The purpose of this fact sheet is to help explain the role of dry wells in meeting infiltration requirements. Therefore, this fact sheet does not describe specific design criteria like the other fact sheets in this manual. The County of San Diego may develop specific design criteria and include in this fact sheet at a future time.

E.13 PR-1 Biofiltration with Partial Retention



Location: 805 and Bonita Road, Chula vista, CA.

MS4 Permit Category

NA

Manual Category

Partial Retention

Applicable Performance Standard

Pollutant Control

Flow Control

Primary Benefits

Volume Reduction

Treatment

Peak Flow Attenuation

Description

Biofiltration with partial retention (partial infiltration and biofiltration) facilities are vegetated surface water systems that filter water through vegetation, and soil or engineered media prior to infiltrating into native soils, discharge via underdrain, or overflow to the downstream conveyance system. Where feasible, these BMPs have an elevated underdrain discharge point that creates storage capacity in the aggregate storage layer. Biofiltration with partial retention facilities are commonly incorporated into the site within parking lot landscaping, along roadsides, and in open spaces. They can be constructed in ground or partially aboveground, such as planter boxes with open bottoms to allow infiltration. Treatment is achieved through filtration, sedimentation, sorption, infiltration, biochemical processes and plant uptake.

Typical biofiltration with partial retention components include:

- Inflow distribution mechanisms (e.g, perimeter flow spreader or filter strips)
- Energy dissipation mechanism for concentrated inflows (e.g., splash blocks or riprap)
- Shallow surface ponding for captured flows
- Side Slope and basin bottom vegetation selected based on climate and ponding depth
- Non-floating mulch layer
- Media layer (planting mix or engineered media) capable of supporting vegetation growth
- Filter course layer consisting of aggregate to prevent the migration of fines into uncompacted native soils or the optional aggregate storage layer
- Aggregate storage layer with underdrain(s)
- Uncompacted native soils at the bottom of the facility
- Overflow structure

PR-1 Biofiltration with Partial Retention

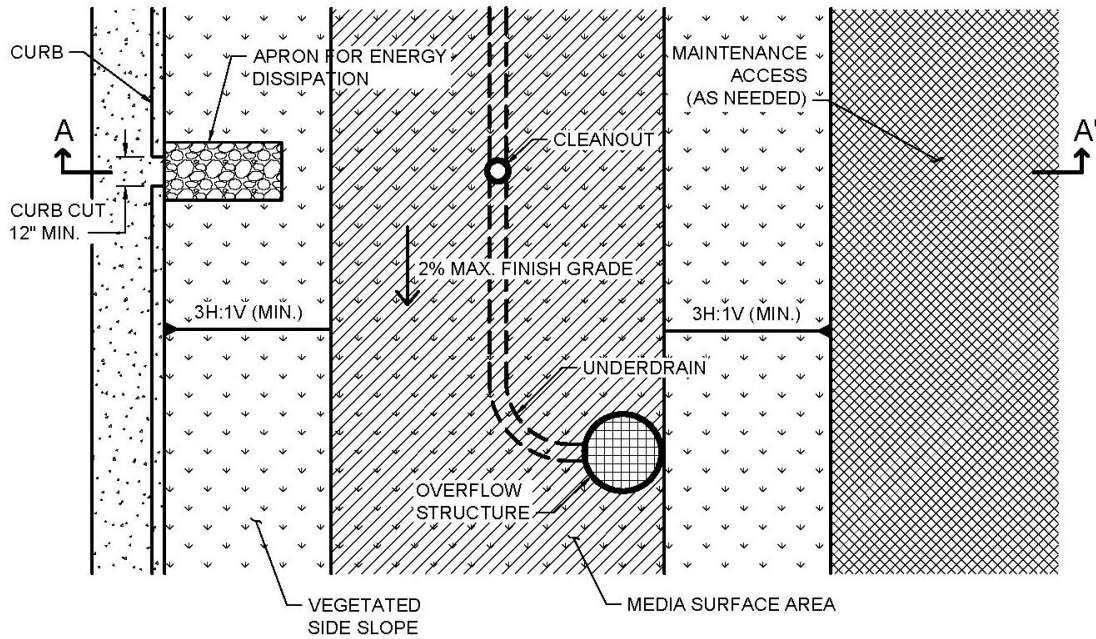

PLAN
NOT TO SCALE

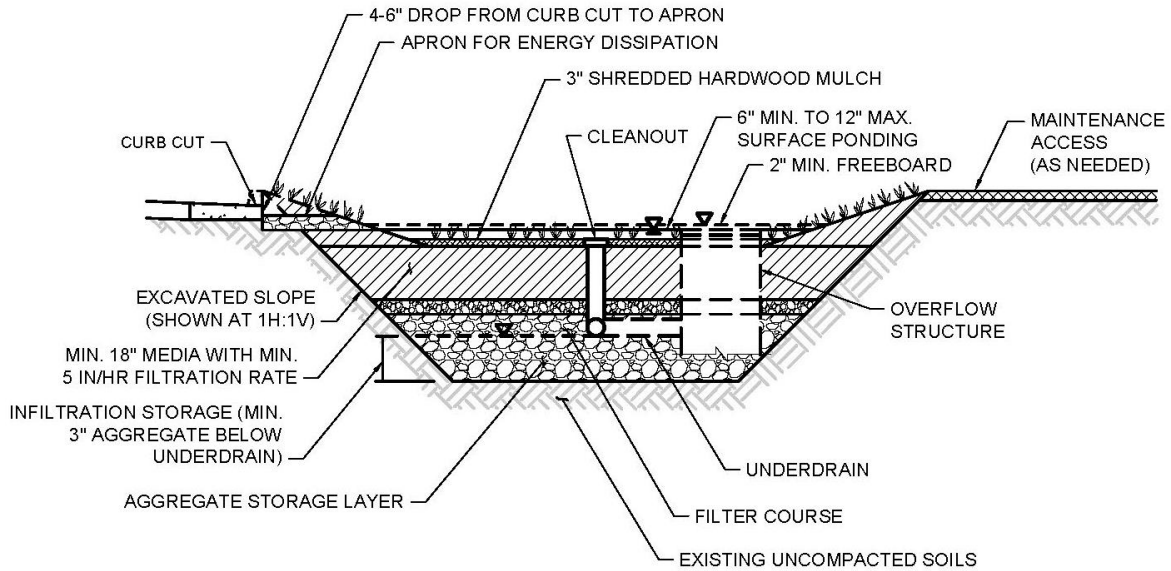

SECTION A-A'
NOT TO SCALE

Typical plan and Section view of a Biofiltration with Partial Retention BMP

Design Adaptations for Project Goals

Partial infiltration BMP with biofiltration treatment for storm water pollutant control. Biofiltration with partial retention can be designed so that a portion of the DCV is infiltrated by providing infiltration storage below the underdrain invert. The infiltration storage depth should be determined by the volume that can be reliably infiltrated within drawdown time limitations. Water discharged through the underdrain is considered biofiltration treatment. Storage provided above the underdrain within surface ponding, media, and aggregate storage is included in the biofiltration treatment volume.

Integrated storm water flow control and pollutant control configuration. The system can be designed to provide flow rate and duration control by primarily providing increased surface ponding and/or having a deeper aggregate storage layer. This will allow for significant detention storage, which can be controlled via inclusion of an orifice in an outlet structure at the downstream end of the underdrain.

Recommended Siting Criteria

<i>Siting Criteria</i>	<i>Intent/Rationale</i>
<input type="checkbox"/> Placement observes geotechnical recommendations regarding potential hazards (e.g., slope stability, landslides, liquefaction zones) and setbacks (e.g., slopes, foundations, utilities).	Must not negatively impact existing site geotechnical concerns.
<input type="checkbox"/> Selection and design of basin is based on infiltration feasibility criteria and appropriate design infiltration rate (See Appendix B and D).	Must operate as a partial infiltration design and must be supported by drainage area and in-situ infiltration rate feasibility findings.
<input type="checkbox"/> Contributing tributary area must be ≤ 5 acres (≤ 1 acre preferred).	Bigger BMPs require additional design features for proper performance. Contributing tributary area greater than 5 acres may be allowed at the discretion of County staff if the following conditions are met: 1) incorporate design features (e.g. flow spreaders) to minimize short circuiting of flows in the BMP and 2) incorporate additional design features requested by County staff for proper performance of the regional BMP.
<input type="checkbox"/> Finish grade of the facility is $\leq 2\%$.	Flatter surfaces reduce erosion and channelization within the facility.

Design Criteria and Considerations

Biofiltration with partial retention must meet the following design criteria and considerations. Deviations from the below criteria may be approved at the discretion of the County reviewer if it is determined to be appropriate:

<i>Design Criteria</i>	<i>Intent/Rationale</i>
<p>Surface Ponding</p> <p><input type="checkbox"/> Surface ponding is limited to a 24-hour drawdown time.</p>	<p>Surface ponding limited to 24 hours for plant health. Surface ponding drawdown time greater than 24-hours but less than 96 hours may be allowed at the discretion of County staff if certified by a landscape architect or agronomist.</p>
<p><input type="checkbox"/> Surface ponding depth is ≥ 6 and ≤ 12 inches.</p>	<p>Surface ponding capacity lowers subsurface storage requirements. Deep surface ponding raises safety concerns. Surface ponding depth greater than 12 inches (for additional pollutant control or surface outlet structures or flow-control orifices) may be allowed at the discretion of County staff if the following conditions are met: 1) surface ponding depth drawdown time is less than 24 hours; and 2) safety issues and fencing requirements are considered (typically ponding greater than 18" will require a fence and/or flatter side slopes) and 3) potential for elevated clogging risk is considered.</p>
<p><input type="checkbox"/> A minimum of 2 inches of freeboard is provided.</p>	<p>Freeboard provides room for head over overflow structures and minimizes risk of uncontrolled surface discharge.</p>
<p><input type="checkbox"/> Side slopes are stabilized with vegetation and are = 3H:1V or shallower.</p>	<p>Gentler side slopes are safer, less prone to erosion, able to establish vegetation more quickly and easier to maintain.</p>

<i>Design Criteria</i>	<i>Intent/Rationale</i>
Vegetation	
<input type="checkbox"/> Plantings are suitable for the climate and expected ponding depth. A plant list to aid in selection can be found in Appendix F.	Plants suited to the climate and ponding depth are more likely to survive.
<input type="checkbox"/> An irrigation system with a connection to water supply should be provided as needed.	Seasonal irrigation might be needed to keep plants healthy.
Mulch (Mandatory)	
<input type="checkbox"/> 3 inches of shredded hardwood mulch. Mulch must be non-floating to avoid clogging of overflow structure.	Mulch will suppress weeds and maintain moisture for plant growth.
Media Layer	
<input type="checkbox"/> Media maintains a minimum filtration rate of 5 in/hr over lifetime of facility. An initial filtration rate of 8 to 12 in/hr is recommended to allow for clogging over time; the initial filtration rate should not exceed 12 inches per hour.	<p>A filtration rate of at least 5 inches per hour allows soil to drain between events, and allows flows to relatively quickly enter the aggregate storage layer, thereby minimizing bypass. The initial rate should be higher than long term target rate to account for clogging over time. However an excessively high initial rate can have a negative impact on treatment performance, therefore an upper limit is needed.</p>
<input type="checkbox"/> Media is a minimum 18 inches deep, meeting either of these two media specifications: Appendix F.2 Biofiltration Soil Media (BSM) or County of San Diego Low Impact Development Handbook: Appendix G - Bioretention Soil Specification (June 2014, unless superseded by more recent edition). Alternatively, for proprietary designs and custom media mixes not meeting the media specifications, the media meets the pollutant treatment performance criteria in Section F.1.1.	<p>A deep media layer provides additional filtration and supports plants with deeper roots.</p> <p>Standard specifications must be followed.</p> <p>For non-standard or proprietary designs, compliance with Appendix F.1.1 ensures that adequate treatment performance will be provided.</p>

<i>Design Criteria</i>	<i>Intent/Rationale</i>
<p><input type="checkbox"/> Media surface area is 3% of contributing area times adjusted runoff factor or greater. Unless demonstrated that the BMP surface area can be smaller than 3%.</p>	<p>Greater surface area to tributary area ratios: a) maximizes volume retention as required by the MS4 Permit and b) decrease loading rates per square foot and therefore increase longevity.</p> <p>Adjusted runoff factor is to account for site design BMPs implemented upstream of the BMP (such as rain barrels, impervious area dispersion, etc.). Refer to Appendix B guidance.</p> <p>If media surface area is under 3% of contributing area, refer to Sediment Loading calculations in Appendix B.</p>
<p><input type="checkbox"/> Where receiving waters are impaired or have a TMDL for nutrients, the system is designed with nutrient sensitive media design (see fact sheet BF-2).</p>	<p>Potential for pollutant export is partly a function of media composition; media design must minimize potential for export of nutrients, particularly where receiving waters are impaired for nutrients.</p>
<i>Filter Course Layer</i>	
<p><input type="checkbox"/> A filter course is used to prevent migration of fines through layers of the facility. Filter fabric is not used.</p>	<p>Migration of media can cause clogging of the aggregate storage layer void spaces or subgrade. Filter fabric is more likely to clog.</p>
<p><input type="checkbox"/> Filter course is a minimum of 6 inches thick provided in two separate 3 inch layers. The top layer shall be made of ASTM C33 choker sand and the bottom layer shall be of ASTM No. 8 aggregate. Marker stakes shall be used to ensure uniform lift thickness.</p>	<p>To prevent reduction of the available storage volume that would lead to clogging of the underdrain and native soil beneath the BMP.</p>
<p><input type="checkbox"/> Filter course is washed and free of fines.</p>	<p>Washing aggregate will help eliminate fines that could clog the facility</p>
<p><input type="checkbox"/> Filter course calculations assessing suitability for particle migration prevention have been completed.</p>	<p>Gradation relationship between layers can evaluate factors (e.g., bridging, permeability, and uniformity) to determine if particle sizing is appropriate or if an intermediate layer is needed.</p>

<i>Design Criteria</i>	<i>Intent/Rationale</i>
<i>Aggregate Storage Layer</i>	
<input type="checkbox"/> Class 2 Permeable per Caltrans specification 68-1.025 is recommended for the storage layer. Washed, open-graded crushed rock may be used, however a 4-6 inch washed pea gravel filter course layer at the top of the crushed rock is required.	Washing aggregate will help eliminate fines that could clog the aggregate storage layer void spaces or subgrade.
<input type="checkbox"/> Maximum aggregate storage layer depth below the underdrain invert is determined based on the infiltration storage volume that will infiltrate within a 48-hour drawdown time.	A maximum drawdown time is needed for vector control and to facilitate providing storm water storage for the next storm event.
<i>Inflow, Underdrain, and Outflow Structures</i>	
<input type="checkbox"/> Inflow, underdrains and outflow structures are accessible for inspection and maintenance.	Maintenance will prevent clogging and ensure proper operation of the flow control structures.
<input type="checkbox"/> Inflow velocities are limited to 3 ft/s or less or use energy dissipation methods. (e.g., riprap, level spreader) for concentrated inflows.	High inflow velocities can cause erosion, scour and/or channeling.
<input type="checkbox"/> Curb cut inlets are at least 12 inches wide, have a 4-6 inch reveal (drop) and an apron and energy dissipation as needed.	Inlets must not restrict flow and apron prevents blockage from vegetation as it grows in. Energy dissipation prevents erosion.
<i>Inflow, Underdrain, and Outflow Structures</i>	
<input type="checkbox"/> Underdrain outlet elevation should be a minimum of 3 inches above the bottom elevation of the aggregate storage layer.	A minimal separation from subgrade or the liner lessens the risk of fines entering the underdrain and can improve hydraulic performance by allowing perforations to remain unblocked.
<input type="checkbox"/> Minimum underdrain diameter is 6 inches.	Smaller diameter underdrains are prone to clogging.
<input type="checkbox"/> Underdrains are made of slotted, PVC pipe conforming to ASTM D 3034 or equivalent or corrugated, HDPE pipe conforming to AASHTO 252M or equivalent.	Slotted underdrains provide greater intake capacity, clog resistant drainage, and reduced entrance velocity into the pipe, thereby reducing the chances of solids migration.
<input type="checkbox"/> An underdrain cleanout with a minimum 6-inch diameter and lockable cap is placed every 250 to 300 feet as required based on underdrain length.	Properly spaced cleanouts will facilitate underdrain maintenance.

<i>Design Criteria</i>	<i>Intent/Rationale</i>
<input type="checkbox"/> Overflow is safely conveyed to a downstream storm drain system or discharge point. Size overflow structure to pass 100-year peak flow for on-line infiltration basins and water quality peak flow for off-line basins.	Planning for overflow lessens the risk of property damage due to flooding.

Nutrient Sensitive Media Design

To design biofiltration with partial retention with underdrain for storm water pollutant control only (no flow control required), the following steps should be taken:

Conceptual Design and Sizing Approach for Storm Water Pollutant Control Only

To design biofiltration with partial retention and an underdrain for storm water pollutant control only (no flow control required), the following steps should be taken:

1. Verify that siting and design criteria have been met, including placement requirements, contributing tributary area, maximum side and finish grade slopes, and the recommended media surface area tributary ratio.
2. Calculate the DCV per Appendix B based on expected site design runoff for tributary areas.
3. Generalized sizing procedure is presented in Appendix B.5. The surface ponding should be verified to have a maximum 24-hour drawdown time.

Conceptual Design and Sizing Approach when Storm Water Flow Control is Applicable

Control of flow rates and/or durations will typically require significant surface ponding and/or aggregate storage volumes, and therefore the following steps should be taken prior to determination of storm water pollutant control design. Pre-development and allowable post-project flow rates and durations should be determined as discussed in Chapter 6 of the manual.

1. Verify that siting and design criteria have been met, including placement requirements, contributing tributary area, maximum side and finish grade slopes, and the recommended media surface area tributary ratio.
2. Iteratively determine the facility footprint area, surface ponding and/or aggregate storage layer depth required to provide detention and/or infiltration storage to reduce flow rates and durations to allowable limits. Flow rates and durations can be controlled from detention storage by altering outlet structure orifice size(s) and/or water control levels. Multi-level orifices can be used within an outlet structure to control the full range of flows.
3. If biofiltration with partial retention cannot fully provide the flow rate and duration control required by this manual, an upstream or downstream structure with significant storage volume such as an underground vault can be used to provide remaining controls.

4. After biofiltration with partial retention has been designed to meet flow control requirements, calculations must be completed to verify if storm water pollutant control requirements to treat the DCV have been met.

Maintenance Overview

Normal Expected Maintenance. Biofiltration with partial retention requires routine maintenance to: remove accumulated materials such as sediment, trash or debris; maintain vegetation health; maintain infiltration capacity of the media layer; replenish mulch; and maintain integrity of side slopes, inlets, energy dissipators, and outlets. A summary table of standard inspection and maintenance indicators is provided within this Fact Sheet.

Non-Standard Maintenance or BMP Failure. If any of the following scenarios are observed, the BMP is not performing as intended to protect downstream waterways from pollution and/or erosion. Corrective maintenance, increased inspection and maintenance, BMP replacement, or a different BMP type will be required.

- The BMP is not drained between storm events. Surface ponding longer than approximately 24 hours following a storm event may be detrimental to vegetation health, and surface ponding longer than approximately 96 hours following a storm event poses a risk of vector (mosquito) breeding. Poor drainage can result from clogging of the media layer, filter course, aggregate storage layer, underdrain, or outlet structure. The specific cause of the drainage issue must be determined and corrected.
- Sediment, trash, or debris accumulation greater than 25% of the surface ponding volume within one month. This means the load from the tributary drainage area is too high, reducing BMP function or clogging the BMP. This would require pretreatment measures within the tributary area draining to the BMP to intercept the materials. Pretreatment components, especially for sediment, will extend the life of components that are more expensive to replace such as media, filter course, and aggregate layers.
- Erosion due to concentrated storm water runoff flow that is not readily corrected by adding erosion control blankets, adding stone at flow entry points, or minor re-grading to restore proper drainage according to the original plan. If the issue is not corrected by restoring the BMP to the original plan and grade, the County reviewer shall be contacted prior to any additional repairs or reconstruction.

Other Special Considerations. Biofiltration with partial retention is a vegetated structural BMP. Vegetated structural BMPs that are constructed in the vicinity of, or connected to, an existing jurisdictional water or wetland could inadvertently result in creation of expanded waters or wetlands. As such, vegetated structural BMPs have the potential to come under the jurisdiction of the United States Army Corps of Engineers, SDRWQCB, California Department of Fish and Wildlife, or the United States Fish and Wildlife Service. This could result in the need for specific resource agency

PR-1 Biofiltration with Partial Retention

permits and costly mitigation to perform maintenance of the structural BMP. Along with proper placement of a structural BMP, routine maintenance is key to preventing this scenario.

Sediment Loading. Consider the effects of BMP design and tributary area land uses on the clogging potential of the BMP. Complete the sediment loading analysis included in Appendix F.

Summary of Standard Inspection and Maintenance

The property owner is responsible to ensure inspection, operation and maintenance of permanent BMPs on their property unless responsibility has been formally transferred to an agency, community facilities district, homeowners association, property owners association, or other special district.

Maintenance frequencies listed in this table are average/typical frequencies. Actual maintenance needs are site-specific, and maintenance may be required more frequently. Maintenance must be performed whenever needed, based on maintenance indicators presented in this table. The BMP owner is responsible for conducting regular inspections to see when maintenance is needed based on the maintenance indicators. During the first year of operation of a structural BMP, inspection is recommended at least once prior to August 31 and then monthly from September through May. Inspection during a storm event is also recommended. After the initial period of frequent inspections, the minimum inspection and maintenance frequency can be determined based on the results of the first year inspections.

Threshold/Indicator	Maintenance Action	Inspection and Maintenance Frequency
Accumulation of sediment, litter, or debris	Remove and properly dispose of accumulated materials, without damage to the vegetation or compaction of the media layer.	<ul style="list-style-type: none"> • Inspect monthly. If the BMP is 25% full* or more in one month, increase inspection frequency to monthly plus after every 0.1-inch or larger storm event. • Remove any accumulated materials found at each inspection.
Obstructed inlet or outlet structure	Clear blockage.	<ul style="list-style-type: none"> • Inspect monthly and after every 0.5-inch or larger storm event. • Remove any accumulated materials found at each inspection.
Damage to structural components such as weirs, inlet or outlet structures	Repair or replace as applicable.	<ul style="list-style-type: none"> • Inspect annually. • Maintain when needed.
Poor vegetation establishment	Re-seed, re-plant, or re-establish vegetation per original plans.	<ul style="list-style-type: none"> • Inspect monthly. • Maintain when needed.

PR-1 Biofiltration with Partial Retention

Threshold/Indicator	Maintenance Action	Inspection and Maintenance Frequency
Dead or diseased vegetation	Remove dead or diseased vegetation, re-seed, re-plant, or re-establish vegetation per original plans.	<ul style="list-style-type: none"> • Inspect monthly. • Maintain when needed.
Overgrown vegetation	Mow or trim as appropriate.	<ul style="list-style-type: none"> • Inspect monthly. • Maintain when needed.
2/3 of mulch has decomposed, or mulch has been removed	Remove decomposed fraction and top off with fresh mulch to a total depth of 3 inches.	<ul style="list-style-type: none"> • Inspect monthly. • Replenish mulch annually, or more frequently when needed based on inspection.
Erosion due to concentrated irrigation flow	Repair/re-seed/re-plant eroded areas and adjust the irrigation system.	<ul style="list-style-type: none"> • Inspect monthly. • Maintain when needed.
Erosion due to concentrated storm water runoff flow	Repair/re-seed/re-plant eroded areas, and make appropriate corrective measures such as adding erosion control blankets, adding stone at flow entry points, or minor re-grading to restore proper drainage according to the original plan. If the issue is not corrected by restoring the BMP to the original plan and grade, the County reviewer shall be contacted prior to any additional repairs or reconstruction.	<ul style="list-style-type: none"> • Inspect after every 0.5-inch or larger storm event. If erosion due to storm water flow has been observed, increase inspection frequency to after every 0.1-inch or larger storm event. • Maintain when needed. If the issue is not corrected by restoring the BMP to the original plan and grade, the County reviewer shall be contacted prior to any additional repairs or reconstruction.
<p>Standing water in BMP for longer than 24 hours following a storm event</p> <p>Surface ponding longer than approximately 24 hours following a storm event may be detrimental to vegetation health</p>	Make appropriate corrective measures such as adjusting irrigation system, removing obstructions of debris or invasive vegetation, clearing underdrains, or repairing/replacing clogged or compacted soils.	<ul style="list-style-type: none"> • Inspect monthly and after every 0.5-inch or larger storm event. If standing water is observed, increase inspection frequency to after every 0.1-inch or larger storm event. • Maintain when needed.

Threshold/Indicator	Maintenance Action	Inspection and Maintenance Frequency
<p>Presence of mosquitos/larvae</p> <p>For images of egg rafts, larva, pupa, and adult mosquitos, see http://www.mosquito.org/biology</p>	<p>If mosquitos/larvae are observed: first, immediately remove any standing water by dispersing to nearby landscaping; second, make corrective measures as applicable to restore BMP drainage to prevent standing water.</p> <p>If mosquitos persist following corrective measures to remove standing water, or if the BMP design does not meet the 96-hour drawdown criteria due to release rates controlled by an orifice installed on the underdrain, the County reviewer shall be contacted to determine a solution. A different BMP type, or a Vector Management Plan prepared with concurrence from the County of San Diego Department of Environmental Health, may be required.</p>	<ul style="list-style-type: none"> • Inspect monthly and after every 0.5-inch or larger storm event. If mosquitos are observed, increase inspection frequency to after every 0.1-inch or larger storm event. • Maintain when needed.
<p>Underdrain clogged</p>	<p>Clear blockage.</p>	<p>Inspect if standing water is observed for longer than 24-96 hours following a storm event.</p> <p>Maintain when needed.</p>

This page was intentionally left blank

E.14 BF-1 Biofiltration



Location: 43rd Street and Logan Avenue, San Diego, California

Description

Biofiltration (Bioretention with underdrain) facilities are vegetated surface water systems that filter water through vegetation, and soil or engineered media prior to discharge via underdrain or overflow to the downstream conveyance system. Bioretention with underdrain facilities are commonly incorporated into the site within parking lot landscaping, along roadsides, and in open spaces. Because these types of facilities have limited or no infiltration, they are typically designed to provide enough hydraulic head to move flows through the underdrain connection to the storm drain system. Treatment is achieved through filtration, sedimentation, sorption, biochemical processes and plant uptake.

Typical biofiltration components include:

- Inflow distribution mechanisms (e.g, perimeter flow spreader or filter strips)
- Energy dissipation mechanism for concentrated inflows (e.g., splash blocks or riprap)
- Shallow surface ponding for captured flows
- Side slope and basin bottom vegetation selected based on expected climate and ponding depth
- Non-floating mulch layer
- Media layer (planting mix or engineered media) capable of supporting vegetation growth
- Filter course layer consisting of aggregate to prevent the migration of fines into uncompacted native soils or the aggregate storage layer
- Aggregate storage layer with underdrain(s)
- Impermeable liner or uncompacted native soils at the bottom of the facility
- Overflow structure

MS4 Permit Category

Biofiltration

Manual Category

Biofiltration

Applicable Performance Standard

Pollutant Control

Flow Control

Primary Benefits

Treatment

Volume Reduction (Incidental)

Peak Flow Attenuation (Optional)

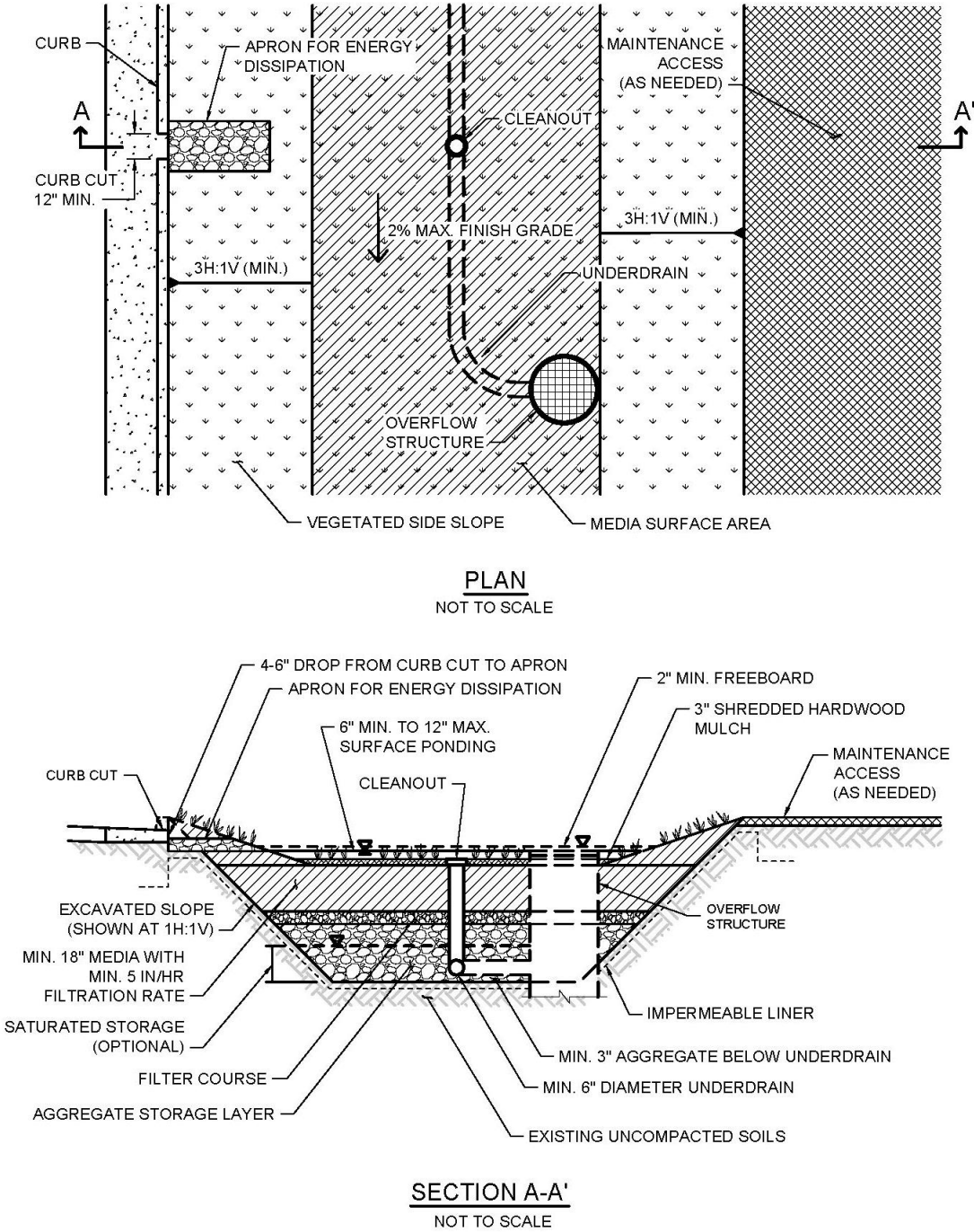

Typical plan and Section view of a Biofiltration BMP

Design Adaptations for Project Goals

Biofiltration Treatment BMP for storm water pollutant control. The system is lined or un-lined to provide incidental infiltration, and an underdrain is provided at the bottom to carry away filtered runoff. This configuration is considered to provide biofiltration treatment via flow through the media

layer. Storage provided above the underdrain within surface ponding, media, and aggregate storage is considered included in the biofiltration treatment volume. Saturated storage within the aggregate storage layer can be added to this design by raising the underdrain above the bottom of the aggregate storage layer or via an internal weir structure designed to maintain a specific water level elevation.

Integrated storm water flow control and pollutant control configuration. The system can be designed to provide flow rate and duration control by primarily providing increased surface ponding and/or having a deeper aggregate storage layer above the underdrain. This will allow for significant detention storage, which can be controlled via inclusion of an outlet structure at the downstream end of the underdrain.

Recommended Siting Criteria

<i>Siting Criteria</i>	<i>Intent/Rationale</i>
<input type="checkbox"/> Placement observes geotechnical recommendations regarding potential hazards (e.g., slope stability, landslides, liquefaction zones) and setbacks (e.g., slopes, foundations, utilities).	Must not negatively impact existing site geotechnical concerns.
<input type="checkbox"/> An impermeable liner or other hydraulic restriction layer is included if site constraints indicate that infiltration or lateral flows should not be allowed.	Lining prevents storm water from impacting groundwater and/or sensitive environmental or geotechnical features. Incidental infiltration, when allowable, can aid in pollutant removal and groundwater recharge.
<input type="checkbox"/> The thickness of the Impermeable Liner shall be 30 MIL per County Green Streets Design Standard Drawing GS-3.00 and County Green Streets Supplement to Caltrans Specifications 20-11.08B.	Considerations when choosing an Impermeable Liner may include placement methods, media and underlying soil characteristics, and intended design life among others.
<input type="checkbox"/> Contributing tributary area must be ≤ 5 acres (≤ 1 acre preferred).	Bigger BMPs require additional design features for proper performance. Contributing tributary area greater than 5 acres may be allowed at the discretion of County staff if the following conditions are met: 1) incorporate design features (e.g. flow spreaders) to minimize short circuiting of flows in the BMP and 2) incorporate additional design features requested by County staff for proper performance of the regional BMP.

<i>Siting Criteria</i>	<i>Intent/Rationale</i>
<input type="checkbox"/> Finish grade of the facility is $\leq 2\%$.	Flatter surfaces reduce erosion and channelization within the facility.

Design Criteria and Considerations

Biofiltration must meet the following design criteria. Deviations from the below criteria may be approved at the discretion of County staff if it is determined to be appropriate:

<i>Siting and Design</i>	<i>Intent/Rationale</i>
Surface Ponding	
<input type="checkbox"/> Surface ponding is limited to a 24-hour drawdown time.	Surface ponding limited to 24 hour for plant health. Surface ponding drawdown time greater than 24-hours but less than 96 hours may be allowed at the discretion of County staff if certified by a landscape architect or agronomist.
<input type="checkbox"/> Surface ponding depth is ≥ 6 and ≤ 12 inches.	Surface ponding capacity lowers subsurface storage requirements. Deep surface ponding raises safety concerns. Surface ponding depth greater than 12 inches (for additional pollutant control or surface outlet structures or flow-control orifices) may be allowed at the discretion of County staff if the following conditions are met: 1) surface ponding depth drawdown time is less than 24 hours; and 2) safety issues and fencing requirements are considered (typically ponding greater than 18" will require a fence and/or flatter side slopes) and 3) potential for elevated clogging risk is considered.
<input type="checkbox"/> A minimum of 2 inches of freeboard is provided.	Freeboard provides room for head over overflow structures and minimizes risk of uncontrolled surface discharge.
<input type="checkbox"/> Side slopes are stabilized with vegetation and are = 3H:1V or shallower.	Gentler side slopes are safer, less prone to erosion, able to establish vegetation more quickly and easier to maintain.

<i>Siting and Design</i>	<i>Intent/Rationale</i>
<i>Vegetation</i>	
<input type="checkbox"/> Plantings are suitable for the climate and expected ponding depth. A plant list to aid in selection can be found in Appendix F.	Plants suited to the climate and ponding depth are more likely to survive.
<input type="checkbox"/> An irrigation system with a connection to water supply should be provided as needed.	Seasonal irrigation might be needed to keep plants healthy.
<i>Mulch (Mandatory)</i>	
<input type="checkbox"/> 3 inches of well-aged, shredded hardwood mulch.	Mulch will suppress weeds and maintain moisture for plant growth.
<i>Media Layer</i>	
<input type="checkbox"/> Media maintains a minimum filtration rate of 5 in/hr over lifetime of facility. An initial filtration rate of 8 to 12 in/hr is recommended to allow for clogging over time; the initial filtration rate should not exceed 12 inches per hour.	A filtration rate of at least 5 inches per hour allows soil to drain between events. The initial rate should be higher than long term target rate to account for clogging over time. However an excessively high initial rate can have a negative impact on treatment performance, therefore an upper limit is needed.
<input type="checkbox"/> Media is a minimum 18 inches deep, meeting either of these two media specifications: Appendix F.2 Biofiltration Soil Media (BSM) or County of San Diego Low Impact Development Handbook: Appendix G -Bioretention Soil Specification (June 2014, unless superseded by more recent edition).	A deep media layer provides additional filtration and supports plants with deeper roots.
<input type="checkbox"/> Alternatively, for proprietary designs and custom media mixes not meeting the media specifications, the media meets the pollutant treatment performance criteria in Section F.1.1.	Standard specifications must be followed. For non-standard or proprietary designs, compliance with F.1.1 ensures that adequate treatment performance will be provided.

<i>Siting and Design</i>	<i>Intent/Rationale</i>
<p><input type="checkbox"/> Media surface area is 3% of contributing area times adjusted runoff factor or greater. Unless demonstrated that the BMP surface area can be smaller than 3%.</p>	<p>Greater surface area to tributary area ratios: a) maximizes volume retention as required by the MS4 Permit and b) decrease loading rates per square foot and therefore increase longevity.</p> <p>Adjusted runoff factor is to account for site design BMPs implemented upstream of the BMP (such as rain barrels, impervious area dispersion, etc.). Refer to Appendix B guidance.</p> <p>If media surface area is under 3% of contributing area, refer to Sediment Loading calculations in Appendix B.</p>
<p><input type="checkbox"/> Where receiving waters are impaired or have a TMDL for nutrients, the system is designed with nutrient sensitive media design (see fact sheet BF-2).</p>	<p>Potential for pollutant export is partly a function of media composition; media design must minimize potential for export of nutrients, particularly where receiving waters are impaired for nutrients.</p>
<i>Filter Course Layer</i>	
<p><input type="checkbox"/> A filter course is used to prevent migration of fines through layers of the facility. Filter fabric is not used.</p>	<p>Migration of media can cause clogging of the aggregate storage layer void spaces or subgrade. Filter fabric is more likely to clog.</p>
<p><input type="checkbox"/> Filter course is a minimum of 6 inches thick provided in two separate 3 inch layers. The top layer shall be made of ASTM C33 choker sand and the bottom layer shall be of ASTM No. 8 aggregate. Marker stakes shall be used to ensure uniform lift thickness.</p>	<p>To prevent reduction of the available storage volume that would lead to clogging of the underdrain and native soil beneath the BMP.</p>
<p><input type="checkbox"/> Filter course is washed and free of fines.</p>	<p>Washing aggregate will help eliminate fines that could clog the facility and impede infiltration.</p>
<p><input type="checkbox"/> Filter course calculations assessing suitability for particle migration prevention have been completed.</p>	<p>Gradation relationship between layers can evaluate factors (e.g., bridging, permeability, and uniformity) to determine if particle sizing is appropriate or if an intermediate layer is needed.</p>

<i>Siting and Design</i>		<i>Intent/Rationale</i>
<i>Aggregate Storage Layer</i>		
<input type="checkbox"/>	Class 2 Permeable per Caltrans specification 68-1.025 is recommended for the storage layer. Washed, open-graded crushed rock may be used, however a 4-6 inch washed pea gravel filter course layer at the top of the crushed rock is required.	Washing aggregate will help eliminate fines that could clog the aggregate storage layer void spaces or subgrade.
<input type="checkbox"/>	The depth of aggregate provided (12-inch typical) and storage layer configuration is adequate for providing conveyance for underdrain flows to the outlet structure.	Proper storage layer configuration and underdrain placement will minimize facility drawdown time.
<i>Inflow, Underdrain, and Outflow Structures</i>		
<input type="checkbox"/>	Inflow, underdrains and outflow structures are accessible for inspection and maintenance.	Maintenance will prevent clogging and ensure proper operation of the flow control structures.
<input type="checkbox"/>	Inflow velocities are limited to 3 ft/s or less or use energy dissipation methods. (e.g., riprap, level spreader) for concentrated inflows.	High inflow velocities can cause erosion, scour and/or channeling.
<input type="checkbox"/>	Curb cut inlets are at least 12 inches wide, have a 4-6 inch reveal (drop) and an apron and energy dissipation as needed.	Inlets must not restrict flow and apron prevents blockage from vegetation as it grows in. Energy dissipation prevents erosion.
<input type="checkbox"/>	Underdrain outlet elevation should be a minimum of 3 inches above the bottom elevation of the aggregate storage layer.	A minimal separation from subgrade or the liner lessens the risk of fines entering the underdrain and can improve hydraulic performance by allowing perforations to remain unblocked.
<input type="checkbox"/>	Minimum underdrain diameter is 6 inches.	Smaller diameter underdrains are prone to clogging.
<i>Inflow, Underdrain, and Outflow Structures</i>		
<input type="checkbox"/>	Underdrains are made of slotted, PVC pipe conforming to ASTM D 3034 or equivalent or corrugated, HDPE pipe conforming to AASHTO 252M or equivalent.	Slotted underdrains provide greater intake capacity, clog resistant drainage, and reduced entrance velocity into the pipe, thereby reducing the chances of solids migration.

<i>Siting and Design</i>	<i>Intent/Rationale</i>
<input type="checkbox"/> An underdrain cleanout with a minimum 6-inch diameter and lockable cap is placed every 250 to 300 feet as required based on underdrain length.	Properly spaced cleanouts will facilitate underdrain maintenance.
<input type="checkbox"/> Overflow is safely conveyed to a downstream storm drain system or discharge point. Size overflow structure to pass 100-year peak flow for on-line infiltration basins and water quality peak flow for off-line basins.	Planning for overflow lessens the risk of property damage due to flooding.

Conceptual Design and Sizing Approach for Storm Water Pollutant Control Only

To design biofiltration for storm water pollutant control only (no flow control required), the following steps should be taken:

1. Verify that siting and design criteria have been met, including placement requirements, contributing tributary area, maximum side and finish grade slopes, and the recommended media surface area tributary ratio.
2. Calculate the DCV per Appendix B based on expected site design runoff for tributary areas.
3. Use the sizing worksheet presented in Appendix B.5 to size biofiltration BMPs.

Conceptual Design and Sizing Approach when Storm Water Flow Control is Applicable

Control of flow rates and/or durations will typically require significant surface ponding and/or aggregate storage volumes, and therefore the following steps should be taken prior to determination of storm water pollutant control design. Pre-development and allowable post-project flow rates and durations should be determined as discussed in Chapter 6 of the manual.

1. Verify that siting and design criteria have been met, including placement requirements, contributing tributary area, maximum side and finish grade slopes, and the recommended media surface area tributary ratio.
2. Iteratively determine the facility footprint area, surface ponding and/or aggregate storage layer depth required to provide detention storage to reduce flow rates and durations to allowable limits. Flow rates and durations can be controlled from detention storage by altering outlet structure orifice size(s) and/or water control levels. Multi-level orifices can be used within an outlet structure to control the full range of flows.
3. If bioretention with underdrain cannot fully provide the flow rate and duration control required by this manual, an upstream or downstream structure with significant storage volume such as an underground vault can be used to provide remaining controls.

4. After bioretention with underdrain has been designed to meet flow control requirements, calculations must be completed to verify if storm water pollutant control requirements to treat the DCV have been met.

Maintenance Overview

Normal Expected Maintenance. Biofiltration requires routine maintenance to: remove accumulated materials such as sediment, trash or debris; maintain vegetation health; maintain infiltration capacity of the media layer; replenish mulch; and maintain integrity of side slopes, inlets, energy dissipators, and outlets. A summary table of standard inspection and maintenance indicators is provided within this Fact Sheet.

Non-Standard Maintenance or BMP Failure. If any of the following scenarios are observed, the BMP is not performing as intended to protect downstream waterways from pollution and/or erosion. Corrective maintenance, increased inspection and maintenance, BMP replacement, or a different BMP type will be required.

- The BMP is not drained between storm events. Surface ponding longer than approximately 24 hours following a storm event may be detrimental to vegetation health, and surface ponding longer than approximately 96 hours following a storm event poses a risk of vector (mosquito) breeding. Poor drainage can result from clogging of the media layer, filter course, aggregate storage layer, underdrain, or outlet structure. The specific cause of the drainage issue must be determined and corrected.
- Sediment, trash, or debris accumulation greater than 25% of the surface ponding volume within one month. This means the load from the tributary drainage area is too high, reducing BMP function or clogging the BMP. This would require pretreatment measures within the tributary area draining to the BMP to intercept the materials. Pretreatment components, especially for sediment, will extend the life of components that are more expensive to replace such as media, filter course, and aggregate layers.
- Erosion due to concentrated storm water runoff flow that is not readily corrected by adding erosion control blankets, adding stone at flow entry points, or minor re-grading to restore proper drainage according to the original plan. If the issue is not corrected by restoring the BMP to the original plan and grade, the County reviewer shall be contacted prior to any additional repairs or reconstruction.

Other Special Considerations. Biofiltration is a vegetated structural BMP. Vegetated structural BMPs that are constructed in the vicinity of, or connected to, an existing jurisdictional water or wetland could inadvertently result in creation of expanded waters or wetlands. As such, vegetated structural BMPs have the potential to come under the jurisdiction of the United States Army Corps of Engineers, SDRWQCB, California Department of Fish and Wildlife, or the United States Fish and Wildlife Service. This could result in the need for specific resource agency permits and costly mitigation to perform maintenance of the structural BMP. Along with proper placement of a structural

BMP, routine maintenance is key to preventing this scenario.

Sediment Loading. Consider the effects of BMP design and tributary area land uses on the clogging potential of the BMP. Complete the sediment loading analysis included in Appendix F.

Summary of Standard Inspection and Maintenance

The property owner is responsible to ensure inspection, operation and maintenance of permanent BMPs on their property unless responsibility has been formally transferred to an agency, community facilities district, homeowners association, property owners association, or other special district.

Maintenance frequencies listed in this table are average/typical frequencies. Actual maintenance needs are site-specific, and maintenance may be required more frequently. Maintenance must be performed whenever needed, based on maintenance indicators presented in this table. The BMP owner is responsible for conducting regular inspections to see when maintenance is needed based on the maintenance indicators. During the first year of operation of a structural BMP, inspection is recommended at least once prior to August 31 and then monthly from September through May. Inspection during a storm event is also recommended. After the initial period of frequent inspections, the minimum inspection and maintenance frequency can be determined based on the results of the first year inspections.

Threshold/Indicator	Maintenance Action	Inspection and Maintenance Frequency
Accumulation of sediment, litter, or debris	Remove and properly dispose of accumulated materials, without damage to the vegetation or compaction of the media layer.	<ul style="list-style-type: none"> • Inspect monthly. If the BMP is 25% full* or more in one month, increase inspection frequency to monthly plus after every 0.1-inch or larger storm event. • Remove any accumulated materials found at each inspection.
Obstructed inlet or outlet structure	Clear blockage.	<ul style="list-style-type: none"> • Inspect monthly and after every 0.5-inch or larger storm event. • Remove any accumulated materials found at each inspection.
Damage to structural components such as weirs, inlet or outlet structures	Repair or replace as applicable	<ul style="list-style-type: none"> • Inspect annually. • Maintain when needed.
Poor vegetation establishment	Re-seed, re-plant, or re-establish vegetation per original plans.	<ul style="list-style-type: none"> • Inspect monthly. • Maintain when needed.

Threshold/Indicator	Maintenance Action	Inspection and Maintenance Frequency
Dead or diseased vegetation	Remove dead or diseased vegetation, re-seed, re-plant, or re-establish vegetation per original plans.	<ul style="list-style-type: none"> • Inspect monthly. • Maintain when needed.
Overgrown vegetation	Mow or trim as appropriate.	<ul style="list-style-type: none"> • Inspect monthly. • Maintain when needed.
2/3 of mulch has decomposed, or mulch has been removed	Remove decomposed fraction and top off with fresh mulch to a total depth of 3 inches.	<ul style="list-style-type: none"> • Inspect monthly. • Replenish mulch annually, or more frequently when needed based on inspection.
Erosion due to concentrated irrigation flow	Repair/re-seed/re-plant eroded areas and adjust the irrigation system.	<ul style="list-style-type: none"> • Inspect monthly. • Maintain when needed.
Erosion due to concentrated storm water runoff flow	Repair/re-seed/re-plant eroded areas, and make appropriate corrective measures such as adding erosion control blankets, adding stone at flow entry points, or minor re-grading to restore proper drainage according to the original plan. If the issue is not corrected by restoring the BMP to the original plan and grade, the County reviewer shall be contacted prior to any additional repairs or reconstruction.	<ul style="list-style-type: none"> • Inspect after every 0.5-inch or larger storm event. If erosion due to storm water flow has been observed, increase inspection frequency to after every 0.1-inch or larger storm event. • Maintain when needed. If the issue is not corrected by restoring the BMP to the original plan and grade, the County reviewer shall be contacted prior to any additional repairs or reconstruction.
<p>Standing water in BMP for longer than 24 hours following a storm event</p> <p>Surface ponding longer than approximately 24 hours following a storm event may be detrimental to vegetation health</p>	Make appropriate corrective measures such as adjusting irrigation system, removing obstructions of debris or invasive vegetation, clearing underdrains, or repairing/replacing clogged or compacted soils.	<ul style="list-style-type: none"> • Inspect monthly and after every 0.5-inch or larger storm event. If standing water is observed, increase inspection frequency to after every 0.1-inch or larger storm event. • Maintain when needed.

Threshold/Indicator	Maintenance Action	Inspection and Maintenance Frequency
<p>Presence of mosquitos/larvae</p> <p>For images of egg rafts, larva, pupa, and adult mosquitos, see http://www.mosquito.org/biology</p>	<p>If mosquitos/larvae are observed: first, immediately remove any standing water by dispersing to nearby landscaping; second, make corrective measures as applicable to restore BMP drainage to prevent standing water.</p> <p>If mosquitos persist following corrective measures to remove standing water, or if the BMP design does not meet the 96-hour drawdown criteria due to release rates controlled by an orifice installed on the underdrain, the County reviewer shall be contacted to determine a solution. A different BMP type, or a Vector Management Plan prepared with concurrence from the County of San Diego Department of Environmental Health, may be required.</p>	<ul style="list-style-type: none"> • Inspect monthly and after every 0.5-inch or larger storm event. If mosquitos are observed, increase inspection frequency to after every 0.1-inch or larger storm event. • Maintain when needed.
<p>Underdrain clogged</p>	<p>Clear blockage.</p>	<p>Inspect if standing water is observed for longer than 24-96 hours following a storm event.</p> <p>Maintain when needed.</p>

“25% full” is defined as ¼ of the depth from the design bottom elevation to the crest of the outflow structure (e.g., if the height to the outflow opening is 12 inches from the bottom elevation, then the materials must be removed when there is 3 inches of accumulation – this should be marked on the outflow structure).

This page was intentionally left blank.

E.15 BF-2 Nutrient Sensitive Media Design

Some studies of bioretention with underdrains have observed export of nutrients, particularly inorganic nitrogen (nitrate and nitrite) and dissolved phosphorus. This has been observed to be a short-lived phenomenon in some studies or a long term issue in some studies. The composition of the soil media, including the chemistry of individual elements is believed to be an important factor in the potential for nutrient export. Organic amendments, often compost, have been identified as the most likely source of nutrient export. The quality and stability of organic amendments can vary widely.

The biofiltration media specifications contained in Appendix F.2 of this Manual and also contained in the County of San Diego Low Impact Development Handbook: Appendix G -Bioretention Soil Specification (June 2014, unless superseded by more recent edition) were developed with consideration of the potential for nutrient export. These specifications include criteria for individual component characteristics and quality in order to control the overall quality of the blended mixes. As of the publication of this manual, the specifications contained in Appendix F.2 of the County of San Diego BMP Design Manual provide more detail regarding mix design and quality control.

The specifications noted above were developed for general purposes to meet permeability and treatment goals. In cases where the BMP discharges to receiving waters with nutrient impairments or nutrient TMDLs, the biofiltration media should be designed with the specific goal of minimizing the potential for export of nutrients from the media. Therefore, in addition to adhering to the County media specifications, the following guidelines should be followed:

1. Select plant palette to minimize plant nutrient needs

A landscape architect or agronomist should be consulted to select a plant palette that minimizes nutrient needs. Utilizing plants with low nutrient needs results in less need to enrich the biofiltration soil mix. If nutrient quantity is then tailored to plants with lower nutrient needs, these plants will generally have less competition from weeds, which typically need higher nutrient content. The following practices are recommended to minimize nutrient needs of the plant palette:

- **Utilize native, drought-tolerant plants and grasses where possible.** Native plants generally have a broader tolerance for nutrient content, and can be longer lived in leaner/lower nutrient soils.
- **Start plants from smaller starts or seed.** Younger plants are generally more tolerant of lower nutrient levels and tend to help develop soil structure as they grow. Given the lower cost of smaller plants, the project should be able to accept a plant mortality rate that is somewhat higher than starting from larger plants and providing high organic content.

2. Minimize excess nutrients in media mix

Once the low-nutrient plant palette is established (item 1), the landscape architect and/or agronomist should be consulted to assist in the design of a biofiltration media to balance the interests of plant establishment, water retention capacity (irrigation demand), and the potential for nutrient export.

Specifications for Biofiltration Soil Media outlined in Appendix F, particularly sections 803-2.5.4 and 803-5.5.5 shall be followed along with the following guidelines: **The mix should not exceed the nutrient needs of plants.** In conventional landscape design, the nutrient needs of plants are often exceeded intentionally in order to provide a factor of safety for plant survival. This practice must be avoided in biofiltration media as excess nutrients will increase the chance of export. The mix designer should keep in mind that nutrients can be added later (through mulching, tilling of amendments into the surface), but it is not possible to remove nutrients, once added.

- **The actual nutrient content and organic content of the selected organic amendment source should be determined when specifying mix proportions.** Nutrient content (i.e., C:N ratio; plant extractable nutrients) and organic content (i.e., % organic material) are relatively inexpensive to measure via standard agronomic methods and can provide important information about mix design. If mix design relies on approximate assumption about nutrient/organic content and this is not confirmed with testing (or the results of prior representative testing), it is possible that the mix could contain much more nutrient than intended.
- **Nutrients are better retained in soils with higher cation exchange capacity.** Cation exchange capacity can be increased through selection of organic material with naturally high cation exchange capacity, such as peat or coconut coir pith, and/or selection of inorganic material with high cation exchange capacity such as some sands or engineered minerals (e.g., low P-index sands, zeolites, rhyolites, etc). Including higher cation exchange capacity materials would tend to reduce the net export of nutrients. Natural silty materials also provide cation exchange capacity; however potential impacts to permeability need to be considered.
- **Focus on soil structure as well as nutrient content.** Soil structure is loosely defined as the ability of the soil to conduct and store water and nutrients as well as the degree of aeration of the soil. Soil structure can be more important than nutrient content in plant survival and biologic health of the system. If a good soil structure can be created with very low amounts of organic amendment, plants survivability should still be provided. While soil structure generally develops with time, biofiltration media can be designed to promote earlier development of soil structure. Soil structure is enhanced by the use of amendments with high humus content (as found in well-aged organic material). In addition, soil structure can be enhanced through the use of organic material with a distribution of particle sizes (i.e., a more heterogeneous mix).
- **Consider alternatives to compost.** Compost, by nature, is a material that is continually evolving and decaying. It can be challenging to determine whether tests previously done on a given compost stock are still representative. It can also be challenging to determine how the properties of the compost will change once placed in the media bed. More stable materials such as aged coco coir pith, peat, biochar, shredded bark, and/or other amendments should be considered.

With these considerations, it is anticipated that less than 10 percent organic amendment by volume could be used, while still balancing plant survivability and water retention. If compost is used, designers should strongly consider utilizing less than 10 percent by volume.

3. Design with partial retention and/or internal water storage

An internal water storage zone, as described in Fact Sheet PR-1 is believed to improve retention of nutrients. For lined systems, an internal water storage zone worked by providing a zone that fluctuates between aerobic and anaerobic conditions, resulting in nitrification/denitrification. In soils that will allow infiltration, a partial retention design (PR-1) allows significant volume reduction and can also promote nitrification/denitrification.

Acknowledgment: This fact sheet has been adapted from the Orange County Technical Guidance Document (May 2011). It was originally developed based on input from: Deborah Deets, City of Los Angeles Bureau of Sanitation, Drew Ready, Center for Watershed Health, Rick Fisher, ASLA, City of Los Angeles Bureau of Engineering, Dr. Garn Wallace, Wallace Laboratories, Glen Dake, GDML, and Jason Schmidt, Tree People. The guidance provided herein does not reflect the individual opinions of any individual listed above and should not be cited or otherwise attributed to those listed.

Maintenance Overview

Refer to maintenance information provided in the Biofiltration (BF-1) Fact Sheet. Adjust maintenance actions and reporting if required based on the specific media design.

This page was intentionally left blank.

E.16 BF-3 Proprietary Biofiltration Systems

The purpose of this fact sheet is to help explain the potential role of proprietary BMPs in meeting biofiltration requirements, when full retention of the DCV is not feasible. The fact sheet does not describe design criteria like the other fact sheets in this appendix because this information varies by BMP product model.

Criteria for Use of a Proprietary BMP as a Biofiltration BMP

A proprietary BMP may be acceptable as a “biofiltration BMP” under the following conditions:

- (1) The BMP meets the minimum design criteria listed in Appendix F, including the selection criteria (i.e. only allowed in No Infiltration Condition and where site-specific documentation demonstrates that the use of larger footprint biofiltration BMPs (i.e. 3 %) would be infeasible) and the pollutant treatment performance standard in Appendix F.1.1;
- (2) The BMP is designed and maintained in a manner consistent with its performance certifications (See explanation in Appendix F.1.2); and
- (3) The BMP is acceptable at the discretion of County staff. While the County has no obligation to accept the use of any proposed proprietary BMP, applicants will be provided a written explanation describing the rationale for the rejection of any proposed devices.

Guidance for Sizing a Proprietary BMP as a Biofiltration BMP

Proprietary biofiltration BMPs must meet the same sizing guidance as non-proprietary BMPs. Sizing is typically based on capturing and treating 1.50 times the DCV not reliably retained. Guidance for sizing biofiltration BMPs to comply with requirements of this manual is provided in Appendix F.1.2.

Maintenance Overview

Refer to manufacturer for maintenance information.

This page was intentionally left blank

E.17 FT-1 Vegetated Swales



MS4 Permit Category

Flow-thru Treatment Control

Manual Category

Flow-thru Treatment Control

Applicable Performance Standard

Pollutant Control

Primary Benefits

Treatment
 Volume Reduction (Incidental)
 Peak Flow Attenuation

Location: Eastlake Business Center, Chula Vista, California; Photo Credit: Eric Mosolgo

Description

Vegetated swales are shallow, open channels that are designed to remove storm water pollutants by physically straining/filtering runoff through vegetation in the channel. Swales can be used in place of traditional curbs and gutters and are well-suited for use in linear transportation corridors to provide both conveyance and treatment via filtration. An effectively designed vegetated swale achieves uniform sheet flow through densely vegetated areas. When soil conditions allow, infiltration and volume reduction are enhanced by adding a gravel drainage layer underneath the swale. Vegetated swales with a subsurface media layer can provide enhanced infiltration, water retention, and pollutant-removal capabilities. Pollutant removal effectiveness can also be maximized by increasing the hydraulic residence time of water in swale using weirs or check dams.

Typical vegetated swale components include:

- Inflow distribution mechanisms (e.g., flow spreader)
- Surface flow
- Vegetated surface layer
- Check dams (if required)
- Optional aggregate storage layer with underdrain(s)

FT-1 Vegetated Swales

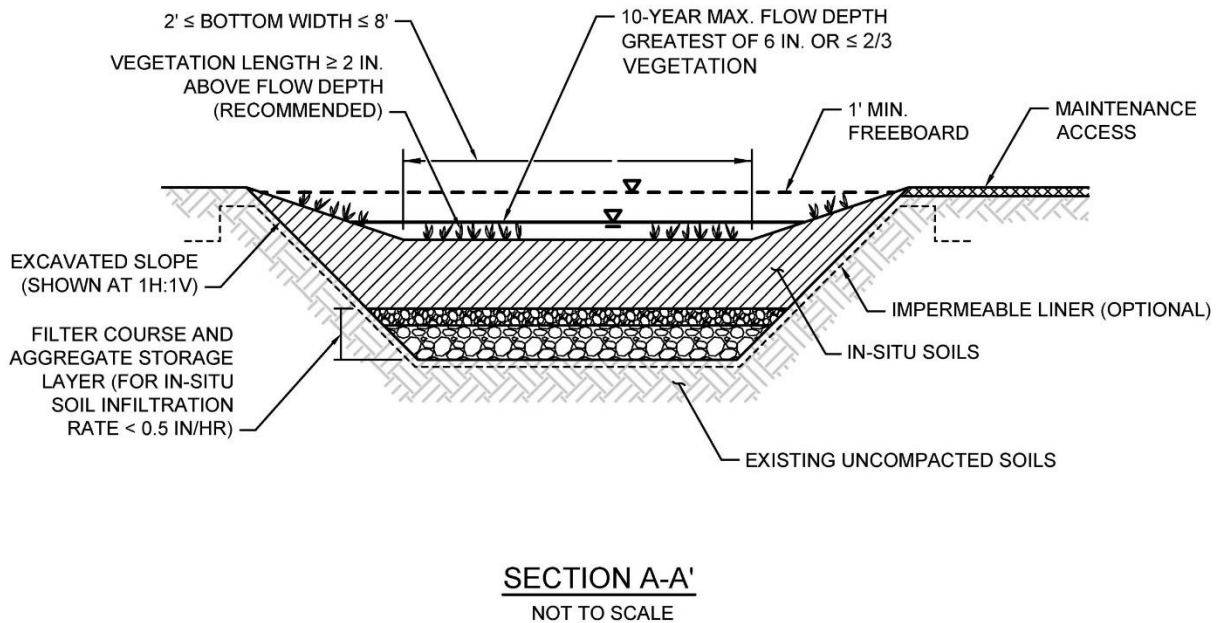
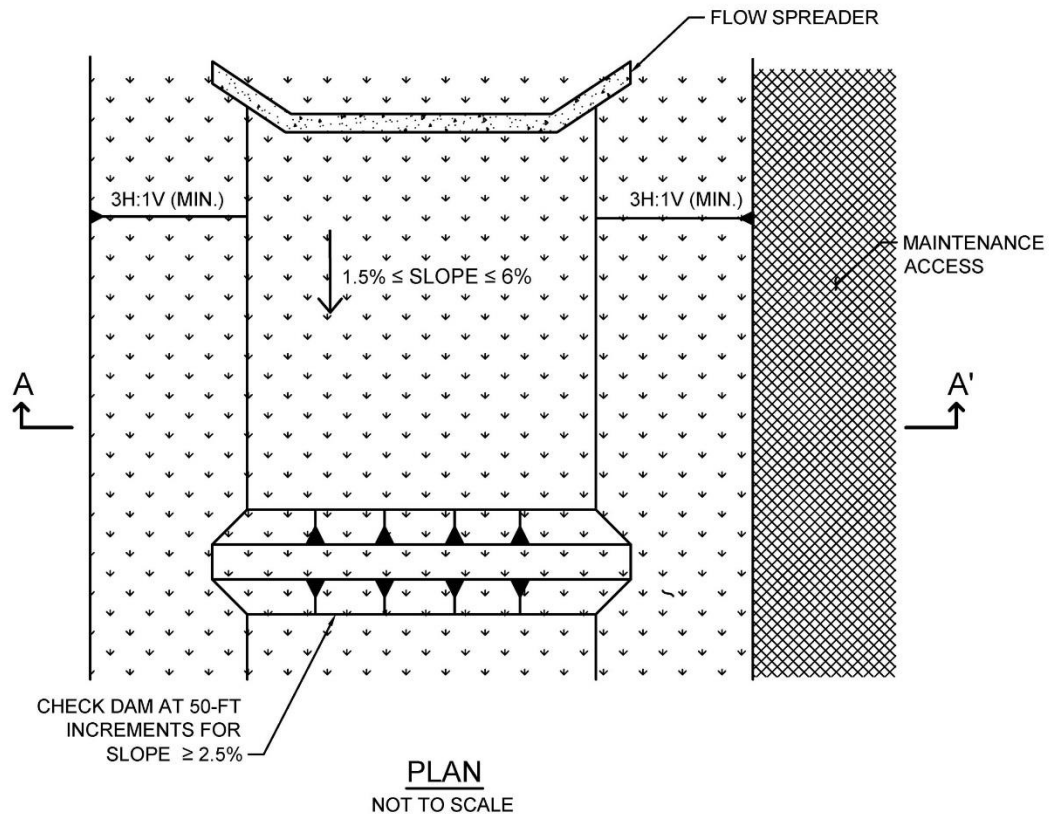

Typical plan and Section view of a Vegetated Swale BMP

Design Adaptations for Project Goals

Site design BMP to reduce runoff volumes and storm peaks. Swales without underdrains are an alternative to lined channels and pipes and can provide volume reduction through infiltration. Swales can also reduce the peak runoff discharge rate by increasing the time of concentration of the site and decreasing runoff volumes and velocities.

Flow-thru treatment BMP for storm water pollutant control. The system is lined or un-lined to provide incidental infiltration with an underdrain and designed to provide pollutant removal through settling and filtration in the channel vegetation (usually grasses). This configuration is considered to provide flow-thru treatment via horizontal surface flow through the swale. Sizing for flow-thru treatment control is based on the surface flow rate through the swale that meets water quality treatment performance objectives.

Design Criteria and Considerations

Vegetated swales must meet the following design criteria. Deviations from the below criteria may be approved at the discretion of County staff if it is determined to be appropriate:

<i>Siting and Design</i>	<i>Intent/Rationale</i>
<input type="checkbox"/> Placement observes geotechnical recommendations regarding potential hazards (e.g., slope stability, landslides, and liquefaction zones) and setbacks (e.g., slopes, foundations, utilities).	Must not negatively impact existing site geotechnical concerns.
<input type="checkbox"/> An impermeable liner or other hydraulic restriction layer is included if site constraints indicate that infiltration or lateral flows should not be allowed.	Lining prevents storm water from impacting groundwater and/or sensitive environmental or geotechnical features. Incidental infiltration, when allowable, can aid in pollutant removal and groundwater recharge.
<input type="checkbox"/> Contributing tributary area ≤ 2 acres.	Higher ratios increase the potential for clogging but may be acceptable for relatively clean tributary areas.
<input type="checkbox"/> Longitudinal slope is ≥ 1.5% and ≤ 6%.	Flatter swales facilitate increased water quality treatment while minimum slopes prevent ponding.
<input type="checkbox"/> For site design goal, in-situ soil infiltration rate ≥ 0.5 in/hr (if < 0.5 in/hr, an underdrain is required and design goal is for pollutant control only).	Well-drained soils provide volume reduction and treatment. An underdrain should only be provided when soil infiltration rates are low or per geotechnical or groundwater concerns.

<i>Siting and Design</i>		<i>Intent/Rationale</i>
Surface Flow		
<input type="checkbox"/>	Maximum flow depth is ≤ 6 inches or $\leq 2/3$ the vegetation length, whichever is greater. Ideally, flow depth will be ≥ 2 inches below shortest plant species.	Flow depth must fall within the height range of the vegetation for effective water quality treatment via filtering.
	A minimum of 1 foot of freeboard is provided.	Freeboard minimizes risk of uncontrolled surface discharge.
<input type="checkbox"/>	Cross sectional shape is trapezoidal or parabolic with side slopes $\geq 3H:1V$.	Gentler side slopes are safer, less prone to erosion, able to establish vegetation more quickly and easier to maintain.
<input type="checkbox"/>	Bottom width is ≥ 2 feet and ≤ 8 feet.	A minimum of 2 feet minimizes erosion. A maximum of 8 feet prevents channel braiding.
<input type="checkbox"/>	Minimum hydraulic residence time ≥ 10 minutes.	Longer hydraulic residence time increases pollutant removal.
<input type="checkbox"/>	Swale is designed to safely convey the 10-yr storm event unless a flow splitter is included to allow only the water quality event.	Planning for larger storm events lessens the risk of property damage due to flooding.
<input type="checkbox"/>	Flow velocity is ≤ 1 ft/s for water quality event. Flow velocity for 10-yr storm event is ≤ 3 ft/s.	Lower flow velocities provide increased pollutant removal via filtration and minimize erosion.
Vegetated Surface Layer (amendment with media is Optional)		
<input type="checkbox"/>	Soil is amended with 2 inches of media mixed into the top 6 inches of in-situ soils, as needed, to promote plant growth (optional). For enhanced pollutant control, 2 feet of media can be used in place of in-situ soils. Media meets either of these two media specifications: City of San Diego Storm Water Standards Appendix F, February 2016; Or County of San Diego Low Impact Development Handbook, June 2014: Appendix G -Bioretention Soil Specification.	Amended soils aid in plant establishment and growth. Media replacement for in-situ soils can improve water quality treatment and site design volume reduction.

<i>Siting and Design</i>		<i>Intent/Rationale</i>
<i>Vegetated Surface Layer (amendment with media is Optional)</i>		
<input type="checkbox"/>	Vegetation is appropriately selected low-growing, erosion-resistant plant species that effectively bind the soil, thrive under site-specific climatic conditions and require little or no irrigation.	Plants suited to the climate and expected flow conditions are more likely to survive.
<i>Check Dams</i>		
<input type="checkbox"/>	Check dams are provided at 50-foot increments for slopes $\geq 2.5\%$.	Check dams prevent erosion and increase the hydraulic residence time by lowering flow velocities and providing ponding opportunities.
<i>Filter Course Layer (For Underdrain Design)</i>		
<input type="checkbox"/>	A filter course is used to prevent migration of fines through layers of the facility. Filter fabric is not used.	Migration of media can cause clogging of the aggregate storage layer void spaces or subgrade. Filter fabric is more likely to clog.
<input type="checkbox"/>	Filter course is washed and free of fines.	Washing aggregate will help eliminate fines that could clog the facility and impede infiltration.
<input type="checkbox"/>	Filter course calculations assessing suitability for particle migration prevention have been completed.	Gradation relationship between layers can evaluate factors (e.g., bridging, permeability, and uniformity) to determine if particle sizing is appropriate or if an intermediate layer is needed.
<i>Aggregate Storage Layer (For Underdrain Design)</i>		
<input type="checkbox"/>	The depth of aggregate provided (12-inch typical) and storage layer configuration is adequate for providing conveyance for underdrain flows to the outlet structure.	Proper storage layer configuration and underdrain placement will minimize facility drawdown time.
<input type="checkbox"/>	Aggregate used for the aggregate storage layer is washed and free of fines.	Washing aggregate will help eliminate fines that could clog aggregate storage layer void spaces or underdrain.
<i>Inflow and Underdrain Structures</i>		
<input type="checkbox"/>	Inflow and underdrains are accessible for inspection and maintenance.	Maintenance will prevent clogging and ensure proper operation of the flow control structures.

<i>Siting and Design</i>		<i>Intent/Rationale</i>
<i>Inflow and Underdrain Structures</i>		
<input type="checkbox"/>	Underdrain outlet elevation should be a minimum of 3 inches above the bottom elevation of the aggregate storage layer.	A minimal separation from subgrade or the liner lessens the risk of fines entering the underdrain and can improve hydraulic performance by allowing perforations to remain unblocked.
<input type="checkbox"/>	Minimum underdrain diameter is 6 inches.	Smaller diameter underdrains are prone to clogging.
<input type="checkbox"/>	Underdrains are made of slotted, PVC pipe conforming to ASTM D 3034 or equivalent or corrugated, HDPE pipe conforming to AASHTO 252M or equivalent.	Slotted underdrains provide greater intake capacity, clog resistant drainage, and reduced entrance velocity into the pipe, thereby reducing the chances of solids migration.
<input type="checkbox"/>	An underdrain cleanout with a minimum 6-inch diameter and lockable cap is placed every 250 to 300 feet as required based on underdrain length.	Properly spaced cleanouts will facilitate underdrain maintenance.

Conceptual Design and Sizing Approach for Site Design

1. Determine the areas where vegetated swales can be used in the site design to replace traditional curb and gutter facilities and provide volume reduction through infiltration.

Conceptual Design and Sizing Approach for Storm Water Pollutant Control Only

To design vegetated swales for storm water pollutant control only, the following steps should be taken:

1. Verify that siting and design criteria have been met, including bottom width and longitudinal and side slope requirements.
2. Calculate the design flow rate per Appendix B based on expected site design runoff for tributary areas.
3. Use the sizing worksheet to determine flow-thru treatment sizing of the vegetated swale and if flow velocity, flow depth, and hydraulic residence time meet required criteria. Swale configuration should be adjusted as necessary to meet design requirements.

Maintenance Overview

Normal Expected Maintenance. Vegetated swales require routine maintenance to: remove accumulated materials such as sediment, trash, and debris; maintain vegetation health; and maintain integrity of side slopes, channel bottom, inlets, energy dissipaters, weirs or check dams, and outlets to

ensure runoff will be conveyed as uniform flow throughout the swale (i.e., flow will spread uniformly across the width of the swale as it is conveyed from upstream to downstream).

Non-Standard Maintenance or BMP Failure. If any of the following scenarios are observed, the BMP is not performing as intended to protect downstream waterways from pollution and/or erosion. Corrective maintenance, increased inspection and maintenance, BMP replacement, or a different BMP type will be required.

- The BMP is not drained between storm events. Surface ponding longer than approximately 24 hours following a storm event may be detrimental to vegetation health, and surface ponding longer than approximately 96 hours following a storm event poses a risk of vector (mosquito) breeding. Poor drainage can result from deposited materials or overgrowth of vegetation within the swale blocking drainage conveyance or blocking an outlet structure, or localized erosion issues that cause channelization and prevent uniform flow throughout the swale. The specific cause of the drainage issue must be determined and corrected. If the issue is not corrected by restoring the BMP to the original plan and grade, the County reviewer shall be contacted prior to any additional repairs or reconstruction.
- Sediment, trash, or debris accumulation blocking drainage becomes a chronic issue observed at every inspection. This means the load from the tributary drainage area is too high, reducing BMP function or clogging the BMP. This would require pretreatment measures within the tributary area draining to the BMP to intercept the materials.
- Erosion due to concentrated storm water runoff flow that is not readily corrected by adding erosion control blankets, adding stone at flow entry points, or minor re-grading to restore proper drainage according to the original plan. If the issue is not corrected by restoring the BMP to the original plan and grade, the County reviewer shall be contacted prior to any additional repairs or reconstruction.

This page was intentionally left blank.

Summary of Standard Inspection and Maintenance

The property owner is responsible to ensure inspection, operation and maintenance of permanent BMPs on their property unless responsibility has been formally transferred to an agency, community facilities district, homeowners association, property owners association, or other special district.

Maintenance frequencies listed in this table are average/typical frequencies. Actual maintenance needs are site-specific, and maintenance may be required more frequently. Maintenance must be performed whenever needed, based on maintenance indicators presented in this table. The BMP owner is responsible for conducting regular inspections to see when maintenance is needed based on the maintenance indicators. During the first year of operation of a structural BMP, inspection is recommended at least once prior to August 31 and then monthly from September through May. Inspection during a storm event is also recommended. After the initial period of frequent inspections, the minimum inspection and maintenance frequency can be determined based on the results of the first year inspections.

Threshold/Indicator	Maintenance Action	Inspection and Maintenance Frequency
Accumulation of sediment, litter, or debris	Remove and properly dispose of accumulated materials, without damage to vegetation.	<ul style="list-style-type: none"> • Inspect monthly. If accumulated materials are observed blocking drainage, increase inspection frequency to monthly plus after every 0.1-inch or larger storm event. • Remove any accumulated materials found at each inspection.
Obstructed inlet or outlet structure	Clear blockage.	<ul style="list-style-type: none"> • Inspect monthly and after every 0.5-inch or larger storm event. • Remove any accumulated materials found at each inspection.
Damage to structural components such as weirs, inlet or outlet structures	Repair or replace as applicable.	<ul style="list-style-type: none"> • Inspect annually. • Maintain when needed.
Poor vegetation establishment	Re-seed, re-plant, or re-establish vegetation per original plans.	<ul style="list-style-type: none"> • Inspect monthly. • Maintain when needed.

FT-1 Vegetated Swales

Threshold/Indicator	Maintenance Action	Inspection and Maintenance Frequency
Dead or diseased vegetation	Remove dead or diseased vegetation, re-seed, re-plant, or re-establish vegetation per original plans.	<ul style="list-style-type: none"> • Inspect monthly. • Maintain when needed.
Overgrown vegetation	Mow or trim as appropriate.	<ul style="list-style-type: none"> • Inspect monthly. • Maintain when needed.
Erosion due to concentrated irrigation flow	Repair/re-seed/re-plant eroded areas and adjust the irrigation system.	<ul style="list-style-type: none"> • Inspect monthly. • Maintain when needed.
Erosion due to concentrated storm water runoff flow	Repair/re-seed/re-plant eroded areas, and make appropriate corrective measures such as adding erosion control blankets, adding stone at flow entry points, or minor re-grading to restore proper drainage according to the original plan. If the issue is not corrected by restoring the BMP to the original plan and grade, the County reviewer shall be contacted prior to any additional repairs or reconstruction.	<ul style="list-style-type: none"> • Inspect after every 0.5-inch or larger storm event. If erosion due to storm water flow has been observed, increase inspection frequency to after every 0.1-inch or larger storm event. • Maintain when needed. If the issue is not corrected by restoring the BMP to the original plan and grade, the County reviewer shall be contacted prior to any additional repairs or reconstruction.
Standing water in BMP following a storm event	Make appropriate corrective measures such as adjusting irrigation system, removing obstructions of debris or invasive vegetation, loosening or replacing top soil to allow for better infiltration, or minor re-grading for proper drainage. If the issue is not corrected by restoring the BMP to the original plan and grade, the County reviewer shall be contacted prior to any additional repairs or reconstruction.	<ul style="list-style-type: none"> • Inspect monthly and after every 0.5-inch or larger storm event. If standing water is observed, increase inspection frequency to after every 0.1-inch or larger storm event. • Maintain when needed.

FT-1 Vegetated Swales

Threshold/Indicator	Maintenance Action	Inspection and Maintenance Frequency
<p>Presence of mosquitos/larvae</p> <p>For images of egg rafts, larva, pupa, and adult mosquitos, see http://www.mosquito.org/biology</p>	<p>If mosquitos/larvae are observed: first, immediately remove any standing water by dispersing to nearby landscaping; second, make corrective measures as applicable to restore BMP drainage to prevent standing water.</p> <p>If mosquitos persist following corrective measures to remove standing water, the County reviewer shall be contacted to determine a solution. A different BMP type, or a Vector Management Plan prepared with concurrence from the County of San Diego Department of Environmental Health, may be required.</p>	<ul style="list-style-type: none"> • Inspect monthly and after every 0.5-inch or larger storm event. If mosquitos are observed, increase inspection frequency to after every 0.1-inch or larger storm event. • Maintain when needed.

This page was intentionally left blank

E.18 FT-2 Media Filters



MS4 Permit Category

Flow-thru Treatment Control

Manual Category

Flow-thru Treatment Control

Applicable Performance Standard

Pollutant Control

Flow Control

Primary Benefits

Treatment

Peak Flow Attenuation (Optional)

Photo Credit: Contech Storm Water Solutions

Description

Media filters are manufactured devices that consist of a series of modular filters packed with engineered media that can be contained in a catch basin, manhole, or vault that provide treatment through filtration and sedimentation. The manhole or vault may be divided into multiple chambers where the first chamber acts as a presettling basin for removal of coarse sediment while the next chamber acts as the filter bay and houses the filter cartridges. A variety of media types are available from various manufacturers that can target pollutants of concern via primarily filtration, sorption, ion exchange, and precipitation. **Specific products must be selected to meet the flow-thru BMP selection requirements described in Appendix J.5.** Treatment effectiveness is contingent upon proper maintenance of filter units.

Typical media filter components include:

- Vault for flow storage and media housing
- Inlet and outlet
- Media filters

Design Adaptations for Project Goals

Flow-thru treatment BMP for storm water pollutant control. Water quality treatment is provided through filtration. This configuration is considered to provide flow-thru treatment, not biofiltration treatment. Storage provided within the vault restricted by an outlet is considered detention storage and is included in calculations for the flow-thru treatment volume.

Integrated storm water flow control and pollutant control configuration. Media filters can also be designed for flow rate and duration control via additional detention storage. The vault storage can be designed to accommodate higher volumes than the storm water pollutant control volume and can utilize multi-stage outlets to mitigate both the duration and rate of flows within a prescribed range.

Design Criteria and Considerations

Media filters must meet the following design criteria. Deviations from the below criteria may be approved at the discretion of County staff if it is determined to be appropriate:

<i>Siting and Design</i>	<i>Intent/Rationale</i>
<input type="checkbox"/> Placement observes geotechnical recommendations regarding potential hazards (e.g., slope stability, landslides, and liquefaction zones) and setbacks (e.g., slopes, foundations, utilities).	Must not negatively impact existing site geotechnical concerns.
<input type="checkbox"/> Recommended for tributary areas with limited available surface area or where surface BMPs would restrict uses.	Maintenance needs may be more labor intensive for media filters than surface BMPs. Lack of surface visibility creates additional risk that maintenance needs may not be completed in a timely manner.
<input type="checkbox"/> Vault storage drawdown time ≤ 96 hours.	Provides vector control.
<input type="checkbox"/> Vault storage drawdown time ≤ 36 hours if the vault is used for equalization of flows for pollutant treatment.	Provides required capacity to treat back to back storms. Exception to the 36 hour drawdown criteria is allowed if additional vault storage is provided using the curves in Appendix B.4.1.
<input type="checkbox"/> All manhole access points to underground BMPs must include a ladder or steps.	Provides required access during inspections.
<input type="checkbox"/> BMPs must include inspection ports.	Inspection ports are for observing all underground components that require inspection and maintenance
<i>Inflow and Outflow Structures</i>	
<input type="checkbox"/> Inflow and outflow structures are accessible by required equipment (e.g., vector truck) for inspection and maintenance.	Maintenance will prevent clogging and ensure proper operation of the flow control structures.

Conceptual Design and Sizing Approach for Storm Water Pollutant Control Only

To design a media filter for storm water pollutant control only (no flow control required), the following steps should be taken

1. Verify that the selected BMP complies with BMP selection requirements in Appendix J.5.
2. Verify that placement and tributary area requirements have been met.
3. Calculate the required DCV and/or flow rate per Appendix J.5.3 based on expected site design runoff for tributary areas.
4. Media filter can be designed either for DCV or flow rate. To estimate the drawdown time, divide the vault storage by the treatment rate of media filters.

Conceptual Design and Sizing Approach when Storm Water Flow Control is Applicable

Control of flow rates and/or durations will typically require significant vault storage volume, and therefore the following steps should be taken prior to determination of storm water pollutant control design. Pre-development and allowable post-project flow rates and durations should be determined as discussed in Chapter 6 of the manual.

1. Verify that placement and tributary area requirements have been met.
2. Iteratively determine the vault storage volume required to provide detention storage to reduce flow rates and durations to allowable limits. Flow rates and durations can be controlled from detention storage by altering outlet structure orifice size(s) and/or water control levels. Multi-level orifices can be used within an outlet structure to control the full range of flows to MS4.
3. If a media filter cannot fully provide the flow rate and duration control required by this manual, an upstream or downstream structure with appropriate storage volume such as an underground vault can be used to provide remaining controls.
4. After the media filter has been designed to meet flow control requirements, calculations must be completed to verify if storm water pollutant control requirements to treat the DCV have been met.
5. Verify that the vault drawdown time is 96 hours or less. To estimate the drawdown time:
 - a. Divide the vault volume by the filter surface area.
 - b. Divide the result (a) by the design filter rate.

This page was intentionally left blank.

Maintenance Overview

Normal Expected Maintenance. Media filters require routine maintenance to: remove accumulated materials such as sediment, trash, and debris; replace filter cartridges; and maintain integrity of any internal components such as weirs and piping. A summary table of standard inspection and maintenance indicators is provided within this Fact Sheet.

Non-Standard Maintenance or BMP Failure. The normal expected maintenance described above ensures the BMP functionality. Lapses in the normal expected maintenance can lead to clogging of the BMP and potentially blocking the storm drain system. If clogging is observed, the BMP is not performing as intended to protect downstream waterways from pollution and/or erosion. In addition, clogged BMPs can lead to flooding, standing water and mosquito breeding habitat. Maintenance is critical to ensure the flood protection capacity of the storm drain system is not compromised. If proper routine maintenance is not performed, corrective maintenance and increased inspection and maintenance will be required. For persistent clogging or presence of mosquitos, contact the County reviewer to determine a permanent solution. For example, adding pretreatment measures within the tributary area draining to the BMP to intercept sediment, trash, and debris. Pretreatment components, especially for sediment, will extend the life of the filter media. For mosquitos, a Vector Management Plan, prepared with concurrence from the County of San Diego Department of Environmental Health, may be required.

Other Special Considerations. Media filters are proprietary systems that include proprietary media that must be replaced as part of normal expected maintenance. They are typically installed underground and may require entry into the underground vault to perform the maintenance. The BMP owner is responsible to hire a maintenance operator qualified to service the units. The maintenance operator must obtain the appropriate filter media and/or any parts that need to be replaced. If maintenance conditions require maintenance personnel to enter the underground structure, the maintenance personnel must be trained and certified in confined space entry. To find a qualified maintenance operator, the BMP owner shall contact the manufacturer of the proprietary BMP.

The design of media filters includes consideration of the specific pollutants expected from the area tributary to the media filter and the specific pollutants of concern for the downstream waterways. Therefore, it is expected that the filter media selected during design of the project will not be substituted. If a need arises to substitute a different filter configuration or filter media, the County reviewer shall be contacted prior to any changes.

Summary of Standard Inspection and Maintenance

The property owner is responsible to ensure inspection, operation and maintenance of permanent BMPs on their property unless responsibility has been formally transferred to an agency, community facilities district, homeowners association, property owners association, or other special district.

Maintenance frequencies listed in this table are average/typical frequencies. Actual maintenance needs are site-specific, and maintenance may be required more frequently. Maintenance must be performed whenever needed, based on maintenance indicators presented in this table. The BMP owner is responsible for conducting regular inspections to see when maintenance is needed based on the maintenance indicators. During the first year of operation of a structural BMP, inspection is recommended at least once prior to August 31 and then monthly from September through May. Inspection during a storm event is also recommended. After the initial period of frequent inspections, the minimum inspection and maintenance frequency can be determined based on the results of the first year inspections.

Threshold/Indicator	Maintenance Action	Inspection and Maintenance Frequency
<p>Accumulation of sediment, litter, or debris.</p> <p>The threshold for removal of materials depends on the specific type of proprietary filter and configuration and shall be based on the manufacturer’s recommendation. In any case, materials must be removed if accumulation blocks flow through the BMP.</p>	<p>Remove and properly dispose of accumulated materials.</p>	<ul style="list-style-type: none"> • Inspect monthly. • Remove materials annually (minimum), or more frequently when BMP reaches manufacturer’s threshold for removal of materials in less than one year, or if accumulation blocks outlet.

Threshold/Indicator	Maintenance Action	Inspection and Maintenance Frequency
<p>Spent or clogged filter media.</p> <p>The threshold for changing media depends on the specific type of proprietary media and shall be based on the manufacturer’s recommendation. In any case, media must be replaced if flow cannot pass through the media or passes through at less than the design capacity.</p>	<p>Remove and properly dispose filter media, and replace with fresh media.</p>	<ul style="list-style-type: none"> • Inspect condition of media annually or more frequently if recommended by manufacturer. • Inspect BMP drainage monthly and after every 0.5-inch or larger storm event. If standing water has been observed, increase inspection frequency to after every 0.1-inch or larger storm event. • Maintain when needed based on manufacturer’s threshold/indicator for the specific media, or if standing water in the BMP indicates flow cannot pass through the media.
<p>Any other recommendations pursuant to the proprietary filter manufacturer’s maintenance guide.</p>	<p>Any other actions pursuant to the proprietary filter manufacturer’s maintenance guide.</p>	<ul style="list-style-type: none"> • As recommended by the proprietary filter manufacturer’s maintenance guide
<p>Obstructed inlet or outlet structure</p>	<p>Clear blockage.</p>	<ul style="list-style-type: none"> • Inspect monthly and after every 0.5-inch or larger storm event. • Remove any accumulated materials found at each inspection.

Threshold/Indicator	Maintenance Action	Inspection and Maintenance Frequency
<p>Presence of mosquitos/larvae</p> <p>For images of egg rafts, larva, pupa, and adult mosquitos, see http://www.mosquito.org/biology</p>	<p>If mosquitos/larvae are observed: first, immediately remove and properly dispose any standing water; second, remove any accumulated materials that obstruct flow through the BMP to restore BMP drainage to prevent standing water. Ensure access covers are tight fitting, with gaps or holes no greater than 1/16 inch, and/or install barriers such as inserts or screens that prevent mosquito access to the subsurface storage.</p> <p>If the BMP includes a permanent sump, contact the County reviewer to determine a permanent solution. A different BMP type, or a Vector Management Plan prepared with concurrence from the County of San Diego Department of Environmental Health, may be required.</p>	<ul style="list-style-type: none"> • Inspect monthly and after every 0.5-inch or larger storm event. If mosquitos are observed, increase inspection frequency to after every 0.1-inch or larger storm event. • Maintain when needed.
<p>Damage to structural components of the filtration system such as weirs, underdrains, inlet or outlet structures</p>	<p>Repair or replace as applicable.</p>	<ul style="list-style-type: none"> • Inspect annually. • Maintain when needed.

E.19 FT-3 Sand Filters



Photo Credit: City of San Diego LID Manual

Description

Sand filters operate by filtering storm water through a constructed sand bed with an underdrain system. Runoff enters the filter and spreads over the surface. Sand filter beds can be enclosed within concrete structures or within earthen containment. As flows increase, water backs up on the surface of the filter where it is held until it can percolate through the sand. The treatment pathway is downward (vertical) through the media to an underdrain system that is connected to the downstream storm drain system. As storm water passes through the sand, pollutants are trapped on the surface of the filter, in the small pore spaces between sand grains or are adsorbed to the sand surface. The high filtration rates of sand filters, which allow a large runoff volume to pass through the media in a short amount of time, can provide efficient treatment for storm water runoff.

Typical sand filter components include:

- Forebay for pretreatment/energy dissipation
- Surface ponding for captured flows
- Sand filter bed
- Aggregate storage layer with underdrain(s)
- Overflow structure

MS4 Permit Category

Flow-thru Treatment Control

Manual Category

Flow-thru Treatment Control

Applicable Performance Standard

Pollutant Control

Flow Control

Primary Benefits

Treatment

Volume Reduction (Incidental)

Peak Flow Attenuation (Optional)

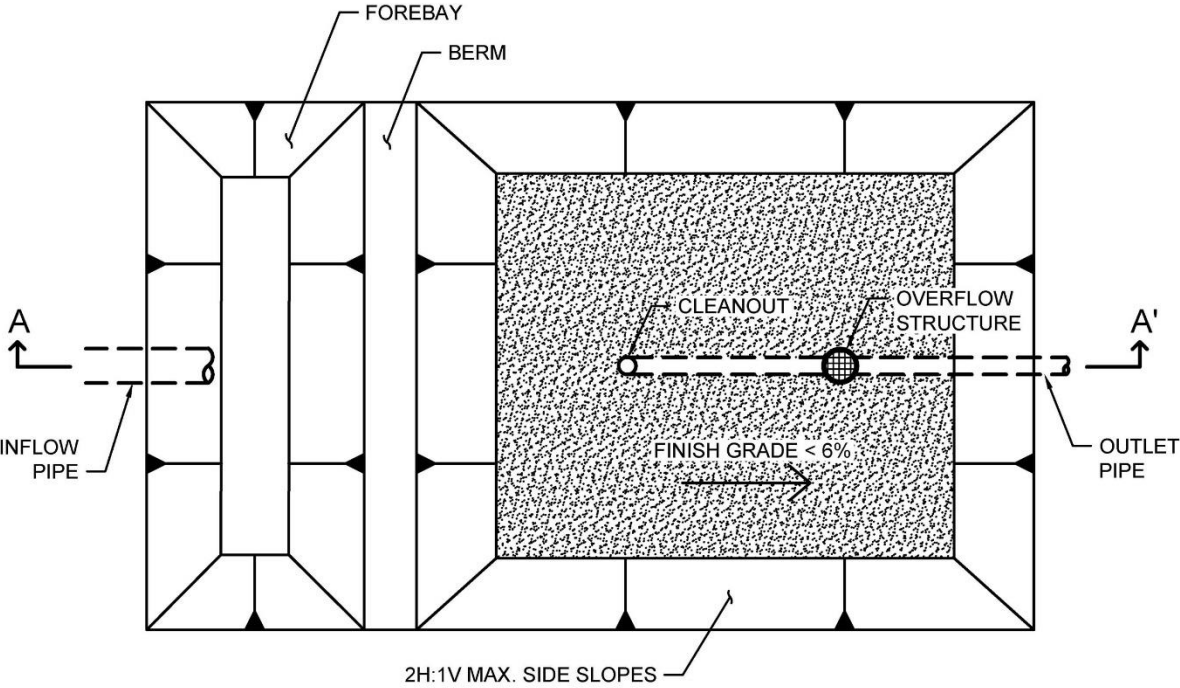

PLAN
NOT TO SCALE

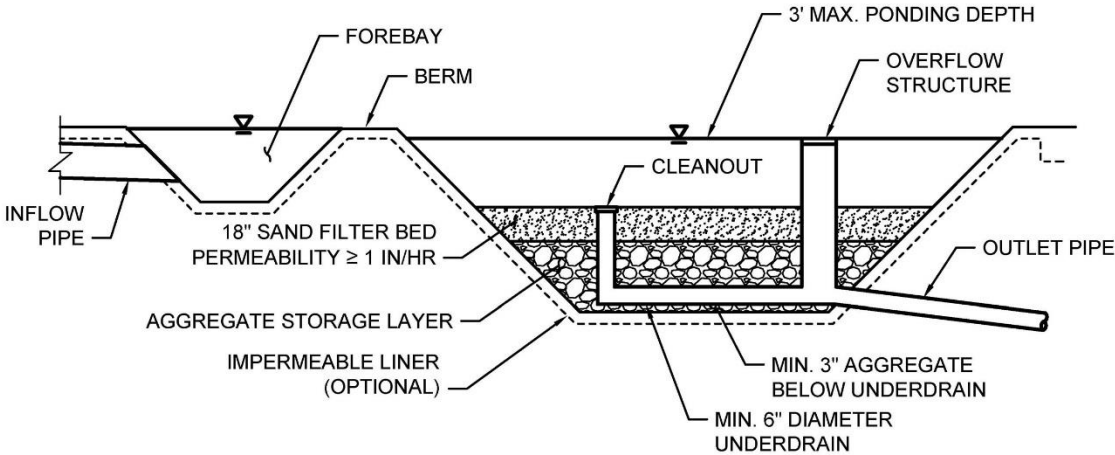

SECTION A-A'
NOT TO SCALE

Typical plan and Section view of a Sand Filter BMP

Design Adaptations for Project Goals

Flow-thru treatment BMP for storm water pollutant control. The system is lined or un-lined to provide incidental infiltration, and an underdrain is provided at the bottom to carry away filtered runoff. This configuration is considered to provide flow-thru treatment via vertical flow through the sand filter bed. Storage provided above the underdrain within surface ponding, the sand filter bed, and aggregate storage is considered included in the flow-thru treatment volume. Saturated storage within the aggregate storage layer can be added to this design by including an upturned elbow installed at the downstream end of the underdrain or via an internal weir structure designed to maintain a specific water level elevation.

Integrated storm water flow control and pollutant control configuration. The system can be designed to provide flow rate and duration control by primarily providing increased surface ponding and/or having a deeper aggregate storage layer above the underdrain. This will allow for significant detention storage, which can be controlled via inclusion of an outlet structure at the downstream end of the underdrain.

Design Criteria and Considerations

Sand filters must meet the following design criteria. Deviations from the below criteria may be approved at the discretion of County staff if it is determined to be appropriate:

<i>Siting and Design</i>	<i>Intent/Rationale</i>
<input type="checkbox"/> Placement observes geotechnical recommendations regarding potential hazards (e.g., slope stability, landslides, and liquefaction zones) and setbacks (e.g., slopes, foundations, utilities).	Must not negatively impact existing site geotechnical concerns.
<input type="checkbox"/> An impermeable liner or other hydraulic restriction layer is included if site constraints indicate that infiltration or lateral flows should not be allowed.	Lining prevents storm water from impacting groundwater and/or sensitive environmental or geotechnical features. Incidental infiltration, when allowable, can aid in pollutant removal and groundwater recharge.
<input type="checkbox"/> Contributing tributary area (\leq 5 acres).	Bigger BMPs require additional design features for proper performance. Contributing tributary area greater than 5 acres may be allowed at the discretion of County staff if the following conditions are met: 1) incorporate design features (e.g. flow spreaders) to minimize short circuiting of flows in the BMP and 2) incorporate additional design features requested by County staff for proper performance of the regional BMP.

<i>Siting and Design</i>	<i>Intent/Rationale</i>
<input type="checkbox"/> Finish grade of facility is < 6%.	Flatter surfaces reduce erosion and channelization within the facility.
<input type="checkbox"/> Earthen side slopes are ≥ 3H:1V.	Gentler side slopes are safer, less prone to erosion, able to establish vegetation more quickly and easier to maintain.
<input type="checkbox"/> Surface ponding is limited to a 36-hour drawdown time.	Provides required capacity to treat back to back storms. A surface ponding drawdown of up to 96 hours may be permitted if additional surface storage is provided using the curves in Appendix B.4.1.
<input type="checkbox"/> Surface ponding is limited to a 96-hour drawdown time.	Prolonged surface ponding can create a vector hazard.
<input type="checkbox"/> Maximum ponding depth does not exceed 3 feet.	Surface ponding capacity lowers subsurface storage requirements and results in lower cost facilities. Deep surface ponding raises safety concerns.
<input type="checkbox"/> Sand filter bed consists of clean washed concrete or masonry sand (passing ¼ inch sieve) or sand similar to the ASTM C33 gradation.	Washing sand will help eliminate fines that could clog the void spaces of the aggregate storage layer.
<input type="checkbox"/> Sand filter bed permeability is at least 1 in/hr.	A high filtration rate through the media allows flows to quickly enter the aggregate storage layer, thereby minimizing bypass.
<input type="checkbox"/> Sand filter bed depth is at least 18 inches deep.	Different pollutants are removed in various zones of the media using several mechanisms. Some pollutants bound to sediment, such as metals, are typically removed within 18 inches of the media.
<input type="checkbox"/> Aggregate storage should be washed, bank-run gravel.	Washing aggregate will help eliminate fines that could clog the aggregate storage layer void spaces or subgrade.
<input type="checkbox"/> The depth of aggregate provided (12-inch typical) and storage layer configuration is adequate for providing conveyance for underdrain flows to the outlet structure.	Proper storage layer configuration and underdrain placement will minimize facility drawdown time.
<input type="checkbox"/> Inflow, underdrains and outflow structures are accessible for inspection and maintenance.	Maintenance will prevent clogging and ensure proper operation of the flow control structures.

<i>Siting and Design</i>	<i>Intent/Rationale</i>
<input type="checkbox"/> Inflow must be non-erosive sheet flow (≤ 3 ft/s) unless an energy-dissipation device, flow diversion/splitter or forebay is installed.	Concentrated flow and/or excessive volumes can cause erosion in a sand filter and can be detrimental to the treatment capacity of the system.
<input type="checkbox"/> Underdrain outlet elevation should be a minimum of 3 inches above the bottom elevation of the aggregate storage layer.	A minimal separation from subgrade or the liner lessens the risk of fines entering the underdrain and can improve hydraulic performance by allowing perforations to remain unblocked.
<input type="checkbox"/> Minimum underdrain diameter is 6 inches.	Smaller diameter underdrains are prone to clogging.
<input type="checkbox"/> Underdrains should be made of slotted, PVC pipe conforming to ASTM D 3034 or equivalent or corrugated, HDPE pipe conforming to AASHTO 252M or equivalent.	Slotted underdrains provide greater intake capacity, clog resistant drainage, and reduced entrance velocity into the pipe, thereby reducing the chances of solids migration.
<input type="checkbox"/> Overflow is safely conveyed to a downstream storm drain system or discharge point.	Planning for overflow lessens the risk of property damage due to flooding.

Conceptual Design and Sizing Approach for Storm Water Pollutant Control Only

To design a sand filter for storm water pollutant control only (no flow control required), the following steps should be taken:

1. Verify that siting and design criteria have been met, including placement requirements, contributing tributary area, and maximum finish grade slope.
2. Calculate the required DCV and/or flow rate per Appendix J.5.3 based on expected site design runoff for tributary areas.
3. Sand filter can be designed either for DCV or flow rate. To estimate the drawdown time, divide the average ponding depth by the permeability of the filter sand.

Conceptual Design and Sizing Approach when Storm Water Flow Control is Applicable

Control of flow rates and/or durations will typically require significant surface ponding and/or aggregate storage volumes, and therefore the following steps should be taken prior to determination of storm water pollutant control design. Pre-development and allowable post-project flow rates and durations should be determined as discussed in Chapter 6 of the Manual.

1. Verify that siting and design criteria have been met, including placement requirements, contributing tributary area, and maximum finish grade slope.
2. Iteratively determine the facility footprint area, surface ponding and/or aggregate storage layer depth required to provide detention storage to reduce flow rates and durations to allowable

limits. Flow rates and durations can be controlled from detention storage by altering outlet structure orifice size(s) and/or water control levels. Multi-level orifices can be used within an outlet structure to control the full range of flows.

3. If a sand filter cannot fully provide the flow rate and duration control required by the MS4 permit, an upstream or downstream structure with appropriate storage volume such as an underground vault can be used to provide remaining controls.
4. After the sand filter has been designed to meet flow control requirements, calculations must be completed to verify if storm water pollutant control requirements to treat the DCV have been met.

Maintenance Overview

Normal Expected Maintenance. Sand filters require routine maintenance to: remove accumulated materials such as sediment, trash, and debris from the forebay; and clear the underdrain(s). To ensure runoff is passed through the sand bed, sand at the top of the sand bed (approximately 2 inches, or more if necessary) must be removed and replaced to restore flow when the drain time exceeds 24-96 hours. A summary table of standard inspection and maintenance indicators is provided within this Fact Sheet.

Non-Standard Maintenance or BMP Failure. The normal expected maintenance described above ensures the BMP functionality. Lapses in the normal expected maintenance can lead to clogging of the BMP and runoff bypassing the filter. If clogging is observed, the BMP is not performing as intended to protect downstream waterways from pollution and/or erosion. In addition, clogged BMPs can lead to flooding, standing water and mosquito breeding habitat. Corrective maintenance and increased inspection and maintenance will be required. For persistent clogging or presence of mosquitos, contact the County reviewer to determine a permanent solution. For example, adding pretreatment measures within the tributary area draining to the BMP to intercept sediment, trash, and debris. Pretreatment components, especially for sediment, will extend the life of the sand bed. For mosquitos, a Vector Management Plan, prepared with concurrence from the County of San Diego Department of Environmental Health, may be required.

Summary of Standard Inspection and Maintenance

The property owner is responsible to ensure inspection, operation and maintenance of permanent BMPs on their property unless responsibility has been formally transferred to an agency, community facilities district, homeowners association, property owners association, or other special district.

Maintenance frequencies listed in this table are average/typical frequencies. Actual maintenance needs are site-specific, and maintenance may be required more frequently. Maintenance must be performed whenever needed, based on maintenance indicators presented in this table. The BMP owner is responsible for conducting regular inspections to see when maintenance is needed based on the maintenance indicators. During the first year of operation of a structural BMP, inspection is recommended at least once prior to August 31 and then monthly from September through May. Inspection during a storm event is also recommended. After the initial period of frequent inspections, the minimum inspection and maintenance frequency can be determined based on the results of the first year inspections.

Threshold/Indicator	Maintenance Action	Inspection and Maintenance Frequency
Accumulation of sediment, litter, or debris in forebay and/or filter bed	Remove and properly dispose of accumulated materials.	<ul style="list-style-type: none"> • Inspect monthly. If the forebay is 25% full* or more in one month, increase inspection frequency to monthly plus after every 0.1-inch or larger storm event. • Remove any accumulated materials found within the filter bed at each inspection. • When the BMP includes a forebay, materials must be removed from the forebay when the forebay is 25% full*, or if accumulation within the forebay blocks flow to the filter bed.
Standing water in BMP for longer than 24-96 hours following a storm event	Make appropriate corrective measures to restore drainage such as removing obstructions of debris from the forebay, clearing underdrains or repairing/replacing clogged sand bed.	<ul style="list-style-type: none"> • Inspect monthly and after every 0.5-inch or larger storm event. If standing water is observed, increase inspection frequency to after every 0.1-inch or larger storm event. • Maintain when needed.

Threshold/Indicator	Maintenance Action	Inspection and Maintenance Frequency
<p>Clogged sand bed</p> <p>This is indicated when the drain time of the surface of the sand bed exceeds 24-96 hours.</p>	<p>Remove and properly dispose sand from the top of the sand bed (approximately 2 inches of sand, or as much as needed to restore flow). Restore sand depth to the design depth.</p>	<ul style="list-style-type: none"> • Inspect monthly and after every 0.5-inch or larger storm event. If standing water is observed, increase inspection frequency to after every 0.1-inch or larger storm event. • Maintain when needed.
<p>Obstructed inlet or outlet structure</p>	<p>Clear blockage.</p>	<ul style="list-style-type: none"> • Inspect monthly and after every 0.5-inch or larger storm event. • Remove any accumulated materials found at each inspection.
<p>Presence of mosquitos/larvae</p> <p>For images of egg rafts, larva, pupa, and adult mosquitos, see http://www.mosquito.org/biology</p>	<p>If mosquitos/larvae are observed: first, immediately remove and properly dispose any standing water by dispersing to nearby landscaping; second, make corrective measures as applicable to restore BMP drainage to prevent standing water.</p> <p>If mosquitos persist following corrective measures to remove standing water, the County reviewer shall be contacted to determine a solution. A different BMP type, or a Vector Management Plan prepared with concurrence from the County of San Diego Department of Environmental Health, may be required.</p>	<ul style="list-style-type: none"> • Inspect monthly and after every 0.5-inch or larger storm event. If mosquitos are observed, increase inspection frequency to after every 0.1-inch or larger storm event. • Maintain when needed
<p>Damage to structural components of the BMP such as weirs, underdrains, inlet or outlet structures</p>	<p>Repair or replace as applicable.</p>	<ul style="list-style-type: none"> • Inspect annually. • Maintain when needed.

E.20 FT-4 Dry Extended Detention Basin



Location: Rolling Hills Ranch, Chula Vista, California; Photo Credit: Eric Mosolgo

MS4 Permit Category

Flow-thru Treatment Control

Manual Category

Flow-thru Treatment Control

Applicable Performance Standard

Pollutant Control

Flow Control

Primary Benefits

Treatment

Volume Reduction (Incidental)

Peak Flow Attenuation

Description

Dry extended detention basins are basins that have been designed to detain storm water for an extended period to allow sedimentation and typically drain completely between storm events. A portion of the dissolved pollutant load may also be removed by filtration, uptake by vegetation, and/or through infiltration. The slopes, bottom, and forebay of dry extended detention basins are typically vegetated. Considerable storm water volume reduction can occur in dry extended detention basins when they are located in permeable soils and are not lined with an impermeable barrier. Dry extended detention basins are generally appropriate for developments of ten acres or larger, and have the potential for multiple uses including parks, playing fields, tennis courts, open space, and overflow parking lots. They can also be used to provide flow control by modifying the outlet control structure and providing additional detention storage.

Typical dry extended detention basins components include:

- Forebay for pretreatment
- Surface ponding for captured flows
- Vegetation selected based on basin use, climate, and ponding depth
- Low flow channel, outlet, and overflow device
- Impermeable liner or uncompacted native soils at the bottom of the facility

FT-4 Dry Extended Detention Basin

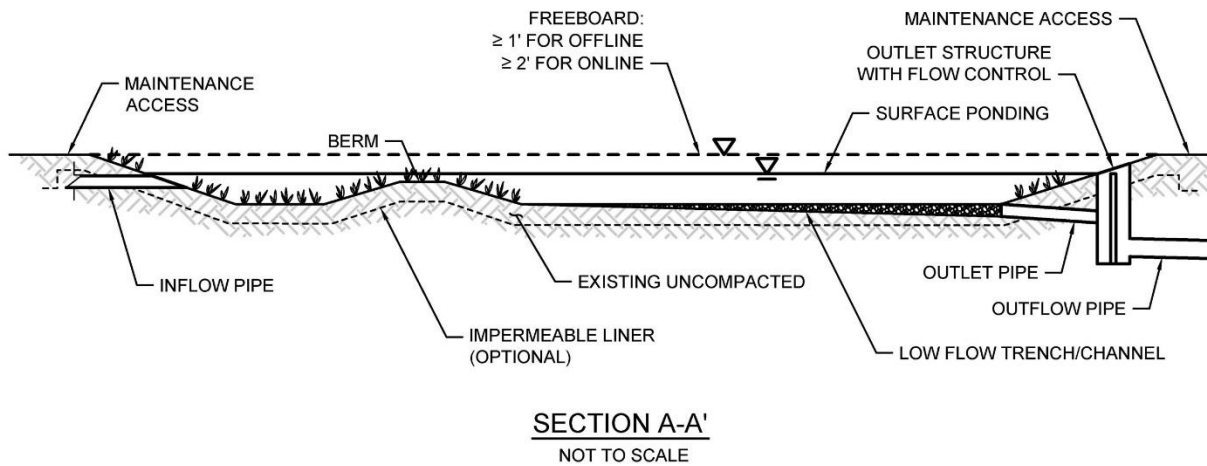
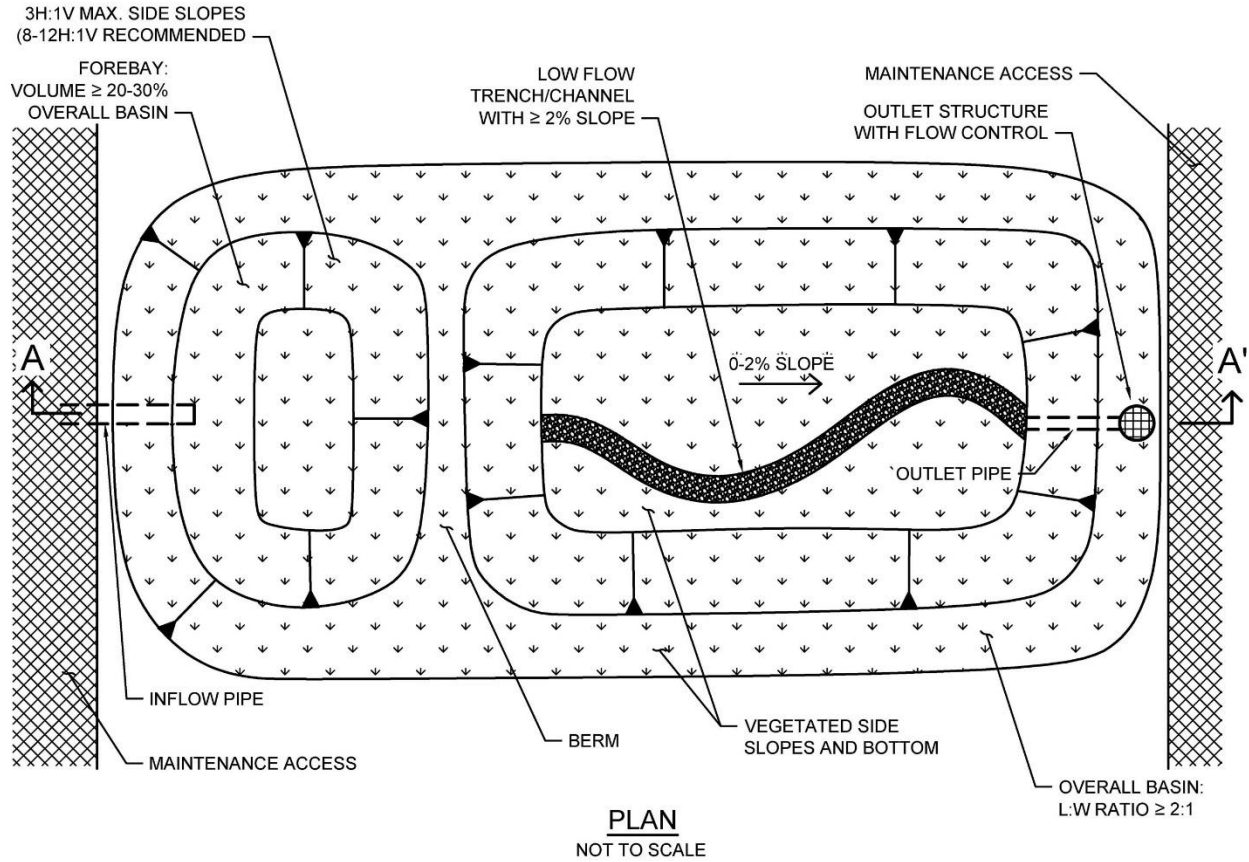

Typical plan and Section view of a Dry Extended Detention Basin BMP

Design Adaptations for Project Goals

Flow-thru treatment BMP for storm water pollutant control. The system is lined or un-lined to provide incidental infiltration and designed to detain storm water to allow particulates and associated pollutants to settle out. This configuration is considered to provide flow-thru treatment, not biofiltration treatment. Storage provided as surface ponding above a restricted outlet invert is considered detention storage and is included in calculations for the flow-thru treatment volume.

Integrated storm water flow control and pollutant control configuration. Dry extended detention basins can also be designed for flow control. The surface ponding can be designed to accommodate higher volumes than the storm water pollutant control volume and can utilize multi-stage outlets to mitigate both the duration and rate of flows within a prescribed range.

Design Criteria and Considerations

Dry extended detention basins must meet the following design criteria. Deviations from the below criteria may be approved at the discretion of County staff if it is determined to be appropriate:

<i>Siting and Design</i>	<i>Intent/Rationale</i>
<input type="checkbox"/> Placement observes geotechnical recommendations regarding potential hazards (e.g., slope stability, landslides, and liquefaction zones) and setbacks (e.g., slopes, foundations, utilities).	Must not negatively impact existing site geotechnical concerns.
<input type="checkbox"/> An impermeable liner or other hydraulic restriction layer is included if site constraints indicate that infiltration or lateral flows should not be allowed.	Lining prevents storm water from impacting groundwater and/or sensitive environmental or geotechnical features. Incidental infiltration, when allowable, can aid in pollutant removal and groundwater recharge.
<input type="checkbox"/> Contributing tributary area is large (typically ≥ 10 acres).	Dry extended detention basins require significant space and are more cost-effective for treating larger drainage areas.
<input type="checkbox"/> Longitudinal basin bottom slope is 0 - 2%.	Flatter slopes promote ponding and settling of particles.
<input type="checkbox"/> Basin length to width ratio is $\geq 2:1$ (L:W).	A larger length to width ratio provides a longer flow path to promote settling.
<input type="checkbox"/> Forebay is included that encompasses 20 - 30% of the basin volume.	A forebay to trap sediment can decrease frequency of required maintenance.
<input type="checkbox"/> Side slopes are $\geq 3H:1V$.	Gentler side slopes are safer, less prone to erosion, able to establish vegetation more quickly and easier to maintain.

<i>Siting and Design</i>	<i>Intent/Rationale</i>
<input type="checkbox"/> Surface ponding drawdown time is between 24 and 96 hours.	Minimum drawdown time of 24 hours allows for adequate settling time and maximizes pollutant removal. Maximum drawdown time of 96 hours provides vector control.
<input type="checkbox"/> Minimum freeboard provided is ≥ 1 foot for offline facilities and ≥ 2 feet for online facilities.	Freeboard provides room for head over overflow structures and minimizes risk of uncontrolled surface discharge.
<input type="checkbox"/> Inflow and outflow structures are accessible by required equipment (e.g., vector truck) for inspection and maintenance.	Maintenance will prevent clogging and ensure proper operation of the flow control structures.
<input type="checkbox"/> A low flow channel or trench with a $\geq 2\%$ slope is provided. A gravel infiltration trench is provided where infiltration is allowable.	Aids in draining or infiltrating dry weather flows.
<input type="checkbox"/> Overflow is safely conveyed to a downstream storm drain system or discharge point. Size overflow structure to pass 100-year peak flow.	Planning for overflow lessens the risk of property damage due to flooding.
<input type="checkbox"/> The maximum rate at which runoff is discharged is set below the erosive threshold for the site.	Extended low flows can have erosive effects.

Conceptual Design and Sizing Approach for Storm Water Pollutant Control Only

To design dry extended detention basins for storm water pollutant control only (no flow control required), the following steps should be taken:

1. Verify that siting and criteria have been met, including placement requirements, contributing tributary area, forebay volume, and maximum slopes for basin sides and bottom.
2. Calculate the DCV per Appendix B based on expected site design runoff for tributary areas.
3. Use the sizing worksheet to determine flow-thru treatment sizing of the surface ponding of the dry extended detention basin, which includes calculations for a maximum 96-hour drawdown time.

Conceptual Design and Sizing Approach when Storm Water Flow Control is Applicable

Control of flow rates and/or durations will typically require significant surface ponding volume, and therefore the following steps should be taken prior to determination of storm water pollutant control design. Pre-development and allowable post-project flow rates and durations should be determined as discussed in Chapter 6 of the manual.

1. Verify that siting and criteria have been met, including placement requirements, tributary area, and maximum slopes for basin sides and bottom.
2. Iteratively determine the surface ponding required to provide detention storage to reduce flow rates and durations to allowable limits. Flow rates and durations can be controlled from detention storage by altering outlet structure orifice size(s) and/or water control levels. Multi-level orifices can be used within an outlet structure to control the full range of flows.
3. If a dry extended detention basin cannot fully provide the flow rate and duration control required by this manual, an upstream or downstream structure with appropriate storage volume such as an additional basin or underground vault can be used to provide remaining controls.
4. After the dry extended detention basin has been designed to meet flow control requirements, calculations must be completed to verify if storm water pollutant control requirements to treat the DCV have been met.

Maintenance Overview

Normal Expected Maintenance. Dry extended detention basins require routine maintenance to: remove accumulated materials such as sediment, trash or debris; maintain vegetation health; and maintain integrity of side slopes, inlets, energy dissipators, and outlets. A summary table of standard inspection and maintenance indicators is provided within this Fact Sheet.

Non-Standard Maintenance or BMP Failure. If any of the following scenarios are observed, the BMP is not performing as intended to protect downstream waterways from pollution and/or erosion. Corrective maintenance, increased inspection and maintenance, BMP replacement, or a different BMP type will be required.

- The BMP is not drained between storm events. Surface ponding longer than approximately 24 hours following a storm event may be detrimental to vegetation health, and surface or underground ponding longer than approximately 96 hours following a storm event poses a risk of vector (mosquito) breeding. Poor drainage can result from clogging of underlying native soils and/or the outlet structure. The specific cause of the drainage issue must be determined and corrected. If it is determined that the drainage of the basin relies on infiltration and the underlying native soils have been compacted or do not have the infiltration capacity expected, the County reviewer shall be contacted prior to any additional repairs or reconstruction.
- Sediment, trash, or debris accumulation greater than 25% of the surface ponding volume within one month. This means the load from the tributary drainage area is too high, reducing BMP function or clogging the BMP. This would require pretreatment measures within the tributary area draining to the BMP to intercept the materials.
- Erosion due to concentrated storm water runoff flow that is not readily corrected by adding erosion control blankets, adding stone at flow entry points, or minor re-grading to restore proper drainage according to the original plan. If the issue is not corrected by restoring the BMP to the original plan and grade, the County reviewer shall be contacted prior to any additional repairs or reconstruction.

Other Special Considerations. Some above-ground dry extended detention basins are vegetated structural BMPs. Vegetated structural BMPs that are constructed in the vicinity of, or connected to, an existing jurisdictional water or wetland could inadvertently result in creation of expanded waters or wetlands. As such, vegetated structural BMPs have the potential to come under the jurisdiction of the United States Army Corps of Engineers, SDRWQCB, California Department of Fish and Wildlife, or the United States Fish and Wildlife Service. This could result in the need for specific resource agency permits and costly mitigation to perform maintenance of the structural BMP. Along with proper placement of a structural BMP, routine maintenance is key to preventing this scenario.

Underground dry extended detention basins are typically designed to be cleaned from above-ground using a vactor. If maintenance conditions require maintenance personnel to enter the underground structure, the maintenance personnel must be trained and certified in confined space entry

Summary of Standard Inspection and Maintenance

The property owner is responsible to ensure inspection, operation and maintenance of permanent BMPs on their property unless responsibility has been formally transferred to an agency, community facilities district, homeowners association, property owners association, or other special district.

Maintenance frequencies listed in this table are average/typical frequencies. Actual maintenance needs are site-specific, and maintenance may be required more frequently. Maintenance must be performed whenever needed, based on maintenance indicators presented in this table. The BMP owner is responsible for conducting regular inspections to see when maintenance is needed based on the maintenance indicators. During the first year of operation of a structural BMP, inspection is recommended at least once prior to August 31 and then monthly from September through May. Inspection during a storm event is also recommended. After the initial period of frequent inspections, the minimum inspection and maintenance frequency can be determined based on the results of the first year inspections.

“25% full” is defined as ¼ of the depth from the design bottom elevation to the crest of the outflow structure (e.g., if the height to the outflow opening is 12 inches from the bottom elevation, then the materials must be removed when there is 3 inches of accumulation – this should be marked on the outflow structure).

Threshold/Indicator	Maintenance Action	Inspection and Maintenance Frequency
Accumulation of sediment, litter, or debris in forebay and/or basin	Remove and properly dispose of accumulated materials, (without damage to vegetation when applicable).	<ul style="list-style-type: none"> • Inspect monthly. If the forebay is 25% full* or more in one month, increase inspection frequency to monthly plus after every 0.1-inch or larger storm event. • Remove any accumulated materials found within the basin area at each inspection. • When the BMP includes a forebay, materials must be removed from the forebay when the forebay is 25% full*, or if accumulation within the forebay blocks flow to the basin.
Obstructed inlet or outlet structure	Clear blockage.	<ul style="list-style-type: none"> • Inspect monthly and after every 0.5-inch or larger storm event. • Remove any accumulated materials found at each inspection.

Threshold/Indicator	Maintenance Action	Inspection and Maintenance Frequency
Poor vegetation establishment (when the BMP includes vegetated surface by design)	Re-seed, re-plant, or re-establish vegetation per original plans.	<ul style="list-style-type: none"> • Inspect monthly. • Maintain when needed.
Dead or diseased vegetation (when the BMP includes vegetated surface by design)	Remove dead or diseased vegetation, re-seed, re-plant, or re-establish vegetation per original plans.	<ul style="list-style-type: none"> • Inspect monthly. • Maintain when needed.
Overgrown vegetation (when the BMP includes vegetated surface by design)	Mow or trim as appropriate.	<ul style="list-style-type: none"> • Inspect monthly. • Maintain when needed.
Erosion due to concentrated irrigation flow	Repair/re-seed/re-plant eroded areas and adjust the irrigation system.	<ul style="list-style-type: none"> • Inspect monthly. • Maintain when needed.
Erosion due to concentrated storm water runoff flow	Repair/re-seed/re-plant eroded areas, and make appropriate corrective measures such as adding erosion control blankets, adding stone at flow entry points, or minor re-grading to restore proper drainage according to the original plan. If the issue is not corrected by restoring the BMP to the original plan and grade, the County reviewer shall be contacted prior to any additional repairs or reconstruction.	<ul style="list-style-type: none"> • Inspect after every 0.5-inch or larger storm event. If erosion due to storm water flow has been observed, increase inspection frequency to after every 0.1-inch or larger storm event. • Maintain when needed. If the issue is not corrected by restoring the BMP to the original plan and grade, the County reviewer shall be contacted prior to any additional repairs or reconstruction.

Threshold/Indicator	Maintenance Action	Inspection and Maintenance Frequency
<p>Standing water in above-ground BMP for longer than 24-96 hours following a storm event</p>	<p>Make appropriate corrective measures such as adjusting irrigation system, removing obstructions of debris or invasive vegetation, or removing/replacing clogged or compacted surface treatments and/or scarifying or tilling native soils. Always remove deposited sediments before scarification, and use a hand-guided rotary tiller. If it is determined that the drainage of the basin relies on infiltration and the underlying native soils have been compacted or do not have the infiltration capacity expected, the County reviewer shall be contacted prior to any additional repairs or reconstruction.</p>	<ul style="list-style-type: none"> • Inspect monthly and after every 0.5-inch or larger storm event. If standing water is observed, increase inspection frequency to after every 0.1-inch or larger storm event. • Maintain when needed.
<p>Standing water in underground BMP for longer than 24-96 hours following a storm event</p>	<p>Make appropriate corrective measures such as removing obstructions at the outlet, clearing underdrains, or flushing fine sediment from aggregate layer when applicable. If it is determined that the drainage of the basin relies on infiltration and the underlying native soils have been compacted or do not have the infiltration capacity expected, the County reviewer shall be contacted prior to any additional repairs or reconstruction.</p>	<ul style="list-style-type: none"> • Inspect monthly and after every 0.5-inch or larger storm event. If standing water is observed, increase inspection frequency to after every 0.1-inch or larger storm event. • Maintain when needed.

Threshold/Indicator	Maintenance Action	Inspection and Maintenance Frequency
<p>Presence of mosquitos/larvae</p> <p>For images of egg rafts, larva, pupa, and adult mosquitos, see http://www.mosquito.org/biology</p>	<p>If mosquitos/larvae are observed: first, immediately remove and properly dispose any standing water; second, make corrective measures as applicable to restore BMP drainage to prevent standing water. For underground detention basins, ensure access covers are tight fitting, with gaps or holes no greater than 1/16 inch, and/or install barriers such as inserts or screens that prevent mosquito access to the subsurface storage.</p> <p>If mosquitos persist following corrective measures to remove standing water, or if the BMP design does not meet the 96-hour drawdown criteria due to release rates controlled by an orifice installed on the underdrain, the County reviewer shall be contacted to determine a solution. A different BMP type, or a Vector Management Plan prepared with concurrence from the County of San Diego Department of Environmental Health, may be required.</p>	<ul style="list-style-type: none"> • Inspect monthly and after every 0.5-inch or larger storm event. If mosquitos are observed, increase inspection frequency to after every 0.1-inch or larger storm event. • Maintain when needed
<p>Damage to structural components such as weirs, inlet or outlet structures</p>	<p>Repair or replace as applicable.</p>	<ul style="list-style-type: none"> • Inspect annually. • Maintain when needed.

E.21 FT-5 Proprietary Flow-Thru Treatment Control BMPs

The purpose of this fact sheet is to help explain the potential role of proprietary BMPs in meeting flow thru treatment control BMP requirements. The fact sheet does not describe design criteria like the other fact sheets in this appendix because this information varies by BMP product model.

Criteria for Use of a Proprietary BMP as a Flow-Thru Treatment Control BMP

A proprietary BMP may be acceptable as a “flow-thru treatment control BMP” under the following conditions:

- (1) The BMP is selected and sized consistent with the method and criteria described in Appendix J.5;
- (2) The BMP is designed and maintained in a manner consistent with its performance certifications (See explanation in Appendix J.5); and
- (3) The BMP is acceptable at the discretion of County staff. While the County has no obligation to accept the use of any proposed proprietary flow-thru BMP, applicants will be provided a written explanation describing the rationale for the rejection of any proposed devices.

Guidance for Sizing Proprietary BMPs

Proprietary flow-thru BMPs must meet the same sizing guidance as other flow-thru treatment control BMPs. Guidance for sizing flow-thru BMPs to comply with requirements of this manual is provided in Appendix J.5.

Maintenance Overview

Refer to manufacturer for maintenance information.

FT-5 Proprietary Flow Thru Treatment Control BMPs

This page was intentionally left blank

General Standards for Bioretention/Biofiltration BMPs

F.1 Biofiltration Standards and Checklist

F.2 Biofiltration Soil Media Composition, Testing, and Installation

F.3 Plant List for Bioretention Facilities

Appendix F: Biofiltration Standard and Checklist

This page was intentionally left blank.

Appendix F General Standards for Bioretention/Biofiltration BMPs

F.1 Biofiltration Standards and Checklist

Introduction

The MS4 Permit and this manual define a specific category of storm water pollutant treatment BMPs called “biofiltration BMPs.” The MS4 Permit (Section E.3.c.1) states:

Biofiltration BMPs must be designed to have an appropriate hydraulic loading rate to maximize storm water retention and pollutant removal, as well as to prevent erosion, scour, and channeling within the BMP, and must be sized to:

- a) **Treat 1.5 times the DCV not reliably retained onsite, OR**
- b) **Treat the DCV not reliably retained onsite with a flow-thru design that has a total volume, including pore spaces and pre-filter detention volume, sized to hold at least 0.75 times the portion of the DCV not reliably retained onsite.**

A project applicant must be able to affirmatively demonstrate that a given BMP is designed and sized in a manner consistent with this definition to be considered as a “biofiltration BMP” as part of a compliant storm water quality management plan. Retention is defined in the MS4 Permit as evapotranspiration, infiltration, and harvest and use of storm water vs. discharge to a surface water system.

Contents and Intended Uses

This appendix contains a checklist of the key underlying criteria that must be met for a BMP to be considered a biofiltration BMP. The purpose of this checklist is to facilitate consistent review and approval of biofiltration BMPs that meet the “biofiltration standard” defined by the MS4 Permit.

This checklist includes specific design criteria that are essential to defining a system as a biofiltration BMP; however, it does not present a complete design basis. This checklist was used to develop BMP Fact Sheets for PR-1 biofiltration with partial retention and BF-1 biofiltration, which do present a complete design basis. Therefore, biofiltration BMPs that substantially meet all aspects of the Fact sheets PR-1 or BF-1 should be able to complete this checklist without additional documentation beyond what would already be required for a project submittal.

Appendix F: Biofiltration Standard and Checklist

Other biofiltration BMP designs³ (including both non-proprietary and proprietary designs) may also meet the underlying MS4 Permit requirements to be considered biofiltration BMPs. These BMPs may be classified as biofiltration BMPs if they (1) meet the minimum design criteria listed in this appendix, including the pollutant treatment performance standard in Appendix F.1.1, (2) are designed and maintained in a manner consistent with their performance certifications (See explanation in Appendix F.1.2), if applicable, and (3) are acceptable at the discretion of County staff. The applicant may be required to provide additional studies and/or required to meet additional design criteria beyond the scope of this document in order to demonstrate that these criteria are met.

Organization

The checklist in this appendix is organized into the six (6) main objectives associated with biofiltration BMP design. It describes the associated minimum criteria that must be met in order to qualify a biofiltration BMP as meeting the biofiltration standard. The seven main objectives are listed below. Specific design criteria and associated manual references associated with each of these objectives is provided in the checklist in the following section.

1. Biofiltration BMPs must be sized using acceptable sizing methods described in this manual.
2. Biofiltration BMPs must be designed with a hydraulic loading rate to maximize pollutant retention, preserve pollutant control/sequestration processes, and minimize potential for pollutant washout.
3. Biofiltration BMPs must contain plants and Biofiltration Soil Media to support and maintain treatment processes.
4. Biofiltration BMPs must be designed to prevent erosion, scour, and channeling within the BMP.
5. Biofiltration BMP must include operations and maintenance design features and planning considerations to provide for continued effectiveness of pollutant and flow control functions.
6. Biofiltration BMPs that are proprietary, project applicants must provide evidence that the BMP has been certified for use as part of the Washington State Technology Assessment Protocol-Ecology certification program or other equivalent third party submit evaluation as outlined below.

Biofiltration Criteria Checklist

The applicant must provide documentation of compliance with each criterion in this checklist as part of the project submittal. The right column of this checklist identifies the submittal information that is

³ Defined as biofiltration designs that do not conform to the specific design criteria described in Fact Sheets PR-1 or BF-1. This category includes proprietary BMPs that are sold by a vendor as well as non-proprietary BMPs that are designed and constructed of primarily of more elementary construction materials.

Appendix F: Biofiltration Standard and Checklist

recommended to document compliance with each criterion. Biofiltration BMPs that substantially meet all aspects of Fact Sheets PR-1 or BF-1 should still use this checklist; however additional documentation (beyond what is already required for project submittal) should not be required.

1. Biofiltration BMPs must be sized using acceptable sizing methods.

Intent: The MS4 Permit and this manual defines specific sizing methods that must be used to size biofiltration BMPs. Sizing of biofiltration BMPs is a fundamental factor in the amount of storm water that can be treated and also influences volume and pollutant retention processes.

- | | | |
|--------------------------|---|--|
| <input type="checkbox"/> | <p>The project applicant has demonstrated that biofiltration BMPs are sized to meet one of the biofiltration sizing options available (Appendix B).</p> | <p>Submit sizing worksheets (Appendix B) or other equivalent documentation with the SWQMP.</p> |
|--------------------------|---|--|

2. Biofiltration BMPs must be designed with a hydraulic loading rate to maximize pollutant retention, preserve pollutant control processes, and minimize potential for pollutant washout.

Intent: Various decisions about biofiltration BMP design influence the degree to which pollutants are retained. The MS4 Permit requires that biofiltration BMPs achieve maximum feasible retention of storm water pollutants.

- | | | |
|--------------------------|---|---|
| <input type="checkbox"/> | <p>Media selected for the biofiltration BMP meets minimum quality and material specifications, including the maximum allowable design filtration rate and minimum thickness of media.</p> | <p>Provide documentation that media meets the BSM specifications outlined in F.2.</p> |
|--------------------------|---|---|

OR

- | | | |
|--------------------------|--|---|
| <input type="checkbox"/> | <p>Alternatively, for proprietary designs and custom media mixes not meeting the media specifications, field scale testing data are provided to demonstrate that proposed media meets the pollutant treatment performance criteria in Section F.1.1 below.</p> | <p>Provide documentation that the media meets the specifications.</p> |
|--------------------------|--|---|

- | | | |
|--------------------------|--|---|
| <input type="checkbox"/> | <p>To the extent practicable, filtration rates are outlet controlled (e.g., via an underdrain and orifice/weir) instead of controlled by the infiltration rate of the media.</p> | <p>Include outlet control in designs or provide documentation of why outlet control is not practicable.</p> |
|--------------------------|--|---|

- | | | |
|--------------------------|---|--|
| <input type="checkbox"/> | <p>The water surface drains to at least 12 inches below the media surface within 24 hours from the end of storm event flow to preserve plant health and promote healthy soil structure.</p> | <p>Include calculations to demonstrate that drawdown rate is adequate.

Surface ponding drawdown time greater than 24-hours but less than 96 hours may be allowed at the discretion of County staff if certified by a landscape architect or agronomist.</p> |
|--------------------------|---|--|

Appendix F: Biofiltration Standard and Checklist

<input type="checkbox"/>	If nutrients are a pollutant of concern, design of the biofiltration BMP follows nutrient-sensitive design criteria.	Follow specifications for nutrient sensitive design in Fact Sheet BF-2. Or provide alternative documentation that nutrient treatment is addressed and potential for nutrient release is minimized.
<input type="checkbox"/>	Media gradation calculations or geotextile selection calculations demonstrate that migration of media between layers will be prevented and permeability will be preserved.	Follow specification for choking layer or geotextile in Fact Sheet PR-1 or BF-1. Or include calculations to demonstrate that choking layer is appropriately specified.
<p>3. Biofiltration BMPs must be vegetated to support and maintain treatment processes.</p> <p>Intent: Plants are important elements of biofiltration performance and longevity.</p>		
<input type="checkbox"/>	Plants have been selected to be tolerant of project climate, design ponding depths and the treatment media composition.	Provide documentation justifying plant selection. Refer to the plant list in Appendix F.
<input type="checkbox"/>	Plants have been selected to minimize irrigation requirements.	Provide documentation describing irrigation requirements for establishment and long-term operation.
<input type="checkbox"/>	Plant location and growth will not impede expected long-term media filtration rates and will enhance long term infiltration rates to the extent possible.	Provide documentation justifying plant selection. Refer to the plant list in Appendix F.
<p>4. Biofiltration BMPs must be designed with a hydraulic loading rate to prevent erosion, scour, and channeling within the BMP.</p> <p>Intent: Erosion, scour, and/or channeling can disrupt treatment processes and reduce biofiltration effectiveness.</p>		
<input type="checkbox"/>	Scour protection has been provided for both sheet flow and pipe inflows to the BMP, where needed.	Provide documentation of scour protection as described in Fact Sheets PR-1 or BF-1 or approved equivalent.
<input type="checkbox"/>	Where scour protection has not been provided, flows into and within the BMP are kept to non-erosive velocities.	Provide documentation of design checks for erosive velocities as described in Fact Sheets PR-1 or BF-1 or approved equivalent.
<input type="checkbox"/>	For proprietary BMPs, the BMP is used in a manner consistent with manufacturer guidelines and conditions of its third-party certification ⁴ (i.e., maximum tributary area, maximum inflow velocities, etc., as applicable).	Provide copy of manufacturer recommendations and conditions of third-party certification.

⁴ Certifications or verifications issued by the Washington Technology Acceptance Protocol-Ecology program and the New Jersey Corporation for Advanced Technology programs are typically accompanied by a set of guidelines regarding appropriate design and maintenance conditions that would be consistent with the certification/verification

5. Biofiltration BMP must include operations and maintenance design features and planning considerations for continued effectiveness of pollutant and flow control functions.

Intent: Biofiltration BMPs require regular maintenance in order provide ongoing function as intended. Additionally, it is not possible to foresee and avoid potential issues as part of design; therefore, plans must be in place to correct issues if they arise.

- | | | |
|--------------------------|--|--|
| <input type="checkbox"/> | The biofiltration BMP maintenance plan describes specific inspection activities, regular/periodic maintenance activities and specific corrective actions relating to scour, erosion, channeling, media clogging, vegetation health, and inflow and outflow structures. | Include maintenance plan with the SWQMP as described in Chapter 7. |
| <input type="checkbox"/> | Adequate site area and features have been provided for BMP inspection and maintenance access. | Illustrate maintenance access routes, setbacks, maintenance features as needed on project water quality plans. |
| <input type="checkbox"/> | For proprietary biofiltration BMPs, the BMP maintenance plan is consistent with manufacturer guidelines and conditions of its third-party certification (i.e., maintenance activities, frequencies). | Provide copy of manufacturer recommendations and conditions of third-party certification. |

6. Proprietary Biofiltration BMPs must provide evidence that the BMP has been certified for use as part of the Washington State Technology Assessment Protocol-Ecology certification program or other equivalent third party submit evaluation.

Intent: Must prove through a vetted testing protocol that the BMP functions at the same level or better than a non-proprietary Biofiltration BMP.

- | | | |
|--------------------------|--|--|
| <input type="checkbox"/> | Must be Biofiltration BMPs that have an active Technology Acceptance Protocol-Ecology certification, with <u>General Use Level Designation</u> . | Provide documentation as outlined in F.1.1, below with the SWQMP |
| <input type="checkbox"/> | BMP must be used in a manner consistent with all conditions of the Technology Acceptance Protocol-Ecology certification while meeting the flow rate or volume design criteria that is required for biofiltration BMPs under this manual. | See guidance below in F.1.2.1 to provide proper documentation. |
| OR | | |
| <input type="checkbox"/> | BMP may be acceptable if it meets other third-party protocol and the pollutant treatment performance of the system is consistent with the performance levels associated with the necessary Technology Acceptance Protocol-Ecology certifications | See Guidance below in F.1.1 to provide proper documentation. |

F.1.1 Pollutant Treatment Performance Standard

Standard biofiltration BMPs that are designed following the criteria in Fact Sheets PR-1 and BF-1 are presumed to meet the pollutant treatment performance standard associated with biofiltration BMPs. This presumption is based on the MS4 Permit Fact Sheet which cites analyses of standard biofiltration BMPs conducted in the Ventura County Technical Guidance Manual (July 2011).

For BMPs that do not meet the biofiltration media specification and/or the range of acceptable media filtration rates described in Fact Sheet, PR-1 and BF-1, additional documentation must be provided to demonstrate that adequate pollutant treatment performance is provided to be considered a biofiltration BMP. Project applicants have three options for documenting compliance:

- 1) Project applicants may provide documentation to substantiate that the minor modifications to the design is expected to provide equal or better pollutant removal performance for the project pollutants of concern than would be provided by a biofiltration design that complies with the criteria in Fact Sheets PR-1 and BF-1. Minor modifications are design elements that deviate only slightly from standard design criteria and are expected to either not impact performance or to improve performance compared to standard biofiltration designs. The County has the discretion to accept or reject this documentation and/or request additional documentation to substantiate equivalent or better performance to BF-1 or PR-1, as applicable. Examples of minor deviations include:
 - Different particle size distribution of aggregate, with documentation that system filtration rate will meet specifications.
 - Alternative source of organic components, with documentation of material suitability and stability from appropriate testing agency.
 - Specialized amendments to provide additional treatment mechanisms, and which have negligible potential to upset other treatment mechanisms or otherwise deteriorate performances.
- 2) For proprietary BMPs, project applicants may provide evidence that the BMP has been certified for use as part of the Washington State Technology Assessment Protocol-Ecology Certification program and meets each of the following requirements:
 - a. The applicant must demonstrate (using the checklist in this Appendix) that the BMP meets all other conditions to be considered as a biofiltration BMP. For example, a cartridge media filter or hydrodynamic separator would not meet biofiltration BMP design criteria regardless of Technology Acceptance Protocol-Ecology certification because they are not vegetated.
 - b. The applicant must select BMPs that have an active Technology Acceptance Protocol-Ecology certification, with General Use Level Designation for the appropriate project pollutants of concern as identified in Table F.1-1. The list of certified technologies is

Appendix F: Biofiltration Standard and Checklist

updated as new technologies are approved (link below). Technologies with Pilot Use Level Designation and Conditional Use Level Designations are not acceptable. Refer to: <http://www.ecy.wa.gov/programs/wq/stormwater/newtech/technologies.html>.

- c. The applicant must demonstrate that BMP is being used in a manner consistent with all conditions of the Technology Acceptance Protocol-Ecology certification while meeting the flow rate or volume design criteria that is required for biofiltration BMPs under this manual. Conditions of Technology Acceptance Protocol-Ecology certification are available by clicking on the technology name at the website listed in bullet b. Additional discussion about sizing of proprietary biofiltration BMPs to comply with applicable sizing standards is provided below in Section F.1.2.
- 3) For BMPs that do not fall into options 1 or 2 above, County staff may allow the applicant to submit alternative third-party documentation that the pollutant treatment performance of the system is consistent with the performance levels associated with the necessary Technology Acceptance Protocol-Ecology certifications. Table F.1-1 describes the required levels of certification and Table F.1-2 describes the pollutant treatment performance levels associated with each level of certification. Acceptance of this approach is at the sole discretion of County staff. While the County has no obligation to accept the use of any proposed proprietary flow-thru BMP, applicants will be provided a written explanation describing the rationale for the rejection of any proposed devices. If Technology Acceptance Protocol-Ecology certifications are not available, preference would be given to:
- a. Verified third-party, field-scale testing performance under the Technology Acceptance Reciprocity Partnership Tier II Protocol. This protocol is no longer operated, however this is considered to be a valid protocol and historic verifications are considered to be representative provided that product models being proposed are consistent with those that were tested. Technology Acceptance Reciprocity Partnership verifications were conducted under New Jersey Corporation for Advance Testing and are archived at the website linked below. Note that Technology Acceptance Reciprocity Partnership verifications must be matched to pollutant treatment standards in Table F.1-2 then matched to an equivalent Technology Acceptance Protocol-Ecology certification in Table F.1-1.
 - b. Verified third-party, field-scale testing performance under the New Jersey Corporation for Advance Testing protocol. Note that New Jersey Corporation for Advance Testing verifications must be matched to pollutant treatment standards in Table F.1-2 then matched to an equivalent Technology Acceptance Protocol-Ecology certification in Table F.1-1.

A list of field-scale verified technologies under Technology Acceptance Reciprocity Partnership Tier II and New Jersey Corporation for Advance Testing can be accessed at:

Appendix F: Biofiltration Standard and Checklist

<http://www.njcat.org/verification-process/technology-verification-database.html> (refer to field verified technologies only).

Table F.1-1: Required Technology Acceptance Protocol-Ecology Certifications for Pollutants of Concern for Biofiltration Performance Standard

Project Pollutant of Concern	Required Technology Acceptance Protocol-Ecology Certification for Biofiltration Performance Standard
Trash	Basic Treatment OR Phosphorus Treatment OR Enhanced Treatment
Sediments	Basic Treatment OR Phosphorus Treatment OR Enhanced Treatment
Oil and Grease	Basic Treatment OR Phosphorus Treatment OR Enhanced Treatment
Nutrients	Phosphorus Treatment ¹
Metals	Enhanced Treatment
Pesticides	Basic Treatment (including filtration) ² OR Phosphorus Treatment OR Enhanced Treatment
Organics	Basic Treatment (including filtration) ² OR Phosphorus Treatment OR Enhanced Treatment
Bacteria and Viruses	Basic Treatment (including bacteria removal processes) ³ OR Phosphorus Treatment OR Enhanced Treatment

1 – There is no Technology Acceptance Protocol-Ecology equivalent for nitrogen compounds; however systems that are designed to retain phosphorus (as well as meet basic treatment designation), generally also provide treatment of nitrogen compounds. Where nitrogen is a pollutant of concern, relative performance of available certified systems for nitrogen removal should be considered in BMP selection.

2 – Pesticides, organics, and oxygen demanding substances are typically addressed by particle filtration consistent with the level of treatment required to achieve Basic treatment certification; if a system with Basic treatment certification does not provide filtration, it is not acceptable for pesticides, organics or oxygen demanding substances.

3 – There is no Technology Acceptance Protocol-Ecology equivalent for pathogens (viruses and bacteria), and testing data are limited because of typical sample hold times. Systems with Technology Acceptance Protocol-Ecology Basic Treatment must include one or more significant bacteria removal process such as media filtration, physical sorption, predation, reduced redox conditions, and/or solar inactivation. Where design options are available to enhance pathogen removal (i.e., pathogen-specific media mix offered by vendor), this design variation should be used.

Table F.1-2: Performance Standards for Technology Acceptance Protocol-Ecology Certification

Performance Goal	Influent Range	Criteria
Basic Treatment	20 – 100 mg/L TSS	Effluent goal \leq 20 mg/L TSS
	100 – 200 mg/L TSS	\geq 80% TSS removal
	>200 mg/L TSS	> 80% TSS removal
Enhanced (Dissolved Metals) Treatment	Dissolved copper 0.005 – 0.02 mg/L	Must meet basic treatment goal and better than basic treatment currently defined as >30% dissolved copper removal
	Dissolved zinc 0.02 – 0.3 mg/L	Must meet basic treatment goal and better than basic treatment currently defined as >60% dissolved zinc removal
Phosphorous Treatment	Total phosphorous 0.1 – 0.5 mg/L	Must meet basic treatment goal and exhibit \geq 50% total phosphorous removal
Oil Treatment	Total petroleum hydrocarbon > 10 mg/L	No ongoing or recurring visible sheen in effluent Daily average effluent Total petroleum hydrocarbon concentration < 10 mg/L Maximum effluent Total petroleum hydrocarbon concentration for a 15 mg/L for a discrete (grab) sample
Pretreatment	50 – 100 mg/L TSS	\leq 50 mg/L TSS
	\geq 200 mg/L TSS	\geq 50% TSS removal

F.1.2 Guidance on Sizing and Design of Non-Standard Biofiltration BMPs

This section explains the general process for design and sizing of non-standard biofiltration BMPs. This section assumes that the BMPs have been selected based on the criteria in Section F.1.1.

F.1.2.1 Guidance on Design per Conditions of Certification/Verification

The biofiltration standard and checklist in this appendix requires that “the BMP is used in a manner consistent with manufacturer guidelines and conditions of its third-party certification.” Practically, what this means is that the BMP is used in the same way in which it was tested and certified. For example, it is not acceptable for a BMP of a given size to be certified/verified with a 100 gallon per minute treatment rate and be applied at a 150 gallon per minute treatment rate in a design.

Certifications or verifications issued by the Washington Technology Acceptance Protocol-Ecology program and the Technology Acceptance Reciprocity Partnership or New Jersey Corporation for Advance Testing programs are typically accompanied by a set of guidelines regarding appropriate

Appendix F: Biofiltration Standard and Checklist

design and maintenance conditions that would be consistent with the certification/verification. It is common for these approvals to specify the specific model of BMP, design capacity for given unit sizes, type of media that is the basis for approval, and/or other parameters. The applicant must demonstrate conclusively that the proposed application of the BMP is consistent with these criteria.

For alternate non-proprietary systems that do not have a Technology Acceptance Protocol-Ecology / Technology Acceptance Reciprocity Partnership / New Jersey Corporation for Advance Testing certification (but which still must provide quantitative data per Appendix F.1.1), it must be demonstrated that the configuration and design proposed for the project is reasonably consistent with the configuration and design under which the BMP was tested to demonstrate compliance with Appendix F.1.1.

F.1.2.2 Sizing of Flow-Based Biofiltration BMP

This sizing method is only available when the BMP meets the pollutant treatment performance standard in Appendix F.1.1.

Proprietary biofiltration BMPs are typically designed as a flow-based BMPs (i.e., a constant treatment capacity with negligible storage volume). Proprietary biofiltration is only acceptable if the sizing criteria in this Appendix and the retention performance standard identified in Appendix B.5 are satisfied. The applicable sizing method for biofiltration is reduced to: Treat 1.5 times the DCV.

The following steps should be followed to demonstrate that the system is sized to treat 1.5 times the DCV.

1. Calculate the flow rate required to meet the pollutant treatment performance standard without scaling for the 1.5 factor. Options include either:
 - Calculate the runoff flow rate from a 0.2 inch per hour uniform intensity precipitation event (See methodology Appendix J.5.3), or
 - Conduct a continuous simulation analysis to compute the size required to capture and treat 80 percent of average annual runoff; for small catchments, 5-minute precipitation data should be used to account for short time of concentration. Nearest rain gage with 5-minute precipitation data is allowed for this analysis.
2. Multiply the flow rate from Step 1 by 1.5 to compute the design flow rate for the biofiltration system.
3. Based on the conditions of certification/verification (discussed above), establish the design capacity, as a flow rate, of a given sized unit.
4. Demonstrates that an appropriate unit size and number of units is provided to provide a flow rate that meets the required flow rate from Step 2.
5. Provide supplemental retention BMPs that will satisfy retention requirements in Appendix B.2.
6. Demonstrate that the BMP design is expected to last 10 years before major maintenance is anticipated per guidance in Appendix B.4.1

F.2 Biofiltration Soil Media Composition, Testing, and Installation

803-1 GENERAL.

Biofiltration Soil Media (BSM) is intended to filter storm water and support plant growth while minimizing the leaching of potential pollutants. This specification includes requirements that apply to BSM used in stormwater treatment BMPs, including bioretention and biofiltration. Biofiltration Soil Media is also referred to as Engineered Soil Media and Bioretention Soil Media.

803-2 BLENDED BSM CRITERIA AND TESTING REQUIREMENTS

803-2.1 General. Blended BSM shall consist of 60% to 80% by volume sand, up to 20% by volume topsoil, and up to 20% by volume compost. Sand, Topsoil, and Compost used in BSM shall conform to requirements listed in Sections 803-3, 803-4, and 803-5, respectively. For bioretention/biofiltration with outlet-controlled designs, it is likely that topsoil will need to be omitted or reduced to achieve permeability targets.

Alternative mix components and proportions may be utilized, provided that the whole blended mix conforms to whole BSM criteria, detailed in Section 803-2.3 through 803-2.5. Alternative mix designs may include alternative proportions and/or alternative organic amendments. Alternative mixes are subject to approval by the County. Alternative mixes that use an alternative organic component (rather than compost) may be necessary when BMPs are installed in areas with nitrogen or phosphorus impaired receiving waters in order to meet more stringent BSM quality requirements as detailed in Section 803-2.5.

803-2.2 Testing and Submittals. At least 30 days prior to ordering materials, the Contractor shall submit the following to the County reviewer (upon request): source/supplier of BSM, location of source/supplier, a physical sample of the BSM, whole BSM test results from a third-party independent laboratory, test results for individual component materials as required, and description of proposed methods and schedule for mixing, delivery, and placement of BSM. The test results shall be no older than 120 days and shall accurately represent the materials and feed stocks that are currently available from the supplier.

Test results shall demonstrate conformance to agronomic suitability and hydraulic suitability criteria listed in Sections 803-2.3 and 803-2.4, respectively. BSM for use in BMPs in areas with water quality impairments in receiving waters shall also comply with applicable Chemical Suitability criteria in Section 803-2.5. No delivery, placement, or planting of BSM shall begin until test results confirm the suitability of the BSM. The Contractor shall submit a written request for approval which shall be accompanied by written analysis results from a written report of a testing agency. The testing agency must be registered by the State for agronomic soil evaluation laboratory test fees shall be paid for by the Contractor.

Appendix F: Biofiltration Standard and Checklist

803-2.3 Agronomic Suitability. The BSM shall conform to the requirements herein to support plant growth. BSM which requires amending to comply with the below specifications shall be uniformly blended and tested in its blended state prior to testing and delivery.

- a) pH range shall be between 6.0-8.5.
- b) Salinity shall be between 0.5 and 3.0 millimho/cm (as measure by electrical conductivity)
- c) Sodium absorption ratio (SAR) shall be less than 5.0
- d) Chloride shall be less than 800 ppm.
- e) Cation exchange capacity shall be greater than 10 meq/100 g.
- f) Organic matter shall be between 2 and 5%.
- g) Carbon:Nitrogen ratio shall be between 12 and 40 (15 to 40 preferred).

Textural class fraction shall adhere to limits in Table 803-2.1, as determined by ASTM Method D422 or an approved alternative method:

TABLE 803-2.3

Textural Class (ASTM D422)	Size Range	Mass Fraction (percent)
Gravel	Larger than 2 mm	0 to 25 of total sample
Clay	Smaller than 0.005 mm	0 to 5 of non-gravel fraction

Test results shall show the following information:

- a) Date of testing
- b) Project name, contractor name, and source of materials and supplier name
- c) Copies of all testing reports including, at a minimum, analytical results sufficient to confirm compliance with all requirements listed in this section.

803-2.4 Hydraulic Suitability. BSM shall meet the have appropriate hydraulic properties for filtering stormwater. The BSM shall conform to the requirements herein to support plant growth. BSM which requires amending, shall be uniformly blended and tested in its blended state prior to testing and delivery.

803-2.4.1 Testing. The saturated hydraulic conductivity of the whole BSM shall be measured according to the method detailed in the measurement of hydraulic conductivity (USDA Handbook 60, method 34b), commonly available as part of standard agronomic soil evaluation, or ASTM D24234 Permeability of Granular Soils (at approximately 85% relative compaction Standard Proctor, ASTM

Appendix F: Biofiltration Standard and Checklist

D698). BSM shall conform to hydraulic criteria associated with the BMP design configuration that best applies to the facility where the BSM will be installed (Section 803-2.4.2 or 803-2.4.3).

803-2.4.2 Systems with Unrestricted Underdrain System (i.e., media control). For systems with underdrains that are not restricted, the BSM shall meet the minimum and maximum measured hydraulic conductivity found in Table 803-2.4 to ensure adequate flow rate through the BMP and longevity of the system but reduce excessive velocities through the media. In all cases, an upturned elbow system on the underdrain, measuring 9 to 12 inches above the invert of the underdrain, should be used to control velocities in the underdrain pipe and reduce potential for solid migration through the system.

803-2.4.3 Systems with Restricted Underdrain System (i.e., outlet control). For systems in which the flow rate of water through the media is controlled via an outlet control device (e.g., orifice or valve) affixed to the outlet of the underdrain system, the hydraulic conductivity of the media should meet the requirements in Table 803-2.4 and the outlet control device should control the flow rate to between 5 and 12 inches per hour. This configuration reduces the sensitivity of system performance to the hydraulic conductivity, compaction, and clogging of the material, reduces the likelihood of preferential flow through media, and allows more precise design and control of system flow rates. For these reasons, outlet control should be considered the preferred design option over unrestricted underdrain systems.

803-2.4.4 Systems without Underdrains. For systems without underdrains, the BSM shall have a hydraulic conductivity of at least 5 inches per hour, or at least 2 times higher than the design infiltration rate of the underlying soil, whichever is greater.

Table 803-2.4.

Underdrain System	Hydraulic Conductivity Requirements	
	Minimum (in/hr)	Maximum (in/hr)
Unrestricted (media control)	8	24
Restricted (outlet control) Preferred Design Option.	20	80

803-2.5 Chemical Suitability for Areas Draining to Impaired Receiving Waters.

803-2.5.1 General. The chemical suitability criteria listed in this section do not apply to systems without underdrains, unless groundwater is impaired or susceptible to nutrient contamination. Limits for a given parameter only apply if that parameter is associated with a water quality impairment, priority water quality condition, and/or TMDL in the receiving water. Limits may be waived at the discretion of the County if it is determined that it is unreasonable to meet the specification using locally-available materials (available within 100 miles).

Appendix F: Biofiltration Standard and Checklist

803-2.5.2 Testing. Potential for pollutant leaching shall be assessed using either the Saturated Media Extract Method (aka, Saturation Extract) that is commonly performed by agronomic laboratories or the Synthetic Precipitation Leaching Procedure (SPLP) (EPA SW-846, Method 1312). If the saturation extract method is used, samples may be rinsed with up to five pore volumes before collecting extract for analysis.

803-2.5.3 BSM Limits in Areas Draining to Impaired Receiving Waters. The limits in this section are in terms of the concentration of a parameter in water that has been contacted with the BSM.

Table 803-2.5.3

Applicable Pollutant(s)	Saturation Extract or SPLP Criteria
Phosphorus*	< 1 mg/L
Zinc	< 1 mg/L
Copper	< 0.04 mg/L
Lead	< 0.025 mg/L
Arsenic	< 0.02 mg/L
Cadmium	< 0.01 mg/L
Mercury	< 0.01 mg/L
Selenium	< 0.01 mg/L

803-2.5.4 Alternative BSM for Reduced Phosphorus Leaching. In areas with impaired receiving waters, alternative BSM should be considered, especially if receiving waters are phosphorus impaired. BSM with 20% compost may result in phosphorus leaching and soluble phosphorus test results in excess of the 1 mg/L limit presented in Table 803-2.5.3. Alternative organic amendments, such as coco coir pith and/or composted wood products, in place of compost should be considered in these areas. Sand and soil components with higher levels of iron and aluminum should also be considered to limit the solubility of phosphorus.

803-5.5.5. Nitrogen Impaired Receiving Waters. In areas with a downstream water quality impairment or TMDL for nitrogen, a combination of BSM composition and BMP design shall be used to reduce the potential for nitrate leaching from BMPs.

- BSM: The C:N ratio of BSM shall be between 15 and 40 to reduce the potential for nitrate leaching.
- BMP design: BMPs shall be designed to either enhance infiltration into underlying soils or with internal water storage to promote reduction of nitrogen:
 - If a BMP is installed with a liner, the BMP must include an internal saturated zone, consisting of at least an 18-inch thick layer of gravel, to enhance denitrification.
 - If a BMP does not include a liner, it must be installed with a retention zone below the

Appendix F: Biofiltration Standard and Checklist

underdrain discharge elevation, consisting of at least an 18-inch thick layer of gravel, to enhance infiltration into underlying soils.

803-3 SAND FOR BSM.

803-3.1 General. Sand used in BSM should preferably be washed prior to delivery. If sand is not washed it must still meet sieve analysis requirements in Table 1.

803-3.2 Gradation Limits. A sieve analysis shall be performed in accordance with California Test 202, ASTM D 422, or approved equivalent method to demonstrate compliance with the gradation limits shown in Table 803-3.2. Fines passing the No. 200 sieve shall be non-plastic.

TABLE 803-3.2

Sieve Size (ASTM D422)	Percentage Passing Sieve (by weight)	
	Minimum	Maximum
3/8 inch	100	100
#4	90	100
#8	70	100
#16	40	95
#30	15	70
#40	5	55
#100	0	15
#200	0	5

803-4 TOPSOIL FOR BSM.

803-4.1 General. Topsoil shall be free of hazardous materials and shall be consistent with a common definition of topsoil. Decomposed granite and derivatives of decomposed granite are not considered to be topsoil for the purpose of this specification.

803-4.2 Textural Class. Topsoil shall be classified as a sandy loam or a loamy sand according to the US Department of Agriculture soil classification system. In addition, a textural class analysis shall be performed in accordance with ASTM D422, or an approved alternative method to demonstrate compliance with the gradation limits in Table 803-4.2.

Table 803-4.2

Textural Class (ASTM D422)	Size Range	Mass Fraction (percent)
Gravel	Larger than 2 mm	0 to 25 of total sample
Clay	Smaller than 0.005 mm	0 to 15 of non-gravel fraction

803-5 COMPOST FOR BSM.

803-5.1 General. Compost shall be produced at a facility inspected and regulated by the local enforcement agency for CalRecycle. Compost should also preferably be certified by the U.S. Composting Council’s Seal of Testing Assurance Program (USCC STA) or an approved equivalent program. Compost shall not be produced from biosolids feedstock.

803-5.1.1 Gradation Limits. A sieve analysis shall be performed in accordance with ASTM D 422 or approved equivalent method to demonstrate compliance with the gradation limits show in Table 803-5.1.1.

Table 803-5.1.1

Sieve Size (ASTM D422)	Percent Passing Sieve (by weight)
1/2”	97 to 100
2 mm	40 to 90

803-5.1.2 Material Content. Organic Material Content shall be 35% to 100% by dry weight and moisture shall be 25% to 60% wet weight basis. Physical contaminants (manmade inert materials) shall not exceed 1% by dry weight.

803-5.2 Compost Testing. Compost shall meet the following requirements as demonstrated through standard agronomic testing methods:

- a) **Carbon to nitrogen (C:N) ratio.** C:N shall be between 15:1 and 40:1, preferably above 20:1 to reduce the potential for nitrogen leaching/washout.
- b) **pH.** pH shall be between 6.0 and 8.5.
- c) **Soluble Salt Concentration.** Soluble Salt Concentration shall be less than 10 dS/m. (Method TMECC 4.10-A, USDA and U.S. Composting Council).
- d) **Stability.** Carbon Dioxide evolution rate shall be less than 3.0 mg CO₂-C per g compost organic matter (OM) per day or less than 6 mg CO₂-C per g compost carbon per day, whichever unit is reported. (Method TMECC 5.08-B, USDA and U.S. Composting Council). Alternatively, a Solvita rating of 5.5 or higher is acceptable.

803-5.2.1 Pathogens and Pollutant Limits. Select pathogens shall pass US EPA Class A standard, 40 CFR Section 503.32(a). Trace Metals shall pass US EPA Class A standard, 40 CFR Section 503.13, Table 1 for Ceiling Concentrations.

803-6 DELIVERY, STORAGE, HANDLING, AND PAYMENT

803-6.1 General. BSM shall be thoroughly mixed prior to delivery using mechanical mixing methods such as a drum mixer. The Contractor shall protect soils and mixes from absorbing excess water and from erosion at all times.

803-6.1.1 Delivery. The Contractor shall not deliver or place soils in wet or muddy conditions.

803-6.1.2 Storage. The Contractor shall not store materials unprotected during large rainfall events (>0.25 inches). If water is introduced into the material while it is stockpiled, the Contractor shall allow the material to drain to the acceptance of the County before placement.

803-6.1.3 Handling and Placement. BSM shall be lightly compacted and placed in loose lifts approximately 12 inches (300 mm) to ensure reasonable settlement without excessive compaction. Compaction within the BSM area should not exceed 75 to 85% standard proctor within the BSM. Machinery shall not be used in the bioretention facility to place the BSM. A conveyor or spray system shall be used for media placement in large facilities. Low ground pressure equipment may be authorized for large facilities at the discretion of the County. Placement methods and BSM quantities shall account for approximately 10% loss of volume due to settling. Planting methods and timing shall account for settling of media without exposing plant root systems.

803-6.1.4 Hydraulic Suitability. The County may request up to three double ring infiltrometer tests (ASTM D3385) or approved alternative tests to confirm that the placed material meets applicable hydraulic suitability criteria. In the event that the infiltration rate of placed material does not meet applicable criteria, the County may require replacement and/or de-compaction of materials.

803-6.2 Quality Control and Acceptance

803-6.2.1 General. Close adherence to the material quality controls herein are necessary in order to support healthy vegetation, minimize pollutant leaching, and assure sufficient permeability to infiltrate/filter runoff during the life of the facility. Amendments may be included to adjust agronomic properties. Acceptance of the material will be based on test results certified to be representative. Test results shall be conducted no more than 120 days prior to delivery of the blended BSM to the project site. For projects installing more than 100 cubic yards of BSM, batch-specific tests of the blended mix shall be provided to the County for every 100 cubic yards of BSM along with a site plan showing the placement locations of each BSM batch within the facility.

803-6.5 Measurement and Payment. Quantities of mixed BSM will be measured as shown in the Bid. The volumetric quantity of mixed BSM to be paid for shall be the volume of BSM placed within the limits of the dimensions shown on the Plans.

803-7 AGGREGATE MATERIALS FOR BIORETENTION AND BIOFILTRATION DRAINAGE LAYERS

803-7.1 General. This section provides material specifications for drainage layers below BSM in bioretention BMPs. This consists of a two-layer filter course placed below the BSM and above an open-graded aggregate stone reservoir.

803-7.2 Rock and Sand Materials for Drainage Layers

803-7.2.1 General. All sand and stone products used in BSM drainage layers shall be clean and thoroughly washed.

803-7.2.2 Filter Course. Graded aggregate choker material is installed as a filter course to separate BSM from the drainage rock reservoir layer. The purpose of this layer is to limit migration of sand or other fines from the BSM. The filter course consists of two layers of choking material increasing in particle size. The top layer (closest to the BSM) of the filter course shall be constructed of thoroughly washed ASTM C33 Choker Sand as detailed in Table 200-1.5.5. The bottom layer of the filter course shall be constructed of thoroughly washed ASTM No. 8 aggregate material conforming to gradation limits contained in Table 200-1.2.1.

803-7.2.3 Open-Graded Aggregate Stone. Open-graded aggregate material is installed below filter course layers to provide additional storm water storage capacity and contain the underdrain pipe(s). This layer shall be constructed of thoroughly washed AASHTO No. 57 open graded aggregate material conforming to gradation limits contained in Table 200-1.2.1.

803-7.3 Layer Thicknesses and Construction.

803-7.3.1 General. Aggregate shall be deposited on underlying layers at a uniform quantity per linear foot (meter), which quantity will provide the required compacted thickness within the tolerances specified herein without resorting to spotting, picking up, or otherwise shifting the aggregate material.

803-7.3.2 Filter Course Layers. Each of the two filter course layers (top layer of ASTM C33 Choker Sand and bottom layer of ASTM No. 8) shall be installed to a thickness of 3 inches (75 mm). Both layers shall be spread in single layers. Marker stakes should be used to ensure uniform lift thickness.

803-7.3.3 Aggregate Drainage and Storage Layer. The thickness of the aggregate drainage and storage layer (AASHTO No. 57) will depend on site specific design and shall be detailed in contract documents.

803-7.3.4 Spreading. Drainage layers shall be as delivered as uniform mixtures and each layer shall be spread in one operation. Segregation within each aggregate layer shall be avoided and the layers shall be free from pockets of coarse or fine material.

803-7.3.5 Compacting. Filter course material and aggregate storage material shall be lightly compacted to approximately 80% standard proctor without the use of vibratory compaction.

Appendix F: Biofiltration Standard and Checklist

803-7.4 Measurement and Payment. Quantities of graded aggregate choker material and open-graded aggregate storage material will be measured as shown in the Bid. The volumetric quantities of graded aggregate choker stone material and open-graded storage material shall be those placed within the limits of the dimensions shown on the Plans. The weight of material to be paid for will be determined by deducting (from the weight of material delivered to the Work) the weight of water in the material (at the time of weighing) in excess of 1% more than the optimum moisture content. No payment will be made for the weight of water deducted as provided in this subsection.

803-8 SUMMARY

Summary of BSM specification requirements for the City of San Diego and County of San Diego included in Table 803-8.

Table 803-8

Component	Requirement
BSM Material Composition	Sand: 60-80% by volume Topsoil: 0-20% by volume Compost: 20% by volume
Alternative Blends Acceptable?	Yes, but they must meet performance-based specifications.
Sand Type	Washed sand conforming to particle size distribution
Topsoil Type	Sandy loam or loamy sand with clay < 15% and gravel < 25%
Compost Type	From a CalRecycle permitted facility. Biosolids derived materials are not acceptable
BSM Permeability	8-24 inches/hour for BMPs without outlet control; 15-80 inches/hour for BMPs with outlet control; testing is required to demonstrate.
Agronomic Suitability Requirements	Limits for salts and potential toxins. C:N ratio between 12 and 40.
Water Quality Related Limits?	Requirements related to specific pollutants when water quality of receiving waters is impaired for those pollutants.

Appendix F: Biofiltration Standard and Checklist

This page was intentionally left blank.

F.3 Plant List for Bioretention Facilities

Plant Name		Irrigation Requirements		Preferred Location in Basin		Applicable Bioretention Sections (Un-Lined Facilities)				Applicability to Flow-Through Planter? (Lined Facility)	
Latin Name	Common Name	Temporary Irrigation during Plant Establishment Period	Permanent Irrigation (Drip / Spray) ⁽¹⁾	Basin Bottom	Basin Side Slopes	Section A Treatment-Only Bioretention in Hydrologic Soil Group A or B Soils	Section B Treatment-Only Bioretention in Hydrologic Soil Group C or D soils	Section C Treatment Plus Flow Control Bioretention in Hydrologic Soil Group A or B Soils	Section D Treatment Plus Flow Control Bioretention in Hydrologic Soil Group C or D Soils	NO Applicable to Un-lined Facilities Only (Bioretention Only)	YES Can Use in Lined or Un-Lined Facility (Flow-Through Planter OR Bioretention)
TREES⁽²⁾											
<i>Alnus rhombifolia</i>	White Alder	X		X	X	X	X	X	X	X	
<i>Platanus racemosa</i>	California Sycamore	X		X	X	X	X	X	X	X	
<i>Salix lasiolepis</i>	Arroyo Willow	X			X	X	X	X	X	X	
<i>Salix lucida</i>	Lance-Leaf Willow	X			X	X	X	X	X	X	
<i>Sambucus mexicana</i>	Blue Elderberry	X			X	X	X	X	X	X	
SHRUBS / GROUNDCOVER											
<i>Achillea millefolium</i>	Yarrow	X			X	X	X				X
<i>Agrostis palens</i>	Thingrass	X			X	X	X	X	X		X
<i>Anemopsis californica</i>	Yerba Manza	X			X	X	X	X	X		X
<i>Baccharis douglasii</i>	Marsh Baccahris	X	X	X		X	X	X	X		X
<i>Carex praegracillis</i>	California Field Sedge	X	X	X		X	X	X	X		X
<i>Carex spissa</i>	San Diego Sedge	X	X	X		X	X	X	X		X
<i>Carex subfusca</i>	Rusty Sedge	X	X	X	X	X	X	X	X		X
<i>Distichlis spicata</i>	Salt Grass	X	X	X		X	X	X	X		X
<i>Eleocharis macrostachya</i>	Pale Spike Rush	X	X	X		X	X	X	X		X
<i>Festuca rubra</i>	Red Fescue	X	X	X	X	X	X				X
<i>Festuca californica</i>	California Fescue	X	X		X	X	X				X
<i>Iva hayesiana</i>	Hayes Iva	X			X	X	X				X
<i>Juncus Mexicana</i>	Mexican Rush	X	X	X	X	X	X	X	X		X
<i>Jucus patens</i>	California Gray Rush	X	X	X	X	X	X	X	X		X
<i>Leymus condensatus 'Canyon Prince'</i>	Canyon Prince Wild Rye	X	X	X	X	X	X	X	X		X
<i>Mahonia nevinii</i>	Nevin's Barberry	X			X	X	X	X	X		X
<i>Muhlenburgia rigens</i>	Deergrass	X	X	X	X	X	X	X	X		X
<i>Mimulus cardinalis</i>	Scarlet Monkeyflower	X		X	X	X	X				X
<i>Ribes speciosum</i>	Fushia Flowering Goose.	X			X	X	X				X
<i>Rosa californica</i>	California Wild Rose	X	X		X	X	X				X
<i>Scirpus cenuus</i>	Low Bullrush	X	X	X		X	X	X	X		X
<i>Sisyrinchium bellum</i>	Blue-eyed Grass	X			X	X	X				X

1. All plants will benefit from some supplemental irrigation during hot dry summer months, particularly those on basin side slopes and further inland.
2. All trees should be planted a min. of 10' away from any drain pipes or structures.
3. This list can also be used for Biofiltration with Partial Retention and Biofiltration Facilities

This page was intentionally left blank

Appendix

G

COUNTY OF SAN DIEGO BMP DESIGN MANUAL

Guidance for Continuous Simulation and Hydromodification Management and Sizing Factors

**Appendix G: Guidance for Continuous Simulation
and Hydromodification Management Sizing Factors**

This page was intentionally left blank.

Appendix G Guidance for Continuous Simulation and Hydromodification Management Sizing Factors

G.1 Guidance for Continuous Simulation Hydrologic Modeling for Hydromodification Management Studies in San Diego County Region 9

This Section G.1 provides guidance for project-specific continuous simulation modeling to demonstrate compliance with hydromodification flow control requirements. Alternatives to project-specific continuous simulation modeling include use of sizing factors described in Section G.2 for structural BMP design or use of dispersion areas or tree wells as SSD-BMPs in lieu of structural BMPs (see Section 5.2.3 and Appendix I).

G.1.1 Introduction

Continuous simulation hydrologic modeling is used to demonstrate compliance with the performance standards for hydromodification management in San Diego. There are several available hydrologic models that can perform continuous simulation analyses. Each has different methods and parameters for determining the amount of rainfall that becomes runoff, and for representing the hydraulic operations of certain structural BMPs such as biofiltration with partial retention or biofiltration. This Appendix is intended to:

- Identify acceptable models for continuous simulation hydrologic analyses for hydromodification management;
- Provide guidance for selecting climatology input to the models;
- Provide standards for rainfall loss parameters to be used in the models;
- Provide standards for defining physical characteristics of LID components; and
- Provide guidance for demonstrating compliance with performance standards for hydromodification management.

This Appendix is not a user's manual for any of the acceptable models, nor a comprehensive manual for preparing a hydrologic model. This Appendix provides guidance for selecting model input parameters for the specific purpose of hydromodification management studies. The model preparer must be familiar with the user's manual for the selected software to determine how the parameters are entered to the model.

G.1.2 Software for Continuous Simulation Hydrologic Modeling

The following software models may be used for hydromodification management studies in San Diego:

- HSPF – Hydrologic Simulation Program-FORTRAN, distributed by USEPA, public domain.
- SDHM – San Diego Hydrology Model, distributed by Clear Creek Solutions, Inc. This is an HSPF-based model with a proprietary interface that has been customized for use in San Diego for hydromodification management studies.
- SWMM – Storm Water Management Model, distributed by USEPA, public domain.

Third-party and proprietary software, such as XPSWMM or PCSWMM, may be used for hydromodification management studies in San Diego, provided that:

- Input and output data from the software can interface with public domain software such as SWMM. In other words, input files from the third party software should have sufficient functionality to allow export to public domain software for independent validation.
- The software's hydromodification control processes are substantiated.

G.1.3 Climatology Parameters

G.1.3.1 Rainfall

In all software applications for preparation of hydromodification management studies in San Diego, rainfall data must be selected from approved data sets that have been prepared for this purpose. As part of the development of the March 2011 Final HMP, long-term hourly rainfall records were prepared for public use. The rainfall record files are provided on the Project Clean Water website. The rainfall station map is provided in the March 2011 Final HMP and is included in this Appendix as Figure G.1-1.

Appendix G: Guidance for Continuous Simulation and Hydromodification Management Sizing Factors

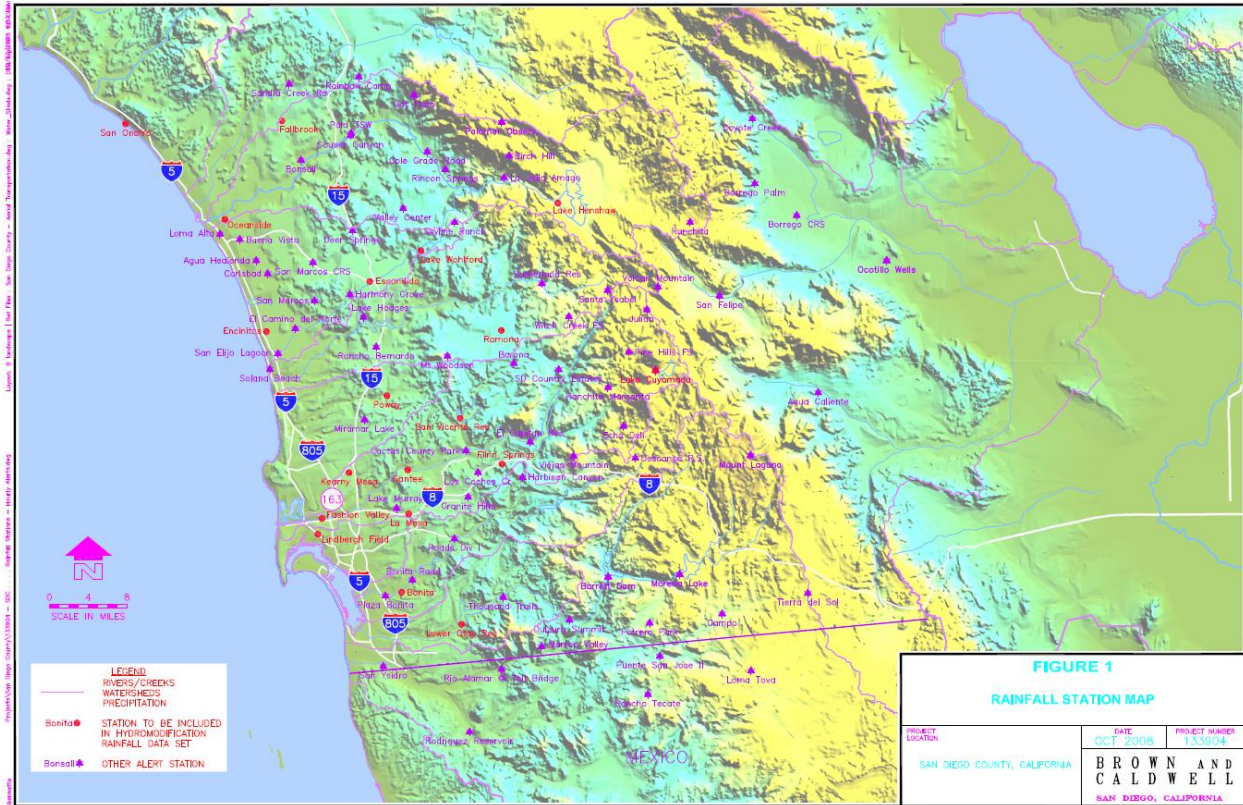

Figure G.1-1: Rainfall Station Map

Project applicants preparing continuous simulation models shall select the most appropriate rainfall data set from the rainfall record files provided on the Project Clean Water website. For a given project location, the following factors should be considered in the selection of the appropriate rainfall data set:

- In most cases, the rainfall data set in closest proximity to the project site will be the appropriate choice (refer to the rainfall station map).
- In some cases, the rainfall data set in closest proximity to the project site may not be the most applicable data set. Such a scenario could involve a data set with an elevation significantly different from the project site. In addition to a simple elevation comparison, the project proponent may also consult with the San Diego County’s average annual precipitation isopluvial map, which is provided in the San Diego County Hydrology Manual (2003). Review of this map could provide an initial estimate as to whether the project site is in a similar rainfall zone as compared to the rainfall stations. Generally, precipitation totals in San Diego County increase with increasing elevation.
- Where possible, rainfall data sets should be chosen so that the data set and the project location are both located in the same topographic zone (coastal, foothill, mountain) and major watershed unit (Upper San Luis Rey, Lower San Luis Rey, Upper San Diego River, Lower San Diego River, etc.).

For SDHM users, the approved rainfall data sets are pre-loaded into the software package. SDHM users may select the appropriate rainfall gage within the SDHM program. HSPF or SWMM users shall

Appendix G: Guidance for Continuous Simulation and Hydromodification Management Sizing Factors

download the appropriate rainfall record from the Project Clean Water website and load it into the software program.

Both the pre-development and post-project model simulation period shall encompass the entire rainfall record provided in the approved rainfall data set. Scaling the rainfall data is not permitted.

G.1.3.2 Potential Evapotranspiration

Project applicants preparing continuous simulation models shall select a data set from the sources described below to represent potential evapotranspiration.

For HSPF users, this parameter may be entered as an hourly time series. The hourly time series that was used to develop the BMP Sizing Calculator parameters is provided on the project clean water website and may be used for hydromodification management studies in San Diego. For SDHM users, the hourly evaporation data set is pre-loaded into the program. HSPF users may download the evaporation record from the Project Clean Water website and load it into the software program.

For HSPF or SWMM users, this parameter may be entered as monthly values in inches per month or inches per day. Monthly values may be obtained from the California Irrigation Management Information System "Reference Evapotranspiration Zones" brochure and map (herein "CIMIS ETo Zone Map"), prepared by California Department of Water Resources, dated January 2012. The CIMIS ETo Zone Map is available from www.cimis.gov, and is provided in this Appendix as Figure G.1-2. Determine the appropriate reference evapotranspiration zone for the project from the CIMIS ETo Zone Map. The monthly average reference evapotranspiration values are provided below in Table G.1-1.

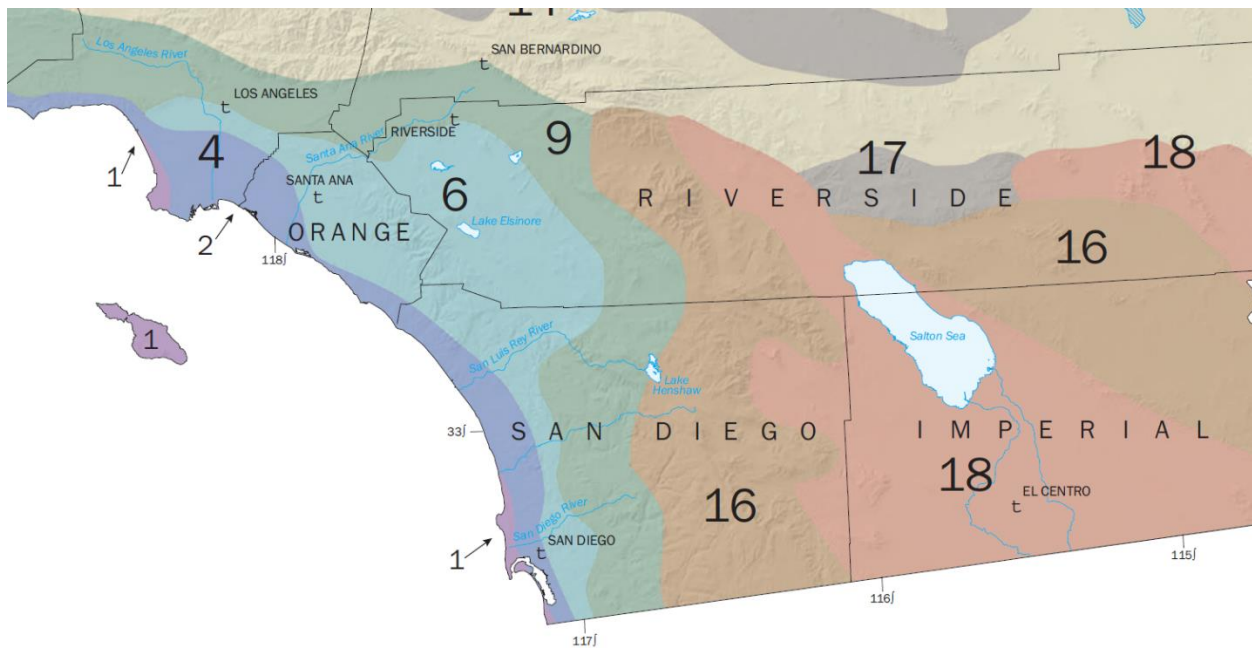

Figure G.1-2: California Irrigation Management Information System "Reference Evapotranspiration Zones"

**Appendix G: Guidance for Continuous Simulation
and Hydromodification Management Sizing Factors**

**Table G.1-1: Monthly Average Reference Evapotranspiration by ETo Zone
(inches/month and inches/day) for use in SWMM Models for Hydromodification Management Studies in San Diego County
CIMIS Zones 1, 4, 6, 9, and 16 (See CIMIS ETo Zone Map)**

	January	February	March	April	May	June	July	August	September	October	November	December
Zone	in/month	in/month	in/month	in/month	in/month	in/month	in/month	in/month	in/month	in/month	in/month	in/month
1	0.93	1.4	2.48	3.3	4.03	4.5	4.65	4.03	3.3	2.48	1.2	0.62
4	1.86	2.24	3.41	4.5	5.27	5.7	5.89	5.58	4.5	3.41	2.4	1.86
6	1.86	2.24	3.41	4.8	5.58	6.3	6.51	6.2	4.8	3.72	2.4	1.86
9	2.17	2.8	4.03	5.1	5.89	6.6	7.44	6.82	5.7	4.03	2.7	1.86
16	1.55	2.52	4.03	5.7	7.75	8.7	9.3	8.37	6.3	4.34	2.4	1.55
	January	February	March	April	May	June	July	August	September	October	November	December
Days	31	28	31	30	31	30	31	31	30	31	30	31
Zone	in/day	in/day	in/day	in/day	in/day	in/day	in/day	in/day	in/day	in/day	in/day	in/day
1	0.030	0.050	0.080	0.110	0.130	0.150	0.150	0.130	0.110	0.080	0.040	0.020
4	0.060	0.080	0.110	0.150	0.170	0.190	0.190	0.180	0.150	0.110	0.080	0.060
6	0.060	0.080	0.110	0.160	0.180	0.210	0.210	0.200	0.160	0.120	0.080	0.060
9	0.070	0.100	0.130	0.170	0.190	0.220	0.240	0.220	0.190	0.130	0.090	0.060
16	0.050	0.090	0.130	0.190	0.250	0.290	0.300	0.270	0.210	0.140	0.080	0.050

**Appendix G: Guidance for Continuous Simulation
and Hydromodification Management Sizing Factors**

This page was intentionally left blank.

G.1.4 Land Characteristics and Loss Parameters

In all software applications for preparation of hydromodification management studies in San Diego, rainfall loss parameters must be consistent with this Appendix unless the preparer can provide documentation to substantiate use of other parameters, subject to County approval. HSPF and SWMM use different processes and different sets of parameters. SDHM is based on HSPF, therefore parameters for SDHM and HSPF are presented together in Section G.1.4.1. Parameters that have been pre-loaded into SDHM may be used for other HSPF hydromodification management studies outside of SDHM. Parameters for SWMM are presented separately in Section G.1.4.2.

G.1.4.1 Rainfall Loss Parameters for HSPF and SDHM

Rainfall losses in HSPF are characterized by PERLND/PWATER parameters and IMPLND parameters, which describe processes occurring when rainfall lands on pervious lands and impervious lands, respectively. "BASINS Technical Notice 6, Estimating Hydrology and Hydraulic Parameters for HSPF," prepared by the USEPA, dated July 2000, provides details regarding these parameters and summary tables of possible ranges of these parameters. Table G.1-2, excerpted from the above-mentioned document, presents the ranges of these parameters.

For HSPF studies for hydromodification management in San Diego, PERLND/PWATER parameters and IMPLND parameters shall fall within the "possible" range provided in EPA Technical Note 6. To select specific parameters, HSPF users may use the parameters established for development of the San Diego BMP Sizing Calculator, and/or the parameters that have been established for SDHM. Parameters for the San Diego BMP Sizing Calculator and SDHM are based on research conducted specifically for HSPF modeling in San Diego.

Documentation of parameters selected for the San Diego BMP Sizing Calculator is presented in the document titled, San Diego BMP Sizing Calculator Methodology, prepared by Brown and Caldwell, dated January 2012 (herein "BMP Sizing Calculator Methodology"). The PERLND/PWATER parameters selected for development of the San Diego BMP Sizing Calculator represent a single composite pervious land cover that is representative of most pre-development conditions for sites that would commonly be managed by the BMP Sizing Calculator. The parameters shown below in Table G.1-3 are excerpted from the BMP Sizing Calculator Methodology.

**Appendix G: Guidance for Continuous Simulation
and Hydromodification Management Sizing Factors**

This page was intentionally left blank.

**Appendix G: Guidance for Continuous Simulation
and Hydromodification Management Sizing Factors**

Table G.1-2: HSPF PERLND/PWATER and IMPLND Parameters from EPA Technical Note 6

Name	Definition	Units	Range of Values				Function of ...	Comment
			Typical		Possible			
			Min	Max	Min	Max		
PWAT – PARM2								
FOREST	Fraction forest cover	none	0.0	0.50	0.0	0.95	Forest cover	Only impact when SNOW is active
LZSN	Lower Zone Nominal Soil Moisture Storage	inches	3.0	8.0	2.0	15.0	Soils, climate	Calibration
INFILT	Index to Infiltration Capacity	in/hr	0.01	0.25	0.001	0.50	Soils, land use	Calibration , divides surface and subsurface flow
LSUR	Length of overland flow	feet	200	500	100	700	Topography	Estimate from high resolution topo maps or GIS
SLSUR	Slope of overland flow plane	ft/ft	0.01	0.15	0.001	0.30	Topography	Estimate from high resolution topo maps or GIS
KVARY	Variable groundwater recession	1/inches	0.0	3.0	0.0	5.0	Baseflow recession variation	Used when recession rate varies with GW levels
AGWRC	Base groundwater recession	none	0.92	0.99	0.85	0.999	Baseflow recession	Calibration
PWAT – PARM3								
PETMAX	Temp below which ET is reduced	deg. F	35.0	45.0	32.0	48.0	Climate, vegetation	Reduces ET near freezing, when SNOW is active
PETMIN	Temp below which ET is set to zero	deg. F	30.0	35.0	30.0	40.0	Climate, vegetation	Reduces ET near freezing, when SNOW is active
INFEXP	Exponent in infiltration equation	none	2.0	2.0	1.0	3.0	Soils variability	Usually default to 2.0
INFILD	Ratio of max/mean infiltration capacities	none	2.0	2.0	1.0	3.0	Soils variability	Usually default to 2.0
DEEPPFR	Fraction of GW inflow to deep recharge	none	0.0	0.20	0.0	0.50	Geology, GW recharge	Accounts for subsurface losses
BASETP	Fraction of remaining ET from baseflow	none	0.0	0.05	0.0	0.20	Riparian vegetation	Direct ET from riparian vegetation
AGWETP	Fraction of remaining ET from active GW	none	0.0	0.05	0.0	0.20	Marsh/wetlands extent	Direct ET from shallow GW
PWAT – PARM4								
CEPSC	Interception storage capacity	inches	0.03	0.20	0.01	0.40	Vegetation type/density, land use	Monthly values usually used
UZSN	Upper zone nominal soil moisture storage	inches	0.10	1.0	0.05	2.0	Surface soil conditions, land use	Accounts for near surface retention
NSUR	Manning's n (roughness) for overland flow	none	0.15	0.35	0.05	0.50	Surface conditions, residue, etc.	Monthly values often used for croplands
INTFW	Interflow inflow parameter	none	1.0	3.0	1.0	10.0	Soils, topography, land use	Calibration , based on hydrograph separation
IRC	Interflow recession parameter	none	0.5	0.70	0.30	0.85	Soils, topography, land use	Often start with a value of 0.7, and then adjust
LZETP	Lower zone ET parameter	none	0.2	0.70	0.1	0.9	Vegetation type/density, root depth	Calibration
IWAT – PARM2								
LSUR	Length of overland flow	feet	50	150	50	250	Topography, drainage system	Estimate from maps, GIS, or field survey
SLSUR	Slope of overland flow plane	ft/ft	0.01	0.05	0.001	0.15	Topography, drainage	Estimate from maps, GIS, or field survey
NSUR	Manning's n (roughness) for overland flow	none	0.03	0.10	0.01	0.15	Impervious surface conditions	Typical range is 0.05 to 0.10 for roads/parking lots
RETSC	Retention storage capacity	inches	0.03	0.10	0.01	0.30	Impervious surface conditions	Typical range is 0.03 to 0.10 for roads/parking lots
IWAT – PARM3 (PETMAX and PETMIN, same values as shown for PWAT – PARM3)								

**Appendix G: Guidance for Continuous Simulation
and Hydromodification Management Sizing Factors**

This page was intentionally left blank

**Appendix G: Guidance for Continuous Simulation
and Hydromodification Management Sizing Factors**

Table G.1-3: HSPF PERLND/PWATER Parameters from BMP Sizing Calculator Methodology

	Slope	Hydrologic Soil Group A			Hydrologic Soil Group B			Hydrologic Soil Group C			Hydrologic Soil Group D		
		5%	10%	15%	5%	10%	15%	5%	10%	15%	5%	10%	15%
PWAT_PAR M2	Units												
FOREST	None	0	0	0	0	0	0	0	0	0	0	0	0
LZSN	inches	5.2	4.8	4.5	5.0	4.7	4.4	4.8	4.5	4.2	4.8	4.5	4.2
INFILT	in/hr	0.090	0.070	0.045	0.070	0.055	0.040	0.050	0.040	0.032	0.040	0.030	0.020
LSUR	Feet	200	200	200	200	200	200	200	200	200	200	200	200
SLSUR	ft/ft	0.05	0.1	0.15	0.05	0.1	0.15	0.05	0.1	0.15	0.05	0.1	0.15
KVARY	1/inches	3	3	3	3	3	3	3	3	3	3	3	3
AGWRC	None	0.92	0.92	0.92	0.92	0.92	0.92	0.92	0.92	0.92	0.92	0.92	0.92
PWAT_PAR M3													
PETMAX (F)	F	35	35	35	35	35	35	35	35	35	35	35	35
PETMIN (F)	F	30	30	30	30	30	30	30	30	30	30	30	30
INFEXP	None	2	2	2	2	2	2	2	2	2	2	2	2
INFILD	None	2	2	2	2	2	2	2	2	2	2	2	2
DEEPR	None	0.4	0.4	0.4	0.4	0.4	0.4	0.4	0.4	0.4	0.4	0.4	0.4
BASETP	None	0.05	0.05	0.05	0.05	0.05	0.05	0.05	0.05	0.05	0.05	0.05	0.05
AGEWTP	None	0.05	0.05	0.05	0.05	0.05	0.05	0.05	0.05	0.05	0.05	0.05	0.05
PWAT_PAR M4													
CEPSC	inches	0.08	0.08	0.08	0.08	0.08	0.08	0.08	0.08	0.08	0.08	0.08	0.08
UZSN	inches	0.6	0.6	0.6	0.6	0.6	0.6	0.6	0.6	0.6	0.6	0.6	0.6
NSUR	None	0.2	0.2	0.2	0.2	0.2	0.2	0.2	0.2	0.2	0.2	0.2	0.2
INTFW	None	1.5	1.5	1.5	1.5	1.5	1.5	1.5	1.5	1.5	1.5	1.5	1.5
IRC	None	0.7	0.7	0.7	0.7	0.7	0.7	0.7	0.7	0.7	0.7	0.7	0.7
LZETP	None	0.5	0.5	0.5	0.5	0.5	0.5	0.5	0.5	0.5	0.5	0.5	0.5

Appendix G: Guidance for Continuous Simulation and Hydromodification Management Sizing Factors

Parameters within SDHM are documented in "San Diego Hydrology Model User Manual," prepared by Clear Creek Solutions, Inc. (as of the development of the Manual, the current version of the SDHM User Manual is dated January 2012). Parameters established for SDHM represent "grass" (non-turf grasslands), "dirt," "gravel," and "urban" cover. The documented PERLND and IMPLND parameters for the various land covers and soil types have been pre-loaded into SDHM. SDHM users shall use the parameters that have been pre-loaded into the program without modification unless the preparer can provide documentation to substantiate use of other parameters.

G.1.4.2 Rainfall Loss Parameters for SWMM

In SWMM, rainfall loss parameters (parameters that describe processes occurring when rainfall lands on pervious lands and impervious lands) are entered in the "subcatchment" module. In addition to specifying parameters, the SWMM user must also select an infiltration model.

The SWMM Manual provides details regarding the subcatchment parameters and summary tables of possible ranges of these parameters. For SWMM studies for hydromodification management in San Diego, subcatchment parameters shall fall within the range provided in the SWMM Manual. Some of the parameters depend on the selection of the infiltration model. For consistency across the San Diego region, SWMM users shall use the Green-Ampt infiltration model for hydromodification management studies. Table G.1-4 presents SWMM subcatchment parameters for use in hydromodification management studies in the San Diego region.

**Appendix G: Guidance for Continuous Simulation
and Hydromodification Management Sizing Factors**

Table G.1-4: Subcatchment Parameters for SWMM Studies for Hydromodification Management in San Diego

SWMM Parameter Name	Unit	Range	Use in San Diego
Name X-Coordinate Y-Coordinate Description Tag Rain Gage Outlet	N/A	N/A – project-specific	Project-specific
Area	acres (ac)	Project-specific	Project-specific
Width	feet (ft)	Project-specific	Project-specific
% Slope	percent (%)	Project-specific	Project-specific
% Imperv	percent (%)	Project-specific	Project-specific
N-imperv	--	0.011 – 0.024 presented in Table A.6 of SWMM Manual	default use 0.012 for smooth concrete, otherwise provide documentation of other surface consistent with Table A.6 of SWMM Manual
N-Perv	--	0.05 – 0.80 presented in Table A.6 of SWMM Manual	default use 0.15 for short prairie grass, otherwise provide documentation of other surface consistent with Table A.6 of SWMM Manual
Dstore-Imperv	inches	0.05 – 0.10 inches presented in Table A.5 of SWMM Manual	0.05
Dstore-Perv	inches	0.10 – 0.30 inches presented in Table A.5 of SWMM Manual	0.10
%ZeroImperv	percent (%)	0% – 100%	25%
Subarea routing	--	OUTLET IMPERVIOUS PERVIOUS	Project-specific, typically OUTLET
Percent Routed	%	0% – 100%	Project-specific, typically 100%
Infiltration	Method	HORTON GREEN_AMPT CURVE_NUMBER	GREEN_AMPT

**Appendix G: Guidance for Continuous Simulation
and Hydromodification Management Sizing Factors**

SWMM Parameter Name	Unit	Range	Use in San Diego
Suction Head (Green-Ampt)	Inches	1.93 – 12.60 presented in Table A.2 of SWMM Manual	Hydrologic Soil Group A: 1.5 Hydrologic Soil Group B: 3.0 Hydrologic Soil Group C: 6.0 Hydrologic Soil Group D: 9.0
Conductivity (Green-Ampt)	Inches per hour	0.01 – 4.74 presented in Table A.2 of SWMM Manual by soil texture class 0.00 – ≥ 0.45 presented in Table A.3 of SWMM Manual by hydrologic soil group	Hydrologic Soil Group A: 0.3 Hydrologic Soil Group B: 0.2 Hydrologic Soil Group C: 0.1 Hydrologic Soil Group D: 0.025 Note: reduce conductivity by 25% in the post-project condition when native soils will be compacted. Conductivity may also be reduced by 25% in the pre-development condition model for redevelopment areas that are currently concrete or asphalt but must be modeled according to their underlying soil characteristics. For fill soils in post-project condition, see Section G.1.4.3.
Initial Deficit (Green-Ampt)		The difference between soil porosity and initial moisture content. Based on the values provided in Table A.2 of SWMM Manual, the range for completely dry soil would be 0.097 to 0.375	Hydrologic Soil Group A: 0.33 Hydrologic Soil Group B: 0.32 Hydrologic Soil Group C: 0.31 Hydrologic Soil Group D: 0.30 Note: in long-term continuous simulation, this value is not important as the soil will reach equilibrium after a few storm events regardless of the initial moisture content specified.
Groundwater	yes/no	yes/no	NO
LID Controls			Project Specific
Snow Pack Land Uses Initial Buildup Curb Length			Not applicable to hydromodification management studies

Appendix G: Guidance for Continuous Simulation and Hydromodification Management Sizing Factors

A schematic of the basic SWMM setup for hydromodification management studies is shown below, with the LID module is shown as a feature within the hydrology computational block. Surface water hydrology is distinguished from groundwater, however the groundwater module is not typically used in hydromodification management studies.

The rainfall and climatology input time series data are used to generate surface runoff which in turn is hydraulically routed through the collection system and storage/treatment facilities. The figure includes the following terms in the water balance equation:

- P = Precipitation
- E/T = Evaporation / Transpiration
- I/S = Infiltration / Seepage
- Q = Runoff

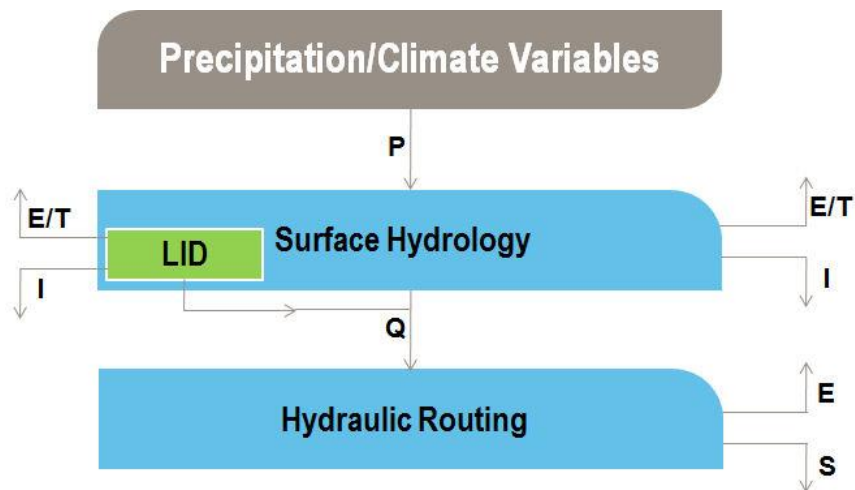

Evapotranspiration was previously addressed above; the remainder of this section discusses the other hydrologic losses and parameters.

Soil and Infiltration Parameters

Of the infiltration options available in SWMM, the Green-Ampt equation can best handle variable water content conditions in the shallow soil layers beneath the ground surface, which is critical for long-term continuous simulation of surface water hydrology. The Green-Ampt parameters suggested in Table G.1-4 are referenced according to hydrologic soil group. Green-Ampt parameters can also be determined by relating infiltration parameters to soil texture properties, as identified by in-situ geotechnical analysis results or published County soil survey information. Infiltration parameters include:

Appendix G: Guidance for Continuous Simulation and Hydromodification Management Sizing Factors

- Capillary Tension (Suction Head): a measure of how tightly water is held within the soil pore space;
- Saturated Hydraulic Conductivity: a measure of how quickly the water can be drained vertically; and
- Initial Moisture Deficit: a measure of the initial soil water deficit, also known as porosity (i.e., the volumetric fraction of water within the soil pore space under initially dry conditions).

Note that when SWMM is used without the Groundwater module, there is no distinction between the upper and lower zone soil moisture storage as in HSPF/SDHM. The LID module does however distinguish several layers/zones within each facility, and these are described below.

Overland Flow Parameters

Overland flow parameters describe the slope and length characteristics of shallow surface runoff. These are determined by identifying representative overland flow paths for each subcatchment using available digital topographic data for pre-development conditions and the proposed grading plan for post-project conditions. Overland flow path lengths and slopes are measured directly from the available information. Generally, overland flow paths should be less than 1,000 feet in length, otherwise channelized flow is likely present and should be modeled hydraulically. Overland flow path widths are determined based on the subcatchment area divided by the corresponding flow path length for each subcatchment.

Although Surface Storage is not depicted in SWMM schematic, it is a component of the water balance equation and includes excess runoff that is held in both hydrologic depression storage and hydraulic storage units.

LID Module

There are two approaches for representing LID facilities in SWMM:

- **Modeling Approach No. 1:** Place LID controls within the appropriate subcatchment and then adjust parameters accordingly to reflect untreated areas within the parent subcatchment; and
- **Modeling Approach No. 2:** Create a new subcatchment for each LID control, allowing “run-on” from the treated portion of the parent subcatchment.

Modeling Approach No.1 schematic is presented below. As described above, a portion of the impervious subarea from a given subcatchment can be routed onto the pervious area for infiltration (see arrow denoting subarea routing fraction). When the LID module of SWMM is used, the portion

Appendix G: Guidance for Continuous Simulation and Hydromodification Management Sizing Factors

of the impervious area that is captured and treated by an LID facility is specified (see arrow denoting LID area fraction). The remaining impervious area, if any, is routed directly to the outlet.

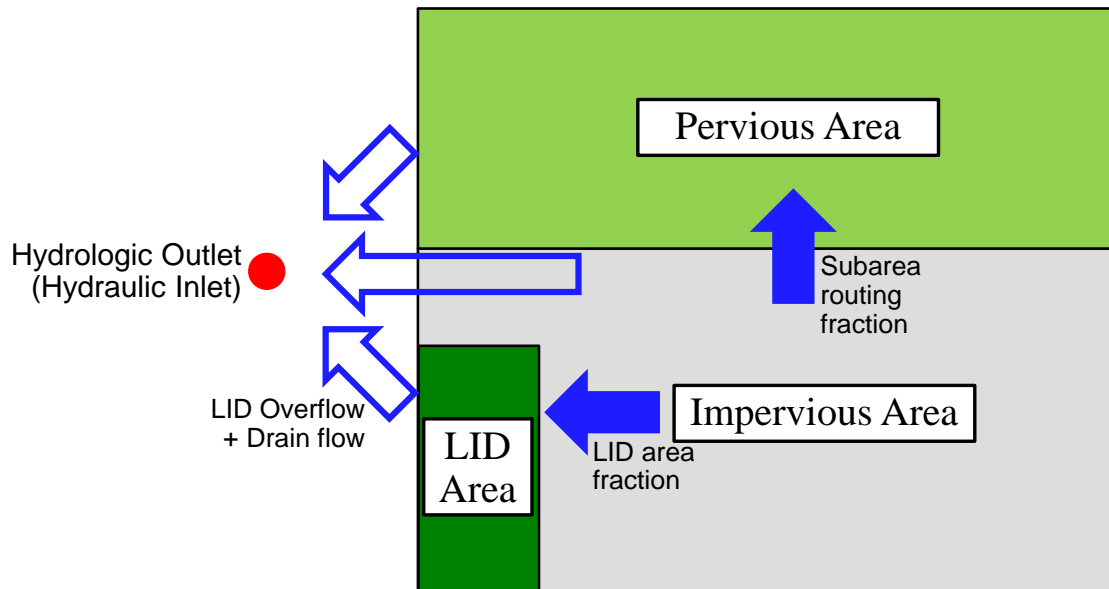

Modeling Approach No. 1 (LID within Parent Subcatchment)

The first approach is the easiest of the two for representing LID facilities in SWMM, as it allows a mix of controls to be placed within an existing subcatchment and each facility can capture and treat a different portion of the runoff generated from the parent subcatchment (i.e., outside of the LID footprint). A drawback of this approach is that it will not appropriately represent LID facilities in series (i.e., where the outflow from one LID control becomes the inflow to another LID control). No adjustments to the parent subcatchment hydrology parameters are needed if the cumulative LID area is small in comparison to the subcatchment area. However when the cumulative LID area is significant (e.g., greater than 10% of the subcatchment), at a minimum, the imperviousness and overland flow width values will need to be adjusted to compensate for the parent subcatchment area that was replaced with the cumulative LID footprint area.

Modeling Approach No.2 schematic is presented below. In this approach the LID facility is assigned to a new subcatchment and runoff from upstream subcatchments can be directed to this new subcatchment (i.e., “run-on”). In this way, LID controls can be modeled in series. Adjustments to the imperviousness and overland flow width values in the parent subcatchment will need to be made. For typical development or redevelopment sites that are evaluated in hydromodification management studies, LID capture areas often comprise a large portion of the parent subcatchments, and therefore this is the preferred approach.

Appendix G: Guidance for Continuous Simulation and Hydromodification Management Sizing Factors

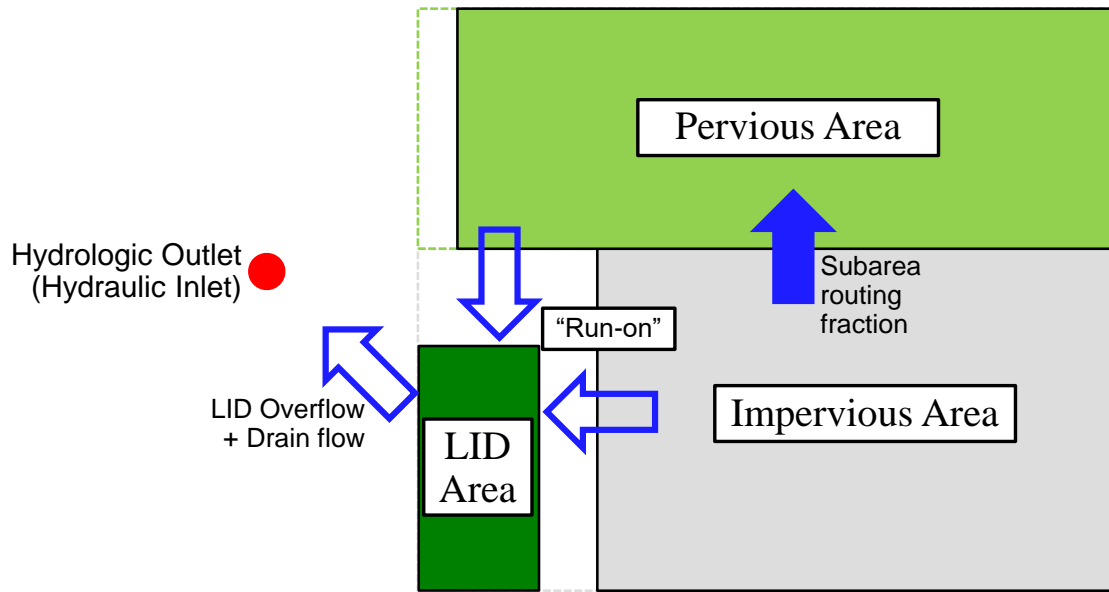

Modeling Approach No. 2 (LID in New Subcatchment)

More details on the use and application of LID controls are provided in the SWMM Manual and program help file. Suggested parameter values for use with hydromodification management studies in San Diego are provided in Appendix G.1.5.

G.1.4.3 Pervious Area Rainfall Loss Parameters in Post-Project Condition (HSPF, SDHM, and SWMM)

The following guidance applies to HSPF, SDHM, and SWMM. When modeling pervious areas in the post-project condition, fill soils shall be modeled as hydrologic soil group Type D soils, or the project applicant may provide an actual expected infiltration rate for the fill soil based on testing (must be approved by the County reviewer for use in the model). Where landscaped areas on fill soils will be re-tilled and/or amended in the post-project condition, the landscaped areas may be modeled as Type C soils. Areas to be re-tilled and/or amended in the post-project condition must be shown on the project plans. For undisturbed pervious areas (i.e., native soils, no fill), use the actual hydrologic soil group, the same as in the pre-development condition.

G.1.5 Modeling Structural BMPs (Ponds and LID Features)

There are many ways to model structural BMPs. There are standard modules for several pond or LID elements included in SDHM and SWMM. Users may also set up project-specific stage-storage-discharge relationships representing structural BMPs. Regardless of the modeling method, certain characteristics of the structural BMP, including infiltration of water from the bottom of the structural BMP into native soils, porosity of biofiltration soils and/or gravel sublayers, and other program-specific parameters must be consistent with those presented below, unless the preparer can provide documentation to substantiate use of other parameters, subject to County approval. The geometry of

Appendix G: Guidance for Continuous Simulation and Hydromodification Management Sizing Factors

structural BMPs is project-specific and shall match the project plans.

G.1.5.1 Infiltration into Native Soils Below Structural BMPs

Infiltration into native soils below structural BMPs may be modeled as a constant outflow rate equal to the project site-specific design infiltration rate (Worksheet D.5-1) multiplied by the area of the infiltrating surface (and converted to cubic feet per second). This infiltration rate is not the same as an infiltration parameter used in the calculation of rainfall losses, such as the HSPF INFILT parameter or the Green-Ampt conductivity parameter in the SWMM subcatchment module. It must be site-specific and must be determined based on the methods presented in Appendix D of this manual.

For preliminary analysis when site-specific geotechnical investigation has not been completed, project applicants proposing infiltration into native soils as part of the structural BMP design shall prepare a sensitivity analysis to determine a potential range for the structural BMP size based on a range of potential infiltration rates. As shown in Appendices B and D of this manual, many factors influence the ability to infiltrate storm water. Therefore even when soils types A and B are present, which are generally expected to infiltrate storm water, the possibility that a very low infiltration rate could be determined at design level must be considered. The range of potential infiltration rates for preliminary analysis is shown below in Table G.1-5.

Table G.1-5: Range of Potential Infiltration Rates to be Studied for Sensitivity Analysis when Native Infiltration is Proposed but Site-Specific Geotechnical Investigation has not been Completed

Hydrologic Soil Group at Location of Proposed Structural BMP	Low Infiltration Rate for Preliminary Study (inches/hour)	High Infiltration Rate for Preliminary Study (inches/hour)
A	0.02	2.4
B	0.02	0.52
C	0	0.08
D	0	0.02

The infiltration rates shown above are for preliminary investigation only. Final design of a structural BMP must be based on the project site-specific design infiltration rate (Worksheet D.5-1).

G.1.5.2 Structural BMPs That Do Not Include Sub-Layers (Ponds)

To model a pond, basin, or other depressed area that does not include processing runoff through sublayers of amended soil and/or gravel, create a stage storage discharge relationship for the pond, and supply the information to the model according to the program requirements. For HSPF users, the stage-storage-discharge relationship is provided in FTABLES. SDHM users may use the TRAPEZOIDAL POND element for a trapezoidal pond or IRREGULAR POND element to request the program to create the stage-storage-discharge relationship, use the SSD TABLE element to supply a user-created stage-storage-discharge relationship, or use other available modules such as TANK or VAULT. For SWMM users, the stage-storage relationship is supplied in the storage unit module, and the stage-discharge relationship may be represented by various other modules such as the orifice, weir, or outlet modules. Stage-storage and stage-discharge curves for structural BMPs must be fully

Appendix G: Guidance for Continuous Simulation and Hydromodification Management Sizing Factors

documented in the project-specific HMP report and must be consistent with the structural BMP(s) shown on project plans.

For user-created stage-discharge relationships, refer to local drainage manual criteria for equations representing hydraulic behavior of outlet structures. Users relying on the software to develop the stage-discharge relationship may use the equations built into the program. This manual does not recommend that all program modules calculating stage-discharge relationships must be uniform because the flows to be controlled for hydromodification management are low flows, calculated differently from the single-storm event peak flows studied for flood control purposes, and hydromodification management performance standards do not represent any performance standard for flood control drainage design. Note that for design of emergency outlet structures, and any calculations related to single-storm event routing for flood control drainage design, stage-discharge calculations must be consistent with the local drainage design requirements. This may require separate calculations for stage-discharge relationship pursuant to local manuals. The HMP flow rates shall not be used for flood control calculations.

G.1.5.3 Structural BMPs That Include Sub-Layers (Bioretention and Other LID)

G.1.5.3.1 Characteristics of Biofiltration Soil Media

The biofiltration soil media used in bioretention, biofiltration with partial retention, and biofiltration structural BMPs is a sandy loam. The following parameters presented in Table G.1-6 are characteristics of a sandy loam for use in continuous simulation models.

Table G.1-6: Characteristics of Sandy Loam to Represent Biofiltration Soil Media in Continuous Simulation for Hydromodification Management Studies in San Diego

Soil Texture	Porosity	Field Capacity	Wilting Point	Conductivity	Suction Head
Sandy Loam	0.4	0.2	0.1	5 inches/hour	1.5 inches

- Porosity is the volume of pore space (voids) relative to the total volume of soil (as a fraction).
- Field Capacity is the volume of pore water relative to total volume after the soil has been allowed to drain fully (as a fraction). Below this level, vertical drainage of water through the soil layer does not occur.
- Wilting point is the volume of pore water relative to total volume for a well dried soil where only bound water remains (as a fraction). The moisture content of the soil cannot fall below this limit.
- Conductivity is the hydraulic conductivity for the fully saturated soil (in/hr or mm/hr).
- Suction head is the average value of soil capillary suction along the wetting front (inches or mm).

Appendix G: Guidance for Continuous Simulation and Hydromodification Management Sizing Factors

Figures G.1-3 and G.1-4, from <http://www.stevenswater.com/articles/irrigationscheduling.aspx>, illustrate unsaturated soil and soil saturation, field capacity, and wilting point.

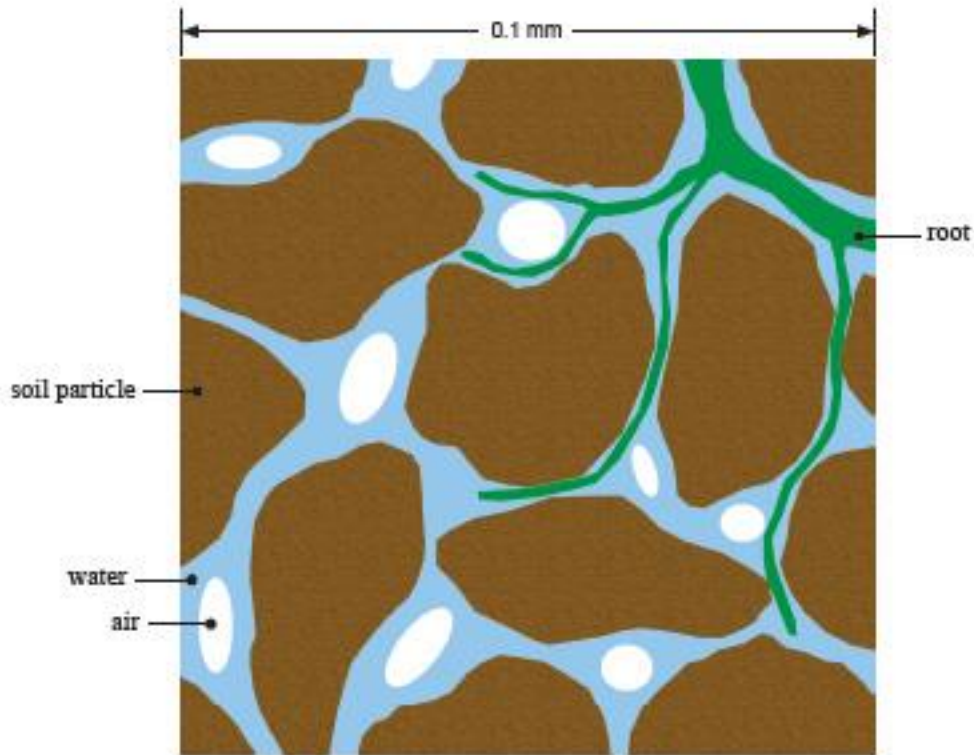

Figure G.1-3: Unsaturated Soil Composition

Unsaturated soil is composed of solid particles, organic material and pores. The pore space will contain air and water.

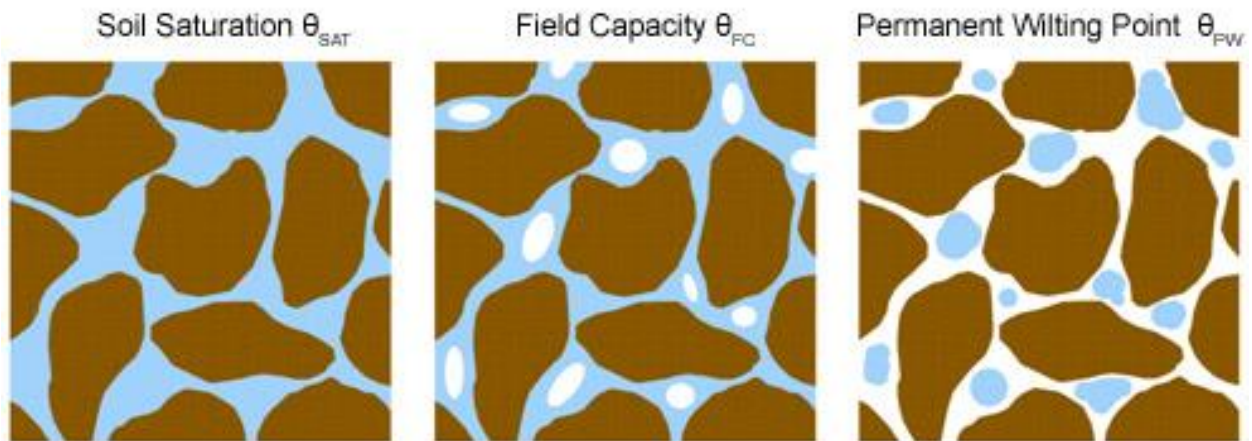

Figure G.1-4: Soil saturation, field capacity, and wilting point

Appendix G: Guidance for Continuous Simulation and Hydromodification Management Sizing Factors

G.1.5.3.2 Characteristics of Gravel

For the purpose of hydromodification management studies, it may be assumed that water moves freely through gravel, not limited by hydraulic properties of the gravel. For the purpose of calculating available volume, use porosity of 0.4, or void ratio of 0.67. Porosity is equal to void ratio divided by $(1 + \text{void ratio})$.

G.1.5.3.3 Additional Guidance for SDHM Users

The module titled "bioretention/rain garden element" may be used to represent bioretention or biofiltration BMPs. SDHM users using the available "bioretention/rain garden element" shall customize the soil media characteristics to use the parameters from Table G.1-6 above, and select "gravel" for gravel sublayers. All other input variables are project-specific. "Native infiltration" refers to infiltration from the bottom of the structural BMP into the native soil. This variable is project-specific, see Section G.1.5.1.

G.1.5.3.4 Additional Guidance for SWMM Users

The latest version of SWMM (version 5.1.012) includes the following eight types of LID controls:

- Bio-Retention Cell: surface storage facility with vegetation in a biofiltration soil mixture placed above a gravel drainage bed.
- Rain Garden: same setup as bio-retention cell, but without an underlying gravel bed.
- Green Roof: bio-retention cell with shallow surface storage and soil layers, underlain by a drainage mat that conveys excess percolated rainfall to the regular roof drainage system.
- Infiltration Trench: drainage swale or narrow storage basin filled with gravel or other porous media designed to capture and infiltrate runoff to the native soil below.
- Permeable Pavement: continuous pavement systems with porous concrete, asphalt mix, or paver blocks above a sand or gravel drainage bed with gravel storage layer below.
- Rain Barrel: container (cistern) to collect roof runoff for later use (e.g., landscape irrigation) or release.
- Rooftop Disconnection: to simulate redirection of downspout discharge onto pervious landscaped areas and lawns instead of directly into storm drains.
- Vegetative Swale: grassed conveyance channel (drainage ditch or swale) with vegetation designed to slow down runoff to allow more time for infiltration into the native soil below.

The "bio-retention cell" LID control may be used to represent bioretention or biofiltration BMPs. For bio-retention cells, a number of LID process layers have been defined in SWMM and these are described below. Table G.1-7 provides parameters required for the standard "bio-retention cell" available in SWMM. The parameters are entered in the LID Control Editor.

**Appendix G: Guidance for Continuous Simulation
and Hydromodification Management Sizing Factors**

**Table G.1-7: Parameters for SWMM "Bio-Retention Cell" Module for Hydromodification
Management Studies in San Diego**

SWMM Parameter Name	Unit	Use in San Diego
Surface		
Berm Height also known as Storage Depth	inches	Project-specific
Vegetative Volume Fraction also known as Vegetative Cover Fraction	---	0
Surface Roughness	---	0 (this parameter is not applicable to bio-retention cell)
Surface Slope	---	0 (this parameter is not applicable to bio-retention cell)
Soil		
Thickness	inches	project-specific
Porosity	---	0.40
Field Capacity	---	0.2
Wilting Point	---	0.1
Conductivity	Inches/hour	5
Conductivity Slope	---	5
Suction Head	inches	1.5
Storage		
Thickness also known as Height	inches	Project-specific
Void Ratio	---	0.67
Seepage Rate also known as Conductivity	Inches/hour	Conductivity from the storage layer refers to infiltration from the bottom of the structural BMP into the native soil. This variable is project-specific, see Section G.5.1. Use 0 if the bio-retention cell includes an impermeable liner
Clogging Factor	---	0
Underdrain		
Flow Coefficient Also known as Drain Coefficient	---	Project-specific
Flow Exponent Also known as Drain Exponent	---	Project-specific, typically 0.5
Offset Height Also known as Drain Offset Height	Inches	Project-specific

Appendix G: Guidance for Continuous Simulation and Hydromodification Management Sizing Factors

Surface Layer

This process layer receives direct rainfall (and run-on from upstream subcatchments) and the resultant storm water is available for ponding, infiltration, evapotranspiration, or overflow to the outlet. The following parameters are used:

- **Berm Height:** This value is the maximum depth that water can pond above the ground surface before overflow occurs. In some cases, this volume may overlap with the hydraulic representation of existing surface storage or another proposed BMP facility. In any case, the user must avoid double-counting the physical storage volume.
- **Vegetation Volume Fraction:** This represents the surface storage volume that is occupied by the stems and leaves of vegetation within the bio-retention cell.

Soil Layer

This process layer is typically composed of an amended soil or compost mix. Water that infiltrates into this component is stored in the soil void space and is available for evapotranspiration via plant roots or can percolate into the storage layer below. The following parameters are used:

- **Thickness:** This parameter represents the depth of the amended soil layer.
- **Porosity:** Ratio of pore space volume to soil volume.
- **Field Capacity:** Pore water volume ratio after the soil has been drained.
- **Wilting Point:** Pore water volume ratio after the soil has been dried.
- **Conductivity:** This represents the saturated hydraulic conductivity.
- **Conductivity Slope:** Rate at which conductivity decreases with decreasing soil moisture content.
- **Suction Head:** This represents the capillary tension of water in the soil.

Porosity, conductivity and suction head values as a function of soil texture were included in Table G.1-5. The flow of water through partially saturated soil is less than under fully saturated conditions. The SWMM program accounts for this reduced hydraulic conductivity to predict the rate at which infiltrated water moves through a layer of unsaturated soil when modeling groundwater or LID controls. The conductivity slope is a dimensionless curve-fitting parameter that relates the partially saturated hydraulic conductivity to the soil moisture content.

Appendix G: Guidance for Continuous Simulation and Hydromodification Management Sizing Factors

Storage Layer

This process layer is typically composed of porous granular media such as crushed stone or gravel. Water that percolates into this component is stored in the void space and is available for infiltration into the native soil, or collected by an underdrain and discharged to the outlet. The following parameters are used:

- Thickness: This parameter represents the depth of the stone base.
- Void Ratio: Volume of void space relative to volume of solids. Note, by definition, Porosity = Void Ratio ÷ (1 + Void Ratio).
- Seepage Rate: Filtration rate from the granular media into the native soil below. A value of zero should be used if the facility has an impermeable bottom (e.g., concrete) or is underlain by an impermeable liner.
- Clogging Factor: This value is determined by the total volume of treated runoff to completely clog the bottom of the layer divided by the void volume of the layer.

Drain Layer

This process layer is used to characterize the discharge rate of an underdrain system to the outlet. The following parameters are used:

Flow Coefficient: This value (coupled with the flow exponent described below) characterizes the rate of discharge to the outlet as a function of the height of water stored in the bio-retention cell. The coefficient can be determined by the following equation:

$$C = c_g \left(\frac{605}{A_{LID}} \right) \left(\frac{\pi D^2}{8} \right) \sqrt{\frac{g}{6}}$$

where,

c_g is the orifice discharge coefficient, typically 0.60-0.65 for thin walled plates and higher for thicker walls;

A_{LID} is the cumulative footprint area (ft²) of all LID controls;

D is the underdrain orifice diameter (in); and

g is the gravitational constant (32.2 ft/s²).

Flow Exponent: A value of 0.5 should be used to represent flow through an orifice.

Offset Height: This represents the height of the underdrain above the bottom of the storage layer in the bio-retention cell.

G.1.6 Flow Frequency and Duration

The continuous simulation model will generate a flow record corresponding to the frequency of the rainfall data input as its output. This flow record must then be processed to determine pre-development and post-project flow rates and durations. Compliance with hydromodification management requirements of this manual is achieved when results for flow duration meet the performance standards. The performance standard is as follows (also presented in Chapter 6 of this manual):

1. For flow rates ranging from 10 percent, 30 percent or 50 percent of the pre-development 2-year runoff event ($0.1Q_2$, $0.3Q_2$, or $0.5Q_2$) to the pre-development 10-year runoff event (Q_{10}), the post-project discharge rates and durations must not exceed the pre-development rates and durations by more than 10 percent. The specific lower flow threshold will depend on the erosion susceptibility of the receiving stream for the project site (see Section 6.3.4).

To demonstrate that a flow control facility meets the hydromodification management performance standard, first pre-development Q_2 and Q_{10} must be identified, then a flow duration summary must be generated and compared for pre-development and post-project conditions between the appropriate fraction of Q_2 to Q_{10} . The range from a fraction of Q_2 to Q_{10} represents the range of geomorphically significant flows for hydromodification management in San Diego. The upper bound of the range of flows to control is pre-development Q_{10} for all projects. The lower bound of the range of flows to control, or "lower flow threshold" is a fraction of pre-development Q_2 that is based on the erosion susceptibility of the stream and depends on the specific natural system (stream) that a project will discharge to. Tools have been developed in the March 2011 Final HMP for assessing the erosion susceptibility of the stream (see Section 6.3.4). Simply multiply the pre-development Q_2 by the appropriate fraction (e.g., $0.1Q_2$) to determine the lower flow threshold.

The following guidelines shall be used for determining flow rates and durations.

G.1.6.1 Determining Flow Rates

In the context of hydromodification management in San Diego, Q_2 and Q_{10} refer to flow rates determined based on either continuous simulation hydrologic modeling or an approved regression equation. Either method may be applied, provided that the same methodology is applied to determination of both Q_2 and Q_{10} (i.e. cannot mix and match methods at a POC) and be consistent across all POCs for the project (i.e. cannot mix and match methods between multiple POCs).

**Appendix G: Guidance for Continuous Simulation
and Hydromodification Management Sizing Factors**

G.1.6.1.1 Determining Flow Rates from Regression Equation

The following approved regression equation may be used to determine pre-development Q_2 and Q_{10} :

$$Q_2 = 3.60 \times A^{0.672} \times P^{0.753}$$

$$Q_{10} = 6.56 \times A^{0.783} \times P^{1.07}$$

where:

Q_2 = 2-year recurrence interval discharge in cubic feet per second
 Q_{10} = 10-year recurrence interval discharge in cubic feet per second
 A = Drainage area in square miles
 P = Mean annual precipitation in inches (Refer to Table 6-1)

When determining Q_2 and Q_{10} the same methodology must be applied to determination of both flow rates (i.e. cannot mix and match methods at a POC), and be consistent across all POCs for the project (i.e. cannot mix and match methods between multiple POCs).

Table G.1-8. Mean Annual Precipitation

Gage	Latitude	Longitude	Mean Annual Precipitation (inches)
Oceanside	33.2105556	-117.353333	12.29
Encinitas	33.044567	-117.277213	10.73
Kearney Mesa	32.835118	-117.128456	11.43
Fashion Valley	32.7652778	-117.1758333	10.75
Bonita	32.6561111	-117.0341667	10.88
Poway	32.9522222	-117.0472222	13.08
Fallbrook AP	33.354669	-117.251279	16.18
Lake Wohlford	33.166423	-117.004955	16.63
Ramona	33.0480556	-116.8608333	16.57
Lake Henshaw	33.2386111	-116.7616667	21.58
Borrego	33.2211111	-116.3369444	4.00
Lindbergh	32.7337	-117.1767	10.75
Escondido	33.1197222	-117.095	14.67
Flinn Springs	32.847104	-116.857801	15.55
Lake Cuyamaca	32.9894	-116.5867	31.30
Lower Otay	32.6111	-116.9319	11.90
San Onofre	33.3513889	-117.5319444	11.13
San Vicente	32.912082	-116.926513	16.47
Santee	32.839016	-117.024857	13.15

Appendix G: Guidance for Continuous Simulation and Hydromodification Management Sizing Factors

G.1.6.1.2 Determining Flow Rates from Continuous Hourly Flow Output

Flow rates for hydromodification management studies in San Diego must be based on partial duration series analysis of the continuous hourly flow output. Partial duration series frequency calculations consider multiple storm events in a given year. To construct the partial duration series:

1. Parse the continuous hourly flow data into discrete runoff events. The following separation criteria may be used for separation of flow events: a new discrete event is designated when the flow falls below an artificially low flow value based on a fraction of the contributing watershed area (e.g., 0.002 to 0.005 cfs/acre) for a time period of 24 hours. Project applicants may consider other separation criteria provided the separation interval is not more than 24 hours and the criteria is clearly described in the submittal document.
2. Rank the peak flows from each discrete flow event, and compute the return interval or plotting position for each event.

Readers who are unfamiliar with how to compute the partial-duration series should consult reference books or online resources for additional information. For example, *Hydrology for Engineers*, by Linsley et al, 1982, discusses partial-duration series on pages 373-374 and computing recurrence intervals or plotting positions on page 359. *Handbook of Applied Hydrology*, by Chow, 1964, contains a detailed discussion of flow frequency analysis, including Annual Exceedance, Partial-Duration and Extreme Value series methods, in Chapter 8. The US Geological Survey (USGS) has several hydrologic study reports available online that use partial duration series statistics (see <http://water.usgs.gov/> and http://water.usgs.gov/osw/bulletin17b/AGU_Langbein_1949.pdf).

Pre-development Q_2 and Q_{10} shall be determined from the partial duration analysis for the pre-development hourly flow record. Pre-development Q_{10} is the upper threshold of flow rates to be controlled in the post-project condition. The lower flow threshold is a fraction of the pre-development Q_2 determined based on the erosion susceptibility of the receiving stream. Simply multiply the pre-development Q_2 by the appropriate fraction (e.g., $0.1Q_2$) to determine the lower flow threshold.

G.1.6.2 Determining Flow Durations from Continuous Hourly Flow Output

Flow durations must also be summarized within the range of flows to control. Flow duration statistics provide a simple summary of how often a particular flow rate is exceeded. To prepare this summary:

1. Rank the entire hourly runoff time series output.
2. Extract the portion of the ranked hourly time series output from the lower flow threshold to the upper flow threshold – this is the portion of the record to be summarized.
3. Divide the applicable portion of the record into 100 equal flow bins (compute the difference between the upper flow threshold (cfs) and lower flow threshold (cfs) and divide this value by 99 to establish the flow bin size).

Appendix G: Guidance for Continuous Simulation and Hydromodification Management Sizing Factors

4. Count the number of hours of flow that fall into each flow bin.

Both pre-development and post-project flow duration summary must be based on the entire length of the flow record. Compare the post-project flow duration summary to the pre-development flow duration summary to determine if it meets performance criteria for post-project flow rates and durations (criteria presented under Section G.1.6).

G.2 Sizing Factors for Hydromodification Management BMPs

This section presents sizing factors for design of flow control structural BMPs based on the sizing factor method identified in Chapter 6.3.5.1. The sizing factors included here have been updated based on the requirements in the 2015 MS4 permit and are different than the sizing factors presented in previous manuals. These updated values replace the previous sizing factors which shall no longer be used for sizing of hydromodification flow control BMPs. A discussion of the rationale for the update is included below.

The sizing factors included in previous edition was re-printed from the "San Diego BMP Sizing Calculator Methodology," dated January 2012, prepared by Brown and Caldwell (herein "BMP Sizing Calculator Methodology"). These sizing factors were linked to the specific details and descriptions that were presented in the BMP Sizing Calculator Methodology, which included certain assumptions and limited options for modifications. The sizing factors were developed based on the 2007 MS4 Permit. Some of the original sizing factors developed based on the 2007 MS4 Permit and presented in the BMP Sizing Calculator Methodology were not compatible with new requirements of the 2015 MS4 Permit, and therefore were not included in the February 2016 manual. Since publishing the 2016 Model Manual, the Copermittees have developed updated hydromodification factors that more accurately represent the BMP configurations specified in this model manual and account for the revised flow-duration performance standard of the 2015 MS4 Permit (110% exceedance allowance for entire flow-duration curve).

The updated sizing factors were generated using continuous simulation models in USEPA SWMM in accordance with the procedures, methodologies, and values presented in Appendix G.1. All sizing factors are in relation to the effective impervious area draining to the BMP.

The sizing factor method is intended for simple studies that do not include diversion, do not include significant offsite area draining through the project from upstream, and do not include offsite area downstream of the project area. Use of the sizing factors is limited to the specific structural BMPs described in this Appendix. When using the sizing factor methodology, the area fraction reported in the sizing tables represents the plan view area at the surface of the BMP before any ponding occurs. The BMP footprint as defined by this methodology is depicted in Figure G.2-1.

Appendix G: Guidance for Continuous Simulation and Hydromodification Management Sizing Factors

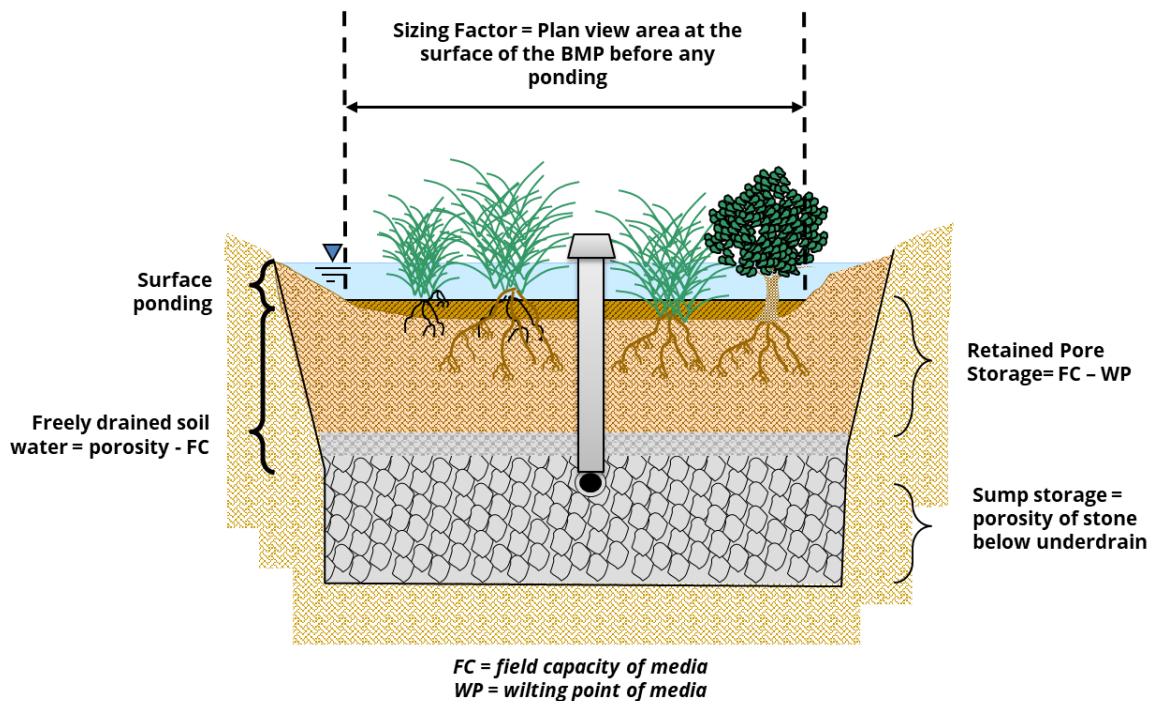

Figure G.2-1: Representation of BMP Footprint for use of Sizing Factors

Sizing factors are available for the following specific structural BMPs:

- **Full infiltration condition:**
 - **Infiltration:** Sizing factors available for A, B, C, and D soils represent surface and/or below-ground structures (infiltration vaults).
- **Partial infiltration condition:**
 - **Biofiltration with partial retention:** Sizing factors available for A, B, C, and D soils represent a bioretention area with biofiltration soil media and gravel storage layer, with an underdrain, with gravel storage below the underdrain and a flow control orifice, with no impermeable liner.
- **No infiltration condition:**
 - **Biofiltration:** Sizing factors available for A, B, C, and D soils represent a biofiltration system with biofiltration soil media and gravel storage layer, with an underdrain and flow control orifice, with gravel storage, with an impermeable liner (formerly known as flow-through planter and/or biofiltration with impermeable liner)

Appendix G: Guidance for Continuous Simulation and Hydromodification Management Sizing Factors

- **Other:**
 - **Cistern:** Sizing factors available for A, B, C, or D soils represent a vessel with a flow control orifice outlet to meet the hydromodification management performance standard. For this BMP, the sizing factor result is a volume in cubic feet, not a surface footprint in square feet.

Sizing factors were created based on three rainfall basins: Lindbergh Field, Oceanside, and Lake Wohlford.

The following information is needed to use the sizing factors:

- Determine the appropriate rainfall basin for the project site from Figure G.2-2, Rainfall Basin Map
- Hydrologic soil group at the project site (use available information pertaining to existing underlying soil type such as soil maps published by the Natural Resources Conservation Service)
- Pre-development and pre-project slope categories (flat = 0% – 5%, moderate = 5% – 10%, steep = >10%)
- Area tributary to the structural BMP
- Area weighted runoff factor (C) for the area draining to the BMP from Table G.2-1. Note: runoff coefficients and adjustments presented in Appendices B.1 and B.2 are for pollutant control only and are not applicable for hydromodification management studies
- Fraction of Q_2 to control (see Chapter 6.3.4)⁵

When using the sizing factor method, Worksheet G.2-1 may be used to present the calculations of the required minimum areas and/or volumes of BMPs as applicable. Additionally, the “BMP Sizing Spreadsheet V3.0” available at projectcleanwater.org implements the sizing factor methodology.

⁵ All updated sizing factors refer to the “High Susceptibility” threshold value of $0.1 \cdot Q_2$, where Q_2 is determined using the Weibull Plotting position and results of the SWMM model runs for unit pervious catchments (refer to Table G.2-2).

**Appendix G: Guidance for Continuous Simulation
and Hydromodification Management Sizing Factors**

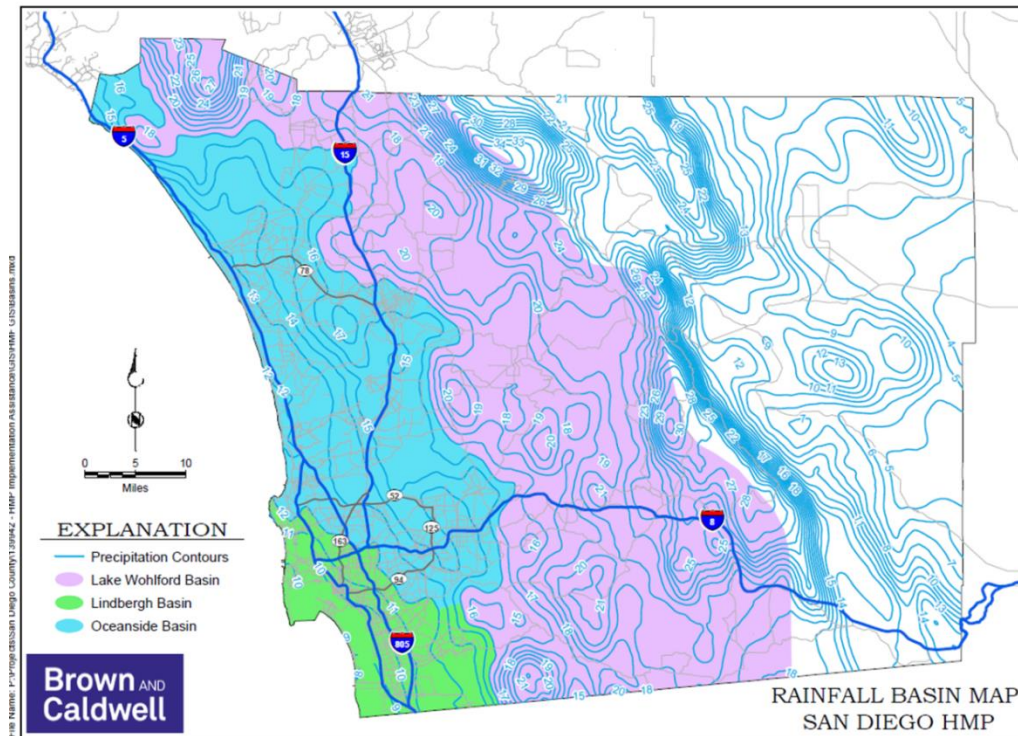

Figure G.2-2: Rainfall Basin Map

Table G.2-1: Runoff factors for surfaces draining to BMPs for Hydromodification Sizing Factors Method

Surface	Runoff Factor
Roofs	1.0
Concrete	1.0
Pervious Concrete	0.10
Porous Asphalt	0.10
Grouted Unit Pavers	1.0
Solid Unit Pavers on granular base, min. 3/16 inch joint space	0.20
Crushed Aggregate	0.10
Turf block	0.10
Amended, mulched soils	0.10
Landscape	0.10

**Appendix G: Guidance for Continuous Simulation
and Hydromodification Management Sizing Factors**

This page was intentionally left blank

**Appendix G: Guidance for Continuous Simulation
and Hydromodification Management Sizing Factors**

Worksheet G.2-1: Sizing Factor Worksheet

Site Information			
Project Name:		Hydrologic Unit	
Project Applicant:		Rain Gauge:	
Jurisdiction:	County of San Diego	Total Project Area:	
Assessor's Parcel Number:		Low Flow Threshold:	0.1Q ₂
BMP Name:		BMP Type:	

Areas Draining to BMP						Sizing Factors		Minimum BMP Size	
DMA Name	Area (sf)	Soil Type	Pre-Project Slope	Post-Project Surface Type	Runoff Factor (From Table G.2-1)	Surface Area	Volume	Surface Area (sf)	Volume (cf)
Total DMA Area								Minimum BMP Size*	
								Proposed BMP Size*	

*Minimum BMP Size = Total of rows above.

*Proposed BMP Size ≥ Minimum BMP size.

**Appendix G: Guidance for Continuous Simulation
and Hydromodification Management Sizing Factors**

This page was intentionally left blank

G.2.1 Unit Runoff Ratios and Low Flow Control Orifice Design

G.2.1.1 Unit Runoff Ratios

Table G.2-2 presents unit runoff ratios for calculating pre-development Q_2 , to be used when applicable to determine the lower flow threshold for low flow control orifice sizing for biofiltration with partial retention, biofiltration, or cistern BMPs. There is no low flow control orifice in the infiltration BMP. The unit runoff ratios are updated from the previously reported BMP Sizing Calculator methodology ratios to account for changes in modeling methodologies. Unit runoff ratios for "urban" and "impervious" cover categories were not transferred to this manual due to the requirement to control runoff to pre-development condition (see Chapter 6.3.3).

How to use the unit runoff ratios:

Obtain unit runoff ratio from Table G.2-2 based on the project's rainfall basin, hydrologic soil group, and pre-development slope (for redevelopment projects, pre-development slope may be considered if historic topographic information is available, otherwise use pre-project slope). Multiply the area tributary to the structural BMP (A, acres) by the unit runoff ratio (Q_2 , cfs/acre) to determine the pre-development Q_2 to determine the lower flow threshold, to use for low flow control orifice sizing.

Table G.2-2: Unit Runoff Ratios for Sizing Factor Method

Rain Gauge	Soil	Pre-Project Slope	Q_2 (cfs/acre)	Q_{10} (cfs/acre)
Lake Wohlford	A	Flat	0.256	0.518
Lake Wohlford	A	Moderate	0.275	0.528
Lake Wohlford	A	Steep	0.283	0.531
Lake Wohlford	B	Flat	0.371	0.624
Lake Wohlford	B	Moderate	0.389	0.631
Lake Wohlford	B	Steep	0.393	0.633
Lake Wohlford	C	Flat	0.490	0.729
Lake Wohlford	C	Moderate	0.495	0.733
Lake Wohlford	C	Steep	0.496	0.735
Lake Wohlford	D	Flat	0.548	0.784
Lake Wohlford	D	Moderate	0.554	0.788
Lake Wohlford	D	Steep	0.556	0.788
Oceanside	A	Flat	0.256	0.679
Oceanside	A	Moderate	0.277	0.694

Appendix G: Guidance for Continuous Simulation and Hydromodification Management Sizing Factors

Rain Gauge	Soil	Pre-Project Slope	Q ₂ (cfs/acre)	Q ₁₀ (cfs/acre)
Oceanside	A	Steep	0.285	0.700
Oceanside	B	Flat	0.377	0.875
Oceanside	B	Moderate	0.391	0.879
Oceanside	B	Steep	0.395	0.881
Oceanside	C	Flat	0.488	0.981
Oceanside	C	Moderate	0.497	0.985
Oceanside	C	Steep	0.499	0.986
Oceanside	D	Flat	0.571	0.998
Oceanside	D	Moderate	0.575	0.999
Oceanside	D	Steep	0.576	0.999
Lindbergh	A	Flat	0.057	0.384
Lindbergh	A	Moderate	0.073	0.399
Lindbergh	A	Steep	0.082	0.403
Lindbergh	B	Flat	0.199	0.496
Lindbergh	B	Moderate	0.220	0.509
Lindbergh	B	Steep	0.230	0.513
Lindbergh	C	Flat	0.335	0.601
Lindbergh	C	Moderate	0.349	0.610
Lindbergh	C	Steep	0.354	0.613
Lindbergh	D	Flat	0.429	0.751
Lindbergh	D	Moderate	0.437	0.753
Lindbergh	D	Steep	0.439	0.753

G.2.1.2 Low Flow Control Orifice Design

When used as hydromodification flow control BMPs, biofiltration with partial retention, biofiltration, and cistern BMPs include a low flow control orifice to control the rate that flow is released from the underdrain or primary outlet. The sizing factors were developed using a standard process for sizing the low flow control orifice, therefore BMPs designed using the sizing factor method must size the low flow control orifice using the same basis. The low flow control orifice must be designed to release the lower flow threshold flow rate (fraction of pre-development Q₂) when the water surface elevation in the BMP is equal to the crest elevation of the next outflow structure. To size the low flow control

Appendix G: Guidance for Continuous Simulation and Hydromodification Management Sizing Factors

orifice, determine the head on the orifice measured from the bottom of the orifice to the minimum elevation of the next outflow structure of the BMP. The next outflow structure is typically the BMP overflow structure, except in some multi-use BMPs (e.g., BMPs that are designed for flood control in addition to hydromodification management). In this application, the difference between the bottom of the orifice and the centroid of the orifice is small relative to the total head for the calculation and may be neglected in the calculation by measuring from the orifice invert. This calculation is automated in the “BMP Sizing Spreadsheet V3.0” posted on www.projectcleanwater.org.

Steps to size the low flow control orifice:

- Determine pre-development Q_2 using the unit runoff ratios above.
- Multiply pre-development Q_2 by 0.1 to determine the low flow threshold flow rate. Note sizing factors are only available for streams with high susceptibility to erosion where the low flow threshold is $0.1Q_2$.
- Determine the head (H) on the orifice measured from the bottom of the orifice to the minimum elevation of the next outflow structure of the BMP.
- Use the orifice equation (below) and solve for the maximum orifice area to release the lower flow threshold flow rate.
- Consider how the orifice will be created. Determine the constructible dimension(s) (e.g., a standard drill bit diameter) that will produce an orifice with an area equal to or less than the maximum orifice area. The final orifice area determined based on constructible dimensions shall not exceed the maximum orifice area.

$$Q = C \times A \times (64.4 \times H)^{0.5}$$

where:

- Q = Flow rate in cubic feet per second
- C = Orifice coefficient; in this application use $C = 0.65$
- A = Area in square feet
- H = Head in feet

G.2.2 Sizing Factors for "Infiltration" BMP

Table G.2-3 presents sizing factors for calculating the required surface area (A) for an infiltration BMP. There is no underdrain and therefore no low flow orifice in the infiltration BMP. Sizing factors were developed for hydrologic soil groups A, B, C, and D. This BMP is generally not applicable in

Appendix G: Guidance for Continuous Simulation and Hydromodification Management Sizing Factors

hydrologic soil groups C and D, but applicants have the option if there are no geotechnical or water balance issues and the underlying design infiltration rate for the BMP is greater than 0.5 inches per hour. The infiltration BMP is surface ponding feature that allows infiltration into the native or amended soils of the BMP surface.

- **Ponding layer:** a nominal 36-inch ponding layer shall be included below the overflow elevation.
- **Design infiltration rate:** the design infiltration rate shall be greater than 0.5 inches per hour.
- **Overflow structure:** San Diego Regional Standard Drawing Type I Catch Basin (D-29). For the purposes of hydromodification flow control other type of overflow structures are allowed.

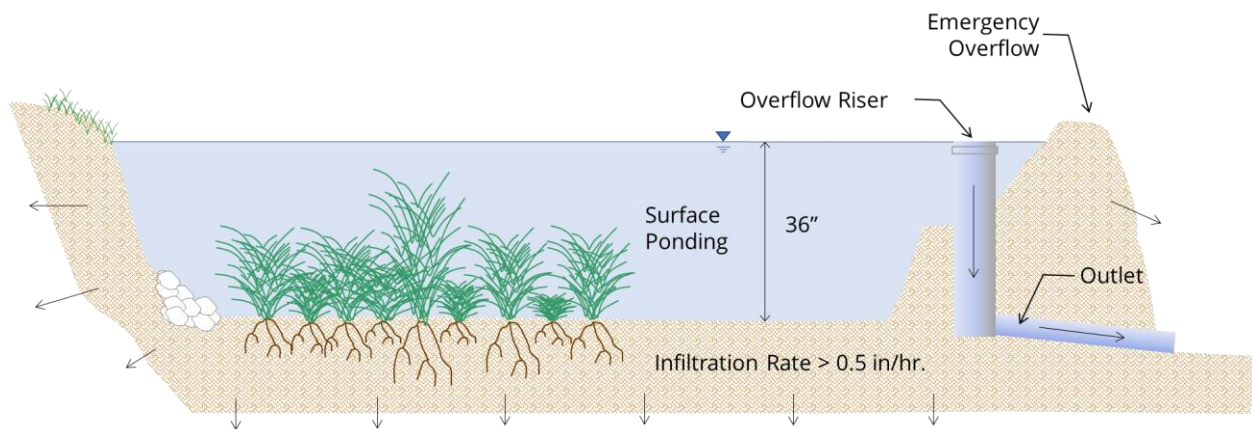

Infiltration BMP Example Illustration

How to use the sizing factors for flow control BMP Sizing:

Obtain sizing factors from Table G.2-3 based on the project's lower flow threshold fraction of Q_2 , hydrologic soil group, pre-project slope, and rain gauge (rainfall basin). Multiply the area tributary to the structural BMP (A, square feet) by the area weighted runoff factor (C, unitless) (see Table G.2-1) by the sizing factors to determine the required surface area (A, square feet) for the infiltration BMP. The civil engineer shall provide the necessary surface area of the BMP on the plans.

Additional steps to use this BMP as a combined pollutant control and flow control BMP:

The BMP sized using the sizing factors in Table G.2-3 meets both pollutant control and flow control requirements.

Appendix G: Guidance for Continuous Simulation and Hydromodification Management Sizing Factors

**Table G.2-3: Sizing Factors for Hydromodification Flow Control Infiltration BMPs
Designed Using Sizing Factor Method**

Lower Flow Threshold	Soil Group	Pre-Project Slope	Rain Gauge	A
0.1Q ₂	A	Flat	Lindbergh	0.055
0.1Q ₂	A	Moderate	Lindbergh	0.055
0.1Q ₂	A	Steep	Lindbergh	0.055
0.1Q ₂	B	Flat	Lindbergh	0.045
0.1Q ₂	B	Moderate	Lindbergh	0.045
0.1Q ₂	B	Steep	Lindbergh	0.045
0.1Q ₂	C	Flat	Lindbergh	0.035
0.1Q ₂	C	Moderate	Lindbergh	0.035
0.1Q ₂	C	Steep	Lindbergh	0.035
0.1Q ₂	D	Flat	Lindbergh	0.030
0.1Q ₂	D	Moderate	Lindbergh	0.030
0.1Q ₂	D	Steep	Lindbergh	0.030
0.1Q ₂	A	Flat	Oceanside	0.060
0.1Q ₂	A	Moderate	Oceanside	0.060
0.1Q ₂	A	Steep	Oceanside	0.060
0.1Q ₂	B	Flat	Oceanside	0.050
0.1Q ₂	B	Moderate	Oceanside	0.050
0.1Q ₂	B	Steep	Oceanside	0.050
0.1Q ₂	C	Flat	Oceanside	0.050
0.1Q ₂	C	Moderate	Oceanside	0.050
0.1Q ₂	C	Steep	Oceanside	0.045
0.1Q ₂	D	Flat	Oceanside	0.035
0.1Q ₂	D	Moderate	Oceanside	0.035
0.1Q ₂	D	Steep	Oceanside	0.035
0.1Q ₂	A	Flat	L Wohlford	0.085
0.1Q ₂	A	Moderate	L Wohlford	0.085
0.1Q ₂	A	Steep	L Wohlford	0.085
0.1Q ₂	B	Flat	L Wohlford	0.070
0.1Q ₂	B	Moderate	L Wohlford	0.070
0.1Q ₂	B	Steep	L Wohlford	0.070
0.1Q ₂	C	Flat	L Wohlford	0.055
0.1Q ₂	C	Moderate	L Wohlford	0.055
0.1Q ₂	C	Steep	L Wohlford	0.055
0.1Q ₂	D	Flat	L Wohlford	0.040
0.1Q ₂	D	Moderate	L Wohlford	0.040
0.1Q ₂	D	Steep	L Wohlford	0.040

Q₂ = 2-year pre-project flow rate based upon partial duration analysis of long-term hourly rainfall records

A = Surface area (at surface of the BMP before any ponding occurs) sizing factor for flow control

G.2.3 Sizing Factors for Biofiltration with Partial Retention

Table G.2-4 presents sizing factors for calculating the required surface area (A) for a biofiltration with partial retention BMP. The BMPs consist of four layers:

- **Ponding layer:** 12-inches active storage, [minimum] 2-inches of freeboard above overflow relief

Appendix G: Guidance for Continuous Simulation and Hydromodification Management Sizing Factors

- **Growing medium Media Layer:** 18-inches of soil [biofiltration soil media]
- **Filter Course:** 6-inches
- **Storage layer:** 18-inches of gravel at 40 percent porosity for A and B soils and 12-inches of gravel at 40 percent porosity for C and D soils. The underdrain offset for A and B soils shall be 18-inches, for C soils it shall be 6-inches and for D soils it shall be 3-inches.
- **Overflow structure:** San Diego Regional Standard Drawing Type I Catch Basin (D-29). For the purposes of hydromodification flow control other type of overflow structures are allowed.

This BMP does not include an impermeable layer at the bottom of the facility to prevent infiltration into underlying soils, regardless of hydrologic soil group. If a facility is to be lined, the designer must use the sizing factors for biofiltration (Refer to Appendix G.2.4).

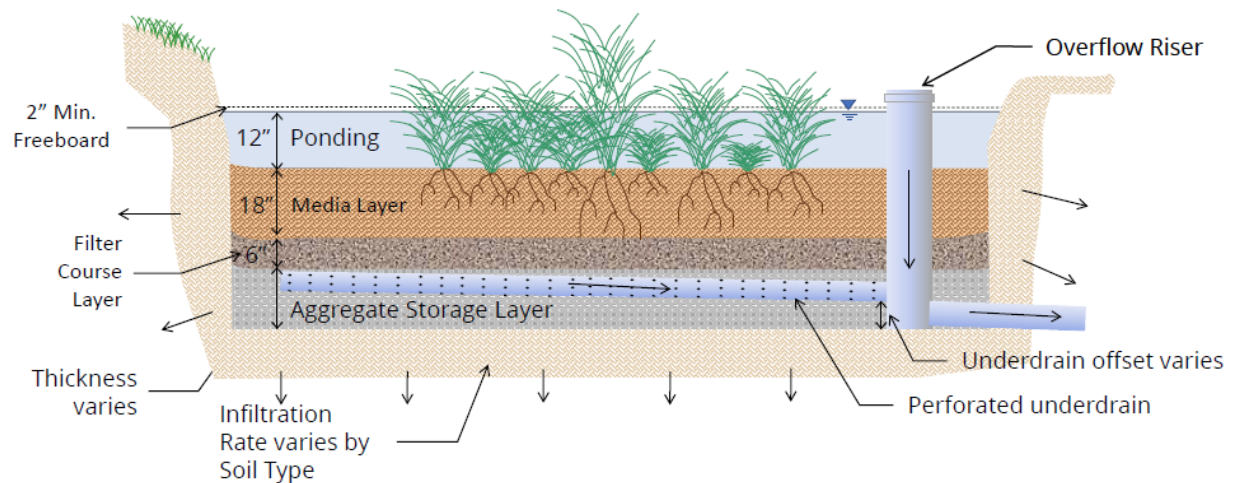

Biofiltration with Partial Retention BMP Example Illustration

How to use the sizing factors for flow control BMP Sizing:

Obtain sizing factors from Table G.2-4 based on the project's lower flow threshold fraction of Q_2 , hydrologic soil group, pre-project slope, and rain gauge (rainfall basin). Multiply the area tributary to the structural BMP (A, square feet) by the area weighted runoff factor (C, unitless) (see Table G.2-1) by the sizing factors to determine the required surface area (A, square feet). Select a low flow control orifice for the underdrain that will discharge the lower flow threshold flow at the overflow riser elevation. Standard head (H) for this calculation (based on the standard detail) is 3.0 feet for A or B soils, 3.5 feet for C soils, or 3.75 feet for D soils. The civil engineer shall provide the necessary surface area of the BMP and the underdrain and orifice detail on the plans.

**Appendix G: Guidance for Continuous Simulation
and Hydromodification Management Sizing Factors**

Additional steps to use this BMP as a combined pollutant control and flow control BMP:

The BMP sized using the sizing factors in Table G.2-4 meets both pollutant control and flow control requirements.

**Table G.2-4: Sizing Factors for Hydromodification Flow Control Biofiltration with Partial Retention
BMPs Designed Using Sizing Factor Method**

Lower Flow Threshold	Soil Group	Pre-Project Slope	Aggregate below low orifice invert (inches)	Rain Gauge	A
0.1Q ₂	A	Flat	18	Lindbergh	0.080
0.1Q ₂	A	Moderate	18	Lindbergh	0.080
0.1Q ₂	A	Steep	18	Lindbergh	0.080
0.1Q ₂	B	Flat	18	Lindbergh	0.065
0.1Q ₂	B	Moderate	18	Lindbergh	0.065
0.1Q ₂	B	Steep	18	Lindbergh	0.060
0.1Q ₂	C	Flat	6	Lindbergh	0.050
0.1Q ₂	C	Moderate	6	Lindbergh	0.050
0.1Q ₂	C	Steep	6	Lindbergh	0.050
0.1Q ₂	D	Flat	3	Lindbergh	0.050
0.1Q ₂	D	Moderate	3	Lindbergh	0.050
0.1Q ₂	D	Steep	3	Lindbergh	0.050
0.1Q ₂	A	Flat	18	Oceanside	0.080
0.1Q ₂	A	Moderate	18	Oceanside	0.075
0.1Q ₂	A	Steep	18	Oceanside	0.075
0.1Q ₂	B	Flat	18	Oceanside	0.070
0.1Q ₂	B	Moderate	18	Oceanside	0.070
0.1Q ₂	B	Steep	18	Oceanside	0.070
0.1Q ₂	C	Flat	6	Oceanside	0.070
0.1Q ₂	C	Moderate	6	Oceanside	0.070
0.1Q ₂	C	Steep	6	Oceanside	0.070
0.1Q ₂	D	Flat	3	Oceanside	0.070

**Appendix G: Guidance for Continuous Simulation
and Hydromodification Management Sizing Factors**

Lower Flow Threshold	Soil Group	Pre-Project Slope	Aggregate below low orifice invert (inches)	Rain Gauge	A
0.1Q ₂	D	Moderate	3	Oceanside	0.070
0.1Q ₂	D	Steep	3	Oceanside	0.070
0.1Q ₂	A	Flat	18	L Wohlford	0.110
0.1Q ₂	A	Moderate	18	L Wohlford	0.110
0.1Q ₂	A	Steep	18	L Wohlford	0.105
0.1Q ₂	B	Flat	18	L Wohlford	0.090
0.1Q ₂	B	Moderate	18	L Wohlford	0.085
0.1Q ₂	B	Steep	18	L Wohlford	0.085
0.1Q ₂	C	Flat	6	L Wohlford	0.065
0.1Q ₂	C	Moderate	6	L Wohlford	0.065
0.1Q ₂	C	Steep	6	L Wohlford	0.065
0.1Q ₂	D	Flat	3	L Wohlford	0.060
0.1Q ₂	D	Moderate	3	L Wohlford	0.060
0.1Q ₂	D	Steep	3	L Wohlford	0.060

Q₂ = 2-year pre-project flow rate based upon partial duration analysis of long-term hourly rainfall records

A = Surface area (at surface of the BMP before any ponding occurs) sizing factor for flow control

G.2.4 Sizing Factors for Biofiltration

Table G.2-5 presents sizing factors for calculating the required surface area (A) for a biofiltration BMP (formerly known as flow-through planter and/or biofiltration BMP with impermeable liner). The BMPs consist of four layers:

- **Ponding layer:** 12-inches active storage, [minimum] 2-inches of freeboard above overflow relief
- **Media layer:** 18-inches of soil [biofiltration soil media]
- **Filter Course:** 6-inches
- **Storage layer:** 12-inches of gravel at 40 percent porosity. The underdrain offset shall be 3-inches.
- **Overflow structure:** San Diego Regional Standard Drawing Type I Catch Basin (D-29). For the purposes of hydromodification flow control other type of overflow structures are allowed.

This BMP includes an impermeable liner to prevent infiltration into underlying soils.

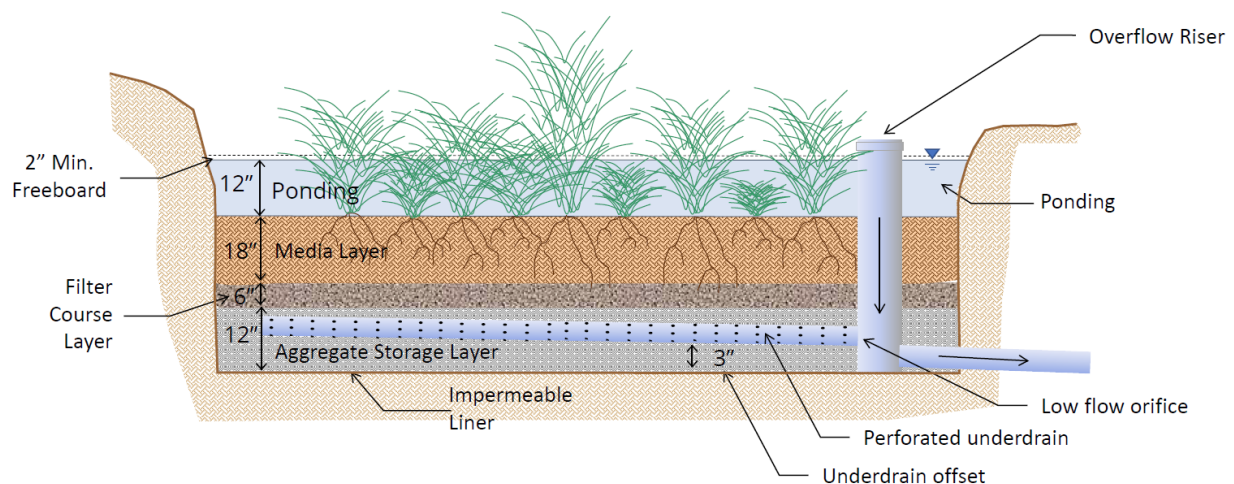

Biofiltration BMP Example Illustration

How to use the sizing factors for flow control BMP Sizing:

Obtain sizing factors from Table G.2-5 based on the project's lower flow threshold fraction of Q_2 , hydrologic soil group, pre-project slope, and rain gauge (rainfall basin). Multiply the area tributary to the structural BMP (A, square feet) by the area weighted runoff factor (C, unitless) (see Table G.2-1) by the sizing factors to determine the required surface area (A, square feet). Select a low flow control orifice for the underdrain that will discharge the lower flow threshold flow at the overflow riser elevation. Standard head (H) for this calculation (based on the standard detail) is 3.75 feet for all soil groups. The civil engineer shall provide the necessary surface area of the BMP and the underdrain and orifice detail on the plans.

Appendix G: Guidance for Continuous Simulation and Hydromodification Management Sizing Factors

Additional steps to use this BMP as a combined pollutant control and flow control BMP:

The BMP sized using the sizing factors in Table G.2-5 meets both pollutant control and flow control requirements except for surface drawdown requirements. Applicant must perform surface drawdown calculations and if needed develop a vector management plan (Refer to Section 6.3.7) or revise the BMP design to meet the drawdown requirements. If changes are made to the BMP design applicants must perform site specific continuous simulation modeling (Refer to Appendix G).

**Table G.2-5: Sizing Factors for Hydromodification Flow Control Biofiltration BMPs
Designed Using Sizing Factor Method**

Lower Flow Threshold	Soil Group	Pre-Project Slope	Rain Gauge	A
0.1Q ₂	A	Flat	Lindbergh	0.320
0.1Q ₂	A	Moderate	Lindbergh	0.300
0.1Q ₂	A	Steep	Lindbergh	0.285
0.1Q ₂	B	Flat	Lindbergh	0.105
0.1Q ₂	B	Moderate	Lindbergh	0.100
0.1Q ₂	B	Steep	Lindbergh	0.095
0.1Q ₂	C	Flat	Lindbergh	0.055
0.1Q ₂	C	Moderate	Lindbergh	0.050
0.1Q ₂	C	Steep	Lindbergh	0.050
0.1Q ₂	D	Flat	Lindbergh	0.050
0.1Q ₂	D	Moderate	Lindbergh	0.050
0.1Q ₂	D	Steep	Lindbergh	0.050
0.1Q ₂	A	Flat	Oceanside	0.150
0.1Q ₂	A	Moderate	Oceanside	0.140
0.1Q ₂	A	Steep	Oceanside	0.135
0.1Q ₂	B	Flat	Oceanside	0.085
0.1Q ₂	B	Moderate	Oceanside	0.085
0.1Q ₂	B	Steep	Oceanside	0.085
0.1Q ₂	C	Flat	Oceanside	0.075
0.1Q ₂	C	Moderate	Oceanside	0.075
0.1Q ₂	C	Steep	Oceanside	0.075

**Appendix G: Guidance for Continuous Simulation
and Hydromodification Management Sizing Factors**

Lower Flow Threshold	Soil Group	Pre-Project Slope	Rain Gauge	A
0.1Q ₂	D	Flat	Oceanside	0.070
0.1Q ₂	D	Moderate	Oceanside	0.070
0.1Q ₂	D	Steep	Oceanside	0.070
0.1Q ₂	A	Flat	L Wohlford	0.285
0.1Q ₂	A	Moderate	L Wohlford	0.275
0.1Q ₂	A	Steep	L Wohlford	0.270
0.1Q ₂	B	Flat	L Wohlford	0.150
0.1Q ₂	B	Moderate	L Wohlford	0.145
0.1Q ₂	B	Steep	L Wohlford	0.145
0.1Q ₂	C	Flat	L Wohlford	0.070
0.1Q ₂	C	Moderate	L Wohlford	0.070
0.1Q ₂	C	Steep	L Wohlford	0.070
0.1Q ₂	D	Flat	L Wohlford	0.060
0.1Q ₂	D	Moderate	L Wohlford	0.060
0.1Q ₂	D	Steep	L Wohlford	0.060

Q₂ = 2-year pre-project flow rate based upon partial duration analysis of long-term hourly rainfall records
flow control

A = Surface area (at surface of the BMP before any ponding occurs)) sizing factor for flow control

G.2.5 Sizing Factors for "Cistern" BMP

Table G.2-6 presents sizing factors for calculating the required volume (V) for a cistern BMP. In this context, a "cistern" is a detention facility that stores runoff and releases it at a controlled rate. A cistern can be a component of a harvest and use system, however the sizing factor method will not account for any retention occurring in the system. The sizing factors were developed assuming runoff is released from the cistern. The sizing factors presented in this section are to meet the hydromodification management performance standard only. The cistern BMP is based on the following assumptions:

- **Cistern configuration:** The cistern is modeled as a 4-foot tall vessel. However, designers could use other configurations (different cistern heights), as long as the lower outlet orifice is sized to properly restrict outflows and the minimum required volume is provided.
- **Cistern upper outlet:** The upper outlet from the cistern would consist of a weir or other flow control structure with the overflow invert set at an elevation of 7/8 of the water height associated with the required volume of the cistern – V. For the assumed 4-foot water depth in the cistern associated with the sizing factor analysis, the overflow invert is assumed to be located at an elevation of 3.5 feet above the bottom of the cistern. The overflow weir would be sized to pass the peak design flow based on the tributary drainage area.

How to use the sizing factors:

Obtain sizing factors from Table G.2-6 based on the project's lower flow threshold fraction of Q_2 , hydrologic soil group, pre-project slope, and rain gauge (rainfall basin). Multiply the area tributary to the structural BMP (A, square feet) by the area weighted runoff factor (C, unitless) (see Table G.2-1) by the sizing factors to determine the required volume (V, cubic feet). Select a low flow control orifice that will discharge the lower flow threshold flow at the overflow elevation (i.e. when there is 3.5 feet of head over the lower outlet orifice or adjusted head as appropriate if the cistern overflow elevation is not 3.5 feet tall). The civil engineer shall provide the necessary volume of the BMP and the lower outlet orifice detail on the plans.

Additional steps to use this BMP as a combined pollutant control and flow control BMP:

A cistern could be a component of a full retention, partial retention, or no retention BMP depending on how the outflow is disposed. However, use of the sizing factor method for design of the cistern in a combined pollutant control and flow control system is not recommended. The sizing factor method for designing a cistern does not account for any retention or storage occurring in BMPs combined with the cistern (i.e., cistern sized using sizing factors may be larger than necessary because sizing factor method does not recognize volume losses occurring in other elements of a combined system). Furthermore, when the cistern is designed using the sizing factor method, the cistern outflow must be set to the low flow threshold flow for the drainage area, which may be inconsistent with requirements for other elements of a combined system. To optimize a system in which a cistern

Appendix G: Guidance for Continuous Simulation and Hydromodification Management Sizing Factors

provides temporary storage for runoff to be either used onsite (harvest and use), infiltrated, or biofiltered, project-specific continuous simulation modeling is recommended. Refer to Sections 5.4 and 6.3.6.

**Table G.2-6: Sizing Factors for Hydromodification Flow Control Cistern BMPs
Designed Using Sizing Factor Method**

Lower Flow Threshold	Soil Group	Pre-Project Slope	Rain Gauge	V
0.1Q ₂	A	Flat	Lindbergh	0.54
0.1Q ₂	A	Moderate	Lindbergh	0.51
0.1Q ₂	A	Steep	Lindbergh	0.49
0.1Q ₂	B	Flat	Lindbergh	0.19
0.1Q ₂	B	Moderate	Lindbergh	0.18
0.1Q ₂	B	Steep	Lindbergh	0.18
0.1Q ₂	C	Flat	Lindbergh	0.11
0.1Q ₂	C	Moderate	Lindbergh	0.11
0.1Q ₂	C	Steep	Lindbergh	0.11
0.1Q ₂	D	Flat	Lindbergh	0.09
0.1Q ₂	D	Moderate	Lindbergh	0.09
0.1Q ₂	D	Steep	Lindbergh	0.09
0.1Q ₂	A	Flat	Oceanside	0.26
0.1Q ₂	A	Moderate	Oceanside	0.25
0.1Q ₂	A	Steep	Oceanside	0.25
0.1Q ₂	B	Flat	Oceanside	0.16
0.1Q ₂	B	Moderate	Oceanside	0.16
0.1Q ₂	B	Steep	Oceanside	0.16
0.1Q ₂	C	Flat	Oceanside	0.14
0.1Q ₂	C	Moderate	Oceanside	0.14
0.1Q ₂	C	Steep	Oceanside	0.14
0.1Q ₂	D	Flat	Oceanside	0.12
0.1Q ₂	D	Moderate	Oceanside	0.12

**Appendix G: Guidance for Continuous Simulation
and Hydromodification Management Sizing Factors**

Lower Flow Threshold	Soil Group	Pre-Project Slope	Rain Gauge	V
0.1Q ₂	D	Steep	Oceanside	0.12
0.1Q ₂	A	Flat	L Wohlford	0.53
0.1Q ₂	A	Moderate	L Wohlford	0.49
0.1Q ₂	A	Steep	L Wohlford	0.49
0.1Q ₂	B	Flat	L Wohlford	0.28
0.1Q ₂	B	Moderate	L Wohlford	0.28
0.1Q ₂	B	Steep	L Wohlford	0.28
0.1Q ₂	C	Flat	L Wohlford	0.14
0.1Q ₂	C	Moderate	L Wohlford	0.14
0.1Q ₂	C	Steep	L Wohlford	0.14
0.1Q ₂	D	Flat	L Wohlford	0.12
0.1Q ₂	D	Moderate	L Wohlford	0.12
0.1Q ₂	D	Steep	L Wohlford	0.12

Q₂ = 2-year pre-project flow rate based upon partial duration analysis of long-term hourly rainfall records

V = Cistern volume sizing factor

Appendix

H

COUNTY OF SAN DIEGO BMP DESIGN MANUAL

Guidance for Investigating Potential Critical Coarse Sediment Yield Areas

Appendix H: Guidance for Investigation Potential Critical Coarse Sediment Yield Areas

This page was intentionally left blank

Appendix H Guidance for Investigating Potential Critical Coarse Sediment Yield Areas

The following guidance provides methodologies for protecting CCSYAs:

- H.1. Step 1: Identify CCSYAs**
- H.2. Step 2: Avoidance of Onsite CCSYAs**
- H.3. Step 3: Bypass Onsite and Upstream CCSYAs**
- H.4. Step 4: Demonstrate No Net Impact**
- H.5. References**
- H.6. PCCSYAs: Regional WMAA Maps**
- H.7. PCCSYAs: Refinement Options**
- H.8. Calculation Methodology for Ep and Sp**
- H.9. Mitigation Measures Fact Sheets**

H.1 Step 1: Identify CCSYAs

A critical coarse sediment yield area (CCSYA) is an active or potential source of bed sediment to downstream channel reaches. When a Priority Development Project (PDP) is constructed, it has the potential to negatively impact characteristics of sediment supply and delivery which can lead to degradation of receiving waters. In order to prevent these impacts, PDP applicants must examine the tributary areas delineated in the project's storm water management plans and identify sources of critical coarse sediment within the following locations:

- **Onsite CCSYAs:** CCSYAs identified within the project's property boundary as indicated in the SWQMP. Refer to Section 1.3 for defining a project.
- **Upstream CCSYAs:** CCSYAs identified within the drainage area draining through the project's property boundary as indicated in the SWQMP. Refer to Section 1.3 for defining a project.

Applicants must first identify potential critical coarse sediment yield areas (PCCSYAs) using one of the methods presented in Appendix H.1.1. Once these PCCSYAs are identified, applicants may either accept the PCCSYA mapping as final, or may elect to further refine the results of the mapping through consideration of the refinement methods outlined in Appendix H.1.2. At the end of Step 1, applicants will have identified CCSYAs that must be avoided and bypassed by the project.

H.1.1 Identification Methods

As outlined on the following pages, applicants have two available options to identify PCCSYAs; (1) the RPO Method, and (2) the WMAA Method.

Appendix H: Guidance for Investigation Potential Critical Coarse Sediment Yield Areas

H.1.1.1 RPO Method

The County of San Diego has performed a jurisdictional analysis demonstrating that, in most cases, enforcement of the existing Resource Protection Ordinance (RPO) effectively preserves sources critical coarse sediment within the Unincorporated County of San Diego. This correlation between critical coarse sediment and lands that are currently protected through existing ordinances typically makes it more feasible for a development project to satisfy critical coarse sediment criteria. As outlined below, the process for identifying onsite sources of critical coarse sediment through the RPO Method may vary with respect to the project scenario, while the process for identifying upstream PCCSYAs through the RPO Method is identical for all project types.

Identification of Onsite PCCSYAs

- **Scenario 1:** PDP is subject to and in compliance with RPO requirements (without utilization of RPO exemptions 86.604(e)(2)(cc) or 86.604(e)(3) that result in impacts to more than 15% of the project scale CCSYAs).
 - Applicant must identify onsite PCCSYAs as areas that are coarse grained⁶, $\geq 25\%$ slope, and $\geq 50'$ in height.
- **Scenario 2:** PDP is entirely exempt/not subject to RPO requirements without utilization of exemptions 86.604(e)(2)(cc) or 86.604(e)(3).
 - Applicant has no obligation to identify and/or avoid onsite critical coarse sediment.
- **Scenario 3:** PDP utilizes exemption(s) via RPO Section 86.604(e)(2)(cc) or 86.604(e)(3) and impacts more than 15% of the project-scale CCSYAs.
 - Applicant is not permitted to use the RPO Method to identify sources of critical coarse sediment. Applicant must instead demonstrate no net impact through utilization of Appendix H.4 of this guidance.

Identification of Upstream PCCSYAs

- **All Scenarios:** All PDP applicants must identify upstream PCCSYAs that drain through their project site as areas that are coarse grained, $\geq 25\%$ slope and $\geq 50'$ in height.
 - Alternatively, if a project can demonstrate that the entire upstream boundary incorporates drainage elements that bypass the 2 year 24 hour flow rate at the peak velocity of 3 fps, then identification of the upstream sources may be omitted from the analysis.

⁶ Refer to Table H.6-1 for a list of geologic units that are anticipated to produce coarse grained sediment.

Appendix H: Guidance for Investigation Potential Critical Coarse Sediment Yield Areas

H.1.1.2 WMAA Mapping Method

It is anticipated that most applicants will elect to identify critical coarse sediment yield areas through the RPO Method presented in the section above; however, applicants are not expressly forbidden from utilizing the Watershed Management Area Analysis PCCSYA maps that were developed through previous regional analysis. Applicants electing to pursue this alternate method must identify onsite and/or upstream sources of critical coarse sediment through examination of the PCCSYA maps provided in Appendix H.6.

H.1.2 Refinement Options

After identifying PCCSYAs using one of the methods above, the applicant may either accept the PCCSYA mapping as final, or may elect to further refine the results of the mapping through consideration of one or more of the refinement methods outlined below.

H.1.2.1 Depositional Analysis

Areas identified as PCCSYAs may be removed from consideration if it is demonstrated that these sources are deposited into existing systems prior to reaching the first downstream unlined water of the state. Systems resulting in deposition may include existing natural sinks, existing structural BMPs, existing hardened MS4 systems, or other existing similar features that produce a peak velocity from the discrete 2-year, 24 hour runoff event of less than three feet per second in the system being analyzed. Applicants electing to perform depositional analysis to refine PCCSYA mapping must refer to the detailed guidance provided in Appendix H.7.1.

H.1.2.2 Threshold Channel Analysis

Areas identified as PCCSYAs may be removed from consideration if they discharge to a “threshold channel” that does not exhibit characteristics associated with significant bed load movement during design flows. Applicants electing to perform threshold channel analysis to refine PCCSYA mapping must refer to the detailed guidance provided in Appendix H.7.2.

H.1.2.3 Coarse Sediment Source Area Verification

Areas identified as PCCSYAs may be removed from consideration if an applicant demonstrates that these areas actually consist of fine grained sediment. Applicants electing to perform coarse sediment source area verification to refine PCCSYA mapping must refer to the detailed guidance provided in Appendix H.7.3.

H.1.2.4 Verification of Geomorphic Landscape Units (GLUs)

If an applicant has identified sources of critical coarse sediment via the alternate WMAA Method discussed in Appendix H.1.1, PCCSYAs mapping may be refined through verification of GLUs. If this method is used, applicants must refer to detailed guidance provided in Appendix H.6.1.

H.2 Step 2: Avoidance of Onsite CCSYAs

A key element of preserving the stability of receiving waters is to avoid changes in bed sediment supply by avoiding development on CCSYAs. Avoidance is best achieved through proper site design. The following are some potential strategies that should be considered while determining the site layout to avoid CCSYAs:

- The civil engineer shall designate onsite CCSYAs that are to be avoided (undisturbed) for the purpose of preserving coarse soil supply. When feasible, use and/or access restriction should be established for these areas.
- Minimize new impervious footprint. Refer to SD-3 in Chapter 4 for guidance on minimizing impervious footprint.

If onsite CCSYAs are not avoided per the metrics defined below, the applicant must demonstrate no net impact to the receiving water using guidance in Appendix H.4.

H.2.1 Avoidance Metrics

H.2.1.1 RPO Method

Avoidance of onsite CCSYA does not always mean that 100% of the CCSYAs must be avoided. Applicants that have identified CCSYAs using the RPO Method are typically permitted to encroach anywhere from 10-20% into the onsite CCSYAs that were determined in Step 1. This onsite encroachment is permitted through the existing RPO enforcement mechanism, which allows each lot within a project to encroach into steep slope areas anywhere from 10-20% depending on the percentage of the lot that is comprised of steep slopes. For example, a lot comprised of less than 75% steep slopes is typically permitted a 10% encroachment while a lot comprised of 100% steep slopes is typically permitted a 20% encroachment.

In some instances, a project (or portions of a project) may be exempted from RPO requirements such that encroachments beyond 10-20% may be permitted. Utilization of specific RPO exemptions 86.604(e)(2)(cc) or 86.604(e)(3) will require an applicant to translate conventional lot-level impact values into a single project-level impact value for analysis.

As outlined below, the metric for avoiding impacts to onsite sources of critical coarse sediment through the RPO Method may vary with respect to the project scenario

Avoidance of Onsite CCSYAs

- **Scenario 1:** PDP is subject to and in compliance with RPO requirements (without utilization of RPO exemptions 86.604(e)(2)(cc) or 86.604(e)(3) that result in impacts to more than 15% of the project scale CCSYAs).
 - Applicant demonstrates avoidance of onsite critical coarse sediment by simply complying with existing RPO encroachment allowances.

Appendix H: Guidance for Investigation Potential Critical Coarse Sediment Yield Areas

- **Scenario 2:** PDP is entirely exempt/not subject to RPO requirements without utilization of exemptions 86.604(e)(2)(cc) or 86.604(e)(3).
 - Applicant has no obligation to identify and/or avoid onsite critical coarse sediment.
- **Scenario 3:** PDP utilizes exemption(s) via RPO Section 86.604(e)(2)(cc) or 86.604(e)(3) and impacts more than 15% of the project-scale CCSYAs.
 - Applicant is not permitted to use the RPO Method to demonstrate avoidance of critical coarse sediment. Applicant must instead demonstrate no net impact through utilization of Appendix H.4 of this guidance.

Avoidance of Upstream CCSYAs

- **All Scenarios:** Upstream CCSYAs must be bypassed per criteria presented in Section H.3 of this guidance.

H.2.1.2 WMAA Mapping Method

If the applicant has identified onsite CCSYAs using the WMAA Mapping Method, encroachments of up to 5% into the onsite CCSYAs may be permitted.

H.3 Step 3: Bypass Onsite and Upstream CCSYAs

Another key element of preserving the stability of receiving waters is to maintain current bed sediment supply characteristics through effective bypass of onsite and upstream sediment sources. Upstream bed sediment sources may include overland flow from CCSYAs and/or concentrated channel flows. Applicants must ensure both onsite and upstream sources of bed sediment are effectively bypassed through their project. If onsite and/or upstream CCSYAs are not effectively bypassed per the criteria below, applicant must demonstrate no net impact to the receiving water per the guidance presented in Appendix H.4.

H.3.1 Bypass CCSYAs from Hillslopes

Both onsite and upstream hillslopes mapped as CCSYAs must be effectively bypassed through and/or around the proposed project site.

- Proposed hardened drainage systems (e.g. storm drains, drainage ditches) that convey the bed sediment from the hillslopes to the downstream waters of the state should maintain a peak velocity from the discrete 2-year, 24-hour runoff event greater than three feet per second.
 - When drainage ditches are proposed for bypass, this velocity may be achieved by designing to the minimum dimensions listed in the San Diego Regional Standard drawing D-75.
 - When an 18” concrete storm drain is proposed for bypass, this velocity may typically be achieved by maintaining a storm drain slope of $\geq 0.5\%$. In instances where 2 year, 24-hour peak flow rates associated with the storm drain are less than 1.1 cfs, applicants may refer to the table below for minimum slopes needed to maintain three feet per second. Applicants may interpolate the values from the table below, or may elect to perform more detailed cleansing velocity calculations presented in Appendix H.7.1.

2-Year, 24-Hour Peak Flow (cfs)	Minimum Slope for 18” Concrete Storm Drain
<0.25	n/a, this PCCSYA is considered de-minimis
0.25	2.0%
0.50	1.0%
1.10	0.5%

- Storm water runoff that contains the bed sediment from CCSYAs must not be routed through detention basins or other facilities with restricted outlets that will trap sediment. Bypass systems shall be designed as necessary so that the bed material is conveyed to the downstream receiving water. Structural BMPs (including most flow-thru BMPs) are likely to trap sediment.
- For scenarios where a BMP must be constructed to treat offsite drainage area and there are CCSYAs outside of the project footprint, it may be feasible to achieve mitigation by construction of an outlet structure that can convey the bed load to the downstream receiving water and clear water through a bypass structure to a BMP.

Appendix H: Guidance for Investigation Potential Critical Coarse Sediment Yield Areas

- Proposed crossings (culverts, driveways, etc.) should not impede the transport of upstream critical coarse sediment. Crossings should be designed to avoid headwater conditions that would result in the trapping/settling of sediment.

H.3.2 Bypass CCSYAs from Channels

Projects that effectively avoid and bypass CCSYAs mapped in Step 1 of this guidance are not required to take specific action to ensure bypass of channel flows. This guidance does not set forth channel bypass criteria for this scenario because it recognizes that existing regulator mechanisms (such as 401 certifications, site design requirements, etc) are generally sufficient to preserve the sediment transport functions of onsite channels.

However, projects that do not effectively avoid and bypass the CCSYAs mapped in Step 1, will be required to specifically account for bypass of channel flows as part of the demonstration of no net impact outlined in Appendix H.4.

H.3.3 De Minimis Upstream CCSYA

Applicants have an option to exclude de minimis upstream CCSYAs. De minimis upstream CCSYAs consist of coarse hillslope areas that are not significant contributors of bed sediment yield due to their small size, and are considered by the owner and County as not practicable to bypass to the downstream waters of the state. In limited scenarios where all of the criteria below are satisfied, de minimis upstream CCSYAs may be omitted from consideration.

- De minimis upstream CCSYA is not disturbed through the proposed project activities.
- De minimis upstream CCSYA is not part of an upstream drainage contributing more than 0.31 total acres to the project site.
- Multiple de minimis upstream CCSYAs cannot be adjacent to each other and hydraulically connected.
- The SWQMP must document the reason why each de minimis upstream CCSYA could not be bypassed to the downstream waters of the state.

The 0.31-acre (13,500 square feet) de minimis threshold was established using 0.25 cfs as the cut off peak flow for the 2-year, 24-hour event, rational method equation and the following assumptions:

- $C = 0.225$ (average runoff coefficient (C) for soil type A and B);
- Average 6-hour, 2-year storm depth = 1.5 inches;
- Time of concentration = 6 minutes; and
- 2-year peak intensity = 3.51 in/hr. (based on procedures from the County Hydrology Manual).

The strategies for sediment bypass do not mitigate for the reduction of CCSYA that have been replaced by development onsite but can only mitigate scenarios where development hinders movement of bed sediment through the project footprint. When preservation of existing channels and/or implementation of sediment bypass measures is not feasible and/or not implemented, the applicant must demonstrate no net impact to the receiving water via the guidance presented in Appendix H.4.

H.4 Step 4: Demonstrate No Net Impact

When impacts to CCSYAs cannot be avoided or effectively bypassed, the applicant must demonstrate that their project generates no net impact to the receiving water per the performance metrics identified herein.

- **Appendix H.4.1** provides background on the state of the current science for predicting hydromodification impacts due to reductions in sediment supply;
- **Appendix H.4.2** defines the management standard that will be the basis for evaluating whether “no net impact to the receiving water” is achieved;
- **Appendix H.4.3** identifies the type of mitigation measures (i.e., additional flow control, stream rehabilitation, and applicant proposed mitigation measures) that can be used to meet the management standard;
- **Appendix H.8** provides the methodology for calculation of Erosion Potential (Ep) and Sediment Supply Potential (Sp); and
- **Appendix H.9** provides fact sheets for implementation of the mitigation measures.

H.4.1 Background

Channel form, by definition, is composed of bed and bank material as well as channel geometry (in plan, cross-section, and profile); however, the dominant forces typically controlling channel form are discharge and sediment supply (notably bed material) since a stream’s most basic function is to convey water and sediment (Knighton, 1998). The interaction between form and function is qualitatively described through Lane’s relationship:

Equation H.4-1: Lane’s Relationship

$$Q_s \times d \propto Q_w \times S$$

Where:

Q_s = Sediment discharge

D = Particle diameter or size of sediment

Q_w = Streamflow

S = Stream slope

Lane’s relationship qualitatively states that the sediment load (size and volume of sediment), which is the first half of the relationship, is proportional to the stream power (volume of runoff and slope) which is represented by the second half of the relationship. The sediment discharge (Q_s) in the relationship is the coarser part of sediment load, referred to as the “bed sediment”, since this is the part of the load which largely molds the bed formation (Lane, 1955). Lane’s relationship (Equation H.4-1) cannot be used for quantitative calculations since the proportionality is not necessarily linear.

For a stream at equilibrium, Lane’s relationship states that if one of the variables changes and the other variables do not change proportionately, then the stream channel is no longer in equilibrium.

Appendix H: Guidance for Investigation Potential Critical Coarse Sediment Yield Areas

Sediment load and stream power can change considerably during and following new development, leading to changes in the equilibrium state of the receiving channel.

- Typically, sediment load increases during the construction period, due to the additional exposure of bare soil during the grading and construction process, and before landscaping vegetation has stabilized the soil. This is regulated through the construction-phase BMP requirements established by the Construction General Permit and/or the MS4 Permit.
- Following the construction period, sediment load typically decreases to below pre-development levels, as less sediment is available from areas that have been paved or stabilized by landscape vegetation. When this decrease is not regulated, the bed sediment supplied to the stream (first half of the relationship) is reduced and the sediment transport capacity (stream power) is increased due to increased flows and durations resulting from the addition of impervious areas (second half of the relationship). This may result in degradation of the stream system as illustrated in Figure H.4-1.

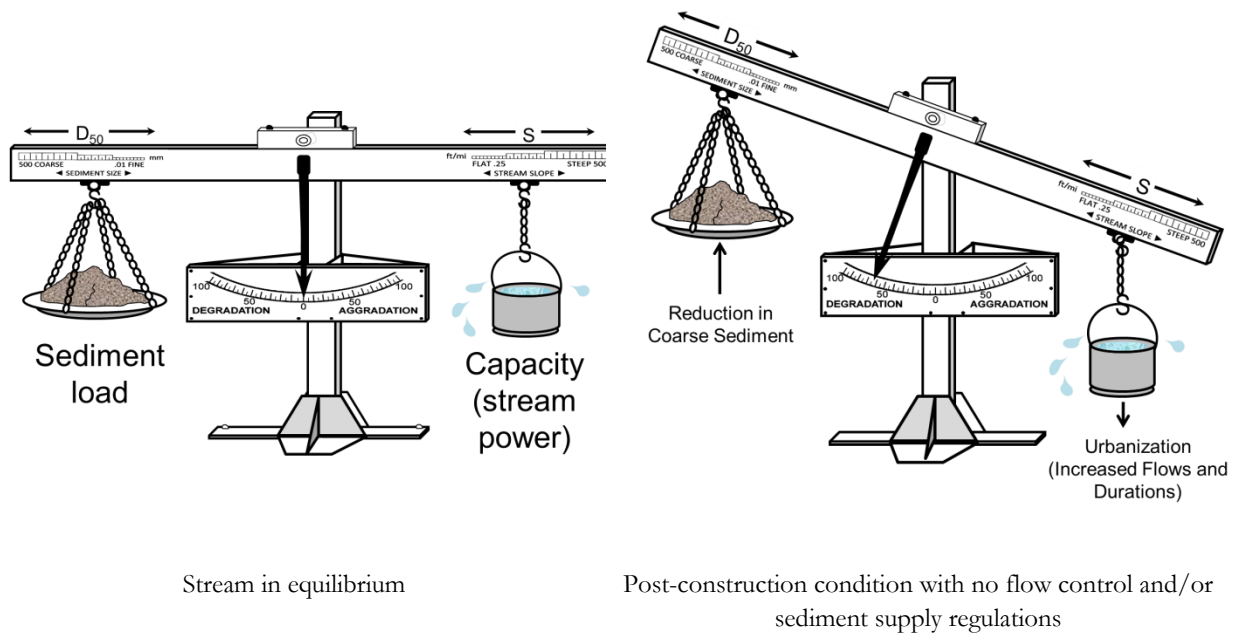

Schematics credit: SCCWRP

Figure H.4-1: Illustration of Lane's Relationship

Lane's relationship is useful for making qualitative predictions concerning channel impacts due to changes in runoff and/or sediment loads from the watershed. Although this qualitative assessment is useful for understanding how the watershed responds to development, quantitative predictions are valuable for determining the magnitude of response and they can inform the identification of locations where the greatest management attention should be invested.

Lane's relationship can be supplemented by the use of quantitative predictions which allow the evaluation of the stream under changing conditions. Quantitative predictions will include bed

Appendix H: Guidance for Investigation Potential Critical Coarse Sediment Yield Areas

sediment supply calculations for the first half of the Lane relationship, and bed sediment transport capacity calculations for the second half of the Lane relationship. Imbalances between the bed sediment supply rate and transport capacity determines the rate of sediment deposition or erosion in the channel and the associated channel change (Wilcock et al., 2009).

The common practice is to use the Erosion Potential (Ep) metric to evaluate the changes in sediment transport capacity and the Sediment Supply Potential (Sp) metric to evaluate the changes in bed sediment supply for susceptible receiving channels of concern. In regards to Ep metric,

- SCCWRP Technical Report 667 (SCCWRP, 2012) states:
“The underlying premise of the erosion potential approach advances the concept of flow duration control by addressing in-stream processes related to sediment transport. An erosion potential calculation combines flow parameters with stream geometry to assess long term (decadal) changes in the sediment transport capacity. The cumulative distribution of shear stress, specific stream power and sediment transport capacity across the entire range of relevant flows can be calculated and expressed using an erosion potential metric, Ep.”
- SCCWRP Technical Report 753 (SCCWRP, 2013) states the following based on review of field measurements from 61 sites in Southern California:
“Results indicate that channel enlargement is highly dependent on the ratio of post- to pre-urban sediment-transport capacity over cumulative duration simulations of 25 years (load ratio, a.k.a. erosion potential), which explained nearly 60% of the variance.”

For the purposes of implementing mitigation measures within the MS4-permitted region of the County of San Diego: this manual defines Ep as the ratio of post-project/pre-development (natural) long-term transport capacity or work; and Sp as the ratio of post-project/pre-project (existing) long-term bed sediment supply. Guidance for calculating Ep and Sp are provided in Appendix H.8.

H.4.2 Management Standard

This guidance defines a sediment supply management standard through which no net impact to receiving water can be quantitatively indicated. This management standard is demonstrated through the Net Impact Index (NII), a dimensionless index that must be used by the applicant to evaluate if there is, or is not, a net impact to the receiving water. NII is defined in this manual as the ratio of Ep to Sp. Mitigation measures shall be designed to meet the NII management standard shown in Equation H.4-2 to achieve no net impact to the receiving water. The NII management standard is based on Lane’s relationship (Ep is directly proportional to Sp) and an allowance of 10% (based on Appendix H.4.2.1). This represents the most appropriate current understanding of how to quantitatively account for sediment supply changes without replacing bed sediment sources (Palhegyi and Rathfelder, 2007 and Parra, 2015).

Equation H.4-2: Net Impact Index

$$NII = \frac{Ep}{Sp} \leq 1.1$$

Where:

NII = Net Impact Index

Ep = Erosion Potential

Sp = Sediment Supply Potential

If $NII \leq 1.1$, then the project produces no net impact to the receiving water in terms of coarse sediment yield, and no further analysis is required. If $NII > 1.1$, then the project generates an impact on the receiving water and the project is required to implement mitigation measures defined in Appendix H.4.3 such that the NII is reduced to a compliant value ($NII \leq 1.1$).

H.4.2.1 Allowance to the NII Management Standard

This manual establishes the NII defined in Appendix H.4.2 as the management standard for coarse sediment supply. The 10% allowance to the management standard is supported by the following research studies or projects:

- The authors of the USACE report for channel design (USACE, 2001) state that, “achieving an optimum Capacity-Supply Ratio, within 10 percent of unity, should ensure dynamic stability while allowing the river itself to recover some of the fluvial detail that cannot be engineered.”
- The authors of SCCWRP Technical Report 605 (SCCWRP, 2010), “anticipate that changes of less than 10% in either driver [discharge or sediment flux] are unlikely to instigate, on their own, significant channel changes. This value is a conservative estimate of the year-to-year variability in either discharge or sediment flux that can be accommodated by a channel system in a state of dynamic equilibrium.”
- Sediment transport and supply measurements and calculations are inherently inexact. Discrepancies of up to 10% should not be a source of concern (PCR et al., 2002).

H.4.3 Types of Mitigation Measures

The following text discusses mitigation measures that may be used by the applicant to meet the NII management standard defined in Appendix H.4.2. These include:

- Additional Flow Control;
- Stream Rehabilitation; and
- Applicant Proposed Mitigation Measures

Appendix H.9 provides additional guidance for implementation of these mitigation measures.

Appendix H: Guidance for Investigation Potential Critical Coarse Sediment Yield Areas

H.4.3.1 Additional Flow Control

One option for managing bed sediment supply reductions is to provide additional detention and retention of site runoff to compensate for the reduction of bed sediment supply. This measure requires increasing flow attenuation by adding storage volume in structural BMPs. This management option accounts for changes in hydrology, channel geometry, and bed/bank material, but not sediment supply. For example, if there is a 30% reduction in bed-load due to proposed urbanization, then the sediment supply potential (Sp) equals 0.7. Assuming the appropriate range is +10%, hydromodification controls can be sized and situated such that the post-project effective in-stream work is lowered to less than 77% of the baseline pre-development condition.

Structural BMPs designed for hydromodification control utilize the following two basic principles:

- Detain runoff and release it in a controlled way that either mimics pre-development in-stream sediment transport capacity, mimics flow durations, or reduces flow durations to account for a reduction in bed sediment supply.
- Manage excess runoff volumes through one or more of the following pathways: (1) infiltration; (2) evapotranspiration; (3) storage and use; (4) discharge at a rate below the critical low flowrate; or (5) discharge downstream to a receiving water that is not susceptible to hydromodification impacts.

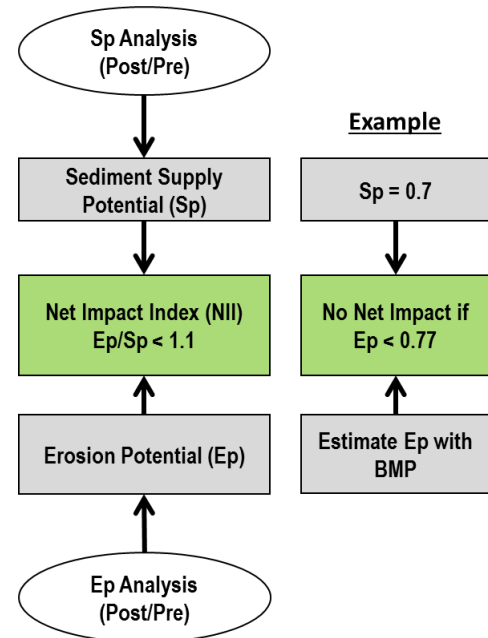

If desired, structural BMPs can be designed to support flood control and LID objectives in addition to hydromodification control. To the maximum extent possible, structural BMPs should be designed to receive flows from developed areas only. This facilitates design optimization as well as avoiding intercepting coarse sediments from open spaces that should ideally be passed through to the stream channel.

A fact sheet for additional flow control is provided in Appendix H.9.1.

H.4.3.2 Stream Rehabilitation

Hydromodification control can be achieved by stream rehabilitation projects including: drop structures, grade control structures, bed and bank reinforcement, increased channel sinuosity or meandering, increased channel width, and flow diversion. The objective of these in-stream controls, or stream restoration measures, is to reduce or maintain the overall Erosion Potential (Ep) of the receiving channel by modifying its hydraulic properties and/or bed/bank material resistance without fully replacing sediment supply or controlling increases in runoff. Stream rehabilitation is only an option where the receiving channel of concern is already impacted by erosive flows and shows evidence of excessive sediment, erosion, deposition, or is a hardened channel.

Appendix H: Guidance for Investigation Potential Critical Coarse Sediment Yield Areas

Stream rehabilitation projects are subject to the permitting requirements of the resource agencies. Stream rehabilitation projects may require the following permits:

- California Department of Fish and Wildlife – 1602 Streambed Alteration Agreement.
- US Fish and Wildlife Service – Authorization under the Endangered Species Act.
- US Army Corps of Engineers – Clean Water Act Section 404 Permit.
- Regional Water Quality Control Board – Clean Water Act Section 401 Water Quality Certification.
- Local Grading Permit

A fact sheet for stream rehabilitation is provided in Appendix H.9.2.

H.4.3.3 Applicant Proposed Mitigation Measures

The applicant may propose a mitigation measure not identified in this manual if it will achieve no net impact to the receiving water. Additional analysis may be requested by the County prior to approval of the mitigation measure to substantiate the finding of no net impact to the receiving water.

H.5 References

- American Society of Civil Engineers and Water Environment Federation. 1992. Design and Construction of Urban Stormwater Management Systems. ASCE Manual No. 77, WEF Manual No. 20, Alexandria, VA.
- ASCE, 1970. Design and construction of sanitary and storm sewers, ASCE Manual of Engineering Practice No. 37, WPCF Manual of Practice No. 9. Prepared by the Joint Committee of the American Society of Civil Engineers and the Water Pollution Control Federation
- Chow, V.T. 1959. Open-Channel Hydraulics. McGraw-Hill Book Company.
- Fischenich, C. 2001. “Stability Thresholds for Stream Restoration Materials.” EMRRP Technical Notes Collection (ERDC TN-EMRRP-SR-29), U.S. Army Engineer Research and Development Center, Vicksburg, MS.
- Hawley, R.J., and Bledsoe, B.P. 2011. “How do flow peaks and durations change in suburbanizing semi-arid watersheds? A southern California Study,” Journal of Hydrology, Elsevier, Vol 405, pp 69-82.
- Knighton D., 1998. Fluvial Forms and Processes: A New Perspective. Arnold Publishers.
- Lane, E.W. 1955. The Importance of Fluvial Morphology in Hydraulic Engineering. American Society of Civil Engineers. Proceedings, Vol. 81, Paper No. 745.
- Los Angeles Regional Water Quality Control Board (LARWQCB). 2012. Los Angeles County MS4 Permit (Order No. R4-2012-0175).
- National Resource Conservation Service (NRCS), 2007. National Engineering Handbook Part 654 - Stream Restoration Design.

Appendix H: Guidance for Investigation Potential Critical Coarse Sediment Yield Areas

- Palhegyi, G.E. and Rathfelder, K. 2007. “Applying the Erosion Potential Methodology to Natural Channel Design Procedures in Southern California”. Presented at CASQA, Sept 2007, Orange County, California.
- Parra, L.A., 2015. Addressing Critical Coarse Sediment Impact by Defining Dimensionless Indexes of Coarse Sediment Production, Transport and Net Impact.
- Parra, L.A., 2016. Link between Flow Duration Curve and Erosion Work – Expanded.
- PCR Services Corporation, Philip Williams and Associates, and Balance Hydrologics, Inc. 2002. Baseline Geomorphic and Hydrologic Conditions Report, Ranch Mission Viejo: Portions of the San Juan and Western San Mateo Watersheds, prepared for Rancho Mission Viejo.
- Renard, K.G., G.R. Foster, G.A. Weesies, D.K. McCool and D.C. Yoder, 1997. Predicting Soil Erosion by Water. A guide to conservation planning with Revised Universal Soil Loss Equation (RUSLE). U.S. Department of Agriculture, Agriculture Handbook No. 703.
- San Diego, County of. 2011. Final Hydromodification Management Plan.
- Santa Clara Valley Urban Runoff Pollution Prevention Program (SCVURPPP). 2005. Hydromodification Management Plan. April 21, 2005.
- Shields, F.D. 1996. Hydraulic and Hydrologic Stability In: A Brooks and FD Shields (Eds.), River Channel Restoration, 23-74.
- Shields, F.D., A. Brooks and J. Haltiner. 1999. Geomorphological Approaches to Incised Stream Channel Restoration in the United States and Europe. In: SE Darby and A Simon (Eds.) Incised River Channels.
- Southern California Coastal Water Research Project (SCCWRP), 2008. Stream Channel Classification and Mapping Systems: Implications for Assessing Susceptibility to Hydromodification Effects in Southern California, Technical Report 562.
- Southern California Coastal Water Research Project (SCCWRP), 2005. Effect of Increases in Peak Flows and Impervious on the Morphology of Southern California Streams, Technical Report 450.
- Southern California Coastal Water Research Project (SCCWRP), 2010. Hydromodification Screening Tools: GIS-based catchment analyses of potential changes in runoff and sediment discharge. Technical Report 605.
- Southern California Coastal Water Research Project (SCCWRP), 2010a. Hydromodification Screening Tools: Field Manual for Assessing Channel Susceptibility. Technical Report 606.
- Southern California Coastal Water Research Project (SCCWRP), 2012. Hydromodification Assessment and Management in California. Technical Report 667.
- Southern California Coastal Water Research Project (SCCWRP), 2013. Modeling and Managing Hydromodification Effects: summary of Available Tools and Decision-Making Approach. Technical Report 753.
- USACE, 2001. Channel Restoration Design for Meandering Rivers. US Army Corps of Engineers, Final Report, ERDC/CHL CR-01-1. Prepared by Soar, P.J., and Thorne, C.R.

Appendix H: Guidance for Investigation Potential Critical Coarse Sediment Yield Areas

USDA, 1974. Present Sediment Yield Rates for Western United States. U. S. Department of Agriculture Soil Conservation Service.

Wilcock, P., J. Pitlick, and Y. Cui. 2009. Sediment Transport Primer Estimating Bed-Material Transport in Gravel-bed Rivers. USDA General Technical Report, RMRS-GTR-226.

H.5.1 Terms of Reference

The guidance described in Appendix H of this manual was developed by Geosyntec Consultants (Geosyntec) on behalf of the County of San Diego and the City of San Diego. Appendix H was specifically developed to provide PDP applicants guidance to meet the MS4 Permit Provision E.3.c.(2)(b) within the MS4-permitted region within the San Diego County. This guidance is not intended to be used for purposes, other than to meet this MS4 Permit requirement.

The guidance was developed with input from a Technical Advisory Committee (TAC) members through a series of meetings conducted in January 2016. The TAC input resulted in a streamlined guidance enhanced to provide applicants with simplified methods to determine impacts to coarse sediment delivery based on complex scientific principles. TAC participants included:

Bill Woolsey | Brian Haines | Charles Mohrlock | Chris Wolff | Dave Hammar | David Garcia | Emir Williams | Eric Mosolgo | Eric Stein | Erica Ryan | Howard Chang | Jon VanRhyn | Jonard Talamayan | Judd Goodman | Ken Susilo | Laura Henry | Luis Parra | Max Dugan | Rich Lucera | Sheri McPherson | Sumer Hasenin | Trevor Alsop | Venkat Gummadi | Wayne Chiu |

H.6 PCCSYAs: Regional WMAA Maps

PCCSYAs identified by the Regional WMAA were delineated using regional datasets for elevation, land cover, and geology. The methodology used to identify PCCSYAs from these datasets is based on Geomorphic Landscape Unit (GLU) methodology presented in the SCCWRP Technical Report 605. GLUs characterize the magnitude of sediment production from areas through three factors judged to exert the greatest influence on the variability on sediment-production rates: geology types, hillslope gradient, and land cover. The Regional WMAA document and the GIS layers for the map can be found on the Project Clean Water website at the following address:

http://www.projectcleanwater.org/index.php?option=com_content&view=article&id=248&Itemid=219

The regional-level mapping is based on the following sources:

Dataset	Source	Year	Description
Elevation	USGS	2013	1/3 rd Arc Second (~10 meter cells) digital elevation model for San Diego County
Land Cover	SanGIS	2013	Ecology-Vegetation layer for San Diego County downloaded from SanGIS
Geology	Kennedy, M.P., and Tan, S.S.	2002	Geologic Map of the Oceanside 30'x60' Quadrangle, California, California Geological Survey, Regional Geologic Map No. 2, 1:100,000 scale.
	Kennedy, M.P., and Tan, S.S.	2008	Geologic Map of the San Diego 30'x60' Quadrangle, California, California Geological Survey, Regional Geologic Map No. 3, 1:100,000 scale.
	Todd, V.R.	2004	Preliminary Geologic Map of the El Cajon 30'x60' Quadrangle, Southern California, United States Geological Survey, Southern California Areal Mapping Project, Open File Report 2004-1361, 1:100,000 scale.
	Jennings et al.	2010	"Geologic Map of California," California Geological Survey, Map No. 2 – Geologic Map of California, 1:750,000 scale

The regional data set is a function of the inherent data resolution of the macro-level data sets and may not conform to all site conditions, or does not reflect changes to particular areas that have occurred since the underlying data was developed. This means slopes, geology, or land cover at the project site can be mischaracterized in the regional data set. If an applicant feels the Regional WMAA analysis inaccurately mapped their project area, they may elect to perform a site-specific GLU analysis based on data collected from project-level investigations to refine the mapping as outlined below.

The following PCCSYAs may be removed from the mapping without performing the full GLU analysis described in Appendix H.6.1 a) areas under 10% slope, b) paved areas.

H.6.1 Site-Specific GLU Analysis

In order to perform a site-specific GLU analysis the applicant must first delineate the project boundary and any areas draining through the project boundary. The applicant must then determine appropriate slopes, geology, and land cover categories for this area as identified below.

There are four slope categories in the GLU analysis. Category numbers shown (1 to 4) were assigned for the purpose of GIS processing.

- 0% to 10% (1)
- 10% to 20% (2)
- 20% to 40% (3)
- >40% (4)

There are seven geology categories in the GLU analysis:

- Coarse bedrock (CB)
- Coarse sedimentary impermeable (CSI)
- Coarse sedimentary permeable (CSP)
- Fine bedrock (FB)
- Fine sedimentary impermeable (FSI)
- Fine sedimentary permeable (FSP)
- Other (O)

There are six land cover categories in the GLU analysis:

- Agriculture/grass
- Forest
- Developed
- Scrub/shrub
- Other
- Unknown

Project site slopes shall be classified into the categories based on project-level topography. Project site geology may be determined from geologic maps (may be the same as regional-level information) or classified in the field by a qualified geologist. Table H.6-1 provides information to classify geologic map units into each geology category. Project site land cover shall be determined from aerial photography and/or field visit. For reference, Table H.6-2 provides information to classify land cover categories from the SanGIS Ecology-Vegetation data set into land cover categories. The civil engineer shall not rely on the SanGIS Ecology-Vegetation data set to identify actual land cover at the project

Appendix H: Guidance for Investigation Potential Critical Coarse Sediment Yield Areas

site (for project-level investigation land cover must be confirmed by aerial photo or field visit). Intersect the geologic categories, land cover categories, and slope categories within the project boundary to create GLUs. The GLUs listed in Table H.6-3 are considered to be PCCSYAs. Note the GLU nomenclature is presented in the following format: Geology – Land Cover – Slope Category (e.g., "CB-Agricultural/Grass-3" for a GLU consisting of coarse bedrock geology, agricultural/grass land cover, and 20% to 40% slope).

GLUs are created by intersecting the geologic categories, land cover categories, and slope categories. This is a similar procedure to intersecting land uses with soil types to determine runoff coefficients or runoff curve numbers for hydrologic studies, but there are three categories to consider for the GLU analysis (slope, geology, and land cover), and the GLUs are not to be composited into a single GLU. When GLUs have been created, determine whether any of the GLUs listed in Table H.6-3 are found within the project boundary. The GLUs listed in Table H.6-3 are considered to be PCCSYAs.

If none of the GLUs listed in Table H.6-3 are present within the project boundary and area draining through the project boundary, no measures for protection of critical coarse sediment yield areas are necessary. If one or more GLUs listed in Table H.6-3 are present within the project boundary, they shall be considered critical coarse sediment yield areas. Complete Worksheet H.6-1 to document verification of GLUs.

Table H.6-1: Geologic Grouping for Different Map Units

Map Unit	Map Name	Anticipated Grain size of Weathered Material	Bedrock or Sedimentary	Impermeable / Permeable	Geology Grouping
gr-m	Jennings; CA	Coarse	Bedrock	Impermeable	CB
grMz	Jennings; CA	Coarse	Bedrock	Impermeable	CB
Jcr	El Cajon 30' x 60'	Coarse	Bedrock	Impermeable	CB
Jhc	El Cajon 30' x 60'	Coarse	Bedrock	Impermeable	CB
Jsp	El Cajon 30' x 60'	Coarse	Bedrock	Impermeable	CB
Ka	El Cajon 30' x 60'	Coarse	Bedrock	Impermeable	CB
Kbm	Oceanside 30' x 60'	Coarse	Bedrock	Impermeable	CB
Kbp	Oceanside 30' x 60'	Coarse	Bedrock	Impermeable	CB
Kcc	Oceanside 30' x 60'	Coarse	Bedrock	Impermeable	CB
Kcg	Oceanside 30' x 60'	Coarse	Bedrock	Impermeable	CB
Kcm	El Cajon 30' x 60'	Coarse	Bedrock	Impermeable	CB
Kcp	El Cajon 30' x 60'	Coarse	Bedrock	Impermeable	CB
Kd	San Diego & Oceanside 30' x 60'	Coarse	Bedrock	Impermeable	CB
Kdl	Oceanside 30' x 60'	Coarse	Bedrock	Impermeable	CB
Kg	Oceanside 30' x 60'	Coarse	Bedrock	Impermeable	CB
Kgbf	Oceanside 30' x 60'	Coarse	Bedrock	Impermeable	CB
Kgd	San Diego & Oceanside 30' x 60'	Coarse	Bedrock	Impermeable	CB
Kgdf	Oceanside 30' x 60'	Coarse	Bedrock	Impermeable	CB
Kgh	San Diego 30' x 60'	Coarse	Bedrock	Impermeable	CB
Kgm	El Cajon 30' x 60'	Coarse	Bedrock	Impermeable	CB
Kgm1	El Cajon 30' x 60'	Coarse	Bedrock	Impermeable	CB
Kgm2	El Cajon 30' x 60'	Coarse	Bedrock	Impermeable	CB

Appendix H: Guidance for Investigation Potential Critical Coarse Sediment Yield Areas

Map Unit	Map Name	Anticipated Grain size of Weathered Material	Bedrock or Sedimentary	Impermeable / Permeable	Geology Grouping
Kgm3	El Cajon 30' x 60'	Coarse	Bedrock	Impermeable	CB
Kgm4	El Cajon 30' x 60'	Coarse	Bedrock	Impermeable	CB
Kgp	Oceanside 30' x 60'	Coarse	Bedrock	Impermeable	CB
Kgr	El Cajon 30' x 60'	Coarse	Bedrock	Impermeable	CB
Kgu	San Diego 30' x 60'	Coarse	Bedrock	Impermeable	CB
Khg	Oceanside 30' x 60'	Coarse	Bedrock	Impermeable	CB
Ki	Oceanside 30' x 60'	Coarse	Bedrock	Impermeable	CB
Kis	Oceanside 30' x 60'	Coarse	Bedrock	Impermeable	CB
Kjd	Oceanside 30' x 60'	Coarse	Bedrock	Impermeable	CB
KJem	El Cajon 30' x 60'	Coarse	Bedrock	Impermeable	CB
KJld	El Cajon 30' x 60'	Coarse	Bedrock	Impermeable	CB
Kjv	El Cajon 30' x 60'	Coarse	Bedrock	Impermeable	CB
Klb	El Cajon 30' x 60'	Coarse	Bedrock	Impermeable	CB
Klh	Oceanside 30' x 60'	Coarse	Bedrock	Impermeable	CB
Klp	El Cajon 30' x 60'	Coarse	Bedrock	Impermeable	CB
Km	Oceanside 30' x 60'	Coarse	Bedrock	Impermeable	CB
Kmg	Oceanside 30' x 60'	Coarse	Bedrock	Impermeable	CB
Kmgrp	El Cajon 30' x 60'	Coarse	Bedrock	Impermeable	CB
Kmm	Oceanside 30' x 60'	Coarse	Bedrock	Impermeable	CB
Kpa	Oceanside 30' x 60'	Coarse	Bedrock	Impermeable	CB
Kpv	El Cajon 30' x 60'	Coarse	Bedrock	Impermeable	CB
Kqbd	Oceanside 30' x 60'	Coarse	Bedrock	Impermeable	CB
Kr	Oceanside 30' x 60'	Coarse	Bedrock	Impermeable	CB
Krm	Oceanside 30' x 60'	Coarse	Bedrock	Impermeable	CB
Krr	Oceanside 30' x 60'	Coarse	Bedrock	Impermeable	CB
Kt	San Diego & Oceanside 30' x 60'	Coarse	Bedrock	Impermeable	CB
Ktr	Oceanside 30' x 60'	Coarse	Bedrock	Impermeable	CB
Kvc	Oceanside 30' x 60'	Coarse	Bedrock	Impermeable	CB
Kwm	Oceanside 30' x 60'	Coarse	Bedrock	Impermeable	CB
Kwp	Oceanside 30' x 60'	Coarse	Bedrock	Impermeable	CB
Kwsr	Oceanside 30' x 60'	Coarse	Bedrock	Impermeable	CB
m	Jennings; CA	Coarse	Bedrock	Impermeable	CB
Mzd	Oceanside 30' x 60'	Coarse	Bedrock	Impermeable	CB
Mzg	Oceanside 30' x 60'	Coarse	Bedrock	Impermeable	CB
Mzq	Oceanside 30' x 60'	Coarse	Bedrock	Impermeable	CB
Mzs	Oceanside 30' x 60'	Coarse	Bedrock	Impermeable	CB
sch	Jennings; CA	Coarse	Bedrock	Impermeable	CB
Kp	San Diego & Oceanside 30' x 60'	Coarse	Bedrock	Impermeable	CB
Ql	El Cajon 30' x 60'	Coarse	Sedimentary	Impermeable	CSI
QTf	El Cajon 30' x 60'	Coarse	Sedimentary	Impermeable	CSI
Ec	Jennings; CA	Coarse	Sedimentary	Impermeable	CSI
K	Jennings; CA	Coarse	Sedimentary	Impermeable	CSI
Kccg	San Diego 30' x 60'	Coarse	Sedimentary	Impermeable	CSI
Kcs	San Diego 30' x 60'	Coarse	Sedimentary	Impermeable	CSI

Appendix H: Guidance for Investigation Potential Critical Coarse Sediment Yield Areas

Map Unit	Map Name	Anticipated Grain size of Weathered Material	Bedrock or Sedimentary	Impermeable / Permeable	Geology Grouping
Kl	San Diego, Oceanside & El Cajon 30' x 60'	Coarse	Sedimentary	Impermeable	CSI
Ku	Jennings; CA	Coarse	Sedimentary	Impermeable	CSI
Qvof	Oceanside 30' x 60'	Coarse	Sedimentary	Impermeable	CSI
Qvop8a	San Diego 30' x 60'	Coarse	Sedimentary	Impermeable	CSI
Qvop9a	San Diego 30' x 60'	Coarse	Sedimentary	Impermeable	CSI
Tmsc	San Diego 30' x 60'	Coarse	Sedimentary	Impermeable	CSI
Tmss	San Diego 30' x 60'	Coarse	Sedimentary	Impermeable	CSI
Tp	San Diego & El Cajon 30' x 60'	Coarse	Sedimentary	Impermeable	CSI
Tpm	San Diego 30' x 60'	Coarse	Sedimentary	Impermeable	CSI
Tsc	San Diego 30' x 60'	Coarse	Sedimentary	Impermeable	CSI
Tscu	San Diego 30' x 60'	Coarse	Sedimentary	Impermeable	CSI
Tsd	San Diego & El Cajon 30' x 60'	Coarse	Sedimentary	Impermeable	CSI
Tsdcg	San Diego 30' x 60'	Coarse	Sedimentary	Impermeable	CSI
Tsdss	San Diego 30' x 60'	Coarse	Sedimentary	Impermeable	CSI
Tsm	Oceanside 30' x 60'	Coarse	Sedimentary	Impermeable	CSI
Tso	Oceanside 30' x 60'	Coarse	Sedimentary	Impermeable	CSI
Tst	San Diego, Oceanside & El Cajon 30' x 60'	Coarse	Sedimentary	Impermeable	CSI
Tt	San Diego & Oceanside 30' x 60'	Coarse	Sedimentary	Impermeable	CSI
Tta	Oceanside 30' x 60'	Coarse	Sedimentary	Impermeable	CSI
Tmv	San Diego, Oceanside & El Cajon 30' x 60'	Coarse	Sedimentary	Impermeable	CSI
Tsi	Oceanside 30' x 60'	Coarse	Sedimentary	Impermeable	CSI
Qvoa	San Diego & Oceanside 30' x 60'	Coarse	Sedimentary	Impermeable	CSI
Qvoa11	Oceanside 30' x 60'	Coarse	Sedimentary	Impermeable	CSI
Qvoa12	Oceanside 30' x 60'	Coarse	Sedimentary	Impermeable	CSI
Qvoa13	Oceanside 30' x 60'	Coarse	Sedimentary	Impermeable	CSI
Qvoc	Oceanside 30' x 60'	Coarse	Sedimentary	Impermeable	CSI
Qvop	San Diego & Oceanside 30' x 60'	Coarse	Sedimentary	Impermeable	CSI
Qvop1	San Diego & Oceanside 30' x 60'	Coarse	Sedimentary	Impermeable	CSI
Qvop10	San Diego & Oceanside 30' x 60'	Coarse	Sedimentary	Impermeable	CSI
Qvop10a	San Diego 30' x 60'	Coarse	Sedimentary	Impermeable	CSI
Qvop11	San Diego & Oceanside 30' x 60'	Coarse	Sedimentary	Impermeable	CSI
Qvop11a	San Diego 30' x 60'	Coarse	Sedimentary	Impermeable	CSI

Appendix H: Guidance for Investigation Potential Critical Coarse Sediment Yield Areas

Map Unit	Map Name	Anticipated Grain size of Weathered Material	Bedrock or Sedimentary	Impermeable / Permeable	Geology Grouping
Qvop12	San Diego & Oceanside 30' x 60'	Coarse	Sedimentary	Impermeable	CSI
Qvop13	San Diego & Oceanside 30' x 60'	Coarse	Sedimentary	Impermeable	CSI
Qvop2	San Diego & Oceanside 30' x 60'	Coarse	Sedimentary	Impermeable	CSI
Qvop3	San Diego & Oceanside 30' x 60'	Coarse	Sedimentary	Impermeable	CSI
Qvop4	San Diego & Oceanside 30' x 60'	Coarse	Sedimentary	Impermeable	CSI
Qvop5	San Diego & Oceanside 30' x 60'	Coarse	Sedimentary	Impermeable	CSI
Qvop6	San Diego 30' x 60'	Coarse	Sedimentary	Impermeable	CSI
Qvop7	San Diego & Oceanside 30' x 60'	Coarse	Sedimentary	Impermeable	CSI
Qvop8	San Diego & Oceanside 30' x 60'	Coarse	Sedimentary	Impermeable	CSI
Qvop9	San Diego 30' x 60'	Coarse	Sedimentary	Impermeable	CSI
Tsa	Oceanside 30' x 60'	Coarse	Sedimentary	Impermeable	CSI
Qof	Oceanside 30' x 60'	Coarse	Sedimentary	Permeable	CSP
Qof1	Oceanside 30' x 60'	Coarse	Sedimentary	Permeable	CSP
Qof2	Oceanside 30' x 60'	Coarse	Sedimentary	Permeable	CSP
Q	Jennings; CA	Coarse	Sedimentary	Permeable	CSP
Qa	Oceanside 30' x 60'	Coarse	Sedimentary	Permeable	CSP
Qd	Oceanside 30' x 60'	Coarse	Sedimentary	Permeable	CSP
Qf	Oceanside 30' x 60'	Coarse	Sedimentary	Permeable	CSP
Qmb	San Diego & Oceanside 30' x 60'	Coarse	Sedimentary	Permeable	CSP
Qop	San Diego & Oceanside 30' x 60'	Coarse	Sedimentary	Permeable	CSP
Qw	San Diego & Oceanside 30' x 60'	Coarse	Sedimentary	Permeable	CSP
Qyf	Oceanside 30' x 60'	Coarse	Sedimentary	Permeable	CSP
Qt	El Cajon 30' x 60'	Coarse	Sedimentary	Permeable	CSP
Qoa1-2	Oceanside 30' x 60'	Coarse	Sedimentary	Permeable	CSP
Qoa2-6	Oceanside 30' x 60'	Coarse	Sedimentary	Permeable	CSP
Qoa5	Oceanside 30' x 60'	Coarse	Sedimentary	Permeable	CSP
Qoa6	Oceanside 30' x 60'	Coarse	Sedimentary	Permeable	CSP
Qoa7	Oceanside 30' x 60'	Coarse	Sedimentary	Permeable	CSP
Qoc	Oceanside 30' x 60'	Coarse	Sedimentary	Permeable	CSP
Qop1	Oceanside 30' x 60'	Coarse	Sedimentary	Permeable	CSP
Qc	El Cajon 30' x 60'	Coarse	Sedimentary	Permeable	CSP
Qu	El Cajon 30' x 60'	Coarse	Sedimentary	Permeable	CSP
Qoa	San Diego, Oceanside & El Cajon 30' x 60'	Coarse	Sedimentary	Permeable	CSP
Qop2-4	San Diego 30' x 60'	Coarse	Sedimentary	Permeable	CSP

Appendix H: Guidance for Investigation Potential Critical Coarse Sediment Yield Areas

Map Unit	Map Name	Anticipated Grain size of Weathered Material	Bedrock or Sedimentary	Impermeable / Permeable	Geology Grouping
Qop3	Oceanside 30' x 60'	Coarse	Sedimentary	Permeable	CSP
Qop4	Oceanside 30' x 60'	Coarse	Sedimentary	Permeable	CSP
Qop6	San Diego & Oceanside 30' x 60'	Coarse	Sedimentary	Permeable	CSP
Qop7	San Diego & Oceanside 30' x 60'	Coarse	Sedimentary	Permeable	CSP
Qya	San Diego, Oceanside & El Cajon 30' x 60'	Coarse	Sedimentary	Permeable	CSP
Qyc	San Diego & Oceanside 30' x 60'	Coarse	Sedimentary	Permeable	CSP
Mzu	San Diego & Oceanside 30' x 60'	Fine	Bedrock	Impermeable	FB
gb	Jennings; CA	Fine	Bedrock	Impermeable	FB
JTRm	El Cajon 30' x 60'	Fine	Bedrock	Impermeable	FB
Kat	Oceanside 30' x 60'	Fine	Bedrock	Impermeable	FB
Kc	El Cajon 30' x 60'	Fine	Bedrock	Impermeable	FB
Kgb	Oceanside 30' x 60'	Fine	Bedrock	Impermeable	FB
Kjvs	El Cajon 30' x 60'	Fine	Bedrock	Impermeable	FB
Kmv	El Cajon 30' x 60'	Fine	Bedrock	Impermeable	FB
Ksp	El Cajon 30' x 60'	Fine	Bedrock	Impermeable	FB
Kvsp	Oceanside 30' x 60'	Fine	Bedrock	Impermeable	FB
Kwmt	Oceanside 30' x 60'	Fine	Bedrock	Impermeable	FB
Qv	Jennings; CA	Fine	Bedrock	Impermeable	FB
Tba	San Diego 30' x 60'	Fine	Bedrock	Impermeable	FB
Tda	Oceanside 30' x 60'	Fine	Bedrock	Impermeable	FB
Tv	Oceanside 30' x 60'	Fine	Bedrock	Impermeable	FB
Tvsr	Oceanside 30' x 60'	Fine	Bedrock	Impermeable	FB
Kgdfg	Oceanside 30' x 60'	Fine	Bedrock	Impermeable	FB
Ta	San Diego 30' x 60'	Fine	Sedimentary	Impermeable	FSI
Tcs	Oceanside 30' x 60'	Fine	Sedimentary	Impermeable	FSI
Td	San Diego & Oceanside 30' x 60'	Fine	Sedimentary	Impermeable	FSI
Td+Tf	San Diego 30' x 60'	Fine	Sedimentary	Impermeable	FSI
Qls	San Diego, Oceanside & El Cajon 30' x 60'	Fine	Sedimentary	Impermeable	FSI
Tm	Oceanside 30' x 60'	Fine	Sedimentary	Impermeable	FSI
Tf	San Diego, Oceanside & El Cajon 30' x 60'	Fine	Sedimentary	Impermeable	FSI
Tfr	El Cajon 30' x 60'	Fine	Sedimentary	Impermeable	FSI
To	San Diego & El Cajon 30' x 60'	Fine	Sedimentary	Impermeable	FSI
Qpe	San Diego & Oceanside 30' x 60'	Fine	Sedimentary	Permeable	FSP
Mexico	San Diego 30' x 60'	NA	NA	Permeable	Other

Appendix H: Guidance for Investigation Potential Critical Coarse Sediment Yield Areas

Map Unit	Map Name	Anticipated Grain size of Weathered Material	Bedrock or Sedimentary	Impermeable / Permeable	Geology Grouping
Kuo	San Diego 30' x 60'	NA (Offshore)	NA	Permeable	Other
Teo	San Diego & Oceanside 30' x 60'	NA (Offshore)	Sedimentary	Permeable	Other
Tmo	Oceanside 30' x 60'	NA (Offshore)	Sedimentary	Permeable	Other
Qmo	San Diego 30' x 60'	NA (Offshore)	Sedimentary	Permeable	Other
QTso	San Diego 30' x 60'	NA (Offshore)	Sedimentary	Permeable	Other
af	San Diego & Oceanside 30' x 60'	Variable, dependent on source material	Sedimentary		Other

Table H.6-2: Land Cover Grouping for SanGIS Ecology-Vegetation Data Set

Id	SanGIS Legend	SanGIS Grouping	Land Cover Grouping
1	42000 Valley and Foothill Grassland	Grasslands, Vernal Pools, Meadows, and Other Herb Communities	Agricultural/Grass
2	42100 Native Grassland		Agricultural/Grass
3	42110 Valley Needlegrass Grassland		Agricultural/Grass
4	42120 Valley Sacaton Grassland		Agricultural/Grass
5	42200 Non-Native Grassland	Grasslands, Vernal Pools, Meadows, and Other Herb Communities	Agriculture/Grass
6	42300 Wildflower Field		Agriculture/Grass
7	42400 Foothill/Mountain Perennial Grassland		Agriculture/Grass
8	42470 Transmontane Dropseed Grassland		Agriculture/Grass
9	45000 Meadow and Seep		Agriculture/Grass
10	45100 Montane Meadow		Agriculture/Grass
11	45110 Wet Montane Meadow		Agriculture/Grass
12	45120 Dry Montane Meadows		Agriculture/Grass
13	45300 Alkali Meadows and Seeps		Agriculture/Grass
14	45320 Alkali Seep		Agriculture/Grass
15	45400 Freshwater Seep		Agriculture/Grass
16	46000 Alkali Playa Community		Agriculture/Grass
17	46100 Badlands/Mudhill Forbs		Agriculture/Grass
18	Non-Native Grassland		Agriculture/Grass
19	18000 General Agriculture	Non-Native Vegetation, Developed Areas, or Unvegetated Habitat	Agriculture/Grass
20	18100 Orchards and Vineyards		Agriculture/Grass
21	18200 Intensive Agriculture		Agriculture/Grass
22	18200 Intensive Agriculture - Dairies, Nurseries, Chicken Ranches		Agriculture/Grass
23	18300 Extensive Agriculture - Field/Pasture, Row Crops		Agriculture/Grass
24	18310 Field/Pasture		Agriculture/Grass
25	18310 Pasture		Agriculture/Grass
26	18320 Row Crops		Agriculture/Grass
27	12000 Urban/Developed		Developed
28	12000 Urban/Develpped	Developed	
29	81100 Mixed Evergreen Forest	Forest	Forest
30	81300 Oak Forest		Forest
31	81310 Coast Live Oak Forest		Forest
32	81320 Canyon Live Oak Forest		Forest

Appendix H: Guidance for Investigation Potential Critical Coarse Sediment Yield Areas

Id	SanGIS Legend	SanGIS Grouping	Land Cover Grouping
33	81340 Black Oak Forest		Forest
34	83140 Torrey Pine Forest		Forest
35	83230 Southern Interior Cypress Forest		Forest
36	84000 Lower Montane Coniferous Forest		Forest
37	84100 Coast Range, Klamath and Peninsular Coniferous Forest		Forest
38	84140 Coulter Pine Forest	Forest	Forest
39	84150 Bigcone Spruce (Bigcone Douglas Fir)-Canyon Oak Forest		Forest
40	84230 Sierran Mixed Coniferous Forest		Forest
41	84500 Mixed Oak/Coniferous/Bigcone/Coulter		Forest
42	85100 Jeffrey Pine Forest		Forest
43	11100 Eucalyptus Woodland	Non-Native Vegetation, Developed Areas, or Unvegetated Habitat	Forest
44	60000 RIPARIAN AND BOTTOMLAND HABITAT	Riparian and Bottomland Habitat	Forest
45	61000 Riparian Forests		Forest
46	61300 Southern Riparian Forest		Forest
47	61310 Southern Coast Live Oak Riparian Forest		Forest
48	61320 Southern Arroyo Willow Riparian Forest		Forest
49	61330 Southern Cottonwood-willow Riparian Forest		Forest
50	61510 White Alder Riparian Forest		Forest
51	61810 Sonoran Cottonwood-willow Riparian Forest		Forest
52	61820 Mesquite Bosque		Forest
53	62000 Riparian Woodlands		Forest
54	62200 Desert Dry Wash Woodland		Forest
55	62300 Desert Fan Palm Oasis Woodland		Forest
56	62400 Southern Sycamore-alder Riparian Woodland	Forest	
57	70000 WOODLAND	Woodland	Forest
58	71000 Cismontane Woodland		Forest
59	71100 Oak Woodland		Forest
60	71120 Black Oak Woodland		Forest
61	71160 Coast Live Oak Woodland		Forest
62	71161 Open Coast Live Oak Woodland		Forest
63	71162 Dense Coast Live Oak Woodland		Forest
64	71162 Dense Coast Love Oak Woodland		Forest
65	71180 Engelmann Oak Woodland	Woodland	Forest
66	71181 Open Engelmann Oak Woodland		Forest
67	71182 Dense Engelmann Oak Woodland		Forest
68	72300 Peninsular Pinon and Juniper Woodlands		Forest
69	72310 Peninsular Pinon Woodland		Forest

Appendix H: Guidance for Investigation Potential Critical Coarse Sediment Yield Areas

Id	SanGIS Legend	SanGIS Grouping	Land Cover Grouping	
70	72320 Peninsular Juniper Woodland and Scrub		Forest	
71	75100 Elephant Tree Woodland		Forest	
72	77000 Mixed Oak Woodland		Forest	
73	78000 Undifferentiated Open Woodland		Forest	
74	79000 Undifferentiated Dense Woodland		Forest	
75	Engelmann Oak Woodland		Forest	
76	52120 Southern Coastal Salt Marsh	Bog and Marsh	Other	
77	52300 Alkali Marsh		Other	
78	52310 Cismontane Alkali Marsh		Other	
79	52400 Freshwater Marsh		Other	
80	52410 Coastal and Valley Freshwater Marsh		Other	
81	52420 Transmontane Freshwater Marsh		Other	
82	52440 Emergent Wetland	Grasslands, Vernal Pools, Meadows, and Other Herb Communities	Other	
83	44000 Vernal Pool		Other	
84	44320 San Diego Mesa Vernal Pool		Other	
85	44322 San Diego Mesa Claypan Vernal Pool (southern mesas)	Non-Native Vegetation, Developed Areas, or Unvegetated Habitat	Other	
86	13100 Open Water		Other	
87	13110 Marine		Other	
88	13111 Subtidal		Other	
89	13112 Intertidal		Other	
90	13121 Deep Bay		Other	
91	13122 Intermediate Bay		Other	
92	13123 Shallow Bay		Other	
93	13130 Estuarine		Other	
94	13131 Subtidal		Other	
95	13133 Brackishwater		Other	
96	13140 Freshwater		Non-Native Vegetation, Developed Areas, or Unvegetated Habitat	Other
97	13200 Non-Vegetated Channel, Floodway, Lakeshore Fringe			Other
98	13300 Saltpan/Mudflats	Other		
99	13400 Beach	Dune Community	Other	
100	21230 Southern Foredunes		Scrub/Shrub	
101	22100 Active Desert Dunes		Scrub/Shrub	
102	22300 Stabilized and Partially-Stabilized Desert Sand Field		Scrub/Shrub	
103	24000 Stabilized Alkaline Dunes		Scrub/Shrub	
104	29000 ACACIA SCRUB		Scrub/Shrub	
105	63000 Riparian Scrubs	Riparian and Bottomland Habitat	Scrub/Shrub	
106	63300 Southern Riparian Scrub		Scrub/Shrub	
107	63310 Mule Fat Scrub		Scrub/Shrub	
108	63310 Mulefat Scrub		Scrub/Shrub	
109	63320 Southern Willow Scrub		Scrub/Shrub	
110	63321 Arundo donnax Dominant/Southern Willow Scrub		Scrub/Shrub	
111	63330 Southern Riparian Scrub		Scrub/Shrub	
112	63400 Great Valley Scrub		Scrub/Shrub	
113	63410 Great Valley Willow Scrub	Scrub/Shrub		

Appendix H: Guidance for Investigation Potential Critical Coarse Sediment Yield Areas

Id	SanGIS Legend	SanGIS Grouping	Land Cover Grouping
114	63800 Colorado Riparian Scrub	Scrub and Chaparral	Scrub/Shrub
115	63810 Tamarisk Scrub		Scrub/Shrub
116	63820 Arrowweed Scrub		Scrub/Shrub
117	31200 Southern Coastal Bluff Scrub		Scrub/Shrub
118	32000 Coastal Scrub		Scrub/Shrub
119	32400 Maritime Succulent Scrub		Scrub/Shrub
120	32500 Diegan Coastal Sage Scrub		Scrub/Shrub
121	32510 Coastal form		Scrub/Shrub
122	32520 Inland form (> 1,000 ft. elevation)		Scrub/Shrub
123	32700 Riversidian Sage Scrub		Scrub/Shrub
124	32710 Riversidian Upland Sage Scrub		Scrub/Shrub
125	32720 Alluvial Fan Scrub		Scrub/Shrub
126	33000 Sonoran Desert Scrub		Scrub/Shrub
127	33100 Sonoran Creosote Bush Scrub		Scrub/Shrub
128	33200 Sonoran Desert Mixed Scrub		Scrub/Shrub
129	33210 Sonoran Mixed Woody Scrub		Scrub/Shrub
130	33220 Sonoran Mixed Woody and Succulent Scrub	Scrub and Chaparral	Scrub/Shrub
131	33230 Sonoran Wash Scrub		Scrub/Shrub
132	33300 Colorado Desert Wash Scrub		Scrub/Shrub
133	33600 Encelia Scrub		Scrub/Shrub
134	34000 Mojavean Desert Scrub		Scrub/Shrub
135	34300 Blackbush Scrub		Scrub/Shrub
136	35000 Great Basin Scrub		Scrub/Shrub
137	35200 Sagebrush Scrub		Scrub/Shrub
138	35210 Big Sagebrush Scrub		Scrub/Shrub
139	35210 Sagebrush Scrub		Scrub/Shrub
140	36110 Desert Saltbush Scrub		Scrub/Shrub
141	36120 Desert Sink Scrub		Scrub/Shrub
142	37000 Chaparral		Scrub/Shrub
143	37120 Southern Mixed Chaparral		Scrub/Shrub
144	37120 Southern Mixed Chapparal		Scrub/Shrub
145	37121 Granitic Southern Mixed Chaparral		Scrub/Shrub
146	37121 Southern Mixed Chaparral		Scrub/Shrub
147	37122 Mafic Southern Mixed Chaparral		Scrub/Shrub
148	37130 Northern Mixed Chaparral		Scrub/Shrub
149	37131 Granitic Northern Mixed Chaparral		Scrub/Shrub
150	37132 Mafic Northern Mixed Chaparral		Scrub/Shrub
151	37200 Chamise Chaparral		Scrub/Shrub
152	37210 Granitic Chamise Chaparral		Scrub/Shrub
153	37220 Mafic Chamise Chaparral		Scrub/Shrub
154	37300 Red Shank Chaparral		Scrub/Shrub
155	37400 Semi-Desert Chaparral		Scrub/Shrub
156	37500 Montane Chaparral		Scrub/Shrub
157	37510 Mixed Montane Chaparral		Scrub/Shrub
158	37520 Montane Manzanita Chaparral		Scrub/Shrub
159	37530 Montane Ceanothus Chaparral		Scrub/Shrub
160	37540 Montane Scrub Oak Chaparral		Scrub/Shrub
161	37800 Upper Sonoran Ceanothus Chaparral		Scrub/Shrub

Appendix H: Guidance for Investigation Potential Critical Coarse Sediment Yield Areas

Id	SanGIS Legend	SanGIS Grouping	Land Cover Grouping
162	37830 Ceanothus crassifolius Chaparral	Scrub and Chaparral	Scrub/Shrub
163	37900 Scrub Oak Chaparral		Scrub/Shrub
164	37A00 Interior Live Oak Chaparral		Scrub/Shrub
165	37C30 Southern Maritime Chaparral		Scrub/Shrub
166	37G00 Coastal Sage-Chaparral Scrub		Scrub/Shrub
167	37K00 Flat-topped Buckwheat		Scrub/Shrub
168	39000 Upper Sonoran Subshrub Scrub		Scrub/Shrub
169	Diegan Coastal Sage Scrub		Scrub/Shrub
170	Granitic Northern Mixed Chaparral		Scrub/Shrub
171	Southern Mixed Chaparral		Scrub/Shrub
172	11000 Non-Native Vegetation	Non-Native Vegetation, Developed Areas, or Unvegetated Habitat	Unknown
173	11000 Non-Native VegetationVegetation		Unknown
174	11200 Disturbed Wetland		Unknown
175	11300 Disturbed Habitat		Unknown
176	13000 Unvegetated Habitat		Unknown
177	Disturbed Habitat		Unknown

Table H.6-3: Potential Critical Coarse Sediment Yield Areas

GLU	Geology	Land Cover	Slope (%)
CB-Agricultural/Grass-3	Coarse Bedrock	Agricultural/Grass	20% - 40%
CB-Agricultural/Grass-4	Coarse Bedrock	Agricultural/Grass	>40%
CB-Forest-2	Coarse Bedrock	Forest	10 – 20%
CB-Forest-3	Coarse Bedrock	Forest	20% - 40%
CB-Forest-4	Coarse Bedrock	Forest	>40%
CB-Scrub/Shrub-4	Coarse Bedrock	Scrub/Shrub	>40%
CB-Unknown-4	Coarse Bedrock	Unknown	>40%
CSI-Agricultural/Grass-2	Coarse Sedimentary Impermeable	Agricultural/Grass	10 – 20%
CSI-Agricultural/Grass-3	Coarse Sedimentary Impermeable	Agricultural/Grass	20% - 40%
CSI-Agricultural/Grass-4	Coarse Sedimentary Impermeable	Agricultural/Grass	>40%
CSP-Agricultural/Grass-4	Coarse Sedimentary Permeable	Agricultural/Grass	>40%
CSP-Forest-3	Coarse Sedimentary Permeable	Forest	20% - 40%
CSP-Forest-4	Coarse Sedimentary Permeable	Forest	>40%
CSP-Scrub/Shrub-4	Coarse Sedimentary Permeable	Scrub/Shrub	>40%

Appendix H: Guidance for Investigation Potential Critical Coarse Sediment Yield Areas

Worksheet H.6-1: Verification of GLUs

Verification of GLUs	Worksheet H.6-1
Detailed project-level review of GLUs may be performed to verify the presence or absence of potential critical coarse sediment yield areas within the project site and/or upstream areas. Use this form to document the evaluation of slope, geology, and land cover combined to determine the site-specific GLUs. Complete all sections of this form.	
Project Name:	
Project Tracking Number / Permit Application Number:	
1	<p>What are the pre-project slopes?</p> <p style="text-align: right;"> <input type="checkbox"/> 0% to 10% (1) <input type="checkbox"/> 10% to 20% (2) <input type="checkbox"/> 20% to 40% (3) <input type="checkbox"/> >40% (4) </p>
2	<p>What is the underlying geology? Refer to Appendix H.6 to classify geologic categories into a geology grouping.</p> <p>Note: site-specific geology may be determined in the field by a qualified geologist.</p> <p style="text-align: right;"> <input type="checkbox"/> Coarse bedrock (CB) <input type="checkbox"/> Coarse sedimentary impermeable (CSI) <input type="checkbox"/> Coarse sedimentary permeable (CSP) <input type="checkbox"/> Fine bedrock (FB) <input type="checkbox"/> Fine sedimentary impermeable (FSI) <input type="checkbox"/> Fine sedimentary permeable (FSP) <input type="checkbox"/> Other (O) </p>
3	<p>What is the pre-project land cover? Refer to Appendix H.6 for land cover category definitions.</p> <p>Note: Land cover shall be determined from aerial photography and/or field visit.</p> <p style="text-align: right;"> <input type="checkbox"/> Agriculture/grass <input type="checkbox"/> Forest <input type="checkbox"/> Developed <input type="checkbox"/> Scrub/shrub <input type="checkbox"/> Other <input type="checkbox"/> Unknown </p>
4	<p>List the GLU(s) within the project site and/or upstream areas.</p> <p>Note the GLU nomenclature format is as follows: Geology – Land Cover – Slope Category (e.g. “CB-Agricultural/Grass-3” for a GLU consisting of coarse bedrock geology, agricultural/grass land cover, and 20% to 40% slope).</p>

Appendix H: Guidance for Investigation Potential Critical Coarse Sediment Yield Areas

Worksheet H.6-1; Page 2 of 2		
5	Photo(s) Insert photos representative of the slopes, land cover, and geology.	
6	Are any of the GLUs found within the project boundary and/or upstream areas listed in Table H.6-3?	<input type="checkbox"/> Yes Go to 7 <input type="checkbox"/> No Go to 8
7	End – Provide management measures for preservation of coarse sediment supply as described in this guidance document, or the project applicant may elect to determine whether downstream systems would be sensitive to reduction of coarse sediment yield from the project site and/or perform site-specific method for mapping critical coarse sediment yield areas.	
8	End – Site-specific GLUs do not warrant preservation of coarse sediment supply, no measures for protection of critical coarse sediment yield areas onsite are necessary. Optional: use the note section below to provide justification for these findings.	
9	Notes	

H.6.2 Assumptions for Regional WMAA PCCSYA Maps

This appendix summarizes the assumptions used while developing Regional WMAA PCCSYA maps that are not discussed in Appendix H.6.1:

- Critical coarse sediment would be generated from GLUs that are
 - composed of geologic units likely to generate coarse sediment (i.e. produces greater than 50% sand (0.074 mm; no. 200 sieve) by weight when weathered); and
 - have a potential for high relative sediment production (GLUs that produce soil loss greater than 8.4 tons/acre/year are assigned a high relative rating, this corresponds to 42% of the total coarse soil loss from the MS4-permitted region within the County of San Diego)
- Relative sediment production was assigned using RUSLE analysis of GLUs. It was assumed that this relative rating represents sediment production from sheet erosion, rill erosion, gullies and lower order channels, since these features are mostly on the hillslopes that are represented by the GLUs.
 - While performing the RUSLE analysis to assign the relative ranking, C factor from the regional maps from USEPA was adjusted to 0 for developed land covers to account for management actions implemented on developed sites (e.g. impervious surfaces).
- WMAA mapping does not account for sediment production from in-stream sediment supply (since these are mostly protected through other regulations) and sediment production from mass failures like landslides which are difficult to estimate on a regional scale without performing extensive field investigations.
- Regional WMAA map assumes that all receiving waters require coarse sediment and the map also does not account for potential existing impediments that may hinder delivery of coarse sediment to receiving waters.

For additional details refer to the Regional WMAA document on the Project Clean Water website at the following address:

http://www.projectcleanwater.org/index.php?option=com_content&view=article&id=248&Itemid=219

H.6.3 Encroachment Allowance for Regional PCCSYA WMAA Map

When an applicant uses the regional PCCSYA map from WMAA to define onsite CCSYAs an encroachment allowance of up to 5% is allowed.

The following provides the supporting rationale for 5% encroachment:

- Step 1. Sp has to be greater than 0.5, based on current understanding of risks to receiving waters arising from changes in sediment production (SCCWRP Technical Report 605, 2010).
- Step 2. Estimated Sp (Equation H.8-11) = $0.7*SY_{RUSLE} + 0.3*SY_{NHD} = 0.7*0.42 + 0.3*1 = 0.59$
 - a. Based on RUSLE analysis conducted during Regional WMAA the GLUs mapped as PCCSYAs contribute 42% of the bed sediment yield (i.e. $SY_{RUSLE} = 0.42$)
 - b. Disturbance to NHDPlus channels are protected through 401 water quality certifications issued by the RWQCB, so it is assumed that $SY_{NHD} = 1$
- Step 3. Dividing the Sp estimate from Step 2 by the required Sp in Step 1 provides the factor of safety that is currently implicit in the regional WMAA PCCSYA map = $0.59/0.5 = 1.18$ or 18% factor of safety
- Step 4. The remaining factor of safety after accounting for the proposed encroachment of 5% = $18\% - 5\% = 13\%$

H.7 PCCSYAs: Refinement Options

If an applicant has identified onsite and/or upstream PCCSYAs and elects to perform additional optional analyses to refine the PCCSYA designation, the guidance presented below should be followed. Protection of critical coarse sediment yield areas is a necessary element of hydromodification management because coarse sediment supply is as much an issue for causing erosive conditions to receiving streams as are accelerated flows. However, not all downstream systems warrant preservation of coarse sediment supply nor all source areas need to be protected. The following guidance shall be used to refine PCCSYA designations:

- Depositional Analysis (Appendix H.7.1)
- Threshold Channel Analysis (Appendix H.7.2)
- Coarse Sediment Source Area Verification (Appendix H.7.3)

H.7.1 Depositional Analysis

Areas identified as PCCSYAs may be removed from consideration if it is demonstrated that these sources are deposited into existing systems prior to reaching the first downstream unlined water of the state. Systems resulting in deposition may include existing natural sinks, existing structural BMPs, existing hardened MS4 systems, or other existing similar features. Applicants electing to perform depositional analysis to refine PCCSYA mapping must meet the following criteria to qualify for exemption from CCSYA designation:

- The existing hardened MS4 system that is being analyzed should be upstream of the first downstream unlined waters of the state; and
- The peak velocity from the discrete 2-year, 24-hour runoff event for the existing hardened MS4 system that is being analyzed is less than three feet per second.

The three feet per second criteria is consistent with the recommended minimum velocity for storm and sanitary sewers in ASCE Manual of Engineering Practice No. 37 (ASCE, 1970).

In limited scenarios, applicant may have the option to establish site specific minimum self-cleansing velocity using Equation H.7-1 or other appropriate equations instead of using the default three feet per second criteria. This site specific analysis must be documented in the SWQMP and the County has the discretion to request additional analysis prior to approving a site specific minimum self-cleansing velocity. If an applicant chooses to establish a site specific minimum self-cleansing velocity for refinement, then the applicant must design any new bypass hardened conveyance systems proposed by the project to meet the site specific criteria.

Appendix H: Guidance for Investigation Potential Critical Coarse Sediment Yield Areas

Equation H.7-1: Minimum Self Cleansing Velocity

$$V = \frac{1.486}{n} R^{1/6} [B(s_g - 1)D_g]^{1/2}$$

Where:

V = minimum self-cleansing velocity (ft/sec)

R = hydraulic radius (ft)

n = Manning's roughness coefficient (unitless)

B = constant equal to 0.04 for clean granular particles (unitless)

s_g = specific gravity of sediment particle (unitless): **Use 2.65**

D_g = sediment particle diameter (inches): **Use 0.20 in**

H.7.2 Threshold Channel Analysis

A threshold channel is a stream channel in which channel boundary material has no significant movement during the design flow. If there is no movement of bed load in the stream channel, then it is not anticipated that reductions in sediment supply will be detrimental to stream stability because the channel bed consists of the parent material and not coarse sediment supplied from upstream. In such a situation, changes in sediment supply are not considered a geomorphic condition of concern. SCCWRP Technical Report 562 (2008) states the following in regards to sand vs. gravel bed behavior/threshold vs. live-bed contrasts:

“Sand and gravel systems are quite varied in their transport of sediment and their sensitivity to sediment supply. On the former, sand-bed channels typically have live beds, which transport sediment continuously even at relatively low flows. Conversely, gravel/cobble-bed channels generally transport the bulk of their bed sediment load more episodically, requiring higher flow events for bed mobility (i.e., threshold behavior).”

“Sand-bed streams without vertical control are much more sensitive to perturbations in flow and sediment regimes than coarse-grain (gravel/cobble) threshold channels. This has clear implications in their respective management regarding hydromodification (i.e., sand systems being relatively more susceptible than coarser systems). This also has direct implications for the issue of sediment trapping by storm water practices in watersheds draining to sand-bed streams, as well as general loss of sediment supply following the conversion from undeveloped sparsely-vegetated to developed well-vegetated via irrigation.”

The following provides guidance for evaluating whether a stream channel is a threshold channel or not. This determination is important because while accounting for changes in bed sediment supply is appropriate for quantifying geomorphic impacts in non-threshold stream channels, it is not considered appropriate for threshold channels. The domain of analysis for this evaluation shall be the same as that used to evaluate susceptibility, per SCCWRP Technical Report 606, Field Manual for Assessing Channel Susceptibility (2010). This domain is defined by the following upstream and downstream boundaries:

- From the point of compliance proceed downstream until reaching one of the following:

Appendix H: Guidance for Investigation Potential Critical Coarse Sediment Yield Areas

- At least one reach downstream of the first grade-control point (preferably second downstream grade control location);
- Tidal backwater/lentic (still water) waterbody;
- Equal order tributary (Strahler 1952);
- A 2-fold increase in drainage area.

OR demonstrate sufficient flow attenuation through existing hydrologic modeling.

- From the point of compliance proceed upstream for 20 channel top widths OR to the first grade control in good condition, whichever comes first.

Applicant must complete Worksheet H.7-1 to document selection of the domain of analysis. If the entire domain of analysis is classified as a threshold channel, then the PDP can be exempt from the MS4 Permit requirement for sediment supply. The following definitions from the Natural Resources Conservation Service's (NRCS) National Engineering Handbook Part 654 - Stream Restoration Design (2007) are helpful in understanding what a threshold channel is.

- **Alluvial Channel:** Streams and channels that have bed and banks formed of material transported by the stream. There is an exchange of material between the inflowing sediment load and the bed and banks of an alluvial channel (NRCS, 2007).
- **Threshold Channel:** A channel in which channel boundary material has no significant movement during the design flow (NRCS, 2007).

The key factor for determining whether a channel is a threshold channel is the composition of its bed material. Larger bed sediment consisting primarily of cobbles and boulders are typically immobile, unless the channel is a large river with sufficient discharge to regularly transport such grain sizes as bed load. As a rule-of-thumb, channels with bed material that can withstand a 10-year peak discharge without incipient motion are considered threshold channels and not live-bed alluvial channels. Threshold channel beds typically consist of cobbles, boulders, bedrock, or very dense vegetation (e.g., a thicket). Threshold channels also includes channels that have existing grade control structures that protect the stream channels from hydromodification impacts.

For a project to be exempt from coarse sediment supply requirements, the applicant must submit the following for approval by the County:

- Photographic documentation and grain size analysis used to determine the d_{50} of the bed material; and
- Calculations that show that the receiving water of concern meets the specific stream power criteria defined below or a finding from a geomorphologist that the stream channel has existing grade control structures that protect the stream channel from hydromodification impacts.

Specific Stream Power

Specific (i.e., unit) stream power is the rate at which the energy of flowing water is expended on the bed and banks of a channel (refer to Equation H.7-2). SCCWRP studies have found that locating channels on a plot of Specific Stream Power at Q_{10} (as calculated by the Hawley et al. method

Appendix H: Guidance for Investigation Potential Critical Coarse Sediment Yield Areas

optimized for Southern California watersheds – Figure H.7-2) versus median channel grain size is a good predictor of channel stability. The Q_{10} equation from SCCWRP TR 606 is presented as Equation H.7-3.

Equation H.7-2: Calculation of Specific Stream Power

$$\text{Specific Stream Power} = \frac{\text{Total Stream Power}}{\text{Channel Width}} = \frac{\gamma QS}{w}$$

Where:

γ : Specific Weight of Water (9810 N/m³)

Q: Flow Rate (dominant discharge in many cases, m³/sec)

S: Slope of Channel

w: Channel Width (meters)

Equation H.7-3: Calculation of Q_{10} using the Hawley et al. method

$$Q_{10\text{cfs}} = 18.2 * A^{0.87} * P^{0.77}$$

Where:

$Q_{10\text{cfs}}$: 10 year Flow Rate in cubic feet per second

A: Drainage Area in sq. miles

P: Mean Annual Precipitation in inches

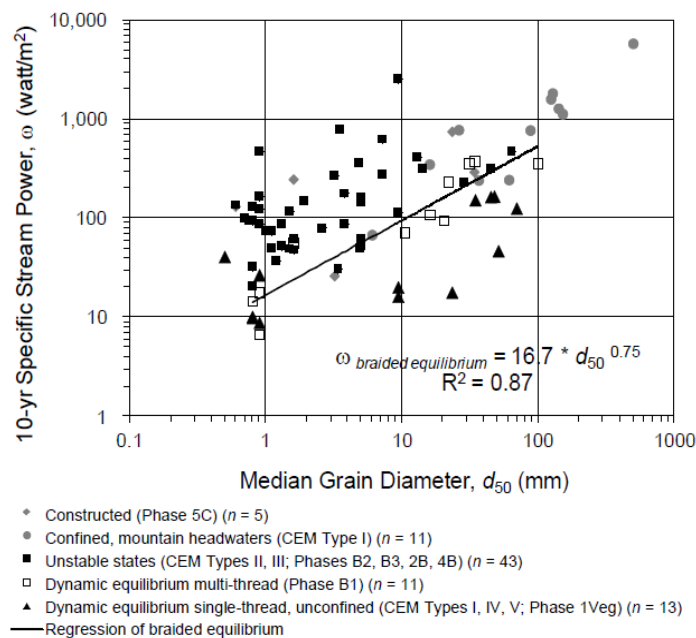

Figure H.7-1: Threshold of stream instability based on specific stream power and channel sediment diameter

Appendix H: Guidance for Investigation Potential Critical Coarse Sediment Yield Areas

Since the SCCWRP TR 606 Q_{10} (Equation H.7-3) does not explicitly consider watershed imperviousness, adjustment factors (AF) shown in Figure H.7-2 were developed using the following Equation H.7-4 for Q_{10} from SCCWRP TR 654 to account for imperviousness while estimating Q_{10} .

Equation H.7-4: Calculation of Q_{10} using equation from SCCWRP TR 654

$$Q_{10} = e^{3.61} * A^{0.865} * DD^{0.804} * P_{224}^{0.778} * IMP^{0.096}$$

Where:

Q_{10} : 10 year Flow Rate

A: Drainage Area in sq. miles

DD: Drainage Density

P_{224} : 2-Year 24-Hour Precipitation in inches

IMP: Watershed Imperviousness

Adjustment factors were developed as part of this methodology by changing the watershed imperviousness in Equation H.7-4 and keeping the remaining terms constant. Adjustment factor for imperviousness of 3.6% was set to 1; since it is the mean imperviousness of the dataset used to develop the stability curve in Figure H.7-1. Updated Q_{10} equation with adjustment factor is presented as Equation H.7-5 below:

Equation H.7-5: Calculation of Q_{10} with Adjustment Factor for Watershed Imperviousness

$$Q_{10cfs} = AF * 18.2 * A^{0.87} * P^{0.77}$$

Where:

Q_{10cfs} : 10 year Flow Rate in cubic feet per second

AF: Adjustment Factor

A: Drainage Area in sq. miles

P: Mean Annual Precipitation in inches

Appendix H: Guidance for Investigation Potential Critical Coarse Sediment Yield Areas

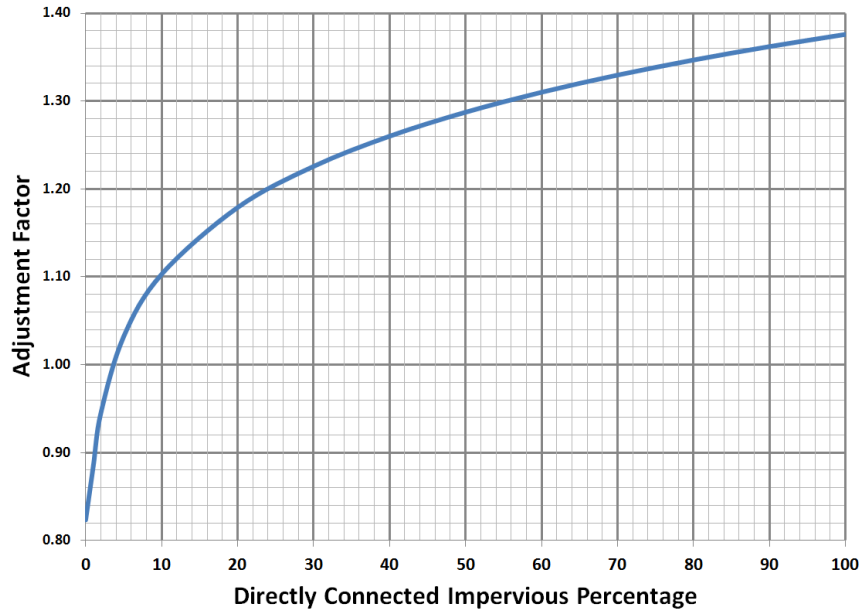

Figure H.7-2: Adjustment factor to account for imperviousness while estimating Q_{10}

Steps for evaluating the specific stream power criteria are presented below:

- **Step 1:** Calculate the specific stream power for the receiving water. Use Equation H.7-2, H.7-5 and Figure H.7-2. Directly connected imperviousness shall be estimated using guidance provided in the Water Quality Equivalency guidance document.
- **Step 2:** Determine the d_{50} of representative cross section within the domain of analysis.
- **Step 3:** Use results from Step 1 and Step 2; and Figure H.7-1 to determine if the receiving water meets the specific stream power criteria. Receiving water shall be considered meeting the specific stream power criteria when the point plotted based on results from Step 1 and Step 2 is below the solid line in Figure H.7-1.

H.7.3 Coarse Sediment Source Area Verification

When it has been determined that PCCSYAs are present, and it has been determined that downstream systems require protection, additional analysis may be performed that may refine the extents of actual CCSYAs to be protected onsite. The following analysis shall be performed to determine if the mapped PCCSYAs are a significant source of bed sediment supply to the receiving water, based on the coarse sediment proportion of the soil onsite

- Obtain a grain size distribution per ASTM D422 for the project's PCCSYA that is being evaluated.
- Identify whether the source material is a coarse grained or fine grained soil. Coarse grained is defined as over 50% by weight coarse than no. 200 sieve (i.e., $d_{50} > 0.074$ mm).
- By performing this analysis, the applicant can exclude PCCSYAs that are determined to be fine grained (i.e., $d_{50} < 0.074$ mm). Fine grained soils are not considered significant sources of bed sediment supply.
- Applicant shall include the following information in the SWQMP when this refinement option is performed:
 - Map with locations on where the grain size distribution analysis was performed;
 - Photographic documentation; and
 - Grain size distribution.
- Additional grain size distribution analysis may be requested at specific locations by the County prior to approval of this refinement.

Areas that are not expected to be a significant source of bed sediment supply (i.e. fine grained soils) to the receiving stream do not require protection and are not considered CCSYAs.

If it is determined that the PCCSYAs are producing sediment that is critical to receiving streams, or if the optional additional analysis presented above has not been performed, the project must provide management measures for protection of critical coarse sediment yield (refer to Appendix H.2, H.3 and H.4).

Appendix H: Guidance for Investigation Potential Critical Coarse Sediment Yield Areas

Worksheet H.7-1: Domain of Analysis

Domain of Analysis		Worksheet H.7-1
Use this form to document the domain of analysis		
Project Name:		
Project Tracking Number / Permit Application Number:		
Part 1: Identify Domain of Analysis		
Project Location (at proposed storm water discharge point)		
1	Address:	
2	Latitude (decimal degrees):	
3	Longitude (decimal degrees):	
4	Watershed:	
Basis for determining downstream limit:		
Channel length from discharge point to downstream limit:		
Basis for determining upstream limit:		
Channel length from discharge point to upstream limit:		

Appendix H: Guidance for Investigation Potential Critical Coarse Sediment Yield Areas

Worksheet H.7-1; Page 2 of 2

Photo(s)

Map or aerial photo of site. Include channel alignment and tributaries, project discharge point, upstream and downstream limits of analysis, ID number and boundaries of geomorphic channel units, and any other features used to determine limits (e.g. exempt water body, grade control).

H.8 Calculation Methodology for Ep and Sp

One method for quantifying hydromodification impacts to stream channels, which takes into account changes in the four factors in Lane's relationship (i.e., hydrology, channel geometry, bed and bank material, and sediment supply), is to compare long-term changes in sediment transport capacity, or in-stream work, to bed sediment supply. For the purposes of demonstrating no net impact within the MS4-permitted region of the County of San Diego, Erosion Potential (Ep) is defined as the ratio of post-project/pre-development (natural) long-term transport capacity or work. To calculate Ep, the hydrology, channel geometry, and bed/bank material factors mentioned above need to be characterized for both land use scenarios. Sediment Supply Potential (Sp) is defined as the ratio of post-project/pre-project (existing) long-term bed sediment supply. While evaluating changes in discharge and sediment supply is done primarily as a desktop analysis, geomorphic field assessment is often necessary to characterize channel geometry and bed/bank material, and to ground truth assumptions for the desktop analyses. This appendix provides methodologies for the following:

- Calculation of Ep, and
- Calculation of Sp.

H.8.1 Calculation of Ep

Erosion Potential (Ep) is defined as the ratio of post-project/pre-development (natural) long-term transport capacity or work. To calculate Ep, the hydrology, channel geometry, and bed/bank material factors mentioned above need to be characterized for both land use scenarios. Traditionally, Ep is calculated based on a watershed-scale analysis (using future built out conditions) of the area tributary to a given receiving channel of concern at the point of compliance. However, watershed-scale continuous hydrologic modeling might not be feasible for small projects, with this understanding specific simplification steps for project-scale modeling are provided in this appendix. The applicant shall perform Ep calculations using one of the following methods, as applicable:

- **Simplified Ep Method:** Applicable when the default low flow threshold of $0.1Q_2$ is used and no changes to the receiving water are proposed. Refer to Appendix H.8.1.1.
- **Standard Ep Method:** Applicable for all scenarios. Refer to Appendix H.8.1.2.

H.8.1.1 Simplified Ep Method

The simplified method is based on the relationships developed by Parra (2016) between the flow duration curve in the pre-development and post-project conditions and the standard simplified work equation. These relationships were developed using standard hydraulic equations and approximations that are applicable for channels of any lateral slope and the following geometrical cross sections: (a) wide rectangular sections; (b) relatively wide parabolic sections, and (c) triangular sections. The simplified Ep method is only applicable when the default low flow threshold of $0.1Q_2$ has been selected by the applicant for flow duration control and no changes to the receiving water geometry are proposed. Applicants shall follow Steps 1 through 3 to calculate Ep using the simplified methodology:

Appendix H: Guidance for Investigation Potential Critical Coarse Sediment Yield Areas

1. Perform continuous hydrologic simulation for the pre-development and post-project condition following guidelines in Appendix G. Generate flow bins and flow duration tables for the range of flows from $0.1Q_2$ to Q_{10} .
2. Calculate the total work in the pre-development and the post-project condition using Equation H.8-1

Equation E.8-1: Total Work (Simplified)

$$W_t = \sum_{j=1}^n \Delta t_j \cdot (Q^{3m/2} - (0.1Q_2)^{3m/2})^{1.5} Q^m$$

Where:

W_t = Total Work [dimensionless]

Δt_j = Duration per flow bin

Q = Flow Rates estimated in STEP 1 [cfs] for a typical bin “j”. Usually, in Flow Duration Curve (FDC) analyses, the number of bins is 100, so $j = 1$ to n (with $n = 100$). However, the number of bins can be as small as 20 ($n = 20$).

Q_2 = Pre-development 2-year peak flow [cfs]

m = exponent based on the function of the receiving channels geometry.

- For narrow creek where the top width is 7 times or less the corresponding depth, $m = 1/4$.
- For intermediate creeks, where the top width is more than 7 times but less than 25 times the depth, $m = 4/13$.
- For wide creeks, where the top width is more than 25 times the depth, $m = 2/5$.

3. E_p is calculated by dividing the total work of the post-project condition by that of the pre-development (natural) condition. E_p is expressed as:

Equation H.8-2: E_p (Simplified)

$$E_p = W_{t,post} / W_{t,pre}$$

Where:

E_p = Erosion Potential [unitless]

$W_{t,post}$ = Total Work associated with the post-project condition [unitless]

$W_{t,pre}$ = Total Work associated with the pre-development condition [unitless]

H.8.1.2 Standard E_p Method

While using the standard method, E_p calculation must be performed using the receiving water information from the point of compliance. Suggested steps for performing an E_p analysis are shown in the Figure H.8-1 below. This appendix describes each analysis step shown in Figure H.8-1, including the inputs and outputs of each step.

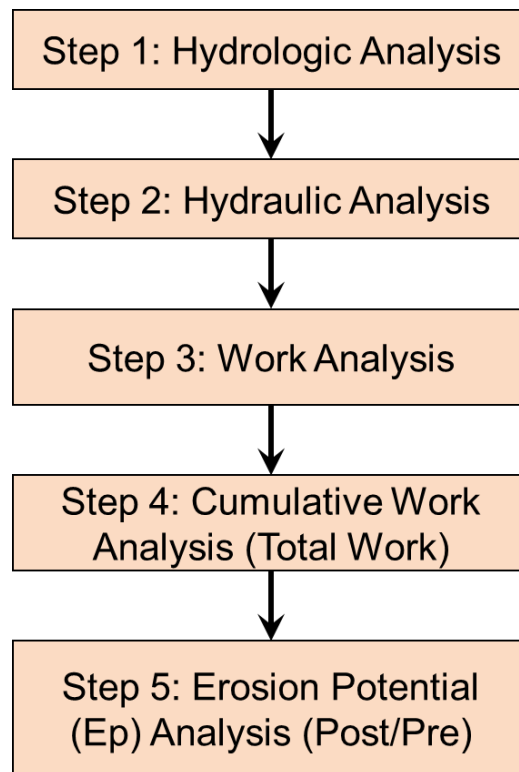

Figure H.8-1: Erosion Potential Flow Chart

STEP 1: CONTINUOUS HYDROLOGIC ANALYSIS

Hydrologic models are applied to simulate the hydrologic response of the watershed under pre-development and post-project conditions for a continuous period of record. Modeling software appropriate for this type of simulation includes USEPA’s Storm Water Management Model (SWMM), Hydrological Simulation Program – Fortran (HSPF) developed by the USGS and USEPA, USACE’s Hydrologic Modeling System (HEC-HMS), and the San Diego Hydrology Model (SDHM) developed by Clear Creek Solutions, Inc. SDHM uses an HSPF computational engine, long-term precipitation data, and is a visually-oriented interactive tool for automated modeling and facility sizing.

Input parameters for these continuous simulations are hourly precipitation data for a long-term (>30 years) record, sub-catchment delineation, impervious cover, soil type, vegetative cover, terrain steepness, lag time or flow path length, and monthly evapotranspiration rate. The primary output is a simulated discharge record associated with the receiving channel of concern. Flow routing through drainage conveyances is necessary for continuous hydrologic analysis at the watershed scale. Appendix G provides guidance for developing continuous simulation models.

Traditionally, a hydrograph (Figure H.8-2) is the primary means for graphically comparing discharge records; however, a hydrograph is not ideal because long-term flow records span several decades.

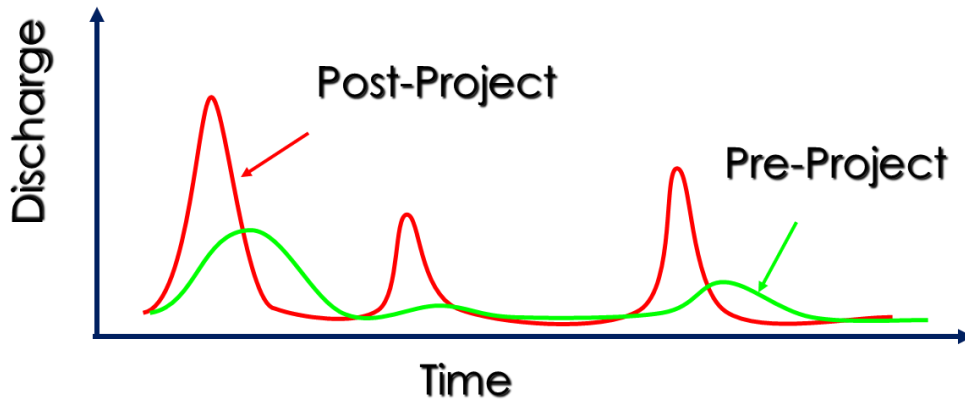

Figure H.8-2: Example Hydrograph Comparison

Instead, a more effective means for comparing long-term continuous discharge records is to create a flow histogram, which differentiates the simulated flowrates into distinct “flow bins” so that the duration of flow for each bin can be tabulated. One method for establishing the distribution of flow bins is to increment the flow bins according to increments of flow stage using a hydraulic analysis, such as the normal depth equation. In this way, the hydraulic analysis step (Step 2) can be considered an input to the continuous hydrologic analysis step. While there is no established rule of thumb for how many flow bins are necessary, it is suggested that no less than 20 be used for an Ep analysis. An example of a flow histogram is provided on Figure H.8-3.

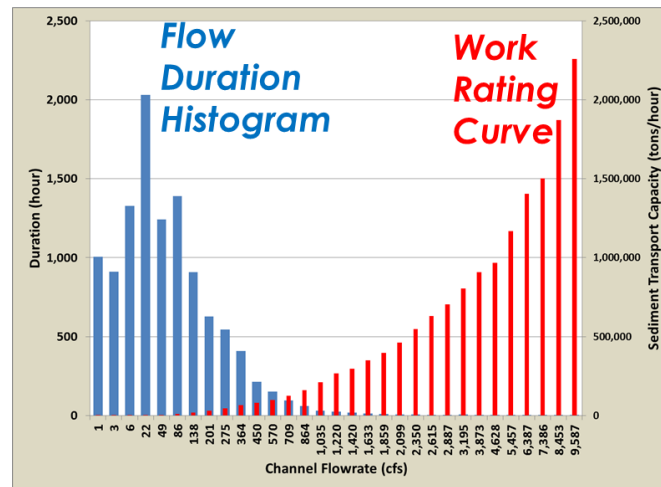

Figure H.8-3: Example Flow Duration Histogram

Flow duration curves are another commonly used method for graphically interpreting long-term flow records. A flow duration curve is simply a plot of flowrate (y-axis) versus the cumulative duration, or percentage of time, that a flowrate is equaled or exceeded in the simulation record (x-axis). Figure H.8-4 provides an example flow duration curve comparison.

Appendix H: Guidance for Investigation Potential Critical Coarse Sediment Yield Areas

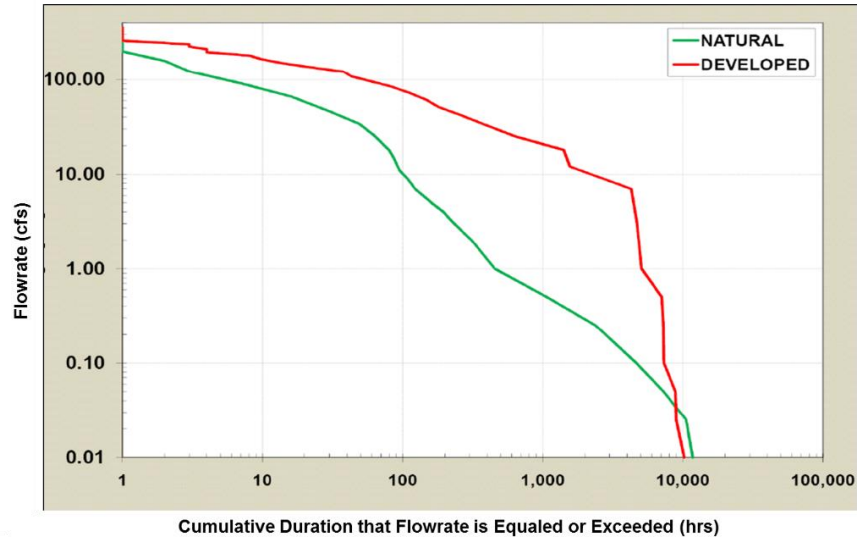

Figure H.8-4: Example Flow Duration Curve

Scaling Factor for Project-Scale Modeling

Project-scale flow rates derived from continuous hydrologic simulation can be scaled using the ratio of the pre-development 2-year peak discharge for the watershed and project catchment (i.e., Q_2 watershed / Q_2 project catchment) so that hydraulic and effective work calculations can be performed at the point of compliance with a larger tributary watershed. This scaling translates the runoff from the project catchment to its contribution to erosivity in the down gradient receiving channel, without the need for a complex watershed-scale continuous hydrologic model.

Applicant can estimate the scaling factor using Equation H.8-3. The scaling factor equation was developed using the 2-year peak flow rate empirical equation from Hawley and Bledsoe (2011) and removing the terms (average annual precipitation and imperviousness (pre-development condition as required by the MS4 Permit) that are constant.

Equation H.8-3: Scaling Factor

$$\text{Scaling Factor} = \left(\frac{A_{\text{watershed}}}{A_{\text{project}}} \right)^{0.667}$$

Where:

$A_{\text{watershed}}$ = total watershed drainage area at the point of compliance(mi²)

A_{project} = total project drainage area (mi²)

STEP 2: HYDRAULIC ANALYSIS

Hydraulic parameters, such as stage, effective shear stress, and flow velocity, are computed for each designated flow bin using channel geometry and roughness data. Hydraulic calculations can be as simple as using the normal flow equation and obtaining results for the central channel or as complicated as using hydraulic models which account for backwater effects, such as HEC-RAS.

Using the formula for unit tractive force (Chow 1959), effective shear stress is expressed using equation H.8-4

Equation H.8-4: Effective Shear Stress

$$\tau = \gamma RS$$

Where:

τ = Effective Shear Stress [lb/ft²]

γ = Unit Weight of Water [62.4 lb/ft³]

R = Hydraulic Radius [ft]

S = Energy Gradient Assumed Equal to Longitudinal Slope [ft/ft].

Normal depth can be estimated using Manning's equation (Equation H.8-5). Several sources provide lists of roughness coefficients for use in hydraulic analysis (Chow, 1959).

Equation H.8-5: Manning's Equation

$$Q = \frac{1.49AR^{0.67}S^{0.5}}{n} \text{ or } V = \frac{1.49R^{0.67}S^{0.5}}{n}$$

Where:

Q = Peak Flowrate [cfs]

V = Average Flow Velocity [ft/s]

A = Cross-Section Flow Area [ft²]

R = Hydraulic Radius [ft] = A/P

P = Wetted Perimeter [ft]

S = Energy Gradient Assumed Equal to Longitudinal Slope [ft/ft]

n = Manning Roughness [unit less]

Channel geometry inputs should be characterized by surveying cross sections and longitudinal profiles of the active channel at strategic locations. Methods of collecting topographic survey data can range from traditional survey techniques (auto level, cloth tape, and survey rod), to conducting a detailed ground based LiDAR survey.

STEP 3: WORK ANALYSIS

Hydraulic results for each flow bin along with the critical bed/bank material strength parameters are input into a work or sediment transport function in order to produce a work or transport rating curve. An example of such a rating curve is provided on Figure H.8-3. The work equations can range from simplistic indices, material-specific sediment transport equations, or more complex functions based on site-calibrated sediment transport rating curves.

- **Simplistic indices:** An acceptable equation for effective work, as stated in the Los Angeles Regional MS4 Permit (LARWQCB, 2012) is expressed using equation H.8-6:

Equation H.8-6: Effective Work

$$W = (\tau - \tau_c)^{1.5}V$$

Where:

W = Work [dimensionless];

τ = Effective Shear Stress [lb/ft²];

τ_c = Critical Shear Stress [lb/ft²];

V = Mid-Channel Flow Velocity [ft/s]

- **Material-specific sediment transport equations:** Material specific sediment transport equations are allowed to estimate the sediment transport capacity in the post-project and pre-development condition.
- **Site-calibrated sediment transport curves:** Applicants may have an option to use site-calibrated sediment transport curves. In the future these may be available based on monitoring efforts being performed to support the County of San Diego’s Hydromodification Management Plan.

The critical shear stress to be used in equation H.8-6 must be estimated using one of the following:

- Shear stress corresponding to the critical flow rate or low flow threshold (Q_c). Q_c is the flowrate that results in incipient motion of bed or bank material, whichever is least resistant. Q_c is expressed as a fraction of the pre-development 2-year peak flow. The allowable low flow threshold Q_c can be estimated as 10%, 30%, or 50% of the pre-development 2-year peak flow (0.1Q₂, 0.3Q₂, or 0.5Q₂) depending on the receiving stream susceptibility to erosion, per SCCWRP Technical Report 606, Field Manual for Assessing Channel Susceptibility (SCCWRP, 2010). If a channel susceptibility assessment is not performed, then the conservative default is a Q_c equal to 0.1Q₂.
- Bed and bank material can also be characterized through a geomorphic field assessment. For each stream location analyzed, a measure of critical shear stress can be obtained for the weakest bed or bank material prevalent in the channel. For non-cohesive material, a Wolman pebble count or sieve analysis can be used to obtain a grain size distribution, which can be converted to a critical shear stress using empirical relationships or published reference tables. For

Appendix H: Guidance for Investigation Potential Critical Coarse Sediment Yield Areas

cohesive material, an in-situ jet test or reference tables are used. For banks reinforced with vegetation, reference tables are generally used. Appropriate references for critical shear stress values are provided in ASCE No.77 (1992) and Fischenich (2001). To account for the effects of vegetation density and channel irregularities, the applied shear stress can be partitioned into channel form and bed/bank roughness components. SCCWRP Technical Report 667 also has guidance for estimating critical shear stress.

STEP 4: CUMULATIVE WORK ANALYSIS

Cumulative work is a measure of the long-term total work or sediment transport capacity performed at a creek location. It incorporates the distribution of both discharge magnitude and duration for the flow rates simulated. The cumulative work analysis must be performed up to the maximum geomorphically significant flow of Q_{10} . To calculate cumulative work, first multiply the work (from STEP 3) and duration associated with each flow bin (from STEP 1). Then, the total work is obtained by summing the cumulative for all flow bins (Q_c to Q_{10}). This analysis can be expressed as:

Equation H.8-7: Cumulative Work

$$W_t = \sum_{i=1}^n W_i \Delta t_i$$

Where:

W_t = Total Work [dimensionless]

W_i = Work per flow bin [dimensionless]

Δt = Duration per flow bin [hours]

n = number of flow bins

The distribution of cumulative work, also referred to as a work curve (or work histogram), is helpful in understanding which flow rates are performing the most work on the channel of interest. An example work curve is provided in Figure H.8-5.

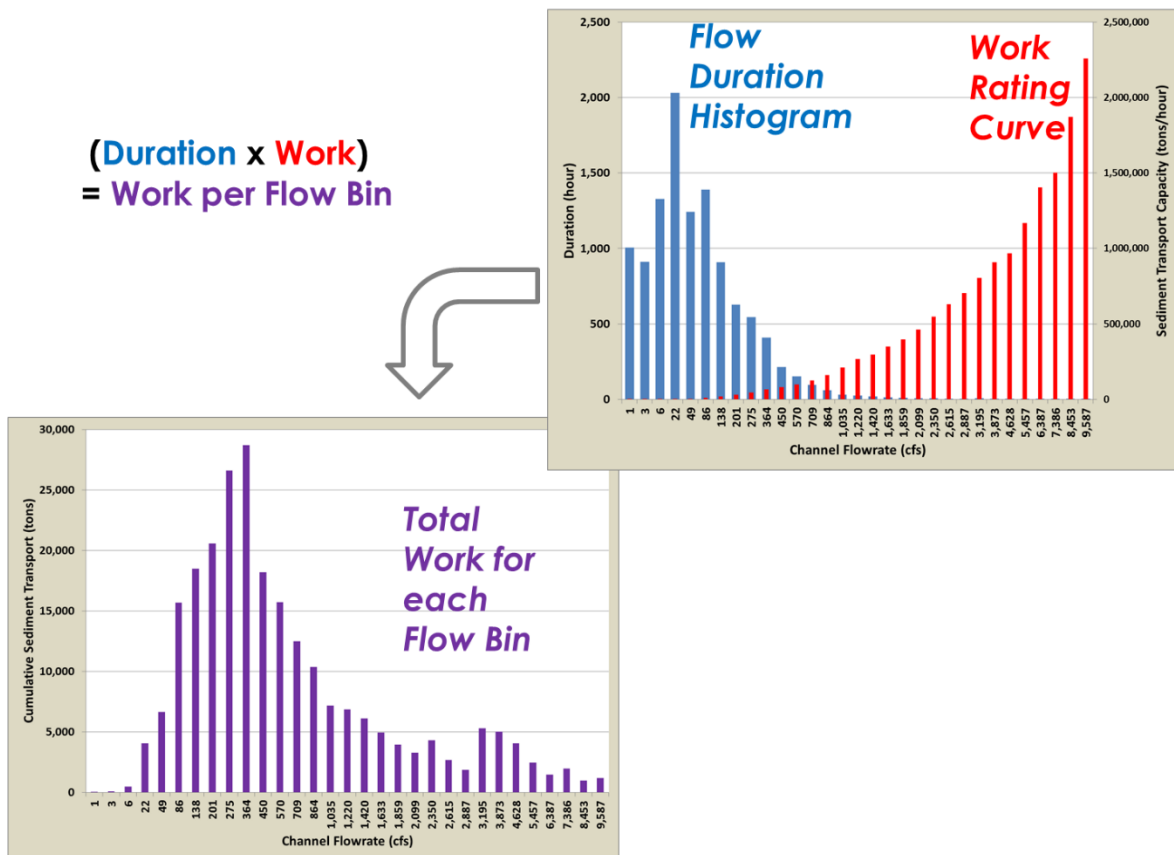

Figure H.8-5: Example Work Curve

STEP 5: EROSION POTENTIAL ANALYSIS

E_p is calculated by simply dividing the total work of the post-project condition by that of the pre-development (natural) condition. E_p is expressed as:

Equation H.8-8: Erosion Potential

$$E_p = W_{t,post} / W_{t,pre}$$

Where:

E_p = Erosion Potential [unitless]

$W_{t,post}$ = Total Work associated with the post-project condition [unitless]

$W_{t,pre}$ = Total Work associated with the pre-development condition [unitless]

As applicable, the applicant must use Worksheet H.8-1 and H.8-2 to document the E_p calculations for each point of compliance.

Appendix H: Guidance for Investigation Potential Critical Coarse Sediment Yield Areas

Erosion Potential (Ep) Analysis		Worksheet H.8-1	
Background Information			
1	Low Flow Threshold: results of SCCWRP channel susceptibility analysis (Select 0.1*Q ₂ if analysis has not been performed).	<input type="checkbox"/> 0.1*Q ₂ <input type="checkbox"/> 0.3*Q ₂ <input type="checkbox"/> 0.5*Q ₂	
2	Selected Ep Method	<input type="checkbox"/> Simplified Ep Method <input type="checkbox"/> Standard Ep Method	
2	Hydrologic Analysis: Select hydrologic analysis method.	<input type="checkbox"/> Project-Scale <input type="checkbox"/> Project-Scale and Watershed-Scale Continuous Simulation	
4	Number of Points of Compliance (Copy and complete worksheet for each Point of Compliance)		unitless
Step 1: Hydrologic Analysis (not applicable for Simplified Ep Method)			
5	Project-Scale Q ₂ (from continuous simulation)		cfs
6	Project Area draining to the point of compliance		sq. miles
7	Watershed Area draining to the point of compliance		sq. miles
8	Scaling Factor for Flows (Line 7/Line 6) ^{0.667}		unitless
9	Low flow threshold (factor from Line 1 x Line 6)		cfs
10	Watershed-Scale Q ₁₀ at Point of Compliance (from continuous simulation or Project Q ₁₀ * Line 8)		cfs
	Hydrologic analysis results (Attach results of continuous simulation including: full pre-development runoff time series at POC, full post-development runoff time series at POC, and flow duration histogram and/or cumulative flow duration curve for each POC).	<input type="checkbox"/> Yes <input type="checkbox"/> No	
Step 2: Hydraulic Analysis (not applicable for Simplified Ep Method)			
11	Provide details about the cross-section (width, depth, slope, roughness, etc.)		
Step 3: Work Analysis (not applicable for Simplified Ep Method)			

Appendix H: Guidance for Investigation Potential Critical Coarse Sediment Yield Areas

Erosion Potential (Ep) Analysis		Worksheet H.8-1	
12	Select work index, equation, or transport curve method for use in work analysis.	<input type="checkbox"/> Equation H.8-6 <input type="checkbox"/> Sediment Transport Equation <input type="checkbox"/> Sediment Transport Curve <input type="checkbox"/> Other: _____	
13	Describe/Justify selection in Line 12 above:		
14	Calculate work done for each flow bin under the pre-development and post-project condition using Worksheet H.8-2. Or similar documentation for sediment transport modeling or transport curve analysis.	<input type="checkbox"/> Yes <input type="checkbox"/> No	
Step 4: Cumulative Work Analysis			
14	Cumulative pre-development work (Equation H.8-1 for Simplified Ep Method) (from Worksheet H.8-2 for Standard Ep Method)		
15	Cumulative post-project work (Equation H.8-1 for Simplified Ep Method) (from Worksheet H.8-2 for Standard Ep Method)		
Step 5: Erosion Potential Analysis			
16	Erosion Potential (Line 15 / Line 14)		unitless

Appendix H: Guidance for Investigation Potential Critical Coarse Sediment Yield Areas

Work Calculations (Supplement to Worksheet H.8-1)									Worksheet H.8-2		
1	Channel Slope								(ft/ft)		
2	Channel Roughness (n)								(unitless)		
3	Low Flow Threshold (Line 9 from Worksheet H.8-1)								cfs		
4	Critical Shear Stress								(lb/ft ²)		
A	B	C	D	E	F	G	H	I	J	K	
Bin	Flow (cfs)			Duration (hours)		Hydraulic Radius (ft)	Average Velocity (ft/s)	Shear Stress (lb/ft²)	Work (unitless)		
	Lower Limit	Upper Limit	Average	Pre-development	Post-Project				Pre-development	Post-Project	
1											
2											
3											
4											
5											
6											
7											
8											
9											
10											
11											
12											
13											
14											
15											
16											
17											
18											
19											
20											
n											
Sum (Bins 1 to n) =											

Appendix H: Guidance for Investigation Potential Critical Coarse Sediment Yield Areas

Worksheet H.8-2 Key

- A** Number of flow bins, add additional rows as needed
- B** Lower limit for the corresponding flow bin
- C** Upper limit for the corresponding flow bin
- D** Average flow for the corresponding flow bin; $[(\mathbf{B} + \mathbf{C})/2]$
- E** Duration in hours for the corresponding flow bin in pre development condition
- F** Duration in hours for the corresponding flow bin in post project condition
- G** Hydraulic radius (in feet) associated with the average flow for the corresponding flow bin (from Manning's equation and/or hydraulic analysis)
- H** Average flow velocity (in fps) associated with the average flow for the corresponding flow bin (from Manning's equation and/or hydraulic analysis)
- I** Shear stress (lb/ft²) associated with the average flow for the corresponding flow bin = $\gamma * \text{Hydraulic Radius} * \text{Slope} = 62.4 * \mathbf{G} * \text{Line 1}$
- J** Pre-development work for associated flow bin
 $\mathbf{J} = 0$; If $(\mathbf{I} - \text{Line 4}) \leq 0$
 $\mathbf{J} = \mathbf{E} * (\mathbf{I} - \text{Line 4})^{1.5} * \mathbf{H}$; If $(\mathbf{I} - \text{Line 4}) > 0$
- K** Post-project work for associated flow bin
 $\mathbf{K} = 0$; If $(\mathbf{I} - \text{Line 4}) \leq 0$
 $\mathbf{K} = \mathbf{F} * (\mathbf{I} - \text{Line 4})^{1.5} * \mathbf{H}$; If $(\mathbf{I} - \text{Line 4}) > 0$

Note: If the receiving water dimensions are different in pre-development and post-project condition then Worksheet H.8-2 is not valid for work calculations.

H.8.2 Calculation of Sp

While there are many categories of erosion processes (e.g., landslides, debris flows, gullies, tree throw, animal burrows, sheetwash erosion, wind erosion, dry ravel, bank erosion), in this evaluation processes will be simplified to sediment production from hillslopes and channels. Under ideal circumstances, the total bed sediment supply rate (tons/year) would be calculated for both the post-project built-out condition and pre-project condition using a watershed-scale Geomorphic Landscape Unit (GLU) and Geomorphic Channel Unit (GCU) approach which:

- (1) identifies different sources of sediment supply based on categories of terrain slope, geology, land cover, and stream order;
- (2) estimates the base erosion rate of those sources (GLUs and GCUs);
- (3) approximates the sediment delivery ratio (SDR) to the receiving channel;
- (4) evaluates the coarse bed-load fraction of the sources; and
- (5) integrates these considerations into a bed-load yield rate for both the existing condition and proposed built-out condition.

However, calculation of sediment yield rates for each GLU (tons/mi²-yr) and GCU (tons/mi-yr) using the available science is inherently inexact and requires extensive field calibration. Additionally, performing the geospatial calculations necessary for such a comprehensive GLU and GCU analysis may not be straightforward for some project applicants. Since the objective is to determine the fraction of reduction in bed sediment supply in the post-project condition compared to the pre-project condition, but not to determine the bed sediment yield in physical units (tons/year/acre, for example) the following simplifications are allowed. These simplifications take into consideration the regional sediment yield map shown in Figure H.8.6.

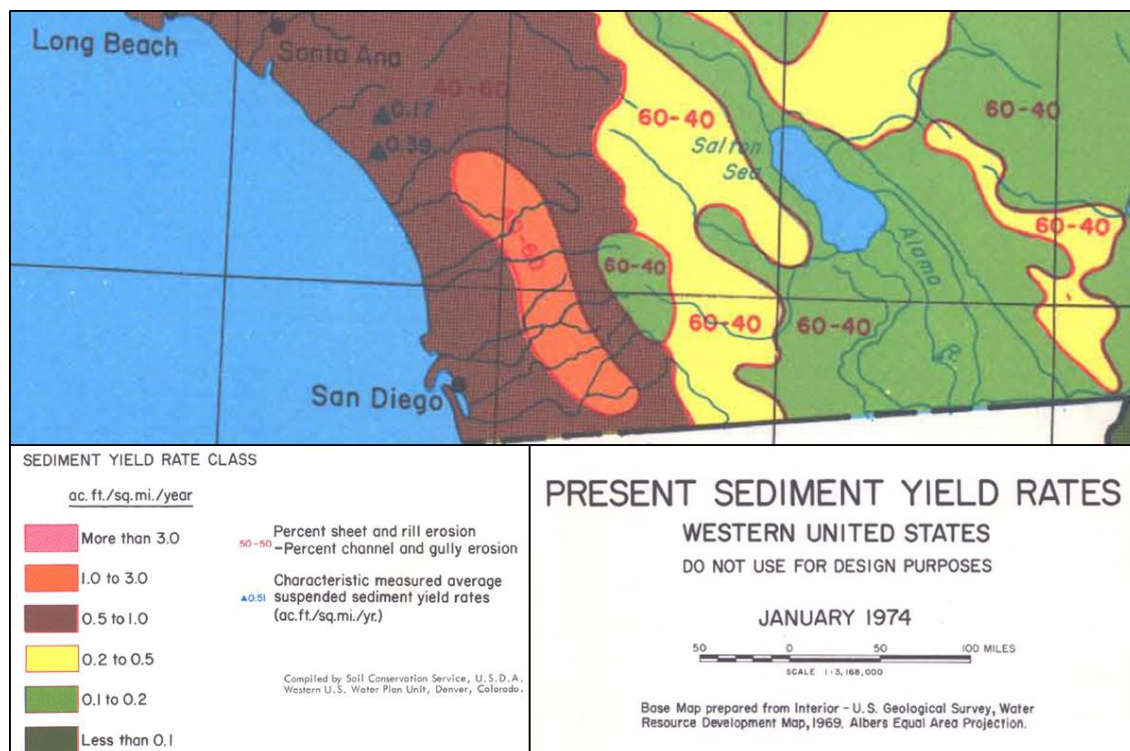

Figure H.8-6: Regional Sediment Yield Map

Appendix H: Guidance for Investigation Potential Critical Coarse Sediment Yield Areas

According to a regional sediment yield map of the Western US (USDA, 1974), hillslope processes (sheet and rill erosion) account for approximately 40% of the sediment yield in the San Diego County region, while channel processes (in-stream and gully erosion) account for approximately 60% of the sediment yield. Figure H.8-7 shows the different erosion processes. Provision E.3.a.(3)(a) of the MS4 Permit requires, “maintenance or restoration of natural storage reservoirs and drainage corridors (including topographic depressions, areas of permeable soils, natural swales, and ephemeral and intermittent streams)”, effectively making maintenance or restoration of channels and gullies within a project site a site design requirement.

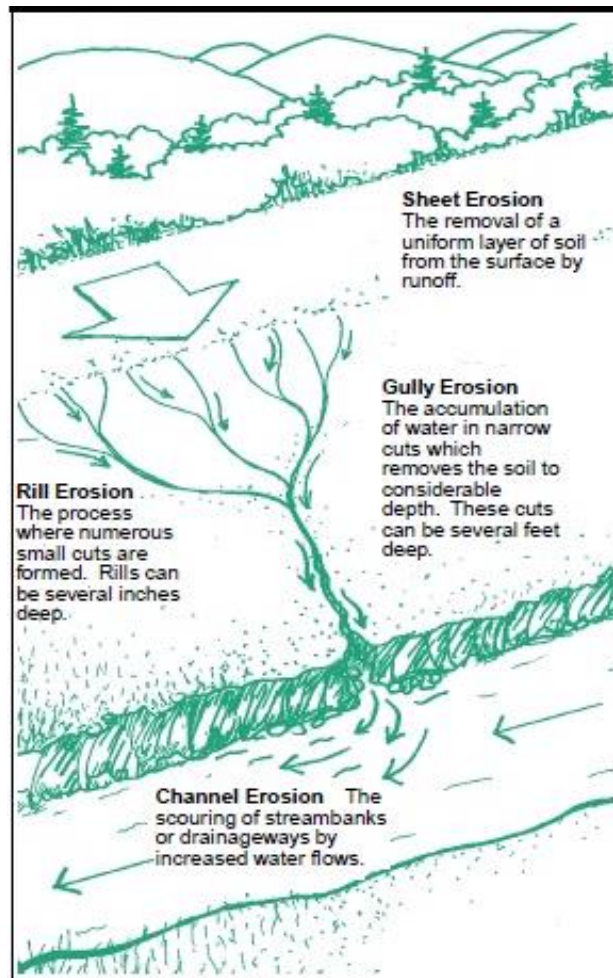

Figure H.8-7: Different Erosion Processes that Contribute Sediment

Source: <http://www.fairfaxcounty.gov/nvswcd/youyourland/soil.htm>

Sediment yield from hillslope processes (sheet and rill erosion) can be estimated using the Revised Universal Soil Loss Equation (RUSLE) and a sediment delivery ratio. For channel processes, the best available regional datasets are the USGS National Hydrography Dataset (NHD) and the NHDPlus dataset from USEPA and USGS (<http://www.horizon-systems.com/nhdplus/>). Both these datasets may not include the lowest order channels or gullies in the stream network, which can contribute a considerable amount of sediment produced from channel processes. Since the lower order channels and gullies originate and are mostly on the hillslopes, it is assumed for the Sp analysis that the sediment

Appendix H: Guidance for Investigation Potential Critical Coarse Sediment Yield Areas

yield from lower order channels and gullies is proportional to the sediment yield from hill slopes. Based on feedback received during the TAC meetings (Appendix H.5.1) the following distribution is proposed for the calculation of Sp:

- 70% of bed sediment yield ratio from RUSLE analysis (assumed to account for sediment yield from hillslope processes (sheet and rill erosion) and channels and gullies not part of the NHDPlus dataset); and
- 30% of bed sediment yield ratio from channels in the NHDPlus dataset.

Note:

- If an applicant elects to map the waters of the state, the Sp distribution shall be revised to
 - 40% of bed sediment yield ratio from RUSLE analysis;
 - 30% of bed sediment yield ratio from waters of the state that are not part of NHDPlus dataset; and
 - 30% of bed sediment yield ratio from channels in the NHDPlus dataset.

SCALE OF ANALYSIS

The project applicant shall perform the Sp analysis at point (or points) where runoff leaves the project site⁷. The steps for performing an Sp analysis are shown in Figure H.8-8 and described below.

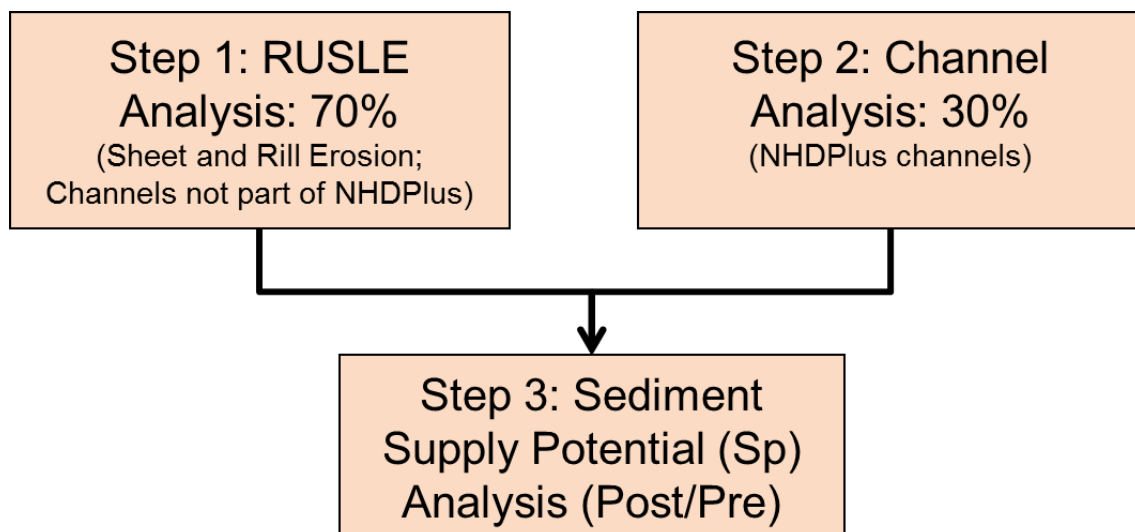

Figure H.8-8: Sediment Supply Potential Flow Chart

⁷ In limited scenarios, the County has the discretion allow for a watershed-scale Sp analysis to be performed at the point of compliance if the future built-out conditions of the watershed are used in the analysis.

STEP 1: RUSLE ANALYSIS

RUSLE analysis is assumed to account for sediment yield from hillslope processes (sheet and rill erosion) and channels and gullies not part of the NHDPlus dataset. The change in bed sediment yield in the post-project condition compared to the pre-project condition using the RUSLE analysis must be estimated using equation H.8-9. This equation is a modified form of the standard RUSLE equation. Only hillslopes that are anticipated to generate coarse sediment must be used in this analysis. Since Sp is a dimensionless index the terms that are relatively constant in the pre and post project condition, such as rainfall factor, have been removed.

Equation H.8-9: Sediment Yield (Hillslope)

$$SY_{RUSLE} = \frac{Post - Project \sum\{A \times K \times LS \times C \times P\}}{Pre - Project \sum\{A \times K \times LS \times C\}}$$

Where:

A = Hillslope Area (acres)

K = Soil erodibility factor, this value can be obtained from regional K factor map from SWRCB or web soil survey or site-specific grain size analysis

LS = Slope length and steepness factor, this value can be obtained from the regional LS factor map from SWRCB or site-specific determination using look up tables based on slope and horizontal slope length from USDA Agriculture Handbook Number 703 (Renard et al., 1997) or other relevant sources

C= Cover management factor, use regional C factor map from USEPA or site-specific information; this is the reciprocal of the amount of surface cover on soil, whether it be vegetation, temporary mulch or other material. It is roughly the percentage of exposed soil, i.e., 95 percent cover yields a “C” value of 0.05. Use C=0 for areas where management actions are implemented (e.g. impervious areas)

P = Practice factor, only included in post-project condition. This term is added to account for sediment yield from engineered slopes. Practice factor of 0.25 shall be used for fill slopes and a practice factor of 0.50 shall be used for cut slopes. Use a practice factor of 1 for undisturbed areas.

The applicant may be allowed to receive credit for bed sediment yield from engineered slopes on the project perimeter directly discharging to conveyance systems if all of the following criteria are met:

- The engineered slopes consist of coarse bed material. This is confirmed by performing grain size distribution per ASTM D422 for the engineered slope and verifying that the d₅₀ is greater than no. 200 sieve (0.074 mm).
- Cover factor in the post project condition shall not be greater than the cover factor used in the pre project condition for the same area.
- A maximum practice factor of 0.25 may applied to proposed fill slopes. A maximum practice factor of 0.50 may be applied to proposed cut slopes.

Appendix H: Guidance for Investigation Potential Critical Coarse Sediment Yield Areas

- A statement from the geotechnical engineer is included in the SWQMP certifying that the engineered slope will be stable even after accounting for bed sediment generation and the anticipated soil loss during the planned lifetime of the engineered slope is acceptable.

Additional analysis and/or documentation may be requested by the County prior to approval of the credit for bed sediment yield from engineered slopes.

STEP 2: CHANNEL ANALYSIS

If an NHDPlus mapped channel exists within the project property boundary, applicants must consider the sediment production from this existing channel system. The change in bed sediment yield in the post-project condition compared to the pre-project condition from channels in the NHDPlus dataset must be estimated using equation H.8-10 (SY_{NHD}). This equation is based on screening-level GIS calculations of stream length that will be contributing sediment in the post-project condition in the watershed tributary to the point of compliance.

Equation H.8-10: Sediment Yield (NHD)

$$SY_{NHD} = \frac{L_{post}}{L_{pre}}$$

Where:

L_{post} = Length of NHDplus streams in the watershed contributing to bed sediment supply in the post-project condition [miles]

L_{pre} = Length of NHDplus streams in the watershed contributing to bed sediment supply in the pre-project existing condition [miles]

STEP 3: SEDIMENT SUPPLY POTENTIAL ANALYSIS

Sediment Supply Potential (S_p) is defined as the ratio of post-project/pre-project (existing) long-term bed sediment supply. S_p must be calculated using equation H.8-11 presented below:

Equation H.8-11: Sediment Supply Potential

$$S_p = 0.7 \times SY_{RUSLE} + 0.3 \times SY_{NHD}$$

Where:

S_p = Sediment Supply Potential [unitless]

SY_{RUSLE} = Change in bed sediment yield from hillslopes and lower order channels and gullies not part of NHDPlus dataset [unitless]

SY_{NHD} = Change in bed sediment yield from channels in NHDPlus dataset [unitless]

When estimating S_p the following additional conditions apply:

- Projects that do not have onsite NHDPlus channels shall omit consideration of SY_{NHD} and weighting factors depicted in Equation H.8-11. This simply results in $S_p = SY_{RUSLE}$.

Appendix H: Guidance for Investigation Potential Critical Coarse Sediment Yield Areas

- It must be assumed that the sediment yield from an area that drains to a structural BMP is zero. Consideration of sediment yield from an area draining to the structural BMP may be allowed if sediment bypass measures are implemented upstream of the structural BMP. However, additional analysis may be requested by the County to substantiate the sediment yield estimates proposed by the applicant from implementing sediment bypass measures.
- For scenarios where an upstream coarse sediment yield area drains through the project footprint and the project footprint cuts off conveyance of bed sediment generated upstream of the project footprint to the point of compliance, (e.g., via debris basins) the contribution from the upstream area shall be assumed to be zero.

As applicable, the applicant must use Worksheet H.8-3 to document the Sp calculations for each point of compliance.

Appendix H: Guidance for Investigation Potential Critical Coarse Sediment Yield Areas

Sediment Supply Potential (Sp) Analysis							Worksheet H.8-3				
1	Scale of Analysis					<input type="checkbox"/> Project Scale <input type="checkbox"/> Watershed Scale (built-out condition)					
Step 1: RUSLE Analysis											
2	GLU	Pre-Project					Post-Project				
		A	K	LS	C	A*K*LS*C	A	K	LS	C	P
	1										
	2										
	3										
	4										
	5										
	6										
	7										
	8										
Add additional rows as needed											
3	Sum Pre-Project					Sum Post-Project					
4	$SY_{RUSLE} = (\text{Sum Post-Project} / \text{Sum Pre-Project})$ (From Line 3)									unitless	
Step 2: Channel Analysis: NHDPlus Channels											
5	L _{pre} (from GIS analysis of pre-project existing condition)									miles	
6	L _{post} (from GIS analysis of post-project condition)									miles	
7	$SY_{NHD} = (\text{Line 6} / \text{Line 5})$									unitless	
Step 3: Sediment Supply Potential Analysis											
8	RUSLE Analysis Bed Sediment Yield Ratio Calculated (Line 4)									unitless	
9	Channel Bed Sediment Yield Ratio from NHDPlus dataset (Line 7)									unitless	
10	Sediment Supply Potential Calculated using Equation H.8-11. (0.7 x Line 8 + 0.3 x Line 9)									unitless	

H.9 Mitigation Measures Fact Sheets

The following fact sheets were developed to assist the project applicants with designing mitigation measures:

- Additional flow control
- Stream Rehabilitation

H.9.1 Additional Flow Control

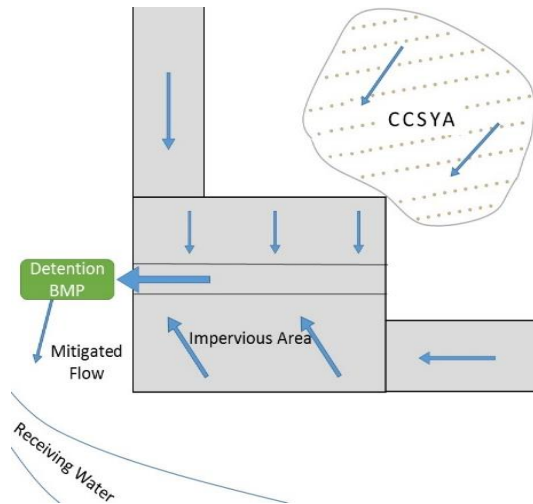

Description

Additional flow control refers to the modification of post-development flow rates and durations beyond the levels required by standard HMP criteria (i.e. control of flow rates and durations from Q_c to Q_{10}). Additional flow control can mitigate the effect of decreased sediment delivery by equivalently limiting sediment transport capacity. BMPs providing additional flow control are detention/retention type BMPs and will typically be larger than those that meet HMP criteria only. The performance standard for additional flow control can be demonstrated through the NII management standard.

Management Standard and Sizing Approach

The management standard additional flow control BMPs need to meet to demonstrate that there is no net impact to the receiving waters is presented in the equation below:

$$NII = \frac{E_p}{S_p} \leq 1.1$$

Where:

E_p : is the ratio of post-project/pre-development sediment transport capacity

S_p : ratio of post-project/pre-project (existing) long-term bed sediment supply

Note: Redevelopment projects typically do not have critical coarse sediment yield areas onsite because management actions have been implemented onsite (e.g. impervious areas, etc.). Refer to Appendix H.8 for methodologies to calculate E_p and S_p .

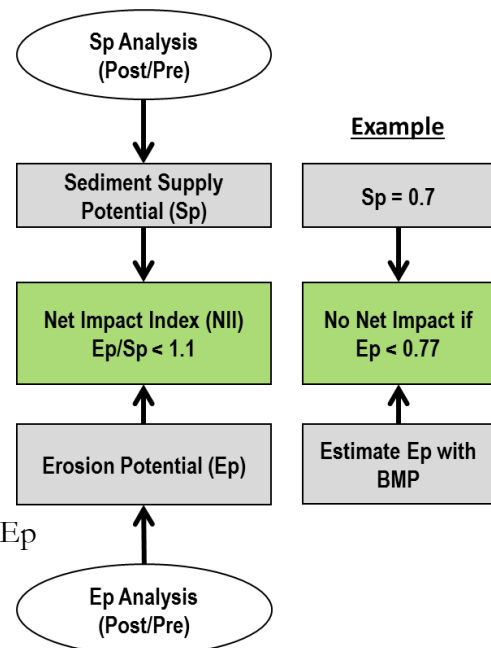

Appendix H: Guidance for Investigation Potential Critical Coarse Sediment Yield Areas

Project applicants must demonstrate that the NII management standard will be met under the post-project scenario through the following steps:

1. Calculate the S_p at the point of compliance using guidance in Appendix H.8.2.
2. Determine the Target E_p : $E_{p\text{Target}} \leq 1.1 * S_p$
3. Calculate the pre-development sediment transport capacity or work (E_p denominator). Refer to Section 6.3.3 for definition of pre-development and refer to Appendix H.8.1 for guidance on calculating the sediment transport capacity or work.
4. Iteratively size additional flow control BMPs and calculate the post-project sediment transport capacity (E_p numerator) until the target E_p is reached.
5. Summarize the calculations performed to size the BMPs in the SWQMP.

In addition to the general approach outlined above, additional flow control BMPs must meet the design criteria presented in the Appendix E Fact Sheets. Deviations from these criteria may be approved at the discretion of the County if it is determined appropriate.

Design Adaption for Project Goals

NII management standard is met by additional flow control. Larger BMPs may be able to provide adequate additional flow control to meet the required performance standard. In this scenario no additional sediment BMPs are required.

For example, project that has an $S_p = 0$ (i.e. 100% of the bed sediment in the drainage area to the point of compliance is impacted by the project) can be mitigated by designing a BMP such that there is no discharge within the geomorphically significant flow range (i.e. Q_c to Q_{10}).

NII management standard is not fully met by additional flow control. Additional flow control alone may not be able to entirely meet the NII management standard due to site, or other, constraints. In scenarios where the target E_p cannot be met by additional flow control, additional BMPs that increase the supply of bed sediment or reduce the susceptibility of the receiving channel will be required.

Note: Additional flow control BMPs can be independent BMPs that provide flow control only or they can be integrated with storm water pollutant control BMPs.

Conceptual Design and Sizing Approach

The following steps detail an approach that can be used to appropriately size BMPs that provide additional flow control:

Step 1: Calculate the Sediment Supply Potential (S_p) based on pre- and post-project condition at the point of compliance.

- Refer to Appendix H.8.2 for methodology to calculate S_p . Applicant must document this analysis using Worksheet H.8-3.

Step 2: Determine the Target E_p based on the results of Step 1.

- $E_{p\text{Target}} \leq 1.1 * S_p$

Step 3: Perform continuous simulation modeling for pre-development condition.

- Perform continuous simulation (refer to Appendix G) for the pre-development condition.

Appendix H: Guidance for Investigation Potential Critical Coarse Sediment Yield Areas

- Determine the flow durations for the pre-project scenario as described in Appendix G.1.6.2.

Step 4: Perform pre-development work analysis.

- Calculate the cumulative work performed by the range of geomorphically significant flows for the pre-development scenario, (refer to Step 3 and Step 4 in Appendix H.8.1 for calculation of work).

Step 5: Implement flow control BMPs and perform continuous simulation modeling for post-project scenario.

- Appropriately size pollutant control and hydromodification management BMPs according to the procedures presented in this manual.
- Perform continuous simulation (refer to Appendix G) for the post-project condition.
- Determine the flow durations for the post-project scenario as described in Appendix G.1.6.2.
- Typically, BMPs sized to satisfy the flow duration control will provide for some level of S_p reduction and will ensure that the minimum design standards and sizing requirements are met.

Step 6: Perform post-project work analysis.

- Follow the steps presented in Step 4 to determine the post-project total work.

Step 7: Calculate E_p and determine if Target E_p has been met.

- Divide the post-project total work by the pre-development total work and determine if the target E_p has been met.
- If the target E_p is met by the standard BMPs, document results and compliance with hydrologic and sediment supply performance standards.
- If the target E_p is not met, proceed to Step 8.

Step 8: Provide additional flow control storage and calculate E_p .

- Following the procedures presented in the previous steps, iteratively calculate E_p for increasingly large BMPs until the target E_p is met.
- Document results and compliance with hydrologic and NII management standard.

As applicable, the applicant must use Worksheet H.8-1, Worksheet H.8-3 and Worksheet H.9-1 to document sizing of the additional flow control mitigation measure.

Appendix H: Guidance for Investigation Potential Critical Coarse Sediment Yield Areas

Additional Flow Control Mitigation Measure		Worksheet H.9-1	
1	Sediment Supply Potential (Line 10 of Worksheet H.8-3)		unitless
2	Attached completed Worksheet H.8-3 and associated documentation	<input type="checkbox"/> Yes <input type="checkbox"/> No	
3	Target $E_p \leq 1.1 * \text{Line 1}$		unitless
4	Erosion Potential (Line 16 of Worksheet H.8-1)		unitless
5	Attached completed Worksheet H.8-1 and associated documentation	<input type="checkbox"/> Yes <input type="checkbox"/> No	
6	Is Line 4 \leq Line 3? If Yes, NII management standard is met. If No, increase the size of the BMP and recalculate Line 4.	<input type="checkbox"/> Yes <input type="checkbox"/> No	

H.9.2 Stream Rehabilitation

Description

Hydromodification control can be achieved by stream rehabilitation projects including: drop structures, grade control structures, bed and bank reinforcement, increased channel sinuosity or meandering, increased channel width, and flow diversion. The objective of these in-stream controls, or stream restoration measures, is to reduce or maintain the overall Erosion Potential (E_p) of the receiving channel. Stream rehabilitation option is only available when the receiving channel of concern is already impacted by erosive flows and shows evidence of excessive sediment, erosion, deposition, or is a hardened channel.

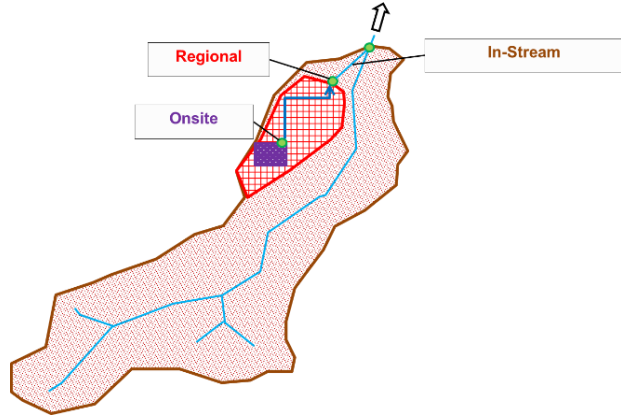

Management Standard and Sizing Approach

The management standard stream rehabilitation projects need to meet to demonstrate that there is no net impact to the receiving waters is presented in the equation below:

$$NII = \frac{E_p}{S_p} \leq 1.1$$

Where:

E_p : is the ratio of post-project/pre-development sediment transport capacity

S_p : ratio of post-project/pre-project (existing) long-term bed sediment supply

Note: Stream rehabilitation project reduce E_p by modifying the stream’s hydraulic properties and/or bed/bank material resistance without fully replacing sediment supply or controlling increases in runoff. Refer to Appendix H.8 for methodologies to calculate E_p and S_p .

Design Adaption for Project Goals

The following describes different types of stream rehabilitation projects that could be implemented to meet the NII management standard by reducing or maintaining the overall E_p :

Drop Structures: Drop structures are designed to reduce the average channel slope, thereby reducing the shear stresses generated by stream flows. These controls can be incorporated as natural looking rock structures with a step-pool design which allows drop energy to be dissipated into the pools while providing a reduced longitudinal slope between structures.

Grade Control Structures: Grade control structures are designed to maintain the existing channel slope while allowing for minor amounts of local scour. These control measures are often buried and entail a narrow trench across the width of the stream backfilled with concrete or similar material, as well as the creation of a “plunge pool” feature by placing boulders and vegetation on the downstream side of the sill. A grade control structure provides a reduced footprint and impact as compared to drop structures, which are designed to alter the channel slope.

Appendix H: Guidance for Investigation Potential Critical Coarse Sediment Yield Areas

Bed and Bank Reinforcement: Channel reinforcement serves to increase bed and bank resistance to instream erosion. A number of vegetated approaches are widely used. Such approaches include large woody debris, live crib walls, vegetated mechanically stabilized earth, live siltation, live brushlayering, willow posts and poles, live staking, live fascine, rootwad revetment, live brush mattresses, and vegetated reinforcement mats. These technologies provide erosion control that stabilizes bed and bank surfaces and allows for re-establishment of native plants, which serves to further increase channel stability.

Channel Sinuosity: Increasing channel sinuosity (meandering) can serve to reduce the channel slope, thereby reducing the shear stresses generated by stream flows. However, forcing a channel to be too sinuous is likely to lead to subsequent channel avulsion (cutting a new stream path) to a straighter course. Channel sinuosity needs to be supported by a geomorphic basis of design that shows the proposed form and gradient are appropriate for the valley slope, sediment, and water regime. This support may take the form of reference reaches in similar watersheds that have supported the proposed morphology over a significant period of time, or comparison between the proposed form and typical literature values.

Channel Widening: Increasing the width-to-depth ratio of a stream's cross section is meant to spread flows out over a wider cross section with lower depths, thereby reducing shear stress for a given flow rate. This approach can be a useful management strategy in incised creeks to restore them to equilibrium conditions once vertical incision has ceased. As with sinuosity, it is important to develop a robust geomorphic basis of design that shows the increase in width-to-depth ratio to be sustainable.

Flow Diversion: Flow diversions can be designed to divert the excess flows caused by development to an hydromodification management exempt water body so that the shear stresses do not increase in the susceptible receiving water. When diversions are proposed to a water body exempt through watershed management area analysis, the applicant is required to provide a supporting analysis that the excess flows diverted to the exempt water body do not invalidate the exemption.

Design Considerations

Each stream rehabilitation project is to some degree unique because of differences in geomorphic process, morphology and previous watershed history. For this reason, this fact sheet does not provide a prescriptive 'cookery book' approach for rehabilitating streams, but instead provides guidelines and recommendations. Shields (1996) provides a helpful overview of the analytical steps involved in stream restoration and Shields et al. (1999) provides examples of approaches used to rehabilitate incised channels. Applicant will need to provide geomorphic and engineering information to support their proposed project approach. It is recommended that multiple lines of technical evidence be used by applicants to develop creek restoration plans based on the preponderance of evidence for design criteria such as channel width, depth, slope and planform. It is also important to understand that all creek rehabilitation projects must comply with relevant Federal, State and local regulations and permits. These will likely include obtaining permits from the RWQCB, USACE and California DF&W, and may involve additional permits or consultation with USDF&W and FEMA, as well as permits from the County. The proposed design shall also meet local drainage design guidelines for channel design.



COUNTY OF SAN DIEGO BMP DESIGN MANUAL

Significant Site Design BMP (SSD-BMP) Sizing Methods and Calculations

Appendix I: Forms and Checklists

This page was intentionally left blank.

Appendix I Significant Site Design BMP (SSD-BMP) Sizing Methods and Calculations

I.1 Significant Site Design BMPs (SSD-BMPs)

I.2 Step 1: Determine DCV

I.3 Step 2: Dispersion Areas

I.4 Step 3: Tree Wells

I.1 Significant Site Design BMPs (SSD-BMPs)

Significant site design BMPs (SSD-BMPs) are site design BMPs designed to fully retain the Design Capture Volume (DCV) for the Drainage Management Area (DMA) (Section 5.2.3). Tree Wells (Fact Sheet SD-A), Impervious Area Dispersion (Fact Sheet SD-B), Permeable Pavement (Fact Sheet SD-D), or any other SSD-BMP acceptable to the County may be used. This Appendix provides sizing methods for impervious area dispersion (“dispersion areas”) and tree wells used as SSD-BMPs. An automated worksheet is available to prepare the calculations described in this Appendix. Dispersion areas and tree wells may be sized for pollutant control only or for pollutant control plus hydromodification control.

Permeable pavement may be used as an SSD-BMP for pollutant control only. Sizing methods for permeable pavement as an SSD-BMP for pollutant control only are provided in Section 5.2.3 and are not included in this Appendix or the automated worksheet. Hydromodification management performance standards can be satisfied using permeable pavement only if the permeable pavement is constructed to structural BMP specifications in accordance with the requirements of Appendix B and Fact Sheet INF-3.

I.2 Step 1: Determine DCV

The first step in performing design calculations for SSD-BMPs is to calculate the DCV. The DCV represents the volume of storm water runoff that must be retained and/or biofiltered in order to satisfy pollutant control requirements. This step is very similar to the first step in performing storm water pollutant control calculations described in Appendix B for the design of structural BMPs, except that the tree well volume reduction described in Appendix B Section B.1.4, when applicable, will be addressed in Step 3 of the SSD-BMP calculations instead of Step 1.

The DCVs for SSD-BMPs can be calculated through use of the SSD-BMP Automated Worksheet I-1: Step 1. Calculation of Design Capture Volume depicted on the following page or can be calculated manually by following procedures presented in Appendix B, Sections B.1.1 through B.1.3 as well as the rain barrel reduction procedure presented in Appendix B, Section B.1.4 when applicable.

$$DCV = \frac{D}{12} \times A \times C - R$$

Where:

DCV: Design Capture Volume (ft³).

D: Rainfall Depth (inches), refer to Appendix B Section B.1.1.

A: Tributary Area (ft²), refer to Appendix B Section B.1.2.

C: Runoff Factor (unitless), refer to Appendix B Section B.1.3.

R: Site Design Volume Reductions from Rain Barrels (ft³). Refer to Appendix B Section B.1.4 regarding rain barrels (note that when tree wells are used as SSD-BMPs, the volume reduction from the use of tree wells will be addressed in Step 3).

If the project includes dispersion areas, proceed to Step 2: Dispersion Areas. If no dispersion areas are proposed, skip Step 2 and proceed to Step 3: Tree Wells.

SSD-BMP Automated Worksheet I-1: Step 1. Calculation of Design Capture Volume

Category	#	Description	<i>i</i>	Units
Standard Drainage Basin Inputs	1	Drainage Basin ID or Name		unitless
	2	85th Percentile 24-hr Storm Depth		inches
	3	Is Hydromodification Control Applicable?		yes/no
	4	Impervious Surfaces <u>Not Directed to Dispersion Area</u> (C=0.90)		sq-ft
	5	Semi-Pervious Surfaces <u>Not Serving as Dispersion Area</u> (C=0.30)		sq-ft
	6	Engineered Pervious Surfaces <u>Not Serving as Dispersion Area</u> (C=0.10)		sq-ft
	7	Natural Type A Soil <u>Not Serving as Dispersion Area</u> (C=0.10)		sq-ft
	8	Natural Type B Soil <u>Not Serving as Dispersion Area</u> (C=0.14)		sq-ft
	9	Natural Type C Soil <u>Not Serving as Dispersion Area</u> (C=0.23)		sq-ft
	10	Natural Type D Soil <u>Not Serving as Dispersion Area</u> (C=0.30)		sq-ft
SSD-BMPs Proposed	11	Does Tributary Incorporate Dispersion and/or Rain Barrels?		yes/no
	12	Does Tributary Incorporate Tree Wells?		yes/no
Dispersion Area & Rain Barrel Inputs (Optional)	13	Impervious Surfaces <u>Directed to Dispersion Area</u> per SD-B (Ci=0.90)		sq-ft
	14	Semi-Pervious Surfaces <u>Serving as Dispersion Area</u> per SD-B (Ci=0.30)		sq-ft
	15	Engineered Pervious Surfaces <u>Serving as Dispersion Area</u> per SD-B (Ci=0.10)		sq-ft
	16	Natural Type A Soil <u>Serving as Dispersion Area</u> per SD-B (Ci=0.10)		sq-ft
	17	Natural Type B Soil <u>Serving as Dispersion Area</u> per SD-B (Ci=0.14)		sq-ft
	18	Natural Type C Soil <u>Serving as Dispersion Area</u> per SD-B (Ci=0.23)		sq-ft
	19	Natural Type D Soil <u>Serving as Dispersion Area</u> per SD-B (Ci=0.30)		sq-ft
	20	Number of Rain Barrels Proposed per SD-E		#
	21	Average Rain Barrel Size		gal
Initial Runoff Factor Calculation	22	Total Tributary Area	0	sq-ft
	23	Initial Runoff Factor for Standard Drainage Areas	0.00	unitless
	24	Initial Runoff Factor for Dispersed & Dispersion Areas	0.00	unitless
	25	Initial Weighted Runoff Factor	0.00	unitless
	26	Initial Design Capture Volume	0	cubic-feet
Dispersion Area Adjustment & Rain Barrel Adjustment	27	Total Impervious Area Dispersed to Pervious Surface	0	sq-ft
	28	Total Pervious Dispersion Area	0	sq-ft
	29	Ratio of Dispersed Impervious Area to Pervious Dispersion Area for DCV Reduction	n/a	ratio
	30	Adjustment Factor for Dispersed & Dispersion Areas	1.00	ratio
	31	Runoff Factor After Dispersion Techniques	n/a	unitless
	32	Design Capture Volume After Dispersion Techniques	0	cubic-feet
	33	Total Rain Barrel Volume Reduction	0	cubic-feet
Results	34	Final Adjusted Runoff Factor	0.00	unitless
	35	Final Effective Tributary Area	0	sq-ft
	36	Initial Design Capture Volume Retained by Dispersion Area and Rain Barrel(s)	0	cubic-feet
	37	Remaining Design Capture Volume Tributary to Tree Well(s)	0	cubic-feet

SSD-BMP Worksheet I-1 Line Item Notes

1. User input from stormwater plans.
2. User input from BMPDM Figure B.1-1.
3. User input from stormwater plans.
4. User input from stormwater plans.
5. User input from stormwater plans.
6. User input from stormwater plans.
7. User input from stormwater plans.
8. User input from stormwater plans.
9. User input from stormwater plans.
10. User input from stormwater plans.
11. User input. Default is "No". Select Yes if any of the referenced elements are proposed.
12. User input. Default is "No". Select Yes if any of the referenced elements are proposed.
13. User input from stormwater plans. Must satisfy criteria from Fact Sheet SD-B.
14. User input from stormwater plans. Must satisfy criteria from Fact Sheet SD-B.
15. User input from stormwater plans. Must satisfy criteria from Fact Sheet SD-B.
16. User input from stormwater plans. Must satisfy criteria from Fact Sheet SD-B.
17. User input from stormwater plans. Must satisfy criteria from Fact Sheet SD-B.
18. User input from stormwater plans. Must satisfy criteria from Fact Sheet SD-B.
19. User input from stormwater plans. Must satisfy criteria from Fact Sheet SD-B.
20. User input. Must satisfy criteria from Fact Sheet SD-E. Cannot provide more than a 25% reduction to initial DCV.
21. User input. Must satisfy criteria from Fact Sheet SD-E. Acceptable range 0-100 gallons for generic volume reductions.
22. Sum of Lines 4 through 19.
23. $[0.9(\text{Line } 4) + 0.3(\text{Line } 5 + \text{Line } 10) + 0.1(\text{Line } 6 + \text{Line } 7) + 0.14(\text{Line } 8) + 0.23(\text{Line } 9)] / (\text{Sum of Lines } 4 \text{ through Line } 10)$.
24. $[0.9(\text{Line } 13) + 0.3(\text{Line } 14 + \text{Line } 19) + 0.1(\text{Line } 15 + \text{Line } 16) + 0.14(\text{Line } 17) + 0.23(\text{Line } 18)] / (\text{Sum of Lines } 13 \text{ through Line } 19)$.
25. $[(\text{Line } 23 \times (\text{Sum of Lines } 4 \text{ through } 10) + \text{Line } 24 \times (\text{Sum of Lines } 13 \text{ through } 19))] / \text{Line } 22$.
26. $(\text{Line } 2/12) \times \text{Line } 22 \times \text{Line } 25$.
27. Line 13.
28. Sum of Lines 14 through 19.
29. $[\text{Line } 27 / \text{Line } 28]$. If greater than 4.0 dispersion benefits are not quantified.
30. Lookup values from Table B.1-1 weighted with respect to distribution of dispersion areas specified in Lines 14-19.
31. $[\text{Line } 23 \times (\text{Sum of Lines } 4 \text{ through Line } 10) + \text{Line } 24 \times \text{Line } 30 \times (\text{Sum of Lines } 13 \text{ through Line } 19)] / \text{Line } 22$.
32. $(\text{Line } 2/12) \times \text{Line } 22 \times \text{Line } 31$.
33. $[\text{Line } 20 \times \text{Line } 21/7.48]$. Limited to 100 gallons per rain barrel and limited to maximum of 25% of Line 26.
34. $\text{Line } 31 \times [1 - (\text{Line } 33/\text{Line } 32)]$. Value must be between zero and one.
35. $\text{Line } 22 \times \text{Line } 34$.
36. $[(\text{Line } 26 - \text{Line } 32) + \text{Line } 33]$.
37. $[\text{Line } 26 - \text{Line } 36]$. Minimum result of 0.

I.3 Step 2: Dispersion Areas

Dispersion areas are dedicated pervious areas, typically vegetated, with in-situ soil infiltration capacity for partial or full infiltration (Figure I.3-1). Impervious area dispersion refers to the practice of effectively disconnecting impervious areas from directly draining to the storm drain system by routing runoff from the impervious area onto an adjacent pervious dispersion area. The pervious dispersion area surface may consist of natural in-situ soils, amended soils, or permeable pavement. This appendix discusses natural in-situ soils and amended soils. For permeable pavement dispersion areas, refer to Section 5.2.3.

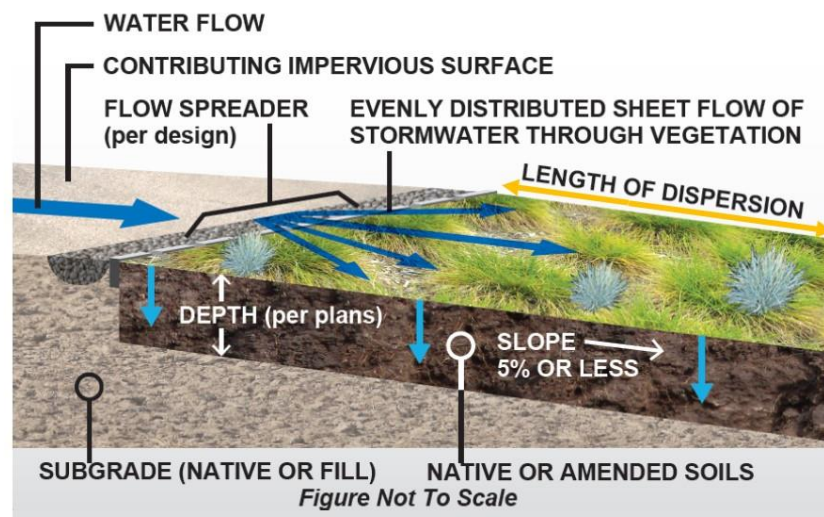

Figure I.3-1 Dispersion Area Schematic

When a dispersion area is proposed to be used as an SSD-BMP, the calculated DCV (Line 37 of the SSD-BMP Automated Worksheet I-1 depicted on the previous pages, “Remaining Design Capture Volume Tributary to Tree Well(s)”) must be zero. This is achieved when the ratio of dispersed impervious surface area to total engineered pervious surface and/or natural hydrologic soil group A or B soil dispersion area meets the requirements outlined in Fact Sheet SD-B (2:1 or 1:1 depending on the dispersion area surface and whether hydromodification control applies) and there are no other surfaces within the DMA that contribute to the project DCV, such as surfaces not directed to the dispersion area, semi-pervious surface used as dispersion area, or natural (non-amended) hydrologic soil group C or D soils used as dispersion area.

Semi-pervious surfaces and/or natural (non-amended) hydrologic soil group C or D soils that receive runoff from impervious surfaces may be used as a regular site design BMP to reduce DCV but may not be used as an SSD-BMP because they do not reduce DCV to zero. When soils are amended in accordance with Fact Sheet SD-F, this is considered “engineered pervious surface” regardless of the subgrade. Any natural hydrologic soil group or fill soil may be amended in accordance with Fact Sheet SD-F and then be considered engineered pervious surface.

If the dispersion area is used for pollutant control plus hydromodification control, the dispersion area must include amended soil. As a minimum, the top 11 inches of the pervious area must use amended soils in accordance with Fact Sheet SD-F.

Table I.3-1 summarizes certain design criteria for the use of dispersion areas as SSD-BMPs and illustrates the difference between the criteria for pollutant control only and for pollutant control plus hydromodification control. Refer to Fact Sheet SD-B for additional requirements applicable to all types of dispersion areas.

Table I.3-1 Criteria for use of Dispersion Areas as SSD-BMPs for Pollutant Control Only vs. Pollutant Control Plus Hydromodification Control

SSD-BMP	Criteria for Pollutant Control Only	Criteria for Pollutant Control Plus Hydromodification Control
Dispersion Area (SD-B)	<ul style="list-style-type: none"> • Ratio of impervious area to engineered pervious surface and/or natural hydrologic soil group A soil area is 2:1 or less; OR ratio of impervious area to natural hydrologic soil group B soil area is 1:1 or less • Sheet flow travel length across dispersion area is 10 feet or more* • Slope is less than 5% 	<ul style="list-style-type: none"> • Ratio of impervious area to engineered pervious surface area is 1:1 or less • Sheet flow travel length across dispersion area is 10 feet or more* • Slope is less than 5% • The top 11 inches of soil is amended in accordance with Fact Sheet SD-F
<p>*Exemption to this minimum travel length criterion may be allowed when the contributing flow path length of the impervious area /pervious area travel length ≤ 2</p>		

The dispersion area sheet flow travel length, slope, and amended soil when applicable must be shown on the project plans. When the SSD-BMP Automated Worksheet is used, these characteristics may be documented in SSD-BMP Automated Worksheet I-2: Step 2. Dispersion Area Validation depicted on the following page in addition to the plans.

Dispersion areas meeting the SSD-BMP criteria do not need an additional downstream BMP. Dispersion areas not meeting the SSD-BMP criteria can be used as regular site design BMPs to reduce the DCV draining to a tree well just as they can be used to reduce the DCV draining to a structural BMP pursuant to Appendix B. If the project includes tree wells, proceed to Step 3: Tree Wells.

SSD-BMP Automated Worksheet I-2: Step 2. Dispersion Area Validation

Category	#	Description	i	Units
Standard Dispersion Area Inputs	1	Drainage Basin ID or Name	-	unitless
	2	Final Design Capture Volume (DCV)	-	cubic-feet
	3	Is Hydromodification Control Applicable?	-	yes/no
	4	Total Impervious Area Dispersed to Pervious Surface	-	sq-ft
	5	Total Engineered Pervious Surface and/or Natural Soil Dispersion Area (Does Not Include Semi-Pervious Surfaces Serving as Dispersion Area)	-	sq-ft
	6	Ratio of Dispersed Impervious Area to Total Engineered Pervious Surface and/or Natural Soil Dispersion Area	-	unitless
	7	Dispersion Area Length (Length of Sheet Flow Across Dispersion Area)		feet
	8	Dispersion Area Slope		%
	9	Thickness of Amended Soil		inches
	10	How is Flow Dispersed Across Width of Dispersion Area (definitions below*)?		unitless
Results	11	Is DCV Requirement Fully Satisfied by Dispersion Area?	-	yes/no
	12	Is Hydromodification Control Requirement Satisfied by Dispersion Area?	-	yes/no
	13	Are Dispersion Area Length, Slope, and Thickness of Amended Soil (when applicable) Adequate?	-	yes/no

Notes:

***How is Flow Dispersed Across Width of Pervious Dispersion Area?**

- Sheet Flow: Flow arrives as sheet flow across the width of the adjacent impervious area
- Spreader(s): Flow is discharged from flow spreader(s) across the width of the pervious area
- Roof Drains: Discharge from roof drains distributed across the width of the pervious area
- Curb Cuts: Discharge from curb cuts distributed across the width of the pervious area
- Other: Other (Describe in PDP SWQMP)

SSD-BMP Worksheet I-2 Line Item Notes
1. Populated per result of Worksheet I-1 (Step 1. DCV) Line 1.
2. Populated per result of Worksheet I-1 (Step 1. DCV) Line 37.
3. Populated per result of Worksheet I-1 (Step 1. DCV) Line 3.
4. Populated per result of Worksheet I-1 (Step 1. DCV) Line 13.
5. Populated per result of Worksheet I-1 (Step 1. DCV) Sum of Lines 15 through 19.
6. Line 4 / Line 5.
7. User input from stormwater plans.
8. User input from stormwater plans.
9. User input from stormwater plans.
10. User input from stormwater plans.
11. "Yes" when DCV = 0.
12. When hydromodification control is applicable, "Yes" when remaining DCV=0, ratio<=1, and thickness >=11.0 inches.
13. "Yes" when length, slope, and thickness (for hydromodification control) meet requirements of SD-B.

I.4 Step 3: Tree Wells

A tree well as a storm water management feature consists of a tree with a minimum amount of soil media to allow for storage, infiltration, and evapotranspiration of runoff (Figure I.4-1).

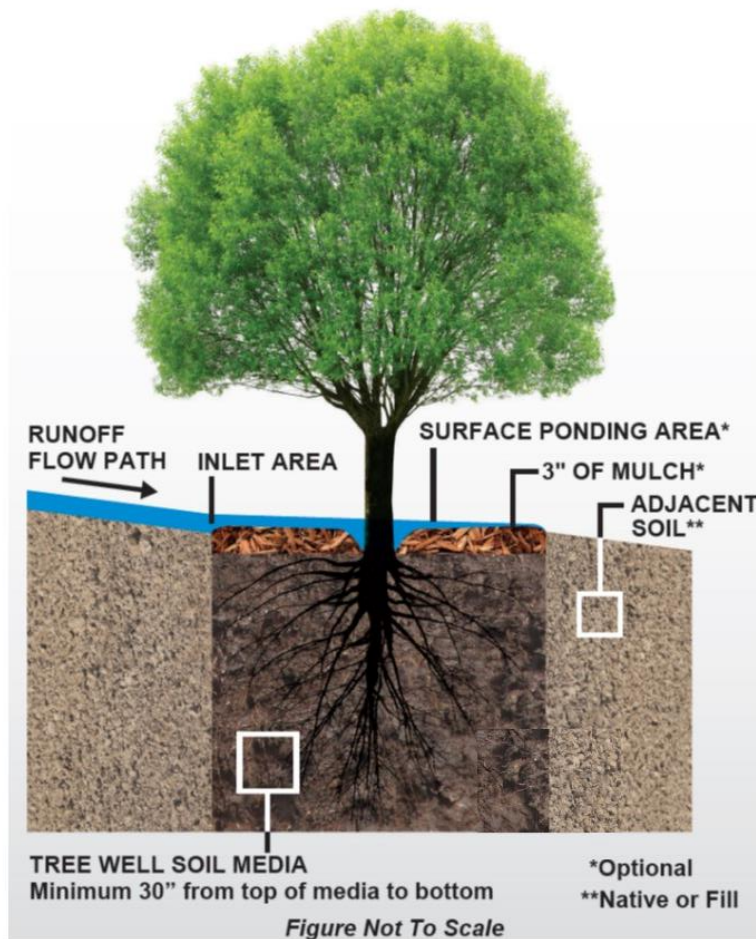

Figure I.4-1 Tree Well Schematic

Tree wells as SSD-BMPs must provide tree credit volume equal to or greater than the DCV for pollutant control only; or for pollutant control plus hydromodification control provide tree credit volume equal to or greater than the required retention volume (RRV), where RRV accounts for a multiplier applied to the DCV value. Tree credit volume for a single tree is based on the mature canopy diameter of the tree. More than one tree may be used in a single DMA in order to provide the total required volume. The tree well must also include tree well soil based on the mature tree canopy diameter in accordance with Fact Sheet SD-A.

Table I.4-1 summarizes certain design criteria for the use of tree wells as SSD-BMPs and illustrates the difference between the criteria for pollutant control only and for pollutant control plus hydromodification control. Refer to Fact Sheet SD-A for additional requirements applicable to all types of tree wells.

**Table I.4-1 Criteria for use of Tree Wells as SSD-BMPs
for Pollutant Control Only vs. Pollutant Control Plus Hydromodification Control**

SSD-BMP	Criteria for Pollutant Control Only	Criteria for Pollutant Control Plus Hydromodification Control
Tree Well (SD-A)	<ul style="list-style-type: none"> • The total tree credit volume is greater than DCV • Provide tree well soil based on the mature tree canopy diameter in accordance with Fact Sheet SD-A 	<ul style="list-style-type: none"> • The total tree credit volume is greater than RRV, where RRV accounts for a multiplier applied to the DCV value • Provide tree well soil based on the mature tree canopy diameter in accordance with Fact Sheet SD-A

Tree well design can be prepared through the use of SSD-BMP Automated Worksheet I-3: Step 3. Tree Well Sizing depicted on the following page or can be calculated manually by following procedures below in Sections I.4.1 through I.4.4.

SSD-BMP Automated Worksheet I-3: Step 3. Tree Well Sizing

Category	#	Description	i	Units
Standard Tree Well Inputs	1	Drainage Basin ID or Name	-	unitless
	2	Design Capture Volume Tributary to BMP	-	cubic-feet
	3	Is Hydromodification Control Applicable?	-	yes/no
	4	Predominant NRCS Soil Type Within Tree Well(s) Location		unitless
	5	Select a Tree Species for the Tree Well(s) Consistent with SD-A Tree Palette Table Note: Numbers shown in list are Tree Species Mature Canopy Diameters		unitless
	6	Tree Well(s) Soil Depth (Installation Depth) Must be 30, 36, 42, or 48 Inches; Select from Standard Depths**		inches
	7	Number of Identical* Tree Wells Proposed for this DMA		trees
	8	Proposed Width of Tree Well(s) Soil Installation for One (1) Tree		feet
	9	Proposed Length of Tree Well(s) Soil Installation for One (1) Tree		feet
Tree Data	10	Botanical Name of Tree Species	-	unitless
	11	Tree Species Mature Height per SD-A	-	feet
	12	Tree Species Mature Canopy Diameter per SD-A	-	feet
	13	Minimum Soil Volume Required In Tree Well (2 Cubic Feet Per Square Foot of Mature Tree Canopy Projection Area)	-	cubic-feet
	14	Credit Volume Per Tree	-	cubic-feet
Tree Well Sizing Calculations	15	DCV Multiplier To Meet Flow Control Requirements	-	unitless
	16	Required Retention Volume (RRV) To Meet Flow Control Requirements	-	cubic-feet
	17	Number of Trees Required	-	trees
	18	Total Area of Tree Well Soil Required for Each Tree	-	sq-ft
	19	Approximate Required Width of Tree Well Soil Area for Each Tree	-	feet
	20	Approximate Required Length of Tree Well Soil Area for Each Tree	-	feet
	21	Number of Trees Proposed for this DMA	-	trees
	22	Total Area of Tree Well Soil Proposed for Each Tree	-	sq-ft
	23	Minimum Spacing Between Multiple Trees To Meet Soil Area Requirements (when applicable)***	-	feet
Results	24	Are Tree Well Soil Installation Requirements Met?	-	yes/no
	25	Is Remaining DCV Requirement Fully Satisfied by Tree Well(s)?	-	yes/no
	26	Is Hydromodification Control Requirement Satisfied by Tree Well(s)?	-	yes/no

Notes:

*If using more than one mature canopy diameter within the same DMA, only the smallest mature canopy diameter should be entered. Alternatively, if more than one mature canopy diameter is proposed and/or the dimensions of multiple tree well installations will vary, separate DMAs may be delineated.

**If the actual proposed installation depth is not available in the table of standard depths, select the next lower depth.

***Tree Canopy or Agency Requirements May Also Influence the Minimum Spacing of Trees.

SSD-BMP Worksheet I-3 Line Item Notes
1. Populated per result of Worksheet I-1 (Step 1. DCV) Line 1.
2. Populated per result of Worksheet I-1 (Step 1. DCV) Line 37.
3. Populated per result of Worksheet I-1 (Step 1. DCV) Line 3.
4. User input from stormwater plans. Only required when hydromodification control is applicable.
5. User input from stormwater plans. Select from Tree Palette Table in SD-A Tree Wells Fact Sheet. Tree species other than those listed are allowable, but must be approved by the County. Provide documentation in PDP SWQMP for alternative species.
6. User input from stormwater plans. In accordance with SD-A Tree Wells Fact Sheet, depth must be 30 inches or greater. Select from standard depths typical of tree box sizes. If the actual proposed installation depth is not available in the table of standard depths, select the next lower depth.
7. User input from stormwater plans.
8. User input from stormwater plans.
9. User input from stormwater plans.
10. Populated based on selected tree species from Tree Palette Table in SD-A Tree Wells Fact Sheet. Provide documentation in PDP SWQMP for alternative species.
11. Populated from Tree Palette Table in SD-A Tree Wells Fact Sheet. Provide documentation in PDP SWQMP for alternative species.
12. Populated from Tree Palette Table in SD-A Tree Wells Fact Sheet. Provide documentation in PDP SWQMP for alternative species.
13. 2 cubic feet per square foot of mature tree canopy projection area: $2 \times \pi \times ((\text{Line } 12)/2)^2$.
14. Populated from Tree Palette Table in SD-A Tree Wells Fact Sheet based on Mature Canopy Diameter.
15. When hydromodification control is applicable, populated from DCV Multiplier Table in SD-A Tree Wells Fact Sheet based on hydrologic soil type and tree well soil installation depth.
16. When hydromodification control is applicable, DCV Multiplier x DCV: Line 15 x Line 2.
17. When hydromodification control is applicable, Line 16 / Line 14 (RRV / Credit Volume per Tree); otherwise Line 2 / Line 14 (DCV / Credit Volume per Tree).
18. Minimum required volume (2 cubic feet per square foot of mature tree canopy projection area) / proposed installation depth: Line 13 / ((Line 6)/12).
19. The square root of the required area (assumes a square installation): $(\text{Line } 13 / ((\text{Line } 6)/12))^{0.5}$. This is a guideline for the user to estimate the installation size; however, the actual length, width and configuration may vary. Lines 7 and 8 control the final result.
20. The square root of the required area (assumes a square installation): $(\text{Line } 13 / ((\text{Line } 6)/12))^{0.5}$. This is a guideline for the user to estimate the installation size; however, the actual length, width and configuration may vary. Lines 7 and 8 control the final result.
21. Reflects user input from Line 7.
22. Line 8 x Line 9.
23. When number of trees proposed > 1, Maximum of Mature Canopy Diameter or Proposed Dimension of Soil Installation (Line 12 or Lines 8 and 9).
24. "Yes" when Lines 3 through 9 are completed and soil installation requirements are satisfied.
25. "Yes" when Lines 3 through 9 are completed and credit volume requirement is satisfied.
26. When hydromodification control is applicable, "Yes" when Lines 3 through 9 are completed and required retention volume is satisfied.

I.4.1 Step 3.1: Determine DCV or RRV as applicable

To design a tree well as an SSD-BMP, first determine whether the tree well is to be sized for pollutant control only or pollutant control plus hydromodification control. Tree wells sized for pollutant control only must provide tree credit volume for the total DCV from the DMA (previously determined in Step 1) tributary to the tree well. Tree wells sized for pollutant control plus hydromodification control must be provide tree credit volume for the RRV tributary to the tree well, where RRV is the total DCV from the DMA increased by a DCV multiplier provided in Fact Sheet SD-A. Table I.4-1 presents the DCV multipliers from Fact Sheet SD-A.

Table I.4-1 DCV Multiplier Table from Fact Sheet SD-A

Minimum Tree Well Soil Depth (inches)	Hydrologic Soil Group				DCV Multiplier
	A	B	C	D (Default)	
30"	1.60	2.20	2.50	2.90	
36"	1.80	2.47	2.83	3.17	
42"	2.00	2.73	3.17	3.43	
48"	2.20	3.00	3.50	3.70	

The DCV multiplier to determine RRV is based on the underlying hydrologic soil group at the location of the tree well and the minimum tree well soil depth. Determining the tree well soil depth requires coordination with the selection of the tree species (Step 3.2). Therefore, determination of the DCV multiplier and RRV may be an iterative process with Step 3.2, selection of tree species and tree well soil depth. The minimum tree well soil depth is 30 inches. If the actual proposed tree well soil depth is not shown in the table of DCV multipliers, select the next lower depth from the table for the purpose of determining the DCV multiplier. For example, if the proposed tree well soil depth is 60 inches, select 48 inches from the table for the purpose of determining the DCV multiplier.

Multiply the DCV by the DCV multiplier to obtain the RRV.

$$RRV (ft^3) = DCV (ft^3) \times DCV \text{ Multiplier}$$

I.4.2 Step 3.2: Select a tree species and tree well soil depth

Select a tree species that will provide sufficient tree credit volume to meet the DCV or RRV as applicable. Fact Sheet SD-A provides a tree palette table and the tree credit volume per tree, which is based on the mature canopy diameter of the tree. Selection of the tree species should be coordinated with the project landscape architect. Multiple trees may be used in a single DMA to collectively provide sufficient tree credit volume, provided that drainage from the DMA is distributed equally to the trees. If the DMA drainage is not distributed equally to the proposed trees, split the DMA into smaller DMAs and size the proposed tree wells individually based on the DCV or RRV tributary to each tree.

Coordinate with the project landscape architect to determine the tree well soil depth. Ensure that the proposed tree well soil depth is appropriate to the size and type of tree(s) proposed.

I.4.3 Step 3.3: Determine the minimum soil volume required in the tree well

The minimum soil volume required in the tree well is based on the mature canopy diameter of the proposed tree. A tree well for storm water control requires a minimum of 2 cubic feet of soil per square foot of mature tree canopy projection area in accordance with the SD-A Tree Wells Fact Sheet. The minimum tree well soil volume can be calculated by the following equation:

$$\text{Minimum Tree Well Soil Volume (ft}^3\text{)} = 2 \times \pi \times \left(\frac{D}{2}\right)^2$$

Where D = mature canopy diameter (feet)

I.4.4 Step 3.4: Determine tree well soil installation area and show on plans

Based on the required tree well soil volume and proposed tree well soil depth, the minimum area required for the tree well soil can be determined.

$$\text{Minimum Tree Well Soil Area (ft}^2\text{)} = \frac{\text{Minimum Tree Well Soil Volume (ft}^3\text{)}}{\text{Tree Well Soil Depth (ft)}}$$

Show the proposed tree well soil area on the project plans. Ensure that the area reserved for tree well soil meets the following requirements:

- The tree well soil must be placed within 1.5 times the mature tree canopy radius.

When multiple trees are used, the trees must be spaced so that the minimum tree well soil volume for each tree does not overlap.

Appendix I: Forms and Checklists

This page was intentionally left blank.

Appendix

J

COUNTY OF SAN DIEGO BMP DESIGN MANUAL

Offsite Alternative Compliance Requirements and Guidance

Appendix J: Offsite Alternative Compliance Requirements and Guidance

This page was intentionally left blank

Appendix J Offsite Alternative Compliance Requirements and Guidance

J.1 Background

The 2013 MS4 Permit lowers the minimum threshold necessary to trigger classification of projects as Priority Development Projects (PDPs) and sets forth more stringent onsite requirements for stormwater pollutant control and hydromodification management. It also allows the County and other Copermittees to establish programs under which project applicants may satisfy applicable PDP requirements through the completion of offsite Alternative Compliance Projects (ACPs).

The MS4 Permit provides two potential pathways in which participation in an offsite alternative compliance program may be determined necessary or allowable. The first pathway is when an applicant has determined that the PDP cannot meet all of the onsite pollutant control obligations via retention and/or biofiltration. This pathway requires performing feasibility analyses for retention and biofiltration BMPs prior to participation in an offsite alternative compliance program. The County may also allow for an applicant to proceed directly to an offsite alternative compliance project without demonstrating infeasibility of retention and/or biofiltration BMPs onsite.

The County Watershed Protection Ordinance (WPO) incorporates the MS4 Permit requirements and provides the policies for implementation with the unincorporated county.

- Section 67.811(b)(4)(C) establishes the requirements for the flow-thru treatment control BMPs to be implemented onsite by the PDP; and
- Section 67.811(b)(6) establishes the ability to utilize offsite alternative compliance projects in lieu of complying with pollutant control and hydromodification BMP performance requirements onsite.
- Offsite ACPs are considered an extension of the PDPs to which they correspond. They must be designed, constructed and maintained consistent with all applicable requirements of Provision E.3.e of the 2013 MS4 Permit and WPO Section 67.812.

This Appendix introduces the types and varieties of ACPs that may potentially be allowed by the County, conditions and restrictions applicable to them, and requirements for obtaining approvals and implementing offsite ACPs in the unincorporated County of San Diego.

J.2 Key Concepts

IMPLEMENTATION SCENARIOS

In accordance with the 2013 MS4 Permit, the December 2015 *Water Quality Equivalency (WQE) Guidance for Region 9* (WQE Guidance) establishes two ACP implementation scenarios that may be included in Copermittee programs, (1) Applicant-implemented ACPs, and (2) Independent ACPs.

- **Applicant-implemented ACPs** are those for which a project applicant owns or proposes to construct an ACP that will be functional⁸ prior to the final release of the proposed PDP. The defining feature of Applicant-implemented ACPs is that the same party is legally responsible for ensuring that all applicable requirements (e.g., design, construction, operation and long term maintenance) are satisfied for both the ACP and the PDP. Because only a single applicant is involved, ACPs can be approved in the absence of a Credit System to track and trade associated Water Quality Impacts and Water Quality Benefits.
- **Independent ACPs** are projects initiated independently of specific PDP impacts. In most instances, they are owned, constructed, or otherwise under the control of a party other than the PDP applicant. Because the completion and approval of Independent ACPs involves more than one legally responsible party, these projects can only be used to mitigate for PDPs within a RWQCB-approved credit system.

At this time, Independent ACPs cannot be approved in the unincorporated County of San Diego. Until such time as the County establishes an in lieu fee structure and/or RWQCB-accepted credit system, Independent ACPs are not allowed under the MS4 Permit. However, please note that Applicant-implemented ACPs providing treatment control or hydromodification benefits in excess of impacts associated with a corresponding PDP may be able to “bank” this additional capacity for future use in the event that a qualifying credit system is established. Applicants are therefore encouraged to fully document excess benefits for potential future application.

ACP TYPES

There are two primary types of ACP: Structural BMPs and Natural System Management Practices (NSMPs). **Structural BMPs** are a subset of BMPs which detain, retain, filter, remove, or prevent the release of pollutants to surface waters from development projects in perpetuity, after construction of the project is completed. These can be further subdivided according to the following project categories:

⁸ For ACPs implemented under an in lieu fee structure, a 4-year time frame for completion of the ACP is allowable. However, applicable treatment or hydromodification performance standards must be met through temporal mitigation of the PDP impacts until the final ACP controls are fully functional.

Appendix J: Offsite Alternative Compliance Requirements and Guidance

- A **Retrofit BMP** adds or modifies structural BMPs in areas of existing development where practices do not already exist, are ineffective, or can be significantly enhanced.
- A **Regional BMP** treats stormwater from a tributary consisting of more than one development. Its primary purpose is to improve water quality, protect downstream channels, reduce flooding, or to meet other specific jurisdictional water quality objectives.
- A **Water Supply BMP** captures stormwater and infiltrates, pumps, or otherwise replenishes groundwater, surface water reservoirs, or other water supply systems.

NSMPs are practices that are implemented to restore and/or preserve predevelopment watershed functions in lieu of providing direct management of stormwater pollutant control and hydromodification flow control. NSMPs include projects that either reduce the release of pollutants through the reduction of runoff volume (e.g.; removal of impervious surfaces) or provide hydromodification management through the restoration of a sensitive stream segment to address impacts caused by the PDP and legacy impacts. They can include structural or engineered elements as part of the system, but non-engineered elements also provide some level of pollutant control and/or hydromodification management benefits. NSMPs include the following project categories:

- **Land Restoration** permanently restores currently developed land back to a stabilized, predevelopment condition. Land Restoration may provide quantifiable stormwater pollutant control and hydromodification flow control benefits by restoring the predevelopment stormwater runoff volumes, peak flows, and pollutant concentrations of a tributary.
- **Land Preservation** permanently preserves undeveloped land in its current state. In limited scenarios, Land Preservation may provide quantifiable stormwater pollutant control and hydromodification flow control benefits by preventing increases in stormwater runoff volumes, peak flows, and pollutant concentrations associated with the future built out condition of a tributary.
- **Stream Rehabilitation** restores a stream to a natural, stabilized condition that can accommodate both legacy and future hydromodification impacts. Stream Rehabilitation may provide quantifiable hydromodification flow control benefits through permanent stabilization of streams. In limited scenarios, Stream Rehabilitation may also provide quantifiable stormwater pollutant control benefits by reducing impervious channel surfaces.

POTENTIAL ACP BENEFITS

Water quality equivalency for stormwater pollutant control is demonstrated when the stormwater pollutant control benefits provided by the ACP are greater than or equal to the stormwater pollutant control impacts generated by the PDP. These benefits may include either of the following:





- **Stormwater Pollutant Control (pollutant or volume reduction), and**
- **Hydromodification Flow Control**

Both structural BMPs and NSMPs can provide pollutant control or hydromodification management benefits, or a combination of both. Regardless of the proposed implementation scenario, applicant

Appendix J: Offsite Alternative Compliance Requirements and Guidance

options will vary depending both on the ACP type and benefit under consideration. Figure J.2-1 summarizes the current availability of different ACP type-benefit combinations. The availability of specific options is largely dependent on the current state of science regarding the demonstration of each benefit type. Because the availability of options is likely to change over time, applicants are advised to consult with staff to make sure they are fully aware of their current availability.

Figure J.2-1: Current Availability ACP Options by Type and Benefit (Source: *Water Quality Equivalency Guidance for Region 9*)

 ACP Category	 Stormwater Pollutant Control Benefits			 Hydromod Flow Control Benefits	
	Pollutant Reduction				Volume Reduction
	Retention	Biofiltration	Flow-Thru		
 BMP	Retrofit	Available	Available	Limited Availability	Available
	Regional	Available	Available	Limited Availability	Available
	Water Supply	Available	Available	Limited Availability	Available
 NSMP	Land Restoration	Not Available	Not Available	Not Available	Available
	Land Preservation	Not Available	Not Available	Not Available	Limited Availability
	Stream Rehabilitation	Not Available	Not Available	Not Available	Limited Availability

J.3 Requirements for ACPs in the County of San Diego

The requirements below are applicable if participating in an offsite alternative compliance program. Section 1.8 of the County BMP Design Manual describes policy and procedural requirements for development projects in greater detail. Applicants should also check with County staff for additional information on the availability of, and requirements pertaining to, specific ACP options. As previously

Appendix J: Offsite Alternative Compliance Requirements and Guidance

noted, all ACP projects are required to utilize the WQE Guidance. This guidance provides additional detail on the general concepts associated with implementing an ACP along with methodologies for calculating the ACP benefits, example calculations and Water Quality Equivalency Worksheets which can be found at Projectcleanwater.org.

PDP REQUIREMENTS

A PDP wishing to utilize offsite alternative compliance must apply the following requirements to the PDP:

- Determine the portion of the design capture volume or total impervious area not managed on the PDP site;
- Provide onsite flow-thru treatment control BMPs that provide a medium to high pollutant removal efficiency to treat runoff leaving the site consistent with the guidance in Section 5.5.4 of the BMP Design Manual and the methodology for selecting and sizing BMPs described in Appendix J.5; and
- Provide temporal mitigation if the ACP is constructed after the completion of the development project that ensures equivalent or better pollutant removal and/or hydrologic control (as applicable) as compared to the case where the ACP is completed at the same time as the PDP.

ACP REQUIREMENTS

A PDP wishing to utilize offsite alternative compliance must apply the following requirements to the ACP:

- The ACP must demonstrate the water quality benefits generated are greater than or equal to the impact of the PDP that is not treated onsite;
- The benefits generated by ACP must be determined utilizing the water quality equivalency metrics established in the *December 2015 Water Quality Equivalency (WQE) Guidance for Region 9* (WQE Guidance), or any other WQE Guidance Document subsequently accepted by the RWQCB;
- The ACP must be located within the same watershed management area (WMA) as the PDP project;
- The ACP must implement all applicable site design and source control BMPs in accordance with the requirements Section 4 of BMP Design Manual;
- ACPs that are Structural BMPS must be designed in accordance with the requirements in Sections 5 and 6 of the BMP Design Manual;
- ACPs designed to manage hydromodification flow control must meet the location requirements defined in the WQE Guidance; and

Appendix J: Offsite Alternative Compliance Requirements and Guidance

- The ACP applicant must ensure effective operation and maintenance in perpetuity consistent with the requirements in Section 7 of the BMP Design Manual.

In addition to the above requirements, any ACP that is partially or wholly located in the County Right-of-way must obtain approval from the Authorized Enforcement Officer.

J.4 Submittal Requirements for Offsite Alternative Compliance Projects

The ACP must be documented in the appropriate attachment of the PDP SWQMP and be consistent with the submittal requirements in Chapter 8. Prior to any design changes to the PDP site layout and/or features that require the PDP SWQMP to be updated; the appropriate attachment in the PDP SWQMP must be reviewed to ensure that the ACP still provides a greater or equal water quality benefit consistent with the requirements of this Manual and the MS4 Permit.

Based on the nature of the project proposal, the County has the discretion to request the submittal of additional information above and beyond the minimum information listed in the PDP SWQMP.

J.5 Flow-Thru Treatment Control BMPs (for use with Alternative Compliance)

The following methodology must be used for selecting and sizing onsite flow-thru treatment control BMPs. These BMPs are to be used only when the project is participating in an alternative compliance program. This methodology consists of three steps:

- 1) Determine the PDP most significant pollutants of concern (Appendix J.5.1).
- 2) Select a flow-thru treatment control BMP that treats the PDP most significant pollutants of concern and meets the pollutant control BMP treatment performance standard (Appendix J.5.2).
- 3) Size the selected flow-thru treatment control BMP (Appendix J.5.3).

J.5.1 PDP Most Significant Pollutants of Concern

The following steps must be followed to identify the PDP most significant pollutants of concern:

- 1) Compile the following information for the PDP and receiving water:
 - a. Receiving water quality (including pollutants for which receiving waters are listed as impaired under the Clean Water Act section 303(d) List; refer to Section 1.9);
 - b. Pollutants, stressors, and/or receiving water conditions that cause or contribute to the highest priority water quality conditions identified in the WQIP (refer to Section 1.9);
 - c. Land use type(s) proposed by the PDP and the storm water pollutants associated with the PDP land use(s) (see Table J.5–1).

Appendix J: Offsite Alternative Compliance Requirements and Guidance

- 2) From the list of pollutants identified in Step 1 identify the most significant PDP pollutants of concern. A PDP could have multiple most significant pollutants of concerns and must include the highest priority water quality condition identified in the watershed WQIP and pollutants anticipated to be present onsite/generated from land use.

Table J.5–1: Anticipated and Potential Pollutants Generated by Land Use Type

Priority Project Categories	General Pollutant Categories								
	Sediment	Nutrients	Heavy Metals	Organic Compounds	Trash & Debris	Oxygen Demanding Substances	Oil & Grease	Bacteria & Viruses	Pesticides
Detached Residential Development	X	X			X	X	X	X	X
Attached Residential Development	X	X			X	P(1)	P(2)	P	X
Commercial Development >one acre	P(1)	P(1)	X	P(2)	X	P(5)	X	P(3)	P(5)
Heavy Industry	X		X	X	X	X	X		
Automotive Repair Shops			X	X(4)(5)	X		X		
Restaurants					X	X	X	X	P(1)
Hillside Development >5,000 ft ²	X	X			X	X	X		X
Parking Lots	P(1)	P(1)	X		X	P(1)	X		P(1)
Retail Gasoline Outlets			X	X	X	X	X		
Streets, Highways & Freeways	X	P(1)	X	X(4)	X	P(5)	X	X	P(1)
X = anticipated P = potential (1) A potential pollutant if landscaping exists onsite. (2) A potential pollutant if the project includes uncovered parking areas. (3) A potential pollutant if land use involves food or animal waste products. (4) Including petroleum hydrocarbons. (5) Including solvents.									

J.5.2 Selection of Flow-Thru Treatment Control BMPs

The following steps must be followed to select the appropriate flow-thru treatment control BMPs for the PDP:

- 1) For each PDP most significant pollutant of concern identify the grouping using Table J.5-2. Table J.5-2 is adopted from the Model SUSMP.
- 2) Select the flow-thru treatment control BMP based on the grouping of pollutants of concern that are identified to be most significant in Step 1. This section establishes the pollutant control BMP treatment performance standard to be met for each grouping of pollutants in order to meet the standards required by the MS4 permit and how an applicant can select a non-proprietary or a proprietary BMP that meets the established performance standard. The grouping of pollutants of concern are:
 - a. Coarse Sediment and Trash (Appendix J.5.2.1)
 - b. Pollutants that tend to associate with fine particles during treatment (Appendix J.5.2.2)
 - c. Pollutants that tend to be dissolved following treatment (Appendix J.5.2.3)

Table J.5–2: Grouping of Potential Pollutants of Concern

Pollutant	Coarse Sediment and Trash	Suspended Sediment and Particulate-bound Pollutants ¹	Soluble-form Dominated Pollutants ²
Sediment	X	X	
Nutrients		X	X
Heavy Metals		X	
Organic Compounds		X	
Trash & Debris	X		
Oxygen Demanding		X	
Bacteria		X	
Oil & Grease		X	
Pesticides		X	

¹ Pollutants in this category can be addressed to Medium or High effectiveness by effectively removing suspended sediments and associated particulate-bound pollutants. Some soluble forms of these pollutants will exist, however treatment mechanisms to address soluble pollutants are not necessary to remove these pollutants to a Medium or High effectiveness.

² Pollutants in this category are not typically addressed to a Medium or High level of effectiveness with particle and particulate-bound pollutant removal alone.

One flow-thru BMP can be used to satisfy the required pollutant control BMP treatment performance standard for the PDP most significant pollutants of concern. In some situations it might be necessary to implement multiple flow-thru BMPs to satisfy the pollutant control BMP treatment performance standards. For example, a PDP has trash, nutrients and bacteria as the most significant pollutants of concern. If a vegetated filter strip is selected as a flow-thru BMP then it is anticipated to meet the

Appendix J: Offsite Alternative Compliance Requirements and Guidance

performance standard in Appendix J.5.2.2 and J.5.2.3 but would need a trash removal BMP to meet the pollutant control BMP treatment performance standard in Appendix J.5.2.1 upstream of the vegetated filter strip. This could be achieved by fitting the inlets and/or outlets with racks or screens on to address trash.

J.5.2.1 Coarse Sediment and Trash

If coarse sediment and/or trash and debris are identified as a pollutant of concern for the PDP, then BMPs must be selected to capture and remove these pollutants from runoff. The BMPs described below can be effective in removing coarse sediment and/or trash. These devices must be sized to treat the flow rate estimated using Worksheet J.5-1. Applicant can only select BMPs that have High or Medium effectiveness.

Trash Racks and Screens [Coarse Sediment: Low effectiveness; Trash: Medium to High effectiveness] are simple devices that can prevent large debris and trash from entering storm drain infrastructure and/or ensure that trash and debris are retained with downstream BMPs. Trash racks and screens can be installed at inlets to the storm drain system, at the inflow line to a BMP, and/or on the outflow structure from the BMP. Trash racks and screens are commercially available in many sizes and configurations or can be designed and fabricated to meet specific project needs.

Hydrodynamic Separation Devices [Coarse Sediment: Medium to High effectiveness; Trash: Medium to High effectiveness] are devices that remove coarse sediment, trash, and other debris from incoming flows through a combination of screening, settlement, and centrifugal forces. The design of hydrodynamic devices varies widely, more specific information can be found by contacting individual vendors. A list of hydrodynamic separator products approved by the Washington State Technology Acceptance Protocol-Ecology protocol can be found at:

http://www.ecy.wa.gov/programs/wq/storm_water/newtech/technologies.html.

Systems should be rated for “pretreatment” with a General Use Level Designation or provide results of field-scale testing indicating an equivalent level of performance.

Catch Basin Insert Baskets [Coarse Sediment: Low effectiveness; Trash: Medium effectiveness, if appropriately maintained] are manufactured filters, fabrics, or screens that are placed in inlets to remove trash and debris. The shape and configuration of catch basin inserts varies based on inlet type and configuration. Inserts are prone to clogging and bypass if large trash items are accumulated, and therefore require frequent observation and maintenance to remain effective. Systems with screen size small enough to retain coarse sediment will tend to clog rapidly and should be avoided.

Other Manufactured Particle Filtration Devices [Coarse Sediment: Medium to High effectiveness; Trash: Medium to High effectiveness] include a range of products such as cartridge filters, bag filters, and other configurations that address medium to coarse particles. Systems should be rated for “pretreatment” with a General Use Level Designation under the Technology Acceptance Protocol-Ecology program or provide results of field-scale testing indicating an equivalent level of performance.

Appendix J: Offsite Alternative Compliance Requirements and Guidance

Note, any BMP that achieves Medium or High performance for suspended solids (See Section J.5.2.2) is also considered to address coarse sediments. However, some BMPs that address suspended solids do not retain trash (for example, swales and detention basins). These types of BMPs could be fitted with racks or screens on inlets or outlets to address trash.

BMP Selection for Pretreatment:

Devices that address both coarse sediment and trash can be used as pretreatment devices for other BMPs, such as infiltration BMPs. However, it is recommended that BMPs that meet the performance standard in Appendix J.5.2.2 be used. A device with a “pretreatment” rating and General Use Level Designation under Technology Acceptance Protocol-Ecology is required for pretreatment upstream of infiltration basins and underground galleries. Pretreatment may also be provided as presettling basins or forebays as part of a pollutant control BMP instead of implementing a specific pretreatment device for systems where maintenance access to the facility surface is possible (to address clogging), expected sediment load is not high, and appropriate factors of safety are included in design.

J.5.2.2 Suspended Sediment and Particulate-Bound Pollutants

Performance Standard

The pollutant treatment performance standard is shown in Table J.5-3. This performance standard is consistent with the Washington State Technology Acceptance Protocol-Ecology Basic Treatment Level, and is also met by technologies receiving Phosphorus Treatment or Enhanced Treatment certification. This standard is based on pollutant removal performance for total suspended solids. Systems that provide effective TSS treatment also typically address trash, debris, and particulate bound pollutants and can serve as pre-treatment for offsite mitigation projects or for onsite infiltration BMPs.

Table J.5-3: Performance Standard for Flow-Thru Treatment Control

Influent Range	Criteria
20 – 100 mg/L TSS	Effluent goal \leq 20 mg/L TSS
100 – 200 mg/L TSS	\geq 80% TSS removal
>200 mg/L TSS	> 80% TSS removal

Selecting Non-Proprietary BMPs

Table J.5-4 identifies the categories of non-proprietary BMPs that are considered to meet the pollutant treatment performance standard if designed to contemporary design standards⁹. BMP types with an

⁹ Contemporary design standards refers to design standards that are reasonably consistent with the current state of practice and are based on desired outcomes that are reasonably consistent with the context of the MS4 Permit and this manual. For example, a detention basin that is designed solely to mitigate peak flow rates would not be considered a contemporary water quality BMP design because it is not consistent with the goal of water quality improvement. Current state of the practice recognizes that a drawdown time of 24 to 72 hours is typically needed to promote settling. For practical purposes,

Appendix J: Offsite Alternative Compliance Requirements and Guidance

“High” ranking should be considered before those with an “Medium” ranking. Statistical analysis by category from the International Storm Water BMP Database (also presented in Table J.5-4) indicates each of these BMP types (as a categorical group) meets or nearly meets the performance standard. The International Storm Water BMP Database includes historic as well as contemporary BMP studies; contemporary BMP designs in these categories are anticipated to meet or exceed this standard on average.

Table J.5-4: Flow-Thru Treatment Control BMPs Meeting Performance Standard

List of Acceptable Flow-Thru Treatment Control BMPs	Statistical Analysis of International Storm Water BMP Database				Evaluation of Conformance to Performance Standard		
	Count In/Out	TSS Mean Influent, mg/L	TSS Mean Effluent ¹ , mg/L	Average Category Volume Reduct.	Volume-Adjusted Effluent Conc ² , mg/L	Volume-Adjusted Removal Efficiency ²	Level of Attainment of Performance Standard (with rationale)
Vegetated Filter Strip	361/282	69	31	38%	19	72%	Medium, effluent < 20 mg/L after volume adjustment
Vegetated Swale	399/346	45	33	48%	17	61%	Medium, effluent < 20 mg/L after volume adjustment
Detention Basin	321/346	125	42	33%	28	77%	Medium, percent removal near 80% after volume adjustment
Sand Filter/Media Bed Filter	381/358	95	19	NA ³	19	80%	High, effluent and % removal meet criteria without adjustment
Lined Porous Pavement ⁴	356/220	229	46	NA ^{3,4}	46	80%	High, % removal meets criteria without adjustment
Wet Pond	923/933	119	31	NA ³	31	74%	Medium, percent removal near 80%

Source: 2014 BMP Performance Summaries and Statistical Appendices; 2010 Volume Performance Summary; available at: www.bmpdatabase.org

- 1 - A statistically significant difference between influent and effluent was detected at a p value of 0.05 for all categories.
- 2 - Estimates were adjusted to account for category-average volume reduction.
- 3 - Not Applicable as these BMPs are not designed for volume reduction and are anticipated to have very small incidental volume reduction.
- 4 - The category presented in this table represents a lined system for flow-thru treatment purposes. Porous pavement for retention purposes is an infiltration BMP, not a flow-thru BMP. This table should not be consulted for porous pavement for infiltration.

design standards can be considered “contemporary” if they have been published within the last 10 years, preferably in California or Washington State, and are specifically intended for storm water quality management.

Selecting Proprietary BMPs

Proprietary BMPs can be used if the BMP meets each of the following conditions:

- (1) The proposed BMP meets the performance standard in Appendix J.5.2.2 as certified through third-party, field scale evaluation.** An active General Use Level Designation for Basic Treatment, Phosphorus Treatment or Enhanced Treatment under the Washington State Technology Acceptance Protocol-Ecology program is the preferred method of demonstrating that the performance standard is met. The list of certified technologies is updated as new technologies are approved (link below). Technologies with Pilot Use Level Designation and Conditional Use Level Designations are not acceptable. Refer to: <http://www.ecy.wa.gov/programs/wq/stormwater/newtech/technologies.html>. Alternatively, other field scale verification of 80 percent TSS capture, such as through Technology Acceptance Reciprocity Partnership or New Jersey Corporation for Advance Testing may be acceptable. A list of field-scale verified technologies under Technology Acceptance Reciprocity Partnership Tier II and New Jersey Corporation for Advance Testing can be accessed at: <http://www.njcat.org/verification-process/technology-verification-database.html> (refer to field verified technologies only).
- (2) The proposed BMP is designed and maintained in a manner consistent with its performance certifications (see explanation below).** The applicant must demonstrate conclusively that the proposed application of the BMP is consistent with the basis of its certification/verification. Certifications or verifications issued by the Washington Technology Acceptance Protocol-Ecology program and the Technology Acceptance Reciprocity Partnership or New Jersey Corporation for Advance Testing programs are typically accompanied by a set of guidelines regarding appropriate design and maintenance conditions that would be consistent with the certification/verification. It is common for these approvals to specify the specific model of BMP, design capacity for given unit sizes, type of media that is the basis for approval, and/or other parameters.
- (3) The proposed BMP is acceptable at the discretion of the County.** The applicant may be required to provide additional studies and/or required to meet additional design criteria beyond the scope of this document in order to demonstrate that these criteria are met. While the County has no obligation to accept the use of any proposed proprietary BMP, applicants will be provided a written explanation describing the rationale for the rejection of any proposed devices.

J.5.2.3 Soluble-form dominated Pollutants (Nutrients)

If nutrients are identified as a most significant pollutant of concern for the PDP, then BMPs must be selected to meet the performance standard described in Appendix J.5.2.2 **and** must be selected to provide medium or high level of effectiveness for nutrient treatment as described in this section. The most common nutrient of concern in the San Diego region is nitrogen, therefore total nitrogen (TN) was used as the primary indicator of nutrient performance in storm water BMPs.

Appendix J: Offsite Alternative Compliance Requirements and Guidance

Selection of BMPs to address nutrients consists of two steps:

- 1) Determine if nutrients can be addressed via source control BMPs as described in Appendix E and Chapter 4. After applying source controls, if there are no remaining source areas for soluble nutrients, then this pollutant can be removed from the list of pollutants of concerns for the purpose of selecting flow-thru treatment control BMPs. Particulate nutrients will be addressed by the performance standard in Appendix J.5.2.2.
- 2) If soluble nutrients cannot be fully addressed with source controls, then select a flow-thru treatment control BMPs that meets the performance criteria in Table J.5-5 or select from the nutrient-specific menu of treatment control BMPs in Table J.5-6.
 - a. The performance standard for nitrogen removal (Table J.5-5) has been developed based on evaluation of the relative performance of available categories of non-proprietary BMPs.
 - b. For proprietary BMPs, submit third party performance data indicating that the criteria in Table J.5-5 are met. The applicant may be required to provide additional studies and/or required to meet additional design criteria beyond the scope of this document in order to demonstrate that these criteria are met. While the County has no obligation to accept the use of any proposed proprietary flow-thru BMP, applicants will be provided a written explanation describing the rationale for the rejection of any proposed devices.

Table J.5-5: Performance Standard for Flow-Thru Treatment Control BMPs for Nutrient Treatment

Basis	Criteria
Treatment Basis	Comparison of mean influent and effluent indicates significant concentration reduction of TN approximately 40 percent or higher based on studies with representative influent concentrations
Combined Treatment and Volume Reduction Basis	Combination of concentration reduction and volume reduction yields TN mass removal of approximately 40 percent or higher based on studies with representative influent concentrations

Appendix J: Offsite Alternative Compliance Requirements and Guidance

Table J.5-6: Flow-Thru Treatment Control BMPs Meeting Nutrient Treatment Performance Standard

List of Acceptable Flow-Thru Treatment Control BMPs for Nutrients	Statistical Analysis of International Storm Water BMP Database				Evaluation of Conformance to Performance Standard		
	Count In/Out	TN Mean Influent, mg/L	TN Mean Effluent ¹ , mg/L	Average Category Volume Reduct.	Volume-Adjusted Effluent Conc ² , mg/L	Volume-Adjusted Removal Efficiency ²	Level of Attainment of Performance Standard (with rationale)
Vegetated Filter Strip	138/ 122	1.53	1.37	38%	0.85	44%	Medium, if designed to include volume reduction processes
Detention Basin	90/ 89	2.34	2.01	33%	1.35	42%	Medium, if designed to include volume reduction processes
Wet Pond	397/ 425	2.12	1.33	NA	1.33	37%	Medium, best concentration reduction among BMP categories, but limited volume reduction

Source: 2014 BMP Performance Summaries and Statistical Appendices; 2010 Volume Performance Summary; available at: www.bmpdatabase.org

1 - A statistically significant difference between influent and effluent was detected at a p value of 0.05 for all categories included.

2 - Estimates were adjusted to account for category-average volume reduction.

J.5.3 Sizing Flow-Thru Treatment Control BMPs:

Flow-thru treatment control BMPs must be sized to filter or treat the maximum flow rate of runoff produced from a rainfall intensity of 0.2 inch of rainfall per hour, for each hour of every storm event. The required flow-thru treatment rate should be adjusted for the portion of the DCV already retained or biofiltered onsite as described in Worksheet J.5-1. The following hydrologic method must be used to calculate the flow rate to be filtered or treated:

$$Q = C \times i \times A$$

Where:

Q = Design flow rate in cubic feet per second

C = Runoff factor, area-weighted estimate using Table B.1-1.

i = Rainfall intensity of 0.2 in/hr.

A = Tributary area (acres) which includes the total area draining to the BMP, including any offsite or onsite areas that comingle with project runoff and drain to the BMP. Refer to Section 3.3.3 for additional guidance. Street projects consult Section 1.4.3.

Appendix J: Offsite Alternative Compliance Requirements and Guidance

Worksheet J.5-1: Flow-Thru Design Flows

Category	#	Description	Value	Units
Flow-Thru BMP Inputs	0	Drainage Basin ID or Name		unitless
	1	Total Tributary Area		sq-ft
	2	Final Adjusted Runoff Factor		unitless
	3	Design Capture Volume		cubic-feet
	4	Volume Effectively Retained and/or Biofiltered		cubic-feet
	5	Deficit of Effectively Treated Stormwater Requiring Flow-Thru Treatment		cubic-feet
Flow Rate Calculations	6	Maximum Rated Water Quality Flow Rate of Proposed BMP		CFS
	7	Adjustment Factor		unitless
	8	Design Rainfall Intensity for Flow-Thru BMPs	0.20	in/hr
Result	9	Water Quality Flow Rate Requiring Flow-Thru Treatment		CFS
	10	Is Flow-Thru BMP Adequately Sized?		unitless

Worksheet J.5-1 General Notes:

A. Applicants may use this worksheet to size flow-thru BMPs. Applicants must provide inputs for yellow shaded cells and calculate appropriate values for unshaded cells. Note that applicants proposing on-site flow-thru BMPs must also implement an offsite alternative compliance project to offset the deficit of effectively treated stormwater volume. An automated version of this worksheet is available for download at the County of San Diego Department of Public Works website.

Worksheet J.5-1 Line Item Notes:

0. Populated per Worksheet B.1-1.
1. Populated per Worksheet B.1-1.
2. Populated per Worksheet B.1-1.
3. Populated per Worksheet B.2-1.
4. Populated per Retention and/or Biofiltration treatment determined in Worksheets B.3-1 through B.5-3.
5. Line 4 - Line 3
6. User input per manufacturer's specification sheet
7. -Line 5 / Line 3
8. Default value of 0.20 inches per hour
9. (Line 1/43,560) x Line 2 x Line 7 x Line 8
10. If Line 6 \geq Line 9 then "Yes". If Line 6 $<$ Line 9 then "No".

Appendix J: Offsite Alternative Compliance Requirements and Guidance

This page was intentionally left blank

Appendix

K

COUNTY OF SAN DIEGO BMP DESIGN MANUAL

Guidance on Green Infrastructure

Appendix K: Guidance on Green Infrastructure

This page was intentionally left blank

Appendix K Guidance on Green Infrastructure

Table of Contents:

- K.1 Guidance on Green Infrastructure
- K.2 Green Streets
 - K.2.1 Green Streets Performance Standard
 - K.2.2 Green Streets Guidelines
- K.3 Green Parking Lots
 - K.3.1 Green Parking Lots Guidelines

Design Criteria, Design Standard Drawings, and Specifications for Green Streets and Green Parking Lots can be found on the County's Watershed Protection Program website under Green Infrastructure Resources within the Development Resources tab:

<https://www.sandiegocounty.gov/stormwater>

K.1 Guidance on Green Infrastructure

County of San Diego Guidance on Green Infrastructure



January 2019

This page is intentionally left blank

COUNTY OF SAN DIEGO GUIDANCE ON GREEN INFRASTRUCTURE



Green Infrastructure is an approach to stormwater and flood management that protects, restores, and mimics the natural water cycle using vegetation, mulch, soils, and natural processes while creating healthier environments. At the County scale, green infrastructure refers to the network of natural features that provides habitat, flood protection, cleaner air, and cleaner water. At the scale of a neighborhood or site, green infrastructure refers to stormwater and flood management systems that mimic nature by soaking up and storing water.

Roadways and parking lots present many opportunities for coordinated Green Infrastructure use. A Green Street or Parking Lot use a natural system approach to reduce stormwater flow, improve water quality, reduce urban heating, enhance pedestrian safety, reduce carbon footprints, and beautify neighborhoods. Green Streets and Parking Lots are components of Green Infrastructure, integrating strategies into roads and right-of-ways.

Green Streets Guidelines are an outreach tool and are also intended to serve as a companion to the rest of the Green Streets publications. They include an introduction, strategies, procedures and design examples for implementing Green Streets projects. The strategies include tree wells, dispersion areas, biofiltration, and permeable pavement.

Green Streets Design Criteria lay out general definitions, general policy, and landscape design criteria for Green Infrastructure strategies in the right-of-way. This can be found on the County's Development Resources website.

Green Streets Supplement to County Design Standard Drawings includes construction details which may be referenced in improvement plans similar to current County Design standard drawings. This can be found on the County's Development Resources website within the Green Streets Standard Drawings.

Green Streets Maintenance Schedules include a list with maintenance tasks, frequency, and time of year for initial, routine, and as-needed maintenance of each Green Infrastructure strategy. This can be found on the County's Development Resources website.

Green Streets Specifications include detailed construction material and installation requirements for Green Infrastructure strategies including aggregates, geosynthetics, underdrains, permeable pavement, bioretention soil media, mulch, overflow risers, check dams, and tree grates. This can be found on the County's Development Resources website.

Green Parking Lots Guidelines are an outreach tool and are also intended to serve as a companion to the rest of the Green Parking Lots publications. They include an introduction, strategies, procedures and design examples for implementing Green Parking Lots projects. The strategies include tree wells, dispersion areas, biofiltration, and permeable pavement.

Green Parking Lots Design Criteria lay out general definitions, general policy, and landscape design criteria for Green Infrastructure strategies in parking lots. This can be found on the County's Development Resources website.

Green Parking Lots Supplement to County Design Standard Drawings includes construction details which may be referenced in improvement plans similar to current County Design standard drawings. This can be found on the County's Development Resources website within the Green Streets Standard Drawings.

Green Parking Lots Maintenance Schedules does not have parking lot specific maintenance and references the Green Streets Maintenance Schedules.

Green Parking Lots Specifications does not have unique parking lot specifications and references the Green Streets Specifications.

K.2 Green Streets

K.2.1 Green Streets Performance Standard

This section builds on text from Section 1.4.3 providing more detailed guidance on compliance with the performance standard for Green Street PDP Exempt projects (herein referred to as Green Street projects).

Green Street projects must provide stormwater treatment for the volume of runoff associated with the project's net increase in impervious area. Compliance with this standard may be demonstrated at the project-scale, meaning there is no obligation to treat runoff from each discrete segment of new impervious area. Green Street projects are encouraged to achieve compliance through treatment of runoff from any combination of land uses including existing/proposed surfaces, onsite/offsite surfaces, pervious/impervious surfaces. As summarized below, Green Street compliance can be demonstrated through determination of the following 1) Required Treatment Volume, 2) Provided Treatment Volume, and 3) Comparison of Required and Provided Treatment.

1) REQUIRED TREATMENT VOLUME

Project proponent must calculate a single water quality runoff volume associated with the net increase in impervious area across the entire project site. This calculation should exclude runoff volumes associated with existing/replaced impervious areas within the project footprint, as treatment is not mandated for these areas. Supporting exhibits delineating new impervious areas, existing/replaced impervious areas, and removed impervious areas must be provided as needed to support this determination.

2) PROVIDED TREATMENT VOLUME

Project proponent must calculate the total volume of stormwater runoff treated through site design elements and/or structural BMPs proposed by the project. Completion of this step requires consideration of all surfaces draining to proposed treatment elements (existing/proposed, onsite/offsite, pervious/impervious areas draining to BMPs).

Project proponent must provide treatment through use of “Conventional” treatment elements where feasible but may also be permitted to use “Alternative” treatment elements upon demonstration of infeasibility.

Conventional Treatment Elements: Elements that utilize conventional retention and/or biofiltration designs that are consistent with the County BMPDM¹⁰. Use of these elements may achieve Green Street compliance and are eligible to generate alternative compliance credits if implemented sufficiently. [*Examples: tree wells, dispersion areas, biofiltration basins (lined or unlined), bioretention basins, infiltration basins (vegetated or non-vegetated), pervious pavements without impermeable liners.*]

¹⁰ Minimum retention requirements waived for Green Streets.

Alternative Treatment Elements: Elements that provide filtration for anticipated pollutants at medium to high efficacy and provide significant pore storage capacity. Use of these elements may achieve Green Street compliance but are typically not eligible¹¹ to generate alternative compliance credits. [*Examples: vegetated swales, non-vegetated filtration BMPs (sand filters, biofiltration soil media, pervious pavements with impermeable liners and underdrains), detention basins, wet ponds, proprietary filtration devices with significant pore storage capacity.*]

Treatment Elements lacking significant pore storage such as filter fabrics, debris racks, filter baskets, CDS units, hydrodynamic separators or similar devices may not be classified as either of the two categories above.

3) COMPARISON OF REQUIRED AND PROVIDED TREATMENT

Project proponent must demonstrate that the provided treatment volume is greater than or equal to the required treatment volume. This may be demonstrated at the project-scale, meaning there is no obligation to demonstrate treatment for each discrete segment of new impervious area. The pages that follow present a standard calculation template for demonstrating Green Street compliance as well as several calculation examples.

¹¹ If project proponent desires to bank credits through use of Alternative Treatment Elements, more detailed guidance outlined in the Regional Water Quality Equivalency must be referenced.

Appendix K: Guidance on Green Infrastructure

Table K.2-1 : Green Street Performance Standard Calculations

Item	Value	Description
Required Treatment Volume	1 Land Use of Net Impervious Area	Transportation <i>Per project drawings.</i>
	2 Total Net Impervious Area ¹²	ft ² <i>Per project drawings.</i>
	3 85 th Percentile Rainfall Depth	in. <i>Determine per BMPDM Appendix B.1.</i>
	4 Runoff Coefficient	0.90 <i>Value of 0.90 applies to new impervious areas.</i>
	5 Required Treatment Volume	ft ³ <i>(Line 2 × Line 3 × Line 4) / 12</i>
Provided Treatment Volume	6 Land Use of Treated Area ¹³	<i>Per project drawings.</i>
	7 Land Use Factor ¹⁴	<i>Determine per Note 5 below.</i>
	8 Conventional Treatment Volume ¹⁵	ft ³ <i>Determine per Note 6 below.</i>
	9 Alternative Treatment Volume	<i>Determine per supplemental applicant calculations.</i>
	10 Final Treatment Volume	ft ³ <i>Line 7 × (Line 8 + Line 9)</i>
Result	11 Is Project Green Street Compliant?	<i>Compliant if Line 10 ≥ Line 5. Otherwise, non-compliant.</i>
	12 Optional Credit	<i>(Line 7 × Line 8) – Line 5</i>

¹² The Net Increase in Impervious Area should **not** reflect any work occurring within existing impervious areas.

¹³ Classify drainage area into following land use types (may use more than one) agriculture, commercial, education, industrial, multi-family residential, orchard, rural residential, single family residential, transportation, open space.

¹⁴ If Land Uses from Lines 1 and 6 match, use a value of 1.0. Otherwise, refer to Regional Water Quality Equivalency Guidance for determination of appropriate Land Use Factor.

¹⁵ Conventional Treatment Volume may be determined by subtracting the project’s total “Deficit of Effectively Treated Stormwater” from the project’s total Design Capture Volume. These values can be found in Version 2.0 of the County of San Diego Automated Control Worksheet on Line 48 of the BMP Performance Tab and Line 26 of the DCV Tab respectively.

Example 1: Green Street Compliance using Conventional Treatment Elements

A green street project will create 20,000 SF of new impervious surface through the addition of a center turn lane on an existing road that currently has a vegetated center divide. The project is divided into two Drainage Management Areas (DMAs) as shown below. DMA 1 consists of impervious roadway surfaces that drain westerly to a proposed biofiltration basin. DMA 2 consists of impervious roadway surfaces that sheet flow in an easterly direction and leave the site without treatment. The project applicant demonstrates compliance with the Green Street Performance Standard as presented below.

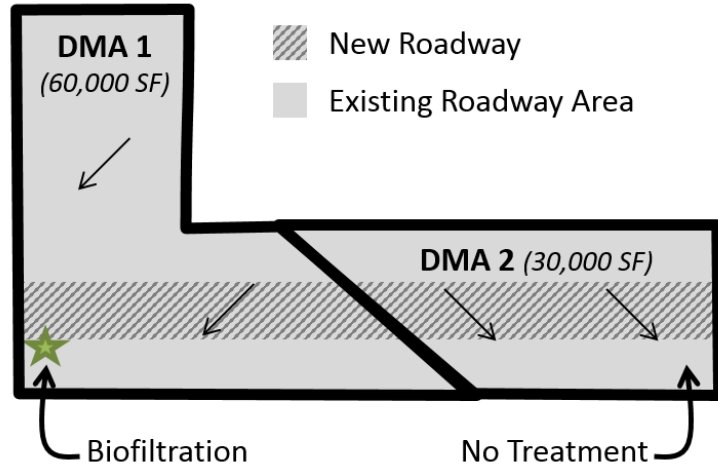

Item		Value
Required Treatment Volume	1 Land Use of New Impervious Area	Transportation
	2 Total New Impervious Area	20,000 ft ²
	3 85 th Percentile Rainfall Depth	0.70 in.
	4 Runoff Coefficient	0.90
	5 Required Treatment Volume <i>(See Excerpt 1 for calculations)</i>	1,050 ft ³
Provided Treatment Volume	6 Land Use of Treated Area	Transportation
	7 Land Use Factor	1.00
	8 Conventional Treatment Volume <i>(See Excerpt 2 for calculations)</i>	3,150 ft ³
	9 Alternative Treatment Volume	0 ft ³
	10 Final Treatment Volume	3,150 ft ³
Result	11 Is Project Green Street Compliant?	Compliant
	12 Optional Credit	2,100 ft ³

Example 2: Green Street Compliance using **Alternative Treatment Elements**

If the project described in the previous Example 1 implemented a sand filter instead of biofiltration, the project would demonstrate compliance with the Green Street Performance Standard as presented below.

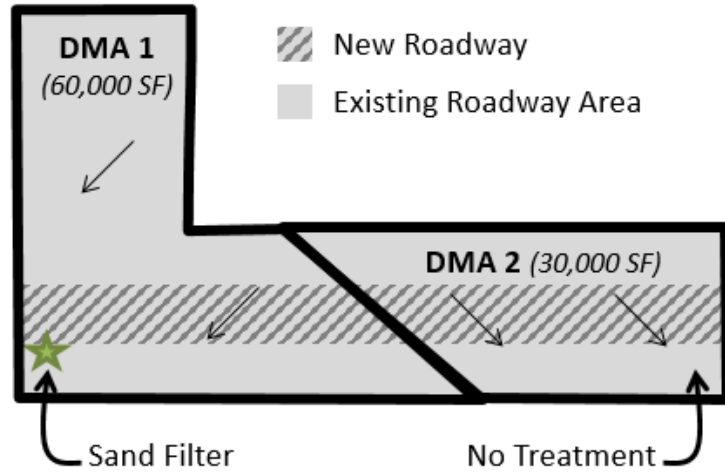

Item		Value
Required Treatment Volume	1 Land Use of New Impervious Area	Transportation
	2 Total New Impervious Area	20,000 ft ²
	3 85 th Percentile Rainfall Depth	0.70 in.
	4 Runoff Coefficient	0.90
	5 Required Treatment Volume <i>(See Excerpt 1 for calculations)</i>	1,050 ft ³
Provided Treatment Volume	6 Land Use of Treated Area	Transportation
	7 Land Use Factor	1.00
	8 Conventional Treatment Volume	0 ft ³
	9 Alternative Treatment Volume <i>(Applicant Calculations)</i>	3,150 ft ³
	10 Final Treatment Volume	3,150 ft ³
Result	11 Is Project Green Street Compliant?	Compliant
	12 Optional Credit <i>(Alternative treatment not eligible)</i>	0 ft ³

Appendix K: Guidance on Green Infrastructure

Example 3: Green Street Compliance using Conventional Treatment Elements for **Offsite Run-on**

If the project described in Example 1 provided stormwater treatment for offsite run-on from an adjacent commercial area, the project would demonstrate compliance with the Green Street Performance Standard as presented below.

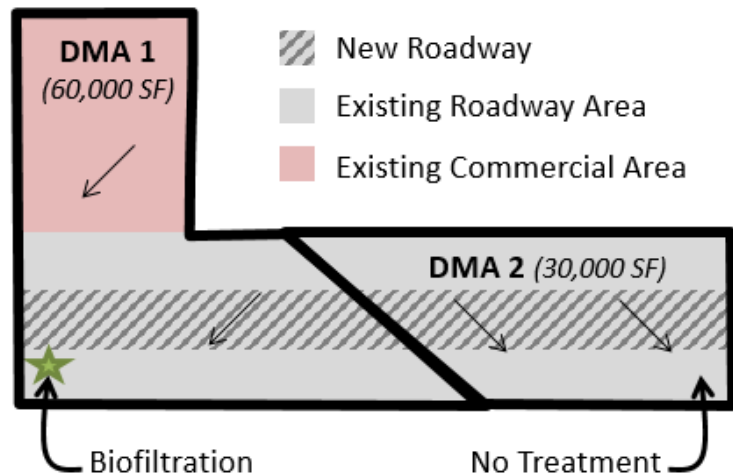

Item		Value
Required Treatment Volume	1 Land Use of New Impervious Area	Transportation
	2 Total New Impervious Area	20,000 ft ²
	3 85 th Percentile Rainfall Depth	0.70 in.
	4 Runoff Coefficient	0.90
	5 Required Treatment Volume <i>(See Excerpt 1 for calculations)</i>	1,050 ft ³
Provided Treatment Volume	6 Land Use of Treated Area	Transportation & Commercial
	7 Land Use Factor <i>(See Excerpt 3 for calculations)</i>	0.82
	8 Conventional Treatment Volume <i>(See Excerpt 2 for calculations)</i>	3,150 ft ³
	9 Alternative Treatment Volume	0 ft ³
	10 Final Treatment Volume	2,583 ft ³
Result	11 Is Project Green Street Compliant?	Compliant
	12 Optional Credit	1,533 ft ³

Appendix K: Guidance on Green Infrastructure

Excerpt 1 - Required Treatment Volume for New Impervious Surface of 20,000 SF

County of San Diego Automated Stormwater Pollutant Control Worksheet B.1 (Version 2.0)

Category	#	Description	<i>i</i>	Units
Standard Drainage Basin Inputs	1	Drainage Basin ID or Name	Perf Std	unitless
	2	85th Percentile 24-hr Storm Depth	0.70	inches
	3	Impervious Surfaces <u>Not Directed to Dispersion Area</u> (C=0.90)	20,000	sq-ft
	4	Semi-Pervious Surfaces <u>Not Serving as Dispersion Area</u> (C=0.30)		sq-ft
	5	Engineered Pervious Surfaces <u>Not Serving as Dispersion Area</u> (C=0.10)		sq-ft
	6	Natural Type A Soil <u>Not Serving as Dispersion Area</u> (C=0.10)		sq-ft
	7	Natural Type B Soil <u>Not Serving as Dispersion Area</u> (C=0.14)		sq-ft
	8	Natural Type C Soil <u>Not Serving as Dispersion Area</u> (C=0.23)		sq-ft
	9	Natural Type D Soil <u>Not Serving as Dispersion Area</u> (C=0.30)		sq-ft
Dispersion Area, Tree Well & Rain Barrel Inputs (Optional)	10	Does Tributary Incorporate Dispersion, Tree Wells, and/or Rain Barrels?	No	yes/no
	11	Impervious Surfaces Directed to Dispersion Area per SD-B (Ci=0.90)		sq-ft
	12	Semi-Pervious Surfaces Serving as Dispersion Area per SD-B (Ci=0.30)		sq-ft
	13	Engineered Pervious Surfaces Serving as Dispersion Area per SD-B (Ci=0.10)		sq-ft
	14	Natural Type A Soil Serving as Dispersion Area per SD-B (Ci=0.10)		sq-ft
	15	Natural Type B Soil Serving as Dispersion Area per SD-B (Ci=0.14)		sq-ft
	16	Natural Type C Soil Serving as Dispersion Area per SD-B (Ci=0.23)		sq-ft
	17	Natural Type D Soil Serving as Dispersion Area per SD-B (Ci=0.30)		sq-ft
	18	Number of Tree Wells Proposed per SD-A		#
	19	Average Mature Tree Canopy Diameter		ft
	20	Number of Rain Barrels Proposed per SD-E		#
Initial Runoff Factor Calculation	21	Average Rain Barrel Size		gal
	22	Total Tributary Area	20,000	sq-ft
	23	Initial Runoff Factor for Standard Drainage Areas	0.90	unitless
	24	Initial Runoff Factor for Dispersed & Dispersion Areas	0.00	unitless
	25	Initial Weighted Runoff Factor	0.90	unitless
Dispersion Area Adjustments	26	Initial Design Capture Volume	1,050	cubic-feet
	27	Total Impervious Area Dispersed to Pervious Surface	0	sq-ft
	28	Total Pervious Dispersion Area	0	sq-ft
	29	Ratio of Dispersed Impervious Area to Pervious Dispersion Area	n/a	ratio
	30	Adjustment Factor for Dispersed & Dispersion Areas	1.00	ratio
	31	Runoff Factor After Dispersion Techniques	0.90	unitless
	32	Design Capture Volume After Dispersion Techniques	1,050	cubic-feet
Tree & Barrel Adjustments	33	Total Tree Well Volume Reduction	0	cubic-feet
	34	Total Rain Barrel Volume Reduction	0	cubic-feet
Results	35	Final Adjusted Runoff Factor	0.90	unitless
	36	Final Effective Tributary Area	18,000	sq-ft
	37	Initial Design Capture Volume Retained by Site Design Elements	0	cubic-feet
	38	Final Design Capture Volume Tributary to BMP	1,050	cubic-feet

Appendix K: Guidance on Green Infrastructure

Excerpt 2- Summary of Stormwater Pollutant Control Calculations (Part 1 of 2)

County of San Diego Automated Stormwater Pollutant Control Worksheet B.1 (Version 2.0)

Category	#	Description	<i>i</i>	Units
Standard Drainage Basin Inputs	1	Drainage Basin ID or Name	DMA 1	unitless
	2	85th Percentile 24-hr Storm Depth	0.70	inches
	3	Impervious Surfaces <u>Not Directed to Dispersion Area</u> (C=0.90)	60,000	sq-ft
	4	Semi-Pervious Surfaces <u>Not Serving as Dispersion Area</u> (C=0.30)		sq-ft
	5	Engineered Pervious Surfaces <u>Not Serving as Dispersion Area</u> (C=0.10)		sq-ft
	6	Natural Type A Soil <u>Not Serving as Dispersion Area</u> (C=0.10)		sq-ft
	7	Natural Type B Soil <u>Not Serving as Dispersion Area</u> (C=0.14)		sq-ft
	8	Natural Type C Soil <u>Not Serving as Dispersion Area</u> (C=0.23)		sq-ft
	9	Natural Type D Soil <u>Not Serving as Dispersion Area</u> (C=0.30)		sq-ft
Dispersion Area, Tree Well & Rain Barrel Inputs (Optional)	10	Does Tributary Incorporate Dispersion, Tree Wells, and/or Rain Barrels?	No	yes/no
	11	Impervious Surfaces Directed to Dispersion Area per SD-B (Ci=0.90)		sq-ft
	12	Semi-Pervious Surfaces Serving as Dispersion Area per SD-B (Ci=0.30)		sq-ft
	13	Engineered Pervious Surfaces Serving as Dispersion Area per SD-B (Ci=0.10)		sq-ft
	14	Natural Type A Soil Serving as Dispersion Area per SD-B (Ci=0.10)		sq-ft
	15	Natural Type B Soil Serving as Dispersion Area per SD-B (Ci=0.14)		sq-ft
	16	Natural Type C Soil Serving as Dispersion Area per SD-B (Ci=0.23)		sq-ft
	17	Natural Type D Soil Serving as Dispersion Area per SD-B (Ci=0.30)		sq-ft
	18	Number of Tree Wells Proposed per SD-A		#
	19	Average Mature Tree Canopy Diameter		ft
	20	Number of Rain Barrels Proposed per SD-E		#
Initial Runoff Factor Calculation	21	Average Rain Barrel Size		gal
	22	Total Tributary Area	60,000	sq-ft
	23	Initial Runoff Factor for Standard Drainage Areas	0.90	unitless
	24	Initial Runoff Factor for Dispersed & Dispersion Areas	0.00	unitless
	25	Initial Weighted Runoff Factor	0.90	unitless
	26	Initial Design Capture Volume	3,150	cubic-feet
Dispersion Area Adjustments	27	Total Impervious Area Dispersed to Pervious Surface	0	sq-ft
	28	Total Pervious Dispersion Area	0	sq-ft
	29	Ratio of Dispersed Impervious Area to Pervious Dispersion Area	n/a	ratio
	30	Adjustment Factor for Dispersed & Dispersion Areas	1.00	ratio
	31	Runoff Factor After Dispersion Techniques	0.90	unitless
	32	Design Capture Volume After Dispersion Techniques	3,150	cubic-feet
Tree & Barrel Adjustments	33	Total Tree Well Volume Reduction	0	cubic-feet
	34	Total Rain Barrel Volume Reduction	0	cubic-feet
Results	35	Final Adjusted Runoff Factor	0.90	unitless
	36	Final Effective Tributary Area	54,000	sq-ft
	37	Initial Design Capture Volume Retained by Site Design Elements	0	cubic-feet
	38	Final Design Capture Volume Tributary to BMP	3,150	cubic-feet

Appendix K: Guidance on Green Infrastructure

Excerpt 2- Summary of Stormwater Pollutant Control Calculations (Part 2 of 2)

County of San Diego Automated Stormwater Pollutant Control Worksheet B.3 (Version 2.0)

Category	#	Description	i	Units
BMP Inputs	1	Drainage Basin ID or Name	DMA 1	sq-ft
	2	Design Infiltration Rate Recommended	0.000	in/hr
	3	Design Capture Volume Tributary to BMP	3,150	cubic-feet
	4	Is BMP Vegetated or Unvegetated?	Vegetated	unitless
	5	Is BMP Impermeably Lined or Unlined?	Lined	unitless
	6	Does BMP Have an Underdrain?	Underdrain	unitless
	7	Does BMP Utilize Standard or Specialized Media?	Standard	unitless
	8	Provided Surface Area	1,620	sq-ft
	9	Provided Surface Ponding Depth	6	inches
	10	Provided Soil Media Thickness	21	inches
	11	Provided Gravel Thickness (Total Thickness)	14	inches
	12	Underdrain Offset	3	inches
	13	Diameter of Underdrain or Hydromod Orifice (Select Smallest)	8.00	inches
	14	Specialized Soil Media Filtration Rate		in/hr
	15	Specialized Soil Media Pore Space for Retention		unitless
	16	Specialized Soil Media Pore Space for Biofiltration		unitless
	17	Specialized Gravel Media Pore Space		unitless
Retention Calculations	18	Volume Infiltrated Over 6 Hour Storm	0	cubic-feet
	19	Ponding Pore Space Available for Retention	0.00	unitless
	20	Soil Media Pore Space Available for Retention	0.05	unitless
	21	Gravel Pore Space Available for Retention (Above Underdrain)	0.00	unitless
	22	Gravel Pore Space Available for Retention (Below Underdrain)	0.40	unitless
	23	Effective Retention Depth	2.25	inches
	24	Fraction of DCV Retained (Independent of Drawdown Time)	0.10	ratio
	25	Calculated Retention Storage Drawdown Time	120	hours
	26	Efficacy of Retention Processes	0.12	ratio
	27	Volume Retained by BMP (Considering Drawdown Time)	381	cubic-feet
	28	Design Capture Volume Remaining for Biofiltration	2,769	cubic-feet
Biofiltration Calculations	29	Max Hydromod Flow Rate through Underdrain	2.8291	cfs
	30	Max Soil Filtration Rate Allowed by Underdrain Orifice	75.44	in/hr
	31	Soil Media Filtration Rate per Specifications	5.00	in/hr
	32	Soil Media Filtration Rate to be used for Sizing	5.00	in/hr
	33	Depth Biofiltered Over 6 Hour Storm	30.00	inches
	34	Ponding Pore Space Available for Biofiltration	1.00	unitless
	35	Soil Media Pore Space Available for Biofiltration	0.20	unitless
	36	Gravel Pore Space Available for Biofiltration (Above Underdrain)	0.40	unitless
	37	Effective Depth of Biofiltration Storage	14.60	inches
	38	Drawdown Time for Surface Ponding	1	hours
	39	Drawdown Time for Effective Biofiltration Depth	3	hours
	40	Total Depth Biofiltered	44.60	inches
	41	Option 1 - Biofilter 1.50 DCV: Target Volume	4,154	cubic-feet
	42	Option 1 - Provided Biofiltration Volume	4,154	cubic-feet
	43	Option 2 - Store 0.75 DCV: Target Volume	2,077	cubic-feet
	44	Option 2 - Provided Storage Volume	1,971	cubic-feet
	45	Portion of Biofiltration Performance Standard Satisfied	1.00	ratio
Result	46	Do Site Design Elements and BMPs Satisfy Annual Retention Requirements?	Yes	yes/no
	47	Overall Portion of Performance Standard Satisfied (BMP Efficacy Factor)	1.00	ratio
	48	Deficit of Effectively Treated Stormwater	0	cubic-feet

Appendix K: Guidance on Green Infrastructure

Excerpt 3 – Determination of Land Use Factor for Example 2

Water Quality Equivalency Automated Land Use Factor Worksheets (Version 1.0)

Automated Spreadsheet Calculation for Worksheet A.5: Land Use Factor Determination (Version 1.0)

Land Use Designation	ACP Tributary Characteristics		Reference Tributary Characteristics ²		Relative Pollutant Concentrations by Land Use ³						
	Area (Acres)	Runoff Factor ¹	Area (Acres)	Runoff Factor ¹	TSS	TP	TN	TCu	TPb	TZn	FC
Agriculture		0.10		0.10	0.45	1.00	1.00	1.00	1.00	0.59	1.00
Commercial	0.69	0.80		0.80	0.13	0.16	0.16	0.56	0.48	1.00	0.87
Education		0.50		0.50	0.13	0.20	0.11	0.14	0.25	0.39	0.13
Industrial		0.90		0.90	0.13	0.19	0.15	0.54	0.68	0.89	0.49
Multi Family Residential		0.60		0.60	0.10	0.13	0.13	0.14	0.15	0.29	0.27
Orchard		0.10		0.10	0.18	0.17	0.67	1.00	1.00	0.59	0.11
Rural Residential		0.30		0.30	1.00	0.51	0.14	0.10	0.71	0.13	0.19
Single Family Residential		0.40		0.40	0.13	0.20	0.15	0.27	0.43	0.35	0.63
Transportation	0.69	0.90	0.46	0.90	0.11	0.26	0.12	0.53	0.31	0.62	0.12
Vacant / Open Space		0.10		0.10	0.16	0.10	0.10	0.12	0.10	0.10	0.10
Water		0.00		0.00	0.00	0.00	0.00	0.00	0.00	0.00	0.00
Total	1.38	-	0.46	-	-	-	-	-	-	-	-
	Relative Pollutant Concentration for ACP Tributary ⁴				0.12	0.21	0.14	0.54	0.39	0.80	0.47
	Relative Pollutant Concentration for Reference Tributary ⁴				0.11	0.26	0.12	0.53	0.31	0.62	0.12
	Watershed Management Area				San Diego River						
	Hydrologic Unit				San Diego (907.00)						
	Land Use Factor ⁵				-	0.82	1.16	-	-	-	3.94

Appendix K: Guidance on Green Infrastructure

This page was intentionally left blank.

K.2.2 Green Streets Guidelines

Appendix K: Guidance on Green Infrastructure

This page was intentionally left blank.

Green Streets Guidelines

A Guide to Green Street Implementation in the
County of San Diego

January 2019



This page was intentionally left blank



WHAT IS A GREEN STREET?

Pavement on roadways can contribute to excess stormwater runoff and increased levels of pollutants in the County's waterways. Green infrastructure reduces stormwater runoff and improves water quality. The Green Streets program incorporates a wide variety of Green Infrastructure design elements including, but not limited to: tree wells, dispersion areas and biofiltration, and permeable pavement. The use of Green Streets offers the capability of transforming a significant stormwater and pollutant source into an innovative treatment system.

Additionally, the State of California is in the midst of a severe drought, with water years of 2012-14 recording the driest three consecutive years in the state's history, as well as setting new records for statewide average temperatures. On April 1st, 2015 Governor Brown signed executive order B-29-15 setting the first mandatory statewide water restrictions. This order prohibits ornamental turf on public street medians, and requires a reduction in potable water use for irrigation. The Green Streets program promotes water conservation through the use of low water use and drought tolerant plants (xeriscape) and improving groundwater supplies through infiltration.

Green infrastructure, unlike traditional "gray" infrastructure approaches to stormwater management, provides multiple benefits to communities. Planting more trees and landscaping in public spaces cleans the air, cools the land, provides more habitat for wildlife, adds green maintenance jobs, increases property values and promotes a better, healthier quality of life for San Diego County residents and visitors.

Under the Municipal Separate Storm Sewer System (MS4) Permit for San Diego Region (Permit [Order No. R9-2013-0001]), the County may make Priority Development Project (PDP) Exemptions for projects redeveloping or retrofitting existing paved roads, streets, and alleys as "EPA Green Streets." This is accomplished by meeting the criteria set forth in section 1.4.3 of the County of San Diego BMP Design Manual and based in part on the EPA publication "Green Streets: Municipal Handbook, Managing Wet Weather with Green Infrastructure."

This guide is to be used along with the County's BMP Design Manual for meeting stormwater requirements within the County's public right-of-way. These Green Streets measures, when implemented, will ensure the County remains a green community for many years to come.

TABLE OF CONTENTS

CHAPTER 1 – INTRODUCTION TO GREEN STREETS.....	K-25
1.1 INTRODUCTION	
1.2 THE NATURAL AND DEVELOPED ENVIRONMENT	
1.3 GREENING THE STREETS	
1.4 THE COUNTY ENVIRONMENT	
1.5 COUNTY RIGHT OF WAY	
CHAPTER 2 – GREEN STREETS STRATEGIES.....	K-30
2.1 INTRODUCTION	
2.2 TREE WELLS	
2.3 DISPERSION AREAS AND BIOFILTRATION	
2.4 PLANTING & IRRIGATION OF DISPERSION AREAS, BIOFILTRATION, TREE WELLS, AND OTHER AREAS	
2.5 TYPES OF PERMEABLE PAVEMENT	
CHAPTER 3 – PROCEDURES & DESIGN EXAMPLES.....	K-55
3.1 INTRODUCTION	
3.2 DESIGN PROCEDURE	
3.3 MEDIANS	
3.4 INTERSECTIONS	
3.5 TRAVELED WAY, BIKE LANE, AND SHOULDER PERMEABLE PAVEMENT	
3.6 PARKWAY	
3.7 PUTTING IT ALL TOGETHER	
CHAPTER 4 – IMPLEMENTING GREEN STREETS PROJECTS.....	K-69
4.1 DESIGN AND CONSTRUCTION	
4.2 MAINTENANCE	
4.3 FUNDING	
REFERENCES.....	K-71



CHAPTER 1

Introduction to Green Streets

1.1 INTRODUCTION

These guidelines have been prepared to assist in the design and construction of projects that retrofit or redevelop existing paved streets and roads. These Guidelines and Standards have been developed in accordance with the United States Environmental Protection Agency Green Streets Guidance “Green Streets: Municipal Handbook, Managing Wet Weather with Green Infrastructure.”

These Guidelines may also be used to assist in the design and construction of new or retrofit paved sidewalks, bicycle lanes, or trails.

The functional goals of these guidelines are to:

- Provide source control of stormwater;
- Limit stormwater transport and pollutant conveyance to the collection system;
- Restore predevelopment hydrology to the extent possible by slowing the runoff down and allowing for infiltration; and
- Provide environmentally enhanced roads.

A review of existing County policies has been performed and included in the accompanying Green Streets Standards document that includes an addendum to the Public Road Standards, as well as Green Streets Standard Drawings and Specifications.

Green Streets configurations and locations presented in this guideline are schematic/conceptual in nature. The configurations (or locations) could be modified as long as the design and construction details are in conformance with the Green Streets technical documents (i.e. – Green Streets Supplement to Public Road Standards, Standard Drawings, Specifications, Plant List, and Maintenance Schedule).

1.2 THE NATURAL AND DEVELOPED ENVIRONMENT

NATURAL AREAS

In areas such as meadows, thickets, woodlands, and parks, rain can soak into the ground and be used by plants. Trees and shrubs intercept rainfall and it slowly trickles down to the ground where it is absorbed by mulch and humic soil. Shaded areas are cooler, moister and provide wildlife habitat. Very little rainwater runs off the ground.

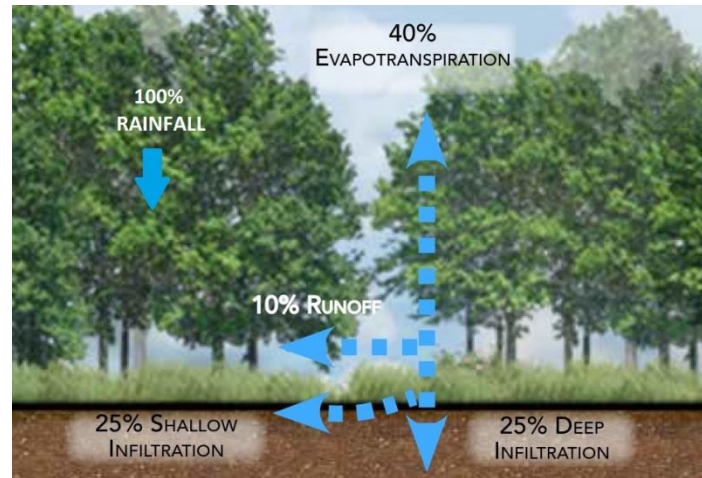

Natural Area Diagram

(Source: DDOT, 2014)

URBAN AREAS

In urban areas, building rooftops, streets, alleys, sidewalks, and other paved surfaces are smooth and mostly impervious. Very little rain has a chance to soak into the ground. These paved urban areas are hotter and offer very little wildlife habitat. Most of the rain that falls in the urban areas quickly runs off impervious surfaces picking up pollutants and carrying them into storm drains. These flows quickly combine to create flash floods that degrade downstream waterways.

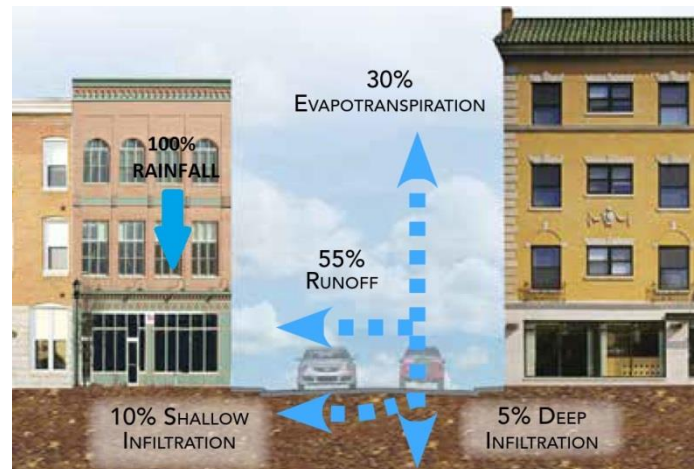

Urban Area Diagram

(Source: DDOT, 2014)

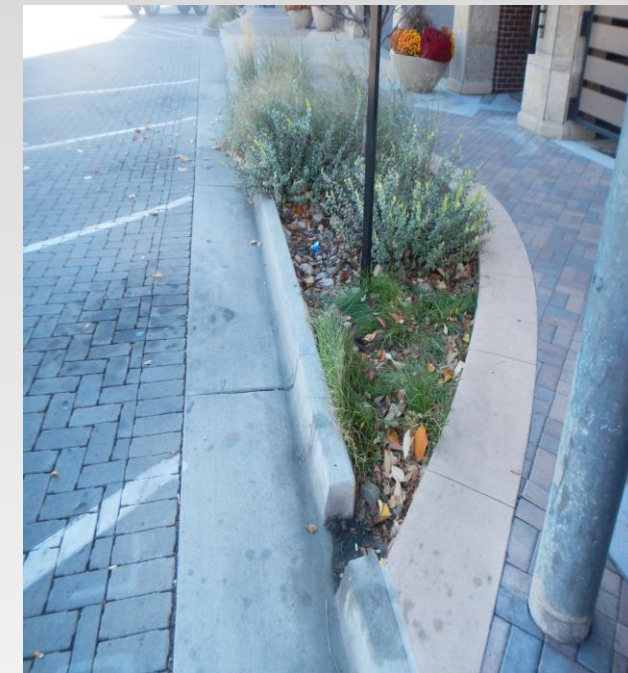

STORMWATER CAPTURE

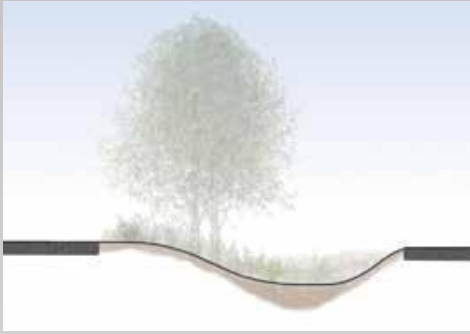

Runoff from impervious surfacing

STORE

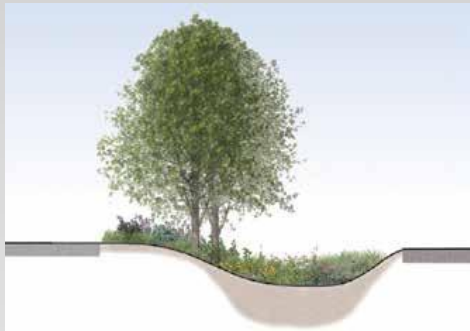

Store and retain captured runoff

INFILTRATE/EVAPOTRANSPIRE



Water is infiltrated into the ground, evapotranspired by plants or drained

1.3 GREENING THE STREETS

Green Streets, which includes Green Infrastructure (GI), incorporates elements found in natural areas into the County road right of way. GI is the living network that connects impervious areas to landscape areas, natural areas, and waterways. GI captures rainfall; cools buildings and pavement; and creates natural pathways for wildlife. GI includes Low Impact Development (LID) techniques, which mimic nature to capture and treat stormwater as close to the source as possible. When implemented, GI creates living green streets that capture, store, and infiltrate stormwater to treat it as a resource and improve the County environment.

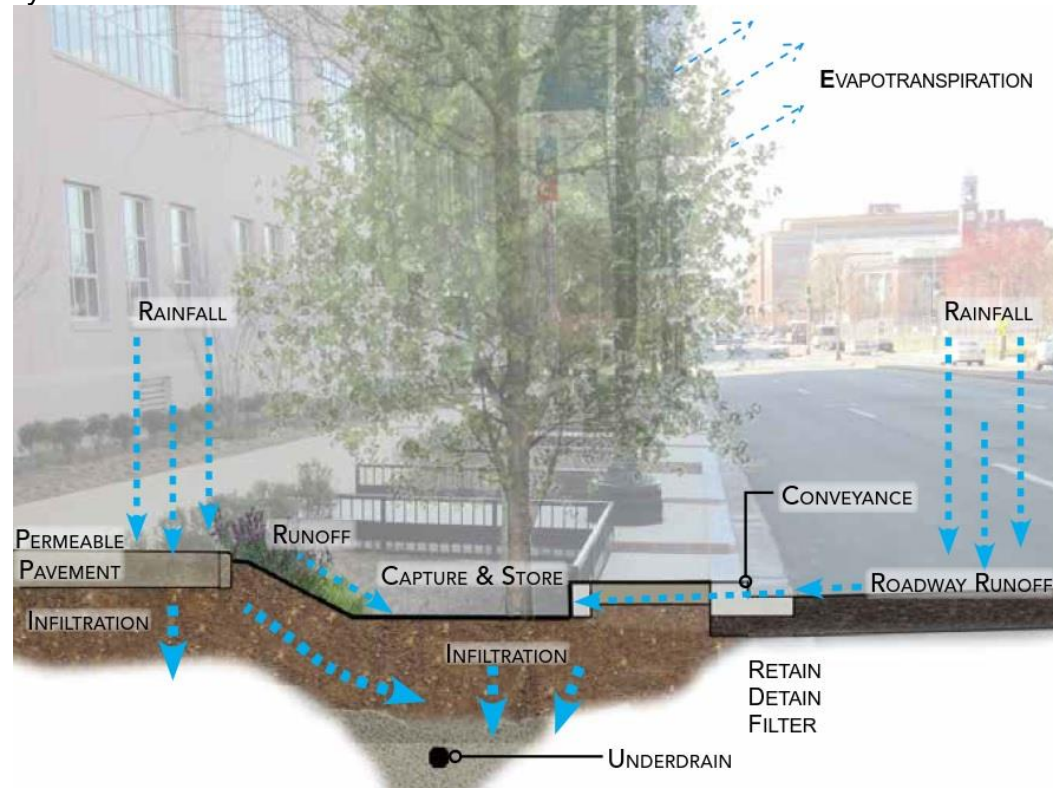

Green Streets Stormwater Diagram

(Source: DDOT, 2014)

1.4 THE COUNTY ENVIRONMENT

The County of San Diego is a unique environment made up of natural, rural, and urban areas. When rain falls in the County and becomes stormwater runoff, it flows through eleven major watersheds. Stormwater carries the pollutants, trash, and warmer temperatures it collects from roads, buildings, and other impervious surfaces and delivers them into our rivers, streams, bays, lagoons, and ocean. Urbanization and other land use changes in the County can modify the natural watershed hydrologic processes and stormwater runoff characteristics resulting in increased stormwater runoff and erosion.

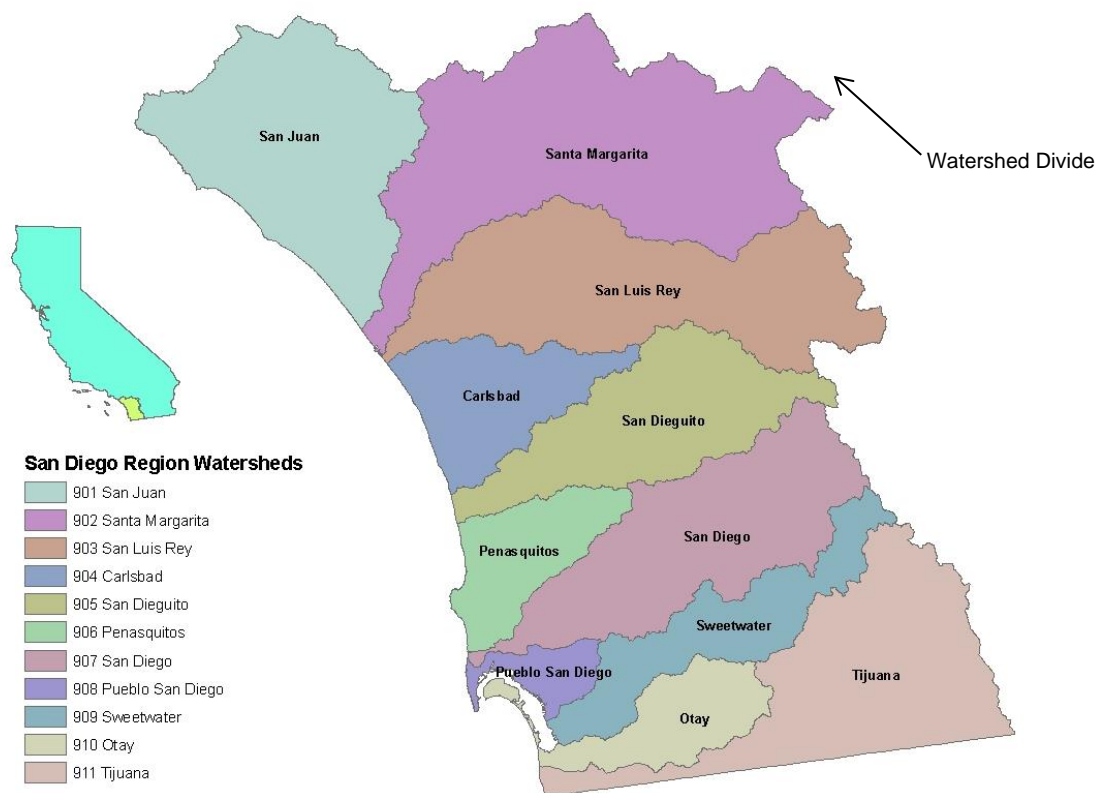



1.5 COUNTY RIGHT-OF-WAY

Land within the road right-of-way (ROW) presents a significant opportunity to reduce runoff and improve the urban environment through Green Streets. This manual introduces techniques to install green infrastructure in the median, street, bike lane, shoulder, parkway, and slope and drainage easements. This guide and the “Green Streets Standards,” which includes supplements to the Public Road Standards, Green Streets Standard Drawings, and specifications, should be used the maximum extent practicable for all public and private project design in the County ROW.

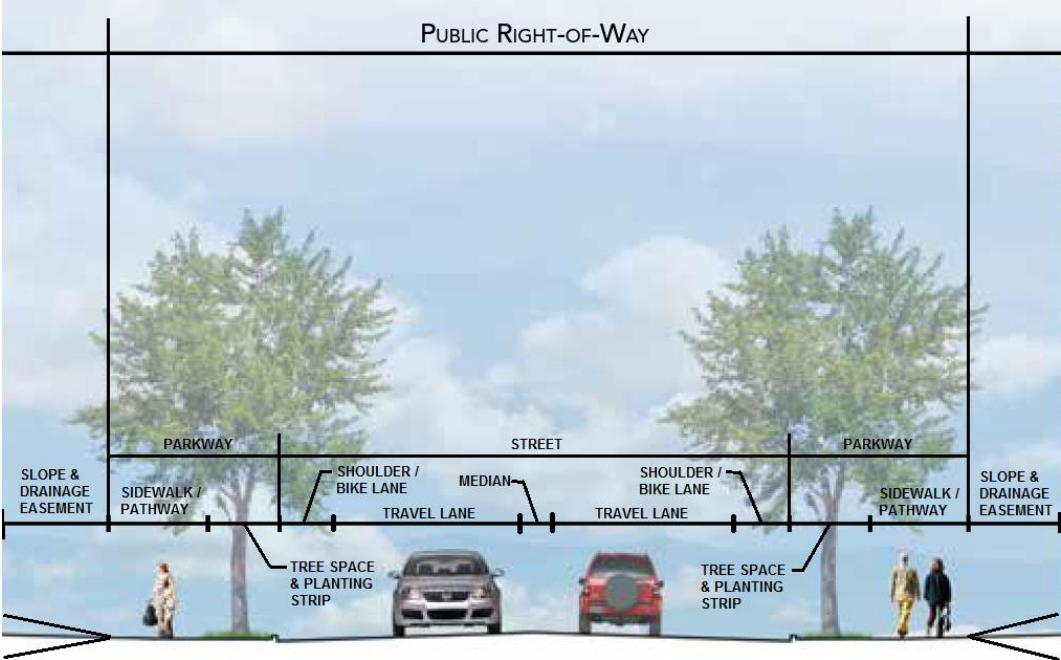

ROAD RIGHT-OF-WAY DIAGRAM
(Source: DDOT, 2014)

Early in the green street planning and design process careful consideration should be given to the location of existing and proposed utilities and appurtenances (utility poles, vaults, and pedestals), fire hydrants, traffic signals, signage, mail boxes, bus stops, and their interaction with the proposed green street measures.



CHAPTER 2

Green Streets Strategies

2.1 INTRODUCTION

Green Streets, including Green Infrastructure (GI), and Low Impact Development (LID) solutions are intended to be sustainable, attractive, and cost effective. The range of opportunities includes tree wells, landscape areas, dispersion areas, biofiltration, permeable pavement, and removal of impervious pavement. These strategies use natural processes to reduce the volume of runoff, peak flow, and pollutants. This chapter will focus on five (5) areas appropriate for use in the road right-of-way.

TREE WELLS

Trees are a powerful green streets tool due to their ability to intercept water on leaves, slowly deliver it to the mulch and soil, absorb it through root systems, and transpire it as water vapor directly back to the atmosphere.

DISPERSION AREAS

Dispersion areas disconnect impervious areas from directly running to the storm drain system. Dispersion areas use the natural functions of plants, mulch, and soils to remove pollutants and slow stormwater runoff. The strategy uses storage, sediment capture, and biological processes to clean the water. These mimic processes that occur in nature before water reaches waterways.

BIOFILTRATION

Biofiltration facilities are vegetated surface water systems that filter water through vegetation, and soil or biofiltration soil media prior to discharge to the storm drain system. They also utilize shallow depressions to provide storage and evapotranspiration.

PERMEABLE PAVEMENT

Permeable paving systems provide a hard surface, while allowing water to flow through to the underlying soils instead of directly to the drainage system. The areas where this strategy may be used include: sidewalks, pathways, medians, and parking lanes.

REMOVE IMPERVIOUS PAVEMENT

Roadway improvement projects have the opportunity to remove portions of impervious pavement within the right of way and replace it with permeable material.



2.2 TREE WELLS

WHY ARE TREES IMPORTANT?

Trees make a streetscape feel welcoming, help manage stormwater, and reduce the urban heat island effect by providing shade. An urban heat island remains significantly warmer than the surrounding rural areas due to less vegetation. Trees promote air quality, natural habitat, the human environment, and well-being.

Trees in a congested road right-of-way are confined to small planting areas where they struggle to reach a mature size or live a long life. Through the use of Structural Soil, Structural Cell, or Suspended Sidewalk techniques, soil volumes and space for tree roots to grow uninhibited can be greatly increased. These techniques also allow for more water and air to reach the tree roots.

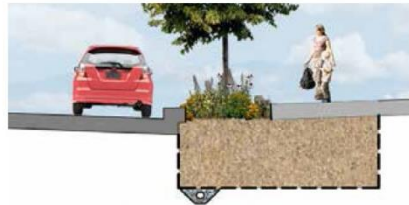

STRUCTURAL SOILS

A specific mix of stone and soil that supports the sidewalk while allowing tree roots to grow normally.



STRUCTURAL CELLS

Manufactured cells support the sidewalk allowing uncompacted soil to promote tree roots to grow below.

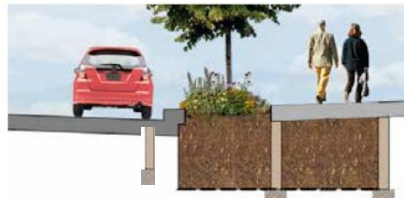

SUSPENDED SIDEWALK

Thickened sidewalk with reinforcement and/or footings can be used allowing tree roots to grow below the sidewalk.

(Source: DDOT, 2014)



SOIL VOLUME SIZING

- Adequate planting soil space provides the nutrients, water, air, and root space that trees need to have a long, healthy life.
- The planting soil volume required depends on the fully-grown tree size (generally two cubic feet of soil per one square foot of the tree's mature drip line area).
- Planting soil amendments for trees should be three-feet deep; the length and width must ensure the appropriate volume for the tree species and site.

OTHER CONSIDERATIONS

- Provide as much open space as possible for the tree to allow the tree to grow and access water.
- Providing structural soils, suspended sidewalks, or structural slabs to edges of paved areas prevents planting soil compaction and encourages tree roots to extend further and into adjacent green areas.
- Evaluate temporary and permanent irrigation needs
- Evaluate utility locations and required clearance.

DESIGN ISSUES

- Maintenance Access: allow for maintenance access from road
- Pedestrian Considerations: allow for 18-inch minimum setback from curb and minimum 48-inch sidewalk width. Comply with ADA requirements.
- Suspended sidewalks and structural slabs/cells: may require evaluation by geotechnical and structural engineers
- Clear Recovery Zone: Consider clear recovery zone requirements and minimum setback requirements.
- Tree Size: Evaluate tree size versus the right of way width.

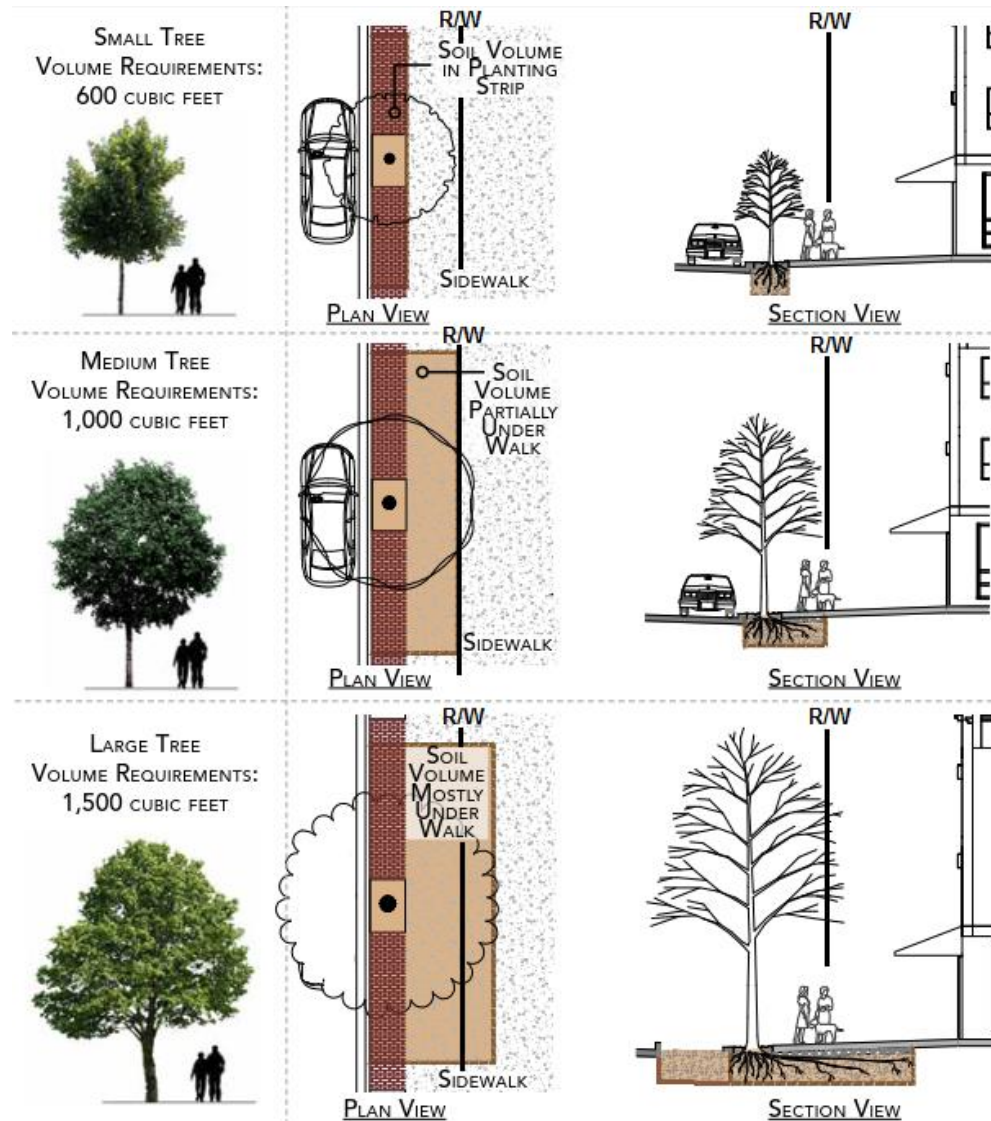

(Source: DDOT, 2014)

Note: Trees may also be located behind the sidewalk/pathway.

TREE WELLS – WHAT’S UNDERNEATH?

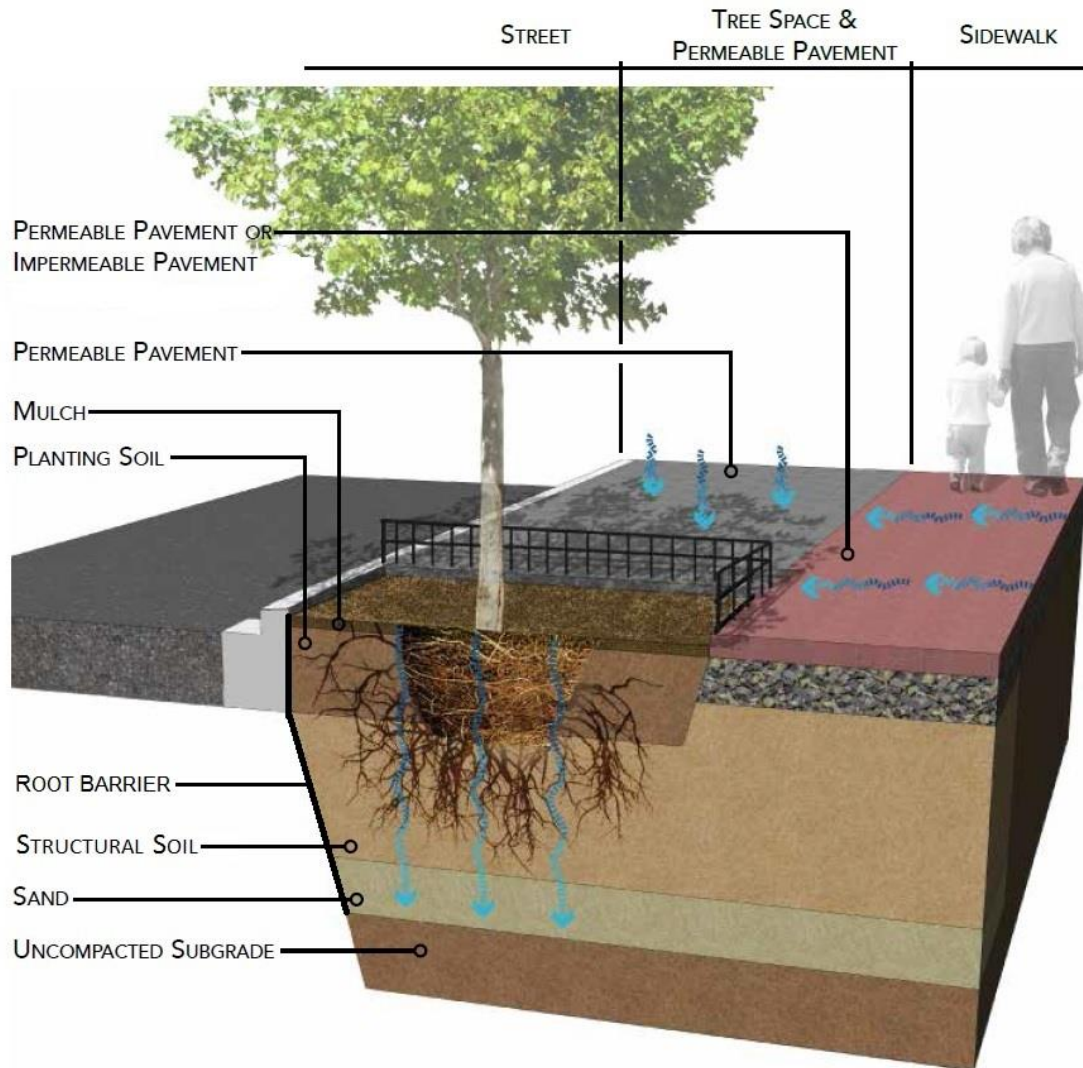

(Source: DDOT, 2014)

Note: Other options include suspended sidewalks and structural cells as shown on page K-30.

PUTTING IT TOGETHER

- Permeable Paver: Permeable pavers allow water to infiltrate into the planting soil to be used by the trees.
- Mulch: A soil topping that may be organic or inorganic material which covers the planting soil to retain water and trap pollutants.
- Planting Soil: Uncompacted and amended soil mix allows root growth when used in open areas, with structural cells, or suspended sidewalks.
- Structural Soil: Supports pavement and allows root growth.
- Sand: Acts as a drainage layer for excess stormwater (when needed).
- Uncompacted Subgrade: Existing soil where stormwater may infiltrate.

WATER TREES WITH STORMWATER

In addition to large planting soil volumes, trees need sufficient water, air, and nutrients to be successful in the road right-of-way environment. Tree space design includes integrating opportunities for directing stormwater into the soil. See the County of San Diego’s Water Conservation in Landscaping Ordinance for irrigation requirements.

2.3 TYPES OF DISPERSION AREAS AND BIOFILTRATION

WHAT ARE DISPERSION AREAS AND BIOFILTRATION?

Dispersion Areas and Biofiltration are landscape systems that filter pollutants and sediment from runoff. The layers of plant material, mulch, biofiltration soil media (a mix of planting soil, sand, and compost), and stone capture metals, nutrients, and bacteria that would otherwise flow into the surrounding creeks and rivers. The rainwater is held in the planting bed until it infiltrates into the ground or evaporates. The entire system can fit into small spaces, making it adaptable to tree spaces along the road, planter boxes, curb extensions, medians, roundabouts, and open areas.



PLANTER BOXES

Runoff enters the facility through curb cuts. Excess runoff exits through the same curb cuts or into drains located in the planting area.



CURB EXTENSION

Runoff enters the facility following the existing curb line. Excess runoff flows through the system and returns to the curb and gutter downstream.



MEDIANS

Runoff follows the existing curb line and enters the facility through curb cuts. Excess runoff flows through the system or into drain inlets.



BULB-OUT AT INTERSECTION

Runoff follows the existing curb line and enters the facility through curb cuts. Excess runoff flows through the system or into drain inlets.



VEGETATED FILTER STRIP

Runoff enters the facility directly via sheet flow. Excess runoff flows through the system to a drain inlet downslope.



SWALES

Runoff enters the facility directly or through curb cuts. Excess runoff flows through the system to a drainage outlet.



TRAFFIC CIRCLE/ROUNDBOUT

Runoff follows the existing curb line and enters the facility through curb cuts. Excess runoff flows through the system or into drains located in the planting area.



OPEN AREAS

Runoff drains into the planting area from the surrounding area. The size and shape can fit the available space.

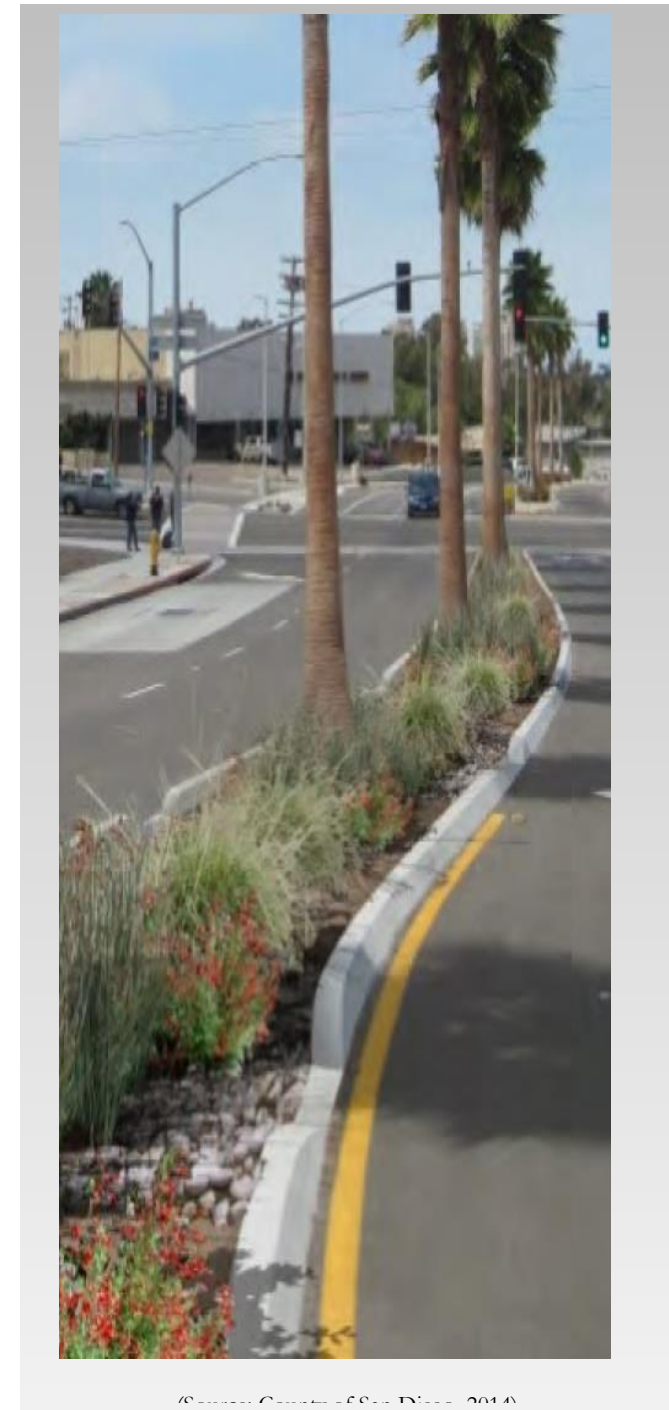

(Source: County of San Diego, 2014)

WHERE TO USE?

- Street with no adjacent on-street parking.
- Where Tree wells are needed.
- Street where bike lane is adjacent to curb.

LIMITATIONS

- Not for on-street parking.

DESIGN ISSUES

Maintenance Access: Allow for adequate maintenance access from road.

Pedestrian Considerations: Allow for minimum allowable sidewalk width. Consider trip hazards and fall protection. Comply with ADA requirements.

PLANTER BOX ADJACENT TO ROADWAY

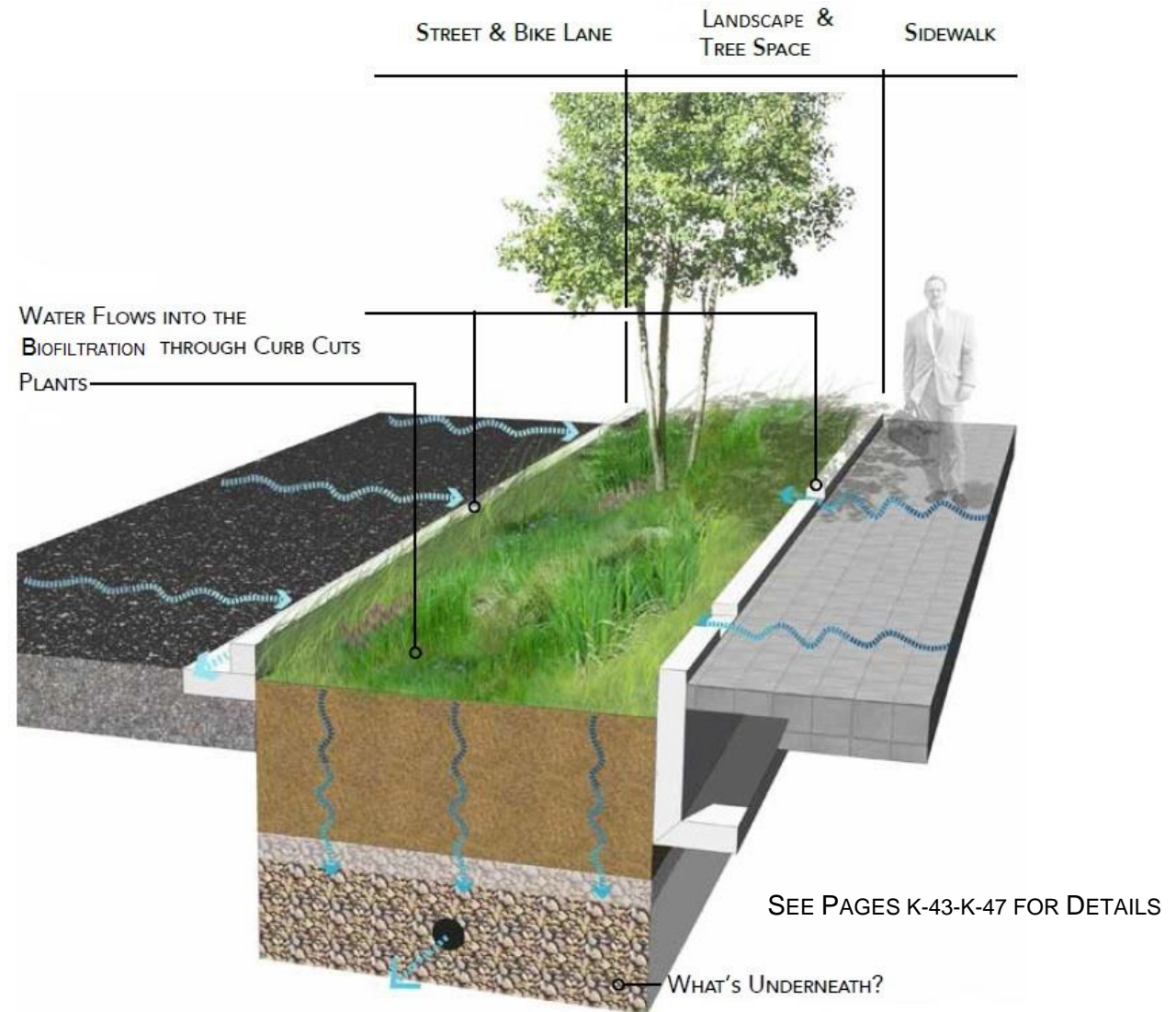

(Source: DDOT, 2014)

PLANTER BOX WITH STEP OUT ZONE

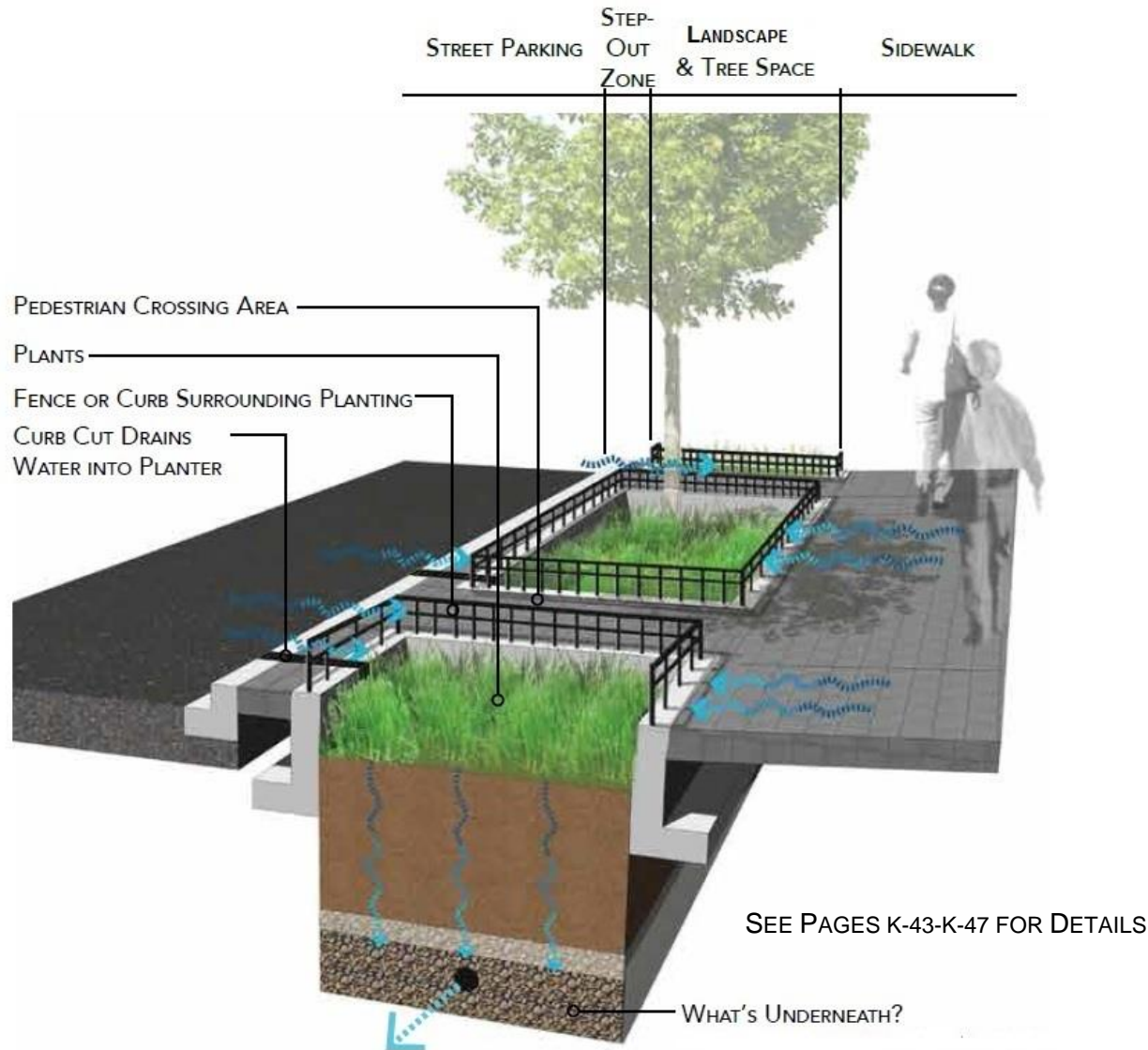

(Source: DDOT, 2014)

WHERE TO USE?

- Wide sidewalk area with adjacent on-street parking.
- High-volume pedestrian areas.
- Areas with other streetscape features (lights, bike racks, bus stops, etc.).

LIMITATIONS

- Do not disturb existing, mature trees and root systems.
- Provide low fence or curb for pedestrian safety.

DESIGN ISSUES

Planting Design: Same as for planter box adjacent to roadway.

Maintenance Access: Allow for adequate maintenance access from road.

Pedestrian Considerations: Areas in the streetscape can have dropped or have sloped sides. Short fences or curbs prevent pedestrians from stepping into a recessed area. Planter boxes with side slopes can use a small step-out area in place of a fence or curb. When the planter box is next to street parking areas, a step-out zone must be provided to allow access from the vehicle to the sidewalk. Crossing areas must be provided between street parking and the sidewalk. Comply with ADA requirements.

WHERE TO USE?

- Areas with low on-street parking demand.
- In wide roadways.
- For traffic calming.
- In “no parking areas” on street (excluding loading zones and curb cuts).
- Next to mature trees.

LIMITATIONS

- Sufficient street parking or off-street parking must be available to residents.
- Do not disturb existing, mature trees and root systems.
- Ensure sight lines and turning radii are preserved.

DESIGN ISSUES

Maintenance Access: Allow for adequate maintenance access from road.

Pedestrian Considerations: Consider trip hazards and fall protection. Short fences or curbs prevent pedestrians from stepping into a recessed area. A 3:1 transition from the sidewalk to planter bottom is an alternative. Comply with ADA requirements.

Parking: Consider trip hazards and adequate spacing in order to park.

Flood Control: Locate so that stormwater can drain away from the roadway and be directed through the curb inlet.

Bike Lanes: Consider bike lane traffic.

CURB EXTENSION

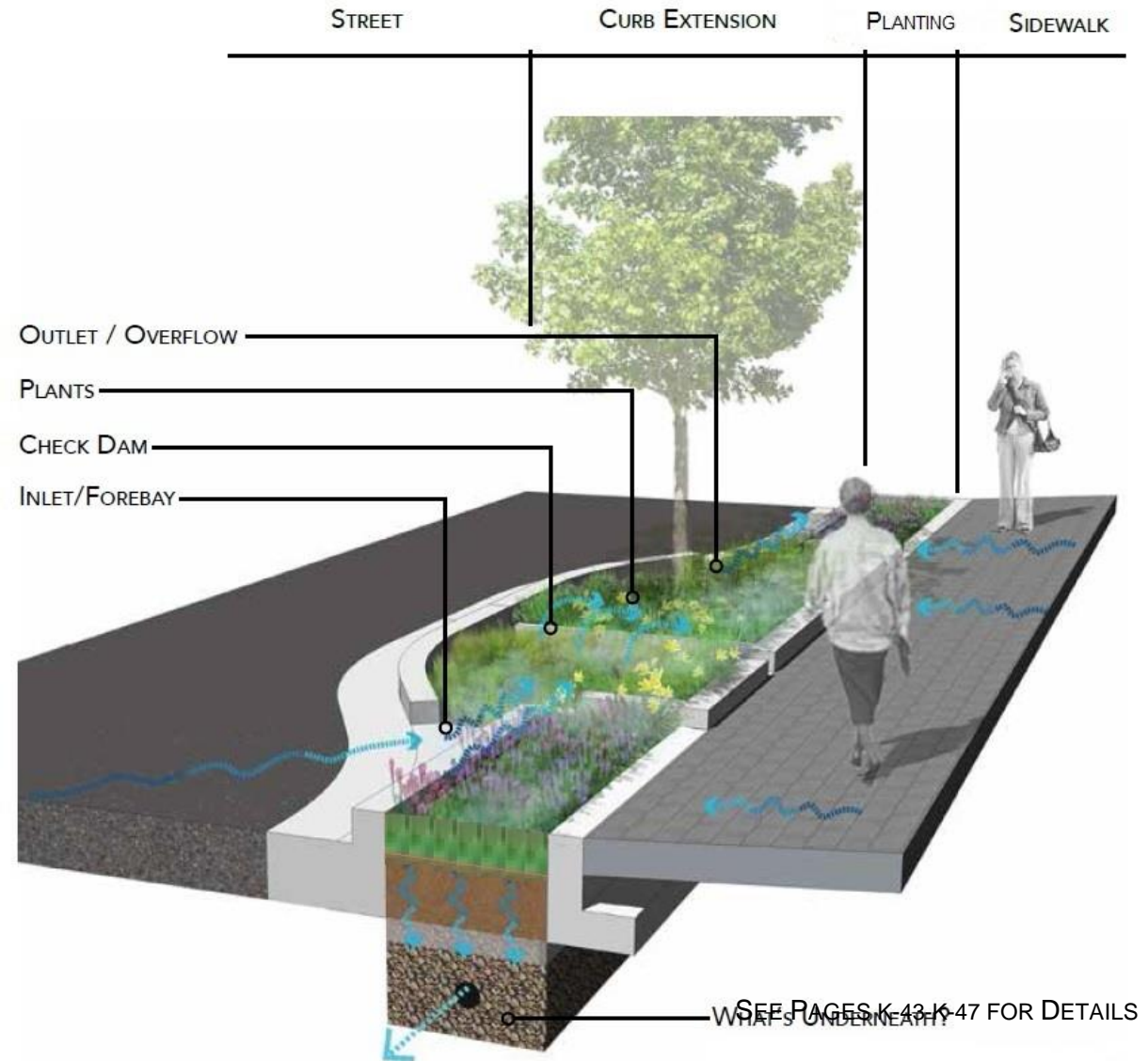

(Source: DDOT, 2014)

SWALE ADJACENT TO ROADWAY

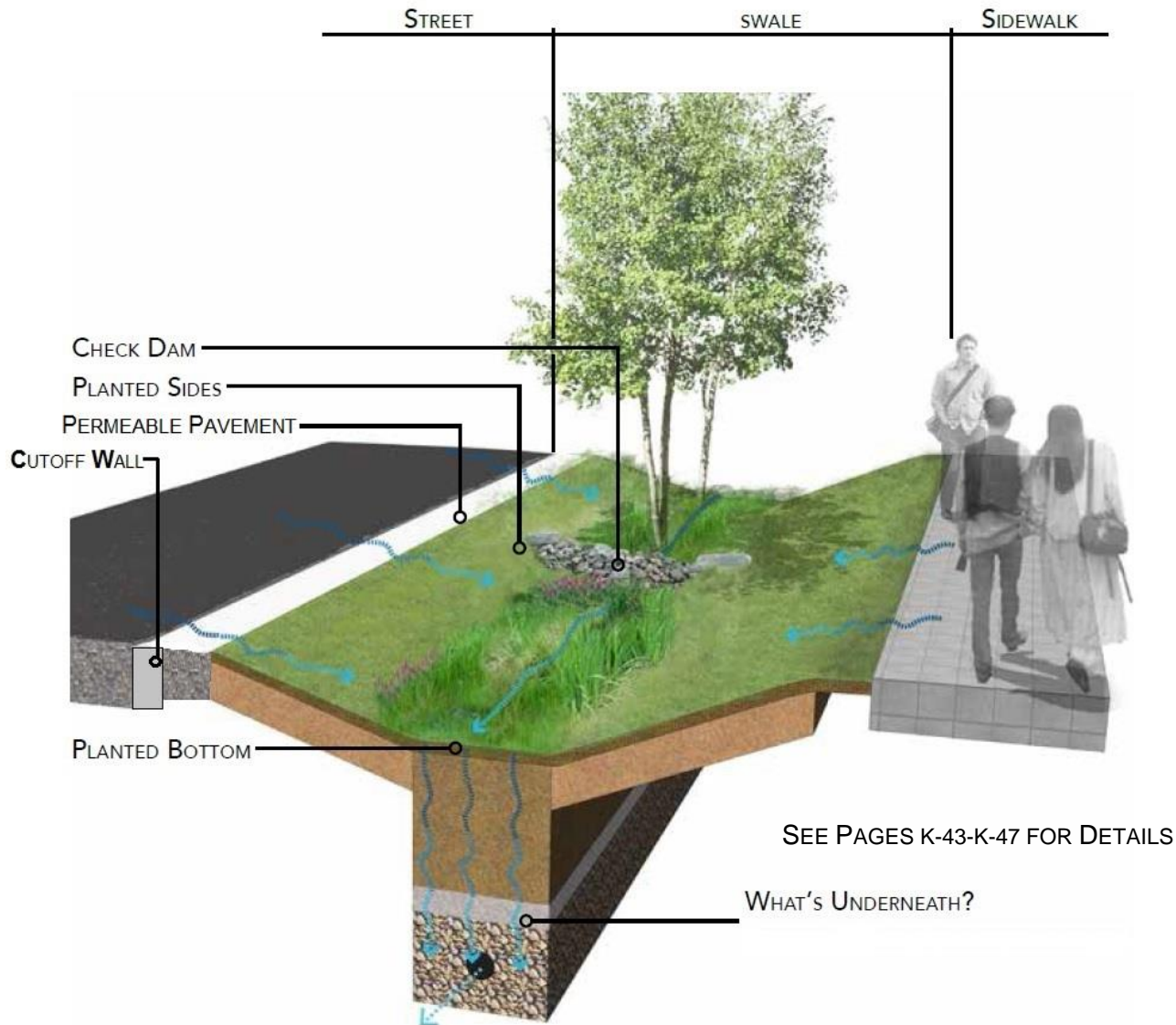

(Source: DDOT, 2014)

WHERE TO USE?

- On street with no curb.
- In wide ROW area with or without sidewalk.
- Areas with less pedestrian use.

LIMITATIONS

- Not suitable for narrow sidewalk areas.

DESIGN ISSUES

Slope and Check Dams: Swales are placed where street runoff is flowing and optimally before catch basins that convey water from the street to the drainage system. Swales may be built on moderate slopes with the use of check dams. Rock armoring or turf reinforcement mat may be required in steep areas with erosive velocities between check dams.

Maintenance Access: Allow for adequate maintenance access from road.

Pedestrian Considerations: Limit pedestrian access to swale. Transition swale at intersections for pedestrian facilities. Comply with ADA requirements.

Driveway Crossings: Driveway crossings may limit swale lengths.

WHERE TO USE?

- Where runoff can sheet flow into filter strip area.
- Moderate slopes (less than 5%) adjacent to impervious area of treatment (sidewalk or road).
- Rural areas.

LIMITATIONS

- Not recommended on steep slopes.
- Prone to rill formation.
- Areas with on-street parking.

DESIGN ISSUES

Maintenance: Vegetated cover must be maintained to ensure that filter strips do not export sediment due to erosion of exposed ground.

Slope: Maximum slopes in the direction of flow will be based upon drainage area size, soil type, vegetation cover, and slope length to prevent rill formation. Slopes less than 5% are preferred.

Maintenance Access: Allow for adequate maintenance access from road.

Pedestrian Considerations: Limit pedestrian access across filter strip to prevent formation of dirt pathways. Comply with ADA requirements.

VEGETATED FILTER STRIP

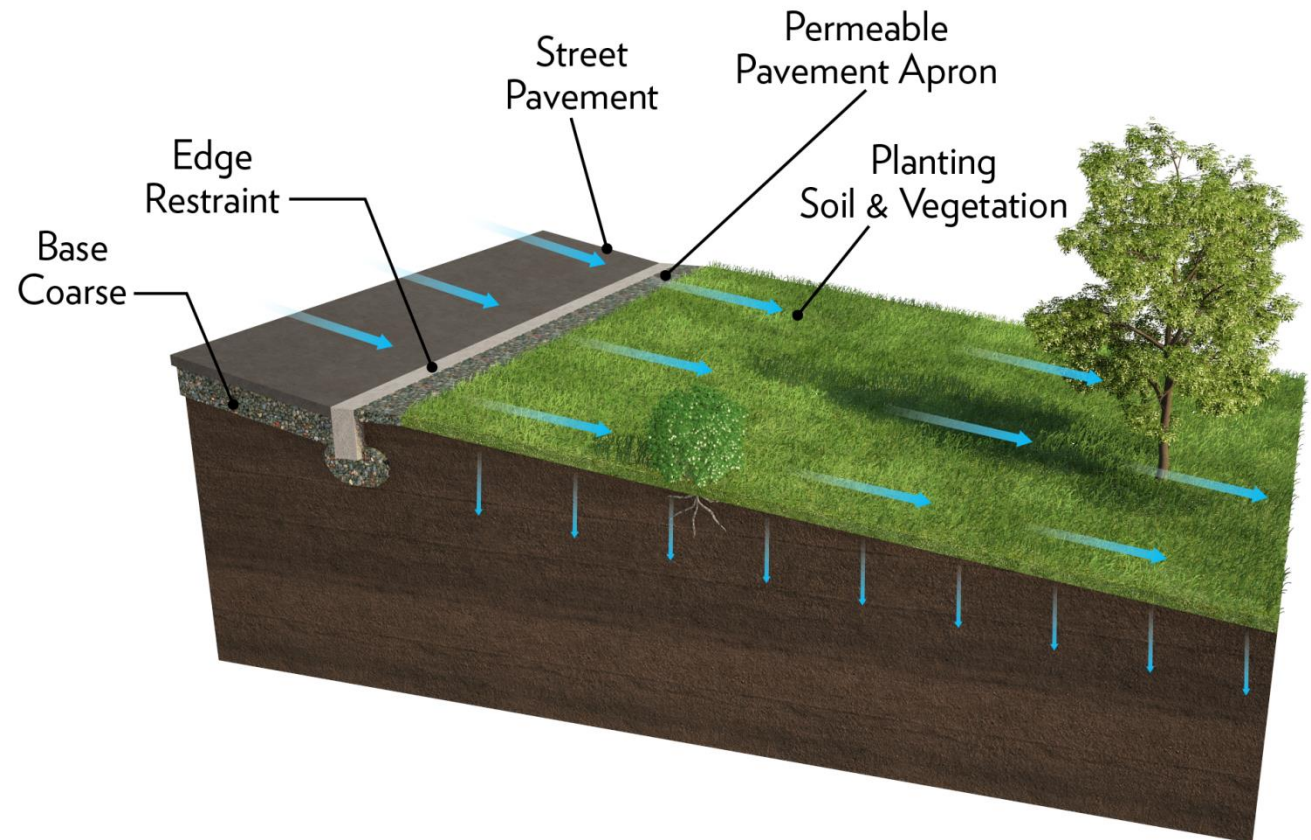

VEGETATED TERRACED FILTER STRIP

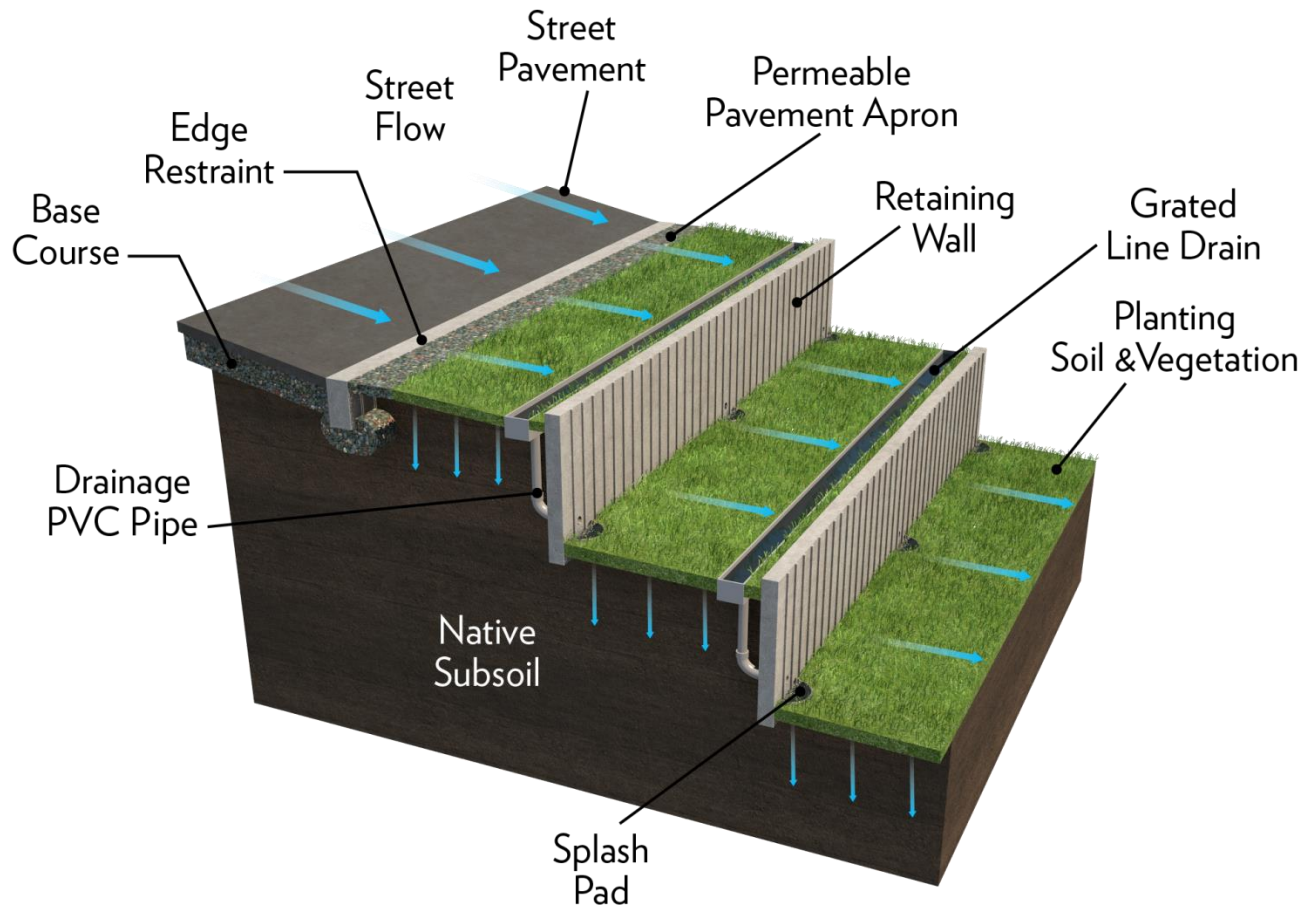

WHERE TO USE?

- Where runoff can sheet flow into filter strip area.
- Steep slopes (greater than 5%) adjacent to impervious area of treatment (sidewalk or road).
- Rural areas.

LIMITATIONS

- Prone to rill formation.
- Areas with on-street parking.
- Walls over 3 feet tall require structural design.

DESIGN ISSUES

Maintenance: Vegetated cover must be maintained to ensure that filter strips do not export sediment due to erosion of exposed ground.

Slope: Maximum slopes in the direction of flow will be based upon drainage area size, soil type, vegetation cover, and slope length to prevent rill formation. Slopes less than 5% are preferred.

Maintenance Access: Allow for adequate maintenance access from road and bottom of slope.

Pedestrian Considerations: Limit pedestrian access across filter strip to prevent formation of dirt pathways. Comply with ADA requirements.

WHERE TO USE?

- Areas with low on-street parking demand.
- In wide roadways.
- For traffic calming.
- In “no parking areas” on street (excluding loading zones and curb cuts).

LIMITATIONS

- Sufficient street parking or off-street parking must be available to residents.
- Ensure sight lines and turning radii are preserved.

DESIGN ISSUES

Maintenance access: Allow for adequate maintenance access from road.

Pedestrian considerations: Short fences or curbs prevent pedestrians from stepping into a recessed area. Walkways and ramps may need to be designed through bulb-outs to provide pedestrian access at intersections. Comply with ADA requirements.

Design: Requires County Traffic Engineering Section approval.

BULB-OUT AT INTERSECTION

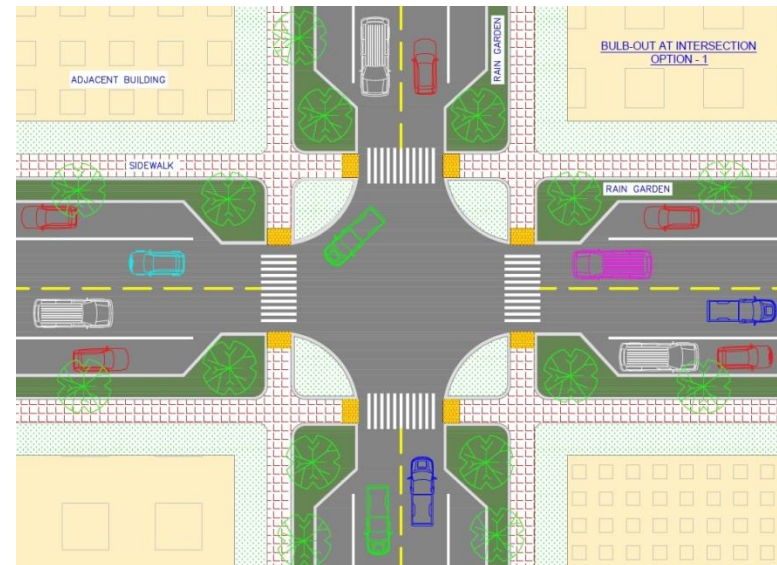

ROUNDBABOUT



WHERE TO USE?

- Areas with low on-street parking demand.
- In wide roadways.
- For traffic calming.

LIMITATIONS

- Sufficient street parking or off-street parking must be available to residents.
- Ensure sight lines and turning radii are preserved.

DESIGN ISSUES

Maintenance Access: Allow for adequate maintenance access from road.

Pedestrian Considerations: Short fences or curbs prevent pedestrians from stepping into a recessed area. Comply with ADA requirements.

Design: Requires County Traffic Engineering Section approval.

The NRCS hydrologic soil groups are defined as:

- **Group A** soils have a high rate of percolation and a low runoff potential. The rate of water transmission is high; thus, runoff potential is low. Group A soils are generally referred to as sandy soils.
- **Group B** soils have moderate percolation rates when thoroughly wet. These are chiefly soils that are moderately deep to deep, moderately well-drained to well-drained, and moderately coarse textured. Rate of water transmission is moderate.
- **Group C** soils have a slow percolation rate when thoroughly wet. They are chiefly soils that have a layer impeding the downward movement of water, or they are moderately fine to fine-textured soils that have a slow infiltration rate. The rate of water transmission is slow.
- **Group D** soils have very slow percolation rates when thoroughly wet. They are clays that have a high shrink-swell potential, soils that have a high permanent water table, soils that have a claypan or clay layer at or near the surface, or soils that are shallow over nearly impervious material. The rate of water transmission for group D soils is very slow.

DISPERSION AREAS AND BIOFILTRATION – WHAT’S UNDERNEATH?

SOIL TYPE AND INFILTRATION RATE

Dispersion areas and biofiltration can be located in many areas. However, site constraints will help to determine what goes underneath the dispersion area or biofiltration. Common considerations include soil type, relative soil compaction, required utility setbacks, slope setbacks, and structural setbacks. Depending on the factors at the site, what’s underneath the dispersion area or biofiltration is determined by the level of infiltration: high, medium, low, or none.

A qualified engineer practicing geotechnical services shall review the proposed stormwater infiltration to provide a professional opinion regarding the potential adverse geotechnical conditions that the implementation of these practices may create. Geotechnical conditions such as slope stability, expansive soils, compressible soils, seepage, groundwater, and loss of foundation or pavement subgrade strength should be considered.

The U.S. Department of Agriculture Natural Resources Conservation Service (NRCS), formerly the Soil Conservation Service, conducted a soil survey of the San Diego area in the early 1970s. The NRCS has classified San Diego area soils with respect to: (1) their ability to accept and absorb water, (2) their tendency to produce runoff, and (3) their erodibility.

The soil survey classified soil runoff potential into four hydrologic soil groups labeled A through D. Group A and B soils exhibit the greatest infiltration rates (unless soils are compacted during construction) and are generally best suited to stormwater percolation. The San Diego area, however, has a relatively high concentration of group C and D soils, which exhibit lower percolation rates that generally limit the use of infiltration-based stormwater management systems. Instead, dispersion areas and biofiltration facilities are often equipped with underdrains. Such a design provides for filtration of the water quality design event through a biofiltration soil media as well as incidental infiltration of low flows.

Retaining a geotechnical engineer and conducting exploratory excavations at the site are highly recommended. Consideration should be given to the effects of urbanization on the natural hydrologic soil group. If heavy equipment can be expected to compact the soil during construction, or if grading will mix the surface and subsurface soils, appropriate changes should be made in the soil group selected.

HIGH INFILTRATION

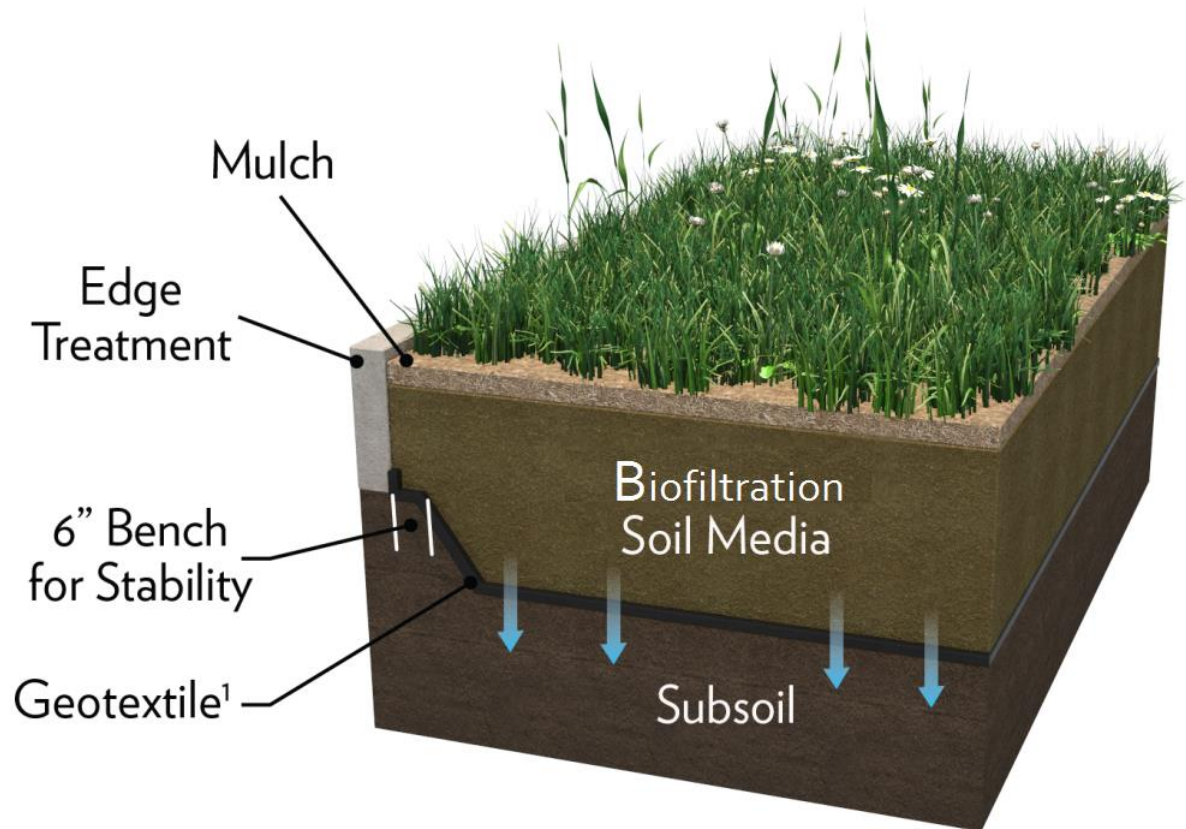

HIGH INFILTRATION

Notes:

1. Geotextile per Geotechnical Engineer's Recommendations (street side and sidewalk side).

PUTTING IT TOGETHER

- Ponding Depth: Stores runoff within the planting area prior to treatment.
- Mulch: A soil topping that may be organic or inorganic material which covers the planting soil to retain water and trap pollutants.
- Biofiltration Soil Media: A specific blend of soil, compost, and sand to retain and drain water and support plant growth.
- Geotextile: Prevents existing soil from migrating into the biofiltration soil media.
- Uncompacted Subsoil: Existing soil where stormwater infiltrates.

COMMON DESIGN ISSUES

Utilities: In the County, utility lines are common and necessary components of infrastructure within the right-of-way. Utility lines should be avoided where necessary and allowed to coexist where possible.

PUTTING IT TOGETHER

- **Ponding Depth:** Stores runoff within the planting area prior to treatment.
- **Mulch:** A soil topping that may be organic or inorganic material which covers the planting soil to retain water and trap pollutants.
- **Biofiltration Soil Media:** A specific blend of soil, compost, and sand to retain and drain water and support plant growth.
- **Choker Layer:** Sand and gravel to prevent biofiltration soil media from migrating into the reservoir.
- **Reservoir Layer:** Stone to hold excess water until it infiltrates.
- **Geotextile:** Prevents existing soil from migrating into the biofiltration soil media and stone reservoir layer.
- **Uncompacted Subgrade:** Existing soil where stormwater infiltrates.

COMMON DESIGN ISSUES

Utilities: In the County, utility lines are common and necessary components of infrastructure within the right-of-way. Utility lines should be avoided where necessary and allowed to coexist where possible.

MEDIUM INFILTRATION

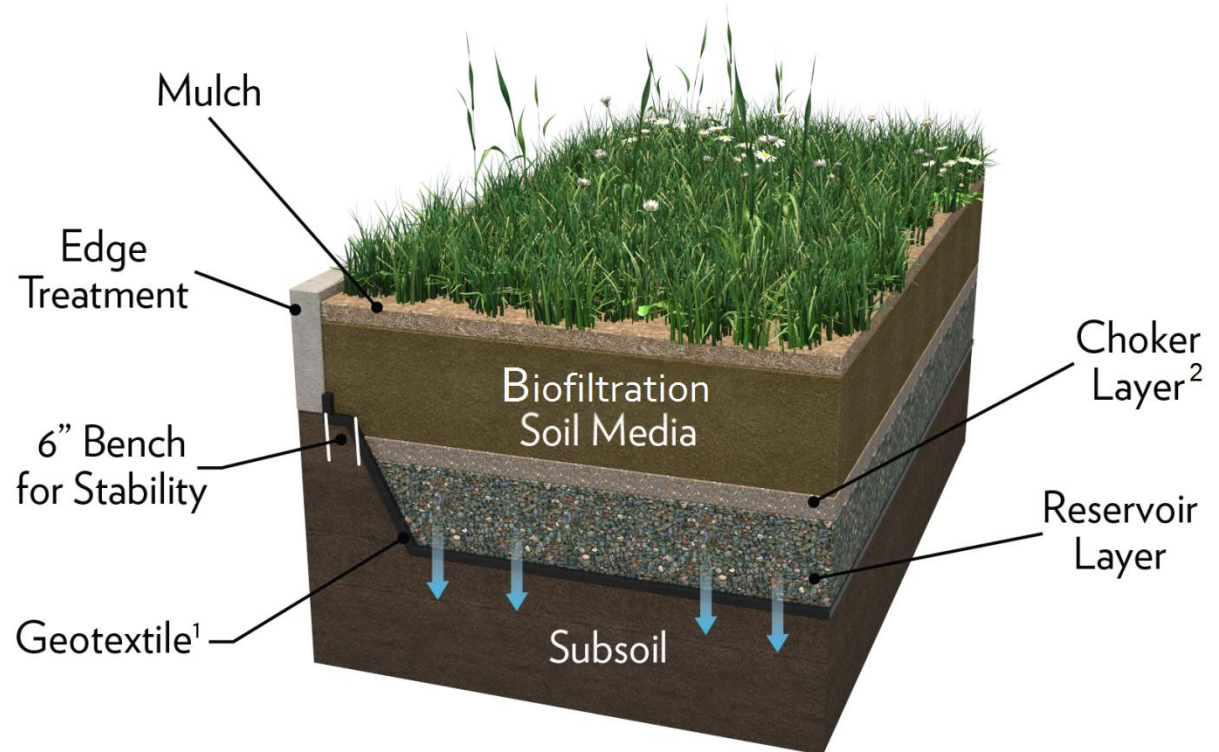

MEDIUM INFILTRATION

Notes:

1. Geotextile per Geotechnical Engineer's Recommendations (street side and sidewalk side).
2. Choker layer may be required depending the type of reservoir layer.

LOW INFILTRATION

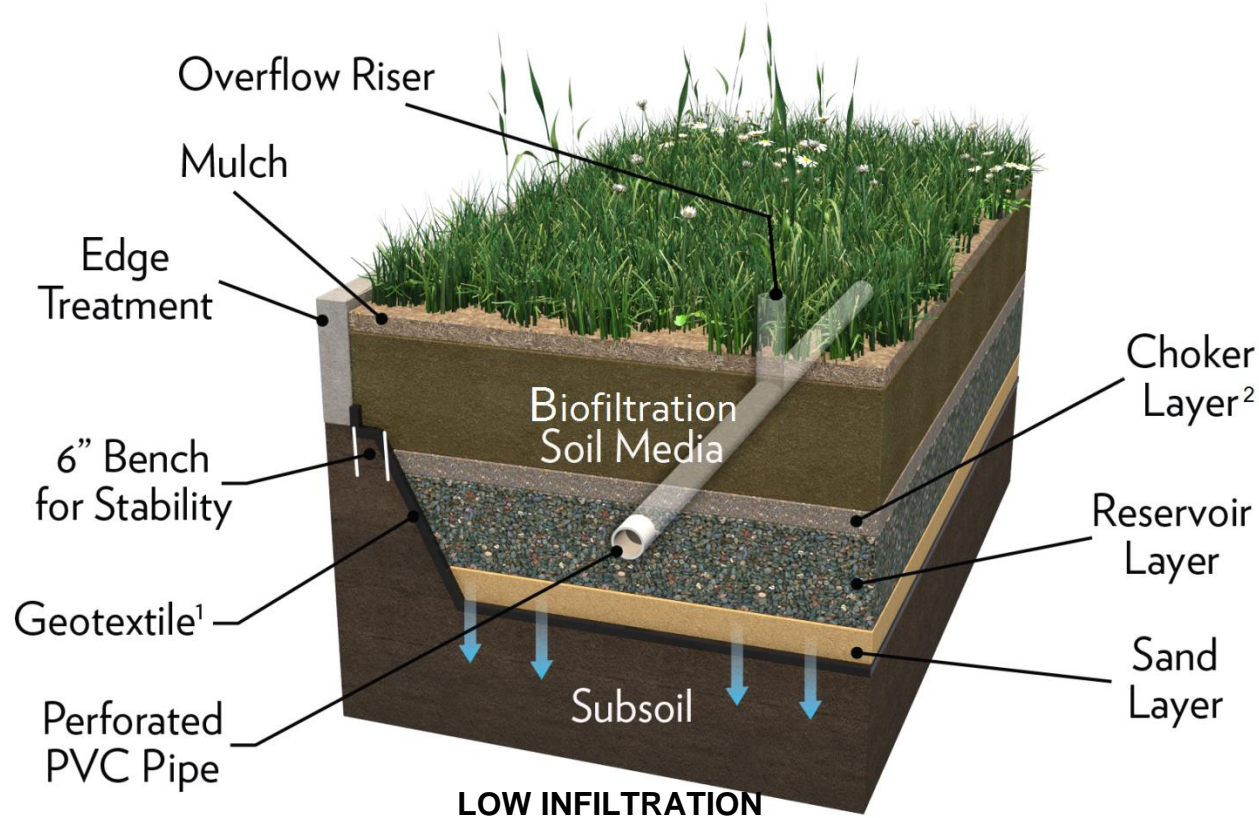

Notes:

1. Geotextile per Geotechnical Engineer's Recommendations (street side and sidewalk side).
2. Choker layer may be required depending on the type of reservoir layer.

PUTTING IT TOGETHER

- **Ponding Depth:** Stores runoff within the planting area prior to treatment.
- **Overflow Riser:** Pipe to capture high water flow.
- **Mulch:** A soil topping that may be organic or inorganic material which covers the planting soil to retain water and trap pollutants.
- **Biofiltration Soil Media:** A specific blend of soil, compost, and sand to retain and drain water and support plant growth.
- **Choker Layer:** Sand and gravel to prevent biofiltration soil media from migrating into the reservoir.
- **Reservoir Layer:** Stone to hold excess water until it infiltrates.
- **Underdrain:** An underdrain is required.
- **Geotextile:** Prevents existing soil from migrating into the biofiltration soil media and stone reservoir layer.
- **Uncompacted Subgrade:** Existing soil where stormwater infiltrates.

COMMON DESIGN ISSUES

Utilities: In the County, utility lines are common and necessary components of infrastructure within the right-of-way. Utility lines should be avoided where necessary and allowed to coexist where possible.

PUTTING IT TOGETHER

- **Ponding Depth:** Stores runoff within the planting area prior to treatment.
- **Overflow Riser:** Pipe to capture high water flow.
- **Mulch:** A soil topping that may be organic or inorganic material which covers the planting soil to retain water and trap pollutants.
- **Biofiltration Soil Media:** A specific blend of soil, compost, and sand to retain and drain water and support plant growth.
- **Choker Layer:** Sand and gravel to prevent biofiltration soil media from migrating into the reservoir.
- **Reservoir Layer:** Stone to hold excess water until it enters the underdrain.
- **Underdrain:** An underdrain is required.
- **Impermeable Liner:** Prevents infiltration and prevents existing soil from migrating into the biofiltration soil media and stone reservoir layer.

COMMON DESIGN ISSUES

Utilities: In the County, utility lines are common and necessary components of infrastructure within the right-of-way. Utility lines should be avoided where necessary and allowed to coexist where possible.

NO INFILTRATION

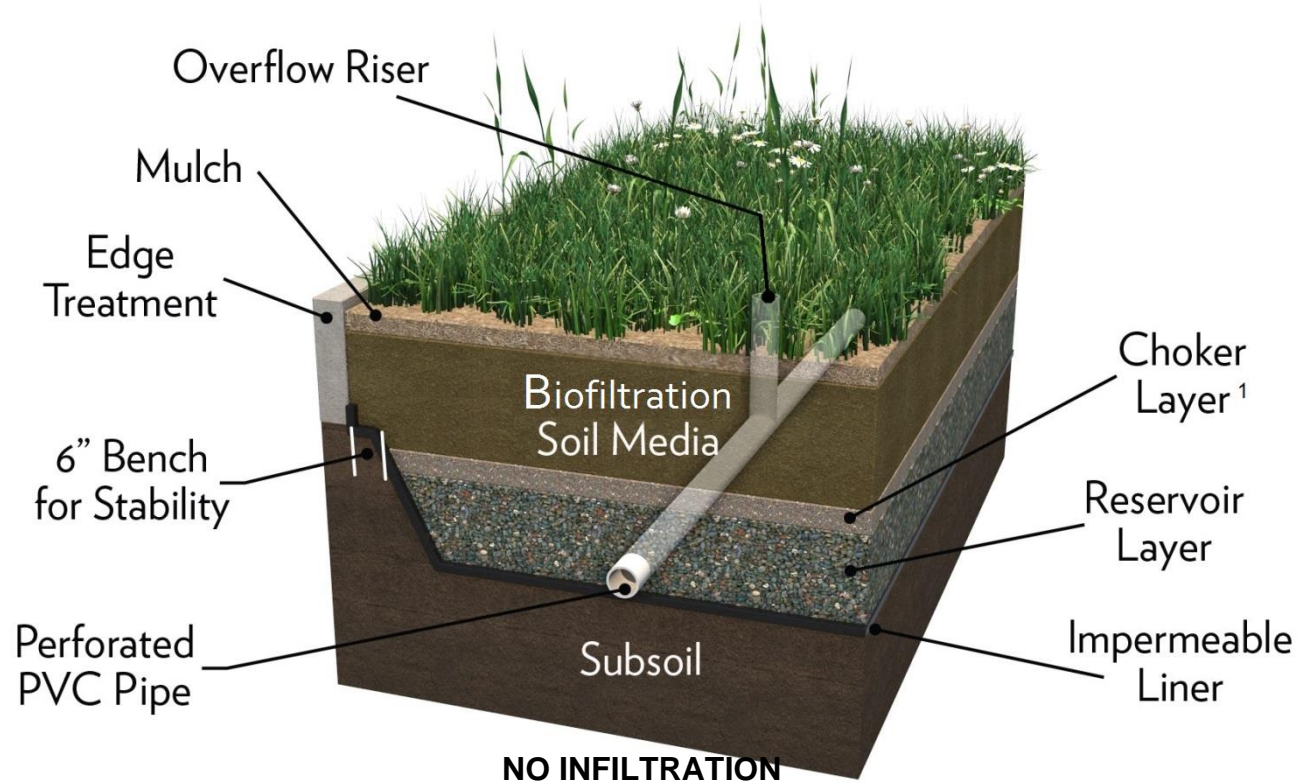

Notes:

1. Choker layer may be required depending the type of reservoir layer.

2.4 PLANTING & IRRIGATION OF DISPERSION AREAS, BIOFILTRATION, TREE WELLS, AND OTHER AREAS

PLANTING DESIGN

Tree wells, dispersion areas, and biofiltration add a landscape amenity to the street-scape. Trees, shrubs, grasses and perennials are used to create a diverse landscape suitable for the site conditions and neighborhood. Plants should be chosen based on the level of care expected at the facility. Planting design must be done to ensure sight lines are preserved for pedestrians, cyclists, and vehicles on the street.

Existing trees are an important component of the green street. Mature trees capture stormwater, provide shade, and cool pavement. Existing trees should be protected when implementing green streets and not disturbed during construction.

Refer to the County of San Diego's Water Efficient Landscape Design Manual and Low Impact Development Handbook for suitable plant species to use in dispersion areas and biofiltration. Also refer to the community right of way development standards for suitable plants within specific communities.

IRRIGATION DESIGN

Irrigation design should comply with the County of San Diego's Water Efficient Landscape Design Manual.

PLANTING ZONES (HYDROZONES)

Grouping plants into hydrozones is an approach to irrigation and planting design where plants with similar water needs are grouped together. Ideally, each zone of the irrigation system will supply plants with the same water needs with the appropriate amount of water.

WATER CONSERVATION

State executive order B-29-15 requires mandatory statewide water restrictions. This order prohibits ornamental turf on public street medians, and requires a reduction in potable water use for irrigation. Low water use, drought tolerant, native plants should be used for Green Streets applications. The use of reclaimed water is recommended to reduce the amount of potable water used for irrigation.



WATER EFFICIENT LANDSCAPE DESIGN MANUAL
COUNTY OF SAN DIEGO

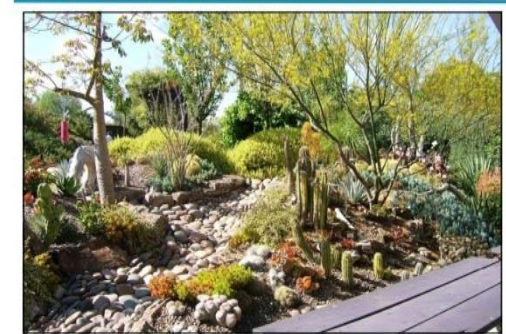

DEPARTMENT OF PLANNING AND LAND USE

DPLU (02/10)



2.5 TYPES OF PERMEABLE PAVEMENT

WHAT IS PERMEABLE PAVEMENT

Permeable pavement is an engineered top layer and base layer that allows water to move through it. The goal is to take rainwater as it falls and quickly move it to the lower layers of the system. Stormwater is stored in an underlying stone layer until it infiltrates into the soil below, aiding in groundwater recharge, or releases slowly to the storm drain system. Pollutants are filtered through the pavement and base layers. The terms 'Permeable Concrete Pavers', 'Pervious Concrete', 'Porous Asphalt', and 'Porous Rubber' are industry standard names, but all surfaces are 'permeable' and provide sufficient openings at the surface to allow stormwater to infiltrate.



PERMEABLE CONCRETE PAVERS

Unlike traditional pavers, there are gaps between each paver to allow water to flow between the pavers and into the base layer.



PERVIOUS CONCRETE

Sands and "fines" are reduced in the concrete mix to allow water to flow through the pavement into a stone bed and eventually the ground.



TYPES OF PERMEABLE PAVEMENT (CONTINUED)



POROUS ASPHALT

Porous asphalt is very similar to traditional asphalt except that the sands or “fines” are reduced in the mix so water can move through the pavement.

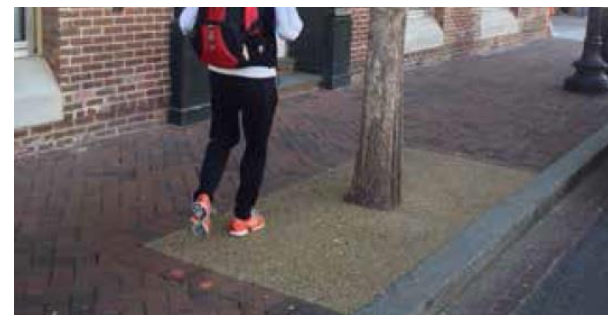

POROUS RUBBER

Made from recycled rubber and small stones, porous rubber works like pervious concrete, but can be installed over tree roots.



DECOMPOSED GRANITE (DG) PATHWAY

Decomposed granite can be used for pathways. It can be installed and compacted to meet ADA handicapped accessibility specifications and criteria. Although highly compacted, the surface has some infiltration capacity.



BOARDWALK

Made from wood or composite, boardwalks may be used for pathways. Rain easily passes through the spaces between the boards to the earth below.

PUTTING IT TOGETHER

- Permeable Surface: Permeable concrete pavers, pervious concrete, porous asphalt, porous rubber, DG, or boardwalk.
- Bedding Layer: Used for pavers so they can be laid flat.
- Choker Layer: A layer of small rock to prevent fine material from migrating into the reservoir layer.
- Reservoir Layer: Stone to hold excess water until it infiltrates.
- Underdrain: Conveys excess water into drainage system when the reservoir fills.
- Filter Layer/Geotextile: A layer of stone or permeable geotextile to separate the reservoir layer from the soil below and prevent migration of fines into the reservoir layer.
- Impermeable Liner: Prevents infiltration into subgrade or adjacent roadway structural section.
- Uncompacted Subgrade: Existing soil into which stormwater infiltrates.

PERMEABLE PAVEMENT – WHAT’S UNDERNEATH?

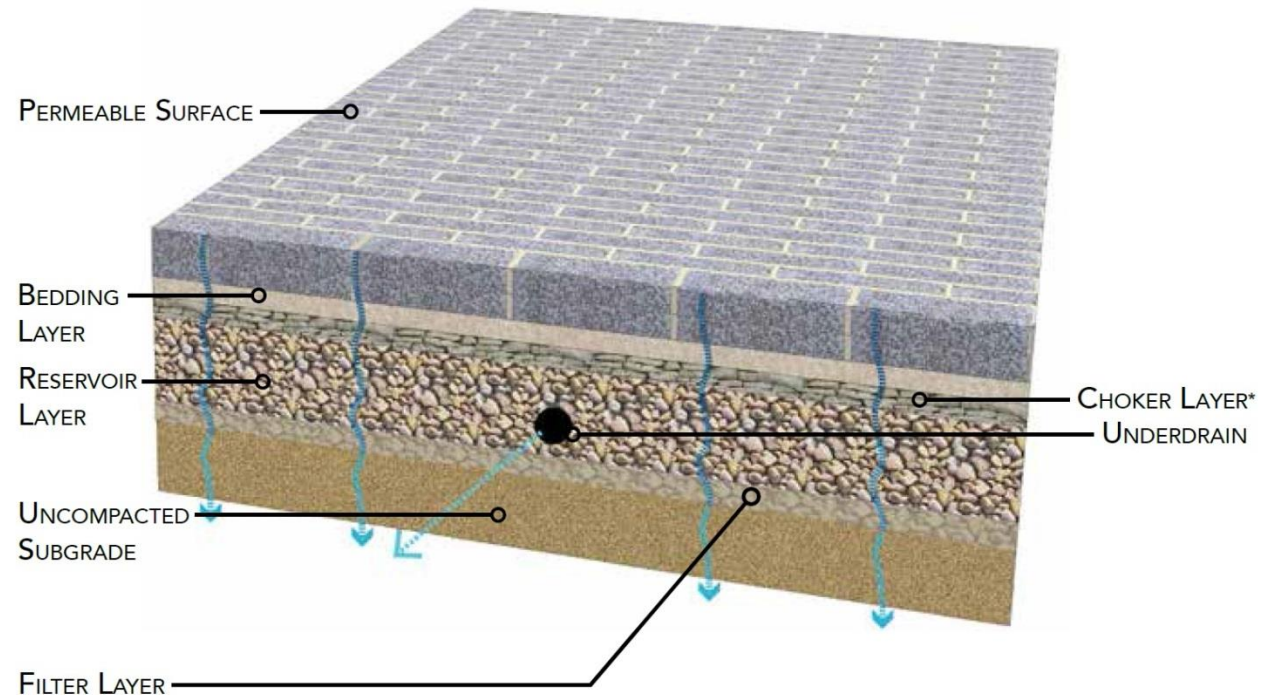

(Source: DDOT, 2014)

*Per Geotechnical Engineer's Recommendations

As with dispersion areas and biofiltration, there are multiple options for the subsurface components for permeable pavement including:

- Reservoir layer only with no underdrain
- Reservoir layer with underdrain (shown)
- Reservoir layer with underdrain and impermeable liner

PERMEABLE PAVEMENT SUBSURFACE DESIGN OPTIONS

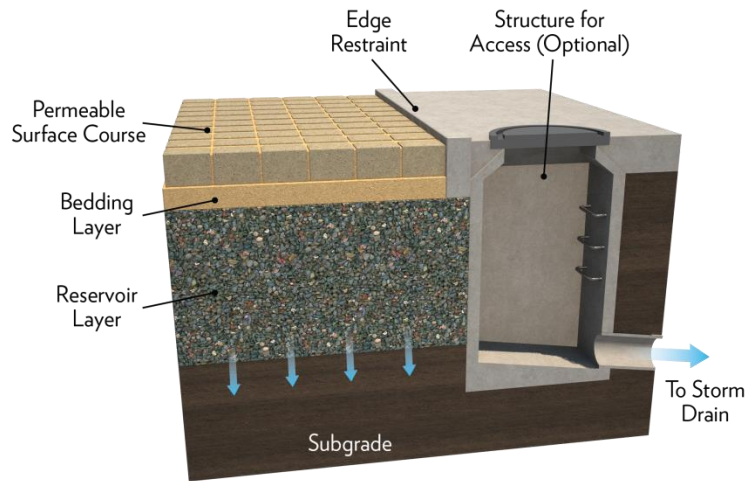

Reservoir layer only with no underdrain

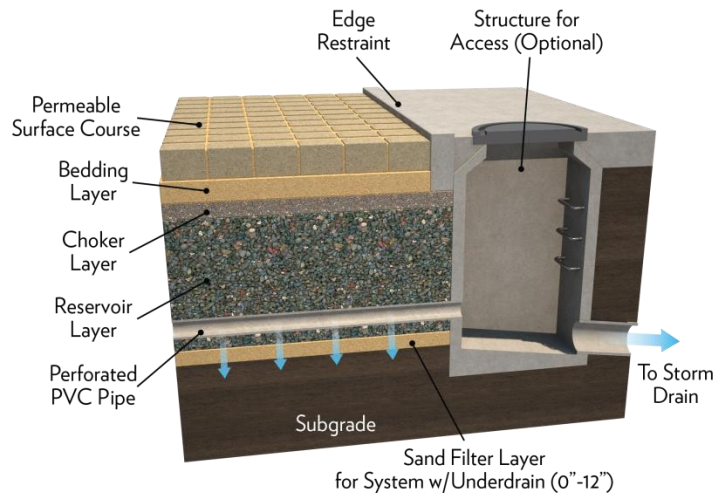

Reservoir layer with underdrain

WHERE TO USE?

- Pedestrian areas
- Pathways
- Parking lanes

LIMITATIONS

- Use is limited to areas curb-separated from the traveled way.
- Use in areas with little to no sediment production.

DESIGN ISSUES

Soil Infiltration and Drainage: Soil infiltration tests must be completed to determine if an underdrain system is required.

Structural Section: A qualified and licensed professional should complete a pavement structural analysis.

Edge Restraints: Provide a concrete transition strip between any permeable and impermeable surface and around the perimeter of paver installations.

Pedestrian Considerations: Provide signage to indicate prohibited activities that cause premature clogging.

Maintenance Access: Provide adequate access for sweeping and/or vacuuming of surface.



PERMEABLE PAVEMENT SUBSURFACE DESIGN OPTIONS (CONTINUED)

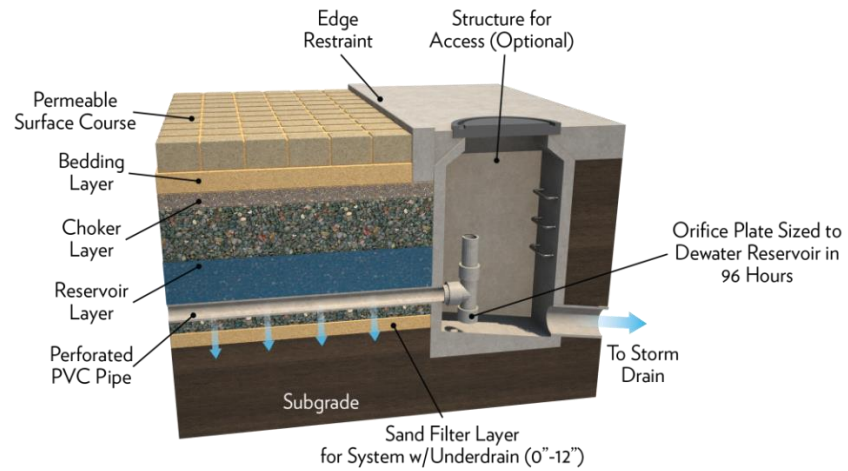

Reservoir layer with upturned underdrain

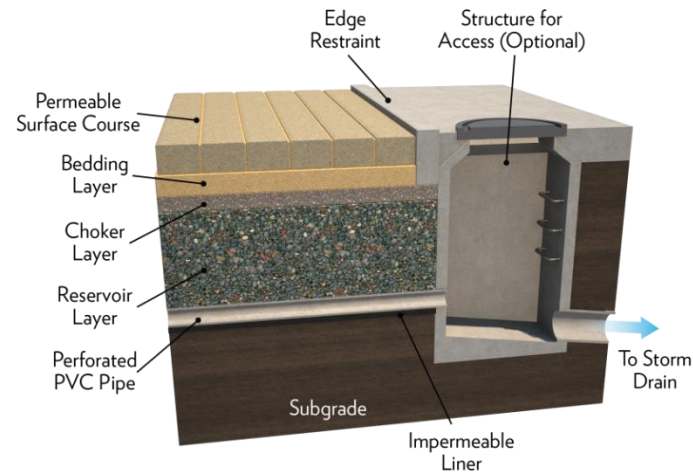

Reservoir layer with underdrain and impermeable liner

CHAPTER 3 Procedures and Design Examples

3.1 INTRODUCTION

Implementing Green Infrastructure (GI) and Low Impact Development (LID) within the road right-of-way requires a number of considerations to create an amenity that is attractive while treating stormwater from the surrounding streets and sidewalks.

Implementation of Green Streets features can be approached from evaluating the opportunities within each zone of the right-of-way: median, traveled lane, bike lane, shoulder, parkway, sidewalk/pathway, slopes and drainage easements. Each zone presents different opportunities, benefits, risks and technical design factors for GI and LID implementation to enhance stormwater quality within the right-of-way.

Conducting a comprehensive inventory and assessment of site conditions is the crucial initial step for implementing GI and LID. The County LID Handbook inventory check list can be used to assist with identifying and evaluating a potential site for LID and to produce a list of opportunities and constraints.

The LID concept from the EPA of “slow it down, spread it out, and soak it in” should be at the forefront in the planning stages of project evaluating the implementation of Green Streets design practices to control runoff and enhance water quality.



The following site design principles should be evaluated and implemented to “slow it down, spread it out, and soak it in”:

- Minimize the impervious footprint of the site by constructing streets and sidewalks to the minimum required widths.
- Minimize soil compaction in landscaped areas. Landscape with native or drought-tolerant species.
- Disconnect impervious surfaces by dispersing runoff from impervious surfaces to pervious areas. To be considered ‘disconnected’ impervious areas should be designed to drain to a pervious area at least one-half their size.
- Design and construct tree wells, dispersion areas, biofiltration, and permeable pavements to effectively receive and infiltrate or retain runoff from impervious areas before it discharges to the storm drain or exits the right of way.

When green street design principles are employed over street design techniques that utilize conventional stormwater quality treatment techniques they have the potential to significantly reduce impervious areas and provide potential project cost savings.



Conventional Design Approach

- Impervious median and parking lane
- Biofiltration and stormwater vault in parkway



Green Street Design Approach

- Permeable median and parking lane
- Tree wells and biofiltration in parkway

(Source: DDOT, 2014)

GREEN STREET APPROACH

Direct stormwater runoff from impervious roadway elements to:

- Tree wells, dispersion areas, and biofiltration in the median or parkway.
- Permeable pavement surfaces located in the median or parking lane.

Construct sidewalks and trails with permeable pavement or direct runoff to adjacent landscaped area.

CONSTRAINTS

In no way shall green streets LID features be designed to block sight distance for motorists from adjacent streets and driveways, create obstacles for pedestrians, impede the visibility and maintenance of traffic control devices and signs, and reduce or eliminate clear recovery area and minimum horizontal clearances from fixed objects.



3.2 DESIGN PROCEDURE

QUALIFICATION

Under the Municipal Separate Storm Sewer System (MS4) Permit for San Diego Region (Permit [Order No. R9-2013-0001]), the County may make Priority Development Project (PDP) Exemptions for projects redeveloping or retrofitting existing paved roads, streets, and alleys as “EPA Green Streets.” This is accomplished under an adopted Green Streets program by the County of San Diego and based in part on the EPA publication “Green Streets: Municipal Handbook, Managing Wet Weather with Green Infrastructure.”

OPPORTUNITIES AND CONSTRAINTS

- Conduct a comprehensive inventory and assessment of site conditions.
- Evaluate each zone of the right-of-way for Green Street implementation opportunities: median, traveled lane, shoulder, parkway, sidewalk/pathway, slopes and drainage easements.
- Evaluate constraints including, but not limited to: right-of-way width, utilities, roadway geometry and slope, site distance, proximity to storm drain, maintenance access, pedestrian and vehicle safety, bike and parking lanes, etc.

DESIGN CAPTURE VOLUME/FLOW RATE

- For volume based features () use the 24-hour, 85th percentile volume. For flow based features (swales) utilize the 24-hour, 85th percentile rainfall intensity (use CASQA method within Caltrans Basin Sizer).

TREATMENT TRAIN

- Utilize a treatment train approach that connects and combines features to maximize water quality treatment within the Green Street. An example Green Street treatment train approach is provided in Section 3.6.

DOCUMENTATION

- Document the design criteria, methodology, drainage areas/treatment areas, calculated volumes/flows, BMP selection, and maintenance requirements in the project Stormwater Management Plan and/or Drainage Report.

3.3 MEDIANS

The median presents an opportunity to implement green streets principles by use of Tree wells, biofiltration, or permeable pavements. The graphics below illustrate various green streets design concepts that can be utilized within the median.



Roadway before Green Streets



Roadway with depressed median and bulb out planter at intersection



Conventional raised median curb, impermeable surfacing and trees



Green street depressed median with curb cuts and planter/swale

DESIGN ELEMENTS

- Raised median:
 - Plant low water use/drought tolerant trees and landscaping.
 - Install permeable pavement.
- Depressed median: Utilize roadway cross slope to direct stormwater runoff from impervious roadway elements to:
 - Tree wells
 - Planter boxes
 - Vegetated swale

DESIGN CONSIDERATIONS

- Vehicle safety
- Median width and length
- Roadway longitudinal and cross slope
- Structural integrity of adjacent traveled way (design to prevent subsurface infiltration or ponding under traveled way)
- Underdrain and overflow devices
- Proximity of storm drain
- Maintenance access
- 'Mid-block' pedestrian crossing potential

DESIGN ELEMENTS

- Raised section:
 - Plant low water use/drought tolerant trees and landscaping.
 - Install permeable pavement.
- Depressed section: Utilize roadway cross slope to direct stormwater runoff from impervious roadway elements to:
 - Tree wells
 - Planter boxes
 - Vegetated swale

DESIGN CONSIDERATIONS

- Roadway geometrics
- Structural integrity of adjacent traveled way to prevent subsurface infiltration or ponding under traveled way
- Underdrain and overflow devices
- Proximity of storm drain
- Maintenance access

3.4 INTERSECTIONS

ROUNDBABOUTS

The design elements and design considerations for roundabouts are similar to medians.



Aerial view of rural intersection before roundabout



Aerial view of constructed roundabout with permeable pavement and biofiltration with connection to storm drain



Closeup view of same roundabout



Street view of same roundabout

BULB-OUT AT INTERSECTION

The design elements and design considerations for bulb-outs are similar to curb extensions. Bulb-outs provide traffic calming at intersections, increase pedestrian visibility, and decrease cross-walk lengths. Bulb-outs at intersections prevent motorists from parking too close to a cross-walk or from blocking a curb ramp. Motor vehicles parked too close to corners present a safety concern, since they block sight lines, obscure visibility of pedestrians and other vehicles, and make turning difficult for emergency vehicles and trucks. Bulb-outs are only appropriate where there is an on-street parking lane or shoulder and must not extend into bike lanes or travel lanes. The turning requirements of larger vehicles such as fire trucks and school buses require consideration in design.



Bulb-out planter box at intersection

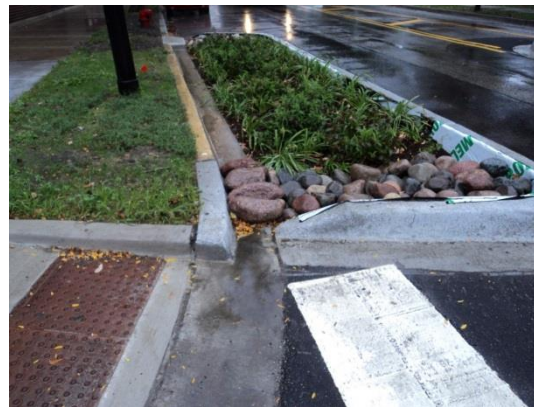

Bulb-out at intersection

DESIGN ELEMENTS

- Raised section:
 - Plant low water use/drought tolerant Tree wells and landscaping
 - Install permeable pavement.
- Depressed section: Utilize roadway cross slope to direct stormwater runoff from impervious roadway elements to:
 - Tree wells
 - Planter boxes
 - Vegetated swale

DESIGN CONSIDERATIONS

- Appropriate only where there is on-street parking or shoulder
- Roadway geometrics
- Structural integrity of adjacent traveled way to prevent subsurface infiltration or ponding under traveled way
- Underdrain and overflow devices
- Proximity of storm drain
- Maintenance access
- Turning requirements for large vehicles
- Bike lanes

DESIGN ELEMENTS

- Traveled Way and Bike Lane:
 - Design lane widths to minimum allowable.
- Shoulder/Parking Lane:
 - Utilize permeable pavement with edge restraint at interface with traveled way

DESIGN CONSIDERATIONS

- Permeable pavement not acceptable in traveled way, bike lane, and parkway
- Structural section design to handle vehicle loading
- Shoulder utilization (with or without parking, temporary use during lane closures)
- Roadway geometrics
- Hydrologic design requirements (stone reservoir depth and underdrain requirements)
- Design to maintain structural integrity of adjacent traveled way with edge restraints and prevention of infiltration beneath traveled way section
- Interrupt permeable pavement at intersections
- Surrounding land use and sediment sources
- Long term maintenance
- Pedestrian safety
- Maintenance access

3.5 TRAVELED WAY, BIKE LANE, AND SHOULDER PERMEABLE PAVEMENT

The use of permeable pavements within the traveled way and bike lanes of County maintained roads is not currently permitted. However, their use may be considered for low volume driving lanes in parking lots, private streets, alleys, and fire access roads. The use of permeable pavement in the shoulder/parking lane should be evaluated based upon the following design considerations listed to the left.



Conventional street with bike lane
and shoulder



Green street with permeable
pavement in parking lane

CURB EXTENSIONS

Curb extensions reduce overall street dimensions and provide traffic calming. Among other benefits, curb extensions provide added space for biofiltration.

Curb extensions shall never encroach upon the traveled way or bike lanes. When existing tree roots are damaging adjacent curb, gutter, or pavement curb extensions provide an excellent opportunity to preserve the tree and provide green infrastructure.

Careful survey of street parking impacts should be considered when locating curb extensions.



Curb extension with planter box



Curb extension with planter box

DESIGN ELEMENTS

- Low water use/drought tolerant trees and landscaping
- Permeable pavement
- Planter boxes

DESIGN CONSIDERATIONS

- Roadway geometrics
- Structural integrity of adjacent traveled way to prevent subsurface infiltration or ponding under traveled way
- Underdrain and overflow devices
- Sight distance at intersection
- Proximity of storm drain
- Utility conflicts
- Pedestrian mobility aspects
- Maintenance access
- Parking requirements

PARKWAY DESIGN ELEMENTS

- Landscape area:
 - Tree wells
 - Planter boxes
 - Curb extensions
 - Bulb outs at intersections
 - Swales
- Sidewalk or trail:
 - Drain to adjacent landscaping
 - Drain to green street LID practice
 - Permeable pavement
- Other areas:
 - Filter Strip
 - Dispersion Area

3.6 PARKWAY

The parkway including the tree space, planting strip, sidewalk, pathway, and other areas has numerous opportunities for Green Street implementation.

TREE WELLS



Existing Road



Conceptual design with Tree wells, and permeable sidewalk



Existing Road



Reconstructed Road with Trees and planter boxes

PLANTER BOXES



Before and After Concept



Road retrofit with planter boxes and trees



Planter Box with step out zone



Planter box with step out zone

PARKWAY DESIGN CONSIDERATIONS

- Roadway classification and parkway width
- Location (urban or rural setting)
- Tree type and spacing requirements
- Sidewalk or trail width requirements
- Streetside parking requirements
- Roadway and parkway horizontal and vertical geometrics (curves and longitudinal slope)
- Pedestrian mobility and safety
- Maintenance access
- Interface with driveways
- Utilities and appurtenant structure locations
- Hydrologic design requirements
- Proximity of storm drain systems
- Structural integrity of adjacent traveled way (utilize edge restraints and prevent infiltration beneath roadway section)
- Low water use/drought tolerant Trees and landscaping

DESIGN ELEMENTS

- Low water use/drought tolerant landscaping
- Rock
- Curb cuts and outlet design
- Energy dissipation
- Check dams

DESIGN CONSIDERATIONS

- Roadway geometrics
- Structural integrity of adjacent traveled way to prevent subsurface infiltration or ponding under traveled way
- Underdrain and overflow devices
- Proximity of storm drain
- Pedestrian mobility aspects
- Maintenance access

SWALES



Swale adjacent to road



Rock swale adjacent to road



Rock swale adjacent to road



Swale adjacent to road

SIDEWALKS AND PATHWAYS



Permeable pavement sidewalk with biofiltration planter in curb extension



DG pathway with rock swale



Pervious concrete sidewalk



Porous asphalt pathway

DESIGN ELEMENTS

- Drain to adjacent landscaping or adjacent LID facility
- Permeable pavement

DESIGN CONSIDERATIONS

- Sidewalk width and ADA requirements
- Public safety
- Pedestrian mobility aspects
- Maintenance access

OTHER PARKWAY AREAS

DESIGN ELEMENTS

- Low water use/drought tolerant landscaping
- Swales
- Dispersion areas
- Vegetated filter strips

DESIGN CONSIDERATIONS

- Available space
- Vehicle and public safety
- Structural integrity of adjacent traveled way to prevent subsurface infiltration or ponding under traveled way
- Underdrain and overflow devices
- Proximity of storm drain
- Maintenance access



Swale outside of sidewalk and road



Curb cuts with filter strip



Dispersion Area



Rock swale

3.7 PUTTING IT ALL TOGETHER

This graphic shows a treatment train concept as an example of how several different techniques may be combined for Green Street implementation.

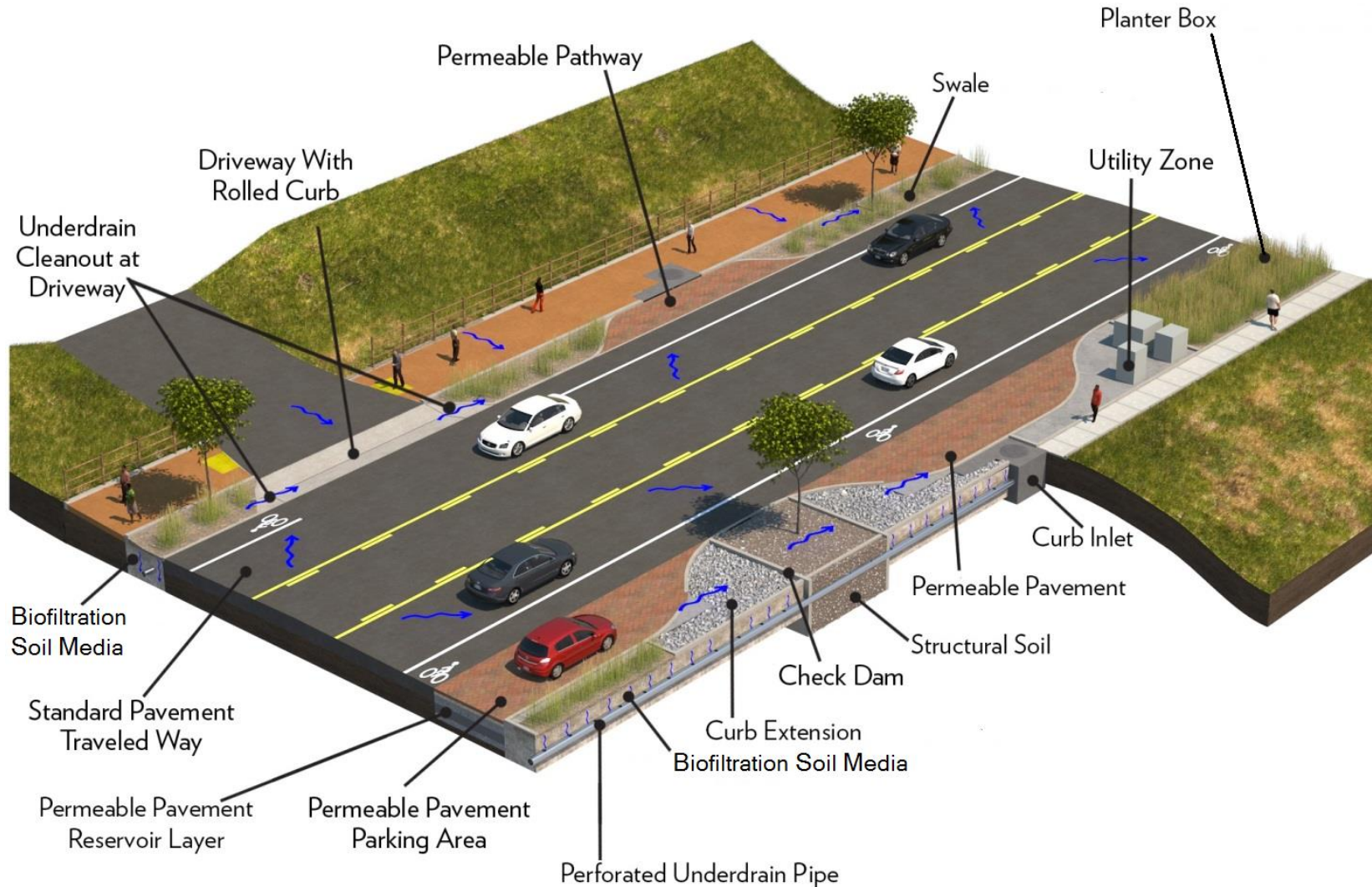



CHAPTER 4

Implementing Green Streets

4.1 DESIGN AND CONSTRUCTION

The goal of the County of San Diego (the County) Low Impact Development (LID) Program is to protect stormwater quality by preserving and simulating natural hydrologic functions through the use of stormwater planning and management techniques on a project site. Both public and private projects constructing in the ROW are required to retain stormwater to the maximum extent practicable. Designers must examine all uses of public space and place stormwater management where space and use allows.

DPW is installing green infrastructure as part of regulated construction projects and retrofit projects to reduce stormwater runoff in more areas of the County. Green Street projects utilize green infrastructure techniques and may be constructed independently to improve watershed health, or as a part of other infrastructure improvement projects.

These Green Street Guidelines are a planning tool intended to assist project engineers with identifying and selecting suitable Best Management Practices (BMPs) for their respective Green Infrastructure projects. Technical standards, including drawings, specifications, maintenance schedule, and plant list, can be found in the Green Street Standards document.



4.2 MAINTENANCE

Implementing green infrastructure and Low Impact Development (LID) practices requires maintenance to keep them attractive and functioning. Maintenance levels of care should be considered during the design phase and plants selected from the Green Streets Plant List according to the following levels:

- Low level of care: Annual maintenance; no irrigation
- Medium level of care: Quarterly maintenance; some water available
- High level of care: Monthly maintenance; site is potentially irrigated

San Diego County DPW is typically responsible for maintaining publicly-installed green infrastructure and LID facilities within their right-of-way. The final determination of maintenance responsibility is determined during project review. Private installations must have a maintenance covenant from the owner. Residents can help with maintenance by removing trash and weeds. Refer to the Green Streets Maintenance Schedule for frequency and detail of maintenance.

Type of Maintenance	Dispersion Areas and Biofiltration	Permeable Pavement	Tree Space
Inspect after storms	•	•	
Remove trash/sediment/leaves	•	•	•
Clean inlets/outlets	•		
Adjust mulch and/or stone	•		
Water for establishment	•		•
Weed/remove invasive species	•		•
Prune (as needed)	•		•
Replace mulch (3" depth)	•		•
Street sweeper/vacuum (as needed)		•	

4.3 FUNDING

Funding mechanisms for Green Streets maintenance may include:

- Community Service Districts
- Home Owner's Associations or other private sources





REFERENCES

Central Coast Low Impact Development Initiative, 2015:

<http://www.centralcoastlidi.org/resources.php>

City of Los Angeles – Green Streets and Green Alleys Design Guidelines Standards, 2009:

nacto.org/docs/usdg/green_streets_and_green_alleys_la.pdf

County of San Diego – Low Impact Development Handbook, 2014:

sandiegocounty.gov/content/sdc/dpw/watersheds/susmp/lid

County of San Diego – Standard Urban Stormwater Mitigation Plan Requirements for Development Applications,

2012: sandiegocounty.gov/dpw/watersheds/susmp/susmp

DDOT – Greening DC Streets, 2014:

ddot.dc.gov/GreenInfrastructure

Low Impact Development Center, Inc. - Low Impact Development Manual for Southern California, 2010:

<https://www.casqa.org/resources/lid/socal-lid-manual>

Montgomery County, MD - Environmental Site Design Implementation in Montgomery County, Maryland: Image Library, 2011:

http://www.montgomeryplanning.org/environment/documents/esd_implementation_graphics_201108.pdf

This page was left intentionally blank.

K.3 Green Parking Lots

This page was intentionally left blank.

K.3.1 Green Parking Lots Guidelines

This page was intentionally left blank.

Green Parking Lots Guidelines

A Guide to Green Parking Lots
Implementation in the County of San Diego

January 2019





WHAT IS A GREEN PARKING LOT?

Pavement on parking lots can contribute to excess stormwater runoff and increased levels of pollutants in the County's waterways. Green infrastructure reduces stormwater runoff and improves water quality. Green Parking Lots incorporate a wide variety of Green Infrastructure design elements including, but not limited to: trees, dispersion areas and biofiltration, and permeable pavement. The use of Green Parking Lots offers the capability of transforming a significant stormwater and pollutant source into an innovative treatment system.

On April 1st, 2015 Governor Brown signed executive order B-29-15 setting the first mandatory statewide water restrictions. This order prohibits ornamental turf on public street medians, and requires a reduction in potable water use for irrigation. Green Parking Lots promote water conservation through the use of low water use and drought tolerant plants (xeriscape) and improving groundwater supplies through infiltration.

Green infrastructure, unlike traditional "gray" infrastructure approaches to stormwater management, provides multiple benefits to communities. Planting more trees and landscaping in public spaces cleans the air, cools the land, provides more habitat for wildlife, adds green maintenance jobs, increases property values and promotes a better, healthier quality of life for County residents and visitors.

This guide is to be used along with the County's Green Parking Lots Standards. These Green Parking Lots measures, when implemented, will ensure the County remains a green community for many years to come.

TABLE OF CONTENTS

CHAPTER 1 – INTRODUCTION TO GREEN PARKING LOTS.....	K-80
1.6 INTRODUCTION	
1.7 THE NATURAL AND DEVELOPED ENVIRONMENT	
1.8 GREENING PARKING LOTS	
1.9 THE COUNTY ENVIRONMENT	
1.10 PARKING LOTS	
CHAPTER 2 – GREEN PARKING LOTS STRATEGIES.....	K-85
2.1 INTRODUCTION	
2.2 TREES	
2.3 TYPES OF DISPERSION AREAS AND BIOFILTRATION	
2.4 PLANTING & IRRIGATION OF DISPERSION AREAS, BIOFILTRATION, TREES AND OTHER AREAS	
2.5 TYPES OF PERMEABLE PAVEMENT	
CHAPTER 3 – PROCEDURES & DESIGN EXAMPLES.....	K-105
3.1 INTRODUCTION	
3.2 SITE DESIGN PRINCIPLES	
3.3 DESIGN PROCEDURE	
3.4 PUTTING IT ALL TOGETHER	
CHAPTER 4 – IMPLEMENTING GREEN PARKING LOTS.....	K-117
4.1 DESIGN AND CONSTRUCTION	
4.2 MAINTENANCE	
REFERENCES.....	K-115

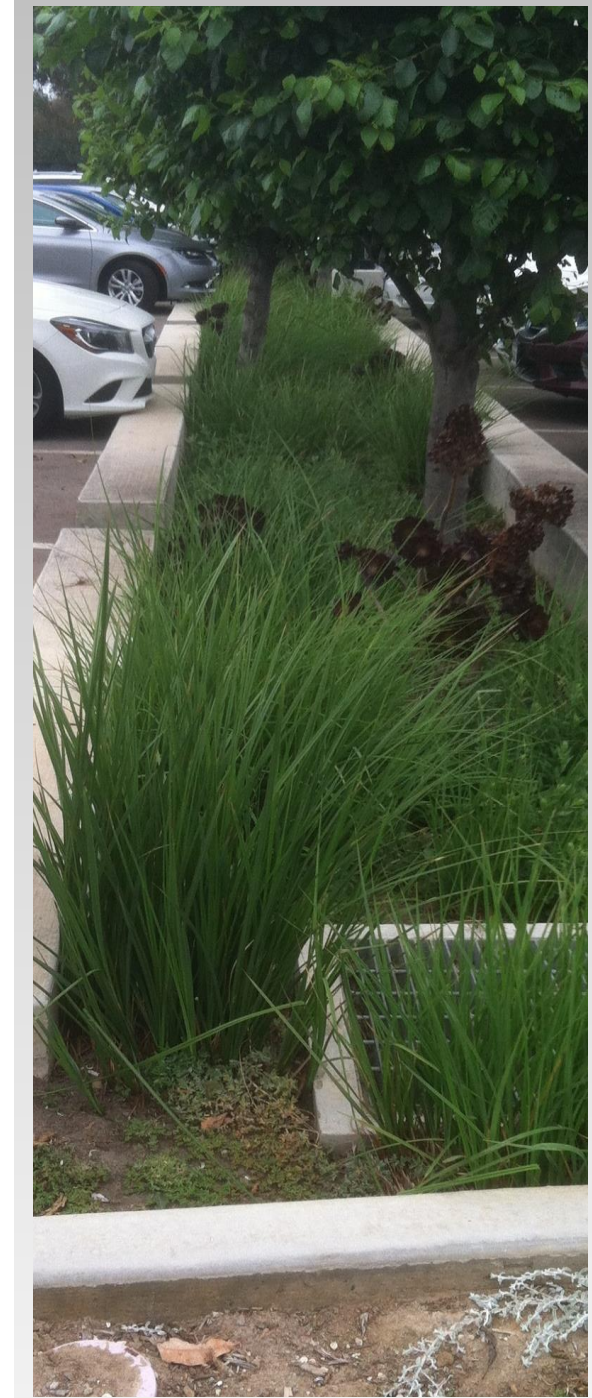



CHAPTER 1

Introduction to Parking Lots

1.1 INTRODUCTION

These guidelines have been prepared to assist in the design and construction of parking lots projects for new or redeveloped parking lots. These Guidelines may also be used to assist in the design and construction of new or retrofit paved sidewalks, bicycle lanes, or trails.

The functional goals of these guidelines are to:

- Provide source control of stormwater;
- Limit stormwater transport and pollutant conveyance to the collection system;
- Restore predevelopment hydrology to the extent possible by slowing the runoff down and allowing for infiltration; and
- Provide environmentally enhanced parking lots.

A review of existing County policies has been performed and included in the accompanying Green Parking Lots Standards document that includes an addendum to the 2016 County of San Diego BMP Design Manual. The Green Parking Lots Standards publications include an addendum to the 2016 County of San Diego BMP Design Manual. The intent is to utilize the current standard drawings with suggested modifications where appropriate.

Green Parking Lot configurations and locations presented in this guideline are schematic/conceptual in nature. The configurations (or locations) could be modified as long as the design and construction details are in conformance with the Green Parking Lots technical documents (i.e. – Green Parking Lots Supplement to the BMP Design Manual, Standard Drawings, Specifications, and Maintenance Schedule).

1.2 THE NATURAL AND DEVELOPED ENVIRONMENT

NATURAL AREAS

In areas such as meadows, thickets, woodlands, and parks, rain can soak into the ground and be used by plants. Trees and shrubs intercept rainfall and it slowly trickles down to the ground where it is absorbed by mulch and humus soil. Shaded areas are cooler, moister and provide wildlife habitat. Very little rainwater runs off the ground.

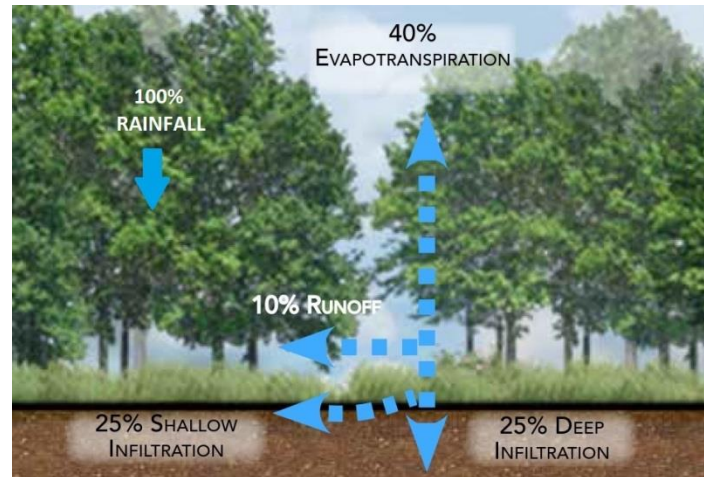

Natural Area Diagram

(Source: DDOT, 2014)

URBAN AREAS

In urban areas, building rooftops, streets, alleys, sidewalks, and other paved surfaces are smooth and mostly impervious. Very little rain has a chance to soak into the ground. These paved urban areas are hotter and offer very little wildlife habitat. Most of the rain that falls in the urban areas quickly runs off impervious surfaces picking up pollutants and carrying them into storm drains. These flows quickly combine to create flash floods that degrade downstream waterways.



Urban Area Diagram



STORMWATER CAPTURE

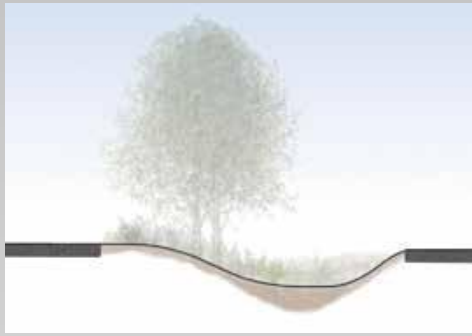

Runoff from impervious surfacing

STORE

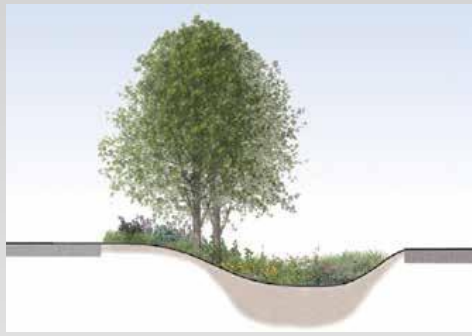

Store and retain captured runoff

INFILTRATE/EVAPOTRANSPIRE



Water is infiltrated into the ground, evapotranspired by plants or drained

1.3 GREENING PARKING LOTS

A Green Parking Lot includes Green Infrastructure (GI), incorporating elements found in natural areas into a parking lot area. GI is the living network that connects impervious areas to landscape areas, natural areas, and waterways. GI captures rainfall; cools buildings and pavement; and creates natural pathways for wildlife. GI includes Low Impact Development (LID) techniques, which mimic nature to capture and treat stormwater as close to the source as possible. When implemented, GI creates living green parking lots that capture, store, and infiltrate stormwater to treat it as a resource and improve the County environment.

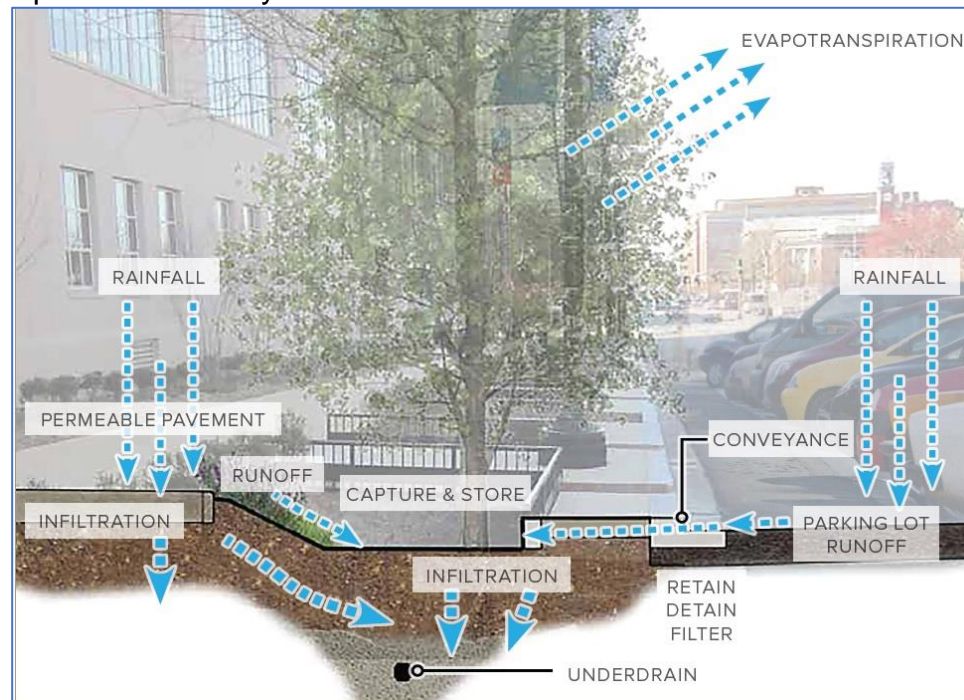

Stormwater Diagram

(Source: DDOT, 2014)

1.4 THE COUNTY ENVIRONMENT

The County of San Diego is a unique environment made up of natural, rural, and urban areas. When rain falls in the County and becomes stormwater runoff, it flows through eleven major watersheds. Stormwater carries the pollutants, trash, and warmer temperatures it collects from roads, buildings, and other impervious surfaces and delivers them into our rivers, streams, bays, lagoons, and ocean. Urbanization and other land use changes in the County can modify the natural watershed hydrologic processes and stormwater runoff characteristics resulting in increased stormwater runoff and erosion.

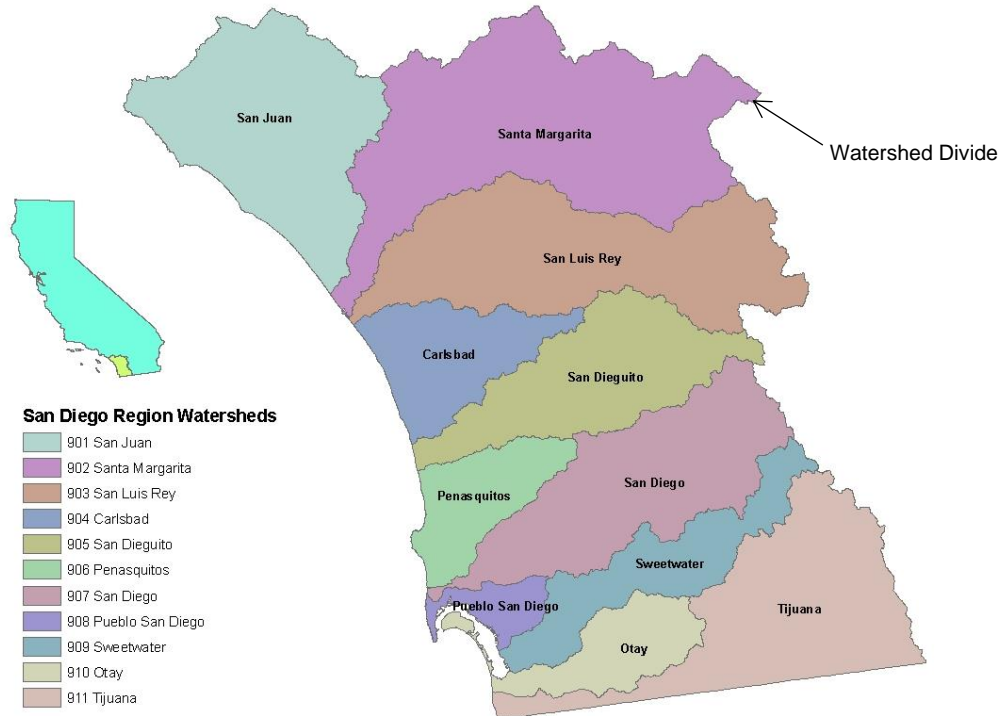

(Source: DDOT, 2014)



Commercial or Industrial Use

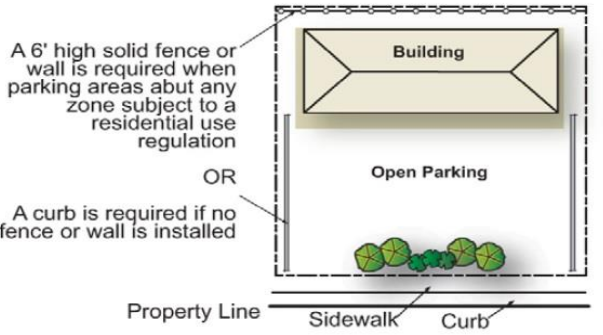

(Source: County of San Diego Parking Design Manual)

Land within parking lots present a significant opportunity to reduce runoff and improve the urban environment through Green Infrastructure. This manual introduces techniques to install green infrastructure in areas within and around parking lots. This guide includes supplements to the BMP Design Manual, Standard Drawings, and specifications, and should be used to the maximum extent practicable for all public and private project design of parking lots.

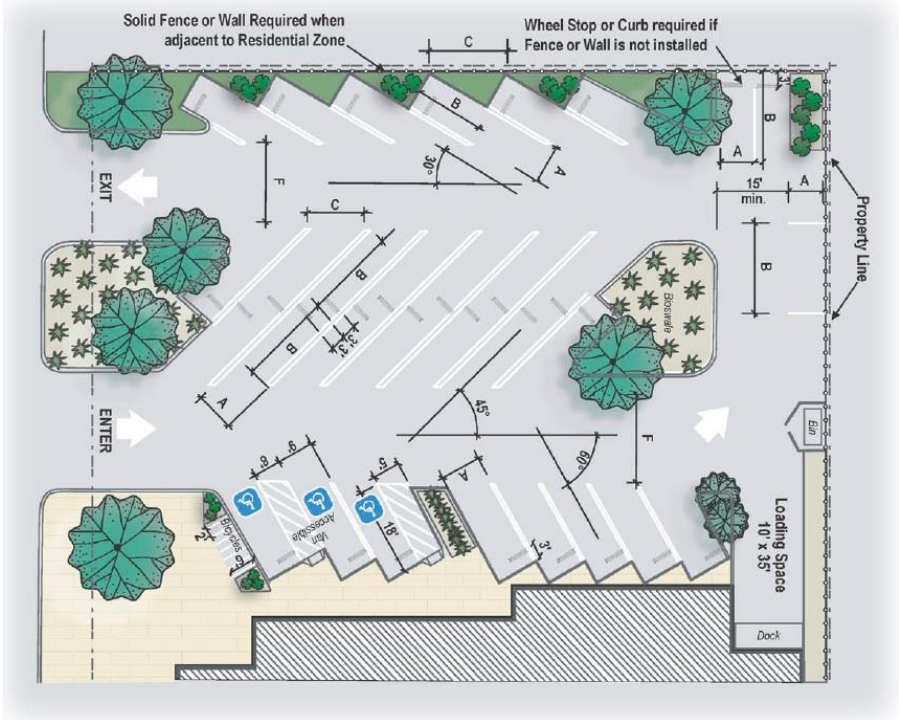

CONCEPTUAL PARKING LOT DIAGRAM
(Source: County of San Diego, Parking Design Manual)

Early in the planning and design process careful consideration should be given to the location of existing and proposed utilities and appurtenances in the parking lot and their interaction with the proposed green parking lot measures.



CHAPTER 2

Green Parking Lots Strategies

2.1 INTRODUCTION

Green Parking Lots, including Green Infrastructure (GI), and Low Impact Development (LID) solutions are intended to be sustainable, attractive, and cost effective. The range of opportunities includes trees, landscape areas, dispersion areas, biofiltration, and permeable pavement. These strategies use natural processes to reduce the volume of runoff, peak flow, and pollutants. This chapter will focus on four (4) areas appropriate for use in the road right-of-way.

TREES

Trees are a powerful tool due to their ability to intercept water on leaves, slowly deliver it to the mulch and soil, absorb it through root systems, and transpire it as water vapor directly back to the atmosphere.

DISPERSION AREAS

Dispersion areas disconnect impervious areas from directly running to the storm drain system. Dispersion areas use the natural functions of plants, mulch, and soils to remove pollutants and slow stormwater runoff. The strategy uses storage, sediment capture, and biological processes to clean the water. These mimic processes that occur in nature before water reaches waterways.

BIOFILTRATION

Biofiltration facilities are vegetated surface water systems that filter water through vegetation, and soil or biofiltration soil media prior to discharge to the storm drain system. They also utilize shallow depressions to provide storage and evapotranspiration.

PERMEABLE PAVEMENT

Permeable paving systems provide a hard surface, while allowing water to flow through to the underlying soils instead of directly to the drainage system. The areas where this strategy may be used include: sidewalks, pathways, medians, and parking lanes.

2.2 TREES

WHY ARE TREES IMPORTANT?

Trees make a parking lot feel welcoming, help manage stormwater, and reduce the urban heat island effect by providing shade. An urban heat island remains significantly warmer than the surrounding rural areas due to less vegetation. Trees promote air quality, natural habitat, the human environment, and well-being.

Trees in parking lots are sometimes confined to small planting areas where they struggle to reach a mature size or live a long life. Through the use of Structural Soil, Structural Cell, or Suspended Sidewalk techniques, soil volumes and space for tree roots to grow uninhibited can be greatly increased. These techniques also allow for more water and air to reach the tree roots.

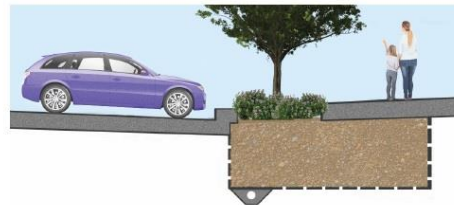

STRUCTURAL SOILS
A specific mix of stone and soil that supports the sidewalk while allowing tree roots to grow normally.



STRUCTURAL CELLS
Manufactured cells support the sidewalk allowing uncompacted soil to promote tree roots to grow below.

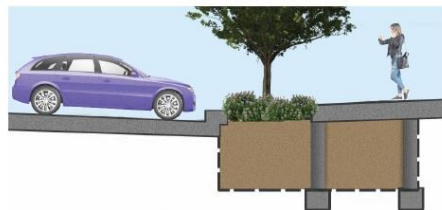

SUSPENDED SIDEWALK
Thickened sidewalk with reinforcement and/or footings can be used allowing tree roots to grow below the sidewalk.



SOIL VOLUME SIZING

- Adequate soil space provides the nutrients, water, air, and root space that trees need to have a long, healthy life.
- The soil volume required depends on the fully-grown tree size (generally two cubic feet of soil per one square foot of the tree's mature drip line area).
- Soil for trees should be three-feet deep; the length and width must ensure the appropriate volume for the tree species and site.

OTHER CONSIDERATIONS

- Provide as much open space as possible for the tree to allow the tree to grow and access water.
- Providing structural soils, suspended sidewalks, or structural slabs to edges of paved areas encourages tree roots to extend further and into adjacent green areas.
- Evaluate temporary and permanent irrigation needs
- Evaluate utility locations and required clearance.

DESIGN ISSUES

- Maintenance Access: allow for maintenance access
- Pedestrian Considerations: allow for 18-inch minimum setback from curb. Comply with ADA requirements.
- Suspended sidewalks and structural slabs/cells: may require evaluation by geotechnical and structural engineers
- Tree Size: Evaluate tree size versus the required parking lot dimensions.
- Tree Location: Refer to Parking Design Manual for minimum numbers of trees and guidance on tree location.

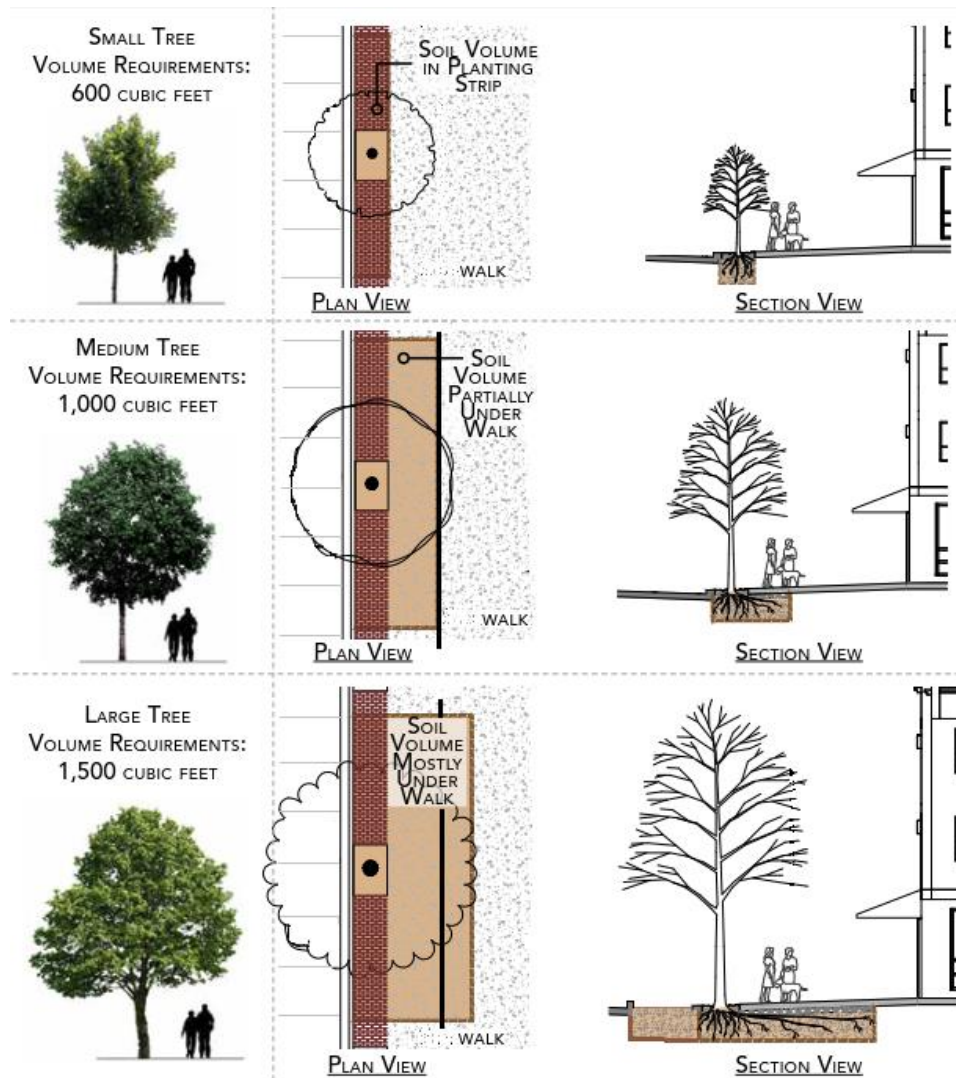

(Source: DDOT, 2014)

TREES – WHAT’S UNDERNEATH?

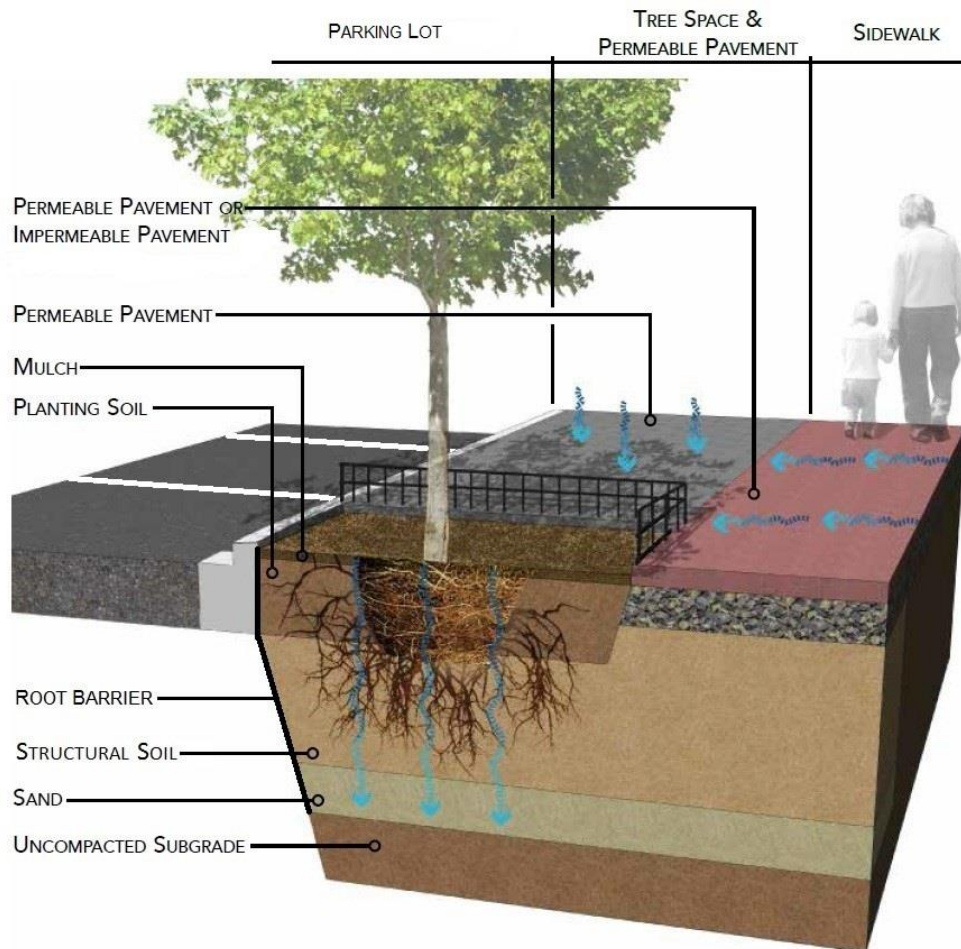

(Source: DDOT, 2014)

Note: Other options include suspended sidewalks and structural cells as shown on page 7.

PUTTING IT TOGETHER

- Permeable Paver: Permeable pavers allow water to infiltrate into the soil to be used by the trees.
- Mulch: Shredded hardwood layer to retain water and trap pollutants.
- Planting Soil: Uncompacted soil mix allows root growth when used in open areas, with structural cells, or suspended sidewalks.
- Structural Soil: Supports pavement and allows root growth.
- Sand: Acts as a drainage layer for excess stormwater (when needed).
- Uncompacted Subgrade: Existing soil where stormwater may infiltrate.

WATER TREES WITH STORMWATER

In addition to large soil volumes, trees need sufficient water, air, and nutrients to be successful in the road right-of-way environment. Tree space design includes integrating opportunities for directing stormwater into the soil. See Water Efficient Landscape Design Manual for irrigation requirements.

2.3 TYPES OF DISPERSION AREAS AND BIOFILTRATION

WHAT ARE DISPERSION AREAS AND BIOFILTRATION?

Dispersion Areas and Biofiltration are landscape systems that filter pollutants and sediment from runoff. The layers of plant material, mulch, planting media (a mix of soil, sand, and compost), and stone capture metals, nutrients, and bacteria that would otherwise flow into the surrounding creeks and rivers. The rainwater is held in the planting bed until it infiltrates into the ground or evaporates. The entire system can fit into small spaces, making it adaptable to tree spaces, planter boxes, and islands.



PLANTER BOXES

Runoff follows the existing curb line and enters the facility through curb cuts. Excess runoff exits through the same curb cuts or into drains located in the planting area.



PARKING ISLANDS

Runoff follows the existing curb line and enters the facility directly. Excess runoff flows through the system or into drain inlets.



SWALES

Runoff enters the facility directly or through curb cuts. Excess runoff flows through the system to a drainage outlet.



FILTER STRIP/DISPERSION AREA

Runoff enters the facility directly via sheet flow. Excess runoff flows through the system to a drain inlet downslope.

PLANTER BOX

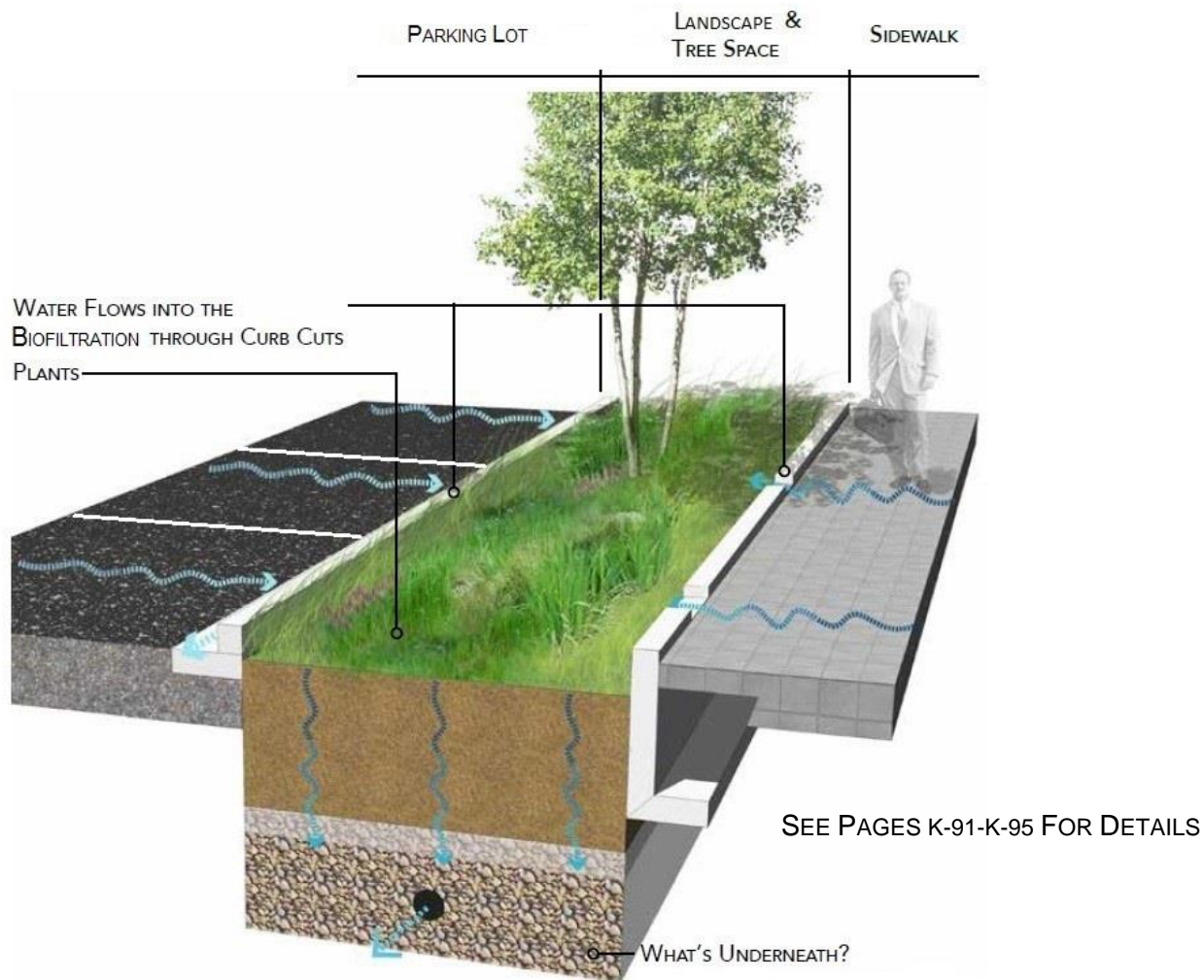

WHERE TO USE?

- Parking lot areas adjacent to sidewalk/walkway/plaza area.
- Where trees and landscaping are needed.

LIMITATIONS

- Limited pedestrian access across planter.

DESIGN ISSUES

Maintenance Access: Allow for adequate maintenance access from parking lot.

Pedestrian Considerations: Allow for minimum allowable sidewalk width. Consider trip hazards and fall protection. Comply with ADA requirements.

WHERE TO USE?

- Parking lots with islands.
- For parking lot traffic calming.
- Next to mature trees.

LIMITATIONS

- Do not disturb existing, mature trees and root systems.
- Ensure sight lines and turning radii are preserved.

DESIGN ISSUES

Maintenance Access: Allow for adequate maintenance access from road.

Pedestrian Considerations: Consider trip hazards and fall protection. Short fences or curbs prevent pedestrians from stepping into a recessed area. A 3:1 transition from the sidewalk to planter bottom is an alternative. Comply with ADA requirements.

Parking: Consider trip hazards and adequate spacing in order to park.

PARKING ISLANDS

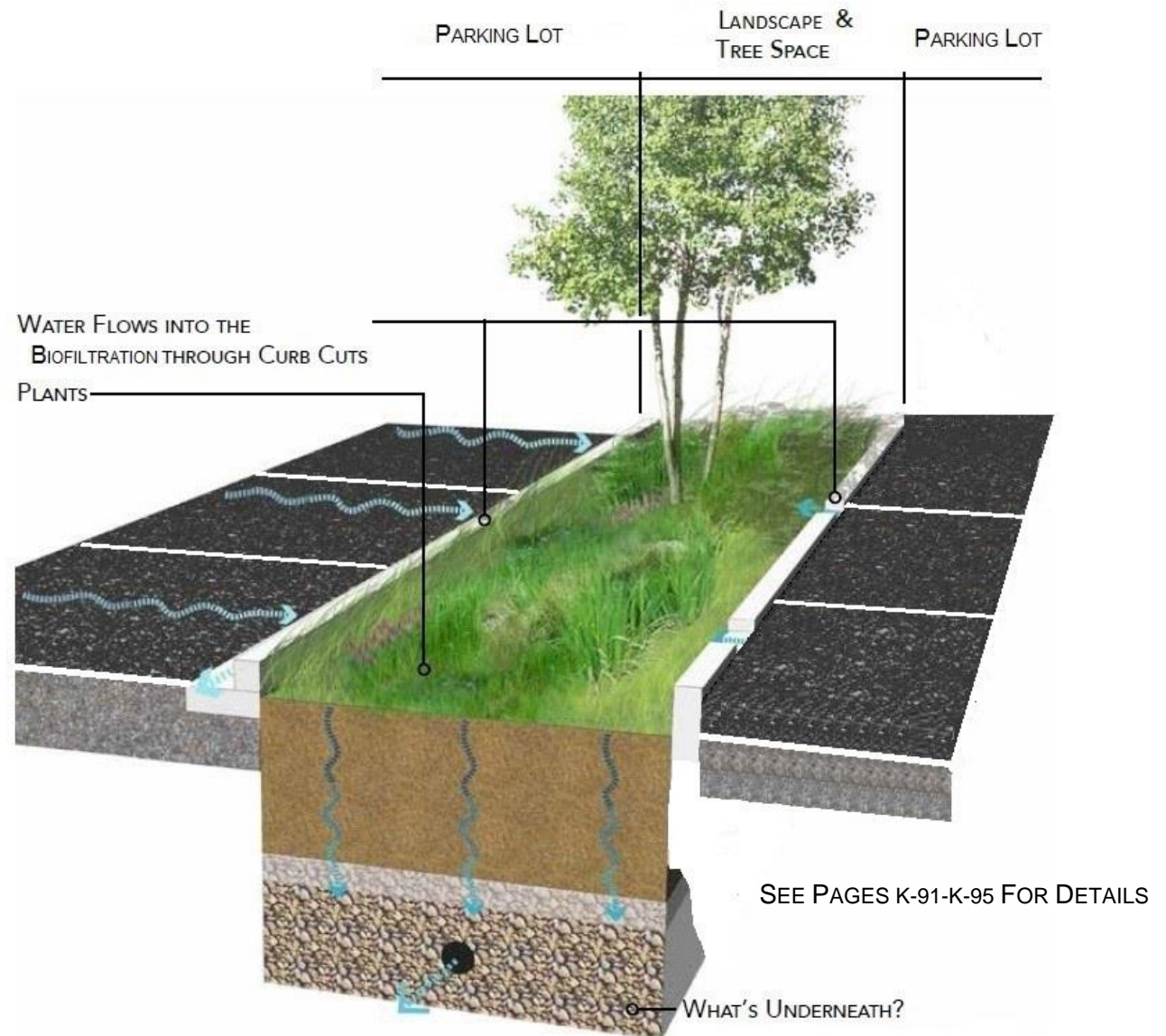

(Source: DDOT, 2014)

SWALE ADJACENT TO PARKING

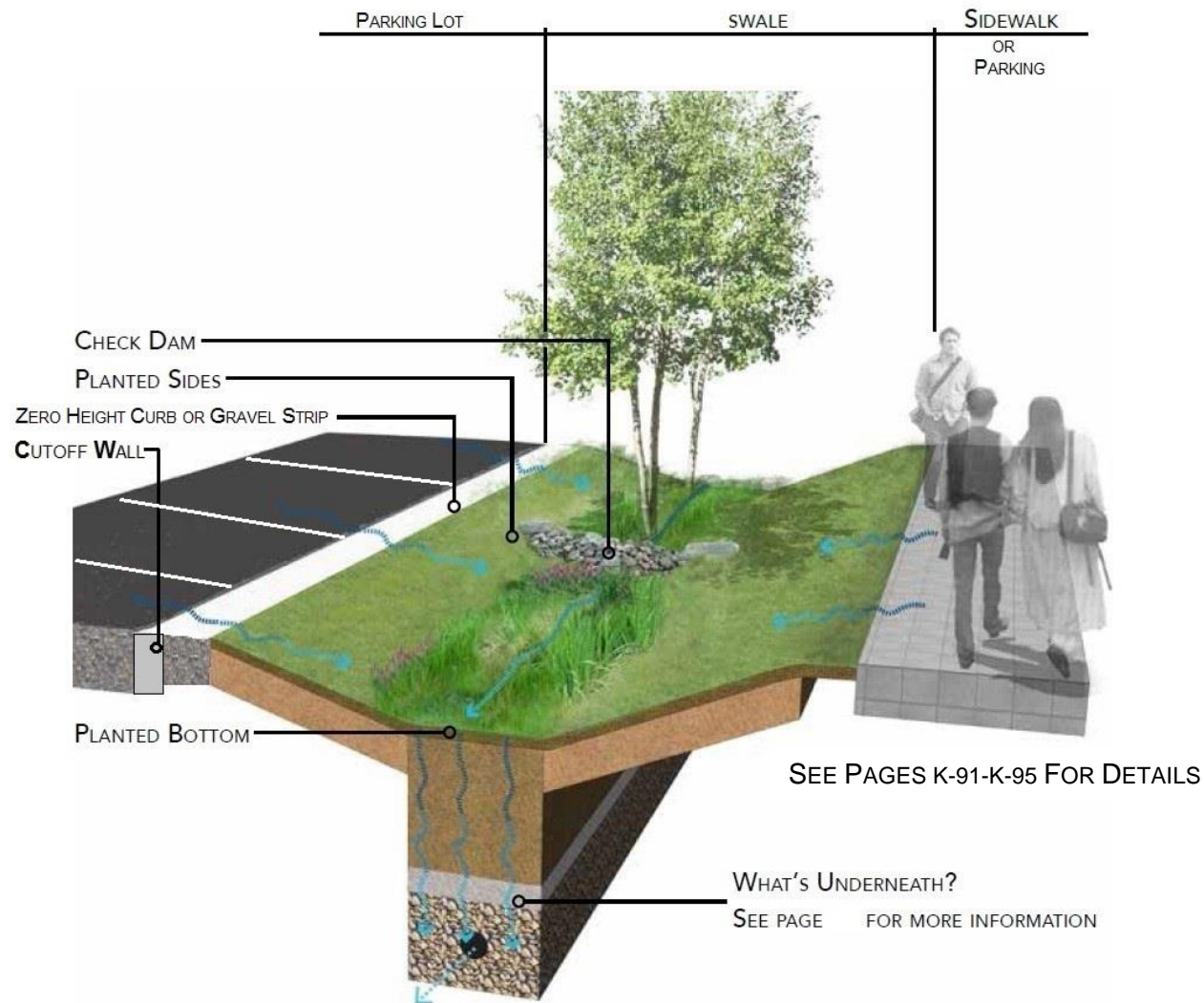

WHERE TO USE?

- In parking lots with zero height curb or curb cuts.
- In parking lot areas with less pedestrian use.

LIMITATIONS

- Not suitable for narrow island areas.

DESIGN ISSUES

Slope and Check Dams: Swales are placed where runoff is flowing and optimally before catch basins that convey water from the parking lot to the drainage system. Swales may be built on moderate slopes with the use of check dams. Rock armoring or turf reinforcement mat may be required in steep areas with erosive velocities between check dams.

Maintenance Access: Allow for adequate maintenance access from parking lot.

Pedestrian Considerations: Limit pedestrian access to swale. Transition swale at intersections for pedestrian facilities. Comply with ADA requirements.

WHERE TO USE?

- Where runoff can sheet flow into filter strip area.
- Moderate slopes (less than 5%) adjacent to impervious area of treatment (parking lot).
- Rural areas.

LIMITATIONS

- Not recommended on steep slopes.
- Prone to rill formation.

DESIGN ISSUES

Maintenance: Vegetated cover must be maintained to ensure that filter strips do not export sediment due to erosion of exposed ground.

Slope: Maximum slopes in the direction of flow will be based upon drainage area size, soil type, vegetation cover, and slope length to prevent rill formation. Slopes less than 5% are preferred.

Maintenance Access: Allow for adequate maintenance access from parking area.

Pedestrian Considerations: Limit pedestrian access across filter strip to prevent formation of dirt pathways. Comply with ADA requirements.

VEGETATED FILTER STRIP/DISPERSION AREA

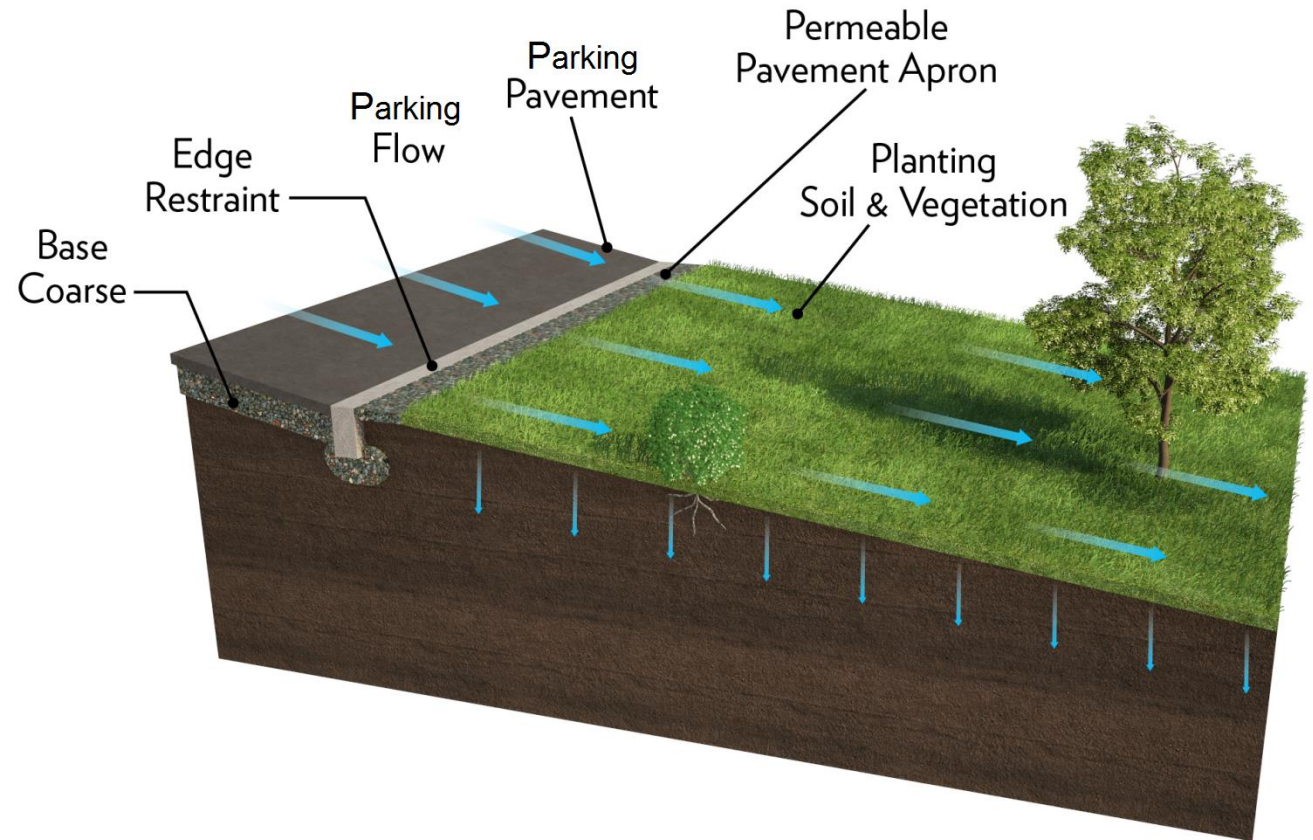

The NRCS hydrologic soil groups are defined as:

- **Group A** soils have a high rate of percolation and a low runoff potential. The rate of water transmission is high; thus, runoff potential is low. Group A soils are generally referred to as sandy soils.
- **Group B** soils have moderate percolation rates when thoroughly wet. These are chiefly soils that are moderately deep to deep, moderately well-drained to well-drained, and moderately coarse textured. Rate of water transmission is moderate.
- **Group C** soils have a slow percolation rate when thoroughly wet. They are chiefly soils that have a layer impeding the downward movement of water, or they are moderately fine to fine-textured soils that have a slow infiltration rate. The rate of water transmission is slow.
- **Group D** soils have very slow percolation rates when thoroughly wet. They are clays that have a high shrink-swell potential, soils that have a high permanent water table, soils that have a claypan or clay layer at or near the surface, or soils that are shallow over nearly impervious material. The rate of water transmission for group D soils is very slow.

DISPERSION AREAS AND BIOFILTRATION – WHAT’S UNDERNEATH?

SOIL TYPE AND INFILTRATION RATE

Dispersion areas and biofiltration can be located in many areas. However, site constraints will help to determine what goes underneath the dispersion area or biofiltration. Common considerations include soil type, relative soil compaction, required utility setbacks, slope setbacks, and structural setbacks. Depending on the factors at the site, what’s underneath the dispersion area or biofiltration is determined by the level of infiltration: high, medium, low, or none.

A qualified engineer practicing geotechnical services shall review the proposed stormwater infiltration to provide a professional opinion regarding the potential adverse geotechnical conditions that the implementation of these practices may create. Geotechnical conditions such as slope stability, expansive soils, compressible soils, seepage, groundwater, and loss of foundation or pavement subgrade strength should be considered.

The U.S. Department of Agriculture Natural Resources Conservation Service (NRCS), formerly the Soil Conservation Service, conducted a soil survey of the San Diego area in the early 1970s. The NRCS has classified San Diego area soils with respect to: (1) their ability to accept and absorb water, (2) their tendency to produce runoff, and (3) their erodibility.

The soil survey classified soil runoff potential into four hydrologic soil groups labeled A through D. Group A and B soils exhibit the greatest infiltration rates (unless soils are compacted during construction) and are generally best suited to stormwater percolation. The San Diego area, however, has a relatively high concentration of group C and D soils, which exhibit lower percolation rates that generally limit the use of infiltration-based stormwater management systems. Instead, dispersion areas and biofiltration facilities are often equipped with underdrains. Such a design provides for filtration of the water quality design event through a biofiltration soil media as well as incidental infiltration of low flows.

Retaining a geotechnical engineer and conducting exploratory excavations at the site are highly recommended. Consideration should be given to the effects of urbanization on the natural hydrologic soil group. If heavy equipment can be expected to compact the soil during construction, or if grading will mix the surface and subsurface soils, appropriate changes should be made in the soil group selected.

HIGH INFILTRATION

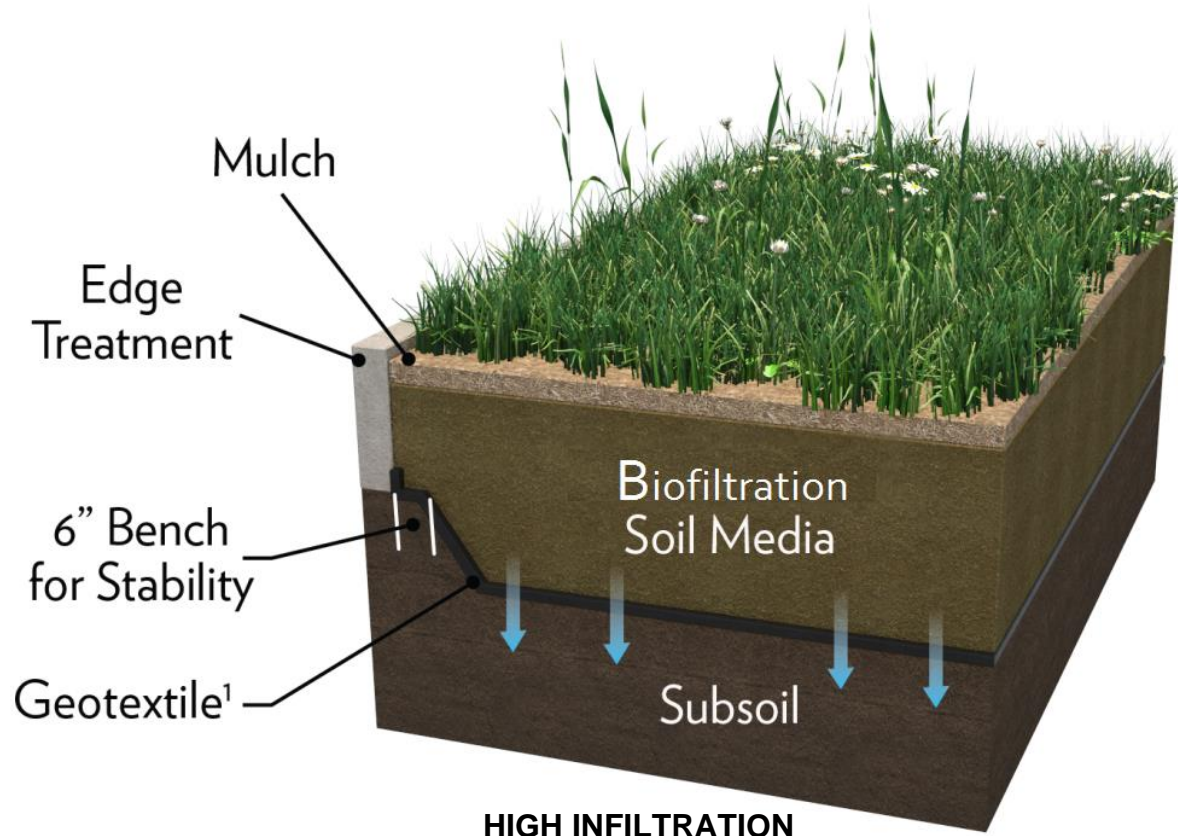

Notes:

1. Geotextile per Geotechnical Engineer's Recommendations.

PUTTING IT TOGETHER

- Ponding Depth: Stores runoff within the planting area prior to treatment.
- Mulch: Shredded hardwood layer to retain water and trap pollutants.
- Biofiltration Soil Media: A specific blend of soil, compost, and sand to retain and drain water and support plant growth.
- Geotextile: Prevents existing soil from migrating into the biofiltration soil media.
- Uncompacted Subsoil: Existing soil where stormwater infiltrates.

COMMON DESIGN ISSUES

Utilities: Utility lines should be avoided where necessary and allowed to coexist where possible.

PUTTING IT TOGETHER

- Ponding Depth: Stores runoff within the planting area prior to treatment.
- Mulch: Shredded hardwood layer to retain water and trap pollutants.
- Biofiltration Soil Media: A specific blend of soil, compost, and sand to retain and drain water and support plant growth.
- Choker Layer: Sand and gravel to prevent biofiltration soil media from migrating into the reservoir.
- Geotextile: Prevents existing soil from migrating into the biofiltration soil media and stone reservoir layer.
- Uncompacted Subgrade: Existing soil where stormwater infiltrates.

COMMON DESIGN ISSUES

Utilities: Utility lines should be avoided where necessary and allowed to coexist where possible.

MEDIUM INFILTRATION

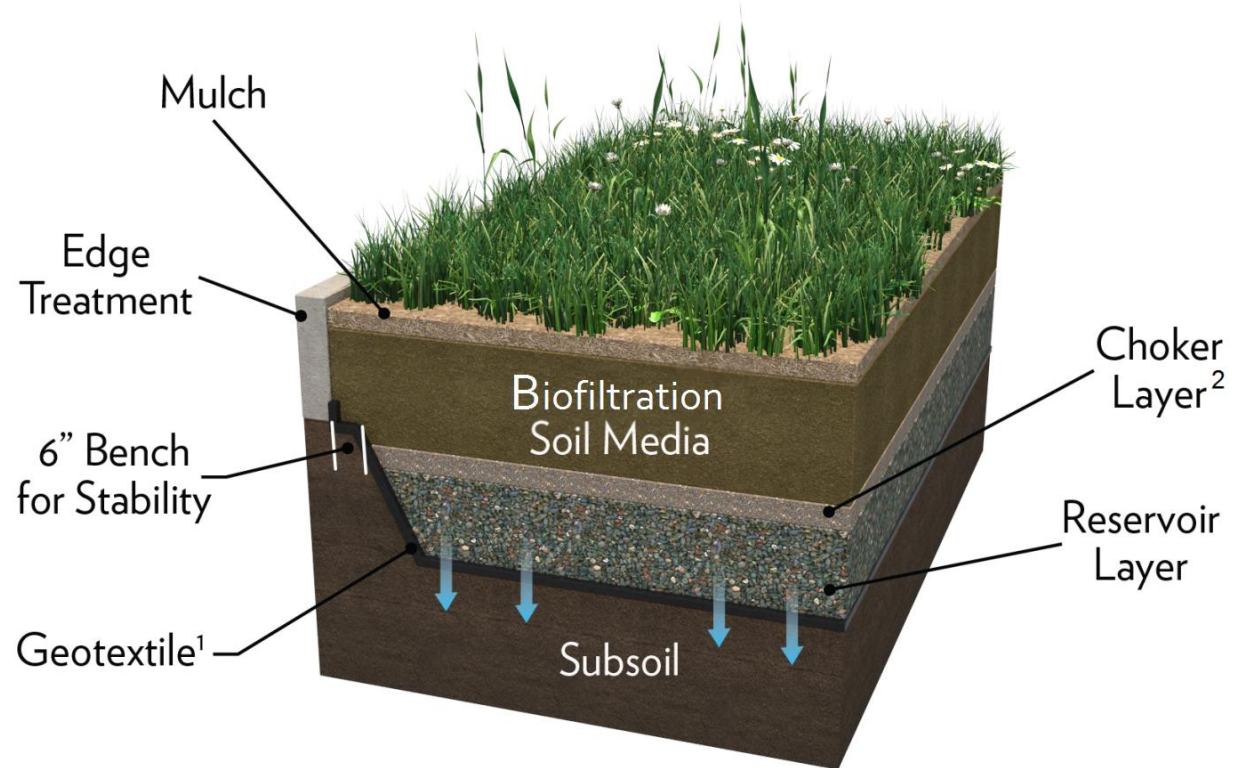

MEDIUM INFILTRATION

Notes:

1. Geotextile per Geotechnical Engineer's Recommendations.
2. Choker layer may be required depending the type of reservoir layer.

LOW INFILTRATION

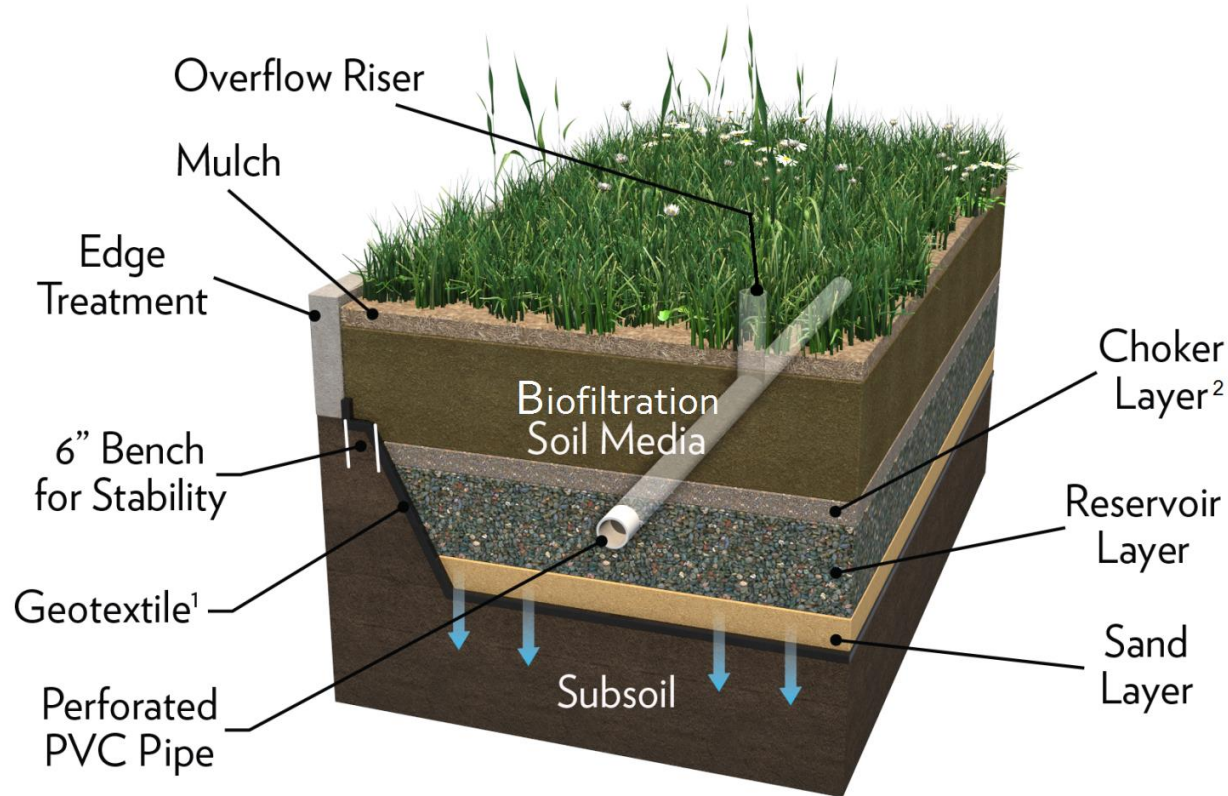

LOW INFILTRATION

Notes:

1. Geotextile per Geotechnical Engineer's Recommendations.
2. Choker layer may be required depending the type of reservoir layer.

PUTTING IT TOGETHER

- **Ponding Depth:** Stores runoff within the planting area prior to treatment.
- **Overflow Riser:** Pipe to capture high water flow.
- **Mulch:** Shredded hardwood layer to retain water and trap pollutants.
- **Biofiltration Soil Media:** A specific blend of soil, compost, and sand to retain and drain water and support plant growth.
- **Choker Layer:** Sand and gravel to prevent biofiltration soil media from migrating into the reservoir.
- **Reservoir Layer:** Stone to hold excess water until it infiltrates.
- **Underdrain:** An underdrain is required.
- **Geotextile:** Prevents existing soil from migrating into the biofiltration soil media and stone reservoir layer.
- **Uncompacted Subgrade:** Existing soil where stormwater infiltrates.

COMMON DESIGN ISSUES

Utilities: Utility lines should be avoided where necessary and allowed to coexist where possible.

PUTTING IT TOGETHER

- Ponding Depth: Stores runoff within the planting area prior to treatment.
- Overflow Riser: Pipe to capture high water flow.
- Mulch: Shredded hardwood layer to retain water and trap pollutants.
- Biofiltration Soil Media: A specific blend of soil, compost, and sand to retain and drain water and support plant growth.
- Choker Layer: Sand and gravel to prevent biofiltration soil media from migrating into the reservoir.
- Reservoir Layer: Stone to hold excess water until it enters the underdrain.
- Underdrain: An underdrain is required.
- Impermeable Liner: Prevents infiltration and prevents existing soil from migrating into the biofiltration soil media and stone reservoir layer.

COMMON DESIGN ISSUES

Utilities: Utility lines should be avoided where necessary and allowed to coexist where possible.

NO INFILTRATION

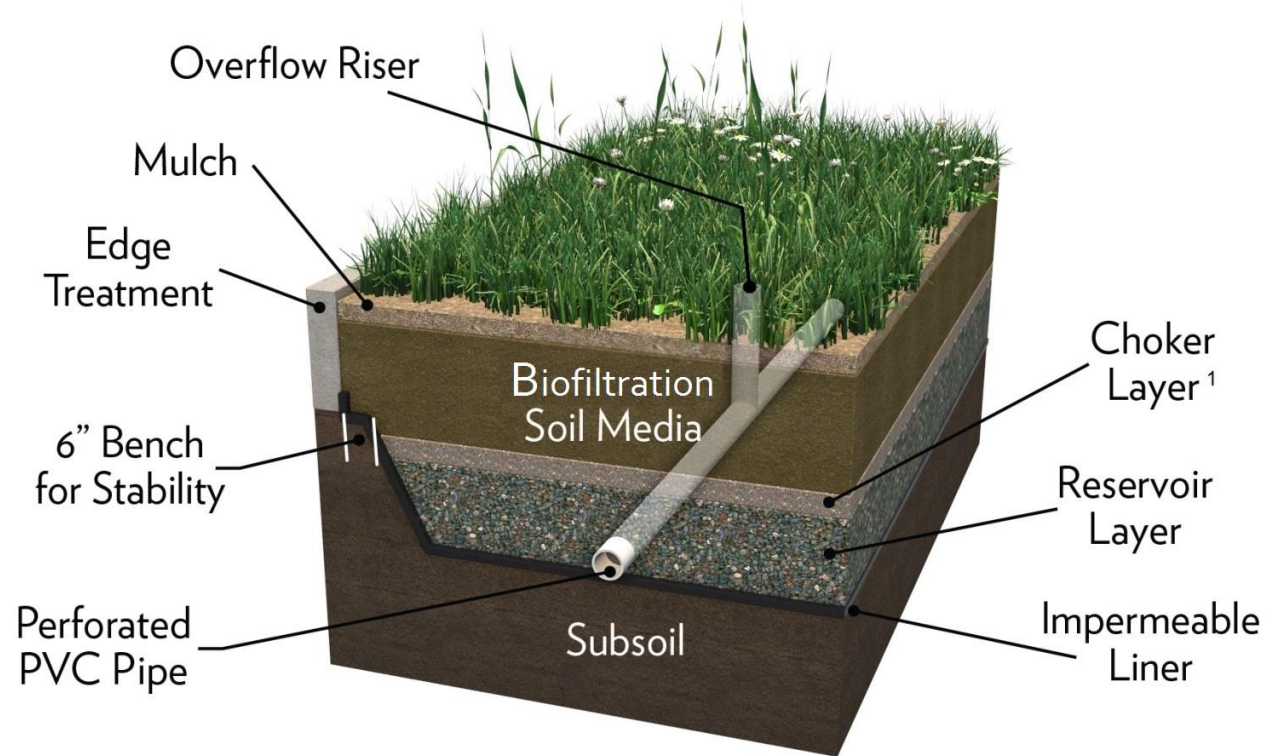

NO INFILTRATION

Notes:

1. Choker layer may be required depending the type of reservoir layer.

2.4 PLANTING & IRRIGATION OF DISPERSION AREAS, BIOFILTRATION, TREES, AND OTHER AREAS

PLANTING DESIGN

Trees, dispersion areas, and biofiltration add a landscape amenity to the parking lot. Trees, shrubs, grasses and perennials are used to create a diverse landscape suitable for the site conditions and neighborhood. Plants should be chosen based on the level of care expected at the facility. Planting design must be done to ensure sight lines are preserved for pedestrians, cyclists, and vehicles in the parking lot.

Trees are an important component of a Green Parking Lot. Mature trees capture stormwater, provide shade, and cool pavement. Existing trees should be protected when possible in parking lot retrofit projects.

Refer to the County of San Diego's Water Efficient Landscape Design Manual and Low Impact Development Handbook for suitable plant species to use in dispersion areas and biofiltration. Also refer to the community right of way development standards for suitable plants within specific communities.

IRRIGATION DESIGN

Irrigation design should comply with the County of San Diego's Water Efficient Landscape Design Manual.

PLANTING ZONES (HYDROZONES)

Grouping plants into hydrozones is an approach to irrigation and planting design where plants with similar water needs are grouped together. Ideally, each zone of the irrigation system will supply plants with the same water needs with the appropriate amount of water.

WATER CONSERVATION

State executive order B-29-15 requires mandatory statewide water restrictions. This order prohibits ornamental turf on public street medians, and requires a reduction in potable water use for irrigation. Low water use, drought tolerant, native plants should be used for Green Parking Lot applications. The use of reclaimed water is recommended to reduce the amount of potable water used for irrigation.



WATER EFFICIENT LANDSCAPE DESIGN MANUAL COUNTY OF SAN DIEGO

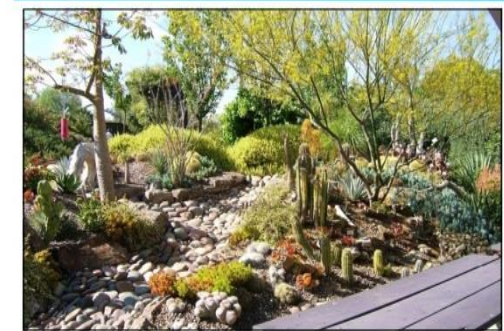

DEPARTMENT OF PLANNING AND LAND USE

DPLU (02/10)



2.5 TYPES OF PERMEABLE PAVEMENT

WHAT IS PERMEABLE PAVEMENT

Permeable pavement is an engineered top layer and base layer that allows water to move through it. The goal is to take rainwater as it falls and quickly move it to the lower layers of the system. Stormwater is stored in an underlying stone layer until it infiltrates into the soil below, aiding in groundwater recharge, or releases slowly to the storm drain system. Pollutants are filtered through the pavement and base layers. The terms 'Permeable Concrete Pavers', 'Pervious Concrete', 'Porous Asphalt', and 'Porous Rubber' are industry standard names, but all surfaces are 'permeable' and provide sufficient openings at the surface to allow stormwater to infiltrate.



PERMEABLE CONCRETE PAVERS

Unlike traditional pavers, there are gaps between each paver to allow water to flow between the pavers and into the base layer.



PERVIOUS CONCRETE

Sands and "fines" are reduced in the concrete mix to allow water to flow through the pavement into a stone bed and eventually the ground.

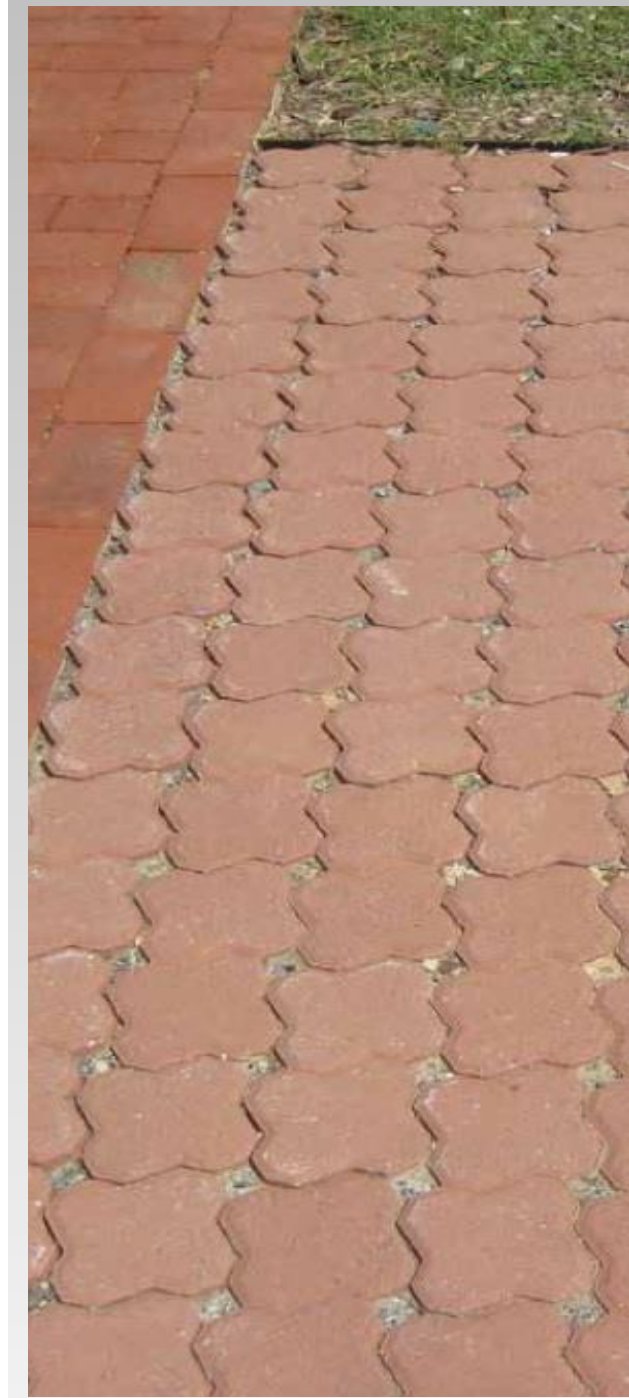

TYPES OF PERMEABLE PAVEMENT (CONTINUED)



POROUS ASPHALT

Porous asphalt is very similar to traditional asphalt except that the sands or “fines” are reduced in the mix so water can move through the pavement.



POROUS RUBBER

Made from recycled rubber and small stones, porous rubber works like pervious concrete, but can be installed over tree roots.



DECOMPOSED GRANITE (DG) PATHWAY

Decomposed granite can be used for pathways. It can be installed and compacted to meet ADA handicapped accessibility specifications and criteria. Although highly compacted, the surface has some infiltration capacity.



BOARDWALK

Made from wood or composite, boardwalks may be used for pathways. Rain easily passes through the spaces between the boards to the soil below.



PUTTING IT TOGETHER

- **Permeable Surface:** Permeable concrete pavers, pervious concrete, porous asphalt, porous rubber, DG, or boardwalk.
- **Bedding Layer:** Used for pavers so they can be laid flat.
- **Choker Layer:** A layer of small rock to prevent fine material from migrating into the reservoir layer.
- **Reservoir Layer:** Stone to hold excess water until it infiltrates.
- **Underdrain:** Conveys excess water into drainage system when the reservoir fills.
- **Filter Layer/Geotextile:** A layer of stone or permeable geotextile to separate the reservoir layer from the soil below and prevent migration of fines into the reservoir layer.
- **Impermeable Liner:** Prevents infiltration into subgrade or adjacent roadway structural section.
- **Uncompacted Subgrade:** Existing soil into which stormwater infiltrates.

PERMEABLE PAVEMENT – WHAT’S UNDERNEATH?

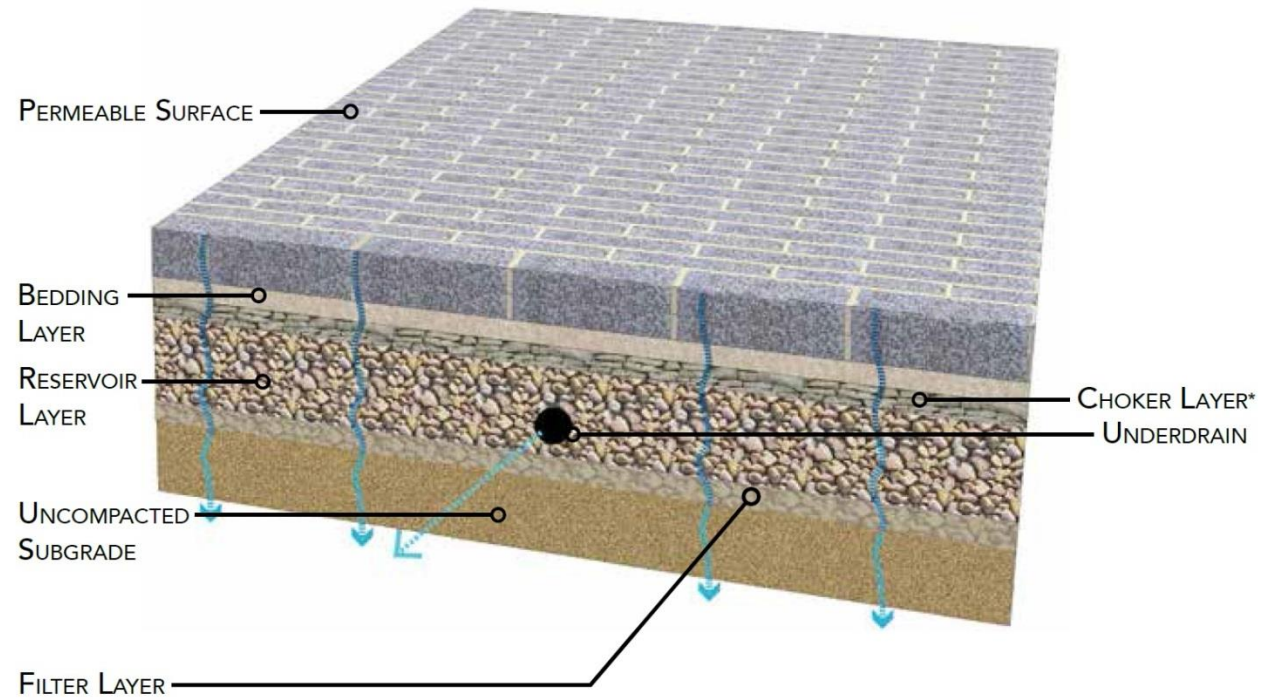

(Source: DDOT, 2014)

*Per Geotechnical Engineer's Recommendations

As with dispersion areas and biofiltration, there are multiple options for the subsurface components for permeable pavement including:

- Reservoir layer only with no underdrain
- Reservoir layer with underdrain (shown)
- Reservoir layer with underdrain and impermeable liner

PERMEABLE PAVEMENT SUBSURFACE DESIGN OPTIONS

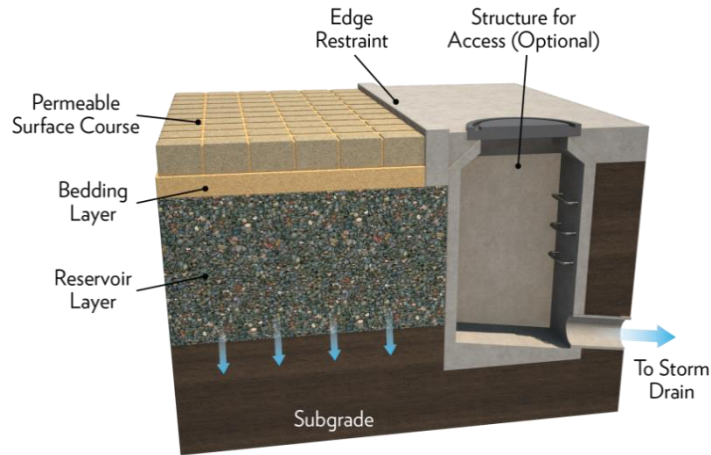

Reservoir layer only with no underdrain

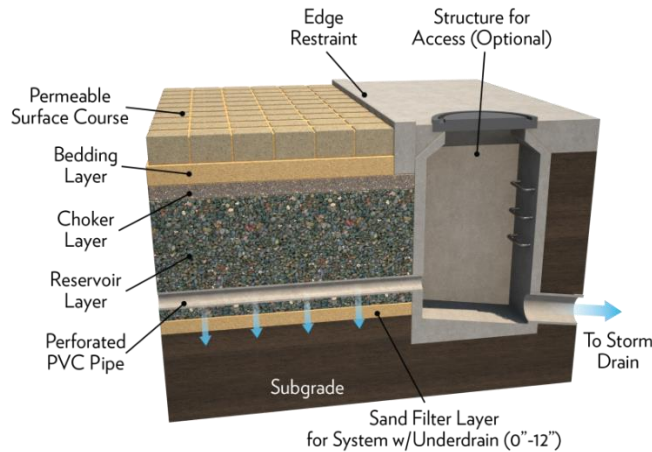

Reservoir layer with underdrain

WHERE TO USE?

- Pedestrian areas
- Parking areas/stalls

LIMITATIONS

- Use in areas with little to no sediment production.

DESIGN ISSUES

Soil Infiltration and Drainage: Soil infiltration tests must be completed to determine if an underdrain system is required.

Structural Section: A qualified and licensed professional should complete a pavement structural analysis.

Edge Restraints: Provide a concrete transition strip between any permeable and impermeable surface and around the perimeter of paver installations.

Pedestrian Considerations: Provide signage to indicate prohibited activities that cause premature clogging.

Maintenance Access: Provide adequate access for sweeping and/or vacuuming of surface.



PERMEABLE PAVEMENT SUBSURFACE DESIGN OPTIONS (CONTINUED)

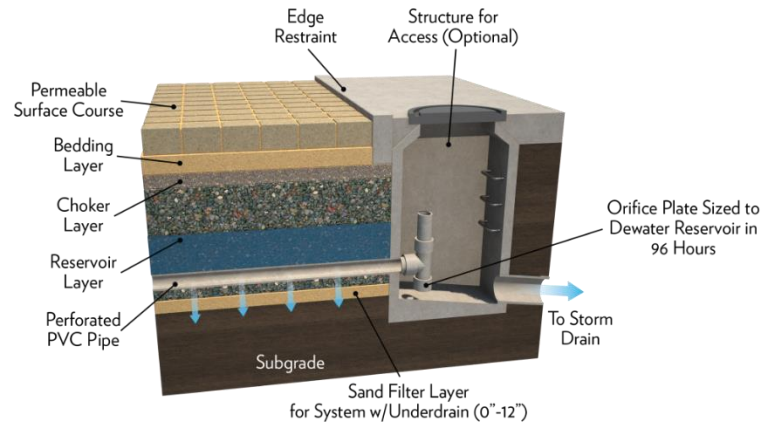

Reservoir layer with upturned underdrain

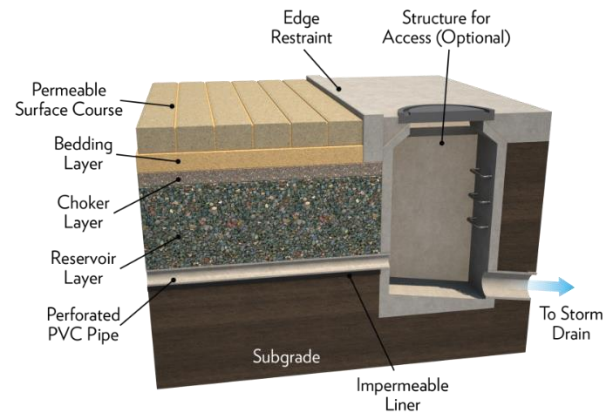

Reservoir layer with underdrain and impermeable liner

CHAPTER 3

Examples

Procedures and Design

3.1 INTRODUCTION

Implementing Green Infrastructure (GI) and Low Impact Development (LID) within a parking lot requires a number of considerations to create an amenity that is attractive while treating stormwater from the surrounding streets and sidewalks.

Implementation of Green Parking Lots features can be approached from evaluating the opportunities within each zone of the parking lot: traveled lane, parking stalls, islands, sidewalk/pathway, slopes and drainage easements. Each zone presents different opportunities, benefits, risks and technical design factors for GI and LID implementation to enhance stormwater quality.

Conducting a comprehensive inventory and assessment of site conditions is the crucial initial step for implementing GI and LID. The County LID Handbook inventory check list can be used to assist with identifying and evaluating a potential site for LID and to produce a list of opportunities and constraints.

The LID concept from the EPA of “slow it down, spread it out, and soak it in” should be at the forefront in the planning stages of project evaluating the implementation of Green Parking Lots design practices to control runoff and enhance water quality.



3.2 SITE DESIGN PRINCIPLES

The following site design principles should be evaluated and implemented to “slow it down, spread it out, and soak it in”:

- Minimize the impervious footprint of the site.
- Minimize soil compaction in landscaped areas. Landscape with native or drought-tolerant species.
- Disconnect impervious surfaces by dispersing runoff from impervious surfaces to pervious areas. To be considered ‘disconnected’ impervious areas should be designed to drain to a pervious area at least one-half their size.
- Design and construct trees, dispersion areas, biofiltration, and permeable pavements to effectively receive and infiltrate or retain runoff from impervious areas before it discharges to the storm drain or exits the right of way.

When Green Parking Lot design principles are employed over typical design techniques that utilize conventional stormwater quality treatment techniques they have the potential to significantly reduce impervious areas and provide potential project cost savings.



Conventional Design Approach

- Conventional storm drain
- Conventional pavement

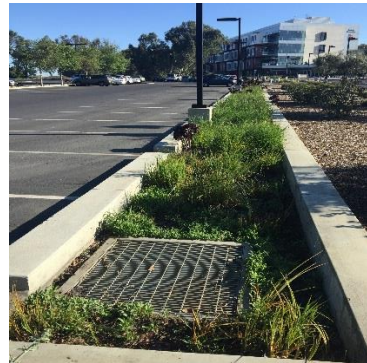

Green Design Approach

- Dispersion areas and biofiltration
- Pervious pavement

GREEN PARKING LOT SITE DESIGN APPROACH

Direct stormwater runoff from impervious parking lot elements to:

- Trees, dispersion areas and biofiltration in islands or on perimeter of parking lot.
- Permeable pavement surfaces located in walkways or parking stalls.
- Adjacent landscaped area

CONSTRAINTS

In no way shall green parking lots LID features be designed to block sight distance for motorists from adjacent streets and driveways, create obstacles for pedestrians, impede the visibility and maintenance of traffic control devices and signs, and reduce or eliminate clear recovery area and minimum horizontal clearances from fixed objects.

GREEN PARKING LOTS SITE DESIGN APPROACH





Grading and Drainage

Direct runoff to trees, biofiltration, swales, permeable pavement:

- When designing large parking lots, break up and direct flows to multiple LID features.
- Avoid compaction in biofiltration areas during construction.

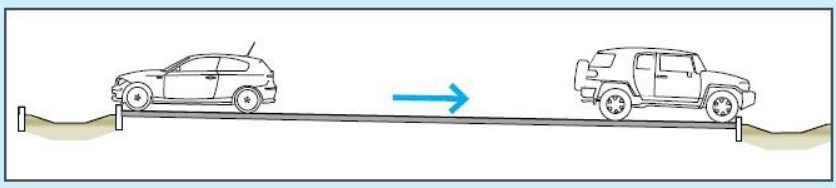
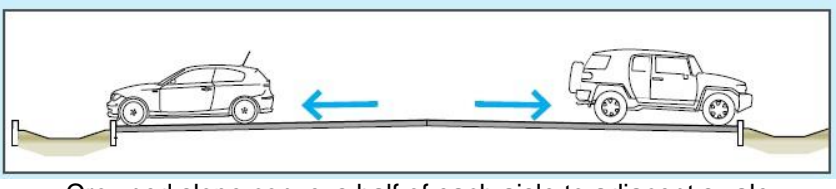
Inlets and Outlets

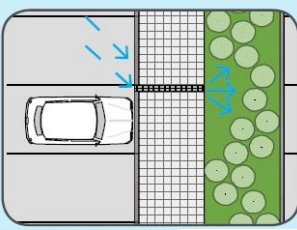
- 2 Direct runoff into, and out of biofiltration areas. Proper placement of inlets helps to spread runoff over the biofiltration planting areas, which slows the flow and reduces erosion.
- 3 Outlet, including overflow structures, direct excess runoff to the storm drain system.
- 4 Avoid placing overflow structures flush with soil to allow stormwater retention.

 <p>Continuous cross slope conveys the full aisle to an adjacent swale</p>	
 <p>Crowned slope conveys half of each aisle to adjacent swale</p>	
 <p>A curb inlet directs runoff into a biofiltration planter</p> <p><small>Source: Illinois Environmental Protection</small></p>	 <p>An overflow outlet conveys runoff that exceeds the biofiltration area capacity</p>
  <p>A patterned steel grate inlet conveys flow under a pedestrian walkway</p> <p><small>Photo Source: Kevin Perry, Bureau of Environmental Services, City of Portland</small></p> <p><small>Source: Central California Coast, Technical Assistance Memo, LID Parking Lots</small></p>	

GREEN PARKING LOTS SITE DESIGN APPROACH

Parking Configuration

Parking configurations can be adapted to meet both parking and stormwater management needs by sizing biofiltration areas to fit compact and full sized parking stalls.

Tree Considerations

- Locate trees on side slope, above areas that pond
- Select trees that will tolerate seasonally wet soils
- Do not specify trees with invasive roots.

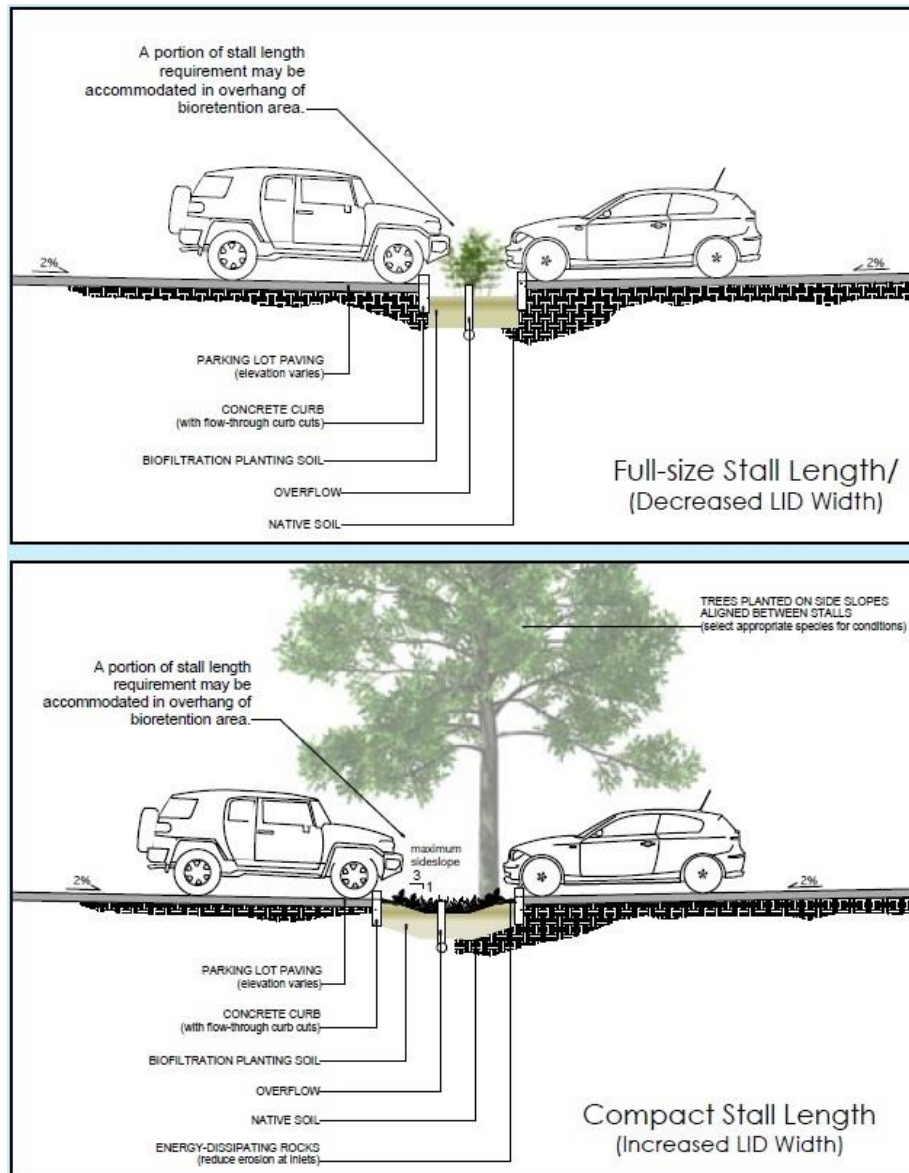

Source: Central California Coast, Technical Assistance Memo, LID Parking Lots

3.3 DESIGN PROCEDURE

GENERAL REQUIREMENTS

- Green Parking Lots features will meet the requirements set forth in Section E.3.b.(3)(a)(iii) and (b) of the 2013 MS4 Permit.
- Many of the low impact development (LID) requirements for site design that were applicable only to Priority Development Projects under the 2007 MS4 Permit are applicable to all projects (Standard Projects and PDPs) under the MS4 Permit.

OPPORTUNITIES AND CONSTRAINTS

- Conduct a comprehensive inventory and assessment of site conditions.
- Evaluate each zone of the parking lot for implementation opportunities: traveled way, parking stalls, islands, sidewalk/pathway, slopes and drainage easements.
- Evaluate constraints including, but not limited to: utilities, parking lot geometry and slope, site distance, proximity to storm drain, maintenance access, pedestrian and vehicle safety, etc.

DESIGN CAPTURE VOLUME/FLOW RATE FOR PRIORITY DEVELOPMENT PROJECTS

- The standard for storm water pollutant control (formerly treatment control) is retention of the 24-hour 85th percentile storm volume, defined as the event that has a precipitation total greater than or equal to 85 percent of all daily storm events larger than 0.01 inches over a given period of record in a specific area or location.
- For situations where onsite retention of the 85th percentile storm volume is technically not feasible, biofiltration must be provided to satisfy specific “biofiltration standards”. These standards consist of a set of siting, selection, sizing, design and maintenance criteria that must be met for a BMP to be considered a “biofiltration BMP” – see Section 2.2.1 and Appendix F of the County BMP Design Manual.

TREATMENT TRAIN

- Utilize a treatment train approach that connects and combines features to maximize water quality treatment within the Green Parking Lot. An example Green Parking Lot treatment train approach is provided in Section 3.6.

DOCUMENTATION

- Document the design criteria, methodology, drainage areas/treatment areas, calculated volumes/flows, BMP selection, and maintenance requirements in the project Stormwater Management Plan and/or Drainage Report.



Parking Islands

The parking island presents an opportunity to implement GI principles by use of street trees, dispersion areas, biofiltration, or permeable pavements. The graphics below illustrate various design concepts that can be utilized within parking lot islands.



Conventional parking lot



Green Parking Lot



Conventional parking lot



Green Parking Lot Swale

DESIGN ELEMENTS

- Raised Island:
 - Plant low water use/drought tolerant street trees and landscaping.
 - Install permeable pavement.
- Depressed Island: Utilize roadway cross slope to direct stormwater runoff from impervious roadway elements to:
 - Trees
 - Planter Boxes
 - Vegetated Swale

DESIGN CONSIDERATIONS

- Vehicle safety
- Island width and length
- Parking lot longitudinal and cross slope
- Structural integrity of adjacent traveled way (design to prevent subsurface infiltration or ponding under traveled way)
- Underdrain and overflow devices
- Proximity of storm drain
- Maintenance access
- Pedestrian crossing potential

DESIGN ELEMENTS

- Traveled Way:
 - Design lane widths to minimum allowable.
- Shoulder/Parking Lane:
 - Utilize permeable pavement with edge restraint at interface with traveled way

DESIGN CONSIDERATIONS

- Structural section design to handle vehicle loading
- Parking space utilization (with or without parking, temporary use during lane closures)
- Parking lot geometrics
- Hydrologic design requirements (stone reservoir depth and underdrain requirements)
- Design to maintain structural integrity of adjacent traveled way with edge restraints and prevention of infiltration beneath traveled way section
- Interrupt permeable pavement at intersections
- Surrounding land use and sediment sources
- Long term maintenance
- Pedestrian safety
- Maintenance access

PERMEABLE PAVEMENT

The use of permeable pavements may be considered for walkways, low volume driving lanes in parking lots, driveways, and fire access roads.



Conventional parking lot with
Asphalt Concrete in stall



Green parking lot with permeable
pavement in parking stall

PLANTER BOXES



Planter Box with trees



Planter Box with trees



Biofiltration Planter



Biofiltration with trees in Island

DESIGN CONSIDERATIONS

- Parking Lot layout
- Location (urban or rural setting)
- Parking Lot tree type and spacing requirements
- Sidewalk or path width requirements
- Parking requirements
- Parkway horizontal and vertical geometrics (curves and longitudinal slope)
- Pedestrian mobility and safety
- Maintenance access
- Interface with driveways
- Utilities and appurtenant structure locations
- Hydrologic design requirements
- Proximity of storm drain systems
- Structural integrity of adjacent traveled way (utilize edge restraints and prevent infiltration beneath roadway section)
- Low water use/drought tolerant street trees and landscaping

SWALES

DESIGN ELEMENTS

- Low water use/drought tolerant landscaping
- Rock
- Curb cuts and outlet design
- Energy dissipation
- Check dams
-

DESIGN CONSIDERATIONS

- Parking Lot geometrics
- Structural integrity of adjacent traveled way to prevent subsurface infiltration or ponding under traveled way
- Underdrain and overflow devices
- Proximity of storm drain
- Pedestrian mobility aspects
- Maintenance access



Swale with trees



Swale with trees between parking



Bioswale adjacent to parking and sidewalk



Swale in Island

SIDEWALKS/PATHWAYS/DRIVEWAYS



Permeable pavement sidewalk with biofiltration



DG pathway with rock swale



Pervious concrete sidewalk



Permeable pavement driveway

DESIGN ELEMENTS

- Drain to adjacent landscaping or adjacent LID facility
- Permeable pavement

SIDEWALK DESIGN

CONSIDERATIONS

- Sidewalk width and ADA requirements
- Public safety
- Pedestrian mobility aspects
- Maintenance access

DRIVEWAY CONSIDERATIONS

- Permeable pavement may require underdrain or overflow storm drain system
- Not appropriate for use in areas of high sediment loading (e.g. debris/soil from adjacent landscaping)

DESIGN ELEMENTS

- Low water use/drought tolerant landscaping
- Swales
- Vegetated filter strips

DESIGN CONSIDERATIONS

- Available space
- Vehicle and public safety
- Structural integrity of adjacent traveled way to prevent subsurface infiltration or ponding under traveled way
- Underdrain and overflow devices
- Proximity of storm drain
- Maintenance access

OUTSIDE OF PARKING AREAS



Swale outside of parking lot

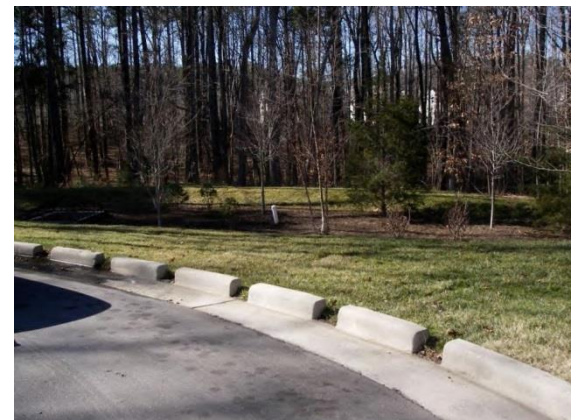

Curb cuts with filter strip/dispersion area

3.4 PUTTING IT ALL TOGETHER

This graphic provides an example of how several different techniques may be combined for Green Parking Lot implementation.



CHAPTER 4

Implementing Green Parking Lots

4.1 DESIGN AND CONSTRUCTION

The goal of the County of San Diego (the County) Low Impact Development (LID) Program is to protect stormwater quality by preserving and simulating natural hydrologic functions through the use of stormwater planning and management techniques on a project site. Both public and private projects constructing parking lots are required to retain stormwater to the maximum extent practicable. Designers must examine all uses of available space and place stormwater management where space and use allows.

DPW is installing green infrastructure as part of regulated construction projects and retrofit projects to reduce stormwater runoff in more areas of the County. Green Parking Lots projects utilize green infrastructure techniques and may be constructed independently to improve watershed health, or as a part of other infrastructure improvement projects.

These Green Parking Lots Guidelines are a planning tool intended to assist project engineers with identifying and selecting suitable Best Management Practices (BMPs) for their respective Green Infrastructure projects. Technical standards, including drawings, specifications, maintenance schedule, and plant list, can be found in the Green Parking Lots document.



4.2 MAINTENANCE

Implementing Green Infrastructure and Low Impact Development (LID) practices requires maintenance to keep them attractive and functioning. Maintenance levels of care should be considered during the design phase and plants selected from the County LID Manual or Water Efficient Landscape Design Manual according to the following levels:

- Low level of care: Annual maintenance; no irrigation
- Medium level of care: Quarterly maintenance; some water available
- High level of care: Monthly maintenance; site is potentially irrigated

San Diego County DPW is typically responsible for maintaining publicly-installed green infrastructure and LID facilities within their right-of-way. The final determination of maintenance responsibility is determined during project review. Private installations must have a maintenance covenant from the owner. Residents can help with maintenance by removing trash and weeds. Refer to the Green Parking Lots Maintenance Schedule for frequency and detail of maintenance.

Type of Maintenance	Dispersion Areas and Biofiltration	Permeable Pavement	Tree Space
Inspect after storms	•	•	
Remove trash/sediment/leaves	•	•	•
Clean inlets/outlets	•		
Adjust mulch and/or stone	•		
Water for establishment	•		•
Weed/remove invasive species	•		•
Prune (as needed)	•		•
Replace mulch (3" depth)	•		•
Street sweeper/vacuum (as needed)		•	





REFERENCES

Central California Coast Technical Assistance Memo, LID Parking Lots
http://centralcoastlidi.org/uploads/LID%20Parking%20TAM_WEB_1.pdf

County of San Diego – Best Management Practice Design Manual, 2016
http://www.sandiegocounty.gov/content/sdc/dpw/watersheds/DevelopmentandConstruction/BMP_Design_Manual.html

County of San Diego – Low Impact Development Handbook, 2014:
sandiegocounty.gov/content/sdc/dpw/watersheds/susmp/lid

County of San Diego – Standard Urban Stormwater Mitigation Plan Requirements for Development Applications, 2012:
sandiegocounty.gov/dpw/watersheds/susmp/susmp

DDOT – Greening DC Streets, 2014:
ddot.dc.gov/GreenInfrastructure

City of Los Angeles – Green Streets and Green Alleys Design Guidelines Standards, 2009:
nacto.org/docs/usdg/green_streets_and_green_alleys_la.pdf

Montgomery County, MD - Environmental Site Design Implementation in Montgomery County, Maryland: Image Library, 2011:
http://www.montgomeryplanning.org/environment/documents/esd_implementation_graphics_201108.pdf

This page was intentionally left blank.

Appendix



COUNTY OF SAN DIEGO BMP DESIGN MANUAL

Prior Lawful Approval Requirements and Guidance

Appendix L: Prior Lawful Approval Requirements and Guidance

This page was intentionally left blank.

Appendix L Prior Lawful Approval Requirements and Guidance

The effective date of the updated requirements of the Municipal Separate Storm Sewer System Permit (Order No. R9-2013-0001; hereinafter "2013 MS4 Permit") in the unincorporated County of San Diego is **February 26, 2016**. Any development or redevelopment project^{16,17} that has not obtained a Prior Lawful Approval (PLA) to proceed under earlier MS4 Permit provisions before that date must fully comply with the 2013 MS4 Permit, and therefore with the applicable requirements of Watershed Protection Ordinance (WPO) Sections 67.811 and 67.812. Under specified conditions, a project may be vested or excepted under WPO Section 67.811(c)(1) or (2). To qualify to proceed under any earlier MS4 Permit provision, a PLA must be obtained prior to its effective date.

L.1 Applicability of MS4 Permit Provisions

The effective dates of specific MS4 Permits and provisions are summarized in Table L.1-1. Options and conditions for obtaining PLAs to proceed under earlier MS4 Permit provisions are described in **Sections 2 and 3** below. The left-hand column of Table L.1-1 lists the effective dates of all land development requirements, beginning with their initial imposition under the 2001 MS4 Permit. The column on the right indicates the applicable MS4 Permit standards for a project obtaining a PLA before each of the effective dates on the left. In any instance where an applicant has established a PLA before the effective date of a newer provision, the project (or portion or phase of the project) may be considered provisionally covered under the earlier standard. So long as all applicable conditions on the PLA have been, and continue to be met (see **Sections 3 and 4** below), the earliest applicable date in Table L.1-1 (i.e., the earliest date after which a PLA is obtained) will normally apply. However, the County may as it determines necessary impose additional conditions that are more restrictive than the minimum requirements of any applicable MS4 Permit provision.

Per WPO Section 67.811(c)(2), the requirements of WPO Sections 67.811(a) and (b) fully apply to all development projects unless a PLA to proceed under the provisions of an earlier MS4 Permit has

¹⁶ **Development** means construction, rehabilitation, redevelopment, or reconstruction of any public or private projects. **Redevelopment** is a subset of development that applies specifically to the creation and/or replacement of impervious surface on an already developed site. Examples of redevelopment include the expansion of a building footprint, road widening, the addition to or replacement of a structure. Replacement of impervious surfaces includes any activity where impervious material(s) are removed, exposing underlying soil during construction. Redevelopment does not include routine maintenance activities, such as trenching and resurfacing associated with utility work; pavement grinding; resurfacing existing roadways, sidewalks, pedestrian ramps, or bike lanes on existing roads; and routine replacement of damaged pavement, such as pothole repair.

¹⁷ For the purposes of this document, further references to development projects are inclusive of both development and redevelopment projects unless a distinction between the two is specifically noted.

Appendix L: Prior Lawful Approval Requirements and Guidance

been obtained from the County. The County may partially or wholly waive these requirements for any project meeting the conditions of either WPO Section 67.811(c)(1) or (2). As described further below, this may occur either because a project applicant¹⁸ has obtained a **vested right** to proceed as a result of the operation of law (PLA Option 1), or because the project is excepted by satisfying specific conditions of the 2013 MS4 Permit (PLA Option 2).

Table L.1-1: Effective Dates of Land Development-Related MS4 Permit Provisions

Permit Provision Effective Dates	Applicable Standard for Projects Excepted Prior to Effective Date
2001 MS4 Permit (Order No. 2001-001)	
<ul style="list-style-type: none"> • February 10, 2003 Initial SUSMP effective date	<ul style="list-style-type: none"> • Order No. 90-42 (adopted July 16, 1990) did not contain explicit requirements for land development projects (discuss on a case basis)
2007 MS4 Permit (Order No. 2007-0001)	
<ul style="list-style-type: none"> • January 24, 2008 All requirements of Order No. 2007-0001 except interim and final hydromodification	<ul style="list-style-type: none"> • February 2003 SUSMP
<ul style="list-style-type: none"> • March 24, 2008 Interim hydromodification requirements (for sites disturbing 50 acres or more)	<ul style="list-style-type: none"> • Land development requirements of 2007 MS4 Permit minus hydromodification
<ul style="list-style-type: none"> • January 8, 2011 Final hydromodification requirements	<ul style="list-style-type: none"> • Land development requirements of 2007 MS4 Permit minus hydromodification
2013 MS4 Permit (Order No. R9-2013-0001 as amended by Order. No. R9-2015-0001 and R9-2015-0100)	
<ul style="list-style-type: none"> • February 26, 2016 All requirements of Provision E.3	<ul style="list-style-type: none"> • 2007 MS4 Permit land development standards effective on January 24, 2008 (except interim and final hydromodification) • Hydromodification requirements apply after March 24, 2008 and January 8, 2011 effective dates

¹⁸ “Applicant” may either mean the original project applicant or any successor(s) in interest to all or any portion of a PDP or Standard Project.

Appendix L: Prior Lawful Approval Requirements and Guidance

Applicants should note the following regarding the use of both PLA options:

- The two options are mutually exclusive. An applicant may utilize either PLA Option 1 or PLA Option 2, but not both at the same time. However, in some cases, it may make sense to document compliance with both options in case a change in approach is needed.
- Projects utilizing PLA Option 1 may potentially establish coverage under the requirements of any earlier MS4 Permit; however, PLA Option 2 establishes a “floor” of full compliance with the 2007 MS4 Permit.
- PLA Option 1 may be utilized both for Standard Projects and PDPs. Because the requirements for Standard Projects have changed very little since they were initially imposed under the 2001 MS4 Permit, there is normally little reason to consider the applicability of vested rights to these projects. However, some projects which were previously classified as Standard Projects under the 2007 MS4 Permit may need to be reclassified as PDPs under the 2013 MS4 Permit if they have not established a vested right to proceed under the earlier MS4 Permit. As such, these “newly designated” PDPs would be required to comply with the PDP requirements of the 2013 MS4 Permit.

L.2 Applicant Responsibilities

While documentation related to vesting rights (PLA Option 1) and exception (PLA Option 2) determinations will be maintained by the County as part of the project record, the applicant ultimately bears the responsibility for demonstrating that a PLA has been granted or continues to exist. Failure to do so may result in the revocation of that right, in which case a project may be required to partially or wholly meet updated MS4 Permit requirements. Applicants must document the basis for their assertion in a written proposal to County staff that includes a detailed explanation and rationale, including supporting calculations and information requested by the County if applicable. Staff will review the proposal and make a determination as to whether or not a vested right exists, or whether additional analysis is required. The adequacy of submitted documentation will be determined on a case-by-case basis.

Applicants must submit proposals and other required documentation in a timely manner (i.e., allowing sufficient time for County review and comment, resubmittal, and approval prior to applicable deadlines), and to demonstrate and maintain documentation of ongoing compliance with the conditions of a vested right initially recognized by the County.

L.3 PLA Option 1 (Vested Rights; WPO Section 67.811(c)(1))

In accordance with the 2013 MS4 Permit, WPO Section 67.811(c)(1) provides that: *“Previous land development requirements may be allowed to apply to any portion or phase of a development project for which the Authorized Enforcement Official determines the County lacks the land use authority or legal authority to require the project to implement the requirements of Sections 67.811(a) and/or (b).”*

Appendix L: Prior Lawful Approval Requirements and Guidance

This means that any project that has obtained a legally vested right to proceed under an existing permit or approval may continue under the MS4 Permit standard applicable at the time that the permit or approval was issued. In most cases, this will mean compliance with the 2007 MS4 Permit (these requirements are described in the *January 2011 Standard Urban Stormwater Mitigation Plan*, or SUSMP¹⁹). However, under limited circumstances a project may qualify for coverage under the provisions of an earlier MS4 Permit.

Vested rights may initially be established in a number of ways under California law, including the following:

- An applicant substantially relies on an issued permit, but then may be limited to work within the scope of that permit (See, for example, *Avco Community Developers v. South Coast Reg'l Comm'n* (1976) 17 Cal.3'd 785.).
- An applicant has entered into a development agreement restricting the application of new requirements (See, *Gov't Code S 65964 et seq.*).
- The *Subdivision Map Act*, *Gov't Code Sec. 66410 et seq.* sets forth circumstances whereby applicants can obtain a vested right to proceed under requirements in effect at the time a tentative map application is deemed complete. (See, for example, *Gov't Code SS 66474.2 & 66498.1-66498.9.*) Vested rights obtained in connection with a tentative map application do not always extend to subsequent discretionary permits or approvals needed to develop the subdivision.
- The County otherwise determines that it lacks the land use authority or legal authority to require the project to implement the requirements of a newer MS4 Permit.

The recognition of vested rights by the County is provisional, and remains valid only so long as all applicable conditions of the applicable PLA(s) continue to be satisfied. Under no circumstances does the mere issuance of a permit or approval guarantee that a vested right will continue to be recognized.

Vested rights granted under any County approval are limited to the conditions of that approval, including the scope and temporal extent of the work authorized under the approval. Applicants are responsible for understanding the specific conditions and limitations of any vested right granted by the County, as well the circumstances under which that right might be modified or revoked. PLA determinations will be periodically reviewed, and updated MS4 provisions applied where necessary.

Per WPO Section 67.803(a) the County may in some instances be required to impose newer requirements at the time that a subsequent permit or approval such as a building or grading permit is sought if it is legally feasible to do so at that time. This may apply in instances where applicable

¹⁹ Approved January 2011 and updated September 2012; Available at <http://www.sandiegocounty.gov/content/sdc/dpw/watersheds/susmp/susmp.html>.

Appendix L: Prior Lawful Approval Requirements and Guidance

stormwater compliance obligations have either been partially or fully satisfied under the earlier approval.²⁰

As noted, applicants must demonstrate, and maintain documentation of, ongoing compliance with the conditions of any vested right initially recognized by the County, including the following:

- Proof of establishment of use and reliance on construction permits. Examples of information that may be acceptable to the County, either as primary or supporting documentation, include:
 - Inspection records,
 - Supervised grading reports
 - Condition satisfaction,
 - Payroll records,
 - Contractor or vendor invoices or payments,
 - Aerial photographs, and
 - Any other form of documentation deemed acceptable by the County.

The adequacy of submitted documentation will be determined on a case-by-case basis. In general, acceptable forms of documentation include only those that are independently verifiable by County staff. Statements by applicants or contractors (even if written or sworn) are not considered sufficient.

- Satisfaction of all applicable MS4 Permit and other County requirements prior to expiration of the permit(s) under which a right is initially deemed to be vested.
- Other documentation as requested by the County.

L.4 PLA Option 2 (Exception Under the 2013 MS4 Permit; WPO Section 67.811(c) (2))

Provision E.3.e.(1)(a) of the 2013 MS4 Permit allows projects that meet specified criteria to be excepted under the requirements of the 2007 MS4 Permit. Under this option, compliance with the 2007 MS4 Permit (e.g., general, source control, low impact development, structural treatment control, and hydromodification management BMP requirements) is established as a minimum compliance standard. Per WPO Section 67.811(c)(2), this option is as follows:

²⁰ For example, if treatment control best management practices (TCBMPs) are installed to treat runoff from streets under a grading permit, but treatment has not been provided under that permit for the individual lots in a development, updated treatment standards applicable at the time of building permit issuance for the lots may be applied. In such case, if any BMPs necessary to comply with the newer requirements cannot be accommodated within the confines of existing lots, the applicant may be compelled to remap the subdivision.

Appendix L: Prior Lawful Approval Requirements and Guidance

“(2) *At its discretion, the Authorized Enforcement Official may allow the requirements of the immediately prior [2007] MS4 Permit to apply to any portion or phase of a Priority Development Project for which all of the conditions below have been satisfied.*

- (A) Initial Approvals. *Prior to the effective date of the current MS4 Permit provisions [i.e., February 26, 2016], the applicant must have:*
- i. *Obtained an approval of a design that incorporates the storm water drainage system for the Priority Development Project in its entirety, including all applicable structural and hydromodification management BMPs consistent with the requirements of the prior [2007] MS4 permit. For public projects, a design stamped by the County Engineer or engineer of record for the project is considered an approved design; and*
 - ii. *Been issued a project permit or approval that authorizes the commencement of construction activities based on the design approved in Section 67.811(c)(2)(A)i;*

For purpose of Section 67.811(c), the effective date of the 2013 MS4 Permit provisions is February 26, 2016.

- (B) *Demonstrated to the County’s satisfaction that construction activities have commenced on any portion of the Priority Development Project site within 365 days prior to [i.e., February 16, 2015], or 180 days after [i.e., August 14, 2016], the effective date of the current [2013] MS4 Permit provisions, where construction activities are undertaken in reliance on the permit or approval.*
- (C) Subsequent Approvals. *Within five years of the effective date of the current MS4 Permit provisions [i.e., prior to February 16, 2021], the applicant must have obtained all subsequent project permits or approvals that are needed to implement the design initially approved in conformance with WPO Section 67.811(c)(2)(A)i. After that time, any portion or phase of a Priority Development Project for which subsequent approvals have not been obtained is required to meet the updated requirements of WPO Section 67.811(a) and (b).*
- (D) Substantial Conformity. *The storm water drainage system for the Priority Development Project in its entirety, including all applicable structural pollutant treatment control and hydromodification management BMPs, must remain in substantial conformity with the design initially approved in conformance with WPO Section 67.811(c)(2)(A)i. Any portion or phase of a Priority Development Project not maintaining substantial conformity with this design is required to meet the updated requirements of WPO Sections 67.811(a) and (b).”*

Applicants should note that the use of this option requires continued compliance with all of the conditions listed above (i.e., Conditions (A)i through (D)) throughout project completion. **Figure L-1** summarizes the dates and ranges applicable to each condition. General guidance for complying with them is also provided below. Applicants should work closely with County staff to assess their specific requirements, including checking for the development of updated or more detailed guidance. As noted, applicants must demonstrate, and maintain documentation of, ongoing compliance with the conditions of any exception right initially recognized by the County.

Condition (A)i: Initial Design Approvals

Applicants must initially obtain a County approval that incorporates the design of the storm water drainage system for the PDP in its entirety. Initial designs used to satisfy this requirement will normally be documented in the PDP Stormwater Quality Management Plan (SWQMP), drainage reports, and associated exhibits and plans. These documents may be submitted in support of any of the following types of approvals:

- Major Use Permits,
- Tentative Maps,
- Site Plans,
- Grading or Improvement Plans,
- Tentative Parcel Maps,
- Building Permits, and
- Any other approval deemed acceptable by the County.

The purpose of this provision is to require applicants to obtain early approval of a design that fully satisfies the requirements of the 2007 MS4 Permit for all areas and phases of the project. At a minimum, this includes the following design features:

- Delineation of Drainage Management Areas (DMAs) for the entire PDP,
- Identification of all applicable TCBMPs,
- Identification of all applicable hydromodification BMPs,
- Identification of all site design BMPs that affect the design or performance requirements of TCBMPs and/or hydromodification BMPs, and
- Supporting calculations and assumptions that demonstrate the ability of the PDP to fully meet all applicable treatment and hydromodification requirements for each identified DMA.

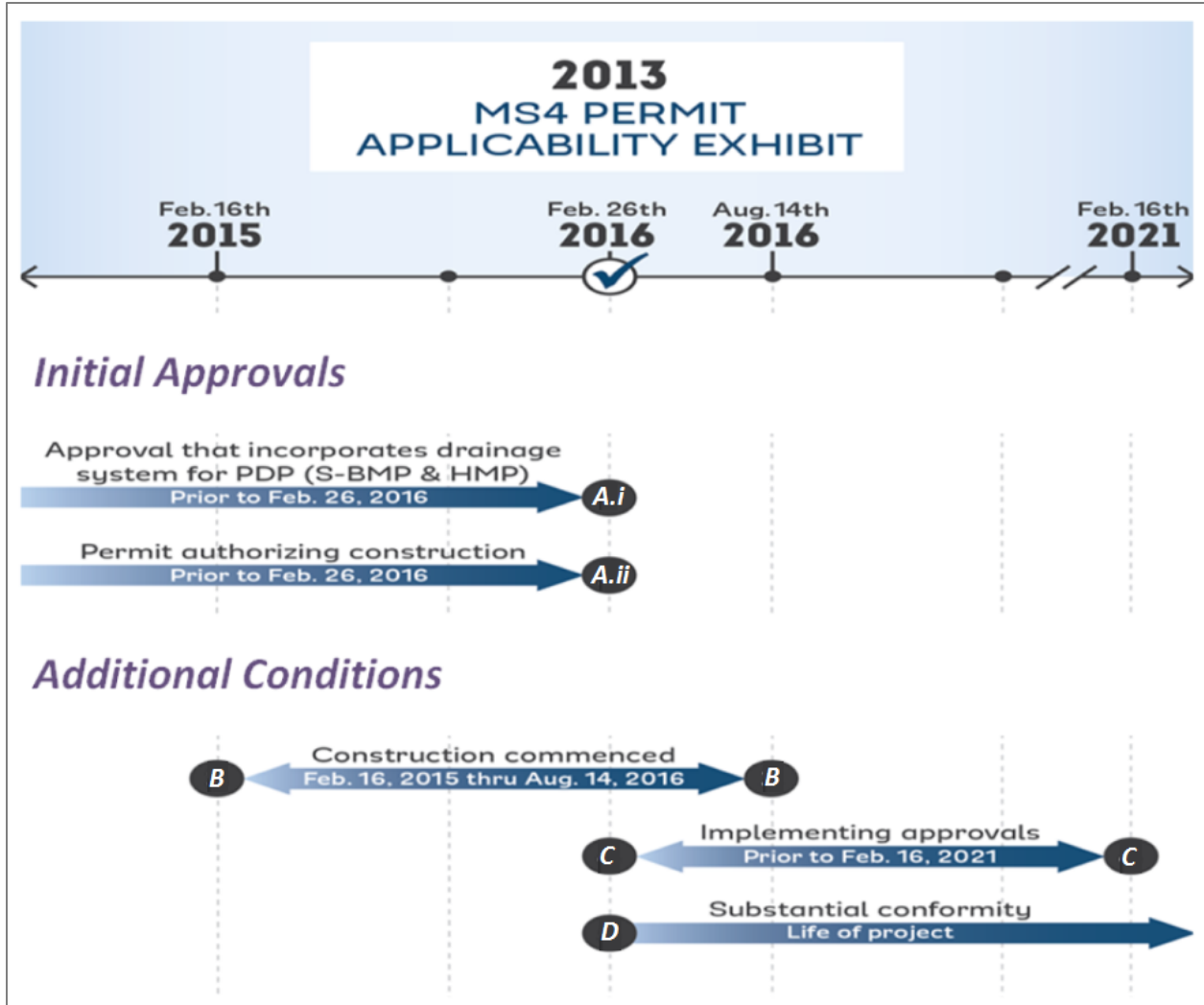

Figure L.4-1: Summary of Deadlines for Complying with 2013 MS4 Permit Exception Provisions (PLA Option 2). Note: Lettering of provisions refers to subsections of WPO Section 67.811(c)(2).

This requirement must be satisfied for the PDP in its entirety; however, at the County’s discretion it may be met by multiple approvals that collectively address the entire storm water drainage system, so long as all approvals are obtained prior to February 26, 2016. BMPs and other proposed design features must be identified and located with sufficient specificity to allow reviewers to fully evaluate the PDP’s compliance with all applicable performance standards for the projected final buildout.

For projects such as business parks or phased residential developments, where the final design details are not initially known, it is acceptable to propose BMPs and delineate DMAs based on documented assumptions about final build-out (e.g., % imperviousness of individual lots or areas, site drainage patterns, and BMP types, locations, performance, etc.). However, as described under **Condition (D)**, below, substantial conformance with these initial assumptions must be maintained throughout the life of the project. Failure to do so may result in the imposition of updated standards during later stages of development.

Condition (A)ii: Issuance of Construction Permits or Approvals

Prior to February 26, 2016, the applicant must also have “*been issued a project permit or approval that authorizes the commencement of construction activities*”²¹ based on the design approved under **Condition (A)ii** above. Permits and approvals that may be used to satisfy this requirement include:

- Grading permits,
- Building permits,
- Improvement plan permits,
- Clearing and grubbing permits,
- Well permits,
- Construction right of way permits, and
- Any other permit or approval recognized by the County as authorizing the applicant to commence construction activities on the PDP.

This condition is considered satisfied on issuance of a construction permit or approval for any portion or phase of the PDP prior to February 26, 2016. Once satisfied, this one-time condition is not subject to further County review.

Applicants are advised to consult with County staff as early as possible to ensure that a qualifying approval is issued before the effective date.

Condition (B): Commencement of Construction

Not more than 365 days before or 180 days after the BMPDM Effective Date, applicants must commence construction activities under a permit issued per **Condition (A)ii**, above. This is also a one-time condition that, once satisfied, is not subject to further review. Its purpose is twofold: (i) it prevents older inactive projects from being excepted under the 2007 MS4 Permit, and (ii) it ensures that newer projects are excepted only if they conduct work within six months of the effective date of the 2013 MS4 Permit. Together, they ensure that the exception provisions of the 2013 MS4 Permit are extended only to active projects.

To satisfy this requirement, construction activities on the project site must have commenced between February 16, 2015 and August 14, 2016 under an open construction permit or approval (including modifications and renewals) issued by the County. Applicants are responsible for

²¹ Attachment C of the 2013 MS4 Permit defines Construction Activities as “Actions implemented during construction of development or redevelopment projects during the Preliminary Task (including rough grading and/or disking, clearing and grubbing operations, or any soil disturbance prior to mass grading), Grading or Land Development (including topography and slope reconfiguration, alluvium removals, canyon cleanouts, rock undercuts, keyway excavations, land form grading, and stockpiling of select material for capping operations), Streets and Utility Installation (including excavation and street paving, lot grading, curbs, gutters and sidewalks, public utilities, public water facilities including fire hydrants, public sanitary sewer systems, storm sewer systems and/or other drainage improvements), or Vertical Construction (including the build out of structures from foundations to roofing, including rough landscaping).”

Appendix L: Prior Lawful Approval Requirements and Guidance

providing documentation of the commencement of these activities. Examples of information that may be acceptable to the County, either as primary or supporting documentation, include:

- Inspection records,
- Supervised grading reports
- Condition satisfaction,
- Payroll records,
- Contractor or vendor invoices or payments,
- Aerial photographs, and
- Any other form of documentation deemed acceptable by the County.

The adequacy of submitted documentation will be determined on a case-by-case basis. In general, acceptable forms of documentation include only those that are independently verifiable by County staff. Statements by applicants or contractors (even if written or sworn) are not considered sufficient.

Conditions (A)i through **(B)**, above, provide a means for a PDP to initially be excepted under the provisions of the 2007 MS4 Permit. However, as noted, these determinations should always be considered provisional. **Conditions (C)** and **(D)**, below, describe additional requirements that must be met for a project to maintain its exception status. Failure to meet either of these conditions may result in the revocation of an excepted right, in which case a project may be required to partially or wholly meet updated MS4 Permit requirements. Exception determinations will be periodically reviewed, and updated MS4 provisions applied where necessary.

Exception rights granted under any County approval are limited to the conditions of that approval, including the scope and temporal extent of the work authorized under the approval. Applicants are responsible for understanding the specific conditions and limitations of any vested right granted by the County, as well the circumstances under which that right might be modified or revoked.

Condition C: Issuance of Implementing Approvals

This provision establishes a “shelf life” on exception decisions by limiting the time allowed to obtain the approvals needed to fully implement the approved design. To maintain the exception status of a PDP, applicants must also have been issued, by February 16, 2021, all subsequent project permits or approvals needed to implement the design initially approved under **Condition (A)i** above. In essence, only work authorized under permits or approvals issued prior to February 16, 2021 may be excepted under the 2007 MS4 Permit. Note that this requirement applies to issuance of permits or other approvals, rather than completion of work under them. As such, work may continue to be conducted under 2007 MS4 Permit standards for the duration of the term of that permit or approval, including allowable modifications and extensions. Depending on the approval type this may be multiple years.

Implementing approvals obtained after February 16, 2021 will be subject to the MS4 Permit provisions applicable at the time that each approval is obtained. In instances where applicable stormwater compliance obligations have only been partially satisfied under earlier approvals, the

Appendix L: Prior Lawful Approval Requirements and Guidance

County may be legally obligated to impose updated MS4 Permit requirements upon subsequent permit issuance²².

The County will review the exception status of PDPs at the time new permits or approvals are issued. All portions or phases of PDPs for which applicable permits or approvals have not been obtained prior to the February 16, 2021 deadline will be reviewed for the applicability of updated MS4 Permit provisions. At that time, applicants may be required to wholly or partially comply with updated MS4 Permit provisions, even where required BMPs cannot be accommodated within the confines of the existing design.

Condition D: Maintaining Substantial Conformity

The storm water drainage system for the PDP in its entirety, including all applicable structural pollutant treatment control and hydromodification management BMPs, must remain in substantial conformity with the design initially approved under **Condition (A)i** above. The intent of this provision is to allow reasonable modifications in the design of a project plan while preserving compliance with the performance standards initially applied to the PDP.

PDPs must always fully comply with the provisions of the 2007 MS4 Permit; however, some changes within the overall project design may be accommodated so long as all applicable narrative and numeric performance standards continue to be met for all portions and phases of the development. As noted above, for projects where initial design parameters were established based on assumptions about final buildout, it is expected that some parameters will be modified as more specific project design details emerge. This is acceptable so long as substantial conformity with all applicable performance standards is maintained over the life of the project. Failure to do so may result in the imposition of updated MS4 Permit standards during later stages of the development.

Proposed design modifications should be presented to and discussed with County staff as early as possible so that feedback and necessary approvals can be provided prior to their implementation. While each proposed change must be evaluated individually, the following will generally be applied to determinations of substantial conformity²³:

- Ministerial non-substantive changes such as a name change, engineer change, text update, or security/bond change are not considered substantial.
- Changes in the selection, location, or design of individual BMPs or site features that will result in equal or better ability to achieve all applicable narrative and numeric treatment and hydromodification performance standards for the PDP as a whole (including applicable portions of the PDP, such as individual lots or DMAs) may be allowed. However, compliance with all applicable standards must be maintained at all times. That is, a “lesser” standard cannot be

²² For example, see footnote 5.

²³ Allowable design changes, even if not determined to be substantial, may require a SWQMP Addendum to be processed for the PDP.

Appendix L: Prior Lawful Approval Requirements and Guidance

approved for one portion of a project unless a corresponding change to offset any potential compliance deficits is also approved at the same time.

- Design changes, including the delineation of DMAs, that increase the overall amount of impervious surface within, or increase the overall footprint of, the PDP may be considered substantial, and will be evaluated on a case-by-case basis.

In instances where a PDP has fallen out of compliance with the requirements of **Condition (D)**, County staff will work with the applicant to determine whether the exception status can be restored, or if updated MS4 Permit requirements must be applied.

Glossary of Key Terms

50% Rule	Refers to an MS4 Permit standard for redevelopment PDPs (PDPs on previously developed sites) that defines whether the redevelopment PDP must meet storm water management requirements for the entire development or only for the newly created or replaced impervious surface. Refer to Section 1.7 .
Aggregate	Hard, durable material of mineral origin typically consisting of gravel, crushed stone, crushed quarry or mine rock. Gradation varies depending on application within a BMP as bedding, filter course, or storage.
Aggregate Storage Layer	Layer within a BMP that serves to provide a conduit for conveyance, detention storage, infiltration storage, saturated storage, or a combination thereof.
Alternative Compliance Project (ACP)	An offsite mitigation project in lieu of implementing the onsite structural BMP performance requirements required under the MS4 Permit. Refer to Section 1.8 for more information on alternative compliance project requirements.
Baseline BMPs	Baseline BMP means any BMP that is required where applicable and feasible on all development projects. Baseline BMPs include both Site Design and Source Control BMPs. Some baseline BMPs can be sized to qualify for Design Capture Volume (DCV) reductions on priority development projects. Baseline BMPs are not required to be sized to qualify for DCV reductions and shall be implemented where applicable and feasible on all development projects even if they do not meet the criteria to qualify for DCV reduction.
Bed Sediment	The part of the sediment load in channel flow that moves along the bed by sliding or saltation, and part of the suspended sediment load, that principally constitutes the channel bed.
Bedding	Aggregate used to establish a foundation for structures such as pipes, manholes, and pavement.
Best Management Practice (BMP)	A procedure or device designed to minimize the quantity of runoff pollutants and / or volumes that flow to downstream receiving water bodies. Refer to Section 2.2.2.1 .

Biodegradation	Decomposition of pollutants by biological means.
Biofiltration BMPs	Biofiltration BMPs are practices that use vegetation and Biofiltration Soil Media to detain and treat runoff from impervious areas. Treatment is achieved through filtration, sedimentation, sorption, biochemical processes and/or vegetative uptake. These BMPs must be sized to:[a] Treat 1.5 times the DCV not reliably retained onsite, OR[b] Treat the DCV not reliably retained onsite with a flow-thru design that has a total volume, including pore spaces and pre-filter detention volume, sized to hold at least 0.75 times the portion of the DCV not reliably retained onsite. (See Section 5.3 and Appendix B for illustration and additional information).
Biofiltration Soil Media (BSM)	Biofiltration Soil Media (BSM) is intended to filter stormwater and support plant growth while minimizing the leaching of potential pollutants. BSM used in stormwater treatment BMPs, including biofiltration and bioretention, is required to meet certain specifications (See Appendix F). Biofiltration Soil Media is also referred to as Engineered soil Media and Bioretention Soil Media.
Biofiltration Treatment	Treatment from a BMP meeting the biofiltration standard.
Biofiltration with Partial Retention BMPs	Biofiltration with partial retention BMPs are practices that use vegetation and Biofiltration Soil Media to detain and treat runoff from impervious areas. Partial retention is characterized by a subsurface stone infiltration storage zone in the bottom of the BMP below the elevation of the discharge from the underdrains. The discharge of biofiltered water from the underdrain occurs when the water level in the infiltration storage zone exceeds the elevation of the underdrain outlet. (See Section 5.3 for illustration and additional information).
Bioretention BMPs	Vegetated surface water systems that filter water through vegetation and soil, or engineered media prior to infiltrating into native soils. Bioretention BMPs in this manual retain the entire DCV prior to overflow to the downstream conveyance system. (See Section 5.3 for illustration and additional information).
BMP Sizing Calculator	An on-line tool that was developed under the 2007 MS4 Permit to facilitate the sizing factor method for designing flow control BMPs for hydromodification management. The BMP Sizing Calculator has been discontinued as of June 30, 2014.

Cistern	A vessel for storing water. In this manual, a cistern is typically a rain barrel, tank, vault, or other artificial reservoir.
Coarse Sediment Yield Area	A GLU with coarse-grained geologic material (material that is expected to produce greater than 50% sand when weathered). See the following terms modifying coarse sediment yield area: critical, potential critical.
Compact Biofiltration BMP	A biofiltration BMP, either proprietary or non-proprietary in origin, that is designed to provide storm water pollutant control within a smaller footprint than a typical biofiltration BMP, usually through use of specialized media that is able to efficiently treat high storm water inflow rates.
Conditions of Approval	Requirements a jurisdiction may adopt for a project in connection with a discretionary action (e.g., issuance of a use permit). COAs may include features to be incorporated into the final plans for the project and may also specify uses, activities, and operational measures that must be observed over the life of the project.
Contemporary Design Standards	This term refers to design standards that are reasonably consistent with the current state of practice and are based on desired outcomes that are reasonably consistent with the context of the MS4 Permit and Model BMP Design Manual. For example, a detention basin that is designed solely to mitigate peak flow rates would not be considered a contemporary water quality BMP design because it is not consistent with the goal of water quality improvement. Current state of the practice recognizes that a drawdown time of 24 to 72 hour is typically needed to promote settling. For practical purposes, design standards can be considered “contemporary” if they have been published within the last 10 years, preferably in California or Washington State, and are specifically intended for storm water quality management.
Continuous Simulation Modeling	A method of hydrological analysis in which a set of rainfall data (typically hourly for 30 years or more) is used as input, and a continuous runoff hydrograph is calculated over the same time period. Continuous simulation models typical track dynamic soil and storage conditions during and between storm events. The output is then analyzed statistically for the purposes of comparing runoff patterns under different conditions (for example, pre- and post-development-project).
Copermittees	See Jurisdiction.

<p>Critical Channel Flow (Q_c)</p>	<p>The channel flow that produces the critical shear stress that initiates bed movement or that erodes the toe of channel banks. When measuring Q_c, it should be based on the weakest boundary material – either bed or bank.</p>
<p>Critical Coarse Sediment Yield Area (CCSYA)</p>	<p>A GLU with coarse-grained geologic material and high relative sediment production, where the sediment produced is critical to the receiving stream (a source of bed material to the receiving stream). See also: potential critical coarse sediment yield area.</p>
<p>Critical Shear Stress</p>	<p>The shear stress that initiates channel bed movement or that erodes the toe of channel banks. See also critical channel flow.</p>
<p>De Minimis DMA</p>	<p>De minimis DMAs are very small areas that are not considered to be significant contributors of pollutants, and are considered not practicable to drain to a BMP. See Section 5.2.2.</p>
<p>Depth</p>	<p>The distance from the top, or surface, to the bottom of a BMP component.</p>
<p>Design Capture Volume (DCV)</p>	<p>A volume of stormwater runoff produced from the 85th percentile, 24-hour storm event. See Section 2.2.2.2.</p>
<p>Detention</p>	<p>Temporarily holding back storm water runoff via a designed outlet (e.g., underdrain, orifice) to provide flow rate and duration control.</p>
<p>Detention Storage</p>	<p>Storage that provides detention as the outflow mechanism.</p>
<p>Development Footprint</p>	<p>The limits of all grading and ground disturbance, including landscaping, associated with a project.</p>
<p>Development Project</p>	<p>Construction, rehabilitation, redevelopment, or reconstruction of any public or private projects. Includes both new development and redevelopment. Also includes whole of the action as defined by CEQA. See Section 1.3.</p>
<p>Direct Discharge</p>	<p>The connection of project site runoff to an exempt receiving water body, which could include an exempt river reach, reservoir or lagoon. To qualify as a direct discharge, the discharge elevation from the project site outfall must be at or below either the normal operating water surface elevation or the reservoir spillway elevation, and properly designed energy dissipation must be provided. “Direct discharge” may be more specifically defined by each municipality.</p>

<p>Direct Infiltration</p>	<p>Infiltration via methods or devices, such as dry wells or infiltration trenches, designed to bypass the mantle of surface soils that is unsaturated and more organically active and transmit runoff directly to deeper subsurface soils.</p>
<p>Drainage Management Area (DMA)</p>	<p>See Section 3.3.2.</p>
<p>Drawdown Time</p>	<p>The time required for a storm water detention or infiltration facility to drain and return to the dry-weather condition. For detention facilities, drawdown time is a function of basin volume and outlet orifice size. For infiltration facilities, drawdown time is a function of basin volume and infiltration rate.</p>
<p>Enclosed Embayments (Enclosed Bays)</p>	<p>Enclosed bays are indentations along the coast that enclose an area of oceanic water within distinct headlands or harbor works. Enclosed bays include all bays where the narrowest distance between the headlands or outermost bay works is less than 75 percent of the greatest dimension of the enclosed portion of the bay. Enclosed bays do not include inland surface waters or ocean waters. In San Diego: Mission Bay and San Diego Bay.</p>
<p>Enhanced Site Design BMPs</p>	<p>Enhanced Site Design BMPs are Site Design BMPs that are sized for crediting toward reductions in the Design Capture Volume (DCV) for a Drainage Management Area (DMA). Enhanced Site Design BMPs are credited in Worksheet B-1.1 of the BMP Design Manual to <i>partially</i> satisfy the Design Capture Volume (DCV) reductions and/or HMP reductions in a DMA. Examples of Enhanced Site Design BMPs are tree wells and impervious area dispersion.</p>
<p>Environmentally Sensitive Areas (ESAs)</p>	<p>Areas that include but are not limited to all Clean Water Act Section 303(d) impaired water bodies; areas designated as Areas of Special Biological Significance by the State Water Board and SDRWQCB; State Water Quality Protected Areas; water bodies designated with the RARE beneficial use by the State Water Board and SDRWQCB; and any other equivalent environmentally sensitive areas which have been identified by the County.</p>
<p>Filter Course</p>	<p>Aggregate used to prevent particle migration between two different materials when storm water runoff passes through.</p>

Filter Fabric	A permeable textile material, also termed a non-woven geotextile, that prevents particle migration between two different materials when storm water runoff passes through.
Filtration	Controlled seepage of storm water runoff through media, vegetation, or aggregate to reduce pollutants via physical separation.
Flow Control	Control of runoff rates and durations as required by the HMP.
Flow Control BMP	A structural BMP designed to provide control of post-project runoff flow rates and durations for the purpose of hydromodification management.
Flow-Thru Treatment	Treatment from a BMP meeting the flow-thru treatment control standard.
Flow-Thru Treatment BMPs	Flow-thru treatment control BMPs are structural, engineered facilities that are designed to remove pollutants from storm water runoff using treatment processes that do not incorporate significant biological methods. Flow-thru BMPs include vegetated swales, media filters, sand filters, and dry extended detention basins. (See Section 5.3 for illustration and additional information).
Forebay	An initial storage area at the entrance to a structural BMP designed to trap and settle out solid pollutants such as sediment in a concentrated location, to provide pre-treatment within the structural BMP and facilitate removal of solid pollutants during maintenance operations.
Full Infiltration	Infiltration of a storm water runoff volume equal to the DCV.
Geomorphic Assessment	A quantification or measure of the changing properties of a stream channel.
Geomorphically Significant Flows	Flows that have the potential to cause, or accelerate, stream channel erosion or other adverse impacts to beneficial stream uses. The range of geomorphically significant flows was determined as part of the development of the March 2011 Final HMP, and has not changed under the 2013 MS4 Permit. However, under the 2013 MS4 Permit, Q2 and Q10 must be based on the pre-development condition rather than the pre-project condition, meaning that no pre-project impervious area may be considered in the computation of pre-development Q2 and Q10.

<p>Geomorphic Landscape Unit (GLU)</p>	<p>Classifications that provide an estimate of sediment yield based upon three factors: geology, hillslope, and land cover. GLUs are developed based on the methodology presented in the SCCWRP Technical Report 605 titled “Hydromodification Screening Tools: GIS-Based Catchment Analyses of Potential Changes in Runoff and Sediment Discharge” (SCCWRP, 2010).</p>
<p>Gross Pollutants</p>	<p>In storm water, generally litter (trash), organic debris (leaves, branches, seeds, twigs, grass clippings), and coarse sediments (inorganic breakdown products from soils, pavement, or building materials).</p>
<p>Harvest and Use BMP</p>	<p>Harvest and use (aka rainwater harvesting) BMPs capture and store storm water runoff for later use. These BMPs are engineered to store a specified volume of water and have no design surface discharge until this volume is exceeded. (See Section 5.3 for illustration and additional information).</p>
<p>Hungry Water</p>	<p>Also known as "sediment-starved" water, "hungry" water refers to channel flow that is hungry for sediment from the channel bed or banks because it currently contains less bed material sediment than it is capable of conveying. The “hungry water” phenomenon occurs when the natural sediment load decreases and the erosive force of the runoff increases as a natural counterbalance, as described by Lane’s Equation.</p>
<p>Hydraulic Head</p>	<p>Energy represented as a difference in elevation, typically as the difference between the inlet and outlet water surface elevation for a BMP.</p>
<p>Hydraulic Residence Time</p>	<p>The length of time between inflow and outflow that runoff remains in a BMP.</p>
<p>Hydrologic Soil Group</p>	<p>Classification of soils by the Natural Resources Conservation Service (NRCS) into A, B, C, and D groups according to infiltration capacity.</p>
<p>Hydromodification</p>	<p>The change in the natural watershed hydrologic processes and runoff characteristics (i.e., interception, infiltration, overland flow, interflow and groundwater flow) caused by urbanization or other land use changes that result in increased stream flows and sediment transport. In addition, alteration of stream and river channels, installation of dams and water impoundments, and excessive stream-bank and shoreline erosion are also considered hydromodification, due to their disruption of natural watershed hydrologic processes.</p>

<p>Hydromodification Management BMP</p>	<p>A structural BMP for the purpose of hydromodification management, either for protection of critical coarse sediment yield areas or for flow control. See also flow control BMP.</p>
<p>Hydromodification Management Plan (HMP)</p>	<p>A plan implemented by the Copermittees so that post-project runoff must not exceed estimated pre-development rates and/or durations by more than 10%, where increased runoff would result in increased potential for erosion or other adverse impacts to beneficial uses. The March 2011 Final HMP and the updated MS4 Permit are the basis of the flow control requirements of this manual.</p>
<p>Impervious Surface</p>	<p>Any material that prevents or substantially reduces infiltration of water into the soil.</p>
<p>Infeasible</p>	<p>As applied to BMPs, refers to condition in which a BMP approach is not practicable based on technical constraints specific to the site, including by not limited to physical constraints, risks of impacts to environmental resources, risks of harm to human health, or risk of loss or damage to property. Feasibility criteria are provided in this manual.</p>
<p>Infiltration</p>	<p>In the context of LID, infiltration is defined as the percolation of water into the ground. Infiltration is often expressed as a rate (inches per hour), which is determined through an infiltration test. In the context of non-storm water, infiltration is water other than wastewater that enters a sewer system (including sewer service connections and foundation drains) from the ground through such means as defective pipes, pipe joints, connections, or manholes. Infiltration does not include, and is distinguished from, inflow [40 CFR 35.2005(20)].</p>
<p>Infiltration BMP</p>	<p>Infiltration BMPs are structural measures that capture, store and infiltrate storm water runoff. These BMPs are engineered to store a specified volume of water and have no design surface discharge (underdrain or outlet structure) until this volume is exceeded. These types of BMPs may also support evapotranspiration processes, but are characterized by having their most dominant volume losses due to infiltration. (See Section 5.3 for illustration and additional information).</p>
<p>Jurisdiction</p>	<p>The term “jurisdiction” is used in this manual to refer to individual copermittees who have independent responsibility for implementing the requirements of the MS4 Permit.</p>

<p>Lower Flow Threshold</p>	<p>The lower limit of the range of flows to be controlled for hydromodification management. The lower flow threshold is the flow at which erosion of sediment from the stream bed or banks begins to occur. See also critical channel flow. For the San Diego region, the lower flow threshold must be a fraction (0.1, 0.3, or 0.5) of the pre-development 2-year flow rate based on continuous simulation modeling (0.1Q2, 0.3Q2, or 0.5Q2).</p>
<p>Low Impact Development (LID)</p>	<p>A storm water management and land development strategy that emphasizes conservation and the use of onsite natural features integrated with engineered, small-scale hydrologic controls to more closely reflect pre-development hydrologic functions. See Site Design.</p>
<p>Maximum Extent Practicable (MEP)</p>	<p>The technology-based standard established by Congress in CWA section 402(p)(3)(B)(iii) for storm water that operators of MS4s must meet. Technology-based standards establish the level of pollutant reductions that dischargers must achieve, typically by treatment or by a combination of source control and treatment control BMPs. MEP generally emphasizes pollution prevention and source control BMPs primarily (as the first line of defense) in combination with treatment methods serving as a backup (additional line of defense). MEP considers economics and is generally, but not necessarily, less stringent than BAT. Refer to the MS4 Permit [(Order No R9-2013-001) Appendix C, Definitions, Page C-6] for more details.</p>
<p>Media</p>	<p>A storm water management and land development strategy that emphasizes conservation and the use of onsite natural features integrated with engineered, small-scale hydrologic controls to more closely reflect pre-development hydrologic functions. See Site Design.</p>

<p>MS4</p>	<p>MS4 stands for Municipal Separate Storm Sewer System. A conveyance or system of conveyances (including roads with drainage systems, municipal streets, catch basins, curbs, gutters, ditches, man-made channels, or storm drains): (i) Owned or operated by a State, city, town, borough, county, parish, district, association, or other public body (created by or pursuant to State law) having jurisdiction over disposal of sewage, industrial wastes, storm water, or other wastes, including special districts under State law such as a sewer district, flood control district or drainage district, or similar entity, or an Indian tribe or an authorized Indian tribal organization, or designated and approved management agency under section 208 of the Clean Water Act that discharges to waters of the United States; (ii) Designated or used for collecting or conveying storm water; (iii) Which is not a combined sewer; (iv) Which is not part of the Publicly Owned Treatment Works as defined at 40 CFR 122.26.</p>
<p>MS4 Permit</p>	<p>The Municipal Separate Storm Sewer System (MS4) Permit is a regulatory tool used by the Regional Water Quality Control Board (RWQCB) to regulate stormwater and non-stormwater discharges into MS4s and from MS4s into local water bodies. The MS4 Permit defines the regulatory obligations that agencies must meet to remain in compliance with the permit and avoid enforcement actions. MS4 Permits are issued to municipalities as owners of the MS4 and are renewed approximately every five years.</p>
<p>National Pollutant Discharge Elimination System (NPDES)</p>	<p>The national program for issuing, modifying, revoking and reissuing, terminating, monitoring and enforcing permits, and imposing and enforcing pretreatment requirements, under Sections 307, 318, 402, and 405 of the Clean Water Act.</p>
<p>New Development</p>	<p>Land disturbing activities; structural development, including construction or installation of a building or structure, the creation of impervious surfaces; and land subdivision. Any development project that will create 10,000 square feet or more of impervious surface (collectively over the entire project site) is considered new development.</p>
<p>Operation and Maintenance (O&M)</p>	<p>Requirements in the MS4 Permit to inspect structural BMPs and verify the implementation of operational practices and preventative and corrective maintenance in perpetuity.</p>

<p>Pacific/Salton Sea Divide</p>	<p>The highest ridge of land in San Diego County which divides run off that drains west to the Pacific Ocean and run off that drain east to the Salton Sea. Also referred to as the Tecate Ridge. The area to the West is governed by Region 9 Water Quality Control Board and the area to the East is governed by Region 7.</p>
<p>Partial Infiltration</p>	<p>Infiltration of a storm water runoff volume less than the DCV.</p>
<p>Partial Retention</p>	<p>Partial retention category is defined by structural measures that incorporate both infiltration (in the lower treatment zone) and biofiltration (in the upper treatment zone).</p>
<p>PDP (Priority Development Project)</p>	<p>As defined by the MS4 Permit provision E.3.b, land development projects that fall under the planning and building authority of the Copermittee for which the Copermittee must impose specific requirements in addition to those required of Standard Projects. Refer to Section 1.4 to determine if your project is a PDP.</p>
<p>PDPs with only Pollutant Control Requirements</p>	<p>PDPs that need to meet Source Control, Site Design and Pollutant Control Requirements (but are exempt from Hydromodification Management Requirements).</p>
<p>PDPs with Pollutant Control and Hydromodification Management Requirements</p>	<p>PDPs that need to meet Source Control, Site Design, Pollutant Control and Hydromodification Management Requirements.</p>
<p>Point of Compliance (POC)</p>	<p>1. For channel screening and determination of low flow threshold: the point at which collected storm water from a development is delivered from a constructed or modified drainage system into a natural or un-lined channel. POC for channel screening may be located onsite or offsite, depending on where runoff from the project meets a natural or un-lined channel. 2. For flow control: the point at which pre-development and post-development flow rates and durations will be compared. POC for flow control is typically onsite. A project may have a different POC for channel screening vs. POC for flow control if runoff from the project site is conveyed in hardened systems from the project site boundary to the natural or un-lined channel.</p>
<p>Pollutant Control</p>	<p>Control of pollutants via physical, chemical or biological processes</p>

<p>Pollution Prevention</p>	<p>Pollution prevention is defined as practices and processes that reduce or eliminate the generation of pollutants, in contrast to source control BMPs, treatment control BMPs, or disposal.</p>
<p>Post-Project Hydrology Flows, Volumes</p>	<p>The peak runoff flows and runoff volume anticipated after the project has been constructed taking into account all permeable and impermeable surfaces, soil and vegetation types and conditions after landscaping is complete, detention or retention basins or other water storage elements incorporated into the site design, and any other site features that would affect runoff volumes and peak flows.</p>
<p>Potential Critical Coarse Sediment Yield Area (PCCSYA)</p>	<p>A GLU with coarse-grained geologic material and high relative sediment production, as defined in the Regional WMAA. The Regional WMAA identified GLUs as potential critical coarse sediment yield areas based on slope, geology, and land cover. GLU analysis does not determine whether the sediment produced is critical to the receiving stream (a source of bed material to the receiving stream) therefore the areas are designated as potential.</p>
<p>Pre-Development Runoff Conditions</p>	<p>Approximate flow rates and durations that exist or existed onsite before land development occurs. For new development projects, this equates to runoff conditions immediately before any new project disturbance or grading. For redevelopment projects, this equates to runoff conditions from the project footprint assuming infiltration characteristics of the underlying soil, and existing grade. Runoff coefficients of concrete or asphalt must not be used. A redevelopment PDP must use available information pertaining to existing underlying soil type and onsite existing grade to estimate pre-development runoff conditions.</p>
<p>Pre-Project Condition</p>	<p>The condition prior to any project work or the existing condition. Note that pre-project condition and pre-development condition will not be the same for redevelopment projects.</p>
<p>Pretreatment</p>	<p>Removal of gross solids, including organic debris and coarse sediment, from runoff to minimize clogging and increase the effectiveness of BMPs.</p>
<p>Project Area</p>	<p>All areas proposed by an applicant to be altered or developed, plus any additional areas that drain on to areas to be altered or developed. Also see Section 1.3.</p>

<p>Project Submittal</p>	<p>Documents submitted to a jurisdiction or Copermittee in connection with an application for development approval and demonstrating compliance with MS4 Permit requirements for the project. Specific requirements vary from municipality to municipality.</p>
<p>Proprietary BMP</p>	<p>BMP designed and marketed by private business for treatment of storm water. Check with County staff prior to proposing to use a proprietary BMP.</p>
<p>Receiving Waters</p>	<p>See Waters of the United States.</p>
<p>Redevelopment</p>	<p>The creation, addition, and or replacement of impervious surface on an already developed site. Examples include the expansion of a building footprint, road widening, the addition to or replacement of a structure. Replacement of impervious surfaces includes any activity where impervious material(s) are removed, exposing underlying soil during construction. Redevelopment does not include routine maintenance activities, such as trenching and resurfacing associated with utility work; pavement grinding; resurfacing existing roadways, sidewalks, pedestrian ramps, or bike lanes on existing roads; and routine replacement of damaged pavement, such as pothole repair.</p>
<p>Required Retention Volume (RRV)</p>	<p>The Required Retention Volume (RRV) is the volume of rainfall that must be retained by tree wells in a DMA to meet flow control requirements. It is calculated by multiplying the Design Capture Volume (DCV) by a DCV multiplier.</p>
<p>Retrofitting</p>	<p>Storm Water management practice put into place after development has occurred in watersheds where the practices previously did not exist or are ineffective. Retrofitting of developed areas is intended to improve water quality, protect downstream channels, reduce flooding, or meet other specific objectives. Retrofitting developed areas may include, but is not limited to replacing roofs with green roofs, disconnecting downspouts or impervious surfaces to drain to pervious surfaces, replacing impervious surfaces with pervious surfaces, installing rain barrels, installing rain gardens, and trash area enclosures.</p>
<p>Retention (Retention BMPs)</p>	<p>A category of BMP that does not have any service outlets that discharge to surface water or to a conveyance system that drains to surface waters for the design event (i.e. 85th percentile 24-hour). Mechanisms used for storm water retention include infiltration, evapotranspiration, and use of retained water for non-potable or potable purposes.</p>

<p>Saturated Storage</p>	<p>Storage that provides a permanent volume of water at the bottom of the BMP as an anaerobic zone to promote denitrification and/or thermal pollution control. Also known as internal water storage or a saturation zone.</p>
<p>Self-mitigating Areas</p>	<p>A natural, landscaped, or turf area that does not generate significant pollutants and drains directly offsite or to the public storm drain system without being treated by a structural BMP. See Section 5.2.1.</p>
<p>Self-retaining DMA via Qualifying Site Design BMPs</p>	<p>An area designed to retain runoff to fully eliminate storm water runoff from the 85th percentile 24 hours storm event; See Section 5.2.3.</p>
<p>Significant Redevelopment</p>	<p>Redevelopment that meets the definition of a “PDP” in this manual. See Section 1.4.</p>
<p>Significant Site Design BMPs (SSD-BMPs)</p>	<p>Significant Site Design BMPs (SSD-BMPs) are Site Design BMPs that are sized and constructed to satisfy Structural Performance Standards for a Drainage Management Area (DMA). Examples of SSD-BMPs are tree wells and impervious area dispersion. SSD-BMPs may be credited in Worksheet B-1.1 of the BMP Design Manual to <i>fully</i> satisfy the Design Capture Volume (DCV) reductions and/or HMP reductions in a DMA.</p>
<p>Site Design BMPs</p>	<p>A storm water management and land development strategy that emphasizes conservation of natural features and the use of onsite natural features integrated with engineered, small-scale hydrologic controls to more closely reflect pre-development hydrologic functions. Site Design BMPs can be sized for Design Capture Volume (DCV) reductions using Worksheet B-1.1 of the BMP Design Manual for PDP projects (See Enhanced Site Design BMPs and Significant Site Design BMPs).</p>
<p>Sizing Factor Method</p>	<p>A method for designing flow control BMPs for hydromodification management using sizing factors developed from unit area continuous simulation models.</p>
<p>Sorption</p>	<p>Physical and/or chemical process where pollutants are taken out of runoff through attachment to another substance.</p>

<p>Source Control BMPs</p>	<p>Land use or site planning practices, or structures that aim to prevent runoff pollution by reducing the potential for contamination at the source of pollution. Source control BMPs minimizes the contact between pollutants and storm water runoff. Examples include roof structures over trash or material storage areas, and berms around fuel dispensing areas. Source control BMPs are described within this manual.</p>
<p>Standard Industrial Classification (SIC)</p>	<p>A Federal government system for classifying industries by 4-digit code. It is being supplanted by the North American Industrial Classification System but SIC codes are still referenced by the Regional Water Board in identifying development sites subject to regulation under the National Pollutant Discharge Elimination System permit. Information and an SIC search function are available at https://www.osha.gov/pls/imis/sicsearch.html.</p>
<p>Standard Project</p>	<p>Any development project that is not defined as a PDP by the MS4 Permit.</p>
<p>Storm Water Pollutant Control BMP</p>	<p>A category of storm water management requirements that includes treatment of storm water to remove pollutants by measures such as retention, biofiltration, and/or flow-thru treatment control, as specified in this manual. Also called a Pollutant Control BMP.</p>
<p>Structural BMP</p>	<p>Throughout the manual, the term "structural BMP" is a general term that encompasses the pollutant control BMPs and hydromodification BMPs required for PDPs under the MS4 Permit. A structural BMP may be a pollutant control BMP, a hydromodification management BMP, or an integrated pollutant control and hydromodification management BMP. Structural BMPs as defined in the MS4 Permit are: a subset of BMPs which detains, retains, filters, removes, or prevents the release of pollutants to surface waters from development projects in perpetuity, after construction of a project is completed.</p>

<p>Structural Performance Standards</p>	<p>Structural Performance Standards are numeric design standards for managing stormwater flows from Priority Development Project sites. Projects that are exempt from hydromodification management requirements must only satisfy the Pollutant Control Structural Performance Standard. All other projects must satisfy both the Pollutant Control Structural Performance Standard and the Hydromodification Management Structural Performance Standard. Both standards may be satisfied through a variety of design approaches, including Structural BMPs and Significant Site Design BMPs.</p>
<p>Subgrade</p>	<p>In-situ soil that lies underneath a BMP.</p>
<p>Tributary Area</p>	<p>The total surface area of land or hardscape that contributes runoff to the BMP; including any offsite or onsite areas that comingle with project runoff and drains to the BMP. Refer to Section 3.3.2 for additional guidance. Also termed the drainage area or catchment area.</p>
<p>Unified BMP Design Approach</p>	<p>This term refers to the standardized process for site and watershed investigation, BMP selection, BMP sizing, and BMP design that is outlined and described in this manual with associated appendices and templates. This approach is considered to be “unified” because it represents a pathway for compliance with MS4 Permit requirements that is anticipated to be reasonably consistent across the local jurisdictions in San Diego County. In contrast, applicants may choose to take an alternative approach where they demonstrate to the satisfaction of the Copermittee, in their submittal, compliance with applicable performance standards without necessarily following the process identified in this manual.</p>
<p>Upper Flow Threshold</p>	<p>The upper limit of the range of flows to be controlled for hydromodification management. For the San Diego region, the upper flow threshold must be the pre-development 10-year flow rate (Q10) based on continuous simulation modeling.</p>
<p>Vector</p>	<p>Refers to a sewer or storm drain cleaning truck equipped to remove materials from sewer or storm drain pipes or structures, including some storm water BMPs.</p>
<p>Vector</p>	<p>An animal or insect capable of transmitting the causative agent of human disease. An example of a vector in San Diego County that is of concern in storm water management is a mosquito.</p>

<p>Water Quality Improvement Plan (WQIP)</p>	<p>Copermittees are required to develop a Water Quality Improvement Plan (WQIP) for each Watershed Management Area in the San Diego Region. The purpose of the Water Quality Improvement Plans is to guide the Copermittees’ jurisdictional runoff management programs towards achieving the outcome of improved water quality in MS4 discharges and receiving waters. WQIPs requirements are defined in the MS4 Permit provision B.</p>
<p>Waters of the United States</p>	<p>Surface bodies of water, including naturally occurring wetlands, streams (perennial, intermittent, and ephemeral (exhibiting bed, bank, and ordinary high water mark)), creeks, rivers, reservoirs, lakes, lagoons, estuaries, harbors, bays and the Pacific Ocean which directly or indirectly receive discharges from storm water conveyance systems. The Copermittee must determine the definition for wetlands and the limits thereof for the purposes of this definition, which must be as protective as the Federal definition utilized by the United States Army Corps of Engineers and the United States Environmental Protection Agency. Constructed wetlands are not considered wetlands under this definition, unless the wetlands were constructed as mitigation for habitat loss. Other constructed BMPs are not considered receiving waters under this definition, unless the BMP was originally constructed within the boundaries of the receiving waters. Also see MS4 permit definition.</p>
<p>Watershed Management Area</p>	<p>The ten areas defined by the SDRWQCB in Regional MS4 Permit provision B.1, Table B-1. Each Watershed Management Area is defined by one or more Hydrologic Unit, major surface water body, and responsible Copermittee.</p>
<p>Watershed Management Area Analysis</p>	<p>For each Watershed Management Area, the Copermittees have the option to perform a WMAA for the purpose of developing watershed-specific requirements for structural BMP implementation. Each WMAA includes: GIS layers developed to provide physical characteristics of the watershed management area, a list of potential offsite alternative compliance projects, and areas exempt from hydromodification management requirements.</p>

This page was intentionally left blank