

Geotechnical Feasibility Investigation
Tentative Tract 31210

**GEOTECHNICAL FEASIBILITY INVESTIGATION
TENTATIVE TRACT MAP NO. 31210
±134-ACRE PARCEL, HORSETHIEF CANYON AREA
RIVERSIDE COUNTY, CALIFORNIA**

FOR

**RENAISSANCE RANCH, LLC
2102 BUSINESS CENTER DRIVE, SUITE 149
IRVINE, CALIFORNIA 92612**

W.O. 3441-A-SC

APRIL 28, 2003

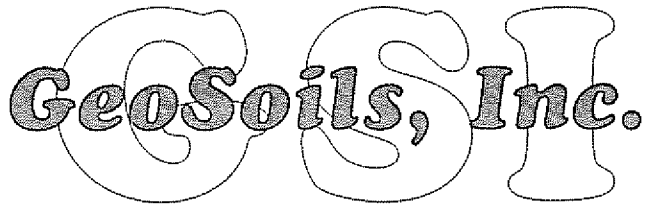

Geotechnical • Geologic • Environmental

26590 Madison Avenue • Murrieta, California 92562 • (909) 677-9651 • FAX (909) 677-9301

April 28, 2003

W.O. 3441-A-SC

Renaissance Ranch, LLC
2102 Business Center Drive, Suite 149
Irvine, California 92612

Attention: Mr. David Schaffer

Subject: Geotechnical Feasibility Investigation, Tentative Tract Map No. 31210,
±134-Acre Parcel, Horsethief Canyon Area, Riverside County, California

Dear Mr. Schaffer:

In accordance with your request and authorization, GeoSoils, Inc., (GSI), is providing the results of our feasibility level geotechnical investigation of the subject site. The purpose of the study was to evaluate the onsite soils and geologic conditions and their effects on the proposed development from a geotechnical point of view. In particular, the primary purpose of our study was to evaluate subsurface conditions with respect to development and provide preliminary remedial removal depths, slope stability analyses, etc., based on current standards of practice. A secondary purpose of this study was to provide preliminary geotechnical foundation design parameters, and general earthwork and grading guidelines, in light of site geotechnical conditions.

EXECUTIVE SUMMARY

Based on our review of data (Appendix A), field exploration, laboratory testing, and geologic and engineering analyses, the proposed project appears suitable for its intended residential use, from a geotechnical viewpoint, provided the recommendations presented in the text of this report are implemented. The primary developmental considerations are summarized below:

- Removal of all artificial fill, colluvium/topsoil, younger alluvium, and near surface weathered Quaternary fan deposits (Pleistocene-age alluvial fans) will be necessary prior to fill placement, in areas proposed for development. Approximate depths of removals are outlined in the conclusions and recommendations section of this report. For preliminary planning purposes, these depths are estimated to be on the

order of ± 2 to ± 10 feet (hilltops and side slopes, respectively) and from ± 4 to ± 30 feet deep, or deeper, in the younger alluvial deposits in the incised canyon areas proposed for development.

- Based on the extremely dense, and locally cemented, nature of the Quaternary fan deposits (Pleistocene-age alluvial fans) that underlie the site at depth, laboratory testing, and our liquefaction screening process (as per Special Publication 117) the potential for liquefaction, after grading within areas proposed for development, is considered very low.
- Based on sampling, laboratory testing, and our slope stability analyses (Appendix E), the proposed 2:1 (horizontal to vertical) cut and fill slopes are considered grossly and superficially stable; however, the need for stabilization fills for cohesionless sand lenses, or other adverse geologic features within the Quaternary fan deposits (Pleistocene-age alluvial fans), may not be totally precluded.
- Based on our subsurface investigation and field reconnaissance mapping, abundant amounts of organic material (i.e., tree remains) are stockpiled and/or exist across localized areas of the site. The organic materials, including all rootball structures (stumps), should be removed and exported offsite. Observation by representatives of GSI should be conducted to verify the organic materials have been properly removed from areas proposed for settlement sensitive improvements.
- Our experience from grading of projects in similar terrain indicates that conventional earthmoving equipment should be able to excavate the majority of the Quaternary fan deposits (Pleistocene-age alluvial fans) within planned excavation areas; however, due to the nature of the site materials, it is likely that some oversized rock materials will be generated during grading. This may necessitate the construction of rock fills or rock fill blankets during grading. Such procedures are outlined in the Fill Placement and Rock Disposal sections of this report.
- As per Riverside County requirements, settlement monitoring will need to be conducted for engineered fill areas in excess of 50 feet in thickness. Settlement monitoring is estimated, at this time, to take place for a time period of approximately six to eight months, or possibly less, based on the settlement data obtained. It should also be noted that the County requires basal fill materials below or thicker than an engineered fill depth of 50 feet (including removals), to be compacted to 95 percent of the laboratory standard.
- Based on laboratory testing, for preliminary planing purposes, the expansion potential of the onsite soils is generally considered to be very low, however soils with medium expansive potentials may not be precluded. Preliminary foundation recommendations for conventional and post-tension design are provided herein.

- Typical samples of the site materials have been analyzed for soluble sulfate/corrosion potential. Based on testing, the use of sulfate resistant concrete is not anticipated at this time. However, based on the test results, the onsite soils are considered mildly to moderately corrosive to ferrous metals in a saturated state. Accordingly, consideration should be given to consulting with a corrosion engineer to provide specific recommendations.
- In general and based upon the available data to date, groundwater is not expected to be a factor in the development of the site. However, due to the nature of the site materials, seepage may be encountered throughout the site along with seasonal perched water within existing canyon drainage areas, and also may be encountered in "daylighted" bedding within the Quaternary fan deposits (Pleistocene-age alluvial fans). Thus, subdrain systems are recommended within canyon areas, where filled, and as encountered during grading. In addition, subdrainage systems for the control of localized groundwater seepage should be anticipated subsequent to grading as a result of excess irrigation or precipitation. Preliminary subdrain locations are provided herein (see Plate 1).
- Evidence of significant mass wasting (i.e, landsliding, lateral spreads, etc.) was not noted during our review of aerial photographs, or during our site reconnaissance and geologic mapping. However, small localized earth failures (i.e., slumps, slopewash, etc.), were noted on the existing slopes/cliffs associated with the incised canyon drainage courses, in the north-northeastern portion of the site. These small slumps are anticipated to lie outside of the areas proposed for residential development, and/or will be completely removed by the proposed grading; and as such, should not pose a major constraint to development. Should such features exist in natural or cut slopes above the proposed residential development, and not be removed by the proposed grading, then debris or impact walls should be considered by the design engineer where these features intercept the proposed development and/or cut slopes. The actual location and need for such devices would best be evaluated at the 40-scale plan stage, when design grades are semi-finalized or finalized.
- Our review indicates no known active faults are crossing the site, and the site is not within an Alquist-Priolo Earthquake Fault Zone, nor is it within a liquefaction zone established by the County of Riverside or State of California.
- Adverse geologic features that would preclude project feasibility were not encountered.
- The recommendations presented in this report should be incorporated into the planning, design, and construction considerations of the project.

The opportunity to be of service is sincerely appreciated. If you should have any questions, please do not hesitate to contact our office.

Respectfully submitted

GeoSoils, Inc.

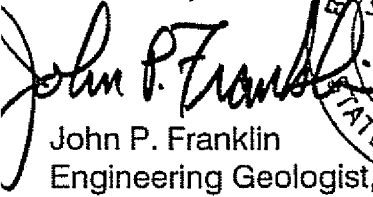

John P. Franklin
Engineering Geologist, SEG 1340

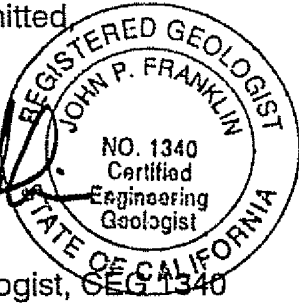

Reviewed by:



Ben Shahrini
Geotechnical Engineer, GE 2296



TAG/JPF/BS/jk

Distribution: (6) Addressee

TABLE OF CONTENTS

SCOPE OF SERVICES	1
SITE DESCRIPTION	1
PROPOSED DEVELOPMENT	3
FIELD STUDIES	3
GEOLOGY	3
Regional Geologic Setting	3
Site Geology	4
GEOLOGIC UNITS	4
Artificial Fill - Undocumented (Map Symbol - Afu)	4
Artificial Fill - Engineered (Map Symbol - Afe)	5
Colluvium/Topsoil - (Not Mapped)	5
Alluvium - younger (Map Symbol - Qal)	5
Quaternary Fan Deposits -older [Pleistocene-Age Alluvial Fans]- (Map Symbol - Qof)	6
FAULTING AND REGIONAL SEISMICITY	6
Lineament Analysis	10
Seismic Shaking Parameters	10
SUBSURFACE WATER	10
LIQUEFACTION POTENTIAL	11
SUBSIDENCE	12
OTHER GEOLOGIC HAZARDS	12
LABORATORY TESTING	13
Classification	13
Moisture Density	13
Laboratory Standard	13
Expansion Potential	13
Soluble Sulfates/Corrosion	14
Consolidation Testing	15
Shear Testing	15
PRELIMINARY EARTHWORK FACTORS	15

CONCLUSIONS AND RECOMMENDATIONS	15
General	16
Demolition/Grubbing	17
Treatment of Existing Ground	17
Fill Placement	18
Slope Considerations and Slope Design	19
Transition and Overexcavation Areas	20
Preliminary Foundation Settlements	20
Settlement Evaluation	21
Rock Disposal	22
Materials 8 Inches in Diameter or Less	22
Materials Greater Than 8 and Less Than 36 Inches in Diameter	23
Materials Greater Than 36 Inches in Diameter	23
PRELIMINARY RECOMMENDATIONS - FOUNDATIONS	24
General	24
Conventional Foundation Design	24
FOUNDATION CONSTRUCTION	25
Expansion Classification - Low (E.I. 21 to 50)	25
Expansion Classification - Medium (E.I. 51 to 90)	27
PRELIMINARY POST-TENSIONED SLAB DESIGN	28
Post-Tensioning Institute Method	29
Slope Setback Considerations for Footings	30
CONVENTIONAL RETAINING WALLS	30
Restrained Walls	30
Cantilevered Walls	31
Wall Backfill and Drainage	31
Footing Excavation Observation	31
Transition Conditions - Retaining	32
DEVELOPMENT CRITERIA	32
Graded Slope Maintenance and Planting	32
Drainage	32
Site Improvements	33
Trenching	33
Footing Trench Excavation	33
Utility Trench Backfill	33
Appurtenant Structures	34
PLAN REVIEW	34
INVESTIGATION LIMITATIONS	35

FIGURES:

Figure 1 - Site Location Map 2
Figure 2 - California Fault Map 9

ATTACHMENTS:

Appendix A - References Rear of Text
Appendix B - Boring and Test Pit Logs Rear of Text
Appendix C - EQFAULT Data Rear of Text
Appendix D - Laboratory Test Results Rear of Text
Appendix E - Slope Stability Analyses Rear of Text
Appendix F - General Earthwork and Grading Guidelines Rear of Text
Plate 1 - Geotechnical Map Rear of Text in Pocket
Plate 2 - Geologic Cross-Section Behind Pocket

**GEOTECHNICAL FEASIBILITY INVESTIGATION
TENTATIVE TRACT MAP NO. 31210
±134-ACRE PARCEL, HORSETHIEF CANYON AREA
RIVERSIDE COUNTY, CALIFORNIA**

SCOPE OF SERVICES

The scope of our services has included the following:

1. Review of available soils and geologic data for the site area, including previous geotechnical reports in the site area (see Appendix A).
2. Geologic site reconnaissance and geologic mapping of significant geologic structures and surficial deposits (see Plate 1).
3. Subsurface exploration consisting of three hollow stem auger borings and 30 exploratory test pits, advanced into the younger alluvial materials and Quaternary fan deposits (Pleistocene-age alluvial fans), for geotechnical logging and sampling (see Appendix B).
4. General areal seismicity evaluation (see Appendix C).
5. Pertinent laboratory testing of representative soil samples collected during our subsurface exploration program. Testing included in-situ moisture and density, maximum density testing, shear, consolidation, soluble sulfate, corrosion analysis, and expansion index testing of the materials encountered during our field studies. Results of our laboratory testing are provided in Appendix D.
6. Geologic and engineering analysis of the data collected, including a liquefaction evaluation. Geologic cross-sections are provided on Plate 2.
7. Appropriate engineering and geologic analyses of data collected, and preparation of this report and accompaniments.

SITE DESCRIPTION

Tentative Tract 31210 is an irregular shaped parcel generally located south of Interstate Highway 15, east of Horsethief Canyon Road, west of relatively undeveloped land, and north of residential development (i.e., Horsethief Canyon Ranch), in the Horsethief Canyon area, Riverside County, California (see Figure 1, Site Location Map). Topographically, the upper (southwestern) portion of the site is relatively flat lying, the lower (north-northeastern) portion of the site is dominated by moderately steep terrain with incised drainage canyons. Elevations generally decrease from the southwest to the northeast, ranging from 1,420 Mean Sea Level (MSL) to 1,180 MSL, for a total relief of approximately 240 feet. Drainage is generally to the north-northeast and is accommodated by relatively steep drainage canyons, outletting to Temescal Creek. Other than an existing gun club and associated dog kennel facility, located in the central portion of the site, the project site

GeoSoils, Inc.

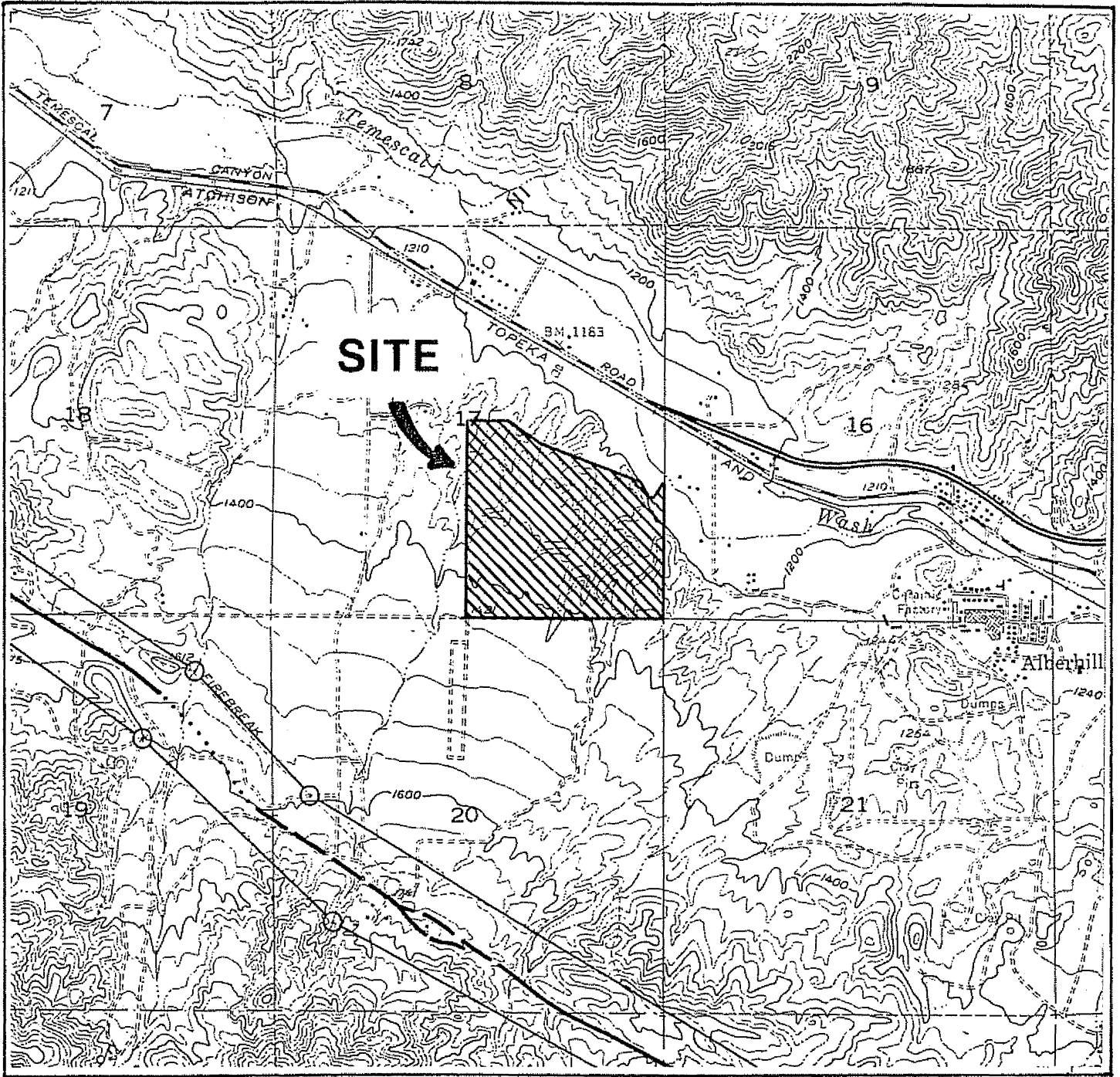

Base Map: Alquist-Priolo Earthquake Fault Zones, 7.5 minute, Alberhill Quadrangle, topographic base USGS 1954, photorevised 1973.

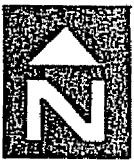

	W.O. 3441-A-SC
<h2>SITE LOCATION MAP</h2>	

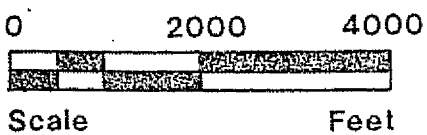

Figure 1

is generally undeveloped. Vegetation consists of chaparral and other native shrubs and grasses, with scattered trees associated with previous citrus groves onsite.

PROPOSED DEVELOPMENT

The 100-scale tentative tract map, dated April 9, 2003, by Hall & Forman, Inc., indicates that typical cut and fill grading techniques would be utilized to prepare the site for construction of approximately ± 330 residential building pads, with associated infrastructure and underground utility improvements. It is our understanding that rough grading will create fill and cut slopes designed at inclinations of 2:1 (horizontal to vertical) or flatter, up to about ± 70 and ± 50 feet high, respectively. Maximum proposed cut and fill thicknesses are on the order of ± 50 feet and ± 80 feet, respectively. It is also our understanding that the residential buildings would be one- and/or two-story structures, utilizing typical wood-frame construction with slabs-on-grade and continuous footings and/or utilizing post tensioned foundations. Building loads are assumed to be typical for this type of relatively light construction. Sewage disposal is assumed to be accommodated by tying into the regional municipal system. The need for import soils is unknown at this time.

FIELD STUDIES

As indicated above, field studies conducted during our evaluation of the property for this investigation consisted of geologic reconnaissance mapping, excavation of three hollow stem borings, and 30 exploratory test pits throughout the site, for evaluation of near-surface soil and geologic conditions. Field exploration was performed on January 23 and February 4, 2003. The borings and test pits were logged by staff from our firm who collected representative bulk and undisturbed soil samples for appropriate laboratory testing. The logs of the borings and test pits are presented in Appendix B. Approximate locations of the exploratory borings and test pits are presented on Plate 1 (Geotechnical Map).

GEOLOGY

Regional Geologic Setting

The site is located on the western margin of the Perris Block, a portion of a prominent natural geomorphic province in southwestern California known as the Peninsular Range. The Peninsular Range is characterized by steep, elongated ranges and valleys that trend northwesterly. The Santa Ana Mountains lie along the western side of the Elsinore fault zone, and the Perris Block is located along the eastern side of the fault zone. This province is typified by plutonic and metamorphic rocks (bedrock) which comprise the majority of the mountain masses, with relatively thin volcanic and sedimentary deposits discontinuously

overlying the bedrock, and with Plio/Pleistocene-aged to older Quaternary-aged alluvial fan deposits filling in the valleys and younger alluvium filling in the incised drainages. The alluvial deposits are derived from the water borne deposition of the products of weathering and erosion of the bedrock.

Site Geology

In general, the site may be characterized as being underlain at depth by late Pleistocene-age fan deposits (Webber, 1977). The late Pleistocene-age fan deposits are generally flat lying, undeformed, incised, and are regionally distinguished from Holocene deposits by the presence of rubified pedogenic soils. The deposits also tend to be better consolidated, slightly to moderately cemented, and less permeable than Holocene sediments, due to advanced sediment compaction and redistribution of binding agents such as clays and silicates. These late Pleistocene-age alluvial fan deposits are preserved as dissected remnants of old uplifted alluvial fans and as terrace deposits situated tens of feet above modern stream courses.

Localized areas of undocumented fill, documented engineered fill, younger alluvial deposits, and colluvium/topsoil mantle the Quaternary fan deposits onsite. As used in this report, the term colluvium refers to undifferentiated surficial deposits, excluding the younger alluvial deposits and artificial fill (documented and undocumented). The earth materials are generally described below from youngest to oldest, and their limits, based on the available data, are indicated on Plate 1.

GEOLOGIC UNITS

The geologic units encountered during our investigation within the project site consist of undocumented artificial fill, colluvium/topsoil, younger alluvium, and Quaternary fan deposits (Pleistocene-age fans). The approximate limits of the mappable units are presented on Plate 1. These units are described, from youngest to oldest, as follows:

Artificial Fill - Undocumented (Map Symbol - Afu)

Locally observed in many locations across the site, were areas of undocumented artificial fill materials. The undocumented fill, locally up to ± 1 to ± 10 feet in thickness (roadway fills), has been placed during previous agricultural operations (i.e., citrus groves). Due to the potentially compressible nature of these soils/materials, they are considered unsuitable for support of structures and/or improvements in their existing state. Clean fill materials may be reused for compacted fills provided that any organic materials have been removed and they have been approved by the geotechnical engineer prior to placement. Concentrated roots, stumps, and other organic materials will be need to be removed from the site, prior to grading, should settlement sensitive improvements be proposed within their influence.

Artificial Fill - Engineered (Map Symbol - Afe)

Localized areas of engineered artificial fill, associated with existing fill slopes, descend to the property on the western and southern perimeters of the site. The fill slopes, up to 10 feet in height onsite, appear to have been constructed during grading of the adjacent residential development (i.e., Horsethief Canyon Ranch). Documentation for these slopes (i.e., a geotechnical report from others) should be obtained in order to verify their suitability, prior to onsite grading, in the affected areas. The slopes should also be observed and tested during future grading to assure that a proper keyway and compaction were attained during construction of the fill slopes. The upper ± 1 to ± 2 feet of the engineered fill is extremely weathered, and erosional rills are common; therefore, these weathered surficial soils are considered unsuitable for support of structures and/or improvements in their existing state. Therefore, these soils will be need to be removed and recompacted, if not removed during planned excavation, should settlement sensitive improvements be proposed within their influence, and proper documentation is not provided.

Colluvium/Topsoil - (Not Mapped)

Colluvium/topsoil was observed in our subsurface investigation mantling the Quaternary fan deposits throughout the site. These soils were generally observed to be approximately ± 1 to ± 4 feet in thickness. The colluvium/topsoil varied from yellowish to reddish brown, medium to dark brown, silty to clayey sands. The colluvium/topsoil was generally non-uniform, dry to locally damp, and loose/soft. These soils typically have a very low to low expansion potential; however, some clayey factions may have a medium expansion potential. Due to the potentially compressible nature of these soils, they are considered unsuitable for support of structures and/or improvements in their existing state. Therefore, these soils will be need to be removed and recompacted, if not removed during planned excavation, should settlement sensitive improvements be proposed within their influence.

Alluvium - younger (Map Symbol - Qal)

Quaternary alluvial sediments were encountered in the incised drainage channels/canyons on the north-northeastern portion of the site (see Plate 1). These sediments were generally observed to be predominantly light to dark brown, silty, fine- to coarse-grained sands and silty sands. The alluvial sediments varied from dry to damp, and were generally loose to medium dense with depth. Where encountered, these sediments generally ranged from ± 4 to ± 30 feet in thickness, in the areas proposed for development. The alluvium typically has a very low expansion potential. Due to the potentially liquefiable, compressible, and collapsible nature of these soils, they are considered unsuitable for support of structures and/or improvements in their existing state and therefore, will be need to be removed and recompacted, in areas proposed for development.

Quaternary Fan Deposits -older [Pleistocene-Age Alluvial Fans]- (Map Symbol - Qof)

Quaternary alluvial fan deposits (Pleistocene-age alluvial fans) were encountered underlying the fill, colluvium/topsoil, and younger alluvial soils onsite. These sediments were generally observed to be generally medium to reddish brown, silty to clayey fine- to coarse-grained sands and sandy gravels with locally abundant cobbles and boulders. The cobbles and boulders were generally granitic, well rounded to sub-rounded and highly weathered (grussified); however, localized areas of intact non-weathered cobbles and boulders were encountered. These deposits are mapped as late Pleistocene-age by Webber (1977). The sediments generally varied from dry to damp, and ranged from medium dense to very dense with depth. As encountered onsite, the fan deposits typically have a very low expansion potential; however, some clayey factions may have a medium expansion potential. Due to the potential for settlement, near surface weathered fan deposits should be removed and/or processed prior to compacted fill placement, if not removed by planned excavation, should settlement sensitive improvements be proposed within their influence.

FAULTING AND REGIONAL SEISMICITY

The project area is situated in Southern California, which is in an area of active faulting. The nearby Elsinore fault zone (design fault for the site) is considered active and is included within Alquist-Priolo Earthquake Fault Zone. Our review indicates that there are no known active faults crossing the site, and the site is not within an Alquist-Priolo Earthquake Fault Zone.

The following table lists the major faults and fault zones in southern California, within 100 km of the site, that could have a significant effect on the site should they experience activity. In addition, the approximate distance and estimated magnitude of the individual faults are also included. The site latitude and longitude is approximately: 33.7313° N by 177.4203° W.

ABBREVIATED FAULT NAME	APPROXIMATE DISTANCE MILES (KM)	FAULT MAGNITUDE
Chino - Central Ave. (Elsinore)	10.8 (17.4)	6.7
Clamshell - Sawpit	42.8 (68.9)	6.5
Cleghorn	38.2 (61.5)	6.5
Compton Thrust	32.7 (52.7)	6.8
Coronado Bank - Auga Blanca	43.2 (69.6)	7.4
Cucamonga	31.0 (49.9)	7.0

ABBREVIATED FAULT NAME	APPROXIMATE DISTANCE MILES (KM)	FAULT MAGNITUDE
Elsinore - Gen Ivy	1.4 (2.3)	6.8
Elsinore - Julian	33.9 (54.5)	7.1
Elsinore - Temecula	7.4 (11.9)	6.8
Elysian Park Seismic Zone	29.6 (47.7)	6.7
Helendale - S. Lockhardt	54.3 (87.4)	7.1
Hollywood	53.7 (86.4)	6.5
Newport - Inglewood - (L.A. Basin)	30.3 (48.7)	6.9
Newport - Inglewood - Offshore	26.5 (42.7)	6.9
North Frontal Fault Zone (East)	49.5 (79.6)	6.7
North Frontal Fault Zone (West)	38.6 (62.1)	7.0
Palos Verdes	41.3 (66.4)	7.1
Pinto Mountain	46.0 (74.0)	7.0
Raymond	45.1 (72.6)	6.5
Rose Canyon	41.6 (66.9)	6.9
San Andreas - 1857 Rupture	40.5 (65.2)	7.8
San Andreas - Cochella	56.2 (90.4)	7.1
San Andreas - Mojave	40.5 (65.2)	7.1
San Andreas - San Bernardino	32.0 (51.5)	7.3
San Andreas - Southern	32.0 (51.5)	7.4
San Jacinto - Anza	29.0 (46.6)	7.2
San Jacinto - Coyote Creek	55.7 (89.7)	6.8
San Jacinto - San Bernardino	22.0 (35.4)	6.7
San Jacinto - San Jacinto Valley	21.4 (34.4)	6.9
San Jose	30.2 (48.6)	6.5
Santa Monica	61.7 (99.3)	6.6
Sierra Madre	32.7 (52.6)	7.0
Sierra Madre (San Fernando)	62.8 (101.1)	6.7
Verdugo	50.4 (81.1)	6.7
Whittier	15.0 (24.2)	6.8

The relationship of the site to these major mapped faults is indicated on Figure 2 (California Fault Map). Other faults have been mapped in the Temecula/Murrieta region; however, these faults are shorter, and hence are generally considered less likely to produce significant seismic events.

The possibility of ground shaking at the site may be considered similar to the southern California region as a whole. The acceleration-attenuation relations of Sadigh (1997), Bozorgnia, Campbell, and Niazi (1999), and Campbell and Bozorgnia (1994 and 1997) have been incorporated into EQFAULT (Blake, 2000a). For this study, peak horizontal ground accelerations anticipated at the site were determined based on the mean and mean plus 1 - sigma attenuation curves developed by those investigators. These acceleration-attenuation relations have been incorporated into EQFAULT (Blake, 2000a), a computer program which performs deterministic seismic hazard analyses using up to 183 digitized California faults as earthquake sources.

The program estimates the closest distance between each fault and a given site. If a fault is found to be within a user-selected radius, the program estimates peak horizontal ground acceleration that may occur at the site from the "upper bound" or "maximum credible" earthquakes on that fault. Site acceleration (g) is computed by any of at least 30 user-selected acceleration-attenuation relations that are contained in EQFAULT. Based on the EQFAULT program, peak horizontal ground accelerations from an upper bound event at the site may be on the order of 0.46g to 0.72g. The computer printouts of portions of the EQFAULT program are included within Appendix C.

Historical site seismicity was evaluated with the acceleration-attenuation relations of Campbell (1997) and the computer program EQSEARCH (Blake, 2000b). This program was utilized to perform a search of historical earthquake records for magnitude 5.0 to 9.0 seismic events within a 100 mile radius, between the years 1800 to 2002. Based on the selected acceleration-attenuation relation, a peak horizontal ground acceleration has been estimated, which may have affected the site during the specific seismic events in the past. Based on the available data and attenuation relationship used, the estimated maximum (peak) site acceleration during the period 1800 to 2002 was 0.53g. In addition, a seismic recurrence curve is also estimated/generated from the historical data (see Appendix C).

A probabilistic seismic hazards analyses was performed using FRISKSP (Blake, 2000c) which models earthquake sources as 3-D planes and evaluates the site specific probabilities of exceedance for given peak acceleration levels or pseudo-relative velocity levels. Based on a review of these data, and considering the relative seismic activity of the southern California region, a peak horizontal ground acceleration of 0.65g was calculated. This value was chosen as it corresponds to a 10 percent probability of exceedance in 50 years (or a 475-year return period). Computer printouts of the FRISKSP program are included in Appendix C.

CALIFORNIA FAULT MAP

Horsethief Canyon

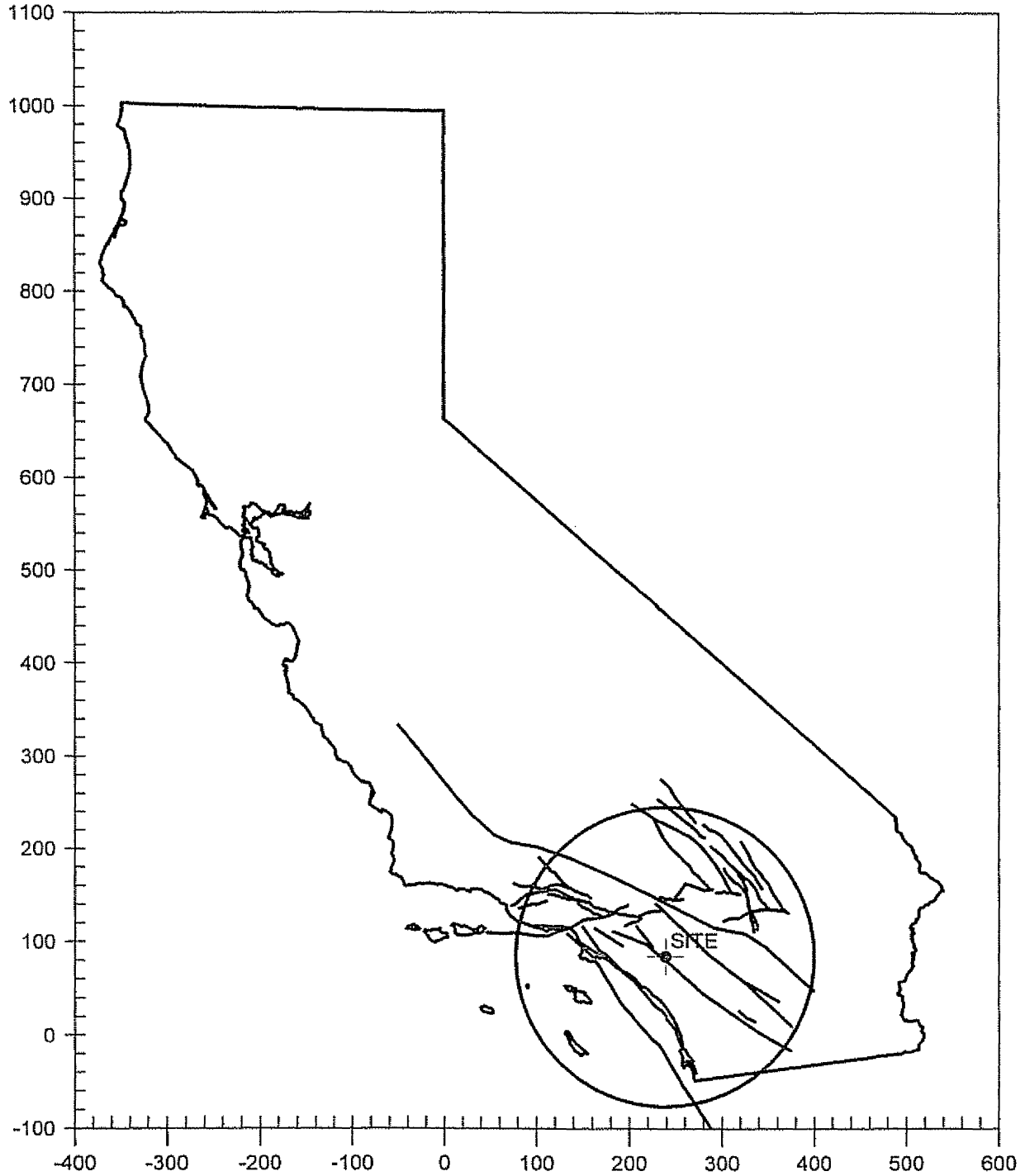

Figure 2

Lineament Analysis

In order to identify possible unmapped faults, identify possible fissures, and to evaluate topographic expressions of nearby published fault and lineament traces, a lineament analysis was performed. As indicated previously, stereoscopic "false-color" infrared aerial photographs (United State Department of Agriculture, 1980) at a scale of approximately 1:40,000 were utilized in our lineament analysis. Lineaments are classified according to their development as strong, moderate, or weak. A strong lineament is a well defined feature that can be continuously traced several hundred feet to a few thousand feet. A moderate lineament is less well defined, somewhat discontinuous, and can be traced for only a few hundred feet. A weak lineament is discontinuous, poorly defined, and can be traced for a few hundred feet or less. No lineaments were observed transecting the site based on the aerial photographs reviewed for this study.

Seismic Shaking Parameters

Based on the site conditions, Chapter 16 of the Uniform Building Code (UBC, International Conference of Building Officials, 1997), the following seismic parameters are provided.

Seismic zone (per Figure 16-2*)	4
Seismic zone factor Z (per Table 16-I*)	0.40
Soil Profile Types (per Table 16-J*)	S _D
Seismic Coefficient C _a (per Table 16-Q*)	0.44 N _a
Seismic Coefficient C _v (per Table 16-R*)	0.64 N _v
Near Source factor N _a (per Table 16-S*)	1.25
Near Source factor N _v (per Table 16-T*)	1.55
Distance to Seismic Source (Elsinore - Glen Ivy)	1.4 mi. (2.3 km)
Seismic Source Type (per Table 16-U*)	B
Upper Bound Earthquake (Elsinore - Glen Ivy)	M _w 6.8
* Figure and table references from Chapter 16 of the Uniform Building Code (1997).	

SUBSURFACE WATER

Subsurface water was not encountered in any of the excavations completed during this study. However, based on information provided by the California Department of Water Resources (CDWR), water data library (see Appendix A), historic high groundwater levels in other nearby wells are reported to range between ±24 feet to ±41 feet below the ground

surface. These wells appear to be located in nearby alluvial valleys, and based on the site's topographic relief and drilling conducted onsite, groundwater is reasonably estimated to be below ± 50 feet in depth, in the areas proposed for development. These observations reflect site conditions at the time of our investigation and do not preclude changes in local groundwater conditions in the future from heavy irrigation, precipitation, or other factors not obvious at the time of our field work. It should be noted however, that groundwater may occur in the alluvium and fan deposits, or along fractures and joints due to migration from adjacent developments and/or during and after periods of above normal or heavy precipitation. Groundwater conditions will also be further evaluated during site grading. Additional discussions of groundwater are presented within the conclusions section of this report.

LIQUEFACTION POTENTIAL

Seismically-induced liquefaction is a phenomenon in which cyclic stresses, produced by earthquake-induced ground motion, create excess pore pressures in soils. The soils may thereby acquire a high degree of mobility, and lead to lateral movement, sliding, sand boils, consolidation and settlement of loose sediments, and other damaging deformations. This phenomenon occurs only below the water table; but after liquefaction has developed, it can propagate upward into overlying, non-saturated soil as excess pore water dissipates. Typically, liquefaction has a relatively low potential at depths greater than 45 feet and is virtually unknown below a depth of 60 feet.

The condition of liquefaction has two principal effects. One is the consolidation of loose sediments with resultant settlement of the ground surface. The other effect is lateral sliding. Significant permanent lateral movement generally occurs only when there is significant differential loading, such as fill on natural ground slopes. Liquefaction susceptibility is related to numerous factors and the following conditions should be present for liquefaction to occur: 1) sediments must be relatively young in age and not have developed a large amount of cementation; 2) sediments generally consist of medium to fine grained, relatively cohesionless sands; 3) the sediments must have low relative density; 4) free groundwater must be present in the sediment; and 5) the site must experience a seismic event of a sufficient duration and magnitude, to induce straining of soil particles.

It should be noted that throughout our site observations, and subsurface investigation, there was no evidence of upward-directed hydraulic force that was suddenly applied, and was of short duration, nor were there any features commonly caused by seismically induced liquefaction, such as dikes, sills, vented sediments, lateral spreads, or soft-sediment deformation. In addition, mottled soils were not noted during our subsurface investigation, which also indicates the absence of high groundwater levels historically. These features would be expected if the site area had been subject to liquefaction in the past (Obermeier, 1996). Inasmuch as the future performance of the site with respect to liquefaction should be similar to the past, excluding the effects of urbanization (irrigation),

GSI concludes that the site generally has not been subject to liquefaction in the geologic past, regardless of the depth of the localized water table.

Inasmuch as, after rough grading operations, three or four of these five conditions will not have the potential to affect the site and the entire site is underlain at depth by very dense, weakly to moderately cemented, Pleistocene-age alluvial fan deposits. All younger alluvial soils, in areas proposed for development, will be mitigated by complete remedial removals. Our evaluation and general liquefaction screening process (pursuant to Special Publication 117) indicates that the potential for liquefaction and associated adverse effects within the site is very low, even with a future rise in groundwater levels.

SUBSIDENCE

Our review of the available literature did not indicate that the site area is subsiding due to down-faulting along bordering fault zones, groundwater withdrawal, or hydrocompaction. Our field investigations and review of aerial photographs showed no features generally associated with areal subsidence (i.e., radially-directed drainages flowing into depressions, linearity of depressions associated with mountain fronts, or ground fissures). Ground fissures are generally associated with excessive groundwater withdrawal and associated subsidence, or regional neotectonics. Our review did not indicate that excessive groundwater withdrawal in the site vicinity is occurring at this time, and faults are not known to transect the property. As such, and given the dense nature of the Quaternary fan deposits, regional groundwater withdrawal is not anticipated to adversely impact the site.

Local ground subsidence may occur over the site because of equipment working (vibrations). Such subsidence depends upon the equipment used and on the dynamic effects of the equipment. Given that the site is underlain by Quaternary fan deposits, the amount of such subsidence would be minimal. We estimate that local ground subsidence due to vibration/loading during grading would be less than 0.15 feet, but will depend on haul routes, etc.

OTHER GEOLOGIC HAZARDS

Mass wasting refers to the various processes by which earth materials are moved down slope in response to the force of gravity. Indications of deep-seated landsliding, slope creep, or significant surficial failures on the site were not observed during our site reconnaissance and geologic mapping. However, small localized features (i.e., slumps, slopewash, etc.), were noted on the existing slopes/cliffs associated with the incised canyon drainage courses, in the north-northeastern portion of the site. These small slumps are anticipated to lie outside of the areas proposed for residential development, and/or will be completely removed by the proposed grading, and as such, should not pose a major constraint to development. Should such features exist in natural or cut slopes above the

proposed residential development, and not be removed by the proposed grading, then debris or impact walls should be considered by the design engineer, where these features intercept the proposed development and/or cut slopes. The actual location and need for such devices would best be evaluated at the 40-scale plan stage, when design grades are semi-finalized or finalized.

LABORATORY TESTING

Classification

Soils were classified visually according to the Unified Soils Classification System. The soil classifications are shown on the Boring and Test Pit Logs, Appendix B; and the Laboratory Test Results are presented in Appendix D.

Moisture Density

The field moisture contents and dry unit weights were determined for undisturbed ring samples for the soils encountered in the exploratory borings and test pits. The dry unit weight was determined in pounds per cubic foot and the field moisture content was determined as a percentage of the dry unit weight. The results of these tests are shown on the Boring and Test Pit Logs (Appendix B).

Laboratory Standard

The maximum density and optimum moisture content was determined for the major soil types encountered in the exploratory borings and test pits. The laboratory standard used was ASTM D-1557. The moisture-density relationship obtained for the site soils are shown below:

SOIL TYPE	LOCATION & DEPTH (FT.)	MAXIMUM DRY DENSITY (PCF)	OPTIMUM MOISTURE CONTENT (%)
Silty SAND w/clay, light brown (Fan Deposits)	TP-1 @ 3'-5'	127.5	11.0
Sandy SILT, brown (Colluvium/Topsoil)	TP-15 @ 0'-1'	123.5	10.5

Expansion Potential

Expansion Index (E.I.) testing was performed on a representative sample of site earth materials in general accordance with Table 18-I-B of the UBC. Test results of 2 (E.I.=2) indicate that site soils are anticipated to be generally very low in expansive potential (E.I.

from 0 to 20). Variations may occur, including soils exhibiting expansion potentials from low to medium (E.I. from 21 to 90), additional E.I. testing should be performed during future development to verify conditions encountered during our subsurface investigations.

Soluble Sulfates/Corrosion

Typical samples of the site materials were analyzed for soluble sulfates, pH, and resistivity. The soluble sulfate and corrosion potential results are shown as follows:

LOCATION AND DEPTH (FT.)	SOLUBLE SULFATES PERCENTAGE BY WEIGHT	pH	RESISTIVITY (OHMS-CM)
TP-8 @ 1'- 2'	0.0055	7.3	12,000
TP-23 @ 2'- 3'	0.0178	7.4	7,700

For preliminary planning purposes, based upon the soluble sulfate test results and the latest edition of the UBC, the soluble sulfate content is categorized as negligible (0.00 to 0.10 Water-Soluble Sulfate in Soil, percentage by weight) and sulfate-resistant concrete should not be necessary. Additionally, a modified cement to water ratio and modified concrete compressive strength should not be necessary.

Based on the results of the resistivity and pH testing, the onsite soils are considered to be generally neutral to mildly alkaline (a pH of 6.6 to 7.3 is considered neutral, a pH of 7.4 to 7.8 is considered mildly alkaline) and are considered mildly to moderately corrosive toward ferrous metals in a saturated state (over 10,000 ohm-cm is considered mildly corrosive, 2,000 to 10,000 ohm-cm is considered moderately corrosive). Based on the laboratory test results, consideration should be given to consulting with a corrosion engineer to provide specific recommendations.

Although the site soils are categorized as being mildly to moderately corrosive to ferrous metals, no exposure conditions stated in Table 19-A-2 of the UBC are found within the subject site. It is our understanding that ferrous metals embedded in properly poured and formed Type I, II, or V concrete should be adequately protected from these conditions. Additionally, as stated above, the soluble sulfate content on the subject lots is considered negligible.

Consolidation Testing

Consolidation tests were performed on selected undisturbed ring samples obtained during our subsurface investigation. Testing was performed in general accordance with ASTM D-2435-90. Test results are presented in Appendix D.

Shear Testing

Shear testing was performed in a direct shear machine of the strain-control type. The rate of deformation is approximately 0.05 inches per minute. The sample was sheared under varying confining loads in order to determine that coulomb shear strength parameters, angle of internal friction and cohesion. The tests were performed on natural and remolded samples of the Quaternary fan deposits (Pleistocene-age alluvial fan deposits). The Shear Testing Results are presented in Appendix D.

PRELIMINARY EARTHWORK FACTORS

Preliminary earthwork factors (shrinkage and bulking) for the subject property have been estimated based upon our field and laboratory testing, visual site observations, and experience in the site area. It is apparent that shrinkage would vary with depth and with areal extent over the site based on previous site use. Variables include vegetation, weed control, discing, and previous filling or exploring. However, all these factors are difficult to define in a three-dimensional fashion.

Therefore, the information presented below represents average shrinkage/bulking values:

Artificial Fill	15% to 20% shrinkage
Topsoil/Colluvium	10% to 15% shrinkage
Younger Alluvium	15% to 20% shrinkage
Weathered Quaternary Fan Deposits (Pleistocene-age fans)	5% to 10% shrinkage
Quaternary Fan Deposits (Pleistocene-age fans)	0% to 5% bulking

An additional shrinkage factor item would include the removal of root systems of individual large plants or trees. These plants and trees vary in size but, when pulled, they may generally result in a loss of ½ to 1½ cubic yards, to locally greater than 3 cubic yards of volume, respectively. The above facts indicate that earthwork balance for the site would be difficult to define and flexibility in design is essential to achieve a balanced end product.

CONCLUSIONS AND RECOMMENDATIONS

Based on our field exploration, laboratory testing, and our engineering and geologic analyses, it is our opinion that the project site appears suited for the proposed residential

use from a soils engineering and geologic viewpoint. The recommendations presented below should be incorporated in the design, grading, and construction considerations.

General

1. Soils engineering and compaction testing services should be provided during grading operations to assist the contractor in removing unsuitable soils and in his effort to compact the fill.
2. Geologic observations should be performed during grading to verify and/or further evaluate geologic conditions. Although unlikely, if adverse geologic structures are encountered during grading operations, supplemental recommendations and earthwork may be warranted.
3. Based on the extremely dense, and locally cemented, nature of the Quaternary fan deposits (Pleistocene-age alluvial fans) that underlie the site, laboratory testing, and our liquefaction screening process (pursuant to Special Publication 117), the potential for liquefaction, within areas proposed for development, is considered very low.
4. Based on our subsurface investigation and field reconnaissance mapping, abundant amounts of organic material (tree remains) are stockpiled and/or exist across localized areas of the site. The organic materials, including all rootball structures, should be removed and exported offsite. Observation by representatives of GSI, should be conducted to verify the organic materials have been properly removed from areas proposed for settlement sensitive improvements.
5. In general and based upon the available data to date, groundwater is not expected to be a factor in the development of the site. However, due to the nature of the site materials, seepage may be encountered throughout the site along with seasonal perched water within existing drainage canyon areas, and also may be encountered in "daylighted" bedding within the Quaternary fan deposits (Pleistocene-age alluvial fans). Thus, subdrain systems are recommended within canyon areas, where filled, and as encountered during grading. In addition, subdrainage systems for the control of localized groundwater seepage should be anticipated subsequent to grading as a result of excess irrigation or precipitation. Preliminary subdrain locations are provided herein (see Plate 1).
6. Experience from past grading of projects in similar terrain indicates that conventional earthmoving equipment should be able to excavate the majority of the Quaternary fan deposits (Pleistocene-age alluvial fans) within planned excavation areas; however, due to the nature of the site materials, it is likely that oversized rock materials will be generated during grading. This may necessitate the construction of rock fills or rock fill blankets during grading. Such procedures are outlined in the Fill Placement and Rock Disposal sections of this report.

7. As per Riverside County requirements, settlement monitoring will need to be conducted for engineered fill areas in excess of 50 feet in thickness. Settlement monitoring is estimated, at this time, to take place for a time period of approximately six to eight months, or possibly less, based on the settlement data obtained. It should also be noted that the County requires basal fill materials below an engineered fill depth of 50 feet to be compacted to 95 percent of the laboratory standard.
8. Due to the noncohesive nature of some of the onsite materials, some caving and sloughing may be anticipated to be a factor in subsurface excavations and trenching. Therefore, current local and state/federal safety ordinances for subsurface trenching should be enforced.
9. General Earthwork and Grading Guidelines are provided at the end of this report as Appendix F. Specific recommendations are provided below.

Demolition/Grubbing

1. Any existing surface/subsurface structures, tree remains (including stumps), and any miscellaneous debris should be removed from the areas of proposed grading.
2. The project soils engineer should be notified of any previous foundation, irrigation lines, cesspools, septic tanks, leach fields, wells, or other subsurface structures that are uncovered during the recommended removals, so that appropriate remedial recommendations can be provided.
3. Cavities or loose soils (including all previous exploratory borings and test pits, as practical) remaining after demolition and site clearance should be cleaned out, observed by the soils engineer, processed, and replaced with fill that has been moisture conditioned to at least optimum moisture content and compacted to at least 90 percent of the laboratory standard, if not removed by proposed cuts.

Treatment of Existing Ground

1. Removal of all artificial fill, colluvium/topsoil, younger alluvium, and near surface weathered Quaternary fan deposits (Pleistocene-age alluvial fans) will be necessary prior to fill placement, in areas proposed for development. Approximate depths of removals are outlined in the conclusions and recommendations section of this report. For preliminary planning purposes, these depths are estimated to be on the order of ± 2 to ± 10 feet (hilltops and side slopes, respectively), and from ± 4 to ± 30 feet deep, or deeper, in the younger alluvial deposits in the canyon areas proposed for development.

2. Where planned cuts, in the Quaternary fan deposits (Pleistocene-age alluvial fans), are equal to or greater than the recommended removal depth, the area should be cut to grade, subgrade observed and tested by the geotechnical consultant, then the upper 12 inches below finish grade should be scarified, brought to at least optimum moisture content, and recompacted to a minimum relative compaction of 90 percent of the laboratory standard.
3. Where the planned cuts are less than the recommended removal depth, the additional removals to attain the recommended removal should be accomplished. The exposed removal surface should be scarified to a depth of 12 inches, moisture conditioned (if necessary), and then compacted prior to fill placement to finish pad grade.
4. Existing colluvium/topsoil, clean artificial fill, younger alluvium, and the Quaternary fan deposits, etc., may be reused as compacted fill provided that major concentrations of organic material (roots and tree remains), and miscellaneous trash and debris are removed prior to fill placement.
5. Localized deeper removal may be necessary due to buried drainage channel meanders or dry porous materials. The project soils engineer/geologist should observe all removal areas during the grading.

Fill Placement

1. Fill materials should be brought to at least optimum moisture, placed in thin 6- to 8-inch lifts and mechanically compacted to obtain a minimum relative compaction of 90 percent of the laboratory standard.
2. Fill materials should be cleansed of major vegetation and debris prior to placement.
3. Any oversized rock materials greater than 8 inches in diameter should be stockpiled and placed under the observation of the soils engineer. As per UBC (1997) requirements, no rock materials greater than 12 inches in diameter should be placed within 10 feet of finish grade, unless prior approval has been granted by the County and geotechnical engineer. Procedures for rock placement are outlined in the Rock Disposal section of this report.
4. As per Riverside County requirements (Part III.1.H.e and III.1.H.f) "deep fills" in excess of 50 feet in depth require settlement monitoring. Based on proposed finish grades and anticipated fill depths, settlement monitoring will be required. Settlement monitoring is estimated, at this time, to take place for a time period of approximately six to eight months, or possibly less, based on the settlement data obtained. It should also be noted that basal fill materials below a fill depth of 50 feet are required to be compacted to 95 percent of the laboratory standard, as per Riverside County criteria (Part III.1.H.f). Based on our review of proposed finish grades, approximately

seven (7) to ten (10) settlement monitoring stations should be placed on lots where fills thicknesses are anticipated to be in excess of 50 feet.

5. Any import materials should be observed and determined suitable by the soils engineer prior to placement on the site. Foundation designs may be altered if import materials have greater sulfate/expansion values than the onsite materials encountered in this investigation.

Slope Considerations and Slope Design

Based on our slope stability analyses and experience on nearby projects, proposed cut and fill slopes constructed using onsite materials, to the heights proposed, should be grossly and surficially stable provided the recommendations contained herein are implemented during site development. Slope stability analyses for the proposed cut and fill slopes is provided in Appendix E.

All slopes should be designed and constructed in accordance with the minimum requirements of the UBC and/or County of Riverside, and the recommendations in the General Earthwork and Grading Guidelines section of this report (Appendix F), and the following:

1. Fill slopes should be designed and constructed at a 2:1 (horizontal to vertical) gradient or flatter and should not exceed about 70 feet in height. Fill slopes should be properly built and compacted to a minimum relative compaction of 90 percent throughout, including the slope surfaces. Fill slopes should be properly overbuilt by ± 3 to ± 5 feet and trimmed/cut back to proposed finish grades. Guidelines for slope construction are presented in Appendix F.
2. Cut slopes should be designed at gradients of 2:1 (h:v) or flatter and should not exceed about 50 feet in height. While stabilization of such slopes is not anticipated, locally adverse geologic conditions (i.e., daylighted joints/fractures, severely weathered fan deposits, or sandy lenses) may be encountered which may require remedial grading, stabilization, or laying back of the slope to an angle flatter than the adverse geologic condition.
3. Local areas of highly to severely weathered fan deposits may be present. Should these materials be exposed in cut slopes, the potential for long term maintenance or possible slope failure exists. Evaluation of cut slopes during grading would be necessary in order to identify any areas of severely weathered materials or non-cohesive sands. Should any of these materials be exposed during construction, the soils engineer/geologist, would assess the magnitude and extent of the materials and their potential affect on long-term maintenance or possible slope failures. Recommendations would then be made at the time of the field inspection.

4. Small localized earth failures (i.e., slumps, slopewash, etc.), were noted on the existing slopes/cliffs associated with the incised canyon drainage courses, in the north-northeastern portion of the site. These small slumps are anticipated to lie outside of the areas proposed for residential development, and/or will be completely removed by the proposed grading, and as such, should not pose a major constraint to development. Should such features exist in natural or cut slopes above the proposed residential development, and not be removed by the proposed grading, then debris or impact walls should be considered by the design engineer, where these features intercept the proposed development and/or cut slopes. The actual location and need for such devices would best be evaluated at the 40-scale plan stage, when design grades are semi-finalized or finalized.
5. Loose rock debris and fines remaining on the face of the cut slopes should be removed during grading. This can be accomplished by high pressure water washing or by hand scaling, as warranted.
6. Where loose materials are exposed on the cut slopes, the project's engineering geologist would require that the slope be cleaned as described above prior to making their final inspection. Final approval of the cut slope can only be made subsequent to the slope being fully cut and cleaned.

Transition and Overexcavation Areas

In order to satisfy County requirements, and reduce the potential for differential settlements between cut and fill materials, and/or materials of differing expansion potentials, the entire cut portion of cut/fill transitions should be overexcavated to a minimum depth of 3 feet below finish grade, or to a maximum ratio of fill thickness of 3:1 (maximum to minimum), and replaced with compacted fill. Due to the existing slopes/cliffs associated with the incised canyon drainage courses, this 3:1 ratio of fill thickness will be a major developmental consideration, and should be additionally evaluated at the 40-scale design stage.

Preliminary Foundation Settlements

GSI has preliminarily estimated the potential magnitudes of total settlement, differential settlement, and angular distortion. The estimated settlement and angular distortion values that an individual structure could be subjected to should be evaluated by a structural engineer. The levels of angular distortion were evaluated on a 40-foot length assumed as minimum dimension of buildings; if, from a structural standpoint, a decreased or increased length over which the tilt is assumed to occur is justified, this change should be incorporated into the design. The structures should be evaluated and designed for the combination of the soil parameters presented herein, and the estimated total settlement, differential settlement and angular distortions provided. These estimated values are based on proposed depths of compacted fill and estimated settlements of the underlying

Quaternary fan deposits. The foundation settlement values provided within this report are considered reasonably conservative, as required by the County.

The analyses were based on the laboratory test results from the subsurface test pits and borings advanced onsite. Site specific conditions affecting potential settlement include depositional environment, grain size distribution and lithology of underlying sediments, cementing agents, stress history, moisture history, material shape, density, void ratio, etc.

Ground settlement should be anticipated due to primary consolidation and secondary compression of the proposed engineered fills. The total amount of settlement and time over which it occurs is dependent upon various factors, including material type, depth of fill, depth of removals, initial and final moisture content, and in-place density of subsurface materials. Planned fills, (up to about ±80 feet in thickness), are not generally prone to excessive differential settlement (on the order of 2 to 2¼ inches). However, some post-construction settlement is expected and the majority of this settlement is anticipated to occur within ±9 months following grading. The total settlement that occurs after this time is anticipated to be within acceptable limits (on the order of 2 to 3 inches). This settlement will be monitored and design recommendations revised, as necessary, based on actual field and settlement monitoring data obtained.

Mitigation of grading settlements may include a combination of:

1. Decreasing the slope of the cut/fill transition under building areas
2. Using either post-tensioned slabs, or mat foundations
3. Monitoring of engineered fill settlements, with settlement monuments installed in accordance with Appendix D.

Settlement Evaluation

Any settlement sensitive structures should be evaluated and designed for the combination of site-specific soil parameters and the estimated settlements and angular distortion values provided below:

DEPTH OF FILL (FT.)	ULTIMATE DIFFERENTIAL SETTLEMENT (IN.)	ULTIMATE ANGULAR DISTORTION (BUILT AT COMPLETION OF GRADING)	SUGGESTED BUILDING WAIT PERIOD UNTIL 50% PRIMARY CONSOLIDATION (MONTHS)	ESTIMATED ANGULAR DISTORTION AFTER WAITING PERIOD
40	1.00	1/480	0 to 2	1/700
50	1.15	1/417 *	3	1/640

DEPTH OF FILL (FT.)	ULTIMATE DIFFERENTIAL SETTLEMENT (IN.)	ULTIMATE ANGULAR DISTORTION (BUILD AT COMPLETION OF GRADING)	SUGGESTED BUILDING WAIT PERIOD UNTIL 50% PRIMARY CONSOLIDATION (MONTHS)	ESTIMATED ANGULAR DISTORTION AFTER WAITING PERIOD
60	1.25	1/384 *	4	1/540
70	1.5	1/320 *	6	1/500
80	1.75	1/275 *	8	1/480
90	2.0	1/240 *	9	1/480
100	2.25	1/210 *	9	1/480

* Non-buildable at this time due to County Criteria

Rock Disposal

During the course of grading, materials generated from the proposed cuts and remedial removals are anticipated to be of varying diameters. Any oversized rock materials greater than 8 inches in diameter should be stockpiled and placed under the observation of the soils engineer. As per UBC (1997) requirements, no rock materials greater than 12 inches in diameter should be placed within 10 feet of finish grade, unless prior approval has been granted by the County and geotechnical engineer. Generally for the purpose of this report the materials may be described as either 8 inches or less, greater than 8 and less than 36 inches, and greater than 36 inches. These three categories set the basic dimensions for where and how the materials are to be placed.

Materials 8 Inches in Diameter or Less

Inasmuch as rock fragments along with the overburden materials are anticipated to be a part of the materials used in the grading of the site, a criteria is needed to facilitate the placement of these materials within guidelines which would be workable during the rough grading, post-grading improvements, and serve as acceptable compacted fill.

1. Fines and rock fragments 8 inches or less in diameter may be placed as compacted fill cap materials within the slopes and street areas as described below. The rock fragments and fines should be brought to at least optimum moisture content and compacted to a minimum relative compaction of 90 percent of the laboratory standard.

The purpose for the 8-inch diameter cut off is to allow reasonable sized rock fragments into the fill under selected conditions surrounded with compacted fines. The 8-inch diameter size also allows a greater volume of the rock fragments to be handled during grading, while staying in reasonable limits for later onsite excavation equipment (backhoes and trenchers) to excavate onsite utility lines.

Materials Greater Than 8 and Less Than 36 Inches in Diameter

1. During the process of excavation, a moderate amount of rock fragments or constituents larger than 8 inches in diameter may be generated. These oversized materials greater than 8 and less than 36 inches in diameter may be incorporated into the fills utilizing a series of rock blankets.
2. Each rock blanket should consist of rock fragments of approximately 8 to 36 inches in diameter along with fines generated from the proposed cuts and overburden materials from removal areas. The blankets should be limited to 24 to 36 inches in thickness and should be placed with fines which have been brought to at least optimum moisture content prior to compaction.
3. Rock blankets should be restricted to areas which are at least 1 foot below the lowest utility invert and/or 10 feet below finish grade within the street right-of-way, and a minimum of 15 horizontal feet from any fill slope surface.
4. Compaction may be achieved by utilizing wheel rolling methods with scrapers and water trucks, track-walking by bulldozers, and sheepsfoot tampers.
5. Each rock blanket should be completed with its surface compacted prior to placement of any subsequent rock blanket or rock windrow.

Materials Greater Than 36 Inches in Diameter

1. Oversize rock greater than 36 inches in diameter should be placed in single rock windrows. The windrows should be at least 15 feet or an equipment width apart, whichever is greatest.
2. The void spaces between rocks in windows should be filled with the more granular soils by flooding them into place.
3. A minimum vertical distance of 3 feet between soil fill and rock lift should be maintained on a preliminary basis. Actual vertical distance should be further evaluated in the field based on existing conditions. Also, the windrows should be staggered from lift to lift. Rock windrows should not be placed closer than 15 feet to the face of fill slopes.
4. Larger rocks too difficult to be placed into windrows may be individually placed into a dozer trench. Each trench should be excavated into the compacted fill or dense natural ground a minimum of one foot deeper than the size of the rock to be buried. After the rocks are placed in the trench (not immediately adjacent to each other), granular fill material should be flooded into the trench to fill the voids.

The oversize rock trenches should be no closer together than 15 feet at a particular elevation and at least 15 feet from any slope face. Trenches at higher elevations should be staggered and there should be four feet of compacted fill between the top of one trench and the bottom of the next higher trench, on a preliminary basis. Actual vertical distances should be further evaluated in the field based on existing conditions. Placement of rock into these trenches should be under the full-time inspection of the soils engineer.

5. Consideration should be given, if applicable, to using oversize materials in open space "green belt" areas which would be designated as non-structural fills.

PRELIMINARY RECOMMENDATIONS - FOUNDATIONS

General

The foundation design and construction recommendations are based on laboratory testing and engineering analysis of onsite earth materials. Recommendations for conventional foundation systems as well as post-tensioned systems are provided in the following sections. The foundation systems may be used to support the proposed structures, provided they are founded in competent bearing material. The proposed foundation systems should be designed and constructed in accordance with the guidelines contained in the UBC and the and the differential settlement and angular distortion discussed previously and herein. Conventional foundations may be utilized for soils with expansion indices (E.I.) of less than 90 (i.e., very low to medium classification) and fill depths under 30 feet in thickness. Where compacted fills in excess of 30 feet in thickness exist, post-tensioned slabs will likely be required. Recommendations for post-tensioned design are included in the following sections.

Conventional Foundation Design

1. Conventional spread and continuous footings may be used to support the proposed residential structures provided they are founded entirely in properly compacted fill or other competent bearing material.
2. Analyses indicate that an allowable bearing value of 1,500 pounds per square foot (psf) may be used for design of footings which maintain a minimum width of 12 inches (continuous) and 24 inches square (isolated), and a minimum depth of at least 12 inches into the properly compacted fill or native Quaternary fan deposits. The bearing value may be increased by one-third for seismic or other temporary loads. This value may be increased by 200 psf for each additional 12 inches in depth, to a maximum of 2,500 psf.

3. For lateral sliding resistance, a 0.35 coefficient of friction may be utilized for a concrete to soil contact when multiplied by the dead load.
4. Passive earth pressure may be computed as an equivalent fluid having a density of 250 pounds per cubic foot (pcf) with a maximum earth pressure of 2,500 psf.
5. When combining passive pressure and frictional resistance, the passive pressure component should be reduced by one-third.
6. All footings should maintain a minimum 7-foot horizontal distance between the base of the footing and any adjacent descending slope, and minimally comply with the guidelines depicted on Figure No. 18-I-1 of the UBC (1997).

FOUNDATION CONSTRUCTION

The following foundation construction recommendations are presented as a minimum criteria from a soils engineering standpoint. Onsite soils will likely vary from very low to low (E.I. 0 to 50); however, soils exhibiting medium expansion potentials (E.I. 51 to 90) can not be entirely precluded. Final foundation design will be based upon which earth material is exposed at finished grades, as verified by testing, during or shortly after site grading.

Accordingly, the following preliminary foundation construction recommendations are for soils in the top 3 feet of finish grade which will have a very low to medium expansion potential, for planning and design considerations. Recommendations by the project's design-structural engineer or architect, which may exceed the soils engineer's recommendations, should take precedence over the following minimum requirements. Final foundation design will be provided based on the actual depth of fill underlying the lot and the expansion potential of the near surface soils encountered during grading.

Expansion Classification - Low (E.I. 21 to 50)

1. Conventional continuous footings should be founded at a minimum depth of 12 inches below the lowest adjacent ground surface for one-story floor loads and 18 inches below the lowest adjacent ground surface for two-story floor loads. Interior footings may be founded at a depth of 12 inches below the lowest adjacent ground surface.

Footings for one-story floor loads should have a minimum width of 12 inches, and footings for two-story floor loads should have a minimum width of 15 inches. All footings should have one No. 4 reinforcing bar placed at the top and one No. 4 reinforcing bar placed at the bottom of the footing. Isolated interior or exterior footings should be founded at a minimum depth of 24 inches below the lowest adjacent ground surface.

2. A grade beam, reinforced as above, and at least 12 inches square, should be provided across the garage entrances. The base of the reinforced grade beam should be at the same elevation as the adjoining footings.
3. Concrete slabs in residential and garage areas should be a minimum of 4 inches thick, and underlain with a vapor barrier consisting of a minimum of 6-mil, polyvinyl-chloride membrane with all laps sealed. This membrane should be covered with a minimum of 2 inches of sand to aid in uniform curing of the concrete.
4. Concrete slabs, including garage slabs, should be reinforced with No. 3 reinforcement bars placed on 18-inch centers, in two horizontally perpendicular directions (i.e., long axis and short axis). All slab reinforcement should be supported to ensure proper mid-slab height positioning during placement of the concrete. "Hooking" of reinforcement is not an acceptable method of positioning.
5. Garage slabs should be poured separately from the residence footings and be quartered with expansion joints or saw cuts. A positive separation from the footings should be maintained with expansion joint material to permit relative movement.
6. The residential and garage slabs should have a minimum thickness of 4 inches, and the slab subgrade should be free of loose and uncompacted material prior to placing concrete.
7. Presaturation is not necessary for these soil conditions; however, the moisture content of the subgrade soils should be equal to or greater than optimum moisture to a depth of 12 inches below the adjacent ground grade in the slab areas, and verified by this office within 72 hours of the vapor barrier placement.
8. Soils generated from footing excavations to be used onsite should be compacted to a minimum relative compaction 90 percent of the laboratory standard, whether it is to be placed inside the foundation perimeter or in the yard/right-of-way areas. This material must not alter positive drainage patterns that direct drainage away from the structural areas and toward the street.
9. Foundations near the top of slope should be deepened to conform to the latest edition of the UBC (1997) and provide a minimum 7-foot horizontal distance from the slope face. Rigid block wall designs located along the top of slope should be reviewed by a soils engineer.
10. Based on post-construction settlement analyses, areas where compacted fill materials in excess of 30 feet exist, an engineered post-tension foundation system will likely be required.

11. As an alternative to conventional foundation systems, an engineered post-tension foundation system may be used. Recommendations for post-tensioned slab design are provided in following sections.

Expansion Classification - Medium (E.I. 51 to 90)

1. Conventional continuous footings should be founded at a minimum depth of 18 inches below the lowest adjacent ground surface for one- or two-story floor loads. Interior footings may be founded at a depth of 12 inches below the lowest adjacent ground surface.

Footings for one-story floor loads should have a minimum width of 12 inches, and footings for two-story floor loads should have a minimum width of 15 inches. All footings should be reinforced with a minimum of two No. 4 reinforcing bars at the top and two No. 4 reinforcing bars at the bottom.

2. A grade beam, reinforced as above, and at least 12 inches square, should be provided across the garage entrances. The base of the reinforced grade beam should be at the same elevation as the adjoining footings.
3. Concrete slabs in residential and garage areas should be a minimum of 4 inches thick, and underlain by a vapor barrier consisting of a minimum of 6-mil, polyvinyl-chloride membrane with all laps sealed. Two inches of the sand base should be placed over and under the membrane (total of 4 inches) to aid in uniform curing of the concrete.
4. Concrete slabs, including garage areas, should be reinforced with No. 4 reinforcement bars placed on 18-inch centers, in two horizontally perpendicular directions (i.e., long axis and short axis). All slab reinforcement should be supported to ensure proper mid-slab height positioning during placement of the concrete. "Hooking" of reinforcement is not an acceptable method of positioning.
5. Garage slabs should be poured separately from the residence footings and be quartered with expansion joints or saw cuts. A positive separation from the footings should be maintained with expansion joint material to permit relative movement.
6. The residential and garage slabs should have a minimum thickness of 4 inches, and the slab subgrade should be free of loose and uncompacted material prior to placing concrete.
7. Presaturation of slab areas is recommended for these soil conditions. The moisture content of each slab area should be 120 percent or greater above optimum and verified by the soil engineer to a depth of 18 inches below adjacent ground grade in the slab areas, within 72 hours of the vapor barrier placement.

8. Soils generated from footing excavations to be used onsite should be compacted to a minimum relative compaction 90 percent of the laboratory standard, whether it is to be placed inside the foundation perimeter or in the yard/right-of-way areas. This material must not alter positive drainage patterns that direct drainage away from the structural areas and toward the street.
9. Foundations near the top of slope should be deepened to conform to the latest edition of the UBC (1997) and provide a minimum 7-foot horizontal distance from the slope face. Rigid block wall designs located along the top of slope should be reviewed by a soils engineer.
10. Based on post-construction settlement analyses, areas where compacted fill materials in excess of 30 feet exist, an engineered post-tension foundation system will likely be required.
11. As an alternative to conventional foundation systems, an engineered post-tension foundation system may be used. Exterior footings for the post-tension foundation should be founded at a minimum depth of 18 inches below the adjacent ground surface. Prior to pouring of the post-tension foundation system, the subgrade materials should be premoistened to 120 percent or greater above optimum moisture content to a depth of 18 inches. In addition, the vapor barrier, as described previously, should be sandwiched by two 2-inch thick layers of sand ($SE > 30$). Engineering parameters for post-tension design are provided in the following section.

PRELIMINARY POST-TENSIONED SLAB DESIGN

It is GSI's opinion that conventional slab design may not accommodate potential foundation movement that the underlying soils would impart from fill depths in excess of 30 feet in thickness and/or potentially expansive soils. Foundations should be designed to accommodate the differential settlement and angular distortion values provided herein. The recommendations presented below should be followed in addition to those contained in the previous sections. The information and recommendations presented in this section are not meant to supersede design by a registered structural engineer or civil engineer familiar with post-tensioned slab design or corrosion engineering consultant. Upon request, GSI could provide additional data/consultation regarding soil parameters as related to post-tensioned slab design.

From a soil expansion/shrinkage standpoint, a fairly common contributing factor to distress of structures using post-tensioned slabs is a significant fluctuation in the moisture content of soils underlying the perimeter of the slab, compared to the center, causing a "dishing" or "arching" of the slabs. To mitigate this possible phenomenon, a combination of soil presaturation and construction of a perimeter "cut off" wall grade beam should be employed.

Perimeter foundations should be a minimum of 12 or 18 inches deep for very low to low, or medium expansive soils, respectively. The walls should be a minimum of 12 inches in thickness. In moisture sensitive slab areas, a vapor barrier should be utilized and be of sufficient thickness to provide a durable separation of foundation from soils (6 mils thick). The vapor barrier should be sealed to provide a continuous water-proof barrier under the entire slab. The vapor barrier should be sandwiched by two 2-inch thick layers of sand (SE>30). Specific soil presaturation is not required; however, the moisture content of the subgrade soils should be at or above the soils' optimum moisture content to a depth of 24 inches below grade.

Post-tensioned slabs should be designed in accordance with the recommendations of the Post-Tensioning Institute Method. Based on review of laboratory data for the onsite materials, the average soil modulus subgrade reaction K, to be used for design, is 100 pounds per cubic inch (pci). This is equivalent to a surface bearing value of 1,000 psf.

Post-Tensioning Institute Method

Post-tensioned slabs should have sufficient stiffness to resist excessive bending due to non-uniform swell and shrinkage of subgrade soils. The differential movement can occur at the corner, edge, or center of slab. The potential for differential uplift can be evaluated using the 1997 UBC Section 1816, based on design specifications of the Post-Tensioning Institute. The following table presents suggested minimum coefficients to be used in the Post-Tensioning Institute design method.

Thornthwaite Moisture Index	-20 inches/year
Correction Factor for Irrigation	20 inches/year
Depth to Constant Soil Suction	7 feet
Constant soil Suction (pf)	3.6

The coefficients are considered minimums and may not be adequate to represent worst case conditions such as adverse drainage and/or improper landscaping and maintenance. The above parameters are applicable provided structures have gutters and downspouts and positive drainage is maintained away from structures. Therefore, it is important that information regarding drainage, site maintenance, settlements, and effects of expansive soils be passed on to future owners.

Based on the above parameters, the following values were obtained from figures or tables of the 1997 UBC Section 1816. The values may not be appropriate to account for possible differential settlement of the slab due to other factors. If a stiffer slab is desired, higher values of y_m may be warranted.

EXPANSION INDEX OF SOIL SUBGRADE (per UBC)	VERY LOW TO LOW EXPANSION POTENTIAL (E.I. = 0-50)	MEDIUM EXPANSION POTENTIAL (E.I. =51-90)
e_m center lift	5.0 feet	5.5 feet
e_m edge lift	3.5 feet	4.0 feet
Y_m center lift	1.70 inches	2.7 inches
Y_m edge lift	0.55 inches	0.75 inches

Deepened footings/edges around the slab perimeter must be used to minimize non-uniform surface moisture migration (from an outside source) beneath the slab. The bottom of the deepened footing/edge should be designed to resist tension, using cable or reinforcement per the structural engineer. Other applicable recommendations presented previous sections should be adhered to during the design and construction phase of the project.

Slope Setback Considerations for Footings

Footings should maintain a horizontal distance, X, between any adjacent descending slope face and the bottom outer edge of the footing. The horizontal distance, X, may be calculated by using $X = h/2$, where h is the height of the slope. X should not be less than 7 feet, nor need not be greater than 80 feet. X may be maintained by deepening the footings.

CONVENTIONAL RETAINING WALLS

The design parameters provided below assume that very low expansive soils are used to backfill any retaining walls. If expansive soils are used to backfill the proposed walls, increased active and at-rest earth pressures will need to be utilized for retaining wall design. Building walls, below grade, should be water-proofed or damp-proofed, depending on the degree of moisture protection desired. The foundation system for the proposed retaining walls should be designed in accordance with the recommendations presented in Conventional Foundation Design section of this report. Design parameters for specialty walls (i.e., crib, keystone, etc.), can be provided upon request, based on their intended use, and site specific conditions.

Restrained Walls

Any proposed retaining walls that will be restrained prior to placing and compacting backfill material or that have re-entrant or male corners, should be designed for an at-rest equivalent fluid pressure of 65 pcf, plus any applicable surcharge loading. For areas of male or re-entrant corners, the restrained wall design should extend a minimum distance of twice the height of the wall laterally from the corner.

Cantilevered Walls

The recommendations presented below are for proposed cantilevered retaining walls up to 15 feet high. Active earth pressure may be used for retaining wall design, provided the top of the wall is not restrained from minor deflections. An equivalent fluid pressure approach may be used to compute the horizontal pressure against the wall. Appropriate fluid unit weights are given below for specific slope gradients of the retained material. These do not include other superimposed loading conditions such as traffic, structures, seismic events or adverse geologic conditions.

SURFACE SLOPE OF RETAINED MATERIAL HORIZONTAL TO VERTICAL	EQUIVALENT FLUID WEIGHT P.C.F. (Select Backfill)
Level	42
2 to 1	55

Wall Backfill and Drainage

The above criteria assumes that very low expansive granular soils are used as backfill, and that hydrostatic pressures are not allowed to build up behind the wall. Positive drainage must be provided behind all retaining walls in the form of perforated pipe placed within gravel wrapped in geofabric and outlets. A backdrain system is considered necessary for retaining walls that are 2 feet or greater in height. For retaining walls up to 5 feet in height (typical rear yard retaining walls) backdrains should consist of a 4-inch diameter perforated PVC or ABS pipe encased in either Class 2 permeable filter material or 1/2- to 3/4-inch gravel wrapped in approved filter fabric (Mirafi 140 or equivalent). The filter material should extend a minimum of 1 horizontal foot behind the base of the walls and upward at least 1 foot. Outlets should consist of a 4-inch diameter solid PVC or ABS pipe spaced no more than ±100 feet apart. The use of weep holes in walls higher than 2 feet should not be considered. The surface of the backfill should be sealed by pavement or the top 18 inches compacted with relatively impermeable soil. Proper surface drainage should also be provided. Consideration should be given to applying a water-proof membrane to all retaining structures. The use of a waterstop should be considered for all concrete and masonry joints.

Footing Excavation Observation

All footing excavations for walls and appurtenant structures should be observed by the geotechnical consultant to evaluate the anticipated near surface conditions prior to the placement of steel or concrete. Based on the conditions encountered during the observations of the footing excavation, supplemental recommendations may be offered, as appropriate.

Transition Conditions - Retaining Walls

Should any proposed retaining walls be situated upon cut-fill transitions, two options may be employed: 1) Increase the amount of reinforcing steel and wall detailing (i.e., expansion joints or crack control joints) such that an angular distortion of 1/360 for a distance of 2H on either side of the transition is accommodated; or 2) overexcavate the cut portion of the foundation materials to a minimum depth of 3 feet and replace with fill compacted to 90 percent relative compaction.

DEVELOPMENT CRITERIA

Graded Slope Maintenance and Planting

Water has been shown to weaken the inherent strength of all earth materials. Slope stability is significantly reduced by overly wet conditions. Positive surface drainage away from graded slopes should be maintained and only the amount of irrigation necessary to sustain plant life should be provided for planted slopes. Over watering should be avoided as it can adversely affect site improvements. Graded slopes constructed within and utilizing onsite materials would be erosive. Eroded debris may be minimized and surficial slope stability enhanced by establishing and maintaining a suitable vegetation cover soon after construction.

Compaction to the face of fill slopes would tend to minimize short-term erosion until vegetation is established. Plants selected for landscaping should be light weight, deep rooted types that require little water and are capable of surviving the prevailing climate. From a geotechnical standpoint leaching is not recommended for establishing landscaping. If the surface soils are processed for the purpose of adding amendments they should be recompacted to 90 percent minimum relative compaction.

Drainage

Positive site drainage should be maintained at all times. Drainage should not flow uncontrolled down any descending slope. Water should be directed away from foundations and not allowed to pond and/or seep into the ground. Pad drainage should be directed toward the street or other approved area. Roof gutters and down spouts should be considered to control roof drainage. Down spouts should outlet a minimum of 5 feet from proposed structures or into a subsurface drainage system. Areas of seepage may develop due to irrigation or heavy rainfall. Minimizing irrigation will lessen this potential. If areas of seepage develop, recommendations for minimizing this effect could be provided upon request.

Site Improvements

Recommendations for exterior concrete flatwork design and construction can be provided upon request. If in the future, any additional improvements are planned for the site, recommendations concerning the geological or geotechnical aspects of design and construction of said improvements could be provided upon request. This office should be notified in advance of any additional fill placement, regrading of the site, or trench backfilling after rough grading has been completed. This includes any grading, utility trench and retaining wall backfills.

Trenching

Considering the nature of the onsite soils, it should be anticipated that caving or sloughing could be a factor in subsurface excavations and trenching. Shoring or excavating the trench walls at the angle of repose (typically 25 to 45 degrees) may be necessary and should be anticipated. All excavations should be observed by one of our representatives and minimally conform to CAL-OSHA and local safety codes.

Footing Trench Excavation

All footing excavations should be observed by a representative of this firm subsequent to trenching and prior to concrete form and reinforcement placement. The purpose of the observations is to verify that the excavations are made into the recommended bearing material and to the minimum widths and depths recommended for construction. If loose or compressible materials are exposed within the footing excavation, a deeper footing or removal and recompaction of the subgrade materials would be recommended at that time. Footing trench spoil and any excess soils generated from utility trench excavations should be compacted to a minimum relative compaction of 90 percent if not removed from the site.

Utility Trench Backfill

1. All interior utility trench backfill should be brought to at least 2 percent above optimum moisture content and then compacted to obtain a minimum relative compaction of 90 percent of the laboratory standard. As an alternative for shallow (12 inches to 18 inches) under-slab trenches, sand having a sand equivalent value of 30 or greater may be utilized and jetted or flooded into place. Observation, probing and testing should be provided to verify the desired results.
2. Exterior trenches adjacent to, and within areas extending below a 1:1 plane projected from the outside bottom edge of the footing, and all trenches beneath hardscape features and in slopes, should be compacted to at least 90 percent of the laboratory standard. Sand backfill, unless excavated from the trench, should not be

used in these backfill areas. Compaction testing and observations, along with probing, should be accomplished to verify the desired results.

3. All trench excavations should conform to CAL-OSHA and local safety codes.

Appurtenant Structures

Plans for construction of any proposed appurtenant structures such as pool, retaining walls, spas, gazebos, decks, etc. should be reviewed by a soils engineer/geologist.

PLAN REVIEW

Final grading plans as well as foundation and improvement plans should be submitted to this office for review and comment, as they become available, to minimize any misunderstandings between the current plans and preliminary recommendations presented herein. In addition, foundation excavations and earthwork construction performed on the site should be observed and tested by this office. If conditions are found to differ substantially from those stated, appropriate recommendations would be offered at that time.

SUMMARY OF RECOMMENDATIONS REGARDING GEOTECHNICAL OBSERVATION AND TESTING

We recommend that observation and/or testing be performed by the geotechnical consultant at each of the following construction stages:

- During grading/recertification.
- After excavation of building footings, retaining wall footings, and free standing walls footings, prior to the placement of reinforcing steel or concrete.
- During retaining wall subdrain installation, prior to backfill placement.
- During placement of backfill for area drain, interior plumbing, utility line trenches, and retaining wall backfill.
- After presoaking/presaturation of building pads and other flatwork subgrade, prior to the placement of reinforcing steel or concrete.
- During slope construction/repair.
- When any unusual soil conditions are encountered during any construction operations, subsequent to the issuance of this report.

INVESTIGATION LIMITATIONS

The materials encountered on the project site and utilized in our laboratory are believed representative of the total area; however, soil materials may vary in characteristics between exploratory excavations. Inasmuch as our investigation is based upon the site materials observed, selective laboratory testing, and engineering analyses, the recommendations are professional opinions. It is possible that variations in the soil conditions could exist beyond the points explored in this investigation. Also, changes in groundwater conditions could occur at some time in the near future due to variations in temperature, regional rainfall, and other factors not obvious at the time of our field investigation.

These opinions have been derived in accordance with current standards of practice, and no warranty is expressed or implied. Standards of practice are subject to change with time. GSI assumes no responsibility or liability for work or testing performed by others. In addition, this report may be subject to review by the controlling authorities. This report should in no way be construed as an environmental assessment, or Phase I Environmental Site Assessment of the subject site, or an environmental viability assessment of the site.

APPENDIX A

REFERENCES

APPENDIX A

REFERENCES

- Blake, T.F., 1989a, EQFAULT, A computer program for the deterministic prediction of peak horizontal acceleration from digitized California faults; Updated through 2000.
- _____, 1989b, EQSEARCH, A computer program for the estimation of peak horizontal acceleration from California historical earthquake catalogs; Updated through December 2001.
- _____, 1995, FRISKSP, A computer program for the probabilistic estimation of peak acceleration and uniform hazard spectra using 3-D faults as earthquake sources; dated December, updated 1998.
- California Department of Conservation, Division of Mines and Geology, 1997, Guidelines for evaluation and mitigating seismic hazards in California, CDMG special publication 117.
- _____, 2002, Water Data Library (www.well.water.ca.gov/).
- Campbell, K.W. and Bozorgnia, Y. 1994, Near-source attenuation of peak horizontal acceleration from worldwide accelerograms recorded from 1957 to 1993; proceedings, Fifth U.S. National Conference on Earthquake Engineering, Vol. III, Earthquake Engineering Research Institute, pp. 283-292.
- Envicom Corporation and the County of Riverside Planning Department, 1976, Seismic safety and safety elements technical report for the County of Riverside and the Cities of Beaumont, Blythe, Coachella, Corona, Desert Hot Springs, Hemet, Indian Wells, Indio, Norco, Perris, Riverside, and San Jacinto, dated September.
- Hall & Foreman, Inc., 2003, Tentative tract map no. 31210, County of Riverside, California, 100-scale plans, job no. 03009, dated April 15.
- International Conference of Building Officials, 1997, Uniform building code: Whittier, California, dated April.
- Joyner, W.B, and Boore, D.M., 1982, Estimation of response-spectral values as functions of magnitude, distance and site conditions, *in* eds., Johnson, J.A., Campbell, K.W., and Blake, T.F.: AEG short course, seismic hazard analysis, June 18, 1994.
- Obermeier, S.F., 1996, Using liquefaction-induced features for paleoseismic analysis, Chapter 7, *in* Paleoseismology, McCalpin, J.P., ed., Academic Press, Inc., San Diego, California.

Sadigh, K., Egan, J., and Youngs, R., 1987, Predictive ground motion equations, in Joyner, W.B. and Boore, D.M., 1988, measurement, characterization, and prediction of strong ground motion, in Von Thun, J.L., ed., Earthquake engineering and soil dynamics II, recent advances in ground motion evaluation, American Society of Civil Engineers Geotechnical Special Publication No. 0, pp. 43-102.

Southern California Earthquake Center, 1999, Recommended procedures for implementation of DMG Special Publication 117, guidelines for analyzing and mitigating liquefaction in California, pp. 28-32, dated March.

United States Department of Agriculture, 1980, Aerial photographs, Project no. 615020, Flight date October 30, Flight line 1380, Photograph nos. 120 and 121.

Weber, H.F., Jr., 1977, Seismic hazards related to geologic factors, Elsinore and Chino fault zones, Northwestern Riverside County, California, California Division of Mines and Geology Open-File Report 77-4, 96p.

APPENDIX B

BORING AND TEST PIT LOGS

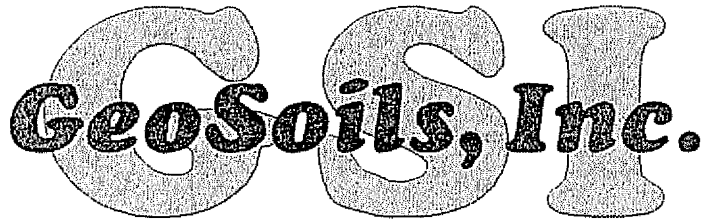

LOG OF EXPLORATORY TEST PITS

GeSoils, Inc.

TEST PIT NO.	DEPTH (ft.)	GROUP SYMBOL	SAMPLE DEPTH (ft.)	MOISTURE (%)	FIELD DRY DENSITY (pcf)	DESCRIPTION
TP-1	0 - 2'	SM	Nuke - 1'	6.52	98.6	<u>COLLUVIUM/TOPSOIL:</u> Silty SAND, medium to reddish brown, dry, loose; minor to locally abundant gravel and cobble sized clasts.
	2' - 5'	SM	Ring - 1½'	11.7	110.1	<u>QUATERNARY FAN DEPOSITS:</u> Silty SAND, reddish brown, dry, dense to very dense; locally abundant gravel to boulder sized clasts.
						Total Depth = 5' No Groundwater Encountered Backfilled 1/23/03
TP-2	0 - 4'	GM				<u>QUATERNARY ALLUVIUM:</u> Silty SAND w/cobbles and boulders, dark brown, moist, loose.
	4' - 6'	SM				<u>QUATERNARY FAN DEPOSITS:</u> Silty SAND, yellowish brown, dry, dense; coarse grained.
						Total Depth = 6' No Groundwater Encountered Backfilled 1/23/03

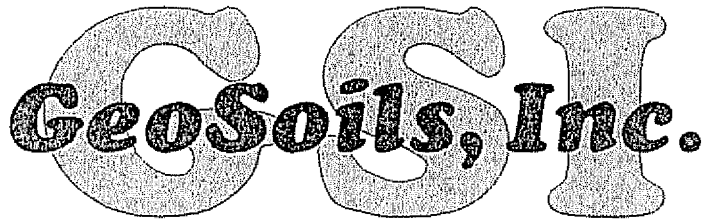

W.O. 3441-A-SC
 Renaissance Ranch, LLC
 January 23, 2003

LOG OF EXPLORATORY TEST PITS

Geosols, Inc.

TEST PIT NO.	DEPTH (ft.)	GROUP SYMBOL	SAMPLE DEPTH (ft.)	MOISTURE (%)	FIELD DRY DENSITY (pcf)	DESCRIPTION
TP-3	0 - 2½'	SM				<u>COLLUVIUM/TOPSOIL</u> : Silty SAND, medium to reddish brown, damp, loose.
	2½' - 4'	SM				<u>QUATERNARY FAN DEPOSITS</u> : Silty SAND, reddish brown, dry, dense to very dense; locally abundant cobbles.
						Total Depth = 4' No Groundwater Encountered Backfilled 1/23/03
TP-4	0 - 1'	SM	Nuke - 1'	9.4	101.6	<u>COLLUMIUM/TOPSOIL</u> : Silty SAND, reddish brown, dry to damp, medium dense; abundant clay film on ped faces.
	1' - 5'	SM	Nuke - 3'	10.6	115.4	<u>QUATERNARY FAN DEPOSITS</u> : Silty SAND, reddish brown, dry to moist, dense to very dense; granitic clasts are extremely weathered.
						Total Depth = 5' No Groundwater Encountered Backfilled 1/23/03

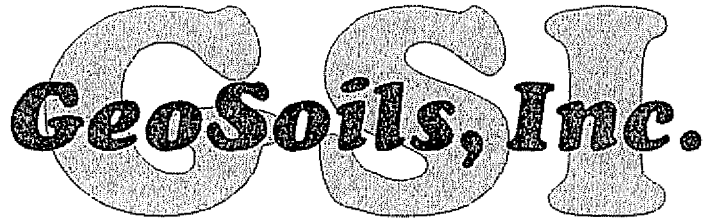

W.O. 3441-A-SC
 Renaissance Ranch, LLC
 January 23, 2003

LOG OF EXPLORATORY TEST PITS

Geosols, Inc.

TEST PIT NO.	DEPTH (ft.)	GROUP SYMBOL	SAMPLE DEPTH (ft.)	MOISTURE (%)	FIELD DRY DENSITY (pcf)	DESCRIPTION
TP-5	0 - 2½'	SM				COLLUVIUM/TOPSOIL: Silty SAND, medium brown, moist, loose; abundant roots and rootlets (old grove area).
	2½' - 4'	SM				QUATERNARY FAN DEPOSITS: Silty SAND w/cobbles, reddish brown, dry, dense to very dense; clasts are extremely weathered.
						Total Depth = 4' No Groundwater Encountered Backfilled 1/23/03
TP-6	0 - 2½'	SM				COLLUVIUM/TOPSOIL: Silty SAND, reddish brown, moist, loose; porous.
	2½' - 5'	SM				QUATERNARY FAN DEPOSITS: Silty SAND, orange brown, damp, dense to very dense with depth.
						Total Depth = 5' No Groundwater Encountered Backfilled 1/23/03

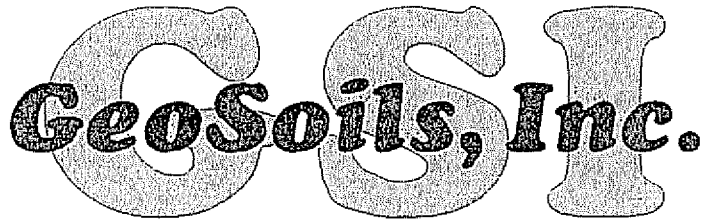

W.O. 3441-A-SC
 Renaissance Ranch, LLC
 January 23, 2003

LOG OF EXPLORATORY TEST PITS

Geosols, Inc.

TEST PIT NO.	DEPTH (ft.)	GROUP SYMBOL	SAMPLE DEPTH (ft.)	MOISTURE (%)	FIELD DRY DENSITY (pcf)	DESCRIPTION
TP-7	0 - 2½'	SM/SC	Nuke - 2'	10.6	108.4	COLLUVIUM/TOPSOIL: Silty SAND and CLAYEY SAND, medium to dark reddish brown, dry, loose; abundant rootlets.
	2½' - 7'	SM	Nuke - 4'	4.2	118.1	QUATERNARY FAN DEPOSITS: Silty SAND, reddish brown, dry, dense to very dense.
						Total Depth = 7' No Groundwater Encountered Backfilled 1/23/03
TP-8	0 - 3'	SM/ML	Nuke - 2' Bulk - 1' - 2'	6.8	108.5	COLLUVIUM/TOPSOIL: Silty SAND and SILT, medium brown, dry, loose to soft; porous.
	3' - 5'	SM				QUATERNARY FAN DEPOSITS: Silty SAND, reddish brown, dry, very dense. At 4' - 5', difficult excavation.
						Total Depth = 5' No Groundwater Encountered Backfilled 1/23/03

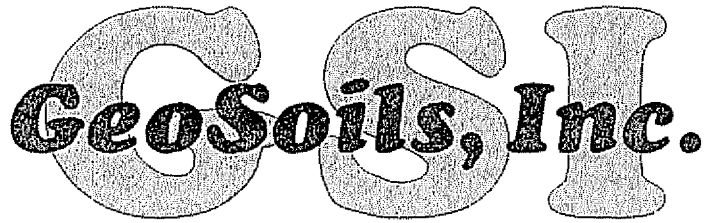

W.O. 3441-A-SC
 Renaissance Ranch, LLC
 January 23, 2003

LOG OF EXPLORATORY TEST PITS

Geosols, Inc.

TEST PIT NO.	DEPTH (ft.)	GROUP SYMBOL	SAMPLE DEPTH (ft.)	MOISTURE (%)	FIELD DRY DENSITY (pcf)	DESCRIPTION
TP-9	0 - 3'	SM				<u>COLLUVIUM/TOPSOIL</u> : Silty SAND, dark brown, dry, loose.
	3' - 8'	SM				<u>QUATERNARY FAN DEPOSITS</u> : Silty SAND, yellowish brown, dense; weathered near surface.
						Total Depth = 8' No Groundwater Encountered Backfilled 1/23/03
TP-10	0 - 4'	SM				<u>COLLUVIUM/TOPSOIL</u> : Silty SAND and Sandy GRAVEL, medium to dark brown, dry, loose; porous, abundant rootlets, locally abundant cobbles and boulders.
	4' - 10'	SM/GM	Nuke - 4'	8.67	106.7	<u>QUATERNARY FAN DEPOSITS</u> : Silty SAND, reddish to yellowish brown, dry, dense.
						Total Depth = 10' No Groundwater Encountered Backfilled 1/23/03

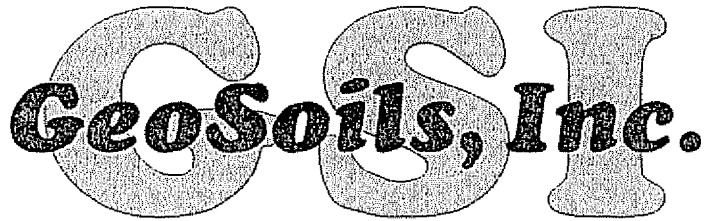

W.O. 3441-A-SC
 Renaissance Ranch, LLC
 January 23, 2003

LOG OF EXPLORATORY TEST PITS

Geosols, Inc.

TEST PIT NO.	DEPTH (ft.)	GROUP SYMBOL	SAMPLE DEPTH (ft.)	MOISTURE (%)	FIELD DRY DENSITY (pcf)	DESCRIPTION
TP-11	0 - 2½'	SC				<u>COLLUVIUM/TOPSOIL</u> : Clayey SAND, reddish brown, damp, loose; porous.
	2½' - 4'	SM	Nuke - 3'	9.2	111.2	<u>QUATERNARY FAN DEPOSITS</u> : Silty SAND, reddish brown, dry dense to very dense; minor cementation.
						Total Depth = 4' No Groundwater Encountered Backfilled 1/23/03
TP-12	0 - 3'	SM				<u>COLLUVIUM/TOPSOIL</u> : Silty SAND, medium brown, dry, loose; locally abundant cobbles and boulders.
	3' - 6'	SM/GM				<u>QUATERNARY FAN DEPOSITS</u> : Silty SAND/Sandy GRAVEL, light yellowish brown, dry, dense; coarse grained, abundant extremely weathered granitic cobbles and boulders.
						Total Depth = 6' No Groundwater Encountered Backfilled 1/23/03

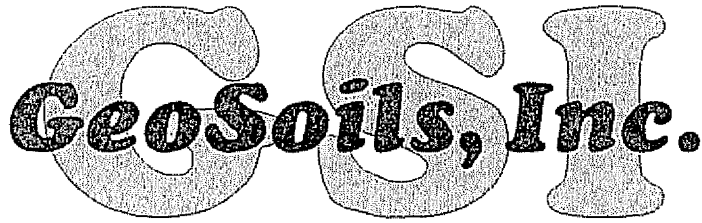

LOG OF EXPLORATORY TEST PITS

Geosols, Inc.

TEST PIT NO.	DEPTH (ft.)	GROUP SYMBOL	SAMPLE DEPTH (ft.)	MOISTURE (%)	FIELD DRY DENSITY (pcf)	DESCRIPTION
TP-13	0 - 2½'	SM	Nuke - 2'	10.6	98.2	<u>COLLUVIUM/TOPSOIL:</u> Silty SAND, medium brown, dry, loose.
	2½' - 6'	SM	Nuke - 4'	6.2	109.7	<u>QUATERNARY FAN DEPOSITS:</u> Silty SAND, light yellowish brown, dry, dense; coarse grained, locally abundant cobbles.
						Total Depth = 6' No Groundwater Encountered Backfilled 1/23/03
TP-14	0 - 3'	SM				<u>COLLUVIUM/TOPSOIL:</u> Silty SAND, reddish brown, dry, loose.
	3' - 8'	SM				<u>QUATERNARY FAN DEPOSITS:</u> Silty SAND, light reddish brown, dry, dense; abundant weathered granitic cobbles and boulders.
						Total Depth = 8' No Groundwater Encountered Backfilled 1/23/03

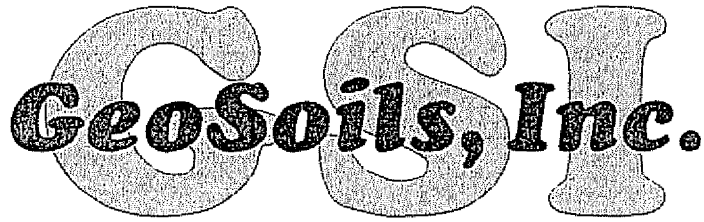

W.O. 3441-A-SC
 Renaissance Ranch, LLC
 January 23, 2003

LOG OF EXPLORATORY TEST PITS

Geosols, Inc.

TEST PIT NO.	DEPTH (ft.)	GROUP SYMBOL	SAMPLE DEPTH (ft.)	MOISTURE (%)	FIELD DRY DENSITY (pcf)	DESCRIPTION
TP-15	0 - 2'	SM/ML	Bulk - 0 - 1'			<u>COLLUVIUM/TOPSOIL</u> : Silty SAND and SILT, medium to grayish brown, dry, loose to soft; porous.
	2' - 4'	SM	Nuke - 3'	10.1	113.4	<u>QUATERNARY FAN DEPOSITS</u> : Silty SAND, reddish brown, dry dense; coarse grained, minor cementation.
						Total Depth = 4' No Groundwater Encountered Backfilled 1/23/03
TP-16	0 - 2'	SM	Nuke - 1'	6.7	105.4	<u>COLLUVIUM/TOPSOIL</u> : Silty SAND, reddish brown, dry, medium dense; abundant rootlets, porous.
	2' - 6'	SM	Nuke - 3'	13.4	114.6	<u>QUATERNARY FAN DEPOSITS</u> : Silty SAND, reddish brown, dry, dense to very dense.
						Total Depth = 6' No Groundwater Encountered Backfilled 1/23/03

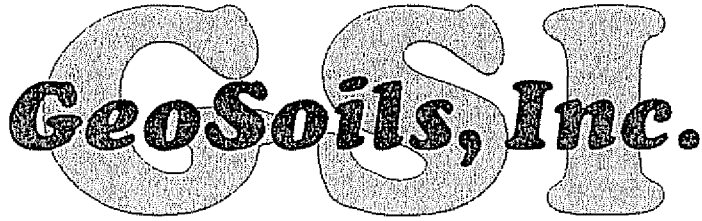

LOG OF EXPLORATORY TEST PITS

Geosols, Inc.

TEST PIT NO.	DEPTH (ft.)	GROUP SYMBOL	SAMPLE DEPTH (ft.)	MOISTURE (%)	FIELD DRY DENSITY (pcf)	DESCRIPTION
TP-17	0 - 2'	SM				<u>COLLUVIUM/TOPSOIL</u> : Silty SAND, reddish brown, dry, loose; porous.
	2' - 5'	SM				<u>QUATERNARY FAN DEPOSITS</u> : Silty SAND, reddish brown, dry, dense to very dense.
						Total Depth = 5' No Groundwater Encountered Backfilled 1/23/03
TP-18	0 - 2½'	SM/ML				<u>COLLUVIUM/TOPSOIL</u> : Silty SAND and SILT, medium to reddish brown, dry, loose to soft; abundant cobble and boulder sized clasts.
	2½' - 6'	SM				<u>QUATERNARY FAN DEPOSITS</u> : Silty SAND, reddish brown, dry, very dense; abundant weathered cobbles and boulders.
						Total Depth = 6' No Groundwater Encountered Backfilled 1/23/03

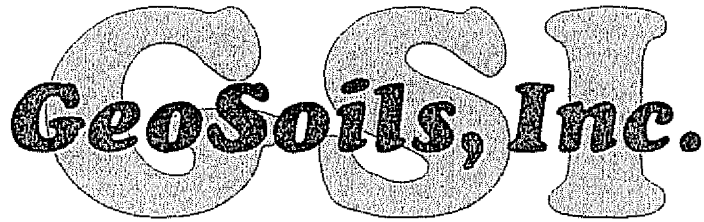

W.O. 3441-A-SC
 Renaissance Ranch, LLC
 January 23, 2003

LOG OF EXPLORATORY TEST PITS

Geosols, Inc.

TEST PIT NO.	DEPTH (ft.)	GROUP SYMBOL	SAMPLE DEPTH (ft.)	MOISTURE (%)	FIELD DRY DENSITY (pcf)	DESCRIPTION
TP-19	0 - 3'	SM/ML				COLLUVIUM/TOPSOIL: Silty SAND and SILT, medium brown, dry, loose; abundant rootlets.
	3' - 8'	GM				QUATERNARY FAN DEPOSITS: Silty SAND w/gravel and cobbles, light brown, dry, dense; clasts are grussified and weathered.
						Total Depth = 8' No Groundwater Encountered Backfilled 1/23/03
TP-20	0 - 1'	SM				COLLUVIUM/TOPSOIL: Silty SAND, reddish brown, dry, loose; porous, abundant rootlets.
	1' - 4'	SM/GM	Nuke - 2'	6.4	110.7	QUATERNARY FAN DEPOSITS: Silty SAND and Sandy GRAVEL w/cobbles and boulders, reddish brown, dry, dense to very dense; very difficult excavation at 4'.
						Total Depth = 4' No Groundwater Encountered Backfilled 1/23/03

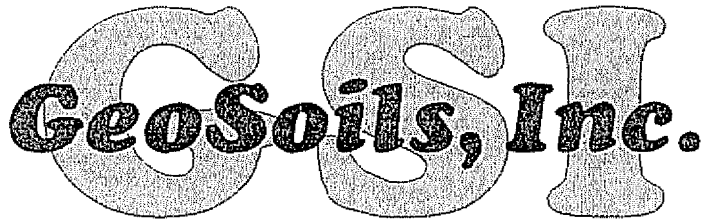

LOG OF EXPLORATORY TEST PITS

Geosols, Inc.

TEST PIT NO.	DEPTH (ft.)	GROUP SYMBOL	SAMPLE DEPTH (ft.)	MOISTURE (%)	FIELD DRY DENSITY (pcf)	DESCRIPTION
TP-21	0 - 2'	SM				<u>ARTIFICIAL FILL UNDOCUMENTED</u> : Silty SAND, very dark brown, damp, loose; abundant rootlets.
	2' - 4'	SC				<u>COLLUVIUM/TOPSOIL</u> : Clayey SAND, dark brown, dry, loose; porous.
	4' - 6'	SM/GM				<u>QUATERNARY FAN DEPOSITS</u> : Silty SAND and Sandy GRAVEL w/cobbles and boulders, reddish brown, dry, dense.
						Total Depth = 6' No Groundwater Encountered Backfilled 1/23/03
TP-22	0 - 5'	SM	Nuke - 3'	6.4	112.6	<u>QUATERNARY FAN DEPOSITS</u> : Silty SAND, yellowish brown, dry, dense; colluvium stripped by grading activity along roadway, material is well cemented.
						Total Depth = 5' No Groundwater Encountered Backfilled 1/23/03

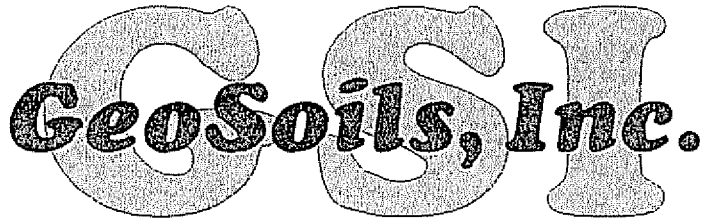

W.O. 3441-A-SC
 Renaissance Ranch, LLC
 January 23, 2003

LOG OF EXPLORATORY TEST PITS

Geosols, Inc.

TEST PIT NO.	DEPTH (ft.)	GROUP SYMBOL	SAMPLE DEPTH (ft.)	MOISTURE (%)	FIELD DRY DENSITY (pcf)	DESCRIPTION
TP-23	0 - 2½'	GM	Nuke - 1½'	9.6	94.2	COLLUVIUM/TOPSOIL: Sandy GRAVEL w/cobbles and boulders, reddish brown, dry, loose to medium dense.
	2½'	SM/GM				QUATERNARY FAN DEPOSITS: Silty SAND w/cobbles and boulders, reddish to light yellowish brown, dry, dense.
						Total Depth = 2½' No Groundwater Encountered Backfilled 1/23/03
TP-24	0 - 3'					ARTIFICIAL FILL/TRASH/DEBRIS: Old dumpsite.
	3' - 5'	SP				QUATERNARY ALLUVIUM: SAND, grayish brown, dry, loose.
						Total Depth = 5' No Groundwater Encountered Backfilled 1/23/03

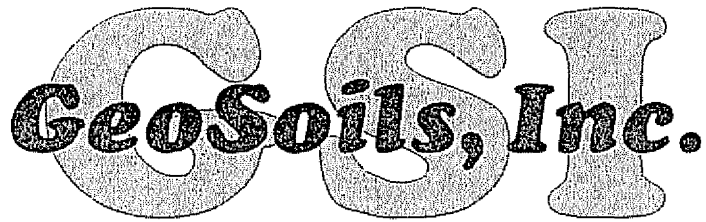

W.O. 3441-A-SC
 Renaissance Ranch, LLC
 January 23, 2003

LOG OF EXPLORATORY TEST PITS

Geosols, Inc.

TEST PIT NO.	DEPTH (ft.)	GROUP SYMBOL	SAMPLE DEPTH (ft.)	MOISTURE (%)	FIELD DRY DENSITY (pcf)	DESCRIPTION
TP-25	0 - 6'	SP/SM	Nuke - 2' Nuke - 4'	10.2 14.6	84.2 91.0	<u>QUATERNARY ALLUVIUM:</u> SAND and Silty SAND, light grayish brown, dry, loose; poorly sorted.
	6' - 10'	SM				<u>QUATERNARY FAN DEPOSITS:</u> Silty SAND, medium brown, damp, medium dense to dense; abundant cobbles and boulders.
						Total Depth = 10' No Groundwater Encountered Backfilled 1/23/03
TP-26	0 - 7'	SP/SM				<u>QUATERNARY ALLUVIUM:</u> SAND and Silty SAND, medium brown to light greyish brown, dry, very loose; abundant cross-beds noted.
	7' - 10'	GM				<u>QUATERNARY FAN DEPOSITS:</u> SANDY GRAVEL w/cobbles and boulders, grayish brown, damp, dense w/depth.
						Total Depth = 10' No Groundwater Encountered Backfilled 1/23/03

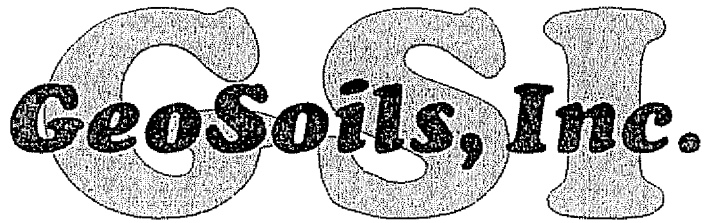

W.O. 3441-A-SC
 Renaissance Ranch, LLC
 January 23, 2003

LOG OF EXPLORATORY TEST PITS

Geosols, Inc.

TEST PIT NO.	DEPTH (ft.)	GROUP SYMBOL	SAMPLE DEPTH (ft.)	MOISTURE (%)	FIELD DRY DENSITY (pcf)	DESCRIPTION
TP-27	0 - 10'	SP/SM				QUATERNARY ALLUVIUM: SAND and Silty SAND, medium to light brown, dry, loose to medium dense.
	10' - 14'	SM				QUATERNARY FAN DEPOSITS: Silty SAND, medium to reddish brown, damp to moist, medium dense to dense.
						Total Depth = 14' No Groundwater Encountered Backfilled 1/23/03
TP-28	0 - 2'	SM				COLLUVIUM/TOPSOIL: Silty SAND, medium to reddish brown, dry, loose to medium dense with depth.
	2' - 4'	GC	Bulk - 3' - 4' Nuke - 3'	6.6	110.5	QUATERNARY FAN DEPOSITS: Clayey SAND w/gravel and cobbles, reddish brown, dry, dense to very dense; some cobbles and boulders are extremely weathered.
						Total Depth = 4' No Groundwater Encountered Backfilled 1/23/03

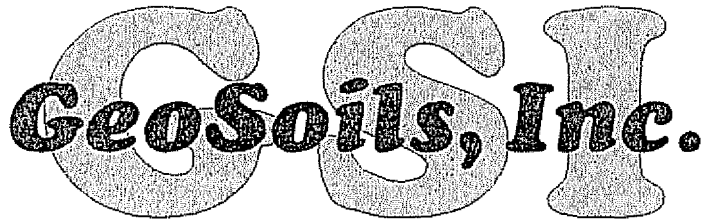

LOG OF EXPLORATORY TEST PITS

Geosols, Inc.

TEST PIT NO.	DEPTH (ft.)	GROUP SYMBOL	SAMPLE DEPTH (ft.)	MOISTURE (%)	FIELD DRY DENSITY (pcf)	DESCRIPTION
TP-29	0 - 1'	SM				COLLUVIUM/TOPSOIL: Silty SAND, reddish brown, dry, medium dense; porous.
	1' - 4'	SC	Nuke - 3'	26.1	105.6	QUATERNARY FAN DEPOSITS: Clayey SAND, red, damp, dense to very dense w/depth.
						Total Depth = 4' No Groundwater Encountered Backfilled 1/23/03
TP-30	0 - 1½'	SM/SC				COLLUVIUM/TOPSOIL: Silty SAND and Clayey SAND, reddish brown, dry, medium dense.
	1½' - 5'	SC	Nuke - 2'	14.2	110.8	QUATERNARY FAN DEPOSITS: Clayey SAND, red, dry, dense to very dense w/depth.
						Total Depth = 5' No Groundwater Encountered Backfilled 1/23/03

BORING LOG





GeoSoils, Inc.

W.O. 3441-A-SC



PROJECT: RENNAISSANCE COMMUNITIES, LLC
 Horsethief Canyon

BORING B-1 SHEET 1 OF 1

DATE EXCAVATED 2-4-03

Depth (ft.)	Sample			USCS Symbol	Dry Unit Wt. (pcf)	Moisture (%)	Saturation (%)	Description of Material
	Bulk	Undis-turbed	Blows/ft.					
5			14	SP	108.4	4.7	23.8	<p>QUATERNARY ALLUVIUM YOUNGER: @ 0' SAND, grayish brown, dry, loose.</p> <p>@ 5' SAND, medium to reddish brown, dry, medium dense; fine to coarse grained, porous.</p>
10			102	SM	115.5	3.5	21.5	<p>QUATERNARY FAN DEPOSITS: @ 10' SILTY SAND, light reddish brown, dry, very dense; minor gravel encountered, minor cementation.</p>
15			31	SMML		13.6		<p>@ 15' SILTY SAND and SILT, yellowish to reddish brown, damp, dense to very stiff.</p>
20			40+ 50-5"	SM	119.9	9.1	63.7	<p>@ 20' SILTY SAND, medium brown, moist, very dense; well cemented.</p>
25								<p>Total Depth = 21' No Groundwater Encountered No Caving Encountered Backfilled 2-4-03</p>

SAMPLE METHOD: 8" HOLLOWSTEM AUGER

-  Standard Penetration Test
-  Undisturbed, Ring Sample

 Groundwater

GeoSoils, Inc.

BORING LOG

W.O. 3441-A-SC

PROJECT: RENNAISSANCE COMMUNITIES, LLC
Horsethief Canyon

BORING B-2 SHEET 1 OF 1

DATE EXCAVATED 2-4-03

Depth (ft.)	Sample		USCS Symbol	Dry Unit Wt. (pcf)	Moisture (%)	Saturation (%)	Description of Material
	Bulk	Undis-turbed					
0-5			SM				QUATERNARY ALLUVIUM YOUNGER: @ 0' SILTY SAND, light gray, loose.
5-10				109.9	2.5	13.0	@ 5' SILTY SAND, medium brown, dry, medium dense, porous.
10-15			SM/SP		3.5		@ 10' SILTY SAND and SAND, medium to reddish brown, dry, medium dense.
15-20			SM	110.3	4.4	23.5	@ 15' SILTY SAND, reddish brown, dry, medium dense; fine to course grained. @ 17½' Minor Gravel.
20-25					9.1		@ 20' SILTY SAND, medium to reddish brown, dry, medium dense.
25			SM	112.7	6.6	37.3	QUATERNARY FAN DEPOSITS: @ 25' SILTY SAND, reddish to yellowish brown, damp, very dense.
Total Depth = 25' No Groundwater Encountered No Caving Encountered Backfilled 2-4-03							

GeoSoils, Inc.

BORING LOG

W.O. 3441-A-SC

PROJECT: RENAISSANCE COMMUNITIES, LLC
 Horsethief Canyon

BORING B-3 SHEET 1 OF 2

DATE EXCAVATED 2-4-03

Depth (ft.)	Sample			USCS Symbol	Dry Unit Wt. (pcf)	Moisture (%)	Saturation (%)	Description of Material
	Bulk	Undis-turbed	Blows/ft.					
				SM				<p>QUATERNARY ALLUVIUM (YOUNGER): SILTY SAND, light gray, dry, very loose.</p>
5			33		111.0	2.1	11.2	@ 5' SILTY SAND, light reddish brown, dry, medium dense; minor gravel.
10			30		110.0	2.2	11.8	@ 10' As per 5'.
15			18			2.3		@ 15' SILTY SAND, light yellowish brown, dry, medium dense; fine to coarse grained.
20			27		106.1	3.3	15.8	@ 20' SILTY SAND, light reddish brown, dry, medium dense.
25			30			4.2		@ 25' As per 20', medium brown.
								@ 27' Minor gravel and cobbles encountered.

SAMPLE METHOD: 8" HOLLOWSTEM AUGER

 Standard Penetration Test

 Undisturbed, Ring Sample

 Groundwater

BORING LOG

GeoSoils, Inc.

W.O. 3441-A-SC

PROJECT: RENNAISSANCE COMMUNITIES, LLC
 Horsethief Canyon

BORING B-3 SHEET 2 OF 2

DATE EXCAVATED 2-4-03

Depth (ft.)	Sample			USCS Symbol	Dry Unit Wt. (pcf)	Moisture (%)	Saturation (%)	SAMPLE METHOD: <u>8" HOLLOWSTEM AUGER</u> Standard Penetration Test Undisturbed, Ring Sample Groundwater	Description of Material
	Bulk	Undis-turbed	Blows/ft.						
35		50-6"	50-6"	SM	118.9	3.9	26.5		@ 30' SILTY SAND, medium brown, damp, dense; abundant coarse grained sands.
40		27+ 50-2"	27+ 50-2"	GM		5.7			QUATERNARY FAN DEPOSITS: @ 35' SILTY SAND w/GRAVEL, medium to light reddish brown, dry, very dense.
45		50-3 1/2"	50-3 1/2"	SM	115.5	5.7	35.1		@ 40' SILTY SAND, yellowish brown, damp, very dense; abundant coarse grained sands.
50									Total Depth = 41' No Groundwater Encountered No Caving Encountered Backfilled 2-4-03
55									

APPENDIX C

EQFAULT DATA

EARTHQUAKE RECURRENCE CURVE

Horsethief Canyon

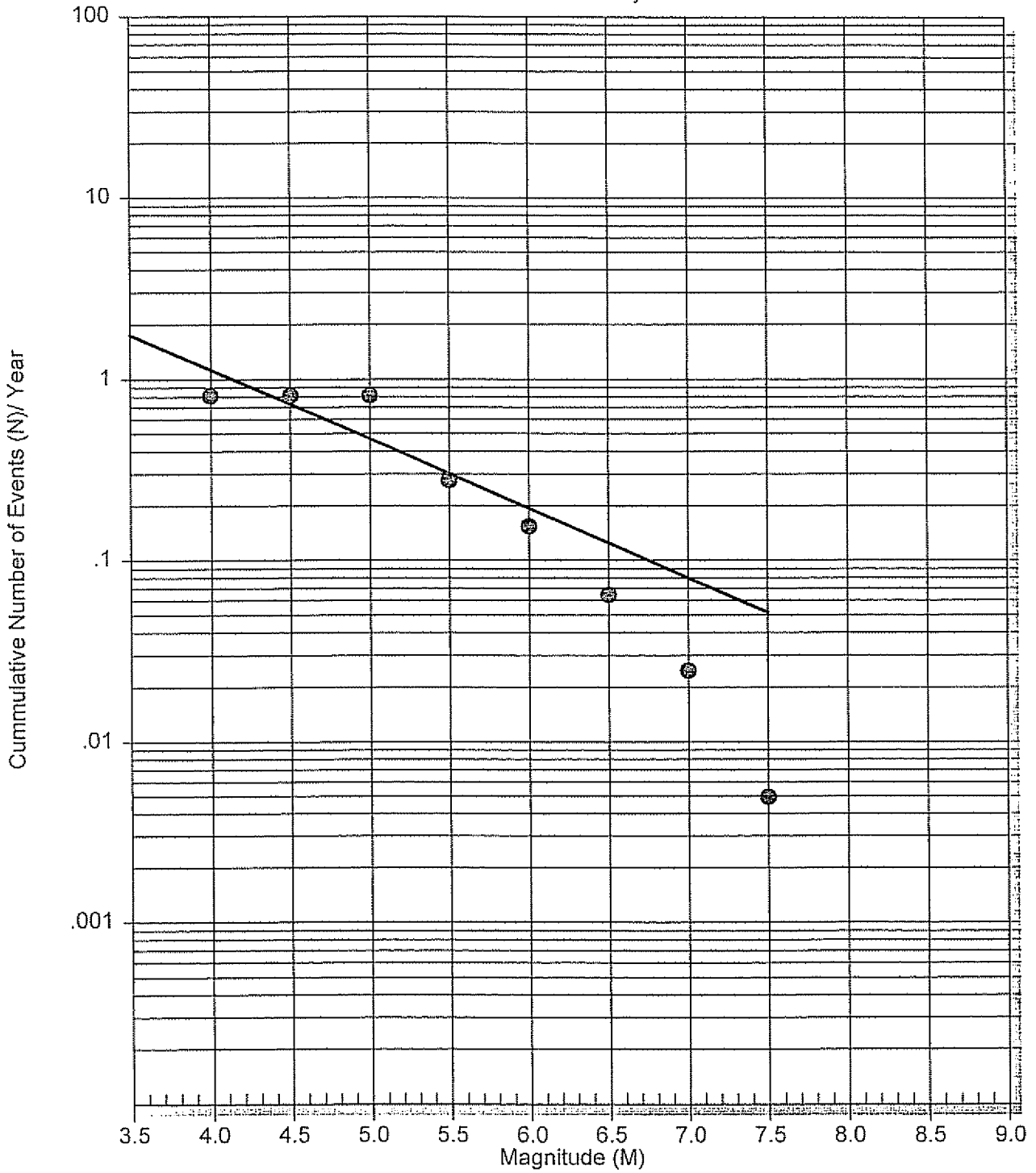

Figure C-2

EARTHQUAKE EPICENTER MAP

Horsethief Canyon

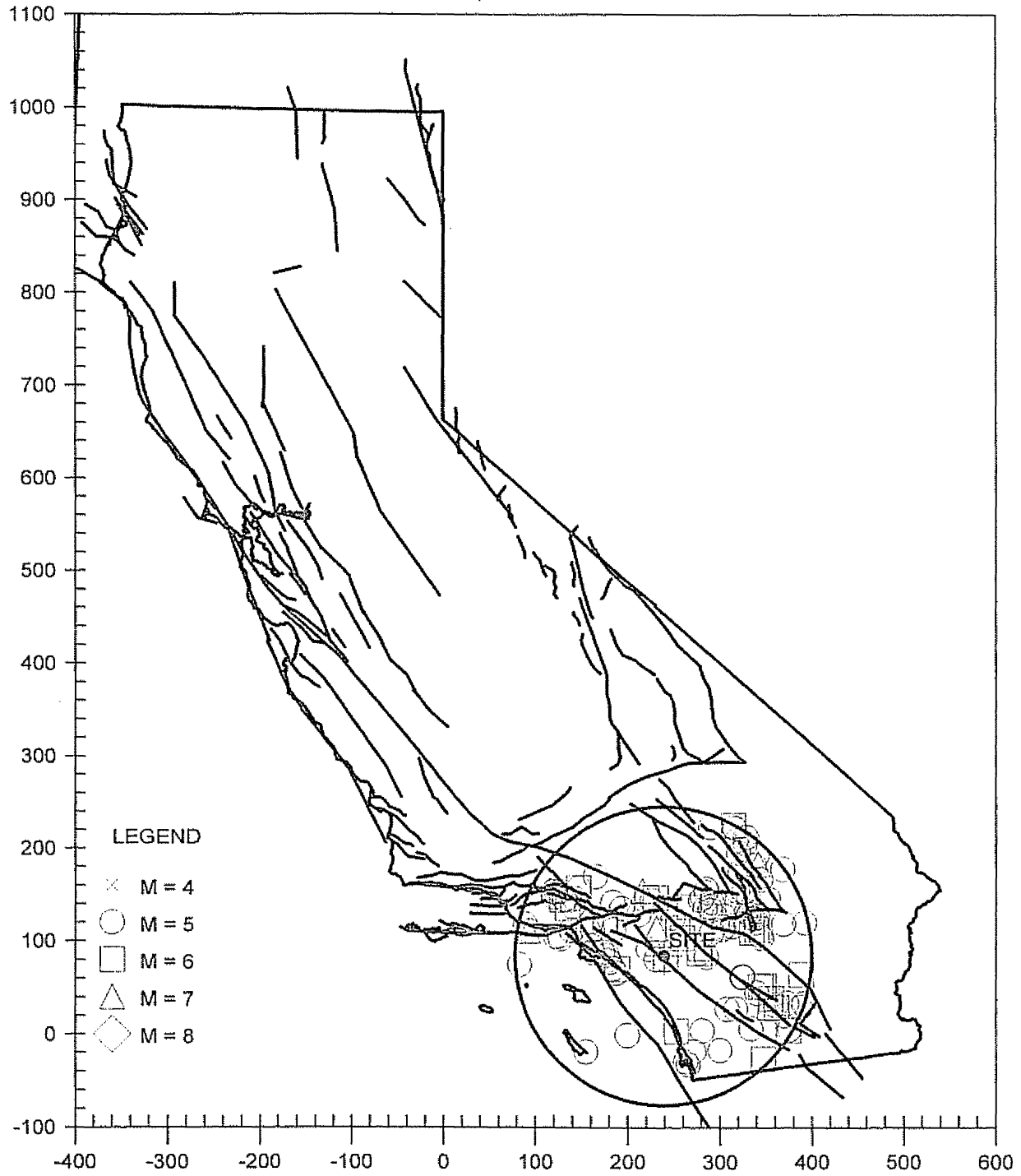

Figure C-3

PROBABILITY OF EXCEEDANCE

BOZ. ET AL.(1999)HOR PS COR 1

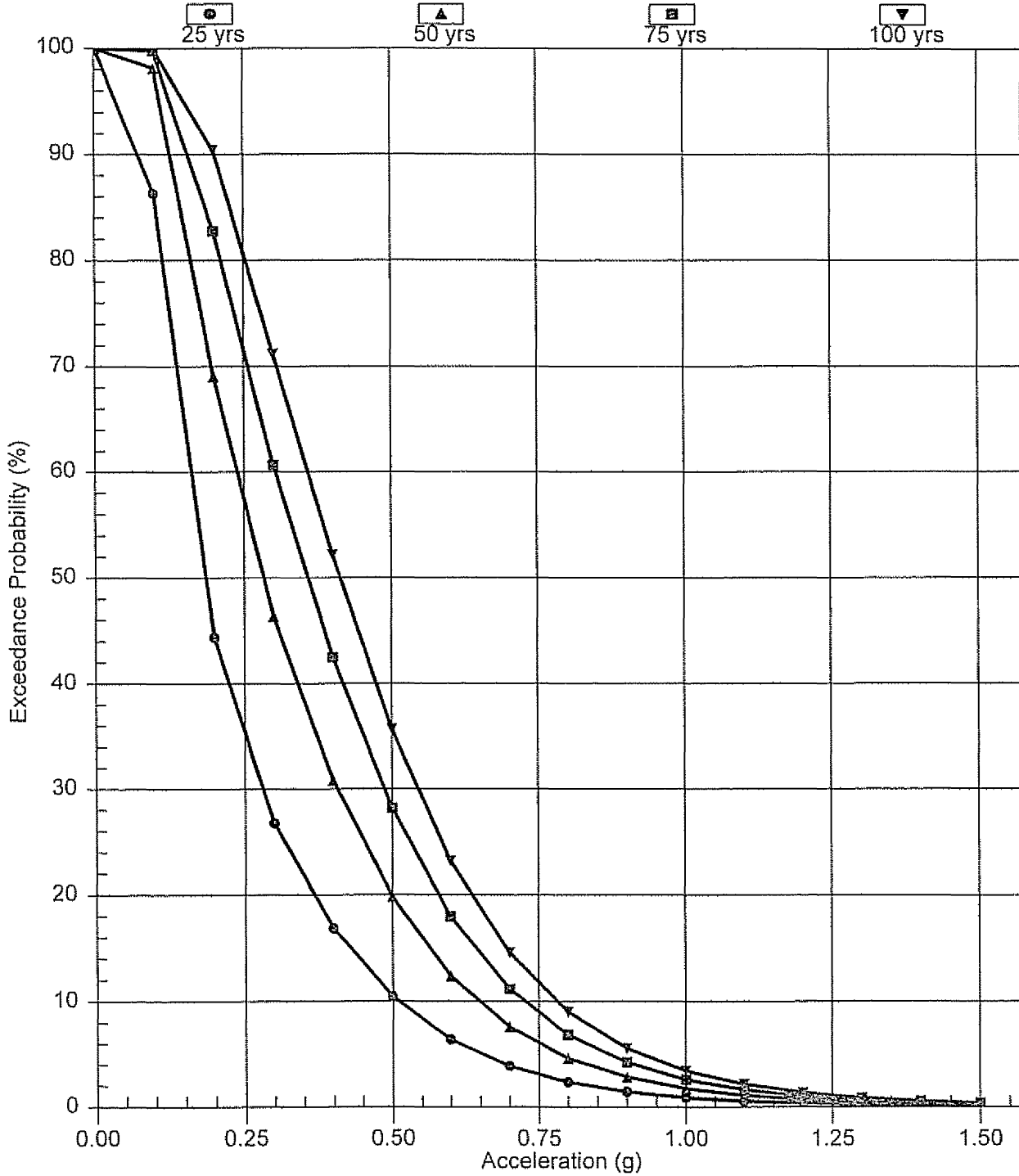

Figure C-4

RETURN PERIOD VS. ACCELERATION

BOZ. ET AL.(1999)HOR PS COR 1

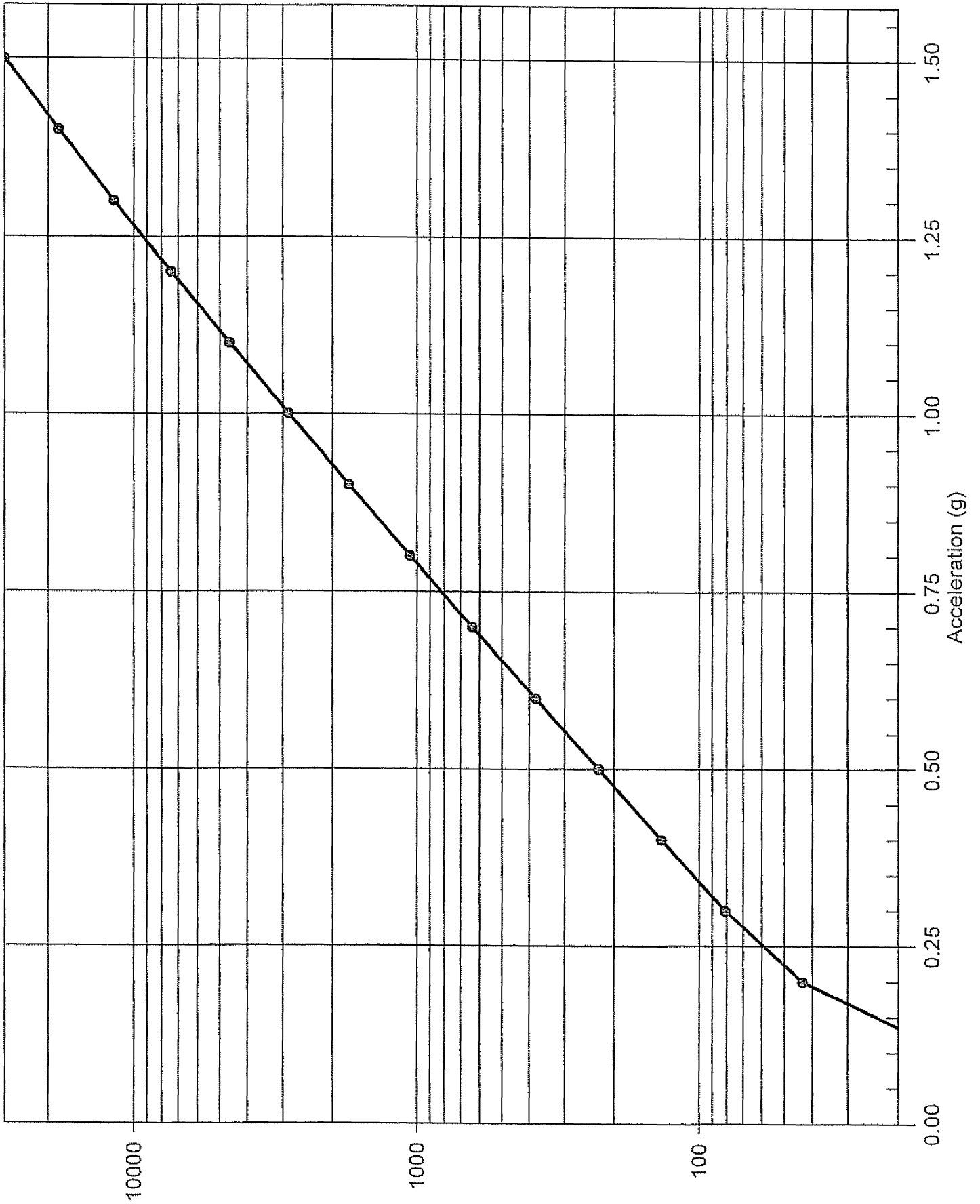

Figure C-5

Table 1 - Laboratory Tests on Soil Samples

Renaissance Dev.
Your #3441-A-SC, MJS&A #03-0128LAB
 29-Jan-03

Sample ID

TP 8 @ 1-2' TP 23 @ 2-3'

				TP 8 @ 1-2'	TP 23 @ 2-3'
Resistivity	Units				
as-received	ohm-cm			79,000	24,000
saturated	ohm-cm			12,000	7,700
pH				7.3	7.4
Electrical					
Conductivity	mS/cm			0.11	0.37
Chemical Analyses					
Cations					
calcium	Ca ²⁺	mg/kg		28	224
magnesium	Mg ²⁺	mg/kg		15	27
sodium	Na ¹⁺	mg/kg		44	5
Anions					
carbonate	CO ₃ ²⁻	mg/kg		ND	ND
bicarbonate	HCO ₃ ¹⁻	mg/kg		171	604
chloride	Cl ¹⁻	mg/kg		20	ND
sulfate	SO ₄ ²⁻	mg/kg		55	178
Other Tests					
ammonium	NH ₄ ¹⁺	mg/kg		na	na
nitrate	NO ₃ ¹⁻	mg/kg		na	na
sulfide	S ²⁻	qual		na	na
Redox		mv		na	na

Electrical conductivity in millisiemens/cm and chemical analysis were made on a 1:5 soil-to-water extract.
 mg/kg = milligrams per kilogram (parts per million) of dry soil.
 Redox = oxidation-reduction potential in millivolts
 ND = not detected
 na = not analyzed

APPENDIX D

LABORATORY TEST RESULTS

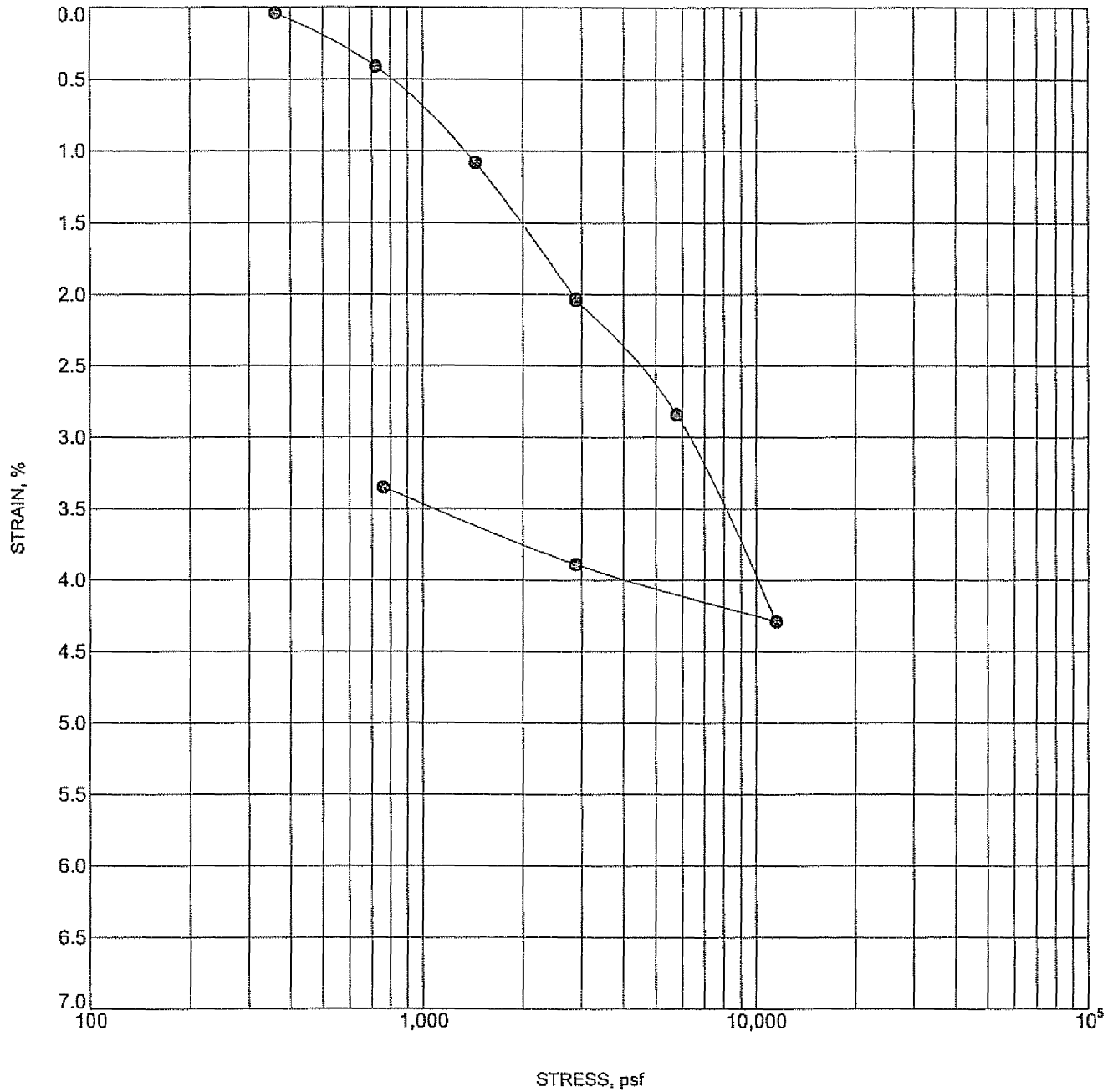

Sample	Depth/El.	Visual Classification	γ_d	MC	MC	H2O
			Initial	Initial	Final	
⊕ B-1	20.0	Silty Sand w/ Gravel	121.5	9.1	6.2	2880

US CONSOL. STRAIN 3441.GPJ US LAB.GDT 4/29/03



GeoSoils, Inc.
 5741 Palmer Way
 Carlsbad, CA 92008
 Telephone: (760) 438-3155
 Fax: (760) 931-0915

CONSOLIDATION TEST

Project: RENAISSANCE DEVELOPMENT

Number: 3441-A-SC

Date: April 2003

Plate: D - 1

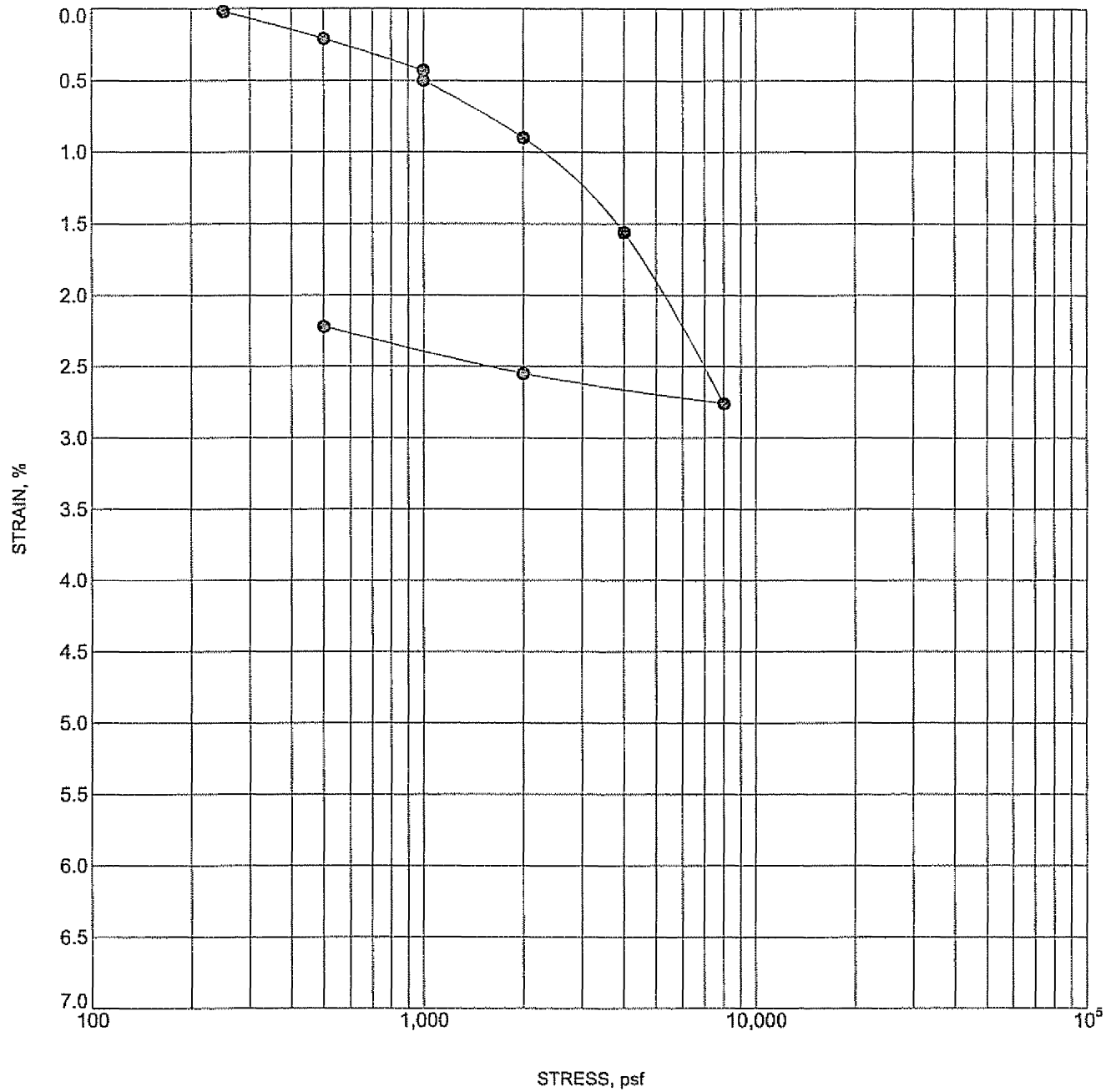

Sample	Depth/EI.	Visual Classification	γ_d Initial	MC Initial	MC Final	H2O
TP-1 TP-28 Mix	3.0		114.8	9.8	11.8	1000

US CONSOL. STRAIN 3441.GPJ US LAB.GDT 4/29/03



GeoSoils, Inc.
 5741 Palmer Way
 Carlsbad, CA 92008
 Telephone: (760) 438-3155
 Fax: (760) 931-0915

CONSOLIDATION TEST

Project: RENAISSANCE DEVELOPMENT

Number: 3441-A-SC

Date: April 2003

Plate: D - 2

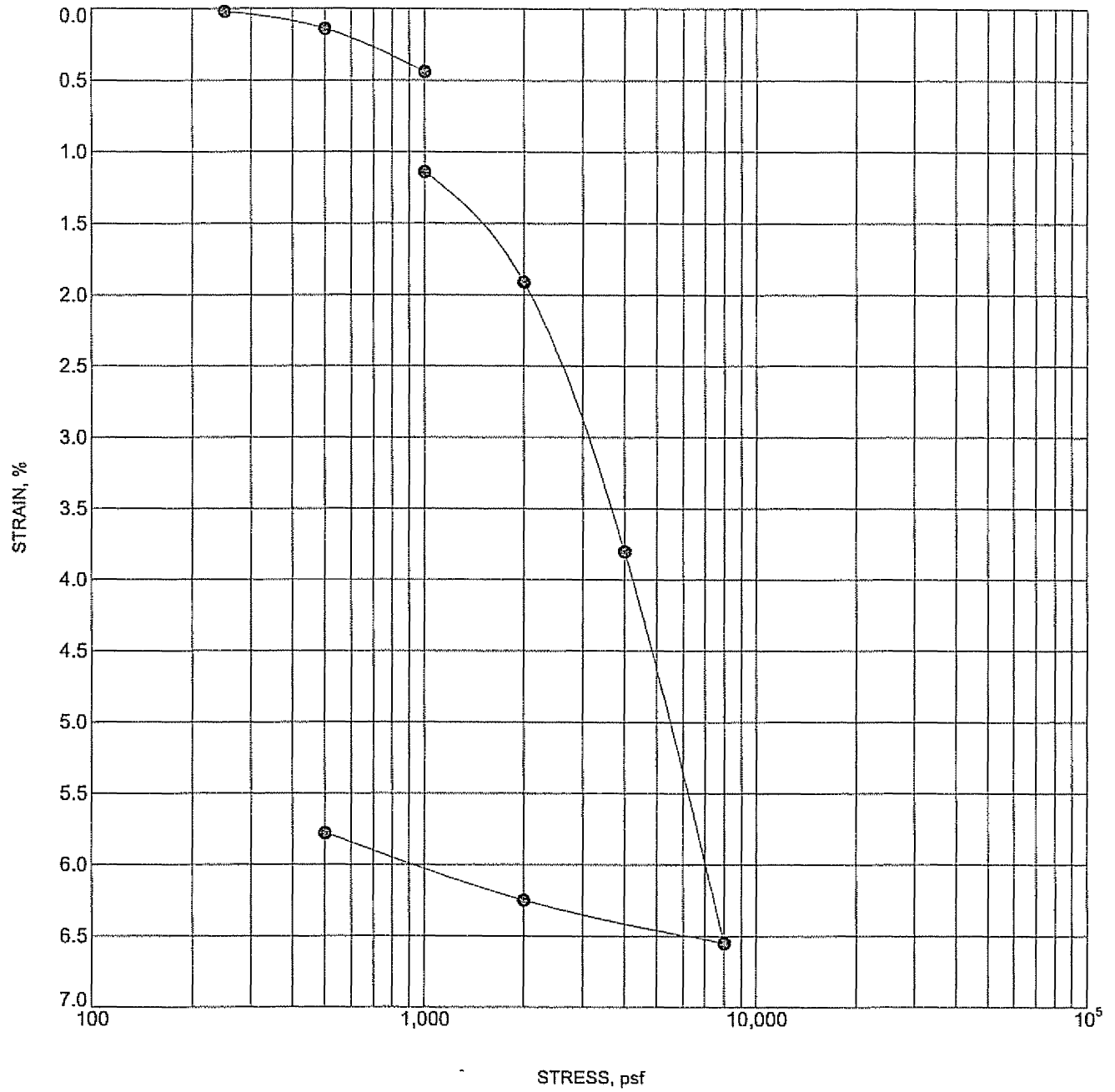

Sample	Depth/EI.	Visual Classification	γ_d Initial	MC Initial	MC Final	H2O
⊕ TP-28	3.0	Silty Sand	110.7	6.6	13.3	1000

US CONSOL STRAIN 3441.GPJ US LAB.GDT 4/29/03



GeoSoils, Inc.
 5741 Palmer Way
 Carlsbad, CA 92008
 Telephone: (760) 438-3155
 Fax: (760) 931-0915

CONSOLIDATION TEST

Project: RENAISSANCE DEVELOPMENT

Number: 3441-A-SC

Date: April 2003

Plate: D - 3

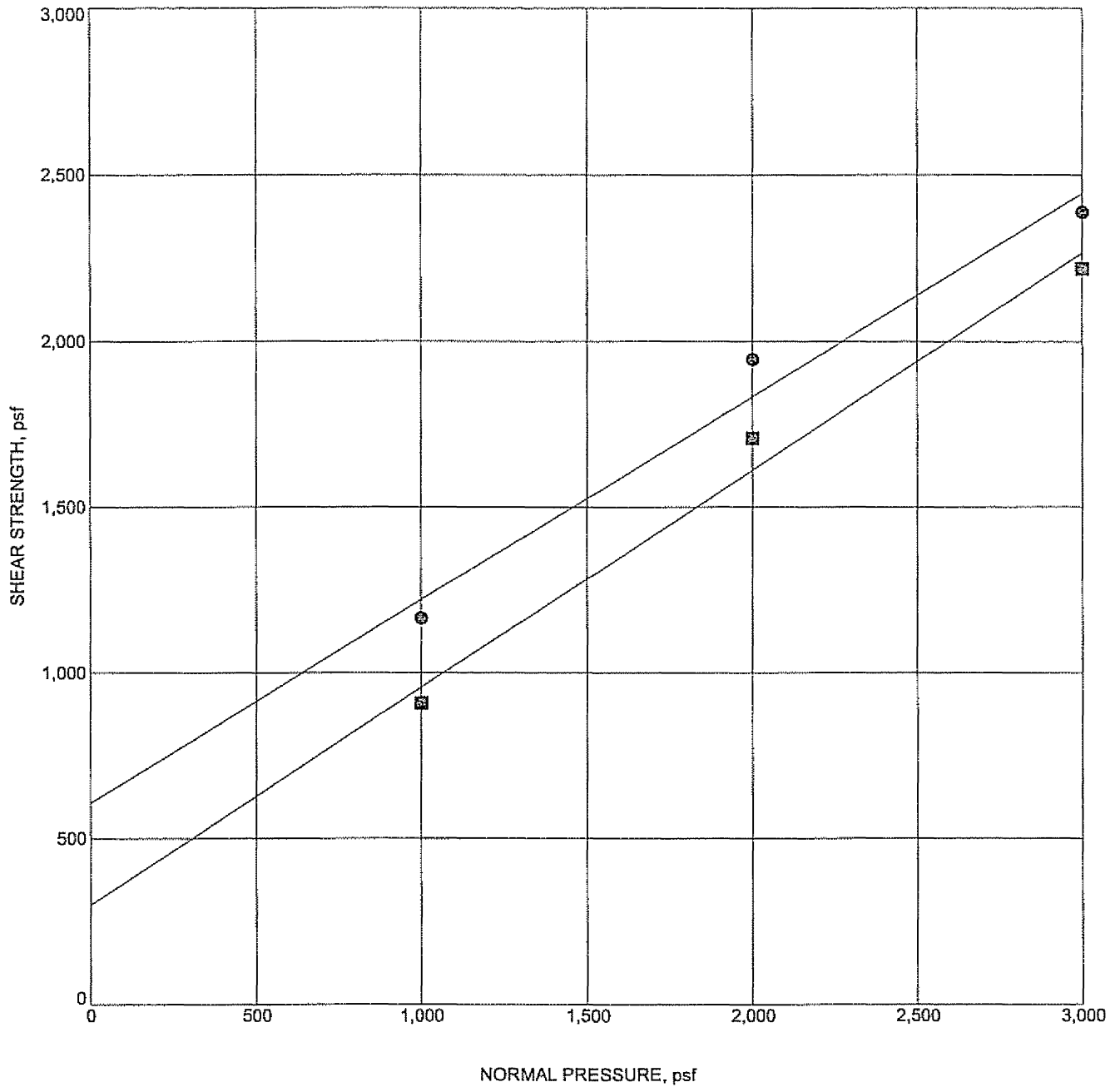

Sample	Depth/EI.	Primary/Residual Shear	Sample Type	γ_d	MC%	c	ϕ
⊕ B-1	20.0	Primary Shear	Undisturbed	118.4	9.1	608	31
⊠ B-1	20.0	Residual Shear	Undisturbed	118.4	9.1	300	33

Note: Sample Inundated prior to testing



GeoSoils, Inc.
 5741 Palmer Way
 Carlsbad, CA 92008
 Telephone: (760) 438-3155
 Fax: (760) 931-0915

DIRECT SHEAR TEST

Project: RENAISSANCE DEVELOPMENT

Number: 3441-A-SC

Date: April 2003

Plate: D - 4

US DIRECT SHEAR 3441.GPJ US LAB GDT 4/29/03

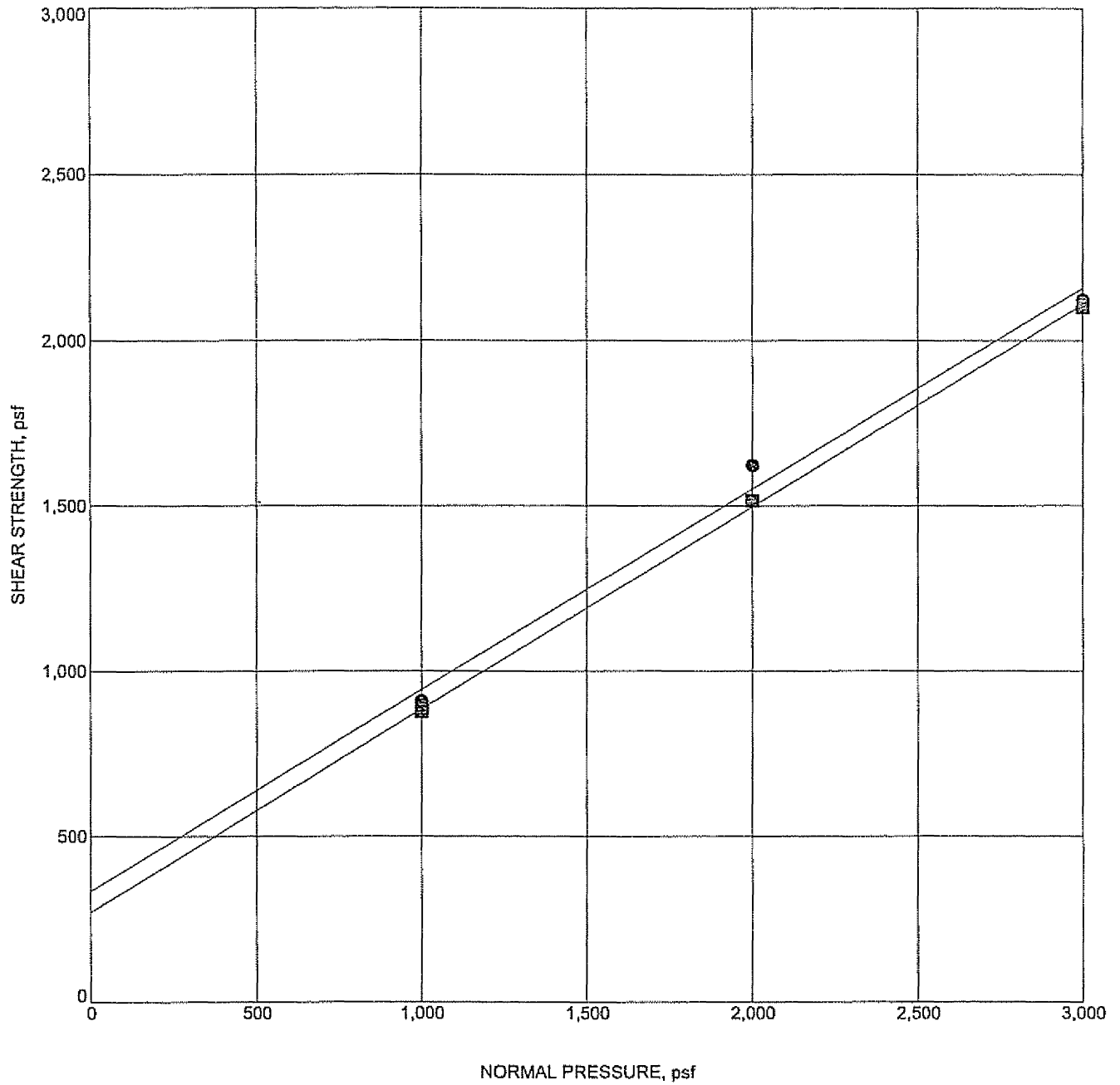

Sample	Depth/EI.	Primary/Residual Shear	Sample Type	γ_d	MC%	c	ϕ
⊙ TP-1	3.0	Primary Shear	Remolded	114.3	11.0	336	31
⊠ TP-1	3.0	Residual Shear	Remolded	114.3	11.0	272	31

Note: Sample Inundated prior to testing



GeoSoils, Inc.
 5741 Palmer Way
 Carlsbad, CA 92008
 Telephone: (760) 438-3155
 Fax: (760) 931-0915

DIRECT SHEAR TEST

Project: RENAISSANCE DEVELOPMENT

Number: 3441-A-SC

Date: April 2003

Plate: D - 5

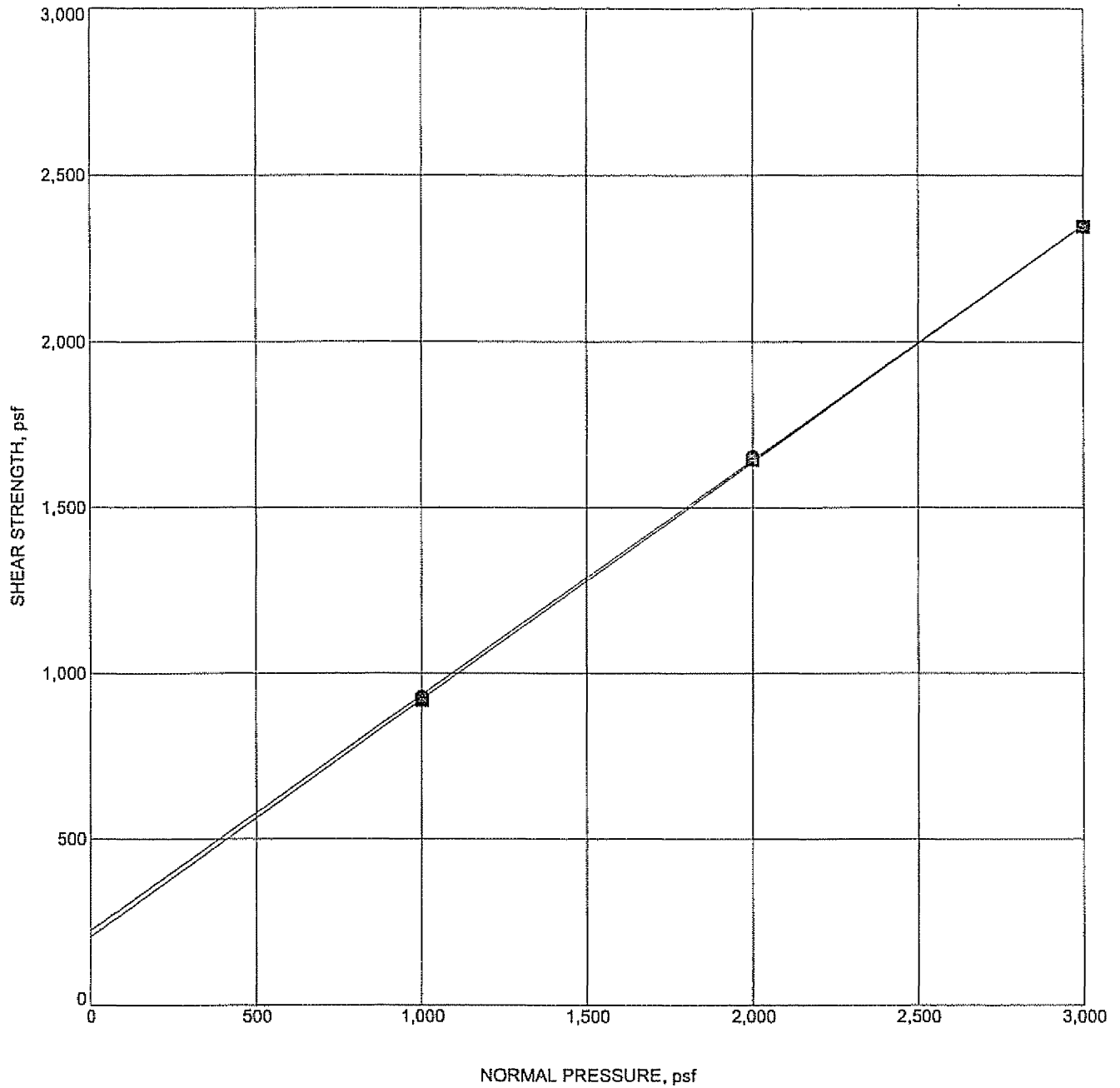

Sample	Depth/EI.	Primary/Residual Shear	Sample Type	γ_d	MC%	c	ϕ
① TP-28	3.0	Primary Shear	Undisturbed	110.7	6.6	225	35
② TP-28	3.0	Residual Shear	Undisturbed	110.7	6.6	207	36

Note: Sample Innundated prior to testing



GeoSoils, Inc.
 5741 Palmer Way
 Carlsbad, CA 92008
 Telephone: (760) 438-3155
 Fax: (760) 931-0915

DIRECT SHEAR TEST

Project: RENAISSANCE DEVELOPMENT

Number: 3441-A-SC

Date: April 2003

Plate: D - 6

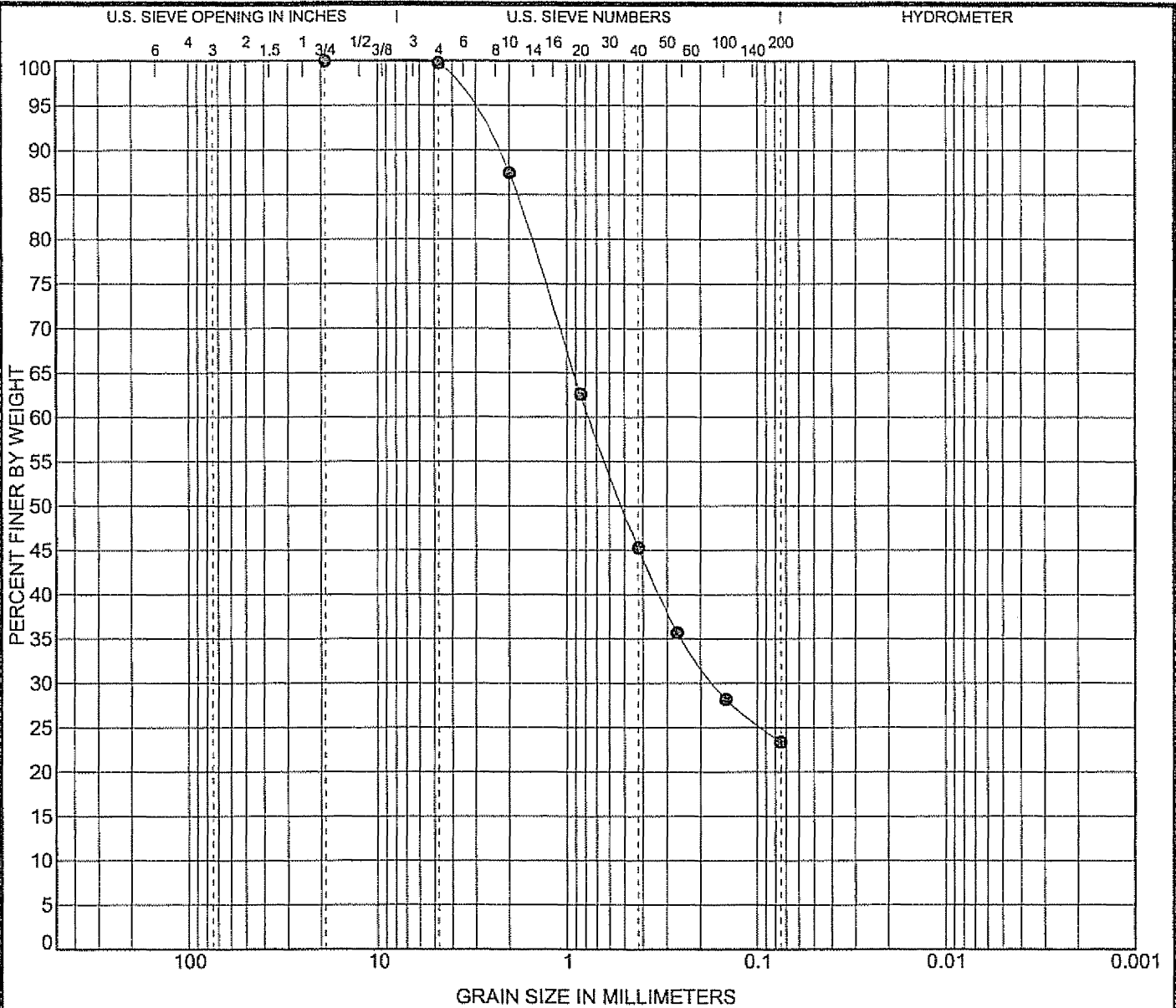

COBBLES	GRAVEL		SAND			SILT OR CLAY
	coarse	fine	coarse	medium	fine	

Sample	Depth	Classification	LL	PL	PI	Cc	Cu
TP-1 TP-28 Mix	3.0						

Sample	Depth	D100	D60	D30	D10	%Gravel	%Sand	%Silt	%Clay
TP-1 TP-28 Mix	3.0	19	0.765	0.17		0.3	76.4		23.4



GeoSoils, Inc.
 5741 Palmer Way
 Carlsbad, CA 92008
 Telephone: (760) 438-3155
 Fax: (760) 931-0915

GRAIN SIZE DISTRIBUTION

Project: RENAISSANCE DEVELOPMENT

Number: 3441-A-SC

Date: April 2003

Plate: D - 7

US GRAIN SIZE 3441.GPJ US LAB.GDT 4/29/03

APPENDIX E

SLOPE STABILITY ANALYSES

APPENDIX E

SLOPE STABILITY ANALYSIS INTRODUCTION OF GSTABL7 v.2 COMPUTER PROGRAM

Introduction

GSTABL7 v.2 is a fully integrated slope stability analysis program. It permits the engineer to develop the slope geometry interactively and perform slope analysis from within a single program. The slope analysis portion of GSTABL7 v.2 uses a modified version of the popular STABL program, originally developed at Purdue University.

GSTABL7 v.2 performs a two dimensional limit equilibrium analysis to compute the factor of safety for a layered slope using the simplified Bishop or Janbu methods. This program can be used to search for the most critical surface or the factor of safety may be determined for specific surfaces. GSTABL7, Version 2, is programmed to handle:

1. Heterogenous soil systems
2. Anisotropic soil strength properties
3. Reinforced slopes
4. Nonlinear Mohr-Coulomb strength envelope
5. Pore water pressures for effective stress analysis using:
 - a. Phreatic and piezometric surfaces
 - b. Pore pressure grid
 - c. R factor
 - d. Constant pore water pressure
6. Pseudo-static earthquake loading
7. Surcharge boundary loads
8. Automatic generation and analysis of an unlimited number of circular, noncircular and block-shaped failure surfaces
9. Analysis of right-facing slopes
10. Both SI and Imperial units

General Information

If the reviewer wishes to obtain more information concerning slope stability analysis, the following publications may be consulted initially:

1. The Stability of Slopes, by E.N. Bromhead, Surrey University Press, Chapman and Hall, N.Y., 411 pages, ISBN 412 01061 5, 1992.
2. Rock Slope Engineering, by E. Hoek and J.W. Bray, Inst. of Mining and Metallurgy, London, England, Third Edition, 358 pages, ISBN 0 900488 573, 1981.
3. Landslides: Analysis and Control, by R.L. Schuster and R.J. Krizek (editors), Special Report 176, Transportation Research Board, National Academy of Sciences, 234 pages, ISBN 0 309 02804 3, 1978.

GSTABL7 v.2 Features

The present version of GSTABL7 v.2 contains the following features:

1. Allows user to calculate factors of safety for static stability and dynamic stability situations.
2. Allows user to analyze stability situations with different failure modes.
3. Allows user to edit input for slope geometry and calculate corresponding factor of safety.
4. Allows user to readily review on-screen the input slope geometry.
5. Allows user to automatically generate and analyze unlimited number of circular, non-circular and block-shaped failure surfaces (i.e., bedding plane, slide plane, etc.).

Input Data

Input data includes the following items:

1. Unit weight, residual cohesion, residual friction angle, peak cohesion, and peak friction angle of fill material, bedding plane, and bedrock, respectively. Residual cohesion and friction angle is used for static stability analysis, where as peak cohesion and friction angle is for dynamic stability analysis.
2. Slope geometry and surcharge boundary loads.
3. Apparent dip of bedding plane can be specified in angular range (i.e., from 0 to 90 degrees).
4. Pseudo-static earthquake loading (an earthquake loading of 0.15 g was used in the analysis).

Seismic Discussion

Seismic stability analyses were approximated using a pseudo-static approach. The major difficulty in the pseudo-static approach arises from the appropriate selection of the seismic coefficient used in the analysis. The use of a static inertia force equal to this acceleration during an earthquake (rigid-body response) would be extremely conservative for several reasons including: (1) only low height, stiff/dense embankments or embankments in confined areas may respond essentially as rigid structures; (2) an earthquake's inertia force is enacted on a mass for a short time period. Therefore, replacing a transient force by a pseudo-static force representing the maximum acceleration is considered unrealistic; (3) assuming that total pseudo-static loading is applied evenly throughout the embankment

for an extended period of time is an incorrect assumption, as the length of the failure surface analyzed is usually much greater than the wave length of seismic waves generated by earthquakes; and (4) the seismic waves would place portions of the mass in compression and some in tension, resulting in only a limited portion of the failure surface analyzed moving in a downslope direction, at any one instant of time.

The coefficients usually suggested by regulating agencies, counties and municipalities are in the range of 0.05g to 0.25g. For example, past regulatory guidelines within the city and county of Los Angeles indicated that the slope stability pseudostatic coefficient = 0.15 *i*.

The method developed by Krinitzsky, Gould, and Edinger (1993) which was in turn based on Taniguchi and Sasaki, 1986, (T&S, 1986), was referenced. This method is based on empirical data and the performance of existing earth embankments during seismic loading. Our review of "Guidelines for Evaluating and Mitigating Seismic Hazards in California (Davis, 1997) indicates the State of California recommends using pseudo-static coefficient of 0.15 for design earthquakes of M 8.25 or greater and using 0.1 for earthquake parameter M 6.5. Therefore, for conservatism a seismic coefficient of 0.15 *i* was used in our analysis.

Output Information

Output information includes:

1. All input data.
2. Factors of safety for the ten most critical surfaces for static and pseudo-static stability situation.
3. High quality plots can be generated. The plots include the slope geometry, the critical surfaces and the factor of safety.
4. Note, that in the analysis, a minimum of 100 trial surfaces were analyzed for each section for either static or pseudo-static analyses.

Results of Slope Stability Calculation

Table E-1 shows parameters used in slope stability calculations. Summaries of the slope stability analysis are presented in Table E-2. Surficial slope stability calculations are presented as Figure E-2. Detailed output information is presented in Figures E-3 to E-6. The locations of the geologic cross-sections are presented on Plate 1. The Geologic cross-sections are presented on Plate 2.

TABLE E-1

SOIL PARAMETERS USED

SOIL MATERIALS	PEAK VALUES	
	C (psf)	Φ (degrees)
Compacted Fill	336	31
Quaternary Fan Deposits	225	35

TABLE E-2

SUMMARY OF SLOPE ANALYSIS

STABILITY	SLOPE CONFIGURATION	SLOPE GRADIENT	FACTORS OF SAFETY		REMARKS
			STATIC	SEISMIC	
Gross A - A'	50 Foot High Cut Slope	2:1	2.06	1.50	Bishop, circular
Gross A - A'	70 Foot High Fill Slope	2:1	1.85	1.35	Bishop, circular

Figure E-1

SURFICIAL SLOPE STABILITY ANALYSIS

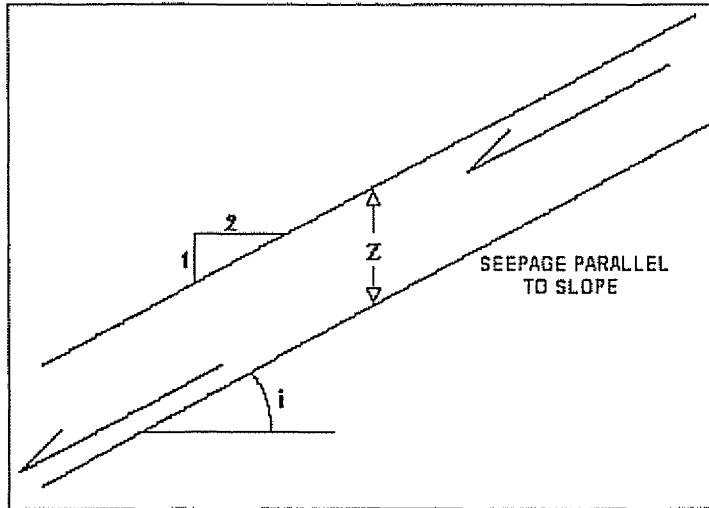

Renaissance Ranch, LLC
W.O 3441-A-SC

COMPACTED
FILL SLOPE

CUT
SLOPE

SECTION
70 FEET HIGH

SECTION
50 FEET HIGH

Depth of Saturation (z) =	4 ft	4 ft
Slope Angle (i) (2:1 slopes)	26.6°	26.6°
Unit Weight of Water (γ_w)	62.4 pcf	62.4 pcf
Saturated Unit of Soil (γ_{SAT})	125 pcf	125 pcf
Apparent Angle of Internal Friction (Θ)	31°	35°
Apparent Cohesion (C) =	336 psf	225 psf

$$F_s, \text{ Static Safety Factor} = \frac{z (\gamma_{SAT} - \gamma_w) \cos^2(i) \tan(\Theta) + C}{z \gamma_{SAT} \sin(i) \cos(i)}$$

DEPTH OF SATURATION	STATIC F.S.	STATIC F.S.
	FILL	CUT
4 FEET	2.28	1.82

Figure E-2

RENAISSANCE COMMUNITIES SECTION A-A'- 50' CUT SLOPE- STATIC

C:\STEDWIN\3914CUT.PL2 Run By: GEOSOILS 4/17/03 3:46PM

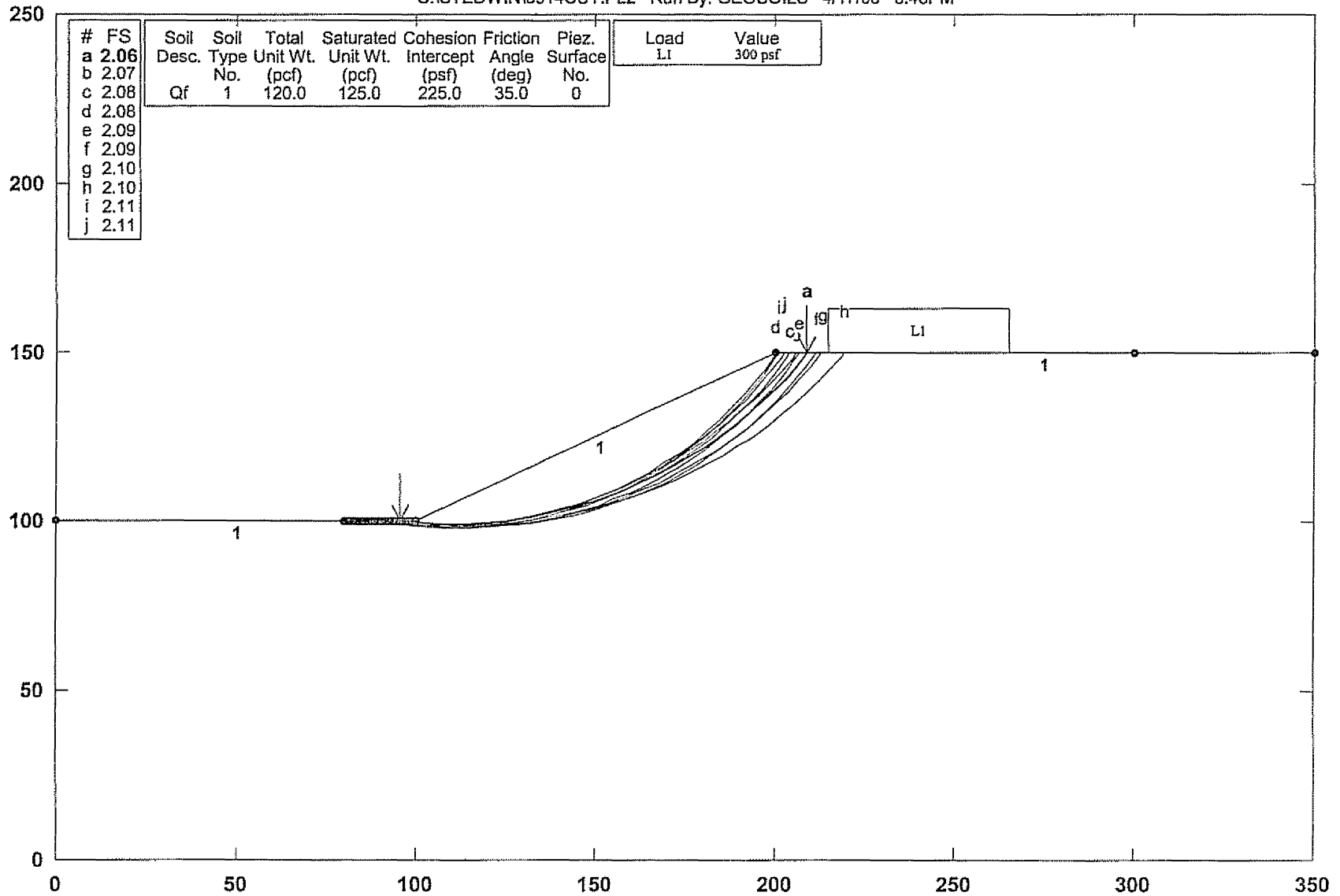

GeoSoils, Inc.

Figure E-3

STED



GSTABL7 v.2 FSmin=2.06

Safety Factors Are Calculated By The Modified Bishop Method

RENAISSANCE COMMUNITIES SECTION A-A'- 50' CUT SLOPE- SEISMIC

C:\STEDWIN\3914CUTS.PL2 Run By: GEOSOILS 4/17/03 3:48PM

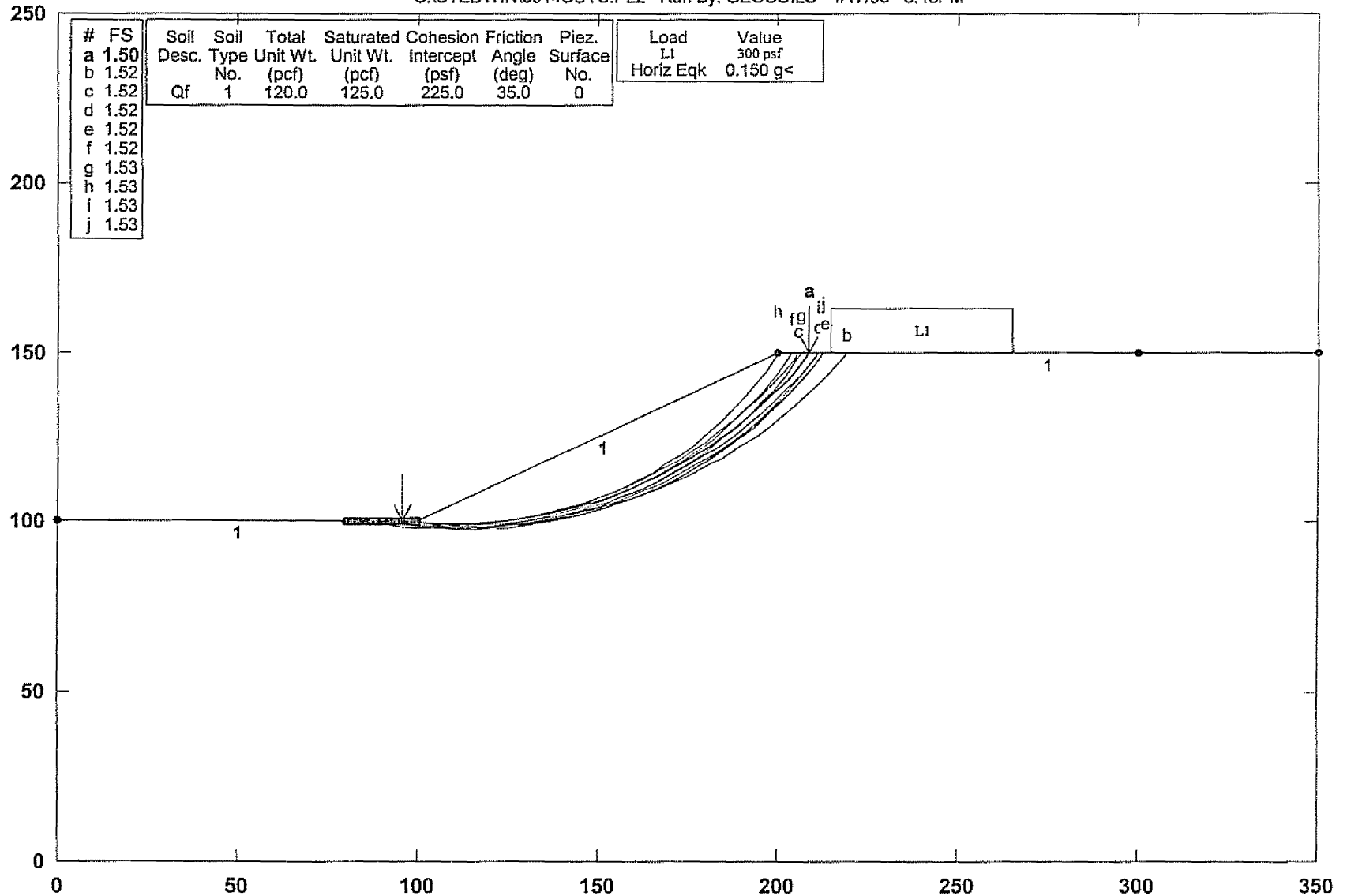

GeSoils, Inc.

Figure E-4

GSTABL7 v.2 FSmin=1.50

Safety Factors Are Calculated By The Modified Bishop Method

STED



RENAISSANCE COMMUNITIES SECTION A-A'- 70' FILL SLOPE- STATIC

C:\STEDWIN\3914FIL.PL2 Run By: GEOSOILS 4/17/03 3:43PM

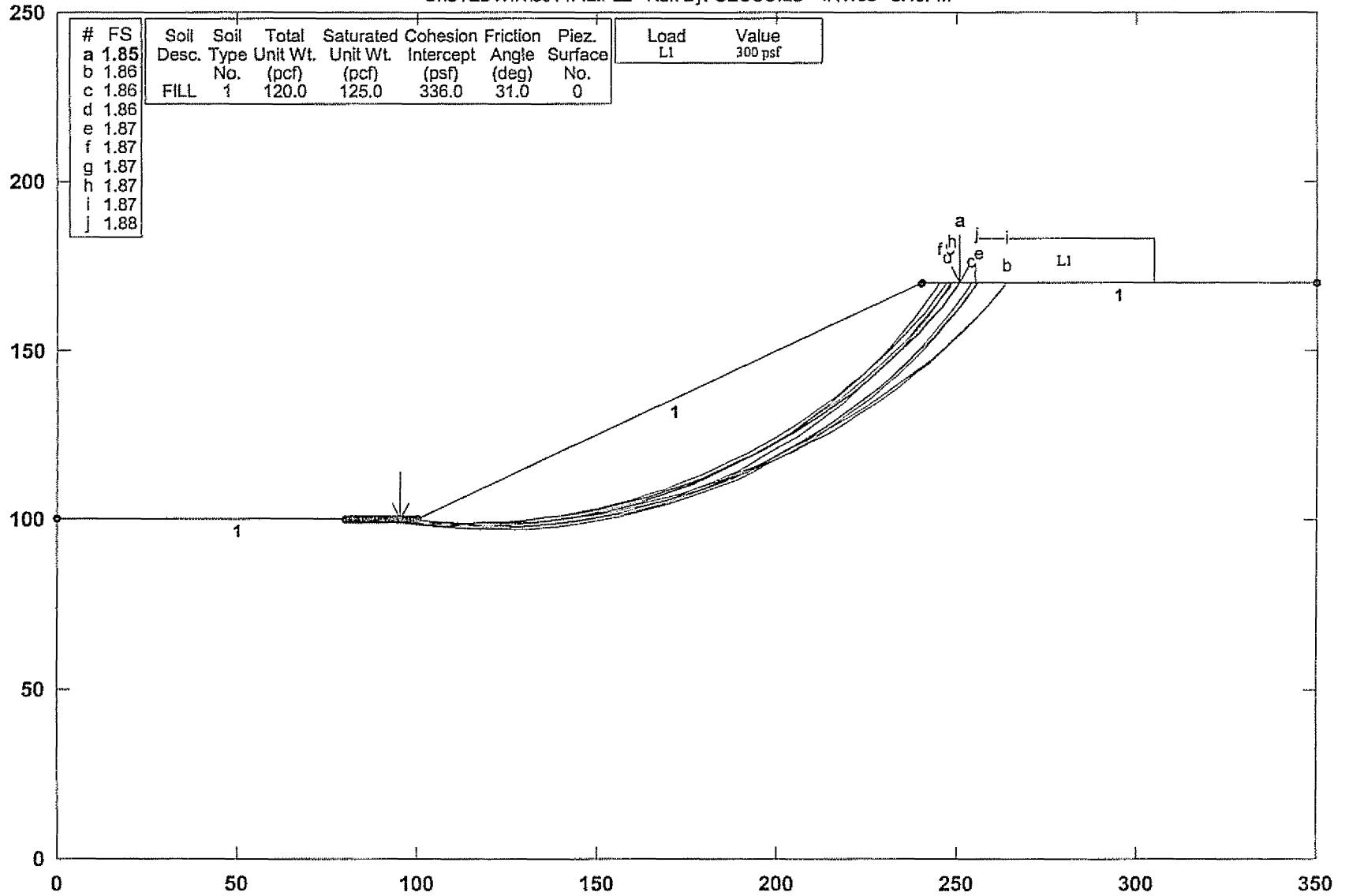

GeoSoils, Inc.

Figure E-5

GSTABL7 v.2 FSmin=1.85

Safety Factors Are Calculated By The Modified Bishop Method

STED



RENAISSANCE COMMUNITIES SECTION A-A'- 70' FILL SLOPE- SEISMIC

C:\STEDWIN\3914\FILS.PL2 Run By: GEOSOILS 4/17/03 3:45PM

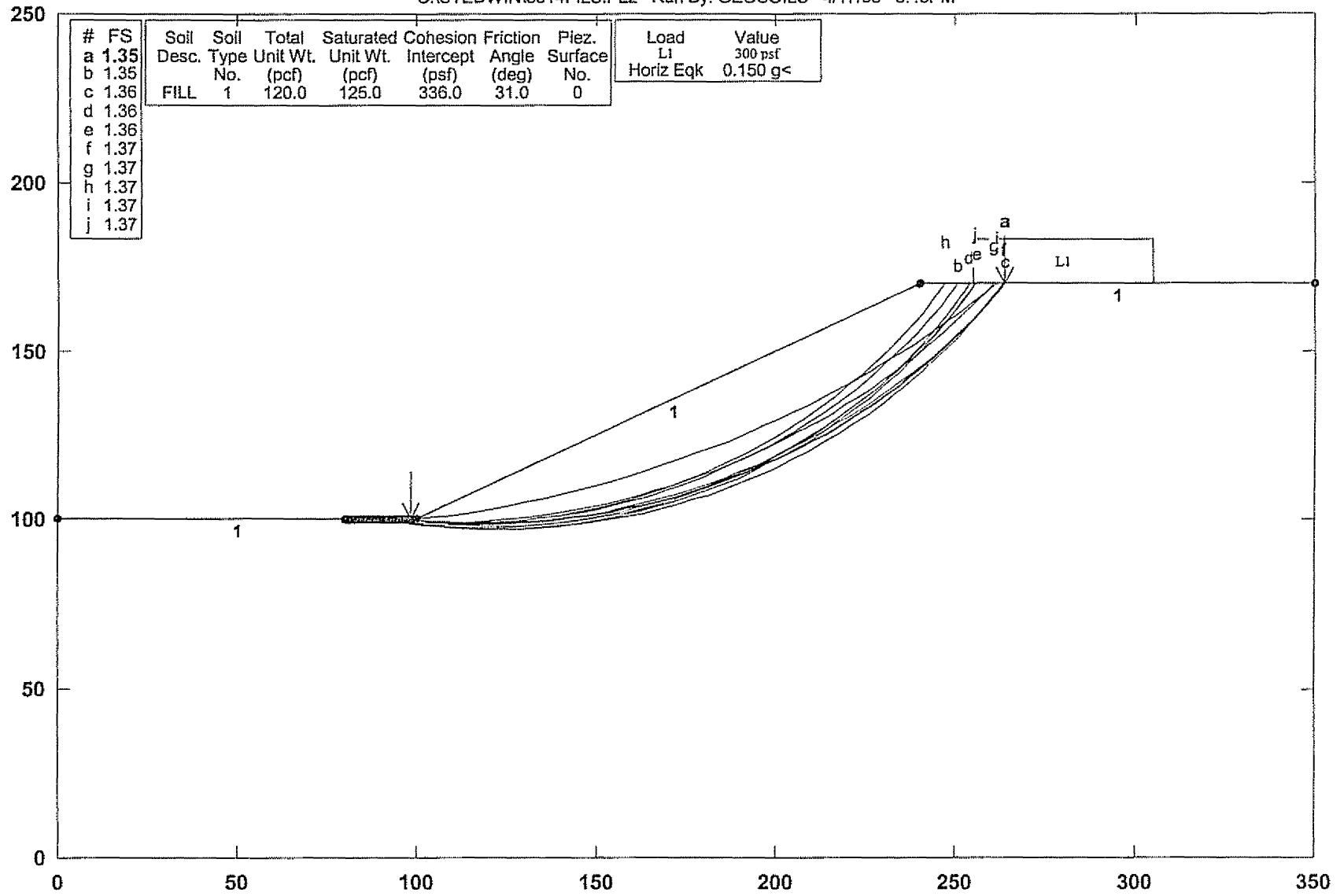

GeoSoils, Inc.

Figure E-6

STED



GSTABL7 v.2 FSmin=1.35
Safety Factors Are Calculated By The Modified Bishop Method

APPENDIX F

GENERAL EARTHWORK AND GRADING GUIDELINES

GENERAL EARTHWORK AND GRADING GUIDELINES

General

These guidelines present general procedures and requirements for earthwork and grading as shown on the approved grading plans, including preparation of areas to be filled, placement of fill, installation of subdrains and excavations. The recommendations contained in the geotechnical report are part of the earthwork and grading guidelines and would supersede the provisions contained hereafter in the case of conflict. Evaluations performed by the consultant during the course of grading may result in new recommendations which could supersede these guidelines or the recommendations contained in the geotechnical report.

The contractor is responsible for the satisfactory completion of all earthwork in accordance with provisions of the project plans and specifications. The project soil engineer and engineering geologist (geotechnical consultant) or their representatives should provide observation and testing services, and geotechnical consultation during the duration of the project.

EARTHWORK OBSERVATIONS AND TESTING

Geotechnical Consultant

Prior to the commencement of grading, a qualified geotechnical consultant (soil engineer and engineering geologist) should be employed for the purpose of observing earthwork procedures and testing the fills for conformance with the recommendations of the geotechnical report, the approved grading plans, and applicable grading codes and ordinances.

The geotechnical consultant should provide testing and observation so that determination may be made that the work is being accomplished as specified. It is the responsibility of the contractor to assist the consultants and keep them apprised of anticipated work schedules and changes, so that they may schedule their personnel accordingly.

All clean-outs, prepared ground to receive fill, key excavations, and subdrains should be observed and documented by the project engineering geologist and/or soil engineer prior to placing and fill. It is the contractor's responsibility to notify the engineering geologist and soil engineer when such areas are ready for observation.

Laboratory and Field Tests

Maximum dry density tests to determine the degree of compaction should be performed in accordance with American Standard Testing Materials test method ASTM designation D-1557-78. Random field compaction tests should be performed in accordance with test method ASTM designation D-1556-82, D-2937 or D-2922 and D-3017, at intervals of approximately 2 feet of fill height or every 100 cubic yards of fill placed. These criteria would vary depending on the soil conditions and the size of the project. The location and frequency of testing would be at the discretion of the geotechnical consultant.

Contractor's Responsibility

All clearing, site preparation, and earthwork performed on the project should be conducted by the contractor, with observation by geotechnical consultants and staged approval by the governing agencies, as applicable. It is the contractor's responsibility to prepare the ground surface to receive the fill, to the satisfaction of the soil engineer, and to place, spread, moisture condition, mix and compact the fill in accordance with the recommendations of the soil engineer. The contractor should also remove all major non-earth material considered unsatisfactory by the soil engineer.

It is the sole responsibility of the contractor to provide adequate equipment and methods to accomplish the earthwork in accordance with applicable grading guidelines, codes or agency ordinances, and approved grading plans. Sufficient watering apparatus and compaction equipment should be provided by the contractor with due consideration for the fill material, rate of placement, and climatic conditions. If, in the opinion of the geotechnical consultant, unsatisfactory conditions such as questionable weather, excessive oversized rock, or deleterious material, insufficient support equipment, etc., are resulting in a quality of work that is not acceptable, the consultant will inform the contractor, and the contractor is expected to rectify the conditions, and if necessary, stop work until conditions are satisfactory.

During construction, the contractor shall properly grade all surfaces to maintain good drainage and prevent ponding of water. The contractor shall take remedial measures to control surface water and to prevent erosion of graded areas until such time as permanent drainage and erosion control measures have been installed.

SITE PREPARATION

All major vegetation, including brush, trees, thick grasses, organic debris, and other deleterious material should be removed and disposed of off-site. These removals must be concluded prior to placing fill. Existing fill, soil, alluvium, colluvium, or rock materials determined by the soil engineer or engineering geologist as being unsuitable in-place should be removed prior to fill placement. Depending upon the soil conditions, these materials may be reused as compacted fills. Any materials incorporated as part of the compacted fills should be approved by the soil engineer.

Any underground structures such as cesspools, cisterns, mining shafts, tunnels, septic tanks, wells, pipelines, or other structures not located prior to grading are to be removed or treated in a manner recommended by the soil engineer. Soft, dry, spongy, highly fractured, or otherwise unsuitable ground extending to such a depth that surface processing cannot adequately improve the condition should be overexcavated down to firm ground and approved by the soil engineer before compaction and filling operations continue. Overexcavated and processed soils which have been properly mixed and moisture

conditioned should be re-compacted to the minimum relative compaction as specified in these guidelines.

Existing ground which is determined to be satisfactory for support of the fills should be scarified to a minimum depth of 6 inches or as directed by the soil engineer. After the scarified ground is brought to optimum moisture content or greater and mixed, the materials should be compacted as specified herein. If the scarified zone is greater than 6 inches in depth, it may be necessary to remove the excess and place the material in lifts restricted to about 6 inches in compacted thickness.

Existing ground which is not satisfactory to support compacted fill should be overexcavated as required in the geotechnical report or by the on-site soils engineer and/or engineering geologist. Scarification, disc harrowing, or other acceptable form of mixing should continue until the soils are broken down and free of large lumps or clods, until the working surface is reasonably uniform and free from ruts, hollow, hummocks, or other uneven features which would inhibit compaction as described previously.

Where fills are to be placed on ground with slopes steeper than 5:1 (horizontal to vertical), the ground should be stepped or benched. The lowest bench, which will act as a key, should be a minimum of 15 feet wide and should be at least 2 feet deep into firm material, and approved by the soil engineer and/or engineering geologist. In fill over cut slope conditions, the recommended minimum width of the lowest bench or key is also 15 feet with the key founded on firm material, as designated by the Geotechnical Consultant. As a general rule, unless specifically recommended otherwise by the Soil Engineer, the minimum width of fill keys should be approximately equal to ½ the height of the slope.

Standard benching is generally 4 feet (minimum) vertically, exposing firm, acceptable material. Benching may be used to remove unsuitable materials, although it is understood that the vertical height of the bench may exceed 4 feet. Pre-stripping may be considered for unsuitable materials in excess of 4 feet in thickness.

All areas to receive fill, including processed areas, removal areas, and the toe of fill benches should be observed and approved by the soil engineer and/or engineering geologist prior to placement of fill. Fills may then be properly placed and compacted until design grades (elevations) are attained.

COMPACTED FILLS

Any earth materials imported or excavated on the property may be utilized in the fill provided that each material has been determined to be suitable by the soil engineer. These materials should be free of roots, tree branches, other organic matter or other deleterious materials. All unsuitable materials should be removed from the fill as directed by the soil engineer. Soils of poor gradation, undesirable expansion potential, or substandard strength

characteristics may be designated by the consultant as unsuitable and may require blending with other soils to serve as a satisfactory fill material.

Fill materials derived from benching operations should be dispersed throughout the fill area and blended with other bedrock derived material. Benching operations should not result in the benched material being placed only within a single equipment width away from the fill/bedrock contact.

Oversized materials defined as rock or other irreducible materials with a maximum dimension greater than 12 inches should not be buried or placed in fills unless the location of materials and disposal methods are specifically approved by the soil engineer. Oversized material should be taken off-site or placed in accordance with recommendations of the soil engineer in areas designated as suitable for rock disposal. Oversized material should not be placed within 10 feet vertically of finish grade (elevation) or within 20 feet horizontally of slope faces.

To facilitate future trenching, rock should not be placed within the range of foundation excavations, future utilities, or underground construction unless specifically approved by the soil engineer and/or the developers representative.

If import material is required for grading, representative samples of the materials to be utilized as compacted fill should be analyzed in the laboratory by the soil engineer to determine its physical properties. If any material other than that previously tested is encountered during grading, an appropriate analysis of this material should be conducted by the soil engineer as soon as possible.

Approved fill material should be placed in areas prepared to receive fill in near horizontal layers that when compacted should not exceed 6 inches in thickness. The soil engineer may approve thick lifts if testing indicates the grading procedures are such that adequate compaction is being achieved with lifts of greater thickness. Each layer should be spread evenly and blended to attain uniformity of material and moisture suitable for compaction.

Fill layers at a moisture content less than optimum should be watered and mixed, and wet fill layers should be aerated by scarification or should be blended with drier material. Moisture condition, blending, and mixing of the fill layer should continue until the fill materials have a uniform moisture content at or above optimum moisture.

After each layer has been evenly spread, moisture conditioned and mixed, it should be uniformly compacted to a minimum of 90 percent of maximum density as determined by ASTM test designation, D-1557-78, or as otherwise recommended by the soil engineer. Compaction equipment should be adequately sized and should be specifically designed for soil compaction or of proven reliability to efficiently achieve the specified degree of compaction.

Where tests indicate that the density of any layer of fill, or portion thereof, is below the required relative compaction, or improper moisture is in evidence, the particular layer or portion shall be re-worked until the required density and/or moisture content has been attained. No additional fill shall be placed in an area until the last placed lift of fill has been tested and found to meet the density and moisture requirements, and is approved by the soil engineer.

Compaction of slopes should be accomplished by over-building a minimum of 3 feet horizontally, and subsequently trimming back to the design slope configuration. Testing shall be performed as the fill is elevated to evaluate compaction as the fill core is being developed. Special efforts may be necessary to attain the specified compaction in the fill slope zone. Final slope shaping should be performed by trimming and removing loose materials with appropriate equipment. A final determination of fill slope compaction should be based on observation and/or testing of the finished slope face. Where compacted fill slopes are designed steeper than 2:1 (horizontal to vertical), specific material types, a higher minimum relative compaction, and special grading procedures, may be recommended.

If an alternative to over-building and cutting back the compacted fill slopes is selected, then special effort should be made to achieve the required compaction in the outer 10 feet of each lift of fill by undertaking the following:

1. An extra piece of equipment consisting of a heavy short shanked sheepsfoot should be used to roll (horizontal) parallel to the slopes continuously as fill is placed. The sheepsfoot roller should also be used to roll perpendicular to the slopes, and extend out over the slope to provide adequate compaction to the face of the slope.
2. Loose fill should not be spilled out over the face of the slope as each lift is compacted. Any loose fill spilled over a previously completed slope face should be trimmed off or be subject to re-rolling.
3. Field compaction tests will be made in the outer (horizontal) 2 to 8 feet of the slope at appropriate vertical intervals, subsequent to compaction operations.
4. After completion of the slope, the slope face should be shaped with a small tractor and then re-rolled with a sheepsfoot to achieve compaction to near the slope face. Subsequent to testing to verify compaction, the slopes should be grid-rolled to achieve compaction to the slope face. Final testing should be used to confirm compaction after grid rolling.
5. Where testing indicates less than adequate compaction, the contractor will be responsible to rip, water, mix and re-compact the slope material as necessary to achieve compaction. Additional testing should be performed to verify compaction.

6. Erosion control and drainage devices should be designed by the project civil engineer in compliance with ordinances of the controlling governmental agencies, and/or in accordance with the recommendation of the soil engineer or engineering geologist.

SUBDRAIN INSTALLATION

Subdrains should be installed in approved ground in accordance with the approximate alignment and details indicated by the geotechnical consultant. Subdrain locations or materials should not be changed or modified without approval of the geotechnical consultant. The soil engineer and/or engineering geologist may recommend and direct changes in subdrain line, grade and drain material in the field, pending exposed conditions. The location of constructed subdrains should be recorded by the project civil engineer.

EXCAVATIONS

Excavations and cut slopes should be examined during grading by the engineering geologist. If directed by the engineering geologist, further excavations or overexcavation and re-filling of cut areas should be performed and/or remedial grading of cut slopes should be performed. When fill over cut slopes are to be graded, unless otherwise approved, the cut portion of the slope should be observed by the engineering geologist prior to placement of materials for construction of the fill portion of the slope.

The engineering geologist should observe all cut slopes and should be notified by the contractor when cut slopes are started. If, during the course of grading, unforeseen adverse or potential adverse geologic conditions are encountered, the engineering geologist and soil engineer should investigate, evaluate and make recommendations to treat these problems. The need for cut slope buttressing or stabilizing should be based on in-grading evaluation by the engineering geologist, whether anticipated or not.

Unless otherwise specified in soil and geological reports, no cut slopes should be excavated higher or steeper than that allowed by the ordinances of controlling governmental agencies. Additionally, short-term stability of temporary cut slopes is the contractors responsibility.

Erosion control and drainage devices should be designed by the project civil engineer and should be constructed in compliance with the ordinances of the controlling governmental agencies, and/or in accordance with the recommendations of the soil engineer or engineering geologist.

COMPLETION

Observation, testing and consultation by the geotechnical consultant should be conducted during the grading operations in order to state an opinion that all cut and filled areas are graded in accordance with the approved project specifications.

After completion of grading and after the soil engineer and engineering geologist have finished their observations of the work, final reports should be submitted subject to review by the controlling governmental agencies. No further excavation or filling should be undertaken without prior notification of the soil engineer and/or engineering geologist.

All finished cut and fill slopes should be protected from erosion and/or be planted in accordance with the project specifications and/or as recommended by a landscape architect. Such protection and/or planning should be undertaken as soon as practical after completion of grading.

JOB SAFETY

General

At GeoSoils, Inc. (GSI) getting the job done safely is of primary concern. The following is the company's safety considerations for use by all employees on multi-employer construction sites. On ground personnel are at highest risk of injury and possible fatality on grading and construction projects. GSI recognizes that construction activities will vary on each site and that site safety is the prime responsibility of the contractor; however, everyone must be safety conscious and responsible at all times. To achieve our goal of avoiding accidents, cooperation between the client, the contractor and GSI personnel must be maintained.

In an effort to minimize risks associated with geotechnical testing and observation, the following precautions are to be implemented for the safety of field personnel on grading and construction projects:

Safety Meetings: GSI field personnel are directed to attend contractors regularly scheduled and documented safety meetings.

Safety Vests: Safety vests are provided for and are to be worn by GSI personnel at all times when they are working in the field.

Safety Flags: Two safety flags are provided to GSI field technicians; one is to be affixed to the vehicle when on site, the other is to be placed atop the spoil pile on all test pits.

Flashing Lights: All vehicles stationary in the grading area shall use rotating or flashing amber beacon, or strobe lights, on the vehicle during all field testing. While operating a vehicle in the grading area, the emergency flasher on the vehicle shall be activated.

In the event that the contractor's representative observes any of our personnel not following the above, we request that it be brought to the attention of our office.

Test Pits Location, Orientation and Clearance

The technician is responsible for selecting test pit locations. A primary concern should be the technicians's safety. Efforts will be made to coordinate locations with the grading contractors authorized representative, and to select locations following or behind the established traffic pattern, preferably outside of current traffic. The contractors authorized representative (dump man, operator, supervisor, grade checker, etc.) should direct excavation of the pit and safety during the test period. Of paramount concern should be the soil technicians safety and obtaining enough tests to represent the fill.

Test pits should be excavated so that the spoil pile is placed away from oncoming traffic, whenever possible. The technician's vehicle is to be placed next to the test pit, opposite the spoil pile. This necessitates the fill be maintained in a driveable condition. Alternatively, the contractor may wish to park a piece of equipment in front of the test holes, particularly in small fill areas or those with limited access.

A zone of non-encroachment should be established for all test pits. No grading equipment should enter this zone during the testing procedure. The zone should extend approximately 50 feet outward from the center of the test pit. This zone is established for safety and to avoid excessive ground vibration which typically decreased test results.

When taking slope tests the technician should park the vehicle directly above or below the test location. If this is not possible, a prominent flag should be placed at the top of the slope. The contractor's representative should effectively keep all equipment at a safe operation distance (e.g., 50 feet) away from the slope during this testing.

The technician is directed to withdraw from the active portion of the fill as soon as possible following testing. The technician's vehicle should be parked at the perimeter of the fill in a highly visible location, well away from the equipment traffic pattern. The contractor should inform our personnel of all changes to haul roads, cut and fill areas or other factors that may affect site access and site safety.

In the event that the technicians safety is jeopardized or compromised as a result of the contractors failure to comply with any of the above, the technician is required, by company policy, to immediately withdraw and notify his/her supervisor. The grading contractors representative will eventually be contacted in an effort to effect a solution. However, in the

interim, no further testing will be performed until the situation is rectified. Any fill place can be considered unacceptable and subject to reprocessing, recompaction or removal.

In the event that the soil technician does not comply with the above or other established safety guidelines, we request that the contractor brings this to his/her attention and notify this office. Effective communication and coordination between the contractors representative and the soils technician is strongly encouraged in order to implement the above safety plan.

Trench and Vertical Excavation

It is the contractor's responsibility to provide safe access into trenches where compaction testing is needed.

Our personnel are directed not to enter any excavation or vertical cut which: 1) is 5 feet or deeper unless shored or laid back; 2) displays any evidence of instability, has any loose rock or other debris which could fall into the trench; or 3) displays any other evidence of any unsafe conditions regardless of depth.

All trench excavations or vertical cuts in excess of 5 feet deep, which any person enters, should be shored or laid back. Trench access should be provided in accordance with CAL-OSHA and/or state and local standards. Our personnel are directed not to enter any trench by being lowered or "riding down" on the equipment.

If the contractor fails to provide safe access to trenches for compaction testing, our company policy requires that the soil technician withdraw and notify his/her supervisor. The contractors representative will eventually be contacted in an effort to effect a solution. All backfill not tested due to safety concerns or other reasons could be subject to reprocessing and/or removal.

If GSI personnel become aware of anyone working beneath an unsafe trench wall or vertical excavation, we have a legal obligation to put the contractor and owner/developer on notice to immediately correct the situation. If corrective steps are not taken, GSI then has an obligation to notify CAL-OSHA and/or the proper authorities.

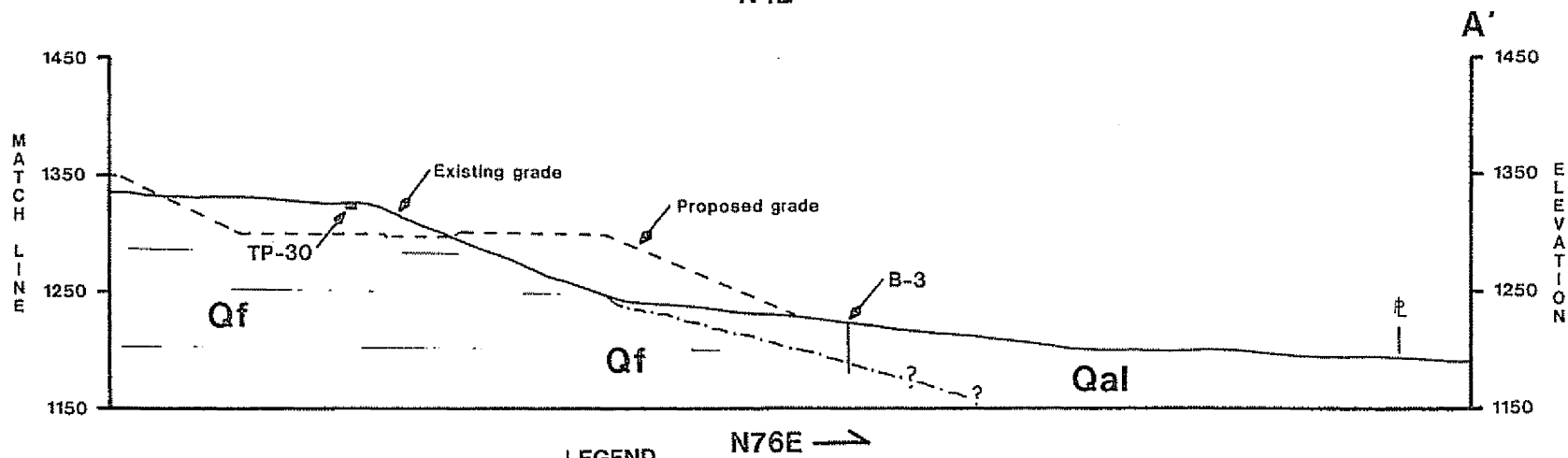
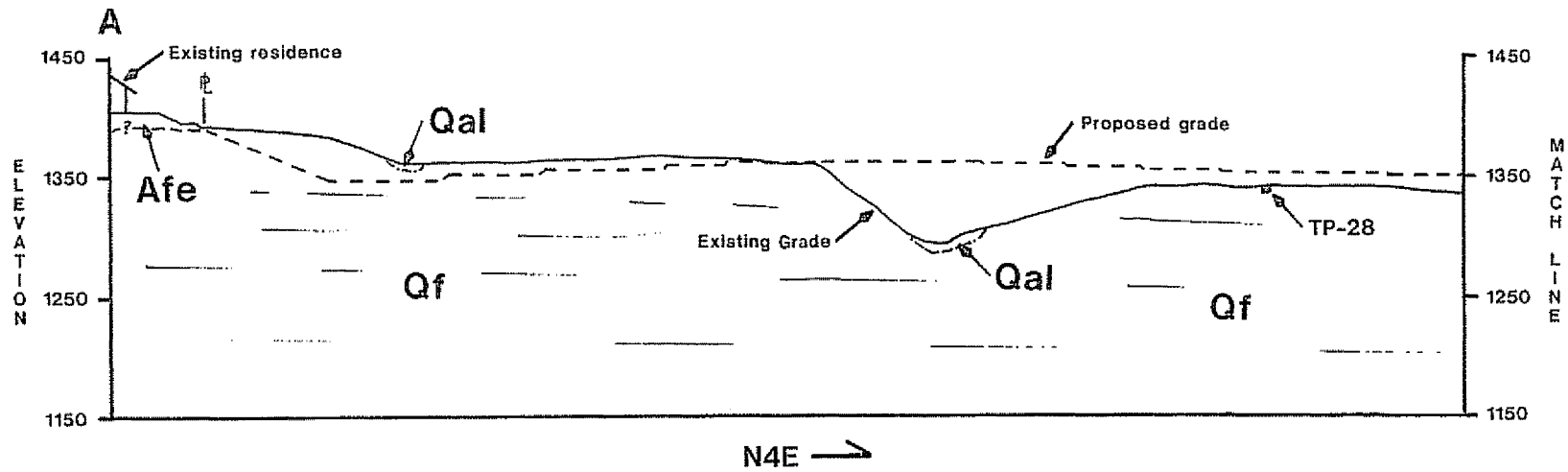

LEGEND

- | | | | |
|------------|--|--------------|---|
| Qal | Quaternary alluvium - younger | TP-30 | Approximate location of exploratory test pit |
| Qf | Quaternary fan deposits (Pleistocene-age fans) | B-3 | Approximate location of exploratory boring |
| Afe | Artificial fill - engineered | ? | Approximate location of geologic contact, queried where uncertain |

	LOS ANGELES CO. RIVERSIDE CO. ORANGE CO. SAN DIEGO CO.
	GEOLOGIC CROSS-SECTION.
Plate 2	
W.G. 3441-A-SC DATE 4/03 SCALE 1"=100'	