

**Hallmark-Barham Specific Plan EIR**  
**Technical Appendices**

**Appendix G**  
**Geotechnical Investigation**

# **GEO TECHNICAL INVESTIGATION**

---

**943 BARHAM DRIVE  
SAN MARCOS, CALIFORNIA**



**GEOCON**  
INCORPORATED

**GEO TECHNICAL  
ENVIRONMENTAL  
MATERIALS**

**PREPARED FOR**

**HALLMARK COMMUNITIES  
SOLANA BEACH, CALIFORNIA**

**JUNE 17, 2020  
PROJECT NO. G2516-32-01**



Project No. G2516-32-01  
June 17, 2020

Hallmark Communities  
740 Lomas Santa Fe Drive, Suite 204  
Solana Beach, California 92075

Attention: Ms. Mariana McGrain

Subject: GEOTECHNICAL INVESTIGATION  
943 BARHAM DRIVE  
SAN MARCOS, CALIFORNIA

Dear Ms. McGrain:


In accordance with your authorization of our Proposal No. LG-20071, dated February 11, 2020, we have performed a geotechnical investigation on the subject property. The accompanying report presents the findings of our study and our recommendations relative to the geotechnical aspects of developing the property as presently proposed.

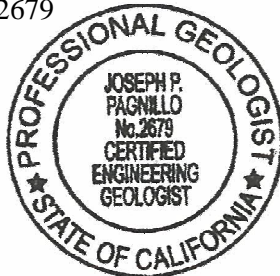
The results of our study indicate that the site can be developed as planned, provided the recommendations of this report are followed. Remedial grading and the presence of shallow rock in areas of planned excavation will be important geotechnical considerations during project development.

Should you have questions regarding this report, or if we may be of further service, please contact the undersigned at your convenience.

Very truly yours,


GEOCON INCORPORATED

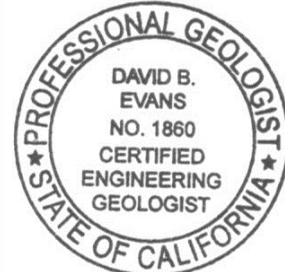
  
Joseph P. Pagnillo  
CEG 2679



  
Trevor E. Myers  
RCE 63773



  
David B. Evans  
CEG 1860



JPP:TEM:DBE:dmc

(e-mail) Addressee

## TABLE OF CONTENTS

|      |  |    |
|------|--|----|
| 1.   | PURPOSE AND SCOPE .....                                      | 1  |
| 2.   | SITE AND PROJECT DESCRIPTION .....                           | 1  |
| 3.   | SOIL AND GEOLOGIC CONDITIONS .....                           | 2  |
| 3.1  | Undocumented Fill (unmapped) .....                           | 2  |
| 3.2  | Topsoil (unmapped).....                                      | 2  |
| 3.3  | Alluvium/Colluvium (Qal/Qcol) .....                          | 3  |
| 3.4  | Granitic Rock (Kgr).....                                     | 3  |
| 4.   | RIPPABILITY AND ROCK CONSIDERATIONS .....                    | 3  |
| 5.   | GROUNDWATER .....  | 4  |
| 6.   | GEOLOGIC HAZARDS .....                                       | 4  |
| 6.1  | Ground Rupture .....   | 4  |
| 6.2  | Seismicity .....   | 4  |
| 6.3  | Liquefaction and Seismically Induced Settlement.....         | 4  |
| 6.4  | Landslides .....   | 4  |
| 6.5  | Compression .....  | 4  |
| 7.   | CONCLUSIONS AND RECOMMENDATIONS.....                         | 6  |
| 7.1  | General.....   | 6  |
| 7.2  | Soil and Excavation Characteristics .....                    | 7  |
| 7.3  | Corrosion .....  | 8  |
| 7.4  | Subdrains .....  | 8  |
| 7.5  | Toe Drains .....   | 9  |
| 7.6  | Grading.....   | 9  |
| 7.7  | Slope Stability.....   | 11 |
| 7.8  | Seismic Design Criteria – 2019 California Building Code..... | 12 |
| 7.9  | Foundation and Concrete Slab-On-Grade Recommendations.....   | 14 |
| 7.10 | Retaining Walls and Lateral Loads Recommendations .....      | 19 |
| 7.11 | Slope Maintenance.....                                       | 21 |
| 7.12 | Site Drainage and Maintenance .....                          | 22 |
| 7.13 | Grading and Foundation Plan Review .....                     | 22 |

### LIMITATIONS AND UNIFORMITY OF CONDITIONS

### FIGURES AND ILLUSTRATIONS

- Figure 1, Vicinity Map
- Figure 2, Geologic Map
- Figure 3, Geologic Cross-Sections A-A' and B-B'
- Figure 4, Regional Geologic Map
- Figure 5, Toe Drain Detail
- Figure 6, Slope Stability Analysis – Fill Slopes
- Figure 7, Slope Stability Analysis – Cut Slopes
- Figure 8, Surficial Stability Analysis
- Figure 9, Wall/Column Footing Dimension Detail
- Figure 10, Typical Retaining Wall Drain Detail



## **TABLE OF CONTENTS (Concluded)**

### **APPENDIX A**

#### **FIELD INVESTIGATION**

Figures A-1 – A-14, Exploratory Trench Logs

### **APPENDIX B**

#### **LABORATORY TESTING**

Table B-I, Summary of Laboratory Maximum Density and Optimum Moisture Content Test Results

Table B-II, Summary of Laboratory Expansion Index Test Results

Table B-III, Summary of Water-Soluble Sulfate Test Results

Consolidation Curves

Direct Shear Test Results

### **APPENDIX C**

SEISMIC REFRACTION STUDY (SOUTHWEST GEOPHYSICS)

### **APPENDIX D**

STORM WATER MANAGEMENT

### **APPENDIX E**

RECOMMENDED GRADING SPECIFICATIONS

### **LIST OF REFERENCES**

# GEOTECHNICAL INVESTIGATION

## 1. PURPOSE AND SCOPE

The purpose of this study was to evaluate the proposed grading for a 25-lot residential subdivision located in San Marcos, California (see *Vicinity Map*, Figure 1). This report provides recommendations relative to the geotechnical engineering aspects of developing the property as proposed. This report is intended to address the project plans entitled *Preliminary Layout, Barham Drive*, prepared by SB&O, Inc., undated.

The scope of our study consisted of the following:

- Reviewing aerial photographs and readily available published and unpublished geologic literature.
- Reviewing the referenced plans prepared by SB&O, Inc.
- Excavating fourteen (14) exploratory trenches using a rubber tire backhoe to evaluate the general extent and condition of surficial deposits (see Appendix A for trench logs).
- Performing laboratory tests on selected soil samples to evaluate the physical characteristics for engineering analysis (see Appendix B).
- Eight (8) seismic traverses were performed by Southwest Geophysics to evaluate the rippability characteristics in areas of granitic rock (see Appendix C).
- Performing one infiltration test in the proposed basin location to be utilized during storm water management design and providing storm water management guidelines in accordance with the City of San Marcos Storm Water Standards (See Appendix D).
- Preparing this report, geologic map, geologic cross-sections and our conclusions and recommendations regarding the geotechnical aspects of developing the property as presently proposed.

The approximate location of the exploratory trenches, seismic traverses and infiltration test are shown on the *Geologic Map*, Figure 2. *Geologic Cross-Sections A-A'* and *B-B'* (Figure 3) represent our interpretation of the geologic conditions across the site.

## 2. SITE AND PROJECT DESCRIPTION

The property consists of approximately 5-acres of undeveloped land located on the south side of Barham Drive west of La Moree Road in San Marcos, California. The site consists of a northwest-trending drainage with moderate to steep slopes along the flanks. Elevations range from 710 feet above Mean Sea Level (MSL) in the southeast portion of the site to 650 feet MSL in the northwest portion. The site is bounded by Barham Drive to the north, to the east by existing housing, to the west

by Grace Church, and to the south by open space. Vegetation consists of low-lying grasses and a few randomly-spaced large trees.

It is our understanding that the project will be developed to create 25 multi-family residential building pads and associated infrastructure. Each building pad will support between 3 to 9 residential units. Retaining walls up to approximately 11-feet-high are planned along the perimeter of the property.

Based on our review of the referenced plans, grading quantities will consist of approximately 39,700 cubic yards of cut, 86,100 cubic yards of fill, with an estimated 46,400 cubic yards of import material. We understand that these estimates do not account for bulking or shrinking of the materials. Maximum cuts and fills, when compared with existing grades, are on the order of 18 feet and 25 feet, respectively. Fill slopes are designed at 2:1 (horizontal:vertical) or flatter, with a maximum height of approximately 20 feet. Cut slopes are designed at 2:1 or flatter, with a maximum height of approximately 30 feet. If development plans differ significantly from those described herein, Geocon Incorporated should be contacted for review and possible revisions to this report.

### **3. SOIL AND GEOLOGIC CONDITIONS**

Four surficial soil types and one geologic formation were encountered during our field investigation. The surficial soil types consist of undocumented fill, topsoil, alluvium and colluvium. The formational unit is the Cretaceous-age granitic rock. The approximate extent of the deposits, excluding undocumented fill and topsoil, are presented on the *Geologic Map* (Figure 2) and *Geologic Cross-Sections* (Figure 3). Mapping of alluvium and colluvium has been combined. Each of the surficial soil types and geologic unit encountered are described below in order of increasing age.

#### **3.1 Undocumented Fill (unmapped)**

Undocumented fill was observed in one exploratory trench (T-4), and is estimated to be approximately one-foot thick. The Qudf consists of loose, moist, silty sand, with some minor trash debris. This material is unsuitable for support of settlement sensitive structures and/or improvements, and will require complete removal and compaction. It is estimated that the undocumented fill is confined to a relatively small area in the north-central portion of the property.

#### **3.2 Topsoil (unmapped)**

Topsoil was encountered in Trench Nos. T-1, T-2, T-12, T-13 and T-14. This deposit is estimated to blanket the property beyond the main northwest-trending drainage and varies in thickness from approximately 1 to 5 feet. This surficial soil is characterized as loose, damp to moist, silty fine- to medium-grained sand. Topsoil is unsuitable in its present condition and will require removal and compaction for support of structural fill and settlement-sensitive structures.

### **3.3 Alluvium/Colluvium (Qal/Qcol)**

Alluvial and colluvial soils were encountered in Trench Nos. T-3 and T-5 through T-11. These deposits are present along the entire length of the northwest-trending drainage and adjacent hillsides, and vary in thickness from approximately 3 to 11-feet-thick. These deposits generally consisted of loose to dense, damp to moist, silty to clayey fine- to coarse-grained sand. A firm, silty clay deposit was encountered in T-3 and T-4. The upper portions of the alluvial/colluvial deposits are poorly consolidated and compressible, and will require removal and compaction during grading. Based on our laboratory testing, the lower portion of these deposits are generally suitable in their present condition for support of structural fill and settlement-sensitive structures. The anticipated thickness of surficial soil requiring remedial grading is shown on Figure 2.

### **3.4 Granitic Rock (Kgr)**

Cretaceous-age granitic rock underlies the surficial deposits throughout the property. The soils derived from excavations within the decomposed portion of this unit typically consist of low-expansive, silty, fine- to coarse-grained sands and provide suitable foundation support in either a natural or properly compacted condition. Deeper excavations than what we encountered in the trenches may generate boulders and oversize material (rocks greater than 12 inches in dimension) that will require special handling and placement.

The rippability characteristics of the granitic rock are discussed in the Rippability and Rock Considerations section below. Granitic units generally exhibit adequate bearing and slope stability characteristics and cut slopes should be stable to the proposed heights if free of adversely oriented joints or fractures.

## **4. RIPPABILITY AND ROCK CONSIDERATIONS**

To aid in evaluating the rippability characteristics of the rock in proposed cut areas, a subsurface exploration program consisting of eight (8) seismic refraction traverses was performed. It should be noted that rock rippability is a function of natural weathering processes that can vary vertically and horizontally over short distances depending on jointing, fracturing, and/or mineralogic discontinuities within the bedrock.

The seismic traverses were conducted by Southwest Geophysics using a 24-channel Geometrics StrataView seismograph. Utilizing seismic refraction data, they obtained bedrock velocity profiles. Calculated depths to non-rippable material (velocities above 6,000 feet per second) at the end of each seismic traverse are presented in the referenced Southwest Geophysics report dated March 23, 2020 (see Appendix C). Prospective contractors should use their own threshold velocities to identify rippable vs. non-rippable rock based on the excavation equipment used.

## **5. GROUNDWATER**

No groundwater or seepage was observed in the excavations performed during our study. Subdrain systems (i.e. canyon subdrain, toe drains) will be necessary for the proposed development to intercept and convey seepage migrating along fractures and impervious strata. The location of proposed underground improvements may result in modifications to the recommended subdrain shown on the *Geologic Map*.

## **6. GEOLOGIC HAZARDS**

### **6.1 Ground Rupture**

United States Geological Survey maps (2016) indicates that there are no mapped Quaternary faults crossing or trending toward the property. In addition, the site is not located within a currently established Alquist-Priolo Earthquake Fault Zone.

The nearest known active-fault zones are the Rose Canyon and Newport Inglewood Faults, located approximately 14 miles west of the subject site. The risk associated with ground rupture hazard is low.

### **6.2 Seismicity**

The San Diego County and Southern California region is seismically active. Considerations important in seismic design include the frequency and duration of motion and the soil conditions underlying the site. Seismic design of structures should be performed in accordance with the California Building Code (CBC) guidelines currently adopted by the local agency. The risk associated with strong ground shaking due to earthquake at the site is no greater than that for the region.

### **6.3 Liquefaction and Seismically Induced Settlement**

The risk associated with liquefaction and seismically induced settlement hazard is low due to the dense nature and age of the underlying formational materials and lack of shallow groundwater.

### **6.4 Landslides**

The risk associated with landslide hazards at the site is low. In addition, Reference No. 1 and Figure 4 does not indicate previously mapped landslide deposits on or near the property.

### **6.5 Compression**

The potentially compressible portions of the alluvium/colluvium (Qal/Qcol) deposits will be removed and compacted during grading. The base of the Qal/Qcol deposits encountered at the site generally consists of dense to very dense, damp to moist, silty to clayey sands with gravel and clay. We

performed laboratory testing on the lower portion of the Qal/Qcol to evaluate its compression potential. Based on the laboratory test results, the lower portion of the Qal/Qcol is suitable for support of compacted fill and structural loading. Laboratory test results are presented in Appendix B.

## 7. CONCLUSIONS AND RECOMMENDATIONS

### 7.1 General

- 7.1.1 No soil or geologic conditions were encountered that, in the opinion of Geocon Incorporated, would preclude the development of the property as proposed, provided the recommendations of this report are followed.
- 7.1.2 The site is underlain by surficial units that include undocumented fill, topsoil, alluvium and colluvium. The undocumented fill, topsoil and upper portions of the alluvium/colluvium are unsuitable in their present condition for support of fill and/or structural loads and will require remedial grading in the form of removal and compaction where improvements are planned. The anticipated thickness of surficial soil deposits requiring remedial grading is shown on Figure 2.
- 7.1.3 Dense alluvium/colluvium was encountered in exploratory trenches T-5 through T-11. These trenches were located within the existing northwest-trending drainage. Laboratory test results indicate that the alluvium/colluvium has adequate consolidation characteristics to receive fill soils and/or structural loads. An engineering geologist should be present during grading to identify the colluvial areas that will not require remedial grading. Additional field testing may be necessary.
- 7.1.4 The presence of hard rock within proposed cut areas will require special consideration during site development. It is anticipated that the majority of the proposed excavations will encounter moderate to heavy ripping with conventional heavy-duty grading equipment. Blasting is not expected for shallow excavations but may be required in areas with deeper cuts. In addition, heavy ripping and blasting will generate oversize materials that may require crushing, special handling and fill placement procedures. Oversize materials should be placed in accordance with Appendix E of this report. The rippability study performed by Southwest Geophysics is presented in Appendix C.
- 7.1.5 Cut slopes should be observed during grading by an engineering geologist to verify that the geologic conditions do not differ significantly from those anticipated. Scaling of loose rock fragments from proposed cut slopes may also be necessary.
- 7.1.6 With the exception of possible strong seismic shaking, no geologic hazards were observed or are known to exist on the site that would adversely affect the proposed project. No special seismic design considerations, other than those recommended herein, are required.

## 7.2 Soil and Excavation Characteristics

- 7.2.1 The soil conditions encountered during our study consist of “low” expansive silty sand and silty/clayey sand.
- 7.2.2 Excavation of the surficial deposits (undocumented fill, topsoil and upper portions of the alluvium/colluvium) should generally require light to moderate effort using conventional heavy-duty grading equipment.
- 7.2.3 Excavating within the granitic rock materials will generally vary in difficulty with depth depending on the degree of weathering. Based on the seismic refraction study, blasting will likely be required for the deeper excavations. Heavy to very heavy ripping is also anticipated and may generate oversize materials. Oversize rock should be placed in accordance with *Recommended Grading Specifications* (Appendix E), and the requirements of the City of San Marcos. Oversize rock may require breakage/crushing to acceptable sizes for incorporation into fills, or exportation from the property. Placement of oversize rock within the areas of proposed underground utilities should not be permitted.
- 7.2.4 Surficial deposits (undocumented fill, topsoil and alluvium) may be very moist to saturated during the winter or early spring depending on preceding precipitation. Overly wet soils will require drying or mixing with drier material prior to their use as compacted fill.
- 7.2.5 The soils encountered are considered to be both non-expansive and expansive (expansion index [EI] greater than 20 as defined by 2019 California Building Code [CBC] Section 1803.5.3). The predominant material encountered was silty sand, with some clayey sands, and exhibit a *low* expansion potential. Table 7.2 presents soil classifications based on the expansion index. Table B-II, Appendix B, presents a summary of the laboratory expansion index tests performed.

**TABLE 7.2  
SOIL CLASSIFICATION BASED ON EXPANSION INDEX**

| <b>Expansion Index (EI)</b> | <b>ASTM D 4829<br/>Expansion Classification</b> | <b>2019 CBC<br/>Expansion Classification</b> |
|-----------------------------|---|--|
| 0 – 20                      | Very Low  | Non-Expansive                                |
| 21 – 50                     | Low   | Expansive                                    |
| 51 – 90                     | Medium  |  |
| 91 – 130                    | High  |  |
| Greater Than 130            | Very High                                       |  |



### 7.3 Corrosion

7.3.1 We performed laboratory tests on a sample of the site materials to evaluate the percentage of water-soluble sulfate content. Results from the laboratory water-soluble sulfate content tests are presented in Appendix B and indicate that the on-site materials at the locations tested possess a “Not Applicable” and “S0” sulfate exposure to concrete structures as defined by 2019 CBC Section 1904 and ACI 318-14 Chapter 19. The presence of water-soluble sulfates is not a visually discernible characteristic; therefore, other soil samples from the site could yield different concentrations. Additionally, over time landscaping activities (i.e., addition of fertilizers and other soil nutrients) may affect the concentration. Table 7.3 presents a summary of concrete requirements set forth by 2019 CBC Section 1904 and ACI 318.

**TABLE 7.3  
REQUIREMENTS FOR CONCRETE EXPOSED  
TO SULFATE-CONTAINING SOLUTIONS**

| Sulfate Severity | Exposure Class | Water-Soluble Sulfate (SO <sub>4</sub> ) Percent by Weight | Cement Type (ASTM C 150) | Maximum Water to Cement Ratio by Weight <sup>1</sup> | Minimum Compressive Strength (psi) |
|------------------|----------------|--|--------------------------|--|------------------------------------|
| Not Applicable   | S0             | SO <sub>4</sub> <0.10                                      | No Type Restriction      | n/a  | 2,500                              |
| Moderate         | S1             | 0.10≤SO <sub>4</sub> <0.20                                 | II                       | 0.50   | 4,000                              |
| Severe           | S2             | 0.20≤SO <sub>4</sub> ≤2.00                                 | V                        | 0.45   | 4,500                              |
| Very Severe      | S3             | SO <sub>4</sub> >2.00                                      | V+Pozzolan or Slag       | 0.45   | 4,500                              |

<sup>1</sup> Maximum water to cement ratio limits do not apply to lightweight concrete.

7.3.2 Geocon Incorporated does not practice in the field of corrosion engineering. Therefore, if improvements that could be susceptible to corrosion are planned, it is recommended that further evaluation by a corrosion engineer be performed.

### 7.4 Subdrains

7.4.1 The geologic units encountered on the site have permeability characteristics and/or fracture systems that could be susceptible under certain conditions to groundwater seepage. The use of a canyon subdrain will be necessary to mitigate the potential for adverse impacts associated with seepage conditions. Appendix E depicts a typical canyon subdrain detail and the proposed location is shown on the *Geologic Map*. In general, subdrains should be extended to within approximately 10 feet of the ultimate ground surface.

- 7.4.2 The final grading plans should show the location of all proposed subdrains. Upon completion of remedial excavations and subdrain installation, the project civil engineer should survey the drain locations and prepare an “as-built” map depicting the existing conditions.

## **7.5 Toe Drains**

- 7.5.1 Building pad areas adjacent to ascending cut slopes or shallow fill over cut slopes may experience wet soil conditions due to water migration through the bedrock from natural or future irrigation sources. To reduce the potential for this to occur, consideration should be given to placing a toe drain along the base of the slopes (i.e. Building Pads 11, 12, and 18 through 25) to collect potential seepage and convey it to a suitable outlet. The drain should be sufficiently deep to intercept the seepage (on the order of 3 feet below finish grade) and constructed in accordance with Figure 5. The need for these drains can be evaluated during grading by your project superintendent. In the event that toe drains are constructed, the project civil engineer should be consulted to evaluate the appropriate drain locations and necessary easements, building restriction zones or disclosure requirements that may be required.

## **7.6 Grading**

- 7.6.1 All grading should be performed in accordance with the attached *Recommended Grading Specifications* (Appendix E). Where the recommendations of this section conflict with Appendix E, the recommendations of this section take precedence. All earthwork should be observed and all fills tested for proper compaction by Geocon Incorporated.
- 7.6.2 Prior to commencing grading, a preconstruction conference should be held at the site with the owner or developer, grading contractor, civil engineer, and geotechnical engineer in attendance. Special soil handling and/or the grading plans can be discussed at that time.
- 7.6.3 Site preparation should begin with the removal of all deleterious material and vegetation. The depth of removal should be such that material exposed in cut areas or soils to be used as fill are relatively free of organic matter. Material generated during stripping and/or site demolition should be exported from the site.
- 7.6.4 All compressible soil deposits, including undocumented fill, topsoil and upper portions of the alluvium/colluvium within areas where structural improvements are planned, should be removed to firm natural ground and properly compacted prior to placing additional fill and/or structural loads. Deeper than normal benching and/or stripping operations for sloping ground surfaces will be required where the thickness of potentially compressible surficial

deposits exceeds 3 feet. The actual extent of unsuitable soil removals will be determined in the field during grading by the geotechnical engineer and/or engineering geologist.

- 7.6.5 After removal of unsuitable materials is performed, the site should then be brought to final subgrade elevations with structural fill compacted in layers. In general, soils native to the site are suitable for re-use as fill if free from vegetation, debris and other deleterious material. Layers of fill should be no thicker than will allow for adequate bonding and compaction. All fill, including backfill and scarified ground surfaces, should be compacted to at least 90 percent of maximum dry density at or above optimum moisture content, as determined in accordance with ASTM Test Procedure D1557. Fill materials below optimum moisture content will require additional moisture conditioning prior to placing additional fill.
- 7.6.6 To reduce the potential for differential settlement, it is recommended that the cut portion of cut/fill transition building pads be undercut at least 3 feet and replaced with properly compacted “very low” to “low” expansive fill soils. Where the thickness of the fill below the building pad exceeds 15 feet, the depth of the undercut should be increased to one-fifth of the maximum fill thickness. The base of the undercuts should be sloped towards the front of the lots.
- 7.6.7 Oversize material (defined as material greater than 12 inches in nominal dimension) may be generated during ripping of formational materials. Placement of oversize material within fills should be conducted in accordance with the recommendations in Appendix E. Grading operations on the site should be scheduled such that oversize materials are placed in designated rock disposal areas and/or deeper fills.
- 7.6.8 Rock greater than 6 inches in maximum dimension should not be placed within 3 feet of finish grade in building pad areas or street subgrade. Rock greater than 12 inches in maximum dimension should not be placed within 10 feet of finish pad grade or within 2 feet of the deepest utility. The gradation of capping materials should conform to the project grading specifications.
- 7.6.9 Where practical, the upper 3 feet of all building pads (cut or fill) should be comprised of soil with a “very low” to “low” expansion potential. The more highly expansive fill soils should be placed in the deeper fill areas and properly compacted. “Very low” to “low” expansive soils are defined by the 2019 California Building Code (CBC) Section 1803.5.3 as those soils that have an Expansion Index of 50 or less.

- 7.6.10 Cut pads exposing granitic rock should be undercut at least 3 feet and replaced with properly compacted “very low” to “low” expansive soil. The base of the undercuts should be sloped towards the front of the lots.
- 7.6.11 Undercutting of street areas should be considered to facilitate the excavation of underground utilities. If subsurface improvements or landscape zones are planned outside these areas, consideration should be given to undercutting these areas as well. This can be evaluated during grading operations by the owner’s field representative.
- 7.6.12 It is the responsibility of the contractor and their competent person to ensure that all excavations, temporary slopes and trenches are properly constructed and maintained in accordance with applicable OSHA regulations in order to maintain safety and the stability of adjacent existing improvements.
- 7.6.13 Import materials (if required), should consist of “very low” to “low” expansive (Expansion Index of 50 or less) soils. Prior to importing the material, samples from proposed borrow areas should be obtained and subjected to laboratory testing to determine whether the material conforms to the recommended criteria. At least 3 working days should be allowed for laboratory testing of the soil prior to its importation. Import materials should be free of oversize rock and construction debris.

## **7.7 Slope Stability**

- 7.7.1 Slope stability analysis utilizing average drained direct shear strength parameters based on laboratory tests and experience with similar soil types indicates that the proposed fill slopes, constructed of on-site materials, should have calculated factors of safety of at least 1.5 under static conditions for both deep-seated failure and shallow sloughing conditions. The proposed cut slopes were also found to possess a calculated factor of safety in excess of 1.5 for a deep-seated failure condition. Surficial and deep-seated slope stability calculations are presented on Figures 6 through 8.
- 7.7.2 It is recommended that all cut slope excavations be observed during grading by an engineering geologist to verify that soil and geologic conditions do not differ significantly from those anticipated.
- 7.7.3 The outer 15 feet (or a distance equal to the height of the slope, whichever is less) of fill slopes should be composed of properly compacted granular "soil" fill to reduce the potential for surficial sloughing. In general, soils with an Expansion Index of less than 90 or at least 35 percent sand size particles should be acceptable as "granular" fill. Soils of questionable

strength to satisfy surficial stability should be tested in the laboratory for acceptable drained shear strength.

- 7.7.4 Fill slopes should be compacted by backrolling with a loaded sheepsfoot roller at vertical intervals not to exceed 4 feet and should be track-walked at the completion of each slope such that the fill soils are uniformly compacted to at least 90 percent relative compaction to the face of the finished sloped. Alternatively, the fill slope may be over-built at least 3 feet and cut back to yield a properly compacted slope face.
- 7.7.5 Where fill slopes and fill-over-cut slopes are planned, following removal of the surficial soils, a 15-foot-wide, 2-foot-deep, undrained keyway should be constructed prior to placing compacted fill. The keyway should be constructed with a minimum 5 percent inclination away from the toe of slope.
- 7.7.6 All slopes should be landscaped with drought-tolerant vegetation, having variable root depths and requiring minimal landscape irrigation. In addition, all slopes should be drained and properly maintained to reduce erosion.

## **7.8 Seismic Design Criteria – 2019 California Building Code**

- 7.8.1 The seismic design criteria is presented for general and preliminary purposes. Geocon Incorporated should be contacted to provide specific seismic design criteria once project plans are developed. Table 7.8.1 summarizes site-specific design criteria obtained from the 2019 California Building Code (CBC; Based on the 2018 International Building Code [IBC] and ASCE 7-16), Chapter 16 Structural Design, Section 1613 Earthquake Loads. We used the computer program *U.S. Seismic Design Maps*, provided by the Structural Engineers Association (SEA) to calculate the seismic design parameters. The short spectral response uses a period of 0.2 second. We evaluated the Site Class based on the discussion in Section 1613.2.2 of the 2019 CBC and Table 20.3-1 of ASCE 7-16. The values presented herein are for the risk-targeted maximum considered earthquake ( $MCE_R$ ). Sites designated as Site Class D, E and F may require additional analyses if requested by the project structural engineer and client.

**TABLE 7.8.1  
2019 CBC SEISMIC DESIGN PARAMETERS**

| Parameter   | Value   | 2019 CBC Reference           |
|---|---------|------------------------------|
| Site Class  | C       | Section 1613.2.2             |
| MCE <sub>R</sub> Ground Motion Spectral Response Acceleration – Class B (short), S <sub>S</sub> | 0.896g  | Figure 1613.2.1(1)           |
| MCE <sub>R</sub> Ground Motion Spectral Response Acceleration – Class B (1 sec), S <sub>1</sub> | 0.329g  | Figure 1613.2.1(2)           |
| Site Coefficient, F <sub>A</sub>  | 1.2     | Table 1613.2.3(1)            |
| Site Coefficient, F <sub>V</sub>  | 1.5*    | Table 1613.2.3(2)            |
| Site Class Modified MCE <sub>R</sub> Spectral Response Acceleration (short), S <sub>MS</sub>    | 1.076g  | Section 1613.2.3 (Eqn 16-36) |
| Site Class Modified MCE <sub>R</sub> Spectral Response Acceleration – (1 sec), S <sub>M1</sub>  | 0.494g* | Section 1613.2.3 (Eqn 16-37) |
| 5% Damped Design Spectral Response Acceleration (short), S <sub>DS</sub>                        | 0.717g  | Section 1613.2.4 (Eqn 16-38) |
| 5% Damped Design Spectral Response Acceleration (1 sec), S <sub>D1</sub>                        | 0.329g* | Section 1613.2.4 (Eqn 16-39) |

\* Using the code-based values presented in this table, in lieu of a performing a ground motion hazard analysis, requires the exceptions outlined in ASCE 7-16 Section 11.4.8 be followed by the project structural engineer. Per Section 11.4.8 of ASCE/SEI 7-16, a ground motion hazard analysis should be performed for projects for Site Class “E” sites with S<sub>s</sub> greater than or equal to 1.0g and for Site Class “D” and “E” sites with S<sub>1</sub> greater than 0.2g. Section 11.4.8 also provides exceptions which indicates that the ground motion hazard analysis may be waived provided the exceptions are followed.

7.8.2 Table 7.8.2 presents the mapped maximum considered geometric mean (MCE<sub>G</sub>) seismic design parameters for projects located in Seismic Design Categories of D through F in accordance with ASCE 7-16.

**TABLE 7.8.2  
ASCE 7-16 PEAK GROUND ACCELERATION**

| Parameter   | Value  | ASCE 7-16 Reference         |
|---|--------|-----------------------------|
| Mapped MCE <sub>G</sub> Peak Ground Acceleration, PGA               | 0.387g | Figure 22-7                 |
| Site Coefficient, F <sub>PGA</sub>                                  | 1.2    | Table 11.8-1                |
| Site Class Modified MCE <sub>G</sub> Peak Ground Acceleration, PGAM | 0.464g | Section 11.8.3 (Eqn 11.8-1) |

7.8.3 Conformance to the criteria in Tables 7.8.1 and 7.8.2 for seismic design does not constitute any kind of guarantee or assurance that significant structural damage or ground failure will

not occur in the event of a large earthquake. The primary goal of seismic design is to protect life, not to avoid all damage, since such design may be economically prohibitive.

7.8.4 The project structural engineer and architect should evaluate the appropriate Risk Category and Seismic Design Category for the planned structures. The values presented herein assume a Risk Category of II and resulting in a Seismic Design Category D. Table 7.8.3 presents a summary of the risk categories in accordance with ASCE 7-16.

**TABLE 7.8.3  
ASCE 7-16 RISK CATEGORIES**

| <b>Risk Category</b> | <b>Building Use</b>  | <b>Examples</b>  |
|----------------------|--|--|
| I                    | Low risk to Human Life at Failure  | Barn, Storage Shelter  |
| II                   | Nominal Risk to Human Life at Failure (Buildings Not Designated as I, III or IV) | Residential, Commercial and Industrial Buildings   |
| III                  | Substantial Risk to Human Life at Failure  | Theaters, Lecture Halls, Dining Halls, Schools, Prisons, Small Healthcare Facilities, Infrastructure Plants, Storage for Explosives/Toxins                                   |
| IV                   | Essential Facilities   | Hazardous Material Facilities, Hospitals, Fire and Rescue, Emergency Shelters, Police Stations, Power Stations, Aviation Control Facilities, National Defense, Water Storage |

## 7.9 Foundation and Concrete Slab-On-Grade Recommendations

7.9.1 The following foundation recommendations are for proposed one- to three-story residential structures. The foundation recommendations have been separated into three categories based on either the maximum and differential fill thickness or Expansion Index. The foundation category criteria are presented in Table 7.9.1.

**TABLE 7.9.1  
FOUNDATION CATEGORY CRITERIA**

| <b>Foundation Category</b> | <b>Maximum Fill Thickness, T (feet)</b> | <b>Differential Fill Thickness, D (feet)</b> | <b>Expansion Index (EI)</b> |
|----------------------------|---|--|-----------------------------|
| I                          | $T < 20$                                | --   | $EI \leq 50$                |
| II                         | $20 \leq T < 50$                        | $10 \leq D < 20$                             | $50 < EI \leq 90$           |
| III                        | $T \geq 50$                             | $D \geq 20$                                  | $90 < EI \leq 130$          |

7.9.2 We will provide final foundation categories for each building or lot after finish pad grades have been achieved and laboratory testing of the finish grade soil has been completed.

7.9.3 Table 7.9.2 presents minimum foundation and interior concrete slab design criteria for conventional foundation systems.

**TABLE 7.9.2  
CONVENTIONAL FOUNDATION RECOMMENDATIONS BY CATEGORY**

| <b>Foundation Category</b> | <b>Minimum Footing Embedment Depth (inches)</b> | <b>Continuous Footing Reinforcement</b> | <b>Interior Slab Reinforcement</b>                 |
|----------------------------|---|---|--|
| I                          | 12  | Two No. 4 bars, one top and one bottom  | 6 x 6 - 10/10 welded wire mesh at slab mid-point   |
| II                         | 18  | Four No. 4 bars, two top and two bottom | No. 3 bars at 24 inches on center, both directions |
| III                        | 24  | Four No. 5 bars, two top and two bottom | No. 3 bars at 18 inches on center, both directions |

7.9.4 The embedment depths presented in Table 7.10.2 should be measured from the lowest adjacent pad grade for both interior and exterior footings. The conventional foundations should have a minimum width of 12 inches and 24 inches for continuous and isolated footings, respectively. A typical wall/column footing detail is presented on Figure 9

7.9.5 The concrete slabs-on-grade should be a minimum of 4 inches thick for Foundation Categories I and II and 5 inches thick for Foundation Category III. The concrete slabs-on-grade should be underlain by 4 inches and 3 inches of clean sand for 4-inch thick and 5-inch-thick slabs, respectively. Slabs expected to receive moisture sensitive floor coverings or used to store moisture sensitive materials should be underlain by a vapor inhibitor covered with at least 2 inches of clean sand or crushed rock. If crushed rock will be used, the thickness of the vapor inhibitor should be at least 10 mil to prevent possible puncturing.

7.9.6 As a substitute, the layer of clean sand (or crushed rock) beneath the vapor inhibitor recommended in the previous section can be omitted if a vapor inhibitor that meets or exceeds the requirements of ASTM E 1745-97 (Class A), and that exhibits permeance not greater than 0.012 perm (measured in accordance with ASTM E 96-95) is used. This vapor inhibitor may be placed directly on properly compacted fill or formational materials. The vapor inhibitor should be installed in general conformance with ASTM E 1643-98 and the manufacturer's recommendations. Two inches of clean sand should then be placed on top of



the vapor inhibitor to reduce the potential for differential curing, slab curl, and cracking. Floor coverings should be installed in accordance with the manufacturer's recommendations.

7.9.7 As an alternative to the conventional foundation recommendations, consideration should be given to the use of post-tensioned concrete slab and foundation systems for the support of the proposed structures. The post-tensioned systems should be designed by a structural engineer experienced in post-tensioned slab design and design criteria of the Post-Tensioning Institute (PTI) DC 10.5-12 *Standard Requirements for Design and Analysis of Shallow Post-Tensioned Concrete Foundations on Expansive Soils* or *WRI/CRSI Design of Slab-on-Ground Foundations*, as required by the 2019 California Building Code (CBC Section 1808.6.2). Although this procedure was developed for expansive soil conditions, it can also be used to reduce the potential for foundation distress due to differential fill settlement. The post-tensioned design should incorporate the geotechnical parameters presented in Table 7.9.3 for the particular Foundation Category designated. The parameters presented in Table 7.9.3 are based on the guidelines presented in the PTI DC 10.5 design manual.

**TABLE 7.9.3  
POST-TENSIONED FOUNDATION SYSTEM DESIGN PARAMETERS**

|   | Foundation Category |      |      |
|---|---------------------|------|------|
|   | I                   | II   | III  |
| Thornthwaite Index                                    | -20                 | -20  | -20  |
| Equilibrium Suction                                   | 3.9                 | 3.9  | 3.9  |
| Edge Lift Moisture Variation Distance, $e_M$ (feet)   | 5.3                 | 5.1  | 4.9  |
| Edge Lift, $y_M$ (inches)                             | 0.61                | 1.10 | 1.58 |
| Center Lift Moisture Variation Distance, $e_M$ (feet) | 9.0                 | 9.0  | 9.0  |
| Center Lift, $y_M$ (inches)                           | 0.30                | 0.47 | 0.66 |

7.9.8 Foundation systems for the lots that possess a foundation Category I and a “very low” expansion potential (expansion index of 20 or less) can be designed using the method described in Section 1808 of the 2016 CBC. If post-tensioned foundations are planned, an alternative, commonly accepted design method (other than PTI DC 10.5) can be used. However, the post-tensioned foundation system should be designed with a total and differential deflection of 1 inch. Geocon Incorporated should be contacted to review the plans and provide additional information, if necessary.

- 7.9.9 If an alternate design method is contemplated, Geocon Incorporated should be contacted to evaluate if additional expansion index testing should be performed to identify the lots that possess a “very low” expansion potential (expansion index of 20 or less).
- 7.9.10 The foundations for the post-tensioned slabs should be embedded in accordance with the recommendations of the structural engineer. If a post-tensioned mat foundation system is planned, the slab should possess a thickened edge with a minimum width of 12 inches and extend below the clean sand or crushed rock layer.
- 7.9.11 If the structural engineer proposes a post-tensioned foundation design method other than PTI DC 10.5:
- The deflection criteria presented in Table 7.9.3 are still applicable.
  - Interior stiffener beams should be used for Foundation Categories II and III.
  - The width of the perimeter foundations should be at least 12 inches.
  - The perimeter footing embedment depths should be at least 12 inches, 18 inches and 24 inches for foundation categories I, II, and III, respectively. The embedment depths should be measured from the lowest adjacent pad grade.
- 7.9.12 Our experience indicates post-tensioned slabs may be susceptible to excessive edge lift, regardless of the underlying soil conditions. Placing reinforcing steel at the bottom of the perimeter footings and the interior stiffener beams may mitigate this potential. The structural engineer should design the foundation system to reduce the potential of edge lift occurring for the proposed structures.
- 7.9.13 During the construction of the post-tension foundation system, the concrete should be placed monolithically. Under no circumstances should cold joints be allowed to form between the footings/grade beams and the slab during the construction of the post-tension foundation system unless designed by the structural engineer.
- 7.9.14 Category I, II, or III foundations may be designed for an allowable soil bearing pressure of 2,000 pounds per square foot (psf) (dead plus live load). This bearing pressure may be increased by one-third for transient loads due to wind or seismic forces.
- 7.9.15 Isolated footings, if present, should have the minimum embedment depth and width recommended for conventional foundations for a particular Foundation Category. The use of isolated footings, which are located beyond the perimeter of the building and support structural elements connected to the building, are not recommended for Category III. Where

this condition cannot be avoided, the isolated footings should be connected to the building foundation system with grade beams.

7.9.16 For Foundation Category III, consideration should be given to using interior stiffening beams and connecting isolated footings and/or increasing the slab thickness. In addition, consideration should be given to connecting patio slabs, which exceed 5 feet in width, to the building foundation to reduce the potential for future separation to occur.

7.9.17 Special subgrade presaturation is not deemed necessary prior to placing concrete; however, the exposed foundation and slab subgrade soil should be moisture conditioned, as necessary, to maintain a moist condition as would be expected in any such concrete placement.

7.9.18 Where buildings or other improvements are planned near the top of a slope 3:1 (horizontal:vertical) or steeper, special foundation and/or design considerations are recommended due to the tendency for lateral soil movement to occur.

- For fill slopes less than 20 feet high, building footings should be deepened such that the bottom outside edge of the footing is at least 7 feet horizontally from the face of the slope.
- When located next to a descending 3:1 (horizontal:vertical) fill slope or steeper, the foundations should be extended to a depth where the minimum horizontal distance is equal to  $H/3$  (where  $H$  equals the vertical distance from the top of the fill slope to the base of the fill soil) with a minimum of 7 feet but need not exceed 40 feet. The horizontal distance is measured from the outer, deepest edge of the footing to the face of the slope. A post-tensioned slab and foundation system or mat foundation system can be used to reduce the potential for distress in the structures associated with strain softening and lateral fill extension. Specific design parameters or recommendations for either of these alternatives can be provided once the building location and fill slope geometry have been determined.
- If swimming pools are planned, Geocon Incorporated should be contacted for a review of specific site conditions.
- Swimming pools located within 7 feet of the top of cut or fill slopes are not recommended. Where such a condition cannot be avoided, the portion of the swimming pool wall within 7 feet of the slope face be designed assuming that the adjacent soil provides no lateral support. This recommendation applies to fill slopes up to 30 feet in height, and cut slopes regardless of height. For swimming pools located near the top of fill slopes greater than 30 feet in height, additional recommendations may be required and Geocon Incorporated should be contacted for a review of specific site conditions.

- Although other improvements, which are relatively rigid or brittle, such as concrete flatwork or masonry walls, may experience some distress if located near the top of a slope, it is generally not economical to mitigate this potential. It may be possible, however, to incorporate design measures, which would permit some lateral soil movement without causing extensive distress. Geocon Incorporated should be consulted for specific recommendations.

7.9.19 The recommendations of this report are intended to reduce the potential for cracking of slabs and foundations due to expansive soil (if present), differential settlement of fill soil or soil with varying thicknesses. However, even with the incorporation of the recommendations presented herein, foundations, stucco walls, and slabs-on-grade placed on such conditions may still exhibit some cracking due to soil movement and/or shrinkage. The occurrence of concrete shrinkage cracks is independent of the supporting soil characteristics. Their occurrence may be reduced by limiting the slump of the concrete, proper concrete placement and curing, and by the placement of crack control joints at periodic intervals, in particular, where re-entrant slab corners occur.

7.9.20 Concrete slabs should be provided with adequate crack-control joints, construction joints and/or expansion joints to reduce unsightly shrinkage cracking. The design of joints should consider criteria of the American Concrete Institute (ACI) when establishing crack-control spacing. Additional steel reinforcing, concrete admixtures and/or closer crack control joint spacing should be considered where concrete-exposed finished floors are planned.

7.9.21 Geocon Incorporated should be consulted to provide additional design parameters as required by the structural engineer.

## **7.10 Retaining Walls and Lateral Loads Recommendations**

7.10.1 Retaining walls not restrained at the top and having a level backfill surface should be designed for an active soil pressure equivalent to the pressure exerted by a fluid with a density of 35 pounds per cubic foot (pcf). Where the backfill will be inclined at 2:1 (horizontal:vertical), an active soil pressure of 50 pcf is recommended. These soil pressures assume that the backfill materials within an area bounded by the wall and a 1:1 plane extending upward from the base of the wall possess an Expansion Index  $\leq 50$ . Geocon Incorporated should be consulted for additional recommendations if backfill materials have an EI > 50.

7.10.2 Retaining walls shall be designed to ensure stability against overturning sliding, excessive foundation pressure and water uplift. Where a keyway is extended below the wall base with the intent to engage passive pressure and enhance sliding stability, it is not necessary to consider active pressure on the keyway.

- 7.10.3 Where walls are restrained from movement at the top, an additional uniform pressure of  $8H$  psf (where  $H$  equals the height of the retaining wall portion of the wall in feet) should be added to the active soil pressure where the wall possesses a height of 8 feet or less and  $12H$  where the wall is greater than 8 feet. For retaining walls subject to vehicular loads within a horizontal distance equal to two-thirds the wall height, a surcharge equivalent to two feet of fill soil should be added (total unit weight of soil should be taken as 130 pcf).
- 7.10.4 Soil contemplated for use as retaining wall backfill, including import materials, should be identified in the field prior to backfill. At that time Geocon Incorporated should obtain samples for laboratory testing to evaluate its suitability. Modified lateral earth pressures may be necessary if the backfill soil does not meet the required expansion index or shear strength. City or regional standard wall designs, if used, are based on a specific active lateral earth pressure and/or soil friction angle. In this regard, on-site soil to be used as backfill may or may not meet the values for standard wall designs. Geocon Incorporated should be consulted to assess the suitability of the on-site soil for use as wall backfill if standard wall designs will be used.
- 7.10.5 Unrestrained walls will move laterally when backfilled and loading is applied. The amount of lateral deflection is dependent on the wall height, the type of soil used for backfill, and loads acting on the wall. The wall designer should provide appropriate lateral deflection quantities for planned retaining walls structures, if applicable. These lateral values should be considered when planning types of improvements above retaining wall structures.
- 7.10.6 Retaining walls should be provided with a drainage system adequate to prevent the buildup of hydrostatic forces and should be waterproofed as required by the project architect. The use of drainage openings through the base of the wall (weep holes) is not recommended where the seepage could be a nuisance or otherwise adversely affect the property adjacent to the base of the wall. The above recommendations assume a properly compacted granular ( $EI \leq 50$ ) free-draining backfill material with no hydrostatic forces or imposed surcharge load. A typical retaining wall drainage detail is presented on Figure 10. If conditions different than those described are expected, or if specific drainage details are desired, Geocon Incorporated should be contacted for additional recommendations.
- 7.10.7 In general, wall foundations having a minimum depth and width of one foot may be designed for an allowable soil bearing pressure of 2,000 psf, provided the soil within three feet below the base of the wall has an Expansion Index  $\leq 90$ . The recommended allowable soil bearing pressure may be increased by 300 psf and 500 psf for each additional foot of foundation width and depth, respectively, up to a maximum allowable soil bearing pressure of 4,000 psf.

- 7.10.8 The proximity of the foundation to the top of a slope steeper than 3:1 could impact the allowable soil bearing pressure. Therefore, Geocon Incorporated should be consulted where such a condition is anticipated. As a minimum, wall footings should be deepened such that the bottom outside edge of the footing is at least seven feet from the face of slope when located adjacent and/or at the top of descending slopes.
- 7.10.9 The structural engineer should determine the Seismic Design Category for the project in accordance with Section 1613.3.5 of the 2016 CBC or Section 11.6 of ASCE 7-10. For structures assigned to Seismic Design Category of D, E, or F, retaining walls that support more than 6 feet of backfill should be designed with seismic lateral pressure in accordance with Section 1803.5.12 of the 2016 CBC. The seismic load is dependent on the retained height where H is the height of the wall, in feet, and the calculated loads result in pounds per square foot (psf) exerted at the base of the wall and zero at the top of the wall. A seismic load of 22H should be used for design. We used the peak ground acceleration adjusted for Site Class effects,  $PGA_M$ , of 0.464g calculated from ASCE 7-10 Section 11.8.3 and applied a pseudo-static coefficient of 0.33.
- 7.10.10 For resistance to lateral loads, a passive earth pressure equivalent to a fluid density of 300 pcf is recommended for footings or shear keys poured neat against properly compacted granular fill soils or undisturbed formational materials. The passive pressure assumes a horizontal surface extending away from the base of the wall at least five feet or three times the surface generating the passive pressure, whichever is greater. The upper 12 inches of material not protected by floor slabs or pavement should not be included in the design for lateral resistance.
- 7.10.11 An ultimate friction coefficient of 0.35 may be used for resistance to sliding between soil and concrete. This friction coefficient may be combined with the passive earth pressure when determining resistance to lateral loads.
- 7.10.12 The recommendations presented above are generally applicable to the design of rigid concrete or masonry retaining walls having a maximum height of 12 feet. In the event that walls higher than 12 feet are planned, Geocon Incorporated should be consulted for additional recommendations.

## **7.11 Slope Maintenance**

- 7.11.1 Slopes steeper than 3:1 (horizontal: vertical) may, under conditions that are both difficult to prevent and predict, be susceptible to near-surface (surficial) slope instability. The instability is typically limited to the outer three feet of the slope and usually does not

directly impact the improvements on pad areas above or below the slope. The occurrence of surficial instability is more prevalent on fill slopes and is generally preceded by a period of heavy rainfall, excessive irrigation or the migration of subsurface seepage. Disturbance and/or loosening of the surficial soils, as might result from root growth, soil expansion or excavation for irrigation lines and slope planting, may also be a significant contributing factor to surficial instability. We recommend that, to the maximum extent practical, (a) disturbed/loosened surficial soils be either removed or properly compacted, (b) irrigation systems be periodically inspected and maintained to eliminate leaks and excessive irrigation, and (c) surface drains on and adjacent to slopes be periodically maintained to preclude ponding or erosion. Although the incorporation of the above recommendations should reduce the potential for surficial slope instability, it will not eliminate the possibility, and it may be necessary to rebuild or repair a portion of the project's slopes in the future.

## **7.12 Site Drainage and Maintenance**

- 7.12.1 Adequate site drainage is critical to reduce the potential for differential soil movement, erosion and subsurface seepage. Under no circumstances should water be allowed to pond adjacent to footings. The site should be graded and maintained such that surface drainage is directed away from structures in accordance with 2019 CBC 1803.3 or other applicable standards. In addition, surface drainage should be directed away from the top of slopes into swales or other controlled drainage devices. Roof and pavement drainage should be directed into storm drains and conduits that carry runoff away from the proposed structure.
- 7.12.2 Underground utilities should be leak free. Utility and irrigation lines should be checked periodically for leaks, and detected leaks should be repaired promptly. Detrimental soil movement could occur if water is allowed to infiltrate the soil for prolonged periods of time.
- 7.12.3 Landscaping planters adjacent to paved areas are not recommended due to the potential for surface or irrigation water to infiltrate the pavement's subgrade and base course. We recommend that area drains to collect excess irrigation water and transmit it to drainage structures or impervious above-grade planter boxes be used. In addition, where landscaping is planned adjacent to the pavement, we recommend construction of a cutoff wall along the edge of the pavement that extends at least 6 inches below the bottom of the base material.

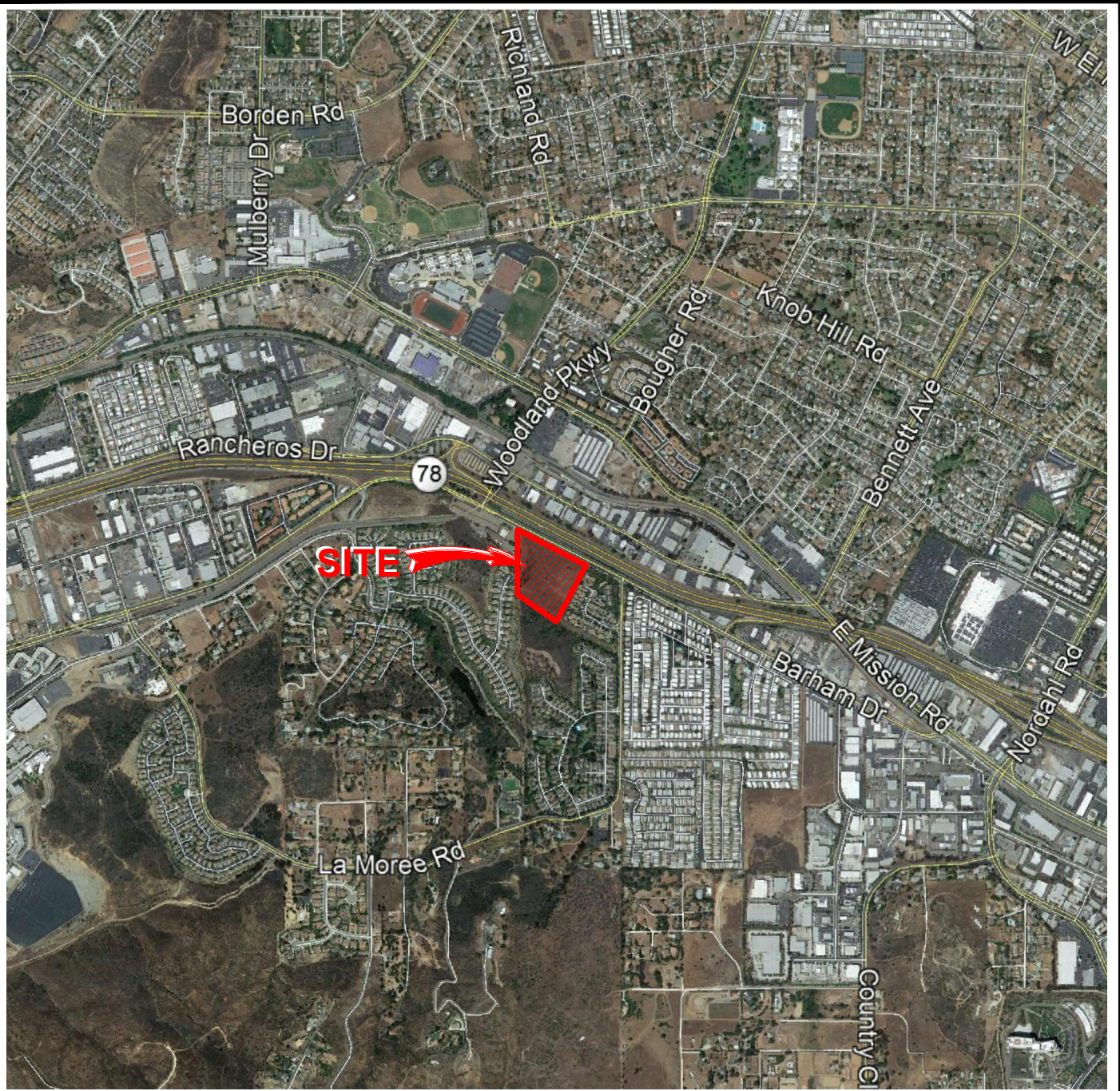
## **7.13 Grading and Foundation Plan Review**

- 7.13.1 Geocon Incorporated should review the grading and foundation plans prior to finalization to verify their compliance with the recommendations of this report and determine the need for additional comments, recommendations, and/or analysis.

## LIMITATIONS AND UNIFORMITY OF CONDITIONS

1. The firm that performed the geotechnical investigation for the project should be retained to provide testing and observation services during construction to provide continuity of geotechnical interpretation and to check that the recommendations presented for geotechnical aspects of site development are incorporated during site grading, construction of improvements, and excavation of foundations. If another geotechnical firm is selected to perform the testing and observation services during construction operations, that firm should prepare a letter indicating their intent to assume the responsibilities of project geotechnical engineer of record. A copy of the letter should be provided to the regulatory agency for their records. In addition, that firm should provide revised recommendations concerning the geotechnical aspects of the proposed development, or a written acknowledgement of their concurrence with the recommendations presented in our report. They should also perform additional analyses deemed necessary to assume the role of Geotechnical Engineer of Record.
2. The recommendations of this report pertain only to the site investigated and are based upon the assumption that the soil conditions do not deviate from those disclosed in the investigation. If any variations or undesirable conditions are encountered during construction, or if the proposed construction will differ from that anticipated herein, Geocon Incorporated should be notified so that supplemental recommendations can be given. The evaluation or identification of the potential presence of hazardous or corrosive materials was not part of the scope of services provided by Geocon Incorporated.
3. This report is issued with the understanding that it is the responsibility of the owner or his representative to ensure that the information and recommendations contained herein are brought to the attention of the architect and engineer for the project and incorporated into the plans, and the necessary steps are taken to see that the contractor and subcontractors carry out such recommendations in the field.
4. The findings of this report are valid as of the present date. However, changes in the conditions of a property can occur with the passage of time, whether they be due to natural processes or the works of man on this or adjacent properties. In addition, changes in applicable or appropriate standards may occur, whether they result from legislation or the broadening of knowledge. Accordingly, the findings of this report may be invalidated wholly or partially by changes outside our control. Therefore, this report is subject to review and should not be relied upon after a period of three years.





THE GEOGRAPHICAL INFORMATION MADE AVAILABLE FOR DISPLAY WAS PROVIDED BY GOOGLE EARTH, SUBJECT TO A LICENSING AGREEMENT. THE INFORMATION IS FOR ILLUSTRATIVE PURPOSES ONLY; IT IS NOT INTENDED FOR CLIENT'S USE OR RELIANCE AND SHALL NOT BE REPRODUCED BY CLIENT. CLIENT SHALL INDEMNIFY, DEFEND AND HOLD HARMLESS GEOCON FROM ANY LIABILITY INCURRED AS A RESULT OF SUCH USE OR RELIANCE BY CLIENT.



NO SCALE

VICINITY MAP

**GEOCON**  
INCORPORATED



GEOTECHNICAL ■ ENVIRONMENTAL ■ MATERIALS  
6960 FLANDERS DRIVE - SAN DIEGO, CALIFORNIA 92121 - 2974  
PHONE 858 558-6900 - FAX 858 558-6159

943 BARHAM DRIVE  
SAN MARCOS, CALIFORNIA

JP / CW

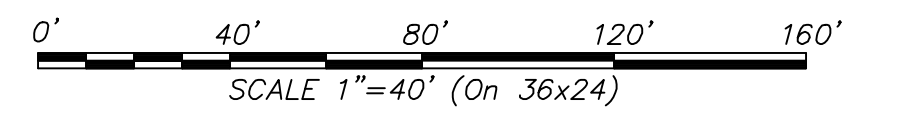
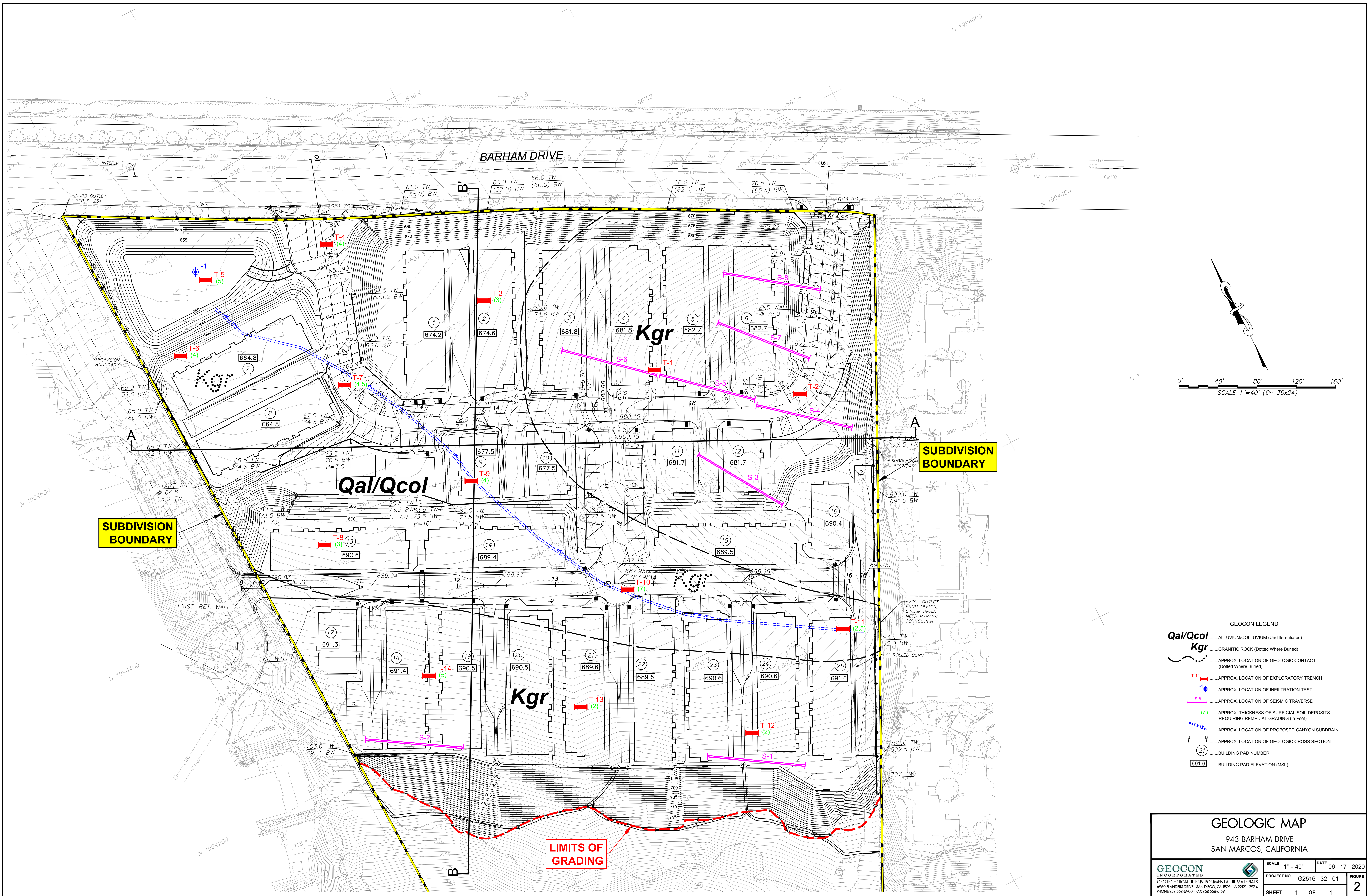
DSK/GTYPD

DATE 06 - 17 - 2020

PROJECT NO. G2516 - 32 - 01

FIG. 1





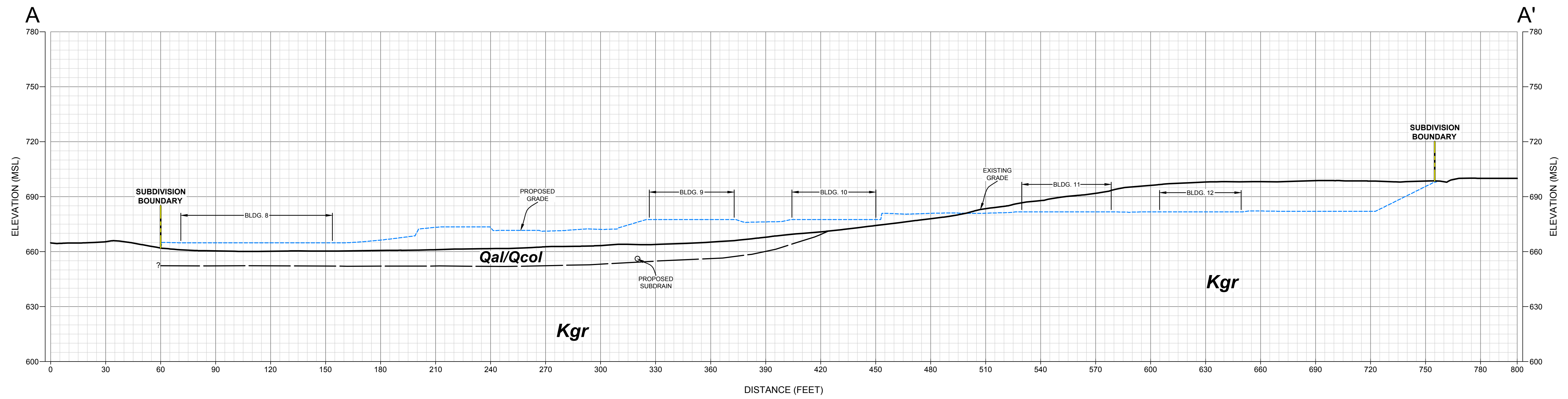
**GEOCON LEGEND**

|                 |   |
|-----------------|---|
| <b>Qal/Qcol</b> | ..... ALLUVIUM/COLLUVIUM (Undifferentiated)   |
| <b>Kgr</b>      | ..... GRANITIC ROCK (Dotted Where Buried)   |
|                 | ..... APPROX. LOCATION OF GEOLOGIC CONTACT (Dotted Where Buried)                            |
|                 | T-14 ..... APPROX. LOCATION OF EXPLORATORY TRENCH FROM OFFSITE                              |
|                 | I-1 ..... APPROX. LOCATION OF INFILTRATION TEST   |
|                 | S-8 ..... APPROX. LOCATION OF SEISMIC TRAVERSE  |
|                 | (7) ..... APPROX. THICKNESS OF SURFICIAL SOIL DEPOSITS REQUIRING REMEDIAL GRADING (In Feet) |
|                 | ..... APPROX. LOCATION OF PROPOSED CANYON SUBDRAIN  |
|                 | A-B ..... APPROX. LOCATION OF GEOLOGIC CROSS SECTION  |
|                 | (21) ..... BUILDING PAD NUMBER  |
|                 | 691.6 ..... BUILDING PAD ELEVATION (MSL)  |

**GEOLOGIC MAP**  
 943 BARHAM DRIVE  
 SAN MARCOS, CALIFORNIA

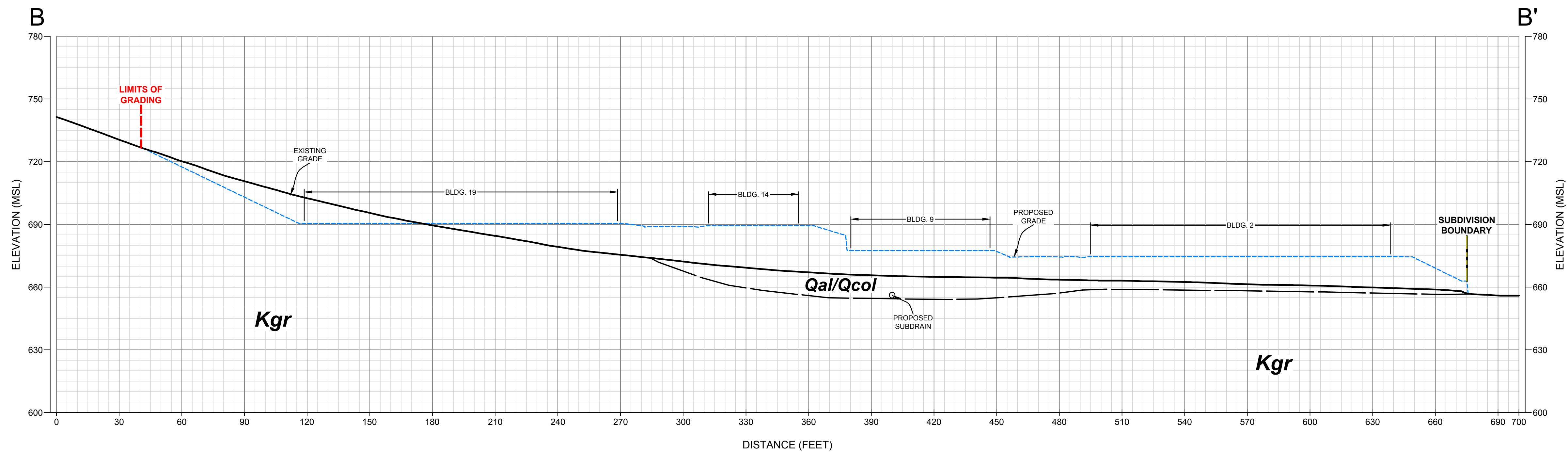
|  |  |                                 |
|--|--|---------------------------------|
| <br>GEOCON<br>INCORPORATED<br>GEOTECHNICAL ■ ENVIRONMENTAL ■ MATERIALS<br>6940 FLANDERS DRIVE, SAN DIEGO, CALIFORNIA 92121-2974<br>PHONE 619 538-6900 - FAX 619 538-6159 | SCALE 1" = 40'<br>PROJECT NO. G2516 - 32 - 01<br>SHEET 1 OF 1  | DATE 06 - 17 - 2020<br>FIGURE 2 |
|  | Printed: 05/17/2020 10:37AM   By: RUBEN AGUILAR   File Location: Y:\PROJECTS\G2516-32-01\943 Barham Drive\Sheets\G2516-32-01_Geo Map.dwg |                                 |





**GEOLOGIC CROSS-SECTION A-A'**

SCALE: 1" = 30' (Vert. = Horiz.)



**GEOLOGIC CROSS-SECTION B-B'**

SCALE: 1" = 30' (Vert. = Horiz.)

**GEOCON LEGEND**

|  |  |
|--|--|
|  | ..... ALLUVIUM/COLLUVIUM (Undifferentiated)                          |
|  | ..... GRANITIC ROCK  |
|  | ..... APPROX. LOCATION OF GEOLOGIC CONTACT (Queried Where Uncertain) |

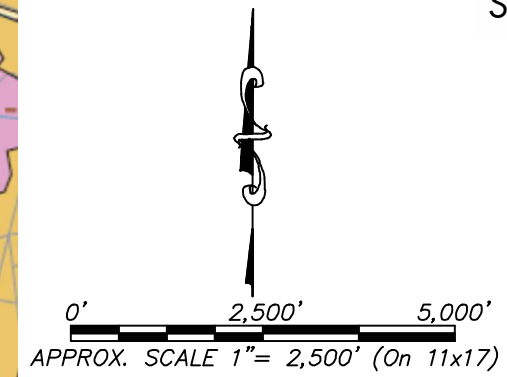
**GEOLOGIC CROSS - SECTIONS**  
 943 BARHAM DRIVE  
 SAN MARCOS, CALIFORNIA

|  |                             |                     |
|--|-----------------------------|---------------------|
| <br>GEOCON<br>6960 FLANDERS DRIVE, SAN DIEGO, CALIFORNIA 92121-2974<br>PHONE 658 538-6900 - FAX 658 538-6159 | SCALE 1" = 40'              | DATE 06 - 17 - 2020 |
|  | PROJECT NO. G2516 - 32 - 01 | FIGURE 3            |
| SHEET 1 OF 1   |                             |                     |

Printed 06/17/2020 10:37AM | By: RUBEN AGUILAR | File Location: Y:\PROJECTS\G2516-32-01 943 Barham Drive\Sheets\G2516-32-01 Cross-Section.dwg



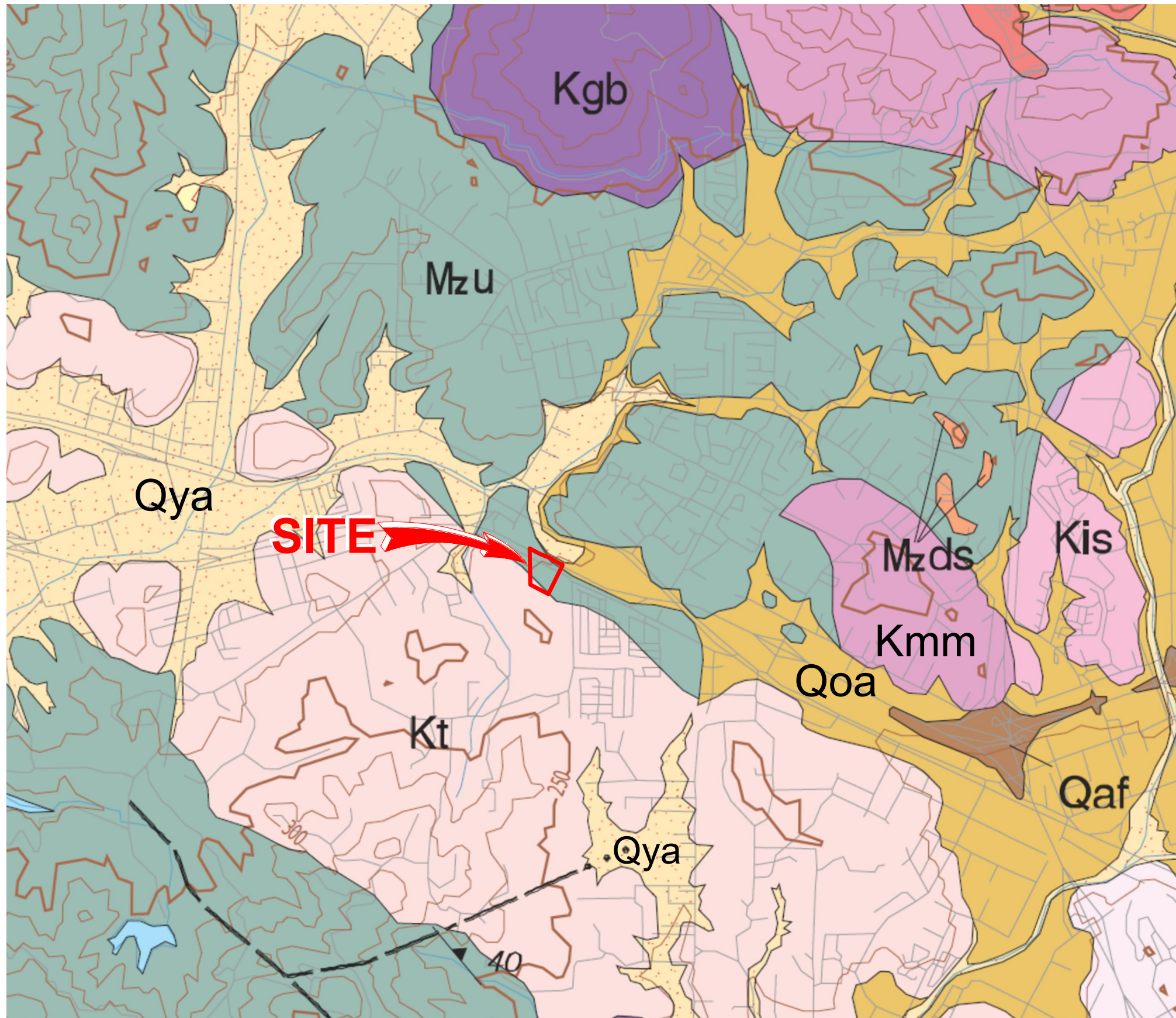
943 BARHAM DRIVE  
SAN MARCOS, CALIFORNIA



**DESCRIPTION OF MAP UNITS**

Fault—Solid where well defined; dashed where inferred, queried where uncertain. Where fault offsets sea floor, age symbol is shown on bar on downthrown side. Where age was determined, age symbol is shown astride fault and relative offset if known is shown by "D" and "U" on downthrown and upthrown sides. Ages of faults are indicated as follows.

- Artificial fill (late Holocene)**—Deposits of fill resulting from human construction, mining, or quarrying activities; includes compacted engineered and non compacted non engineered fill. Some large deposits are mapped, but in some areas no deposits are shown
- Young alluvial flood plain deposits (Holocene and late Pleistocene)**—Mostly poorly consolidated, poorly sorted, permeable flood plain deposits
- Old alluvial flood plain deposits undivided (late to middle Pleistocene)**—Fluvial sediments deposited on canyon floors. Consists of moderately well consolidated, poorly sorted, permeable, commonly slightly dissected gravel, sand, silt, and clay-bearing alluvium. Where more than one number is shown (e.g., Qoa<sub>2-6</sub>) those deposits are undivided (Fig. 3). Includes:
- Tonalite undivided (mid-Cretaceous)**—Mostly massive coarse-grained, light-gray hornblende-biotite tonalite
- Gabbro undivided (mid-Cretaceous)**—Mostly massive, coarse-grained, dark-gray and black biotite-hornblende-hypersthene gabbro
- Granite of Indian Springs (mid-Cretaceous)**—Fine-grained biotite granite. Similar in appearance to Kdl
- Monzogranite of Merriam Mountain (mid-Cretaceous)**—Massive, medium- to coarse-grained, leucocratic hornblende-biotite monzogranite
- Metavolcanic dikes (Mesozoic)**—Very fine-grained, dark-gray, massive dikes within ju
- Metasedimentary and metavolcanic rocks undivided (Mesozoic)**—Wide variety of low- to high-metamorphic grade metavolcanic and metasedimentary rocks that are mostly volcanoclastic breccia and metaandesitic flows, tuffs and tuff-breccia

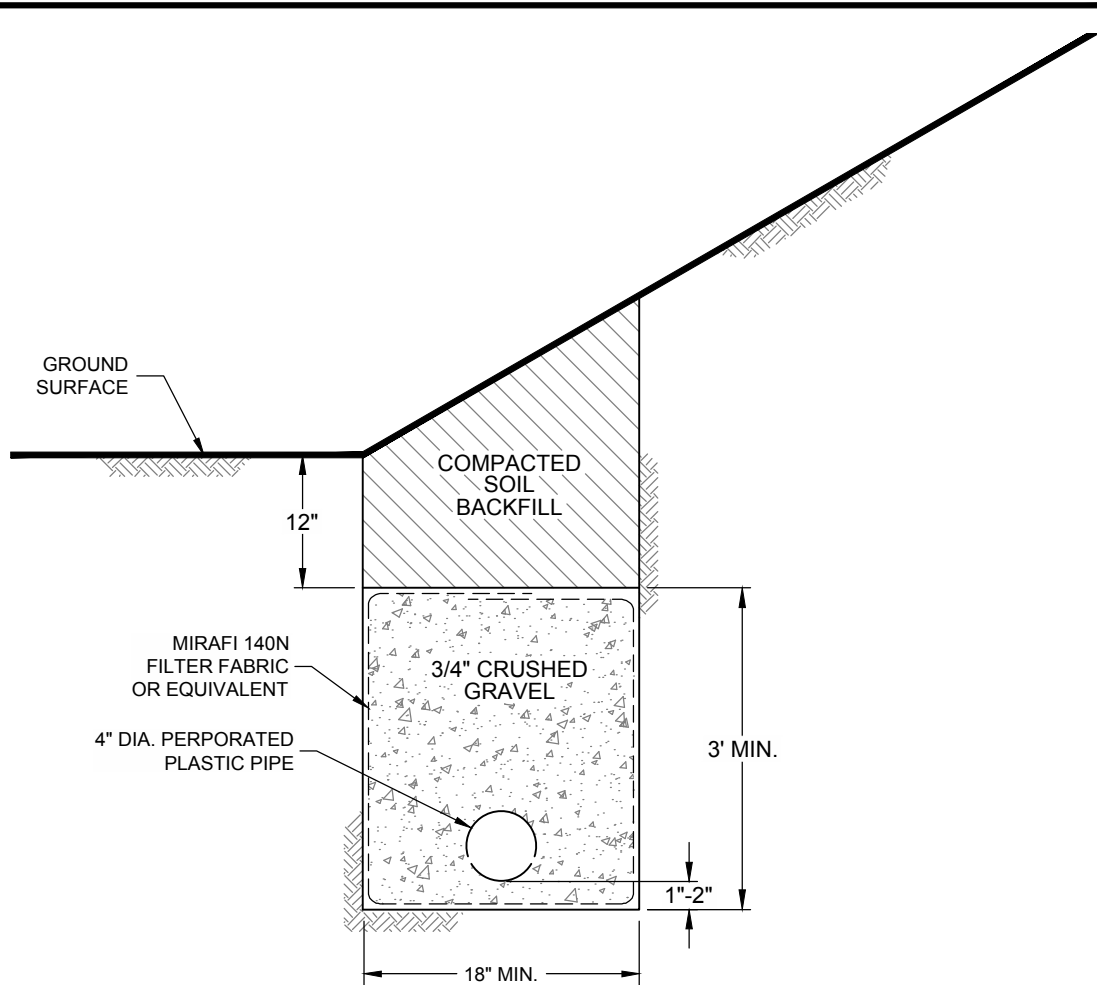


SOURCE: GEOLOGIC MAP OF THE OCEANSIDE 30'X60' QUADRANGLE, DATED 2005, CALIFORNIA PREPARED BY THE U.S. GEOLOGICAL SURVEY

**GEOCON**  
INCORPORATED  
GEO TECHNICAL ■ ENVIRONMENTAL ■ MATERIALS  
6960 FLANDERS DRIVE • SAN DIEGO, CALIFORNIA 92121 • 297.4  
PHONE 858 558-6900 • FAX 858 558-6159  
PROJECT NO. G2516 - 32 - 01  
FIGURE 4  
DATE 06 - 17 - 2020

**REGIONAL GEOLOGIC MAP**





**NOTES:**

1. SOIL CAP COMPACTED TO 90% RELATIVE COMPACTION
2. PERMEABLE MATERIAL SHALL BE ¾" CRUSHED GRAVEL WRAPPED IN FILTER FABRIC (MIRAFI 140N OR EQUIVALENT)
3. 4" DIAMETER PERFORATED PIPE (SDR-35 OR EQUIVALENT) WITH PERFORATIONS DOWN
4. PIPE TO MAINTAIN A MINIMUM 1 PERCENT FALL
5. CONCRETE CUTOFF WALL TO BE PROVIDED AT TRANSITION TO SOLID OUTLET PIPE
6. SOLID OUTLET PIPE TO DRAIN TO APPROVED AREA
7. CLEANOUTS SHOULD BE PROVIDED

**TOE DRAIN DETAIL**

**GEOCON**  
INCORPORATED



GEOTECHNICAL ■ ENVIRONMENTAL ■ MATERIALS  
6960 FLANDERS DRIVE - SAN DIEGO, CALIFORNIA 92121 - 2974  
PHONE 858 558-6900 - FAX 858 558-6159

943 BARHAM DRIVE  
SAN MARCOS, CALIFORNIA

JP / CW

DSK/GTYPD

DATE 06 - 17 - 2020

PROJECT NO. G2516 - 32 - 01

FIG. 5

ASSUMED CONDITIONS :

|                            |  |
|----------------------------|--|
| SLOPE HEIGHT               | H = 20 feet                            |
| SLOPE INCLINATION          | 2 : 1 (Horizontal : Vertical)          |
| TOTAL UNIT WEIGHT OF SOIL  | $\gamma_t = 125$ pounds per cubic foot |
| ANGLE OF INTERNAL FRICTION | $\phi = 30$ degrees                    |
| APPARENT COHESION          | C = 300 pounds per square foot         |
| NO SEEPAGE FORCES          |  |

ANALYSIS :

|  |   |
|--|---|
| $\lambda_{c\phi} = \frac{\gamma_t H \tan \phi}{C}$ | EQUATION (3-3), REFERENCE 1                 |
| FS = $\frac{N_{cf} C}{\gamma_t H}$                 | EQUATION (3-2), REFERENCE 1                 |
| $\lambda_{c\phi} = 4.8$                            | CALCULATED USING EQ. (3-3)                  |
| $N_{cf} = 19$                                      | DETERMINED USING FIGURE 10, REFERENCE 2     |
| FS = 2.3   | FACTOR OF SAFETY CALCULATED USING EQ. (3-2) |

REFERENCES :

- .....Janbu, N., Stability Analysis of Slopes with Dimensionless Parameters, Harvard Soil Mechanics, Series No. 46, 1954
- .....Janbu, N., Discussion of J.M. Bell, Dimensionless Parameters for Homogeneous Earth Slopes, Journal of Soil Mechanics and Foundation Design, No. SM6, November 1967.

SLOPE STABILITY ANALYSIS - FILL SLOPES

**GEOCON**  
INCORPORATED



GEOTECHNICAL ■ ENVIRONMENTAL ■ MATERIALS  
6960 FLANDERS DRIVE - SAN DIEGO, CALIFORNIA 92121 - 2974  
PHONE 858 558-6900 - FAX 858 558-6159

943 BARHAM DRIVE  
SAN MARCOS, CALIFORNIA

JP / CW

DSK/GTYPD

DATE 06 - 17 - 2020

PROJECT NO. G2516 - 32 - 01

FIG. 6

ASSUMED CONDITIONS :

|                            |  |
|----------------------------|--|
| SLOPE HEIGHT               | H = 30 feet                            |
| SLOPE INCLINATION          | 2 : 1 (Horizontal : Vertical)          |
| TOTAL UNIT WEIGHT OF SOIL  | $\gamma_t = 130$ pounds per cubic foot |
| ANGLE OF INTERNAL FRICTION | $\phi = 33$ degrees                    |
| APPARENT COHESION          | C = 400 pounds per square foot         |
| NO SEEPAGE FORCES          |  |

ANALYSIS :

|   |   |
|---|---|
| $\lambda_{c\phi} = \frac{\gamma_t H \tan\phi}{C}$ | EQUATION (3-3), REFERENCE 1                 |
| FS = $\frac{NcfC}{\gamma_t H}$                    | EQUATION (3-2), REFERENCE 1                 |
| $\lambda_{c\phi} = 6.3$                           | CALCULATED USING EQ. (3-3)                  |
| Ncf = 24  | DETERMINED USING FIGURE 10, REFERENCE 2     |
| FS = 2.5  | FACTOR OF SAFETY CALCULATED USING EQ. (3-2) |

REFERENCES :

- 1.....Janbu, N., Stability Analysis of Slopes with Dimensionless Parameters, Harvard Soil Mechanics, Series No. 46, 1954
- 2.....Janbu, N., Discussion of J.M. Bell, Dimensionless Parameters for Homogeneous Earth Slopes, Journal of Soil Mechanics and Foundation Design, No. SM6, November 1967.

SLOPE STABILITY ANALYSIS - CUT SLOPES

**GEOCON**  
INCORPORATED



GEOTECHNICAL ■ ENVIRONMENTAL ■ MATERIALS  
6960 FLANDERS DRIVE - SAN DIEGO, CALIFORNIA 92121 - 2974  
PHONE 858 558-6900 - FAX 858 558-6159

943 BARHAM DRIVE  
SAN MARCOS, CALIFORNIA

JP / CW

DSK/GTYPD

DATE 06 - 17 - 2020

PROJECT NO. G2516 - 32 - 01

FIG. 7

ASSUMED CONDITIONS :

|                            |   |
|----------------------------|---|
| SLOPE HEIGHT               | H = Infinite                            |
| DEPTH OF SATURATION        | Z = 3 feet                              |
| SLOPE INCLINATION          | 2 : 1 (Horizontal : Vertical)           |
| SLOPE ANGLE                | i = 26.6 degrees                        |
| UNIT WEIGHT OF WATER       | $\gamma_w$ = 62.4 pounds per cubic foot |
| TOTAL UNIT WEIGHT OF SOIL  | $\gamma_t$ = 125 pounds per cubic foot  |
| ANGLE OF INTERNAL FRICTION | $\phi$ = 30 degrees                     |
| APPARENT COHESION          | C = 300 pounds per square foot          |

SLOPE SATURATED TO VERTICAL DEPTH Z BELOW SLOPE FACE

SEEPAGE FORCES PARALLEL TO SLOPE FACE

ANALYSIS :

$$FS = \frac{C + (\gamma_t - \gamma_w) Z \cos^2 i \tan \phi}{\gamma_t Z \sin i \cos i} = 2.6$$

REFERENCES :

- 1.....Haefeli, R. *The Stability of Slopes Acted Upon by Parallel Seepage*, Proc. Second International Conference, SMFE, Rotterdam, 1948, 1, 57-62
- 2.....Skempton, A. W., and F.A. Delory, *Stability of Natural Slopes in London Clay*, Proc. Fourth International Conference, SMFE, London, 1957, 2, 378-81

SURFICIAL SLOPE STABILITY ANALYSIS

**GEOCON**  
INCORPORATED



GEOTECHNICAL ■ ENVIRONMENTAL ■ MATERIALS  
6960 FLANDERS DRIVE - SAN DIEGO, CALIFORNIA 92121 - 2974  
PHONE 858 558-6900 - FAX 858 558-6159

943 BARHAM DRIVE  
SAN MARCOS, CALIFORNIA

JP / CW

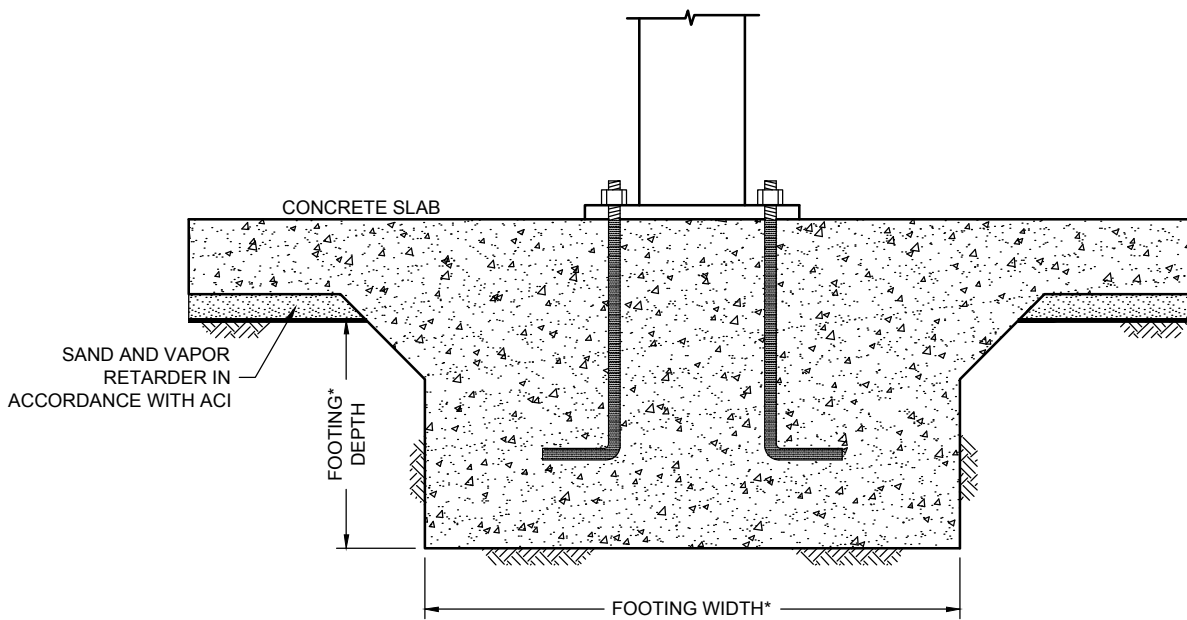
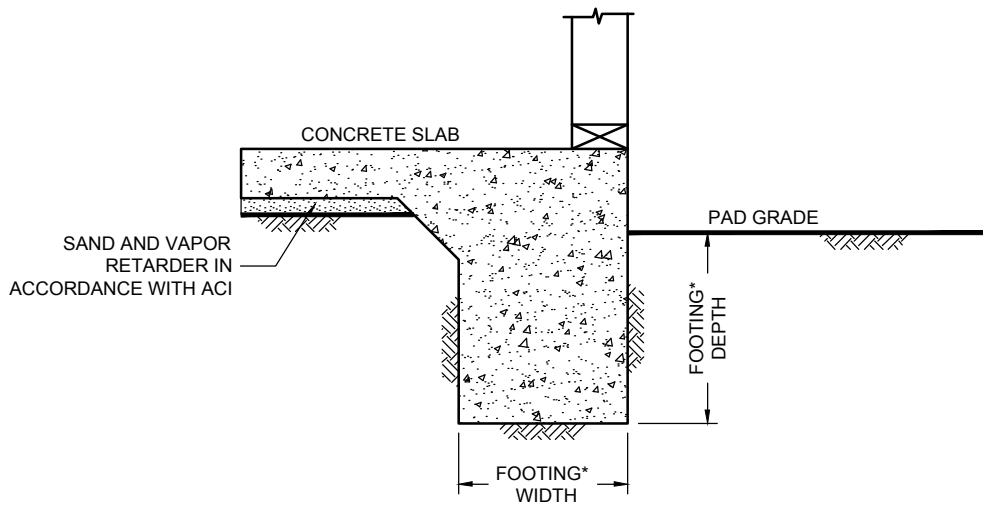
DSK/GTYPD

DATE 06 - 17 - 2020

PROJECT NO. G2516 - 32 - 01

FIG. 8





\* ...SEE REPORT FOR FOUNDATION WIDTH AND DEPTH RECOMMENDATION

NO SCALE

### WALL / COLUMN FOOTING DIMENSION DETAIL

**GEOCON**  
INCORPORATED



GEOTECHNICAL ■ ENVIRONMENTAL ■ MATERIALS  
6960 FLANDERS DRIVE - SAN DIEGO, CALIFORNIA 92121 - 2974  
PHONE 858 558-6900 - FAX 858 558-6159

943 BARHAM DRIVE  
SAN MARCOS, CALIFORNIA

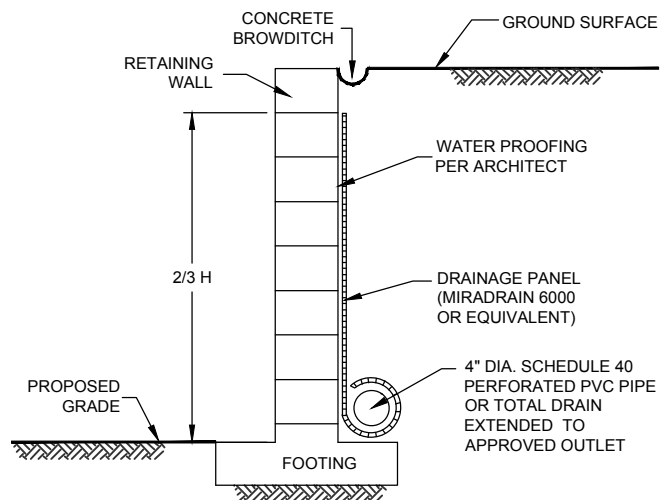
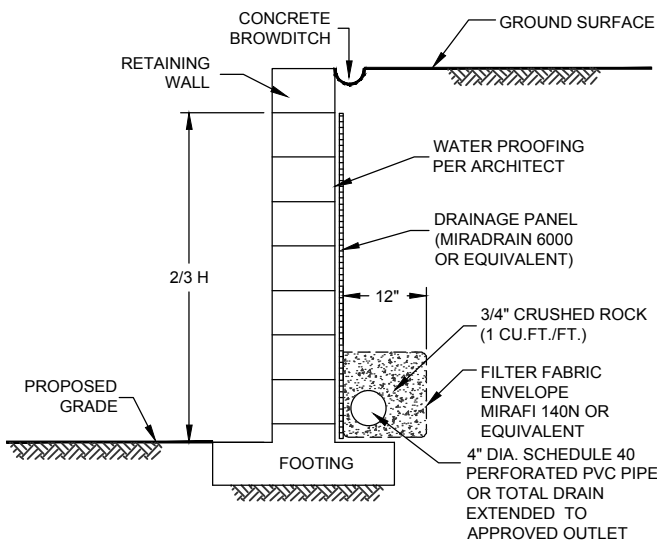
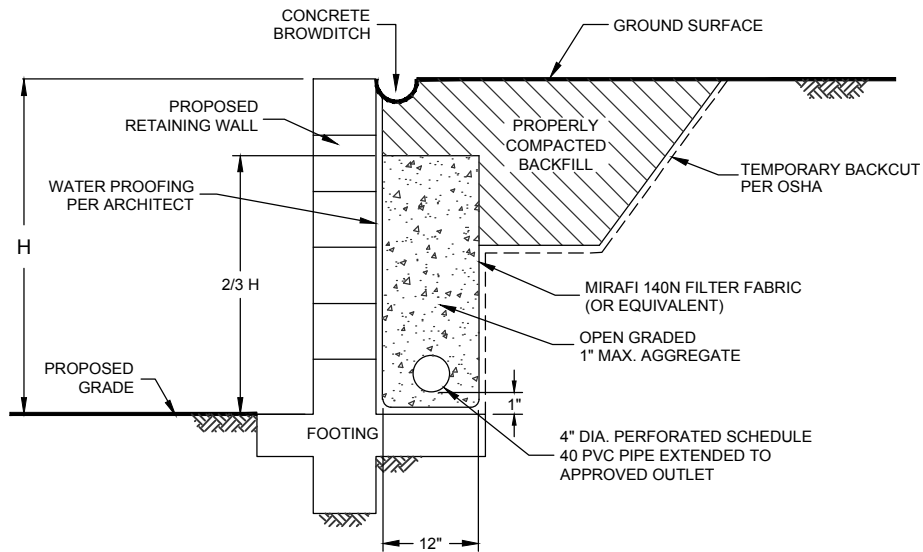
JP / CW

DSK/GTYPD

DATE 06 - 17 - 2020

PROJECT NO. G2516 - 32 - 01

FIG. 9



NOTE :

DRAIN SHOULD BE UNIFORMLY SLOPED TO GRAVITY OUTLET OR TO A SUMP WHERE WATER CAN BE REMOVED BY PUMPING

NO SCALE

## TYPICAL RETAINING WALL DRAIN DETAIL

**GEOCON**  
INCORPORATED



GEOTECHNICAL ■ ENVIRONMENTAL ■ MATERIALS  
6960 FLANDERS DRIVE - SAN DIEGO, CALIFORNIA 92121 - 297 4  
PHONE 858 558-6900 - FAX 858 558-6159

943 BARHAM DRIVE  
SAN MARCOS, CALIFORNIA

JP / CW

DSK/GTYPD

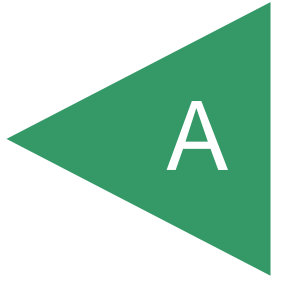
DATE 06 - 17 - 2020

PROJECT NO. G2516 - 32 - 01

FIG. 10

APPENDIX

A



## **APPENDIX A**

### **FIELD INVESTIGATION**

The field investigation, performed on February 19, 2020, consisted of excavating 14 exploratory trenches (Trench Nos. T-1 through T-14). In addition, one infiltration test (Infiltration Test No. I-1) was performed within a proposed storm water management area at the location provided by SB&O Engineering. The approximate locations of the trenches and infiltration test are shown on the *Geologic Map*, tab 2.







The exploratory trenches were excavated with a John Deere 310G backhoe, using a 24-inch-wide bucket. Logs of the trenches depicting the soil and geologic conditions encountered are presented on Figures A-1 through A-14.

The soils encountered in the excavations were visually classified and logged in general accordance with American Society for Testing and Materials (ASTM) practice for Description and Identification of Soils (Visual Manual Procedure D 2488).

| DEPTH IN FEET               | SAMPLE NO. | LITHOLOGY | GROUNDWATER | SOIL CLASS (USCS) | <b>TRENCH T 1</b><br>ELEV. (MSL.) <u>686'</u> DATE COMPLETED <u>02-19-2020</u><br>EQUIPMENT <u>JD 310G BACKHOE WITH 24" BUCKET</u> BY: <u>J. PAGNILLO</u>   | PENETRATION RESISTANCE (BLOWS/FT.) | DRY DENSITY (P.C.F.) | MOISTURE CONTENT (%) |
|-----------------------------|------------|-----------|-------------|-------------------|---|------------------------------------|----------------------|----------------------|
| MATERIAL DESCRIPTION        |            |           |             |                   |   |                                    |                      |                      |
| 0                           |            |           |             | SM                | <b>TOPSOIL</b><br>Loose, damp, brown, Silty, fine to medium SAND  |                                    |                      |                      |
| 2                           |            |           |             |                   | <b>GRANITIC ROCK (Kgr)</b><br>Highly weathered, brownish gray, weak, GRANITIC ROCK; excavates to silty sand with angular rock fragments up to 4-inches size |                                    |                      |                      |
| 4                           |            |           |             |                   |   |                                    |                      |                      |
| 6                           | T1-1       |           |             |                   | -At 5 feet: becomes moderately weak   |                                    |                      |                      |
| TRENCH TERMINATED AT 7 FEET |            |           |             |                   |   |                                    |                      |                      |

**Figure A-1,**  
**Log of Trench T 1, Page 1 of 1**

G2516-32-01.GPJ

|                |   |   |  |
|----------------|---|---|--|
| SAMPLE SYMBOLS |  ... SAMPLING UNSUCCESSFUL   |  ... STANDARD PENETRATION TEST |  ... DRIVE SAMPLE (UNDISTURBED) |
|                |  ... DISTURBED OR BAG SAMPLE |  ... CHUNK SAMPLE              |  ... WATER TABLE OR SEEPAGE     |

NOTE: THE LOG OF SUBSURFACE CONDITIONS SHOWN HEREON APPLIES ONLY AT THE SPECIFIC BORING OR TRENCH LOCATION AND AT THE DATE INDICATED. IT IS NOT WARRANTED TO BE REPRESENTATIVE OF SUBSURFACE CONDITIONS AT OTHER LOCATIONS AND TIMES.

| DEPTH<br>IN<br>FEET  | SAMPLE<br>NO. | LITHOLOGY | GROUNDWATER | SOIL<br>CLASS<br>(USCS) | <b>TRENCH T 2</b>  |                                  | PENETRATION<br>RESISTANCE<br>(BLOWS/FT.) | DRY DENSITY<br>(P.C.F.) | MOISTURE<br>CONTENT (%) |
|----------------------|---------------|-----------|-------------|-------------------------|--|----------------------------------|--|-------------------------|-------------------------|
|                      |               |           |             |                         | ELEV. (MSL.) <u>697'</u>   | DATE COMPLETED <u>02-19-2020</u> |  |                         |                         |
|                      |               |           |             |                         | EQUIPMENT <u>JD 310G BACKHOE WITH 24" BUCKET</u>   |                                  | BY: <u>J. PAGNILLO</u>                   |                         |                         |
| MATERIAL DESCRIPTION |               |           |             |                         |  |                                  |  |                         |                         |
| 0                    |               |           |             | SM                      | <b>TOPSOIL</b><br>Loose, moist, dark brown, Silty, fine to medium SAND   |                                  |  |                         |                         |
| 2                    | T2-1          |           |             |                         | <b>GRANITIC ROCK (Kgr)</b><br>Highly weathered, brownish gray, weak GRANITIC ROCK; excavates to silty sand with gravel |                                  |  |                         |                         |
| 4                    |               |           |             |                         | -At 4 feet: becomes gray, moderately weak; excavates to silty sand with angular rock fragments up to 4-inch size       |                                  |  |                         |                         |
| 6                    | T2-2          |           |             |                         | PRACTICAL REFUSAL AT 6 FEET  |                                  |  |                         |                         |

**Figure A-2,**  
**Log of Trench T 2, Page 1 of 1**

G2516-32-01.GPJ

|                       |                             |                               |                                |
|-----------------------|-----------------------------|-------------------------------|--------------------------------|
| <b>SAMPLE SYMBOLS</b> | ... SAMPLING UNSUCCESSFUL   | ... STANDARD PENETRATION TEST | ... DRIVE SAMPLE (UNDISTURBED) |
|                       | ... DISTURBED OR BAG SAMPLE | ... CHUNK SAMPLE              | ... WATER TABLE OR SEEPAGE     |

NOTE: THE LOG OF SUBSURFACE CONDITIONS SHOWN HEREON APPLIES ONLY AT THE SPECIFIC BORING OR TRENCH LOCATION AND AT THE DATE INDICATED. IT IS NOT WARRANTED TO BE REPRESENTATIVE OF SUBSURFACE CONDITIONS AT OTHER LOCATIONS AND TIMES.

NOTE: THE LOG OF SUBSURFACE CONDITIONS SHOWN HEREON APPLIES ONLY AT THE SPECIFIC BORING OR TRENCH LOCATION AND AT THE DATE INDICATED. IT IS NOT WARRANTED TO BE REPRESENTATIVE OF SUBSURFACE CONDITIONS AT OTHER LOCATIONS AND TIMES.

| SAMPLE SYMBOLS |                                |
|----------------|--------------------------------|
|                | ... SAMPLING UNSUCCESSFUL      |
|                | ... DISTURBED OR BAG SAMPLE    |
|                | ... CHUNK SAMPLE               |
|                | ... STANDARD PENETRATION TEST  |
|                | ... DRIVE SAMPLE (UNDISTURBED) |
|                | ... WATER TABLE OR SEEPAGE     |

Figure A-3,  
Log of Trench T 3, Page 1 of 1

G2516-32-01.GPJ

| DEPTH IN FEET  | SAMPLE NO. | LITHOLOGY | GROUNDWATER | SOIL CLASS (USCS) | MATERIAL DESCRIPTION   | MOISTURE CONTENT (%) | DRY DENSITY (P.C.F.) | PENETRATION RESISTANCE (BLOWS/FT.) |
|--|------------|-----------|-------------|-------------------|--|----------------------|----------------------|------------------------------------|
| 0  |            |           |             | SM                | ALUVIUM/COLLUVIUM (Qa/Qcl)<br>Loose, moist, dark reddish brown, Silty fine SAND                      |                      |                      |                                    |
| 2  | T3-1       |           |             | CL                | Firm, moist, dark yellowish brown, Silty CLAY  |                      |                      |                                    |
| 4  |            |           |             |                   | GRANITIC ROCK (Kgr)<br>Highly weathered, brownish gray, weak, GRANITIC ROCK; excavates to silty sand |                      |                      |                                    |
| TRENCH TERMINATED AT 5 FEET  |            |           |             |                   |  |                      |                      |                                    |
| <p><b>TRENCH T 3</b></p> <p>ELEV. (MSL.) <u>662'</u> DATE COMPLETED <u>02-19-2020</u> BY: <u>J. PAGNILLO</u></p> <p>EQUIPMENT <u>JD 310G BACKHOE WITH 24" BUCKET</u></p> |            |           |             |                   |  |                      |                      |                                    |

| DEPTH IN FEET   | SAMPLE NO. | LITHOLOGY | GROUNDWATER | SOIL CLASS (USCS) | MATERIAL DESCRIPTION   | MOISTURE CONTENT (%) |
|---|------------|-----------|-------------|-------------------|--|----------------------|
| 0   |            |           |             | SM                | UNDOCUMENTED FILL (Qud)<br>Loose, moist, dark brown, Silty, fine to medium SAND; minor trash debris          |                      |
| 2   |            |           |             | SM                | ALUVIUM/COLLUVIUM (Qal/Qcl)<br>Medium dense, moist, dark grayish brown, Silty, fine to medium SAND with clay |                      |
| 4   |            |           |             | CL                | Firm, moist, grayish brown, Silty CLAY   |                      |
| 4   |            |           |             |                   | GRANITIC ROCK (Kgr)<br>Completely weathered, reddish brown, weak, GRANITIC ROCK                              |                      |
|   |            |           |             |                   | TRENCH TERMINATED AT 5.5 FEET  |                      |
| <p><b>TRENCH T 4</b><br/>                     ELEV. (MSL.) <u>654'</u> DATE COMPLETED <u>02-19-2020</u><br/>                     BY: <u>J. PAGNILLO</u><br/>                     EQUIPMENT <u>JD 310G BACKHOE WITH 24" BUCKET</u></p> |            |           |             |                   |  |                      |

G2516-32-01.GPJ

Figure A-4,  
Log of Trench T 4, Page 1 of 1

**SAMPLE SYMBOLS**

- ... SAMPLING UNSUCCESSFUL
- ▣ ... STANDARD PENETRATION TEST
- ... DRIVE SAMPLE (UNDISTURBED)
- ⊠ ... DISTURBED OR BAG SAMPLE
- ◻ ... CHUNK SAMPLE
- ▲ ... WATER TABLE OR SEEPAGE

NOTE: THE LOG OF SUBSURFACE CONDITIONS SHOWN HEREON APPLIES ONLY AT THE SPECIFIC BORING OR TRENCH LOCATION AND AT THE DATE INDICATED. IT IS NOT WARRANTED TO BE REPRESENTATIVE OF SUBSURFACE CONDITIONS AT OTHER LOCATIONS AND TIMES.



|            |   |   |                   |             |           |            |               |
|------------|---|---|-------------------|-------------|-----------|------------|---------------|
| TRENCH T 5 | ELEV. (MSL.) 652' DATE COMPLETED 02-19-2020 BY: J. PAGNILLO | EQUIPMENT JD 310G BACKHOE WITH 24" BUCKET | SOIL CLASS (USCS) | GROUNDWATER | LITHOLOGY | SAMPLE NO. | DEPTH IN FEET |
|            | MATERIAL DESCRIPTION  |   |                   |             |           |            |               |

|   |    |  |  |  |  |                      |  |
|---|----|--|--|--|--|----------------------|--|
| 0 | SM | ALUVIUM/COLLUVIUM (Qal/Qcl)<br>Loose, moist, dark brown, silty, fine to medium SAND<br>-At 2 feet; becomes medium dense    |  |  |  |                      |  |
| 2 |    |  |  |  |  | T5-1                 |  |
| 4 |    |  |  |  |  |                      |  |
| 6 | SC | Medium dense to dense, damp to moist, grayish brown, clayey, fine to medium SAND with few rock fragments up to 3-inch size |  |  |  | T5-2<br>T5-3<br>T5-4 |  |
| 8 |    |  |  |  |  |                      |  |

|                              |  |  |  |  |  |  |  |
|------------------------------|--|--|--|--|--|--|--|
| 10                           |  | GRANITIC ROCK (Kgr)<br>Completely weathered, grayish brown with red oxidation, weak, GRANITIC ROCK; excavates to silty/clayey, fine to coarse sand with moderately weak angular rock fragments up to 5-inch size |  |  |  |  |  |
| TRENCH TERMINATED AT 11 FEET |  |  |  |  |  |  |  |

|  |  |  |  |  |  |  |  |
|--|--|--|--|--|--|--|--|
|  |  |  |  |  |  |  |  |
|--|--|--|--|--|--|--|--|

**Figure A-5, Log of Trench T 5, Page 1 of 1**

**SAMPLE SYMBOLS**

- ... SAMPLING UNSUCCESSFUL
- ▣ ... STANDARD PENETRATION TEST
- ... DRIVE SAMPLE (UNDISTURBED)
- ⊠ ... DISTURBED OR BAG SAMPLE
- ◼ ... CHUNK SAMPLE
- ▲ ... WATER TABLE OR SEEPAGE

NOTE: THE LOG OF SUBSURFACE CONDITIONS SHOWN HEREON APPLIES ONLY AT THE SPECIFIC BORING OR TRENCH LOCATION AND AT THE DATE INDICATED. IT IS NOT WARRANTED TO BE REPRESENTATIVE OF SUBSURFACE CONDITIONS AT OTHER LOCATIONS AND TIMES.

| DEPTH IN FEET   | SAMPLE NO. | LITHOLOGY | GROUNDWATER | SOIL CLASS (USCS) | MATERIAL DESCRIPTION   | MOISTURE CONTENT (%) | DRY DENSITY (P.C.F.) | PENETRATION RESISTANCE (BLOWS/FT.) |
|---|------------|-----------|-------------|-------------------|--|----------------------|----------------------|------------------------------------|
| 0   |            |           |             | SM                | ALUVIUM/COLLUVIUM (Qal/Qcl)<br>Loose, moist, dark brown, silty, fine to medium SAND  |                      |                      |                                    |
| 2   |            |           |             |                   | -At 2 feet; becomes medium dense   |                      |                      |                                    |
| 4   | T6-1       |           |             | SC                | Dense to very dense, damp to moist, grayish brown, Clayey, fine to medium SAND with rock fragments up 3-inch size  | 12.1                 | 95.1                 |                                    |
| 6   | T6-2       |           |             |                   |  | 10.2                 | 105.3                |                                    |
| 8   |            |           |             |                   | GRANITIC ROCK (Kgr)<br>Completely weathered, grayish brown, moderately weak, GRANITIC ROCK; excavates to silty/clayey, fine to coarse sand with moderate strong rock fragments up to 5-inch size |                      |                      |                                    |
| TRENCH TERMINATED AT 9 FEET   |            |           |             |                   |  |                      |                      |                                    |
| <p><b>TRENCH T 6</b></p> <p>ELEV. (MSL.) <u>655</u>      DATE COMPLETED <u>02-19-2020</u>      BY: <u>J. PAGNILLO</u></p> <p>EQUIPMENT <u>JD 310G BACKHOE WITH 24" BUCKET</u></p> |            |           |             |                   |  |                      |                      |                                    |

G2516-32-01.GPJ

Figure A-6,  
Log of Trench T 6, Page 1 of 1

**SAMPLE SYMBOLS**

- ... SAMPLING UNSUCCESSFUL
- ▣ ... STANDARD PENETRATION TEST
- ... DRIVE SAMPLE (UNDISTURBED)
- ⊠ ... DISTURBED OR BAG SAMPLE
- ◻ ... CHUNK SAMPLE
- ▲ ... WATER TABLE OR SEEPAGE

NOTE: THE LOG OF SUBSURFACE CONDITIONS SHOWN HEREON APPLIES ONLY AT THE SPECIFIC BORING OR TRENCH LOCATION AND AT THE DATE INDICATED. IT IS NOT WARRANTED TO BE REPRESENTATIVE OF SUBSURFACE CONDITIONS AT OTHER LOCATIONS AND TIMES.

NOTE: THE LOG OF SUBSURFACE CONDITIONS SHOWN HEREON APPLIES ONLY AT THE SPECIFIC BORING OR TRENCH LOCATION AND AT THE DATE INDICATED. IT IS NOT WARRANTED TO BE REPRESENTATIVE OF SUBSURFACE CONDITIONS AT OTHER LOCATIONS AND TIMES.

| SAMPLE SYMBOLS                |                                  |
|-------------------------------|----------------------------------|
| □ ... SAMPLING UNSUCCESSFUL   | ■ ... STANDARD PENETRATION TEST  |
| ⊠ ... DISTURBED OR BAG SAMPLE | ▣ ... CHUNK SAMPLE               |
| ▲ ... WATER TABLE OR SEEPAGE  | ■ ... DRIVE SAMPLE (UNDISTURBED) |

Figure A-7,  
Log of Trench T 7, Page 1 of 1

G2516-32-01.GPJ

| DEPTH IN FEET | SAMPLE NO. | LITHOLOGY | GROUNDWATER | SOIL CLASS (USCS) | MATERIAL DESCRIPTION   | MOISTURE CONTENT (%) | DRY DENSITY (P.C.F.) | PENETRATION RESISTANCE (BLOWS/FT.) |
|---------------|------------|-----------|-------------|-------------------|--|----------------------|----------------------|------------------------------------|
| 0             |            |           |             | SM                | ALUVIUM/COLLUVIUM (Qal/Qcl)<br>Loose, moist, dark brown, silty, fine SAND  |                      |                      |                                    |
| 2             | T7-1       |           |             |                   | -At 2 feet: becomes medium-dense   |                      |                      |                                    |
| 4             |            |           |             | SC                |  |                      |                      |                                    |
| 4.5           | T7-2       |           |             |                   |  |                      | 107.4                |                                    |
| 5.5           | T7-3       |           |             |                   | Medium dense to dense, damp to moist, grayish brown, clayey, fine to medium SAND with few angular rock fragments up to 3-inch size |                      | 14.9                 |                                    |
| 6             | T7-4       |           |             |                   |  |                      | 107.8                |                                    |
| 6.5           | T7-5       |           |             |                   |  |                      | 16.2                 |                                    |
| 8             |            |           |             |                   |  |                      |                      |                                    |
| 8.5           |            |           |             |                   | GRANITIC ROCK (Kgr)<br>Completely weathered, grayish brown with red oxidation, weak, GRANITIC ROCK                                 |                      |                      |                                    |
| 10            |            |           |             |                   | TRENCH TERMINATED AT 10.5 FEET   |                      |                      |                                    |

TRENCH T 7

ELEV. (MSL.) 659' DATE COMPLETED 02-19-2020

EQUIPMENT JD 310G BACKHOE WITH 24" BUCKET BY: J. PAGNILLO

NOTE: THE LOG OF SUBSURFACE CONDITIONS SHOWN HEREON APPLIES ONLY AT THE SPECIFIC BORING OR TRENCH LOCATION AND AT THE DATE INDICATED. IT IS NOT WARRANTED TO BE REPRESENTATIVE OF SUBSURFACE CONDITIONS AT OTHER LOCATIONS AND TIMES.

|   |  |
|---|--|
| <p>... SAMPLING UNSUCCESSFUL</p> <p>... STANDARD PENETRATION TEST</p> <p>... DRIVE SAMPLE (UNDISTURBED)</p> | <p>... DISTURBED OR BAG SAMPLE</p> <p>... CHUNK SAMPLE</p> <p>... WATER TABLE OR SEEPAGE</p> |
|---|--|

Figure A-8,  
Log of Trench T 8, Page 1 of 1

G2516-32-01.GPJ

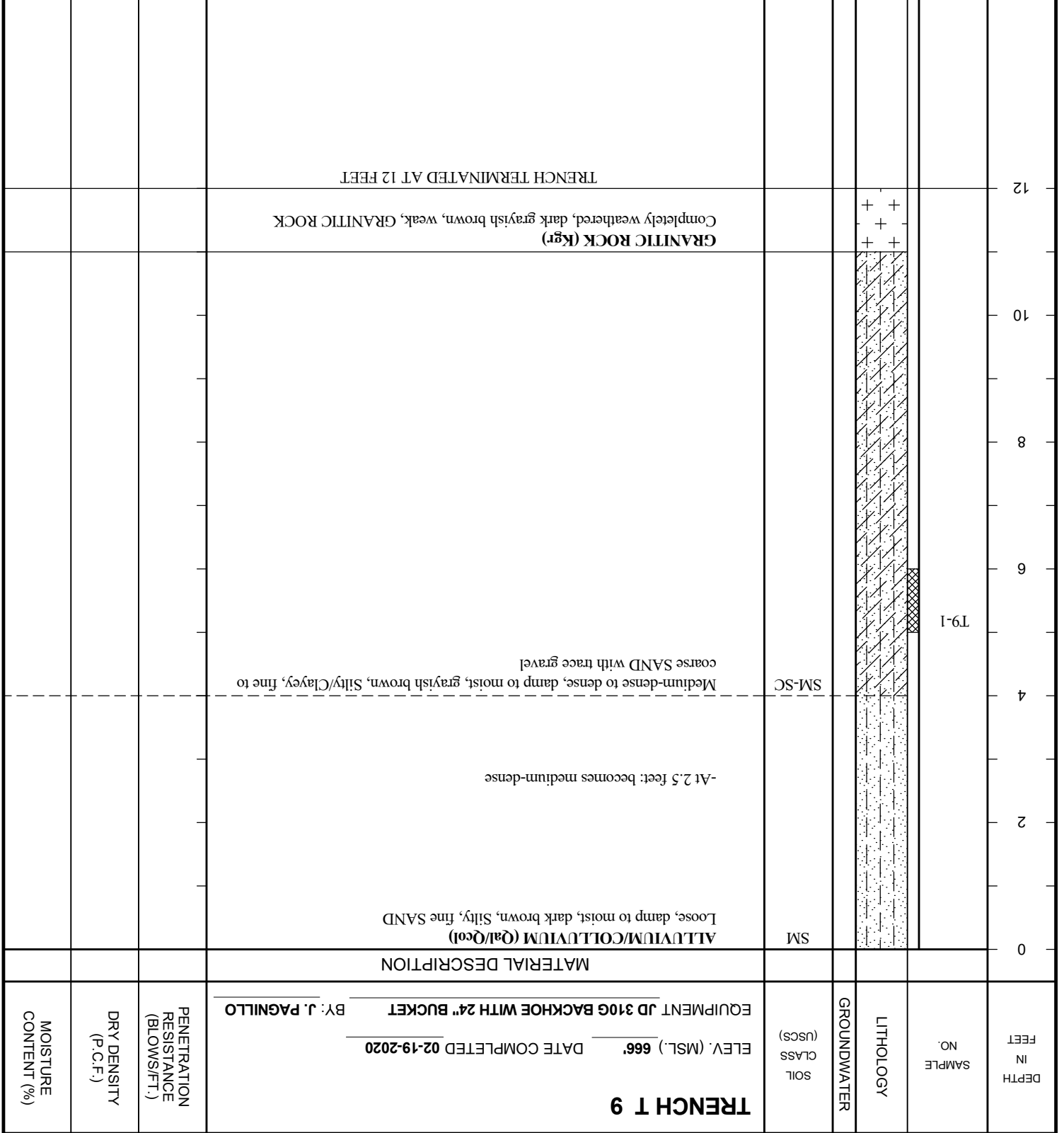
| DEPTH IN FEET | SAMPLE NO. | LITHOLOGY | GROUNDWATER | SOIL CLASS (USCS) | MATERIAL DESCRIPTION   | TRENCH T 8  | MOISTURE CONTENT (%) |
|---------------|------------|-----------|-------------|-------------------|--|---|----------------------|
| 0             |            |           |             | SM                | ALUVIUM/COLLUVIUM (Qal/Qcl)<br>Loose, damp to moist, dark brown, Silty, fine SAND                                | ELEV. (MSL.) 668' DATE COMPLETED 02-19-2020<br>BY: J. PAGNILLO<br>EQUIPMENT JD 310G BACKHOE WITH 24" BUCKET |                      |
| 2             |            |           |             |                   |  |   |                      |
| 4             |            |           |             | SM-SC             | Medium dense to dense, damp, dark grayish brown, Silty/Clayey, fine to coarse SAND with trace gravel             |   |                      |
| 6             |            |           |             |                   | GRANITIC ROCK (kgf)<br>Highly weathered, grayish brown, moderately weak, GRANITIC ROCK; very intensely fractured |   |                      |
|               |            |           |             |                   |  | TRENCH TERMINATED AT 7 FEET   |                      |
|               |            |           |             |                   |  |   |                      |
|               |            |           |             |                   |  |   |                      |

NOTE: THE LOG OF SUBSURFACE CONDITIONS SHOWN HEREON APPLIES ONLY AT THE SPECIFIC BORING OR TRENCH LOCATION AND AT THE DATE INDICATED. IT IS NOT WARRANTED TO BE REPRESENTATIVE OF SUBSURFACE CONDITIONS AT OTHER LOCATIONS AND TIMES.

| SAMPLE SYMBOLS                |                                  |
|-------------------------------|----------------------------------|
| ☐ ... SAMPLING UNSUCCESSFUL   | ☐ ... STANDARD PENETRATION TEST  |
| ☒ ... DISTURBED OR BAG SAMPLE | ▣ ... CHUNK SAMPLE               |
| ▲ ... WATER TABLE OR SEEPAGE  | ■ ... DRIVE SAMPLE (UNDISTURBED) |

Figure A-9,  
Log of Trench T 9, Page 1 of 1

G2516-32-01.GPJ



**TRENCH T 9**

ELEV. (MSL.) 666' DATE COMPLETED 02-19-2020

BY: J. PAGNILLO

EQUIPMENT JD 310G BACKHOE WITH 24" BUCKET

MOISTURE CONTENT (%)

DRY DENSITY (P.C.F.)

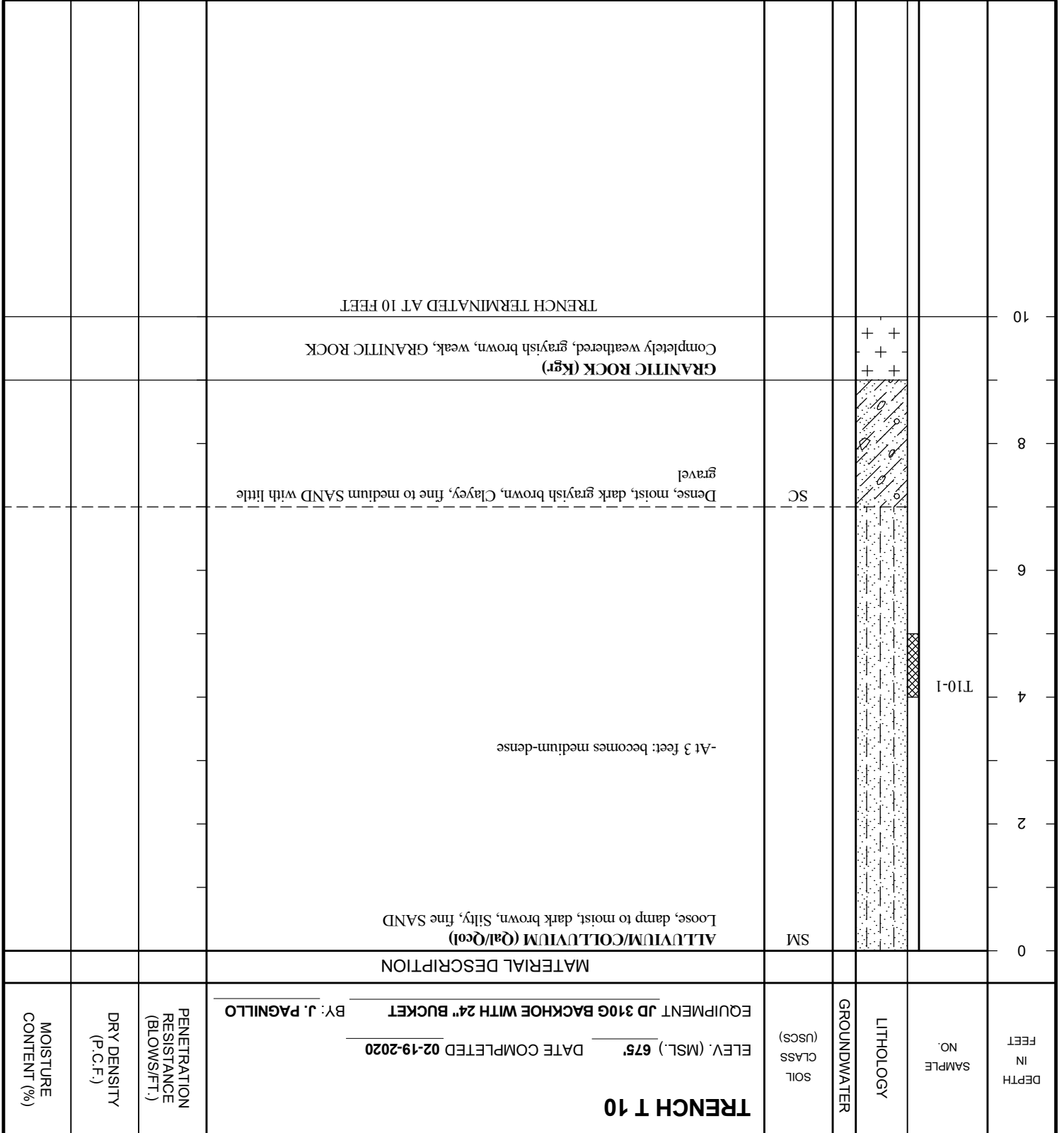
PENETRATION RESISTANCE (BLOWS/FT.)

NOTE: THE LOG OF SUBSURFACE CONDITIONS SHOWN HEREON APPLIES ONLY AT THE SPECIFIC BORING OR TRENCH LOCATION AND AT THE DATE INDICATED. IT IS NOT WARRANTED TO BE REPRESENTATIVE OF SUBSURFACE CONDITIONS AT OTHER LOCATIONS AND TIMES.

| SAMPLE SYMBOLS                |                                  |
|-------------------------------|----------------------------------|
| □ ... SAMPLING UNSUCCESSFUL   | ■ ... STANDARD PENETRATION TEST  |
| ⊗ ... DISTURBED OR BAG SAMPLE | ◼ ... CHUNK SAMPLE               |
|                               | ▲ ... WATER TABLE OR SEEPAGE     |
|                               | ■ ... DRIVE SAMPLE (UNDISTURBED) |

Figure A-10,  
Log of Trench T 10, Page 1 of 1

G2516-32-01.GPJ



TRENCH T 10

ELEV. (MSL.) 675 DATE COMPLETED 02-19-2020

BY: J. PAGNILLO

EQUIPMENT JD 310G BACKHOE WITH 24" BUCKET

MOISTURE CONTENT (%)

DRY DENSITY (P.C.F.)

PENETRATION RESISTANCE (BLOWS/FT.)

NOTE: THE LOG OF SUBSURFACE CONDITIONS SHOWN HEREON APPLIES ONLY AT THE SPECIFIC BORING OR TRENCH LOCATION AND AT THE DATE INDICATED. IT IS NOT WARRANTED TO BE REPRESENTATIVE OF SUBSURFACE CONDITIONS AT OTHER LOCATIONS AND TIMES.

| SAMPLE SYMBOLS                |                                  |
|-------------------------------|----------------------------------|
| □ ... SAMPLING UNSUCCESSFUL   | ■ ... STANDARD PENETRATION TEST  |
| ⊠ ... DISTURBED OR BAG SAMPLE | ◼ ... CHUNK SAMPLE               |
|                               | ▲ ... WATER TABLE OR SEEPAGE     |
|                               | ■ ... DRIVE SAMPLE (UNDISTURBED) |

Figure A-11,  
Log of Trench T 11, Page 1 of 1

G2516-32-01.GPJ

| DEPTH IN FEET | SAMPLE NO. | LITHOLOGY | GROUNDWATER | SOIL CLASS (USCS) | MATERIAL DESCRIPTION   | TRENCH T 11   | MOISTURE CONTENT (%) |
|---------------|------------|-----------|-------------|-------------------|--|---|----------------------|
| 0             |            |           |             | SM                | ALUVIUM/COLLUVIUM (Qal/Qcl)<br>Loose, damp to moist, dark brown, Silty, fine SAND                      | ELEV. (MSL.) 688' DATE COMPLETED 02-19-2020<br>BY: J. PAGNILLO<br>EQUIPMENT JD 310G BACKHOE WITH 24" BUCKET |                      |
| 2             |            |           |             | SM-SC             | Medium-dense to dense, moist, dark grayish brown, Silty/Clayey, fine to medium SAND with little gravel |   |                      |
| 4             |            |           |             |                   |  |   |                      |
| 6             |            |           |             |                   |  |   |                      |
| 8             |            |           |             |                   |  |   |                      |
| 10            |            |           |             |                   | GRANITIC ROCK (Kgr)<br>Completely weathered, dark grayish brown, weak, GRANITIC ROCK                   |   |                      |
|               |            |           |             |                   |  | TRENCH TERMINATED AT 10.5 FEET  |                      |

| DEPTH IN FEET   | SAMPLE NO. | LITHOLOGY | GROUNDWATER | SOIL CLASS (USCS) | MATERIAL DESCRIPTION  | MOISTURE CONTENT (%) |
|---|------------|-----------|-------------|-------------------|---|----------------------|
| 0   |            |           |             | SM                | TOPSOIL<br>Loose, moist, dark brown, Silty, fine SAND   |                      |
| 2   |            |           |             |                   |   |                      |
| 4   | T12-1      |           |             |                   | GRANITIC ROCK (kg)<br>Highly weathered, grayish brown, moderately weak, GRANITIC ROCK; moderately strong rock fragments up to 3-inch size |                      |
| 4   |            |           |             |                   | TRENCH TERMINATED AT 4 FEET   |                      |
| <p><b>TRENCH T 12</b><br/>                 ELEV. (MSL.) <u>693'</u>      DATE COMPLETED <u>02-19-2020</u><br/>                 BY: <u>J. PAGNILLO</u><br/>                 EQUIPMENT <u>JD 310G BACKHOE WITH 24" BUCKET</u></p> |            |           |             |                   |   |                      |

G2516-32-01.GPJ

**Figure A-12,**  
**Log of Trench T 12, Page 1 of 1**

**SAMPLE SYMBOLS**

- ... SAMPLING UNSUCCESSFUL
- ▣ ... STANDARD PENETRATION TEST
- ... DRIVE SAMPLE (UNDISTURBED)
- ⊠ ... DISTURBED OR BAG SAMPLE
- ◻ ... CHUNK SAMPLE
- ▲ ... WATER TABLE OR SEEPAGE

NOTE: THE LOG OF SUBSURFACE CONDITIONS SHOWN HEREON APPLIES ONLY AT THE SPECIFIC BORING OR TRENCH LOCATION AND AT THE DATE INDICATED. IT IS NOT WARRANTED TO BE REPRESENTATIVE OF SUBSURFACE CONDITIONS AT OTHER LOCATIONS AND TIMES.



| DEPTH IN FEET   | SAMPLE NO. | LITHOLOGY | GROUNDWATER | SOIL CLASS (USCS) | MATERIAL DESCRIPTION   | MOISTURE CONTENT (%)               |
|---|------------|-----------|-------------|-------------------|--|------------------------------------|
| 0   |            |           |             | SM                | TOPSOIL<br>Loose, moist, dark brown, Silty, fine SAND  |                                    |
| 2   |            |           |             |                   | GRANITIC ROCK (kg)<br>Highly weathered, grayish brown, moderately weak, GRANITIC ROCK; excavates to silty, fine to coarse sand with angular moderately strong rock fragments up to 4-inch size |                                    |
| 4   |            |           |             |                   | TRENCH TERMINATED AT 4 FEET  |                                    |
| <p><b>TRENCH T 13</b><br/>                 ELEV. (MSL.) <u>688'</u>      DATE COMPLETED <u>02-19-2020</u><br/>                 EQUIPMENT <u>JD 310G BACKHOE WITH 24" BUCKET</u>      BY: <u>J. PAGNILLO</u></p> |            |           |             |                   |  |                                    |
|   |            |           |             |                   |  | DRY DENSITY (P.C.F.)               |
|   |            |           |             |                   |  | PENETRATION RESISTANCE (BLOWS/FT.) |

**Figure A-13,**  
**Log of Trench T 13, Page 1 of 1**

G2516-32-01.GPJ

**SAMPLE SYMBOLS**

- ... SAMPLING UNSUCCESSFUL
- ... STANDARD PENETRATION TEST
- ... DRIVE SAMPLE (UNDISTURBED)
- ... DISTURBED OR BAG SAMPLE
- ... CHUNK SAMPLE
- ... WATER TABLE OR SEEPAGE

NOTE: THE LOG OF SUBSURFACE CONDITIONS SHOWN HEREON APPLIES ONLY AT THE SPECIFIC BORING OR TRENCH LOCATION AND AT THE DATE INDICATED. IT IS NOT WARRANTED TO BE REPRESENTATIVE OF SUBSURFACE CONDITIONS AT OTHER LOCATIONS AND TIMES.

| DEPTH IN FEET   | SAMPLE NO. | LITHOLOGY | GROUNDWATER | SOIL CLASS (USCS) | MATERIAL DESCRIPTION   | MOISTURE CONTENT (%) |
|---|------------|-----------|-------------|-------------------|--|----------------------|
| 0   |            |           |             | SM                | <p>TOPSOIL</p> <p>Loose, moist, dark brown, Silty, fine SAND</p> <p>-At 2 feet: Becomes medium-dense</p>                             |                      |
| 2   |            |           |             |                   |  |                      |
| 4   |            |           |             |                   |  |                      |
| 6   |            |           |             |                   | <p>GRANITIC ROCK (kg)</p> <p>Highly weathered, light grayish brown, weak, GRANITIC ROCK, excavates to silty, fine to medium sand</p> |                      |
|   |            |           |             |                   | TRENCH TERMINATED AT 6.5 FEET  |                      |
| <p><b>TRENCH T 14</b></p> <p>ELEV. (MSL.) <u>687'</u> DATE COMPLETED <u>02-19-2020</u> BY: <u>J. PAGNILLO</u></p> <p>EQUIPMENT <u>JD 310G BACKHOE WITH 24" BUCKET</u></p> |            |           |             |                   |  |                      |

G2516-32-01.GPJ

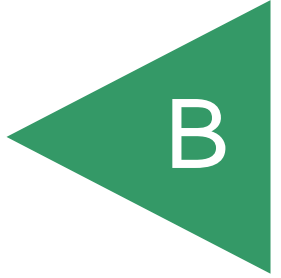
**Figure A-14,**  
**Log of Trench T 14, Page 1 of 1**

**SAMPLE SYMBOLS**

- ... SAMPLING UNSUCCESSFUL
- ... DRIVE SAMPLE (UNDISTURBED)
- ... STANDARD PENETRATION TEST
- ... CHUNK SAMPLE
- ... DISTURBED OR BAG SAMPLE
- ... WATER TABLE OR SEEPAGE

NOTE: THE LOG OF SUBSURFACE CONDITIONS SHOWN HEREON APPLIES ONLY AT THE SPECIFIC BORINGS OR TRENCH LOCATION AND AT THE DATE INDICATED. IT IS NOT WARRANTED TO BE REPRESENTATIVE OF SUBSURFACE CONDITIONS AT OTHER LOCATIONS AND TIMES.

APPENDIX



## APPENDIX B

### LABORATORY TESTING

Laboratory tests were performed in accordance with generally accepted test methods of the American Society for Testing and Materials (ASTM) or other suggested procedures. Selected bulk samples were tested for maximum dry density and optimum moisture content, expansion index, soluble sulfate content, and direct shear strength. Selected relatively undisturbed samples were tested for their in-place dry density and moisture content and consolidation characteristics. The in-place dry density and moisture content results are indicated on the exploratory trench logs. The results of our laboratory tests are summarized on Tables B-I through B-III. The results of the consolidation tests and direct shear tests are also presented.

**TABLE B-I  
SUMMARY OF LABORATORY MAXIMUM DRY DENSITY  
AND OPTIMUM MOISTURE CONTENT TEST RESULTS**

| Sample No.<br>[Geologic Unit<br>(Soil Class)] | Description   | Maximum<br>Dry Density<br>(pcf) | Optimum<br>Moisture Content<br>(% dry wt.) |
|---|---|---------------------------------|--|
| T2-2 [Kgr (SM)]                               | Dark brown, Silty, fine to coarse SAND                            | 133.4                           | 8.5  |
| T3-1 [Qal (SM)]                               | Reddish brown, Silty, fine to medium SAND, with little clay       | 126.6                           | 10.7                                       |
| T7-1 [Qal (SM)]                               | Dark reddish brown, Silty, fine to medium SAND, with trace gravel | 128.5                           | 9.6  |
| T10-1 [Qal (SM)]                              | Brown, Silty, fine to medium SAND, with trace clay and gravel     | 126.4                           | 10.7                                       |

**TABLE B-II  
SUMMARY OF LABORATORY EXPANSION INDEX TEST RESULTS**

| Sample No. | Moisture Content (%) |            | Dry Density<br>(pcf) | Expansion<br>Index |
|------------|----------------------|------------|----------------------|--------------------|
|            | Before Test          | After Test |                      |                    |
| T2-2       | 7.3                  | 12.7       | 119.1                | 1                  |
| T3-1       | 9.8                  | 21.1       | 110.4                | 49                 |
| T7-1       | 7.9                  | 15.6       | 117.0                | 9                  |
| T10-1      | 9.6                  | 20.8       | 109.5                | 25                 |

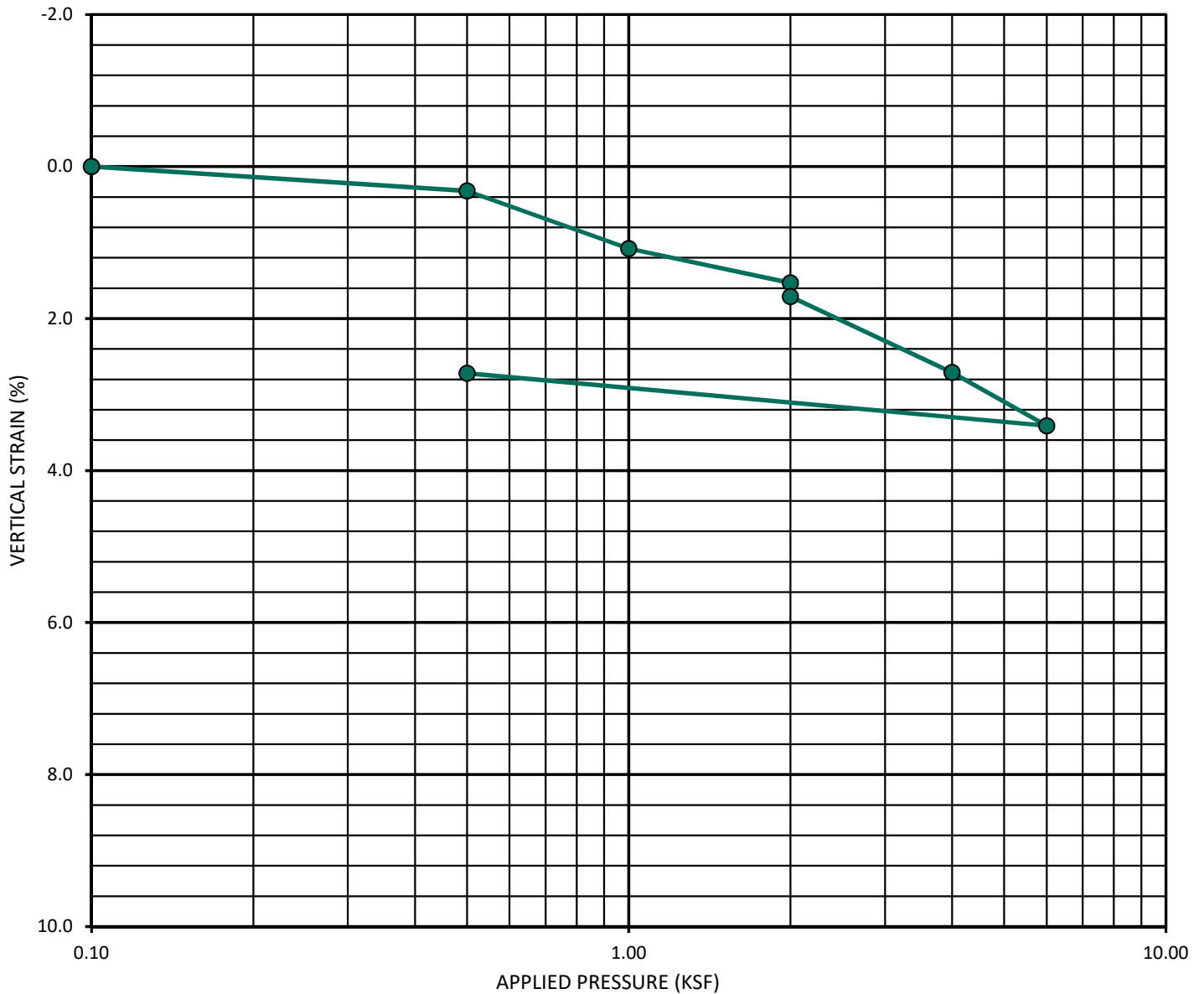
**TABLE B-III  
SUMMARY OF LABORATORY WATER-SOLUBLE SULFATE TEST RESULTS**

| Sample No. | Water-Soluble Sulfate Content (%) | Exposure       |
|------------|-----------------------------------|----------------|
| T2-2       | 0.001                             | Not Applicable |
| T10-1      | 0.007                             | Not Applicable |

SAMPLE NO.: **T5-2**  
 SAMPLE DEPTH (FT): **5.5**

GEOLOGIC UNIT: **Qc**

| TEST INFORMATION           |       |
|----------------------------|-------|
| INITIAL DRY DENSITY (PCF): | 103.4 |
| INITIAL WATER CONTENT (%): | 16.5% |
| SAMPLE SATURATED AT (KSF): | 2.0   |
| INITIAL SATURATION (%):    | 80.0% |



**CONSOLIDATION CURVE - ASTM D 2435**

**943 BARHAM DR., SAN MARCOS, CA**

**PROJECT NO.: G2516-32-01**

**GEOCON**  
 INCORPORATED

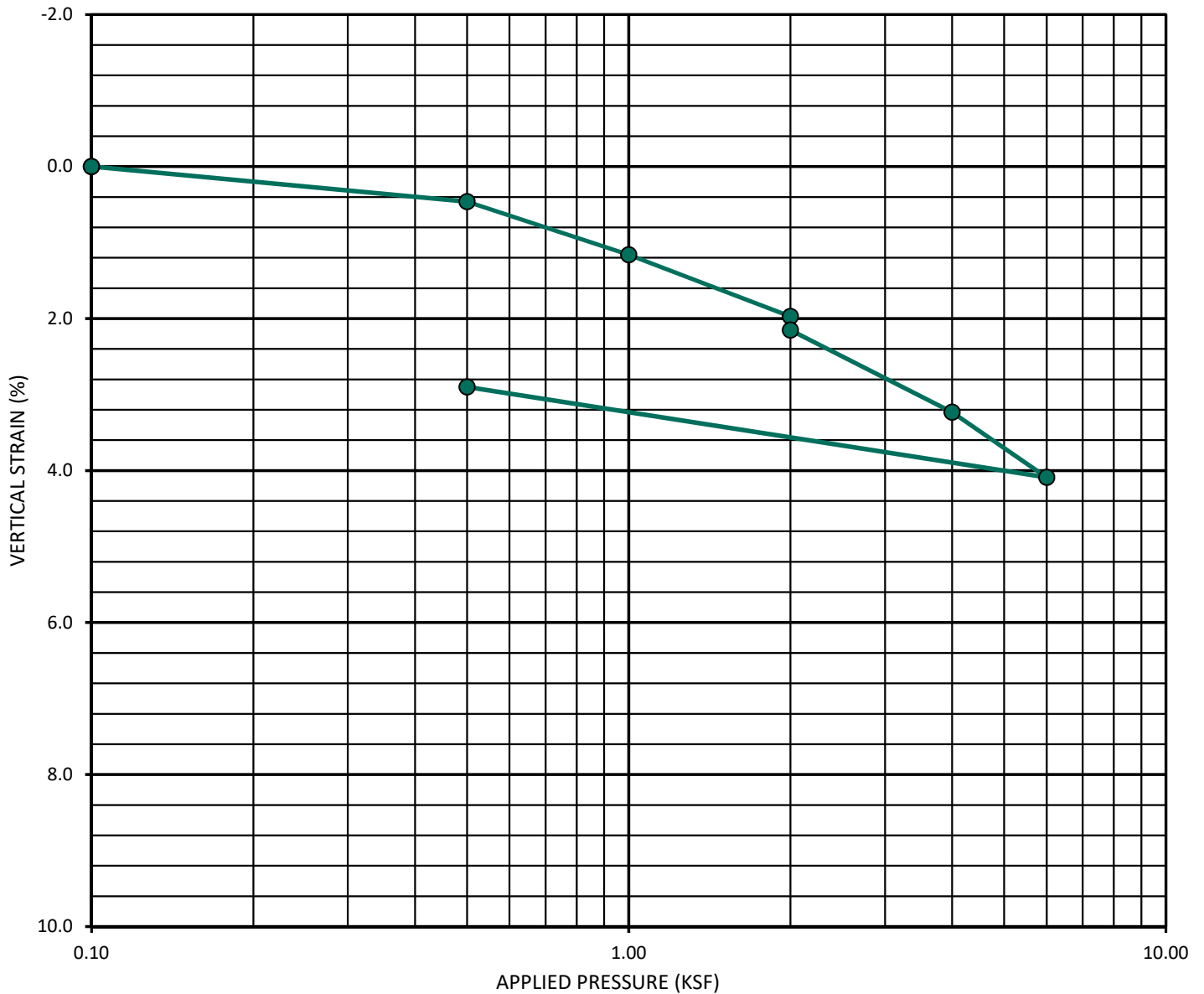


GEOTECHNICAL CONSULTANTS  
 6960 FLANDERS DRIVE - SAN DIEGO, CALIFORNIA 92121 - 2974  
 PHONE 858 558-6900 - FAX 858 558-6159

SAMPLE NO.: **T5-4**  
 SAMPLE DEPTH (FT): **7.5**

GEOLOGIC UNIT: **Qc**

| TEST INFORMATION           |       |
|----------------------------|-------|
| INITIAL DRY DENSITY (PCF): | 112.2 |
| INITIAL WATER CONTENT (%): | 14.5% |
| SAMPLE SATURATED AT (KSF): | 2.0   |
| INITIAL SATURATION (%):    | 80.7% |



**CONSOLIDATION CURVE - ASTM D 2435**

**943 BARHAM DR., SAN MARCOS, CA**

**PROJECT NO.: G2516-32-01**

**GEOCON**  
 INCORPORATED

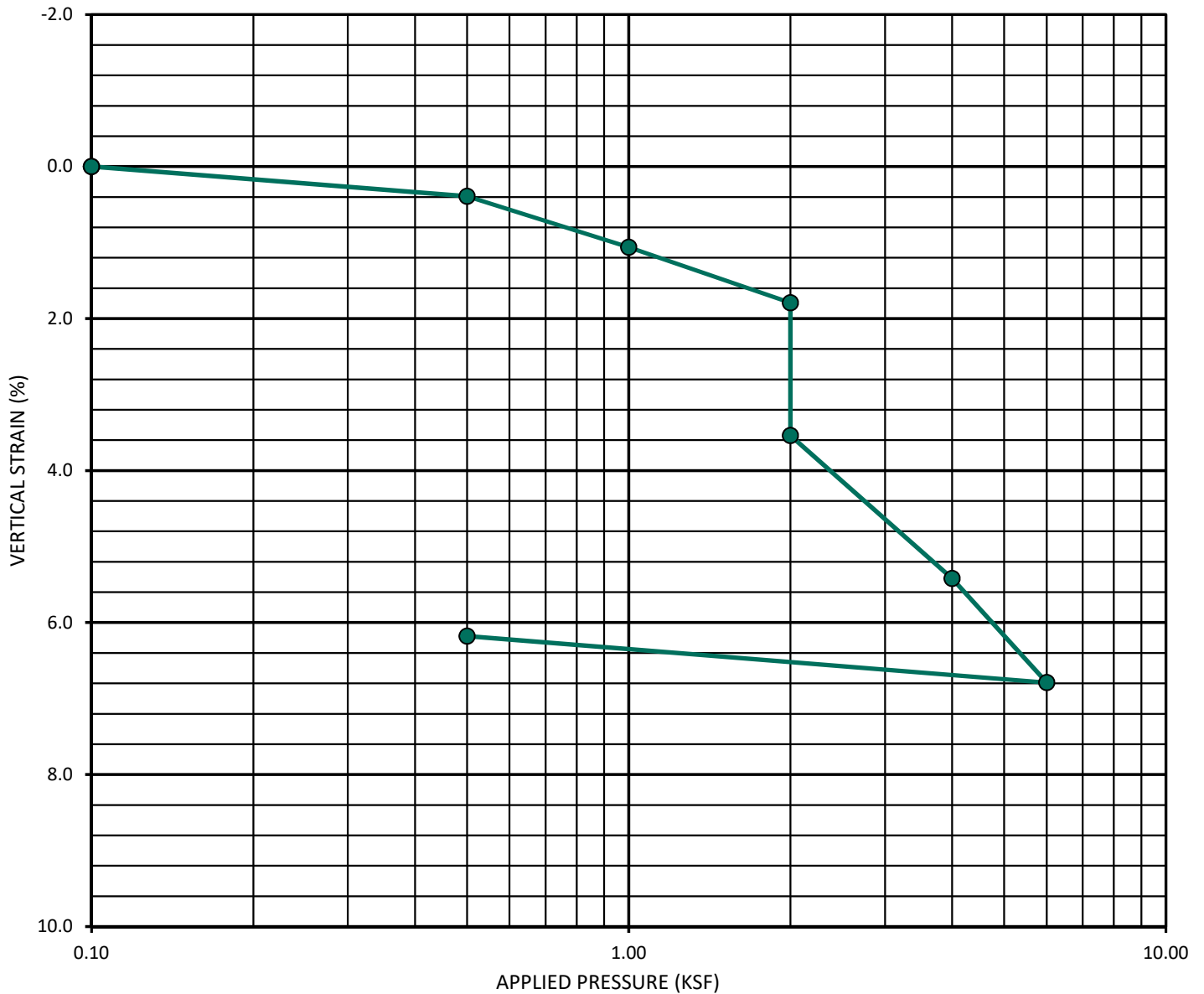


GEOTECHNICAL CONSULTANTS  
 6960 FLANDERS DRIVE - SAN DIEGO, CALIFORNIA 92121 - 2974  
 PHONE 858 558-6900 - FAX 858 558-6159

SAMPLE NO.: T6-1  
 SAMPLE DEPTH (FT): 4

GEOLOGIC UNIT: Qc

| TEST INFORMATION           |       |
|----------------------------|-------|
| INITIAL DRY DENSITY (PCF): | 95.1  |
| INITIAL WATER CONTENT (%): | 12.1% |
| SAMPLE SATURATED AT (KSF): | 2.0   |
| INITIAL SATURATION (%):    | 47.0% |



**CONSOLIDATION CURVE - ASTM D 2435**

**943 BARHAM DR., SAN MARCOS, CA**

**PROJECT NO.: G2516-32-01**

**GEOCON**  
 INCORPORATED

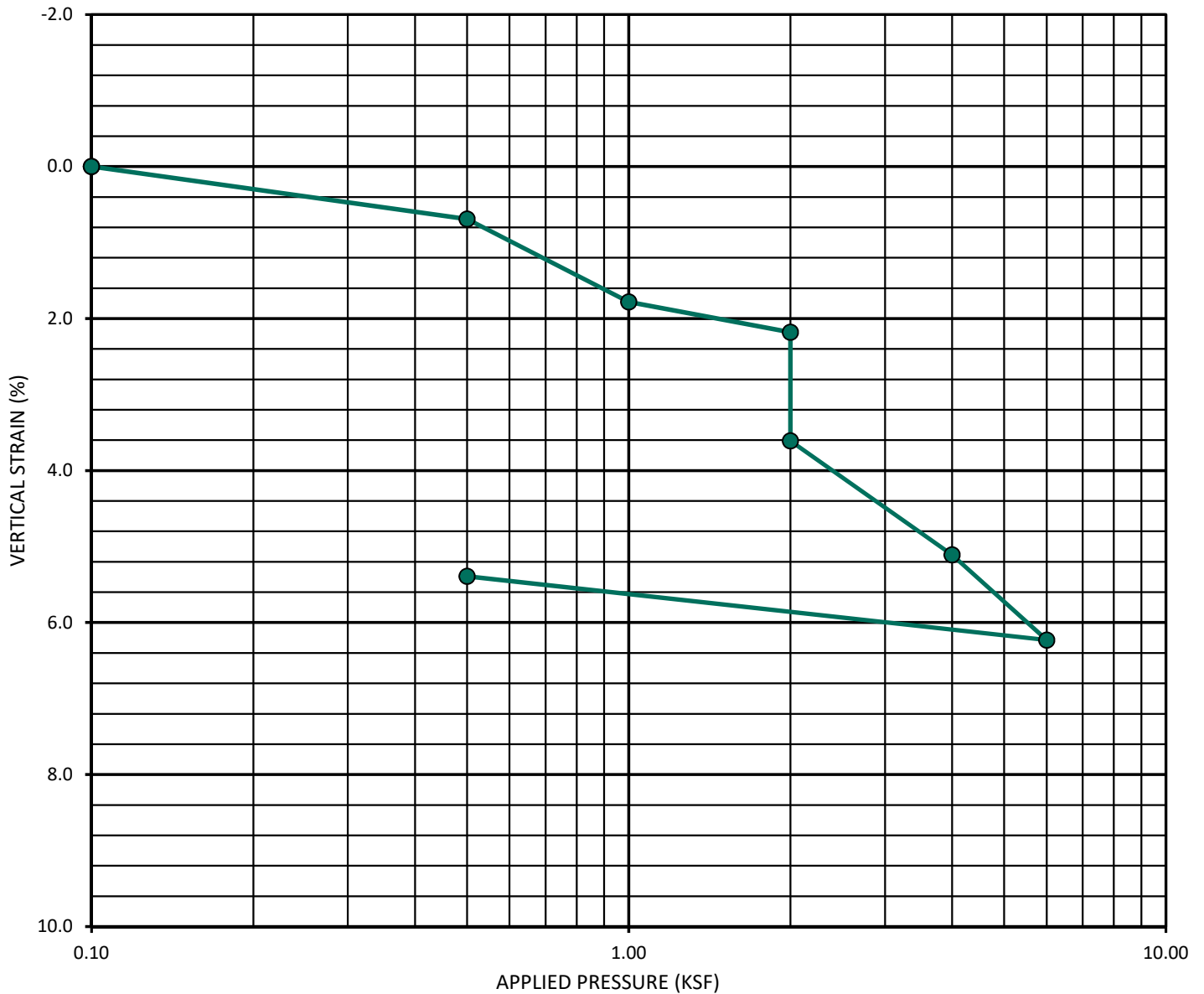


GEOTECHNICAL CONSULTANTS  
 6960 FLANDERS DRIVE - SAN DIEGO, CALIFORNIA 92121 - 2974  
 PHONE 858 558-6900 - FAX 858 558-6159

SAMPLE NO.: **T6-2**  
 SAMPLE DEPTH (FT): **5**

GEOLOGIC UNIT: **Qc**

| TEST INFORMATION           |       |
|----------------------------|-------|
| INITIAL DRY DENSITY (PCF): | 105.3 |
| INITIAL WATER CONTENT (%): | 10.2% |
| SAMPLE SATURATED AT (KSF): | 2     |
| INITIAL SATURATION (%):    | 52.1% |



**CONSOLIDATION CURVE - ASTM D 2435**

**943 BARHAM DR., SAN MARCOS, CA**

**PROJECT NO.: G2516-32-01**

**GEOCON**  
 INCORPORATED



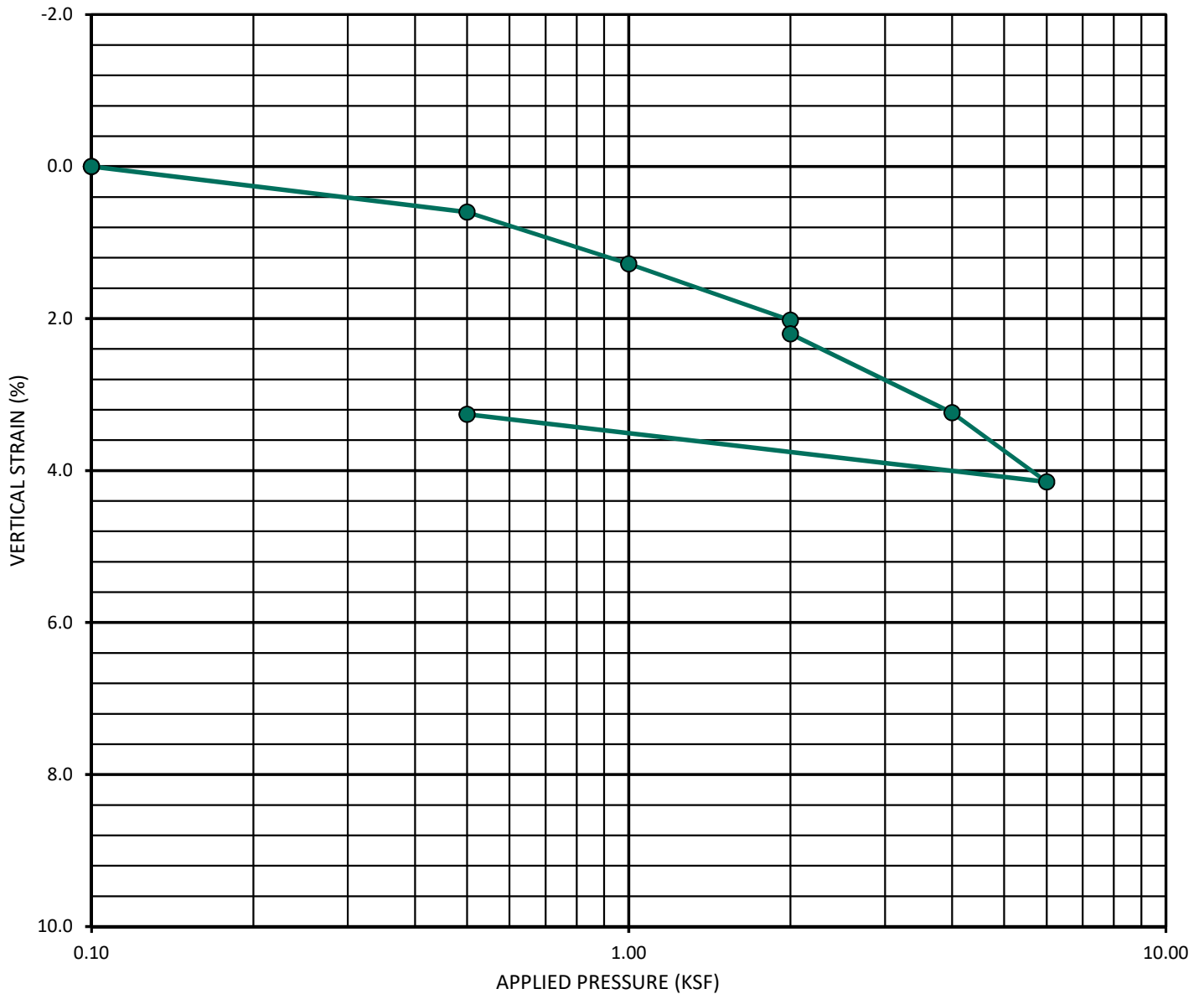
GEOTECHNICAL CONSULTANTS  
 6960 FLANDERS DRIVE - SAN DIEGO, CALIFORNIA 92121 - 2974  
 PHONE 858 558-6900 - FAX 858 558-6159



SAMPLE NO.: **T7-2**  
 SAMPLE DEPTH (FT): **4.5**

GEOLOGIC UNIT: **Qc**

| TEST INFORMATION           |       |
|----------------------------|-------|
| INITIAL DRY DENSITY (PCF): | 107.4 |
| INITIAL WATER CONTENT (%): | 14.9% |
| SAMPLE SATURATED AT (KSF): | 2.0   |
| INITIAL SATURATION (%):    | 72.8% |



**CONSOLIDATION CURVE - ASTM D 2435**

**943 BARHAM DR., SAN MARCOS, CA**

**PROJECT NO.: G2516-32-01**

**GEOCON**  
 INCORPORATED

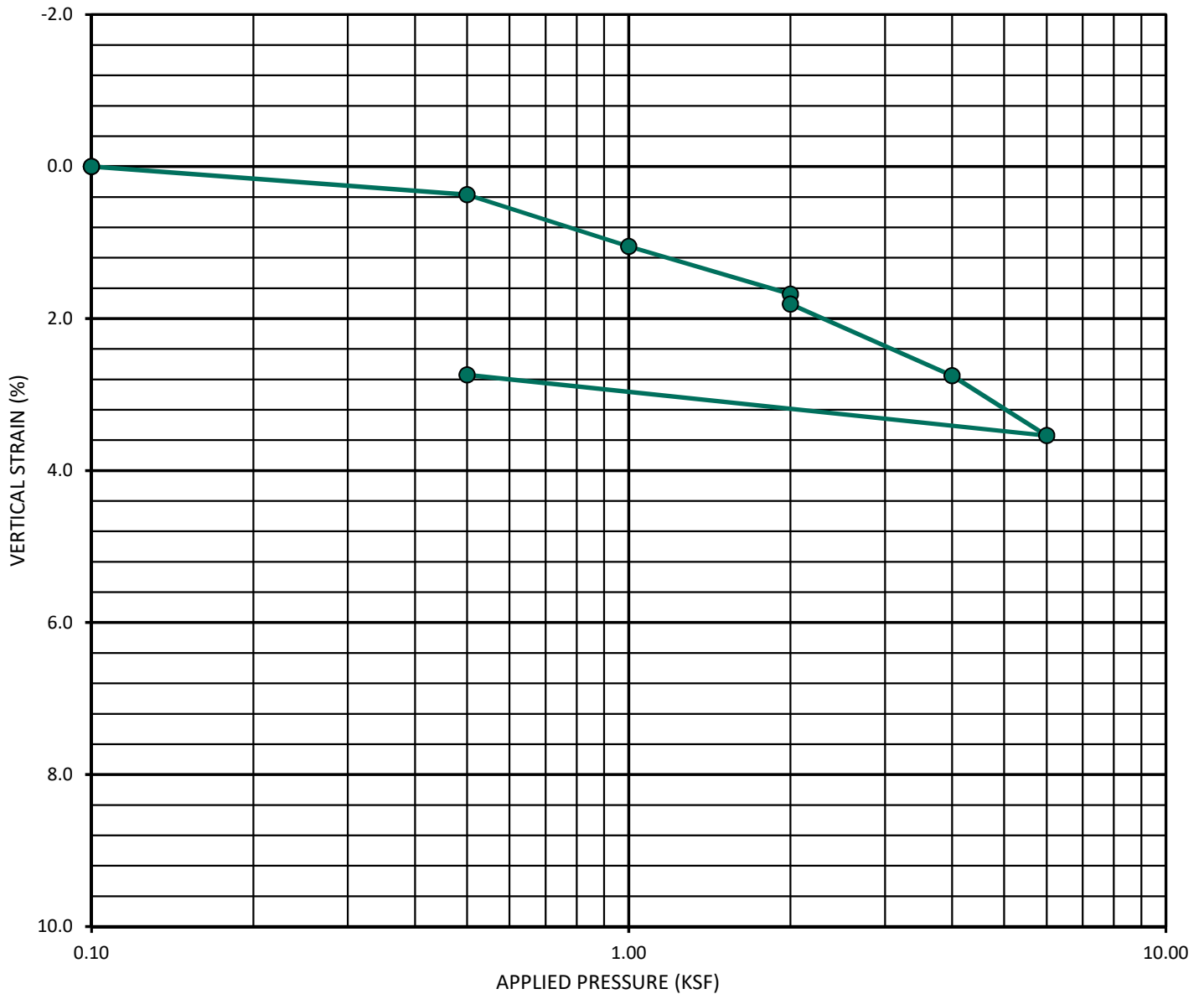


GEOTECHNICAL CONSULTANTS  
 6960 FLANDERS DRIVE - SAN DIEGO, CALIFORNIA 92121 - 2974  
 PHONE 858 558-6900 - FAX 858 558-6159

SAMPLE NO.: **T7-4**  
 SAMPLE DEPTH (FT): **6**

GEOLOGIC UNIT: **Qc**

| TEST INFORMATION           |       |
|----------------------------|-------|
| INITIAL DRY DENSITY (PCF): | 107.8 |
| INITIAL WATER CONTENT (%): | 16.2% |
| SAMPLE SATURATED AT (KSF): | 2.0   |
| INITIAL SATURATION (%):    | 79.9% |



**CONSOLIDATION CURVE - ASTM D 2435**

**943 BARHAM DR., SAN MARCOS, CA**

**PROJECT NO.: G2516-32-01**

**GEOCON**  
 INCORPORATED



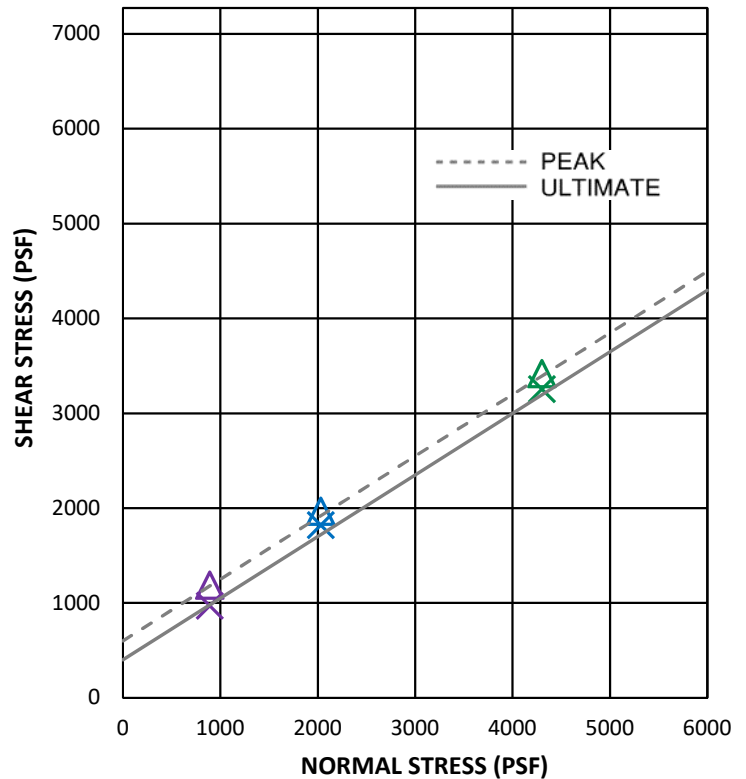
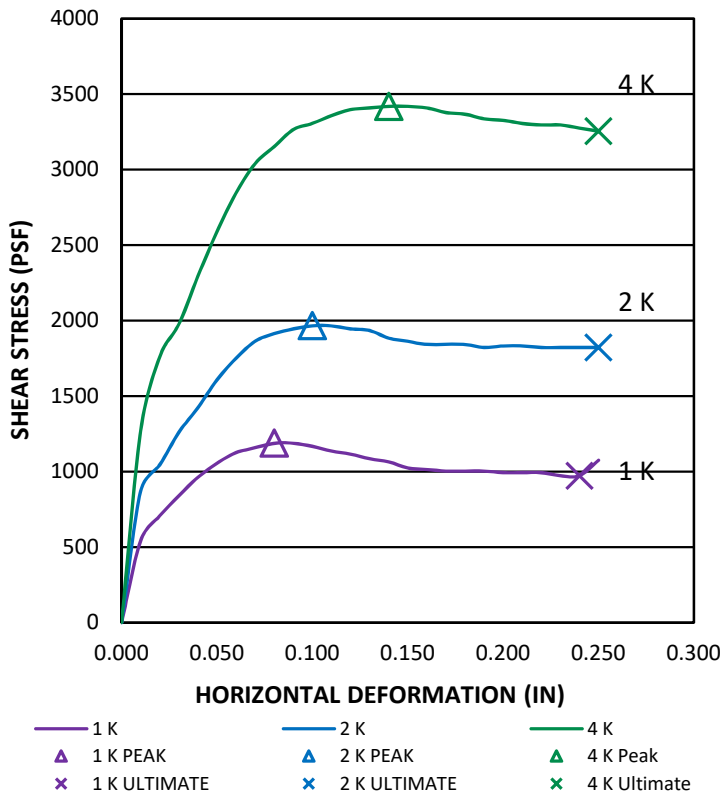
GEOTECHNICAL CONSULTANTS  
 6960 FLANDERS DRIVE - SAN DIEGO, CALIFORNIA 92121 - 2974  
 PHONE 858 558-6900 - FAX 858 558-6159

SAMPLE NO.: T2-2 GEOLOGIC UNIT: Kgr  
 SAMPLE DEPTH (FT): 5 NATURAL/REMOVED: R

| INITIAL CONDITIONS          |       |       |       |         |
|-----------------------------|-------|-------|-------|---------|
| NORMAL STRESS TEST LOAD     | 1 K   | 2 K   | 4 K   | AVERAGE |
| ACTUAL NORMAL STRESS (PSF): | 890   | 2030  | 4300  | --      |
| WATER CONTENT (%):          | 8.4   | 8.1   | 8.2   | 8.2     |
| DRY DENSITY (PCF):          | 119.9 | 120.4 | 120.1 | 120.1   |

| AFTER TEST CONDITIONS           |      |      |      |         |
|---------------------------------|------|------|------|---------|
| NORMAL STRESS TEST LOAD         | 1 K  | 2 K  | 4 K  | AVERAGE |
| WATER CONTENT (%):              | 13.0 | 13.1 | 12.8 | 13.0    |
| PEAK SHEAR STRESS (PSF):        | 1187 | 1965 | 3418 | --      |
| ULT.-E.O.T. SHEAR STRESS (PSF): | 972  | 1822 | 3255 | --      |

| RESULTS         |                          |     |
|-----------------|--------------------------|-----|
| <b>PEAK</b>     | COHESION, C (PSF)        | 600 |
|                 | FRICTION ANGLE (DEGREES) | 33  |
| <b>ULTIMATE</b> | COHESION, C (PSF)        | 400 |
|                 | FRICTION ANGLE (DEGREES) | 33  |



**DIRECT SHEAR - ASTM D 3080**

**943 Barham Dr., San Marcos, CA**

**PROJECT NO.: G2516-32-01**

**GEOCON**  
 INCORPORATED



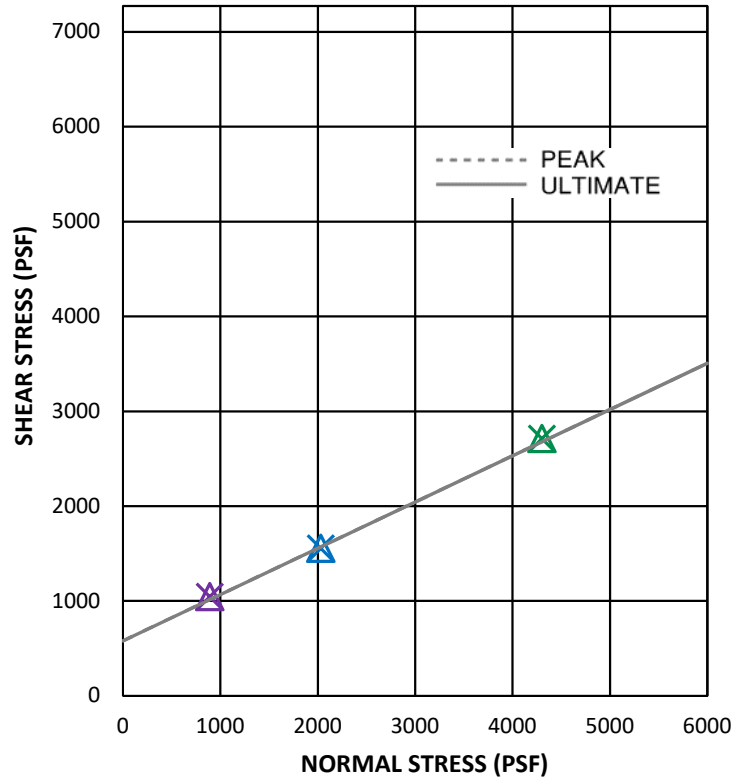
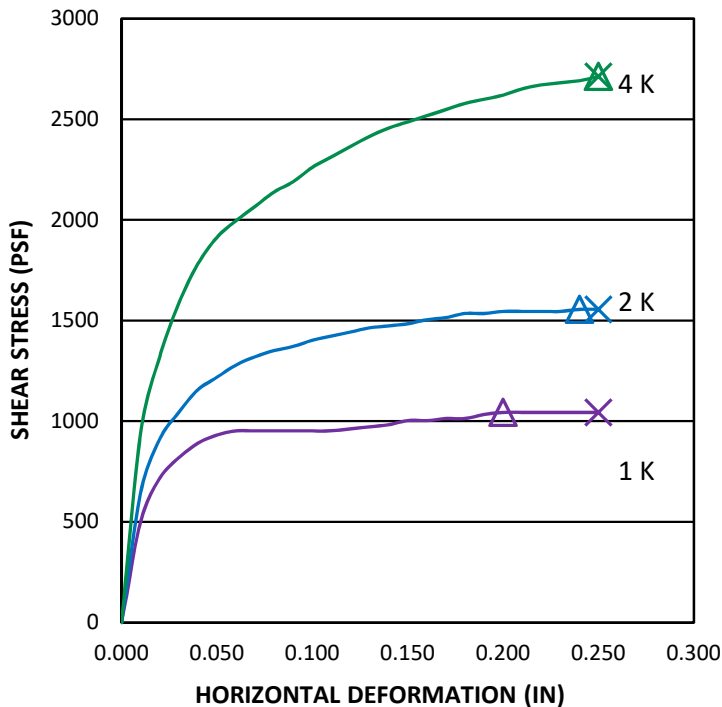
GEOTECHNICAL CONSULTANTS  
 6960 FLANDERS DRIVE - SAN DIEGO, CALIFORNIA 92121-2974  
 PHONE 858 558-6900 - FAX 858 558-6159

SAMPLE NO.: T3-1 GEOLOGIC UNIT: Qal  
 SAMPLE DEPTH (FT): 1.5 NATURAL/REMODELED: R

| INITIAL CONDITIONS          |       |       |       |         |
|-----------------------------|-------|-------|-------|---------|
| NORMAL STRESS TEST LOAD     | 1 K   | 2 K   | 4 K   | AVERAGE |
| ACTUAL NORMAL STRESS (PSF): | 890   | 2030  | 4300  | --      |
| WATER CONTENT (%):          | 10.2  | 9.8   | 10.2  | 10.1    |
| DRY DENSITY (PCF):          | 114.4 | 114.5 | 114.1 | 114.3   |

| AFTER TEST CONDITIONS           |      |      |      |         |
|---------------------------------|------|------|------|---------|
| NORMAL STRESS TEST LOAD         | 1 K  | 2 K  | 4 K  | AVERAGE |
| WATER CONTENT (%):              | 17.2 | 17.3 | 16.8 | 17.1    |
| PEAK SHEAR STRESS (PSF):        | 1044 | 1556 | 2712 | --      |
| ULT.-E.O.T. SHEAR STRESS (PSF): | 1044 | 1556 | 2712 | --      |

| RESULTS         |                          |     |
|-----------------|--------------------------|-----|
| <b>PEAK</b>     | COHESION, C (PSF)        | 580 |
|                 | FRICTION ANGLE (DEGREES) | 26  |
| <b>ULTIMATE</b> | COHESION, C (PSF)        | 580 |
|                 | FRICTION ANGLE (DEGREES) | 26  |



1 K                      2 K                      4 K  
 ▲ 1 K PEAK            ▲ 2 K PEAK            ▲ 4 K Peak  
 × 1 K ULTIMATE      × 2 K ULTIMATE      × 4 K Ultimate

**DIRECT SHEAR - ASTM D 3080**

**GEOCON**  
 INCORPORATED



GEOTECHNICAL CONSULTANTS  
 6960 FLANDERS DRIVE - SAN DIEGO, CALIFORNIA 92121-2974  
 PHONE 858 558-6900 - FAX 858 558-6159

**943 Barham Dr., San Marcos, CA**

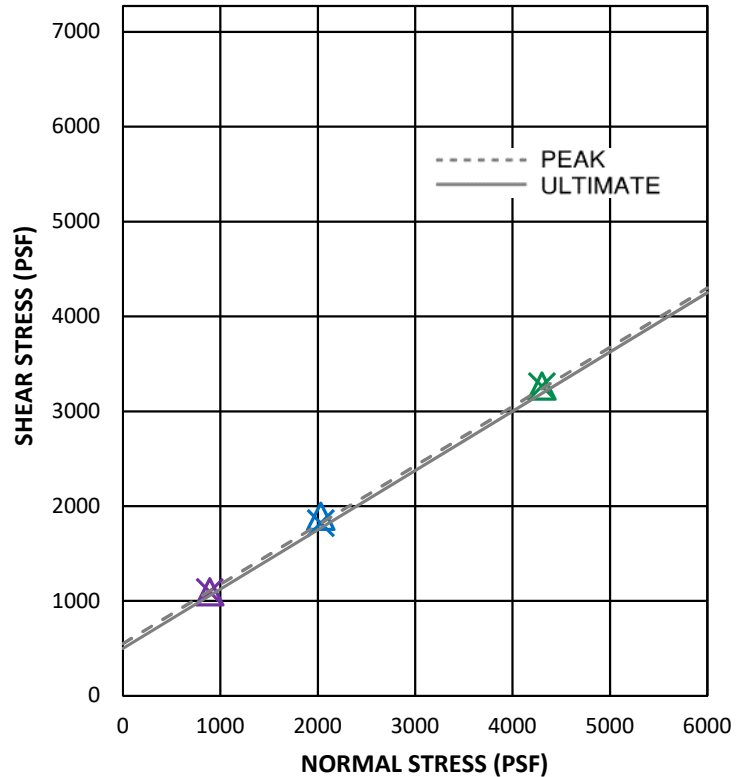
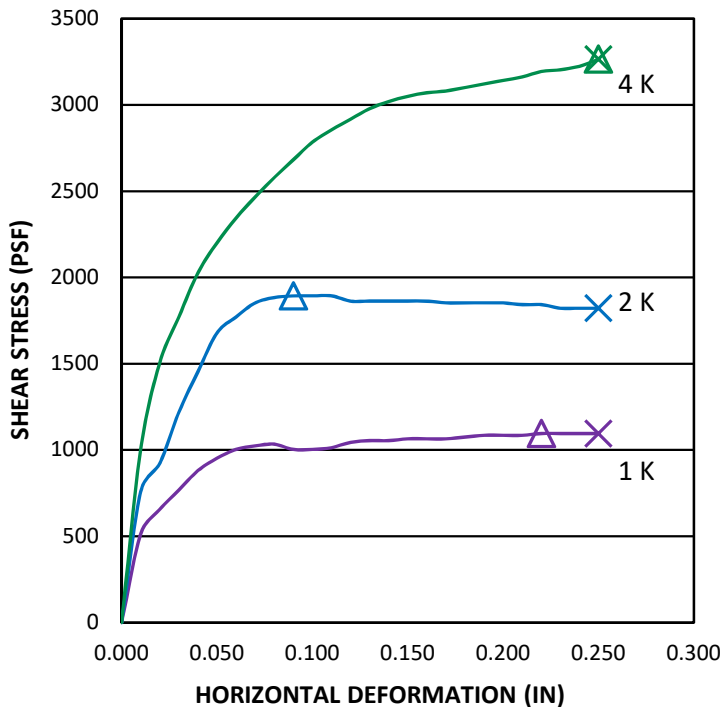
**PROJECT NO.: G2516-32-01**

SAMPLE NO.: T7-1 GEOLOGIC UNIT: Qal  
 SAMPLE DEPTH (FT): I NATURAL/REMOLDED: R

| INITIAL CONDITIONS          |       |       |       |         |
|-----------------------------|-------|-------|-------|---------|
| NORMAL STRESS TEST LOAD     | 1 K   | 2 K   | 4 K   | AVERAGE |
| ACTUAL NORMAL STRESS (PSF): | 890   | 2030  | 4300  | --      |
| WATER CONTENT (%):          | 8.9   | 8.7   | 9.2   | 8.9     |
| DRY DENSITY (PCF):          | 116.0 | 116.3 | 116.0 | 116.1   |

| AFTER TEST CONDITIONS           |      |      |      |         |
|---------------------------------|------|------|------|---------|
| NORMAL STRESS TEST LOAD         | 1 K  | 2 K  | 4 K  | AVERAGE |
| WATER CONTENT (%):              | 14.5 | 14.3 | 15.1 | 14.6    |
| PEAK SHEAR STRESS (PSF):        | 1095 | 1893 | 3265 | --      |
| ULT.-E.O.T. SHEAR STRESS (PSF): | 1095 | 1822 | 3265 | --      |

| RESULTS  |                          |     |
|----------|--------------------------|-----|
| PEAK     | COHESION, C (PSF)        | 550 |
|          | FRICTION ANGLE (DEGREES) | 32  |
| ULTIMATE | COHESION, C (PSF)        | 500 |
|          | FRICTION ANGLE (DEGREES) | 32  |



1 K                      2 K                      4 K  
 ▲ 1 K PEAK            ▲ 2 K PEAK            ▲ 4 K Peak  
 × 1 K ULTIMATE      × 2 K ULTIMATE      × 4 K Ultimate

**DIRECT SHEAR - ASTM D 3080**

**GEOCON**  
 INCORPORATED



GEOTECHNICAL CONSULTANTS  
 6960 FLANDERS DRIVE - SAN DIEGO, CALIFORNIA 92121-2974  
 PHONE 858 558-6900 - FAX 858 558-6159

**943 Barham Dr., San Marcos, CA**

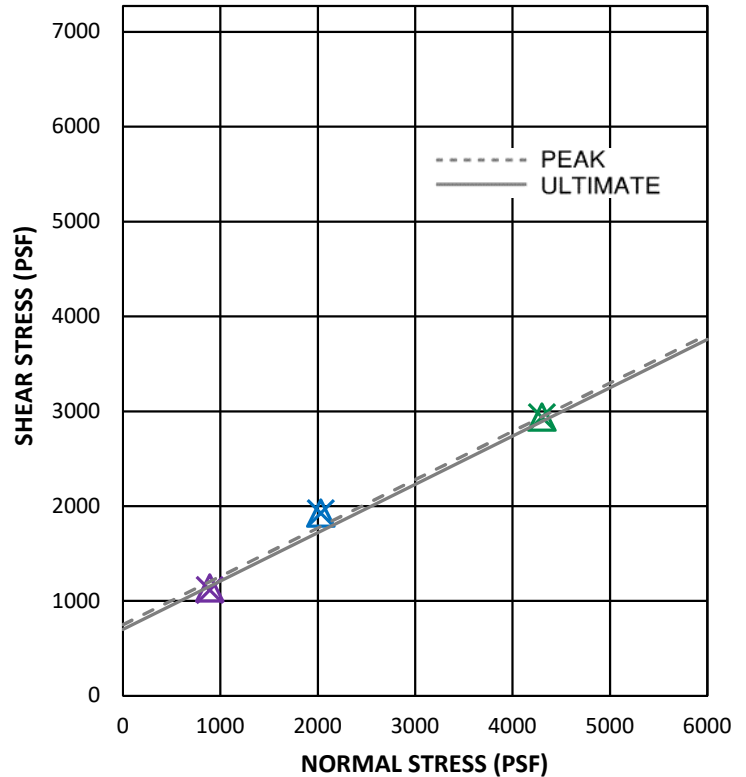
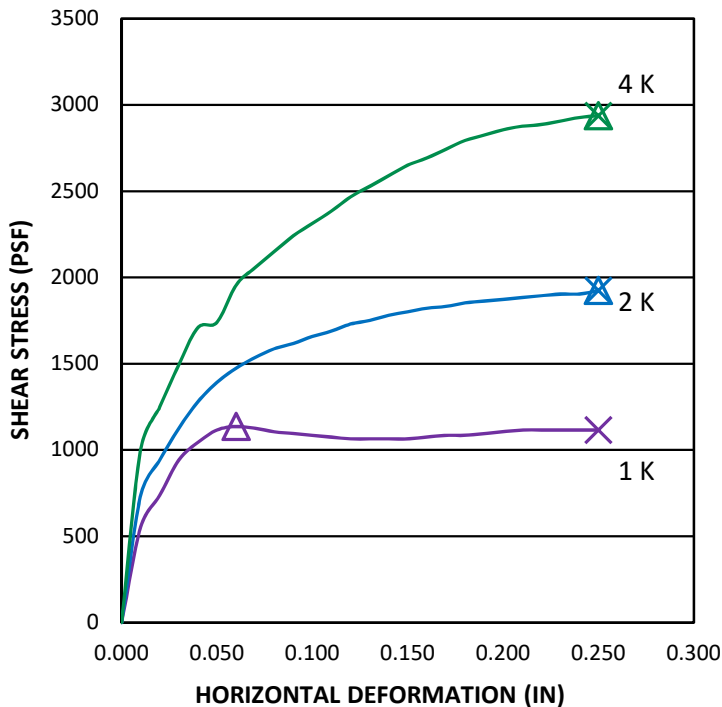
**PROJECT NO.: G2516-32-01**

SAMPLE NO.: T10-1 GEOLOGIC UNIT: Qal  
 SAMPLE DEPTH (FT): 4 NATURAL/REMOVED: R

| INITIAL CONDITIONS          |       |       |       |         |
|-----------------------------|-------|-------|-------|---------|
| NORMAL STRESS TEST LOAD     | 1 K   | 2 K   | 4 K   | AVERAGE |
| ACTUAL NORMAL STRESS (PSF): | 890   | 2030  | 4300  | --      |
| WATER CONTENT (%):          | 10.2  | 9.9   | 10.4  | 10.2    |
| DRY DENSITY (PCF):          | 114.1 | 114.4 | 113.7 | 114.1   |

| AFTER TEST CONDITIONS           |      |      |      |         |
|---------------------------------|------|------|------|---------|
| NORMAL STRESS TEST LOAD         | 1 K  | 2 K  | 4 K  | AVERAGE |
| WATER CONTENT (%):              | 16.4 | 16.3 | 17.1 | 16.6    |
| PEAK SHEAR STRESS (PSF):        | 1136 | 1924 | 2937 | --      |
| ULT.-E.O.T. SHEAR STRESS (PSF): | 1116 | 1924 | 2937 | --      |

| RESULTS  |                          |     |
|----------|--------------------------|-----|
| PEAK     | COHESION, C (PSF)        | 750 |
|          | FRICTION ANGLE (DEGREES) | 27  |
| ULTIMATE | COHESION, C (PSF)        | 700 |
|          | FRICTION ANGLE (DEGREES) | 27  |



1 K                      2 K                      4 K  
 ▲ 1 K PEAK            ▲ 2 K PEAK            ▲ 4 K Peak  
 × 1 K ULTIMATE      × 2 K ULTIMATE      × 4 K Ultimate

**DIRECT SHEAR - ASTM D 3080**

**GEOCON**  
INCORPORATED

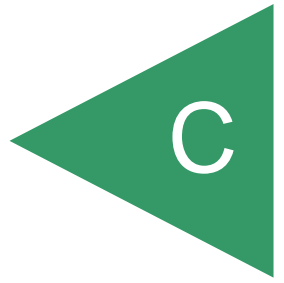


GEOTECHNICAL CONSULTANTS  
 6960 FLANDERS DRIVE - SAN DIEGO, CALIFORNIA 92121-2974  
 PHONE 858 558-6900 - FAX 858 558-6159

**943 Barham Dr., San Marcos, CA**

**PROJECT NO.: G2516-32-01**

APPENDIX



**APPENDIX C**

**SEISMIC REFRACTION STUDY  
SOUTHWEST GEOPHYSICS**

**FOR**

**943 BARHAM DRIVE  
SAN MARCOS, CALIFORNIA**

**PROJECT NO. G2516-32-01**





# **SEISMIC REFRACTION STUDY**

**943 BARHAM DRIVE  
SAN MARCOS, CALIFORNIA**

**PREPARED FOR:**

Geocon Inc.  
6960 Flanders Drive  
San Diego, CA 92121

**PREPARED BY:**

Southwest Geophysics, LLC  
6280 Riverdale Street, Suite 200  
San Diego, CA 92120

March 23, 2020  
120120SWG



March 23, 2020

Project No. 120120SWG

Mr. Joe Pagnillo, C.E.G.  
Geocon Inc.  
6960 Flanders Drive  
San Diego, California 92121

Subject: SEISMIC REFRACTION STUDY  
943 BARHAM DRIVE  
SAN MARCOS, CALIFORNIA

Dear Mr. Pagnillo:

In accordance with your authorization, we have performed a seismic refraction study pertaining to a portion of the property located at 943 Barham Drive in San Marcos, California. Specifically, our evaluation consisted of performing eight seismic P-wave refraction traverses at the project site. The purpose of our study was to develop subsurface velocity profiles of the areas studied, and to assess the depth to bedrock and apparent rippability of the subsurface materials. Our field services were conducted on March 3, 2020. This data report presents our methodology, equipment used, analysis, and results.

We appreciate the opportunity to be of service on this project. Should you have any questions please contact the undersigned at your convenience.

Respectfully submitted,  
**SOUTHWEST GEOPHYSICS, LLC**

Evan C. Anderson  
Senior Staff Geophysicist

Patrick F. Lehrmann, P.G., P.Gp.  
Principal Geologist/Geophysicist

ECA:PFL:ds

Distribution: pagnillo@geoconinc.com

**TABLE OF CONTENTS**

| <b>SECTION</b>                       | <b>PAGE</b> |
|--------------------------------------|-------------|
| 1. Introduction .....                | 1           |
| 2. Scope of Services .....           | 1           |
| 3. Site and Project Description..... | 1           |
| 4. Study Methodology .....           | 1           |
| 5. Data Analysis .....               | 3           |
| 6. Results and Conclusions.....      | 3           |
| 7. Limitations .....                 | 3           |
| 8. Selected References.....          | 4           |

**TABLE**

|  |   |
|--|---|
| Table 1 – Rippability Classification ..... | 2 |
|--|---|

**ATTACHMENTS**

**FIGURES**

|           |                                     |
|-----------|-------------------------------------|
| Figure 1  | Site Location Map                   |
| Figure 2  | Seismic Line Location Map           |
| Figure 3a | Site Photographs, SL-1 through SL-4 |
| Figure 3b | Site Photographs, SL-5 through SL-8 |
| Figure 4a | P-Wave Profile, SL-1                |
| Figure 4b | P-Wave Profile, SL-2                |
| Figure 4c | P-Wave Profile, SL-3                |
| Figure 4d | P-Wave Profile, SL-4                |
| Figure 4e | P-Wave Profile, SL-5                |
| Figure 4f | P-Wave Profile, SL-6                |
| Figure 4g | P-Wave Profile, SL-7                |
| Figure 4h | P-Wave Profile, SL-8                |

## **1. INTRODUCTION**

In accordance with your authorization, we have performed a seismic refraction study pertaining to a portion of the property located at 943 Barham Drive in San Marcos (Figure 1). Specifically, our evaluation consisted of performing eight seismic P-wave refraction traverses at the project site. The purpose of the study was to develop subsurface velocity profiles of the areas studied, and to assess the depth to bedrock and apparent rippability of the subsurface materials. Our field services were conducted on March 3, 2020.

## **2. SCOPE OF SERVICES**

Our scope of services included:

- Performance of eight seismic P-wave refraction traverses at the project site.
- Compilation and analysis of the data collected.
- Preparation of this data report presenting our results and conclusions.

## **3. SITE AND PROJECT DESCRIPTION**

The project site located at 943 Barham Drive (Figure 1). The study site lies in a vacant lot southwest of Barham Drive and Highway 78. The northeast corner of the site contained a small hill, while the southwest portion of the study site sloped upwards. Several remnants of former structures/foundations were observed near the surface on the northeastern hill. The seismic traverses were conducted around the northeastern hill as well as along the southwestern slope. Figures 2 and 3 depict the general site conditions in the areas of the seismic traverses.

## **4. STUDY METHODOLOGY**

A seismic P-wave (compression wave) refraction study was conducted at a portion of the project site to evaluate the rippability characteristics of the subsurface materials and to develop subsurface velocity profiles of the areas studied. The seismic refraction method uses first-arrival times of refracted seismic waves to estimate the thicknesses and seismic velocities of subsurface layers. Seismic P-waves generated at the surface, using a hammer and plate, are refracted at boundaries separating materials of contrasting velocities. These refracted seismic waves are then detected by a series of surface vertical component 14-Hz geophones and recorded with a 24-channel Geometrics StrataView seismograph. The travel times of the seismic P-waves are used in conjunction with the shot-to-geophone distances to obtain thickness and velocity information on the subsurface materials.

Eight seismic lines (SL-1 through SL-8) were conducted at the study area. The general locations and lengths of the lines were pre-determined by you and your office and adjusted where needed to account for surface conditions. The lines were all 100 feet in length. Shot points (signal generation locations) were conducted along the lines at the ends, midpoint, and intermediate points between the ends and the midpoint.

The seismic refraction theory requires that subsurface velocities increase with depth. A layer having a velocity lower than that of the layer above will not generally be detectable by the seismic refraction method and, therefore, could lead to errors in the depth calculations of subsequent layers. In addition, lateral variations in velocity, such as those caused by core stones, intrusions or boulders can also result in the misinterpretation of the subsurface conditions. In general, the effective depth of evaluation for a seismic refraction traverse is approximately one-third to one-fifth the length of the spread.

The seismic P-wave velocity of a material can be correlated to rippability (see Table 1 below), or to some degree “hardness.” Table 1 is based on published information from the Caterpillar Performance Handbook (Caterpillar, 2018) as well as our experience with similar materials, and assumes that a Caterpillar D-9 dozer ripping with a single shank is used. We emphasize that the cutoffs in this classification scheme are approximate and that rock characteristics, such as fracture spacing and orientation, play a significant role in determining rock quality or rippability. The rippability of a mass is also dependent on the excavation equipment used and the skill and experience of the equipment operator.

**Table 1 – Rippability Classification**

| <b>Seismic P-wave Velocity</b> | <b>Rippability</b>                |
|--------------------------------|-----------------------------------|
| 0 to 2,000 feet/second         | Easy                              |
| 2,000 to 4,000 feet/second     | Moderate                          |
| 4,000 to 5,500 feet/second     | Difficult, Possible Blasting      |
| 5,500 to 7,000 feet/second     | Very Difficult, Probable Blasting |
| Greater than 7,000 feet/second | Blasting Generally Required       |

For trenching operations, the rippability values should be scaled downward. For example, velocities as low as 3,500 feet/second may indicate difficult ripping during trenching operations. In addition, the presence of boulders, which can be troublesome in narrow trenching operations, should be anticipated.

It should be noted that the rippability cutoffs presented in Table 1 are slightly more conservative than those published in the Caterpillar Performance Handbook. Accordingly, the above classification scheme should be used with discretion, and contractors should not be relieved of making their own independent evaluation of the rippability of the on-site materials prior to submitting their bids.

## **5. DATA ANALYSIS**

The collected data were processed using SIPwin (Rimrock Geophysics, 2003), a seismic interpretation program, and analyzed using SeisOpt Pro (Optim, 2008). SeisOpt Pro uses first arrival picks and elevation data to produce subsurface velocity models through a nonlinear optimization technique called adaptive simulated annealing. The resulting velocity model provides a tomography image of the estimated geologic conditions. Both vertical and lateral velocity information is contained in the tomography model. Changes in layer velocity are revealed as gradients rather than discrete contacts, which typically are more representative of actual conditions.

## **6. RESULTS AND CONCLUSIONS**

As previously indicated, eight seismic traverses were conducted as part of our study. Figures 4a through 4h present the velocity models generated from our analysis. Based on the results it appears that the project site is underlain by low velocity materials (i.e., topsoil, fill, etc.) in the near surface and higher velocity materials, likely bedrock, at depth. Distinct vertical and lateral velocity variations are evident in the models. Moreover, the degree of weathering and the depth to possible bedrock appears to be variable across the study areas. In addition, remnant boulders in the subsurface appear to be present in some areas.

Based on the refraction results, variability in the excavatability (including depth of rippability) of the subsurface materials should be expected across the project area. Furthermore, blasting may be required depending on the excavation depth, location, equipment used, and desired rate of production. In addition, oversized materials should be expected. A contractor with excavation experience in similar difficult conditions should be consulted for expert advice on excavation methodology, equipment and production rate.

## **7. LIMITATIONS**

The field evaluation and geophysical analyses presented in this report have been conducted in general accordance with current practice and the standard of care exercised by consultants performing similar tasks in the project area. No warranty, express or implied, is made regarding

the conclusions, recommendations, and opinions presented in this report. There is no evaluation detailed enough to reveal every subsurface condition. Variations may exist and conditions not observed or described in this report may be present. Uncertainties relative to subsurface conditions can be reduced through additional subsurface exploration. Additional subsurface surveying will be performed upon request.

This document is intended to be used only in its entirety. No portion of the document, by itself, is designed to completely represent any aspect of the project described herein. Southwest Geophysics should be contacted if the reader requires additional information or has questions regarding the content, interpretations presented, or completeness of this document. This report is intended exclusively for use by the client. Any use or reuse of the findings, conclusions, and/or recommendations of this report by parties other than the client is undertaken at said parties' sole risk.

## **8. SELECTED REFERENCES**

Caterpillar, Inc., 2018, Caterpillar Performance Handbook, Edition 48, Caterpillar, Inc., Peoria, Illinois.

Mooney, H.M., 1976, Handbook of Engineering Geophysics, dated February.

Optim, Inc., 2008, SeisOpt Pro, V-5.0.

Rimrock Geophysics, 2003, Seismic Refraction Interpretation Program (SIPwin), V-2.76.

Telford, W.M., Geldart, L.P., Sheriff, R.E., and Keys, D.A., 1976, Applied Geophysics, Cambridge University Press.





**SITE LOCATION MAP**



943 Barham Drive  
San Marcos, California

Project No.: 120120SWG

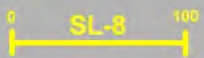
Date: 03/20



Figure 1





LEGEND  
Seismic Line 

**SEISMIC LINE LOCATION  
MAP**



943 Barham Drive  
San Marcos, California

Project No.: 120120SWG

Date: 03/20

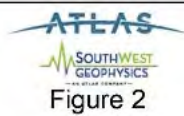
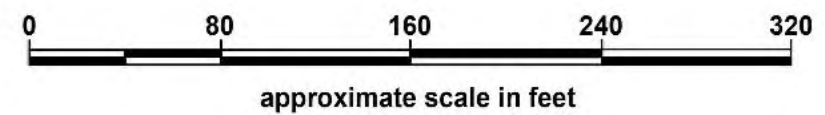
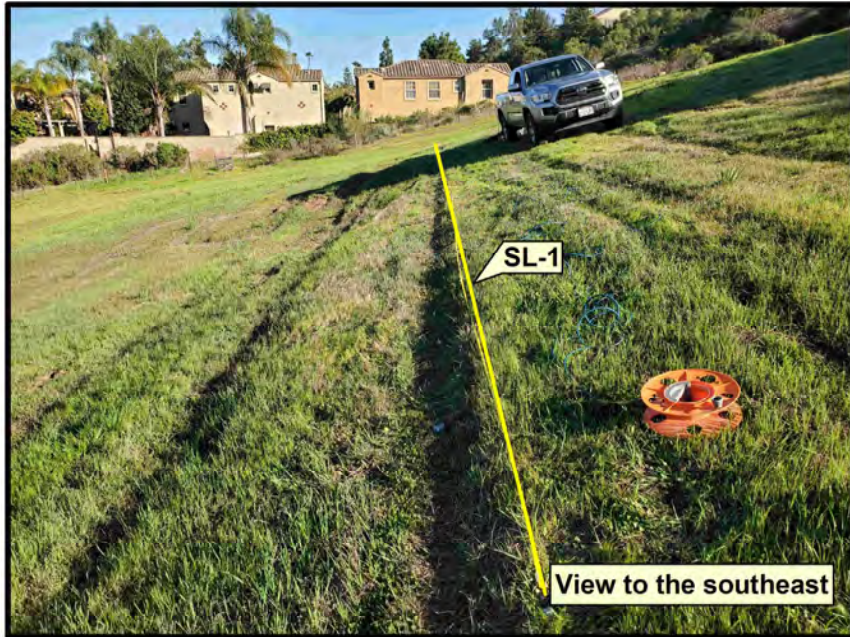


Figure 2







**SITE PHOTOGRAPHS**  
(SL-1, SL-2, SL-3 & SL-4)

943 Barham Drive  
San Marcos, California

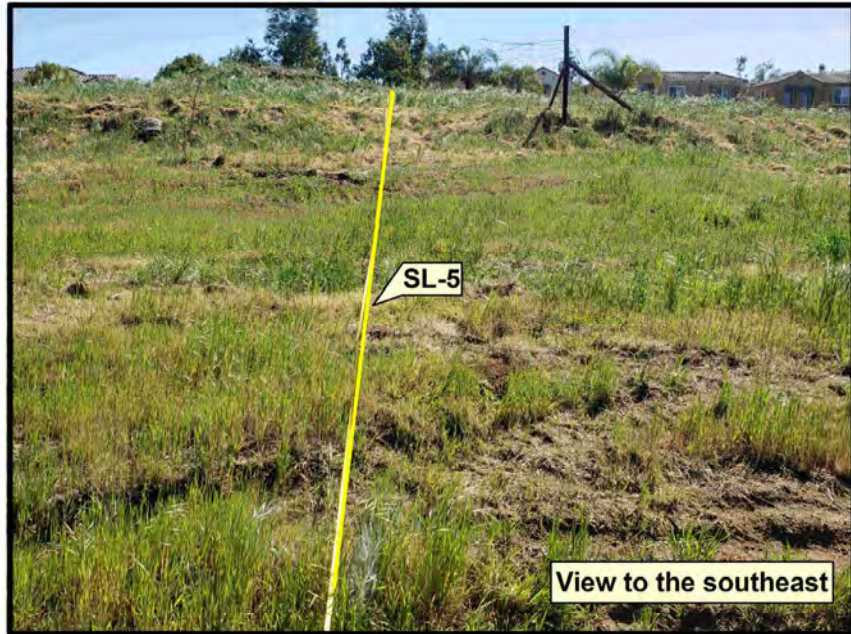
Project No.: 120120SWG

Date: 03/20

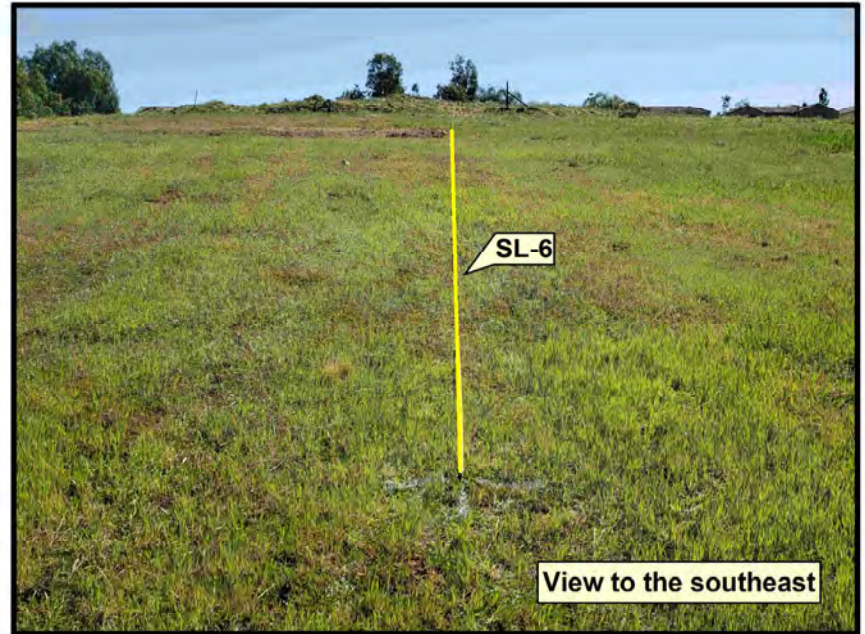


Figure 3a

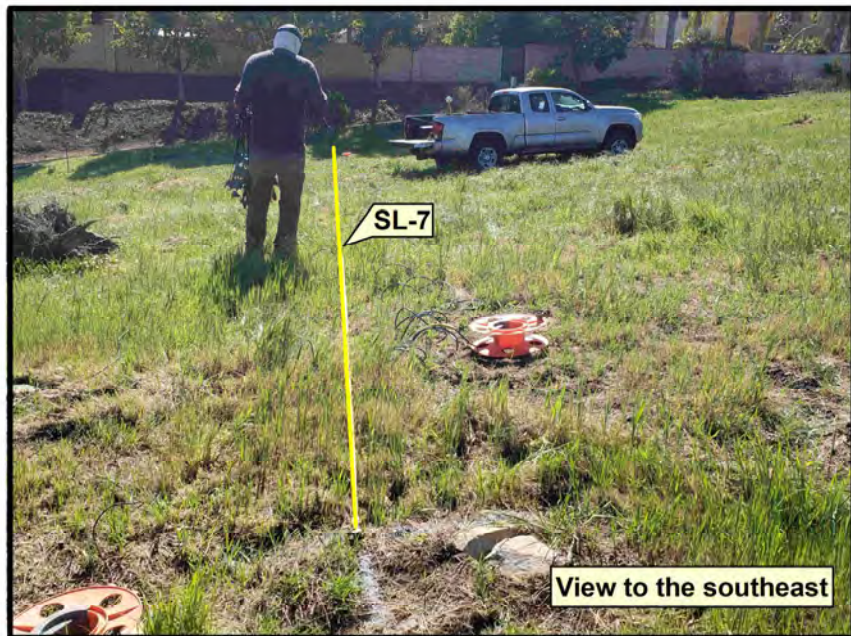




View to the southeast



View to the southeast



View to the southeast



View to the southeast

**SITE PHOTOGRAPHS**  
(SL-5, SL-6, SL-7 & SL-8)

943 Barham Drive  
San Marcos, California

Project No.: 120120SWG

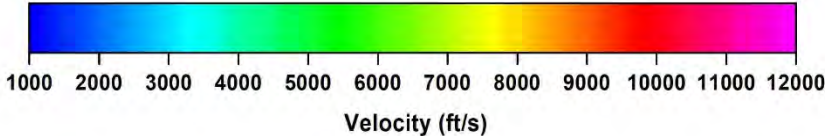
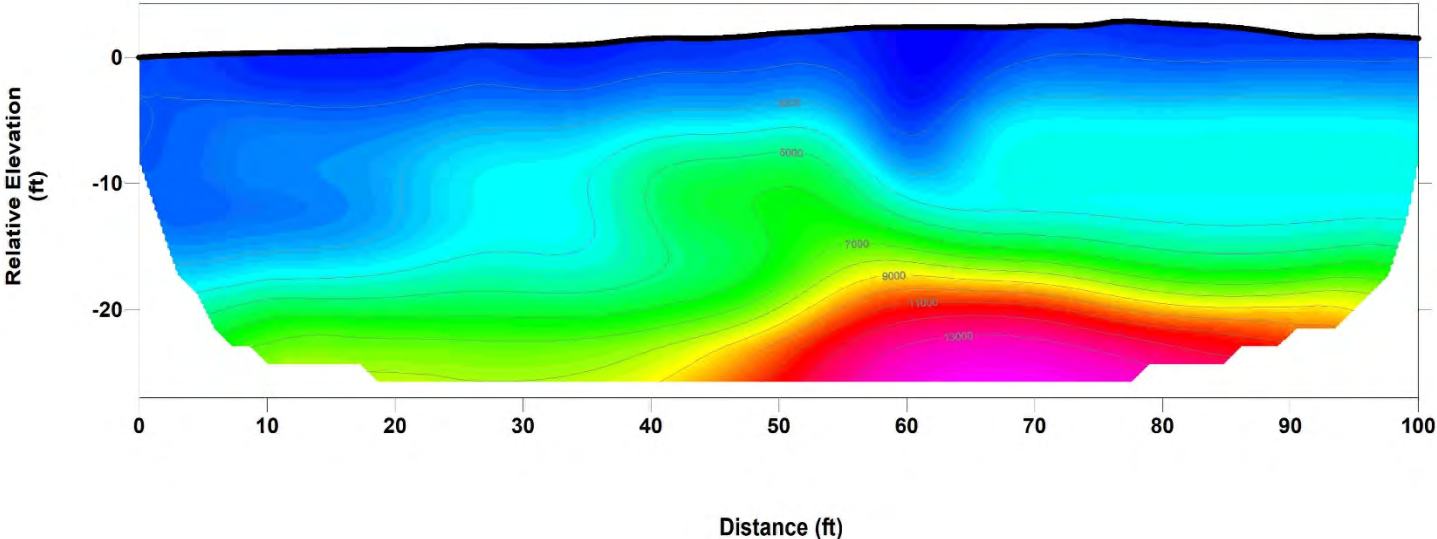
Date: 03/20



Figure 3b



# TOMOGRAPHY MODEL



**P-WAVE PROFILE  
SL-1**

943 Barham Drive  
San Marcos, California

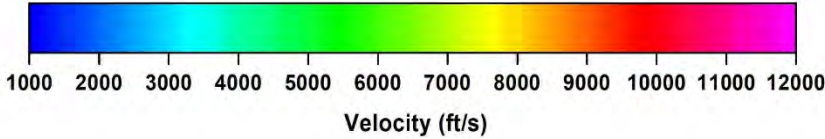
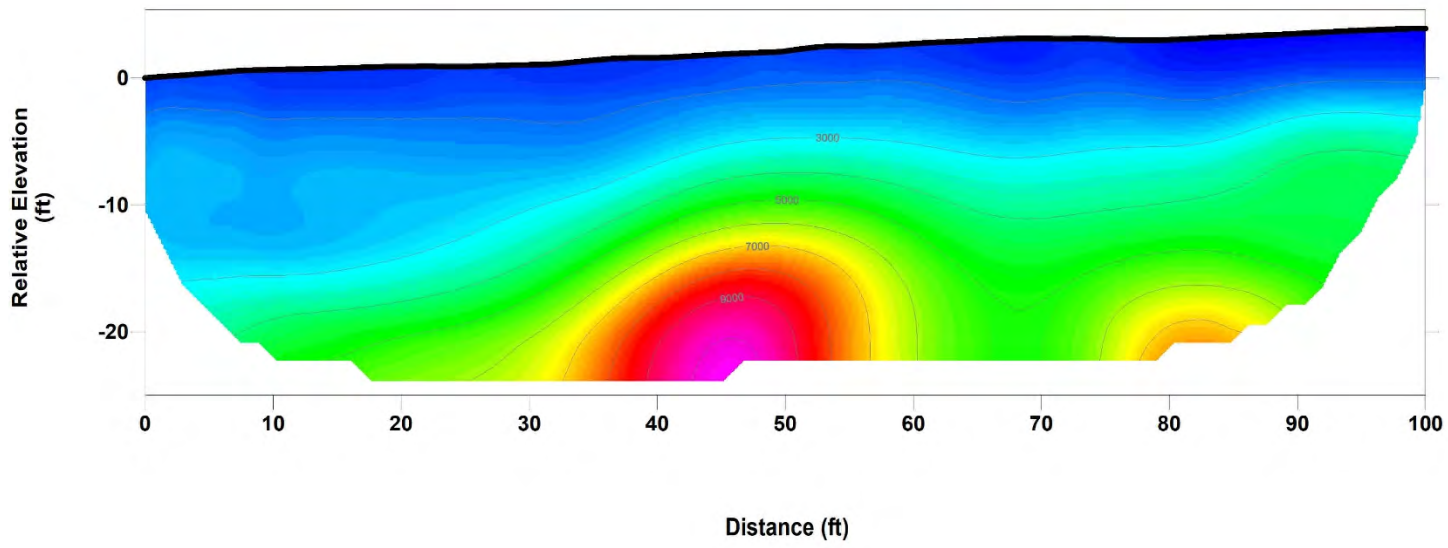
Project No.: 120120SWG      Date: 03/20



Figure 4a

Note: Contour Interval = 1,000 feet per second

# TOMOGRAPHY MODEL



**P-WAVE PROFILE  
SL-2**

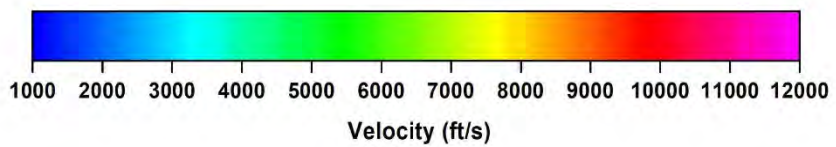
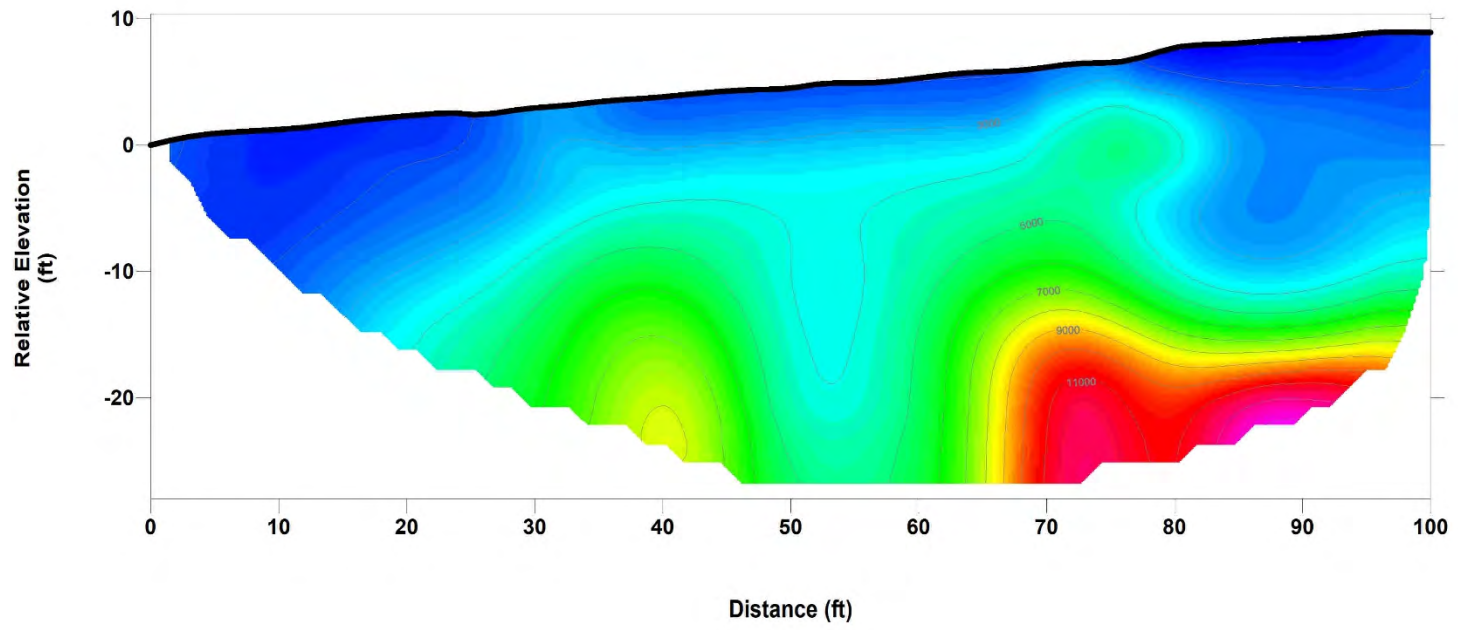
943 Barham Drive  
San Marcos, California

Project No.: 120120SWG      Date: 03/20



Note: Contour Interval = 1,000 feet per second

# TOMOGRAPHY MODEL



**P-WAVE PROFILE  
SL-3**

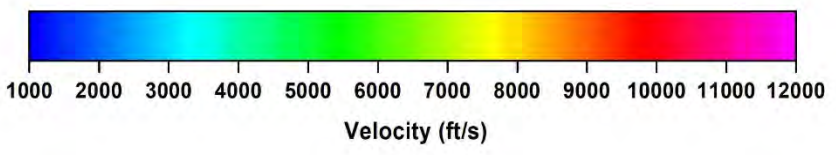
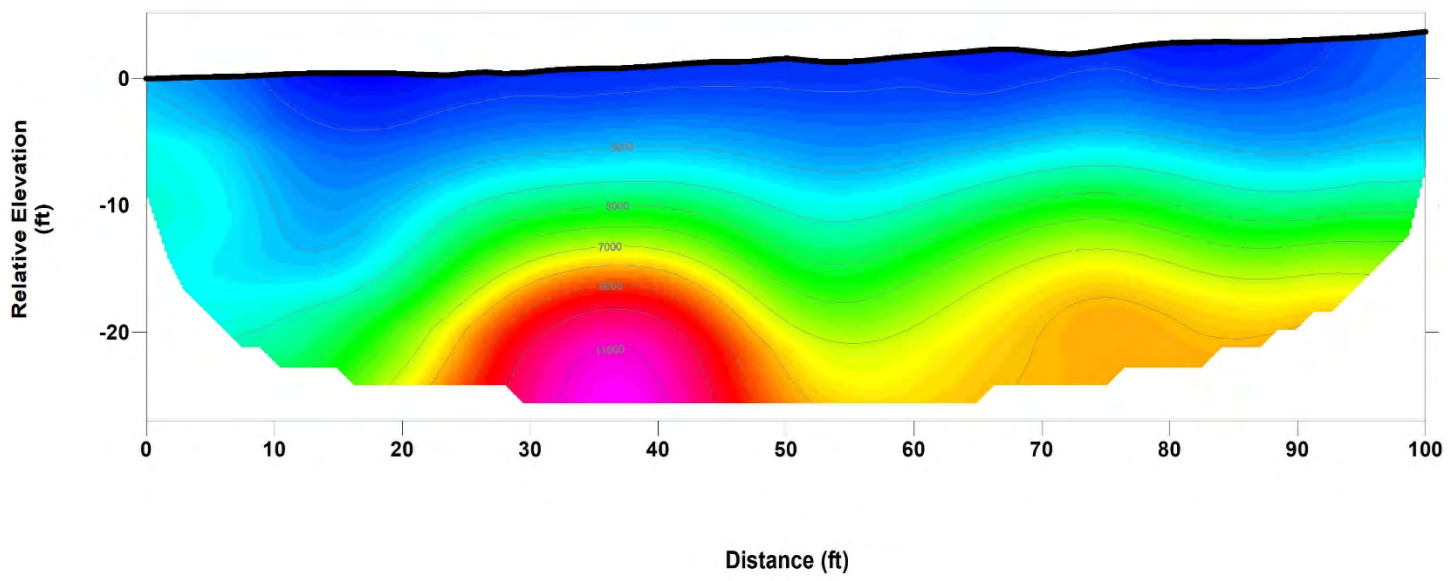
943 Barham Drive  
San Marcos, California

Project No.: 120120SWG      Date: 03/20



Note: Contour Interval = 1,000 feet per second

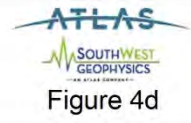
# TOMOGRAPHY MODEL



**P-WAVE PROFILE  
SL-4**

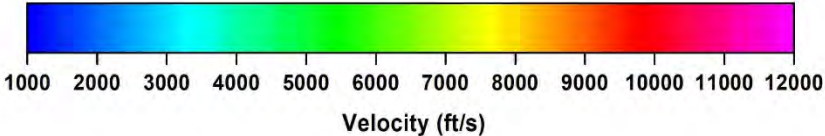
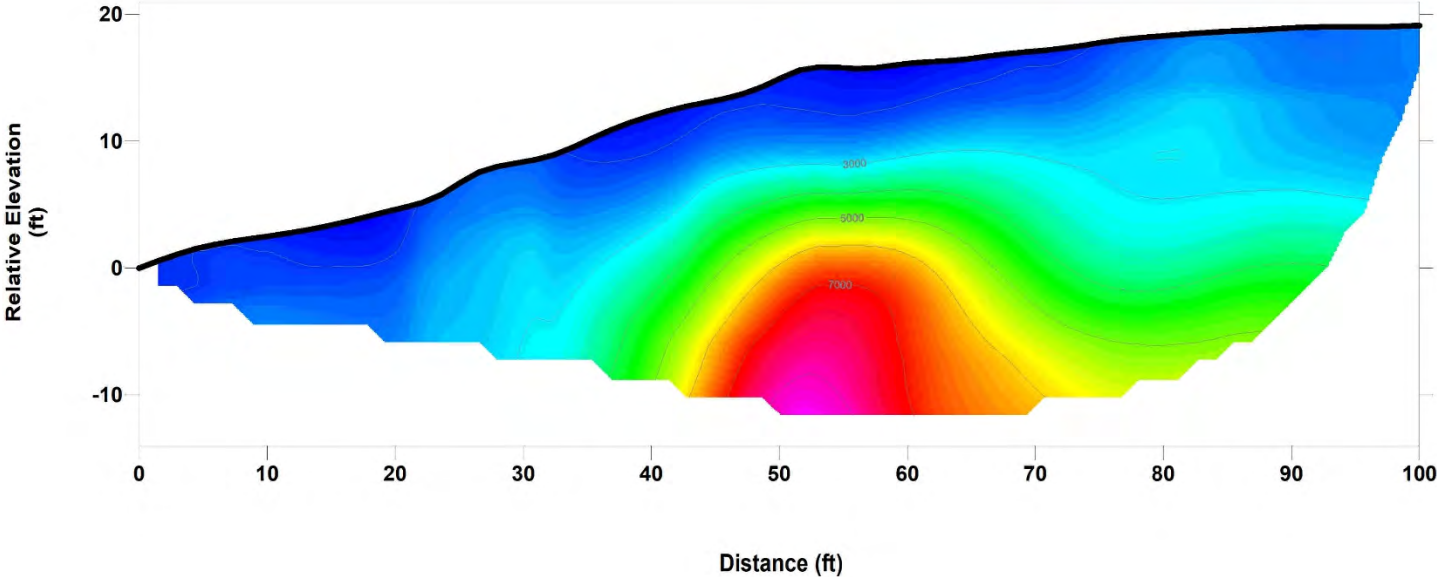
943 Barham Drive  
San Marcos, California

Project No.: 120120SWG      Date: 03/20



Note: Contour Interval = 1,000 feet per second

# TOMOGRAPHY MODEL



**P-WAVE PROFILE  
SL-5**

943 Barham Drive  
San Marcos, California

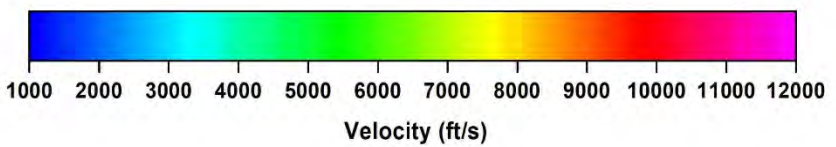
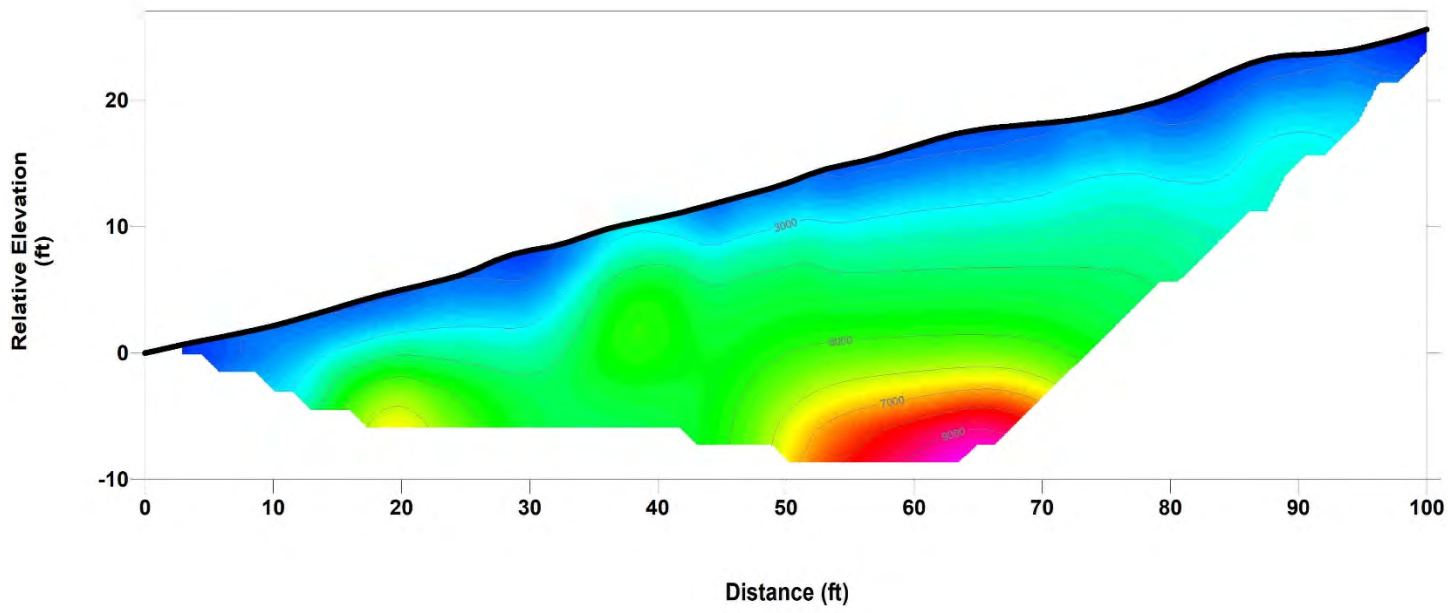
Project No.: 120120SWG      Date: 03/20



Note: Contour Interval = 1,000 feet per second



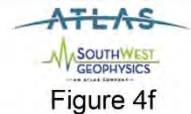
# TOMOGRAPHY MODEL



**P-WAVE PROFILE  
SL-6**

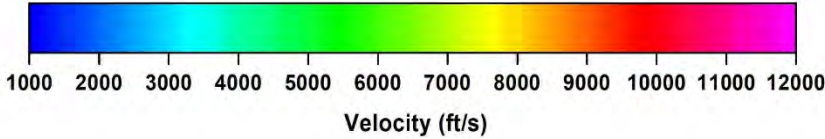
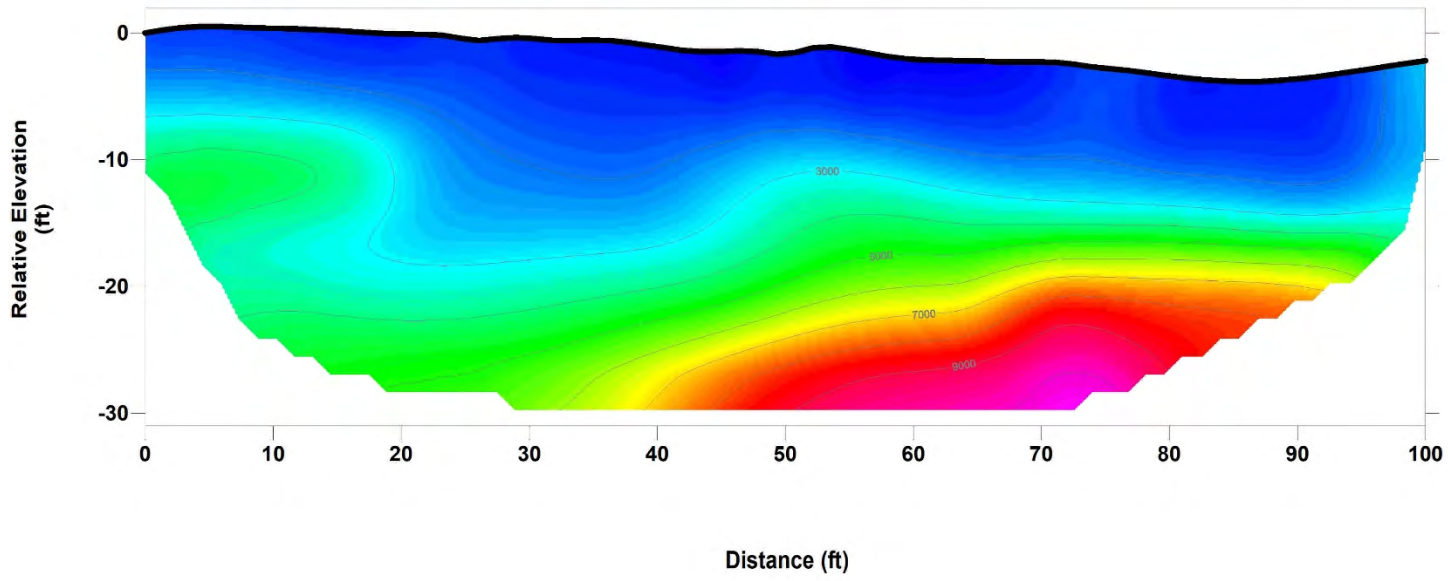
943 Barham Drive  
San Marcos, California

Project No.: 120120SWG      Date: 03/20



Note: Contour Interval = 1,000 feet per second

# TOMOGRAPHY MODEL



**P-WAVE PROFILE  
SL-7**

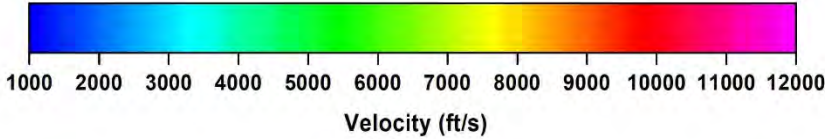
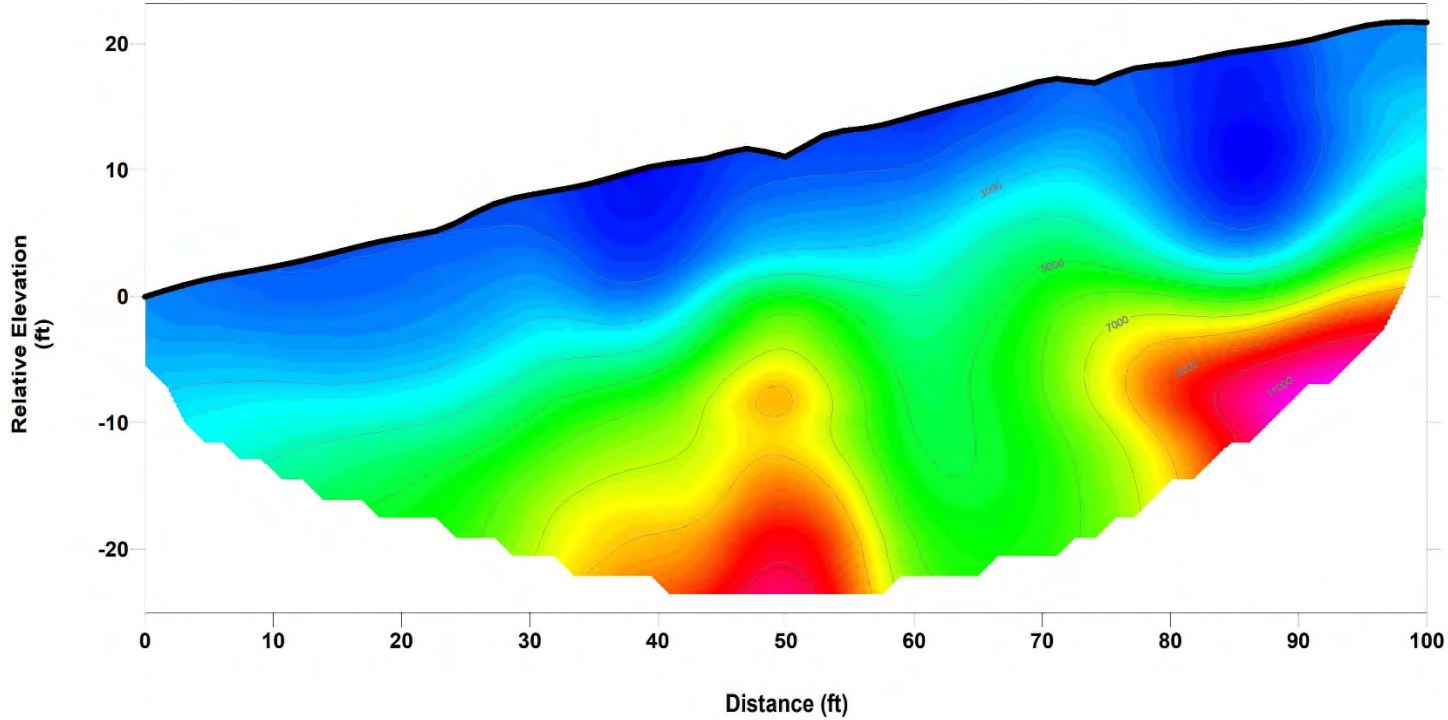
943 Barham Drive  
San Marcos, California

Project No.: 120120SWG      Date: 03/20



Note: Contour Interval = 1,000 feet per second

# TOMOGRAPHY MODEL



**P-WAVE PROFILE  
SL-8**

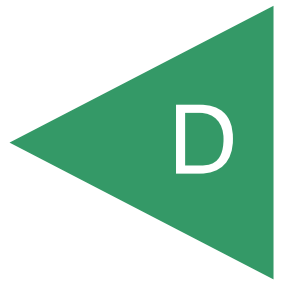
943 Barham Drive  
San Marcos, California

Project No.: 120120SWG      Date: 03/20

**ATLAS**  
SOUTHWEST  
GEOPHYSICS  
Figure 4h

Note: Contour Interval = 1,000 feet per second

APPENDIX



**APPENDIX D**

**STORM WATER MANAGEMENT INVESTIGATION**

**FOR**

**943 BARHAM DRIVE**  
**SAN MARCOS, CALIFORNIA**

**PROJECT NO. G2516-32-01**

## APPENDIX D

### STORM WATER MANAGEMENT INVESTIGATION

We understand storm water management devices are being proposed in accordance with the City of San Marcos *BMP Design Manual*. If not properly constructed, there is a potential for distress to improvements and properties located hydrologically down gradient or adjacent to these devices. Factors such as the amount of water to be detained, its residence time, and soil permeability have an important effect on seepage transmission and the potential adverse impacts that may occur if the storm water management features are not properly designed and constructed. We have not performed a hydrogeological study at the site. If infiltration of storm water runoff occurs, downstream properties may be subjected to seeps, springs, slope instability, raised groundwater, movement of foundations and slabs, or other undesirable impacts as a result of water infiltration.

#### Hydrologic Soil Group

The United States Department of Agriculture (USDA), Natural Resources Conservation Services, possesses general information regarding the existing soil conditions for areas within the United States. The USDA website also provides the Hydrologic Soil Group. Table D-I presents the descriptions of the hydrologic soil groups. If a soil is assigned to a dual hydrologic group (A/D, B/D, or C/D), the first letter is for drained areas and the second is for undrained areas. In addition, the USDA website also provides an estimated saturated hydraulic conductivity for the existing soil.

**TABLE D-I  
HYDROLOGIC SOIL GROUP DEFINITIONS**

| Soil Group | Soil Group Definition  |
|------------|--|
| A          | Soils having a high infiltration rate (low runoff potential) when thoroughly wet. These consist mainly of deep, well drained to excessively drained sands or gravelly sands. These soils have a high rate of water transmission.   |
| B          | Soils having a moderate infiltration rate when thoroughly wet. These consist chiefly of moderately deep or deep, moderately well drained or well drained soils that have moderately fine texture to moderately coarse texture. These soils have a moderate rate of water transmission.   |
| C          | Soils having a slow infiltration rate when thoroughly wet. These consist chiefly of soils having a layer that impedes the downward movement of water or soils of moderately fine texture or fine texture. These soils have a slow rate of water transmission.  |
| D          | Soils having a very slow infiltration rate (high runoff potential) when thoroughly wet. These consist chiefly of clays that have a high shrink-swell potential, soils that have a high water table, soils that have a claypan or clay layer at or near the surface, and soils that are shallow over nearly impervious material. These soils have a very slow rate of water transmission. |



The property is underlain by alluvium, colluvium, and granitic rock. After site grading, the property will be underlain with compacted fill. Compacted fill should be classified as Hydrologic Soil Group D. The Hydrologic Soil Group Map presents output from the USDA website showing the limits of the soil units.



Hydrologic Soil Group Map

Table D-II presents the information from the USDA website for the subject property.

**TABLE D-II  
USDA WEB SOIL SURVEY – HYDROLOGIC SOIL GROUP**

| Map Unit Name  | Map Unit Symbol | Approximate Percentage of Property | Hydrologic Soil Group | k <sub>SAT</sub> of Most Limiting Layer (Inches/ Hour) |
|--|-----------------|------------------------------------|-----------------------|--|
| Vista coarse sandy loam,<br>5 to 9 percent slopes              | VsC             | 67                                 | B                     | 1.98 – 5.95  |
| Vista coarse sandy loam,<br>9 to 15 percent slopes,<br>MLRA 20 | VsD             | 7                                  | B                     | 0.00 – 0.06  |
| Vista coarse sandy loam,<br>15 to 30 percent slopes,<br>eroded | VsE2            | 26                                 | B                     | 1.98 – 5.95  |

### In Situ Testing

We performed one constant-head infiltration test using the Aardvark permeameter at the location shown on the Geologic Map, Figure 2. Table D-III presents the result of the infiltration test. The test results are presented herein. We applied a feasibility factor of safety of 2.0 to the in-situ infiltration rates in accordance with the SWS. Soil infiltration rates from in-situ tests can vary significantly from one location to another due to the heterogeneous characteristics inherent to most soil.

**TABLE D-III  
INFILTRATION TEST RESULTS**

| Test No. | Geologic Unit | Test Elevation (feet, MSL) | Field-Saturated Hydraulic Conductivity/Infiltration Rate, k <sub>sat</sub> (inch/hour) | Worksheet Infiltration Rate <sup>1</sup> (inch/hour) |
|----------|---------------|----------------------------|--|--|
| I-1      | Qal           | 651                        | 0.022  | 0.011  |
| Average  |               |                            | 0.022  | 0.011  |

<sup>1</sup> Using a Factor of Safety of 2.

Infiltration categories include full infiltration, partial infiltration and no infiltration. Table D-IV presents the commonly accepted definitions of the potential infiltration categories based on the infiltration rates.



**TABLE D-IV  
INFILTRATION CATEGORIES**

| Infiltration Category        | Field Infiltration Rate, I<br>(inches/hour) | Factored Infiltration Rate <sup>1</sup> , I<br>(inches/hour) |
|------------------------------|---|--|
| Full Infiltration            | $I > 1.0$                                   | $I > 0.5$  |
| Partial Infiltration         | $0.10 < I \leq 1.0$                         | $0.05 < I \leq 0.5$  |
| No Infiltration (Infeasible) | $I < 0.10$                                  | $I < 0.05$   |

<sup>1</sup> Using a Factor of Safety of 2.

Based on our observations and test results, the factored infiltration rates for the alluvium is less than 0.05 inches per hour. Therefore, infiltration on the property is considered infeasible based on the calculated infiltrations rates.

## GEOTECHNICAL CONSIDERATIONS

### Groundwater Elevations

Groundwater is not expected within 10 feet from the bottom of any proposed infiltration BMP's, therefore infiltration due to groundwater is feasible.

### New or Existing Utilities

We expect underground utilities are located beneath Barham Drive and within the public right of way on the northern portion of the project where the proposed stormwater BMP is situated. Therefore, full and partial infiltration within the areas near these utilities should be considered infeasible. Setbacks for infiltration should be incorporated. The setback for infiltration devices should be a minimum of 10 feet and not located below a 1:1 plane from top of BMP water high water elevation to the closest edge of the deepest adjacent utility.

### Existing or Planned Structures

Water should not be allowed to infiltrate in areas where it could affect the neighboring properties and adjacent structures. Mitigation for existing structures consists of not allowing water infiltration within 10 feet of the existing foundations.

### Soil or Groundwater Contamination

We are unaware of contaminated soil on the property. Therefore, infiltration associated with this risk is considered feasible. However, if contamination is present the underlying soil, the introduction of water could contribute to the underground migration of contaminants.

## CONCLUSIONS AND RECOMMENDATIONS

### Storm Water Evaluation Narrative

We encountered alluvium, colluvium and granitic rock at the site during our investigation. We performed one infiltration test within the alluvium and the results indicate a rate of 0.01 inches per hour (with an applied factor of safety of 2). We selected the test location to be within the footprint of the proposed BMP and adjacent to the exploratory trench.

### Storm Water Evaluation Conclusion

Based on our test results, the infiltration rate for the surficial soil is less than 0.05 inches per hour. Therefore, full or partial infiltration on the property is considered infeasible based on the calculated infiltrations rates.

### Storm Water Management Devices

Liners and subdrains should be incorporated into the design and construction of the planned storm water devices. The liners should be impermeable (e.g. High-density polyethylene, HDPE, with a thickness of about 30 mil or equivalent Polyvinyl Chloride, PVC) to prevent water migration. The subdrains should be perforated within the liner area, installed at the base and above the liner, be at least 4 inches in diameter and consist of Schedule 40 PVC pipe. The subdrains outside of the liner should consist of solid pipe. The penetration of the liners at the subdrains should be properly waterproofed. The subdrains should be connected to a proper outlet. The devices should also be installed in accordance with the manufacturer's recommendations. The liners can be removed from the base of the devices to allow incidental infiltration as discussed herein, provided an overflow device is installed to prevent overtopping of the BMP slopes.

### Storm Water Standard Worksheets

The City of San Marcos requests the geotechnical engineer complete the *Categorization of Infiltration Feasibility Condition* (Worksheet C.4-1) worksheet information to help evaluate the potential for infiltration on the property. Worksheet C.4-1 presents the completed information for the submittal process and is attached herein.

The regional storm water standards also have a worksheet (Worksheet D.5-1: Form I-9) that helps the project civil engineer estimate the factor of safety based on several factors. Table D-V describes the suitability assessment input parameters related to the geotechnical engineering aspects for the factor of safety determination.

**TABLE D-V  
SUITABILITY ASSESSMENT RELATED CONSIDERATIONS FOR INFILTRATION FACILITY  
SAFETY FACTORS**

| Consideration                          | High Concern – 3 Points  | Medium Concern – 2 Points   | Low Concern – 1 Point  |
|--|--|---|--|
| Assessment Methods                     | Use of soil survey maps or simple texture analysis to estimate short-term infiltration rates. Use of well permeameter or borehole methods without accompanying continuous boring log. Relatively sparse testing with direct infiltration methods | Use of well permeameter or borehole methods with accompanying continuous boring log. Direct measurement of infiltration area with localized infiltration measurement methods (e.g., Infiltrometer). Moderate spatial resolution | Direct measurement with localized (i.e. small-scale) infiltration testing methods at relatively high resolution or use of extensive test pit infiltration measurement methods. |
| Predominant Soil Texture               | Silty and clayey soils with significant fines  | Loamy soils   | Granular to slightly loamy soils   |
| Site Soil Variability                  | Highly variable soils indicated from site assessment or unknown variability  | Soil boring/test pits indicate moderately homogenous soils  | Soil boring/test pits indicate relatively homogenous soils   |
| Depth to Groundwater/ Impervious Layer | <5 feet below facility bottom  | 5-15 feet below facility bottom   | >15 feet below facility bottom   |

Based on our geotechnical investigation and the previous table, Table D-VI presents the estimated factor values for the evaluation of the factor of safety. This table only presents the suitability assessment safety factor (Part A) of the worksheet. The project civil engineer should evaluate the safety factor for design (Part B) and use the combined safety factor for the design infiltration rate.

**TABLE D-VI  
FACTOR OF SAFETY WORKSHEET DESIGN VALUES – PART A1**

| Suitability Assessment Factor Category               | Assigned Weight (w) | Factor Value (v) | Product (p = w x v) |
|--|---------------------|------------------|---------------------|
| Assessment Methods                                   | 0.25                | 3                | 0.75                |
| Predominant Soil Texture                             | 0.25                | 2                | 0.50                |
| Site Soil Variability                                | 0.25                | 2                | 0.50                |
| Depth to Groundwater/ Impervious Layer               | 0.25                | 1                | 0.25                |
| Suitability Assessment Safety Factor, $S_A = \sum p$ |                     |                  | 2.0                 |

\* The project civil engineer should complete Worksheet D.5-1 or Form I-9 using the data on this table. Additional information is required to evaluate the design factor of safety.

**Worksheet C.4-1: Categorization of Infiltration Feasibility Condition**

| Categorization of Infiltration Feasibility Condition   |   | Worksheet C.4-1 |    |
|--|---|-----------------|----|
| <p><b>Part 1 - Full Infiltration Feasibility Screening Criteria</b></p> <p><b>Would infiltration of the full design volume be feasible from a physical perspective without any undesirable consequences that cannot be reasonably mitigated?</b></p>   |   |                 |    |
| Criteria   | Screening Question  | Yes             | No |
| 1  | <p><b>Is the estimated reliable infiltration rate below proposed facility locations greater than 0.5 inches per hour?</b> The response to this Screening Question shall be based on a comprehensive evaluation of the factors presented in Appendix C.2 and Appendix D.</p>   |                 | X  |
| <p><b>Provide basis:</b> We performed one infiltration test using our Aardvark constant head permeameter. The results indicate a design infiltration rate of 0.01 inches per hour (with an applied factor of safety of 2). Full infiltration is considered infeasible if the design rate is below 0.5 iph. Therefore, full infiltration is not considered feasible at the site.</p>  |   |                 |    |
| 2  | <p><b>Can infiltration greater than 0.5 inches per hour be allowed without increasing risk of geotechnical hazards (slope stability, groundwater mounding, utilities, or other factors) that cannot be mitigated to an acceptable level?</b> The response to this Screening Question shall be based on a comprehensive evaluation of the factors presented in Appendix C.2.</p> | X               |    |
| <p><b>Provide basis:</b> Infiltration at the proposed location may result in lateral water migration that could adversely impact adjacent utilities, roadways, and foundations. The adverse impacts of infiltration could be reasonably mitigated to accepted levels provided side liners and a subdrain are incorporated into the design. In addition, an overflow device should be added to prevent overtopping of the BMP slopes.</p> |   |                 |    |

Worksheet C.4-1 Page 2 of 4

| Criteria   | Screening Question  | Yes | No        |
|--|---|-----|-----------|
| 3  | <p><b>Can infiltration greater than 0.5 inches per hour be allowed without increasing risk of groundwater contamination (shallow water table, storm water pollutants or other factors) that cannot be mitigated to an acceptable level? The response to this Screening Question shall be based on a comprehensive evaluation of the factors presented in Appendix C.3.</b></p>    | X   |           |
| <p>Provide basis: Groundwater is not located within 10 feet of the proposed BMP basin. The risk of storm water infiltration adversely impacting groundwater is considered negligible.</p> <p>Summarize findings of studies; provide reference to studies, calculations, maps, data sources, etc. Provide narrative discussion of study/data source applicability.</p>  |   |     |           |
| 4  | <p><b>Can infiltration greater than 0.5 inches per hour be allowed without causing potential water balance issues such as change of seasonality of ephemeral streams or increased discharge of contaminated groundwater to surface waters? The response to this Screening Question shall be based on a comprehensive evaluation of the factors presented in Appendix C.3.</b></p> | X   |           |
| <p>Provide basis: We are not aware of any potential water balance issues or change of ephemeral stream flow as a result of infiltrating storm water. Researching downstream water rights and evaluating water balance issues to stream flows is beyond the scope of the geotechnical engineer.</p> <p>Summarize findings of studies; provide reference to studies, calculations, maps, data sources, etc. Provide narrative discussion of study/data source applicability.</p> |   |     |           |
| <b>Part 1 Result*</b>  | <p>If all answers to rows 1 - 4 are "Yes" a full infiltration design is potentially feasible. The feasibility screening category is <b>Full Infiltration</b></p> <p>If any answer from row 1-4 is "No", infiltration may be possible to some extent but would not generally be feasible or desirable to achieve a "full infiltration" design. Proceed to Part 2</p>               |     | <b>NO</b> |

\*To be completed using gathered site information and best professional judgment considering the definition of MEP in the MS4 Permit. Additional testing and/or studies may be required by City Engineer to substantiate findings.

**Part 2 – Partial Infiltration vs. No Infiltration Feasibility Screening Criteria**

**Would infiltration of water in any appreciable amount be physically feasible without any negative consequences that cannot be reasonably mitigated?**

| Criteria | Screening Question   | Yes | No |
|----------|--|-----|----|
| 5        | <b>Do soil and geologic conditions allow for infiltration in any appreciable rate or volume?</b> The response to this Screening Question shall be based on a comprehensive evaluation of the factors presented in Appendix C.2 and Appendix D. |     | X  |

**Provide basis:** An appreciable rate is typically defined as a factored rate of at least 0.05 inches per hour (using a factor of safety of 2). Based on our experience and field testing, we anticipate that the saturated hydraulic conductivity (Ksat) of the compacted fill will be less than 0.05 inches per hour. The in-situ infiltration test results on the underlying alluvium indicated a design rate of 0.01 iph. The colluvium and granitic rock are expected to be less permeable than the alluvium tested. Therefore, in our opinion the soil and geologic conditions do not allow for infiltration in any appreciable rate or volume based on infiltration rates.

Summarize findings of studies; provide reference to studies, calculations, maps, data sources, etc. Provide narrative discussion of study/data source applicability and why it was not feasible to mitigate low infiltration rates.

|   |   |   |  |
|---|---|---|--|
| 6 | <b>Can Infiltration in any appreciable quantity be allowed without increasing risk of geotechnical hazards (slope stability, groundwater mounding, utilities, or other factors) that cannot be mitigated to an acceptable level?</b> The response to this Screening Question shall be based on a comprehensive evaluation of the factors presented in Appendix C.2. | X |  |
|---|---|---|--|

**Provide basis:** Infiltration at the proposed location may result in lateral water migration that could adversely impact adjacent utilities, roadways, and foundations. The adverse impacts of infiltration could be reasonably mitigated to accepted levels provided side liners and a subdrain are incorporated into the design. In addition, an overflow device should be added to prevent overtopping of the BMP slopes.

Summarize findings of studies; provide reference to studies, calculations, maps, data sources, etc. Provide narrative discussion of study/data source applicability and why it was not feasible to mitigate low infiltration rates.

Worksheet C.4-1 Page 4 of 4

| Criteria   | Screening Question   | Yes                           | No |
|--|--|-------------------------------|----|
| 7  | <p><b>Can Infiltration in any appreciable quantity be allowed without posing significant risk for groundwater related concerns (shallow water table, storm water pollutants or other factors)?</b> The response to this Screening Question shall be based on a comprehensive evaluation of the factors presented in Appendix C.3.</p>  | X                             |    |
| <p>Provide basis: Groundwater is not located within 10 feet of the proposed BMP basin. The risk of storm water infiltration adversely impacting groundwater is considered negligible.</p> <p>Summarize findings of studies; provide reference to studies, calculations, maps, data sources, etc. Provide narrative discussion of study/data source applicability and why it was not feasible to mitigate low infiltration rates.</p> |  |                               |    |
| 8  | <p><b>Can infiltration be allowed without violating downstream water rights?</b> The response to this Screening Question shall be based on a comprehensive evaluation of the factors presented in Appendix C.3.</p>  | X                             |    |
| <p>Provide basis: We are not aware of any downstream water rights. Researching downstream water rights is beyond the scope of the geotechnical engineer.</p> <p>Summarize findings of studies; provide reference to studies, calculations, maps, data sources, etc. Provide narrative discussion of study/data source applicability and why it was not feasible to mitigate low infiltration rates.</p>                              |  |                               |    |
| <p><b>Part 2 Result*</b></p>   | <p>If all answers from row 5-8 are yes then partial infiltration design is potentially feasible. The feasibility screening category is <b>Partial Infiltration</b>.</p> <p>If any answer from row 5-8 is no, then infiltration of any volume is considered to be <b>infeasible</b> within the drainage area. The feasibility screening category is <b>No Infiltration</b>.</p> | <p><b>No Infiltration</b></p> |    |

\*To be completed using gathered site information and best professional judgment considering the definition of MEP in the MS4 Permit. Additional testing and/or studies may be required by Agency/Jurisdictions to substantiate findings.



### Aardvark Permeameter Data Analysis

Project Name: 943 Barham  
 Project Number: G2516-32-01  
 Test Number: I-1

Date: 2/19/2020  
 By: AFR

Borehole Diameter, *d* (in.): 4.00  
 Borehole Depth, *H* (in.): 15.00  
 Distance Between Reservoir & Top of Borehole (in.): 51.00  
 Estimated Depth to Water Table, *S* (feet): 50.00  
 Height APM Raised from Bottom (in.): 2.00  
 Pressure Reducer Used: No

Ref. EL (feet, MSL): 651.0  
 Bottom EL (feet, MSL): 649.8

Distance Between Reservoir and APM Float, *D* (in.): 56.75

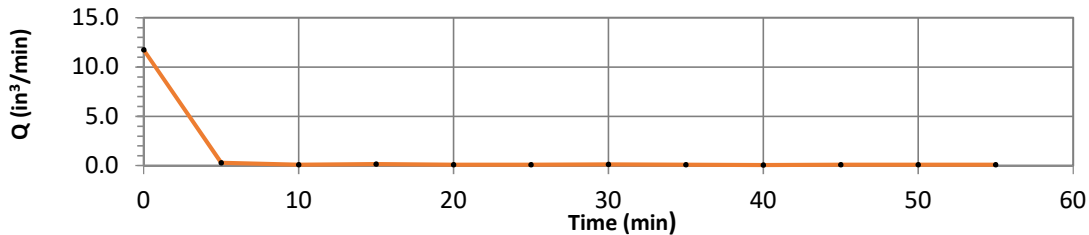
Head Height Calculated, *h* (in.): 5.69

Head Height Measured, *h* (in.): 4.25

Distance Between Constant Head and Water Table, *L* (in.): 589.25

| Reading | Time Elapsed (min) | Water Weight Consummed (lbs) | Water Volume Consummed (in <sup>3</sup> ) | Q (in <sup>3</sup> /min) |
|---------|--------------------|------------------------------|---|--------------------------|
| 1       | 0.00               | 0.000                        | 0.00                                      | 0.00                     |
| 2       | 5.00               | 2.120                        | 58.71                                     | 11.742                   |
| 3       | 5.00               | 0.050                        | 1.38                                      | 0.277                    |
| 4       | 5.00               | 0.015                        | 0.42                                      | 0.083                    |
| 5       | 5.00               | 0.030                        | 0.83                                      | 0.166                    |
| 6       | 5.00               | 0.015                        | 0.42                                      | 0.083                    |
| 7       | 5.00               | 0.020                        | 0.55                                      | 0.111                    |
| 8       | 5.00               | 0.025                        | 0.69                                      | 0.138                    |
| 9       | 5.00               | 0.015                        | 0.42                                      | 0.083                    |
| 10      | 5.00               | 0.010                        | 0.28                                      | 0.055                    |
| 11      | 5.00               | 0.020                        | 0.55                                      | 0.111                    |
| 12      | 5.00               | 0.015                        | 0.42                                      | 0.083                    |
| 13      | 5.00               | 0.015                        | 0.42                                      | 0.083                    |

Steady Flow Rate, *Q* (in<sup>3</sup>/min): 0.083



#### Soil Matrix Flux Potential, $\Phi_m$

$\Phi_m =$  0.00122 in<sup>2</sup>/min

#### Field-Saturated Hydraulic Conductivity (Infiltration Rate)

$K_{sat} =$  3.71E-04 in/min      0.022 in/hr





United States  
Department of  
Agriculture

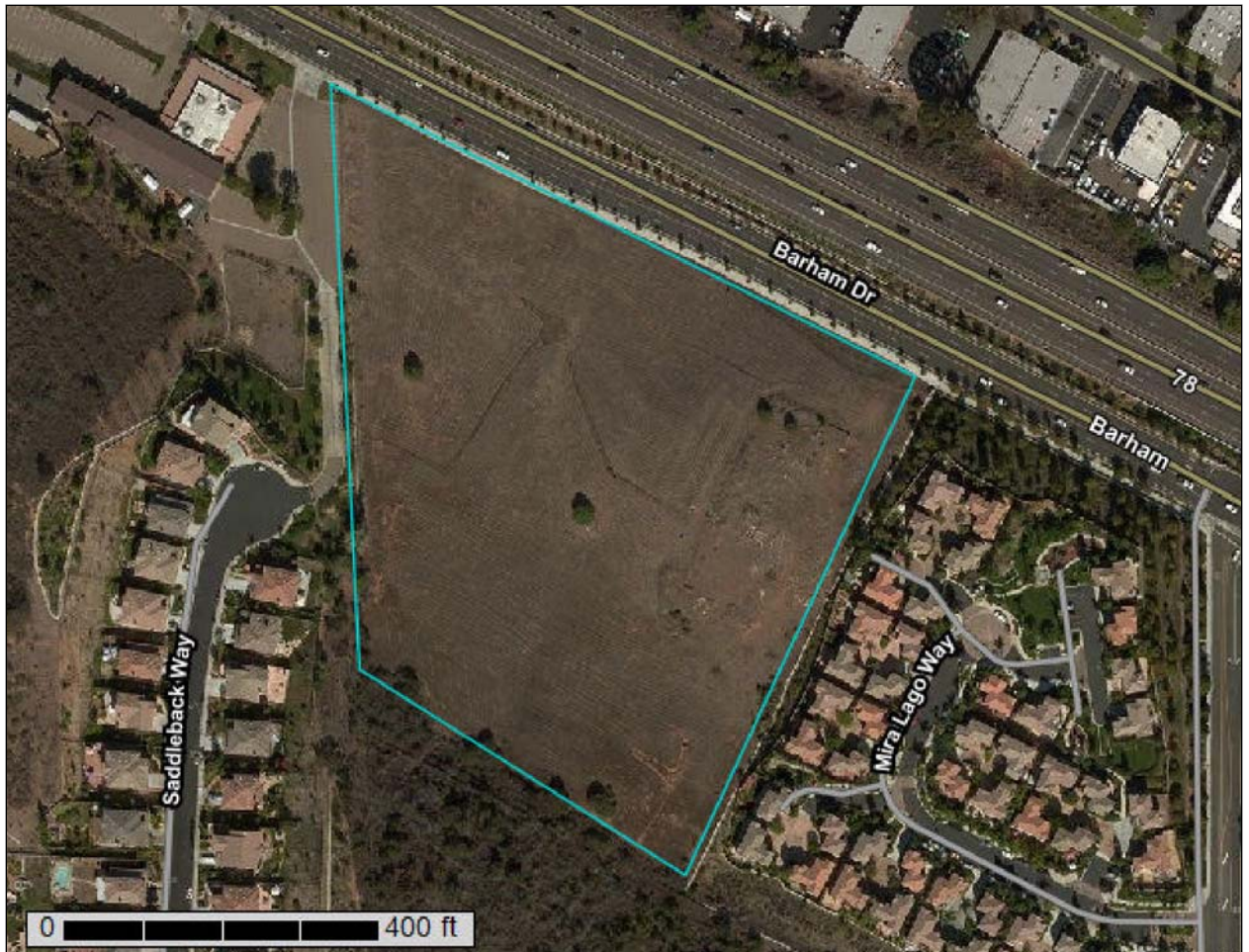
**NRCS**

Natural  
Resources  
Conservation  
Service

A product of the National  
Cooperative Soil Survey,  
a joint effort of the United  
States Department of  
Agriculture and other  
Federal agencies, State  
agencies including the  
Agricultural Experiment  
Stations, and local  
participants

# Custom Soil Resource Report for San Diego County Area, California

943 Barham Drive, San Marcos,  
CA



# Preface

---

Soil surveys contain information that affects land use planning in survey areas. They highlight soil limitations that affect various land uses and provide information about the properties of the soils in the survey areas. Soil surveys are designed for many different users, including farmers, ranchers, foresters, agronomists, urban planners, community officials, engineers, developers, builders, and home buyers. Also, conservationists, teachers, students, and specialists in recreation, waste disposal, and pollution control can use the surveys to help them understand, protect, or enhance the environment.

Various land use regulations of Federal, State, and local governments may impose special restrictions on land use or land treatment. Soil surveys identify soil properties that are used in making various land use or land treatment decisions. The information is intended to help the land users identify and reduce the effects of soil limitations on various land uses. The landowner or user is responsible for identifying and complying with existing laws and regulations.

Although soil survey information can be used for general farm, local, and wider area planning, onsite investigation is needed to supplement this information in some cases. Examples include soil quality assessments (<http://www.nrcs.usda.gov/wps/portal/nrcs/main/soils/health/>) and certain conservation and engineering applications. For more detailed information, contact your local USDA Service Center (<https://offices.sc.egov.usda.gov/locator/app?agency=nrcs>) or your NRCS State Soil Scientist ([http://www.nrcs.usda.gov/wps/portal/nrcs/detail/soils/contactus/?cid=nrcs142p2\\_053951](http://www.nrcs.usda.gov/wps/portal/nrcs/detail/soils/contactus/?cid=nrcs142p2_053951)).

Great differences in soil properties can occur within short distances. Some soils are seasonally wet or subject to flooding. Some are too unstable to be used as a foundation for buildings or roads. Clayey or wet soils are poorly suited to use as septic tank absorption fields. A high water table makes a soil poorly suited to basements or underground installations.

The National Cooperative Soil Survey is a joint effort of the United States Department of Agriculture and other Federal agencies, State agencies including the Agricultural Experiment Stations, and local agencies. The Natural Resources Conservation Service (NRCS) has leadership for the Federal part of the National Cooperative Soil Survey.

Information about soils is updated periodically. Updated information is available through the NRCS Web Soil Survey, the site for official soil survey information.

The U.S. Department of Agriculture (USDA) prohibits discrimination in all its programs and activities on the basis of race, color, national origin, age, disability, and where applicable, sex, marital status, familial status, parental status, religion, sexual orientation, genetic information, political beliefs, reprisal, or because all or a part of an individual's income is derived from any public assistance program. (Not all prohibited bases apply to all programs.) Persons with disabilities who require

alternative means for communication of program information (Braille, large print, audiotape, etc.) should contact USDA's TARGET Center at (202) 720-2600 (voice and TDD). To file a complaint of discrimination, write to USDA, Director, Office of Civil Rights, 1400 Independence Avenue, S.W., Washington, D.C. 20250-9410 or call (800) 795-3272 (voice) or (202) 720-6382 (TDD). USDA is an equal opportunity provider and employer.

# Contents

---

|  |    |
|--|----|
| <b>Preface</b> .....   | 2  |
| <b>How Soil Surveys Are Made</b> .....                             | 5  |
| <b>Soil Map</b> .....  | 8  |
| Soil Map.....  | 9  |
| Legend.....  | 10 |
| Map Unit Legend.....   | 11 |
| Map Unit Descriptions.....   | 11 |
| San Diego County Area, California.....                             | 13 |
| VsC—Vista coarse sandy loam, 5 to 9 percent slopes.....            | 13 |
| VsD—Vista coarse sandy loam, 9 to 15 percent slopes, MLRA 20.....  | 14 |
| VsE2—Vista coarse sandy loam, 15 to 30 percent slopes, eroded..... | 16 |
| <b>References</b> .....  | 18 |

# How Soil Surveys Are Made

---

Soil surveys are made to provide information about the soils and miscellaneous areas in a specific area. They include a description of the soils and miscellaneous areas and their location on the landscape and tables that show soil properties and limitations affecting various uses. Soil scientists observed the steepness, length, and shape of the slopes; the general pattern of drainage; the kinds of crops and native plants; and the kinds of bedrock. They observed and described many soil profiles. A soil profile is the sequence of natural layers, or horizons, in a soil. The profile extends from the surface down into the unconsolidated material in which the soil formed or from the surface down to bedrock. The unconsolidated material is devoid of roots and other living organisms and has not been changed by other biological activity.

Currently, soils are mapped according to the boundaries of major land resource areas (MLRAs). MLRAs are geographically associated land resource units that share common characteristics related to physiography, geology, climate, water resources, soils, biological resources, and land uses (USDA, 2006). Soil survey areas typically consist of parts of one or more MLRA.

The soils and miscellaneous areas in a survey area occur in an orderly pattern that is related to the geology, landforms, relief, climate, and natural vegetation of the area. Each kind of soil and miscellaneous area is associated with a particular kind of landform or with a segment of the landform. By observing the soils and miscellaneous areas in the survey area and relating their position to specific segments of the landform, a soil scientist develops a concept, or model, of how they were formed. Thus, during mapping, this model enables the soil scientist to predict with a considerable degree of accuracy the kind of soil or miscellaneous area at a specific location on the landscape.

Commonly, individual soils on the landscape merge into one another as their characteristics gradually change. To construct an accurate soil map, however, soil scientists must determine the boundaries between the soils. They can observe only a limited number of soil profiles. Nevertheless, these observations, supplemented by an understanding of the soil-vegetation-landscape relationship, are sufficient to verify predictions of the kinds of soil in an area and to determine the boundaries.

Soil scientists recorded the characteristics of the soil profiles that they studied. They noted soil color, texture, size and shape of soil aggregates, kind and amount of rock fragments, distribution of plant roots, reaction, and other features that enable them to identify soils. After describing the soils in the survey area and determining their properties, the soil scientists assigned the soils to taxonomic classes (units). Taxonomic classes are concepts. Each taxonomic class has a set of soil characteristics with precisely defined limits. The classes are used as a basis for comparison to classify soils systematically. Soil taxonomy, the system of taxonomic classification used in the United States, is based mainly on the kind and character of soil properties and the arrangement of horizons within the profile. After the soil

## Custom Soil Resource Report

scientists classified and named the soils in the survey area, they compared the individual soils with similar soils in the same taxonomic class in other areas so that they could confirm data and assemble additional data based on experience and research.

The objective of soil mapping is not to delineate pure map unit components; the objective is to separate the landscape into landforms or landform segments that have similar use and management requirements. Each map unit is defined by a unique combination of soil components and/or miscellaneous areas in predictable proportions. Some components may be highly contrasting to the other components of the map unit. The presence of minor components in a map unit in no way diminishes the usefulness or accuracy of the data. The delineation of such landforms and landform segments on the map provides sufficient information for the development of resource plans. If intensive use of small areas is planned, onsite investigation is needed to define and locate the soils and miscellaneous areas.

Soil scientists make many field observations in the process of producing a soil map. The frequency of observation is dependent upon several factors, including scale of mapping, intensity of mapping, design of map units, complexity of the landscape, and experience of the soil scientist. Observations are made to test and refine the soil-landscape model and predictions and to verify the classification of the soils at specific locations. Once the soil-landscape model is refined, a significantly smaller number of measurements of individual soil properties are made and recorded. These measurements may include field measurements, such as those for color, depth to bedrock, and texture, and laboratory measurements, such as those for content of sand, silt, clay, salt, and other components. Properties of each soil typically vary from one point to another across the landscape.

Observations for map unit components are aggregated to develop ranges of characteristics for the components. The aggregated values are presented. Direct measurements do not exist for every property presented for every map unit component. Values for some properties are estimated from combinations of other properties.

While a soil survey is in progress, samples of some of the soils in the area generally are collected for laboratory analyses and for engineering tests. Soil scientists interpret the data from these analyses and tests as well as the field-observed characteristics and the soil properties to determine the expected behavior of the soils under different uses. Interpretations for all of the soils are field tested through observation of the soils in different uses and under different levels of management. Some interpretations are modified to fit local conditions, and some new interpretations are developed to meet local needs. Data are assembled from other sources, such as research information, production records, and field experience of specialists. For example, data on crop yields under defined levels of management are assembled from farm records and from field or plot experiments on the same kinds of soil.

Predictions about soil behavior are based not only on soil properties but also on such variables as climate and biological activity. Soil conditions are predictable over long periods of time, but they are not predictable from year to year. For example, soil scientists can predict with a fairly high degree of accuracy that a given soil will have a high water table within certain depths in most years, but they cannot predict that a high water table will always be at a specific level in the soil on a specific date.

After soil scientists located and identified the significant natural bodies of soil in the survey area, they drew the boundaries of these bodies on aerial photographs and

## Custom Soil Resource Report

identified each as a specific map unit. Aerial photographs show trees, buildings, fields, roads, and rivers, all of which help in locating boundaries accurately.

# Soil Map

---

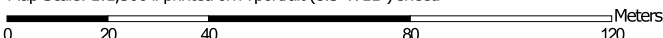
The soil map section includes the soil map for the defined area of interest, a list of soil map units on the map and extent of each map unit, and cartographic symbols displayed on the map. Also presented are various metadata about data used to produce the map, and a description of each soil map unit.



# Custom Soil Resource Report Soil Map







































Map Scale: 1:1,500 if printed on A portrait (8.5" x 11") sheet.



Map projection: Web Mercator Corner coordinates: WGS84 Edge tics: UTM Zone 11N WGS84



## MAP LEGEND

|                               |  |   |
|-------------------------------|--|---|
| <b>Area of Interest (AOI)</b> |  Area of Interest (AOI) |  Spoil Area            |
| <b>Soils</b>                  |  Soil Map Unit Polygons |  Stony Spot            |
|                               |  Soil Map Unit Lines    |  Very Stony Spot       |
|                               |  Soil Map Unit Points   |  Wet Spot              |
| <b>Special Point Features</b> |  Blowout                |  Other                 |
|                               |  Borrow Pit             |  Special Line Features |
|                               |  Clay Spot              | <b>Water Features</b>   |
|                               |  Closed Depression      |  Streams and Canals    |
|                               |  Gravel Pit             | <b>Transportation</b>   |
|                               |  Gravelly Spot          |  Rails                 |
|                               |  Landfill               |  Interstate Highways   |
|                               |  Lava Flow              |  US Routes             |
|                               |  Marsh or swamp         |  Major Roads           |
|                               |  Mine or Quarry         |  Local Roads           |
|                               |  Miscellaneous Water    | <b>Background</b>   |
|                               |  Perennial Water        |  Aerial Photography    |
|                               |  Rock Outcrop           |   |
|                               |  Saline Spot            |   |
|                               |  Sandy Spot             |   |
|                               |  Severely Eroded Spot   |   |
|                               |  Sinkhole               |   |
|                               |  Slide or Slip         |   |
|                               |  Sodic Spot           |   |

## MAP INFORMATION

The soil surveys that comprise your AOI were mapped at 1:24,000.

Warning: Soil Map may not be valid at this scale.

Enlargement of maps beyond the scale of mapping can cause misunderstanding of the detail of mapping and accuracy of soil line placement. The maps do not show the small areas of contrasting soils that could have been shown at a more detailed scale.

Please rely on the bar scale on each map sheet for map measurements.

Source of Map: Natural Resources Conservation Service  
 Web Soil Survey URL:  
 Coordinate System: Web Mercator (EPSG:3857)

Maps from the Web Soil Survey are based on the Web Mercator projection, which preserves direction and shape but distorts distance and area. A projection that preserves area, such as the Albers equal-area conic projection, should be used if more accurate calculations of distance or area are required.

This product is generated from the USDA-NRCS certified data as of the version date(s) listed below.

Soil Survey Area: San Diego County Area, California  
 Survey Area Data: Version 14, Sep 16, 2019

Soil map units are labeled (as space allows) for map scales 1:50,000 or larger.

Date(s) aerial images were photographed: Nov 3, 2014—Nov 22, 2014

The orthophoto or other base map on which the soil lines were compiled and digitized probably differs from the background imagery displayed on these maps. As a result, some minor shifting of map unit boundaries may be evident.

## Map Unit Legend

| Map Unit Symbol                    | Map Unit Name  | Acres in AOI | Percent of AOI |
|------------------------------------|--|--------------|----------------|
| VsC                                | Vista coarse sandy loam, 5 to 9 percent slopes           | 6.7          | 67.2%          |
| VsD                                | Vista coarse sandy loam, 9 to 15 percent slopes, MLRA 20 | 0.7          | 7.3%           |
| VsE2                               | Vista coarse sandy loam, 15 to 30 percent slopes, eroded | 2.6          | 25.5%          |
| <b>Totals for Area of Interest</b> |  | <b>10.0</b>  | <b>100.0%</b>  |

## Map Unit Descriptions

The map units delineated on the detailed soil maps in a soil survey represent the soils or miscellaneous areas in the survey area. The map unit descriptions, along with the maps, can be used to determine the composition and properties of a unit.

A map unit delineation on a soil map represents an area dominated by one or more major kinds of soil or miscellaneous areas. A map unit is identified and named according to the taxonomic classification of the dominant soils. Within a taxonomic class there are precisely defined limits for the properties of the soils. On the landscape, however, the soils are natural phenomena, and they have the characteristic variability of all natural phenomena. Thus, the range of some observed properties may extend beyond the limits defined for a taxonomic class. Areas of soils of a single taxonomic class rarely, if ever, can be mapped without including areas of other taxonomic classes. Consequently, every map unit is made up of the soils or miscellaneous areas for which it is named and some minor components that belong to taxonomic classes other than those of the major soils.

Most minor soils have properties similar to those of the dominant soil or soils in the map unit, and thus they do not affect use and management. These are called noncontrasting, or similar, components. They may or may not be mentioned in a particular map unit description. Other minor components, however, have properties and behavioral characteristics divergent enough to affect use or to require different management. These are called contrasting, or dissimilar, components. They generally are in small areas and could not be mapped separately because of the scale used. Some small areas of strongly contrasting soils or miscellaneous areas are identified by a special symbol on the maps. If included in the database for a given area, the contrasting minor components are identified in the map unit descriptions along with some characteristics of each. A few areas of minor components may not have been observed, and consequently they are not mentioned in the descriptions, especially where the pattern was so complex that it was impractical to make enough observations to identify all the soils and miscellaneous areas on the landscape.

The presence of minor components in a map unit in no way diminishes the usefulness or accuracy of the data. The objective of mapping is not to delineate pure taxonomic classes but rather to separate the landscape into landforms or

## Custom Soil Resource Report

landform segments that have similar use and management requirements. The delineation of such segments on the map provides sufficient information for the development of resource plans. If intensive use of small areas is planned, however, onsite investigation is needed to define and locate the soils and miscellaneous areas.

An identifying symbol precedes the map unit name in the map unit descriptions. Each description includes general facts about the unit and gives important soil properties and qualities.

Soils that have profiles that are almost alike make up a *soil series*. Except for differences in texture of the surface layer, all the soils of a series have major horizons that are similar in composition, thickness, and arrangement.

Soils of one series can differ in texture of the surface layer, slope, stoniness, salinity, degree of erosion, and other characteristics that affect their use. On the basis of such differences, a soil series is divided into *soil phases*. Most of the areas shown on the detailed soil maps are phases of soil series. The name of a soil phase commonly indicates a feature that affects use or management. For example, Alpha silt loam, 0 to 2 percent slopes, is a phase of the Alpha series.

Some map units are made up of two or more major soils or miscellaneous areas. These map units are complexes, associations, or undifferentiated groups.

A *complex* consists of two or more soils or miscellaneous areas in such an intricate pattern or in such small areas that they cannot be shown separately on the maps. The pattern and proportion of the soils or miscellaneous areas are somewhat similar in all areas. Alpha-Beta complex, 0 to 6 percent slopes, is an example.

An *association* is made up of two or more geographically associated soils or miscellaneous areas that are shown as one unit on the maps. Because of present or anticipated uses of the map units in the survey area, it was not considered practical or necessary to map the soils or miscellaneous areas separately. The pattern and relative proportion of the soils or miscellaneous areas are somewhat similar. Alpha-Beta association, 0 to 2 percent slopes, is an example.

An *undifferentiated group* is made up of two or more soils or miscellaneous areas that could be mapped individually but are mapped as one unit because similar interpretations can be made for use and management. The pattern and proportion of the soils or miscellaneous areas in a mapped area are not uniform. An area can be made up of only one of the major soils or miscellaneous areas, or it can be made up of all of them. Alpha and Beta soils, 0 to 2 percent slopes, is an example.

Some surveys include *miscellaneous areas*. Such areas have little or no soil material and support little or no vegetation. Rock outcrop is an example.

## San Diego County Area, California

### VsC—Vista coarse sandy loam, 5 to 9 percent slopes

#### Map Unit Setting

*National map unit symbol:* hbh8

*Elevation:* 400 to 3,900 feet

*Mean annual precipitation:* 10 to 18 inches

*Mean annual air temperature:* 59 to 64 degrees F

*Frost-free period:* 210 to 300 days

*Farmland classification:* Farmland of statewide importance

#### Map Unit Composition

*Vista and similar soils:* 85 percent

*Minor components:* 15 percent

*Estimates are based on observations, descriptions, and transects of the mapunit.*

#### Description of Vista

##### Setting

*Landform:* Hills

*Landform position (two-dimensional):* Backslope

*Landform position (three-dimensional):* Side slope

*Down-slope shape:* Convex

*Across-slope shape:* Convex

*Parent material:* Residuum weathered from granodiorite and quartz-diorite

##### Typical profile

*H1 - 0 to 19 inches:* coarse sandy loam

*H2 - 19 to 35 inches:* coarse sandy loam, sandy loam

*H2 - 19 to 35 inches:* weathered bedrock

*H3 - 35 to 39 inches:*

##### Properties and qualities

*Slope:* 5 to 9 percent

*Depth to restrictive feature:* 20 to 40 inches to paralithic bedrock

*Natural drainage class:* Well drained

*Runoff class:* Low

*Capacity of the most limiting layer to transmit water (Ksat):* High (1.98 to 5.95 in/hr)

*Depth to water table:* More than 80 inches

*Frequency of flooding:* None

*Frequency of ponding:* None

*Available water storage in profile:* Low (about 5.6 inches)

##### Interpretive groups

*Land capability classification (irrigated):* 3e

*Land capability classification (nonirrigated):* 4e

*Hydrologic Soil Group:* B

*Ecological site:* LOAMY (1975) (R019XD029CA)

*Hydric soil rating:* No

#### Minor Components

##### Fallbrook

*Percent of map unit:* 5 percent

## Custom Soil Resource Report

*Hydric soil rating:* No

### **Bonsall**

*Percent of map unit:* 5 percent

*Hydric soil rating:* No

### **Greenfield**

*Percent of map unit:* 3 percent

*Hydric soil rating:* No

### **Ramona**

*Percent of map unit:* 2 percent

*Hydric soil rating:* No

## **VsD—Vista coarse sandy loam, 9 to 15 percent slopes, MLRA 20**

### **Map Unit Setting**

*National map unit symbol:* 2xgtp

*Elevation:* 70 to 3,900 feet

*Mean annual precipitation:* 13 to 17 inches

*Mean annual air temperature:* 62 to 65 degrees F

*Frost-free period:* 320 to 360 days

*Farmland classification:* Not prime farmland

### **Map Unit Composition**

*Vista and similar soils:* 85 percent

*Minor components:* 15 percent

*Estimates are based on observations, descriptions, and transects of the mapunit.*

### **Description of Vista**

#### **Setting**

*Landform:* Hills

*Landform position (two-dimensional):* Backslope

*Landform position (three-dimensional):* Side slope

*Down-slope shape:* Convex

*Across-slope shape:* Convex

*Parent material:* Residuum weathered from granodiorite and quartz-diorite

#### **Typical profile**

*A - 0 to 3 inches:* coarse sandy loam

*Bw - 3 to 19 inches:* coarse sandy loam

*C - 19 to 35 inches:* coarse sandy loam

*Cr - 35 to 45 inches:* weathered bedrock

#### **Properties and qualities**

*Slope:* 9 to 15 percent

*Depth to restrictive feature:* 20 to 40 inches to paralithic bedrock

*Natural drainage class:* Well drained

*Runoff class:* Low

*Capacity of the most limiting layer to transmit water (Ksat):* Very low to moderately low (0.00 to 0.06 in/hr)

## Custom Soil Resource Report

*Depth to water table:* More than 80 inches  
*Frequency of flooding:* None  
*Frequency of ponding:* None  
*Salinity, maximum in profile:* Nonsaline (0.0 to 1.0 mmhos/cm)  
*Available water storage in profile:* Low (about 3.5 inches)

### Interpretive groups

*Land capability classification (irrigated):* 4e  
*Land capability classification (nonirrigated):* 4e  
*Hydrologic Soil Group:* B  
*Ecological site:* LOAMY (1975) (R019XD029CA)  
*Hydric soil rating:* No

### Minor Components

#### Cieneba

*Percent of map unit:* 4 percent  
*Landform:* Hills  
*Landform position (two-dimensional):* Shoulder  
*Landform position (three-dimensional):* Side slope  
*Down-slope shape:* Convex  
*Across-slope shape:* Convex  
*Hydric soil rating:* No

#### Rock outcrop

*Percent of map unit:* 3 percent  
*Hydric soil rating:* No

#### Fallbrook

*Percent of map unit:* 3 percent  
*Landform:* Hills  
*Landform position (two-dimensional):* Backslope  
*Landform position (three-dimensional):* Side slope  
*Down-slope shape:* Convex  
*Across-slope shape:* Convex  
*Hydric soil rating:* No

#### Bonsall

*Percent of map unit:* 3 percent  
*Landform:* Hills  
*Landform position (two-dimensional):* Backslope  
*Landform position (three-dimensional):* Side slope  
*Down-slope shape:* Concave  
*Across-slope shape:* Concave  
*Hydric soil rating:* No

#### Capistrano

*Percent of map unit:* 2 percent  
*Landform:* Hills  
*Landform position (two-dimensional):* Toeslope  
*Landform position (three-dimensional):* Base slope  
*Down-slope shape:* Linear  
*Across-slope shape:* Linear  
*Hydric soil rating:* No



## **VsE2—Vista coarse sandy loam, 15 to 30 percent slopes, eroded**

### **Map Unit Setting**

*National map unit symbol:* hbhd  
*Elevation:* 400 to 3,900 feet  
*Mean annual precipitation:* 10 to 18 inches  
*Mean annual air temperature:* 59 to 64 degrees F  
*Frost-free period:* 210 to 300 days  
*Farmland classification:* Not prime farmland

### **Map Unit Composition**

*Vista and similar soils:* 85 percent  
*Minor components:* 15 percent  
*Estimates are based on observations, descriptions, and transects of the mapunit.*

### **Description of Vista**

#### **Setting**

*Landform:* Hills  
*Landform position (two-dimensional):* Backslope  
*Landform position (three-dimensional):* Side slope  
*Down-slope shape:* Convex  
*Across-slope shape:* Convex  
*Parent material:* Residuum weathered from granodiorite and quartz-diorite

#### **Typical profile**

*H1 - 0 to 15 inches:* coarse sandy loam  
*H2 - 15 to 30 inches:* coarse sandy loam, sandy loam  
*H2 - 15 to 30 inches:* weathered bedrock  
*H3 - 30 to 34 inches:*

#### **Properties and qualities**

*Slope:* 15 to 30 percent  
*Depth to restrictive feature:* 20 to 40 inches to paralithic bedrock  
*Natural drainage class:* Well drained  
*Runoff class:* Medium  
*Capacity of the most limiting layer to transmit water (Ksat):* High (1.98 to 5.95 in/hr)  
*Depth to water table:* More than 80 inches  
*Frequency of flooding:* None  
*Frequency of ponding:* None  
*Available water storage in profile:* Low (about 4.9 inches)

#### **Interpretive groups**

*Land capability classification (irrigated):* 6e  
*Land capability classification (nonirrigated):* 6e  
*Hydrologic Soil Group:* B  
*Ecological site:* LOAMY (1975) (R019XD029CA)  
*Hydric soil rating:* No



## Custom Soil Resource Report

### Minor Components

#### **Fallbrook**

*Percent of map unit: 10 percent*

*Hydric soil rating: No*

#### **Cieneba**

*Percent of map unit: 5 percent*

*Hydric soil rating: No*

# References

---

- American Association of State Highway and Transportation Officials (AASHTO). 2004. Standard specifications for transportation materials and methods of sampling and testing. 24th edition.
- American Society for Testing and Materials (ASTM). 2005. Standard classification of soils for engineering purposes. ASTM Standard D2487-00.
- Cowardin, L.M., V. Carter, F.C. Golet, and E.T. LaRoe. 1979. Classification of wetlands and deep-water habitats of the United States. U.S. Fish and Wildlife Service FWS/OBS-79/31.
- Federal Register. July 13, 1994. Changes in hydric soils of the United States.
- Federal Register. September 18, 2002. Hydric soils of the United States.
- Hurt, G.W., and L.M. Vasilas, editors. Version 6.0, 2006. Field indicators of hydric soils in the United States.
- National Research Council. 1995. Wetlands: Characteristics and boundaries.
- Soil Survey Division Staff. 1993. Soil survey manual. Soil Conservation Service. U.S. Department of Agriculture Handbook 18. [http://www.nrcs.usda.gov/wps/portal/nrcs/detail/national/soils/?cid=nrcs142p2\\_054262](http://www.nrcs.usda.gov/wps/portal/nrcs/detail/national/soils/?cid=nrcs142p2_054262)
- Soil Survey Staff. 1999. Soil taxonomy: A basic system of soil classification for making and interpreting soil surveys. 2nd edition. Natural Resources Conservation Service, U.S. Department of Agriculture Handbook 436. [http://www.nrcs.usda.gov/wps/portal/nrcs/detail/national/soils/?cid=nrcs142p2\\_053577](http://www.nrcs.usda.gov/wps/portal/nrcs/detail/national/soils/?cid=nrcs142p2_053577)
- Soil Survey Staff. 2010. Keys to soil taxonomy. 11th edition. U.S. Department of Agriculture, Natural Resources Conservation Service. [http://www.nrcs.usda.gov/wps/portal/nrcs/detail/national/soils/?cid=nrcs142p2\\_053580](http://www.nrcs.usda.gov/wps/portal/nrcs/detail/national/soils/?cid=nrcs142p2_053580)
- Tiner, R.W., Jr. 1985. Wetlands of Delaware. U.S. Fish and Wildlife Service and Delaware Department of Natural Resources and Environmental Control, Wetlands Section.
- United States Army Corps of Engineers, Environmental Laboratory. 1987. Corps of Engineers wetlands delineation manual. Waterways Experiment Station Technical Report Y-87-1.
- United States Department of Agriculture, Natural Resources Conservation Service. National forestry manual. [http://www.nrcs.usda.gov/wps/portal/nrcs/detail/soils/home/?cid=nrcs142p2\\_053374](http://www.nrcs.usda.gov/wps/portal/nrcs/detail/soils/home/?cid=nrcs142p2_053374)
- United States Department of Agriculture, Natural Resources Conservation Service. National range and pasture handbook. <http://www.nrcs.usda.gov/wps/portal/nrcs/detail/national/landuse/rangepasture/?cid=stelprdb1043084>

## Custom Soil Resource Report

United States Department of Agriculture, Natural Resources Conservation Service. National soil survey handbook, title 430-VI. [http://www.nrcs.usda.gov/wps/portal/nrcs/detail/soils/scientists/?cid=nrcs142p2\\_054242](http://www.nrcs.usda.gov/wps/portal/nrcs/detail/soils/scientists/?cid=nrcs142p2_054242)

United States Department of Agriculture, Natural Resources Conservation Service. 2006. Land resource regions and major land resource areas of the United States, the Caribbean, and the Pacific Basin. U.S. Department of Agriculture Handbook 296. [http://www.nrcs.usda.gov/wps/portal/nrcs/detail/national/soils/?cid=nrcs142p2\\_053624](http://www.nrcs.usda.gov/wps/portal/nrcs/detail/national/soils/?cid=nrcs142p2_053624)

United States Department of Agriculture, Soil Conservation Service. 1961. Land capability classification. U.S. Department of Agriculture Handbook 210. [http://www.nrcs.usda.gov/Internet/FSE\\_DOCUMENTS/nrcs142p2\\_052290.pdf](http://www.nrcs.usda.gov/Internet/FSE_DOCUMENTS/nrcs142p2_052290.pdf)

APPENDIX

A solid green triangle pointing to the left, containing the letter 'E' in white.

E

**APPENDIX E**

**RECOMMENDED GRADING SPECIFICATIONS**

**FOR**

**943 BARHAM DRIVE**  
**SAN MARCOS, CALIFORNIA**

**PROJECT NO. G2516-32-01**

## RECOMMENDED GRADING SPECIFICATIONS

### 1. GENERAL

- 1.1 These Recommended Grading Specifications shall be used in conjunction with the Geotechnical Report for the project prepared by Geocon. The recommendations contained in the text of the Geotechnical Report are a part of the earthwork and grading specifications and shall supersede the provisions contained hereinafter in the case of conflict.
- 1.2 Prior to the commencement of grading, a geotechnical consultant (Consultant) shall be employed for the purpose of observing earthwork procedures and testing the fills for substantial conformance with the recommendations of the Geotechnical Report and these specifications. The Consultant should provide adequate testing and observation services so that they may assess whether, in their opinion, the work was performed in substantial conformance with these specifications. It shall be the responsibility of the Contractor to assist the Consultant and keep them apprised of work schedules and changes so that personnel may be scheduled accordingly.
- 1.3 It shall be the sole responsibility of the Contractor to provide adequate equipment and methods to accomplish the work in accordance with applicable grading codes or agency ordinances, these specifications and the approved grading plans. If, in the opinion of the Consultant, unsatisfactory conditions such as questionable soil materials, poor moisture condition, inadequate compaction, and/or adverse weather result in a quality of work not in conformance with these specifications, the Consultant will be empowered to reject the work and recommend to the Owner that grading be stopped until the unacceptable conditions are corrected.

### 2. DEFINITIONS

- 2.1 **Owner** shall refer to the owner of the property or the entity on whose behalf the grading work is being performed and who has contracted with the Contractor to have grading performed.
- 2.2 **Contractor** shall refer to the Contractor performing the site grading work.
- 2.3 **Civil Engineer** or **Engineer of Work** shall refer to the California licensed Civil Engineer or consulting firm responsible for preparation of the grading plans, surveying and verifying as-graded topography.
- 2.4 **Consultant** shall refer to the soil engineering and engineering geology consulting firm retained to provide geotechnical services for the project.



- 2.5 **Soil Engineer** shall refer to a California licensed Civil Engineer retained by the Owner, who is experienced in the practice of geotechnical engineering. The Soil Engineer shall be responsible for having qualified representatives on-site to observe and test the Contractor's work for conformance with these specifications.
- 2.6 **Engineering Geologist** shall refer to a California licensed Engineering Geologist retained by the Owner to provide geologic observations and recommendations during the site grading.
- 2.7 **Geotechnical Report** shall refer to a soil report (including all addenda) which may include a geologic reconnaissance or geologic investigation that was prepared specifically for the development of the project for which these Recommended Grading Specifications are intended to apply.

### 3. MATERIALS

- 3.1 Materials for compacted fill shall consist of any soil excavated from the cut areas or imported to the site that, in the opinion of the Consultant, is suitable for use in construction of fills. In general, fill materials can be classified as *soil* fills, *soil-rock* fills or *rock* fills, as defined below.
- 3.1.1 **Soil fills** are defined as fills containing no rocks or hard lumps greater than 12 inches in maximum dimension and containing at least 40 percent by weight of material smaller than  $\frac{3}{4}$  inch in size.
- 3.1.2 **Soil-rock fills** are defined as fills containing no rocks or hard lumps larger than 4 feet in maximum dimension and containing a sufficient matrix of soil fill to allow for proper compaction of soil fill around the rock fragments or hard lumps as specified in Paragraph 6.2. **Oversize rock** is defined as material greater than 12 inches.
- 3.1.3 **Rock fills** are defined as fills containing no rocks or hard lumps larger than 3 feet in maximum dimension and containing little or no fines. Fines are defined as material smaller than  $\frac{3}{4}$  inch in maximum dimension. The quantity of fines shall be less than approximately 20 percent of the rock fill quantity.
- 3.2 Material of a perishable, spongy, or otherwise unsuitable nature as determined by the Consultant shall not be used in fills.
- 3.3 Materials used for fill, either imported or on-site, shall not contain hazardous materials as defined by the California Code of Regulations, Title 22, Division 4, Chapter 30, Articles 9

and 10; 40CFR; and any other applicable local, state or federal laws. The Consultant shall not be responsible for the identification or analysis of the potential presence of hazardous materials. However, if observations, odors or soil discoloration cause Consultant to suspect the presence of hazardous materials, the Consultant may request from the Owner the termination of grading operations within the affected area. Prior to resuming grading operations, the Owner shall provide a written report to the Consultant indicating that the suspected materials are not hazardous as defined by applicable laws and regulations.

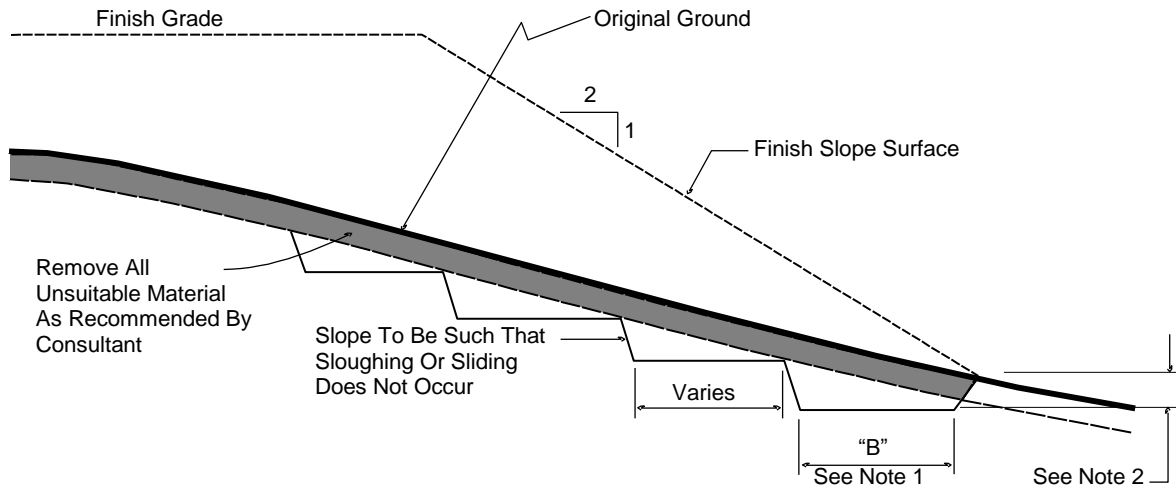
- 3.4 The outer 15 feet of *soil-rock* fill slopes, measured horizontally, should be composed of properly compacted *soil* fill materials approved by the Consultant. *Rock* fill may extend to the slope face, provided that the slope is not steeper than 2:1 (horizontal:vertical) and a soil layer no thicker than 12 inches is track-walked onto the face for landscaping purposes. This procedure may be utilized provided it is acceptable to the governing agency, Owner and Consultant.
- 3.5 Samples of soil materials to be used for fill should be tested in the laboratory by the Consultant to determine the maximum density, optimum moisture content, and, where appropriate, shear strength, expansion, and gradation characteristics of the soil.
- 3.6 During grading, soil or groundwater conditions other than those identified in the Geotechnical Report may be encountered by the Contractor. The Consultant shall be notified immediately to evaluate the significance of the unanticipated condition.

#### **4. CLEARING AND PREPARING AREAS TO BE FILLED**

- 4.1 Areas to be excavated and filled shall be cleared and grubbed. Clearing shall consist of complete removal above the ground surface of trees, stumps, brush, vegetation, man-made structures, and similar debris. Grubbing shall consist of removal of stumps, roots, buried logs and other unsuitable material and shall be performed in areas to be graded. Roots and other projections exceeding 1½ inches in diameter shall be removed to a depth of 3 feet below the surface of the ground. Borrow areas shall be grubbed to the extent necessary to provide suitable fill materials.
- 4.2 Asphalt pavement material removed during clearing operations should be properly disposed at an approved off-site facility or in an acceptable area of the project evaluated by Geocon and the property owner. Concrete fragments that are free of reinforcing steel may be placed in fills, provided they are placed in accordance with Section 6.2 or 6.3 of this document.

- 4.3 After clearing and grubbing of organic matter and other unsuitable material, loose or porous soils shall be removed to the depth recommended in the Geotechnical Report. The depth of removal and compaction should be observed and approved by a representative of the Consultant. The exposed surface shall then be plowed or scarified to a minimum depth of 6 inches and until the surface is free from uneven features that would tend to prevent uniform compaction by the equipment to be used.
- 4.4 Where the slope ratio of the original ground is steeper than 5:1 (horizontal:vertical), or where recommended by the Consultant, the original ground should be benched in accordance with the following illustration.

**TYPICAL BENCHING DETAIL**



No Scale

- DETAIL NOTES: (1) Key width "B" should be a minimum of 10 feet, or sufficiently wide to permit complete coverage with the compaction equipment used. The base of the key should be graded horizontal, or inclined slightly into the natural slope.
- (2) The outside of the key should be below the topsoil or unsuitable surficial material and at least 2 feet into dense formational material. Where hard rock is exposed in the bottom of the key, the depth and configuration of the key may be modified as approved by the Consultant.

- 4.5 After areas to receive fill have been cleared and scarified, the surface should be moisture conditioned to achieve the proper moisture content, and compacted as recommended in Section 6 of these specifications.

## 5. COMPACTION EQUIPMENT

- 5.1 Compaction of *soil* or *soil-rock* fill shall be accomplished by sheepsfoot or segmented-steel wheeled rollers, vibratory rollers, multiple-wheel pneumatic-tired rollers, or other types of acceptable compaction equipment. Equipment shall be of such a design that it will be capable of compacting the *soil* or *soil-rock* fill to the specified relative compaction at the specified moisture content.
- 5.2 Compaction of *rock* fills shall be performed in accordance with Section 6.3.

## 6. PLACING, SPREADING AND COMPACTION OF FILL MATERIAL

- 6.1 *Soil* fill, as defined in Paragraph 3.1.1, shall be placed by the Contractor in accordance with the following recommendations:
- 6.1.1 *Soil* fill shall be placed by the Contractor in layers that, when compacted, should generally not exceed 8 inches. Each layer shall be spread evenly and shall be thoroughly mixed during spreading to obtain uniformity of material and moisture in each layer. The entire fill shall be constructed as a unit in nearly level lifts. Rock materials greater than 12 inches in maximum dimension shall be placed in accordance with Section 6.2 or 6.3 of these specifications.
- 6.1.2 In general, the *soil* fill shall be compacted at a moisture content at or above the optimum moisture content as determined by ASTM D 1557.
- 6.1.3 When the moisture content of *soil* fill is below that specified by the Consultant, water shall be added by the Contractor until the moisture content is in the range specified.
- 6.1.4 When the moisture content of the *soil* fill is above the range specified by the Consultant or too wet to achieve proper compaction, the *soil* fill shall be aerated by the Contractor by blading/mixing, or other satisfactory methods until the moisture content is within the range specified.
- 6.1.5 After each layer has been placed, mixed, and spread evenly, it shall be thoroughly compacted by the Contractor to a relative compaction of at least 90 percent. Relative compaction is defined as the ratio (expressed in percent) of the in-place dry density of the compacted fill to the maximum laboratory dry density as determined in accordance with ASTM D 1557. Compaction shall be continuous over the entire area, and compaction equipment shall make sufficient passes so that the specified minimum relative compaction has been achieved throughout the entire fill.

- 6.1.6 Where practical, soils having an Expansion Index greater than 50 should be placed at least 3 feet below finish pad grade and should be compacted at a moisture content generally 2 to 4 percent greater than the optimum moisture content for the material.
  - 6.1.7 Properly compacted *soil* fill shall extend to the design surface of fill slopes. To achieve proper compaction, it is recommended that fill slopes be over-built by at least 3 feet and then cut to the design grade. This procedure is considered preferable to track-walking of slopes, as described in the following paragraph.
  - 6.1.8 As an alternative to over-building of slopes, slope faces may be back-rolled with a heavy-duty loaded sheepsfoot or vibratory roller at maximum 4-foot fill height intervals. Upon completion, slopes should then be track-walked with a D-8 dozer or similar equipment, such that a dozer track covers all slope surfaces at least twice.
- 6.2 *Soil-rock* fill, as defined in Paragraph 3.1.2, shall be placed by the Contractor in accordance with the following recommendations:
- 6.2.1 Rocks larger than 12 inches but less than 4 feet in maximum dimension may be incorporated into the compacted *soil* fill, but shall be limited to the area measured 15 feet minimum horizontally from the slope face and 5 feet below finish grade or 3 feet below the deepest utility, whichever is deeper.
  - 6.2.2 Rocks or rock fragments up to 4 feet in maximum dimension may either be individually placed or placed in windrows. Under certain conditions, rocks or rock fragments up to 10 feet in maximum dimension may be placed using similar methods. The acceptability of placing rock materials greater than 4 feet in maximum dimension shall be evaluated during grading as specific cases arise and shall be approved by the Consultant prior to placement.
  - 6.2.3 For individual placement, sufficient space shall be provided between rocks to allow for passage of compaction equipment.
  - 6.2.4 For windrow placement, the rocks should be placed in trenches excavated in properly compacted *soil* fill. Trenches should be approximately 5 feet wide and 4 feet deep in maximum dimension. The voids around and beneath rocks should be filled with approved granular soil having a Sand Equivalent of 30 or greater and should be compacted by flooding. Windrows may also be placed utilizing an "open-face" method in lieu of the trench procedure, however, this method should first be approved by the Consultant.

- 6.2.5 Windrows should generally be parallel to each other and may be placed either parallel to or perpendicular to the face of the slope depending on the site geometry. The minimum horizontal spacing for windrows shall be 12 feet center-to-center with a 5-foot stagger or offset from lower courses to next overlying course. The minimum vertical spacing between windrow courses shall be 2 feet from the top of a lower windrow to the bottom of the next higher windrow.
- 6.2.6 Rock placement, fill placement and flooding of approved granular soil in the windrows should be continuously observed by the Consultant.
- 6.3 *Rock* fills, as defined in Section 3.1.3, shall be placed by the Contractor in accordance with the following recommendations:
- 6.3.1 The base of the *rock* fill shall be placed on a sloping surface (minimum slope of 2 percent). The surface shall slope toward suitable subdrainage outlet facilities. The *rock* fills shall be provided with subdrains during construction so that a hydrostatic pressure buildup does not develop. The subdrains shall be permanently connected to controlled drainage facilities to control post-construction infiltration of water.
- 6.3.2 *Rock* fills shall be placed in lifts not exceeding 3 feet. Placement shall be by rock trucks traversing previously placed lifts and dumping at the edge of the currently placed lift. Spreading of the *rock* fill shall be by dozer to facilitate *seating* of the rock. The *rock* fill shall be watered heavily during placement. Watering shall consist of water trucks traversing in front of the current rock lift face and spraying water continuously during rock placement. Compaction equipment with compactive energy comparable to or greater than that of a 20-ton steel vibratory roller or other compaction equipment providing suitable energy to achieve the required compaction or deflection as recommended in Paragraph 6.3.3 shall be utilized. The number of passes to be made should be determined as described in Paragraph 6.3.3. Once a *rock* fill lift has been covered with *soil* fill, no additional *rock* fill lifts will be permitted over the *soil* fill.
- 6.3.3 Plate bearing tests, in accordance with ASTM D 1196, may be performed in both the compacted *soil* fill and in the *rock* fill to aid in determining the required minimum number of passes of the compaction equipment. If performed, a minimum of three plate bearing tests should be performed in the properly compacted *soil* fill (minimum relative compaction of 90 percent). Plate bearing tests shall then be performed on areas of *rock* fill having two passes, four passes and six passes of the compaction equipment, respectively. The number of passes required for the *rock* fill shall be determined by comparing the results of the plate bearing tests for the *soil* fill and the *rock* fill and by evaluating the deflection



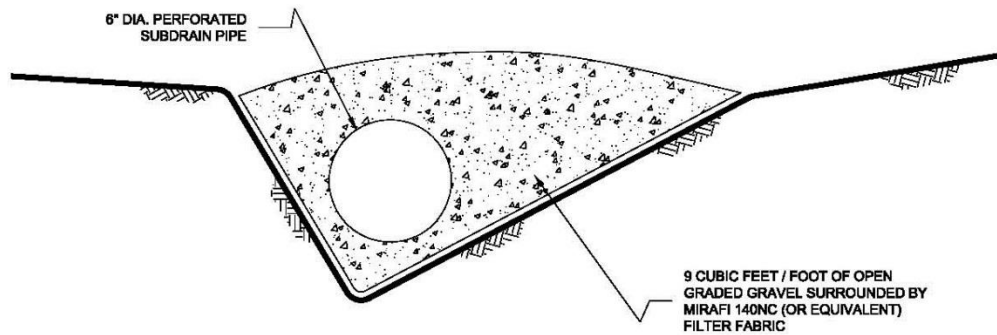
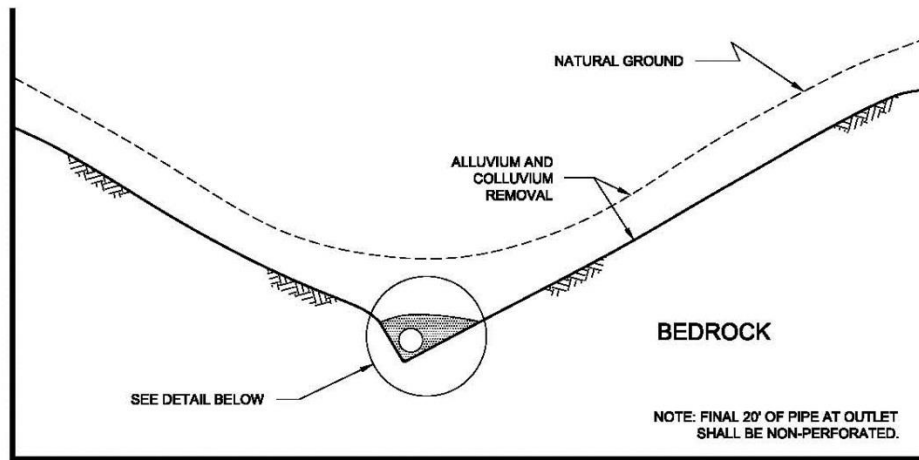
variation with number of passes. The required number of passes of the compaction equipment will be performed as necessary until the plate bearing deflections are equal to or less than that determined for the properly compacted *soil* fill. In no case will the required number of passes be less than two.

- 6.3.4 A representative of the Consultant should be present during *rock* fill operations to observe that the minimum number of “passes” have been obtained, that water is being properly applied and that specified procedures are being followed. The actual number of plate bearing tests will be determined by the Consultant during grading.
- 6.3.5 Test pits shall be excavated by the Contractor so that the Consultant can state that, in their opinion, sufficient water is present and that voids between large rocks are properly filled with smaller rock material. In-place density testing will not be required in the *rock* fills.
- 6.3.6 To reduce the potential for “piping” of fines into the *rock* fill from overlying *soil* fill material, a 2-foot layer of graded filter material shall be placed above the uppermost lift of *rock* fill. The need to place graded filter material below the *rock* should be determined by the Consultant prior to commencing grading. The gradation of the graded filter material will be determined at the time the *rock* fill is being excavated. Materials typical of the *rock* fill should be submitted to the Consultant in a timely manner, to allow design of the graded filter prior to the commencement of *rock* fill placement.
- 6.3.7 *Rock* fill placement should be continuously observed during placement by the Consultant.

## **7. SUBDRAINS**

- 7.1 The geologic units on the site may have permeability characteristics and/or fracture systems that could be susceptible under certain conditions to seepage. The use of canyon subdrains may be necessary to mitigate the potential for adverse impacts associated with seepage conditions. Canyon subdrains with lengths in excess of 500 feet or extensions of existing offsite subdrains should use 8-inch-diameter pipes. Canyon subdrains less than 500 feet in length should use 6-inch-diameter pipes.

## TYPICAL CANYON DRAIN DETAIL



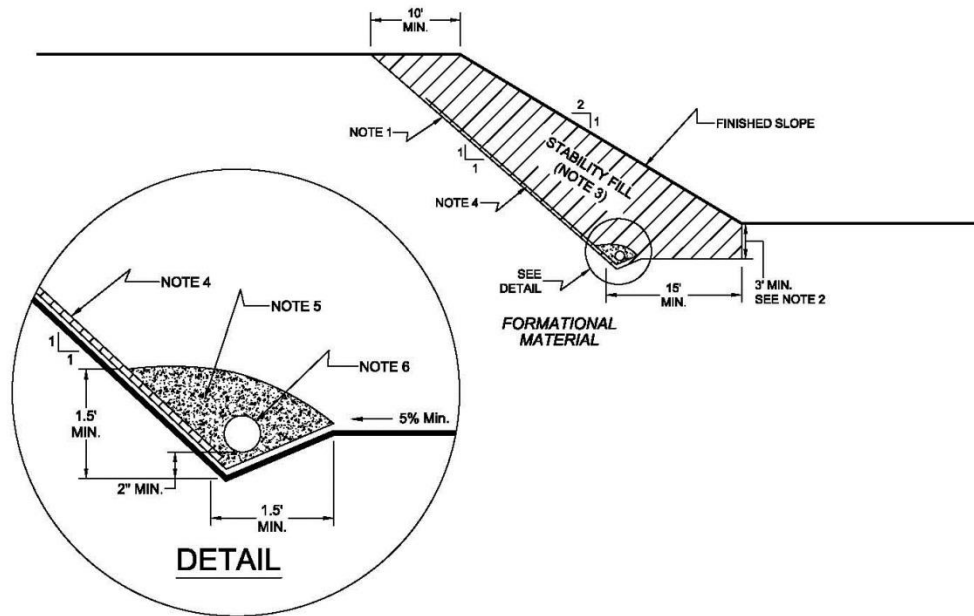
### NOTES:

- 1.....8-INCH DIAMETER, SCHEDULE 80 PVC PERFORATED PIPE FOR FILLS IN EXCESS OF 100-FEET IN DEPTH OR A PIPE LENGTH OF LONGER THAN 500 FEET.
- 2.....6-INCH DIAMETER, SCHEDULE 40 PVC PERFORATED PIPE FOR FILLS LESS THAN 100-FEET IN DEPTH OR A PIPE LENGTH SHORTER THAN 500 FEET.

NO SCALE

7.2 Slope drains within stability fill keyways should use 4-inch-diameter (or larger) pipes.

## TYPICAL STABILITY FILL DETAIL



### NOTES:

- 1.....EXCAVATE BACKCUT AT 1:1 INCLINATION (UNLESS OTHERWISE NOTED).
- 2.....BASE OF STABILITY FILL TO BE 3 FEET INTO FORMATIONAL MATERIAL, SLOPING A MINIMUM 5% INTO SLOPE.
- 3.....STABILITY FILL TO BE COMPOSED OF PROPERLY COMPACTED GRANULAR SOIL.
- 4.....CHIMNEY DRAINS TO BE APPROVED PREFABRICATED CHIMNEY DRAIN PANELS (MIRADRAIN G200N OR EQUIVALENT) SPACED APPROXIMATELY 20 FEET CENTER TO CENTER AND 4 FEET WIDE. CLOSER SPACING MAY BE REQUIRED IF SEEPAGE IS ENCOUNTERED.
- 5.....FILTER MATERIAL TO BE 3/4-INCH, OPEN-GRADED CRUSHED ROCK ENCLOSED IN APPROVED FILTER FABRIC (MIRAFI 140NC).
- 6.....COLLECTOR PIPE TO BE 4-INCH MINIMUM DIAMETER, PERFORATED, THICK-WALLED PVC SCHEDULE 40 OR EQUIVALENT, AND SLOPED TO DRAIN AT 1 PERCENT MINIMUM TO APPROVED OUTLET.

NO SCALE

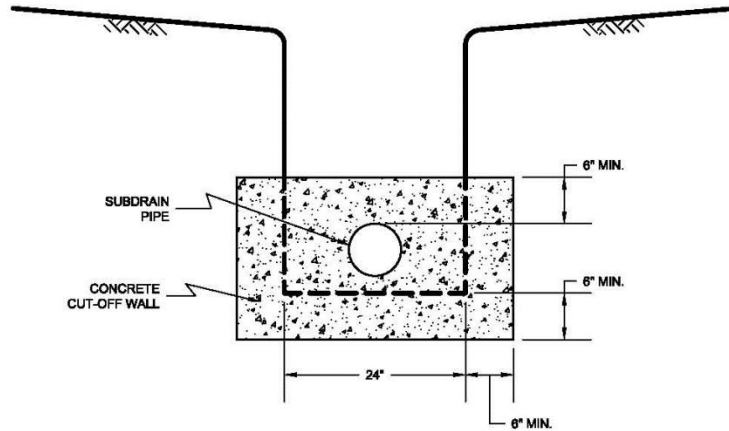
7.3 The actual subdrain locations will be evaluated in the field during the remedial grading operations. Additional drains may be necessary depending on the conditions observed and the requirements of the local regulatory agencies. Appropriate subdrain outlets should be evaluated prior to finalizing 40-scale grading plans.

7.4 *Rock fill* or *soil-rock fill* areas may require subdrains along their down-slope perimeters to mitigate the potential for buildup of water from construction or landscape irrigation. The subdrains should be at least 6-inch-diameter pipes encapsulated in gravel and filter fabric. *Rock fill* drains should be constructed using the same requirements as canyon subdrains.

7.5 Prior to outletting, the final 20-foot segment of a subdrain that will not be extended during future development should consist of non-perforated drainpipe. At the non-perforated/perforated interface, a seepage cutoff wall should be constructed on the downslope side of the pipe.

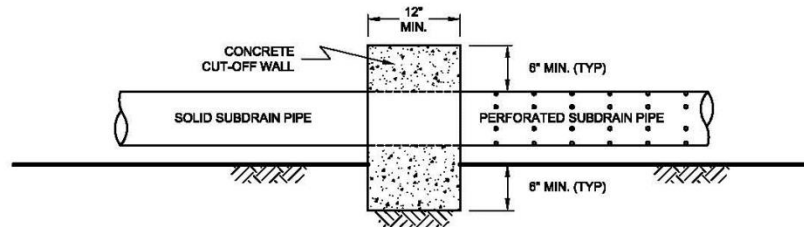
TYPICAL CUT OFF WALL DETAIL

FRONT VIEW



NO SCALE

SIDE VIEW

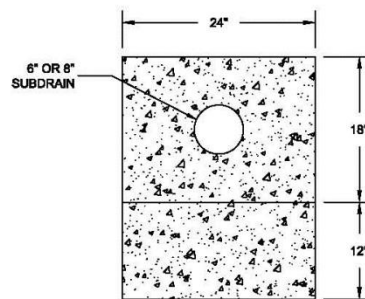


NO SCALE

7.6 Subdrains that discharge into a natural drainage course or open space area should be provided with a permanent headwall structure.

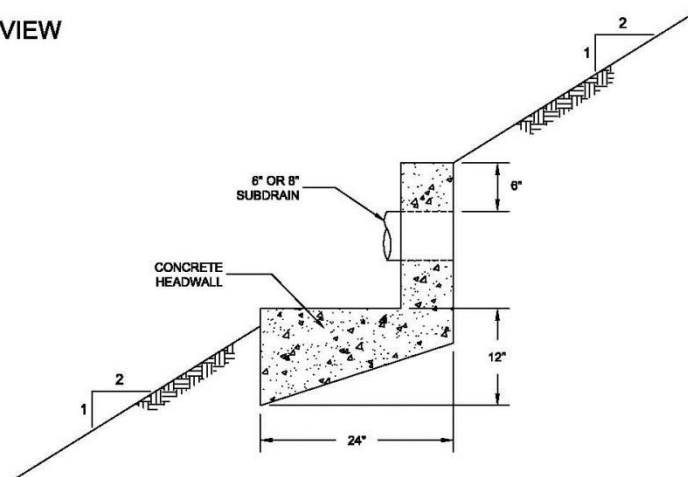
## TYPICAL HEADWALL DETAIL

### FRONT VIEW



NO SCALE

### SIDE VIEW



NOTE: HEADWALL SHOULD OUTLET AT TOE OF FILL SLOPE  
OR INTO CONTROLLED SURFACE DRAINAGE

NO SCALE

- 7.7 The final grading plans should show the location of the proposed subdrains. After completion of remedial excavations and subdrain installation, the project civil engineer should survey the drain locations and prepare an “as-built” map showing the drain locations. The final outlet and connection locations should be determined during grading operations. Subdrains that will be extended on adjacent projects after grading can be placed on formational material and a vertical riser should be placed at the end of the subdrain. The grading contractor should consider videoing the subdrains shortly after burial to check proper installation and functionality. The contractor is responsible for the performance of the drains.

## 8. OBSERVATION AND TESTING

- 8.1 The Consultant shall be the Owner's representative to observe and perform tests during clearing, grubbing, filling, and compaction operations. In general, no more than 2 feet in vertical elevation of *soil* or *soil-rock* fill should be placed without at least one field density test being performed within that interval. In addition, a minimum of one field density test should be performed for every 2,000 cubic yards of *soil* or *soil-rock* fill placed and compacted.
- 8.2 The Consultant should perform a sufficient distribution of field density tests of the compacted *soil* or *soil-rock* fill to provide a basis for expressing an opinion whether the fill material is compacted as specified. Density tests shall be performed in the compacted materials below any disturbed surface. When these tests indicate that the density of any layer of fill or portion thereof is below that specified, the particular layer or areas represented by the test shall be reworked until the specified density has been achieved.
- 8.3 During placement of *rock* fill, the Consultant should observe that the minimum number of passes have been obtained per the criteria discussed in Section 6.3.3. The Consultant should request the excavation of observation pits and may perform plate bearing tests on the placed *rock* fills. The observation pits will be excavated to provide a basis for expressing an opinion as to whether the *rock* fill is properly seated and sufficient moisture has been applied to the material. When observations indicate that a layer of *rock* fill or any portion thereof is below that specified, the affected layer or area shall be reworked until the *rock* fill has been adequately seated and sufficient moisture applied.
- 8.4 A settlement monitoring program designed by the Consultant may be conducted in areas of *rock* fill placement. The specific design of the monitoring program shall be as recommended in the Conclusions and Recommendations section of the project Geotechnical Report or in the final report of testing and observation services performed during grading.
- 8.5 We should observe the placement of subdrains, to check that the drainage devices have been placed and constructed in substantial conformance with project specifications.
- 8.6 Testing procedures shall conform to the following Standards as appropriate:

### 8.6.1 Soil and Soil-Rock Fills:

- 8.6.1.1 Field Density Test, ASTM D 1556, *Density of Soil In-Place By the Sand-Cone Method.*



- 8.6.1.2 Field Density Test, Nuclear Method, ASTM D 6938, *Density of Soil and Soil-Aggregate In-Place by Nuclear Methods (Shallow Depth)*.
- 8.6.1.3 Laboratory Compaction Test, ASTM D 1557, *Moisture-Density Relations of Soils and Soil-Aggregate Mixtures Using 10-Pound Hammer and 18-Inch Drop*.
- 8.6.1.4 Expansion Index Test, ASTM D 4829, *Expansion Index Test*.

## **9. PROTECTION OF WORK**

- 9.1 During construction, the Contractor shall properly grade all excavated surfaces to provide positive drainage and prevent ponding of water. Drainage of surface water shall be controlled to avoid damage to adjoining properties or to finished work on the site. The Contractor shall take remedial measures to prevent erosion of freshly graded areas until such time as permanent drainage and erosion control features have been installed. Areas subjected to erosion or sedimentation shall be properly prepared in accordance with the Specifications prior to placing additional fill or structures.
- 9.2 After completion of grading as observed and tested by the Consultant, no further excavation or filling shall be conducted except in conjunction with the services of the Consultant.

## **10. CERTIFICATIONS AND FINAL REPORTS**

- 10.1 Upon completion of the work, Contractor shall furnish Owner a certification by the Civil Engineer stating that the lots and/or building pads are graded to within 0.1 foot vertically of elevations shown on the grading plan and that all tops and toes of slopes are within 0.5 foot horizontally of the positions shown on the grading plans. After installation of a section of subdrain, the project Civil Engineer should survey its location and prepare an *as-built* plan of the subdrain location. The project Civil Engineer should verify the proper outlet for the subdrains and the Contractor should ensure that the drain system is free of obstructions.
- 10.2 The Owner is responsible for furnishing a final as-graded soil and geologic report satisfactory to the appropriate governing or accepting agencies. The as-graded report should be prepared and signed by a California licensed Civil Engineer experienced in geotechnical engineering and by a California Certified Engineering Geologist, indicating that the geotechnical aspects of the grading were performed in substantial conformance with the Specifications or approved changes to the Specifications.

## LIST OF REFERENCES

1. California Department of Conservation – California Geological Survey, *Geologic Map of the Oceanside 30' x 60' Quadrangle, Regional Geologic Map Series*, 1:100,000 Scale, Compiled by Michael P. Kennedy and Siang S. Tan, 2007.
2. California Division of Mines and Geology, *Landslide Hazards in the Northern Part of the San Diego Metropolitan Area, San Diego County, California*, Open File Report 95-04 (1995).
3. United States Department of Agriculture, *1953 Steroscopic Aerial Photographs, Flight AXN-3M*, Photo Nos. 169 and 170 (scale 1:20,000).
4. United States Geological Survey, *San Marcos Quadrangle, 7.5 Minute Series (Topographic)*, 1:24,000 Scale, 1968, photorevised 1983.
5. USGS (2016), *Quaternary Fault and Fold Database of the United States*: U.S. Geological Survey website, <http://earthquakes.usgs.gov/hazards/qfaults>, accessed March 2020.
6. Unpublished reports, aerial photographs, and maps on file with Geocon Incorporated.