

**PRELIMINARY
GEOTECHNICAL INVESTIGATION**

**TOWNE CENTRE VIEW
NORTHERN TERMINUS OF
TOWNE CENTRE DRIVE
SAN DIEGO, CALIFORNIA**



GEOCON
INCORPORATED

GEOTECHNICAL
ENVIRONMENTAL
MATERIALS

PREPARED FOR

**BRE-BMR TOWNE CENTRE SCIENCE PARK, LLC
SAN DIEGO, CALIFORNIA**

**OCTOBER 6, 2020
REVISED FEBRUARY 3, 2021
PROJECT NO. G2326-52-02**



Project No. G2326-52-02
October 6, 2020
Revised February 3, 2021

BRE-BMR Towne Centre Science Park LLC,
17190 Bernardo Center Drive
San Diego, California 92128

Attention: Mr. Jonathan Bergschneider

Subject: PRELIMINARY GEOTECHNICAL INVESTIGATION
TOWNE CENTRE VIEW
NORTHERN TERMINUS OF TOWNE CENTRE DRIVE
SAN DIEGO, CALIFORNIA

Dear Mr. Bergschneider:

In accordance with your request and authorization of our Proposal No. LG-20302 dated July 20, 2020, we herein submit the results of our preliminary geotechnical investigation for the subject project. We performed our investigation to evaluate the underlying soil and geologic conditions and potential geologic hazards, and to assist in the design of the proposed building and associated improvements.

The accompanying report presents the results of our study and conclusions and recommendations pertaining to geotechnical aspects of the proposed project. The site is suitable for the proposed buildings and improvements provided the recommendations of this report are incorporated into the design and construction of the planned project.

Should you have questions regarding this report, or if we may be of further service, please contact the undersigned at your convenience.

Very truly yours,

GEOCON INCORPORATED

Matt Love
RCE 84154



ML:SFW:JH:arm

(e-mail) Addressee

Shawn Foy Weedon
GE 2714



John Hoobs
CEG 1524

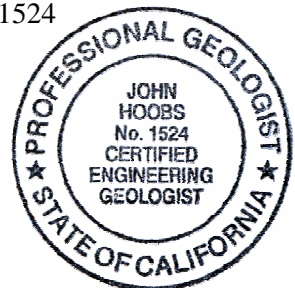

TABLE OF CONTENTS

1.	PURPOSE AND SCOPE	1
2.	SITE AND PROJECT DESCRIPTION.....	2
3.	PREVIOUS GRADING.....	3
4.	GEOLOGIC SETTING	3
5.	SOIL AND GEOLOGIC CONDITIONS	4
5.1	Previously Placed Fill (Qpf).....	5
5.2	Undocumented Fill (Qudf)	5
5.3	Very Old Paralic Deposits (Qvop).....	5
5.4	Scripps Formation (Tsc).....	6
5.5	Ardath Shale (Ta)	6
6.	GROUNDWATER	6
7.	GEOLOGIC HAZARDS	6
7.1	Geologic Hazard Category	6
7.2	Faulting and Seismicity	7
7.3	Ground Rupture	9
7.4	Liquefaction.....	9
7.5	Storm Surge, Tsunamis, and Seiches	10
7.6	Landslides.....	10
7.7	Slope Stability	10
8.	CONCLUSIONS AND RECOMMENDATIONS	12
8.1	General	12
8.2	Excavation and Soil Characteristics	13
8.3	Preliminary Grading Recommendations	14
8.4	Subdrains	17
8.5	Excavation Slopes, Shoring and Tiebacks.....	17
8.6	Soil Nail Wall.....	23
8.7	Seismic Design Criteria.....	25
8.8	Settlement Due to Fill Loads.....	27
8.9	Shallow Foundations	28
8.10	Drilled Pier Recommendations.....	31
8.11	Concrete Slabs-On-Grade.....	33
8.12	Exterior Concrete Flatwork	34
8.13	Retaining Walls	36
8.14	Lateral Loading	39
8.15	Preliminary Pavement Recommendations.....	40
8.16	Site Drainage and Moisture Protection.....	42
8.17	Updated Geotechnical Investigation.....	43

LIMITATIONS AND UNIFORMITY OF CONDITIONS

TABLE OF CONTENTS (Concluded)

MAPS AND ILLUSTRATIONS

Figure 1, Geologic Map

Figure 2, Regional Geologic Map

APPENDIX A

FIELD INVESTIGATION

APPENDIX B

LABORATORY TESTING

APPENDIX C

RECOMMENDED GRADING SPECIFICATIONS

LIST OF REFERENCES

PRELIMINARY GEOTECHNICAL INVESTIGATION

1. PURPOSE AND SCOPE

This report presents the results of our preliminary geotechnical investigation for the proposed science and technology development in the Sorrento Mesa area of San Diego, California (see Vicinity Map). The purpose of this preliminary geotechnical investigation is to evaluate the surface and subsurface soil conditions and general site geology, and to identify geotechnical constraints that may affect development of the property including faulting, liquefaction and seismic shaking based on the 2019 CBC seismic design criteria. In addition, we provided preliminary recommendations for remedial grading, shallow foundations, concrete slab-on-grade, concrete flatwork, pavement, and retaining walls.



Vicinity Map

The scope of this investigation included reviewing readily available published and unpublished geologic literature (see List of References), performing engineering analyses and preparing this report. We also advanced 14 exploratory borings to a maximum depth of about 61 feet, sampled soil and performed laboratory testing. Appendix A presents the exploratory boring logs and details of the field investigation. The details of the laboratory tests and a summary of the test results are shown in Appendix B and on the boring logs in Appendix A.

2. SITE AND PROJECT DESCRIPTION

The subject site includes several parcels of land located north of Towne Centre Drive at the intersection of Westerra Court. The western portion of the site includes the Towne Centre Corporate Plaza property that was previously graded to receive two commercial buildings and is currently being used as a construction-staging yard by Mid-Coast Transit Constructors. The central portion of the site includes three office buildings (9865, 9875 and 9885 Towne Centre Drive) that are two- to three-stories with accommodating utilities, surface parking and landscaping. The eastern portion consists of a two-story commercial building with surface parking to the south and a basketball court to the north (9855 Towne Centre Drive). The elevations on the property in the areas of the existing buildings and graded pads are about 330 to 360 feet mean sea level (MSL). Descending natural slopes exist on the north, west and southwest of the properties. The descending slope located on the south side of the Towne Centre Drive cul-de-sac consists of a fill slope that was constructed under our testing and observation services. The Existing Site Map shows the current configuration of the subject property and the approximate limits of the overall property. Grading will generally be limited to the existing top of slope boundary (as shown in the Geologic Map and other Figures in this report).



Existing Site Map

Based on our review of the preliminary site plan prepared by Perkins + Will (see *List of References*), we understand the proposed development will include construction of a new science, research and development, laboratory, technology and office building campus that includes four new buildings (Buildings A through D) connected with subterranean parking with accommodating utilities, surface parking and driveways and landscaping. Additionally, an above-ground parking garage and additional

commercial building (Building E) are proposed for the eastern portion of the site. Based on the referenced plans, the grading for the proposed campus will consist of cuts and fills on the order of 50 and 15 feet, respectively. In order to construct the parking garage, about 50 feet of cut will be performed that would incorporate temporary slopes and soil nail walls. We expect the proposed structures will consist of a shallow foundation system that will be embedded into the underlying formational materials.

The locations, site descriptions, and proposed development are based on our site reconnaissance, review of published geologic literature, field investigations, and discussions with project personnel. If development plans differ from those described herein, Geocon Incorporated should be contacted for review of the plans and possible revisions to this report.

3. PREVIOUS GRADING

The western portion of the project, which is currently being used as a construction-staging yard, consists of previously graded property originally called Summit Pointe Plaza. The grading operations of the site occurred in 2008 and 2009 and consisted of sheet grading of the site for future building pads, driveways and parking areas with maximum cuts from natural grade of approximately 20 feet and fill of up to approximately 15 feet deep. Additionally, several mechanically stabilized earth (MSE) retaining walls with a maximum height of 20 feet were constructed along the northern, western and southern perimeters of the site. The reinforcing grid behind the MSE walls ranged from 5 to 19 feet in length behind the walls. The development originally consisted of hillside topography. The general geologic conditions prior to mass grading consisted of surficial soil composed of topsoil, undocumented fill and colluvium overlying formational materials of Very Old Paralic Deposits and the Ardath Shale.

The previous grading operations consisted of performing canyon clean-outs, subdrain placement, and the removal of unsuitable materials (i.e. surficial soil and vegetation) prior to the placement of properly compacted fill and construction of retaining walls. A subdrain was installed in the major canyon area to the south of the site. Geocon Incorporated provided the testing and observation services during grading operations that consisted of performing laboratory and compaction testing. Our field density test results (provided in our Final Report of Testing and Observation During Site Grading and Installation of Retaining Walls (Geocon, 2010) indicate that the fill soil was placed at a dry density of at least 90 percent of the laboratory maximum dry density.

4. GEOLOGIC SETTING

Regionally, the site is located in the Peninsular Ranges geomorphic province. The province is bounded by the Transverse Ranges to the north, the San Jacinto Fault Zone on the east, the Pacific Ocean coastline on the west, and the Baja California on the south. The province is characterized by elongated northwest-trending mountain ridges separated by straight-sided sediment-filled valleys. The northwest

trend is further reflected in the direction of the dominant geologic structural features of the province that are northwest to west-northwest trending folds and faults, such as the nearby Rose Canyon fault zone.

Locally, the site is within the coastal plain of San Diego County. The coastal plain is underlain by a thick sequence of relatively undisturbed and non-conformable sedimentary bedrock units that thicken to the west and range in age from Upper Cretaceous age through the Pleistocene age which have been deposited on Cretaceous to Jurassic age igneous and volcanic bedrock. Geomorphically, the coastal plain is characterized by a series of 21, stair-stepped marine terraces (younger to the west) that have been dissected by west flowing rivers. The coastal plain is a relatively stable block that is dissected by relatively few faults consisting of the potentially active La Nacion Fault Zone and the active Rose Canyon Fault Zone. The western portion of the coastal plain contains several inactive and potentially active faults associated with the Rose Canyon Fault Zone

The site is located on the western portion of the coastal plain. Marine sedimentary units make up the geologic sequence encountered on the site and consist of Pleistocene-age Very Old Paralic Deposits (formerly known as the Lindavista Formation) and the Tertiary-aged Scripps Formation and Ardath Shale. The Very Old Paralic Deposits are shallow near shore marine deposits generally consisting of clayey to silty sandstone interfingering with occasional thin layers of conglomerate, siltstone and claystone. The regional geologic map shows a north trending contact before grading operations between Units 9 and 10 of the Very Old Paralic Deposits. Unit 9 is exposed on the eastern portion of the site and is correlative to the Linda Vista Terrace that is roughly 855,000 years old. Unit 10 is exposed on the western portion of the site correlative to the Tecolote Terrace that is 800,000 years old. The center portion of the site removed the terraces and currently exposes the Ardath Shale. The terraces were deposits on a sloping Ardath Shale surface creating locally thick Very Old Paralic deposits.

The Scripps Formation is exposed on the north side of the Torrey Pines Fault located on the northern portion of the site above an elevation of roughly 250 feet MSL. The Scripps Formation is typically composed of silty to clayey sandstone with occasional conglomerate layers. The Ardath Shale is typically composed of fine grained soils that are exposed on the south side of the fault below the Very Old Paralic Deposits on the west and east portions of the site and in the central portion. This unit is typically several hundred feet thick. Regionally the Scripps Formation and Ardath Shale have dips up to 10 degrees and are folded into north plunging synclines and anticlines in the area. The Regional Geologic Map, Figure 2, shows the geologic units in the area of the site.

5. SOIL AND GEOLOGIC CONDITIONS

We encountered two surficial soil units (consisting of previously compacted fill and undocumented fill) and three geologic units (consisting of Very Old Paralic Deposits, the Scripps Formation and the Ardath Shale). The occurrence, distribution, and description of each unit encountered is shown on the

Geologic Map, Figure 1 and on the boring logs in Appendix A. The geologic units are described herein in order of increasing age.

5.1 Previously Placed Fill (Qpf)

We encountered previously placed fill in Borings B-1 and B-2 to depths ranging from about 5 to 10 feet. The fill materials were placed during prior grading activities in 2008/2009 on the western portion of the site (currently used as construction-staging yard) which was observed by Geocon Incorporated (see *List of References*). In general, the fill consists of medium dense to dense, mixed silty and clayey sand with some gravel and cobble. The previously placed fill typically possess a “very low” to “medium” expansion potential (expansion index of 90 or less) and a “S0” sulfate class. With the exception of the upper 1 to 2 feet, the previously placed fill materials are considered acceptable to support the planned fill and foundation loads for the development.

5.2 Undocumented Fill (Qudf)

We encountered undocumented fill in our Borings B-11 and B-13 to depths ranging from about 12 to 58 feet. We expect the undocumented fill materials were placed in the early 2000’s to fill the existing canyon and match adjacent site grades during previous grading at the site. While we were not able to review specific documentation of the placement of the fill, we do expect that these materials were placed as compacted fills based on the field and laboratory test results of the materials. In general, the fill consists of medium dense to dense, clayey sand and stiff to very stiff, sandy clay. The undocumented fill is considered potentially suitable in its current condition for the support of foundations or structural fill and remedial grading of the materials can be limited as recommended herein; however, the project civil and structural engineers should evaluate if the fill-related settlements can be accommodated by the proposed improvements. The undocumented fill can be reused for new compacted fill during grading operations provided it is generally free of roots and debris.

5.3 Very Old Paralic Deposits (Qvop)

The Quaternary-age Very Old Paralic Deposits exist below the fill materials or at-grade across the western (Unit 10) and eastern portions (Unit 9) of the site. These deposits generally consist of dense to very dense, light to dark reddish brown and olive brown, silty to clayey, fine to medium sand with gravel and cobble. The Very Old Paralic Deposits typically possess a “very low” to “medium” expansion potential (expansion index of 90 or less) and a “S0” sulfate class. The Very Old Paralic Deposits are considered acceptable to support the planned fill and foundation loads for the development.

5.4 Scripps Formation (Tsc)

Tertiary-age Scripps Formation is mapped to underly the Very Old Paralic Deposits on the northern portion of the site, north of the mapped fault. The Scripps Formation is generally brown, yellowish brown to light gray, silty to clayey sandstone and sandy siltstone/claystone containing layers of strongly cemented material. Our laboratory tests and experience indicate the Scripps Formation possesses a “very low” to “medium” expansion potential (expansion index of 90 or less) and an “S0” to “S2” water-soluble sulfate exposure. The Scripps Formation is generally considered suitable for support of properly compacted structural fill and improvements. However, based on our observations at the site, we do not anticipate that the Scripps Formation will be encountered during the development of the site.

5.5 Ardath Shale (Ta)

We encountered the Ardath Shale underlying the fill materials and Very Old Paralic Deposits in all of our borings. The Ardath Shale generally consists of hard, gray, clayey siltstone and sandy siltstone. The Ardath Shale may contain localized areas of highly cemented concretionary beds. Soil generated from this unit typically possess a “very low” to “medium” expansion potential (expansion index of 90 or less) and an “S0” to “S2” water-soluble sulfate exposure. The Ardath Shale is generally considered suitable for support of properly compacted structural fill and improvements.

6. GROUNDWATER

We did not encounter groundwater or seepage during our site investigation to the maximum depth explored of 61 feet. We expect the groundwater table is at least 200 feet below existing grades. However, it is not uncommon for seepage conditions to develop where none previously existed when sites are irrigated or infiltration is implemented. Seepage is dependent on seasonal precipitation, irrigation, land use, among other factors, and varies as a result. Proper surface drainage will be important to future performance of the project. We expect groundwater is deeper than about 100 feet below existing grade. We do not expect groundwater to be encountered during construction of the proposed development.

7. GEOLOGIC HAZARDS

7.1 Geologic Hazard Category

The City of San Diego Seismic Safety Study, Geologic Hazards and Faults, Sheet 34 defines the majority of the site with *Hazard Category 51: Level Mesas – Underlain by Terrace Deposits and Bedrock, Nominal Risk*, *Hazard Category 53: Level or Sloping Terrain, Unfavorable Geologic Structures, Low to Moderate Risk*, and *Hazard Category 25: Ardath – Neutral or Favorable Geologic Structure* (as shown on the Hazard Category Map). Additionally, the northwestern corner is defined

as Hazard Category 12: Fault Zone – Potentially Active, Inactive, Presumed Inactive, or Activity Unknown.

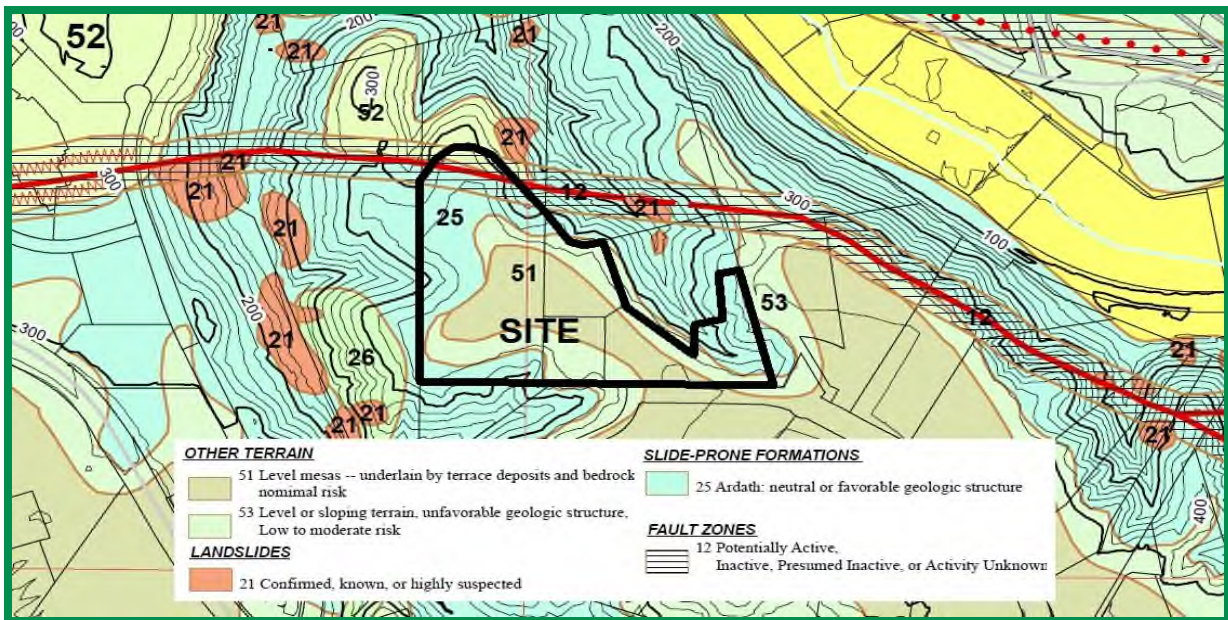

Hazard Category Map

7.2 Faulting and Seismicity

An active fault is defined by the California Geological Survey (CGS) as a fault showing evidence for activity within the last 11,700 years. The site is not located within a State of California Earthquake Fault Zone.

As shown in the Hazard Category Map, the City of San Diego Seismic Safety Study indicates a trace of the Torrey Pines Fault bisects the northern portion of the property generally with an east-to-west trend. The Torrey Pines Fault is not known to displace Quaternary-aged Very Old Paralic Deposits and is not classified as being active according to M. P. Kennedy, 1975, Bulletin 200, California Division of Mines and Geology (CDMG). We performed trenching within the fault trace during a previous investigation at the site (see *References*), where we observed that there was no indication of disturbance to the Pleistocene-aged Very Old Paralic Deposits Unit 10 or the Linda Vista Terrace that is roughly 800,000 years old (formerly Lindavista Formation). Based on a review of published geologic literature and observations during previous site investigations, we opine known active faults do not exist on the site. Therefore, the fault may be classified as potentially active, defined as no movement in the last 11,700 years. Based on the geologic conditions on site, the fault has not moved in at least the last 800,000 years. Furthermore, we do not consider structural setbacks would be necessary from a geotechnical engineering standpoint due to faulting.

The USGS has developed a program to evaluate the approximate location of faulting in the area of properties. The following figure shows the location of the existing faulting in the San Diego County and Southern California region. The fault traces are shown as solid, dashed and dotted that represent well-constrained, moderately constrained and inferred, respectively. The fault line colors represent fault with ages less than 150 years (red), 15,000 years (orange), 130,000 years (green), 750,000 years (blue) and 1.6 million years (black).



Faults in Southern California

The San Diego County and Southern California region is seismically active. The following figure presents the occurrence of earthquakes with a magnitude greater than 2.5 from the period of 1900 through 2015 according to the Bay Area Earthquake Alliance website.

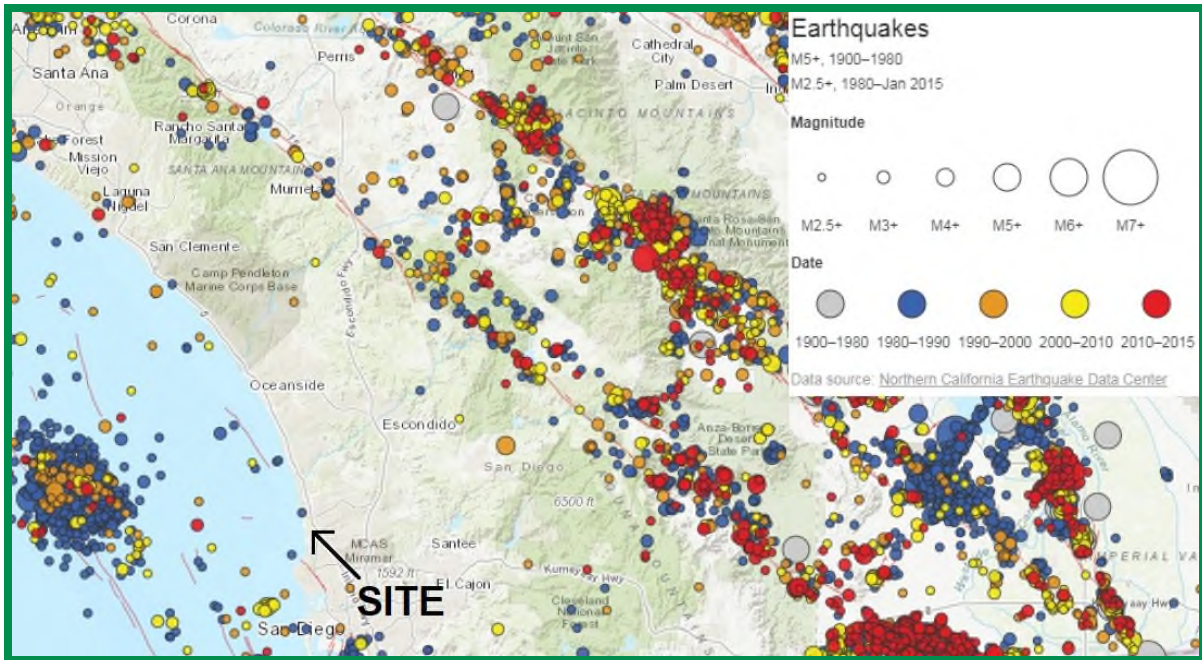

Earthquakes in Southern California

Considerations important in seismic design include the frequency and duration of motion and the soil conditions underlying the site. Seismic design of structures should be evaluated in accordance with the California Building Code (CBC) guidelines currently adopted by the local agency.

7.3 Ground Rupture

Ground surface rupture occurs when movement along a fault is sufficient to cause a gap or rupture where the upper edge of the fault zone intersects the ground surface. The potential for ground rupture is considered to be very low due to the absence of active faults at the subject site.

7.4 Liquefaction

Liquefaction typically occurs when a site is located in a zone with seismic activity, onsite soils are cohesionless or silt/clay with low plasticity, groundwater is encountered within 50 feet of the surface and soil densities are less than about 70 percent of the maximum dry densities. If the four previous criteria are met, a seismic event could result in a rapid pore water pressure increase from the earthquake-generated ground accelerations. Due to the lack of a permanent, near-surface groundwater table and the very dense nature of the underlying Very Old Paralic Deposits and the Ardath Shale, liquefaction potential for the site is considered very low.

7.5 Storm Surge, Tsunamis, and Seiches

Storm surges are large ocean waves that sweep across coastal areas when storms make landfall. Storm surges can cause inundation, severe erosion and backwater flooding along the water front. The site is located approximately 2 miles from the Pacific Ocean and is at an elevation of about 330 feet or greater above Mean Sea Level (MSL). Therefore, the potential of storm surges affecting the site is considered low.

A tsunami is a series of long period waves generated in the ocean by a sudden displacement of large volumes of water. Causes of tsunamis include underwater earthquakes, volcanic eruptions, or offshore slope failures. The site is at a minimum elevation of 330 above feet MSL and is about 2 miles from the Pacific Ocean. Therefore, the potential for the site to be affected by a tsunami is negligible.

A seiche is a run-up of water within a lake or embayment triggered by fault- or landslide-induced ground displacement. The site is not located in the vicinity of or downstream from such bodies of water. Therefore, the risk of seiches affecting the site is negligible.

7.6 Landslides

We did not observe evidence of previous or incipient slope instability on the southern, northern or eastern slopes during this or previous studies. We did encounter previous landslide debris in the west/northwest corner of the site previous during grading for the retaining walls. However, the majority of the landslide debris materials was removed during grading and replaced with compacted fill, and subsequent slope stability evaluations of the graded slope indicated a calculated factor of safety of at least 1.5 under static conditions. Additionally, the *City of San Diego Seismic Safety Study, Geologic Hazards and Faults*, Map Sheet 34 has mapped two landslides to the north of the property defined as Hazard Category 21: *Landslides, confirmed, known, or highly suspected*. The mapped landslides are at least 300 feet away from the proposed structures at the site and 150 feet away from the proposed limits of grading. Therefore, we do not expect landsliding is an issue for this property.

7.7 Slope Stability

Fill slopes are proposed at the site with heights on the order of 20 feet. Slope stability analyses for the proposed fill slopes with inclinations as steep as 2:1 (horizontal:vertical) indicate a calculated factor of safety of at least 1.5 under static conditions for both deep-seated and surficial failure. Table 7.7.1 presents the slope stability analysis for the proposed sloping conditions.

**TABLE 7.7.1
SLOPE STABILITY EVALUATION**

Parameter	Value
Slope Height, H	20 Feet
Slope Inclination, I (Horizontal to Vertical)	2:1
Total Soil Unit Weight, γ	130 pcf
Friction Angle, ϕ	28 Degrees
Cohesion, C	300 psf
Slope Factor $\gamma_c \phi = (\gamma H \tan \phi) / C$	4.6
NCf (From Chart)	20
Factor of Safety = $(N_c C) / (\gamma H)$	2.3

Table 7.7.2 presents the surficial slope stability analysis for the proposed sloping conditions.

**TABLE 7.7.2
SURFICIAL SLOPE STABILITY EVALUATION**

Parameter	Value
Slope Height, H	∞
Vertical Depth of Saturation, Z	3 Feet
Slope Inclination, I (Horizontal to Vertical)	2:1 (26.6 Degrees)
Total Soil Unit Weight, γ	130 pcf
Water Unit Weight, γ_w	62.4 pcf
Friction Angle, ϕ	28 Degrees
Cohesion, C	300 psf
Factor of Safety = $(C + (\gamma + \gamma_w) Z \cos^2 I \tan \phi) / (\gamma Z \sin I \cos I)$	2.5

Slopes should be landscaped with drought-tolerant vegetation having variable root depths and requiring minimal landscape irrigation. In addition, slopes should be drained and properly maintained to reduce erosion.

8. CONCLUSIONS AND RECOMMENDATIONS

8.1 General

- 8.1.1 We did not encounter soil or geologic conditions during our exploration that would preclude the proposed development, provided the recommendations presented herein are followed and implemented during design and construction. We will provide supplemental recommendations if we observe variable or undesirable conditions during construction, or if the proposed construction will differ from that anticipated herein.
- 8.1.2 With the exception of possible moderate to strong seismic shaking, we did not observe or know of significant geologic hazards to exist on the site that would adversely affect the proposed project.
- 8.1.3 The previously placed fill, Very Old Paralic Deposits and Ardath Shale are considered suitable for the support of proposed fill and structural loads. The undocumented fill is also considered potentially suitable for support of the proposed improvements, assuming that the project civil and structural engineers consider the fill-related settlement discussed herein can be accommodated by the proposed improvements. Remedial grading of these materials should be performed as discussed herein.
- 8.1.4 We did not encounter groundwater during our subsurface exploration and we do not expect it to be a constraint to project development. However, seepage within surficial soil and formational materials may be encountered during the grading operations, especially during the rainy seasons.
- 8.1.5 Excavation of the fill and formational materials should generally be possible with moderate to heavy effort using conventional, heavy-duty equipment during construction operations. We did encounter very difficult drilling and refusal in the formational materials during our field investigation. Therefore, we expect very heavy effort with possible refusal in localized areas for excavations into strongly cemented portions of the Very Old Paralic Deposits and Ardath Shale.
- 8.1.6 Based on our review of the project plans, we opine the planned development can be constructed in accordance with our recommendations provided herein. We do not expect the planned development will destabilize or result in settlement of adjacent properties if properly constructed.
- 8.1.7 Surface settlement monuments and new canyon subdrains will not be required on this project.

8.2 Excavation and Soil Characteristics

- 8.2.1 Excavation of the in-situ soil should be possible with moderate to heavy effort using conventional heavy-duty equipment. Excavation of the formational materials will require very heavy effort and may generate oversized material using conventional heavy-duty equipment during the grading operations. Oversized rock (rocks greater than 12-inches in dimension) may be generated with the formational units that can be incorporated into landscape use or deep compacted fill areas, if available. We encountered very difficult drilling and refusal in the formational materials during our field investigation. Therefore, we expect very heavy effort with possible refusal in localized areas for excavations into strongly cemented portions of the Very Old Paralic Deposits and Ardath Shale. However, we do not expect that blasting will be needed for this project.
- 8.2.2 The soil encountered in the field investigation is considered to be “non-expansive” and “expansive” (expansion index [EI] of 20 or less and greater than 20, respectively) as defined by 2019 California Building Code (CBC) Section 1803.5.3. Table 8.2.1 presents soil classifications based on the expansion index. We expect a majority of the soil encountered possess a “very low” to “medium” expansion potential (EI of 90 or less).

**TABLE 8.2.1
EXPANSION CLASSIFICATION BASED ON EXPANSION INDEX**

Expansion Index (EI)	ASTM D 4829 Expansion Classification	2019 CBC Expansion Classification
0 – 20	Very Low	Non-Expansive
21 – 50	Low	Expansive
51 – 90	Medium	
91 – 130	High	
Greater Than 130	Very High	

- 8.2.3 We performed laboratory tests on samples of the site materials to evaluate the percentage of water-soluble sulfate content. Appendix B presents results of the laboratory water-soluble sulfate content tests. The test results indicate the on-site materials at the locations tested possess “S0” sulfate exposure to concrete structures as defined by 2019 CBC Section 1904 and ACI 318-14 Chapter 19. However, some areas of the Ardath Shale possess “S1” to “S2” water-soluble sulfate contents and additional concrete design recommendations may be encountered during construction. Table 8.2.2 presents a summary of concrete requirements set forth by 2019 CBC Section 1904 and ACI 318. The presence of water-soluble sulfates is not a visually discernible characteristic; therefore, other soil samples from the site could

yield different concentrations. Additionally, over time landscaping activities (i.e., addition of fertilizers and other soil nutrients) may affect the concentration.

**TABLE 8.2.2
REQUIREMENTS FOR CONCRETE EXPOSED TO
SULFATE-CONTAINING SOLUTIONS**

Exposure Class	Water-Soluble Sulfate (SO ₄) Percent by Weight	Cement Type (ASTM C 150)	Maximum Water to Cement Ratio by Weight ¹	Minimum Compressive Strength (psi)
S0	SO ₄ <0.10	No Type Restriction	n/a	2,500
S1	0.10≤SO ₄ <0.20	II	0.50	4,000
S2	0.20≤SO ₄ ≤2.00	V	0.45	4,500
S3	SO ₄ >2.00	V+Pozzolan or Slag	0.45	4,500

¹ Maximum water to cement ratio limits do not apply to lightweight concrete

8.2.4 Geocon Incorporated does not practice in the field of corrosion engineering. Therefore, further evaluation by a corrosion engineer may be performed if improvements susceptible to corrosion are planned.

8.3 Preliminary Grading Recommendations

8.3.1 Grading should be performed in accordance with the recommendations provided in this report, the Recommended Grading Specifications contained in Appendix C and the City of San Diego's Grading Ordinance. Geocon Incorporated should observe the grading operations on a full-time basis and provide testing during the fill placement.

8.3.2 Prior to commencing grading, a preconstruction conference should be held at the site with the city inspector, developer, grading and underground contractors, civil engineer, and geotechnical engineer in attendance. Special soil handling and/or the grading plans can be discussed at that time.

8.3.3 Site preparation should begin with the removal of deleterious material, debris, and vegetation. The depth of vegetation removal should be such that material exposed in cut areas or soil to be used as fill is relatively free of organic matter. Material generated during stripping and/or site demolition should be exported from the site. Asphalt and concrete should not be mixed with the fill soil unless approved by the Geotechnical Engineer.

- 8.3.4 Abandoned foundations and buried utilities (if encountered) should be removed and the resultant depressions and/or trenches should be backfilled with properly compacted material as part of the remedial grading.
- 8.3.5 We expect Very Old Paralic Deposits or Ardath Shale will be exposed at the base of the excavation for the subterranean parking garage. Additional remedial grading will likely not be required where the formational materials are exposed at finish grade elevation within the entire footprint of the buildings (***Buildings A, C and D***). We expect that the southern portion of Building B will be situated over the subterranean parking garage on formational materials and that the northern portion of Building B will likely be supported by deep foundations embedded within the underlying formational materials. Additionally, we expect that the above-ground parking structure (referred to as “Parking Structure” herein) might be supported on deep foundations due to the differential fill depths below the building pad. The minimum removal where fill materials are present at proposed grade and the building is supported by deep foundations should be 3 feet below pad grade (***Building B and Parking Structure***). For buildings underlain by fill, the existing fill within the building pad should be removed to expose the underlying formational materials and replaced with properly compacted fill (***Building E and Parking Structure***). However, if the structural engineer determines that the fill-related settlements provided herein can be accommodated by the structures, the removals can be limited to the upper 5 feet of materials (***Building E and Parking Structure***). The removals should extend at least 5 feet outside of the building areas, where possible.
- 8.3.6 In areas of proposed improvements outside of the building areas, the upper 1 to 2 feet of existing soil should be processed, moisture conditioned as necessary and recompact. Deeper removals may be required in areas where loose or saturated materials are encountered. The removals should extend at least 2 feet outside of the improvement area, where possible. Table 8.3.1 provides a summary of the grading recommendations.

**TABLE 8.3.1
SUMMARY OF GRADING RECOMMENDATIONS**

Area	Removal Requirements
Building Pads A, B*, C & D – Formational Materials	Removal to Pad Grade
Building Pads B* and Parking Structure – Fill Materials (Deep Foundation Areas)	Removal to 3 Feet Below Pad Grade
Building Pads E and Parking Structure – Fill Materials (Shallow Foundation Areas)	Removal of Undocumented Fill to Expose Underlying Formational Materials; or
	Removal of Upper 5 Feet of Existing Materials (if fill-related settlement can be accommodated by structure, as determined by structural engineer).
Site Development	Process Upper 1 to 2 Feet of Existing Materials
Grading Limits	5 Feet Outside of Buildings/2 Feet Outside of Improvement Areas, Where Possible
Exposed Bottoms of Remedial Grading	Scarify Upper 12 Inches

*The southern half of Building B will be supported by the subterranean parking structure, while the northern portion is situated at-grade over fill materials.

- 8.3.7 We understand that the existing mechanically stabilized earth (MSE) walls at the site are intended to remain in place as part of the proposed development. The geogrid reinforcement for the walls ranges from about 5 to 19 feet behind the walls. To maintain the stability of the walls, the proposed grading and foundation systems at the site should not disturb or intersect with the existing geogrid reinforcement. Based on our review of the current site plans, it appears that the excavations for the proposed subterranean parking structure do not intersect with the existing walls and geogrid. We should provide additional analysis and recommendations if it is determined that the existing walls will be disturbed during site development or if surcharge loads are added.
- 8.3.8 The bottom of the excavations should be sloped 1 percent to the adjacent street or deepest fill. Prior to fill soil being placed, the existing ground surface should be scarified, moisture conditioned as necessary, and compacted to a depth of at least 12 inches. Deeper removals may be required if saturated or loose fill soil is encountered. A representative of Geocon should be on-site during removals to evaluate the limits of the remedial grading.
- 8.3.9 Some areas of overly wet and saturated soil could be encountered due to the existing landscape and pavement areas. The saturated soil would require additional effort prior to placement of compacted fill or additional improvements. Stabilization of the soil would include scarifying and air-drying, removing and replacement with drier soil, use of

stabilization fabric (e.g. Tensar TX7 or other approved fabric), or chemical treating (i.e. cement or lime treatment).

- 8.3.10 The site should then be brought to final subgrade elevations with fill compacted in layers. In general, soil native to the site is suitable for use from a geotechnical engineering standpoint as fill if relatively free from vegetation, debris and other deleterious material. Layers of fill should be about 6 to 8 inches in loose thickness and no thicker than will allow for adequate bonding and compaction. Fill, including backfill and scarified ground surfaces, should be compacted to a dry density of at least 90 percent of the laboratory maximum dry density near to slightly above optimum moisture content in accordance with ASTM Test Procedure D 1557. Fill materials placed below optimum moisture content may require additional moisture conditioning prior to placing additional fill. The upper 12 inches of subgrade soil underlying pavement should be compacted to a dry density of at least 95 percent of the laboratory maximum dry density near to slightly above optimum moisture content shortly before paving operations.
- 8.3.11 Import fill (if necessary) should consist of the characteristics presented in Table 8.3.2. Geocon Incorporated should be notified of the import soil source and should perform laboratory testing of import soil prior to its arrival at the site to evaluate its suitability as fill material.

**TABLE 8.3.2
SUMMARY OF IMPORT FILL RECOMMENDATIONS**

Soil Characteristic	Values
Expansion Potential	“Very Low” to “Low” (Expansion Index of 50 or less)
Particle Size	Maximum Dimension Less Than 3 Inches
	Generally Free of Debris

8.4 Subdrains

- 8.4.1 With the exception of retaining wall drains, we do not expect the installation of additional subdrains on this project.

8.5 Excavation Slopes, Shoring and Tiebacks

- 8.5.1 The recommendations included herein are provided for stable excavations. It is the responsibility of the contractor and their competent person to ensure all excavations, temporary slopes and trenches are properly constructed and maintained in accordance with applicable OSHA guidelines in order to maintain safety and the stability of the excavations

and adjacent improvements. These excavations should not be allowed to become saturated or to dry out. Surcharge loads should not be permitted to a distance equal to the height of the excavation from the top of the excavation. The top of the excavation should be a minimum of 15 feet from the edge of existing improvements. Excavations steeper than those recommended or closer than 15 feet from an existing surface improvement should be shored in accordance with applicable OSHA codes and regulations.

- 8.5.2 The stability of the excavations is dependent on the design and construction of the shoring system and site conditions. Therefore, Geocon Incorporated cannot be responsible for site safety and the stability of the proposed excavations.
- 8.5.3 The design of temporary shoring is governed by soil and groundwater conditions, and by the depth and width of the excavated area. Continuous support of the excavation face can be provided by a system of soldier piles and wood lagging or sheet piles. Excavations exceeding 15 feet may require soil nails, tieback anchors or internal bracing to provide additional wall restraint.
- 8.5.4 The condition of existing buildings, streets, sidewalks, and other structures/improvements around the perimeter of the planned excavations should be documented prior to the start of shoring and excavation work. Special attention should be given to documenting existing cracks or other indications of differential settlement within these adjacent structures, pavements and other improvements. Underground utilities sensitive to settlement should be videotaped prior to construction to check the integrity of pipes. In addition, monitoring points should be established indicating location and elevation around the excavation and upon existing buildings. These points should be monitored on a weekly basis during excavation work and on a monthly basis thereafter. Inclinerometers should be installed and monitored behind any shoring sections that will be advanced deeper than 30 feet below the existing ground surface.
- 8.5.5 In general, ground conditions are moderately suited for soldier pile and tieback anchor wall construction techniques. However, gravel, cobble, cemented material and oversized material may be encountered in the existing materials that could be difficult to drill. Additionally, if cohesionless sands are encountered, some raveling may result along the unsupported portions of excavations.
- 8.5.6 Temporary shoring with a level backfill should be designed using a lateral pressure envelope acting on the back of the shoring as presented in Table 8.5.1. The distributions are shown on the Active Pressures for Temporary Shoring.

**TABLE 8.5.1
SUMMARY OF TEMPORARY SHORING WALL RECOMMENDATIONS**

Parameter	Value
Triangular Distribution, A	32H psf
Rectangular Distribution, B	20H psf
Trapezoidal Distribution, C	25H psf
Passive Pressure, P	350D + 500 psf
Effective Zone Angle, E	28 degrees
Maximum Design Lateral Movement	1 Inch
Maximum Design Vertical Movement	½ Inch
Maximum Design Retained Height, H	40 Feet

H equals the height of the retaining portion of the wall in feet
D equals the embedment depth of the retaining wall in feet

8.5.7 Triangular distribution should be used for cantilevered shoring and, the trapezoidal and rectangular distribution should be used for multi-braced systems such as tieback anchors and rakers. The project shoring engineer should determine the applicable soil distribution for the design of the temporary shoring system. Additional lateral earth pressure due to the surcharging effects from construction equipment, sloping backfill, planned stockpiles, adjacent structures and/or traffic loads should be considered, where appropriate, during design of the shoring system.

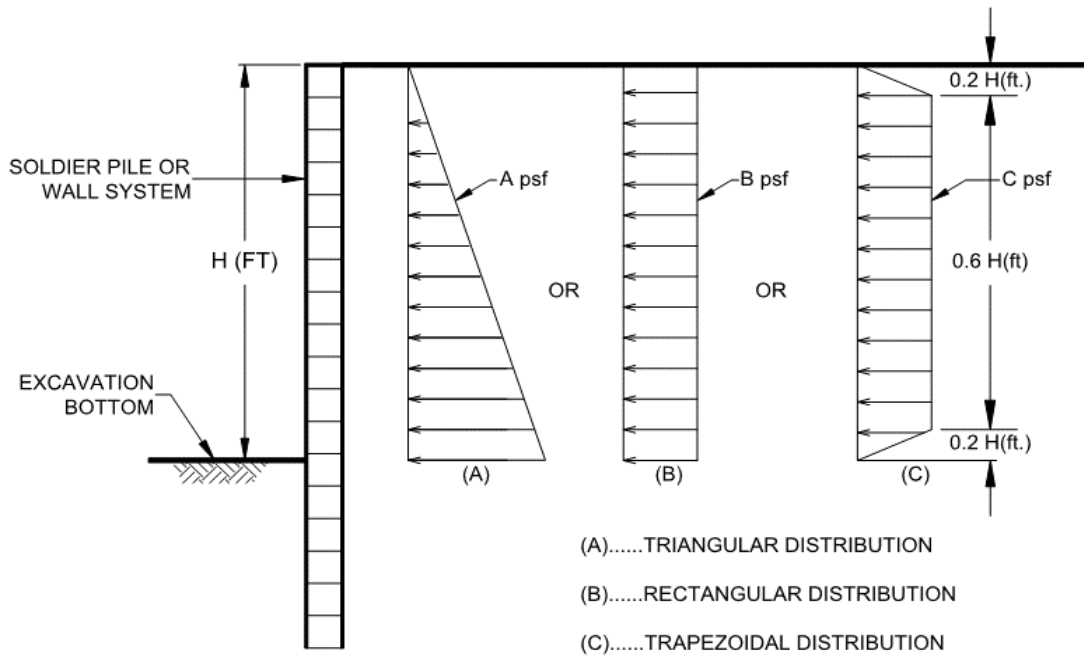

Active Pressures on Temporary Shoring

- 8.5.8 The passive resistance can be assumed to act over a width of three pile diameters. Typically, soldier piles are embedded a minimum of 0.5 times the maximum height of the excavation (this depth is to include footing excavations) if tieback anchors are not employed. The project structural engineer should determine the actual embedment depth.

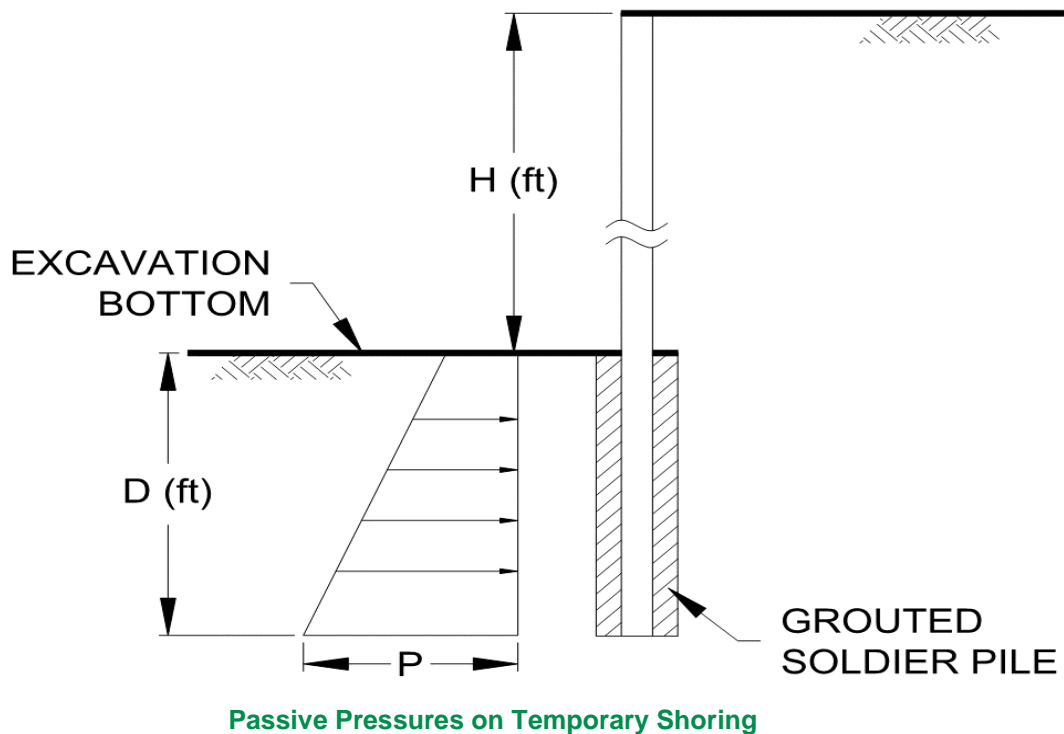

- 8.5.9 We should observe the drilled shafts for the soldier piles prior to the placement of steel reinforcement to check that the exposed soil conditions are similar to those expected and that footing excavations have been extended to the appropriate bearing strata and design depths. If unexpected soil conditions are encountered, foundation modifications may be required.
- 8.5.10 Lateral movement of shoring is associated with vertical ground settlement outside of the excavation. Therefore, it is essential that the soldier pile and tieback system allow very limited amounts of lateral displacement. Earth pressures acting on a lagging wall can cause movement of the shoring toward the excavation and result in ground subsidence outside of the excavation. Consequently, horizontal movements of the shoring wall should be accurately monitored and recorded during excavation and anchor construction.
- 8.5.11 Survey points should be established at the top of the pile on at least 20 percent of the soldier piles. An additional point located at an intermediate point between the top of the pile and the

base of the excavation should be monitored on at least 20 percent of the piles if tieback anchors will be used. These points should be monitored on a weekly basis during excavation work and on a monthly basis thereafter until the permanent support system is constructed.

8.5.12 The project civil engineer should provide the approximate location, depth, and pipe type of the underground utilities to the shoring engineer to help select the shoring type and shoring design. The shoring system should be designed to limit horizontal soldier pile movement to a maximum of 1 inch. The amount of horizontal deflection can be assumed to be essentially zero along the Active Zone and Effective Zone boundary. The magnitude of movement for intermediate depths and distances from the shoring wall can be linearly interpolated.

8.5.13 Tieback anchors employed in shoring should be designed such that anchors fully penetrate the Active Zone behind the shoring. The Active Zone can be considered the wedge of soil from the face of the shoring to a plane extending upward from the base of the excavation as shown on the Active Zone Detail. Normally, tieback anchors are contractor-designed and installed, and there are numerous anchor construction methods available. Non-shrinkage grout should be used for the construction of the tieback anchors.

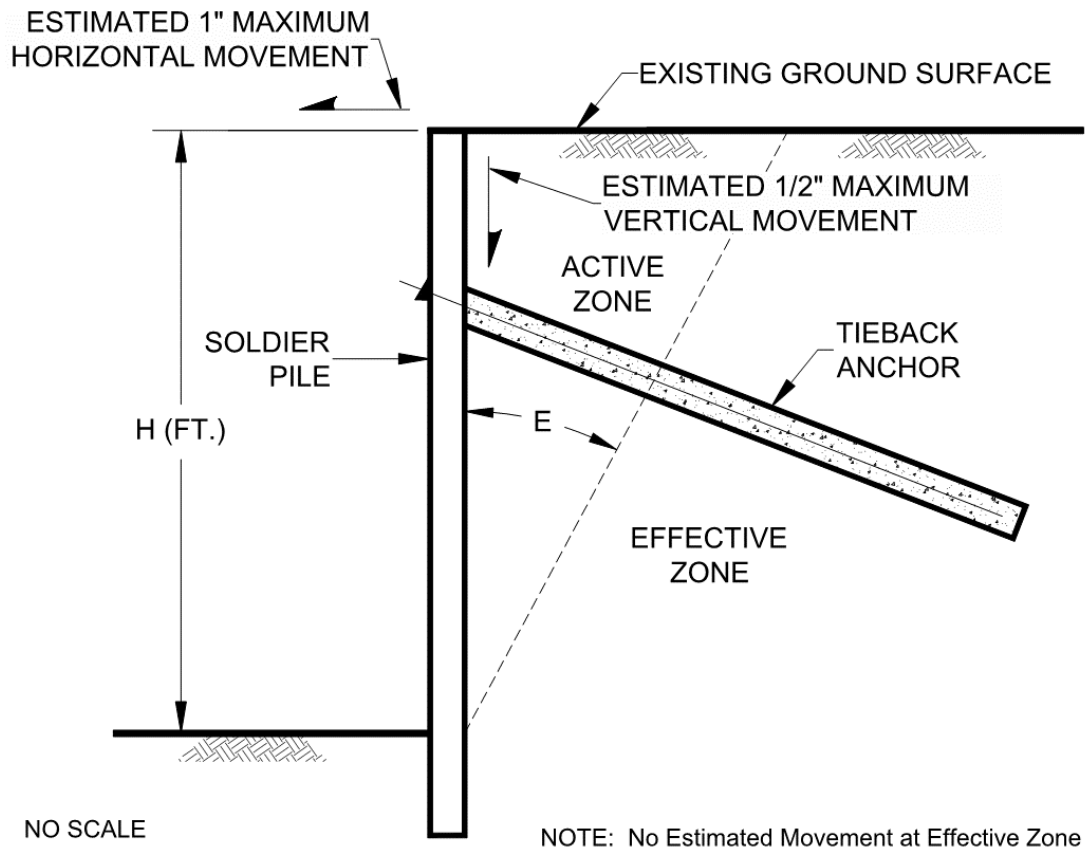

Active Zone Detail

- 8.5.14 Experience has shown that the use of pressure grouting during formation of the bonded portion of the anchor will increase the soil-grout bond stress. A pressure grouting tube should be installed during the construction of the tieback. Post grouting should be performed if adequate capacity cannot be obtained by other construction methods.
- 8.5.15 Anchor capacity is a function of construction method, depth of anchor, batter, diameter of the bonded section and the length of the bonded section. Anchor capacity should be evaluated using the strength parameters shown in Table 8.5.2.

**TABLE 8.5.2
SOIL STRENGTH PARAMETERS FOR TEMPORARY SHORING**

Description	Cohesion (psf)	Friction Angle (Degrees)
Compacted Fill	300	28
Very Old Parallic Deposits/Ardath Shale	500	30

- 8.5.16 Grout should only be placed in the tieback anchor’s bonded section prior to testing. Tieback anchors should be proof-tested to at least 130 percent of the anchor’s design working load. Following a successful proof test, the tieback anchors should be locked off at 80 percent of the allowable working load. Tieback anchor test failure criteria should be established in project plans and specifications. The tieback anchor test failure criteria should be based upon a maximum allowable displacement at 130 percent of the anchor’s working load (anchor creep) and a maximum residual displacement within the anchor following stressing. Tieback anchor stressing should only be conducted after sufficient hydration has occurred within the grout. Tieback anchors that fail to meet project specified test criteria should be replaced or additional anchors should be constructed.
- 8.5.17 Lagging should keep pace with excavation. The excavation should not be advanced deeper than three feet below the bottom of lagging at any time. These unlagged gaps of up to three feet should only be allowed to stand for short periods of time in order to decrease the probability of soil instability and should never be unsupported overnight. Backfilling should be conducted when necessary between the back of lagging and excavation sidewalls to reduce sloughing in this zone and all voids should be filled by the end of each day. Further, the excavation should not be advanced further than four feet below a row of tiebacks prior to those tiebacks being proof tested and locked off unless otherwise specific by the shoring engineer.

8.5.18 If tieback anchors are employed, an accurate survey of existing utilities and other underground structures adjacent to the shoring wall should be conducted. The survey should include both locations and depths of existing utilities. Locations of anchors should be adjusted as necessary during the design and construction process to accommodate the existing and proposed utilities.

8.5.19 The shoring system should incorporate a drainage system for the proposed retaining wall as shown herein.

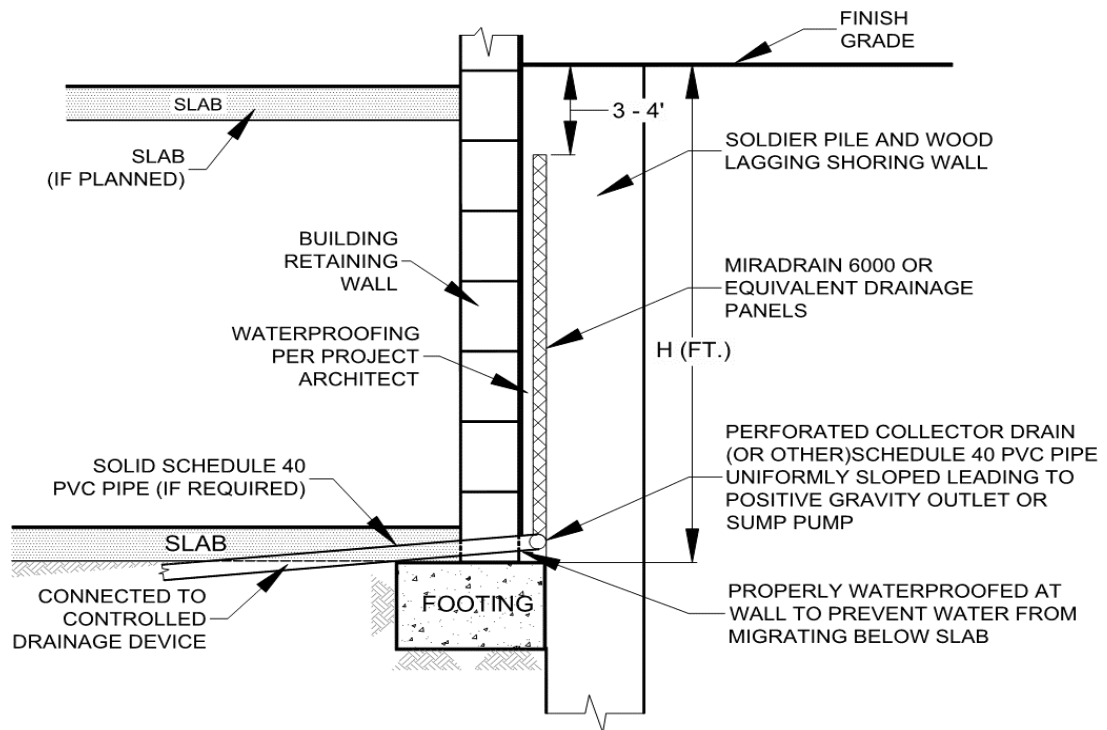

Shoring Retaining Wall Drainage Detail

8.6 Soil Nail Wall

8.6.1 As an alternative to temporary shoring followed by construction of a permanent basement wall, a soil nail wall can be used. Soil nail walls consist of installing closely spaced steel bars (nails) into a slope or excavation in a top-down construction sequence. Following installation of a horizontal row of nails, drains, waterproofing and wall reinforcing steel are placed and shotcrete applied to create a final wall. The wall should be designed by an engineer familiar with the design of soil nail walls.

- 8.6.2 Temporary soil nail walls should not be considered a permanent design to support the seismic lateral loads and soil pressures on a building wall. Therefore, the proposed building should be designed to support the expected lateral loads.
- 8.6.3 In general, ground conditions are moderately suited to soil nail wall construction techniques. However, localized gravel, cobble, oversized material and cemented materials could be encountered in the existing materials that could be difficult to drill. Additionally, relatively clean sands may be encountered within the existing soil that may result in some raveling of the unsupported excavation. Casing or specialized drilling techniques should be planned where raveling exists (e.g. casing).
- 8.6.4 Testing of the soil nails should be performed in accordance with the guidelines of the Federal Highway Administration or similar guidelines. At least two verification tests should be performed to confirm design assumptions for each soil/rock type encountered. Verification tests nails should be sacrificial and should not be used to support the proposed wall. The bond length should be adjusted to allow for pullout testing of the verification nails to evaluate the ultimate bond stress. A minimum of 5 percent of the production nails should also be proof tested and a minimum of 4 sacrificial nails should be tested at the discretion of Geocon Incorporated. Consideration should be given to testing sacrificial nails with an adjusted bond length rather than testing production nails. Geocon Incorporated should observe the nail installation and perform the nail testing.
- 8.6.5 The soil strength parameters listed in Table 8.6.1 can be used in design of the soil nails. The bond stress is dependent on drilling method, diameter, and construction method. Therefore, the designer should evaluate the bond stress based on the existing soil conditions and the construction method.

**TABLE 8.6.1
SOIL STRENGTH PARAMETERS FOR SOIL NAIL WALLS**

Description	Cohesion (psf)	Friction Angle (degrees)	Estimated Ultimate Bond Stress (psi)*
Previously Placed Fill	300	28	10
Very Old Paralic Deposits/Ardath Shale	500	30	20

*Assuming gravity fed, open hole drilling techniques.

- 8.6.6 A wall drain system should be incorporated into the design of the soil nail wall as shown herein. Corrosion protection should be provided for the nails if the wall will be a permanent structure.

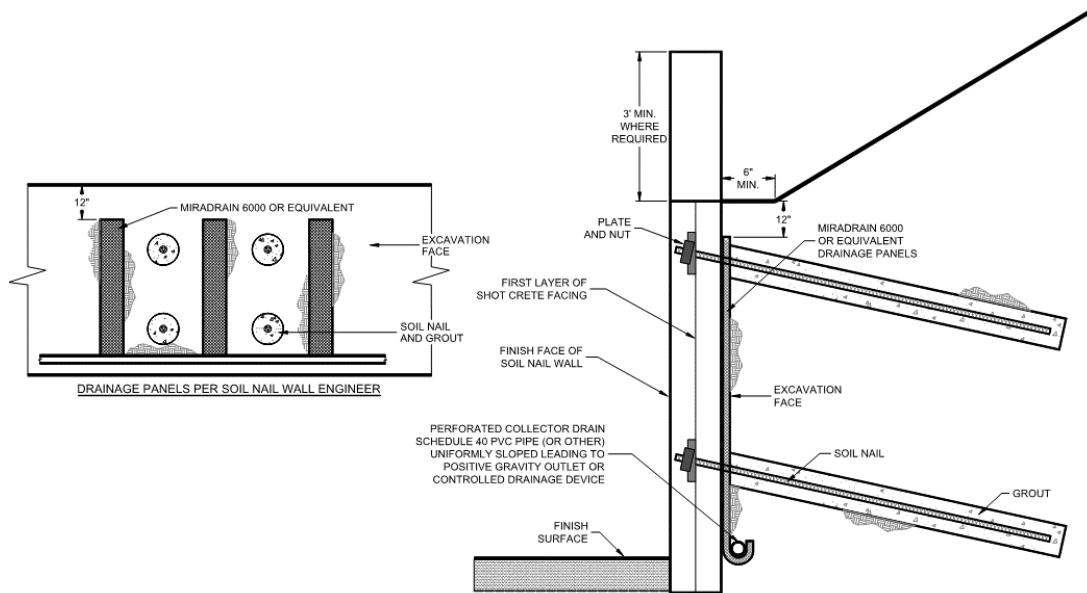

Soil Nail Wall Drainage Detail

8.7 Seismic Design Criteria

8.7.1 Table 8.7.1 summarizes site-specific design criteria obtained from the 2019 California Building Code (CBC; Based on the 2018 International Building Code [IBC] and ASCE 7-16), Chapter 16 Structural Design, Section 1613 Earthquake Loads. We used the computer program *U.S. Seismic Design Maps*, provided by the Structural Engineers Association (SEA) to calculate the seismic design parameters. The short spectral response uses a period of 0.2 second. The buildings and improvements should be designed using a Site Class C where the fill thickness is 20 feet or less or a Site Class D where the fill is thicker than 20 feet. We evaluated the Site Class based on the discussion in Section 1613.2.2 of the 2019 CBC and Table 20.3-1 of ASCE 7-16. The values presented herein are for the risk-targeted maximum considered earthquake (MCE_R). Sites designated as Site Class D, E and F may require additional analyses if requested by the project structural engineer and client.

**TABLE 8.7.1
2019 CBC SEISMIC DESIGN PARAMETERS**

Parameter	Value		2019 CBC Reference
Site Class	C	D	Section 1613.2.2
Fill Thickness, T (Feet)	$T \leq 20$	$T > 20$	--
Associated Buildings	A, B, C, D	Parking Structure, E	--
MCE _R Ground Motion Spectral Response Acceleration – Class B (short), S _S	1.158g	1.158g	Figure 1613.2.1(1)
MCE _R Ground Motion Spectral Response Acceleration – Class B (1 sec), S ₁	0.409g	0.409g	Figure 1613.2.1(2)
Site Coefficient, F _A	1.200	1.200	Table 1613.2.3(1)
Site Coefficient, F _V	1.500	1.891*	Table 1613.2.3(2)
Site Class Modified MCE _R Spectral Response Acceleration (short), S _{MS}	1.390g	1.390g	Section 1613.2.3 (Eqn 16-36)
Site Class Modified MCE _R Spectral Response Acceleration – (1 sec), S _{M1}	0.613g	0.773g*	Section 1613.2.3 (Eqn 16-37)
5% Damped Design Spectral Response Acceleration (short), S _{DS}	0.927g	0.927g	Section 1613.2.4 (Eqn 16-38)
5% Damped Design Spectral Response Acceleration (1 sec), S _{D1}	0.409g	0.515g*	Section 1613.2.4 (Eqn 16-39)

* Using the code-based values presented in this table, in lieu of a performing a ground motion hazard analysis, requires the exceptions outlined in ASCE 7-16 Section 11.4.8 be followed by the project structural engineer. Per Section 11.4.8 of ASCE/SEI 7-16, a ground motion hazard analysis should be performed for projects for Site Class “E” sites with S_s greater than or equal to 1.0g and for Site Class “D” and “E” sites with S₁ greater than 0.2g. Section 11.4.8 also provides exceptions which indicates that the ground motion hazard analysis may be waived provided the exceptions are followed.

8.7.2 Table 8.7.2 presents the mapped maximum considered geometric mean (MCE_G) seismic design parameters for projects located in Seismic Design Categories of D through F in accordance with ASCE 7-16.

**TABLE 8.7.2
ASCE 7-16 PEAK GROUND ACCELERATION**

Parameter	Value	ASCE 7-16 Reference
Mapped MCE _G Peak Ground Acceleration, PGA	0.520g	Figure 22-7
Site Coefficient, F _{PGA}	1.200	Table 11.8-1
Site Class Modified MCE _G Peak Ground Acceleration, PGA _M	0.623g	Section 11.8.3 (Eqn 11.8-1)

8.7.3 Conformance to the criteria in Tables 8.7.1 and 8.7.2 for seismic design does not constitute any kind of guarantee or assurance that significant structural damage or ground failure will

not occur if a large earthquake occurs. The primary goal of seismic design is to protect life, not to avoid all damage, since such design may be economically prohibitive.

8.8 Settlement Due to Fill Loads

- 8.8.1 Fill soil, even if properly compacted, will experience settlement over the lifetime of the improvements that it supports. The ultimate settlement potential of the fill is a function of the soil classification, placement relative compaction, and subsequent increases in the soil moisture content.
- 8.8.2 We expect that the northern portion of Building B will be supported by a deep foundation system embedded in the formational materials to mitigate the potential differential settlement due to the underlying compacted fill materials. However, the Parking Structure and Building E could be supported by a shallow foundation system underlain by fill with a maximum thickness on the order of 60 feet. The settlement of compacted fill is expected to continue over a relatively extended time period resulting from both gravity loading and hydrocompression upon wetting from rainfall and/or landscape irrigation. The previously placed fill has existed for approximately 25 years; therefore, a majority of the expected settlement has likely occurred.
- 8.8.3 Due to the variable fill thickness beneath proposed Building E and the Parking Structure, a potential for differential settlement across the proposed buildings exist and special foundation design consideration as discussed herein will be necessary. Based on measured settlement of similar fill depths on other sites and the time period since the fill was placed, we estimate that maximum settlement of the existing fill on the eastern portion of the site will be approximately 0.15 percent.
- 8.8.4 Table 8.8 presents the estimated total and differential fill thickness and settlements of the impacted building pads using an estimated settlement of 0.15 percent for the existing fill soils. These settlement magnitudes should be considered in design of the foundation system and adjacent flatwork that connects to the proposed buildings.

**TABLE 8.8
EXPECTED DIFFERENTIAL SETTLEMENT OF EXISTING FILL SOIL**

Building No.	Maximum Depth of Fill Beneath Structure (Feet)	Maximum Fill Differential (Feet)	Estimated Maximum Settlement (Inches)	Estimated Differential Settlement (Inches)	Approx. Distance for Differential Settlement (Feet)	Estimated Maximum Angular Distortion
Parking Structure	60	50	1.1	0.9	180	1/2,400
Building E*	20	20	0.4	0.4	70	1/2,100

*Additional soil boring information will be necessary to verify the assumed fill depths within the area of Building E.

- 8.8.5 Deep foundations such as driven piles or drilled piers are the most effective means of reducing the ultimate settlement potential of the proposed structures to a negligible amount. Alternatively, highly reinforced shallow foundation systems and slabs-on-grade may be used for support of the buildings; however, the shallow foundation systems would not eliminate the potential for cosmetic distress related to differential settlement of the underlying fill. Some cosmetic distress should be expected over the life of the structure as a result of long-term differential settlement. The owner, tenants, and future owners should be made aware that cosmetic distress, including separation of caulking at wall joints, small non-structural wall panel cracks, and separation of concrete flatwork is likely to occur.

8.9 Shallow Foundations

- 8.9.1 The proposed structures situated at-grade can be supported on a shallow foundation system founded in compacted fill (i.e. Building E and Parking Structure). Foundations for the structure should consist of continuous strip footings and/or isolated spread footings. Footings should be deepened such that the bottom outside edge of the footing is at least 7 feet horizontally from the face of the slope. Table 8.9.1 provides a summary of the foundation design recommendations.

TABLE 8.9.1
SUMMARY OF FOUNDATION RECOMMENDATIONS (AT-GRADE)
BUILDING E AND PARKING STRUCTURE

Parameter	Value
Minimum Continuous Foundation Width, W_C	12 inches
Minimum Isolated Foundation Width, W_I	24 inches
Minimum Foundation Depth, D	24 Inches Below Lowest Adjacent Grade
Minimum Steel Reinforcement	4 No. 5 Bars, 2 at the Top and 2 at the Bottom
Allowable Bearing Capacity – Fill	2,500 psf
Bearing Capacity Increase	500 psf per Foot of Depth or Width
Maximum Allowable Bearing Capacity - Fill	4,000 psf
Estimated Total Settlement	1 Inch
Estimated Differential Settlement	½ Inch in 40 Feet
Footing Size Used for Settlement	9-Foot Square
Design Expansion Index	90 or less

8.9.2 We understand that the subterranean parking garage for Buildings A, B, C and D are proposed to be supported at 2- to 4-levels below grade. The proposed subterranean structure can be supported on a shallow foundation system founded in formational materials. Foundations for the structure should consist of continuous strip footings and/or isolated spread footings. Table 8.9.2 provides a summary of the foundation design recommendations for subterranean levels.

TABLE 8.9.2
SUMMARY OF FOUNDATION RECOMMENDATIONS (SUBTERRANEAN)
BUILDINGS A, B, C AND D

Parameter	Value
Minimum Continuous Foundation Width, W_C	12 inches
Minimum Isolated Foundation Width, W_I	24 inches
Minimum Foundation Depth, D	24 Inches Below Lowest Adjacent Grade
Minimum Steel Reinforcement	4 No. 5 Bars, 2 at the Top and 2 at the Bottom
Allowable Bearing Capacity – Formation	7,500 psf *
Bearing Capacity Increase	500 psf per Foot of Depth or Width
Maximum Allowable Bearing Capacity – Formation	10,000 psf *
Estimated Total Settlement	1 Inch
Estimated Differential Settlement	½ Inch in 40 Feet
Footing Size Used for Settlement	8-Foot Square
Design Expansion Index	90 or less

*Assuming subterranean foundations will be situated at least 20 feet below adjacent grade in formational materials.

8.9.3 The foundations should be embedded in accordance with the recommendations herein and the Wall/Column Footing Dimension Detail. The embedment depths should be measured from the lowest adjacent pad grade for both interior and exterior footings. Footings should be deepened such that the bottom outside edge of the footing is at least 7 feet horizontally from the face of the slope (unless designed with a post-tensioned foundation system as discussed herein).

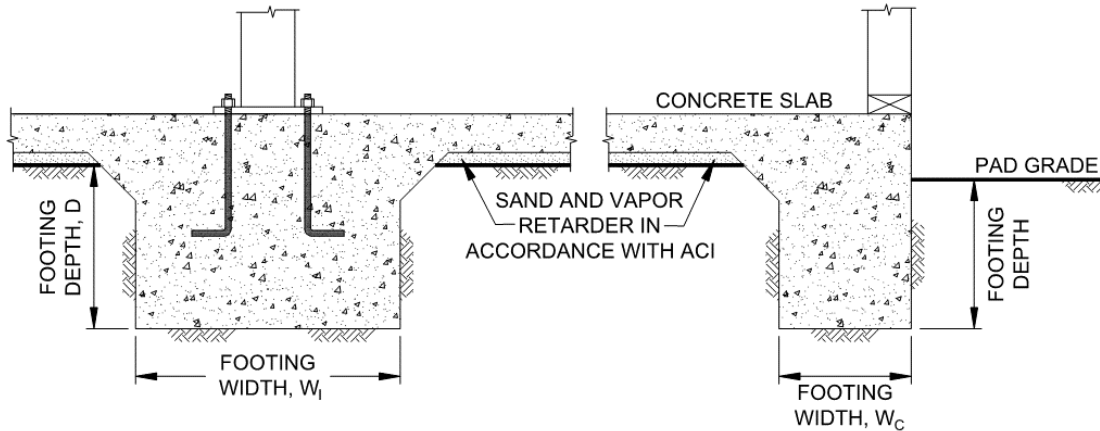

Wall/Column Footing Dimension Detail

8.9.4 The bearing capacity values presented herein are for dead plus live loads and may be increased by one-third when considering transient loads due to wind or seismic forces.

8.9.5 For building pads that primarily expose formational materials, overexcavation of the footings and replacement with slurry can be performed in areas where formational materials are not encountered at the bottom of the footing. Minimum two-sack slurry can be placed in the excavations for the conventional foundations to the bottom of proposed footing elevation. Additional remedial grading should be considered where overexcavation depths exceed 10 feet or more than 25% of the pad exposes fill materials.

8.9.6 Where buildings or other improvements are planned near the top of a slope steeper than 3:1 (horizontal:vertical), special foundations and/or design considerations are recommended due to the tendency for lateral soil movement to occur.

- For fill slopes less than 20 feet high, building footings should be deepened such that the bottom outside edge of the footing is at least 7 feet horizontally from the face of the slope.
- When located next to a descending 3:1 (horizontal:vertical) fill slope or steeper, the foundations should be extended to a depth where the minimum horizontal distance is equal to $H/3$ (where H equals the vertical distance from the top of the fill slope to the base of the fill soil) with a minimum of 7 feet but need not exceed 40 feet. The

horizontal distance is measured from the outer, deepest edge of the footing to the face of the slope. An acceptable alternative to deepening the footings would be the use of a post-tensioned slab and foundation system or increased footing and slab reinforcement. Specific design parameters or recommendations for either of these alternatives can be provided once the building location and fill slope geometry have been determined.

- Although other improvements, which are relatively rigid or brittle, such as concrete flatwork or masonry walls, may experience some distress if located near the top of a slope, it is generally not economical to mitigate this potential. It may be possible, however, to incorporate design measures that would permit some lateral soil movement without causing extensive distress. Geocon Incorporated should be consulted for specific recommendations.

8.9.7 We should observe the foundation excavations prior to the placement of reinforcing steel and concrete to check that the exposed soil conditions are similar to those expected and that they have been extended to the appropriate bearing strata. Foundation modifications may be required if unexpected soil conditions are encountered.

8.9.8 Geocon Incorporated should be consulted to provide additional design parameters as required by the structural engineer.

8.10 Drilled Pier Recommendations

8.10.1 We understand that drilled piers will be used for foundation support for the northern portion of Building B and might be used for the Parking Structure and Building E. The foundation recommendations herein assume that the piers will extend through fill into the Very Old Paralic Deposits or Ardath Shale materials. The piers should be at least 10 feet long and be embedded at least 5 feet within the formational materials.

8.10.2 Piers can be designed to develop support by end bearing within the formational materials and skin friction within the formational materials and portions of the fill soil. An allowable skin friction resistance of 400 psf can be used for that portion of the drilled pier embedded in fill soil and formational materials. The end bearing capacity can be determined by the End Bearing Capacity Chart. These allowable values possess a factor of safety of at least 2 and 3 for skin friction and end bearing, respectively.

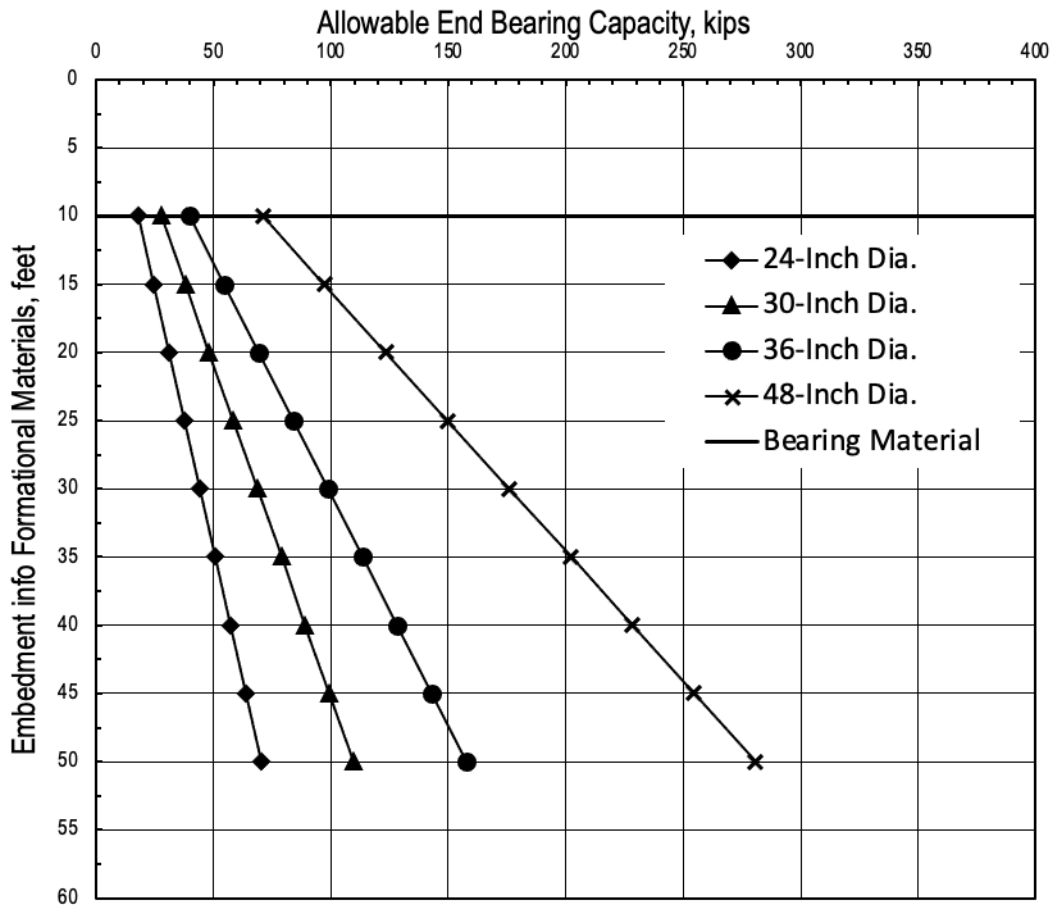

End Bearing Capacity Chart

- 8.10.3 The diameter of the piers should be a minimum of 24 inches. The design length of the drilled piers should be determined by the designer based on the elevation of the pile cap or grade beam and the elevation of the top of the formational materials obtained from the Geologic Map and Geologic Cross-Sections presented herein. It is difficult to evaluate the exact length of the proposed drilled piers due to the variable thickness of the existing fill; therefore, some variation should be expected during drilling operations.

- 8.10.4 If pier spacing is at least three times the maximum dimension of the pier, no reduction in axial capacity for group effects is considered necessary. If piles are spaced between 2 and 3 pile diameters (center to center), the single pile axial capacity should be reduced by 25 percent. Geocon Incorporated should be contacted to provide single-pile capacity if piers are spaced closer than 2 diameters.

- 8.10.5 The allowable downward capacity may be increased by one-third when considering transient wind or seismic loads.

- 8.10.6 The formational materials may contain gravel and cobble and may possess very dense zones; therefore, the drilling contractor should expect difficult drilling conditions during excavations for the piers. Because a significant portion of the piers capacity will be developed by end bearing, the bottom of the borehole should be cleaned of loose cuttings prior to the placement of steel and concrete. Experience indicates that backspinning the auger does not remove loose material and a flat cleanout plate is necessary. Concrete should be placed within the excavation as soon as possible after the auger/cleanout plate is withdrawn to reduce the potential for discontinuities or caving.
- 8.10.7 Pile settlement of production piers is expected to be on the order of ½ to 1 inch if the piers are loaded to their allowable capacities. Geocon should provide updated settlement estimates once the foundation plans are available. Settlements should be essentially complete shortly after completion of the building superstructure.
- 8.10.8 We can provide a lateral pile capacity analysis using the *LPILE* computer program once the pile type, size, and approximate length has been provided. The total capacity of pile groups should be considered less than the sum of the individual pile capacities for pile spacing of less than 8D (where D is pile diameter) for lateral loads parallel to the pile group and 3D for loads perpendicular to the pile group. The reduction in capacity is based on pile spacing and positioning and can result in group efficiency on the order of 50 percent of the sum of single-pile capacities. We can evaluate the lateral capacity of pile groups using the *GROUP* computer program, if requested.

8.11 Concrete Slabs-On-Grade

- 8.11.1 Concrete slabs-on-grade for the structures should be constructed in accordance with Table 8.11.

**TABLE 8.11
MINIMUM CONCRETE SLAB-ON-GRADE RECOMMENDATIONS**

Parameter	Value
Minimum Concrete Slab Thickness	5 inches
Minimum Steel Reinforcement	No. 4 Bars 18 Inches on Center, Both Directions
Typical Slab Underlayment	3 to 4 Inches of Sand/Gravel/Base
Design Expansion Index	90 or less

- 8.11.2 Slabs that may receive moisture-sensitive floor coverings or may be used to store moisture-sensitive materials should be underlain by a vapor retarder. The vapor retarder design should be consistent with the guidelines presented in the American Concrete Institute's (ACI) *Guide for*

Concrete Slabs that Receive Moisture-Sensitive Flooring Materials (ACI 302.2R-06). In addition, the membrane should be installed in accordance with manufacturer's recommendations and ASTM requirements and installed in a manner that prevents puncture. The vapor retarder used should be specified by the project architect or developer based on the type of floor covering that will be installed and if the structure will possess a humidity controlled environment.

- 8.11.3 The bedding sand thickness should be determined by the project foundation engineer, architect, and/or developer. It is common to have 3 to 4 inches of sand in the southern California region. However, we should be contacted to provide recommendations if the bedding sand is thicker than 6 inches. The foundation design engineer should provide appropriate concrete mix design criteria and curing measures to assure proper curing of the slab by reducing the potential for rapid moisture loss and subsequent cracking and/or slab curl. We suggest that the foundation design engineer present the concrete mix design and proper curing methods on the foundation plans. It is critical that the foundation contractor understands and follows the recommendations presented on the foundation plans.
- 8.11.4 Concrete slabs should be provided with adequate crack-control joints, construction joints and/or expansion joints to reduce unsightly shrinkage cracking. The design of joints should consider criteria of the American Concrete Institute (ACI) when establishing crack-control spacing. Crack-control joints should be spaced at intervals no greater than 12 feet. Additional steel reinforcing, concrete admixtures and/or closer crack control joint spacing should be considered where concrete-exposed finished floors are planned.
- 8.11.5 Special subgrade presaturation is not deemed necessary prior to placing concrete; however, the exposed foundation and slab subgrade soil should be moisturized to maintain a moist condition as would be expected in any such concrete placement.
- 8.11.6 The concrete slab-on-grade recommendations are based on soil support characteristics only. The project structural engineer should evaluate the structural requirements of the concrete slabs for supporting expected loads.

8.12 Exterior Concrete Flatwork

- 8.12.1 Exterior concrete flatwork not subject to vehicular traffic should be constructed in accordance with the recommendations presented in Table 8.12. The recommended steel reinforcement would help reduce the potential for cracking.

**TABLE 8.12
MINIMUM CONCRETE FLATWORK RECOMMENDATIONS**

Expansion Index, EI	Minimum Steel Reinforcement* Options	Minimum Thickness
EI ≤ 90	6x6-W2.9/W2.9 (6x6-6/6) welded wire mesh	4 Inches
	No. 3 Bars 18 inches on center, Both Directions	

*In excess of 8 feet square.

- 8.12.2 The subgrade soil should be properly moisturized and compacted prior to the placement of steel and concrete. The subgrade soil should be compacted to a dry density of at least 90 percent of the laboratory maximum dry density near to slightly above optimum moisture content in accordance with ASTM D 1557.
- 8.12.3 Even with the incorporation of the recommendations of this report, the exterior concrete flatwork has a potential to experience some uplift due to expansive soil beneath grade. The steel reinforcement should overlap continuously in flatwork to reduce the potential for vertical offsets within flatwork. Additionally, flatwork should be structurally connected to the curbs, where possible, to reduce the potential for offsets between the curbs and the flatwork.
- 8.12.4 Concrete flatwork should be provided with crack control joints to reduce and/or control shrinkage cracking. Crack control spacing should be determined by the project structural engineer based upon the slab thickness and intended usage. Criteria of the American Concrete Institute (ACI) should be taken into consideration when establishing crack control spacing. Subgrade soil for exterior slabs not subjected to vehicle loads should be compacted in accordance with criteria presented in the grading section prior to concrete placement. Subgrade soil should be properly compacted and the moisture content of subgrade soil should be verified prior to placing concrete. Base materials will not be required below concrete improvements.
- 8.12.5 Where exterior flatwork abuts the structure at entrant or exit points, the exterior slab should be dowelled into the structure's foundation stemwall. This recommendation is intended to reduce the potential for differential elevations that could result from differential settlement or minor heave of the flatwork. Dowelling details should be designed by the project structural engineer.
- 8.12.6 The recommendations presented herein are intended to reduce the potential for cracking of exterior slabs as a result of differential movement. However, even with the incorporation of the recommendations presented herein, slabs-on-grade will still crack. The occurrence of concrete shrinkage cracks is independent of the soil supporting characteristics. Their occurrence may be reduced and/or controlled by limiting the slump of the concrete, the use of crack control joints

and proper concrete placement and curing. Crack control joints should be spaced at intervals no greater than 12 feet. Literature provided by the Portland Concrete Association (PCA) and American Concrete Institute (ACI) present recommendations for proper concrete mix, construction, and curing practices, and should be incorporated into project construction.

8.13 Retaining Walls

- 8.13.1 Retaining walls should be designed using the values presented in Table 8.13.1 Soil with an expansion index (EI) of greater than 50 should not be used as backfill material behind retaining walls.

**TABLE 8.13.1
RETAINING WALL DESIGN RECOMMENDATIONS**

Parameter	Value
Active Soil Pressure, A (Fluid Density, Level Backfill)	40 pcf
Active Soil Pressure, A (Fluid Density, 2:1 Sloping Backfill)	55 pcf
Seismic Pressure, S	16H psf
At-Rest/Restrained Walls Additional Uniform Pressure (0 to 8 Feet High)	7H psf
At-Rest/Restrained Walls Additional Uniform Pressure (8+ Feet High)	13H psf
Expected Expansion Index for the Subject Property	EI \leq 90

H equals the height of the retaining portion of the wall

- 8.13.2 The project retaining walls should be designed as shown in the Retaining Wall Loading Diagram.

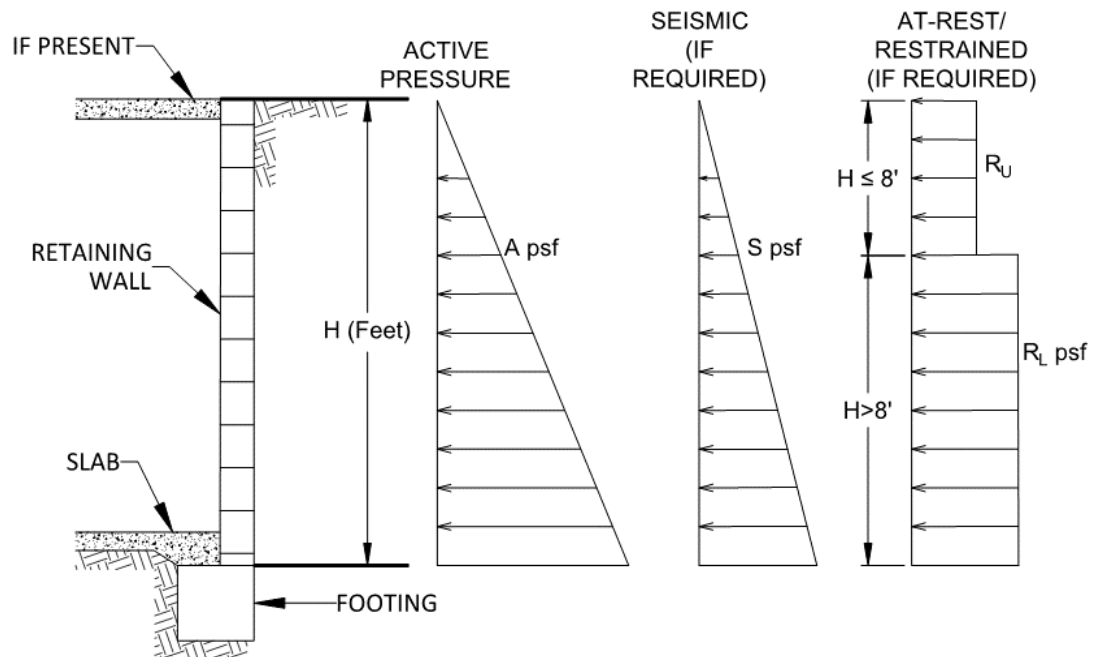

Retaining Wall Loading Diagram

- 8.13.3 Unrestrained walls are those that are allowed to rotate more than $0.001H$ (where H equals the height of the retaining portion of the wall) at the top of the wall. Where walls are restrained from movement at the top (at-rest condition), an additional uniform pressure should be applied to the wall. For retaining walls subject to vehicular loads within a horizontal distance equal to two-thirds the wall height, a surcharge equivalent to 2 feet of fill soil should be added.
- 8.13.4 The retaining walls may be designed using either the active and restrained (at-rest) loading condition or the active and seismic loading condition as suggested by the structural engineer. Typically, it appears the design of the restrained condition for retaining wall loading may be adequate for the seismic design of the retaining walls. However, the active earth pressure combined with the seismic design load should be reviewed and also considered in the design of the retaining walls.
- 8.13.5 The structural engineer should determine the Seismic Design Category for the project in accordance with Section 1613.3.5 of the 2019 CBC or Section 11.6 of ASCE 7-10. For structures assigned to Seismic Design Category of D, E, or F, retaining walls that support more than 6 feet of backfill should be designed with seismic lateral pressure in accordance with Section 1803.5.12 of the 2019 CBC. The seismic load is dependent on the retained height where H is the height of the wall, in feet, and the calculated loads result in pounds per square foot (psf) exerted at the base of the wall and zero at the top of the wall.

8.13.6 Retaining walls should be designed to ensure stability against overturning sliding, and excessive foundation pressure. Where a keyway is extended below the wall base with the intent to engage passive pressure and enhance sliding stability, it is not necessary to consider active pressure on the keyway.

8.13.7 Drainage openings through the base of the wall (weep holes) should not be used where the seepage could be a nuisance or otherwise adversely affect the property adjacent to the base of the wall. The recommendations herein assume a properly compacted granular (EI of 90 or less) free-draining backfill material with no hydrostatic forces or imposed surcharge load. The retaining wall should be properly drained as shown in the Typical Retaining Wall Drainage Detail. If conditions different than those described are expected, or if specific drainage details are desired, Geocon Incorporated should be contacted for additional recommendations.

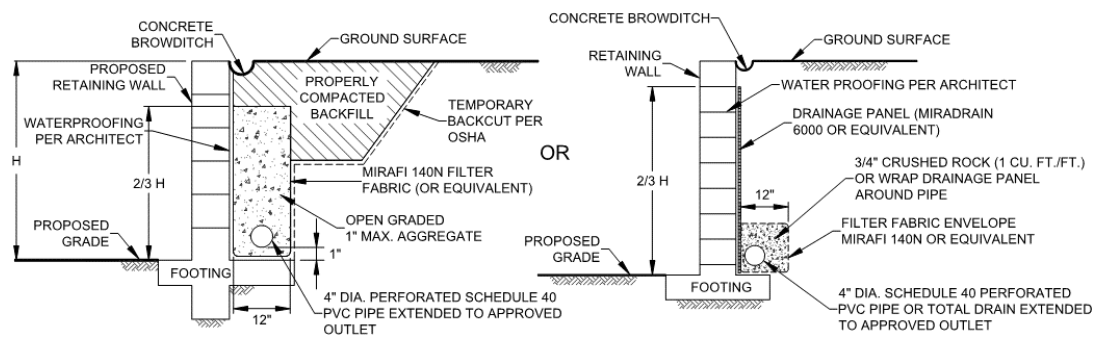

Typical Retaining Wall Drainage Detail

8.13.8 In general, the site wall foundations should be designed in accordance with Table 8.13.2. The proximity of the foundation to the top of a slope steeper than 3:1 could impact the allowable soil bearing pressure. Therefore, retaining wall foundations should be deepened such that the bottom outside edge of the footing is at least 7 feet horizontally from the face of the slope.

**TABLE 8.13.2
SUMMARY OF RETAINING WALL FOUNDATION RECOMMENDATIONS**

Parameter	Value
Minimum Retaining Wall Foundation Width	12 inches
Minimum Retaining Wall Foundation Depth	12 Inches
Minimum Steel Reinforcement	Per Structural Engineer
Allowable Bearing Capacity	2,500 psf
Estimated Total Settlement	1 Inch
Estimated Differential Settlement	½ Inch in 40 Feet

- 8.13.9 The recommendations presented herein are generally applicable to the design of rigid concrete or masonry retaining walls. In the event that other types of walls (such as mechanically stabilized earth [MSE] walls, soil nail walls, or soldier pile walls) are planned, Geocon Incorporated should be consulted for additional recommendations.
- 8.13.10 Unrestrained walls will move laterally when backfilled and loading is applied. The amount of lateral deflection is dependent on the wall height, the type of soil used for backfill, and loads acting on the wall. The retaining walls and improvements above the retaining walls should be designed to incorporate an appropriate amount of lateral deflection as determined by the structural engineer.
- 8.13.11 Soil contemplated for use as retaining wall backfill, including import materials, should be identified in the field prior to backfill. At that time, Geocon Incorporated should obtain samples for laboratory testing to evaluate its suitability. Modified lateral earth pressures may be necessary if the backfill soil does not meet the required expansion index or shear strength. City or regional standard wall designs, if used, are based on a specific active lateral earth pressure and/or soil friction angle. In this regard, on-site soil to be used as backfill may or may not meet the values for standard wall designs. Geocon Incorporated should be consulted to assess the suitability of the on-site soil for use as wall backfill if standard wall designs will be used.

8.14 Lateral Loading

- 8.14.1 Table 8.14 should be used to help design the proposed structures and improvements to resist lateral loads for the design of footings or shear keys. The allowable passive pressure assumes a horizontal surface extending at least 5 feet, or three times the surface generating the passive pressure, whichever is greater. The upper 12 inches of material in areas not protected by floor slabs or pavement should not be included in design for passive resistance.

**TABLE 8.14
SUMMARY OF LATERAL LOAD DESIGN RECOMMENDATIONS**

Parameter	Value
Passive Pressure Fluid Density	350 pcf
Coefficient of Friction (Concrete and Soil)	0.35
Coefficient of Friction (Along Vapor Barrier)	0.2 to 0.25*

*Per manufacturer's recommendations.

- 8.14.2 The passive and frictional resistant loads can be combined for design purposes. The lateral passive pressures may be increased by one-third when considering transient loads due to wind or seismic forces.

8.15 Preliminary Pavement Recommendations

8.15.1 We calculated the flexible pavement sections in general conformance with the *Caltrans Method of Flexible Pavement Design* (Highway Design Manual, Section 608.4) using an estimated Traffic Index (TI) of 5.0, 5.5, 6.0, and 7.0 for parking stalls, driveways, medium truck traffic areas, and heavy truck traffic areas, respectively. The project civil engineer and owner should review the pavement designations to determine appropriate locations for pavement thickness. The final pavement sections for the parking lot should be based on the R-Value of the subgrade soil encountered at final subgrade elevation. We assumed an R-Value of 10 (based on laboratory testing) and 78 for the subgrade soil and base materials, respectively, for the purposes of this preliminary analysis. Table 8.15.1 presents the preliminary flexible pavement sections.

**TABLE 8.15.1
PRELIMINARY FLEXIBLE PAVEMENT SECTION**

Location	Assumed Traffic Index	Assumed Subgrade R-Value	Asphalt Concrete (inches)	Class 2 Aggregate Base (inches)
Parking stalls for automobiles and light-duty vehicles	5.0	10	3	8
Driveways for automobiles and light-duty vehicles	5.5	10	3	11
Medium truck traffic areas	6.0	10	3½	12
Driveways for heavy truck traffic	7.0	10	4	15

8.15.2 Prior to placing base materials, the upper 12 inches of the subgrade soil should be scarified, moisture conditioned as necessary, and recompacted to a dry density of at least 95 percent of the laboratory maximum dry density near to slightly above optimum moisture content as determined by ASTM D 1557. Similarly, the base material should be compacted to a dry density of at least 95 percent of the laboratory maximum dry density near to slightly above optimum moisture content. Asphalt concrete should be compacted to a density of at least 95 percent of the laboratory Hveem density in accordance with ASTM D 2726.

8.15.3 A rigid Portland cement concrete (PCC) pavement section should be placed in roadway aprons and cross gutters. We calculated the rigid pavement section in general conformance with the procedure recommended by the American Concrete Institute report ACI 330R-08 Guide for Design and Construction of Concrete Parking Lots using the parameters presented in Table 8.15.2.

**TABLE 8.15.2
RIGID PAVEMENT DESIGN PARAMETERS**

Design Parameter	Design Value
Modulus of subgrade reaction, k	50 pci
Modulus of rupture for concrete, M_R	500 psi
Concrete Compressive Strength	3,000 psi
Traffic Category, TC	A and C
Average daily truck traffic, ADTT	10 and 100

8.15.4 Based on the criteria presented herein, the PCC pavement sections should have a minimum thickness as presented in Table 8.15.3.

**TABLE 8.15.3
RIGID VEHICULAR PAVEMENT RECOMMENDATIONS**

Location	Portland Cement Concrete (inches)
Automobile Parking Stalls (TC=A)	6.0
Driveways (TC=C)	7.5

8.15.5 The PCC vehicular pavement should be placed over subgrade soil that is compacted to a dry density of at least 95 percent of the laboratory maximum dry density near to slightly above optimum moisture content.

8.15.6 The rigid pavement should also be designed and constructed incorporating the parameters presented in Table 8.15.4.

**TABLE 8.15.4
ADDITIONAL RIGID PAVEMENT RECOMMENDATIONS**

Subject	Value
Thickened Edge	1.2 Times Slab Thickness
	Minimum Increase of 2 Inches
	4 Feet Wide
Crack Control Joint Spacing	30 Times Slab Thickness
	Max. Spacing of 12 feet for 5.5-Inch-Thick
	Max. Spacing of 15 Feet for Slabs 6 Inches and Thicker
Crack Control Joint Depth	Per ACI 330R-08
	1 Inch Using Early-Entry Saws on Slabs Less Than 9 Inches Thick
Crack Control Joint Width	¼-Inch for Sealed Joints
	⅜-Inch is Common for Sealed Joints
	1/10- to 1/8-Inch is Common for Unsealed Joints

- 8.15.7 Reinforcing steel will not be necessary within the concrete for geotechnical purposes with the possible exception of dowels at construction joints as discussed herein.
- 8.15.8 To control the location and spread of concrete shrinkage cracks, crack-control joints (weakened plane joints) should be included in the design of the concrete pavement slab. Crack-control joints should be sealed with an appropriate sealant to prevent the migration of water through the control joint to the subgrade materials. The depth of the crack-control joints should be determined by the referenced ACI report.
- 8.15.9 To provide load transfer between adjacent pavement slab sections, a butt-type construction joint should be constructed. The butt-type joint should be thickened by at least 20 percent at the edge and taper back at least 4 feet from the face of the slab. As an alternative to the butt-type construction joint, dowelling can be used between construction joints for pavements of 7 inches or thicker. As discussed in the referenced ACI guide, dowels should consist of smooth, 1-inch-diameter reinforcing steel 14 inches long embedded a minimum of 6 inches into the slab on either side of the construction joint. Dowels should be located at the midpoint of the slab, spaced at 12 inches on center and lubricated to allow joint movement while still transferring loads. In addition, tie bars should be installed as recommended in Section 3.8.3 of the referenced ACI guide. The structural engineer should provide other alternative recommendations for load transfer.
- 8.15.10 Concrete curb/gutter should be placed on soil subgrade compacted to a dry density of at least 90 percent of the laboratory maximum dry density near to slightly above optimum moisture content. Cross-gutters that receives vehicular should be placed on subgrade soil compacted to a dry density of at least 95 percent of the laboratory maximum dry density near to slightly above optimum moisture content. Base materials should not be placed below the curb/gutter, or cross-gutters so water is not able to migrate from the adjacent parkways to the pavement sections. Where flatwork is located directly adjacent to the curb/gutter, the concrete flatwork should be structurally connected to the curbs to help reduce the potential for offsets between the curbs and the flatwork.

8.16 Site Drainage and Moisture Protection

- 8.16.1 Adequate site drainage is critical to reduce the potential for differential soil movement, erosion and subsurface seepage. Under no circumstances should water be allowed to pond adjacent to footings. The site should be graded and maintained such that surface drainage is directed away from structures in accordance with 2019 CBC 1804.4 or other applicable standards. In addition, surface drainage should be directed away from the top of slopes into

swales or other controlled drainage devices. Roof and pavement drainage should be directed into conduits that carry runoff away from the proposed structure.

- 8.16.2 In the case of basement walls or building walls retaining landscaping areas, a water-proofing system should be used on the wall and joints, and a Miradrain drainage panel (or similar) should be placed over the waterproofing. The project architect or civil engineer should provide detailed specifications on the plans for all waterproofing and drainage.
- 8.16.3 Underground utilities should be leak free. Utility and irrigation lines should be checked periodically for leaks, and detected leaks should be repaired promptly. Detrimental soil movement could occur if water is allowed to infiltrate the soil for prolonged periods of time.
- 8.16.4 Landscaping planters adjacent to paved areas are not recommended due to the potential for surface or irrigation water to infiltrate the pavement's subgrade and base course. Area drains to collect excess irrigation water and transmit it to drainage structures or impervious above-grade planter boxes can be used. In addition, where landscaping is planned adjacent to the pavement, construction of a cutoff wall along the edge of the pavement that extends at least 6 inches below the bottom of the base material should be considered.
- 8.16.5 We should prepare a storm water infiltration feasibility report of storm water management devices are planned.

8.17 Updated Geotechnical Investigation

- 8.17.1 We should be contacted to provide an updated geotechnical investigation for the project once the grading and building foundation are available. We should provide review of the project plans prior to final design submittal to evaluate if additional analyses and/or recommendations are required.

LIMITATIONS AND UNIFORMITY OF CONDITIONS

1. The firm that performed the geotechnical investigation for the project should be retained to provide testing and observation services during construction to provide continuity of geotechnical interpretation and to check that the recommendations presented for geotechnical aspects of site development are incorporated during site grading, construction of improvements, and excavation of foundations. If another geotechnical firm is selected to perform the testing and observation services during construction operations, that firm should prepare a letter indicating their intent to assume the responsibilities of project geotechnical engineer of record. A copy of the letter should be provided to the regulatory agency for their records. In addition, that firm should provide revised recommendations concerning the geotechnical aspects of the proposed development, or a written acknowledgement of their concurrence with the recommendations presented in our report. They should also perform additional analyses deemed necessary to assume the role of Geotechnical Engineer of Record.
2. The recommendations of this report pertain only to the site investigated and are based upon the assumption that the soil conditions do not deviate from those disclosed in the investigation. If any variations or undesirable conditions are encountered during construction, or if the proposed construction will differ from that anticipated herein, Geocon Incorporated should be notified so that supplemental recommendations can be given. The evaluation or identification of the potential presence of hazardous or corrosive materials was not part of the scope of services provided by Geocon Incorporated.
3. This report is issued with the understanding that it is the responsibility of the owner or his representative to ensure that the information and recommendations contained herein are brought to the attention of the architect and engineer for the project and incorporated into the plans, and the necessary steps are taken to see that the contractor and subcontractors carry out such recommendations in the field.
4. The findings of this report are valid as of the present date. However, changes in the conditions of a property can occur with the passage of time, whether they be due to natural processes or the works of man on this or adjacent properties. In addition, changes in applicable or appropriate standards may occur, whether they result from legislation or the broadening of knowledge. Accordingly, the findings of this report may be invalidated wholly or partially by changes outside our control. Therefore, this report is subject to review and should not be relied upon after a period of three years.

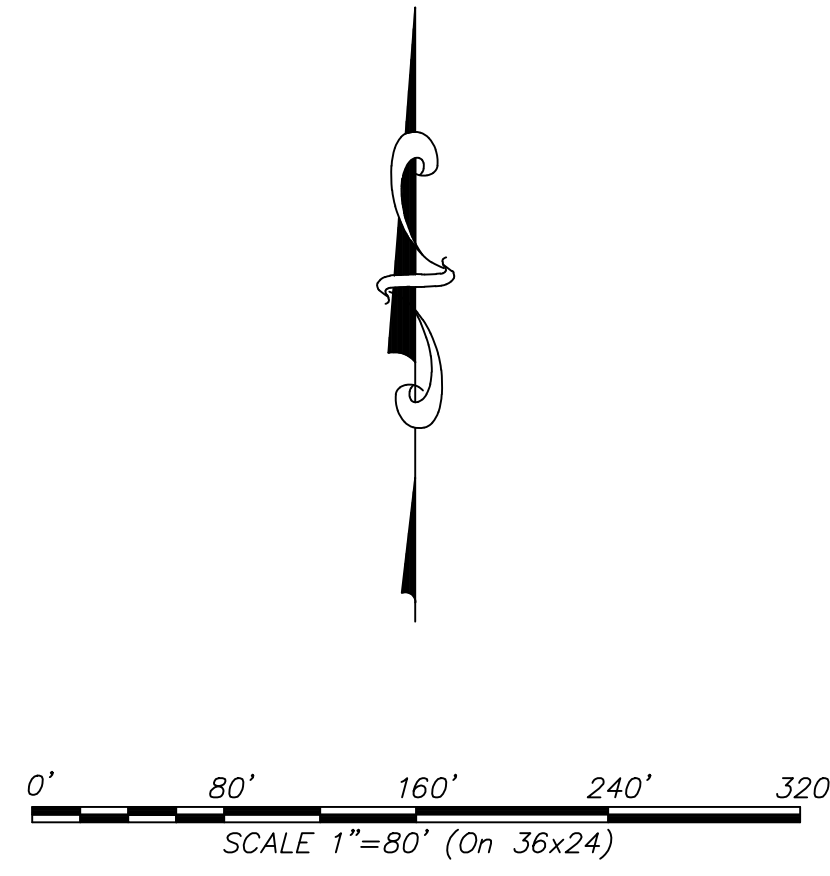
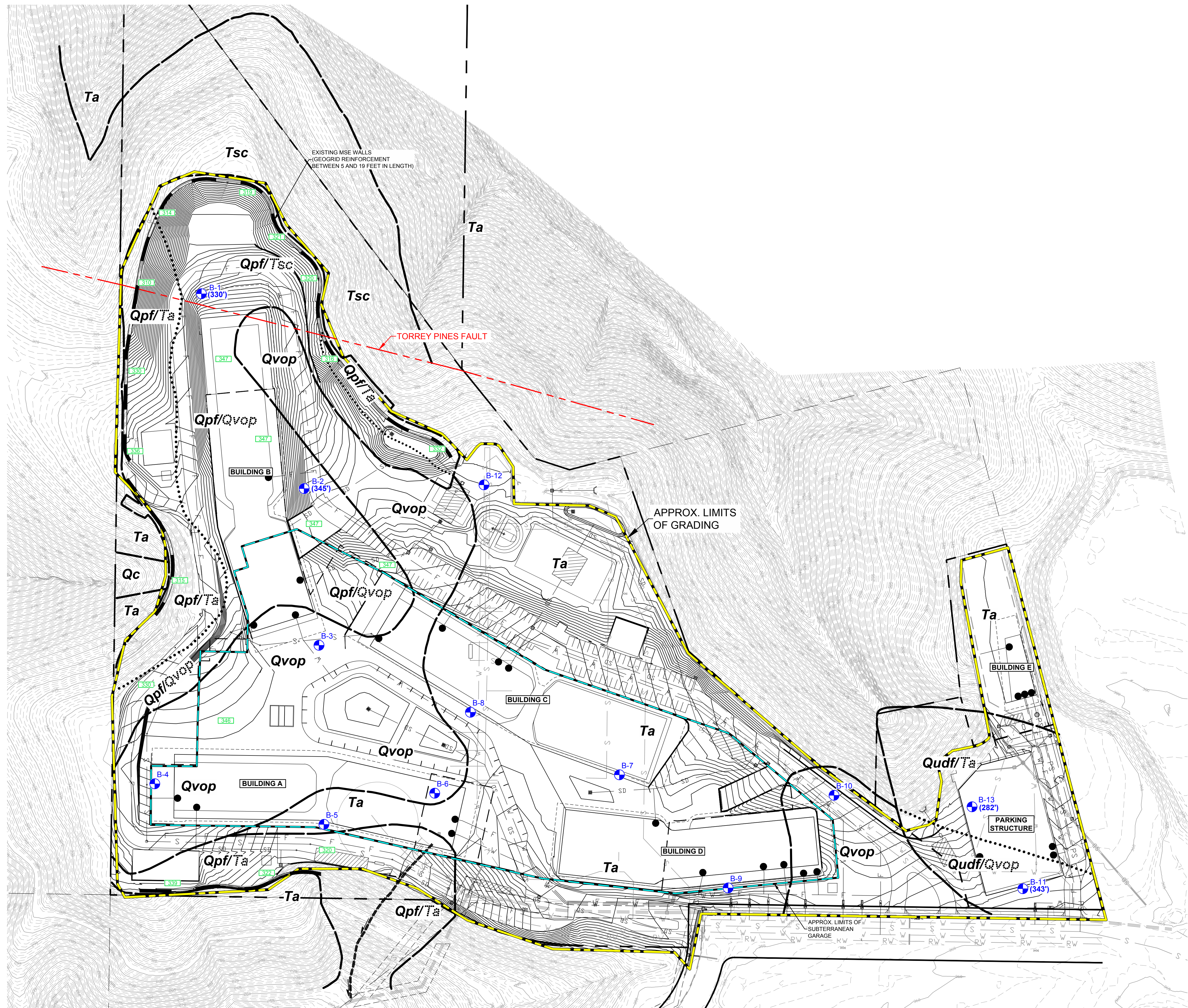

- GEOCON LEGEND**
- Qudf** UNDOCUMENTED FILL
 - Qpf** PREVIOUSLY PLACED FILL (Dotted Where Buried)
 - Qc** COLLUVIUM
 - Qvop** VERY OLD PARALIC DEPOSITS
 - Ta** ARDATH SHALE (Dotted Where Buried)
 - B-14** APPROX. LOCATION OF BORING
 - 325'** APPROX. ELEVATION AT TOP OF FORMATION (In Feet, MSL)
 - 345'** APPROX. ELEVATION AT BOTTOM OF REMOVALS DURING PREVIOUS GRADING (In Feet, MSL)
 - APPROX. LOCATION OF GEOLOGIC CONTACT (Dotted Where Buried)
 - APPROX. LOCATION OF EXISTING SUBDRAIN
 - APPROX. LIMITS OF SUBTERRANEAN GARAGE
 - B' APPROX. LOCATION OF GEOLOGIC CROSS-SECTION

GEOLOGIC MAP
TOWNE CENTRE VIEW
SAN DIEGO, CALIFORNIA

GEOCON <small>INCORPORATED</small> GEOTECHNICAL ■ ENVIRONMENTAL ■ MATERIALS 6960 FLANDERS DRIVE - SAN DIEGO, CALIFORNIA 92121 - 2974 PHONE 619 558-6900 - FAX 619 558-6159	SCALE 1" = 80' PROJECT NO. G2326 - 52 - 02 SHEET 1 OF 1	DATE 02 - 03 - 2021 FIGURE 1
-----------------------------------------------------------------------------------------------------------------------------------------------------------------------------------------------	---------------------------------------------------------------	---------------------------------

Plotted 02/03/2021 8:20AM | By: JONATHAN WILKINS | File Location: Y:\PROJECTS\G2326-52-02 Towne Centre View\SHEETS\G2326-52-02 GeologicMAP.dwg

TOWNE CENTRE VIEW
SAN DIEGO, CALIFORNIA

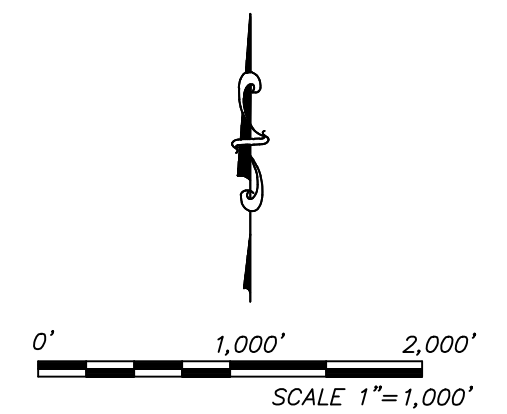
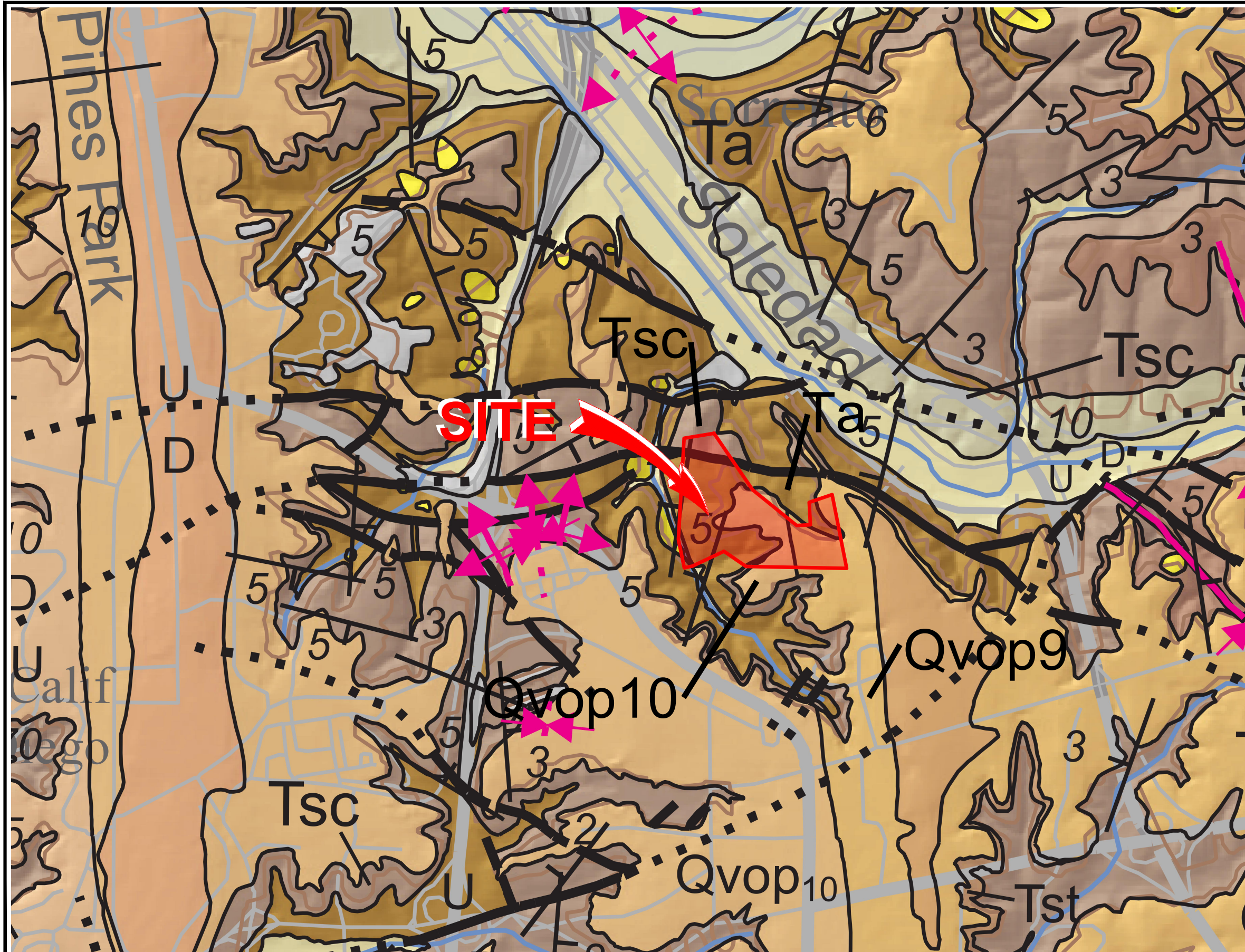

GEOCON LEGEND

- Qvop8**VERY OLD PARALIC DEPOSITS UNIT 8
- Qvop9**VERY OLD PARALIC DEPOSITS UNIT 9
- Qvop10**VERY OLD PARALIC DEPOSITS UNIT 10
- Tst**STADIUM CONGLOMERATE
- Tsc**SCRIPPS FORMATION
- Tscu**SCRIPPS FORMATION UPPER UNIT
- Ta**ARDATH SHALE

GEOCON
INCORPORATED
 GEOTECHNICAL ■ ENVIRONMENTAL ■ MATERIALS
 6960 FLANDERS DRIVE - SAN DIEGO, CALIFORNIA 92121 - 2974
 PHONE 858 558-6900 - FAX 858 558-6159
 PROJECT NO. G2326 - 52 - 02

SOURCE: Kennedy P. Michael and Tan S. Siang, 2008, *Geologic Map of San Diego 30'x60' Quadrangle, California*
 U.S. Geological Survey, Department of Earth Sciences, University of California, Riverside

REGIONAL GEOLOGIC MAP
 FIGURE 2
 DATE 02 - 03 - 2021

APPENDIX

A

APPENDIX A

FIELD INVESTIGATION

We performed the drilling operations on August 31, 2020 through September 4, 2020. The locations of the current exploratory borings are shown on the Geologic Map, Figure 1. The boring logs are presented in this Appendix. We located the borings in the field using a measuring tape and existing reference points; therefore, actual boring locations may deviate slightly. The geotechnical borings were drilled to depths ranging from approximately 20 to 61 feet below existing grade using a CME 95 drill rig equipped with hollow-stem augers.

We obtained samples during our subsurface exploration in the borings using a California split-spoon sampler or a Standard Penetration Test (SPT) sampler. Both samplers are composed of steel and are driven to obtain the soil samples. The California sampler has an inside diameter of 2.5 inches and an outside diameter of 2.875 inches. Up to 18 rings are placed inside the sampler that is 2.4 inches in diameter and 1 inch in height. The SPT sampler has an inside diameter of 1.5 inches and an outside diameter of 2 inches. We obtained ring samples in moisture-tight containers at appropriate intervals and transported them to the laboratory for testing.

The samplers were driven 12 inches and 18 inches using the California and SPT samplers, respectively, into the bottom of the excavations with the use of an automatic down-hole hammer. The sampler is connected to A rods and driven into the bottom of the excavation using a 140-pound hammer with a 30-inch drop. Blow counts are recorded for every 6 inches the sampler is driven. The penetration resistances shown on the boring logs are shown in terms of blows per foot. The values indicated on the boring logs are the sum of the last 12 inches of the sampler. If the sampler was not driven for 12 inches, an approximate value is calculated in terms of blows per foot or the final 6-inch interval is reported. These values are not to be taken as N-values as adjustments have not been applied. We estimated elevations shown on the boring logs either from a topographic map or by using a benchmark. Each excavation was backfilled as noted on the boring logs.

We visually examined, classified, and logged the soil encountered in the borings in general accordance with American Society for Testing and Materials (ASTM) practice for Description and Identification of Soils (Visual-Manual Procedure D 2488). The logs depict the soil and geologic conditions observed and the depth at which samples were obtained.























DEPTH IN FEET	SAMPLE NO.	LITHOLOGY	GROUNDWATER	SOIL CLASS (USCS)	BORING B 1		PENETRATION RESISTANCE (BLOWS/FT.)	DRY DENSITY (P.C.F.)	MOISTURE CONTENT (%)
					ELEV. (MSL.) <u>340'</u>	DATE COMPLETED <u>08-31-2020</u>			
					EQUIPMENT <u>CME 95</u> BY: <u>B. KUNA</u>				
MATERIAL DESCRIPTION									
0	B1-1			SC	2-INCHES OF CEMENT-TREATED BASE				
2					PREVIOUSLY PLACED FILL (Qpf) Medium dense, moist, mottled brown, gray and yellowish brown, Clayey, fine to coarse SAND; little gravel				
4									
6	B1-2						29	189.5	15.2
8									
10	B1-3			SM	SCRIPPS FORMATION (Tsc) Very dense, damp, reddish brown and brownish gray, Silty, fine SANDSTONE		50/5"	120.3	8.6
12									
14									
16	B1-4				-Becomes light yellowish brown with some iron oxide staining		98/8"	116.3	7.3
18									
20	B1-5			CL	Hard, moist, yellowish brown, laminated CLAYSTONE, some iron oxide staining		50/6"	105.4	20.5
22									
24									
26	B1-6				-Becomes brownish gray		90/10		
28									
30	B1-7						90-9"	107.2	120.4
32									
34									

Figure A-1,
Log of Boring B 1, Page 1 of 2

G2326-52-02.GPJ

SAMPLE SYMBOLS			
	... SAMPLING UNSUCCESSFUL		... STANDARD PENETRATION TEST
	... DISTURBED OR BAG SAMPLE		... DRIVE SAMPLE (UNDISTURBED)
			... WATER TABLE OR SEEPAGE

NOTE: THE LOG OF SUBSURFACE CONDITIONS SHOWN HEREON APPLIES ONLY AT THE SPECIFIC BORING OR TRENCH LOCATION AND AT THE DATE INDICATED. IT IS NOT WARRANTED TO BE REPRESENTATIVE OF SUBSURFACE CONDITIONS AT OTHER LOCATIONS AND TIMES.







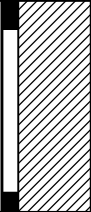

DEPTH IN FEET	SAMPLE NO.	LITHOLOGY	GROUNDWATER	SOIL CLASS (USCS)	BORING B 1		PENETRATION RESISTANCE (BLOWS/FT.)	DRY DENSITY (P.C.F.)	MOISTURE CONTENT (%)
					ELEV. (MSL.) <u>340'</u>	DATE COMPLETED <u>08-31-2020</u>			
					EQUIPMENT <u>CME 95</u> BY: <u>B. KUNA</u>				
					MATERIAL DESCRIPTION				
36	B1-8			CL			92/10"	104.6	20.3
40	B1-9						50/5"	107.0	19.3
					BORING TERMINATED AT 40.5 FEET Groundwater not encountered				

Figure A-1,
Log of Boring B 1, Page 2 of 2

G2326-52-02.GPJ







SAMPLE SYMBOLS	 ... SAMPLING UNSUCCESSFUL	 ... STANDARD PENETRATION TEST	 ... DRIVE SAMPLE (UNDISTURBED)
	 ... DISTURBED OR BAG SAMPLE	 ... CHUNK SAMPLE	 ... WATER TABLE OR SEEPAGE

NOTE: THE LOG OF SUBSURFACE CONDITIONS SHOWN HEREON APPLIES ONLY AT THE SPECIFIC BORING OR TRENCH LOCATION AND AT THE DATE INDICATED. IT IS NOT WARRANTED TO BE REPRESENTATIVE OF SUBSURFACE CONDITIONS AT OTHER LOCATIONS AND TIMES.

DEPTH IN FEET	SAMPLE NO.	LITHOLOGY	GROUNDWATER	SOIL CLASS (USCS)	BORING B 2		PENETRATION RESISTANCE (BLOWS/FT.)	DRY DENSITY (P.C.F.)	MOISTURE CONTENT (%)
					ELEV. (MSL.) <u>350'</u>	DATE COMPLETED <u>08-31-2020</u>			
					EQUIPMENT <u>CME 95</u> BY: <u>B. KUNA</u>				
MATERIAL DESCRIPTION									
0				SM	2-INCHES OF CEMENT-TREATED BASE				
2					PREVIOUSLY PLACED FILL (Qpf) Medium dense, moist, light reddish brown, Silty, fine to medium SAND				
4									
6	B2-1 B2-2			SM	-Disturbed sample VERY OLD PARALIC DEPOSITS (Qvop) Very dense, moist, light yellowish brown, Silty fine SAND		50/3"		5.3
8									
10	B2-3						92/8"		
12				CL	ARDATH SHALE (Ta) Hard, moist, light yellowish brown and brownish gray, laminated CLAYSTONE				
14									
16	B2-4						92/10"	106.8	18.0
18									
20	B2-5				-Becomes gray, some iron oxide staining		87/9"	108.2	16.9
22									
24					-Becomes very stiff, olive brown				
26	B2-6						66	105.9	20.9
28									
30	B2-7				-Becomes hard, gray		97/11"	103.6	22.2
32									
34									

Figure A-2,
Log of Boring B 2, Page 1 of 2

G2326-52-02.GPJ

SAMPLE SYMBOLS	 ... SAMPLING UNSUCCESSFUL	 ... STANDARD PENETRATION TEST	 ... DRIVE SAMPLE (UNDISTURBED)
	 ... DISTURBED OR BAG SAMPLE	 ... CHUNK SAMPLE	 ... WATER TABLE OR SEEPAGE

NOTE: THE LOG OF SUBSURFACE CONDITIONS SHOWN HEREON APPLIES ONLY AT THE SPECIFIC BORING OR TRENCH LOCATION AND AT THE DATE INDICATED. IT IS NOT WARRANTED TO BE REPRESENTATIVE OF SUBSURFACE CONDITIONS AT OTHER LOCATIONS AND TIMES.







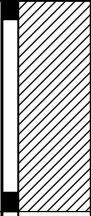

DEPTH IN FEET	SAMPLE NO.	LITHOLOGY	GROUNDWATER	SOIL CLASS (USCS)	BORING B 2		PENETRATION RESISTANCE (BLOWS/FT.)	DRY DENSITY (P.C.F.)	MOISTURE CONTENT (%)
					ELEV. (MSL.) <u>350'</u>	DATE COMPLETED <u>08-31-2020</u>			
					EQUIPMENT <u>CME 95</u> BY: <u>B. KUNA</u>				
					MATERIAL DESCRIPTION				
36	B2-8			CL	-Becomes dark gray		50/5"		
38					-Very difficult hard drilling at 38-40 feet				
40	B2-9				BORING TERMINATED AT 40.5 FEET Groundwater not encountered Backfilled on 08-31-2020		50/5"		

Figure A-2,
Log of Boring B 2, Page 2 of 2

G2326-52-02.GPJ







SAMPLE SYMBOLS	 ... SAMPLING UNSUCCESSFUL	 ... STANDARD PENETRATION TEST	 ... DRIVE SAMPLE (UNDISTURBED)
	 ... DISTURBED OR BAG SAMPLE	 ... CHUNK SAMPLE	 ... WATER TABLE OR SEEPAGE

NOTE: THE LOG OF SUBSURFACE CONDITIONS SHOWN HEREON APPLIES ONLY AT THE SPECIFIC BORING OR TRENCH LOCATION AND AT THE DATE INDICATED. IT IS NOT WARRANTED TO BE REPRESENTATIVE OF SUBSURFACE CONDITIONS AT OTHER LOCATIONS AND TIMES.

DEPTH IN FEET	SAMPLE NO.	LITHOLOGY	GROUNDWATER	SOIL CLASS (USCS)	BORING B 3		PENETRATION RESISTANCE (BLOWS/FT.)	DRY DENSITY (P.C.F.)	MOISTURE CONTENT (%)
					ELEV. (MSL.) <u>350'</u>	DATE COMPLETED <u>08-31-2020</u>			
					EQUIPMENT <u>CME 95</u>	BY: <u>B. KUNA</u>			
MATERIAL DESCRIPTION									
0					6-INCH CLASS 2 BASE				
2				SM	VERY OLD PARALIC DEPOSITS (Qvop) Very dense, moist, reddish brown, Silty, fine SAND				
4									
6									
8						-Gravelly layer at 8-11 feet			
10						-Becomes light yellowish brown			
12	B3-1						50/3.5"	107.7	11.9
14									
16									
18				SM/CL	Very dense, moist, pale yellowish brown and reddish brown, Silty, fine to medium SAND with chunks of claystone				
20	B3-2						87/10"	107.3	9.0
22				GW	Very dense, moist, grayish brown, Silty GRAVEL with sand				
24									
26									
28									
30						-Sampling unsuccessful	80/1"		
32									
34				SM	Very dense, moist, gray, Silty fine SAND; little iron oxide staining				

Figure A-3,
Log of Boring B 3, Page 1 of 2

G2326-52-02.GPJ

SAMPLE SYMBOLS	 ... SAMPLING UNSUCCESSFUL	 ... STANDARD PENETRATION TEST	 ... DRIVE SAMPLE (UNDISTURBED)
	 ... DISTURBED OR BAG SAMPLE	 ... CHUNK SAMPLE	 ... WATER TABLE OR SEEPAGE

NOTE: THE LOG OF SUBSURFACE CONDITIONS SHOWN HEREON APPLIES ONLY AT THE SPECIFIC BORING OR TRENCH LOCATION AND AT THE DATE INDICATED. IT IS NOT WARRANTED TO BE REPRESENTATIVE OF SUBSURFACE CONDITIONS AT OTHER LOCATIONS AND TIMES.

DEPTH IN FEET	SAMPLE NO.	LITHOLOGY	GROUNDWATER	SOIL CLASS (USCS)	BORING B 3		PENETRATION RESISTANCE (BLOWS/FT.)	DRY DENSITY (P.C.F.)	MOISTURE CONTENT (%)	
					ELEV. (MSL.) <u>350'</u>	DATE COMPLETED <u>08-31-2020</u>				
					EQUIPMENT <u>CME 95</u> BY: <u>B. KUNA</u>					
MATERIAL DESCRIPTION										
36	B3-3			SM			50/3"	103.4	10.3	
38										
40	B3-4			SM/CL	Very dense, moist, light yellowish brown and grayish brown, Silty, fine to medium SAND with abundant gravel; iron oxide staining, some chunks of claystone		50/3"			
42										
44										
46	B3-5						50/2"	116.1	12.5	
48										
50	B3-6			CL	ARDATH SHALE (Ta) Hard, moist, gray, laminated CLAYSTONE; little iron oxide staining		50/3.5"	99.1	18.0	
52										
54	B3-7				-Becomes dark gray		50/3.5"	110.8	15.8	
56										
58										
60	B3-8						50/3"	113.0	16.0	
					BORING TERMINATED AT 60.25 FEET Groundwater not encountered					

Figure A-3,
Log of Boring B 3, Page 2 of 2

G2326-52-02.GPJ







SAMPLE SYMBOLS	... SAMPLING UNSUCCESSFUL	... STANDARD PENETRATION TEST	... DRIVE SAMPLE (UNDISTURBED)
	... DISTURBED OR BAG SAMPLE	... CHUNK SAMPLE	... WATER TABLE OR SEEPAGE

NOTE: THE LOG OF SUBSURFACE CONDITIONS SHOWN HEREON APPLIES ONLY AT THE SPECIFIC BORING OR TRENCH LOCATION AND AT THE DATE INDICATED. IT IS NOT WARRANTED TO BE REPRESENTATIVE OF SUBSURFACE CONDITIONS AT OTHER LOCATIONS AND TIMES.

DEPTH IN FEET	SAMPLE NO.	LITHOLOGY	GROUNDWATER	SOIL CLASS (USCS)	BORING B 4		PENETRATION RESISTANCE (BLOWS/FT.)	DRY DENSITY (P.C.F.)	MOISTURE CONTENT (%)
					ELEV. (MSL.) <u>345'</u>	DATE COMPLETED <u>09-01-2020</u>			
					EQUIPMENT <u>CME 95</u>		BY: <u>B. KUNA</u>		
MATERIAL DESCRIPTION									
0					6-INCH CEMENT-TREATED BASE				
2				SC	VERY OLD PARALIC DEPOSITS (Qvop) Very dense, moist, brown, Clayey, fine SAND				
8				SM	Very dense, moist, pale yellowish brown, Silty, fine SAND				
10	B4-1						96/8.5"	107.8	5.8
20	B4-2						96/10.1"	101.3	6.1
26				SM	Very dense, damp, brownish gray, Silty, fine SAND with iron oxide staining, little cohesion				
30	B4-3 B4-4				-No recovery		50/5" 50/5"		
34					-Intermittent gravelly layers from 34-43 feet				

Figure A-4,
Log of Boring B 4, Page 1 of 2

G2326-52-02.GPJ

SAMPLE SYMBOLS			
	... SAMPLING UNSUCCESSFUL		... STANDARD PENETRATION TEST
	... DISTURBED OR BAG SAMPLE		... DRIVE SAMPLE (UNDISTURBED)
	... CHUNK SAMPLE		... WATER TABLE OR SEEPAGE

NOTE: THE LOG OF SUBSURFACE CONDITIONS SHOWN HEREON APPLIES ONLY AT THE SPECIFIC BORING OR TRENCH LOCATION AND AT THE DATE INDICATED. IT IS NOT WARRANTED TO BE REPRESENTATIVE OF SUBSURFACE CONDITIONS AT OTHER LOCATIONS AND TIMES.

DEPTH IN FEET	SAMPLE NO.	LITHOLOGY	GROUNDWATER	SOIL CLASS (USCS)	BORING B 4		PENETRATION RESISTANCE (BLOWS/FT.)	DRY DENSITY (P.C.F.)	MOISTURE CONTENT (%)
					ELEV. (MSL.) <u>345'</u>	DATE COMPLETED <u>09-01-2020</u>			
					EQUIPMENT <u>CME 95</u>		BY: <u>B. KUNA</u>		
MATERIAL DESCRIPTION									
36				SM					
38									
40	B4-5 B4-6				-No recovery		50/4.5"		
42							50/5"		
44				SM	Very dense, moist, brownish gray, Silty, fine-medium SAND with chunks of gray claystone; iron oxide staining				
46	B4-7						50/6"		
48				SC	Very dense, moist, brown, Clayey, fine to medium SAND; chunks of gray siltstone; abundant gravel iron oxide staining, very hard drilling				
50	B4-8 B4-9				-No recovery		50/1"		
52							50/1"		
54				SM/CL	Very dense, moist, reddish brown, Silty, fine SAND; chunks of gray siltstone, some gravel				
56	B4-10						93/7.5"		
58									
60	B4-11 B4-12				-No recovery		50/2.5"		
					BORING TERMINATED AT 60.5 FEET Groundwater not encountered		50/3"		

Figure A-4,
Log of Boring B 4, Page 2 of 2

G2326-52-02.GPJ

SAMPLE SYMBOLS			
	... SAMPLING UNSUCCESSFUL		... STANDARD PENETRATION TEST
	... DISTURBED OR BAG SAMPLE		... DRIVE SAMPLE (UNDISTURBED)
			... CHUNK SAMPLE
			... WATER TABLE OR SEEPAGE

NOTE: THE LOG OF SUBSURFACE CONDITIONS SHOWN HEREON APPLIES ONLY AT THE SPECIFIC BORING OR TRENCH LOCATION AND AT THE DATE INDICATED. IT IS NOT WARRANTED TO BE REPRESENTATIVE OF SUBSURFACE CONDITIONS AT OTHER LOCATIONS AND TIMES.









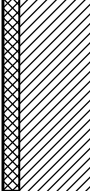

DEPTH IN FEET	SAMPLE NO.	LITHOLOGY	GROUNDWATER	SOIL CLASS (USCS)	BORING B 5		PENETRATION RESISTANCE (BLOWS/FT.)	DRY DENSITY (P.C.F.)	MOISTURE CONTENT (%)	
					ELEV. (MSL.) <u>345'</u>	DATE COMPLETED <u>09-01-2020</u>				
					EQUIPMENT <u>CME 95</u>		BY: <u>B. KUNA</u>			
MATERIAL DESCRIPTION										
0	B5-1			CL	ARDATH SHALE (Ta) Hard, moist, olive brown and reddish brown, CLAYSTONE -Becomes yellowish brown and brownish gray -Becomes laminated					
2										
4										
6										
8										
10	B5-2					65	108.4	16.3		
12										
14										
16										
18										
20	B5-3					71	104.7	19.2		
22										
24										
26										
28										
30	B5-4					50/5.5"	104.6	20.5		
32										
34										

Figure A-5,
Log of Boring B 5, Page 1 of 2

G2326-52-02.GPJ







SAMPLE SYMBOLS			
	... SAMPLING UNSUCCESSFUL		... STANDARD PENETRATION TEST
	... DISTURBED OR BAG SAMPLE		... DRIVE SAMPLE (UNDISTURBED)
			... CHUNK SAMPLE
			... WATER TABLE OR SEEPAGE

NOTE: THE LOG OF SUBSURFACE CONDITIONS SHOWN HEREON APPLIES ONLY AT THE SPECIFIC BORING OR TRENCH LOCATION AND AT THE DATE INDICATED. IT IS NOT WARRANTED TO BE REPRESENTATIVE OF SUBSURFACE CONDITIONS AT OTHER LOCATIONS AND TIMES.

DEPTH IN FEET	SAMPLE NO.	LITHOLOGY	GROUNDWATER	SOIL CLASS (USCS)	BORING B 5		PENETRATION RESISTANCE (BLOWS/FT.)	DRY DENSITY (P.C.F.)	MOISTURE CONTENT (%)	
					ELEV. (MSL.) <u>345'</u>	DATE COMPLETED <u>09-01-2020</u>				
					EQUIPMENT <u>CME 95</u> BY: <u>B. KUNA</u>					
MATERIAL DESCRIPTION										
36				CL-ML						
40	B5-5							76/11"	105.5	20.4
42										
44										
46	B5-6						-Few calcite veins	50/6"	104.3	19.7
48										
50	B5-7 B5-8						-Becomes dark gray with yellow and light gray streaks at 50 feet	98/9.5"	107.5	19.7
52										
54										
56	B5-9							50/5.5"	110.0	18.2
58										
60	B5-10					50/4.5"	108.3	18.0		
					BORING TERMINATED AT 60.5 FEET Groundwater not encountered					

Figure A-5,
Log of Boring B 5, Page 2 of 2

G2326-52-02.GPJ

SAMPLE SYMBOLS	 ... SAMPLING UNSUCCESSFUL	 ... STANDARD PENETRATION TEST	 ... DRIVE SAMPLE (UNDISTURBED)
	 ... DISTURBED OR BAG SAMPLE	 ... CHUNK SAMPLE	 ... WATER TABLE OR SEEPAGE

NOTE: THE LOG OF SUBSURFACE CONDITIONS SHOWN HEREON APPLIES ONLY AT THE SPECIFIC BORING OR TRENCH LOCATION AND AT THE DATE INDICATED. IT IS NOT WARRANTED TO BE REPRESENTATIVE OF SUBSURFACE CONDITIONS AT OTHER LOCATIONS AND TIMES.











DEPTH IN FEET	SAMPLE NO.	LITHOLOGY	GROUNDWATER	SOIL CLASS (USCS)	BORING B 6		PENETRATION RESISTANCE (BLOWS/FT.)	DRY DENSITY (P.C.F.)	MOISTURE CONTENT (%)	
					ELEV. (MSL.) <u>345'</u>	DATE COMPLETED <u>09-01-2020</u>				
					EQUIPMENT <u>CME 95</u> BY: <u>B. KUNA</u>					
MATERIAL DESCRIPTION										
0				SC	VERY OLD PARALIC DEPOSITS (Qvop) Very dense, damp, brown, Clayey, fine to coarse SAND; some gravel					
2										
4										
6										
8				CL	ARDATH SHALE (Ta) Hard, moist, yellowish brown CLAYSTONE					
10	B6-1						85/9"	108.5	18.7	
12										
14										
16										
18										
20	B6-2						-Becomes olive brown and yellowish brown, laminated	50/5"	106.5	20.1
22										
24										
26										
28										
30	B6-3					95/10.5"	104.4	20.4		
32										
34										

Figure A-6,
Log of Boring B 6, Page 1 of 2

G2326-52-02.GPJ







SAMPLE SYMBOLS		... SAMPLING UNSUCCESSFUL		... STANDARD PENETRATION TEST		... DRIVE SAMPLE (UNDISTURBED)
		... DISTURBED OR BAG SAMPLE		... CHUNK SAMPLE		... WATER TABLE OR SEEPAGE

NOTE: THE LOG OF SUBSURFACE CONDITIONS SHOWN HEREON APPLIES ONLY AT THE SPECIFIC BORING OR TRENCH LOCATION AND AT THE DATE INDICATED. IT IS NOT WARRANTED TO BE REPRESENTATIVE OF SUBSURFACE CONDITIONS AT OTHER LOCATIONS AND TIMES.

DEPTH IN FEET	SAMPLE NO.	LITHOLOGY	GROUNDWATER	SOIL CLASS (USCS)	BORING B 6		PENETRATION RESISTANCE (BLOWS/FT.)	DRY DENSITY (P.C.F.)	MOISTURE CONTENT (%)
					ELEV. (MSL.) <u>345'</u>	DATE COMPLETED <u>09-01-2020</u>			
					EQUIPMENT <u>CME 95</u>		BY: <u>B. KUNA</u>		
MATERIAL DESCRIPTION									
36				CL					
40	B6-4						50/5.5"	108.3	19.0
46	B6-5				-Few calcite veins		50/5"	106.2	19.5
50	B6-6				-Becomes dark gray -Few calcite veins, little iron oxide staining		50/4"	107.9	17.5
56	B6-7				-Very hard drilling from 50-60 feet -Calcite veins		50/2.5"	106.5	14.9
60	B6-8				-Little iron oxide staining		50/6"	102.2	20.8
					BORING TERMINATED AT 60.5 FEET Groundwater not encountered Backfilled on 09-02-2020				

Figure A-6,
Log of Boring B 6, Page 2 of 2

G2326-52-02.GPJ

SAMPLE SYMBOLS	 ... SAMPLING UNSUCCESSFUL	 ... STANDARD PENETRATION TEST	 ... DRIVE SAMPLE (UNDISTURBED)
	 ... DISTURBED OR BAG SAMPLE	 ... CHUNK SAMPLE	 ... WATER TABLE OR SEEPAGE

NOTE: THE LOG OF SUBSURFACE CONDITIONS SHOWN HEREON APPLIES ONLY AT THE SPECIFIC BORING OR TRENCH LOCATION AND AT THE DATE INDICATED. IT IS NOT WARRANTED TO BE REPRESENTATIVE OF SUBSURFACE CONDITIONS AT OTHER LOCATIONS AND TIMES.











DEPTH IN FEET	SAMPLE NO.	LITHOLOGY	GROUNDWATER	SOIL CLASS (USCS)	BORING B 7		PENETRATION RESISTANCE (BLOWS/FT.)	DRY DENSITY (P.C.F.)	MOISTURE CONTENT (%)
					ELEV. (MSL.) <u>345'</u>	DATE COMPLETED <u>09-02-2020</u>			
					EQUIPMENT <u>CME 95</u>		BY: <u>B. KUNA</u>		
MATERIAL DESCRIPTION									
0					4-INCH ASPHALT CONCRETE OVER 6-INCH AGGREGATE BASE				
2	B7-1			CL	ARDATH SHALE (Ta) Hard, moist, yellowish brown and gray, laminated CLAYSTONE				
10	B7-2						81/11"	105.9	19.4
20	B7-3				-Becomes dark gray, damp		95/11.5"		
30	B7-4						93/10.5"	107.3	19.6
34									

Figure A-7,
Log of Boring B 7, Page 1 of 2

G2326-52-02.GPJ

SAMPLE SYMBOLS		... SAMPLING UNSUCCESSFUL		... STANDARD PENETRATION TEST		... DRIVE SAMPLE (UNDISTURBED)
		... DISTURBED OR BAG SAMPLE		... CHUNK SAMPLE		... WATER TABLE OR SEEPAGE

NOTE: THE LOG OF SUBSURFACE CONDITIONS SHOWN HEREON APPLIES ONLY AT THE SPECIFIC BORING OR TRENCH LOCATION AND AT THE DATE INDICATED. IT IS NOT WARRANTED TO BE REPRESENTATIVE OF SUBSURFACE CONDITIONS AT OTHER LOCATIONS AND TIMES.

DEPTH IN FEET	SAMPLE NO.	LITHOLOGY	GROUNDWATER	SOIL CLASS (USCS)	BORING B 7		PENETRATION RESISTANCE (BLOWS/FT.)	DRY DENSITY (P.C.F.)	MOISTURE CONTENT (%)
					ELEV. (MSL.) <u>345'</u>	DATE COMPLETED <u>09-02-2020</u>			
					EQUIPMENT <u>CME 95</u>		BY: <u>B. KUNA</u>		
MATERIAL DESCRIPTION									
36				CL					
40	B7-5						89/11.5"	107.2	20.2
46	B7-6						82/11.5"	102.5	22.9
50	B7-7				-Trace silt		91	108.8	16.9
54	B7-8			ML	Very stiff, damp, brownish gray with streaks of yellowish brown, Clayey SILTSTONE		60		
58					-Very hard drilling from 57-60 feet, possible concreton				
60	B7-9						-50/2.5"	107.0	19.1
					BORING TERMINATED AT 60.25 FEET Groundwater not encountered				

Figure A-7,
Log of Boring B 7, Page 2 of 2

G2326-52-02.GPJ

SAMPLE SYMBOLS		... SAMPLING UNSUCCESSFUL		... STANDARD PENETRATION TEST		... DRIVE SAMPLE (UNDISTURBED)
		... DISTURBED OR BAG SAMPLE		... CHUNK SAMPLE		... WATER TABLE OR SEEPAGE

NOTE: THE LOG OF SUBSURFACE CONDITIONS SHOWN HEREON APPLIES ONLY AT THE SPECIFIC BORING OR TRENCH LOCATION AND AT THE DATE INDICATED. IT IS NOT WARRANTED TO BE REPRESENTATIVE OF SUBSURFACE CONDITIONS AT OTHER LOCATIONS AND TIMES.









DEPTH IN FEET	SAMPLE NO.	LITHOLOGY	GROUNDWATER	SOIL CLASS (USCS)	BORING B 8		PENETRATION RESISTANCE (BLOWS/FT.)	DRY DENSITY (P.C.F.)	MOISTURE CONTENT (%)
					ELEV. (MSL.) <u>345'</u>	DATE COMPLETED <u>09-02-2020</u>			
					EQUIPMENT <u>CME 95</u>		BY: <u>B. KUNA</u>		
MATERIAL DESCRIPTION									
0					4-INCH ASPHALT CONCRETE OVER 9-INCH AGGREGATE BASE				
2				CL	ARDATH SHALE (Ta) Hard, moist, gray and yellowish brown, laminated CLAYSTONE				
10	B8-1						90/10.5"	108.4	19.9
20	B8-2						98/10"	111.1	18.3
30	B8-3						50/6"	109.1	19.6
34									

Figure A-8,
Log of Boring B 8, Page 1 of 2

G2326-52-02.GPJ







SAMPLE SYMBOLS		... SAMPLING UNSUCCESSFUL		... STANDARD PENETRATION TEST		... DRIVE SAMPLE (UNDISTURBED)
		... DISTURBED OR BAG SAMPLE		... CHUNK SAMPLE		... WATER TABLE OR SEEPAGE

NOTE: THE LOG OF SUBSURFACE CONDITIONS SHOWN HEREON APPLIES ONLY AT THE SPECIFIC BORING OR TRENCH LOCATION AND AT THE DATE INDICATED. IT IS NOT WARRANTED TO BE REPRESENTATIVE OF SUBSURFACE CONDITIONS AT OTHER LOCATIONS AND TIMES.

DEPTH IN FEET	SAMPLE NO.	LITHOLOGY	GROUNDWATER	SOIL CLASS (USCS)	BORING B 8		PENETRATION RESISTANCE (BLOWS/FT.)	DRY DENSITY (P.C.F.)	MOISTURE CONTENT (%)
					ELEV. (MSL.) <u>345'</u>	DATE COMPLETED <u>09-02-2020</u>			
					EQUIPMENT <u>CME 95</u> BY: <u>B. KUNA</u>				
MATERIAL DESCRIPTION									
36				CL					
38						-Very difficult drilling from 38-60 feet			
40	B8-4					-Few calcite veins	78/10"	114.6	16.8
42									
44									
46	B8-5						50/5.5"	111.1	19.0
48									
50	B8-6 B8-7					-Becomes dark gray, damp	50/5"		
52									
54									
56	B8-8					50/3"	105.4	18.7	
58									
60	B8-9				-Becomes moist	50/9.5"	110.0	18.6	
					BORING TERMINATED AT 60.5 FEET Groundwater not encountered				

Figure A-8,
Log of Boring B 8, Page 2 of 2

G2326-52-02.GPJ







SAMPLE SYMBOLS					
	... SAMPLING UNSUCCESSFUL		... STANDARD PENETRATION TEST		... DRIVE SAMPLE (UNDISTURBED)
	... DISTURBED OR BAG SAMPLE		... CHUNK SAMPLE		... WATER TABLE OR SEEPAGE

NOTE: THE LOG OF SUBSURFACE CONDITIONS SHOWN HEREON APPLIES ONLY AT THE SPECIFIC BORING OR TRENCH LOCATION AND AT THE DATE INDICATED. IT IS NOT WARRANTED TO BE REPRESENTATIVE OF SUBSURFACE CONDITIONS AT OTHER LOCATIONS AND TIMES.

DEPTH IN FEET	SAMPLE NO.	LITHOLOGY	GROUNDWATER	SOIL CLASS (USCS)	BORING B 9		PENETRATION RESISTANCE (BLOWS/FT.)	DRY DENSITY (P.C.F.)	MOISTURE CONTENT (%)
					ELEV. (MSL.) <u>345'</u>	DATE COMPLETED <u>09-03-2020</u>			
					EQUIPMENT <u>CME 95</u>		BY: <u>B. KUNA</u>		
MATERIAL DESCRIPTION									
0					4-INCH ASPHALT CONCRETE OVER 8-INCH AGGREGATE BASE				
2				CL	ARDATH SHALE (Ta) Hard, moist, grayish brown and yellowish brown, laminated CLAYSTONE				
10	B9-1						90/10"	109.6	18.9
20	B9-2				-Becomes stiff		37	101.2	21.2
30	B9-3				-Becomes hard, pale yellowish brown		50/6"	102.8	21.2
34					-Very hard drilling from 34-57 feet				

Figure A-9,
Log of Boring B 9, Page 1 of 2

G2326-52-02.GPJ







SAMPLE SYMBOLS	 ... SAMPLING UNSUCCESSFUL	 ... STANDARD PENETRATION TEST	 ... DRIVE SAMPLE (UNDISTURBED)
	 ... DISTURBED OR BAG SAMPLE	 ... CHUNK SAMPLE	 ... WATER TABLE OR SEEPAGE

NOTE: THE LOG OF SUBSURFACE CONDITIONS SHOWN HEREON APPLIES ONLY AT THE SPECIFIC BORING OR TRENCH LOCATION AND AT THE DATE INDICATED. IT IS NOT WARRANTED TO BE REPRESENTATIVE OF SUBSURFACE CONDITIONS AT OTHER LOCATIONS AND TIMES.

DEPTH IN FEET	SAMPLE NO.	LITHOLOGY	GROUNDWATER	SOIL CLASS (USCS)	BORING B 9		PENETRATION RESISTANCE (BLOWS/FT.)	DRY DENSITY (P.C.F.)	MOISTURE CONTENT (%)	
					ELEV. (MSL.) <u>345'</u>	DATE COMPLETED <u>09-03-2020</u>				
					EQUIPMENT <u>CME 95</u> BY: <u>B. KUNA</u>					
MATERIAL DESCRIPTION										
36				CL	-Becomes gray with yellowish brown streaks					
38										
40	B9-4							85/11"	107.7	20.8
42										
44										
46	B9-5							96/11"	106.7	21.4
48										
50	B9-6							93/10.5"		
52	B9-7									
54										
56	B9-8					50/5.5"				
					REFUSAL AT 57 FEET Groundwater not encountered					

Figure A-9,
Log of Boring B 9, Page 2 of 2

G2326-52-02.GPJ







SAMPLE SYMBOLS					
	... SAMPLING UNSUCCESSFUL		... STANDARD PENETRATION TEST		... DRIVE SAMPLE (UNDISTURBED)
	... DISTURBED OR BAG SAMPLE		... CHUNK SAMPLE		... WATER TABLE OR SEEPAGE

NOTE: THE LOG OF SUBSURFACE CONDITIONS SHOWN HEREON APPLIES ONLY AT THE SPECIFIC BORING OR TRENCH LOCATION AND AT THE DATE INDICATED. IT IS NOT WARRANTED TO BE REPRESENTATIVE OF SUBSURFACE CONDITIONS AT OTHER LOCATIONS AND TIMES.

DEPTH IN FEET	SAMPLE NO.	LITHOLOGY	GROUNDWATER	SOIL CLASS (USCS)	BORING B 10		PENETRATION RESISTANCE (BLOWS/FT.)	DRY DENSITY (P.C.F.)	MOISTURE CONTENT (%)
					ELEV. (MSL.) <u>345'</u>	DATE COMPLETED <u>09-03-2020</u>			
					EQUIPMENT <u>CME 95</u> BY: <u>B. KUNA</u>				
					MATERIAL DESCRIPTION				
0					4-INCH ASPHALT CONCRETE OVER 6-INCH AGGREGATE BASE				
2				SC/SM	VERY OLD PARALIC DEPOSITS (Qvop) Very dense, moist, yellowish brown, Clayey to Silty, fine to coarse SAND; little gravel				
8				CL	ARDATH SHALE (Ta) Hard, moist, olive gray and yellowish brown, Silty CLAY; some fine sand				
10	B10-1			CL			74	111.7	16.4
14					Hard, moist, olive gray and yellowish brown, laminated CLAYSTONE				
20	B10-2				-Few calcite veins				
24					-Very difficult drilling from 24-40 feet				
30	B10-3						90/10"	111.6	18.9
34									

Figure A-10,
Log of Boring B 10, Page 1 of 2

G2326-52-02.GPJ







SAMPLE SYMBOLS	 ... SAMPLING UNSUCCESSFUL	 ... STANDARD PENETRATION TEST	 ... DRIVE SAMPLE (UNDISTURBED)
	 ... DISTURBED OR BAG SAMPLE	 ... CHUNK SAMPLE	 ... WATER TABLE OR SEEPAGE

NOTE: THE LOG OF SUBSURFACE CONDITIONS SHOWN HEREON APPLIES ONLY AT THE SPECIFIC BORING OR TRENCH LOCATION AND AT THE DATE INDICATED. IT IS NOT WARRANTED TO BE REPRESENTATIVE OF SUBSURFACE CONDITIONS AT OTHER LOCATIONS AND TIMES.

DEPTH IN FEET	SAMPLE NO.	LITHOLOGY	GROUNDWATER	SOIL CLASS (USCS)	BORING B 10		PENETRATION RESISTANCE (BLOWS/FT.)	DRY DENSITY (P.C.F.)	MOISTURE CONTENT (%)	
					ELEV. (MSL.) <u>345'</u>	DATE COMPLETED <u>09-03-2020</u>				
					EQUIPMENT <u>CME 95</u> BY: <u>B. KUNA</u>					
					MATERIAL DESCRIPTION					
36		[Hatched Pattern]		CL	<p style="text-align: center;">-Little recovery -Large calcite vein and charcoal in sample</p> <p style="text-align: center;">REFUSAL AT 40.5 FEET Groundwater not encountered</p>					
38										
40	B10-4								50/.5"	

Figure A-10,
Log of Boring B 10, Page 2 of 2

G2326-52-02.GPJ







SAMPLE SYMBOLS	 ... SAMPLING UNSUCCESSFUL	 ... STANDARD PENETRATION TEST	 ... DRIVE SAMPLE (UNDISTURBED)
	 ... DISTURBED OR BAG SAMPLE	 ... CHUNK SAMPLE	 ... WATER TABLE OR SEEPAGE

NOTE: THE LOG OF SUBSURFACE CONDITIONS SHOWN HEREON APPLIES ONLY AT THE SPECIFIC BORING OR TRENCH LOCATION AND AT THE DATE INDICATED. IT IS NOT WARRANTED TO BE REPRESENTATIVE OF SUBSURFACE CONDITIONS AT OTHER LOCATIONS AND TIMES.

DEPTH IN FEET	SAMPLE NO.	LITHOLOGY	GROUNDWATER	SOIL CLASS (USCS)	BORING B 11		PENETRATION RESISTANCE (BLOWS/FT.)	DRY DENSITY (P.C.F.)	MOISTURE CONTENT (%)
					ELEV. (MSL.) <u>355'</u>	DATE COMPLETED <u>09-03-2020</u>			
					EQUIPMENT <u>CME 95</u> BY: <u>B. KUNA</u>				
					MATERIAL DESCRIPTION				
0					4-INCH ASPHALT CONCRETE OVER 12-INCH AGGREGATE BASE				
2				SC	UNDOCUMENTED FILL (Qudf) Medium dense, moist, mottled dark brown, brown and gray, Clayey, fine to medium SAND; little gravel				
10	B11-1				-Disturbed sample				
12				SM/CL	VERY OLD PARALIC DEPOSITS (Qvop) Very dense, moist, reddish brown, Silty, fine to medium SAND with chunks of gray clay, trace gravel				
16	B11-2				50/6"				
20	B11-3				-No recovery due to gravelly layer between 20-25 feet				
20					50/1.5"				
22				CL	ARDATH SHALE (Ta) Hard, moist, gray and yellowish brown, laminated CLAYSTONE				
26	B11-4								
30	B11-5				-No recovery				
30					50/4"				
34									

Figure A-11,
Log of Boring B 11, Page 1 of 2

G2326-52-02.GPJ

SAMPLE SYMBOLS	 ... SAMPLING UNSUCCESSFUL	 ... STANDARD PENETRATION TEST	 ... DRIVE SAMPLE (UNDISTURBED)
	 ... DISTURBED OR BAG SAMPLE	 ... CHUNK SAMPLE	 ... WATER TABLE OR SEEPAGE

NOTE: THE LOG OF SUBSURFACE CONDITIONS SHOWN HEREON APPLIES ONLY AT THE SPECIFIC BORING OR TRENCH LOCATION AND AT THE DATE INDICATED. IT IS NOT WARRANTED TO BE REPRESENTATIVE OF SUBSURFACE CONDITIONS AT OTHER LOCATIONS AND TIMES.









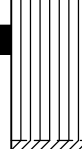

DEPTH IN FEET	SAMPLE NO.	LITHOLOGY	GROUNDWATER	SOIL CLASS (USCS)	BORING B 11		PENETRATION RESISTANCE (BLOWS/FT.)	DRY DENSITY (P.C.F.)	MOISTURE CONTENT (%)
					ELEV. (MSL.) <u>355'</u>	DATE COMPLETED <u>09-03-2020</u>			
					EQUIPMENT <u>CME 95</u>		BY: <u>B. KUNA</u>		
MATERIAL DESCRIPTION									
36	B11-6			CL			50/5.5"	109.4	18.4
38									
40									
42									
44									
46	B11-7						50/4.5"	109.1	16.1
48									
50	B11-8			ML	Hard, moist, gray and yellowish brown, laminated SILTSTONE		96/8.5"	102.2	21.7
52									
54	B11-9			CL	Hard, moist, pale yellowish brown and gray, laminated CLAYSTONE, hard drilling from 53-61 feet		50/5"	103.4	22.1
56									
58									
60	B11-10				-Becomes gray and yellowish brown		92	104.1	21.9
					BORING TERMINATED AT 61 FEET Groundwater not encountered				

Figure A-11,
Log of Boring B 11, Page 2 of 2

G2326-52-02.GPJ

SAMPLE SYMBOLS		... SAMPLING UNSUCCESSFUL		... STANDARD PENETRATION TEST		... DRIVE SAMPLE (UNDISTURBED)
		... DISTURBED OR BAG SAMPLE		... CHUNK SAMPLE		... WATER TABLE OR SEEPAGE

NOTE: THE LOG OF SUBSURFACE CONDITIONS SHOWN HEREON APPLIES ONLY AT THE SPECIFIC BORING OR TRENCH LOCATION AND AT THE DATE INDICATED. IT IS NOT WARRANTED TO BE REPRESENTATIVE OF SUBSURFACE CONDITIONS AT OTHER LOCATIONS AND TIMES.











DEPTH IN FEET	SAMPLE NO.	LITHOLOGY	GROUNDWATER	SOIL CLASS (USCS)	BORING B 12		PENETRATION RESISTANCE (BLOWS/FT.)	DRY DENSITY (P.C.F.)	MOISTURE CONTENT (%)
					ELEV. (MSL.) <u>340'</u>	DATE COMPLETED <u>09-04-2020</u>			
					EQUIPMENT <u>CME 95</u> BY: <u>B. KUNA</u>				
MATERIAL DESCRIPTION									
0					4-INCH ASPHALT CONCRETE OVER 8-INCH AGGREGATE BASE				
2	B12-1			CL	ARDATH SHALE (Ta) Very stiff, yellowish brown and gray, CLAYSTONE				
6	B12-2						53	104.7	21.4
10	B12-3				-Becomes grayish brown and pale yellowish brown		53	103.8	21.9
16	B12-4				-Becomes hard, brownish gray with yellowish brown streaks		62	105.1	21.5
20	B12-5						65	104.9	22.1
					BORING TERMINATED AT 20 FEET Groundwater not encountered				

Figure A-12,
Log of Boring B 12, Page 1 of 1

G2326-52-02.GPJ







SAMPLE SYMBOLS		... SAMPLING UNSUCCESSFUL		... STANDARD PENETRATION TEST		... DRIVE SAMPLE (UNDISTURBED)
		... DISTURBED OR BAG SAMPLE		... CHUNK SAMPLE		... WATER TABLE OR SEEPAGE

NOTE: THE LOG OF SUBSURFACE CONDITIONS SHOWN HEREON APPLIES ONLY AT THE SPECIFIC BORING OR TRENCH LOCATION AND AT THE DATE INDICATED. IT IS NOT WARRANTED TO BE REPRESENTATIVE OF SUBSURFACE CONDITIONS AT OTHER LOCATIONS AND TIMES.

DEPTH IN FEET	SAMPLE NO.	LITHOLOGY	GROUNDWATER	SOIL CLASS (USCS)	BORING B 13		PENETRATION RESISTANCE (BLOWS/FT.)	DRY DENSITY (P.C.F.)	MOISTURE CONTENT (%)
					ELEV. (MSL.) <u>350'</u>	DATE COMPLETED <u>09-04-2020</u>			
					EQUIPMENT <u>CME 95</u> BY: <u>B. KUNA</u>				
MATERIAL DESCRIPTION									
0				SC	UNDOCUMENTED FILL (Qudf) Medium dense, moist, reddish brown to brownish gray, Clayey fine to medium SAND; little gravel				
2									
4									
6									
8									
10	B13-1						42	123.6	8.8
12									
14									
16									
18									
20	B13-2				-Becomes dark brownish gray		44	118.8	14.4
22									
24									
26									
28									
30	B13-3				-No recovery		62		
32	B13-4						48		
34									

Figure A-13,
Log of Boring B 13, Page 1 of 2

G2326-52-02.GPJ

SAMPLE SYMBOLS	 ... SAMPLING UNSUCCESSFUL	 ... STANDARD PENETRATION TEST	 ... DRIVE SAMPLE (UNDISTURBED)
	 ... DISTURBED OR BAG SAMPLE	 ... CHUNK SAMPLE	 ... WATER TABLE OR SEEPAGE

NOTE: THE LOG OF SUBSURFACE CONDITIONS SHOWN HEREON APPLIES ONLY AT THE SPECIFIC BORING OR TRENCH LOCATION AND AT THE DATE INDICATED. IT IS NOT WARRANTED TO BE REPRESENTATIVE OF SUBSURFACE CONDITIONS AT OTHER LOCATIONS AND TIMES.

DEPTH IN FEET	SAMPLE NO.	LITHOLOGY	GROUNDWATER	SOIL CLASS (USCS)	BORING B 13		PENETRATION RESISTANCE (BLOWS/FT.)	DRY DENSITY (P.C.F.)	MOISTURE CONTENT (%)
					ELEV. (MSL.) <u>350'</u>	DATE COMPLETED <u>09-04-2020</u>			
					EQUIPMENT <u>CME 95</u> BY: <u>B. KUNA</u>				
MATERIAL DESCRIPTION									
36				CL	Very stiff, moist, dark brownish gray, Sandy CLAY; small chunks of gray and yellowish brown claystone	52	107.6	18.5	
38									
40	B13-5								
42									
44				SM	Dense, moist, dark brownish gray, Silty, fine to medium SAND; trace gravel, few roots and other organics, little charcoal staining	55		9.4	
46	B13-6								
48				CL	Stiff, moist, dark brownish gray and yellowish brown, Silty CLAY; trace gravel, chunks of claystone				
50	B13-7					38			
52	B13-8								
54									
56	B13-9				34	103.2	21.3		
58									
60	B13-10			CL	ARDATH SHALE (Ta) Hard, most, gray with yellowish brown streaks, CLAYSTONE	82	110.0	19.5	
					BORING TERMINATED AT 61 FEET Groundwater not encountered				

Figure A-13,
Log of Boring B 13, Page 2 of 2

G2326-52-02.GPJ

SAMPLE SYMBOLS	... SAMPLING UNSUCCESSFUL	... STANDARD PENETRATION TEST	... DRIVE SAMPLE (UNDISTURBED)
	... DISTURBED OR BAG SAMPLE	... CHUNK SAMPLE	... WATER TABLE OR SEEPAGE

NOTE: THE LOG OF SUBSURFACE CONDITIONS SHOWN HEREON APPLIES ONLY AT THE SPECIFIC BORING OR TRENCH LOCATION AND AT THE DATE INDICATED. IT IS NOT WARRANTED TO BE REPRESENTATIVE OF SUBSURFACE CONDITIONS AT OTHER LOCATIONS AND TIMES.

APPENDIX

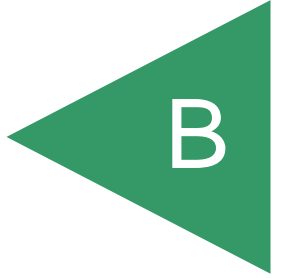

APPENDIX B

LABORATORY TESTING

We performed laboratory tests in accordance with generally accepted test methods of the American Society for Testing and Materials (ASTM) or other suggested procedures. Selected soil samples were tested for in-place dry density and moisture content, maximum density and optimum moisture content, direct shear strength, expansion index, water soluble sulfate, R-Value, consolidation, and gradation characteristics. The results of our current laboratory tests are presented herein. The in-place dry density and moisture content of the samples tested are presented on the boring logs in Appendix A.

**TABLE B-I
SUMMARY OF LABORATORY MAXIMUM DRY DENSITY
AND OPTIMUM MOISTURE CONTENT TEST RESULTS
ASTM D 1557**

Sample No.	Description	Maximum Dry Density (pcf)	Optimum Moisture Content (% dry wt.)
B2-2	Yellowish Brown, Silty, fine SAND (Qvop)	130.2	9.3
B7-1	Yellowish Brown and Gray CLAY (Ta)	117.9	12.9

**TABLE B-II
SUMMARY OF LABORATORY EXPANSION INDEX TEST RESULTS
ASTM D 4829**

Sample No.	Moisture Content (%)		Dry Density (pcf)	Expansion Index	2019 CBC Expansion Classification	ASTM Soil Expansion Classification
	Before Test	After Test				
B1-1	10.9	20.7	106.9	47	Expansive	Low
B2-2	10.0	18.6	109.8	29	Expansive	Low
B5-1	13.6	30.2	98.8	80	Expansive	Medium
B9-7	11.0	24.8	105.5	65	Expansive	Medium
B11-4	7.9	16.4	117.9	21	Expansive	Low
B13-8	12.0	22.7	104.0	44	Expansive	Low

**TABLE B-III
SUMMARY OF LABORATORY WATER-SOLUBLE SULFATE TEST RESULTS
CALIFORNIA TEST NO. 417**

Sample No.	Depth (feet)	Geologic Unit	Water-Soluble Sulfate (%)	ACI 318 Sulfate Exposure
B2-3	10	Qvop	0.003	S0
B2-8	35	Ta	0.171	S1
B4-2	20	Qvop	0.012	S0
B7-3	20	Ta	0.027	S0
B7-6	45	Ta	0.016	S0
B11-7	45	Ta	0.029	S0

**TABLE B-IV
SUMMARY OF LABORATORY RESISTANCE VALUE (R-VALUE) TEST RESULTS
ASTM D 2844**

Sample No.	Depth (Feet)	Description (Geologic Unit)	R-Value
B5-1	0 - 5	Olive and Reddish Brown CLAY (Ta)	11
B12-1	1 - 5	Yellowish Brown and Gray CLAY (Ta)	6

SAMPLE NO.: **B2-3** GEOLOGIC UNIT: **Qvop**
 SAMPLE DEPTH (FT): **10'** NATURAL/REMOLDED: **N**

INITIAL CONDITIONS				
NORMAL STRESS TEST LOAD	1 K	2 K	4 K	AVERAGE
ACTUAL NORMAL STRESS (PSF):	890	2030	4300	--
WATER CONTENT (%):	19.0	18.5	22.7	20.1
DRY DENSITY (PCF):	105.4	103.2	101.7	103.4

AFTER TEST CONDITIONS				
NORMAL STRESS TEST LOAD	1 K	2 K	4 K	AVERAGE
WATER CONTENT (%):	22.8	23.3	24.4	23.5
PEAK SHEAR STRESS (PSF):	1392	2159	3817	--
ULT.-E.O.T. SHEAR STRESS (PSF):	1300	2159	3817	--

RESULTS		
PEAK	COHESION, C (PSF)	725
	FRICTION ANGLE (DEGREES)	36
ULTIMATE	COHESION, C (PSF)	650
	FRICTION ANGLE (DEGREES)	36

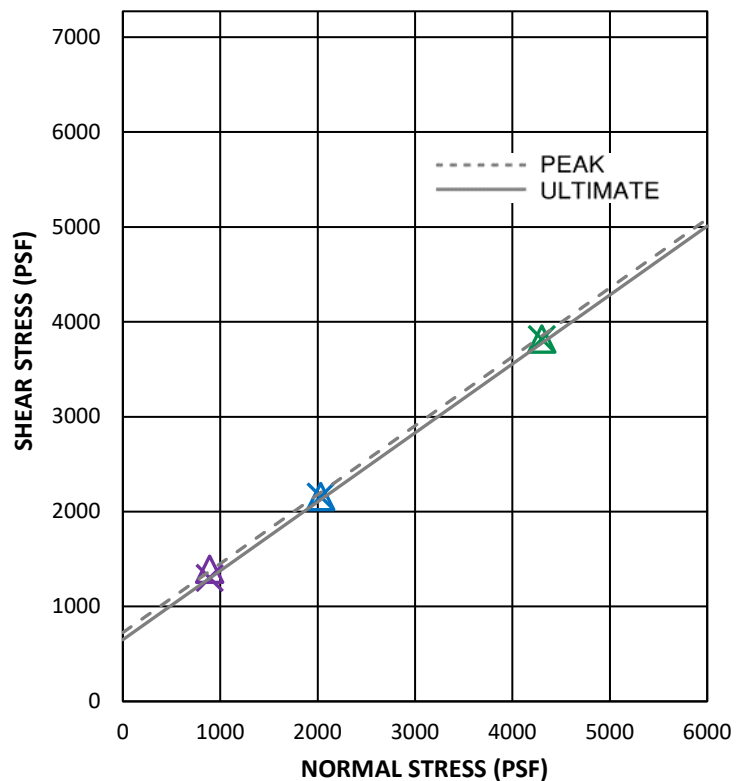
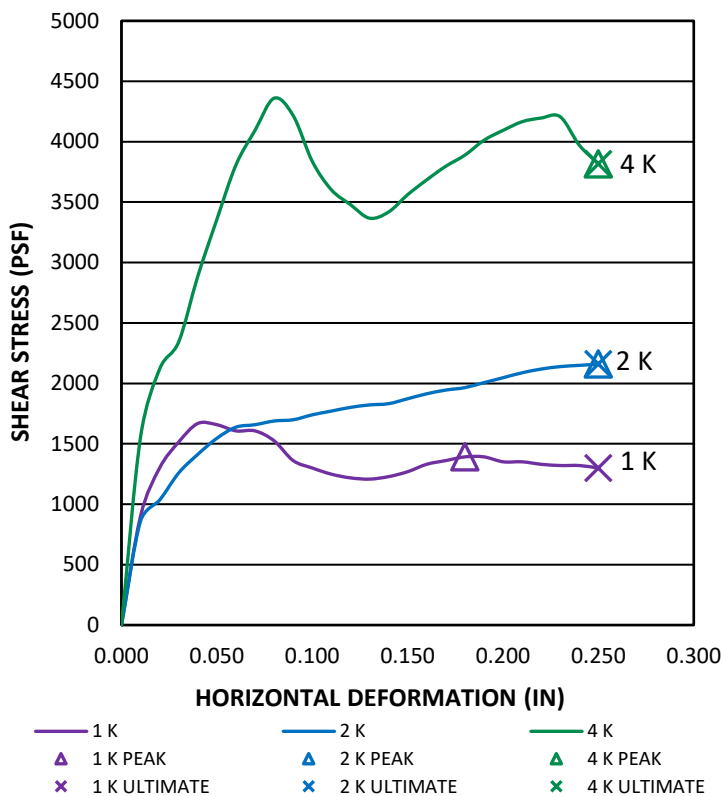

DIRECT SHEAR - ASTM D 3080

TOWNE CENTRE VIEW

PROJECT NO.: G2326-52-02

GEOCON
INCORPORATED



GEOTECHNICAL CONSULTANTS
 6960 FLANDERS DRIVE - SAN DIEGO, CALIFORNIA 92121-2974
 PHONE 858 558-6900 - FAX 858 558-6159

SAMPLE NO.: **B2-8** GEOLOGIC UNIT: **Ta**
 SAMPLE DEPTH (FT): **35'** NATURAL/REMOVED: **N**

INITIAL CONDITIONS				
NORMAL STRESS TEST LOAD	1 K	2 K	4 K	AVERAGE
ACTUAL NORMAL STRESS (PSF):	890	2030	4300	--
WATER CONTENT (%):	19.1	19.6	19.8	19.5
DRY DENSITY (PCF):	110.8	106.5	104.2	107.1

AFTER TEST CONDITIONS				
NORMAL STRESS TEST LOAD	1 K	2 K	4 K	AVERAGE
WATER CONTENT (%):	21.7	23.6	24.3	23.2
PEAK SHEAR STRESS (PSF):	2415	2692	4165	--
ULT.-E.O.T. SHEAR STRESS (PSF):	2129	2221	3797	--

RESULTS		
PEAK	COHESION, C (PSF)	1800
	FRICTION ANGLE (DEGREES)	28
ULTIMATE	COHESION, C (PSF)	1500
	FRICTION ANGLE (DEGREES)	27

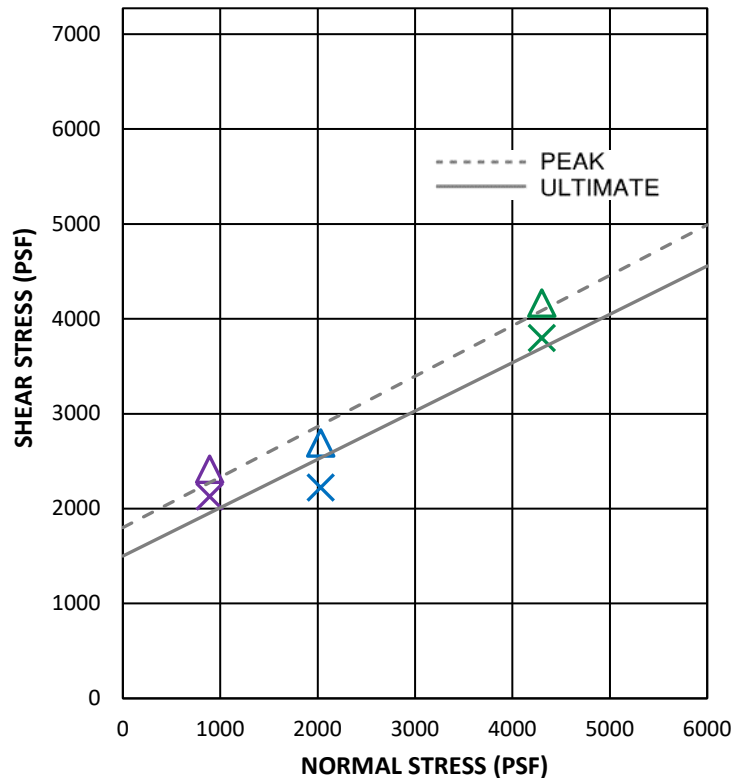
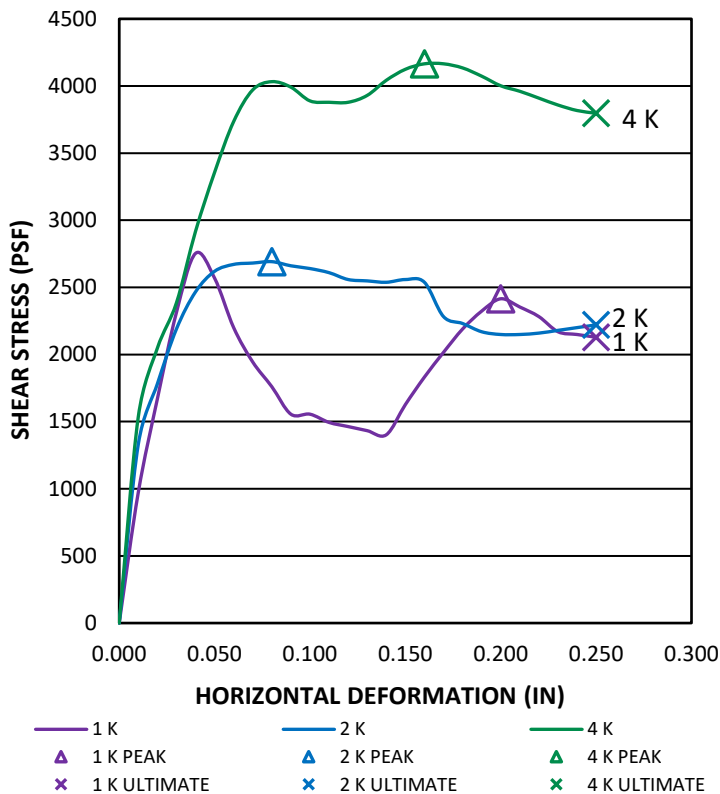

DIRECT SHEAR - ASTM D 3080

TOWNE CENTRE VIEW

PROJECT NO.: G2326-52-02

GEOCON
INCORPORATED



GEOTECHNICAL CONSULTANTS
 6960 FLANDERS DRIVE - SAN DIEGO, CALIFORNIA 92121-2974
 PHONE 858 558-6900 - FAX 858 558-6159

SAMPLE NO.: **B7-3** GEOLOGIC UNIT: **Ta**
 SAMPLE DEPTH (FT): **20'** NATURAL/REMODELED: **N**

INITIAL CONDITIONS				
NORMAL STRESS TEST LOAD	1 K	2 K	4 K	AVERAGE
ACTUAL NORMAL STRESS (PSF):	890	2030	4300	--
WATER CONTENT (%):	20.4	21.2	21.1	20.9
DRY DENSITY (PCF):	107.6	106.2	105.8	106.5

AFTER TEST CONDITIONS				
NORMAL STRESS TEST LOAD	1 K	2 K	4 K	AVERAGE
WATER CONTENT (%):	22.7	24.4	23.7	23.6
PEAK SHEAR STRESS (PSF):	1842	2548	4084	--
ULT.-E.O.T. SHEAR STRESS (PSF):	1515	2231	3643	--

RESULTS		
PEAK	COHESION, C (PSF)	1200
	FRICTION ANGLE (DEGREES)	33
ULTIMATE	COHESION, C (PSF)	950
	FRICTION ANGLE (DEGREES)	32

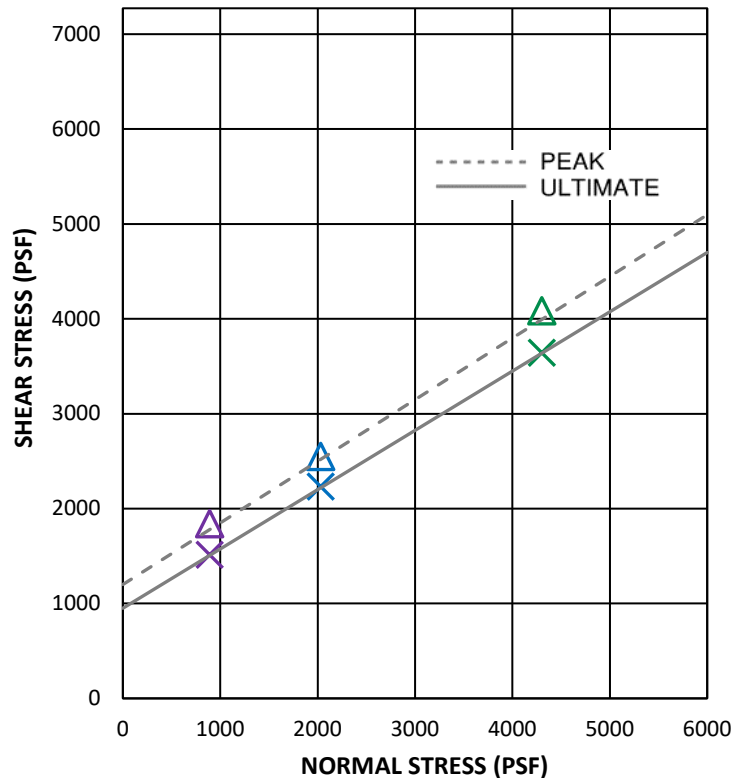
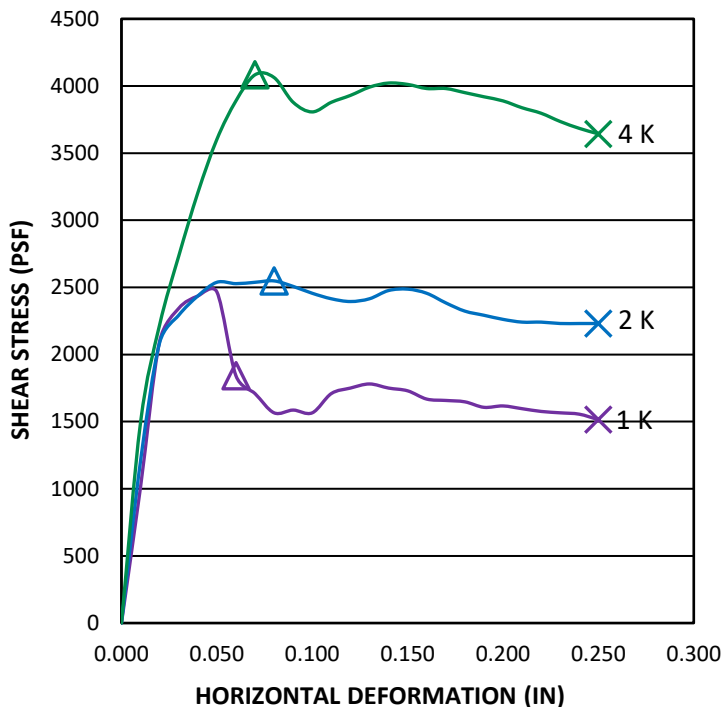

1 K 2 K 4 K
 ▲ 1 K PEAK ▲ 2 K PEAK ▲ 4 K PEAK
 × 1 K ULTIMATE × 2 K ULTIMATE × 4 K ULTIMATE

DIRECT SHEAR - ASTM D 3080

GEOCON
INCORPORATED



GEOTECHNICAL CONSULTANTS
 6960 FLANDERS DRIVE - SAN DIEGO, CALIFORNIA 92121-2974
 PHONE 858 558-6900 - FAX 858 558-6159

TOWNE CENTRE VIEW

PROJECT NO.: G2326-52-02

SAMPLE NO.: **B9-6** GEOLOGIC UNIT: **Ta**
 SAMPLE DEPTH (FT): **50'** NATURAL/REMOLDED: **N**

INITIAL CONDITIONS				
NORMAL STRESS TEST LOAD	1 K	2 K	4 K	AVERAGE
ACTUAL NORMAL STRESS (PSF):	890	2030	4300	--
WATER CONTENT (%):	21.3	21.1	21.5	21.3
DRY DENSITY (PCF):	106.1	105.8	106.1	106.0

AFTER TEST CONDITIONS				
NORMAL STRESS TEST LOAD	1 K	2 K	4 K	AVERAGE
WATER CONTENT (%):	23.9	24.1	23.6	23.9
PEAK SHEAR STRESS (PSF):	1638	2026	3869	--
ULT.-E.O.T. SHEAR STRESS (PSF):	1197	1975	3193	--

RESULTS		
PEAK	COHESION, C (PSF)	900
	FRICTION ANGLE (DEGREES)	34
ULTIMATE	COHESION, C (PSF)	725
	FRICTION ANGLE (DEGREES)	30

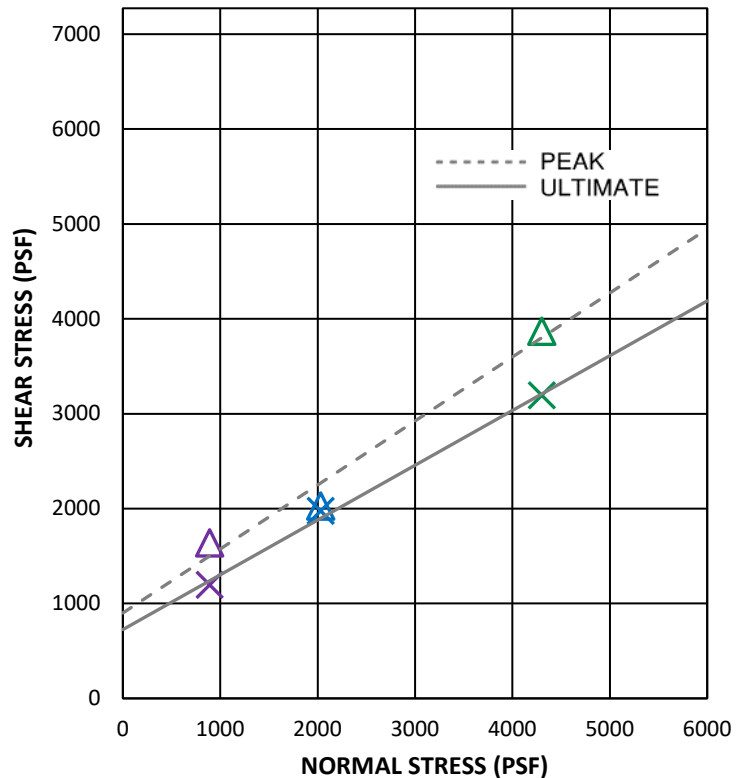
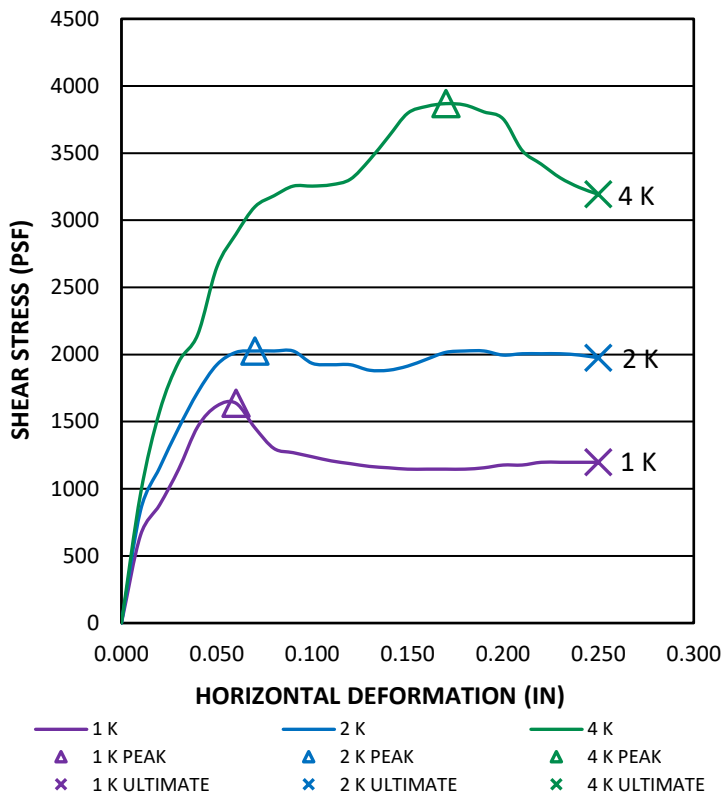

DIRECT SHEAR - ASTM D 3080

TOWNE CENTRE VIEW

PROJECT NO.: G2326-52-02

GEOCON
INCORPORATED



GEOTECHNICAL CONSULTANTS
 6960 FLANDERS DRIVE - SAN DIEGO, CALIFORNIA 92121-2974
 PHONE 858 558-6900 - FAX 858 558-6159

SAMPLE NO.: B11-2 GEOLOGIC UNIT: Qvop
 SAMPLE DEPTH (FT): 15' NATURAL/REMOVED: N

INITIAL CONDITIONS				
NORMAL STRESS TEST LOAD	1 K	2 K	4 K	AVERAGE
ACTUAL NORMAL STRESS (PSF):	890	2030	4300	--
WATER CONTENT (%):	11.1	10.2	10.1	10.5
DRY DENSITY (PCF):	100.2	101.6	101.0	100.9

AFTER TEST CONDITIONS				
NORMAL STRESS TEST LOAD	1 K	2 K	4 K	AVERAGE
WATER CONTENT (%):	21.1	20.8	20.6	20.8
PEAK SHEAR STRESS (PSF):	1105	1914	3244	--
ULT.-E.O.T. SHEAR STRESS (PSF):	1034	1914	3244	--

RESULTS		
PEAK	COHESION, C (PSF)	600
	FRICTION ANGLE (DEGREES)	32
ULTIMATE	COHESION, C (PSF)	525
	FRICTION ANGLE (DEGREES)	32

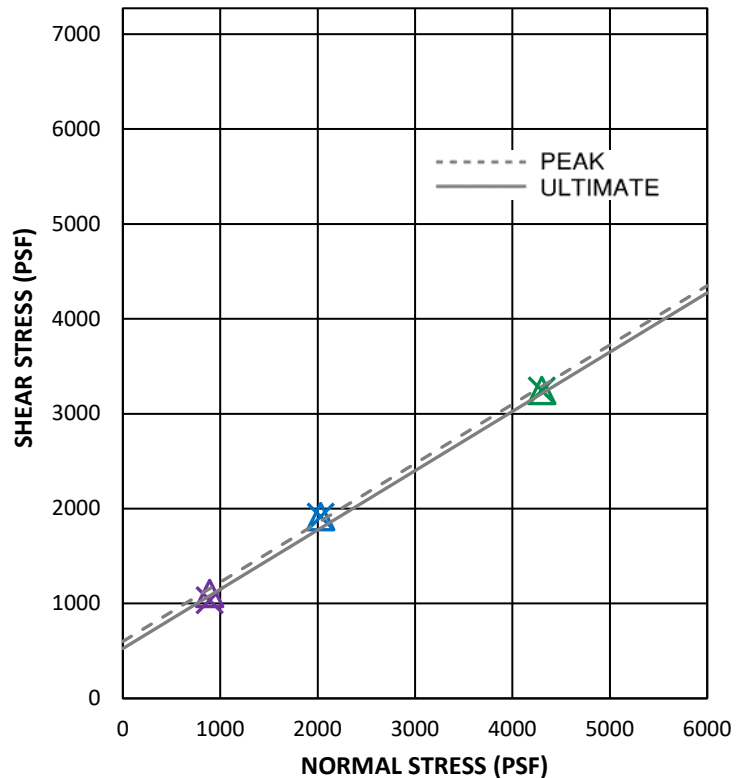
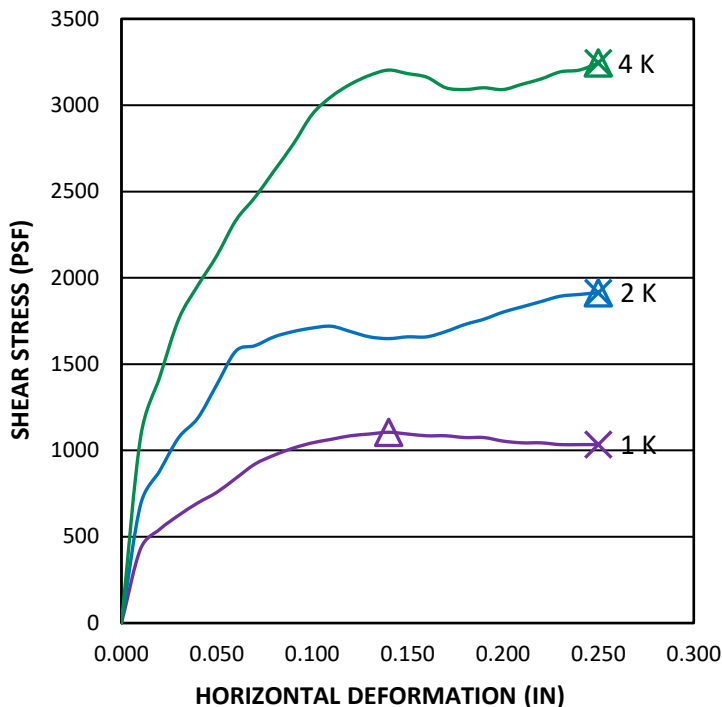

1 K 2 K 4 K
 ▲ 1 K PEAK ▲ 2 K PEAK ▲ 4 K PEAK
 ✕ 1 K ULTIMATE ✕ 2 K ULTIMATE ✕ 4 K ULTIMATE

DIRECT SHEAR - ASTM D 3080

GEOCON
 INCORPORATED



GEOTECHNICAL CONSULTANTS
 6960 FLANDERS DRIVE - SAN DIEGO, CALIFORNIA 92121-2974
 PHONE 858 558-6900 - FAX 858 558-6159

TOWNE CENTRE VIEW

PROJECT NO.: G2326-52-02

SAMPLE NO.: B13-2 GEOLOGIC UNIT: Qudf
 SAMPLE DEPTH (FT): 20' NATURAL/REMODELED: N

INITIAL CONDITIONS				
NORMAL STRESS TEST LOAD	1 K	2 K	4 K	AVERAGE
ACTUAL NORMAL STRESS (PSF):	890	2030	4300	--
WATER CONTENT (%):	11.5	11.1	13.6	12.1
DRY DENSITY (PCF):	116.0	112.8	115.0	114.6

AFTER TEST CONDITIONS				
NORMAL STRESS TEST LOAD	1 K	2 K	4 K	AVERAGE
WATER CONTENT (%):	15.3	16.2	16.0	15.8
PEAK SHEAR STRESS (PSF):	1341	1842	3695	--
ULT.-E.O.T. SHEAR STRESS (PSF):	1341	1719	3439	--

RESULTS		
PEAK	COHESION, C (PSF)	600
	FRICTION ANGLE (DEGREES)	35
ULTIMATE	COHESION, C (PSF)	600
	FRICTION ANGLE (DEGREES)	32

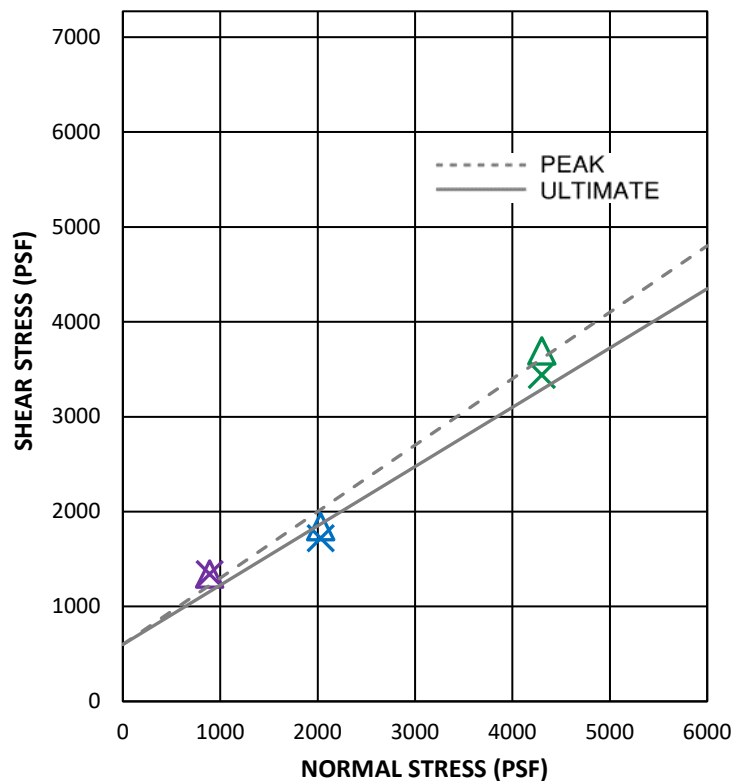
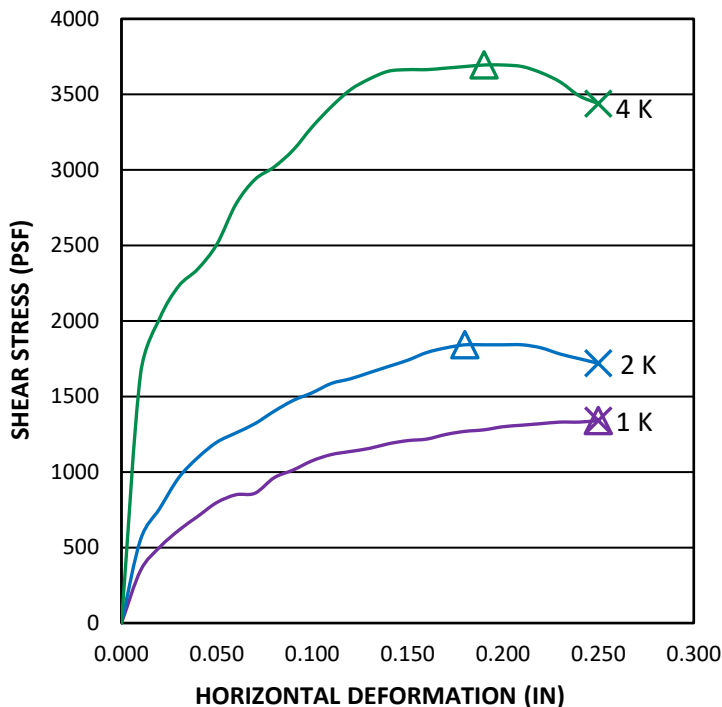

1 K 2 K 4 K
 ▲ 1 K PEAK ▲ 2 K PEAK ▲ 4 K PEAK
 ✕ 1 K ULTIMATE ✕ 2 K ULTIMATE ✕ 4 K ULTIMATE

DIRECT SHEAR - ASTM D 3080

GEOCON
 INCORPORATED



GEOTECHNICAL CONSULTANTS
 6960 FLANDERS DRIVE - SAN DIEGO, CALIFORNIA 92121-2974
 PHONE 858 558-6900 - FAX 858 558-6159

TOWNE CENTRE VIEW

PROJECT NO.: G2326-52-02

SAMPLE NO.: **B1-6**
 SAMPLE DEPTH (FT): **25'**

GEOLOGIC UNIT: **Tsc**

TEST INFORMATION	
INITIAL DRY DENSITY (PCF):	105.9
INITIAL WATER CONTENT (%):	21.3%
SAMPLE SATURATED AT (KSF):	2.0
INITIAL SATURATION (%):	100+

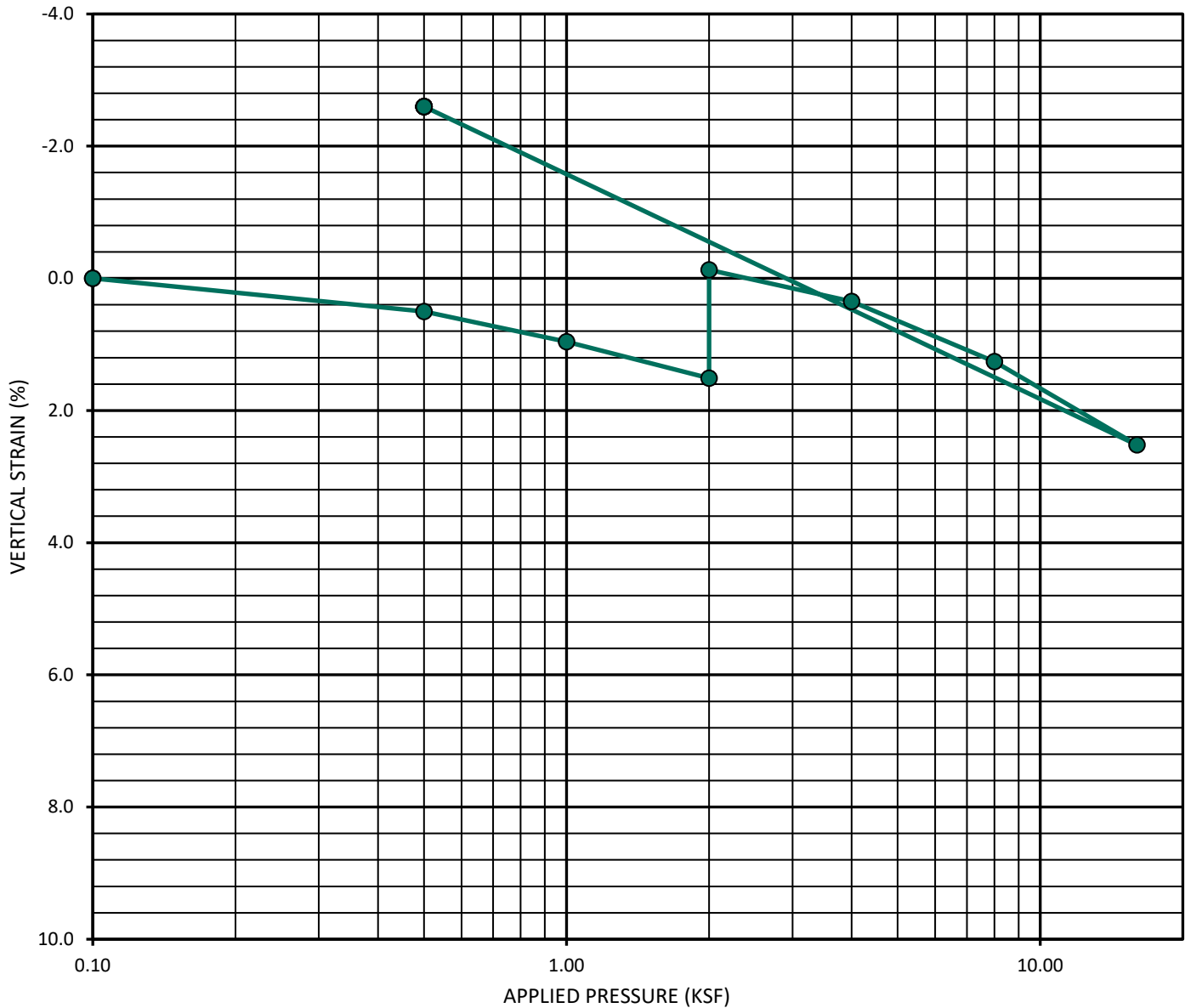

CONSOLIDATION CURVE - ASTM D 2435

TOWNE CENTRE VIEW

PROJECT NO.: G2326-52-02

GEOCON
 INCORPORATED



GEOTECHNICAL CONSULTANTS
 6960 FLANDERS DRIVE - SAN DIEGO, CALIFORNIA 92121 - 2974
 PHONE 858 558-6900 - FAX 858 558-6159

SAMPLE NO.: **B4-10**
 SAMPLE DEPTH (FT): **55'**

GEOLOGIC UNIT: **Qvop**

TEST INFORMATION	
INITIAL DRY DENSITY (PCF):	100.9
INITIAL WATER CONTENT (%):	16.4%
SAMPLE SATURATED AT (KSF):	2.0
INITIAL SATURATION (%):	67.7%

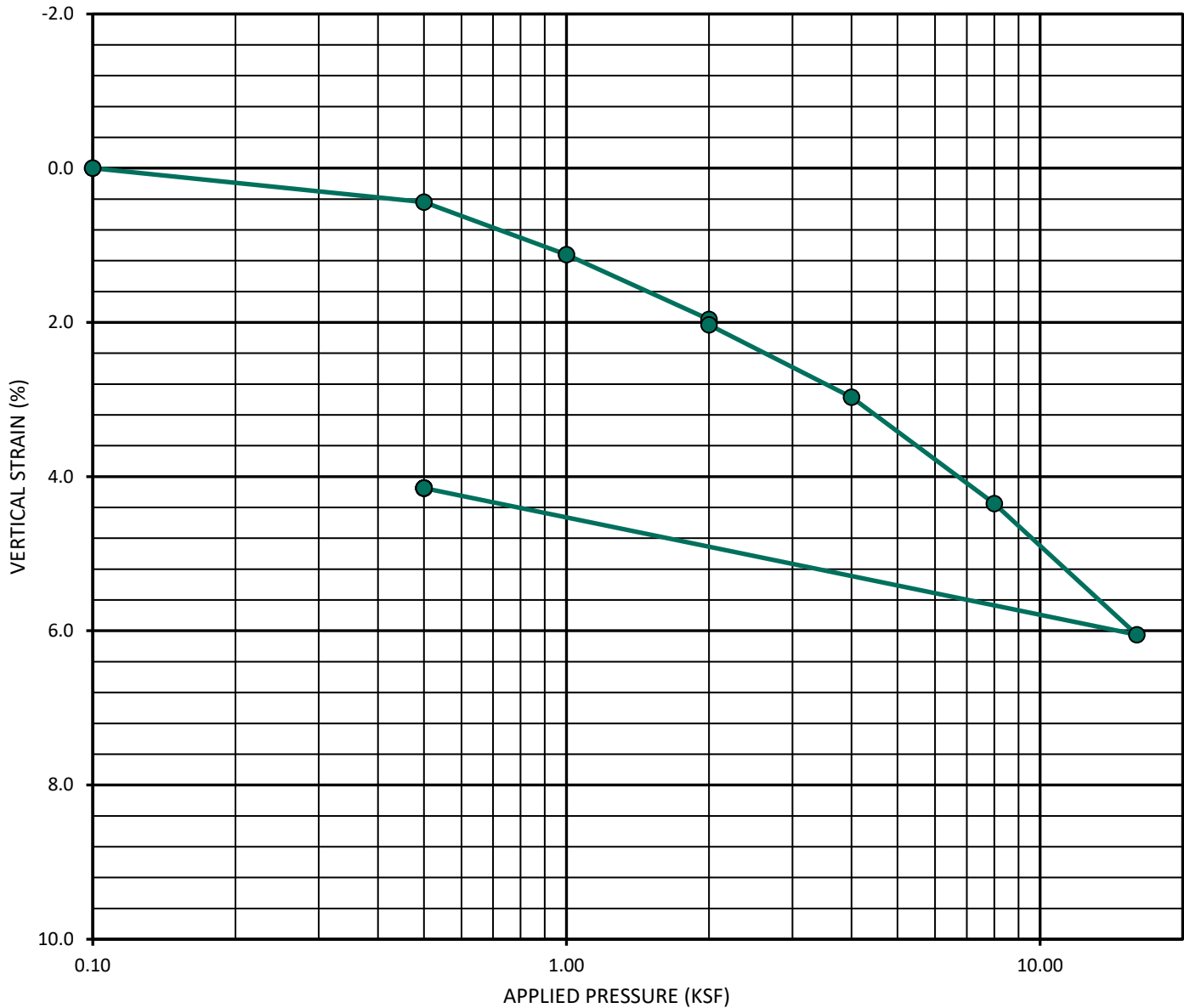

CONSOLIDATION CURVE - ASTM D 2435

TOWNE CENTRE VIEW

PROJECT NO.: G2326-52-02

GEOCON
 INCORPORATED



GEOTECHNICAL CONSULTANTS
 6960 FLANDERS DRIVE - SAN DIEGO, CALIFORNIA 92121 - 2974
 PHONE 858 558-6900 - FAX 858 558-6159

SAMPLE NO.: **B8-6**
 SAMPLE DEPTH (FT): **50'**

GEOLOGIC UNIT: **Ta**

TEST INFORMATION	
INITIAL DRY DENSITY (PCF):	111.9
INITIAL WATER CONTENT (%):	18.3%
SAMPLE SATURATED AT (KSF):	2.0
INITIAL SATURATION (%):	100+

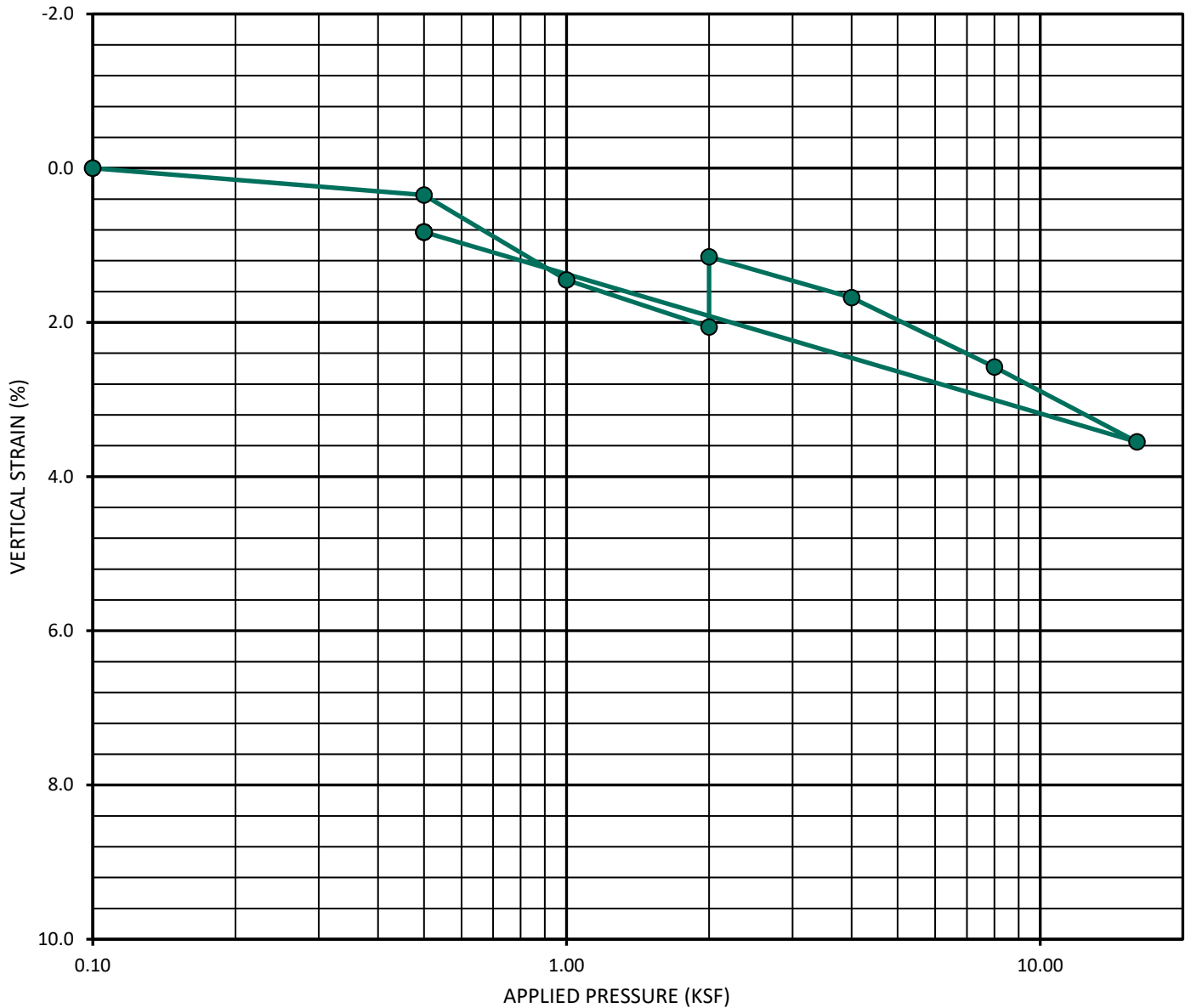

CONSOLIDATION CURVE - ASTM D 2435

TOWNE CENTRE VIEW

PROJECT NO.: G2326-52-02

GEOCON
 INCORPORATED



GEOTECHNICAL CONSULTANTS
 6960 FLANDERS DRIVE - SAN DIEGO, CALIFORNIA 92121 - 2974
 PHONE 858 558-6900 - FAX 858 558-6159

SAMPLE NO.: **B9-8**
 SAMPLE DEPTH (FT): **55'**

GEOLOGIC UNIT: **Ta**

TEST INFORMATION	
INITIAL DRY DENSITY (PCF):	107.3
INITIAL WATER CONTENT (%):	21.0%
SAMPLE SATURATED AT (KSF):	2.0
INITIAL SATURATION (%):	100+

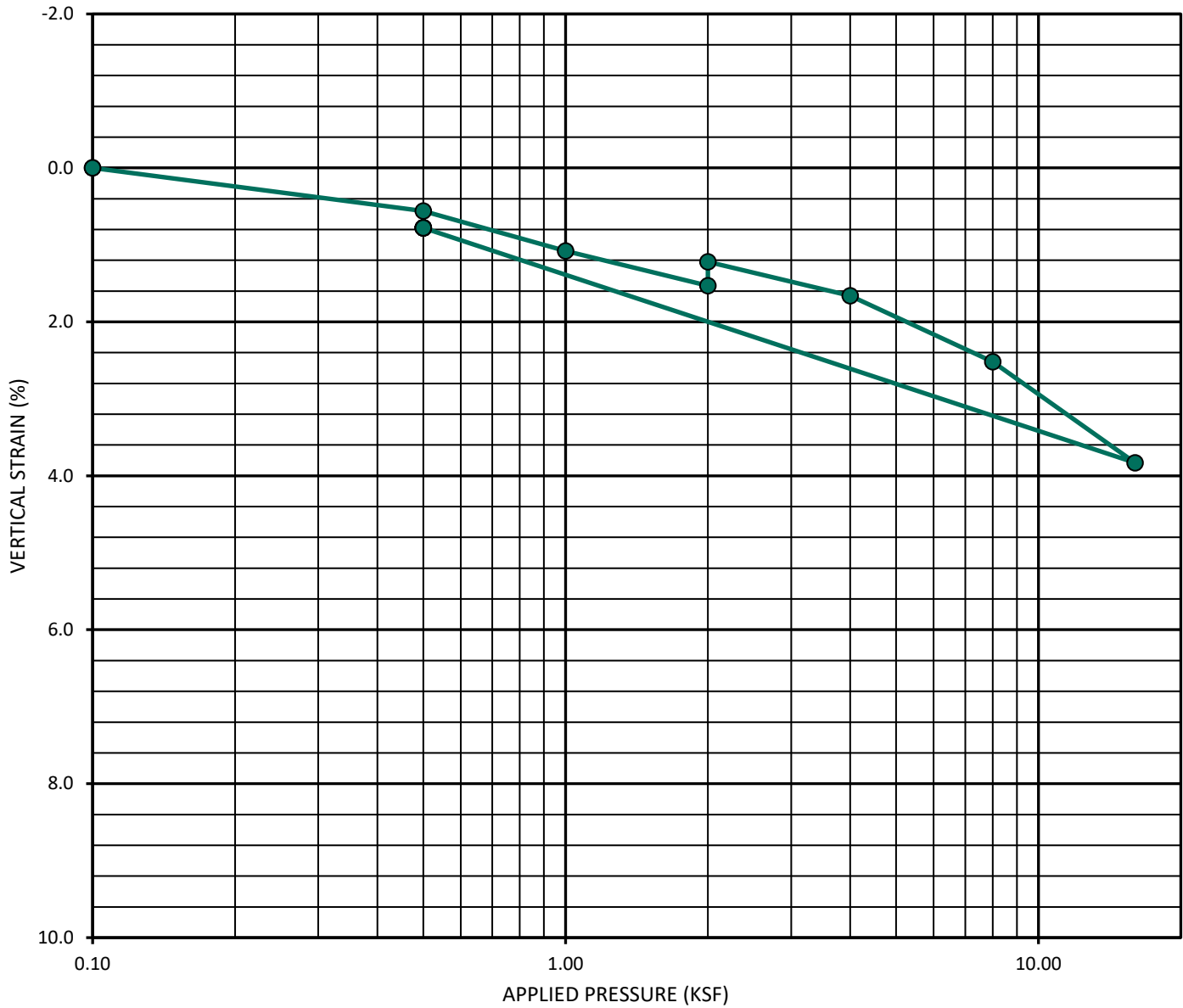

CONSOLIDATION CURVE - ASTM D 2435

TOWNE CENTRE VIEW

PROJECT NO.: G2326-52-02

GEOCON
 INCORPORATED



GEOTECHNICAL CONSULTANTS
 6960 FLANDERS DRIVE - SAN DIEGO, CALIFORNIA 92121 - 2974
 PHONE 858 558-6900 - FAX 858 558-6159

SAMPLE NO.: **B13-1**
 SAMPLE DEPTH (FT): **10'**

GEOLOGIC UNIT: **Qudf**

TEST INFORMATION	
INITIAL DRY DENSITY (PCF):	121.8
INITIAL WATER CONTENT (%):	11.5%
SAMPLE SATURATED AT (KSF):	2.0
INITIAL SATURATION (%):	84.7%

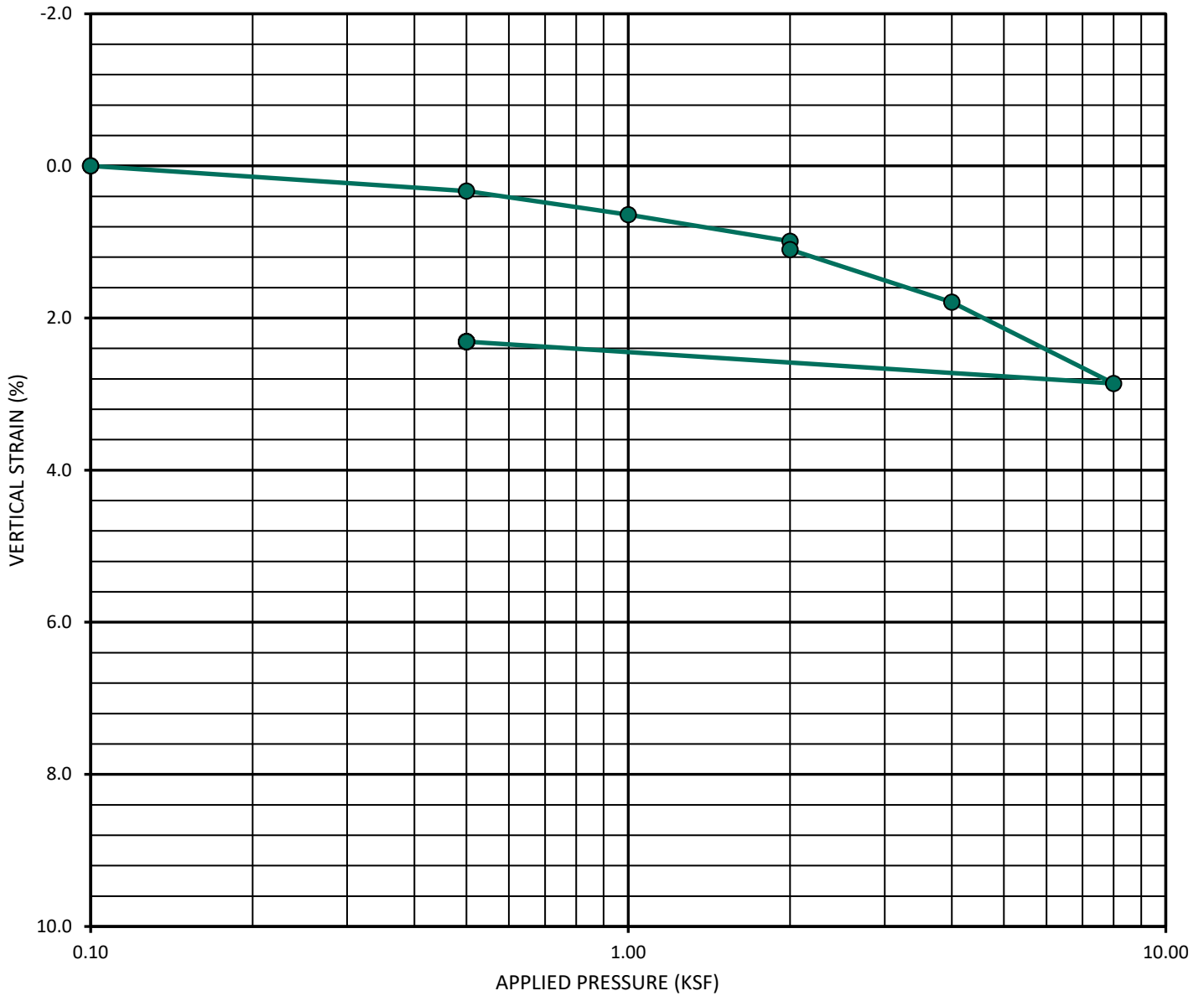

CONSOLIDATION CURVE - ASTM D 2435

TOWNE CENTRE VIEW

PROJECT NO.: G2326-52-02

GEOCON
 INCORPORATED



GEOTECHNICAL CONSULTANTS
 6960 FLANDERS DRIVE - SAN DIEGO, CALIFORNIA 92121 - 2974
 PHONE 858 558-6900 - FAX 858 558-6159

SAMPLE NO.: **B13-7**
 SAMPLE DEPTH (FT): **50'**

GEOLOGIC UNIT: **Qudf**

TEST INFORMATION	
INITIAL DRY DENSITY (PCF):	105.4
INITIAL WATER CONTENT (%):	22.1%
SAMPLE SATURATED AT (KSF):	2.0
INITIAL SATURATION (%):	100+

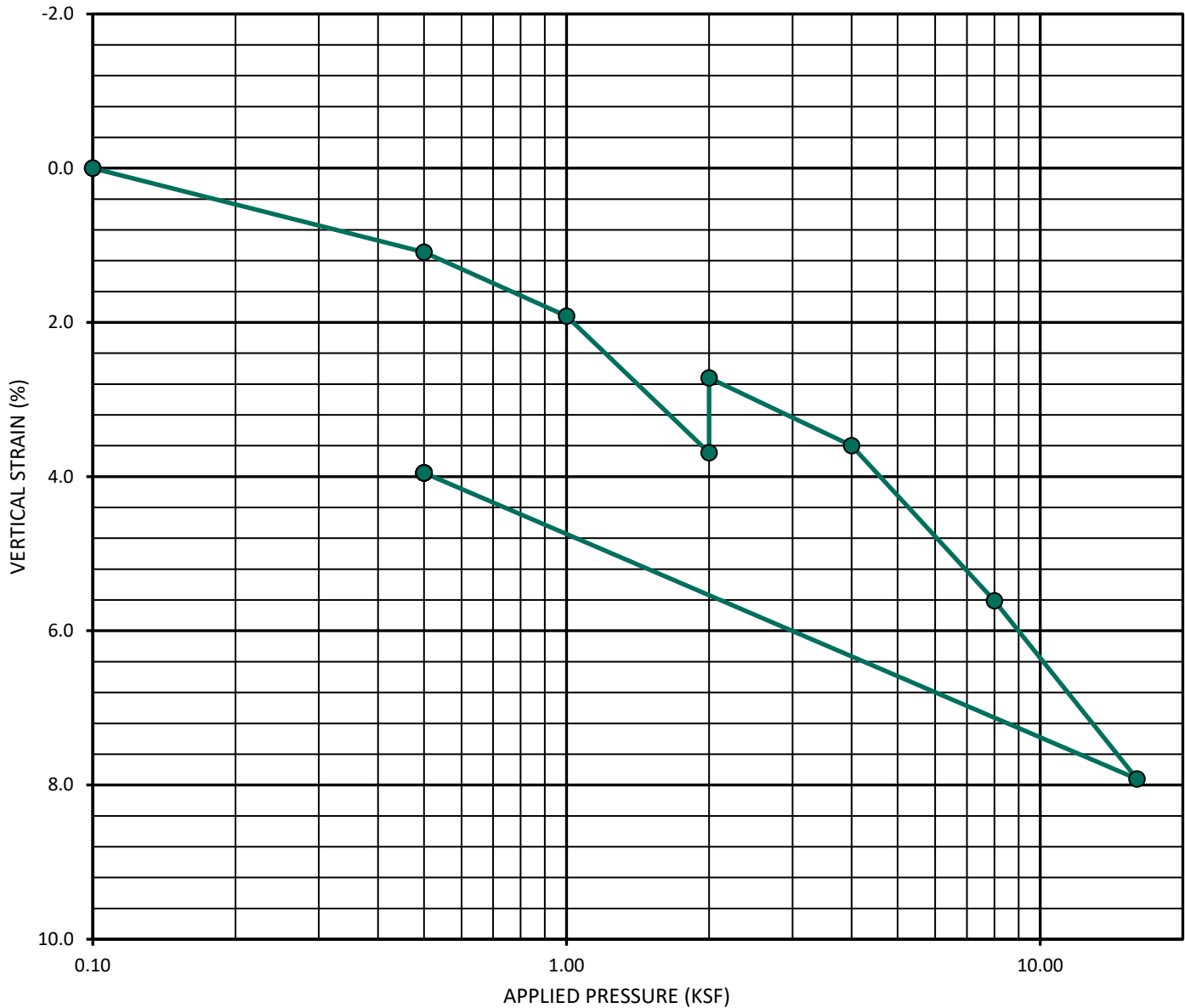

CONSOLIDATION CURVE - ASTM D 2435

TOWNE CENTRE VIEW

PROJECT NO.: G2326-52-02

GEOCON
 INCORPORATED



GEOTECHNICAL CONSULTANTS
 6960 FLANDERS DRIVE - SAN DIEGO, CALIFORNIA 92121 - 2974
 PHONE 858 558-6900 - FAX 858 558-6159

SAMPLE NO.: **B2-4**
 SAMPLE DEPTH (FT.): **15'**

GEOLOGIC UNIT: **Ta**

GRAVEL		SAND			SILT OR CLAY
COARSE	FINE	COARSE	MEDIUM	FINE	

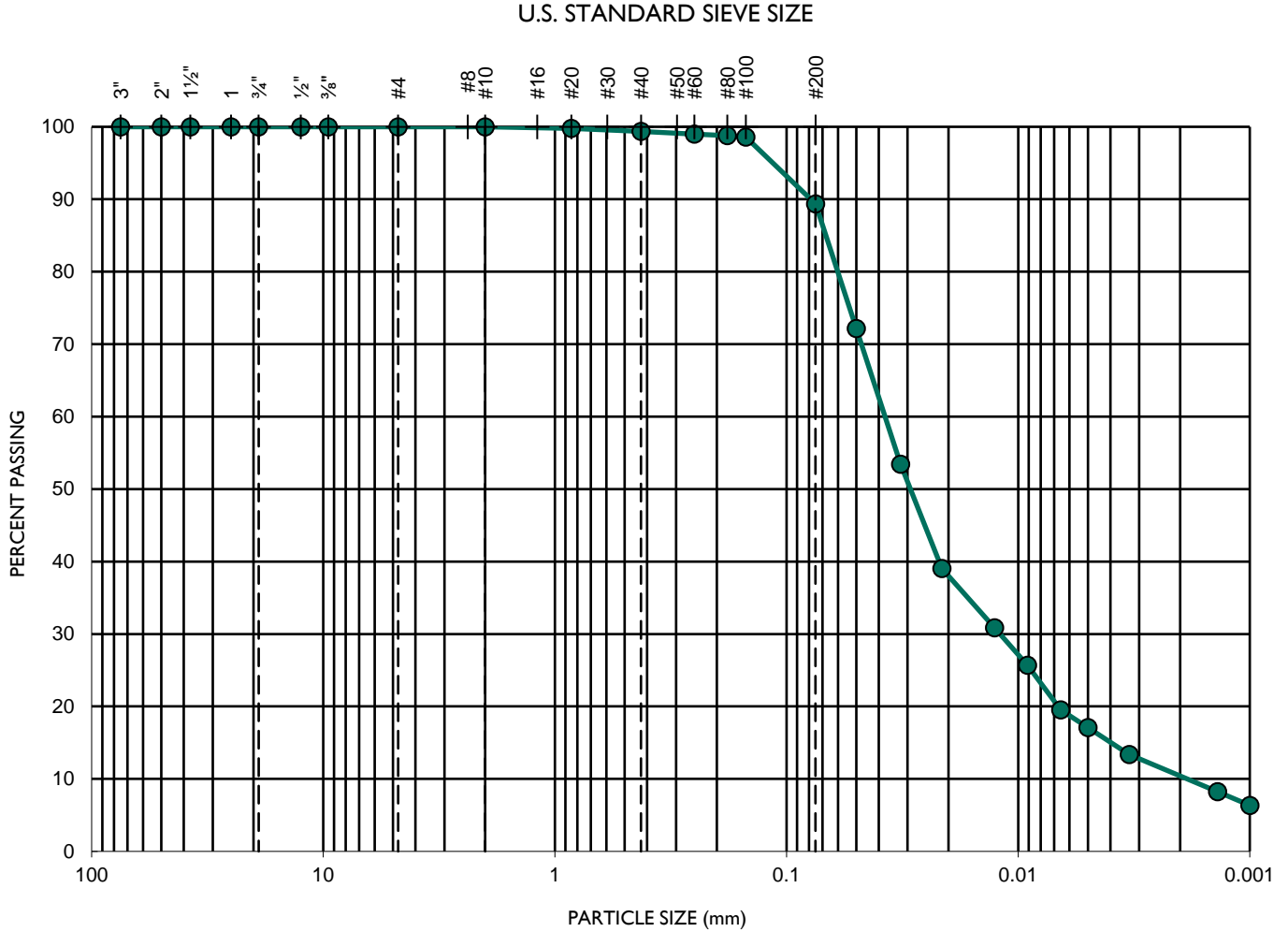

TEST DATA					
D ₁₀ (mm)	D ₃₀ (mm)	D ₆₀ (mm)	C _c	C _u	SOIL DESCRIPTION
0.00205	0.01207	0.03843	1.9	18.8	CLAY

GEOCON
INCORPORATED



GEOTECHNICAL CONSULTANTS
 6960 FLANDERS DRIVE - SAN DIEGO, CALIFORNIA 92121 - 2974
 PHONE 858 558-6900 - FAX 858 558-6159

SIEVE ANALYSES - ASTM D 135 & D 422

TOWNE CENTRE VIEW

PROJECT NO.: G2326-52-02

SAMPLE NO.: **B5-8**
 SAMPLE DEPTH (FT.): **50'**

GEOLOGIC UNIT: **Ta**

GRAVEL		SAND			SILT OR CLAY
COARSE	FINE	COARSE	MEDIUM	FINE	

U.S. STANDARD SIEVE SIZE

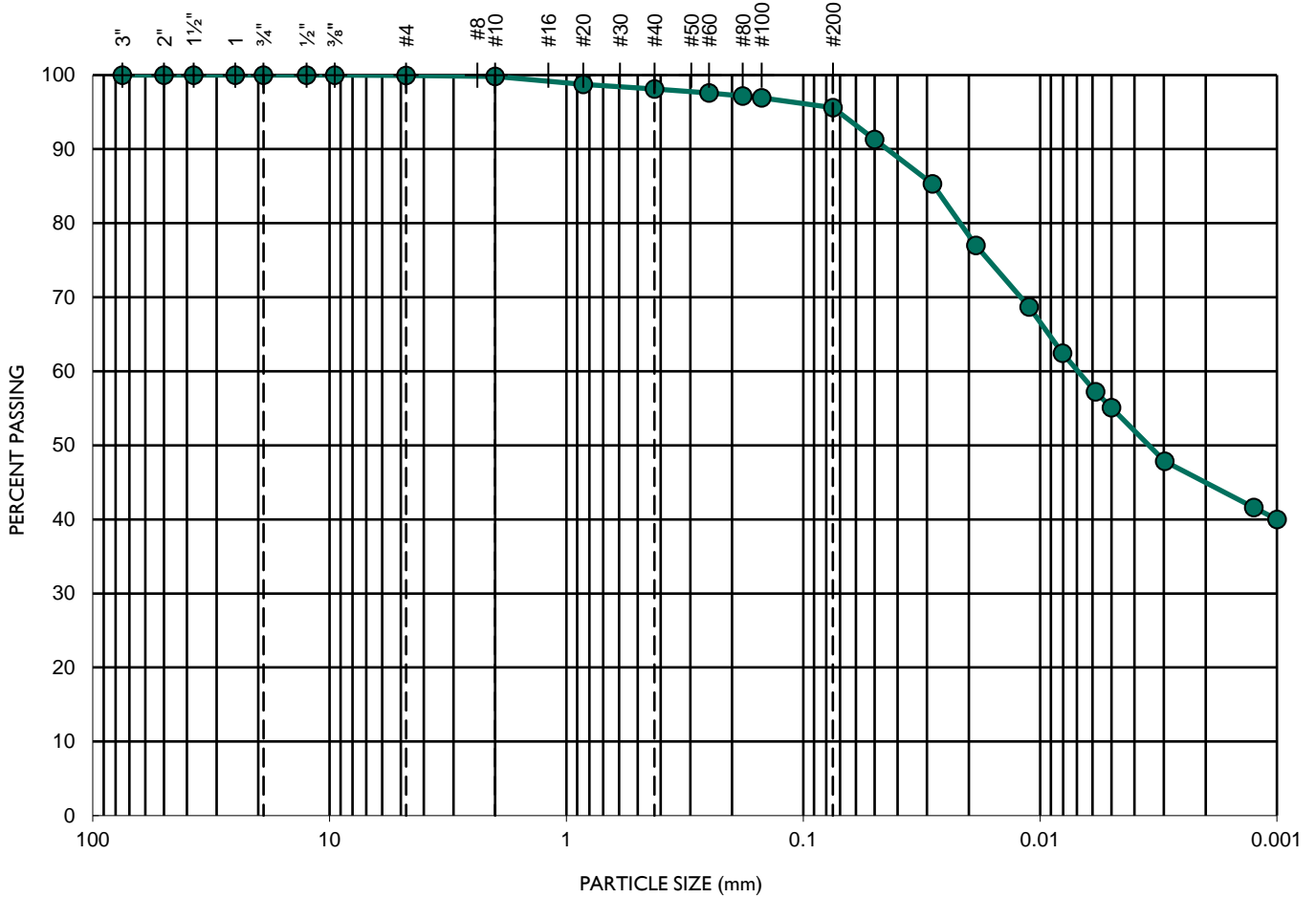

TEST DATA					
D ₁₀ (mm)	D ₃₀ (mm)	D ₆₀ (mm)	C _c	C _u	SOIL DESCRIPTION
--	-0.00056	0.00701	--	--	CLAY

GEOCON
INCORPORATED



GEOTECHNICAL CONSULTANTS
 6960 FLANDERS DRIVE - SAN DIEGO, CALIFORNIA 92121 - 2974
 PHONE 858 558-6900 - FAX 858 558-6159

SIEVE ANALYSES - ASTM D 135 & D 422

TOWNE CENTRE VIEW

PROJECT NO.: G2326-52-02

SAMPLE NO.: **B11-8**
 SAMPLE DEPTH (FT.): **50'**

GEOLOGIC UNIT: **Ta**

GRAVEL		SAND			SILT OR CLAY
COARSE	FINE	COARSE	MEDIUM	FINE	

U.S. STANDARD SIEVE SIZE

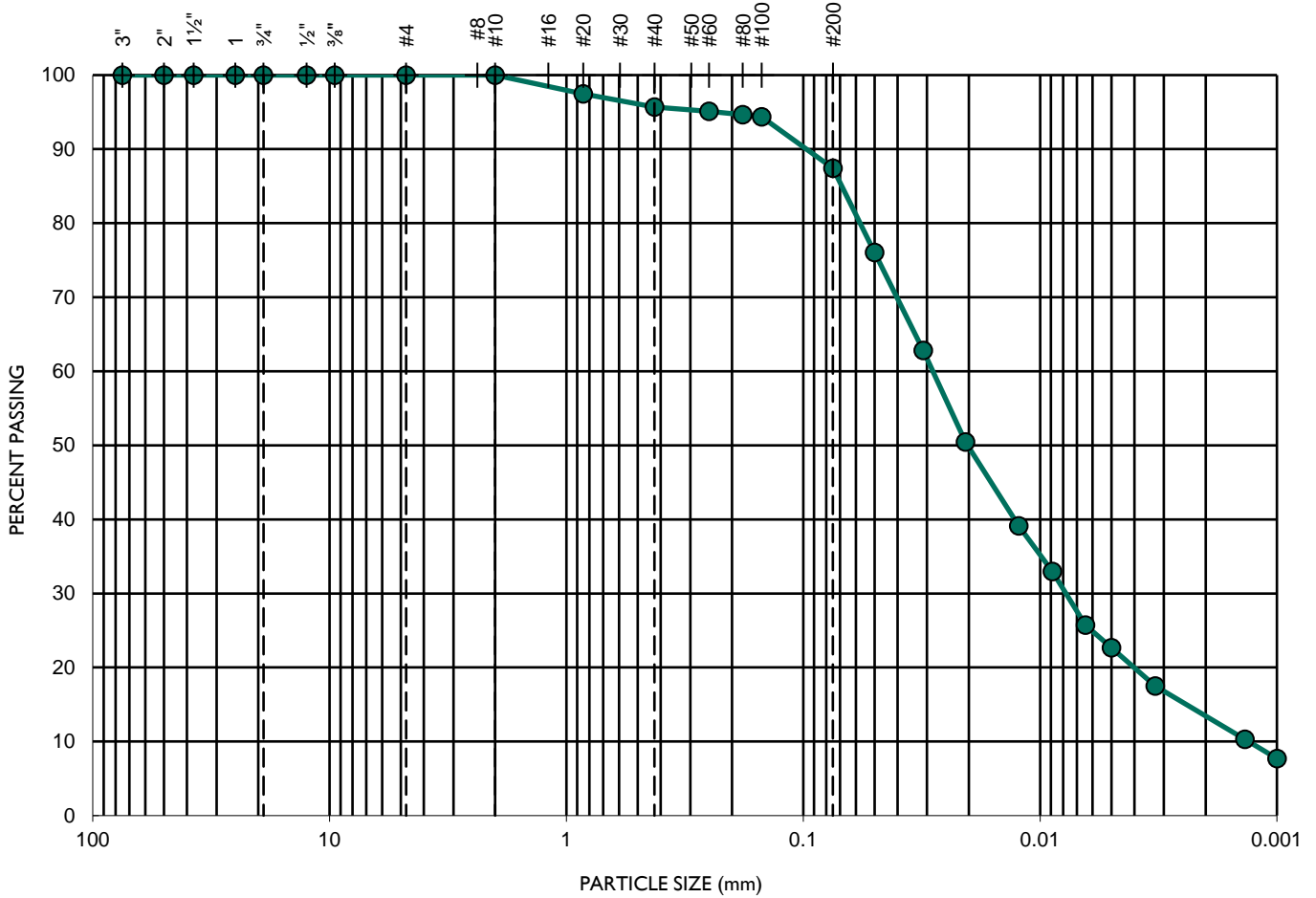

TEST DATA					
D ₁₀ (mm)	D ₃₀ (mm)	D ₆₀ (mm)	C _c	C _u	SOIL DESCRIPTION
0.00132	0.00788	0.02878	1.6	21.7	SILT

GEOCON
INCORPORATED



GEOTECHNICAL CONSULTANTS
 6960 FLANDERS DRIVE - SAN DIEGO, CALIFORNIA 92121-2974
 PHONE 858 558-6900 - FAX 858 558-6159

SIEVE ANALYSES - ASTM D 135 & D 422

TOWNE CENTRE VIEW

PROJECT NO.: G2326-52-02

APPENDIX

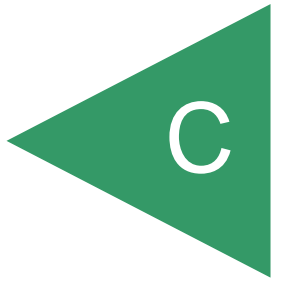

APPENDIX C

RECOMMENDED GRADING SPECIFICATIONS

FOR

TOWNE CENTRE VIEW
SAN DIEGO, CALIFORNIA

PROJECT NO. G2326-52-02

RECOMMENDED GRADING SPECIFICATIONS

1. GENERAL

- 1.1 These Recommended Grading Specifications shall be used in conjunction with the Geotechnical Report for the project prepared by Geocon. The recommendations contained in the text of the Geotechnical Report are a part of the earthwork and grading specifications and shall supersede the provisions contained hereinafter in the case of conflict.
- 1.2 Prior to the commencement of grading, a geotechnical consultant (Consultant) shall be employed for the purpose of observing earthwork procedures and testing the fills for substantial conformance with the recommendations of the Geotechnical Report and these specifications. The Consultant should provide adequate testing and observation services so that they may assess whether, in their opinion, the work was performed in substantial conformance with these specifications. It shall be the responsibility of the Contractor to assist the Consultant and keep them apprised of work schedules and changes so that personnel may be scheduled accordingly.
- 1.3 It shall be the sole responsibility of the Contractor to provide adequate equipment and methods to accomplish the work in accordance with applicable grading codes or agency ordinances, these specifications and the approved grading plans. If, in the opinion of the Consultant, unsatisfactory conditions such as questionable soil materials, poor moisture condition, inadequate compaction, and/or adverse weather result in a quality of work not in conformance with these specifications, the Consultant will be empowered to reject the work and recommend to the Owner that grading be stopped until the unacceptable conditions are corrected.

2. DEFINITIONS

- 2.1 **Owner** shall refer to the owner of the property or the entity on whose behalf the grading work is being performed and who has contracted with the Contractor to have grading performed.
- 2.2 **Contractor** shall refer to the Contractor performing the site grading work.
- 2.3 **Civil Engineer** or **Engineer of Work** shall refer to the California licensed Civil Engineer or consulting firm responsible for preparation of the grading plans, surveying and verifying as-graded topography.
- 2.4 **Consultant** shall refer to the soil engineering and engineering geology consulting firm retained to provide geotechnical services for the project.

- 2.5 **Soil Engineer** shall refer to a California licensed Civil Engineer retained by the Owner, who is experienced in the practice of geotechnical engineering. The Soil Engineer shall be responsible for having qualified representatives on-site to observe and test the Contractor's work for conformance with these specifications.
- 2.6 **Engineering Geologist** shall refer to a California licensed Engineering Geologist retained by the Owner to provide geologic observations and recommendations during the site grading.
- 2.7 **Geotechnical Report** shall refer to a soil report (including all addenda) which may include a geologic reconnaissance or geologic investigation that was prepared specifically for the development of the project for which these Recommended Grading Specifications are intended to apply.

3. MATERIALS

- 3.1 Materials for compacted fill shall consist of any soil excavated from the cut areas or imported to the site that, in the opinion of the Consultant, is suitable for use in construction of fills. In general, fill materials can be classified as *soil* fills, *soil-rock* fills or *rock* fills, as defined below.
- 3.1.1 **Soil fills** are defined as fills containing no rocks or hard lumps greater than 12 inches in maximum dimension and containing at least 40 percent by weight of material smaller than $\frac{3}{4}$ inch in size.
- 3.1.2 **Soil-rock fills** are defined as fills containing no rocks or hard lumps larger than 4 feet in maximum dimension and containing a sufficient matrix of soil fill to allow for proper compaction of soil fill around the rock fragments or hard lumps as specified in Paragraph 6.2. **Oversize rock** is defined as material greater than 12 inches.
- 3.1.3 **Rock fills** are defined as fills containing no rocks or hard lumps larger than 3 feet in maximum dimension and containing little or no fines. Fines are defined as material smaller than $\frac{3}{4}$ inch in maximum dimension. The quantity of fines shall be less than approximately 20 percent of the rock fill quantity.
- 3.2 Material of a perishable, spongy, or otherwise unsuitable nature as determined by the Consultant shall not be used in fills.
- 3.3 Materials used for fill, either imported or on-site, shall not contain hazardous materials as defined by the California Code of Regulations, Title 22, Division 4, Chapter 30, Articles 9

and 10; 40CFR; and any other applicable local, state or federal laws. The Consultant shall not be responsible for the identification or analysis of the potential presence of hazardous materials. However, if observations, odors or soil discoloration cause Consultant to suspect the presence of hazardous materials, the Consultant may request from the Owner the termination of grading operations within the affected area. Prior to resuming grading operations, the Owner shall provide a written report to the Consultant indicating that the suspected materials are not hazardous as defined by applicable laws and regulations.

- 3.4 The outer 15 feet of *soil-rock* fill slopes, measured horizontally, should be composed of properly compacted *soil* fill materials approved by the Consultant. *Rock* fill may extend to the slope face, provided that the slope is not steeper than 2:1 (horizontal:vertical) and a soil layer no thicker than 12 inches is track-walked onto the face for landscaping purposes. This procedure may be utilized provided it is acceptable to the governing agency, Owner and Consultant.
- 3.5 Samples of soil materials to be used for fill should be tested in the laboratory by the Consultant to determine the maximum density, optimum moisture content, and, where appropriate, shear strength, expansion, and gradation characteristics of the soil.
- 3.6 During grading, soil or groundwater conditions other than those identified in the Geotechnical Report may be encountered by the Contractor. The Consultant shall be notified immediately to evaluate the significance of the unanticipated condition.

4. CLEARING AND PREPARING AREAS TO BE FILLED

- 4.1 Areas to be excavated and filled shall be cleared and grubbed. Clearing shall consist of complete removal above the ground surface of trees, stumps, brush, vegetation, man-made structures, and similar debris. Grubbing shall consist of removal of stumps, roots, buried logs and other unsuitable material and shall be performed in areas to be graded. Roots and other projections exceeding 1½ inches in diameter shall be removed to a depth of 3 feet below the surface of the ground. Borrow areas shall be grubbed to the extent necessary to provide suitable fill materials.
- 4.2 Asphalt pavement material removed during clearing operations should be properly disposed at an approved off-site facility or in an acceptable area of the project evaluated by Geocon and the property owner. Concrete fragments that are free of reinforcing steel may be placed in fills, provided they are placed in accordance with Section 6.2 or 6.3 of this document.

- 4.3 After clearing and grubbing of organic matter and other unsuitable material, loose or porous soils shall be removed to the depth recommended in the Geotechnical Report. The depth of removal and compaction should be observed and approved by a representative of the Consultant. The exposed surface shall then be plowed or scarified to a minimum depth of 6 inches and until the surface is free from uneven features that would tend to prevent uniform compaction by the equipment to be used.
- 4.4 Where the slope ratio of the original ground is steeper than 5:1 (horizontal:vertical), or where recommended by the Consultant, the original ground should be benched in accordance with the following illustration.

TYPICAL BENCHING DETAIL

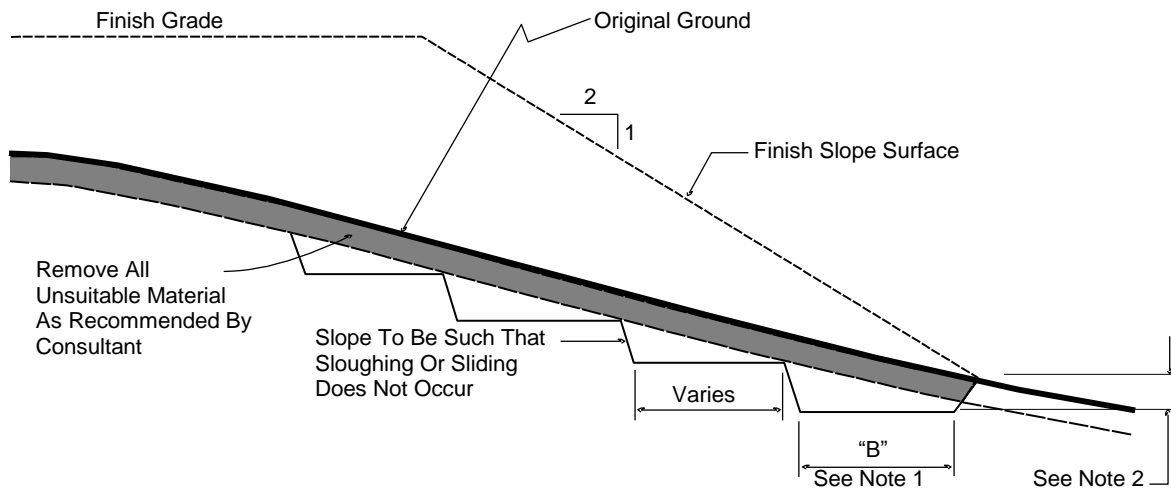

No Scale

- DETAIL NOTES:
- (1) Key width "B" should be a minimum of 10 feet, or sufficiently wide to permit complete coverage with the compaction equipment used. The base of the key should be graded horizontal, or inclined slightly into the natural slope.
 - (2) The outside of the key should be below the topsoil or unsuitable surficial material and at least 2 feet into dense formational material. Where hard rock is exposed in the bottom of the key, the depth and configuration of the key may be modified as approved by the Consultant.

- 4.5 After areas to receive fill have been cleared and scarified, the surface should be moisture conditioned to achieve the proper moisture content, and compacted as recommended in Section 6 of these specifications.

5. COMPACTION EQUIPMENT

- 5.1 Compaction of *soil* or *soil-rock* fill shall be accomplished by sheepsfoot or segmented-steel wheeled rollers, vibratory rollers, multiple-wheel pneumatic-tired rollers, or other types of acceptable compaction equipment. Equipment shall be of such a design that it will be capable of compacting the *soil* or *soil-rock* fill to the specified relative compaction at the specified moisture content.
- 5.2 Compaction of *rock* fills shall be performed in accordance with Section 6.3.

6. PLACING, SPREADING AND COMPACTION OF FILL MATERIAL

- 6.1 *Soil* fill, as defined in Paragraph 3.1.1, shall be placed by the Contractor in accordance with the following recommendations:
- 6.1.1 *Soil* fill shall be placed by the Contractor in layers that, when compacted, should generally not exceed 8 inches. Each layer shall be spread evenly and shall be thoroughly mixed during spreading to obtain uniformity of material and moisture in each layer. The entire fill shall be constructed as a unit in nearly level lifts. Rock materials greater than 12 inches in maximum dimension shall be placed in accordance with Section 6.2 or 6.3 of these specifications.
- 6.1.2 In general, the *soil* fill shall be compacted at a moisture content at or above the optimum moisture content as determined by ASTM D 1557.
- 6.1.3 When the moisture content of *soil* fill is below that specified by the Consultant, water shall be added by the Contractor until the moisture content is in the range specified.
- 6.1.4 When the moisture content of the *soil* fill is above the range specified by the Consultant or too wet to achieve proper compaction, the *soil* fill shall be aerated by the Contractor by blading/mixing, or other satisfactory methods until the moisture content is within the range specified.
- 6.1.5 After each layer has been placed, mixed, and spread evenly, it shall be thoroughly compacted by the Contractor to a relative compaction of at least 90 percent. Relative compaction is defined as the ratio (expressed in percent) of the in-place dry density of the compacted fill to the maximum laboratory dry density as determined in accordance with ASTM D 1557. Compaction shall be continuous over the entire area, and compaction equipment shall make sufficient passes so that the specified minimum relative compaction has been achieved throughout the entire fill.

- 6.1.6 Where practical, soils having an Expansion Index greater than 50 should be placed at least 3 feet below finish pad grade and should be compacted at a moisture content generally 2 to 4 percent greater than the optimum moisture content for the material.
 - 6.1.7 Properly compacted *soil* fill shall extend to the design surface of fill slopes. To achieve proper compaction, it is recommended that fill slopes be over-built by at least 3 feet and then cut to the design grade. This procedure is considered preferable to track-walking of slopes, as described in the following paragraph.
 - 6.1.8 As an alternative to over-building of slopes, slope faces may be back-rolled with a heavy-duty loaded sheepsfoot or vibratory roller at maximum 4-foot fill height intervals. Upon completion, slopes should then be track-walked with a D-8 dozer or similar equipment, such that a dozer track covers all slope surfaces at least twice.
- 6.2 *Soil-rock* fill, as defined in Paragraph 3.1.2, shall be placed by the Contractor in accordance with the following recommendations:
- 6.2.1 Rocks larger than 12 inches but less than 4 feet in maximum dimension may be incorporated into the compacted *soil* fill, but shall be limited to the area measured 15 feet minimum horizontally from the slope face and 5 feet below finish grade or 3 feet below the deepest utility, whichever is deeper.
 - 6.2.2 Rocks or rock fragments up to 4 feet in maximum dimension may either be individually placed or placed in windrows. Under certain conditions, rocks or rock fragments up to 10 feet in maximum dimension may be placed using similar methods. The acceptability of placing rock materials greater than 4 feet in maximum dimension shall be evaluated during grading as specific cases arise and shall be approved by the Consultant prior to placement.
 - 6.2.3 For individual placement, sufficient space shall be provided between rocks to allow for passage of compaction equipment.
 - 6.2.4 For windrow placement, the rocks should be placed in trenches excavated in properly compacted *soil* fill. Trenches should be approximately 5 feet wide and 4 feet deep in maximum dimension. The voids around and beneath rocks should be filled with approved granular soil having a Sand Equivalent of 30 or greater and should be compacted by flooding. Windrows may also be placed utilizing an "open-face" method in lieu of the trench procedure, however, this method should first be approved by the Consultant.

- 6.2.5 Windrows should generally be parallel to each other and may be placed either parallel to or perpendicular to the face of the slope depending on the site geometry. The minimum horizontal spacing for windrows shall be 12 feet center-to-center with a 5-foot stagger or offset from lower courses to next overlying course. The minimum vertical spacing between windrow courses shall be 2 feet from the top of a lower windrow to the bottom of the next higher windrow.
- 6.2.6 Rock placement, fill placement and flooding of approved granular soil in the windrows should be continuously observed by the Consultant.
- 6.3 *Rock* fills, as defined in Section 3.1.3, shall be placed by the Contractor in accordance with the following recommendations:
- 6.3.1 The base of the *rock* fill shall be placed on a sloping surface (minimum slope of 2 percent). The surface shall slope toward suitable subdrainage outlet facilities. The *rock* fills shall be provided with subdrains during construction so that a hydrostatic pressure buildup does not develop. The subdrains shall be permanently connected to controlled drainage facilities to control post-construction infiltration of water.
- 6.3.2 *Rock* fills shall be placed in lifts not exceeding 3 feet. Placement shall be by rock trucks traversing previously placed lifts and dumping at the edge of the currently placed lift. Spreading of the *rock* fill shall be by dozer to facilitate *seating* of the rock. The *rock* fill shall be watered heavily during placement. Watering shall consist of water trucks traversing in front of the current rock lift face and spraying water continuously during rock placement. Compaction equipment with compactive energy comparable to or greater than that of a 20-ton steel vibratory roller or other compaction equipment providing suitable energy to achieve the required compaction or deflection as recommended in Paragraph 6.3.3 shall be utilized. The number of passes to be made should be determined as described in Paragraph 6.3.3. Once a *rock* fill lift has been covered with *soil* fill, no additional *rock* fill lifts will be permitted over the *soil* fill.
- 6.3.3 Plate bearing tests, in accordance with ASTM D 1196, may be performed in both the compacted *soil* fill and in the *rock* fill to aid in determining the required minimum number of passes of the compaction equipment. If performed, a minimum of three plate bearing tests should be performed in the properly compacted *soil* fill (minimum relative compaction of 90 percent). Plate bearing tests shall then be performed on areas of *rock* fill having two passes, four passes and six passes of the compaction equipment, respectively. The number of passes required for the *rock* fill shall be determined by comparing the results of the plate bearing tests for the *soil* fill and the *rock* fill and by evaluating the deflection

variation with number of passes. The required number of passes of the compaction equipment will be performed as necessary until the plate bearing deflections are equal to or less than that determined for the properly compacted *soil* fill. In no case will the required number of passes be less than two.

- 6.3.4 A representative of the Consultant should be present during *rock* fill operations to observe that the minimum number of “passes” have been obtained, that water is being properly applied and that specified procedures are being followed. The actual number of plate bearing tests will be determined by the Consultant during grading.
- 6.3.5 Test pits shall be excavated by the Contractor so that the Consultant can state that, in their opinion, sufficient water is present and that voids between large rocks are properly filled with smaller rock material. In-place density testing will not be required in the *rock* fills.
- 6.3.6 To reduce the potential for “piping” of fines into the *rock* fill from overlying *soil* fill material, a 2-foot layer of graded filter material shall be placed above the uppermost lift of *rock* fill. The need to place graded filter material below the *rock* should be determined by the Consultant prior to commencing grading. The gradation of the graded filter material will be determined at the time the *rock* fill is being excavated. Materials typical of the *rock* fill should be submitted to the Consultant in a timely manner, to allow design of the graded filter prior to the commencement of *rock* fill placement.
- 6.3.7 *Rock* fill placement should be continuously observed during placement by the Consultant.

7. SUBDRAINS

- 7.1 The geologic units on the site may have permeability characteristics and/or fracture systems that could be susceptible under certain conditions to seepage. The use of canyon subdrains may be necessary to mitigate the potential for adverse impacts associated with seepage conditions. Canyon subdrains with lengths in excess of 500 feet or extensions of existing offsite subdrains should use 8-inch-diameter pipes. Canyon subdrains less than 500 feet in length should use 6-inch-diameter pipes.

TYPICAL CANYON DRAIN DETAIL

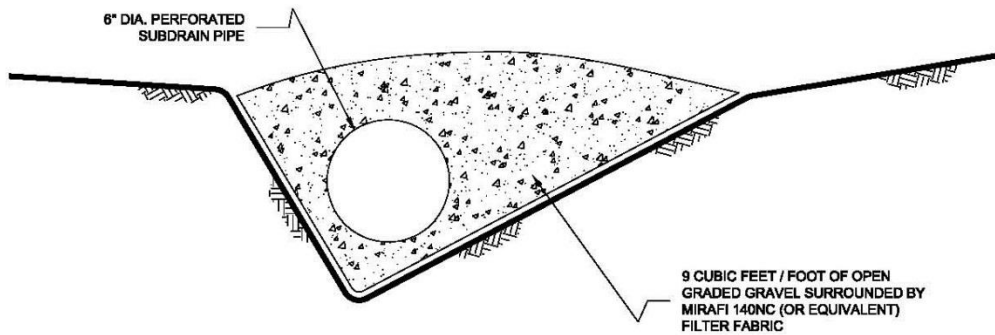
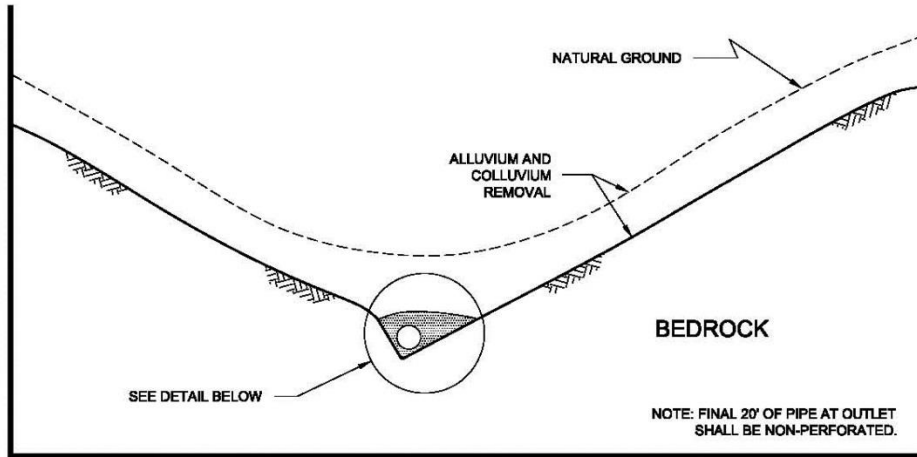

NOTES:

- 1.....8-INCH DIAMETER, SCHEDULE 80 PVC PERFORATED PIPE FOR FILLS IN EXCESS OF 100-FEET IN DEPTH OR A PIPE LENGTH OF LONGER THAN 500 FEET.
- 2.....6-INCH DIAMETER, SCHEDULE 40 PVC PERFORATED PIPE FOR FILLS LESS THAN 100-FEET IN DEPTH OR A PIPE LENGTH SHORTER THAN 500 FEET.

NO SCALE

7.2 Slope drains within stability fill keyways should use 4-inch-diameter (or larger) pipes.

TYPICAL STABILITY FILL DETAIL

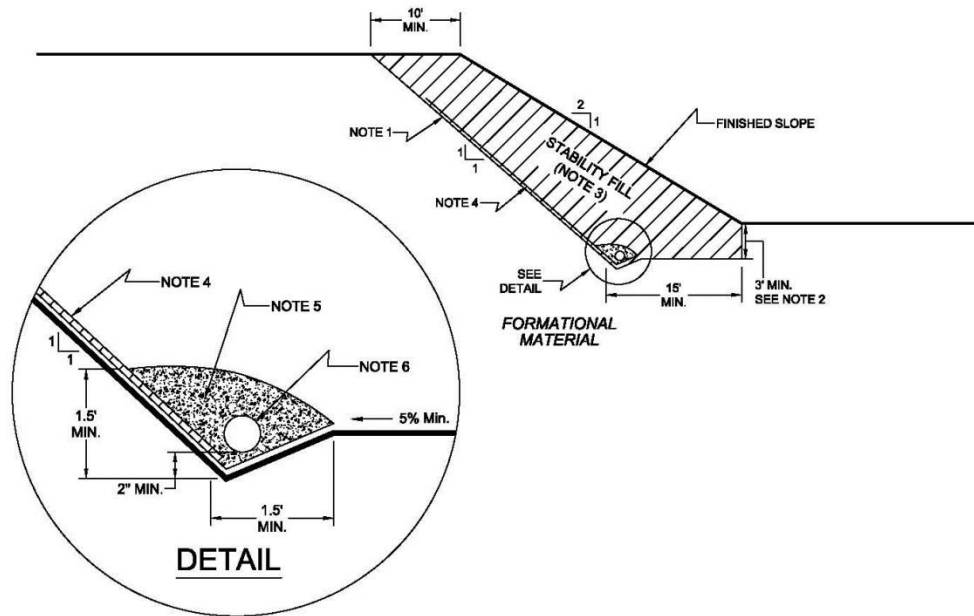

NOTES:

- 1.....EXCAVATE BACKCUT AT 1:1 INCLINATION (UNLESS OTHERWISE NOTED).
- 2.....BASE OF STABILITY FILL TO BE 3 FEET INTO FORMATIONAL MATERIAL, SLOPING A MINIMUM 5% INTO SLOPE.
- 3.....STABILITY FILL TO BE COMPOSED OF PROPERLY COMPACTED GRANULAR SOIL.
- 4.....CHIMNEY DRAINS TO BE APPROVED PREFABRICATED CHIMNEY DRAIN PANELS (MIRADRAIN G200N OR EQUIVALENT) SPACED APPROXIMATELY 20 FEET CENTER TO CENTER AND 4 FEET WIDE. CLOSER SPACING MAY BE REQUIRED IF SEEPAGE IS ENCOUNTERED.
- 5.....FILTER MATERIAL TO BE 3/4-INCH, OPEN-GRADED CRUSHED ROCK ENCLOSED IN APPROVED FILTER FABRIC (MIRAFI 140NC).
- 6.....COLLECTOR PIPE TO BE 4-INCH MINIMUM DIAMETER, PERFORATED, THICK-WALLED PVC SCHEDULE 40 OR EQUIVALENT, AND SLOPED TO DRAIN AT 1 PERCENT MINIMUM TO APPROVED OUTLET.

NO SCALE

7.3 The actual subdrain locations will be evaluated in the field during the remedial grading operations. Additional drains may be necessary depending on the conditions observed and the requirements of the local regulatory agencies. Appropriate subdrain outlets should be evaluated prior to finalizing 40-scale grading plans.

7.4 *Rock fill or soil-rock fill* areas may require subdrains along their down-slope perimeters to mitigate the potential for buildup of water from construction or landscape irrigation. The subdrains should be at least 6-inch-diameter pipes encapsulated in gravel and filter fabric. *Rock fill* drains should be constructed using the same requirements as canyon subdrains.

7.5 Prior to outletting, the final 20-foot segment of a subdrain that will not be extended during future development should consist of non-perforated drainpipe. At the non-perforated/perforated interface, a seepage cutoff wall should be constructed on the downslope side of the pipe.

TYPICAL CUT OFF WALL DETAIL

FRONT VIEW

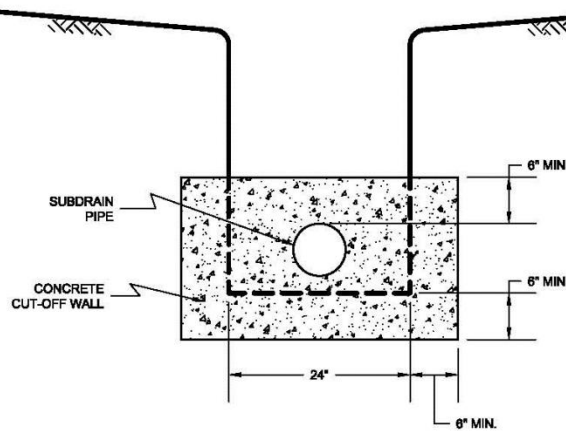

NO SCALE

SIDE VIEW

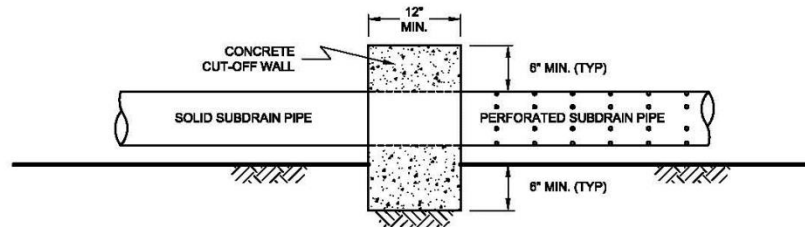

NO SCALE

7.6 Subdrains that discharge into a natural drainage course or open space area should be provided with a permanent headwall structure.

TYPICAL HEADWALL DETAIL

FRONT VIEW

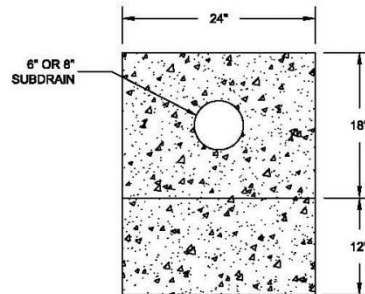

NO SCALE

SIDE VIEW

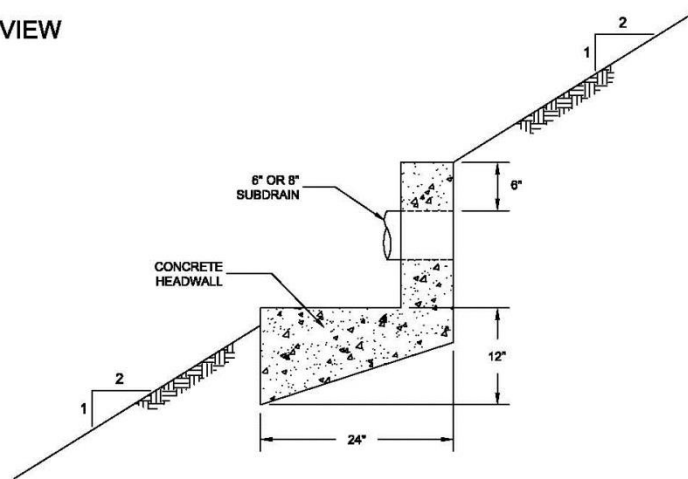

NOTE: HEADWALL SHOULD OUTLET AT TOE OF FILL SLOPE
OR INTO CONTROLLED SURFACE DRAINAGE

NO SCALE

- 7.7 The final grading plans should show the location of the proposed subdrains. After completion of remedial excavations and subdrain installation, the project civil engineer should survey the drain locations and prepare an “as-built” map showing the drain locations. The final outlet and connection locations should be determined during grading operations. Subdrains that will be extended on adjacent projects after grading can be placed on formational material and a vertical riser should be placed at the end of the subdrain. The grading contractor should consider videoing the subdrains shortly after burial to check proper installation and functionality. The contractor is responsible for the performance of the drains.

8. OBSERVATION AND TESTING

- 8.1 The Consultant shall be the Owner's representative to observe and perform tests during clearing, grubbing, filling, and compaction operations. In general, no more than 2 feet in vertical elevation of *soil* or *soil-rock* fill should be placed without at least one field density test being performed within that interval. In addition, a minimum of one field density test should be performed for every 2,000 cubic yards of *soil* or *soil-rock* fill placed and compacted.
- 8.2 The Consultant should perform a sufficient distribution of field density tests of the compacted *soil* or *soil-rock* fill to provide a basis for expressing an opinion whether the fill material is compacted as specified. Density tests shall be performed in the compacted materials below any disturbed surface. When these tests indicate that the density of any layer of fill or portion thereof is below that specified, the particular layer or areas represented by the test shall be reworked until the specified density has been achieved.
- 8.3 During placement of *rock* fill, the Consultant should observe that the minimum number of passes have been obtained per the criteria discussed in Section 6.3.3. The Consultant should request the excavation of observation pits and may perform plate bearing tests on the placed *rock* fills. The observation pits will be excavated to provide a basis for expressing an opinion as to whether the *rock* fill is properly seated and sufficient moisture has been applied to the material. When observations indicate that a layer of *rock* fill or any portion thereof is below that specified, the affected layer or area shall be reworked until the *rock* fill has been adequately seated and sufficient moisture applied.
- 8.4 A settlement monitoring program designed by the Consultant may be conducted in areas of *rock* fill placement. The specific design of the monitoring program shall be as recommended in the Conclusions and Recommendations section of the project Geotechnical Report or in the final report of testing and observation services performed during grading.
- 8.5 We should observe the placement of subdrains, to check that the drainage devices have been placed and constructed in substantial conformance with project specifications.
- 8.6 Testing procedures shall conform to the following Standards as appropriate:

8.6.1 Soil and Soil-Rock Fills:

- 8.6.1.1 Field Density Test, ASTM D 1556, *Density of Soil In-Place By the Sand-Cone Method.*

- 8.6.1.2 Field Density Test, Nuclear Method, ASTM D 6938, *Density of Soil and Soil-Aggregate In-Place by Nuclear Methods (Shallow Depth)*.
- 8.6.1.3 Laboratory Compaction Test, ASTM D 1557, *Moisture-Density Relations of Soils and Soil-Aggregate Mixtures Using 10-Pound Hammer and 18-Inch Drop*.
- 8.6.1.4 Expansion Index Test, ASTM D 4829, *Expansion Index Test*.

9. PROTECTION OF WORK

- 9.1 During construction, the Contractor shall properly grade all excavated surfaces to provide positive drainage and prevent ponding of water. Drainage of surface water shall be controlled to avoid damage to adjoining properties or to finished work on the site. The Contractor shall take remedial measures to prevent erosion of freshly graded areas until such time as permanent drainage and erosion control features have been installed. Areas subjected to erosion or sedimentation shall be properly prepared in accordance with the Specifications prior to placing additional fill or structures.
- 9.2 After completion of grading as observed and tested by the Consultant, no further excavation or filling shall be conducted except in conjunction with the services of the Consultant.

10. CERTIFICATIONS AND FINAL REPORTS

- 10.1 Upon completion of the work, Contractor shall furnish Owner a certification by the Civil Engineer stating that the lots and/or building pads are graded to within 0.1 foot vertically of elevations shown on the grading plan and that all tops and toes of slopes are within 0.5 foot horizontally of the positions shown on the grading plans. After installation of a section of subdrain, the project Civil Engineer should survey its location and prepare an *as-built* plan of the subdrain location. The project Civil Engineer should verify the proper outlet for the subdrains and the Contractor should ensure that the drain system is free of obstructions.
- 10.2 The Owner is responsible for furnishing a final as-graded soil and geologic report satisfactory to the appropriate governing or accepting agencies. The as-graded report should be prepared and signed by a California licensed Civil Engineer experienced in geotechnical engineering and by a California Certified Engineering Geologist, indicating that the geotechnical aspects of the grading were performed in substantial conformance with the Specifications or approved changes to the Specifications.

LIST OF REFERENCES

1. *2019 California Building Code, California Code of Regulations, Title 24, Part 2, based on the 2018 International Building Code*, prepared by California Building Standards Commission, dated July 2019.
2. American Concrete Institute, *ACI 318-11, Building Code Requirements for Structural Concrete and Commentary*, dated August, 2011.
3. American Concrete Institute, *ACI 330-08, Guide for the Design and Construction of Concrete Parking Lots*, dated June, 2008.
4. American Society of Civil Engineers (ASCE), *ASCE 7-16, Minimum Design Loads and Associated Criteria for Buildings and Other Structures*, 2017.
5. California Department of Conservation, Division of Mines and Geology, *Probabilistic Seismic Hazard Assessment for the State of California*, Open File Report 96-08, 1996.
6. California Geological Survey, *Seismic Shaking Hazards in California*, Based on the USGS/CGS Probabilistic Seismic Hazards Assessment (PSHA) Model, 2002 (revised April 2003). 10% probability of being exceeded in 50 years.
<http://redirect.conservation.ca.gov/cgs/rghm/pshamap/pshamain.html>
7. County of San Diego, *San Diego County Multi Jurisdiction Hazard Mitigation Plan, San Diego, California – Final Draft*, dated 2017.
8. Geocon Incorporated, 2005, *Update Geotechnical Investigation, Towne Centre Corporate Plaza, San Diego, California*, dated July 15, 2005 (Project No. 06376-52-03).
9. Geocon Incorporated, 2010, *Final Report of Testing and Observation Services Performed During Site Grading and Installation of Retaining Walls, Summit Pointe Plaza, Phase 1 and Phase 2, San Diego, California*, dated September 22, 2010 (Project No. 06376-52-04).
10. Historical Aerial Photos. <http://www.historicaerials.com>
11. Jennings, C. W., 1994, California Division of Mines and Geology, *Fault Activity Map of California and Adjacent Areas*, California Geologic Data Map Series Map No. 6.
12. Kennedy, M. P., and S. S. Tan, 2008, *Geologic Map of the San Diego 30'x60' Quadrangle, California*, USGS Regional Map Series Map No. 3, Scale 1:100,000.
13. Special Publication 117A, *Guidelines For Evaluating and Mitigating Seismic Hazards in California 2008*, California Geological Survey, Revised and Re-adopted September 11, 2008.
14. Unpublished reports, aerial photographs, and maps on file with Geocon Incorporated.
15. USGS computer program, *Seismic Hazard Curves and Uniform Hazard Response Spectra*,
<http://geohazards.usgs.gov/designmaps/us/application.php>.