

**Diamond Street Industrial
Technical Appendices**

**Appendix E
Geotechnical Report**

GEOTECHNICAL INVESTIGATION

MELROSE INDUSTRIAL SITE SAN MARCOS, CALIFORNIA



GEOCON
INCORPORATED

GEOTECHNICAL
ENVIRONMENTAL
MATERIALS

PREPARED FOR

**EXCEL ENGINEERING
ESCONDIDO, CALIFORNIA**

**MARCH 13, 2020
PROJECT NO. G2520-42-01**



Project No. G2520-42-01
March 13, 2020

Excel Engineering
440 State Place
Escondido, California, 92029

Attention: Mr. Mike Levin

Subject: GEOTECHNICAL INVESTIGATION
MELROSE INDUSTRIAL SITE
SAN MARCOS, CALIFORNIA

Dear Mr. Levin:

In accordance with your request, we have prepared this geotechnical investigation for the proposed Melrose Industrial Site located northeast of the intersection of Melrose Drive and Diamond Street in San Marcos, California. The accompanying report presents the findings of our study, and our conclusions and recommendations pertaining to geotechnical aspects of proposed design and construction. Based on the results of our investigation, it is our opinion that the site can be developed into a large sheet graded pad for support of industrial buildings provided the recommendations of this report are followed and implemented during design and construction.

Should you have questions regarding this report, or if we may be of further service, please contact the undersigned at your convenience.

Very truly yours,

GEOCON INCORPORATED

Rodney C. Mikesell
GE 2533



Rupert S. Adams
CEG 2561

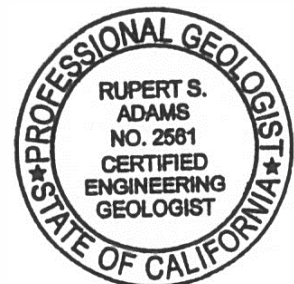

RCM:RSA:arm

(e-mail) Addressee

TABLE OF CONTENTS

1.	PURPOSE AND SCOPE	1
2.	SITE AND PROJECT DESCRIPTION	1
3.	PREVIOUS GEOTECHNICAL STUDIES	2
4.	SOIL AND GEOLOGIC CONDITIONS	2
4.1	Undocumented Fill (Qudf)	3
4.2	Topsoil (Unmapped).....	3
4.3	Colluvium (Qcol).....	3
4.4	Alluvium (Qal)	3
4.5	Granitic Rock (Kgr).....	3
4.6.	Rippability And Rock Considerations	4
5.	GROUNDWATER	6
6.	GEOLOGIC HAZARDS	6
6.1	Ground Rupture and Faulting	6
6.2	Seismicity	7
6.3	Liquefaction and Seismically Induced Settlement.....	8
6.4	Landslides.....	8
6.5	Tsunamis and Seiches.....	9
6.6	Subsidence.....	9
6.7	Flooding.....	9
7.	CONCLUSIONS AND RECOMMENDATIONS.....	10
7.1	General.....	10
7.2	Excavation and Soil Characteristics	11
7.3	Subdrains	12
7.4	Grading	12
7.5	Slopes.....	14
7.6	Temporary Excavation Slopes	15
7.7	Earthwork Grading Factors.....	15
7.8	Seismic Design Criteria	16
7.9	Preliminary Foundation Recommendations.....	18
7.10	Retaining Walls	19
7.11	Lateral Loading.....	21
7.12	Soil Nail Wall	21
7.13	MSE Retaining Wall Recommendations	23
7.14	Storm Water Management.....	24
7.15	Site Drainage and Moisture Protection.....	24
7.16	Grading and Foundation Plan Review	25

LIMITATIONS AND UNIFORMITY OF CONDITIONS

TABLE OF CONTENTS (Concluded)

MAPS AND ILLUSTRATIONS

- Figure 1, Vicinity Map
- Figure 2, Geologic Map
- Figures 3 and 4, Geologic Cross Sections
- Figure 5, Rock Placement Detail
- Figures 6 through 8, Subdrain Details
- Figure 9, Typical Detail for Limits of Remedial Grading
- Figures 10 and 11, Slope Stability Analysis
- Figure 12, Typical Retaining Wall Drain Detail

APPENDIX A

FIELD INVESTIGATION – GEOCON 2001

APPENDIX B

FIELD INVESTIGATION – GEOCON 1979

APPENDIX C

FIELD INVESTIGATION – GEOCON 1986

APPENDIX D

LABORATORY TESTING – GEOCON 1979 AND 1986

APPENDIX E

RECOMMENDED GRADING SPECIFICATIONS

LIST OF REFERENCES

GEOTECHNICAL INVESTIGATION

1. PURPOSE AND SCOPE

This report presents the results of a geotechnical investigation for the proposed sheet graded industrial pad located northeast of the intersection of Melrose Drive and Diamond Street in San Marcos, California (see Vicinity Map, Figure 1). The purpose of this geotechnical investigation is to evaluate surface and subsurface soil conditions and general site geology and to identify geotechnical constraints that may impact development of the property.

The scope of this investigation included performing a site reconnaissance, reviewing previous geotechnical reports prepared by Geocon Incorporated for the property, and preparing this report.

Geocon previously performed exploratory trenches and borings, air-track borings, and seismic refraction traverses on the property in 1979, 1986, and 2001. The approximate locations of our exploratory trenches, borings and seismic lines are shown on Figure 2. Details of our field investigation and copies of the trench and air-track boring logs are presented in Appendices A through C.

We performed laboratory tests on selected soil samples obtained during our previous field investigations to evaluate pertinent physical properties used for engineering analyses and to assist in providing recommendations for site grading and foundation design criteria. Details of the laboratory testing and a summary of test results are presented in Appendix D.

The conclusions and recommendations presented herein are based on our analysis of the data obtained from previous field investigation, laboratory test results, our experience with similar soil and geologic conditions on this and adjacent properties, and our understanding of proposed site development. References reviewed to prepare this report are provided in the *List of References*. If project details vary significantly from those described herein, Geocon should be contacted to evaluate the necessity for review and possible revision of this report.

2. SITE AND PROJECT DESCRIPTION

The project site is located east of Melrose Drive near the intersection of Melrose Drive and Diamond Street in San Marcos, California. The property is bounded on the north and east sides by open space, to the northwest by a residential subdivision, to the west by Melrose Drive, and to the south by an abandoned rock quarry.

The site topography is characterized by a northeast-southwest trending ridge and moderate to steep-sided hillside terrain. Natural slopes extend to higher elevations northeast, east, and southeast of the

property limits. A canyon exists along the northeast property margin which transitions into a widened valley as it crosses the southern portion of the site.

Surface elevations vary from near 510 feet above Mean Sea Level (MSL) in the north portion of the site to near 415 feet at the southwest corner adjacent to Melrose Drive. The majority of the property is ungraded vacant land with sparse to moderate growth of grass and brush native to the area. Dirt access roads cross portions of the property and an SDG&E power pole pad has been graded on the west side of the site above a cut slope that was constructed during grading of Melrose Drive. Undocumented fills and soil stockpiles have been placed on the property.

The Tentative Parcel Map indicates development will consist of grading the site to construct a large sheet graded pad that will be utilized for industrial buildings. Grading will consist of cuts and fills up to approximately 20 feet and 40 feet, respectively. Cut and fill slopes are planned with inclinations of 2:1 (horizontal to vertical), and maximum heights of approximately 20 feet and 25 feet, respectively. Mechanically stabilized earth (MSE) retaining walls and soil nail walls with heights up to approximately 11 feet are also planned. Three water quality basins will also be constructed.

The locations and descriptions of the site and proposed development are based on the tentative map and our understanding of the project. If project details vary significantly from those described herein, Geocon Incorporated should be contacted to evaluate the necessity for review and revision of this report.

3. PREVIOUS GEOTECHNICAL STUDIES

Beginning in 1979, several geotechnical studies associated with different phases of project development were performed for the subject property. Pertinent information from the previous studies was utilized during this investigation to assist in evaluating the soil and geologic conditions at the site (see *List of References*). Seismic traverse information, selected laboratory data, and descriptive exploratory boring and trench logs from previous studies have been included in this report in Appendices A through D. Information contained in the trench and boring logs from the previous studies reflect the conditions present at that time and may not correlate to the current site topography or soil conditions.

4. SOIL AND GEOLOGIC CONDITIONS

Four surficial soil types and one geologic formation were encountered during the field investigation. The surficial deposits consist of undocumented fill, topsoil, colluvium and alluvium. The formational unit observed was Cretaceous Granitic Rock. Each of the surficial soil types and the geologic unit encountered is described below. The approximate extent of the deposits is shown on the Geologic Map, Figure 2.

4.1 Undocumented Fill (Qudf)

Poorly compacted undocumented fills (Qudf) were observed on the property. Observations from numerous trenches indicate the fills are poorly consolidated, and in some areas are underlain by potentially compressible topsoil, alluvium or colluvium. The undocumented fill, as well as underlying topsoil, colluvium, and alluvium, will require removal and recompaction. The approximate depth of fill at trench and boring locations at the time of excavation is shown on Figure 2. Present day fill depths may differ from those reported in prior reports (Appendices A through D).

4.2 Topsoil (Unmapped)

Topsoil blankets most of the site, varying in thickness from approximately 1 to 2 feet. The topsoil is medium dense to dense, dry to moist, orange brown to brown, silty, fine to coarse sand. Topsoil deposits are unsuitable in their present condition and will require removal and compaction in areas planned to receive structural fill and/or settlement sensitive structures.

4.3 Colluvium (Qcol)

Colluvial deposits (Qcol) were encountered in the gentle, low lying, slope areas near alluvial drainages overlying the Granitic Rock. For the purpose of this study, colluvial materials are only indicated on the Geologic Map where they are combined with alluvial deposits in the main drainage areas. These deposits generally possess very low to medium expansion potential, are poorly consolidated, and will require remedial grading in areas of planned development. The colluvium was observed to be up to approximately 7 feet at some trench locations.

Trench Nos. T-16 and T-17 at the east end of the site encountered cemented colluvium. These deposits generally consist of normally consolidated dense, damp, reddish brown, clayey sand with abundant sub-angular gravel. The suitability of the cemented colluvium with respect to remedial grading will be evaluated during construction.

4.4 Alluvium (Qal)

Alluvial soils were found within the canyon drainage and tributary channels. These deposits consist of relatively loose/soft, silty/clayey sands and sandy clays with varying amounts of gravel and cobble derived from bedrock units. The alluvial deposits are compressible and will require remedial grading. Deeper removals may be required in the main drainage areas or where alluvium is overlain by undocumented fill.

4.5 Granitic Rock (Kgr)

Cretaceous-age Granitic Rock (commonly referred to as Escondido Creek Granodiorite) was encountered throughout the property. The rock materials exhibited a variable weathering pattern

ranging from completely weathered decomposed granite to outcrops of fresh, extremely strong, hard rock that will require blasting to excavate. Granitic units generally exhibit adequate bearing and have good slope stability characteristics if free of adversely oriented joints or fractures.

Given the nature of the rock materials on site, consideration should be given to undercutting cut areas to facilitate fine grading, foundation excavations and the construction of underground utilities without the necessity for heavy ripping or blasting. Based on the grades shown on the tentative map, cuts into granitic rock are expected across the northern portion of the site. If undercutting is performed, final development plans for each lot should be designed as close as possible to the sheet-grade elevations so the undercut thicknesses are not significantly reduced.

Soils derived from excavations within the decomposed granitic rock are anticipated to consist of low-expansive, silty, medium- to coarse-grained sands and should provide suitable foundation support in either a natural or properly compacted condition. We expect excavations in Granitic Rock will generate oversize materials (rocks greater than 12 inches in dimension) that will require special handling and placement as recommended hereinafter and discussed in the *Rippability and Rock Considerations* section of this report.

4.6. Rippability And Rock Considerations

Based on the results of our previous studies, the rock materials observed have a highly variable weathering pattern ranging from completely weathered fractured material to outcrops of fresh, extremely strong hard rock. To evaluate the rippability characteristics of the rock in proposed cut areas, part of the subsurface exploration included performing air-track borings and seismic refraction traverses. Several of the seismic traverses located in areas of undocumented fill and blast affected Granitic Rock do not correlate well with the results of the air-track borings. This condition suggests that the site has been modified in these areas since the initial investigation. The approximate locations of the air track borings and seismic traverses are shown on the Geologic Map, Figure 2.

Seismic traverses were conducted with a Nimbus ES 125 Signal Enhancement Seismograph. Each traverse was 100 feet long and was performed in forward and reverse directions. Typically, the depth evaluated by a seismic survey is approximately one-third of the traverse length, which generally correlates to 30 feet for a 100-foot traverse. The results of the seismic refraction study and approximate thickness of rippable rock based on the seismic traverses are presented on Tables A-I and A-II, Appendix A.

Air-track borings utilizing an Ingersoll Rand 490 drill rig with a 4-inch bit were advanced to the estimated maximum proposed grading depth in selected areas. Drill penetration rates were used to evaluate rock rippability and to estimate the depth at which difficult excavation will occur. Rock rippability is a function of natural weathering processes that can vary vertically and horizontally over

short distances depending on jointing, fracturing and/or mineralogic discontinuities within the bedrock.

A frequently used guideline to equate rock rippability to drill penetration rate, is a penetration rate of approximately 0 to 20 seconds per foot (spf) for generally rippable material, 20 to 30 spf for marginally to non-rippable material, and greater than 30 spf for non-rippable rock. These general guidelines are typically based on drill rates using a rotary percussion drill rig similar to an Ingersoll Rand ECM 360 with a 3½-inch drill bit. The penetration rates (recorded in seconds per foot) for each air track boring along with a description of the equipment used during the study are presented in Appendix A. The estimated thickness of rippable material based on the discussion herein is shown next to each boring on Figure 2.

Based on our previous study, it is expected that portions of cuts will encounter very hard granitic rock. The results of the field investigation indicate that, where fresh rock is not exposed near the surface, the Granitic Rock is characterized by a rippable weathered mantle varying from 3 to 54 feet thick. Therefore, excavations greater than the rippable depths indicated on Figure 2 will likely require blasting.

Perspective contractors should use their own judgment to identify the penetration rate boundary between productive and non-productive ripping, and rippable and non-rippable rock. Volume of rock materials requiring blasting should be evaluated based on information from each seismic line and air-track boring using bedrock velocity criteria and air-track penetration rates acceptable to the contractor. Proposed cuts in hard rock areas can be expected to generate oversized fragments (rocks greater than 12 inches in dimension) which will necessitate typical rock handling and placement procedures during grading operations.

Overexcavation of nonrippable rock during mass grading in areas of building pads and utility trenches may be advantageous to fine grading and would facilitate future trenching for foundations and utilities. Rippable to marginally rippable zones will contain oversize boulders and “floaters” which will require special handling and placement procedures within fill areas. Undercutting of streets to the lowest elevation of proposed utility lines and replacing with soil fill should mitigate the potential for encountering oversize rock and/or trenching refusal.

During blasting operations, the contractor should provide a blasting program that will result in maximum rock breakage, and generally limit the maximum rock size to 2 feet. Materials greater than 6 inches in maximum dimension will require placement in rock fill areas.

Earthwork construction should be carefully planned to efficiently utilize available rock placement areas. Oversize materials should be placed in accordance with Figure 5 and rock placement procedures presented in Appendix E of this report and governing jurisdictions.

5. GROUNDWATER

The most likely location of groundwater is within the canyon drainage that runs along the eastern side of the property and crosses through the southern portion of the site. The extent of water management necessary during remedial grading will be dependent on the time of the year and rainfall conditions just prior to the grading activities. Groundwater was encountered in previous explorations at depths between 2 and 19 feet. Groundwater elevations are expected to fluctuate seasonally, and may occur at shallower depths in the future.

A subdrain systems will be necessary within the canyon drainage that crosses the southern portion of the property to intercept and convey seepage migrating along impervious strata. The proposed subdrain location is shown on Figure 2. Additional subdrains may be necessary if other seepage conditions are encountered during grading or subsequent to development due to landscape irrigation.

It is not uncommon for groundwater seepage conditions to develop where none previously existed due to the permeability characteristics of the geologic units encountered on site. During the rainy season, seepage conditions may develop that require special consideration during grading operations. Groundwater elevations are dependent on seasonal precipitation, irrigation and land use, among other factors, and vary as a result. Proper surface drainage will be critical to future performance of the project.

6. GEOLOGIC HAZARDS

6.1 Ground Rupture and Faulting

The USGS (2020) shows that there are no mapped Quaternary faults crossing or trending toward the property. No evidence of faulting was observed during our investigation.

An active fault is defined by the California Geological Survey (CGS) as a fault showing evidence for activity within the last 11,000 years. The USGS (2020) has developed a program to evaluate the approximate location of faulting in the area of properties. The following figure shows the location of the existing faulting in the San Diego County and Southern California region. The fault traces are shown as solid, dashed and dotted that represent well-constrained, moderately constrained and inferred, respectively. The fault line colors represent fault with ages less than 150 years (red), 15,000 years (orange), 130,000 years (green), 750,000 years (blue) and 1.6 million years (black).

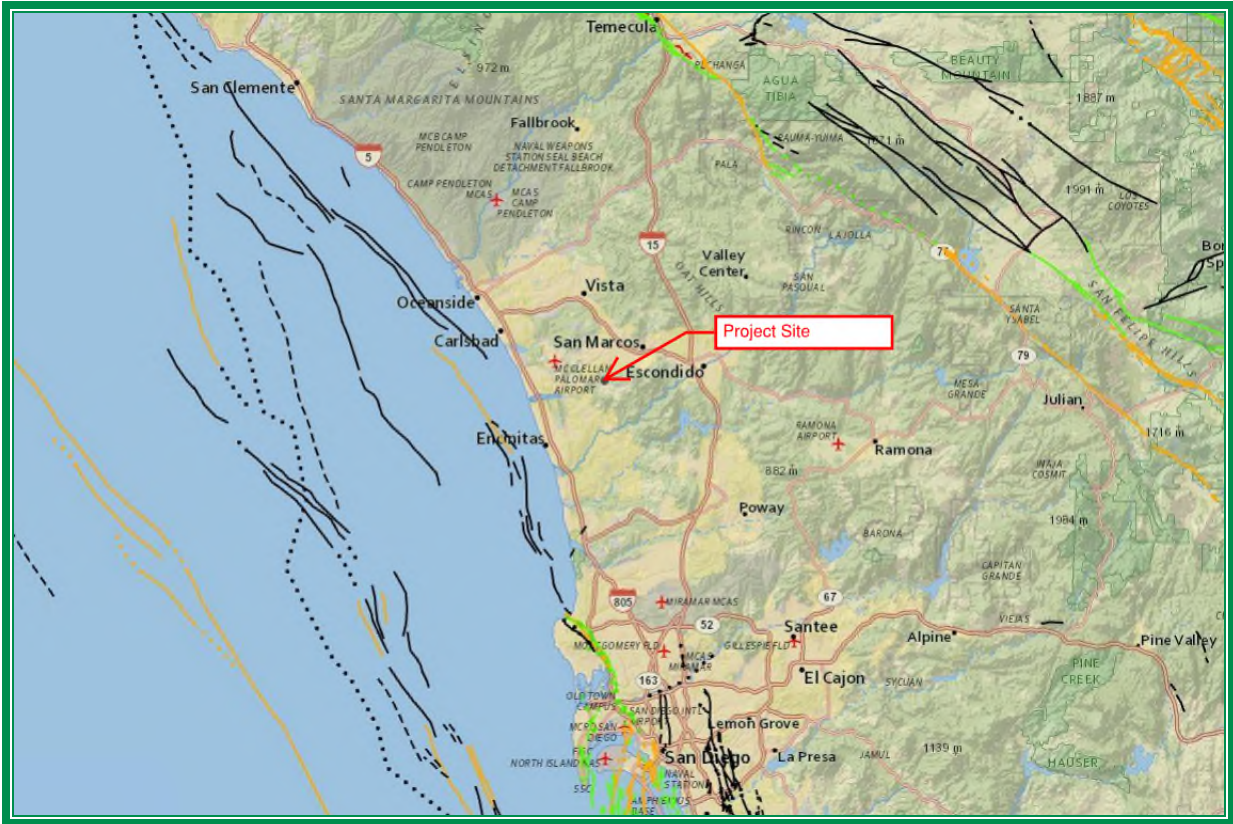

Faults in Southern California

The site is not located within a currently established Alquist-Priolo Earthquake Fault Zone. No active faults are known to exist at the site. The risk associated with ground rupture hazard is low.

6.2 Seismicity

The San Diego County and Southern California region is seismically active. The following figure presents the occurrence of earthquakes with a magnitude greater than 2.5 from the period of 1900 through 2015 (Bay Area Earthquake Alliance, 2020).

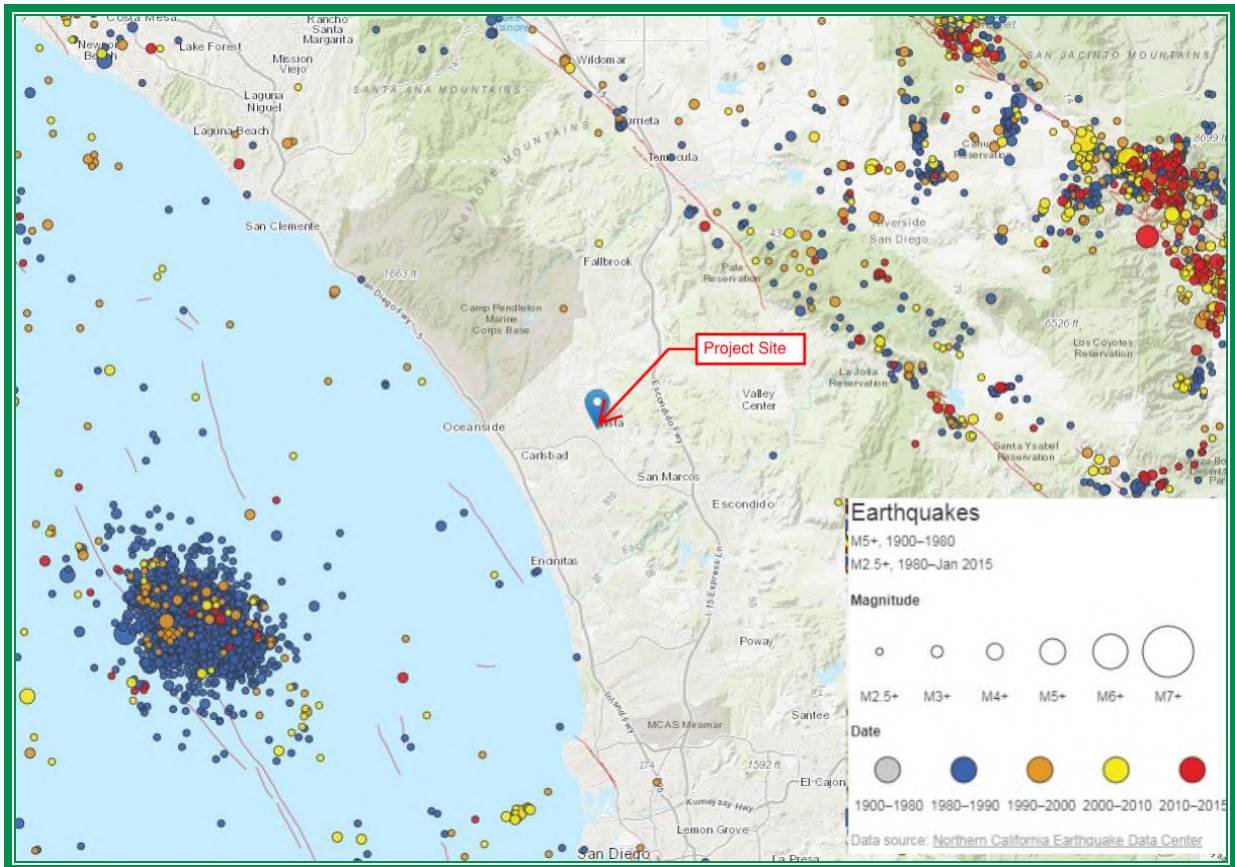

Earthquakes in Southern California

Considerations important in seismic design include the frequency and duration of motion and the soil conditions underlying the site. Seismic design of structures should be evaluated in accordance with the California Building Code (CBC) guidelines currently adopted by the local agency. The risk associated with strong ground shaking due to earthquake at the site is high; however, the risk is no greater than that for the region.

6.3 Liquefaction and Seismically Induced Settlement

The risk associated with liquefaction and seismically induced settlement hazard is low due to removal of compressible deposits that will occur during grading, the lack of permanent, near surface groundwater and the dense nature of the underlying granitic bedrock.

6.4 Landslides

Our site reconnaissance and review of available geologic literature and geotechnical reports for the site vicinity indicate that no landslides are present on the property or at a location that could impact the site. The risk associated with landslide hazard at the site is low.

6.5 Tsunamis and Seiches

The subject site is not located within a mapped tsunami inundation zone.

San Marcos Lake is located approximately 1,700 feet east of the site. Potential flooding associated with a seiche generated in Lake San Marcos would be confined to San Marcos Creek which passes 800 feet south of the site through an abandoned quarry. Therefore, the risk associated with inundation hazard associated with seiche is low.

6.6 Subsidence

Based on the subsurface soil conditions encountered during our field investigation, the risk associated with ground subsidence hazard is low.

6.7 Flooding

The Federal Emergency Management Agency (FEMA 2012) locates the site within a Flood Zone X area, indicating a minimal risk to inundation by 100-year and 500-year floods. Potential flooding associated with failure of the dam located at the south end of Lake San Marcos would be confined to San Marcos Creek which passes 800 feet south of the site through an abandoned quarry.

7. CONCLUSIONS AND RECOMMENDATIONS

7.1 General

- 7.1.1 From a geotechnical standpoint, it is our opinion that the site is suitable for the planned development provided the recommendations presented herein are implemented in design and construction of the project.
- 7.1.2 The site is not located within a currently established State of California Earthquake Fault Zone. We did not observe evidence of faulting during our previous investigations, and no active faults are known to exist at the site.
- 7.1.3 With the exception of possible strong seismic shaking, significant geologic hazards were not observed or are known to exist on the site that would adversely affect the proposed project. Special seismic design considerations, other than those recommended herein, are not required.
- 7.1.4 The site is underlain by undocumented fill, topsoil, alluvium, and colluvium that will require removal and recompaction during grading.
- 7.1.5 Seismic refraction data and air track borings indicated zones of potential nonrippable bedrock. Very difficult excavation and blasting should be anticipated in cuts that extend below the weathered mantel. Within more weathered portions of the bedrock a heavy to very heavy effort with conventional heavy-duty grading equipment and/or rock-breaking techniques should be anticipated. Floaters, if encountered, may also require blasting or rock breaking procedures to remove the rock and/or reduce the rock in size to handle.
- 7.1.6 Estimates of anticipated volume of rock materials requiring blasting should be evaluated based on information from each seismic line and air-track boring using bedrock velocity criteria and air-track penetration rates acceptable to the contractor. Overall grading costs should include an extra amount to account for increased excavation costs and placement of oversize materials. In addition, heavy ripping and blasting will generate oversize materials that will require special handling and fill placement procedures. Oversize materials should be placed in accordance with Appendix E of this report.
- 7.1.7 Fill soil is anticipated to consist of shot-rock and/or soil-rock materials. Stockpiling of soil materials and/or selective grading may be necessary to provide sufficient soil for capping of pads and streets. The civil engineer and contractor should evaluate soil quantities to determine if enough soil exists on-site to provide capping material.

7.1.8 Subsurface conditions observed may be extrapolated to reflect general soil/geologic conditions; however, some variations in subsurface conditions between boring locations should be anticipated.

7.2 Excavation and Soil Characteristics

7.2.1 The surficial soil conditions consist primarily of silty sands with varying amounts of gravel and rock fragments. Some areas of sandy clay and clayey sands should also be expected within undocumented fill soils. In general, the surficial soils will likely require light to moderate effort to excavate utilizing conventional earthmoving equipment. Excavations within the alluvial deposits or the undocumented fill, particularly along the main drainage, may encounter seepage or groundwater which could require special equipment and/or dewatering to facilitate the excavation.

7.2.2 Excavations within the granitic rock will generally vary in difficulty depending on the depth of excavation. Large embedded boulders that may require blasting or special handling are not uncommon. The necessity for undercutting utility trench locations should be considered during the grading phase of site development. If dense granitic rock is encountered during utility installation, linear blasting may be necessary. Air-track borings were performed to aid in determining the thickness of rippable material. In general, blasting should be expected for excavations deeper than the thickness of rippable material indicated next to each air-track boring on Figure 2.

7.2.3 The soil encountered in the field investigation is considered to be both non-expansive (Expansion Index [EI] less than 20) and “expansive” (EI greater than 20) as defined by 2019 California Building Code (CBC) Section 1803.5.3. Table 7.2 presents soil classifications based on the expansion index. We expect a majority of the soil to be “low” expansion potential (expansion index of 50 or less).

**TABLE 7.2
EXPANSION CLASSIFICATION BASED ON EXPANSION INDEX**

Expansion Index (EI)	Expansion Classification	2019 CBC Expansion Classification
0 – 20	Very Low	Non-Expansive
21 – 50	Low	Expansive
51 – 90	Medium	
91 – 130	High	
Greater Than 130	Very High	

- 7.2.4 Geocon Incorporated does not practice in the field of corrosion engineering. Therefore, further evaluation by a corrosion engineer may be needed if improvements that could be susceptible to corrosion are planned.
- 7.2.5 Remedial grading of surficial deposits, particularly along the northeast property edge and in the south buried canyon drainage may encounter wet to saturated soils and excavation and compaction, could be difficult, particularly if grading occurs during the winter months or early spring. Areas where perched water or seepage was not encountered may exhibit groundwater during rainy periods.

7.3 Subdrains

- 7.3.1 The use of canyon subdrains will be necessary to mitigate the potential for adverse impacts associated with seepage conditions. The proposed subdrain location is depicted on Figure 2. Figure 6 depicts a typical canyon subdrain detail. The lower approximately 20 feet of subdrains should consist of non-perforated PVC pipe. The perforated/non-perforated joint should have a concrete cutoff wall built in accordance with Figure 7. Subdrains should outlet at the toe of fill slopes or connected to the storm drain system. Figure 2 currently depicts the subdrain connecting to a storm drain structure at a proposed basin. This may require modification during remedial grading in the event that the axis of the buried natural canyon is different than anticipated. Subdrains that outlet at the toe of slopes or onto surface grades should be provided with a concrete outlet headwall at the outlet point in accordance with Figure 8. The potential for conflict with proposed underground utilities should be evaluated for all subdrain locations.
- 7.3.2 The final grading plans should show the location of all proposed subdrains. After installation of the subdrains, the project civil engineer should survey its location and elevation and prepare an “as built” plan showing subdrain locations. The project civil engineer should verify the proper outlet for the canyon subdrains and the contractor should ensure that the drain system outlet is free of obstructions.

7.4 Grading

- 7.4.1 Grading should be performed in accordance with the recommendations provided in this report, the *Recommended Grading Specifications* contained in Appendix E and the City of San Marcos Grading Ordinance. Where the recommendations of this report conflict with Appendix E, the recommendations of this section take precedence.
- 7.4.2 Prior to commencing grading, a pre-construction conference should be held at the site with the project architect, grading contractor, civil engineer, geotechnical engineer, and inspection officials in attendance. Special soil handling requirements can be discussed at that time.

- 7.4.3 Grading should be performed in conjunction with the observation and compaction testing services of Geocon Incorporated. Fill soil should be observed on a full-time basis during placement and tested to check in-place dry density and moisture content.
- 7.4.4 Site preparation should begin with removal of all deleterious matter and vegetation and existing structures, foundations, septic tanks and leach fields. The depth of removal should be such that material to be used in fills is free of organic matter. Material generated during stripping operations and/or site demolition should be exported from the site.
- 7.4.5 All compressible soil deposits, including undocumented fill, topsoil, alluvium and colluvium within areas where structural improvements and/or structural fill areas should be removed to expose firm natural ground (Granitic Rock) and properly compacted prior to placing additional fill and/or structural loads. Deeper than normal benching and/or stripping operations for sloping ground surfaces will be required where the thickness of potentially compressible surficial deposits exceeds 3 feet. The actual extent of unsuitable soil removals will be determined in the field during grading by the geotechnical engineer and/or engineering geologist.
- 7.4.6. Removals within areas of canyon cleanouts and/or toes of proposed fill slopes should extend horizontally beyond the edge of improvements a distance equal to the depth of removal. A typical detail of remedial grading beyond proposed grading is presented in Figure 9.
- 7.4.7 The site should then be brought to final subgrade elevations with structural fill compacted in layers. In general, soils native to the site are suitable for re-use as fill if free from vegetation, debris and other deleterious material. Layers of fill should be no thicker than will allow for adequate bonding and compaction. All fill, including backfill and scarified ground surfaces, should be compacted to at least 90 percent of maximum dry density at or above optimum moisture content, as determined in accordance with ASTM Test Procedure D 1557. Fill materials near and/or below optimum moisture content may require additional moisture conditioning prior to placing additional fill.
- 7.4.8 Consideration should be given to undercutting cut areas that expose granitic rock and the cut portion of cut-fill transition pads during initial sheet-grading operation, especially if blasting is required to achieve sheet-grade elevations. The undercut should extend to a depth of 5 feet below finish grade. Oversized rock generated during the undercutting process can then be placed within deep fill areas, thus reducing the volume of oversized rock that may have to be exported at a later date. Undercuts should be based on finish grade elevation of future building structures, if available. Undercutting of street areas should be considered to facilitate the excavation of underground utilities where the streets are located in cut areas composed of marginally- to non-rippable hard rock. Undercuts due to hard rock in streets

should extend to a depth of at least 2 feet below the bottom of the deepens utility. If subsurface improvements or landscape zones are planned outside these areas, consideration should be given to undercutting these areas as well.

- 7.4.9 Where practical, the upper 5 feet of all building pads (cut or fill) and 12 inches in pavement areas should be composed of “very low” to “low” expansive soils. The more highly expansive fill soils, if encountered, should be placed in the deeper fill areas and properly compacted. “Very low” to “low” expansive soils are defined as those soils that have an Expansion Index of 50 or less.
- 7.4.10 Imported fill soil (if necessary) should consist of granular materials with a “very low” to “low” expansion potential (EI of 50 or less) free of deleterious material and stones larger than 3 inches and should be compacted as recommended herein. Geocon Incorporated should be notified of the import soil source and should perform laboratory testing of import soil prior to its arrival at the site to determine its suitability as fill material.

7.5 Slopes

- 7.5.1 Slope stability analysis utilizing soil strength parameters based on laboratory tests and experience with similar soil types in nearby areas indicates that the proposed fill slopes, constructed of on-site materials, should have calculated factors of safety of at least 1.5 under static conditions for both deep-seated failure and shallow sloughing conditions. Fill slope stability and surficial slope stability calculations are presented on Figures 10 and 11.
- 7.5.2 Cut slopes in rock materials do not lend themselves to conventional slope stability analyses. Based on experience with similar rock conditions, 2:1 cut slopes to the planned heights should possess a factor of safety of at least 1.5 with respect to slope instability if free of adversely oriented joints or fractures. It is recommended that all cut slope excavations be observed during grading by an engineering geologist to verify that soil and geologic conditions do not differ significantly from those anticipated.
- 7.5.3 The outer 15 feet (or a distance equal to the height of the slope, whichever is less) of fill slopes should be composed of properly compacted granular “soil” fill to reduce the potential for surficial sloughing. In general, soils with an Expansion Index of less than 50 or at least 35 percent sand size particles should be acceptable as “granular” fill. Soils of questionable strength to satisfy surficial stability should be tested in the laboratory for acceptable drained shear strength.

- 7.5.4 Fill slopes should be compacted by backrolling with a loaded sheepsfoot roller at vertical intervals not to exceed 4 feet and should be track-walked at the completion of each slope such that the fill soils are uniformly compacted to at least 90 percent relative compaction to the face of the finished sloped. Alternatively, the fill slope may be over-built at least 3 feet and cut back to yield a properly compacted slope face.
- 7.5.5 All slopes should be landscaped with drought-tolerant vegetation, having variable root depths and requiring minimal landscape irrigation. In addition, all slopes should be drained and properly maintained to reduce erosion.

7.6 Temporary Excavation Slopes

- 7.6.1 The recommendations included herein are provided for stable excavations. It is the responsibility of the contractor to provide a safe excavation during the construction of the proposed project.
- 7.6.2 Temporary excavations should be made in conformance with OSHA requirements. In general, special shoring requirements will not be necessary if temporary excavations will be less than 4 feet in height. Temporary excavations greater than 4 feet in height, however, should be sloped back at an appropriate inclination. We expect temporary 1:1 excavations can be made in the on-site soils. However, the suitability of sloped excavations should be evaluated during grading by the contractor's OSHA competent person. Temporary excavations should not be allowed to become saturated or to dry out. Surcharge loads should not be permitted to a distance equal to the height of the excavation from the top of the excavation. The top of the excavation should be a minimum of 15 feet from the edge of existing improvements. Excavations steeper than those recommended or closer than 15 feet from an existing surface improvement should be shored in accordance with applicable OSHA codes and regulations.

7.7 Earthwork Grading Factors

- 7.7.1 Estimates of embankment shrink-swell factors are based on comparing laboratory compaction tests with the density of the material in its natural state and experience with similar soil and rock types. It should be emphasized that variations in natural soil density, as well as in compacted fill, render shrinkage value estimates very approximate. As an example, the contractor can compact fills to any relative compaction of 90 percent or higher of the laboratory maximum dry density. Thus, the contractor has at least a 10 percent range of control over the fill volume. Based on the work performed to date and considering the above discussion, the following earthwork factors may be used as a basis for estimating how much the on-site soils may shrink or swell when removed from their natural state and placed in compacted fills.

**TABLE 7.7
ESTIMATED BULK AND SHRINK VALUES**

Soils Unit	Shrink-Swell Factors
Topsoils, Alluvium, Colluvium, Undocumented Fill	10 to 15 Percent Shrink
Granitic Rock	15 to 20 percent bulk

7.8 Seismic Design Criteria

7.8.1 Table 7.8.1 summarizes site-specific design criteria obtained from the 2019 California Building Code (CBC; Based on the 2018 International Building Code [IBC] and ASCE 7-16), Chapter 16 Structural Design, Section 1613 Earthquake Loads. We used the computer program *Seismic Design Maps*, provided by the Structural Engineers Association (SEA) to calculate the seismic design parameters. The short spectral response uses a period of 0.2 second. We evaluated the Site Class based on the discussion in Section 1613.2.2 of the 2019 CBC and Table 20.3-1 of ASCE 7-16. The values presented herein are for the risk-targeted maximum considered earthquake (MCE_R) for Site Classes C and D. Site Class C should be used for building pads underlain by compacted fill that is less than 35 feet thick overlying granitic rock. Site Class D should be used for building pads underlain by compacted fill greater than 35 feet. A designation for each building pad will need to be determined once building locations are known.

**TABLE 7.8.1
2019 CBC SEISMIC DESIGN PARAMETERS**

Parameter	Value		2019 CBC Reference
	C	D	
Site Class	C	D	Section 1613.2.2
MCE_R Ground Motion Spectral Response Acceleration – Class B (short), S_S	0.912g	0.912g	Figure 1613.2.1(1)
MCE_R Ground Motion Spectral Response Acceleration – Class B (1 sec), S_1	0.335g	0.335g	Figure 1613.2.1(2)
Site Coefficient, F_A	1.2	1.135	Table 1613.2.3(1)
Site Coefficient, F_V	1.5	1.965*	Table 1613.2.3(2)
Site Class Modified MCE_R Spectral Response Acceleration (short), S_{MS}	1.094g	1.035g	Section 1613.2.3 (Eqn 16-36)
Site Class Modified MCE_R Spectral Response Acceleration – (1 sec), S_{MI}	0.503g	0.658g*	Section 1613.2.3 (Eqn 16-37)
5% Damped Design Spectral Response Acceleration (short), S_{DS}	0.729g	0.69g	Section 1613.2.4 (Eqn 16-38)
5% Damped Design Spectral Response Acceleration (1 sec), S_{D1}	0.335g	0.439g*	Section 1613.2.4 (Eqn 16-39)

*Using the code-based values presented in this table, in lieu of a performing a ground motion hazard analysis, requires the exceptions outlined in ASCE 7-16 Section 11.4.8 be followed by the project structural engineer. Per Section 11.4.8 of ASCE/SEI 7-16, a ground motion hazard analysis should be performed for projects for Site Class “E” sites with S_S greater than or equal to 1.0g and for Site Class “D” and “E” sites with S_1 greater than 0.2g. Section 11.4.8 also provides exceptions which indicates that the ground motion hazard analysis may be waived provided the exceptions are followed.

7.8.2 Table 7.8.2 presents the mapped maximum considered geometric mean (MCE_G) seismic design parameters for projects located in Seismic Design Categories of D through F in accordance with ASCE 7-16.

**TABLE 7.8.2
ASCE 7-16 PEAK GROUND ACCELERATION**

Parameter	Value		ASCE 7-16 Reference
Site Class	C	D	Section 1613.2.2 (2019 CBC)
Mapped MCE_G Peak Ground Acceleration, PGA	0.395g	0.395g	Figure 22-7
Site Coefficient, F_{PGA}	1.2	1.205	Table 11.8-1
Site Class Modified MCE_G Peak Ground Acceleration, PGA_M	0.474g	0.476g	Section 11.8.3 (Eqn 11.8-1)

7.8.3 Conformance to the criteria in Tables 7.8.1 and 7.8.2 for seismic design does not constitute any kind of guarantee or assurance that significant structural damage or ground failure will not occur if a large earthquake occurs. The primary goal of seismic design is to protect life, not to avoid all damage, since such design may be economically prohibitive.

7.8.4 The project structural engineer and architect should evaluate the appropriate Risk Category and Seismic Design Category for the planned structures. The values presented herein assume a Risk Category of II and resulting in a Seismic Design Category D. Table 7.8.3 presents a summary of the risk categories.

**TABLE 8.8.3
ASCE 7-16 RISK CATEGORIES**

Risk Category	Building Use	Examples
I	Low risk to Human Life at Failure	Barn, Storage Shelter
II	Nominal Risk to Human Life at Failure (Buildings Not Designated as I, III or IV)	Residential, Commercial and Industrial Buildings
III	Substantial Risk to Human Life at Failure	Theaters, Lecture Halls, Dining Halls, Schools, Prisons, Small Healthcare Facilities, Infrastructure Plants, Storage for Explosives/Toxins
IV	Essential Facilities	Hazardous Material Facilities, Hospitals, Fire and Rescue, Emergency Shelters, Police Stations, Power Stations, Aviation Control Facilities, National Defense, Water Storage

7.9 Preliminary Foundation Recommendations

- 7.9.1 Specific foundation recommendations should be provided in an update report once final building type and location are determined for each pad and should be included in an updated geotechnical reports. In general, we expect that conventional foundation systems will be suitable to for support the buildings. For preliminary planning and cost estimating, the following preliminary recommendations can be utilized. Footing depths and bearing pressures may be different than what is recommended below depending on the location of the building and the depth of fill underlying the building pad.
- 7.9.2 Foundations for the structure can consist of continuous strip footings and/or isolated spread footings. Continuous footings should be at least 12 inches wide and extend at least 24 inches below lowest adjacent pad grade. Isolated spread footings should have a minimum width of 2 feet and should also extend at least 24 inches below lowest adjacent pad grade.
- 7.9.3 Steel reinforcement for continuous footings should consist of at least four No. 5 steel reinforcing bars placed horizontally in the footings, two near the top and two near the bottom. Steel reinforcement for the spread footings should be designed by the project structural engineer.
- 7.9.4 The recommendations presented herein are based on soil characteristics only and are not intended to replace steel reinforcement required for structural considerations.
- 7.9.5 The use of isolated footings, which are located beyond the perimeter of the building and support structural elements connected to the building, are not recommended. Where this condition cannot be avoided, isolated footings should be connected to the building foundation system with grade beams.
- 7.9.6 Foundations bearing on compacted fill may be designed for an allowable soil bearing pressure of 2,500 pounds per square foot (psf) (dead plus live load). This soil bearing pressure may be increased by 300 psf and 500 psf for each additional foot of foundation width and depth, respectively, up to a maximum allowable soil bearing of 4,000 psf.
- 7.9.7 The allowable bearing pressures recommended above are for dead plus live loads only and may be increased by up to one-third when considering transient loads such as those due to wind or seismic forces.

7.9.8 An estimate of settlement as a result of static loading and hydro-compression will be provide in update geotechnical reports once building types, locations, and the depth of compacted fill below each building pad location is known.

7.10 Retaining Walls

7.10.1 Retaining walls that are allowed to rotate more than $0.001H$ (where H equals the height of the retaining portion of the wall) at the top of the wall and having a level backfill surface should be designed for an active soil pressure equivalent to the pressure exerted by a fluid density of 35 pcf. Where the backfill will be inclined at 2:1 (horizontal:vertical), an active soil pressure of 50 pcf is recommended. Expansive soil should not be used as backfill material behind retaining walls. Soil placed for retaining wall backfill should have an Expansion Index less than 50.

7.10.2 Where walls are restrained from movement at the top, an additional uniform pressure of $8H$ psf (where H equals the height of the retaining wall portion of the wall in feet) should be added to the active soil pressure where the wall possesses a height of 8 feet or less and $12H$ where the wall is greater than 8 feet. For retaining walls subject to vehicular loads within a horizontal distance equal to two-thirds the wall height, a surcharge equivalent to two feet of fill soil should be added.

7.10.3 In general, wall foundations having should be designed in accordance with Table 7.10.3. The proximity of the foundation to the top of a slope steeper than 3:1 could impact the allowable soil bearing pressure. Therefore, retaining wall foundations should be deepened such that the bottom outside edge of the footing is at least 7 feet horizontally from the face of the slope.

**TABLE 7.10.3
SUMMARY OF RETAINING WALL FOUNDATION RECOMMENDATIONS**

Parameter	Value
Minimum Retaining Wall Foundation Width	12 inches
Minimum Retaining Wall Foundation Depth	12 Inches
Minimum Steel Reinforcement	Per Structural Engineer
Bearing Capacity	2,500 psf
Bearing Capacity Increase	500 psf per additional foot of footing depth
	300 psf per additional foot of footing width
Maximum Bearing Capacity	4,000 psf

7.10.4 Soil contemplated for use as retaining wall backfill, including imported soils, should be identified in the field prior to backfill. At that time Geocon Incorporated should obtain

samples for laboratory testing to evaluate its suitability. Modified lateral earth pressures may be necessary if the backfill soil does not meet the required expansion index or shear strength. City or regional standard wall designs, if used, are based on a specific active lateral earth pressure and/or soil friction angle. In this regard, on-site soil or import soil to be used as backfill may or may not meet the values for standard wall designs. Geocon Incorporated should be consulted to assess the suitability of the on-site soil or import soil for use as wall backfill if standard wall designs will be used.

- 7.10.5 Unrestrained walls will move laterally when backfilled and loading is applied. The amount of lateral deflection is dependent on the wall height, the type of soil used for backfill, and loads acting on the wall. The wall designer should provide appropriate lateral deflection quantities for planned retaining walls structures, if applicable. These lateral values should be considered when planning types of improvements above retaining wall structures.
- 7.10.6 Retaining walls should be provided with a drainage system adequate to prevent the buildup of hydrostatic forces and should be waterproofed as required by the project architect. The use of drainage openings through the base of the wall (weep holes) is not recommended where the seepage could be a nuisance or otherwise adversely affect the property adjacent to the base of the wall. The above recommendations assume a properly compacted granular ($EI \leq 50$) free-draining backfill material with no hydrostatic forces or imposed surcharge load. Figure 12 presents a typical retaining wall drain detail. If conditions different than those described are expected, or if specific drainage details are desired, Geocon Incorporated should be contacted for additional recommendations.
- 7.10.7 The structural engineer should determine the seismic design category for the project in accordance with Section 1613 of the CBC. If the project possesses a seismic design category of D, E, or F, retaining walls that support more than 6 feet of backfill should be designed with seismic lateral pressure in accordance with Section 1803.5.12 of the 2019 CBC. The seismic load is dependent on the retained height where H is the height of the wall, in feet, and the calculated loads result in pounds per square foot (psf) exerted at the base of the wall and zero at the top of the wall. A seismic load of 17H should be used for design. We used the peak ground acceleration adjusted for Site Class effects, PGA_M , of 0.476g calculated from ASCE 7-10 Section 11.8.3 and applied a pseudo-static coefficient of 0.33.
- 7.10.8 Unrestrained walls will move laterally when backfilled and loading is applied. The amount of lateral deflection is dependent on the wall height, the type of soil used for backfill, and loads acting on the wall. Improvements above retaining walls should be designed to incorporate an appropriate amount of lateral deflection as determined by the structural engineer.

7.11 Lateral Loading

- 7.11.1 Table 7.11 should be used to help design the proposed structures and improvements to resist lateral loads for the design of footings or shear keys. The allowable passive pressure assumes a horizontal surface extending at least 5 feet, or three times the surface generating the passive pressure, whichever is greater. The upper 12 inches of material in areas not protected by floor slabs or pavement should not be included in design for passive resistance. Where walls are planned adjacent to and/or on descending slopes, a passive pressure of 150 pcf should be used in design.

**TABLE 7.11
SUMMARY OF LATERAL LOAD DESIGN RECOMMENDATIONS**

Parameter	Value
Passive Pressure Fluid Density	350 pcf
Passive Pressure Fluid Density Adjacent to and/or on Descending Slopes	150 pcf
Coefficient of Friction (Concrete and Soil)	0.4
Coefficient of Friction (Along Vapor Barrier)	0.2 to 0.25*

*Per manufacturer's recommendations.

- 7.11.2 The passive and frictional resistant loads can be combined for design purposes. The lateral passive pressures may be increased by one-third when considering transient loads due to wind or seismic forces.

7.12 Soil Nail Wall

- 7.12.1 Soil nail walls consist of installing closely spaced steel bars (nails) into a slope or excavation in a top-down construction sequence. Following installation of a horizontal row of nails, drains, waterproofing and wall reinforcing steel are placed and shotcrete applied to create a final wall. The wall should be designed by an engineer familiar with the design of soil nail walls.
- 7.12.2 At the proposed location of the soil nail wall, granitic bedrock will likely be encountered. As such, drilling for soil nails will encounter very difficult drilling conditions.
- 7.12.3 Testing of the soil nails should be performed in accordance with the guidelines of the Federal Highway Administration or similar guidelines. At least two verification tests should be performed to confirm design assumptions for each soil/rock type encountered. Verification tests nails should be sacrificial and should not be used to support the proposed wall. The bond length should be adjusted to allow for pullout testing of the verification nails to evaluate the ultimate bond stress. A minimum of 5 percent of the production nails should

also be proof tested and a minimum of 4 sacrificial nails should be tested at the discretion of Geocon Incorporated. Consideration should be given to testing sacrificial nails with an adjusted bond length rather than testing production nails. Geocon Incorporated should observe the nail installation and perform the nail testing.

7.12.4 The soil strength parameters listed in Table 7.12 can be used in design of the soil nails. The bond stress is dependent on drilling method, diameter, and construction method. Therefore, the designer should evaluate the bond stress based on the existing soil conditions and the construction method.

**TABLE 7.12
SOIL STRENGTH PARAMETERS FOR SOIL NAIL WALLS**

Description	Cohesion (psf)	Friction Angle (degrees)	Estimated Ultimate Bond Stress (psi)*
Compacted Fill (Qcf)	100	30	10
Granitic Rock (Kgr)	0	40	40

*Assuming gravity fed, open hole drilling techniques.

7.12.5 A wall drain system should be incorporated into the design of the soil nail wall as shown herein. Corrosion protection should be provided for the nails if the wall will be a permanent structure.

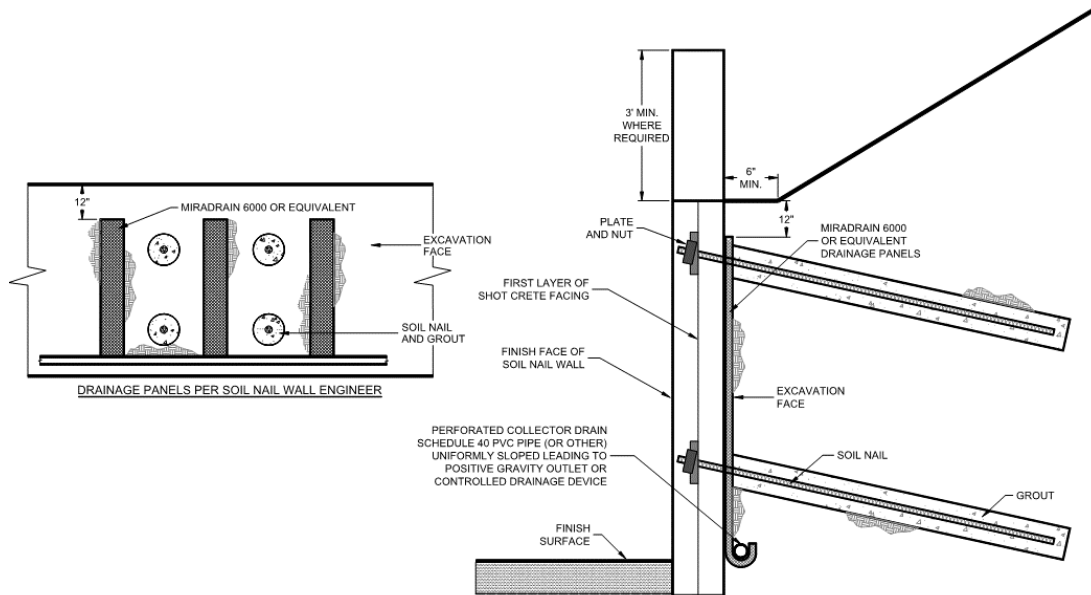

Soil Nail Wall Drainage Detail

7.13 MSE Retaining Wall Recommendations

7.13.1 We recommend the following geotechnical parameters be used for design of the MSE retaining walls.

**TABLE 7.13
GEOTECHNICAL DESIGN PARAMETERS**

Parameter	Reinforced Zone	Retained Zone	Foundation Zone
Angle of Internal Friction	30 degrees	30 degrees	30 degrees
Cohesion	100 psf	100 psf	100 psf
Moist Unit Weight	130 pcf	130 pcf	130 pcf

7.13.2 The shear strength values provided in Table 7.13 for the reinforced zone assume that granular materials will be used as backfill. Once proposed backfill materials are identified or stockpiled, sufficient samples should be collected and subjected to laboratory testing to assess the soils suitability for use as wall backfill. Results should be provided to the designer to re-evaluate stability of the walls. Dependent upon test results, the designer may require modifications to the original wall design (e.g., longer geogrid embedment lengths). Wall designers usually will not allow soil with significant amounts of short rock fragments or cobbles to be used as backfill for geogrid walls.

7.13.3 Backfill materials within the reinforced zone should be compacted to a dry density of at least 90 percent of the laboratory maximum dry density near to or slightly above optimum moisture content in accordance with ASTM D 1557. This is applicable to the entire embedment length of the geogrid reinforcement. Typically, wall designers specify that heavy compaction equipment be excluded from within 3 feet of the face of the wall; however, smaller equipment (e.g., walk-behind, self-driven compactors or hand whackers) should be used to compact the materials without causing deformation of the wall. If the designer specifies no compactive effort for this zone, the materials are essentially not properly compacted and the geogrid within the uncompacted zone should not be relied upon for reinforcement and overall embedment lengths should be increased to account for the difference.

7.13.4 The wall should be provided with drainage system sufficient enough to prevent excessive seepage through the wall and water at the base of the wall to prevent hydrostatic pressures behind the wall.

- 7.13.5 Geosynthetic reinforcement must elongate to develop full tensile resistance. This elongation generally results in movement at the top of the wall. The amount of movement is dependent upon the height of the wall (e.g., higher walls rotate more), construction, and the type of geosynthetic used. In addition, over time reinforced-earth retaining walls have been known to exhibit creep and can undergo additional movement. Given this condition, the owner should be aware that structures and pavement placed within the reinforced and retained zones of the wall may undergo movement and should be designed to accommodate this movement.

7.14 Storm Water Management

- 7.14.1 If storm water management devices are not properly designed and constructed, there is a risk for distress to improvements and properties located hydrologically down gradient or adjacent to these devices. Factors such as the amount of water being detained, its residence time, and soil permeability have an important effect on seepage transmission and the potential adverse impacts that may occur if the storm water management features are not properly designed and constructed. We have not performed a hydrogeological study at the site. If infiltration of storm water runoff into the subsurface occurs, downstream improvements may be subjected to seeps, springs, slope instability, raised groundwater, movement of foundations and slabs, or other undesirable impacts as a result of water infiltration.

- 7.14.2 The proposed BMP basin at the northwest corner of the site will be underlain by compacted fill and will be situated at the top of a fill slope. This basin should be lined with an impermeable liner to reduce the potential for seepage into the fill and onto the fill slope. The proposed basin at the southwest corner of the site should also be lined with an impermeable liner due to the dense nature of granitic rock expected to be exposed at the base of the liner and the proximity of existing Melrose Drive and associated improvements. We expect water will perch on the underlying granitic rock and could migrate laterally below the adjacent street improvements. The proposed basin at the southeast corner of the property is expected to be underlain by both dense granitic bedrock and compacted fill. This basin should also be lined with an impermeable liner due to the presence of compacted fill and dense granitic bedrock.

7.15 Site Drainage and Moisture Protection

- 7.15.1 Adequate site drainage is critical to reduce the potential for differential soil movement, erosion and subsurface seepage. Under no circumstances should water be allowed to pond adjacent to footings. The site should be graded and maintained such that surface drainage is directed away from structures in accordance with 2019 CBC 1804.3 or other applicable

standards. In addition, surface drainage should be directed away from the top of slopes into swales or other controlled drainage devices. Roof and pavement drainage should be directed into conduits that carry runoff away from the proposed structure.

7.15.2 In the case of basement walls or building walls retaining landscaping areas, a water-proofing system should be used on the wall and joints, and a Miradrain drainage panel (or similar) should be placed over the waterproofing. The project architect or civil engineer should provide detailed specifications on the plans for all waterproofing and drainage.

7.15.3 Underground utilities should be leak free. Utility and irrigation lines should be checked periodically for leaks, and detected leaks should be repaired promptly. Detrimental soil movement could occur if water is allowed to infiltrate the soil for prolonged periods of time.

7.16 Grading and Foundation Plan Review

7.16.1 Geocon Incorporated should review the final grading and foundation plans prior to finalization to check their compliance with the recommendations of this report and evaluate the need for additional comments, recommendations, and/or analyses.

LIMITATIONS AND UNIFORMITY OF CONDITIONS

1. The firm that performed the geotechnical investigation for the project should be retained to provide testing and observation services during construction to provide continuity of geotechnical interpretation and to check that the recommendations presented for geotechnical aspects of site development are incorporated during site grading, construction of improvements, and excavation of foundations. If another geotechnical firm is selected to perform the testing and observation services during construction operations, that firm should prepare a letter indicating their intent to assume the responsibilities of project geotechnical engineer of record. A copy of the letter should be provided to the regulatory agency for their records. In addition, that firm should provide revised recommendations concerning the geotechnical aspects of the proposed development, or a written acknowledgement of their concurrence with the recommendations presented in our report. They should also perform additional analyses deemed necessary to assume the role of Geotechnical Engineer of Record.
2. The recommendations of this report pertain only to the site investigated and are based upon the assumption that the soil conditions do not deviate from those disclosed in the investigation. If any variations or undesirable conditions are encountered during construction, or if the proposed construction will differ from that anticipated herein, Geocon Incorporated should be notified so that supplemental recommendations can be given. The evaluation or identification of the potential presence of hazardous or corrosive materials was not part of the scope of services provided by Geocon Incorporated.
3. This report is issued with the understanding that it is the responsibility of the owner, or of his representative, to ensure that the information and recommendations contained herein are brought to the attention of the architect and engineer for the project and incorporated into the plans, and that the necessary steps are taken to see that the contractor and subcontractors carry out such recommendations in the field.
4. The findings of this report are valid as of the present date. However, changes in the conditions of a property can occur with the passage of time, whether they are due to natural processes or the works of man on this or adjacent properties. In addition, changes in applicable or appropriate standards may occur, whether they result from legislation or the broadening of knowledge. Accordingly, the findings of this report may be invalidated wholly or partially by changes outside our control. Therefore, this report is subject to review and should not be relied upon after a period of three years.

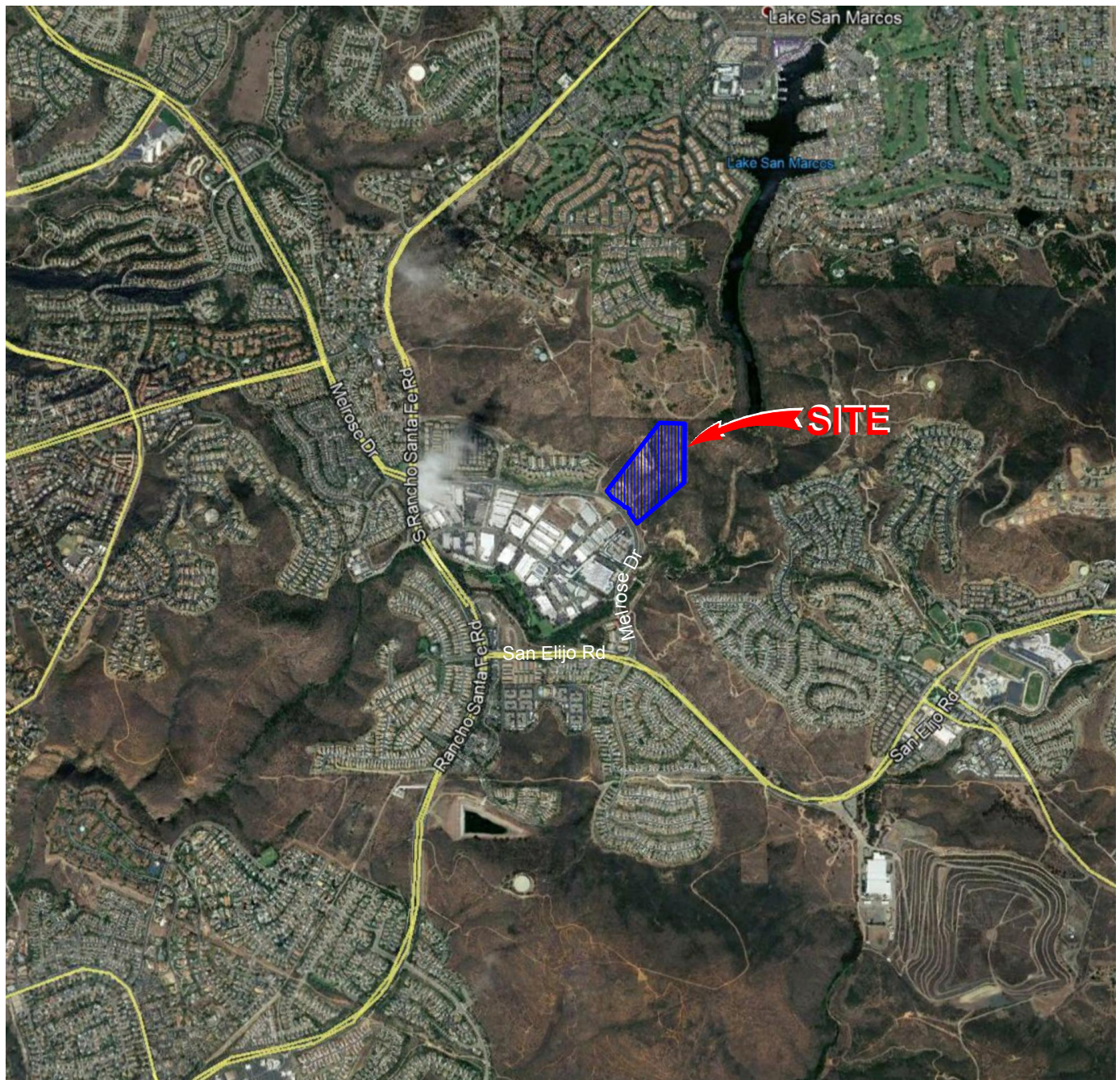

THE GEOGRAPHICAL INFORMATION MADE AVAILABLE FOR DISPLAY WAS PROVIDED BY GOOGLE EARTH, SUBJECT TO A LICENSING AGREEMENT. THE INFORMATION IS FOR ILLUSTRATIVE PURPOSES ONLY; IT IS NOT INTENDED FOR CLIENT'S USE OR RELIANCE AND SHALL NOT BE REPRODUCED BY CLIENT. CLIENT SHALL INDEMNIFY, DEFEND AND HOLD HARMLESS GEOCON FROM ANY LIABILITY INCURRED AS A RESULT OF SUCH USE OR RELIANCE BY CLIENT.



NO SCALE

VICINITY MAP

GEOCON
INCORPORATED



GEOTECHNICAL ■ ENVIRONMENTAL ■ MATERIALS
6960 FLANDERS DRIVE - SAN DIEGO, CALIFORNIA 92121 - 2974
PHONE 858 558-6900 - FAX 858 558-6159

MELROSE INDUSTRIAL SITE SAN MARCOS, CALIFORNIA

RM / AML

DSK/GTYPD

DATE 03 - 13 - 2020

PROJECT NO. G2520 - 42 - 01

FIG. 1

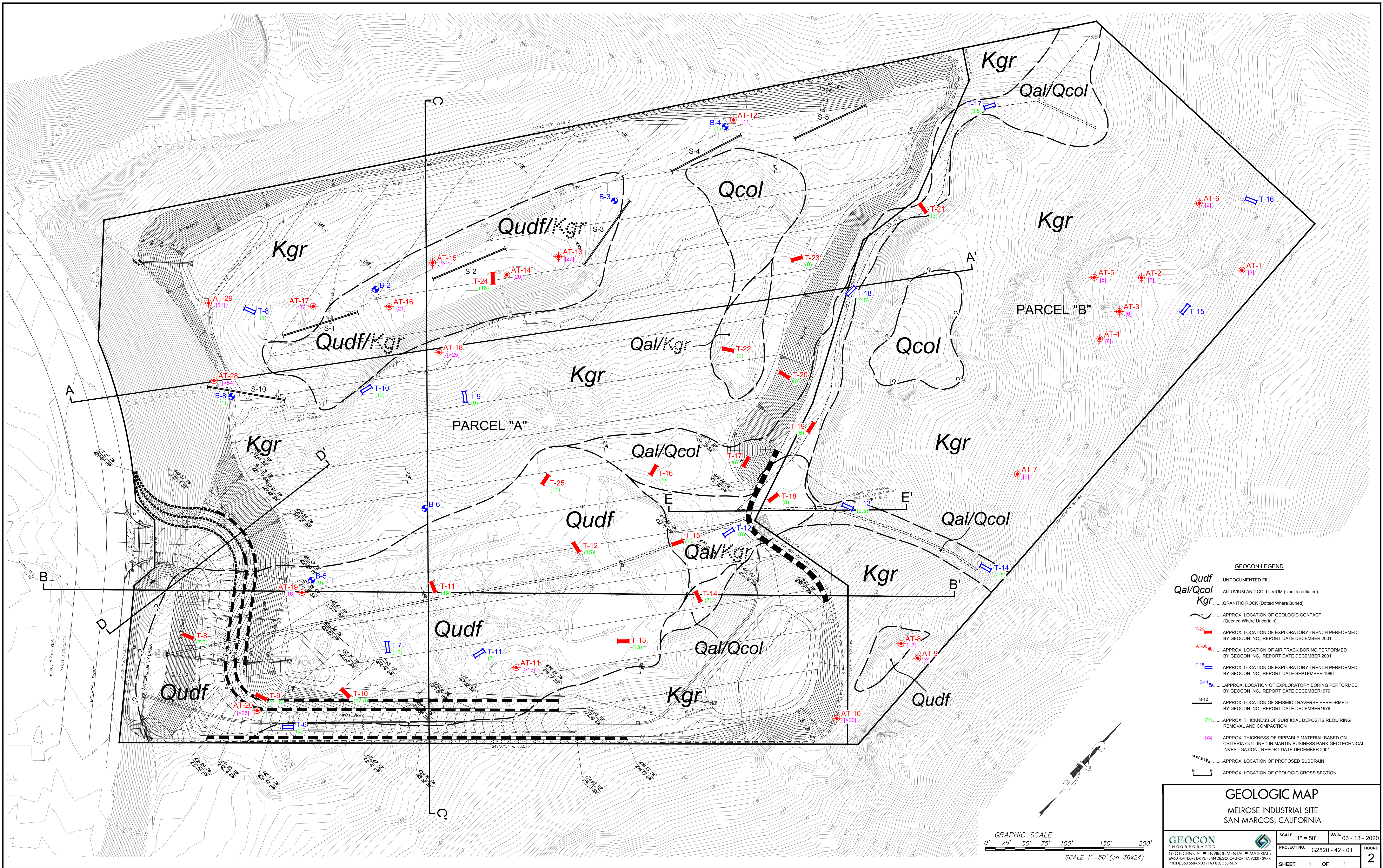

- GEOCON LEGEND**
- Qudf UNDOCUMENTED FILL
 - Qal/Qcol ALLUVIUM AND COLLUVIUM (Undifferentiated)
 - Kgr GRANITIC ROCK (Dotted Where Buried)
 - APPROX. LOCATION OF GEOLOGIC CONTACT (Queried Where Uncertain)
 - T-25 APPROX. LOCATION OF EXPLORATORY TRENCH PERFORMED BY GEOCON INC., REPORT DATE DECEMBER 2001
 - AT-30 APPROX. LOCATION OF AIR TRACK BORING PERFORMED BY GEOCON INC., REPORT DATE DECEMBER 2001
 - T-18 APPROX. LOCATION OF EXPLORATORY TRENCH PERFORMED BY GEOCON INC., REPORT DATE SEPTEMBER 1986
 - B-11 APPROX. LOCATION OF EXPLORATORY BORING PERFORMED BY GEOCON INC., REPORT DATE DECEMBER 1979
 - S-12 APPROX. LOCATION OF SEISMIC TRAVERSE PERFORMED BY GEOCON INC., REPORT DATE DECEMBER 1979
 - (20) APPROX. THICKNESS OF SURFICIAL DEPOSITS REQUIRING REMOVAL AND COMPACTION
 - [25] APPROX. THICKNESS OF RIPPLE MATERIAL BASED ON CRITERIA OUTLINED IN MARTIN BUSINESS PARK GEOTECHNICAL INVESTIGATION, REPORT DATE DECEMBER 2001
 - APPROX. LOCATION OF PROPOSED SUBDRAIN
 - E APPROX. LOCATION OF GEOLOGIC CROSS SECTION

GEOLOGIC MAP
MELROSE INDUSTRIAL SITE
SAN MARCOS, CALIFORNIA

<p>GEOCON INCORPORATED</p> <p>GEOTECHNICAL ■ ENVIRONMENTAL ■ MATERIALS 6940 ANDERS DRIVE ■ SAN DIEGO, CALIFORNIA 92121-2974 PHONE 858.558.4900 ■ FAX 858.558.4159</p>	SCALE 1" = 50'	DATE 03 - 13 - 2020	
	PROJECT NO. G2520 - 42 - 01	FIGURE	2
	SHEET 1 OF 1		

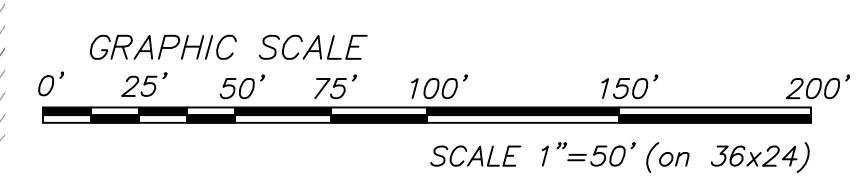

Plotfile: 03132020 7 33AM | By: ACRYL LADRILLON | File Location: Y:\PROJECTS\G2520-42-01 (Melrose Industrial Site)\SHEET\G2520-42-01 Geo Map.dwg

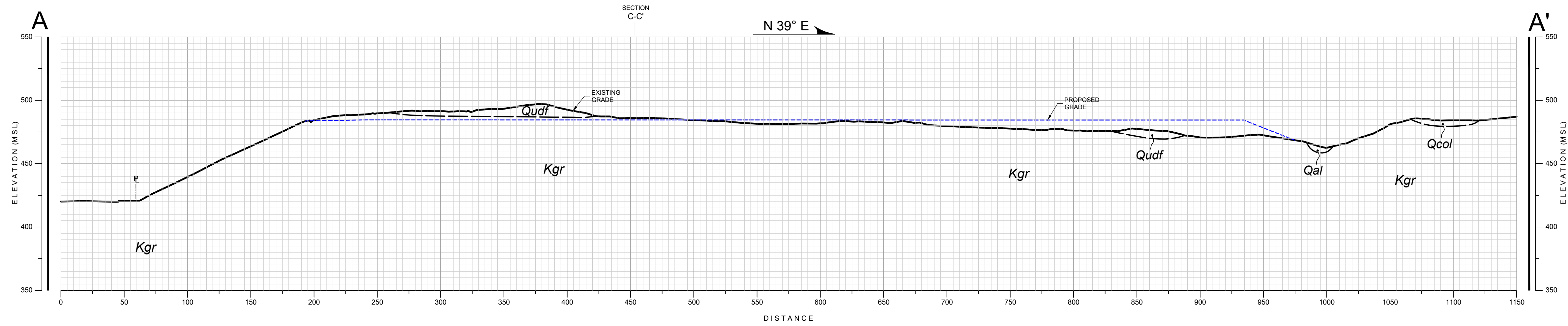

GEOLOGIC CROSS-SECTION A-A'
SCALE: 1" = 50' (Vert. = Horiz.)

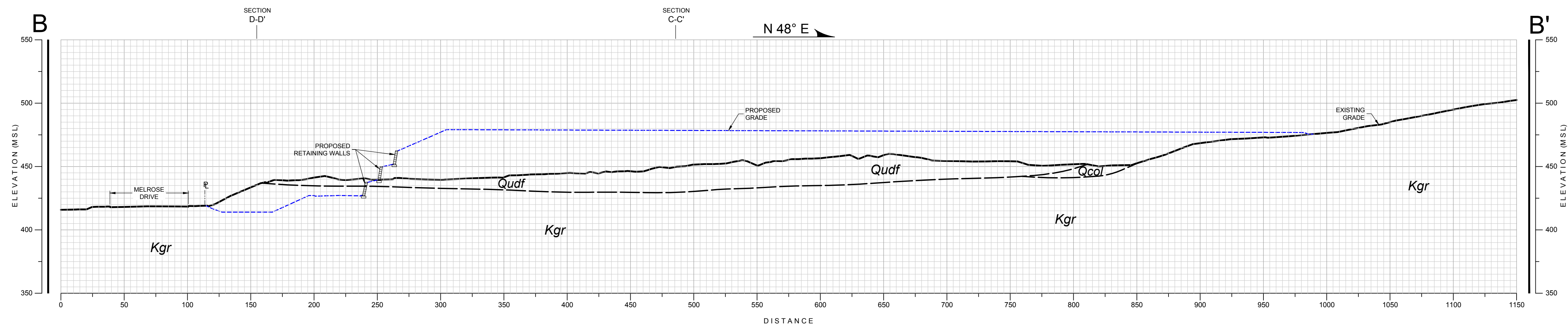

GEOLOGIC CROSS-SECTION B-B'
SCALE: 1" = 50' (Vert. = Horiz.)

GEOCON LEGEND

- Qudf UNDOCUMENTED FILL
- Qal ALLUVIUM
- Qcol COLLUVIUM
- Kgr GRANITIC ROCK
- ~ APPROX. LOCATION OF GEOLOGIC CONTACT

GEOLOGIC CROSS SECTION

MELROSE INDUSTRIAL SITE
SAN MARCOS, CALIFORNIA

GEOCON INCORPORATED GEOTECHNICAL ■ ENVIRONMENTAL ■ MATERIALS 6940 SANDERS DRIVE ■ SAN DIEGO, CALIFORNIA 92121-2974 PHONE 858.558.4900 ■ FAX 858.558.4159	SCALE 1" = 50'	DATE 03 - 13 - 2020
	PROJECT NO. G2520 - 42 - 01	FIGURE 3
	SHEET 1 OF 2	

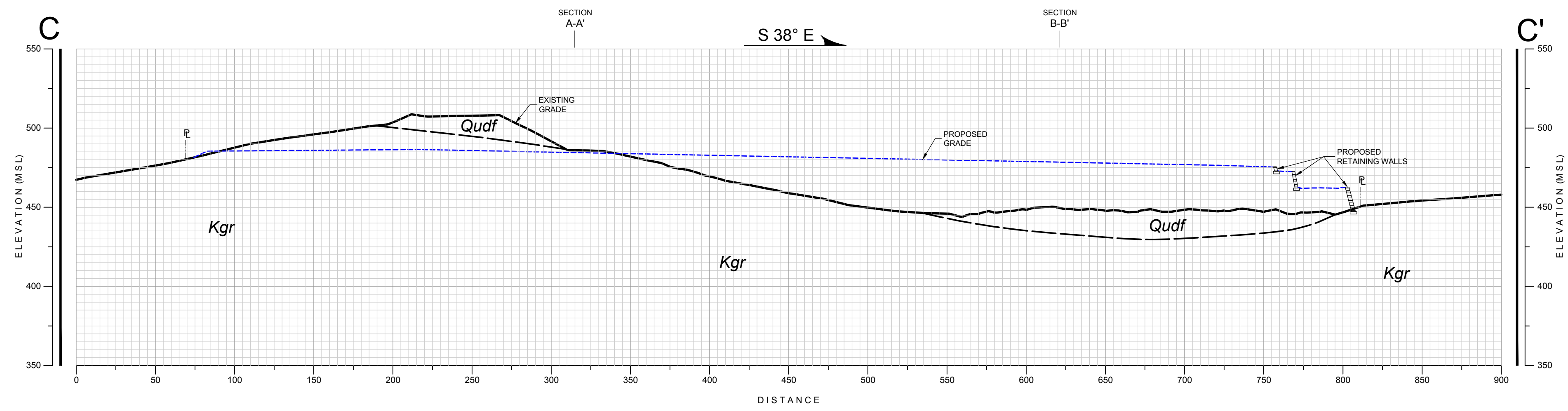

GEOLOGIC CROSS-SECTION C-C'
SCALE: 1" = 50' (Vert. = Horiz.)

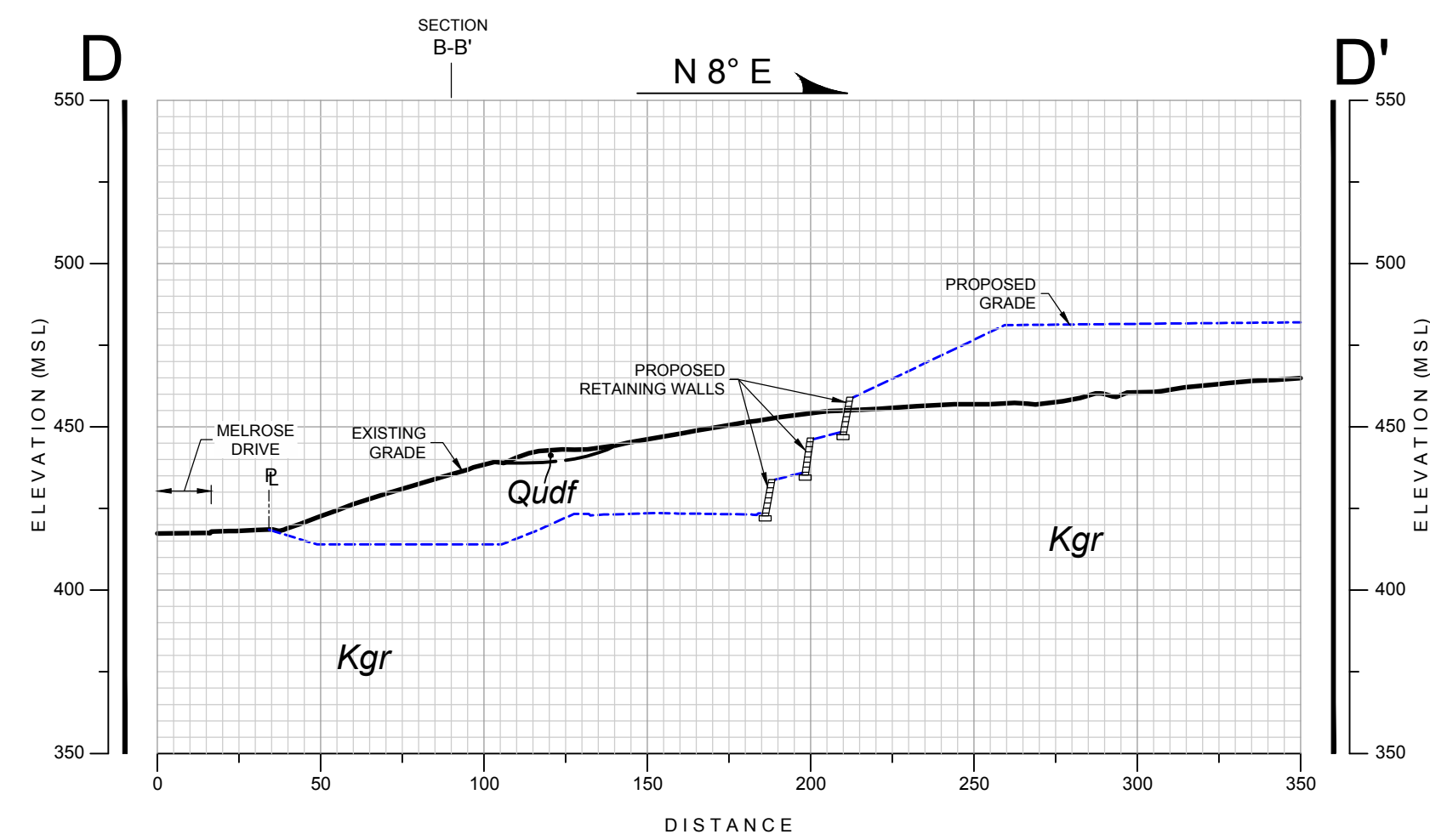

GEOLOGIC CROSS-SECTION D-D'
SCALE: 1" = 50' (Vert. = Horiz.)

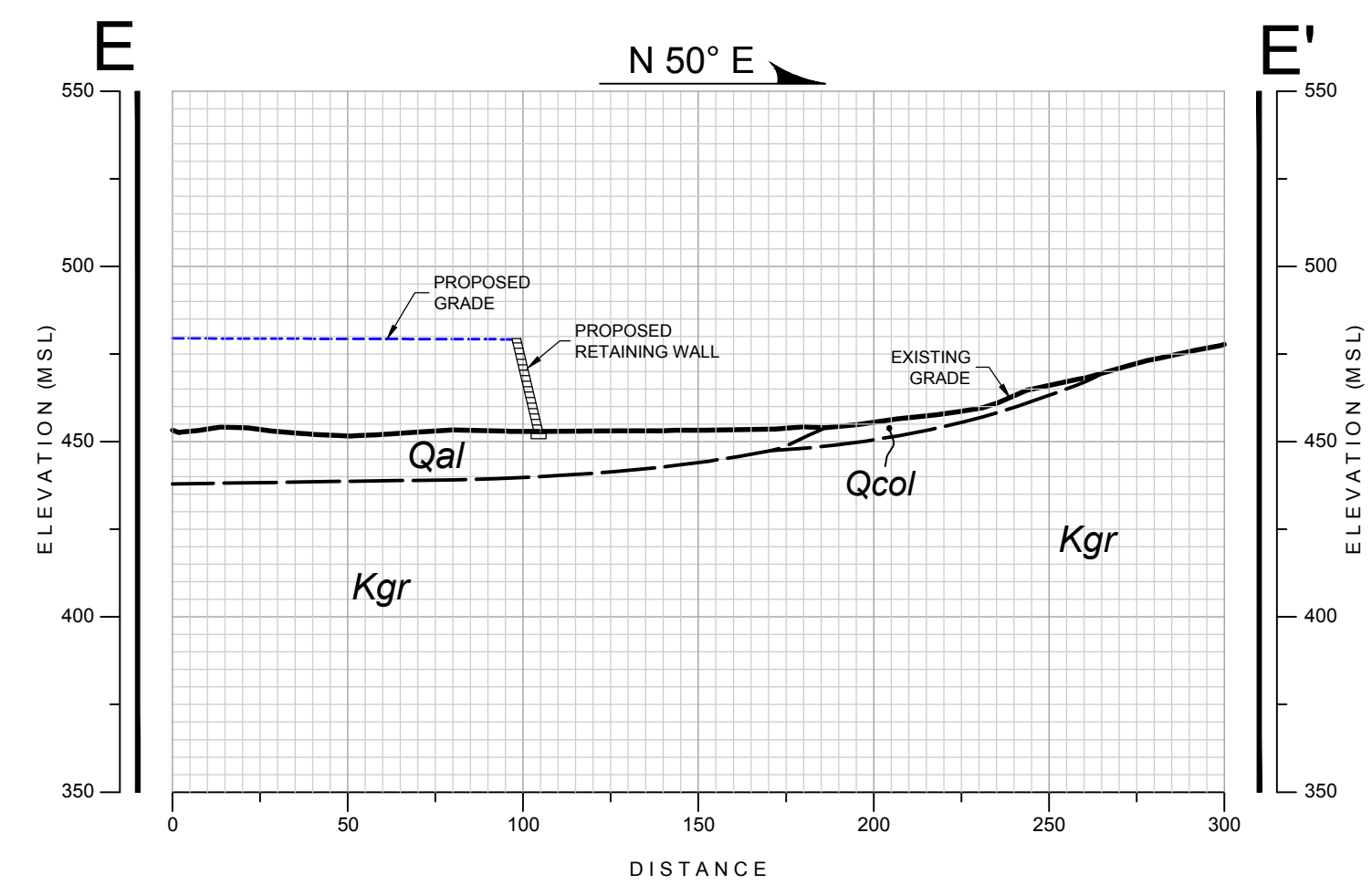

GEOLOGIC CROSS-SECTION E-E'
SCALE: 1" = 50' (Vert. = Horiz.)

GEOCON LEGEND

- Qudf UNDOCUMENTED FILL
- Qal ALLUVIUM
- Qcol COLLUVIUM
- Kgr GRANITIC ROCK
- APPROX. LOCATION OF GEOLOGIC CONTACT

GEOLOGIC CROSS SECTION

MELROSE INDUSTRIAL SITE
SAN MARCOS, CALIFORNIA

GEOCON INCORPORATED <small>GEOTECHNICAL ■ ENVIRONMENTAL ■ MATERIALS</small> 6940 SANDERS DRIVE ■ SAN DIEGO, CALIFORNIA 92121-2974 PHONE 858.558.4900 ■ FAX 858.558.4159	SCALE	DATE	FIGURE
	1" = 50'	03 - 13 - 2020	
SHEET	PROJECT NO.	G2520 - 42 - 02	
	2	OF 2	
			4

ZONE B

WINDROWS DETAIL
(PLAN VIEW)

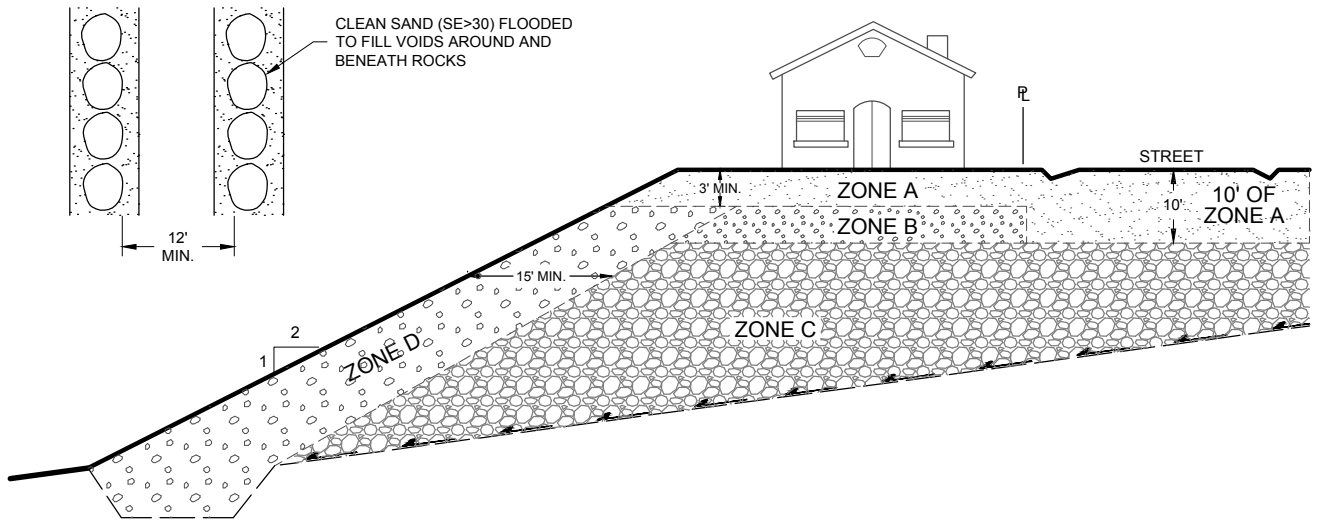

NO SCALE

LEGEND

ZONE A: COMPACTED SOIL FILL. NO ROCK FRAGMENTS OVER 6 INCHES IN DIMENSION. 3 FEET THICK FOR RESIDENTIAL PADS AND 5 FEET THICK FOR SHEET GRADED PADS.

ZONE B: ROCKS UP TO 1 FOOT IN MAXIMUM DIMENSION IN A MATRIX OF COMPACTED "SOIL FILL" WITHIN BUILDING PADS AND SLOPE AREAS ONLY.

ZONE C: ROCK OR SOIL-ROCK FILL GENERALLY CONSISTING OF 2 FOOT MINUS MATERIAL WITH OCCASIONAL INDIVIDUAL FRAGMENTS UP TO 4 FEET MAXIMUM DIMENSION
ALTERNATE: ROCKS 2 TO 4 FEET IN MAXIMUM DIMENSION CAN BE PLACED IN WINDROWS IN COMPACTED SOIL FILL POSSESSING A SAND EQUIVALENT OF AT LEAST 30.

ZONE D: ROCKS UP TO 12 INCHES IN MAXIMUM DIMENSION IN A MATRIX OF COMPACTED "SOIL FILL".

NOTES

1. COMPACTED "SOIL FILL" IN UPPER 3 FEET SHALL CONTAIN AT LEAST 40 PERCENT SOIL PASSING THE 3/4 - INCH SIEVE (BY WEIGHT).
2. CONTINUOUS OBSERVATION REQUIRED BY GEOCON DURING ROCK PLACEMENT.
3. ROCK FILL (LESS THAN 40 PERCENT SOIL SIZES) MAY BE PERMITTED IN DESIGNATED AREAS UPON APPROVAL OF THE GEOTECHNICAL ENGINEER.
4. COMBINED DEPTH OF ZONE A AND D SHOULD BE AT LEAST 7 FEET AND SHOULD BE EXTENDED TO AT LEAST 2 FEET BELOW DEEPEST UTILITY WITHIN ROADWAYS.
5. SUBDRAINS PLACED AT THE BASE OF ROCK/SOIL-ROCK FILLS MAY BE NECESSARY. THE NECESSITY FOR THE DRAINS WILL BE EVALUATED BY THE GEOTECHNICAL ENGINEER DURING GRADING.

ROCK PLACEMENT DETAIL

GEOCON
INCORPORATED



GEOTECHNICAL ■ ENVIRONMENTAL ■ MATERIALS
6960 FLANDERS DRIVE - SAN DIEGO, CALIFORNIA 92121 - 2974
PHONE 858 558-6900 - FAX 858 558-6159

MELROSE INDUSTRIAL SITE
SAN MARCOS, CALIFORNIA

RM / AML

DSK/GTYPD

DATE 03 - 13 - 2020

PROJECT NO. G2520 - 42 - 01

FIG. 5

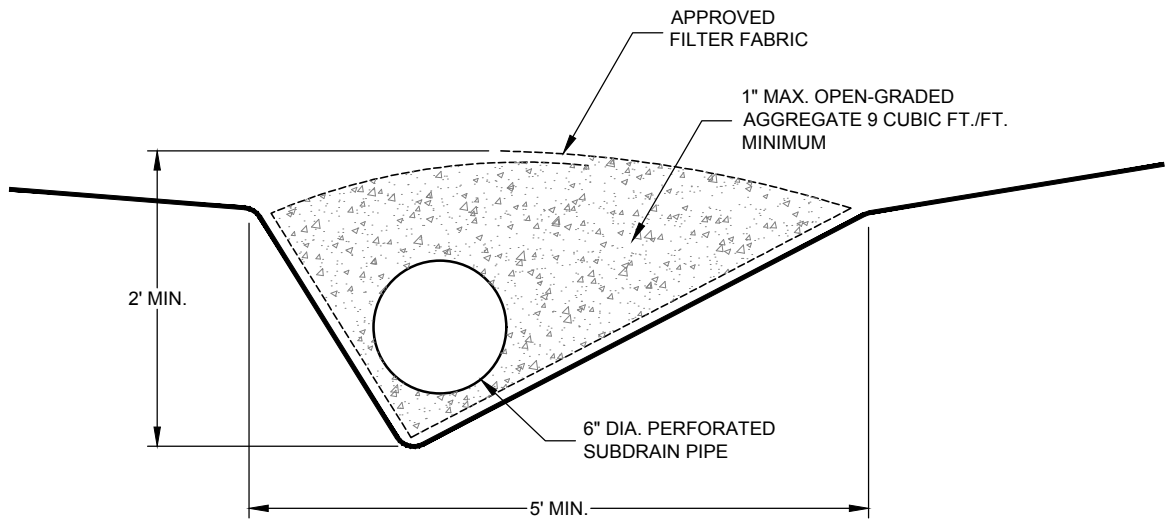

NOTES:

- 1....SUBDRAIN PIPE SHOULD BE 6-INCH MINIMUM DIAMETER, PERFORATED, THICK WALLED SCHEDULED 40 PVC, SLOPED TO DRAIN AT 1 PERCENT MINIMUM AND CONNECTED TO STORM DRAIN SYSTEM OR APPROVED OUTLET.
- 2....WHERE SUBDRAIN PIPE EXCEEDS 1,000 FEET IN LENGTH, THE DOWNSTREAM (LOWEST PORTION) 1,000 FEET SHOULD BE INCREASED TO 8 INCHES DIAMETER PVC.
- 3....FILTER FABRIC TO BE MIRAFI 140N OR EQUIVALENT.

TYPICAL SUBDRAIN DETAIL

GEOCON
INCORPORATED



GEOTECHNICAL ■ ENVIRONMENTAL ■ MATERIALS
6960 FLANDERS DRIVE - SAN DIEGO, CALIFORNIA 92121 - 2974
PHONE 858 558-6900 - FAX 858 558-6159

MELROSE INDUSTRIAL SITE
SAN MARCOS, CALIFORNIA

RM / AML

DSK/GTYPD

DATE 03 - 13 - 2020

PROJECT NO. G2520 - 42 - 01

FIG. 6

FRONT VIEW

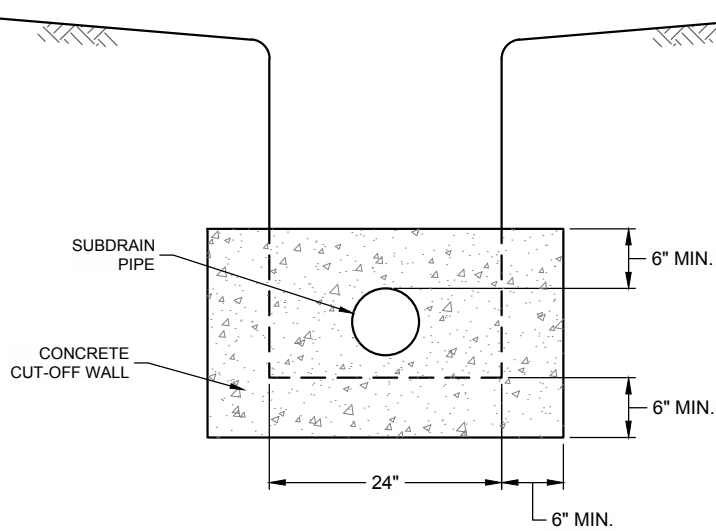

NO SCALE

SIDE VIEW

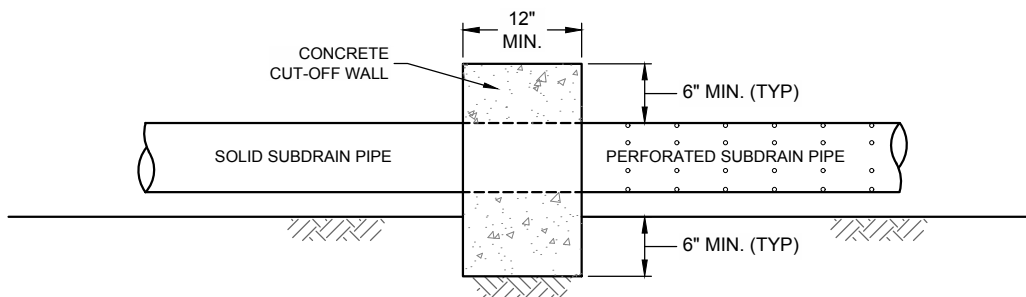

NO SCALE

RECOMMENDED SUBDRAIN CUT-OFF WALL DETAIL

GEOCON
INCORPORATED



GEOTECHNICAL ■ ENVIRONMENTAL ■ MATERIALS
6960 FLANDERS DRIVE - SAN DIEGO, CALIFORNIA 92121 - 2974
PHONE 858 558-6900 - FAX 858 558-6159

MELROSE INDUSTRIAL SITE
SAN MARCOS, CALIFORNIA

RM / AML

DSK/GTYPD

DATE 03 - 13 - 2020

PROJECT NO. G2520 - 42 - 01

FIG. 7

FRONT VIEW

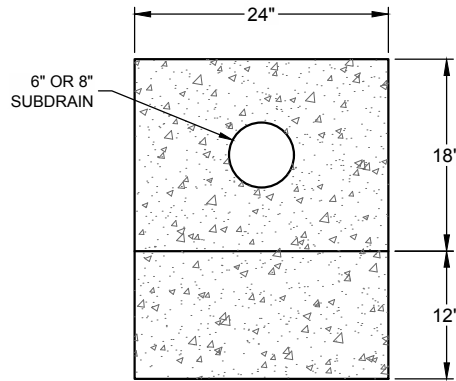

NO SCALE

SIDE VIEW

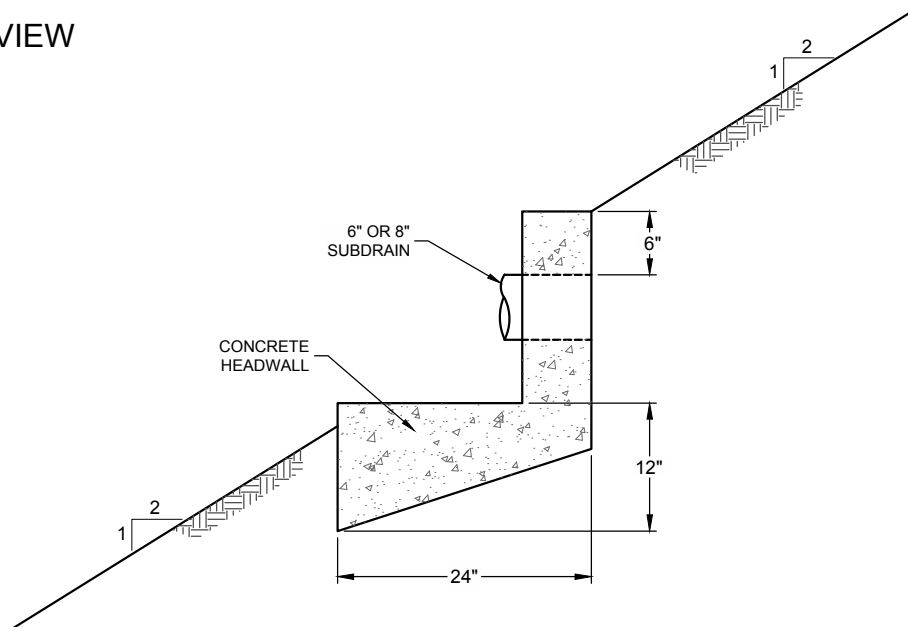

NOTES:

1. HEADWALL SHOULD OUTLET AT TOE OF FILL SLOPE OR INTO CONTROLLED SURFACE DRAINAGE
2. TO BE APPROVED BY PROJECT CIVIL ENGINEER

NO SCALE

SUBDRAIN OUTLET HEADWALL DETAIL

GEOCON
INCORPORATED



GEOTECHNICAL ■ ENVIRONMENTAL ■ MATERIALS
6960 FLANDERS DRIVE - SAN DIEGO, CALIFORNIA 92121 - 297 4
PHONE 858 558-6900 - FAX 858 558-6159

MELROSE INDUSTRIAL SITE
SAN MARCOS, CALIFORNIA

RM / AML

DSK/GTYPD

DATE 03 - 13 - 2020

PROJECT NO. G2520 - 42 - 01

FIG. 8

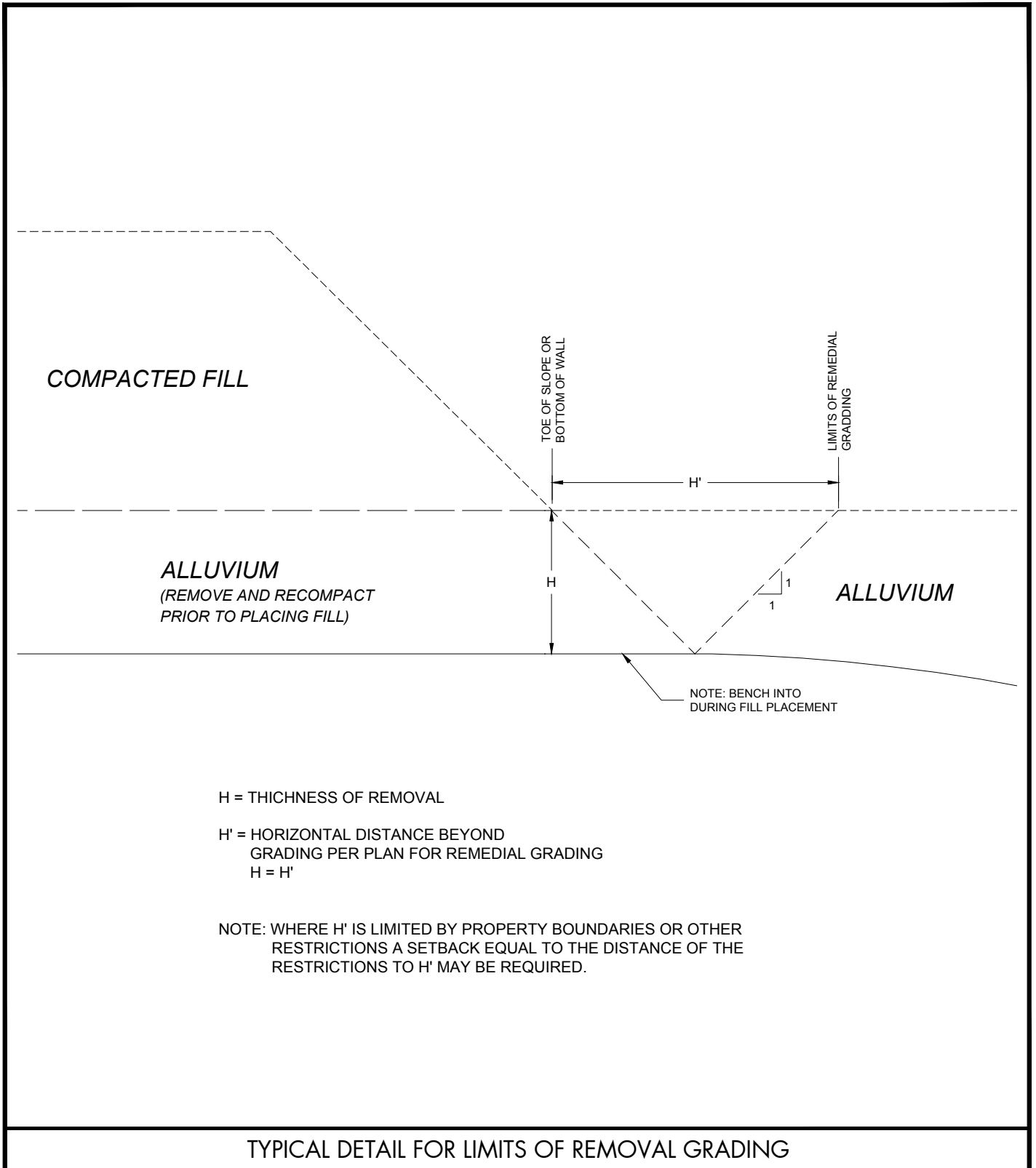

GEOCON
INCORPORATED



GEOTECHNICAL ■ ENVIRONMENTAL ■ MATERIALS
6960 FLANDERS DRIVE - SAN DIEGO, CALIFORNIA 92121 - 2974
PHONE 858 558-6900 - FAX 858 558-6159

RM / AML		DSK/GTYPD
----------	--	-----------

MELROSE INDUSTRIAL SITE
SAN MARCOS, CALIFORNIA

DATE 03 - 13 - 2020	PROJECT NO. G2520 - 42 - 01	FIG. 9
---------------------	-----------------------------	--------

ASSUMED CONDITIONS :

SLOPE HEIGHT	H = 25 feet
SLOPE INCLINATION	2 : 1 (Horizontal : Vertical)
TOTAL UNIT WEIGHT OF SOIL	$\gamma_t = 130$ pounds per cubic foot
ANGLE OF INTERNAL FRICTION	$\phi = 30$ degrees
APPARENT COHESION	C = 300 pounds per square foot
NO SEEPAGE FORCES	

ANALYSIS :

$\gamma_{c\phi} = \frac{\gamma_t H \tan \phi}{C}$	EQUATION (3-3), REFERENCE 1
FS = $\frac{N_{cf} C}{\gamma_t H}$	EQUATION (3-2), REFERENCE 1
$\gamma_{c\phi} = 6.3$	CALCULATED USING EQ. (3-3)
$N_{cf} = 24$	DETERMINED USING FIGURE 10, REFERENCE 2
FS = 2.2	FACTOR OF SAFETY CALCULATED USING EQ. (3-2)

REFERENCES :

- 1.....Janbu, N., Stability Analysis of Slopes with Dimensionless Parameters, Harvard Soil Mechanics, Series No. 46, 1954
- 2.....Janbu, N., Discussion of J.M. Bell, Dimensionless Parameters for Homogeneous Earth Slopes, Journal of Soil Mechanics and Foundation Design, No. SM6, November 1967.

SLOPE STABILITY ANALYSIS - FILL SLOPES

GEOCON
INCORPORATED



GEOTECHNICAL ■ ENVIRONMENTAL ■ MATERIALS
6960 FLANDERS DRIVE - SAN DIEGO, CALIFORNIA 92121 - 2974
PHONE 858 558-6900 - FAX 858 558-6159

MELROSE INDUSTRIAL SITE
SAN MARCOS, CALIFORNIA

RM / AML

DSK/GTYPD

DATE 03 - 13 - 2020

PROJECT NO. G2520 - 42 - 01

FIG. 10

ASSUMED CONDITIONS :

SLOPE HEIGHT	H = Infinite
DEPTH OF SATURATION	Z = 3 feet
SLOPE INCLINATION	2 : 1 (Horizontal : Vertical)
SLOPE ANGLE	i = 26.6 degrees
UNIT WEIGHT OF WATER	γ_w = 62.4 pounds per cubic foot
TOTAL UNIT WEIGHT OF SOIL	γ_t = 130 pounds per cubic foot
ANGLE OF INTERNAL FRICTION	ϕ = 30 degrees
APPARENT COHESION	C = 300 pounds per square foot

SLOPE SATURATED TO VERTICAL DEPTH Z BELOW SLOPE FACE

SEEPAGE FORCES PARALLEL TO SLOPE FACE

ANALYSIS :

$$FS = \frac{C + (\gamma_t - \gamma_w) Z \cos^2 i \tan \phi}{\gamma_t Z \sin i \cos i} = 2.52$$

REFERENCES :

- 1.....Haefeli, R. *The Stability of Slopes Acted Upon by Parallel Seepage*, Proc. Second International Conference, SMFE, Rotterdam, 1948, 1, 57-62
- 2.....Skempton, A. W., and F.A. Delory, *Stability of Natural Slopes in London Clay*, Proc. Fourth International Conference, SMFE, London, 1957, 2, 378-81

SURFICIAL SLOPE STABILITY ANALYSIS

GEOCON
INCORPORATED



GEOTECHNICAL ■ ENVIRONMENTAL ■ MATERIALS
6960 FLANDERS DRIVE - SAN DIEGO, CALIFORNIA 92121 - 2974
PHONE 858 558-6900 - FAX 858 558-6159

MELROSE INDUSTRIAL SITE
SAN MARCOS, CALIFORNIA

RM / AML

DSK/GTYPD

DATE 03 - 13 - 2020

PROJECT NO. G2520 - 42 - 01

FIG. 11

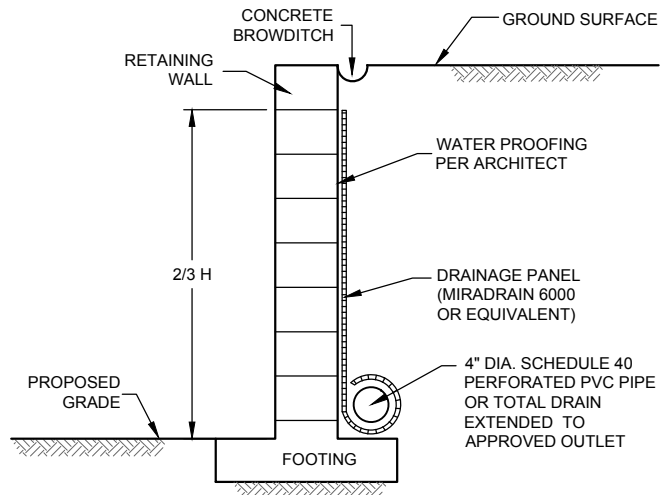
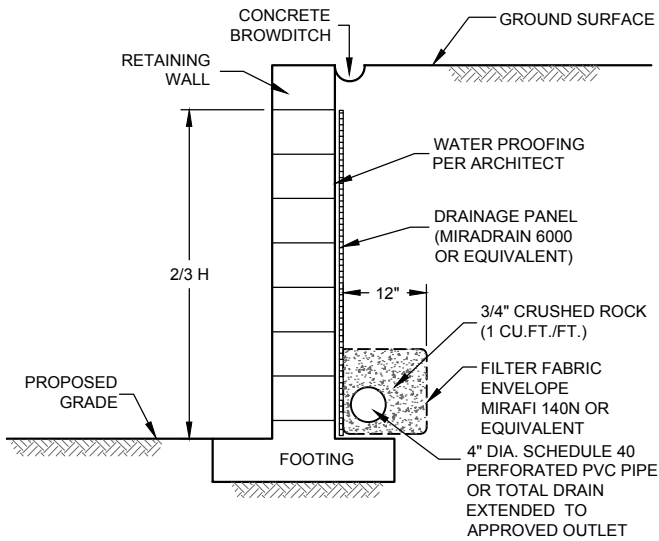
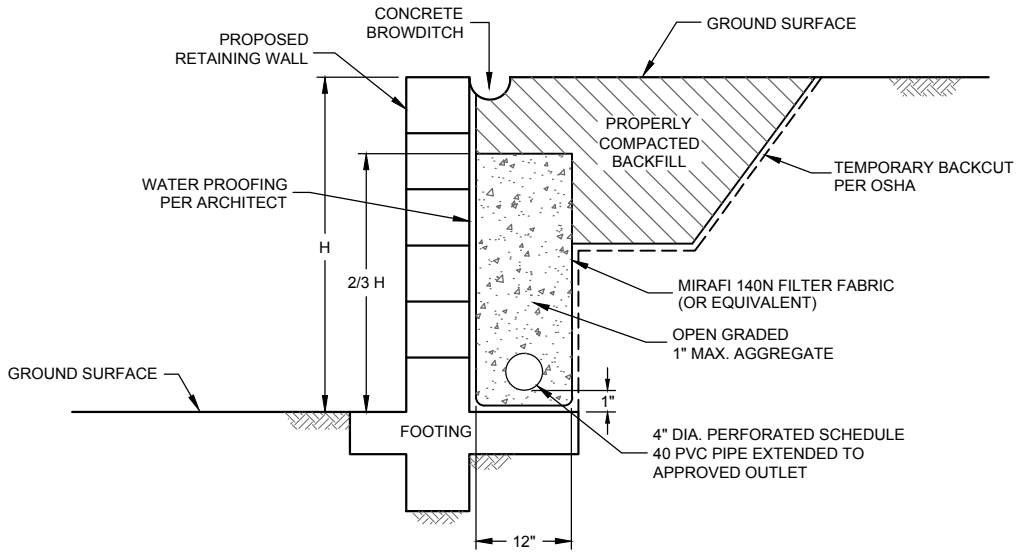

NOTE :

DRAIN SHOULD BE UNIFORMLY SLOPED TO GRAVITY OUTLET OR TO A SUMP WHERE WATER CAN BE REMOVED BY PUMPING

NO SCALE

TYPICAL RETAINING WALL DRAIN DETAIL

GEOCON
INCORPORATED



GEOTECHNICAL ■ ENVIRONMENTAL ■ MATERIALS
6960 FLANDERS DRIVE - SAN DIEGO, CALIFORNIA 92121 - 297 4
PHONE 858 558-6900 - FAX 858 558-6159

MELROSE INDUSTRIAL SITE
SAN MARCOS, CALIFORNIA

RM / AML

DSK/GTYPD

DATE 03 - 13 - 2020

PROJECT NO. G2520 - 42 - 01

FIG. 12

APPENDIX

A

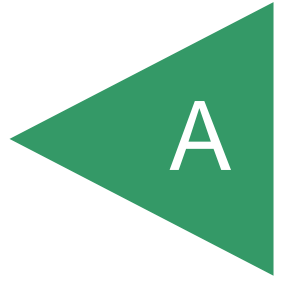

APPENDIX A

FIELD INVESTIGATION

Previous field investigations were performed between 1979 and 2001, and consisted of a visual site reconnaissance, the excavation of exploratory trenches and borings, drilling of air-track borings and performing seismic refraction surveys. The approximate locations of the exploratory trenches, borings and seismic refraction surveys are shown on Figure 2.

The soils encountered in the backhoe trenches and borings were visually examined, classified, and logged in general accordance with ASTM Test Method D-2488 *Description and Identification of Soils (Visual-Manual Method)*. Logs of the trenches and borings are presented in Appendices A through C. The logs depict the soil and geologic conditions encountered and the depth at which samples were obtained. Air-track borings were performed with an Ingersoll Rand 490 with a 4-inch bit. Air-track boring logs are presented herein.

Seismic traverses were performed with a Nimbus ES 125 Signal Enhancement Seismograph. The traverses, 100 feet long, were performed in both a forward and reverse direction. The results of each seismic traverse are summarized on Table A-I. Table A-II presents our interpretation of rippable thickness of the rock based on the data obtained.

**TABLE A-I
SEISMIC TRAVERSES (GEOCON 1979)**

Seismic Traverse No.	Average Velocity (ft./sec.)			Average Depth (ft.)		Length of Traverse (ft.)	Approximate Maximum Depth Explored (ft.)
	V ₁	V ₂	V ₃	D ₁	D ₂		
S-1	1240	6640	---	4	---	100	30
S-2	1075	6460	---	3	---	100	30
S-3	1370	8580	---	4	---	100	30
S-4	1250	8025	---	4	---	100	30
S-5	1280	10,270	---	3	---	100	30
S-6	1370	8500	---	5	---	100	30
S-7	1370	8830	---	4	---	100	30
S-9	1370	6665	---	3	---	100	30
S-10	1250	4765	9000	3	20	100	30
S-12	1390	8040	---	3	---	100	30

V₁ = Velocity in feet per second of first layer of materials
V₂ = Second layer velocities
V₃ = Third layer velocities

D₁ = Depth in feet to base of first layer
D₂ = Depth to base of second layer

Note:

For mass grading, materials with velocities of less than 4500 fps are generally rippable with a D9 Caterpillar Tractor equipped with a single shank hydraulic ripper. Velocities of 4500 to 5500 fps indicate marginal ripping and blasting. Velocities greater than 5500 fps generally require pre-blasting. For trenching, materials with velocities less than 3800 fps are generally rippable depending upon the degree of fracturing and the presence or absence of boulders. Velocities between 3800 and 4300 fps generally indicate marginal ripping, and velocities greater than 4300 fps generally indicate non-rippable conditions. The above velocities are based on a Kohring 505.

The reported velocities represent average velocities over the length of each traverse, and should not generally be used for subsurface interpretation greater than 100 feet from a traverse.

**TABLE A-II
APPROXIMATE THICKNESS OF RIPPABLE ROCK (GEOCON 1979)**

Traverse No.	Approximate Thickness (ft.)*
S-1	4
S-2	3
S-3	4
S-4	4
S-5	3
S-6	5
S-7	4
S-9	3
S-10	Marginally rippable from 3 to 20 feet
S-12	3

*Assumes D9 Caterpillar tractor.







DEPTH IN FEET	SAMPLE NO.	LITHOLOGY	GROUNDWATER	TRENCH T 1		PENETRATION RESISTANCE (BLOWS/FT.)	DRY DENSITY (P.C.F.)	MOISTURE CONTENT (%)
				ELEV. (MSL.) <u>414</u>	DATE COMPLETED <u>11/26/01</u>			
					EQUIPMENT <u>JOHN DEERE 710D</u>			
MATERIAL DESCRIPTION								
0				CL/SC	<p>UNDOCUMENTED FILL Soft, damp, dark reddish-brown, fine to coarse Sandy CLAY/Clayey, fine to coarse SAND -Numerous 1 foot subangular rock fragments -Abundant stockpiles containing gravel and 2-3 foot boulders at surface</p>			
2								
4					<p>GRANITIC ROCK Moderately weathered, yellowish-brown, weak, GRANITIC ROCK -Becomes slightly weathered and highly fractured with moderate weathering along fractures at 4 feet -Excavates to fine to coarse, Silty SAND with 3 inch to 1 foot angular rock fragments -Numerous 2 foot fragments below 6 feet</p>			
6								
8								
TRENCH TERMINATED AT 8.5 FEET								

Figure A-1, Log of Trench T 1

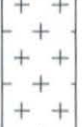
MARBP

SAMPLE SYMBOLS	 ... SAMPLING UNSUCCESSFUL	 ... STANDARD PENETRATION TEST	 ... DRIVE SAMPLE (UNDISTURBED)
	 ... DISTURBED OR BAG SAMPLE	 ... CHUNK SAMPLE	 ... WATER TABLE OR SEEPAGE

NOTE: THE LOG OF SUBSURFACE CONDITIONS SHOWN HEREON APPLIES ONLY AT THE SPECIFIC BORING OR TRENCH LOCATION AND AT THE DATE INDICATED. IT IS NOT WARRANTED TO BE REPRESENTATIVE OF SUBSURFACE CONDITIONS AT OTHER LOCATIONS AND TIMES.

DEPTH IN FEET	SAMPLE NO.	LITHOLOGY	GROUNDWATER	SOIL CLASS (USCS)	TRENCH T 2		PENETRATION RESISTANCE (BLOWS/FT.)	DRY DENSITY (P.C.F.)	MOISTURE CONTENT (%)
					ELEV. (MSL.)	DATE COMPLETED			
					ELEV. (MSL.)	421	DATE COMPLETED	11/26/01	
					EQUIPMENT	JOHN DEERE 710D			
MATERIAL DESCRIPTION									
0				SM	<p>UNDOCUMENTED FILL Medium dense, damp, yellowish-brown, Silty, fine to very coarse SAND with little clay and abundant subangular gravel -Becomes reddish-brown at 2.5 feet -Boulder stockpiles with boulders up to 2 feet at surface -Concrete debris at surface</p>				
2					<p>GRANITIC ROCK Moderately weathered, reddish-brown to yellowish-brown, moderately strong, GRANITIC ROCK -Excavates to Silty, fine to very coarse SAND with 1 to 4 inch angular rock fragments</p>				
4									
6									
8					TRENCH TERMINATED AT 8 FEET				

Figure A-2, Log of Trench T 2

MARBP

SAMPLE SYMBOLS	<input type="checkbox"/>	... SAMPLING UNSUCCESSFUL	<input type="checkbox"/>	... STANDARD PENETRATION TEST	<input type="checkbox"/>	... DRIVE SAMPLE (UNDISTURBED)
	<input checked="" type="checkbox"/>	... DISTURBED OR BAG SAMPLE	<input checked="" type="checkbox"/>	... CHUNK SAMPLE		... WATER TABLE OR SEEPAGE

NOTE: THE LOG OF SUBSURFACE CONDITIONS SHOWN HEREON APPLIES ONLY AT THE SPECIFIC BORING OR TRENCH LOCATION AND AT THE DATE INDICATED. IT IS NOT WARRANTED TO BE REPRESENTATIVE OF SUBSURFACE CONDITIONS AT OTHER LOCATIONS AND TIMES.

DEPTH IN FEET	SAMPLE NO.	LITHOLOGY	GROUNDWATER	SOIL CLASS (USCS)	TRENCH T 3		PENETRATION RESISTANCE (BLOWS/FT.)	DRY DENSITY (P.C.F.)	MOISTURE CONTENT (%)				
					ELEV. (MSL.) 430	DATE COMPLETED 11/26/01							
					EQUIPMENT JOHN DEERE 710D								
MATERIAL DESCRIPTION													
0				SM	ALLUVIUM/COLLUVIUM Loose, damp, reddish-brown to yellowish-brown, Silty, fine to coarse SAND with abundant gravel GRANITIC ROCK Slightly weathered, bluish-gray with some pink, strong to very strong, highly fractured GRANITIC ROCK -Minor seepage along fractures -Excavates to Silty, fine to very coarse SAND and 1 inch to 1 foot angular rock fragments -Occasional fragments up to 2 feet								
2													
4													
6													
8													
10													
TRENCH TERMINATED AT 10 FEET													

Figure A-3, Log of Trench T 3

MARBP

SAMPLE SYMBOLS	<input type="checkbox"/> ... SAMPLING UNSUCCESSFUL	<input type="checkbox"/> ... STANDARD PENETRATION TEST	<input type="checkbox"/> ... DRIVE SAMPLE (UNDISTURBED)
	<input checked="" type="checkbox"/> ... DISTURBED OR BAG SAMPLE	<input type="checkbox"/> ... CHUNK SAMPLE	<input type="checkbox"/> ... WATER TABLE OR SEEPAGE

NOTE: THE LOG OF SUBSURFACE CONDITIONS SHOWN HEREON APPLIES ONLY AT THE SPECIFIC BORING OR TRENCH LOCATION AND AT THE DATE INDICATED. IT IS NOT WARRANTED TO BE REPRESENTATIVE OF SUBSURFACE CONDITIONS AT OTHER LOCATIONS AND TIMES.

DEPTH IN FEET	SAMPLE NO.	LITHOLOGY	GROUNDWATER	SOIL CLASS (USCS)	TRENCH T 4		PENETRATION RESISTANCE (BLOWS/FT.)	DRY DENSITY (P.C.F.)	MOISTURE CONTENT (%)	
					ELEV. (MSL.) <u>448</u>	DATE COMPLETED <u>11/26/01</u>				
					EQUIPMENT <u>JOHN DEERE 710D</u>					
MATERIAL DESCRIPTION										
0		+			<p>GRANITIC ROCK(BLAST AFFECTED) Slightly weathered, grayish-brown to yellowish-brown, moderately strong to strong, highly fractured GRANITIC ROCK</p> <p>-Excavates to Silty, fine to very coarse SAND and 1-6 inch subangular rock fragments with occasional 1 foot fragments</p> <p>-Becomes bluish-gray, slightly weathered to fresh at 4 feet. Continuous to be highly fractured</p> <p>-Caving of trench walls from 0 to 10 feet -Easy to dig due to degree of fractured rock -Blasting wires observed in upper 5 feet</p>					
2		+								
4		+								
6		+								
8		+								
10		+								
						TRENCH TERMINATED AT 11 FEET				

Figure A-4, Log of Trench T 4

MARBP

SAMPLE SYMBOLS	<input type="checkbox"/> ... SAMPLING UNSUCCESSFUL	<input type="checkbox"/> ... STANDARD PENETRATION TEST	<input type="checkbox"/> ... DRIVE SAMPLE (UNDISTURBED)
	<input type="checkbox"/> ... DISTURBED OR BAG SAMPLE	<input type="checkbox"/> ... CHUNK SAMPLE	<input type="checkbox"/> ... WATER TABLE OR SEEPAGE

NOTE: THE LOG OF SUBSURFACE CONDITIONS SHOWN HEREON APPLIES ONLY AT THE SPECIFIC BORING OR TRENCH LOCATION AND AT THE DATE INDICATED. IT IS NOT WARRANTED TO BE REPRESENTATIVE OF SUBSURFACE CONDITIONS AT OTHER LOCATIONS AND TIMES.

DEPTH IN FEET	SAMPLE NO.	LITHOLOGY	GROUNDWATER	SOIL CLASS (USCS)	TRENCH T 5		PENETRATION RESISTANCE (BLOWS/FT.)	DRY DENSITY (P.C.F.)	MOISTURE CONTENT (%)
					ELEV. (MSL.) <u>428</u>	DATE COMPLETED <u>11/26/01</u>			
					EQUIPMENT <u>JOHN DEERE 710D</u>				
MATERIAL DESCRIPTION									
0		+ + + + + +			GRANITIC ROCK Highly weathered, reddish-brown, weak GRANITIC ROCK -Becomes slightly weathered and very strong at 1 foot -Excavates to Silty, fine to very coarse SAND with 1 inch to 6 inch angular fragments -Moderately fractured PRACTICAL REFUSAL AT 3 FEET				
2		+ + + +							

Figure A-5, Log of Trench T 5

MARBP

SAMPLE SYMBOLS	<input type="checkbox"/> ... SAMPLING UNSUCCESSFUL	<input type="checkbox"/> ... STANDARD PENETRATION TEST	<input type="checkbox"/> ... DRIVE SAMPLE (UNDISTURBED)
	<input checked="" type="checkbox"/> ... DISTURBED OR BAG SAMPLE	<input type="checkbox"/> ... CHUNK SAMPLE	<input type="checkbox"/> ... WATER TABLE OR SEEPAGE

NOTE: THE LOG OF SUBSURFACE CONDITIONS SHOWN HEREON APPLIES ONLY AT THE SPECIFIC BORING OR TRENCH LOCATION AND AT THE DATE INDICATED. IT IS NOT WARRANTED TO BE REPRESENTATIVE OF SUBSURFACE CONDITIONS AT OTHER LOCATIONS AND TIMES.

DEPTH IN FEET	SAMPLE NO.	LITHOLOGY	GROUNDWATER	SOIL CLASS (USCS)	TRENCH T 6		PENETRATION RESISTANCE (BLOWS/FT.)	DRY DENSITY (P.C.F.)	MOISTURE CONTENT (%)		
					ELEV. (MSL.) <u>478</u>	DATE COMPLETED <u>11/26/01</u>					
					EQUIPMENT <u>JOHN DEERE 710D</u>						
MATERIAL DESCRIPTION											
0		++			<p>GRANITIC ROCK(BLAST AFFECTED) Slightly weathered, light yellowish-brown with some gray and pink, strong, highly fractured, GRANITIC ROCK</p> <p>-Fracturing both horizontal and vertical with up to 2 inches of separation. Some fractures infilled with loose, damp, reddish-brown to yellowish-brown, silty, fine to very coarse sand</p> <p>-Blasting wires observed in upper 5 feet</p> <p>-Excavates to 1 inch to 2 foot subangular rock fragments with abundant fines</p> <p>-Becomes slightly weathered to fresh and very strong at 2 feet</p> <p>-Continues to be highly fractured the depth of trench</p> <p>-Caving of trench walls from 0 to 10 feet</p>						
2		++									
4		++									
6		++									
8		++									
10		++									
12		++									
TRENCH TERMINATED AT 13 FEET											

Figure A-6, Log of Trench T 6

MARBP

SAMPLE SYMBOLS	<input type="checkbox"/> ... SAMPLING UNSUCCESSFUL	<input type="checkbox"/> ... STANDARD PENETRATION TEST	<input type="checkbox"/> ... DRIVE SAMPLE (UNDISTURBED)
	<input checked="" type="checkbox"/> ... DISTURBED OR BAG SAMPLE	<input checked="" type="checkbox"/> ... CHUNK SAMPLE	<input checked="" type="checkbox"/> ... WATER TABLE OR SEEPAGE

NOTE: THE LOG OF SUBSURFACE CONDITIONS SHOWN HEREON APPLIES ONLY AT THE SPECIFIC BORING OR TRENCH LOCATION AND AT THE DATE INDICATED. IT IS NOT WARRANTED TO BE REPRESENTATIVE OF SUBSURFACE CONDITIONS AT OTHER LOCATIONS AND TIMES.

DEPTH IN FEET	SAMPLE NO.	LITHOLOGY	GROUNDWATER	SOIL CLASS (USCS)	TRENCH T 7		PENETRATION RESISTANCE (BLOWS/FT.)	DRY DENSITY (P.C.F.)	MOISTURE CONTENT (%)	
					ELEV. (MSL.) <u>457</u>	DATE COMPLETED <u>11/26/01</u>				
					EQUIPMENT <u>JOHN DEERE 710D</u>					
MATERIAL DESCRIPTION										
0		+			<p>GRANITIC ROCK Highly to moderately weathered, reddish-brown to yellowish-brown, weak, GRANITIC ROCK -Becomes moderately weathered and strong and moderately fractured at 1 foot</p> <p>-Excavates to Silty, fine to very coarse SAND and 1 inch to 6 inch subangular rock fragments with occasional 1 foot fragments -Becomes moderately to slightly weathered at 6 feet</p> <p>Continues to be moderately fractured</p> <p>-Fractures infilled with decomposed granite</p> <p>-Numerous 2 foot boulders at 10 feet</p>					
2		+								
4		+								
6		+								
8		+								
10		+								
12		+								
14		+								
						TRENCH TERMINATED AT 14 FEET				

Figure A-7, Log of Trench T 7

MARBP

SAMPLE SYMBOLS	<input type="checkbox"/> ... SAMPLING UNSUCCESSFUL	<input type="checkbox"/> ... STANDARD PENETRATION TEST	<input type="checkbox"/> ... DRIVE SAMPLE (UNDISTURBED)
	<input type="checkbox"/> ... DISTURBED OR BAG SAMPLE	<input type="checkbox"/> ... CHUNK SAMPLE	<input type="checkbox"/> ... WATER TABLE OR SEEPAGE

NOTE: THE LOG OF SUBSURFACE CONDITIONS SHOWN HEREON APPLIES ONLY AT THE SPECIFIC BORING OR TRENCH LOCATION AND AT THE DATE INDICATED. IT IS NOT WARRANTED TO BE REPRESENTATIVE OF SUBSURFACE CONDITIONS AT OTHER LOCATIONS AND TIMES.



DEPTH IN FEET	SAMPLE NO.	LITHOLOGY	GROUNDWATER	SOIL CLASS (USCS)	TRENCH T 8		PENETRATION RESISTANCE (BLOWS/FT.)	DRY DENSITY (P.C.F.)	MOISTURE CONTENT (%)			
					ELEV. (MSL.) <u>430</u>	DATE COMPLETED <u>11/26/01</u>						
					EQUIPMENT <u>JOHN DEERE 710D</u>							
MATERIAL DESCRIPTION												
0				SM	<p>UNDOCUMENTED FILL* Loose to damp, dark yellowish-brown, Silty, fine to very coarse SAND with little clay and some gravel</p> <p>-Abundant subangular rock fragments from 6 inches to 1.5 feet in size from 0 to 6 feet -2 foot boulders visible at top of stockpile -Fill becomes dry at 2 feet</p>							
2												
4				SM	<p>ALLUVIUM/COLLUVIUM Dense, damp, dark brown, Silty, fine to coarse SAND with little clay -Abundant voids visible in matrix</p>							
6												
8					<p>GRANITIC ROCK Moderately to slightly weathered, reddish-brown to yellowish-brown, strong to very strong, GRANITIC ROCK</p> <p style="text-align: center;">REFUSAL AT 8 FEET</p> <p>*NOTE: Deposits described herein are overlain by approximately 8 feet of Undocumented Fill immediately adjacent the trench to the North.</p>							

Figure A-8, Log of Trench T 8

MARBP

SAMPLE SYMBOLS	 ... SAMPLING UNSUCCESSFUL	 ... STANDARD PENETRATION TEST	 ... DRIVE SAMPLE (UNDISTURBED)
	 ... DISTURBED OR BAG SAMPLE	 ... CHUNK SAMPLE	 ... WATER TABLE OR SEEPAGE

NOTE: THE LOG OF SUBSURFACE CONDITIONS SHOWN HEREON APPLIES ONLY AT THE SPECIFIC BORING OR TRENCH LOCATION AND AT THE DATE INDICATED. IT IS NOT WARRANTED TO BE REPRESENTATIVE OF SUBSURFACE CONDITIONS AT OTHER LOCATIONS AND TIMES.

DEPTH IN FEET	SAMPLE NO.	LITHOLOGY	GROUNDWATER	SOIL CLASS (USCS)	TRENCH T 9		PENETRATION RESISTANCE (BLOWS/FT.)	DRY DENSITY (P.C.F.)	MOISTURE CONTENT (%)
					ELEV. (MSL.) <u>439</u>	DATE COMPLETED <u>11/26/01</u>			
					EQUIPMENT <u>JOHN DEERE 710D</u>				
MATERIAL DESCRIPTION									
0				SC	UNDOCUMENTED FILL Loose, damp, dark brown, Clayey, fine to medium SAND				
2				SM	Loose, dry, light orange-brown, Silty, fine to very coarse SAND with abundant 1 inch to 1.5 foot angular to subangular rock fragments -Numerous 2 foot rock fragments below 3 feet -Becomes medium dense at 4 feet				
4									
6									
8									
10					-Moderate caving of trench walls from 0 to 8 feet -Difficult digging due to oversize rock -Occasional 3 foot rock fragments -Becomes damp with dense matrix at 6 feet				
12	T9-1			SC	ALLUVIUM/COLLUVIUM Dense, damp, dark bluish-gray to black, Clayey, fine to coarse SAND with abundant organics				
14									
16				ML	Stiff, damp to moist, dark brown, fine to medium Sandy SILT -No oversize rock past 15 feet				
18									
20									
22					GRANITIC ROCK Moderately weathered, yellowish-brown to reddish-brown, moderately strong, GRANITIC ROCK				
TRENCH TERMINATED AT 22 FEET									

Figure A-9, Log of Trench T 9

MARBP

SAMPLE SYMBOLS	
□ ... SAMPLING UNSUCCESSFUL	■ ... STANDARD PENETRATION TEST
▣ ... DISTURBED OR BAG SAMPLE	■ ... DRIVE SAMPLE (UNDISTURBED)
▣ ... CHUNK SAMPLE	▼ ... WATER TABLE OR SEEPAGE

NOTE: THE LOG OF SUBSURFACE CONDITIONS SHOWN HEREON APPLIES ONLY AT THE SPECIFIC BORING OR TRENCH LOCATION AND AT THE DATE INDICATED. IT IS NOT WARRANTED TO BE REPRESENTATIVE OF SUBSURFACE CONDITIONS AT OTHER LOCATIONS AND TIMES.

DEPTH IN FEET	SAMPLE NO.	LITHOLOGY	GROUNDWATER	SOIL CLASS (USCS)	TRENCH T 10		PENETRATION RESISTANCE (BLOWS/FT.)	DRY DENSITY (P.C.F.)	MOISTURE CONTENT (%)	
					ELEV. (MSL.) <u>445</u>	DATE COMPLETED <u>11/27/01</u>				
					EQUIPMENT <u>JOHN DEERE 710D</u>					
MATERIAL DESCRIPTION										
0					<p>UNDOCUMENTED FILL Loose, damp, yellowish-brown to reddish-brown, Silty, fine to coarse SAND with abundant gravel size to boulder size rock fragments -Becomes medium dense to dense at 1.5 feet -Rock fragments from 2 inches to 2 feet in size and matrix supported -Limited zones of loose, dry matrix below 2 feet</p> <p>-Difficult trenching due to amount of oversize rock</p> <p>-Excavates to Silty, fine to coarse SAND matrix with abundant angular to subangular rock fragments up to 2 feet</p>					
2										
4						SM				
6										
8										
10										
12										
14										
16						SM				
18							<p>ALLUVIUM/COLLUVIUM Dense, damp, dark brown, Silty, fine to coarse SAND -Numerous pinhole voids</p> <p>GRANITIC ROCK Moderately weathered, yellowish-brown, moderately strong, GRANITIC ROCK</p> <p>TRENCH TERMINATED AT 18 FEET</p>			

Figure A-10, Log of Trench T 10

MARBP

SAMPLE SYMBOLS	... SAMPLING UNSUCCESSFUL	... STANDARD PENETRATION TEST	... DRIVE SAMPLE (UNDISTURBED)
	... DISTURBED OR BAG SAMPLE	... CHUNK SAMPLE	... WATER TABLE OR SEEPAGE

NOTE: THE LOG OF SUBSURFACE CONDITIONS SHOWN HEREON APPLIES ONLY AT THE SPECIFIC BORING OR TRENCH LOCATION AND AT THE DATE INDICATED. IT IS NOT WARRANTED TO BE REPRESENTATIVE OF SUBSURFACE CONDITIONS AT OTHER LOCATIONS AND TIMES.

DEPTH IN FEET	SAMPLE NO.	LITHOLOGY	GROUNDWATER	SOIL CLASS (USCS)	TRENCH T 11		PENETRATION RESISTANCE (BLOWS/FT.)	DRY DENSITY (P.C.F.)	MOISTURE CONTENT (%)
					ELEV. (MSL.) <u>444</u>	DATE COMPLETED <u>11/27/01</u>			
					EQUIPMENT <u>JOHN DEERE 710D</u>				
MATERIAL DESCRIPTION									
0	T11-1			SC	<p>UNDOCUMENTED FILL Loose, damp, brown to reddish-brown, Clayey, fine to coarse SAND with gravel -Becomes dark brown at 2 feet</p>				
2				SM	<p>Medium dense to dense, damp, yellowish-brown to reddish-brown, Silty, fine to very coarse SAND with abundant subangular rock and little clay -Matrix supported with rock size from 3 inches to 2 feet -Observed blasting wire at 6 feet</p>				
4				SM/SC	<p>-Difficult to dig due to oversize rock -3 foot boulder which could not be excavated at 5 feet -Becomes brown to reddish-brown with more clay at 7 feet -Minor caving at 7 feet -Limited zones of point on point rock contact below 7 feet</p>				
6									
8									
10									
12									
14									
16				SM	<p>ALLUVIUM/COLLUVIUM Medium dense, damp to moist, very dark brown to black, Silty, fine to medium SAND with abundant organics -Becomes olive-gray with abundant gravel and less organics at 15.5 feet -Becomes dense to very dense at 16 feet with no organics</p>				
18									
					<p>GRANITIC ROCK Moderately weathered to slightly weathered, grayish-brown to yellowish-brown, strong to very strong, GRANITIC ROCK</p> <p style="text-align: center;">TRENCH TERMINATED AT 19.5 FEET</p>				

Figure A-11, Log of Trench T 11

MARBP

SAMPLE SYMBOLS	
... SAMPLING UNSUCCESSFUL	... STANDARD PENETRATION TEST
... DISTURBED OR BAG SAMPLE	... DRIVE SAMPLE (UNDISTURBED)
... CHUNK SAMPLE	... WATER TABLE OR SEEPAGE

NOTE: THE LOG OF SUBSURFACE CONDITIONS SHOWN HEREON APPLIES ONLY AT THE SPECIFIC BORING OR TRENCH LOCATION AND AT THE DATE INDICATED. IT IS NOT WARRANTED TO BE REPRESENTATIVE OF SUBSURFACE CONDITIONS AT OTHER LOCATIONS AND TIMES.

DEPTH IN FEET	SAMPLE NO.	LITHOLOGY	GROUNDWATER	SOIL CLASS (USCS)	TRENCH T 12		PENETRATION RESISTANCE (BLOWS/FT.)	DRY DENSITY (P.C.F.)	MOISTURE CONTENT (%)			
					ELEV. (MSL.) <u>453</u>	DATE COMPLETED <u>11/27/01</u>						
					EQUIPMENT <u>JOHN DEERE 710D</u>							
MATERIAL DESCRIPTION												
0				SM	<p>UNDOCUMENTED FILL Loose, damp, light olive, Silty, fine to medium SAND</p> <p>Medium dense, dry, dark brown, Silty, fine to coarse SAND with little clay and occasional 6 inch rock fragments</p> <p>Medium stiff, dry, dark reddish-brown, fine to medium Sandy SILT with gravel</p> <p>Medium dense, dry, brown, Silty, fine to coarse SAND with numerous 6 inch rock fragments and some clay</p> <p>-Occasional asphalt chunks at 6 feet</p> <p>-Numerous 2 foot subangular rock at 9 feet</p> <p>-Becomes damp with abundant 6-inch matrix supported fragments at 6 feet</p>							
2			SM									
4			ML									
6			SM									
8				SM								
10	T12-1											
12												
14				SM	<p>ALLUVIUM/COLLUVIUM Medium dense, damp to moist, very dark brown to black, Silty, fine to medium SAND with some gravel and abundant organics</p> <p>-Becomes olive-gray with abundant gravel and no organics at 14 feet</p> <p>Stiff, moist, olive-blue-gray, fine to coarse Sandy CLAY</p> <p>REFUSAL ON GRANITIC ROCK AT 15 FEET</p>							
				CL								

Figure A-12, Log of Trench T 12

MARBP

SAMPLE SYMBOLS	□ ... SAMPLING UNSUCCESSFUL	■ ... STANDARD PENETRATION TEST	■ ... DRIVE SAMPLE (UNDISTURBED)
	⊗ ... DISTURBED OR BAG SAMPLE	▣ ... CHUNK SAMPLE	▼ ... WATER TABLE OR SEEPAGE

NOTE: THE LOG OF SUBSURFACE CONDITIONS SHOWN HEREON APPLIES ONLY AT THE SPECIFIC BORING OR TRENCH LOCATION AND AT THE DATE INDICATED. IT IS NOT WARRANTED TO BE REPRESENTATIVE OF SUBSURFACE CONDITIONS AT OTHER LOCATIONS AND TIMES.

DEPTH IN FEET	SAMPLE NO.	LITHOLOGY	GROUNDWATER	SOIL CLASS (USCS)	TRENCH T 13		PENETRATION RESISTANCE (BLOWS/FT.)	DRY DENSITY (P.C.F.)	MOISTURE CONTENT (%)
					ELEV. (MSL.) <u>453</u>	DATE COMPLETED <u>11/27/01</u>			
					EQUIPMENT <u>JOHN DEERE 710D</u>				
MATERIAL DESCRIPTION									
0				SM	UNDOCUMENTED FILL ASPHALT stockpile at surface Loose, damp, dark brown, Silty, fine to medium SAND				
2				SC	Medium dense, damp, grayish-brown to reddish-brown, Clayey, fine to coarse SAND with abundant gravel and 6 inch to 1 foot subangular rock fragments -Rock fragments are matrix supported -Excavates to Clayey, fine to coarse SAND with gravel and rock -Difficult digging below 5 feet due to rock fragments -Numerous 3 foot boulders at 8 feet -Minor caving of trench walls from 0 to 9 feet				
4									
6									
8									
10									
12				SM	ALLUVIUM/COLLUVIUM Medium dense to dense, damp to moist, very dark brown to black, Silty, fine to coarse SAND with some gravel REFUSAL ON GRANITIC ROCK AT 13 FEET				

Figure A-13, Log of Trench T 13

MARBP

SAMPLE SYMBOLS	□ ... SAMPLING UNSUCCESSFUL	▣ ... STANDARD PENETRATION TEST	■ ... DRIVE SAMPLE (UNDISTURBED)
	⊠ ... DISTURBED OR BAG SAMPLE	▤ ... CHUNK SAMPLE	▼ ... WATER TABLE OR SEEPAGE

NOTE: THE LOG OF SUBSURFACE CONDITIONS SHOWN HEREON APPLIES ONLY AT THE SPECIFIC BORING OR TRENCH LOCATION AND AT THE DATE INDICATED. IT IS NOT WARRANTED TO BE REPRESENTATIVE OF SUBSURFACE CONDITIONS AT OTHER LOCATIONS AND TIMES.

DEPTH IN FEET	SAMPLE NO.	LITHOLOGY	GROUNDWATER	SOIL CLASS (USCS)	TRENCH T 14		PENETRATION RESISTANCE (BLOWS/FT.)	DRY DENSITY (P.C.F.)	MOISTURE CONTENT (%)
					ELEV. (MSL.) <u>447</u>	DATE COMPLETED <u>11/27/01</u>			
					EQUIPMENT <u>JOHN DEERE 710D</u>				
MATERIAL DESCRIPTION									
0				ML	ALLUVIUM/COLLUVIUM Loose, damp, very dark brown, fine Sandy SILT				
2				SM	Loose, dry, brown, Silty, fine to coarse SAND with abundant 6 inch and 1 foot angular rock fragments -Becomes medium dense and damp at 2 feet				
4									
6									
8					GRANITIC ROCK Slightly weathered, yellowish-brown, very strong, highly fractured, GRANITIC ROCK PRACTICAL REFUSAL AT 8 FEET				

Figure A-14, Log of Trench T 14

MARBP

SAMPLE SYMBOLS	<input type="checkbox"/>	... SAMPLING UNSUCCESSFUL	<input type="checkbox"/>	... STANDARD PENETRATION TEST	<input type="checkbox"/>	... DRIVE SAMPLE (UNDISTURBED)
	<input checked="" type="checkbox"/>	... DISTURBED OR BAG SAMPLE	<input type="checkbox"/>	... CHUNK SAMPLE	<input type="checkbox"/>	... WATER TABLE OR SEEPAGE

NOTE: THE LOG OF SUBSURFACE CONDITIONS SHOWN HEREON APPLIES ONLY AT THE SPECIFIC BORING OR TRENCH LOCATION AND AT THE DATE INDICATED. IT IS NOT WARRANTED TO BE REPRESENTATIVE OF SUBSURFACE CONDITIONS AT OTHER LOCATIONS AND TIMES.

DEPTH IN FEET	SAMPLE NO.	LITHOLOGY	GROUNDWATER	SOIL CLASS (USCS)	TRENCH T 15		PENETRATION RESISTANCE (BLOWS/FT.)	DRY DENSITY (P.C.F.)	MOISTURE CONTENT (%)
					ELEV. (MSL.) 450	DATE COMPLETED 11/27/01			
					EQUIPMENT JOHN DEERE 710D				
MATERIAL DESCRIPTION									
0				SM	UNDOCUMENTED FILL Loose, damp, yellowish-brown, Silty, fine to very coarse SAND with abundant 3-inch to 1 foot subangular rock fragments and occasional 2 foot fragments -Mostly matrix supported with some point on point contact of rock -Becomes dry and medium dense at 2 feet				
2									
4									
6					REFUSAL ON GRANITIC ROCK AT 7 FEET				

Figure A-15, Log of Trench T 15

MARBP

SAMPLE SYMBOLS	<input type="checkbox"/> ... SAMPLING UNSUCCESSFUL	<input type="checkbox"/> ... STANDARD PENETRATION TEST	<input type="checkbox"/> ... DRIVE SAMPLE (UNDISTURBED)
	<input checked="" type="checkbox"/> ... DISTURBED OR BAG SAMPLE	<input checked="" type="checkbox"/> ... CHUNK SAMPLE	<input checked="" type="checkbox"/> ... WATER TABLE OR SEEPAGE

NOTE: THE LOG OF SUBSURFACE CONDITIONS SHOWN HEREON APPLIES ONLY AT THE SPECIFIC BORING OR TRENCH LOCATION AND AT THE DATE INDICATED. IT IS NOT WARRANTED TO BE REPRESENTATIVE OF SUBSURFACE CONDITIONS AT OTHER LOCATIONS AND TIMES.











DEPTH IN FEET	SAMPLE NO.	LITHOLOGY	GROUNDWATER	SOIL CLASS (USCS)	TRENCH T 16		PENETRATION RESISTANCE (BLOWS/FT.)	DRY DENSITY (P.C.F.)	MOISTURE CONTENT (%)
					ELEV. (MSL.) <u>450</u>	DATE COMPLETED <u>11/27/01</u>			
					EQUIPMENT <u>JOHN DEERE 710D</u>				
MATERIAL DESCRIPTION									
0									
2	T16-1			CL	ALLUVIUM/COLLUVIUM Medium stiff, moist, dark reddish-brown, fine to medium Sandy CLAY				
4	T16-2				-Abundant gravel from 2 to 4 feet				
6	T16-3			SC	Very dense, damp, reddish-brown, moderately cemented Clayey SAND with some gravel				
8					GRANITIC ROCK Moderately weathered, reddish-brown, moderately strong, GRANITIC ROCK				
TRENCH TERMINATED AT 8 FEET									

Figure A-16, Log of Trench T 16

MARBP

SAMPLE SYMBOLS		... SAMPLING UNSUCCESSFUL		... STANDARD PENETRATION TEST		... DRIVE SAMPLE (UNDISTURBED)
		... DISTURBED OR BAG SAMPLE		... CHUNK SAMPLE		... WATER TABLE OR SEEPAGE

NOTE: THE LOG OF SUBSURFACE CONDITIONS SHOWN HEREON APPLIES ONLY AT THE SPECIFIC BORING OR TRENCH LOCATION AND AT THE DATE INDICATED. IT IS NOT WARRANTED TO BE REPRESENTATIVE OF SUBSURFACE CONDITIONS AT OTHER LOCATIONS AND TIMES.







DEPTH IN FEET	SAMPLE NO.	LITHOLOGY	GROUNDWATER	SOIL CLASS (USCS)	TRENCH T 17		PENETRATION RESISTANCE (BLOWS/FT.)	DRY DENSITY (P.C.F.)	MOISTURE CONTENT (%)
					ELEV. (MSL.) <u>455</u>	DATE COMPLETED <u>11/27/01</u>			
					EQUIPMENT <u>JOHN DEERE 710D</u>				
MATERIAL DESCRIPTION									
0				SM	<p>ALLUVIUM/COLLUVIUM Loose, dry, Silty, fine to medium SAND with some gravel</p> <p>Dense to very dense, damp, reddish-brown, moderately cemented, Clayey, fine to coarse SAND with abundant gravel</p>				
2				SC/GC					
4									
6					<p>GRANITIC ROCK Highly to moderately weathered, reddish-brown to yellowish-brown, strong, GRANITIC ROCK</p> <p>PRACTICAL REFUSAL AT 6.5 FEET</p>				

Figure A-17, Log of Trench T 17

MARBP

SAMPLE SYMBOLS					
	... SAMPLING UNSUCCESSFUL		... STANDARD PENETRATION TEST		... DRIVE SAMPLE (UNDISTURBED)
	... DISTURBED OR BAG SAMPLE		... CHUNK SAMPLE		... WATER TABLE OR SEEPAGE

NOTE: THE LOG OF SUBSURFACE CONDITIONS SHOWN HEREON APPLIES ONLY AT THE SPECIFIC BORING OR TRENCH LOCATION AND AT THE DATE INDICATED. IT IS NOT WARRANTED TO BE REPRESENTATIVE OF SUBSURFACE CONDITIONS AT OTHER LOCATIONS AND TIMES.

DEPTH IN FEET	SAMPLE NO.	LITHOLOGY	GROUNDWATER	SOIL CLASS (USCS)	TRENCH T 18		PENETRATION RESISTANCE (BLOWS/FT.)	DRY DENSITY (P.C.F.)	MOISTURE CONTENT (%)			
					ELEV. (MSL.) <u>448</u>	DATE COMPLETED <u>11/27/01</u>						
					EQUIPMENT <u>JOHN DEERE 710D</u>							
MATERIAL DESCRIPTION												
0				SC	<p>UNDOCUMENTED FILL Loose, damp, brown to dark brown, Clayey, fine to coarse SAND with abundant 4 inch to 2 foot subangular rock fragments -Becomes medium dense at 2 feet</p> <p>-Predominantly matrix supported with some point on point contact of fragments</p> <p>-Occasional 3 foot boulders</p>							
2												
4												
6												
8		+ +			<p>GRANITIC ROCK Moderately weathered, reddish-brown to yellowish-brown, strong, GRANITIC ROCK TRENCH TERMINATED AT 8.5 FEET</p>							

Figure A-18, Log of Trench T 18

MARBP

SAMPLE SYMBOLS	<input type="checkbox"/> ... SAMPLING UNSUCCESSFUL	<input type="checkbox"/> ... STANDARD PENETRATION TEST	<input type="checkbox"/> ... DRIVE SAMPLE (UNDISTURBED)
	<input type="checkbox"/> ... DISTURBED OR BAG SAMPLE	<input type="checkbox"/> ... CHUNK SAMPLE	<input type="checkbox"/> ... WATER TABLE OR SEEPAGE

NOTE: THE LOG OF SUBSURFACE CONDITIONS SHOWN HEREON APPLIES ONLY AT THE SPECIFIC BORING OR TRENCH LOCATION AND AT THE DATE INDICATED. IT IS NOT WARRANTED TO BE REPRESENTATIVE OF SUBSURFACE CONDITIONS AT OTHER LOCATIONS AND TIMES.

DEPTH IN FEET	SAMPLE NO.	LITHOLOGY	GROUNDWATER	SOIL CLASS (USCS)	TRENCH T 19		PENETRATION RESISTANCE (BLOWS/FT.)	DRY DENSITY (P.C.F.)	MOISTURE CONTENT (%)
					ELEV. (MSL.) <u>450</u>	DATE COMPLETED <u>11/27/01</u>			
					EQUIPMENT <u>JOHN DEERE 710D</u>				
MATERIAL DESCRIPTION									
0				SM	<p>ALLUVIUM/COLLUVIUM Dry, loose, dark brown to dark reddish-brown, Silty, fine to medium SAND -Becomes medium dense and damp at 2 feet</p> <p>-Gravel layer at 4 feet</p> <p>-Moderate seepage at 5 feet</p>				
2									
4									
6					<p>GRANITIC ROCK Moderately weathered, yellowish-brown, moderately strong, GRANITIC ROCK TRENCH TERMINATED AT 6.5 FEET</p>				

Figure A-19, Log of Trench T 19

MARBP

SAMPLE SYMBOLS	□ ... SAMPLING UNSUCCESSFUL	▣ ... STANDARD PENETRATION TEST	■ ... DRIVE SAMPLE (UNDISTURBED)
	⊠ ... DISTURBED OR BAG SAMPLE	▤ ... CHUNK SAMPLE	▼ ... WATER TABLE OR SEEPAGE

NOTE: THE LOG OF SUBSURFACE CONDITIONS SHOWN HEREON APPLIES ONLY AT THE SPECIFIC BORING OR TRENCH LOCATION AND AT THE DATE INDICATED. IT IS NOT WARRANTED TO BE REPRESENTATIVE OF SUBSURFACE CONDITIONS AT OTHER LOCATIONS AND TIMES.

DEPTH IN FEET	SAMPLE NO.	LITHOLOGY	GROUNDWATER	SOIL CLASS (USCS)	TRENCH T 20		PENETRATION RESISTANCE (BLOWS/FT.)	DRY DENSITY (P.C.F.)	MOISTURE CONTENT (%)
					ELEV. (MSL.) <u>465</u>	DATE COMPLETED <u>11/27/01</u>			
					EQUIPMENT <u>JOHN DEERE 710D</u>				
MATERIAL DESCRIPTION									
0		+ + + + + +			GRANITIC ROCK Moderately weathered, reddish-brown, moderately strong to strong, GRANITIC ROCK				
2		- +					TRENCH TERMINATED AT 2 FEET		

Figure A-20, Log of Trench T 20

MARBP

SAMPLE SYMBOLS	<input type="checkbox"/> ... SAMPLING UNSUCCESSFUL	<input type="checkbox"/> ... STANDARD PENETRATION TEST	<input type="checkbox"/> ... DRIVE SAMPLE (UNDISTURBED)
	<input checked="" type="checkbox"/> ... DISTURBED OR BAG SAMPLE	<input checked="" type="checkbox"/> ... CHUNK SAMPLE	<input type="checkbox"/> ... WATER TABLE OR SEEPAGE

NOTE: THE LOG OF SUBSURFACE CONDITIONS SHOWN HEREON APPLIES ONLY AT THE SPECIFIC BORING OR TRENCH LOCATION AND AT THE DATE INDICATED. IT IS NOT WARRANTED TO BE REPRESENTATIVE OF SUBSURFACE CONDITIONS AT OTHER LOCATIONS AND TIMES.

DEPTH IN FEET	SAMPLE NO.	LITHOLOGY	GROUNDWATER	SOIL CLASS (USCS)	TRENCH T 21		PENETRATION RESISTANCE (BLOWS/FT.)	DRY DENSITY (P.C.F.)	MOISTURE CONTENT (%)
					ELEV. (MSL.) <u>471</u>	DATE COMPLETED <u>11/27/01</u>			
					EQUIPMENT <u>JOHN DEERE 710D</u>				
MATERIAL DESCRIPTION									
0				SM	ALLUVIUM/COLLUVIUM Medium dense, wet, dark brown, Silty, fine to coarse SAND with gravel -Moderate seepage at 2.5 feet				
2			GRANITIC ROCK Slightly weathered, light yellowish-brown to pink, very strong, GRANITIC ROCK REFUSAL AT 3.5 FEET						

Figure A-21, Log of Trench T 21

MARBP

SAMPLE SYMBOLS	<input type="checkbox"/>	... SAMPLING UNSUCCESSFUL	<input type="checkbox"/>	... STANDARD PENETRATION TEST	<input type="checkbox"/>	... DRIVE SAMPLE (UNDISTURBED)
	<input checked="" type="checkbox"/>	... DISTURBED OR BAG SAMPLE	<input checked="" type="checkbox"/>	... CHUNK SAMPLE		... WATER TABLE OR SEEPAGE

NOTE: THE LOG OF SUBSURFACE CONDITIONS SHOWN HEREON APPLIES ONLY AT THE SPECIFIC BORING OR TRENCH LOCATION AND AT THE DATE INDICATED. IT IS NOT WARRANTED TO BE REPRESENTATIVE OF SUBSURFACE CONDITIONS AT OTHER LOCATIONS AND TIMES.

DEPTH IN FEET	SAMPLE NO.	LITHOLOGY	GROUNDWATER	SOIL CLASS (USCS)	TRENCH T 22		PENETRATION RESISTANCE (BLOWS/FT.)	DRY DENSITY (P.C.F.)	MOISTURE CONTENT (%)
					ELEV. (MSL.) <u>472</u>	DATE COMPLETED <u>11/27/01</u>			
					EQUIPMENT <u>JOHN DEERE 710D</u>				
MATERIAL DESCRIPTION									
0				SM	UNDOCUMENTED FILL Loose, dry, dark brown, Silty, fine to medium SAND with abundant 4 inch to 1 foot subangular rock fragments				
2			-Minor caving from 0 to 5 feet						
4			GRANITIC ROCK Moderately weathered, reddish to yellowish-brown, strong, GRANITIC ROCK TRENCH TERMINATED AT 5.5 FEET						

Figure A-22, Log of Trench T 22

MARBP

SAMPLE SYMBOLS	<input type="checkbox"/>	... SAMPLING UNSUCCESSFUL	<input type="checkbox"/>	... STANDARD PENETRATION TEST	<input type="checkbox"/>	... DRIVE SAMPLE (UNDISTURBED)
	<input checked="" type="checkbox"/>	... DISTURBED OR BAG SAMPLE	<input checked="" type="checkbox"/>	... CHUNK SAMPLE	<input type="checkbox"/>	... WATER TABLE OR SEEPAGE

NOTE: THE LOG OF SUBSURFACE CONDITIONS SHOWN HEREON APPLIES ONLY AT THE SPECIFIC BORING OR TRENCH LOCATION AND AT THE DATE INDICATED. IT IS NOT WARRANTED TO BE REPRESENTATIVE OF SUBSURFACE CONDITIONS AT OTHER LOCATIONS AND TIMES.

PROJECT NO. 06827-32-01

DEPTH IN FEET	SAMPLE NO.	LITHOLOGY	GROUNDWATER	SOIL CLASS (USCS)	TRENCH T 23		PENETRATION RESISTANCE (BLOWS/FT.)	DRY DENSITY (P.C.F.)	MOISTURE CONTENT (%)
					ELEV. (MSL.) <u>473</u>	DATE COMPLETED <u>11/27/01</u>			
					EQUIPMENT <u>JOHN DEERE 710D</u>				
MATERIAL DESCRIPTION									
0		+ + + +			GRANITIC ROCK Slightly weathered, grayish-brown with pink, very strong, GRANITIC ROCK REFUSAL AT 1 FOOT				

Figure A-23, Log of Trench T 23

MARBP

SAMPLE SYMBOLS	<input type="checkbox"/> ... SAMPLING UNSUCCESSFUL	<input type="checkbox"/> ... STANDARD PENETRATION TEST	<input type="checkbox"/> ... DRIVE SAMPLE (UNDISTURBED)
	<input checked="" type="checkbox"/> ... DISTURBED OR BAG SAMPLE	<input checked="" type="checkbox"/> ... CHUNK SAMPLE	<input checked="" type="checkbox"/> ... WATER TABLE OR SEEPAGE

NOTE: THE LOG OF SUBSURFACE CONDITIONS SHOWN HEREON APPLIES ONLY AT THE SPECIFIC BORING OR TRENCH LOCATION AND AT THE DATE INDICATED. IT IS NOT WARRANTED TO BE REPRESENTATIVE OF SUBSURFACE CONDITIONS AT OTHER LOCATIONS AND TIMES.

DEPTH IN FEET	SAMPLE NO.	LITHOLOGY	GROUNDWATER	SOIL CLASS (USCS)	TRENCH T 24		PENETRATION RESISTANCE (BLOWS/FT.)	DRY DENSITY (P.C.F.)	MOISTURE CONTENT (%)
					ELEV. (MSL.) 508	DATE COMPLETED 11/27/01			
					EQUIPMENT JOHN DEERE 710D				
MATERIAL DESCRIPTION									
0									
2									
4	T24-1			SM					
6									
8									
10									
12									
14									
16									
					GRANITIC ROCK Moderately weathered, grayish to yellowish-brown, strong, GRANITIC ROCK TRENCH TERMINATED AT 17 FEET				

Figure A-24, Log of Trench T 24

MARBP

SAMPLE SYMBOLS	□ ... SAMPLING UNSUCCESSFUL	▣ ... STANDARD PENETRATION TEST	■ ... DRIVE SAMPLE (UNDISTURBED)
	⊠ ... DISTURBED OR BAG SAMPLE	▤ ... CHUNK SAMPLE	▼ ... WATER TABLE OR SEEPAGE

NOTE: THE LOG OF SUBSURFACE CONDITIONS SHOWN HEREON APPLIES ONLY AT THE SPECIFIC BORING OR TRENCH LOCATION AND AT THE DATE INDICATED. IT IS NOT WARRANTED TO BE REPRESENTATIVE OF SUBSURFACE CONDITIONS AT OTHER LOCATIONS AND TIMES.









DEPTH IN FEET	SAMPLE NO.	LITHOLOGY	GROUNDWATER	SOIL CLASS (USCS)	TRENCH T 25		PENETRATION RESISTANCE (BLOWS/FT.)	DRY DENSITY (P.C.F.)	MOISTURE CONTENT (%)
					ELEV. (MSL.) <u>449</u>	DATE COMPLETED <u>11/27/01</u>			
					EQUIPMENT <u>JOHN DEERE 710D</u>				
MATERIAL DESCRIPTION									
0				CL/SC	UNDOCUMENTED FILL Stiff/dense, damp, dark brown, fine to coarse Sandy CLAY/Clayey, fine to coarse SAND				
2									
4				SM	ALLUVIUM/COLLUVIUM Loose to medium dense, dry, very dark brown, Silty, fine to medium SAND				
6									
8									
10					GRANITIC ROCK Moderately weathered, reddish-brown to yellowish-brown, strong, GRANITIC ROCK TRENCH TERMINATED AT 11.5 FEET				

Figure A-25, Log of Trench T 25

MARBP

SAMPLE SYMBOLS	 ... SAMPLING UNSUCCESSFUL	 ... STANDARD PENETRATION TEST	 ... DRIVE SAMPLE (UNDISTURBED)
	 ... DISTURBED OR BAG SAMPLE	 ... CHUNK SAMPLE	 ... WATER TABLE OR SEEPAGE

NOTE: THE LOG OF SUBSURFACE CONDITIONS SHOWN HEREON APPLIES ONLY AT THE SPECIFIC BORING OR TRENCH LOCATION AND AT THE DATE INDICATED. IT IS NOT WARRANTED TO BE REPRESENTATIVE OF SUBSURFACE CONDITIONS AT OTHER LOCATIONS AND TIMES.

AIR TRACK BORING AT-1
Elevation - 555 Feet (MSL)



GEOCON
INCORPORATED

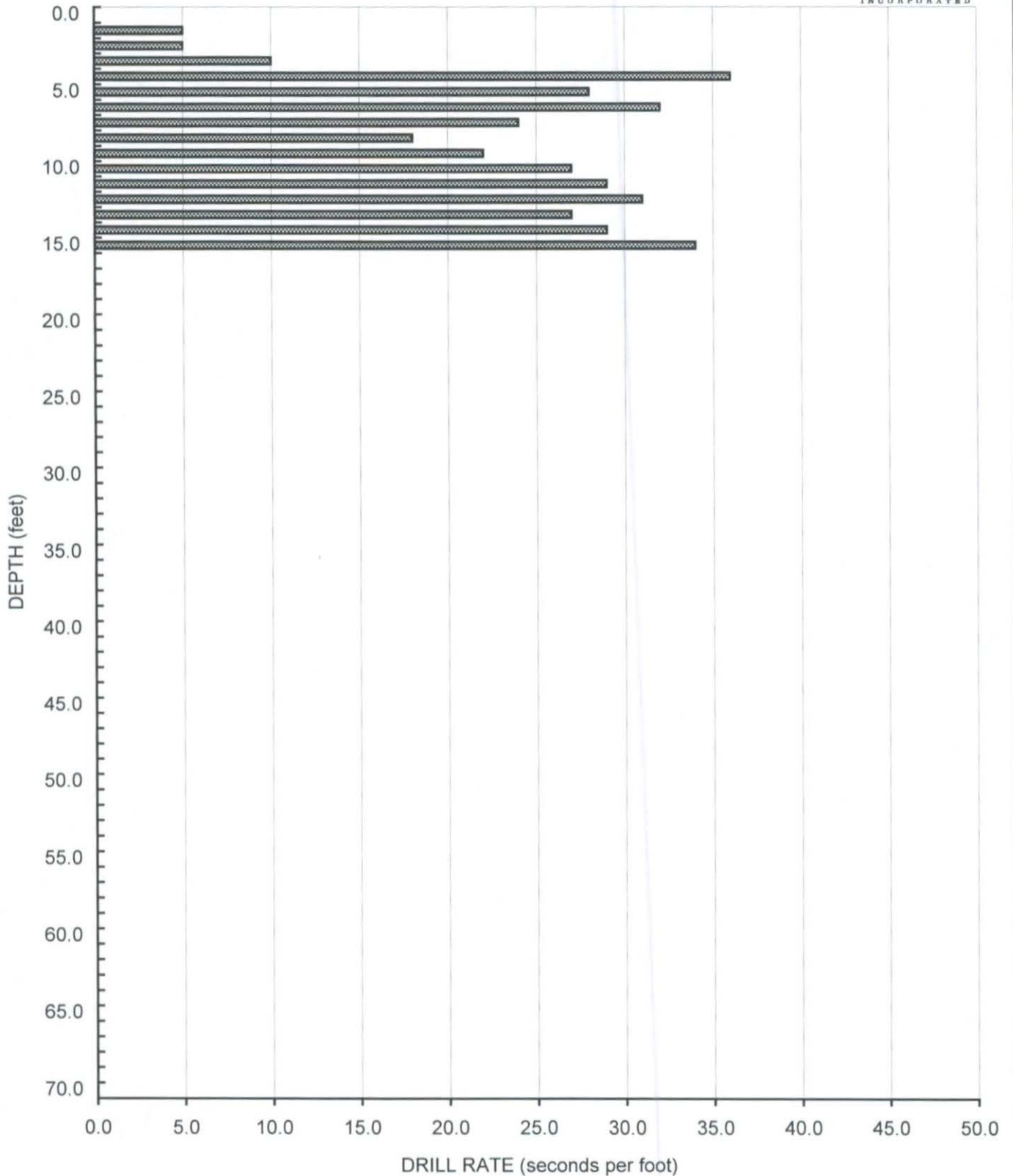

AIR TRACK BORING AT-2
Elevation - 538 Feet (MSL)



GEOCON
INCORPORATED

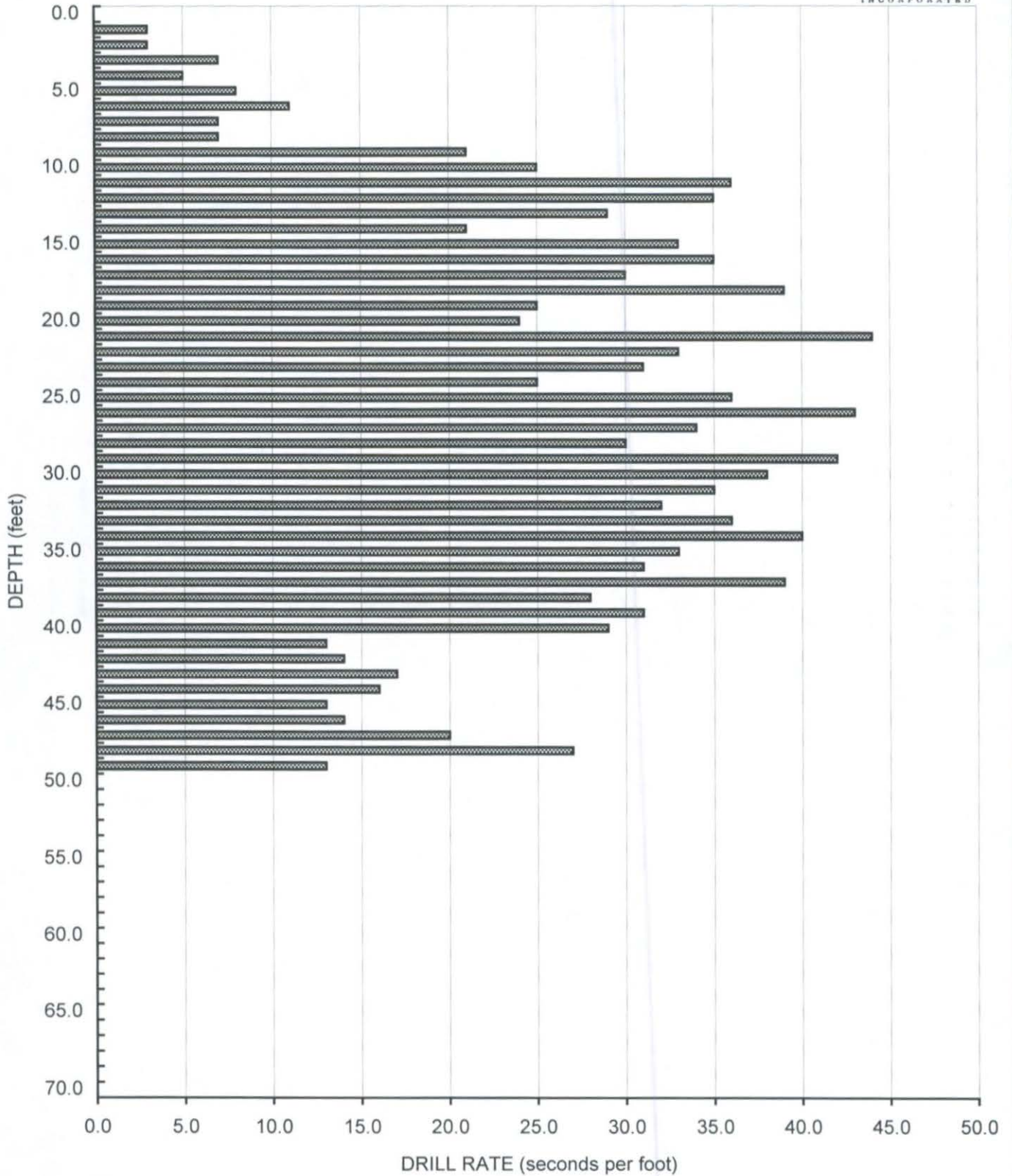

AIR TRACK BORING AT-3
Elevation - 532 Feet (MSL)



GEOCON
INCORPORATED

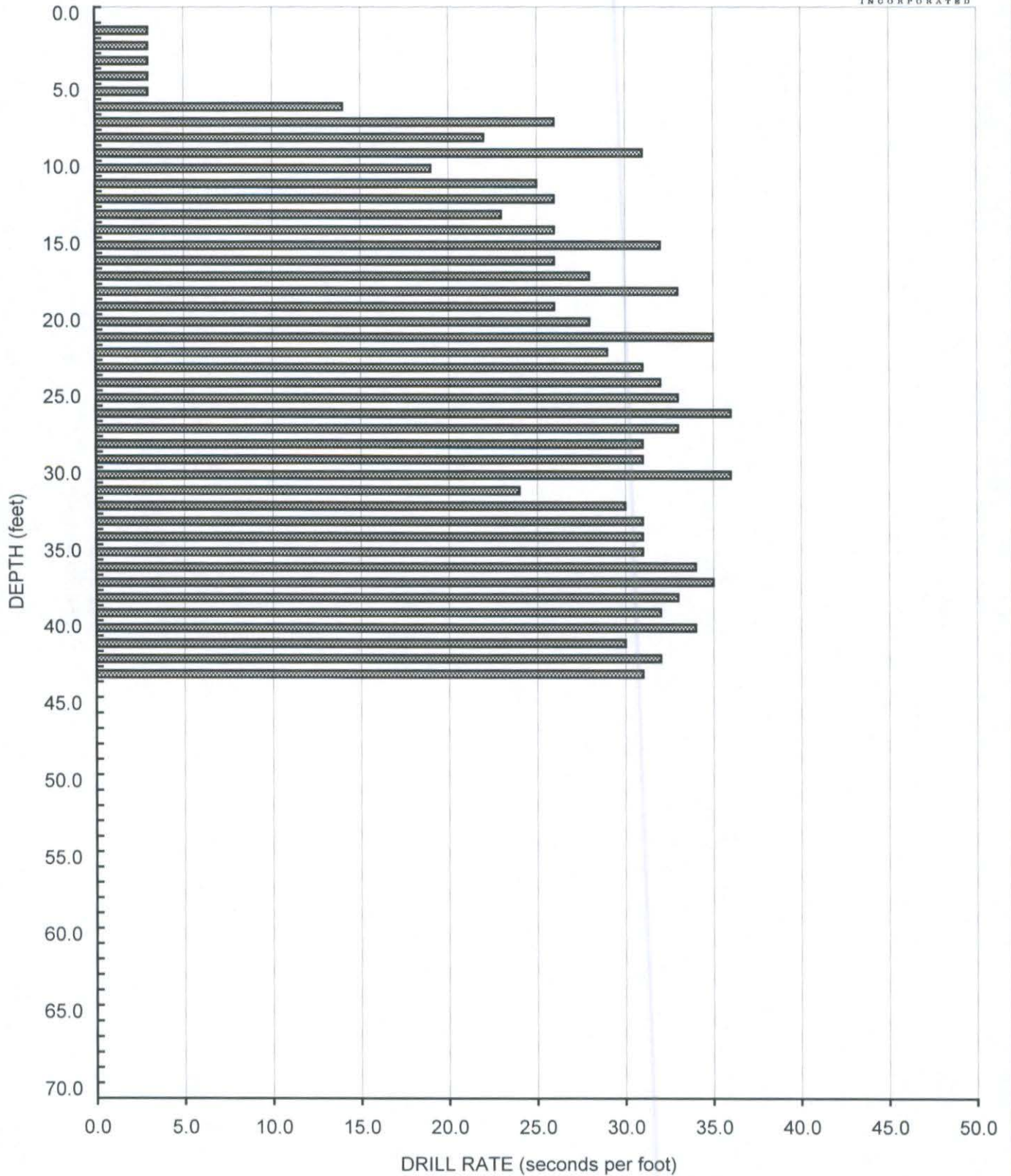

AIR TRACK BORING AT-4
Elevation - 525 Feet (MSL)



GEOCON
INCORPORATED

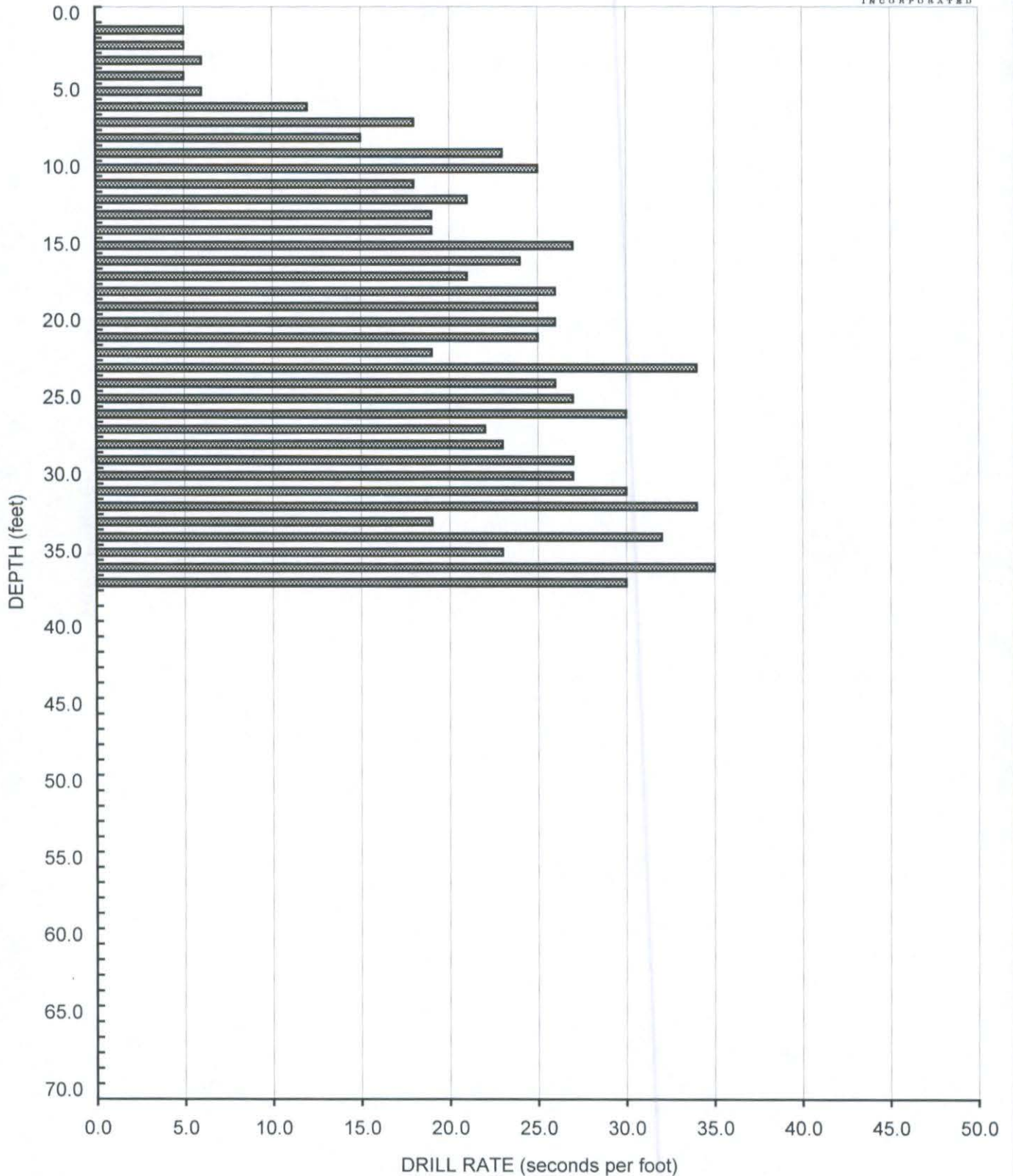

AIR TRACK BORING AT-5
Elevation - 525 Feet (MSL)



GEOCON
INCORPORATED

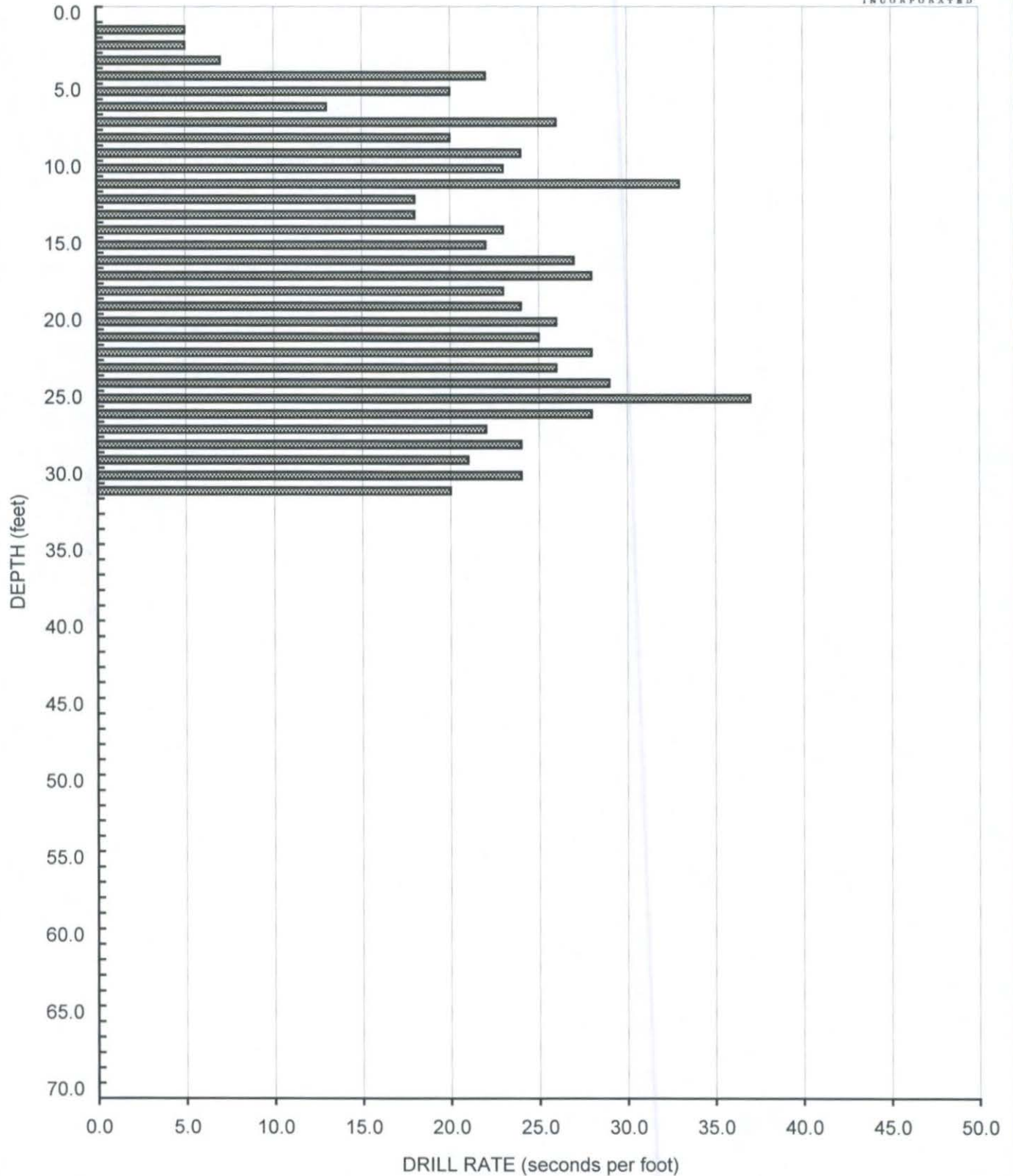

AIR TRACK BORING AT-6
Elevation - 530 Feet (MSL)



GEOCON
INCORPORATED

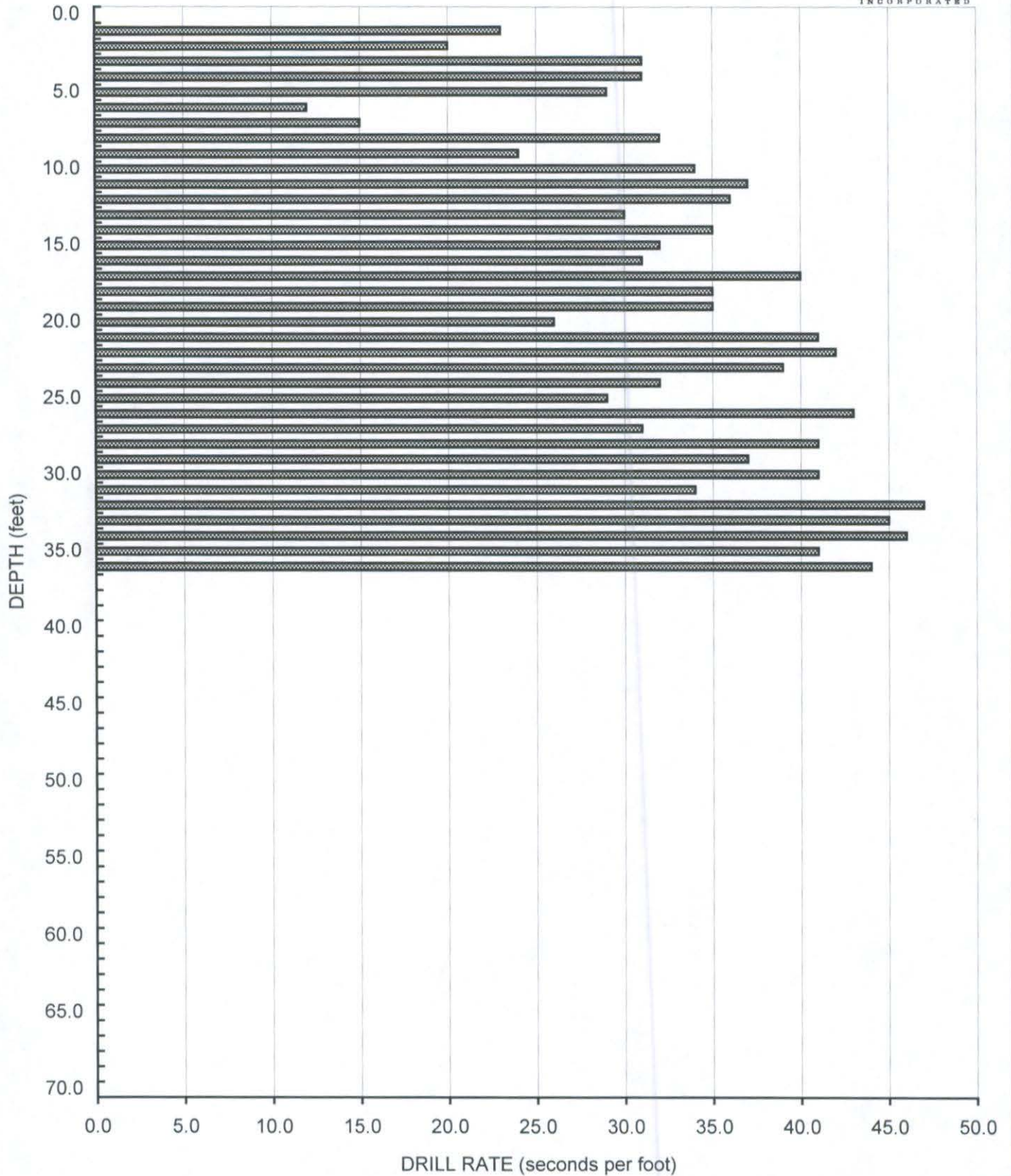

AIR TRACK BORING AT-7
Elevation - 510 Feet (MSL)



GEOCON
INCORPORATED

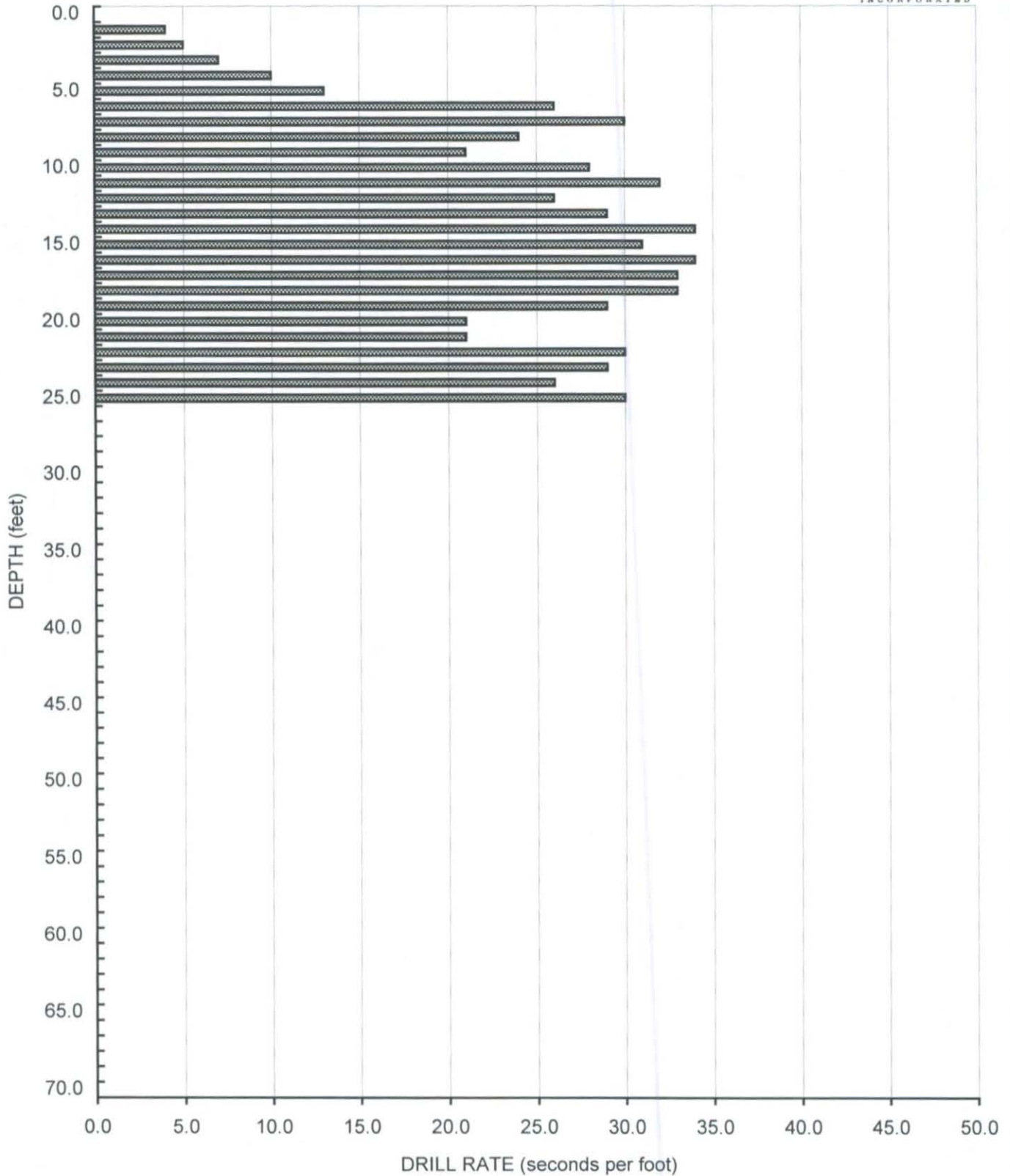

AIR TRACK BORING AT-8
Elevation - 500 Feet (MSL)



GEOCON
INCORPORATED

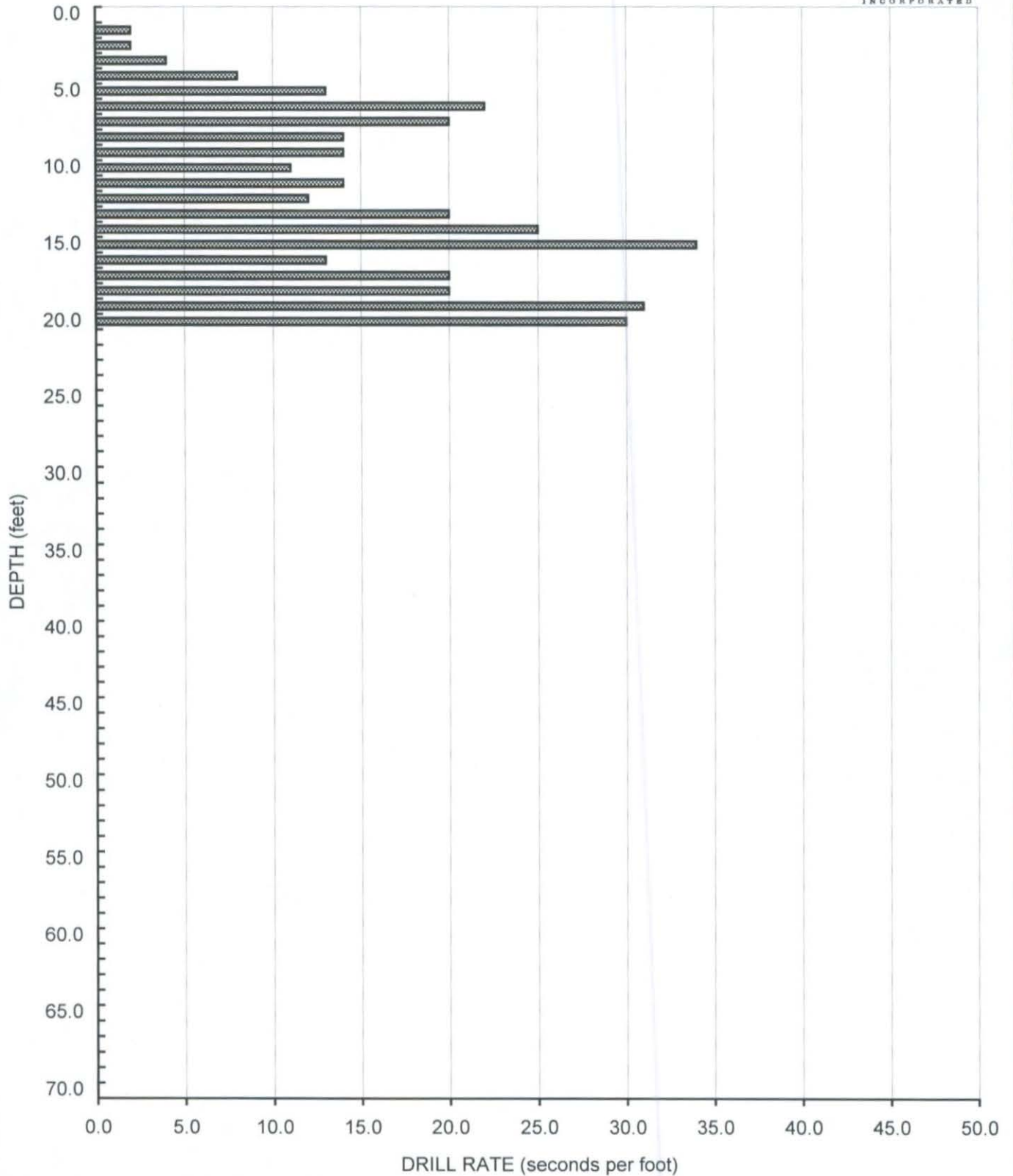

AIR TRACK BORING AT-9
Elevation - 504 Feet (MSL)



GEOCON
INCORPORATED

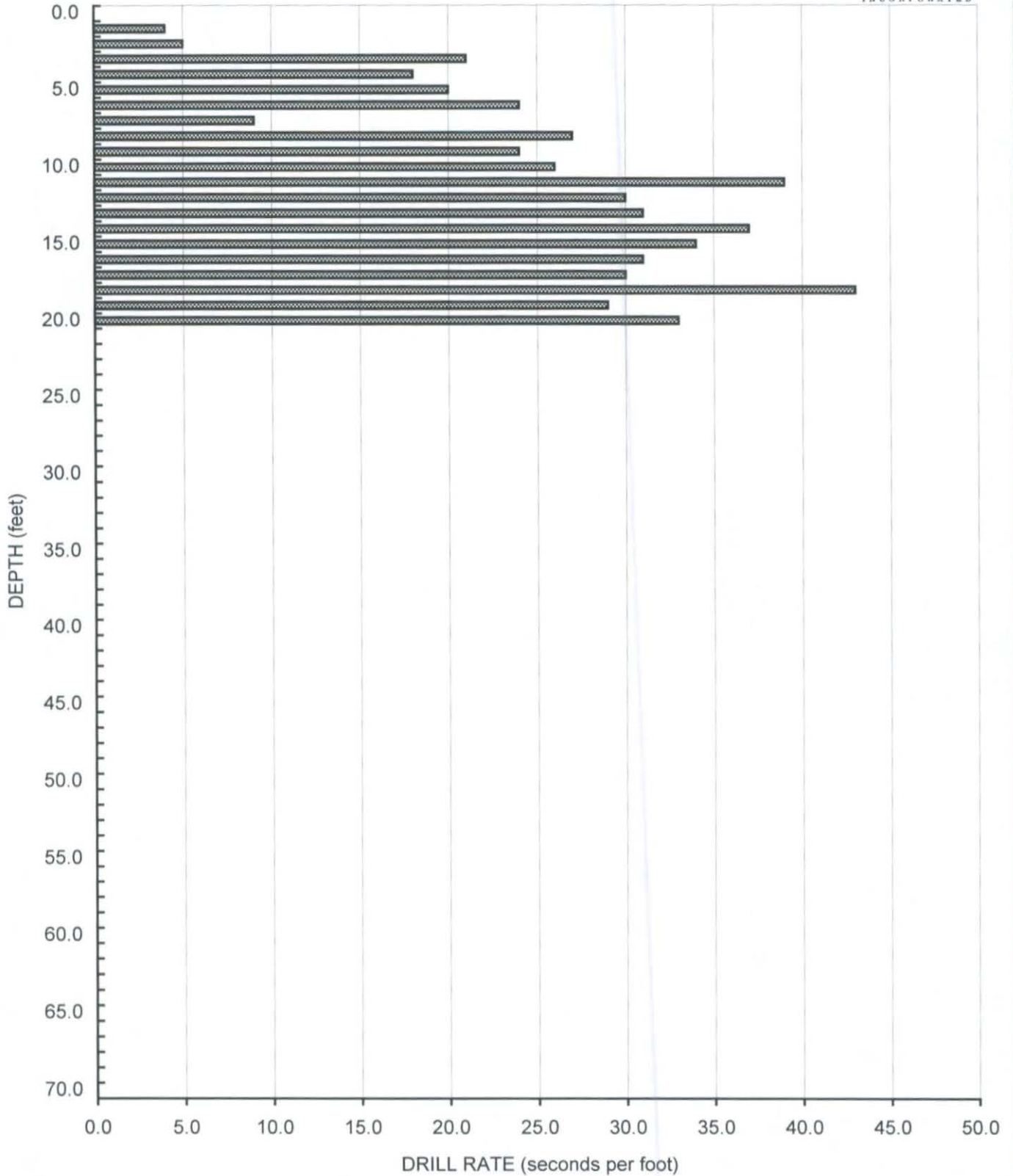

AIR TRACK BORING AT-10
Elevation - 491 Feet (MSL)



GEOCON
INCORPORATED

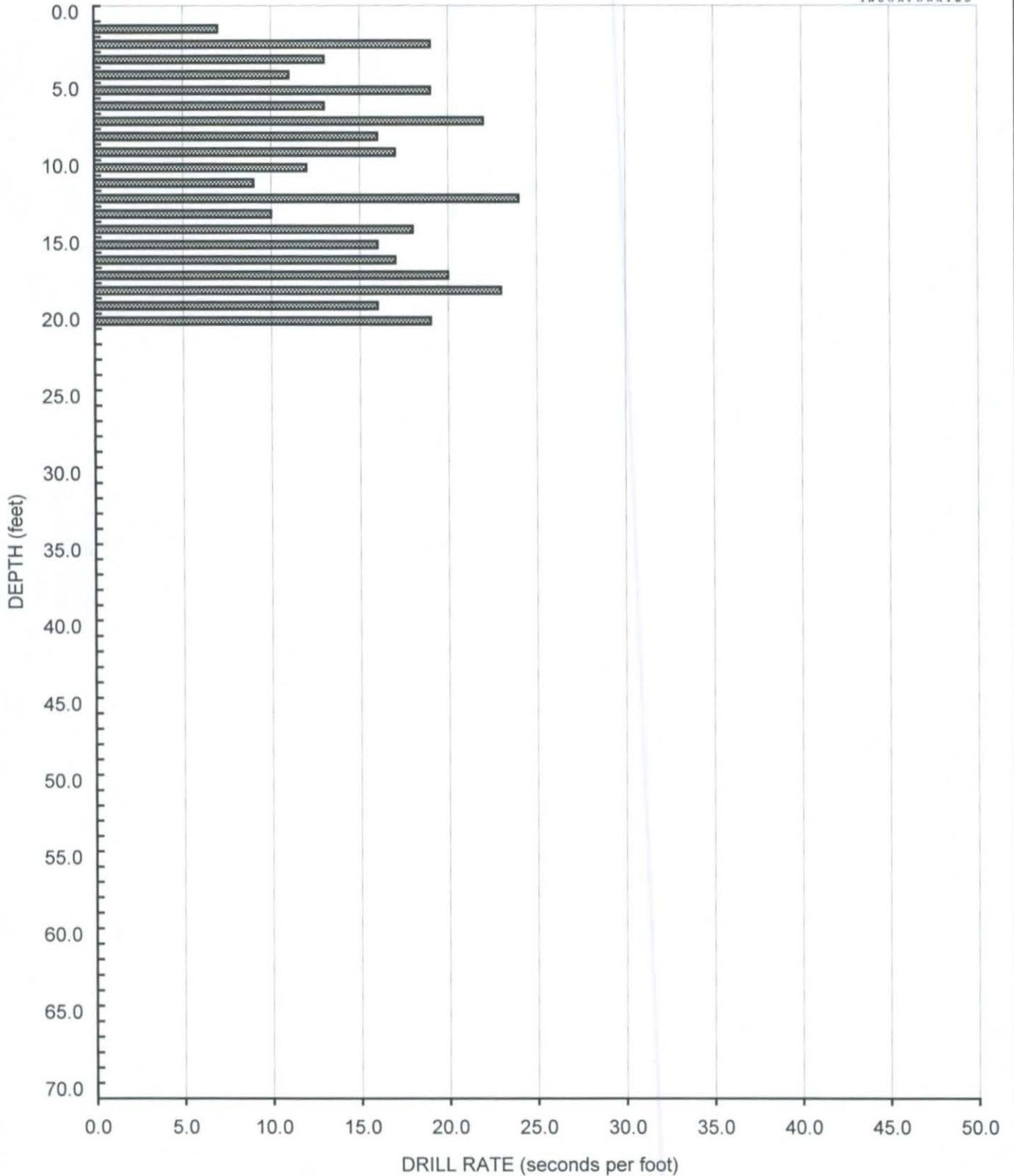

AIR TRACK BORING AT-11
Elevation - 452 Feet (MSL)



GEOCON
INCORPORATED

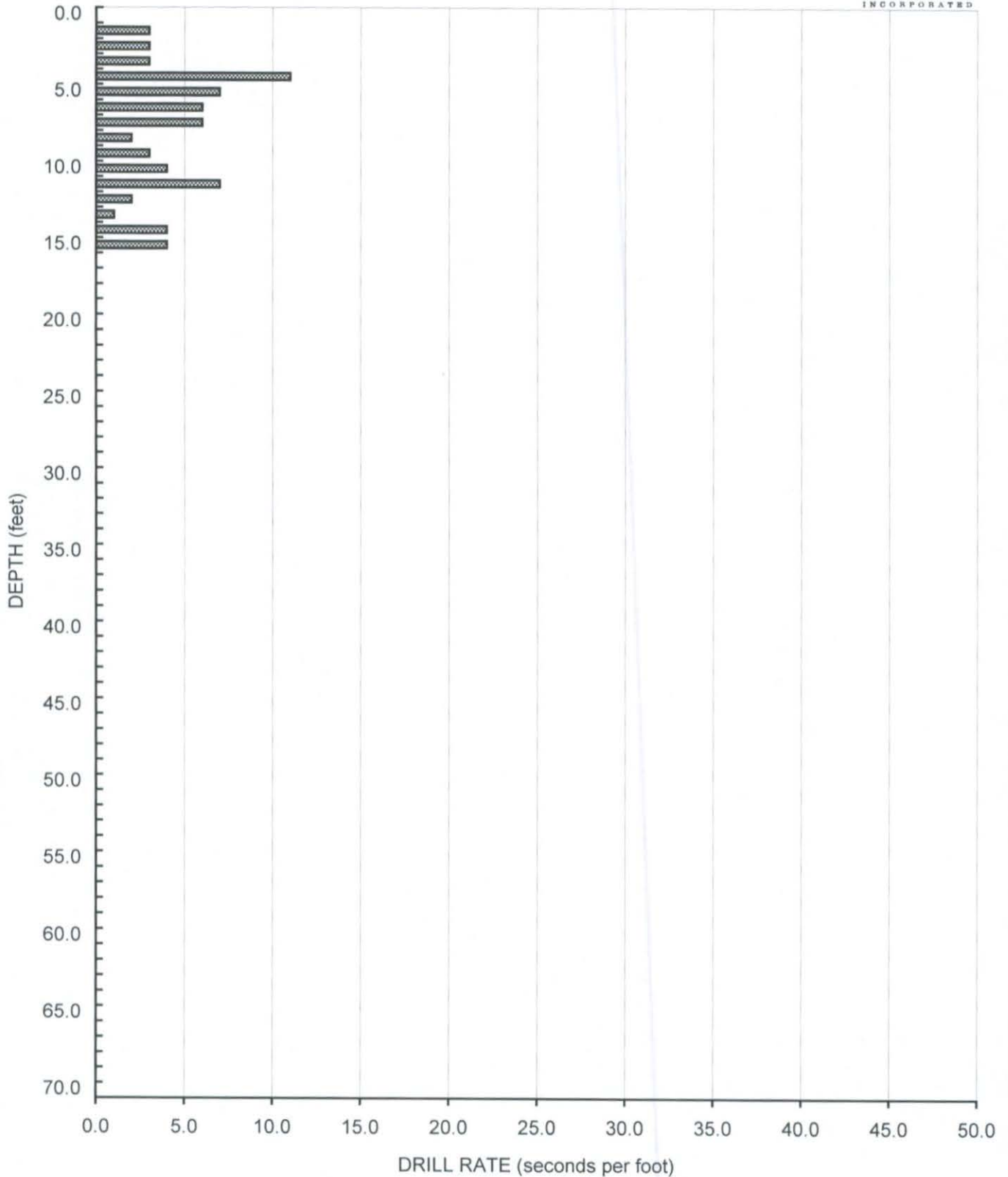

AIR TRACK BORING AT-12
Elevation - 499 Feet (MSL)



GEOCON
INCORPORATED

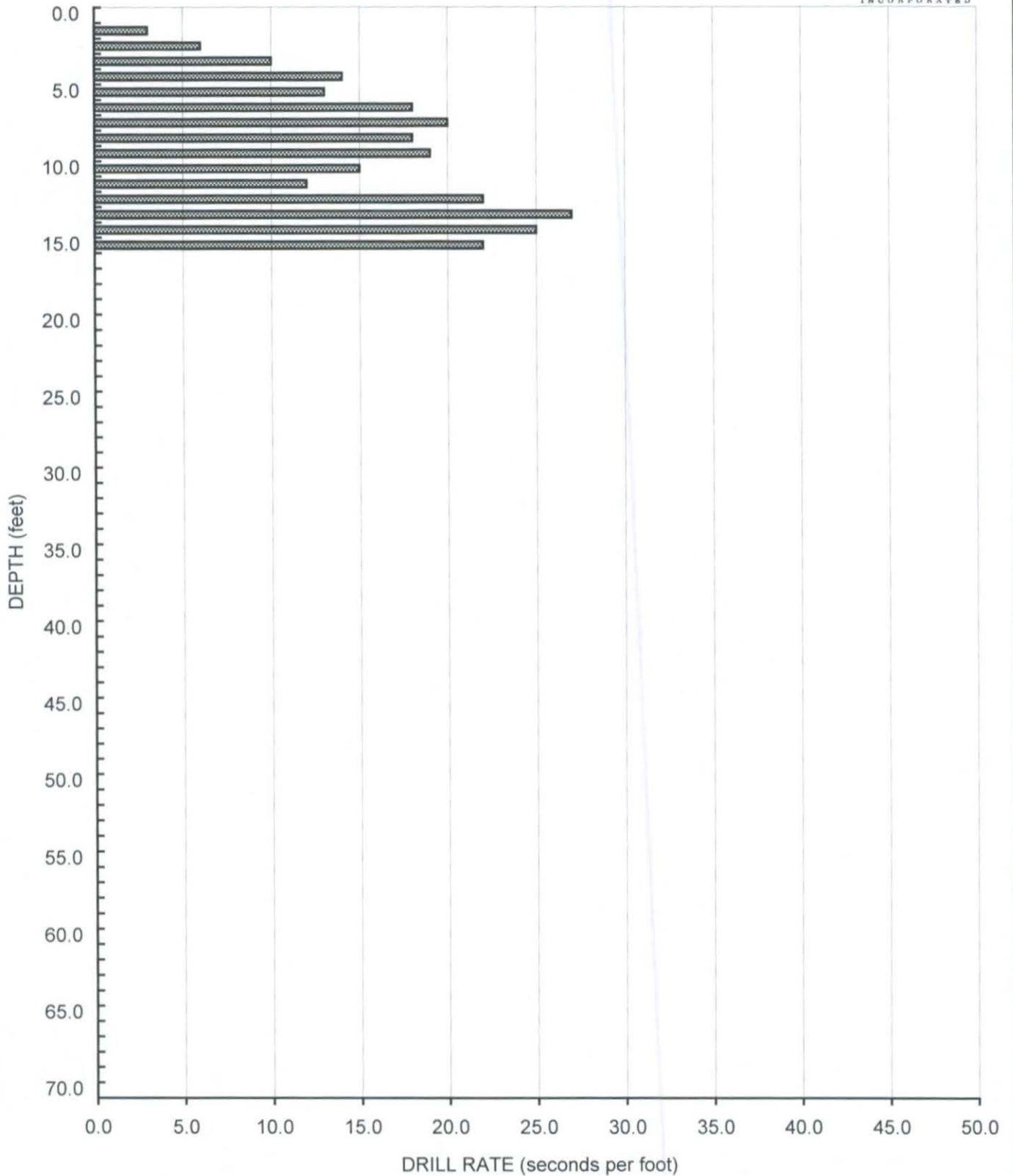

AIR TRACK BORING AT-13
Elevation - 504 Feet (MSL)



GEOCON
INCORPORATED

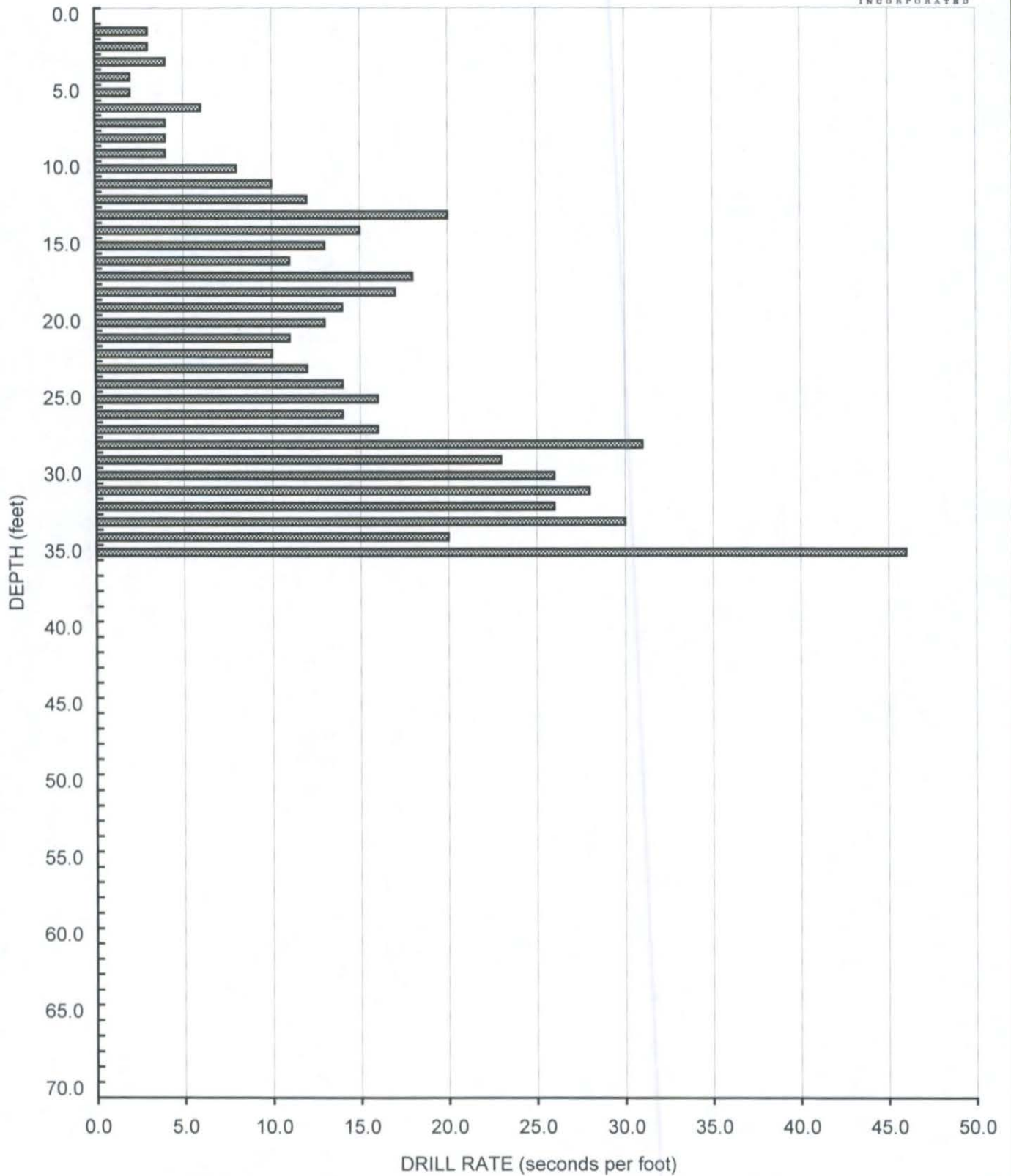

AIR TRACK BORING AT-14
Elevation - 508 Feet (MSL)



GEOCON
INCORPORATED

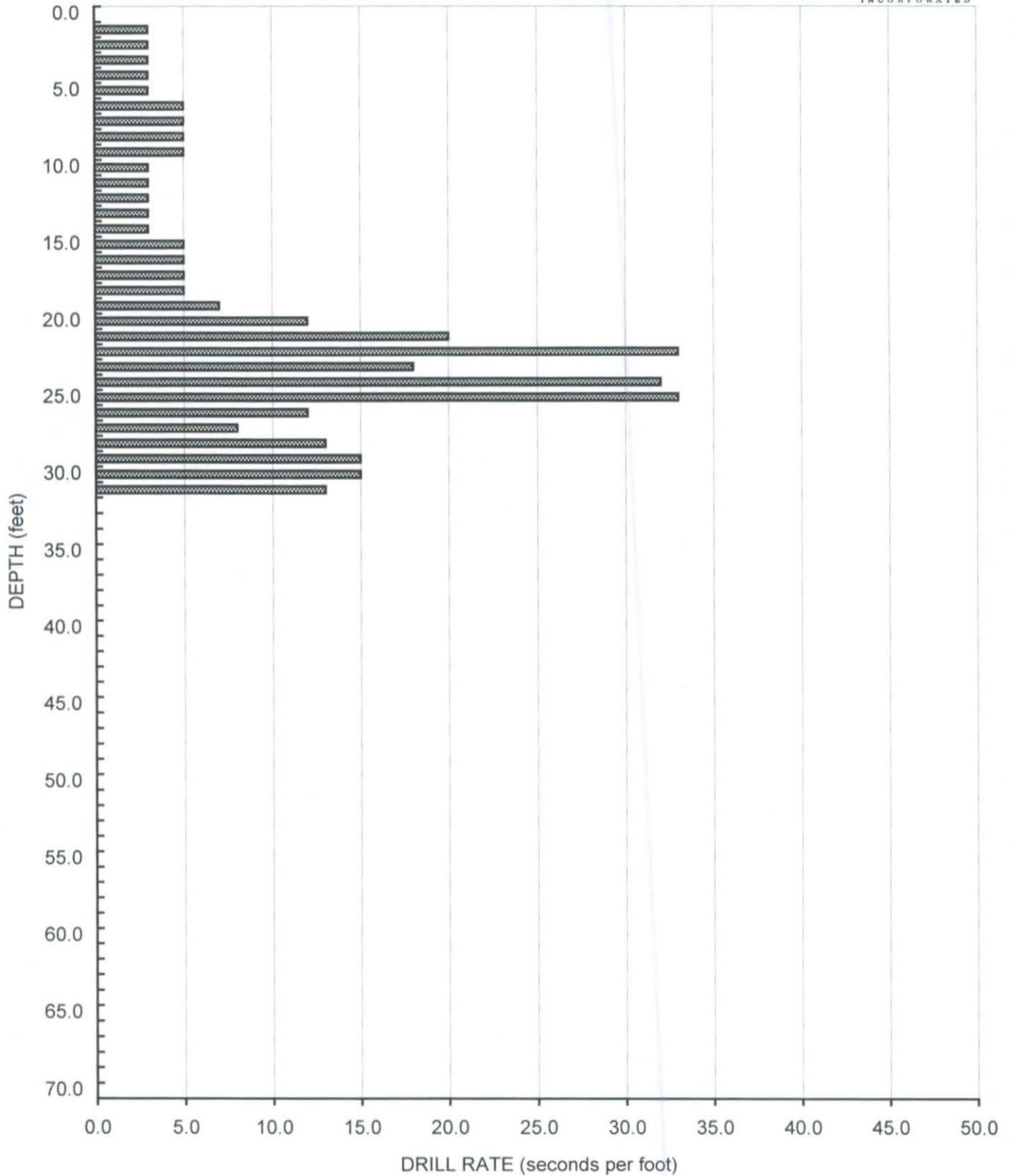

AIR TRACK BORING AT-15
Elevation - 504 Feet (MSL)



GEOCON
INCORPORATED

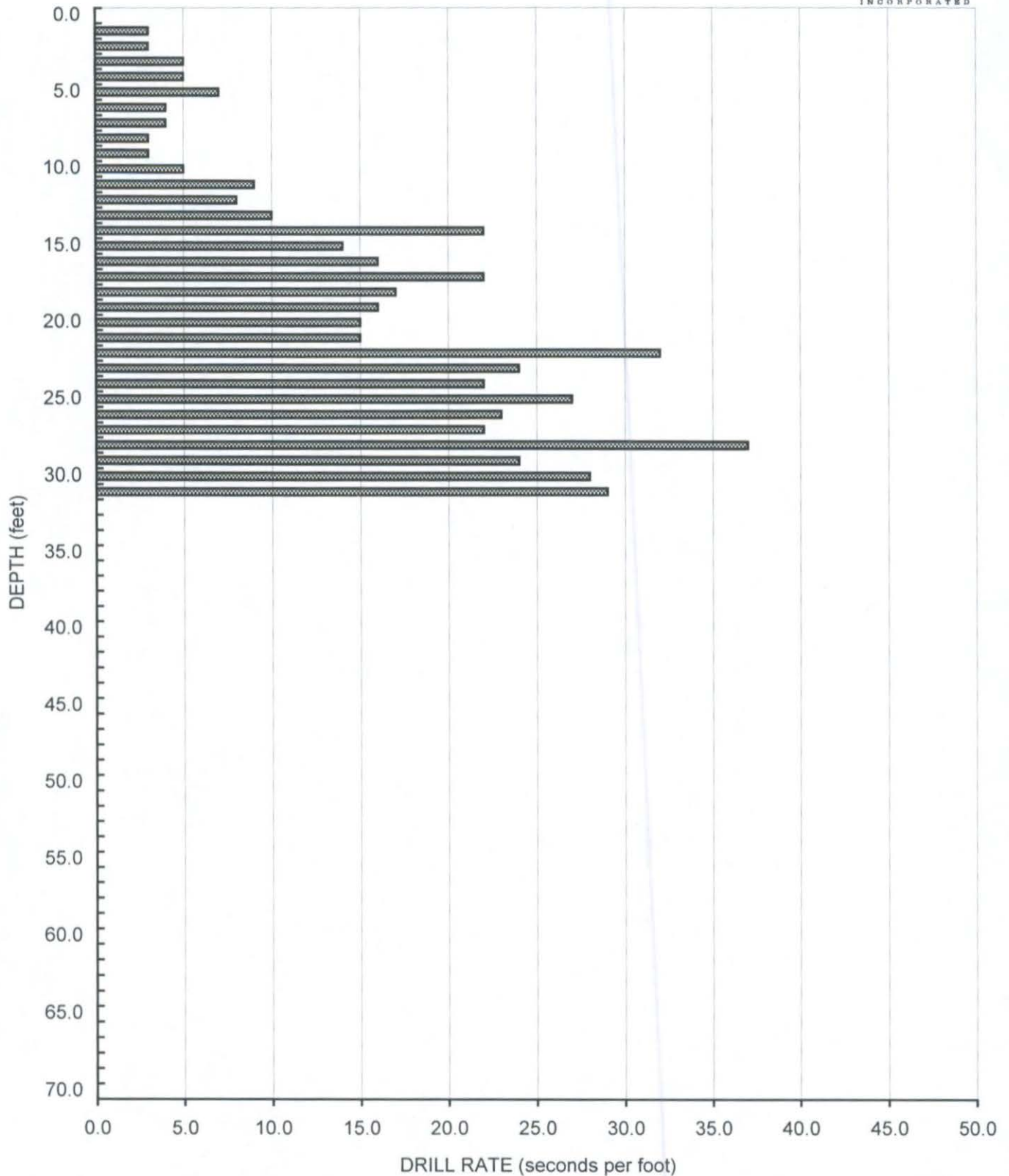

AIR TRACK BORING AT-16
Elevation - 503 Feet (MSL)



GEOCON
INCORPORATED

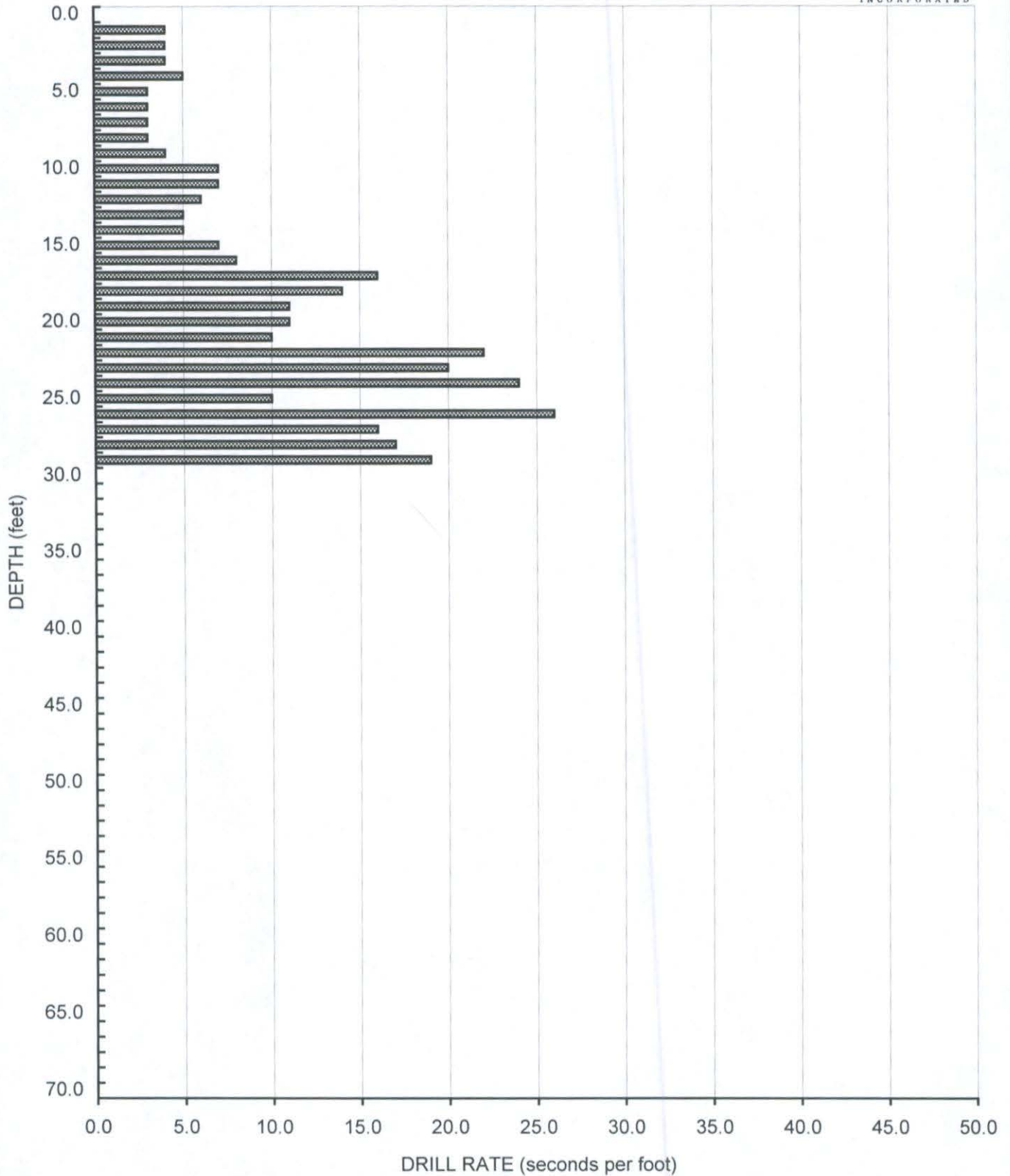

AIR TRACK BORING AT-17
Elevation - 497 Feet (MSL)



GEOCON
INCORPORATED

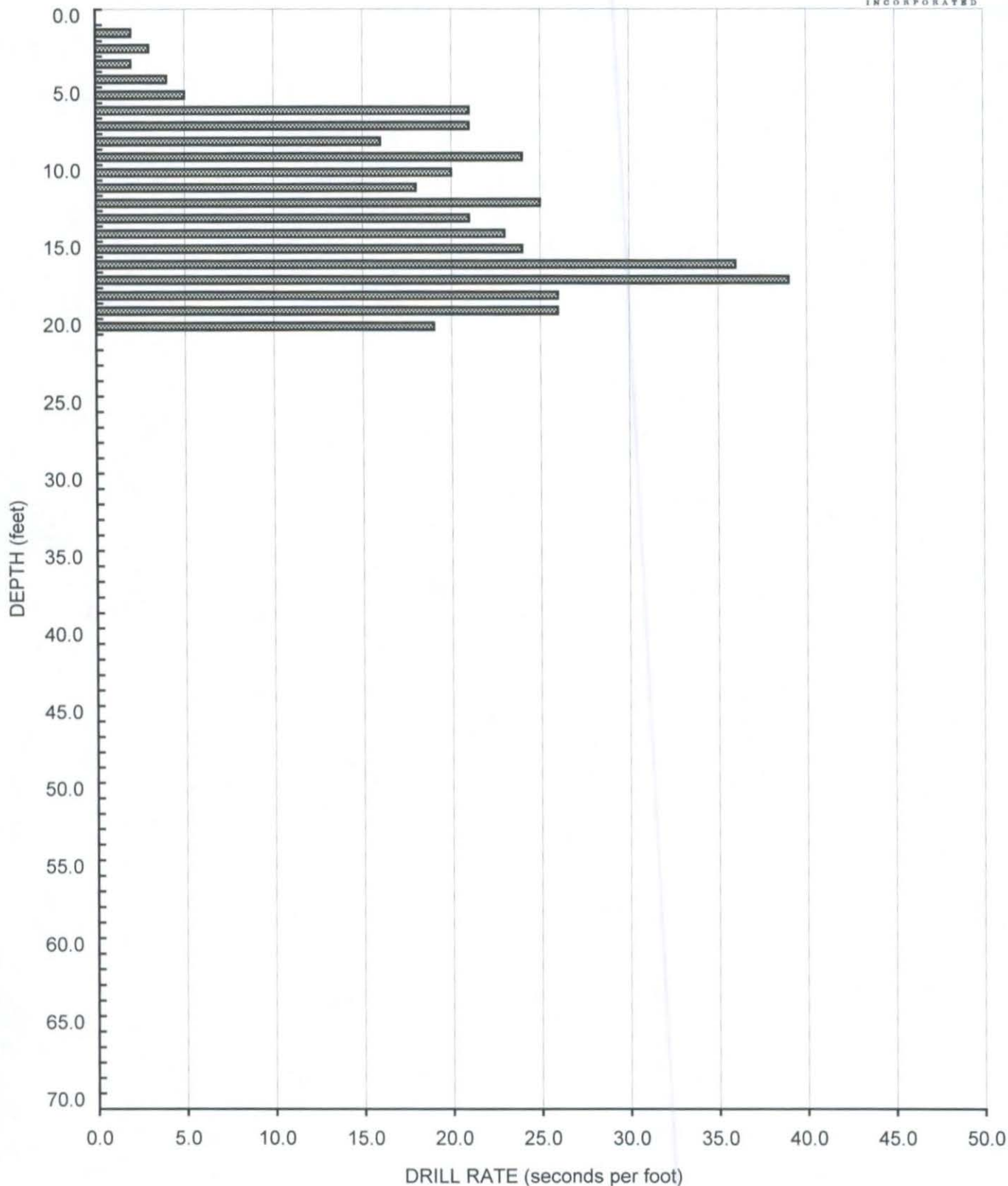

AIR TRACK BORING AT-18
Elevation - 484 Feet (MSL)



GEOCON
INCORPORATED

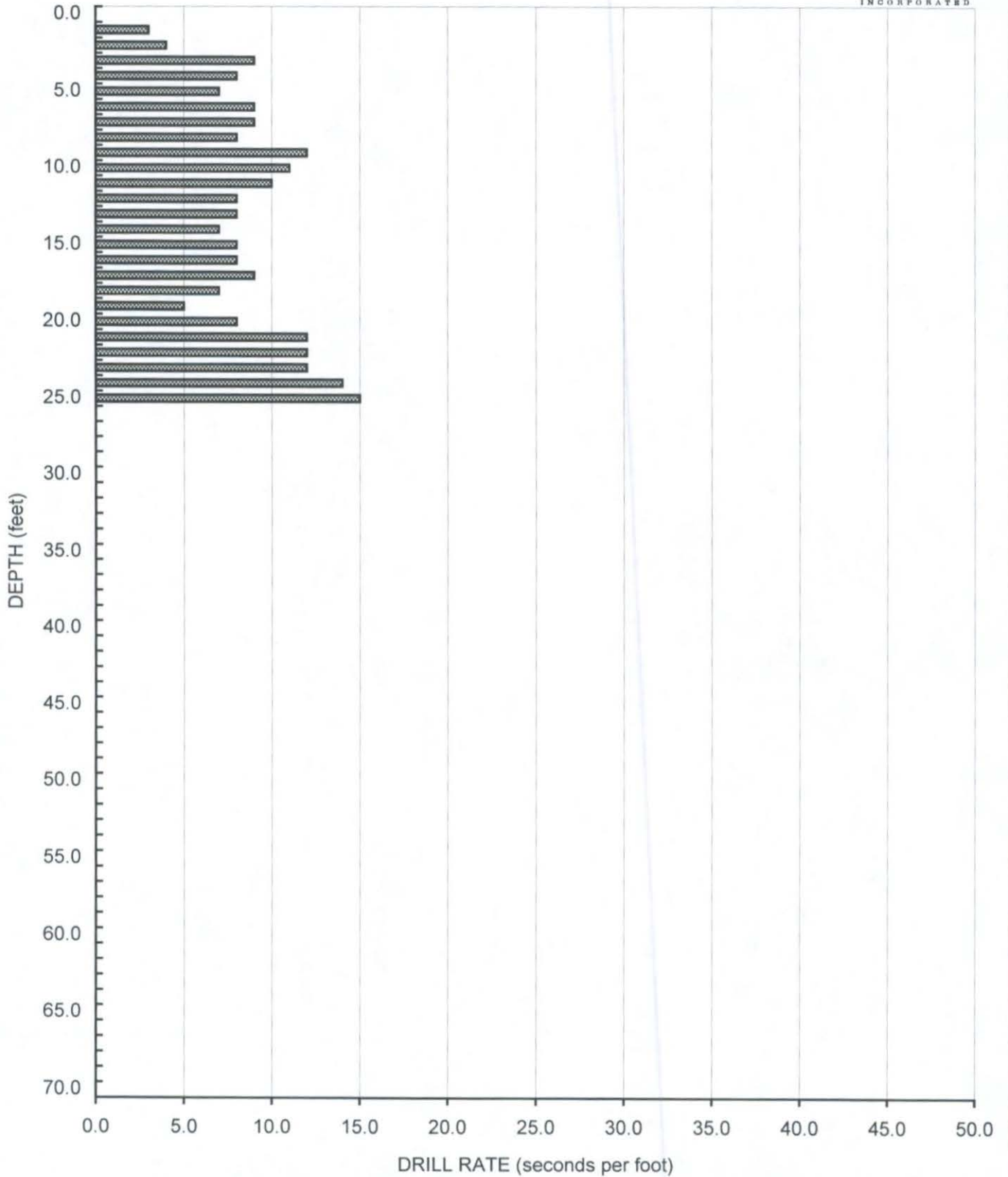

AIR TRACK BORING AT-19
Elevation - 439 Feet (MSL)



GEOCON
INCORPORATED

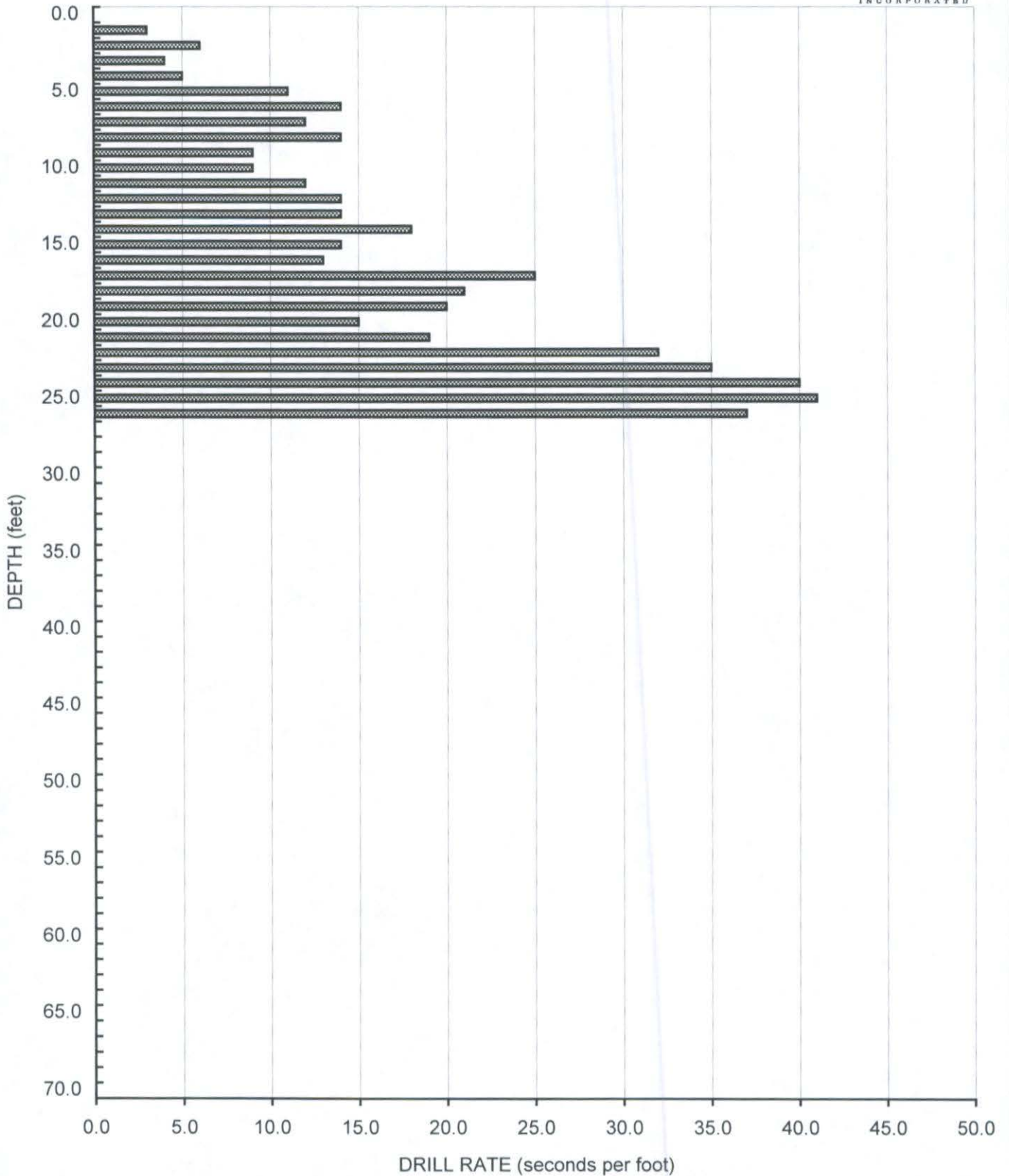

AIR TRACK BORING AT-20
Elevation - 438 Feet (MSL)



GEOCON
INCORPORATED

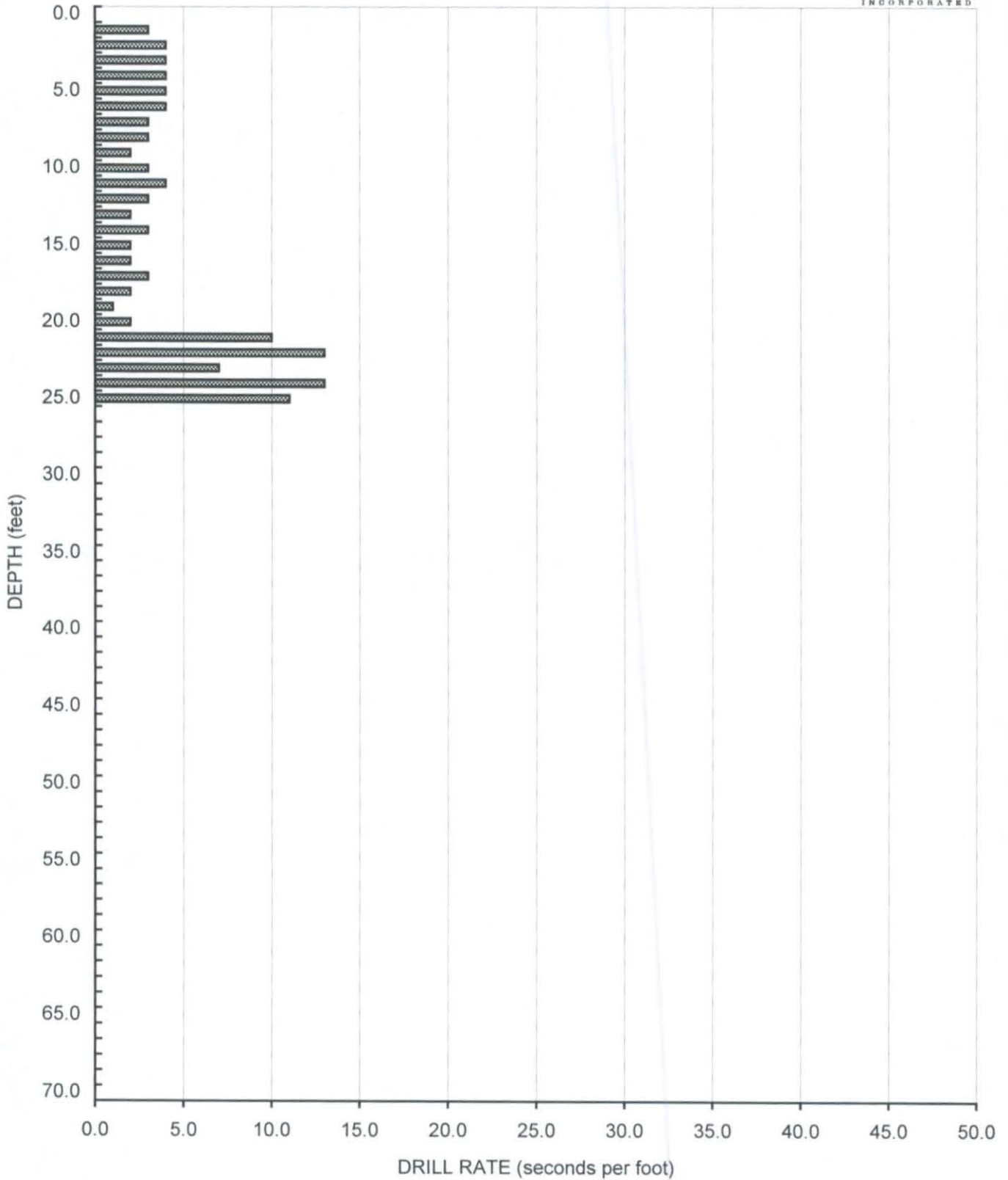

AIR TRACK BORING AT-21
Elevation - 419 Feet (MSL)



GEOCON
INCORPORATED

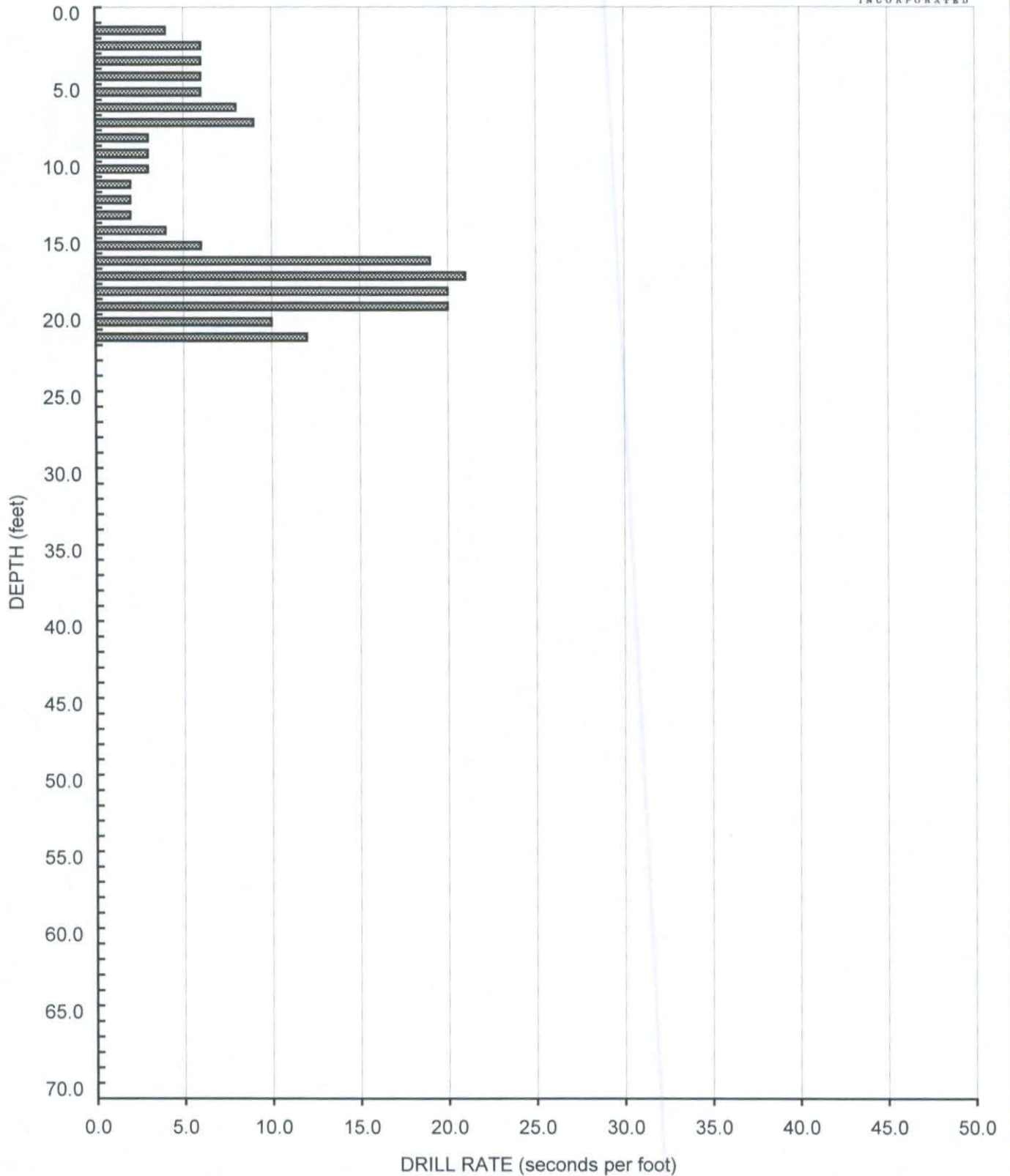

AIR TRACK BORING AT-22
Elevation - 427 Feet (MSL)



GEOCON
INCORPORATED

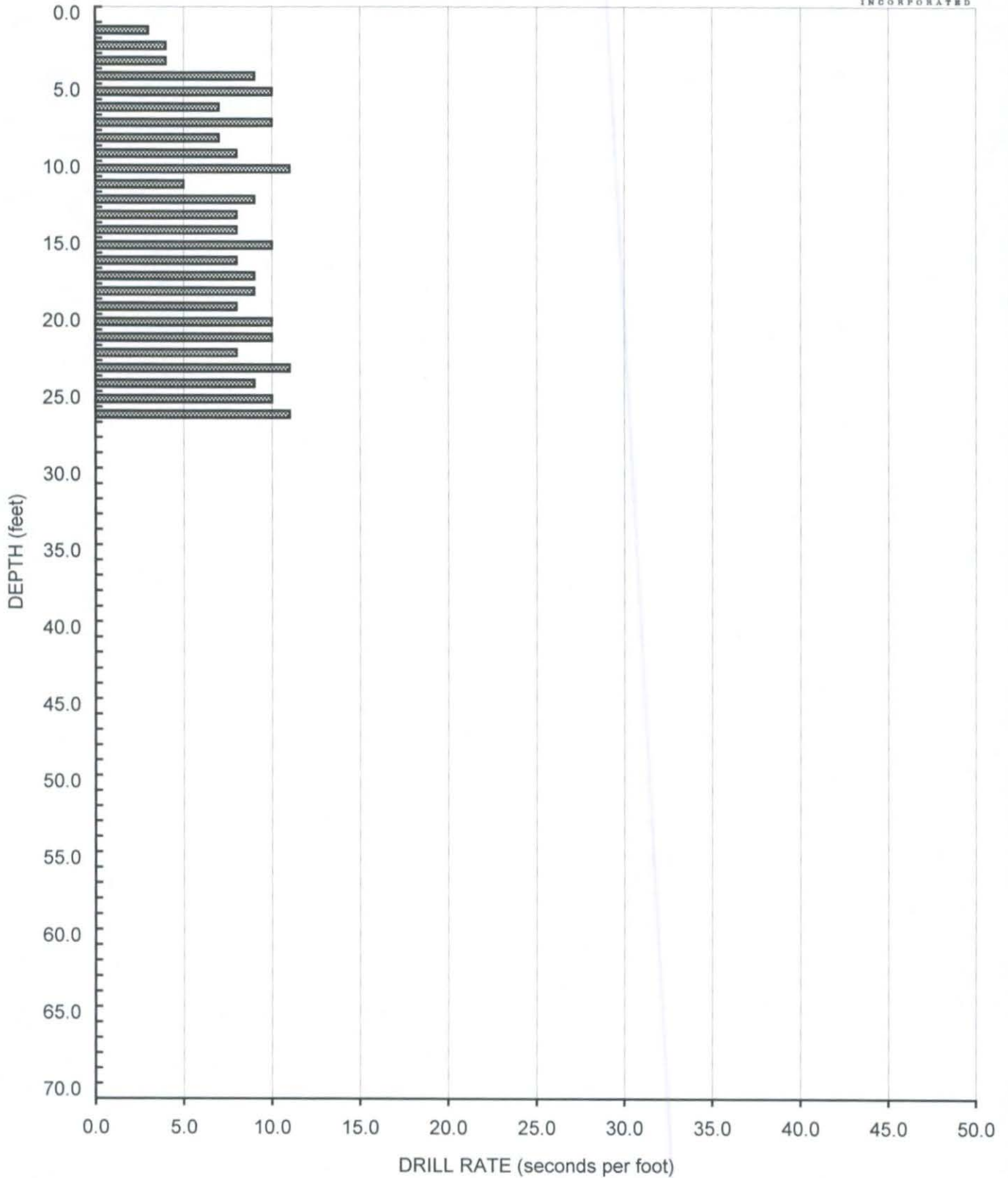

AIR TRACK BORING AT-23
Elevation - 437 Feet (MSL)



GEOCON
INCORPORATED

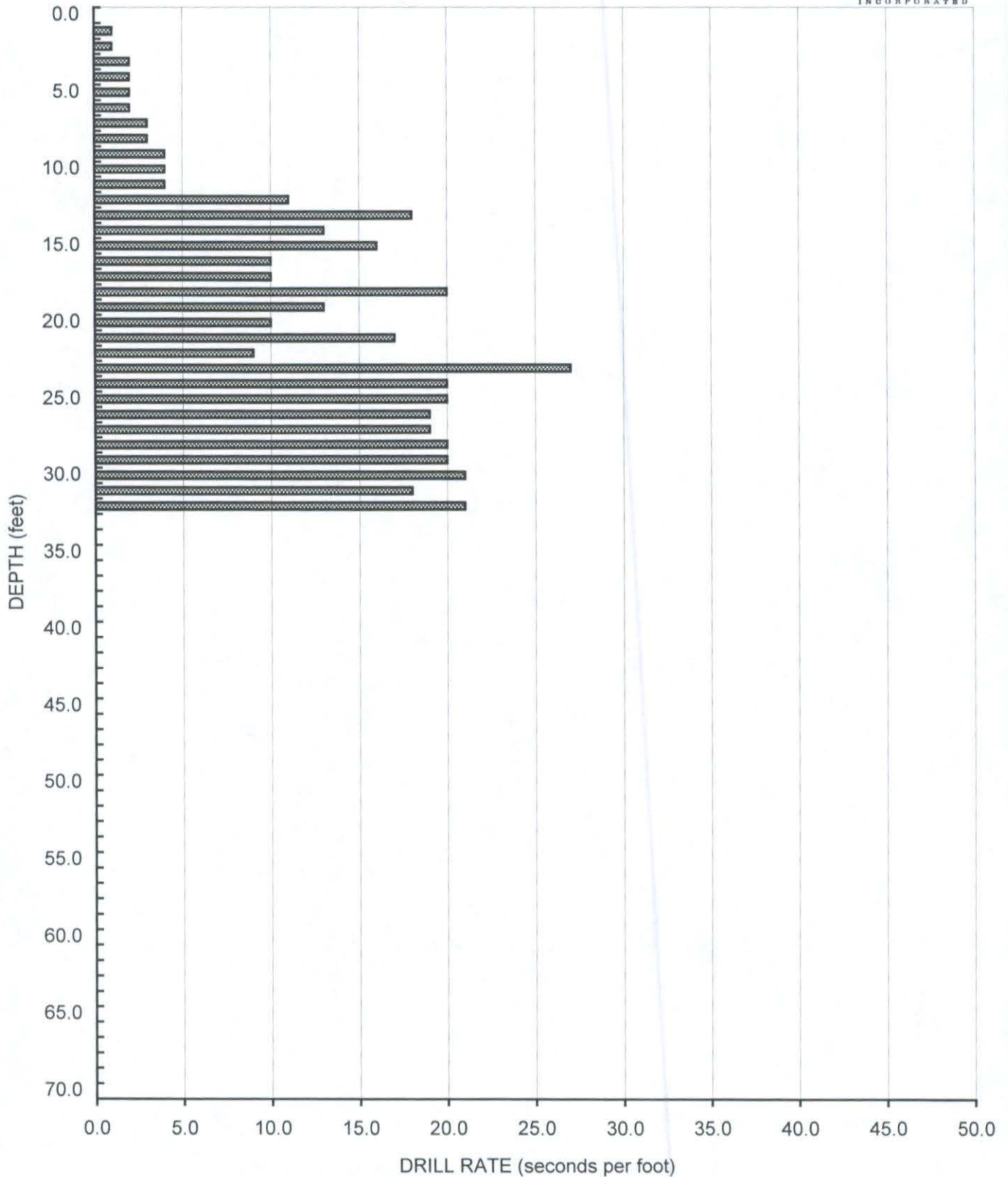

AIR TRACK BORING AT-24
Elevation - 464 Feet (MSL)



GEOCON
INCORPORATED

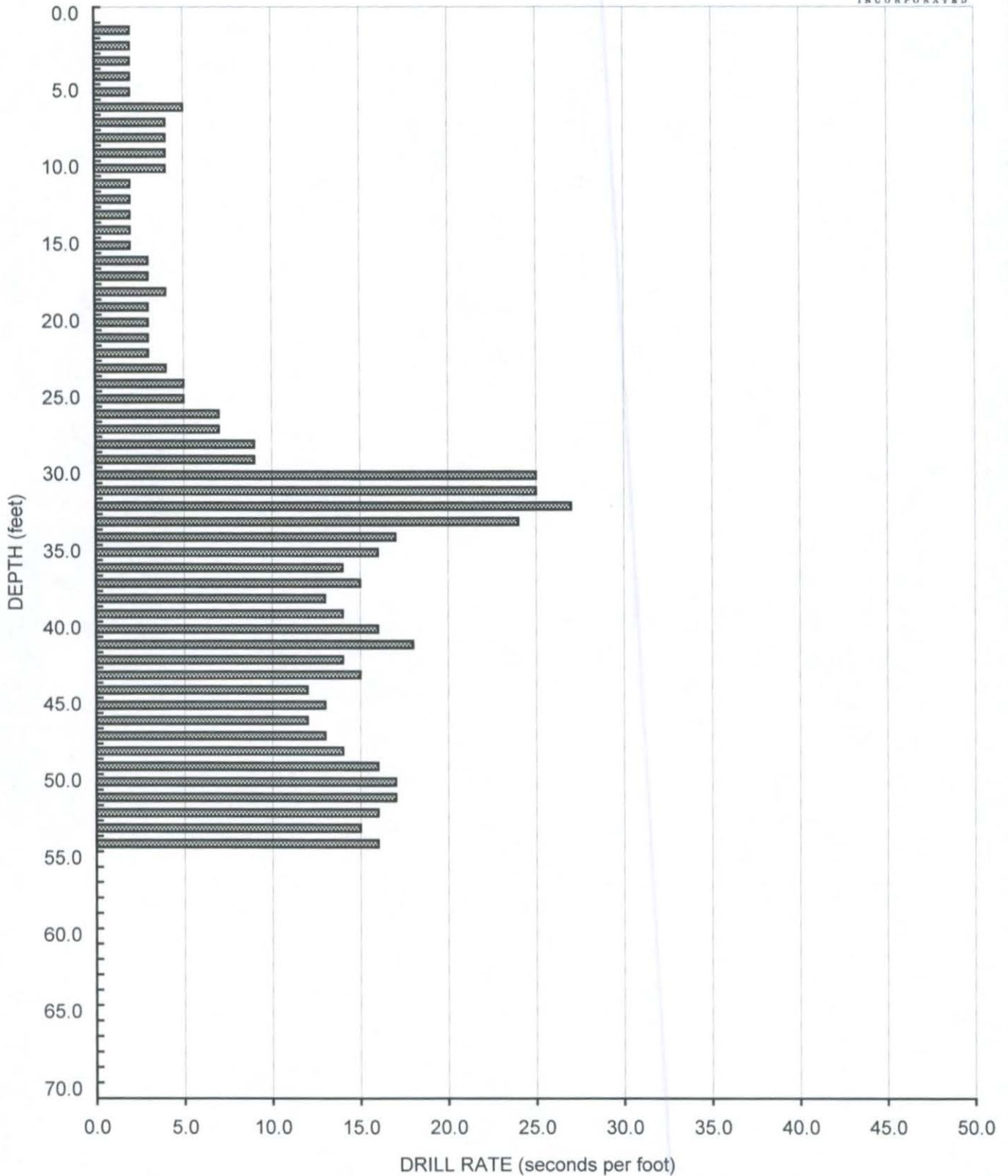

AIR TRACK BORING AT-25
Elevation - 467 Feet (MSL)



GEOCON
INCORPORATED

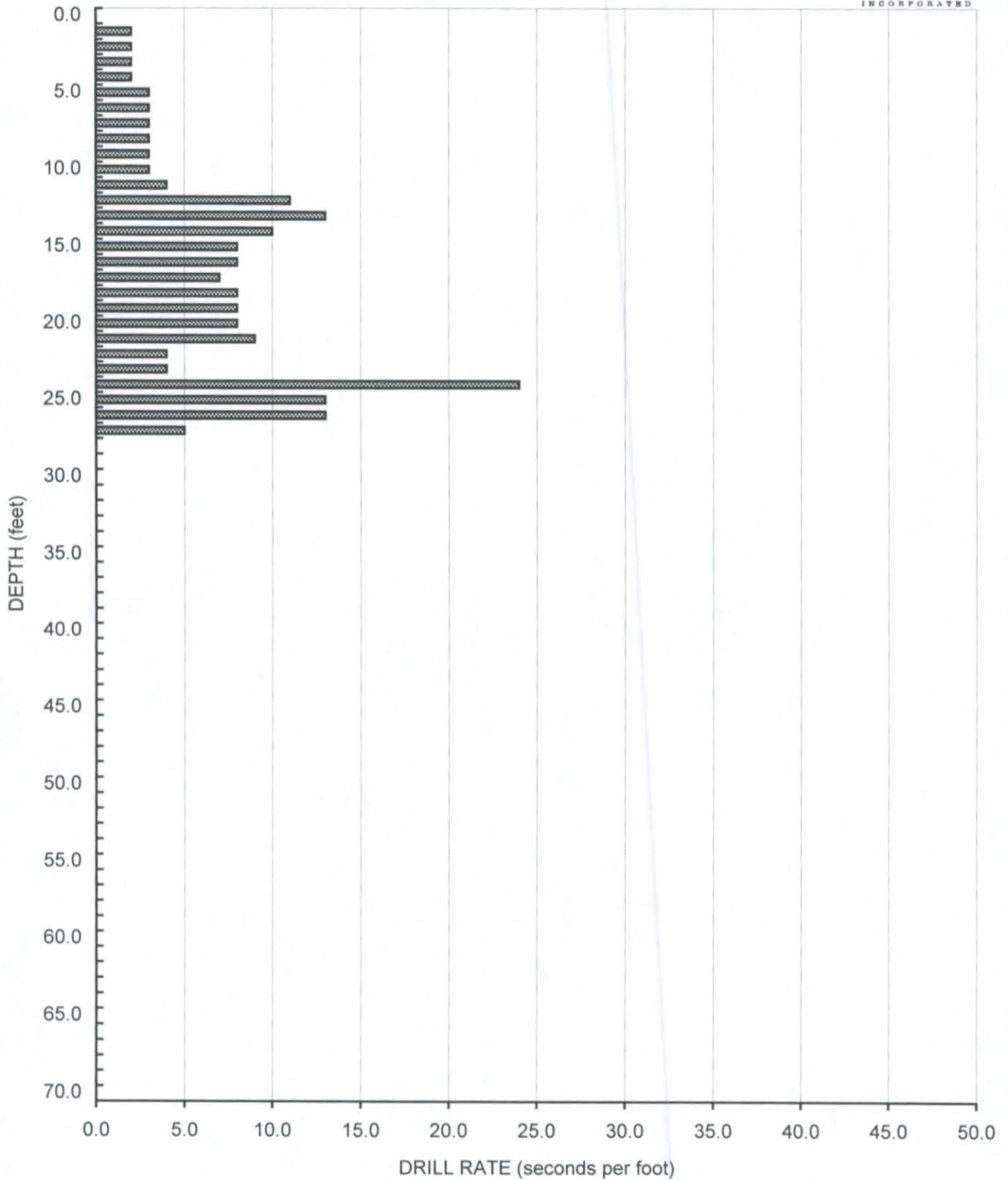

AIR TRACK BORING AT-26
Elevation - 467 Feet (MSL)



GEOCON
INCORPORATED

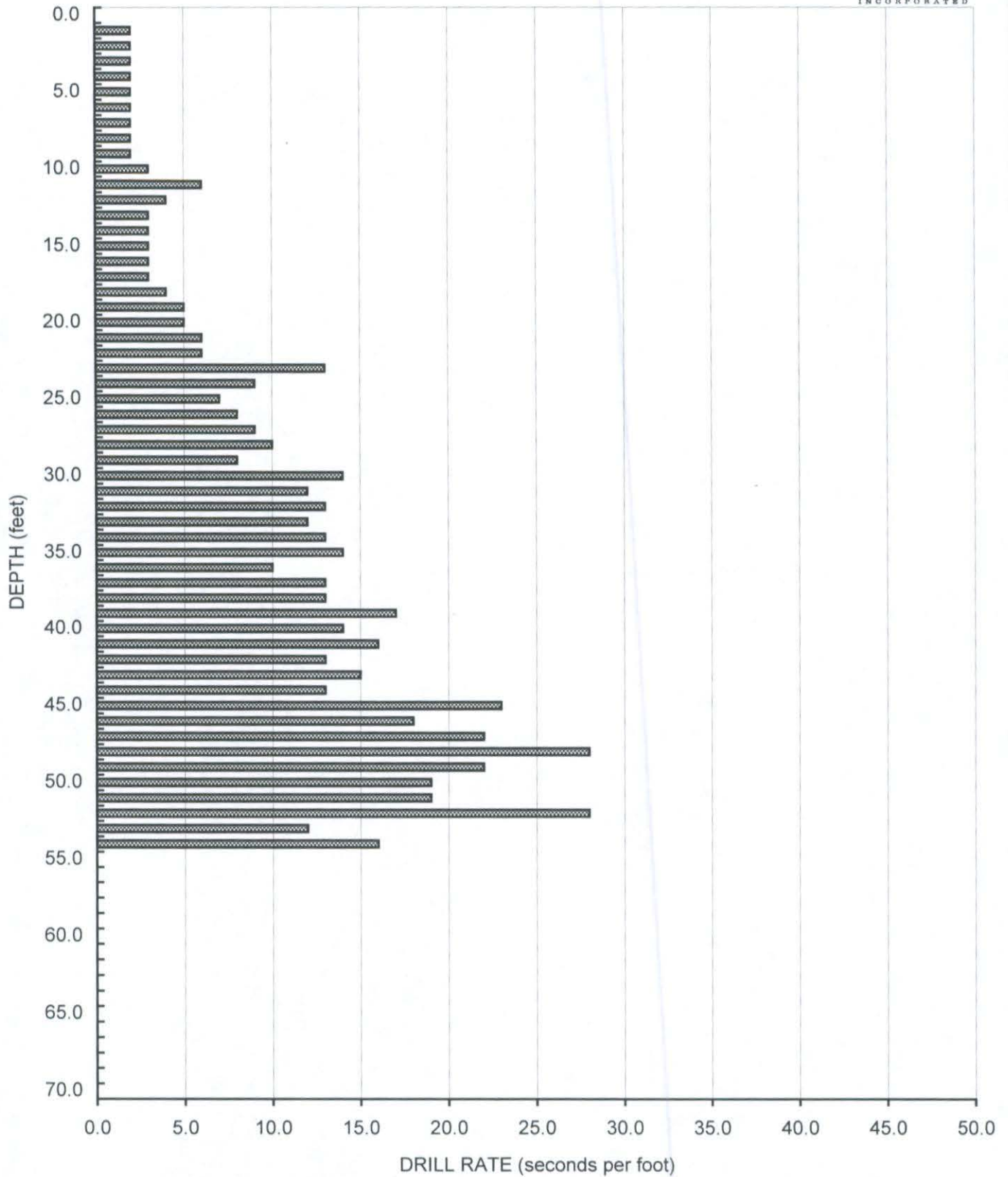

AIR TRACK BORING AT-27
Elevation - 478 Feet (MSL)



GEOCON
INCORPORATED

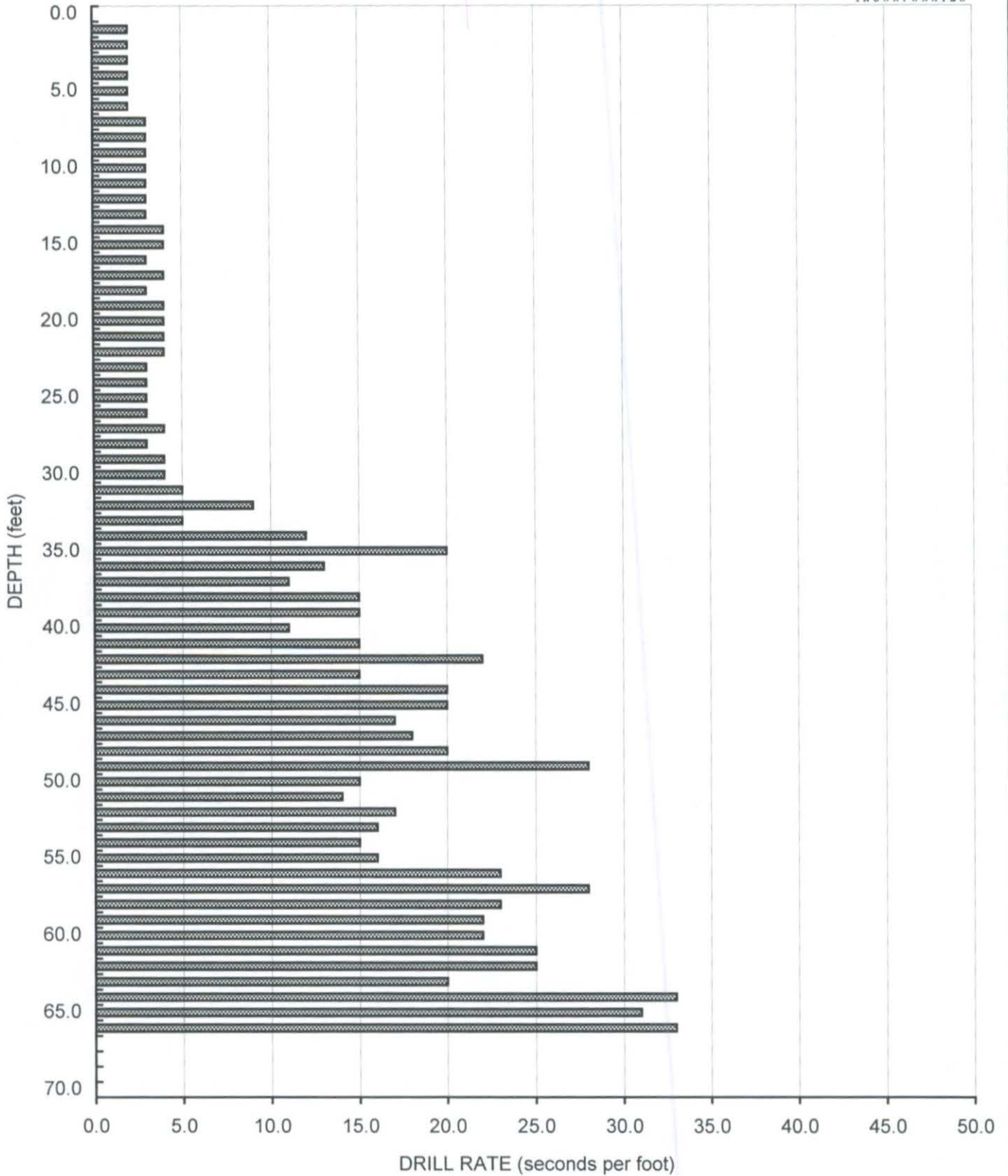

AIR TRACK BORING AT-28
Elevation - 481 Feet (MSL)



GEOCON
INCORPORATED

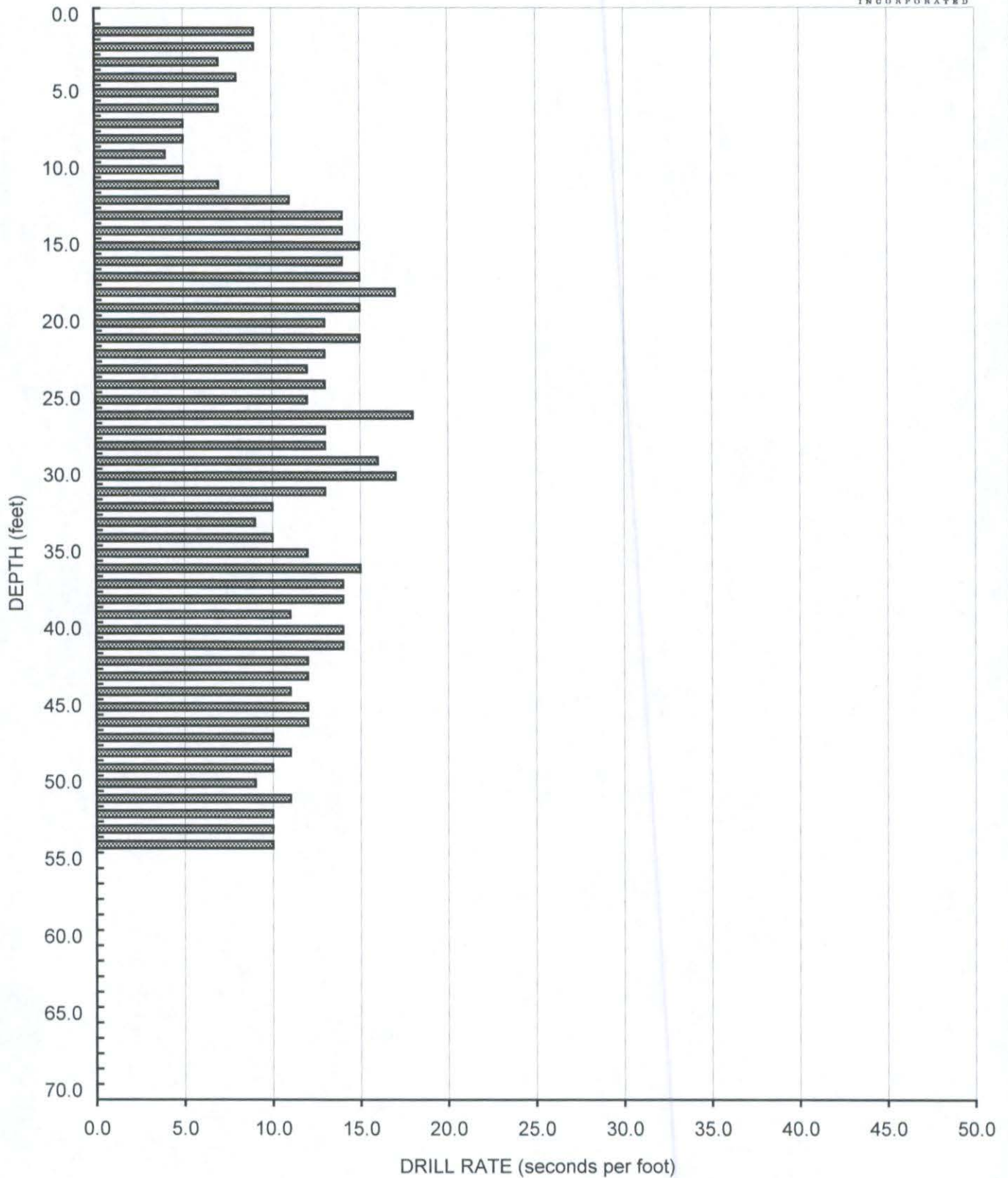

AIR TRACK BORING AT-29
Elevation - 480 Feet (MSL)



GEOCON
INCORPORATED

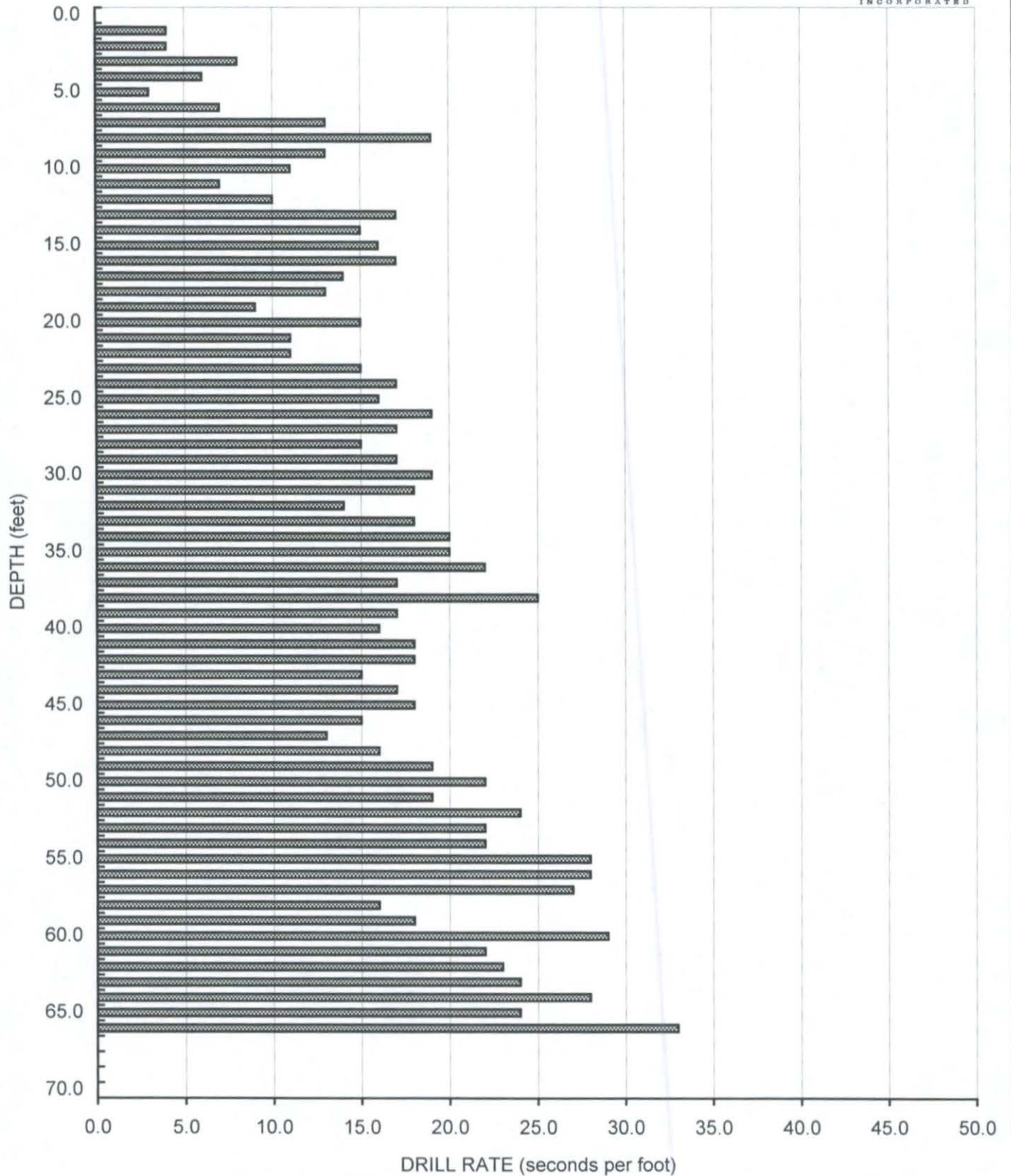

AIR TRACK BORING AT-30
Elevation - 478 Feet (MSL)



GEOCON
INCORPORATED

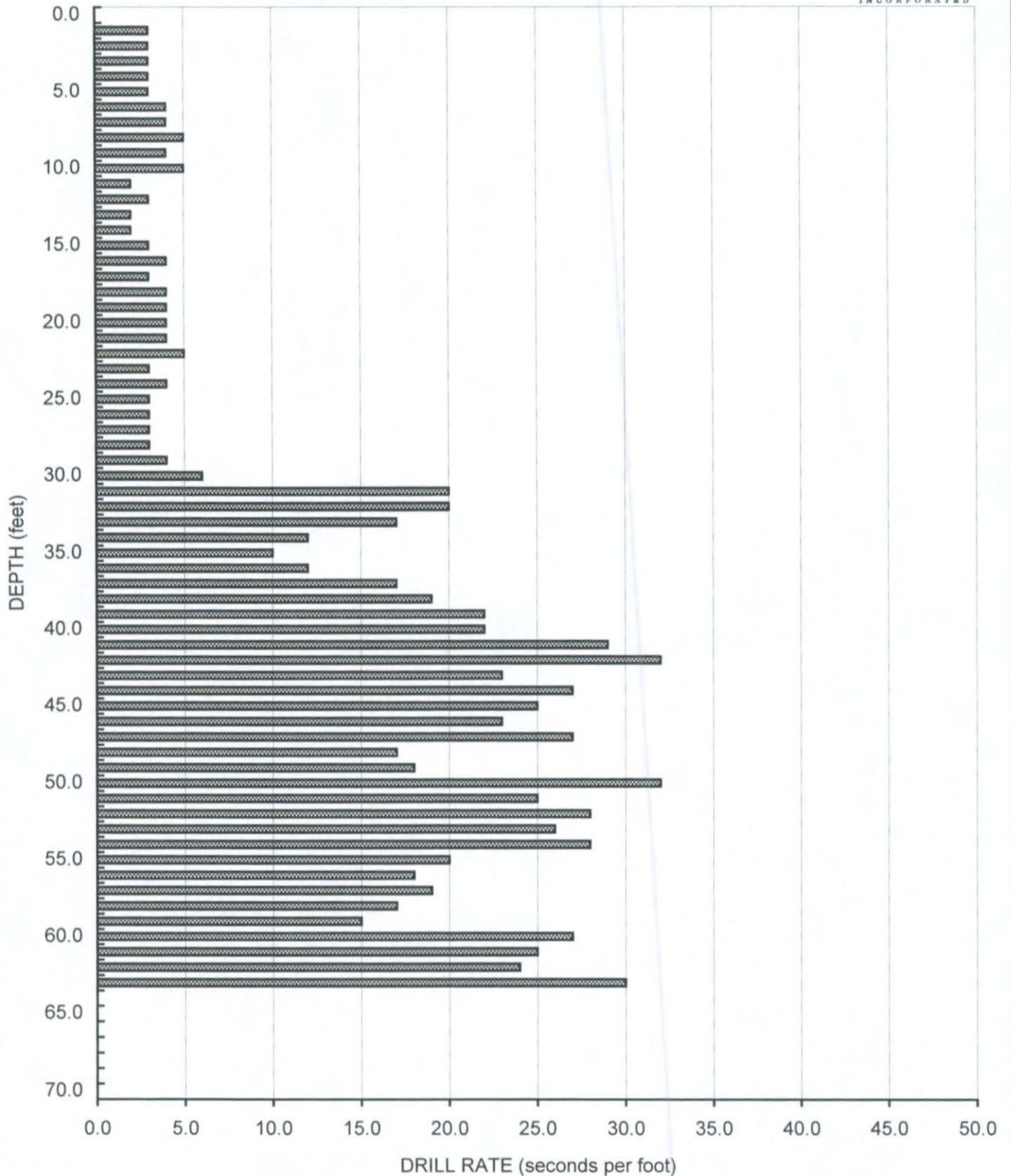

APPENDIX

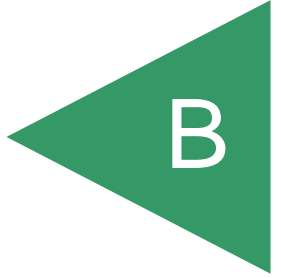

APPENDIX B

**EXPLORATORY BORINGS
PERFORMED BY
GEOCON INCORPORATED, DECEMBER 1979**

FOR

**SAN MARCOS TRACT 207
SAN MARCOS, CALIFORNIA**

PROJECT NO. D-2059-J01

File No. D-2059-J01
 December 5, 1979



DEPTH IN FEET	SAMPLE NUMBER	LOG & LOCATION OF SAMPLE	Penetration Resistance Blows/ft	DESCRIPTION	IN-PLACE	
					DRY DENSITY p.c.f	MOISTURE CONTENT % dry wt
0				BORING NO. 1		
0-2	1-1		50 3"	TOPSOIL Loose, slightly damp, brown, Silty fine SAND		NO SAMPLE
2-4	1-2			ALLUVIUM Dense, slightly damp, tan, Clayey, Gravelly, Silty, fine SAND	BULK SAMPLE	
4-6				becomes Sandy CLAY		
6-8	1-3				BULK SAMPLE	
8-12						
12-14				becomes moist to wet		
14-18						
18-22				METAVOLCANIC Dense, moist, white, gravelly, Sandy CLAY		
22-24				becomes tan		
24-28						
28-30				REFUSAL AT 29.0 FEET		

Figure 4, Log of Test Boring 1

File No. D-2059-J01
 December 5, 1979

DEPTH IN FEET	SAMPLE NUMBER	LOG & LOCATION OF SAMPLE	Penetration Resistance Blows/ft	DESCRIPTION	IN-PLACE	
					DRY DENSITY p.c.f	MOISTURE CONTENT % dry wt
BORING NO. 2						
0				TOPSOIL		
2				Medium dense, dry, brown, Silty, fine SAND		
4				DECOMPOSED GRANITE		
				Dense, dry, tan, Silty, fine to coarse SAND		
6				becomes very dense		
				REFUSAL AT 5.0 FEET		
BORING NO. 3						
0				TOPSOIL		
2	3-1			Loose, dry, brown, Silty, fine SAND		
4				DECOMPOSED GRANITE	BULK SAMPLE	
				Dense, dry, tan, Silty, fine to very coarse SAND		
6				REFUSAL AT 4.0 FEET		
BORING NO. 4						
0				TOPSOIL		
2				Loose, dry, brown, Silty, fine SAND		
4				DECOMPOSED GRANITE		
				Dense, dry, tan, Silty, fine to coarse SAND		
6				Dense, dry, tan, Silty, Sandy GRAVEL		
				REFUSAL AT 6.5 FEET		

Figure 5, Log of Test Borings 2, 3, and 4

DEPTH IN FEET	SAMPLE NUMBER	LOG & LOCATION OF SAMPLE	Penetration Resistance Blows/ft	DESCRIPTION	IN-PLACE	
					DRY DENSITY p.c.f	MOISTURE CONTENT % dry wt
BORING NO. 5						
0				ALLUVIUM		
2				Loose, slightly damp, brown, Gravelly, fine to coarse SAND		
4				Loose, slightly damp, brown, slightly Silty, fine to coarse SAND		
5-1				becomes gravelly, dark brown	BULK SAMPLE	
8				DECOMPOSED GRANITE		
10				Very dense, slightly damp, tan, Silty, fine to very coarse SAND		
BORING TERMINATED AT 10.0 FEET						
BORING NO. 6						
0				TOPOSIL		
2				Loose, damp, dark brown, Silty, fine SAND		
4				DECOMPOSED GRANITE		
6				Dense, damp, tan, Silty, fine to coarse SAND		
8				becomes yellow, moderately gravelly		
10						
BORING TERMINATED AT 10.0 FEET						

Figure 6, Log of Test Borings 5 & 6

File No. D-2059-J01
 December 5, 1979

DEPTH IN FEET	SAMPLE NUMBER	LOG & LOCATION OF SAMPLE	Penetration Resistance Blows/ft	DESCRIPTION	IN-PLACE	
					DRY DENSITY p.c.f.	MOISTURE CONTENT % dry wt
BORING NO. 7						
0				TOPSOIL		
2				Loose, dry, brown, Silty fine SAND		
4				DECOMPOSED GRANITE		
6				Dense, dry, tan, Silty, fine to coarse SAND		
6.5				Dense, dry, tan, gravel		
8				BORING TERMINATED AT 6.5 FEET		
BORING NO. 8						
0				TOPSOIL		
2				Loose, dry, light brown, Silty, fine SAND		
4				DECOMPOSED GRANITE		
6				Dense, dry, tan, Silty, fine to coarse SAND		
8						
10						
12				becomes damp		
14						
16				becomes very dense		
18						

REFUSAL AT 18.0 FEET

Figure 7, Log of Test Borings 7 & 8

File No. D-2059-J01
 December 5, 1979

DEPTH IN FEET	SAMPLE NUMBER	LOG & LOCATION OF SAMPLE	Penetration Resistance Blows/ft	DESCRIPTION	IN-PLACE	
					DRY DENSITY p.c.f	MOISTURE CONTENT % dry wt
BORING NO. 9						
0				TOPSOIL		
2				Loose, dry, brown, Silty, fine SAND		
4				DECOMPOSED GRANITE		
				Dense, dry, tan, Silty, fine to very coarse SAND		
6				Becomes gravel		
8				Becomes Silty, fine to very coarse SAND		
10				Becomes Sandy GRAVEL		
12				REFUSAL AT 12.0 FEET		
BORING NO. 10						
0				TOPSOIL		
2				Loose, dry, brown, Silty, fine SAND		
4				DECOMPOSED GRANITIC		
				Dense, dry, tan, Silty, fine to very coarse SAND		
8				REFUSAL AT 8.5 FEET		
10						

Figure 8, Log of Test Borings 9 & 10

File No. D-2059-J01
 December 5, 1979

DEPTH IN FEET	SAMPLE NUMBER	LOG & LOCATION OF SAMPLE	Penetration Resistance Blows/ft	DESCRIPTION	IN-PLACE	
					DRY DENSITY p.c.f	MOISTURE CONTENT % dry wt
BORING NO. 11						
0				TOPSOIL		
2				Loose, dry, red-brown, Silty, fine SAND		
4				Stiff, dry, red-brown, Sandy CLAY		
6				ALLUVIUM		
8				Dense, slightly damp, red-brown, Clayey, Gravelly, fine SAND becomes tan		
10				METAVOLCANIC		
12				Dense, white, to light green, Sandy CLAY becomes gravelly		
14				becomes moist		
16				BORING TERMINATED AT 15.0 FEET		

Figure 9, Log of Test Boring No. 11

APPENDIX

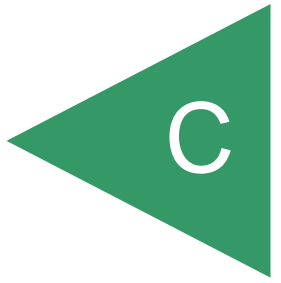

APPENDIX C

**EXPLORATORY TRENCHES
PERFORMED BY
GEOCON INCORPORATED, SEPTEMBER 1986**

FOR

**SAN MARCOS T.S.M. 292 LOTS 16 THROUGH 30
SAN MARCOS, CALIFORNIA**

PROJECT NO. D-2059-J02

DEPTH IN FEET	SAMPLE NO.	LITHOLOGY	GROUNDWATER	SOIL CLASS (USCS)	TRENCH 1		PENETRATION RESISTANCE BLOWS/FT.	DRY DENSITY P.C.F.	MOISTURE CONTENT, %
					ELEVATION _____	DATE DRILLED 9/17/86			
					EQUIPMENT J.D. 555 Trackhoe with Extendahoe				
0					MATERIAL DESCRIPTION				
2	T1-1 T1-2				FILL Medium dense to dense, slightly moist, orange-brown Silty fine to coarse SAND with some gravel and boulders boulders > 1 foot		BULK SAMPLE	124.8	2.7
6	T1-3 T1-4				GRANITIC ROCK Weathered: very dense, slightly moist, light gray-green, Silty fine to medium SAND, clay along joints N67W27S N70E85N		BULK SAMPLE	121.0	8.7
					TRENCH TERMINATED AT 6.5 FEET				
0					TRENCH 2				
2	T2-1 T2-2				TOPSOIL Dense, slightly moist to moist, orange Clayey fine to coarse SAND rocks contact in places is gradational		BULK SAMPLE	108.5	12.1
5	T2-3				GRANITIC ROCKS/SANTIAGO PEAK VOLCANICS Highly fractured, pink and tan, medium-grained transition rock, B-C,C,D,D, joints approximately 2 inches apart, joint surfaces moist and with clay N10W85S N75E70S		BULK SAMPLE		
					TRENCH TERMINATED AT 6.0 FEET (REFUSAL)				

Figure A-1, Log of Test Trenches 1 and 2

SAMPLE SYMBOLS		SAMPLING UNSUCCESSFUL		STANDARD PENETRATION TEST		DRIVE SAMPLE (UNDISTURBED)
		DISTURBED OR BAG SAMPLE		CHUNK SAMPLE		WATER TABLE OR SEEPAGE

NOTE: THE LOG OF SUBSURFACE CONDITIONS SHOWN HEREON APPLIES ONLY AT THE SPECIFIC BORING OR TRENCH LOCATION AND AT THE DATE INDICATED. IT IS NOT WARRANTED TO BE REPRESENTATIVE OF SUBSURFACE CONDITIONS AT OTHER LOCATIONS AND TIMES.

DEPTH IN FEET	SAMPLE NO.	LITHOLOGY	GROUNDWATER	SOIL CLASS (U.S.C.S.)	TRENCH 3			PENETRATION RESISTANCE BLOWS/FT.	DRY DENSITY P.C.F.	MOISTURE CONTENT, %
					ELEVATION _____	DATE DRILLED	EQUIPMENT			
					ELEVATION _____ DATE DRILLED 9/17/86					
					EQUIPMENT J.D. 555 Trackhoe with Extendahoe					
					MATERIAL DESCRIPTION					
0					GRANITIC ROCK					
2					Gray and tan medium grained granite, extensively fractured, jointed, B-C,B,D,D joints approximately 1 foot apart					
4										
6					N10W80N: joint					
8					evidence of blasting (voids)					
10					TRENCH TERMINATED AT 10 FEET					
					TRENCH 4					
0					FILL					
2					Medium dense, slightly moist to moist, brown Clayey fine to coarse SAND becomes green and clayey					
4										
6					COLLUVIUM					
					Medium dense, slightly moist, dark brown Silty fine to coarse SAND with cobbles					
					GRANITIC ROCKS/SANTIAGO PEAK VOLCANICS					
					Weathered, medium-grained transition rock: dense, moist, reddish-brown Silty fine to coarse SAND with joint cracks up to 1/2 inch wide filled with clay					
					TRENCH TERMINATED AT 5.0 FEET					

Figure A-2, Log of Test Trenches 3 and 4

SAMPLE SYMBOLS	<input type="checkbox"/> SAMPLING UNSUCCESSFUL	<input type="checkbox"/> STANDARD PENETRATION TEST	<input type="checkbox"/> DRIVE SAMPLE (UNDISTURBED)
	<input checked="" type="checkbox"/> DISTURBED OR BAG SAMPLE	<input type="checkbox"/> CHUNK SAMPLE	<input type="checkbox"/> WATER TABLE OR SEEPAGE

NOTE: THE LOG OF SUBSURFACE CONDITIONS SHOWN HEREON APPLIES ONLY AT THE SPECIFIC BORING OR TRENCH LOCATION AND AT THE DATE INDICATED. IT IS NOT WARRANTED TO BE REPRESENTATIVE OF SUBSURFACE CONDITIONS AT OTHER LOCATIONS AND TIMES.

DEPTH IN FEET	SAMPLE NO.	LITHOLOGY	GROUNDWATER	SOIL CLASS (USCS)	TRENCH 5	PENETRATION RESISTANCE (BLOWS/FT)	DRY DENSITY (PCF)	MOISTURE CONTENT (%)
					ELEVATION _____ DATE DRILLED <u>9/17/86</u> EQUIPMENT <u>J.D. 555 Trackhoe with Extendahoe</u>			
0					MATERIAL DESCRIPTION			
0-2	T5-1 T5-2				FILL Medium dense, slightly moist, tan, Silty fine to coarse SAND with boulders	BULK	SAMPLE 109.2	2.2
2-4					dark brown			
4-6					dark brown, clayey SAND with roots			
6-8					COLLUVIUM Dense, slightly moist, dark brown Silty fine to coarse SAND with cobbles			
8-10					GRANITIC ROCK Weathered: very dense, slightly moist, gray, Silty fine to medium SAND with gravel			
10-11					TRENCH TERMINATED AT 5.5 FEET			
0					TRENCH 6			
0-2					COLLUVIUM Medium dense, moist, dark brown, Silty fine to coarse SAND with cobbles and roots			
2-4					GRANITIC ROCKS/SANTIAGO PEAK VOLCANICS Pink and gray, fine-grained transition rock: B-C,C,D-E,D highly jointed, much clay along joints, joints approximately 1 inch apart			
4-6					TRENCH TERMINATED AT 4.5 FEET			

Figure A-3, Log of Test Trenches 5 and 6

SAMPLE SYMBOLS	SAMPLING UNSUCCESSFUL	STANDARD PENETRATION TEST	DRIVE SAMPLE (UNDISTURBED)
	DISTURBED OR BAG SAMPLE	CHUNK SAMPLE	WATER TABLE OR SEEPAGE

NOTE: THE LOG OF SUBSURFACE CONDITIONS SHOWN HEREON APPLIES ONLY AT THE SPECIFIC BORING OR TRENCH LOCATION AND AT THE DATE INDICATED. IT IS NOT WARRANTED TO BE REPRESENTATIVE OF SUBSURFACE CONDITIONS AT OTHER LOCATIONS AND TIMES.

DEPTH IN FEET	SAMPLE NO.	LITHOLOGY	GROUNDWATER	SOIL CLASS (USCS)	TRENCH 7		PENETRATION RESISTANCE BLOWS/FT.	DRY DENSITY P.C.F.	MOISTURE CONTENT, %
					ELEVATION _____	DATE DRILLED <u>9/17/86</u>			
					EQUIPMENT <u>J.D. 555 Trackhoe with Extendahoe</u>				
MATERIAL DESCRIPTION									
0					FILL				
2					Loose, moist, tan Silty, fine to coarse SAND with some clay, boulders to 1 foot				
4									
6									
8	T7-1							BULK	SAMPLE
10						more and larger boulders, approximately 4 feet in diameter			
12	T7-2					Medium dense, moist, black-brown Clayey, fine to coarse SAND		BULK	SAMPLE
						GRANITIC ROCK/SANTIAGO PEAK VOLCANICS Pink and gray, fine-grained transition rock B,A,B,D			
						TRENCH TERMINATED AT 12 FEET (REFUSAL)			

Figure A-4, Log of Test Trench 7

SAMPLE SYMBOLS	<input type="checkbox"/> SAMPLING UNSUCCESSFUL	<input type="checkbox"/> STANDARD PENETRATION TEST	<input type="checkbox"/> DRIVE SAMPLE (UNDISTURBED)
	<input checked="" type="checkbox"/> DISTURBED OR BAG SAMPLE	<input type="checkbox"/> CHUNK SAMPLE	WATER TABLE OR SEEPAGE

NOTE: THE LOG OF SUBSURFACE CONDITIONS SHOWN HEREON APPLIES ONLY AT THE SPECIFIC BORING OR TRENCH LOCATION AND AT THE DATE INDICATED. IT IS NOT WARRANTED TO BE REPRESENTATIVE OF SUBSURFACE CONDITIONS AT OTHER LOCATIONS AND TIMES.



DEPTH IN FEET	SAMPLE NO.	LITHOLOGY	GROUNDWATER	SOIL CLASS (U.S.C.S.)	TRENCH 8	PENETRATION RESISTANCE BLOWS/FT	DRY DENSITY P.C.F.	MOISTURE CONTENT, %
					ELEVATION _____ DATE DRILLED <u>9/17/86</u> EQUIPMENT <u>J.D. 555 Trackhoe with Extendahoe</u>			
0					MATERIAL DESCRIPTION			
2					TOPSOIL Dense, slightly moist, orange-brown, Clayey fine to coarse SAND (weathered Kgr/Jsp)			
					GRANITIC ROCK/SANTIAGO PEAK VOLCANICS Light gray, fine-grained granite C,B-C,D,D N45W82S			
					TRENCH TERMINATED AT 1.5 FEET (REFUSAL)			
0					TRENCH 9			
2					GRANITIC ROCK Light gray, fine to medium-grained granite, weathered, clayey in parts			
4					TRENCH TERMINATED AT 3.5 FEET (REFUSAL)			

Figure A-5, Log of Test Trenches 8 and 9

SAMPLE SYMBOLS	<input type="checkbox"/> SAMPLING UNSUCCESSFUL	<input type="checkbox"/> STANDARD PENETRATION TEST	<input type="checkbox"/> DRIVE SAMPLE (UNDISTURBED)
	<input checked="" type="checkbox"/> DISTURBED OR BAG SAMPLE	<input type="checkbox"/> CHUNK SAMPLE	 WATER TABLE OR SEEPAGE

NOTE: THE LOG OF SUBSURFACE CONDITIONS SHOWN HEREON APPLIES ONLY AT THE SPECIFIC BORING OR TRENCH LOCATION AND AT THE DATE INDICATED. IT IS NOT WARRANTED TO BE REPRESENTATIVE OF SUBSURFACE CONDITIONS AT OTHER LOCATIONS AND TIMES.

DEPTH IN FEET	SAMPLE NO.	LITHOLOGY	GROUNDWATER	SOIL CLASS (U.S.C.S)	TRENCH 10 ELEVATION _____ DATE DRILLED <u>9/17/86</u> EQUIPMENT <u>J.D, 555 Trackhoe with Extendahoe</u>	PENETRATION RESISTANCE BLOWS/FT.	DRY DENSITY PCF.	MOISTURE CONTENT, %
0					MATERIAL DESCRIPTION			
2					GRANITIC ROCK Medium-grained, orange and tan granite with euhedral feldspar crystal, C,C,D,D joints approximately 1 inch apart N5E70N N30E73N N27W30S			
					TRENCH TERMINATED AT 2.0 FEET (REFUSAL)			
0					TRENCH 11			
2					FILL Dense, slightly moist, tan, Silty, fine to coarse SAND with some boulders			
4	T11-1				Loose, moist, black-brown Clayey, fine to coarse SAND with boulders and roots)	BULK SAMPLE		
6					GRANITIC ROCK Weathered, medium-grained, gray and white granite			
8					TRENCH TERMINATED AT 7.5 FEET (REFUSAL)			

Figure A-6, Log of Test Trenches 10 and 11

SAMPLE SYMBOLS	SAMPLING UNSUCCESSFUL	STANDARD PENETRATION TEST	DRIVE SAMPLE (UNDISTURBED)
	DISTURBED OR BAG SAMPLE	CHUNK SAMPLE	WATER TABLE OR SEEPAGE

NOTE: THE LOG OF SUBSURFACE CONDITIONS SHOWN HEREON APPLIES ONLY AT THE SPECIFIC BORING OR TRENCH LOCATION AND AT THE DATE INDICATED. IT IS NOT WARRANTED TO BE REPRESENTATIVE OF SUBSURFACE CONDITIONS AT OTHER LOCATIONS AND TIMES.

DEPTH IN FEET	SAMPLE NO.	LITHOLOGY	GROUNDWATER	SOIL CLASS (USCS)	TRENCH 12			PENETRATION RESISTANCE BLOWS/FT.	DRY DENSITY P.C.F.	MOISTURE CONTENT, %
					ELEVATION _____	DATE DRILLED 9/17/86	EQUIPMENT J.D. 555 Trackhoe with Extendahoe			
0					MATERIAL DESCRIPTION					
2					FILL Medium dense, slightly moist, tan Silty, fine to coarse SAND with some boulders					
4	T12-1				Loose to medium dense, moist, dark brown Clayey, fine to coarse SAND with some roots and boulders				121.6	14.6
6										
8					GRANITIC ROCK Medium-grained tan and gray granite, weathered					
					TRENCH TERMINATED AT 8.0 FEET					
0	T13-1				TRENCH 13 COLLUVIUM Medium dense, very slightly moist, brown Clayey, fine to medium SAND with few gravel			BULK	SAMPLE	
2	T13-2							107.0	1.0	
4					Medium dense, slightly moist, brown, Clayey SAND					
					GRANITIC ROCK Orange and tan, medium-grained granite, joints approximately 2 inches apart N65W90-joint					
					TRENCH TERMINATED AT 4.0 FEET (REFUSAL)					

Figure A-7, Log of Test Trenches 12 and 13

SAMPLE SYMBOLS		SAMPLING UNSUCCESSFUL		STANDARD PENETRATION TEST		DRIVE SAMPLE (UNDISTURBED)
		DISTURBED OR BAG SAMPLE		CHUNK SAMPLE		WATER TABLE OR SEEPAGE

NOTE: THE LOG OF SUBSURFACE CONDITIONS SHOWN HEREON APPLIES ONLY AT THE SPECIFIC BORING OR TRENCH LOCATION AND AT THE DATE INDICATED. IT IS NOT WARRANTED TO BE REPRESENTATIVE OF SUBSURFACE CONDITIONS AT OTHER LOCATIONS AND TIMES.

DEPTH IN FEET	SAMPLE NO.	LITHOLOGY	GROUNDWATER	SOIL CLASS (U.S.C.S.)	TRENCH 14			PENETRATION RESISTANCE BLOWS/FT	DRY DENSITY P.C.F.	MOISTURE CONTENT, %
					ELEVATION _____	DATE DRILLED	9/18/86			
					EQUIPMENT					
					JD 510 Backhoe with 24" Bucket					
MATERIAL DESCRIPTION										
0					COLLUVIUM					
2	T14-1				Loose to medium dense, slightly moist, brown, Clayey, fine to coarse SAND with roots, boulders			106.1	0.2	
4					TRENCH TERMINATED AT 3.5 FEET					
TRENCH 15										
0					COLLUVIUM					
2	T15-1				Medium dense, slightly moist, brown, Silty, fine to coarse SAND with gravel			104.1	3.4	
4	T15-2				GRANITIC ROCK/SANTIAGO PEAK VOLCANICS Dense, slightly moist, light orange, Silty, fine to coarse SAND with few round holes Pink and gray, medium-grained granite; C-D, C, D-E, D, clay along joints, joint spacing, approximately 2 inches apart N32E78N less weathered			132.3	5.4	
TRENCH TERMINATED AT 4.0 FEET (REFUSAL)										

Figure A-8, Log of Test Trenches 14 and 15

SAMPLE SYMBOLS	<input type="checkbox"/>	SAMPLING UNSUCCESSFUL	<input type="checkbox"/>	STANDARD PENETRATION TEST	<input type="checkbox"/>	DRIVE SAMPLE (UNDISTURBED)
	<input checked="" type="checkbox"/>	DISTURBED OR BAG SAMPLE	<input checked="" type="checkbox"/>	CHUNK SAMPLE		WATER TABLE OR SEEPAGE

NOTE: THE LOG OF SUBSURFACE CONDITIONS SHOWN HEREON APPLIES ONLY AT THE SPECIFIC BORING OR TRENCH LOCATION AND AT THE DATE INDICATED. IT IS NOT WARRANTED TO BE REPRESENTATIVE OF SUBSURFACE CONDITIONS AT OTHER LOCATIONS AND TIMES.

DEPTH IN FEET	SAMPLE NO	LITHOLOGY	GROUNDWATER	SOIL CLASS (USCS)	TRENCH 16			PENETRATION RESISTANCE BLOWS/FT.	DRY DENSITY PCF.	MOISTURE CONTENT, %
					ELEVATION _____	DATE DRILLED	9/18/86			
					EQUIPMENT _____					
MATERIAL DESCRIPTION										
0					COLLUVIUM					
2	T16-1				Medium dense, slightly moist, brown, Silty, fine to coarse SAND with roots and cobbles				107.5	7.6
4					GRANITIC ROCK/SANTIAGO PEAK VOLCANICS					
					Weathered topsoil: dense, slightly moist, orange-red Clayey fine to coarse SAND					
					Pink and purple, medium-grained granite C,C-B,D,D					
					TRENCH TERMINATED AT 2.5 FEET (REFUSAL)					
0					TRENCH 17					
2					FILL					
					Loose, moist, tan, Silty, fine to coarse SAND black with organics					
4					ALLUVIUM					
					Loose, saturated, brown, Clayey GRAVEL					
					TRENCH TERMINATED AT 2.5 FEET (REFUSAL)					
0					TRENCH 18					
2	T18-1				FILL					
					Loose, very moist, dark brown, Clayey, fine to coarse SAND black with organics				BULK	SAMPLE
4					ALLUVIUM					
					Loose, saturated, brown, Clayey GRAVEL					
					TRENCH TERMINATED AT 2.5 FEET (REFUSAL)					

Figure A-9, Log of Test Trenches 16, 17 and 18

SAMPLE SYMBOLS		SAMPLING UNSUCCESSFUL		STANDARD PENETRATION TEST		DRIVE SAMPLE (UNDISTURBED)
		DISTURBED OR BAG SAMPLE		CHUNK SAMPLE		WATER TABLE OR SEEPAGE

NOTE: THE LOG OF SUBSURFACE CONDITIONS SHOWN HEREON APPLIES ONLY AT THE SPECIFIC BORING OR TRENCH LOCATION AND AT THE DATE INDICATED. IT IS NOT WARRANTED TO BE REPRESENTATIVE OF SUBSURFACE CONDITIONS AT OTHER LOCATIONS AND TIMES.

APPENDIX

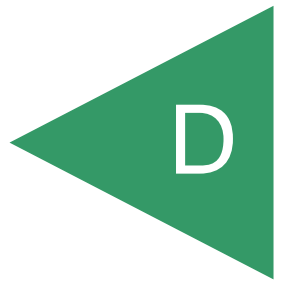

APPENDIX D

LABORATORY TESTING

Laboratory tests were performed during previous studies of 1979 and 1986 in general accordance with the test methods of the American Society for Testing and Materials (ASTM) or other suggested procedures at the time of the study. Selected soil samples were tested for their in-place dry density, moisture content and shear strength. The grain size distribution, maximum dry density and optimum moisture content and Expansion Index of selected bulk samples were determined in accordance with ASTM Test Procedures D 1557-70 and D 1557-78. Portions of the bulk samples were then subjected to direct shear testing.

The results of our laboratory tests performed in 1979 and 1986 are presented in their original format hereinafter.

File No. D-2059-J01
December 5, 1979

TABLE I
Summary of In-Place Moisture-Density and Direct Shear Test Results

<u>Sample No.</u>	<u>Depth ft.</u>	<u>Dry Density pcf</u>	<u>Moisture Content %</u>	<u>Unit Cohesion psf</u>	<u>Angle of Shear Resistance Degrees</u>
1-3	6-8	116.2	9.8	230	32
3-1	1-4	118.5	8.5	110	41
5-1	2-8	113.5	11.9	180	39

TABLE II
Summary of Laboratory Compaction Test Results
A.S.T.M. D1557-70

<u>Sample No.</u>	<u>Depth ft.</u>	<u>Description</u>	<u>Max. Dry Density pcf</u>	<u>Optimum Moisture % dry wt.</u>
1-3	6-8	Tan, Sandy CLAY	129.2	10.0
3-1	1-4	Tan, Silty, fine to coarse SAND	131.0	9.1
5-1	2-8	Brown, gravelly, fine to coarse SAND	125.9	11.3

TABLE III
Summary of Laboratory Expansion Test Results

<u>Sample No.</u>	<u>Description</u>	<u>Depth ft.</u>	<u>Moisture Content</u>		<u>Dry Density pcf</u>	<u>Expansion (+) or Settlement (-) Surcharge</u>	
			<u>Before Test %</u>	<u>After Test %</u>		<u>%</u>	<u>psf</u>
1-3	Tan, Sandy CLAY	6-8	9.1	17.6	117.0	(+)4.5	150

File No. D-2059-J02
October 3, 1986

TABLE I

Summary of In-Place Moisture-Density and Direct Shear Test Results

Sample No.	Dry Density pcf	Moisture Content %	Unit Cohesion psf	Angle of Shear Resistance Degrees
1-1	124.8	2.7		
*1-2	118.4	8.4	327	39
1-3	121.0	8.7		
*1-4	108.3	11.1	380	31
2-1	108.5	12.1		
5-2	109.2	2.2		
7-2		15.1		
*11-1	114.1	9.9	320	38
12-1	121.6	14.6		
13-2	107.0	1.0		
14-1	104.3	0.2		
15-1	104.0	3.4		
15-2	132.3	5.4		
16-1	107.5	7.6		

*Remolded to 90% of maximum density and near optimum moisture content.

File No. D-2059-J02
 October 3, 1986

TABLE II

Summary of Laboratory Compaction Test Results

ASTM D1557-78

Sample No.	Description	Maximum Dry Density pcf	Optimum Moisture % Dry Wt.
1-2	Orange-brown Silty, fine to coarse SAND	131.2	8.7
1-4	Light gray-green, Silty, fine to medium SAND	119.9	11.4
11-1	Black-brown, Clayey, fine to SAND	126.4	10.2
13-1	Brown, Clayey, fine to medium SAND	115.5	13.3

TABLE III

Summary of Laboratory Expansion Test Results

FHA Method

Sample No.	<u>Moisture Content</u>			Dry Density pcf	Expansion (+) or Settlement(-) Surcharge	
	Before Test %	Air Dry %	After Test %		%	psf
1-2	8.1	0.6	13.3	118.7	+0.3	150
1-4	12.0	3.5	22.0	07.5	+3.7	150
11-1	9.8	0.8	14.2	114.0	+0.3	150

SAMPLE		T2-3	T11-1			
DEPTH (ft.)						
GRADATION (% FINER BY WEIGHT)	U.S. STANDARD SIEVES	1/2"	69.0	95.1		
		1"	41.3	88.7		
		3/4"	31.7	84.9		
		1/2"	21.8	80.2		
		3/8"	16.9	76.6		
		#4	10.6	67.2		
		#8	7.1	58.0		
		#16	5.0	46.4		
		#30	3.8	35.0		
		#50	2.8	25.5		
		#80	--	--		
		#100	2.1	18.7		
		#200	1.5	14.4		
		HYDROMETRY	.05mm			
	.005mm					
.001mm						

LIQUID LIMIT					
PLASTIC LIMIT					
PLASTICITY INDEX					

GRAIN SIZE ANALYSIS AND ATTERBERG LIMITS

SAN MARCOS TRACT 218
 SAN MARCOS, CALIFORNIA

Figure B-1

APPENDIX

A solid green triangle pointing to the left, containing the letter 'E' in white.

E

APPENDIX E

RECOMMENDED GRADING SPECIFICATIONS

FOR

MELROSE INDUSTRIAL SITE
SAN MARCOS, CALIFORNIA

PROJECT NO. G2520-42-01

RECOMMENDED GRADING SPECIFICATIONS

1. GENERAL

- 1.1 These Recommended Grading Specifications shall be used in conjunction with the Geotechnical Report for the project prepared by Geocon. The recommendations contained in the text of the Geotechnical Report are a part of the earthwork and grading specifications and shall supersede the provisions contained hereinafter in the case of conflict.
- 1.2 Prior to the commencement of grading, a geotechnical consultant (Consultant) shall be employed for the purpose of observing earthwork procedures and testing the fills for substantial conformance with the recommendations of the Geotechnical Report and these specifications. The Consultant should provide adequate testing and observation services so that they may assess whether, in their opinion, the work was performed in substantial conformance with these specifications. It shall be the responsibility of the Contractor to assist the Consultant and keep them apprised of work schedules and changes so that personnel may be scheduled accordingly.
- 1.3 It shall be the sole responsibility of the Contractor to provide adequate equipment and methods to accomplish the work in accordance with applicable grading codes or agency ordinances, these specifications and the approved grading plans. If, in the opinion of the Consultant, unsatisfactory conditions such as questionable soil materials, poor moisture condition, inadequate compaction, and/or adverse weather result in a quality of work not in conformance with these specifications, the Consultant will be empowered to reject the work and recommend to the Owner that grading be stopped until the unacceptable conditions are corrected.

2. DEFINITIONS

- 2.1 **Owner** shall refer to the owner of the property or the entity on whose behalf the grading work is being performed and who has contracted with the Contractor to have grading performed.
- 2.2 **Contractor** shall refer to the Contractor performing the site grading work.
- 2.3 **Civil Engineer** or **Engineer of Work** shall refer to the California licensed Civil Engineer or consulting firm responsible for preparation of the grading plans, surveying and verifying as-graded topography.
- 2.4 **Consultant** shall refer to the soil engineering and engineering geology consulting firm retained to provide geotechnical services for the project.

- 2.5 **Soil Engineer** shall refer to a California licensed Civil Engineer retained by the Owner, who is experienced in the practice of geotechnical engineering. The Soil Engineer shall be responsible for having qualified representatives on-site to observe and test the Contractor's work for conformance with these specifications.
- 2.6 **Engineering Geologist** shall refer to a California licensed Engineering Geologist retained by the Owner to provide geologic observations and recommendations during the site grading.
- 2.7 **Geotechnical Report** shall refer to a soil report (including all addenda) which may include a geologic reconnaissance or geologic investigation that was prepared specifically for the development of the project for which these Recommended Grading Specifications are intended to apply.

3. MATERIALS

- 3.1 Materials for compacted fill shall consist of any soil excavated from the cut areas or imported to the site that, in the opinion of the Consultant, is suitable for use in construction of fills. In general, fill materials can be classified as *soil* fills, *soil-rock* fills or *rock* fills, as defined below.
- 3.1.1 **Soil fills** are defined as fills containing no rocks or hard lumps greater than 12 inches in maximum dimension and containing at least 40 percent by weight of material smaller than $\frac{3}{4}$ inch in size.
- 3.1.2 **Soil-rock fills** are defined as fills containing no rocks or hard lumps larger than 4 feet in maximum dimension and containing a sufficient matrix of soil fill to allow for proper compaction of soil fill around the rock fragments or hard lumps as specified in Paragraph 6.2. **Oversize rock** is defined as material greater than 12 inches.
- 3.1.3 **Rock fills** are defined as fills containing no rocks or hard lumps larger than 3 feet in maximum dimension and containing little or no fines. Fines are defined as material smaller than $\frac{3}{4}$ inch in maximum dimension. The quantity of fines shall be less than approximately 20 percent of the rock fill quantity.
- 3.2 Material of a perishable, spongy, or otherwise unsuitable nature as determined by the Consultant shall not be used in fills.
- 3.3 Materials used for fill, either imported or on-site, shall not contain hazardous materials as defined by the California Code of Regulations, Title 22, Division 4, Chapter 30, Articles 9

and 10; 40CFR; and any other applicable local, state or federal laws. The Consultant shall not be responsible for the identification or analysis of the potential presence of hazardous materials. However, if observations, odors or soil discoloration cause Consultant to suspect the presence of hazardous materials, the Consultant may request from the Owner the termination of grading operations within the affected area. Prior to resuming grading operations, the Owner shall provide a written report to the Consultant indicating that the suspected materials are not hazardous as defined by applicable laws and regulations.

- 3.4 The outer 15 feet of *soil-rock* fill slopes, measured horizontally, should be composed of properly compacted *soil* fill materials approved by the Consultant. *Rock* fill may extend to the slope face, provided that the slope is not steeper than 2:1 (horizontal:vertical) and a soil layer no thicker than 12 inches is track-walked onto the face for landscaping purposes. This procedure may be utilized provided it is acceptable to the governing agency, Owner and Consultant.
- 3.5 Samples of soil materials to be used for fill should be tested in the laboratory by the Consultant to determine the maximum density, optimum moisture content, and, where appropriate, shear strength, expansion, and gradation characteristics of the soil.
- 3.6 During grading, soil or groundwater conditions other than those identified in the Geotechnical Report may be encountered by the Contractor. The Consultant shall be notified immediately to evaluate the significance of the unanticipated condition.

4. CLEARING AND PREPARING AREAS TO BE FILLED

- 4.1 Areas to be excavated and filled shall be cleared and grubbed. Clearing shall consist of complete removal above the ground surface of trees, stumps, brush, vegetation, man-made structures, and similar debris. Grubbing shall consist of removal of stumps, roots, buried logs and other unsuitable material and shall be performed in areas to be graded. Roots and other projections exceeding 1½ inches in diameter shall be removed to a depth of 3 feet below the surface of the ground. Borrow areas shall be grubbed to the extent necessary to provide suitable fill materials.
- 4.2 Asphalt pavement material removed during clearing operations should be properly disposed at an approved off-site facility or in an acceptable area of the project evaluated by Geocon and the property owner. Concrete fragments that are free of reinforcing steel may be placed in fills, provided they are placed in accordance with Section 6.2 or 6.3 of this document.

- 4.3 After clearing and grubbing of organic matter and other unsuitable material, loose or porous soils shall be removed to the depth recommended in the Geotechnical Report. The depth of removal and compaction should be observed and approved by a representative of the Consultant. The exposed surface shall then be plowed or scarified to a minimum depth of 6 inches and until the surface is free from uneven features that would tend to prevent uniform compaction by the equipment to be used.
- 4.4 Where the slope ratio of the original ground is steeper than 5:1 (horizontal:vertical), or where recommended by the Consultant, the original ground should be benched in accordance with the following illustration.

TYPICAL BENCHING DETAIL

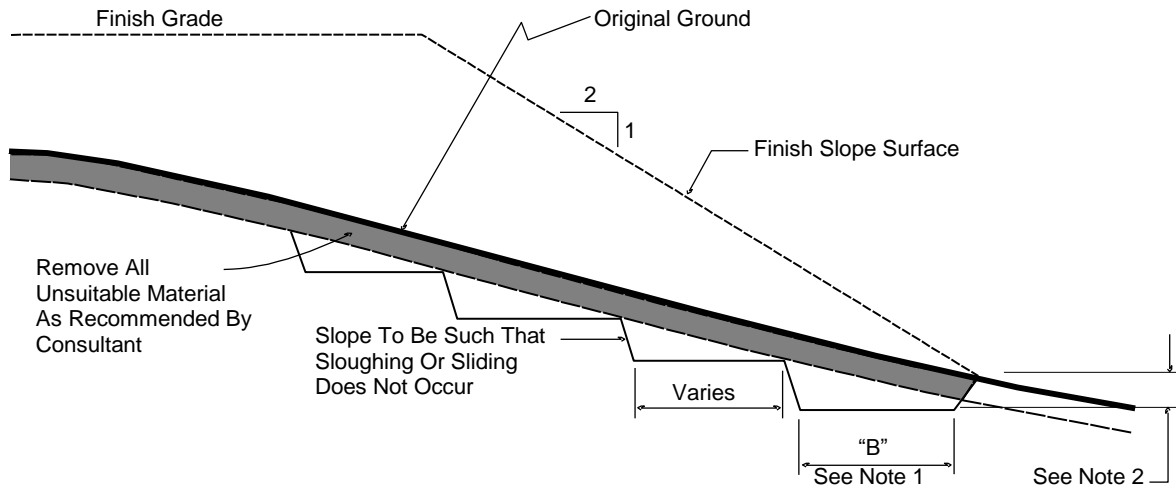

No Scale

- DETAIL NOTES: (1) Key width "B" should be a minimum of 10 feet, or sufficiently wide to permit complete coverage with the compaction equipment used. The base of the key should be graded horizontal, or inclined slightly into the natural slope.
- (2) The outside of the key should be below the topsoil or unsuitable surficial material and at least 2 feet into dense formational material. Where hard rock is exposed in the bottom of the key, the depth and configuration of the key may be modified as approved by the Consultant.

- 4.5 After areas to receive fill have been cleared and scarified, the surface should be moisture conditioned to achieve the proper moisture content, and compacted as recommended in Section 6 of these specifications.

5. COMPACTION EQUIPMENT

- 5.1 Compaction of *soil* or *soil-rock* fill shall be accomplished by sheepsfoot or segmented-steel wheeled rollers, vibratory rollers, multiple-wheel pneumatic-tired rollers, or other types of acceptable compaction equipment. Equipment shall be of such a design that it will be capable of compacting the *soil* or *soil-rock* fill to the specified relative compaction at the specified moisture content.
- 5.2 Compaction of *rock* fills shall be performed in accordance with Section 6.3.

6. PLACING, SPREADING AND COMPACTION OF FILL MATERIAL

- 6.1 *Soil* fill, as defined in Paragraph 3.1.1, shall be placed by the Contractor in accordance with the following recommendations:
- 6.1.1 *Soil* fill shall be placed by the Contractor in layers that, when compacted, should generally not exceed 8 inches. Each layer shall be spread evenly and shall be thoroughly mixed during spreading to obtain uniformity of material and moisture in each layer. The entire fill shall be constructed as a unit in nearly level lifts. Rock materials greater than 12 inches in maximum dimension shall be placed in accordance with Section 6.2 or 6.3 of these specifications.
- 6.1.2 In general, the *soil* fill shall be compacted at a moisture content at or above the optimum moisture content as determined by ASTM D 1557.
- 6.1.3 When the moisture content of *soil* fill is below that specified by the Consultant, water shall be added by the Contractor until the moisture content is in the range specified.
- 6.1.4 When the moisture content of the *soil* fill is above the range specified by the Consultant or too wet to achieve proper compaction, the *soil* fill shall be aerated by the Contractor by blading/mixing, or other satisfactory methods until the moisture content is within the range specified.
- 6.1.5 After each layer has been placed, mixed, and spread evenly, it shall be thoroughly compacted by the Contractor to a relative compaction of at least 90 percent. Relative compaction is defined as the ratio (expressed in percent) of the in-place dry density of the compacted fill to the maximum laboratory dry density as determined in accordance with ASTM D 1557. Compaction shall be continuous over the entire area, and compaction equipment shall make sufficient passes so that the specified minimum relative compaction has been achieved throughout the entire fill.

- 6.1.6 Where practical, soils having an Expansion Index greater than 50 should be placed at least 3 feet below finish pad grade and should be compacted at a moisture content generally 2 to 4 percent greater than the optimum moisture content for the material.
 - 6.1.7 Properly compacted *soil* fill shall extend to the design surface of fill slopes. To achieve proper compaction, it is recommended that fill slopes be over-built by at least 3 feet and then cut to the design grade. This procedure is considered preferable to track-walking of slopes, as described in the following paragraph.
 - 6.1.8 As an alternative to over-building of slopes, slope faces may be back-rolled with a heavy-duty loaded sheepsfoot or vibratory roller at maximum 4-foot fill height intervals. Upon completion, slopes should then be track-walked with a D-8 dozer or similar equipment, such that a dozer track covers all slope surfaces at least twice.
- 6.2 *Soil-rock* fill, as defined in Paragraph 3.1.2, shall be placed by the Contractor in accordance with the following recommendations:
- 6.2.1 Rocks larger than 12 inches but less than 4 feet in maximum dimension may be incorporated into the compacted *soil* fill, but shall be limited to the area measured 15 feet minimum horizontally from the slope face and 5 feet below finish grade or 3 feet below the deepest utility, whichever is deeper.
 - 6.2.2 Rocks or rock fragments up to 4 feet in maximum dimension may either be individually placed or placed in windrows. Under certain conditions, rocks or rock fragments up to 10 feet in maximum dimension may be placed using similar methods. The acceptability of placing rock materials greater than 4 feet in maximum dimension shall be evaluated during grading as specific cases arise and shall be approved by the Consultant prior to placement.
 - 6.2.3 For individual placement, sufficient space shall be provided between rocks to allow for passage of compaction equipment.
 - 6.2.4 For windrow placement, the rocks should be placed in trenches excavated in properly compacted *soil* fill. Trenches should be approximately 5 feet wide and 4 feet deep in maximum dimension. The voids around and beneath rocks should be filled with approved granular soil having a Sand Equivalent of 30 or greater and should be compacted by flooding. Windrows may also be placed utilizing an "open-face" method in lieu of the trench procedure, however, this method should first be approved by the Consultant.

- 6.2.5 Windrows should generally be parallel to each other and may be placed either parallel to or perpendicular to the face of the slope depending on the site geometry. The minimum horizontal spacing for windrows shall be 12 feet center-to-center with a 5-foot stagger or offset from lower courses to next overlying course. The minimum vertical spacing between windrow courses shall be 2 feet from the top of a lower windrow to the bottom of the next higher windrow.
- 6.2.6 Rock placement, fill placement and flooding of approved granular soil in the windrows should be continuously observed by the Consultant.
- 6.3 *Rock* fills, as defined in Section 3.1.3, shall be placed by the Contractor in accordance with the following recommendations:
- 6.3.1 The base of the *rock* fill shall be placed on a sloping surface (minimum slope of 2 percent). The surface shall slope toward suitable subdrainage outlet facilities. The *rock* fills shall be provided with subdrains during construction so that a hydrostatic pressure buildup does not develop. The subdrains shall be permanently connected to controlled drainage facilities to control post-construction infiltration of water.
- 6.3.2 *Rock* fills shall be placed in lifts not exceeding 3 feet. Placement shall be by rock trucks traversing previously placed lifts and dumping at the edge of the currently placed lift. Spreading of the *rock* fill shall be by dozer to facilitate *seating* of the rock. The *rock* fill shall be watered heavily during placement. Watering shall consist of water trucks traversing in front of the current rock lift face and spraying water continuously during rock placement. Compaction equipment with compactive energy comparable to or greater than that of a 20-ton steel vibratory roller or other compaction equipment providing suitable energy to achieve the required compaction or deflection as recommended in Paragraph 6.3.3 shall be utilized. The number of passes to be made should be determined as described in Paragraph 6.3.3. Once a *rock* fill lift has been covered with *soil* fill, no additional *rock* fill lifts will be permitted over the *soil* fill.
- 6.3.3 Plate bearing tests, in accordance with ASTM D 1196, may be performed in both the compacted *soil* fill and in the *rock* fill to aid in determining the required minimum number of passes of the compaction equipment. If performed, a minimum of three plate bearing tests should be performed in the properly compacted *soil* fill (minimum relative compaction of 90 percent). Plate bearing tests shall then be performed on areas of *rock* fill having two passes, four passes and six passes of the compaction equipment, respectively. The number of passes required for the *rock* fill shall be determined by comparing the results of the plate bearing tests for the *soil* fill and the *rock* fill and by evaluating the deflection

variation with number of passes. The required number of passes of the compaction equipment will be performed as necessary until the plate bearing deflections are equal to or less than that determined for the properly compacted *soil* fill. In no case will the required number of passes be less than two.

- 6.3.4 A representative of the Consultant should be present during *rock* fill operations to observe that the minimum number of “passes” have been obtained, that water is being properly applied and that specified procedures are being followed. The actual number of plate bearing tests will be determined by the Consultant during grading.
- 6.3.5 Test pits shall be excavated by the Contractor so that the Consultant can state that, in their opinion, sufficient water is present and that voids between large rocks are properly filled with smaller rock material. In-place density testing will not be required in the *rock* fills.
- 6.3.6 To reduce the potential for “piping” of fines into the *rock* fill from overlying *soil* fill material, a 2-foot layer of graded filter material shall be placed above the uppermost lift of *rock* fill. The need to place graded filter material below the *rock* should be determined by the Consultant prior to commencing grading. The gradation of the graded filter material will be determined at the time the *rock* fill is being excavated. Materials typical of the *rock* fill should be submitted to the Consultant in a timely manner, to allow design of the graded filter prior to the commencement of *rock* fill placement.
- 6.3.7 *Rock* fill placement should be continuously observed during placement by the Consultant.

7. SUBDRAINS

- 7.1 The geologic units on the site may have permeability characteristics and/or fracture systems that could be susceptible under certain conditions to seepage. The use of canyon subdrains may be necessary to mitigate the potential for adverse impacts associated with seepage conditions. Canyon subdrains with lengths in excess of 500 feet or extensions of existing offsite subdrains should use 8-inch-diameter pipes. Canyon subdrains less than 500 feet in length should use 6-inch-diameter pipes.

TYPICAL CANYON DRAIN DETAIL

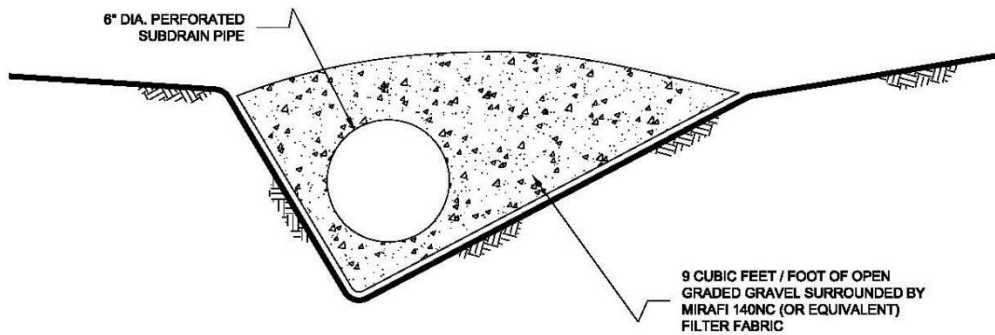
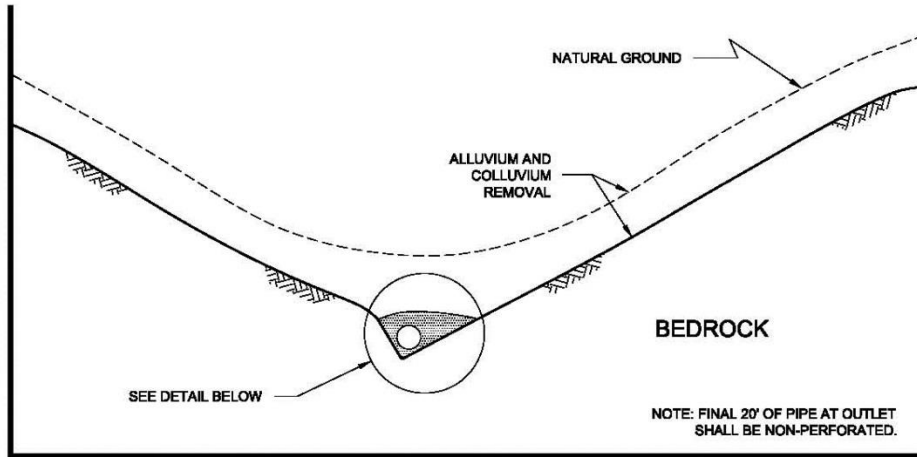

NOTES:

- 1.....8-INCH DIAMETER, SCHEDULE 80 PVC PERFORATED PIPE FOR FILLS IN EXCESS OF 100-FEET IN DEPTH OR A PIPE LENGTH OF LONGER THAN 500 FEET.
- 2.....6-INCH DIAMETER, SCHEDULE 40 PVC PERFORATED PIPE FOR FILLS LESS THAN 100-FEET IN DEPTH OR A PIPE LENGTH SHORTER THAN 500 FEET.

NO SCALE

7.2 Slope drains within stability fill keyways should use 4-inch-diameter (or larger) pipes.

TYPICAL STABILITY FILL DETAIL

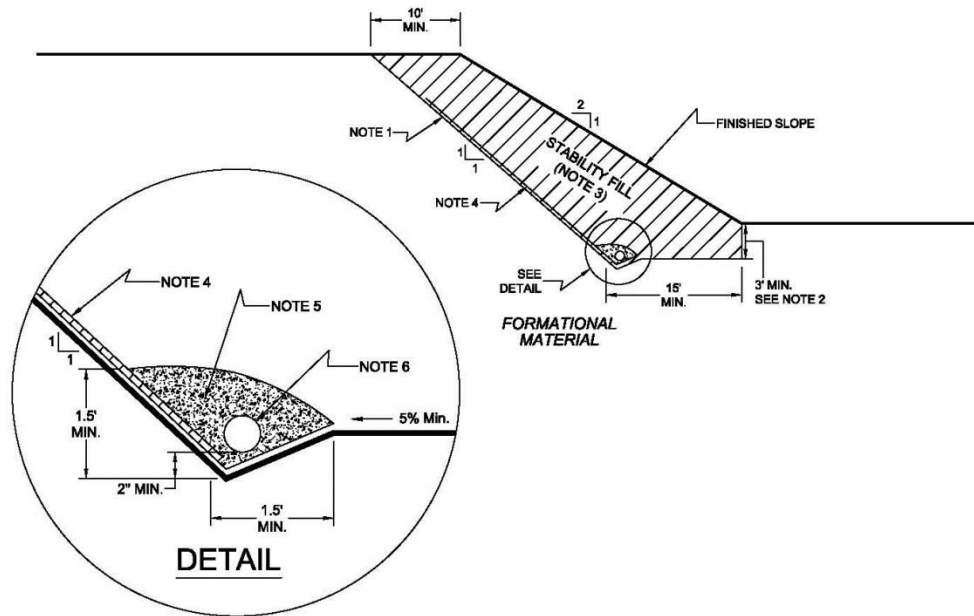

NOTES:

- 1.....EXCAVATE BACKCUT AT 1:1 INCLINATION (UNLESS OTHERWISE NOTED).
- 2.....BASE OF STABILITY FILL TO BE 3 FEET INTO FORMATIONAL MATERIAL, SLOPING A MINIMUM 5% INTO SLOPE.
- 3.....STABILITY FILL TO BE COMPOSED OF PROPERLY COMPACTED GRANULAR SOIL.
- 4.....CHIMNEY DRAINS TO BE APPROVED PREFABRICATED CHIMNEY DRAIN PANELS (MIRADRAIN G200N OR EQUIVALENT) SPACED APPROXIMATELY 20 FEET CENTER TO CENTER AND 4 FEET WIDE. CLOSER SPACING MAY BE REQUIRED IF SEEPAGE IS ENCOUNTERED.
- 5.....FILTER MATERIAL TO BE 3/4-INCH, OPEN-GRADED CRUSHED ROCK ENCLOSED IN APPROVED FILTER FABRIC (MIRAFI 140NC).
- 6.....COLLECTOR PIPE TO BE 4-INCH MINIMUM DIAMETER, PERFORATED, THICK-WALLED PVC SCHEDULE 40 OR EQUIVALENT, AND SLOPED TO DRAIN AT 1 PERCENT MINIMUM TO APPROVED OUTLET.

NO SCALE

7.3 The actual subdrain locations will be evaluated in the field during the remedial grading operations. Additional drains may be necessary depending on the conditions observed and the requirements of the local regulatory agencies. Appropriate subdrain outlets should be evaluated prior to finalizing 40-scale grading plans.

7.4 *Rock fill* or *soil-rock fill* areas may require subdrains along their down-slope perimeters to mitigate the potential for buildup of water from construction or landscape irrigation. The subdrains should be at least 6-inch-diameter pipes encapsulated in gravel and filter fabric. *Rock fill* drains should be constructed using the same requirements as canyon subdrains.

7.5 Prior to outletting, the final 20-foot segment of a subdrain that will not be extended during future development should consist of non-perforated drainpipe. At the non-perforated/perforated interface, a seepage cutoff wall should be constructed on the downslope side of the pipe.

TYPICAL CUT OFF WALL DETAIL

FRONT VIEW

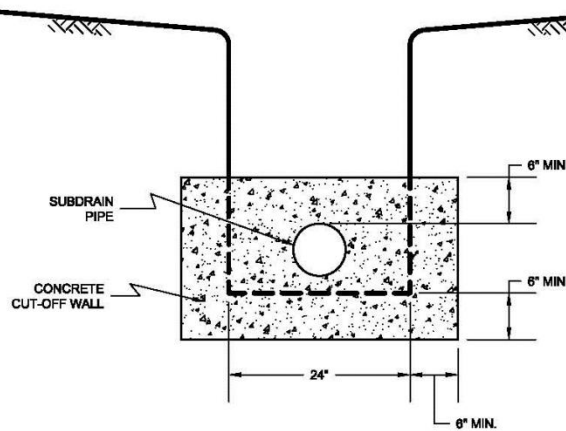

NO SCALE

SIDE VIEW

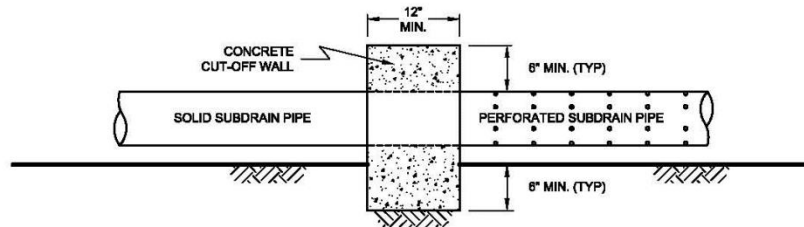

NO SCALE

7.6 Subdrains that discharge into a natural drainage course or open space area should be provided with a permanent headwall structure.

TYPICAL HEADWALL DETAIL

FRONT VIEW

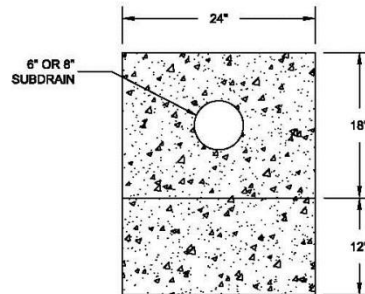

NO SCALE

SIDE VIEW

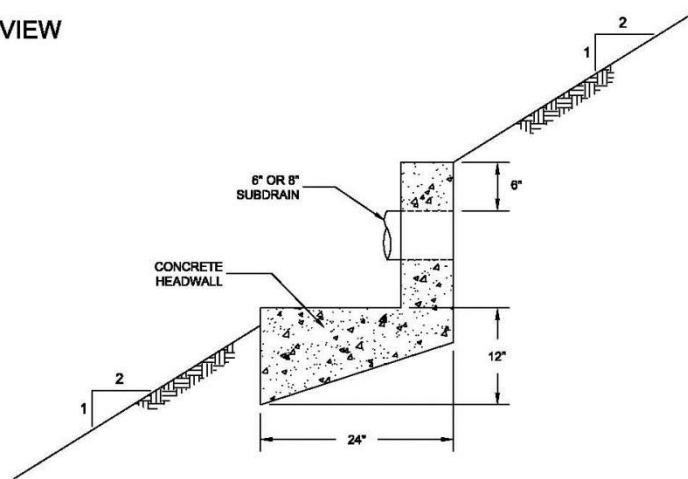

NOTE: HEADWALL SHOULD OUTLET AT TOE OF FILL SLOPE
OR INTO CONTROLLED SURFACE DRAINAGE

NO SCALE

- 7.7 The final grading plans should show the location of the proposed subdrains. After completion of remedial excavations and subdrain installation, the project civil engineer should survey the drain locations and prepare an “as-built” map showing the drain locations. The final outlet and connection locations should be determined during grading operations. Subdrains that will be extended on adjacent projects after grading can be placed on formational material and a vertical riser should be placed at the end of the subdrain. The grading contractor should consider videoing the subdrains shortly after burial to check proper installation and functionality. The contractor is responsible for the performance of the drains.

8. OBSERVATION AND TESTING

- 8.1 The Consultant shall be the Owner's representative to observe and perform tests during clearing, grubbing, filling, and compaction operations. In general, no more than 2 feet in vertical elevation of *soil* or *soil-rock* fill should be placed without at least one field density test being performed within that interval. In addition, a minimum of one field density test should be performed for every 2,000 cubic yards of *soil* or *soil-rock* fill placed and compacted.
- 8.2 The Consultant should perform a sufficient distribution of field density tests of the compacted *soil* or *soil-rock* fill to provide a basis for expressing an opinion whether the fill material is compacted as specified. Density tests shall be performed in the compacted materials below any disturbed surface. When these tests indicate that the density of any layer of fill or portion thereof is below that specified, the particular layer or areas represented by the test shall be reworked until the specified density has been achieved.
- 8.3 During placement of *rock* fill, the Consultant should observe that the minimum number of passes have been obtained per the criteria discussed in Section 6.3.3. The Consultant should request the excavation of observation pits and may perform plate bearing tests on the placed *rock* fills. The observation pits will be excavated to provide a basis for expressing an opinion as to whether the *rock* fill is properly seated and sufficient moisture has been applied to the material. When observations indicate that a layer of *rock* fill or any portion thereof is below that specified, the affected layer or area shall be reworked until the *rock* fill has been adequately seated and sufficient moisture applied.
- 8.4 A settlement monitoring program designed by the Consultant may be conducted in areas of *rock* fill placement. The specific design of the monitoring program shall be as recommended in the Conclusions and Recommendations section of the project Geotechnical Report or in the final report of testing and observation services performed during grading.
- 8.5 We should observe the placement of subdrains, to check that the drainage devices have been placed and constructed in substantial conformance with project specifications.
- 8.6 Testing procedures shall conform to the following Standards as appropriate:

8.6.1 Soil and Soil-Rock Fills:

- 8.6.1.1 Field Density Test, ASTM D 1556, *Density of Soil In-Place By the Sand-Cone Method.*

- 8.6.1.2 Field Density Test, Nuclear Method, ASTM D 6938, *Density of Soil and Soil-Aggregate In-Place by Nuclear Methods (Shallow Depth)*.
- 8.6.1.3 Laboratory Compaction Test, ASTM D 1557, *Moisture-Density Relations of Soils and Soil-Aggregate Mixtures Using 10-Pound Hammer and 18-Inch Drop*.
- 8.6.1.4 Expansion Index Test, ASTM D 4829, *Expansion Index Test*.

9. PROTECTION OF WORK

- 9.1 During construction, the Contractor shall properly grade all excavated surfaces to provide positive drainage and prevent ponding of water. Drainage of surface water shall be controlled to avoid damage to adjoining properties or to finished work on the site. The Contractor shall take remedial measures to prevent erosion of freshly graded areas until such time as permanent drainage and erosion control features have been installed. Areas subjected to erosion or sedimentation shall be properly prepared in accordance with the Specifications prior to placing additional fill or structures.
- 9.2 After completion of grading as observed and tested by the Consultant, no further excavation or filling shall be conducted except in conjunction with the services of the Consultant.

10. CERTIFICATIONS AND FINAL REPORTS

- 10.1 Upon completion of the work, Contractor shall furnish Owner a certification by the Civil Engineer stating that the lots and/or building pads are graded to within 0.1 foot vertically of elevations shown on the grading plan and that all tops and toes of slopes are within 0.5 foot horizontally of the positions shown on the grading plans. After installation of a section of subdrain, the project Civil Engineer should survey its location and prepare an *as-built* plan of the subdrain location. The project Civil Engineer should verify the proper outlet for the subdrains and the Contractor should ensure that the drain system is free of obstructions.
- 10.2 The Owner is responsible for furnishing a final as-graded soil and geologic report satisfactory to the appropriate governing or accepting agencies. The as-graded report should be prepared and signed by a California licensed Civil Engineer experienced in geotechnical engineering and by a California Certified Engineering Geologist, indicating that the geotechnical aspects of the grading were performed in substantial conformance with the Specifications or approved changes to the Specifications.

LIST OF REFERENCES

- FEMA (2012), *Flood Insurance Rate Map (FIRM) Map Number 06073C1616G, Effective May 16, 2012*, <http://www.fema.gov>, accessed March 12, 2020;
- Kennedy, M. P., and S. S. Tan, 2007, *Geologic Map of the Oceanside 30'x60' Quadrangle, California*, USGS Regional Map Series Map No. 1, Scale 1:100,000.
- SEAOCC (2020), *Seismic Design Maps*, website interface that queries the U.S. Geological Survey (USGS) web servers and retrieves the seismic design variables using ASCE 7-16, ASCE 7-10, ASCE 41-13, ASCE 41-17, IBC 2015, IBC 2012, NEHRP-2015, and NEHRP 2009 seismic design map data, <http://seismicmaps.org>, accessed February 20, 2020;
- USGS (2016), *Quaternary Fault and Fold Database of the United States*: U.S. Geological Survey website, <https://usgs.maps.arcgis.com/apps/webappviewer/index.html?id=5a6038b3a1684561a9b0aadf88412fcf>, accessed February 20, 2020.
- Geocon Incorporated (2001), *Martin Business Park, City of San Marcos T.S.M. 292, San Marcos, California*, dated December 17, 2001 (Project No. 06827-32-01).
- Geocon Incorporated (1986), *Supplemental Soil and Geologic Investigation, San Marcos T. S. M. 292, Lots 16 Through 30, San Marcos, California*, dated October 3, 1986, revised January 22, 1987 (Project No. D-2059-J02).
- Geocon Incorporated (1979), *Soil and Geologic Investigation, San Marcos Tract 207, San Marcos, California*, prepared by Geocon Incorporated, dated December 4, 1979 (Project No. D-2059-J01)