

**PRELIMINARY GEOTECHNICAL
INVESTIGATION AND PERCOLATION
TESTING**

**TTM 37731, TTM 37732, AND TTM 37733
COLE AVENUE, BARTON STREET,
AND OBSIDIAN DRIVE
RIVERSIDE, CALIFORNIA**



GEOCON
WEST, INC.

GEOTECHNICAL
ENVIRONMENTAL
MATERIALS

PREPARED FOR

**LURIN LAND, LLC
RANCHO CUCAMONGA, CALIFORNIA**

**MAY 28, 2019
PROJECT NO. T2864-22-01**



Project No. T2864-22-01

May 28, 2019

Lurin Land, LLC
10621 Civic Center Drive
Rancho Cucamonga, California 91730

Attention: Mr. Nolan C. Leggio

Subject: PRELIMINARY GEOTECHNICAL INVESTIGATION AND
PERCOLATION TESTING
TTM 37731, TTM 37732, AND TTM 37733
COLE AVENUE, BARTON STREET, AND OBSIDIAN DRIVE
RIVERSIDE, CALIFORNIA

Dear Mr. Leggio:

In accordance with *Offsite Contract # Lurin20118*, dated April 17, 2019, Geocon West, Inc. (Geocon) has performed a preliminary geotechnical investigation and percolation testing for TTM 37731, TTM 37732, and TTM 37733, located adjacent to Cole Avenue, Barton Street, and Obsidian Drive, respectively, in the City of Riverside, California. The accompanying preliminary geotechnical report presents the results of our study and includes our conclusions and recommendations pertaining to the geotechnical aspects of the design and construction of the three proposed developments and their appurtenant improvements. Based on the results of this study, it is our opinion that the sites are suitable for their proposed developments and appurtenant improvements, provided the recommendations of this report are followed.

This report is preliminary in nature, and as such, Geocon should be afforded the opportunity to review the final project design and plans and to revise this report and provide additional geotechnical recommendations as needed.

Should you have questions regarding this report, or if we may be of further service, please contact the undersigned at your convenience.

Very truly yours,

GEOCON WEST, INC.

Andrew Shoashekan
EIT 151871

Lisa A. Battiato
CEG 2316



Chet E. Robinson
GE 2890



ATS: LAB:JV:hd

Distribution: Addressee (email)

TABLE OF CONTENTS

1. PURPOSE AND SCOPE 1

2. SITE AND PROJECT DESCRIPTION 2

 2.1 TTM 37731 (Cole Avenue) 2

 2.2 TTM 37732 (Barton Street) 3

 2.3 TTM 37733 (Obsidian Drive) 4

3. GEOLOGIC SETTING 5

4. GEOLOGIC MATERIALS 5

 4.1 Undocumented Fill (afu) 5

 4.2 Colluvium (Qcol) 5

 4.3 Val Verde Tonalite Bedrock (Kvt) 6

5. GROUNDWATER 6

6. GEOLOGIC HAZARDS 6

 6.1 Surface Fault Rupture 6

 6.3 Expansive Soil 9

 6.4 Hydrocompression 9

 6.5 Landslides 9

 6.6 Slope Stability 9

 6.7 Rock Fall Hazards 10

 6.8 Tsunamis and Seiches 10

 6.9 Dam Inundation and Flooding 10

7. PERCOLATION TESTING 10

8. CONCLUSIONS AND RECOMMENDATIONS 12

 8.1 General 12

 8.2 Soil and Excavation Characteristics 13

 8.3 Grading 15

 8.4 Earthwork Grading Factors 17

 8.5 Utility Trench Backfill 17

 8.6 Seismic Design Criteria 18

 8.7 Foundation and Concrete Slabs-On-Grade Recommendations 19

 8.8 Exterior Concrete Flatwork 25

 8.9 Conventional Retaining Walls 26

 8.10 Lateral Design 27

 8.11 Preliminary Pavement Recommendations 28

 8.12 Temporary Excavations 30

 8.13 Site Drainage and Moisture Protection 31

 8.14 Plan Review 32

LIMITATIONS AND UNIFORMITY OF CONDITIONS

REFERENCES

MAPS AND ILLUSTRATIONS

- Figure 1, Vicinity Map
- Figure 2a, Geologic Map – TTM 37731
- Figure 2b, Geologic Map – TTM 37732
- Figure 2c, Geologic Map – TTM 37733
- Figure 3, Wall/Column Footing Detail
- Figure 4, Typical Retaining Wall Drain Detail

APPENDIX A

FIELD INVESTIGATION

- Figures A-1 through A-18, Logs of Borings and Test Pits for TTM 37731
- Figures A-19 through A-36, Logs of Borings and Test Pits for TTM 37732
- Figures A-37 through A-46, Logs of Borings and Test Pits for TTM 37733
- Figures A-47 through A-56, Percolation Test Results

APPENDIX B

LABORATORY TESTING

- Figures B-1 through B-16, Laboratory Program Test Data and Results

APPENDIX C

RECOMMENDED GRADING SPECIFICATIONS

PRELIMINARY GEOTECHNICAL INVESTIGATION

1. PURPOSE AND SCOPE

This report presents the findings of the preliminary geotechnical investigation and percolation testing performed on May 1 through May 3, 2019, for three discontinuous sites located in the City of Riverside, California, as depicted on the *Vicinity Map*, Figure 1. Site TTM 37731 is located west of Cole Avenue, site TTM 37732 is located west of Barton Street, and TTM 37733 is located east of Obsidian Drive if extended north; the three sites are located immediately south of Lurin Avenue. A 33.8756 longitude and -117.3234 latitude is utilized to represent the three sites for our reporting. The proposed project consists of a residential development at each of the three sites, which would include single-family residential lots, recreational areas, appurtenant utility infrastructure, roadways, concrete flatwork, water quality and storm water basins, and landscape.

The purpose of the investigation was to assess the geologic conditions, identify potential geologic hazards, conduct percolation testing in areas of proposed infiltration basins, collect soil samples, perform laboratory testing on select soils samples, and, based on the conditions encountered, provide recommendations regarding the geotechnical aspects of the proposed development at each site.

The scope of the field investigation included performing a site reconnaissance and Underground Service Alert mark out and notification, and the drilling, excavating, and logging of geotechnical borings, percolation test borings, and test pits. We reviewed preliminary *Tentative Tract Maps* prepared by KWC Engineers for this investigation. The approximate locations of the exploratory borings and test pits have been plotted on the *Geologic Maps*, Figures 2a, 2b, and 2c, which correspond to sites TTM 37731 (Cole Avenue), TTM 37732 (Barton Street), and TTM 37733 (Obsidian Drive), respectively. A summary of the information reviewed for this study is presented in the *List of References*. *Appendix A* presents a discussion of the field investigation and logs of the exploratory borings, test pits, and percolation data.

Laboratory testing was performed on soil samples obtained from the exploratory borings and test pits to evaluate the engineering properties and characteristics of the subsurface material. *Appendix B* presents our laboratory testing procedure and results for this project.

2. SITE AND PROJECT DESCRIPTION

2.1 TTM 37731 (Cole Avenue)

TTM 37731 is an irregularly shaped 35.8 acre property located southwest of Cole Avenue and Lurin Avenue. Elevations within the site range from a high of approximately 1,691 feet above mean sea level (MSL) on the eastern portion of the site near Cole Avenue, to a low of approximately 1,668 feet MSL in the southwestern portion of the site. Due to the site's irregular shape and the elevation differentials, drainage is locally random.

Based on a review of readily available historic aerial photography (Historic Aerials, 2019) and our site reconnaissance, the site has been undeveloped since the earliest available photograph from 1948. Sometime between 1948 and 1966, an improvement was made on the northeastern corner of the site, adjacent to the intersection of Lurin Avenue and Cole Avenue; it is unknown what this improvement was due to the low resolution of the photograph. Sometime between 1966 and 1978, the eastern half of the site was improved upon as an agricultural farm. Sometime between 2002 and 2005, the portions of the site being utilized for agricultural were demolished. The site has not undergone any further improvements to the present. During our field investigation, we observed various existing improvements and spoil piles, with their approximate locations noted on Figure 2a, *Geologic Map – TTM 37731*. Subsurface structures associated with the previous farming improvements are likely present at the site.

Based on the site layout provided on the preliminary tentative tract map (KWC, undated), the proposed development appears to consist of 133 – single-family residential lots, 12 – HOA slope, recreational park, and WQMP / infiltration basin lots, with appurtenant roadways, concrete flatwork, landscape, and utility improvements. WQMP basins and infiltration basins are proposed on the southwestern portion of the site, in two separate areas.

Based on existing site grades and proposed elevations provided on the preliminary tentative tract map (KWC, undated) for the site, we expect grading will entail cuts and fills generally on the order of 10 feet or less, with cut, fill, and fill-over-cut slopes not exceeding 10 feet in height or slope inclinations of 2:1 (horizontal:vertical) to achieve finished grades.

Based on our knowledge of developments of this type, we expect that the proposed structures will be constructed of wood and light gauge steel framing, founded on a conventional shallow foundation with a concrete slab-on-grade floor.

Preliminary structural loading information for proposed structures have not been provided to us at this time, therefore we expect column loads will not exceed 50 kips per square foot, while wall loads will not exceed 5 kips per linear foot. Should structural loads vary significantly from those described herein, Geocon should be contacted to evaluate the necessity for review and possible revision of this report.

2.2 TTM 37732 (Barton Street)

TTM 37732 is an irregularly shaped 22.6 acre parcel located on the west side of Barton Street and south of Lurin Avenue. Based on the preliminary tentative tract map for the site (KWC, undated), elevations range across the site; however, there appears to be a general trend downward toward the southwest. An elevation high point of approximately 1,742 feet above mean sea level (MSL) exists on the southeastern portion of the site near the intersection of Barton Street and Mariposa Avenue, with an elevation low point of approximately 1,707 feet MSL on the southwestern portion of the site. Drainage is by sheet flow to the southwest.

Based on a review of readily available historic aerial photography (Historic Aerials, 2019) and our site reconnaissance, the site has been undeveloped since the earliest available photograph from 1948. Sometime between 1948 and 1966, most of the site was utilized for agriculture. Sometime between 1967 and 1978, a residence was constructed in the southwestern portion of the property. Sometime between 2002 and 2005, the portions of the site being utilized for agriculture were demolished. Sometime between 2010 and 2012, one of the buildings constructed on the southwestern portion of the site was demolished. The site has not undergone any further improvements to the present. During our field investigation, we observed various existing improvements with their approximate locations noted on Figure 2b, *Geologic Map – TTM 37732*. Subsurface structures associated with the previous farming improvements are likely present at the site.

Based on the site layout provided on the preliminary tentative tract map (KWC, undated) for the site, the proposed development appears to consist of 81 – single-family residential lots, 7 – HOA slope, recreational park, and WQMP / infiltration basin lots, with appurtenant roadways, concrete flatwork, landscape, and utility improvements. WQMP basins and infiltration basins are proposed on the southwestern portion of the site, in two separate areas.

Based on existing site grades and proposed elevations provided on the preliminary tentative tract map (KWC, undated) for the site, we expect grading will entail cuts and fills generally on the order of 10 feet or less, with cut, fill, and fill-over-cut slopes not exceeding 11 feet in height or slope inclinations of 2:1 (horizontal:vertical) to achieve finished grades.

Based on our knowledge of developments of this type, we expect that the proposed structures will be constructed of wood and light gauge steel framing, founded on a conventional shallow foundation with a concrete slab-on-grade floor.

Preliminary structural loading information for proposed structures have not been provided to us at this time, therefore we expect column loads will not exceed 50 kips per square foot, while wall loads will not exceed 5 kips per linear foot. Should structural loads vary significantly from those described herein, Geocon should be contacted to evaluate the necessity for review and possible revision of this report.

2.3 TTM 37733 (Obsidian Drive)

TTM 37733 is a square shaped approximately 9-acre site (acreage based on Google Earth Pro, 2019), and is located northeast of the current end of Obsidian Drive and south of Lurin Avenue. Based on the preliminary tentative tract map for the site (KWC, undated), site elevations generally trend downward toward the east and southeast, with an elevation differential of approximately 34 feet between the highest and lowest areas of the site. An elevation high point of approximately 1,737 feet above mean sea level (MSL) exists on the northwestern portion of the site, with an elevation low point of approximately 1,703 feet MSL in the southeastern portion of the site. Drainage is by sheet flow toward the east and southeast.

Based on a review of readily available historic aerial photography (Historic Aerials, 2019 and Google, 2019) and our site reconnaissance, the site has been undeveloped since the earliest available photograph from 1948. Between 1948 and 1966, the site was utilized for agriculture. Between 1978 and 1994, a single-family residential building and separate garage building were constructed on the northeastern portion of the site. Sometime between 2002 and 2005, the portions of the site being utilized for agricultural were demolished. Between 2006 and 2009, a brow ditch was constructed along the eastern perimeter of the site, in support of grading which took place on the adjacent eastern site. Sometime between 2013 and 2014, single-family residential building was demolished; it appears portions of the concrete foundation and slab remain to the present. The site has not undergone any further improvements to the present. During our field investigation, we observed various existing improvements with their approximate locations noted on Figure 2c, *Geologic Map – TTM 37733*. Subsurface structures associated with the previous farming improvements are likely present at the site.

Based on the site layout provided on the preliminary tentative tract map (KWC, undated), and our experience with similar projects, the proposed development appears to consist of 40 – single-family residential lots. It is unknown as to the number of HOA slope, recreational park, or WQMP lots are proposed due to the preliminary nature of the tentative tract map, however an infiltration basin lot is proposed on the southeastern corner of the site. Additionally, other improvements include appurtenant roadways, concrete flatwork, landscape, and utility improvements.

As of the date of this report, lot elevations have not yet been finalized, and were not indicated on the preliminary tentative tract map (KWC, undated) for the site; however, we anticipate grading will entail cuts and fills similar to those for TTM 37731 and TTM 37732, which we expect to be generally on the order of 10 feet or less, with anticipated cut, fill, and fill-over-cut slopes to not exceed 10 feet in height or slope inclinations steeper than 2:1 (horizontal:vertical) to achieve finished grades.

Based on our knowledge of developments of this type, we expect that the proposed structures will be constructed of wood and light gauge steel framing, founded on a conventional shallow foundation with a concrete slab-on-grade floor.

Preliminary structural loading information for proposed structures have not been provided to us at this time, therefore we expect column loads will not exceed 50 kips per square foot, while wall loads will not exceed 5 kips per linear foot. Should structural loads vary significantly from those described herein, Geocon should be contacted to evaluate the necessity for review and possible revision of this report.

3. GEOLOGIC SETTING

The project site is located within the Peninsular Ranges geomorphic province, which forms a broad, northwest-southeast trending mountain belt that extends from Baja California to the Los Angeles and San Bernardino basins, and terminates against the Transverse Ranges. The Peninsular Ranges are primarily composed of Mesozoic granites and volcanic rocks. Locally, the site resides on granitic rocks, with a thin cover of colluvial deposits.

4. GEOLOGIC MATERIALS

Geologic materials encountered at the three sites consist of colluvium and Val Verde Tonalite. Although not encountered during our investigation, undocumented fill likely exists at the TTM 37732 site on the southwestern portion of the site, and at the TTM 37733 site on the northeastern portion of the site, where buildings were previously constructed, see Figures 2b and 2c for the inferred geologic contacts. The upper ½ foot to 1 foot of colluvium is disturbed across the three sites, generally in areas that had previous agricultural usage. Geologic units and descriptions follow that of D. M. Morton and Brett Cox (2001). Descriptions of the soil and geologic conditions are shown on the boring logs located in *Appendix A*, and are generally described herein in order of increasing age.

4.1 Undocumented Fill (afu)

Although not encountered during our exploration, undocumented fill associated with buildings previously constructed at the TTM 37732 and TTM 37733 sites will likely be encountered during excavation activities on the southwestern and northeastern portion of the sites, respectively. Undocumented fill is expected to consist of silty sand sourced from locally derived colluvium and bedrock material.

4.2 Colluvium (Qcol)

Colluvium was encountered across the three sites to depths ranging between 1½ feet and 6 feet. The deposits at sites TTM 37731 and TTM 37732 generally consist of clayey sand, silty sand, silt and clay, where site TTM 37733 generally consists of silty sand and silt. The materials are characterized as loose to very dense or soft to very stiff, and dry to moist. Material color varies significantly across the three sites.

4.3 Val Verde Tonalite Bedrock (Kvt)

Granitic bedrock was encountered underlying the colluvium across the three sites, to the maximum depth explored of 23 feet. The granitic bedrock encountered is generally characterized as a weathered, moderately strong material that is medium to coarse grained. Material color varies significantly across the three sites. During the excavation of the test pits, refusal was met between 4 feet and 7½ feet for the TTM 37731 site, between 5 feet and 8 feet for the TTM 37732 site, and between 2 feet and 7 feet for the TTM 37733 site.

5. GROUNDWATER

Groundwater was encountered in borings B-2a, B-2b, and B-3b at depths of approximately 13 feet, 10 feet, and 11 feet, respectively. Groundwater was not encountered at the TTM 37733 site. Nearby historic well data is unavailable from the California Water Data Library (DWR, 2018) for our use. Groundwater elevations are dependent on seasonal precipitation, irrigation, and land use, among other factors, and vary as a result.

6. GEOLOGIC HAZARDS

6.1 Surface Fault Rupture

The numerous faults in southern California include active, potentially active, and inactive faults. The criteria for these major groups are based on criteria developed by the California Geological Survey (CGS, formerly known as CDMG) for the Alquist-Priolo Earthquake Fault Zone Program (Bryant and Hart, 2007). An active fault is one that has had surface displacement within Holocene time (about the last 11,000 years). A potentially active fault has demonstrated surface displacement during Quaternary time (approximately the last 1.6 million years) but has had no known Holocene movement. Faults that have not moved in the last 1.6 million years are considered inactive.

The site is not located within a State of California Fault Hazard Zone. The mapped fault closest to any areas of the project is the San Jacinto fault, which is located approximately 13 miles to the northeast of the site. Faults within a 50-mile radius of the site are listed in Table 6.1.1. Historic earthquakes in southern California of magnitude 6.0 and greater, their magnitude, distance, and direction from the site are listed in Table 6.1.2.

**Table 6.1.1
Active Faults within 50 Miles of the Site**

| Fault Name | Maximum Magnitude (Mw) | Geometry (Slip Character) | Slip Rate (mm/yr) | Information Source | Distance from Site (mi) | Direction from Site |
|-------------------------------------|-------------------------------|----------------------------------|--------------------------|---------------------------|--------------------------------|----------------------------|
| San Jacinto Fault | 6.9 | RL-SS | 12.0 | a | 13 | NE |
| Elsinore Fault | 6.8 | RL-SS | 5.0 | a | 14 | SW |
| Crafton Hills Fault | - | n/a | - | a | 20 | NE |
| Banning Fault | - | RL-SS | - | a | 22 | NE |
| San Andreas Fault | 7.5 | RL-SS | 24.0 | a | 23 | NE |
| Beaumont Plain Fault | - | n/a | - | a | 24 | NE |
| Sierra Madre Fault | 7.2 | THRUST | 2.0 | a | 26 | NW |
| Red Hill-Etiwanda Avenue Fault | - | n/a | - | a | 27 | NW |
| San Gorgonio Pass Fault | | THRUST | | a | 28 | NE |
| San Joaquin Hills Thrust | 6.6 | THRUST | 0.5 | a | 33 | NW |
| Pinto Mountain Fault | 7.2 | LL-SS | 2.5 | a | 42 | NE |
| North Frontal Thrust | 7.2 | THRUST | 1.0 | a | 42 | NE |
| Newport-Inglewood-Rose Canyon Fault | 7.1 | RL-SS | 1.0 | a | 48 | SW |
| Puente Hills Blind Thrust | 7.1 | THRUST | 0.7 | a | 48 | NW |

Geometry: BT = blind thrust, LL = left lateral, N = normal, O = oblique, R = reverse, RL = right lateral, SS = strike slip.
Information Sources: a = Cao, T., Bryant, W.A., Rowshandel, B., Branum, D., and Wills, C.J., 2003, The Revised 2002 California Probabilistic Seismic Hazard Maps, including Appendices A, B, and C, dated June; b = online Fault Activity Map of California website, maps.conservation.ca.gov/cgs/fam/, as of 1/2017.
n/a = data not available

**Table 6.1.2
Historic Earthquake Events with Respect to the Site**

| Earthquake (Oldest to Youngest) | Date of Earthquake | Magnitude | Distance to Epicenter (Miles) | Direction to Epicenter |
|--|---------------------------|------------------|--|---------------------------------------|
| San Jacinto | December 25, 1899 | 6.7 | 36 | SSW |
| San Jacinto | April 21, 1918 | 6.8 | 36 | SSW |
| Loma Linda Area | July 22, 1923 | 6.3 | 29 | SW |
| Long Beach | March 10, 1933 | 6.4 | 78 | SW |
| Buck Ridge | March 25, 1937 | 6.0 | 68 | SE |
| Imperial Valley | May 18, 1940 | 6.9 | 34 | ESE |
| Desert Hot Springs | December 4, 1948 | 6.0 | 36 | SE |
| Arroyo Salada | March 19, 1954 | 6.4 | 80 | SE |
| Borrego Mountain | April 8, 1968 | 6.5 | 87 | SE |
| San Fernando | February 9, 1971 | 6.6 | 97 | W |
| Joshua Tree | April 22, 1992 | 6.1 | 40 | ESE |
| Landers | June 28, 1992 | 7.3 | 27 | E |
| Big Bear | June 28, 1992 | 6.4 | 5 | SSE |
| Northridge | January 17, 1994 | 6.7 | 105 | W |
| Hector Mine | October 16, 1999 | 7.1 | 44 | ENE |

6.2 Liquefaction and Seismic Settlement

Liquefaction is a phenomenon in which loose, saturated, relatively cohesion-less soil deposits lose shear strength during strong ground motions. Primary factors controlling liquefaction include intensity and duration of ground motion, gradation characteristics of the subsurface soils, in-situ stress conditions, and the depth to groundwater. Seismically induced settlement may occur whether the potential for liquefaction exists or not.

The current standard of practice as outlined in the *Recommended Procedures for Implementation of DMG Special Publication 117, Guidelines for Analyzing and Mitigating Liquefaction in California* (SCEC, 1999) requires a liquefaction analysis to a depth of 50 feet below the lowest portion of the proposed structure. Liquefaction typically occurs in areas where the soils below the water table are composed of poorly consolidated, fine to medium-grained, primarily sandy soil. In addition to the requisite soil conditions, the ground acceleration and duration of the earthquake must also be of a sufficient level to induce liquefaction.

According to the Riverside County Information Technology public web data (RCIT, 2019), the three sites are not located within areas mapped as having a potential for liquefaction.

Due to the lack of shallow groundwater, and site geology generally consisting of shallow Val Verde Tonalite bedrock, neither liquefaction nor seismic “dry-sand” settlement is a design consideration for the site.

6.3 Expansive Soil

The geologic units near the ground surface generally consist of clayey sand, silty sand, silt and clay at the TTM 37731 and TTM 37732 sites, and generally consist of silty sand and silt at the TTM 37733 site. Laboratory testing on samples of the surficial colluvium collected from the three sites indicate these soils are “non-expansive” (Expansion Index [EI] of 0 to 20) for the TTM 37731 site, and “expansive” (Expansion Index [EI] of 21 to 90) for the TTM 37732 and TTM 37733 sites, as defined by 2016 CBC Section 1803.5.3, with an Expansion Index of 18, 68, and 50 for the TTM 37731, TTM 37732, and the TTM 37733 sites, respectively, which are in accordance with ASTM D4829.

6.4 Hydrocompression

Hydrocompression is the tendency of unsaturated soil structure to collapse upon wetting resulting in the overall settlement of the affected soil and overlying foundations or improvements supported thereon. Potentially compressible soils underlying the site are typically removed and recompacted during remedial site grading. However, if compressible soil is left in-place, a potential for settlement due to hydrocompression of the soil exists.

We tested a soil sample obtained during our investigation of site TTM 37733 for hydrocompression. This site contains the thickest section of colluvium encountered of the three sites, and thus would be most prone to the effects of hydrocompression. The soil sample tested exhibited a collapse potential of approximately 0.3 percent when loaded to the expected post-grading pressures. The test results indicate that the degrees of specimen collapse for the colluvium would be classified as “slight” (0.1 to 2.0 percent), in accordance with ASTM D 5333.

6.5 Landslides

Due to the lack of significant slopes on or adjacent to the site, the potential for landslides at the three sites are not a design consideration,

6.6 Slope Stability

Based on the preliminary tentative tract maps for TTM 37731 and TTM 37732 (KWC, 2019), proposed grading will create fill, cut, and fill-over-cut slopes of up to 11 feet in height. Proposed slopes were not indicated on the preliminary tentative tract map for TTM 37733; however, we expect that proposed slopes will be similar in design to the other two sites.

In general, permanent graded cut slopes, fill slopes, and fill-over-cut slopes inclined no steeper than 2:1 (h:v) with vertical heights of 11 feet or less will possess Factors of Safety of 1.5 or greater, and 1.1 or greater under pseudo-static loading. Grading of slopes should be designed in accordance with the requirements of the local building codes of the County of Riverside and the 2016 California Building Code (CBC). The stability of the planned slopes should be reviewed when grading plans are available and additional recommendations provided as needed.

6.7 Rock Fall Hazards

The project sites are located within a broad valley. No hill slopes or boulders are situated above the sites. Therefore, rock fall is not considered a hazard for the sites.

6.8 Tsunamis and Seiches

A tsunami is a series of long period waves generated in the ocean by a sudden displacement of large volumes of water. Causes of tsunamis include underwater earthquakes, volcanic eruptions, or offshore slope failures. The first order driving force for locally generated tsunamis offshore of southern California is expected to be tectonic deformation from large earthquakes (Legg, *et al.*, 2002). The site is located 35 miles from the nearest coastline with a mountain range between, at an elevation of more than 3,000 feet MSL, therefore, the risk associated with tsunamis is not a design consideration.

A seiche is a run-up of water within a lake or embayment triggered by fault- or landslide-induced ground displacement. The project sites are not located adjacent to a body of water, therefore, seiches are not a design consideration for the sites.

6.9 Dam Inundation and Flooding

The sites are located within an area mapped as a Minimal Flood Hazard, as per information provided by the Federal Emergency Management Agency Flood Map Service Center, *Flood Map 06071C7944H*, effective August 28, 2008.

7. PERCOLATION TESTING

Percolation testing was performed in accordance with Table 1 Infiltration Basin Option 2 of *Appendix A of Riverside County – Low Impact Development BMP Design Handbook* (Handbook). The percolation tests were run in accordance with *Section 2.3 Shallow Percolation Test Method*. This method requires two percolation tests and one deep boring (extending 10 feet below the proposed infiltration facility) per basin.

Ten percolation tests were performed in total, within proposed BMP areas indicated on the preliminary tentative tract maps (KWC, undated). Test depths at proposed BMP locations were approximately between 2 and 13 feet below existing grades. The percolation test locations are depicted on the *Geologic Maps*, Figures 2a, 2b, and 2c. Boring logs and percolation test data are presented in *Appendix A*.

Geocon utilized a truck-mounted hollow-stem auger bore rig with 8”-diameter drill to drill the percolation test holes in the BMP areas. A “deep” boring within BMP areas were utilized to check for groundwater clearance. Groundwater was encountered in borings B-2a, B-2b, and B-3b at depths of approximately 13 feet, 10 feet, and 11 feet, respectively. Groundwater was not encountered at the TTM 37733 site.

Approximately 2 inches of gravel was placed at the bottom of each test hole and a 3-inch-diameter PVC pipe was placed within the test hole. Several feet of ¾-inch gravel was placed outside of the pipe to stabilize it within the excavation. The test locations were pre-saturated with five gallons of water. Percolation testing began approximately 24 hours after the holes were pre-saturated. Percolation data sheets are presented in *Appendix A*. Calculations to convert the percolation test rates to infiltration test rates in accordance with Section 2.3 of the Handbook are presented in the table below. The Handbook requires a factor of safety of 3 be applied to these values based on the test method used.

**TABLE 7
INFILTRATION TEST RATES**

| | P-1a | P-2a | P-3a | P-4a | P-1b | P-2b | P-3b | P-4b | P-1c | P-2c |
|--|-------------|-------------|-------------|-------------|-------------|-------------|-------------|-------------|-------------|-------------|
| Soil Type | Normal | Normal | Normal | Normal | Normal | Normal | Normal | Normal | Normal | Normal |
| Change in head over time (in): ΔH | 0 | 4.8 | 3.0 | 12.0 | 0 | 0.6 | 4.2 | 0.6 | 0.6 | 2.4 |
| Time Interval (minutes): Δt | 30 | 30 | 30 | 30 | 30 | 30 | 30 | 30 | 30 | 30 |
| Radius of test hole (in): r | 4 | 4 | 4 | 4 | 4 | 4 | 4 | 4 | 4 | 4 |
| Average head over time interval (in): H_{avg} | 9.6 | 8.4 | 21.3 | 15.6 | 9.6 | 11.7 | 17.1 | 18.9 | 21.3 | 22.8 |
| Tested Infiltration Rate (in/hr): I_t | 0 | 1.8 | 0.5 | 2.7 | 0 | 0.2 | 0.9 | 0.1 | 0.1 | 0.4 |

8. CONCLUSIONS AND RECOMMENDATIONS

8.1 General

- 8.1.1 Neither soil nor geologic conditions were observed which would preclude the construction of the proposed developments at the TTM 37731 (Cole Avenue), TTM 37732 (Barton Street), and TTM 37733 (Obsidian Drive) sites as presently proposed, provided that the recommendations of this report are followed and implemented during design and construction.
- 8.1.2 Potential geologic hazards at the site include seismic shaking, compressible near-surface soil, bedrock rippability, oversize rock, and expansive soil. Based on our investigation and available geologic information, active, potentially active, or inactive faults are not present underlying or trending toward the sites.
- 8.1.3 For the three sites, the upper portions of colluvium and bedrock material are considered unsuitable for the support of new compacted fill or settlement-sensitive improvements. Additionally, localized undocumented fill is considered unsuitable in its entirety. Remedial grading of the surficial soils and bedrock material will be required and discussed herein. New compacted fill and slightly weathered bedrock material is considered suitable to support the proposed improvements.
- 8.1.4 Laboratory tests indicate that the TTM 37731 site soils are “non-expansive” (Expansion Index [EI] of 0 to 20), and that the TTM 37732 and TTM 37733 site soils are “expansive” (Expansion Index [EI] of 21 to 90), in accordance with ASTM D4829. Due to the variation in the expansiveness of the materials, the foundation recommendations in this report assume that the structures are founded in the expansive material across the three sites. Additional testing should be conducted during earthwork to confirm the expansion potential and additional recommendations provided, as needed.
- 8.1.5 Excavations in the bedrock material are expected to generate cobble and boulder size rock fragments. Oversize materials (greater than 6 inches) are not suitable for reuse as engineered fill. Processing of oversize material by screening or crushing may be needed before reuse as engineered fill material.
- 8.1.6 Proper drainage should be maintained in order to preserve the engineering properties of the compacted fill in planned improvement areas. Recommendations for site drainage are provided herein.

8.1.7 Once design or civil grading plans are made available, the recommendations within this preliminary report should be reviewed and revised, as necessary. Additionally, as the project design progresses toward a final design, changes in the design, location, or elevation of any proposed improvement should be reviewed by this office. Geocon should be contacted to evaluate the necessity for review and possible revision of this report.

8.2 Soil and Excavation Characteristics

8.2.1 Site soils and highly weathered bedrock material should generally be excavatable and rippable with moderate effort. Less weathered sections of bedrock material will present difficulties during excavation and ripping process.

8.2.2 Based on the material classifications and laboratory testing by Geocon, the soils across the three sites possess a “very low” to “medium” expansion potential classification, with an expansion index of (EI) of 0 to 90, and for design purposes should considered “expansive” as defined by 2016 CBC Section 1803.5.3. Table 8.2.2 presents soil classifications based on the EI.

**TABLE 8.2.2
SOIL CLASSIFICATION BASED ON EXPANSION INDEX**

| Expansion Index (EI) | Expansion Classification | 2016 CBC Expansion Classification |
|-----------------------------|---------------------------------|--|
| 0 – 20 | Very Low | Non-Expansive |
| 21 – 50 | Low | Expansive |
| 51 – 90 | Medium | |
| 91 – 130 | High | |
| Greater Than 130 | Very High | |

8.2.3 Excavations generally on the order of 10 feet or less are expected to meet finished grades for the three sites (this does not include remedial grading of compressible soils). Excavations should be performed in conformance with OSHA requirements. Some site soils may be encountered which have little cohesion and may be subject to caving in un-shored excavations. The contractor should evaluate the necessity for lay back of vertical cut areas.

8.2.4 We performed laboratory tests on representative samples of soil collected from the three sites, to measure the percentage of water-soluble sulfate content. Results from these tests indicate that the on-site materials tested for the TTM 37731 site possess a sulfate content of 0.0532% (532 part per million [ppm]), the on-site materials tested for the TTM 37732 site possess a sulfate content of 0.0287% (287 ppm), and the on-site materials tested for the TTM 37733 site

possess a sulfate content of 0.0148% (148 ppm), equating to an exposure class of “S0” to concrete structures as defined by 2016 CBC Section 1904.3 and ACI 318, for the three sites. Table 8.2.4 presents a summary of concrete requirements set forth by 2016 CBC Section 1904.3 and ACI 318.

**TABLE 8.2.4
REQUIREMENTS FOR CONCRETE EXPOSED TO
SULFATE-CONTAINING SOLUTIONS**

| Exposure Class | Water-Soluble Sulfate (SO₄) Percent by Weight | Cement Type (ASTM C 150) | Maximum Water to Cement Ratio by Weight¹ | Minimum Compressive Strength (psi) |
|-----------------------|---|---------------------------------|--|---|
| S0 | SO₄<0.10 | No Type Restriction | n/a | 2,500 |
| S1 | 0.10≤SO ₄ <0.20 | II | 0.50 | 4,000 |
| S2 | 0.20≤SO ₄ ≤2.00 | V | 0.45 | 4,500 |
| S3 | SO ₄ >2.00 | V+Pozzolan or Slag | 0.45 | 4,500 |

¹ Maximum water to cement ratio limits do not apply to lightweight concrete

8.2.5 The presence of water-soluble sulfates is not a visually discernible characteristic; therefore, other soil samples from the sites could yield different concentrations. Additionally, over time landscaping activities along the access roads or from nearby developments (i.e., addition of fertilizers and other soil nutrients) may affect the concentration.

8.2.6 Laboratory testing indicates the soils for the TTM 37731 site have a minimum electrical resistivity of 730 ohm-cm, possess 390 ppm chloride, 532 ppm sulfate, and have a pH of 7.5, soils for the TTM 37732 site have a minimum electrical resistivity of 900 ohm-cm, possess 135 ppm chloride, 287 ppm sulfate, and have a pH of 7.0, and soils for the TTM 37733 site have a minimum electrical resistivity of 100 ohm-cm, possess 210 ppm chloride, 148 ppm sulfate, and have a pH of 6.6. As shown in Table 8.2.6, the three sites would be classified as “corrosive” to buried improvements in accordance with the Caltrans Corrosion Guidelines (Caltrans, 2018).

**TABLE 8.2.6
CALTRANS CORROSION GUIDELINES**

| Corrosion Exposure | Resistivity (ohm-cm) | Chloride (ppm) | Sulfate (ppm) | pH |
|---------------------------|-----------------------------|-----------------------|----------------------|-------------|
| Corrosive | <1,100 | 500 or greater | 1,500 or greater | 5.5 or less |

8.2.7 Geocon does not practice in the field of corrosion engineering. Therefore, further evaluation by a corrosion engineer may be performed if improvements that could be susceptible to corrosion are planned.

8.3 Grading

8.3.1 Earthwork should be observed, and compacted fill tested by representatives of Geocon.

8.3.2 Grading should be performed in accordance with the *Recommended Grading Specifications* contained in *Appendix C*, and the Grading Ordinances of the City of Riverside.

8.3.3 Prior to commencing grading operations, a preconstruction conference should be held at the site with a representative from the City of Riverside, owner or developer, grading contractor, civil engineer, and geotechnical engineer in attendance. Special soil handling and/or the grading plans can be discussed at that time.

8.3.4 Site preparation should begin with the removal of previous structures and infrastructure, deleterious material, debris, buried trash, and vegetation. The depth of removal should be such that material exposed in cut areas or soil to be used as fill is relatively free of organic matter. Material generated during stripping and/or site demolition should be exported from the site. The contractor should be aware that significant amounts cobble and boulder size bedrock fragments may be generated during the excavation process. Rock over 6 inches in diameter should be screened and removed, and not used in the fill, or processed by crushing prior to use as fill. Water wells should be abandoned in accordance with California Well Standards Bulletin 74-81, amended by Bulletin 74-90.

8.3.5 For the three sites, the upper portion of the colluvium and bedrock material within a 1:1 (h:v) projection of the limits of grading should be removed to expose competent colluvium soils with a relative compaction of at least 85 percent (based on ASTM D1557), or competent bedrock. Removals in proposed structural areas should extend to depths on the order of 2 to 6½ feet below the existing ground surface, or at least 3 feet below the bottom of the planned foundations, whichever is deeper. Removals in pavement and walkway areas should extend at least 4 feet beneath the pavement or flatwork subgrade elevation. Remedial removal depths are depicted on Figure 2a, 2b, and 2c. Where localized areas of undocumented fill are encountered, it should be removed in its entirety until competent colluvium or bedrock is reached. Areas of loose, dry, or compressible soils will require deeper excavation and processing prior to fill placement. The actual depth of removal should be evaluated by the engineering geologist during grading operations. Where overexcavation and compaction is to be conducted, the excavations should be extended laterally a minimum distance of 6 feet beyond the foundation footprint or for a distance equal to the depth of removal, whichever is greater. The bottom of the excavations should be scarified to a depth of at least 1 foot,

moisture conditioned at 0 to 2 percent above optimum moisture content, and properly compacted.

- 8.3.6 Geocon should observe the removal bottoms to check the competence of the exposed soil. Deeper excavations may be required if dry, loose, soft, or porous materials are present at the base of the removals.
- 8.3.7 The fill placed within 3 feet of proposed foundations should possess a “medium” expansion potential (EI of 90 or less).
- 8.3.8 If perched groundwater or saturated materials are encountered during remedial grading, extensive drying and mixing with dryer soil may be required, if the saturated material is to be utilized as fill material in achieving finished grades. The excavated materials should then be moisture conditioned at 0 to 2 percent above optimum moisture content prior to placement as compacted fill.
- 8.3.9 The three sites should be brought to finish grade elevations with fill compacted in layers. Oversize materials (greater than 6 inches in dimension) should be removed from the excavated soils prior to use as fill or reduced in size. Layers of fill should be no thicker than will allow for adequate bonding and compaction. Fill, including backfill and scarified ground surfaces, should be compacted to a dry density of at least 90 percent of the laboratory maximum dry density and moisture conditioned at 0 to 2 percent above optimum moisture content as evaluated by ASTM D1557. Fill materials placed below the recommended moisture content may require additional moisture conditioning prior to placing additional fill.
- 8.3.10 If needed, import fill should consist of granular materials with a “low” expansion potential (EI of 50 or less), non-corrosive, generally free of deleterious material, and contain rock no larger than 6 inches. Geocon should be notified of the import soil source and should be afforded the opportunity to perform laboratory testing of the import soil prior to its arrival at the site to evaluate its suitability as fill material.
- 8.3.11 For fill slopes, a fill keyway should be constructed at the base of the slope below the toe. The keyway should be at least 15 feet wide, or ½ the slope height, whichever is greater. The slope should be brought to finish grade elevations with engineered fill compacted in layers. Fill slopes should be overbuilt at least 2 feet and cut back to the tight fill core or be compacted by back rolling with a loaded roller at vertical intervals not to exceed 4 feet to maintain the moisture content of the fill. The slopes should be track-walked at the completion of each slope such that the fill is compacted to a dry density of at least 90 percent of the laboratory maximum dry density, at 0 to 2 percent above optimum moisture content, to the face of the finished slope.

- 8.3.12 Finished slopes should be landscaped with drought-tolerant vegetation having variable root depths and requiring minimal landscape irrigation. In addition, the slopes should be drained and properly maintained to reduce erosion.

8.4 Earthwork Grading Factors

- 8.4.1 Estimates of shrinkage factors are based on empirical judgments comparing the material in its existing or natural state as encountered in the exploratory excavations to a compacted state. Variations in natural soil density and in compacted fill density render shrinkage value estimates as rough approximations. As an example, the contractor can compact the fill to a dry density of 90 percent or higher of the laboratory maximum dry density. Thus, the contractor has an approximately 10 percent range of control over the fill volume. Based on our experience with similar soils present at the three sites, the shrinkage of colluvium is estimated to be on the order of 7 to 12 percent. The bedrock material at the three sites is estimated to bulk by 0 to 5 percent. This estimate is for preliminary quantity estimates only. Due to the variations in the actual shrinkage/bulking factors, a balance area should be provided to accommodate variations.

8.5 Utility Trench Backfill

- 8.5.1 Utility trenches should be properly backfilled in accordance with the requirements of the City of Riverside and the latest edition of the *Standard Specifications for Public Works Construction* (Greenbook). The pipes should be bedded with well-graded crushed rock or clean sands (Sand Equivalent greater than 30) to a depth of at least one foot over the pipe. The bedding material must be inspected and approved in writing by a qualified representative of Geocon. The use of well-graded crushed rock is only acceptable if used in conjunction with filter fabric to prevent the gravel from having direct contact with soil. The remainder of the trench backfill may be derived from onsite soil or approved import soil. Backfill of utility trenches should not contain rocks greater than 3 inches in diameter. The use of 2-sack slurry and controlled low strength material (CLSM) are also acceptable as backfill. However, consideration should be given to the possibility of differential settlement where the slurry ends and earthen backfill begins. These transitions should be minimized, and additional stabilization should be considered at these transitions.
- 8.5.2 Trench excavation bottoms must be observed and approved in writing by a qualified representative of Geocon, prior to placement of bedding materials, fill, gravel, or concrete.

- 8.5.3 Utility trench backfill should be placed in layers no thicker than will allow for adequate bonding and compaction. Utility backfill should be compacted to a dry density of at least 90 percent of the laboratory maximum dry density and moisture conditioned at 0 to 2 percent above optimum moisture content as evaluated by ASTM D 1557. Backfill at the finish subgrade elevation of new pavements should be compacted to at least 95 percent of the maximum dry density. Backfill materials placed below the recommended moisture content may require additional moisture conditioning prior to placing additional fill.
- 8.5.4 Oversize materials such as cobbles were encountered during our investigation and should be expected by the contractor.

8.6 Seismic Design Criteria

- 8.6.1 We used the computer program *U.S. Seismic Design Maps*, provided by the California Office of Statewide Health Planning and Development (OSHPD) to evaluate the seismic design criteria. Table 8.6.1 summarizes site-specific design criteria obtained from the 2016 California Building Code (CBC; Based on the 2015 International Building Code [IBC] and ASCE 7-10), Chapter 16 Structural Design, Section 1613 Earthquake Loads. The short spectral response uses a period of 0.2 second. The developments as currently proposed should be designed using a Site Class C in accordance with ASCE 7-10 Section 20.3.1. We evaluated the Site Class based on the discussion in Section 1613.3.2 of the 2016 CBC and Table 20.3-1 of ASCE 7-10 using blow count data presented on the boring logs in *Appendix A*. The values presented in Table 8.6.1 are for the risk-targeted maximum considered earthquake (MCE_R).

**TABLE 8.6.1
2016 CBC SEISMIC DESIGN PARAMETERS**

| Parameter | Value | 2016 CBC Reference |
|---|--------|------------------------------|
| Site Class | C | Section 1613.3.2 |
| MCE_R Ground Motion Spectral Response Acceleration – Class B (short), S_S | 1.500g | Figure 1613.3.1(1) |
| MCE_R Ground Motion Spectral Response Acceleration – Class B (1 sec), S_1 | 0.600g | Figure 1613.3.1(2) |
| Site Coefficient, F_A | 1.0 | Table 1613.3.3(1) |
| Site Coefficient, F_V | 1.3 | Table 1613.3.3(2) |
| Site Class Modified MCE_R Spectral Response Acceleration (short), S_{MS} | 1.500g | Section 1613.3.3 (Eqn 16-37) |
| Site Class Modified MCE_R Spectral Response Acceleration (1 sec), S_{M1} | 0.780g | Section 1613.3.3 (Eqn 16-38) |
| 5% Damped Design Spectral Response Acceleration (short), S_{DS} | 1.000g | Section 1613.3.4 (Eqn 16-39) |
| 5% Damped Design Spectral Response Acceleration (1 sec), S_{D1} | 0.520g | Section 1613.3.4 (Eqn 16-40) |

8.6.2 Table 8.6.2 presents additional seismic design parameters for projects located in Seismic Design Categories of D through F in accordance with ASCE 7-10 for the mapped maximum considered geometric mean (MCE_G).

**TABLE 8.6.2
2016 CBC SITE ACCELERATION PARAMETERS**

| Parameter | Value | ASCE 7-10 Reference |
|--|--------|-----------------------------|
| Site Class | C | Section 1613.3.2 |
| Mapped MCE_G Peak Ground Acceleration, PGA | 0.500g | Figures 2 through 42-7 |
| Site Coefficient, F_{PGA} | 1.0 | Table 11.8-1 |
| Site Class Modified MCE_G Peak Ground Acceleration, PGA_M | 0.500g | Section 11.8.3 (Eqn 11.8-1) |

8.6.3 The Maximum Considered Earthquake Ground Motion (MCE) is the level of ground motion that has a 2 percent chance of exceedance in 50 years, with a statistical return period of 2,475 years. According to the 2016 California Building Code and ASCE 7-10, the MCE is to be utilized for the evaluation of liquefaction, lateral spreading, seismic settlements, and it is our understanding that the intent of the Building code is to maintain “Life Safety” during a MCE event.

8.6.4 Deaggregation of the MCE peak ground acceleration was performed using the USGS online BETA Unified Hazard Tool, 2008 Conterminous U.S. Dynamic edition. The result of the deaggregation analysis indicates that the predominant earthquake contributing to the MCE peak ground acceleration is characterized as an approximately 6.8 magnitude event occurring at a hypocentral distance of approximately 15.3 kilometers from the three sites.

8.6.5 Conformance to the criteria in the above tables for seismic design does not constitute any kind of guarantee or assurance that significant structural damage or ground failure will not occur if a large earthquake occurs. The primary goal of seismic design is to protect life, not to avoid all damage, since such design may be economically prohibitive.

8.7 Foundation and Concrete Slabs-On-Grade Recommendations

8.7.1 The foundation recommendations herein are for proposed one- to three-story residential structures following remedial grading at the three sites. The foundation recommendations have been separated into three categories based on either the maximum and differential fill thickness or Expansion Index. Based on the expansion potential of site soils and estimated cut/fill geometry we estimate Category II will apply to most residences. The foundation category criteria are presented in Table 8.7.1.

**TABLE 8.7.1
FOUNDATION CATEGORY CRITERIA**

| Foundation Category | Maximum Fill Thickness, T (Feet) | Differential Fill Thickness, D (Feet) | Expansion Index (EI) |
|----------------------------|---|--|-----------------------------|
| I | T<20 | D<10 | EI≤50 |
| II | 20≤T<50 | 10≤D<20 | 50<EI≤90 |
| III | T≥50 | D≥20 | 90<EI≤130 |

8.7.2 We will provide final foundation categories for each building or lot after finish pad grades have been achieved, and after we have performed laboratory testing of the subgrade soil.

8.7.3 Table 8.7.3 presents minimum foundation and interior concrete slab design criteria for conventional foundation systems.

**TABLE 8.7.3
CONVENTIONAL FOUNDATION RECOMMENDATIONS BY CATEGORY**

| Foundation Category | Minimum Footing Embedment Depth (inches) | Continuous Footing Reinforcement | Interior Slab Reinforcement |
|----------------------------|---|--|---|
| I | 18 | Two No. 4 bars, one top and one bottom | 6 x 6 - 10/10 welded wire mesh at slab mid-point |
| II | 24 | Four No. 4 bars, two top and two bottom | No. 3 bars at 24 inches on center, both directions |
| III | 30 | Four No. 5 bars, two top and two bottom | No. 3 bars at 18 inches on center, both directions |

8.7.4 The embedment depths presented in Table 8.7.3 should be measured from the lowest adjacent pad grade for both interior and exterior footings. A wall/column footing dimension detail depicting the depth to lowest adjacent grade is provided on Figure 3. The conventional foundations should have a minimum width of 12 inches and 24 inches for continuous and isolated footings, respectively.

8.7.5 The concrete slab-on-grade should be a minimum of 4 inches thick for Foundation Categories I and II and 5 inches thick for Foundation Category III.

8.7.6 Slabs-on-grade that may receive moisture-sensitive floor coverings or may be used to store moisture-sensitive materials should be underlain by a vapor retarder placed directly beneath the slab. The vapor retarder and acceptable permeance should be specified by the project architect or developer based on the type of floor covering that will be installed.

The vapor retarder design should be consistent with the guidelines presented in Section 9.3 of the American Concrete Institute's (ACI) *Guide for Concrete Slabs that Receive Moisture-Sensitive Flooring Materials* (ACI 302.2R-06) and should be installed in general conformance with ASTM E1643 (latest edition) and the manufacturer's recommendations. A minimum thickness of 15 mils extruded polyolefin plastic is recommended; vapor retarders which contain recycled content or woven materials are not recommended. The vapor retarder should have a permeance of less than 0.01 perms demonstrated by testing before and after mandatory conditioning. The vapor retarder should be installed in direct contact with the concrete slab with proper perimeter seal. If the California Green Building Code requirements apply to this project, the vapor retarder should be underlain by 4 inches of clean aggregate. It is important that the vapor retarder be puncture resistant since it will be in direct contact with angular gravel. As an alternative to the clean aggregate suggested in the Green Building Code, the concrete slab-on-grade may be underlain by a vapor retarder over 4 inches of clean sand (sand equivalent greater than 30), since the sand will serve as a capillary break and will minimize the potential for punctures and damage to the vapor barrier.

- 8.7.7 The bedding sand thickness should be determined by the project foundation engineer, architect, and/or developer. However, we should be contacted to provide recommendations if the bedding sand is thicker than 4 inches. Placement of 3 inches and 4 inches of sand is common practice in southern California for 5-inch and 4-inch thick slabs, respectively. The foundation engineer should provide appropriate concrete mix design criteria and curing measures that may be utilized to assure proper curing of the slab to reduce the potential for rapid moisture loss and subsequent cracking and/or slab curl.
- 8.7.8 As an alternative to the conventional foundation recommendations, consideration should be given to the use of post-tensioned concrete slab and foundation systems for the support of the proposed structures. The post-tensioned systems should be designed by a structural engineer experienced in post-tensioned slab design and design criteria of the Post-Tensioning Institute (PTI) DC 10.5-12 *Standard Requirements for Design and Analysis of Shallow Post-Tensioned Concrete Foundations on Expansive Soils* or *WRI/CRSI Design of Slab-on-Ground Foundations*, as required by the 2016 California Building Code (CBC Section 1808.6.2). Although this procedure was developed for expansive soil conditions, it can also be used to reduce the potential for foundation distress due to differential fill settlement. The post-tensioned design should incorporate the geotechnical parameters presented in Table 8.7.8 for the Foundation Category designated. The parameters presented in Table 8.7.8 are based on the guidelines presented in the PTI DC 10.5 design manual.

**TABLE 8.7.8
POST-TENSIONED FOUNDATION SYSTEM DESIGN PARAMETERS**

| Post-Tensioning Institute (PTI) DC 10.5-12 Design Parameters | Foundation Category | | |
|---|---------------------|-------------|------|
| | I | II | III |
| 1. Thornthwaite Index | -20 | -20 | -20 |
| 2. Equilibrium Suction | 3.9 | 3.9 | 3.9 |
| 3. Edge Lift Moisture Variation Distance, e_M (Feet) | 5.3 | 5.1 | 4.9 |
| 4. Edge Lift, y_M (Inches) | 0.61 | 1.10 | 1.58 |
| 5. Center Lift Moisture Variation Distance, e_M (Feet) | 9.0 | 9.0 | 9.0 |
| 6. Center Lift, y_M (Inches) | 0.30 | 0.47 | 0.66 |

8.7.9 The foundations for the post-tensioned slabs should be embedded in accordance with the recommendations of the structural engineer. If a post-tensioned mat foundation system is planned, the slab should possess a thickened edge with a minimum width of 12 inches and extend below the clean sand or crushed rock layer.

8.7.10 If the structural engineer proposes a post-tensioned foundation design method other than the 2016 CBC:

- The deflection criteria presented in Table 8.7.8 are still applicable.
- Interior stiffener beams should be used for Foundation Categories II and III.
- The width of the perimeter foundations should be at least 12 inches.
- The perimeter footing embedment depths should be at least 12 inches, 18 inches and 24 inches for foundation categories I, II, and III, respectively. The embedment depths should be measured from the lowest adjacent pad grade.

8.7.11 Our experience indicates post-tensioned slabs may be susceptible to excessive edge lift, regardless of the underlying soil conditions. Placing reinforcing steel at the bottom of the perimeter footings and the interior stiffener beams may mitigate this potential. The structural engineer should design the foundation system to reduce the potential of edge lift occurring for the proposed structures.

- 8.7.12 During the construction of the post-tension foundation system, the concrete should be placed monolithically. Under no circumstances should cold joints form between the footings/grade beams and the slab during the construction of the post-tension foundation system unless designed by the structural engineer.
- 8.7.13 Category I, II, or III foundations may be designed for an allowable soil bearing pressure of 3,000 pounds per square foot (psf) (dead plus live load) for the TTM 37731 site, 2,500 psf for the TTM 37732 site, and 3,750 psf for the TTM 37732 site. This bearing pressure may be increased by one-third for transient loads due to wind or seismic forces.
- 8.7.14 The maximum expected static settlement for the planned structures, supported on conventional foundation systems with the above allowable bearing pressures, and deriving support in engineered fill is estimated to be ½ inch and to occur below the heaviest loaded structural element. Settlement of the foundation system is expected to occur on initial application of loading. Differential settlement is not expected to exceed ½ inch over a horizontal distance of 40 feet.
- 8.7.15 Isolated footings outside of the slab area, if present, should have the minimum embedment depth and width recommended for conventional foundations for a Foundation Category. The use of isolated footings, which are located beyond the perimeter of the building and support structural elements connected to the building, are not recommended for Category III. Where this condition cannot be avoided, the isolated footings should be connected to the building foundation system with grade beams. In addition, consideration should be given to connecting patio slabs that exceed 5 feet in width to the building foundation, to reduce the potential for future separation to occur.
- 8.7.16 Interior stiffening beams should be incorporated into the design of the foundation system in accordance with the PTI design procedures.
- 8.7.17 Special subgrade presaturation is not deemed necessary prior to placing concrete; however, the exposed foundation and slab subgrade soil should be moisture conditioned to 0 to 2 percent above optimum moisture content.

8.7.18 Where buildings or other improvements are planned near the top of a slope 3:1 (horizontal:vertical) or steeper, special foundation and/or design considerations are recommended due to the tendency for lateral soil movement to occur.

- When located next to a descending 3:1 (horizontal:vertical) or steeper fill slope or cut slope, the foundations should be extended to a depth where the minimum horizontal distance is equal to $H/3$ (where H equals the vertical distance from the top of the fill slope to the base of the fill soil) with a minimum of 7 feet, but need not exceed 40 feet. The horizontal distance is measured from the outer, deepest edge of the footing to the face of the slope. A post-tensioned slab and foundation system or mat foundation system can be used to reduce the potential for distress in the structures associated with strain softening and lateral fill extension. Specific design parameters or recommendations for either of these alternatives can be provided once the building location and fill slope geometry have been determined.
- If swimming pools are planned, Geocon should be contacted for a review of specific site conditions.
- Swimming pools located within 7 feet of the top of cut or fill slopes are not recommended. Where such a condition cannot be avoided, the portion of the swimming pool wall within 7 feet of the slope face be designed assuming that the adjacent soil provides no lateral support. This recommendation applies to fill slopes up to 30 feet in height and cut slopes regardless of height. For swimming pools located near the top of fill slopes greater than 30 feet in height, additional recommendations may be required and Geocon should be contacted for a review of specific site conditions.
- Although other improvements, which are relatively rigid or brittle, such as concrete flatwork or masonry walls, may experience some distress if located near the top of a slope, it is generally not economical to mitigate this potential. It may be possible, however, to incorporate design measures which would permit some lateral soil movement without causing extensive distress. Geocon should be consulted for specific recommendations.

8.7.19 The recommendations of this report are intended to reduce the potential for cracking of slabs and foundations due to expansive soil (if present), differential settlement of fill soil with varying thicknesses. However, even with the incorporation of the recommendations presented herein, foundations, stucco walls, and slabs-on-grade placed on such conditions may still exhibit some cracking due to soil movement and/or shrinkage. The occurrence of concrete shrinkage cracks is independent of the supporting soil characteristics. Their occurrence may be reduced by limiting the slump of the concrete, proper concrete placement and curing, and by the placement of crack control joints at periodic intervals, in particular, where re-entrant slab corners occur.

- 8.7.20 Concrete slabs should be provided with adequate crack-control joints, construction joints and/or expansion joints to reduce unsightly shrinkage cracking. The design of joints should consider criteria of the American Concrete Institute when establishing crack-control spacing. Additional steel reinforcing, concrete admixtures and/or closer crack control joint spacing should be considered where concrete-exposed finished floors are planned.
- 8.7.21 Geocon should be consulted to provide additional design parameters as required by the structural engineer.

8.8 Exterior Concrete Flatwork

- 8.8.1 Exterior concrete flatwork not subject to vehicular traffic should be constructed in accordance with the recommendations herein assuming the subgrade materials possess an Expansion Index of 90 or less. Subgrade soils should be compacted to 90 percent relative compaction. Slab panels should be a minimum of 4 inches thick and when in excess of 8 feet square should be reinforced with No. 3 steel reinforcing bars placed 24 inches on center in both directions at slab mid-point. In addition, concrete flatwork should be provided with crack control joints to reduce and/or control shrinkage cracking. Crack control spacing should be determined by the project structural engineer based upon the slab thickness and intended usage. Criteria of the American Concrete Institute (ACI) should be taken into consideration when establishing crack control spacing. Subgrade soil for exterior slabs not subjected to vehicle loads should be compacted in accordance with criteria presented in the grading section prior to concrete placement. Subgrade soil should be properly compacted and the moisture content of subgrade soil should be verified prior to placing concrete. Base materials will not be required below concrete improvements.
- 8.8.2 Even with the incorporation of the recommendations of this report, the exterior concrete flatwork has a potential to experience some uplift due to expansive soil beneath grade or differential settlement. The steel reinforcement should overlap continuously in flatwork to reduce the potential for vertical offsets within flatwork.
- 8.8.3 Where exterior flatwork abuts the structure at entrant or exit points, the exterior slab should be dowelled into the structure's foundation stem wall. This recommendation is intended to reduce the potential for differential elevations that could result from differential settlement or minor heave of the flatwork. Dowelling details should be designed by the project structural engineer.

- 8.8.4 The recommendations presented herein are intended to reduce the potential for cracking of exterior slabs as a result of differential movement. However, even with the incorporation of the recommendations presented herein, slabs will still crack. The occurrence of concrete shrinkage cracks is independent of the soil supporting characteristics. Their occurrence may be reduced and/or controlled by limiting the slump of the concrete, the use of crack control joints and proper concrete placement and curing. Crack control joints should be spaced at intervals no greater than 12 feet. Literature provided by the Portland Concrete Association (PCA) and American Concrete Institute (ACI) present recommendations for proper concrete mix, construction, and curing practices, and should be incorporated into project construction.

8.9 Conventional Retaining Walls

- 8.9.1 The recommendations presented herein are generally applicable to the design of rigid concrete or masonry retaining walls having a maximum height of 10 feet. If walls higher than 10 feet or other types of walls are planned, Geocon should be consulted for additional recommendations.
- 8.9.2 Retaining walls not restrained at the top and having a level backfill surface should be designed for an active soil pressure equivalent to the pressure exerted by a fluid density of 50 pounds per cubic foot (pcf). Where the backfill will be inclined at no steeper than 2:1 (horizontal to vertical), an active soil pressure of 75 pcf is recommended. These soil pressures assume that the backfill materials within an area bounded by the wall and a 1:1 plane extending upward from the base of the wall are medium expansion and possess an EI of 90 or less. For walls where backfill materials do not conform to the criteria herein, Geocon should be consulted for additional recommendations.
- 8.9.3 Unrestrained walls are those that are allowed to rotate more than $0.001H$ (where H equals the height of the retaining portion of the wall in feet) at the top of the wall. Where walls are restrained from movement at the top, the walls should be designed for a soil pressure equivalent to the pressure exerted by a fluid density of 70 pcf.
- 8.9.4 The structural engineer should determine the seismic design category for the project in accordance with Section 1613 of the CBC. If the project possesses a seismic design category of D, E, or F, proposed retaining walls in excess of 6 feet in height should be designed with seismic lateral pressure (Section 1803.5.12 of the 2016 CBC).
- 8.9.5 A seismic load of 10 pcf should be used for design of walls that support more than 6 feet of backfill in accordance with Section 1803.5.12 of the 2016 CBC. The seismic load is applied as an equivalent fluid pressure along the height of the wall and the calculated loads result in a maximum load exerted at the base of the wall and zero at the top of the wall. This seismic load should be applied in addition to the active earth pressure. The earth pressure is based on half of two-thirds of PGA_M calculated from ASCE 7-10 Section 11.8.3.

- 8.9.6 Unrestrained walls will move laterally when backfilled and loading is applied. The amount of lateral deflection is dependent on the wall height, the type of soil used for backfill, and loads acting on the wall. The retaining walls and improvements above the retaining walls should be designed to incorporate an appropriate amount of lateral deflection as determined by the structural engineer.
- 8.9.7 Retaining walls should be provided with a drainage system adequate to prevent the buildup of hydrostatic forces and waterproofed as required by the project architect. The soil immediately adjacent to the backfilled retaining wall should be composed of free draining material completely wrapped in Mirafi 140N (or equivalent) filter fabric for a lateral distance of 1 foot for the bottom two-thirds of the height of the retaining wall. The upper one-third should be backfilled with less permeable compacted fill to reduce water infiltration. Alternatively, a drainage panel, such as a Miradrain 6000 or equivalent, can be placed along the back of the wall. Typical retaining wall drainage details are shown on Figure 4. The use of drainage openings through the base of the wall (weep holes) is not recommended where the seepage could be a nuisance or otherwise adversely affect the property adjacent to the base of the wall. The recommendations herein assume a properly compacted backfill (EI of 90 or less) with no hydrostatic forces or imposed surcharge load. If conditions different than those described are expected or if specific drainage details are desired, Geocon should be contacted for additional recommendations.
- 8.9.8 Wall foundations should be designed in accordance with the above foundation recommendations.

8.10 Lateral Design

- 8.10.1 To resist lateral loads, a passive pressure exerted by an equivalent fluid weight of 200 pounds per cubic foot (pcf) should be used for the design of footings or shear keys poured neat against newly compacted engineered fill or dense colluvium material. The allowable passive pressure assumes a horizontal surface extending at least 5 feet, or three times the surface generating the passive pressure, whichever is greater. The upper 12 inches of material in areas not protected by slabs or pavement should not be included in design for passive resistance.
- 8.10.2 If friction is to be used to resist lateral loads, an allowable coefficient of friction between soil and concrete of 0.30 should be used for design.
- 8.10.3 The passive and frictional resistant loads can be combined for design purposes. The lateral passive pressures may be increased by one-third when considering transient loads due to wind or seismic forces.

8.11 Preliminary Pavement Recommendations

8.11.1 The final pavement design should be based on R-value testing of soils at subgrade. Streets should be designed in accordance with the City of Riverside, *Standard Drawings for Construction* (2011) when final Traffic Indices (TI's) and R-value test results of subgrade soil are completed. Based on laboratory testing, we used an assumed R-value of 18 for the preliminary pavement design recommendations. Preliminary flexible pavement section recommendations are presented in Table 8.11.1 and are based on a range of Traffic Indices specified on Standard No. 114 of the County of Riverside, *Road Improvement Standards & Specifications* (2007). The civil engineer should evaluate the final traffic indices for pavements.

**TABLE 8.11.1
PRELIMINARY FLEXIBLE PAVEMENT SECTIONS**

| Road Classification/Use | Assumed Subgrade R-Value | Asphalt Concrete (Inches) | Base Material (Inches) |
|--|--------------------------|---------------------------|------------------------|
| Access Road / Local Street (TI = 5.5) | 18 | 4 | 7 |
| Collector (TI = 7.0) | 18 | 5 | 11 |

8.11.2 The upper 12 inches of the subgrade soil should be compacted to a dry density of at least 95 percent of the laboratory maximum dry density, at 0 to 2 percent optimum moisture content, and be in accordance with the City of Riverside requirements.

8.11.3 The base material and asphalt concrete materials should conform to Section 200-2.2 and Section 203-6, respectively, of the Greenbook. Base materials should be compacted to a dry density of at least 95 percent of the laboratory maximum dry density near to slightly above optimum moisture content. Asphalt concrete should be compacted to a density of 95 percent of the laboratory Hveem density in accordance with ASTM D 2726.

8.11.4 A rigid Portland cement concrete (PCC) pavement section should be placed in driveway aprons and cross gutters. We calculated the rigid pavement section in general conformance with the procedure recommended by the American Concrete Institute report ACI 330R *Guide for Design and Construction of Concrete Parking Lots* using the parameters presented in Table 8.11.4.

**TABLE 8.11.4
RIGID PAVEMENT DESIGN PARAMETERS**

| Design Parameter | Design Value |
|--|--------------|
| Modulus of subgrade reaction, k | 100 pci |
| Modulus of rupture for concrete, M_R | 500 psi |
| Traffic Category, TC | A and C |
| Average daily truck traffic, ADTT | 10 and 300 |

8.11.5 Based on the criteria presented herein, the PCC pavement sections should have a minimum thickness as presented in Table 8.11.5.

**TABLE 8.11.5
RIGID PAVEMENT RECOMMENDATIONS**

| Location | Portland Cement Concrete (inches) |
|-----------------------------------|-----------------------------------|
| Access Lanes (TC=A) | 5.5 |
| Entrance / Driveway Aprons (TC=C) | 7.5 |

8.11.6 The PCC pavement should be placed over subgrade soil that is compacted to a dry density of at least 95 percent of the laboratory maximum dry density, at 0 to 2 percent above optimum moisture content. This pavement section is based on a minimum concrete compressive strength of approximately 3,000 psi (pounds per square inch). Base material will not be required beneath concrete improvements.

8.11.7 A thickened edge or integral curb should be constructed on the outside of concrete slabs subjected to wheel loads. The thickened edge should be 1.2 times the slab thickness or a minimum thickness of 2 inches, whichever results in a thicker edge, and taper back to the recommended slab thickness 4 feet behind the face of the slab (e.g., a 9-inch-thick slab would have an 11-inch-thick edge). Reinforcing steel will not be necessary within the concrete for geotechnical purposes with the possible exception of dowels at construction joints as discussed herein.

8.11.8 In order to control the location and spread of concrete shrinkage cracks, crack-control joints (weakened plane joints) should be included in the design of the concrete pavement slab in accordance with the referenced ACI report.

8.11.9 Performance of the pavements is highly dependent on providing positive surface drainage away from the edge of the pavement. Ponding of water on or adjacent to the pavement

surfaces will likely result in pavement distress and subgrade failure. Drainage from landscaped areas should be directed to controlled drainage structures. Landscape areas adjacent to the edge of asphalt pavements are not recommended due to the potential for surface or irrigation water to infiltrate the underlying permeable aggregate base and cause distress. Where such a condition cannot be avoided, consideration should be given to incorporating measures that will significantly reduce the potential for subsurface water migration into the aggregate base. If planter islands are planned, the perimeter curb should extend at least 6 inches below the level of the base materials.

8.12 Temporary Excavations

- 8.12.1 Excavations of up to 10 feet in vertical height are expected during grading operations and utility installation. The contractor’s competent person should evaluate the necessity for lay back of vertical cut areas. Vertical excavations up to 5 feet may be attempted where loose soils or caving sands are not present, and where not surcharged by existing structures or vehicle/construction equipment loads.
- 8.12.2 Vertical excavations greater than 5 feet will require sloping or shoring measures in order to provide a stable excavation.
- 8.12.3 We expect that braced shoring, such as conventionally braced shields, cross-braced hydraulic shoring, or driven sheet piles may be utilized. The selection of the shoring system is the responsibility of the contractor. Shoring systems should be designed by a California licensed civil or structural engineer with experience in designing shoring systems.
- 8.12.4 We recommend that an equivalent fluid pressure based on the table below be utilized for design of temporary shoring. These pressures are based on the assumption that the shoring is supporting a level backfill and there are no hydrostatic pressures above the bottom of the excavation.

**TABLE 8.12.4
RECOMMENDED SHORING PRESSURES**

| HEIGHT OF SHORED EXCAVATION (FEET) | EQUIVALENT FLUID PRESSURE (Pounds Per Cubic Foot) (ACTIVE PRESSURE) | EQUIVALENT FLUID PRESSURE (Pounds Per Cubic Foot) (ACTIVE PRESSURE with 2:1 Slope) | EQUIVALENT FLUID PRESSURE (Pounds Per Cubic Foot) (AT-REST PRESSURE) |
|---|--|---|---|
| Up to 10 | 40 | 70 | 65 |

- 8.12.5 Active pressures can only be achieved when movement in the soil (earth wall) occurs. If movement in the soil is not acceptable, such as adjacent to an existing structure or where braced shoring will be utilized, the at-rest pressure should be considered for design purposes.
- 8.12.6 Additional active pressure should be added for a surcharge condition due to sloping ground, construction equipment, vehicular traffic, or adjacent structures and should be designed for each condition as the project progresses.
- 8.12.7 In addition to the recommended earth pressure, the upper 10 feet of the shoring adjacent to roadways or driveway areas should be designed to resist a uniform lateral pressure of 100 psf, acting as a result of an assumed 300 psf surcharge behind the shoring due to normal street traffic. If the traffic is kept back at least 15 feet from the shoring, the traffic surcharge may be neglected. Higher surcharge loads may be required to account for construction equipment.
- 8.12.8 It is difficult to accurately predict the amount of deflection of a shored embankment. Some deflection will occur. We recommend that the deflection be minimized to prevent damage to existing structures and adjacent improvements. Where public rights-of-way are present or adjacent offsite structures do not surcharge the shoring excavation, the shoring deflection should be limited to less than 1 inch at the top of the shored embankment. Where offsite structures are within the shoring surcharge area, we recommend the beam deflection be limited to less than ½ inch at the elevation of the adjacent offsite foundation, and no deflection at all if deflections will damage existing structures. The allowable deflection is dependent on many factors, such as the presence of structures and utilities near the top of the embankment and will be assessed and designed by the project shoring engineer.

8.13 Site Drainage and Moisture Protection

- 8.13.1 Adequate site drainage is critical to reduce the potential for differential soil movement, erosion and subsurface seepage. Under no circumstances should water be allowed to pond adjacent to footings. The site should be graded and maintained such that surface drainage is directed away from structures in accordance with 2016 CBC 1804.4 or other applicable standards. In addition, surface drainage should be directed away from the top of slopes into swales or other controlled drainage devices. Roof and pavement drainage should be directed into conduits that carry runoff away from the proposed structure.
- 8.13.2 Underground utilities should be leak free. Utility and irrigation lines should be checked periodically for leaks and detected leaks should be repaired promptly. Detrimental soil movement could occur if water can infiltrate the soil for prolonged periods of time.

- 8.13.3 Landscaping planters adjacent to paved areas are not recommended due to the potential for surface or irrigation water to infiltrate the pavement's subgrade and base course. We recommend that area drains to collect excess irrigation water and transmit it to drainage structures or impervious above-grade planter boxes be used. In addition, where landscaping is planned adjacent to the pavement, we recommend construction of a cutoff wall along the edge of the pavement that extends at least 6 inches below the bottom of the base material.
- 8.13.4 If not properly constructed, there is a potential for distress to improvements and properties located hydrologically down gradient or adjacent to infiltration areas. Factors such as the amount of water to be detained, its residence time, and soil permeability have an important effect on seepage transmission and the potential adverse impacts that may occur if the storm water management features are not properly designed and constructed. We have not performed a hydrogeology study at the site. Down-gradient and adjacent structures may be subjected to seeps, movement of foundations and slabs, or other impacts as a result of water infiltration.

8.14 Plan Review

- 8.14.1 Geocon should be provided the opportunity to review the grading and structural/foundation plans for the project prior to final submittal, to verify that the plans have been prepared in substantial conformance with the recommendations of this report. Additional analyses may be required after review of the project plans.

LIMITATIONS AND UNIFORMITY OF CONDITIONS

1. The recommendations of this report pertain only to the site investigated and are based upon the assumption that the soil conditions do not deviate from those disclosed in the investigation. If any variations or undesirable conditions are encountered during construction, or if the proposed construction will differ from that anticipated herein, Geocon should be notified so that supplemental recommendations can be given. The evaluation or identification of the potential presence of hazardous materials was not part of the scope of services provided by Geocon.
2. This report is issued with the understanding that it is the responsibility of the owner, or of their representative, to ensure that the information and recommendations contained herein are brought to the attention of the architect and engineer for the project and incorporated into the plans, and the necessary steps are taken to see that the contractor and subcontractors carry out such recommendations in the field.
3. The findings of this report are valid as of the date of this report. However, changes in the conditions of a property can occur with the passage of time, whether they are due to natural processes or the works of man on this or adjacent properties. In addition, changes in applicable or appropriate standards may occur, whether they result from legislation or the broadening of knowledge. Accordingly, the findings of this report may be invalidated wholly or partially by changes outside our control. Therefore, this report is subject to review and should not be relied upon after a period of three years.
4. The firm that performed the geotechnical investigation for the project should be retained to provide testing and observation services during construction to provide continuity of geotechnical interpretation and to check that the recommendations presented for geotechnical aspects of site development are incorporated during site grading, construction of improvements, and excavation of foundations. If another geotechnical firm is selected to perform the testing and observation services during construction operations, that firm should prepare a letter indicating their intent to assume the responsibilities of project geotechnical engineer of record. A copy of the letter should be provided to the regulatory agency for their records. In addition, that firm should provide revised recommendations concerning the geotechnical aspects of the proposed development, or a written acknowledgement of their concurrence with the recommendations presented in our report. They should also perform additional analyses deemed necessary to assume the role of Geotechnical Engineer of Record.

REFERENCES

1. American Concrete Institute, 2006, Report 302.2R-06, *Guide for Concrete Slabs that Receive Moisture-Sensitive Flooring Materials*, undated.
2. American Concrete Institute, 2010, Report 360R-10, *Guide to Design of Slabs-on-Ground*, undated.
3. American Concrete Institute, 2011, *Building Code Requirements for Structural Concrete*, Report by ACI Committee 318.
4. Bryant, W.A., and E.W. Hart, 2007, *Fault-Rupture Hazard Zones in California: Alquist-Priolo Earthquake Fault Zoning Act with Index to Earthquake Fault Zones Maps*; California Geological Survey Special Publication 42, 54 p.
5. Boore, D. M. and G. M Atkinson, *Ground-Motion Prediction for the Average Horizontal Component of PGA, PGV, and 5%-Damped PSA at Spectral Periods Between 0.01 and 10.0 S*, Earthquake Spectra, Volume 24, Issue 1, pages 99-138, February 2008.
6. California Building Standards Commission, 2016, *California Building Code (CBC)*, California Code of Regulations Title 24, Part 2.
7. California Geological Survey (CGS), *Earthquake Shaking Potential for California*, from USGS/CGS Seismic Hazards Model, CSSC No. 03-02, 2003.
8. California Geological Survey, *Seismic Shaking Hazards in California*, Based on the USGS/CGS Probabilistic Seismic Hazards Assessment (PSHA) Model, 2002 (revised April 2003). 10% probability of being exceeded in 50 years;
<http://redirect.conservation.ca.gov/cgs/rghm/pshamap/pshamain.html>
9. California Department of Conservation (CA DC), 2010, *Fault Activity Map of California* online database, <http://maps.conservation.ca.gov/cgs/fam/>, accessed May 20, 2019.
10. California Department of Conservation (CA DC), 2015a, *Landslides* online database, <http://maps.conservation.ca.gov/cgs/informationwarehouse/index.html?map=regulatorymaps>, accessed May 20, 2019.
11. California Department of Conservation (CA DC), 2015b, *Regulatory Maps* online database, <http://maps.conservation.ca.gov/cgs/informationwarehouse/index.html?map=regulatorymaps>, accessed May 20, 2019.
12. California Department of Transportation (Caltrans), 2015, *Corrosion Guidelines, Version 2.1*, Division of Engineering Services, Materials Engineering and Testing Services, Corrosion and Structural Concrete Field Investigation Branch, dated January.
13. California Department of Water Resources, 1990, *Water Well Standards: State of California*, Bulletin 74-90, January, 1990.
14. California Department of Water Resources (DWR), 2019, *Water Data Library* online database, www.water.ca.gov/waterdatalibrary/, accessed May 20, 2019.

REFERENCES (Continued)

15. Campbell, K. W. and Y. Bozorgnia, *NGA Ground Motion Model for the Geometric Mean Horizontal Component of PGA, PGV, PGD and 5% Damped Linear Elastic Response Spectra for Periods Ranging from 0.01 to 10 s*, Preprint of version submitted for publication in the NGA Special Volume of Earthquake Spectra, Volume 24, Issue 1, pages 139-171, February 2008.
16. Chiou, Brian S. J. and Robert R. Youngs, *A NGA Model for the Average Horizontal Component of Peak Ground Motion and Response Spectra*, preprint for article to be published in NGA Special Edition for Earthquake Spectra, Spring 2008.
17. City of Riverside, 2011, *Standard Drawings for Construction*, Ordinance, dated month of May.
18. County of Riverside, 2007, *Road Improvement Standards & Specifications*, Ordinance No. 461, dated December 20.
19. D.M. Morton and B.F. Cox, 2001, *Geologic Map of the Riverside East 7.5' Quadrangle, Riverside County, California*, Open-File Report OF 01-452, undated.
20. Federal Emergency Management Agency Flood Map Service Center, 2019, *Flood Map 06071C7944H*, (effective August 28, 2008), accessed May 20, 2019.
21. Historic Aerials, Aerial Imagery Viewer, accessed May 15, 2019.
22. KWC Engineers, *Tentative Trace Map No. XXXXX* (Preliminary Drawing for TTM 37731), *In the City of Riverside*, Scale: 1" = 60', Sheet 1 of 1, undated.
23. KWC Engineers, *Tentative Trace Map No. XXXXX* (Preliminary Drawing for TTM 37732), *In the City of Riverside*, Scale: 1" = 60', Sheet 1 of 1, undated.
24. KWC Engineers, *Untitled* (Preliminary Drawing for TTM 37732), undated.
25. Legg, M. R., J. C. Borrero, and C. E. Synolakis, *Evaluation of Tsunami Risk to Southern California Coastal Cities*, 2002 NEHRP Professional Fellowship Report, dated January.
26. OSHPD, 2019, *Seismic Design Maps*, <https://seismicmaps.org>, accessed May 22, 2019.
27. Public Works Standards, Inc., 2015, *Standard Specifications for Public Works Construction "Greenbook"*, Published by BNi Building News.
28. U.S. Geological Survey (USGS), *Deaggregation of Seismic Hazard for PGA and 2 Periods of Spectral Acceleration*, 2002, USGS Website: www.earthquake.usgs.gov/research/hazmaps.

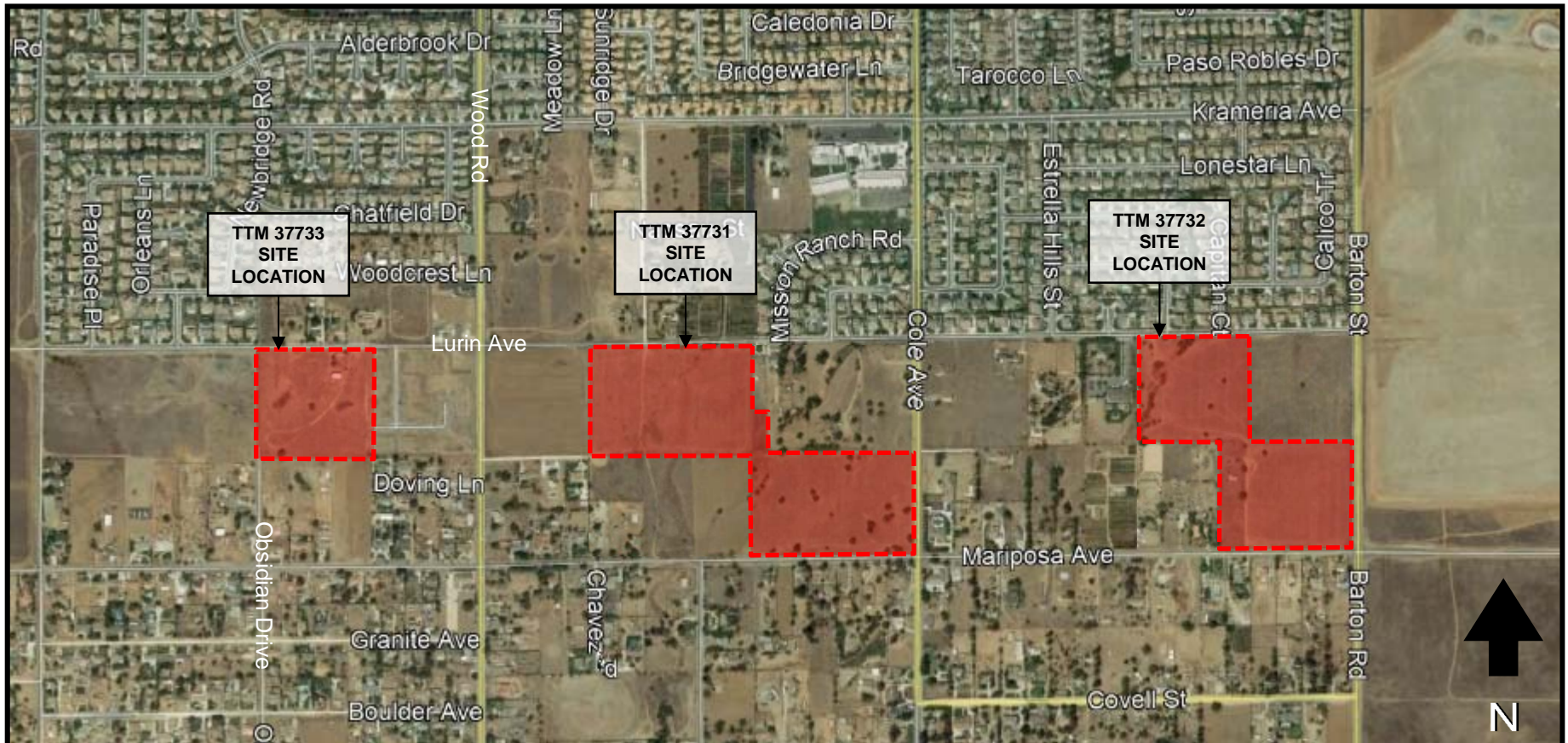

SOURCE: Google, Inc., 2019, Google Earth Pro

SCALE: 1" = 1,000'

VICINITY MAP

GEOCON
WEST, INC.



GEOTECHNICAL ENVIRONMENTAL MATERIALS
41571 CORNING PLACE, SUITE 101, MURRIETA, CA 92562-7065
PHONE 951-304-2300 FAX 951-304-2392

ATS

TTM 37731, TTM 37732, AND TTM 37733
COLE AVENUE, BARTON STREET, AND OBSIDIAN DRIVE
RIVERSIDE, CALIFORNIA

MAY 2019

PROJECT NO. T2864-22-01

FIG. 1

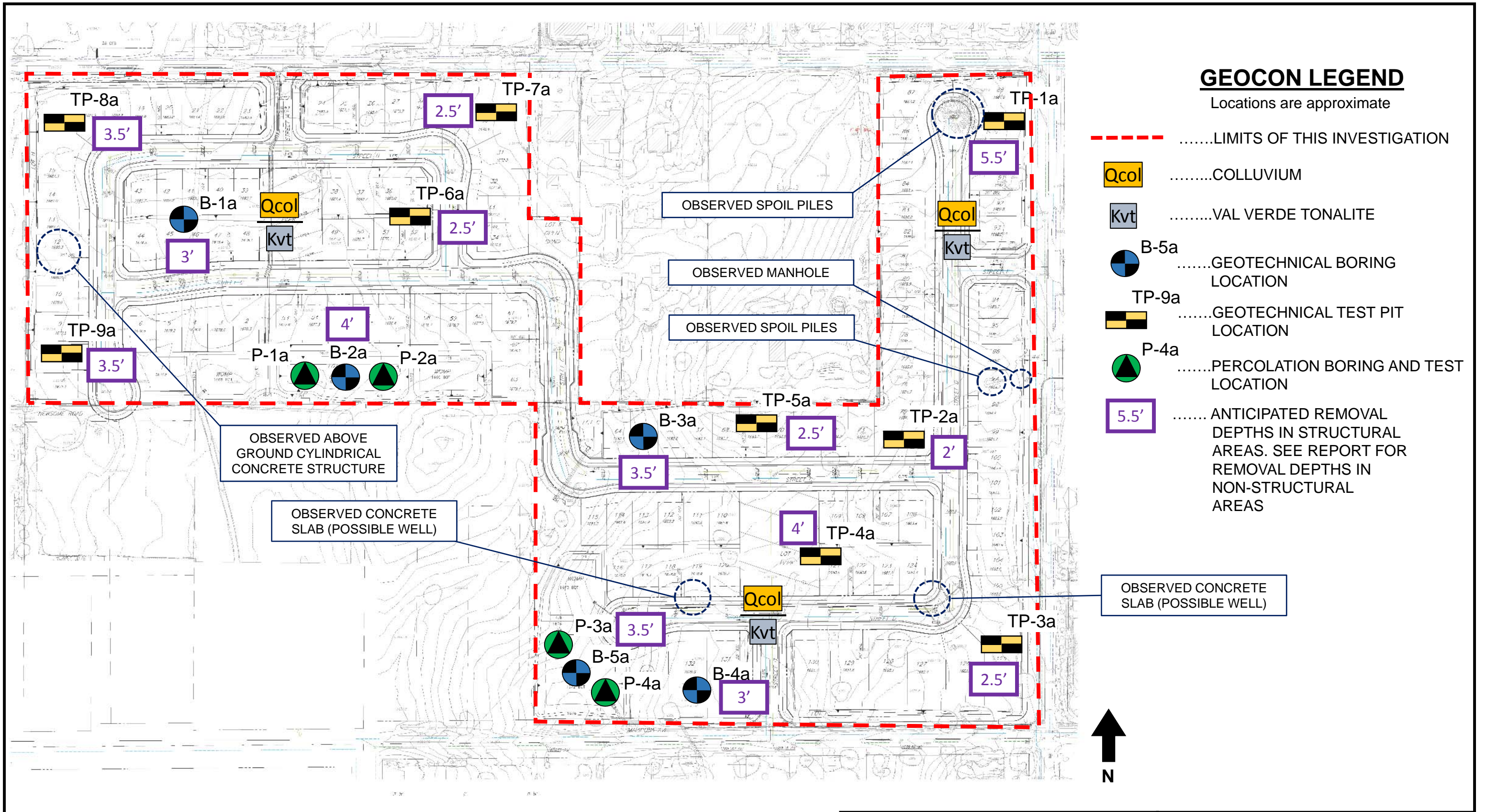

GEOCON LEGEND

Locations are approximate

-LIMITS OF THIS INVESTIGATION
- QcolCOLLUVIUM
- KvtVAL VERDE TONALITE
- B-5aGEOTECHNICAL BORING LOCATION
- TP-9aGEOTECHNICAL TEST PIT LOCATION
- P-4aPERCOLATION BORING AND TEST LOCATION
- 5.5' ANTICIPATED REMOVAL DEPTHS IN STRUCTURAL AREAS. SEE REPORT FOR REMOVAL DEPTHS IN NON-STRUCTURAL AREAS



SOURCE: KWC Engineers, 2019, Untitled Plan, Undated.

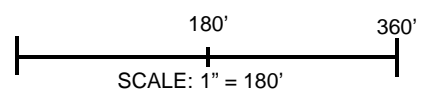

GEOCON
WEST, INC.
GEOTECHNICAL ENVIRONMENTAL MATERIALS
41571 CORNING PLACE, SUITE 101, MURRIETA, CA 92562-7065
PHONE 951-304-2300 FAX 951-304-2392

| | | |
|---|----------|-----------------------------------|
| GEOLOGIC MAP – TTM 37731 | | |
| TTM 37731, TTM 37732, AND TTM 37733 COLE AVENUE, BARTON STREET, AND OBSIDIAN DRIVE RIVERSIDE, CALIFORNIA | | |
| ATS | MAY 2019 | PROJECT NO. T2864-22-01 FIG. 2a |

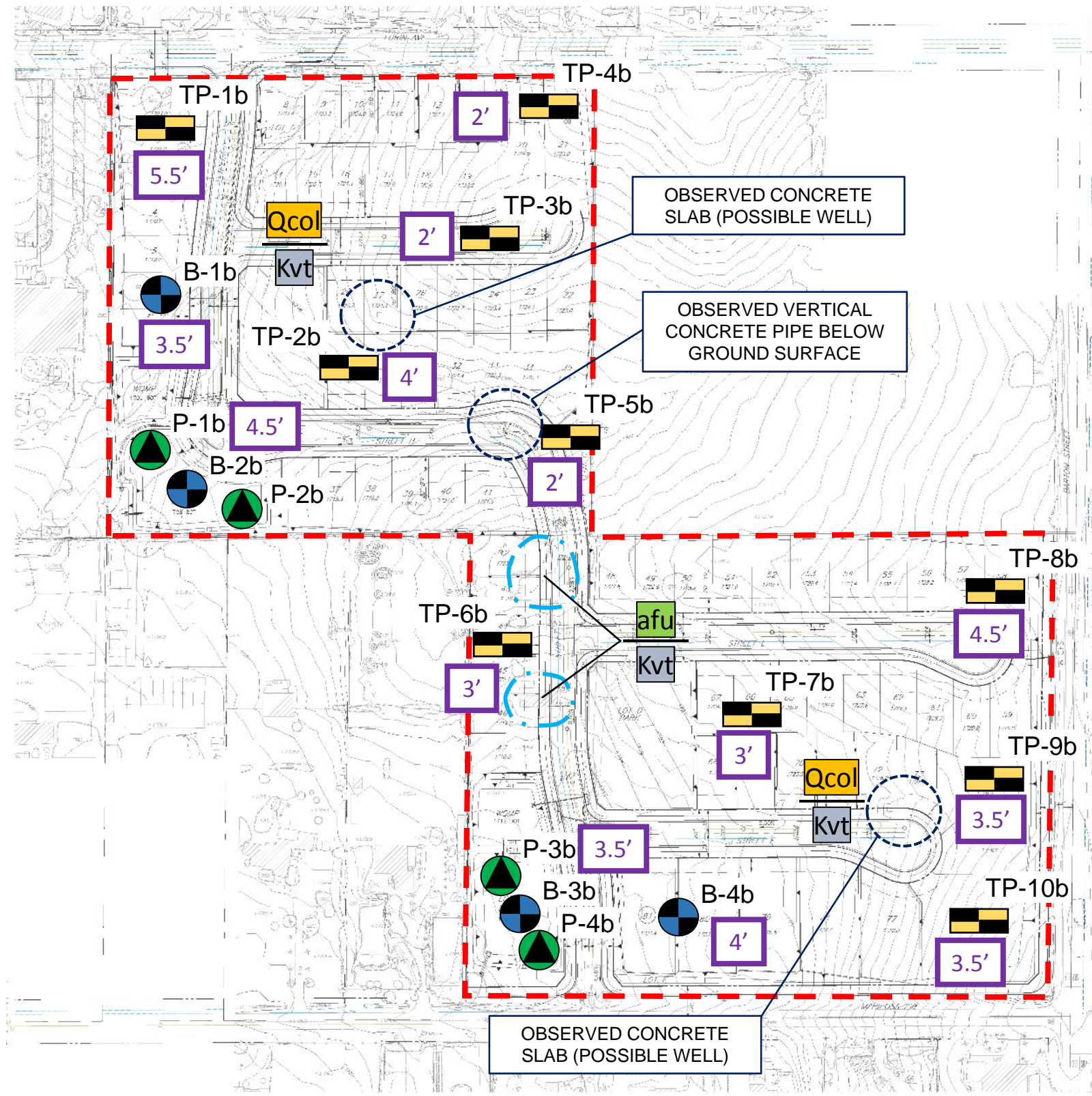

GEOCON LEGEND

Locations are approximate

- - - - -LIMITS OF THIS INVESTIGATION
- · - · -GEOLOGIC CONTACT
- afuUNDOCUMENTED FILL
- QcolCOLLUVIUM
- KvtVAL VERDE TONALITE
- B-4bGEOTECHNICAL BORING LOCATION
- TP-10bGEOTECHNICAL TEST PIT LOCATION
- P-4bPERCOLATION BORING AND TEST LOCATION
- 5.5' ANTICIPATED REMOVAL DEPTHS IN STRUCTURAL AREAS. SEE REPORT FOR REMOVAL DEPTHS IN NON-STRUCTURAL AREAS

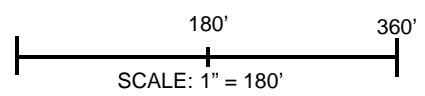

SOURCE: KWC Engineers, 2019, Untitled Plan, Undated.

GEOCON
WEST, INC.
GEOTECHNICAL ENVIRONMENTAL MATERIALS
41571 CORNING PLACE, SUITE 101, MURRIETA, CA 92562-7065
PHONE 951-304-2300 FAX 951-304-2392

GEOLOGIC MAP – TTM 37732
TTM 37731, TTM 37732, AND TTM 37733
COLE AVENUE, BARTON STREET, AND
OBSIDIAN DRIVE
RIVERSIDE, CALIFORNIA

| | | | |
|-----|--|----------|-------------------------|
| ATS | | MAY 2019 | PROJECT NO. T2864-22-01 |
| | | | FIG. 2b |

GEOCON LEGEND

Locations are approximate

-LIMITS OF THIS INVESTIGATION
-GEOLOGIC CONTACT
-UNDOCUMENTED FILL
-COLLUVIUM
-VAL VERDE TONALITE
-GEO TECHNICAL BORING LOCATION
- TP-6cGEO TECHNICAL TEST PIT LOCATION
- P-2cPERCOLATION BORING AND TEST LOCATION
- ANTICIPATED REMOVAL DEPTHS IN STRUCTURAL AREAS. SEE REPORT FOR REMOVAL DEPTHS IN NON-STRUCTURAL AREAS

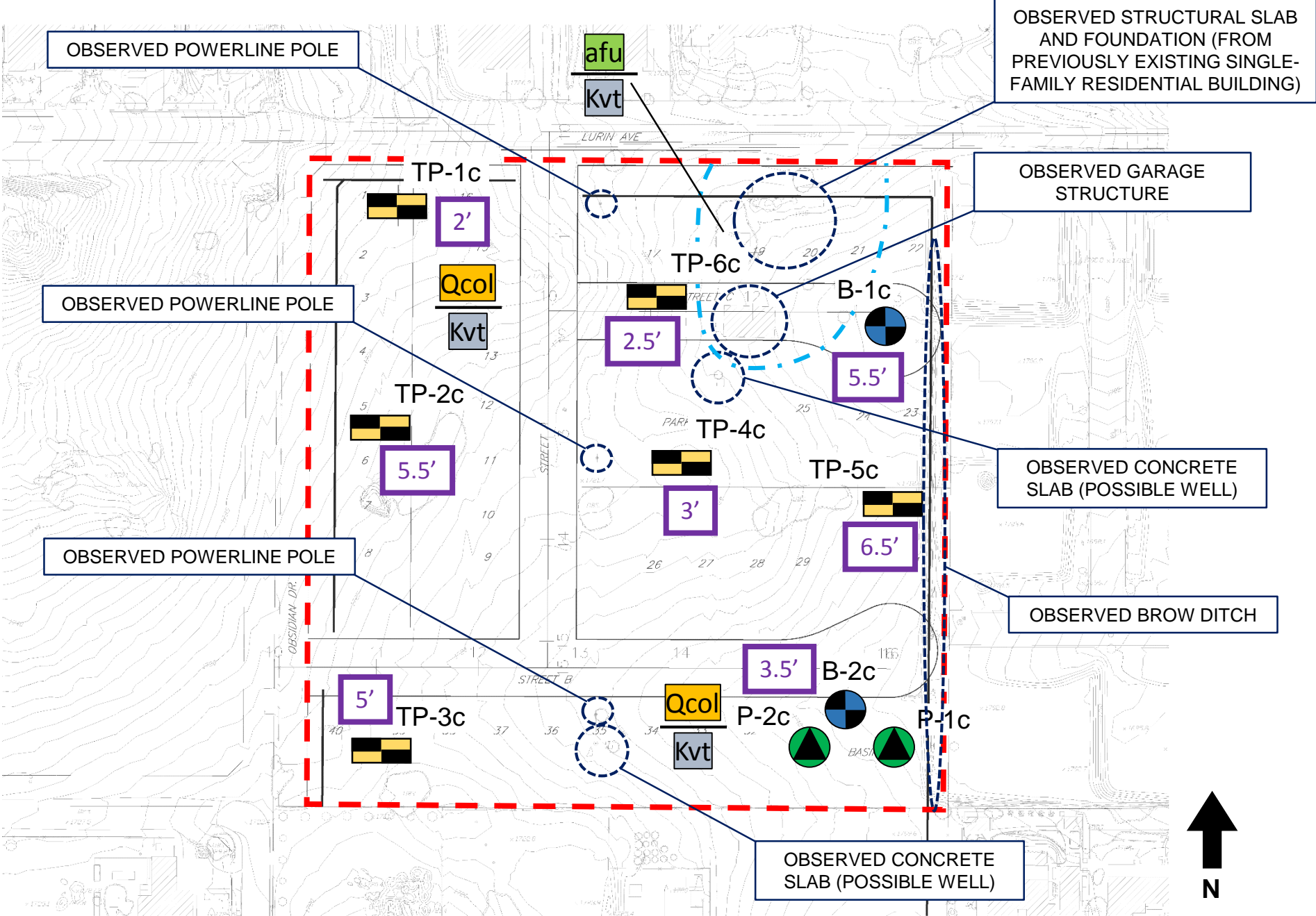

SOURCE: KWC Engineers, 2019, Untitled Plan, Undated.

GEOCON
 WEST, INC.
 GEOTECHNICAL ENVIRONMENTAL MATERIALS
 41571 CORNING PLACE, SUITE 101, MURRIETA, CA 92562-7065
 PHONE 951-304-2300 FAX 951-304-2392

GEOLOGIC MAP – TTM 37733
 TTM 37731, TTM 37732, AND TTM 37733
 COLE AVENUE, BARTON STREET, AND
 OBSIDIAN DRIVE
 RIVERSIDE, CALIFORNIA

| | | | |
|-----|--|----------|-----------------------------------|
| ATS | | MAY 2019 | PROJECT NO. T2864-22-01 FIG. 2c |
|-----|--|----------|-----------------------------------|

WALL FOOTING

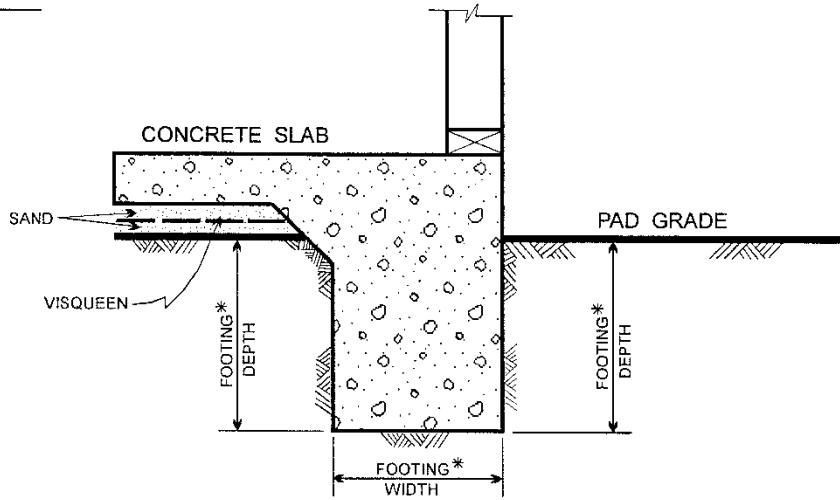

COLUMN FOOTING

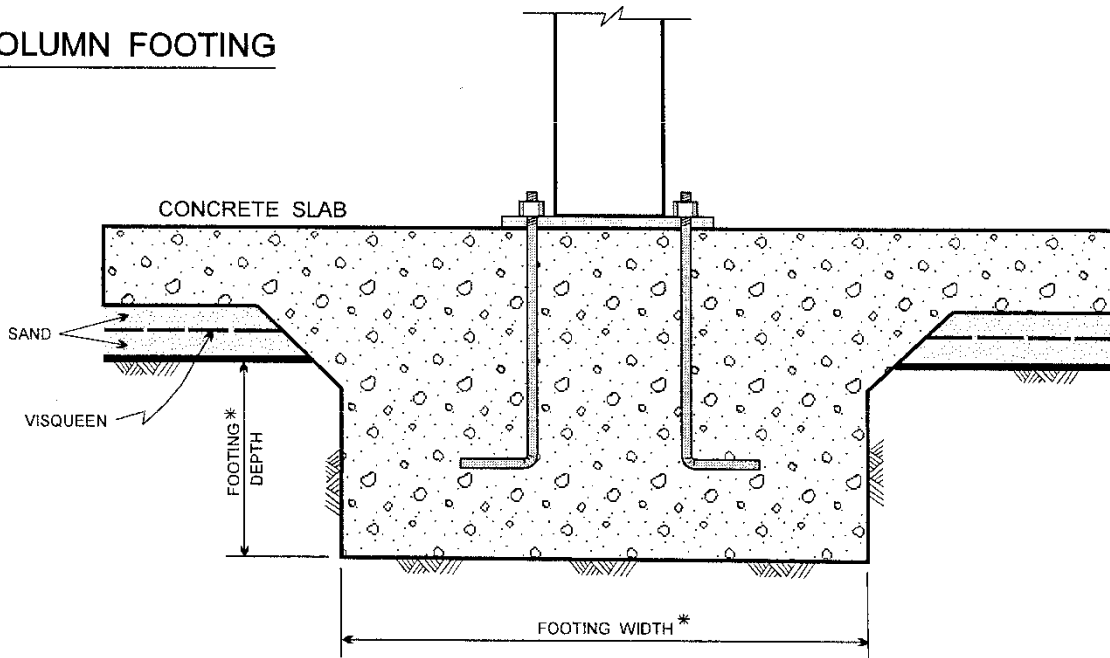

*.....SEE REPORT FOR FOUNDATION WIDTH AND DEPTH RECOMMENDATION

NO SCALE

GEOCON
WEST, INC.



GEOTECHNICAL ENVIRONMENTAL MATERIALS
41571 CORNING PLACE, SUITE 101, MURRIETA, CA 92562-7065
PHONE 951-304-2300 FAX 951-304-2392

WALL / COLUMN FOOTING DETAIL

TTM 37731, TTM 37732, AND TTM 37733
COLE AVENUE, BARTON STREET, AND
OBSIDIAN DRIVE
RIVERSIDE, CALIFORNIA

ATS

MAY 2019

PROJECT NO. T2864-22-01

FIG. 3

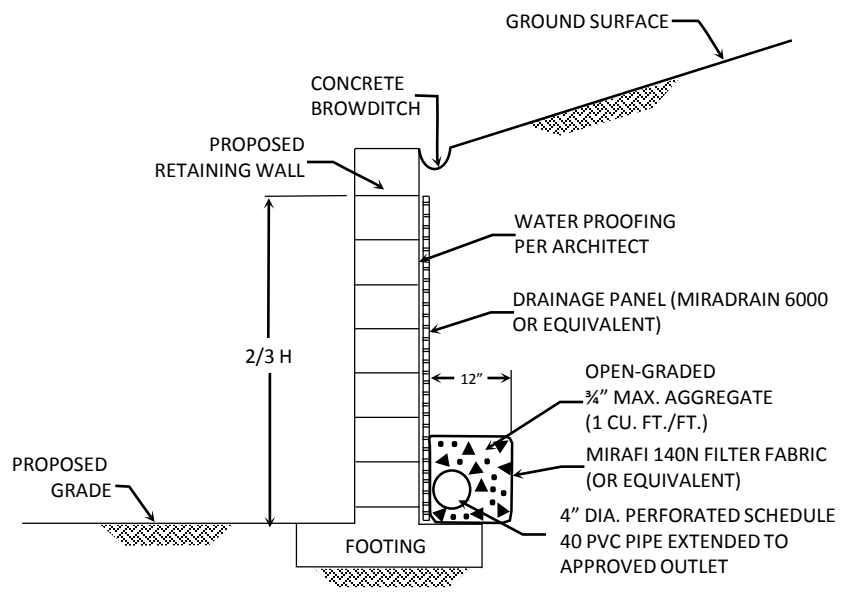
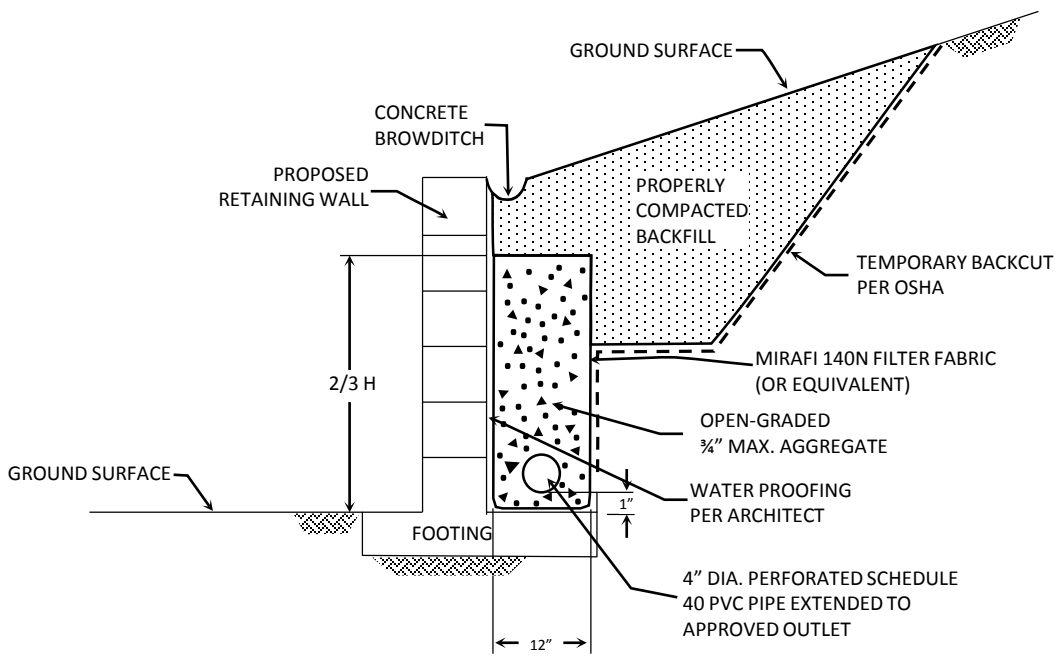

NOTES:
 DRAIN SHOULD BE UNIFORMLY SLOPED TO GRAVITY OUTLET OR TO A SUMP WHERE WATER CAN BE REMOVED BY PUMPING
 CONCRETE BROW DITCH RECOMMENDED FOR SLOPE HEIGHTS GREATER THAN 6 FEET

NO SCALE

GEOCON
 WEST, INC.
 GEOTECHNICAL ENVIRONMENTAL MATERIALS
 41571 CORNING PLACE, SUITE 101, MURRIETA, CA 92562-7065
 PHONE 951-304-2300 FAX 951-304-2392

TYPICAL RETAINING WALL DRAIN DETAIL
 TTM 37731, TTM 37732, AND TTM 37733
 COLE AVENUE, BARTON STREET, AND
 OBSIDIAN DRIVE
 RIVERSIDE, CALIFORNIA

| | | |
|-----|--|--|
| ATS | | |
|-----|--|--|

| | | |
|----------|-------------------------|--------|
| MAY 2019 | PROJECT NO. T2864-22-01 | FIG. 4 |
|----------|-------------------------|--------|

APPENDIX



A

APPENDIX A

FIELD INVESTIGATION

Geocon performed the field investigation for sites TTM 37731 (Cole Avenue), TTM 37732 (Barton Street)), and TTM 37733 (Obsidian Drive) on May 1 through 3, 2019, which included the drilling of twenty-one exploratory borings to depths ranging from approximately 2 feet to 23 feet, and the excavation of twenty-five test pits to depths ranging from approximately 2 feet to 8 feet, to observe the subsurface geological conditions at the site, identify the shallow bedrock contact, collect relatively undisturbed in-situ and disturbed bulk samples for laboratory testing, and evaluate the depth to groundwater. Additionally, ten of the exploratory borings were utilized as percolation test borings, to evaluate subsurface infiltration rates in proposed infiltration areas.

We collected relatively undisturbed samples from the borings by driving a 3-inch O. D., California Modified Sampler into the “undisturbed” soil mass with blows from a 140-pound hammer falling 30 inches. The California Modified Sampler was equipped with 1-inch high by 2³/₈-inch inside diameter brass sampler rings to facilitate removal and testing. Bulk samples of disturbed soils were collected from both the exploratory borings and test pits. The relatively undisturbed samples and bulk samples of disturbed soils were transported to our laboratory for testing.

The soil conditions encountered in the borings and test pits were visually examined, classified and logged in general accordance with the Unified Soil Classification System (USCS). Logs of the borings and test pits are presented on Figures A-1 through A-46. The logs depict the soil and geologic conditions encountered and the depth at which samples were obtained. The approximate locations of the exploratory borings and test pits are depicted on the *Geologic Map*, Figures 2a, 2b, and 2c.

Percolation testing was performed on May 2 through 3, 2019, in accordance with *Riverside County Flood Control and Water Conservation District, LID BMP Manual, Appendix A*. The percolation test data is presented on Figures A-47 and A-56.

| DEPTH IN FEET | SAMPLE NO. | LITHOLOGY | GROUNDWATER | SOIL CLASS (USCS) | BORING B-1a | | PENETRATION RESISTANCE (BLOWS/FT.) | DRY DENSITY (P.C.F.) | MOISTURE CONTENT (%) | | | |
|---------------|------------|-----------|-------------|-------------------|---|------------------------------|------------------------------------|----------------------|----------------------|-----|--|--|
| | | | | | ELEV. (MSL.) 1673 | DATE COMPLETED 5/1/19 | | | | | | |
| | | | | | EQUIPMENT HOLLOW STEM AUGER BY: A. Shoashekan | | | | | | | |
| | | | | | MATERIAL DESCRIPTION | | | | | | | |
| 0 | B-1a@0-5 | | | ML | COLLUVIUM (Qcol) Sandy SILT, soft, dry, light yellowish brown; few medium sand; rootlets and root hairs; upper 1' disturbed | | | | | | | |
| 2 | | | | SM | | | | | | | | |
| | B-1a@2.5 | | | SC | Silty SAND, loose, damp, brown; fine sand with few medium sand Clayey SAND, firm, damp, brown; fine sand with trace coarse sand | | | 84/10" | 135.9 | 5.5 | | |
| 4 | | | | | VAL VERDE TONALITE (Kvt) Weathered, grayish brown, moderately strong GRANITIC BEDROCK; medium- to coarse-grained; excavates as a poorly-graded sand | | | | | | | |
| | B-1a@5 | | | | | | | 50/3" | 97 | 5.3 | | |
| | | | | | Total Depth = 5'-3" Groundwater not encountered Penetration resistance for 140-lb hammer falling 30-inches by auto-hammer Backfilled with cuttings on 05/01/2019 | | | | | | | |

Figure A-1,
Log of Boring B-1a, Page 1 of 1

T2864-22-01 BORING LOGS - A LOGS.GPJ

| | | | |
|-----------------------|-----------------------------|-------------------------------|--------------------------------|
| SAMPLE SYMBOLS | ... SAMPLING UNSUCCESSFUL | ... STANDARD PENETRATION TEST | ... DRIVE SAMPLE (UNDISTURBED) |
| | ... DISTURBED OR BAG SAMPLE | ... CHUNK SAMPLE | ... WATER TABLE OR SEEPAGE |

NOTE: THE LOG OF SUBSURFACE CONDITIONS SHOWN HEREON APPLIES ONLY AT THE SPECIFIC BORING OR TRENCH LOCATION AND AT THE DATE INDICATED. IT IS NOT WARRANTED TO BE REPRESENTATIVE OF SUBSURFACE CONDITIONS AT OTHER LOCATIONS AND TIMES.

| DEPTH IN FEET | SAMPLE NO. | LITHOLOGY | GROUNDWATER | SOIL CLASS (USCS) | BORING B-2a | | PENETRATION RESISTANCE (BLOWS/FT.) | DRY DENSITY (P.C.F.) | MOISTURE CONTENT (%) |
|----------------------|------------|-----------|-------------|-------------------|--|------------------------------|------------------------------------|----------------------|----------------------|
| | | | | | ELEV. (MSL.) 1669 | DATE COMPLETED 5/1/19 | | | |
| | | | | | EQUIPMENT HOLLOW STEM AUGER | | BY: A. Shoashekan | | |
| MATERIAL DESCRIPTION | | | | | | | | | |
| 0 | B-2a@0-5 | | | CL | COLLUVIUM (Qco) Sandy CLAY, soft, moist, grayish brown; few fine to medium sand; rootlets and root hairs; upper 0.5' disturbed | | | | |
| 2 | B-2a@2.5 | | | SC | -micaceous Clayey SAND, stiff, moist, grayish brown; fine sand with some medium and coarse sand | | 35 | 119.2 | 14.8 |
| 4 | B-2a@5 | | | | VAL VERDE TONALITE (Kvt) Weathered, pale yellow to light gray, moderately strong GRANITIC BEDROCK; medium- to coarse-grained; trace calcium carbonate stringers; excavates as a poorly-graded sand | | 98/9" | 129.9 | 6.9 |
| 6 | | | | | | | | | |
| 8 | | | | | | | | | |
| 10 | | | | | | | | | |
| 12 | | | | | | | | | |
| 14 | | | | | | | | | |
| | | | | | Total Depth = 15' Groundwater encountered at 12'-11" Penetration resistance for 140-lb hammer falling 30-inches by auto-hammer Backfilled with cuttings on 05/02/2019 | | | | |

Figure A-2,
Log of Boring B-2a, Page 1 of 1

T2864-22-01 BORING LOGS - A LOGS.GPJ

| | | | | | | |
|----------------|--|-----------------------------|--|-------------------------------|--|--------------------------------|
| SAMPLE SYMBOLS | | ... SAMPLING UNSUCCESSFUL | | ... STANDARD PENETRATION TEST | | ... DRIVE SAMPLE (UNDISTURBED) |
| | | ... DISTURBED OR BAG SAMPLE | | ... CHUNK SAMPLE | | ... WATER TABLE OR SEEPAGE |

NOTE: THE LOG OF SUBSURFACE CONDITIONS SHOWN HEREON APPLIES ONLY AT THE SPECIFIC BORING OR TRENCH LOCATION AND AT THE DATE INDICATED. IT IS NOT WARRANTED TO BE REPRESENTATIVE OF SUBSURFACE CONDITIONS AT OTHER LOCATIONS AND TIMES.

| DEPTH IN FEET | SAMPLE NO. | LITHOLOGY | GROUNDWATER | SOIL CLASS (USCS) | BORING B-3a | | PENETRATION RESISTANCE (BLOWS/FT.) | DRY DENSITY (P.C.F.) | MOISTURE CONTENT (%) |
|---------------------|---------------|-----------|-------------|-------------------------|---|------------------------------|--|-------------------------|-------------------------|
| | | | | | ELEV. (MSL.) 1675 | DATE COMPLETED 5/1/19 | | | |
| | | | | | EQUIPMENT HOLLOW STEM AUGER BY: A. Shoashekan | | | | |
| | | | | | MATERIAL DESCRIPTION | | | | |
| 0 | | | | | | | | | |
| 2 | B-3a@2.5 | | | ML | COLLUVIUM (Qco) Sandy SILT, soft, damp, yellowish brown; fine sand with trace medium and coarse sand; rootlets and root hairs; upper 0.5' disturbed -becomes hard, reddish brown | | 50/5" | 107.8 | 6 |
| 4 | B-3a@5 | | | | VAL VERDE TONALITE (Kvt) Weathered, brown gray, moderately strong GRANITIC BEDROCK; medium- to coarse-grained; excavates as a poorly-graded sand | | 50/3" | | |
| | | | | | Total Depth = 5'-3" Groundwater not encountered Penetration resistance for 140-lb hammer falling 30-inches by auto-hammer Backfilled with cuttings on 05/01/2019 | | | | |

Figure A-3,
Log of Boring B-3a, Page 1 of 1

T2864-22-01 BORING LOGS - A LOGS.GPJ

| | | | |
|----------------|-----------------------------|-------------------------------|--------------------------------|
| SAMPLE SYMBOLS | ... SAMPLING UNSUCCESSFUL | ... STANDARD PENETRATION TEST | ... DRIVE SAMPLE (UNDISTURBED) |
| | ... DISTURBED OR BAG SAMPLE | ... CHUNK SAMPLE | ... WATER TABLE OR SEEPAGE |

NOTE: THE LOG OF SUBSURFACE CONDITIONS SHOWN HEREON APPLIES ONLY AT THE SPECIFIC BORING OR TRENCH LOCATION AND AT THE DATE INDICATED. IT IS NOT WARRANTED TO BE REPRESENTATIVE OF SUBSURFACE CONDITIONS AT OTHER LOCATIONS AND TIMES.

| DEPTH IN FEET | SAMPLE NO. | LITHOLOGY | GROUNDWATER | SOIL CLASS (USCS) | BORING B-4a | | PENETRATION RESISTANCE (BLOWS/FT.) | DRY DENSITY (P.C.F.) | MOISTURE CONTENT (%) | | | |
|---------------|------------|-----------|-------------|-------------------|---|------------------------------|------------------------------------|----------------------|----------------------|-------|-------|-----|
| | | | | | ELEV. (MSL.) 1671 | DATE COMPLETED 5/1/19 | | | | | | |
| | | | | | EQUIPMENT HOLLOW STEM AUGER BY: A. Shoashekan | | | | | | | |
| | | | | | MATERIAL DESCRIPTION | | | | | | | |
| 0 | B-4a@0-5 | | | ML SM | COLLUVIUM (Qco) Sandy SILT, soft, dry, yellowish brown; fine sand with few medium sand; rootlets and root hairs; upper 0.5' disturbed | | | | | | | |
| 2 | B-4a@2.5 | | | | Silty SAND, dense, damp, reddish brown; fine to coarse sand | | | | | | | |
| 4 | B-4a@5 | | | | VAL VERDE TONALITE (Kvt) Weathered, olive gray, moderately strong GRANITIC BEDROCK; medium- to coarse-grained; excavates as a poorly-graded sand | | | 84/10" | 102.4 | 5.2 | | |
| | | | | | Total Depth = 5'-3" Groundwater not encountered Penetration resistance for 140-lb hammer falling 30-inches by auto-hammer Backfilled with cuttings on 05/01/2019 | | | | | 50/3" | 123.9 | 7.5 |

Figure A-4,
Log of Boring B-4a, Page 1 of 1

T2864-22-01 BORING LOGS - A LOGS.GPJ







| | | | |
|----------------|-----------------------------|-------------------------------|--------------------------------|
| SAMPLE SYMBOLS | ... SAMPLING UNSUCCESSFUL | ... STANDARD PENETRATION TEST | ... DRIVE SAMPLE (UNDISTURBED) |
| | ... DISTURBED OR BAG SAMPLE | ... CHUNK SAMPLE | ... WATER TABLE OR SEEPAGE |

NOTE: THE LOG OF SUBSURFACE CONDITIONS SHOWN HEREON APPLIES ONLY AT THE SPECIFIC BORING OR TRENCH LOCATION AND AT THE DATE INDICATED. IT IS NOT WARRANTED TO BE REPRESENTATIVE OF SUBSURFACE CONDITIONS AT OTHER LOCATIONS AND TIMES.

| DEPTH IN FEET | SAMPLE NO. | LITHOLOGY | GROUNDWATER | SOIL CLASS (USCS) | BORING B-5a | | PENETRATION RESISTANCE (BLOWS/FT.) | DRY DENSITY (P.C.F.) | MOISTURE CONTENT (%) |
|----------------------|---------------|-----------|-------------|-------------------------|---|------------------------------|--|-------------------------|-------------------------|
| | | | | | ELEV. (MSL.) 1678 | DATE COMPLETED 5/1/19 | | | |
| | | | | | EQUIPMENT HOLLOW STEM AUGER | | BY: A. Shoashekan | | |
| MATERIAL DESCRIPTION | | | | | | | | | |
| 0 | | | | SC | COLLUVIUM (Qco) Clayey SAND, loose, dry, reddish brown; fine sand with few medium and coarse sand; rootlets and root hairs; upper 0.5' disturbed -becomes damp | | | | |
| 2 | | | | | | | | | |
| 4 | | | | | VAL VERDE TONALITE (Kvt) Weathered, yellowish brown, moderately strong GRANITIC BEDROCK; medium- to coarse-grained; excavates as a poorly-graded sand | | | | |
| 6 | | | | | | | | | |
| 8 | | | | | -becomes olive gray | | | | |
| 10 | | | | | | | | | |
| 12 | | | | | | | | | |
| 14 | | | | | | | | | |
| 16 | | | | | -becomes gray | | | | |
| 18 | | | | | Total Depth = 18' Groundwater not encountered Backfilled with cuttings on 05/02/2019 | | | | |

Figure A-5,
Log of Boring B-5a, Page 1 of 1

T2864-22-01 BORING LOGS - A LOGS.GPJ

| | | | |
|----------------|---|---|--|
| SAMPLE SYMBOLS |  ... SAMPLING UNSUCCESSFUL |  ... STANDARD PENETRATION TEST |  ... DRIVE SAMPLE (UNDISTURBED) |
| |  ... DISTURBED OR BAG SAMPLE |  ... CHUNK SAMPLE |  ... WATER TABLE OR SEEPAGE |

NOTE: THE LOG OF SUBSURFACE CONDITIONS SHOWN HEREON APPLIES ONLY AT THE SPECIFIC BORING OR TRENCH LOCATION AND AT THE DATE INDICATED. IT IS NOT WARRANTED TO BE REPRESENTATIVE OF SUBSURFACE CONDITIONS AT OTHER LOCATIONS AND TIMES.







| DEPTH IN FEET | SAMPLE NO. | LITHOLOGY | GROUNDWATER | SOIL CLASS (USCS) | BORING P-1a | | PENETRATION RESISTANCE (BLOWS/FT.) | DRY DENSITY (P.C.F.) | MOISTURE CONTENT (%) |
|---------------------|---------------|---|-------------|-------------------------|---|------------------------------|--|-------------------------|-------------------------|
| | | | | | ELEV. (MSL.) 1668 | DATE COMPLETED 5/1/19 | | | |
| | | | | | EQUIPMENT HOLLOW STEM AUGER BY: A. Shoashekan | | | | |
| | | | | | MATERIAL DESCRIPTION | | | | |
| 0 | | | | | | | | | |
| | P-1a@1-2 |  | | CL | COLLUVIUM (Qco) Sandy CLAY, soft, moist, grayish brown; fine sand with some medium and coarse sand; rootlets and root hairs; upper 0.5' disturbed | | | | |
| 2 | | | | | Total Depth = 2' Groundwater not encountered Backfilled with cuttings on 05/02/2019 | | | | |

Figure A-6,
Log of Boring P-1a, Page 1 of 1

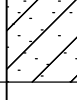
T2864-22-01 BORING LOGS - A LOGS.GPJ

| | | | |
|-----------------------|---|---|--|
| SAMPLE SYMBOLS |  ... SAMPLING UNSUCCESSFUL |  ... STANDARD PENETRATION TEST |  ... DRIVE SAMPLE (UNDISTURBED) |
| |  ... DISTURBED OR BAG SAMPLE |  ... CHUNK SAMPLE |  ... WATER TABLE OR SEEPAGE |

NOTE: THE LOG OF SUBSURFACE CONDITIONS SHOWN HEREON APPLIES ONLY AT THE SPECIFIC BORING OR TRENCH LOCATION AND AT THE DATE INDICATED. IT IS NOT WARRANTED TO BE REPRESENTATIVE OF SUBSURFACE CONDITIONS AT OTHER LOCATIONS AND TIMES.

| DEPTH IN FEET | SAMPLE NO. | LITHOLOGY | GROUNDWATER | SOIL CLASS (USCS) | BORING P-2a | | PENETRATION RESISTANCE (BLOWS/FT.) | DRY DENSITY (P.C.F.) | MOISTURE CONTENT (%) |
|---------------------|---------------|-----------|-------------|-------------------------|--|------------------------------|--|-------------------------|-------------------------|
| | | | | | ELEV. (MSL.) 1671 | DATE COMPLETED 5/1/19 | | | |
| | | | | | EQUIPMENT HOLLOW STEM AUGER BY: A. Shoashekan | | | | |
| | | | | | MATERIAL DESCRIPTION | | | | |
| 0 | | | | | | | | | |
| 2 | P-2a@2-3 | | | SM | COLLUVIUM (Qco) Silty SAND, loose, dry, light yellowish brown; fine sand with some medium and coarse sand; rootlets and root hairs; upper 0.5' disturbed -becomes damp, dark grayish brown; fine sand with few medium sand | | | | |
| | | | | | Total Depth = 3' Groundwater not encountered Backfilled with cuttings on 05/02/2019 | | | | |

Figure A-7,
Log of Boring P-2a, Page 1 of 1

T2864-22-01 BORING LOGS - A LOGS.GPJ

| | | | | | | |
|----------------|-------------------------------------|-----------------------------|-------------------------------------|-------------------------------|-------------------------------------|--------------------------------|
| SAMPLE SYMBOLS | <input type="checkbox"/> | ... SAMPLING UNSUCCESSFUL | <input type="checkbox"/> | ... STANDARD PENETRATION TEST | <input type="checkbox"/> | ... DRIVE SAMPLE (UNDISTURBED) |
| | <input checked="" type="checkbox"/> | ... DISTURBED OR BAG SAMPLE | <input checked="" type="checkbox"/> | ... CHUNK SAMPLE | <input checked="" type="checkbox"/> | ... WATER TABLE OR SEEPAGE |

NOTE: THE LOG OF SUBSURFACE CONDITIONS SHOWN HEREON APPLIES ONLY AT THE SPECIFIC BORING OR TRENCH LOCATION AND AT THE DATE INDICATED. IT IS NOT WARRANTED TO BE REPRESENTATIVE OF SUBSURFACE CONDITIONS AT OTHER LOCATIONS AND TIMES.

| DEPTH IN FEET | SAMPLE NO. | LITHOLOGY | GROUNDWATER | SOIL CLASS (USCS) | BORING P-3a | | PENETRATION RESISTANCE (BLOWS/FT.) | DRY DENSITY (P.C.F.) | MOISTURE CONTENT (%) |
|---------------------|---------------|-----------|-------------|-------------------------|--|------------------------------|--|-------------------------|-------------------------|
| | | | | | ELEV. (MSL.) 1675 | DATE COMPLETED 5/1/19 | | | |
| | | | | | EQUIPMENT HOLLOW STEM AUGER BY: A. Shoashekan | | | | |
| | | | | | MATERIAL DESCRIPTION | | | | |
| 0 | | | | | | | | | |
| 2 | | | | ML SM | COLLUVIUM (Qco) Sandy SILT, soft, dry, light yellowish brown; fine sand with few medium and coarse sand; rootlets and root hairs; upper 0.5' disturbed | | | | |
| 4 | P-3a@4-5 | | | | VAL VERDE TONALITE (Kvt) Weathered, olive gray, moderately strong GRANITIC BEDROCK; medium- to coarse-grained; excavates as a silty sand | | | | |
| | | | | | Total Depth = 5' Groundwater not encountered Backfilled with cuttings on 05/03/2019 | | | | |

Figure A-8,
Log of Boring P-3a, Page 1 of 1

T2864-22-01 BORING LOGS - A LOGS.GPJ

| | | | | | | |
|----------------|-------------------------------------|-----------------------------|-------------------------------------|-------------------------------|-------------------------------------|--------------------------------|
| SAMPLE SYMBOLS | <input type="checkbox"/> | ... SAMPLING UNSUCCESSFUL | <input type="checkbox"/> | ... STANDARD PENETRATION TEST | <input type="checkbox"/> | ... DRIVE SAMPLE (UNDISTURBED) |
| | <input checked="" type="checkbox"/> | ... DISTURBED OR BAG SAMPLE | <input checked="" type="checkbox"/> | ... CHUNK SAMPLE | <input checked="" type="checkbox"/> | ... WATER TABLE OR SEEPAGE |

NOTE: THE LOG OF SUBSURFACE CONDITIONS SHOWN HEREON APPLIES ONLY AT THE SPECIFIC BORING OR TRENCH LOCATION AND AT THE DATE INDICATED. IT IS NOT WARRANTED TO BE REPRESENTATIVE OF SUBSURFACE CONDITIONS AT OTHER LOCATIONS AND TIMES.

| DEPTH IN FEET | SAMPLE NO. | LITHOLOGY | GROUNDWATER | SOIL CLASS (USCS) | BORING P-4a | | PENETRATION RESISTANCE (BLOWS/FT.) | DRY DENSITY (P.C.F.) | MOISTURE CONTENT (%) |
|---------------------|---------------|-----------|-------------|-------------------------|--|------------------------------|--|-------------------------|-------------------------|
| | | | | | ELEV. (MSL.) 1679 | DATE COMPLETED 5/1/19 | | | |
| | | | | | EQUIPMENT HOLLOW STEM AUGER BY: A. Shoashekan | | | | |
| | | | | | MATERIAL DESCRIPTION | | | | |
| 0 | | | | SM | COLLUVIUM (Qco) Silty SAND, loose, damp, reddish brown; fine sand with few medium sand; rootlets and root hairs; upper 0.5' disturbed | | | | |
| 2 | | | | | | | | | |
| 4 | | | | | VAL VERDE TONALITE (Kvt) Weathered, olive gray, moderately strong GRANITIC BEDROCK; medium- to coarse-grained; excavates as a silty sand | | | | |
| 6 | | | | | | | | | |
| 8 | P-4a@7-8 | | | | | | | | |
| | | | | | Total Depth = 8' Groundwater not encountered Backfilled with cuttings on 05/03/2019 | | | | |

Figure A-9,
Log of Boring P-4a, Page 1 of 1

T2864-22-01 BORING LOGS - A LOGS.GPJ







| SAMPLE SYMBOLS | | | | | |
|-------------------------------------|-----------------------------|-------------------------------------|-------------------------------|-------------------------------------|--------------------------------|
| <input type="checkbox"/> | ... SAMPLING UNSUCCESSFUL | <input type="checkbox"/> | ... STANDARD PENETRATION TEST | <input checked="" type="checkbox"/> | ... DRIVE SAMPLE (UNDISTURBED) |
| <input checked="" type="checkbox"/> | ... DISTURBED OR BAG SAMPLE | <input checked="" type="checkbox"/> | ... CHUNK SAMPLE | <input type="checkbox"/> | ... WATER TABLE OR SEEPAGE |

NOTE: THE LOG OF SUBSURFACE CONDITIONS SHOWN HEREON APPLIES ONLY AT THE SPECIFIC BORING OR TRENCH LOCATION AND AT THE DATE INDICATED. IT IS NOT WARRANTED TO BE REPRESENTATIVE OF SUBSURFACE CONDITIONS AT OTHER LOCATIONS AND TIMES.

| DEPTH IN FEET | SAMPLE NO. | LITHOLOGY | GROUNDWATER | SOIL CLASS (USCS) | TEST PIT TP-1a | | PENETRATION RESISTANCE (BLOWS/FT.) | DRY DENSITY (P.C.F.) | MOISTURE CONTENT (%) |
|----------------------|------------|-----------|-------------|-------------------|---|----------------------------------|------------------------------------|----------------------|----------------------|
| | | | | | ELEV. (MSL.) <u>1687</u> | DATE COMPLETED <u>05/03/2019</u> | | | |
| | | | | | EQUIPMENT <u>BACKHOE BUCKET 24"</u> | | BY: <u>P. Theriault</u> | | |
| MATERIAL DESCRIPTION | | | | | | | | | |
| 0 | | | | SM | COLLUVIUM (Qco) Silty SAND, medium dense, damp, strong brown; fine sand some medium sand; grass; upper 1' disturbed | | | | |
| 2 | | | | CL | Sandy CLAY, stiff, moist, strong brown; fine sand; some medium sand | | | 89.9 | 20.7 |
| 4 | TP-1a@4-5 | | | SM | Silty SAND (residual soil), dense, moist; fine sand; some medium sand in silt matrix; trace pinhole porosity | | | | |
| 6 | | | | | VAL VERDE TONALITE (Kvt) Weathered, moderately strong, reddish brown; GRANITIC BEDROCK; medium- to coarse-grained; excavates as a poorly graded sand with gravel. | | | | |
| | | | | | Total Depth = 7' 6" (Refusal) Groundwater not encountered Dry density and moisture content performed by nuclear density Backfilled with spoils on 05/03/2019 | | | | |

Figure A-10,
Log of Test Pit TP-1a, Page 1 of 1

T2864-22-01 TEST PIT LOGS - A LOGS.GPJ

| | | | |
|----------------|---|---|--|
| SAMPLE SYMBOLS |  ... SAMPLING UNSUCCESSFUL |  ... STANDARD PENETRATION TEST |  ... DRIVE SAMPLE (UNDISTURBED) |
| |  ... DISTURBED OR BAG SAMPLE |  ... CHUNK SAMPLE |  ... WATER TABLE OR SEEPAGE |

NOTE: THE LOG OF SUBSURFACE CONDITIONS SHOWN HEREON APPLIES ONLY AT THE SPECIFIC BORING OR TRENCH LOCATION AND AT THE DATE INDICATED. IT IS NOT WARRANTED TO BE REPRESENTATIVE OF SUBSURFACE CONDITIONS AT OTHER LOCATIONS AND TIMES.

| DEPTH IN FEET | SAMPLE NO. | LITHOLOGY | GROUNDWATER | SOIL CLASS (USCS) | TEST PIT TP-2a | | PENETRATION RESISTANCE (BLOWS/FT.) | DRY DENSITY (P.C.F.) | MOISTURE CONTENT (%) |
|---|---------------|-----------|-------------|-------------------------|--|----------------------------------|--|-------------------------|-------------------------|
| | | | | | ELEV. (MSL.) <u>1680</u> | DATE COMPLETED <u>05/03/2019</u> | | | |
| | | | | | EQUIPMENT <u>BACKHOE BUCKET 24"</u> BY: <u>P. Theriault</u> | | | | |
| MATERIAL DESCRIPTION | | | | | | | | | |
| 0 | | | | SM | COLLUVIUM (Qco) Silty SAND, medium dense, damp, strong brown; fine to coarse sand; grass; upper 1' disturbed | | | | |
| 2 | | | | | VAL VERDE TONALITE (Kvt) Weathered, moderately strong, reddish brown; GRANITIC BEDROCK; medium- to coarse-grained; micaceous; excavates as a poorly graded sand with gravel. | | | | |
| 4 | TP-2a@3.5 | | | | | | | | |
| Total Depth = 5' (Refusal) Groundwater not encountered Backfilled with spoils on 05/03/2019 | | | | | | | | | |

Figure A-11,
Log of Test Pit TP-2a, Page 1 of 1

T2864-22-01 TEST PIT LOGS - A LOGS.GPJ

| | | | |
|----------------|---|--|--|
| SAMPLE SYMBOLS | <input type="checkbox"/> ... SAMPLING UNSUCCESSFUL | <input type="checkbox"/> ... STANDARD PENETRATION TEST | <input type="checkbox"/> ... DRIVE SAMPLE (UNDISTURBED) |
| | <input checked="" type="checkbox"/> ... DISTURBED OR BAG SAMPLE | <input checked="" type="checkbox"/> ... CHUNK SAMPLE | <input checked="" type="checkbox"/> ... WATER TABLE OR SEEPAGE |

NOTE: THE LOG OF SUBSURFACE CONDITIONS SHOWN HEREON APPLIES ONLY AT THE SPECIFIC BORING OR TRENCH LOCATION AND AT THE DATE INDICATED.
IT IS NOT WARRANTED TO BE REPRESENTATIVE OF SUBSURFACE CONDITIONS AT OTHER LOCATIONS AND TIMES.

| DEPTH IN FEET | SAMPLE NO. | LITHOLOGY | GROUNDWATER | SOIL CLASS (USCS) | TEST PIT TP-3a | | PENETRATION RESISTANCE (BLOWS/FT.) | DRY DENSITY (P.C.F.) | MOISTURE CONTENT (%) |
|----------------------|---------------|-----------|-------------|-------------------------|--|----------------------------------|--|-------------------------|-------------------------|
| | | | | | ELEV. (MSL.) <u>1681</u> | DATE COMPLETED <u>05/03/2019</u> | | | |
| | | | | | EQUIPMENT <u>BACKHOE BUCKET 24"</u> | | BY: <u>P. Theriault</u> | | |
| MATERIAL DESCRIPTION | | | | | | | | | |
| 0 | | | | SM | COLLUVIUM (Qco) | | | | |
| | | | | CL | Silty SAND, medium dense, damp, reddish brown; fine to medium sand; grass; upper 1' disturbed | | | | |
| 2 | | | | | Sandy CLAY, stiff, moist, strong brown; fine to medium sand | | | | |
| 4 | | | | | VAL VERDE TONALITE (Kvt) | | | | |
| | | | | | Weathered, moderately strong, reddish brown; GRANITIC BEDROCK; medium- to coarse-grained; excavates as a poorly graded sand with gravel. | | | | |
| | | | | | Total Depth = 4' 6" (Refusal) Groundwater not encountered Backfilled with spoils on 05/03/2019 | | | | |

Figure A-12,
Log of Test Pit TP-3a, Page 1 of 1

T2864-22-01 TEST PIT LOGS - A LOGS.GPJ

| | | | |
|----------------|-----------------------------|-------------------------------|--------------------------------|
| SAMPLE SYMBOLS | ... SAMPLING UNSUCCESSFUL | ... STANDARD PENETRATION TEST | ... DRIVE SAMPLE (UNDISTURBED) |
| | ... DISTURBED OR BAG SAMPLE | ... CHUNK SAMPLE | ... WATER TABLE OR SEEPAGE |

NOTE: THE LOG OF SUBSURFACE CONDITIONS SHOWN HEREON APPLIES ONLY AT THE SPECIFIC BORING OR TRENCH LOCATION AND AT THE DATE INDICATED. IT IS NOT WARRANTED TO BE REPRESENTATIVE OF SUBSURFACE CONDITIONS AT OTHER LOCATIONS AND TIMES.

| DEPTH IN FEET | SAMPLE NO. | LITHOLOGY | GROUNDWATER | SOIL CLASS (USCS) | TEST PIT TP-4a | | PENETRATION RESISTANCE (BLOWS/FT.) | DRY DENSITY (P.C.F.) | MOISTURE CONTENT (%) |
|----------------------|---------------|-----------|-------------|-------------------------|--|----------------------------------|--|-------------------------|-------------------------|
| | | | | | ELEV. (MSL.) <u>1676</u> | DATE COMPLETED <u>05/03/2019</u> | | | |
| | | | | | EQUIPMENT <u>BACKHOE BUCKET 24"</u> BY: <u>P. Theriault</u> | | | | |
| MATERIAL DESCRIPTION | | | | | | | | | |
| 0 | | | | SM | COLLUVIUM (Qco) Silty SAND, medium dense, damp, reddish brown; fine to medium sand; grass; upper 1' disturbed | | | | |
| 2 | | | | | | | | | |
| 4 | | + | | | VAL VERDE TONALITE (Kvt) Weathered, moderately strong, reddish brown; GRANITIC BEDROCK; medium- to coarse-grained; excavates as a poorly graded sand with gravel. | | | | |
| | | | | | Total Depth = 4' 6" (Refusal) Groundwater not encountered Backfilled with spoils on 05/03/2019 | | | | |

Figure A-13,
Log of Test Pit TP-4a, Page 1 of 1

T2864-22-01 TEST PIT LOGS - A LOGS.GPJ

| | | | | | | |
|----------------|-------------------------------------|-----------------------------|-------------------------------------|-------------------------------|-------------------------------------|--------------------------------|
| SAMPLE SYMBOLS | <input type="checkbox"/> | ... SAMPLING UNSUCCESSFUL | <input type="checkbox"/> | ... STANDARD PENETRATION TEST | <input type="checkbox"/> | ... DRIVE SAMPLE (UNDISTURBED) |
| | <input checked="" type="checkbox"/> | ... DISTURBED OR BAG SAMPLE | <input checked="" type="checkbox"/> | ... CHUNK SAMPLE | <input checked="" type="checkbox"/> | ... WATER TABLE OR SEEPAGE |

NOTE: THE LOG OF SUBSURFACE CONDITIONS SHOWN HEREON APPLIES ONLY AT THE SPECIFIC BORING OR TRENCH LOCATION AND AT THE DATE INDICATED.
 IT IS NOT WARRANTED TO BE REPRESENTATIVE OF SUBSURFACE CONDITIONS AT OTHER LOCATIONS AND TIMES.

| DEPTH IN FEET | SAMPLE NO. | LITHOLOGY | GROUNDWATER | SOIL CLASS (USCS) | TEST PIT TP-5a | | PENETRATION RESISTANCE (BLOWS/FT.) | DRY DENSITY (P.C.F.) | MOISTURE CONTENT (%) |
|----------------------|---------------|-----------|-------------|-------------------------|---|----------------------------------|--|-------------------------|-------------------------|
| | | | | | ELEV. (MSL.) <u>1684</u> | DATE COMPLETED <u>05/03/2019</u> | | | |
| | | | | | EQUIPMENT <u>BACKHOE BUCKET 24"</u> BY: <u>P. Theriault</u> | | | | |
| MATERIAL DESCRIPTION | | | | | | | | | |
| 0 | | | | SM | COLLUVIUM (Qco) Silty SAND, medium dense, damp, reddish brown; fine to medium sand; grass; upper 1' disturbed; roots | | | | |
| 2 | | | | | VAL VERDE TONALITE (Kvt) Weathered, moderately strong, brownish red; GRANITIC BEDROCK; medium- to coarse-grained; excavates as a poorly graded sand with gravel. | | | | |
| 4 | | | | | | | | | |
| | | | | | Total Depth = 5' (Refusal) Groundwater not encountered Backfilled with spoils on 05/03/2019 | | | | |

Figure A-14,
Log of Test Pit TP-5a, Page 1 of 1

T2864-22-01 TEST PIT LOGS - A LOGS.GPJ

| | | | |
|----------------|---|--|---|
| SAMPLE SYMBOLS | <input type="checkbox"/> ... SAMPLING UNSUCCESSFUL | <input type="checkbox"/> ... STANDARD PENETRATION TEST | <input type="checkbox"/> ... DRIVE SAMPLE (UNDISTURBED) |
| | <input checked="" type="checkbox"/> ... DISTURBED OR BAG SAMPLE | <input checked="" type="checkbox"/> ... CHUNK SAMPLE | <input type="checkbox"/> ... WATER TABLE OR SEEPAGE |

NOTE: THE LOG OF SUBSURFACE CONDITIONS SHOWN HEREON APPLIES ONLY AT THE SPECIFIC BORING OR TRENCH LOCATION AND AT THE DATE INDICATED.
IT IS NOT WARRANTED TO BE REPRESENTATIVE OF SUBSURFACE CONDITIONS AT OTHER LOCATIONS AND TIMES.

| DEPTH IN FEET | SAMPLE NO. | LITHOLOGY | GROUNDWATER | SOIL CLASS (USCS) | TEST PIT TP-6a | | PENETRATION RESISTANCE (BLOWS/FT.) | DRY DENSITY (P.C.F.) | MOISTURE CONTENT (%) |
|----------------------|---------------|-----------|-------------|-------------------------|--|----------------------------------|--|-------------------------|-------------------------|
| | | | | | ELEV. (MSL.) <u>1673</u> | DATE COMPLETED <u>05/03/2019</u> | | | |
| | | | | | EQUIPMENT <u>BACKHOE BUCKET 24"</u> BY: <u>P. Theriault</u> | | | | |
| MATERIAL DESCRIPTION | | | | | | | | | |
| 0 | | | | SM | COLLUVIUM (Qcol) Silty SAND, medium dense, damp, strong brown; fine to medium sand | | | | |
| 2 | | | | | VAL VERDE TONALITE (Kvt) Weathered, moderately strong, grayish brown; GRANITIC BEDROCK; medium- to coarse-grained; excavates as a poorly graded sand with gravel. | | | | |
| 4 | | | | | Total Depth = 5' (Refusal) Groundwater not encountered Backfilled with spoils on 05/03/2019 | | | | |

Figure A-15,
Log of Test Pit TP-6a, Page 1 of 1

T2864-22-01 TEST PIT LOGS - A LOGS.GPJ

| | | | |
|----------------|-----------------------------|-------------------------------|--------------------------------|
| SAMPLE SYMBOLS | ... SAMPLING UNSUCCESSFUL | ... STANDARD PENETRATION TEST | ... DRIVE SAMPLE (UNDISTURBED) |
| | ... DISTURBED OR BAG SAMPLE | ... CHUNK SAMPLE | ... WATER TABLE OR SEEPAGE |

NOTE: THE LOG OF SUBSURFACE CONDITIONS SHOWN HEREON APPLIES ONLY AT THE SPECIFIC BORING OR TRENCH LOCATION AND AT THE DATE INDICATED.
IT IS NOT WARRANTED TO BE REPRESENTATIVE OF SUBSURFACE CONDITIONS AT OTHER LOCATIONS AND TIMES.

| DEPTH IN FEET | SAMPLE NO. | LITHOLOGY | GROUNDWATER | SOIL CLASS (USCS) | TEST PIT TP-7a | | PENETRATION RESISTANCE (BLOWS/FT.) | DRY DENSITY (P.C.F.) | MOISTURE CONTENT (%) |
|----------------------|---------------|-----------|-------------|-------------------------|--|----------------------------------|--|-------------------------|-------------------------|
| | | | | | ELEV. (MSL.) <u>1679</u> | DATE COMPLETED <u>05/03/2019</u> | | | |
| | | | | | EQUIPMENT <u>BACKHOE BUCKET 24"</u> BY: <u>P. Theriault</u> | | | | |
| MATERIAL DESCRIPTION | | | | | | | | | |
| 0 | TP-7a@1-2' | | | SM | COLLUVIUM (Qco) Silty SAND, medium dense, damp, reddish brown; fine to medium sand; grass; upper 1' disturbed | | | | |
| 2 | | | | CL | Sandy CLAY, stiff, moist, brownish red; fine to coarse sand | | | | |
| 4 | | | | | VAL VERDE TONALITE (Kvt) Weathered, moderately strong, reddish brown; GRANITIC BEDROCK; medium- to coarse-grained; excavates as a poorly graded sand with gravel. | | | | |
| | | | | | Total Depth = 4' (Refusal) Groundwater not encountered Backfilled with spoils on 05/03/2019 | | | | |

Figure A-16,
Log of Test Pit TP-7a, Page 1 of 1

T2864-22-01 TEST PIT LOGS - A LOGS.GPJ

| | | | |
|----------------|-----------------------------|-------------------------------|--------------------------------|
| SAMPLE SYMBOLS | ... SAMPLING UNSUCCESSFUL | ... STANDARD PENETRATION TEST | ... DRIVE SAMPLE (UNDISTURBED) |
| | ... DISTURBED OR BAG SAMPLE | ... CHUNK SAMPLE | ... WATER TABLE OR SEEPAGE |

NOTE: THE LOG OF SUBSURFACE CONDITIONS SHOWN HEREON APPLIES ONLY AT THE SPECIFIC BORING OR TRENCH LOCATION AND AT THE DATE INDICATED.
IT IS NOT WARRANTED TO BE REPRESENTATIVE OF SUBSURFACE CONDITIONS AT OTHER LOCATIONS AND TIMES.

| DEPTH IN FEET | SAMPLE NO. | LITHOLOGY | GROUNDWATER | SOIL CLASS (USCS) | TEST PIT TP-8a | | PENETRATION RESISTANCE (BLOWS/FT.) | DRY DENSITY (P.C.F.) | MOISTURE CONTENT (%) |
|----------------------|---------------|-----------|-------------|-------------------------|---|----------------------------------|--|-------------------------|-------------------------|
| | | | | | ELEV. (MSL.) <u>1673</u> | DATE COMPLETED <u>05/03/2019</u> | | | |
| | | | | | EQUIPMENT <u>BACKHOE BUCKET 24"</u> BY: <u>P. Theriault</u> | | | | |
| MATERIAL DESCRIPTION | | | | | | | | | |
| 0 | | | | SM | COLLUVIUM (Qco) Silty SAND, medium dense, moist, reddish brown; fine to medium sand; some coarse; grass; upper 1' disturbed; root hairs | | | 90.0 | 11.3 |
| 2 | | | | | VAL VERDE TONALITE (Kvt) Weathered, moderately strong, brownish gray; GRANITIC BEDROCK; medium- to coarse-grained; excavates as a poorly graded sand with gravel. -becomes gray | | | | |
| 4 | | | | | Total Depth = 4' 6" (Refusal) Groundwater not encountered Dry density and moisture content performed by nuclear density Backfilled with spoils on 05/03/2019 | | | | |

Figure A-17,
Log of Test Pit TP-8a, Page 1 of 1

T2864-22-01 TEST PIT LOGS - A LOGS.GPJ

| | | | |
|----------------|---|--|--|
| SAMPLE SYMBOLS | <input type="checkbox"/> ... SAMPLING UNSUCCESSFUL | <input type="checkbox"/> ... STANDARD PENETRATION TEST | <input type="checkbox"/> ... DRIVE SAMPLE (UNDISTURBED) |
| | <input checked="" type="checkbox"/> ... DISTURBED OR BAG SAMPLE | <input checked="" type="checkbox"/> ... CHUNK SAMPLE | <input checked="" type="checkbox"/> ... WATER TABLE OR SEEPAGE |

NOTE: THE LOG OF SUBSURFACE CONDITIONS SHOWN HEREON APPLIES ONLY AT THE SPECIFIC BORING OR TRENCH LOCATION AND AT THE DATE INDICATED.
IT IS NOT WARRANTED TO BE REPRESENTATIVE OF SUBSURFACE CONDITIONS AT OTHER LOCATIONS AND TIMES.

| DEPTH IN FEET | SAMPLE NO. | LITHOLOGY | GROUNDWATER | SOIL CLASS (USCS) | TEST PIT TP-9a | | PENETRATION RESISTANCE (BLOWS/FT.) | DRY DENSITY (P.C.F.) | MOISTURE CONTENT (%) |
|----------------------|---------------|--------------------------------|-------------|-------------------------|--|---|--|-------------------------|-------------------------|
| | | | | | ELEV. (MSL.) <u>1669</u> | DATE COMPLETED <u>05/03/2019</u> | | | |
| | | | | | EQUIPMENT <u>BACKHOE BUCKET 24"</u> BY: <u>P. Theriault</u> | | | | |
| MATERIAL DESCRIPTION | | | | | | | | | |
| 0 | | [Lithology symbol: silty sand] | | SM | COLLUVIUM (Qco) Silty SAND, medium dense, damp, reddish brown; fine to medium sand; some coarse | | | | |
| 2 | | | | | | VAL VERDE TONALITE (Kvt) Weathered, moderately strong, gray; GRANITIC BEDROCK; medium- to coarse-grained; excavates as a poorly graded sand with gravel. | | | |
| 4 | | | | | Total Depth = 4' (Refusal) Groundwater not encountered Backfilled with spoils on 05/03/2019 | | | | |

Figure A-18,
Log of Test Pit TP-9a, Page 1 of 1

T2864-22-01 TEST PIT LOGS - A LOGS.GPJ

| | | | | | | |
|----------------|-------------------------------------|-----------------------------|-------------------------------------|-------------------------------|-------------------------------------|--------------------------------|
| SAMPLE SYMBOLS | <input type="checkbox"/> | ... SAMPLING UNSUCCESSFUL | <input type="checkbox"/> | ... STANDARD PENETRATION TEST | <input type="checkbox"/> | ... DRIVE SAMPLE (UNDISTURBED) |
| | <input checked="" type="checkbox"/> | ... DISTURBED OR BAG SAMPLE | <input checked="" type="checkbox"/> | ... CHUNK SAMPLE | <input checked="" type="checkbox"/> | ... WATER TABLE OR SEEPAGE |

NOTE: THE LOG OF SUBSURFACE CONDITIONS SHOWN HEREON APPLIES ONLY AT THE SPECIFIC BORING OR TRENCH LOCATION AND AT THE DATE INDICATED.
IT IS NOT WARRANTED TO BE REPRESENTATIVE OF SUBSURFACE CONDITIONS AT OTHER LOCATIONS AND TIMES.

| DEPTH IN FEET | SAMPLE NO. | LITHOLOGY | GROUNDWATER | SOIL CLASS (USCS) | BORING B-1b | | PENETRATION RESISTANCE (BLOWS/FT.) | DRY DENSITY (P.C.F.) | MOISTURE CONTENT (%) |
|---------------------|---------------|-----------|-------------|-------------------------|--|------------------------------|--|-------------------------|-------------------------|
| | | | | | ELEV. (MSL.) 1712 | DATE COMPLETED 5/1/19 | | | |
| | | | | | EQUIPMENT HOLLOW STEM AUGER BY: A. Shoashekan | | | | |
| | | | | | MATERIAL DESCRIPTION | | | | |
| 0 | B-1b@0-5 | | | SM | COLLUVIUM (Qco) Silty SAND, medium dense, damp, brown; fine sand with few medium sand; rootlets and root hairs; upper 1' disturbed | | | | |
| 2 | B-1b@2.5 | | | | -becomes very dense, damp, reddish brown; fine sand with few medium and coarse sand | | 84/10" | 125.3 | 9.1 |
| 4 | B-1b@5 | | | | VAL VERDE TONALITE (Kvt) Weathered, yellowish brown, moderately strong GRANITIC BEDROCK; medium- to coarse-grained; micaceous; excavates as a poorly-graded sand | | | | |
| | | | | | Total Depth = 5'-4" Groundwater not encountered Penetration resistance for 140-lb hammer falling 30-inches by auto-hammer Backfilled with cuttings on 05/01/2019 | | | | |

Figure A-19,
Log of Boring B-1b, Page 1 of 1

T2864-22-01 BORING LOGS - B LOGS.GPJ

| | | | |
|-----------------------|-----------------------------|-------------------------------|--------------------------------|
| SAMPLE SYMBOLS | ... SAMPLING UNSUCCESSFUL | ... STANDARD PENETRATION TEST | ... DRIVE SAMPLE (UNDISTURBED) |
| | ... DISTURBED OR BAG SAMPLE | ... CHUNK SAMPLE | ... WATER TABLE OR SEEPAGE |

NOTE: THE LOG OF SUBSURFACE CONDITIONS SHOWN HEREON APPLIES ONLY AT THE SPECIFIC BORING OR TRENCH LOCATION AND AT THE DATE INDICATED. IT IS NOT WARRANTED TO BE REPRESENTATIVE OF SUBSURFACE CONDITIONS AT OTHER LOCATIONS AND TIMES.

| DEPTH IN FEET | SAMPLE NO. | LITHOLOGY | GROUNDWATER | SOIL CLASS (USCS) | BORING B-2b | | PENETRATION RESISTANCE (BLOWS/FT.) | DRY DENSITY (P.C.F.) | MOISTURE CONTENT (%) |
|----------------------|---------------|-----------|-------------|-------------------------|---|------------------------------|--|-------------------------|-------------------------|
| | | | | | ELEV. (MSL.) 1710 | DATE COMPLETED 5/1/19 | | | |
| | | | | | EQUIPMENT HOLLOW STEM AUGER | | BY: A. Shoashekan | | |
| MATERIAL DESCRIPTION | | | | | | | | | |
| 0 | | | | ML | COLLUVIUM (Qco) SILT, soft, dry, yellowish brown; trace coarse sand; rootlets and root hairs; upper 1' disturbed -becomes reddish brown | | | | |
| 2 | | | | | | | | | |
| 4 | | | | | VAL VERDE TONALITE (Kvt) Weathered, olive gray, moderately strong GRANITIC BEDROCK; medium- to coarse-grained; excavates as a poorly-graded sand -becomes moderately strong | | | | |
| 6 | | | | | | | | | |
| 8 | | | | | | | | | |
| 10 | | | ▽ | | | | | | |
| 12 | | | | | | | | | |
| 14 | | | | | | | | | |
| | | | | | Total Depth = 15' Groundwater encountered at 10'-4" Backfilled with cuttings on 05/03/2019 | | | | |

Figure A-20,
Log of Boring B-2b, Page 1 of 1

T2864-22-01 BORING LOGS - B LOGS.GPJ







| | | | |
|-----------------------|---|--|--|
| SAMPLE SYMBOLS | <input type="checkbox"/> ... SAMPLING UNSUCCESSFUL | <input type="checkbox"/> ... STANDARD PENETRATION TEST | <input type="checkbox"/> ... DRIVE SAMPLE (UNDISTURBED) |
| | <input checked="" type="checkbox"/> ... DISTURBED OR BAG SAMPLE | <input checked="" type="checkbox"/> ... CHUNK SAMPLE | <input checked="" type="checkbox"/> ... WATER TABLE OR SEEPAGE |

NOTE: THE LOG OF SUBSURFACE CONDITIONS SHOWN HEREON APPLIES ONLY AT THE SPECIFIC BORING OR TRENCH LOCATION AND AT THE DATE INDICATED. IT IS NOT WARRANTED TO BE REPRESENTATIVE OF SUBSURFACE CONDITIONS AT OTHER LOCATIONS AND TIMES.

| DEPTH IN FEET | SAMPLE NO. | LITHOLOGY | GROUNDWATER | SOIL CLASS (USCS) | BORING B-3b | | PENETRATION RESISTANCE (BLOWS/FT.) | DRY DENSITY (P.C.F.) | MOISTURE CONTENT (%) |
|----------------------|---------------|-----------|-------------|-------------------------|---|------------------------------|--|-------------------------|-------------------------|
| | | | | | ELEV. (MSL.) 1711 | DATE COMPLETED 5/1/19 | | | |
| | | | | | EQUIPMENT HOLLOW STEM AUGER | | BY: A. Shoashekan | | |
| MATERIAL DESCRIPTION | | | | | | | | | |
| 0 | | | | SC | COLLUVIUM (Qco) Clayey SAND, loose, damp, brown; fine sand with few medium sand; rootlets and root hairs | | | | |
| 2 | | | | | -becomes medium dense, moist, grayish brown; fine to medium sand with few coarse sand | | | | |
| 4 | | | | | VAL VERDE TONALITE (Kvt) Weathered, gray, moderately strong GRANITIC BEDROCK; medium- to coarse-grained; excavates as a poorly-graded sand | | | | |
| 6 | | | | | | | | | |
| 8 | | | | | | | | | |
| 10 | | | | | | | | | |
| 12 | | | | | | | | | |
| 14 | | | | | | | | | |
| | | | | | Total Depth = 15' Groundwater encountered at 11'-4" Backfilled with cuttings on 05/03/2019 | | | | |

Figure A-21,
Log of Boring B-3b, Page 1 of 1

T2864-22-01 BORING LOGS - B LOGS.GPJ

| | | | |
|-----------------------|---|---|--|
| SAMPLE SYMBOLS |  ... SAMPLING UNSUCCESSFUL |  ... STANDARD PENETRATION TEST |  ... DRIVE SAMPLE (UNDISTURBED) |
| |  ... DISTURBED OR BAG SAMPLE |  ... CHUNK SAMPLE |  ... WATER TABLE OR SEEPAGE |

NOTE: THE LOG OF SUBSURFACE CONDITIONS SHOWN HEREON APPLIES ONLY AT THE SPECIFIC BORING OR TRENCH LOCATION AND AT THE DATE INDICATED. IT IS NOT WARRANTED TO BE REPRESENTATIVE OF SUBSURFACE CONDITIONS AT OTHER LOCATIONS AND TIMES.

| DEPTH IN FEET | SAMPLE NO. | LITHOLOGY | GROUNDWATER | SOIL CLASS (USCS) | BORING B-4b ELEV. (MSL.) 1716 DATE COMPLETED 5/1/19 EQUIPMENT HOLLOW STEM AUGER BY: A. Shoashekan | PENETRATION RESISTANCE (BLOWS/FT.) | DRY DENSITY (P.C.F.) | MOISTURE CONTENT (%) |
|---------------|------------|-----------|-------------|-------------------|---|------------------------------------|----------------------|----------------------|
| 0 | B-4b@0-5 | | | SC CL | MATERIAL DESCRIPTION COLLUVIUM (Qco) Clayey SAND, loose, damp, dry, brown; fine sand with few coarse sand; rootlets and root hairs; upper 0.5' disturbed | | | |
| 2 | B-4b@2.5 | | | | Sandy CLAY, very stiff, moist, brown; fine sand with few medium sand; calcium carbonate stringers | 58 | 121.8 | 13.1 |
| 4 | B-4b@5 | | | | VAL VERDE TONALITE (Kvt) Weathered, yellowish brown, moderately strong GRANITIC BEDROCK; medium- to coarse-grained; trace manganese staining; excavates as a poorly-graded sand | 98/10" | 87.7 | 13.3 |
| 6 | B-4b@7.5 | | | | -becomes yellowish gray | 50/3" | 106.7 | 5.9 |
| | | | | | Total Depth = 7'-9" Groundwater not encountered Penetration resistance for 140-lb hammer falling 30-inches by auto-hammer Backfilled with cuttings on 04/30/2019 | | | |

Figure A-22,
Log of Boring B-4b, Page 1 of 1

T2864-22-01 BORING LOGS - B LOGS.GPJ

| | | | | | | |
|----------------|--|-----------------------------|--|-------------------------------|--|--------------------------------|
| SAMPLE SYMBOLS | | ... SAMPLING UNSUCCESSFUL | | ... STANDARD PENETRATION TEST | | ... DRIVE SAMPLE (UNDISTURBED) |
| | | ... DISTURBED OR BAG SAMPLE | | ... CHUNK SAMPLE | | ... WATER TABLE OR SEEPAGE |

NOTE: THE LOG OF SUBSURFACE CONDITIONS SHOWN HEREON APPLIES ONLY AT THE SPECIFIC BORING OR TRENCH LOCATION AND AT THE DATE INDICATED. IT IS NOT WARRANTED TO BE REPRESENTATIVE OF SUBSURFACE CONDITIONS AT OTHER LOCATIONS AND TIMES.

| DEPTH IN FEET | SAMPLE NO. | LITHOLOGY | GROUNDWATER | SOIL CLASS (USCS) | BORING P-1b | | PENETRATION RESISTANCE (BLOWS/FT.) | DRY DENSITY (P.C.F.) | MOISTURE CONTENT (%) |
|---------------------|---------------|-----------|-------------|-------------------------|---|------------------------------|--|-------------------------|-------------------------|
| | | | | | ELEV. (MSL.) 1708 | DATE COMPLETED 5/1/19 | | | |
| | | | | | EQUIPMENT HOLLOW STEM AUGER BY: A. Shoashekan | | | | |
| 0 | | | | | MATERIAL DESCRIPTION | | | | |
| | P-1b@1-2 | | | ML SM | COLLUVIUM (Qco) Sandy SILT, soft, dry, yellowish brown; fine sand with few medium sand; rootlets and root hairs; upper 0.5' disturbed | | | | |
| 2 | | | | | Silty SAND, loose, damp, dark grayish brown; fine to medium sand with trace coarse sand | | | | |
| | | | | | Total Depth = 2' Groundwater not encountered Backfilled with cuttings on 05/03/2019 | | | | |

Figure A-23,
Log of Boring P-1b, Page 1 of 1

T2864-22-01 BORING LOGS - B LOGS.GPJ

| | | | |
|-----------------------|-----------------------------|-------------------------------|--------------------------------|
| SAMPLE SYMBOLS | ... SAMPLING UNSUCCESSFUL | ... STANDARD PENETRATION TEST | ... DRIVE SAMPLE (UNDISTURBED) |
| | ... DISTURBED OR BAG SAMPLE | ... CHUNK SAMPLE | ... WATER TABLE OR SEEPAGE |

NOTE: THE LOG OF SUBSURFACE CONDITIONS SHOWN HEREON APPLIES ONLY AT THE SPECIFIC BORING OR TRENCH LOCATION AND AT THE DATE INDICATED. IT IS NOT WARRANTED TO BE REPRESENTATIVE OF SUBSURFACE CONDITIONS AT OTHER LOCATIONS AND TIMES.

| DEPTH IN FEET | SAMPLE NO. | LITHOLOGY | GROUNDWATER | SOIL CLASS (USCS) | BORING P-2b | | PENETRATION RESISTANCE (BLOWS/FT.) | DRY DENSITY (P.C.F.) | MOISTURE CONTENT (%) |
|---------------------|---------------|-----------|-------------|-------------------------|--|------------------------------|---|-------------------------|-------------------------|
| | | | | | ELEV. (MSL.) 1712 | DATE COMPLETED 5/1/19 | | | |
| | | | | | EQUIPMENT HOLLOW STEM AUGER BY: A. Shoashekan | | | | |
| | | | | | MATERIAL DESCRIPTION | | | | |
| 0 | | | | ML | COLLUVIUM (Qco) Sandy SILT, soft, dry, light reddish brown; fine sand with few medium sand; rootlets and root hairs; upper 0.5' disturbed | | | | |
| 2 | | | | SM | | | Silty SAND, loose, moist, light brown; fine sand with little medium and coarse sand | | |
| 4 | P-2b@3-4 | | | | VAL VERDE TONALITE (Kvt) Weathered, olive gray, moderately strong GRANITIC BEDROCK; medium- to coarse-grained; excavates as a poorly-graded sand | | | | |
| | | | | | Total Depth = 4' Groundwater not encountered Backfilled with cuttings on 05/03/2019 | | | | |

Figure A-24,
Log of Boring P-2b, Page 1 of 1

T2864-22-01 BORING LOGS - B LOGS.GPJ

| | | | |
|-----------------------|---|--|--|
| SAMPLE SYMBOLS | <input type="checkbox"/> ... SAMPLING UNSUCCESSFUL | <input type="checkbox"/> ... STANDARD PENETRATION TEST | <input type="checkbox"/> ... DRIVE SAMPLE (UNDISTURBED) |
| | <input checked="" type="checkbox"/> ... DISTURBED OR BAG SAMPLE | <input checked="" type="checkbox"/> ... CHUNK SAMPLE | <input checked="" type="checkbox"/> ... WATER TABLE OR SEEPAGE |

NOTE: THE LOG OF SUBSURFACE CONDITIONS SHOWN HEREON APPLIES ONLY AT THE SPECIFIC BORING OR TRENCH LOCATION AND AT THE DATE INDICATED. IT IS NOT WARRANTED TO BE REPRESENTATIVE OF SUBSURFACE CONDITIONS AT OTHER LOCATIONS AND TIMES.







| DEPTH IN FEET | SAMPLE NO. | LITHOLOGY | GROUNDWATER | SOIL CLASS (USCS) | BORING P-3b | | PENETRATION RESISTANCE (BLOWS/FT.) | DRY DENSITY (P.C.F.) | MOISTURE CONTENT (%) | | | |
|---------------------|---------------|---|-------------|-------------------------|---|------------------------------|--|-------------------------|-------------------------|--|--|--|
| | | | | | ELEV. (MSL.) 1712 | DATE COMPLETED 5/1/19 | | | | | | |
| | | | | | EQUIPMENT HOLLOW STEM AUGER BY: A. Shoashekan | | | | | | | |
| | | | | | MATERIAL DESCRIPTION | | | | | | | |
| 0 | | | | | | | | | | | | |
| | P-3b@1-2 |  | | SC | <p>COLLUVIUM (Qco) Clayey SAND, loose, damp, brown; fine sand with few medium sand; rootlets and root hairs -becomes medium dense, dark yellowish brown; fine to medium sand with few coarse sand</p> <p style="text-align: center;">Total Depth = 2' Groundwater not encountered Backfilled with cuttings on 05/03/2019</p> | | | | | | | |
| 2 | | | | | | | | | | | | |

Figure A-25,
Log of Boring P-3b, Page 1 of 1

T2864-22-01 BORING LOGS - B LOGS.GPJ

| | | | |
|-----------------------|---|---|--|
| SAMPLE SYMBOLS |  ... SAMPLING UNSUCCESSFUL |  ... STANDARD PENETRATION TEST |  ... DRIVE SAMPLE (UNDISTURBED) |
| |  ... DISTURBED OR BAG SAMPLE |  ... CHUNK SAMPLE |  ... WATER TABLE OR SEEPAGE |

NOTE: THE LOG OF SUBSURFACE CONDITIONS SHOWN HEREON APPLIES ONLY AT THE SPECIFIC BORING OR TRENCH LOCATION AND AT THE DATE INDICATED. IT IS NOT WARRANTED TO BE REPRESENTATIVE OF SUBSURFACE CONDITIONS AT OTHER LOCATIONS AND TIMES.







| DEPTH IN FEET | SAMPLE NO. | LITHOLOGY | GROUNDWATER | SOIL CLASS (USCS) | BORING P-4b | | PENETRATION RESISTANCE (BLOWS/FT.) | DRY DENSITY (P.C.F.) | MOISTURE CONTENT (%) |
|---------------------|---------------|---|-------------|-------------------------|---|------------------------------|--|-------------------------|-------------------------|
| | | | | | ELEV. (MSL.) 1712 | DATE COMPLETED 5/1/19 | | | |
| | | | | | EQUIPMENT HOLLOW STEM AUGER BY: A. Shoashekan | | | | |
| | | | | | MATERIAL DESCRIPTION | | | | |
| 0 | | | | | | | | | |
| | P-4b@1-2 |  | | SC | COLLUVIUM (Qco) Clayey SAND, loose, damp, brown; fine sand with few medium sand; rootlets and root hairs -becomes medium dense, dark yellowish brown; fine to medium sand with few coarse sand | | | | |
| 2 | | | | | Total Depth = 2' Groundwater not encountered Backfilled with cuttings on 05/03/2019 | | | | |

Figure A-26,
Log of Boring P-4b, Page 1 of 1

T2864-22-01 BORING LOGS - B LOGS.GPJ

| | | | | | | |
|----------------|---|-----------------------------|---|-------------------------------|---|--------------------------------|
| SAMPLE SYMBOLS |  | ... SAMPLING UNSUCCESSFUL |  | ... STANDARD PENETRATION TEST |  | ... DRIVE SAMPLE (UNDISTURBED) |
| |  | ... DISTURBED OR BAG SAMPLE |  | ... CHUNK SAMPLE |  | ... WATER TABLE OR SEEPAGE |

NOTE: THE LOG OF SUBSURFACE CONDITIONS SHOWN HEREON APPLIES ONLY AT THE SPECIFIC BORING OR TRENCH LOCATION AND AT THE DATE INDICATED. IT IS NOT WARRANTED TO BE REPRESENTATIVE OF SUBSURFACE CONDITIONS AT OTHER LOCATIONS AND TIMES.

| DEPTH IN FEET | SAMPLE NO. | LITHOLOGY | GROUNDWATER | SOIL CLASS (USCS) | TEST PIT TP-1b | | PENETRATION RESISTANCE (BLOWS/FT.) | DRY DENSITY (P.C.F.) | MOISTURE CONTENT (%) |
|----------------------|------------|-----------|-------------|-------------------|---|----------------------------------|------------------------------------|----------------------|----------------------|
| | | | | | ELEV. (MSL.) <u>1719</u> | DATE COMPLETED <u>05/03/2019</u> | | | |
| | | | | | EQUIPMENT <u>BACKHOE BUCKET 24"</u> BY: <u>P. Theriault</u> | | | | |
| MATERIAL DESCRIPTION | | | | | | | | | |
| 0 | | | | SM | COLLUVIUM (Qco) Silty SAND, medium dense, damp, brown; fine to medium sand | | | | |
| 2 | | | | SC | Clayey SAND, stiff, moist, brown; fine to coarse sand | | | | |
| 4 | | | | SM | Silty SAND (residual soil), dense, moist; fine to coarse sand; moderately indurated calcium carbonate; some porosity up to 1/16" | | | | |
| 6 | | | | | VAL VERDE TONALITE (Kvt) Weathered, moderately strong, grayish brown; GRANITIC BEDROCK; fine- to coarse-grained; excavates as a poorly graded sand with gravel. | | | | |
| | | | | | Total Depth = 7' (Refusal) Groundwater not encountered Backfilled with spoils on 05/03/2019 | | | | |

Figure A-27,
Log of Test Pit TP-1b, Page 1 of 1

T2864-22-01 TEST PIT LOGS - B LOGS.GPJ







| | | | |
|----------------|-----------------------------|-------------------------------|--------------------------------|
| SAMPLE SYMBOLS | ... SAMPLING UNSUCCESSFUL | ... STANDARD PENETRATION TEST | ... DRIVE SAMPLE (UNDISTURBED) |
| | ... DISTURBED OR BAG SAMPLE | ... CHUNK SAMPLE | ... WATER TABLE OR SEEPAGE |

NOTE: THE LOG OF SUBSURFACE CONDITIONS SHOWN HEREON APPLIES ONLY AT THE SPECIFIC BORING OR TRENCH LOCATION AND AT THE DATE INDICATED. IT IS NOT WARRANTED TO BE REPRESENTATIVE OF SUBSURFACE CONDITIONS AT OTHER LOCATIONS AND TIMES.

| DEPTH IN FEET | SAMPLE NO. | LITHOLOGY | GROUNDWATER | SOIL CLASS (USCS) | TEST PIT TP-2b | | PENETRATION RESISTANCE (BLOWS/FT.) | DRY DENSITY (P.C.F.) | MOISTURE CONTENT (%) |
|---|---------------|-----------|-------------|-------------------------|--|----------------------------------|--|-------------------------|-------------------------|
| | | | | | ELEV. (MSL.) <u>1718</u> | DATE COMPLETED <u>05/03/2019</u> | | | |
| | | | | | EQUIPMENT <u>BACKHOE BUCKET 24"</u> BY: <u>P. Theriault</u> | | | | |
| MATERIAL DESCRIPTION | | | | | | | | | |
| 0 | | | | SM | COLLUVIUM (Qco) Silty SAND, medium dense, damp, reddish brown; fine to medium sand; grass | | | | |
| 2 | | | | SC | Clayey SAND, medium dense, moist, reddish brown; fine to medium sand | | | | |
| 4 | | | | | VAL VERDE TONALITE (Kvt) Weathered, moderately strong, grayish brown; GRANITIC BEDROCK; medium- to coarse-grained; micaceous; excavates as a poorly graded sand with gravel. | | | | |
| Total Depth = 5' (Refusal) Groundwater not encountered Backfilled with spoils on 05/03/2019 | | | | | | | | | |

Figure A-28,
Log of Test Pit TP-2b, Page 1 of 1

T2864-22-01 TEST PIT LOGS - B LOGS.GPJ

| | | | |
|----------------|---|---|--|
| SAMPLE SYMBOLS |  ... SAMPLING UNSUCCESSFUL |  ... STANDARD PENETRATION TEST |  ... DRIVE SAMPLE (UNDISTURBED) |
| |  ... DISTURBED OR BAG SAMPLE |  ... CHUNK SAMPLE |  ... WATER TABLE OR SEEPAGE |

NOTE: THE LOG OF SUBSURFACE CONDITIONS SHOWN HEREON APPLIES ONLY AT THE SPECIFIC BORING OR TRENCH LOCATION AND AT THE DATE INDICATED.
IT IS NOT WARRANTED TO BE REPRESENTATIVE OF SUBSURFACE CONDITIONS AT OTHER LOCATIONS AND TIMES.

| DEPTH IN FEET | SAMPLE NO. | LITHOLOGY | GROUNDWATER | SOIL CLASS (USCS) | TEST PIT TP-3b | | PENETRATION RESISTANCE (BLOWS/FT.) | DRY DENSITY (P.C.F.) | MOISTURE CONTENT (%) |
|----------------------|------------|-----------|-------------|-------------------|--|----------------------------------|------------------------------------|----------------------|----------------------|
| | | | | | ELEV. (MSL.) <u>1752</u> | DATE COMPLETED <u>05/03/2019</u> | | | |
| | | | | | EQUIPMENT <u>BACKHOE BUCKET 24"</u> BY: <u>P. Theriault</u> | | | | |
| MATERIAL DESCRIPTION | | | | | | | | | |
| 0 | | | | SM | COLLUVIUM (Qco) Silty SAND, medium dense, damp, red; fine to medium sand; some coarse sand; grass; upper 1' disturbed | | | | |
| 2 | | | | | VAL VERDE TONALITE (Kvt) Weathered, moderately strong, red; GRANITIC BEDROCK; medium- to coarse-grained; some clay; micaceous; excavates as a poorly graded sand with gravel. -becomes brownish red | | | | |
| 4 | | | | | | | | | |
| 6 | | | | | | | | | |
| | | | | | Total Depth = 7' (Refusal) Groundwater not encountered Backfilled with spoils on 05/03/2019 | | | | |

Figure A-29,
Log of Test Pit TP-3b, Page 1 of 1

T2864-22-01 TEST PIT LOGS - B LOGS.GPJ

| | | | |
|----------------|---|--|--|
| SAMPLE SYMBOLS | <input type="checkbox"/> ... SAMPLING UNSUCCESSFUL | <input type="checkbox"/> ... STANDARD PENETRATION TEST | <input type="checkbox"/> ... DRIVE SAMPLE (UNDISTURBED) |
| | <input checked="" type="checkbox"/> ... DISTURBED OR BAG SAMPLE | <input checked="" type="checkbox"/> ... CHUNK SAMPLE | <input checked="" type="checkbox"/> ... WATER TABLE OR SEEPAGE |

NOTE: THE LOG OF SUBSURFACE CONDITIONS SHOWN HEREON APPLIES ONLY AT THE SPECIFIC BORING OR TRENCH LOCATION AND AT THE DATE INDICATED. IT IS NOT WARRANTED TO BE REPRESENTATIVE OF SUBSURFACE CONDITIONS AT OTHER LOCATIONS AND TIMES.

| DEPTH IN FEET | SAMPLE NO. | LITHOLOGY | GROUNDWATER | SOIL CLASS (USCS) | TEST PIT TP-4b | | PENETRATION RESISTANCE (BLOWS/FT.) | DRY DENSITY (P.C.F.) | MOISTURE CONTENT (%) |
|----------------------|---------------|-----------|-------------|-------------------------|---|----------------------------------|--|-------------------------|-------------------------|
| | | | | | ELEV. (MSL.) <u>1732</u> | DATE COMPLETED <u>05/03/2019</u> | | | |
| | | | | | EQUIPMENT <u>BACKHOE BUCKET 24"</u> | | BY: <u>P. Theriault</u> | | |
| MATERIAL DESCRIPTION | | | | | | | | | |
| 0 | | | | SM | COLLUVIUM (Qco) Silty SAND, medium dense, damp, brown; fine to medium sand; grass; upper 1' disturbed | | | | |
| 2 | | + | | | VAL VERDE TONALITE (Kvt) Weathered, moderately strong, red; GRANITIC BEDROCK; fine- to coarse-grained; micaceous; excavates as a poorly graded sand with gravel. -becomes grayish brown | | | | |
| 4 | | + | | | | | | | |
| 6 | | + | | | | | | | |
| 8 | | + | | | | | | | |
| | | | | | Total Depth = 8' (Refusal) Groundwater not encountered Backfilled with spoils on 05/03/2019 | | | | |

Figure A-30,
Log of Test Pit TP-4b, Page 1 of 1

T2864-22-01 TEST PIT LOGS - B LOGS.GPJ

| | | | | | | |
|----------------|-------------------------------------|-----------------------------|-------------------------------------|-------------------------------|-------------------------------------|--------------------------------|
| SAMPLE SYMBOLS | <input type="checkbox"/> | ... SAMPLING UNSUCCESSFUL | <input type="checkbox"/> | ... STANDARD PENETRATION TEST | <input type="checkbox"/> | ... DRIVE SAMPLE (UNDISTURBED) |
| | <input checked="" type="checkbox"/> | ... DISTURBED OR BAG SAMPLE | <input checked="" type="checkbox"/> | ... CHUNK SAMPLE | <input checked="" type="checkbox"/> | ... WATER TABLE OR SEEPAGE |

NOTE: THE LOG OF SUBSURFACE CONDITIONS SHOWN HEREON APPLIES ONLY AT THE SPECIFIC BORING OR TRENCH LOCATION AND AT THE DATE INDICATED.
IT IS NOT WARRANTED TO BE REPRESENTATIVE OF SUBSURFACE CONDITIONS AT OTHER LOCATIONS AND TIMES.











| DEPTH IN FEET | SAMPLE NO. | LITHOLOGY | GROUNDWATER | SOIL CLASS (USCS) | TEST PIT TP-5b | | PENETRATION RESISTANCE (BLOWS/FT.) | DRY DENSITY (P.C.F.) | MOISTURE CONTENT (%) |
|----------------------|---------------|---|-------------|-------------------------|--|----------------------------------|--|-------------------------|-------------------------|
| | | | | | ELEV. (MSL.) <u>1718</u> | DATE COMPLETED <u>05/03/2019</u> | | | |
| | | | | | EQUIPMENT <u>BACKHOE BUCKET 24"</u> | | BY: <u>P. Theriault</u> | | |
| MATERIAL DESCRIPTION | | | | | | | | | |
| 0 | |  | | SM CL | COLLUVIUM (Qco) Silty SAND, medium dense, damp, brown; fine to medium sand; grass; upper 1' disturbed | | | | |
| 2 | |  | | | Sandy CLAY, stiff, moist, reddish brown; fine to coarse sand | | | | |
| 4 | |  | | | VAL VERDE TONALITE (Kvt) Weathered, moderately strong, reddish brown; GRANITIC BEDROCK; fine- to coarse-grained; micaceous; excavates as a poorly graded sand with gravel. | | | | |
| 6 | |  | | | -becomes grayish brown | | | | |
| 8 | |  | | | Total Depth = 8' (Refusal) Groundwater not encountered Backfilled with spoils on 05/03/2019 | | | | |

Figure A-31,
Log of Test Pit TP-5b, Page 1 of 1

T2864-22-01 TEST PIT LOGS - B LOGS.GPJ

| | | | | | | |
|----------------|---|-----------------------------|---|-------------------------------|---|--------------------------------|
| SAMPLE SYMBOLS |  | ... SAMPLING UNSUCCESSFUL |  | ... STANDARD PENETRATION TEST |  | ... DRIVE SAMPLE (UNDISTURBED) |
| |  | ... DISTURBED OR BAG SAMPLE |  | ... CHUNK SAMPLE |  | ... WATER TABLE OR SEEPAGE |

NOTE: THE LOG OF SUBSURFACE CONDITIONS SHOWN HEREON APPLIES ONLY AT THE SPECIFIC BORING OR TRENCH LOCATION AND AT THE DATE INDICATED.
IT IS NOT WARRANTED TO BE REPRESENTATIVE OF SUBSURFACE CONDITIONS AT OTHER LOCATIONS AND TIMES.

| DEPTH IN FEET | SAMPLE NO. | LITHOLOGY | GROUNDWATER | SOIL CLASS (USCS) | TEST PIT TP-6b | | PENETRATION RESISTANCE (BLOWS/FT.) | DRY DENSITY (P.C.F.) | MOISTURE CONTENT (%) |
|----------------------|---------------|-----------|-------------|-------------------------|--|----------------------------------|--|-------------------------|-------------------------|
| | | | | | ELEV. (MSL.) <u>1722</u> | DATE COMPLETED <u>05/03/2019</u> | | | |
| | | | | | EQUIPMENT <u>BACKHOE BUCKET 24"</u> | | BY: <u>P. Theriault</u> | | |
| MATERIAL DESCRIPTION | | | | | | | | | |
| 0 | | | | SM | COLLUVIUM (Qco) Silty SAND, medium dense, damp, reddish brown; fine to medium sand; some coarse sand; grass; upper 1' disturbed | | | 89.1 | 8.4 |
| 2 | | | | | VAL VERDE TONALITE (Kvt) Weathered, moderately strong, reddish brown; GRANITIC BEDROCK; fine- to coarse-grained; micaceous; excavates as a poorly graded sand with gravel. -becomes grayish brown | | | | |
| 4 | | | | | Total Depth = 5' (Refusal) Groundwater not encountered Dry density and moisture content performed by nuclear density Backfilled with spoils on 05/03/2019 | | | | |

Figure A-32,
Log of Test Pit TP-6b, Page 1 of 1

T2864-22-01 TEST PIT LOGS - B LOGS.GPJ

| | | | |
|----------------|-----------------------------|-------------------------------|--------------------------------|
| SAMPLE SYMBOLS | ... SAMPLING UNSUCCESSFUL | ... STANDARD PENETRATION TEST | ... DRIVE SAMPLE (UNDISTURBED) |
| | ... DISTURBED OR BAG SAMPLE | ... CHUNK SAMPLE | ... WATER TABLE OR SEEPAGE |

NOTE: THE LOG OF SUBSURFACE CONDITIONS SHOWN HEREON APPLIES ONLY AT THE SPECIFIC BORING OR TRENCH LOCATION AND AT THE DATE INDICATED.
 IT IS NOT WARRANTED TO BE REPRESENTATIVE OF SUBSURFACE CONDITIONS AT OTHER LOCATIONS AND TIMES.

| DEPTH IN FEET | SAMPLE NO. | LITHOLOGY | GROUNDWATER | SOIL CLASS (USCS) | TEST PIT TP-7b | | PENETRATION RESISTANCE (BLOWS/FT.) | DRY DENSITY (P.C.F.) | MOISTURE CONTENT (%) |
|----------------------|---------------|-----------|-------------|-------------------------|--|----------------------------------|--|-------------------------|-------------------------|
| | | | | | ELEV. (MSL.) <u>1723</u> | DATE COMPLETED <u>05/03/2019</u> | | | |
| | | | | | EQUIPMENT <u>BACKHOE BUCKET 24"</u> BY: <u>P. Theriault</u> | | | | |
| MATERIAL DESCRIPTION | | | | | | | | | |
| 0 | | | | SM | COLLUVIUM (Qco) Silty SAND, medium dense, damp, strong brown; fine to medium sand; trace coarse sand -some clay | | | 99.7 | 7.9 |
| 2 | | | | | VAL VERDE TONALITE (Kvt) Weathered, moderately strong, brownish yellow; GRANITIC BEDROCK; medium- to coarse-grained; micaceous; excavates as a poorly graded sand with gravel. | | | | |
| 4 | | | | | Total Depth = 5' (Refusal) Groundwater not encountered Dry density and moisture content performed by nuclear density Backfilled with spoils on 05/03/2019 | | | | |

Figure A-33,
Log of Test Pit TP-7b, Page 1 of 1

T2864-22-01 TEST PIT LOGS - B LOGS.GPJ

| | | | |
|----------------|-----------------------------|-------------------------------|--------------------------------|
| SAMPLE SYMBOLS | ... SAMPLING UNSUCCESSFUL | ... STANDARD PENETRATION TEST | ... DRIVE SAMPLE (UNDISTURBED) |
| | ... DISTURBED OR BAG SAMPLE | ... CHUNK SAMPLE | ... WATER TABLE OR SEEPAGE |

NOTE: THE LOG OF SUBSURFACE CONDITIONS SHOWN HEREON APPLIES ONLY AT THE SPECIFIC BORING OR TRENCH LOCATION AND AT THE DATE INDICATED.
IT IS NOT WARRANTED TO BE REPRESENTATIVE OF SUBSURFACE CONDITIONS AT OTHER LOCATIONS AND TIMES.

| DEPTH IN FEET | SAMPLE NO. | LITHOLOGY | GROUNDWATER | SOIL CLASS (USCS) | TEST PIT TP-8b | | PENETRATION RESISTANCE (BLOWS/FT.) | DRY DENSITY (P.C.F.) | MOISTURE CONTENT (%) |
|----------------------|---------------|--|-------------|-------------------------|--|----------------------------------|--|-------------------------|-------------------------|
| | | | | | ELEV. (MSL.) <u>1735</u> | DATE COMPLETED <u>05/03/2019</u> | | | |
| | | | | | EQUIPMENT <u>BACKHOE BUCKET 24"</u> BY: <u>P. Theriault</u> | | | | |
| MATERIAL DESCRIPTION | | | | | | | | | |
| 0 | | [Lithology symbols: vertical lines with dots] | | SM | COLLUVIUM (Qcol) Silty SAND, medium dense, damp, reddish brown; fine to medium sand; some coarse sand; grass; upper 1' disturbed -becomes moist | | | 96.3 | 11.3 |
| 2 | | | | | | | | | |
| 4 | | [Lithology symbols: vertical lines with crosses] | | | VAL VERDE TONALITE (Kvt) Weathered, moderately strong, brownish gray; GRANITIC BEDROCK; fine- to coarse-grained; excavates as a poorly graded sand with gravel; some cobble size | | | | |
| | | | | | Total Depth = 7' (Refusal) Groundwater not encountered Dry density and moisture content performed by nuclear density Backfilled with spoils on 05/03/2019 | | | | |

Figure A-34,
Log of Test Pit TP-8b, Page 1 of 1

T2864-22-01 TEST PIT LOGS - B LOGS.GPJ

| | | | | | | |
|----------------|-------------------------------------|-----------------------------|-------------------------------------|-------------------------------|-------------------------------------|--------------------------------|
| SAMPLE SYMBOLS | <input type="checkbox"/> | ... SAMPLING UNSUCCESSFUL | <input type="checkbox"/> | ... STANDARD PENETRATION TEST | <input type="checkbox"/> | ... DRIVE SAMPLE (UNDISTURBED) |
| | <input checked="" type="checkbox"/> | ... DISTURBED OR BAG SAMPLE | <input checked="" type="checkbox"/> | ... CHUNK SAMPLE | <input checked="" type="checkbox"/> | ... WATER TABLE OR SEEPAGE |

NOTE: THE LOG OF SUBSURFACE CONDITIONS SHOWN HEREON APPLIES ONLY AT THE SPECIFIC BORING OR TRENCH LOCATION AND AT THE DATE INDICATED.
IT IS NOT WARRANTED TO BE REPRESENTATIVE OF SUBSURFACE CONDITIONS AT OTHER LOCATIONS AND TIMES.

| DEPTH IN FEET | SAMPLE NO. | LITHOLOGY | GROUNDWATER | SOIL CLASS (USCS) | TEST PIT TP-9b | | PENETRATION RESISTANCE (BLOWS/FT.) | DRY DENSITY (P.C.F.) | MOISTURE CONTENT (%) |
|--|------------|-----------|-------------|-------------------|--|----------------------------------|------------------------------------|----------------------|----------------------|
| | | | | | ELEV. (MSL.) <u>1732</u> | DATE COMPLETED <u>05/03/2019</u> | | | |
| | | | | | EQUIPMENT <u>BACKHOE BUCKET 24"</u> BY: <u>P. Theriault</u> | | | | |
| MATERIAL DESCRIPTION | | | | | | | | | |
| 0 | | | | SM | COLLUVIUM (Qco) Silty SAND, medium dense, damp, reddish brown; fine to medium sand; grass; upper 1' disturbed | | | 89.2 | 7.8 |
| 2 | | | | CL | Sandy CLAY, stiff, moist, reddish brown; fine to coarse sand | | | | |
| 4 | | | | | VAL VERDE TONALITE (Kvt) Weathered, moderately strong, brownish gray; GRANITIC BEDROCK; medium- to coarse-grained; micaceous; excavates as a poorly graded sand with gravel. | | | | |
| Total Depth = 5' (Refusal) Groundwater not encountered Dry density and moisture content performed by nuclear density Backfilled with spoils on 05/03/2019 | | | | | | | | | |

Figure A-35,
Log of Test Pit TP-9b, Page 1 of 1

T2864-22-01 TEST PIT LOGS - B LOGS.GPJ

| | | | | | | |
|----------------|--|-----------------------------|--|-------------------------------|--|--------------------------------|
| SAMPLE SYMBOLS | | ... SAMPLING UNSUCCESSFUL | | ... STANDARD PENETRATION TEST | | ... DRIVE SAMPLE (UNDISTURBED) |
| | | ... DISTURBED OR BAG SAMPLE | | ... CHUNK SAMPLE | | ... WATER TABLE OR SEEPAGE |

NOTE: THE LOG OF SUBSURFACE CONDITIONS SHOWN HEREON APPLIES ONLY AT THE SPECIFIC BORING OR TRENCH LOCATION AND AT THE DATE INDICATED. IT IS NOT WARRANTED TO BE REPRESENTATIVE OF SUBSURFACE CONDITIONS AT OTHER LOCATIONS AND TIMES.

| DEPTH IN FEET | SAMPLE NO. | LITHOLOGY | GROUNDWATER | SOIL CLASS (USCS) | TEST PIT TP-10b ELEV. (MSL.) <u>1735</u> DATE COMPLETED <u>05/03/2019</u> EQUIPMENT <u>BACKHOE BUCKET 24"</u> BY: <u>P. Theriault</u> | PENETRATION RESISTANCE (BLOWS/FT.) | DRY DENSITY (P.C.F.) | MOISTURE CONTENT (%) |
|----------------------|------------|-----------|-------------|-------------------|---|---|----------------------|----------------------|
| MATERIAL DESCRIPTION | | | | | | | | |
| 0 | TP-10b@1 | | | SM | COLLUVIUM (Qcol) Silty SAND, medium dense, damp, brownish red; fine to medium sand; some coarse sand; grass; upper 1' disturbed; root hairs | | | |
| 2 | | | | | | VAL VERDE TONALITE (Kvt) Weathered, moderately strong, grayish brown to brownish red; GRANITIC BEDROCK; fine- to coarse-grained; micaceous; excavates as a poorly graded sand with gravel. | | |
| 4 | TP-10b@4 | | | | Total Depth = 5' (Refusal) Groundwater not encountered Backfilled with spoils on 05/03/2019 | | | |

Figure A-36,
Log of Test Pit TP-10b, Page 1 of 1

T2864-22-01 TEST PIT LOGS - B LOGS.GPJ

| | | | |
|----------------|-----------------------------|-------------------------------|--------------------------------|
| SAMPLE SYMBOLS | ... SAMPLING UNSUCCESSFUL | ... STANDARD PENETRATION TEST | ... DRIVE SAMPLE (UNDISTURBED) |
| | ... DISTURBED OR BAG SAMPLE | ... CHUNK SAMPLE | ... WATER TABLE OR SEEPAGE |

NOTE: THE LOG OF SUBSURFACE CONDITIONS SHOWN HEREON APPLIES ONLY AT THE SPECIFIC BORING OR TRENCH LOCATION AND AT THE DATE INDICATED. IT IS NOT WARRANTED TO BE REPRESENTATIVE OF SUBSURFACE CONDITIONS AT OTHER LOCATIONS AND TIMES.

| DEPTH IN FEET | SAMPLE NO. | LITHOLOGY | GROUNDWATER | SOIL CLASS (USCS) | BORING B-1c | | PENETRATION RESISTANCE (BLOWS/FT.) | DRY DENSITY (P.C.F.) | MOISTURE CONTENT (%) |
|----------------------|---------------|-----------|-------------|-------------------------|---|------------------------------|--|-------------------------|-------------------------|
| | | | | | ELEV. (MSL.) 1710 | DATE COMPLETED 5/1/19 | | | |
| | | | | | EQUIPMENT HOLLOW STEM AUGER | | BY: A. Shoashekan | | |
| MATERIAL DESCRIPTION | | | | | | | | | |
| 0 | B-1c@0-5 | | | SM | COLLUVIUM (Qcol) Silty SAND, loose, damp, olive brown; fine sand with few medium and coarse sand; rootlets and root hairs; upper 0.5' disturbed -becomes medium dense, yellowish brown; fine sand | | | | |
| 2 | B-1c@2.5 | | | | | | 27 | 119.5 | 9.4 |
| 4 | B-1c@5 | | | | VAL VERDE TONALITE (Kvt) Weathered, reddish brown to gray, moderately strong GRANITIC BEDROCK; medium- to coarse-grained; excavates as a poorly-graded sand | | | | |
| 6 | B-1c@7.5 | | | | | | 50/5" | 119.9 | 5.9 |
| 8 | B-1c@10 | | | | | | 50/3" | | |
| 10 | B-1c@10 | | | | Total Depth = 10'-2" Groundwater not encountered Penetration resistance for 140-lb hammer falling 30-inches by auto-hammer Backfilled with cuttings on 05/01/2019 | | 50/2" | 73.8 | 4.4 |

Figure A-37,
Log of Boring B-1c, Page 1 of 1

T2864-22-01 BORING LOGS - C LOGS.GPJ

| SAMPLE SYMBOLS | | | |
|----------------|-----------------------------|--|-------------------------------|
| | ... SAMPLING UNSUCCESSFUL | | ... STANDARD PENETRATION TEST |
| | ... DISTURBED OR BAG SAMPLE | | ... CHUNK SAMPLE |
| | | | ... WATER TABLE OR SEEPAGE |

NOTE: THE LOG OF SUBSURFACE CONDITIONS SHOWN HEREON APPLIES ONLY AT THE SPECIFIC BORING OR TRENCH LOCATION AND AT THE DATE INDICATED. IT IS NOT WARRANTED TO BE REPRESENTATIVE OF SUBSURFACE CONDITIONS AT OTHER LOCATIONS AND TIMES.

| DEPTH IN FEET | SAMPLE NO. | LITHOLOGY | GROUNDWATER | SOIL CLASS (USCS) | BORING B-2c | | PENETRATION RESISTANCE (BLOWS/FT.) | DRY DENSITY (P.C.F.) | MOISTURE CONTENT (%) | |
|----------------------|------------|-----------|-------------|-------------------|---|------------------------------|------------------------------------|----------------------|----------------------|--|
| | | | | | ELEV. (MSL.) 1709 | DATE COMPLETED 5/1/19 | | | | |
| | | | | | EQUIPMENT HOLLOW STEM AUGER BY: A. Shoashekan | | | | | |
| MATERIAL DESCRIPTION | | | | | | | | | | |
| 0 | B-2c@0-5 | | | SC CL | COLLUVIUM (Qco) Clayey SAND, loose, damp, olive brown; fine sand with few medium and coarse sand; rootlets and root hairs; upper 0.5' disturbed | | | | | |
| 2 | B-2c@2.5 | | | | Sandy CLAY, stiff, damp, reddish brown; fine sand -becomes stiff, calcium carbonate stringers; trace pores | 66 | 109.3 | 12.2 | | |
| 4 | B-2c@5 | | | | VAL VERDE TONALITE (Kvt) Weathered, reddish brown, moderately strong GRANITIC BEDROCK; medium- to coarse-grained; calcium carbonate stringers; excavates as a poorly-graded sand -becomes reddish brown to white | 65/5" | 122.2 | 9.4 | | |
| 8 | B-2c@7.5 | | | | | 50/5" | 90.2 | 6.4 | | |
| 10 | | | | | | | | | | |
| 12 | | | | | | | | | | |
| 14 | | | | | | | | | | |
| 16 | | | | | | | | | | |
| 18 | | | | | | | | | | |
| 20 | | | | | | | | | | |
| 22 | | | | | | | | | | |
| | | | | | Total Depth = 23' Groundwater not encountered Penetration resistance for 140-lb hammer falling 30-inches by auto-hammer Backfilled with cuttings on 05/02/2019 | | | | | |

Figure A-38,
Log of Boring B-2c, Page 1 of 1

T2864-22-01 BORING LOGS - C LOGS.GPJ

| | | | | | | |
|----------------|--|-----------------------------|--|-------------------------------|--|--------------------------------|
| SAMPLE SYMBOLS | | ... SAMPLING UNSUCCESSFUL | | ... STANDARD PENETRATION TEST | | ... DRIVE SAMPLE (UNDISTURBED) |
| | | ... DISTURBED OR BAG SAMPLE | | ... CHUNK SAMPLE | | ... WATER TABLE OR SEEPAGE |

NOTE: THE LOG OF SUBSURFACE CONDITIONS SHOWN HEREON APPLIES ONLY AT THE SPECIFIC BORING OR TRENCH LOCATION AND AT THE DATE INDICATED. IT IS NOT WARRANTED TO BE REPRESENTATIVE OF SUBSURFACE CONDITIONS AT OTHER LOCATIONS AND TIMES.

| DEPTH IN FEET | SAMPLE NO. | LITHOLOGY | GROUNDWATER | SOIL CLASS (USCS) | BORING P-1c | | PENETRATION RESISTANCE (BLOWS/FT.) | DRY DENSITY (P.C.F.) | MOISTURE CONTENT (%) |
|--|---------------|-----------|-------------|-------------------------|--|------------------------------|--|-------------------------|-------------------------|
| | | | | | ELEV. (MSL.) 1708 | DATE COMPLETED 5/1/19 | | | |
| | | | | | EQUIPMENT HOLLOW STEM AUGER BY: A. Shoashekan | | | | |
| | | | | | MATERIAL DESCRIPTION | | | | |
| 0 | | | | SM | COLLUVIUM (Qco) Silty SAND, loose, damp, olive brown; fine sand with few medium and coarse sand; rootlets and root hairs; upper 0.5' disturbed Sandy SILT, stiff, moist, reddish brown; fine sand | | | | |
| 2 | | | | ML | | | | | |
| 4 | | | | | VAL VERDE TONALITE (Kvt) Weathered, yellowish brown to reddish brown, moderately strong GRANITIC BEDROCK; medium- to coarse-grained; excavates as a silty sand | | | | |
| 6 | | | | | | | | | |
| 8 | | | | | | | | | |
| 10 | | | | | | | | | |
| 12 | | | | | | | | | |
| | | | | | | | | | |
| | | | | | | | | | |
| | | | | | | | | | |
| | | | | | | | | | |
| | | | | | | | | | |
| Total Depth = 12' Groundwater not encountered Backfilled with cuttings on 05/02/2019 | | | | | | | | | |

Figure A-39,
Log of Boring P-1c, Page 1 of 1

T2864-22-01 BORING LOGS - C LOGS.GPJ

| | | | |
|----------------|---|--|---|
| SAMPLE SYMBOLS | <input type="checkbox"/> ... SAMPLING UNSUCCESSFUL | <input type="checkbox"/> ... STANDARD PENETRATION TEST | <input type="checkbox"/> ... DRIVE SAMPLE (UNDISTURBED) |
| | <input checked="" type="checkbox"/> ... DISTURBED OR BAG SAMPLE | <input checked="" type="checkbox"/> ... CHUNK SAMPLE | <input type="checkbox"/> ... WATER TABLE OR SEEPAGE |

NOTE: THE LOG OF SUBSURFACE CONDITIONS SHOWN HEREON APPLIES ONLY AT THE SPECIFIC BORING OR TRENCH LOCATION AND AT THE DATE INDICATED. IT IS NOT WARRANTED TO BE REPRESENTATIVE OF SUBSURFACE CONDITIONS AT OTHER LOCATIONS AND TIMES.

| DEPTH IN FEET | SAMPLE NO. | LITHOLOGY | GROUNDWATER | SOIL CLASS (USCS) | BORING P-2c | | PENETRATION RESISTANCE (BLOWS/FT.) | DRY DENSITY (P.C.F.) | MOISTURE CONTENT (%) |
|--|---------------|-----------|-------------|-------------------------|--|------------------------------|--|-------------------------|-------------------------|
| | | | | | ELEV. (MSL.) 1710 | DATE COMPLETED 5/1/19 | | | |
| | | | | | EQUIPMENT HOLLOW STEM AUGER BY: A. Shoashekan | | | | |
| | | | | | MATERIAL DESCRIPTION | | | | |
| 0 | | | | SM ML | COLLUVIUM (Qco) Silty SAND, loose, damp, olive brown; fine sand with few medium and coarse sand; rootlets and root hairs; upper 0.5' disturbed Sandy SILT, stiff, moist, reddish brown; fine sand | | | | |
| 2 | | | | | VAL VERDE TONALITE (Kvt) Weathered, yellowish brown to reddish brown, moderately strong GRANITIC BEDROCK; medium- to coarse-grained; excavates as a silty sand | | | | |
| 4 | | | | | | | | | |
| 6 | | | | | | | | | |
| 8 | | | | | | | | | |
| 10 | | | | | | | | | |
| 12 | P-2c@12-13 | | | | | | | | |
| Total Depth = 13' Groundwater not encountered Backfilled with cuttings on 05/02/2019 | | | | | | | | | |

Figure A-40,
Log of Boring P-2c, Page 1 of 1

T2864-22-01 BORING LOGS - C LOGS.GPJ

| | | | | | | |
|----------------|-------------------------------------|-----------------------------|-------------------------------------|-------------------------------|--------------------------|--------------------------------|
| SAMPLE SYMBOLS | <input type="checkbox"/> | ... SAMPLING UNSUCCESSFUL | <input type="checkbox"/> | ... STANDARD PENETRATION TEST | <input type="checkbox"/> | ... DRIVE SAMPLE (UNDISTURBED) |
| | <input checked="" type="checkbox"/> | ... DISTURBED OR BAG SAMPLE | <input checked="" type="checkbox"/> | ... CHUNK SAMPLE | <input type="checkbox"/> | ... WATER TABLE OR SEEPAGE |

NOTE: THE LOG OF SUBSURFACE CONDITIONS SHOWN HEREON APPLIES ONLY AT THE SPECIFIC BORING OR TRENCH LOCATION AND AT THE DATE INDICATED. IT IS NOT WARRANTED TO BE REPRESENTATIVE OF SUBSURFACE CONDITIONS AT OTHER LOCATIONS AND TIMES.

| DEPTH IN FEET | SAMPLE NO. | LITHOLOGY | GROUNDWATER | SOIL CLASS (USCS) | TEST PIT TP-1c | | PENETRATION RESISTANCE (BLOWS/FT.) | DRY DENSITY (P.C.F.) | MOISTURE CONTENT (%) |
|---------------------|---------------|-----------|-------------|-------------------------|--|----------------------------------|--|-------------------------|-------------------------|
| | | | | | ELEV. (MSL.) <u>1734</u> | DATE COMPLETED <u>05/03/2019</u> | | | |
| | | | | | EQUIPMENT <u>BACKHOE BUCKET 24"</u> BY: <u>P. Theriault</u> | | | | |
| 0 | | | | | MATERIAL DESCRIPTION | | | | |
| 2 | | | | SM | COLLUVIUM (Qco) Silty SAND, medium dense, damp, brownish red; fine to medium sand; grass; upper 1' disturbed; root hairs | | | | |
| 4 | | | | | VAL VERDE TONALITE (Kvt) Weathered, moderately strong, reddish brown; GRANITIC BEDROCK; medium- to coarse-grained; micaceous; excavates as a poorly graded sand with gravel. | | | | |
| | | | | | Total Depth = 4' (Refusal) Groundwater not encountered Backfilled with spoils on 05/03/2019 | | | | |

Figure A-41,
Log of Test Pit TP-1c, Page 1 of 1

T2864-22-01 TEST PIT LOGS - C LOGS.GPJ

| | | | | | | |
|----------------|-------------------------------------|-----------------------------|-------------------------------------|-------------------------------|-------------------------------------|--------------------------------|
| SAMPLE SYMBOLS | <input type="checkbox"/> | ... SAMPLING UNSUCCESSFUL | <input type="checkbox"/> | ... STANDARD PENETRATION TEST | <input type="checkbox"/> | ... DRIVE SAMPLE (UNDISTURBED) |
| | <input checked="" type="checkbox"/> | ... DISTURBED OR BAG SAMPLE | <input checked="" type="checkbox"/> | ... CHUNK SAMPLE | <input checked="" type="checkbox"/> | ... WATER TABLE OR SEEPAGE |

NOTE: THE LOG OF SUBSURFACE CONDITIONS SHOWN HEREON APPLIES ONLY AT THE SPECIFIC BORING OR TRENCH LOCATION AND AT THE DATE INDICATED.
 IT IS NOT WARRANTED TO BE REPRESENTATIVE OF SUBSURFACE CONDITIONS AT OTHER LOCATIONS AND TIMES.

| DEPTH IN FEET | SAMPLE NO. | LITHOLOGY | GROUNDWATER | SOIL CLASS (USCS) | TEST PIT TP-2c | | PENETRATION RESISTANCE (BLOWS/FT.) | DRY DENSITY (P.C.F.) | MOISTURE CONTENT (%) |
|----------------------|---------------|-----------|-------------|-------------------------|---|----------------------------------|--|-------------------------|-------------------------|
| | | | | | ELEV. (MSL.) <u>1729</u> | DATE COMPLETED <u>05/03/2019</u> | | | |
| | | | | | EQUIPMENT <u>BACKHOE BUCKET 24"</u> BY: <u>P. Theriault</u> | | | | |
| MATERIAL DESCRIPTION | | | | | | | | | |
| 0 | | | | SM | COLLUVIUM (Qco) Silty SAND, medium dense, damp, reddish brown; fine to medium sand; trace coarse sand; grass; upper 1' disturbed; moderate porosity up to 1/8" -becomes brownish red; some clay | | | | |
| 2 | | | | | | | | | |
| 4 | | | | | | | | | |
| 6 | | | | | VAL VERDE TONALITE (Kvt) Weathered, moderately strong, reddish brown; GRANITIC BEDROCK; medium- to coarse-grained; micaceous; excavates as a poorly graded sand with gravel. | | | | |
| | | | | | Total Depth = 6' (Refusal) Groundwater not encountered Backfilled with spoils on 05/03/2019 | | | | |

Figure A-42,
Log of Test Pit TP-2c, Page 1 of 1

T2864-22-01 TEST PIT LOGS - C LOGS.GPJ

| | | | | | | |
|----------------|-------------------------------------|-----------------------------|-------------------------------------|-------------------------------|-------------------------------------|--------------------------------|
| SAMPLE SYMBOLS | <input type="checkbox"/> | ... SAMPLING UNSUCCESSFUL | <input type="checkbox"/> | ... STANDARD PENETRATION TEST | <input type="checkbox"/> | ... DRIVE SAMPLE (UNDISTURBED) |
| | <input checked="" type="checkbox"/> | ... DISTURBED OR BAG SAMPLE | <input checked="" type="checkbox"/> | ... CHUNK SAMPLE | <input checked="" type="checkbox"/> | ... WATER TABLE OR SEEPAGE |

NOTE: THE LOG OF SUBSURFACE CONDITIONS SHOWN HEREON APPLIES ONLY AT THE SPECIFIC BORING OR TRENCH LOCATION AND AT THE DATE INDICATED. IT IS NOT WARRANTED TO BE REPRESENTATIVE OF SUBSURFACE CONDITIONS AT OTHER LOCATIONS AND TIMES.

| DEPTH IN FEET | SAMPLE NO. | LITHOLOGY | GROUNDWATER | SOIL CLASS (USCS) | TEST PIT TP-3c | | PENETRATION RESISTANCE (BLOWS/FT.) | DRY DENSITY (P.C.F.) | MOISTURE CONTENT (%) |
|--|---------------|-----------|-------------|-------------------------|--|----------------------------------|--|-------------------------|-------------------------|
| | | | | | ELEV. (MSL.) <u>1722</u> | DATE COMPLETED <u>05/03/2019</u> | | | |
| | | | | | EQUIPMENT <u>BACKHOE BUCKET 24"</u> | | BY: <u>P. Theriault</u> | | |
| MATERIAL DESCRIPTION | | | | | | | | | |
| 0 | TP-3c@2-3' | | | SM | COLLUVIUM (Qcol) | | | 91.8 | 9.0 |
| 2 | | | | | Silty SAND, medium dense, damp, brown; fine to medium sand; trace coarse; grass; upper 1' disturbed; root hairs | | | | |
| 4 | | | | | | | | | |
| 6 | | | | | VAL VERDE TONALITE (Kvt) | | | | |
| | | | | | Weathered, moderately strong, gray; GRANITIC BEDROCK; fine- to coarse-grained; micaceous; excavates as a poorly graded sand with gravel. | | | | |
| Total Depth = 7' (Refusal) Groundwater not encountered Dry density and moisture content performed by nuclear density Backfilled with spoils on 05/03/2019 | | | | | | | | | |

Figure A-43,
Log of Test Pit TP-3c, Page 1 of 1

T2864-22-01 TEST PIT LOGS - C LOGS.GPJ

| | | | |
|----------------|-----------------------------|-------------------------------|--------------------------------|
| SAMPLE SYMBOLS | ... SAMPLING UNSUCCESSFUL | ... STANDARD PENETRATION TEST | ... DRIVE SAMPLE (UNDISTURBED) |
| | ... DISTURBED OR BAG SAMPLE | ... CHUNK SAMPLE | ... WATER TABLE OR SEEPAGE |

NOTE: THE LOG OF SUBSURFACE CONDITIONS SHOWN HEREON APPLIES ONLY AT THE SPECIFIC BORING OR TRENCH LOCATION AND AT THE DATE INDICATED.
 IT IS NOT WARRANTED TO BE REPRESENTATIVE OF SUBSURFACE CONDITIONS AT OTHER LOCATIONS AND TIMES.

| DEPTH IN FEET | SAMPLE NO. | LITHOLOGY | GROUNDWATER | SOIL CLASS (USCS) | TEST PIT TP-4c | | PENETRATION RESISTANCE (BLOWS/FT.) | DRY DENSITY (P.C.F.) | MOISTURE CONTENT (%) |
|---------------------|---------------|-------------------|-------------|-------------------------|---|----------------------------------|--|-------------------------|-------------------------|
| | | | | | ELEV. (MSL.) <u>1720</u> | DATE COMPLETED <u>05/03/2019</u> | | | |
| | | | | | EQUIPMENT <u>BACKHOE BUCKET 24"</u> BY: <u>P. Theriault</u> | | | | |
| | | | | | MATERIAL DESCRIPTION | | | | |
| 0 | | + + + + + + | | | <p>VAL VERDE TONALITE (Kvt) Highly weathered, moderately strong, reddish brown; GRANITIC BEDROCK; fine- to coarse-grained; micaceous; excavates as a poorly graded sand with gravel</p> | | | | |
| 2 | | | | | <p>Total Depth = 2' (Refusal) Groundwater not encountered Backfilled with spoils on 05/03/2019</p> | | | | |

Figure A-44,
Log of Test Pit TP-4c, Page 1 of 1

T2864-22-01 TEST PIT LOGS - C LOGS.GPJ

| | | | |
|----------------|---|--|--|
| SAMPLE SYMBOLS | <input type="checkbox"/> ... SAMPLING UNSUCCESSFUL | <input type="checkbox"/> ... STANDARD PENETRATION TEST | <input type="checkbox"/> ... DRIVE SAMPLE (UNDISTURBED) |
| | <input checked="" type="checkbox"/> ... DISTURBED OR BAG SAMPLE | <input checked="" type="checkbox"/> ... CHUNK SAMPLE | <input checked="" type="checkbox"/> ... WATER TABLE OR SEEPAGE |

NOTE: THE LOG OF SUBSURFACE CONDITIONS SHOWN HEREON APPLIES ONLY AT THE SPECIFIC BORING OR TRENCH LOCATION AND AT THE DATE INDICATED.
 IT IS NOT WARRANTED TO BE REPRESENTATIVE OF SUBSURFACE CONDITIONS AT OTHER LOCATIONS AND TIMES.







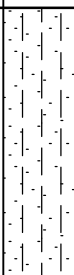

| DEPTH IN FEET | SAMPLE NO. | LITHOLOGY | GROUNDWATER | SOIL CLASS (USCS) | TEST PIT TP-5c | | PENETRATION RESISTANCE (BLOWS/FT.) | DRY DENSITY (P.C.F.) | MOISTURE CONTENT (%) |
|----------------------|---------------|---|-------------|-------------------------|--|----------------------------------|--|-------------------------|-------------------------|
| | | | | | ELEV. (MSL.) <u>1723</u> | DATE COMPLETED <u>05/03/2019</u> | | | |
| | | | | | EQUIPMENT <u>BACKHOE BUCKET 24"</u> | | BY: <u>P. Theriault</u> | | |
| MATERIAL DESCRIPTION | | | | | | | | | |
| 0 | |  | | SM | COLLUVIUM (Qco) Silty SAND, medium dense, damp, strong brown; fine to medium sand; trace coarse; grass; upper 1' disturbed -becomes moist, reddish brown | | | | |
| 2 | | | | | | | | | |
| 4 | | | | | | | | | |
| 6 | |  | | | VAL VERDE TONALITE (Kvt) Weathered, moderately strong, grayish brown; GRANITIC BEDROCK; fine- to coarse-grained; micaceous; excavates as a poorly graded sand with gravel. | | | | |
| | | | | | Total Depth = 7' (Refusal) Groundwater not encountered Backfilled with spoils on 05/03/2019 | | | | |

Figure A-45,
Log of Test Pit TP-5c, Page 1 of 1

T2864-22-01 TEST PIT LOGS - C LOGS.GPJ

| | | | | | | |
|----------------|---|-----------------------------|---|-------------------------------|---|--------------------------------|
| SAMPLE SYMBOLS |  | ... SAMPLING UNSUCCESSFUL |  | ... STANDARD PENETRATION TEST |  | ... DRIVE SAMPLE (UNDISTURBED) |
| |  | ... DISTURBED OR BAG SAMPLE |  | ... CHUNK SAMPLE |  | ... WATER TABLE OR SEEPAGE |

NOTE: THE LOG OF SUBSURFACE CONDITIONS SHOWN HEREON APPLIES ONLY AT THE SPECIFIC BORING OR TRENCH LOCATION AND AT THE DATE INDICATED.
 IT IS NOT WARRANTED TO BE REPRESENTATIVE OF SUBSURFACE CONDITIONS AT OTHER LOCATIONS AND TIMES.

| DEPTH IN FEET | SAMPLE NO. | LITHOLOGY | GROUNDWATER | SOIL CLASS (USCS) | TEST PIT TP-6c | | PENETRATION RESISTANCE (BLOWS/FT.) | DRY DENSITY (P.C.F.) | MOISTURE CONTENT (%) |
|----------------------|---------------|-----------|-------------|-------------------------|--|----------------------------------|--|-------------------------|-------------------------|
| | | | | | ELEV. (MSL.) <u>1719</u> | DATE COMPLETED <u>05/03/2019</u> | | | |
| | | | | | EQUIPMENT <u>BACKHOE BUCKET 24"</u> BY: <u>P. Theriault</u> | | | | |
| MATERIAL DESCRIPTION | | | | | | | | | |
| 0 | | | | SM | COLLUVIUM (Qco) Silty SAND, medium dense, damp, brown; fine to coarse sand; trace coarse; grass; upper 1' disturbed; root hairs | | | | |
| 2 | | | | | VAL VERDE TONALITE (Kvt) Weathered, moderately strong, reddish brown; GRANITIC BEDROCK; fine- to coarse-grained; micaceous; excavates as a poorly graded sand with gravel. | | | | |
| 4 | | | | | Total Depth = 4' 6" (Refusal) Groundwater not encountered Backfilled with spoils on 05/03/2019 | | | | |

Figure A-46,
Log of Test Pit TP-6c, Page 1 of 1

T2864-22-01 TEST PIT LOGS - C LOGS.GPJ

| | | | | | | |
|----------------|-------------------------------------|-----------------------------|-------------------------------------|-------------------------------|-------------------------------------|--------------------------------|
| SAMPLE SYMBOLS | <input type="checkbox"/> | ... SAMPLING UNSUCCESSFUL | <input type="checkbox"/> | ... STANDARD PENETRATION TEST | <input type="checkbox"/> | ... DRIVE SAMPLE (UNDISTURBED) |
| | <input checked="" type="checkbox"/> | ... DISTURBED OR BAG SAMPLE | <input checked="" type="checkbox"/> | ... CHUNK SAMPLE | <input checked="" type="checkbox"/> | ... WATER TABLE OR SEEPAGE |

NOTE: THE LOG OF SUBSURFACE CONDITIONS SHOWN HEREON APPLIES ONLY AT THE SPECIFIC BORING OR TRENCH LOCATION AND AT THE DATE INDICATED.
IT IS NOT WARRANTED TO BE REPRESENTATIVE OF SUBSURFACE CONDITIONS AT OTHER LOCATIONS AND TIMES.

| PERCOLATION TEST REPORT | | | | | | | |
|---|----------|----------------------------------|--------------------------|--------------------------|-----------------------------|-----------------------------------|-----------------------------|
| Project Name: | | TTM 37731, TTM 37732, & TTM37733 | | | Project No.: | | T2864-22-01 |
| Test Hole No.: | | P-1a | | | Date Excavated: | | 5/1/2019 |
| Length of Test Pipe: | | 24.0 inches | | | Soil Classification: | | CL |
| Height of Pipe above Ground: | | -2.4 inches | | | Presoak Date: | | 5/1/2019 |
| Depth of Test Hole: | | 26.4 inches | | | Perc Test Date: | | 5/2/2019 |
| Check for Sandy Soil Criteria Tested by: | | | | ATS | | Percolation Tested by: ATS | |
| Water level measured from BOTTOM of hole | | | | | | | |
| Sandy Soil Criteria Test | | | | | | | |
| Trial No. | Time | Time Interval (min) | Total Elapsed Time (min) | Initial Water Level (in) | Final Water Level (in) | Δ in Water Level (inches) | Percolation Rate (min/inch) |
| 1 | 7:53 AM | 25 | 25 | 9.6 | 9.6 | 0.0 | No Rate |
| | 8:18 AM | | | | | | |
| 2 | 8:19 AM | 25 | 50 | 9.6 | 9.6 | 0.0 | No Rate |
| | 8:44 AM | | | | | | |
| Soil Criteria: Normal | | | | | | | |
| Percolation Test | | | | | | | |
| Reading No. | Time | Time Interval (min) | Total Elapsed Time (min) | Initial Water Level (in) | Final Water Level (in) | Δ in Water Level (inches) | Percolation Rate (min/inch) |
| 1 | 9:11 AM | 30 | 30 | 9.6 | 9.6 | 0.0 | No Rate |
| | 9:41 AM | | | | | | |
| 2 | 9:42 AM | 30 | 60 | 9.6 | 9.6 | 0.0 | No Rate |
| | 10:12 AM | | | | | | |
| 3 | 10:13 AM | 30 | 90 | 9.6 | 9.6 | 0.0 | No Rate |
| | 10:43 AM | | | | | | |
| 4 | 10:44 AM | 30 | 120 | 9.6 | 9.6 | 0.0 | No Rate |
| | 11:14 AM | | | | | | |
| 5 | 11:15 AM | 30 | 150 | 9.6 | 9.6 | 0.0 | No Rate |
| | 11:45 AM | | | | | | |
| 6 | 11:46 AM | 30 | 180 | 9.6 | 9.6 | 0.0 | No Rate |
| | 12:16 PM | | | | | | |
| 7 | 12:17 PM | 30 | 210 | 9.6 | 9.6 | 0.0 | No Rate |
| | 12:47 PM | | | | | | |
| 8 | 12:48 PM | 30 | 240 | 9.6 | 9.6 | 0.0 | No Rate |
| | 1:18 PM | | | | | | |
| 9 | 1:19 PM | 30 | 270 | 9.6 | 9.6 | 0.0 | No Rate |
| | 1:49 PM | | | | | | |
| 10 | 1:50 PM | 30 | 300 | 9.6 | 9.6 | 0.0 | No Rate |
| | 2:20 PM | | | | | | |
| 11 | 2:21 PM | 30 | 330 | 9.6 | 9.6 | 0.0 | No Rate |
| | 2:51 PM | | | | | | |
| 12 | 2:52 PM | 30 | 360 | 9.6 | 9.6 | 0.0 | No Rate |
| | 3:22 PM | | | | | | |
| Infiltration Rate (in/hr): | | | 0.0 | | | | |
| Radius of test hole (in): | | | 4 | Figure A-47 | | | |
| Average Head (in): | | | 9.6 | | | | |

PERCOLATION TEST REPORT

| Project Name: | TTM 37731, TTM 37732, & TTM37733 | | | Project No.: | T2864-22-01 | | |
|---|----------------------------------|----------------------------|---------------------------------|---------------------------------|-------------------------------|----------------------------------|------------------------------------|
| Test Hole No.: | P-2a | | | Date Excavated: | 5/1/2019 | | |
| Length of Test Pipe: | 32.4 inches | | | Soil Classification: | SM | | |
| Height of Pipe above Ground: | -1.2 inches | | | Presoak Date: | 5/1/2019 | | |
| Depth of Test Hole: | 33.6 inches | | | Perc Test Date: | 5/2/2019 | | |
| Check for Sandy Soil Criteria Tested by: | ATS | | | Percolation Tested by: | ATS | | |
| Water level measured from BOTTOM of hole | | | | | | | |
| Sandy Soil Criteria Test | | | | | | | |
| Trial No. | Time | Time Interval (min) | Total Elapsed Time (min) | Initial Water Level (in) | Final Water Level (in) | Δ in Water Level (inches) | Percolation Rate (min/inch) |
| 1 | 8:00 AM | 25 | 25 | 10.8 | 0.0 | 10.8 | 2.3 |
| | 8:25 AM | | | | | | |
| 2 | 8:26 AM | 25 | 50 | 10.8 | 1.2 | 9.6 | 2.6 |
| | 8:51 AM | | | | | | |
| Soil Criteria: Normal | | | | | | | |
| Percolation Test | | | | | | | |
| Reading No. | Time | Time Interval (min) | Total Elapsed Time (min) | Initial Water Level (in) | Final Water Level (in) | Δ in Water Level (inches) | Percolation Rate (min/inch) |
| 1 | 9:06 AM | 30 | 30 | 10.8 | 1.2 | 9.6 | 3.1 |
| | 9:36 AM | | | | | | |
| 2 | 9:37 AM | 30 | 60 | 10.8 | 2.4 | 8.4 | 3.6 |
| | 10:07 AM | | | | | | |
| 3 | 10:08 AM | 30 | 90 | 10.8 | 3.6 | 7.2 | 4.2 |
| | 10:38 AM | | | | | | |
| 4 | 10:39 AM | 30 | 120 | 10.8 | 4.2 | 6.6 | 4.5 |
| | 11:09 AM | | | | | | |
| 5 | 11:10 AM | 30 | 150 | 10.8 | 4.8 | 6.0 | 5.0 |
| | 11:40 AM | | | | | | |
| 6 | 11:41 AM | 30 | 180 | 10.8 | 5.4 | 5.4 | 5.6 |
| | 12:11 PM | | | | | | |
| 7 | 12:12 PM | 30 | 210 | 10.8 | 4.8 | 6.0 | 5.0 |
| | 12:42 PM | | | | | | |
| 8 | 12:43 PM | 30 | 240 | 10.8 | 4.8 | 6.0 | 5.0 |
| | 1:13 PM | | | | | | |
| 9 | 1:14 PM | 30 | 270 | 10.8 | 6.0 | 4.8 | 6.3 |
| | 1:44 PM | | | | | | |
| 10 | 1:45 PM | 30 | 300 | 10.8 | 6.0 | 4.8 | 6.3 |
| | 2:15 PM | | | | | | |
| 11 | 2:16 PM | 30 | 330 | 10.8 | 6.0 | 4.8 | 6.3 |
| | 2:46 PM | | | | | | |
| 12 | 2:47 PM | 30 | 360 | 10.8 | 6.0 | 4.8 | 6.3 |
| | 3:17 PM | | | | | | |
| Infiltration Rate (in/hr): | 1.8 | | | | | | |
| Radius of test hole (in): | 4 | | | | | | Figure A-48 |
| Average Head (in): | 8.4 | | | | | | |

PERCOLATION TEST REPORT

| Project Name: | TTM 37731, TTM 37732, & TTM37733 | | | Project No.: | T2864-22-01 | | |
|---|----------------------------------|----------------------------|---------------------------------|---------------------------------|-------------------------------|----------------------------------|------------------------------------|
| Test Hole No.: | P-3a | | | Date Excavated: | 5/1/2019 | | |
| Length of Test Pipe: | 68.4 inches | | | Soil Classification: | Kvt | | |
| Height of Pipe above Ground: | 10.8 inches | | | Presoak Date: | 5/2/2019 | | |
| Depth of Test Hole: | 57.6 inches | | | Perc Test Date: | 5/3/2019 | | |
| Check for Sandy Soil Criteria Tested by: | ATS | | | Percolation Tested by: | ATS | | |
| Water level measured from BOTTOM of hole | | | | | | | |
| Sandy Soil Criteria Test | | | | | | | |
| Trial No. | Time | Time Interval (min) | Total Elapsed Time (min) | Initial Water Level (in) | Final Water Level (in) | Δ in Water Level (inches) | Percolation Rate (min/inch) |
| 1 | 6:49 AM | 25 | 25 | 22.8 | 16.8 | 6.0 | 4.2 |
| | 7:14 AM | | | | | | |
| 2 | 7:15 AM | 25 | 50 | 22.8 | 18.0 | 4.8 | 5.2 |
| | 7:40 AM | | | | | | |
| Soil Criteria: Normal | | | | | | | |
| Percolation Test | | | | | | | |
| Reading No. | Time | Time Interval (min) | Total Elapsed Time (min) | Initial Water Level (in) | Final Water Level (in) | Δ in Water Level (inches) | Percolation Rate (min/inch) |
| 1 | 8:26 AM | 30 | 30 | 22.8 | 19.2 | 3.6 | 8.3 |
| | 8:56 AM | | | | | | |
| 2 | 8:57 AM | 30 | 60 | 22.8 | 19.2 | 3.6 | 8.3 |
| | 9:27 AM | | | | | | |
| 3 | 9:28 AM | 30 | 90 | 22.8 | 19.2 | 3.6 | 8.3 |
| | 9:58 AM | | | | | | |
| 4 | 9:59 AM | 30 | 120 | 22.8 | 19.2 | 3.6 | 8.3 |
| | 10:29 AM | | | | | | |
| 5 | 10:30 AM | 30 | 150 | 22.8 | 19.2 | 3.6 | 8.3 |
| | 11:00 AM | | | | | | |
| 6 | 11:01 AM | 30 | 180 | 22.8 | 19.2 | 3.6 | 8.3 |
| | 11:31 AM | | | | | | |
| 7 | 11:32 AM | 30 | 210 | 22.8 | 19.2 | 3.6 | 8.3 |
| | 12:02 PM | | | | | | |
| 8 | 12:03 PM | 30 | 240 | 22.8 | 19.2 | 3.6 | 8.3 |
| | 12:33 PM | | | | | | |
| 9 | 12:34 PM | 30 | 270 | 22.8 | 19.8 | 3.0 | 10.0 |
| | 1:04 PM | | | | | | |
| 10 | 1:05 PM | 30 | 300 | 22.8 | 19.8 | 3.0 | 10.0 |
| | 1:35 PM | | | | | | |
| 11 | 1:36 PM | 30 | 330 | 22.8 | 19.8 | 3.0 | 10.0 |
| | 2:06 PM | | | | | | |
| 12 | 2:07 PM | 30 | 360 | 22.8 | 19.8 | 3.0 | 10.0 |
| | 2:37 PM | | | | | | |
| Infiltration Rate (in/hr): | | | 0.5 | | | | |
| Radius of test hole (in): | | | 4 | | | | |
| Average Head (in): | | | 21.3 | | | | |

Figure A-49

PERCOLATION TEST REPORT

| Project Name: | TTM 37731, TTM 37732, & TTM37733 | | | Project No.: | T2864-22-01 | | |
|---|----------------------------------|----------------------------|---------------------------------|---------------------------------|-------------------------------|----------------------------------|------------------------------------|
| Test Hole No.: | P-4a | | | Date Excavated: | 5/1/2019 | | |
| Length of Test Pipe: | 96.0 inches | | | Soil Classification: | Kvt | | |
| Height of Pipe above Ground: | -1.2 inches | | | Presoak Date: | 5/2/2019 | | |
| Depth of Test Hole: | 97.2 inches | | | Perc Test Date: | 5/3/2019 | | |
| Check for Sandy Soil Criteria Tested by: | ATS | | | Percolation Tested by: | ATS | | |
| Water level measured from BOTTOM of hole | | | | | | | |
| Sandy Soil Criteria Test | | | | | | | |
| Trial No. | Time | Time Interval (min) | Total Elapsed Time (min) | Initial Water Level (in) | Final Water Level (in) | Δ in Water Level (inches) | Percolation Rate (min/inch) |
| 1 | 6:53 AM | 25 | 25 | 10.8 | 14.4 | 3.6 | 6.9 |
| | 7:18 AM | | | | | | |
| 2 | 7:19 AM | 25 | 50 | 13.2 | 12.0 | 1.2 | 20.8 |
| | 7:44 AM | | | | | | |
| Soil Criteria: Normal | | | | | | | |
| Percolation Test | | | | | | | |
| Reading No. | Time | Time Interval (min) | Total Elapsed Time (min) | Initial Water Level (in) | Final Water Level (in) | Δ in Water Level (inches) | Percolation Rate (min/inch) |
| 1 | 8:31 AM | 30 | 30 | 21.6 | 15.6 | 6.0 | 5.0 |
| | 9:01 AM | | | | | | |
| 2 | 9:02 AM | 30 | 60 | 21.6 | 18.0 | 3.6 | 8.3 |
| | 9:32 AM | | | | | | |
| 3 | 9:33 AM | 30 | 90 | 21.6 | 17.4 | 4.2 | 7.1 |
| | 10:03 AM | | | | | | |
| 4 | 10:04 AM | 30 | 120 | 21.6 | 9.6 | 12.0 | 2.5 |
| | 10:34 AM | | | | | | |
| 5 | 10:35 AM | 30 | 150 | 21.6 | 10.8 | 10.8 | 2.8 |
| | 11:05 AM | | | | | | |
| 6 | 11:06 AM | 30 | 180 | 21.6 | 9.6 | 12.0 | 2.5 |
| | 11:36 AM | | | | | | |
| 7 | 11:37 AM | 30 | 210 | 21.6 | 9.6 | 12.0 | 2.5 |
| | 12:07 PM | | | | | | |
| 8 | 12:08 PM | 30 | 240 | 21.6 | 9.6 | 12.0 | 2.5 |
| | 12:38 PM | | | | | | |
| 9 | 12:39 PM | 30 | 270 | 21.6 | 9.0 | 12.6 | 2.4 |
| | 1:09 PM | | | | | | |
| 10 | 1:10 PM | 30 | 300 | 21.6 | 9.6 | 12.0 | 2.5 |
| | 1:40 PM | | | | | | |
| 11 | 1:41 PM | 30 | 330 | 21.6 | 9.6 | 12.0 | 2.5 |
| | 2:11 PM | | | | | | |
| 12 | 2:12 PM | 30 | 360 | 21.6 | 9.6 | 12.0 | 2.5 |
| | 2:42 PM | | | | | | |
| Infiltration Rate (in/hr): | 2.7 | | | | | | |
| Radius of test hole (in): | 4 | | | | | | Figure A-50 |
| Average Head (in): | 15.6 | | | | | | |

| PERCOLATION TEST REPORT | | | | | | | |
|---|----------|----------------------------------|--------------------------|--------------------------|-----------------------------|-----------------------------------|-----------------------------|
| Project Name: | | TTM 37731, TTM 37732, & TTM37733 | | | Project No.: | | T2864-22-01 |
| Test Hole No.: | | P-1b | | | Date Excavated: | | 5/1/2019 |
| Length of Test Pipe: | | 21.6 inches | | | Soil Classification: | | SM |
| Height of Pipe above Ground: | | 0.0 inches | | | Presoak Date: | | 5/2/2019 |
| Depth of Test Hole: | | 21.6 inches | | | Perc Test Date: | | 5/3/2019 |
| Check for Sandy Soil Criteria Tested by: | | | | ATS | | Percolation Tested by: ATS | |
| Water level measured from BOTTOM of hole | | | | | | | |
| Sandy Soil Criteria Test | | | | | | | |
| Trial No. | Time | Time Interval (min) | Total Elapsed Time (min) | Initial Water Level (in) | Final Water Level (in) | Δ in Water Level (inches) | Percolation Rate (min/inch) |
| 1 | 7:14 AM | 25 | 25 | 9.6 | 9.0 | 0.6 | 41.7 |
| | 7:39 AM | | | | | | |
| 2 | 7:40 AM | 25 | 50 | 9.6 | 9.0 | 0.6 | 41.7 |
| | 8:05 AM | | | | | | |
| Soil Criteria: Normal | | | | | | | |
| Percolation Test | | | | | | | |
| Reading No. | Time | Time Interval (min) | Total Elapsed Time (min) | Initial Water Level (in) | Final Water Level (in) | Δ in Water Level (inches) | Percolation Rate (min/inch) |
| 1 | 8:47 AM | 30 | 30 | 9.6 | 9.0 | 0.6 | 50.0 |
| | 9:17 AM | | | | | | |
| 2 | 9:18 AM | 30 | 60 | 9.6 | 9.0 | 0.6 | 50.0 |
| | 9:48 AM | | | | | | |
| 3 | 9:49 AM | 30 | 90 | 9.6 | 9.6 | 0.0 | No Rate |
| | 10:19 AM | | | | | | |
| 4 | 10:20 AM | 30 | 120 | 9.6 | 9.6 | 0.0 | No Rate |
| | 10:50 AM | | | | | | |
| 5 | 10:51 AM | 30 | 150 | 9.6 | 9.6 | 0.0 | No Rate |
| | 11:21 AM | | | | | | |
| 6 | 11:22 AM | 30 | 180 | 9.6 | 9.6 | 0.0 | No Rate |
| | 11:52 AM | | | | | | |
| 7 | 11:53 AM | 30 | 210 | 9.6 | 9.6 | 0.0 | No Rate |
| | 12:23 PM | | | | | | |
| 8 | 12:24 PM | 30 | 240 | 9.6 | 9.6 | 0.0 | No Rate |
| | 12:54 PM | | | | | | |
| 9 | 12:55 PM | 30 | 270 | 9.6 | 9.6 | 0.0 | No Rate |
| | 1:25 PM | | | | | | |
| 10 | 1:26 PM | 30 | 300 | 9.6 | 9.6 | 0.0 | No Rate |
| | 1:56 PM | | | | | | |
| 11 | 1:57 PM | 30 | 330 | 9.6 | 9.6 | 0.0 | No Rate |
| | 2:27 PM | | | | | | |
| 12 | 2:28 PM | 30 | 360 | 9.6 | 9.6 | 0.0 | No Rate |
| | 2:58 PM | | | | | | |
| Infiltration Rate (in/hr): | | | 0.0 | | | | |
| Radius of test hole (in): | | | 4 | Figure A-51 | | | |
| Average Head (in): | | | 9.6 | | | | |

| PERCOLATION TEST REPORT | | | | | | | |
|---|----------|----------------------------------|--------------------------|--------------------------|-----------------------------|-----------------------------------|-----------------------------|
| Project Name: | | TTM 37731, TTM 37732, & TTM37733 | | | Project No.: | | T2864-22-01 |
| Test Hole No.: | | P-2b | | | Date Excavated: | | 5/1/2019 |
| Length of Test Pipe: | | 51.6 inches | | | Soil Classification: | | Kvt |
| Height of Pipe above Ground: | | 0.0 inches | | | Presoak Date: | | 5/2/2019 |
| Depth of Test Hole: | | 51.6 inches | | | Perc Test Date: | | 5/3/2019 |
| Check for Sandy Soil Criteria Tested by: | | | | ATS | | Percolation Tested by: ATS | |
| Water level measured from BOTTOM of hole | | | | | | | |
| Sandy Soil Criteria Test | | | | | | | |
| Trial No. | Time | Time Interval (min) | Total Elapsed Time (min) | Initial Water Level (in) | Final Water Level (in) | Δ in Water Level (inches) | Percolation Rate (min/inch) |
| 1 | 7:16 AM | 25 | 25 | 12.0 | 10.8 | 1.2 | 20.8 |
| | 7:41 AM | | | | | | |
| 2 | 7:42 AM | 25 | 50 | 12.0 | 11.4 | 0.6 | 41.7 |
| | 8:07 AM | | | | | | |
| Soil Criteria: Normal | | | | | | | |
| Percolation Test | | | | | | | |
| Reading No. | Time | Time Interval (min) | Total Elapsed Time (min) | Initial Water Level (in) | Final Water Level (in) | Δ in Water Level (inches) | Percolation Rate (min/inch) |
| 1 | 8:49 AM | 30 | 30 | 12.0 | 11.4 | 0.6 | 50.0 |
| | 9:19 AM | | | | | | |
| 2 | 9:20 AM | 30 | 60 | 12.0 | 11.4 | 0.6 | 50.0 |
| | 9:50 AM | | | | | | |
| 3 | 9:51 AM | 30 | 90 | 12.0 | 11.4 | 0.6 | 50.0 |
| | 10:21 AM | | | | | | |
| 4 | 10:22 AM | 30 | 120 | 12.0 | 11.4 | 0.6 | 50.0 |
| | 10:52 AM | | | | | | |
| 5 | 10:53 AM | 30 | 150 | 12.0 | 11.4 | 0.6 | 50.0 |
| | 11:23 AM | | | | | | |
| 6 | 11:24 AM | 30 | 180 | 12.0 | 11.4 | 0.6 | 50.0 |
| | 11:54 AM | | | | | | |
| 7 | 11:55 AM | 30 | 210 | 12.0 | 11.4 | 0.6 | 50.0 |
| | 12:25 PM | | | | | | |
| 8 | 12:26 PM | 30 | 240 | 12.0 | 11.4 | 0.6 | 50.0 |
| | 12:56 PM | | | | | | |
| 9 | 12:57 PM | 30 | 270 | 12.0 | 11.4 | 0.6 | 50.0 |
| | 1:27 PM | | | | | | |
| 10 | 1:28 PM | 30 | 300 | 12.0 | 11.4 | 0.6 | 50.0 |
| | 1:58 PM | | | | | | |
| 11 | 1:59 PM | 30 | 330 | 12.0 | 11.4 | 0.6 | 50.0 |
| | 2:29 PM | | | | | | |
| 12 | 2:30 PM | 30 | 360 | 12.0 | 11.4 | 0.6 | 50.0 |
| | 3:00 PM | | | | | | |
| Infiltration Rate (in/hr): | | | 0.2 | | | | |
| Radius of test hole (in): | | | 4 | Figure A-52 | | | |
| Average Head (in): | | | 11.7 | | | | |

PERCOLATION TEST REPORT

| Project Name: | TTM 37731, TTM 37732, & TTM37733 | | | Project No.: | T2864-22-01 | | |
|---|----------------------------------|---------------------|--------------------------|-------------------------------|------------------------|---------------------------|-----------------------------|
| Test Hole No.: | P-3b | | | Date Excavated: | 5/1/2019 | | |
| Length of Test Pipe: | 32.4 inches | | | Soil Classification: | SC | | |
| Height of Pipe above Ground: | 10.8 inches | | | Presoak Date: | 5/2/2019 | | |
| Depth of Test Hole: | 21.6 inches | | | Perc Test Date: | 5/3/2019 | | |
| Check for Sandy Soil Criteria Tested by: | ATS | | | Percolation Tested by: | ATS | | |
| Water level measured from BOTTOM of hole | | | | | | | |
| Sandy Soil Criteria Test | | | | | | | |
| Trial No. | Time | Time Interval (min) | Total Elapsed Time (min) | Initial Water Level (in) | Final Water Level (in) | Δ in Water Level (inches) | Percolation Rate (min/inch) |
| 1 | 7:01 AM | 25 | 25 | 19.2 | 13.8 | 5.4 | 4.6 |
| | 7:26 AM | | | | | | |
| 2 | 7:27 AM | 25 | 50 | 19.2 | 15.0 | 4.2 | 6.0 |
| | 7:52 AM | | | | | | |
| Soil Criteria: Normal | | | | | | | |
| Percolation Test | | | | | | | |
| Reading No. | Time | Time Interval (min) | Total Elapsed Time (min) | Initial Water Level (in) | Final Water Level (in) | Δ in Water Level (inches) | Percolation Rate (min/inch) |
| 1 | 8:39 AM | 30 | 30 | 19.2 | 14.4 | 4.8 | 6.3 |
| | 9:09 AM | | | | | | |
| 2 | 9:10 AM | 30 | 60 | 19.2 | 15.0 | 4.2 | 7.1 |
| | 9:40 AM | | | | | | |
| 3 | 9:41 AM | 30 | 90 | 19.2 | 15.0 | 4.2 | 7.1 |
| | 10:11 AM | | | | | | |
| 4 | 10:12 AM | 30 | 120 | 19.2 | 14.4 | 4.8 | 6.3 |
| | 10:42 AM | | | | | | |
| 5 | 10:43 AM | 30 | 150 | 19.2 | 14.4 | 4.8 | 6.3 |
| | 11:13 AM | | | | | | |
| 6 | 11:14 AM | 30 | 180 | 19.2 | 15.0 | 4.2 | 7.1 |
| | 11:44 AM | | | | | | |
| 7 | 11:45 AM | 30 | 210 | 19.2 | 15.0 | 4.2 | 7.1 |
| | 12:15 PM | | | | | | |
| 8 | 12:16 PM | 30 | 240 | 19.2 | 14.4 | 4.8 | 6.3 |
| | 12:46 PM | | | | | | |
| 9 | 12:47 PM | 30 | 270 | 19.2 | 14.4 | 4.8 | 6.3 |
| | 1:17 PM | | | | | | |
| 10 | 1:18 PM | 30 | 300 | 19.2 | 15.0 | 4.2 | 7.1 |
| | 1:48 PM | | | | | | |
| 11 | 1:49 PM | 30 | 330 | 19.2 | 15.0 | 4.2 | 7.1 |
| | 2:19 PM | | | | | | |
| 12 | 2:20 PM | 30 | 360 | 19.2 | 15.0 | 4.2 | 7.1 |
| | 2:50 PM | | | | | | |
| Infiltration Rate (in/hr): | 0.9 | | | | | | |
| Radius of test hole (in): | 4 | | | | | | Figure A-53 |
| Average Head (in): | 17.1 | | | | | | |

| PERCOLATION TEST REPORT | | | | | | | |
|---|----------|----------------------------------|--------------------------|--------------------------|-----------------------------|-----------------------------------|-----------------------------|
| Project Name: | | TTM 37731, TTM 37732, & TTM37733 | | | Project No.: | | T2864-22-01 |
| Test Hole No.: | | P-4b | | | Date Excavated: | | 5/1/2019 |
| Length of Test Pipe: | | 27.6 inches | | | Soil Classification: | | SC |
| Height of Pipe above Ground: | | 3.6 inches | | | Presoak Date: | | 5/2/2019 |
| Depth of Test Hole: | | 24.0 inches | | | Perc Test Date: | | 5/3/2019 |
| Check for Sandy Soil Criteria Tested by: | | | | ATS | | Percolation Tested by: ATS | |
| Water level measured from BOTTOM of hole | | | | | | | |
| Sandy Soil Criteria Test | | | | | | | |
| Trial No. | Time | Time Interval (min) | Total Elapsed Time (min) | Initial Water Level (in) | Final Water Level (in) | Δ in Water Level (inches) | Percolation Rate (min/inch) |
| 1 | 7:08 AM | 25 | 25 | 19.2 | 16.2 | 3.0 | 8.3 |
| | 7:33 AM | | | | | | |
| 2 | 7:34 AM | 25 | 50 | 19.2 | 18.0 | 1.2 | 20.8 |
| | 7:59 AM | | | | | | |
| Soil Criteria: Normal | | | | | | | |
| Percolation Test | | | | | | | |
| Reading No. | Time | Time Interval (min) | Total Elapsed Time (min) | Initial Water Level (in) | Final Water Level (in) | Δ in Water Level (inches) | Percolation Rate (min/inch) |
| 1 | 8:44 AM | 30 | 30 | 19.2 | 18.0 | 1.2 | 25.0 |
| | 9:14 AM | | | | | | |
| 2 | 9:15 AM | 30 | 60 | 19.2 | 18.6 | 0.6 | 50.0 |
| | 9:45 AM | | | | | | |
| 3 | 9:46 AM | 30 | 90 | 19.2 | 18.6 | 0.6 | 50.0 |
| | 10:16 AM | | | | | | |
| 4 | 10:17 AM | 30 | 120 | 19.2 | 18.0 | 1.2 | 25.0 |
| | 10:47 AM | | | | | | |
| 5 | 10:48 AM | 30 | 150 | 19.2 | 18.6 | 0.6 | 50.0 |
| | 11:18 AM | | | | | | |
| 6 | 11:19 AM | 30 | 180 | 19.2 | 18.6 | 0.6 | 50.0 |
| | 11:49 AM | | | | | | |
| 7 | 11:50 AM | 30 | 210 | 19.2 | 18.6 | 0.6 | 50.0 |
| | 12:20 PM | | | | | | |
| 8 | 12:21 PM | 30 | 240 | 19.2 | 18.6 | 0.6 | 50.0 |
| | 12:51 PM | | | | | | |
| 9 | 12:52 PM | 30 | 270 | 19.2 | 18.6 | 0.6 | 50.0 |
| | 1:22 PM | | | | | | |
| 10 | 1:23 PM | 30 | 300 | 19.2 | 18.6 | 0.6 | 50.0 |
| | 1:53 PM | | | | | | |
| 11 | 1:54 PM | 30 | 330 | 19.2 | 18.6 | 0.6 | 50.0 |
| | 2:24 PM | | | | | | |
| 12 | 2:25 PM | 30 | 360 | 19.2 | 18.6 | 0.6 | 50.0 |
| | 2:55 PM | | | | | | |
| Infiltration Rate (in/hr): | | | 0.1 | | | | |
| Radius of test hole (in): | | | 4 | Figure A-54 | | | |
| Average Head (in): | | | 18.9 | | | | |

| PERCOLATION TEST REPORT | | | | | | | |
|---|----------|----------------------------------|--------------------------|--------------------------|-----------------------------|-----------------------------------|-----------------------------|
| Project Name: | | TTM 37731, TTM 37732, & TTM37733 | | | Project No.: | | T2864-22-01 |
| Test Hole No.: | | P-1c | | | Date Excavated: | | 5/1/2019 |
| Length of Test Pipe: | | 142.8 inches | | | Soil Classification: | | Kvt |
| Height of Pipe above Ground: | | 0.0 inches | | | Presoak Date: | | 5/1/2019 |
| Depth of Test Hole: | | 142.8 inches | | | Perc Test Date: | | 5/2/2019 |
| Check for Sandy Soil Criteria Tested by: | | | | ATS | | Percolation Tested by: ATS | |
| Water level measured from BOTTOM of hole | | | | | | | |
| Sandy Soil Criteria Test | | | | | | | |
| Trial No. | Time | Time Interval (min) | Total Elapsed Time (min) | Initial Water Level (in) | Final Water Level (in) | Δ in Water Level (inches) | Percolation Rate (min/inch) |
| 1 | 7:45 AM | 25 | 25 | 18.0 | 14.4 | 3.6 | 6.9 |
| | 8:10 AM | | | | | | |
| 2 | 8:11 AM | 25 | 50 | 18.0 | 15.6 | 2.4 | 10.4 |
| | 8:36 AM | | | | | | |
| Soil Criteria: Normal | | | | | | | |
| Percolation Test | | | | | | | |
| Reading No. | Time | Time Interval (min) | Total Elapsed Time (min) | Initial Water Level (in) | Final Water Level (in) | Δ in Water Level (inches) | Percolation Rate (min/inch) |
| 1 | 9:21 AM | 30 | 30 | 21.6 | 20.4 | 1.2 | 25.0 |
| | 9:51 AM | | | | | | |
| 2 | 9:52 AM | 30 | 60 | 21.6 | 20.4 | 1.2 | 25.0 |
| | 10:22 AM | | | | | | |
| 3 | 10:23 AM | 30 | 90 | 21.6 | 20.4 | 1.2 | 25.0 |
| | 10:53 AM | | | | | | |
| 4 | 10:54 AM | 30 | 120 | 21.6 | 21.0 | 0.6 | 50.0 |
| | 11:24 AM | | | | | | |
| 5 | 11:25 AM | 30 | 150 | 21.6 | 21.0 | 0.6 | 50.0 |
| | 11:55 AM | | | | | | |
| 6 | 11:56 AM | 30 | 180 | 21.6 | 21.0 | 0.6 | 50.0 |
| | 12:26 PM | | | | | | |
| 7 | 12:27 PM | 30 | 210 | 22.2 | 21.6 | 0.6 | 50.0 |
| | 12:57 PM | | | | | | |
| 8 | 12:58 PM | 30 | 240 | 21.6 | 21.0 | 0.6 | 50.0 |
| | 1:28 PM | | | | | | |
| 9 | 1:29 PM | 30 | 270 | 21.6 | 20.4 | 1.2 | 25.0 |
| | 1:59 PM | | | | | | |
| 10 | 2:00 PM | 30 | 300 | 21.6 | 21.0 | 0.6 | 50.0 |
| | 2:30 PM | | | | | | |
| 11 | 2:31 PM | 30 | 330 | 21.6 | 21.0 | 0.6 | 50.0 |
| | 3:01 PM | | | | | | |
| 12 | 3:02 PM | 30 | 360 | 21.6 | 21.0 | 0.6 | 50.0 |
| | 3:32 PM | | | | | | |
| Infiltration Rate (in/hr): | | | 0.1 | | | | |
| Radius of test hole (in): | | | 4 | Figure A-55 | | | |
| Average Head (in): | | | 21.3 | | | | |

| PERCOLATION TEST REPORT | | | | | | | |
|---|----------|----------------------------------|--------------------------|--------------------------|-----------------------------|-----------------------------------|-----------------------------|
| Project Name: | | TTM 37731, TTM 37732, & TTM37733 | | | Project No.: | | T2864-22-01 |
| Test Hole No.: | | P-2c | | | Date Excavated: | | 5/1/2019 |
| Length of Test Pipe: | | 154.8 inches | | | Soil Classification: | | Kvt |
| Height of Pipe above Ground: | | 0.0 inches | | | Presoak Date: | | 5/1/2019 |
| Depth of Test Hole: | | 154.8 inches | | | Perc Test Date: | | 5/2/2019 |
| Check for Sandy Soil Criteria Tested by: | | | | ATS | | Percolation Tested by: ATS | |
| Water level measured from BOTTOM of hole | | | | | | | |
| Sandy Soil Criteria Test | | | | | | | |
| Trial No. | Time | Time Interval (min) | Total Elapsed Time (min) | Initial Water Level (in) | Final Water Level (in) | Δ in Water Level (inches) | Percolation Rate (min/inch) |
| 1 | 7:40 AM | 25 | 25 | 24.0 | 20.4 | 3.6 | 6.9 |
| | 8:05 AM | | | | | | |
| 2 | 8:06 AM | 25 | 50 | 24.0 | 20.4 | 3.6 | 6.9 |
| | 8:31 AM | | | | | | |
| Soil Criteria: Normal | | | | | | | |
| Percolation Test | | | | | | | |
| Reading No. | Time | Time Interval (min) | Total Elapsed Time (min) | Initial Water Level (in) | Final Water Level (in) | Δ in Water Level (inches) | Percolation Rate (min/inch) |
| 1 | 9:18 AM | 30 | 30 | 24.0 | 21.6 | 2.4 | 12.5 |
| | 9:48 AM | | | | | | |
| 2 | 9:49 AM | 30 | 60 | 24.0 | 21.6 | 2.4 | 12.5 |
| | 10:19 AM | | | | | | |
| 3 | 10:20 AM | 30 | 90 | 24.0 | 21.6 | 2.4 | 12.5 |
| | 10:50 AM | | | | | | |
| 4 | 10:51 AM | 30 | 120 | 24.0 | 22.2 | 1.8 | 16.7 |
| | 11:21 AM | | | | | | |
| 5 | 11:22 AM | 30 | 150 | 24.0 | 22.2 | 1.8 | 16.7 |
| | 11:52 AM | | | | | | |
| 6 | 11:53 AM | 30 | 180 | 24.0 | 22.2 | 1.8 | 16.7 |
| | 12:23 PM | | | | | | |
| 7 | 12:24 PM | 30 | 210 | 24.6 | 22.8 | 1.8 | 16.7 |
| | 12:54 PM | | | | | | |
| 8 | 12:55 PM | 30 | 240 | 24.0 | 21.6 | 2.4 | 12.5 |
| | 1:25 PM | | | | | | |
| 9 | 1:26 PM | 30 | 270 | 25.2 | 24.0 | 1.2 | 25.0 |
| | 1:56 PM | | | | | | |
| 10 | 1:57 PM | 30 | 300 | 24.0 | 21.6 | 2.4 | 12.5 |
| | 2:27 PM | | | | | | |
| 11 | 2:28 PM | 30 | 330 | 24.0 | 21.6 | 2.4 | 12.5 |
| | 2:58 PM | | | | | | |
| 12 | 2:59 PM | 30 | 360 | 24.0 | 21.6 | 2.4 | 12.5 |
| | 3:29 PM | | | | | | |
| Infiltration Rate (in/hr): | | | 0.4 | | | | |
| Radius of test hole (in): | | | 4 | Figure A-56 | | | |
| Average Head (in): | | | 22.8 | | | | |

APPENDIX

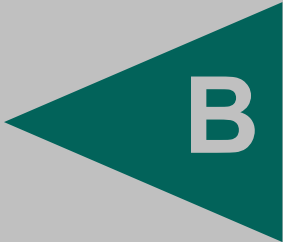

B

APPENDIX B

LABORATORY TESTING

Laboratory tests were performed in general accordance with test methods of ASTM International (ASTM), Caltrans test methods, or other suggested procedures. Selected samples were tested to evaluate maximum dry density and optimum moisture content, expansion index, plasticity, corrosivity, consolidation characteristics, grain size distribution, R-value, remolded and in-situ shear strength properties, and in-situ moisture and density content. The results of our laboratory tests are presented on Figures B-1 through B-16. The in-place dry density and moisture content of the samples tested are presented on the boring and test pit logs in *Appendix A*.

**SUMMARY OF LABORATORY MAXIMUM DRY DENSITY
AND OPTIMUM MOISTURE CONTENT TEST RESULTS
ASTM D1557**

| Sample No. | Description | Maximum Dry Density (pcf) | Optimum Moisture Content (% of dry wt.) |
|---------------|--|---------------------------|---|
| B-1a @ 0-5' | Silty, Clayey SAND (SC-SM), grayish brown | 132.0 | 9.0 |
| TP-2a @ 3½-4' | Poorly-graded SAND with gravel (SP), reddish brown | 129.0 | 9.0 |
| B-1c @ 0-5' | Silty SAND (SM), yellowish brown | 133.5 | 8.0 |

*Samples combined

**SUMMARY OF LABORATORY R-VALUE TEST RESULTS
ASTM D2844**

| Sample No. | R-Value |
|-------------|---------|
| B-1b @ 0-5' | 18 |

| | | |
|--|--|---|
| GEOCON WEST, INC. | |  |
| GEOTECHNICAL ENVIRONMENTAL MATERIALS 41571 CORNING PLACE, SUITE 101, MURRIETA, CA 92562-7065 PHONE 951-304-2300 FAX 951-304-2392 | | |
| ATS | | |

| | | |
|---|-------------------------|---------|
| LABORATORY TEST RESULTS | | |
| TTM 37731, TTM 37732, AND TTM 37733 COLE AVENUE, BARTON STREET, AND OBSIDIAN DRIVE RIVERSIDE, CALIFORNIA | | |
| MAY 2019 | PROJECT NO. T2864-22-01 | FIG B-1 |

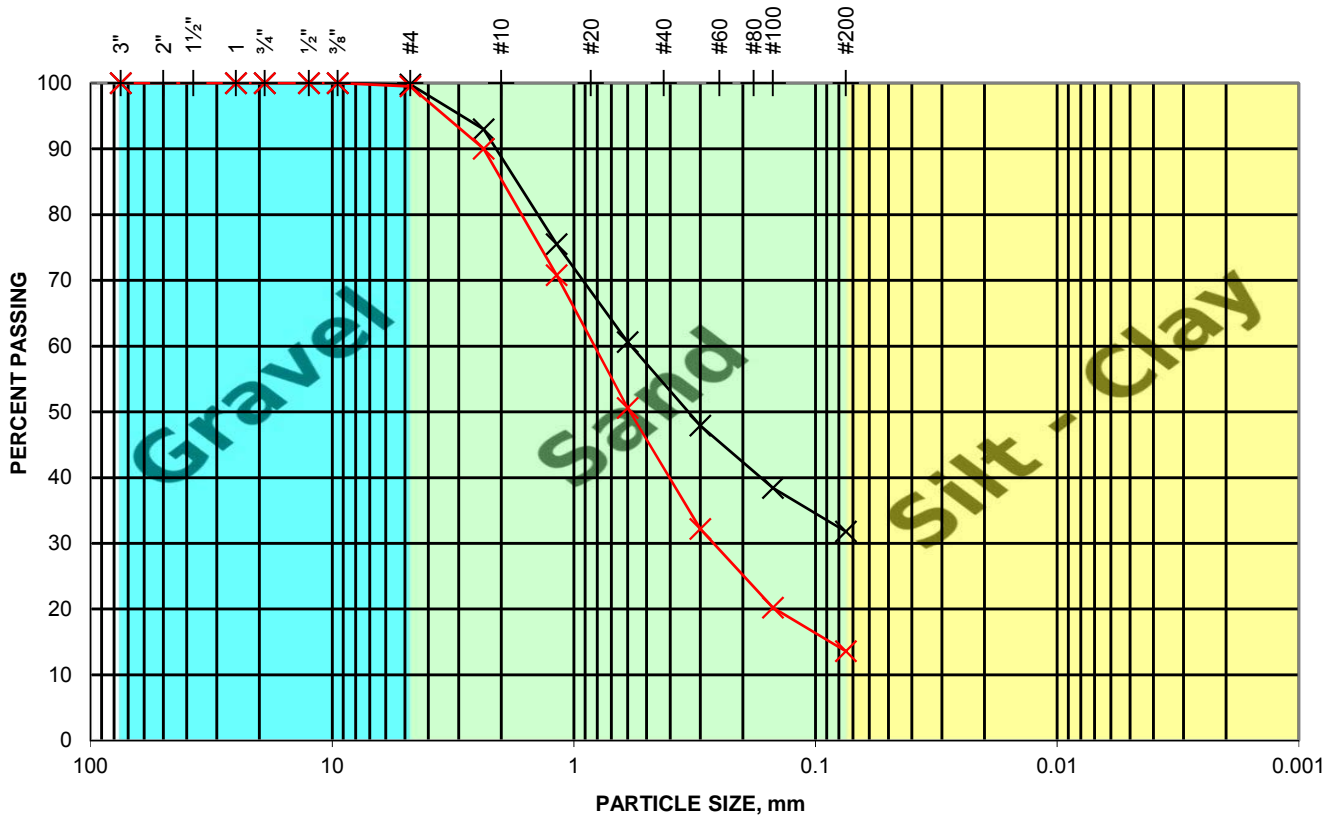

| SAMPLE ID | SAMPLE DESCRIPTION |
|-------------|---|
| P-2a @ 2-3' | Silty SAND (SM) |
| P-3a @ 4-5' | Silty SAND (SM) - derived from bedrock material |

GEOCON
WEST, INC.
GEOTECHNICAL ENVIRONMENTAL MATERIALS
41571 CORNING PLACE, SUITE 101, MURRIETA, CA 92562-7065
PHONE 951-304-2300 FAX 951-304-2392



ATS

GRAIN SIZE DISTRIBUTION

TTM 37731, TTM 37732, AND TTM 37733
COLE AVENUE, BARTON STREET, AND
OBSIDIAN DRIVE
RIVERSIDE, CALIFORNIA

MAY 2019

PROJECT NO. T2864-22-01

FIG B-2

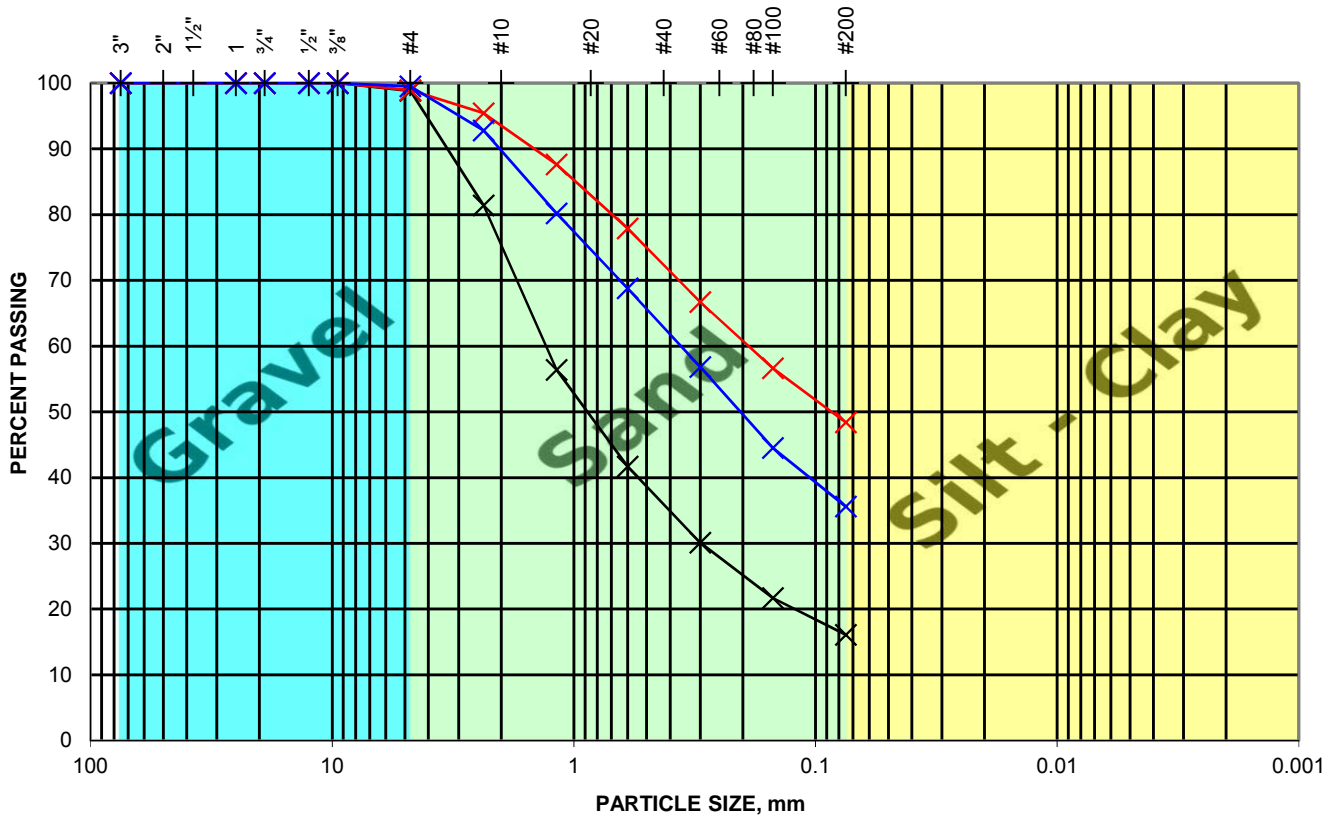

| SAMPLE ID | SAMPLE DESCRIPTION |
|---------------|---|
| P-1b @ 1-2' | Silty SAND (SM) |
| P-3b @ 1-2' | Clayey SAND (SC) |
| P-1c @ 11-12' | Silty SAND (SM) - derived from bedrock material |

GEOCON
WEST, INC.
GEOTECHNICAL ENVIRONMENTAL MATERIALS
41571 CORNING PLACE, SUITE 101, MURRIETA, CA 92562-7065
PHONE 951-304-2300 FAX 951-304-2392



ATS

GRAIN SIZE DISTRIBUTION

TTM 37731, TTM 37732, AND TTM 37733
COLE AVENUE, BARTON STREET, AND
OBSIDIAN DRIVE
RIVERSIDE, CALIFORNIA

MAY 2019

PROJECT NO. T2864-22-01

FIG B-3

B-4b @ 0-5'

| MOLDED SPECIMEN | | BEFORE TEST | AFTER TEST |
|-------------------------|--------------------|-------------|------------|
| Specimen Diameter | (in.) | 4.0 | 4.0 |
| Specimen Height | (in.) | 1.0 | 1.0 |
| Wt. Comp. Soil + Mold | (gm) | 611.0 | 655.3 |
| Wt. of Mold | (gm) | 197.7 | 197.7 |
| Specific Gravity | (Assumed) | 2.7 | 2.7 |
| Wet Wt. of Soil + Cont. | (gm) | 558.5 | 655.3 |
| Dry Wt. of Soil + Cont. | (gm) | 535.3 | 381.3 |
| Wt. of Container | (gm) | 258.5 | 197.7 |
| Moisture Content | (%) | 8.4 | 20.0 |
| Wet Density | (pcf) | 124.7 | 137.9 |
| Dry Density | (pcf) | 115.0 | 114.9 |
| Void Ratio | | 0.5 | 0.4 |
| Total Porosity | | 0.3 | 0.3 |
| Pore Volume | (cc) | 65.8 | 59.4 |
| Degree of Saturation | (%) [S_{meas}] | 49.1 | 128.6 |

| Date | Time | Pressure (psi) | Elapsed Time (min) | Dial Readings (in.) |
|-------------------------------------|-------|----------------|--------------------|---------------------|
| 5/3/2019 | 10:00 | 1.0 | 0 | 0.4009 |
| 5/3/2019 | 10:10 | 1.0 | 10 | 0.401 |
| Add Distilled Water to the Specimen | | | | |
| 5/4/2019 | 10:00 | 1.0 | 1430 | 0.469 |
| 5/4/2019 | 11:00 | 1.0 | 1490 | 0.469 |

| | |
|------------------------------|-----------|
| Expansion Index (EI meas) = | 68 |
| Expansion Index (Report) = | 68 |

| Expansion Index, EI_{50} | CBC CLASSIFICATION * | UBC CLASSIFICATION ** |
|----------------------------|----------------------|-----------------------|
| 0-20 | Non-Expansive | Very Low |
| 21-50 | Expansive | Low |
| 51-90 | Expansive | Medium |
| 91-130 | Expansive | High |
| >130 | Expansive | Very High |

* Reference: 2016 California Building Code, Section 1803.5.3

** Reference: 1997 Uniform Building Code, Table 18-I-B.

| | | |
|--|-------------------------------------|--|
|  GEOCON | EXPANSION INDEX TEST RESULTS | Project No.: T2864-22-01 |
| | ASTM D 4829 | TTM 37731, TTM 37732, and TTM 37733 COLE AVE, BARTON ST, AND OBSIDIAN DR RIVERSIDE, CALIFORNIA |
| | Checked by: AT5 | MAY 2019 Figure B-5 |

B-2c @ 0-5'

| MOLDED SPECIMEN | BEFORE TEST | AFTER TEST |
|---|-------------|------------|
| Specimen Diameter (in.) | 4.0 | 4.0 |
| Specimen Height (in.) | 1.0 | 0.9 |
| Wt. Comp. Soil + Mold (gm) | 595.3 | 639.1 |
| Wt. of Mold (gm) | 200.4 | 200.4 |
| Specific Gravity (Assumed) | 2.7 | 2.7 |
| Wet Wt. of Soil + Cont. (gm) | 556.7 | 639.1 |
| Dry Wt. of Soil + Cont. (gm) | 529.4 | 359.0 |
| Wt. of Container (gm) | 256.7 | 200.4 |
| Moisture Content (%) | 10.0 | 22.2 |
| Wet Density (pcf) | 119.1 | 132.2 |
| Dry Density (pcf) | 108.3 | 108.2 |
| Void Ratio | 0.6 | 0.5 |
| Total Porosity | 0.4 | 0.3 |
| Pore Volume (cc) | 74.0 | 60.0 |
| Degree of Saturation (%) [S_{meas}] | 48.9 | 132.9 |

| Date | Time | Pressure (psi) | Elapsed Time (min) | Dial Readings (in.) |
|-------------------------------------|-------|----------------|--------------------|---------------------|
| 5/3/2019 | 10:00 | 1.0 | 0 | 0.3825 |
| 5/3/2019 | 10:10 | 1.0 | 10 | 0.3821 |
| Add Distilled Water to the Specimen | | | | |
| 5/4/2019 | 10:00 | 1.0 | 1430 | 0.4321 |
| 5/4/2019 | 11:00 | 1.0 | 1490 | 0.4321 |

| | |
|------------------------------|-----------|
| Expansion Index (EI meas) = | 50 |
| Expansion Index (Report) = | 50 |

| Expansion Index, EI_{50} | CBC CLASSIFICATION * | UBC CLASSIFICATION ** |
|----------------------------|----------------------|-----------------------|
| 0-20 | Non-Expansive | Very Low |
| 21-50 | Expansive | Low |
| 51-90 | Expansive | Medium |
| 91-130 | Expansive | High |
| >130 | Expansive | Very High |

* Reference: 2016 California Building Code, Section 1803.5.3

** Reference: 1997 Uniform Building Code, Table 18-I-B.

| | | |
|--|--|--|
|  GEOCON | EXPANSION INDEX TEST RESULTS ASTM D 4829 | Project No.: T2864-22-01 TTM 37731, TTM 37732, and TTM 37733 COLE AVE, BARTON ST, AND OBSIDIAN DR RIVERSIDE, CALIFORNIA |
| | Checked by: ATS | MAY 2019 |

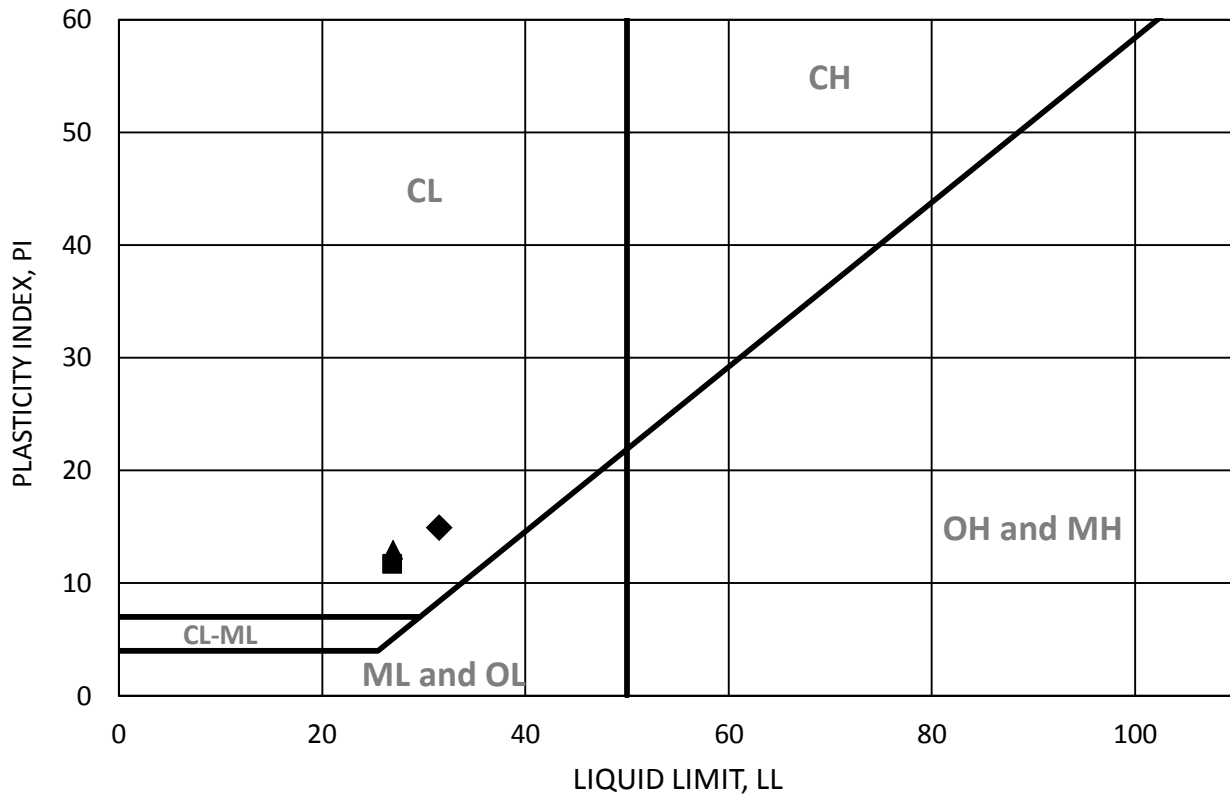

| SYMBOL | BORING | DEPTH (ft) | LL | PL | PI | MOISTURE CONTENT AT SATURATION | SOIL BEHAVIOR |
|--------|--------|------------|----|----|----|--------------------------------|---------------|
| ■ | B-2a | 0-5' | 27 | 15 | 12 | | CL |
| ◆ | B-2c | 0-5' | 32 | 17 | 15 | | CL |
| ▲ | B-4b | 0-5' | 27 | 14 | 13 | | CL |
| ● | | | | | | | |
| □ | | | | | | | |
| ◇ | | | | | | | |
| △ | | | | | | | |
| ○ | | | | | | | |



ATTERBERG LIMITS

ASTM D-4318

Checked by: **ATS**

Project No.: **T2864-22-01**
 TTM 37731, TTM 37732, and TTM 37733
 COLE AVE, BARTON ST, AND OBSIDIAN DR
 RIVERSIDE, CALIFORNIA

MAY 2019

Figure B-7

SUMMARY OF LABORATORY WATER SOLUBLE SULFATE TEST RESULTS
CALIFORNIA TEST NO. 417

| Sample No. | Water Soluble Sulfate (% SO ₄) | Sulfate Exposure* |
|-------------|---|-------------------|
| B-4b @ 0-5' | 0.029 | S0 |
| B-2a @ 0-5' | 0.053 | S0 |
| B-2c @ 0-5' | 0.015 | S0 |

| | | |
|---|---------------------------------|--|
|  | CORROSIVITY TEST RESULTS | Project No.: T2864-22-01 |
| | Checked by: ATS | TTM 37731, TTM 37732, and TTM 37733 COLE AVE, BARTON ST, AND OBSIDIAN DR RIVERSIDE, CALIFORNIA |
| | | MAY 2019 Figure B-8 |

SUMMARY OF LABORATORY CHLORIDE CONTENT TEST RESULTS
EPA NO. 325.3

| Sample No. | Chloride Ion Content (%) |
|-------------|--------------------------|
| B-2a @ 0-5' | 0.039 |
| B-2c @ 0-5' | 0.021 |
| B-4b @ 0-5' | 0.014 |

| | | |
|--|---------------------------------|--|
|  GEOCON | CORROSIVITY TEST RESULTS | Project No.: T2864-22-01 |
| | Checked by: ATS | TTM 37731, TTM 37732, and TTM 37733 COLE AVE, BARTON ST, AND OBSIDIAN DR RIVERSIDE, CALIFORNIA |
| | | MAY 2019 |

SUMMARY OF LABORATORY POTENTIAL
OF HYDROGEN (pH) AND RESISTIVITY TEST RESULTS
CALIFORNIA TEST NO. 643

| Sample No. | pH | Resistivity (ohm centimeters) |
|-------------|-----|----------------------------------|
| B-4a @ 0-5' | 7.0 | 900 (Severely Corrosive) |
| B-2a @ 0-5' | 7.5 | 730 (Severely Corrosive) |
| B-2c @ 0-5' | 6.6 | 100 (Severely Corrosive) |

| | | |
|--|---------------------------------|--|
|  GEOCON | CORROSIVITY TEST RESULTS | Project No.: T2864-22-01 |
| | Checked by: ATS | TTM 37731, TTM 37732, and TTM 37733 COLE AVE, BARTON ST, AND OBSIDIAN DR RIVERSIDE, CALIFORNIA |
| | | MAY 2019 |

WATER ADDED AT 2.0 KSF

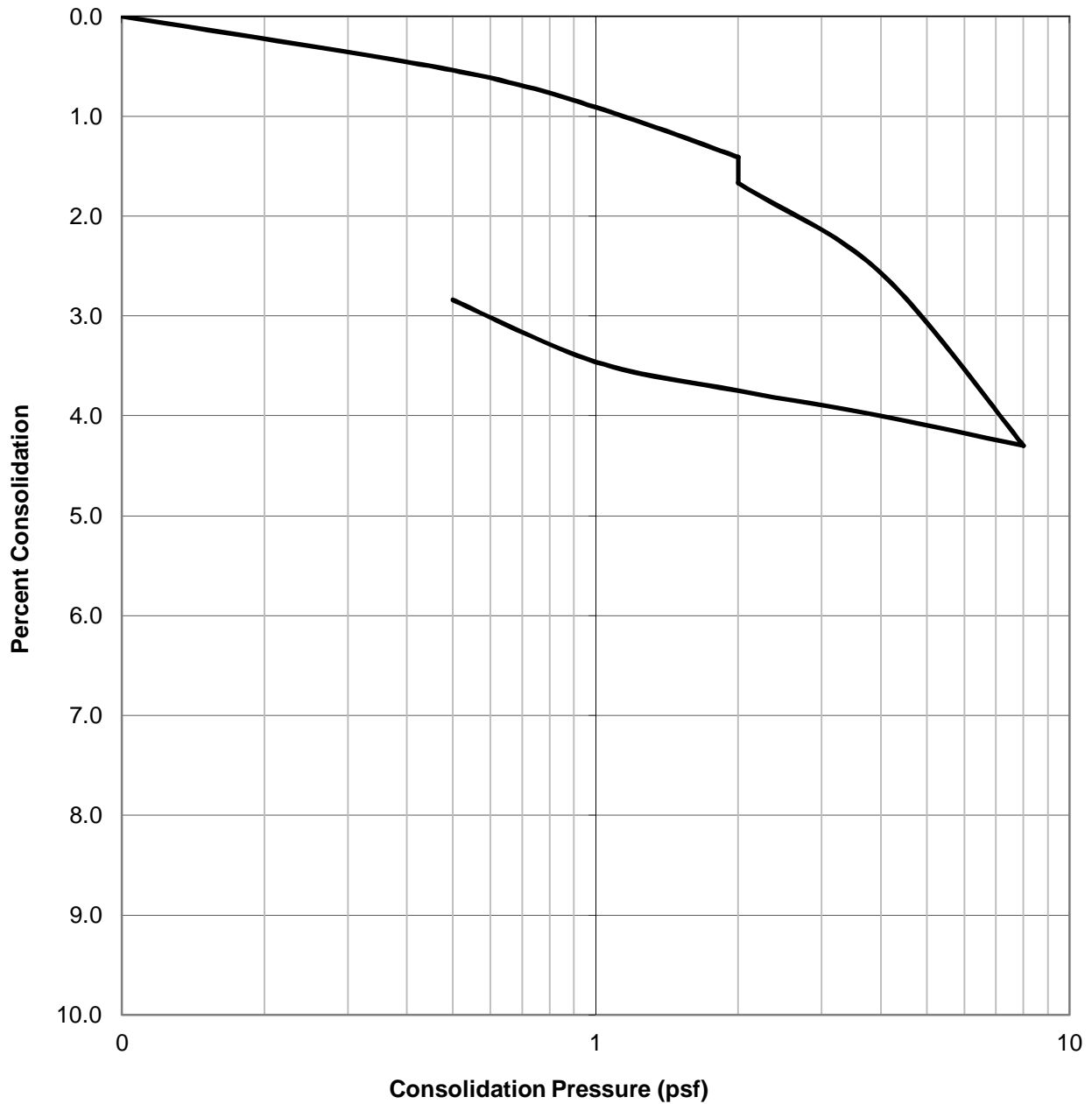

| SAMPLE ID. | SOIL TYPE | DRY DENSITY (PCF) | INITIAL MOISTURE (%) | FINAL MOISTURE (%) |
|-------------|-----------------|-------------------|----------------------|--------------------|
| B-1c @ 2.5' | Silty SAND (SM) | 119.5 | 9.4 | 14.0 |



CONSOLIDATION TEST RESULTS

ASTM D-2435

Checked by: ATS

Project No.: T2864-22-01

TTM 37731, TTM 37732, and TTM 37733
 COLE AVE, BARTON ST, AND OBSIDIAN DR
 RIVERSIDE, CALIFORNIA

MAY 2019

Figure B-11

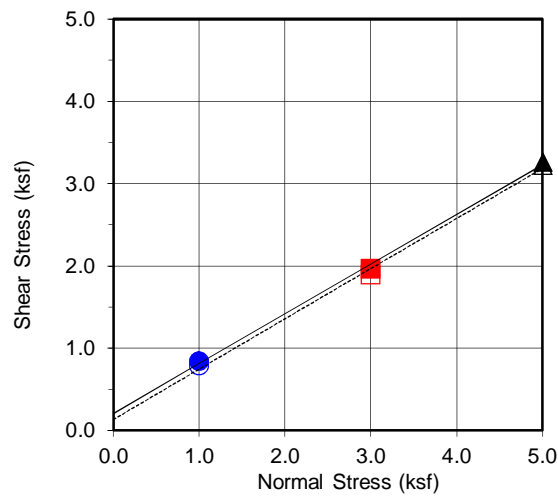
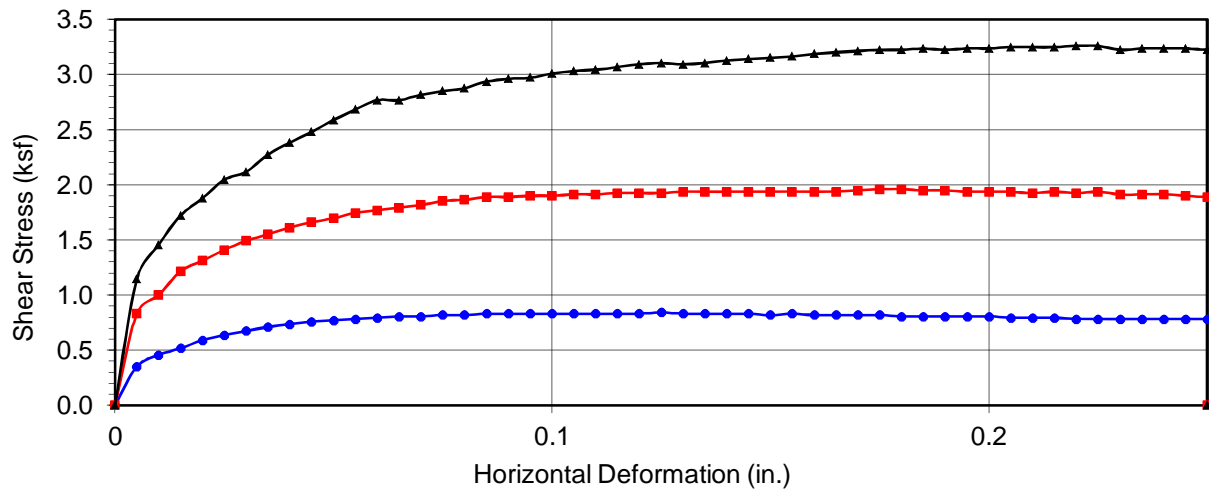

| | |
|---------------------|--------------------|
| Boring No. | B-1a |
| Sample No. | B-1a @ 0-5' |
| Depth (ft) | 0-5' |
| <u>Sample Type:</u> | Ring |

| | | |
|-----------------------------|---------|-----------------------|
| <u>Soil Identification:</u> | | |
| Silty, Clayey SAND (SC-SM) | | |
| Strength Parameters | | |
| | C (psf) | ϕ ($^{\circ}$) |
| Peak | 208 | 31.1 |
| Ultimate | 134 | 31.4 |

| | | | |
|--|--------|--------|--------|
| Normal Stress (kip/ft ²) | 1 | 3 | 5 |
| Peak Shear Stress (kip/ft ²) | ● 0.84 | ■ 1.96 | ▲ 3.26 |
| Shear Stress @ End of Test (ksf) | ○ 0.78 | □ 1.89 | △ 3.22 |
| Deformation Rate (in./min.) | 0.05 | 0.05 | 0.05 |
| Initial Sample Height (in.) | 1.0 | 1.0 | 1.0 |
| Ring Inside Diameter (in.) | 2.375 | 2.375 | 2.375 |
| Initial Moisture Content (%) | 8.9 | 9.0 | 8.9 |
| Initial Dry Density (pcf) | 118.8 | 118.8 | 118.8 |
| Initial Degree of Saturation (%) | 57.4 | 58.0 | 57.4 |
| Soil Height Before Shearing (in.) | 1.2 | 1.2 | 1.2 |
| Final Moisture Content (%) | 14.3 | 12.7 | 11.6 |



DIRECT SHEAR TEST RESULTS

Consolidated Drained ASTM D-3080

Checked by: ATS

Project No.: T2864-22-01

TTM 37731, TTM 37732, and TTM 37733
 COLE AVE, BARTON ST, AND OBSIDIAN DR
 RIVERSIDE, CALIFORNIA

MAY 2019

Figure B-12

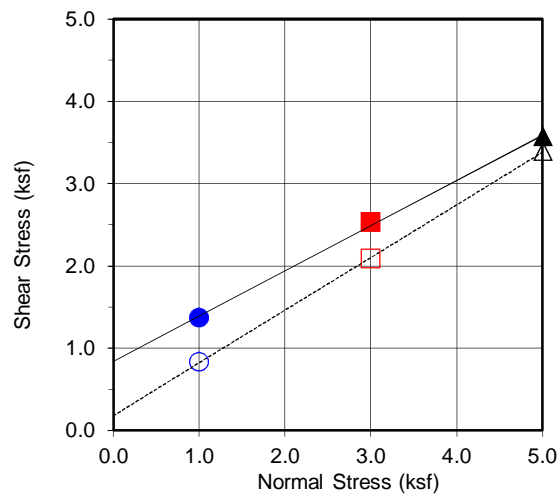
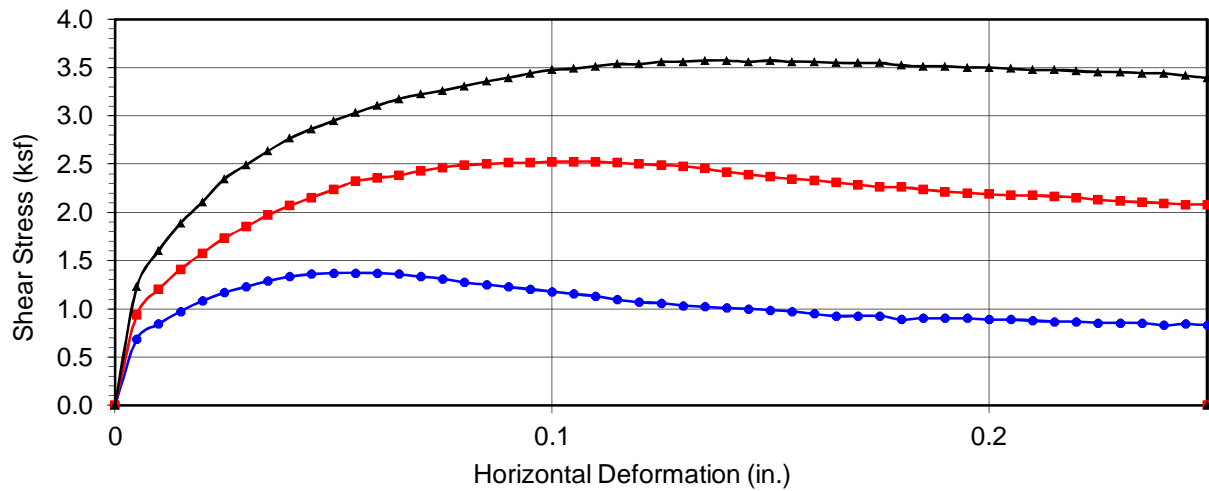

| | |
|---------------------|--------------------|
| Boring No. | B-2a |
| Sample No. | B-2a @ 2.5' |
| Depth (ft) | 2.5' |
| <u>Sample Type:</u> | Ring |

| | | |
|-----------------------------|---------|-----------------------|
| <u>Soil Identification:</u> | | |
| Clayey SAND (SC) | | |
| Strength Parameters | | |
| | C (psf) | ϕ ($^{\circ}$) |
| Peak | 839 | 28.8 |
| Ultimate | 180 | 32.6 |

| | | | |
|--|--------|--------|--------|
| Normal Stress (kip/ft ²) | 1 | 3 | 5 |
| Peak Shear Stress (kip/ft ²) | ● 1.37 | ■ 2.53 | ▲ 3.57 |
| Shear Stress @ End of Test (ksf) | ○ 0.83 | □ 2.08 | △ 3.39 |
| Deformation Rate (in./min.) | 0.05 | 0.05 | 0.05 |
| Initial Sample Height (in.) | 1.0 | 1.0 | 1.0 |
| Ring Inside Diameter (in.) | 2.375 | 2.375 | 2.375 |
| Initial Moisture Content (%) | 14.0 | 15.2 | 15.3 |
| Initial Dry Density (pcf) | 121.1 | 118.2 | 118.4 |
| Initial Degree of Saturation (%) | 96.1 | 96.4 | 97.8 |
| Soil Height Before Shearing (in.) | 1.2 | 1.2 | 1.2 |
| Final Moisture Content (%) | 15.6 | 16.4 | 15.3 |



DIRECT SHEAR TEST RESULTS

Consolidated Drained ASTM D-3080

Checked by: ATS

Project No.: T2864-22-01

TTM 37731, TTM 37732, and TTM 37733
 COLE AVE, BARTON ST, AND OBSIDIAN DR
 RIVERSIDE, CALIFORNIA

MAY 2019

Figure B-13

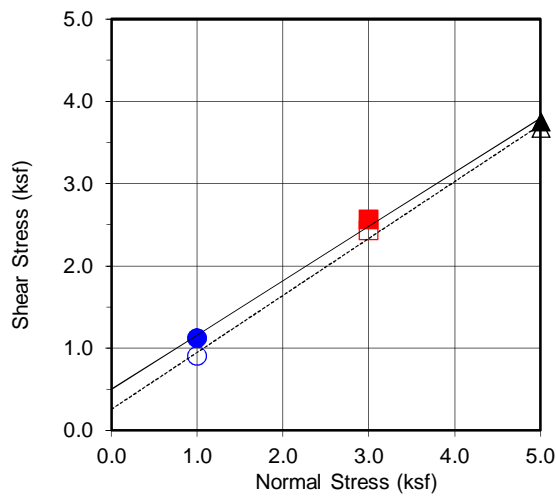
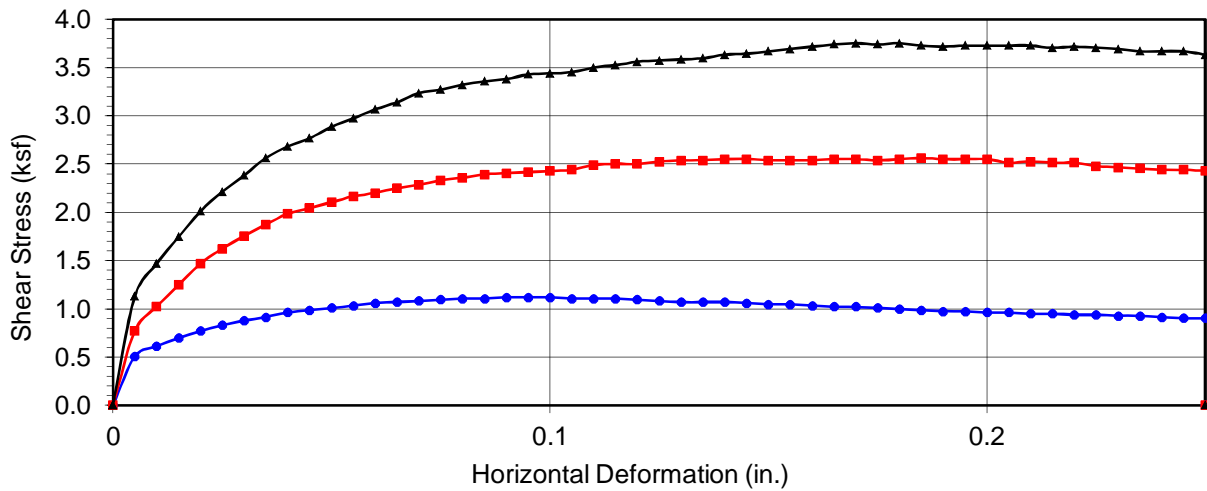

| | |
|---------------------|---------------|
| Boring No. | TP-2a |
| Sample No. | TP-2a @ 3.5-4 |
| Depth (ft) | 3.5-4 |
| Sample Type: | Ring |

| | | |
|-------------------------------------|---------|-----------------------|
| Soil Identification: | | |
| Poorly-graded SAND with gravel (SP) | | |
| Strength Parameters | | |
| | C (psf) | ϕ ($^{\circ}$) |
| Peak | 503 | 33.4 |
| Ultimate | 258 | 34.7 |

| | | | |
|--|--------|--------|--------|
| Normal Stress (kip/ft ²) | 1 | 3 | 5 |
| Peak Shear Stress (kip/ft ²) | ● 1.12 | ■ 2.56 | ▲ 3.75 |
| Shear Stress @ End of Test (ksf) | ○ 0.90 | □ 2.43 | △ 3.67 |
| Deformation Rate (in./min.) | 0.05 | 0.05 | 0.05 |
| Initial Sample Height (in.) | 1.0 | 1.0 | 1.0 |
| Ring Inside Diameter (in.) | 2.375 | 2.375 | 2.375 |
| Initial Moisture Content (%) | 9.0 | 8.9 | 8.9 |
| Initial Dry Density (pcf) | 116.1 | 116.1 | 116.1 |
| Initial Degree of Saturation (%) | 53.5 | 53.0 | 53.1 |
| Soil Height Before Shearing (in.) | 1.2 | 1.2 | 1.2 |
| Final Moisture Content (%) | 13.5 | 13.6 | 13.0 |



DIRECT SHEAR TEST RESULTS

Consolidated Drained ASTM D-3080

Checked by: ATS

Project No.: T2864-22-01

TTM 37731, TTM 37732, and TTM 37733
 COLE AVE, BARTON ST, AND OBSIDIAN DR
 RIVERSIDE, CALIFORNIA

MAY 2019

Figure B-14

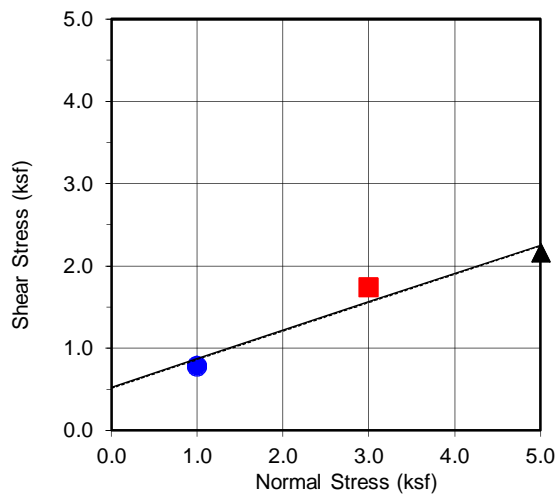
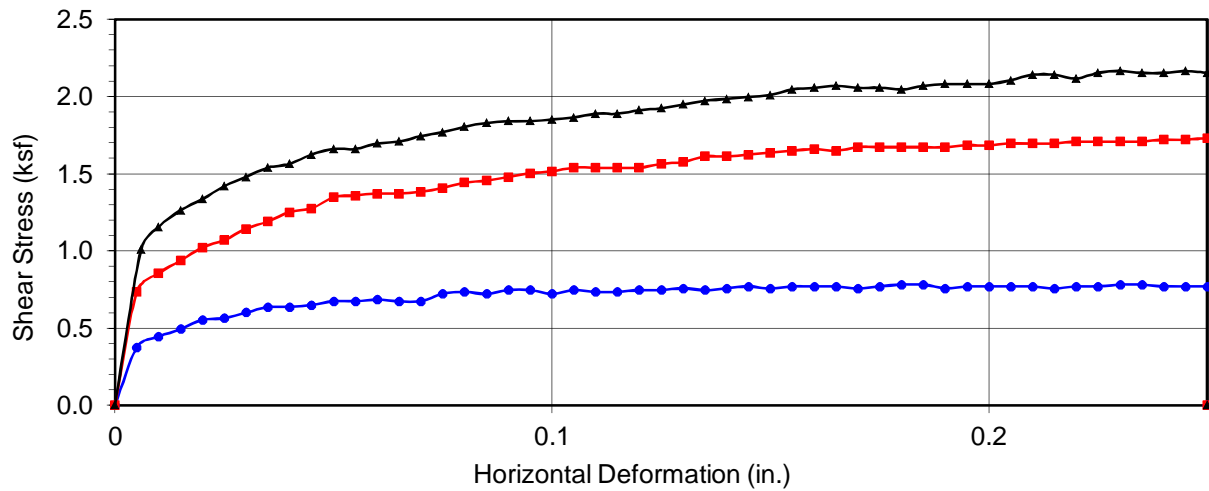

| | |
|---------------------|--------------------|
| Boring No. | B-4b |
| Sample No. | B-4b @ 2.5' |
| Depth (ft) | 2.5' |
| Sample Type: | Ring |

| | | |
|-----------------------------|---------|-----------------------|
| Soil Identification: | | |
| Sandy CLAY (CL) | | |
| Strength Parameters | | |
| | C (psf) | ϕ ($^{\circ}$) |
| Peak | 522 | 19.1 |
| Ultimate | 514 | 19.1 |

| | | | |
|--|--------|--------|--------|
| Normal Stress (kip/ft ²) | 1 | 3 | 5 |
| Peak Shear Stress (kip/ft ²) | ● 0.78 | ■ 1.73 | ▲ 2.17 |
| Shear Stress @ End of Test (ksf) | ○ 0.77 | □ 1.73 | △ 2.15 |
| Deformation Rate (in./min.) | 0.05 | 0.05 | 0.05 |
| Initial Sample Height (in.) | 1.0 | 1.0 | 1.0 |
| Ring Inside Diameter (in.) | 2.375 | 2.375 | 2.375 |
| Initial Moisture Content (%) | 13.0 | 12.9 | 13.4 |
| Initial Dry Density (pcf) | 121.9 | 121.7 | 121.7 |
| Initial Degree of Saturation (%) | 91.3 | 90.4 | 93.9 |
| Soil Height Before Shearing (in.) | 1.2 | 1.2 | 1.2 |
| Final Moisture Content (%) | 19.0 | 16.4 | 16.7 |



DIRECT SHEAR TEST RESULTS

Consolidated Drained ASTM D-3080

Checked by: ATS

Project No.: T2864-22-01

TTM 37731, TTM 37732, and TTM 37733
 COLE AVE, BARTON ST, AND OBSIDIAN DR
 RIVERSIDE, CALIFORNIA

MAY 2019

Figure B-15

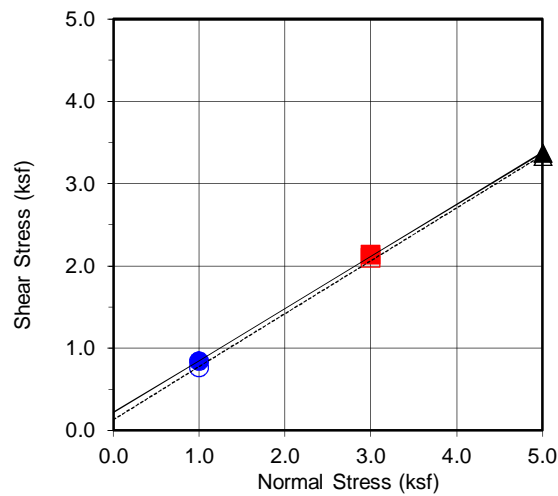
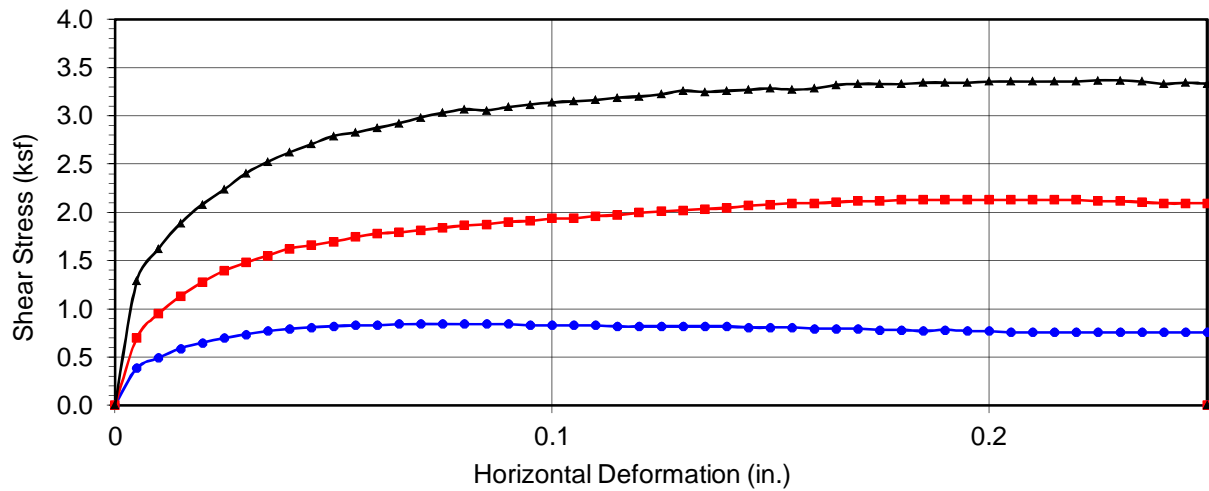

| | |
|---------------------|--------------------|
| Boring No. | B-1c |
| Sample No. | B-1c @ 0-5' |
| Depth (ft) | 0-5' |
| <u>Sample Type:</u> | Ring |

| | | |
|-----------------------------|---------|-----------------------|
| <u>Soil Identification:</u> | | |
| Silty SAND (SM) | | |
| Strength Parameters | | |
| | C (psf) | ϕ ($^{\circ}$) |
| Peak | 218 | 32.3 |
| Ultimate | 131 | 32.8 |

| | | | |
|--|--------|--------|--------|
| Normal Stress (kip/ft ²) | 1 | 3 | 5 |
| Peak Shear Stress (kip/ft ²) | ● 0.84 | ■ 2.13 | ▲ 3.37 |
| Shear Stress @ End of Test (ksf) | ○ 0.76 | □ 2.09 | △ 3.33 |
| Deformation Rate (in./min.) | 0.05 | 0.05 | 0.05 |
| Initial Sample Height (in.) | 1.0 | 1.0 | 1.0 |
| Ring Inside Diameter (in.) | 2.375 | 2.375 | 2.375 |
| Initial Moisture Content (%) | 7.9 | 7.9 | 8.0 |
| Initial Dry Density (pcf) | 120.1 | 120.1 | 120.1 |
| Initial Degree of Saturation (%) | 52.7 | 53.0 | 53.3 |
| Soil Height Before Shearing (in.) | 1.2 | 1.2 | 1.2 |
| Final Moisture Content (%) | 10.3 | 11.5 | 10.5 |



DIRECT SHEAR TEST RESULTS

Consolidated Drained ASTM D-3080

Checked by: ATS

Project No.: T2864-22-01

TTM 37731, TTM 37732, and TTM 37733
 COLE AVE, BARTON ST, AND OBSIDIAN DR
 RIVERSIDE, CALIFORNIA

MAY 2019

Figure B-16

APPENDIX

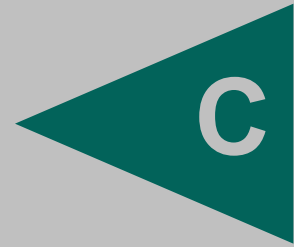

APPENDIX C

RECOMMENDED GRADING SPECIFICATIONS

FOR

TTM 37731, TTM 37732, AND TTM 37733
COLE AVENUE, BARTON STREET, AND OBSIDIAN DRIVE
RIVERSIDE, CALIFORNIA

PROJECT NO. T2864-22-01

RECOMMENDED GRADING SPECIFICATIONS

1. GENERAL

- 1.1 These Recommended Grading Specifications shall be used in conjunction with the Geotechnical Report for the project prepared by Geocon. The recommendations contained in the text of the Geotechnical Report are a part of the earthwork and grading specifications and shall supersede the provisions contained hereinafter in the case of conflict.
- 1.2 Prior to the commencement of grading, a geotechnical consultant (Consultant) shall be employed for the purpose of observing earthwork procedures and testing the fills for substantial conformance with the recommendations of the Geotechnical Report and these specifications. The Consultant should provide adequate testing and observation services so that they may assess whether, in their opinion, the work was performed in substantial conformance with these specifications. It shall be the responsibility of the Contractor to assist the Consultant and keep them apprised of work schedules and changes so that personnel may be scheduled accordingly.
- 1.3 It shall be the sole responsibility of the Contractor to provide adequate equipment and methods to accomplish the work in accordance with applicable grading codes or agency ordinances, these specifications and the approved grading plans. If, in the opinion of the Consultant, unsatisfactory conditions such as questionable soil materials, poor moisture condition, inadequate compaction, and/or adverse weather result in a quality of work not in conformance with these specifications, the Consultant will be empowered to reject the work and recommend to the Owner that grading be stopped until the unacceptable conditions are corrected.

2. DEFINITIONS

- 2.1 **Owner** shall refer to the owner of the property or the entity on whose behalf the grading work is being performed and who has contracted with the Contractor to have grading performed.
- 2.2 **Contractor** shall refer to the Contractor performing the site grading work.
- 2.3 **Civil Engineer** or **Engineer of Work** shall refer to the California licensed Civil Engineer or consulting firm responsible for preparation of the grading plans, surveying and verifying as-graded topography.
- 2.4 **Consultant** shall refer to the soil engineering and engineering geology consulting firm retained to provide geotechnical services for the project.

- 2.5 **Soil Engineer** shall refer to a California licensed Civil Engineer retained by the Owner, who is experienced in the practice of geotechnical engineering. The Soil Engineer shall be responsible for having qualified representatives on-site to observe and test the Contractor's work for conformance with these specifications.
- 2.6 **Engineering Geologist** shall refer to a California licensed Engineering Geologist retained by the Owner to provide geologic observations and recommendations during the site grading.
- 2.7 **Geotechnical Report** shall refer to a soil report (including all addenda) which may include a geologic reconnaissance or geologic investigation that was prepared specifically for the development of the project for which these Recommended Grading Specifications are intended to apply.

3. MATERIALS

- 3.1 Materials for compacted fill shall consist of any soil excavated from the cut areas or imported to the site that, in the opinion of the Consultant, is suitable for use in construction of fills. In general, fill materials can be classified as *soil* fills, *soil-rock* fills or *rock* fills, as defined below.
- 3.1.1 **Soil fills** are defined as fills containing no rocks or hard lumps greater than 12 inches in maximum dimension and containing at least 40 percent by weight of material smaller than $\frac{3}{4}$ inch in size.
- 3.1.2 **Soil-rock fills** are defined as fills containing no rocks or hard lumps larger than 4 feet in maximum dimension and containing a sufficient matrix of soil fill to allow for proper compaction of soil fill around the rock fragments or hard lumps as specified in Paragraph 6.2. **Oversize rock** is defined as material greater than 12 inches.
- 3.1.3 **Rock fills** are defined as fills containing no rocks or hard lumps larger than 3 feet in maximum dimension and containing little or no fines. Fines are defined as material smaller than $\frac{3}{4}$ inch in maximum dimension. The quantity of fines shall be less than approximately 20 percent of the rock fill quantity.
- 3.2 Material of a perishable, spongy, or otherwise unsuitable nature as determined by the Consultant shall not be used in fills.
- 3.3 Materials used for fill, either imported or on-site, shall not contain hazardous materials as defined by the California Code of Regulations, Title 22, Division 4, Chapter 30, Articles 9

and 10; 40CFR; and any other applicable local, state or federal laws. The Consultant shall not be responsible for the identification or analysis of the potential presence of hazardous materials. However, if observations, odors or soil discoloration cause Consultant to suspect the presence of hazardous materials, the Consultant may request from the Owner the termination of grading operations within the affected area. Prior to resuming grading operations, the Owner shall provide a written report to the Consultant indicating that the suspected materials are not hazardous as defined by applicable laws and regulations.

- 3.4 The outer 15 feet of *soil-rock* fill slopes, measured horizontally, should be composed of properly compacted *soil* fill materials approved by the Consultant. *Rock* fill may extend to the slope face, provided that the slope is not steeper than 2:1 (horizontal:vertical) and a soil layer no thicker than 12 inches is track-walked onto the face for landscaping purposes. This procedure may be utilized provided it is acceptable to the governing agency, Owner and Consultant.
- 3.5 Samples of soil materials to be used for fill should be tested in the laboratory by the Consultant to determine the maximum density, optimum moisture content, and, where appropriate, shear strength, expansion, and gradation characteristics of the soil.
- 3.6 During grading, soil or groundwater conditions other than those identified in the Geotechnical Report may be encountered by the Contractor. The Consultant shall be notified immediately to evaluate the significance of the unanticipated condition

4. CLEARING AND PREPARING AREAS TO BE FILLED

- 4.1 Areas to be excavated and filled shall be cleared and grubbed. Clearing shall consist of complete removal above the ground surface of trees, stumps, brush, vegetation, man-made structures, and similar debris. Grubbing shall consist of removal of stumps, roots, buried logs and other unsuitable material and shall be performed in areas to be graded. Roots and other projections exceeding 1½ inches in diameter shall be removed to a depth of 3 feet below the surface of the ground. Borrow areas shall be grubbed to the extent necessary to provide suitable fill materials.
- 4.2 Asphalt pavement material removed during clearing operations should be properly disposed at an approved off-site facility or in an acceptable area of the project evaluated by Geocon and the property owner. Concrete fragments that are free of reinforcing steel may be placed in fills, provided they are placed in accordance with Section 6.2 or 6.3 of this document.

- 4.3 After clearing and grubbing of organic matter and other unsuitable material, loose or porous soils shall be removed to the depth recommended in the Geotechnical Report. The depth of removal and compaction should be observed and approved by a representative of the Consultant. The exposed surface shall then be plowed or scarified to a minimum depth of 6 inches and until the surface is free from uneven features that would tend to prevent uniform compaction by the equipment to be used.
- 4.4 Where the slope ratio of the original ground is steeper than 5:1 (horizontal:vertical), or where recommended by the Consultant, the original ground should be benched in accordance with the following illustration.

TYPICAL BENCHING DETAIL

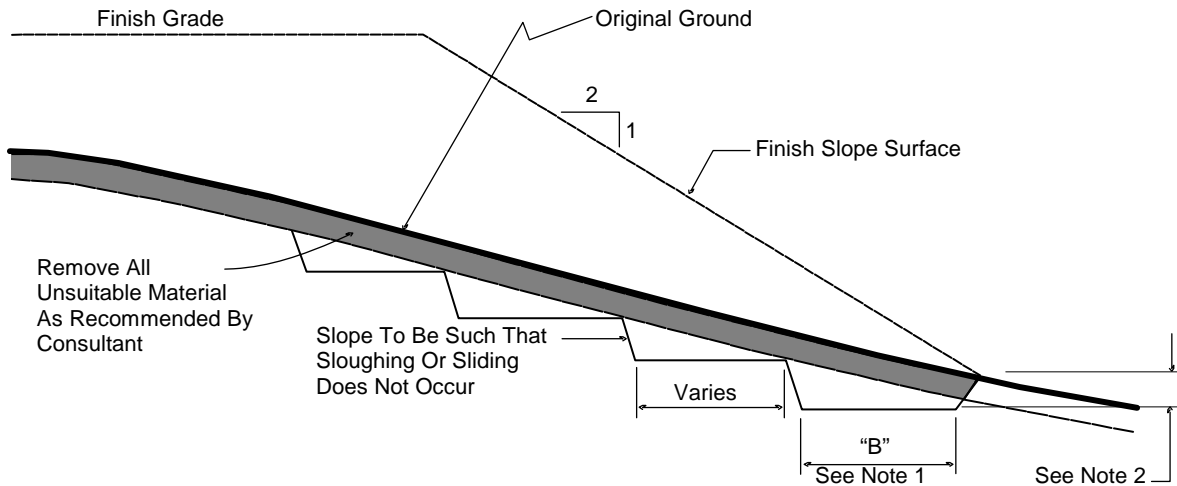

No Scale

- DETAIL NOTES: (1) Key width "B" should be a minimum of 10 feet, or sufficiently wide to permit complete coverage with the compaction equipment used. The base of the key should be graded horizontal, or inclined slightly into the natural slope.
- (2) The outside of the key should be below the topsoil or unsuitable surficial material and at least 2 feet into dense formational material. Where hard rock is exposed in the bottom of the key, the depth and configuration of the key may be modified as approved by the Consultant.

- 4.5 After areas to receive fill have been cleared and scarified, the surface should be moisture conditioned to achieve the proper moisture content, and compacted as recommended in Section 6 of these specifications.

5. COMPACTION EQUIPMENT

- 5.1 Compaction of *soil* or *soil-rock* fill shall be accomplished by sheepsfoot or segmented-steel wheeled rollers, vibratory rollers, multiple-wheel pneumatic-tired rollers, or other types of acceptable compaction equipment. Equipment shall be of such a design that it will be capable of compacting the *soil* or *soil-rock* fill to the specified relative compaction at the specified moisture content.
- 5.2 Compaction of *rock* fills shall be performed in accordance with Section 6.3.

6. PLACING, SPREADING AND COMPACTION OF FILL MATERIAL

- 6.1 *Soil* fill, as defined in Paragraph 3.1.1, shall be placed by the Contractor in accordance with the following recommendations:
- 6.1.1 *Soil* fill shall be placed by the Contractor in layers that, when compacted, should generally not exceed 8 inches. Each layer shall be spread evenly and shall be thoroughly mixed during spreading to obtain uniformity of material and moisture in each layer. The entire fill shall be constructed as a unit in nearly level lifts. Rock materials greater than 12 inches in maximum dimension shall be placed in accordance with Section 6.2 or 6.3 of these specifications.
- 6.1.2 In general, the *soil* fill shall be compacted at a moisture content at or above the optimum moisture content as determined by ASTM D 1557.
- 6.1.3 When the moisture content of *soil* fill is below that specified by the Consultant, water shall be added by the Contractor until the moisture content is in the range specified.
- 6.1.4 When the moisture content of the *soil* fill is above the range specified by the Consultant or too wet to achieve proper compaction, the *soil* fill shall be aerated by the Contractor by blading/mixing, or other satisfactory methods until the moisture content is within the range specified.
- 6.1.5 After each layer has been placed, mixed, and spread evenly, it shall be thoroughly compacted by the Contractor to a relative compaction of at least 90 percent. Relative compaction is defined as the ratio (expressed in percent) of the in-place dry density of the compacted fill to the maximum laboratory dry density as determined in accordance with ASTM D 1557. Compaction shall be continuous over the entire area, and compaction equipment shall make sufficient passes so that the specified minimum relative compaction has been achieved throughout the entire fill.

- 6.1.6 Where practical, soils having an Expansion Index greater than 50 should be placed at least 3 feet below finish pad grade and should be compacted at a moisture content generally 2 to 4 percent greater than the optimum moisture content for the material.
 - 6.1.7 Properly compacted *soil* fill shall extend to the design surface of fill slopes. To achieve proper compaction, it is recommended that fill slopes be over-built by at least 3 feet and then cut to the design grade. This procedure is considered preferable to track-walking of slopes, as described in the following paragraph.
 - 6.1.8 As an alternative to over-building of slopes, slope faces may be back-rolled with a heavy-duty loaded sheepsfoot or vibratory roller at maximum 4-foot fill height intervals. Upon completion, slopes should then be track-walked with a D-8 dozer or similar equipment, such that a dozer track covers all slope surfaces at least twice.
- 6.2 *Soil-rock* fill, as defined in Paragraph 3.1.2, shall be placed by the Contractor in accordance with the following recommendations:
- 6.2.1 Rocks larger than 12 inches but less than 4 feet in maximum dimension may be incorporated into the compacted *soil* fill, but shall be limited to the area measured 15 feet minimum horizontally from the slope face and 5 feet below finish grade or 3 feet below the deepest utility, whichever is deeper.
 - 6.2.2 Rocks or rock fragments up to 4 feet in maximum dimension may either be individually placed or placed in windrows. Under certain conditions, rocks or rock fragments up to 10 feet in maximum dimension may be placed using similar methods. The acceptability of placing rock materials greater than 4 feet in maximum dimension shall be evaluated during grading as specific cases arise and shall be approved by the Consultant prior to placement.
 - 6.2.3 For individual placement, sufficient space shall be provided between rocks to allow for passage of compaction equipment.
 - 6.2.4 For windrow placement, the rocks should be placed in trenches excavated in properly compacted *soil* fill. Trenches should be approximately 5 feet wide and 4 feet deep in maximum dimension. The voids around and beneath rocks should be filled with approved granular soil having a Sand Equivalent of 30 or greater and should be compacted by flooding. Windrows may also be placed utilizing an "open-face" method in lieu of the trench procedure, however, this method should first be approved by the Consultant.

- 6.2.5 Windrows should generally be parallel to each other and may be placed either parallel to or perpendicular to the face of the slope depending on the site geometry. The minimum horizontal spacing for windrows shall be 12 feet center-to-center with a 5-foot stagger or offset from lower courses to next overlying course. The minimum vertical spacing between windrow courses shall be 2 feet from the top of a lower windrow to the bottom of the next higher windrow.
- 6.2.6 Rock placement, fill placement and flooding of approved granular soil in the windrows should be continuously observed by the Consultant.
- 6.3 *Rock* fills, as defined in Section 3.1.3, shall be placed by the Contractor in accordance with the following recommendations:
- 6.3.1 The base of the *rock* fill shall be placed on a sloping surface (minimum slope of 2 percent). The surface shall slope toward suitable subdrainage outlet facilities. The *rock* fills shall be provided with subdrains during construction so that a hydrostatic pressure buildup does not develop. The subdrains shall be permanently connected to controlled drainage facilities to control post-construction infiltration of water.
- 6.3.2 *Rock* fills shall be placed in lifts not exceeding 3 feet. Placement shall be by rock trucks traversing previously placed lifts and dumping at the edge of the currently placed lift. Spreading of the *rock* fill shall be by dozer to facilitate *seating* of the rock. The *rock* fill shall be watered heavily during placement. Watering shall consist of water trucks traversing in front of the current rock lift face and spraying water continuously during rock placement. Compaction equipment with compactive energy comparable to or greater than that of a 20-ton steel vibratory roller or other compaction equipment providing suitable energy to achieve the required compaction or deflection as recommended in Paragraph 6.3.3 shall be utilized. The number of passes to be made should be determined as described in Paragraph 6.3.3. Once a *rock* fill lift has been covered with *soil* fill, no additional *rock* fill lifts will be permitted over the *soil* fill.
- 6.3.3 Plate bearing tests, in accordance with ASTM D 1196, may be performed in both the compacted *soil* fill and in the *rock* fill to aid in determining the required minimum number of passes of the compaction equipment. If performed, a minimum of three plate bearing tests should be performed in the properly compacted *soil* fill (minimum relative compaction of 90 percent). Plate bearing tests shall then be performed on areas of *rock* fill having two passes, four passes and six passes of the compaction equipment, respectively. The number of passes required for the *rock* fill shall be determined by comparing the results of the plate bearing tests for the *soil* fill and the *rock* fill and by evaluating the deflection

variation with number of passes. The required number of passes of the compaction equipment will be performed as necessary until the plate bearing deflections are equal to or less than that determined for the properly compacted *soil* fill. In no case will the required number of passes be less than two.

- 6.3.4 A representative of the Consultant should be present during *rock* fill operations to observe that the minimum number of “passes” have been obtained, that water is being properly applied and that specified procedures are being followed. The actual number of plate bearing tests will be determined by the Consultant during grading.
- 6.3.5 Test pits shall be excavated by the Contractor so that the Consultant can state that, in their opinion, sufficient water is present and that voids between large rocks are properly filled with smaller rock material. In-place density testing will not be required in the *rock* fills.
- 6.3.6 To reduce the potential for “piping” of fines into the *rock* fill from overlying *soil* fill material, a 2-foot layer of graded filter material shall be placed above the uppermost lift of *rock* fill. The need to place graded filter material below the *rock* should be determined by the Consultant prior to commencing grading. The gradation of the graded filter material will be determined at the time the *rock* fill is being excavated. Materials typical of the *rock* fill should be submitted to the Consultant in a timely manner, to allow design of the graded filter prior to the commencement of *rock* fill placement.
- 6.3.7 *Rock* fill placement should be continuously observed during placement by the Consultant.

7. SUBDRAINS

- 7.1 The geologic units on the site may have permeability characteristics and/or fracture systems that could be susceptible under certain conditions to seepage. The use of canyon subdrains may be necessary to mitigate the potential for adverse impacts associated with seepage conditions. Canyon subdrains with lengths in excess of 500 feet or extensions of existing offsite subdrains should use 8-inch-diameter pipes. Canyon subdrains less than 500 feet in length should use 6-inch-diameter pipes.

TYPICAL CANYON DRAIN DETAIL

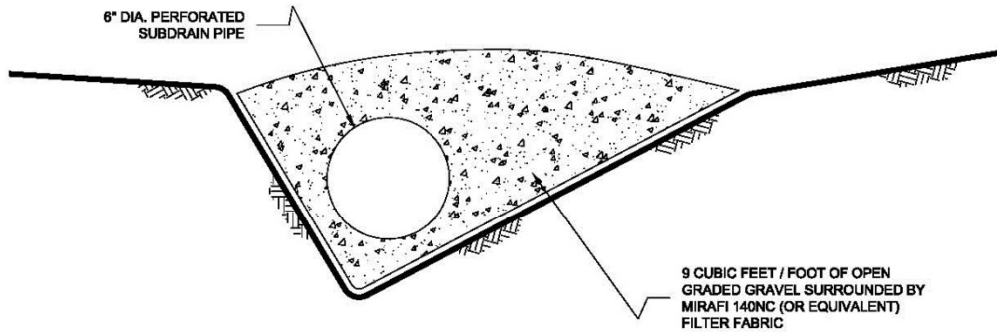
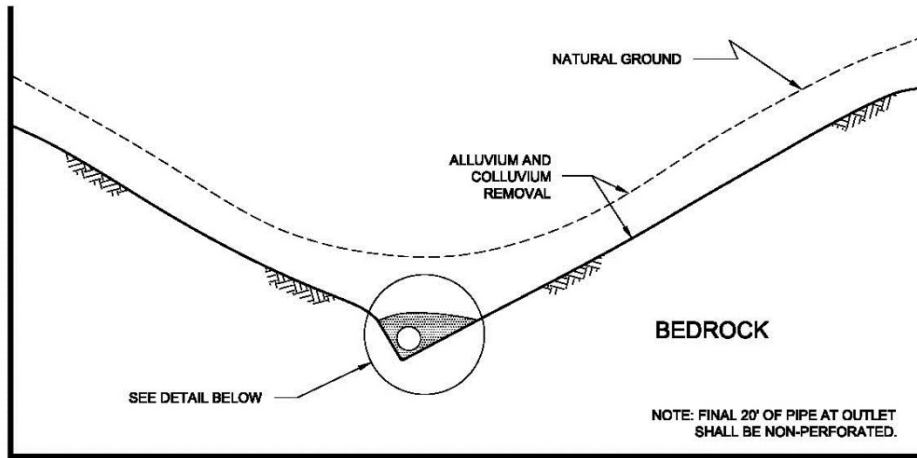

NOTES:

- 1.....8-INCH DIAMETER, SCHEDULE 80 PVC PERFORATED PIPE FOR FILLS IN EXCESS OF 100-FEET IN DEPTH OR A PIPE LENGTH OF LONGER THAN 500 FEET.
- 2.....6-INCH DIAMETER, SCHEDULE 40 PVC PERFORATED PIPE FOR FILLS LESS THAN 100-FEET IN DEPTH OR A PIPE LENGTH SHORTER THAN 500 FEET.

NO SCALE

7.2 Slope drains within stability fill keyways should use 4-inch-diameter (or larger) pipes.

TYPICAL STABILITY FILL DETAIL

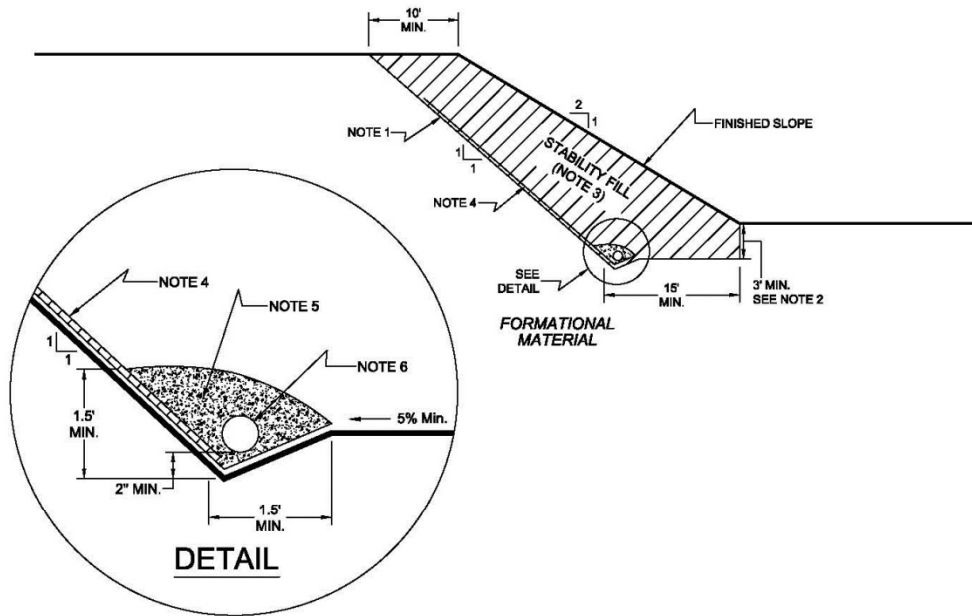

NOTES:

- 1.....EXCAVATE BACKCUT AT 1:1 INCLINATION (UNLESS OTHERWISE NOTED).
- 2.....BASE OF STABILITY FILL TO BE 3 FEET INTO FORMATIONAL MATERIAL, SLOPING A MINIMUM 5% INTO SLOPE.
- 3.....STABILITY FILL TO BE COMPOSED OF PROPERLY COMPACTED GRANULAR SOIL.
- 4.....CHIMNEY DRAINS TO BE APPROVED PREFABRICATED CHIMNEY DRAIN PANELS (MIRADRAIN G200N OR EQUIVALENT) SPACED APPROXIMATELY 20 FEET CENTER TO CENTER AND 4 FEET WIDE. CLOSER SPACING MAY BE REQUIRED IF SEEPAGE IS ENCOUNTERED.
- 5.....FILTER MATERIAL TO BE 3/4-INCH, OPEN-GRADED CRUSHED ROCK ENCLOSED IN APPROVED FILTER FABRIC (MIRAFI 140NC).
- 6.....COLLECTOR PIPE TO BE 4-INCH MINIMUM DIAMETER, PERFORATED, THICK-WALLED PVC SCHEDULE 40 OR EQUIVALENT, AND SLOPED TO DRAIN AT 1 PERCENT MINIMUM TO APPROVED OUTLET.

NO SCALE

7.3 The actual subdrain locations will be evaluated in the field during the remedial grading operations. Additional drains may be necessary depending on the conditions observed and the requirements of the local regulatory agencies. Appropriate subdrain outlets should be evaluated prior to finalizing 40-scale grading plans.

7.4 *Rock fill* or *soil-rock fill* areas may require subdrains along their down-slope perimeters to mitigate the potential for buildup of water from construction or landscape irrigation. The subdrains should be at least 6-inch-diameter pipes encapsulated in gravel and filter fabric. *Rock fill* drains should be constructed using the same requirements as canyon subdrains.

7.5 Prior to outletting, the final 20-foot segment of a subdrain that will not be extended during future development should consist of non-perforated drainpipe. At the non-perforated/perforated interface, a seepage cutoff wall should be constructed on the downslope side of the pipe.

TYPICAL CUT OFF WALL DETAIL

FRONT VIEW

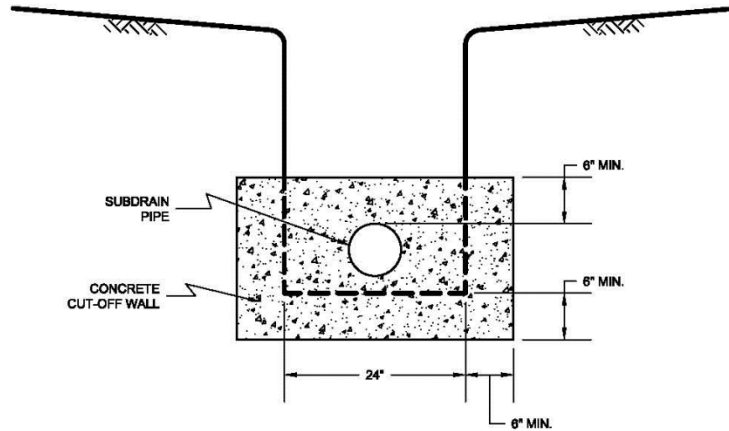

NO SCALE

SIDE VIEW

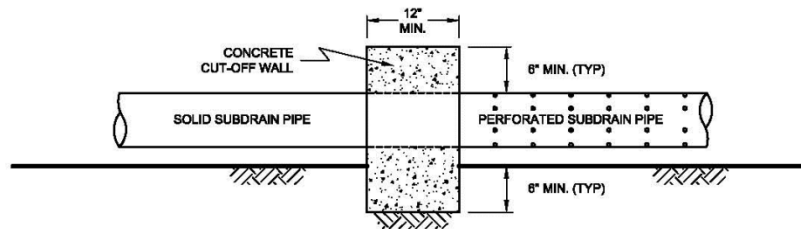

NO SCALE

7.6 Subdrains that discharge into a natural drainage course or open space area should be provided with a permanent headwall structure.

TYPICAL HEADWALL DETAIL

FRONT VIEW

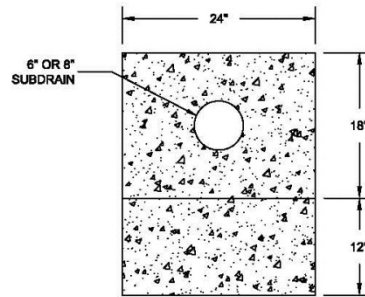

NO SCALE

SIDE VIEW

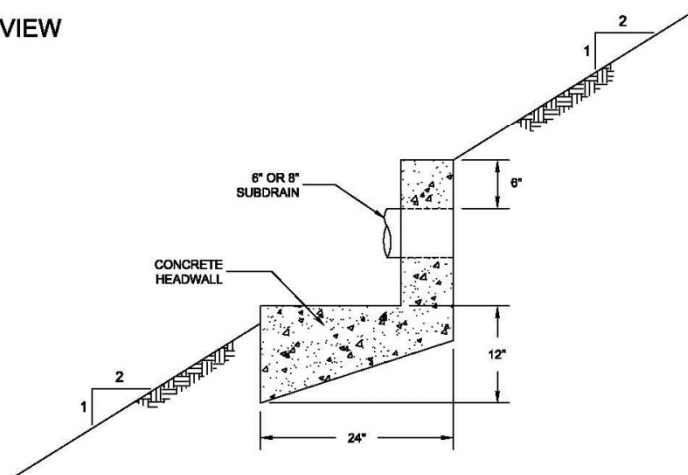

NOTE: HEADWALL SHOULD OUTLET AT TOE OF FILL SLOPE
OR INTO CONTROLLED SURFACE DRAINAGE

NO SCALE

- 7.7 The final grading plans should show the location of the proposed subdrains. After completion of remedial excavations and subdrain installation, the project civil engineer should survey the drain locations and prepare an “as-built” map showing the drain locations. The final outlet and connection locations should be determined during grading operations. Subdrains that will be extended on adjacent projects after grading can be placed on formational material and a vertical riser should be placed at the end of the subdrain. The grading contractor should consider videoing the subdrains shortly after burial to check proper installation and functionality. The contractor is responsible for the performance of the drains.

8. OBSERVATION AND TESTING

- 8.1 The Consultant shall be the Owner's representative to observe and perform tests during clearing, grubbing, filling, and compaction operations. In general, no more than 2 feet in vertical elevation of *soil* or *soil-rock* fill should be placed without at least one field density test being performed within that interval. In addition, a minimum of one field density test should be performed for every 2,000 cubic yards of *soil* or *soil-rock* fill placed and compacted.
- 8.2 The Consultant should perform a sufficient distribution of field density tests of the compacted *soil* or *soil-rock* fill to provide a basis for expressing an opinion whether the fill material is compacted as specified. Density tests shall be performed in the compacted materials below any disturbed surface. When these tests indicate that the density of any layer of fill or portion thereof is below that specified, the particular layer or areas represented by the test shall be reworked until the specified density has been achieved.
- 8.3 During placement of *rock* fill, the Consultant should observe that the minimum number of passes have been obtained per the criteria discussed in Section 6.3.3. The Consultant should request the excavation of observation pits and may perform plate bearing tests on the placed *rock* fills. The observation pits will be excavated to provide a basis for expressing an opinion as to whether the *rock* fill is properly seated and sufficient moisture has been applied to the material. When observations indicate that a layer of *rock* fill or any portion thereof is below that specified, the affected layer or area shall be reworked until the *rock* fill has been adequately seated and sufficient moisture applied.
- 8.4 A settlement monitoring program designed by the Consultant may be conducted in areas of *rock* fill placement. The specific design of the monitoring program shall be as recommended in the Conclusions and Recommendations section of the project Geotechnical Report or in the final report of testing and observation services performed during grading.
- 8.5 We should observe the placement of subdrains, to check that the drainage devices have been placed and constructed in substantial conformance with project specifications.
- 8.6 Testing procedures shall conform to the following Standards as appropriate:

8.6.1 Soil and Soil-Rock Fills:

- 8.6.1.1 Field Density Test, ASTM D 1556, *Density of Soil In-Place By the Sand-Cone Method.*

- 8.6.1.2 Field Density Test, Nuclear Method, ASTM D 6938, *Density of Soil and Soil-Aggregate In-Place by Nuclear Methods (Shallow Depth)*.
- 8.6.1.3 Laboratory Compaction Test, ASTM D 1557, *Moisture-Density Relations of Soils and Soil-Aggregate Mixtures Using 10-Pound Hammer and 18-Inch Drop*.
- 8.6.1.4 Expansion Index Test, ASTM D 4829, *Expansion Index Test*.

9. PROTECTION OF WORK

- 9.1 During construction, the Contractor shall properly grade all excavated surfaces to provide positive drainage and prevent ponding of water. Drainage of surface water shall be controlled to avoid damage to adjoining properties or to finished work on the site. The Contractor shall take remedial measures to prevent erosion of freshly graded areas until such time as permanent drainage and erosion control features have been installed. Areas subjected to erosion or sedimentation shall be properly prepared in accordance with the Specifications prior to placing additional fill or structures.
- 9.2 After completion of grading as observed and tested by the Consultant, no further excavation or filling shall be conducted except in conjunction with the services of the Consultant.

10. CERTIFICATIONS AND FINAL REPORTS

- 10.1 Upon completion of the work, Contractor shall furnish Owner a certification by the Civil Engineer stating that the lots and/or building pads are graded to within 0.1 foot vertically of elevations shown on the grading plan and that all tops and toes of slopes are within 0.5 foot horizontally of the positions shown on the grading plans. After installation of a section of subdrain, the project Civil Engineer should survey its location and prepare an *as-built* plan of the subdrain location. The project Civil Engineer should verify the proper outlet for the subdrains and the Contractor should ensure that the drain system is free of obstructions.
- 10.2 The Owner is responsible for furnishing a final as-graded soil and geologic report satisfactory to the appropriate governing or accepting agencies. The as-graded report should be prepared and signed by a California licensed Civil Engineer experienced in geotechnical engineering and by a California Certified Engineering Geologist, indicating that the geotechnical aspects of the grading were performed in substantial conformance with the Specifications or approved changes to the Specifications.