

INITIAL STUDY

Environmental Checklist and Evaluation for the County of Santa Clara

File Number:	PLN18-12010	Date: June 30, 2021
Project Type:	Building Site Approval and Grading Approval	APN(s): 701-37-004
Project Location / Address:	21551 Schillingsburg Avenue San Jose	GP Designation: Rural Residential
Owner's Name:	Junping Zheng	Zoning: RR-sr
Applicant's Name:	Oscar Osuna of Osuna Engineering	Urban Service Area: N/A
Project Description		
<p>This application is for a Building Site Approval and Grading Approval to build a new 4,567 sq. ft. residence including attached garage and 1,200 sq. ft. accessory dwelling unit including attached garage off Tyr Lane with on-site improvements (driveway, septic system, detention pond and landscaping) and maintenance of existing private well. The project also includes demolition of the existing residence (2,360 sq. ft.) on-site and broken storage shed (sq. ft. unknown), and maintenance of existing private horse barn (1,400 sq. ft.) horse stables (2,000 sq. ft. and 1,600 sq. ft.), horse stables with chicken coop (2,200 sq. ft.), and detached storage sheds (2,000 sq. ft., and 1,080 sq. ft.). Grading quantities are approximately 1,458 cubic yards of cut and 2,342 cubic yards of fill with a maximum depth of 3 ft. Of the proposed grading, 1,111 cubic yards of fill are outside the scope of the Grading Approval associated with the building pads for the residence and accessory dwelling unit. See Attachment B -Plan Set.</p>		
Environmental Setting and Surrounding Land Uses		
<p>The subject property has an average slope of 1.3%, with an existing residence and driveway located off Schillingsburg Avenue, in an unincorporated area of San Jose. The parcel is a corner lot located off the intersection of Schillingsburg Avenue and Tyr Lane. Surrounding uses include other single family residences in the immediate neighborhood. The creek is located in the rear yard of the property (Arroyo Calero Creek). The property is located in a rural area of unincorporated County in the Sphere of Influence of San Jose. Trees include a mix of coast live oak, sycamore, willow and blue elderberry trees, and a mix of plants and grasses (wildoats, coyote brush, mustard, ripgut brome, Italian thistle, poison hemlock, wild rye, California poppy, prickly lettuce, whitetop, horehound, rabbitsfoot, wild radish, Himalayan blackberry, curly dock, grape, and stinging nettle, watercress, and cattail) along the creek banks and within channel of creek as a mixed riparian woodland and forest habitat. The new residence, accessory dwelling unit, and improvements are at a minimum of 200 ft. setback from the top bank of the creek. Arroyo Calero Creek is a Category 1 Habitat Plan creek with a 200 ft. setback from top bank of creek. As the 200 ft. setback is maintained, no Habitat Plan riparian fees are applicable. See Attachment A – Project vicinity map and Attachment B – Plan Set and Attachment C – Biological Report.</p>		
Other agencies sent a copy of this document:		
<p>CA Dept. of Fish and Wildlife U.S Fish and Wildlife Service, Habitat Plan Agency</p>		

The environmental factors checked below would be potentially affected by this project, involving at least one impact that is a “Potentially Significant Impact” as indicated by the checklist on the following pages.

ENVIRONMENTAL FACTORS POTENTIALLY AFFECTED

The proposed project could potentially result in one or more environmental effects in the following areas:

- | | | |
|---|---|--|
| <input type="checkbox"/> Aesthetics | <input type="checkbox"/> Agriculture / Forest Resources | <input type="checkbox"/> Air Quality |
| <input checked="" type="checkbox"/> Biological Resource | <input type="checkbox"/> Cultural Resources | <input type="checkbox"/> Energy |
| <input type="checkbox"/> Geology/Soils | <input type="checkbox"/> Greenhouse Gas Emissions | <input type="checkbox"/> Hazards & Hazardous Materials |
| <input type="checkbox"/> Hydrology / Water Quality | <input type="checkbox"/> Land Use / Planning | <input type="checkbox"/> Mineral Resources |
| <input type="checkbox"/> Noise | <input type="checkbox"/> Population / Housing | <input type="checkbox"/> Public Services |
| <input type="checkbox"/> Recreation | <input type="checkbox"/> Transportation | <input type="checkbox"/> Tribal Cultural Resources |
| <input type="checkbox"/> Utilities / Service Systems | <input type="checkbox"/> Wildfire | <input checked="" type="checkbox"/> Mandatory Findings of Significance |

DETERMINATION: (To be completed by the Lead Agency)

On the basis of this initial evaluation:

- I find that the proposed project COULD NOT have a significant effect on the environment, and a **NEGATIVE DECLARATION** will be prepared.
- I find that although the proposed project could have a significant effect on the environment, there will not be a significant effect in this case because revisions in the project have been made by or agreed to by the project proponent. A **MITIGATED NEGATIVE DECLARATION** will be prepared.
- I find that although the proposed project could have a significant effect on the environment, because all potentially significant effects (a) have been analyzed adequately in an earlier EIR or **NEGATIVE DECLARATION** pursuant to applicable standards, and (b) have been avoided or mitigated pursuant to that earlier EIR or **NEGATIVE DECLARATION**, including revisions or mitigation measures that are imposed upon the proposed project, nothing further is required.
- I find that the proposed project MAY have a significant effect on the environment, and an **ENVIRONMENTAL IMPACT REPORT** is required.
- I find that the proposed project MAY have a “potentially significant impact” or “potentially significant unless mitigated” impact on the environment, but at least one effect 1) has been adequately analyzed in an earlier document pursuant to applicable legal standards, and 2) has been addressed by mitigation measures based on the earlier analysis as described on the attached sheets. An **ENVIRONMENTAL IMPACT REPORT** is required, but it must analyze only the effects that remain to be addressed.

Colleen A. Tsuchimoto
Signature

6/30/21
Date

Colleen Tsuchimoto – Printed Name

For Santa Clara County Planning Dept

ENVIRONMENTAL CHECKLIST AND DISCUSSION OF IMPACTS

A. AESTHETICS							
	IMPACT						
Except as provided in Public Resources Code section 21099, would the project:	<u>Potentially Significant Impact</u>	<u>Less Than Significant with Mitigation Incorporated</u>	<u>Less Than Significant Impact</u>	<u>No Impact</u>	<u>Analyzed in the Prior EIR</u>	<u>Substantially Mitigated by Uniformly Applicable Development Policies</u>	Source
a) Have a substantial adverse effect on a scenic vista?	<input type="checkbox"/>	<input type="checkbox"/>	<input type="checkbox"/>	<input checked="" type="checkbox"/>	<input type="checkbox"/>	<input type="checkbox"/>	2,3,4, 6,17f
b) Substantially damage scenic resources, including, but not limited to, trees, rock outcroppings, and historic buildings, along a designated scenic highway?	<input type="checkbox"/>	<input type="checkbox"/>	<input type="checkbox"/>	<input checked="" type="checkbox"/>	<input type="checkbox"/>	<input type="checkbox"/>	3, 6,7 17f
c) In non-urbanized areas, substantially degrade the existing visual character or quality of public views of the site and its surroundings? (Public views are those that are experienced from publicly accessible vantage point.) If the project is in an urbanized area, would the project conflict with applicable zoning and other regulations governing scenic quality?	<input type="checkbox"/>	<input type="checkbox"/>	<input type="checkbox"/>	<input checked="" type="checkbox"/>	<input type="checkbox"/>	<input type="checkbox"/>	2,3
d) Create a new source of substantial light or glare which would adversely affect day or nighttime views in the area?	<input type="checkbox"/>	<input type="checkbox"/>	<input type="checkbox"/>	<input checked="" type="checkbox"/>	<input type="checkbox"/>	<input type="checkbox"/>	3,4

SETTING:

The project site is located within the RR-sr zoning district, within an unincorporated area of San Jose. The nearest scenic road is located at McKean Rd (over 100 ft. from the subject property). The lot is surrounded by other residential homes in the neighborhood. The site has an existing residence, private accessory structures (horse barn, stables, chicken coop, and storage sheds) with Arroyo Calero Creek in the rear yard of the property – surrounding by riparian vegetation (trees, plants).

DISCUSSION:

a, b, c, & d) No Impact - The purpose of this project is to construct a new 4,567 sq. ft. residence and 1,200 sq. ft. accessory dwelling unit. As noted in the project description, the scope of work includes the following: This application is for a Building Site Approval and Grading Approval to build a new 4,567 sq. ft. residence including attached garage and 1,200 sq. ft. accessory dwelling unit including attached garage off Tyr Lane with on-site improvements (driveway, septic system, detention pond and landscaping) and maintenance of existing private well. The project also includes demolition of the existing residence (2,360 sq. ft.) on-site and broken storage shed (sq. ft. unknown), and maintenance of existing private horse barn (1,400 sq. ft.) horse stables (2,000 sq. ft. and 1,600 sq. ft.), horse stables with chicken coop (2,200 sq. ft.), and detached storage sheds (2,000 sq. ft., and 1,080 sq. ft.). Grading quantities are approximately 1,458 cubic yards of cut and 2,342 cubic yards of fill with a

maximum depth of 3 ft. Of the proposed grading, 1,111 cubic yards of fill are outside the scope of the Grading Approval associated with the building pads for the residence and accessory dwelling unit. See **Attachment B -Plan Set**.

Building a new residence and accessory dwelling unit will not create any visual impacts to the site. No trees are proposed for removal, and there are no historical features such as rock outcroppings. The property has substantial screening of riparian vegetation (trees including coast live oak, sycamore, willow and blue elderberry trees). The lot is over 100 ft. away from the scenic road – McKean Rd. There is no exterior lighting proposed with the project.

MITIGATION:
None required.

B. AGRICULTURE / FOREST RESOURCES							
In determining whether impacts to agricultural resources are significant environmental effects, lead agencies may refer to the California Agricultural Land Evaluation and Site Assessment Model (1997) prepared by the California Dept. of Conservation as an optional model to use in assessing impacts on agriculture and farmland. In determining whether impacts to forest resources, including timberland, are significant environmental effects, lead agencies may refer to information compiled by the California Department of Forestry and Fire Protection regarding the state's inventory of forest land, including the Forest and Range Assessment Project and the Forest Legacy Assessment Project; and forest carbon measurement methodology provided in Forest Protocols adopted by the California Air Resources Board.							
WOULD THE PROJECT:	IMPACT						Source
	<u>Potentially Significant Impact</u>	<u>Less Than Significant with Mitigation Incorporated</u>	<u>Less Than Significant Impact</u>	<u>No Impact</u>	<u>Analyzed in the Prior EIR</u>	<u>Substantially Mitigated by Uniformly Applicable Development Policies</u>	
a) Convert Prime Farmland, Unique Farmland, or Farmland of Statewide Importance (Farmland), as shown on the maps prepared pursuant to the Farmland Mapping and Monitoring Program of the California Resources Agency, to non-agricultural use?	<input type="checkbox"/>	<input type="checkbox"/>	<input checked="" type="checkbox"/>	<input type="checkbox"/>	<input type="checkbox"/>	<input type="checkbox"/>	3,23,24,26
b) Conflict with existing zoning for agricultural use?	<input type="checkbox"/>	<input type="checkbox"/>	<input type="checkbox"/>	<input checked="" type="checkbox"/>	<input type="checkbox"/>	<input type="checkbox"/>	9,21a
c) Conflict with an existing Williamson Act Contract or the County's Williamson Act Ordinance (Section C13 of County Ordinance Code)?	<input type="checkbox"/>	<input type="checkbox"/>	<input type="checkbox"/>	<input checked="" type="checkbox"/>	<input type="checkbox"/>	<input type="checkbox"/>	
d) Conflict with existing zoning for, or cause rezoning of, forest land (as defined in Public Resources Code section 12220(g)), timberland (as defined by Public Resources Code section 4526), or timberland zoned Timberland Production (as defined by Government Code section 51104(g))?	<input type="checkbox"/>	<input type="checkbox"/>	<input type="checkbox"/>	<input checked="" type="checkbox"/>	<input type="checkbox"/>	<input type="checkbox"/>	1, 28
e) Result in the loss of forest land or conversion of forest land to non-forest use?	<input type="checkbox"/>	<input type="checkbox"/>	<input type="checkbox"/>	<input checked="" type="checkbox"/>	<input type="checkbox"/>	<input type="checkbox"/>	32

B. AGRICULTURE / FOREST RESOURCES

In determining whether impacts to agricultural resources are significant environmental effects, lead agencies may refer to the California Agricultural Land Evaluation and Site Assessment Model (1997) prepared by the California Dept. of Conservation as an optional model to use in assessing impacts on agriculture and farmland. In determining whether impacts to forest resources, including timberland, are significant environmental effects, lead agencies may refer to information compiled by the California Department of Forestry and Fire Protection regarding the state's inventory of forest land, including the Forest and Range Assessment Project and the Forest Legacy Assessment Project; and forest carbon measurement methodology provided in Forest Protocols adopted by the California Air Resources Board.

WOULD THE PROJECT:	IMPACT						Source
	Potentially Significant Impact	Less Than Significant with Mitigation Incorporated	Less Than Significant Impact	No Impact	Analyzed in the Prior EIR	Substantially Mitigated by Uniformly Applicable Development Policies	
f) Involve other changes in the existing environment which, due to their location or nature, could result in conversion of Farmland, to non-agricultural use or conversion of forest land to non-forest use?	<input type="checkbox"/>	<input type="checkbox"/>	<input type="checkbox"/>	<input checked="" type="checkbox"/>	<input type="checkbox"/>	<input type="checkbox"/>	

SETTING:

The project consists of prime farmland agricultural soil type described as Stevens Creek sandy clay loam (0 to 2 percent slopes) – prime farmland when irrigated. The property is located within a non agricultural zone – rural district (RR-sr). There is no forest land on this site. The property is not under any Williamson Act contract.

DISCUSSION:

a)– Less than Significant Impact - As noted in the Setting Section of this analysis, the project site has prime farmland soil (Stevens Creek sandy clay loam – 0 to 2 percent slopes) considered to be prime farmland when irrigated. There are currently agriculture type uses for private use by the owner with the accessory horse barn, stables and chicken coop. As there currently is no active irrigation of the soil, the property owner residing in the new residence would maintain the existing accessory ag. structures and the impacted area is less than the threshold of 10 acres of taking of new development area, the project would have a less than significant impact for the conversion of prime farmland to a non agriculture use.

b, c, d, e & f)– No Impact -As noted in the Setting Section of this analysis, the project site has no prime farmland and no forest land. The soil type is urban – not suitable for agriculture. The property is zoned for residential use RR-sr. The property does not have a Williamson Act contract, and not located within any forestland/timberland area. No trees are proposed for removal. Therefore the project would have no impacts to agricultural resources.

MITIGATION:

None required.

C. AIR QUALITY

Where available, the significance criteria established by the applicable air quality management district or air pollution control district may be relied upon to make the following determinations.

WOULD THE PROJECT:	IMPACT						Source
	Potentially Significant Impact	Less Than Significant with Mitigation Incorporated	Less Than Significant Impact	No Impact	Analyzed in the Prior EIR	Substantially Mitigated by Uniformly Applicable Development Policies	
a) Conflict with or obstruct implementation of the applicable air quality plan?	<input type="checkbox"/>	<input type="checkbox"/>	<input type="checkbox"/>	<input checked="" type="checkbox"/>	<input type="checkbox"/>	<input type="checkbox"/>	5,29, 30
b) Result in a cumulatively considerable net increase of any criteria pollutant for which the project region is non-attainment under an applicable federal or state ambient air quality standard?	<input type="checkbox"/>	<input type="checkbox"/>	<input type="checkbox"/>	<input checked="" type="checkbox"/>	<input type="checkbox"/>	<input type="checkbox"/>	5,29, 30
c) Expose sensitive receptors to substantial pollutant concentrations?	<input type="checkbox"/>	<input type="checkbox"/>	<input type="checkbox"/>	<input checked="" type="checkbox"/>	<input type="checkbox"/>	<input type="checkbox"/>	5,29, 30
d) Result in other emissions (such as those leading to odors) adversely affecting a substantial number of people?	<input type="checkbox"/>	<input type="checkbox"/>	<input type="checkbox"/>	<input checked="" type="checkbox"/>	<input type="checkbox"/>	<input type="checkbox"/>	5, 29, 30

SETTING:

The proposed project is located within the San Francisco Bay Area Air Quality Management District (BAAQMD), which regulates air pollutants, including those that may be generated by construction and operation of development projects. These criteria pollutants include reactive organic gases, carbon monoxide, nitrogen dioxide, and particulate matter (PM). BAAQMD also regulates toxic air contaminants (fine particulate matter), long-term exposure to particulates linked with respiratory health conditions, and increased risk of cancer. Major sources of toxic air contaminants in the Bay Area include major automobile and truck transportation corridors (e.g., freeways and expressways) and stationary sources (e.g., factories, refineries, power plants).

DISCUSSION:

a,b,c & d) No Impact

Operation

The proposed project would involve construction of a new residence and accessory dwelling unit, and removal of one residence and broken shed. BAAQMD has published screening criteria for operational criteria pollutants for different land use types.¹ The land use type applicable to the proposed project is single-family residential. Single family residential uses are the most appropriate use category for the project, as the project proposes two dwelling units. The operational screening threshold for criteria pollutants for this land use type is 325 dwelling units. The proposed project proposes 2 dwelling units,

¹Although the BAAQMD CEQA Guidelines that contain these screening level sizes have been overturned in court, the County has determined that these thresholds are based on substantial evidence, as identified in Appendix D of the Guidelines, and has therefore incorporated them into this Initial Study.

which is well under this threshold. As such, operation of the proposed project would not conflict with or obstruct implementation of the applicable air quality plan, violate any air quality standard, contribute substantially to an existing or projected air quality violation, or result in a cumulatively considerable net increase of any criteria pollutant for which the project region is non-attainment.

Demolition/Construction

Fugitive dust will be created during the grading, demolition and construction activities. Standard dust control measures and best management practices, as stipulated by County Land Development Engineering and the BAAQMD, would be employed to ensure that any air quality impacts, such as fugitive dust from NO_x (oxides of nitrogen) and PM₁₀ (respirable particulate matter with aerodynamic resistance diameter of 10 micrometers), would remain less than significant during construction. Grading operations would not exceed BAAQMD maximum thresholds.

MITIGATION:

None required.

D. BIOLOGICAL RESOURCES							
WOULD THE PROJECT:	IMPACT						Source
	Potentially Significant Impact	Less Than Significant with Mitigation Incorporated	Less Than Significant Impact	No Impact	Analyzed in the Prior EIR	Substantially Mitigated by Uniformly Applicable Development Policies	
a) Have a substantial adverse effect, either directly or through habitat modifications, on any species identified as a candidate, sensitive, or special status species in local or regional plans, policies, or regulations, or by the California Department of Fish and Game or U.S. Fish and Wildlife Service?	<input type="checkbox"/>	<input checked="" type="checkbox"/>	<input type="checkbox"/>	<input type="checkbox"/>	<input type="checkbox"/>	<input type="checkbox"/>	1, 7, 17b, 17o
b) Have a substantial adverse effect on any riparian habitat or other sensitive natural community identified in local or regional plans, policies, regulations or by the California Department of Fish and Game or US Fish and Wildlife Service?	<input type="checkbox"/>	<input type="checkbox"/>	<input type="checkbox"/>	<input checked="" type="checkbox"/>	<input type="checkbox"/>	<input type="checkbox"/>	3,7, 8a, 17b, 17e, 22d, 22e, 33
c) Have a substantial adverse effect on state or federally protected wetlands (including, but not limited to, marsh, vernal pool, coastal, etc.) through direct removal, filling, hydrological interruption, or other means?	<input type="checkbox"/>	<input type="checkbox"/>	<input type="checkbox"/>	<input checked="" type="checkbox"/>	<input type="checkbox"/>	<input type="checkbox"/>	3, 7, 17n, 33
d) Have a substantial adverse effect on oak woodland habitat as defined by Oak Woodlands Conservation Law (conversion/loss of oak woodlands) – Public Resource Code 21083.4?	<input type="checkbox"/>	<input type="checkbox"/>	<input type="checkbox"/>	<input checked="" type="checkbox"/>	<input type="checkbox"/>	<input type="checkbox"/>	1, 3, 31, 32
e) Interfere substantially with the movement of any native resident or migratory fish or wildlife species or with established native resident or migratory wildlife corridors or impede the use of native wildlife nursery sites?	<input type="checkbox"/>	<input type="checkbox"/>	<input type="checkbox"/>	<input checked="" type="checkbox"/>	<input type="checkbox"/>	<input type="checkbox"/>	1,7, 17b, 17o
f) Conflict with any local policies or ordinances protecting biological resources, such as a tree preservation policy or ordinance?	<input type="checkbox"/>	<input type="checkbox"/>	<input type="checkbox"/>	<input checked="" type="checkbox"/>	<input type="checkbox"/>	<input type="checkbox"/>	32
g) Conflict with the provisions of an adopted Habitat Conservation Plan, Natural Community Conservation Plan, or other approved local, regional or state habitat conservation plan?	<input type="checkbox"/>	<input checked="" type="checkbox"/>	<input type="checkbox"/>	<input type="checkbox"/>	<input type="checkbox"/>	<input type="checkbox"/>	3,4, 17i

SETTING:

As noted in the project description, this application includes a request for building a new 4,567 sq. ft. residence and 1,200 sq. ft. accessory dwelling unit. As noted in the project description, the scope of work includes the following: This application is for a Building Site Approval and Grading Approval to build a new 4,567 sq. ft. residence including attached garage and 1,200 sq. ft. accessory dwelling unit including attached garage off Tyr Lane with on-site improvements (driveway, septic system, detention pond and landscaping. The project also includes demolition of the existing residence (2,360 sq. ft.) on-site and broken storage shed (sq. ft. unknown), and maintenance of existing private horse barn (1,400 sq. ft.) horse stables (2,000 sq. ft. and 1,600 sq. ft.), horse stables with chicken coop (2,200 sq. ft.), and detached storage sheds (2,000 sq. ft., and 1,080 sq. ft.).

The creek is located in the rear yard of the property (Arroyo Calero Creek). The new residence, accessory dwelling unit, and improvements are at a minimum of 200 ft. setback from the top bank of the creek. Arroyo Calero Creek is a Category 1 Habitat Plan creek with a 200 ft. setback from top bank of creek. As the 200 ft. setback is maintained, no Habitat Plan riparian fees are applicable. See **Attachment A – Project vicinity map**, **Attachment B – Plan Set**, and **Attachment C, - Biological Report**.

Biological habitat types in the proposed development area as confirmed in the biological report – **Attachment C** include CA annual grassland, rural residential and Coyote Brush Scrub habitat. The creek (Arroyo Calero Creek) to the rear of the property provides mixed riparian woodland and forest and seasonal wetland habitat with surrounding rural residential and ornamental woodland habitat. The riparian habitat of the creek includes a mix of coast live oak, sycamore, willow and blue elderberry trees, and a mix of plants and grasses (wildoats, coyote brush, mustard, ripgut brome, Italian thistle, poison hemlock, wild rye, California poppy, prickly lettuce, whitetop, horehound, rabbitsfoot, wild radish, Himalayan blackberry, curly dock, grape, and stinging nettle, watercress, and cattail) along the creek banks and within channel of creek as a mixed riparian woodland and forest habitat.

DISCUSSION:

b, c, d, e, f, & g) No Impact -There are no serpentine soils, and oak woodland vegetation on-site. No trees are proposed for removal as there are no existing trees in close proximity to the development area. The riparian habitat on-site identified as mixed riparian woodland and forest and seasonal wetlands is not impacted by the new development. As noted above in the Setting Section of this analysis, the new residence, and accessory dwelling unit with improvements is a minimum of 200 ft. away from the top bank of the creek. Demolition activity will not disturb the top bank of the creek as the existing residence and broken shed are over 100 ft away from the top bank of the creek.

a, g) Less than Significant with Mitigation -As the proposed work may impact special status and endangered species, mitigation will be required as part of the conditions of approval and Habitat Plan application. CA Natural Diversity Database shows sightings of CA red legged frog on the subject site as of 1983 within the creek (Arroyo Calero Creek). “21551 Schillingsburg Avenue Technical Biological Report,” prepared by Live Oak Associates Inc, dated January 16, 2020 provides the biological resources analysis and mitigation. See **Attachment C – Biological Report**. The project site is located in the Habitat Plan Area, subject to a Habitat Conservation Plan application due to the identified special status/endangered species impacts verified in **Attachment C – Biological Report** including impacts to Burrowing Owls, Tricolored Blackbirds, Foothill Yellow-Legged Frogs, CA Red-

Legged frogs, Western Pond Turtles, San Francisco Dusky Footed Woodrats and American Badgers. Pre-Construction surveys and followup monitoring is required to avoid and mitigate impacts to the above special status/endangered species. The surveys are required as part of the Habitat Plan application, and Habitat Plan Agency fees will be determined based on the result of the biological surveys. As the Habitat Plan coverage is required, separate endangered species take permits are not required from the CA Dept. of Fish and Wildlife Service. Burrowing Owl impact fees will only be applicable if the pre-construction survey for burrowing owls finds presence of the species in the proposed development area.

MITIGATION:

As noted above in the Discussion section of this analysis, mitigation for special status and endangered species includes Pre-construction surveys and follow up monitoring – see **Attachment C**. A qualified biologist will conduct surveys to determine presence of species and provide follow up monitoring services for any verified species found within the proposed development area.

Below is a list of the specific mitigation measures that will be incorporated into the Mitigation Monitoring Program:

(Bio-Mit No. 1 – Burrowing Owls) –

All Habitat Plan conditions for Burrowing Owl are incorporated into the mitigation measures as follows: See Habitat Plan Condition 15. Western Burrowing Owl

1a) Pre-construction surveys for burrowing owls conducted by a qualified biologist are required with submittal of the Habitat Plan Application to confirm presence and suitability of habitat for the species within the proposed development area and within a 250 ft. radius of the development area. Note: Suitable habitat is considered fully avoided if the project footprint does not impinge on a 250-foot buffer around the suitable burrow.

To maximize the likelihood of detecting owls, the preconstruction survey will last a minimum of 3 hours. The survey will begin 1 hour before sunrise and continue until 2 hours after sunrise (for 3 hrs. total). A minimum of two surveys will be conducted (if owls are detected on the first survey, a second survey is not needed). All owls observed will be counted and their locations will be mapped.

1b) If active nests are found onsite, a 250-foot non-disturbance buffer will be established around all nest sites as determined by a qualified biologist.

1c). If presence/suitability are determined follow up pre-construction surveys are required as follows (to be submitted to the Planning Dept. prior to final inspection):

- 14 days prior to initial construction activities – preliminary survey
- 2 days prior to initial construction activities (2 days of surveying plus up to 2 days between surveys and construction).

1d) If evidence of western burrowing owls is found during the breeding season (February 1 to August 31), the project proponent will avoid all nest sites that could be disturbed by project construction during the remainder of the breeding season or while the nest is occupied by adults or young (occupation includes individuals or family groups foraging on or near the site following fledging). Avoidance will include establishment of the 250 foot non disturbance buffer zone.

1e) Construction may occur inside of the 250 foot non disturbance buffer during the breeding season if

- The nest is not disturbed, and
- The project proponent develops an avoidance, minimization and monitoring plan that will be reviewed by the Habitat Agency and the Wildlife Agencies with submittal of the Habitat Plan application based on the following criteria:
 - The Habitat Agency and the Wildlife Agencies approve of the avoidance and minimization plan provided by the project proponent.
 - A qualified biologist monitoring the owls for at least 3 days prior to construction to determine baseline nesting and foraging behavior (i.e. behavior without construction)
 - The same qualified biologist monitors the owls during construction and finds no change in owl nesting and foraging behavior in response to construction activities.
 - If there is a change in owl nesting and foraging behavior as a result of construction activities, these activities will cease within the 250 foot buffer. Construction cannot resume within the 250 foot buffer until the adults and juveniles from the occupied burrows have moved out of the project site.
 - If monitoring indicates that the nest is abandoned prior to the end of nesting season and the burrow is no longer in use by owls, the non-disturbance buffer zone may be removed. The biologist will excavate the burrow to prevent reoccupation after receiving approval from the Wildlife Agencies.
 - The Habitat Agency and the Wildlife Agencies have 21 calendar days to respond to a request from the project proponent to review the proposed avoidance, minimization, and monitoring plan. If these parties do not respond within 21 calendar days, it will be presumed that they concur with the proposal and work can commence.

1f) Construction may occur inside of the 250 foot non disturbance buffer during the non breeding season (September 1 to January 31) if

- A qualified biologist monitoring the owls for at least 3 days prior to construction to determine baseline foraging behavior (i.e. behavior without construction)
- The same biologist monitors the owls during construction and finds no change in owl foraging behavior in response to construction activities.
- If there is any change in owl foraging behavior as a result of construction activities, these activities will cease within the 250 foot buffer.
- If the owls are gone for at least 1 week, the project proponent may request approval from the Habitat Agency that a qualified biologist excavate usable burrows to prevent owls from reoccupying the site. After all usable burrows are excavated, the buffer zone will be removed and construction may continue.
- Monitoring must continue as described above for the non-breeding season as long as the burrow remains active.

1g) Construction Monitoring: Based on the avoidance, minimization and monitoring plan developed the following measures are required:

- During construction, the non-disturbance buffer zones will be established and maintained as applicable.
- A qualified biologist will monitor the site consistent with the plan to ensure that buffers are enforced and owls are not disturbed.

- The biological monitor will conduct training of construction personnel on avoidance procedures, buffer zones, and protocols in the event that a burrowing owl enters an active construction zone.
- Construction monitoring report to be submitted to Planning Dept. and Habitat Agency prior to final inspection.

1h) Exceptions to Passive Relocation Prohibition: Passive relocation is currently not allowed under the Habitat Plan until the positive growth trend is achieved. If burrowing owls continually persist on a site where avoidance is not feasible, the project proponent may apply for an exception based on the following process: Note: For this condition the term exception means an allowance to conduct passive relocation of burrowing owls during the non-breeding season only when this activity is not otherwise allowed. Apply for exception through the Habitat Plan Application.

Submit a passive relocation plan with the request for the exception. The plan must document the following information:

- Owls have occupied the site for a full year without relocating voluntarily. Surveys documenting presence must be completed by a qualified biologist and results must be provided in a written report. The report should confirm that one or more individuals (i.e. unique owls) were monitored for a year and that the owls had used the site for a full year).
- The proposed process for relocation, including schedule for the proposed passive relocation and name of the qualified biologist.

Note: The Habitat Plan Agency, Wildlife Agencies and Planning Dept. will meet to discuss the proposed passive relocation plans. Exceptions will be considered based on, but not limited to the following factors:

- The parcel is equal to or less than 3 acres and is more than 1,000 feet from other suitable nesting or foraging habitat such that it is unlikely the site can sustain burrowing owls into the future.
- If the site has historically been used for nesting (within the last 3 yrs).
- If the site is a target for burrowing owl temporary or permanent management agreement.

(Bio-Mit No. 2 – Tri-Colored Blackbird)

All Habitat Plan conditions for Tri-Colored Blackbird are incorporated into the mitigation measures as follows: See Habitat Plan Condition 17. Tri-Colored Blackbird

2a) Pre-construction surveys for Tri-Colored Blackbird conducted by a qualified biologist are required with submittal of the Habitat Plan Application to confirm presence and suitability of habitat for the species within the proposed development area and within a 250 ft. radius of the development area. Note: If the qualified biologist verifies that the project area is within 250 feet of landcovers (riparian, marsh, ponds), the qualified biologist will conduct a field investigation to identify and map potential nesting substrate. If potential nesting substrate is found, the project proponent may revise the proposed project to avoid all areas within a 250-foot buffer around the potential nesting habitat, and surveys will be concluded.

2b) If active nests are found onsite, a 250-foot non-disturbance buffer will be established around all nest sites as determined by a qualified biologist.

2c). If presence/suitability are determined and applicant chooses not to avoid the potential nesting habitat and 250-foot buffer – follow up pre-construction surveys are required up to 14 days prior to grading/construction activities (submitted to Planning Dept. prior to final inspection). As part to the surveys, a qualified biologist will

- Make effort to determine if there has been nesting at the site in the past 5 years. This includes checking the CA Natural Diversity Database, contacting local experts, and looking for evidence of historical nesting (i.e. old nests).
- If no nesting in the past 5 years is evident, conduct a preconstruction survey in areas identified in the habitat survey as supporting potential tricolored blackbird nesting habitat. Surveys will be made at the appropriate times of year when nesting use is expected to occur. The surveys will document the presence or absence of nesting colonies of tricolored blackbird. Surveys will conclude no more than 2 calendar days prior to construction.
- If a tri-colored blackbird nesting colony is present, a 250-foot buffer will be applied from the outer edge of all hydric vegetation associated with the site and the site and the sit plus buffer will be avoided.
- The qualified biologist will notify the Planning Dept. and the Habitat Agency immediately of nest locations. The Habitat Agency will notify the Wildlife Agencies.

2d) Covered activities must avoid tricolored blackbird nesting habitat that is currently occupied or has been used in the past 5 years. If tricolored blackbird colonies are identified during the breeding season, covered activities will be prohibited within a 250-foot no activity buffer zone around the outer edge of all hydric vegetation associated with the colony.

- This buffer may be reduced in areas with dense forest, building, or other habitat features between the construction activities and the active nest colony, or where there is sufficient topographic relief to protect the colony from excessive noise or visual disturbance.
- Depending on the site characteristics, the sensitivity of the colony, and surrounding land uses, the buffer zone may be increased. Land uses potentially affecting a colony will be observed by a qualified biologist to verify that the activity is not disturbing the colony. If it is, the buffer will be increased. Habitat Agency technical staff will coordinate with the Wildlife Agency and evaluate exception to the minimum no-activity buffer distance on a case-by-case basis.

2e) Construction Monitoring: If construction takes place during the breeding season when an active colony is present, a qualified biologist will monitor construction.

- A qualified biologist will monitor the site to ensure that the 250-foot buffer zone is enforced.
- If monitoring indicates that construction outside of the buffer is affecting a breeding colony, the buffer will be increased if space allows (e.g. staging area moved farther away). If space does not allow increased buffer, construction will cease until the colony abandons the site or until the end of the breeding season, whichever occurs first.

- The biological monitor will conduct training of construction personnel on avoidance procedures, buffer zones, and protocols in the event that a tricolored blackbird enters an active construction zone.
- Construction monitoring report to be submitted to Planning Dept. and Habitat Agency prior to final inspection.

(Bio-Mit. No. 3) – Foothill Yellow Legged Frog, California Red Legged Frog, Western Pond Turtles
All Habitat Plan conditions for these species are incorporated into the mitigation measures as follows:
See Habitat Plan Condition 1. Avoid direct Impacts on Legally Protected Plant and Wildlife Species.

3a) Pre-construction surveys for Foothill Yellow Legged Frog, California Red Legged Frog, and Western Pond Turtles conducted by a qualified biologist are required with submittal of the Habitat Plan Application to confirm presence and suitability of habitat for the species to travel within the proposed development area. The biologist shall survey Arroyo Calero Creek on the subject site for presence of all these species. Note: If the qualified biologist verifies that the project area has impacts to the species, the qualified biologist will conduct a field investigation to identify and map location of such species.

3b) If species are found, final grading and building plans shall include a standard silt fence erected around perimeter of the grading and construction work. The fence material should be at least 2 feet in height and buried into the ground at least 5 to 6 inches. The silt fence shall be erected prior to ground disturbing work.

3c). If presence/suitability are determined – follow up pre-construction surveys are required up to 14 days prior to grading/construction activities (submitted to Planning Dept. prior to final inspection)

3d) Construction Monitoring: A qualified biologist will monitor construction.

- A qualified biologist will monitor the site to ensure that the silt fence remain erected properly.
- The biological monitor will conduct training of construction personnel on avoidance procedures, and protocol in the event that species enters an active construction zone.
- Construction monitoring report to be submitted to Planning Dept. and Habitat Agency prior to final inspection.

(Bio-Mit. No. 4) – San Francisco Dusky-Footed Woodrat

All conditions for these species are incorporated into the mitigation measures as follows. Please note that the San Francisco Dusky-Footed Woodrat is not a covered Habitat Plan species. Take requires a separate federal permit from U.S Fish and Wildlife Service and CA Dept. of Fish and Wildlife Service.

4a) Pre-construction surveys for San Francisco Dusky-Footed Woodrat conducted by a qualified biologist are required with submittal of the Habitat Plan Application to confirm presence and suitability of habitat within the proposed development area and surrounding area of 50 feet and riparian land cover. The biologist shall survey Arroyo Calero Creek on the subject site, and development area with 50 ft buffer for presence. Note: If the qualified biologist verifies that the project area has impacts to the species, the qualified biologist will conduct a field investigation to identify and map location of San Francisco Dusky-Footed Woodrat. If it is determined that young may be present

during the preconstruction survey, a buffer shall be established around the nest until the young are independent enough to successfully be moved from the deconstructed nest.

4b). If presence/suitability are determined follow up pre-construction surveys are required up to 14 days prior to grading/construction activities (submitted to Planning Dept. prior to final inspection)

4c) If active nests are found onsite, identified nests should be avoided. If avoidance is not possible, the nests should be manually deconstructed when the young are not present, during the non-breeding season (October through January). A qualified biologist shall deconstruct the nests. Deconstruction nest report to be submitted to Planning Dept. and Habitat Agency prior to final inspection.

(Bio-Mit. No. 5) – American Badger

All conditions for these species are incorporated into the mitigation measures as follows. Please note that the American Badger is not a covered Habitat Plan species. Take requires a separate federal permit from U.S Fish and Wildlife Service and CA Dept. of Fish and Wildlife Service.

5a) Pre-construction surveys for American Badger conducted by a qualified biologist are required with submittal of the Habitat Plan Application to confirm presence and suitability of habitat within the proposed development area and surrounding area of 300 feet. . Note: If the qualified biologist verifies that the project area has impacts to the species, the qualified biologist will conduct a field investigation to identify and map location of San Francisco Dusky-Footed Woodrat.

5b). If presence/suitability are determined follow up pre-construction surveys are required up to 14 days prior to grading/construction activities (submitted to Planning Dept. prior to final inspection)

5c). If an active badger den is identified during pre-construction surveys a buffer area of 300 feet shall be established around the den and avoided. If avoidance is not possible, after the biologist has determined that badger has vacated the borrow, the burrow can be collapsed or excavated. A qualified biologist shall deconstruct the burrow. Deconstruction nest report to be submitted to Planning Dept. and Habitat Agency prior to final inspection.

5d). If the burrow is determined to be natal or reproductive den and because badgers are known to use multiple burrowing in a breeding burrow complex, construction monitoring is required if this scenario is applicable.

- The biologist shall ensure the buffer is adequate to avoid direct impacts to individuals or natal/reproductive den abandonment.
- The biologist shall determine that American badgers would not be harmed by construction activities.
- The biological monitor will conduct training of construction personnel on avoidance procedures, and protocol in the event that species enters an active construction zone.
- Construction monitoring report to be submitted to Planning Dept. and Habitat Agency prior to final inspection.

E. CULTURAL RESOURCES							
WOULD THE PROJECT:	IMPACT						Source
	Potentially Significant Impact	Less Than Significant with Mitigation Incorporated	Less Than Significant Impact	No Impact	Analyzed in the Prior EIR	Substantially Mitigated by Uniformly Applicable Development Policies	
a) Cause a substantial adverse change in the significance of a historical resource pursuant to §15064.5 of the CEQA Guidelines, or the County's Historic Preservation Ordinance (Division C17 of County Ordinance Code) – including relocation, alterations or demolition of historic resources?	<input type="checkbox"/>	<input type="checkbox"/>	<input type="checkbox"/>	<input checked="" type="checkbox"/>	<input type="checkbox"/>	<input type="checkbox"/>	3, 16, 19, 40, 41
b) Cause a substantial adverse change in the significance of an archaeological resource pursuant to §15064.5 of the CEQA Guidelines?	<input type="checkbox"/>	<input type="checkbox"/>	<input type="checkbox"/>	<input checked="" type="checkbox"/>	<input type="checkbox"/>	<input type="checkbox"/>	3, 19, 40, 41
c) Disturb any human remains including, those interred outside of formal cemeteries?	<input type="checkbox"/>	<input type="checkbox"/>	<input type="checkbox"/>	<input checked="" type="checkbox"/>	<input type="checkbox"/>	<input type="checkbox"/>	3, 19, 40, 41

SETTING:

The California Historical Resources Northwest Information Center indicated that the proposed project area has the possibility of containing unrecorded archaeological site(s). As the rear of the site has a major creek (Arroyo Calero Creek), there may be a potential for archaeological resources.

DISCUSSION:

a, b, & c) No Impact - An archaeological study prepared by a qualified archaeologist was required for submittal, evaluating the project’s impacts to cultural resources. “Archaeological Resources Study of 21551 Schillingsburg Avenue- APN 701-37-004 – San Jose, Santa Clara County, California,” prepared by Sonoma State University Anthropological Studies Center,” dated August 2020, concludes that the project area has low potential to uncover archaeological resources. The field work did not discover any artifacts or other archaeological resources of concern.

The following is a standard condition of approval in meeting Ordinance requirements: (In the event that human skeletal remains are encountered, the applicant is required by County Ordinance No. B6-18 to immediately notify the County Coroner. Upon determination by the County Coroner that the remains are Native American, the coroner shall contact the California Native American Heritage Commission, pursuant to subdivision (c) of section 7050.5 of the Health and Safety Code and the County Coordinator of Indian affairs. No further disturbance of the site may be made except as authorized by the County Coordinator Of Indian Affairs in accordance with the provisions of state law and this chapter. If artifacts are found on the site a qualified archaeologist shall be contacted along with the County Planning Office. No further disturbance of the artifacts may be made except as authorized by the County Planning Office.)

MITIGATION:

None required.

F. ENERGY							
WOULD THE PROJECT:	IMPACT						Source
	Potentially Significant Impact	Less Than Significant with Mitigation Incorporated	Less Than Significant Impact	No Impact	Analyzed in the Prior EIR	Substantially Mitigated by Uniformly Applicable Development Policies	
a) Result in potentially significant environmental impact do to wasteful, inefficient, or unnecessary construction of energy resources during project consumption or operation?	<input type="checkbox"/>	<input type="checkbox"/>	<input type="checkbox"/>	<input checked="" type="checkbox"/>	<input type="checkbox"/>	<input type="checkbox"/>	3, 5
b) Conflict with or obstruct a state or local plan for renewable energy or energy efficiency?	<input type="checkbox"/>	<input type="checkbox"/>	<input type="checkbox"/>	<input checked="" type="checkbox"/>	<input type="checkbox"/>	<input type="checkbox"/>	5

SETTING:

As noted in the project description the project includes construction of a new residence and accessory dwelling unit and demolition of existing residence and broken shed. No energy resources are involved with this project.

DISCUSSION:

a & b) No Impact – The project has no negative impacts to energy resources. The project will not conflict with any renewable energy plan.

MITIGATION: N/A

G. GEOLOGY AND SOILS							
WOULD THE PROJECT:	IMPACT						Source
	Potentially Significant Impact	Less Than Significant with Mitigation Incorporated	Less Than Significant Impact	No Impact	Analyzed in the Prior EIR	Substantially Mitigated by Uniformly Applicable Development Policies	
a) Directly or indirectly cause potential substantial adverse effects, including the risk of loss, injury or death involving:							
i) Rupture of a known earthquake fault, as delineated on the most recent Alquist-Priolo Earthquake Fault Zoning Map issued by the State Geologist for the area or based on other substantial evidence of a known fault? Refer to Division of Mines and Geology Special Publication 42.	<input type="checkbox"/>	<input type="checkbox"/>	<input type="checkbox"/>	<input checked="" type="checkbox"/>	<input type="checkbox"/>	<input type="checkbox"/>	6, 17c, 43
ii) Strong seismic ground shaking?	<input type="checkbox"/>	<input type="checkbox"/>	<input type="checkbox"/>	<input checked="" type="checkbox"/>	<input type="checkbox"/>	<input type="checkbox"/>	6, 17c

G. GEOLOGY AND SOILS							
WOULD THE PROJECT:	IMPACT						Source
	Potentially Significant Impact	Less Than Significant with Mitigation Incorporated	Less Than Significant Impact	No Impact	Analyzed in the Prior EIR	Substantially Mitigated by Uniformly Applicable Development Policies	
iii) Seismic-related ground failure, including liquefaction?	<input type="checkbox"/>	<input type="checkbox"/>	<input type="checkbox"/>	<input checked="" type="checkbox"/>	<input type="checkbox"/>	<input type="checkbox"/>	6, 17c, 17n, 18b
iv) Landslides	<input type="checkbox"/>	<input type="checkbox"/>	<input type="checkbox"/>	<input checked="" type="checkbox"/>	<input type="checkbox"/>	<input type="checkbox"/>	6, 17L, 118b
b) Result in substantial soil erosion or the loss of topsoil?	<input type="checkbox"/>	<input type="checkbox"/>	<input type="checkbox"/>	<input checked="" type="checkbox"/>	<input type="checkbox"/>	<input type="checkbox"/>	6, 14, 23, 24
c) Be located on a geologic unit or soil that is unstable, or that would become unstable as a result of the project, and potentially result in on- or off-site landslide, lateral spreading, subsidence, liquefaction or collapse?	<input type="checkbox"/>	<input type="checkbox"/>	<input type="checkbox"/>	<input checked="" type="checkbox"/>	<input type="checkbox"/>	<input type="checkbox"/>	2, 3, 17c, 23, 24, 42
d) Be located on expansive soil, as defined in the report, <i>Soils of Santa Clara County</i> , creating substantial direct or indirect risks to life or property?	<input type="checkbox"/>	<input type="checkbox"/>	<input type="checkbox"/>	<input checked="" type="checkbox"/>	<input type="checkbox"/>	<input type="checkbox"/>	14,23, 24,
e) Have soils incapable of adequately supporting the use of septic tanks or alternative wastewater disposal systems where sewers are not available for the disposal of waste water?	<input type="checkbox"/>	<input type="checkbox"/>	<input type="checkbox"/>	<input checked="" type="checkbox"/>	<input type="checkbox"/>	<input type="checkbox"/>	3,6, 23,24,
f) Directly or indirectly destroy a unique paleontological resource or site or unique geologic feature?	<input type="checkbox"/>	<input type="checkbox"/>	<input type="checkbox"/>	<input checked="" type="checkbox"/>	<input type="checkbox"/>	<input type="checkbox"/>	2,3,4,40,41

SETTING:

The site is located within a County liquefaction hazard zone. The soil type (Stevens Creek sandy clay loam – 0 to 2 percent slopes) is considered to have moderate expansive shrink swell potential.

DISCUSSION:

a, b, c, d, e, & f) No Impact – A geotechnical report was submitted to review the project’s potential impacts for liquefaction hazards. A geotechnical report was submitted, “Geotechnical and Liquefaction Study Report for the Proposed Development at 221551 Schillingsburg Avenue San Jose, CA 95120,” by Achievement Engineering Corp. dated March 20, 2020. The County Geologist has determined there are no conditions required for liquefaction issues as the geotechnical report reports risk of liquefaction is low based on the cone penetrometer tests. As such there are no adverse impacts for liquefaction hazards.

The project will be subject to Santa Clara County’s Policies and Standards Pertaining to Grading and Erosion Control. Land Development Engineering requires a geotechnical report prior to final grading permit issuance, focusing on soil stability for all the grading restoration. As the grading does not

involve occupancy of any building or structures, with no geology hazards zones on-site, the County Geologist does not require further review.

The required grading will be carried out in accordance with the recommendations set forth by the County Grading Ordinance. At the time of construction, all graded areas shall be reseeded in conformance with the County Grading Ordinance to ensure that the project will minimize the potential for erosion on the site. All other land use and engineering aspects of this project will be conditioned by the recommendations set forth by the County Land Development Engineering Office.

MITIGATION:

None required.

H. GREENHOUSE GAS EMISSIONS							
	IMPACT						
WOULD THE PROJECT:	<u>Potentially Significant Impact</u>	<u>Less Than Significant with Mitigation Incorporated</u>	<u>Less Than Significant Impact</u>	<u>No Impact</u>	<u>Analyzed in the Prior EIR</u>	<u>Substantially Mitigated by Uniformly Applicable Development Policies</u>	Source
a) Generate greenhouse gas emissions, either directly or indirectly, that may have a significant impact on the environment?	<input type="checkbox"/>	<input type="checkbox"/>	<input type="checkbox"/>	<input checked="" type="checkbox"/>	<input type="checkbox"/>	<input type="checkbox"/>	5,29, 30
b) Conflict with any applicable plan, policy or regulation of an agency adopted for the purpose of reducing the emissions of greenhouse gases?	<input type="checkbox"/>	<input type="checkbox"/>	<input type="checkbox"/>	<input checked="" type="checkbox"/>	<input type="checkbox"/>	<input type="checkbox"/>	5,29, 30

SETTING:

Given the overwhelming scope of global climate change, it is not anticipated that a single development project would have an individually discernible effect on global climate change. It is more appropriate to conclude that the greenhouse gas emissions generated by a proposed project would combine with emissions across the state, nation, and globe to cumulatively contribute to global climate change. The primary GHG associated with a development project is carbon dioxide, which is directly generated by fuel combustion (vehicle trips, use of natural gas for buildings) and indirectly generated by use of electricity.

DISCUSSION:

a, & b) No Impact - The proposed project would construct two new dwelling units (primary residence and accessory dwelling unit) and demolish an existing residence and shed. BAAQMD has published screening level sizes for operational GHG emission for different land use types.² The land use type applicable to the proposed project is “Single-family.” Single family residential is the most appropriate for the project as the project is for residential development. The operational screening level sizes for

²Although the BAAQMD CEQA Guidelines that contain these screening level sizes have been overturned in court, the County has determined that these thresholds are based on substantial evidence, as identified in Appendix D of the Guidelines, and has therefore incorporated them into this Initial Study.

GHG emissions for this land use type is 56 dwelling units. GHG emissions from construction are considered to be less than significant when the development is below the operational screening level size. Therefore, construction of two new dwelling units and removal of one residence would not result in a cumulatively considerable net increase in GHG emissions.

MITIGATION:

None required.

I. HAZARDS & HAZARDOUS MATERIALS							
WOULD THE PROJECT:	IMPACT						Source
	<u>Potentially Significant Impact</u>	<u>Less Than Significant with Mitigation Incorporated</u>	<u>Less Than Significant Impact</u>	<u>No Impact</u>	<u>Analyzed in the Prior EIR</u>	<u>Substantially Mitigated by Uniformly Applicable Development Policies</u>	
a) Create a significant hazard to the public or the environment through the routine transport, use, or disposal of hazardous materials?	<input type="checkbox"/>	<input type="checkbox"/>	<input type="checkbox"/>	<input checked="" type="checkbox"/>	<input type="checkbox"/>	<input type="checkbox"/>	1, 3, 4, 5
b) Create a significant hazard to the public or the environment through reasonably foreseeable upset and accident conditions involving the release of hazardous materials into the environment?	<input type="checkbox"/>	<input type="checkbox"/>	<input type="checkbox"/>	<input checked="" type="checkbox"/>	<input type="checkbox"/>	<input type="checkbox"/>	2, 3, 5
c) Emit hazardous emissions or handle hazardous or acutely hazardous materials, substances, or waste within 1/4 mile of an existing or proposed school?	<input type="checkbox"/>	<input type="checkbox"/>	<input type="checkbox"/>	<input checked="" type="checkbox"/>	<input type="checkbox"/>	<input type="checkbox"/>	46
d) Be located on a site which is included on a list of hazardous materials sites compiled pursuant to Government Code Section 65962.5 and, as a result, would it create a significant hazard to the public or the environment?	<input type="checkbox"/>	<input type="checkbox"/>	<input type="checkbox"/>	<input checked="" type="checkbox"/>	<input type="checkbox"/>	<input type="checkbox"/>	47
e) For a project located within an airport land use plan referral area or, where such a plan has not been adopted, within two miles of a public airport or public use airport, or in the vicinity of a private airstrip, would the project result in a safety hazard, or excessive noise for people residing or working in the project area?	<input type="checkbox"/>	<input type="checkbox"/>	<input type="checkbox"/>	<input checked="" type="checkbox"/>	<input type="checkbox"/>	<input type="checkbox"/>	3, 22a
f) Impair implementation of or physically interfere with an adopted emergency response plan or emergency evacuation plan?	<input type="checkbox"/>	<input type="checkbox"/>	<input type="checkbox"/>	<input checked="" type="checkbox"/>	<input type="checkbox"/>	<input type="checkbox"/>	5, 48

I. HAZARDS & HAZARDOUS MATERIALS							
WOULD THE PROJECT:	IMPACT						Source
	Potentially Significant Impact	Less Than Significant with Mitigation Incorporated	Less Than Significant Impact	No Impact	Analyzed in the Prior EIR	Substantially Mitigated by Uniformly Applicable Development Policies	
g) Expose people or structures either directly or indirectly to a significant risk of loss, injury or death involving wildland fires?	<input type="checkbox"/>	<input type="checkbox"/>	<input type="checkbox"/>	<input checked="" type="checkbox"/>	<input type="checkbox"/>	<input type="checkbox"/>	4, 17g

SETTING:

The property is located in the Santa Clara County Fire Department Response Area and Calfire State Response Area. The site is not located near any airport. The site is located within a moderate Wildland Urban Interface Area.

DISCUSSION:

a, b, c, d, e, f, & g) No Impact - There is no storage of hazardous materials associated with this project. There is no risk of wildland fires as this is not in a high risk Wildland Urban Interface Area, with no impacts to trees. The project shall comply with County and State fire regulations for fire access with the construction of the primary dwelling and accessory dwelling unit.

MITIGATION:

None required.

J. HYDROLOGY AND WATER QUALITY							
Would the project:	IMPACT						SOURCE
	Potential Significant Impact	Less Than Significant With Mitigation Incorporated	Less Than Significant Impact	No Impact	Analyzed in the Prior EIR	Substantially Mitigated by Uniformly Applicable Development Policies	
a) Violate any water quality standards or waste discharge requirements or otherwise substantially degrade surface or ground water quality?	<input type="checkbox"/>	<input type="checkbox"/>	<input type="checkbox"/>	<input checked="" type="checkbox"/>	<input type="checkbox"/>	<input type="checkbox"/>	34, 36
b) Substantially decrease groundwater supplies or interfere substantially with groundwater recharge such that the project may impede sustainable groundwater management of the basin?	<input type="checkbox"/>	<input type="checkbox"/>	<input type="checkbox"/>	<input checked="" type="checkbox"/>	<input type="checkbox"/>	<input type="checkbox"/>	3, 4
c) Substantially alter the existing drainage pattern of the site or area, including through the alteration of the course of a stream or river or through the addition of impervious surfaces, in a manner which would:	<input type="checkbox"/>	<input type="checkbox"/>	<input type="checkbox"/>	<input checked="" type="checkbox"/>	<input type="checkbox"/>	<input type="checkbox"/>	3, 17n,
i) Result in substantial erosion or siltation on- or off-site	<input type="checkbox"/>	<input type="checkbox"/>	<input type="checkbox"/>	<input checked="" type="checkbox"/>	<input type="checkbox"/>	<input type="checkbox"/>	3, 17p
ii) Substantially increase the rate or amount of surface runoff in a manner which would result in flooding on- or offsite;	<input type="checkbox"/>	<input type="checkbox"/>	<input checked="" type="checkbox"/>	<input type="checkbox"/>	<input type="checkbox"/>	<input type="checkbox"/>	1, 3, 5, 36, 21a
iii) Create or contribute runoff water which would exceed the capacity of existing or planned stormwater drainage systems or	<input type="checkbox"/>	<input type="checkbox"/>	<input type="checkbox"/>	<input checked="" type="checkbox"/>	<input type="checkbox"/>	<input type="checkbox"/>	1, 3, 5

	provide substantial additional sources of polluted runoff; or							
IV)	Impede or redirect flood flows?	<input type="checkbox"/>	<input type="checkbox"/>	<input checked="" type="checkbox"/>	<input type="checkbox"/>	<input type="checkbox"/>	<input type="checkbox"/>	3, 17p, 18b, 18d
d)	In flood hazard, tsunami, or seiche zones, risk release of pollutants due to project inundation?	<input type="checkbox"/>	<input type="checkbox"/>	<input type="checkbox"/>	<input checked="" type="checkbox"/>	<input type="checkbox"/>	<input type="checkbox"/>	3, 18b, 18d
e)	Conflict with or obstruct implementation of a water quality control plan or sustainable groundwater management plan?	<input type="checkbox"/>	<input type="checkbox"/>	<input type="checkbox"/>	<input checked="" type="checkbox"/>	<input type="checkbox"/>	<input type="checkbox"/>	2, 3, 4, 17p

SETTING:

As note in the project description and Biological Resources Section, this application includes a request for building a new 4,567 sq. ft. residence and 1,200 sq. ft. accessory dwelling unit with demolition of the existing residence and broken shed. As noted in the project description, the scope of work includes the following: This application is for a Building Site Approval and Grading Approval to build a new 4,567 sq. ft. residence including attached garage and 1,200 sq. ft. accessory dwelling unit including attached garage off Tyr Lane with on-site improvements (driveway, septic system, detention pond and landscaping.

The creek is located in the rear yard of the property (Arroyo Calero Creek). The new residence, accessory dwelling unit, and improvements are at a minimum of 200 ft. setback from the top bank of the creek. The existing residence and shed are over 100 ft. away from the top bank of the creek. Arroyo Calero Creek is a Category 1 Habitat Plan creek with a 200 ft. setback from top bank of creek. As the 200 ft. setback is maintained, no Habitat Plan riparian fees are applicable. See **Attachment A – Project vicinity map, Attachment B – Plan Set, and Attachment C, - Biological Report.**

DISCUSSION:

a, b, c, d, & e – No Impact – The project would not discharge pollutants from surface or ground water, or decrease groundwater supply, or exceed storm drainage runoff. There is an existing residence to be demolished to be replaced with a new residence and accessory dwelling unit. This project would not conflict with any groundwater management plan. The development is 200 ft. away from the major creek (Arroyo Calero Creek).

cII and cIV – Less than Significant Impact – The project is in a 100 yr. flood zone. As part of the standard conditions during building permit/grading permit issuance, the new development shall comply with the County Floodplain Management Ordinance (SCC Code C12-800 to C12-826). A No Rise Certification, and No Adverse Certification from FEMA is required as part of the site development.

MITIGATION:

None required.

K. LAND USE							
WOULD THE PROJECT:	IMPACT						SOURCE
	Potentially Significant Impact	Less Than Significant With Mitigation Incorporated	Less Than Significant Impact	No Impact	Analyzed in the Prior EIR	Substantially Mitigated by Uniformly Applicable Development Policies	
a) Physically divide an established community?	<input type="checkbox"/>	<input type="checkbox"/>	<input type="checkbox"/>	<input checked="" type="checkbox"/>	<input type="checkbox"/>	<input type="checkbox"/>	2, 4
b) Cause a significant environmental impact due to a conflict with any land use plan, policy, or regulation adopted for the purpose of avoiding or mitigating an environmental effect?	<input type="checkbox"/>	<input type="checkbox"/>	<input type="checkbox"/>	<input checked="" type="checkbox"/>	<input type="checkbox"/>	<input type="checkbox"/>	8a, 9, 18a

SETTING:

The proposed project is an application for a Building Site Approval and Grading approval to construct a new residence and accessory dwelling unit. An existing residence and broken shed are also proposed for demolition. Surrounding land uses include other single-family residences in the neighborhood.

DISCUSSION:

a, & b) No Impact - The subject property is zoned RR-sr. It is the intent of the Rural Residential zone to provide for single-family dwellings. The subject project is not requiring a subdivision of the lot.

This is in consistency with the Zoning Ordinance standards for the property. The existing land use – residential will not change as a result of the project.

MITIGATION:

None required.

L. MINERAL RESOURCES							
WOULD THE PROJECT:	IMPACT						SOURCE
	Potentially Significant Impact	Less Than Significant With Mitigation Incorporated	Less Than Significant Impact	No Impact	Analyzed in the Prior EIR	Substantially Mitigated by Uniformly Applicable Development Policies	
a) Result in the loss of availability of a known mineral resource that would be of value to the region and the residents of the state?	<input type="checkbox"/>	<input type="checkbox"/>	<input type="checkbox"/>	<input checked="" type="checkbox"/>	<input type="checkbox"/>	<input type="checkbox"/>	1, 2, 3, 6, 44
b) Result in the loss of availability of a locally-important mineral resource recovery site delineated on a local general plan, specific plan or other land use plan?	<input type="checkbox"/>	<input type="checkbox"/>	<input type="checkbox"/>	<input checked="" type="checkbox"/>	<input type="checkbox"/>	<input type="checkbox"/>	1, 2, 3, 6, 8a

SETTING:

The proposed project is an application for Building Site approval and Grading approval to construct a new residence and accessory dwelling unit and demolition of a residence and broken shed. This would not entail the removal of any mineral resources.

DISCUSSION:

a, & b) No Impact - There are no mineral resources on-site. Thus, there are no impacts to mineral resources.

MITIGATION:

None required.

M. NOISE							
WOULD THE PROJECT RESULT IN:	IMPACTS						SOURCE
	<u>Potentially Significant Impact</u>	<u>Less Than Significant With Mitigation Incorporated</u>	<u>Less Than Significant Impact</u>	<u>No Impact</u>	<u>Analyzed in the Prior EIR</u>	<u>Substantially Mitigated by Uniformly Applicable Development Policies</u>	
	a) Generation of a substantial temporary or permanent increase in ambient noise levels in the vicinity of the project in excess of standards established in the local general plan or noise ordinance, or applicable standards of other agencies?	<input type="checkbox"/>	<input type="checkbox"/>	<input type="checkbox"/>	<input checked="" type="checkbox"/>	<input type="checkbox"/>	
b) Generation of excessive groundborne vibration or groundborne noise levels?	<input type="checkbox"/>	<input type="checkbox"/>	<input type="checkbox"/>	<input checked="" type="checkbox"/>	<input type="checkbox"/>	<input type="checkbox"/>	13, 45
c) For a project located within the vicinity of a private airstrip or an airport land use plan referral area or, where such a plan has not been adopted, within two miles of a public airport, public use airport, or private airstrip, would the project expose people residing or working in the project area to excessive noise levels?	<input type="checkbox"/>	<input type="checkbox"/>	<input type="checkbox"/>	<input checked="" type="checkbox"/>	<input type="checkbox"/>	<input type="checkbox"/>	1, 5, 22a

SETTING:

The project site is located off Shillingsburg and Tyr. The surrounding land uses are other single-family residences in the neighborhood. The nearest sensitive receptors are neighboring homes across the street and immediately adjacent on each side of the lot.

DISCUSSION:

a, b, & c) No Impact - The noise levels created during the grading/construction/demolition of this project could create a temporary construction noise disturbance to neighboring properties. As the construction/demolition noise would be temporary and would not affect the ambient noise levels beyond the construction period, the impacts are considered of no impact. Furthermore, the project would be required to conform to the County Noise Ordinance. The resulting homes are not anticipated to create a significant impact to ambient noise levels after construction is completed. Furthermore, the County Noise Ordinance (Section B11-152) sets maximum exterior noise levels for land use categories, and compliance with these specifications will ensure that the neighboring properties are not significantly impacted.

MITIGATION:

None required.

N. POPULATION AND HOUSING							
WOULD THE PROJECT:	IMPACT						SOURCE
	Potentially Significant Impact	Less Than Significant With Mitigation Incorporated	Less Than Significant Impact	No Impact	Analyzed in the Prior EIR	Substantially Mitigated by Uniformly Applicable Development Policies	
a) Induce substantial unplanned population growth in an area, either directly (for example, by proposing new homes and businesses) or indirectly (for example, through extension of roads or other infrastructure)?	<input type="checkbox"/>	<input type="checkbox"/>	<input type="checkbox"/>	<input checked="" type="checkbox"/>	<input type="checkbox"/>	<input type="checkbox"/>	1, 3, 4
b) Displace substantial numbers of existing housing or people, necessitating the construction of replacement housing elsewhere?	<input type="checkbox"/>	<input type="checkbox"/>	<input type="checkbox"/>	<input checked="" type="checkbox"/>	<input type="checkbox"/>	<input type="checkbox"/>	1, 2, 3, 4

SETTING:

The proposed project will create two new homes and demolition of a residence.

DISCUSSION:

a, & b) No Impact - The project will not alter or increase population growth in the area. As discussed in the setting section above, there is already a home on the lot – Adding a new accessory dwelling unit is not substantial growth.

MITIGATION:

None required.

O. PUBLIC SERVICES							
WOULD THE PROJECT:	IMPACT						SOURCE
	Potentially Significant Impact	Less Than Significant With Mitigation Incorporated	Less Than Significant Impact	No Impact	Analyzed in the Prior EIR	Substantially Mitigated by Uniformly Applicable Development Policies	
a) Result in substantial adverse physical impacts associated with the provision of new or physically altered governmental facilities, need for new or physically altered governmental facilities, the construction of which could cause significant environmental impacts, in order to maintain acceptable service ratios, response times or other performance objectives for any of the following public services:							
i) Fire Protection?	<input type="checkbox"/>	<input type="checkbox"/>	<input type="checkbox"/>	<input checked="" type="checkbox"/>	<input type="checkbox"/>	<input type="checkbox"/>	1, 3, 5
ii) Police Protection?	<input type="checkbox"/>	<input type="checkbox"/>	<input type="checkbox"/>	<input checked="" type="checkbox"/>	<input type="checkbox"/>	<input type="checkbox"/>	1, 3, 5
iii) School facilities?	<input type="checkbox"/>	<input type="checkbox"/>	<input type="checkbox"/>	<input checked="" type="checkbox"/>	<input type="checkbox"/>	<input type="checkbox"/>	1, 3, 5
iv) Parks?	<input type="checkbox"/>	<input type="checkbox"/>	<input type="checkbox"/>	<input checked="" type="checkbox"/>	<input type="checkbox"/>	<input type="checkbox"/>	1, 3, 5, 17h
v) Other public facilities?	<input type="checkbox"/>	<input type="checkbox"/>	<input type="checkbox"/>	<input checked="" type="checkbox"/>	<input type="checkbox"/>	<input type="checkbox"/>	1, 3, 5

SETTING:

The proposed project will create two new homes and demolition of a residence. The homes on the property will have access to fire, police, school and park facility access.

DISCUSSION:

a) No impact - No major expansion of public services is required for this project. As discussed in the setting section above, there is already a home on the lot – Adding a new accessory dwelling unit is not substantial growth.

MITIGATION:

None required.

P. RECREATION							
WOULD THE PROJECT:	IMPACT						SOURCE
	Potentially Significant Impact	Less Than Significant With Mitigation Incorporated	Less Than Significant Impact	No Impact	Analyzed in the Prior EIR	Substantially Mitigated by Uniformly Applicable Development Policies	
a) Increase the use of existing neighborhood and regional parks or other recreational facilities such that substantial physical deterioration of the facility would occur or be accelerated?	<input type="checkbox"/>	<input type="checkbox"/>	<input type="checkbox"/>	<input checked="" type="checkbox"/>	<input type="checkbox"/>	<input type="checkbox"/>	1, 2, 4, 5, 17h
b) Include recreational facilities or require the construction or expansion of recreational facilities which might have an adverse physical effect on the environment?	<input type="checkbox"/>	<input type="checkbox"/>	<input type="checkbox"/>	<input checked="" type="checkbox"/>	<input type="checkbox"/>	<input type="checkbox"/>	1, 3, 4, 5

SETTING:

There are no parks or trails on the subject property or within the neighborhood.

DISCUSSION:

a & b) No Impact - The proposed project would not require the construction of or expansion of recreational facilities. This project would not increase the use of any parks.

MITIGATION:

None required.

Q. TRANSPORTATION							
WOULD THE PROJECT:	IMPACT						SOURCE
	YES			No Impact	Analyzed in the Prior EIR	NO	
	Potentially Significant Impact	Less Than Significant With Mitigation Incorporated	Less Than Significant Impact			Substantially Mitigated by Uniformly Applicable Development Policies	
a) Conflict with a program, plan, ordinance or policy addressing the circulation system, including transit, roadway, bicycle and pedestrian facilities?	<input type="checkbox"/>	<input type="checkbox"/>	<input type="checkbox"/>	<input checked="" type="checkbox"/>	<input type="checkbox"/>	<input type="checkbox"/>	1, 4, 5, 6, 7, 49, 52
b) Conflict or be inconsistent with CEQA Guidelines Section 15064.3, subdivision (b)? ³	<input type="checkbox"/>	<input type="checkbox"/>	<input type="checkbox"/>	<input checked="" type="checkbox"/>	<input type="checkbox"/>	<input type="checkbox"/>	6, 49, 50, 52
c) Substantially increase hazards due to a geometric design feature (e.g., sharp curves or dangerous intersections) or incompatible uses (e.g., farm equipment)?	<input type="checkbox"/>	<input type="checkbox"/>	<input type="checkbox"/>	<input checked="" type="checkbox"/>	<input type="checkbox"/>	<input type="checkbox"/>	3, 5, 6, 7, 52
d) Result in inadequate emergency access?	<input type="checkbox"/>	<input type="checkbox"/>	<input type="checkbox"/>	<input checked="" type="checkbox"/>	<input type="checkbox"/>	<input type="checkbox"/>	1, 3, 5, 48, 52

SETTING:

The proposed project is to construct a new residence and accessory dwelling unit and demolish one existing residence and broken shed. Grading quantities are approximately 1,458 cubic yards of cut and 2,342 cubic yards of fill with a maximum depth of 3 ft. Of the proposed grading, 1,111 cubic yards of fill are outside the scope of the Grading Approval associated with the building pads for the residence and accessory dwelling unit. See **Attachment B -Plan Set**.

DISCUSSION:

a, b, c, & d) No Impact - No new operational traffic will be created as result of the project. There may be a temporary increase in trips to and from the site while grading activities are occurring. Up to 12 cubic yards of dirt can be hauled in one truck load. The applicant will be required to use approved haul routes and expose of hauled earthwork to an approved disposal site.

MITIGATION:

None required.

R. TRIBAL CULTURAL RESOURCES							
WOULD THE PROJECT:	IMPACT						SOURCE
	Potentially Significant Impact	Less Than Significant With Mitigation Incorporated	Less Than Significant Impact	No Impact	Analyzed in the Prior EIR	Substantially Mitigated by Uniformly Applicable Development Policies	
	a) Cause a substantial adverse change in the significance of a tribal cultural resource, defined in Public Resources Code section 21074 as either a site, feature, place, cultural landscape that is	<input type="checkbox"/>	<input type="checkbox"/>	<input type="checkbox"/>	<input checked="" type="checkbox"/>	<input type="checkbox"/>	

³ The provisions of this section shall apply prospectively as described in section 15007. A lead agency may elect to be governed by the provisions of this section immediately. Beginning on July 1, 2020, the provisions of this section shall apply statewide. The County of Santa Clara has elected not to be governed by the provisions of this section until they become effective statewide on July 1, 2020.

geographically defined in terms of the size and scope of the landscape, sacred place, or object with cultural value to a California Native American tribe, and that is:

- | | | | | | | |
|---|--------------------------|--------------------------|--------------------------|-------------------------------------|--------------------------|--------------------------|
| <p>i. Listed or eligible for listing in the California Register of Historical Resources, or in a local register of historical resources as defined in Public Resources Code section 5020.1(k), or</p> | <input type="checkbox"/> | <input type="checkbox"/> | <input type="checkbox"/> | <input checked="" type="checkbox"/> | <input type="checkbox"/> | <input type="checkbox"/> |
| <p>ii. A resource determined by the lead agency, in its discretion and supported by substantial evidence, to be significant pursuant to criteria set forth in subdivision (c) of Public Resources Code Section 5024.1. In applying the criteria set forth in subdivision (c) of Public Resource Code Section 5024.1, the lead agency shall consider the significance of the resource to a California Native American tribe.</p> | <input type="checkbox"/> | <input type="checkbox"/> | <input type="checkbox"/> | <input checked="" type="checkbox"/> | <input type="checkbox"/> | <input type="checkbox"/> |

SETTING:

The project area has no recorded tribal cultural resources. The submitted cultural resources report, “Archaeological Resources Study of 21551 Schillingsburg Avenue- APN 701-37-004 – San Jose, Santa Clara County, California,” prepared by Sonoma State University Anthropological Studies Center,” dated August 2020 shows no evidence of tribal cultural resources on-site. There is a potential to uncover archaeological resources during grading/construction (See Cultural Resources Section for details).

DISCUSSION:

a)No Impact - Legislative law AB52 requires that tribes notify local agencies of any tribal concerns. Section 21080.3.1 of the code states the following:

Prior to release of a mitigated negative declaration, the lead agency shall begin consultation with a California Native American tribe that is traditionally and culturally affiliated with the geographic area of the proposed project if (1) the California Native American tribe requested to the lead agency, in writing, to be informed by the lead agency through formal notification of proposed project in the geographic area that is traditionally and culturally affiliated with the tribe, and (2) the California Native American tribe responds, in writing, within 30 days of receipt of the formal notification, and requests the consultation.

No tribes have notified the County of any concerns of tribal cultural resources related to this project. Therefore, no tribal consultation has been conducted.

MITIGATION:

None required.

S. UTILITIES AND SERVICE SYSTEMS							
WOULD THE PROJECT:	IMPACT						SOURCE
	Potentially Significant Impact	Less Than Significant With Mitigation Incorporated	Less Than Significant Impact	No Impact	Analyzed in the Prior EIR	Substantially Mitigated by Uniformly Applicable Development Policies	
a) Require or result in the relocation or construction of new or expanded water, wastewater treatment or storm water drainage, electric power, natural gas, or telecommunications facilities, the construction or relocation of which could cause significant environmental effects?	<input type="checkbox"/>	<input type="checkbox"/>	<input type="checkbox"/>	<input checked="" type="checkbox"/>	<input type="checkbox"/>	<input type="checkbox"/>	3,6,70
b) Have sufficient water supplies available to serve the project and reasonably foreseeable future development during normal, dry and multiple dry years	<input type="checkbox"/>	<input type="checkbox"/>	<input type="checkbox"/>	<input checked="" type="checkbox"/>	<input type="checkbox"/>	<input type="checkbox"/>	1, 3, 6,24b
c) Result in a determination by the wastewater treatment provider which serves or may serve the project that it has inadequate capacity to serve the project's projected demand in addition to the provider's existing commitments?	<input type="checkbox"/>	<input type="checkbox"/>	<input type="checkbox"/>	<input checked="" type="checkbox"/>	<input type="checkbox"/>	<input type="checkbox"/>	1, 3,6,70
d) Generate solid waste in excess of State or local standards, or in excess of the capacity of local infrastructure, or otherwise impair the attainment of solid waste reduction goals?	<input type="checkbox"/>	<input type="checkbox"/>	<input type="checkbox"/>	<input checked="" type="checkbox"/>	<input type="checkbox"/>	<input type="checkbox"/>	1, 3, 5,6
e) Be in non-compliance with federal, state, and local management and reduction statutes and regulations related to solid waste?	<input type="checkbox"/>	<input type="checkbox"/>	<input type="checkbox"/>	<input checked="" type="checkbox"/>	<input type="checkbox"/>	<input type="checkbox"/>	3,5, 6

SETTING:

Underground utilities will be constructed as part of the project to establish a new residence and accessory dwelling unit. There is an existing well for private water use on the site.

DISCUSSION:

a, b, c, d, & e) No Impact - The proposed project will not exceed the capacity of existing utilities and service system or result in the construction of new facilities that could cause significant environmental effects. Furthermore, the proposed project will be in compliance with any statutes or regulations relative to solid waste and will not employ equipment that would introduce interference with any communication system.

MITIGATION:

None required.

T. WILDFIRE							
If located in or near state responsibility areas or lands classified as very high fire hazard severity zones, would the project:	IMPACT						SOURCE
	Potentially Significant Impact	Less Than Significant With Mitigation Incorporated	Less Than Significant Impact	No Impact	Analyzed in the Prior EIR	Substantially Mitigated by Uniformly Applicable Development Policies	
a) Substantially impair an adopted emergency response plan or emergency evacuation plan?	<input type="checkbox"/>	<input type="checkbox"/>	<input type="checkbox"/>	<input checked="" type="checkbox"/>	<input type="checkbox"/>	<input type="checkbox"/>	1, 2, 3, 6, 44
b) Due to slope, prevailing winds, and other factors, exacerbate wildfire risks, and thereby expose project occupants to, pollutant concentrations from a wildfire or the uncontrolled spread of a wildfire?	<input type="checkbox"/>	<input type="checkbox"/>	<input type="checkbox"/>	<input checked="" type="checkbox"/>	<input type="checkbox"/>	<input type="checkbox"/>	1, 2, 3, 6, 8a
c) Require the installation or maintenance of associated infrastructure (such as roads, fuel breaks, emergency water sources, power lines or other utilities) that may exacerbate fire risk or that may result in temporary or ongoing impacts to the environment?	<input type="checkbox"/>	<input type="checkbox"/>	<input type="checkbox"/>	<input checked="" type="checkbox"/>	<input type="checkbox"/>	<input type="checkbox"/>	1, 2, 4, 5, 17h
d) Expose people or structures to significant risks, including downslope or downstream flooding or landslides, as a result of runoff, post-fire slope instability, or drainage changes?	<input type="checkbox"/>	<input type="checkbox"/>	<input type="checkbox"/>	<input checked="" type="checkbox"/>	<input type="checkbox"/>	<input type="checkbox"/>	1, 3, 4, 5

SETTING:

The property is located within a moderate Wildland Urban Interface zone. The trees are within the creek banks 200 ft. away from the proposed development area and over 100 ft. away from the residence and shed to be demolished.

DISCUSSION:

a,b,c,d,& e) No Impact - The project will not have any wildland fire impacts. No trees are being removed, or impacted as part of the project.

MITIGATION:

None required.

U. MANDATORY FINDING OF SIGNIFICANCE							
WOULD THE PROJECT:	IMPACT						SOURCE
	YES			No Impact	Analyzed in the Prior EIR	NO	
	Potentially Significant Impact	Less Than Significant With Mitigation Incorporated	Less Than Significant Impact			Substantially Mitigated by Uniformly Applicable Development Policies	
a) Have the potential to substantially degrade the quality of the environment, substantially reduce the habitat of a fish or wildlife species, cause a fish or wildlife population to drop below self-sustaining levels, threaten to eliminate a plant or animal community, substantially reduce the number or restrict the range of a rare or endangered plant or animal or eliminate important examples of the major periods of California history or prehistory?	<input type="checkbox"/>	<input checked="" type="checkbox"/>	<input type="checkbox"/>	<input type="checkbox"/>	<input type="checkbox"/>	<input type="checkbox"/>	1 to 52
b) Have impacts that are individually limited, but cumulatively considerable ("Cumulatively considerable" means that the incremental effects of an individual project are considerable when viewed in connection with the effects of past projects, the effects of other current projects, and the effects of probable future projects)?	<input type="checkbox"/>	<input type="checkbox"/>	<input type="checkbox"/>	<input checked="" type="checkbox"/>	<input type="checkbox"/>	<input type="checkbox"/>	1 to 52
c) Have environmental effects, which will cause substantial adverse effects on human beings, either directly or indirectly?	<input type="checkbox"/>	<input type="checkbox"/>	<input type="checkbox"/>	<input checked="" type="checkbox"/>	<input type="checkbox"/>	<input type="checkbox"/>	1 to 52

DISCUSSION:

a) **Less Than Significant Impact with Mitigation Incorporated.** As discussed in the Biological Resources section, impacts of the proposed project on special status/endangered species would be reduced to a less-than-significant level through incorporation of mitigation measures. The proposed project has the potential to substantially reduce the habitat of any wildlife species, cause a fish or wildlife population to drop below self-sustaining levels, threaten to eliminate a plant or animal community, and reduce the number of, or restrict the range of, a rare or endangered plant or animal.

b) **No Impact.** No past, current, or probable future projects were identified in the project vicinity that, when added to project-related impacts, would result in cumulatively considerable impacts. No cumulatively considerable impacts would occur with development of the proposed project. As discussed in the analyses provided in this Initial Study, project impacts were found to be less than significant. The incremental effects of the proposed project are not cumulatively significant when

viewed in context of the past, current, and/or probable future projects. No cumulative impacts would occur.

c) **No Impact.** The proposed project is for Building Site Approval and Grading Approval. As described in the environmental topic sections of this Initial Study, the proposed project would not have environmental effects that would cause substantial adverse effects on human beings, either directly or indirectly.

Initial Study Source List*

1. Environmental Information Form
https://www.sccgov.org/sites/dpd/DocsForms/Documents/EnvAss_Form.pdf
2. Field Inspection
3. Project Plans
4. Working knowledge of site and conditions
5. Experience with other Projects of This Size and Nature
6. County Expert Sources:
 - Geologist
<https://www.sccgov.org/sites/dpd/PlansOrdinances/GeoHazards/Pages/Geology.aspx>
 - Fire Marshal
<https://www.sccgov.org/sites/dpd/AboutUs/Fire/Pages/Fire.aspx>
 - Roads & Airports
<https://www.sccgov.org/sites/rda/Pages/rda.aspx>
 - Environmental Health
<https://www.sccgov.org/sites/deh/Pages/deh.aspx>
 - Land Development Engineering
<https://www.sccgov.org/sites/dpd/AboutUs/LDE/Pages/LDE.aspx>
 - Parks & Recreation
<https://www.sccgov.org/sites/parks/Pages/Welcome-to-Santa-Clara-County-Parks.aspx>
 - Zoning Administration,
Comprehensive Planning,
Architectural & Site Approval Committee
Secretary
7. Agency Sources:
 - Santa Clara Valley Water District
<https://www.valleywater.org/>
 - Santa Clara Valley Transportation Authority
<http://www.vta.org/>
 - Midpeninsula Regional Open Space District
<https://openspace.org/>
 - U.S. Fish & Wildlife Service
<https://www.fws.gov/>
 - CA Dept. of Fish & Game
<https://www.wildlife.ca.gov/>
 - Caltrans
<https://dot.ca.gov/>
 - U.S. Army Corps of Engineers
<https://www.usace.army.mil/>
 - Regional Water Quality Control Board
<https://www.waterboards.ca.gov/>
 - Public Works Depts. of individual cities
8. Planning Depts. of individual cities:
 - Santa Clara County (SCC) General Plan
<https://www.sccgov.org/sites/dpd/PlansOrdinances/GP/Pages/GP.aspx>
 - The South County Joint Area Plan
https://www.sccgov.org/sites/dpd/DocsForms/Documents/GP_Book_B.pdf
9. SCC Zoning Regulations (Ordinance)
<https://www.sccgov.org/sites/dpd/DocsForms/Documents/ZonOrd.pdf>
10. County Grading Ordinance
https://library.municode.com/ca/santa_clara_county/codes/code_of_ordinances?nodeId=TITCCODELAUS_DIVC12SULADE_CHIIIGRDR#TOPTITLE
11. SCC Guidelines for Architecture and Site Approval
https://www.sccgov.org/sites/dpd/DocsForms/Documents/ASA_Guidelines.pdf
12. SCC Development Guidelines for Design Review
https://www.sccgov.org/sites/dpd/DocsForms/Documents/DR_Guidelines.pdf
13. County Standards and Policies Manual (Vol. I - Land Development)
https://www.sccgov.org/sites/dpd/DocsForms/Documents/StandardsPoliciesManual_Vol1.pdf
14. Table 18-1-B of the Uniform Building Code (expansive soil regulations) [1994 version]
http://digitalassets.lib.berkeley.edu/ubc/UBC_1994_v2.pdf
15. SCC Land Use Database
16. Santa Clara County Heritage Resource (including Trees) Inventory [computer database]
17. GIS Database
 - a. SCC General Plan Land Use, and Zoning
 - b. USFWS Critical Habitat & Riparian Habitat
 - c. Geologic Hazards
 - d. Archaeological Resources
 - e. Water Resources
 - f. Viewshed and Scenic Roads
 - g. Fire Hazard
 - h. Parks, Public Open Space, and Trails
 - i. Heritage Resources - Trees
 - j. Topography, Contours, Average Slope
 - k. Soils
 - l. HCP Data (habitat models, land use coverage etc)
 - m. Air photos
 - n. USGS Topographic
 - o. Dept. of Fish & Game, Natural Diversity Data
 - p. FEMA Flood Zones
 - q. Williamson Act
 - r. Farmland monitoring program
 - s. Traffic Analysis Zones
 - t. Base Map Overlays & Textual Reports (GIS)
18. Paper Maps
 - a. SCC Zoning
 - b. Barclay's Santa Clara County Locaide Street Atlas
 - c. Color Air Photos (MPSI)
 - d. Santa Clara Valley Water District - Maps of Flood Control Facilities & Limits of 1% Flooding

Initial Study Source List*

- e. Soils Overlay Air Photos
- f. "Future Width Line" map set

19. 2019 CEQA Statute Guidelines [Current Edition]
http://resources.ca.gov/ceqa/docs/2019_CEQA_Statutes_and_Guidelines.pdf

Area Specific: San Martin, Stanford, and Other Areas

San Martin

20a. San Martin Integrated Design Guidelines
https://www.sccgov.org/sites/dpd/DocsForms/Documents/SanMartin_DesignGuidelines.pdf

20b. San Martin Water Quality Study

20c. Memorandum of Understanding (MOU) between Santa Clara County & Santa Clara Valley Water District

Stanford

21a. Stanford University General Use Permit (GUP), Community Plan (CP), Mitigation and Monitoring Reporting Program (MMRP) and Environmental Impact Report (EIR)
<https://www.sccgov.org/sites/dpd/Programs/Stanford/Pages/Docs.aspx>

21b. Stanford Protocol and Land Use Policy Agreement
<https://www.sccgov.org/sites/dpd/Programs/Stanford/Pages/Docs.aspx>

Other Areas

22a. South County Airport Comprehensive Land Use Plan and Palo Alto Airport comprehensive Land Use Plan [November 19, 2008]

22b. Los Gatos Hillside Specific Area Plan
https://www.sccgov.org/sites/dpd/DocsForms/Documents/GP_Book_B.pdf

22c. County Lexington Basin Ordinance Relating to Sewage Disposal

22d. User Manual Guidelines & Standards for Land Uses Near Streams: A Manual of Tools, Standards and Procedures to Protect Streams and Streamside Resources in Santa Clara County by Valley Water Resources Protection Collaborative, August 2005 – Revised July 2006.

<https://www.valleywater.org/contractors/doing-business-with-the-district/permits-for-working-on-district-land-or-easement/guidelines-and-standards-for-land-use-near-streams>

22e. Guidelines and Standards for Land Use Near Streams: Streamside Review Area – Summary prepared by Santa Clara County Planning Office, September 2007.

22f. Monterey Highway Use Permit Area
https://www.sccgov.org/sites/dpd/DocsForms/Documents/SanMartin_GeneralPlanInformation.pdf

Soils

23. USDA, SCS, "Soils of Santa Clara County"

24. USDA, SCS, "Soil Survey of Eastern Santa Clara County"

Agricultural Resources/Open Space

25. Right to Farm Ordinance

26. State Dept. of Conservation, "CA Agricultural Land Evaluation and Site Assessment Model"
<https://www.conservation.ca.gov/dlrp/Documents/TOC%20and%20Intro.pdf>

27. Open Space Preservation, Report of the Preservation 2020 Task Force, April 1987 [Chapter IV]

28. Williamson Act Ordinance and Guidelines (current version)
<https://www.sccgov.org/sites/dpd/Programs/WA/Pages/WA.aspx>

Air Quality

29. BAAQMD Clean Air Plan
<http://www.baaqmd.gov/~media/files/planning-and-research/plans/2017-clean-air-plan/attachment-a-proposed-final-cap-vol-1-pdf.pdf?la=en>

30. BAAQMD CEQA Air Quality Guidelines (2017)-
http://www.baaqmd.gov/~media/files/planning-and-research/ceqa/ceqa_guidelines_may2017-pdf.pdf?la=en

31. BAAQMD Annual Summary of Contaminant Excesses & BAAQMD, "Air Quality & Urban Development - Guidelines for Assessing Impacts of Projects & Plans" [current version]

**Biological Resources/
Water Quality & Hydrological Resources/
Utilities & Service Systems"**

32. Site-Specific Biological Report

33. Santa Clara County Tree Preservation Ordinance
https://www.sccgov.org/sites/dpd/DocsForms/Documents/Tree_Ordinance.pdf

Section C16, Santa Clara County Guide to Evaluating Oak Woodlands Impacts
https://www.sccgov.org/sites/dpd/DocsForms/Documents/Oakwoodlands_Guide.pdf

Initial Study Source List*

Santa Clara County Guidelines for Tree Protection and Preservation for Land Use Applications
https://www.sccgov.org/sites/dpd/DocsForms/Documents/Brochure_TreePreservation.pdf

33. Clean Water Act, Section 404
<https://www.epa.gov/cwa-404/permit-program-under-cwa-section-404>
34. Santa Clara Valley Water District – GIS Data:
<https://www.valleywater.org/learning-center/watersheds-of-santa-clara-valley>
35. CA Regional Water Quality Control Board, Water Quality Control Plan, San Francisco Bay Region [1995]
36. Santa Clara Valley Water District, Private Well Water Testing Program [12-98]
37. SCC Nonpoint Source Pollution Control Program, Urban Runoff Management Plan [1997]
38. County Environmental Health / Septic Tank Sewage Disposal System - Bulletin "A"
39. County Environmental Health Department Tests and Reports

Archaeological Resources

40. Northwest Information Center, Sonoma State University
41. Site Specific Archaeological Reconnaissance Report

Geological Resources

42. Site Specific Geologic Report
43. State Department of Mines and Geology, Special Report #42
44. State Department of Mines and Geology, Special Report #146

Greenhouse Gas Emissions

45. BAAQMD CEQA Air Quality Guidelines (2017)-
http://www.baaqmd.gov/~media/files/planning-and-research/ceqa/ceqa_guidelines_may2017-pdf.pdf?la=en

Hazards & Hazardous Materials

46. Section 21151.4 of California Public Resources Code
47. State Department of Toxic Substances, Hazardous Waste and Substances Sites List
48. County Office of Emergency Services Emergency Response Plan [1994 version]

Noise

49. County Noise Ordinance
https://www.sccgov.org/sites/cpd/programs/NP/Documents/NP_Noise_Ordinance.pdf

Transportation/Traffic

50. Official County Road Book
51. **Site-specific Traffic Impact Analysis Report**

Tribal Cultural Resources

52. Office of Planning and Research. 2017. Technical Advisory: AB 52 and Tribal Cultural Resources in CEQA

Wildfire

53. Office of Planning and Research. 2020. Fire Hazard Planning Technical Advisory

***Items listed in bold are the most important sources and should be referred to during the first review of the project, when they are available. The planner should refer to the other sources for a particular environmental factor if the former indicates a potential environmental impact.**

References:

- 1) "21551 Schillingsburg Avenue Technical Biological Report," prepared by Live Oak Associates Inc, dated January 16, 2020
- 2) "Archaeological Resources Study of 21551 Schillingsburg Avenue- APN 701-37-004 – San Jose, Santa Clara County, California," prepared by Sonoma State University Anthropological Studies Center," dated August 2020
- 3) "Geotechnical and Liquefaction Study Report for the Proposed Development at 221551 Schillingsburg Avenue San Jose, CA 95120," by Achievement Engineering Corp. dated March 20, 2020.

Attachments:

Attachment A – Project Vicinity Map

Attachment B – Plan Set

Attachment C – Biological Report – See reference #1 above

Attachment A – Project Vicinity Map

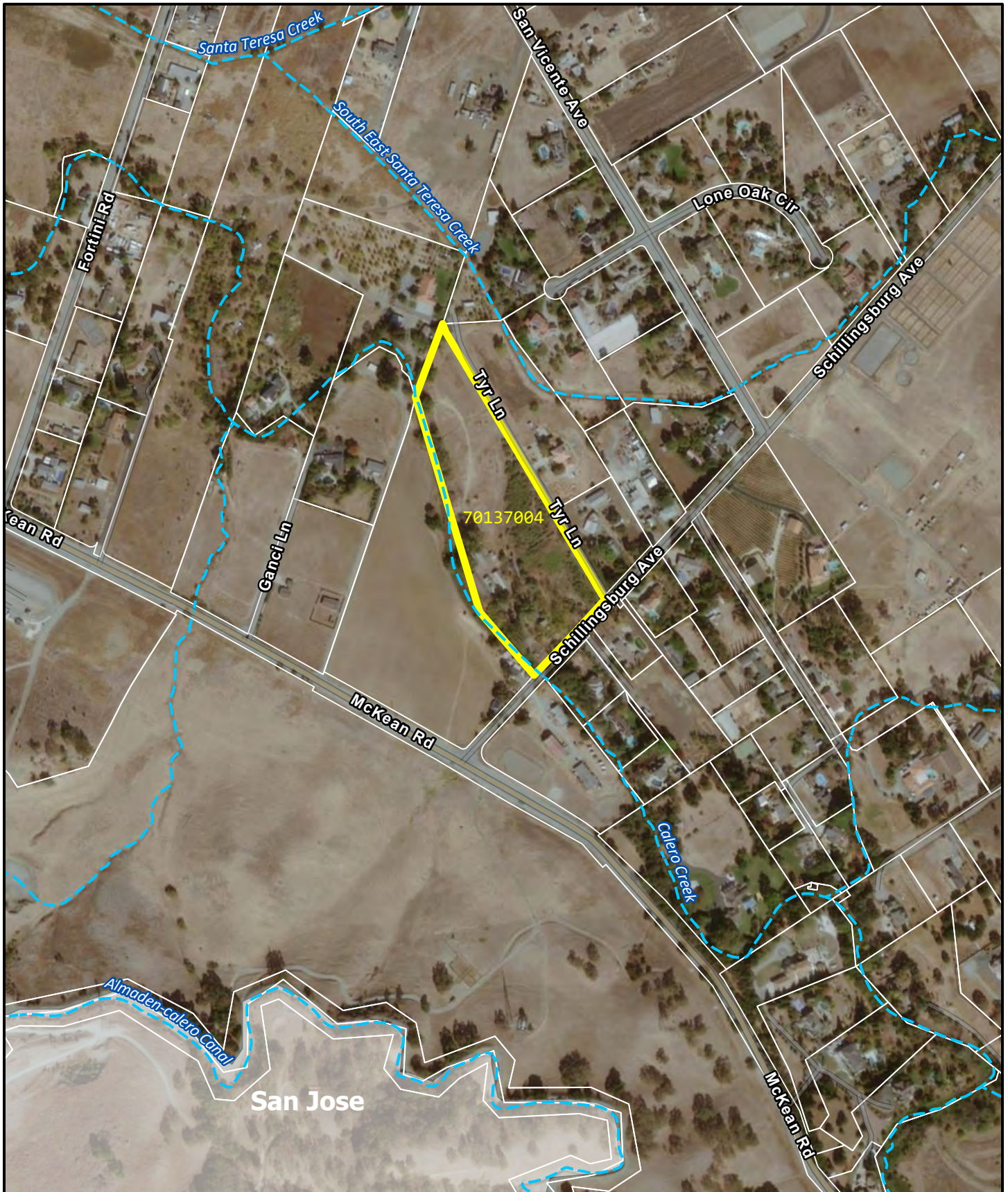

Vicinity Map

File: PLN18-12010
 APN: 701-37-004

Attachment A - Project Vicinity Map

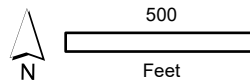

ATTACHMENT B - Plans

ABBREVIATIONS

- | | |
|--------------------------------|--------------------------------------|
| AC = ASPHALT CONCRETE | LP = LOW POINT |
| AD = AREA DRAIN | PAD = PAD ELEVATION |
| BC = BEGIN CURVE | PCC = PORTLAND CEMENT CONCRETE |
| BS = BOTTOM OF STAIR | PL = PROPERTY LINE |
| BU = BUBBLE UP | PV = PAVEMENT GRADE |
| BVC = BEGIN VERTICAL CURVE | PVC = POLYVINYL CHLORIDE PIPE |
| BRW = BOTTOM OF RETAINING WALL | PVI = POINT OF VERTICAL INTERSECTION |
| CB = CATCH BASIN | RCF = REINFORCED CONCRETE PIPE |
| CL = CENTERLINE | ROW = RIGHT OF WAY |
| CO = CLEANOUT | S=0.04> SLOPE |
| DS = DOWNSPOUT WITH SPLASH BOX | SD = STORM DRAIN |
| EC = END CURVE | SDMH = STORM DRAIN MANHOLE |
| ELEV. = ELEVATION | SG = SUBGRADE ELEVATION |
| EVC = END VERTICAL CURVE | SS = SANITARY SEWER |
| EX. = EXISTING | SSMH = SANITARY SEWER MANHOLE |
| F/C = FACE OF CURB | STA = STATION |
| FF = FINISHED FLOOR ELEVATION | TC = TOP OF CURB |
| FH = FIRE HYDRANT | TF = TOP OF FENCE |
| FL = FLOW LINE | TRW = TOP OF RETAINING WALL |
| GB = GRADE BREAK | TS = TOP OF STAIR |
| GFF = GARAGE FINISH FLOOR | TW = TOP OF WALL |
| HP = HIGH POINT | VCP = VITRIFIED CLAY PIPE |
| HC = HANDICAP UNIT | WM = WATER METER |
| INV = INVERT | WV = WATER VALVE |

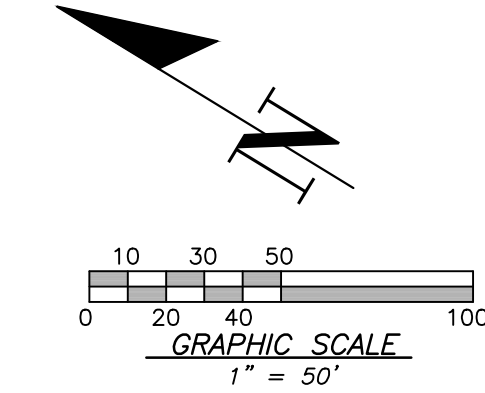

CONTRACTOR AGREES THAT HE SHALL ASSUME SOLE AND COMPLETE RESPONSIBILITY FOR JOB SITE CONDITIONS DURING THE COURSE OF CONSTRUCTION OF THIS PROJECT, INCLUDING THE SAFETY OF ALL PERSONS AND PROPERTY. THIS RESPONSIBILITY SHALL INCLUDE, BUT NOT BE LIMITED TO, NORMAL WORKING HOURS, AND THAT THE CONTRACTOR SHALL MAINTAIN THE NEAREST ADJACENT PROPERTIES AND NEIGHBORHOODS AS ALLEGED, IN CONNECTION WITH THE PERFORMANCE OF WORK ON THIS PROJECT, EXCEPTING FOR LIABILITY ARISING FROM THE SOLE NEGLIGENCE OF THE OWNER OR THE ENGINEER.

LEGEND

- | DESCRIPTION | SYMBOL |
|-------------------------------|--------|
| BOUNDARY LINE | --- |
| LOT LINE | --- |
| EASEMENT LINE | --- |
| SIDEWALK | ▨ |
| WOOD FENCE | X X |
| CHAIN LINK FENCE | ○ ○ |
| RETAINING WALL | ▬ |
| DRIVEWAY DRAIN INLET | ⊕ |
| AREA DRAIN | ⊕ |
| DROP INLET | ⊕ |
| MONUMENT | ⊕ |
| FIRE HYDRANT | ⊕ |
| ELECTRODER | ⊕ |
| WATER METER | ⊕ |
| AC UNIT | ⊕ |
| SANITARY SEWER LATERAL | ⊕ |
| STORM DRAIN | SD |
| SANITARY SEWER | SS |
| STREET LIGHT CONDUITS | SL |
| WATER | W |
| JOINT TRENCH | JT |
| HOUSE SERVICE | SVC |
| SLOPE ARROW | ↘ |
| EXISTING CONTOUR | 100 |
| PROPOSED CONTOUR | 100 |
| OVERLAND RELEASE | → |
| DIRECTION OF SURFACE DRAINAGE | → |
| SEE SLOPE AWAY FROM BUILDING | >> |

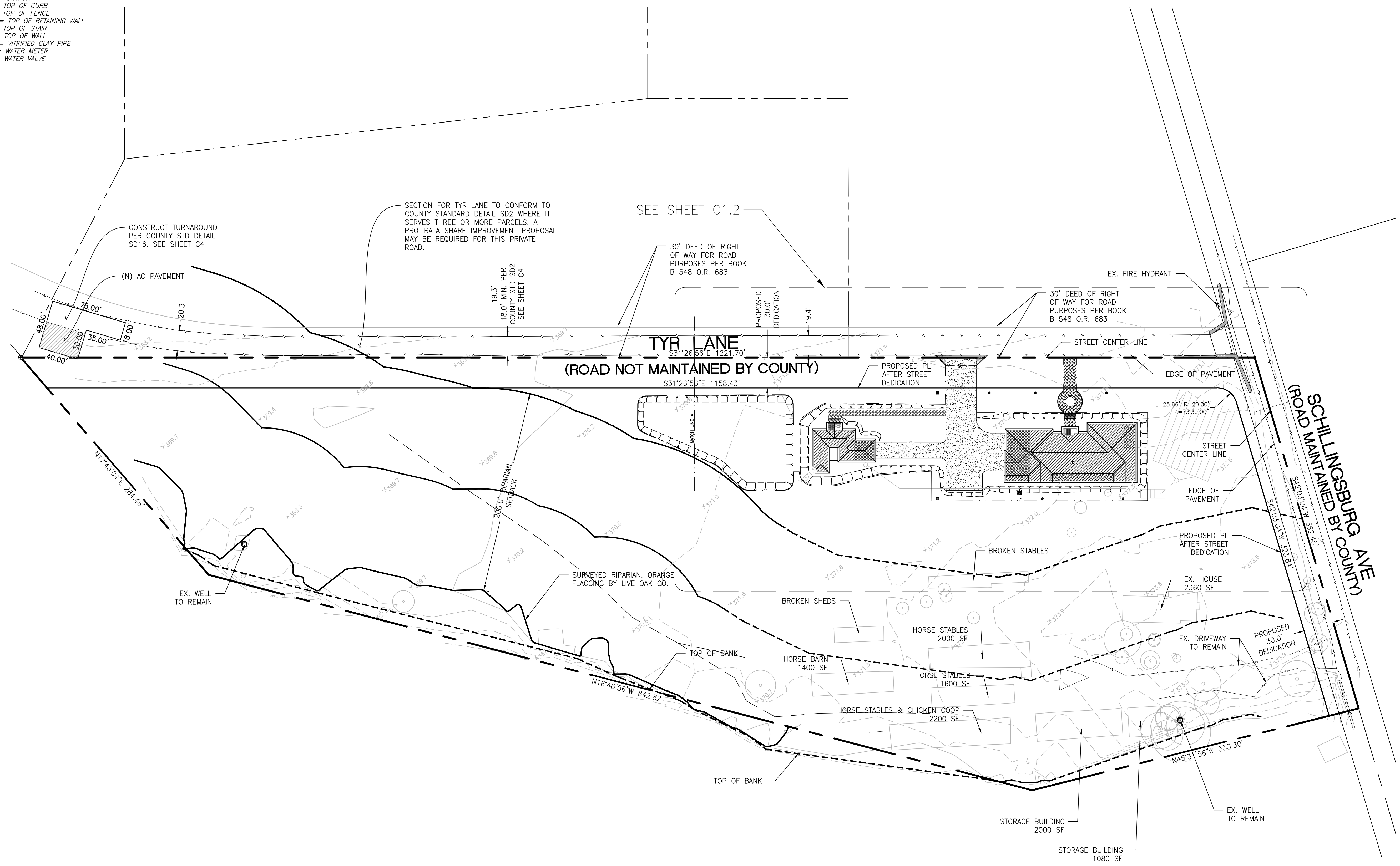

NO.	DATE	BY	CITY	REVISIONS



P. Oscar Osuna
 PORFIRIO OSCAR OSUNA
 RCE 70829 EXP. 6-30-21

OSUNA ENGINEERING INC.
 Planning | Surveying | Civil Engineering

CONSULTING CIVIL ENGINEERS & LAND SURVEYORS
 117 BERNAL RD. STE. 70-336
 SAN JOSE, CA 95119
 TEL: (408) 772-4381
 info@osunaengineering.com

GRADING & DRAINAGE PLAN
 21551 SCHILLINGSBURG AVE
 SAN JOSE, CALIFORNIA
 Project No.: 1463 | Designed: J.O. | Checked: O.O. | Date: 12/11/20

ATTACHMENT C – Biological Report



LIVE OAK ASSOCIATES, INC.

an Ecological Consulting Firm

**21551 SCHILLINGSBURG AVENUE
TECHNICAL BIOLOGICAL REPORT
SANTA CLARA COUNTY, CALIFORNIA**

Prepared by

LIVE OAK ASSOCIATES, INC.

Rick Hopkins, Ph.D., Principal/Senior Wildlife Ecologist
Katrina Krakow, M.S., Project Manager/Staff Ecologist

Prepared for

Junping Zheng
16141 Alum Rock Avenue
San Jose, CA 95127

January 16, 2020

PN 2360-01

Oakhurst: P.O. Box 2697 • 39930 Sierra Way, Suite B • Oakhurst, CA 93644 • Phone: (559) 642-4880 • Fax: (559) 642-4883
San Jose: 6840 Via Del Oro, Suite 220 • San Jose, CA 95119 • Phone: (408) 224-8300 • Fax: (408) 224-1411
Truckee: P.O. Box 8810 • Truckee, CA 96161 • Phone: (530) 214-8947

www.loainc.com

TABLE OF CONTENTS

1 INTRODUCTION.....1
 1.1 PROJECT DESCRIPTION.....3

2 EXISTING CONDITIONS.....4
 2.1 BIOTIC HABITATS5
 2.1.1 California Annual Grassland5
 2.1.2 Coyote Brush Scrub.....6
 2.1.3 Mixed Riparian Woodland and Forest6
 2.1.4 Category 1 Stream (Calero Arroyo)6
 2.1.5 Potential Seasonal Wetland7
 2.1.6 Rural Residential7
 2.1.7 Ornamental Woodland7
 2.2 MOVEMENT CORRIDORS9
 2.3 SPECIAL STATUS PLANTS AND ANIMALS11
 2.4 JURISDICTIONAL WATERS.....23

3 IMPACTS AND MITIGATIONS.....24
 3.1 SIGNIFICANCE CRITERIA24
 3.2 RELEVANT GOALS, POLICIES, AND LAWS25
 3.2.1 Threatened and Endangered Species25
 3.2.2 Migratory Birds25
 3.2.3 Birds of Prey.....26
 3.2.4 Bats.....26
 3.2.5 Wetlands and Other “Jurisdictional Waters”.....26
 3.2.6 Local Ordinances, Policies29
 3.2.7 Santa Clara Valley Habitat Plan.....29
 3.3 IMPACTS SPECIFIC TO THE PROJECT33
 3.3.1 Loss of Habitat for Special Status Plants34
 3.3.2 Loss of Habitat for Special Status Animals.....34
 3.3.3 Loss of Habitat for Native Wildlife.....35
 3.3.4 Interference with the Movement of Native Wildlife35
 3.3.5 Impacts to Nesting Migratory Birds Including Nesting Raptors and other
 Protected Birds35
 3.3.6 Impacts to Western Burrowing Owls36
 3.3.7 Impacts to Tricolored Blackbirds38
 3.3.8 Impacts to Foothill Yellow-Legged Frogs40
 3.3.9 Impacts to California Red-Legged Frogs40
 3.3.10 Impacts to Western Pond Turtles.....41
 3.3.11 Impacts to San Francisco Dusky-Footed Woodrats41
 3.3.12 Impacts to American Badgers42
 3.3.13 Impacts to Riparian Habitat and Other Sensitive Natural Communities, Including
 Federally and State Protected Wetlands43
 3.3.14 Degradation of Water Quality in Seasonal Drainages, Stock Ponds and
 Downstream Waters43
 3.3.15 Conflict with Local Policies and Ordinances: Santa Clara County Tree Ordinance
 44

3.3.16 Conflict with Local Policies and Ordinances: Santa Clara Valley Habitat
Conservation Plan..... 44

4 LITERATURE CITED.....48

1 INTRODUCTION

This site was evaluated by Live Oak Associates, Inc. (LOA) to ascertain whether or not build-out of the proposed project would have a significant impact (as defined by CEQA) on the biological resources of the site and region. This report describes the biotic resources of the Property (hereafter referred to as the “study area” or “site”), located at 21551 Schillingsburg Avenue in Santa Clara County, California and evaluates possible impacts to these resources resulting from the proposed land use changes upon these resources. The site is bordered by Tyr Lane to the east, Schillingsburg Avenue to the south, Calero Arroyo and an open field to the west, and a residence to the north. The surrounding land use is rural residential with pastureland. The site is located in Santa Clara County, California (Figure 1). The site can be found on the Santa Teresa Hills U.S.G.S. 7.5’ quadrangle in Section 31 of Township 8 South, Range 2 East. Structures onsite are in the southwestern corner of the site and include a residence, stables, barn, outbuildings. The remainder of the site includes California annual grassland, coyote brush scrub, ornamental woodland, and Calero Arroyo bounds the western side of the property.

In general, the development of parcels can damage or modify biotic habitats used by sensitive plant and wildlife species. In such cases, site development may be regulated by state or federal agencies, subject to provisions of the California Environmental Quality Act (CEQA), and/or covered by policies and ordinances of Santa Clara County. Therefore, this report addresses issues related to: 1) sensitive biotic resources occurring in the study area; 2) the federal, state, and local laws regulating such resources, 3) evaluate whether or not the project results in any significant impacts to these resources; and if so, 4) includes mitigation measures to reduce these impacts to less-than-significant (as defined by CEQA).

The analysis of impacts, as discussed in Section 3.0 of this report, was based on the known and potential biotic resources of the study area discussed in Section 2.0. Sources of information used in the preparation of this analysis included: 1) the *California Natural Diversity Data Base* (RareFind5, 2020); 2) the *California Rare Plant Rank* (CNPS 2020); 3) manuals and references related to plants and animals of the Santa Clara Valley region; 4) Santa Clara County policies and ordinances; and 5) the Santa Clara Valley Habitat Plan (SCVHP; 2012).

A field survey of the study area was conducted on May 20, 2019 by LOA ecologist Katrina Krakow.

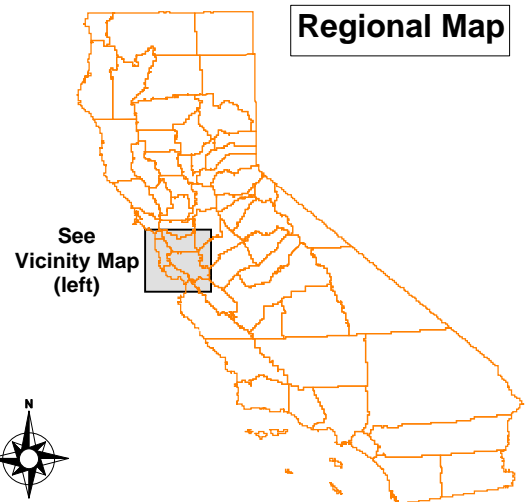
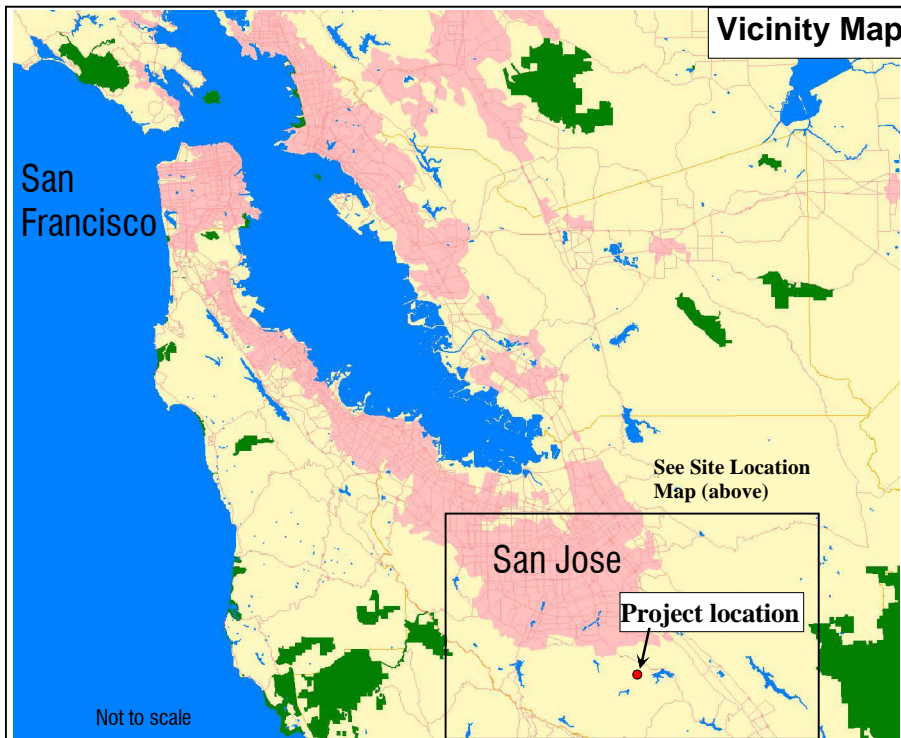
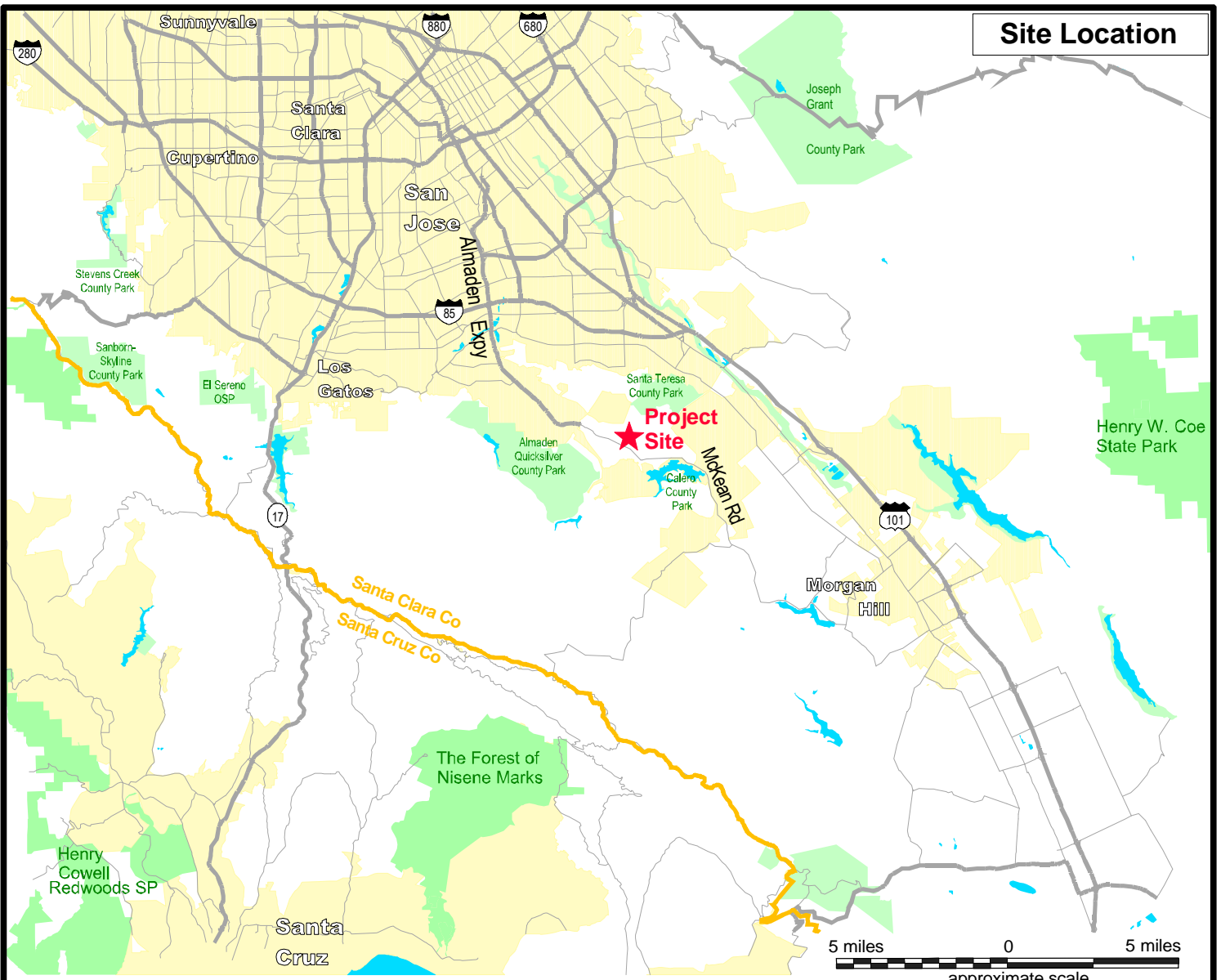

	Live Oak Associates, Inc.	
	21551 Schillingsburg Ave BE Site / Vicinity Map	
Date 6/11/2019	Project # 2360-01	Figure # 1

1.1 PROJECT DESCRIPTION

The project, as proposed, would develop a single-family residence on the northern portion of the site and is not expected to require the removal of any trees onsite. The current plan is to build the residence in the northernmost corner of the site, however, as this is a tentative location, and the location may be moved southwards some, this report evaluates the entirety of the site outside of the developed area, as structures will not be removed as a part of this project.

2 EXISTING CONDITIONS

The project site is located 21551 Schillingsburg Avenue in Santa Clara County, California. The site is bordered by Tyr Lane to the east, Schillingsburg Avenue to the south, Calero Arroyo and an open field to the west, and a residence to the north. The surrounding land use is rural residential with pastureland. The site has a relatively flat topography with the elevation increasing as the site progresses to the south and is approximately 370-375 feet (112-115 meters) National Geodetic Vertical Datum (NGVD).

Annual precipitation in the general vicinity of the study area is about 15-20 inches, almost 85% of which falls between the months of October and March. Virtually all precipitation falls in the form of rain.

Two soil map units occur onsite: Stevenscreek sandy clay loam, 0 to 2 percent slopes (very deep, well drained soils with low runoff and moderately slow permeability); and Montavista-Togasara complex, 2 to 9 percent slopes (very deep, well drained soils with moderately slow to slow permeability). Neither of the soils onsite are considered to be hydric.

2.1 BIOTIC HABITATS

Seven land cover types are present on the project site and these have been named consistent with nomenclature for land cover types contained in the Santa Clara Valley Habitat Plan (SCVHP). These seven land cover types include California Annual Grassland; Coyote Brush Scrub, Mixed Riparian Woodland and Forest; Category 1 Stream (Calero Arroyo), Rural Residential; and Ornamental Woodland. These land cover types are described in greater detail below.

2.1.1 California Annual Grassland

This is the most prevalent land cover type present on the property. This land cover type is comprised of California annual grassland habitat dominated by non-native species. Constituent grass species observed in this habitat included grasses including wild oat (*Avena* sp.), and ripgut brome (*Bromus diandrus*), farmer's foxtail (*Hordeum murinum*), soft chess (*Bromus hordeaceus*), wild rye (*Elymus* sp.), annual bluegrass (*Poa annua*), and canary grass (*Phalaris* sp.). In addition to the grasses, several forb species were also observed including fiddleneck (*Amsinckia* sp.), coyote brush (*Baccharis pilularis*), common mustard (*Brassica rapa*), Italian thistle (*Carduus pycnocephalus*), poison hemlock (*Conium maculatum*), bindweed (*Convolvulus arvensis*), stinkwort (*Dittrichia graveolens*), California poppy (*Eschscholzia californica*), whitetop (*Lepidium draba*), mallow (*Malva* sp.), burclover (*Medicago polymorpha*), white poplar (*Populus alba*), wild radish (*Raphanus raphanistrum*), curly dock (*Rumex crispus*), milk thistle (*Silybum marianum*), and stinging nettle (*Urtica dioica*).

Wildlife observed within or flying over the grasslands of the site during the May 2019 survey included the mallard (*Anas platyrhynchos*), Canada goose (*Branta canadensis*), peafowl (*Pavo cristatus*), acorn woodpecker (*Melanerpes formicivorus*), mourning dove (*Zenaida macroura*), Anna's hummingbird (*Calypte anna*), American crow (*Corvus brachyrhynchos*), black phoebe (*Sayornis nigricans*), tree swallow (*Tachycineta bicolor*), northern mockingbird (*Mimus polyglottos*), California towhee (*Melospiza crissalis*), and house finch (*Haemorhous mexicanus*). Additionally, Botta's pocket gopher (*Thomomys bottae*) sign and California ground squirrel (*Otospermophilus beecheyi*) burrows were observed onsite. A few debris and slash piles occur within this habitat as well.

2.1.2 Coyote Brush Scrub

The next most prevalent land cover type on the parcel is coyote brush scrub, which is almost entirely made up of dense coyote brush which reaches heights of 10 or more feet. Understory was largely bare, but did include some species also present within the California annual grassland habitat, and also includes scarlet pimpernel (*Anagallis arvensis*), wild cucumber (*Cucumis anguria*), coast live oak (*Quercus agrifolia*) sapling, and blue elderberry (*Sambucus nigra ssp. caerulea*). The project, as currently planned is not expected to impact this habitat, however, as current location of the residence is tentative, this habitat may be impacted should the building site move southward.

Wildlife observed in this habitat was limited to the California scrub jay (*Aphelocoma californica*). Species occurring in adjacent habitats are likely to occur within this habitat as well.

2.1.3 Mixed Riparian Woodland and Forest

Sparse mixed riparian woodland occurs along the banks of Calero Arroyo on the western edge of the project site. Trees within this habitat include walnut (*Juglans sp.*), coast live oak, sycamore (*Platanus racemosa*), willow (*Salix sp.*), and blue elderberry. Understory plants include century plant (*Agave americana*), wild oats, coyote brush, mustard, ripgut brome (*Bromus diandrus*), Italian thistle (*Carduus pycnocephalus*), poison hemlock (*Conium maculatum*), wild rye, California poppy (*Eschscholzia californica*), prickly lettuce (*Lactuca serriola*), whitetop, horehound (*Marrubium vulgare*), rabbitsfoot grass (*Polypogon monspeliensis*), wild radish (*Raphanus raphanistrum*), Himalayan blackberry (*Rubus armeniacus*), curly dock (*Rumex crispus*), grape (*Vitis sp.*), and stinging nettle (*Urtica dioica*). The project is not expected to impact this habitat.

Wildlife observed within this habitat was limited to the peafowl, red-shouldered hawk (*Buteo lineatus*), California quail (*Callipepla californica*), and ground squirrel burrows. Species occurring in adjacent habitats are likely to occur within this habitat as well.

2.1.4 Category 1 Stream (Calero Arroyo)

Calero Arroyo runs along the western boundary of the property. Stream width is approximately 8-10 feet wide at the ordinary-high-water mark. Calero Arroyo is considered to be a “Category 1 Stream” under the SCVHP. Plants occurring on the banks of this habitat are included within the mixed riparian woodland and forest description above. In addition, watercress (*Nasturtium officinale*) and cattail (*Typha sp.*) occur within the channel.

Wildlife occurring in adjacent habitats are likely to occur within this habitat as well.

2.1.5 Potential Seasonal Wetland

A potential seasonal wetland appears to drain into Calero Arroyo in the northern portion of the site.

2.1.6 Rural Residential

The southwest corner of the site supports a residence, horse stables, barn, and outbuildings. Some of these structures support potential roosting habitat for bats. Plant species within this habitat includes silver wattle (*Acacia dealbata*), century plant, tree-of-heaven (*Ailanthus altissima*), aloe (*Aloe vera*), coyote brush, wild cucumber, fennel (*Foeniculum vulgare*), English ivy (*Hedera helix*), walnut, mallow (*Malva sp.*), olive (*Olea sp.*), prickly pear cactus (*Opuntia sp.*), date palm (*Phoenix sp.*), pomegranate (*Punica granatum*), apricot (*Prunus armeniaca*), and blue elderberry.

Wildlife observed within this habitat included the peafowl, mourning dove (*Zenaida macroura*), black phoebe (*Sayornis nigricans*), California towhee (*Melospiza crissalis*), and house finch (*Haemorhous mexicanus*). Species occurring in adjacent habitats are likely to occur within this habitat as well.





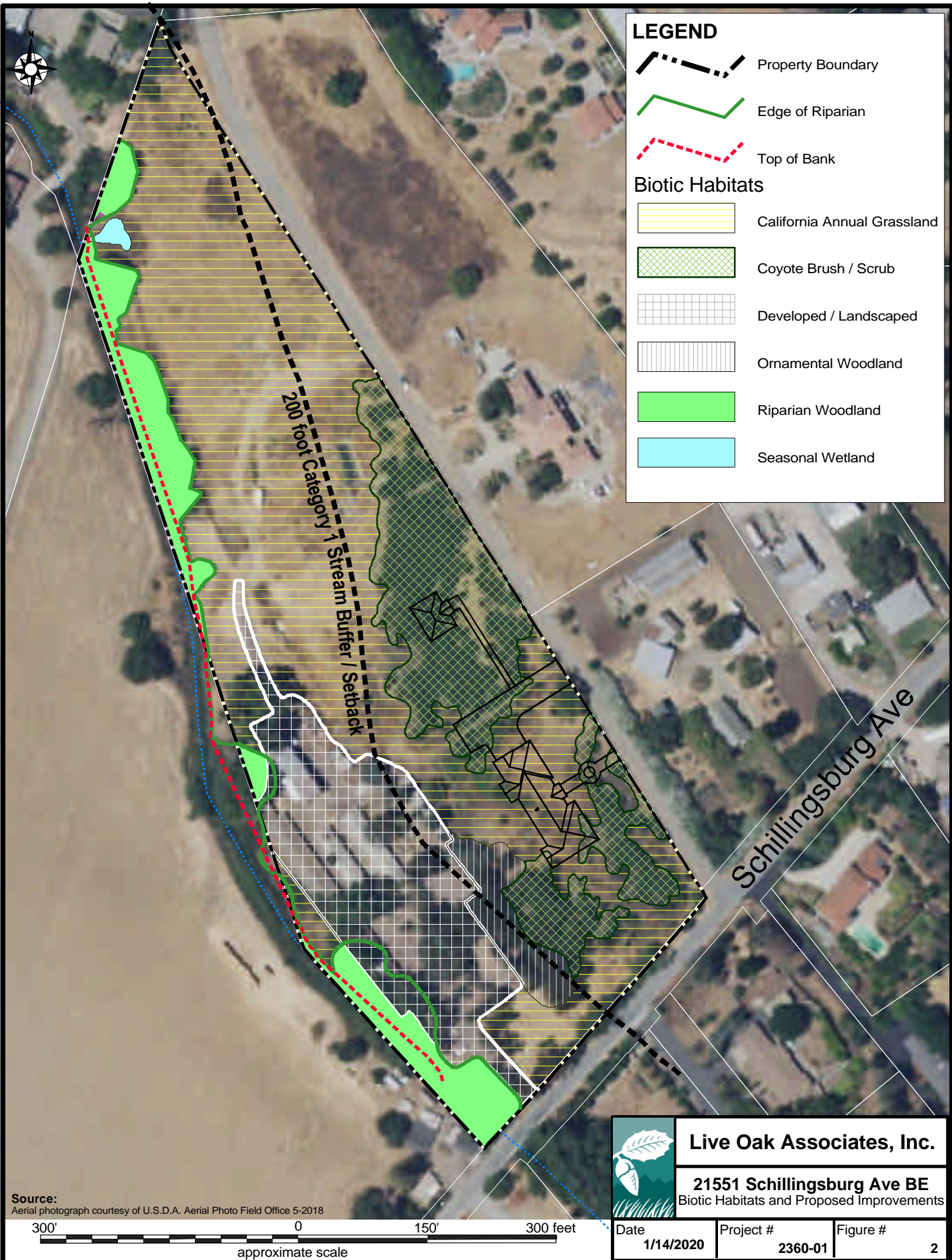

2.1.7 Ornamental Woodland

A section of ornamental woodland occurs adjacent to the residence and is comprised almost entirely of tree-of-heaven, with a smattering of some other trees mentioned in the rural residential habitat above.

Wildlife observed within this habitat was limited to the peafowl and California towhee. Species occurring in adjacent habitats are likely to occur within this habitat as well.

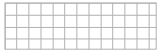

LEGEND

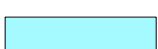
-  Property Boundary
-  Edge of Riparian
-  Top of Bank
- Biotic Habitats**
-  California Annual Grassland
-  Coyote Brush / Scrub
-  Developed / Landscaped
-  Ornamental Woodland
-  Riparian Woodland
-  Seasonal Wetland

200 foot Category 1 Stream Buffer / Setback

Schillingsburg Ave

Source:
Aerial photograph courtesy of U.S.D.A. Aerial Photo Field Office 5-2018

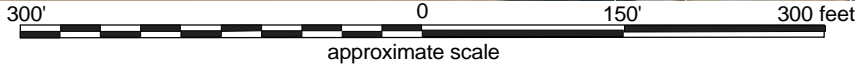

	Live Oak Associates, Inc.	
	21551 Schillingsburg Ave BE Biotic Habitats and Proposed Improvements	
Date	Project #	Figure #
1/14/2020	2360-01	2

2.2 MOVEMENT CORRIDORS

Ecologists and conservation biologists have expended a great deal of energy since the early 1980's advocating the protection and restoration of landscape linkages among suitable habitat patches. Movement corridors or landscape linkages are usually linear habitats that connect two or more habitat patches (Harris and Gallager 1989), providing assumed benefits to the species by reducing inbreeding depression, and increasing the potential for recolonization of habitat patches. Some researchers have even demonstrated that poor quality corridors can still provide some benefit to the species that use them (Beier 1996).

Beier and Noss (1998) evaluated the claims of the efficacy of wildlife corridors of 32 scientific papers. In general, these authors believed that the utility of corridors was demonstrated in fewer than half of the reviewed papers, and they believed that study design played a role in whether or not given corridors were successful. Examples of well-designed studies supported the value of corridors. They believed, however, that connectivity questions make sense only in terms "of a particular focal species and landscape." For example, volant (flying) species are less affected by barriers than small, slow moving species such as frogs or snakes (Beier and Noss 1998). In addition, large mammals such as carnivores that can move long distances in a single night (e.g., cougars) are more capable of making use of poor quality or inhospitable terrain than species that move more slowly and can easily fall prey to various predators or that are less able to avoid traffic or other anthropogenic effects (Beier 1996). Therefore, it is reasonable to conclude that landscape linkages, even poor ones, can be and are useful, especially for terrestrial species.

Therefore, while the importance of landscape linkages is well demonstrated in the scientific literature, the cautionary note of Beier and Noss (1998) that consideration of context and ecological scale are also of critical importance in evaluating linkages.

Habitat corridors are vital to terrestrial animals for connectivity between core habitat areas (i.e., larger intact habitat areas where species make their living). Connections between two or more core habitat areas help ensure that genetic diversity is maintained, thereby diminishing the probability of inbreeding depression and geographic extinctions.

The quality of habitat within the corridors is important: "better" habitat consists of an area with a minimum of human interference (e.g., roads, homes, etc.) and is more desirable to more species

than areas with sparse vegetation and high-density roads. Movement corridors in California are typically associated with valleys, rivers and creeks supporting riparian vegetation, and ridgelines. With increasing encroachment of humans on wildlife habitats, it has become important to establish and maintain linkages, or movement corridors, for animals to be able to access locations containing different biotic resources that are essential to maintaining their life cycles.

Healthy riparian areas (supporting structural diversity, i.e., understory species to saplings to mature riparian trees) have a high biological value as they not only support a rich and diverse wildlife community but have also been shown to facilitate regional wildlife movement. Riparian areas can vary from tributaries winding through scrubland to densely vegetated riparian forests.

A riparian zone can be defined as an area that has a source of fresh water (e.g., rill, stream, river), a defined bank, and upland areas consisting of moist soils (e.g., wetter than would be expected simply due to seasonal precipitation). These areas support a characteristic suite of vegetative species, many of which are woody, that are adapted to moister soils. Such vegetation in hills surrounding San Jose include California buckeye (*Aesculus californica*), dogwood (*Cornus* sp.), California hazelnut (*Corylus cornuta* var. *californica*), elderberry (*Sambucus* sp.), Oregon ash (*Fraxinus latifolia*), walnut (*Juglans* sp.), California laurel (*Umbellularia californica*), toyon (*Heteromeles arbutifolia*), oaks (*Quercus* sp.), and willow (*Salix* sp.).

Beier and Loe (1992) noted five functions of corridors (rather than physical traits) that are relevant when conducting an analysis regarding the value of linkages. The following five functions should be used to evaluate the suitability of a given tract of land for use as a habitat corridor:

1. Wide ranging mammals can migrate and find mates;
2. Plants can propagate within the corridor and beyond;
3. Genetic integrity can be maintained;
4. Animals can use the corridor in response to environmental changes or a catastrophic event;
5. Individuals can recolonize areas where local extinctions have occurred.

A corridor is “wide enough” when it meets these functions for the suite of animals in the area. It is important to note that landscape linkages are used differently by different species. For instance, medium to large mammals (or some bird species) may traverse a corridor in a matter of minutes or hours, while smaller mammals or other species may take a longer period of time to move through the same corridor (e.g., measured in days, weeks and even years). For example, an individual

cougar may traverse the entire length of a long narrow corridor in an hour while travel of smaller species (such as rodent or rabbit species) may best be measured as gene flow within regional populations. These examples demonstrate that landscape linkages are not simply highways that animals use to move back and forth. While linkages may serve this purpose, they also allow for slower or more infrequent movement. Width and length must be considered in evaluating the value of a landscape linkage. A long narrow corridor would most likely only be useful to wide ranging animals such as cougars and coyotes when moving between core habitat areas.

To the extent practicable, conservation of linkages should address the needs of “passage species” (those species that typically use a corridor for the express purpose of moving from one intact area to another) *and* “corridor dwellers” (slow moving species such as plants and some amphibians and reptiles that require days or generations to move through the corridor).

Although the reach of Calero Arroyo onsite may support local wildlife movement, the project site does not fall within any regional corridor defined by the SCVHP. Movements on and across the site consists of normal movements associated with an individual animal’s home range or territory, or animals dispersing from their natal range.

2.3 SPECIAL STATUS PLANTS AND ANIMALS

Several species of plants and animals within the state of California have low populations, limited distributions, or both. Such species may be considered “rare” and are vulnerable to extirpation as the state’s human population grows and the habitats these species occupy are converted to agricultural and urban uses. As described more fully in Section 3.2, state and federal laws have provided the California Department of Fish and Wildlife (CDFW) and the U.S. Fish and Wildlife Service (USFWS) with a mechanism for conserving and protecting the diversity of plant and animal species native to the state. A sizable number of native plants and animals have been formally designated as threatened or endangered under state and federal endangered species legislation. Others have been designated as “candidates” for such listing. Still others have been designated as “species of special concern” by the CDFW. The California Native Plant Society (CNPS) has developed its own set of lists of native plants considered rare, threatened, or endangered (CNPS 2001). Collectively, these plants and animals are referred to as “special status species.”

A number of special status plants and animals occur in the vicinity of the study area. These species, and their potential to occur in the study area, are listed in Table 1. Sources of information for this table included *California Natural Diversity Data Base* (CDFW 2020), *Listed Plants and Listed Animals* (USFWS 2019), *State and Federally Listed Endangered and Threatened Animals of California* (CDFW 2019), *The California Native Plant Society's Inventory of Rare and Endangered Vascular Plants of California* (CNPS 2020), *California Bird Species of Special Concern* (Shuford and Gardall 2008), and *California Amphibian and Reptile Species of Special Concern* (Thompson et al. 2016). This information was used to evaluate the potential for special status plant and animal species that occur on the site. Figures 3a and 3b depict the location of special status species found by the California Natural Diversity Data Base (CNDDB).

A search of published accounts for all of the relevant special status plant and animal species was conducted for the Santa Teresa Hills USGS 7.5 minute quadrangle in which the project site occurs, and for the eight surrounding quadrangles (San Jose West, San Jose East, Lick Observatory, Los Gatos, Morgan Hill, Laurel, Loma Prieta, and Mt. Madonna) using the California Natural Diversity Data Base (CNDDB) Rarefind5. All species listed as occurring in these quadrangles on CNPS Lists 1A, 1B, 2, or 4 were also reviewed (See Figures 3a and 3b).

Serpentine soils are absent from the site; as such, those species that are uniquely adapted to serpentine conditions in the project's vicinity are considered absent from the site. These species include the Bay checkerspot butterfly (*Euphydryas editha bayensis*), Smith's blue butterfly (*Euphilotes enoptes smithi*), big-scale balsamroot (*Balsamorhiza macrolepis* var. *macrolepis*), chaparral harebell (*Campanula exigua*), Tiburon Indian paintbrush (*Castilleja affinis* ssp. *neglecta*), pink creamsacs (*Castilleja rubicundula* ssp. *rubicundula*), coyote ceanothus (*Ceanothus ferrisiae*), dwarf soaproot (*Chlorogalum pomeridianum* var. *minus*), Mt. Hamilton fountain thistle (*Cirsium fontinale* var. *campylon*), San Francisco collinsia (*Collinsia multicolor*), Santa Clara Valley dudleya (*Dudleya abramsii* ssp. *setchellii*), smooth lessingia (*Lessingia micradenia* ssp. *glabrata*), woodland woollythreads (*Monolopia gracilens*), white-rayed pentachaeta (*Pentachaeta bellidiflora*), Metcalf Canyon jewel-flower (*Streptanthus albidus* ssp. *albidus*), and most beautiful jewel-flower (*Streptanthus albidus* ssp. *peramoenus*).

Several other special status plant species have been ruled out on the site as they occur in habitats not present in the study area (e.g., vernal pool, chaparral, broadleafed forest, coastal prairie, coastal

scrub, etc.) or at elevations significantly below or above elevations of the site (approximately 112-115 meters NGVD) and, therefore, are also considered absent from the site. These species include the Anderson's manzanita (*Arctostaphylos andersonii*), Bonny Doon manzanita (*Arctostaphylos andersonii*), Santa Cruz Mountains pussypaws (*Calyptridium parryi* var. *hesseae*), bristly sedge (*Carex comosa*), Monterey spineflower (*Chorizanthe pungens* var. *pungens*), Ben Lomond spineflower (*Chorizanthe pungens* var. *hartwegiana*), Scotts Valley spineflower (*Chorizanthe robusta* var. *hartwegii*), robust spineflower (*Chorizanthe robusta* var. *robusta*), Santa Clara red ribbons (*Clarkia concinna* ssp. *automixa*), Ben Lomond buckwheat (*Eriogonum nudum* var. *decurrens*), Hoover's button-celery (*Eryngium aristulatum* var. *hooveri*), Santa Cruz wallflower (*Erysimum teretifolium*), minute pocket moss (*Fissidens pauperculus*), Kellogg's horkelia (*Horkelia cuneata* var. *sericea*), Mt. Hamilton coreopsis (*Leptosyne hamiltonii*), Mt. Hamilton lomatium (*Lomatium observatorium*), arcuate bush-mallow (*Malacothamnus arcuatus*), Hall's bush-mallow (*Malacothamnus hallii*), northern curly-leaved monardella (*Monardella sinuata* ssp. *nigrescens*), Santa Cruz Mountains beardtongue (*Penstemon rattanii* var. *kleei*), Mt. Diablo phacelia (*Phacelia phacelioides*), Choris' popcorn-flower (*Plagiobothrys chorisianus* var. *chorisianus*), Scotts Valley polygonum (*Polygonum hickmanii*), chaparral ragwort (*Senecio aphanactis*), Santa Cruz clover (*Trifolium buckwestiorum*), and Pacific Grove clover (*Trifolium polyodon*).

Other species having potential to occur on the project site or immediate vicinity because suitable habitats are present are discussed further below.

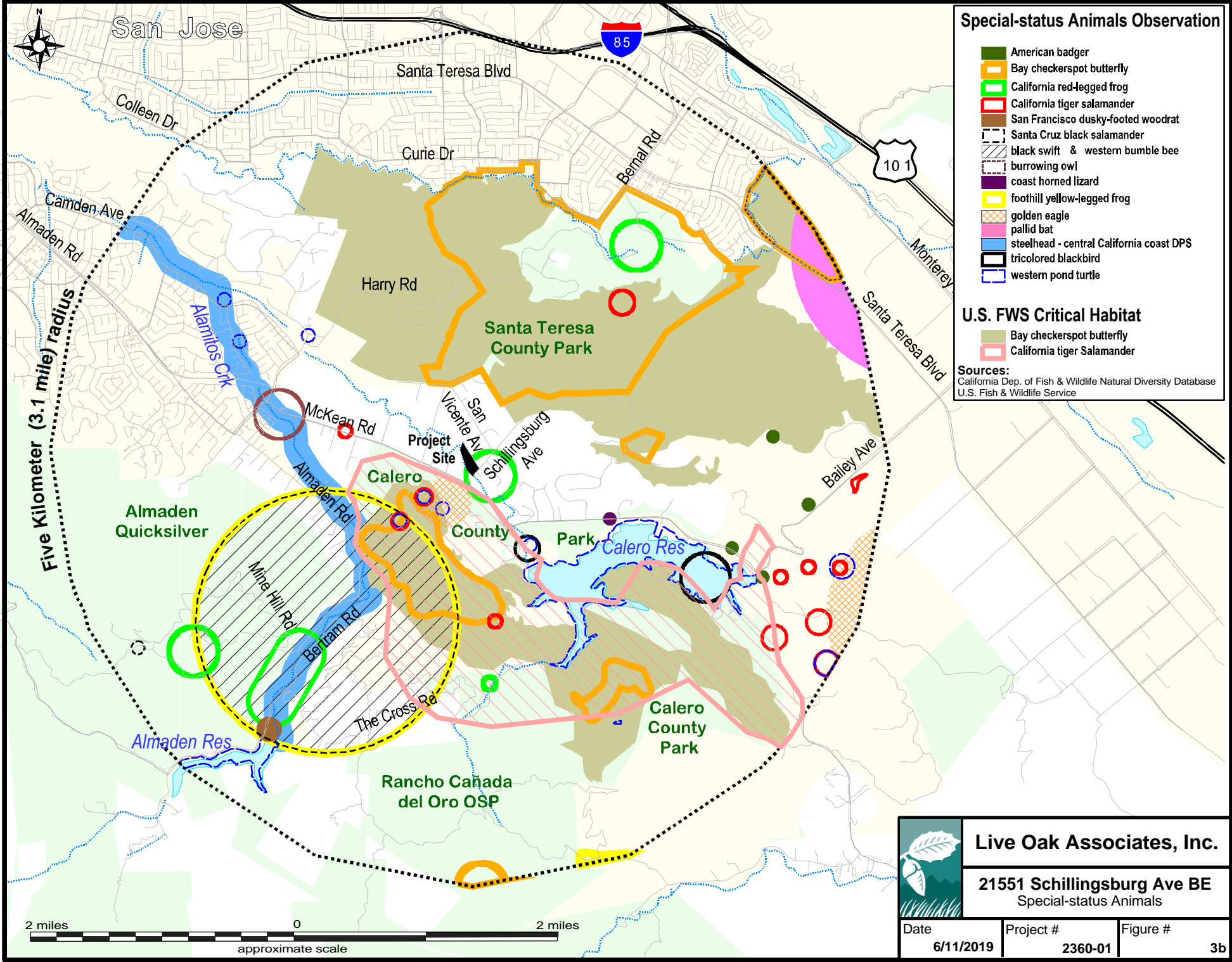

Live Oak Associates, Inc.

21551 Schillingsburg Ave BE
 Special-status Animals

Date	Project #	Figure #
6/11/2019	2360-01	3b

TABLE 1. LIST OF SPECIAL STATUS SPECIES THAT COULD OCCUR IN THE PROJECT VICINITY

PLANTS (adapted from CDFW 2020 and CNPS 2020)

Species Listed as Threatened or Endangered under the State and/or Federal Endangered Species Act

Species	Status	Habitat	Occurrence in the Study Area
Santa Cruz tarplant (<i>Holocarpha macradenia</i>)	FT, CE, CNPS 1B	<u>Habitat</u> : Coastal prairie, coastal scrub, and valley and foothill grasslands. Often occurs in clay, sandy soils. <u>Elevation</u> : 10-220 meters. <u>Blooms</u> : June–October. <u>Life form</u> : Annual herb.	Absent. Grassland habitat on the site appears to have been frequently disturbed and constitutes marginal to poor habitat for this species. Occurrences of this species are localized to the Santa Cruz area more than twelve miles southwest of the site.
Contra Costa Goldfields (<i>Lasthenia conjugens</i>)	FE	<u>Habitat</u> : Cismontane woodlands, alkaline playas, valley and foothill grasslands, and vernal pools. Occurs in mesic soils. <u>Elevation</u> : 0-470 meters. <u>Blooms</u> : March–June. <u>Life form</u> : Annual herb.	Absent. Alkaline soils and mesic habitats are absent from the site. The nearest documented occurrences of this species are more than seven miles north of the site (CDFW 2020).
San Francisco popcornflower (<i>Plagiobothrys diffusus</i>)	CE, CNPS 1B	<u>Habitat</u> : Occurs in coastal prairie and valley and foothill grassland. <u>Elevation</u> : 60-360 meters. <u>Blooms</u> : March–June. <u>Life form</u> : Annual herb.	Absent. Grassland habitat on the site appears to have been frequently disturbed and constitutes marginal to poor habitat for this species. There are no documented occurrences of this species in Santa Clara Valley (CDFW 2020).

PLANTS (adapted from CDFW 2020 and CNPS 2020)

Other special status plants listed by CNPS

Species	Status	Habitat	Occurrence in the Study Area
Bent-flowered fiddleneck (<i>Amsinckia lunaris</i>)	CNPS 1B	<u>Habitat</u> : Coastal bluff scrub, cismontane woodland, and valley and foothill grasslands. <u>Elevation</u> : 3-795 meters. <u>Blooms</u> : March–June. <u>Life form</u> : Annual herb.	Unlikely. Grassland habitat on the site appears to have been frequently disturbed and constitutes marginal to poor habitat for this species. There are no known occurrences of this species within a three-mile radius of the site (CDFW 2020).
Congdon’s tarplant (<i>Centromadia parryi</i> ssp. <i>congdonii</i>)	CNPS 1B	<u>Habitat</u> : Valley and foothill grassland on alkaline soils. <u>Elevation</u> : 0-230 meters. <u>Blooms</u> : May–October. <u>Life form</u> : Annual herb.	Absent. Alkaline soils are absent from the site. There are no known occurrences of this species within a three-mile radius of the site (CDFW 2020).
Fragrant fritillary (<i>Fritillaria liliacea</i>)	CNPS 1B	<u>Habitat</u> : Cismontane woodland, coastal prairie, coastal scrub, and valley and foothill grasslands. Often occurs on serpentinite. <u>Elevation</u> : 3-410 meters. <u>Blooms</u> : February–April. <u>Life form</u> : Perennial bulbiferous herb.	Absent. Grassland habitats of the site appears to have been frequently disturbed and provide poor habitat for this species. The site does not support serpentine soils.

TABLE 1. LIST OF SPECIAL STATUS SPECIES THAT COULD OCCUR IN THE PROJECT VICINITY

PLANTS (Continued adapted from CDFW 2020 and CNPS 2020)

Other special status plants listed by CNPS

Species	Status	Habitat	Occurrence in the Study Area
Loma Prieta hoita (<i>Hoita strobilina</i>)	CNPS 1B	<u>Habitat</u> : Occurs in chaparral, cismontane woodland, coastal prairie, and valley and foothill grassland, usually on serpentinite and mesic soils. <u>Elevation</u> : 30-860 meters. <u>Blooms</u> : May-July. <u>Life form</u> : Perennial herb.	Absent. This species is typically found on serpentine soils, which are absent from the site. The grasslands of the site appears to have been disturbed and dominated by annual grasses, and therefore do not provide suitable habitat for this species. The nearest documented occurrences of this species are approximately one mile from the site on serpentine soils (CDFW 2020).
Hairless Popcorn Flower (<i>Plagiobothrys glaber</i>)	CNPS 1A	<u>Habitat</u> : Occurs in heavy clay soils of alkaline meadows and in coastal salt marshes and swamps. Last confirmed observance of species was in 1954; all old records are from the Hollister area. <u>Elevation</u> : 15-180 meters. <u>Blooms</u> : March-May. <u>Life form</u> : Annual herb.	Absent. Suitable habitat and alkaline soils are absent from the site.
Rock sanicle (<i>Sanicula saxatilis</i>)	CR, CNPS 1B	<u>Habitat</u> : Bedrock outcrops and talus slopes in chaparral, oak woodlands, and valley and foothill grasslands. <u>Elevation</u> : 620-1175 meters. <u>Blooms</u> : April-May. <u>Life form</u> : Perennial herb.	Absent. The site occurs at an elevation well below the known range for this species, and the site lacks suitable habitat (i.e., rock outcrops and talus slopes) for this species. Additionally, there are no known occurrences within a three-mile radius of the site (CDFW 2020).
Saline clover (<i>Trifolium hydrophilum</i>)	CNPS 1B	<u>Habitat</u> : Marshes and swamps, mesic and alkaline areas of valley and foothill grasslands, and vernal pools. <u>Elevation</u> : 0-300 meters. <u>Blooms</u> : April-June. <u>Life form</u> : Annual herb.	Absent. Alkaline soils are absent from the site.

TABLE 1. LIST OF SPECIAL STATUS SPECIES THAT COULD OCCUR IN THE PROJECT VICINITY

ANIMALS (adapted from CDFW 2020 and USFWS 2020)

Species Listed as Threatened or Endangered under the State and/or Federal Endangered Species Act

Species	Status	Habitat	Occurrence in the Study Area
Crotch bumble bee (<i>Bombus crotchii</i>)	CCE	In California, inhabits open grassland and scrub habitats of the southern 2/3 of California. Historically in, but largely extirpated from the Central Valley. Flight period for queens is late February to late October peaking in April and July; flight period for males and workers is March through September peaking in early July. Constructs nests underground in animal burrows. Overwintering sites are likely in soft soils or in debris or leaf litter.	Unlikely. Suitable nesting sites for this species occurs onsite in the form of ground squirrel burrows, and the site supports non-native California annual grassland, which may provide flowering plants on which this species can forage, however, this portion of the site appears to have been disturbed over time, likely reducing the amount of suitable forage, therefore, although this species cannot be completely discounted, it is unlikely to occur onsite.
Western bumble bee (<i>Bombus occidentalis</i>)	CCE	In California, mainly occurring within the coastal and Sierra Nevada ranges within meadows and grasslands and some natural areas within urban environments. Indication of recent population potentially being restricted to high elevation and coastal areas. Historically occurred from the Channel Islands to the northern California border. Flight period is February to late November, peaking in late June and late September. Tends to construct nest underground in animal burrows on west and south-west facing slopes. Overwintering sites are likely in friable soils or in debris or leaf litter.	Unlikely. Suitable nesting sites for this species occurs onsite in the form of ground squirrel burrows, and the site supports non-native California annual grassland, which may provide flowering plants on which this species can forage, however, this portion of the site appears to have been disturbed over time, likely reducing the amount of suitable forage, therefore, although this species cannot be completely discounted, it is unlikely to occur onsite. An occurrence of the western bumble bee was generally mapped with the accuracy polygon centered on Alamitos Creek; the project site is located approximately 0.75 miles from the accuracy polygon associated with this occurrence (CDFW 2020).
Steelhead - Central California Coast ESU / South-Central Calif Coast ESU (<i>Oncorhynchus mykiss irideus</i>)	FT/ FT, CSC	Spawn in freshwater rivers or streams in the spring and spend the remainder of their life in the ocean.	Possible. Steelhead are known from Alamitos Creek (CDFW 2020), therefore, as Calero Arroyo is a branch which flows into Alamitos Creek, this species could swim upstream during seasonal high flows.
Coho salmon- Central California Coast ESU / So. Oregon, No. Calif ESU (<i>Oncorhynchus kisutch</i>)	FE, CE / FT, CT, CSC	Spawn in freshwater streams, adults live in ocean, usually within 30 km of their natal stream. Occupied California streams are located in central to northern California.	Possible. Coho salmon are known from the Alamitos Creek watershed (UCANS 2020), therefore, as Calero Arroyo is a branch which flows into Alamitos Creek, this species could swim upstream during seasonal high flows.

TABLE 1. LIST OF SPECIAL STATUS SPECIES THAT COULD OCCUR IN THE PROJECT VICINITY

ANIMALS (Continued adapted from CDFW 2020 and USFWS 2020)

Species Listed as Threatened or Endangered under the State and/or Federal Endangered Species Act

Species	Status	Habitat	Occurrence in the Study Area
California Tiger Salamander (<i>Ambystoma californiense</i>)	FT, CT	Breeds in vernal pools and stock ponds of central California; adults aestivate in grassland habitats adjacent to the breeding sites.	Unlikely. Suitable breeding habitat for this species in the form of stagnant pools with continuous inundation for a minimum of three months is absent from the site. This species is known from more than a half-mile from the site (CDFW 2020) on the west side of Calero Arroyo. Therefore, although this species may move onto the site from time to time, it is unlikely to do so due to lack of breeding habitat.
Foothill yellow-legged frog (<i>Rana boylei</i>)	CSC CCT	Occurs in swiftly flowing streams and rivers with rocky substrate with open, sunny banks in forest, chaparral, and woodland habitats, and can sometimes be found in isolated pools.	Possible. An occurrence of the foothill yellow-legged frog was generally mapped with the accuracy polygon centered on Alamitos Creek; the project site is located approximately 0.75 miles from the accuracy polygon associated with this occurrence (CDFW 2020) and Calero Arroyo flows into Alamitos Creek, therefore, this species may be expected to occur within Calero Arroyo and the upland habitat directly around Calero Arroyo. This species, although sometimes travels overland, mainly occurs within the stream and riparian vegetation, and is unlikely to move further outside of the riparian habitat, therefore, we would expect this species to occur only in close proximity to Calero Arroyo along the western edge of the project site.
California Red-legged Frog (<i>Rana aurora draytonii</i>)	FT, CSC	Rivers, creeks and stock ponds of the Sierra foothills and Bay Area, preferring pools with overhanging vegetation.	Likely. An occurrence of the California red-legged was generally mapped with the accuracy polygon centered on Calero Arroyo; the project site is located partially within the accuracy polygon associated with this occurrence (CDFW 2020). As this species is known to exist in upland areas within burrows and under leaf litter and debris, this species may occur throughout the site both in proximity to and away from Calero Arroyo.
Tricolored Blackbird (<i>Agelaius tricolor</i>)	CSC, CCE	Breeds near fresh water in dense emergent vegetation.	Possible. Suitable nesting habitat is present in portions of Calero Arroyo. Additionally, the SCVHP identifies the northern portion of the project site as a survey area for tricolored blackbirds. The nearest documented observation of this species is less than a mile upstream from the site in Calero Arroyo (CDFW 2020).

TABLE 1. LIST OF SPECIAL STATUS SPECIES THAT COULD OCCUR IN THE PROJECT VICINITY

ANIMALS (Continued adapted from CDFW 2020 and USFWS 2020)

Species Listed as Threatened or Endangered under the State and/or Federal Endangered Species Act

Species	Status	Habitat	Occurrence in the Study Area
Swainson’s hawk (nesting) (<i>Buteo swainsoni</i>)	CT	Breeds in stands with few trees in juniper-sage flats, riparian areas, and in oak savannah. Requires adjacent suitable foraging areas such as grasslands or alfalfa fields supporting rodent populations.	Possible. The SWHA is only known in the region from one pair which breeds each year in Coyote Valley. Therefore, Swainson’s hawks are not expected to nest onsite, but may be expected to forage over the site from time to time (CDFW 2020).

ANIMALS (adapted from CDFG 2020 and USFWS 2020)

State Species of Special Concern and Protected Species

Species	Status	Habitat	Occurrence in the Study Area
Monterey roach (<i>Lavinia symmetricus subditus</i>)	CSC	Occurs in the Pajaro, Salinas, and San Lorenzo River and their tributaries.	Absent. The Monterey roach is not known in the Alamitos Creek Watershed (UCANS 2020), and therefore, Calero Arroyo would not be expected to support this species.
Santa Cruz black salamander (<i>Aneides niger</i>)	CSC	Occurs in deciduous woodland, coniferous forests, and coastal grasslands around the Santa Cruz Mountains and foothills. This species is also known to occur on the developed flats in pockets within older developments. They can be found under rocks near streams, in talus, under damp logs, rotting wood, and other objects.	Absent. Suitable habitat for the Santa Cruz black salamander is absent from the project site. An occurrence of the Santa Cruz black salamander was generally mapped with the accuracy polygon centered on Alamitos Creek; the project site is located approximately 0.75 miles from the accuracy polygon associated with this occurrence (CDFW 2020).
Northern California legless lizard (<i>Anniella pulchra</i>)	CSC	The NCLL (previously called black legless lizard) occurs mostly underground in warm moist areas with loose soil and substrate. The NCLL occurs in habitats including sparsely vegetated areas of beach dunes, chaparral, pine-oak woodlands, desert scrub, sandy washes, and stream terraces with sycamores, cottonwoods, or oaks.	Unlikely. Habitats required by northern California legless lizards are moderately suitable, as the site lacks sandy soils. Additionally, the nearest documented observation of this species is more than three miles from the site (CDFW 2020).
Coast horned lizard (<i>Phrynosoma blainvillii</i>)	CSC	Occur in grasslands, scrublands, oak woodlands, etc. of central California. Common in sandy washes with scattered shrubs.	Unlikely. Habitats required by coast horned lizards are moderately suitable, as the site lacks sandy soils. The nearest documented observation of this species is approximately a mile from the site near Calero Reservoir (CDFW 2020).

TABLE 1. LIST OF SPECIAL STATUS SPECIES THAT COULD OCCUR IN THE PROJECT VICINITY

ANIMALS (Continued adapted from CDFG 2020 and USFWS 2020)

State Species of Special Concern and Protected Species

Species	Status	Habitat	Occurrence in the Study Area
Western pond turtle (WPT) (<i>Actinemys marmorata</i>)	CSC	Intermittent and permanent waterways including streams, marshes, rivers, ponds and lakes. Open slow-moving water of rivers and creeks of central California with rocks and logs for basking.	Possible. WPT are known to occur in Calero Reservoir and Calero Arroyo just over a half-mile from the site (CDFW 2020).
Northern harrier (nesting) (<i>Circus cyaneus</i>)	CSC	Frequents meadows, grasslands, open rangelands, freshwater emergent wetlands; uncommon in wooded habitats.	Possible. Although the nearest documented observation of this species is more than 3 miles from the site (CDFW 2020), the site provides suitable foraging habitat for this species.
American peregrine falcon (<i>Falco peregrines anatum</i>)	CP	Individuals breed on cliffs in the Sierra or in coastal habitats; occurs in many habitats of the state during migration and winter.	Unlikely. The peregrine falcon is known to nest on buildings in the City of San Jose and is not known to occur within the vicinity of the site. Additionally, the nearest documented observation of this species is more than 3 miles from the site (CDFW 2020).
White-tailed Kite (nesting) (<i>Elanus leucurus</i>)	CP	Open grasslands and agricultural areas throughout central California.	Possible. Although the nearest documented observation of this species is more than 3 miles from the site (CDFW 2020), suitable breeding habitat exists onsite for this species and the site supports foraging habitat onsite and in the vicinity of the site.
Golden Eagle (nesting & nonbreeding/wintering) (<i>Aquila chrysaetos</i>)	CP	Typically frequents rolling foothills, mountain areas, sage-juniper flats and desert.	Possible. Although suitable breeding habitat for the golden eagle is absent from the site, foraging habitat exists onsite. The nearest documented occurrence of the GE is within a fourth mile to the southwest of the site (CDFW 2020).
Burrowing Owl (<i>Athene cunicularia</i>)	CSC	Found in open, dry grasslands, deserts and ruderal areas. Requires suitable burrows. This species is often associated with California ground squirrels.	Possible. Suitable overwintering habitat is present onsite. The nearest documented occurrence of BUOW is less than nearly three miles to the southeast of the site (CDFW 2020).
Loggerhead Shrike (nesting) (<i>Lanius ludovicianus</i>)	CSC	Frequents open habitats with sparse shrubs and trees, other suitable perches, bare ground, and low herbaceous cover. Nests in tall shrubs and dense trees. Forages in grasslands, marshes, and ruderal habitats. Can often be found in cropland.	Possible. Suitable breeding and foraging habitat exist onsite and they are known to occur in the area.

TABLE 1. LIST OF SPECIAL STATUS SPECIES THAT COULD OCCUR IN THE PROJECT VICINITY

ANIMALS (Continued adapted from CDFW 2020 and USFWS 2020)

State Species of Special Concern and Protected Species

Species	Status	Habitat	Occurrence in the Study Area
Black swift (<i>Cypseloides niger</i>)	CSC	Migrants found in many habitats of state; in Sierra nests are often associated with waterfalls.	Unlikely. The site does not provide suitable breeding or foraging habitat for this species; however, this species can be expected to move over the site during migration. The nearest recorded observation of this species was generally mapped with the accuracy polygon centered on Alamitos Creek; the project site is located approximately 0.75 miles from the accuracy polygon associated with this occurrence (CDFW 2020).
Purple martin (<i>Progne subis</i>)	CSC	Cavity nester, nests widely in man-made birdhouses.	Unlikely. The trees of the site may provide potential nesting habitat; however, these birds are known to nest near open water, which is not present onsite or in the vicinity of the site. The purple martin may be expected to fly over or forage on the site from time to time.
Yellow-breasted chat (<i>Icteria virens</i>)	CSC	Frequently breeds in dense shrubs and blackberry thickets and uses areas of dense vegetation during migration.	Unlikely. Potential nesting habitat of dense vegetation is generally absent from the site. The YBC may be expected to fly over or forage on the site from time to time.
Grasshopper sparrow (<i>Ammodramus savannarum</i>)	CSC	Occurs in California during spring and summer in open grasslands with scattered shrubs.	Possible. Suitable breeding habitat exists onsite. The nearest documented occurrence is more than 3 miles from the site (CDFW 2020).
Townsend’s Big-eared bat (<i>Corynorhinus townsendii</i>)	CSC	Primarily a cave-dwelling bat that may also roost in buildings. Occurs in a variety of habitats.	Possible. Although suitable roosting habitat occurs within the structures of the site, removal of structure is not a part of this project. This species may forage over the remainder of the site. The nearest documented occurrence is more than 3 miles from the site (CDFW 2020).
Pallid Bat (<i>Antrozous pallidus</i>)	CSC	Grasslands, chaparral, woodlands, and forests; most common in dry rocky open areas providing roosting opportunities.	Possible. Although suitable roosting habitat occurs within the structures of the site, removal of structure is not a part of this project. This species may forage over the remainder of the site. The nearest documented occurrence is nearly 3 miles from the site (CDFW 2020).
San Francisco Dusky-Footed Woodrat (<i>Neotoma fuscipes annectens</i>)	CSC	Found in hardwood forests, oak riparian and shrub habitats.	Possible. Suitable habitat is present in the coyote brush habitat onsite. The nearest documented occurrence is approximately 2.5 miles from the site (CDFW 2020).
American Badger (<i>Taxidea taxus</i>)	CSC	Found in drier open stages of most shrub, forest and herbaceous habitats with friable soils, specifically grassland environments. Natal dens occur on slopes.	Possible. Suitable habitat is present onsite. The nearest documented occurrence is approximately 2 miles to the east of the site (CDFW 2020).

***Explanation of Occurrence Designations and Status Codes**

- Present: Species observed on the sites at time of field surveys or during recent past.
- Likely: Species not observed on the site, but it may reasonably be expected to occur there on a regular basis.
- Possible: Species not observed on the sites, but it could occur there from time to time.
- Unlikely: Species not observed on the sites, and would not be expected to occur there except, perhaps, as a transient.
- Absent: Species not observed on the sites, and precluded from occurring there because habitat requirements not met.

STATUS CODES

FE	Federally Endangered	CE	California Endangered
FT	Federally Threatened	CT	California Threatened
FPE	Federally Endangered (Proposed)	CR	California Rare
FC	Federal Candidate	CP	California Protected
CSC	California Species of Special Concern		
		CCE	California Candidate Endangered
CNPS	California Native Plant Society Listing		
1A	Plants Presumed Extinct in California	3	Plants about which we need more information – a review list
1B	Plants Rare, Threatened, or Endangered in California and elsewhere	4	Plants of limited distribution – a watch list
2	Plants Rare, Threatened, or Endangered in California, but more common elsewhere		

2.4 JURISDICTIONAL WATERS

Jurisdictional waters include rivers, creeks, and drainages that have a defined bed and bank and which, at the very least, carry ephemeral flows. Jurisdictional waters also include lakes, ponds, reservoirs, and wetlands. Such waters may be subject to the regulatory authority of the U.S. Army Corps of Engineers (USACE), the California Department of Fish and Wildlife (CDFW), and the California Regional Water Quality Control Board (RWQCB). See Section 3.2.14 of this report for additional information. Calero Arroyo onsite is considered to be a jurisdictional water. A seasonal wetland may also be claimed by the CDFW and/or the RWQCB.

3 IMPACTS AND MITIGATIONS

3.1 SIGNIFICANCE CRITERIA

General plans, area plans, and specific projects are subject to the provisions of the California Environmental Quality Act (CEQA). The purpose of CEQA is to assess the impacts of proposed projects on the environment before they are constructed. For example, site development may require the removal of some or all of its existing vegetation. Animals associated with this vegetation could be destroyed or displaced. Animals adapted to humans, roads, buildings, pets, etc., may replace those species formerly occurring on a site. Plants and animals that are state and/or federally listed as threatened or endangered may be destroyed or displaced. Sensitive habitats such as wetlands and riparian woodlands may be altered or destroyed. These impacts may be considered significant. According to *Guide to the California Environmental Quality Act* (Remy et al. 1996), “Significant effect on the environment” means a substantial, or potentially substantial, adverse change in any of the physical conditions within the area affected by the project including land, air, water, minerals, flora, fauna, ambient noise, and objects of historic or aesthetic interest. Specific project impacts to biological resources may be considered “significant” if they will:

- Have a substantial adverse effect, either directly or through habitat modifications, on any species identified as a candidate, sensitive, or special status species in local or regional plans, policies, or regulations, or by the California Department of Fish and Game or U.S. Fish and Wildlife Service;
- Have a substantial adverse effect on any riparian habitat or other sensitive natural community identified in local or regional plans, policies, regulations or by the California Department of Fish and Game or U.S. Fish and Wildlife Service;
- Have a substantial adverse effect on federally protected wetlands as defined by Section 404 of the Clean Water Act (including, but not limited to, marsh, vernal pool, coastal, etc.) through direct removal, filling, hydrological interruption, or other means;
- Interfere substantially with the movement of any native resident or migratory fish or wildlife species or with established native resident or migratory wildlife corridors, or impede the use of native wildlife nursery sites.

- Reduce substantially the habitat of a fish or wildlife species, including causing a fish or wildlife population to drop below self-sustaining levels or threaten to eliminate an animal community.
- Conflict with any local policies or ordinances protecting biological resources, such as a tree preservation policy or ordinance.
- Conflict with the provisions of an adopted Habitat Conservation Plan, Natural Community Conservation Plan, or other approved local, regional, or state habitat conservation plan.

For the purposes of this report, it is assumed that impacts will be buildout of the entire property outside of the proposed riparian setbacks.

3.2 RELEVANT GOALS, POLICIES, AND LAWS

3.2.1 Threatened and Endangered Species

State and federal “endangered species” legislation has provided the California Department of Fish and Wildlife (CDFW) and the U.S. Fish and Wildlife Service (USFWS) with a mechanism for conserving and protecting plant and animal species of limited distribution and/or low or declining populations. Species listed as threatened or endangered under provisions of the state and federal Endangered Species Acts, candidate species for such listing, state species of special concern, and some plants listed as endangered by the California Native Plant Society are collectively referred to as “species of special status.” Permits may be required from both the CDFW and USFWS if activities associated with a proposed project will result in the take of a listed species. To “take” a listed species, as defined by the state of California, is “to hunt, pursue, catch, capture, or kill, or attempt to hunt, pursue, catch, capture or kill” said species (California Fish and Game Code, Section 86). “Take” is more broadly defined by the federal Endangered Species Act to include “harm” of a listed species (16 USC, Section 1532(19), 50 CFR, Section 17.3). Furthermore, the CDFW and the USFWS are responding agencies under the California Environmental Quality Act (CEQA). Both agencies review CEQA documents in order to determine the adequacy of their treatment of endangered species issues and to make project-specific recommendations for their conservation.

3.2.2 Migratory Birds

State and federal laws also protect most bird species. The Federal Migratory Bird Treaty Act (FMBTA: 16 U.S.C., sec. 703, Supp. I, 1989) prohibits killing, possessing, or trading in migratory

birds, except in accordance with regulations prescribed by the Secretary of the Interior. This act encompasses whole birds, parts of birds, and bird nests and eggs.

3.2.3 Birds of Prey

Birds of prey are protected in California under provisions of the State Fish and Game Code, Section 3503.5, which states that it is “unlawful to take, possess, or destroy any birds in the order *Falconiformes* or *Strigiformes* (birds of prey) or to take, possess, or destroy the nest or eggs of any such bird except as otherwise provided by this code or any regulation adopted pursuant thereto”. Construction disturbance during the breeding season could result in the incidental loss of fertile eggs or nestlings, or otherwise lead to nest abandonment. Disturbance that causes nest abandonment and/or loss of reproductive effort is considered “taking” by the CDFW.

Additionally, the Bald and Golden Eagle Protection Act (16 U.S.C., sec. 668-668c) prohibits anyone from taking bald or golden eagles, including their parts, nests, or eggs, unless authorized under a federal permit. The act prohibits any disturbance that directly affects an eagle or an active eagle nest as well as any disturbance caused by humans around a previously used nest site during a time when eagles are not present such that it agitates or bothers an eagle to a degree that interferes with or interrupts normal breeding, feeding, or sheltering habits, and causes injury, death or nest abandonment.

3.2.4 Bats

Section 2000 and 4150 of the California Fish and Game Code states that it is unlawful to take or possess a number of species, including bats, without a license or permit, as required by Section 3007. Additionally, Title 14 of the California Code of Regulations states it is unlawful to harass, herd, or drive a number of species, including bats. To harass is defined as “an intentional act which disrupts an animal's normal behavior patterns, which includes, but is not limited to, breeding, feeding or sheltering.” For these reasons, bat colonies in particular are considered to be sensitive and therefore, disturbances that cause harm to bat colonies are unlawful.

3.2.5 Wetlands and Other “Jurisdictional Waters”

The USACE regulates the filling or grading of Waters of the U.S. under the authority of Section 404 of the Clean Water Act. Natural drainage channels and adjacent wetlands may be considered “Waters of the United States” or “jurisdictional waters” subject to the jurisdiction of the USACE.

The extent of jurisdiction has been defined in the Code of Federal Regulations and clarified in federal courts.

On June 29, 2015, the Environmental Protection Agency and USACE jointly issued the Clean Water Rule as a synthesis of statute, science, and U.S. Supreme Court decisions. The Clean Water Rule defines Waters of the U.S. to include the following:

1. All waters used in interstate or foreign commerce (also known as traditional navigable waters), including all waters subject to the ebb and flow of the tide;
2. All interstate waters including interstate wetlands;
3. The territorial seas;
4. All impoundments of Waters of the U.S.;
5. All tributaries of waters defined in Nos. 1 through 4 above, where “tributary” refers to a water (natural or constructed) that contributes flow to another water and is characterized by the physical indicators of a bed and bank and an ordinary high water (OHW) mark;
6. Adjacent waters, defined as either (a) located in whole or in part within 100 feet of the OHW mark of waters defined in Nos. 1 through 5 above, or (b) located in whole or in part within the 100-year floodplain and within 1,500 feet of the OHW mark of waters defined in Nos. 1 through 5 above;
7. Western vernal pools, prairie potholes, Carolina bays and Delmarva bays, pocosins, and Texas coastal prairie wetlands, if determined on a case-specific basis to have a significant nexus to waters defined in Nos. 1 through 3 above;
8. Waters that do not meet the definition of adjacency, but are determined on a case-specific basis to have a significant nexus to waters defined in Nos. 1 through 3 above, and are either (a) located in whole or in part within the 100-year floodplain of waters defined in Nos. 1 through 3 above, or (b) located within 4,000 feet of the OHW mark of waters defined in Nos. 1 through 5 above.

The 2015 rule also redefines exclusions from jurisdiction, which include:

1. Waste treatment systems;
2. Prior converted cropland;

3. Artificially irrigated areas that would revert to dry land should application of irrigation water to the area cease;
4. Groundwater;
5. Stormwater control features constructed to convey treat or store stormwater created in dry land; and
6. Three types of ditches: (a) ditches with ephemeral flow that are not a relocated or excavated tributary, (b) ditches with intermittent flow that are not a relocated or excavated tributary or that do not drain wetlands, and (c) ditches that do not flow, either directly or through another water, to a traditional navigable water.

A ditch may be a water of the U.S. only if it meets the definition of “tributary” and is not otherwise excluded under the provision.

All activities that involve the discharge of dredge or fill material into Waters of the U.S. are subject to the permit requirements of the USACE. Such permits are typically issued on the condition that the applicant agrees to provide mitigation that result in no net loss of wetland functions or values. No permit can be issued until the RWQCB issues a Section 401 Water Quality Certification (or waiver of such certification) verifying that the proposed activity will meet state water quality standards.

Under the Porter-Cologne Water Quality Control Act of 1969, the State Water Resources Control Board has regulatory authority to protect the water quality of all surface water and groundwater in the State of California (“Waters of the State”). Nine RWQCBs oversee water quality at the local and regional level. The RWQCB for a given region regulates discharges of fill or pollutants into Waters of the State through the issuance of various permits and orders. Discharges into Waters of the State that are also Waters of the U.S. require a Section 401 Water Quality Certification from the RWQCB as a prerequisite to obtaining certain federal permits, such as a Section 404 Clean Water Act permit. Discharges into all Waters of the State, even those that are not also Waters of the U.S., require Waste Discharge Requirements (WDRs), or waivers of WDRs, from the RWQCB.

The RWQCB also administers the Construction Stormwater Program and the federal National Pollution Discharge Elimination System (NPDES) program. Projects that disturb one or more acres of soil must obtain a Construction General Permit under the Construction Stormwater Program. A

prerequisite for this permit is the development of a Stormwater Pollution Prevention Plan (SWPPP) by a certified Qualified SWPPP Developer. Projects that discharge wastewater, stormwater, or other pollutants into a Water of the U.S. may require a NPDES permit.

CDFW has jurisdiction over the bed and bank of natural drainages and lakes according to provisions of Section 1601 and 1602 of the California Fish and Game Code. Activities that may substantially modify such waters through the diversion or obstruction of their natural flow, change or use of any material from their bed or bank, or the deposition of debris require a Notification of Lake or Streambed Alteration. If CDFW determines that the activity may adversely affect fish and wildlife resources, a Lake or Streambed Alteration Agreement will be prepared. Such an agreement typically stipulates that certain measures will be implemented to protect the habitat values of the lake or drainage in question.

3.2.6 Local Ordinances, Policies

Tree ordinance. The County of Santa Clara has an ordinance for the preservation and removal of trees (Division C16 of the Santa Clara County Code). This ordinance requires that a permit first be obtained prior to the removal of any tree on public or private property in designated areas of the County, including trees having a main trunk or stem measuring at least 37.7 inches in circumference (12 in. in diameter) at a height of 4.5 ft. above ground level or exceeds 20 ft. in height on property owned or leased by the County, or any tree regardless of size within road rights-of-way and easements of the County. Certain exceptions may apply.

3.2.7 Santa Clara Valley Habitat Plan

Six local partners (i.e., County of Santa Clara, Santa Clara Valley Transportation Authority; Santa Clara Valley Water District; and the Cities of San Jose, Gilroy, and Morgan Hill) and two wildlife agencies (the California Department of Fish and Wildlife and the U.S. Fish and Wildlife Service) prepared and adopted this multi-species habitat conservation plan, which primarily covers southern Santa Clara County, as well as the City of San Jose with the exception of the bayland areas. The SCVHP addresses listed species and species that are likely to become listed during the plan's 50-year permit term. The eighteen covered species include nine plants and nine animals. The animal species covered include, but are not limited to, the California tiger salamander, California red-legged frog, western pond turtle, and western burrowing owl. The SCVHP requires that the agencies comment on reportable interim projects and recommend mitigation measures or project alternatives

that would help achieve the preliminary conservation objectives and not preclude important conservation planning options or connectivity between areas of high habitat value. Funding sources for the SCVHP include development fees based on land cover types (natural, agricultural or small vacant sites surrounded by urban development). Additional fees are charged based on the occurrence of certain sensitive habitat types such as serpentine and wetlands.

The project is considered a covered project under the SCVHP. As a result, the project would be subject to conditions and fees of the SCVHP.

3.2.7.1 SCVHP Fees

Chapter 9 of the SCVHP identifies fees that would be required by this project. The following describes fees that are based on the 2018-2019 fee schedule; however, fees are calculated at the time the project submits the SCVHP application, which corresponds to application timing of grading and/or building permits. Thus, the following numbers are provided for a sense of magnitude and should be considered approximate.

The site is within Fee Zone B “Mostly Cultivated Agricultural Lands”. The 2018-2019 SCVHP fees for development of Zone B lands are \$14,725 per acre. In addition, a Nitrogen Deposition Fee would also be required at \$48.33 per new single-family residence. Temporary impact fees, such as for utility trenching, are assessed at a fraction of these fees.

3.2.7.2 Conditions on Covered Activities

The SCVHP provides several conditions for covered activities under the SCVHP. These conditions can be found in Chapter 6 of the SCVHP and are summarized below.

- **Condition 1 (page 6-7). Avoid Direct Impacts on Legally Protected Plant and Wildlife Species-** Condition 1 instructs developers to avoid direct impacts on legally protected plant and wildlife species, including federally endangered Contra Costa goldfields and fully protected wildlife species including the golden eagle, bald eagle, American peregrine falcon, southern bald eagle, white-tailed kite, California condor, and ring-tailed cat. Several of these species are likely to occur on or forage over the site (golden eagle, bald eagle, white-tailed kite, and ringtail). Condition 1 also protects bird species and their nests that are protected under the Migratory Bird Treaty Act (MBTA); additionally, golden eagles and bald eagles are protected under the Bald and Golden Eagle Protection Act. Additionally,

page 6-94 and Table 6-8 identify required surveys for breeding habitat of select covered wildlife species.

- **Condition 2 (page 6-9). Incorporate Urban-Reserve System Interface Design Requirements-** Condition 2 provides design requirements for the urban-reserve system interface. Some of the design requirements included in Condition 2 are installing non-permeable fences between urban and reserve areas, fencing public roads that run adjacent to reserve areas, minimizing the length of shared boundaries between urban and reserve areas, outdoor lighting limitations, and landscaping requirements.
- **Condition 3 (page 6-12). Maintain Hydrologic Conditions and Protect Water Quality- (Condition applies to project)-** Condition 3 is for all projects due to the fact that implementation of projects could result in impacts on watershed health, including impacts to aquatic habitat for species, through changes in hydrology and water quality. This condition incorporates all of the most important measures for water quality protection of the National Pollutant Discharge Elimination System (NPDES) Program of the Clean Water Act. Required measures of Condition 3 are located in Table 6-2 of the SCVHP; these measures relate to water quality and habitat protection during and after project construction. They include measures typically included in a Storm Water Pollution Prevention Plan (SWPPP) but may include measures that are in addition to such plans.
- **Condition 4 (page 6-14). Avoidance and Minimization for In-Stream Projects-** Condition 4 minimizes impacts on riparian and aquatic habitat through appropriate design requirements and construction practices and provides avoidance and minimization measures for in-stream projects that may impact stream morphology, aquatic and riparian habitat, flow conditions, covered species, natural communities, and wildlife movement.
- **Condition 5 (page 6-18). Avoidance and Minimization Measures for In-Stream Operations and Maintenance-** Condition 5 provides avoidance and minimization measures for in-stream operations and maintenance activities, which includes, but is not limited to trail, bridge, road, and culvert maintenance, bank stabilization, removal of debris, and vegetation management.
- **Condition 6 (Page 6-21). Design and Construction Requirements for Covered Transportation Projects-** Condition 6 provides requirements for rural development design, construction, and post-construction. Types of projects that Condition 6 includes highway

projects, mass transit projects, roadway projects and interchange upgrades, road safety and operational improvements, and dirt road construction.

- **Condition 7 (page 6-28). Rural Development Design and Construction Requirements-** Condition 7 provides requirements for development design and construction of new development outside of the urban service area including requirements relating to site hydrology, vineyards, private rural roads, vegetation management, soils, and lighting.
- **Condition 8 (page 6-35). Implement Avoidance and Minimization Measures for Rural Road Maintenance-** Condition 8 provides requirements for rural roads, road median, and barrier maintenance including requirements regarding riparian setbacks, erosion measures, herbicide and pesticide use, seasonal restrictions, mower cleaning, revegetation, ground-disturbing road maintenance, and flow lines.
- **Condition 9 (page 6-37). Prepare and Implement a Recreation Plan-** Condition 9 requires providing public access to all reserve lands owned by a public entity; each reserve land must provide a recreation plan.
- **Condition 10 (page 6-42). Fuel Buffer-** Condition 10 provides requirements for fuel buffers between 30 and 100 feet of structures. Requirements include measures relating to fuel buffers near structures and on reserve lands; the most notable measure is the requirement for nesting bird surveys prior to any fuel buffer maintenance during the nesting season.
- **Condition 11 (page 6-44). Stream and Riparian Setbacks-** Condition 11 provides requirements for stream and riparian setbacks; as the development area is outside the Urban Service Area, stream setbacks measured from the top of the stream bank should be 35 to 200 feet depending on the category rating of the stream and the slope class. Setbacks for Category 1 streams with 0-30% slopes should be at least 150 feet, and with >30% slopes should be at least 200 feet. The setback would be more if the edge-of-riparian line plus 35 feet is greater than the stream setback. Category 2 streams should have a setback of 35 feet.
- **Condition 12 (page 6-56). Wetland and Pond Avoidance and Minimization-** Condition 12 provides measures to protect wetlands and ponds, including planning actions, design, and construction actions.
- **Condition 13 (page 6-58). Serpentine and Associated Covered Species Avoidance and Minimization-** Condition 13 requires surveys for special status plants and the Bay

checkerspot butterfly as well as its larval host plant in areas that support serpentine bunchgrass grassland, serpentine rock outcrops, serpentine seeps, and serpentine chaparral. Fees apply for impacts to serpentine habitat.

- **Condition 14 (page 6-60). Valley Oak and Blue Oak Woodland Avoidance and Minimization-** Condition 14 provides requirements for project planning and project construction, including avoidance of large oaks, guidance on irrigation near oak trees, and a buffer around the root protection zone, roads and pathways within 25 feet of the dripline of an oak tree, trenching, and pruning activities.
- **Condition 15 (page 6-62). Western Burrowing Owl-** Condition 15 requires preconstruction surveys for burrowing owls in appropriate habitat prior to construction activities, provides avoidance measures for owls and nests in the breeding season and owls in the non-breeding season, and requirements for construction monitoring.
- **Condition 16 (page 6-68) Least Bell's Vireo-** Condition 16 requires preconstruction surveys in appropriate habitat for the least Bell's vireo prior to construction activities, and provides avoidance and construction monitoring measures.
- **Condition 17 (page 6-69) Tricolored Blackbird-** Condition 17 requires preconstruction surveys in appropriate habitat for the tricolored blackbird prior to construction activities, and provides avoidance and construction monitoring measures.
- **Condition 18 (page 6-71) San Joaquin Kit Fox-** Condition 18 requires preconstruction surveys in appropriate habitat for the San Joaquin kit fox prior to construction activities, and provides avoidance and construction monitoring measures.
- **Condition 19 (page 6-74). Plant Salvage when Impacts are Unavoidable-** Condition 19 provides salvage guidance and requirements for covered plants.
- **Condition 20 (page 6-76). Avoid and Minimize Impacts to Covered Plant Occurrences-** Condition 20 provides requirements for preconstruction surveys for appropriate covered plants (per habitat).

3.3 IMPACTS SPECIFIC TO THE PROJECT

The project, as proposed, would build a single-family residence in the northern portion of the site and would not remove any trees or buildings onsite. As discussed above, activities resulting in

impacts to biotic resources may be regulated by local, state, and federal laws. The natural resource issues specific to this project are discussed in detail below.

3.3.1 Loss of Habitat for Special Status Plants

Potential Impact. Of the 10 special status plant species that occur, or that once occurred, regionally, habitat in the form of serpentine and/or alkaline soils, woodlands, vernal pools, etc., are absent from the site and therefore most of these plant species that occur on those soils or in those habitat types are considered absent from the site. Additionally, special status plant species that occur in grassland habitats are considered absent due to the disturbed nature of the grasslands on the site and their overwhelming dominance by non-native annual grasses.

Mitigation. None warranted.

3.3.2 Loss of Habitat for Special Status Animals

Potential Impact. Twenty-eight (28) special status animal species occur, or once occurred, regionally. Of these, 11 species would be absent or unlikely to occur on the site due to a lack of suitable habitat for these species. The species that would be absent or unlikely to occur include the crotch bumble bee, western bumble bee, Monterey roach, California tiger salamander, Santa Cruz black salamander, northern California legless lizard, Coast horned lizard, American peregrine falcon, black swift, purple martin, and yellow-breasted chat.

The remaining 17 special status animal species from Table 1 potentially occur more frequently as potential foragers, transients, may be resident to the site, or they may occur within areas adjacent to the site. These include steelhead, coho salmon, Foothill yellow-legged frog, California red-legged frog, western pond turtle, Swainson's hawk, northern harrier, white-tailed kite, golden eagle, burrowing owl, loggerhead shrike, grasshopper sparrow, tricolored blackbird, Townsend's big-eared bat, pallid bat, San Francisco dusky-footed woodrat, and American badger.

As the project does not plan to impact Calero Arroyo, the project is not expected to impact fish (steelhead and coho salmon) or their habitat.

Although bats may roost in buildings onsite, bats are not expected to roost in other areas onsite. As buildings are not planned for removal, the project is not expected to impact roosting bats. However, individual Townsend's big-eared bats and pallid bats may forage within the site from time to time.

Swainson's hawks and golden eagles are only expected to forage over the site, so the loss of this small amount of foraging habitat is not significant.

Potential impacts to individuals of Foothill yellow-legged frog, California red-legged frog, western pond turtle, nesting birds and raptors, burrowing owl, tricolored blackbird, San Francisco dusky-footed woodrat, and American badger are discussed further below (Sections 3.3.5-3.3.12).

Mitigation. No mitigation warranted.

3.3.3 Loss of Habitat for Native Wildlife

Potential Impact. The habitats of the site comprise only a small portion of the regionally available habitat for plant and animal species that are expected to use the habitat. The proposed project would result in the loss of California annual grassland habitat and potentially coyote brush scrub habitat. This is not expected to result in a significant effect on local wildlife. Therefore, impacts due to the loss of habitats for native wildlife resulting from the proposed project are considered less-than-significant.

Mitigation. No mitigation would be warranted for the loss of habitat for native wildlife.

3.3.4 Interference with the Movement of Native Wildlife

Potential Impact. Building of the single-family residence onsite would not constrain native wildlife movement, as any wildlife using the site as a local movement corridor would continue to use it in the same manner after development. Additionally, any wildlife using the Calero Arroyo as a local movement corridor would continue to use it in the same manner after site development. The site does not support a major wildlife movement corridor or landscape linkage.

Mitigation. No mitigation would be warranted for interference with the movement of native wildlife.

3.3.5 Impacts to Nesting Migratory Birds Including Nesting Raptors and other Protected Birds

Potential Impacts. Trees, shrubs, and grasslands areas onsite may support nesting birds and raptors. Buildout of the project during the nesting period for migratory birds (i.e., typically between February 1 to August 31), including initial site grading, soil excavation, and/or tree and vegetation removal, poses a risk of nest abandonment and death of any live eggs or young that may be present

within the nest within or near the site. Such an effect would be considered a significant impact. To ensure that any active nests will not be disturbed and individual birds will not be harmed by construction activities, the following measures should be followed.

Mitigation. The following measures will ensure that active migratory bird and raptor nests will not be disturbed and individual birds will not be harmed by construction activities, especially including tree removal. Completion of the following measures will reduce the potential impacts to nesting migratory birds to a less-than-significant level.

Mitigation Measure 3.3.5a. If initial site disturbance activities, including tree, shrub, or vegetation removal, are to occur during the breeding season (typically February 1 to August 31), a qualified biologist would conduct pre-construction surveys for nesting migratory birds onsite and within 250 feet (for raptors) of the site, where accessible. The survey should occur within 14-days prior to the onset of ground disturbance. If a nesting migratory bird were to be detected, an appropriate construction-free buffer would be established. Actual size of buffer, which would be determined by the project biologist, would depend on species, topography, and type of activity that would occur in the vicinity of the nest. The project buffer would be monitored periodically by the project biologist to ensure compliance. After the nesting is completed, as determined by the biologist, the buffer would no longer be required.

3.3.6 Impacts to Western Burrowing Owls

Potential Impacts. The site outside of the burrowing owl fee area for the SCVHP, however, the site provides overwintering habitat for burrowing owls in the form of California ground squirrel burrows, slash piles, and foraging land. As burrowing owls are protected under Condition 1 of the SCVHP, following measures within Condition 15 of the SCVHP is required, and the project shall conduct pre-construction surveys in accordance with the Condition 15 of the SCVHP. Measures to ensure compliance with this condition are included below as Mitigation Measure 3.3.6.

Should site grading occur during the nesting season for this species (February 1 through August 31), nests and nestlings that may be present would likely be destroyed. Overwintering burrowing owls may also be buried in their roost burrows outside of the nesting season (September 1 through January 31). Any actions related to site development that result in the mortality of burrowing owls would constitute a violation of the federal Migratory Bird Treaty Act and provisions of the

California Fish and Game Code. Therefore, the mortality of burrowing owls would constitute a significant impact under CEQA.

Mitigation. The following measures will ensure that burrowing owls will not be harmed by construction activities. Completion of the following measures will reduce the potential impacts to burrowing owls to a less-than-significant level.

Mitigation Measure 3.3.6a: Preconstruction surveys are required to ascertain whether or not burrowing owls occupy burrows on the site prior to construction. These surveys consist of a minimum of two surveys, with the first survey no more than 14 days prior to initial construction activities (i.e. vegetation removal, grading, excavation, etc.) and the second survey conducted no more than 2 days prior to initial construction activities. If no burrowing owls or fresh sign of burrowing owls are observed during pre-construction surveys, construction may continue; however, if a burrowing owl is observed during these surveys, occupied burrows will be identified by the monitoring biologist and a buffer, as described in Mitigation Measure 3.3.6b, will be established.

- If an active nest is found onsite, a 250-foot non-disturbance buffer will be established around all nest sites as identified and defined by a qualified biologist. If the biologist determines that the nest is vacant, the non-disturbance buffer zone may be removed. The SCVHP specifies that a vacation from the site for a week or more by a burrowing owl, as determined by a qualified biologist, would constitute a voluntary relocation by the owl, and the qualified biologist could then take measures to collapse suitable burrows of the site to discourage reoccupation. The biologist will supervise hand excavation of the burrow to prevent reoccupation only after receiving approval from the wildlife agencies (SCVHP, Chapter 6, Condition 15)

For permission to encroach within 250 feet of such burrows during the nesting season (February 1 through August 31), an Avoidance, Minimization, and Monitoring Plan would need to be prepared and approved by the Implementing Entity and the Wildlife Agencies prior to such encroachment (review Chapter 6, pp. 6-64 & 6-65, of the SCVHP for further detail).

- Should a burrowing owl be located onsite in the non-breeding season (September through January), construction activities would not be allowed within this 250-foot buffer of the

active burrow(s) used by any burrowing owl unless the following avoidance measures are adhered to:

- A qualified biologist monitors the owls for at least 3 days prior to construction to determine baseline foraging behavior (i.e., behavior without construction).
- The same qualified biologist monitors the owls during construction and finds no change in owl foraging behavior in response to construction activities.
- If there is any change in owl nesting and foraging behavior as a result of construction activities, these activities will cease within the 250-foot buffer.
- If the owls are gone for at least one week, the project proponent may request approval from the Implementing Entity that a qualified biologist excavates usable burrows to prevent owls from reoccupying the site. After all usable burrows are excavated, the buffer zone will be removed and construction may continue;

Mitigation Measure 3.3.6b: The SCVHP stipulates that passive relocation or exclusion of burrowing owls would not be allowed until a positive regional growth trend is achieved as defined in Section 5.4.6 of the SCVHP; however, a project may qualify for an exception to this prohibition. In the event that voluntary relocation of site burrowing owls does not occur (defined as owls of the site having vacated the site for 10 or more consecutive days), permission to engage in passive relocation during the non-breeding season would need to be requested through the standard application process (Section 6.8 of the SCVHP). Application for an exception would need additional information including a relocation plan/schedule and documentation by a qualified biologist that owls have occupied the site for the full year without vacating the site for 10 or more consecutive days. The application would need to be submitted to the Implementing Entity, and the Wildlife Agencies would then evaluate the application and make a determination for granting the exception. If passive relocation is granted, additional measures may be required by the Implementing Entity.

However, if the owls voluntarily vacate the site for 10 or more consecutive days, as documented by a qualified biologist, the applicant could seek permission to have the qualified biologist take measures to collapse vacated and other suitable burrows to ensure that owls do not recolonize the site.

3.3.7 Impacts to Tricolored Blackbirds

Potential Impacts. Riparian habitat associated with Calero Arroyo occurs in the northern corner of the site and off-site along the western edge of the site. Potentially suitable nesting habitat occurs

within a portion of Calero Arroyo. Calero Arroyo and a portion of the site are identified as areas to survey for tricolored blackbird; therefore, the project must follow measures in Condition 17 of the SCVHP (2012) below.

Mitigation. The following measures will ensure that tricolored blackbirds will not be harmed by construction activities. Implementation of the following measures will reduce the project's potential impacts to tricolored blackbirds to a less-than-significant level under CEQA and will ensure compliance with the SCVHP and state and federal laws.

Mitigation Measure 3.3.7a: If possible, the site will avoid the area identified in the SCVHP as potential nesting habitat and 250-foot buffer from that habitat.

Mitigation Measure 3.3.7b: If the project proponent chooses not to avoid the potential nesting habitat and the 250-foot buffer, additional nesting surveys are required. Prior to any ground disturbance related to covered activities, a qualified biologist will make his/her best effort to determine if there has been nesting at the site in the past five years. This includes checking the CNDDDB, contacting local experts, and looking for evidence of historical nesting (i.e., old nests).

If no nesting in the past five years is evident, the qualified biologist will conduct a preconstruction survey in areas identified in the habitat survey as supporting potential tricolored blackbird nesting habitat. Surveys will be made at the appropriate times of year when nesting use is expected to occur. The surveys will document the presence or absence of nesting colonies of tricolored blackbird. Surveys will conclude no more than two calendar days prior to construction. To avoid last minute changes in schedule or contracting that may occur if an active nest is found, the project proponent may also conduct a preliminary survey up to 14 days before construction. The Wildlife Agencies will be notified immediately of any nest locations.

Mitigation Measure 3.3.7c: Covered activities must avoid tricolored blackbird nesting habitat that is currently occupied or have been used in the past 5 years. If tricolored blackbird colonies are identified during the breeding season, covered activities will be prohibited within a 250-foot no-activity buffer zone around the outer edge of all hydric vegetation associated with the colony. This buffer may be reduced in areas with dense forest, buildings, or other habitat features between the construction activities and the active nest colony, or where there is sufficient topographic relief to

protect the colony from excessive noise or visual disturbance. Depending on site characteristics, the sensitivity of the colony, and surrounding land uses, the buffer zone may be increased. Land uses potentially affecting a colony will be observed by a qualified biologist to verify that the activity is not disrupting the colony. If it is, the buffer will be increased. Implementing Entity technical staff will coordinate with the Wildlife Agencies and evaluate exceptions to the minimum no-activity buffer distance on a case-by-case basis.

Mitigation Measure 3.3.7d: If construction takes place during the breeding season when an active colony is present, a qualified biologist will monitor construction to ensure that the 250-foot buffer zone is enforced. If monitoring indicates that construction outside of the buffer is affecting a breeding colony, the buffer will be increased if space allows (e.g., move staging areas farther away). If space does not allow, construction will cease until the colony abandons the site or until the end of the breeding season, whichever occurs first. The biological monitor will also conduct training of construction personnel on the avoidance procedures, buffer zones, and protocols to follow in the event that tricolored blackbirds fly into an active construction zone (i.e., outside the buffer zone).

3.3.8 Impacts to Foothill Yellow-Legged Frogs

Potential Impacts. Potentially suitable breeding and upland habitat for the Foothill yellow-legged frog (FYLF) is present within the project site in the form of Calero Arroyo and riparian habitat associated with Calero Arroyo. FYLF may also be expected to move out of the riparian area onto the remainder of the site from time to time as well. The project, as proposed, will not impact any breeding habitat. Injury or mortality of an individual FYLF would be considered a significant impact to FYLF under CEQA.

Mitigation. Implementation of the following mitigation measures would reduce impacts to FYLF to a less-than-significant level.

Mitigation Measure 3.3.8a: The applicant will follow all SCVHP requirements in regard to FYLF, including the submittal of relevant applications and payment of required fees discussed in Mitigation Measure 3.3.16. The SCVHP does not require surveys for this species.

3.3.9 Impacts to California Red-Legged Frogs

Potential Impacts. Potentially suitable breeding and upland habitat for the California red-legged frog (CRLF) is present within the project site in the form of Calero Arroyo and riparian habitat

associated with Calero Arroyo. CRLF may also be expected to move out of the riparian area onto the remainder of the site from time to time as well. The project, as proposed, will not impact any breeding habitat. Injury or mortality of an individual CRLF would be considered a significant impact to CRLF under CEQA.

Mitigation. Implementation of the following mitigation measures would reduce impacts to CRLF to a less-than-significant level.

Mitigation Measure 3.3.9a: The applicant will follow all SCVHP requirements in regard to CRLF, including the submittal of relevant applications and payment of required fees discussed in Mitigation Measure 3.3.16. The SCVHP does not require surveys for this species.

3.3.10 Impacts to Western Pond Turtles

Potential Impacts. The proposed project would result in the loss of a small area of upland habitat for western pond turtles. Rearing habitat exists adjacent to the site in the form of Calero Arroyo. Impacts to WPT habitat would be considered minimal. However, it is possible that WPT would move into the construction zone, which may result in mortality to individual western pond turtles. The loss of these individuals would constitute a significant impact under CEQA.

Mitigation. To reduce impacts to the WPT to a less-than-significant level, the applicant will implement the following mitigation in conjunction with the Santa Clara Valley Habitat Plan.

- **Mitigation Measure 3.3.11a:** The applicant will follow all Habitat Plan requirements in regard to WPT, including the submittal of relevant applications and payment of required fees discussed in Mitigation Measure 3.3.16.

3.3.11 Impacts to San Francisco Dusky-Footed Woodrats

Potential Impacts. Woodrat nests have the potential to occur within the coyote brush habitat of the site. Construction activities could result in harm to individual woodrats while in their nests. This would be considered a significant impact under CEQA.

Mitigation. Implementation of the following mitigation measures would reduce impacts to the San Francisco dusky-footed woodrat to a less-than-significant level.

- **Mitigation Measure 3.3.12a:** A qualified biologist should conduct a pre-construction survey for San Francisco dusky-footed woodrat nests no more than 30 days prior to the onset of construction activities. The survey should encompass all construction zones within the riparian habitat and developed areas, and surrounding lands within 50 feet.
- **Mitigation Measure 3.3.12b:** Identified nests should be avoided, where possible. If avoidance is not possible, the nest(s) should be manually deconstructed when helpless young are not present, typically during the non-breeding season (October through January).
- **Mitigation Measure 3.3.12c:** If it is determined that young may be present during the pre-construction survey, a suitable buffer should be established around the nest until the young are independent enough to successfully move from the deconstructed nest.

3.3.12 Impacts to American Badgers

Potential Impacts. American badgers have been observed within the general vicinity of the site (CDFW 2020) and the site supports suitable habitat for this species. No badgers or badger burrows were observed on the project site during the 2019 site visit; however, should badgers occur onsite at the time of construction, the project could result in mortality of individuals of this species, which would constitute a significant impact under CEQA.

Mitigations. Implementation of the following measures prior to construction activities will reduce impacts to American badgers from direct mortality to a less-than-significant level.

Mitigation Measure 3.3.13a (Pre-construction Surveys). During the course of the preconstruction surveys for other species, a qualified biologist shall also determine the presence or absence of badgers prior to the start of construction. If badgers are found to be absent, no other mitigations for the protection of badgers shall be warranted.

Mitigation Measure 3.3.13b (Avoidance and Monitoring). If an active badger den is identified during pre-construction surveys within or immediately adjacent to an area subject to construction, a construction-free buffer of up to 300 feet shall be established around the den. Once the biologist has determined that badger has vacated the burrow, the burrow can be collapsed or excavated, and ground disturbance can proceed. Should the burrow be determined to be a natal or reproductive den, and because badgers are known to use multiple burrows in a breeding burrow complex, a biological monitor shall be present onsite during construction activities in the vicinity of the burrows to ensure the buffer is adequate to avoid direct impact to individuals or natal/reproductive

den abandonment. The monitor will be required to be present until it is determined that young are of an independent age and construction activities would not harm individual badgers.

Mitigation Measure 3.3.13c (Tailgate Training). All workers on the project and access corridor shall attend a tailgate training that includes a description of the species, a brief summary of its biology, and minimization measures and instructions on what to do if an American badger is observed.

3.3.13 Impacts to Riparian Habitat and Other Sensitive Natural Communities, Including Federally and State Protected Wetlands

Potential Impacts. As Calero Arroyo is considered to be a Category 1 Stream under the SCVHP, and the SCVHP geobrowser shows a required setback of 200 feet from the creek and riparian habitat.

Mitigation. As all project elements are outside the 200' setback, impacts to riparian habitat and other sensitive natural communities is not a part of this project. No mitigation is warranted.

3.3.14 Degradation of Water Quality in Seasonal Drainages, Stock Ponds and Downstream Waters

Potential Impact. Eventual site development and construction may require grading that leaves the soil of construction zones barren of vegetation and, therefore, vulnerable to sheet, rill, or gully erosion. Eroded soil is generally carried as sediment in surface runoff to be deposited in natural creek beds, canals, and adjacent wetlands. Furthermore, urban runoff is often polluted with grease, oil, pesticide and herbicide residues, heavy metals, etc. These pollutants may eventually be carried to sensitive wetland habitats used by a diversity of native wildlife species. The deposition of pollutants and sediments in sensitive riparian and wetland habitats would be considered a potentially significant adverse environmental impact. The project would comply with the County's grading requirements. Therefore, the project buildout would result in a less-than-significant impact to water quality.

Mitigation. No mitigation is warranted.

3.3.15 Conflict with Local Policies and Ordinances: Santa Clara County Tree Ordinance

Potential Impacts. A tree survey was not conducted as a part of this project. A tree survey should be conducted should any trees onsite in order to confirm whether ordinance-sized trees occur onsite. A permit from the County would be required to remove ordinance-sized trees onsite.

Mitigation. Should protected trees occurring onsite require removal a permit must be obtained from the County and compensatory mitigation for loss of trees should occur. All measures of the permit must be followed.

3.3.16 Conflict with Local Policies and Ordinances: Santa Clara Valley Habitat Conservation Plan

Proposed development would be considered a covered project under the SCVHP and, as such, would be subject to conditions and fees of the SCVHP. Failure to comply with the SCVHP would constitute a significant impact under CEQA.

Compliance with the SCVHP includes payment of fees according to the “Fee Zone” designation of the property, payment of nitrogen deposition fees related to the number of residential units and/or anticipated car trips (for non-residential projects) resulting from the development, and any surcharge fees that are required based on site-specific impacts to sensitive habitats or sensitive species. The onsite portion of the proposed project would be subject to Zone B fees, which are currently \$14,725 per acre (2018-2019 rates), and nitrogen deposition fees, which are currently \$48.33 for each new single-family residence. For any temporary impacts, all the same fees are applied, but at a fraction of the total cost depending on how long the project expects the temporary impact to last. Potential onsite temporary fees include, but are not limited to trenching for utilities or leach fields. The project is not expected to impact the Mixed Riparian Woodland and Forest onsite along Calero Arroyo.

In addition to fees, the project would be required to comply with applicable conditions of the SCVHP. Conditions of the SCVHP, summarized above (Section 3.2.7.2), that would apply to the project include Conditions 1, 3, 7, 10, 11, 12, 15 and 17 (Table 3).

TABLE 3. APPLICABLE SANTA CLARA VALLEY HABITAT PLAN (SCVHP) CONDITIONS OF THE PROPOSED 21551 SCHILLINGSBURG AVENUE PROJECT, LOCATED IN SANTA CLARA COUNTY, CALIFORNIA		
Condition (page references ICF International 2012)	Applicable to project	Comments/Requirements
Condition 1 (page 6-7). Avoid Direct Impacts on Legally Protected Plant and Wildlife Species	Applies	This condition requires actions conducted under the SCVHP to comply with existing laws protecting plant and wildlife species including those species not covered as part of the SCVHP. This requires compliance with Migratory Bird Treaty Act, which prohibits killing or possessing covered migratory birds, their young, nests, feathers, or eggs. Several species of nesting bird that could use the project site are protected by the MBTA. Project mitigations for pre-construction surveys for migratory birds, including for burrowing owls, ensures compliance with this condition.
Condition 2 (page 6-9). Incorporate Urban-Reserve System Interface Design Requirements	N/A	The project is not interfacing with the reserve system.
Condition 3 (page 6-12). Maintain Hydrologic Conditions and Protect Water Quality	Applies	This condition requires all projects to incorporate appropriate measures itemized in the SCVHP’s Table 6-2 (refer to ICF International 2012) to minimize indirect and direct effects to covered species and their aquatic habitat. This condition also requires the local jurisdiction (i.e. the City of San Jose) to verify that all appropriate measures from Table 6-2 are implemented. Measures from Table 6-2 should be incorporated into project engineering and SWPPP plans.
Condition 4 (page 6-14). Avoidance and Minimization for In-Stream Projects	N/A	The project is not impacting streams.
Condition 5 (page 6-18). Avoidance and Minimization Measures for In-Stream Operations and Maintenance	N/A	The project is not impacting streams.
Condition 6 (Page 6-21). Design and Construction Requirements for Covered Transportation Projects	N/A	Project is not a transportation project.
Condition 7 (page 6-28). Rural Development Design and Construction Requirements	Applies	The project is considered to be a rural development, and therefore, must implement design and construction requirements of Condition 7, including, but not limited to outdoor lighting design limitations and maintaining as much natural vegetation as possible.
Condition 8 (page 6-35). Implement Avoidance and Minimization Measures for Rural Road Maintenance	N/A	No rural road maintenance.
Condition 9 (page 6-37). Prepare and Implement a Recreation Plan	N/A	Project is not part of the Reserve System.
Condition 10 (page 6-42). Fuel Buffer	Applies	A fuel buffer is required for this project.

TABLE 3. APPLICABLE SANTA CLARA VALLEY HABITAT PLAN (SCVHP) CONDITIONS OF THE PROPOSED 21551 SCHILLINGSBURG AVENUE PROJECT, LOCATED IN SANTA CLARA COUNTY, CALIFORNIA		
Condition (page references ICF International 2012)	Applicable to project	Comments/Requirements
Condition 11 (page 6-44). Stream and Riparian Setbacks	Applies	The project is not impacting streams, however, construction of the project should ensure the 200-foot setback from Calero Arroyo is upheld.
Condition 12 (page 6-56). Wetland and Pond Avoidance and Minimization	Applies	The project is not impacting wetlands or ponds, however, as a potential wetland occurs onsite adjacent to the creek, avoidance and minimization of Condition 12 measures would apply.
Condition 13 (page 6-58). Serpentine and Associated Covered Species Avoidance and Minimization	N/A	Serpentine habitat and species are absent.
Condition 14 (page 6-60). Valley Oak and Blue Oak Woodland Avoidance and Minimization	N/A	Valley and blue oak woodlands are absent.
Condition 15 (page 6-62). Western Burrowing Owl	Applies	Although the site is outside the burrowing owl fee zone, overwintering burrowing owls may occur onsite, and therefore, in order to comply with Condition 1, this project must also comply with Condition 15, including preconstruction surveys and avoidance measures for owls and nests, and requirements for construction monitoring. Measure 3.3.6 (above) defines the required actions for compliance with this condition.
Condition 16 (page 6-68). Least Bell's Vireo	N/A	Suitable habitat is absent from the site, and this species is only known to occur in southern Santa Clara County.
Condition 17 (page 6-69). Tricolored Blackbird	Applies	Suitable habitat for the tricolored blackbird occurs adjacent to the site in Calero Arroyo and the northern half of the property occurs within 250 feet of SCVHP-mapped tricolored blackbird habitat.
Condition 18 (page 6-71). San Joaquin Kit Fox	N/A	Project outside of modeled habitat for the San Joaquin kit fox.
Condition 19 (page 6-74). Plant Salvage when Impacts are Unavoidable	N/A	Covered plants are absent.
Condition 20 (page 6-76). Avoid and Minimize Impacts to Covered Plant Occurrences	N/A	Covered plants are absent.

Implementation of the measures listed and described above, including payment of Land Zone B, and nitrogen deposition fees and compliance with Conditions 1, 3, 7, 10, 11, 12, 15, and 17, the project would be in compliance with the SCVHP. To ensure compliance, it is recommended that the project proponent thoroughly review the identified sections of the SCVHP, including Table 6-2.

Mitigation. As all fees will be paid, there is no mitigation is warranted.

4 LITERATURE CITED

- Beier, P 1996 Dispersal of juvenile cougars in fragmented habitat. [Abstract]. Fifth Mountain Lion Workshop. Organized by the California Department of Fish and Game and the Southern California Chapter of the Wildlife Society, San Diego, California, February 27 - March 1, 1996.
- Beier, P. and S. Loe. 1992. A Checklist for Evaluating Impacts to Wildlife Movement Corridors. *Wildlife Society Bulletin* 20(4):434-440.
- Beier, P. and R.F. Noss. 1998. Do Habitat Corridors Provide Connectivity? *Conservation Biology* 12(6):1241-1252. December.
- California Department of Fish and Wildlife. 2019. Annual Report on the Status of California State Listed Threatened and Endangered Animals and Plants. The Resources Agency, Sacramento, CA.
- California Department of Fish and Game. 2002. California Fish and Game code. Gould Publications. Binghamton, N.Y.
- California Department of Fish and Wildlife. 2020. California Natural Diversity Database, Rarefind5. The Resources Agency, Sacramento, CA.
- California Native Plant Society (CNPS). 2020. Inventory of Rare and Endangered Plants (online edition, v6-05c). California Native Plant Society. Sacramento, CA.
<http://www.cnps.org/inventory>.
- Harris, L.D., Gallagher, P.B., 1989. New initiatives for wildlife conservation: the need for movement corridors. In: Mackintosh, G. (Ed.), *Preserving Communities and Corridors*. Defenders of Wildlife, Washington DC, pp. 11–34.
- Holland, R.F. 1986. Preliminary Description of the Terrestrial Natural Communities of California. Resources Agency, Sacramento, CA. 156 pp.
- Mayer, K. E., and W. F. Laudenslayer, Jr. Ed. 1988. A guide to wildlife habitats of California. California Department of Forestry and Fire Protection. Sacramento, CA. 166 pp.
- Natural Resource Conservation Service. 2019. Web Soil Survey. USDA.
- Remy, M. H., T. A. Thomas, J. G. Moose, and W. F. Manley. 1996. Guide to the California Environmental Quality Act.
- Shuford, W. David and Thomas Gardall eds. 2008. California Bird Species of Special Concern. Western Field Ornithologists and California Department of Fish and Game.
- Thomson, Robert C., Amber N. Wright, and H. Bradley Shaffer. 2016. California Amphibian and Reptile Species of Special Concern. California Department of Wildlife. University of California Press.

University of California Agriculture and Natural Resources (UCANS). California Fish Website. Accessed January 2020.

<http://calfish.ucdavis.edu/location/?ds=698&reportnumber=1293&catcol=4712&categoryse arch=%27Alamitos%20Creek%2D180500030301%27>

USACE. 1987. Corps of Engineers Wetlands Delineation Manual. Department of the Army.

U.S. Fish and Wildlife Service. 2018. Endangered and threatened wildlife and plants.

Wetland Training Institute, Inc. 1990. Federal Wetland Regulation Reference Manual. B.N. Goode and R.J. Pierce (eds.) WTI 90-1. 281pp.