

# **STORM WATER DRAINAGE REPORT**

## **CAMPO DOLLAR GENERAL**

**PDS2019-LDGMJ-30250**

**Campo Road and Buckman Springs Road**

**CAMPO, CA 91906**

**SAN DIEGO COUNTY**

**APN: 655-120-09**

**PREPARED BY:**

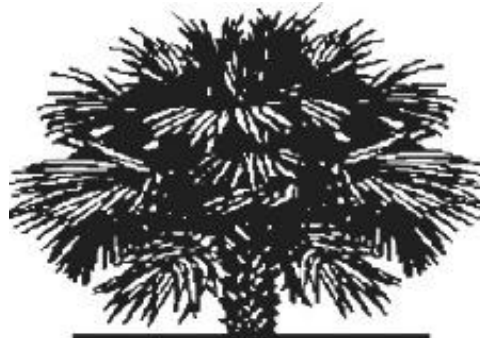

**Palmetto**  
**Engineering**  
**&**  
**Land Surveying**

4300 ASHE ROAD, SUITE 103  
BAKERSFIELD, CALIFORNIA 93311  
(661) 664-4806

*May 28, 2021*

## **PURPOSE OF REPORT**

This report is being submitted in conjunction with the development of the proposed Dollar General, located northeast of the intersection of Campo Road and Buckman Springs Road at in the Community of Campo, County of San Diego. This report will discuss 5 main topics: 1) Pre-development stormwater site conditions, 2) Pre-development peak flow rate, 3) Post development storm water site conditions, 4) Post Development Pipe Routing analysis for a 100-year storm event, and 5) Retention Basis Analysis.

## **DESCRIPTION OF WATERSHED**

### **Current Land Use:**

Undeveloped vacant land

### **Proposed Land Use:**

Single commercial store development

### **Surrounding Land Use:**

North: Undeveloped Vacant Land, Residential homes

East: Undeveloped Vacant Land

South: Campo Road, Fire Station #40

West: Undeveloped Vacant Land, Industrial Facilities

### **Watershed Boundary:**

Property boundaries within the subject parcel land as shown on the submitted Civil Plans prepared Palmetto Engineering and Land Surveying as illustrated on Figure A – GRADING AND DRAINAGE PLAN

### **Watershed Location:**

Approximately 920 feet northeast of the intersection of Campo Road and Buckman Springs Road, directly north of Fire Station #40 in the community of Campo, County of San Diego, State of California.

## **METHODOLOGY**

In accordance with the San Diego Hydrology Manual, Section 6 was used for the Rational Method Hydrograph Procedure. Rainfall intensities and runoff coefficients are in accordance with section 3 of the SD Hydrology Manual. Initial time of concentration is calculated using the FAA method. Software used for calculating volumetric rates and total volume are RATHYDRO, Rational Hydrograph Software provided by San Diego County Department of Public Works, and Hydraflow Hydrographs Extension for Autodesk® Civil 3D® 2019 by Autodesk, Inc. v2019.2.

## **PRE-DEVELOPMENT**

- Existing Site Conditions

The existing land of the subject parcel is currently open space, vacant, and undeveloped with more than 90% of the property area consisting of desert land with desert vegetation. The project site's drainage conveyance is by way of surface sheet flow of the natural grade of the land. There are no existing man-made drainage facilities or networks to

convey any runoff from or to the site or to store any runoff volume. As illustrated in FIGURE(s) B-1 and B-2 of this report, the pre-development drainage area includes the area within the property boundaries as well as a large portion of land directly north of the property.

The pre-project drainage area is the lot in its entirety and after further investigation it was found that a larger portion of the land directly adjacent to the north flows to and through the subject parcel. The existing topographic profile of the existing land is generally sloping from the north to the south/southeast at grades varying from 0.86% to 24.41%, as illustrated on FIGURE B-2 – On-Site Existing Topo, draining on to Campo Road and the adjacent property to the east.

- Pre-Development Peak runoff

With the majority of the land surface consisting of uniform soil material, calculation of the 100-year 6-hour peak runoff rate,  $Q_{pk}$ , for pre-development conditions was fairly straight forward. Rainfall intensities were calculated from a combination of Time of Concentration,  $T_c$ , using the method developed by the Federal Aviation Administration and the Rainfall Intensity equation listed in section 3.1.3 of the San Diego Hydrology Manual.

Analysis of the existing topographic data shows that runoff that exits the property site does not exit via one central location and disperses along the south boundary line onto Campo Road and the adjacent properties. As FIGURE B-2 illustrates, it was determined that there are four(4) pre-development drainage areas. It was also determined that each of the four pre-development drainage areas have a discharge location. Though these are not the exact locations for runoff discharge, they will be used as a general location for discharge when comparing to post development discharge locations. These pre-development drainage areas include the property site consisting of 2.632 acres and the additional land to the north with an area of 6.311 Acres. Totaling a pre-development watershed area equal to 8.943 acres. Using a C-factor of 0.25 and NOAA rainfall data for the 100-year 6-hour storm event; time(s) of concentration, rain fall intensities, and peak discharge rates were calculated using the methods described earlier in this report. Values for each pre-development drainage area are presented in the follow table.

Pre-Development 100-Year 6-Hour Storm Event.

Discharge Point	Drainage Area	Acreage	Time of Conc. (min)	6-hr Rainfall Depth. (in)	Rainfall Intensity (in/hr.)	Peak Runoff Rate (cfs)
Point A	PRE-1	0.239	9.19	3.41	6.069	0.363
Point B	PRE-2	0.133	9.82	3.41	5.814	0.193
Point C	PRE-3	0.342	9.10	3.41	6.107	0.522
Point D	PRE-4	8.229	27.19	3.41	3.014	6.200
	TOTAL	8.94	-	-	-	7.278

As required by the County of San Diego, these points of discharge or points of compliance will be evaluated and compared to post development discharge rates within the same area. Calculations for the values above are presented in the section titled "PRE-DEVELOPMENT RUNOFF CALCULATIONS" of this report.

## **POST DEVELOPMENT**

- Site Conditions

With the development of the new Dollar general, approximately 60% or 1.64 acres of the existing area will be graded/improved as illustrated on the submitted civil plans and on the attached Figure A – GRADING AND DRAINAGE PLAN with the remaining areas to the west and north to remain undisturbed. New AC pavement for parking, concrete paving for sidewalk and loading areas, curb and gutter, curbing, v-gutter, and landscaping will be installed. Additionally, a new underground drainage system consisting of catch basins and a slotted drain connected via PVC drainage pipe will be constructed. Storm water runoff will enter into 1 of 7 catch basins and slotted drain and drain into a retention basin on-site located in the southeast portion of the property as illustrated in Figure A. The retention basin will serve as to temporarily store storm water runoff which will infiltrate into the underlying soils of the basin or discharge onto Campo Road via an overflow discharge pipe.

- Post Development Peak Runoff Rates

For the purposes for this report and calculations, the project area is divided into 18 drainage or watershed areas as depicted on Figure C – WATERSHED DRAINAGE MAP. Areas 1 through 8 are to drain into the proposed drainage system and continue flowing to the retention basin or sump (area 9). Areas 15 through 18 contain portions of undisturbed land. These areas are to be hydraulically separated from the improvement area as to not introduce any runoff from off-site locations such as the area to the north as previous stated. The separation will be by way of a concrete Type C Terrace Ditch as detailed on County of San Diego Regional Standard Drawing Number D-75. The concrete ditch will be installed adjacent to the cut slope along watershed areas 1 and 10 to the west, the cut slopes along areas 1 and 4, and the fill slope adjacent to the watershed area 12. This ditch will serve as to direct any runoff from the undisturbed area within the property boundary as well as any runoff from the adjacent properties to the north and west of the project property boundaries.

Watershed areas 10 through 13 contain sections of newly developed/graded land that will be draining onto Campo Road and area 14 contains the loading dock and trash enclosure. Due to County of San Diego requirements, area 14 is required to be hydraulically separated to prevent any runoff from entering the retention basin or draining off-site. Therefore, this area has been designed to flow into a 4-inch drainage inlet and discharge into an on-site underground septic system. Since areas 10 through 16 are not draining into the proposed retention pond, these areas will not be included in the Pipe Routing Analysis discussed in the next section.

C-Factors for each watershed area were calculated as well as a composite C-Factor for sections that are to drain to the retention basin. For the purposes of the pipe routing analysis and the analysis of the retention basin, the composite C-Factor will be used. Surface Peak Rates, **Q<sub>100</sub>**, were calculated for each watershed area and are presented in the table below. Area information and C-Factor values are presented in the section titled "SUB AREA STATISTICS" of this report. Calculations for the **Q<sub>100</sub>** flow rates are presented in the section titled "100-YEAR SURFACE FLOW FOR PIPE ROUTING ANALYSIS" of this report.

Post Development Watershed Flow Rates

Drainage Area	Peak Runoff Rate, Q <sub>100</sub>	Drain On-Site/Off-Site	Drainage Area	Peak Runoff Rate, Q <sub>100</sub>	Drain On-Site/Off-Site
1	0.726	On-Site	10	0.118	Off-site
2	0.166	On-Site	11	0.119	Off-site
3	0.843	On-Site	12	0.065	Off-site
4	0.416	On-Site	13	0.102	Off-site
5	0.464	On-Site	14	0.194	-
6	0.043	On-Site	15	4.758	Off-site
7	0.253	On-Site	16	0.180	Off-site
8	0.938	On-Site	17	0.363	Off-site
9 (sump)	-	On-Site	18	0.147	Off-site

As required by the County of San Diego, pre-developed discharge rates listed in the previous section are not to be exceeded. Said rates will be compared to discharge rates of post developed drainage areas that fall within the same or general vicinity of the pre-developed discharge points. As illustrated in the Figure B-2 and Figure C, there are four points of discharge that are to be evaluated. The discharge rates for these points are listed in the table below.

Comparison of Peak Flows at Discharge Locations

Discharge Location	Pre-Dev Drainage Area	Pre-Dev Acreage	Post Dev Drainage Area	Post Dev Acreage	Pre-Dev Peak Rate (cfs)	Post Dev Peak Rate (cfs)
Point A	PRE-1	0.239	17	0.239	0.363	0.363
Point B	PRE-2	0.133	16	0.124	0.193	0.180
Point C	PRE-3	0.342	18	0.094	0.522	0.147
Point D	PRE-4	8.229	15	6.863	6.200	4.758

As shown in the table above, post development vs pre-development peak discharge rates have remained the same or have decreased. As illustrated in Figure B-2 and Figure C, through the locations of Point D of pre-development area PRE-4 and post development area 15 do not lie on the exact same location, it was determined that the general flow of

these areas are in the same direction and the discharge points for the these areas are in the same or general vicinity of the property boundary, it would be sufficient to compare these two points as one.

- Pipe Routing Analysis

Using the calculated surface flow rates for areas 1 through 8, the storm drainpipe could be sized appropriately to accommodate the flow of surface runoff to the proposed retention basin. All pipe will be of Polyvinyl Chloride (PVC) material, will be a minimum of 8" (nominal) diameter pipe, and sloped at a minimum of 0.40%. As part of the pipe routing analysis, proper pipe diameter, flow depth, percent full (flow depth relative to pipe diameter), flow velocity, and flow condition of either "subcritical" or "supercritical" were calculated and determined for each pipe segment. All flows within the pipe were held to a minimum of 2 feet per second flow velocity and are to have "subcritical" flow condition as to avoid a "hydraulic jump" within the pipe section to avoid pipe erosion and/or exceeding the flow rate capacity of the storm drain pipe. In addition, time of Concentration and peak rate from the farthest reach within the area that is to be retained was also established. These would be used to calculate and produce the inflow hydrograph and subsequently be used for sizing of the retention basin discussed in the next section.

The pipe network of the proposed drainage system consists of 7 catch basins (CB) and 1 slotted drain (SLD) with each connected to one another, in series, with PVC pipe. PVC nominal pipe diameters range from 8" to 12". There are two discharge or outlet structures at the retention basin. Outlet #1 serves to discharge runoff from watershed areas 1 through 7 and Outlet #2 serves to discharge runoff solely from watershed area 8. Pipe routing analysis as stated above was performed starting at the farthest reach and ending at the outlet(s) of the pipe network. As the analysis moved from one CB to the next, additional area and runoff was taken into account and a total "Q" flow rate at each CB was calculated. Subsequently, this "Q" rate would be used to for the downstream pipe segment and the process being repeated until ending at the outlet structure. Analysis of the calculated **T<sub>c</sub>**, Peak Rate, and Peak Velocity are presented in the table below.

Pipe Flow Summary Table

Max. T <sub>c</sub> (mins)	Peak Rate (cfs)	Peak Velocity (fps)
24.00	2.100	4.040

A schematic of the pipe layout, calculations for the pipe routing analysis, and specific pipe segment calculations are presented in sections titled "STORM DRAIN SYSTEM LAYOUT" and "PIPE FLOW CALCULATIONS" of this report

- Retention Basin Analysis

All collected storm water runoff will be routed through the proposed drainage system to a retention basin located in the southwest corner of the property. The retention basin will be sized to retain the runoff volume generated from a 100-year 6-hour storm event for the areas to be retained on-site. The runoff will infiltrate into the underlying soils of the

basin. The basin will have a bottom elevation of 2625.25 and dimensions of 39.50 feet by 29.50 feet. Side slopes are to be a maximum of 3:1 horizontal to vertical ratio with a maximum height of 6.75 feet establishing the top of embankment(basin) elevation at 2632.00. Any runoff generated from a storm larger than the 100-year storm event will be discharged off-site via an overflow discharge structure (ODS).

The discharge structure will consist of a discharge drainage inlet (DDI) to serve as an overflow inlet for any runoff that will be discharged off-site. Runoff entering the DDI will be routed via a 12-inch PVC discharge pipe connecting the DDI to a straight concrete headwall. The discharge pipe will be set at invert elevation of 2629.44 at the DDI and head southeast for approximately 9.4 feet at a slope of 0.40% with an exit invert elevation at the headwall of 2629.40. Once exiting, runoff will flow through energy dissipating rip-rap for approximately 10.0 feet at a slope of 2.0% prior to discharging onto Campo Road.

Using the same procedure that was used to develop the inflow hydrograph, the same is done for producing the post development inflow hydrograph and subsequently sizing of the retention basin. Using the values for time concentration and peak listed in the table above as well as a C-Factor of 0.599, a watershed area of 1.414 acres, and the 6-hour rainfall depth of 3.41, these can now be entered into the RATHYDRO software to produce the discharge intervals for the 6-hour storm event. These intervals can then be entered manually into the Hydraflow Hydrograph software extension for Civil 3D to produce the Rational Method Hydrograph as per the SD County Hydrology Manual.

As required by the County of San Diego, storm water within the retention basin cannot be analysis from the bottom of the basin and must be analyzed from the Hydromodification Plan (HMP) Water level. With this requirement, inflow from the storm event was analyzed at an elevation in the retention basin of 2628.25, 3 feet from the bottom of the basin.

Using the Hydraflow Hydrograph software extension for Autodesk® Civil 3D®, a hydrograph for the 100-year 6-hour was developed to calculate total runoff volume for the areas to be retained on-site. The runoff volume for the 100-year 6-hour storm event is calculated to be **10,224 cubic feet**. A retention pond was created within the Hydraflow Hydrograph software using the parameters discussed above for the specifics on the basin, discharge structure, as well as the infiltration rate of the underlying soils. The post development inflow hydrograph was then routed and processed through the retention basin to create an output hydrograph. This would calculate the required storage needed and the maximum elevation within the retention basin the 100-year storm event would fill too. This process takes into account that during the duration of the storm event, runoff will be infiltrating into the underlying soils concurrently until the basin has been emptied. Soils test conducted by Krazan and Associates, Inc. indicate that the soils have an infiltration rate of **0.51 inches per hour**. Using these parameters, the required storage volume for the 100-year storm event is calculated to be **9,355 cubic feet** and have a maximum water elevation of 2630.87.

The volume provided by the retention basin is between the top of grate elevation of the DDI, elevation 2631.00, and the HMP water level, elevation 2628.25. Using the above-mentioned software, provided volume capacity, stage-storage, and stage-discharge tables and curves were calculated and developed. Calculations within the software were based on using the Conic method and contour areas at each 0.25-foot elevation interval from HMP water level to the top of the embankment. Available storage capacity of the retention basin prior to runoff being discharged at elevation 2631.00 is calculated to be **9,982 cubic feet** with a high-water level height of **2.75 feet**. This volume will be sufficient enough to retain the 100-year storm event.

Infiltration time of the provided storage volume was calculated by dividing the height of the high-water level height by the soils infiltration rate. Using infiltration rate of **0.51 inches per hour**, the time for the provided volume at the high-water level height is calculated to be approximately **64.7 hours**. This meets the County of San Diego requirement of 96-hours. Calculations for the total runoff volume, provided storage volume, infiltration time, and spread sheets of the stage/storage/discharge tables and curves are presented in the section title "RETENTION BASIN ANALYSIS" of this report.

### **CONCLUSION**

The development of the new Dollar General will include the installation of new drainage facilities which retain storm water on-site, reducing the total runoff volume flowing onto Campo Road. As such, this project will not detrimentally impact Campo Road.

### DECLARATION OF RESPONSIBLE CHARGE

I HEARBY DECLARE THAT I AM THE ENGINEER OF WORK FOR THIS PROJECT, THAT I HAVE EXERCISED RESPONSIBLE CHARGE OVER THE DESIGN OF THE PROJECT AS DEFINED IN SECTION 6703 OF THE BUSINESS AND PROFESSIONS CODE, AND THAT THE DESIGN IS CONSISTENT WITH THE CURRENT STANDARDS.

I UNDERSTAND THAT THE CHECK OF PROJECT DRAWINGS AND SPECIFICATIONS BY THE COUNTY OF SAN DIEGO IS CONFINED TO A REVIEW ONLY AND DOES NOT RELIEVE ME, AS ENGINEER OF WORK, OF MY RESPONSIBILITIES FOR PROJECT DESIGN

  
\_\_\_\_\_  
Gregory O. Black RCE 53952

6/15/21  
\_\_\_\_\_  
DATE

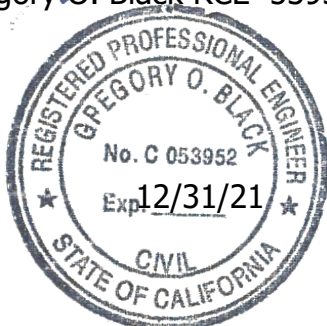



# **FIGURES**

**CONSTRUCTION CALLOUTS**

- 1 INSTALL CATCH BASIN (TYPE I) WITH GRATE PER S.D. CO. REGIONAL STD. DRAWINGS D-29, D-13 & D15, SHEET 10.
- 2 INSTALL STRAIGHT HEADWALL PER S.D. CO. REGIONAL STD. DRAWINGS D-32, SHEET 10.
- 3 INSTALL DISCHARGE STRUCTURE PER DETAIL 1, SHEET 11.
- 4 INSTALL 10'X3' RIP RAP ENERGY DISSIPATER PER S.D. CO. REGIONAL STD. D-40, SHEET 10.
- 5 INSTALL TYPE C TERRACE DITCH PER S.D. CO. REGIONAL STD. DRAWING D-75, SHEET 10.
- 6 INSTALL TYPE A BROW DITCH PER S.D. CO. REGIONAL STD. DRAWING D-75, SHEET 10.
- 7 INSTALL DOWNSPOUT AND SPLASH BLOCK PER DETAIL 9, SHEET 9.
- 8 INSTALL TYPE "F" CATCH BASIN WITH LIGHT DUTY 24" MANHOLE FRAME AND COVER PER DETAILS S.D. REGIONAL STD. DRAWINGS D-07 AND M-02, SHEET 10.
- 9 INSTALL 15'X10' RIP RAP ENERGY DISSIPATER PER S.D. CO. REGIONAL STD. D-40, SHEET 10.

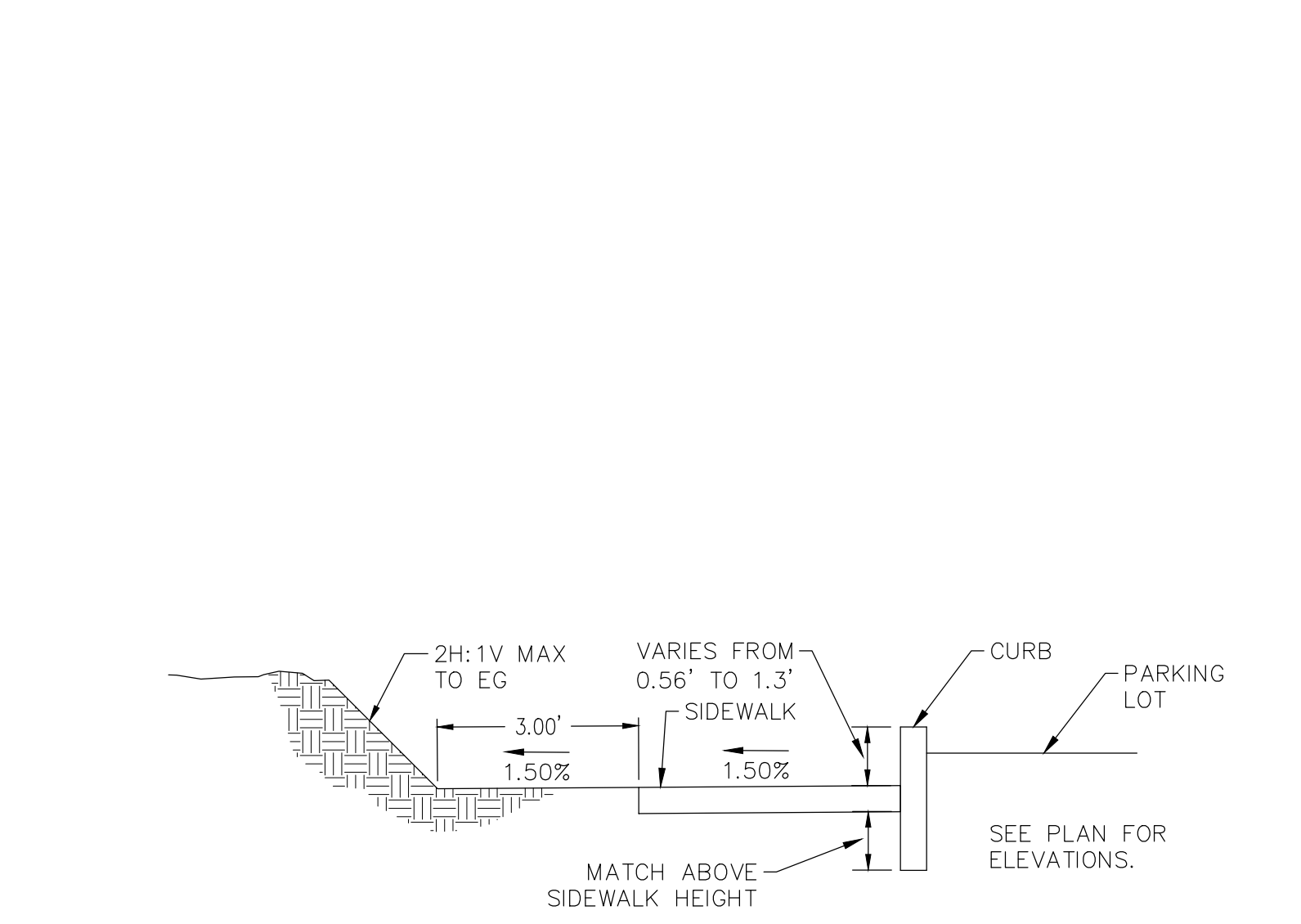
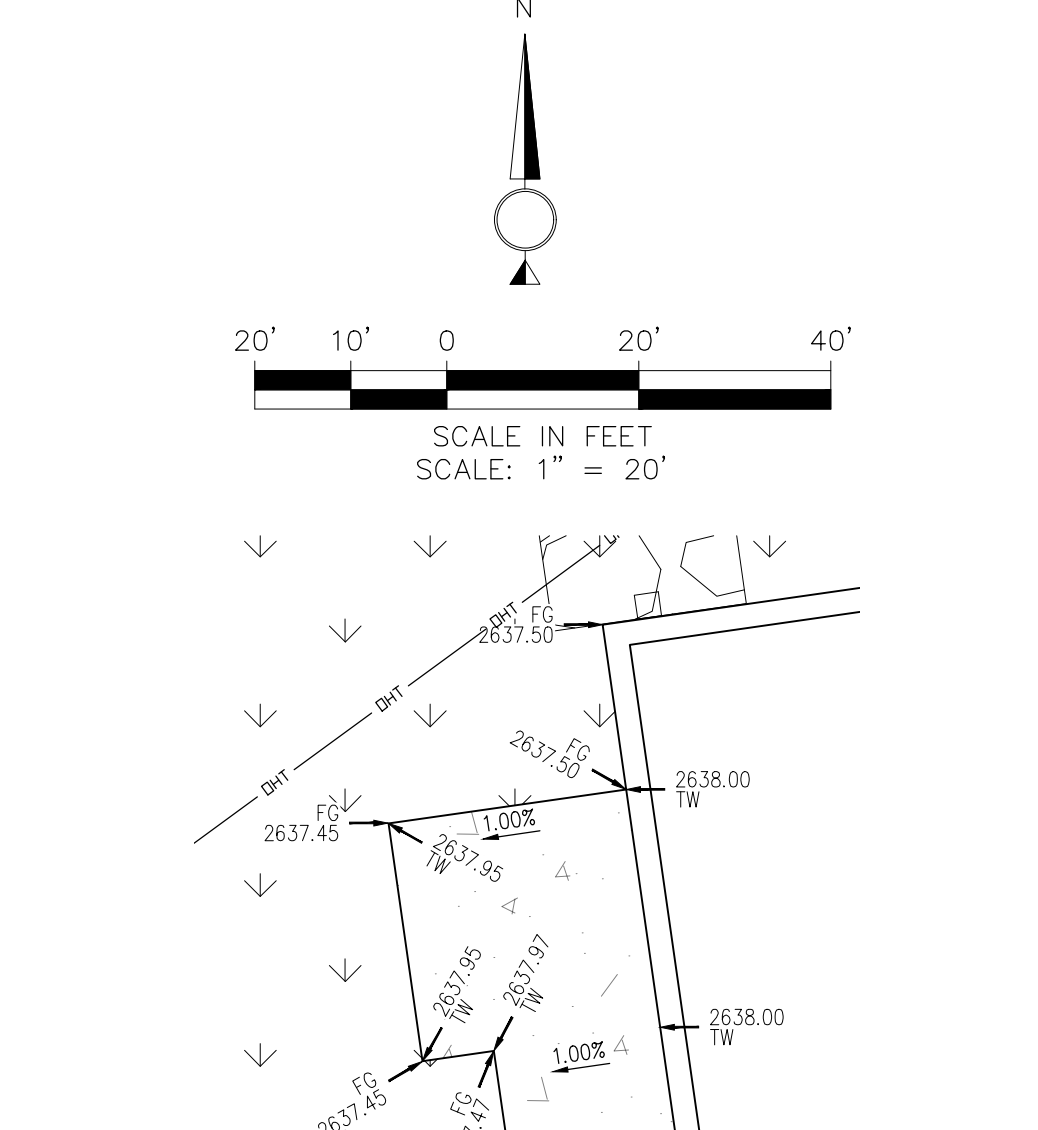
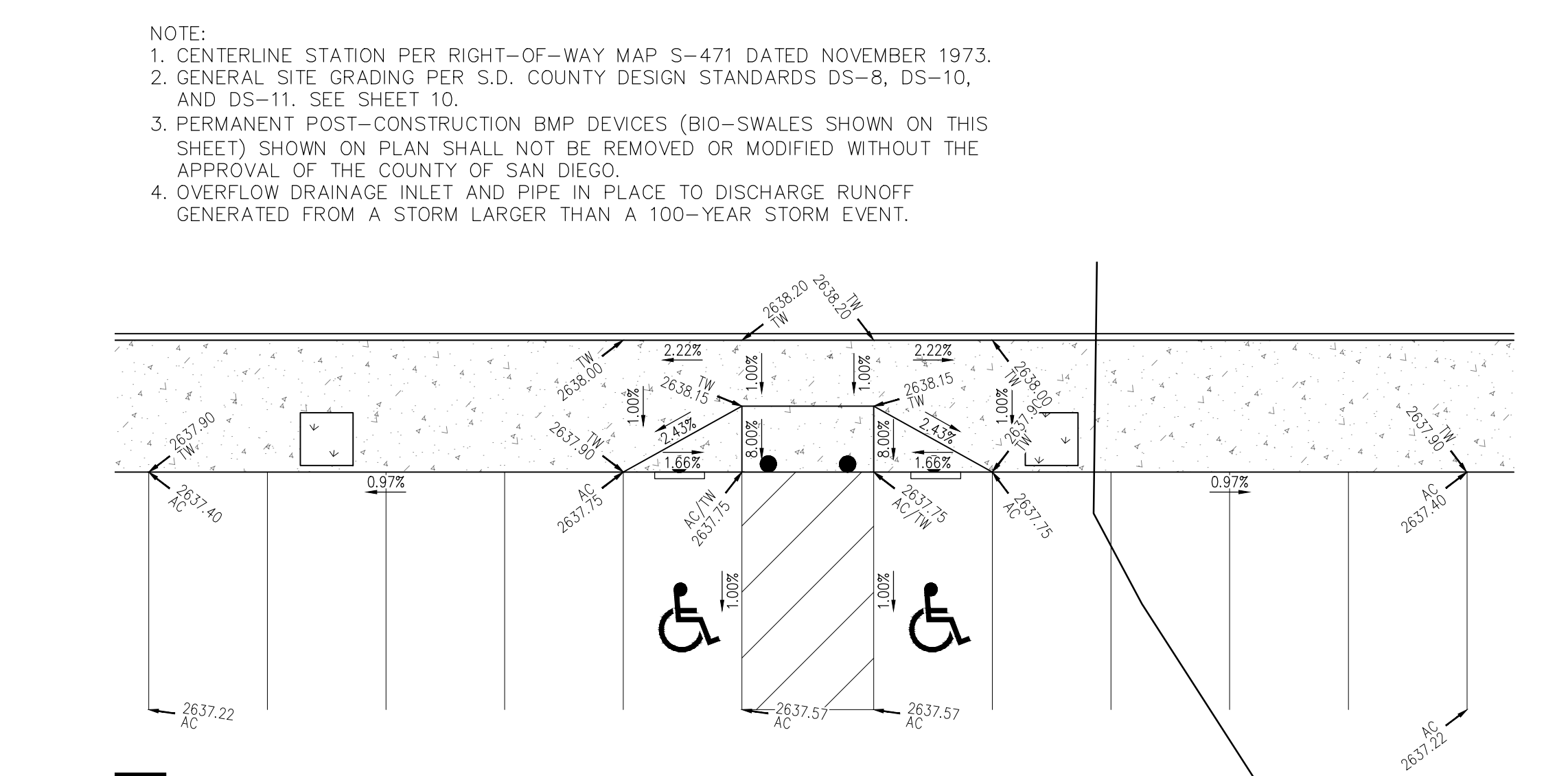
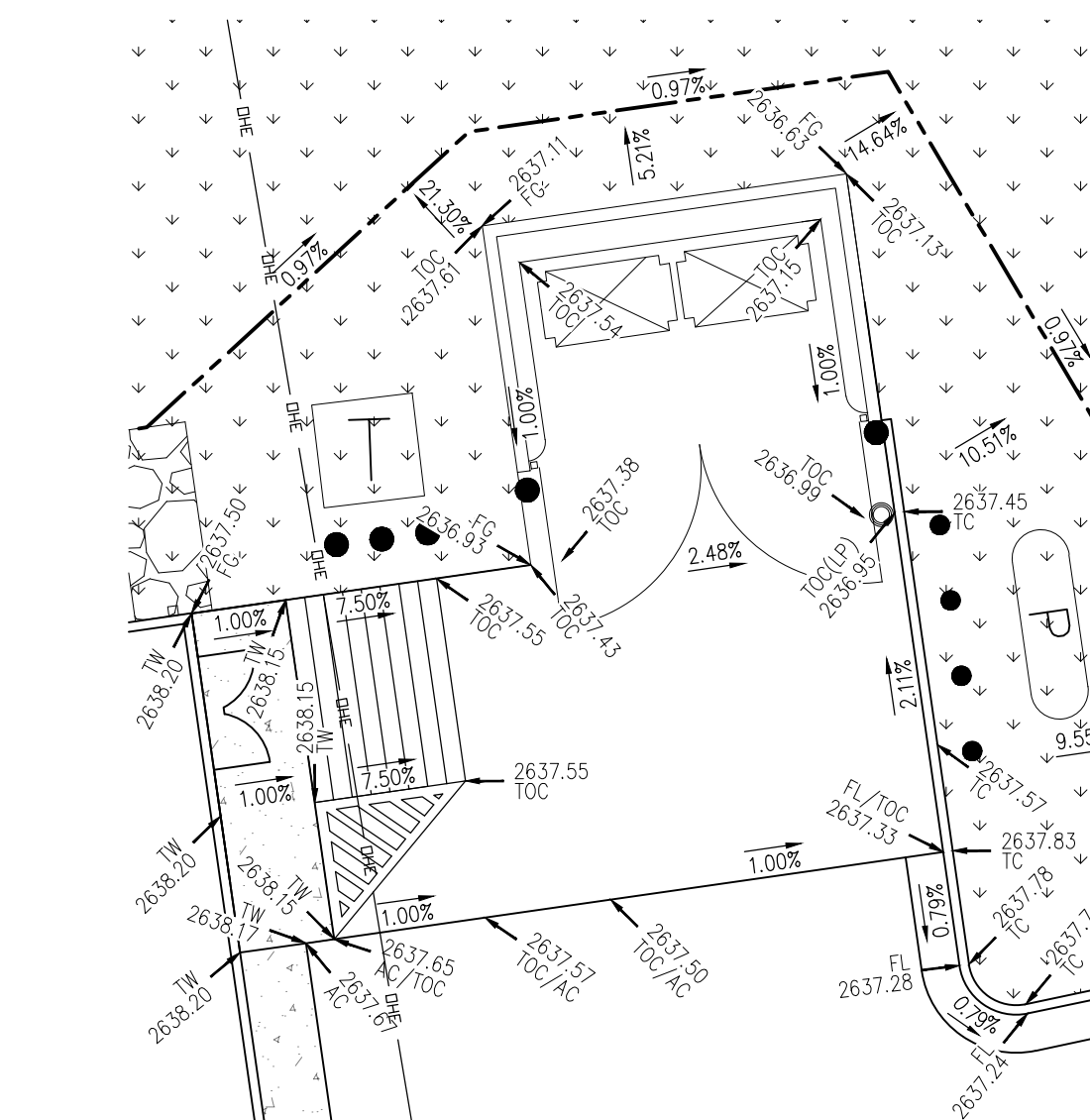
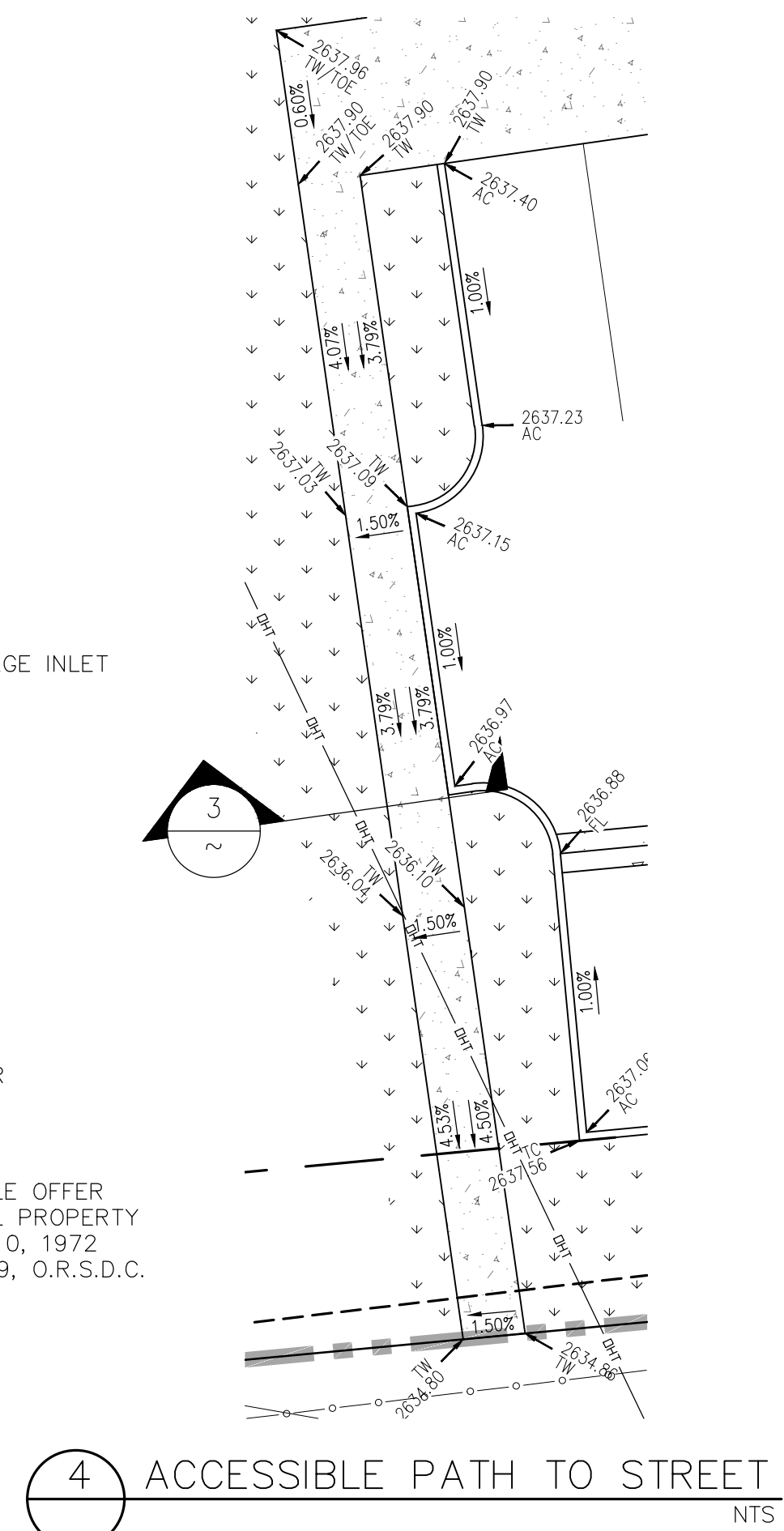
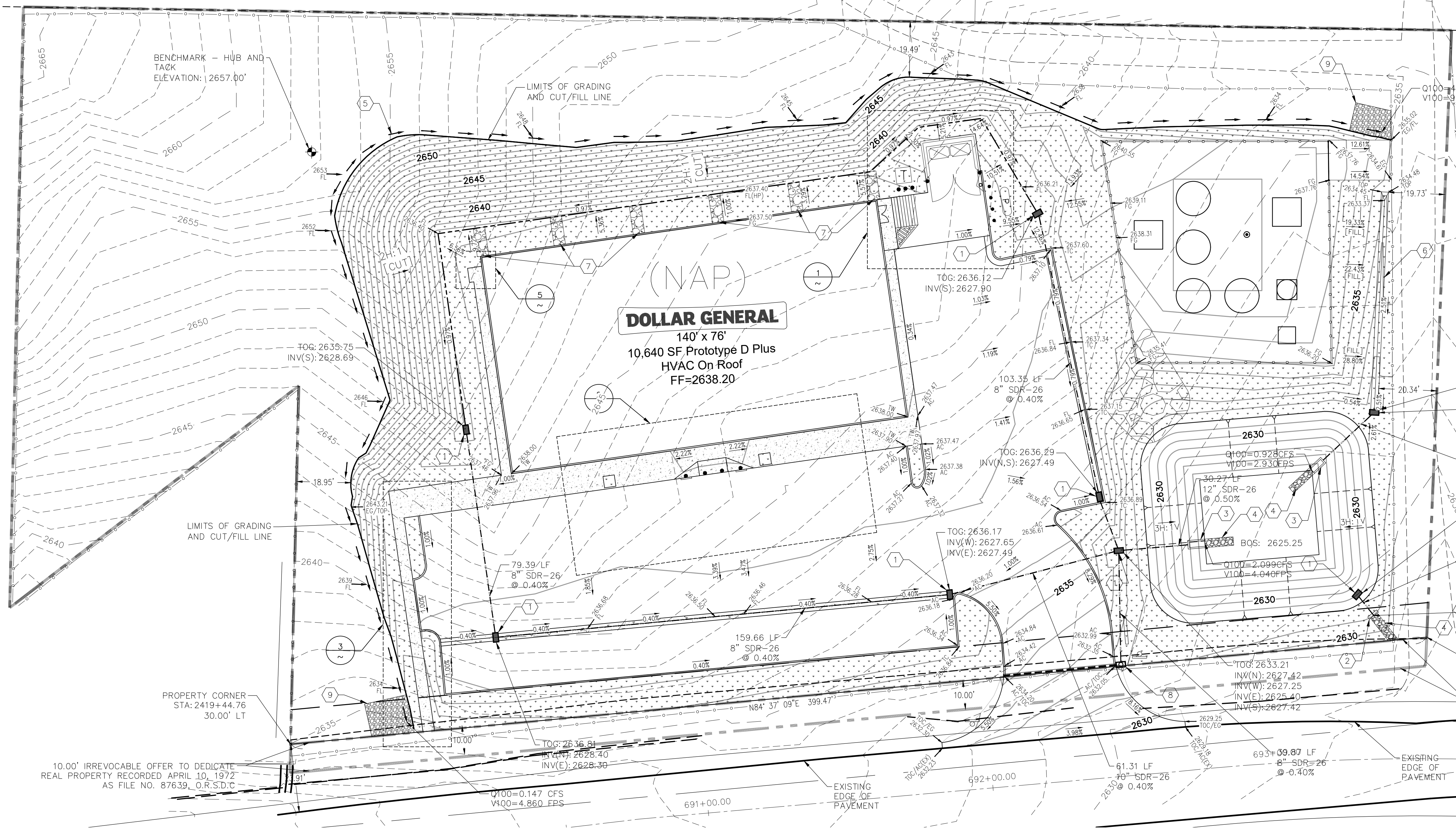

1 TRASH ENCLOSURE & RAMP DETAIL 1"=10'      2 ACCESSIBLE RAMP DETAIL 1"=10'      5 SIDEWALK PLAN DETAIL 1"=4'      3 SIDEWALK DETAIL NTS

NOTE:  
 1. CENTERLINE STATION PER RIGHT-OF-WAY MAP S-471 DATED NOVEMBER 1973.  
 2. GENERAL SITE GRADING PER S.D. COUNTY DESIGN STANDARDS DS-8, DS-10, AND DS-11. SEE SHEET 10.  
 3. PERMANENT POST-CONSTRUCTION BMP DEVICES (BIO-SWALES SHOWN ON THIS SHEET) SHOWN ON PLAN SHALL NOT BE REMOVED OR MODIFIED WITHOUT THE APPROVAL OF THE COUNTY OF SAN DIEGO.  
 4. OVERFLOW DRAINAGE INLET AND PIPE IN PLACE TO DISCHARGE RUNOFF GENERATED FROM A STORM LARGER THAN A 100-YEAR STORM EVENT.

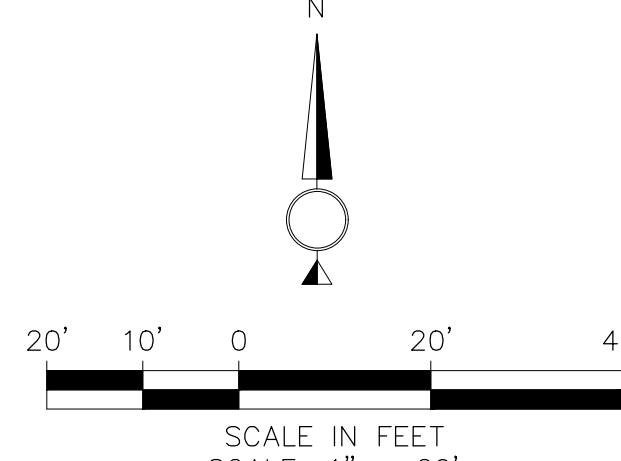

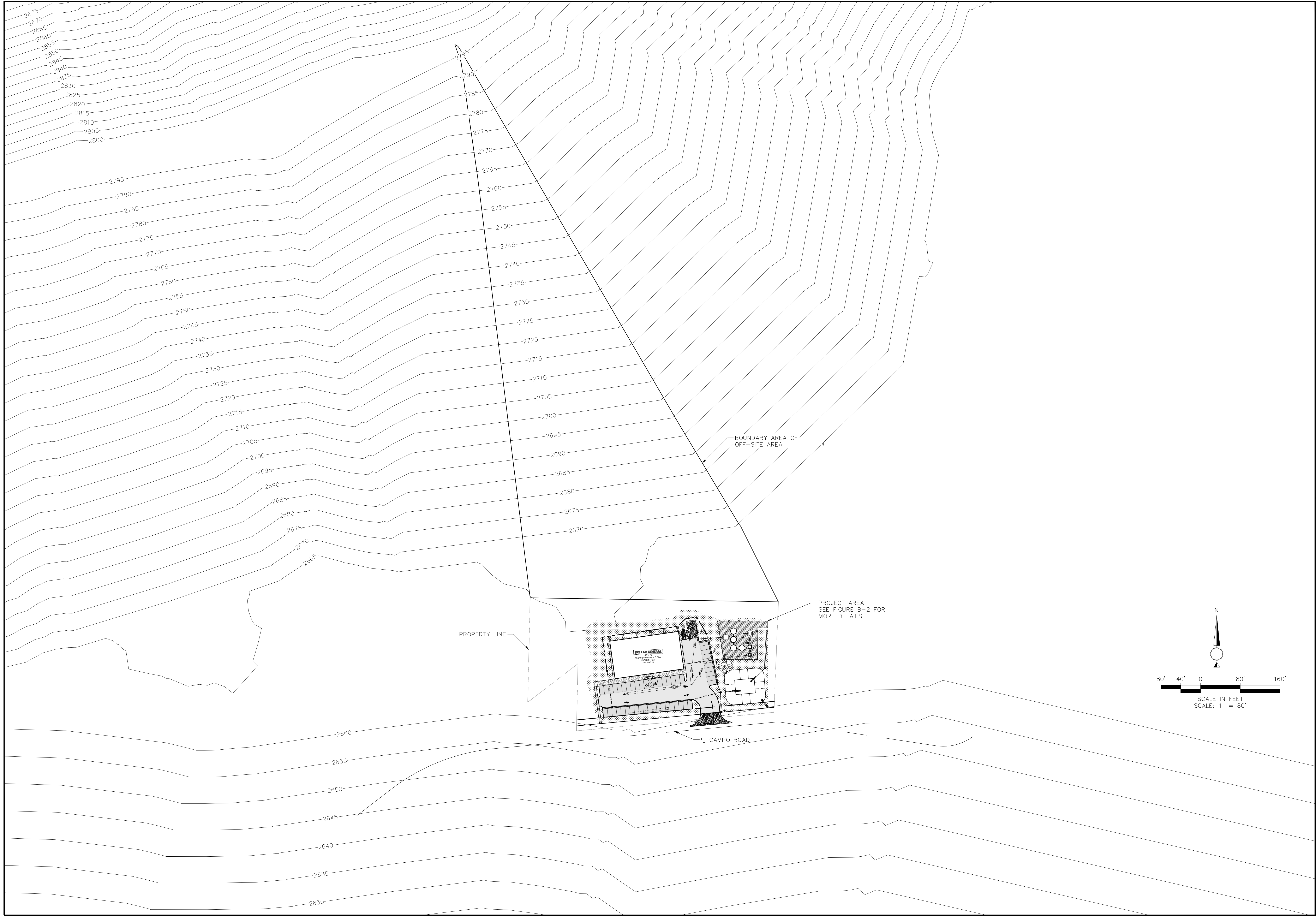

4300 ASHE ROAD, SUITE 103  
 BAKERSFIELD, CALIFORNIA 93313  
 661-664-4806 PHONE  
 888-260-7357 FAX

DATE:	5/25/2021
SCALE:	AS-NOTED
DRAWN BY:	SMS
CK'D BY:	GOB
DATE CK'D:	5/25/2021
JOB NO.:	19-015

REVISIONS NO.	DATE	CK'D BY	DESCRIPTION

PROJECT TITLE: NNN RETAIL DEVELOPMENT  
 DOLLAR GENERAL  
 CITY OF CAMPO, COUNTY OF SAN DIEGO, STATE OF CALIFORNIA  
 SHEET DESCRIPTION: OFF-SITE EXISTING TOPO

FIGURE B-1

REVISIONS	NO.	DATE	CKD BY/DESCRIPTION

PROJECT TITLE: NNN RETAIL DEVELOPMENT  
DOLLAR GENERAL  
CITY OF CAMPO, COUNTY OF SAN DIEGO, STATE OF CALIFORNIA  
SHEET DESCRIPTION: ON-SITE EXISTING TOPO

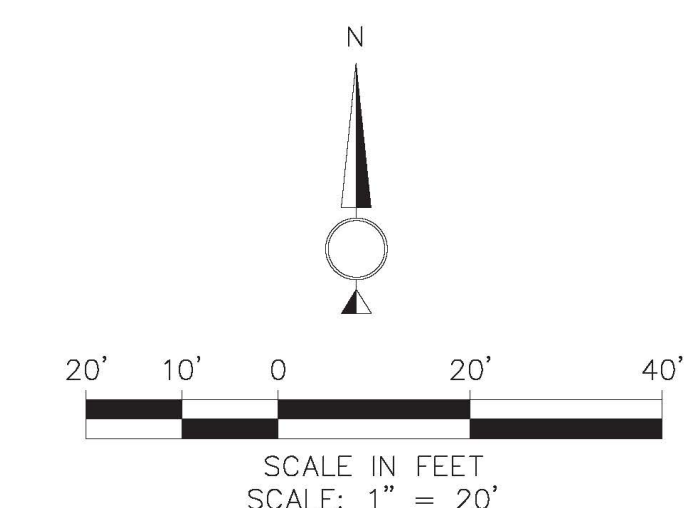
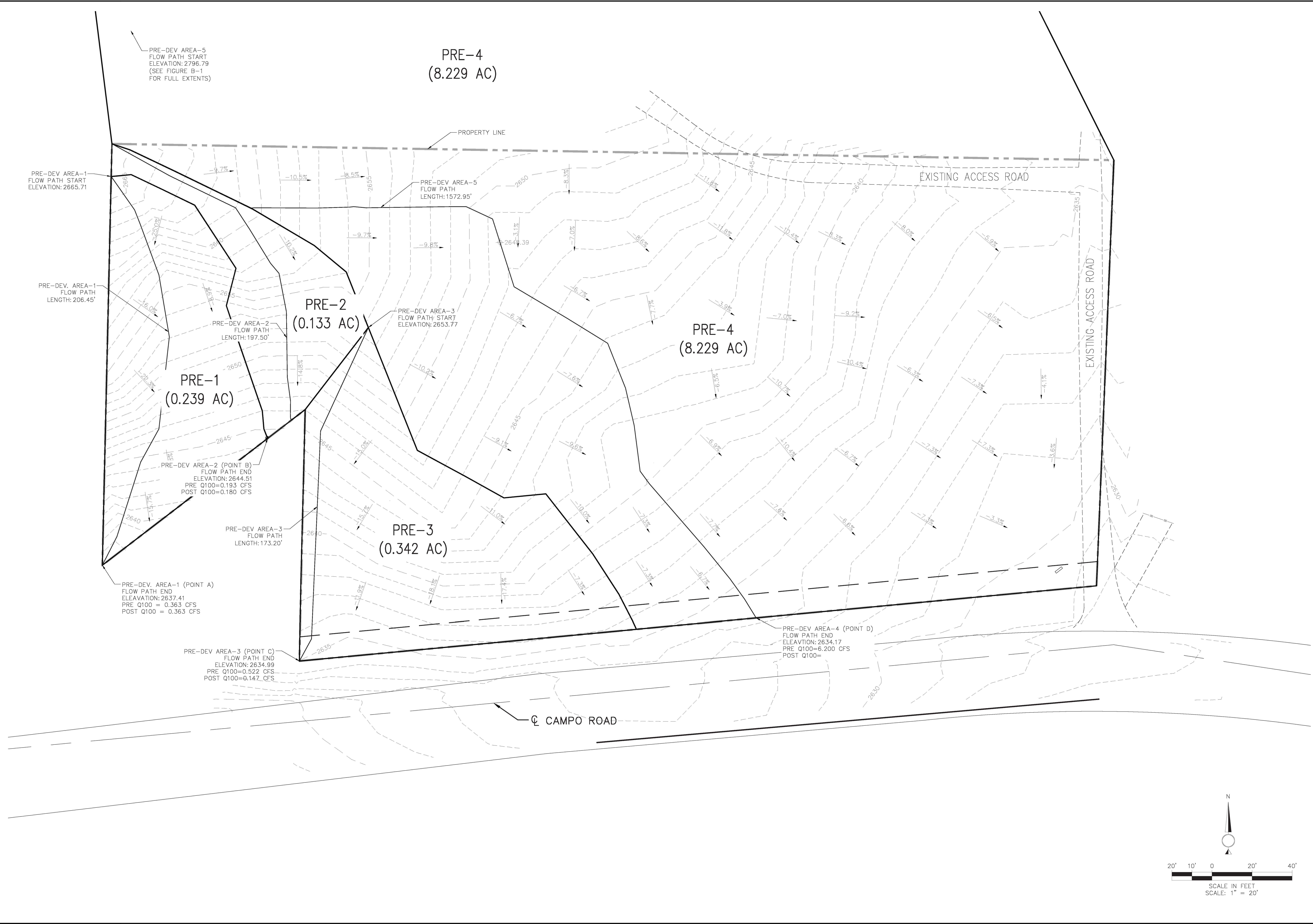

NO.	DATE	CK'D BY	DESCRIPTION

PROJECT TITLE	DESCRIPTION
NNN RETAIL DEVELOPMENT	DOLLAR GENERAL
CITY OF CAMPO, COUNTY OF SAN DIEGO, STATE OF CALIFORNIA	STORM WATER DRAINAGE AREA MAP

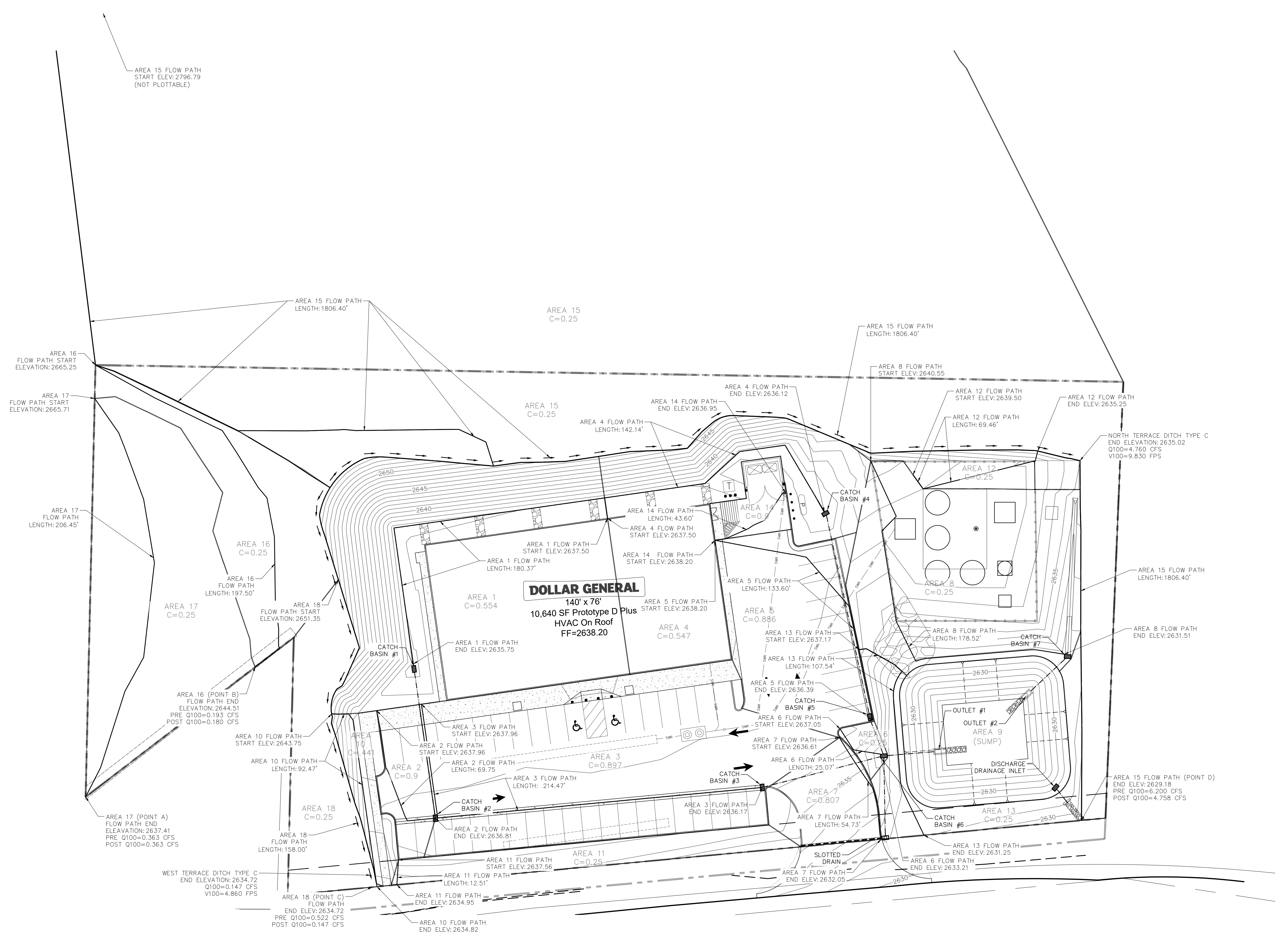

AREA 15 FLOW PATH  
 START ELEV: 2796.79  
 (NOT PLOTTABLE)

**DOLLAR GENERAL**  
 140' x 76'  
 10,640 SF Prototype D Plus  
 HVAC On Roof  
 FF=2638.20

AREA 17 (POINT A)  
 FLOW PATH END  
 ELEVATION: 2637.41  
 PRE Q100=0.363 CFS  
 POST Q100=0.363 CFS

WEST TERRACE DITCH TYPE C  
 END ELEVATION: 2634.72  
 Q100=0.147 CFS  
 V100=4.860 FPS

AREA 18 (POINT C)  
 FLOW PATH  
 END ELEV: 2634.72  
 PRE Q100=0.522 CFS  
 POST Q100=0.147 CFS

NORTH TERRACE DITCH TYPE C  
 END ELEVATION: 2635.02  
 Q100=4.760 CFS  
 V100=9.830 FPS

AREA 15 FLOW PATH (POINT D)  
 END ELEV: 2629.18  
 PRE Q100=6.200 CFS  
 POST Q100=4.758 CFS

# **NRCS SOILS MAP**



United States  
Department of  
Agriculture

**NRCS**

Natural  
Resources  
Conservation  
Service

A product of the National  
Cooperative Soil Survey,  
a joint effort of the United  
States Department of  
Agriculture and other  
Federal agencies, State  
agencies including the  
Agricultural Experiment  
Stations, and local  
participants

# Custom Soil Resource Report for San Diego County Area, California

## Campo Dollar General



# Preface

---

Soil surveys contain information that affects land use planning in survey areas. They highlight soil limitations that affect various land uses and provide information about the properties of the soils in the survey areas. Soil surveys are designed for many different users, including farmers, ranchers, foresters, agronomists, urban planners, community officials, engineers, developers, builders, and home buyers. Also, conservationists, teachers, students, and specialists in recreation, waste disposal, and pollution control can use the surveys to help them understand, protect, or enhance the environment.

Various land use regulations of Federal, State, and local governments may impose special restrictions on land use or land treatment. Soil surveys identify soil properties that are used in making various land use or land treatment decisions. The information is intended to help the land users identify and reduce the effects of soil limitations on various land uses. The landowner or user is responsible for identifying and complying with existing laws and regulations.

Although soil survey information can be used for general farm, local, and wider area planning, onsite investigation is needed to supplement this information in some cases. Examples include soil quality assessments (<http://www.nrcs.usda.gov/wps/portal/nrcs/main/soils/health/>) and certain conservation and engineering applications. For more detailed information, contact your local USDA Service Center (<https://offices.sc.egov.usda.gov/locator/app?agency=nrcs>) or your NRCS State Soil Scientist ([http://www.nrcs.usda.gov/wps/portal/nrcs/detail/soils/contactus/?cid=nrcs142p2\\_053951](http://www.nrcs.usda.gov/wps/portal/nrcs/detail/soils/contactus/?cid=nrcs142p2_053951)).

Great differences in soil properties can occur within short distances. Some soils are seasonally wet or subject to flooding. Some are too unstable to be used as a foundation for buildings or roads. Clayey or wet soils are poorly suited to use as septic tank absorption fields. A high water table makes a soil poorly suited to basements or underground installations.

The National Cooperative Soil Survey is a joint effort of the United States Department of Agriculture and other Federal agencies, State agencies including the Agricultural Experiment Stations, and local agencies. The Natural Resources Conservation Service (NRCS) has leadership for the Federal part of the National Cooperative Soil Survey.

Information about soils is updated periodically. Updated information is available through the NRCS Web Soil Survey, the site for official soil survey information.

The U.S. Department of Agriculture (USDA) prohibits discrimination in all its programs and activities on the basis of race, color, national origin, age, disability, and where applicable, sex, marital status, familial status, parental status, religion, sexual orientation, genetic information, political beliefs, reprisal, or because all or a part of an individual's income is derived from any public assistance program. (Not all prohibited bases apply to all programs.) Persons with disabilities who require



alternative means for communication of program information (Braille, large print, audiotape, etc.) should contact USDA's TARGET Center at (202) 720-2600 (voice and TDD). To file a complaint of discrimination, write to USDA, Director, Office of Civil Rights, 1400 Independence Avenue, S.W., Washington, D.C. 20250-9410 or call (800) 795-3272 (voice) or (202) 720-6382 (TDD). USDA is an equal opportunity provider and employer.

# Contents

---

<b>Preface</b> .....	2
<b>How Soil Surveys Are Made</b> .....	5
<b>Soil Information for All Uses</b> .....	8
Soil Properties and Qualities.....	8
Soil Qualities and Features.....	8
Hydrologic Soil Group (Campo Dollar General).....	8
<b>References</b> .....	13

# How Soil Surveys Are Made

---

Soil surveys are made to provide information about the soils and miscellaneous areas in a specific area. They include a description of the soils and miscellaneous areas and their location on the landscape and tables that show soil properties and limitations affecting various uses. Soil scientists observed the steepness, length, and shape of the slopes; the general pattern of drainage; the kinds of crops and native plants; and the kinds of bedrock. They observed and described many soil profiles. A soil profile is the sequence of natural layers, or horizons, in a soil. The profile extends from the surface down into the unconsolidated material in which the soil formed or from the surface down to bedrock. The unconsolidated material is devoid of roots and other living organisms and has not been changed by other biological activity.

Currently, soils are mapped according to the boundaries of major land resource areas (MLRAs). MLRAs are geographically associated land resource units that share common characteristics related to physiography, geology, climate, water resources, soils, biological resources, and land uses (USDA, 2006). Soil survey areas typically consist of parts of one or more MLRA.

The soils and miscellaneous areas in a survey area occur in an orderly pattern that is related to the geology, landforms, relief, climate, and natural vegetation of the area. Each kind of soil and miscellaneous area is associated with a particular kind of landform or with a segment of the landform. By observing the soils and miscellaneous areas in the survey area and relating their position to specific segments of the landform, a soil scientist develops a concept, or model, of how they were formed. Thus, during mapping, this model enables the soil scientist to predict with a considerable degree of accuracy the kind of soil or miscellaneous area at a specific location on the landscape.

Commonly, individual soils on the landscape merge into one another as their characteristics gradually change. To construct an accurate soil map, however, soil scientists must determine the boundaries between the soils. They can observe only a limited number of soil profiles. Nevertheless, these observations, supplemented by an understanding of the soil-vegetation-landscape relationship, are sufficient to verify predictions of the kinds of soil in an area and to determine the boundaries.

Soil scientists recorded the characteristics of the soil profiles that they studied. They noted soil color, texture, size and shape of soil aggregates, kind and amount of rock fragments, distribution of plant roots, reaction, and other features that enable them to identify soils. After describing the soils in the survey area and determining their properties, the soil scientists assigned the soils to taxonomic classes (units). Taxonomic classes are concepts. Each taxonomic class has a set of soil characteristics with precisely defined limits. The classes are used as a basis for comparison to classify soils systematically. Soil taxonomy, the system of taxonomic classification used in the United States, is based mainly on the kind and character of soil properties and the arrangement of horizons within the profile. After the soil

## Custom Soil Resource Report

scientists classified and named the soils in the survey area, they compared the individual soils with similar soils in the same taxonomic class in other areas so that they could confirm data and assemble additional data based on experience and research.

The objective of soil mapping is not to delineate pure map unit components; the objective is to separate the landscape into landforms or landform segments that have similar use and management requirements. Each map unit is defined by a unique combination of soil components and/or miscellaneous areas in predictable proportions. Some components may be highly contrasting to the other components of the map unit. The presence of minor components in a map unit in no way diminishes the usefulness or accuracy of the data. The delineation of such landforms and landform segments on the map provides sufficient information for the development of resource plans. If intensive use of small areas is planned, onsite investigation is needed to define and locate the soils and miscellaneous areas.

Soil scientists make many field observations in the process of producing a soil map. The frequency of observation is dependent upon several factors, including scale of mapping, intensity of mapping, design of map units, complexity of the landscape, and experience of the soil scientist. Observations are made to test and refine the soil-landscape model and predictions and to verify the classification of the soils at specific locations. Once the soil-landscape model is refined, a significantly smaller number of measurements of individual soil properties are made and recorded. These measurements may include field measurements, such as those for color, depth to bedrock, and texture, and laboratory measurements, such as those for content of sand, silt, clay, salt, and other components. Properties of each soil typically vary from one point to another across the landscape.

Observations for map unit components are aggregated to develop ranges of characteristics for the components. The aggregated values are presented. Direct measurements do not exist for every property presented for every map unit component. Values for some properties are estimated from combinations of other properties.

While a soil survey is in progress, samples of some of the soils in the area generally are collected for laboratory analyses and for engineering tests. Soil scientists interpret the data from these analyses and tests as well as the field-observed characteristics and the soil properties to determine the expected behavior of the soils under different uses. Interpretations for all of the soils are field tested through observation of the soils in different uses and under different levels of management. Some interpretations are modified to fit local conditions, and some new interpretations are developed to meet local needs. Data are assembled from other sources, such as research information, production records, and field experience of specialists. For example, data on crop yields under defined levels of management are assembled from farm records and from field or plot experiments on the same kinds of soil.

Predictions about soil behavior are based not only on soil properties but also on such variables as climate and biological activity. Soil conditions are predictable over long periods of time, but they are not predictable from year to year. For example, soil scientists can predict with a fairly high degree of accuracy that a given soil will have a high water table within certain depths in most years, but they cannot predict that a high water table will always be at a specific level in the soil on a specific date.

After soil scientists located and identified the significant natural bodies of soil in the survey area, they drew the boundaries of these bodies on aerial photographs and

## Custom Soil Resource Report

identified each as a specific map unit. Aerial photographs show trees, buildings, fields, roads, and rivers, all of which help in locating boundaries accurately.

# **Soil Information for All Uses**

---

## **Soil Properties and Qualities**

The Soil Properties and Qualities section includes various soil properties and qualities displayed as thematic maps with a summary table for the soil map units in the selected area of interest. A single value or rating for each map unit is generated by aggregating the interpretive ratings of individual map unit components. This aggregation process is defined for each property or quality.

## **Soil Qualities and Features**

Soil qualities are behavior and performance attributes that are not directly measured, but are inferred from observations of dynamic conditions and from soil properties. Example soil qualities include natural drainage, and frost action. Soil features are attributes that are not directly part of the soil. Example soil features include slope and depth to restrictive layer. These features can greatly impact the use and management of the soil.

## **Hydrologic Soil Group (Campo Dollar General)**

Hydrologic soil groups are based on estimates of runoff potential. Soils are assigned to one of four groups according to the rate of water infiltration when the soils are not protected by vegetation, are thoroughly wet, and receive precipitation from long-duration storms.

The soils in the United States are assigned to four groups (A, B, C, and D) and three dual classes (A/D, B/D, and C/D). The groups are defined as follows:

Group A. Soils having a high infiltration rate (low runoff potential) when thoroughly wet. These consist mainly of deep, well drained to excessively drained sands or gravelly sands. These soils have a high rate of water transmission.

Group B. Soils having a moderate infiltration rate when thoroughly wet. These consist chiefly of moderately deep or deep, moderately well drained or well drained soils that have moderately fine texture to moderately coarse texture. These soils have a moderate rate of water transmission.

## Custom Soil Resource Report

Group C. Soils having a slow infiltration rate when thoroughly wet. These consist chiefly of soils having a layer that impedes the downward movement of water or soils of moderately fine texture or fine texture. These soils have a slow rate of water transmission.

Group D. Soils having a very slow infiltration rate (high runoff potential) when thoroughly wet. These consist chiefly of clays that have a high shrink-swell potential, soils that have a high water table, soils that have a claypan or clay layer at or near the surface, and soils that are shallow over nearly impervious material. These soils have a very slow rate of water transmission.

If a soil is assigned to a dual hydrologic group (A/D, B/D, or C/D), the first letter is for drained areas and the second is for undrained areas. Only the soils that in their natural condition are in group D are assigned to dual classes.

Custom Soil Resource Report  
Map—Hydrologic Soil Group (Campo Dollar General)

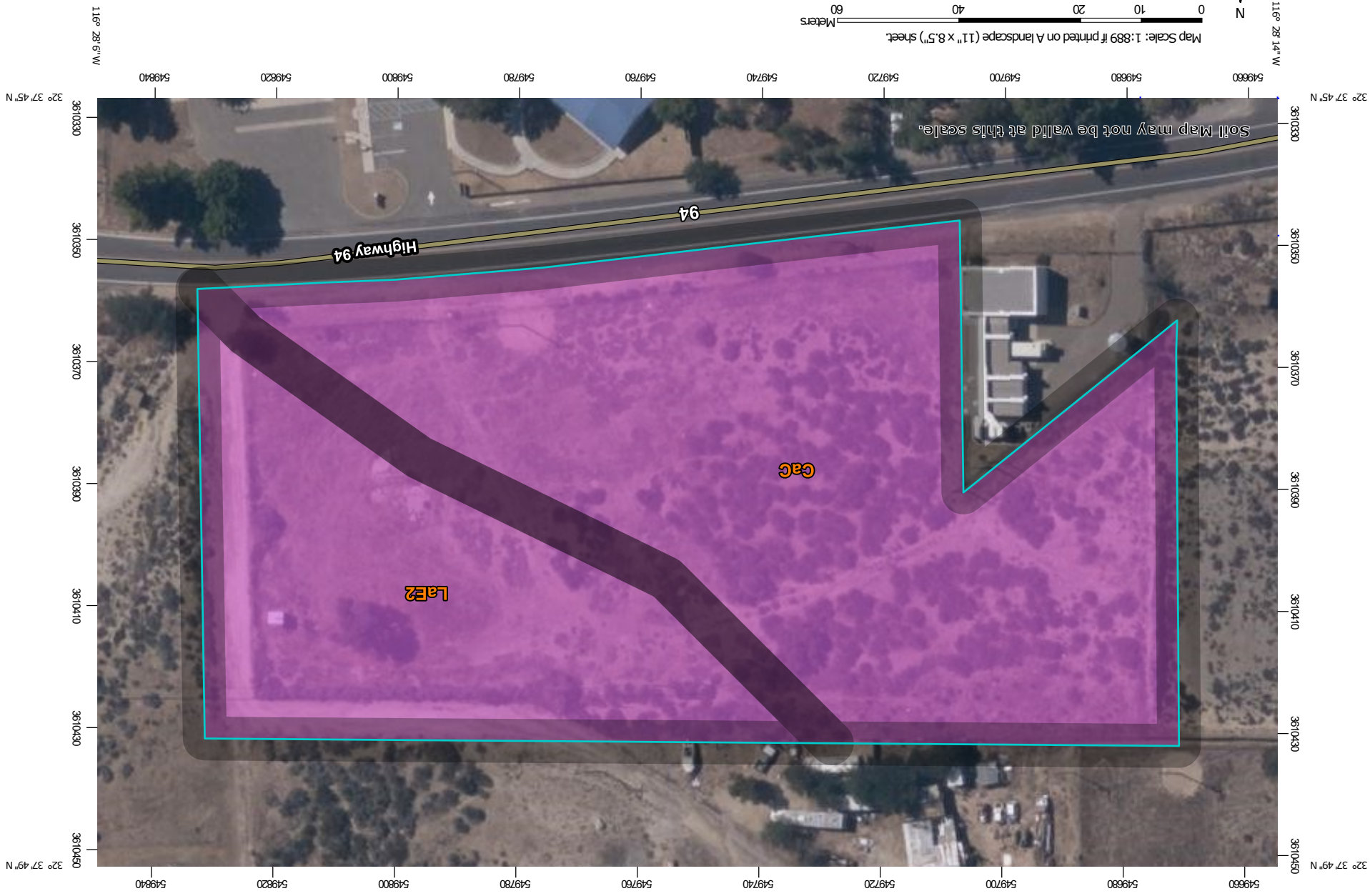

Map Scale: 1:889 if printed on A landscape (11" x 8.5") sheet

Meters

0

40

80

160

Map projection: Web Mercator Corner coordinates: WGS84 Edge tics: UTM Zone 11N WGS84

240

Feet











### MAP LEGEND









**Area of Interest (AOI)**  
 Area of Interest (AOI)

**Soils**





**Soil Rating Polygons**

-  A
-  A/D
-  B
-  B/D
-  C
-  C/D
-  D
-  Not rated or not available

**Soil Rating Lines**

-  A
-  A/D
-  B
-  B/D
-  C
-  C/D
-  D
-  Not rated or not available

**Soil Rating Points**

-  A
-  A/D
-  B
-  B/D

 C

 C/D





 D

 Not rated or not available

**Water Features**

-  Streams and Canals

**Transportation**

-  Rails
-  Interstate Highways
-  US Routes
-  Major Roads
-  Local Roads

**Background**

-  Aerial Photography

### MAP INFORMATION

The soil surveys that comprise your AOI were mapped at 1:24,000.

Warning: Soil Map may not be valid at this scale.

Enlargement of maps beyond the scale of mapping can cause misunderstanding of the detail of mapping and accuracy of soil line placement. The maps do not show the small areas of contrasting soils that could have been shown at a more detailed scale.

Please rely on the bar scale on each map sheet for map measurements.

Source of Map: Natural Resources Conservation Service  
 Web Soil Survey URL:  
 Coordinate System: Web Mercator (EPSG:3857)

Maps from the Web Soil Survey are based on the Web Mercator projection, which preserves direction and shape but distorts distance and area. A projection that preserves area, such as the Albers equal-area conic projection, should be used if more accurate calculations of distance or area are required.

This product is generated from the USDA-NRCS certified data as of the version date(s) listed below.

Soil Survey Area: San Diego County Area, California  
 Survey Area Data: Version 15, May 27, 2020

Soil map units are labeled (as space allows) for map scales 1:50,000 or larger.

Date(s) aerial images were photographed: Aug 18, 2018—Aug 22, 2018

The orthophoto or other base map on which the soil lines were compiled and digitized probably differs from the background imagery displayed on these maps. As a result, some minor shifting of map unit boundaries may be evident.

**Table—Hydrologic Soil Group (Campo Dollar General)**

Map unit symbol	Map unit name	Rating	Acres in AOI	Percent of AOI
CaC	Calpine coarse sandy loam, 5 to 9 percent slopes	A	2.0	66.4%
LaE2	La Posta loamy coarse sand, 5 to 30 percent slopes, eroded	A	1.0	33.6%
<b>Totals for Area of Interest</b>			<b>2.9</b>	<b>100.0%</b>

**Rating Options—Hydrologic Soil Group (Campo Dollar General)**

*Aggregation Method:* Dominant Condition

*Component Percent Cutoff:* None Specified

*Tie-break Rule:* Higher

# References

---

- American Association of State Highway and Transportation Officials (AASHTO). 2004. Standard specifications for transportation materials and methods of sampling and testing. 24th edition.
- American Society for Testing and Materials (ASTM). 2005. Standard classification of soils for engineering purposes. ASTM Standard D2487-00.
- Cowardin, L.M., V. Carter, F.C. Golet, and E.T. LaRoe. 1979. Classification of wetlands and deep-water habitats of the United States. U.S. Fish and Wildlife Service FWS/OBS-79/31.
- Federal Register. July 13, 1994. Changes in hydric soils of the United States.
- Federal Register. September 18, 2002. Hydric soils of the United States.
- Hurt, G.W., and L.M. Vasilas, editors. Version 6.0, 2006. Field indicators of hydric soils in the United States.
- National Research Council. 1995. Wetlands: Characteristics and boundaries.
- Soil Survey Division Staff. 1993. Soil survey manual. Soil Conservation Service. U.S. Department of Agriculture Handbook 18. [http://www.nrcs.usda.gov/wps/portal/nrcs/detail/national/soils/?cid=nrcs142p2\\_054262](http://www.nrcs.usda.gov/wps/portal/nrcs/detail/national/soils/?cid=nrcs142p2_054262)
- Soil Survey Staff. 1999. Soil taxonomy: A basic system of soil classification for making and interpreting soil surveys. 2nd edition. Natural Resources Conservation Service, U.S. Department of Agriculture Handbook 436. [http://www.nrcs.usda.gov/wps/portal/nrcs/detail/national/soils/?cid=nrcs142p2\\_053577](http://www.nrcs.usda.gov/wps/portal/nrcs/detail/national/soils/?cid=nrcs142p2_053577)
- Soil Survey Staff. 2010. Keys to soil taxonomy. 11th edition. U.S. Department of Agriculture, Natural Resources Conservation Service. [http://www.nrcs.usda.gov/wps/portal/nrcs/detail/national/soils/?cid=nrcs142p2\\_053580](http://www.nrcs.usda.gov/wps/portal/nrcs/detail/national/soils/?cid=nrcs142p2_053580)
- Tiner, R.W., Jr. 1985. Wetlands of Delaware. U.S. Fish and Wildlife Service and Delaware Department of Natural Resources and Environmental Control, Wetlands Section.
- United States Army Corps of Engineers, Environmental Laboratory. 1987. Corps of Engineers wetlands delineation manual. Waterways Experiment Station Technical Report Y-87-1.
- United States Department of Agriculture, Natural Resources Conservation Service. National forestry manual. [http://www.nrcs.usda.gov/wps/portal/nrcs/detail/soils/home/?cid=nrcs142p2\\_053374](http://www.nrcs.usda.gov/wps/portal/nrcs/detail/soils/home/?cid=nrcs142p2_053374)
- United States Department of Agriculture, Natural Resources Conservation Service. National range and pasture handbook. <http://www.nrcs.usda.gov/wps/portal/nrcs/detail/national/landuse/rangepasture/?cid=stelprdb1043084>

## Custom Soil Resource Report

United States Department of Agriculture, Natural Resources Conservation Service. National soil survey handbook, title 430-VI. [http://www.nrcs.usda.gov/wps/portal/nrcs/detail/soils/scientists/?cid=nrcs142p2\\_054242](http://www.nrcs.usda.gov/wps/portal/nrcs/detail/soils/scientists/?cid=nrcs142p2_054242)

United States Department of Agriculture, Natural Resources Conservation Service. 2006. Land resource regions and major land resource areas of the United States, the Caribbean, and the Pacific Basin. U.S. Department of Agriculture Handbook 296. [http://www.nrcs.usda.gov/wps/portal/nrcs/detail/national/soils/?cid=nrcs142p2\\_053624](http://www.nrcs.usda.gov/wps/portal/nrcs/detail/national/soils/?cid=nrcs142p2_053624)

United States Department of Agriculture, Soil Conservation Service. 1961. Land capability classification. U.S. Department of Agriculture Handbook 210. [http://www.nrcs.usda.gov/Internet/FSE\\_DOCUMENTS/nrcs142p2\\_052290.pdf](http://www.nrcs.usda.gov/Internet/FSE_DOCUMENTS/nrcs142p2_052290.pdf)

**PRE-DEVELOPMENT SURFACE**  
**RUNOFF CALCULATIONS**

## RATIONAL METHOD DRAINAGE STUDY

**DATE:** May 28, 2021      **JOB NO.:** 19-015      **PROJECT:** Campo Dollar General  
**FREQ:** 100-Year      **STUDY OF:** PRE-DEVELOPMENT 100-YEAR SUB-AREA SURFACE FLOW ANALYSIS

P6 Rainfall Depth: 3.41 inches  
 P24 Rainfall Depth: 6.74 inches

P6/P24: 50.6%

*Time of Concentration*  
 $T_c = 1.8(1.1 - C)L^{0.5}S^{-0.333}$

*Intensity*  
 $I = 7.44P_6D^{-0.645}$   
 $D = T_c$

AREA	ACREAGE	LENGTH (FEET)	FALL (FEET)	AVG. SLOPE	C VALUE	TIME OF CONCENTRATION (MIN)	I VALUE	FLOW Q(CFS)	COMMENTS
PRE-1	0.239	206.45	28.30	13.71%	0.250	9.19	6.069	0.363	= Q <sub>100</sub> @ Point A
PRE-2	0.133	197.50	20.74	10.50%	0.250	9.82	5.814	0.193	= Q <sub>100</sub> @ Point B
PRE-3	0.342	173.20	18.78	10.84%	0.250	9.10	6.107	0.522	= Q <sub>100</sub> @ Point C
PRE-4	8.229	1527.95	162.62	10.64%	0.250	27.19	3.014	6.200	= Q <sub>100</sub> @ Point D
<b>Total</b>	<b>8.943</b>	<b>-</b>	<b>-</b>	<b>-</b>	<b>-</b>	<b>-</b>	<b>-</b>	<b>7.278</b>	<b>= Q<sub>100</sub></b>

PRE = Pre-Development Sub Area

Note:

Refer to Figure(s) B-1 and B-2 for Pre-Development Sub Area Map

**POST DEVELOPMENT**  
**SUB AREA STATISTICS**

**POST DEVELOPMENT SUB-AREA STATISTICS**

**Job Number: 19-015 Campo Dollar General**

<b>WATERSHED AREA</b>	<b>AREA (sf) Acres</b>	<b>Impervious Area C= 0.90</b>	<b>Pervious Area C= 0.25</b>	<b>Composite "C" Factor</b>	<b>LENGTH (feet)</b>	<b>FALL (feet)</b>	<b>AVERAGE SLOPE</b>
1	15,357	7175	8182	0.554	180.37	1.75	0.97%
	0.353	0.165	0.188				
2	1,551	1551	0	0.900	69.75	1.15	1.65%
	0.036	0.036	0.000				
3	13,283	13220	63	0.897	214.47	1.79	0.83%
	0.305	0.303	0.001				
4	8,448	3859	4589	0.547	142.14	1.38	0.97%
	0.194	0.089	0.105				
5	5,662	5540	122	0.886	133.60	1.81	1.35%
	0.130	0.127	0.00				
6	356	0	356	0.250	25.07	3.84	15.32%
	0.008	0.000	0.008				
7	2,069	1772	297	0.807	54.73	4.56	8.33%
	0.047	0.041	0.007				
8	9,466	0	9466	0.250	178.52	9.01	5.05%
	0.217	0.000	0.217				
SUMP(9)	5,407	0	5407	-	-	-	-
	0.124	0.000	0.124				
<b>TOTAL</b>	61,599	33117	28482	0.599	-	-	-
	1.414	0.760	0.654				

10*	1,332	391	941	0.441	92.47	8.93	9.66%
	0.031	0.009	0.022				
11*	2,287	0	2287	0.250	12.15	2.61	21.48%
	0.053	0.000	0.053				
12*	1,581	0	1581	0.250	69.46	4.25	6.12%
	0.036	0.000	0.036				
13*	2,881	0	2881	0.250	107.54	5.92	5.50%
	0.066	0.000	0.066				
14* <sup>†</sup>	1,030	1030	0	0.900	43.60	1.25	2.87%
	0.024	0.024	0.000				
15*	298,934	0	299187	0.250	1806.40	167.61	9.28%
	6.863	0.000	6.868				
16*	5,393	0	5393	0.250	197.50	20.74	10.50%
	0.124	0.000	0.124				
17*	10,430	0	10430	0.250	206.45	28.30	13.71%
	0.239	0.000	0.239				
18*	4,106	0	4106	0.250	158.00	16.63	10.53%
	0.094	0.000	0.094				
<b>TOTAL</b>	327,974	1421	312270	-	-	-	-
	7.529	0.033	7.169				

\*Areas discharge off-site via surface flow and will not be considered for pipe sizing calculations

<sup>†</sup>Trash Enclosure and Loading Dock Area - Area to discharge into on-site septic system.



**POST DEVELOPMENT**  
**100-YEAR SURFACE FLOW**  
**FOR PIPE ROUTING ANALYSIS**

## RATIONAL METHOD DRAINAGE STUDY

**DATE:** May 28, 2021

**JOB NO.:** 19-015

**PROJECT:** Campo Dollar General

**FREQ:** 100-Year

**STUDY OF:** POST DEVELOPMENT 100-YEAR SUB-AREA SURFACE FLOW ANALYSIS

P6 Rainfall Depth: 3.41 inches  
P24 Rainfall Depth: 6.74 inches

P6/P24: 50.6%

*Time of Concentration*  
 $T_c = 1.8(1.1 - C)L^{0.5}S^{-0.333}$

*Intensity*  
 $I = 7.44P_6D^{-0.645}$   
 $D = T_c$

	AREA #	ACREAGE	LENGTH (FEET)	FALL (FEET)	AVG. SLOPE	C VALUE	TIME OF CONC. (MIN)*			I VALUE	FLOW Q(CFS)	COMMENTS
							FLOW PATH	ROOF	TOTAL			
CB #1	1	0.353	180.37	1.75	0.97%	0.599	12.23	10.00	22.23	3.432	0.726	= Q <sub>100</sub> @ CB#1
CB #2	2	0.036	69.75	1.15	1.65%	0.599	6.37	0.00	6.37	7.682	0.166	= Q <sub>100</sub> @ CB#2
CB #3	3	0.305	214.47	1.79	0.83%	0.599	14.05	0.00	14.05	4.613	0.843	= Q <sub>100</sub> @ CB#3
CB #4	4	0.194	142.14	1.38	0.97%	0.599	10.86	10.00	20.86	3.576	0.416	= Q <sub>100</sub> @ CB#4
CB #5	5	0.130	133.60	1.81	1.35%	0.599	9.43	0.00	9.43	5.967	0.465	= Q <sub>100</sub> @ CB#5
CB #6	6	0.008	25.07	3.84	15.32%	0.599	5.00	0.00	5.00	8.984	0.043	= Q <sub>100</sub> @ CB#6
SLD #1	7	0.047	54.73	4.56	8.33%	0.599	5.00	0.00	5.00	8.984	0.253	= Q <sub>100</sub> @ SLD#1
CB #7	8	0.217	178.52	9.01	5.05%	0.599	7.02	0.00	7.02	7.216	0.938	= Q <sub>100</sub> @ CB#7
OFF #1	10	0.031	92.47	8.93	9.66%	0.441	5.36	0.00	5.36	8.595	0.118	= Q <sub>100</sub>
OFF #2	11	0.053	12.15	2.61	21.48%	0.250	5.00	0.00	5.00	8.984	0.119	= Q <sub>100</sub>
OFF #3	12	0.036	69.46	4.25	6.12%	0.250	6.97	0.00	6.97	7.251	0.065	= Q <sub>100</sub>
OFF #4	13	0.066	107.54	5.92	5.50%	0.250	8.99	0.00	8.99	6.155	0.102	= Q <sub>100</sub>
TRL #1	14	0.024	43.60	1.25	2.87%	0.900	5.00	0.00	5.00	8.984	0.194	= Q <sub>100</sub>
OFF #5	15	6.863	1806.40	167.61	9.28%	0.250	30.94	0.00	30.94	2.773	4.758	= Q <sub>100</sub> @ Point D
OFF #6	16	0.124	197.50	20.74	10.50%	0.250	9.82	0.00	9.82	5.813	0.180	= Q <sub>100</sub> @ Point B
OFF #7	17	0.239	206.45	28.3	0.1371	0.250	9.19	0.00	9.19	6.07	0.363	= Q <sub>100</sub> @ Point A
OFF #8	18	0.094	158.00	16.63	0.1053	0.250	8.77	0.00	8.8	6.25	0.147	= Q <sub>100</sub> @ Point C

CB = Catch Basin/Drainage Inlet

SLD = Slotted Drain

OFF = Off- Site Discharge

TRL = Trash Enclosure/Loading Dock Area

\*Minimum Tc of 5 minutes to be used for Flow Path. Areas that include Roof area assumed to have an additional 10 Minutes

Note:

Watershed Area 9 is not listed as this is the Retention Basin/Sump

**POST DEVELOPMENT**  
**STORM DRAINPIPE SYSTEM LAYOUT**

# STORM DRAIN PIPE SYSTEM LAYOUT

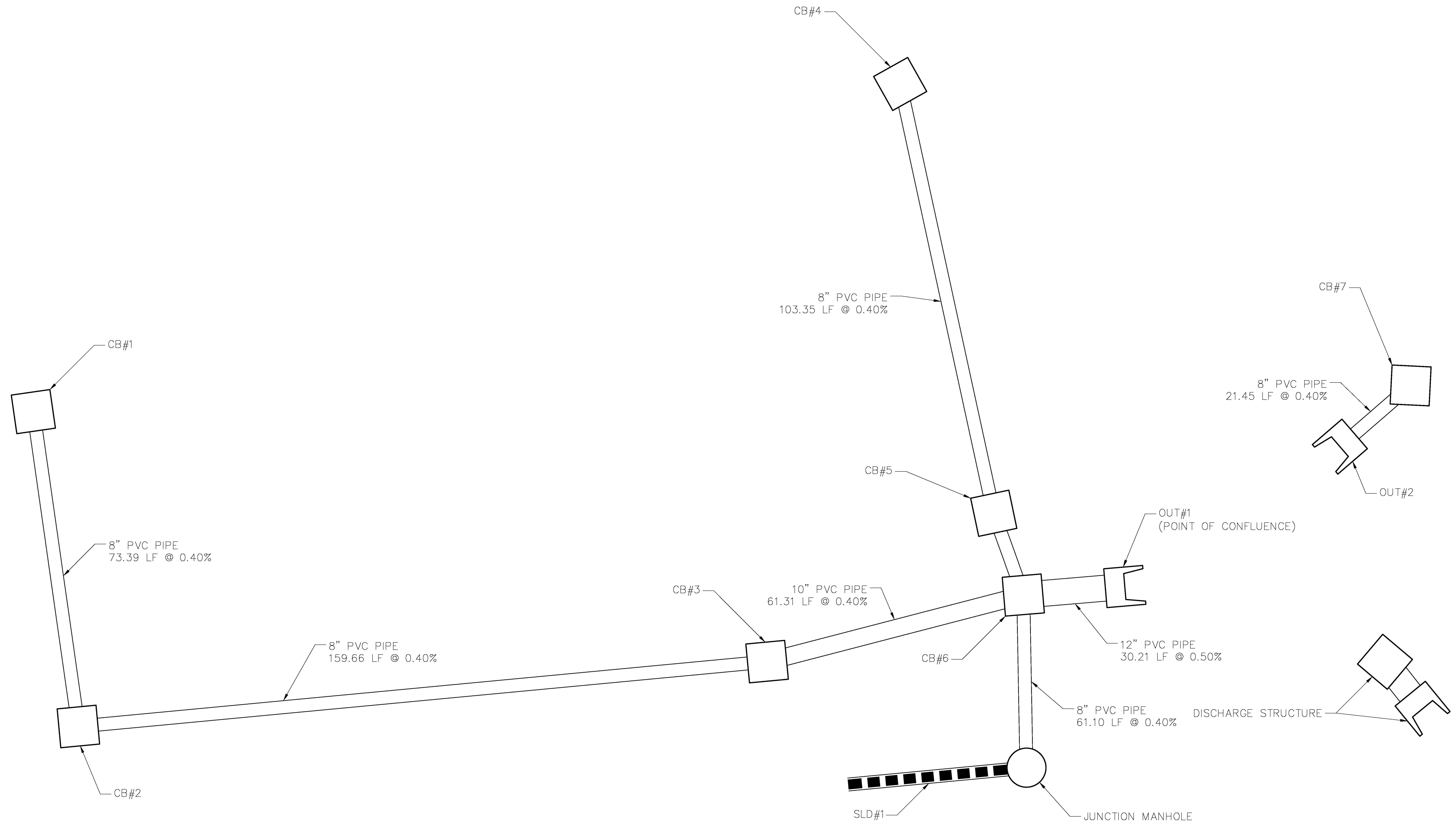

4300 ASHE ROAD, SUITE 103  
 BAKERSFIELD, CALIFORNIA 93313  
 661-664-4806 PHONE  
 888-260-7357 FAX

DATE: 5/28/2021  
 SCALE: AS-NOTED  
 DRAWN BY: SMS  
 CK'D BY: GDB  
 DATE CK'D: 5/28/2021  
 JOB NO.: 19-015

REVISIONS NO.	DATE	CK'D BY	DESCRIPTION

PROJECT TITLE: NNN RETAIL DEVELOPMENT  
 DOLLAR GENERAL  
 CITY OF CAMPO, COUNTY OF SAN DIEGO, STATE OF CALIFORNIA  
 SHEET DESCRIPTION: STORM DRAIN PIPE SYSTEM LAYOUT

**POST DEVELOPMENT**  
**CATCH BASIN SIZING CALCULATIONS**

## RATIONAL METHOD DRAINAGE STUDY

**DATE:** May 28, 2021  
**FREQ:** 100-Year

**JOB NO.** 19-015      **PROJECT** Campo Dollar General  
**STUDY OF:** POST DEVELOPMENT 100-YEAR CATCH BASIN CAPACITY SIZING

Drainage Inlet	Surface In-flow (cfs)	Upstream Surface In-flow (cfs)	Total Surface In-flow at Inlet, $Q_t$ (cfs)	Inlet Location	Downstream Inlet	Flow Bypass Q (cfs)	Flow Depth at Drainage Inlet (in)	COMMENTS
CB #1	0.726	0.000	0.726	Sag	CB #2	0.000	0.940	
CB #2	0.166	0.000	0.166	On-Grade	CB #3	0.030	0.600	
CB #3	0.843	0.030	0.873	Sag	CB #6	0.000	1.040	
CB #4	0.416	0.000	0.416	Sag	CB #5	0.000	0.650	
CB #5	0.465	0.000	0.465	Sag	CB #6	0.000	1.790	
CB #6	0.043	0.000	0.043	Sag	-	0.000	0.140	
SLD #1	0.253	0.000	0.253	On-Grade	CB #6	0.000	0.360	
CB #7	0.938	0.000	0.938	Sag	-	0.000	1.110	

CB = Catch Basin/Drainage Inlet

SLD = Slotted Drain

Note: See Inlet reports for bypass and flow depth calculations

# Inlet Report

## Drainage Inlet CB#1

### Drop Grate Inlet

Location	= Sag
Curb Length (ft)	= -0-
Throat Height (in)	= -0-
Grate Area (sqft)	= 7.18
Grate Width (ft)	= 2.08
Grate Length (ft)	= 3.45

### Gutter

Slope, Sw (ft/ft)	= 0.198
Slope, Sx (ft/ft)	= 0.198
Local Depr (in)	= -0-
Gutter Width (ft)	= 2.08
Gutter Slope (%)	= -0-
Gutter n-value	= -0-

### Calculations

Compute by:	Known Q
Q (cfs)	= 0.73

### Highlighted

Q Total (cfs)	= 0.73
Q Capt (cfs)	= 0.73
Q Bypass (cfs)	= -0-
Depth at Inlet (in)	= 0.94
Efficiency (%)	= 100
Gutter Spread (ft)	= 2.87
Gutter Vel (ft/s)	= 2.12
Bypass Spread (ft)	= -0-
Bypass Depth (in)	= -0-

All dimensions in feet

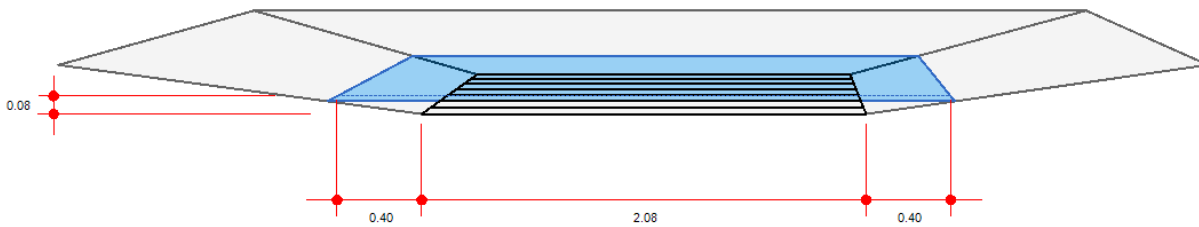

# Inlet Report

## Drainage Inlet CB#2

### Drop Grate Inlet

Location	= On grade
Curb Length (ft)	= -0-
Throat Height (in)	= -0-
Grate Area (sqft)	= -0-
Grate Width (ft)	= 3.45
Grate Length (ft)	= 2.08

### Gutter

Slope, Sw (ft/ft)	= 0.013
Slope, Sx (ft/ft)	= 0.013
Local Depr (in)	= -0-
Gutter Width (ft)	= 2.00
Gutter Slope (%)	= 0.40
Gutter n-value	= 0.011

### Calculations

Compute by:	Known Q
Q (cfs)	= 0.17

### Highlighted

Q Total (cfs)	= 0.17
Q Capt (cfs)	= 0.14
Q Bypass (cfs)	= 0.03
Depth at Inlet (in)	= 0.60
Efficiency (%)	= 82
Gutter Spread (ft)	= 9.69
Gutter Vel (ft/s)	= 0.57
Bypass Spread (ft)	= 5.08
Bypass Depth (in)	= 0.24

All dimensions in feet

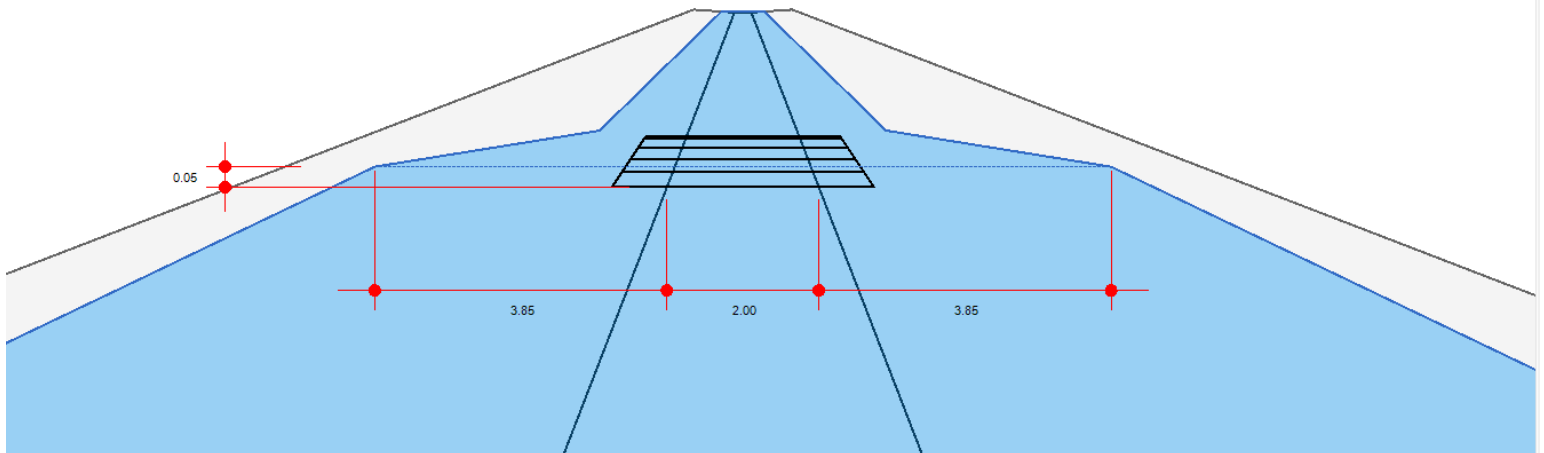



# Inlet Report

## Drainage Inlet CB#3

### Drop Grate Inlet

Location	= Sag
Curb Length (ft)	= -0-
Throat Height (in)	= -0-
Grate Area (sqft)	= 7.18
Grate Width (ft)	= 3.45
Grate Length (ft)	= 2.08

### Gutter

Slope, Sw (ft/ft)	= 0.016
Slope, Sx (ft/ft)	= 0.016
Local Depr (in)	= -0-
Gutter Width (ft)	= 2.00
Gutter Slope (%)	= -0-
Gutter n-value	= -0-

### Calculations

Compute by:	Known Q
Q (cfs)	= 0.84

### Highlighted

Q Total (cfs)	= 0.84
Q Capt (cfs)	= 0.84
Q Bypass (cfs)	= -0-
Depth at Inlet (in)	= 1.04
Efficiency (%)	= 100
Gutter Spread (ft)	= 14.24
Gutter Vel (ft/s)	= 0.57
Bypass Spread (ft)	= -0-
Bypass Depth (in)	= -0-

All dimensions in feet

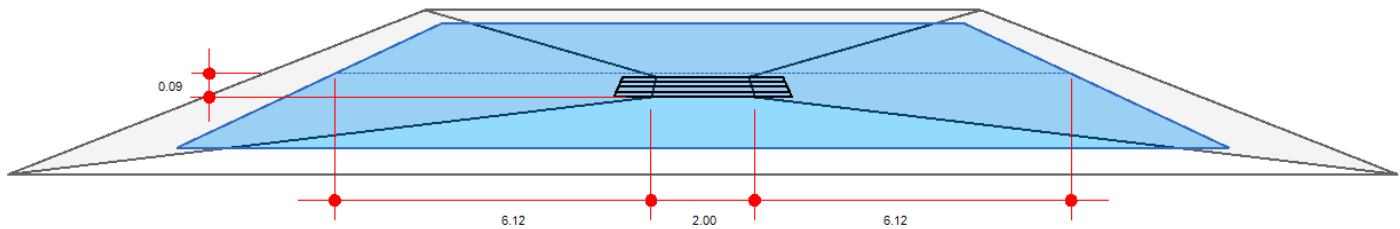

# Inlet Report

## Drainage Inlet CB#4

### Drop Grate Inlet

Location	= Sag
Curb Length (ft)	= -0-
Throat Height (in)	= -0-
Grate Area (sqft)	= 7.18
Grate Width (ft)	= 3.45
Grate Length (ft)	= 2.08

### Gutter

Slope, Sw (ft/ft)	= 0.098
Slope, Sx (ft/ft)	= 0.098
Local Depr (in)	= -0-
Gutter Width (ft)	= 3.45
Gutter Slope (%)	= -0-
Gutter n-value	= -0-

### Calculations

Compute by:	Known Q
Q (cfs)	= 0.42

### Highlighted

Q Total (cfs)	= 0.42
Q Capt (cfs)	= 0.42
Q Bypass (cfs)	= -0-
Depth at Inlet (in)	= 0.65
Efficiency (%)	= 100
Gutter Spread (ft)	= 4.55
Gutter Vel (ft/s)	= 0.91
Bypass Spread (ft)	= -0-
Bypass Depth (in)	= -0-

All dimensions in feet

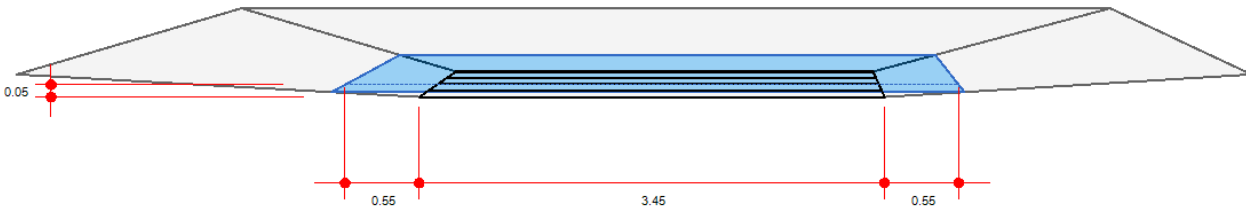

# Inlet Report

## Drainage Inlet CB#5

### Grate Inlet

Location	= Sag
Curb Length (ft)	= -0-
Throat Height (in)	= -0-
Grate Area (sqft)	= 7.18
Grate Width (ft)	= 2.08
Grate Length (ft)	= 3.45

### Gutter

Slope, Sw (ft/ft)	= 0.083
Slope, Sx (ft/ft)	= 0.010
Local Depr (in)	= -0-
Gutter Width (ft)	= 2.00
Gutter Slope (%)	= -0-
Gutter n-value	= -0-

### Calculations

Compute by:	Known Q
Q (cfs)	= 0.47

### Highlighted

Q Total (cfs)	= 0.47
Q Capt (cfs)	= 0.47
Q Bypass (cfs)	= -0-
Depth at Inlet (in)	= 1.79
Efficiency (%)	= 100
Gutter Spread (ft)	= 1.80
Gutter Vel (ft/s)	= 0.71
Bypass Spread (ft)	= -0-
Bypass Depth (in)	= -0-

All dimensions in feet

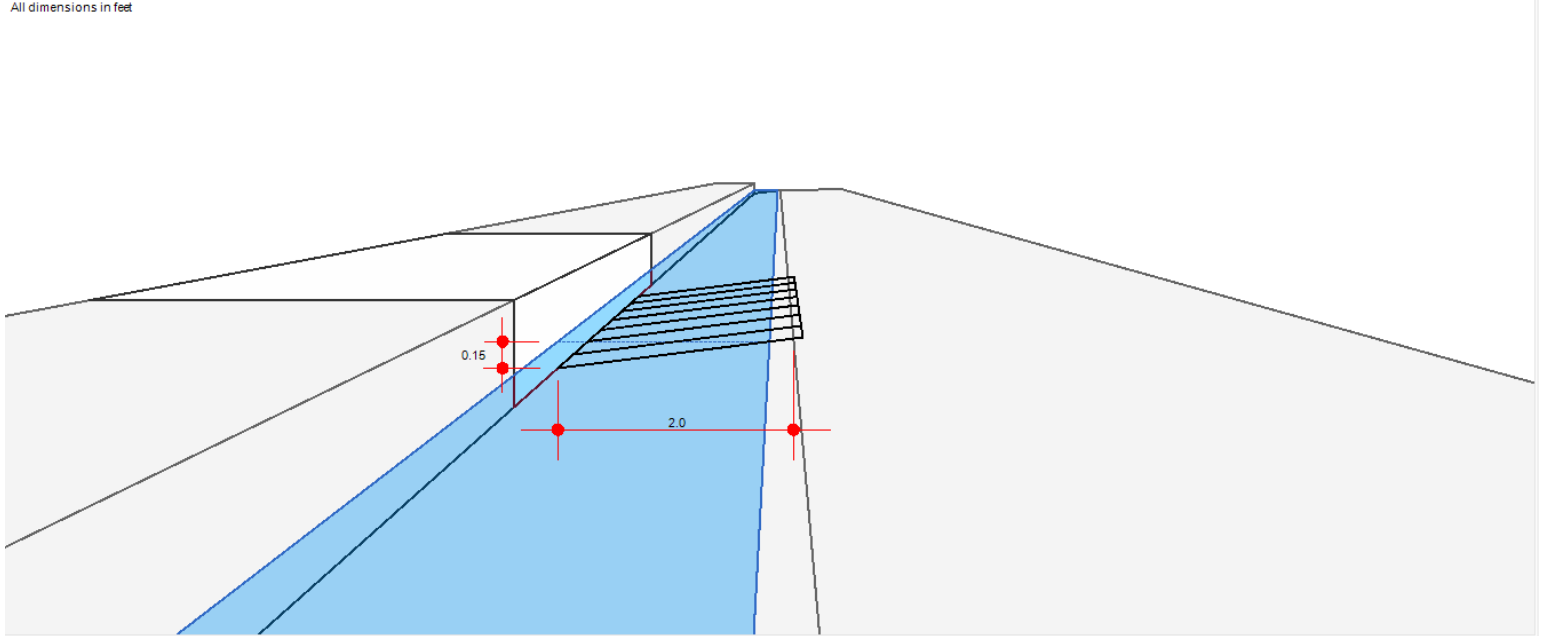

# Inlet Report

## Drainage Inlet CB#6

### Drop Grate Inlet

Location	= Sag
Curb Length (ft)	= -0-
Throat Height (in)	= -0-
Grate Area (sqft)	= 7.18
Grate Width (ft)	= 2.08
Grate Length (ft)	= 3.45

### Gutter

Slope, Sw (ft/ft)	= 0.153
Slope, Sx (ft/ft)	= 0.153
Local Depr (in)	= -0-
Gutter Width (ft)	= 2.08
Gutter Slope (%)	= -0-
Gutter n-value	= -0-

### Calculations

Compute by:	Known Q
Q (cfs)	= 0.04

### Highlighted

Q Total (cfs)	= 0.04
Q Capt (cfs)	= 0.04
Q Bypass (cfs)	= -0-
Depth at Inlet (in)	= 0.14
Efficiency (%)	= 100
Gutter Spread (ft)	= 2.24
Gutter Vel (ft/s)	= 0.71
Bypass Spread (ft)	= -0-
Bypass Depth (in)	= -0-

All dimensions in feet

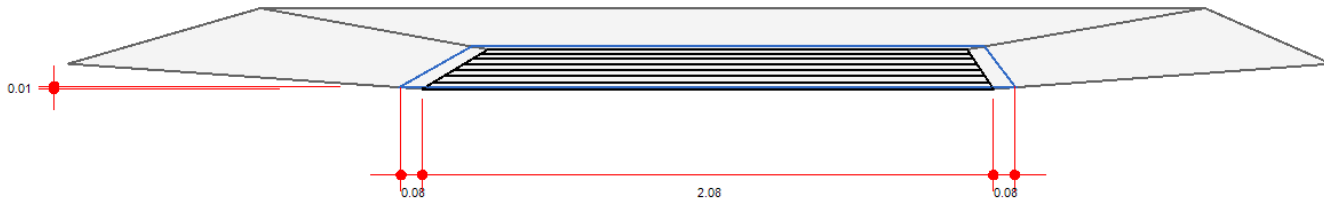

# Inlet Report

## Drainage Inlet CB#7

### Drop Grate Inlet

Location	= Sag
Curb Length (ft)	= -0-
Throat Height (in)	= -0-
Grate Area (sqft)	= 7.18
Grate Width (ft)	= 3.45
Grate Length (ft)	= 2.08

### Gutter

Slope, Sw (ft/ft)	= 0.015
Slope, Sx (ft/ft)	= 0.015
Local Depr (in)	= -0-
Gutter Width (ft)	= 2.00
Gutter Slope (%)	= -0-
Gutter n-value	= -0-

### Calculations

Compute by:	Known Q
Q (cfs)	= 0.94

### Highlighted

Q Total (cfs)	= 0.94
Q Capt (cfs)	= 0.94
Q Bypass (cfs)	= -0-
Depth at Inlet (in)	= 1.11
Efficiency (%)	= 100
Gutter Spread (ft)	= 15.81
Gutter Vel (ft/s)	= 0.22
Bypass Spread (ft)	= -0-
Bypass Depth (in)	= -0-

All dimensions in feet

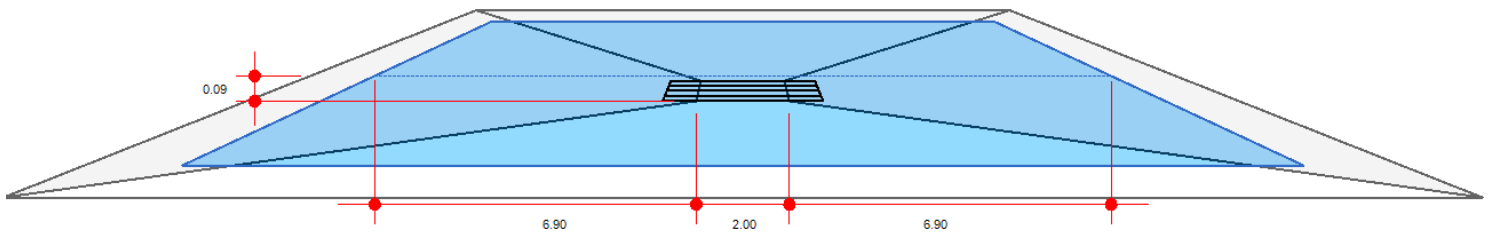



**POST DEVELOPMENT**  
**PIPE FLOW CALCULATIONS**

## RATIONAL METHOD DRAINAGE STUDY

DATE: May 28, 2021

JOB NO.: 19-015

PROJECT Campo Dollar General

FREQ: 100 YEAR

STUDY OF: POST DEVELOPMENT 100-YEAR PIPE ROUTING ANALYSIS

FROM	TO	SUMMAT'N ACREAGE	RUN (FEET)	FALL (FEET)	PIPE SLOPE	VELOCITY (FPS)	TIME OF CONC. (MIN.)		I VALUE	C VALUE	C*A TOTAL	FLOW Q(CFS)	COMMENTS
							CHANGE	TOTAL					
Surface	CB #1	0.353	-	-	-	-	-	22.23	3.432	0.599	0.211	0.726	
CB #1	CB #2	0.353	73.39	0.29	0.40%	2.870	0.43	22.66	3.389	0.599	0.211	0.717	8" PVC @ 0.40%
Surface	CB #2	0.036	-	-	-	-	-	6.37	7.682	0.599	0.022	0.166	
Σ @ CB #2		0.389	-	-	-	-	-	22.66	3.389	0.599	0.233	0.790	
CB #2	CB #3	0.389	159.66	0.64	0.40%	2.920	0.91	23.57	3.304	0.599	0.233	0.770	8" PVC @ 0.40%
Surface	CB #3	0.305	-	-	-	-	-	14.05	4.613	0.599	0.183	0.843	
Σ @ CB #3		0.694	-	-	-	-	-	23.57	3.304	0.599	0.416	1.373	
Surface	CB #4	0.194	-	-	-	-	-	20.86	3.576	0.599	0.116	0.416	
CB #4	CB #5	0.194	103.35	0.41	0.40%	2.490	0.69	21.55	3.501	0.599	0.116	0.407	8" PVC @ 0.40%
Surface	CB #5	0.130	-	-	-	-	-	9.43	5.967	0.599	0.078	0.465	
Σ @ CB #5		0.324	-	-	-	-	-	21.55	3.501	0.599	0.194	0.679	
Surface	SLD#1	0.047						7.02	7.216	0.599	0.028	0.203	
SLD#1	CB #6	0.047	61.10	0.240	0.40%	2.000	0.51	7.53	6.897	0.599	0.028	0.194	8" PVC @ 0.40%
CB #3	CB #6	0.694	61.31	0.25	0.40%	3.330	0.31	23.88	3.277	0.599	0.416	1.362	10" PVC @ 0.40%
CB #5	CB #6	0.324	18.02	0.07	0.40%	2.840	0.11	21.66	3.490	0.599	0.194	0.677	8" PVC @ 0.40%
Surface	CB #6	0.008	-	-	-	-	-	5.00	8.984	0.599	0.005	0.043	
Σ @ CB #6		1.073	-	-	-	-	-	23.88	3.277	0.599	0.643	2.106	
CB #6	OUT #1	1.073	30.27	0.15	0.50%	4.040	0.12	24.00	3.266	0.599	0.643	2.099	12" PVC @ 0.50%
Surface	CB #7	0.217	-	-	-	-	-	7.02	7.216	0.599	0.130	0.938	
CB #7	OUT #2	0.217	21.45	0.09	0.40%	2.930	0.12	7.14	7.138	0.599	0.130	0.928	8" PVC @ 0.40%

Point of Confluence/Longest Path to the Retention Basin (Watershed area 9/DMA-9)

Note: See post development channel reports for pipe flow depth and velocity calculations



# Channel Report

## CB#1 to CB#2

### Circular

Diameter (ft) = 0.67

Invert Elev (ft) = 2628.69

Slope (%) = 0.40

N-Value = 0.011

### Calculations

Compute by: Known Q

Known Q (cfs) = 0.73

### Highlighted

Depth (ft) = 0.45

Q (cfs) = 0.726

Area (sqft) = 0.25

Velocity (ft/s) = 2.87

Wetted Perim (ft) = 1.29

Crit Depth,  $Y_c$  (ft) = 0.41

Top Width (ft) = 0.63

EGL (ft) = 0.58

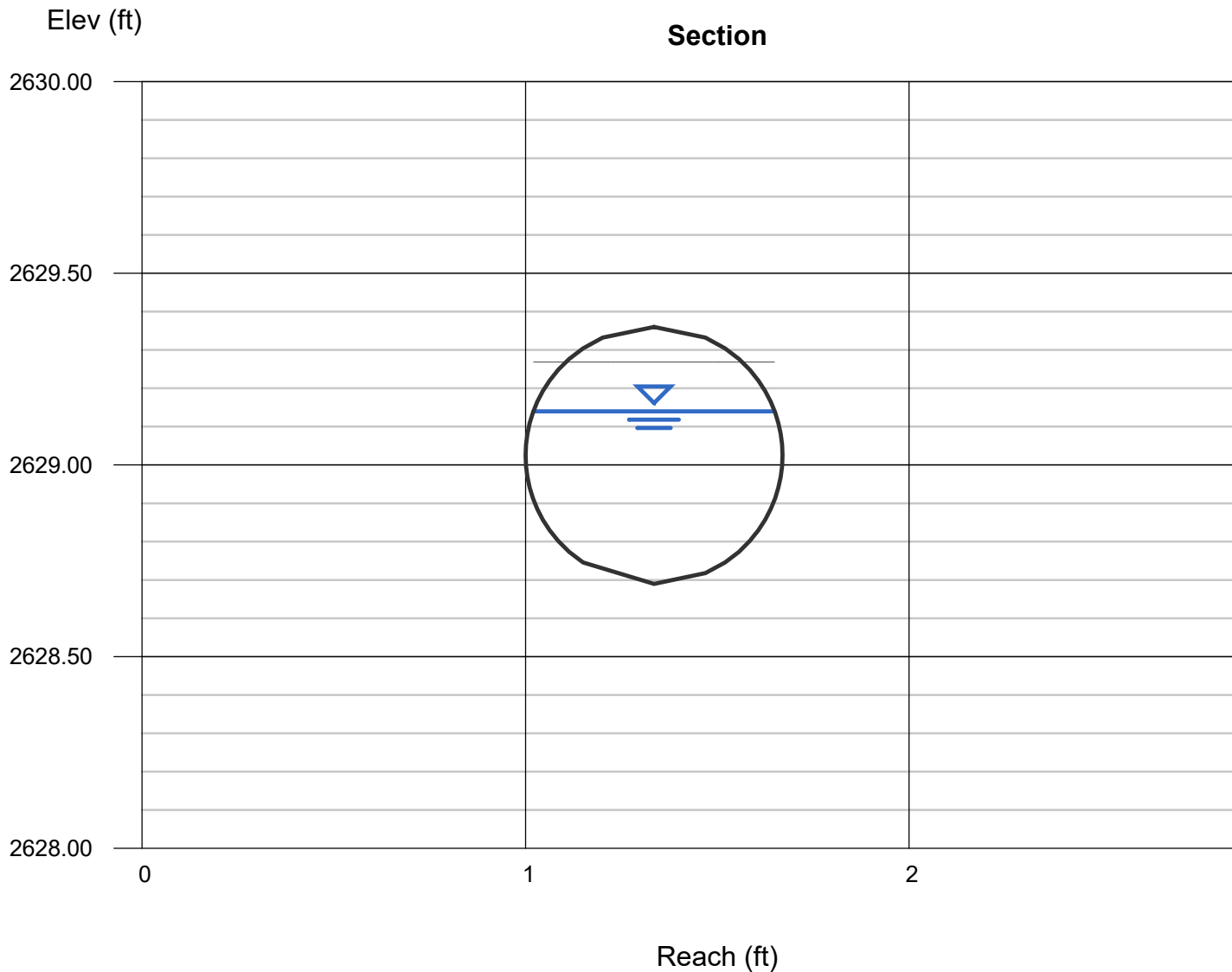

# Channel Report

## CB#2 to CB#3

### Circular

Diameter (ft) = 0.67  
  
Invert Elev (ft) = 2628.30  
Slope (%) = 0.40  
N-Value = 0.011

### Calculations

Compute by: Known Q  
Known Q (cfs) = 0.79

### Highlighted

Depth (ft) = 0.48  
Q (cfs) = 0.790  
Area (sqft) = 0.27  
Velocity (ft/s) = 2.92  
Wetted Perim (ft) = 1.35  
Crit Depth, Yc (ft) = 0.42  
Top Width (ft) = 0.60  
EGL (ft) = 0.61

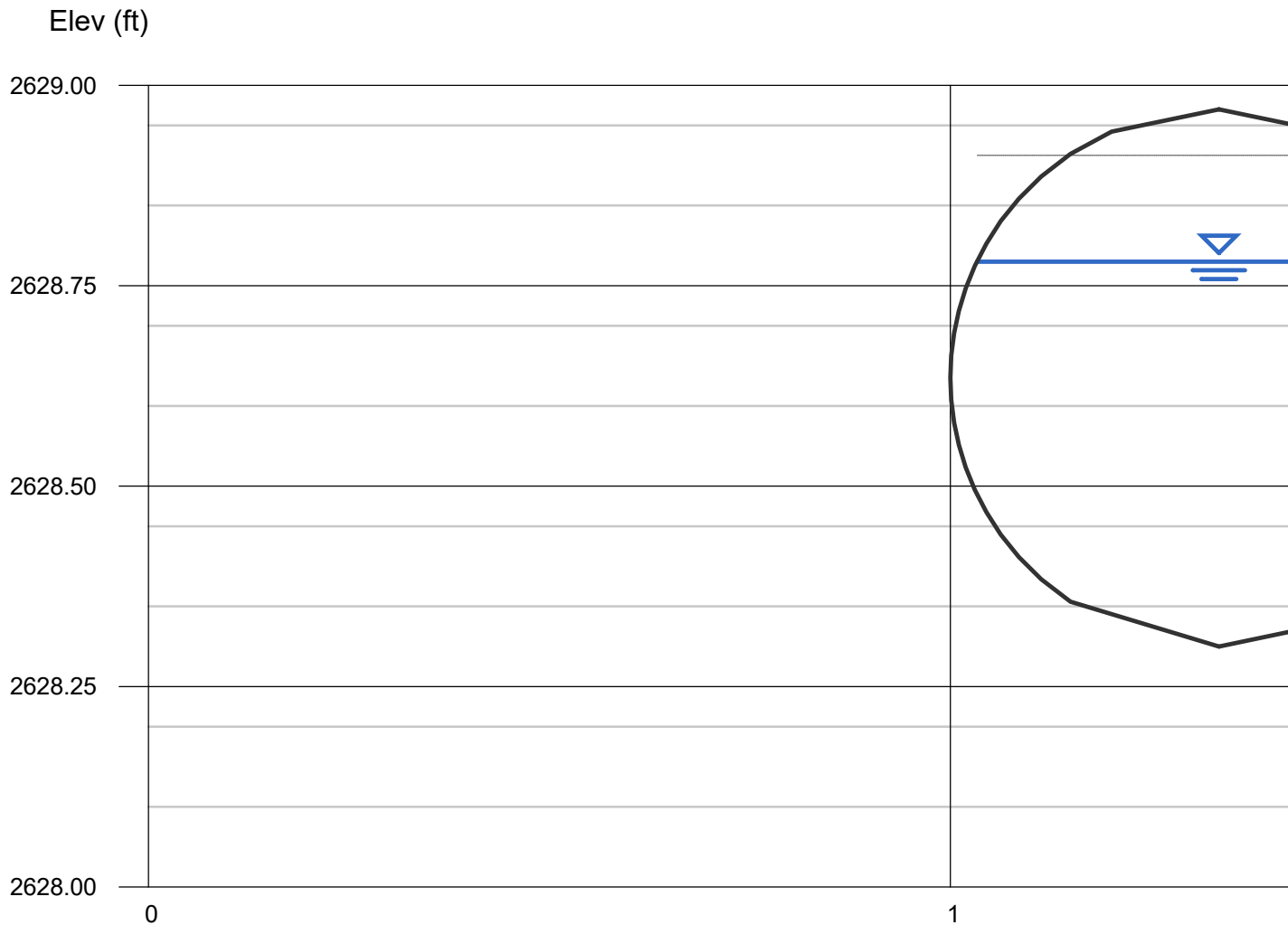

# Channel Report

## CB#4 to CB#5

### Circular

Diameter (ft) = 0.67  
  
Invert Elev (ft) = 2627.90  
Slope (%) = 0.40  
N-Value = 0.011

### Calculations

Compute by: Known Q  
Known Q (cfs) = 0.42

### Highlighted

Depth (ft) = 0.32  
Q (cfs) = 0.416  
Area (sqft) = 0.17  
Velocity (ft/s) = 2.49  
Wetted Perim (ft) = 1.03  
Crit Depth, Yc (ft) = 0.30  
Top Width (ft) = 0.67  
EGL (ft) = 0.42

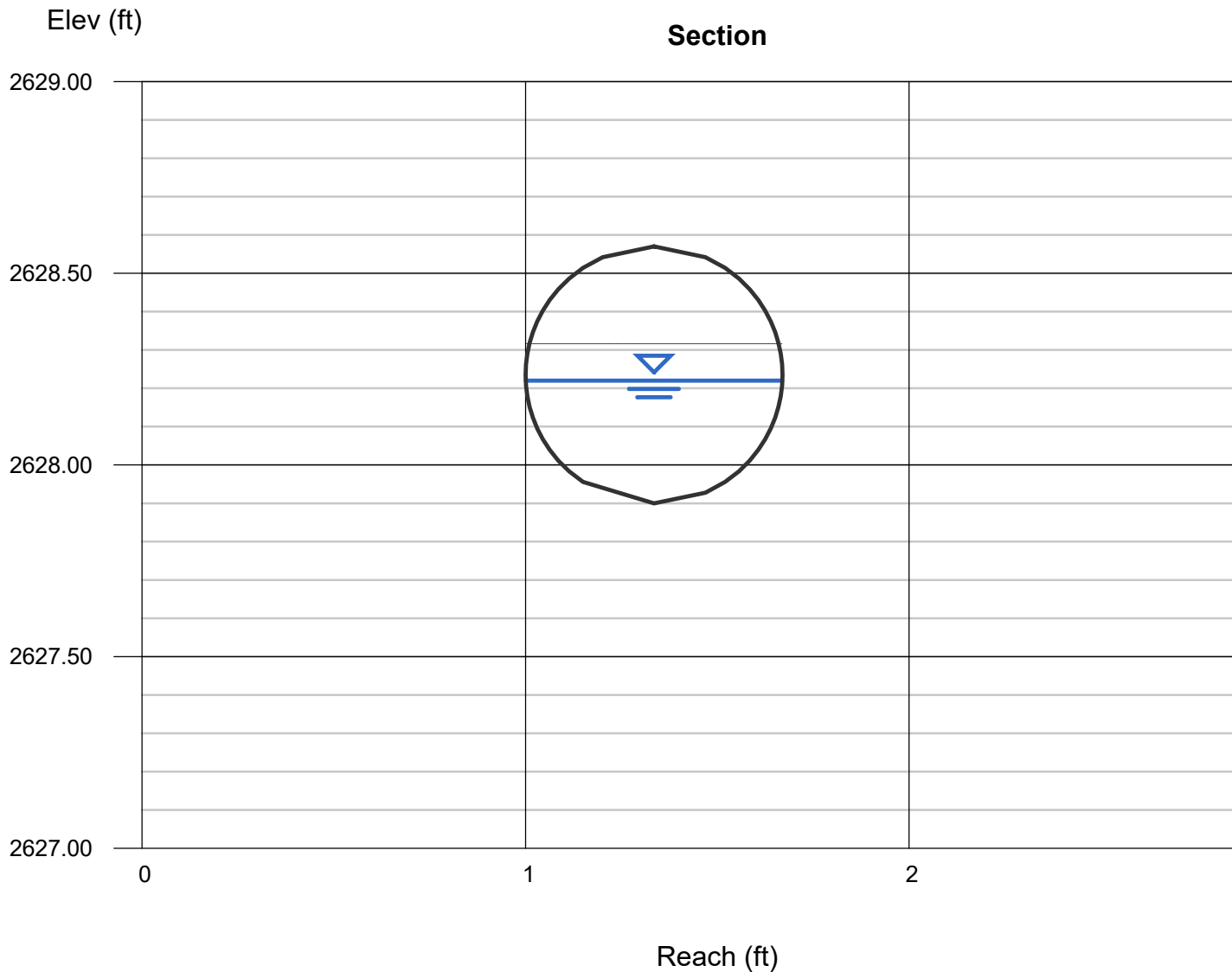

# Channel Report

## CB#3 to CB#6

### Circular

Diameter (ft) = 0.83

Invert Elev (ft) = 2627.49

Slope (%) = 0.40

N-Value = 0.011

### Calculations

Compute by: Known Q

Known Q (cfs) = 1.37

### Highlighted

Depth (ft) = 0.59

Q (cfs) = 1.373

Area (sqft) = 0.41

Velocity (ft/s) = 3.33

Wetted Perim (ft) = 1.67

Crit Depth,  $Y_c$  (ft) = 0.53

Top Width (ft) = 0.75

EGL (ft) = 0.76

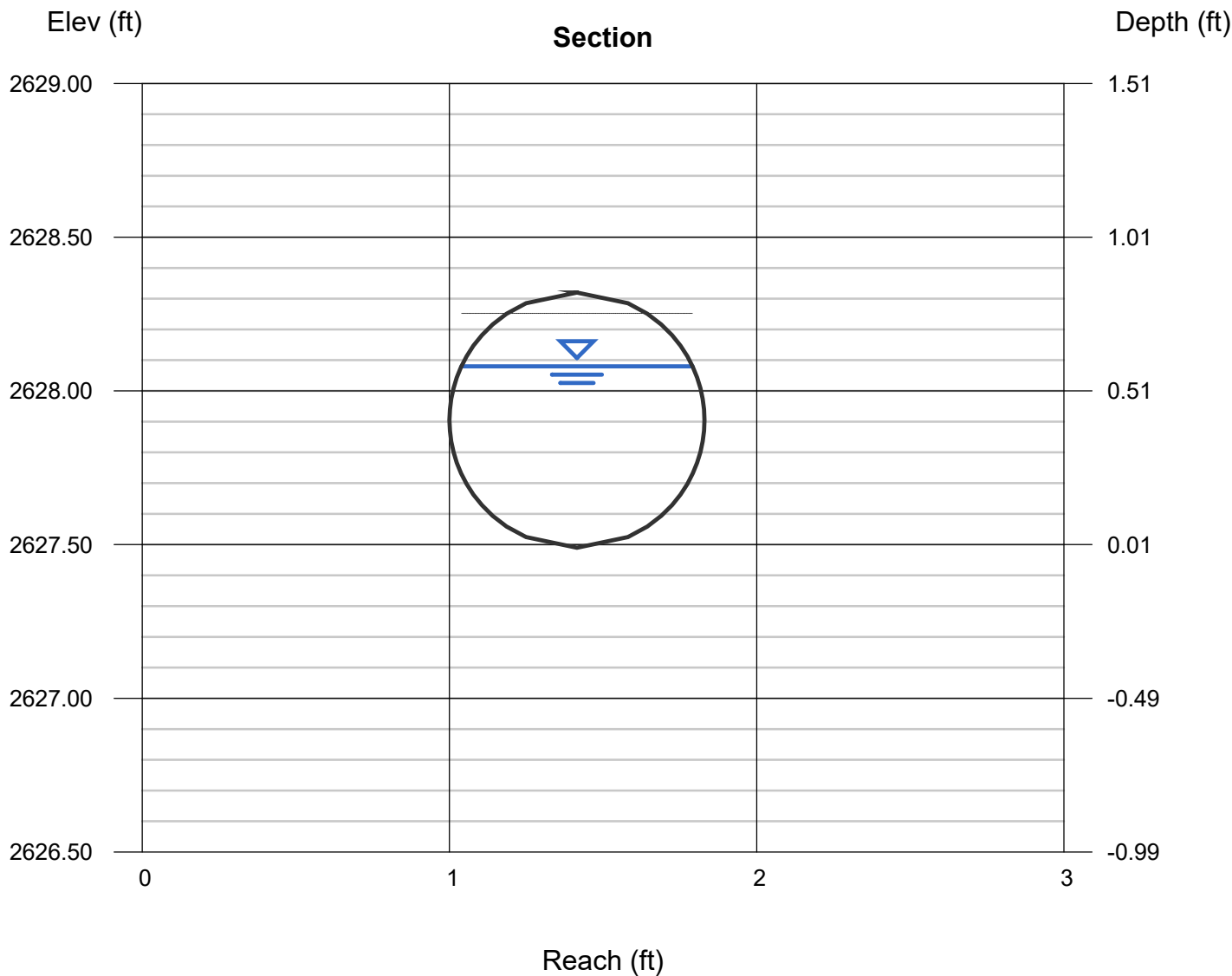



# Channel Report

## SLD#1 to CB#6

### Circular

Diameter (ft) = 0.67  
  
Invert Elev (ft) = 2627.58  
Slope (%) = 0.40  
N-Value = 0.011

### Calculations

Compute by: Known Q  
Known Q (cfs) = 0.20

### Highlighted

Depth (ft) = 0.22  
Q (cfs) = 0.200  
Area (sqft) = 0.10  
Velocity (ft/s) = 1.97  
Wetted Perim (ft) = 0.82  
Crit Depth, Yc (ft) = 0.21  
Top Width (ft) = 0.63  
EGL (ft) = 0.28

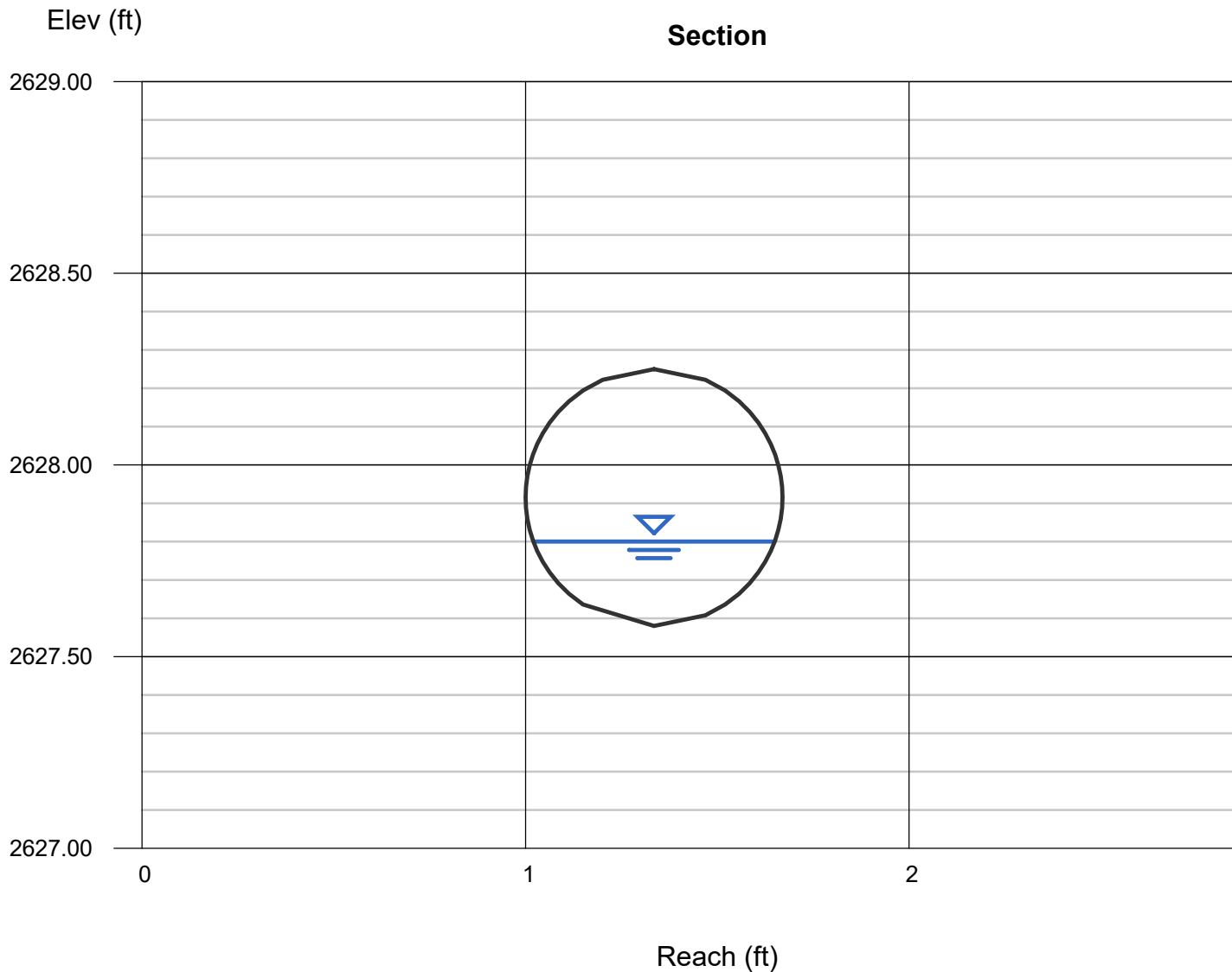

# Channel Report

## CB#6 to OUT#1

### Circular

Diameter (ft) = 1.00  
  
Invert Elev (ft) = 2625.40  
Slope (%) = 0.50  
N-Value = 0.011

### Highlighted

Depth (ft) = 0.63  
Q (cfs) = 2.106  
Area (sqft) = 0.52  
Velocity (ft/s) = 4.04  
Wetted Perim (ft) = 1.83  
Crit Depth, Yc (ft) = 0.62  
Top Width (ft) = 0.97  
EGL (ft) = 0.88

### Calculations

Compute by: Known Q  
Known Q (cfs) = 2.11

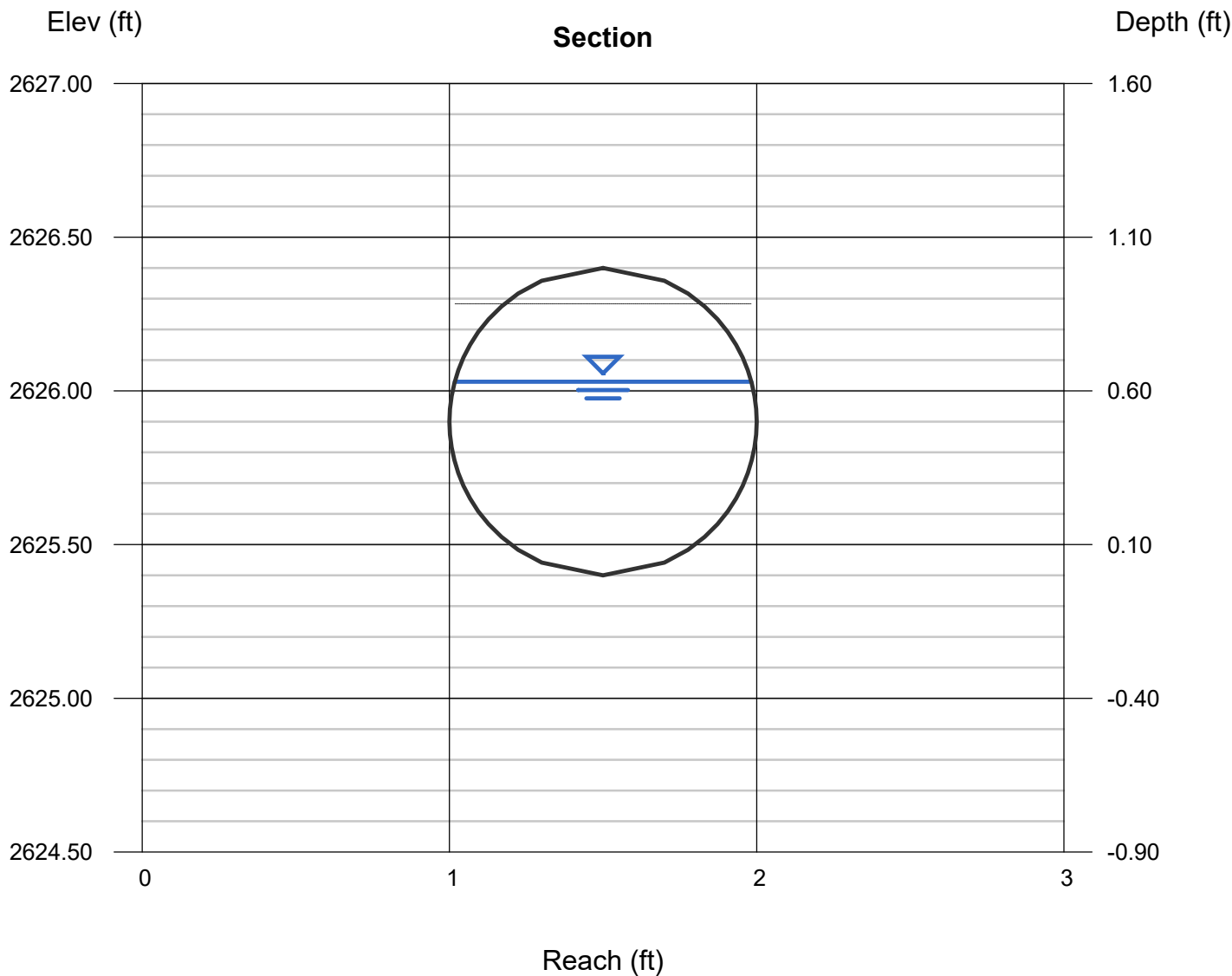

# Channel Report

## CB#7 to OUT#2

### Circular

Diameter (ft) = 0.67

Invert Elev (ft) = 2627.09

Slope (%) = 0.40

N-Value = 0.011

### Calculations

Compute by: Known Q

Known Q (cfs) = 0.94

### Highlighted

Depth (ft) = 0.57

Q (cfs) = 0.938

Area (sqft) = 0.32

Velocity (ft/s) = 2.93

Wetted Perim (ft) = 1.57

Crit Depth, Yc (ft) = 0.46

Top Width (ft) = 0.48

EGL (ft) = 0.70

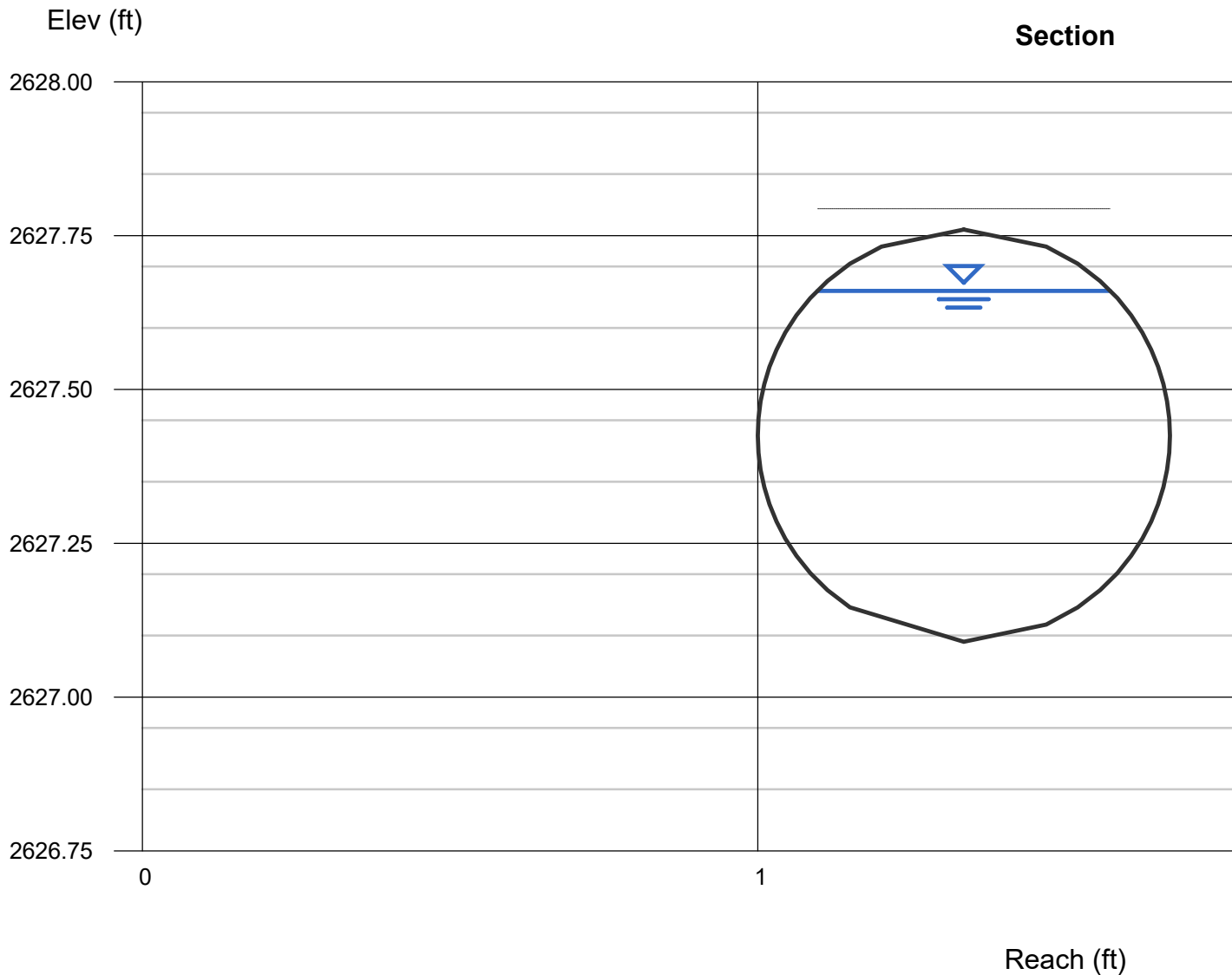



**POST DEVELOPMENT**  
**RETENTION BASIN ANALYSIS**

RAIONAL METHOD HYDROGRAPH PROGRAM  
COPYRIGHT 1992, 2001 RICK ENGINEERING COMPANY

RUN DATE 5/26/2021  
HYDROGRAPH FILE NAME 100-YEAR POST DEVELOPMENT INFLOW TO RETENTION BASIN  
TIME OF CONCENTRATION 24 MIN.  
6 HOUR RAINFALL 3.41 INCHES  
BASIN AREA 1.414 ACRES  
RUNOFF COEFFICIENT 0.599  
PEAK DISCHARGE 2.1 CFS

TIME (MIN) = 0	DISCHARGE (CFS) = 0
TIME (MIN) = 24	DISCHARGE (CFS) = 0.2
TIME (MIN) = 48	DISCHARGE (CFS) = 0.2
TIME (MIN) = 72	DISCHARGE (CFS) = 0.2
TIME (MIN) = 96	DISCHARGE (CFS) = 0.2
TIME (MIN) = 120	DISCHARGE (CFS) = 0.2
TIME (MIN) = 144	DISCHARGE (CFS) = 0.3
TIME (MIN) = 168	DISCHARGE (CFS) = 0.3
TIME (MIN) = 192	DISCHARGE (CFS) = 0.4
TIME (MIN) = 216	DISCHARGE (CFS) = 0.5
TIME (MIN) = 240	DISCHARGE (CFS) = 1.4
TIME (MIN) = 264	DISCHARGE (CFS) = 2.1
TIME (MIN) = 288	DISCHARGE (CFS) = 0.4
TIME (MIN) = 312	DISCHARGE (CFS) = 0.3
TIME (MIN) = 336	DISCHARGE (CFS) = 0.2
TIME (MIN) = 360	DISCHARGE (CFS) = 0.2
TIME (MIN) = 384	DISCHARGE (CFS) = 0

# Hydrograph Report

## Hyd. No. 2

100-Yr Post Dev Runoff

Hydrograph type	= Manual	Peak discharge	= 2.100 cfs
Storm frequency	= 100 yrs	Time to peak	= 4.40 hrs
Time interval	= 24 min	Hyd. volume	= 10,224 cuft

Time of Concentration, Tc

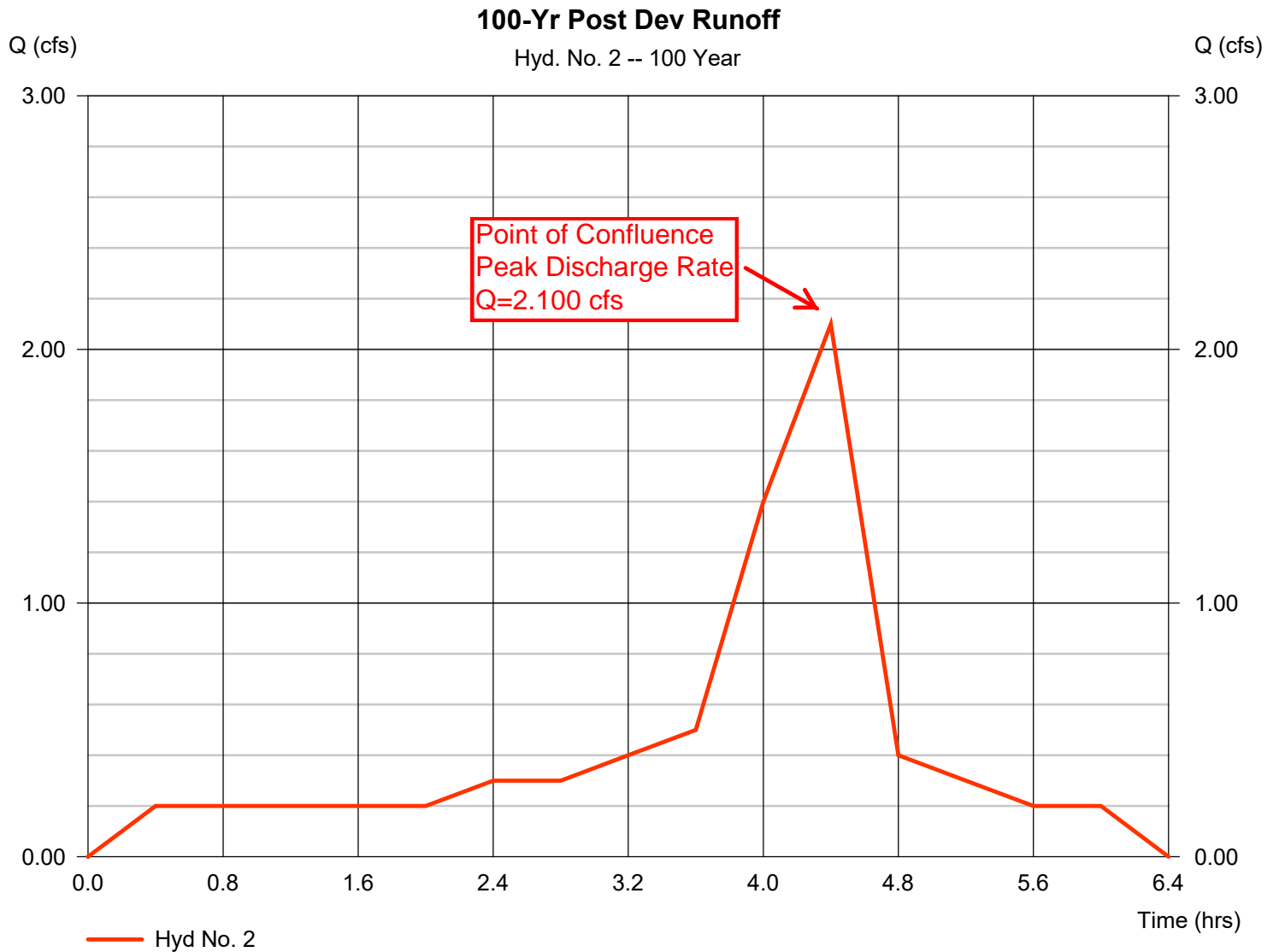

# Hydrograph Report

## Hyd. No. 3

Post Dev to Ret Basin

Hydrograph type	= Reservoir	Peak discharge	= 0.000 cfs
Storm frequency	= 100 yrs	Time to peak	= 12.40 hrs
Time interval	= 24 min	Hyd. volume	= 0 cuft
Inflow hyd. No.	= 2 - 100-Yr Post Development Runoff	Max. Elevation	= 2630.87 ft
Reservoir name	= Ret Basin @ HMP	Max. Storage	= 9,355 cuft

Storage Indication method used. Exfiltration extracted from Outflow.

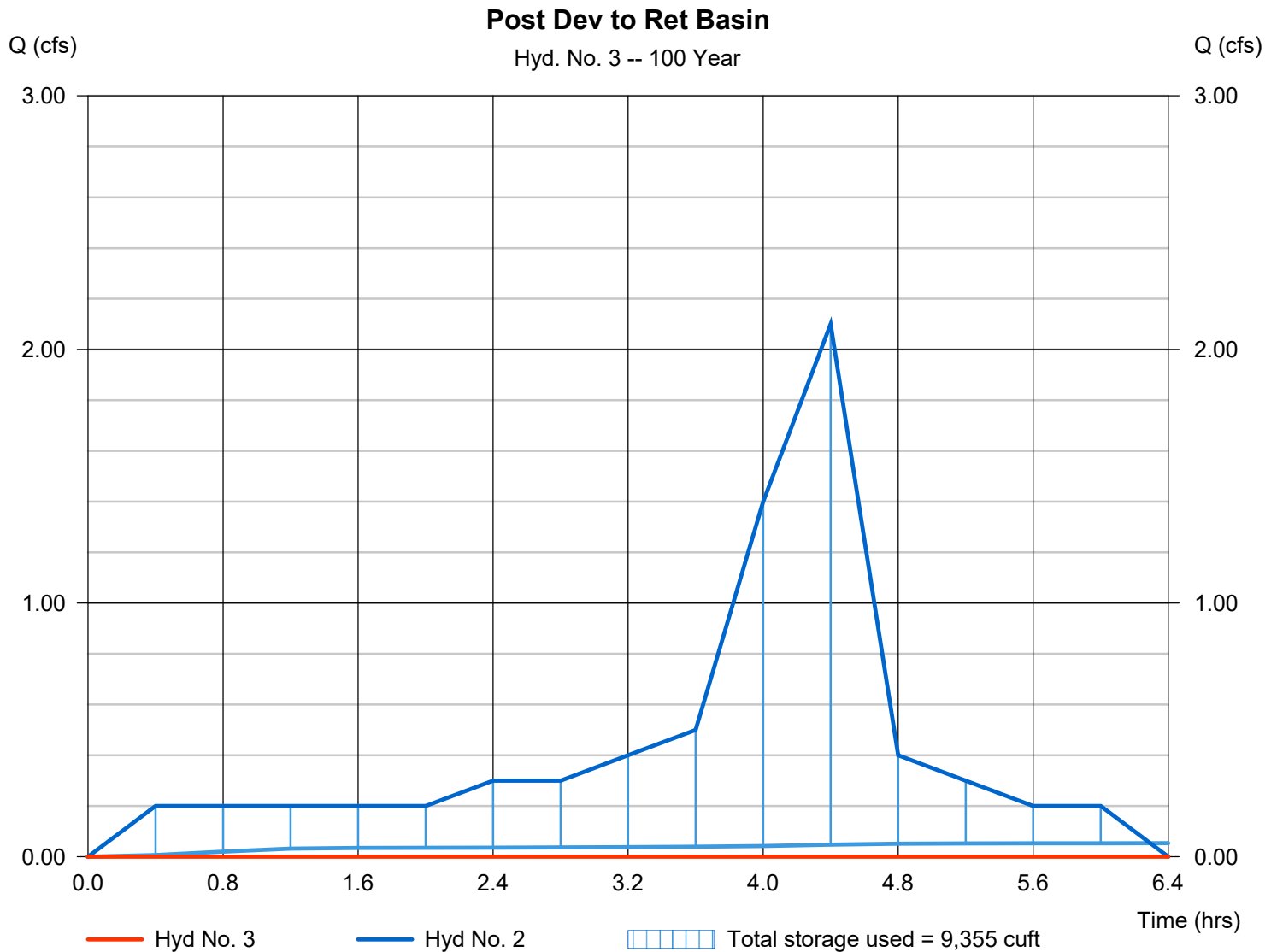

# Pond Report

Hydraflow Hydrographs Extension for Autodesk® Civil 3D® 2019 by Autodesk, Inc. v2019.2

Tuesday, 05 / 25 / 2021

## Pond No. 1 - Retention Pond From HMP Elevation

### Pond Data

Contours -User-defined contour areas. Conic method used for volume calculation. Beginning Elevation = 2628.25 ft

### Stage / Storage Table

Stage (ft)	Elevation (ft)	Contour area (sqft)	Incr. Storage (cuft)	Total storage (cuft)
0.00	2628.25	2,719	0	0
0.25	2628.50	2,874	699	699
0.50	2628.75	3,032	738	1,437
0.75	2629.00	3,193	778	2,215
1.00	2629.25	3,358	819	3,034
1.25	2629.50	3,527	860	3,894
1.50	2629.75	3,699	903	4,797
1.75	2630.00	3,874	946	5,744
2.00	2630.25	4,054	991	6,734
2.25	2630.50	4,236	1,036	7,770
2.50	2630.75	4,423	1,082	8,853
2.75	2631.00	4,612	1,129	9,982
3.00	2631.25	4,806	1,177	11,159
3.25	2631.50	5,003	1,226	12,385
3.50	2631.75	5,203	1,275	13,660
3.75	2632.00	5,407	1,326	14,986

0 ← HMP WATER LEVEL

### Culvert / Orifice Structures

	[A]	[B]	[C]	[PrfRsr]	[A]	[B]	[C]	[D]
Rise (in)	= 12.00	0.00	0.00	0.00	Crest Len (ft)	= 7.27	0.00	0.00
Span (in)	= 12.00	0.00	0.00	0.00	Crest EI. (ft)	= 2631.00	0.00	0.00
No. Barrels	= 1	0	0	0	Weir Coeff.	= 3.33	3.33	3.33
Invert EI. (ft)	= 2629.44	0.00	0.00	0.00	Weir Type	= 1	---	---
Length (ft)	= 9.40	0.00	0.00	0.00	Multi-Stage	= Yes	No	No
Slope (%)	= 0.40	0.00	0.00	n/a				
N-Value	= .011	.013	.013	n/a				
Orifice Coeff.	= 1.00	0.60	0.60	0.60	Exfil. (in/hr)	= 0.510 (by Contour) ←	INFILTRATION RATE	
Multi-Stage	= n/a	No	No	No	TW Elev. (ft)	= 0.00		

Note: Culvert/Orifice outflows are analyzed under inlet (ic) and outlet (oc) control. Weir risers checked for orifice conditions (ic) and submergence (s).

### Stage / Discharge

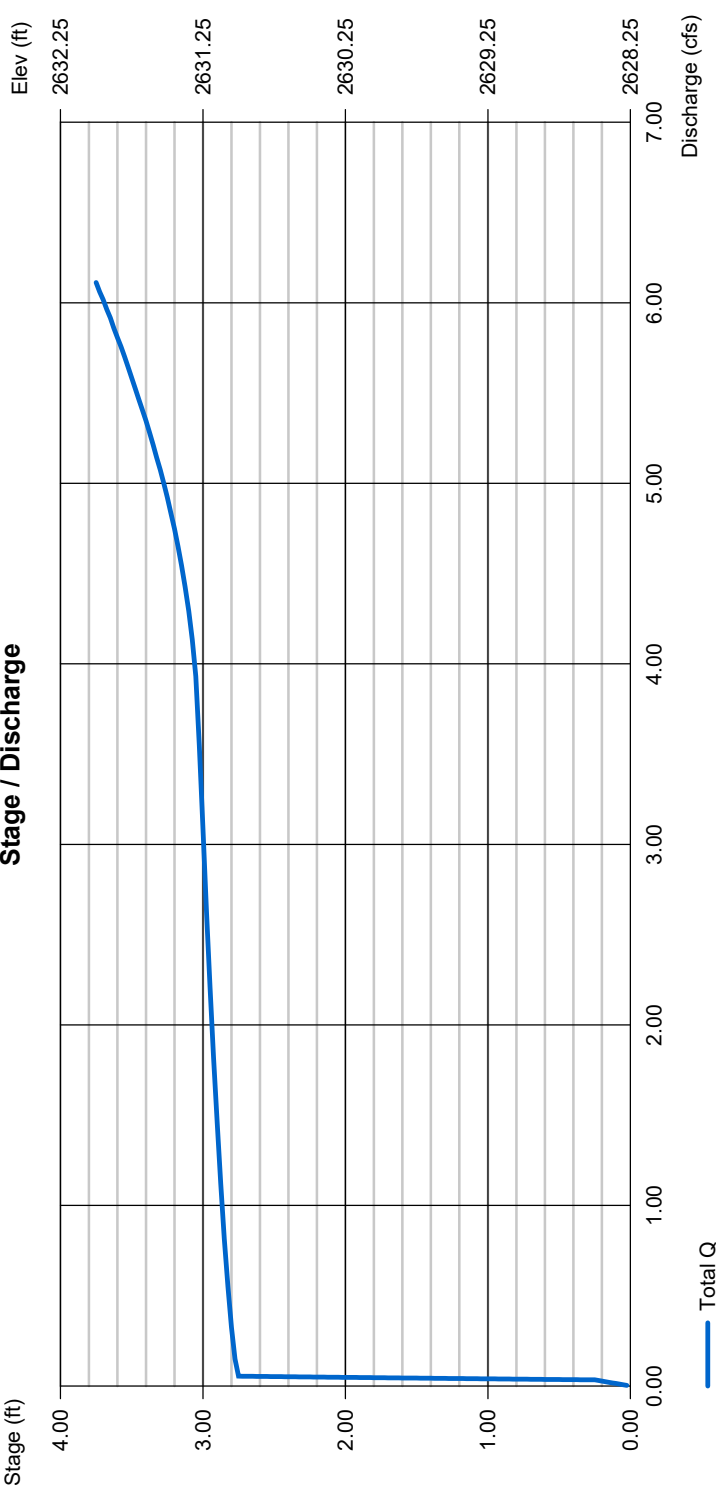

# Pond Report

Hydraflow Hydrographs Extension for Autodesk® Civil 3D® 2019 by Autodesk, Inc. v2019.2

Tuesday, 05 / 25 / 2021

## Pond No. 1 - Retention Pond From HMP Elevation

### Pond Data

Contours -User-defined contour areas. Conic method used for volume calculation. Beginning Elevation = 2628.25 ft

### Stage / Storage Table

Stage (ft)	Elevation (ft)	Contour area (sqft)	Incr. Storage (cuft)	Total storage (cuft)
0.00	2628.25	2,719	0	0
0.25	2628.50	2,874	699	699
0.50	2628.75	3,032	738	1,437
0.75	2629.00	3,193	778	2,215
1.00	2629.25	3,358	819	3,034
1.25	2629.50	3,527	860	3,894
1.50	2629.75	3,699	903	4,797
1.75	2630.00	3,874	946	5,744
2.00	2630.25	4,054	991	6,734
2.25	2630.50	4,236	1,036	7,770
2.50	2630.75	4,423	1,082	8,853
2.75	2631.00	4,612	1,129	9,982
3.00	2631.25	4,806	1,177	11,159
3.25	2631.50	5,003	1,226	12,385
3.50	2631.75	5,203	1,275	13,660
3.75	2632.00	5,407	1,326	14,986

← HMP WATER LEVEL

### Culvert / Orifice Structures

	[A]	[B]	[C]	[PrfRsr]	[A]	[B]	[C]	[D]
Rise (in)	= 12.00	0.00	0.00	0.00	Crest Len (ft)	= 7.27	0.00	0.00
Span (in)	= 12.00	0.00	0.00	0.00	Crest EI. (ft)	= 2631.00	0.00	0.00
No. Barrels	= 1	0	0	0	Weir Coeff.	= 3.33	3.33	3.33
Invert EI. (ft)	= 2629.44	0.00	0.00	0.00	Weir Type	= 1	---	---
Length (ft)	= 9.40	0.00	0.00	0.00	Multi-Stage	= Yes	No	No
Slope (%)	= 0.40	0.00	0.00	n/a				
N-Value	= .011	.013	.013	n/a				
Orifice Coeff.	= 1.00	0.60	0.60	0.60	Exfil. (in/hr)	= 0.510 (by Contour) ←	INFILTRATION RATE	
Multi-Stage	= n/a	No	No	No	TW Elev. (ft)	= 0.00		

### Weir Structures

Note: Culvert/Orifice outflows are analyzed under inlet (ic) and outlet (oc) control. Weir risers checked for orifice conditions (ic) and submergence (s).

### Stage / Storage

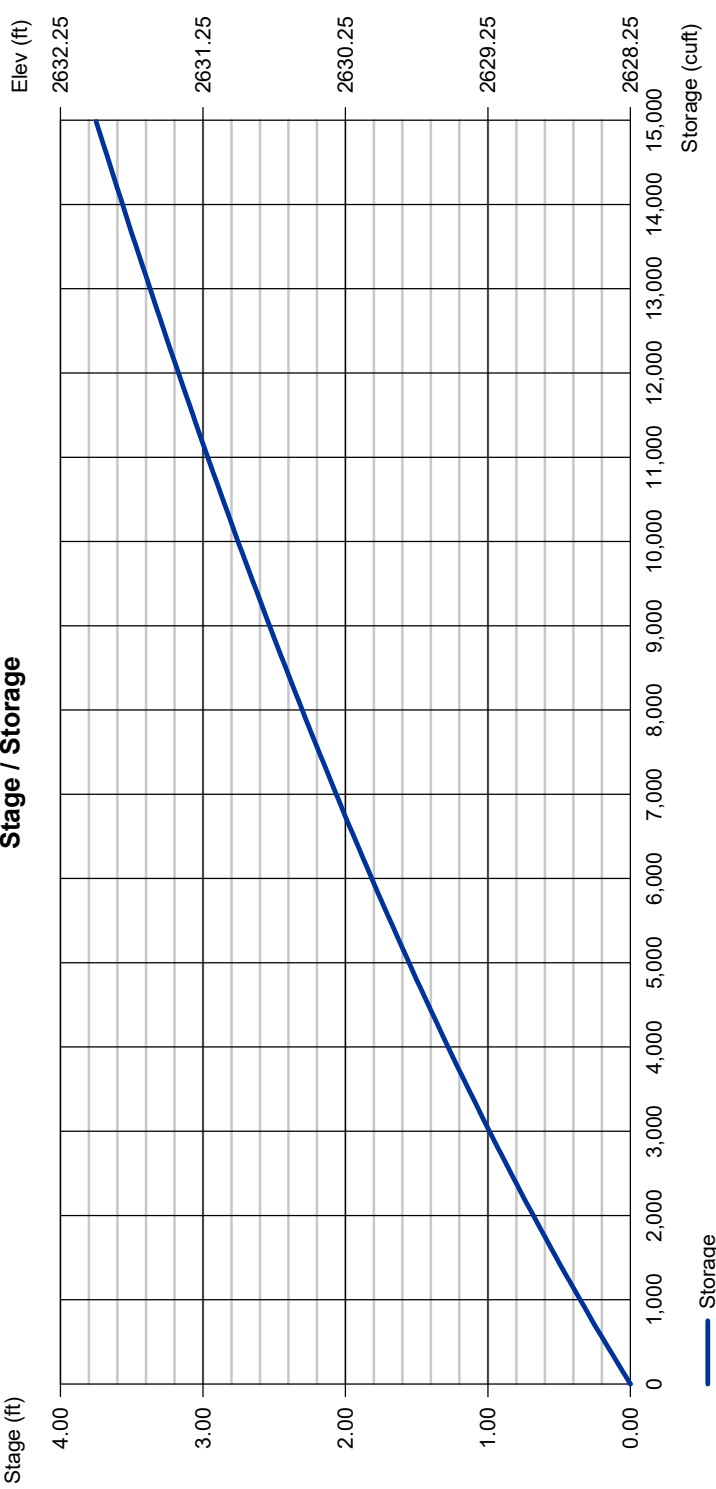

# Pond Report

## Pond No. 1 - Retention Pond From HMP Elevation

### Pond Data

Contours -User-defined contour areas. Conic method used for volume calculation. Begining Elevation = 2628.25 ft

### Stage / Storage Table

Stage (ft)	Elevation (ft)	Contour area (sqft)	Incr. Storage (cuft)	Total storage (cuft)
0.00	2628.25	2,719	0	0 ← HMP WATER LEVEL
0.25	2628.50	2,874	699	699
0.50	2628.75	3,032	738	1,437
0.75	2629.00	3,193	778	2,215
1.00	2629.25	3,358	819	3,034
1.25	2629.50	3,527	860	3,894
1.50	2629.75	3,699	903	4,797
1.75	2630.00	3,874	946	5,744
2.00	2630.25	4,054	991	6,734
2.25	2630.50	4,236	1,036	7,770
2.50	2630.75	4,423	1,082	8,853
2.75	2631.00	4,612	1,129	9,982
3.00	2631.25	4,806	1,177	11,159
3.25	2631.50	5,003	1,226	12,385
3.50	2631.75	5,203	1,275	13,660
3.75	2632.00	5,407	1,326	14,986

### Culvert / Orifice Structures

	[A]	[B]	[C]	[PrfRsr]
Rise (in)	= 12.00	0.00	0.00	0.00
Span (in)	= 12.00	0.00	0.00	0.00
No. Barrels	= 1	0	0	0
Invert El. (ft)	= 2629.44	0.00	0.00	0.00
Length (ft)	= 9.40	0.00	0.00	0.00
Slope (%)	= 0.40	0.00	0.00	n/a
N-Value	= .011	.013	.013	n/a
Orifice Coeff.	= 1.00	0.60	0.60	0.60
Multi-Stage	= n/a	No	No	No

### Weir Structures

	[A]	[B]	[C]	[D]
Crest Len (ft)	= 7.27	0.00	0.00	0.00
Crest El. (ft)	= 2631.00	0.00	0.00	0.00
Weir Coeff.	= 3.33	3.33	3.33	3.33
Weir Type	= 1	---	---	---
Multi-Stage	= Yes	No	No	No
Exfil.(in/hr)	= 0.510 (by Contour) ← INFILTRATION RATE			
TW Elev. (ft)	= 0.00			

Note: Culvert/Orifice outflows are analyzed under inlet (ic) and outlet (oc) control. Weir risers checked for orifice conditions (ic) and submergence (s).

### Stage / Storage / Discharge Table

Stage ft	Storage cuft	Elevation ft	Civ A cfs	Civ B cfs	Civ C cfs	PrfRsr cfs	Wr A cfs	Wr B cfs	Wr C cfs	Wr D cfs	Exfil cfs	User cfs	Total cfs
0.00	0	2628.25	0.00	---	---	---	0.00	---	---	---	0.000	---	0.000
0.03	70	2628.27	0.00	---	---	---	0.00	---	---	---	0.003	---	0.003
0.05	140	2628.30	0.00	---	---	---	0.00	---	---	---	0.007	---	0.007
0.08	210	2628.32	0.00	---	---	---	0.00	---	---	---	0.010	---	0.010
0.10	280	2628.35	0.00	---	---	---	0.00	---	---	---	0.014	---	0.014
0.13	349	2628.38	0.00	---	---	---	0.00	---	---	---	0.017	---	0.017
0.15	419	2628.40	0.00	---	---	---	0.00	---	---	---	0.020	---	0.020
0.17	489	2628.42	0.00	---	---	---	0.00	---	---	---	0.024	---	0.024
0.20	559	2628.45	0.00	---	---	---	0.00	---	---	---	0.027	---	0.027
0.22	629	2628.47	0.00	---	---	---	0.00	---	---	---	0.031	---	0.031
0.25	699	2628.50	0.00	---	---	---	0.00	---	---	---	0.034	---	0.034
0.28	773	2628.52	0.00	---	---	---	0.00	---	---	---	0.034	---	0.034
0.30	847	2628.55	0.00	---	---	---	0.00	---	---	---	0.034	---	0.034
0.32	920	2628.57	0.00	---	---	---	0.00	---	---	---	0.034	---	0.034
0.35	994	2628.60	0.00	---	---	---	0.00	---	---	---	0.035	---	0.035
0.38	1,068	2628.63	0.00	---	---	---	0.00	---	---	---	0.035	---	0.035
0.40	1,142	2628.65	0.00	---	---	---	0.00	---	---	---	0.035	---	0.035
0.43	1,216	2628.67	0.00	---	---	---	0.00	---	---	---	0.035	---	0.035
0.45	1,289	2628.70	0.00	---	---	---	0.00	---	---	---	0.035	---	0.035
0.48	1,363	2628.72	0.00	---	---	---	0.00	---	---	---	0.036	---	0.036
0.50	1,437	2628.75	0.00	---	---	---	0.00	---	---	---	0.036	---	0.036
0.52	1,515	2628.77	0.00	---	---	---	0.00	---	---	---	0.036	---	0.036
0.55	1,593	2628.80	0.00	---	---	---	0.00	---	---	---	0.036	---	0.036
0.57	1,670	2628.82	0.00	---	---	---	0.00	---	---	---	0.036	---	0.036
0.60	1,748	2628.85	0.00	---	---	---	0.00	---	---	---	0.037	---	0.037
0.62	1,826	2628.88	0.00	---	---	---	0.00	---	---	---	0.037	---	0.037
0.65	1,904	2628.90	0.00	---	---	---	0.00	---	---	---	0.037	---	0.037

Continues on next page...

## Retention Pond From HMP Elevation

**Stage / Storage / Discharge Table**

Stage ft	Storage cuft	Elevation ft	Civ A cfs	Civ B cfs	Civ C cfs	PrfRsr cfs	Wr A cfs	Wr B cfs	Wr C cfs	Wr D cfs	Exfil cfs	User cfs	Total cfs
0.67	1,981	2628.92	0.00	---	---	---	0.00	---	---	---	0.037	---	0.037
0.70	2,059	2628.95	0.00	---	---	---	0.00	---	---	---	0.037	---	0.037
0.72	2,137	2628.97	0.00	---	---	---	0.00	---	---	---	0.038	---	0.038
0.75	2,215	2629.00	0.00	---	---	---	0.00	---	---	---	0.038	---	0.038
0.77	2,297	2629.02	0.00	---	---	---	0.00	---	---	---	0.038	---	0.038
0.80	2,379	2629.05	0.00	---	---	---	0.00	---	---	---	0.038	---	0.038
0.82	2,460	2629.07	0.00	---	---	---	0.00	---	---	---	0.038	---	0.038
0.85	2,542	2629.10	0.00	---	---	---	0.00	---	---	---	0.038	---	0.038
0.87	2,624	2629.13	0.00	---	---	---	0.00	---	---	---	0.039	---	0.039
0.90	2,706	2629.15	0.00	---	---	---	0.00	---	---	---	0.039	---	0.039
0.92	2,788	2629.17	0.00	---	---	---	0.00	---	---	---	0.039	---	0.039
0.95	2,870	2629.20	0.00	---	---	---	0.00	---	---	---	0.039	---	0.039
0.97	2,952	2629.22	0.00	---	---	---	0.00	---	---	---	0.039	---	0.039
1.00	3,034	2629.25	0.00	---	---	---	0.00	---	---	---	0.040	---	0.040
1.02	3,120	2629.27	0.00	---	---	---	0.00	---	---	---	0.040	---	0.040
1.05	3,206	2629.30	0.00	---	---	---	0.00	---	---	---	0.040	---	0.040
1.08	3,292	2629.32	0.00	---	---	---	0.00	---	---	---	0.040	---	0.040
1.10	3,378	2629.35	0.00	---	---	---	0.00	---	---	---	0.040	---	0.040
1.13	3,464	2629.38	0.00	---	---	---	0.00	---	---	---	0.041	---	0.041
1.15	3,550	2629.40	0.00	---	---	---	0.00	---	---	---	0.041	---	0.041
1.17	3,636	2629.42	0.00	---	---	---	0.00	---	---	---	0.041	---	0.041
1.20	3,722	2629.45	0.00	---	---	---	0.00	---	---	---	0.041	---	0.041
1.23	3,808	2629.47	0.00	---	---	---	0.00	---	---	---	0.041	---	0.041
1.25	3,894	2629.50	0.00	---	---	---	0.00	---	---	---	0.042	---	0.042
1.27	3,984	2629.52	0.00	---	---	---	0.00	---	---	---	0.042	---	0.042
1.30	4,075	2629.55	0.00	---	---	---	0.00	---	---	---	0.042	---	0.042
1.33	4,165	2629.57	0.00	---	---	---	0.00	---	---	---	0.042	---	0.042
1.35	4,255	2629.60	0.00	---	---	---	0.00	---	---	---	0.042	---	0.042
1.38	4,346	2629.63	0.00	---	---	---	0.00	---	---	---	0.043	---	0.043
1.40	4,436	2629.65	0.00	---	---	---	0.00	---	---	---	0.043	---	0.043
1.42	4,526	2629.67	0.00	---	---	---	0.00	---	---	---	0.043	---	0.043
1.45	4,616	2629.70	0.00	---	---	---	0.00	---	---	---	0.043	---	0.043
1.48	4,707	2629.72	0.00	---	---	---	0.00	---	---	---	0.043	---	0.043
1.50	4,797	2629.75	0.00	---	---	---	0.00	---	---	---	0.044	---	0.044
1.52	4,892	2629.77	0.00	---	---	---	0.00	---	---	---	0.044	---	0.044
1.55	4,986	2629.80	0.00	---	---	---	0.00	---	---	---	0.044	---	0.044
1.58	5,081	2629.82	0.00	---	---	---	0.00	---	---	---	0.044	---	0.044
1.60	5,176	2629.85	0.00	---	---	---	0.00	---	---	---	0.044	---	0.044
1.63	5,270	2629.88	0.00	---	---	---	0.00	---	---	---	0.045	---	0.045
1.65	5,365	2629.90	0.00	---	---	---	0.00	---	---	---	0.045	---	0.045
1.67	5,460	2629.92	0.00	---	---	---	0.00	---	---	---	0.045	---	0.045
1.70	5,554	2629.95	0.00	---	---	---	0.00	---	---	---	0.045	---	0.045
1.73	5,649	2629.97	0.00	---	---	---	0.00	---	---	---	0.046	---	0.046
1.75	5,744	2630.00	0.00	---	---	---	0.00	---	---	---	0.046	---	0.046
1.77	5,843	2630.02	0.00	---	---	---	0.00	---	---	---	0.046	---	0.046
1.80	5,942	2630.05	0.00	---	---	---	0.00	---	---	---	0.046	---	0.046
1.83	6,041	2630.07	0.00	---	---	---	0.00	---	---	---	0.046	---	0.046
1.85	6,140	2630.10	0.00	---	---	---	0.00	---	---	---	0.047	---	0.047
1.88	6,239	2630.13	0.00	---	---	---	0.00	---	---	---	0.047	---	0.047
1.90	6,338	2630.15	0.00	---	---	---	0.00	---	---	---	0.047	---	0.047
1.92	6,437	2630.17	0.00	---	---	---	0.00	---	---	---	0.047	---	0.047
1.95	6,536	2630.20	0.00	---	---	---	0.00	---	---	---	0.047	---	0.047
1.98	6,635	2630.22	0.00	---	---	---	0.00	---	---	---	0.048	---	0.048
2.00	6,734	2630.25	0.00	---	---	---	0.00	---	---	---	0.048	---	0.048
2.03	6,838	2630.27	0.00	---	---	---	0.00	---	---	---	0.048	---	0.048
2.05	6,942	2630.30	0.00	---	---	---	0.00	---	---	---	0.048	---	0.048
2.08	7,045	2630.32	0.00	---	---	---	0.00	---	---	---	0.049	---	0.049
2.10	7,149	2630.35	0.00	---	---	---	0.00	---	---	---	0.049	---	0.049
2.13	7,252	2630.38	0.00	---	---	---	0.00	---	---	---	0.049	---	0.049
2.15	7,356	2630.40	0.00	---	---	---	0.00	---	---	---	0.049	---	0.049
2.18	7,460	2630.42	0.00	---	---	---	0.00	---	---	---	0.049	---	0.049
2.20	7,563	2630.45	0.00	---	---	---	0.00	---	---	---	0.050	---	0.050
2.23	7,667	2630.47	0.00	---	---	---	0.00	---	---	---	0.050	---	0.050
2.25	7,770	2630.50	0.00	---	---	---	0.00	---	---	---	0.050	---	0.050
2.28	7,879	2630.52	0.00	---	---	---	0.00	---	---	---	0.050	---	0.050
2.30	7,987	2630.55	0.00	---	---	---	0.00	---	---	---	0.050	---	0.050
2.33	8,095	2630.57	0.00	---	---	---	0.00	---	---	---	0.051	---	0.051
2.35	8,203	2630.60	0.00	---	---	---	0.00	---	---	---	0.051	---	0.051
2.38	8,312	2630.63	0.00	---	---	---	0.00	---	---	---	0.051	---	0.051
2.40	8,420	2630.65	0.00	---	---	---	0.00	---	---	---	0.051	---	0.051
2.43	8,528	2630.67	0.00	---	---	---	0.00	---	---	---	0.052	---	0.052
2.45	8,636	2630.70	0.00	---	---	---	0.00	---	---	---	0.052	---	0.052

Continues on next page...



Retention Pond From HMP Elevation

**Stage / Storage / Discharge Table**

Stage ft	Storage cuft	Elevation ft	Clv A cfs	Clv B cfs	Clv C cfs	PrfRsr cfs	Wr A cfs	Wr B cfs	Wr C cfs	Wr D cfs	Exfil cfs	User cfs	Total cfs
2.48	8,744	2630.72	0.00	---	---	---	0.00	---	---	---	0.052	---	0.052
2.50	8,853	2630.75	0.00	---	---	---	0.00	---	---	---	0.052	---	0.052
2.53	8,966	2630.77	0.00	---	---	---	0.00	---	---	---	0.052	---	0.052
2.55	9,078	2630.80	0.00	---	---	---	0.00	---	---	---	0.053	---	0.053
2.58	9,191	2630.82	0.00	---	---	---	0.00	---	---	---	0.053	---	0.053
2.60	9,304	2630.85	0.00	Q100 WTR LEVEL			0.00	---	---	---	0.053	---	0.053
2.63	9,417	2630.88	0.00	---	---	---	0.00	---	---	---	0.053	---	0.053
2.65	9,530	2630.90	0.00	---	---	---	0.00	---	---	---	0.054	---	0.054
2.68	9,643	2630.92	0.00	---	---	---	0.00	---	---	---	0.054	---	0.054
2.70	9,756	2630.95	0.00	OUTLET/DISCHARGE/RISER ELEVATION			0.00	---	---	---	0.054	---	0.054
2.73	9,869	2630.97	0.00	---	---	---	0.00	---	---	---	0.054	---	0.054
2.75	9,982	2631.00	0.00	---	---	---	0.00	---	---	---	0.054	---	0.054
2.78	10,099	2631.02	0.10 oc	---	---	---	0.10	---	---	---	0.055	---	0.150
2.80	10,217	2631.05	0.27 oc	---	---	---	0.27	---	---	---	0.055	---	0.324
2.83	10,335	2631.07	0.50 oc	---	---	---	0.49	---	---	---	0.055	---	0.549
2.85	10,453	2631.10	0.77 oc	---	---	---	0.76	---	---	---	0.055	---	0.816
2.88	10,570	2631.13	1.06 oc	---	---	---	1.06	---	---	---	0.056	---	1.119
2.90	10,688	2631.15	1.40 oc	---	---	---	1.40	---	---	---	0.056	---	1.454
2.93	10,806	2631.17	1.76 oc	---	---	---	1.76	---	---	---	0.056	---	1.818
2.95	10,923	2631.20	2.15 oc	---	---	---	2.15	---	---	---	0.056	---	2.209
2.98	11,041	2631.22	2.57 oc	---	---	---	2.57	---	---	---	0.057	---	2.625
3.00	11,159	2631.25	3.03 oc	---	---	---	3.03	---	---	---	0.057	---	3.083
3.03	11,281	2631.27	3.49 oc	---	---	---	3.49	---	---	---	0.057	---	3.546
3.05	11,404	2631.30	3.87 oc	---	---	---	3.87 s	---	---	---	0.057	---	3.931
3.08	11,527	2631.32	4.08 oc	---	---	---	4.08 s	---	---	---	0.057	---	4.134
3.10	11,649	2631.35	4.24 oc	---	---	---	4.24 s	---	---	---	0.058	---	4.293
3.13	11,772	2631.38	4.37 oc	---	---	---	4.37 s	---	---	---	0.058	---	4.428
3.15	11,894	2631.40	4.49 oc	---	---	---	4.49 s	---	---	---	0.058	---	4.545
3.18	12,017	2631.42	4.59 oc	---	---	---	4.59 s	---	---	---	0.058	---	4.650
3.20	12,140	2631.45	4.69 oc	---	---	---	4.69 s	---	---	---	0.059	---	4.747
3.23	12,262	2631.47	4.78 oc	---	---	---	4.78 s	---	---	---	0.059	---	4.836
3.25	12,385	2631.50	4.86 oc	---	---	---	4.86 s	---	---	---	0.059	---	4.922
3.28	12,512	2631.52	4.94 oc	---	---	---	4.94 s	---	---	---	0.059	---	5.000
3.30	12,640	2631.55	5.02 oc	---	---	---	5.01 s	---	---	---	0.060	---	5.074
3.33	12,767	2631.57	5.09 oc	---	---	---	5.08 s	---	---	---	0.060	---	5.144
3.35	12,895	2631.60	5.16 oc	---	---	---	5.15 s	---	---	---	0.060	---	5.214
3.38	13,022	2631.63	5.22 oc	---	---	---	5.22 s	---	---	---	0.060	---	5.281
3.40	13,150	2631.65	5.29 oc	---	---	---	5.28 s	---	---	---	0.060	---	5.345
3.43	13,278	2631.67	5.35 oc	---	---	---	5.35 s	---	---	---	0.061	---	5.406
3.45	13,405	2631.70	5.41 oc	---	---	---	5.40 s	---	---	---	0.061	---	5.465
3.48	13,533	2631.72	5.47 oc	---	---	---	5.46 s	---	---	---	0.061	---	5.523
3.50	13,660	2631.75	5.53 oc	---	---	---	5.52 s	---	---	---	0.061	---	5.584
3.53	13,793	2631.77	5.58 oc	---	---	---	5.58 s	---	---	---	0.062	---	5.644
3.55	13,925	2631.80	5.64 oc	---	---	---	5.64 s	---	---	---	0.062	---	5.701
3.58	14,058	2631.82	5.69 oc	---	---	---	5.69 s	---	---	---	0.062	---	5.756
3.60	14,191	2631.85	5.75 oc	---	---	---	5.74 s	---	---	---	0.062	---	5.807
3.63	14,323	2631.88	5.80 oc	---	---	---	5.80 s	---	---	---	0.063	---	5.859
3.65	14,456	2631.90	5.85 oc	---	---	---	5.85 s	---	---	---	0.063	---	5.917
3.68	14,588	2631.92	5.91 oc	---	---	---	5.90 s	---	---	---	0.063	---	5.962
3.70	14,721	2631.95	5.96 oc	---	---	---	5.95 s	---	---	---	0.063	---	6.017
3.73	14,854	2631.97	6.01 oc	---	---	---	6.00 s	---	---	---	0.064	---	6.061
3.75	14,986	2632.00	6.06 oc	---	---	---	6.05 s	---	---	---	0.064	---	6.112

...End

THEORETICAL MAX DISCHARGE RATE IF WATER LEVEL IS AT TOP OF RETENTION BASIN. THIS LEVEL EXCEEDS THE LEVEL OF Q100 FROM HMP WATER LEVEL.

RETENTION BASIN AREA: 5,407 SQ. FT.  
TOTAL DEPTH: 6.75 FT

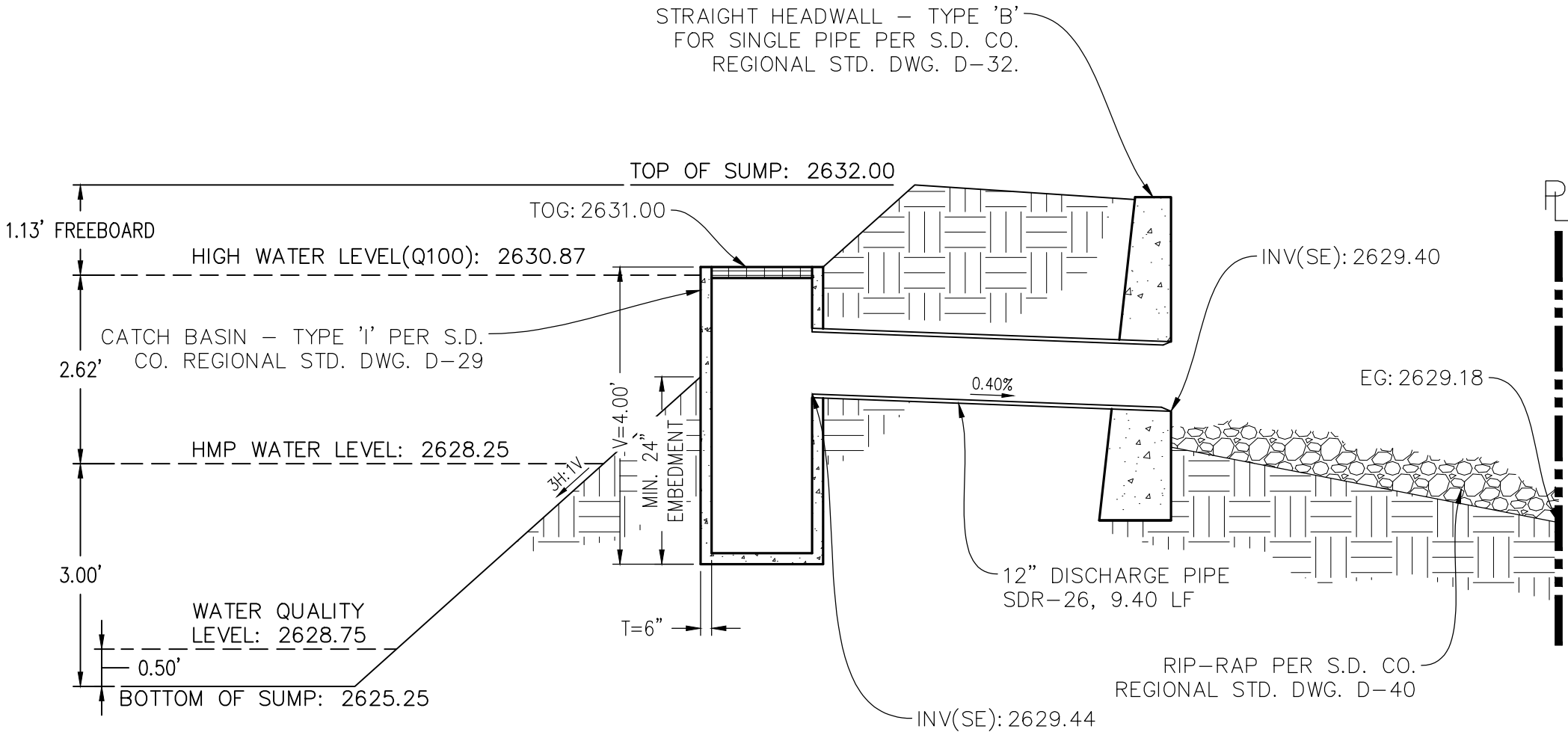

## RETENTION BASIN, OVERFLOW DRAINAGE INLET, AND OVERFLOW DISCHARGE PIPE SECTION DETAIL

NTS

**POST DEVELOPMENT**  
**CHANNEL REPORTS FOR OFF-SITE**  
**DISCHARGE**

# Channel Report

## 12in Discharge Pipe to Off-Site

### Circular

Diameter (ft) = 1.00

Invert Elev (ft) = 2629.44

Slope (%) = 0.40

N-Value = 0.011

### Calculations

Compute by: Known Q

Known Q (cfs) = 2.10

### Highlighted

Depth (ft) = 0.67

Q (cfs) = 2.100

Area (sqft) = 0.56

Velocity (ft/s) = 3.75

Wetted Perim (ft) = 1.92

Crit Depth, Yc (ft) = 0.62

Top Width (ft) = 0.94

EGL (ft) = 0.89

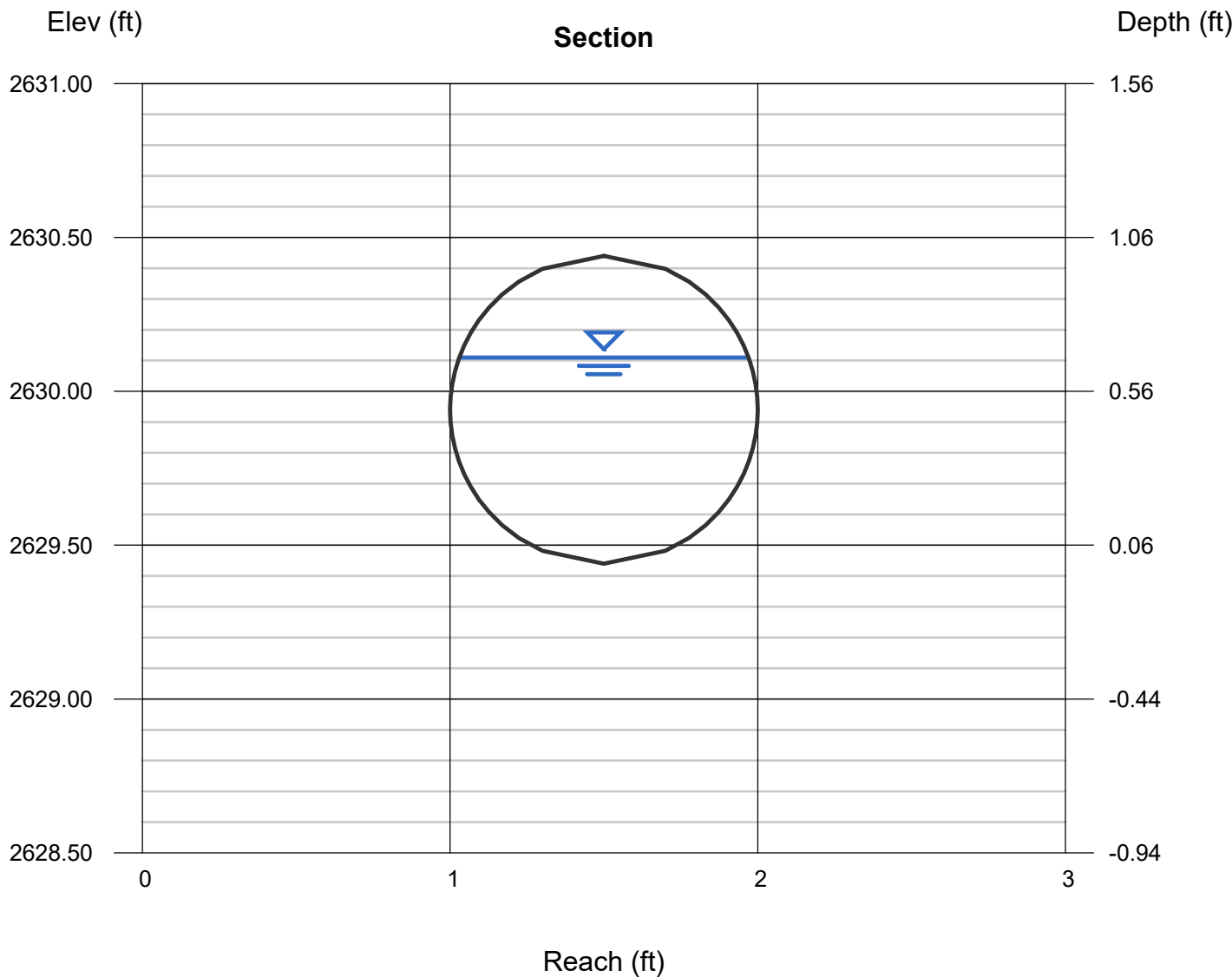

# Channel Report

## North Terrace Ditch Type C

### Triangular

Side Slopes (z:1) = 2.50, 2.50

Total Depth (ft) = 1.00

Invert Elev (ft) = 2635.02

Slope (%) = 4.52

N-Value = 0.011

### Calculations

Compute by: Known Q

Known Q (cfs) = 4.76

### Highlighted

Depth (ft) = 0.44

Q (cfs) = 4.760

Area (sqft) = 0.48

Velocity (ft/s) = 9.83

Wetted Perim (ft) = 2.37

Crit Depth, Yc (ft) = 0.75

Top Width (ft) = 2.20

EGL (ft) = 1.94

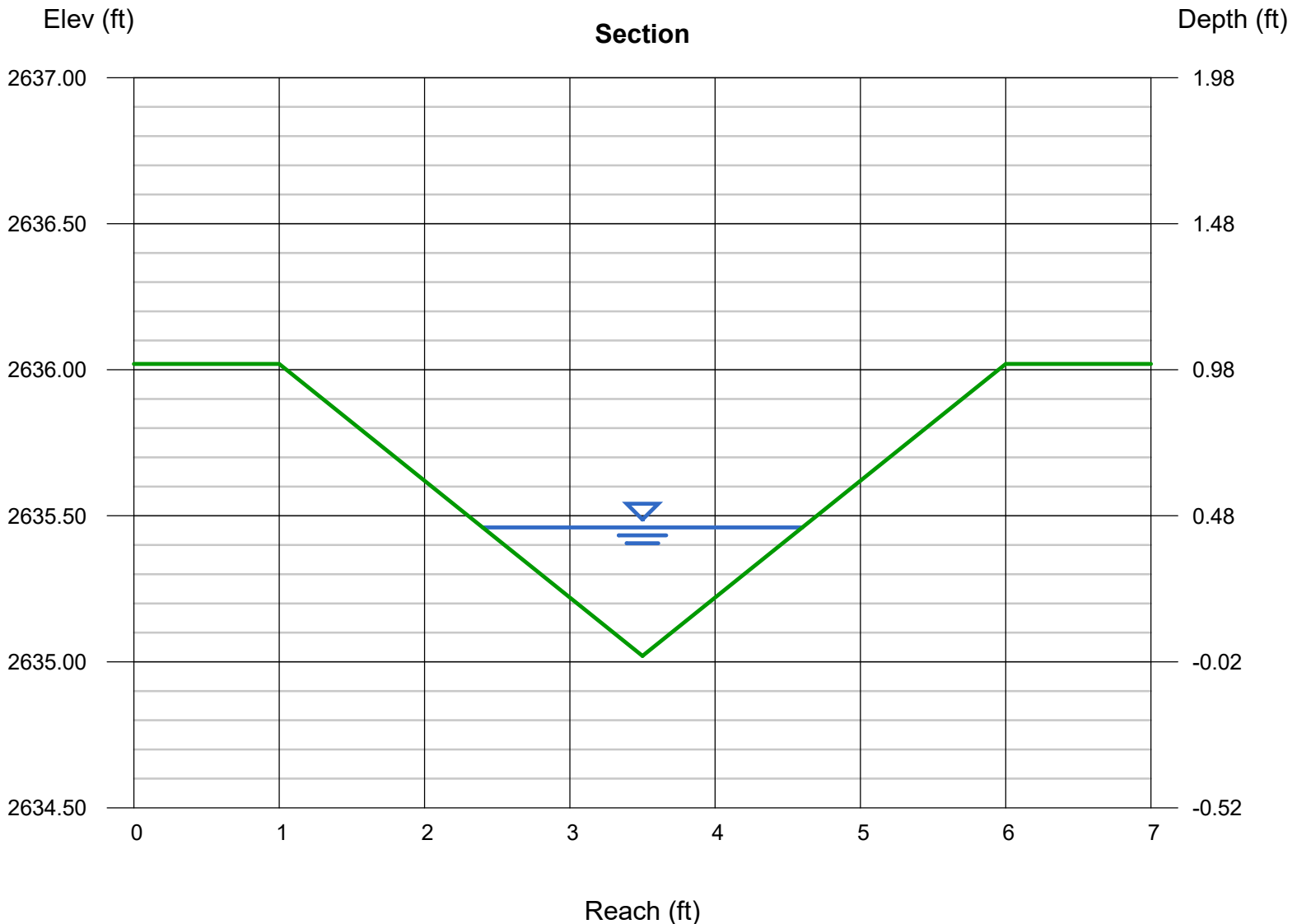

# Channel Report

## West Terrace Ditch Type C

### Triangular

Side Slopes (z:1) = 2.50, 2.50  
Total Depth (ft) = 1.00

Invert Elev (ft) = 2634.72  
Slope (%) = 10.53  
N-Value = 0.013

### Calculations

Compute by: Known Q  
Known Q (cfs) = 0.15

### Highlighted

Depth (ft) = 0.11  
Q (cfs) = 0.147  
Area (sqft) = 0.03  
Velocity (ft/s) = 4.86  
Wetted Perim (ft) = 0.59  
Crit Depth, Yc (ft) = 0.19  
Top Width (ft) = 0.55  
EGL (ft) = 0.48

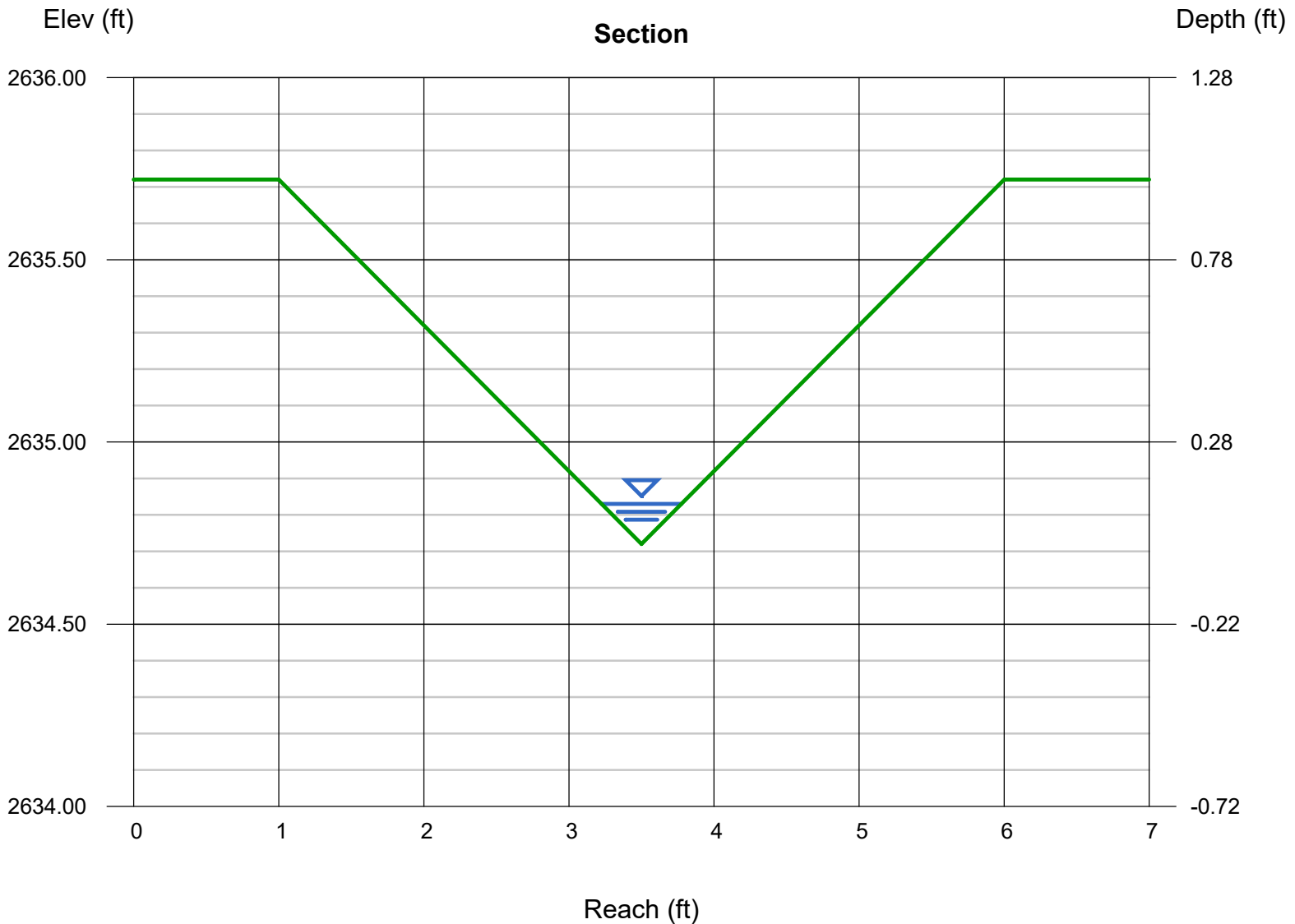

# **SOILS REPORT EXCERPTS**

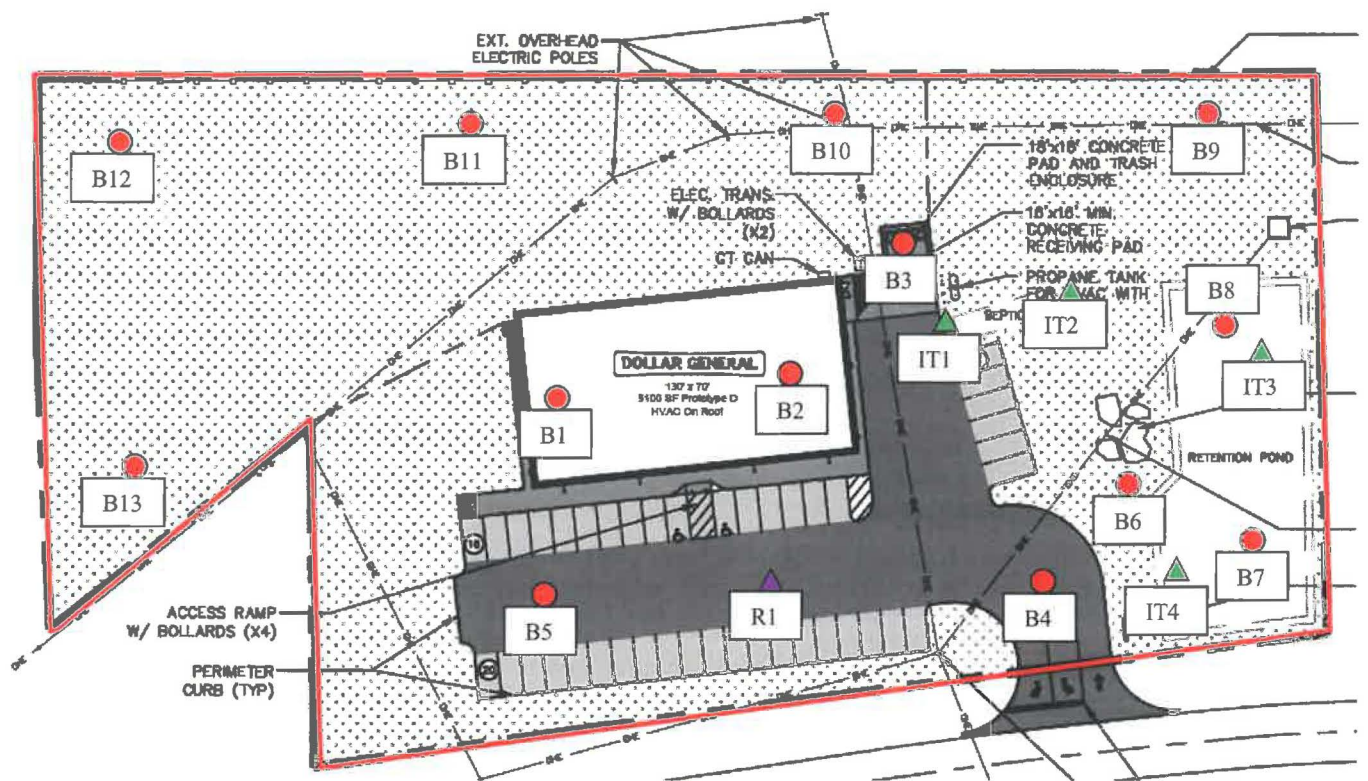

- APPROXIMATE BORING LOCATION
- ▲ APPROXIMATE INFILTRATION TEST LOCATION
- ▲ APPROXIMATE R-VALUE LOCATION

<b>SITE MAP</b> <b>PROPOSED DOLLAR GENERAL CAMPO</b> <b>NEQ HIGHWAY 94 &amp; DEWEY PLACE</b> <b>CAMPO, CALIFORNIA</b>	Scale: NTS	Date: April, 2019	
	Drawn by: JP	Approved by: JK	
	Project No. 112-19016	Figure No. 2	



**RESULTS OF INFILTRATION TESTS - REVERSE BOREHOLE**

<b>Project #</b>	11219016	<b>Date</b>	4/24/2019
<b>Project Name</b>	Dollar General Campo		
<b>Project Address</b>	Campo, CA		

<b>Test No:</b>	IT-4	<b>Total Depth (in.)</b>	96	<b>Test Size (in)</b>	9
<b>Depth To Water</b>	>50'	<b>Soil Classification</b>	Weathered Granite		

Reading	Elapsed Time(min.)	Incremental Time (min.)	Initial Depth To Water(in.)	Final Depth To Water(in.)	Incremental Fall of Water(in.)	Incremental Infiltration Rate (in/hr)
Start	0	0.00		4.0	--	--
1	20.00	20.00	4.0	11.0	7.00	0.56
2	40.00	20.00	11.0	17.0	6.00	0.52
3	60.00	20.00	17.0	22.5	5.50	0.51
4	80.00	20.00	22.5	28.0	5.50	0.55
5	100.00	20.00	28.0	33.0	5.00	0.54
6	120.00	20.00	33.0	38.0	5.00	0.58
7	140.00	20.00	38.0	42.5	4.50	0.57
8	160.00	20.00	42.5	46.5	4.00	0.54
9	180.00	20.00	46.5	50.5	4.00	0.59
10	200.00	20.00	50.5	54.0	3.50	0.56
11	220.00	20.00	54.0	57.5	3.50	0.61
12	240.00	20.00	57.5	60.5	3.00	0.56
<b>Infiltration Rate in Inches per Hour</b>						<b>0.51</b>

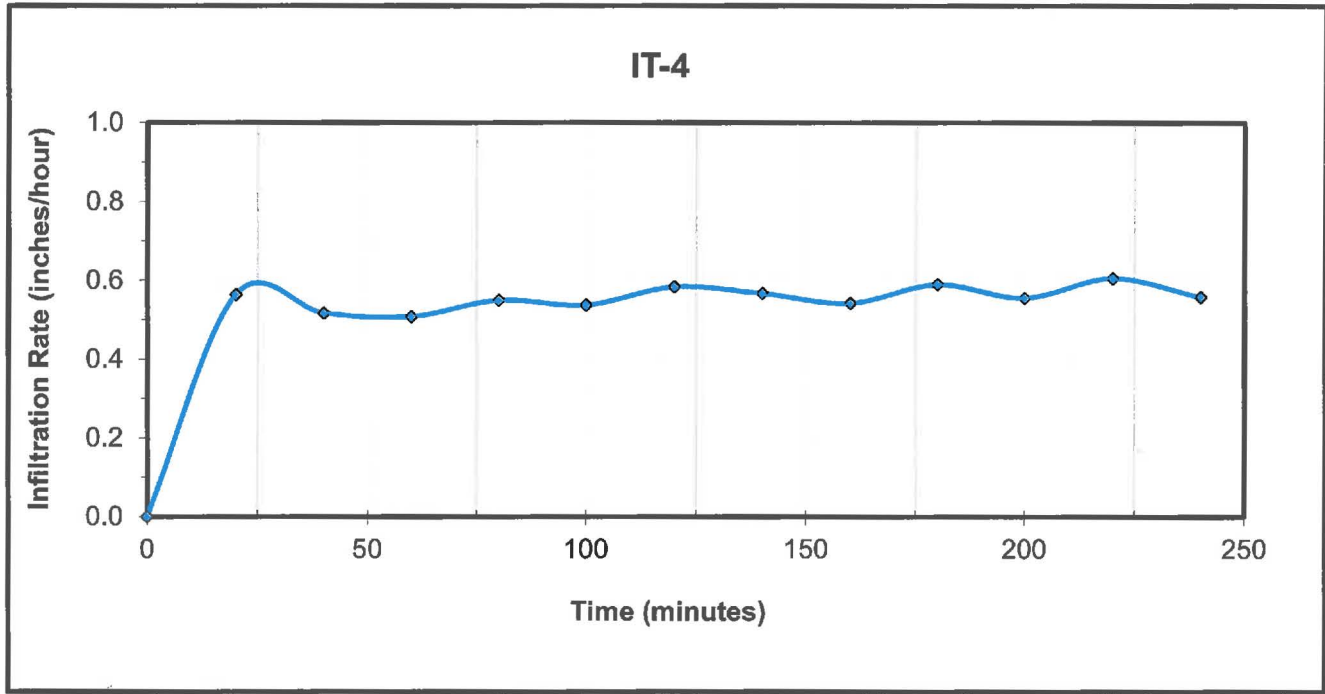

# **NOAA RAINFALL DATA**



\* source: ESRI Maps  
 \*\* source: USGS

**POINT PRECIPITATION FREQUENCY ESTIMATES**

Sanja Perica, Sarah Dietz, Sarah Heim, Lillian Hiner, Kazungu Maitaria, Deborah Martin, Sandra Pavlovic,  
 Ishani Roy, Carl Trypaluk, Dale Uhrh, Fenglin Yan, Michael Yekta, Tan Zhao, Geoffrey Bonnin, Daniel  
 Brewer, Li-Chuan Chen, Tye Parzybok, John Yarchoan

NOAA, National Weather Service, Silver Spring, Maryland

[PF\\_tabular](#) | [PF\\_graphical](#) | [Maps\\_&\\_aerials](#)

**PF tabular**

<b>PDS-based point precipitation frequency estimates with 90% confidence intervals (in inches)<sup>1</sup></b>										
Duration	Average recurrence interval (years)									
	1	2	5	10	25	50	100	200	500	1000
5-min	0.124 (0.105-0.149)	0.158 (0.133-0.189)	0.212 (0.178-0.255)	0.265 (0.220-0.322)	0.354 (0.284-0.445)	0.437 (0.343-0.563)	0.538 (0.412-0.711)	0.662 (0.492-0.901)	0.868 (0.617-1.23)	1.06 (0.728-1.57)
10-min	0.178 (0.150-0.213)	0.226 (0.190-0.271)	0.304 (0.255-0.366)	0.380 (0.316-0.461)	0.507 (0.407-0.638)	0.627 (0.492-0.807)	0.772 (0.590-1.02)	0.949 (0.705-1.29)	1.24 (0.884-1.77)	1.52 (1.04-2.24)
15-min	0.215 (0.181-0.258)	0.273 (0.230-0.328)	0.367 (0.308-0.442)	0.459 (0.382-0.558)	0.613 (0.492-0.772)	0.758 (0.595-0.976)	0.933 (0.714-1.23)	1.15 (0.852-1.56)	1.50 (1.07-2.14)	1.84 (1.26-2.71)
30-min	0.290 (0.244-0.347)	0.368 (0.310-0.442)	0.494 (0.414-0.595)	0.618 (0.514-0.751)	0.825 (0.662-1.04)	1.02 (0.801-1.31)	1.26 (0.961-1.66)	1.55 (1.15-2.10)	2.02 (1.44-2.88)	2.48 (1.70-3.65)
60-min	0.388 (0.327-0.465)	0.493 (0.415-0.591)	0.662 (0.555-0.797)	0.828 (0.688-1.00)	1.11 (0.887-1.39)	1.37 (1.07-1.76)	1.68 (1.29-2.22)	2.07 (1.54-2.81)	2.71 (1.93-3.85)	3.32 (2.27-4.89)
2-hr	0.519 (0.437-0.622)	0.659 (0.554-0.791)	0.881 (0.739-1.06)	1.10 (0.912-1.33)	1.45 (1.17-1.83)	1.78 (1.40-2.29)	2.18 (1.67-2.88)	2.66 (1.97-3.61)	3.44 (2.44-4.88)	4.17 (2.86-6.14)
3-hr	0.603 (0.508-0.723)	0.767 (0.646-0.921)	1.03 (0.861-1.24)	1.27 (1.06-1.55)	1.68 (1.35-2.12)	2.06 (1.61-2.65)	2.50 (1.91-3.30)	3.03 (2.25-4.12)	3.90 (2.77-5.54)	4.70 (3.22-6.92)
6-hr	0.829 (0.698-0.994)	1.06 (0.895-1.28)	1.43 (1.20-1.72)	1.77 (1.47-2.15)	2.32 (1.87-2.92)	2.82 (2.22-3.63)	3.41 (2.61-4.50)	4.10 (3.05-5.58)	5.21 (3.70-7.40)	6.21 (4.26-9.15)
12-hr	1.11 (0.938-1.34)	1.45 (1.22-1.74)	1.96 (1.64-2.36)	2.43 (2.02-2.96)	3.18 (2.55-4.00)	3.84 (3.01-4.94)	4.59 (3.51-6.07)	5.48 (4.07-7.45)	6.85 (4.87-9.74)	8.09 (5.54-11.9)
24-hr	1.59 (1.40-1.84)	2.11 (1.85-2.45)	2.89 (2.53-3.36)	3.60 (3.13-4.22)	4.70 (3.97-5.68)	5.66 (4.69-6.97)	6.74 (5.46-8.50)	7.99 (6.31-10.3)	9.90 (7.53-13.3)	11.6 (8.53-16.1)
2-day	1.96 (1.73-2.28)	2.71 (2.38-3.15)	3.83 (3.35-4.45)	4.84 (4.21-5.67)	6.39 (5.39-7.72)	7.73 (6.40-9.52)	9.24 (7.48-11.6)	11.0 (8.66-14.2)	13.6 (10.3-18.3)	15.9 (11.7-22.0)
3-day	2.17 (1.91-2.52)	3.07 (2.70-3.56)	4.40 (3.86-5.12)	5.61 (4.88-6.58)	7.46 (6.30-9.02)	9.07 (7.51-11.2)	10.9 (8.81-13.7)	12.9 (10.2-16.7)	16.1 (12.2-21.6)	18.8 (13.9-26.1)
4-day	2.35 (2.06-2.72)	3.34 (2.93-3.88)	4.81 (4.22-5.60)	6.15 (5.35-7.22)	8.21 (6.93-9.93)	10.0 (8.28-12.3)	12.0 (9.73-15.1)	14.3 (11.3-18.5)	17.8 (13.5-23.9)	20.9 (15.4-29.0)
7-day	2.68 (2.36-3.11)	3.78 (3.32-4.39)	5.43 (4.76-6.32)	6.93 (6.03-8.13)	9.26 (7.82-11.2)	11.3 (9.36-13.9)	13.6 (11.0-17.1)	16.2 (12.8-21.0)	20.3 (15.4-27.3)	23.9 (17.6-33.1)
10-day	2.99 (2.63-3.47)	4.19 (3.68-4.86)	5.97 (5.24-6.95)	7.61 (6.62-8.93)	10.2 (8.57-12.3)	12.4 (10.2-15.2)	14.9 (12.1-18.8)	17.8 (14.1-23.0)	22.3 (16.9-29.9)	26.2 (19.3-36.3)
20-day	3.70 (3.25-4.29)	5.08 (4.47-5.90)	7.15 (6.27-8.32)	9.04 (7.86-10.6)	12.0 (10.1-14.5)	14.5 (12.0-17.9)	17.4 (14.1-21.9)	20.7 (16.3-26.7)	25.8 (19.6-34.6)	30.3 (22.3-41.9)
30-day	4.54 (3.99-5.27)	6.18 (5.43-7.17)	8.60 (7.54-10.0)	10.8 (9.40-12.7)	14.2 (12.0-17.2)	17.1 (14.2-21.1)	20.4 (16.6-25.8)	24.2 (19.1-31.3)	30.0 (22.8-40.3)	35.1 (25.8-48.6)
45-day	5.50 (4.83-6.38)	7.39 (6.49-8.58)	10.2 (8.91-11.8)	12.7 (11.0-14.9)	16.5 (13.9-20.0)	19.8 (16.4-24.4)	23.5 (19.0-29.6)	27.7 (21.9-35.8)	34.0 (25.9-45.7)	39.6 (29.1-54.8)
60-day	6.41 (5.64-7.44)	8.55 (7.51-9.92)	11.7 (10.2-13.6)	14.4 (12.6-16.9)	18.7 (15.8-22.6)	22.3 (18.4-27.4)	26.3 (21.3-33.1)	30.8 (24.3-39.8)	37.6 (28.6-50.5)	43.5 (32.1-60.3)

<sup>1</sup> Precipitation frequency (PF) estimates in this table are based on frequency analysis of partial duration series (PDS).  
 Numbers in parenthesis are PF estimates at lower and upper bounds of the 90% confidence interval. The probability that precipitation frequency estimates (for a given duration and average recurrence interval) will be greater than the upper bound (or less than the lower bound) is 5%. Estimates at upper bounds are not checked against probable maximum precipitation (PMP) estimates and may be higher than currently valid PMP values.  
 Please refer to NOAA Atlas 14 document for more information.

[Back to Top](#)

**PF graphical**

PDS-based depth-duration-frequency (DDF) curves  
 Latitude: 32.6299°, Longitude: -116.4696°

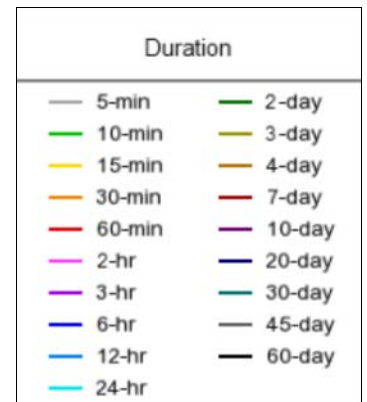
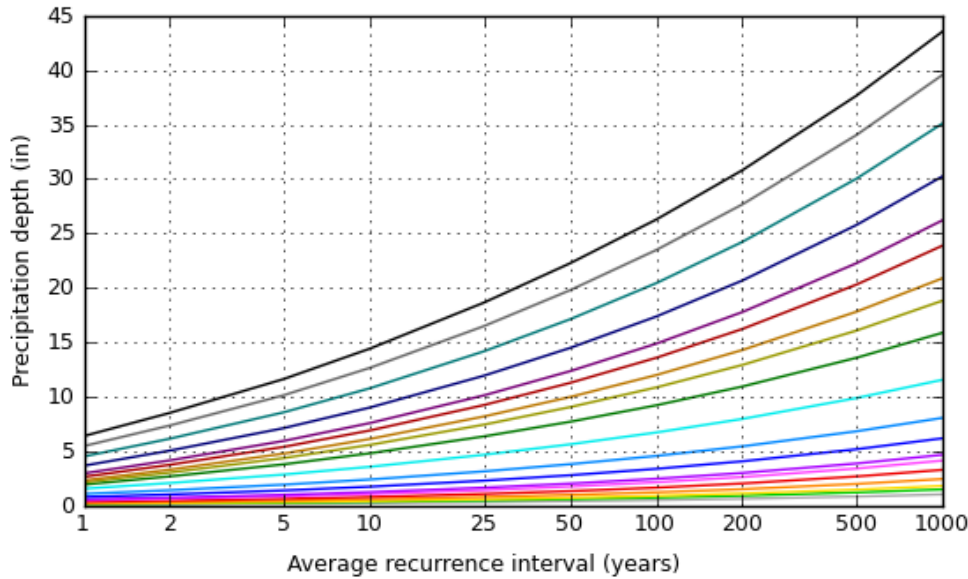
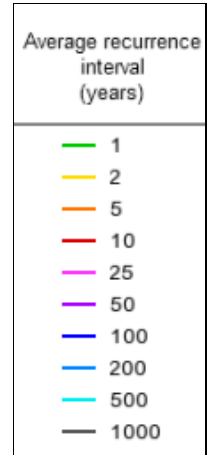
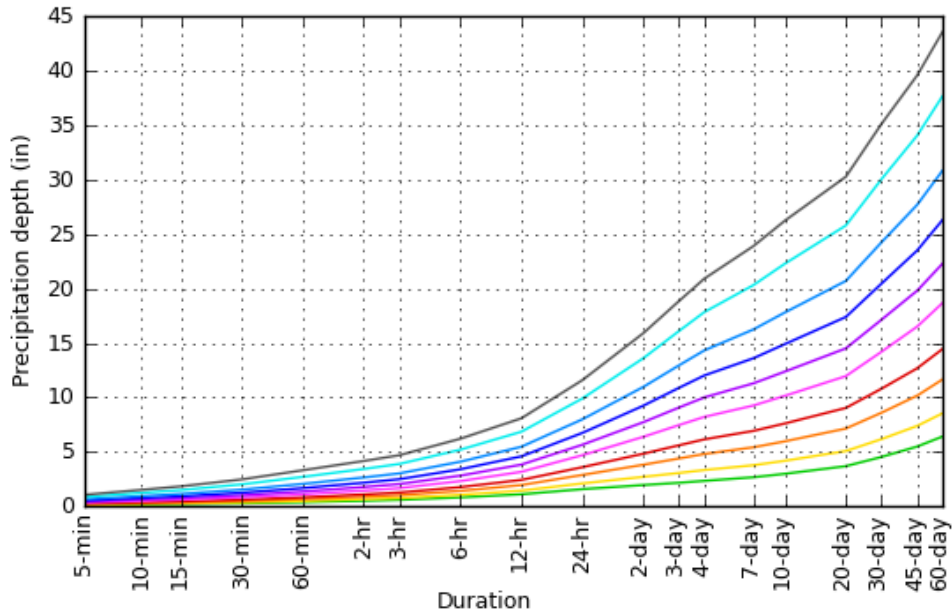

[Back to Top](#)

**Maps & aerials**

Small scale terrain

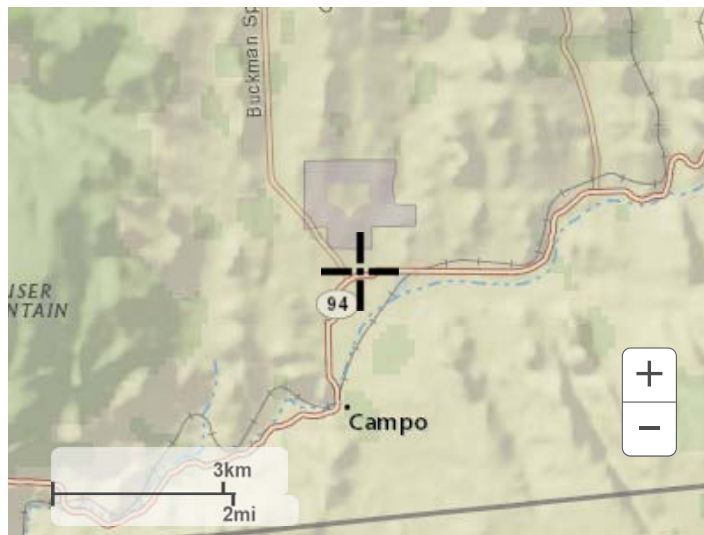

Large scale terrain



Large scale map



Large scale aerial



[Back to Top](#)

---

[US Department of Commerce](#)  
[National Oceanic and Atmospheric Administration](#)  
[National Weather Service](#)  
[National Water Center](#)  
1325 East West Highway  
Silver Spring, MD 20910  
Questions?: [HDSC.Questions@noaa.gov](mailto:HDSC.Questions@noaa.gov)

[Disclaimer](#)