

# CA3 Backup Generating Facility - Vantage

## Draft Environmental Impact Report



CALIFORNIA  
ENERGY  
COMMISSION  
Gavin Newsom,  
Governor

January 2022  
CEC-700-2022-002

DOCKET NUMBER 21-SPPE-01

# DRAFT ENVIRONMENTAL IMPACT REPORT

## CA3 Backup Generating Facility

(21-SPPE-01)

Lead Agency

**California Energy Commission**



January 2022

# Table of Contents

<b>1</b>	<b>Summary .....</b>	<b>1-1</b>
<b>2</b>	<b>Introduction.....</b>	<b>2-1</b>
<b>3</b>	<b>Project Description .....</b>	<b>3-1</b>
<b>4</b>	<b>Environmental Setting and Environmental Impacts</b>	
4.1	Aesthetics .....	4.1-1
4.2	Agriculture and Forestry Resources.....	4.2-1
4.3	Air Quality.....	4.3-1
4.4	Biological Resources .....	4.4-1
4.5	Cultural and Tribal Cultural Resources .....	4.5-1
4.6	Energy and Energy Resources .....	4.6-1
4.7	Geology and Soils .....	4.7-1
4.8	Greenhouse Gas Emissions .....	4.8-1
4.9	Hazards and Hazardous Materials .....	4.9-1
4.10	Hydrology and Water Quality .....	4.10-1
4.11	Land Use and Planning .....	4.11-1
4.12	Mineral Resources .....	4.12-1
4.13	Noise.....	4.13-1
4.14	Population and Housing.....	4.14-1
4.15	Public Services.....	4.15-1
4.16	Recreation .....	4.16-1
4.17	Transportation .....	4.17-1
4.18	Utilities and Service Systems.....	4.18-1
4.19	Wildfire .....	4.19-1
4.20	Mandatory Findings of Significance .....	4.20-1
4.21	Environmental Justice .....	4.21-1
<b>5</b>	<b>Alternatives .....</b>	<b>5-1</b>
<b>6</b>	<b>Authors and Reviewers .....</b>	<b>6-1</b>
	<b>Appendix A: Project’s Jurisdictional and Generating Capacity Analysis</b>	
	<b>Appendix B: Silicon Valley Power’s Transmission System and Related Pacific Gas &amp; Electric Company’s Transmission System</b>	
	<b>Appendix C: Renewable Diesel and Natural Gas Supplemental Information</b>	
	<b>Appendix D: Mailing List</b>	

# Section 1

---

Summary

## **1 Summary**

This environmental impact report (EIR) has been prepared by the California Energy Commission (CEC) staff to evaluate the potential environmental effects of the development of the CA3 Data Center and associated Backup Generating Facility (CA3BGF), referred to together as the project (project), in compliance with the California Environmental Quality Act (CEQA), the CEQA Guidelines, the Warren-Alquist State Energy Resources Conservation and Development Act, and California Code of Regulations, Title 20, chapter 5, article 5 (Small Power Plant Exemptions).

The CEC has the exclusive authority to certify all thermal power plants of 50 megawatts (MW) and greater and related facilities proposed for construction in California. The Small Power Plant Exemption (SPPE) process allows applicants with facilities between 50 and 100 MW to obtain an exemption from CEC's jurisdiction and proceed with local permitting rather than requiring CEC certification. The CEC can grant an exemption if it finds that the proposed facility would not create a substantial adverse impact on the environment or energy resources. Public Resources Code section 25519(c) designates the CEC as the lead agency, in accordance with CEQA, for all facilities seeking an SPPE.

### **1.1 Project Summary**

Vantage Data Services is seeking an exemption from the CEC's jurisdiction as an SPPE project. The applicant proposes to construct and operate the project, at 2590 Walsh Avenue, Santa Clara, California. The project would consist of an approximately 468,000-square-foot four-story data center building. To provide for the reliable operation of the project in the event of the loss of electrical service from the local electric utility provider, Silicon Valley Power (SVP), the project includes 44 2.75-MW diesel-fired emergency backup generators to provide uninterruptible power supply for its servers. The CA3BGF would be capable of generating sufficient electricity to serve the data center building that makes up the CA3DC. Eight of the 40 data center generators would be redundant, yielding the applicant's goal of a 99.999 percent reliability factor. The remaining four emergency backup generators are house generators (two of which are redundant) that would support portions of the CA3 administration building and features necessary for emergency response. The CA3BGF would only be operated for maintenance and testing and during emergency utility power outages. The maximum electrical load of the data center would be 96 MW.

The data center building would have two main components. The first would be the data center suites that house client servers. The second would be administrative facilities, including support facilities such as the building lobby, restrooms, conference rooms, landlord office space, customer office space, loading dock, and storage. The data center suite would have four levels, each containing four data center suites and corresponding electrical/uninterruptible power supply rooms.

## 1.2 Summary of Environmental Impacts and Mitigation Measures

In accordance with Public Resources Code section 25519(c) and CEQA, the CEC serves as the lead agency to review an SPPE application and perform any required environmental analyses. Upon the granting of an exemption, the local permitting authorities—in this case the City of Santa Clara and Bay Area Air Quality Management District (BAAQMD)—would perform any follow-up CEQA analysis and impose mitigation, as necessary, for granting approval of the project.

Below is an overview of the analysis included in **Section 4 Environmental Setting, Environmental Impacts and Mitigation**. Impacts are categorized by type as follows:

- **No Impact.** The scenario in which no adverse physical changes to (or impacts on) the environment would be expected.
- **Less Than Significant Impact.** An impact that would not exceed the defined significance criteria or would be eliminated or reduced to a less than significant level through the implementation of mitigation measures or compliance with existing federal, state, and local laws and regulations.
- **Less Than Significant with Mitigation Incorporated.** An impact that would be reduced to a less than significant level through the implementation of the identified mitigation measure.
- **Significant and Unavoidable Impact.** An adverse effect that meets the significance criteria but appears to have no feasible mitigation that would reduce the impact to a less than significant level. In some cases, mitigation may be available to lessen a given impact, but the residual effects of that impact would continue to be significant even after the implementation of the mitigation measure.

Staff concludes that with the implementation of the following mitigation measures, potentially significant impacts identified in this EIR would be avoided or reduced to less than significant levels. Staff concluded that impacts in the areas of Air Quality (including Public Health), Biological Resources, Cultural and Tribal Cultural Resources, Geology and Soils (paleontology), Greenhouse Gas Emissions, Hazards and Hazardous Materials, Noise, and Transportation would be potentially significant, but, with mitigation measures, would be reduced to less than significant. The areas of Aesthetics, Energy and Energy Resources, Hydrology and Water Quality, Land Use, and Utilities and Service Systems would have less than significant impacts from the project. The areas of Agriculture and Forestry Resources, Mineral Resources, and Wildfire would have no impact from the project. The mitigation measures would be enforced by the appropriate responsible agency under CEQA, which includes the City of Santa Clara. The following summarizes the potential impacts and mitigation as required.

**Air Quality.** *Less Than Significant with Mitigation Incorporated.* The project would not conflict with or obstruct the implementation of the applicable air quality plan. The project would not expose sensitive receptors to substantial pollutant concentrations. The project would not result in other emissions (such as those leading to odors) adversely affecting a substantial number of people. The mitigation measure **AQ-1** would reduce air quality impacts during project construction. This measure requires the incorporation of BAAQMD's best management practices to control fugitive dust. This measure also incorporates exhaust control measures to reduce emissions from construction equipment. The project owner would fully offset the oxides of nitrogen (NO<sub>x</sub> [as an ozone precursor]) emissions of the emergency backup generators from readiness testing and maintenance during the permitting process with BAAQMD. With the implementation of **AQ-1** during construction and the procurement of NO<sub>x</sub> offsets for readiness testing and maintenance through BAAQMD's permitting requirements, the project would not cause a cumulatively considerable net increase of any air pollutant, and impacts would be reduced to less than significant.

**AQ-1:** To ensure that fugitive dust impacts are less than significant, the project will implement BAAQMD-recommended Best Management Practices (BMPs) during the construction phase. The project owner also shall implement a construction emissions control plan that has been reviewed and approved by the Director or Director's designee of the City of Santa Clara Planning Division prior to the issuance of any grading or building permits, whichever occurs earliest. These BMPs are incorporated into the design of the project and will require the project owner to do or ensure the following:

- Water all exposed areas (e.g., parking areas, graded areas, unpaved access roads) twice a day.
- Maintain a minimum soil moisture of 12% in exposed areas by maintaining proper watering frequency.
- Cover all haul trucks carrying sand, soil, or other loose material.
- Suspend excavation, grading, and/or demolition activities when average wind speed exceeds 20 miles per hour.
- Pave all roadways, driveways, and sidewalks as soon as possible. Lay building pads as soon as grading is completed, unless seeding or soil binders are used.
- Install wind breaks (e.g., trees, fences) on the windward side(s) of actively disturbed areas of construction with a maximum 50 percent air porosity.
- Use a power vacuum to sweep and remove any mud or dirt-track next to public streets, if visible soil material is carried onto the streets.
- Limit vehicle speeds on unpaved roads to 15 miles per hour (mph).
- Minimize idling time for all engines by shutting engines when not in use or limiting idling time to a maximum of five minutes. Provide clear signage for construction workers at all access points.

- Properly tune and maintain construction equipment in accordance with manufacturer's specifications. Check all equipment against a certified visible emissions calculator.
- Post a publicly visible sign with the telephone number and person to contact at the Lead Agency regarding dust complaints.
- Install vegetative ground cover in disturbed areas as soon as possible and water appropriately until vegetation is established.
- Limit simultaneous occurrence of excavation, grading, and ground-disturbing construction activities.
- Install water washers to wash all trucks and equipment prior to leaving site.
- Treat site access to 100 feet from the paved road with a 6- to 12-inch compacted layer of wood chip, mulch, or gravel.
- Install sandbag or other erosion control measures to prevent silt runoff to public roadways from sites with a slope greater than one percent.
- Minimize idling time of diesel-powered construction vehicles to two minutes.
- Develop a plan demonstrating that off-road equipment (more than 50 horsepower) used for construction would comply with Tier 4 emission limits.
- Use low volatile organic compound (i.e., reactive organic compounds) coatings beyond the local requirements (i.e., Regulation 8, Rule 3: Architectural Coatings).
- All construction equipment, diesel trucks, and generators be equipped with Best Available Control Technology for emission reductions of oxides of nitrogen and particulate matter.
- All contractors use equipment that meets the California Air Resources Board's most recent certification standard for off-road, heavy-duty diesel engines.

**Biological Resources.** *Less Than Significant with Mitigation Incorporated.* The project would not adversely affect any species identified as candidate, sensitive, or special-status species in local or regional plans, policies, or regulations, or by the California Department of Fish and Wildlife (CDFW) or United States Fish and Wildlife Service (USFWS), with mitigation incorporated. Staff proposes mitigation measures **BIO-1**, which requires nesting bird pre-construction surveys and the implementation of appropriate nest buffers, and **BIO-2**, which requires conducting bat clearance surveys prior to the demolition of the existing buildings or removal of trees and to develop a Bat Mitigation and Monitoring Plan , which details exclusion methods, roost removal procedures, and compensatory mitigation methods for permanent impacts for roost removal.

The project would not have a substantial adverse effect on any riparian habitat or other sensitive natural community identified in local plans, policies, and regulations or by the CDFW or USFWS. The project would not have a substantial adverse effect on state or federally protected wetlands (including, but not limited to, marsh, vernal pool, coastal)



through direct removal, filing, hydrological interruption, or other means. The project would not interfere with the movement of any native resident or migratory fish or wildlife species or established native resident or migratory wildlife corridors or impede the use of native wildlife nursery sites.

With mitigation, the project would not conflict with tree preservation policies or ordinances or tree replacement policies. To avoid conflict with city of Santa Clara General Plan (General Plan) policies regarding tree removal and protection of trees, staff proposes mitigation measures **BIO-3**, which provides detailed requirements for the replacement of trees removed as part of the project, and **BIO-4**, which requires the implementation of tree protection measures to avoid and minimize impacts to trees to remain on site.

The project would not conflict with the provisions of an adopted Habitat Conservation Plan, Natural Community Conservation Plan, or other approved local, regional, or state habitat conservation plan.

The implementation of mitigation measures **BIO-1** through **BIO-4** would ensure all impacts are reduced to less than significant.

**BIO-1:** If possible, demolition and construction activities, including the removal of trees and vegetation clearing, shall take place between September and January. If demolition or construction activities, including the removal of the trees on the site, would take place between January and September, a pre-construction survey for nesting raptors and other protected native or migratory birds shall be conducted by a qualified ornithologist, approved by the city of Santa Clara, to identify active nests that may be disturbed during project implementation. Pre-construction surveys shall be conducted no more than 14 days prior to the initiation of demolition or construction activities or tree relocation or removal. Surveys shall be repeated if project activities are suspended or delayed for more than 14 days during the nesting season. The surveying ornithologist shall inspect all trees in and immediately adjacent to the construction area to be disturbed by these activities, and the ornithologist shall, in consultation with CDFW, designate a construction-free buffer zone (typically 250 feet for non-raptors to 500 feet for raptors) around the nest until the end of the nesting activity. Any changes to a buffer zone must be approved by the city of Santa Clara, in consultation with CDFW. The nests and buffers will be field checked weekly by the approved ornithologist. The approved buffer zone will be marked in the field with exclusion fencing, within which no construction, tree removal, or vegetation clearing shall commence until the ornithologist verifies that the nest(s) are no longer active. If an active bird nest is discovered during demolition or construction, then a buffer zone shall be established under the guidelines specified.

- The applicant shall submit a report indicating the results of the survey and any designated buffer zones to the satisfaction of the city of Santa Clara's Director of Community Development prior to the issuance of a tree removal permit by the city arborist. The report(s) shall contain maps showing the location of all nests, species nesting, status of the nest (e.g., incubation of eggs, feeding of young, near fledging), and the buffer size around each nest (including reasoning behind any alterations to

the initial buffer size). The report shall be provided within 10 days of completing a pre-construction nest survey.

**BIO-2:** If suitable roosting habitat for special-status bats will be affected by project construction (e.g., removal of buildings, removal of trees), a qualified wildlife biologist shall conduct surveys for special-status bats during the appropriate time of day to maximize detectability to determine if bat species are roosting near the work area no less than 7 days and no more than 14 days prior to beginning tree removal and/or demolition ground disturbance. Survey methodology may include visual surveys of bats (e.g., observation of bats during foraging period), inspection for suitable habitat, bat sign (e.g., guano), or use of ultrasonic detectors (e.g., Anabat, etc.). Visual surveys shall include trees within 0.25 mile of construction activities. The type of survey will depend on the condition of the potential roosting habitat. If no bat roosts are found, then no further study is required.

- If evidence of bat use is observed, the number and species of bats using the roost shall be determined. Bat detectors may be used to supplement survey efforts.
- If roosts are determined to be present and must be removed, the bats shall be excluded from the roosting site before the tree or structure is removed. Exclusion methods may include the use of one-way doors at roost entrances (bats may leave, but not reenter) or sealing roost entrances when the site can be confirmed to contain no bats. Exclusion efforts may be restricted during periods of sensitive activity (e.g., during hibernation or while females in maternity colonies are nursing young).
- If roosts cannot be avoided or it is determined that construction activities may cause roost abandonment, such activities shall not commence until permanent, elevated bat houses have been installed outside of, but near, the construction area. Placement and height will be determined by a qualified wildlife biologist, but the height of the bat house shall be at least 15 feet. Bat houses shall be multi-chambered and be purchased or constructed in accordance with CDFW standards. The number of bat houses required shall be dependent upon the size and number of colonies found, but at least one bat house shall be installed for each pair of bats (if occurring individually) or of a sufficient number to accommodate each colony of bats to be relocated.
- If bat roosts are detected, then a Bat Mitigation and Monitoring Plan shall be prepared and implemented to mitigate for the loss of roosting habitat. The Bat Mitigation and Monitoring Plan shall include information pertaining to the species of bat and location of the roost, exclusion methods and roost removal procedures, compensatory mitigation for permanent impacts (including specific mitigation ratios and location of proposed mitigation as described in above bullet) and monitoring to assess bat use of mitigation areas. This Plan shall be submitted to CDFW for review.

**BIO-3:** The project applicant shall obtain the appropriate tree removal permits from the city of Santa Clara for the removal of all healthy mature trees. The acquisition of this permit shall include details of the final mitigation numbers. The city of Santa Clara's landscape ordinance mandates a 2:1 replacement with 24-inch box size trees or 1.5:1

replacement with 36-inch box size trees. Depending on the species and size of the tree, additional mitigation may be required by the city of Santa Clara. The project proposes to mitigate for the loss of 66 trees through a combination of 24-inch box size and 36-inch box size.

**BIO-4:** The project applicant shall follow the tree protection measures for trees that are to remain in place, as included as specific conditions by the city of Santa Clara as part of Architectural Review approval and included on the approved landscape plans for the project.

**Cultural and Tribal Cultural Resources.** *Less Than Significant with Mitigation Incorporated.* The project would not impact any known resources that could meet CEQA's criteria for historical resources, unique archaeological resources, or tribal cultural resources. However, previous cultural resources studies in the project area indicate that buried archaeological or ethnographic resources could be encountered during ground disturbing activities at the site. Staff recommends two mitigation measures, **CUL-1** and **CUL-2**, to address the discovery of previously unknown buried cultural resources, including human remains. **CUL-1** proposes to require monitoring by both a qualified archaeological resources specialist and a Native American monitor and implement a Workforce Environmental Awareness Program. **CUL-2** proposes measures to be taken in the event human remains are discovered during ground disturbance. With the implementation of these mitigation measures, potential impacts on cultural and tribal cultural resources would be reduced to a less than significant level. Consultation between the Tamien Nation (a California Native American tribe) and CEC is ongoing. This consultation might result in changes to the Cultural and Tribal Cultural Resources section of the EIR, as well as the mitigation measures, for the final EIR. At present, the identification of new impacts or mitigation measures does not appear likely.

**Geology and Soils (paleontology).** *Less Than Significant with Mitigation Incorporated.* Construction would temporarily increase sedimentation and erosion by exposing soils to wind and runoff until construction is complete and new vegetation is established. The city's National Pollutant Discharge Elimination System Municipal Permit, urban runoff policies, and the City Code are the primary means of enforcing erosion control measures through the grading and building permit process. In accordance with General Plan policies, the implementation of the regulatory programs and policies in place would reduce possible impacts of accelerated erosion during construction to a less than significant level. The continuous operation and maintenance work would not result in increased erosion or topsoil loss. The probability that the construction, operation, or maintenance of the proposed project would have an impact on the risk of loss, injury, or death involving the rupture of an earthquake fault during operation is remote. As the project site is relatively flat with no open faces or slopes near the site, there is a low potential for landslides.

A project-specific geotechnical engineering report, along with the final project design, would be required to address, as needed, any potential issues arising from expansive soils, liquefaction, unstable geologic, or soil units that could result from the construction of this project. With the implementation of applicable design criteria per the California Building Standards Code, as well as the incorporation of the anticipated project-specific mitigation recommendations in the final geotechnical engineering report, seismic hazards would be minimized, to the extent feasible with conformance to the applicable seismic design criteria of the California Building Standards Code. Also, adherence to these standards would ensure the project, which is on expansive soil, would ensure that impacts from expansive soils would be less than significant. Earth moving during project construction has the potential to disturb paleontological resources. Staff proposes mitigation measure **GEO-1** to ensure the project design conforms to the requirements of a final geotechnical engineering investigation and California and local building standards and codes. Staff proposes mitigation measure **GEO-2** to train field staff in the identification and handling of paleontological resources. Staff concludes that with the implementation of **GEO-1** and **GEO-2**, that impacts of any geologic hazards and the impacts to unique paleontological resources would be reduced to a less than significant levels.

**GEO-1:** To avoid or minimize potential damage from seismic shaking, the project would be built using standard engineering and seismic safety design techniques. Building redevelopment design and construction at the site shall be completed in conformance with the recommendations of a design-level geotechnical investigation, which will be included in a report to the City. The report shall be reviewed and approved by the City of Santa Clara's Building Division as part of the building permit review and issuance process. The building shall meet the requirements of applicable Building and Fire Codes, including the 2019 California Building Code, as adopted or updated by the City. The project shall be designed to withstand potential geologic hazards identified on the site, and the project shall be designed to reduce the risk to life or property to the extent feasible and in compliance with the Building Code.

**GEO-2:** Prior to the start of any subsurface excavations that would extend beyond previously disturbed soils, all construction forepersons and field supervisors shall receive training by a qualified professional paleontologist, as defined by the Society of Vertebrate Paleontology, who is experienced in teaching non-specialists, to ensure they can recognize fossil materials and shall follow proper notification procedures in the event any are uncovered during construction. Procedures to be conveyed to workers include halting construction within 50 feet of any potential fossil find and notifying a qualified paleontologist, who shall evaluate its significance.

- If a fossil is found and determined by the qualified paleontologist to be significant and avoidance is not feasible, the paleontologist shall develop and implement an excavation and salvage plan in accordance with Society of Vertebrate Paleontology standards. Construction work in these areas shall be halted or diverted to allow the recovery of fossil remains in a timely manner. Fossil remains collected during

the monitoring and salvage portion of the mitigation program shall be cleaned, repaired, sorted, and cataloged. Prepared fossils, along with copies of all pertinent field notes, photos, and maps, shall then be deposited in a scientific institution with paleontological collections. A final Paleontological Mitigation Plan Report shall be prepared that outlines the results of the mitigation program. The city's Director of Planning and Inspection shall be responsible for ensuring that the paleontologist's recommendations regarding treatment and reporting are implemented.

**Greenhouse Gas Emissions.** *Less Than Significant with Mitigation Incorporated.* The greenhouse gas (GHG) emissions for the annual readiness testing and maintenance emissions from the facility's stationary sources would not exceed the existing BAAQMD CEQA significance threshold of 10,000 metric tons of carbon dioxide equivalent per year (MTCO<sub>2</sub>e/yr) for stationary sources. However, BAAQMD is in the process of preparing and presenting to the BAAQMD board for approval an update to the CEQA GHG threshold for stationary sources to 2,000 MTCO<sub>2</sub>e/yr or compliance with the California Air Resources Board's cap-and-trade program. Therefore, staff proposes mitigation measure **GHG-1** to require the applicant to limit the GHG emissions of the emergency backup generators to whichever BAAQMD CEQA GHG threshold is effective at the time of permitting. To further reduce GHG emissions, staff proposes mitigation measure **GHG-2** to require the applicant to use an increasing mix of renewable diesel and phase out the use of conventional petroleum diesel. Staff concludes with the implementation of **GHG-1** and **GHG-2**, the project's GHG emissions from the emergency backup generators would not have a significant direct or indirect impact on the environment.

The city of Santa Clara Climate Action Plan is a Qualified Climate Action Plan under CEQA. Pursuant to California Code of Regulations, title 14, section 15183.5, the CEC may rely on the compliance with the Qualified Climate Action Plan in its analysis of GHG emissions impacts. With the implementation of **GHG-2** and **GHG-3**, the project would comply with the requirements of the city's Climate Action Plan and other plans, policies, or regulations adopted for the purpose of reducing the emissions of GHGs. **GHG-2** requires the project to use an increasing mix of renewable diesel to ensure that the operation of the emergency backup generators would not hinder California's efforts to achieve statewide 2030 or 2045 GHG emissions reduction goals. **GHG-3** requires the applicant to participate in SVP's Large Customer Renewable Energy (LCRE) program for 100 percent carbon-free electricity or purchase carbon offsets or similar instruments that accomplish the same goals of 100 percent carbon-free electricity. The project's likelihood of operating for non-testing/non-maintenance (emergency) purposes is low and, if such operation did occur, it would be infrequent and of short duration. Staff concludes that these emissions would be less than significant.

With the implementation of **GHG-1**, **GHG-2**, **GHG-3**, and the efficiency measures to be incorporated into the project, GHG emissions related to the project would not conflict with the BAAQMD CEQA significance threshold, the city's Climate Action Plan, or other plans, policies, or regulations adopted for the purpose of reducing the emissions of GHGs.

Because the project would be consistent with applicable plans and policies adopted to reduce GHG emissions and would comply with all regulations or requirements adopted to implement a statewide, regional, or local plan for the reduction or mitigation of GHG emissions, the potential for the project to conflict with an applicable plan, policy, or regulation for GHG reductions would be less than significant. With the implementation of **GHG-1**, **GHG-2**, and **GHG-3**, impacts related to GHG emissions would be reduced to less than significant.

**GHG-1:** If the Bay Area Air Quality Management District (BAAQMD) has adopted a new threshold of significance for stationary sources on or before CA3 receives its Authority to Construct permit, the project shall reduce the time the engines operate for readiness testing and maintenance on an annual basis to ensure the project complies with the new limit. Prior to the start of operation, the project owner shall provide a report to the director, or director's designee, of the city of Santa Clara Planning Division describing how the project intends to comply with the limit, including a proposed schedule of readiness testing and maintenance operations for the year. The project owner shall provide an annual report thereafter to the Director, or Director's designee, of the city of Santa Clara Planning Division describing all operations of the facility that occurred for readiness testing and maintenance and calculating the attendant GHG emissions that resulted for the year.

**GHG-2:** The project owner shall use renewable diesel as the primary fuel for the emergency backup generators to the maximum extent feasible, and only use ultra-low sulfur diesel (ULSD) as a secondary fuel in the event of supply challenges or disruption in obtaining renewable diesel. If testing confirms that use of this fuel will not result in emissions that would cause the project to exceed applicable thresholds after any available mitigation for such emissions has been applied, the project owner shall ensure that renewable fuels are used for a minimum of at least 44 percent of total energy use by the emergency backup generators by December 31, 2024; 52 percent by December 31, 2027; and 60 percent by December 31, 2030. Renewable fuels shall be used for 100 percent of total energy use by the emergency backup generators by December 31, 2045. The project owner shall provide an annual report of the status of procuring and using renewable diesel to the director, or director's designee, of the city of Santa Clara Planning Division demonstrating compliance with the mitigation measure.

**GHG-3:** The project owner shall ensure that 100 percent of the electricity purchased to power the project is covered by carbon-free resources using one of the following options: (1) participate in SVP's LLCRE program for 100 percent carbon-free electricity, or (2) purchase carbon offsets or similar instruments that accomplish the same goals of 100 percent carbon-free electricity. The project owner shall provide documentation to the director, or director's designee, of the city of Santa Clara Planning Division of enrollment and annual reporting of continued participation in SVP's LCRE program with 100 percent carbon-free electricity coverage. If not enrolled in SVP's LCRE Program, the project owner shall provide documentation and annual reporting to the director, or director's designee, of the city of Santa Clara Planning Division that confirms that alternative measures

achieve the same 100 percent carbon free electricity as SVP's LCRE program, with verification by a qualified third-party auditor specializing in greenhouse gas emissions.

**Hazards and Hazardous Materials.** *Less Than Significant with Mitigation Incorporated.* During the construction phase of the project, the only hazardous materials used would be paints, cleaners, solvents, gasoline, motor oil, welding gases, and lubricants. When not in use, any hazardous material would be stored in designated construction staging areas in compliance with local, state, and federal requirements. Any impacts resulting from spills or other accidental releases of these materials would be limited to the site due to the small quantities involved and their infrequent use. The transportation of the diesel fuel to the site would take a few tanker-truck trips for the initial fill and, during operation, one fuel truck delivery would occur every three months. Diesel fuel has a long history of being routinely transported and used as a common motor fuel. The risk to the off-site public or environment through the routine transport, use or disposal of hazardous materials would have a less than significant impact.

Hazardous materials would be stored, handled, and used in accordance with applicable regulations. Personnel would be required to follow instructions on health and safety precautions and procedures to follow in the event of a release of hazardous materials. All equipment and materials storage would be routinely inspected for leaks. Records would be maintained for documenting compliance with the storage and handling of hazardous materials. In addition, there would be engineering controls for the diesel, such as a double walled tank for the diesel fuel and leak detection gas, that would mitigate the risk of a spill or release. The risk to the off-site public or environment through reasonably foreseeable upset and accident conditions involving the release of hazardous materials would have a less than significant impact.

Ground disturbing activities associated with the grading and construction of the project would have the potential to encounter the impacted groundwater and/or soil. Staff proposes mitigation measure **HAZ-1** requiring the preparation of a SMP to establish proper procedures to be taken when contaminated soil is found and how to dispose of the contaminated soil properly. Staff concludes that with the implementation of **HAZ-1**, impacts to the public or the environment due to contaminated soils would be reduced to a less than significant level.

**HAZ-1:** The project will implement the following measures to reduce potentially significant soil and or groundwater impacts to construction workers to a less than significant level.

- Prior to the issuance of grading permits, shallow soil samples shall be taken in areas where soil disturbance is anticipated to determine if contaminated soils with concentrations above established construction/trench worker thresholds may be present due to historical agricultural use and from historical leaks and spills. The soil sampling plan must be reviewed and approved by the Santa Clara Fire Department Fire Prevention and Hazardous Materials Division prior to the initiation of work. Once the soil sampling analysis is complete, a report of the findings will be provided to the

Santa Clara Fire Department Fire Prevention and Hazardous Materials Division and other applicable City staff for review.

- Documentation of the results of the soil sampling shall be submitted to and reviewed by the City of Santa Clara prior to the issuance of a grading permit. Any soil with concentrations above applicable Environmental Screening Levels or hazardous waste limits would be characterized, removed, and disposed of off-site at an appropriate landfill according to all state and federal requirements.
- A Site Management Plan (SMP) will be prepared to establish management practices for handling impacted groundwater and/or soil material that may be encountered during site development and soil-disturbing activities. Components of the SMP will include:
  - a detailed discussion of the site background.
  - a summary of the analytical results.
  - preparation of a Health and Safety Plan by an industrial hygienist.
  - protocols for conducting earthwork activities in areas where impacted soil and/or groundwater are present or suspected.
  - worker training requirements, health and safety measures and soil handling procedures shall be described.
  - protocols shall be prepared to characterize/profile soil suspected of being contaminated so that appropriate mitigation, disposal, or reuse alternatives, if necessary, can be implemented.
  - notification procedures if previously undiscovered significantly impacted soil or groundwater is encountered during construction.
  - notification procedures if previously unidentified hazardous materials, hazardous waste, underground storage tanks are encountered during construction.
  - on-site soil reuse guidelines.
  - Sampling and laboratory analyses of excess soil requiring disposal at an appropriate off-site waste disposal facility.
  - soil stockpiling protocols; and
  - protocols to manage groundwater that may be encountered during trenching and/or subsurface excavation activities. Prior to issuance of grading permits, a copy of the SMP must be approved by the Santa Clara County Environmental Health Department, and the Santa Clara Fire Department Fire Prevention and Hazardous Materials Division. Prior to issuance of grading permits, a copy of the SMP must be approved by the Santa Clara County Environmental Health Department, and the Gilroy Planning Division



- If contaminated soils are found in concentrations above risk-based thresholds pursuant to the terms of the SMP, remedial actions and/or mitigation measures will be taken to reduce concentrations of contaminants to levels deemed appropriate by the selected regulatory oversight agency for ongoing site uses. Any contaminated soils found in concentrations above thresholds to be determined in coordination with regulatory agencies shall be either 1) managed or treated in place, if deemed appropriate by the oversight agency or 2) removed and disposed of at an appropriate disposal facility according to California Hazardous Waste Regulations and applicable local, state, and federal laws.

**Noise.** *Less Than Significant with Mitigation Incorporated.* The area surrounding the project site consists of Light Industrial land uses to the north, east, and west. Approximately 150-200 feet to the south-southwest, the Caltrain corridor separates the project site from medium-density residential development. The nearest airport is Norman Y. Mineta San Jose International Airport approximately 1.75 miles east of the project site.

Sources of groundborne vibration associated with project operation would include the backup generators and rooftop equipment. These pieces of equipment would be well-balanced as they are designed to produce very low vibration levels throughout the life of a project. In most cases, even when there is an imbalance, they could contribute to ground vibration levels only in the vicinity of the equipment and would be dampened within a short distance. Furthermore, the backup generators would be equipped with specifications that ensure sufficient exhaust silencing to reduce vibration. Therefore, vibration impacts due to project operation would be less than significant. The predominant long-term ambient noise sources are nearby and distant traffic, and by cooling and mechanical noise from various facilities. Additionally, noise events that interrupt the ambient noise are caused by trains and loud vehicles occasionally passing by.

Temporary construction activities at the project site may significantly increase the existing ambient noise levels at the residential area immediately south of the project site (depending on the activity occurring and equipment being used at the time). However, with the implementation of the proposed mitigation measure **NOI-1**, noise impacts would be reduced during construction to less than significant. Likewise, with the implementation of **NOI-1**, the project's contribution to cumulative noise impacts during project construction would not be cumulatively considerable.

**NOI-1:** The project shall implement the following measures to reduce temporary construction noise to less than significant levels.

- Construction is not permitted during the hours of 6 p.m. to 7 a.m. Monday through Friday, and between 6 p.m. to 9 a.m. on Saturday.
- Prior to the start of construction, identify a noise control disturbance coordinator. The disturbance coordinator shall be responsible for responding to any local complaints about construction noise. The disturbance coordinator shall determine the cause

of any noise complaint received (e.g., starting too early, bad muffler, etc.) and shall ensure that reasonable measures warranted to correct the problem are implemented as soon as possible.

- Prior to the start of construction, establish a telephone number for the disturbance coordinator, and post it in a conspicuous location on the construction site.
- Prior to the start of construction, notify the residents within 800 feet from the center of the project to the south across the rail line and industrial buildings to the north, east, and west of the project site of the construction schedule, in writing, and provide a written schedule of “noisy” construction activities to the adjacent land uses.
- Include the telephone number for the disturbance coordinator construction site in the above notice regarding the construction schedule sent to residences south across the rail line and industrial buildings to the north, east, and west of the project site.
- The project owner shall orient construction equipment and locate construction staging areas within the project site away from the nearest residences to the south, to the extent feasible.
- Equip all construction-related internal combustion engine-driven equipment with the best available noise control equipment (including mufflers, intake silencers, ducts, engine enclosures, and acoustically attenuating shields or shrouds) and use best noise control practices to minimize noise levels from construction activities.

**Transportation.** *Less Than Significant with Mitigation Incorporated.* Project construction would not significantly obstruct any transit, roadway, bicycle, or pedestrian facilities in the area. Construction activities would occur mostly onsite and not in the public right-of-way, except for an extension to an existing recycled water line from the intersection of Walsh Avenue and Northwestern Parkway (approximately 500 feet east of the project site) to the site for secondary water needs. While this construction would require temporary lane blockages/closures on Walsh Avenue during daytime hours, it would not interfere with a designated bike lane or transit route, as none exist on the affected portion of Walsh Avenue. Furthermore, Walsh Avenue has four travel lanes. The temporary construction associated with connecting the project site to the existing buried recycled water line is not anticipated to disrupt more than one travel lane at a time. This would ensure at least one travel lane remains open in each direction. Project construction would not otherwise temporarily or permanently alter any public roadways or intersections.

The project would not result in hazards to aircraft from either a geometric design feature, such as structure height, or incompatible uses, including land uses or thermal plumes. The project would not increase any other hazards.

The City of Santa Clara Fire Department reviewed the project and recommended several access and internal circulation changes to ensure proper turning radius and movement of emergency vehicles would occur. These changes include:

- Expanding the width and apron radius at the existing entrance on Walsh Avenue (west side);
- Creating a new entrance on Walsh Avenue at the east side to allow for circular movement of vehicles through the project site; and
- Expanding the width of internal access roads and adjusting the location of the proposed substation to ensure the turning radius requested by the Fire Department is provided at all four corners of the proposed building.

With the incorporation of these changes into the project design, all requests by the City of Santa Clara Fire Department have been met to ensure proper access and movement of emergency service vehicles throughout the project site. Lastly, the City of Santa Clara, as the permitting agency, would ensure the project is consistent with building and zoning code requirements ensuring adequate emergency access. Therefore, the impact would be less than significant.

The project would not physically block any access roads or result in traffic congestion that could significantly compromise timely access to this facility or other facilities located within the project vicinity during construction and operation.

To meet the target vehicle miles travelled (VMT) for the project, the applicant has agreed to an alternative work schedule for employees reflecting a 4-40 workweek (40 hours in 4 days) so that the project VMT would be below the city's threshold. This is a Transportation Demand Management (TDM) measure, which is the commitment to a 4-40 work schedule. Staff evaluated the measure in the context of impacts to VMT and concludes that the requirement defined in this TDM measure is sufficient. This TDM measure would reduce the project VMT to 13.20 per employee, causing the project VMT to fall below the city-approved threshold of 14.14. The city requires a TDM annual report, which would allow it to obtain confirmation that the 4-day, 40-hour work schedule has been complied with. Staff proposes mitigation measure **TRANS-1**, which would require the implementation of a TDM program that incorporates the 4-40 work schedule TMD measure.

**TRANS-1:** The project shall implement a TDM program sufficient to demonstrate that the VMT associated with the project would be reduced to 14.14 or less per employee. The TDM program shall include, but is not limited to, the following measure, which has been determined to be a feasible method for achieving the required VMT reduction:

- The operations workforce at the project shall work a 4-40 work schedule (40 hours in 4 days).

Prior to the issuance of an occupancy permit, the TDM program shall be submitted and approved by the Director of Community Development and shall be monitored annually to gauge its effectiveness in meeting the required VMT reduction. The TDM program shall establish an appropriate estimate of initial vehicle trips generated by the occupant of the proposed project and shall include the conducting of driveway traffic counts annually to measure peak-hour entering and exiting vehicle volumes. The volumes shall be compared

to trip thresholds established in the TDM program to determine whether the required reduction in vehicle trips is being met. The results of annual vehicle counts shall be reported in writing to the Director of Community Development.

If TDM program monitoring results show that the trip reduction targets are not being met, the TDM program shall be updated to identify replacement and/or additional feasible TDM measures to be implemented. The updated TDM program shall be subject to the same approvals and monitoring requirements listed above.

### ***Summary***

The CEC determines whether the project qualifies for an SPPE and if the project is granted the exemption, the project would seek permits from the local responsible agencies.

## **1.3 Summary of Alternatives to the Project**

CEQA requires that an EIR identify alternatives to the project as proposed and evaluate their comparative merits. CEQA Guidelines section 15126.6 states that an EIR must describe a “reasonable range of potentially feasible alternatives,” focusing on those that “would feasibly attain most of the basic objectives of the project but would avoid or substantially lessen any of the significant environmental effects of the project.” Based on the requirements of CEQA and the summary of environmental impacts presented above, this EIR describes and analyzes three alternatives to the proposed project, including the “No Project” alternative, which is required to be analyzed even though it does not meet the project objectives. A summary of the project alternatives follows. A full analysis of project alternatives is provided in **Section 5 Alternatives**, along with a description of other alternatives considered but not carried forward for full analysis.

### **1.3.1 Alternative 1: No Project Alternative**

Staff evaluated a “No Project” scenario in which no development of the project would occur and current conditions would continue at the site for an unknown period. Although a different project would likely be proposed at the site in the future, no development plan exists to allow a comparison with the proposed project, and it would be speculative to assume the characteristics of such an alternative. Alternative 1 would avoid the proposed project’s potentially significant impacts identified in this EIR and would have no impact compared to the proposed project; therefore, it would be *environmentally superior* to the project. However, if the project is not constructed, the applicant’s project objectives would not be attained.

### **1.3.2 Alternative 2: Renewable Diesel Fuel**

Staff also evaluated a renewable diesel fuel alternative. Renewable diesel is not a fossil fuel and is made of nonpetroleum renewable resources (vegetable oil or other biomass feedstock, such as wood, agricultural waste, garbage, etc.). Renewable diesel is a cleaner burning fuel alternative to conventional diesel that would be expected to meet the project objectives as a source of fuel for the emergency backup generators. Under this

alternative, the project would be developed the same as proposed, except it would use renewable diesel as the fuel source for the emergency backup generators. There would be no changes to the number, size, or placement of the emergency backup generators.

Air quality and public health impacts using renewable diesel during project operations would *likely be similar* to those that would occur with the project. However, this conclusion would need to be confirmed by testing emissions under controlled conditions for the size of engines proposed for the project. Also, while the project would meet BAAQMD GHG thresholds for the readiness testing and maintenance of the diesel emergency backup generators with the implementation of mitigation measure **GHG-1**, GHG emissions could be reduced further by using renewable diesel in place of petroleum-based diesel. The impact from GHG emissions is *likely less* under this alternative. Staff considers Alternative 2 to be *somewhat environmentally superior* to the proposed project, although further study and analysis would be needed to fully compare this alternative to the proposed project.

In the foreseeable future, as more renewable diesel suppliers come online and the supply becomes more plentiful, the project should incorporate renewable diesel in increasing amounts as the primary source of fuel. Due to supply issues and cost, reliance on the sole use of renewable diesel fuel could compromise the reliability of the data center. Staff has proposed mitigation measure **GHG-2** to reflect the expected increasing availability of renewable diesel over time. **GHG-2** would require the project owner to use an increasing mix of renewable diesel to the maximum extent feasible, and only use ULSD as a secondary fuel in the event of supply challenges or disruption in obtaining renewable diesel.

### 1.3.3 Alternative 3: Natural Gas Internal Combustion Engines

Natural gas internal combustion engines (ICEs) are fueled by natural gas, while the proposed engines for the project would use conventional diesel. The preferred, most feasible method to supply fuel for the natural gas ICEs would be by pipeline through Pacific Gas and Electric's underground natural gas transmission system. The two closest locations for independent natural gas pipeline connections are one adjacent to the project site on Walsh Avenue and one approximately 1.36 miles west of the project site on the Lawrence Expressway<sup>1</sup>. The project's primary pipeline would connect to the nearby gas line on Walsh Avenue. A secondary pipeline connecting to the gas line at Lawrence Avenue would be installed to provide added reliability under this alternative.

Air quality impacts using natural gas ICEs are expected to be *much less* than those that would occur with the proposed project's conventional diesel-fired engines. Public health impacts from toxic air contaminants using natural gas ICEs are *likely less* than those that would occur under the proposed project. Impacts from GHG are also *likely less* under this alternative.

---

<sup>1</sup> Along Walsh Avenue to Lawrence Expressway.

Staff considers Alternative 3 to be *environmentally superior* to the proposed project due to its deep reductions in criteria air pollutants. Redesigning the project with natural gas ICE technology could increase the number of engines on-site depending upon the MW sizing and physical dimensions. As discussed, two gas pipeline connections are available and likely needed to match the fuel supply reliability of the proposed project. Permitting and construction of the new pipelines to these connections would take time to complete.

## 1.4 Known Areas of Controversy

The CEC issued a Notice of Preparation on August 20, 2021, seeking input from responsible and trustee agencies and the public regarding the scope and context of environmental areas in the EIR. The comment period began August 24, 2021, ending September 22, 2021. Four<sup>2</sup> comment letters were received. Issues of concern reflected in these letters and emails include, but are not limited to, the following:

- Air Quality and Greenhouse Gas Emissions (GHG):
  - Because the project is in an area that has long been disproportionately impacted by air pollution and is identified as a priority community by the State of California as a Senate Bill 535 disadvantaged community, the air district is concerned about the potential for any increase in emissions that could result from the project.
  - Highly recommend the CEC to go beyond regulatory requirements and require the project applicant to adopt the use of cleaner, non-diesel technologies.
  - The GHG impact analysis should include an evaluation of the project's consistency with the most recent draft of the AB 32 Scoping Plan by the California Air Resources Board and with the State's 2030, 2045, and 2050 climate goals.
  - The EIR should estimate and evaluate the potential health risk to existing and future sensitive populations within and near the project area from toxic air contaminants (TAC) and fine particulate matter (PM<sub>2.5</sub>) as a result of the project's construction and operation.
  - The EIR should include various scenarios of backup power generation operations beyond routine testing and maintenance.
  - The EIR should evaluate all feasible measures, both onsite and offsite, to minimize air quality and GHG impacts.
  - The EIR should evaluate the Project's consistency with the Air District's 2017 Clean Air Plan (2017 CAP).
- Tribal Cultural Resources:
  - Ensure that the CEC complies with Assembly Bill 52 (includes tribal consultation requirements) in its review of the proposed project. Additional comments and

---

<sup>2</sup> Bay Area Air Quality Management District, dated 9/21/2021; Native American Heritage Commission, dated 9/10/2021; J. Montemayor dated 7/31/2021; Empere, LLC, dated 8/30/2021

concerns include tribal monitoring during construction, terms and definitions in the DEIR, and the confidential document handling process at the local municipal level.

### **1.5 Issues to be Resolved**

Staff concluded that all potentially significant impacts can be mitigated to a less than significant level. There are no remaining issues to be resolved.

# **Section 2**

---

Introduction



## **2 Introduction**

### **2.1 Energy Commission Jurisdiction and the Small Power Plant Exemption Process**

The California Energy Commission (CEC) is responsible for reviewing, and ultimately approving or denying, all thermal electric power plants 50 megawatts (MW) and greater proposed for construction in California. CEC has a regulatory process, referred to as the Small Power Plant Exemption (SPPE) process, which allows applicants with projects between 50 and 100 MW to obtain an exemption from the CEC's jurisdiction and proceed with local permitting rather than requiring a CEC license. CEC can grant an exemption if it finds that the proposed project would not create a substantial adverse impact on the environment or energy resources. See **Appendix A** for more information about the project's jurisdictional and generating capacity analysis.

### **2.2 CEQA Lead Agency**

In accordance with Public Resources Code section 25519(c) and the California Environmental Quality Act (CEQA), CEC serves as the lead agency to review an SPPE application and perform any required environmental analyses. Upon granting an exemption, the local permitting authorities—in this case the City of Santa Clara and Bay Area Air Quality Management District (BAAQMD) would undertake any additional review of the project necessary for their permitting processes.

### **2.3 Purpose of the Environmental Impact Report**

The purpose of this document is to provide agency decision makers and the public with objective information regarding the project's significant effects on the environment and energy resources, identify possible ways to minimize the significant effects, and describe reasonable alternatives to the project. This information will be used by the CEC Commissioners in considering the applicant's request for an SPPE to exempt the project from CEC's power plant licensing jurisdiction. If the CEC ultimately exempts the project from its jurisdiction, the City of Santa Clara and BAAQMD, as well as any other local permitting agency, would use this environmental analysis in their project review process.

### **2.4 Environmental Process**

#### **2.4.1 Notice of Preparation**

A Notice of Preparation (NOP) of the EIR was circulated to the public and public agencies from August 24, 2021, to September 22, 2021 (State Clearinghouse #2021080438). The NOP was combined with a request for agency participation, as required by CEC's SPPE regulations (see subsection 2.5.1 below).

### **2.4.2 Draft EIR**

The Draft EIR will be circulated for agency and public review during a 45-day public review period prior to certification of the document by the CEC. This includes submitting the Draft EIR to the State Clearinghouse, sending direct mailing to state and other agencies, sending via direct mailing to libraries, and posting the document to the project's CEC docket.

### **2.4.3 Final EIR**

Substantive comments received on the Draft EIR will be formally addressed in the Final EIR. Consistent with CEQA Guidelines section 15095, the Final EIR will be posted to the project docket and, once certified, will be provided to responsible agencies (City of Santa Clara and BAAQMD).

The decision-making body must certify that it has reviewed and considered the information in the Final EIR and that the EIR has been completed in conformity with the requirements of CEQA. The CEC must consider the information in the EIR and respond to comments submitted during the comment period. If the CEC Commissioners find that the proposed project would create a substantial adverse impact on the environment or energy resources, the SPPE would be denied and the project would be required to go through the Application for Certification permitting process in order to move forward.

If the project is determined as qualifying for an exemption, the project would seek permits from the responsible agencies. Any required mitigation measures would be enforced by the appropriate responsible agency, which includes the City of Santa Clara and BAAQMD.

## **2.5 CEQA Analysis Format**

The environmental analysis of this SPPE application takes the form of an EIR, which is prepared to conform to the requirements of CEQA and the CEQA Guidelines (California Code of Regulations, title 14, section 15000 et. seq.). The EIR is based on information from the applicant's SPPE application and associated submittals, data requests and responses, and additional staff research, including consultation with other agencies, such as responsible and trustee agencies.

### **2.5.1 Notification and Coordination**

The noticing of documents is governed by both CEC's regulations set forth in California Code of Regulations Title 20 and the CEQA Guidelines set forth in Title 14. The specific noticing requirements depend on the document at issue and are described below.

### ***2.5.1.1 Application for Small Power Plant Exemption***

The Application for SPPE (Application for Exemption) is filed by the project applicant to initiate the exemption proceeding. As specified in Title 20, section 1936(d), the noticing of the Application for Exemption is set forth in Title 20, sections 1713 and 1714. Section 1713(b) requires that a summary of the Application for Exemption be sent to public libraries in the communities near the proposed site as well as libraries in Eureka, Fresno, Los Angeles, San Diego, and San Francisco, and to any person who requests such mailing. As required by section 1713(c), the summary is to be published in a newspaper of general circulation in the county of the project site. In this case the advertisements ran in the San Jose Mercury News (in English), Daily News (in Vietnamese), World Journal (in Chinese), and El Observador (in Spanish). The relevant mailing lists covering the requirements of section 1713(b) are found in **Appendix D**.

In accordance with section 1714, staff provided notification to stakeholder agencies via an Agency Request for Participation letter. This letter provided information on how to participate in CEC's evaluation and decision-making process to agencies with potential interest in the project, most notably the California Department of Fish and Wildlife, the San Francisco Bay Regional Water Quality Control Board, BAAQMD, and various departments of the City of Santa Clara's local government. The mailing list used to engage with stakeholder agencies can be found in **Appendix D**.

Staff conducted further outreach to and consultation with regional tribal governments as described in **Section 4.5 Cultural and Tribal Cultural Resources**.

In addition to the required noticing set forth in sections 1713 and 1714, staff provided public notice of the Application for Exemption on July 30, 2021, through a Notice of Receipt (NOR). This notice was mailed to property owners and occupants within 1,000 feet of the project site and 500 feet of project linears. The NOR was also mailed to a list of environmental and environmental justice organizations developed in collaboration with the CEC Public Advisor's Office with the goal of reaching groups with potential interest in energy generation projects in the Santa Clara region. The NOR pointed recipients to the CEC's project webpage and included instructions on how to sign up for the project listserv to receive electronic notification of events and the availability of documents related to the SPPE proceeding. The relevant mailing lists staff used for this outreach can be found in **Appendix D**.

### ***2.5.1.2 Notice of Preparation and Public Scoping Meeting***

On August 24, 2021, staff issued a Notice of Preparation of an EIR to responsible and trustee agencies, starting a 30-day comment period. A scoping meeting was not required under CEQA Guidelines section 15082(c)(1) and no entity requested one; therefore, no scoping meeting was conducted for the project. During the comment period, staff received comments from the Native American Heritage Commission, the Bay Area Air Quality Management District, and from two individuals.

### ***2.5.1.3 Draft Environmental Impact Report***

The process for public notification of the Draft EIR is set forth in CEQA guidelines section 15087 and requires at least one of the following procedures:

- (1) Publication at least one time in a newspaper of general circulation in the area affected by the proposed project.
- (2) Posting of notice by the lead agency on and off site in the area where the project is to be located.
- (3) Direct mailing to the owners and occupants of property contiguous to the parcel or parcels on which the project is located. Owners of such property shall be identified as shown on the latest equalized assessment roll.

Staff exceeded the requirements of section 15087 by additionally mailing notification of the Draft EIR to all owners and occupants not just contiguous to the project site but also to property owners within 1,000 feet of the project site and 500 feet of project linears. The Draft EIR was also filed with the State Clearinghouse.

## **2.6 Organization of this EIR**

This EIR is organized into five sections, as described below:

- Section 1 Summary. This section provides a concise overview of the proposed project and the necessary approvals; the environmental impacts that would result from the proposed project; mitigation measures identified to reduce or eliminate these impacts; project alternatives; and areas of known controversy and issues to be resolved.
- Section 2 Introduction. This section summarizes the proposed project and describes the type, purpose, and function of the EIR; the environmental review process and the comments received on the NOP; and the organization of the EIR.
- Section 3 Project Description. This section presents the location of the site and project boundaries, characteristics of the proposed project, and objectives sought by the proposed project.
- Section 4 Environmental Setting, Impacts, and Mitigation. This section includes the environmental setting; regulatory framework; approach to analysis; project-specific and cumulative impacts; and mitigation measures, when appropriate. Staff evaluates the potential environmental impacts that might reasonably be anticipated to result from the construction and operation of the proposed project. Staff's analysis is broken down into the following environmental resource topics derived from CEQA Appendix G:
  - Aesthetics
  - Agricultural and Forestry Resources
  - Air Quality
  - Land Use and Planning
  - Mineral Resources
  - Noise

- Biological Resources
- Cultural and Tribal Resources
- Energy and Energy Resources
- Geology and Soils
- Greenhouse Gases
- Hazards and Hazardous Materials
- Hydrology and Water Quality
- Population and Housing
- Public Services
- Recreation
- Transportation
- Utilities and Service Systems
- Wildfire
- Mandatory Findings of Significance

In addition, this document includes an analysis of how the project would potentially impact an Environmental Justice<sup>1</sup> population.

For each subject area, the analysis includes a description of the existing conditions and setting related to the subject area, an analysis of the proposed project's potential environmental impacts, and a discussion of mitigation measures, if necessary, to reduce potentially significant impacts to less than significant levels.

- Section 5 Alternatives. This section includes a discussion of a reasonable range of alternatives to the proposed project, or to the location of the project, that could feasibly attain most of the basic objectives of the project but would avoid or substantially lessen any of the significant effects of the project, and an evaluation of the comparative merits of the alternatives. This section also includes an evaluation of the no project alternative.

---

<sup>1</sup> An environmental justice population is based on race and ethnicity or low-income status. See **Section 4.21 Environmental Justice** for more information.

# **Section 3**

---

## Project Description

### **3 Project Description**

The applicant, Vantage Data Services, filed an application with the California Energy Commission (CEC) seeking an exemption from the CEC's jurisdiction (Small Power Plant Exemption or SPPE) for the CA3 Backup Generating Facility (CA3BGF) (21-SPPE-01). The CA3BGF would be part of the CA3 Data Center (CA3DC) located in the city of Santa Clara. Both the CA3BGF and the CA3DC components comprise the larger project (CA3).

The proposed project site, located at 2590 Walsh Avenue in Santa Clara, California, encompasses 6.69 acres total. The applicant proposes to construct a four-story, approximately 468,000 square foot data center building; a 100 Megavolt amperes (MVA) electric utility substation using a two-bay design (directly adjacent across the property line from the existing Uranium Substation owned by Silicon Valley Power (SVP)); a switching station, generator equipment yard (CA3BGF); and surface parking. The data center building portion of the project would consist of two main components: the data center suites that house client servers and the administrative facilities, which would include support functions.

CA3 would consist of diesel-fired emergency backup generators (gensets), capable of generating sufficient electricity to serve the data center building. Eight of the project's 40 gensets would be redundant, yielding the applicant's goal of a 99.999 percent reliability factor. The remaining four gensets would be house generators (two of which are redundant) that would support portions of administration and features necessary for emergency response.

The new substation would deliver electricity to CA3 from Silicon Valley Power (SVP) via the new switching station, providing 60 kilovolt (kV) service to the site and supporting the need for the CA3BGF to provide uninterruptible power supply for the CA3DC servers. The CA3BGF would only be operated for maintenance, for testing, and during emergency utility power outages.

#### **3.1 Project Title**

CA3 Backup Generating Facility/Data Center (CA3)

#### **3.2 Lead Agency Name and Address**

California Energy Commission  
715 P Street  
Sacramento, California 95814-6400

#### **3.3 Lead Agency Contact Person and Phone Number**

Eric Veerkamp, Project Manager  
Siting, Transmission and Environmental Protection Division  
California Energy Commission  
(916) 661-8458

### 3.4 Project Location

The proposed CA3 would be located at 2590 Walsh Avenue in Santa Clara, California. **Figure 3-1** shows the regional location and **Figure 3-2** identifies the project location.

### 3.5 Project Overview

The CA3BGF would be an emergency backup generating facility with a generation capacity of 96 megawatts (MW) to support the CA3DC. The CA3BGF would consist of 44 2.75 MW gensets arranged in a single generation yard.

The CA3DC would consist of two main components: first, the data center suites that house client servers, and second, administrative and support facilities, such as the building lobby, restrooms, conference rooms, landlord office space, customer office space, loading dock, and storage. The data center suite components would have four levels, each containing four data center suites and corresponding electrical/uninterruptible power supply rooms.

The proposed four-story building for CA3 would have approximately 468,000 square feet of data hall space, composed of administration, data hall, and loading dock masses. Other building elements would include a utility substation, generator equipment yard, surface parking, landscaping, and a recycled water pipeline. An architectural site plan is provided in **Figure 3-3**.

The administrative portion of the CA3DC would be located on the west side of the building. The top of the parapet of the administrative and data hall would top out at 88.75 feet, as per the architectural design; however, as per the city of Santa Clara city code, a total building height at the parapet of 87.5 feet is allowable with approval from the city's Zoning Administrator. The mechanical equipment screen on the roof of the building would extend to a height of 104.83 feet from the top of the slab.

The new building for CA3DC would house computer servers and supporting equipment for private clients in a secure and environmentally controlled structure and would be designed to provide 64 MW of power to information technology (critical IT) equipment. The east side of the proposed project would house the 44 diesel gensets arranged in a generation yard. Forty of the 2.75 MW gensets would be dedicated to replacing the electricity needs of the project in case of emergency and four of the gensets would be used to support redundant critical cooling equipment and other general building and life safety services. Each of the gensets would use an approximately 5,400-gallon diesel fuel tank, with a high fuel level estimated to be 5,100 gallons. Approximately 4,700 gallons would be required for 24 hours of operation. The total diesel fuel available for all gensets would be approximately 238,000 gallons, enough to provide 24 hours of operation in a worst-case scenario. The project would be supported by an onsite substation providing 60 kV to the CA3DC. The substation would be located adjacent to and across the property line from the existing SVP-owned Uranium substation. The station would be configured as a loop with two radial taps to the substation, such that reliability is maintained by



ensuring that if there is a fault along any section of the loop, electric service would still be supplied from the receiving station at the other end of the 60 kV loop.











This Environmental Impact Report (EIR) analyzes the environmental impacts of the whole project, as described above, because of the CEC's lead agency status for this proposed project.

### **3.5.1 Electrical Power Delivery**

#### ***Electrical Supply***

Electricity for the project would be supplied via a new Vantage-Data Services-owned substation constructed on the project site, connecting through SVP's 60 kV Central Loop. The substation would include two 100 MVA (60/34.5 kV) transformers, only one is required to supply project loads. The three circuit breakers proposed in the on-site substation would allow one of the transformers to be taken out of service for repairs or maintenance while the other can fully support the project load. The Central Loop is fed from the Scott Receiving Station (SRS) and Kifer Receiving Station (KRS). Both the SRS and KRS are 115/60 kV receiving stations. Both SRS and KRS have two 115/60 kV transformers for redundancy and reliability.

SVP is currently conducting a system impact study to identify network upgrades needed to serve growing loads within their system. Pacific Gas and Electric Company (PG&E) and the California Independent System Operator (ISO) are evaluating the need to upgrade the transmission facilities delivering power to the SVP system through the California ISO's Transmission Planning Process (TPP). If these studies identify the need to upgrade the transmission system to reliably serve growing SVP loads, the build out of CA3 may be restricted until the upgrades are put into service. The CA3 and other growing loads in the SVP area are expected to be included in the California ISO 2022-2023 TPP load forecast. SVP's practice is to not add additional project load growth until after completion of environmental review and the granting of necessary entitlements. The projected timeline for CA3 would see entitlements issued after the end of January 2022. Hence, the load growth would be added to a future TPP study. Based on available information, this would likely be in the 2022-2023 TPP study since these are done annually. Any transmission upgrades identified through these studies would be subject to California Environmental Quality Act (CEQA) review (See Appendix B).

#### ***Electrical Generation Equipment***

The 44 gensets would be Caterpillar Model 3516E internal combustion engines, equipped with Miratech Selective Catalytic Reduction (SCR) equipment and diesel particulate filters (DPF) to achieve compliance with Tier 4 emission standards. The DPFs are expected to control particulate matter by approximately 71 percent. The peak rated output capacity of each genset is 3.75 MW with a steady state continuous output capacity of 2.2 MW. Each individual genset is a fully independent package system, each with dedicated fuel tank and urea storage on a skid below the unit and within the generator enclosure. (DayZenLLC 2021e).

To ensure no interruption of electricity service to the servers housed in the CA3DC building, the servers would be connected to uninterruptable power supply (UPS) systems that store energy and provide near-instantaneous protection from input power interruptions. However, to provide electricity during a prolonged electricity interruption, the UPS systems would require a flexible and reliable backup power generation source to continue supplying steady power to the servers and other equipment. The CA3BGF provides that backup power generation source with the gensets. The CA3BGF would only be interconnected to the CA3DC and would not be interconnected to the transmission or distribution grid; therefore, the CA3BGF would be unable to supply electrical power or respond to power demands off the project site.

**Fuel System.** The gensets would use ultra-low sulfur diesel fuel (< 15 parts per million sulfur by weight). The total diesel fuel available across all 44 gensets would be approximately 238,000 gallons, enough to provide 24 hours of operation.

**Cooling System.** The adiabatic cooling system would use air to cool each genset independently as part of its integrated package and, therefore, there would be no common cooling system for the project.

### 3.5.2 Water Use

The project would use a relatively small amount of water as part of its core business function. The project estimates that it would use approximately 1.75-acre feet of water for each of the two phases of construction and approximately 2.8 acre-feet per year (AFY) for operation of the CA3DC facility (primarily as part of its adiabatic cooling system, and for personal hygienic purposes and landscape watering), 2.0 AFY of potable water and 0.08 AFY of recycled water.

For potable water, the project site is within the jurisdiction and service territory of the city of Santa Clara Department of Water and Sewer Utilities. Water for the project would be provided via the San Francisco Public Utilities Commission. For recycled water, the project would be served by South Bay Water Recycling program (SBWRP), with the project plans to extend a recycled water supply from a pre-existing main in Walsh Avenue at the intersection of Northwestern Parkway.

### 3.5.3 Proposed Utility Connections

The project would not require new connections to utilities and service systems. Rather, because of the previous industrial tenant at the site, the project would avail itself of the pre-existing connections to the city's storm water, electric, telecommunications, and waste systems where possible. The following sections highlight the current conditions of those connections and where the proposed project would make minor adjustments to what currently exists.

### ***Electrical***

The project proposes to construct a new on-site switching station to SVP specifications and an on-site Vantage-Data-Services-owned substation that would provide 60 kV service to the site. The switching station would be located adjacent to and across the property line from the existing SVP Uranium Substation and cut-in to the existing 60 kV line passing nearby. The switching station would ultimately become part of SVP's infrastructure as part of its 60 kV loop system. The station would be configured as a loop with two radial taps to the onsite project substation. If there is a fault along any section of the loop, electric service would still be supplied from the receiving station at the other end of the 60 kV loop, maintaining reliability. (DayZenLLC 2021e).

### ***Storm Drainage***

The city of Santa Clara owns and maintains the municipal storm drainage system that currently serves the developed site and would continue to serve the proposed project. Existing storm water runoff exits the site at multiple locations. There are (2) 15-inch storm drain lines serving the site directly off Walsh Ave, with an additional 36-inch storm drain line serving the site in the southeast corner. This line exits the site to the easterly adjacent property before heading north to Walsh Avenue. The on-site drainage system is comprised of overland release flows and an underground pipe network to convey the anticipated peak flows that eventually discharge to the Guadalupe River, which ultimately flows to the San Francisco Bay (DayZenLLC 2021a).

### ***Domestic (Potable) Water***

Water services to the site are provided by the city of Santa Clara Department of Water and Sewer Utilities. Approximately 70 percent of the city's potable water is provided by an extensive underground aquifer (accessed by the city's wells). The remaining roughly 30 percent is provided by two wholesale water importers: the Santa Clara Valley Water District (imported from the Sacramento-San Joaquin Delta) and the San Francisco Hetch Hetchy Regional Water System (imported from the Sierra Nevada). The water system consists of more than 335 miles of water mains, 27 active water wells, and seven storage tanks with 28.8 million gallons of water storage capacity.

### ***Recycled Water***

Tertiary treated (or "recycled") water comprises approximately 16 percent of the overall water supplied by the city. Recycled water is supplied from SBWRP, which provides advanced tertiary treated water from the San Jose-Santa Clara Regional Wastewater Facility (RWF; formerly known as the San Jose/Santa Clara Water Pollution Control Plant). The city's recycled water program delivers recycled water throughout the city in addition to existing potable water supplies; recycled water is used for landscaping, parks, public services and businesses. The proposed project plans to utilize recycled water for landscaping needs.

### ***Fire Water***

There is a 12-inch diameter domestic water line operated by the city of Santa Clara under Walsh Avenue along the frontage of the property. This domestic water line would serve as the primary source for fire supply in addition to domestic water serving the project. A recycled water pipeline lies at the intersection of Walsh Avenue and Northwestern Parkway, approximately 500-feet to the southeast of the project's property. The project intends to extend the recycled water line as a secondary source of water (DayZenLLC 2021a).

### ***Wastewater (Sanitary Sewer)***

Wastewater from the city of Santa Clara is treated at the RWF. Until recently, wastewater from the pre-existing buildings on-site discharged to either a 12- or 15-inch sanitary sewer line flowing to a 30-inch line and eventually to the RWF. Sanitary sewer lines that serve the project site are and will continue to be maintained by the city of Santa Clara Water and Sewer Utilities.

The RWF is owned jointly by the two cities and operated by the city of San Jose's Department of Environmental Services. The facility is one of the largest advanced wastewater treatment facilities in California and serves over 1,400,000 people in Santa Clara and the surrounding region. The RWF provides primary, secondary, and tertiary treatment of wastewater and has the capacity to treat 167 million gallons of wastewater a day. Approximately 10 percent of the RWF's effluent is recycled for non-potable uses and the remainder flows into San Francisco Bay. The National Pollutant Discharge Elimination System (NPDES) permit for RWF includes wastewater discharge requirements.

### **3.5.4 Landscaping**

Along with demolishing the existing structure and ancillary improvements, the project would remove existing trees and other vegetation (primarily within the parking lot) associated with the existing commercial enterprise. Additional native and non-native trees and ornamental landscaping along the Walsh Avenue frontage of the property will be removed (66 trees of the 108 existing). Trees would be replaced according to the city of Santa Clara landscape ordinance standards. Other new landscaping, including shrubs and groundcover, would be planted throughout the site, including along the CA3 building's perimeter and property boundaries. All landscaping would meet city of Santa Clara requirements for low water use (DayZenLLC 2021a).

### **3.5.5 Storm Water Management**

The San Francisco Bay Regional Water Quality Control Board (RWQCB) has issued a Municipal Regional Stormwater NPDES Permit (MRP) to regulate storm water discharges from municipalities and local agencies. Under Provision C.3 of the MRP, new and redevelopment projects that create or replace 10,000 square feet or more of impervious surface area are required to implement site design, source control, and Low-Impact Development (LID)-based storm water treatment controls to treat post-construction storm water runoff.



According to Appendix E-2, HMP Applicability Map, of the “C.3 Stormwater Handbook” published by the Santa Clara Valley Urban Runoff Pollution Prevention Program (SCVURPPP), the project site is in a “purple area,” defined as catchments draining to a hardened channel and/or tidal area. According to the MRP, hydromodification controls (HMC) are not required for projects located in purple areas of the HMP Applicability Map. Therefore, the project would not incorporate HMC, but would incorporate the following measures:

The measures to be implemented for the project would include, but are not limited to, the following:

- Site Design Measures:
  - Replacing a portion of the existing paved parking area with pervious pavement (turf block).
- Source Control Measures:
  - Beneficial landscaping (minimize irrigation, runoff, pesticides, and fertilizers).
  - Directing site runoff into bioswales.
- Low-Impact Development-based controls:
  - Bioretention basin area and at-grade flow-through planter boxes totalling approximately 10,000 square feet.
  - Roof rainwater discharge directly into bioretention areas or planters OR direct rainwater discharge to pipes under sidewalks for discharge to the pavement surface for ultimate surface flow to bioretention planters along the perimeter of the site.

### **3.5.6 Waste Management**

The project would not create any waste material other than minor amounts of solid waste created during construction and maintenance activities. Solid waste and recycling collection in the city of Santa Clara is provided by Mission Trail Waste System through a contract with the city. The city has an arrangement with the owners of Newby Island Sanitary Landfill (NISL), located in San Jose to provide disposal capacity for the city of Santa Clara through 2024. (DayzenLLC 2021a)

### **3.5.7 Hazardous Materials Management**

The project applicant would prepare a Spill Prevention, Control, and Countermeasure Plan (SPCC) to address the storage, use, and delivery of diesel fuel for the gensets. Each genset and its integrated fuel tanks would be designed with double walls. The interstitial space between the walls of each tanks would be continuously monitored electronically for the existence of liquids. This monitoring system would be electronically linked to an alarm system in the security office that alerts personnel if a leak is detected. Additionally, the gensets would be housed within a self-sheltering enclosure that prevents the intrusion of storm water.

Diesel fuel would be delivered on an as-needed basis in a compartmentalized tanker truck with a maximum capacity of 8,500 gallons. The tanker truck would park on the access road to the south of the CA3BGF generator yard and extend the fuel fill hose through one of multiple hinged openings in the precast screen wall surrounding the generator equipment yard. There would be no loading/unloading racks or containment for re-fueling events; however, a spill catch basin would be located at each fill port for the gensets. To prevent a release from entering the storm drain system, drains would be blocked off by the truck driver and/or facility staff during fueling events. Rubber pads or similar devices would be kept in the generation yard to allow for the quick blockage of the storm sewer drains during fueling events. To further minimize the potential for diesel fuel to come into contact with stormwater, to the extent feasible, fueling operations would be scheduled at times when storm events are improbable. Warning signs and/or wheel chocks would be used in the loading and/or unloading areas to prevent vehicles from departing before the complete disconnection of flexible or fixed transfer lines. An emergency pump shut-off would be used if a pump hose breaks while fueling the tanks. Tanker truck loading and unloading procedures would be posted at the loading and unloading areas. Urea or diesel exhaust fluid (DEF) would be used as part of the diesel engine combustion process to meet the emissions requirements. Urea would be stored in two 55-gallon drums located within the generator enclosure. These drums can be filled in place from other drums, totes, or bulk tanker truck at the tank top or swapped out for new using quick connection fittings at the tank top.

### **3.6 Project Construction**

The construction would occur in two separate phases. If approved, Phase I activities would include all demolition, site work and grading, construction of the entire building shell and substation, and placement of approximately half of the gensets, and is estimated to take approximately 15 months to complete. Phase II of the construction would involve placement of the other half of the gensets, and tenant improvements, i.e., walls and other customized space alterations to satisfy tenant requirements. Phase II would begin as soon as feasible, likely in the second or third quarter of 2023 and take approximately seven (7) months to complete for anticipated commercial operation in the fourth quarter of 2024 (total estimated construction time of 22 months (CEC 2022a)).

After provision of the requisite time necessary to complete the CEQA environmental review and local permitting, CEC staff estimates that construction is likely to begin during the third or fourth quarter of 2022, but no earlier than mid-third quarter.

### **3.7 Workforce**

The Phase I construction workforce would be approximately 150 per month and an average of approximately 100 per month. The Phase II construction workforce is estimated to have a peak number of workers of approximately 200 per month with an average of approximately 80 per month.

Operations personnel for the project is estimated to be 33-35 persons per typical workday, including operations personnel, security guards, a janitor, tenants, and possibly visitors.

### **3.8 Site Access**

The existing curb locations and geometric design of vehicle site access from Walsh Avenue would remain identical to their current locations. For vehicle access, vehicles would be able to enter the project site from the two gated entrances located at the eastern driveway and the western driveway. However, security protocols would most likely require vehicles to enter through the security checkpoint located at the eastern driveway. Vehicles exiting the site may exit from either the western or eastern driveways. As these driveways would be identical to the existing vehicle ingress and egress points of the site, the operation of the project would not increase surface transportation hazards.

The project would provide a total of 30 off-street parking spaces total on the site. Of these 30 spaces, four spaces for electric vehicles would be provided on site and six spaces would be for clean air vehicles. Additional parking would be provided across the street at the Vantage CA1 facility to meet the city's overall code requirement (87 spaces total). The additional parking is provided to meet city requirements, but Vantage Data Services' experience has demonstrated that the 30 on-site parking spaces will be sufficient on their own to support project operations.

### **3.9 Existing Site Condition**

The project site is in a developed industrial park zoned for light industrial uses. The area is surrounded by light industrial and office uses on the north, east, and west. These uses are characterized by data centers, manufacturing, and auto-related services typically up to four stories high. Developed medium-density residential land lies to the south across an active Caltrain regional rail line.

The approximately seven-acre project site on Walsh Avenue is within a developed office/industrial park and contains a defunct (planned for demolition) single-story, solar panel manufacturing facility with loading docks at each end along with ancillary structures supporting the use. Grading of the site is not expected to require the import of fill material. It is possible that up to 10,000 cubic yards of soil and undocumented fill would be removed from the site. The building is surrounded by a parking lot, interspersed with landscaping and sidewalks. See **Figure 3-1**, **Figure 3-2**, and **Figure 3-3** for regional, vicinity, and aerial site location maps.

As stated above, existing municipal storm drainage system, existing wastewater lines, domestic water, and recycled water serve the project site.

### 3.10 Project Objectives

The applicant's primary goal is to develop a state-of-the-art data center, CA3, that would be part of the single, largest internet hub on the west coast. The project is intended to reliably meet the increased demand of the digital economy and its customers.

In addition to its primary goal, the applicant has set forth these project objectives:

- Develop a state-of-the-art data center large enough to meet projected growth.
- Develop the data center on land that has been zoned for data center use at a location acceptable to the city of Santa Clara.
- Develop a data center that can be constructed in two phases that can be timed to match projected customer growth.
- Incorporate the most reliable and flexible form of backup electric generating technology into the CA3BGF, considering the following evaluation criteria:

Reliability. The selected backup electric generation technology must be extremely reliable in the case of an emergency loss of electricity from the utility.

- The CA3BGF must provide a higher reliability than 99.999 percent in order for the CA3DC to achieve an overall reliability of equal to or greater than 99.999 percent reliability.
- The CA3BGF must provide reliability to the greatest extent feasible during natural disasters, including earthquakes.
- The selected backup electric generation technology must have a proven built-in resilience so if any of the backup unit fails due to external or internal failure, the system will have redundancy to continue to operate without interruption.
- The CA3DC must have on-site means to sustain power for 24 hours minimum in failure mode, inclusive of utility outage.

Commercial Availability and Feasibility. The selected backup electric generation technology must currently be in use and proved as an accepted industry standard for technology sufficient to receive commercial guarantees in a form and amount acceptable to financing entities. It must be operational within a reasonable timeframe where permits and approvals are required.

Technical Feasibility. The selected backup electric generation technology must utilize systems that are compatible with one another. (DayzenLLC 2021a)

## 3.11 Facility Operation

### 3.11.1 Electricity Usage and Building Load

Data centers are an energy-intensive land use, requiring more electricity than other types of development. The proposed project houses computer servers, which require electricity and cooling 24 hours a day to operate. Other electricity using components of the project in addition to the CA3DC servers and cooling are general lighting, the UPS, data center monitoring equipment, and miscellaneous power loads. The projected maximum demand for the project is 96 MW. Annual greenhouse gas (GHG) emissions associated with electricity usage are the product of the maximum estimated annual electricity usage and the utility-specific carbon intensity factor, which depends on the utility's portfolio of power generation sources, and in other words, which generation technology the energy comes from. The proposed project would be served by SVP.

The energy use emissions for the first phase of operations (the building shell and a portion of the interior for a data center tenant(s) along with sufficient backup generation) for the project were conservatively based on the annual average carbon dioxide (CO<sub>2</sub>) intensity per megawatt hour (MWh) for 2023 and 2024. Energy use emissions for full buildout (all interior spaces leased to data center tenants) in 2025 were based on the CO<sub>2</sub> intensity per MWh for 2025 for a similar project previously exempted under SPPE by the CEC. Energy use expressed as the annual maximum building load from the CA3 data center activities for Phase 1 is estimated to be 54 MW. After full buildout of Phase II, the maximum load from the CA3 data center activities is estimated to be 96 MW.

### 3.11.2 Backup System Design

CA3 is made up of 16 data center suites in the CA3DC. Each data center suite would be designed to handle 4 MW of IT equipment load. The total maximum load of each data center suite would be 6 MW, which includes the IT equipment load, mechanical equipment to cool the IT equipment load, lighting, and data center monitoring equipment. The sum of the 16-center suite would result in 64 MW of IT equipment load and 96 MW of total electrical load.

The backup electrical system has been designed to serve the lineups in pairs. Each redundant system of five 2.75 MW gensets would serve two data center lineups. Each five-genset redundant system is designed for one genset to be taken out of service at any moment in time (called "5 to make 4"). During an emergency, all five gensets would start and carry load up to approximately 80 percent of their nameplate rating supporting the two lineups they serve. If one of the gensets fails or needs to be taken out of service during the emergency, the 5 to make 4 design allows the failing genset to be removed from operation automatically with the remaining four generators to continue to serve the lineups up to the maximum design load of the two data center suites.

Each redundant backup generation system is made up of five “capacity groups” with each electrical capacity group sized at 2.75 MW (2750 kW) of total power. An electrical capacity group consists of one 2.75 kW generator, one 3,000kVA 34.5kV-480V medium voltage transformer, one 4,000 ampere 480-volt service switchboard, and a 2,000 kW UPS system. The 13.750 MW of total power equipment capacity installed for each 5-to-make-4 system effectively provides only 11 MW of total power.

The electrical load would be monitored by the building automation system. When any of the five redundant genset systems reaches 72 percent loaded (based on 90 percent of the 80 percent maximum loading under normal operation), an alarm would be activated in the engineering office. The operations staff would work with the tenants to ensure that the leased power levels would not be exceeded. It is vital to the reliability of the CA3 data center to make sure that all redundant backup generating systems remain below the 80 percent threshold. (DayzenLLC 2021a)

### **3.11.3 Energy and Water Efficiency Measures**

Due to the heat generated by the data center equipment, cooling is one of the main uses of electricity in data center operations. To reduce GHG emissions and reduce the use of energy related to building operations, the project proposes to implement the following energy and water efficiency measures:

- Daylight penetration to offices.
- Reflective roof surface.
- Meet or exceed Title 24 building standards requirements.
- Electric vehicle (EV) parking.
- Low flow plumbing fixtures.
- Landscaping would meet city of Santa Clara requirements for low water use.

Power usage effectiveness (PUE) is a metric used to compare the efficiency of facilities that house computer servers. It is defined as the ratio of total facility energy draw, including the facility's mechanical and electrical loads to IT server electrical power draw ( $PUE = \frac{\text{total facility source energy [including the Critical IT source energy]}}{\text{critical IT source energy}}$ ). While the PUE is always greater than 1, the closer it is to 1, the greater the portion of the power drawn by the facility that goes to the critical IT server equipment. The PUE has been used as a guideline for assessing and comparing energy and power efficiencies associated with data centers since 2007. According to the Uptime Institute 2019 Annual Data Center Survey Results, the current average PUE is 1.67. Vantage Data Services estimates that for the project, the maximum peak PUE is expected to be 1.45, the average annual PUE is expected to be 1.26, and actual PUE will be about 1.25, all well below the industry average. (DayzenLLC 2021e)

### 3.12 Required Approvals and Permits

If the CEC grants an SPPE exemption for the project, the city of Santa Clara would then be responsible for the approval or denial of the project in addition to an approval from the Zoning Administrator for a minor modification for the exceedance of the building height. The Bay Area Air Quality Management District would need to grant an approval for an Authority to Construct permit and a Permit to Operate.

### 3.14 References

CEC 2022a – California Energy Commission (CEC). (TN 241160). Report of Conversation – Modifications to Project Construction Phasing, dated January 4-12, 2022.

Available online

at: <https://efiling.energy.ca.gov/Lists/DocketLog.aspx?docketnumber=21-SPPE-01>

DayZenLLC 2021a – DayZenLLC (DayZenLLC). (TN 237380). VDC CA3BGF SPPE Application Part I, dated April 5, 2021. Available online

at: <https://efiling.energy.ca.gov/Lists/DocketLog.aspx?docketnumber=21-SPPE-01>

DayZenLLC 2021b – DayZenLLC (DayZenLLC). (TN 237381). VDC CA3BGF SPPE Application Part III, dated April 5, 2021. Available online

at: <https://efiling.energy.ca.gov/Lists/DocketLog.aspx?docketnumber=21-SPPE-01>

DayZenLLC 2021e – DayZenLLC (DayZenLLC). (TN 237423). VDC CA3BGF SPPE Application Part II, dated April 12, 2021. Available online

at: <https://efiling.energy.ca.gov/Lists/DocketLog.aspx?docketnumber=21-SPPE-01>

DayZenLLC 2021z – DayZenLLC (DayZenLLC). (TN240157). CA3DC PPC Drawing Set Rev3 – Part II, dated October 28, 2021. Available online

at: <https://efiling.energy.ca.gov/Lists/DocketLog.aspx?docketnumber=21-SPPE-01>

## **Section 4**

---

### Environmental Setting and Environmental Impacts



## 4.1 Aesthetics

This section describes the environmental setting and regulatory background and discusses impacts specific to aesthetics associated with the construction and operation of the project in the existing landscape.<sup>1</sup>

<b>AESTHETICS</b>		<b>Potentially Significant Impact</b>	<b>Less Than Significant with Mitigation Incorporated</b>	<b>Less Than Significant Impact</b>	<b>No Impact</b>
Except as provided in Public Resources Code Section 21099 <sup>2</sup> , would the project:					
a. Have a substantial adverse effect on a scenic vista?	<input type="checkbox"/>	<input type="checkbox"/>	<input checked="" type="checkbox"/>	<input type="checkbox"/>	
b. Substantially damage scenic resources, including, but not limited to, trees, rock outcroppings, and historic buildings within a State scenic highway?	<input type="checkbox"/>	<input type="checkbox"/>	<input checked="" type="checkbox"/>	<input type="checkbox"/>	
c. In non-urbanized areas, substantially degrade the existing visual character or quality of public views of the site and its surroundings? (Public views are those that are experienced from publicly accessible vantage point). If the project is in an urbanized area, would the project conflict with applicable zoning and other regulations governing scenic quality?	<input type="checkbox"/>	<input type="checkbox"/>	<input checked="" type="checkbox"/>	<input type="checkbox"/>	
d. Create a new source of substantial light or glare which would adversely affect day or nighttime views in the area?	<input type="checkbox"/>	<input type="checkbox"/>	<input checked="" type="checkbox"/>	<input type="checkbox"/>	

Environmental checklist established by CEQA Guidelines, Appendix G.

### 4.1.1 Environmental Setting

The proposed project is to be located on relatively flat land in a highly developed urban area within the city of Santa Clara, California. U.S. Highway 101 (Highway 101) is one mile to the north. Norman Y. Mineta San Jose International Airport (Airport) is a little

<sup>1</sup> Landscape is defined as, "The outdoor environment, natural or built, which can be directly perceived by a person visiting and using that environment. A scene is the subset of a landscape which is viewed from one location (vantage point) looking in one direction." (Hull and Revell 1989) "The term landscape clearly focuses upon the visual properties or characteristics of the environment, these include natural and man-made elements and physical and biological resources which could be identified visually; thus non-visual biological functions, cultural/historical values, wildlife and endangered species, wilderness value, opportunities for recreation activities and a large array of tastes, smells and feelings are not included." (Daniel and Vining 1983; Amir and Gidalizon 1990)

<sup>2</sup> Public Resources Code (PRC) section 21099 asks is the proposed project an "employment center project" on an "infill site" within a "transit priority area" as defined in this section. PRC § 21099(d)(1) states, "Aesthetic and parking impacts of a residential, mixed-use residential, or employment center project on an infill site within a transit priority area shall not be considered significant impacts on the environment."

more than one and three-quarter miles to the east, respectively. The Caltrain<sup>3</sup> corridor is to the south.

The area between Highway 101, the Caltrain corridor, and the Airport consists of low-intensity, heavy- and light-industrial uses that include developments of larger mid-rise buildings, manufacturing, construction-related industries, warehousing and distribution, data centers, and repair services with a combination of surface and structured parking and well-landscaped grounds. South of the Caltrain corridor are medium-density residential uses.

The project, on a 6.69-acre parcel, includes the demolition of an existing 115,000-square-foot, single-story office building, warehouse and other improvements on the site and the construction of a four-story building totaling 468,170 square feet and supporting facilities. The exterior surface of the building would consist primarily of precast concrete.<sup>4</sup> The project includes 44 diesel-fired emergency backup generators and a substation. New landscaping consisting of trees, large and medium shrubs, and groundcovers would be installed along the property boundaries, building perimeters, and throughout the parking area. Perimeter fencing and wall would be included. Refer to **Section 3 Project Description** for details regarding the project.

## Regulatory Background

### *Federal*

No federal regulations related to aesthetics apply to the project.

### *State*

**State Scenic Highway Program.** The State Scenic Highway Program was established by the Legislature as Article 2.5 (commencing with Section 260) of the Streets and Highways Code. Beginning in 1964, the State Scenic Highway Program was intended for the development of a state scenic highway system for the protection and enhancement of the state's natural scenic beauty by identifying those portions of the state highway system that, together with the adjacent scenic corridors, require special scenic conservation treatment.

### *Local*

**City of Santa Clara 2010-2035 General Plan.** The City of Santa Clara 2010-2035 General Plan (General Plan) adopted November 16, 2010, as amended, shows the project site designated Light Industrial (ML). "This classification is intended to accommodate a

---

<sup>3</sup> Caltrain is a California commuter rail line in the Santa Clara Valley and the San Francisco Peninsula.

<sup>4</sup> Architectural finishes for precast are varied. Concrete can be integrally colored with mineral pigments. The range of colors is quite wide if white cement is used. One of the most common surface treatments is exposed aggregate. Alternately, panels may be cast with a form liner and painted with a masonry-type paint. This allows the simulation of many other finishes such as hand laid masonry (brick or stone). (PCA 2021)

range of light industrial uses, including general service, warehousing, storage, distribution and manufacturing. It includes flexible space, such as buildings that allow combinations of single and multiple users, warehouses, mini-storage, wholesale, bulk retail, gas stations, data centers, indoor auto-related uses and other uses that require large, warehouse-style buildings. Because uses in this designation may be noxious or include hazardous materials, places of assembly, such as religious institutions and schools, and uses catering to sensitive receptors, such as children and the elderly, as well as entertainment uses such as clubs, theaters and sports venues south of U.S. Highway 101, are prohibited. Parking is typically surface level. The maximum FAR [floor area ratio] is 0.60." (Code Section 5.2.2)

**Santa Clara City Code.** The city of Santa Clara zoning map shows the project site within the Light Industrial (ML) zoning district. "This district is intended to provide an optimum general industrial environment, and it is intended to accommodate industries operating substantially within an enclosed building. Such permitted uses shall not be objectionable or detrimental to adjacent properties because of signing, noise, smoke, odor, dust, noxious gases, vibrations, glare, heat, fire hazards, or industrial wastes emanating from the property." (Code Section 18.48.020)

Staff reviewed the following applicable zoning code requirements that have some relation to scenic quality. They are discussed under the subsection "Environmental Impacts and Mitigation."

- Height. Maximum permitted height shall not exceed seventy (70) feet. (Code Section 18.48.070)
- Yard. The yard requirements (minimum setbacks):
  - Front yard. Each lot shall have a street side front yard of not less than fifteen (15) feet in depth.
  - Side yard adjacent to street as measured from front of curb fifteen (15) feet.
  - Rear yard - none. (Code Sections 18.48.080, 90, 100)
- Open Landscaped Area. The following yards and areas shall be developed into and permanently maintained as open landscaped areas containing ground cover, trees, and shrubs. (Code Section 18.48.120)
  - Required Front Yards and Street Side Yards. A landscaped berm or planning division-approved equivalent, not less than thirty (30) inches in height, shall be provided between the required street setback area and any open area used for parking, storage, and the like, except when the open area is necessary for driveways and walkways.
  - A minimum area equal to at least 10 percent of the required parking area to be evenly distributed throughout the parking area and adjacent to buildings.

- An alternative proposal, equal to or exceeding the open landscaped area provisions provided herein, may be used subject to approval by the Director of Community Development in accordance with the provisions of Chapter 18.76 SCCC.
- Additional Development Standards. (Code Section 18.48.140)
  - Lighting. Lighting shall be directed away from residential areas and public streets. (Code Section 18.48.140 c)
  - Trash Disposal. Each property shall provide adequate and accessible trash disposal areas. Said disposal shall be screened from public view by a masonry enclosure, with solid wood gates, at least six (6) feet in height. (Code Section 18.48.140 d)
  - Outdoor Storage and Exposed Mechanical Equipment. Subject to the applicable development standards, outdoor storage and exposed mechanical equipment shall not exceed six (6) feet in height within the first six (6) feet immediately adjacent to the front or street side yard setback line or any interior side or rear lot line. Beyond this point, storage may extend to a maximum height of ten (10) feet. Height of mechanical equipment and any accompanying screening shall be subject to Director of Community Development approval. (Code Section 18.48.140 f)

## 4.1.2 Environmental Impacts

### a. Would the project have a substantial adverse effect on a scenic vista?

Neither CEQA nor the CEQA Guidelines provide a clear-cut definition of what constitutes a scenic vista. Lead agencies may look to local planning thresholds for guidance when defining the visual impact standard for the purpose of CEQA.<sup>5</sup> A general plan, specific plan, zoning code, or other planning document may provide guidance.

#### *Construction and Operation*

*Less Than Significant Impact.* The construction and operation of the project would not have a substantial adverse effect on a scenic vista.

The General Plan does not identify a distinct scenic vista or a specific related policy. In addition, staff uses as the definition for a scenic vista “a distant view of high pictorial quality perceived through and along a corridor or opening.” The California Energy Commission in its Commission Decision (certification) for a number of thermal power plant projects used this definition.<sup>6</sup> A staff review of aerial and street view imagery and

---

5 *Mira Mar Mobile Community v. City of Oceanside* (2004) 119 Cal. App. 4th 477.

6 California Energy Commission Final Decision for GWF Tracy Combined Cycle Power Plant Project Docket Number 08-AFC-7, Visual Resources, pg. 321; California Energy Commission Decision for Mariposa Energy Project Docket Number 09-AFC-3, Visual Resources, pg. 5; California Energy Commission Decision for Blythe Solar Power Project Docket Number 09-AFC-6, Visual Resources, pg. 514; California Energy Commission Decision for Genesis Solar Energy Project Docket Number 09-AFC-8, Visual Resources, pg. 7-8; California Energy Commission Decision for Pio Pico Energy Center Docket Number 11-AFC-01, Visual Resources, pg. 8.5-4.

site photographs concluded the project would be located on a relatively unenclosed plain, the south Santa Clara Valley floor, and not within a scenic vista, as defined.

**b. Would the project substantially damage scenic resources, including, but not limited to, trees, rock outcroppings, and historic buildings within a state scenic highway?**

Neither CEQA nor the CEQA Guidelines provide a clear-cut definition of what constitutes a scenic resource. A scenic resource may be explained as a widely recognized natural or man-made feature tangible in the landscape (e.g., a scenic resource designated in an adopted federal, state, or local government document, plan, or regulation, a landmark, or a cultural resource [historic values, however, differ from aesthetic or scenic values]). This analysis evaluated if the project would substantially damage—eliminate or obstruct—the *public view*<sup>7</sup> of a scenic resource, and if the project is situated so that it changes the visual aspect of the scenic resource by being different or in sharp contrast.

***Construction and Operation***

*Less Than Significant Impact.* The construction and operation of the project would not substantially damage a scenic resource.

Review of aerial and street view imagery and the General Plan found no scenic resource on the site or in the vicinity.

A five-mile distance zone surrounding the project was used in the identification and evaluation of scenic resources. Existing aboveground buildings, structures, earthworks, equipment, trees, and vegetation, etc., block or limit the public view of the project from scenic resources.

**c. Would the project, in non-urbanized areas, substantially degrade the existing visual character or quality of public views of the site and its surroundings? (Public views are those that are experienced from publicly accessible vantage point). If the project is in an urbanized area, would the project conflict with applicable zoning and other regulations governing scenic quality?**

The proposed project is within an urbanized area. CEQA defines an “urbanized area.”<sup>8</sup> An incorporated city with a population greater than 100,000 constitutes an urbanized

---

<sup>7</sup> A public view can be defined as the visible area from a location where the public has a legal and physical right of access to real property (e.g., city sidewalk, public park, town square, state highway). CEQA Guidelines Appendix G Environmental Checklist Form, I. Aesthetics, c. states “Public views are those that are experienced from publicly accessible vantage point.”

<sup>8</sup> Public Resources Code section 21071 an “urbanized area” includes “(a) An incorporated city that meets either of the following criteria: (1) Has a population of a least 100,000 persons. (2) Has a population of less than 100,000 persons if the population of that city and not more than two contiguous incorporated cities combined equals at least 100,000 persons.”

area. Based on information from the U.S. Census Bureau, the city of Santa Clara 2019-population estimate was 130,365 (US Census 2019). As a result, the project was reviewed for conformance with zoning and other regulations governing scenic quality.

### ***Construction and Operation***

*Less Than Significant Impact.* The construction and operation of the project would not conflict with applicable zoning and other regulations governing scenic quality.

The project site is in the Light Industrial (ML) zoning district. "This district is intended to provide an optimum general industrial environment, and it is intended to accommodate industries operating substantially within an enclosed building. Such permitted uses shall not be objectionable or detrimental to adjacent properties because of signing, noise, smoke, odor, dust, noxious gases, vibrations, glare, heat, fire hazards, or industrial wastes emanating from the property." (Santa Clara 2021a, § 18.48.020)

The project includes a four-story data center building approximately 87.5 feet in height to the coping of the main parapet. The parapet conceals the rooftop exhaust fans, other mechanical and electrical equipment, and roof access. The mechanical equipment screen on the roof of the building is approximately 102 feet in height. The maximum permitted height is 70 feet in the ML zoning district. A few purposes of a height limit include to preserve a scenic vista, protect the public view of a scenic resource (e.g., architectural structure, a landmark, natural feature), and to maintain the character of a site and surrounding area (e.g., residential or commercial area). As previously discussed, a review of aerial, surface, and street imagery shows the data center building is not within a scenic vista, would not block the public view of a scenic resource and the height of the data center building would be concordant with heights of other buildings on adjacent properties.

The revised general arrangement and site layout plan shows an accessible trash disposal enclosure on the east side of the data center building. The east elevation diagram of the data center building shows a masonry enclosure. (CA3BGF 2021)

The applicant has provided a landscape plan (CA3BGF 2021a). The plan shows new landscaping consisting of trees, large and medium shrubs, and groundcover being installed along the property boundaries, building perimeters, and landscape beds distributed throughout the parking facilities. Review of the submitted landscape plan shows conformance with the city's landscaping requirements. (CA3BGF 2021a)

The project would have 44 diesel-fired emergency generators to provide backup generation in case of an interruption in electrical supply from Silicon Valley Power. The applicant has provided modeling parameters for the emergency generators for the project specifically exhaust temperature and flow rates. (CA3BGF 2021b) The modeled diesel generator data shows the exhaust stack gas temperatures at 566.93 degrees. This high of a temperature would evaporate the necessary saturated moisture rising from the exhaust stack that could condense in the atmosphere becoming a publicly visible water

vapor plume (visible plume). As a result, the operation of the modeled emergency generator would not result in the formation of visible plumes that could be an aesthetic nuisance to the site and adjacent properties and the project would not conflict with intended uses of the ML zone.

**d. Would the project create a new source of substantial light or glare which would adversely affect day or nighttime views in the area?**

Light pollution is “[t]he inappropriate or excessive use of artificial light...” (IDA 2021) Light pollution “occurs when outdoor lighting is misdirected, misplaced, unshielded, excessive or unnecessary. As a result, light spills unnecessarily upward and outward, causing glare, light trespass, and a nighttime urban ‘sky glow’ overhead, indicating wasted energy and obscuring the stars overhead.” (DSS 2017) In addition, there is reflectivity. Reflectivity “...does not create its own light. It borrows light from another source. The borrowed light waves strike an object and ‘bounce’ from it. The reflectance of the object—how bright it shines—depends on the intensity of the light striking it and the materials from which it is made.” (3M 2004)

***Construction and Operation***

*Less Than Significant Impact.* The construction and operation of the project would not create a new source of substantial light, glare or reflectivity adversely affecting day or nighttime views in the area.

Lighting shall be directed away from residential areas and public streets. (Code Section 18.48.140c)

The nearest and only residential area is across the Caltrain corridor south of the project site.

The project includes outdoor lighting for driveways, entrances, walkways, parking areas, and security purposes. The project design includes pole-mounted light fixtures along the site perimeter and directional and/or shielded light fixtures. Directional and shielded luminaires minimize glare, reduce light trespass, and do not pollute the night sky.

The exterior surface of the data center building would consist primarily of precast concrete. Precast concrete provides the ability to include colors and texture that help to reduce reflectivity.

The construction laydown and staging areas may have nighttime lighting for security purposes. Outdoor construction-related lighting would be directed onsite and away from surrounding properties and the public right of way. Light fixtures would be hooded/shielded.

**4.1.3 Mitigation Measures**

None.

#### 4.1.4 References

- Amir and Gidalizon 1990 – S. Amir and E. Gidalizon (Amir and Gidalizon). “Expert-based method for the evaluation of visual absorption capacity of the landscape.” *Journal of Environmental Management*, Vol. 30, No. 3, April 1990, cited by *The James Hutton Institute*, August 12, 2014. Accessed on: October 13, 2021. Available online at: <https://macaulay.webarchive.hutton.ac.uk/ccw/task-two/evaluate.html>
- CA3BGF 2021 – CA3 Backup Generating Facility-Vantage (CA3BGF). SPPE Application Part 1 (TN #237380). Accessed on May 2, 2021. Available online at: <https://efiling.energy.ca.gov/Lists/DocketLog.aspx?docketnumber=21-SPPE-01>
- CA3BGF 2021a – CA3 Backup Generating Facility-Vantage (CA3BGF). Landscape Planting Plan (TN #240157). Accessed on: November 4, 2021. Available online at: <https://efiling.energy.ca.gov/Lists/DocketLog.aspx?docketnumber=21-SPPE-01>
- CA3BGF 2021b – CA3 Backup Generating Facility-Vantage (CA3BGF). Application Part III (TN #237381). Accessed on June 2, 2021. Available online at: <https://efiling.energy.ca.gov/Lists/DocketLog.aspx?docketnumber=21-SPPE-01>
- Daniel and Vining 1983 – Terry C. Daniel and Joanne Vining (Daniel and Vining), *Behaviour and the Natural Environment*, Plenum Press, New York, 1983, “Methodological Issues in the Assessment of Landscape Quality,” cited by *The James Hutton Institute*, August 12, 2014. Accessed on: October 13, 2021. Available online at: <https://macaulay.webarchive.hutton.ac.uk/ccw/task-two/evaluate.html>
- DSS 2017 - Dark Sky Society (DSS). Accessed on: October 13, 2021. Available online at: <https://www.darksksociety.org/>
- Hull and Revell 1989 – R. Bruce Hull and Grant R.B. Revell (Hull and Revell), “Issues in sampling landscapes for visual quality assessments,” *Landscape and Urban Planning*, Vol. 17, No. 4, August 1989, pgs. 323-330 cited by *The James Hutton Institute*, August 12, 2014. Accessed on: October 13, 2021. Available online at: <https://macaulay.webarchive.hutton.ac.uk/ccw/task-two/evaluate.html>
- IDA 2021 – International Dark-Sky Association (IDA). Accessed on: October 13, 2021. Available online at: <https://www.darksky.org/light-pollution/>
- 3M 2004 – 3M Traffic Safety Systems Division (3M). “Reflectivity,” 2004. Accessed on: October 13, 2021. Available online at: <https://multimedia.3m.com/mws/media/2957670/reflectivity-flyer.pdf>
- PCA 2021 – PCA American’s Cement Manufactures (PCA). “Pre-Cast Concrete.” 2019. Accessed on: June 7, 2021. Available online at: <https://www.cement.org/cement-concrete/paving/buildings-structures/concrete-homes/building-systems-for-every-need/pre-cast-concrete>



Santa Clara 2010 – City of Santa Clara (Santa Clara). City of Santa Clara 2010-2035 General Plan (General Plan) adopted November 16, 2010. Accessed on: May 20, 2021. Available online at:  
<https://www.santaclaraca.gov/home/showpublisheddocument/56139/636619791319700000>

Santa Clara 2021a – City of Santa Clara (Santa Clara). Santa Clara City Code. February 23, 2021. Accessed on: May 20, 2021. Available online at:  
<https://www.codepublishing.com/CA/SantaClara/#!/SantaClara18/SantaClara18.html>

US Census 2019 – United States Census Bureau (US Census). QuickFacts. Last updated: July 1, 2019. Accessed on: May 25, 2021. Available online at:  
<https://www.census.gov/quickfacts/santaclaracitycalifornia>

## 4.2 Agriculture and Forestry Resources

This section describes the environmental setting and regulatory background and discusses impacts associated with the construction and operation of the project specific to agriculture and forestry resources.

<b>AGRICULTURE AND FORESTRY RESOURCES</b>  In determining whether impacts to agricultural resources are significant environmental effects, lead agencies may refer to the California Agricultural Land Evaluation and Site Assessment Model (1997) prepared by the California Department of Conservation as an optional model to use in assessing impacts on agriculture and farmland. In determining whether impacts to forest resources, including timberland, are significant environmental effects, lead agencies may refer to information compiled by the California Department of Forestry and Fire Protection regarding the state's inventory of forest land, including the Forest and Range Assessment Project and the Forest Legacy Assessment Project; and forest carbon measurement methodology provided in Forest Protocols adopted by the California Air Resources Board.	<b>Potentially Significant Impact</b>	<b>Less Than Significant with Mitigation Incorporated</b>	<b>Less Than Significant Impact</b>	<b>No Impact</b>
a. Convert Prime Farmland, Unique Farmland, or Farmland of Statewide Importance (Farmland), as shown on the maps prepared pursuant to the Farmland Mapping and Monitoring Program of the California Resources Agency, to non-agricultural use?	<input type="checkbox"/>	<input type="checkbox"/>	<input type="checkbox"/>	<input checked="" type="checkbox"/>
b. Conflict with existing zoning for agricultural use, or a Williamson Act contract?	<input type="checkbox"/>	<input type="checkbox"/>	<input type="checkbox"/>	<input checked="" type="checkbox"/>
c. Conflict with existing zoning for, or cause rezoning of, forest land (as defined in Public Resources Code section 12220(g)), timberland (as defined by Public Resources Code section 4526), or timberland zoned Timberland Production (as defined by Government Code section 51104(g))?	<input type="checkbox"/>	<input type="checkbox"/>	<input type="checkbox"/>	<input checked="" type="checkbox"/>
d. Result in the loss of forest land or conversion of forest land to non-forest use?	<input type="checkbox"/>	<input type="checkbox"/>	<input type="checkbox"/>	<input checked="" type="checkbox"/>
e. Involve other changes in the existing environment which, due to their location or nature, could result in conversion of Farmland to non-agricultural use or conversion of forest land to non-forest use?	<input type="checkbox"/>	<input type="checkbox"/>	<input type="checkbox"/>	<input checked="" type="checkbox"/>

Environmental checklist established by CEQA Guidelines, Appendix G.

## 4.2.1 Environmental Setting

Although the city of Santa Clara (city) was historically an agricultural community through the mid-1900s, the city has shifted over time into a suburban community that includes residential, commercial, and industrial land uses (city of Santa Clara 2010). The project is located in a commercial and industrial area within the city and the proposed site is zoned Light Industrial (ML). The nearest agricultural production operations are in southern Santa Clara County, more than 30 miles outside city boundaries (city of Santa Clara 2010).

### Regulatory Background

#### *Federal*

No federal regulations relating to agriculture and forestry resources apply to the project.

#### *State*

**Farmland Mapping and Monitoring Program.** The California Department of Conservation (CDOC) established the Farmland Mapping and Monitoring Program (FMMP) in 1982 to assess the location, quantity, and quality of agricultural lands and conversion of those lands to other uses. The FMMP identifies and maps agricultural lands as Prime Farmland, Farmland of Statewide Importance, Unique Farmland, Farmland of Local Importance, and Grazing Land (CDOC 2019).<sup>1</sup> Non-agricultural land that is occupied by structures is classified as Urban and Built-Up Land.<sup>2</sup>

Per the CDOC's FMMP, there is no designated agricultural land within the city (CDOC 2021a). The project site is identified by the CDOC as Urban and Built-Up Land (CDOC 2021a).

**Williamson Act.** The California Land Conservation Act of 1965, or Williamson Act, is the principal method for encouraging the preservation of agricultural lands in California (Gov. Code, § 51200 et seq.). It enables local governments to enter into contracts with private landowners who agree to maintain specified parcels of land as agricultural or related open space use in exchange for tax benefits.

---

1 Prime Farmland: Farmland with the best combination of physical and chemical features able to sustain long-term agricultural production.

Farmland of Statewide Importance: Similar to Prime Farmland but with greater slopes or less ability to store soil moisture.

Unique Farmland: Lesser quality soils used for the production of the state's leading agricultural crops.

Farmland of Local Importance: Land of importance to the local agricultural economy as determined by each county's board of supervisors and a local advisory committee.

2 Urban and Built-Up Land: Occupied by structures with a building density of at least 1 unit to 1.5 acres, or approximately 6 structures to a 10-acre parcel. Examples include residential, industrial, commercial, institutional facilities, cemeteries, airports, golf courses, sanitary landfills, sewage treatment, and water control structures.

Williamson Act contracts are primarily located in northeastern, eastern, and southern Santa Clara County, with the nearest Williamson Act contract located more than seven miles from the project site (County of Santa Clara 2021). As there are no agricultural lands within city boundaries, there are no lands under a Williamson Act contract within the city.

### *Local*

**City of Santa Clara General Plan and Zoning Ordinance.** The project site is in an area designated by the city as Light Industrial (ML), which accommodates a range of uses that require large warehouse-style buildings, such as data centers (city of Santa Clara 2010). The project site is zoned Light Industrial; permitted uses within an ML zone include “plants and facilities for the assembly, compounding, manufacture, packaging, processing, repairing, or treatment of equipment, materials, merchandise, or products” (Santa Clara 2021a, Code Section 18.48.030, subd. (c)).

While the City of Santa Clara 2010-2035 General Plan does not include agricultural resources within its list of land use types, the city’s City Code includes an Agricultural Zoning District (“A”) that is intended to “provide for the protection of existing agricultural lands, to encourage the preservation and the retention of the land in its natural state and to provide an interim zoning for lands newly annexed to the city” (City of Santa Clara Zoning Code, tit. 18, Code Section 18.08.020). The nearest “A” zoning district, located approximately 2.5 miles north of the project site, is the site of the Westside Retention Basin along the San Tomas Aquino Creek Trail (city of Santa Clara 2021). This “A” zoning district has not been developed for agricultural use.

## **4.2.2 Environmental Impacts**

- a. Convert Prime Farmland, Unique Farmland, or Farmland of Statewide Importance (Farmland), as shown on the maps prepared pursuant to the Farmland Mapping and Monitoring Program of the California Department of Conservation, to non-agricultural use?**

### *Construction and Operation*

*No Impact.* There is no evidence of historic agricultural activities or CDOC-designated Farmland at the project site. Staff reviewed past Important Farmland maps for Santa Clara County on the CDOC website, which date back to 1984 (CDOC 2021b). Since 1984, the project site and surrounding area were designated by CDOC as Urban and Built-Up Land. Therefore, the project would not convert Farmland to a non-agricultural use. Construction and operation activities would cause no impact to Farmland.

**b. Conflict with existing zoning for agricultural use or a Williamson Act contract?**

*Construction and Operation*

*No Impact.* The project site is zoned ML and the parcels surrounding the project site are zoned either ML or Public/Quasi-Public (PQP) (i.e., public uses such as Uranium Substation, an adjacent Silicon Valley Power substation). There are no "A" zoning districts within a mile of the project site. As the city does not contain farmland or agricultural operations, there are no Williamson Act contracts within the city. Therefore, the project would not conflict with zoning for agricultural use or a Williamson Act contract, and no impact would occur.

**c. Conflict with existing zoning for, or cause rezoning of, forest land (as defined in Public Resources Code section 12220(g)), timberland (as defined by Public Resources Code section 4526), or timberland zoned Timberland Production (as defined by Government Code section 51104(g))?**

*Construction and Operation*

*No Impact.* The project site is zoned ML and the parcels surrounding the project site are zoned either ML or PQP. There are no land use types or zoning designations within the city for forest land, timberland, or timberland production. Therefore, project construction and operation would not create an impact on such lands or uses.

**d. Result in the loss of forest land or conversion of forest land to non-forest use?**

*Construction and Operation*

*No Impact.* The project site does not contain forest land and is not in a region where forest land is present; therefore, project construction and operation would cause no loss of forest land, and no impact would occur.

**e. Involve other changes in the existing environment which, due to their location or nature, could result in conversion of Farmland to non-agricultural use or conversion of forest land to non-forest use?**

*Construction and Operation*

*No Impact.* As discussed above, there is no evidence of historic agricultural activities or CDOC -designated farmland at the project site. According to staff's review of CDOC Important Farmland maps that date back to 1984, the project site and surrounding area were designated by the CDOC as Urban and Built-Up Land. Therefore, neither project construction nor operation would cause a change in the environment that could convert farmland to a non-agricultural use.

Furthermore, there are no land use types or zoning designations within the city specific to forest land, timberland, or timberland production. Neither project construction nor operation would cause a change in the environment that could convert forest land to non-forest use. Therefore, no impact would occur.

### 4.2.3 Mitigation Measures

None.

### 4.2.4 References

- CDOC 2019 – California Department of Conservation (CDOC). Farmland Mapping and Monitoring Program. Important Farmland Categories. Copyright 2019. Accessed on June 14, 2021. Available online at: <https://www.conservation.ca.gov/dlrp/fmmp/Pages/Important-Farmland-Categories.aspx>
- CDOC 2021a – California Department of Conservation (CDOC). Farmland Mapping and Monitoring Program. California Important Farmland Finder. Accessed on June 14, 2021. Available online at: <https://www.conservation.ca.gov/dlrp/fmmp>
- CDOC 2021b - California Department of Conservation (CDOC). Farmland Mapping and Monitoring Program. Important Farmland Time Series. Accessed on June 14, 2021. Available online at: <https://www.conservation.ca.gov/dlrp/fmmp>
- City of Santa Clara 2010. *City of Santa Clara General Plan 2010-2035*. Adopted on November 16, 2010. Chapter 1, pg. 1-3; Chapter 5.2.2; Chapter 8.12, pg. 8.12-21. Accessed on June 14, 2021. Available online at: <https://www.santaclaraca.gov/our-city/departments-a-f/community-development/planning-division/general-plan>
- City of Santa Clara 2021. Interactive. Amended February 23, 2021. Accessed on: June 14, 2021. Available online at: <https://www.santaclaraca.gov/our-city/departments-a-f/community-development/planning-division/zoning>
- County of Santa Clara 2021. Williamson Act and Open Space Easement in Santa Clara County. Interactive Map of Williamson Act Properties. Accessed on June 14, 2021. Available online at: <https://www.sccgov.org/sites/dpd/Programs/WA/Pages/WA.aspx>

### 4.3 Air Quality

This section describes the environmental setting and regulatory background and discusses impacts specific to air quality associated with the demolition/construction, readiness testing and maintenance, and the potential for emergency operation of the CA3 Data Center (CA3DC) and the associated CA3 Backup Generating Facility (CA3BGF), known together as the project. It is important to note that intermittent and standby emitting sources, like those proposed in this project, could operate for emergency use, and such emergency operations would be infrequent and for unplanned circumstances, which are beyond the control of the project owner. Emergency operations and the impacts of air pollutants during emergencies are generally exempt from air district offsetting and modeling requirements. Emissions from emergency operations are not regular, expected, or easily quantifiable such that they cannot be modeled or predicted with certainty.

<b>AIR QUALITY</b>  Where available, the significance criteria established by the applicable air quality management district or air pollution control district may be relied upon to make the following determinations. Would the project:	<b>Potentially Significant Impact</b>	<b>Less Than Significant with Mitigation Incorporated</b>	<b>Less Than Significant Impact</b>	<b>No Impact</b>
a. Conflict with or obstruct implementation of the applicable air quality plan?	<input type="checkbox"/>	<input type="checkbox"/>	<input checked="" type="checkbox"/>	<input type="checkbox"/>
b. Result in a cumulatively considerable net increase of any criteria pollutant for which the project region is nonattainment under an applicable federal or state ambient air quality standard?	<input type="checkbox"/>	<input checked="" type="checkbox"/>	<input type="checkbox"/>	<input type="checkbox"/>
c. Expose sensitive receptors to substantial pollutant concentrations?	<input type="checkbox"/>	<input type="checkbox"/>	<input checked="" type="checkbox"/>	<input type="checkbox"/>
d. Result in other emissions (such as those leading to odors) adversely affecting a substantial number of people?	<input type="checkbox"/>	<input type="checkbox"/>	<input checked="" type="checkbox"/>	<input type="checkbox"/>

Environmental checklist established by CEQA Guidelines, Appendix G.

#### 4.3.1 Summary

In this analysis, CEC staff (staff) concludes that, with the implementation of mitigation measure **AQ-1** and oxides of nitrogen (NOx) emissions fully offset through the permitting process with Bay Area Air Quality Management District (BAAQMD), the project would not have a significant impact on air quality. Staff analyzes two primary types of air emissions: (1) criteria pollutants, which have health-based ambient air quality standards (AAQS); and (2) toxic air contaminants (TACs), which are identified as potentially harmful even at low levels and have no established safe levels or health-based AAQS. The project would be constructed in two phases, with Phase I including demolition, grading, the installation of utility services, the construction of an on-site substation, the construction of the entire

shell of the CA3DC building, and placement of approximately one-half of the gensets, and Phase II including the interior buildout and placement of the emergency backup generators for the second half of the CA3DC building (CEC 2022a). Staff analyzes the project's impacts on air quality during demolition/construction, routine operation, and the potential for emergency operation of the emergency backup generators (gensets). Staff also analyzes the potential cumulative effects of the project on air quality.

#### 4.3.1.1 Significance Criteria

This air quality evaluation assesses the degree to which the project would potentially cause a significant impact according to the California Environmental Quality Act (CEQA) guidelines. BAAQMD is the local air district responsible for the attainment and maintenance of the federal and state AAQS and associated program requirements at the project location. The analysis is based upon the methodologies and related thresholds of significance in BAAQMD's May 2017 CEQA Air Quality Guidelines (BAAQMD 2017b) to determine the significance of the potential air quality emissions and impacts. These methodologies include qualitative determinations and the quantification of whether project construction or operation would exceed numeric emissions and health risk thresholds (BAAQMD 2017b).

BAAQMD CEQA Guidelines project-level thresholds of significance ("BAAQMD significance thresholds") for criteria pollutants and precursor pollutants and the health risks of TACs that apply during construction and operation are shown in **Table 4.3-1**. If a project exceeds the identified significance thresholds, its emissions would be cumulatively considerable, resulting in significant adverse air quality impacts to the Bay Area region's existing air quality conditions. Staff evaluates project emissions against the BAAQMD significance thresholds under environmental checklist criterion "b."

For fugitive dust emissions during construction periods, the BAAQMD CEQA Guidelines do not have a significance threshold. Rather, BAAQMD recommends using a current Best Management Practices (BMPs) approach, which has been a pragmatic and effective approach to the control of fugitive dust emissions.

Staff also evaluates the project's potential to expose sensitive receptors to substantial pollutant concentrations under environmental checklist criterion "c." Staff addresses both the ambient air quality impacts of criteria pollutants, which have health-based standards, and the impacts of TACs, which are identified as potentially harmful even at low levels and have no established safe levels or health-based ambient air quality standards.

The analysis includes ambient air quality impact modeling for demolition/construction and operation, which consists of readiness testing and maintenance, of the proposed diesel-fueled gensets to estimate the air quality impacts caused by the emissions. The AAQS, shown in **Table 4.3-2**, are health protective values, so staff uses these health-based regulatory standards to help define what is considered a substantial pollutant



concentration for criteria pollutants.<sup>1</sup> Staff's analysis determines whether the project would be likely to exceed any AAQS or contribute substantially to an existing or projected air quality violation, and, if necessary, proposes mitigation to reduce or eliminate these pollutant exceedances or substantial contributions.

**TABLE 4.3-1 BAAQMD THRESHOLDS OF SIGNIFICANCE**

Pollutant	Construction	Operation	
	Average Daily Emissions (lbs/day)	Average Daily Emissions (lbs/day)	Maximum Annual Emissions (tpy)
ROG	54	54	10
NOx	54	54	10
PM10	82 (exhaust)	82	15
PM2.5	54 (exhaust)	54	10
PM10/ PM2.5 (fugitive dust)	Best Management Practices	None	
Local CO	None	9.0 ppm (8-hour average), 20.0 ppm (1-hour average)	
Risk and Hazards for New Sources and Receptors (Individual Project)	Same as Operation Threshold	Compliance with Qualified Community Risk Reduction Plan OR Increased cancer risk of >10.0 in a million Increased non-cancer risk of > 1.0 Hazard Index (Chronic or Acute) Ambient PM2.5 increase: > 0.3 µg/m <sup>3</sup> annual average <u>Zone of Influence:</u> 1,000-foot radius from property line of source or receptor	
Risk and Hazards for New Sources and Receptors (Cumulative Threshold)	Same as Operation Threshold	Compliance with Qualified Community Risk Reduction Plan OR Cancer: > 100 in a million (from all local sources) Non-cancer: > 10.0 Hazard Index (from all local sources) (Chronic) PM2.5: > 0.8 µg/m <sup>3</sup> annual average (from all local sources) <u>Zone of Influence:</u> 1,000-foot radius from property line of source or receptor	

Source: BAAQMD 2017b, Table 2-1

Significance criteria also include Significant Impact Levels (SILs) for the particulate matter portions of the analysis. Regulatory agencies have traditionally applied SILs as a de minimis value, which represents the off-site concentration predicted to result from a source's emissions that does not warrant additional analysis or mitigation. If a source's modeled impacts at any off-site location do not exceed relevant SILs, the source owner

<sup>1</sup> This approach provides a complete analysis that describes the foreseeable effects of the project in relation to all potential air quality related health impacts, including impacts of criteria pollutants to sensitive receptors; and therefore, addresses the California Supreme Court December 2018 *Sierra Club v. County of Fresno* opinion (<https://www.courts.ca.gov/opinions/archive/S219783A.PDF>).

would typically not need to assess multi-source or cumulative air quality to determine whether or not that source's emissions would cause or contribute to a violation of the relevant National Ambient Air Quality Standard (NAAQS) or California Ambient Air Quality Standard (CAAQS). In the project's vicinity, based on data from the local San Jose-Jackson Street air quality monitoring station about 4.6 miles east-southeast of the project site, shown in **Table 4.3-4**, the background levels of particulate matter of 10 micrometers or less in diameter (PM10) and particulate matter of 2.5 micrometers and smaller in diameter (PM2.5) already exceed the 24-hour and annual AAQS even before accounting for the project's emissions. Staff compares the project's contribution to local criteria pollutant concentrations to SILs to determine whether the project's emissions would contribute significantly to those exceedances.

BAAQMD does not have significance criteria in terms of PM10 concentrations or 24-hour concentrations of PM2.5. To determine if the project could contribute substantially to the existing PM10 exceedances, this analysis relies on the United States Environmental Protection Agency (U.S. EPA) PM10 SILs established in federal regulations for non-attainment areas (40 CFR 51.165(b)(2)) for 24-hour impacts ( $5 \mu\text{g}/\text{m}^3$ ) and for annual impacts ( $1 \mu\text{g}/\text{m}^3$ ). The same federal regulation (40 CFR 51.165(b)(2)) also established the U.S. EPA PM2.5 SILs concentrations for 24-hour impacts ( $1.2 \mu\text{g}/\text{m}^3$ ) and for annual impacts ( $0.3 \mu\text{g}/\text{m}^3$ ).

- The BAAQMD significance threshold for a project-level increase in annual PM2.5 concentrations is also 0.3 micrograms per cubic meter ( $\mu\text{g}/\text{m}^3$ ), as shown in **Table 4.3-1**. However, in April 2018, the U.S. EPA issued *Guidance on Significant Impact Levels for Ozone and Fine Particles in the Prevention of Significant Deterioration Permitting Program* (U.S. EPA 2018a), which recommends PM2.5 SILs levels for 24-hour impacts to be  $1.2 \mu\text{g}/\text{m}^3$  (as in [40 CFR 51.165(b)(2)]) and for annual impacts to be  $0.2 \mu\text{g}/\text{m}^3$  (lower than  $0.3 \mu\text{g}/\text{m}^3$ ). Note that the U.S. EPA SILs values are all based on the forms of the applicable NAAQS. For example, the 24-hour PM2.5 SILs of  $1.2 \mu\text{g}/\text{m}^3$  is based on the 98<sup>th</sup> percentile 24-hour concentrations averaged over three years. The annual PM2.5 SILs of  $0.2 \mu\text{g}/\text{m}^3$  is based on a three-year average of annual average concentrations. For this analysis, staff uses the U.S. EPA SILs as well as the BAAQMD CEQA Guidelines significance threshold to determine project impact significance of PM2.5 concentrations.

The health risks from the project's TACs are compared with the BAAQMD significance thresholds. If risks to the maximally exposed sensitive receptors are below significance thresholds, then impacts to other receptors would also be below significance thresholds. Cumulative health risk assessment (HRA) results are also compared with the BAAQMD significance thresholds for cumulative risk and hazards. For HRA purposes, TACs are separated into carcinogens and non-carcinogens based on the nature of the physiological effects associated with exposure to the pollutant. Therefore, there are two kinds of thresholds for TACs: cancer risk and non-cancer risk. Cancer risk is expressed as excess cancer cases per one million exposed individuals, typically over a lifetime of exposure.

Acute and chronic exposure to non-carcinogens is expressed as a hazard index (HI), which is the ratio of expected exposure levels to acceptable reference exposure levels (REL) for each of the TACs with acute and chronic health effects. The significance thresholds for TACs and PM<sub>2.5</sub> are listed in **Table 4.3-1** and summarized in the following text (BAAQMD 2017b).

The BAAQMD significance thresholds for a single source are as follows:

- An excess lifetime cancer risk level of more than 10 in one million.
- A non-cancer chronic HI greater than 1.0.
- A non-cancer acute HI greater than 1.0.
- An incremental increase in the annual average PM<sub>2.5</sub> concentration of greater than 0.3 µg/m<sup>3</sup>.

The BAAQMD CEQA Guidelines significance thresholds for cumulative impacts are also summarized below. A project would have a cumulatively considerable impact if the aggregate total of all past, present, and foreseeable future sources within a 1,000-foot distance from the fence line of a source and the contribution from the project, exceeds the following:

- An excess lifetime cancer risk level of more than 100 in one million.
- A non-cancer chronic HI greater than 10.0.
- An annual average PM<sub>2.5</sub> concentration of greater than 0.8 µg/m<sup>3</sup>.

Additionally, if a project would not exceed the BAAQMD significance thresholds discussed above, then a project would also be consistent with and not have any impact on BAAQMD's Bay Area 2017 Clean Air Plan. This plan provides a regional strategy to protect public health and the climate, and it defines an integrated, multipollutant control strategy to reduce emissions of particulate matter, TACs, ozone and key ozone precursors, and greenhouse gases (GHG). The environmental checklist criterion "a" in this air quality analysis addresses the consistency of the project with BAAQMD's Bay Area 2017 Clean Air Plan.

#### **4.3.1.2 Criteria Pollutants (including Fugitive Dust)**

##### *i. Construction*

Under environmental checklist criterion "b," staff explains that construction-phase emissions are a result of construction equipment, material movement, paving activities, and on-site and off-site vehicle trips, such as material haul trucks, worker commutes, and delivery vehicles. The project would be constructed in two phases, with Phase I including demolition, grading, the installation of utility services, the construction of an on-site substation, the construction of the entire shell of the CA3DC building, and placement of approximately one-half of the gensets and Phase II including the interior buildout and

placement of the emergency backup generators for the second half of the CA3DC building. Project construction would occur for a total of about 22 months.

As shown in **Table 4.3-5**, the project's average daily criteria pollutant emissions during construction would be lower than the relevant numeric BAAQMD significance thresholds. There is no numerical threshold for fugitive dust generated during construction. The BAAQMD CEQA Guidelines recommend the control of fugitive dust through BMPs to conclude that impacts from fugitive dust emissions are less than significant (BAAQMD 2017b). Staff recommends **AQ-1**, which incorporates the project applicant's proposed measures that would include BAAQMD's recommended construction BMPs and exhaust emissions mitigation measures. With the implementation of **AQ-1**, the fugitive dust impacts from construction would be less than significant.

Under environmental checklist criterion "c," staff also analyzes the localized impacts of construction criteria pollutant emissions by comparing them with the AAQS. As shown in **Table 4.3-7**, staff finds that construction emissions would not contribute to any exceedance of the AAQS, except to the preexisting exceedances of PM10 and PM2.5. For PM10 and PM2.5, the project's contributions to the concentrations of PM10 and PM2.5 at sensitive receptor locations would be below the relevant SILs. Therefore, the project would not expose sensitive receptors to substantial criteria pollutant concentrations during construction. Construction is considered short-term, and construction impacts would be further reduced with the implementation of **AQ-1**, which includes BAAQMD's recommended construction BMPs and exhaust emissions mitigation measures.

With the implementation of **AQ-1**, criteria pollutant and fugitive dust emissions from project construction would not exceed any BAAQMD CEQA Guidelines significance threshold, cause a cumulatively considerable net increase of any criteria pollutant, conflict with or obstruct any applicable regional or local air quality plan, or expose sensitive receptors to substantial criteria pollutant concentrations, and would, thus, be less than significant.

## *ii. Operation and Maintenance*

Staff evaluates criteria pollutant emissions from operation and maintenance in two sections: (A) "routine operation" emissions including, among other things, emissions from readiness testing and maintenance of the 44 gensets; and (B) "emergency operation" emissions from using the gensets to support the electricity demand of the project.

### (A) Routine Operation

Under environmental checklist criterion "b," staff concludes that criteria pollutant emissions from the project's routine operation would be less than significant with NOx emissions fully offset through the permitting process with BAAQMD. Routine operation of the project would generate criteria pollutant emissions from readiness testing and maintenance of the 44 gensets, off-site vehicle trips for worker commutes and material

deliveries, and facility upkeep, such as architectural coatings, consumer product use, landscaping, water use, waste generation, natural gas use for comfort heating, and electricity use.

As shown in **Table 4.3-6**, staff finds that the project's total annual and average daily emissions of criteria pollutants from routine operation would be below the BAAQMD CEQA Guidelines significance thresholds, except for NO<sub>x</sub> emissions. The project's gross total NO<sub>x</sub> emissions would exceed BAAQMD significance thresholds and could, therefore, contribute to a cumulatively considerable net increase of NO<sub>x</sub> emissions. However, during BAAQMD's permitting process, BAAQMD will require the applicant to fully offset its NO<sub>x</sub> emissions. With NO<sub>x</sub> emissions fully offset, the project's total net annual and average daily emissions would not exceed any of the BAAQMD significance thresholds.

The project would also emit ammonia from the urea used in the selective catalytic reduction (SCR) system. There is no BAAQMD threshold for ammonia, which is not a criteria pollutant but instead a precursor to particulate matter. Because the project's primary emissions of particulate matter are well below the BAAQMD CEQA Guidelines significance thresholds, secondary particulate matter impacts from the project's ammonia emissions of 0.29 tons per year (tpy) would be less than significant and not require additional mitigation or offsets.

Under environmental checklist criterion "c," staff also analyzes the localized impacts of the project's criteria pollutant emissions during readiness testing and maintenance of the gensets by comparing them with the AAQS. As shown in **Table 4.3-8**, staff finds that the project's routine operation emissions would not contribute to any exceedance of any AAQS, except to the preexisting exceedances of PM<sub>10</sub> and PM<sub>2.5</sub>. However, staff finds that the project's contributions to concentrations of PM<sub>10</sub> and PM<sub>2.5</sub> would be below the relevant SILs, and, therefore, would not expose sensitive receptors to substantial criteria pollutant concentrations.

Staff concludes that, with NO<sub>x</sub> emissions fully offset through the BAAQMD permitting process, criteria pollutant emissions from routine operation of the project would not exceed any BAAQMD CEQA Guidelines significance threshold, cause a cumulatively considerable net increase of any criteria pollutant, conflict with or obstruct any applicable regional or local air quality plan, or expose sensitive receptors to substantial criteria pollutant concentrations, and would, thus, be less than significant.

#### (B) Emergency Operation

The emergency use of the gensets could occur in the event of a power outage or other disruption, upset, or instability that triggers a need for the project to use emergency backup power.

##### (1) Criteria Pollutant Emissions from Emergency Operation

As discussed under environmental checklist criterion “b,” the BAAQMD 2019 policy, *Calculating Potential to Emit for Emergency Backup Power Generators*, requires a facility’s potential to emit (PTE) to be calculated based on emissions proportional to emergency operation for 100 hours per year per genset, in addition to the permitted limits for readiness testing and maintenance (BAAQMD 2019). However, after comparing the PTE calculated to determine the account eligibility threshold, the applicant would only be required to offset permitted emissions from readiness testing and maintenance and not the emissions from emergency operation. BAAQMD requires the use of offsets to counterbalance increases in regular and predictable emissions, not increases in emissions occurring infrequently when emergency conditions arise.

In addition, emissions during routine operation are conservatively estimated with the assumption of 35 hours of readiness testing and maintenance per year per engine. As discussed in **Section 4.8 Greenhouse Gas Emissions**, the project applicant would probably need to limit the readiness testing and maintenance to 20 hours per year per engine to lower the GHG emissions to the pending, still-to-be-adopted BAAQMD CEQA GHG threshold of significance of 2,000 metric tons of carbon dioxide equivalent per year (MTCO<sub>2</sub>e/yr) if applicable at the time of permitting. However, other data center project applicants previously have stated that routine testing and maintenance would rarely exceed 12 hours per year. Based on the evidence about the likelihood and duration of emergency operation, the allowance of 20 (or 35) hours per engine per year likely accommodates the average annual emergency operation emissions. Thus, staff concludes that the project would be unlikely to cause a cumulatively considerable net increase of any criteria pollutant.

## (2) Criteria Pollutant Impacts from Emergency Operation

As discussed in detail under *Emergency Operations Impacts for Criteria Pollutants* under environmental checklist criterion “c,” the air quality impacts of genset operation during emergencies are not quantified below because the impacts of emergency operations are typically not evaluated during facility permitting and local air districts do not normally conduct an air quality impact assessment of such impacts. Staff assessed the likelihood of emergency events but finds that assessing the air quality impacts of emergency operations would require a host of unvalidated, unverifiable, and speculative assumptions about when and under what circumstances such a hypothetical emergency would occur. Such a speculative analysis is not required under CEQA (CEQA Guidelines §§ 15064(d)(3) and 15145), and, most importantly, would not provide meaningful information by which to determine project impacts. If emergency operation becomes a more frequent occurrence and more data is gathered regarding when and how these facilities operate during emergency situations, this conclusion might change.

Staff reviewed the BAAQMD comments on the Notice of Preparation (NOP) regarding the use of diesel engines for “non-testing/non-maintenance” purposes (BAAQMD 2021b) and confirmed that these types of events are infrequent, irregular, and unlikely and the resulting emissions are not easily predictable or quantifiable. See more detailed discussion under *Emergency Operations Impacts for Criteria Pollutants* under environmental checklist criterion “c.”

### *iii. Cumulative Impacts*

Staff concludes that the project’s criteria pollutant emissions would not be cumulatively significant. BAAQMD CEQA Guidelines state that if a project’s daily average or annual emissions of operational-related criteria pollutants or precursors do not exceed any BAAQMD threshold of significance, as listed in **Table 4.3-1** above, the project would not result in a cumulatively significant impact. As explained above, staff finds that all the criteria pollutant emissions would be below the BAAQMD CEQA Guidelines thresholds of significance with the implementation of **AQ-1** and NO<sub>x</sub> emissions would be fully offset through the BAAQMD permitting process.

In addition, under environmental checklist criterion “c,” staff performed a cumulative impacts analysis for annual PM<sub>2.5</sub> impacts as part of a cumulative HRA. Staff concludes that the project’s contribution to the annual PM<sub>2.5</sub> concentrations would not be cumulatively significant.

Thus, staff concludes that the project’s criteria pollutant emissions from the routine operation of the project would not be cumulatively significant.

#### **4.3.1.3 Toxic Air Contaminants (TACs)**

Under environmental checklist criterion “c,” staff analyzes the potential impacts of the project’s TAC emissions separately for construction and routine operation. Staff also analyzes the cumulative effects of the project’s TAC emissions together with the impacts of other sources within 1,000 feet. Staff concludes that the individual and cumulative impacts from the project’s TAC emissions would be less than significant.

Staff finds the health risks at most sensitive receptor locations would be less than the BAAQMD CEQA Guidelines significance thresholds shown in **Table 4.3-1**. Staff concludes that the health risks from project construction and routine operation would be less than significant and would be further reduced with the implementation of **AQ-1**.

Staff finds that cumulative health risks at sensitive receptor locations would be less than the BAAQMD CEQA Guidelines significance thresholds shown in **Table 4.3-1**. Staff concludes that the effect of cumulative TAC emissions would be less than significant.

### 4.3.1.4 Background on Air Quality Evaluation

#### Criteria Pollutant Evaluation

California Air Resources Board (CARB) and U.S. EPA have each established federal and state AAQS for criteria pollutants. While both NAAQS and CAAQS apply to every location in California, typically the state standards are lower (i.e., more stringent) than federal standards. Air monitoring stations, usually operated by local air districts or CARB, measure the ambient air to determine an area's attainment status for NAAQS and CAAQS. Depending on the pollutant, the time over which these pollutants are measured varies from 1-hour, to 3-hours, to 8-hours, to 24-hours and to annual averages. Most criteria pollutants have ambient standards with more than one averaging time. Pollutant concentrations are expressed in terms of mass of pollution per unit volume of air, typically using micrograms for the mass portion of the expression and cubic meters of air for the volume, or "micrograms per cubic meter of air, expressed as  $\mu\text{g}/\text{m}^3$ ." The concentration can also be expressed as parts of pollution per million parts of air or "ppm." AAQS appear in Section 4.3.2 of this analysis.

Some forms of air pollution are primary air pollutants, which are gases and particles directly emitted from stationary and mobile sources. Other forms of air pollution are secondary air pollutants that result from complex interactions between primary pollutants, background atmospheric constituents, and other secondary pollutants. Some pollutants can be a combination of both primary and secondary formation, such as PM<sub>2.5</sub>. In this case, the primary pollutant component of PM<sub>2.5</sub> is directly emitted from the stack of diesel-fueled engines and the secondary pollutant component of PM<sub>2.5</sub> is formed in the air by the transformation of gaseous NO<sub>x</sub> and sulfur oxides (SO<sub>x</sub>) into particles. In this case, the NO<sub>x</sub> and SO<sub>x</sub> emissions are precursors to the formation of the secondary aerosol pollutant.

Emissions of NO<sub>x</sub> include nitric oxide (NO) and nitrogen dioxide (NO<sub>2</sub>). In the case of stack emissions from diesel-fueled engines, approximately 90 percent of the NO<sub>x</sub> is in the form of NO while the remainder is directly emitted NO<sub>2</sub>. The ambient standards are expressly for NO<sub>2</sub>, not NO. Once these gases exit the stack, chemical reactions in the region downwind of the facility, meteorological conditions, and sunlight interact to convert the NO into NO<sub>2</sub>, ozone, and particulates. Most ozone in the ambient air is not directly emitted. Rather, it is formed in the air when the NO to NO<sub>2</sub> reaction occurs, followed by a set of complex reactions including interactions with volatile organic compounds (VOC). BAAQMD uses the term precursor organic compounds (POC) instead of VOC.

California is divided into 35 local air districts. Some of these local governmental agencies are called "air quality management districts," while others are called "air pollution control districts." Generally, state law designates local air districts as having primary responsibility for the control of air pollution from all sources other than mobile sources while the control of vehicular air sources is the responsibility of CARB. (Health and Safety Code, §39002)



Additionally, CARB is charged with coordinating efforts to attain and maintain CAAQS and NAAQS. (Health and Safety Code, §39003) Areas that meet the AAQS, based upon air monitoring measurements made by either the local air district or CARB, are classified as “attainment areas,” and areas that have monitoring data that exceed AAQS are classified as “nonattainment areas.” (Health and Safety Code, §39608) Additionally, any given area can be classified as attainment for some pollutants and nonattainment for others. Even for the same pollutant, an area can be attainment for one averaging time and nonattainment for another.

Air districts adopt rules and attainment and maintenance plans aimed at protecting public health and reducing emissions. (Health and Safety Code, §40001) Air districts incorporate these requirements into the State Implementation Plan (SIP), which CARB submits for approval to the U.S. EPA as the state’s overall plan to come into attainment for federal NAAQS. (Health and Safety Code, §39602) Once a SIP is approved by the U.S. EPA and published in the Federal Register, the requirements in the SIP become federally enforceable. Consistency of the project with the applicable air quality management plan is addressed as part of environmental checklist criterion “a” in this air quality analysis.

For those facilities subject to CEC jurisdiction, the project is evaluated to determine whether it would be able to comply with all applicable local, state, and federal requirements. If the CEC is issuing the license, this analysis occurs during the review of the Application for Certification (AFC), with the local air district participating in this process by preparing a Determination of Compliance (DOC). However, since this project is going through an exemption to the AFC process under the Small Power Plant Exemption, the DOC is not prepared. If the proposed generating capacity is 50 megawatts (MW) to 100 MW, the CEC conducts a CEQA review before allowing the project to be exempt from CEC’s AFC licensing. Once the CEC’s jurisdictional process is approved, the local air district would then implement its permit review process and, if the proposed facility meets local air district requirements, an operating permit would be issued by that air district.

The local air district’s New Source Review (NSR) program does the following: (1) defines the facility’s potential-to-emit; (2) determines whether the sources would achieve minimum performance standards; (3) assesses whether the sources would achieve the Best Available Control Technology (BACT) requirements; and (4) determines whether the project would trigger offset requirements. These issues are addressed as part of environmental checklist criterion “b” in this air quality analysis.

### **Non-Criteria Pollutant Evaluation**

Non-criteria pollutants that are typically evaluated are airborne toxic pollutants identified to have potential harmful human health impacts. Evaluations assess the potential risks from TACs and hazardous air pollutants (HAPs). TACs include toxic air pollutants identified by CARB, and HAPs include toxic air pollutants identified at the federal level. Most toxic air pollutants do not have AAQS; however, AAQS have been established for a few pollutants. Since TACs have no AAQS that specify health-based levels considered safe for

everyone, a HRA is used to determine if people might be exposed to those types of pollutants at unhealthy levels.

TACs are separated into “carcinogens” and “non-carcinogens” based on the nature of the physiological effects associated with exposure. There are two types of thresholds for TACs: cancer risk and non-cancer risk. Cancer risk is expressed as excess cancer cases per 1 million exposed individuals, typically over a lifetime of exposure. Acute and chronic exposure to non-carcinogens is expressed as a HI, which is the ratio of expected exposure levels to acceptable REL for each of the TACs associated with acute and chronic health effects.

The impact evaluation of toxic pollutants focuses on the project’s incremental impact due to diesel particulate matter (DPM) exhaust from construction equipment and from the stacks of the diesel-fueled gensets. That is because DPM is the primary TAC of concern. This issue is addressed as part of environmental checklist criterion “c” in this air quality analysis.

### **Odor Impact Evaluation**

Aside from criteria pollutants and TACs, impacts may arise from other emissions, notably related to odor. This issue is addressed as part of environmental checklist criterion “d” in this air quality analysis.

## **4.3.2 Environmental Setting**

The proposed project is proposed to be located at 2590 Walsh Avenue in Santa Clara. The property is irregularly shaped and is bounded on the northwest by an existing microelectronics testing facility, on the northeast by a software research and development facility, on the south by an operational CalTrain rail line, on the east by Walsh Avenue, and on the west by an existing Silicon Valley Power (SVP) substation (Uranium Substation). The Vantage Santa Clara Data Center Campus CA1 is east across Walsh Avenue.

Refer to the **Section 3 Project Description** for further details regarding the project.

### **Criteria Pollutants**

The U.S. EPA and the CARB have established AAQS for several pollutants based on their adverse health effects. The U.S. EPA has set NAAQS for ozone (O<sub>3</sub>), carbon monoxide (CO), NO<sub>2</sub>, PM<sub>10</sub>, PM<sub>2.5</sub>, sulfur dioxide (SO<sub>2</sub>), and lead (Pb). These pollutants are commonly referred to as “criteria pollutants.” Primary standards were set to protect public health; secondary standards were set to protect public welfare against visibility impairment, damage to animals, crops, vegetation, and buildings. In addition, CARB has established CAAQS for these pollutants, as well as for sulfate (SO<sub>4</sub>), visibility reducing particles, hydrogen sulfide (H<sub>2</sub>S), and vinyl chloride. CAAQS are generally stricter than NAAQS. The standards currently in effect in California and relevant to the project are shown in **Table 4.3-2**.

**TABLE 4.3-2 NATIONAL AND CALIFORNIA AMBIENT AIR QUALITY STANDARDS**

Pollutant	Averaging Time	California Standards <sup>a</sup>	National Standards <sup>b</sup>	
			Primary	Secondary
O <sub>3</sub>	1-hour	0.09 ppm (180 µg/m <sup>3</sup> )	—	Same as Primary Standard
	8-hour	0.070 ppm (137 µg/m <sup>3</sup> )	0.070 ppm (137 µg/m <sup>3</sup> )	
PM <sub>10</sub>	24-hour	50 µg/m <sup>3</sup>	150 µg/m <sup>3</sup>	Same as Primary Standard
	Annual Mean	20 µg/m <sup>3</sup>	—	
PM <sub>2.5</sub>	24-hour	—	35 µg/m <sup>3</sup>	Same as Primary Standard
	Annual Mean	12 µg/m <sup>3</sup>	12 µg/m <sup>3</sup>	15 µg/m <sup>3</sup>
CO	1-hour	20 ppm (23 mg/m <sup>3</sup> )	35 ppm (40 mg/m <sup>3</sup> )	—
	8-hour	9.0 ppm (10 mg/m <sup>3</sup> )	9 ppm (10 mg/m <sup>3</sup> )	—
NO <sub>2</sub>	1-hour	0.18 ppm (339 µg/m <sup>3</sup> )	0.100 ppm (188 µg/m <sup>3</sup> ) <sup>c</sup>	—
	Annual Mean	0.030 ppm (57 µg/m <sup>3</sup> )	0.053 ppm (100 µg/m <sup>3</sup> )	Same as Primary Standard
SO <sub>2</sub> <sup>d</sup>	1-hour	0.25 ppm (655 µg/m <sup>3</sup> )	75 ppb (196 µg/m <sup>3</sup> )	—
	3-hour	—	—	0.5 ppm (1,300 µg/m <sup>3</sup> )
	24-hour	0.04 ppm (105 µg/m <sup>3</sup> )	0.14 ppm (for certain areas) <sup>d</sup>	—
	Annual Mean	—	0.030 ppm (for certain areas) <sup>d</sup>	—

Notes: ppm=parts per million; ppb = parts per billion; µg/m<sup>3</sup> = micrograms per cubic meter; mg/m<sup>3</sup> = milligrams per cubic meter; “—” = no standard

<sup>a</sup> California standard for O<sub>3</sub>, CO (except 8-hour Lake Tahoe), SO<sub>2</sub> (1 and 24 hour), NO<sub>2</sub>, and particulate matter (PM<sub>10</sub>, PM<sub>2.5</sub>, and visibility reducing particles), are values that are not to be exceeded. All others are not to be equaled or exceeded.

<sup>b</sup> National standards (other than O<sub>3</sub>, PM, NO<sub>2</sub> [see note c below], and those based on annual arithmetic mean) are not to be exceeded more than once a year. The 8-hour O<sub>3</sub> standard is attained when the fourth highest 8-hour concentration measured at each site in a year, averaged over three years, is equal to or less than the standard. The 24-hour PM<sub>10</sub> standard of 150 µg/m<sup>3</sup> is not to be exceeded more than once per year on average over a 3-year period. The 24-hour PM<sub>2.5</sub> standard is attained when the 3-year average of 98th percentile concentration is less than or equal to 35 µg/m<sup>3</sup>.

<sup>c</sup> To attain the 1-hour national standard, the 3-year average of the annual 98th percentile of the 1-hour daily maximum concentrations at each site must not exceed 0.100 ppm.

<sup>d</sup> On June 2, 2010, a new 1-hour SO<sub>2</sub> standard was established and the existing 24-hour and annual primary standards were revoked. To attain the 1-hour national standard, the 3-year average of the annual 99th percentile of the 1-hour daily maximum concentrations at each site must not exceed 75 ppb. The previous SO<sub>2</sub> standards (24-hour and annual) will additionally remain in effect in certain areas: (1) any area for which it is not yet 1 year since the effective date of designation under the current (2010) standards, and (2) any area for which an implementation plan providing for attainment of the current (2010) standard has not been submitted and approved and which is designated nonattainment under the previous SO<sub>2</sub> standards or is not meeting the requirements of a SIP call under the previous SO<sub>2</sub> standards (40 CFR 50.4(3)). A SIP call is a U.S. EPA action requiring a state to resubmit all or part of its State Implementation Plan to demonstrate attainment of the required NAAQS.

Sources: BAAQMD 2021a, U.S. EPA 2021a

## Attainment Status and Air Quality Plans

The U.S. EPA, CARB, and the local air districts classify an area as attainment, unclassified, or nonattainment, depending on whether the monitored ambient air quality data show compliance, insufficient data are available, or non-compliance with the AAQS, respectively. The proposed project would be in Santa Clara County in the San Francisco Bay Area Air Basin (SFBAAB), under the jurisdiction of BAAQMD. **Table 4.3-3** summarizes attainment status for the relevant criteria pollutants in the SFBAAB with both NAAQS and CAAQS.

**TABLE 4.3-3 ATTAINMENT STATUS FOR SFBAAB**

Pollutant	Averaging Time	State Designation	Federal Designation
O <sub>3</sub>	1-hour	Nonattainment	—
	8-hour	Nonattainment	Nonattainment
PM <sub>10</sub>	24-hour	Nonattainment	Unclassified
	Annual	Nonattainment	—
PM <sub>2.5</sub>	24-hour	—	Nonattainment <sup>a</sup>
	Annual	Nonattainment	Unclassifiable/attainment <sup>b</sup>
CO	1-hour	Attainment	Attainment
	8-hour	Attainment	Attainment
NO <sub>2</sub>	1-hour	Attainment	Unclassifiable/Attainment
	Annual	Attainment	Attainment
SO <sub>2</sub>	1-hour	Attainment	Attainment/Unclassifiable <sup>c</sup>
	24-hour	Attainment	— <sup>d</sup>
	Annual	—	— <sup>d</sup>

Notes:

<sup>a</sup> On January 9, 2013, U.S. EPA issued a final rule to determine that the Bay Area attains the 24-hour PM<sub>2.5</sub> national standard (U.S. EPA 2013). This U.S. EPA rule suspends key SIP requirements as long as monitoring data continues to show that the Bay Area attains the standard. Despite this U.S. EPA action, the Bay Area will continue to be designated as “non-attainment” for the national 24-hour PM<sub>2.5</sub> standard until such time as the BAAQMD submits a “redesignation request” and a “maintenance plan” to U.S. EPA, and U.S. EPA approves the proposed redesignation.

<sup>b</sup> In December 2012, U.S. EPA strengthened the annual PM<sub>2.5</sub> NAAQS from 15.0 to 12.0 µg/m<sup>3</sup>. In December 2014, U.S. EPA issued final area designations for the 2012 primary annual PM<sub>2.5</sub> NAAQS (U.S. EPA 2014). Areas designated “unclassifiable/attainment” must continue to take steps to prevent their air quality from deteriorating to unhealthy levels. The effective date of this standard is April 15, 2015.

<sup>c</sup> On January 9, 2018, U.S. EPA issued a final rule to establish the initial air quality designations for certain areas in the U.S. for the 2010 SO<sub>2</sub> primary NAAQS (U.S. EPA 2018b). This final rule designated the SFBAAB as attainment/unclassifiable for the 2010 SO<sub>2</sub> primary NAAQS.

<sup>d</sup> See noted under **Table 4.3-2**.

Sources: CARB 2021a, BAAQMD 2021a, U.S. EPA 2013, U.S. EPA 2014, U.S. EPA 2018b

Overall air quality in the SFBAAB is better than most other developed areas in California, including the South Coast, San Joaquin Valley, and Sacramento air basin regions. This is due to a more favorable climate with cooler temperatures and regional air flow patterns that transport pollutants emitted in the air basin out of the air basin. Although air quality improvements have occurred, violations and exceedances of the state ozone and PM standards continue to persist in the SFBAAB, and still pose challenges to CARB and local air districts (CARB 2013). The project area's proximity to both the Pacific Ocean and the San Francisco Bay has a moderating influence on the climate. This portion of the Santa Clara Valley is bounded by the San Francisco Bay to the north, the Santa Cruz Mountains to the southwest and west, and the Diablo Range to the northeast. The surrounding terrain greatly influences winds in the valley, resulting in a prevailing wind that flows along the Santa Clara Valley's northwest-southeast axis.

Pollutants in the air can cause health problems, especially for children, the elderly, and people with heart or lung problems. Healthy adults may experience symptoms during periods of intense exercise. Pollutants can also cause damage to vegetation, animals, and property.

### Existing Ambient Air Quality

The nearest background ambient air quality monitoring station to the project is the San Jose-Jackson Street station, which is about 4.6 miles east-southeast of the project site. **Table 4.3-4** presents the air quality monitoring data from the San Jose-Jackson Street monitoring station from 2016 to 2020, the most recent years for which data are available. Data in this table that are marked in **bold** indicate that the most-stringent current standard was exceeded during that period.

<b>Pollutant</b>	<b>Averaging Time</b>	<b>2016</b>	<b>2017</b>	<b>2018</b>	<b>2019</b>	<b>2020</b>
O <sub>3</sub> (ppm)	1-hour	0.087	<b>0.121</b>	0.078	<b>0.095</b>	<b>0.106</b>
	8-hour	0.066	<b>0.098</b>	0.061	<b>0.081</b>	<b>0.085</b>
PM <sub>10</sub> (µg/m <sup>3</sup> )	24-hour	41	<b>70</b>	<b>121.8</b>	<b>77.1</b>	<b>137.1</b>
	Annual	18.5	<b>21.3</b>	<b>23.1</b>	19.1	<b>24.8</b>
PM <sub>2.5</sub> (µg/m <sup>3</sup> )	24-hour (98th percentile)	19	34.3	<b>73.4</b>	20.6	<b>56.1</b>
	Annual	8.4	9.5	<b>12.9</b>	9.1	11.5
NO <sub>2</sub> (ppb)	1-hour (maximum)	51.1	67.5	86.1	59.8	51.9
	1-hour (98th percentile)	42	50	59	52	45
	Annual	11.26	12.24	12.04	10.63	9
CO (ppm)	1-hour	2	2.1	2.5	1.7	1.9
	8-hour	1.4	1.8	2.1	1.3	1.5
SO <sub>2</sub> (ppb)	1-hour (maximum)	1.8	3.6	6.9	14.5	2.9
	1-hour (99th percentile)	2	3	3	2	2
	24-hour	0.8	1.1	1.1	1.5	0.8

Notes: All data from San Jose-Jackson Street monitoring station.  
Concentrations in **bold** type are those that exceed the limiting ambient air quality standard.  
Sources: CARB 2021b, U.S. EPA 2021b

The maximum concentration values listed in **Table 4.3-4** have not been screened to remove values that are designated as exceptional events. Violations that are the result of exceptional events, such as wildfires, are normally excluded from consideration as AAQS violations. Exceptional events undoubtedly affected many of the maximum concentration values in recent years, especially between September to mid-November during wildfire activity. The ozone, PM10, and PM2.5 in 2017, 2018, and 2020 illustrate the effect of events like the extensive northern California wildland fires.<sup>2</sup> Even though fires tended to be far from the monitoring stations, the blanket of smoke and adverse air quality most likely affected air monitoring stations in the urban areas surrounding the project. For a conservative analysis, staff uses the background ambient air quality concentrations from 2018 to 2020 to represent the baseline condition at the project site.

### *Health Effects of Criteria Pollutants*

Below are descriptions of the health effects of criteria pollutants that are a concern in the regional study area. Health and Safety Code, section 39606 requires CARB to adopt ambient air quality standards at levels that adequately protect the health of the public, including infants and children, with an adequate margin of safety. Ambient air quality standards define clean air (CARB 2021c).

**Ozone.** Ozone is a respiratory irritant and an oxidant that increases susceptibility to respiratory infections and that can cause substantial damage to vegetation and other materials. Ozone is not emitted directly into the atmosphere but is a secondary air pollutant produced in the atmosphere through a complex series of photochemical reactions involving reactive organic gases (ROG) and NO<sub>x</sub>, including NO<sub>2</sub>. ROG and NO<sub>x</sub> are known as precursor compounds for ozone. Significant ozone production generally requires ozone precursors to be present in a stable atmosphere with strong sunlight.

Ozone can cause the muscles in the airways to constrict, trapping air in the alveoli, potentially leading to wheezing and shortness of breath. Ozone can make it more difficult to breathe deeply and vigorously; cause shortness of breath and pain when taking a deep breath; cause coughing and sore or scratchy throat; inflame and damage the airways; aggravate lung diseases, such as asthma, emphysema, and chronic bronchitis; increase the frequency of asthma attacks; make the lungs more susceptible to infection; continue to damage the lungs even when the symptoms have disappeared; and cause chronic obstructive pulmonary disease. Long-term exposure to ozone is linked to the aggravation of asthma and is likely to be one of many causes of asthma development. Long-term exposures to higher concentrations of ozone may also be linked to permanent lung damage, such as abnormal lung development in children. The inhalation of ozone causes inflammation and irritation of the tissues lining human airways, causing, and worsening a variety of symptoms, and exposure to ozone can reduce the volume of air that the lungs breathe in and cause shortness of breath.

---

<sup>2</sup> Wildfires also emit substantial amounts of volatile and semi-volatile organic materials and nitrogen oxides that form ozone and organic particulate matter (NOAA 2019).

People most at risk for adverse health effects from breathing air containing ozone include people with asthma, children, older adults, and people who are active outdoors, especially outdoor workers. Children are at greatest risk from exposure to ozone because their lungs are still developing and they are more likely to be active outdoors when ozone levels are high, which increases their exposure. Studies show that children are no more or less likely to suffer harmful effects than adults; however, children and teens may be more susceptible to ozone and other pollutants because they spend nearly twice as much time outdoors and engage in vigorous activities compared to adults. Children breathe more rapidly than adults and inhale more pollution per pound of their body weight than adults and are less likely than adults to notice their own symptoms and avoid harmful exposures.

**Particulate Matter.** PM10 and PM2.5 represent size fractions of particulate matter that can be inhaled into air passages and the lungs and can cause adverse health effects. Very small particles of certain substances (e.g., sulfates and nitrates) can cause lung damage directly or can contain absorbed gases (e.g., chlorides or ammonium) that may be injurious to health. The health effects of particulate matter may include cardiovascular effects, such as cardiac arrhythmias and heart attacks, and respiratory effects, such as asthma attacks and bronchitis. Particulates can also reduce visibility.

**Nitrogen Dioxide.** Breathing air with a high concentration of NO<sub>2</sub> can irritate airways in the human respiratory system. Such exposures over short periods (as represented by the 1-hour standards) can aggravate respiratory diseases, particularly asthma, leading to respiratory symptoms (such as coughing, wheezing or difficulty breathing), hospital admissions, and visits to emergency rooms. Longer exposures to elevated concentrations of NO<sub>2</sub> (as represented by the annual standards) may contribute to the development of asthma and potentially increase susceptibility to respiratory infections. People with asthma, as well as children and the elderly, are generally at greater risk for the health effects of NO<sub>2</sub>. NO<sub>x</sub> (includes NO<sub>2</sub> and NO) reacts with other chemicals in the air and sunlight to form both particulate matter and ozone.

**Carbon Monoxide.** CO is a pollutant that is a product of incomplete combustion and is mostly associated with motor vehicle traffic. High CO concentrations develop primarily during winter when periods of light winds combine with the formation of ground-level temperature inversions (typically from the evening through early morning). These conditions result in the reduced dispersion of vehicle emissions. Motor vehicles also exhibit increased CO emission rates at low air temperatures. When inhaled at high concentrations, CO combines with hemoglobin in the blood and reduces the oxygen-carrying capacity of the blood. This results in reduced oxygen reaching the brain, heart, and other body tissues. This condition is especially critical for people with cardiovascular diseases, chronic lung disease, or anemia.

**Sulfur Dioxide.** SO<sub>2</sub> is produced through the combustion of sulfur or sulfur-containing fuels, such as coal. SO<sub>2</sub> is also a precursor to the formation of atmospheric sulfate and particulate matter (PM10 and PM2.5) and contributes to potential atmospheric sulfuric acid formation that could precipitate downwind as acid rain.

**Lead.** Lead has a range of adverse neurotoxin health effects and previously was predominately released into the atmosphere primarily via the combustion of leaded gasoline. The phase-out of leaded gasoline has resulted in decreasing levels of atmospheric lead.

### **Toxic Air Contaminants**

Health and Safety Code, section 39655 defines a toxic air contaminant as "an air pollutant which may cause or contribute to an increase in mortality or an increase in serious illness, or which may pose a present or potential hazard to human health." In addition, substances that have been listed as HAPs pursuant to 42 U.S.C. section 7412 are TACs under the state law pursuant to Health and Safety Code, section 39657 (b). CARB formally identified HAPs in California Code of Regulations, Title 17, section 93001 (OEHHA 2021). TACs, also referred to as HAPs or air toxics, are different from criteria pollutants, such as ground-level ozone, particulate matter, carbon monoxide, nitrogen dioxide, sulfur dioxide, and lead. Criteria pollutants are regulated using NAAQS and CAAQS, as noted above. However, there are no ambient standards for most TACs<sup>3</sup> so site-specific HRAs are conducted to evaluate whether risks of exposure to TACs create an adverse impact. Specific TACs have known acute, chronic, and cancer health impacts. CARB has identified TACs in California Code of Regulations, Title 17, sections 93000 and 93001. The nearly 200 regulated TACs include asbestos, organic chemical compounds, and inorganic chemical compounds and compound categories, diesel exhaust, and certain metals. The requirements of the Air Toxic "Hot Spots" Information and Assessment Act of 1987 (Health and Safety Code, sec. 44300 et. seq) apply to facilities that emit these listed TACs above regulated threshold quantities.

#### ***Health Effects of TACs***

The health effects associated with TACs are quite diverse and generally are assessed locally rather than regionally. TACs could cause long-term health effects, such as cancer, birth defects, neurological damage, asthma, bronchitis, or genetic damage; or short-term effects, such as eye watering, respiratory irritation (a cough), runny nose, throat pain, and headaches (BAAQMD 2017b, pg. 5-1). Numerous other health effects also have been linked to exposure to TACs, including heart disease, Sudden Infant Death Syndrome, respiratory infections in children, lung cancer, and breast cancer (OEHHA 2015).

The primary on-site TAC emission sources for the CA3BGF would be diesel engines, including engines in vehicles and equipment used during construction and stationery genset engines during readiness testing and maintenance. Diesel exhaust is a complex mixture of thousands of gases and fine particles and contains over 40 substances listed by the U.S. EPA as HAPs and by CARB as TACs. The solid material in diesel exhaust is known as DPM (CARB 2021d).

---

<sup>3</sup> Ambient air quality standards for TACs exist for lead (federal and state standards), hydrogen sulfide (state standard), and vinyl chloride (state standard).



DPM has been the accepted surrogate for whole diesel exhaust since the late 1990s. CARB identified DPM as the surrogate compound for whole diesel exhaust in its Proposed Identification of Diesel Exhaust as a Toxic Air Contaminant staff report in April 1998 (Appendix III, Part A, Exposure Assessment [CARB 1998]). DPM is primarily composed of aggregates of spherical carbon particles coated with organic and inorganic substances. Diesel exhaust deserves particular attention mainly because of its ability to induce serious noncancerous effects and its status as a likely human carcinogen. Diesel exhaust is also characterized by CARB as “particulate matter from diesel-fueled engines.” The impacts from human exposure would include both short and long-term health effects. Short-term effects can include increased coughing, labored breathing, chest tightness, wheezing, and eye and nasal irritation. Effects from long-term exposure can include increased coughing, chronic bronchitis, reductions in lung function, and inflammation of the lung. Epidemiological studies strongly suggest a causal relationship between occupational diesel exhaust exposure and lung cancer. Diesel exhaust is listed by the U.S. EPA as “likely to be carcinogenic to humans” (U.S. EPA 2002).

### ***Sensitive Receptors***

Sensitive receptors are defined as groups of individuals that may be more susceptible to health risks due to chemical exposure. Sensitive individuals, such as infants, the aged, and people with specific illnesses or diseases, are the subpopulations that are more sensitive to the effects of toxic substance exposure. Examples of sensitive receptors include residences, schools and school yards, parks and playgrounds, daycare centers, nursing homes, and medical facilities. Residences could include houses, apartments, and senior living complexes. Medical facilities could include hospitals, convalescent homes, and health clinics. Playgrounds could be play areas associated with parks or community centers (BAAQMD 2017b, pg. 5-8). The potential sensitive receptor locations evaluated in the HRA for CA3DC include (DayZenLLC 2021b, pg. 2):

- Residential dwellings, including apartments, houses, and condominiums.
- Schools, colleges, and universities.
- Daycare centers.
- Hospitals and health clinics.
- Senior-care facilities.

### ***Sensitive Receptors Near the Project***

BAAQMD CEQA Guidelines recommends that any proposed project, including the siting of a new TAC emissions source, assess associated community risks and hazards impacts within 1,000 feet of the proposed project and take into account both individual and nearby cumulative sources (that is, proposed project plus existing and foreseeable future projects). Cumulative sources represent the combined total risk values of each individual source within the 1,000-foot evaluation zone. A lead agency should enlarge the 1,000-foot radius on a case-by-case basis if an unusually large source or sources of risk or

hazard emissions that may affect a proposed project is beyond the recommended radius (BAAQMD 2017b, Table 2-1, pg. 5-2, and pg. 5-3).

Staff previously used a six-mile radius for cumulative impacts analyses of power plant projects. Based on staff's modeling experience, beyond six miles there is no statistically significant concentration overlap for nonreactive pollutant concentration between two stationary emission sources. The six-mile radius is more appropriate to be used for the turbines with tall stacks and more buoyant plumes. But the diesel genset engines would result in more localized impacts due to shorter stacks and less buoyant plumes. The worst-case impacts of the diesel genset engines would occur at or near the fence line and decrease rapidly with distance from fence line. Therefore, staff believes that the BAAQMD CEQA Guidelines-recommended 1,000 feet is reasonable for the cumulative HRA of the project.

The project site is approximately 6.69 acres (DayZenLLC 2021a, pg. 2-1). The applicant conducted a sensitive receptor search within the 1,000-meter (3,280-ft) of the project, which is farther than the BAAQMD recommended 1,000-ft evaluation zone and determined that the closest residential uses are to the south across the existing Caltrain railroad right-of-way. The applicant also included a park directly south of the project site across the rail line as a potential sensitive receptor. The nearest sensitive receptor would be the nearest residential areas to the south across the existing Caltrain railroad right-of-way, which is about 175 feet from the fence line. The nearest school or daycare to the facility was found to be a school (i.e., Bracher Elementary) approximately 650 feet south of the project boundary. All schools and daycare facilities within 1,000 meters were also analyzed in the HRA (DayZenLLC 2021b, pg. 2). A list of the nonresidential sensitive receptors, such as school, recreation, and daycare, within or just beyond a 1,000-foot radius of the CA3DC project site was presented in Response to Data Request 22 (DayZenLLC 2021t, pg. 18). **Figure 4.3-1** shows the map of sensitive receptors near the project.

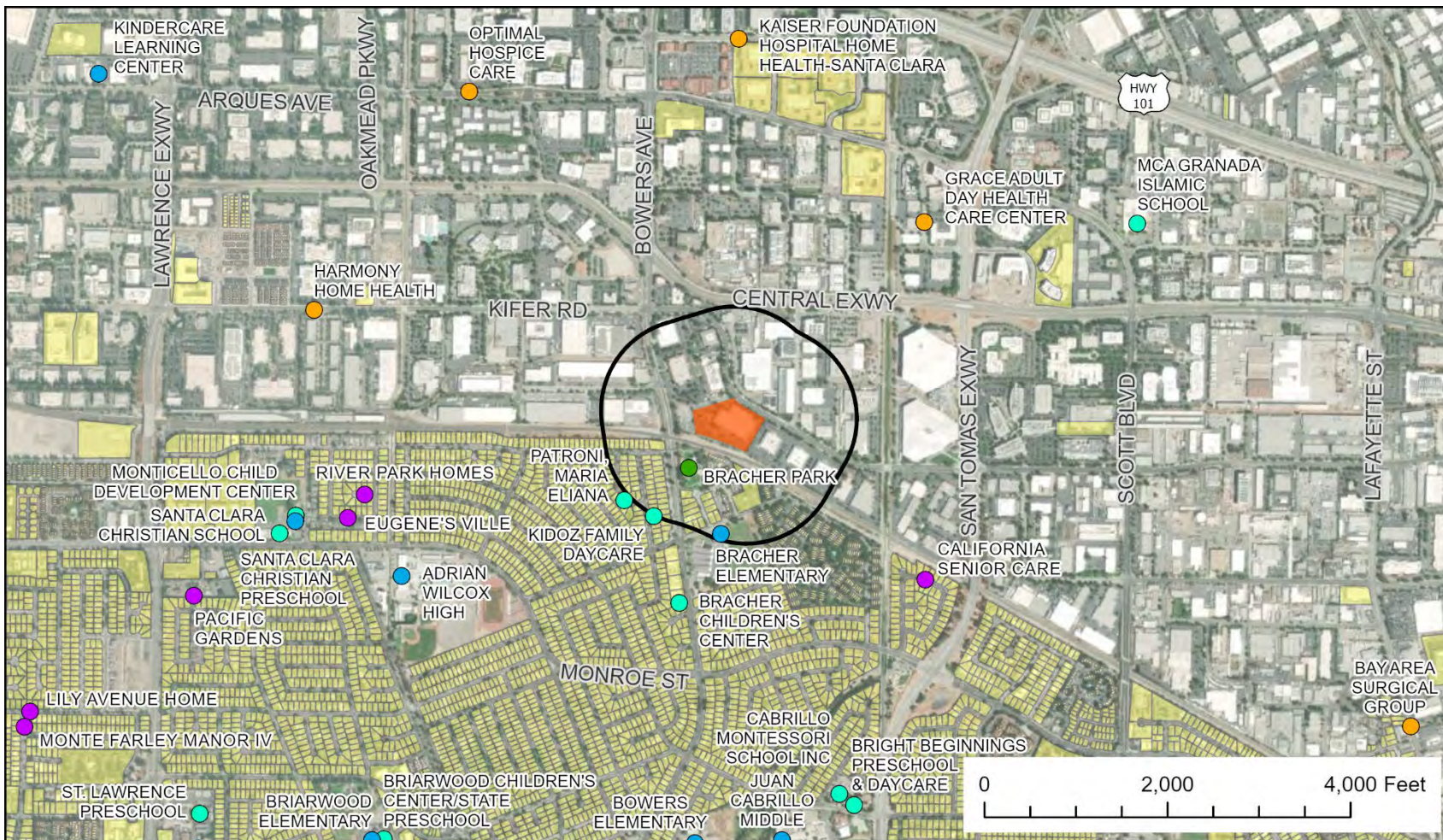

CA3 (Vantage) Backup Generating Facility

- Project Footprint
- 1,000 Ft. Influence Zone

Sensitive Receptors

- Day Care Facility
- Health Care Facility
- Nursing Home
- School
- Recreation
- Residential Community

**Figure 4.3-1**  
**1,000 Foot Influence Zone**

Sources: California Energy Commission, HIFLD, USGS, CDPH, ORNL, Esri

## Regulatory Background

Federal, state, and regional agencies share responsibility for managing and regulating air quality in the SFBA.

### *Federal*

**Federal Clean Air Act.** The federal Clean Air Act (CAA) (42 U.S.C. section 7401 et. seq) establishes the statutory framework for regulation of air quality in the United States. Under the CAA, the U.S. EPA oversees the implementation of federal programs for permitting new and modified stationary sources, controlling TACs, and reducing emissions from motor vehicles and other mobile sources.

Title I (Air Pollution Prevention and Control) of CAA requires the establishment of NAAQS, air quality designations, and plan requirements for nonattainment areas. States are required to submit a SIP to the U.S. EPA for areas in nonattainment with NAAQS. The SIP must demonstrate how state and local regulatory agencies will institute rules, regulations, and other programs to attain NAAQS. Once approved by the U.S. EPA and published in the Federal Register, the local air district rules contained in the SIP are federally enforceable.

The Prevention of Significant Deterioration (PSD) program is a federal program for federal attainment areas. The purpose of the federal PSD program is to ensure that attainment areas remain in attainment of NAAQS based upon a proposed facility's annual PTE. If the annual emissions of a proposed project are less than prescribed amounts, a PSD review is not required. CA3DC is not expected to be subject to PSD, with a final determination made by BAAQMD at the time of permitting subsequent to the CEC determination.

**New Source Performance Standard (NSPS) Subpart IIII—Standards of Performance for Stationary Compression Ignition Internal Combustion Engines.** CAA section 111 (42 U.S.C. section 7411) authorizes the U.S. EPA to develop technology-based standards for specific categories of sources. Manufacturers of emergency stationary internal combustion engines (ICE) using diesel fuel must certify that new engines comply with these emission standards (40 CFR 60.4205). Under NSPS Subpart IIII, owners and operators of emergency engines must limit operation to a maximum of 100 hours per year for maintenance and testing, which allows for some use if necessary, to protect grid reliability; there is no time limit on the use of an emergency stationary ICE in emergency situations (40 CFR 60.4211(f)). The project's Tier 4 diesel-fired gensets would be subject to and likely to comply with the requirements in NSPS Subpart IIII.

**National Emission Standards for Hazardous Air Pollutants.** CAA section 112 (42 U.S.C. section 7412) addresses emissions of HAPs. CAA defines HAPs as a variety of substances that pose serious health risks. Direct exposure to HAPs has been shown to cause cancer, reproductive effects or birth defects, damage to the brain and nervous system, and respiratory disorders. Categories of sources that cause HAP emissions are controlled through separate standards under CAA Section 112: National Emission



Standards for Hazardous Air Pollutants (NESHAP). These standards are specifically designed to reduce the potency, persistence, or potential bioaccumulation of HAPs. New sources that emit more than 10 tpy of any specified HAP or more than 25 tpy of any combination of HAPs are required to apply Maximum Achievable Control Technology (MACT).

Asbestos is a HAP regulated under the NESHAP. The asbestos NESHAP is intended to provide protection from the release of asbestos fibers during activities involving the handling of asbestos. CAA air toxics regulations specify work practices for asbestos to be followed during demolitions and renovations. The regulations require a thorough inspection of the area where the demolition or renovation would occur and advance notification of the appropriate delegated entity. Work practice standards that control asbestos emissions must be implemented, such as removing all asbestos-containing materials (ACM), adequately wetting all regulated ACM, and sealing ACM in leak-tight containers and disposing of the asbestos-containing waste material as expediently as practicable.

### *State*

Generally, state law designates local air districts as having primary responsibility for the control of air pollution from all sources other than mobile sources while the control of vehicular air sources is the responsibility of CARB. (Health and Safety Code, §39002) CARB is also responsible for the state's overall air quality management, including, among other things, establishing CAAQS for criteria pollutants identifying TACs of statewide concern and adopting measures to reduce the emissions of those TACs through airborne toxic control measures (ATCM), and regulating emissions of GHGs.

**Air Toxic “Hot Spots” Information and Assessment Act of 1987.** The Air Toxic “Hot Spots” Information and Assessment Act of 1987 (Health and Safety Code, sec. 44300 et. seq), also known as Assembly Bill (AB) 2588, identifies TAC hot spots where emissions from specific stationary sources may expose individuals to an elevated risk of adverse health effects, particularly cancer or reproductive harm. Many TACs are also classified as HAPs. AB 2588 requires that a business or other establishment identified as a significant stationary source of toxic emissions provide the affected population with information about the health risks posed by their emissions.

**Airborne Toxic Control Measure (ATCM) for Stationary Compression Ignition Engines, Emergency Standby Diesel-Fueled Compression Ignition Engines.** Statewide regulations govern the use of and emissions performance standards for emergency standby diesel-fueled engines, including those of the project. As defined in regulation (17 CCR §93115.4(a)(29)), an emergency standby engine is, among other possible use, one that provides electrical power during an emergency use and is not the source of primary power at the facility and is not operated to supply power to the electric grid. The corresponding ATCM (17 CCR §93115.6) restricts each emergency standby engine to operate no more than 50 hours per year for maintenance and testing purposes.

The ATCM establishes no limit on engine operation for emergency use or for emission testing to show compliance with the ATCM's standards.

**Asbestos Airborne Toxic Control Measure for Construction, Grading, Quarrying, and Surface Mining Operations.** CARB has adopted the Asbestos ATCM for Construction, Grading, Quarrying, and Surface Mining Operations to minimize the generation of asbestos from earth disturbance or construction activities (17 CCR §93105). The Asbestos ATCM applies to any project that would include sites to be disturbed in a geographic ultramafic rock unit area or an area where naturally occurring asbestos (NOA), serpentine, or ultramafic rocks are determined to be present. Based upon review of the U.S. Geological Survey map detailing the natural occurrence of asbestos in California, NOA is not expected to be present at the project site (Van Gosen and Clinkenbeard 2011).

### *Regional*

BAAQMD is the regional agency charged with preparing, adopting, and implementing emissions control measures and standards for stationary sources of air pollution pursuant to state and federal authority for all stationary projects located within their jurisdiction. Under the California CAA state law, the BAAQMD is required to develop an air quality plan to achieve and/or maintain compliance with federal and state nonattainment AAQS within the air district's boundary.

**Bay Area 2017 Clean Air Plan.** BAAQMD adopted the Bay Area 2017 Clean Air Plan on April 19, 2017 (BAAQMD 2017a). The 2017 Clean Air Plan provides a regional strategy to protect public health and protect the climate. The 2017 Clean Air Plan updates the most recent Bay Area ozone plan, the 2010 Clean Air Plan, pursuant to air quality planning requirements defined in state law. The 2017 Clean Air Plan defines an integrated, multi-pollutant control strategy to reduce emissions of particulate matter, TACs, ozone and key ozone precursors, and greenhouse gases.

**BAAQMD California Environmental Quality Act Guidelines.** BAAQMD publishes CEQA Air Quality Guidelines to assist lead agencies in evaluating a project's potential impacts on air quality. The BAAQMD published the most recent version of its CEQA Air Quality Guidelines in May 2017 (BAAQMD 2017b).

**BAAQMD Regulation 2, Rule 2: New Source Review (NSR).** This rule applies to all new or modified sources requiring an Authority to Construct permit and/or Permit to Operate. The NSR process requires the applicant to use BACT to control emissions if the source will have the PTE of a BAAQMD BACT pollutant in an amount of 10 or more pounds per day (lbs/day). The NSR process also establishes the requirements to offset emissions increases and to protect NAAQS.

For emergency-use diesel engines with output over 1,000 brake horsepower, BAAQMD updated the definition of BACT in December 2020 to reflect the use of engines achieving Tier 4 exhaust standards (BAAQMD 2020); this requires Tier 4-compliant engines that may include Tier 2 engines abated by catalyzed diesel particulate filter (DPF) and selective

catalytic reduction (SCR). Each of the 44 diesel back-up emergency generators would be equipped with SCR equipment and DPF to achieve compliance with Tier 4 emission standards. Staff expects the proposed generators would meet the current BAAQMD BACT requirements. However, BAAQMD would make the final determination of BACT during the permitting process.

To prevent sources from worsening regional nonattainment conditions, the NSR rule requires offsets at a 1:1 ratio if more than 10 tpy of NO<sub>x</sub> or Precursor Organic Compounds (POC), or more than 100 tpy of PM<sub>2.5</sub>, PM<sub>10</sub>, or SO<sub>2</sub>, are emitted. If the PTE for NO<sub>x</sub> or POC is more than 10 tpy but less than 35 tpy, BAAQMD needs to provide any required offsets at 1:1 ratio from the Small Facility Banking Account in BAAQMD's Emissions Bank. If the PTE for NO<sub>x</sub> or POC is 35 tpy or more, the offset ratio increases to 1.15:1 and offsets can no longer be obtained through the Small Facility Banking Account.

On June 3, 2019, BAAQMD staff issued a new policy to protect the Small Facility Banking Account from over-withdrawal by new emergency backup generator sources. The policy provides procedures, applicable to the determination of access to the Small Facility Banking Account only, for calculating a facility's PTE to determine eligibility for emission reduction credits (ERCs) from the Small Facility Banking Account for emergency backup generators (BAAQMD 2019). When determining the PTE for a facility with emergency backup generators, the PTE shall include as a proxy, emissions proportional to emergency operation for 100 hours per year per standby generator, in addition to the permitted limits for readiness testing and maintenance (generally 50 hours/year or less per standby or backup engine). BAAQMD would not allow an owner/operator to accept a permit condition to limit emergency operation to less than 100 hours per year to reduce the source's PTE for purposes of qualifying for the Small Facility Banking Account.

After comparing the PTE calculated to determine the account eligibility threshold, the amount of offsets required would be determined only upon the permitted emissions from readiness testing and maintenance and not the emissions from emergency operation. Emissions offsets represent ongoing emission reductions that continue every year, year after year, in perpetuity. BAAQMD requires the use of offsets to counterbalance increases in regular and predictable emissions, not increases in emissions occurring infrequently when emergency conditions arise. An owner/operator may reduce the hours of readiness testing and maintenance or install emissions controls to achieve a PTE of less than 35 tons per year (BAAQMD 2019).

#### **BAAQMD Regulation 2, Rule 5: New Source Review of Toxic Air Contaminants.**

This rule provides for the review of new and modified sources of TAC emissions to evaluate potential public exposure and health risk. Under this rule, a project would be denied an Authority to Construct permit if it exceeds any of the specified risk limits, which are consistent with BAAQMD's recommended significance thresholds. Best Available Control Technology for Toxics (TBACT) would also be required for any new or modified source of TACs where the source has a cancer risk greater than 1.0 in 1 million or a chronic hazard index (HI) greater than 0.20. The specific toxicity values of each TAC for

use in an HRA, as identified by California Office of Environmental Health Hazard Assessment (OEHHA), are listed in Table 2-5-1 of BAAQMD Rule 2-5.

**BAAQMD Regulation 9, Rule 8: Nitrogen Oxides and Carbon Monoxide from Stationary Internal Combustion Engines.** This rule limits NO<sub>x</sub> and CO emissions from stationary internal combustion engines with an output rated by the manufacturer at more than 50 brake horsepower, including the standby gensets of the project. This regulation (Rule 9-8-231) defines emergency use as “the use of an emergency standby or low usage engine during any of the following:”

- In the event of unforeseeable loss of regular natural gas supply;
- In the event of unforeseeable failure of regular electric power supply;
- Mitigation or prevention of an imminent flood;
- Mitigation of or prevention of an imminent overflow of sewage or waste water;
- Fire or prevention of an imminent fire;
- Failure or imminent failure of a primary motor or source of power, but only for such time as needed to repair or replace the primary motor or source of power; or
- Prevention of the imminent release of hazardous material.

### *Local*

The city of Santa Clara 2010-2035 General Plan (General Plan) includes goals and policies to reduce exposure of the city's sensitive population to the exposure of air pollution and TACs. The following goals, policies, and actions are applicable to the project:

- Air Quality Goals
  - 5.10.2-G1 Improved air quality in Santa Clara and the region.
  - 5.10.2-G2 Reduced greenhouse gas (GHG) emissions that meet the State and regional goals and requirements to combat climate change.
- Air Quality Policies
  - 5.10.2-P1 Support alternative transportation modes and efficient parking mechanisms to improve air quality.
  - 5.10.2-P2 Encourage development patterns that reduce vehicle miles traveled and air pollution.
  - 5.10.2-P3 Encourage implementation of technological advances that minimize public health hazards and reduce the generation of air pollutants.
  - 5.10.2-P4 Encourage measures to reduce GHG emissions to reach 30 percent below 1990 levels by 2020.
  - 5.10.2-P5 Promote regional air pollution prevention plans for local industry and businesses.



- 5.10.2-P6 Require “Best Management Practices” for construction dust abatement.

### 4.3.3 Environmental Impacts

#### a. Would the project conflict with or obstruct implementation of the applicable air quality plan?

This section considers the project’s consistency with the applicable air quality plan (AQP). This is a qualitative determination that considers the combined effects of project construction and operation.

#### *Construction and Operations*

*Less Than Significant Impact.* BAAQMD has permit authority over stationary sources, acts as the primary reviewing agency for environmental documents, and adopts rules that must be consistent with or more stringent than federal and state air quality laws and regulations. The applicable AQP is the Bay Area 2017 Clean Air Plan (BAAQMD 2017a).

A project would be consistent with the AQP if that project (BAAQMD 2017b, pg. 9-2 and 9-3):

- 1) Supports the primary goals of the AQP.

The determination for this criterion can be met through consistency with the BAAQMD significance thresholds. As can be seen in the discussions under environmental checklist criteria “b” and “c” of this air quality analysis, the project would have less than significant impacts related to the BAAQMD significance thresholds. Therefore, the project would have a less than significant impact related to the primary goals of the AQP.

- 2) Includes applicable control measures from the AQP.

The project would include the implementation of applicable control measures from the AQP. The project-level applicable control measures set forth in the Bay Area 2017 Clean Air Plan include: Decarbonize Electricity Generation (EN1), Green Buildings (BL1), and Bicycle and Pedestrian Access and Facilities (TR9). The project would comply with these control measures through compliance with General Plan and the city’s Climate Action Plan, as demonstrated in more detail in **Section 4.8 Greenhouse Gas Emissions**.

- 3) Does not disrupt or hinder implementation of any AQP control measures.

Examples of disrupting or hindering implementation of an AQP would be proposing excessive parking or precluding the extension of public transit or bike paths. The project design as proposed is not known to hinder the implementation of any AQP control measure.

The analysis in this section demonstrates that the project emissions would not exceed BAAQMD significance thresholds with NO<sub>x</sub> emissions fully offset through the permitting process with BAAQMD, as discussed under criterion “b” of the environmental checklist, and the project would not expose sensitive receptors to substantial pollutant

concentrations, as discussed under criterion “c” of the environmental checklist. Thus, the project would be consistent with the Bay Area 2017 Clean Air Plan and would have a less than significant impact related to implementation of the applicable AQP.

**BAAQMD Regulation 2, Rule 2: New Source Review (NSR).** As discussed under criterion “b” of the environmental checklist, the NOx emissions of the gensets during readiness testing and maintenance would be fully offset through the permitting process with BAAQMD. Final details regarding the calculation of the facility’s PTE and the ultimate NSR permitting requirements under BAAQMD’s Regulation 2, Rule 2, would be determined through the permitting process with BAAQMD. The discussion below explains how the district will calculate the necessary offsets.

**b. Would the project result in a cumulatively considerable net increase of any criteria pollutant for which the project region is non-attainment under an applicable federal or state ambient air quality standard?**

This section quantifies the project’s nonattainment criteria pollutant emissions and other criteria pollutant emissions to determine whether the net emissions increase would exceed any of the BAAQMD emissions thresholds for criteria pollutants. TAC effects are not included because this section focuses only on criteria pollutants.

***Construction***

***Less Than Significant with Mitigation Incorporated.***

Project demolition/construction would include two phases. The first phase of construction (Phase I) would take approximately 15 months. Phase I construction includes demolition activities, grading and site work installation of utility services for interim power, construction of an on-site substation, construction of the entire shell of the CA3DC building, and placement of approximately one-half of the gensets. The second phase of construction (Phase II) would take approximately seven months. Phase II includes the placement of the remaining half of the gensets and interior buildout (CEC 2022a) Construction-phase emissions are a result of construction equipment, material movement, paving activities, and on-site and off-site vehicle trips, such as material haul trucks, worker commutes, and delivery vehicles.

Emissions from the 22-month construction period were estimated using the California Emissions Estimator Model<sup>4</sup> (CalEEMod) program. The estimated criteria pollutant construction-phase emissions are summarized in **Table 4.3-5**.

---

<sup>4</sup> CalEEMod was developed by the California Air Pollution Control Officers Association in collaboration with California Air Districts. This model is a construction and emissions estimating computer model that estimates direct criteria pollutant and direct and indirect greenhouse gas emissions for a variety of land use projects. The model calculates maximum daily and annual emissions. The model also identifies mitigation measures to reduce criteria pollutant and GHG emissions along with calculating the benefits achieved from measures.

**TABLE 4.3-5 CRITERIA POLLUTANT EMISSIONS FROM PROJECT CONSTRUCTION**

Pollutant	Average Daily Emissions (lbs/day) <sup>a</sup>		Maximum Annual Construction Emissions (tpy)	BAAQMD Significance Thresholds for Construction-related Average Daily Emissions (lbs/day) <sup>c</sup>	Threshold Exceeded ?
	Phase I	Phase II			
ROG/VOC	15.9	0.3	2.4	54	No
CO	22.5	5.3	3.2	None	N/A
NOx	9.9	0.7	1.5	54	No
SOx	0.06	0.01	0.009	None	N/A
PM10 <sup>b</sup>	0.07 (exhaust) 2.5 (fugitive)	0.02 (exhaust) 0.8 (fugitive)	0.009 (exhaust) 0.4 (fugitive)	82	No
PM2.5 <sup>b</sup>	0.06 (exhaust) 0.8 (fugitive)	0.02 (exhaust) 0.2 (fugitive)	0.009 (exhaust) 0.1 (fugitive)	54	No

Notes:

<sup>a</sup> There are no annual construction-related BAAQMD significance thresholds. BAAQMD's thresholds are average daily thresholds for construction. Accordingly, the average daily emissions are the total estimated construction emissions in each phase averaged over total workdays for that phase.

<sup>b</sup> The average daily PM10 and PM2.5 exhaust emissions are compared to BAAQMD's significance thresholds for exhaust emissions. Fugitive emissions will be controlled with best management practices (BMPs), in accordance with the significance threshold.

<sup>c</sup> BAAQMD 2017b, Table 2-1.

Source: CEC 2022a, CEC staff analysis

The average daily emissions for each phase shown in **Table 4.3-5** indicate that construction emissions would be lower than the applicable BAAQMD significance thresholds for all criteria pollutants.

BAAQMD's numerical thresholds for PM10 and PM2.5 construction-phase emissions apply to exhaust emissions only. BAAQMD has no numerical threshold for fugitive dust generated during construction. The BAAQMD CEQA Guidelines recommend the control of fugitive dust through BMPs to conclude that impacts from fugitive dust emissions are less than significant (BAAQMD 2017b). The applicant proposed measures that would incorporate BAAQMD's recommended construction BMPs as well as exhaust emissions mitigation measures. Staff reviewed the measures and finds them sufficient to address impacts from construction emissions. Staff recommends **AQ-1** to ensure that PM10 and PM2.5 emissions are reduced to a level that would not result in a considerable increase of these pollutants. This impact would be reduced to less than significant with the implementation of **AQ-1**.

### ***Operation***

*Less Than Significant with Mitigation Incorporated.*

Operation emissions would result from diesel fuel combustion from the gensets, off-site vehicle trips for worker commutes and material deliveries, and facility upkeep, such as architectural coatings, consumer product use, landscaping, water use, waste generation, natural gas use for comfort heating, and electricity use (DayZenLLC 2021e). Each of the primary emission sources are described in more detail below.

**Stationary Sources – Generator Emissions.** The project would include 44 gensets powered by 2.75-MW Caterpillar Model 3516E engines. Each engine would be equipped with SCR and DPF to achieve compliance with Tier 4 emission standards (DayZenLLC 2021a).

All gensets would be operated for routine readiness maintenance and testing to ensure they would function during an emergency event. During routine readiness testing, criteria pollutants and TACs would be emitted directly from the gensets. The applicant used emissions factors provided by Peterson Power Systems for the ecoCUBE engine configuration based on inlet and outlet emission performance (DayZenLLC 2021b). In estimating the annual emissions, the applicant assumed that testing would occur for no more than 35 hours per year averaged over all engines for a total of 1,540 hours. The average daily emissions are estimated by averaging the annual emissions (assuming all generators are operated for 35 hours per year) over the year (i.e. 365 days). The Airborne Toxic Control Measure for Stationary Compression Ignition Engines (CCR, Title 17, Section 93115) limits testing to 50 hours per year per engine. However, it is the applicant's experience that each engine would be operated for considerably less than 50 hours a year. The applicant is proposing an annual readiness testing and maintenance schedule not to exceed 35 hours per year averaged over all engines for a total of 1,540 hours. The NO<sub>x</sub> emissions are conservatively based on the Tier 2 emissions standards (uncontrolled emission factors), with the conservative assumption that the SCR will not operate during testing and maintenance purposes. Additionally, **GHG-1** could limit this to no more than 20 hours if BAAQMD updates its threshold of significance before this project receives its permit.

**Emergency Operations.** Emissions that could occur in the event of a power outage or other disruption, upset, or instability that triggers emergency operations would not occur on a regular or predictable basis. However, the BAAQMD 2019 policy, *Calculating Potential to Emit for Emergency Backup Power Generators*, requires a facility's PTE to be calculated based on emissions proportional to emergency operation for 100 hours per year per genset, in addition to the permitted limits for readiness testing and maintenance (BAAQMD 2019). However, after comparing the PTE calculated to determine the account eligibility threshold, the applicant would only be required to offset permitted emissions from readiness testing and maintenance and not the emissions from emergency operation. BAAQMD requires the use of offsets to counterbalance increases in regular and predictable emissions, not increases in emissions occurring infrequently when emergency conditions arise. The potential ambient air quality impacts of emissions during emergency operations are analyzed qualitatively under environmental checklist criterion "c."

**Miscellaneous Operational Emissions.** Miscellaneous emissions would occur from operational activities, such as worker travel, deliveries, energy and fuel use for facility electrical, heating and cooling needs, periodic use of architectural coatings, and landscaping. The applicant estimated the miscellaneous operational emissions using CalEEMod.

**Table 4.3-6** provides the annual and average daily criteria pollutant emission estimates for project operation, including readiness testing and maintenance, using the emission source assumptions noted above. The average daily emissions are based on annual emissions averaged over 365 days per year. The NO<sub>x</sub> emissions of the gensets are conservatively estimated using Tier 2 emission factors, assuming the SCRs are not effective during readiness testing and maintenance (even though, depending on load, the SCR would be expected to kick on within 15 minutes, providing some additional emissions control for tests that run longer than this). With the conservative assumption of Tier 2 emissions, the NO<sub>x</sub> PTE of the project would exceed 35 tpy, and, therefore, the NO<sub>x</sub> emissions would be fully offset by the applicant through the air permitting process at a ratio of 1.15:1. However, in response to staff's Data Request #4, the applicant provided a more refined calculation of the NO<sub>x</sub> PTE assuming 35 individual 1-hour readiness testing and maintenance, each consisting of 15 minutes of warm up with Tier 2 emissions and 45 minutes with Tier 4 emissions. For the 100 hours of emergency operations (considering the BAAQMD 2019 policy [BAAQMD 2019]), the applicant assumed 15 minutes of uncontrolled emissions and 2 hours and 45 minutes of controlled emissions for every three hours of operation. Total NO<sub>x</sub> PTE from the applicant's refined calculation would be 28.7 tpy, which is less than 35 tpy (DayZenLLC 2021t). Therefore, the offset ratio would be 1:1 with the refined calculation. The exact amount and the source of the NO<sub>x</sub> offsets would be confirmed through the permitting process with BAAQMD. When BAAQMD reviews the permit application for the project, it would perform a refined emissions calculation if the applicant provides a detailed testing plan (including testing frequency, duration, and load, etc.) and the specifications from the SCR vendor. If it is uncertain whether the SCR would become effective during readiness testing and maintenance, BAAQMD would also use the most conservative calculation assuming Tier 2 emissions.

Therefore, the NO<sub>x</sub> emissions and offsets shown in **Table 4.3-6** assuming Tier 2 emissions are conservative estimates. Analysis of Tier 4 emissions would result in less impact than that for the analysis of Tier 2 emissions. Nonetheless, the NO<sub>x</sub> emissions of the gensets during readiness testing and maintenance would be fully offset through the permitting process with BAAQMD. Emissions from miscellaneous sources are not required to be offset under BAAQMD permitting policy, which only applies to stationary sources.

**Table 4.3-6** shows that with NO<sub>x</sub> emissions from the readiness testing and maintenance of the gensets fully offset through the permitting process with BAAQMD, the project would not exceed any of the BAAQMD emissions significance thresholds. The BAAQMD CEQA Guidelines state that, if the project's daily average or annual emissions of operational-related criteria pollutants or precursors do not exceed any applicable threshold of significance listed in **Table 4.3-1**, the proposed project would not result in a cumulatively

significant impact (BAAQMD 2017b). Therefore, **Table 4.3-6** shows that the project would not be expected to result in a cumulatively considerable net increase of criteria pollutants during the lifetime of the project, including the readiness testing and maintenance of the gensets.

In addition to the emissions shown in **Table 4.3-6**, ammonia would also be emitted from the urea used in the SCR system. Ammonia is considered a particulate precursor but not a criteria pollutant. Reactive with sulfur and nitrogen compounds, ammonia is common in the atmosphere primarily from natural sources or as a byproduct of tailpipe controls on motor vehicles. Currently, there are no BAAQMD-recommended models or procedures for estimating secondary particulate nitrate or sulfate formation from individual sources, such as the proposed project. BAAQMD CEQA Guidelines do not include a significance threshold for ammonia emissions. The primary emissions of particulate matter from this project are well below the BAAQMD significance threshold and do not require additional mitigation or trigger the need for offsets. In addition, the applicant conservatively estimated the ammonia emissions of the project to be 0.29 tpy (582 lbs/yr), assuming the SCR is effective for a total of 35 hours per year per engine (DayZenLLC 2021w). However, it would take time for the SCR to warm up, especially during low-load readiness testing and maintenance, and, therefore, actual ammonia emissions would be less than applicant's estimates. Therefore, staff expects the secondary particulate matter impacts from ammonia emissions would be less than significant and would not require additional mitigation or offsets.

The project's operations would not result in a cumulatively considerable net increase of any criteria pollutant, and these impacts would be less than significant.

### *Cumulative Impacts*

According to the 2017 BAAQMD CEQA Guidelines (BAAQMD 2017b), in developing thresholds of significance for air pollutants (as shown in **Table 4.3-1**), BAAQMD considered the emission levels for which a project's individual emissions would be cumulatively considerable. If a project exceeds the identified significance thresholds, its emissions would be cumulatively considerable, resulting in significant adverse air quality impacts to the region's existing air quality conditions.

As discussed above, with the implementation of mitigation measure **AQ-1** during construction and NO<sub>x</sub> offsets for readiness testing and maintenance, the project emissions would not exceed the BAAQMD significance thresholds. Therefore, the project would not result in a cumulatively considerable net increase of any criteria pollutant, and these impacts would be less than significant with mitigation incorporated.

**TABLE 4.3-6 CRITERIA POLLUTANT EMISSIONS FROM PROJECT READINESS TESTING AND MAINTENANCE**

Source Type	ROG/VOC	CO	NOx	SO <sub>2</sub>	PM10	PM2.5
	Annual Emissions (tpy)					
Phase I Miscellaneous Operational Emissions	1.14	0.48	0.09	0.001	0.15	0.04
Phase II Miscellaneous Operational Emissions	2.16	0.82	0.16	0.003	0.29	0.08
Standby Generators (Testing Only) <sup>a</sup>	0.44	4.39	35.14 <sup>b</sup>	0.03 <sup>c</sup>	0.14	0.14
Proposed Offsets <sup>d</sup>	--	--	(-40.41)	--	--	--
Total Phase I Mitigated Emissions	1.36	2.68	-2.54	0.02	0.22	0.11
Total Full Buildout Mitigated Emissions	2.60	5.22	-5.11	0.03	0.42	0.22
BAAQMD Annual Significance Thresholds	10	--	10	--	15	10
Mitigated Emissions Exceed BAAQMD Threshold? (Y/N)	N	N/A	N	N/A	N	N
Average Daily Emissions (lbs/day) <sup>e</sup>						
Phase I Miscellaneous Operational Emissions	6.27	2.63	0.51	0.01	0.83	0.23
Phase II Miscellaneous Operational Emissions	11.82	4.51	0.90	0.01	1.57	0.43
Standby Generators (Testing Only)	2.41	24.07	192.55	0.17	0.75	0.75
Proposed Offsets <sup>c</sup>	--	--	(-221.43)	--	--	--
Total Phase I Mitigated Emissions	7.48	14.67	-13.93	0.09	1.20	0.60
Total Full Buildout Mitigated Emissions	14.24	28.58	-27.98	0.19	2.33	1.18
BAAQMD Average Daily Significance Thresholds	54	--	54	--	82	54
Mitigated Emissions Exceed BAAQMD Threshold? (Y/N)	N	N/A	N	N/A	N	N

Notes:

<sup>a</sup> The annual emissions of the standby generators are estimated assuming readiness testing and maintenance would occur 35 hours per year per engine.

<sup>b</sup> The NOx emissions for readiness testing and maintenance are conservatively estimated based on Tier 2 emission factors.

<sup>c</sup> Staff estimated the SO<sub>2</sub> emissions of the standby generators based on the hourly SO<sub>2</sub> emission rate of from the VDC Supplemental Responses to CEC Data Request Set 2 Air Quality (DayZenLLC 2021t, Table 7-5) assuming readiness testing and maintenance would occur 35 hours per year per engine.

<sup>d</sup> The conservatively estimated NOx emissions of the standby generators would exceed 35 tpy based on Tier 2 emission factors. Therefore, the offset ratio would be 1.15:1 (DayZenLLC 2021e).

<sup>e</sup> The average daily emissions and offsets are based on the annual emissions and offsets averaged over 365 days per year.

Sources: DayZenLLC 2021e, DayZenLLC 2021b, DayZenLLC 2021t with calculation spreadsheets, CEC staff analysis

### **c. Would the project expose sensitive receptors to substantial pollutant concentrations?**

This section quantifies the ambient air quality pollutant concentrations caused by the project and determines whether sensitive receptors could be exposed to substantial pollutant concentrations.

This section is comprised of separate discussions addressing impacts from criteria pollutants in staff's Air Quality Impact Analysis (AQIA) and impacts from TACs in staff's HRA. Staff's AQIA discusses criteria pollutant impacts from construction and operation. The section also discusses issues associated with potential emergency operations. Staff's HRA discusses the results of TACs for both construction and operation (readiness testing and maintenance) and cumulative sources.

#### **Air Quality Impact Analysis for Criteria Pollutants**

Staff considers any new AAQS exceedance and substantial contribution to any existing AAQS exceedance caused by the project's emissions to be substantial evidence of potentially significant impacts that would require the evaluation of potential mitigation measures. In this case, the existing background levels of PM10 and PM2.5 already exceed the AAQS.

#### ***Construction***

*Less Than Significant with Mitigation Incorporated.* Construction emissions of criteria pollutants are shown in **Table 4.3-5** under criterion "b" of the environmental checklist. Emissions during project construction would not exceed significance thresholds for construction activities, as established in the BAAQMD CEQA Guidelines. With the staff recommendation to implement **AQ-1** to control fugitive dust and exhaust emissions, construction emissions would not exceed the BAAQMD significance thresholds. Although project construction emissions would fall below the emissions thresholds, this section of the staff analysis explores the ambient air quality impacts of criteria pollutant emissions during construction to evaluate whether substantial pollutant concentrations could occur.

In response to staff data requests, the applicant provided the modeled ambient air quality concentrations caused by the construction emissions (DayZenLLC 2021t; TN 239390). Staff reviewed the applicant's dispersion modeling files and agreed with the inputs used by the applicant and the outputs from the model for the construction AQIA for pollutants other than PM10 and PM2.5. This discussion presents the results of staff's independent analysis for PM10 and PM2.5.

The applicant's AQIA uses the U.S. EPA preferred and recommended dispersion model, American Meteorological Society/Environmental Protection Agency Regulatory Model (AERMOD [version 21112]) to estimate ambient air quality impacts. For certain runs that provide a sum of NO<sub>2</sub> impacts and NO<sub>2</sub> background concentrations, an earlier version of AERMOD (version 19191) was used due to a known bug in the current version of AERMOD (DayZenLLC 2021t, pg. 4). For the 1-hour NO<sub>2</sub> modeling analyses, the applicant used the



Plume Volume Molar Ratio Method (PVMRM) in AERMOD, as described in U.S. EPA's *Guideline on Air Quality Models* (U.S. EPA 2017).

**Meteorological Data.** The applicant processed a five-year (2015-2019) record of hourly meteorological data collected at the Norman Y. Mineta San Jose International Airport surface station, approximately two miles east of the project site, and this sufficiently represents the meteorology at the project site for use in AERMOD. The concurrent daily upper air sounding data from the Oakland International Airport station were also included. The applicant's consultant processed the data with AERMET (version 19191), AERMOD's meteorological data preprocessor module, for direct use in AERMOD (DayZenLLC 2021b, pg. 9; TN 237381).

**Modeling Assumptions.** The applicant modeled the construction equipment and vehicle exhaust emissions from the project's on-site off-road equipment, as well as the exhaust emissions from the project's off-site on-road sources up to 2,000 feet from the project boundary (DayZenLLC 2021t, pg. 4). The applicant's dispersion modeling analysis divided the construction emissions into two construction phases. The applicant proposes to complete construction of the CA3DC building shell in its entirety in Phase I (during a 15-month period). Phase II would involve a much more limited scope of activity and emissions than Phase I and would consist of interior buildout and the placement of generators for the second half of the building (CEC 2022a). There would be a limited period (about seven months) in which half of the project operational activities could occur concurrently with Phase II construction activities. The applicant modeled the two separate phases of construction emissions as two different area polygons with an initial release height at five meters, which approximates equipment exhaust sources. Staff confirmed that the maximum impacts of construction would occur during the Phase I activities, because the rates of emissions during the limited duration of Phase II would be a fraction of those during Phase I (approximately one-quarter to less than one-tenth, depending on pollutant). Additionally, since the construction emissions in Phase II would be much less than those for Phase I, staff does not expect the impacts during the limited overlapping period of operational activities to be higher than the worst-case impacts modeled for Phase I construction or operation separately.

The applicant's construction modeling does not include fugitive dust emissions (DayZenLLC 2021t, pg. 4). Accordingly, staff independently evaluated PM<sub>10</sub> and PM<sub>2.5</sub> to determine the impacts of fugitive dust with the equipment and vehicle exhaust. Staff's analysis for PM<sub>10</sub> and PM<sub>2.5</sub> uses the same area polygons at an initial release height of one meter to approximate fugitive dust being released near the ground level. The area sources are shaped as polygons to cover the full site for Phase I and the eastern side of the site for Phase II. Applicant's and staff's dispersion modeling of construction activities both assume that exhaust emissions and fugitive dust could be released 11 hours per day, between 7:00 a.m. to 6:00 p.m. (DayZenLLC 2021t, pg. 5).

**Table 4.3-7** shows the impacts of the project during the construction period. The project impact column shows the worst-case impacts of the project from modeling. The background column shows the highest concentrations, or the three-year averages of the

highest concentrations for 24-hour PM<sub>2.5</sub> and federal 1-hour NO<sub>2</sub> and SO<sub>2</sub> standards according to the forms of these standards, from the prior three years (2018-2020) from the Jackson Street station. The background PM<sub>10</sub> and PM<sub>2.5</sub> concentrations are shown in **bold** because they already exceeded the corresponding limiting standards. The total impact column shows the sum of the existing background condition plus the maximum impact predicted by the modeling analysis for construction. The limiting standard column combines CAAQS and NAAQS, whichever is more stringent.

**TABLE 4.3-7 MAXIMUM AMBIENT AIR QUALITY IMPACTS DURING CONSTRUCTION (µg/m<sup>3</sup>)**

Pollutant	Averaging Time	Project Impact	Background	Total Impact	Limiting Standard	Percent of Standard
PM <sub>10</sub>	24-hour	1.908	<b>137.1</b>	<b>139</b>	50	<b>278%</b>
	Annual	0.681	<b>24.8</b>	<b>25</b>	20	<b>127%</b>
PM <sub>2.5</sub>	24-hour	0.853	<b>73.4</b>	<b>74</b>	35	<b>212%</b>
	Annual	0.305	<b>12.9</b>	<b>13</b>	12	<b>110%</b>
CO	1-hour	329	2,857	3,186	23,000	14%
	8-hour	100	2,400	2,500	10,000	25%
NO <sub>2</sub> <sup>a</sup>	State 1-hour	86.3	162	248.8	339	73%
	Federal 1-hour	---	---	110.8	188	59%
	Annual	1.68	22.6	24	57	43%
SO <sub>2</sub>	State 1-hour	0.570	37.9	38	655	6%
	Federal 1-hour	0.570	7.8	8	196	4%
	24-hour	0.055	3.9	4	105	4%

Notes: Concentrations in **bold** type are those that exceed the limiting ambient air quality standard.

<sup>a</sup> 1-hour NO<sub>2</sub> impacts are evaluated using the PVMRM setting with a default initial NO<sub>2</sub>/NO<sub>x</sub> ratio of 0.5. The state 1-hour NO<sub>2</sub> total impacts include the maximum modeled project impact combined with maximum NO<sub>2</sub> background value. The federal 1-hour NO<sub>2</sub> total impacts include the combined seasonal hour of day 98<sup>th</sup> percentile daily maximum 1-hour background NO<sub>2</sub> with modeled NO<sub>2</sub> project impact. Source: DayZenLLC 2021t (Tables 5-6 and 5-7), CEC 2022a, with independent staff analysis for PM<sub>10</sub> and PM<sub>2.5</sub>.

**Table 4.3-7** shows that the impacts from project construction would be below the limiting standards for CO, NO<sub>2</sub>, and SO<sub>2</sub>. **Table 4.3-7** also shows that the existing 24-hour and annual PM<sub>10</sub> background concentrations are already above the CAAQS. The project would, therefore, contribute to existing exceedances of the 24-hour and annual PM<sub>10</sub> CAAQS. The modeled 24-hour PM<sub>10</sub> concentration of 1.908 µg/m<sup>3</sup> from project construction would not exceed the U.S. EPA PM<sub>10</sub> SILs of 5 µg/m<sup>3</sup> for 24-hour impacts, and the maximum modeled annual PM<sub>10</sub> concentration of 0.681 µg/m<sup>3</sup> would not exceed the PM<sub>10</sub> SILs of 1 µg/m<sup>3</sup> for annual impacts. The results provided in **Table 4.3-7** are maximum impacts predicted to occur primarily due to fugitive dust at the project fence line. The impacts would decrease rapidly with distance from the fence line, and for any location south of the fence line, the 24-hour PM<sub>10</sub> concentration would be below the U.S. EPA PM<sub>10</sub> SILs of 5 µg/m<sup>3</sup>. The maximum annual PM<sub>10</sub> impacts at the nearest residential receptors would be lower than the maximum shown. In addition, construction is considered short term, and the impacts during construction would be reduced with the implementation of **AQ-1**. With mitigation, the PM<sub>10</sub> impacts of the project during construction would be less than significant.

Similarly, **Table 4.3-7** also shows that the existing 24-hour and annual PM<sub>2.5</sub> background concentrations are already above the limiting standards. The project would therefore contribute to existing exceedances of the 24-hour and annual PM<sub>2.5</sub> standards. The maximum 24-hour PM<sub>2.5</sub> impacts of 0.853 µg/m<sup>3</sup> would not exceed the 24-hour PM<sub>2.5</sub> SILs of 1.2 µg/m<sup>3</sup>. The maximum modeled 24-hour PM<sub>2.5</sub> impact would occur at the project fence line and would decrease rapidly with distance from the fence line. At the project fence line, the annual average PM<sub>2.5</sub> impact during construction of 0.305 µg/m<sup>3</sup> would be greater than the BAAQMD significance threshold of 0.3 µg/m<sup>3</sup> and greater than the annual PM<sub>2.5</sub> SILs for annual impacts of 0.2 µg/m<sup>3</sup> (US EPA 2018a). For all receptors beyond 150 feet of the fence line, concentrations would be less than 0.2 µg/m<sup>3</sup> during construction.

Sensitive receptors include residents and a park directly south of the CA3 project site. Two daycare facilities, an elementary school, and a city park are within 1,000 feet of the project fence line (DayZenLLC 2021t, pg. 18; Response to Data Request 22). The nearest sensitive receptor (i.e., the nearest residential areas) is about 175 ft south of the fence line. The maximum modeled annual PM<sub>2.5</sub> impacts at all sensitive receptors would be much lower than the BAAQMD CEQA Guidelines significance threshold of 0.3 µg/m<sup>3</sup> and U.S. EPA annual PM<sub>2.5</sub> SILs level of 0.2 µg/m<sup>3</sup>. The PM<sub>2.5</sub> impacts of the project during construction would be less than significant.

Project construction would not expose sensitive receptors to substantial criteria pollutant concentrations, and this impact would be less than significant.

### ***Operation***

*Less Than Significant Impact.* The AQIA for project operation includes emissions from the project's diesel gensets during readiness testing and maintenance use to compare worst-case ground-level impacts with established state and federal AAQS. No other on-site stationary emission sources, such as natural gas combustion devices, are proposed. The applicant's modeling analysis is described in more detail below.

The applicant's AQIA compares worst-case ground-level impacts resulting from the project operation with established state and federal AAQS. Staff reviewed the applicant's dispersion modeling files, and staff agrees with the inputs used by the applicant and the outputs from the model for the AQIA.

**Modeling Assumptions.** Stack parameters (e.g., stack height, exit temperature, stack diameter, and stack exit velocity) were based on the parameters given by the engine manufacturer and the applicant. The 44 gensets include 40 gensets for the data center suites and four house gensets for supporting the administration building. All generators would be located along the northern edge of the data center building. The design includes redundancy so that eight data center generators are redundant, and two of the house generators are redundant (DayZenLLC 2021a, pg. 2-2). Each engine-generator set would emit from a point with a stack height of 10.09 meters and diameter of 0.559 meters (DayZenLLC 2021t, pg. 15).

All engines could be tested or used at any load condition. The applicant's analysis modeled all engines at five different load conditions representing 10, 25, 50, 75, and 100 percent load settings to determine the worst-case concentrations.

In the applicant's analysis, two readiness testing and maintenance scenarios were evaluated. The first scenario represents the applicant's proposed monthly generator testing. During these tests, up to four gensets will be operated concurrently at 0 percent load for up to 15 minutes; this is conservatively characterized with emissions at 10 percent load. The second scenario represents the applicant's proposed annual genset testing. These tests are conducted on individual gensets once per year at a series of stepped loads up to 100 percent load. All discrete load levels for which emissions data is available (i.e., 10 percent, 25 percent, 50 percent, 75 percent, and 100 percent) were analyzed to identify the potential worst-case ambient air quality impacts.

The applicant proposes to accept a permit condition from BAAQMD to limit testing to no more than one generator at a time for annual testing at any load and no more than four generators at a time for monthly testing under 10 percent load (DayZenLLC 2021t, Response to Data Request 8).

Additionally, the modeling also presumes that routine readiness testing would be limited to occur within certain hours of the day. The applicant proposes to accept a permit condition from BAAQMD for limiting readiness testing to only be allowed during a 10-hour period between 7:00 a.m. and 5:00 p.m. daily (DayZenLLC 2021t, Response to Data Request 10).

**Refined Modeling Analyses.** The modeling considers the use of the diesel-fired gensets in all proposed readiness testing and maintenance scenarios. The AQIA for project operation includes generator operating assumptions that vary depending on the averaging period of the applicable CAAQS or NAAQS. Refined modeling for all 1-hour averaging periods considers the possibility of any single generator operating at any of five different load conditions. The 1-hour scenarios also include 11 different four-engine groups for the monthly testing under 10 percent load. The AQIA for readiness testing and maintenance assumes that engines may startup for 1-hour runs; each hour consists of 15 minutes of uncontrolled emissions and 45 minutes of controlled emissions a given load (DayZenLLC 2021t, Table 7-5).

Modeling for comparison to the short-term NAAQS follows the applicable multi-year statistical forms (one-hour NO<sub>2</sub> and SO<sub>2</sub> and 24-hour PM<sub>2.5</sub>). Similarly, for the 1-hour NO<sub>2</sub> and SO<sub>2</sub> CAAQS impacts analyses, the applicant reported the highest 1-hour NO<sub>2</sub> and SO<sub>2</sub> modeled concentrations in a manner consistent with the forms of the CAAQS.

Modeled 1-hour NO<sub>2</sub> concentrations reflect an ambient equilibrium between NO and NO<sub>2</sub> computed using PVMRM for single-source runs and the Ozone Limiting Method (OLM) for groups of multiple sources. Both methods represent Tier 3 approaches for NO<sub>2</sub> analysis as defined in U.S. EPA's *Guideline on Air Quality Models* (U.S. EPA 2017). The applicant

used an NO<sub>2</sub>/NO<sub>x</sub> in-stack ratio of 0.1 (10 percent), which is typical for large diesel engines.

For analysis relative to the state one-hour NO<sub>2</sub> standard, the modeled NO<sub>2</sub> results from PVMRM or OLM are added to the maximum 1-hour background NO<sub>2</sub> value from the Jackson Street monitoring site (2018-2020) to arrive at the total NO<sub>2</sub> impact for the 1-hour NO<sub>2</sub> CAAQS analysis (DayZenLLC 2021t, pg. 8 and Response to Data Request 18). For the NAAQS analysis, the modeled NO<sub>2</sub> results from PVMRM or OLM are added to the three-year average of the second-highest hourly background NO<sub>2</sub> value, consistent with U.S. EPA guidance for the NO<sub>2</sub> NAAQS (U.S. EPA 2011).

Staff's review for the state 1-hour NO<sub>2</sub> standard confirmed the applicant's PVMRM runs (using AERMOD version 19191) as being representative of worst-case NO<sub>2</sub> 1-hour results. In confirming this, staff also used the earlier version of PVMRM and the current version of OLM, with staff's seasonal hour-by-day highest single hour background NO<sub>2</sub> values to test the sources likely to result in the highest NO<sub>2</sub> concentrations.

Modeling for comparison with the 24-hour PM<sub>10</sub> and PM<sub>2.5</sub> standards assumes that any single genset could operate at the maximum 1-hour rate during any given 24-hour period (DayZenLLC 2021t, Table 7-6).

**Table 4.3-8** shows the maximum impacts from project operation, including readiness testing and maintenance. The project impact column shows the worst-case impacts of the project from modeling. The background column shows the highest (or three-year averages for the 24-hour PM<sub>2.5</sub> and federal 1-hour SO<sub>2</sub> standards) of the background concentrations from the last three years of representative data (2018-2020) from the Jackson Street station. The background PM<sub>10</sub> and PM<sub>2.5</sub> concentrations are shown in **bold** because they already exceeded the corresponding limiting standards. Except for the 1-hour NO<sub>2</sub> total impacts, the total impact column shows the sum of the existing background condition plus the maximum impact predicted by the modeling analysis for readiness testing and maintenance. The limiting standard column combines CAAQS and NAAQS, whichever is more stringent.

**Table 4.3-8** shows that the project's stationary sources would not cause exceedances of the CO, NO<sub>2</sub>, or SO<sub>2</sub> standards. **Table 4.3-8** also shows that the existing PM<sub>10</sub> and PM<sub>2.5</sub> background concentrations are already above the limiting standards. The project would, therefore, contribute to existing exceedances of the PM<sub>10</sub> and PM<sub>2.5</sub> standards.

The modeled PM<sub>10</sub> concentrations from the project's operation in **Table 4.3-8** are well below the U.S. EPA PM<sub>10</sub> SILs of 5 µg/m<sup>3</sup> for 24-hour impacts and 1 µg/m<sup>3</sup> for annual impacts. Similarly, the maximum modeled PM<sub>2.5</sub> concentrations from project operation would not exceed the U.S. EPA PM<sub>2.5</sub> SILs of 1.2 µg/m<sup>3</sup> for 24-hour impacts at any location. **Table 4.3-8** also shows that the annual PM<sub>2.5</sub> project impacts of 0.054 µg/m<sup>3</sup> would not exceed the U.S. EPA PM<sub>2.5</sub> of 0.2 µg/m<sup>3</sup> for annual impacts (US EPA 2018a) or the project-level BAAQMD CEQA Guidelines threshold for annual-average PM<sub>2.5</sub> of 0.3 µg/m<sup>3</sup>, for risk and hazards.

**TABLE 4.3-8 MAXIMUM AMBIENT AIR QUALITY IMPACTS DURING OPERATION ( $\mu\text{g}/\text{m}^3$ )**

Pollutant	Averaging Time	Project Impact	Background	Total Impact	Limiting Standard	Percent of Standard
PM10	24-hour	0.13	<b>137.1</b>	<b>137</b>	50	<b>274%</b>
	Annual	0.054	<b>24.8</b>	<b>25</b>	20	<b>124%</b>
PM2.5 <sup>a</sup>	24-hour	0.13	<b>73.4</b>	<b>74</b>	35	<b>210%</b>
	Annual	0.054	<b>12.9</b>	<b>13</b>	12	<b>108%</b>
CO	1-hour	172	2,857	3,029	23,000	13%
	8-hour	115	2,400	2,515	10,000	25%
NO <sub>2</sub> <sup>b,c</sup>	State 1-hour	---	---	327	339	96%
	Federal 1-hour	---	---	179	188	95%
	Annual	8.6	22.6	31	57	55%
SO <sub>2</sub> <sup>c</sup>	State 1-hour	0.84	37.9	39	655	6%
	Federal 1-hour	0.84	7.8	9	196	4%
	24-hour	0.76	3.9	5	105	4%

Notes: Concentrations in **bold** type are those that exceed the limiting ambient air quality standard.

<sup>a</sup> To compute the total impacts for the 24-hour PM2.5 NAAQS, staff conservatively combined the maximum modeled 24-hour PM2.5 impacts to the three-year average of 98th percentile PM2.5 background.

<sup>b</sup> The NO<sub>2</sub> impacts are evaluated using the U.S. EPA PVMRM for single source scenarios and OLM for multiple-source scenarios, with each source's NO<sub>2</sub>/NO<sub>x</sub> in-stack ratio of 0.10.

<sup>c</sup> Impacts for the 1-hour NO<sub>2</sub> and SO<sub>2</sub> CAAQS are based on the maximum 1-hour modeled concentrations and maximum seasonal hour-of-day backgrounds since these CAAQS are "values that are not to be exceeded." Impacts for the 1-hour statistical-based NO<sub>2</sub> NAAQS use seasonal hour-of-day background concentrations adjusted to reflect the form of the standard.

Source: DayZen LLC 2021t (Tables 7-8 through 7-10).

**Table 4.3-8** shows that use of the diesel-fired gensets in all proposed readiness testing and maintenance scenarios would not expose sensitive receptors to substantial pollutant concentrations, and this impact would be less than significant.

**Localized CO Concentrations.** Engine exhaust may elevate localized CO concentrations, resulting in "hot spots." Receptors exposed to these CO hot spots may have a greater likelihood of developing adverse health effects. CO hot spots are typically observed at heavily congested intersections where a substantial number of vehicles idle for prolonged durations throughout the day. BAAQMD screening guidance indicates that a project would not exceed the CO significance threshold if a project's traffic projections indicate traffic levels would not increase at any affected intersection to more than 44,000 vehicles per hour or at any affected intersections to more than 24,000 vehicles per hour where vertical and/or horizontal mixing is substantially limited (BAAQMD 2017b).

The proposed project would generate a small number of vehicle trips to the site. These trips would include workers and material and equipment deliveries. It is unlikely that the addition of vehicle trips from the project on any roadway in the vicinity of the project site would result in an exceedance of the BAAQMD screening threshold. As a result, the additional vehicle trips associated with the project would result in a negligible effect on CO concentrations in the vicinity of the project site.

**Table 4.3-7** and **Table 4.3-8** show the CO concentrations resulting from the project's construction and operation and modeling results confirm that impacts would be well below the limiting standards and BAAQMD CEQA Guidelines significance thresholds of 20.0 ppm (23,000  $\mu\text{g}/\text{m}^3$ ) for 1-hour average concentrations and 9.0 ppm (10,000  $\mu\text{g}/\text{m}^3$ ) for 8-hour average concentrations.

Localized CO impacts during construction and operation, including readiness testing and maintenance, would not expose sensitive receptors to substantial pollutant concentrations, and this impact would be less than significant.

### *Emergency Operations Impacts for Criteria Pollutants*

This section addresses the potential for emergency situations that could trigger the unplanned operation of the project's diesel-fired gensets. Emergency use of the gensets could occur in the event of a power outage or other disruption, upset, or instability that triggers a need for emergency backup power at CA3DC.

The air quality impacts of genset operation during emergencies are not quantified below because the impacts of emergency operations are typically not evaluated during facility permitting and local air districts do not normally conduct an air quality impact assessment of such impacts. CEC staff assessed the likelihood of emergency events but finds that modeling the air quality impacts of emergency operations would require a host of unvalidated, unverifiable, and speculative assumptions about when and under what circumstances such a hypothetical emergency would occur. Such a speculative analysis is not required under CEQA (CEQA Guidelines, CCR, Tit. 14, § 15064(d)(3) and § 15145), and, most importantly, would not provide meaningful information by which to determine project impacts.

Emissions that occur during the emergency use of the gensets would not occur on a regular or predictable basis (see **Appendix B** for more information). During the permitting process, BAAQMD policy requires facilities to presume that each of their generators will experience 100 hours per year of emergency operation when calculating their PTE for determining the applicability of certain permitting regulations (BAAQMD 2019).

Although normally excluded from ambient air quality impact analysis during permit review, BAAQMD comments on the NOP requested that this air quality analysis include various scenarios of backup power generation operations beyond routine testing and maintenance (BAAQMD 2021b). The comments from BAAQMD provided a review of data centers that initiated operation of diesel engines for "non-testing/non-maintenance" purposes, for the purpose of informing staff's consideration of scenarios of backup power generation operations beyond routine testing and maintenance (BAAQMD 2021b).

Staff reviewed the BAAQMD comments regarding the use of diesel engines for “non-testing/non-maintenance” purposes and confirmed that these types of events are infrequent, irregular, and unlikely and the resulting emissions are not easily predictable or quantifiable. The BAAQMD comments showed that extended durations of standby generator engines use occurred for “non-testing/non-maintenance” purposes, mostly due to extreme events within the 13-month record of the data. The 13-month period of BAAQMD’s review (September 1, 2019, to September 30, 2020) included the implementation of Pacific Gas and Electric’s Public Safety Power Shutoff (PSPS), severe wildfires, several California Independent System Operator (CAISO)-declared emergencies, and winter storms.

In staff’s analysis of BAAQMD’s review, without excluding the extreme events, 1,877 engine-hours of diesel engine use occurred at 20 data centers for “non-testing/non-maintenance” purposes (less than half of the 45 facilities included in the review, and less than a third of such facilities under BAAQMD’s jurisdiction). BAAQMD’s review covered 288 individual diesel engines that operated over a 13-month record. Because the backup generator engines were collectively available for over 2.74 million engine-hours during the 13-month period (288 engines \* 9,504 hours in the 13-month record), and they were used for “non-testing/non-maintenance” purposes for 1,877 engine-hours, at those facilities where operation occurred, the engines entered into emergency operations during 0.07 percent of their available time (1,877 / 2.74 million). Staff’s analysis of BAAQMD’s information found that the average runtime for each diesel backup generator engine per event in BAAQMD’s review was approximately 5.0 hours. Based on this data, staff determined that the emergency use of the standby generator engines was infrequent and of short duration.

Due to the number of factors that need to be considered, using an air quality model to evaluate ambient air quality impacts during emergency operations would require unnecessary speculation and would render the results of any such exercise too speculative to be meaningful. This remains especially true when neither the CEC nor any other agency has established or used in practice a threshold of significance by which to interpret air quality modeling results from emergency operations. Emergency operation would be very infrequent, and emergency operations would not occur routinely during the lifetime of the facility. Accordingly, the potential for any adverse impacts to ambient air quality concentrations would be a very-low probability event.

Thus, staff concludes that assessing the impacts of emergency operation of the gensets would be speculative due to the infrequent, irregular, and unplanned nature of emergency events. Emissions and impacts during emergency operation are not easily predictable or quantifiable.

Because of the infrequent nature of emergency conditions and the reliability of the grid as detailed in **Appendix B**, the project’s emergency operation would be unlikely to expose sensitive receptors to substantial concentrations of criteria air pollutants.



### ***Cumulative Impacts for Criteria Pollutants***

Under environmental checklist criterion “b” above, staff concludes that the project emissions would not exceed the BAAQMD significance thresholds with the implementation of **AQ-1** during construction and NO<sub>x</sub> offsets for readiness testing and maintenance. Therefore, the project would not result in a cumulatively considerable net increase of any criteria pollutant, and these impacts would be less than significant with mitigation incorporated.

### **Health Risk Assessment for Toxic Air Contaminants**

The HRA for the project was conducted separately for (1) the period of project's demolition, excavation, and construction, and (2) the period of operation, which consists of readiness testing and maintenance. A separate discussion summarizes the risk and hazards for the project in a cumulative HRA that includes the project's impact with the impacts of existing sources in the area.

The HRA estimated risks of cancer, non-cancer chronic exposure, and non-cancer acute exposure for residential, worker, and sensitive receptors, including the maximally exposed individual resident (MEIR), maximally exposed individual worker (MEIW), maximally exposed school receptor (MESR), maximally exposed daycare receptor (MEDR) and the maximally exposed recreational receptor (MERR) (DayZenLLC 2021b, pg. 16). As required by the 2015 OEHHA Guidance, sensitive receptor (including residential) cancer risks were estimated assuming exposure beginning in the third trimester of pregnancy and worker cancer risk was estimated assuming an 8-hour-per-day, 250 day-per-year exposure, beginning at the age of 16 (OEHHA 2015).

Some exposure assumptions (DayZenLLC 2021b, pg. 11-12):

- For construction, off-site residents were assumed to be present at one location for the entire duration of the construction period. For operation, off-site residents were assumed to be present at one location for a 30-year period, beginning with exposure in the third trimester.
- For off-site school and childcare receptors, the applicant selected exposure parameters using the conservative assumption that a child would be located at the daycare facility starting at age of six weeks until age six, and for the school receptor, a child would be at the school starting at age six until 18 years. For construction and operation, the child was assumed to be present at the location for eight hours a day, for five days a week.
- For off-site recreational receptors, exposure parameters were selected with the conservative assumption that a child would be present at the park starting at age zero for two hours a day and would be present for 30 years, 180 days per year.
- For off-site receptors, including fence line and all other public spaces adjacent sidewalk receptors, the applicant adopted the staff-requested methodology of

assigning the exposure parameters of worker to those locations for assessment of health impacts. A 25-year exposure duration for workers is assumed based on the OEHHA recommended exposure duration period and an exposure frequency of 250 days in a year is used in the analysis.

### ***Construction HRA***

*Less Than Significant Impact.* Project construction is expected to occur over two phases, with Phase I construction lasting for about 15 months, and Phase II construction lasting for 7 months (DayZenLLC 2021e, pg. 4-31; CEC 2022a). Emissions from the approximate 22-month construction period were estimated using CalEEMod (DayZenLLC 2021e, pg. 4-25; CEC 2022a). Construction emissions are a result of construction equipment, material movement, paving activities, and on- and off-site vehicle trips, such as material haul trucks, worker commutes, and delivery vehicles (DayZenLLC 2021e, pg. 4-25). Construction health risk impacts are based on the assumption that all construction off-road equipment meets Tier 4 final engine standards and that all exposed areas in the site would undergo watering twice a day. The risks and health impacts reported are for the entire duration of construction period (DayZenLLC 2021e, pg. 4-31). Only DPM emissions from off-road construction equipment and on-road vehicles are analyzed (DayZenLLC 2021e, Table 4.3-10).

Staff reviewed the applicant's modeling files and agrees with the inputs used by the applicant and the outputs from the model for carcinogenic and chronic health risks. There are no acute risks analyzed (DayZenLLC 2021e, Table 4.3-10) for construction HRA. Acute (non-cancer) health risks were not estimated because there is no acute inhalation REL for DPM, indicating that DPM is not known to result in acute health hazards. The results of the construction HRA are presented in **Table 4.3-9**. It shows that the maximum cancer risk impact, chronic HIs, and PM<sub>2.5</sub> concentrations at the MEIR, MEIW, MEDR, MESR, and MERR during the construction of the project would be less than BAAQMD's significance thresholds. Therefore, staff concluded that the health risks of the project construction would be a less than significant impact.

Note that the risk values shown in **Table 4.3-9** are the highest of those modeled for each type of sensitive receptors. The risk values at other locations for each type of sensitive receptors would be lower than those shown in **Table 4.3-9**. Health risks at nearby worker/residential/sensitive receptors would all be below the significance thresholds. The health risks from project construction would be less than significant, and no mitigation would be necessary. The health risks from project construction would be less than significant with the implementation of **AQ-1**.

**TABLE 4.3-9 CONSTRUCTION -- MODELED RECEPTOR MAXIMUM HEALTH RISK**

Receptor Type	Cancer Risk Impact (in one million)	Chronic Non-Cancer Hazard Index (HI) (unitless)	Acute Non-Cancer Hazard Index (HI) (unitless)	PM2.5 Concentration ( $\mu\text{g}/\text{m}^3$ )
Residential-MEIR <sup>1</sup>	1.5	0.0017	N/A	0.09
Worker-MEIW <sup>2</sup>	0.45	0.005	N/A	0.27
Daycare-MEDR <sup>3</sup>	0.8	2.6E-04	N/A	0.014
School-MESR <sup>4</sup>	0.17	3.9E-04	N/A	0.021
Recreational-MERR <sup>5</sup>	0.1	8.2E-04	N/A	0.0044
<b>BAAQMD Threshold</b>	10	1	1	0.3

Notes:

<sup>1</sup> Maximally Exposed Individual Resident (MEIR). It is located about 175 ft south the project boundary (just across the street of the project).<sup>2</sup> Maximally Exposed Individual Worker (MEIW). It is located on the southeast of the project boundary. Risks at the worker receptors include a Worker Adjustment Factor of 4.2 (7/5\*24/8) to account for the hours a worker is present at a site.

<sup>3</sup> Maximally Exposed Daycare Receptor (MEDR). It is located approximately 1750 ft southeast of the project boundary. Risks at the daycare and school receptors include a modeling adjustment factor of 4.2 (7/5\*24/8) to account for the hours when a child is present at the site.

<sup>4</sup> Maximally Exposed School Receptor (MESR). It is the Bracher Elementary, approximately 650 feet south of the Project boundary. Risks at the daycare and school receptors include a modeling adjustment factor of 4.2 (7/5\*24/8) to account for the hours when a child is present at the site.

<sup>5</sup> Maximally Exposed Recreational Receptor (MERR). It is the Bracher Park. Locating about 150 ft south of the project boundary (just across the street of the project).

Source: DayZenLLC 2021e, Table 4.3-10, DayZenLLC 2021b, pg. 2, and DayZenLLC 2021t, pg. 18 and Table 20-3.

### **Operation HRA**

*Less Than Significant Impact.* Project operation emissions are a result of diesel fuel combustion from the gensets, off-site vehicle trips for worker commutes and material deliveries, and facility upkeep, such as architectural coatings, consumer product use, landscaping, water use, waste generation, natural gas use for comfort heating, and electricity use. They are categorized into two major sources: (1) stationary sources and (2) miscellaneous operation emissions (DayZenLLC 2021e, pg. 4-26 through 4-28).

(1) Stationary Sources: CA3BGF's 44 diesel gensets. Each of the 44 gensets for the data center suites would be powered by Caterpillar Model 3516E engines equipped with SCR equipment and DPF to comply with Tier 4 emissions standards. The DPFs are expected to control particulate matter by approximately 71 percent. All gensets would be tested routinely to ensure they would function during an emergency. TAC emissions resulting from diesel stationary combustion were assumed equal to PM10 emissions or estimated using speciated emission factors from CARB profile 818<sup>5</sup> (DayZenLLC 2021e, pg. 4-26).

CARB's ATCM limits each engine to no more than 50 hours annually for reliability purposes (i.e., testing and maintenance). The applicant's health impacts are based on an annual maximum operating limit of 35 hours per year averaged over all engines for a total of

<sup>5</sup> <https://ww2.arb.ca.gov/speciation-profiles-used-carb-modeling>

1,540 hours for readiness testing and maintenance operations (DayZenLLC 2021e, pg. 4-26 and pg. 4-32).

(2) Miscellaneous Operational Emissions: Miscellaneous emissions from operational activities such as worker travel, deliveries, energy and fuel use for facility electrical, heating and cooling needs, periodic use of architectural coatings, landscaping, etc. were evaluated by CalEEMod (DayZenLLC 2021e, pg. 4-28). However, these emissions were not included in the operation HRA. The health impacts are based on an annual maximum operating limit of 35 hours for readiness testing and maintenance operations (DayZenLLC 2021e, pg. 4-32).

All discrete loads levels for which emissions data is available (i.e., 10%, 25%, 50%, 75%, and 100%) were analyzed to identify the potential worst-case PM<sub>2.5</sub> annual average concentrations which correspond to the worst-base health risk impacts. The applicant reported the second greatest impact at 25% load, where the greatest impact is at 100% load. Since it is impossible to run the generators at 100% load for the entire maximum run time, the HRA was run at 25% load for all engines for all hours. Even that is an overestimate of the impacts, as much of the run time will be at 0% load, which is characterized by the parameters for 10% load (DayZenLLC 2021t, pg. 16).

**Table 4.3-10** shows that the cancer risks, chronic HIs, acute HIs, and PM<sub>2.5</sub> concentrations at the MEIR, MEIW, MEDR, MESR, and MERR during the project's operation would be less than the BAAQMD's significance thresholds. Therefore, staff concluded that the health risks of the project operation would be a less-than-significant impact.

It should be noted that the risk values shown in **Table 4.3-10** are the highest of those modeled for each type of sensitive receptors. The risk values at other locations for each type of sensitive receptors would be lower than those shown in **Table 4.3-10**. Health risks at nearby worker/residential/sensitive receptors would all be below the significance thresholds. The health risks from the project's operation would be less than significant, and no mitigation would be necessary. The health risks from the project's construction would be less than significant with the implementation of **AQ-1**.

In conclusion, staff finds the health risks at sensitive receptor locations would be less than the BAAQMD CEQA Guidelines significance thresholds shown in **Table 4.3-1**. Staff concludes that the health risks from the project's construction and routine operation would be less than significant and would be further reduced with the implementation of **AQ-1**.

**TABLE 4.3-10 OPERATION -- MODELED RECEPTOR MAXIMUM HEALTH RISK**

Receptor Type	Cancer Risk Impact <sup>6</sup> (in one million)	Chronic Non-Cancer Hazard Index (HI) <sup>6</sup> (unitless)	Acute Non-Cancer Hazard Index (HI) <sup>7</sup> (unitless)	PM2.5 Concentration <sup>6</sup> (µg/m <sup>3</sup> )
Residential-MEIR <sup>1</sup>	8.73	0.0037	0.027	0.012
Worker-MEIW <sup>2</sup>	8.99	0.0108	0.053	0.035
Daycare-MEDR <sup>3</sup>	4.38	0.001	0.015	0.003
School-MESR <sup>4</sup>	1.35	0.0008	0.016	0.003
Recreational-MERR <sup>5</sup>	0.31	0.001	0.029	0.003
<b>BAAQMD Threshold</b>	10	1	1	0.3

Notes:

<sup>1</sup> Maximally Exposed Individual Resident (MEIR). It is located about 175 ft south the project boundary (just across the street of the project).

<sup>2</sup> Maximally Exposed Individual Worker (MEIW). It is located on the southeast of the project boundary. Risks at the worker receptors include a Worker Adjustment Factor of 4.2 (7/5\*24/8) to account for the hours a worker is present at a site.

<sup>3</sup> Maximally Exposed Daycare Receptor (MEDR). It is located approximately 1750 ft southeast of the project boundary. Risks at the daycare and school receptors include a modeling adjustment factor of 4.2 (7/5\*24/8) to account for the hours when a child is present at the site.

<sup>4</sup> Maximally Exposed School Receptor (MESR). It is the Bracher Elementary, approximately 650 feet south of the Project boundary. Risks at the daycare and school receptors include a modeling adjustment factor of 4.2 (7/5\*24/8) to account for the hours when a child is present at the site.

<sup>5</sup> Maximally Exposed Recreational Receptor (MERR). It is the Bracher Park. Locating about 150 ft south of the project boundary (just across the street of the project).

<sup>6</sup> Load scenario: 25%.

<sup>7</sup> Value of the worst-case generator at 25% load.

Source: DayZenLLC 2021e, pg 4-32, and DayZenLLC 2021t, Table 20-2.

### ***Emergency Operations HRA***

*Less Than Significant Impact.* As discussed above and in **Appendix B**, any operation of this project for emergency purposes would be infrequent, irregular, and unlikely and the resulting emissions are not easily predictable or quantifiable. Nevertheless, because the Health Risk Assessment thresholds and modeling of TACs are less sensitive to minor adjustments in variable assumptions than is the case for criteria air pollutants, staff can generally extrapolate some of the modeling that is done for testing and routine maintenance to explore what emissions could look like under an emergency operation scenario. This is more true, however, for cancer and chronic impacts than it is for acute HI which, like some criteria pollutant modeling, relies on 1-hour modeling results to determine impact.

For this project, the HRA of acute TAC impacts, shown in **Table 4.3-10**, represents the acute HI of the generator of reasonable worst-case (25% load). In other words, the engines would result in greater impacts at 25% load than at any other load except for 100%. However, data provided about real-world operation of data center backup generating facilities during emergency situations show that they do not run at 100% load. Therefore, it is reasonable to use 25% as a reasonable worst-case scenario for purposes of modeling. Staff also concludes that modeling the project at 25% load results in an overestimation of reasonable worst-case conditions because much of the actual

operation would be at 0% load, which must be reflected in the model as 10% load. In other words, typical backup generating facilities for data centers do not run for an hour when operating during an emergency situation. Nevertheless, to estimate potential impacts for acute HI, the project must be modeled as if it is operating for the full hour. Since the value provided by the applicant is only for one engine, staff summed the acute HIs of all 44 diesel gensets, assuming they operated concurrently for one hour. The acute HIs of each receptor are shown in **Table 4.3-11** and most of them are all still below the significance threshold. As mentioned above, the design includes redundancy so that eight gensets are redundant, and two of the four house gensets are redundant (DayZenLLC 2021a, pg. 2-2). Therefore, it is very conservative to suppose 44 gensets operate concurrently. For some receptors (i.e., MEIR and MEIW) with acute HI higher than one (1), staff recalculated by excluding 10 redundant engines with the lowest HI, which brought the HIs down to less than the threshold of one (1). As discussed above, this represents one of the reasonable worst-case scenarios because the total available gensets exceed what would be operated.

This approach is typical of how air quality modeling is done. Certain worst-case assumptions are made to conduct the initial screening-level modeling. If the results show project impacts would fall below all applicable thresholds, then no further refinement is necessary. If, however, the results show the potential for predicted exceedances, then further refinements are necessary to ensure the model reflects likely real-world operation parameters.

While concurrently operating all gensets could approximate what might occur during an undefined emergency, the analysis of acute non-cancer hazards showed the acute health risks to be below the relevant significance thresholds. Therefore, staff concludes that the project is expected to have less than significant acute health risks from emergency operations.

**TABLE 4.3-11 EMERGENCY OPERATION -- MODELED RECEPTOR MAXIMUM HEALTH RISK**

Receptor Type	Acute <sup>6</sup> Non-Cancer Hazard Index (HI) (unitless)	Acute <sup>7</sup> Non-Cancer Hazard Index (HI) (unitless)
Residential-MEIR <sup>1</sup>	0.027	0.832 <sup>8</sup>
Worker-MEIW or PMI <sup>2</sup>	0.053	0.985 <sup>9</sup>
Daycare-MEDR <sup>3</sup>	0.015	0.504
School-MESR <sup>4</sup>	0.016	0.621
Recreational-MERR <sup>5</sup>	0.029	0.931
<b>BAAQMD Threshold</b>	<b>1</b>	<b>1</b>

Notes:

<sup>1</sup> Maximally Exposed Individual Resident (MEIR), Receptor # 2621. It is located about 175 ft south the project boundary (just across the street of the project).

<sup>2</sup> Maximally Exposed Individual Worker (MEIW) and Point of Maximum Impact (PMI), Receptor # 5082. It is located on the southeast of the project boundary. Risks at the worker receptors include a Worker Adjustment Factor of 4.2 (7/5\*24/8) to account for the hours a worker is present at a site.

<sup>3</sup> Maximally Exposed Daycare Receptor (MEDR). It is located approximately 1750 ft southeast of the project boundary. Risks at the daycare and school receptors include a modeling adjustment factor of 4.2 (7/5\*24/8) to account for the hours when a child is present at the site.

<sup>4</sup> Maximally Exposed School Receptor (MESR). It is the Bracher Elementary, approximately 650 feet south of the Project boundary. Risks at the daycare and school receptors include a modeling adjustment factor of 4.2 (7/5\*24/8) to account for the hours when a child is present at the site.

<sup>5</sup> Maximally Exposed Recreational Receptor (MERR). It is the Bracher Park. Locating about 150 ft south of the project boundary (just across the street of the project).

<sup>6</sup> Value of the generator of the worst-case at 25% load.

<sup>7</sup> Assume all 44 generators operate concurrently for one hour.

<sup>8</sup> Receptor # 5080. HI was calculated by excluding 10 redundant engines with lowest HI.

<sup>9</sup> Receptor # 4137. HI was calculated by excluding 10 redundant engines with lowest HI.

Source: DayZenLLC 2021e, pg 4-32, DayZenLLC 2021t, Table 20-2., and CEC staff analysis.

### **Cumulative HRA**

*Less Than Significant Impact.* This discussion addresses the impacts from cumulative sources in comparison to the BAAQMD significance thresholds for risk and hazards from cumulative sources (BAAQMD, 2017b). The cumulative HRA is an assessment of the project's impact summed with the impacts of existing sources within 1,000 feet of the project. The results of this cumulative HRA are compared to the BAAQMD CEQA cumulative thresholds of: no more than 100 cancer cases per million; a chronic HI of no more than 10.0; and PM2.5 concentrations of no more than 0.8 µg/m<sup>3</sup> annual average PM2.5 concentrations.

Per staff's request in Data Requests 25 and 26, the applicant provided a cumulative HRA and compared results with the BAAQMD threshold of significance for cumulative risk and hazards (DayZenLLC 2021t, pg. 19-20). The BAAQMD CEQA Guidelines for assessing cumulative health risk impacts recommend investigating all sources of TACs within 1,000 feet of a proposed project. Because of the nearby railroad (CalTrain) and surrounding industrial stationary sources that could present elevated existing levels of TACs, staff requested information on TAC sources within 2,000 feet of the project fence-line (DayZenLLC 2021t, pg. 19).

However, the applicant only conducted the cumulative HRA for the MEISR as part of the project (DayZenLLC 2021t, pg. 20), and not other sensitive receptors. The applicant's cumulative HRA shows that the maximum cumulative cancer risk would be 133 in a million, higher than the threshold of 100 in a million; the maximum cumulative HI would be 0.15, below the threshold of 10; and the maximum cumulative PM<sub>2.5</sub> concentration would be 1.3 µg/m<sup>3</sup>, higher than the threshold of 0.8 µg/m<sup>3</sup>. This exceedance is driven largely by the proximity of the MEISR to the nearby railroad (CalTrain). The exceedance is also impacted by the conservative nature of the cumulative analysis. BAAQMD CEQA Guidelines and tools were developed to analyze the impacts from all stationary sources within 1,000 feet of the project site, rather than the 2,000-foot distance requested by staff. As a result, the distance multipliers do not account for the incrementally decreasing risk and hazard impacts from sources that are further than 1,000 feet from the MEISR and are overestimates of the impact. Therefore, the total cumulative risk is overestimated (DayZenLLC 2021t, pg. 20, Table 26-1).

Staff also conducted an independent cumulative HRA, assessing the proposed project's impact summed with the impacts of existing sources within 1,000 feet<sup>6</sup> of the maximally exposed sensitive receptors, including MEIR, MEIW, MEDR, MESR, and MERR. The results of staff's cumulative HRA are compared to the BAAQMD significance thresholds (BAAQMD 2017b) in **Table 4.3-12**, **Table 4.3-13**, and **Table 4.3-14**. Staff's cumulative HRA includes four major sources of impacts: (1) existing stationary sources; (2) surrounding highways, main streets, and railways; (3) the China Mobile International data center; and (4) the project.

### *1. Existing Stationary Sources*

The cumulative cancer risk, non-cancer HI, and PM<sub>2.5</sub> concentrations of existing stationary sources were first retrieved from BAAQMD'S Permitted Sources Risk and Hazards Map<sup>7</sup>. Then the risks were calculated using BAAQMD's Health Risk Calculator<sup>8</sup> to refine screen-level cancer risk, non-cancer health hazard index, and PM<sub>2.5</sub> concentrations. The Health Risk Calculator incorporates factors such as risk associated with individual TACs emitted from an existing stationary source and how far a stationary source is from the project's maximally exposed sensitive receptor locations to calculate overall cancer risk, hazard index, and PM<sub>2.5</sub> concentration from a stationary source.

Stationary sources contributing health risks and hazard impacts within a 2,000-foot radius of the project site were determined using BAAQMD's updated CEQA Tool Permitted Stationary Sources Risk and Hazards Map, a GIS map that provides the

---

<sup>6</sup> Per the BAAQMD CEQA Guidelines, the zone of influence for the cumulative threshold is 1,000 feet from the source or receptor.

<sup>7</sup> The BAAQMD'S Permitted Sources Risk and Hazards Map can be accessed here: <https://baaqmd.maps.arcgis.com/apps/webappviewer/index.html?id=2387ae674013413f987b1071715daa65>

<sup>8</sup>The BAAQMD Health Risk Calculator Beta 4.0 can be downloaded here: <https://www.baaqmd.gov/~media/files/planning-and-research/ceqa/tools/baaqmd-health-risk-calculator-beta-4-0-xlsx.xlsx?la=en>



locations of stationary sources permitted by BAAQMD. The applicant also submitted a subsequent stationary source data request to BAAQMD to ensure the most recent health risk and hazard data had been identified. Appropriate distance multipliers provided by the BAAQMD CEQA Tool Health Risk Calculator with Distance Multipliers were applied to represent adjusted risk and hazard impacts that can be expected with farther distances from the sources of emissions (DayZenLLC 2021t, pg. 19).

Staff searched the risk data for existing stationary sources within 1,000 feet of MEIR, MEIW, MEDR, MESR, and MERR. There is no stationary source found within 1,000 feet of MESR.

## *2. Surrounding Highways, Main Streets, and Railways*

Mobile impacts were determined using BAAQMD's raster tools, which provide impacts from major streets, highways, and railroads<sup>9</sup>. The tools developed by BAAQMD incorporate risk assessment procedures from the 2015 OEHHA Air Toxics Hot Spots Program Guidance (DayZenLLC 2021t, pg. 19). The cancer risk and PM<sub>2.5</sub> concentration from surrounding highways, major streets and railways were determined using BAAQMD raster files that incorporate annual average daily traffic (AADT) per EMFAC 2014 data for fleet mix and includes OEHHA's 2015 Guidance Methods. The raster files encompass highways, major streets, and rails with greater than 30,000 AADT. Staff received the raster files directly from BAAQMD, and then extracted the risk numbers by ArcGIS for the surrounding highways, main streets, and railways.

## *3. The Project*

For the project, please see the result of the applicant's HRA for facility-wide operation of CA3 presented in **Table 4.3-10**.

**Table 4.3-12**, **Table 4.3-13**, and **Table 4.3-14** summarize the results of the staff cumulative HRA and compares them to the BAAQMD significance thresholds for cumulative risk and hazards. The cumulative cancer risk, HI, and PM<sub>2.5</sub> concentration were conservatively calculated using the maximum value in relation to the maximally exposed sensitive receptors as well as at the nearest residences. **Table 4.3-12**, **Table 4.3-13**, and **Table 4.3-14** show that most of the project's health risks would not exceed the cumulative health risk thresholds when summed with the health risks of cumulative sources within 1,000 feet (or 2,000 feet) of each receptor.

**Table 4.3-12** shows that the proposed project's health risks (i.e., cancer risks) would exceed the cumulative health risk thresholds when summed with the health risks of cumulative sources within 2,000 feet of MEISR and 1,000 feet of MEIR. Also, **Table 4.3-14** shows that the proposed project's health risks (i.e., PM<sub>2.5</sub> concentration) would

---

<sup>9</sup> [https://www.baaqmd.gov/~media/files/planning-and-research/ceqa/tools/2020\\_02\\_20-methodology-risk-and-hazards-screening-tool-pdf.pdf?la=en](https://www.baaqmd.gov/~media/files/planning-and-research/ceqa/tools/2020_02_20-methodology-risk-and-hazards-screening-tool-pdf.pdf?la=en)

exceed the cumulative health risk thresholds when summed with the health risks of cumulative sources within 2,000 feet of MEISR and 1,000 feet of MEIW.

However, as mentioned above, the cumulative impacts are the summation of each category (cancer risks, PM<sub>2.5</sub> concentrations) from all the sources to each receptor, and the exceedances in cancer risk (**Table 4.3-12**) and PM<sub>2.5</sub> concentration (**Table 4.3-14**) are because the background values (i.e., sources of surrounding highways, major streets, and railways) are already very high or even have already exceeded the thresholds. In other words, the exceedance is not due to the project itself.

As set forth in **Table 4.3-12**, the modeled cancer risk at the receptor of MEISR is 9.9 in one million, meaning the project only contributes 9.9 in one million to this total number of 113 in one million. Comparing 9.9 in one million to 113 in one million, the project only contributes eight percent to the existing exceedances. Note the risk numbers for MEISR were overestimated because it is the summation of all sources within 2,000 feet. As for MEIR, its modeled cancer risk is only 0.69 in one million, meaning the project only contributes 0.69 in one million to this total number of 111.73 in one million. Comparing 0.69 in one million to 111.73 in one million, the project only contributes 0.6 percent to the existing exceedances and the contribution is, therefore, not cumulatively considerable. Therefore, staff concluded the project's contribution is not cumulatively considerable and the project does not cause cumulatively considerable impacts.

As set forth in **Table 4.3-14**, the modeled total PM<sub>2.5</sub> concentration at the receptor of MEISR is only 0.013 µg/m<sup>3</sup>, meaning the project only contributes 0.013 µg/m<sup>3</sup> to this total number of 1.3 µg/m<sup>3</sup>. Comparing 0.013 µg/m<sup>3</sup> to 1.3 µg/m<sup>3</sup>, the project only contributes one percent to the existing exceedances and the contribution is, therefore, not cumulatively considerable. Also, the modeled cancer risk at the receptor of MEIW is only 0.035 µg/m<sup>3</sup>, meaning the project only contributes 0.035 µg/m<sup>3</sup> to this total number of 1.3 µg/m<sup>3</sup>. Comparing 0.035 µg/m<sup>3</sup> to 1.3 µg/m<sup>3</sup>, the project only contributes two percent to the existing exceedances and the contribution is, therefore, not cumulatively considerable. Therefore, staff concluded the project's contribution is not cumulatively considerable and the project does not cause cumulatively considerable impacts.

In conclusion, staff finds that cumulative health risks at most sensitive receptor locations would be less than the BAAQMD CEQA Guidelines significance thresholds shown in **Table 4.3-1**. Staff concludes that the effect of cumulative TAC emissions would be less than significant.

**TABLE 4.3-12 CANCER RISKS (PER MILLION) FROM CUMULATIVE SOURCES**

Sources of Cumulative Impacts	Cancer Risk at MEISR <sup>a</sup>	Cancer Risk at MEIR <sup>b</sup>	Cancer Risk at MEIW <sup>c</sup>	Cancer Risk at MEDR <sup>d</sup>	Cancer Risk at MESR <sup>e</sup>	Cancer Risk at MERR <sup>f</sup>
Existing Stationary Sources	32	0.69	3.92	0.05	0	0.46
Surrounding Highways, Major Streets, and Railways	91	102.31	81.95	52.11	43.71	90.04
CA3	9.9 <sup>g</sup>	8.73	8.99	4.38	1.35	0.31
<b>Total - Cumulative Sources</b>	<b>113</b>	<b>111.73</b>	<b>94.86</b>	<b>56.54</b>	<b>45.06</b>	<b>90.80</b>
<b>Significance Threshold</b>	100	100	100	100	100	100
<b>Potential Significant Impact?</b>	<b>Yes</b>	<b>Yes</b>	No	No	No	No

Notes:

<sup>a</sup> Maximally Exposed Individual Sensitive Receptor (MEISR). The cumulative health risk impact of the proposed project was calculated including the stationary and mobile sources within 2,000 ft of the project boundary. Staff used the data provided by the applicant.

<sup>b</sup> Maximally Exposed Individual Resident (MEIR). The cumulative health risk impact of the proposed project was calculated including the stationary and mobile sources within 1,000 ft of this receptor. Staff used the data provided by BAAQMD.

<sup>c</sup> Maximally Exposed Individual Worker (MEIW). The cumulative health risk impact of the proposed project was calculated including the stationary and mobile sources within 1,000 ft of this receptor. Staff used the data provided by BAAQMD.

<sup>d</sup> Maximally Exposed Daycare Receptor (MEDR). The cumulative health risk impact of the proposed project was calculated including the stationary and mobile sources within 1,000 ft of this receptor. Staff used the data provided by BAAQMD.

<sup>e</sup> Maximally Exposed School Receptor (MESR). The cumulative health risk impact of the proposed project was calculated including the stationary and mobile sources within 1,000 ft of this receptor. Staff used the data provided by BAAQMD.

<sup>f</sup> Maximally Exposed Recreational Receptor (MERR). The cumulative health risk impact of the proposed project was calculated including the stationary and mobile sources within 1,000 ft of this receptor. Staff used the data provided by BAAQMD.

<sup>g</sup> Load scenario: 100% load.

Sources: CEC staff analysis of data from BAAQMD, and DayZenLLC 2021t, pg. 19-20, Table 26-1

**TABLE 4.3-13 CHRONIC HAZARD INDICES FROM CUMULATIVE SOURCES**

Sources of Cumulative Impacts	Chronic Hazard Index					
	MEISR <sup>a</sup>	MEIR <sup>b</sup>	MEIW <sup>c</sup>	MEDR <sup>d</sup>	MESR <sup>e</sup>	MERR <sup>f</sup>
Existing Stationary Sources	0.15	0	0	0.0015	0	0.0004
Surrounding Highways, Major Streets, and Railways	No Data Available <sup>g</sup>	No Data Available <sup>g</sup>	No Data Available <sup>g</sup>	No Data Available <sup>g</sup>	No Data Available <sup>g</sup>	No Data Available <sup>g</sup>
CA3	0.0037 <sup>h</sup>	0.0037	0.0108	0.001	0.0008	0.001
<b>Total - Cumulative Sources</b>	<b>0.1537</b>	<b>0.0037</b>	<b>0.0108</b>	<b>0.0025</b>	<b>0.0008</b>	<b>0.0014</b>
<b>Significance Threshold</b>	10	10	10	10	10	10
<b>Potential Significant Impact?</b>	No	No	No	No	No	No

Notes:

<sup>a</sup> Maximally Exposed Individual Sensitive Receptor (MEISR). The cumulative health risk impact of the proposed project was calculated including the stationary and mobile sources within 2,000 ft of the project boundary. Staff used the data provided by the applicant.

<sup>b</sup> Maximally Exposed Individual Resident (MEIR). The cumulative health risk impact of the proposed project was calculated including the stationary and mobile sources within 1,000 ft of this receptor. Staff used the data provided by BAAQMD.

<sup>c</sup> Maximally Exposed Individual Worker (MEIW). The cumulative health risk impact of the proposed project was calculated including the stationary and mobile sources within 1,000 ft of this receptor. Staff used the data provided by BAAQMD.

<sup>d</sup> Maximally Exposed Daycare Receptor (MEDR). The cumulative health risk impact of the proposed project was calculated including the stationary and mobile sources within 1,000 ft of this receptor. Staff used the data provided by BAAQMD.

<sup>e</sup> Maximally Exposed School Receptor (MESR). The cumulative health risk impact of the proposed project was calculated including the stationary and mobile sources within 1,000 ft of this receptor. Staff used the data provided by BAAQMD.

<sup>f</sup> Maximally Exposed Recreational Receptor (MERR). The cumulative health risk impact of the proposed project was calculated including the stationary and mobile sources within 1,000 ft of this receptor. Staff used the data provided by BAAQMD.

<sup>g</sup> No data available — BAAQMD staff did not provide data for these sources.

<sup>h</sup> Load scenario: 100% load.

Sources: CEC staff analysis of data from BAAQMD, and DayZenLLC 2021t, pg. 19-20, Table 26-1

**TABLE 4.3-14 ANNUAL PARTICULATE MATTER (PM2.5) CONCENTRATIONS ( $\mu\text{g}/\text{m}^3$ ) FROM CUMULATIVE SOURCES**

Sources of Cumulative Impacts	Annual DPM/PM2.5 Concentration					
	MEISR <sup>a</sup>	MEIR <sup>b</sup>	MEIW <sup>c</sup>	MEDR <sup>d</sup>	MESR <sup>e</sup>	MERR <sup>f</sup>
Existing Stationary Sources	0.73	0	0.433	0.004	0	0
Surrounding Highways, Major Streets, and Railways	0.57	0.569	0.542	0.207	0.139	0.541
CA3	0.013 <sup>g</sup>	0.012	0.035	0.003	0.003	0.003
<b>Total - Cumulative Sources</b>	<b>1.3</b>	<b>0.581</b>	<b>1.010</b>	<b>0.214</b>	<b>0.142</b>	<b>0.544</b>
<b>Significance Threshold</b>	0.8	0.8	0.8	0.8	0.8	0.8
<b>Potential Significant Impact?</b>	<b>Yes</b>	No	<b>Yes</b>	No	No	No

Notes:

<sup>a</sup> Maximally Exposed Individual Sensitive Receptor (MEISR). The cumulative health risk impact of the proposed project was calculated including the stationary and mobile sources within 2,000 ft of the project boundary. Staff used the data provided by the applicant.

<sup>b</sup> Maximally Exposed Individual Resident (MEIR). The cumulative health risk impact of the proposed project was calculated including the stationary and mobile sources within 1,000 ft of this receptor. Staff used the data provided by BAAQMD.

<sup>c</sup> Maximally Exposed Individual Worker (MEIW). The cumulative health risk impact of the proposed project was calculated including the stationary and mobile sources within 1,000 ft of this receptor. Staff used the data provided by BAAQMD.

<sup>d</sup> Maximally Exposed Daycare Receptor (MEDR). The cumulative health risk impact of the proposed project was calculated including the stationary and mobile sources within 1,000 ft of this receptor. Staff used the data provided by BAAQMD.

<sup>e</sup> Maximally Exposed School Receptor (MESR). The cumulative health risk impact of the proposed project was calculated including the stationary and mobile sources within 1,000 ft of this receptor. Staff used the data provided by BAAQMD.

<sup>f</sup> Maximally Exposed Recreational Receptor (MERR). The cumulative health risk impact of the proposed project was calculated including the stationary and mobile sources within 1,000 ft of this receptor. Staff used the data provided by BAAQMD.

<sup>g</sup> Load scenario: 100% load.

Sources: CEC staff analysis of data from BAAQMD, and DayZenLLC 2021t, pg. 19-20, Table 26-1

**d. Would the project result in other emissions (such as those leading to odors) adversely affecting a substantial number of people?**

This section considers impacts that may arise from emissions other than criteria air pollutants and TACs, such as emissions that may lead to odors.

BAAQMD states that, while offensive odors rarely cause direct health impacts or any physical harm, they still can be very unpleasant and lead to considerable distress among the public, often generating citizen complaints to local governments and BAAQMD (BAAQMD 2017b). Any project with the potential to frequently expose members of the public to objectionable odors would be deemed to have a significant impact. Odor impacts on residential areas and other sensitive receptors warrant the closest scrutiny, but consideration should also be given to other land uses where people may congregate, such as recreational facilities, worksites, and commercial areas.

BAAQMD CEQA Guidelines recommend a two-step process for determining the significance of potential odor impacts. First, determine whether the project would result in an odor source affecting receptors within the distances indicated in **Table 4.3-15**. Second, if the proposed project would result in an odor source and receptors within the screening level distances indicated in **Table 4.3-15**, a more detailed analysis should be conducted (BAAQMD 2017b).

**TABLE 4.3-15 PROJECT SCREENING TRIGGER LEVELS FOR POTENTIAL ODOR SOURCES**

Land Use/Type of Operation	Project Screening Distance
Wastewater Treatment Plant	2 miles
Wastewater Pumping Facilities	1 mile
Sanitary Landfill	2 miles
Transfer Station	1 mile
Composting Facility	1 mile
Petroleum Refinery	2 miles
Asphalt Batch Plant	2 miles
Chemical Manufacturing	2 miles
Fiberglass Manufacturing	1 mile
Painting/Coating Operations	1 mile
Rendering Plant	2 miles
Coffee Roaster	1 mile
Food Processing Facility	1 mile
Confined Animal Facility/Feed Lot/Dairy	1 mile
Green Waste and Recycling Operations	1 mile
Metal Smelting Plants	2 miles

Source: BAAQMD 2017b, Table 3-3.

The project is not a type of operation that is classified as a typical odor source by BAAQMD, as shown in **Table 4.3-15**. The diesel engine generators would not be stationary sources of a type that are typically known to cause significant odor impacts.

### *Construction*

*Less Than Significant Impact.* Minor odor sources during construction activities include diesel exhaust from heavy-duty equipment. Odors from construction activities near existing receptors would be temporary in nature and dissipate as a function of distance. Accordingly, the construction of the project is not expected to result in substantial emissions that may lead to odor impacts or impacts of emissions other than those of criteria pollutants and TACs identified elsewhere in this analysis.

Fugitive dust emissions can also create a nuisance that can cause adverse effects. The project is proposing to comply with the BAAQMD construction fugitive dust control BMPs and so should not have substantial fugitive dust emissions during construction that could adversely affect a substantial number of people.

Therefore, the construction of the project would not result in other emissions, such as those leading to odors, that could adversely affect a substantial number of people and would have less than significant impacts.

### *Operation*

*Less Than Significant Impact.* Potential odor sources from the project's readiness testing and maintenance along with emergency operation would include diesel exhaust from genset readiness testing and maintenance, trash pick-up and other heavy-duty delivery vehicles, and the occasional use of architectural coatings during routine maintenance. When compared to existing odor sources near the project site, which include heavy and light industrial uses, odor impacts from project readiness testing and maintenance along with emergency operations would be similar.

Once built and operating, the project would have no notable emissions other than those of criteria pollutants and TACs identified elsewhere in this analysis. Therefore, nuisance impacts would not be likely to occur during operation, including readiness testing and maintenance or emergency operation. During readiness testing and maintenance and during emergency operation, the project would not result in odors or other emissions that could adversely affect a substantial number of people and would have a less than significant impact related to odors. In conclusion, staff finds that the project would not likely create objectionable odors affecting a substantial number of people.

#### **4.3.4 Mitigation Measures**

To ensure that fugitive dust impacts are less than significant, the project will implement BAAQMD's recommended BMPs during the construction phase. On September 13, 2021, the applicant provided a revised mitigation measure **AQ-1**, as shown below, to ensure it reflects the assumptions used as the bases for construction equipment emissions estimates and modeling (DayZenLLC 2021w).

**AQ-1:** To ensure that fugitive dust impacts are less than significant, the project will implement the Bay Area Air Quality Management District (BAAQMD) recommended Best Management Practices (BMPs) during the construction phase, the project owner shall implement a construction emissions control plan that has been reviewed and approved by the Director or Director's designee of the City of Santa Clara Planning Division prior to the issuance of any grading or building permits, whichever occurs earliest. These BMPs are incorporated into the design of the project and will include:

- Water all exposed areas (e.g., parking areas, graded areas, unpaved access roads) twice a day.
- Maintain a minimum soil moisture of 12% in exposed areas by maintaining proper watering frequency.
- Cover all haul trucks carrying sand, soil, or other loose material.
- Suspend excavation, grading, and/or demolition activities when average wind speed exceeds 20 miles per hour.
- Pave all roadways, driveways, and sidewalks as soon as possible. Lay building pads as soon as grading is completed, unless seeding or soil binders are used.
- Install wind breaks (e.g., trees, fences) on the windward side(s) of actively disturbed areas of construction with a maximum 50 percent air porosity.
- Use a power vacuum to sweep and remove any mud or dirt-track next to public streets if visible soil material is carried onto the streets.
- Limit vehicle speeds on unpaved roads to 15 miles per hour (mph).
- Minimize idling time for all engines by shutting engines when not in use or limiting idling time to a maximum of five minutes. Provide clear signage for construction workers at all access points.
- Properly tune and maintain construction equipment in accordance with manufacturer's specifications. Check all equipment against a certified visible emissions calculator.
- Post a publicly visible sign with the telephone number and person to contact at the Lead Agency regarding dust complaints.
- Install vegetative ground cover in disturbed areas as soon as possible and water appropriately until vegetation is established.
- Limit simultaneous occurrence of excavation, grading, and ground-disturbing construction activities.
- Install water washers to wash all trucks and equipment prior to leaving site.
- Treat site access to a distance of 100 feet from the paved road with a 6- to 12-inch compacted layer of wood chip, mulch, or gravel.
- Install sandbag or other erosion control measures to prevent silt runoff to public roadways from sites with a slope greater than one percent.



- Minimize idling time of diesel-powered construction vehicles to two minutes.
- Develop a plan demonstrating that off-road equipment (more than 50 horsepower) used for construction would comply with Tier 4 emission limits.
- Use low VOC (i.e., ROG) coatings beyond the local requirements (i.e., Regulation 8, Rule 3: Architectural Coatings).
- All construction equipment, diesel trucks, and generators be equipped with Best Available Control Technology for emission reductions of NO<sub>x</sub> and PM.
- All contractors use equipment that meets CARB's most recent certification standard for off-road heavy-duty diesel engines.

### 4.3.5 References

- BAAQMD 2016 – Bay Area Air Quality Management District (BAAQMD). Regulation 2 Rule 5: New Source Review of Toxic Air Contaminants. Dated December 7, 2016. Accessed September 2021. Available online at: [https://www.baaqmd.gov/~media/dotgov/files/rules/reg-2-rule-5-new-source-review-of-toxic-air-contaminants/documents/rg0205\\_120716-pdf.pdf?la=en](https://www.baaqmd.gov/~media/dotgov/files/rules/reg-2-rule-5-new-source-review-of-toxic-air-contaminants/documents/rg0205_120716-pdf.pdf?la=en)
- BAAQMD 2017a – Bay Area Air Quality Management District (BAAQMD). Final 2017 Clean Air Plan, Adopted April 19, 2017. Accessed September 2021. Available online at: [http://www.baaqmd.gov/~media/files/planning-and-research/plans/2017-clean-air-plan/attachment-a\\_-proposed-final-cap-vol-1-pdf.pdf](http://www.baaqmd.gov/~media/files/planning-and-research/plans/2017-clean-air-plan/attachment-a_-proposed-final-cap-vol-1-pdf.pdf)
- BAAQMD 2017b – Bay Area Air Quality Management District (BAAQMD). California Environmental Quality Act, Air Quality Guidelines. Updated May 2017. Accessed September 2021. Available online at: [http://www.baaqmd.gov/~media/files/planning-and-research/ceqa/ceqa\\_guidelines\\_may2017-pdf.pdf?la=en](http://www.baaqmd.gov/~media/files/planning-and-research/ceqa/ceqa_guidelines_may2017-pdf.pdf?la=en)
- BAAQMD 2019 – Bay Area Air Quality Management District (BAAQMD). Calculating Potential to Emit for Emergency Backup Power Generators. Dated June 3, 2019. Accessed September 2021. Available online at: [http://www.baaqmd.gov/~media/files/engineering/policy\\_and\\_procedures/banking-and-offsets/calculating-pte-for-emergency-generators-06032019-pdf](http://www.baaqmd.gov/~media/files/engineering/policy_and_procedures/banking-and-offsets/calculating-pte-for-emergency-generators-06032019-pdf)
- BAAQMD 2020 – Bay Area Air Quality Management District (BAAQMD). BAAQMD Letter Re: BACT Determination for Diesel Back-up Engines Greater Than or Equal to 1,000 Brake Horsepower: Great Oaks South Backup Generating Facility (TN 236091), December 2020. Accessed September 2021. Available online at: <https://efiling.energy.ca.gov/Lists/DocketLog.aspx?docketnumber=20-SPPE-01>
- BAAQMD 2021a – Bay Area Air Quality Management District (BAAQMD). Air Quality Standards and Attainment Status. Accessed August 2021. Available online at: <https://www.baaqmd.gov/about-air-quality/research-and-data/air-quality-standards-and-attainment-status>

- BAAQMD 2021b – Bay Area Air Quality Management District Comments (BAAQMD). (TN 239805). Letter for CA3 Data Center NOP, dated September 21, 2021. Available online at: <https://efiling.energy.ca.gov/Lists/DocketLog.aspx?docketnumber=21-SPPE-01>
- CARB 1998 – California Air Resources Board (CARB). Proposed Identification of Diesel Exhaust as a Toxic Air Contaminant. Appendix III, Part A, Exposure Assessment. April 1998. Accessed September 2021. Available online at: [https://ww3.arb.ca.gov/toxics/dieseltac/part\\_a.pdf](https://ww3.arb.ca.gov/toxics/dieseltac/part_a.pdf)
- CARB 2013 – California Air Resources Board (CARB). The California Almanac of Emissions and Air Quality – 2013 Edition. Accessed August 2021. Available online at: <https://www.arb.ca.gov/aqd/almanac/almanac13/almanac13.htm>
- CARB 2021a – California Air Resources Board (CARB). Maps of State and Federal Area Designations. Accessed August 2021. Available online at: <https://www.arb.ca.gov/desig/adm/adm.htm>
- CARB 2021b – California Air Resources Board (CARB). Air Quality Data Statistics Top 4 Summary. Accessed September 2021. Available online at: <https://www.arb.ca.gov/adam/topfour/topfour1.php>
- CARB 2021c – California Air Resources Board (CARB). California Ambient Air Quality Standards. Accessed September 2021. Available online at: <https://ww2.arb.ca.gov/resources/california-ambient-air-quality-standards>
- CARB 2021d – California Air Resources Board (CARB). Accessed September 2021. Overview: Diesel Exhaust & Health. Available online at: <https://ww2.arb.ca.gov/resources/overview-diesel-exhaust-and-health>
- CEC 2022a – California Energy Commission (CEC). (TN 241160). Report of Conversation – Modifications to Project Construction Phasing, dated January 4-12, 2022. Available online at: <https://efiling.energy.ca.gov/Lists/DocketLog.aspx?docketnumber=21-SPPE-01>
- DayZenLLC 2021a – DayZenLLC (DayZenLLC). (TN 237380). VDC CA3BGF SPPE Application Part I, dated April 5, 2021. Available online at: <https://efiling.energy.ca.gov/Lists/DocketLog.aspx?docketnumber=21-SPPE-01>
- DayZenLLC 2021b – DayZenLLC (DayZenLLC). (TN 237381). VDC CA3BGF SPPE Application Part III, dated April 5, 2021. Available online at: <https://efiling.energy.ca.gov/Lists/DocketLog.aspx?docketnumber=21-SPPE-01>
- DayZenLLC 2021e – DayZenLLC (DayZenLLC). (TN 237423). VDC CA3BGF SPPE Application Part II, dated April 12, 2021. Available online at: <https://efiling.energy.ca.gov/Lists/DocketLog.aspx?docketnumber=21-SPPE-01>
- DayZenLLC 2021t – DayZenLLC (DayZenLLC). (TN 239390). VDC Supplemental Responses to CEC Data Request Set 2 Air Quality – CA3BGF, dated August 19, 2021. Available online at: <https://efiling.energy.ca.gov/Lists/DocketLog.aspx?docketnumber=21-SPPE-01>

- DayZenLLC 2021w – DayZenLLC (DayZenLLC). (TN 239678). Updated Ammonia Slip Emission Calculations, dated September 13, 2021. Available online at: <https://efiling.energy.ca.gov/Lists/DocketLog.aspx?docketnumber=21-SPPE-01>
- NOAA 2019 – National Oceanic and Atmospheric Administration (NOAA). The Impact of Wildfires on Climate and Air Quality, An emerging focus of the NOAA ESRL Chemical Sciences Division. Accessed September 2021. Available online at: <https://www.esrl.noaa.gov/csd/factsheets/csdWildfiresFIREX.pdf>
- OEHHA 2015 – Office of Environmental Health Hazard Assessment (OEHHA). Air Toxics Hot Spots Program Risk Assessment Guidelines. Guidance Manual for Preparation of Health Risk Assessments, March 6, 2015. Accessed September 2021. Available online at: <https://oehha.ca.gov/media/downloads/crn/2015guidancemanual.pdf>
- OEHHA 2021 – Office of Environmental Health Hazard Assessment (OEHHA). Toxic Air Contaminants. Accessed September 2021. Available online at: <https://oehha.ca.gov/air/toxic-air-contaminants>
- U.S. EPA 2002 – United States Environmental Protection Agency (U.S. EPA). Health Assessment Document For Diesel Engine Exhaust. May 2002. Accessed September 2021. Available online at: [https://cfpub.epa.gov/si/si\\_public\\_file\\_download.cfm?p\\_download\\_id=36319&Lab=NCEA](https://cfpub.epa.gov/si/si_public_file_download.cfm?p_download_id=36319&Lab=NCEA)
- U.S. EPA 2011 – United States Environmental Protection Agency (U.S. EPA). Additional Clarification Regarding Application of Appendix W Modeling Guidance for the 1-hour NO<sub>2</sub> National Ambient Air Quality Standard. March 2011. Accessed January 2022. Available online at: [https://www.epa.gov/sites/default/files/2015-07/documents/appwno2\\_2.pdf](https://www.epa.gov/sites/default/files/2015-07/documents/appwno2_2.pdf)
- U.S. EPA 2013 – United States Environmental Protection Agency (U.S. EPA). Determination of Attainment for the San Francisco Bay Area Nonattainment Area for the 2006 Fine Particle Standard; California; Determination Regarding Applicability of Clean Air Act Requirements. Accessed August 2021. Available online at: <https://www.federalregister.gov/documents/2013/01/09/2013-00170/determination-of-attainment-for-the-san-francisco-bay-area-nonattainment-area-for-the-2006-fine>
- U.S. EPA 2014 – United States Environmental Protection Agency (U.S. EPA). EPA Finalizes Initial Area Designations for the 2012 National Air Quality Standard for Fine Particles - Dec 2014. Accessed August 2021. Available online at: <https://www.epa.gov/particle-pollution-designations/epa-finalizes-initial-area-designations-2012-national-air-quality>
- U.S. EPA 2017 – United States Environmental Protection Agency (U.S. EPA). 2017. Guideline on Air Quality Models. 40 Code of Federal Regulations (CFR) Part 51, Appendix W. January. Accessed December 2021. Available online at: [https://www.epa.gov/sites/default/files/2020-09/documents/appw\\_17.pdf](https://www.epa.gov/sites/default/files/2020-09/documents/appw_17.pdf)

- U.S. EPA 2018a – United States Environmental Protection Agency (U.S. EPA). Guidance on Significant Impact Levels for Ozone and Fine Particles in the Prevention of Significant Deterioration Permitting Program. Accessed September 2021. Available online at: [https://www.epa.gov/sites/production/files/2018-04/documents/sils\\_policy\\_guidance\\_document\\_final\\_signed\\_4-17-18.pdf](https://www.epa.gov/sites/production/files/2018-04/documents/sils_policy_guidance_document_final_signed_4-17-18.pdf)
- U.S. EPA 2018b – United States Environmental Protection Agency (U.S. EPA). Air Quality Designations for the 2010 Sulfur Dioxide (SO<sub>2</sub>) Primary National Ambient Air Quality Standard—Round 3. Accessed August 2021. Available online at: <https://www.govinfo.gov/content/pkg/FR-2018-01-09/pdf/2017-28423.pdf>
- U.S. EPA 2021a – United States Environmental Protection Agency (U.S. EPA). NAAQS Table. Accessed August 2021. Available online at: <https://www.epa.gov/criteria-air-pollutants/naaqs-table>
- U.S. EPA 2021b – United States Environmental Protection Agency (U.S. EPA). Outdoor Air Quality Data, Monitor Values Report. Accessed September 2021. Available online at: <https://www.epa.gov/outdoor-air-quality-data/monitor-values-report>
- Van Gosen and Clinkenbeard 2011 – Van Gosen, B.S., and Clinkenbeard, J.P. (Van Gosen and Clinkenbeard). Reported Historic Asbestos Mines, Historic Asbestos Prospects, and Other Natural Occurrences of Asbestos in California: U.S. Geological Survey Open-File Report 2011-1188. Accessed September 2021. Available online at: <http://pubs.usgs.gov/of/2011/1188/>

## 4.4 Biological Resources

This section describes the environmental setting and regulatory background, and discusses impacts associated with the construction and operation of the project with respect to biological resources that occur in the project area.

<b>BIOLOGICAL RESOURCES</b>		<b>Less Than Significant with Mitigation Incorporated</b>	<b>Less Than Significant Impact</b>	<b>No Impact</b>
Except as provided in Public Resources Code Section 21099, would the project:	<b>Potentially Significant Impact</b>			
a. Have a substantial adverse effect, either directly or through habitat modifications, on any species identified as a candidate, sensitive, or special-status species in local or regional plans, policies, or regulations, or by the California Department of Fish and Wildlife or U.S. Fish and Wildlife Service?	<input type="checkbox"/>	<input checked="" type="checkbox"/>	<input type="checkbox"/>	<input type="checkbox"/>
b. Have a substantial adverse effect on any riparian habitat or other sensitive natural community identified in local or regional plans, policies, regulations or by the California Department of Fish and Wildlife or U.S. Fish and Wildlife Service?	<input type="checkbox"/>	<input type="checkbox"/>	<input checked="" type="checkbox"/>	<input type="checkbox"/>
c. Have a substantial adverse effect on state or federally protected wetlands (including, but not limited to, marsh, vernal pool, coastal, etc.) through direct removal, filling, hydrological interruption, or other means?	<input type="checkbox"/>	<input type="checkbox"/>	<input type="checkbox"/>	<input checked="" type="checkbox"/>
d. Interfere substantially with the movement of any native resident or migratory fish or wildlife species or with established native resident or migratory wildlife corridors, or impede the use of native wildlife nursery sites?	<input type="checkbox"/>	<input type="checkbox"/>	<input type="checkbox"/>	<input checked="" type="checkbox"/>
e. Conflict with any local policies or ordinances protecting biological resources, such as a tree preservation policy or ordinance?	<input type="checkbox"/>	<input checked="" type="checkbox"/>	<input type="checkbox"/>	<input type="checkbox"/>
f. Conflict with the provisions of an adopted Habitat Conservation Plan, Natural Community Conservation Plan, or other approved local, regional, or State habitat conservation plan?	<input type="checkbox"/>	<input type="checkbox"/>	<input type="checkbox"/>	<input checked="" type="checkbox"/>

Environmental checklist established by CEQA Guidelines, Appendix G.

### 4.4.1 Environmental Setting

#### Existing Habitat

The proposed project is located on an approximately 6.69-acre site within a commercial and industrial area in the city of Santa Clara, California (DayZenLLC 2021e). Construction of the proposed project would occur on a Light-Industrial-zoned property, which is currently developed with an approximately 115,000-square-foot single-story office and

warehouse building and associated paved surface parking and loading dock (DayZenLLC 2021e). The adjacent existing properties consist of industrial facilities to the northwest and northeast, a Caltrain railroad line to the south, a Silicon Valley Power (SVP) substation to the west, and the Vantage Santa Clara Data Center Campus CA1 to the east across Walsh Avenue (DayZenLLC 2021e). The Norman Y. Mineta San Jose International Airport (SJC) is located approximately 1.75 miles to the southeast. Mature native and non-native trees and other ornamental landscaping are located along the Walsh Avenue frontage of the property, as well as the northern, western, and southern property boundaries and throughout the parking area and outdoor areas of the existing office building.

Due to the developed nature of the project site and surrounding areas, as well as on-going disturbance, the site does not provide habitat capable of supporting a diverse assemblage of native plants or wildlife. However, the project site does provide suitable habitat for nesting and foraging birds and minimal habitat for other foraging common wildlife. Reconnaissance-level surveys for biological resources were conducted for the proposed project by a FirstCarbon Solutions biologist on February 24, 2021 (DayZenLLC 2021e). No special-status plant or wildlife species were identified in the area during the surveys (DayZenLLC 2021e). Urban adapted species, such as western fence lizard (*Sceloporus occidentalis*), American crow (*Corvus brachyrhynchos*), and house finch (*Haemorhous mexicanus*), may tolerate the conditions of disturbed habitats (Mayer & Laudenslayer, Jr. 1988) and were observed during the site visit by the applicant's biologist. Other common wildlife species observed during surveys included rock pigeon (*Columba livia*) and Anna's hummingbird (*Calypte anna*). No small mammal burrows were observed on site. However, common wildlife, such as racoons, opossums, and rats, may utilize the adjacent railroad corridor and forage on site in landscaped areas. Potential roosting habitat for bat species was identified in the existing building, specifically in the roof tile cavities and other suitable crevasses, as well as in mature trees. However, no bats or their sign were identified during surveys.

### **Special Status Species and Sensitive Habitats**

Special-status species are plant and wildlife species that have been afforded special recognition by federal, state, or local resource agencies or organizations. Based on the specialized habitat requirements (e.g., vernal pools, marsh, riparian, chaparral, coastal scrub, or serpentine soils) for special-status plants potentially occurring in the region, there are no special-status plant species with the potential to occur on the project's site (CNDDDB 2021; CNPS 2021). In addition, most rare, threatened, endangered, and sensitive wildlife species are not expected to occur due to a lack of suitable habitat, most notably natural habitat for pollinating bees and vernal pools, or other aquatic habitats (CNDDDB 2021). No special-status plant or wildlife species were identified in the area during field surveys (DayZenLLC 2021e).

Existing mature trees, as well as lawn and barren areas, on and near the project site, provide potential nesting habitat and food sources for bird species, primarily raptors (birds of prey) and other migratory birds, protected by the Migratory Bird Treaty Act of 1918 (MBTA) and sections 3503 and 3503.5 of the Fish and Game Code. Cooper's hawk

(*Accipiter cooperii*), on the California Department of Fish and Wildlife (CDFW) Watch List, potentially occurs in the project area based on the presence of mature trees. Other special-status raptors are not likely to occur based on lack of specific habitat requirements, such as Swainson's hawk (*Buteo swainsoni*; ST), which require such open grasslands near agricultural areas for foraging, or American peregrine falcon (*Falco peregrinus anatum*; FP), which require high-rise buildings or cliffs for nesting. Western burrowing owls (*Athene cunicularia*; SSC) are known to occur as year-round residents at the SJC, located approximately 1.75 miles east of the proposed project site (CNDDDB 2020; Albion 1997). This species is not expected to occur due to a lack of suitable habitat, including a lack of herbaceous ground cover and foraging habitat as well as the absence of burrows or burrow surrogates.

Pallid bats (*Antrozous pallidus*) occur in a variety of forested and open habitats and are historically known to occur in the project vicinity. The species is most common in open, dry habitats with rocky areas for roosting. The site does not contain high-quality roosting habitat, and no known maternity colonies of this species are present on or adjacent to the project site (DayZenLLC 2021b). However, pallid bats may move through the site occasionally based on proximity to maternity colonies (DayZenLLC 2021b). The existing building consists primarily of concrete, wood, and stucco materials with mission-style stucco archways and a sloping tile roof. The existing building has the potential to provide habitat to house bat species in the roof cavities and other suitable crevasses. No evidence of bat roosts was observed during a search of the vacant building, including under roof tiles, and no structures or trees with high-quality roost sites were detected on the site.

Sensitive habitats include areas that provide habitat for rare or endangered species and sensitive natural communities, such as oak woodlands, wetlands, waterways or vernal pools. There is no designated or proposed critical habitat for federally listed species or other natural or sensitive habitats in the project area or vicinity (USFWS 2021; CNDDDB 2021). In addition, there are no waterways, wetlands, or other aquatic resources located on or adjacent to the site. San Tomas Aquinas Creek is the nearest waterway, located approximately 0.25 mile east of the site, and drains into the San Francisco Bay. Northern coastal salt marsh, located approximately 5 miles northwest, is known to support several special-status species of birds and mammals. Northern coastal salt marsh is considered a sensitive habitat by CDFW and included as a sensitive natural community in the California Natural Diversity Database (CNDDDB).

### **Landscape Trees**

Mature trees and other ornamental landscaping are present along Walsh Avenue to the northeast, along the remaining property boundaries, as well as throughout the parking and outdoor areas of the existing office building and warehouse. A certified arborist conducted a survey and provided an inventory report of the trees on the project site (DayZenLLC 2021b). There are 108 existing trees, including 3 dead trees and 3 in poor health, which consist of 12 species. (Refer to the arborist report presented as Attachment C to the Biological Resource Assessment, which is included in Appendix B of the SPPE Application) (DayZenLLC 2021b). Of these 12 species, 2 species are considered protected

under City of Santa Clara 2010-2035 General Plan (General Plan), Policy 5.10.1-P4, specifically bay laurel (*Laurus nobilis*) and coast redwood (*Sequoia sempervirens*). The four most common species include coast redwood, ash (*Fraxinus uhdei*), sweet gum (*Liquidambar styraciflua*), and tulip tree (*Liriodendron tulipifera*) (DayZenLLC 2021b).

## Regulatory Background

### *Federal*

**Endangered Species Act of 1973 (16 U.S.C.A., §1530 et seq., and 50 C.F.R., part 17).** The Endangered Species Act (ESA) of 1973 designates and provides for the protection of threatened and endangered plant and animal species, and their critical habitat. Under ESA, no one can “take” a federally listed species without incidental take authorization. “Take” is broadly defined in ESA to include “harass, harm, pursue, hunt, shoot, wound, kill, trap, capture, collect, or attempt to engage in any such conduct” (16 U.S.C.A §1532(19)) Take can also include significant habitat modification or degradation that directly results in death or injury to a listed wildlife species by significantly impairing essential behavioral patterns, including breeding, feeding, or sheltering (50 C.F.R., §17.3). Take authorization may be obtained through a Section 7 consultation (between federal agencies) or a Section 10 Habitat Conservation Plan (non-federal landowners). The administering agencies are the U.S. Fish and Wildlife Service (USFWS), National Oceanic Atmospheric Administration (NOAA), and National Marine Fisheries Service (NMFS).

**Migratory Bird Treaty Act of 1918 (16 U.S.C., §§ 703-712).** TMBTA makes it unlawful to take or possess any migratory nongame bird (or any part of such migratory nongame bird, including nests with viable eggs). The administering agency is USFWS.

### *State*

**California Endangered Species Act (Fish and Game Code, § 2050 et seq.).** The California Endangered Species Act (CESA) protects California’s rare, threatened, and endangered species. CESA allows the CDFW to issue an incidental take permit for a species listed as candidate, threatened, or endangered only if that take is incidental to otherwise lawful activities and specific criteria are met. These criteria are listed in the California Code of Regulations, Title 14, section 783.4, subdivisions (a) and (b). For purposes of CESA, “take” means to “hunt, pursue, catch, capture, or kill, or attempt to hunt, pursue, catch, capture, or kill” (Fish and Game Code, § 86). The administering agency is CDFW.

**Fully Protected Species (Fish and Game Code, §§ 3511, 4700, 5050, and 5515).** These sections designate certain species as fully protected and prohibit the take of such species or their habitat unless for scientific purposes (see also Cal. Code Regs., tit. 14, § 670.7). The incidental take of fully protected species may also be authorized in an approved natural community conservation plan (Fish and Game Code, § 2835). The administering agency is CDFW.



**Fish and Game Code.** The following sections of the Fish and Game Code designate protections for birds and/or their nests or eggs. The administering agency is CDFW.

- Section 3503: This section makes it unlawful to take, possess, or needlessly destroy the nest or eggs of any bird, except as otherwise provided by the Fish and Game Code or any regulation made pursuant thereto.
- Section 3503.5: This section makes it unlawful to take, possess, or destroy any birds in the orders Falconiformes and Strigiformes or to take, possess, or destroy the nest or eggs of any such bird, except as otherwise provided by the Fish and Game Code or any regulation made pursuant thereto.
- Section 3513: This section protects California's migratory birds by making it unlawful to take or possess any migratory nongame bird as designated in the MBTA or any part of such migratory nongame birds.

**Native Plant Protection (Fish and Game Code, § 1900 et seq.).** Fish and Game Code, § 1900 et seq. was enacted in 1977 and designates state rare and endangered plants and provides specific protection measures for identified populations. Those laws prohibit the take of endangered or rare native plants but include some exceptions for agricultural and nursery operations; for emergencies; after properly notifying CDFW, for vegetation removal, from canals, roads, and other sites; due to changes in land use; and in certain other situations. The administering agency is CDFW.

### *Local*

**City of Santa Clara.** The General Plan (adopted November 16, 2010) goals and policies that address the protection and preservation of the city's natural habitat and wildlife are described in Section 10.5, Environmental Quality (Santa Clara 2010). The administering agency is the Planning Division of the city of Santa Clara. General Plan goals and policies applicable to the proposed project are as follows:

- 5.3.1-P10 Provide opportunities for increased landscaping and trees in the community, including requirements for new development to provide street trees and a minimum 2:1 on- or off-site replacement for trees removed as part of the proposal to help increase the urban forest and minimize the heat island effect.
- 5.10.1-G1 Protect fish, wildlife, and their habitats, including rare and endangered species.
- 5.10.1-P1 Require environmental review prior to approval of any development with the potential to degrade the habitat of any threatened or endangered species.
- 5.10.1-P3 Require preservation of all City-designated heritage trees listed in the Heritage Tree Appendix 8.10 of the General Plan.
- 5.10.1-P4 Protect all healthy cedars, redwoods, oaks, olives, bay laurel and pepper trees of any size, and all other trees over 36 inches in circumference measured from 48 inches above-grade on private and public property as well as in the public right-of-way.

- 5.10.1-P12 Encourage property owners and landscapers to use native plants and wildlife-compatible nonnative plants, when feasible.

**Santa Clara City Code, Chapter 12.35.020.** This section of the Santa Clara City Code specifies how to proceed with certain issues with trees and shrubs growing in the streets or public places (Santa Clara 2020). This includes addressing the removal, alteration, or damage to trees via trenching. Special authorization for removal or alteration of trees and shrubs growing in the streets or public places is required. The administering agency is the Streets Department in the Department of Public Works of the city of Santa Clara.

#### 4.4.2 Environmental Impacts

**a. Would the project have a substantial adverse effect, either directly or through habitat modifications, on any species identified as a candidate, sensitive, or special status species in local or regional plans, policies, or regulations, or by the California Department of Fish and Wildlife or U.S. Fish and Wildlife Service?**

The proposed project site is within an urbanized area and located on developed land that is surrounded by industrial development. Land cover includes an office building and warehouse as well as paved parking areas with vegetation limited to landscaping, which consists of mature trees, shrubs, and ground cover plants (DayZenLLC 2021e). The existing office and warehouse buildings would be demolished prior to construction. Shrubs and groundcover as well as 66 of the 108 trees on the site would be removed (DayZenLLC 2021bb). However, the existing trees not in conflict with proposed utilities, grading, stormwater treatment facilities, and architectural improvements would be protected in place (DayZenLLC 2021bb).

*Less Than Significant with Mitigation Incorporated.* Rare, threatened, endangered, and sensitive plant species are not expected to occur on site because the site does not contain suitable habitat (e.g., vernal pools, marsh, riparian, chaparral, coastal scrub, or serpentine soils), excluding Cooper's hawk and pallid bat.

Existing mature trees on and near the project site provide potential habitat and food sources for bird species, including raptors and other migratory birds, protected by MBTA and sections 3503 and 3503.5 of the Fish and Game Code. Bat species, such as pallid bat, may occur occasionally on site and utilize existing landscape trees and buildings for roosting.

**Nesting Birds.** Tree removal associated with project implementation could result in direct destruction of active nests of protected bird and raptor species if tree removal occurs during the nesting season (generally defined as February 15 to September 15). Project construction could also result in indirect disturbance of protected nesting birds on or near the project site causing nest abandonment by the adults and mortality of chicks and eggs. The destruction of active protected bird nests, nest abandonment, and/or loss

of reproductive effort caused by disturbance are considered a "take" by CDFW, and, therefore, would be a significant impact.

Implementation of mitigation measure **BIO-1** would reduce construction impacts to a less-than-significant level because it includes requirements to schedule, if possible, construction activities involving tree removal to months outside the nesting period, to conduct nesting bird surveys prior to initiation of any type of construction activities during the nesting period, and to establish buffers to avoid disturbance of nesting birds if active nests are detected, in consultation with CDFW. In addition, a survey report that would include recommended buffer zones would be submitted to the city's Director of Community Development prior to issuance of grading and/or building permits from the city.

**Bats.** Demolition and tree removal associated with project implementation could result in direct destruction of active roosts of protected bats, if present. Pallid bats are considered a special-status species by CDFW and listed as a Species of Special Concern. Destruction of active special-status bat roosts and direct impacts on individual bats include injury and mortality and would be a significant impact.

Implementation of mitigation measure **BIO-2** would reduce construction impacts on special-status bats to a less-than-significant level because it includes requirements to conduct bat clearance surveys prior to demolition of the existing buildings or removal of trees and to develop a Bat Mitigation and Monitoring Plan (Plan), which details exclusion methods, roost removal procedures, and compensatory mitigation methods for permanent impacts for roost removal to be submitted to CDFW for review and approval.

Implementation of **BIO-1** and **BIO-2** would reduce potential impacts to protected wildlife species, including raptors and other migratory birds as well as bats, resulting from implementation of the proposed project to less than significant. Therefore, the construction phase of the project would not have a substantial adverse effect on special-status species.

## **Operation**

*Less Than Significant.* Operation and maintenance activities, such as landscape and irrigation maintenance, are expected to result in the same level of human presence and disturbance as current landscape and irrigation maintenance activities. The only other operational impacts that could potentially affect biological resources are indirect impacts resulting from project-related nitrogen deposition on nitrogen-sensitive habitats.

Operation of the project's 44, 2.75-megawatt, emergency backup diesel generators would result in emissions of oxides of nitrogen (NOx). Nitrogen deposition is defined as the input of NOx and ammonia (NH3) derived pollutants, primarily nitric acid (HNO3), from the atmosphere to the biosphere. The sources of these pollutants are primarily vehicle and industrial emissions, including power generation. Increased nitrogen deposition in nitrogen-poor habitat allows the proliferation of non-native species, which crowds out

native species (Fenn et al. 2003; Weiss 2006). Threats to sensitive species habitat from noxious weeds are exacerbated by nitrogen fertilization, and the deposition of additional nitrogen in an already stressed ecosystem would be a potentially significant indirect impact.

CEC staff considered protected areas and designated critical habitat within a 6-mile radius around the proposed project in the analysis of nitrogen deposition from the proposed project. It has been CEC staff's experience that, by the time the plume from a conventional power plant has traveled this distance, in-plume concentrations become indistinguishable from background concentrations. In addition, for a data center, the plume(s) often touches down immediately adjacent to the site since the stacks are low, depending on the terrain and other factors. Further, CEC staff considered habitat modification to protected areas and designated critical habitat to be a potentially significant effect if these communities were known to be sensitive to nitrogen deposition. There is no designated or proposed critical habitat for federally listed species within 6 miles of the project area.

Northern coastal salt marsh located in the Guadalupe Slough near the San Francisco Bay Trail, approximately 5 miles northwest of the proposed project site, is the only protected area within 6 miles of the project known to be sensitive to nitrogen deposition. This habitat occurs along margins of the San Francisco Bay in areas that are sheltered from excessive wave action (Mayer, K.E. and W.F. Laudenslayer, Jr. 1988). Northern coastal salt marsh is also considered a sensitive natural community by CDFW and included in the CNDDDB (CNDDDB 2021). Several special-status species are known to occur in this area of northern coastal salt marsh habitat, including California Ridgway's rail (*Rallus obsoletus*; FE, SE, FP), salt marsh common yellowthroat (*Geothlypis trichas sinuosa*; SSC), Alameda song sparrow (*Melospiza melodia pusillula*; BCC, SSC), salt marsh wandering shrew (*Sorex vagrans halicoetes*; SSC), and salt marsh harvest mouse (*Reithrodontomys raviventris*; FE, SE) (CNDDDB 2021).

One approach for quantifying nitrogen deposition is through critical load, which is defined as the input of a pollutant below which no detrimental ecological effects occur over the long-term. Salt marsh habitat tends to have a higher critical load than other ecosystems due to its open nutrient cycles that are less affected by atmospheric deposition than other nitrogen loading sources (Pardo et. al. 2011, pg. 3071). Critical load for early successional salt marsh has been estimated to be in the range of 30-40 kilograms nitrogen per hectare per year (kg N/ha/yr) (Bobbink et. al. 2010, pg. 21-22), and 50-100 kg N/ha/yr for intertidal wetlands and 63-400 kg N/ha/yr for intertidal salt marshes (Pardo et. al. 2011, pg. 3059). CEC staff used the conservative estimate of 30-40 kg N/ha/yr as the critical load for northern coastal salt marsh.

Impacts potentially could occur if the emissions from the proposed project in conjunction with baseline nitrogen deposition levels exceeded the critical load for the community. For a baseline nitrogen deposition estimate, CEC staff used the Community Multiscale Air Quality (CMAQ) modeling system, which provides estimates of ozone, particulates, toxics, and acid deposition. CEC staff considered the most recent CMAQ-predicted value of 11.4

kg N/ha/yr from 2012 at northern coastal salt marsh habitat as the best available data to determine baseline nitrogen deposition (CMAQ 2020). CEC staff modeled the potential nitrogen deposition impacts from readiness testing and maintenance of the proposed emergency standby generators within a 2-mile radius of the project site using American Meteorological Society/Environmental Protection Agency Regulatory Model (AERMOD). Although the available modeling grid only extended 2 miles, it was adequate for CEC staff to estimate contributions at the salt marsh habitat within 6 miles of the proposed project site. Based on conservative modeling using AERMOD, the project's estimated contributions to existing nitrogen deposition would be between 0.02 and 0.20 kg N/ha/yr at 2 miles from the project site. In addition, the concentrations would continue to decrease by the time the plume reaches the northern coastal salt marsh habitat.

The project's estimated contribution (between 0.02 and 0.20 kg N/ha/yr) when added to the baseline nitrogen deposition value (11.4 kg N/ha/yr) at northern coastal salt marsh would be substantially below the critical load (30-40 kg N/ha/yr) for this habitat type. Operation of the proposed project would not result in a substantial adverse effect from nitrogen deposition, either directly or through habitat modifications, on any species identified as a candidate, sensitive, or special status. Therefore, this impact would be less than significant.

**b. Would the project have a substantial adverse effect on any riparian habitat or other sensitive natural community identified in local or regional plans, policies, and regulations or by the California Department of Fish and Wildlife or U.S. Fish and Wildlife Service?**

***Construction***

*No Impact.* The project site is paved, developed land that is surrounded by industrial development. Land cover includes office buildings and paved parking lots with vegetation limited to landscaping, which consists of mature trees, shrubs, and ground cover plants. There are no riparian habitats or other sensitive natural communities identified in local or regional plans, policies, and regulations or by CDFW or USFWS within the project site. Therefore, there would be no impact.

***Operation***

*Less Than Significant Impact.* No direct impacts would occur during operation of the proposed project. However, CEC staff also considered indirect impacts from nitrogen deposition resulting from operation of the proposed project as a potential impact on sensitive natural communities. Northern coastal salt marsh is the only sensitive natural community known to occur within 6 miles of the proposed project.

As stated previously, indirect impacts could potentially occur if emissions from the proposed project along with the baseline nitrogen deposition exceeded the critical load for the sensitive natural community. Vegetation-specific critical loads for nitrogen deposition would not be exceeded at any location with northern coastal salt marsh. Therefore, this impact would be less than significant.

- c. Have a substantial adverse effect on state or federally protected wetlands (including, but not limited to, marsh, vernal pool, coastal, etc.) through direct removal, filling, hydrological interruption, or other means?**

*Construction and Operation*

*No Impact.* There are no state or federally protected wetlands within or adjacent to the project site. The closest aquatic feature to the project site is the San Tomas Aquino Creek located approximately 0.25 mile east and separated from the site by Walsh Avenue as well as light industrial development and office parks. Construction related impacts are generally limited to the site itself; therefore, there would be no impact resulting from construction or operation of the proposed project.

- d. Would the project interfere substantially with the movement of any native resident or migratory fish or wildlife species or with established native resident or migratory wildlife corridors, or impede the use of wildlife nursery sites?**

*Construction and Operation*

*No Impact.* There are no established wildlife corridors, such as rivers or streams, in the immediate project vicinity. The Guadalupe River is the closest corridor where the movement or migration of native resident or migratory fish or wildlife species would likely occur. The nearest access point to the river is approximately 2 miles east of the proposed project. There are no known wildlife nursery sites, such as a rookery, fawning area, or fish spawning habitat, in the project area. There would be no impact resulting from the construction or operation of the proposed project.

- e. Would the project conflict with any local policies or ordinances protecting biological resources, such as a tree preservation policy or ordinance?**

*Construction*

*Less Than Significant Impact with Mitigation Incorporated.* As part of the project, the applicant proposes removal of 66 of the 108 trees documented as occurring on site, including removal of 3 dead trees and 3 trees in poor health (DayZenLLC 2021bb). Of the 66 trees to be removed, the 63 live trees are considered part of the urban forest under General Plan Policy 5.3.1-P10, which requires all removed trees, regardless of species, to be replaced at a minimum 2:1 ratio. No mitigation would be required for the 3 dead trees. There are 8 coastal redwood trees proposed to be removed that have a diameter greater than 36" at 48" above grade or diameter at breast height (dbh). No heritage trees listed in the Heritage Tree Appendix 8.10 of the General Plan are present (Santa Clara 2010).

The project proposes to remove protected tree species cited in General Plan Policy 5.10.1-P4, specifically coastal redwood and bay laurel trees due to conflicts with the layout. Specifically, the Revised Project Clearance Committee (PCC) Drawing Set lists 29 coastal redwoods (Trees 31-34, 36-38, 63-65, 77-80, 90, 91, 91, 92, 99-103, 105-108, and 120 – note there are two trees labeled 91) and 1 bay laurel (Tree 116) (DayZenLLC 2021z) that are proposed to be removed based on conflicts with the layout. The city expects an applicant to retain protected trees on site, if feasible, where they would not conflict with building or required parking placement (CEC 2021q). These protected trees are all located in areas that would conflict with proposed utilities, grading, stormwater treatment facilities, or architectural improvements. Therefore, there would be no conflict with General Plan Policy 5.10.1-P4 resulting from removal of these 30 trees.

Conflicts with local policies or ordinances protecting biological resources, such as a tree preservation policy or an ordinance or tree replacement policies (for example, General Plan Policies 5.10.1-P4 and 5.3.1-P10) would be a significant impact. General Plan Policy 5.3.1-P10 also calls for new development to provide street trees and conflicts with this part of the policy would also be a significant impact. The project applicant is proposing replacement of the 66 trees to be removed with adequate trees at 24" box size or 36" box size to be planted on site or offsite, as necessary. The city would apply specific conditions of Architectural Review approval calling for a tree replacement at a minimum of 2:1 at 24 -inch box size or 1.5:1 at 36-inch box size and protection of trees to be retained according to the approved landscape plan (Note – this ratio is incorrect in the ROC where it is listed as 1:1.5) (CEC 2021q). Depending on the tree species and size, standard replacement ratios may not be adequate, especially for the large (>36 inches dbh) coastal redwoods that are proposed for removal. Additional mitigation beyond the standard replacement ratios may be required. Final mitigation ratios and the number and placement of trees designated as street trees would be part of approval of the final design package and would be finalized prior to issuance of grading and/or building permits from the city (CEC 2021q). The remaining trees to be retained would require fencing to establish tree-protection zones to ensure the trees are not damaged during demolition or construction. In addition, the project applicant would be required to implement standard protection measures, such as those included in the city of Santa Clara Arborist Notes included in the Revised PCC drawing set, or as updated as part of approval by the city of Santa Clara.

The tree species proposed to be planted as replacement trees are included in the proposed Landscape Planting Plan and include a mix of native and ornamental species (DayZenLLC 2021z). New landscaping is proposed to be planted around the boundaries of the site and building perimeter, stormwater treatment facilities, and landscape beds within the parking areas (DayZenLLC 2021bb). The Landscape Planting Plan would be part of the final design package subject to review and approval by the city Community Development Department and would be finalized prior to issuance of grading and/or building permits from the city of Santa Clara (CEC 2021q).

Implementation of mitigation measures **BIO-3** and **BIO-4** would reduce construction impacts on trees covered by General Plan Policies 5.10.1-P4 and 5.3.1-P10 to a less-than-significant level because these measures include requirements for the project applicant to implement tree protection measures included as part of approval of the final design package by the city Community Development Department. In addition, the applicant would be required to provide adequate replacement trees for impacts related to tree removal. This also is part of the approval of the final design package by the city Community Development Department and includes implementation of tree protection measures included on the approved landscape plans for the project. Proposed measures are included on the city of Santa Clara Arborist Notes included in CA3 PCC Drawing Set (DayZenLLC 2021z). Standard tree protection measures include, but are not limited to, the establishment of Tree Protection Zones (TPZs), measures to avoid impacts during boring and trenching near tree roots, measures to avoid impacts during grading near trees, and measures to take prior to cutting any tree limbs or roots.

Implementation of **BIO-3** and **BIO-4** would ensure implementation of the proposed project would not conflict with tree preservation policies and tree replacement policies. Therefore, construction of the project would not have a substantial adverse effect on biological resources protected by local policies or ordinances.

### *Operation*

*No Impact.* Tree removal or other activities that conflict with any local policies or ordinances protecting biological resources are not proposed to occur during operation of the project. Therefore, no impact would occur.

### **f. Would the project conflict with the provisions of an adopted Habitat Conservation Plan, Natural Communities Conservation Plan, or other approved local, regional, or State habitat conservation plan?**

#### *Construction and Operation*

*No Impact.* There are no approved habitat conservation plans, natural community conservation plans, or other adopted plans that would apply to the proposed project. The Santa Clara Valley Habitat Plan (SCVHA 2012) provides for the protection and recovery of resources for the majority of land in Santa Clara County, however the proposed project is not within the permitting area of this plan (SCVHA 2020). Therefore, there would be no impact during construction or operation of the proposed project.

### **4.4.3 Mitigation Measures**

CEC staff reviewed the applicant's "project design measures" and incorporated their proposed measures, as appropriate, in the following mitigation measures to reduce impacts to biological resources to less than significant.

### **BIO-1 Avoid and Minimize Impacts to Protected Bird Species**



- If possible, demolition and construction activities, including removal of trees and vegetation clearing, shall take place between September and January. If demolition or construction activities, including removal of the trees on –site, would take place between January and September, a pre-construction survey for nesting raptors and other protected native or migratory birds shall be conducted by a qualified ornithologist, approved by the city of Santa Clara, to identify active nests that may be disturbed during project implementation. Pre-construction surveys shall be conducted no more than 14 days prior to the initiation of demolition or construction activities or tree relocation or removal. Surveys shall be repeated if project activities are suspended or delayed for more than 14 days during the nesting season. The surveying ornithologist shall inspect all trees in and immediately adjacent to the construction area to be disturbed by these activities, and the ornithologist shall, in consultation with the California Department of Fish and Wildlife (CDFW), designate a construction-free buffer zone (typically 250 feet for non-raptors to 500 feet for raptors) around the nest until the end of the nesting activity. Any changes to a buffer zone must be approved by the city of Santa Clara, in consultation with CDFW. The nests and buffers will be field checked weekly by the approved ornithologist. The approved buffer zone will be marked in the field with exclusion fencing, within which no construction, tree removal, or vegetation clearing shall commence until the ornithologist verifies that the nest(s) are no longer active. If an active bird nest is discovered during demolition or construction, then a buffer zone shall be established under the guidelines specified.
- The applicant shall submit a report indicating the results of the survey and any designated buffer zones to the satisfaction of the city of Santa Clara’s Director of Community Development prior to the issuance of a tree removal permit by the city arborist. The report(s) shall contain maps showing the location of all nests, species nesting, status of the nest (e.g. incubation of eggs, feeding of young, near fledging), and the buffer size around each nest (including reasoning behind any alterations to the initial buffer size). The report shall be provided within 10 days of completing a pre-construction nest survey.

## **BIO-2 Avoid and Minimize Impacts to Bat Species**

- If suitable roosting habitat for special-status bats will be affected by project construction (e.g., removal of buildings, removal of trees), a qualified wildlife biologist shall conduct surveys for special-status bats during the appropriate time of day to maximize detectability to determine if bat species are roosting near the work area no less than 7 days and no more than 14 days prior to beginning tree removal and/or demolition ground disturbance. Survey methodology may include visual surveys of bats (e.g., observation of bats during foraging period), inspection for suitable habitat, bat sign (e.g., guano), or use of ultrasonic detectors (e.g., Anabat, etc.). Visual surveys shall include trees within 0.25 mile of construction activities. The type of survey will depend on the condition of the potential roosting habitat. If no bat roosts are found, then no further study is required.

- If evidence of bat use is observed, the number and species of bats using the roost shall be determined. Bat detectors may be used to supplement survey efforts.
- If roosts are determined to be present and must be removed, the bats shall be excluded from the roosting site before the tree or structure is removed. Exclusion methods may include use of one-way doors at roost entrances (bats may leave, but not reenter) or sealing roost entrances when the site can be confirmed to contain no bats. Exclusion efforts may be restricted during periods of sensitive activity (e.g., during hibernation or while females in maternity colonies are nursing young).
- If roosts cannot be avoided or it is determined that construction activities may cause roost abandonment, such activities shall not commence until permanent, elevated bat houses have been installed outside of, but near, the construction area. Placement and height will be determined by a qualified wildlife biologist, but the height of bat house shall be at least 15 feet. Bat houses shall be multi-chambered and be purchased or constructed in accordance with CDFW standards. The number of bat houses required shall be dependent upon the size and number of colonies found, but at least one bat house shall be installed for each pair of bats (if occurring individually) or of a sufficient number to accommodate each colony of bats to be relocated.
- If bat roosts are detected, then a Bat Mitigation and Monitoring Plan (Plan) shall be prepared and implemented to mitigate for the loss of roosting habitat. The Plan shall include information pertaining to the species of bat and location of the roost, exclusion methods and roost removal procedures, compensatory mitigation for permanent impacts (including specific mitigation ratios and location of proposed mitigation as described in above bullet) and monitoring to assess bat use of mitigation areas. This Plan shall be submitted to CDFW for review.

### **BIO-3 Tree Removal Permit**

The project applicant shall obtain the appropriate tree removal permits from the city of Santa Clara for removal of all healthy mature trees. Acquisition of this permit shall include details of the final mitigation numbers. The city of Santa Clara's landscape ordinance mandates a 2:1 replacement with 24-inch box size trees, or 1.5:1 replacement with 36-inch box size trees. Depending on the species and size of the tree, additional mitigation may be required by the city of Santa Clara. The project proposes to mitigate for the loss of 66 trees through a combination of 24-inch box size and 36-inch box size.

### **BIO-4 Trees to Remain: Avoidance and Minimization of Impacts**

The project applicant shall follow the tree protection measures for trees that are to remain in place, as included as specific conditions by the city of Santa Clara as part of Architectural Review approval and included on the approved landscape plans for the project.

#### 4.4.4 References

- Bobbink et. al. 2010 – Bobbink, R., S. Braun, A. Nordin, K Schutz, J Strengbom, M. Weijters, H. Tommassen. Empirical N critical loads for natural and semi-natural ecosystems: 2010 update and review. Background document. B-WARE Research Centre, Nijmegen, The Netherlands Institute for Applied Plant Biology, Schönenbuch, Switzerland 23 Swedish University of Agricultural Sciences, Uppsala & Umeå, Sweden
- CEC 2021(q) – California Energy Commission (CEC). (TN 240097). Report of Conversation – Coordination Regarding Applicant Proposed Measures and Tree Removal Guidance, dated October 19, 2021. Available online at: <https://efiling.energy.ca.gov/Lists/DocketLog.aspx?docketnumber=21-SPPE-01>
- CNDDDB 2021 – California Natural Diversity Database (CNDDDB). Rarefind 5 (Government Version) 9 quad search around the proposed project. Accessed May 27, 2021
- CNPS 2021 – California Native Plant Society (CNPS), Rare Plant Program – Inventory of Rare and Endangered Plants of California (online edition, v8-03 0 39). Accessed July 6, 2020. Available online at <http://www.rareplants.cnps.org>.
- CMAQ 2020 – Community Multiscale Air Quality Modeling System (CMAQ) Download shapefiles of CMAQ-predicted values of annual total deposition across the US for 2002 through 2012. Available online at: [http://www.epa.gov/cmaq/cmaq-output#CMAS\\_Data\\_Warehouse](http://www.epa.gov/cmaq/cmaq-output#CMAS_Data_Warehouse)
- DayZenLLC 2021b – DayZenLLC (DayZenLLC). (TN 237381). VDC CA3BGF SPPE Application Part III, dated April 5, 2021. Available online at: <https://efiling.energy.ca.gov/Lists/DocketLog.aspx?docketnumber=21-SPPE-01>
- DayZenLLC 2021e – DayZenLLC (DayZenLLC). (TN 237423). VDC CA3BGF SPPE Application Part II, dated April 12, 2021. Available online at: <https://efiling.energy.ca.gov/Lists/DocketLog.aspx?docketnumber=21-SPPE-01>
- DayZenLLC 2021z – DayZenLLC (DayZenLLC). (TN240157). CA3DC PPC Drawing Set Rev3 – Part II, dated October 28, 2021. Available online at: <https://efiling.energy.ca.gov/Lists/DocketLog.aspx?docketnumber=21-SPPE-01>
- DayZenLLC 2021bb – DayZenLLC (DayZenLLC). (TN 240159). CA3DC Revised Project Description – PCC Revisions, dated October 28, 2021. Available online at: <https://efiling.energy.ca.gov/Lists/DocketLog.aspx?docketnumber=21-SPPE-01>
- Fenn et al. 2003 – Fenn, M.E., Baron, J.S., Allen, E.B., Rueth, H.M., Nydick, K.R., Geiser, L., Bowman, W.D., Sickman, J.O., Meixner, T., Johnson, D.W., P. Neitlich (Fenn et al.). 2003. Ecological effects of nitrogen deposition in the western United States. *Bioscience* 53(4): 404-420
- Mayer&Laudenslayer, Jr. 1988 – Mayer, K.E. and W.F. Laudenslayer, Jr. 1988. A Guide to Wildlife Habitats of California. State of California, Resources Agency, Department of Fish and Game. Sacramento, CA. 166 pp.

- Pardo et al. 2011 – Pardo LH, ME Fenn, GL Goodale, LH Geiser, CT Briscoll, EB Allen, J Baron, R. Bobbink, WD Bowman, C Clark, E Emmett, FS Gillian, T Greaver, SJ Hall, EA Lilleskor, L Liu, J Lynch, K Nodelhoffer, SS Perakis, MJ Robin-Abbott, J Stoddard, K Weathers, and RL Dennis (Pardo et al.). Effects of nitrogen deposition and empirical nitrogen critical loads for ecoregions of the United States. *Ecological Applications* 21:3049-3082
- Santa Clara 2010 – City of Santa Clara (Santa Clara). City of Santa Clara 2010-2035 General Plan. November 16, 2010. Accessed on: July 6, 2020. Available online at: <https://www.santaclaraca.gov/our-city/departments-a-f/community-development/planning-division/general-plan>
- Santa Clara 2020 – Santa Clara City Code, Title 20: Zoning. Version: June 23, 2020. Accessed on: July 6, 2020. Available online at: <https://www.codepublishing.com/CA/SantaClara/html/SantaClara12/SantaClara1235.html>
- SCVHP 2012 – Santa Clara Valley Habitat Plan (SCVHP). Final Santa Clara Valley Habitat Plan. August 2012. Available online at: <https://scv-habitatagency.org/178/Santa-Clara-Valley-Habitat-Plan>
- SCVHA 2020 – Santa Clara Valley Habitat Agency Geobrowser. Accessed 11/9/2020. Available online: <http://www.hcpmaps.com/habitat/>
- USFWS 2021 – United States Fish and Wildlife Service (USFWS). Critical Habitat Mapper. Available online at: <https://fws.maps.arcgis.com/home/webmap/viewer.html?webmap=9d8de5e265ad4fe09893cf75b8dbfb77>
- Weiss 2006 – Weiss. Impacts of Nitrogen Deposition on California Ecosystems and Biodiversity. California Energy Commission, PIER Energy-Related Environmental Research. CEC-500-2005-165

## 4.5 Cultural and Tribal Cultural Resources

This section describes the environmental setting and regulatory background and discusses the impacts associated with the construction and operation of the project with respect to cultural and tribal cultural resources.

<b>CULTURAL RESOURCES</b>				
<b>Would the project:</b>	<b>Potentially Significant Impact</b>	<b>Less Than Significant with Mitigation Incorporated</b>	<b>Less Than Significant Impact</b>	<b>No Impact</b>
a. Cause a substantial adverse change in the significance of a historical resource pursuant to §15064.5?	<input type="checkbox"/>	<input checked="" type="checkbox"/>	<input type="checkbox"/>	<input type="checkbox"/>
b. Cause a substantial adverse change in the significance of a unique archaeological resource pursuant to §15064.5?	<input type="checkbox"/>	<input checked="" type="checkbox"/>	<input type="checkbox"/>	<input type="checkbox"/>
c. Disturb any human remains, including those interred outside of dedicated cemeteries?	<input type="checkbox"/>	<input checked="" type="checkbox"/>	<input type="checkbox"/>	<input type="checkbox"/>

<b>TRIBAL CULTURAL RESOURCES</b>				
<b>Would the project cause a substantial adverse change in the significance of a tribal cultural resource, defined in Public Resources Code section 21074 as either a site, feature, place, cultural landscape that is geographically defined in terms of the size and scope of the landscape, sacred place, or object with cultural value to a California Native American tribe, and that is:</b>	<b>Potentially Significant Impact</b>	<b>Less Than Significant with Mitigation Incorporated</b>	<b>Less Than Significant Impact</b>	<b>No Impact</b>
a. Listed or eligible for listing in the California Register of Historical Resources, or in a local register of historical resources as defined in Public Resources Code section 5020.1(k), or	<input type="checkbox"/>	<input type="checkbox"/>	<input type="checkbox"/>	<input checked="" type="checkbox"/>
b. A resource determined by the lead agency, in its discretion and supported by substantial evidence, to be significant pursuant to criteria set forth in subdivision (c) of Public Resources Code Section 5024.1. In applying the criteria set forth in subdivision (c) of Public Resource Code Section 5024.1, the lead agency shall consider the significance of the resource to a California Native American tribe.	<input type="checkbox"/>	<input checked="" type="checkbox"/>	<input type="checkbox"/>	<input type="checkbox"/>

Environmental checklist established by CEQA Guidelines, Appendix G.

### 4.5.1 Environmental Setting

This section considers four broad classes of cultural resources: prehistoric, ethnographic, historic-period, and tribal cultural resources. The next four paragraphs briefly describe these classes of resources. Afterward, the Cultural and Tribal Cultural Resources section presents the environmental setting pertinent to these resources:

- *Prehistoric, ethnographic, and historic contexts*—generally describes who lived in the project vicinity, the timing of their occupation, and what uses they made of the area
- *Methods of analysis*—establishes what kinds of physical traces (cultural and tribal cultural resources) past peoples might have left in the project area, given the project vicinity's prehistoric, ethnographic, and historic contexts
- *Results* ensuing from those methods—identifies the specific resources present or expectable in the project area
- *Regulatory setting*—presents the criteria for identifying *significant* cultural and tribal cultural resources under the California Environmental Quality Act (CEQA) and other applicable authorities, as well as the criteria for identifying significant impacts on these resources
- *Impacts*—identifies any impacts on cultural and tribal cultural resources, along with the severity of any such impacts
- *Mitigation measures*—proposes measures to avoid, minimize, rectify, reduce, or eliminate, or compensate for, any identified, significant impacts

Prehistoric archaeological resources are those materials relating to Native American occupation and the use of a particular environment. These resources may include sites and deposits, structures, artifacts, rock art, trails, and other traces of Native American activity. In California, the prehistoric period began more than 12,000 years ago and extended through the 18th century until A.D. 1769, when Europeans first settled in California.

Ethnographic resources are those materials important to the heritage of a particular ethnic or cultural group, such as Native Americans or African, European, or Asian immigrants. They may include traditional resource-collecting areas, ceremonial sites, topographic features, value-imbued landscapes, cemeteries, shrines, or neighborhoods and structures. Ethnographic resources are variations of natural resources and standard cultural resources types. They are subsistence and ceremonial locales and sites, structures, objects, and rural and urban landscapes assigned cultural significance by traditional users. The decision to call resources "ethnographic" depends on whether associated peoples perceive them as traditionally meaningful to their identity as a group and the survival of their lifeways.

Historic-period resources are those materials, archaeological and architectural, usually but not necessarily associated with Euro-American exploration and settlement of an area and the beginning of a written historical record. They may include archaeological deposits, sites, structures, trail and road corridors, artifacts, or other evidence of historic human activity. Under federal and state requirements, historic period cultural resources must be 50 years or older to be considered of potential historic importance. A resource less than 50 years of age may be historically significant if the resource is of exceptional importance. The Office of Historic Preservation (OHP 1995, page 2) endorses recording

and evaluating resources 45 years or older to accommodate a five-year lag in the planning process.

Tribal cultural resources are a category of historical resources recently introduced into CEQA by Assembly Bill 52 (Chapter 532 , Stats. 2014). Tribal cultural resources are resources that are any of the following: sites, features, places, cultural landscapes, sacred places, or objects that are included in or determined eligible to the California Register of Historical Resources (CRHR) or are included on a local register of historical resources, as defined in Public Resources Code, section 5020.1(k). Tribal cultural resources can be prehistoric, ethnographic, or historic.

### **Prehistoric Context**

The archaeological record in the Santa Clara Valley began about 9,000 years before present (B.P., or before 1950) with the Metcalf Creek Aspect, the local expression of the Millingstone cultural pattern. Archaeological deposits dating to this time contain milling slabs and handstones, and large wide-stemmed and leaf-shaped projectile points. Native people during this period were mobile foragers and burials were typically flexed and placed beneath millingstone cairns. (Milliken et al. 2007, page 114.)

This Early Holocene culture extended until the beginning of the Early Period (circa 5500 B.P.), which exhibits developments in groundstone technology (i.e., replacing millingstones with the mortar and pestle), less movement of entire communities, regional symbolic integration between cultural groups, and increased trade. Also referred to locally as the Sandhill Bluff Aspect, this cultural pattern lasted until circa (ca.) 2500 B.P., when the Lower Middle Period began with a “major disruption in symbolic integration systems.” (Milliken et al. 2007, page 115.) Archaeological assemblages from the Lower Middle Period include more olive snail-shell saucer beads and circular abalone-shell ornaments (and the disappearance of the rectangular shell beads), as well as bone tools and whistles.

The Upper Middle Period began ca. 1520 B.P. with a disruption of the olive snail-shell bead trade network, abandonment of some village sites, and changes in shell bead manufacture. Some South Bay burials from this period were extended rather than flexed burials, and grave goods were lacking. (Milliken et al. 2007, page 116.)

The Late Period began ca. 900 B.P. with groups increasingly intensifying the creation of wealth objects, as seen in burials. Smaller projectile points for use in the bow and arrow emerged during this period and some of the mortuary evidence suggests the introduction of cremation, at least among the wealthiest of individuals. (Milliken et al. 2007, page 117.)

Archaeological research in the project vicinity reveals a rich and lengthy archaeological record. Archaeologists have found numerous buried Native American sites throughout the lower Santa Clara Valley. Rapid development of the valley covered numerous archaeological sites in pavement or with structures (Busby et al. 1996a, pages 2–4; Hylkema 1994, page 252; Parsons and KEMCO 1983, pages 18 and 35). Below even the

archaeological sites capped by the veneer of recent building, the Guadalupe River and smaller streams (Saratoga and San Tomas Aquino creeks) buried generations of Native American sites under layers of silt and clay. As a result, the surface archaeological record of Santa Clara Valley represents only the last 2,000 years of human occupation. The remaining 7,000 years of native history lay anywhere from near surface up to 30 feet below the modern ground surface. (Busby et al. 1996a, pages 2–4; Busby et al. 1996b, page 2; Jones et al. 2007, page 130; Parsons and KEMCO 1983, pages 16, 25–26, 33; Ruby et al. 1992:9, 12, 17–19.)

### **Ethnographic Context**

The Costanoans are the Native Americans who inhabited the Bay Area since time immemorial. The Costanoan designation refers to those who spoke one of eight separate but related languages (Shiple 1978, pages 84, 89). The Costanoan languages are similar to Miwok and are part of the Yok-Utian language family of the Penutian stock (Golla 2007, pages 75–76). Tamyen (Santa Clara Costanoan) was spoken around the southern end of San Francisco Bay and the lower Santa Clara Valley (and was spoken by Costanoans in the project vicinity). (Milliken et al. 2007, Figure 8.1; Shiple 1978, pages 84 and 89.)

Each village was a separate and politically autonomous tribelet, with about 200 people living within each. Tribelets were the basic unit of political organization, with chiefs, either women or men, descended from their patrilineal relative. In the late 1700s, there were two tribelets near the proposed project (project site), San José Cupertino and Santa Clara; both are presumably Tamyen speakers. (Levy 1978, Figure 1.) Kroeber (1976, Figure 42) indicates that two settlements were located within a few miles of the project site on the Guadalupe River, Tamie-n near Santa Clara, and Ulis-tak farther north near the San Francisco Bay.

Like most other Native Americans in California, acorns were the staple food of the Costanoan people in the Santa Clara region. Other nuts, such as buckeye, California laurel, and hazelnuts, were also eaten. The Costanoans set controlled fires to promote the growth of the nuts and seeds upon which they relied. The primary mammals taken by the Costanoan included the black-tailed deer, elk, antelope, grizzly bear, mountain lion, sea lion, and whale. Waterfowl, salmon, steelhead, and lampreys were also important components of the Costanoan diet. (Levy 1978, page 491.)

Thatched, domed houses were the most common type of structure for the Costanoans. Sweathouses along the banks of rivers were also constructed, in addition to dance enclosures and assembly houses. (Levy 1978, page 492.)

Bodies were either buried or cremated on the day of death. The community either buried the deceased's property with the body or destroyed their property. (Kroeber 1976, page 469; Levy 1978, page 490.)



Trade was important for the Costanoan groups, and their primary partners in trade were the Plains Miwok, Sierra Miwok, and Yokuts. The Costanoan provided coastal resources, such as mussels, abalone shell, dried abalone, and salt, to the Yokuts in exchange for piñon pine nuts. The Miwok obtained olive snail shells from the Costanoans. Warfare occurred between Costanoan tribelets as well as the Esselen, Salinan, and Northern Valley Yokuts. (Davis 1961, page 19; Levy 1978, page 488.)

A common archaeological manifestation of a Costanoan village site is the shellmound deposit (Kroeber 1976, page 466). Mussels are the primary shells that constitute these mounds, in addition to other household wastes.

The Spanish established seven missions in Costanoan territory between 1770 and 1797. By 1810, the mission system subsumed the last Costanoan village. Missions in the Bay Area mixed together various language and cultural groups, including the Esselen, Foothill Yokuts, Plains Miwok, Saclan Miwok, Lake Miwok, Coast Miwok, and Patwin. The mission closest to the proposed project area was Santa Clara de Asís, built in 1777. The mission is no longer extant, but the area is still rich in archaeological manifestations from the mission period and before. (Levy 1978, page 486.)

## **Historic Context**

To inform an understanding of the potential significance of built environment resources near the project, a review of the major historical timeline markers for the project area provides context. This subsection offers a brief look at those events and trends in the history of the Santa Clara Valley region that provide that context, especially for the project site:

- Spanish Mission Period
- Mexican Period
- American Period
  - Transportation and Railroads
  - Agriculture and Fruit Industry
  - Post-World War II (WWII) and Silicon Valley
  - San Tomas Aquino Creek
  - Project Site History

### ***Spanish/Mission Period (1769 to 1821)***

The Spanish Period hosted several important developments, such as the establishment of Spanish colonial military outposts (presidios), pueblos, and 21 missions throughout Alta California. Nearest to the location of the proposed project were the Santa Clara de Asís Mission (1777), El Pueblo de San José de Guadalupe (1777) and associated Mission (1797), and Santa Cruz Mission (1791). The Spanish government also awarded land grants to soldiers and others and thus began the tradition of large land grants used for

agriculture and livestock. Little remains of the cultural landscape that existed during this time aside from some roads that follow the same early transportation routes (Santa Clara County 2012, pages 22–26).

### ***Mexican Period (1821 to 1848)***

Following Mexican independence from Spain in 1821, Mexican Governor Pío Pico granted lands to Mexican settlers, including the former mission lands, whose connection to the government was lost in the Decree of Secularization in 1834. The Mexican governor granted 43 ranchos in the Santa Clara Valley between 1802 and 1845. Local planning agencies lack detailed information on the location and integrity of these early California sites (Santa Clara County 2012, pages 30–32). The project site appears to be within the boundaries of the Rancho Ulistác (USGS 1899). Governor Pío Pico granted the land in 1845 to two Santa Clara Mission Indians: Marcelo Pío and Cristóbal. After the Mexican War (1846–1848), Jacob D. Hoppe obtained title to the rancho. Following Hoppe's death, his heirs divided and sold the land (Oosterhous et al. 2002, page 6). Santa Clara's historic context statement laments that most traces of original haciendas, adobes, and other rancho structures are not discernible in the landscape today and few records exist (Santa Clara County 2012, page 32).

### ***American Period (1848 to Present)***

California became the thirty-first state in the Union in 1850. In 1851, Santa Clara College, now Santa Clara University, was founded on the site of the Santa Clara de Asís Mission. The incorporation of the city of Santa Clara followed in 1852. In 1866, the city officially established a gridded street system to accommodate anticipated growth. Today, this area is known as the Old Quad neighborhood. Early industries in the city included wheat production and flour milling, seed and fruit packing, and manufacturing. Leather tanning and wood products were two key industries of the city well into the 20th century. Similarly, seed growing and fruit farming and packing (especially pears, cherries, apricots, and prunes) were mainstays, contributing to the city's exports. (Santa Clara 2010, page 3-2.)

### **Transportation and Railroads**

Railroads played a significant part in the development of the Santa Clara Valley. In 1869, the Western Pacific Railroad completed a rail line from Niles, California, to San Jose, California, effectively connecting San Jose with the Transcontinental Railroad. This opened new markets for the agricultural and manufactured products of the entire Santa Clara Valley. Senator James Fair, a multi-millionaire, envisioned a route from the east side of the San Francisco Bay, south to San Jose, then on to Los Gatos and through the mountains to Felton, ultimately connecting to Santa Cruz. Senator Fair incorporated the South Pacific Coast Railroad in 1876 and immediately began building the segment from Dumbarton in the East Bay to Los Gatos, by way of Santa Clara and San Jose. Following that segment, the rail line passed through the Santa Cruz Mountains to connect with the narrow-gauge railroad at Felton. The Southern Pacific Railroad (SPRR) acquired these rail

lines in 1887 and eventually converted the narrow-gauge lines to standard gauge (Lehmann 2000, pages 31–33).

The SPRR Monterey Division segment from San Francisco to San Jose was originally constructed in 1864 by the San Francisco and San Jose Railroad Company (SFSJRR) and purchased by SPRR in 1869. The SPRR extended the tracks to Gilroy in 1869, then to Hollister in 1871 and Tres Pinos in 1873 (JRP 2002, pages 10–12). This railroad line provided freight and passenger access from San Francisco to the South Bay, San Jose, South County regions and beyond. A 1915 U.S. Geological Survey (USGS) topographic map shows the entire route of the SPRR Santa Cruz and Monterey Divisions from central San Jose through the Santa Cruz Mountains to Santa Cruz and Monterey, respectively, and indicating an ultimate connection to Los Angeles (USGS 1915). The Monterey Division passed adjacent to the project site where the alignment is currently used by Caltrain. The California Department of Transportation (Caltrans) assumed operation of the railroad right-of-way (ROW) from SPRR in 1979, and hence the name “Caltrain” in use today. The Peninsula Corridor Joint Powers Board purchased the ROW from San Francisco to San Jose and obtained trackage rights in the southern section in 1991 (JRP 2002, page 34).

### **Santa Clara Valley Agriculture and Fruit Industry**

Fruit orchards and vegetable farms dominated the Santa Clara Valley from the 1890s to the 1940s. Wheat and flour milling were the first major agricultural activities. In support of the fruit and vegetable industry, canning operations flourished in the northeastern portion of the county. Fruit packing companies were common in the Santa Clara Valley in the first third of the 20<sup>th</sup> century. Nearly half of the world’s supply of fresh, dried, and canned fruit through the end of WWII originated from the valley. The agricultural-based economy and its support operations were gradually displaced by expanding suburban development, light industrial, and high-tech research and development operations by the 1970s (Fike 2016, page 2).

### **Post WWII and Silicon Valley**

The Santa Clara Valley’s current commercial and industrial operations are indicative of the shift that took place after WWII from agricultural-based businesses to light industrial and ultimately high-tech research and development facilities. The Owens-Corning plant was one of the first new industrial businesses in the Santa Clara Valley and represents the shift toward industrial business in the valley after WWII. A 1949 aerial photograph shows the brand-new plant along Lafayette Street with agricultural uses surrounding it (Draper 1949). The plant remains in that location today. Throughout the valley, residential home developments slowly replaced orchards and agricultural fields. Due to the increased pressure from housing, the city of Santa Clara grew from 6,500 residents in 1940 to 86,000 by 1970 (Fike 2016, page 2). The landscape was forever transformed.

From 1960 to 1980, much of the industrial growth was in the electronics research and manufacturing sectors. The city of Santa Clara is home to Intel, Applied Materials, Sun Microsystems, Nvidia, National Semiconductor, and other high technology companies (Santa Clara 2010, pages 3-3 through 3-6). More recently, Santa Clara has become home to numerous data centers supporting the operations of the high technology companies of the Silicon Valley. This represents yet another contextual shift in the history of the Santa Clara/Silicon Valley.

### **Project Site**

The project site is in the city of Santa Clara, Santa Clara County, California. The site encompasses approximately 6.69 acres and is located at 2590 Walsh Avenue in Santa Clara, California, Assessor's Parcel Number (APN) 216-28-112. The project site is located within Township 6S, Range 1W, Section 33 of the *San Jose West, California* USGS 7.5-minute Topographic Quadrangle Map (Ngo and DePietro 2021, page 3). It is located 3.54 miles south of the San Francisco Bay (TRC 2020, page 5).

The parcel is irregularly shaped and is generally bound to the northwest by a microelectronics testing facility, to the northeast by a software research and development facility, to the south by a railroad line operated by Caltrain, to the east by Walsh Avenue, and to the west by a Silicon Valley Power (SVP) substation. The Vantage Santa Clara Data Center Campus CA1 is located to the east of the site across Walsh Avenue. The closest residential uses are to the south across the railroad ROW (Ngo and DePietro 2021, page 3). The current building on site dates to ca. 1980 to 1982 (Smart Permit 2021; TRC 2020, page 4).

The project site served as farmland from at least 1897 to the 1970s (Ngo and DePietro 2021, pages 17–18). Maps and aerial images indicate that from 1939 to 1968 there existed private residences, agricultural structures, and orchards. A creek historically bisected the project site. The 1953 USGS topographic map labels the creek bisecting the property as Saratoga Creek. Saratoga Creek has had a few names over the years: Campbell's Creek, Sanjon Creek, and Quito Creek. The name was changed to Saratoga Creek sometime after the conclusion of WWII and by 1951 (Hickman 1974, page 11). South of the project site, the creek may have been diverted to join the San Tomas Aquino Creek to the east in the 1950s (Hickman 1974, page 12). Historical aerial images show remnants of the creek still bisecting the project property sometime between 1974 and 1982 (TRC 2020). Both creeks' origins are in the foothills of the South Coast Ranges. Throughout the early 19th century, most creeks originating in the foothills did not maintain a defined channel from the hills to the San Francisco Bay, including San Tomas Aquino Creek and Saratoga Creek (SFEI 2010, pages 13–14). Portions of Saratoga Creek were straightened as early as 1897, especially in the project site area. San Tomas Aquino Creek also appears to have been straightened by 1897 (USGS 1897). Today, a bicycle trail traverses the west side of the channel on a levee. The San Tomas Aquino Creek and bicycle trail are approximately 0.25 mile east of the project site.

Suburban residential development appears southwest of the project site as early as the 1950s. That development continued in the 1960s and 1970s (TRC 2020). By 1974, the property had been cleared of all residences and agricultural uses. The parcel was developed as an industrial property in 1982. Maps and aerial images indicate similar histories on some of the adjacent properties. The existing Caltrain rail alignment to the south dates to 1864 (JRP 2002, page 10), and is identified as the SPRR Monterey Line on topographic maps (TRC 2020, pages 13–16, and 1130 of 1213).

The adjacent parcels are listed in Table 4.5-1 below.

**Table 4.5-1 Parcels Adjacent to the Project Site**

Address	APN	Description	Year Constructed
2590 Walsh Ave	216-28-112	Project Site, Industrial	ca. 1980–1982
2550 Walsh Ave	216-28-113	Commercial/Office	1980
2565 Walsh Ave/2820 Northwestern Parkway	216-28-132	Commercial/Industrial	unknown
2630 Walsh Ave	216-28-106	Commercial/Office	1977
2705 Bowers Ave	216-28-062	Uranium Substation	1976
N/A	216-28-121	Railroad tracks (SPRR, Caltrain)	1864

Abbreviations: APN = Assessor's Parcel Number; Ave = Avenue; N/A = not applicable; SPRR = Southern Pacific Railroad

The pedestrian survey completed on March 18, 2021, by the applicant's consultants (First Carbon Solutions) did not identify any adjacent properties 45 years or older (DayZenLLC 2021e, page 4-46). However, city of Santa Clara building permit records indicate that the Uranium Substation was issued a permit to construct in 1974 and was finished in 1976, making it at least 45 years old (Smart Permit 2021). The route of the SPRR Monterey Line dates to 1864, when it was initially constructed as the San Francisco & San Jose Railroad. The applicant's consultant prepared a supplemental report at CEC staff's request to investigate properties within one parcel distance from the project site. Both the Uranium Substation and the railroad tracks were determined to be 45 years or older and were evaluated for their eligibility for the National Register of Historic Places (NRHP), CRHR, and the local city of Santa Clara register (Murray 2021). Methods and results are below.

## Methods

### *Project Area of Analysis*

The project area of analysis (PAA) defines the geographic area in which the proposed project has the potential to affect cultural or tribal cultural resources. Effects may be immediate, further removed in time, or cumulative. They may be physical, visual, audible, or olfactory in character. The PAA may or may not be one uninterrupted expanse. It could include the site of the project site, the routes of requisite transmission lines and water and natural gas pipelines, and other offsite ancillary facilities, in addition to one or several discontinuous areas where the project could arguably affect cultural or tribal cultural resources.

CEC staff defines the PAA as comprising the proposed project site, immediately adjacent parcels, and all appurtenant, proposed improvements. The PAA has archaeological, ethnographic, and historic built environment components, as described in the following paragraphs.

CEC staff defines the archaeological component of the PAA as all areas in which the applicant proposes ground disturbance to construct, operate, and decommission the proposed project. This includes building demolition, the proposed building sites, areas slated for concrete and hardscape removal, areas to be filled and graded, staging and laydown areas, installation of underground utilities, subsurface drainage, and installation of two transmission line poles. The applicant proposes demolition and excavation to variable depths. Trench excavations would extend up to 15-feet below grade. Foundation piles for the data center buildings would be augered to depths more than 30-feet below grade. (DayZenLLC 2021e, page 4-67.) Transmission line poles would be installed via truck-mounted auger to a depth of 20–30 feet.

For ethnographic resources, the PAA considers sacred sites, tribal cultural resources, traditional cultural properties (places), and larger areas, such as ethnographic landscapes that can be vast and encompassing, including view sheds that contribute to the historical significance of such resources. The Native American Heritage Commission (NAHC) assists project-specific cultural resources consultants and agency staff in identifying these resources, and consultation with Native Americans and other ethnic or community groups may contribute to defining the PAA. In the case of the proposed project, the immediate environs consist largely of commercial and light industrial buildings, offices, a park, residential areas, and an electrical substation. Staff, therefore, treats the ethnographic component of the PAA as coterminous with the archaeological component.

The project site consists primarily of a pre-existing industrial one-story building, pavement, hardscape, and modest landscape elements, much of which dates to 1980 to 1982. The historic built environment PAA for this project includes the project site and properties within a one-parcel boundary of the project site. This includes all properties directly across Walsh Avenue from the project site.

### ***Literature Review***

The literature review for this analysis consisted of a records search at the California Historical Resources Information System (CHRIS), a review of the application for small power plant exemption (SPPE), and an examination of pertinent literature concerning cultural resources in the northern Santa Clara Valley.

The applicant conducted the records search at the Northwest Information Center (NWIC) of the CHRIS on May 5, 2021 (Ngo and DePietro 2021, page 1). The NWIC is the State of California's official repository of cultural resources records, previous cultural resources studies, and historical information concerning cultural resources for 16 counties, including Santa Clara County. The records search area included the project site and a 0.5-mile buffer around it (Ngo and DePietro 2021, page 1).

CEC staff also examined historic maps and aerial photographs of the PAA and vicinity to identify cultural resources (EDR 2017a, 2017b; Edward Denny & Co. 1913; GLO 1866; TRC 2020; USGS 1897, 1899). These sources depict the historic appearance of the PAA each decade from 1857 through 1980 (excepting the 1870s, 1880s, 1900s, and 1920s). The historic maps studied date to 1897, 1899, 1953, 1961, 1968, 1973, 1980, and 2012, and include the following USGS quadrangles: Palo Alto, San Jose (15-minute series), Cupertino, Milpitas, Mountain View, and San Jose West (7.5-minute series). The historic aerial images studied are: 1939, 1948, 1950, 1956, 1963, 1968, 1974, 1982, 1993, 1998, 2006, 2009, 2012, and 2016.

In addition, CEC staff consulted:

- City of Santa Clara's General Plan 2010–2035 (General Plan), including its Historic Preservation and Resource Inventory (Santa Clara 2010)
- County of Santa Clara Historic Context Statement (Santa Clara County 2012)
- City of Santa Clara's Map Santa Clara tool (Santa Clara 2021).

CEC staff also consulted the NRHP, CRHR, Historic American Building Survey, Historic American Engineering Record, Historic American Landscape Survey, and other repositories of documentation of historical resources.

### *Tribal Consultation*

#### **Applicant's Correspondence**

The applicant contacted the NAHC on February 23, and May 5, 2021, to request a list of tribes that might be interested in the project and a search of the Sacred Lands File. The NAHC responded on March 9, and May 21, 2021, providing contact information for 10 representatives of California Native American tribes. These individuals represent:

1. Muwekma Ohlone Indian Tribe of the San Francisco Bay Area
2. North Valley Yokuts Tribe
3. The Ohlone Indian Tribe
4. Amah Mutsun Tribal Band
5. Indian Canyon Mutsun Band of Costanoan
6. Amah Mutsun Tribal Band of Mission San Juan Bautista
7. Wuksache Indian Tribe/Eshom Valley Band
8. Rumsen Am:a Tur:ataj Ohlone
9. Tamien Nation

The applicant sent letters to these tribes on March 10, and May 21, 2021. (Ngo and DePietro 2021, page 21; DayZenLLC 2021e, page 4-46.)

## **CEC Consultation**

CEQA requires lead agencies to consult with all California Native American tribes that have traditional and cultural affiliation with the geographic area of a project and that have previously requested consultation. To invoke an agency's requirement to consult under CEQA, a tribe must first send the lead agency a written request for formal notification of any projects within the geographic area with which they traditionally and culturally affiliate. (Pub. Resources Code, § 21080.3.1(b).) The CEC has a request for formal notification on file from the Wuksache Indian Tribe/Eshom Valley Band, a California Native American tribe that has traditional and cultural affiliation with the geographic area of the proposed project (Woodrow 2016). Accordingly, the CEC's Tribal Liaison mailed a letter (dated July 1, 2021) to the Wuksache Indian Tribe/Eshom Valley Band's chairperson inviting consultation pursuant to Public Resources Code, section 21080.3.1, and providing general information concerning the proposed project. The letter included four figures illustrating the proposed project and its location. (CEC and NAHC 2021, PDF pages 48–55.)

Consistent with the CEC's tribal consultation policy (CEC 2017), CEC staff contacted the NAHC on April 14, 2021, to request a search of the Sacred Lands File and a list of California Native American tribes that might be interested in the proposed project. The NAHC responded on April 28, 2021, and provided a list of nine California Native American tribes to contact (CEC and NAHC 2021, PDF pages 2–3); the listed tribes were the same tribes that the applicant's consultant contacted in March 2021. CEC staff mailed initial consultation letters to these tribes on July 1, 2021 (See CEC and NAHC 2021, PDF pages 4–47). See the following subsection, "Results," for tribal responses and lead agency follow-up.

The CEC also initiated consultation under Public Resources Code, section 21080.3.1, with the Tamien Nation after receiving the tribe's request for formal consultation on September 17, 2021 (see the discussion under "Results").

### ***Archaeological Survey***

An archaeologist and a historian from FirstCarbon Solutions conducted an archaeological survey of the project site on March 18, 2021. Where obstructions did not hinder traversing the project site, FirstCarbon Solutions surveyed by walking transects at 5-meter (16-foot) intervals and making observations concerning the ground surface. The surveyors examined all available soil exposures in the project site. (DayZenLLC 2021e, page 4-45.)

### ***Historic Architectural Survey***

CEC cultural resources staff conducted an architectural investigation inclusive of the project site and a one-parcel buffer from the proposed project boundaries. Buildings or structures 45 years or older, or considered significant, were identified as part of this effort. Any building or facility constructed in 1976 or earlier, or potentially eligible for the CRHR or local register, was surveyed and evaluated by the applicant's consultant for potential significance (Murray 2021).



## Results

### *Literature Review Results*

The NWIC records search identified six previous cultural resources studies conducted within the project site (BioSystems 1989; Carrico et al. 2000; Holson et al. 2002; Jurich and Grady 2011; Nelson et al. 2000; SWCA 2006). Eleven previous cultural resources studies have been conducted within 0.5 mile of the proposed project (Anastasio and Garaventa 1988; Baker 1998; Basin 2009a, 2009b; Busby 1999; Flynn 1979; Hammerle 2015; Hickman 1974; Jones & Stokes 2001; JRP 2002; Nelson et al. 2002). The city of Santa Clara’s Planning website documents additional cultural resources impact analyses within 0.5 mile of the proposed project (Akmenkalns 2020; Guldenbrein 2017; Psota 2016).

The NWIC has no records of previously recorded cultural resources within 0.5 mile of the project site (Ngo and DePietro 2021, page 19). However, the adjacent railroad line (P-43-000928) has been surveyed for infrastructure for the entire Caltrain corridor on the San Francisco Peninsula (Murray 2021, page 9). Staff identified one additional cultural resource that has been previously investigated, the San Tomas Aquino Creek, located approximately 0.25 mile from the project site (Baker 1998). These cultural resources are listed in **Table 4.5-2**.

**TABLE 4.5-2. CULTURAL RESOURCES IDENTIFIED IN THE LITERATURE REVIEW**

No.	Resource Name	APN	Description, Year Built	Eligibility Status
1.	San Tomas Aquino Creek		Channelized water conveyance structure, 1897	Ineligible
2.	Caltrain/SPRR Tracks (P-43-000928)	216-28-121	1864	Ineligible

Notes: APN = Assessor’s Parcel Number; SPRR = Southern Pacific Railroad

### *Tribal Consultation Results*

The April 28, 2021, search of the Sacred Lands File did not identify Native American cultural resources in the search area (CEC and NAHC 2021, PDF pages 2–3). The applicant did not receive any responses to letters sent to these tribes.

The Wuksache Indian Tribe/Eshom Valley Band has not responded to the CEC’s invitation to consult under Public Resources Code, Section 21080.3.1.

In response to the CEC Tribal Liaison’s letters inviting consultation with California Native American tribes, the Tamien Nation responded by letter on August 6, 2021, specifically requesting consultation about the following topics.

- Recommended mitigation measures
- Significant effects of the project

- Type of environmental review necessary
- Significance of tribal cultural resources, including any regulations, policies, or standards used by the CEC to determine significance of tribal cultural resources
- Significance of the project's impacts on tribal cultural resources
- Project alternatives and/or appropriate measures for preservation or mitigation that we may recommend, including, but not limited to:
  - Avoidance and preservation of the resources in place, pursuant to Public Resources Code section 21084.3, including, but not limited to, planning and construction to avoid the resources and protect the cultural and natural context, or planning greenspace, parks, or other open space, to incorporate the resources with culturally appropriate protection and management criteria;
  - Treating the resources with culturally appropriate dignity considering the tribal cultural values and meaning of the resources, including, but not limited to, the following:
    - Protecting the cultural character and integrity of the resource;
    - Protecting the traditional use of the resource; and
    - Protecting the confidentiality of the resource.
  - Permanent conservation easements or other interests in real property, with culturally appropriate management criteria for the purposes of preserving or utilizing the resources or places.
  - Protecting the resource.

Tamien Nation also requested any cultural resources assessments or other assessments that have been completed on all or part of the PAA. Consultation between the CEC and Tamien Nation is ongoing as of the time of this writing; CEC staff will update this results discussion in the final environmental impact report after the consultation concludes.

### ***Archaeological Survey Results***

FirstCarbon Solutions found the archaeological PAA to be almost completely covered in pavement, hardscape, buildings, and landscaping. Landscaping offered minimal opportunity to see the ground surface in the archaeological PAA. The surveyors did not identify any archaeological resources in the archaeological PAA.

### ***Historic Architectural Survey Results***

The built environment PAA used for this project includes properties within a one-parcel boundary of the project site. The study area was established to analyze the project's potential for impacts to built-environment historical resources. The initial built environment survey and archival search conducted by the applicant did not identify any properties containing buildings or structures 45 years or older within the PAA. CEC staff identified two historic-era resources 45 years or older within the PAA. A subsequent

investigation by the applicant's consultant concurred with staff's conclusion (Murray 2021). The two resources 45 years or older are the Caltrain Railroad Tracks (historic SPRR Monterey Line) and the SVP Uranium Substation. Both resources have been surveyed and evaluated by the applicant's consultant (Murray 2021).

### **Caltrain Railroad Tracks (Historic SPRR Monterey Line, P-43-000928)**

The railroad predates the commercial and industrial operations in the area. The Caltrain electrification project has produced numerous studies over time of the Caltrain rail corridor and associated infrastructure. Most of these studies have been prepared by JRP Historical Consulting (JRP) (for example, JRP 2002). Generally, JRP and others have found modern railroad segments do not retain their integrity to the period of significance. Integrity has seven aspects: design, setting, materials, workmanship, feeling, association, and location. While the location of the railroad line has not changed, most railroads undergo maintenance and upgrades of facilities that generally change the design, materials, and workmanship over time. This railroad does not appear to retain sufficient integrity to its setting, feeling, and association during the period of significance, 1860 to 1873, when SFSJRR and SPRR first operated the passenger and freight line. For the segment adjacent to the project site, the addition of a second track in the early 1900s, replacement of the original rails in the late 1950s, the grade separation at Bowers Avenue, and the addition of electrification equipment in the last decade (Murray 2021, Attachment A) degrade the integrity of the resource. The railroad has changed from its initial use as a passenger and freight line from San Francisco to Monterey and Los Angeles to strictly passenger commuter service on the San Francisco Peninsula, from San Francisco to Gilroy. The lack of integrity to the period of significance makes it ineligible for listing under the NRHP, CRHR, or city of Santa Clara's significance criteria. Thus, the resource does not qualify as a historical resource under CEQA.

### **Uranium Substation**

The SVP Uranium Substation was constructed between 1974 and 1976. Like the neighboring properties, the substation is located on what was farmland until the 1970s. Sited on an irregularly shaped parcel at 2705 Bowers Avenue in the city of Santa Clara, the substation is comprised of utilitarian buildings and structures typical of these kinds of facilities. Clues to its origins in the mid-1970s include the concrete-block utility building with a shed roof and wood-panel fascia evoking the shed style popular in the 1970s, and the north concrete-block entry wall bearing the substation's name in metal lettering. The substation was constructed to support ongoing population and industry growth within the context of a larger electrical system (Murray 2021, Attachment A). While it is associated with the rapid growth of the Santa Clara Valley and the rise of the tech industry in Santa Clara, it is not directly associated with any significant events in the development of the SVP electrical infrastructure (Murray 2021, Attachment A). The Uranium Substation has no significant historical or architectural associations (Murray 2021, page 11). This lack of historical or architectural significance makes it ineligible for listing under the NRHP, CRHR,

or city of Santa Clara's significance criteria. Thus, the resource does not qualify as a historical resource under CEQA.

### **2590 Walsh Avenue**

The building located at 2590 Walsh Avenue dates to the early 1980s. It is best described as a single-story office and warehouse structure, designed with a nod to the Spanish Eclectic style of architecture. This is found in the clay tile roof and the predominant arched windows. There is a nearly identical building next door at 2630 Walsh Avenue. The project site is completely developed, consisting of the large office warehouse building bordering Walsh Avenue to the north and parking lots, associated infrastructure, and landscape elements. None of the structures or elements on the project site are 45 years or older in age, and thus, are ineligible for inclusion on the CRHR or the city of Santa Clara's register and do not warrant further consideration as potential historic resources under CEQA.

### ***Archaeological Sensitivity***

The application and staff's literature review indicate that the potential for buried archaeological resources to occur in the project vicinity mirrors the high frequency of buried archaeological deposits throughout the Santa Clara Valley (Byrd et al. 2017, page 4-2; Mission College 2019, pages 92–93; Hylkema 1998, page 20). Researchers have identified at least 16 buried prehistoric archaeological sites in the Santa Clara Valley (Rehor and Kubal 2014, page 4-1, Table 4-1). Archaeologists working independently of the present analysis have estimated the PAA's likelihood to contain buried, prehistoric, archaeological resources as moderate (Byrd et al. 2017, Figure 27). The PAA is situated in an area that historically lay near J. Kiefer's barn and house, orchards, natural and channelized forms of present-day Saratoga Creek, roads, and encompassed a residence and part of an adjoining orchard since the middle of the 1800s to about 1968 or 1974. Therefore, buried historic archaeological resources are also expectable in the PAA, below modern construction. (DayZenLLC 2021c; GLO 1866; USGS 1899.)

### **Regulatory Background**

#### ***Federal***

No federal regulations related to cultural or tribal cultural resources apply to the project.

#### **State**

**California Environmental Quality Act.** Various laws apply to the evaluation and treatment of cultural resources. CEQA requires lead agencies to evaluate cultural resources by determining whether they meet several sets of specified criteria that make such resources eligible to the CRHR. Those cultural resources eligible to the CRHR are historical resources. The evaluation then influences the analysis of potential impacts to such historical resources and the mitigation that may be required to ameliorate any such impacts.

CEQA and the CEQA Guidelines define significant cultural resources under two regulatory definitions: historical resources and unique archaeological resources. A historical resource is defined as a “resource listed in, or determined to be eligible by the State Historical Resources Commission, for listing in the California Register of Historical Resources,” or “a resource included in a local register of historical resources, as defined in section 5020.1(k) of the Public Resources Code or identified as significant in an historical resource survey meeting the requirements of Section 5024.1(g) of the Public Resources Code,” or “any object, building, structure, site, area, place, record, or manuscript which a lead agency determines to be historically significant or significant in the architectural, engineering, scientific, economic, agricultural, educational, social, political, military, or cultural annals of California, provided the agency’s determination is supported by substantial evidence in light of the whole record.” (Cal. Code Regs., tit. 14, § 15064.5(a).) Historical resources that are automatically listed in the CRHR include California historical resources listed in or formally determined eligible for the NRHP and California Registered Historical Landmarks from No. 770 onward (Pub. Resources Code, § 5024.1(d)).

CEQA generally considers a resource historically significant if it meets the criteria for listing in the CRHR. In addition to being at least 45 years old, a resource must meet one or more of the following four criteria (Pub. Resources Code, § 5024.1):

- Criterion 1, is associated with events that have made a significant contribution to the broad patterns of California’s history and cultural heritage;
- Criterion 2, is associated with the lives of persons important in our past;
- Criterion 3, embodies the distinctive characteristics of a type, period, region, or method of construction, or represents the work of an important creative individual, or possesses high artistic values; or
- Criterion 4, has yielded, or may be likely to yield, information important in prehistory or history.

In addition, historical resources must also possess integrity of location, design, setting, materials, workmanship, feeling, and association (Cal. Code Regs., tit. 14, § 4852(c)).

Even if a resource is not listed or determined to be eligible for listing in the CRHR, CEQA requires the lead agency to determine whether the resource is a historical resource as defined in Public Resources Code, sections 5020.1(j) or 5024.1.

In addition to historical resources, archaeological artifacts, objects, or sites can meet CEQA’s definition of a unique archaeological resource even if the resource does not qualify as a historical resource (Cal. Code Regs., tit. 14, § 15064.5(c)(3)). Archaeological artifacts, objects, or sites qualify as unique archaeological resources if it is clearly demonstrable that, without merely adding to the current body of knowledge, there is a high probability that the resource meets any of the following criteria:

1. Contains information needed to answer important scientific research questions and that there is a demonstrable public interest in that information

2. Has a special and particular quality such as being the oldest of its type or the best available example of its type
3. Is directly associated with a scientifically recognized important prehistoric or historic event or person (Pub. Resources Code, § 21083.2(g).)

To determine whether a proposed project may have a significant effect on the environment, staff analyzes the project's potential to cause a substantial adverse change in the significance of historical or unique archaeological resources. The magnitude of an impact depends on:

- the historical resource(s) affected;
- the specific historic significance of any potentially impacted historical resource(s);
- how the historical resource(s) significance is manifested physically and perceptually;
- appraisals of those aspects of any historical resource's integrity that figure importantly in the manifestation of the resource's historical significance; and
- how much the impact will change historical resource integrity appraisals.

Title 14, California Code of Regulations, section 15064.5(b) defines a "substantial adverse change" as the "physical demolition, destruction, relocation, or alteration of the resource or its immediate surroundings such that the significance of an historical resource would be materially impaired."

**California Native American Tribes, Lead Agency Tribal Consultation Responsibilities, and Tribal Cultural Resources.** CEQA provides definitions for California Native American tribes, lead agency responsibilities to consult with California Native American tribes, and tribal cultural resources. A "California Native American tribe" is a "Native American tribe located in California that is on the contact list maintained by the Native American Heritage Commission for the purposes of Chapter 905 of the Statutes of 2004" (Pub. Resources Code, § 21073). Lead agencies implementing CEQA are responsible to consult with California Native American tribes about tribal cultural resources within specific timeframes. If tribal cultural resources could be impacted by a CEQA project, lead agencies are to exhaust the consultation to points of agreement or termination.

Tribal cultural resources are either of the following:

1. Sites, features, places, cultural landscapes, sacred places, and objects with cultural value to a California Native American tribe that are either of the following:
  - a. Included or determined to be eligible for inclusion in the CRHR
  - b. Included in a local register of historical resources as defined in the Public Resources Code, section 5020.1(k).

2. A resource determined by the lead agency, in its discretion and supported by substantial evidence, to be significant pursuant to criteria set forth in the Public Resources Code, section 5024.1(c). In applying these criteria, the lead agency shall consider the significance of the resource to a California Native American tribe. (Pub. Resources Code, § 21074(a).)

A cultural landscape that meets the criteria of Public Resources Code, section 21074(a), is a tribal cultural resource to the extent that the landscape is geographically defined in terms of its size and scope (Pub. Resources Code, § 21074(b)). Historical resources, unique archaeological resources, and non-unique archaeological resources, as defined at Public Resources Code, sections 21084.1, 21083.2(g), and 21083.2(h), respectively, may also be tribal cultural resources if they conform to the criteria of Public Resources Code, section 21074(a).

CEQA also states that a project with an impact that may cause a substantial adverse change in the significance of a tribal cultural resource is a project that may have a significant effect on the environment (Pub. Resources Code, § 21084.2).

### *Local*

**City of Santa Clara General Plan.** Section 5.6.3 of the city of the General Plan outlines the goals and policies related to archaeological and cultural resources. The applicable goals in this section of the General Plan encourage the protection and preservation of cultural resources, including archaeological and paleontological sites, and encourage appropriate mitigation in the event of discovery during construction.

Relevant policies require protecting historic resources through the avoidance or reduction of potential impacts, using the Secretary of the Interior's Standards for the Treatment of Historic Properties, and using the city's established historic preservation program for ensuring resource evaluation, protection, and integrity (Santa Clara 2010).

Appendix 8.9 of the General Plan, the Historic Preservation and Resource Inventory, established criteria for local significance and included a list of recorded historic properties (Santa Clara 2010). In addition, the city has embedded in its City Code a section on Historic Preservation (Title 18 Zoning, Chapter 18.106, Historic Preservation). The purpose of Chapter 18.106 is "to promote the identification, protection, enhancement and perpetuation of buildings, structures and properties within the City that reflect special elements of the City's social, economical, historical, architectural, engineering, archaeological, cultural, natural, or aesthetic heritage" (Santa Clara 2018). The chapter requires the maintenance of a Historic Resource Inventory.

Appendix 8.9 of the General Plan also identifies significance criteria for local listings. The city of Santa Clara's City Council adopted the Criteria for Local Significance on April 20, 2004 and incorporated the criteria into the General Plan Appendix 8.9. Any building, site, or property in the city that is 50 years old or older and meets certain criteria of architectural, cultural, historical, geographical, or archaeological significance is potentially

eligible. The Criteria for Local Significance established in General Plan Appendix 8.9 (Santa Clara 2010) are as follows:

**Criterion for Historical or Cultural Significance - To be historically or culturally significant, a property must meet at least one of the following criteria:**

1. The site, building or property has character, interest, integrity and reflects the heritage and cultural development of the city, region, state, or nation.
2. The property is associated with a historical event.
3. The property is associated with an important individual or group who contributed in a significant way to the political, social and/or cultural life of the community.
4. The property is associated with a significant industrial, institutional, commercial, agricultural, or transportation activity.
5. A building's direct association with broad patterns of local area history, including development and settlement patterns, early or important transportation routes or social, political, or economic trends and activities. Included is the recognition of urban street pattern and infrastructure.
6. A notable historical relationship between a site, building, or property's site and its immediate environment, including original native trees, topographical features, outbuildings, or agricultural setting.

**Criterion for Architectural Significance - To be architecturally significant, a property must meet at least one of the following criteria:**

1. The property characterizes an architectural style associated with a particular era and/or ethnic group.
2. The property is identified with a particular architect, master builder, or craftsman.
3. The property is architecturally unique or innovative.
4. The property has a strong or unique relationship to other areas potentially eligible for preservation because of architectural significance.
5. The property has a visual symbolic meaning or appeal for the community.
6. A building's unique or uncommon building materials or its historically early or innovative method of construction or assembly.
7. A building's notable or special attributes of an aesthetic or functional nature. These may include massing, proportion, materials, details, fenestration, ornamentation, artwork, or functional layout.



Criterion for Geographic Significance - To be geographically significant, a property must meet at least one of the following criteria:

1. A neighborhood, group, or unique area directly associated with broad patterns of local area history.
2. A building's continuity and compatibility with adjacent buildings and/or visual contribution to a group of similar buildings.
3. An intact, historical landscape or landscape features associated with an existing building.
4. A notable use of landscaping design in conjunction with an existing building.

Criterion for Archaeological Significance - For the purposes of CEQA, an "important archaeological resource" is one which:

1. Is associated with an event or person of
  - a. Recognized significance in California or American history, or
  - b. Recognized scientific importance in prehistory.
2. Can provide information, which is both of demonstrable public interest, and useful in addressing scientifically consequential and reasonable or archaeological research questions;
3. Has a special or particular quality such as oldest, best example, largest, or last surviving example of its kind;
4. Is at least 100 years old and possesses substantial stratigraphic integrity; or
5. Involves important research questions that historical research has shown can be answered only with archaeological methods.

#### **4.5.2 Environmental Impacts**

##### **Cultural Resources CEQA Checklist Questions**

- a. Would the project cause a substantial adverse change in the significance of a historical resource as defined in §15064.5?**

##### *Construction*

*Less Than Significant Impact with Mitigation Incorporated.* No historic built environment resources meeting CEQA's criteria for historical resources are located on site or within the PAA. No archaeological or ethnographic resources meeting CEQA's criteria for historical resources occupy the surface of the PAA. Previous studies in the

project vicinity, however, indicate that the PAA could harbor buried archaeological or ethnographic resources. The PAA is located between two waterways (Saratoga and San Tomas Aquino creeks) on the former grounds of historic farms. Archaeologists working independently of the present analysis have estimated the PAA's likelihood to contain buried, prehistoric archaeological resources as moderate (Byrd et al. 2017, Figure 27).

The ground disturbance required to build the proposed project would extend into native soils more than 30 feet below grade. Known buried archaeological sites in the Santa Clara Valley are located at depths of 1.0–10.5 feet below grade (Rehor and Kubal 2014, Table 4-1). If such resources were to be damaged during construction, it would be considered a significant impact, particularly since virtually all archaeological sites 5,000 years or older occur only in buried contexts.

This EIR, however, proposes a mitigation measure, **CUL-1**, to reduce the significance of any such impacts on historical resources. **CUL-1** requires qualified professionals to survey the exposed ground surface for cultural resources once the demolition of existing structures is complete. It also requires test excavation to determine the presence or absence of buried cultural resources and describes criteria for avoidance measures and construction monitoring (see **Section 4.5.3: Mitigation Measures**). This measure would reduce impacts to any discovered historical resources to a less-than-significant level.

### *Operation*

*No Impact.* Ground-disturbing activities are not part of the operational or maintenance profile of the proposed project. Therefore, there would be no impact to historical resources, as described in CEQA Guidelines Section 15064.5.

## **b. Would the project cause a substantial adverse change in the significance of a unique archaeological resource pursuant to §15064.5?**

### *Construction*

*Less Than Significant Impact with Mitigation Incorporated.* As discussed in the potential construction impacts for CEQA Checklist Question "a" above, mitigation measure **CUL-1** would reduce impacts to unique archaeological resources to a less-than-significant level.

### *Operation*

*No Impact.* Ground-disturbing activities are not part of the operational or maintenance profile of the proposed project. The operation and maintenance of the proposed project would not require excavation or other ground-disturbance. Therefore, there would be no impact to unique archaeological resources, as described in CEQA Guidelines Section 15064.5.

**c. Would the project disturb any human remains, including those interred outside of formal cemeteries?**

*Construction*

*Less Than Significant Impact with Mitigation Incorporated.* See staff's response to CEQA Checklist Questions "a" and "b" above for construction. In addition to mitigation measure **CUL-1**, mitigation measure **CUL-2** describes a protocol to minimize or avoid impacts on inadvertently discovered human remains. Combined, mitigation measures **CUL-1** and **CUL-2** would reduce the impacts to human remains to a less-than-significant level.

*Operation*

*No Impact.* Ground-disturbing activities are not part of the operational or maintenance profile of the proposed project. Therefore, there would be no impact to human remains during the operation and maintenance of the proposed project.

**Tribal Cultural Resources CEQA Checklist Questions**

**Would the project cause a substantial adverse change in the significance of a tribal cultural resource, defined in Public Resources Code, section 21074, as either a site, feature, place, cultural landscape that is geographically defined in terms of the size and scope of the landscape, sacred place, or object with cultural value to a California Native American tribe, and that is:**

**a. Listed or eligible for listing in the California Register of Historical Resources or in a local register of historical resources, as defined in Public Resources Code, section 5020.1(k)?**

*Construction*

*No Impact.* There are no tribal cultural resources listed or eligible for listing in the CRHR or other state registers, NRHP, or local register of historical resources in the PAA, and, therefore, no impacts would occur during construction.

*Operation*

*No Impact.* Ground-disturbing activities are not part of the operational or maintenance profile of the proposed project. Impacts on tribal cultural resources listed or eligible for listing in the CRHR or other state registers, NRHP, or local register of historical resources would, therefore, not occur during operation or maintenance.

- b. A resource determined by the lead agency, in its discretion and supported by substantial evidence, to be significant pursuant to criteria set forth in Public Resources Code, section 5024.1 (c). In applying the criteria set forth in Public Resources Code, section 5024.1 (c), the lead agency shall consider the significance of the resource to a California Native American tribe?**

### *Construction*

*Less Than Significant Impact with Mitigation Incorporated.* Although there are no known tribal cultural resources on or directly adjacent to the proposed site, ground-disturbance associated with the proposed project could result in the exposure and destruction of buried, as-yet-unknown prehistoric archaeological resources that could qualify as tribal cultural resources. If these resources were to be exposed or destroyed, it would be a significant impact. Implementation of **CUL-1** and **CUL-2** would reduce the impacts on buried, tribal cultural resources to a less than significant level (see Cultural Resources CEQA Checklist Questions “a” and “b” above).

### *Operation*

*No Impact.* Ground-disturbing activities are not part of the operational or maintenance profile of the proposed project. Impacts on tribal cultural resources listed or eligible for listing in the CRHR or other state registers, NRHP, or local registers of historical resources would, therefore, not occur during operation and maintenance.

## **4.5.3 Mitigation Measures**

**CUL-1:** The following project-specific measures would be implemented during construction to avoid significant impacts to unknown subsurface cultural resources:

- A Secretary of the Interior-qualified archaeologist and a Native American cultural resources monitor shall be on site to monitor all ground-disturbing activity, including the removal of foundations and landscaping, on the project site. The project applicant shall submit the name and qualifications of the selected archaeologist and Native American monitor, along with a signed letter of commitment or agreement to monitor, to the City’s Director of Community Development prior to the issuance of a grading permit. Preference in selecting Native American monitors shall be given to Native Americans with:
  - Aboriginal, culturally affiliated ties to the area being monitored.
  - Knowledge of local historic and prehistoric Native American village sites.
  - Knowledge and understanding of Health and Safety Code, section 7050.5, and Public Resources Code, section 5097.9 et seq.
  - Ability to effectively communicate the requirements of Health and Safety Code, section 7050.5, and Public Resources Code, section 5097.9 et seq.

- Ability to work with law enforcement officials and the Native American Heritage Commission to ensure the return of all associated grave goods taken from a Native American grave during excavation.
- Ability to travel to project sites within traditional tribal territory.
- Knowledge and understanding of Title 14, California Code of Regulations, Section 15064.5.
- Ability to advocate for the preservation in place of Native American cultural features through knowledge and understanding of CEQA mitigation provisions.
- Ability to read a topographical map and be able to locate site and reburial locations for future inclusions in the Native American Heritage Commission's Sacred Lands Inventory.
- Knowledge and understanding of archaeological practices, including the phases of archaeological investigation.

After the removal of pavement and prior to grading, the archaeologist shall conduct a pedestrian survey over the exposed soils to determine if any surface archaeological manifestations are present.

- After the demolition of the existing building and paved parking lot on the site, a qualified archaeologist with a native American monitor present shall complete mechanical presence/absence testing for archaeological deposits and cultural materials. In the event any prehistoric site indicators are discovered, additional backhoe testing will be conducted to map the aerial extent and depth below the surface of the deposits. In the event prehistoric or historic archaeological deposits are found during presence/absence testing, the significance of the find will be determined. If deemed significant, a treatment plan will be prepared and provided to the city's Director of Community Development. Where Native American cultural materials are identified, the archaeological monitor will prepare a treatment plan in collaboration with the monitoring California Native American tribe. The key elements of a treatment plan shall include the following:
  - Identify the scope of work and range of subsurface effects (include location map and development plan),
  - Describe the environmental setting (past and present) and the historic/prehistoric background of the parcel (potential range of what might be found),
  - Develop research questions and goals to be addressed by the investigation (what is significant vs. what is redundant information),
  - Detail the field strategy used to record, recover, or avoid the finds (photos, drawings, written records, provenience data maps, soil profiles, excavation techniques, standard archaeological methods) and address research goals.
  - Analytical methods (radiocarbon dating, obsidian studies, bone studies, historic artifacts studies [list categories and methods], packaging methods for artifacts,

etc.); the monitoring California Native American tribe shall determine the appropriateness of analytical methods proposed for Native American cultural materials,

- Report structure, including a technical and layperson's report and an outline of document contents in one year of completion of development (provide a draft for review before a final report),
- Disposition of the artifacts (the monitoring California Native American tribe will determine the disposition of California Native American cultural materials),
- Appendices: site records, update site records, correspondence, consultation with Native Americans, etc.

The archaeologist and California Native American monitor will monitor full-time all grading and ground disturbing activities associated with the construction of the proposed project. If the archaeologist and Native American monitor believe that a reduction in monitoring activities is prudent, then a letter report detailing the rationale for making such a reduction and summarizing the monitoring results shall be provided to the city's Director of Community Development. Department of Recreation 523 forms shall be submitted along with the report for any cultural resources encountered over 50 years old.

- If prehistoric or historic resources are encountered during on-site construction activities, all activity within a 50-foot radius of the find shall be stopped, the city's Director of Community Development shall be notified, and a Secretary of the Interior-qualified archaeologist shall examine the find and record the site, including field notes, measurements, and photography for a Department of Parks and Recreation 523 Primary Record form. The archaeologist shall make a recommendation in collaboration with the monitoring California Native American tribe regarding eligibility for the California Register of Historical Resources, data recovery, curation, or other appropriate mitigation. Ground-disturbance within the 50-foot radius can resume once these steps are taken and the city's Director of Community Development has concurred with the recommendations. Within 30 days of the completion of the construction or cultural resources monitoring, whichever comes first, a report of findings documenting any cultural resource finds, recommendations, data recovery efforts, and other pertinent information gleaned during cultural resources monitoring shall then be submitted to the city's Director of Community Development under confidential cover, along with a report that redacts the location(s) of all cultural resources. Once finalized, this report shall be submitted to the Northwest Information Center at Sonoma State University.
- Prior to and for the duration of ground-disturbance, the project owner shall provide Worker Environmental Awareness Program training to all existing and any new employees. This training should include: a discussion of the applicable laws and penalties under the laws; samples or visual aids of the artifacts that could be encountered in the project vicinity, including what those artifacts may look like partially buried, or wholly buried and freshly exposed; and instructions to halt work in

the vicinity of any potential cultural resource discovery, and notify the city-approved archaeologist and Native American cultural resources monitor. The Native American monitor shall provide a Tribal Cultural Resources Sensitivity Training in conjunction with the Worker Environmental Awareness Program.

**CUL-2:** The project proposes to implement the following measure to ensure the project's impacts to human remains are less than significant:

- If human remains are discovered during the presence/absence testing or excavation and/or grading of the site, all activity within a 50-foot radius of the find will be stopped. The Santa Clara County Coroner will be notified and shall determine whether the remains are of Native American origin or whether an investigation into the cause of death is required. If the remains are determined to be Native American, the coroner will notify the NAHC immediately. Once NAHC identifies the most likely descendants, the descendants will make recommendations regarding proper burial, which will be implemented in accordance with the California Code of Regulations, Title 14, section 15064.5(e) of the CEQA Guidelines. All actions taken under this mitigation measure shall comply with the Health and Safety Code, section 7050.5(b).

#### 4.5.4 References

- Akmenkalns 2020 – Jessika Akmenkalns, Letter Regarding Record Search Results for the Proposed CoreSite SV9 Project located at 2905 Stender Way, Santa Clara, Santa Clara County, California. Prepared by Northwest Information Center, California Historical Resources Information System, Rohnert Park. Appendix B to *CoreSite SV9 Data Center, 2905 Stender Way, CEQ2020-01075: Initial Study with Proposed Mitigated Negative Declaration (MND)*, by Circlepoint, San Jose, CA. Prepared for Community Development Department, City of Santa Clara, CA. July 2020.
- Anastasio and Garaventa 1988 – Rebecca L. Anastasio and Donna M. Garaventa, *Historic Property Survey of the Proposed Central Expressway Commuter Lane Project Located in the Cities of Santa Clara, Sunnyvale, and Mountain View in Santa Clara County, California*. Confidential report on file, Northwest Information Center, California Historical Resources Information System, Rohnert Park. Study S-010154. Prepared for Donaldson Associates, Albany, CA. Prepared by Basin Research Associates, Inc., Hayward, CA. Revised April 1988.
- Baker 1998 – Susan Baker, *Archaeological Survey, San Tomas Aquino/Saratoga Creek Trail Project, Santa Clara County, California*. Confidential report on file, Northwest Information Center, California Historical Resources Information System, Rohnert Park. Study S-022570. July 1998.
- Basin 2009a – Basin Research Associates, *Historic Property Survey Report/Finding of Effect: South Bay Water Recycling (SBWR) Stimulus Projects, Santa Clara Industrial 2, City of Santa Clara, Santa Clara County*. Prepared for Mid-Pacific Region, Bureau of Reclamation, U.S. Department of the Interior, Sacramento,

- CA, and CH2M Hill, Sacramento, CA. Confidential report on file, Northwest Information Center, California Historical Resources Information System, Rohnert Park. Study S-036717. Prepared by Basin Research Associates, Inc., San Leandro, CA. October 2009.
- Basin 2009b – Basin Research Associates, *Historic Property Survey Report/Finding of Effect: South Bay Water Recycling (SBWR) Stimulus Projects, Santa Clara Industrial 3A, City of Santa Clara, Santa Clara County*. Prepared for Mid-Pacific Region, Bureau of Reclamation, U.S. Department of the Interior, Sacramento, CA, and South Bay Water Recycling, San Jose, CA. Confidential report on file, Northwest Information Center, California Historical Resources Information System, Rohnert Park. Study S-037218. Prepared by Basin Research Associates, Inc., San Leandro, CA. Revised, December 2009.
- BioSystems 1989 – BioSystems Analysis, *Technical Report of Cultural Resources Studies for the Proposed WTG-WEST, Inc., Los Angeles to San Francisco and Sacramento, California: Fiber Optic Cable Project*. Confidential report on file, Northwest Information Center, California Historical Resources Information System, Rohnert Park. Study S-011396. Prepared for Applied Conservation Technology, Inc., Westminster, CA. Prepared by BioSystems Analysis, Inc., Santa Cruz, CA. October 1989.
- Busby 1999 – Colin I. Busby, Letter Regarding Historic Properties Affected or Potentially Affected by the South Bay Water Recycling Program (SBWRP), Phase 2 Master Plan, Tasman Drive Interconnection, SC-2 and SC-4 Segments, Cities of Milpitas and Santa Clara, Santa Clara County. Confidential report on file, Northwest Information Center, California Historical Resources Information System, Rohnert Park. Study S-023364. Submitted to Montgomery Watson Americas, Inc., San Jose, CA. Prepared by Basin Research Associates, San Leandro, CA. December 7, 1999.
- Busby et al. 1996a – Colin I. Busby, Donna M. Garaventa, Melody E. Tannam, and Stuart A. Guedon, *Historic Properties Treatment Plan, South Bay Water Recycling Program*. Revised. Confidential report on file, Northwest Information Center, California Historical Resources Information System, Rohnert Park. Study S-019072. Prepared for Parsons Engineering Science, Alameda, CA. Prepared by Basin Research Associates, San Leandro, CA. July 1996.
- Busby et al. 1996b – Colin I. Busby, Donna M. Garaventa, Melody E. Tannam, and Stuart A. Guedon, *Supplemental Report: Historic Properties Affected or Potentially Affected by the South Bay Water Recycling Program*. Prepared for Parsons Engineering Science, Alameda, CA. Confidential report on file, Northwest Information Center, California Historical Resources Information System, Rohnert Park. Study S-019072a. June 1996.
- Byrd et al. 2017 – Brian F. Byrd, Adrian R. Whitaker, Patricia J. Mikkelsen, and Jeffrey S. Rosenthal, *San Francisco Bay-Delta Regional Context and Research Design for Native American Archaeological Resources, Caltrans District 4*. Prepared for



- Office of Cultural Resources Studies, District 4, California Department of Transportation, Oakland. Confidential report on file, Northwest Information Center, California Historical Resources Information System, Rohnert Park. Study S-049780. June 2017.
- Carrico et al. 2000 – Richard Carrico, Theodore Cooley, and William Eckhardt, *Cultural Resources Reconnaissance Survey and Inventory Report for the Metromedia Fiber Optic Cable Project, San Francisco Bay Area and Los Angeles Basin Networks*. Confidential report on file, Northwest Information Center, California Historical Resources Information System, Rohnert Park. Study S-026045. Submitted to ESA Environmental Science Associates, San Francisco, CA. Prepared for Metromedia Fiber Network Services, Inc., Hayward, CA. Prepared by Mooney & Associates, San Diego, CA. March 2000.
- CEC 2017 – California Energy Commission, *Tribal Consultation Policy*. Revised. December 2017. Sacramento, CA. CEC-700-2017-002-D. Accessed March 10, 2020. Electronic document, [https://www.energy.ca.gov/sites/default/files/2020-01/2017CEC\\_Tribal\\_Consultation\\_Policy\\_ADA.pdf](https://www.energy.ca.gov/sites/default/files/2020-01/2017CEC_Tribal_Consultation_Policy_ADA.pdf)
- CEC and NAHC 2021-California Energy Commission and Native American Heritage Commission (TN 239156). CA3 Tribal Consultation Request Letter, dated August 2, 2021. Available online at: <https://efiling.energy.ca.gov/Lists/DocketLog.aspx?docketnumber=21-SPPE-01>
- Davis 1961 – James T. Davis, *Trade Routes and Economic Exchange among the Indians of California*. Report No. 54. Berkeley: University of California Archaeological Survey, March 31, 1961.
- DayZenLLC 2021a – DayZenLLC (DayZenLLC). (TN 237380). VDC CA3BGF SPPE Application Part I, dated April 5, 2021. Available online at: <https://efiling.energy.ca.gov/Lists/DocketLog.aspx?docketnumber=21-SPPE-01>
- DayZenLLC 2021c – DayZenLLC (DayZenLLC). (TN 237382). VDC CA3BGF SPPE Application Part IV, dated April 5, 2021. Available online at: <https://efiling.energy.ca.gov/Lists/DocketLog.aspx?docketnumber=21-SPPE-01>
- DayZenLLC 2021e – DayZenLLC (DayZenLLC). (TN 237423). VDC CA3BGF SPPE Application Part II, dated April 12, 2021. Available online at: <https://efiling.energy.ca.gov/Lists/DocketLog.aspx?docketnumber=21-SPPE-01>
- Draper 1949 – W. Marvin Draper, Owens-Corning Fiberglass Plant, Santa Clara, CA, 1949. May 5. Aerial photograph. W. Marvin Draper Collection, Santa Clara City Library. Electronic Document. Available online at: <https://oac.cdlib.org/ark:/13030/kt9s2024bv/?brand=oac4>, accessed October 18, 2021
- EDR 2017a – Environmental Data Resources, EDR Historical Topo Map Report with QuadMatch™. May 17. Shelton, CT. Inquiry Number 4940607.4. Prepared for Vishay Siliconix, Santa Clara, CA. Appendix C to *Phase I Environmental Site Assessment, 2201 Laurelwood Road, Santa Clara, California*, by Cornerstone

- Earth Group. Project No. 1075-1-1. Prepared for MECP1 Santa Clara 1, LLC. November 26, 2018.
- EDR 2017b – Environmental Data Resources, The EDR Aerial Photo Decade Package. May 18. Shelton, CT. Inquiry Number 4940607.12. Prepared for Vishay Siliconix, Santa Clara, CA. Appendix C to *Phase I Environmental Site Assessment, 2201 Laurelwood Road, Santa Clara, California*, by Cornerstone Earth Group. Project No. 1075-1-1. Prepared for MECP1 Santa Clara 1, LLC. November 26, 2018
- Edward Denny & Co. 1913 – Edward Denny & Co. Map Publishers, *Denny's Pocket Map, Santa Clara County, California*.
- Fike 2016 – Aisha Fike, *651 Mathew Street*. California Department of Recreation Primary Record Form. October 25. ICF international. Prepared for the City of Santa Clara.
- Flynn 1979 – Katherine Flynn, Letter Regarding Archaeological Reconnaissance of Approximately 9 Miles of Central Expressway from De La Cruz Boulevard to San Antonio Road (WO #872824). Confidential report on file, Northwest Information Center, California Historical Resources Information System, Rohnert Park. Study S-008521. Submitted to Property Division, Transportation Agency, County of Santa Clara, San Jose, CA. Prepared by Archaeological Resource Service, Novato, CA. September 13, 1979.
- GLO 1866 – General Land Office, Survey Plat of Township No. 6 South, Range No. 1 West, Mount Diablo Meridian. May 12. San Francisco, CA. Surveyed 1851, 1853, 1857–1862, 1865–1866.
- Golla 2007 – Victor Golla, Linguistic Prehistory. Chapter 6 in *California Prehistory: Colonization, Culture, and Complexity*, edited by Terry L. Jones and Kathryn A. Klar, pp. 71–82. Lanham, MD: Altamira, 2007.
- Guldenbrein 2017 – Jillian Guldenbrein, Letter Regarding Record Search Results for the Proposed Coresite SV8 Data Center Project, 3045 Stender Way, Santa Clara, APN 216-29-084. Prepared for Circlepoint, Oakland, CA. Appendix B to *Mitigated Negative Declaration: Coresite SV8 Data Center*, prepared for Community Development Department, City of Santa Clara, CA. May 2018.
- Hammerle 2015 – Esme Hammerle, *Cultural Resources Constraints Report: Gas Main Bowers & Kifer, Santa Clara City and County*. Confidential report on file, Northwest Information Center, California Historical Resources Information System, Rohnert Park. Study S-47529. Prepared for Pacific Gas and Electric Company. Prepared by Garcia and Associates. January 29, 2015.
- Hickman 1974 – Patricia P. Hickman, *An Archeological Survey of a Portion of Saratoga Creek, Santa Clara County, California*. Confidential report on file, Northwest Information Center, California Historical Resources Information System, Rohnert Park. Study S-004391. Submitted to Creegan and D'Angelo, San Jose, CA. June 1974.

- Holson et al. 2002 – John Holson, Cordelia Sutch, and Stephanie Pau, *Cultural Resources Report for San Jose Local Loops, Level 3 Fiber Optics Project in Santa Clara and Alameda Counties, California*. Confidential report on file, Northwest Information Center, California Historical Resources Information System, Rohnert Park. Study S-025173. Prepared for Fluor Global Services, Inc., Aliso Viejo, CA. Prepared by Pacific Legacy, Albany, CA. May 2002.
- Hylkema 1994 – Mark G. Hylkema, Tamien Station Archaeological Project. In *The Ohlone Past and Present: Native Americans of the San Francisco Bay Region*, compiled and edited by Lowell J. Bean, pp. 249–270. Anthropological Papers No. 42. Menlo Park, CA: Ballena Press, 1994.
- Hylkema 1998 – Mark G. Hylkema, *Extended Phase I Archaeological Survey Report: Subsurface Presence/Absence Testing at the Woolen Mills Chinatown Site (CA-SCL-807/H) and Three Storm Water Detention Basins, for the Route 87 Guadalupe Corridor Freeway Project, City of San Jose, Santa Clara County, California*. 04-SCL-87 PM 6.3/9.4, 04-SCL-101 PM 40.2/41.2. On file, Northwest Information Center, California Historical Resources Information System, Rohnert Park. Study S-020327. Office of Environmental Planning, South, District 4, California Department of Transportation, Oakland. May 8, 1998.
- NAHC 2021a – Native American Heritage Commission (NAHC). (TN 239156). CA3 Tribal Consultation Request Letter, dated August 2, 2021. Available online at: <https://efiling.energy.ca.gov/Lists/DocketLog.aspx?docketnumber=21-SPPE-01>
- Jones & Stokes 2001 – Jones & Stokes, *Cultural Resources Investigations for XO California, Inc. Fiber Optic Installations in San Francisco and Santa Clara Counties*. Prepared for XO California, Inc., Fremont, CA. Confidential report on file, Northwest Information Center, California Historical Resources Information System, Rohnert Park. Study S-023934. Oakland, CA. June 2001.
- Jones et al. 2007 – Terry L. Jones, Nathan E. Stevens, Deborah A. Jones, Richard T. Fitzgerald, and Mark G. Hylkema, The Central Coast: A Midlatitude Milieu. Chapter 9 in *California Prehistory: Colonization, Culture, and Complexity*, edited by Terry L. Jones and Kathryn A. Klar, pp. 125–146. Lanham, MD: Altamira, 2007.
- JRP 2002 – JRP Historical Consulting. Inventory and Evaluation of Historic Resources, Caltrain Electrification Program, San Francisco to Gilroy (MP 0.0 to 77.4). S-043525. July 2002.
- Jurich and Grady 2011 – Denise Jurich and Amber Grady, *California High-Speed Train Project, Environmental Impact Report/Environmental Impact Statement, San Francisco to San Jose Section, Archaeological Survey Report, Technical Report*. Confidential report on file, Northwest Information Center, California Historical Resources Information System, Rohnert Park. Study S-048738. Prepared for California High Speed Rail Authority and Federal Railroad Administration, U.S. Department of Transportation. Prepared by PBS&J, San Francisco, CA. Draft. March 2011.

- Kroeber 1976 – A. L. Kroeber, *Handbook of the Indians of California*. Originally published in 1925, Bulletin No. 78, Bureau of American Ethnology, Smithsonian Institution, Washington, D.C. Reprinted. New York, NY: Dover Publications, 1976.
- Lehmann 2000 – Susan Lehmann, Economic Development of the City of Santa Cruz, 1850-1950. From: *Fully Developed Context Statement for the City of Santa Cruz*. Prepared for the City of Santa Cruz Planning and Development Department. Chapter 3, Context I: Economic Development of the City of Santa Cruz 1850-1950, pp. 25–27. Accessed March 9, 2020. Electronic Document: <https://history.santacruzpl.org/omeka/items/show/134510#?c=0&m=0&s=0&cv=0>
- Levy 1978 – Richard Levy, Costanoan. In *California*, edited by Robert F. Heizer, pp. 485–495. Handbook of North American Indians, vol. 8, William C. Sturtevant, ed. Washington, D.C.: Smithsonian Institution, 1978.
- Milliken et al. 2007 – Randall Milliken, Richard T. Fitzgerald, Mark G. Hylkema, Randy Groza, Tom Origer, David G. Bieling, Alan Leventhal, Randy S. Wiberg, Andrew Gottsfield, Donna Gillette, Viviana Bellifemine, Eric Strother, Robert Cartier, and David A. Fredrickson, Punctuated Culture Change in the San Francisco Bay Area. Chapter 8 in *California Prehistory: Colonization, Culture, and Complexity*, edited by Terry L. Jones and Kathryn A. Klar, pp. 99–123. Lanham, MD: Altamira, 2007.
- Mission College 2019 – Application for Small Power Plant Exemption: Mission College Data Center, dated November 2019. (TN 230848). Available online at: <https://efiling.energy.ca.gov/Lists/DocketLog.aspx?docketnumber=19-SPPE-05>.
- Murray 2021 – Samantha Murray. Historic Built Environment Assessment: CA3-2590 Walsh Avenue Project. TN 239260. August 2, 2021. Available online at: <https://efiling.energy.ca.gov/Lists/DocketLog.aspx?docketnumber=21-SPPE-01>
- Nelson et al. 2000 – Wendy J. Nelson, Maureen Carpenter, and Julia G. Costello, *Cultural Resources Survey for the Level (3) Communications Long Haul Fiber Optics Project, Segment WS05: San Jose to San Luis Obispo*. Confidential report on file, Northwest Information Center, California Historical Resources Information System, Rohnert Park. Study S-022819. Prepared for Parson Brinckerhoff Network Services, Pleasanton, CA. Prepared by Far Western Anthropological Research Group, Inc., Davis, CA. June 30, 2000.
- OHP 1995 – Office of Historic Preservation, *Instructions for Recording Historical Resources*. Sacramento, CA: Office of Historic Preservation, March 1995.
- Oosterhous et al. 2002 – Kara Oosterhous, Franklin Maggi, and Leslie A. G. Dill, *Historical and Architectural Evaluation: 4423 Cheeney Street, Santa Clara, County of Santa Clara, California*. Prepared for Lauson Fargher, Santa Clara, CA. On file, Northwest Information Center, California Historical Resources Information System, Rohnert Park. Study S-026095. Dill Design Group, Los Gatos, CA, September 17, 2002.

- Ngo and DePietro 2021 – Ti Ngo and Dana D. DePietro, *Phase I Cultural Resources Assessment, CA3-2590 Walsh Avenue City of Santa Clara, Santa Clara County, California*. Confidential report prepared for Vantage Data Centers, Sterling, VA. Prepared by First Carbon Solutions, Walnut Creek, CA. April 1, 2021, revised May 25 and August 18, 2021.
- Parsons and KEMCO 1983 – Parsons Brinckerhoff Quade & Douglas and Kabori Environmental Management Corp, *Data Recovery Plan for the Guadalupe Corridor Transportation Project, Santa Clara County, California*. Prepared for Santa Clara County Transportation Agency. Confidential report on file, Northwest Information Center, California Historical Resources Information System, Rohnert Park. Study S-006066. February 1983.
- Psota 2016 – Sunshine Psota, Letter Regarding Results of a Cultural Resources Literature Search for the San Tomas Expressway & Monroe Blvd. Park and Community Garden, Santa Clara, Santa Clara County. Prepared for David J. Powers & Associates, San José, CA. Prepared by Holman & Associates, San Francisco, CA. June 8, 2016. Appendix A in *Initial Study for the San Tomas Expressway & Monroe Street Park and Community Garden Project*, by City of Santa Clara, CA. December 2016.
- Rehor and Kubal 2014 – Jay Rehor and Kathleen Kubal, *Extended Phase I Study: US 101 Express Lands Project, Santa Clara County, California*. Prepared for District 4, Department of Transportation, State of California, Oakland, and Santa Clara Valley Transportation Authority, San Jose, CA. US PM 16.0/52.55, SR 85 PM 23.0/R24.1. Project No. 0412000459. EA 2G7100. On file, Northwest Information Center, California Historical Resources Information System, Rohnert Park. Study S-045670c. URS Corporation, Oakland, CA. April 2014.
- Ruby et al. 1992 – Allika Ruby, Jason Bass, and Mike Kelley, *Evaluation of Archaeological Resources for the San Jose/Santa Clara Nonpotable Water Reclamation Project*. Prepared for Engineering Science, Alameda, CA. Project #60800-92-62. Confidential report on file, Northwest Information Center, California Historical Resources Information System, Rohnert Park. Study S-014230. Prepared by Archaeological Resource Management, San Jose, CA. May 11, 1992.
- Santa Clara 2010 – City of Santa Clara, *City of Santa Clara General Plan 2010-2035*. Adopted on November 16, 2010. Accessed on February 28, 2020. Available at: <https://www.santaclaraca.gov/our-city/departments-a-f/community-development/planning-division/general-plan>
- Santa Clara 2018 – City of Santa Clara, City Code, Title 18 Zoning, Chapter 18.106 Historic Preservation. Accessed on: June 30, 2021. Available online at: <http://www.codepublishing.com/CA/SantaClara/#!/santaclara18/SantaClara18106.html#18.106.030>

- Santa Clara 2021 – City of Santa Clara, Map Santa Clara tool. Accessed August 20, 2021. Available online at: <https://www.santaclaraca.gov/our-city/about-santa-clara/maps>
- Santa Clara County 2012 – County of Santa Clara Department of Planning and Development, Planning Office, *County of Santa Clara Historic Context Statement*. December 2004, Revised February 2012
- SFEI 2010 – San Francisco Estuary Institute (SFEI), *Historical Vegetation and Drainage Patterns of Western Santa Clara Valley: A Technical Memorandum Describing Landscape Ecology in Lower Peninsula, West Valley, and Guadalupe Watershed Management Areas*. Historical Ecology Program, Contribution No. 622
- Shibley 1978 – William F. Shibley, Native Languages of California. In *California*, edited by Robert F. Heizer, pp. 80–90. Handbook of North American Indians, vol. 8, William C. Sturtevant, ed. Washington, D.C.: Smithsonian Institution, 1978.
- SWCA 2006 – SWCA Environmental Consultants, *Cultural Resources Final Report of Monitoring and Findings for the Qwest Network Construction Project, State of California*. Confidential report on file, Northwest Information Center, California Historical Resources Information System, Rohnert Park. Study S-033061. Prepared for Qwest Communications, Denver, CO. Prepared by SWCA Environmental Consultants, Sacramento, CA. December 2006.
- Smart Permit 2021 – City of Santa Clara Smart Permit Search. Accessed April 15, 2021. <https://www.santaclaraca.gov/our-city/departments-a-f/community-development/building-division/permits/permit-parcel-search>
- TRC 2020 – TRC. Phase 1 Environmental Site Assessment. 2590 Walsh Avenue, Santa Clara, CA 95051. Prepared for Vantage Data Centers. 21-SPPE-01. TN 237382. August 2020. <https://efiling.energy.ca.gov/Lists/DocketLog.aspx?docketnumber=21-SPPE-01>
- USGS 1897 – United States Geological Survey. California San Jose Quadrangle. USGS Historical File, Topographic Division. November 23, 1897.
- USGS 1899 – United States Geological Survey. California San Jose Quadrangle. USGS Historical File, Topographic Division. May 1, 1899.
- USGS 1915 – United States Geological Survey. Santa Clara & Santa Cruz Counties from a portion of Sheet 6a: Geologic and Topographic Map of the Coast Route from Los Angeles, California to San Francisco, California. 1915.
- Woodrow 2016 – Kenneth Woodrow, Letter Regarding California Environmental Quality Act Public Resources Code Section 21080.3, subd. (b) Request for Formal Notification of Proposed Projects within the Tribe's Geographic Area of Traditional and Cultural Affiliation. Submitted to California Energy Commission, Sacramento. Prepared by Wucksachi Indian Tribe, Salinas, CA. December 8, 2016.

## 4.6 Energy and Energy Resources

This section describes the environmental and regulatory setting and discusses impacts associated with the construction and operation of the project specific to energy and energy resources<sup>1</sup>.

<b>ENERGY</b>		<b>Potentially Significant Impact</b>	<b>Less Than Significant with Mitigation Incorporated</b>	<b>Less Than Significant Impact</b>	<b>No Impact</b>
Would the project:					
a. Result in potentially significant environmental impact due to wasteful, inefficient, or unnecessary consumption of energy resources, during project construction or operation?	<input type="checkbox"/>	<input type="checkbox"/>	<input checked="" type="checkbox"/>	<input type="checkbox"/>	<input type="checkbox"/>
b. Conflict with or obstruct a state or local plan for renewable energy or energy efficiency?	<input type="checkbox"/>	<input type="checkbox"/>	<input type="checkbox"/>	<input type="checkbox"/>	<input checked="" type="checkbox"/>

Environmental checklist established by CEQA Guidelines, Appendix G.

### 4.6.1 Environmental Setting

The project would consist of a four-story building, utility substation, generator equipment yard, surface parking and landscaping, recycled water pipeline and a total of 44 diesel-fired emergency backup generators (gensets). Forty 2.75-megawatt (MW) gensets (of which eight gensets would be redundant) would be used to provide backup power to support an uninterruptible power supply exclusively for the project (DayZenLLC 2021a, Section 2.1). The remaining four gensets of the same capacity (two of which are redundant) would support house functions primarily for critical cooling equipment, other general building (administration), and life safety services. The gensets, delivering a reliability factor of 99.999 percent, would serve the data center only during emergency outages when electric service provided by Silicon Valley Power (SVP), via Pacific Gas & Electric Company (PG&E) transmission lines, is interrupted. The backup generators would be electrically isolated from the PG&E electrical transmission grid with no means to deliver electricity offsite.

The 44 gensets would each be a Caterpillar Model 3516E (Tier 4 compliant) with a peak rated output capacity of 2.75 MW and a continuous, steady-state output capacity of 2.2 MW, and fuel consumption rate of 191.8 gallons per hour (gal/hr) at full load (DayZenLLC 2021e, Section 4.6.3.1). Staff has verified the output capacity and rate of fuel consumption of these gensets from their product sheets (Caterpillar 2021). The maximum electrical load requirement of the data center would be 96 MW, which includes the electrical power load of the Information Technology (IT) servers, the cooling load of the

<sup>1</sup> This section includes staff's analysis of the project's potential impact on Energy Resources, as required by Public Resources Code section 25541 when considering a Small Power Plant Exemption

data center buildings, as well as the facility's ancillary loads. See **Section 3.0 Project Description** for further information. For the purposes of testing and maintenance, only one genset would run at any given time.

## Regulatory Background

### *Federal*

**Energy Star and Fuel Efficiency.** At the federal level, energy standards set by the United States Environmental Protection Agency (EPA) apply to numerous consumer products and appliances. The EPA also sets fuel efficiency standards for automobiles and other modes of transportation.

### *State*

**California 2019 Energy Efficiency Standards for Residential and Nonresidential Buildings—Green Building Standards Code, California Code of Regulations, Title 24.** The California Green Building Standards Code (California Code of Regulations, Title 24, Part 11) applies to the planning, design, operation, construction, use, and occupancy of newly constructed buildings and requires the installation of energy- and water-efficient indoor infrastructure.

**Senate Bill 100—The 100 Percent Clean Energy Act of 2018.** Senate Bill (SB) 100 (Chapter 312, Statutes of 2018) requires that retail sellers and local publicly owned electric utilities procure a minimum quantity of electricity products from eligible renewable energy resources so that the total kilowatt-hours of those products sold to their retail end-use customers achieve 44 percent of retail sales by December 31, 2024, 52 percent by December 31, 2027, and 60 percent by December 31, 2030. This requirement applies to Silicon Valley Power (SVP) program, which would be the primary source of energy supply for the project. The bill also requires the Public Utilities Commission, California Energy Commission, and State Air Resources Board to utilize programs authorized under existing statutes to meet the state policy goal of 100 percent of total retail sales of electricity in California provided by eligible renewable energy resources and zero-carbon resources by December 31, 2045.

### *Local*

**City of Santa Clara Climate Action Plan.** The city's Climate Action Plan (CAP) was adopted on December 3, 2013, and it specifies strategies and measures to be taken for several focus areas, one of which is energy efficiency. To achieve the goals set in the CAP, the city adopted some policies in the City of Santa Clara 2010-2035 General Plan (General Plan) as discussed below.

**City of Santa Clara General Plan 2010-2035.** The General Plan was adopted by the Santa Clara City Council in November 2010. Applicable General Plan Policies and Actions regarding energy are detailed in Chapter 5.10.3 – Energy Goals and Policies and are summarized below:



- Policy 5.10.3-P1: Promote the use of renewable energy resources, conservation and recycling programs.
- Policy 5.10.3-P4: Encourage new development to incorporate sustainable building design, site planning and construction, including encouraging solar opportunities.
- Policy 5.10.3-P5: Reduce energy consumption through sustainable construction practices, materials and recycling.
- Policy 5.10.3-P6: Promote sustainable buildings and land planning for all new development, including programs that reduce energy and water consumption in new development.
- Policy 5.10.3-P8: Provide incentives for LEED certified, or equivalent development.

The project would be required to comply with the applicable provisions in the city's General Plan and zoning ordinance, as verified by the city's design review process.

## 4.6.2 Environmental Impacts

### a. Result in potentially significant environmental impact due to wasteful, inefficient, or unnecessary consumption of energy resources, during project construction or operation?

#### *Construction*

*Less Than Significant Impact.* Construction activities would consume nonrenewable energy resources, primarily fossil fuels (oil, gasoline, and diesel), for construction equipment and vehicles. It is anticipated that these nonrenewable energy resources would be used efficiently during construction activities and would not result in the long-term significant depletion of these energy resources or permanently increase the project's reliance on them.

Under AQ-1, the project would implement measures to minimize the idling of construction equipment and would require all such equipment to be maintained and properly tuned (see **Section 4.3 Air Quality**). This would ensure that fuel consumed during construction would not be wasted through unnecessary idling or the operation of poorly maintained equipment, and not add to unnecessary air emissions. Additionally, the project would participate in the city's Construction & Demolition Debris Recycling Program by recycling or diverting at least 65 percent of materials generated for discards by the project to reduce the amount of demolition and construction waste going to the landfill (DayZenLLC 2021e, Section 4.6.3.1). Diversion saves energy by reusing and recycling materials for other uses (instead of landfilling materials and using additional non-renewable resources).

Therefore, the construction phase of the project would create a less-than-significant impact on local and regional energy supplies and a less-than-significant environmental impact due to wasteful, inefficient, or unnecessary consumption of energy resources.

## *Operation*

*Less Than Significant Impact.* The total number of hours of operation for reliability purposes (i.e., readiness testing and maintenance) for the gensets would be limited by the data center to no more than 50 hours per genset annually (DayZenLLC 2021e, Section 4.6.3). At this rate, the total quantities of diesel fuel used for all the gensets operating at full load would be approximately 10,047 barrels per year (bbl/yr)<sup>2</sup>. California has a diesel fuel supply of approximately 316,441,000 bbl/yr.<sup>3</sup> The project's use of fuel constitutes a small fraction (less than 0.003 percent) of available resources, and the supply is more than sufficient to meet necessary demand. For these reasons, the project's use of fuel is less than significant.

It is important to note that maintenance and readiness testing of the gensets are crucial to the project's viability. The most important data center criterion is reliability. Crucial public services, such as the 911, Offices of Emergency Management, and utilities infrastructure, are increasingly using data centers for their operation. The reliability and data security requirements of a data center would be compromised by limiting or reducing fuel consumption for maintenance and readiness testing. This includes both the primary and redundant gensets. Even though the redundant gensets are purposed to provide backup service to the primary gensets, their operational reliability is equally important, and they are designed to start up at the same time as the primary gensets during emergency operations, with each genset running at 80 percent capacity (DayZenLLC 2021a, Section 2.2.4.1). If any of the primary gensets fails to operate, a redundant one must be immediately ready to run to take up the lost load. So, it is crucial that the redundant gensets be regularly tested and maintained according to the same testing and maintenance requirements as the primary ones and as prescribed by the manufacturer's warranty conditions. The use of diesel fuel for the gensets for readiness testing and maintenance would not be wasteful, inefficient, or unnecessary.

The gensets would use diesel and lubricating oils. However, the use of the standby gensets for emergency purposes would be limited to times when there is an interruption of SVP's delivery of electric service or other rare emergency that would require the facility to switch to genset use. Under emergency conditions, defined as the loss of electrical power to the data center, which are infrequent and short-duration events, the gensets could operate and use diesel fuel, as necessary, to maintain data center operations. Data centers, such as CA3DC, could voluntarily participate in CPUC's Emergency Load Reduction Program, in which case, they would disconnect from the grid and use their on-site generators to supply their own electricity in the event of an energy shortage emergency. However, based on the recent years (between 2001 and 2020), energy

---

2 Calculated as: (191.8 gal/hr x 50 hours per year x 44 generators) = 421,960 gallons per year = 10,047 bbl/yr.

3 This is the sum of the annual production of 114,267,000 bbl and available stocks of 202,174,000 bbl obtained from the Energy Commission's Weekly Fuels Watch Report for 2020 (latest annual report available).

shortages are rare events. Such events have not impacted SVP customers directly and staff expects their effects to decrease over time; see **Appendix B** for more discussion.

The Caterpillar generator models selected for this project have an efficiency rating comparable to other Tier 4 commercially available diesel-fueled generators of similar generating capacity.

Power Usage Effectiveness (PUE) is a metric used to compare the energy efficiency of facilities that house computer servers. It is a common metric for determining how effectively a data center's infrastructure systems can deliver power to the computer systems it houses. PUE was published in 2016 as a global standard under the International Organization for Standardization, the International Electrotechnical Commission, as well as the European Standards (ISO 20160, European Standards 2016). It is defined as the ratio of total facility energy draw (including the facility's mechanical and electrical loads) to IT server electrical power draw ( $PUE = \text{total facility source energy [including the IT source energy]} / \text{IT source energy}$ ). This approach to calculating a data center's energy efficiency is similar to the American Society of Heating, Refrigerating, and Air-conditioning Engineers (ASHRAE) Energy Standard for Data Centers (ASHRAE 90.4). However, there is a notable difference: ASHRAE 90.4, which intends to tackle and regulate poorer performers, calculates energy efficiency by providing an alternative path that allows tradeoffs between mechanical and electrical loads particularly within existing, older data centers while the PUE is a more appropriate path to determining a new data center's energy efficiency.

A PUE of 2 means that the data center must draw two watts of electricity for each watt of power consumed by the IT server equipment. While the PUE is always greater than 1, the closer it is to 1 the greater the portion of the power drawn by the facility that goes to the IT server equipment.

The PUE has been used as a guideline for assessing and comparing energy and power efficiencies associated with data centers since 2007 (ASHRAE 2016). It must be noted that the PUE metric was designed to compare facilities of similar size and within similar climatic conditions. PUE factors started around 2.0, but values have since been migrating down to 1.25 or lower, demonstrating a significant improvement in efficient energy usage over the years. A facility with a PUE of 1.5-2.0 is considered "efficient" while one with a PUE of 1.2-1.5 is considered "very efficient." The peak PUE for the project would be 1.45, and its annual average PUE would be 1.26 (DayZenLLC 2021a, Section 2.2.3.2). The project's peak operation PUE estimate is based on design assumptions and represents worst case; that is, the hottest day with all server bays occupied and all servers operating at 100 percent capacity.

Additionally, rack power rating is an indicator of the server rack's power density. The lower the value the higher the power density and the more information it processes per unit of electricity consumed, resulting in a more efficient use of energy.

Measure 2.3 of the city's CAP encourages the completion of a feasibility study of energy efficient practices for new data center projects with an average rack power rating<sup>4</sup> of 15 kilowatts or more to achieve a PUE of 1.2 or lower. The project would have an average rack power rating of 8.3 kW, which is below the city's CAP suggestion that a feasibility study be performed (DayZenLLC 2021a, Section 2.3.1). The project's low rack power rating shows that it would use energy efficiently.

The project would be constructed in accordance with the 2019 California Green Building Standards Code and would include green building measures to reduce energy consumption (SV1 2020a, Table 2.3-1). Examples of these measures include:

- Utilizing lighting control to reduce energy usage; and
- Air economization<sup>5</sup> integrated into the central air handling system for building cooling.

The project's consumption of energy resources during operation would not be wasteful, inefficient, or unnecessary. Project operation would have a less-than-significant adverse effect on local or regional energy supplies and energy resources.

## **b. Conflict with or obstruct a state or local plan for renewable energy or energy efficiency?**

### *Construction and Operation*

*No Impact.* During operation, the project would use energy resources in SVP's portfolio of resources. SVP's 2018 Integrated Resource Plan identifies that it expects to exceed 50 percent eligible renewable resources by 2030 (SVP 2018). SVP's 2019 non-residential power mix was composed of approximately 39 percent eligible renewable, 28 percent large hydroelectric, 23 percent nonrenewable, and 10 percent unspecified sources of power (SVP 2021). In addition, SVP offers large customers, such as CA3, renewable energy as part of their Large Customer Renewable Energy (LCRE) program. The program offers customers 100 percent carbon-free renewable electricity.

Under **GHG-3**, the applicant would be required to participate in SVP's LCRE program for 100 percent carbon-free electricity or purchase carbon removal offsets that accomplish the same goals of 100 percent carbon-free electricity (see **Section 4.8 Greenhouse Gas Emissions**).

---

4 Average rack power rating is a measure of the power available for use on a rack used to store computer servers. The higher the value of kilowatts, the more energy use per square foot of building area in a data center.

5 An air economizer is a ducting arrangement, including dampers, linkages, and an automatic control system that allows a cooling supply fan system to supply outside air to reduce or eliminate the need for mechanical cooling.

The project would receive electricity from SVP sources either through the LCRE program or through a standard electricity product supplemented by the project's purchase of carbon removal offsets. SVP is currently in compliance with SB 100 and can accommodate the electricity demand from this project while continuing compliance with the SB 100 requirements (CEC 2021).

As electricity demand from SVP increase, SVP would continue to procure additional capacity by adding new (or new to SVP) resource facilities and contracts to supplement the existing facilities, and to accommodate electricity demand growth. Under LCRE, the additional need above renewable resources would be met with 100 percent renewables.

Therefore, the project will not obstruct SVP's compliance with a state plan for renewable energy.

Given the project's gensets would operate only during routine testing and maintenance, which is limited to 50 hours per genset annually, and in the case of emergencies, and that the generated electricity would only serve the project and not the wider electric grid, the project's use of diesel fuel would not obstruct or inhibit the state from achieving these energy-related goals. Additionally, it is likely that renewable fuels could be broadly available in the future for these generator models (i.e., renewable diesel) should requirements or incentives be put in place for these types of facilities to transition to more renewable sources of fuel. See **Section 5 Alternatives** for more discussion.

The project would participate in the city's Construction & Demolition Debris Recycling Program and implement measures to promote walking, bicycling, and transit use, thereby reducing motor vehicle use. Through the city's design review process, the project would be required to comply with the California Green Building Standards Code and the city's General Plan land use policies related to energy, which are consistent with the EPA's Energy Star and Fuel Efficiency program.

Through energy efficient design and increased renewable electricity use from its primary electricity source of SVP, the project would neither conflict with nor obstruct state or local plans for renewable energy or energy efficiency, and, therefore, would have no impact on them.

### **4.6.3 Mitigation Measures**

None.

### **4.6.4 References**

ASHRAE 2016 – American Society of Heating, Refrigerating, and Air-conditioning Engineers ASHRAE Journal (ASHRAE). Article: Supercomputers, Super Efficiency, pp. 38-39. Published in January 2016. Available online at: <https://technologyportal.ashrae.org/journal/articledetail/1670>

- CEC 2021 – California Energy Commission (CEC). (TN 230953). Review of Silicon Valley Power’s 2018 Integrated Resource Plan, dated December 2, 2019. Available online at:  
<https://efiling.energy.ca.gov/GetDocument.aspx?tn=230953&DocumentContentId=62579>
- DayZenLLC 2021a – DayZenLLC (DayZenLLC). (TN 237380). VDC CA3BGF SPPE Application Part I, dated April 5, 2021. Available online at:  
<https://efiling.energy.ca.gov/Lists/DocketLog.aspx?docketnumber=21-SPPE-01>
- DayZenLLC 2021e – DayZenLLC (DayZenLLC). (TN 237423). VDC CA3BGF SPPE Application Part II, dated April 12, 2021. Available online at:  
<https://efiling.energy.ca.gov/Lists/DocketLog.aspx?docketnumber=21-SPPE-01>
- Caterpillar 2021 – Caterpillar. Available online at:  
<https://s7d2.scene7.com/is/content/Caterpillar/CM20170920-28394-33789>
- European Standards 2016 – European Standards. CSN EN 50600-4-2 Information technology – Data centre facilities and infrastructures – Part 4-1: Power Usage Effectiveness. Released 2016. Available online at: <https://www.en-standard.eu/csn-en-50600-4-2-information-technology-data-centre-facilities-and-infrastructures-part-4-2-power-usage-effectiveness/>
- ISO 2016 – ISO. ISO/IEC 30134-2:2016, Information technology – Data centres – key performance indicators – Part 2: Power usage effectiveness (PUE). Published April 2016. Available online at: <https://www.iso.org/standard/63451.html>
- SVP 2018 – Silicon Valley Power (SVP). 2018 Integrated Resource Plan for Silicon Valley Power. November 12, 2018. Available online at:  
<https://www.siliconvalleypower.com/home/showdocument?id=62481>
- SVP 2021 – Silicon Valley Power (SVP). 2019 Power Content Label. Available online at:  
<https://www.siliconvalleypower.com/svp-and-community/about-svp/power-content-label>

## 4.7 Geology and Soils

This section describes the environmental and regulatory setting and discusses impacts associated with the demolition, construction, and operation of the project with respect to geology and soils.

<b>GEOLOGY AND SOILS</b>	<b>Potentially Significant Impact</b>	<b>Less Than Significant with Mitigation Incorporated</b>	<b>Less Than Significant Impact</b>	<b>No Impact</b>
Would the project:				
a. Directly or indirectly cause potential substantial adverse effects, including the risk of loss, injury, or death involving:				
i. Rupture of a known earthquake fault, as delineated on the most recent Alquist-Priolo Earthquake Fault Zoning Map issued by the State Geologist for the area or based on other substantial evidence of a known fault? Refer to Division of Mines and Geology Special Publication 42.	<input type="checkbox"/>	<input type="checkbox"/>	<input checked="" type="checkbox"/>	<input type="checkbox"/>
ii. Strong seismic ground shaking?	<input type="checkbox"/>	<input checked="" type="checkbox"/>	<input type="checkbox"/>	<input type="checkbox"/>
iii. Seismic-related ground failure, including liquefaction?	<input type="checkbox"/>	<input checked="" type="checkbox"/>	<input type="checkbox"/>	<input type="checkbox"/>
iv. Landslides?	<input type="checkbox"/>	<input type="checkbox"/>	<input checked="" type="checkbox"/>	<input type="checkbox"/>
b. Result in substantial soil erosion or the loss of topsoil?	<input type="checkbox"/>	<input type="checkbox"/>	<input checked="" type="checkbox"/>	<input type="checkbox"/>
c. Be located on geologic units or soil that is unstable, or that would become unstable as a result of the project, and potentially result in on- or off-site landslide, lateral spreading, subsidence, liquefaction, or collapse?	<input type="checkbox"/>	<input checked="" type="checkbox"/>	<input type="checkbox"/>	<input type="checkbox"/>
d. Be located on expansive soil, as defined in Section 1803.5.3 of the California Building Code (2010), creating substantial direct or indirect risks to life or property?*	<input type="checkbox"/>	<input type="checkbox"/>	<input checked="" type="checkbox"/>	<input type="checkbox"/>
e. Have soils incapable of adequately supporting the use of septic tanks or alternative wastewater disposal systems where sewers are not available for the disposal of wastewater?	<input type="checkbox"/>	<input type="checkbox"/>	<input type="checkbox"/>	<input checked="" type="checkbox"/>
f. Directly or indirectly destroy a unique paleontological resource or site or unique geologic feature?	<input type="checkbox"/>	<input type="checkbox"/>	<input checked="" type="checkbox"/>	<input type="checkbox"/>

\*Geology and Soils question (d) reflects the 2013 California Building Code (CBC), effective January 1, 2014, which is based on the International Building Code (2009).

Environmental checklist established by CEQA Guidelines, Appendix G.

## 4.7.1 Setting

Analysis of existing data included reviews of publicly available literature, maps, air photos, and documents presented with the application. The geologic map review of the project area included maps published by the U.S. Geological Survey (Helley and Wesling 1989; Wesling and Helley 1989, and Helley et al. 1994).). The literature reviewed included published and unpublished scientific papers. A paleontological record search of the University of California Museum of Paleontology, Berkeley online paleontological database was conducted for the disturbed project areas, including a 10-mile buffer zone surrounding the proposed data center (UCMP 2021).

### Paleontological Sensitivity

Paleontological resources are the fossilized remains of organisms from prehistoric environments found in geologic strata. They range from mammoth and dinosaur bones to impressions of ancient animals and plants, trace remains, and microfossils. These are valued for the information they yield about the history of the earth and its past ecological settings. The California Public Resources Code (Section 5097.5) specifies that unauthorized removal of a paleontological resource is a misdemeanor.

The potential for paleontological resources to occur in the project area was evaluated using the federal Potential Fossil Yield Classification (PFYC) system developed by the Bureau of Land Management (BLM 2016). Because of its demonstrated usefulness as a resource management tool, the PFYC has been utilized for many years for projects across the country, regardless of land ownership. It is a predictive resource management tool that classifies geologic units on their likelihood to contain paleontological resources on a scale of 1 (very low potential) to 5 (very high potential) or Unknown. This system is intended to aid in predicting, assessing, and mitigating impacts to paleontological resources. The PFYC ranking system is summarized in **Table 4.7-1**.

<b>TABLE 4.7-1: POTENTIAL FOSSIL YIELD CLASSIFICATION</b>	
<b>BLM PFYC Designation</b>	<b>Assignment Criteria Guidelines and Management Summary</b>
1 Very Low Potential	Geologic units are not likely to contain recognizable paleontological resources.
	Units are igneous or metamorphic, excluding air-fall and reworked volcanic ash units.
	Units are Precambrian in age.
	Management concern is usually negligible, and impact mitigation is unnecessary except in rare or isolated circumstances.
2 Low	Geologic units are not likely to contain paleontological resources.
	Field surveys have verified that significant paleontological resources are not present or are very rare.
	Units are generally younger than 10,000 years before present.
	Recent aeolian deposits.
	Sediments exhibit significant physical and chemical changes (i.e., diagenetic alteration) that make fossil preservation unlikely
Management concern is generally low, and impact mitigation is usually unnecessary except in occasional or isolated circumstances.	



3 Moderate Potential	Sedimentary geologic units where fossil content varies in significance, abundance, and predictable occurrence.
	Marine in origin with sporadic known occurrences of paleontological resources.
	Paleontological resources may occur intermittently, but these occurrences are widely scattered.
	The potential for authorized land use to impact a significant paleontological resource is known to be low-to-moderate.
	Management concerns are moderate. Management options could include record searches, pre-disturbance surveys, monitoring, mitigation, or avoidance. Opportunities may exist for hobby collecting. Surface-disturbing activities may require sufficient assessment to determine whether significant paleontological resources occur in a proposed action and whether the action could affect the paleontological resources.
4 High Potential	Geologic units that are known to contain a high occurrence of paleontological resources.
	Significant paleontological resources have been documented but may vary in occurrence and predictability.
	Surface-disturbing activities may adversely affect paleontological resources.
	Rare or uncommon fossils, including invertebrate (such as soft body preservation) or unusual plant fossils, may be present.
	Illegal collecting activities may impact some areas.
	Management concern is moderate to high depending on the proposed action. A field survey by a qualified paleontologist is often needed to assess local conditions. On-site monitoring or spot-checking may be necessary during land disturbing activities. Avoidance of known paleontological resources may be necessary.
5 Very High Potential	Highly fossiliferous geologic units that consistently and predictably produce significant paleontological resources.
	Significant paleontological resources have been documented and occur consistently.
	Paleontological resources are highly susceptible to adverse impacts from surface disturbing activities.
	Unit is frequently the focus of illegal collecting activities.
	Management concern is high to very high. A field survey by a qualified paleontologist is almost always needed and on-site monitoring may be necessary during land use activities. Avoidance or resource preservation through controlled access, designation of areas of avoidance, or special management designations should be considered.
U Unknown	Geologic units that cannot receive an informed PFYC assignment.
	Geological units may exhibit features or preservation conditions that suggest significant paleontological resources could be present, but little information about the actual paleontological resources of the unit or area is known.
	Geologic units represented on a map are based on lithologic character or basis of origin but have not been studied in detail.
	Scientific literature does not exist or does not reveal the nature of paleontological resources.
	Reports of paleontological resources are anecdotal or have not been verified.
	Area or geologic unit is poorly or under-studied.
	BLM staff has not yet been able to assess the nature of the geologic unit.

---

Until a provisional assignment is made, geologic units with unknown potential have medium to high management concerns. Field surveys are normally necessary, especially prior to authorizing a ground-disturbing activity.
--

---

Source: Summarized and modified from BLM 2016

## Regional Geologic Setting

The proposed project site is situated in the Southern Coastal Ranges geomorphic province. The division between the Northern and Southern Coastal Ranges is one of convenience. Both provinces contain many elongate ridges and narrow valleys that are approximately parallel to the coast, although the coast trends slightly northward more than the ridges and valleys, except at San Francisco Bay where a pronounced gap separates the two provinces (Norris and Webb 1990). The differences between the two provinces occur because the northern ranges lie east of the San Andreas Fault zone, whereas the southern ranges predominantly lie to the west (Norris and Webb 1990). The two Ranges have dissimilar basement rocks. The Northern Range and portions of the Southern Range east of the San Andreas Fault zone are underlain by strongly deformed Franciscan subduction complex rocks, and the areas west of the San Andreas Fault zone, in both the Northern and Southern Range, are underlain by a strongly deformed granitic-metamorphic complex known as the Salinian block. The basement rock beneath the project site, which lies east of the San Andreas Fault zone consists of Franciscan Complex rocks (Norris and Webb 1990).

## Local Geology

The Santa Clara Valley, a relatively flat basin, contains alluvial deposits derived from the Diablo Range and the Santa Cruz Mountains. Alluvial deposits are interbedded with bay and lacustrine (lake) deposits in the San Jose area. The valley sediments were deposited as a series of coalescing alluvial fans by streams that drain the adjacent mountains. These alluvial sediments make up the groundwater aquifers of the area (Norris and Webb 1990).

The project site is underlain by Holocene age (less than 11,000 years old) levee deposits and basin deposits (Wentworth et al. 1999). Levee deposits are generally described as loose, moderate- to well-sorted sandy or clayey silt grading to sandy or silty clay. Basin deposits are generally described as dark-colored clay with very fine silty clay, rich in organic material, and deposited beyond the levees and flood plains in the flood basins where stilling flood waters drop their finest sediment (DayZenLLC 2021a). These sediments have low potential to yield fossil resources or to contain significant nonrenewable paleontological resources (DayZenLLC 2021a). However, these Holocene age sediments overlie older, Pleistocene age sediments that have a high potential to contain paleontological resources. The Pleistocene age sediments, often found at depths of ten feet or more below the ground surface in the region, have yielded the fossil remains of plants and extinct terrestrial Pleistocene vertebrates. The City of Santa Clara General Plan, on page 328, suggests that ground disturbing activities of ten feet or more have the potential to impact undiscovered paleontological resources in older Pleistocene

sediments (Santa Clara 2010). These geologic materials may be susceptible to some degree of compressibility when subject to new building loads.

### **Groundwater**

Based on cone penetration testing performed during the soil borings completed for the Limited Preliminary Geotechnical Investigation (DayZenLLC 2021b), depth to groundwater in the area can range from approximately 4 to 10 feet below ground surface (bgs). Fluctuations in groundwater levels are common due to seasonal weather patterns, underground drainage patterns, regional fluctuations, and other factors (DayZenLLC 2021a).

### **Seismicity and Seismic Hazards**

The San Francisco Bay Area is one of the most seismically active areas in the United States. The significant earthquakes that occur in the Bay Area are generally associated with crustal movement along well-defined active fault zones of the San Andreas Fault system, which regionally trend in a northwesterly direction (CGS 2010). Higher levels of shaking and damage would be expected for earthquakes occurring at closer distances to the project site. There are no known active or potentially active faults crossing the project site. The three major faults in the region are the Calaveras Fault (approximately 9.4 miles east of the site), the San Andreas Fault (approximately 11.3 miles west of the site), and the Hayward Fault (approximately 6.1 miles east of the site) (DayZenLLC 2021a). The site is not located within an Earthquake Fault Zone as defined by the State of California Alquist-Priolo Earthquake Fault Zoning Act. However, because of the proximity of the site to major active faults, ground shaking, ground failure, or liquefaction due to an earthquake could cause damage to the structures.

Structural design of facilities in California are required to incorporate design features to ensure public safety if a seismic event generates sufficient ground motion to impact the structural integrity of the facility in accordance with California Building Code (CBC 2019). Loose unsaturated sandy soils can settle during strong seismic shaking. However, the soils encountered below the design groundwater level at the site are predominantly clays, separated by a gravel layer (DayZenLLC 2021a). There is a very low potential for liquefaction-induced settlement at the site (DayZenLLC 2021b). Thus, the potential for significant differential seismic settlement affecting the proposed project is relatively low.

### **Soils**

The project site is underlain by alluvium soil. This alluvium consists of moderately consolidated, deeply weathered, poorly sorted, irregularly interbedded clay, silt, sand, and gravel. The topsoil contains agricultural organics primarily consisting of roots and hay. The subsurface soil conditions consist of fill overlying an upper layer of lean clay, a granular layer, and a lower layer of lean clay. Fill encountered at the project site consists of agricultural topsoil composed of lean clay, approximately 2.5 feet thick. The lean clay is generally brown and contains varying amounts of gravel. Organics are also present within the fill, consisting primarily of roots and hay. The upper layer of lean clay is brown

in color, generally medium stiff to very stiff, with varying amounts of sand and gravel present. The thickness of this layer varies across the site, ranging from five to 20 feet thick (DayZenLLC 2021a).

Construction of the Project would occur in phases. Roughly 210,000 cubic yards of fill would be imported to the site to raise the base elevation by approximately four feet (1.5 feet above the base flood elevation). Excavation for utilities would extend to depths of up to 15 feet below the new base elevation (about 11 feet below existing grade) (DayZenLLC 2021a). However, this trenching would most likely occur within the Quaternary age upper clay layer (DayZenLLC 2021a).

Expansive soil can undergo volume changes with changes in moisture content. Specifically, when wetted during the rainy season expansive soil tends to swell, and when dried during the summer months the material shrinks. These volume changes can cause heaving and cracking of slabs-on-grade, pavements, and structures founded on shallow foundations. However, expansive soil can be mitigated through removal or mixing with non-expansive soil. The upper clay layer at the project site may have moderate expansion potential and therefore could experience some degree of volume change when subjected to changes in moisture content. An existing mound of stockpiled fill in the northeast corner of the site appears to have a similar or greater expansion potential than that of the upper clay layer (DayZenLLC 2021a).

### **Liquefaction**

During strong ground shaking, loose, saturated, cohesionless soils can experience a temporary loss of shear strength and act as a fluid. This phenomenon is known as liquefaction. Liquefaction depends on the depth to water, grain size distribution, relative soil density, degree of saturation, and intensity and duration of the earthquake. Soils most susceptible to liquefaction are loose, uniformly graded, saturated, fine-grained sands that lie close to the ground surface (Youd et al. 2001). According to the State of California Official Seismic Hazard Zones Map for the San Jose West Quadrangle (California Geological Survey, 2002), the site is in an area considered potentially susceptible to earthquake-induced liquefaction. Plate 1.2 of the State Seismic Hazard Zone Report 058 (California Geological Survey, 2002) estimates the depth to groundwater in the site vicinity to be less than 10 feet below existing site grades. In addition, according to the Association of Bay Area Governments (ABAG) Earthquake Liquefaction Susceptibility Map (Knudsen et al., 2000), the site is in an area considered to have a moderate susceptibility to earthquake-induced liquefaction.

### **Lateral Spreading**

Lateral spreading typically occurs as a form of horizontal displacement of relatively flat-lying alluvial material toward an open or "free" face such as an open body of water, channel, or excavation. In soils, this movement is generally due to failure along a weak plane and may often be associated with liquefaction. As cracks develop within the weakened material, blocks of soil displace laterally towards the open face. Cracking and lateral movement may gradually propagate away from the face as blocks continue to

break free. Lateral spreading is generally the most pervasive and damaging type of liquefaction-induced ground failure induced by earthquakes. However, failure in this mode is analytically unpredictable because it is difficult to evaluate where the first tension crack would occur. The project site is relatively flat and there is no open face slope. There are no stream channels on or adjacent to the site, therefore the project site would not be subject to lateral spreading. (DayZenLLC 2021a).

## **Regulatory Background**

### *Federal*

There are no federal regulations related to geology and soils and paleontological resources that apply to this project. However, the Bureau of Land Management (BLM 2016) has developed a Potential Fossil Yield Classification (PFYC) system. Because of its demonstrated usefulness as a resource management tool, the PFYC has been utilized for many years for projects across the country, regardless of land ownership. It is a predictive resource management tool that classifies geologic units on their likelihood to contain paleontological resources

### *State*

**Alquist-Priolo Earthquake Fault Zoning Act.** The Alquist-Priolo Earthquake Fault Zoning Act was passed following the 1971 San Fernando earthquake. The act regulates development in California near known active faults due to hazards associated with surface fault ruptures. Alquist-Priolo maps are distributed to affected cities, counties, and state agencies for their use in planning and controlling new construction. Areas within an Alquist-Priolo Earthquake Fault Zone require special studies to evaluate the potential for surface rupture to ensure that no structures intended for human occupancy are constructed across an active fault.

**Seismic Hazards Mapping Act.** The Seismic Hazards Mapping Act (SHMA) was passed in 1990 following the 1989 Loma Prieta earthquake. The SHMA directs the California Geological Survey (CGS) to identify and map areas prone to liquefaction, earthquake-induced landslides, and amplified ground shaking. CGS has completed seismic hazard mapping for the portions of California most susceptible to liquefaction, landslides, and ground shaking, including the central San Francisco Bay Area. The SHMA requires that agencies only approve projects in seismic hazard zones following site-specific geotechnical investigations to determine if the seismic hazard is present and identify measures to reduce earthquake-related hazards.

**California Building Standards Code.** The California Building Standards Code (CBC) prescribes standards for constructing safer buildings. The CBC contains provisions for earthquake safety based on factors including occupancy type, soil and rock profile, ground strength, and distance to seismic sources. The CBC requires that a site-specific geotechnical investigation report be prepared for most development projects to evaluate seismic and geologic conditions, such as surface fault ruptures, ground shaking,

liquefaction, differential settlement, lateral spreading, expansive soils, and slope stability. The CBC is updated every three years; the current version is the 2019 CBC.

**California Division of Occupational Safety and Health Regulations.** Excavation, shoring, and trenching activities during construction are subject to occupational safety standards for stabilization by the California Division of Occupational Safety and Health (Cal/OSHA) under Title 8 of the California Code of Regulations and Excavation Rules. These regulations minimize the potential for instability and collapse that could injure construction workers on the site.

**Public Resources Coded Section 5097.5.** Paleontological resources are the fossilized remains of organisms from prehistoric environments found in geologic strata. They range from mammoth and dinosaur bones to impressions of ancient animals and plants, trace remains, and microfossils. These are valued for the information they yield about the history of the earth and its past ecological settings. The California Public Resources Code (Section 5097.5) specifies that unauthorized removal of a paleontological resource is a misdemeanor. Under the California Environmental Quality Act (CEQA) Guidelines, a project would have a significant impact on paleontological resources if it would disturb or destroy a unique paleontological resource or site or unique geologic feature.

CEQA encourages the protection of all aspects of the environment by requiring state and local agencies to prepare multidisciplinary analyses of the environmental impacts of a project and to make decisions based on the findings of those analyses. CEQA includes, in its definition of historical resources, any object or site that “has yielded, or may be likely to yield, information important in prehistory” (California Code Regulations, title 14, § 15064.5(a)(3)(D)), which is typically interpreted by professional scientists as including fossil materials and other paleontological resources. More specifically, destruction of a “unique paleontological resource or site or unique geologic feature” may be a significant impact under CEQA (CEQA Guidelines Appendix G.VII. (f)).

### *Local*

#### **Santa Clara General Plan**

Staff reviewed the City of Santa Clara General Plan (Santa Clara 2010) for provisions relevant to geology and soils applicable to the project. Section 5.6.3 of the general plan identifies protection of paleontological resources as a goal of the city and policies 5.6.3-P1 through P6 outline how the protection of paleontological resources would be achieved. Section 5.10.5 identifies policies related to geotechnical engineering.

- 5.6.3-G1 Protection and preservation of cultural resources, as well as archaeological and paleontological sites.
- 5.6.3-G2 Appropriate mitigation if human remains, archaeological resources or paleontological resources are discovered during construction activities.
- 5.6.3-P1 Require that new development avoid or reduce potential impacts to archaeological, paleontological, and cultural resources.

- 5.6.3-P2 Encourage salvage and preservation of scientifically valuable paleontological or archaeological materials.
- 5.6.3-P3 Consult with California Native American tribes prior to considering amendments to the City's General Plan.
- 5.6.3-P4 Require that a qualified paleontologist/archaeologist monitor all grading and/or excavation if there is a potential to affect archeological or paleontological resources, including sites within 500 feet of natural water courses and in the Old Quad neighborhood.
- 5.6.3-P5 In the event that archaeological/paleontological resources are discovered, require that work be suspended until the significance of the find and recommended actions are determined by a qualified archaeologist/paleontologist.
- 5.6.3-P6 In the event that human remains are discovered, work with the appropriate Native American representative and follow the procedures set forth in State law.
- 5.10.5-P5: Regulate development, including remodeling or structural rehabilitation, to ensure adequate mitigation of safety hazards, including flooding, seismic, erosion, liquefaction, and subsidence dangers.
- 5.10.5-P6: Require that new development is designed to meet current safety standards and implement appropriate building codes to reduce risks associated with geologic conditions.
- 5.10.5-P7: Implement all recommendations and design solutions identified in project soils reports to reduce potential adverse effects associated with unstable soils or seismic hazards.

### **Santa Clara City Code**

Title 15 of the Santa Clara City Code includes the City's adopted Building and Construction Code. These regulations are based on the CBC and include requirements for building foundations, walls, and seismic resistant design. Requirements for grading and excavation permits and erosion control are included in Chapter 15.15 Building Code. Requirements for building safety and earthquake reduction hazard are addressed in Chapter 15.55 Seismic Hazard Identification.

## **4.7.2 Environmental Impacts**

- a. Would the project directly or indirectly cause potential substantial adverse effects, including the risk of loss, injury, or death involving:**
  - i. Rupture of a known earthquake fault, as delineated on the most recent Alquist-Priolo Earthquake Fault Zoning Map issued by the State Geologist for the area or based on other substantial evidence of a known fault? Refer to Division of Mines and Geology Special Publication 42.**

### ***Construction and Operation***

*Less Than Significant Impact.* The probability that construction of the proposed project would have an impact on the risk of loss, injury, or death involving rupture of an earthquake fault during construction is remote. The project site is located within the seismically active San Francisco Bay region, but there are no known active or potentially active faults crossing the project site. The site is not located within an Earthquake Fault Zone as defined by the State of California Alquist-Priolo Earthquake Fault Zoning Act. The project site is not located within a fault rupture zone (DayZenLLC 2021a). Due to the distance of faults from the site and the absence of known faults within or near the site, development of the project would not expose people or buildings to known risks of fault rupture. Additionally, operation of the project is not expected to exacerbate rupture of known earthquake faults. Therefore, impacts related to fault rupture will be less than significant.

#### **ii. Strong seismic ground shaking?**

### ***Construction and Operation***

*Less Than Significant Impact with Mitigation Incorporated.* Earthquakes along several nearby active faults in the region could cause moderate to strong ground shaking at the site. The intensity of ground motion and the damage done by ground shaking would depend on the characteristics of the generating fault, distance to the fault and rupture zone, earthquake magnitude, earthquake duration, and site-specific geologic conditions. Geologic conditions on the site would require the new building be designed and constructed in accordance with standard engineering techniques and current California Building Code requirements, and mitigation measure **GEO-1** (DayZenLLC 2021a). Building design and construction at the site will be completed in conformance with the recommendations of a design-level geotechnical investigation as required by the CBC, which would be included in a report to the city. With implementation of the seismic design guidelines per the CBC, as well as the mitigation measure (**GEO-1**), construction of the project would not expose people or property, directly or indirectly, to significant impacts associated with geologic or seismic ground shaking. Therefore, risks to people or structures from strong seismic ground-shaking would continue to be less than significant with mitigation incorporated into the project design and the project would not exacerbate the effects of seismic ground shaking.

#### **iii. Seismic-related ground failure, including liquefaction?**

### ***Construction and Operation***

*Less Than Significant Impact with Mitigation Incorporated.* The site is in an area considered to have a moderate susceptibility to earthquake-induced liquefaction (DayZenLLC 2021a). However, the project site is not subject to lateral spreading due to its distance from stream channels. The project site and vicinity are flat and the project site is not within a landslide hazard zone.



The likely consequence of potential liquefaction at the site would be settlement. However, with implementation of seismic design guidelines per the California Building Code (CBC 2019), as well as the anticipated project-specific recommendations in the design-level geotechnical investigation required by the CBC, the project would not expose people or property, directly or indirectly, to significant impacts associated with geologic or seismic ground shaking, including ground failure, liquefaction, or seismically induced subsidence. Therefore, risks to people or structures, or exacerbating ground failure, during strong seismic ground-shaking would continue to be less than significant with mitigation incorporated into the project design.

#### **iv. Landslides?**

##### ***Construction and Operation***

*Less Than Significant Impact.* The proposed project is not located within a landslide hazard zone (DayZenLLC 2021a). Grading of the project site would not create steep slopes and construction of the proposed project would not cause a landslide. Therefore, risks to people or structures from strong seismic ground-shaking would be less than significant and the project would not exacerbate the effects of seismic ground shaking or a resultant landslide.

#### **b. Would the project result in substantial soil erosion or the loss of topsoil?**

##### ***Construction and Operation***

*Less Than Significant Impact.* Ground disturbance at the site would be required for demolition and on-site improvements. Ground disturbance would expose soils and increase the potential for wind or water related erosion and sedimentation at the site until construction is complete. Compliance with the erosion control measures, as required by the National Pollutant Discharge Elimination System is the primary means of enforcing erosion control measures through the grading and building permit process (DayZenLLC 2021a). In accordance with General Plan policies, construction activities would be subject to the requirements of the regulatory programs and policies in place and, therefore, would have a less than significant soil erosion impact.

Occasional minor surface disturbance may continue to be required during maintenance activities, but such disturbance would be temporary and likely small. Continuous operation and maintenance work would not result in increased erosion or topsoil loss and therefore, a less than significant impact would be associated with erosion or loss of topsoil.

- c. Would the project be located on geologic units or soil that is unstable, or that would become unstable as a result of the project, and potentially result in on- or off-site landslide, lateral spreading, subsidence, liquefaction, or collapse?**

*Construction and Operation*

*Less Than Significant Impact.* The project site and immediate surrounding area are not subject to landslides or lateral spreading. The project site is in a mapped liquefaction hazard zone. The project would not be located on a geologic unit or soil that is unstable, or that would become unstable as a result of the project, and potentially result in on- or off-site landslide, lateral spreading, subsidence, liquefaction, or collapse. This is because the applicant is required to follow the California Building Code (CBC) plus any local amendments, which requires that a final geotechnical report is prepared and the design of the building adheres to the findings in the final report, as required in the CBC. Therefore, impacts associated with construction on geologic units or soil that is or would become unstable would have a less than significant impact.

Operation and maintenance activities would not materially change the surface runoff or geotechnical characteristics of the material beneath the project facilities. Thus, operation and maintenance activities would not introduce new soil stability hazards. Occasional minor surface disturbance may continue to be required during maintenance activities, but such disturbance would be temporary and likely small. The project would not expose people or property, directly or indirectly, to unstable geologic or soil units. Therefore, there would be a less than significant impact with mitigation incorporated.

- d. Would the project be located on expansive soil, as defined in Section 1803.5.3 of the California Building Code (2010), creating substantial direct or indirect risks to life or property?**

*Construction and Operation*

*Less Than Significant Impact.* Expansive soil behavior is a condition where clay soils react to changes in moisture content by expanding or contracting. Poorly drained soils have greater shrink-swell potential. Potential causes of moisture fluctuations include drying during construction, and subsequent wetting from rain, capillary rise, landscape irrigation, and type of plant selection. If untreated, expansive soils could damage future buildings and pavements on the project site.

The project site is located on expansive soil as defined in Section 1803.5.3 of the CBC. The project would be required to adhere to the SHMA and CBC, which would reduce impacts related to expansive soils to a less than significant level. The policies of the City of Santa Clara 2010-2035 General Plan have been adopted for the purpose of avoiding or mitigating environmental effects resulting from planned development within the City. Santa Clara General Plan Policy 5.10.5-P6 requires that new development be designed to meet current safety standards and implement appropriate building codes to reduce risk

associated with geologic conditions (DayZenLLC 2021a). Therefore, risks to people or structures from expansive soil would be less than significant with mitigation incorporated into the project design.

**e. Would the project have soils incapable of adequately supporting the use of septic tanks or alternative wastewater disposal systems where sewers are not available for the disposal of wastewater?**

*Construction and Operation*

*No Impact.* The project would connect to an existing city-provided sanitary sewer connection, so the project site would not need to support septic tanks or alternative wastewater disposal systems (DayZenLLC 2021a). Therefore, there would be no impact to soils because of sanitary waste disposal from the project during construction or operation.

**f. Directly or indirectly destroy a unique paleontological resource or site or unique geologic feature?**

*Construction and Operation*

*Less Than Significant with Mitigation Incorporated.* There are no known paleontological resources within the project site. A search of the University of California Museum of Paleontology database failed to identify any paleontological resources in the vicinity of the site (UCMP 2021). However, ground disturbing activities of ten feet or more have the potential to impact undiscovered paleontological resources. The CA3 Data Center would require excavation trenching of depths of up to 15 feet. Foundations could be augered cast piles or driven piles, likely to exceed depths of 80 feet. However, alternative foundation designs could be viable based on the results of future geotechnical investigations (DayZenLLC 2021b). Although unlikely, paleontological resources could be encountered during construction of the CA3 Data Center.

The applicant has proposed a measure to reduce impacts to a unique paleontological resource. The measure includes protocols for training, identification of paleontological resources and salvage plan, including treatment and reporting. Staff evaluated this measure in the context of impacts to paleontological resources and considers the measure sufficient to reduce impacts. Staff proposes **GEO-1** to address the potential for discovery of paleontological resources during excavation in native materials.

Although the CA3 Data Center site will be graded and any excavation for deep foundations would be completed prior to installation of any of the CA3 Backup Generating Facilities, construction of the CA3 Backup Generating Facilities would include trenching to install the underground cabling for the electrical interconnection between each generator yard and the facilities they serve. This trenching is most likely to occur in previously disturbed soils shallower than 10 feet. It is unlikely that trenching activities will encounter potential paleontological resources. However, any potential impacts from the trenching activities would be reduced to less than significant levels significant with **GEO-1**.

There is no potential to disturb paleontological resources during operations because there would be no earth-moving activities required for operations. Occasional minor surface disturbance may continue to be required during maintenance activities, but such disturbance would be temporary, small, and most likely limited to disturbance of fill.

With implementation of **GEO-1**, impacts to paleontological resources would be reduced to a less than significant level. There are no unique geologic features within the site footprint.

### 4.7.3 Mitigation Measures

**GEO-1:** The project proposes to implement the following measures to ensure impacts to paleontological resources are reduced to less than significant.

- Prior to the start of any subsurface excavations that would extend beyond previously disturbed soils, all construction forepersons and field supervisors shall receive training by a qualified professional paleontologist, as defined by the Society of Vertebrate Paleontology, who is experienced in teaching non-specialists, to ensure they can recognize fossil materials and shall follow proper notification procedures in the event any are uncovered during construction. Procedures to be conveyed to workers include halting construction within 50 feet of any potential fossil find and notifying a qualified paleontologist, who shall evaluate its significance.
- If a fossil is found and determined by the qualified paleontologist to be significant and avoidance is not feasible, the paleontologist shall develop and implement an excavation and salvage plan in accordance with Society of Vertebrate Paleontology standards. Construction work in these areas shall be halted or diverted to allow preparation of the plan and recovery of fossil remains in a timely manner. Fossil remains collected during the monitoring and salvage portion of the mitigation program shall be cleaned, repaired, sorted, and cataloged. Prepared fossils, along with copies of all pertinent field notes, photos, and maps, shall then be deposited in a scientific institution with paleontological collections. A final Paleontological Mitigation Plan Report that outlines the results of the mitigation program shall be prepared and submitted to the Director or Director's designee with the City of Santa Clara Department of Planning, Building and Code Enforcement (PBC) at the conclusion of construction. The Director or Director's Designee with the City of Santa Clara PBCE shall be responsible for ensuring that the paleontologist's recommendations regarding treatment and reporting are implemented.

### 4.7.4 References

- BLM 2016 – Bureau of Land Management (BLM). Potential Fossil Yield Classification System: BLM Instruction Memorandum No. 2016-124. July 8, 2016. Accessed on: June 22, 2021. Available online at: <https://edit.blm.gov/policy/im-2016-124>
- CBC 2019 – California Building Code (CBC). California Building Standard Commission. Accessed on: June 22, 2021. Available online at: <http://www.bsc.ca.gov/Codes.aspx>

- CGS 2010 – California Geological Survey (CGS), California Department of Conservation. Fault Activity Map of California. Accessed on: June 22, 2021. Available online at: <http://maps.conservation.ca.gov/cgs/fam/>
- CGS 2002 State of California Official Seismic Hazard Zones Map for the San Jose West Quadrangle, Report 058
- DayZenLLC 2021a – DayZenLLC (DayZenLLC). (TN 237380). VDC CA3BGF SPPE Application Part I, dated April 5, 2021. Available online at: <https://efiling.energy.ca.gov/Lists/DocketLog.aspx?docketnumber=21-SPPE-01>
- DayZenLLC 2021b – DayZenLLC (DayZenLLC). (TN 237381). VDC CA3BGF SPPE Application Part III, dated April 5, 2021. Available online at: <https://efiling.energy.ca.gov/Lists/DocketLog.aspx?docketnumber=21-SPPE-01>
- Helley et al. 1994 – E. J. Helley, R.W. Graymer, G.A. Phelps, P.K. Showalter, and C.M. Wentworth. Preliminary Quaternary geologic maps of Santa Clara Valley, Santa Clara, Alameda, and San Mateo Counties, California: A Digital Database, USGS Open-File Report 94.231, 1994. Available online at: <https://pubs.usgs.gov/of/1994/0231/report.pdf>. Accessed on: June 22, 2021
- Knudsen et al. 2000, Association of Bay Area Governments (ABAG) Earthquake Liquefaction Susceptibility Map. Last Updated March 2020. Accessed on: June 22, 2021. Available online at: <https://abag.ca.gov/our-work/resilience/data-research/hazard-viewer>
- Norris and Webb 1990 – Robert M. Norris and Robert W. Webb, 1990, Geology of California, Second Edition, John Wiley and Sons. ISBN-13: 978-0471509806
- Santa Clara 2010 – City of Santa Clara (Santa Clara). 2010-2035 General Plan. Approved November 16, 2010. Available online at: <http://santaclaraca.gov/government/departments/community-development/planning-division/general-plan>. Accessed on: June 20, 2021
- UCMP 2021 – University of California Museum of Paleontology (UCMP) 2021. *UCMP database*. Accessed on: June 22, 2021. Available online at: <http://ucmpdb.berkeley.edu/>
- Wentworth, Carl M. et al. 1999. Preliminary geologic map of the San Jose 30 x 60-minute quadrangle, California, U.S. Geological Survey Open-File Report 98-795. Available online at: <https://doi.org/10.3133/ofr98795>. Accessed on: June 21, 2021
- Wesling and Helley 1989 – J.R. Wesling and E.J. Helley, Quaternary Geologic Map of the San Jose West Quadrangle, Santa Clara County, California, U.S. Geological Survey Open-File Report 89-672, 1989. Available online at: <https://pubs.usgs.gov/of/1989/0672/report.pdf>. Accessed on: June 22, 2021
- Youd et al. 2001 – T. L. Youd, I. M. Idriss, Ronald D. Andrus, Ignacio Arango, Gonzalo Castro, John T. Christian, Richardo Dobry, W. D. Liam Finn, Leslie F. Harder, Mary Ellen Hynes, Kenji Ishihara, Joseph P. Koester, Sam S.C. Liao, William F.

Marcuson, Geoffrey R. Martin, James K. Mitchell, Yoshiharu Moriwaki, Maurice S. Power, Peter K. Robertson, Raymond B. Seed, and Kenneth H Stokoe  
"Liquefaction Resistance of Soils: Summary Report from the 1996 NCEER and 1998 NCEER/NSF Workshops on Evaluation of Liquefaction Resistance of Soils."  
ASCE Journal of Geotechnical and Geoenvironmental Engineering, Vol 127, No. 10. October

## 4.8 Greenhouse Gas Emissions

This section describes the environmental and regulatory setting and discusses greenhouse gas (GHG) emissions impacts associated with the demolition/construction, direct “stationary source” emissions from emergency backup generators, and indirect and “non-stationary source” emissions from the operation of the CA3 Data Center (CA3DC) and the associated CA3 Backup Generating Facility (CA3BGF), collectively called “the project” in the analysis that follows.

GREENHOUSE GAS EMISSIONS	Potentially Significant Impact	Less Than Significant with Mitigation Incorporated	Less Than Significant Impact	No Impact
Would the project: a. Generate greenhouse gas emissions, either directly or indirectly, that may have a significant impact on the environment?	<input type="checkbox"/>	<input checked="" type="checkbox"/>	<input type="checkbox"/>	<input type="checkbox"/>
b. Conflict with an applicable plan, policy or regulation adopted for the purpose of reducing the emissions of greenhouse gases?	<input type="checkbox"/>	<input checked="" type="checkbox"/>	<input type="checkbox"/>	<input type="checkbox"/>

Environmental checklist established CEQA Guidelines, Appendix G.

### 4.8.1 Summary

In this analysis, CEC staff (staff) concludes that, with the implementation of mitigation measures **GHG-1**, **GHG-2**, and **GHG-3**, the project’s potential GHG emissions impacts would be less than significant.

This section includes both quantitative and qualitative analyses of the project’s three categories of GHG emissions: (1) emissions related to the construction/demolition phase of the project; (2) direct “stationary source” emissions from the operation of the emergency backup generators; and (3) indirect and “non-stationary source” emissions from the operation of the project, the vast majority of which are indirect emissions from the electricity consumed by the project.

For each category of GHG emissions, this section describes and calculates the emissions, identifies the threshold of significance that applies to the project’s emissions source, and applies the applicable methodology or threshold of significance to determine if the project’s GHG emissions impacts are less than significant.

### Significance Criteria

**CEQA Guidelines for GHG Emissions.** With the enactment of Senate Bill 97 (Chapter 185, Statutes of 2007), the Governor’s Office of Planning and Research was required by July 1, 2009, to prepare, develop, and transmit to the Natural Resources Agency guidelines for the feasible mitigation of GHG emissions or the effects of GHG emissions.

Those amendments to the CEQA guidelines became effective March 18, 2010, and were subsequently updated in December 2018 to further address the analysis of GHG emissions, including the following:

- Lead agencies must analyze the GHG emissions of proposed projects. (See CEQA Guidelines, § 15064.4, subd. (a))
- The focus of the lead agency's analysis should be on the project's effect on climate change, rather than simply focusing on the quantity of emissions and how that quantity of emissions compares to statewide or global emissions. (See CEQA Guidelines, § 15064.4, subd. (b))
- The impacts analysis of GHG emissions is global in nature and thus should be considered in a broader context. A project's incremental contribution may be cumulatively considerable even if it appears relatively small compared to statewide, national, or global emissions. (See CEQA Guidelines, § 15064.4, subd. (b))
- Lead agencies should consider a timeframe for the analysis that is appropriate for the project. (See CEQA Guidelines, § 15064.4, subd. (b))
- A lead agency's analysis must reasonably reflect evolving scientific knowledge and state regulatory schemes. (See CEQA Guidelines, § 15064.4, subd. (b).)
- Lead agencies may rely on an adopted statewide, regional, or local plan in evaluating a project's GHG emissions. (See CEQA Guidelines, § 15064.4, subd. (b)(3)) Lead agencies may analyze and mitigate the significant impact of GHG emissions as part of a larger plan for the reduction of greenhouse gases. (See CEQA Guidelines, §15183.5, sub. (a)) A project's incremental contribution to a cumulative GHG emissions effect may be determined not to be significant and the effects of the project to not be cumulatively considerable if the project complies with the requirements of the GHG emissions reduction strategy. (See CEQA Guidelines, §§ 15064, sub. (h)(3); 15130, sub. (d); 15183, sub. (b))
- In determining the significance of a project's impacts, the lead agency may consider a project's consistency with the state's long-term climate goals or strategies, provided that substantial evidence supports the agency's analysis of how those goals or strategies address the project's incremental contribution to climate change and its conclusion that the project's incremental contribution is consistent with those plans, goals, or strategies. (See CEQA Guidelines, § 15064.4, subd. (b)(3))

The lead agency has discretion to select the model or methodology it considers most appropriate to enable decision makers to intelligently account for the project's incremental contribution to climate change. (See CEQA Guidelines, § 15064.4, subd. (c).)

The Bay Area Air Quality Management District (BAAQMD) California Environmental Quality Act (CEQA) Guidelines include recommended thresholds of significance for determining whether projects would have significant adverse environmental impacts.



**Construction/Demolition Emissions.** For construction-related GHG emissions, the BAAQMD CEQA Guidelines do not identify a GHG emissions threshold of significance, but instead recommend that those emissions should be quantified and disclosed. BAAQMD further recommends the incorporation of best management practices (BMPs) to reduce GHG emissions during construction, as feasible and applicable.

**Direct Stationary Sources Emissions.** For stationary sources, BAAQMD adopted in the BAAQMD CEQA Guidelines a numeric threshold of significance of 10,000 metric tons of carbon dioxide equivalent per year (MTCO<sub>2</sub>e/yr) for projects that require permits from BAAQMD (BAAQMD 2017b). However, the threshold of 10,000 MTCO<sub>2</sub>e/yr was based on the state's 2020 GHG target, codified in Health and Safety Code, section 38550, which is now superseded by the 2030 GHG target, codified in Health and Safety Code, section 38566, as enacted in SB 32, and a 2045 target set forth in former Governor Brown's Executive Order B-55-18. BAAQMD staff is in the process of preparing and presenting to the BAAQMD board for approval an update to the CEQA GHG threshold of significance for stationary sources to 2,000 MTCO<sub>2</sub>e/yr or compliance with the State Air Resources Board's (CARB) cap-and-trade program, codified in Health and Safety Code, section 38562. The current planned adoption date for the proposed changes in the CEQA GHG significance thresholds is February or March 2022 (BAAQMD 2021). In this analysis in addition to the existing BAAQMD CEQA Guidelines threshold of significance of 10,000 MTCO<sub>2</sub>e/yr, staff also evaluates the GHG impacts of the emergency backup generators with the consideration of the pending update to the BAAQMD CEQA GHG threshold of significance, under which the GHG impacts from the project's emergency backup generators would be considered to have a less-than-significant impact if emissions are below BAAQMD's proposed threshold of 2,000 MTCO<sub>2</sub>e/yr.

**Indirect and Non-Stationary Source Emissions.** Other project-related emissions from mobile sources, area sources, energy use, and water use would not be included for comparison to the stationary source threshold of significance, based on guidance in the BAAQMD CEQA Guidelines (BAAQMD 2017b). Instead, GHG impacts from all other project-related emissions sources would be considered to have a less-than-significant impact if the project is consistent with the city of Santa Clara Climate Action Plan (CAP). Other applicable regulatory programs and policies adopted by CARB or other California agencies, described under Regulatory Background, also contribute to staff's analysis of impacts.

The city of Santa Clara CAP and accompanying environmental documentation are consistent with the guidelines set forth by BAAQMD for a Qualified GHG Reduction Strategy, which parallel and elaborate upon criteria established in the CEQA Guidelines, California Code of Regulations, Title 14, section 15183.5(b)(1) (Santa Clara 2013). As a result, a lead agency may conclude that a project's incremental contribution to a cumulative effect is not cumulatively considerable if it complies with the requirements of the Santa Clara CAP. However, an environmental document that relies on it "must identify those requirements specified in the plan that apply to the project, and, if those

requirements are not otherwise binding and enforceable, incorporate those requirements as mitigation measures applicable to the project.”<sup>1</sup>

Specifically, the 2013 Santa Clara CAP meets the following criteria for a Qualified Climate Action Plan (with Chapter references referring to the 2013 CAP):

- Quantify emissions, both existing and projected over a specified time period, resulting from activities within a defined geographic area (see Chapter 2).
- Establish a level, based on substantial evidence, below which the contribution of emissions from activities covered by the plan would not be cumulatively considerable (see Chapter 2).
- Identify and analyze the emissions resulting from specific actions or categories of actions anticipated within the geographic area (see Chapter 3 and Chapter 4).
- Specify measures or a group of measures, including performance standards that substantial evidence demonstrates, if implemented on a project-by-project basis, would collectively achieve the specified emissions level (see Chapter 4).
- Establish a mechanism to monitor the plan’s progress toward achieving the level and to require amendment if the plan is not achieving specific levels (see Chapter 5).
- Adopt the GHG Reduction Strategy in a public process following environmental review. (Santa Clara 2013, p. 8.)

It should be noted that the current versions of the CAP and CARB’s scoping plan are somewhat outdated, having focused on the near-term 2020 and 2030 GHG goals. They do not address the sharp cuts that will be needed to meet the Executive Order’s 2045 goals and beyond.

The city of Santa Clara is in the process of updating the CAP with a planned adoption date of April 2022 (Santa Clara 2021, CEC 2021x). Staff expects this update to similarly function as a Qualified GHG Reduction Strategy; therefore, this analysis discusses the new requirements of the proposed updates where applicable. The 2022 update to CARB’s scoping plan, a statewide planning document that coordinates the main strategies the state will use to reduce GHG emissions, is currently under development to incorporate the Executive Order’s 2045 target.

### ***a. Construction/Demolition Emissions***

As discussed in more detail under environmental checklist criterion “a,” the applicant estimated that the construction sources would generate a total of approximately 974 MTCO<sub>2</sub>e during the estimated 22 months of construction and demolition (CEC 2022a). Therefore, the project’s short-term construction-related GHG emissions have been quantified and disclosed. In addition, the project would implement BMPs, as specified in

---

<sup>1</sup> CEQA Guidelines, § 15183.5(b)(2).

mitigation measure **AQ-1**, that would reduce construction-related GHG emissions. The project would also participate in the city's Construction & Demolition Debris Recycling Program to further reduce GHG emissions. The city could also make the use of alternative fuels a condition of approval for new developments during pre-construction review meetings. Staff concludes that the project's construction-related GHG emissions impacts would be less than significant.

***b. Direct Stationary Source Emissions (Emergency Backup Generators)***

The project's emergency backup generators are stationary sources of direct GHG emissions from project operation. The emergency backup generators would emit GHG emissions mostly during readiness testing and maintenance and infrequently during short durations of emergency operation. The GHG emissions from the emergency backup generators are subject to the BAAQMD CEQA Guidelines GHG threshold of significance for stationary sources. As discussed above, the BAAQMD CEQA Guidelines' current GHG threshold for stationary sources is 10,000 MTCO<sub>2</sub>e/yr and BAAQMD staff is in the process of preparing and presenting to the BAAQMD board for approval an update to lower the threshold of significance to 2,000 MTCO<sub>2</sub>e/yr or compliance with CARB's cap-and-trade program.

As discussed in more detail under environmental checklist criterion "a," the applicant conservatively estimated that GHG emissions from the emergency backup generators would be 3,387 MTCO<sub>2</sub>e/yr based on 35 hours of annual readiness testing and maintenance at 100 percent load per engine. GHG emissions from the emergency backup generators would be lower than the BAAQMD CEQA Guidelines' current GHG threshold of significance of 10,000 MTCO<sub>2</sub>e/yr. But in the future, the project may be subject to a new BAAQMD CEQA Guidelines GHG threshold of 2,000 MTCO<sub>2</sub>e/yr or compliance with CARB's cap-and-trade program. GHG emissions from the project would not exceed CARB's regulatory threshold level for required inclusion in and compliance with the cap-and-trade program, which is 25,000 MTCO<sub>2</sub>e/yr. To reflect a potential change in the BAAQMD significance threshold, staff proposes mitigation measure **GHG-1** to require the applicant to limit the GHG emissions of the emergency backup generators to whichever BAAQMD CEQA Guidelines GHG threshold is applicable at the time of permitting with BAAQMD. Staff expects that if the applicant accepts a permit limit of 20 hours of annual readiness testing and maintenance per engine, the GHG emissions of the emergency backup generators would be about 1,935 MTCO<sub>2</sub>e/yr, which is lower than 2,000 MTCO<sub>2</sub>e/yr. Staff also proposes mitigation measure **GHG-2** to require the applicant to use an increasing mix of renewable diesel and ultimately phase out the use of ultra-low sulfur petroleum-based diesel.

The project's likelihood of operating the emergency backup generators for unplanned circumstances or emergency purposes is low and, if such operation did occur, it would be infrequent and of short duration. Staff concludes the GHG emissions of the emergency backup generators during unplanned circumstances or emergency purposes would not add significantly to the GHG emissions estimated for readiness testing and maintenance.

Additionally, the GHG emissions during the routine operation of the emergency backup generators are overestimated even with a limit of 20 hours of readiness testing and maintenance per year per engine. Project applicants previously stated that routine readiness testing and maintenance would rarely exceed 12 hours per year. The emergency operation of the emergency backup generators is expected to be infrequent and of short duration. It would be speculative to estimate that the project would engage in emergency operation averaging over eight (= 20-12) hours per year. Thus, a limit of 20 hours of emergency backup generator operation per year should be enough to accommodate both readiness testing and maintenance and emergency operation for any given year.

Staff concludes that with the implementation of mitigation measures **GHG-1** and **GHG-2**, the GHG emissions from the project's stationary sources would be less than significant.

### *c. Indirect and Non-Stationary Source Emissions*

The operation of the project would generate GHG emissions beyond those from the operation of the emergency backup generators, including offsite vehicle trips for worker commutes and material deliveries, and facility upkeep, including architectural coatings, consumer product use, landscaping, water use, waste generation, natural gas use for comfort heating, and electricity use. The GHG emissions from indirect and non-stationary sources are shown in **Table 4.8-4** under environmental checklist criterion "a."

The GHG impacts from the indirect and non-stationary sources would be considered to have a less-than-significant impact if the project is consistent with the CAP and applicable regulatory programs and policies adopted by CARB or other California agencies. Under environmental checklist criterion "b," staff identifies the requirements specified in the CAP and regulatory programs and policies that apply to the project.

**Indirect Emissions from Electricity Use.** Staff conservatively assumes the project could consume up to 840,960 megawatt hours (MWh) of electricity per year after full build-out, but actual electricity demand would be lower. With the carbon intensity of 277 lbs CO<sub>2</sub>/MWh for 2025 based on Silicon Valley Power's (SVP) prediction and CalEEMod default methane (CH<sub>4</sub>) and nitrous oxide (N<sub>2</sub>O) intensity factors, the worst-case GHG emissions due to electricity use during full build-out operation would be 106,596 MTCO<sub>2</sub>e/yr.

Electricity to the project would be provided by SVP, a utility that is on track to meet their 2030 GHG emissions reductions target. SVP is subject to CARB's cap-and-trade program requirements and the Renewables Portfolio Standard (RPS) requirements.

Actual GHG emissions associated with electricity use at the project will be much less than 106,596 MTCO<sub>2</sub>e/yr since actual electricity use will be less than the maximum and the SVP annual average emission factor will be tracking downward towards "zero net" with the implementation of state and local measures to reduce GHG emissions associated with electricity production and California's fuels.

In addition, the city of Santa Clara is in the process of updating the CAP with a planned adoption date of April 2022 (Santa Clara 2021, CEC 2021x). The draft 2022 CAP Update would include Action B-1-7, "Carbon neutral data centers: requiring all new data centers to operate on 100 percent carbon neutral energy, with offsets as needed." Considering the additional time needed for the city and BAAQMD to permit the project, it is likely that the project would be subject to Action B-1-7. Even if the project obtains its permits in time to avoid application of Action B-1-7, staff concludes that without this requirement the project could result in a significant, adverse impact as a result of its indirect GHG emissions. Therefore, staff proposes mitigation measure **GHG-3** to require the applicant to participate in SVP's Large Customer Renewable Energy (LCRE) program for 100 percent carbon-free electricity or purchase carbon offsets or similar instruments that accomplish the same goals of 100 percent carbon-free electricity.

As discussed in detail under environmental checklist criterion "b," the project would implement a variety of energy efficiency measures. The project would comply with all applicable city and state green building standards code measures. The project would comply with Energy and Climate Measure (ECM)-1 – Energy Efficiency in BAAQMD's 2017 Bay Area Clean Air Plan. Therefore, for these and the reasons discussed above, and with implementation of **GHG-2** and **GHG-3**, the project would not conflict with plans, policies, or regulations adopted to achieve long-term GHG emissions reduction goals.

**Other Indirect and Non-Stationary Source Emissions.** The project's other indirect and non-stationary sources include mobile sources, landscaping, water use, waste, and refrigerant use as shown in **Table 4.8-4**. The project's compliance with the CAP and applicable regulatory programs and policies adopted by CARB and other California agencies would ensure the project's GHG emissions from these sources would not have a significant impact. For example, staff analyzed the project's compliance and consistency with policies related to transportation (5.8.5-P1 in the City of Santa Clara 2010-2035 General Plan [General Plan], Measure 6.1 and Measure 6.3 in the 2013 CAP, Action T-3-1 and Action T-1-5 in the draft 2022 CAP Update), water (5.10.3-P6, 5.10.4-P6, 5.10.4-P7 in the General Plan, Measure 3.1 in the 2013 CAP, Action N-3-4 and Action N-3-6 in the draft 2022 CAP Update), and waste (Measure 4.2 in the 2013 CAP, Action M-3-1 in the draft 2022 CAP Update). Therefore, staff concludes that these indirect and non-stationary sources would comply with local and regional plans and strategies adopted to reduce GHG emissions and the project's GHG impacts from these sources would be less than significant.

In summary, staff concludes that with the implementation of mitigation measures **GHG-2** and **GHG-3**, GHG emissions related to the project from indirect and non-stationary sources would be consistent with the applicable plans and policies adopted to reduce GHG emissions and would comply with all regulations or requirements adopted to implement a statewide, regional, or local plan for the reduction or mitigation of GHG emissions. The potential for the project to conflict with an applicable plan, policy, or regulation for GHG reductions would be less than significant.

## 4.8.2 Environmental Setting

Unlike emissions of criteria and toxic air pollutants, which have local or regional impacts, emissions of GHGs have a much broader, global impact. Global warming associated with the "greenhouse effect" is a process whereby GHGs accumulating in the atmosphere contribute to an increase in the temperature of the Earth's atmosphere. The principal GHGs that contribute to global warming and climate change include carbon dioxide (CO<sub>2</sub>), methane (CH<sub>4</sub>), nitrous oxide (N<sub>2</sub>O), black carbon, and fluorinated gases (F-gases) (hydrofluorocarbons [HFCs], perfluorocarbons [PFCs], and sulfur hexafluoride [SF<sub>6</sub>]). Emissions of GHGs contributing to global climate change are attributable in large part to human activities associated with the transportation, industrial/manufacturing, utility, residential, commercial, and agricultural sectors.

Each GHG has its own potency and effect upon the Earth's energy balance, expressed in terms of a global warming potential (GWP), with CO<sub>2</sub> being assigned a value of 1. Specifically, the GWP is a measure of how much energy the emissions of 1 ton of a gas will absorb over a given time relative to the emissions of 1 ton of CO<sub>2</sub>. The larger the GWP, the more that a given gas warms the Earth compared to CO<sub>2</sub> over that time. The time usually used for GWPs is 100 years.

For example, CH<sub>4</sub> has a GWP of 28 over 100 years from the Fifth Assessment Report (AR5) of the Intergovernmental Panel on Climate Change (IPCC 2013), which means that it has a global warming effect 28 times greater than CO<sub>2</sub> on an equal-mass basis. The F-gases are sometimes called high-GWP gases because, for a given amount of mass, they trap substantially more heat than CO<sub>2</sub>. The GWPs for these gases can be in the thousands or tens of thousands. The carbon dioxide equivalent (CO<sub>2</sub>e) for a source is obtained by multiplying each quantity of GHG by its GWP and then adding the results together to obtain a single, combined emission rate representing all GHGs in terms of CO<sub>2</sub>e. The Sixth Assessment Report is due in 2022 (IPCC 2017).

## Regulatory Background

### *Federal*

The project would not be subject to any federal requirements for GHGs.

### *State*

#### **Early State Actions**

**California Global Warming Solutions Act of 2006.** In 2006, the state Legislature passed the California Global Warming Solutions Act of 2006 Health and Safety Code, section 38500 et. seq), or Assembly Bill (AB) 32, which provided the initial framework for regulating GHG emissions in California. This law required CARB to design and implement GHG emissions limits, regulations, and other measures such that statewide GHG emissions are reduced in a technologically feasible and cost-effective manner to 1990 levels by 2020. AB 32 also required CARB to implement a mandatory GHG emissions

reporting program for major sources, which includes electricity generators, industrial facilities, fuel suppliers, and electricity importers.

**CARB Scoping Plan.** Part of the Legislature's direction to CARB under AB 32 was to develop a scoping plan that serves as a statewide planning document to coordinate the main strategies California will use to reduce GHG emissions that cause climate change. CARB approved the AB 32 Climate Change Scoping Plan (scoping plan) in 2008 and released updates in 2014 and 2017 with the next update planned for 2022. The scoping plan includes a range of GHG emissions reduction actions, which include direct regulations, alternative compliance mechanisms, monetary and non-monetary incentives, voluntary actions, and market-based compliance mechanisms, such as the cap-and-trade program. In December 2007, CARB set the statewide 2020 emissions limit, defined as reducing emissions to 1990 levels, at 427 million metric tons of CO<sub>2</sub>e (MMTCO<sub>2</sub>e). The 2014 scoping plan adjusted the 1990 emissions estimate and the statewide 2020 emissions limit goal to 431 MMTCO<sub>2</sub>e (CARB 2014). The 2017 scoping plan (CARB 2017a) demonstrates the approach necessary to achieve California's 2030 target, which is to reduce GHG emissions 40 percent below 1990 levels to 260 MMTCO<sub>2</sub>e. The 2022 update of the scoping plan is a plan for California's targets beyond 2030.

**Mandatory Reporting of Greenhouse Gas Emissions.** AB 32 also required CARB to adopt regulations to require the reporting and verification of statewide greenhouse gas emissions (Health and Safety Code, section 38530). CARB's Regulation for the Mandatory Reporting of Greenhouse Gas Emissions (17 CCR §§95100 to 95163), which took effect January 2009, requires annual GHG emissions reporting from electric power entities, fuel suppliers, CO<sub>2</sub> suppliers, petroleum and natural gas system operators, and industrial facilities that emit at least 10,000 MTCO<sub>2</sub>e/yr from stationary combustion and/or process sources. The project would not be impacted by this regulation because stationary source testing and maintenance combustion GHG emissions are expected to be below the reporting threshold of 10,000 MTCO<sub>2</sub>e/yr, as shown in **Table 4.8-3**.

**Cap-and-Trade Program.** CARB's cap-and-trade program (Health and Safety Code, section 38562; 17 CCR §§95801 to 96022) took effect January 1, 2012. The cap-and-trade program establishes a declining limit on major sources of GHG emissions by sector throughout California, and it creates economic incentives for sources to invest in cleaner, more efficient technologies. The current version of the regulation, effective April 2019, established the increasingly stringent compliance obligations for years 2021 to 2030. The cap-and-trade program applies to covered entities that fall within certain source categories, including first deliverers of electricity (such as fossil fuel power plants) and electrical distribution utilities; in this case, the project would obtain electrical service from SVP. Covered entities in the cap-and-trade program, including SVP, must hold compliance instruments sufficient to cover their actual GHG emissions, as set and verified through the CARB's Mandatory Reporting regulation. For the electricity supplied to the project from the grid, SVP bears the GHG emissions compliance obligation under the cap-and-trade program for delivering electricity to the grid from its power plants and for making

deliveries to end-users, such as the project, unless the project is otherwise a covered entity in the cap-and-trade program.

**Executive Order B-30-15.** On April 29, 2015, former Governor Brown issued Executive Order B-30-15, directing state agencies to implement measures to reduce GHG emissions 40 percent below their 1990 levels by 2030 and to make it possible to achieve the previously stated goal of an 80 percent GHG emissions reduction below 1990 GHG emissions by 2050 (CARB 2017a).

**Statewide 2030 GHG Emissions Limit.** On September 8, 2016, SB 32, codified as Health and Safety Code, section 38566, extended California's commitment to reduce GHG emissions by requiring the state to reduce statewide GHG emissions by 40 percent below 1990 levels by 2030 (CARB 2017a).

### **Other Key Programmatic Milestones**

**Renewable Energy Programs.** In 2002, California initially established the RPS with the goal of increasing the percentage of renewable energy in the state's electricity mix to 20 percent by 2017. State energy agencies recommended accelerating that goal, and former Governor Schwarzenegger's Executive Order S-14-08 (November 2008) required California utilities to reach the 33 percent renewable electricity goal by 2020, consistent with the CARB's 2008 scoping plan. In April 2011, Senate Bill (SB) X1-2 of the First Extraordinary Session (SB X1-2) was signed into law. SB X1-2 expressly applied the 33 percent RPS by December 31, 2020, to all retail sellers of electricity and established renewable energy standards for interim years prior to 2020.

- **Senate Bill 350:** Beginning in 2016, SB 350 took effect as the Clean Energy and Pollution Reduction Act of 2015, declaring it the intent of the Legislature to acknowledge Governor Brown's clean energy, clean air and greenhouse gas emissions reduction goals for 2030 and beyond. SB 350 increases California's renewable electricity procurement goal from 33 percent by 2020 to 50 percent by 2030.
- **Senate Bill 100:** Beginning in 2019, the RPS deadlines advanced to 50 percent renewable resources by December 31, 2026, and 60 percent by December 31, 2030. In addition, SB 100 establishes policy that renewable energy resources and zero-carbon resources supply 100 percent of all retail sales of electricity by December 31, 2045.

**Short-Lived Climate Pollutant Strategy.** To best support the reduction of GHG emissions consistent with AB 32, CARB released the Short-Lived Climate Pollutant (SLCP) Strategy, under Health and Safety Code, section 39730, in March 2017. Health and Safety Code, section 39730, defined SLCPs as having lifetimes in the atmosphere ranging from "a few days to a few decades." Then beginning in 2017 under Health and Safety Code, section 39730.5, CARB was directed to set targets to reduce SLCP emissions 40 percent below 2013 levels by 2030 for methane and hydrofluorocarbons and 50 percent below 2013 levels by 2030 for anthropogenic black carbon (CARB 2017b). The SLCP Strategy was integrated into the 2017 update to CARB's scoping plan.



**Executive Order B-55-18.** On September 10, 2018, the same day he signed SB 100 into law, former Governor Brown issued Executive Order B-55-18 to achieve carbon neutrality, stating the governor's intention "to achieve carbon neutrality as soon as possible, and no later than 2045, and achieve and maintain net negative emissions thereafter. This goal is in addition to the existing statewide targets of reducing greenhouse gas emissions." In 2019, emissions from GHG emitting activities statewide were 418.2 MMTCO<sub>2e</sub>, 7.2 MMTCO<sub>2e</sub> lower than 2018 levels and almost 13 MMTCO<sub>2e</sub> below the 2020 GHG Limit of 431 MMTCO<sub>2e</sub> (CARB 2021). California will need to reduce statewide emissions another 170 million tons to meet its 2030 statutory target of 260 million tons per year (40 percent below 1990 levels). The state will need to cut annual emissions by a further 175 million tons to meet its 2050 goal (set by executive order) of 85 million tons per year (80 percent below 1990 levels). The 2022 update to CARB's Scoping Plan is currently under development to plan for the 2045 target set forth by Executive Order B-55-18.

**Reducing SF<sub>6</sub> Emissions from Gas Insulated Switchgear.** In early 2011, CARB adopted a regulation (17 CCR §§95350 to 95359) to reduce SF<sub>6</sub> emissions in gas insulated switchgear (GIS) used in the electricity sector's transmission and distribution system as an early action measure pursuant to AB 32. SF<sub>6</sub> is an extremely powerful and long-lived GHG. The 100-year GWP of SF<sub>6</sub> is 22,800, making it the most potent of the six main GHGs, according to the U.S. EPA. Because of its extremely high GWP, small reductions in SF<sub>6</sub> emissions can have a large impact on reducing GHG emissions, which are the main drivers of climate change. The regulation requires GIS owners to report SF<sub>6</sub> emissions annually and requires reductions of SF<sub>6</sub> emissions from GIS over time, setting an annual emission rate limit for each GIS owner. The maximum allowable emission rate started at 10 percent in 2011 and has decreased one percent per year since then. The limit would reach one percent in 2020 and remain at that level going forward. However, data show that statewide SF<sub>6</sub> capacity is growing by one to five percent per year, which will increase the expected SF<sub>6</sub> emissions. On August 31, 2021, CARB submitted to the Office of Administrative Law amendments to the SF<sub>6</sub> regulation that, among other things, will expand the scope to include other GHGs beyond SF<sub>6</sub>, change the term GIS to "gas-insulated equipment" (GIE) to include more devices beyond switchgear, establish a timeline for phasing out the acquisition of SF<sub>6</sub> GIE in California that would take effect in stages between 2025 and 2033, and reduce total GHG emissions from GIE.

### *Regional*

**2017 Bay Area Clean Air Plan.** BAAQMD adopted the 2017 Bay Area Clean Air Plan on April 19, 2017 (BAAQMD 2017a). It provides a regional strategy to protect public health and protect the climate. To protect public health, the plan describes how BAAQMD will continue its progress toward attaining all state and federal ambient air quality standards and eliminating health risk disparities from exposure to air pollution among Bay Area communities. To protect the climate, the plan defines a vision for transitioning the region to a post-carbon economy needed to achieve ambitious GHG emissions reduction targets

for 2030 and 2050 and provides a regional climate protection strategy that will put the Bay Area on a pathway to achieving those GHG emissions reduction targets.

**BAAQMD CEQA Guidelines.** The purpose of the BAAQMD CEQA Guidelines is to assist lead agencies in evaluating a project's impacts on air quality (BAAQMD 2017b). This document describes the criteria that BAAQMD uses when reviewing and commenting on the adequacy of environmental documents. It recommends thresholds of significance for determining whether a project would have significant adverse environmental impacts, identifies methodologies for predicting project emissions and impacts, and identifies measures that can be used to avoid or reduce air quality impacts. The BAAQMD CEQA Guidelines include methodologies for estimating GHG emissions. In the comment letter on the Notice of Preparation for this EIR, BAAQMD indicated that the current recommended GHG thresholds in the BAAQMD 2017 CEQA Guidelines are based on the statewide 2020 GHG targets, which are now superseded by the statewide 2030 GHG targets established in Health and Safety Code, section 38566. BAAQMD recommends that the GHG analysis should evaluate the consistency of the project with California's 2030, 2045 and 2050 climate goals (BAAQMD 2021b). BAAQMD staff is in the process of preparing and presenting to the BAAQMD board for approval an update to the CEQA GHG threshold for stationary sources from the current value of 10,000 MTCO<sub>2</sub>e/yr to 2,000 MTCO<sub>2</sub>e/yr or compliance with CARB's cap-and-trade program. The current planned BAAQMD board adoption date for the proposed changes in the CEQA Guidelines GHG significance thresholds is February or March 2022 (BAAQMD 2021).

**Diesel Free by '33.** In 2018, BAAQMD established a program intended to reduce GHG and criteria pollutant emissions by eliminating petroleum use by the end of 2033. Local Bay Area agencies are encouraged to voluntarily adopt the Statement of Purpose of this initiative. Entities signing the Statement of Purpose pledge to develop their own individual strategies to achieve the goal of reaching zero diesel emissions in their communities. Signatories to this agreement express their intent to:

1. Collaborate and coordinate on ordinances, policies, and procurement practices that will reduce diesel emissions to zero within their jurisdictions, communities, or companies;
2. Share and promote effective financing mechanisms domestically and internationally to the extent feasible that allow for the purchase of zero emissions equipment;
3. Share information and assessments regarding zero emissions technology;
4. Build capacity for action and technology adaptation through technology transfer and sharing expertise;
5. Use policies and incentives that assist the private sector as it moves to diesel-free fleets and buildings; and
6. Periodic reporting to all signers of progress towards the zero- diesel emissions goal.

**Plan Bay Area 2040.** Under the requirements of Senate Bill 375 (Chapter 728, Statutes of 2008), all metropolitan regions in California must complete a Sustainable Communities

Strategy (SCS) as part of their Regional Transportation Plan. In the Bay Area, the Metropolitan Transportation Commission (MTC) and Association of Bay Area Governments (ABAG) are jointly responsible for developing and adopting an SCS that integrates transportation, land use, and housing to meet GHG emissions reduction targets set by CARB. In July 2017, the MTC and ABAG approved Plan Bay Area 2040, which is a strategic update to the previous plan approved in July 2013. The Bay Area GHG emissions reduction targets established by CARB in September 2010 include a seven percent reduction in GHG emissions per capita from passenger vehicles by 2020 compared to 2005 emissions. Similarly, Plan Bay Area 2040 includes a target to reduce GHG emissions per capita from passenger vehicles 15 percent by 2035 compared to 2005 emissions (MTC & ABAG 2017).

### *Local*

**City of Santa Clara 2010-2035 General Plan.** The City of Santa Clara 2010-2035 General Plan (General Plan) includes policies that address the reduction of GHG emissions during the planning horizon of the General Plan. Goals and policies that address sustainability (see Appendix 8.13: Sustainability Goals and Policies Matrix in the General Plan) are aimed at reducing the city's contribution to GHG emissions. As described below, the development of a comprehensive GHG emissions reduction strategy for the city is also included in the General Plan.

**City of Santa Clara Climate Action Plan.** The city has a comprehensive GHG emissions reduction strategy, referred to as the city's Climate Action Plan (CAP, Santa Clara 2013). The 2013 CAP identified the city's approach to achieve its share of statewide emissions reductions for the 2020 timeframe established by Health and Safety Code, section 38550. The original CAP, adopted on December 3, 2013, specified the strategies and measures to be taken for a number of focus areas city-wide to achieve the overall emissions reduction target. The 2013 CAP also includes an adaptive management process that can incorporate new technology and respond when goals are not being met.

A key reduction measure undertaken by the city under the CAP is in the Coal-Free and Large Renewables focus area. SVP, the city's municipal electricity utility, provides electricity for the city, including the project site. Since nearly half (48 percent) of the city's GHG emissions are from electricity use, reducing GHG-intensive electricity generation (such as coal) is a major focus area in the CAP (Santa Clara 2013). SVP reduced coal generation in 2017 by divesting its interest in San Juan Generating Station located in New Mexico effective January 1, 2018 (Santa Clara 2018).

The CAP also includes measures to improve energy efficiency. Measure 2.3 in this focus area calls for 10 percent of new data centers to incorporate energy efficient practices. All new data centers since 2013 have utilized energy efficient cooling practices, exceeding this goal (Santa Clara 2018).

In 2016 the city produced its first Annual Report on the CAP. It reviewed its 2013 CAP again in the summer of 2018 (Santa Clara 2018), stating that the 2013 CAP "meets the criteria for a Qualified GHG Reduction Strategy" as established by the CEQA guidelines.

As such, the CAP can be used to streamline the environmental review process for new development. However, to remain a Qualified GHG Reduction Strategy, the city must monitor and update the CAP. In the updated 2018 Annual Report, the city stated that it has been successful in achieving a 4.5 percent reduction in GHG emissions relative to their 2008 baseline, which is equivalent to the city's 1990 emissions. The 2018 Annual Report indicated the city was on track to reduce the city's emissions to 15 percent below their baseline amount by 2020. It also stated that the CAP includes three "reach measures" to reduce GHG emissions 55 percent below the city's 1990 GHG emissions by the year 2035, to meet post-2020 GHG reduction goals. These reach goals call for a more aggressive implementation of CAP strategies for the 2020 time-frame (Santa Clara 2013).

In 2016, SVP was the largest source of GHG emissions in the city's GHG emissions inventory, with 97 percent of all GHG sources attributed to the city.

The city of Santa Clara has prepared a draft CAP Update, which is tentatively planned to be adopted in early 2022 (Santa Clara 2021, CEC 2021x). The draft 2022 CAP Update reflects the 2030 GHG emissions limit requirements and progress toward meeting the long-term targets of Executive Order B-55-18. In addition to these targets, the city aspires to reduce emissions more aggressively in the near-term: achieve an 80 percent reduction in per-service population emissions by 2035. The draft 2022 CAP Update identifies strategies and actions in these main areas: building and energy, transportation and land use, materials and consumption, natural systems and water resources, and community resilience and well-being. To achieve the interim target of an 80 percent reduction in per-service population emissions by 2035, the city will take additional actions including achieve 100 percent carbon neutral electricity by 2035 and require all new construction to be all-electric (with minor exemptions). Actions specifically related to data centers for achieving GHG emissions reductions include:

- B-1-7, Carbon neutral data centers:  
Require all new data centers to operate on 100% carbon neutral energy, with offsets as needed. This requirement does not apply to data centers with planning application approval within six months of the CAP adoption date (CEC 2021x).
- B-3-6, Alternative fuel backup generators:  
Provide information and technical assistance to data centers and other large commercial users to transition from diesel to lower-carbon backup generators (e.g., renewable diesel).
- B-3-7, Renewable electricity for new data centers:  
Support convening of a data center working group to identify and implement renewable electricity purchasing options for commercial customers.

The CEQA Guidelines allow a lead agency to use a Qualified GHG Reduction Strategy to determine the degree to which a proposed project would cause a significant adverse impact. Compliance with appropriate measures in the CAP would ensure an individual project is not cumulatively significant under CEQA.

**Silicon Valley Power’s Integrated Resource Plan and Other Programs.** The city of Santa Clara adopted an Integrated Resource Plan (IRP) for SVP dated November 12, 2018 (SVP 2018). The IRP was developed as required by SB 350 and must be updated at least every five years. The IRPs provide a framework to evaluate how utilities have chosen to align with greenhouse gas emissions reduction targets as well as energy and other policy goals outlined in SB 350. The most challenging goals in the IRP call for the city to: (1) increase procurement of energy from renewable electricity sources to 60 percent by 2030, and (2) double energy efficiency savings in electricity and natural gas end uses by 2030.

Staff in the Supply Analysis Office of the Energy Assessments Division have reviewed SVP’s 2018 IRP (CEC 2019) and found that, among other things, by the year 2030 SVP: (1) achieves a 40 percent GHG emissions reduction from 1990 levels, and (2) meets the RPS goals of SB 350 to use 50 percent renewables.

In addition to carrying out activities related to their IRP, SVP has also recently created a Large Customer Renewable Energy (LCRE) program to allow its large customers to sign up for 100 percent renewable energy. In November 2021, the city approved SVP’s LCRE program, which became effective January 1, 2022 (SVP 2021b). The program is a voluntary green program for large customers to purchase additional renewable energy above the amount of renewable energy already included in SVP’s energy delivery portfolio to accelerate customers’ higher corporate renewable and sustainability goals. Customers have two options to participate in the program: (1) SVP procures supplemental renewable energy for customers for a one-year term, and (2) customer provides their own supplemental renewable energy resource under a five-year or 10-year term customer agreement with SVP. The program is available for the project applicant to use.

## Existing Conditions

California is a substantial contributor to global GHG emissions. The total gross California GHG emissions in 2019 were 418.2 MMTCO<sub>2</sub>e (CARB 2021). The largest category of GHG emissions in California is transportation, followed by industrial activities and electricity generation in state and out of state (CARB 2021). In 2019, total gross U.S. greenhouse gas emissions were 6,558 MMTCO<sub>2</sub>e, or 5,769 MMTCO<sub>2</sub>e after accounting for sequestration from the land sector (U.S. EPA 2021).

The city prepares an annual report to assess progress towards meeting the GHG emissions reduction targets established in the 2013 CAP and recommend next steps to help the city meet its targets. The city tracks changes in communitywide GHG emissions since 2008, which is the city’s jurisdictional baseline year for the GHG emissions inventory. The CAP 2018 Annual Report provides the city’s GHG emissions inventory in 2016, which is the most recent GHG emissions inventory for the city. **Table 4.8-1** presents the city’s 2016 GHG emissions inventory (Santa Clara 2018).

**TABLE 4.8-1 CITY OF SANTA CLARA 2016 GHG EMISSIONS INVENTORY**

Sector	Carbon dioxide equivalent emissions (MTCO <sub>2e</sub> )
Commercial Energy	1,080,261
Residential Energy	132,912
Transportation & Mobile Sources	505,989
Solid Waste	25,724
Water & Wastewater	24,292
Total Emissions	1,769,178

**Source:** Santa Clara 2018.

As stated in their 2018 IRP (SVP 2018), SVP follows the state's preferred loading order in procuring new energy resources. First, the current load (customer) is encouraged to participate in energy efficiency programs to reduce their usage, thus freeing up existing resources (and any related emissions) for new load (electricity demand). In addition, both the city and SVP encourage the use of renewable resources and clean distributed generation, and the local area has seen a significant increase in the use of large and small rooftop photovoltaics. Demand displaced by customer-based renewable projects is also available to meet new loads.

SVP seeks to meet its RPS milestones through the addition of new renewable resources. In January 2018, SVP began providing 100 percent carbon-free power to all residential customers. This is reflected in the Power Content Label through separate products for the residential and non-residential mix (SVP 2021a). A comparison of SVP's and the statewide power mix for 2020 is shown in **Table 4.8-2**. SVP is in various stages of clean energy procurement for the future, negotiating contracts for over 700 Megawatts of energy, totaling over 2,200,000 MWh annually. This is equivalent to powering 366,000 homes. These resources will be constructed and brought online over the next five years (SVP 2021a). As with all load serving entities in California, the carbon intensity factor will continue to change as the power mix gradually increases the use of renewable resources to achieve California's GHG and renewable energy goals.

**TABLE 4.8-2 COMPARISON OF SVP AND STATEWIDE POWER MIX – 2020**

Energy Resources	Santa Clara Residential Mix	Santa Clara Non-Residential Mix	Santa Clara Green Power Standard Mix	Santa Clara Green Power National Mix	2020 CA Power Mix
<b>Eligible Renewable</b>	<b>40.2%</b>	<b>31.7%</b>	<b>100%</b>	<b>26.0%</b>	<b>33.1%</b>
Biomass & Biowaste	0%	2.6%	0%	0.5%	2.5%
Geothermal	0%	8.1%	0%	5.2%	4.9%
Eligible Hydroelectric	0%	8.8%	0%	6.4%	1.4%
Solar	11.1%	0%	100%	0%	13.2%
Wind	29.1%	12.2%	0%	13.9%	11.1%
<b>Coal</b>	<b>0%</b>	<b>0%</b>	<b>0%</b>	<b>0%</b>	<b>2.7%</b>

**TABLE 4.8-2 COMPARISON OF SVP AND STATEWIDE POWER MIX – 2020**

Energy Resources	Santa Clara Residential Mix	Santa Clara Non-Residential Mix	Santa Clara Green Power Standard Mix	Santa Clara Green Power National Mix	2020 CA Power Mix
Large Hydroelectric	59.8%	12.2%	0%	13.5%	12.2%
Natural Gas	0%	18.4%	0%	36.9%	37.1%
Nuclear	0%	0%	0%	0%	9.3%
Other	0%	0%	0%	0%	0.2%
Unspecified sources of power	0%	37.6%	0%	23.7%	5.4%
<b>TOTAL</b>	<b>100%</b>	<b>100%</b>	<b>100%</b>	<b>100%</b>	<b>100%</b>

Source: SVP 2021a

### 4.8.3 Environmental Impacts

#### Methodology

The applicant estimated GHG emissions for demolition/construction from the demolition/construction equipment, vendor and hauling truck trips, and worker vehicle trips.

GHG emissions from the project operation are a result of diesel fuel combustion from the readiness testing and maintenance of the emergency backup generators, offsite vehicle trips for worker commutes and material deliveries, and facility upkeep (such as architectural coatings, consumer product use, landscaping, water use, waste generation, natural gas use for comfort heating, and electricity use).

**a. Would the project generate greenhouse gas emissions, either directly or indirectly, that may have a significant impact on the environment?**

#### *Construction*

*Less Than Significant Impact.* Construction of the project would result in GHG emissions generated by the on-site operation of construction equipment, vendor and hauling truck trips, and worker trips. The applicant estimated that these sources would generate a total of approximately 974 MTCO<sub>2e</sub> during the estimated 22 months of construction and demolition (CEC 2022a).

Because construction emissions would cease once construction is complete, these emissions are considered short term. The BAAQMD CEQA Guidelines do not identify a GHG emissions threshold for construction-related emissions. Instead, BAAQMD recommends that GHG emissions from construction be quantified and disclosed. BAAQMD further recommends the incorporation of BMPs to reduce GHG emissions during construction, as feasible and applicable. BMPs may include the use of alternative-fueled (for example, renewable diesel or electric) construction vehicles and equipment for at

least 15 percent of the fleet, use of at least 10 percent of local building materials, and recycling or reusing at least 50 percent of construction waste (BAAQMD 2017b). The project would implement mitigation measure **AQ-1**, which would require, among other things, that the construction equipment be tuned and maintained in accordance with manufacturer's specifications and that construction equipment idling time be limited to five minutes to reduce GHG emissions from fuel consumed from unnecessary idling or the operation of poorly maintained equipment. The project would also participate in the city's Construction & Demolition Debris Recycling Program by recycling or diverting at least 65 percent of materials generated for discards by the project to reduce the amount of demolition and construction waste going to the landfill. The quantity of construction-related GHG emissions would be limited to the construction phase, which would ensure GHG impacts are less than significant.

The CAP Measure 5.2 calls for construction vehicles to use alternative fuels, such as electricity, biodiesel, or compressed natural gas, when possible. The CAP notes that the city can make the use of alternative fuels a condition of approval for new developments during pre-construction review meetings (Santa Clara 2013).

### ***Operation and Maintenance***

*Less Than Significant with Mitigation Incorporated.* GHG emissions from project operation and maintenance would consist of direct "stationary source" emissions from routine readiness testing and maintenance of the emergency backup generators and indirect and "non-stationary source" emissions from offsite vehicle trips for worker commutes and material deliveries, and facility upkeep, including architectural coatings, consumer product use, landscaping, water use, waste generation, natural gas use for comfort heating, and electricity use.

#### **i. Direct Project Stationary Combustion Sources**

**Table 4.8-3** shows the maximum potential annual GHG emission estimates for the emergency backup generators routine readiness testing and maintenance. The emissions are estimated based on 35 hours of annual testing and maintenance at 100 percent load per engine.

**Table 4.8-3** shows that the estimated average annual GHG emissions from the project's stationary sources, the emergency backup generators, for routine readiness testing and maintenance are well below the current BAAQMD CEQA Guidelines GHG emissions significance threshold of 10,000 MTCO<sub>2</sub>e/yr for stationary sources and would not exceed the threshold level for inclusion in CARB's cap-and-trade program, which is 25,000 MTCO<sub>2</sub>e/yr. However, as mentioned above, BAAQMD staff is in the process of preparing and presenting to the BAAQMD board for approval an update to the CEQA GHG threshold for stationary sources from 10,000 MTCO<sub>2</sub>e/yr to 2,000 MTCO<sub>2</sub>e/yr or compliance with CARB's cap-and-trade program. Therefore, staff proposes mitigation measure **GHG-1** to require the applicant to limit the GHG emissions of the emergency backup generators to the BAAQMD CEQA Guidelines GHG threshold applicable at the time



of permitting. These emissions could be reduced further by using renewable diesel in place of petroleum-based diesel. Because of California's ambitious GHG emissions reduction goals, staff concludes it is imperative that all feasible methods of carbon reduction be employed to ensure the project GHG emissions are less than significant. Therefore, staff also proposes mitigation measure **GHG-2** to require the applicant to use an increasing mix of renewable diesel and phase out the use of ultra-low sulfur diesel. Staff analyzes the effectiveness of these approaches separately.

**TABLE 4.8-3 GREENHOUSE GAS EMISSIONS FROM EMERGENCY BACKUP GENERATORS TESTING AND MAINTENANCE**

Source	Maximum Annual Emissions (MTCO <sub>2</sub> e/yr)
Emergency backup generators – Testing and Maintenance	3,387
Proposed Future BAAQMD Threshold	2,000
Exceeds Threshold?	Yes

Source: DayZenLLC 2021b, CEC staff analysis

- 1) **Limiting GHG Emissions.** The applicant estimated the GHG emissions of the emergency backup generators shown in **Table 4.8-3** are conservatively based on 35 hours of annual readiness testing and maintenance at 100 percent load per engine. Staff estimates that, if the applicant accepts a permit limit of 20 hours of annual readiness testing and maintenance per engine, the GHG emissions of the emergency backup generators would be about 1,935 MTCO<sub>2</sub>e/yr, which would not exceed 2,000 MTCO<sub>2</sub>e/yr. Since the monthly testing would occur at 0 percent load for up to 15 minutes and annual testing would only be conducted once per year at a series of stepped loads up to 100 percent load (DayZenLLC 2021t), staff expects the applicant would be able to accept a permit limit of 20 hours of annual testing and maintenance per engine to lower the GHG emissions to 2,000 MTCO<sub>2</sub>e/yr, if it is applicable at the time of permitting.
  
- 2) **Using Renewable Diesel.** The applicant could also reduce the GHG emissions of the emergency backup generators by replacing the ultra-low sulfur petroleum-based diesel with renewable diesel. BAAQMD indicates that biogenic CO<sub>2</sub> emissions would not be included in the quantification of GHG emissions for characterizing the CEQA impact significance for a project (BAAQMD2017b, page 4-5). Accordingly, if the project can substitute the proposed use of ultra-low sulfur petroleum-based diesel with a renewable non-petroleum resource, the portion of the project's GHG emissions from the biogenic resources would be exempt from the stationary source threshold.

As shown in **Table D-1** in **Appendix C**, renewable diesel used in place of ultra-low sulfur petroleum-based diesel can reduce CO<sub>2</sub> tailpipe emissions approximately 3 to 4 percent. However, renewable diesel is produced with a fuel-cycle that is a far lower carbon intensity (CI) than ultra-low sulfur petroleum-based diesel. In staff's independent analysis, staff compared fuel-cycle GHG emissions from using renewable diesel and petroleum-based diesel. Based on data from CARB's Low-

Carbon Fuel Standard regulations (17 CCR §§95480 to 95503), staff computed that the fuel-cycle GHG emissions of the emergency backup generators would decrease from 3,387 MTCO<sub>2</sub>e/yr using petroleum diesel to 1,107 MTCO<sub>2</sub>e/yr with renewable diesel.

As discussed in **Section 5 Alternatives**, renewable diesel is expected to become more widely available in the future when more suppliers come online and fuel-cycle GHG emissions would be reduced using renewable diesel. As explained in detail under environmental checklist criterion “b,” staff recommends mitigation measure **GHG-2** to require the project to use an increasing mix of renewable diesel. With **GHG-2**, the project’s GHG emissions from stationary sources would be further reduced.

With the implementation of **GHG-1** and **GHG-2**, the environmental impact of GHG emissions from the project’s stationary sources would be reduced to a level that would not be significant.

## ii. Indirect and Non-Stationary Sources Emissions

Maximum GHG emissions from indirect and non-stationary sources (i.e. energy use, mobile sources and building operation) are provided in **Table 4.8-4**.

**Project Electricity Usage.** **Table 4.8-4** shows the indirect GHG emissions attributed to electricity use. The primary function of the project is to house computer servers, which require electricity and cooling 24 hours a day to operate. Annual GHG emissions associated with electricity usage are the product of the maximum estimated annual electricity usage and the utility-specific carbon intensity factor, which depends on the utility’s portfolio of power generation sources. The projected maximum demand for the project is 96 MW but will be built in phases. The applicant estimated energy use from the project activities for Phase 1 to be 473,040 MWh/year. After full build-out, staff estimates that the worst-case energy use from the project’s activities would be up to 840,960 MWh/year (= 96 MW × 8,760 hours/year).

Electricity for the project would be provided by SVP. The applicant used carbon intensity factors from “SVP Email to City of Santa Clara on Carbon Intensity Factor” from the Sequoia Data Center Project proceeding (SVP 2019). For energy use emissions for the first phase of operations, the applicant used a carbon intensity value of 250 pounds CO<sub>2</sub> per MWh (lbs CO<sub>2</sub>/MWh), which is the average value for 2023 and 2024 from SVP’s email. For operation with full build-out, the applicant used a carbon intensity value of 277 lbs CO<sub>2</sub>/MWh for 2025 from SVP’s email. SVP’s carbon intensity factor for electricity generation will continue to change as SVP’s power mix continues to increase the percentage of electricity obtained from renewable resources. Since it is not clear whether the SVP carbon intensity values already include CH<sub>4</sub> or N<sub>2</sub>O, the applicant conservatively used the CalEEMod default CH<sub>4</sub> and N<sub>2</sub>O intensity factors of 0.029 and 0.006 lbs/MWh, respectively. **Table 4.8-4** shows the worst-case GHG emissions due to electricity use, which would be during full build-out operation. Even as SVP improves its fuel mix to meet

2030 and other GHG emissions reduction goals, the project would indirectly emit a significant amount of GHGs as a result of its energy needs. With the carbon intensity value of 219 lbs CO<sub>2</sub>/MWh for 2030 from SVP's email, the worst-case GHG emissions due to electricity use would still be about 84,472 MTCO<sub>2</sub>e/yr.

**Project Mobile Emissions Sources.** Table 4.8-4 shows the applicant's estimated annual GHG emissions from mobile emissions sources. The applicant relied on a project operational trip generation consistent with the transportation operation analysis memo. The transportation analysis states that the net project trip rate would be negative (-658 trips per day) based on an estimate of 1,125 trips per day from the existing land use and 467 trips per day from project operations. However, the applicant conservatively estimated the GHG emissions based on 467 trips per day for the project.

**Project Water Consumption and Waste Generation.** Table 4.8-4 shows the estimated annual GHG emissions from water consumption and waste generation. Water consumption results in indirect emissions from electricity usage for water conveyance and wastewater treatment. Daily operations at the project would also generate solid waste, which results in fugitive GHG emissions during waste decomposition at the landfill.

**Refrigerant Use.** The project would use refrigerants in forty-eight (48) air-cooled chillers with ambient free-cooling economizers located on roof dunnage. The refrigerant used in the air-cooled chillers proposed would be R-134a. The chiller manufacturer estimates a worst case (barring unpredictable catastrophes) of 1 percent annual refrigerant loss a year. Each chiller is charged with 811.4 lbs of R-134a (DayZenLLC 2021m). Staff estimated a total of 389 lbs of refrigerant would be lost in a year for all (48) of the chillers for the whole project. Since R-134a has a GWP of 1,430, the project would create about 253 MTCO<sub>2</sub>e into the atmosphere due to refrigerant loss.

**Summary of Indirect and Non-stationary GHG Emissions.** As shown in Table 4.8-4, operation of the project is estimated to generate 107,383 MTCO<sub>2</sub>e/yr from maximum possible electricity use and other non-stationary sources. The majority of emissions would be from the energy use, which is estimated to be up to 106,596 MTCO<sub>2</sub>e/yr. As described above, electricity to the project would be provided by SVP, a utility that is on track to meet their 2030 GHG emissions reductions target, as described in their CAP 2018 Annual Report and as verified by staff. Actual GHG emissions associated with electricity use at the project would be much less than 106,596 MTCO<sub>2</sub>e/yr since actual electricity use will be less than the maximum and the SVP annual average emission factor will be tracking downward towards "zero net" with the implementation of state and local measures to reduce GHG emissions associated with electricity production and California's fuels. For example, programs to implement SB 350 and SB 100 would continue to promote renewable resources in the power mix and ensure ongoing substantial reductions in GHG emissions from electricity generation.

To reduce GHG emissions associated with the use of energy during building operations, the project proposes to implement a variety of energy efficiency measures: daylight

penetration to offices, reflective roof surface, meet or exceed Title 24 building standards requirements, electric vehicle (EV) parking, low-flow plumbing fixtures, and landscaping would meet the city's requirements for low water use. The project would comply with all applicable city and state green building standards measures, including California Code of Regulations, Title 24, Part 6, baseline standard requirements for energy efficiency, based on the 2019 Energy Efficiency Standards requirements, and the 2019 California Green Building Standards Code, commonly referred to as CALGreen (California Code of Regulations, Title 24, Part 11).

**TABLE 4.8-4. MAXIMUM GHG EMISSIONS FROM ENERGY USE, MOBILE SOURCES, AND BUILDING OPERATION DURING PROJECT OPERATION**

Source	Annual Emissions (MTCO <sub>2</sub> e/yr)
Energy Use <sup>a</sup>	106,596
Mobile Sources <sup>b</sup>	248
Landscaping	0.0102
Water Use	2
Waste Disposed	284
Cooling System R-134a Leakage <sup>c</sup>	253
<b>Total</b>	<b>107,383</b>

Sources: DayZenLLC 2021b, DayZenLLC 2021m, CEC staff analysis.

Notes:

<sup>a</sup> Based on SVP carbon intensity factor of 277 lbs of CO<sub>2</sub> per MWh for 2025, with 0.029 lbs of CH<sub>4</sub> per MWh and 0.006 lbs of N<sub>2</sub>O per MWh. CEC staff assumed the worst-case electricity use of 840,960 MWh/year after full build-out.

<sup>b</sup> Conservatively based on 467 trips per day from project operations.

<sup>c</sup> Estimate based on the chiller manufacturer estimated worst-case 1 percent leakage rate per year (DayZenLLC 2021m) and an AR4 GWP of 1,430 for R-134a (more conservative than AR5 GWP of 1,300). The regulatory leakage rate limit would be 10 percent per year, which would increase the maximum allowable GHG annual emissions tenfold to 2,526 MTCO<sub>2</sub>e.

## Conclusion

*Less Than Significant with Mitigation Incorporated.* The project's GHG emissions are estimated to be a total of approximately 974 MTCO<sub>2</sub>e during the 22-month demolition and construction period. Post-construction estimated emissions from the emergency backup generators during readiness testing and maintenance are estimated to be 3,387 MTCO<sub>2</sub>e/yr as shown in **Table 4.8-3**.

The project's GHG emissions from the annual readiness testing and maintenance of the emergency backup generators would be below the current BAAQMD CEQA Guidelines threshold of significance of 10,000 MTCO<sub>2</sub>e/yr. However, BAAQMD staff is in the process of preparing and presenting to the BAAQMD board an update to the CEQA GHG threshold for stationary sources from 10,000 MTCO<sub>2</sub>e/yr to 2,000 MTCO<sub>2</sub>e/yr or compliance with CARB's cap-and-trade program. To ensure the project would comply with the possible future CEQA GHG threshold change, staff recommends mitigation measure **GHG-1** to ensure that the GHG emissions of the emergency backup generators are limited to the BAAQMD CEQA Guidelines GHG threshold of significance applicable at the time of permitting. Additionally, staff recommends **GHG-2** to require the emergency backup

generators to use renewable diesel to ensure that operation of the emergency backup generators would not hinder California's efforts to achieve statewide 2030 or 2045 GHG emissions reduction goals. With these measures, the project's direct GHG emissions from stationary sources would not have a significant direct or indirect impact on the environment.

As discussed below, with the implementation of **GHG-2** and **GHG-3**, the GHG emissions from the project's electricity use, mobile sources, and building operation would occur in a manner consistent with the policies reflected in Executive Order B-55-18, CARB's scoping plan, and later programs to implement SB 350 and SB 100 to achieve the statewide 2030 and other future GHG emissions reduction targets. These categories of GHG emissions would not result in a "cumulatively considerable" contribution under CEQA because they would conform with all applicable plans, policies, and regulations adopted for the purpose of GHG emissions reductions, as discussed further in "b" below. Therefore, the maximum potential rate of GHG emissions from the project's electricity use, mobile sources, and building operation are determined to have less-than-significant GHG impacts.

The majority of the project's operational GHG emissions would occur from electricity use or during the readiness testing and maintenance of the emergency backup generators. The project's likelihood of operating for unplanned circumstances or emergency purposes is low and if such operation did occur it would be infrequent and of short duration. Additionally, the requirement to use increasing amounts of renewable diesel fuel would ensure that any GHG emissions resulting from emergency operations are minimized to the extent feasible. Staff, therefore, concludes that these emissions would be less than significant.

**b. Would the project conflict with an applicable plan, policy or regulation adopted for the purpose of reducing the emissions of greenhouse gases?**

*Construction*

*Less Than Significant.* The project's short-term demolition and construction GHG emissions would not interfere with the state's ability to achieve long-term GHG emissions reduction goals. As mentioned above, the project would implement BMPs, as specified in mitigation measure **AQ-1**, that would reduce construction-related GHG emissions. The project would also participate in the city's Construction & Demolition Debris Recycling Program to further reduce GHG emissions. The city could also make the use of alternative fuels a condition of approval for new developments during pre-construction review meetings. The project would conform to relevant programs and recommended actions detailed in CARB's scoping plan. Similarly, the project components would not conflict with regulations adopted to achieve the goals of CARB's scoping plan. The project would be consistent with General Plan Energy Policies 5.10.3-P1 (promote the use of renewable energy resources, conservation, and recycling programs) and 5.10.3-P5 (reduce energy

consumption through sustainable construction practices, materials, and recycling). The project would also be consistent with Measure 4.2, Increased Waste Diversion, and Measure 5.2, Alternative Construction Fuels, in the 2013 CAP and Action M-3-1, Reuse of salvageable building materials, in the draft 2022 CAP Update.

### ***Operation and Maintenance***

*Less Than Significant with Mitigation Incorporated.* The project's GHG emissions related to operation and maintenance would be caused by the combustion of diesel fuel in the emergency backup generator engines and other routine operational activities (including energy use, mobile sources, and building operation).

#### **i. Direct Project Stationary Combustion Sources**

The direct project stationary combustion sources are the emergency backup generator engines.

### **State Plans, Policies, and Regulations**

As discussed under Regulatory Background above, California has set ambitious 2030, 2045, and 2050 GHG emissions reduction goals. Because of these goals, staff concludes it is imperative that all feasible methods of carbon reduction be employed to ensure the project's GHG emissions are less than significant. To reduce the GHG emissions from the emergency backup generator engines, staff recommends mitigation measure **GHG-2** to require the project to use an increasing mix of renewable diesel in the emergency backup generator engines that reflects statutory targets for renewable resources in California's electricity supply. Staff concludes SB 100 establishes a reasonable schedule for increasing reductions in emissions associated with electricity generation, and while the project is not directly required to comply with the SB 100 provisions, it is technically a generator of electricity and, therefore, it is reasonable to apply that schedule to the project for the purpose of increasing the portion of renewable diesel used over time. The mitigation would require annually reporting the status of procuring and using renewable diesel. The mitigation measure would require renewable diesel for a minimum of at least 44 percent of total energy use by the emergency backup generators by December 31, 2024; 52 percent by December 31, 2027; and 60 percent by December 31, 2030. Renewable diesel would be 100 percent of total energy use by the emergency backup generators by December 31, 2045. With **GHG-2**, the project's stationary sources would use renewable diesel to ensure that the operation of the emergency backup generators would not hinder California's efforts to achieve the statewide 2030 or 2045 GHG emissions reduction goals.

### **Regional Plans, Policies, and Regulations**

**Bay Area 2017 Clean Air Plan.** With **GHG-2**, the direct project stationary combustion sources (i.e. emergency backup generator engines) would also be consistent with BAAQMD's Bay Area 2017 Clean Air Plan measure to Decarbonize Electricity Generation (EN1).

**Diesel Free by '33.** In 2018, the Mayor of Santa Clara personally became a signatory to the BAAQMD's Diesel Free by '33 initiative. However, the CEC has concluded that Diesel Free by '33 is not an applicable GHG emissions reduction strategy, program or law that facilities must comply with. Nevertheless, it is a regional goal to reduce petroleum-based diesel fuel emissions in communities.

Renewable diesel is currently used as a transportation fuel. There are both federal (CEC 2020) and state incentives that offset the increased cost of renewable diesel compared to petroleum-based diesel when used in transportation applications. However, staff is unaware of any incentives that would apply to stationary sources, including the project. Staff proposes mitigation measure **GHG-2** to require the applicant to use an increasing mix of renewable diesel and phase out the use of petroleum-based diesel.

### **Local Plans, Policies, and Regulations**

**Applicable General Plan Policies.** Air quality policy 5.10.2-P3 encourages the implementation of technological advances that minimize public health hazards and reduce the generation of air pollutants. The project proposes to use emergency backup generators with advanced air pollution controls. The generator testing schedule includes measures to reduce local air quality impacts. The project would be consistent with the air quality policy 5.10.2-P3 in the General Plan.

**Alternative Fuel Backup Generators.** The draft 2022 CAP Update includes Action B-3-6 Alternative fuel backup generators, which would require the city to provide information and technical assistance to data centers and other large commercial users to transition from petroleum-based diesel to lower-carbon backup generators (e.g., renewable diesel) by 2030. The applicant has recently set a corporate commitment to achieve net zero carbon emissions by 2030. As part of the strategy to achieve this aggressive goal, the project applicant is actively exploring all options to reduce or eliminate the emissions from the use of diesel-fueled emergency backup generators. The applicant is conducting a feasibility analysis for the use of renewable diesel. The applicant is measuring its GHG footprint and will be achieving commitment to net zero carbon emissions by 2030. Carbon removal offsets will be purchased for emissions that the applicant cannot eliminate through efficiency measures. Investments in carbon removal projects at a local/regional level where the applicant's projects operate will be prioritized (DayZenLLC 2021m).

As discussed in **Section 5 Alternatives**, renewable diesel is expected to become more widely available in the future and would reduce the project's GHG emissions. Therefore, staff proposes mitigation measure **GHG-2** to require the applicant to use an increasing mix of renewable diesel and phase out use of ultra-low sulfur petroleum-based diesel.

### **ii. Indirect and Non-Stationary Sources Emissions**

The project's indirect and non-stationary sources emissions include those from energy use, mobile sources and building operation.

## State Plans, Policies, and Regulations

The project's GHG emissions are predominantly from electricity usage. Multiple measures contained in CARB's scoping plan address GHG emissions from energy use. For example, CARB's cap-and-trade program, through the regulation of upstream electricity producers, will account for GHG emissions in the project's power mix and requires these emissions to be reduced by the amount needed to achieve the statewide 2030 GHG emissions reduction goal. Electricity sources and suppliers used by the project must comply with the RPS and cap-and-trade program requirements. This, however, is not to say that new large consumers of electricity should not also be responsible for the GHG emissions resulting from their electricity use.

While SVP itself is compliant with SB 100, staff concludes that because the project would present such a large, single potential increase in load (up to 96 MW at full build out), it is not sufficient to point to SVP's compliance to conclude the project's indirect emissions from electricity use are less than significant. The more electricity demand added to the grid, the harder it becomes to meet long-term GHG emissions reduction goals. Transmission resources are not infinite, and renewable imports are increasingly being taken as other states establish their own GHG emissions reduction goals. Adding renewable generation, while obviously preferable to fossil-fueled generation, is not without its own potential environmental impacts, and asking all customers of a load serving entity to share in the costs of greening additional demand brought on by large commercial customers raises equity concerns. Numerous data centers, many with just under 100 MW loads, are being proposed in SVP territory, with several already under construction or about to start. Without a requirement that these data center facilities bear responsibility for ensuring that their electricity use would not impede the attainment of the state's GHG emissions reduction goals, including SB 100, it is unclear how the state is going to make the increasingly steep reductions needed to avert the most catastrophic climate change scenarios. Staff has confirmed with SVP that the applicant can participate in SVP's LCRE program to purchase 100 percent renewable electricity. Therefore, to conclude the project would not impede the attainment of the state's GHG emissions reduction goals, staff recommends mitigation measure **GHG-3** to require the project applicant to participate in SVP's LCRE program for 100 percent carbon-free electricity or purchase carbon offsets or similar instruments that accomplish the same goals of 100 percent carbon-free electricity.

Other project activities, such as mobile sources and building operation, would be similar to those of other commercial or industrial projects subject to development review by the city of Santa Clara. The project would comply with all applicable city and state green building standards measures, including California Code of Regulations, Title 24, Part 6, baseline standard requirements for energy efficiency, based on the 2019 Energy Efficiency Standards requirements, and the 2019 California Green Building Standards



Code, commonly referred to as CALGreen (California Code of Regulations, Title 24, Part 11).

With **GHG-3**, the operation of the project would not conflict with regulations adopted to achieve the goals of the scoping plan. Accordingly, the project's operational activities would not interfere with the state's ability to achieve long-term GHG emissions reduction goals.

### **Regional Plans, Policies, and Regulations**

**Bay Area 2017 Clean Air Plan.** BAAQMD's Bay Area 2017 Clean Air Plan includes Energy and Climate Measure (ECM)-1 – Energy Efficiency, and due to the relatively high project electrical demand, energy efficiency measures are included in the design and operation of the onsite electrical and mechanical systems, consistent with this measure. The energy efficiency measures include: (1) premium efficiency electrical distribution equipment for the critical information technology (IT) systems, (2) ambient free-cooling coils on the air cooled chillers, (3) adiabatic assist pads on the condenser coils of the chillers, and (4) heat recovery on the Variable Refrigerant Flow (VRF) systems (DayZenLLC 2021m). Staff also proposes mitigation measure **GHG-3** to require the project applicant to participate in SVP's LCRE program for 100 percent carbon-free electricity or purchase carbon offsets or similar instruments that accomplish the same goals of 100 percent carbon-free electricity. These features would be consistent with BAAQMD's Bay Area 2017 Clean Air Plan measure to Decarbonize Electricity Generation (EN1).

**Plan Bay Area 2040/SB 375.** MTC and ABAG developed an SCS with the adopted Plan Bay Area 2040 to achieve the Bay Area's regional GHG emissions reduction target. Plan Bay Area 2040 sets a 15 percent GHG emissions reduction per capita target from passenger vehicles by 2035 when compared to the project 2005 emissions. However, these emission reduction targets are intended for land use and transportation strategies only. The project has a low concentration of employment and would not contribute to a substantial increase in passenger vehicle travel within the region.

### **Local Plans, Policies, and Regulations**

**Applicable General Plan Policies.** The city adopted the General Plan to accommodate planned housing and employment growth through 2035. As part of the city's General Plan Update in 2011, new policies were adopted that address the reduction of GHG emissions during the planning horizon of the General Plan. In addition to the reduction measures in the CAP, the General Plan includes goals and policies to address sustainability aimed at reducing the city's contribution to GHG emissions. For the project, the implementation of policies that increase energy efficiency or reduce energy use would effectively reduce indirect GHG emissions associated with energy consumption. The consistency of the project with the applicable land use, air quality, energy, and water policies in the General Plan is analyzed in **Table 4.8-5** below. As shown, the project would be consistent with the applicable sustainability policies in the General Plan.

**TABLE 4.8-5 PROJECT CONSISTENCY WITH GENERAL PLAN SUSTAINABILITY POLICIES RELATED TO INDIRECT AND NON-STATIONARY SOURCES EMISSIONS**

Emission Reduction Policies	Project Consistency
<b><i>Air Quality Policies</i></b>	
5.10.2-P4 Encourage measures to reduce greenhouse gas emissions to reach 30 percent below 1990 levels by 2020.	Water conservation and energy efficiency measures included in the project would reduce GHG emissions associated with the generation of electricity.
<b><i>Energy Policies</i></b>	
5.10.3-P1 Promote the use of renewable energy resources, conservation, and recycling programs.	The project would utilize lighting control to reduce energy usage for new exterior lighting and air economization for building cooling. Water efficient landscaping and ultra-low flow plumbing fixtures in the building would be installed to limit water consumption.
5.10.3-P4 Encourage new development to incorporate sustainable building design, site planning, and construction, including encouraging solar opportunities.	
5.10.3-P5 Reduce energy consumption through sustainable construction practices, materials, and recycling.	
5.10.3-P6 Promote sustainable buildings and land planning for all new development, including programs that reduce energy and water consumption in new development.	
5.10.3-P8 Provide incentives for LEED certified, or equivalent development.	
<b><i>Water Use Policies</i></b>	
5.10.4-P6 Maximize the use of recycled water for construction, maintenance, irrigation, and other appropriate applications.	The project would use recycled water for mechanical cooling and for landscaping.
5.10.4-P7 Require installation of native and low-water consumption plant species in new development and public spaces to reduce water usage.	The project would use water efficient landscaping with low-water usage plant material to minimize irrigation requirements.

**City of Santa Clara Climate Action Plan.** Discussion of the project’s conformance with the applicable reduction measures for new development in both the 2013 CAP and the draft 2022 CAP Update are provided below:

**Energy Efficiency Measures.** Measure 2.3, Data Centers, in the 2013 CAP calls for the completion of a feasibility study of energy efficient practices for new data center projects with an average rack power rating<sup>2</sup> of 15 kilowatts (kW) or more to achieve a power usage effectiveness (PUE) of 1.2 or lower. The average rack power rating for the project is estimated at 8.3 kW, which is significantly below the threshold to trigger a formal feasibility study of energy efficient practices. The annual average PUE of the project would be 1.26 if the building was fully leased and every client utilized its full capacity. The applicant has found that clients do not utilize the full capacity of what

<sup>2</sup> Average rack power rating is a measure of the power available for use on a rack used to store computer servers. The higher the value of kilowatts, the greater power density per rack and generally more energy use per square foot of building area in a data center.

they lease and, therefore, expects the actual PUE to be on the order of 1.25 or lower, which is slightly above Measure 2.3's goal of a PUE of 1.2 or lower. However, the project would have an average rack rating estimated to be 8.3 kW, which is lower than the threshold of 15 kW at which the city requires a feasibility study (DayZenLLC 2021m). The draft 2022 CAP Update does not include this control measure, but includes more actions specifically related to data centers as described below.

The project would comply with all applicable city and state green building standards measures, including California Code of Regulations, Title 24, Part 6, baseline standard requirements for energy efficiency, based on the 2019 Energy Efficiency Standards requirements, and the 2019 California Green Building Standards Code, commonly referred to as CALGreen (Title 24, Part 11 of the California Code of Regulations). This would be consistent with the purpose of Action B-2-3 Energy-efficient and electric-ready building code in the draft 2022 CAP Update.

**Water Conservation Measures.** Measure 3.1, Water Conservation, in the 2013 CAP calls for a reduction in per capita water use to meet urban water management targets by 2020. Development standards for water conservation would be applied to increase efficiency in indoor and outdoor water use areas. Water conservation measures include the use of the following:

- Recycled or non-potable graywater for landscape irrigation;
- Water efficient landscaping with low-water usage plant material to minimize irrigation requirements; and
- Ultra-low flow toilets and plumbing fixtures in the building.

These water conservation measures would be consistent with Action N-3-4, Water-efficient landscaping requirements, and Action N-3-6, Recycled water connection requirements, in the draft 2022 CAP Update.

**Transportation and Land Use Measures.** Measure 6.1, Transportation Demand Management, program in the 2013 CAP requires new development located in the city's transportation districts to implement a transportation demand management (TDM) program to reduce drive-alone trips. The project would be required to have a 25-percent vehicle miles traveled (VMT) reduction, with 10 percent coming from TDM measures. An exception to these reduction requirements is made for projects located on properties with a General Plan designation of Light Industrial, such as the project site. Nevertheless, the project would be required to comply with General Plan Policy 5.8.5-P1, which requires new development to implement TDM programs that can include site-design measures, including preferred carpool and vanpool parking, enhanced pedestrian access, bicycle storage, and recreational facilities. Action T-3-1 TDM plan requirements in the draft 2022 CAP Update would also require a 25 percent reduction in project based VMT through active TDM requirements for large employers

over 500 employees, including aggressive regulations to reduce parking in new development.

**Electric Vehicle Charging Spaces.** Measure 6.3 of the 2013 CAP recommends five percent of all new parking spaces be designated for electric vehicle (EV) charging. The project would provide a total of 30 parking spaces on site including one accessible and one van-accessible parking space. The applicant would provide four EV charging spaces and six Clean Air Vehicle spaces on site. Additionally, up to 96 parking places for the project will be provided across Walsh Avenue on Vantage's CA1 existing campus, but only 87 would be required. Nine EV charging spaces and 12 Clean Air Vehicle spaces would be provided at the CA1 campus (DayZenLLC 2021hh). The project would be consistent with Measure 6.3 of the 2013 CAP. Action T-1-5 Office EV chargers in the draft 2022 CAP Update would also require the city's Community Development Department, Building Division, to implement proposed Reach Code to require all new commercial office units to install Level 2 charging stations at 10 percent of parking spaces, Level 1 circuits at 10 percent of parking spaces, and 30 percent EV-capable.

**Urban Cooling.** Measure 7.2 of the 2013 CAP and Action C-2-3, High-albedo parking lots, in the draft 2022 CAP Update both require new parking lots be surfaced with more sustainable pavement materials to reduce heat gain. The project would meet the CAP as adopted in its City Code. Trees are proposed to be planted adjacent to the parking bays. If identified as a requirement by the city during the building permit phase, a high-albedo surface paving course (such as a light-colored chip-seal) can be placed over the asphalt paving in the parking bays (DayZenLLC 2021m).

**Carbon Neutral Data Centers and Renewable Electricity for New Data Centers.** The draft 2022 CAP Update includes Action B-1-7, Carbon neutral data centers, which would require all new data centers to operate on 100 percent carbon neutral energy, with offsets as needed. However, this requirement would not apply to data centers with planning application approval within six months of the CAP adoption date, which is planned for April 2022 (CEC 2021x). In addition, the draft 2022 CAP Update also includes Action B-3-7, Renewable electricity for new data centers, which requires the city/SVP to support convening of a data center working group to identify and implement renewable electricity purchasing options for commercial customers. SVP is on track to meet the state's GHG emissions reduction goals. As mentioned above, the applicant is measuring its GHG footprint and will be achieving its commitment to net zero carbon emissions by 2030. It is unclear whether the project would be approved by the city within six months of the 2022 CAP Update adoption date. Considering the additional time needed for the city and BAAQMD to permit the project, it is possible the project could be subject to Action B-1-7 in the draft 2022 CAP Update. Even if the project's applicant obtains its city permit in time to avoid the application of Action B-1-7, staff concludes that the project must employ all feasible means available to reduce its GHG emissions to avoid a significant adverse environmental impact. Therefore, staff proposes mitigation measure **GHG-3** to

require the applicant to participate in SVP's LCRE program for 100 percent carbon-free electricity or purchase carbon offsets or similar instruments that accomplish the same goals of 100 percent carbon-free electricity. The applicant is working with SVP to see if an option for the provision of lower carbon electricity is available and feasible.

The applicant would incorporate measures from the CAP, as specified by the city during the design review process to ensure compliance with applicable laws, ordinances, regulations, and standards. Conformance with the applicable design codes and policies will be enforced during the city design review process.

### ***Conclusion***

*Less Than Significant with Mitigation Incorporated.* With the implementation of the efficiency measures to be incorporated into the project and mitigation measures **GHG-2** and **GHG-3**, GHG emissions related to the project would be consistent with the applicable plans and policies adopted to reduce GHG emissions and would comply with all regulations or requirements adopted to implement a statewide, regional, or local plan for the reduction or mitigation of GHG emissions. The potential for the project to conflict with an applicable plan, policy, or regulation for GHG emissions reductions would be less than significant.

#### **4.8.4 Mitigation Measures**

**GHG-1:** If the Bay Area Air Quality Management District (BAAQMD) has adopted a new threshold of significance for stationary sources on or before the date CA3 receives its Authority to Construct permit, the project shall reduce the time the engines operate for readiness testing and maintenance on an annual basis to ensure the project complies with the new limit. Prior to the start of operation, the project owner shall provide a report to the Director, or Director's designee, of the City of Santa Clara Planning Division describing how the project intends to comply with the limit, including a proposed schedule of readiness testing and maintenance operations for the year. The project owner shall provide an annual report thereafter to the Director, or Director's designee, of the City of Santa Clara Planning Division describing all operations of the facility that occurred for readiness testing and maintenance and calculating the attendant GHG emissions that resulted for the year.

**GHG-2:** The project owner shall use renewable diesel as the primary fuel for the emergency backup generators to the maximum extent feasible, and only use ultra-low sulfur diesel (ULSD) as a secondary fuel in the event of supply challenges or disruption in obtaining renewable diesel. The project owner shall ensure that renewable fuels are used for a minimum of at least 44 percent of total energy use by the emergency backup generators by December 31, 2024; 52 percent by December 31, 2027; and 60 percent by December 31, 2030. Renewable fuels shall be used for 100 percent of total energy use by the emergency backup generators by December 31, 2045. The project owner shall provide an annual report of the status of procuring and using renewable diesel to the

Director, or Director's designee, of the City of Santa Clara Planning Division demonstrating compliance with the mitigation measure.

**GHG-3:** The project owner shall ensure that 100 percent of the electricity purchased to power the project is covered by carbon-free resources using one of the following options: (1) participate in Silicon Valley Power (SVP) Large Customer Renewable Energy (LCRE) Program for 100 percent carbon-free electricity, or (2) purchase carbon offsets or similar instruments that accomplish the same goals of 100 percent carbon-free electricity. The project owner shall provide documentation to the Director, or Director's designee, of the City of Santa Clara Planning Division of enrollment and annual reporting of continued participation in SVP's LCRE Program with 100 percent carbon-free electricity coverage. If not enrolled in SVP's LCRE Program, the project owner shall provide documentation and annual reporting to the Director, or Director's designee, of the City of Santa Clara Planning Division that confirms that alternative measures achieve the same 100 percent carbon free electricity as SVP's LCRE Program, with verification by a qualified third-party auditor specializing in greenhouse gas emissions.

#### 4.8.5 References

BAAQMD 2017a – Bay Area Air Quality Management District (BAAQMD). Final 2017 Clean Air Plan, Adopted April 19, 2017. Accessed August 2021. Available online at: [http://www.baaqmd.gov/~media/files/planning-and-research/plans/2017-clean-air-plan/attachment-a\\_-proposed-final-cap-vol-1-pdf.pdf](http://www.baaqmd.gov/~media/files/planning-and-research/plans/2017-clean-air-plan/attachment-a_-proposed-final-cap-vol-1-pdf.pdf).

BAAQMD 2017b – Bay Area Air Quality Management District (BAAQMD). California Environmental Quality Act Air Quality Guidelines, Updated May 2017. Accessed August 2021. Available online at: [http://www.baaqmd.gov/~media/files/planning-and-research/ceqa/ceqa\\_guidelines\\_may2017-pdf.pdf?la=en](http://www.baaqmd.gov/~media/files/planning-and-research/ceqa/ceqa_guidelines_may2017-pdf.pdf?la=en).

BAAQMD 2021 – Bay Area Air Quality Management District Comments (BAAQMD). BAAQMD Presentation at the Equity and Environmental Justice Focus Group on the Air District Update to the CEQA Thresholds of Significance for Greenhouse Gases, November 16, 2021. Available online at: <https://www.baaqmd.gov/~media/files/planning-and-research/ceqa/ceqa-thresholds-workshop-111621/ceqa-ghg-thresholds-nov-16-focus-group-ppt-pdf.pdf?la=en&rev=78a67c87a79c4d718b252dbd3fb00472>

BAAQMD 2021b – Bay Area Air Quality Management District Comments (BAAQMD). (TN 239805). Letter for CA3 Data Center NOP, dated September 21, 2021. Available online at: <https://efiling.energy.ca.gov/Lists/DocketLog.aspx?docketnumber=21-SPPE-01>

CARB 2014 – California Air Resources Board (CARB). First Update to the Climate Change Scoping Plan, dated May 2014. Accessed August 2021. Available online at:

[https://ww3.arb.ca.gov/cc/scopingplan/2013\\_update/first\\_update\\_climate\\_change\\_scoping\\_plan.pdf](https://ww3.arb.ca.gov/cc/scopingplan/2013_update/first_update_climate_change_scoping_plan.pdf).

CARB 2016 – California Air Resources Board (CARB). Mobile Source Strategy. Accessed August 2021. Available online at:  
<https://ww3.arb.ca.gov/planning/sip/2016sip/2016mobsrsrc.pdf>.

CARB 2017a – California Air Resources Board (CARB). 2017 Climate Change Scoping Plan Update: The Strategy for Achieving California’s 2030 GHG Target, November 2017. Accessed August 2021. Available online at:  
[https://ww3.arb.ca.gov/cc/scopingplan/scoping\\_plan\\_2017.pdf](https://ww3.arb.ca.gov/cc/scopingplan/scoping_plan_2017.pdf).

CARB 2017b – California Air Resources Board (CARB). Short-Lived Climate Pollutant Reduction Strategy, March 2017. Accessed August 2021. Available online at:  
[https://ww2.arb.ca.gov/sites/default/files/2020-07/final\\_SLCP\\_strategy.pdf](https://ww2.arb.ca.gov/sites/default/files/2020-07/final_SLCP_strategy.pdf).

CARB 2021 – California Air Resources Board (CARB). California Greenhouse Gas Emissions for 2000 to 2019. Date of Release: July 28, 2021. Accessed August 2021. Available online at:  
[https://ww3.arb.ca.gov/cc/inventory/pubs/reports/2000\\_2019/ghg\\_inventory\\_trends\\_00-19.pdf](https://ww3.arb.ca.gov/cc/inventory/pubs/reports/2000_2019/ghg_inventory_trends_00-19.pdf).

CEC 2019 – California Energy Commission (CEC). September 23, 2019 California Energy Commission Letter to Ms Kathleen Hughes – Silicon Valley Power (TN 229814). Accessed August 2021. Available online at:  
<https://efiling.energy.ca.gov/GetDocument.aspx?tn=229814&DocumentContentId=61260>.

CEC 2020 – California Energy Commission (CEC). ROC with US EPA and CEC staff G. Bemis - Supersedes TN 234348 (TN 234353), August 2020. Accessed August 2021. Available online at:  
<https://efiling.energy.ca.gov/Lists/DocketLog.aspx?docketnumber=20-SPPE-01>

CEC 2021x – California Energy Commission (CEC). (TN 241090). Report of Conversation – Climate Action Plan Update and Applicability between CEC and City of Santa Clara, dated December 28, 2021. Available online at:  
<https://efiling.energy.ca.gov/Lists/DocketLog.aspx?docketnumber=21-SPPE-01>

CEC 2022a – California Energy Commission (CEC). (TN 241160). Report of Conversation – Modifications to Project Construction Phasing, dated January 4-12, 2022. Available online at:  
<https://efiling.energy.ca.gov/Lists/DocketLog.aspx?docketnumber=21-SPPE-01>

- DayZenLLC 2021b – DayZenLLC (DayZenLLC). (TN 237381). VDC CA3BGF SPPE Application Part III, dated April 5, 2021. Available online at: <https://efiling.energy.ca.gov/Lists/DocketLog.aspx?docketnumber=21-SPPE-01>
- DayZenLLC 2021e – DayZenLLC (DayZenLLC). (TN 237423). VDC CA3BGF SPPE Application Part II, dated April 12, 2021. Available online at: <https://efiling.energy.ca.gov/Lists/DocketLog.aspx?docketnumber=21-SPPE-01>
- DayZenLLC 2021m – DayZenLLC (DayZenLLC). (TN 238970). VDC Initial Responses to CEC Data Request Set 2, dated July 22, 2021. Available online at: <https://efiling.energy.ca.gov/Lists/DocketLog.aspx?docketnumber=21-SPPE-01>
- DayZenLLC 2021t – DayZenLLC (DayZenLLC). (TN 239390). VDC Supplemental Responses to CEC Data Request Set 2 Air Quality – CA3BGF, dated August 19, 2021. Available online at: <https://efiling.energy.ca.gov/Lists/DocketLog.aspx?docketnumber=21-SPPE-01>
- DayZenLLC 2021hh – DayZenLLC (DayZenLLC). (TN 240597). Summary of Parking Changes due to City PCC Comments – CA3BGF, dated November 15, 2021. Available online at: <https://efiling.energy.ca.gov/Lists/DocketLog.aspx?docketnumber=21-SPPE-01>
- IPCC 2013 – Intergovernmental Panel on Climate Change (IPCC). Climate Change 2013: The Physical Science Basis. Contribution of Working Group I to the Fifth Assessment Report of the Intergovernmental Panel on Climate Change [Stocker, T.F., D. Qin, G.-K. Plattner, M. Tignor, S.K. Allen, J. Boschung, A. Nauels, Y. Xia, V. Bex and P.M. Midgley (eds.)]. Cambridge University Press, Cambridge, United Kingdom and New York, NY, USA, 1535 pp, doi:10.1017/CBO9781107415324. Accessed August 2021. Available online at: <https://www.ipcc.ch/report/ar5/wg1/>.
- IPCC 2017 – Intergovernmental Panel on Climate Change (IPCC). Chair’s Vision Paper; AR6 Scoping Meeting. Accessed August 2021. Available online at: <https://www.ipcc.ch/site/assets/uploads/2018/11/AR6-Chair-Vision-Paper.pdf>.
- MTC & ABAG 2017 – Metropolitan Transportation Commission and Association of Bay Area Governments (MTC & ABAG). Plan Bay Area 2040. Adopted July 26, 2017. Accessed August 2021. Available online at: <https://mtc.ca.gov/our-work/plans-projects/plan-bay-area-2040>.
- Santa Clara 2013 – City of Santa Clara (Santa Clara). Santa Clara Climate Action Plan. December 2013. Accessed August 2021. Available online at: <http://santaclaraca.gov/Home/ShowDocument?id=10170>.
- Santa Clara 2018 – City of Santa Clara (Santa Clara). City of Santa Clara Climate Action Plan Annual Report. July 2018. Accessed August 2021. Available online at: <http://santaclaraca.gov/home/showdocument?id=62433>.



- Santa Clara 2021 – City of Santa Clara (Santa Clara). Climate Action Plan Update. Accessed August 2021. Available online at: <https://www.santaclaraca.gov/our-city/departments-a-f/community-development/planning-division/general-plan/climate-action-plan>.
- SVP 2018 – Silicon Valley Power (SVP). Final 2018 Integrated Resource Plan dated 12 November 2018. Accessed August 2021. Available online at: <https://www.siliconvalleypower.com/svp-and-community/about-svp/integrated-resource-plan>.
- SVP 2019 – Silicon Valley Power (SVP). SVP Email to City of Santa Clara on Carbon Intensity Factor (TN 233088) dated February 6, 2019. Accessed August 2021. Available online at: <https://efiling.energy.ca.gov/GetDocument.aspx?tn=233088&DocumentContentId=65571>.
- SVP 2021a – Silicon Valley Power (SVP). 2020 Power Content Label. Accessed November 2021. Available online at: <https://www.siliconvalleypower.com/svp-and-community/about-svp/power-content-label>.
- SVP 2021b – Silicon Valley Power (SVP). Action on a Resolution Establishing Silicon Valley Power (SVP) Large Customer Renewable Energy (LCRE) Program – A Voluntary Program for Large Customers to Purchase Additional Renewable Energy Above the Amount of Renewable Energy Already Required in SVP's Energy Delivery Portfolio. November 2021. Available online at: <https://santaclara.legistar.com/LegislationDetail.aspx?ID=5215843&GUID=1BACDF6A-915D-48D4-981F-949273F4EEA1&Options=ID%7CText%7C&Search=Green+Energy>
- SVP 2022 – Silicon Valley Power (SVP). Green Power for Your Business. Accessed January 2022. Available online at: <https://www.siliconvalleypower.com/sustainability/santa-clara-green-power/green-power-for-your-business>.
- U.S. EPA 2021 – United States Environmental Protection Agency (U.S. EPA). Inventory of U.S. Greenhouse Gas Emissions and Sinks. Accessed August 2021. Available online at: <https://www.epa.gov/ghgemissions/inventory-us-greenhouse-gas-emissions-and-sinks>.

## 4.9 Hazards and Hazardous Materials

This section describes the environmental and regulatory setting and discusses impacts specific to hazards and hazardous materials associated with the construction and operation of the project.

<b>HAZARDS AND HAZARDOUS MATERIALS</b>	<b>Potentially Significant Impact</b>	<b>Less Than Significant with Mitigation Incorporated</b>	<b>Less Than Significant Impact</b>	<b>No Impact</b>
Would the project:				
a. Create a significant hazard to the public or the environment through the routine transport, use, or disposal of hazardous materials?	<input type="checkbox"/>	<input type="checkbox"/>	<input checked="" type="checkbox"/>	<input type="checkbox"/>
b. Create a significant hazard to the public or the environment through reasonably foreseeable upset and accident conditions involving the release of hazardous materials into the environment?	<input type="checkbox"/>	<input type="checkbox"/>	<input checked="" type="checkbox"/>	<input type="checkbox"/>
c. Emit hazardous emissions or handle hazardous or acutely hazardous materials, substances, or waste within one-quarter mile of an existing or proposed school?	<input type="checkbox"/>	<input checked="" type="checkbox"/>	<input type="checkbox"/>	<input type="checkbox"/>
d. Be located on a site which is included on a list of hazardous materials sites compiled pursuant to Government Code Section 65962.5 and, as a result, would it create a significant hazard to the public or the environment?	<input type="checkbox"/>	<input checked="" type="checkbox"/>	<input type="checkbox"/>	<input type="checkbox"/>
e. For a project located within an airport land use plan or, where such a plan has not been adopted, within two miles of a public airport or public use airport, would the project result in a safety hazard or excessive noise for people residing or working in the project area?	<input type="checkbox"/>	<input type="checkbox"/>	<input checked="" type="checkbox"/>	<input type="checkbox"/>
f. Impair implementation of or physically interfere with an adopted emergency response plan or emergency evacuation plan?	<input type="checkbox"/>	<input type="checkbox"/>	<input checked="" type="checkbox"/>	<input type="checkbox"/>
g. Expose people or structures, either directly or indirectly, to a significant risk of loss, injury or death involving wildland fires?	<input type="checkbox"/>	<input type="checkbox"/>	<input type="checkbox"/>	<input checked="" type="checkbox"/>

Environmental checklist established by CEQA Guidelines, Appendix G.

### 4.9.1 Environmental Setting

#### Hazardous Waste and Substances Sites

The project owner hired TRC Solutions, Inc. (TRC) to conduct a Phase 1 Environmental Site Assessment (ESA) and to determine the location of hazardous wastes and hazardous material release sites within 0.25 mile of the project. The analysis provided by TRC included within the Phase 1 ESA a search through Environmental Data Resources, Inc (EDR) a proprietary database related to generation, storage, handling, transportation,

treatment of wastes, and the remediation of contaminated soil and groundwater sites. TRC included searches of the State Water Resources Control Board's (SWRCB), Geotracker database, and the California Department of Toxic Substance Control's (DTSC) EnviroStor database.

In 1939, the eastern portion of the project site was covered by agricultural orchards and the western portion of the project was undeveloped. Based on an aerial photograph, the project site conditions remained consistent through 1968. In 1974, the eastern portion of the project site was completely cleared of all agricultural orchards and remained undeveloped land. In 1982, the project site had been redeveloped as a commercial property with only one building located on the site. Currently, the project site is leased by Mia Sole for operation as a solar panel manufacturing facility (CA3 2021b).

In 2020, TRC completed a Phase II ESA to evaluate the presence of potential contaminants in soil and soil vapor from past uses at the project site. TRC conducted a limited subsurface investigation that included sixteen soil samples and five soil vapor samples to evaluate the current subsurface conditions. In the soil samples collected, low levels of petroleum hydrocarbons and fuel-related volatile organic compounds (VOCs) were detected at levels less than their residential screening criteria. Several organochlorine pesticides dichloroethane (DDD), dichlorodiphenyldichloroethylene (DDE), dichlorodiphenyltrichloroethane (DDT), dieldrin, and endosulfan II were detected at levels less than their residential screening. Lead was also detected in several soil samples at levels less than their residential screening criteria. Heavy metals (cobalt and nickel) were detected in some soil samples at concentrations exceeding the toxicity-based screening levels, but below regional natural background concentrations. Arsenic concentrations exceeded the toxicity-based screening levels and regional natural background concentrations. Elevated concentration of lead and arsenic were detected at the greatest frequency and magnitude in the soil samples likely associated with the prior agricultural uses of the property.

Soil vapor detections included fuel-related VOCs and chlorinated solvents. However, all the detections were below the most stringent (i.e., residential land use) screening criteria published by the U.S. Environmental Protection Agency and the California Environmental Protection Agency for evaluation of vapor intrusion risks, except for chloroform. Per the Phase II ESA, the source of the chloroform is unknown, but is often found as a laboratory contaminant. TRC stated the detected soil vapor concentrations do not represent a significant adverse impact to the planned commercial land use. In the event the project site is redeveloped for residential land use, additional evaluation of soil vapor conditions may be warranted.

## **Airports**

The Norman Y. Mineta San Jose International Airport, a public airport, is approximately 1.75 miles west of the proposed project and has two runways that exceed 3,200 feet in length (Air Nav 2019). The Santa Clara County Airport Land Use Commission Plan (CLUP) shows that the proposed project does not fall within any Airport Safety Zone. The project's Federal Aviation Regulations (FAR) Part 77 (obstruction) surface is 212 feet above mean sea level (AMSL), as identified in Figure 6 of the Comprehensive Land Use Plan for San Jose International Airport (SCCALUC 2016).

## **Schools**

The Bracher Elementary School, a public school, is approximately 0.25 miles west of the proposed project site.

## **Emergency Evacuation Routes**

The Santa Clara Local Hazard Mitigation Plan (Santa Clara County 2017) identifies hazards and provides a risk assessment for the potential natural hazards, such as a flood, wildfire, or earthquake, that could impact the county. The plan does not identify any designated evacuation routes near the project site.

## **Wildfire Hazards**

The California Department of Forestry and Fire Protection (Cal Fire) identifies, and maps areas of significant fire hazards based on fuels, terrain, and other relevant factors. The maps identify this information as a series of Fire Hazard Severity Zones, which are progressively ranked in severity as un-zoned, moderate, high, and very high. State responsibility areas (SRAs) are locations where the State of California is responsible for wildland fire protection. Local responsibility areas (LRAs) are locations where the responding agency is the local county or city. The project site would be located within Santa Clara County.

The Cal Fire maps for Santa Clara County (CalFire 2007) indicate that the project site is in an LRA. Within the LRA, the project site falls within an un-zoned Fire Hazard Severity Zone that indicates that the project site has a less than moderate susceptibility to wildland fires. For more information on wildfire hazards, see **Section 4.19 Wildfire**.

## **Regulatory Background**

### *Federal*

**Resource Conservation and Recovery Act.** The federal Toxic Substances Control Act (1976) and the Resource Conservation and Recovery Act of 1976 (RCRA) established a program administered by the United States Environmental Protection Agency (U.S. EPA) for the regulation of the generation, transportation, treatment, storage, and disposal of hazardous waste. RCRA was amended in 1984 by the Hazardous and Solid Waste Act, which affirmed and extended the "cradle to grave" system of regulating hazardous

wastes. The use of certain techniques for the disposal of some hazardous wastes was specifically prohibited by the Hazardous and Solid Waste Act.

**Comprehensive Environmental Response, Compensation, and Liability Act.**

Congress enacted the federal CERCLA, including the Superfund program, on December 11, 1980. This law provided broad federal authority to respond directly to releases or threatened releases of hazardous substances that may endanger public health or the environment. CERCLA established requirements concerning closed and abandoned hazardous waste sites; provided for liability of persons responsible for releases of hazardous waste at these sites; and established a trust fund to provide for cleanup when no responsible party could be identified. CERCLA also enabled the revision of the National Contingency Plan. The National Contingency Plan provided the guidelines and procedures needed to respond to releases and threatened releases of hazardous substances, pollutants, and/or contaminants. The National Contingency Plan also established the National Priorities List. CERCLA was amended by the Superfund Amendments and Reauthorization Act on October 17, 1986.

**Department of Transportation.** The United States Department of Transportation (DOT) is the primary federal agency responsible for regulating the proper handling and storage of hazardous materials during transportation (49 C.F.R. §§ 171-177 and 350-399).

**Federal Aviation Administration.** Title 14, Part 77.9 of the Code of Federal Regulations requires Federal Aviation Administration (FAA) notification for any construction or alteration of navigable airspace exceeding 200 feet above ground level (AGL). It also requires notification for construction or alterations within 20,000 feet of an airport with a runway more than 3,200 feet in length if the height of the construction or alteration exceeds a slope of 100 to 1 extending outward and upward from the nearest point of the nearest runway of the airport.

If a project's height exceeds 200 feet or exceeds the 100:1 surface, the project applicant must submit a copy of FAA Form 7460-1, Notice of Proposed Construction or Alteration, to the FAA.

*State*

**California Environmental Protection Agency.** The California Environmental Protection Agency (CalEPA) created in 1991, unified California's environmental authority in a single cabinet-level agency and brought the California Air Resources Board (CARB), State Water Resources Control Board (SWRCB), Regional Water Quality Control Boards (RWQCBs), Integrated Waste Management Board, DTSC, Office of Environmental Health Hazard Assessment, and Department of Pesticide Regulation under one agency. These agencies under the CalEPA "umbrella" provide protection of human health and the environment and ensure the coordinated deployment of state resources. Their mission is to restore, protect and enhance the environment, to ensure public health, environmental quality, and economic vitality.

**The California Hazardous Waste Control Law.** CalEPA administers the California Hazardous Waste Control Law to regulate hazardous wastes. The Hazardous Waste Control Law lists 791 chemicals and about 300 common materials that may be hazardous; establishes criteria for identifying, packaging and labeling hazardous wastes; prescribes management controls; establishes permit requirements for treatment, storage, disposal and transportation; and identifies some wastes that cannot be disposed of in landfills.

**Department of Toxic Substances Control.** DTSC is the primary agency in California that regulates hazardous waste, cleans up existing contamination, and looks for ways to reduce the hazardous waste produced in California. DTSC regulates hazardous waste in California primarily under the authority of RCRA and the California Health and Safety Code. Other laws that affect hazardous waste are specific to handling, storage, transportation, disposal, treatment, reduction, cleanup, and emergency planning.

**California Occupational Safety and Health Administration.** California Occupational Safety and Health Administration (Cal OSHA) is the primary agency responsible for worker safety related to the handling and use of chemicals in the workplace. Cal OSHA standards are generally more stringent than federal regulations. Employers are required to monitor worker exposure to listed hazardous substances and notify workers of exposure (Title 8, Cal. Code Regs., §§ 337-340). The regulations specify requirements for employee training, availability of safety equipment, accident-prevention programs, and hazardous substance exposure warnings.

**Department of California Highway Patrol.** Department of California Highway Patrol is the primary agency responsible for enforcing the regulations related to the transport of hazardous materials on California roads and highways (Title 13, Cal. Code Regs., §§ 1160-1167).

### *Local*

**Santa Clara County Operational Area Hazard Mitigation Plan.** The plan includes a risk assessment that identifies the natural hazards and risks that can impact a community based on historical experience, estimates the potential frequency and magnitude of disasters, and assesses potential losses to life and property. The plan also includes developed mitigation goals and objectives as part of a strategy for mitigating hazard-related losses.

## 4.9.2 Environmental Impacts

### a. Create a significant hazard to the public or the environment through the routine transport, use, or disposal of hazardous materials?

#### *Construction*

*Less Than Significant Impact.* During the construction phase of the project, the only hazardous materials used would be paints, cleaners, solvents, gasoline, motor oil, welding gases, and lubricants. When not in use, any hazardous material would be stored in designated construction staging areas in compliance with local, state, and federal requirements. Any impacts resulting from spills or other accidental releases of these materials would be limited to the site due to the small quantities involved and their infrequent use, hence reduced chances of release. Temporary containment berms would also be used to help contain any spills during the construction of the project.

During construction, all 44 2.75 MW diesel generators fuel tanks would have to be filled. The transportation of the diesel fuel to the site would take many tanker trucks trips. Deliveries of diesel fuel during the project's operation would be scheduled on an as-needed basis resulting in four fuel tanker truck trips annually. Diesel fuel has a long history of being routinely transported and used as a common motor fuel. It is appropriate to rely upon the extensive regulatory framework that applies to the shipment of hazardous materials on California highways and roads to ensure safe handling in general transportation (see Federal Hazardous Materials Transportation Law 49 USC § 5101 et seq., DOT regulations 49 CFR subpart H, §§ 172–700, and California Department of Motor Vehicles (DMV) regulations on hazardous cargo). The site contains no unique features that would prohibit existing regulations from serving as adequate mitigation; therefore, the transportation of diesel fuel would pose a less than significant risk to the surrounding public.

The routine transport use or disposal of hazardous materials would have a less than significant impact to the public or the environment.

#### *Operation*

*Less Than Significant Impact.* Diesel fuel would be used during routine testing and maintenance, and emergencies if they occurred. The 2.75 MW generator fuel tanks have an approximately 5,400-gallon diesel fuel storage tank that would only be filled to 95 percent capacity. Based on the maintenance and testing schedule, the average fuel consumption for each generator per month would be approximately 174 gallons of diesel fuel. These monthly tests would require each generator fuel tank to be refilled to 95 percent capacity approximately every 3 months (CA3 2021f).

The project would use standard practice for fuel quality and maintenance of stored diesel fuel. Standard practice includes that each engine would have a fuel filtration system that would filter the fuel contents daily. Commercial diesel fuels also contain biocides that prevent microbial growth and additives that help to stabilize the fuel for several months.

These Tier 4 diesel generators would use selective catalytic reduction (SCR) that injects a liquid-reductant through a special catalyst into the exhaust stream of the diesel engine. The reductant source would be called diesel exhaust fluid (DEF) which is a non-hazardous solution of 67.5 percent water and 32.5 percent automotive grade urea. The estimated shelf life of the DEF based on ambient temperatures for Santa Clara county is approximately 12-18 months (CA3 2021f). The replacement strategy is to contract with Valley Oil to either replenish the DEF supply by adding DEF from a bulk tanker truck to the existing 55-gallon DEF drum containers or replace old 55-gallon DEF drum containers with new (CA3 2021f).

The DEF consumption would vary depending upon the environment, operation, and duty cycle of equipment. Each generator enclosure is equipped with 110 gallons (two 55-gallon drums) of DEF. The maximum consumption of DEF per generator is 13 gallons per hour, resulting in 8 hours of generator run time. Based on the maintenance and testing schedule anticipated of 35 hours per year per generator, the upper bound of DEF consumption per generator would be 455 gallons per year. CA3DC replacement strategy is to have Valley Oil replenish the DEF supply by adding DEF from a bulk tanker truck or tank to the existing 55-gallon drums located inside the generator enclosure or replace the 55-gallon drums with new DEF (CA3 2021f). The DEF tank levels would be monitored and refilled as necessary.

With the above listed safety features and precautions, the risk to the off-site public or environment through the routine transport, use, or disposal of hazardous materials would have a less than significant impact.

**b. Create a significant hazard to the public or the environment through reasonably foreseeable upset and accident conditions involving the release of hazardous materials into the environment?**

***Construction***

*Less Than Significant Impact.* As described under the discussion for impact criteria "a", project construction would require the limited use of hazardous materials, such as fuels, lubricants, and solvents. The storage and use of hazardous materials during construction could result in the accidental release of small quantities of hazardous materials typically associated with minor spills or leaks. However, as discussed in impact criteria "a", hazardous materials would be stored, handled, and used in accordance with applicable regulations. Personnel would be required to follow instructions on health and safety precautions and procedures to follow in the event of a release of hazardous materials. All equipment and materials storage would be routinely inspected for leaks. Records would be maintained for documenting compliance with the storage and handling of hazardous materials.

For the above reasons, the project impacts would be less than significant.



### *Operation*

*Less Than Significant Impact.* The project would not create a significant hazard to the public or environment due to an accidental release of a hazardous material. Although a substantial quantity of diesel fuel would be stored on-site, its storage would be in a dedicated fuel tank beneath each 2.75 MW generator. The 2.75 MW generator fuel tank would hold a maximum of 5,100 gallons of diesel fuel (CA3 2021b).

Each generator's integrated fuel tank would be of a double-walled high integrity design. The interstitial space between the inner and outer walls of each tank would be continuously monitored electronically for the presence of leaks through the inner wall. The monitoring system would be electronically linked to an alarm system in the engineering office that would alert personnel if a leak were detected in any of the inner tanks.

Deliveries of diesel fuel by tanker truck during the project's operation would be scheduled approximately every 3 months or on an as-needed basis. Diesel tanker trucks would use warning signs and/or wheel chocks in the loading/unloading areas to prevent the truck from moving before complete disconnection of the flexible or fixed transfer lines. An emergency pump shut-off would be available in case a pump hose breaks during the fueling of the tanks. In addition, a temporary spill catch basin would be located at each fill port for the generators during fueling events. During fueling events, storm drains will be temporarily blocked off by the truck driver and/or facility staff (CA3 2021b).

For the above listed safety features and precautions, the risk to the off-site public or environment through reasonably foreseeable upset and accident conditions involving the release of hazardous materials would have a less than significant impact.

### **c. Emit hazardous emissions or handle hazardous or acutely hazardous materials, substances, or waste within one-quarter mile of an existing or proposed school?**

#### *Construction*

*Less Than Significant Impact with Mitigation Incorporated.* The Bracher Elementary school is approximately one-quarter mile south of the project site. As described under the discussion for impact criteria "a", project construction would require the limited use of hazardous materials which would be stored, handled, and used in accordance with applicable local, state, and federal regulations. Any impacts resulting from spills or other accidental releases of these materials would be limited to the site due to the small quantities involved and their infrequent use. In addition, ground disturbing activities associated with the grading and construction activities of the project would have the potential to encounter contaminated soil. The applicant proposed measure **HAZ-1** would require a site mitigation plan (SMP) to be created to establish proper procedures to be taken when contaminated soil is found and how to dispose of the contaminated soil properly. If contaminated soils are found in concentrations above thresholds, the project would halt construction and the soil would be treated in place or removed to an

appropriate disposal facility. For the above listed safety measures and with implementation of **HAZ-1**, the construction of the project would create a less than significant impact to the public or the environment.

### *Operation*

*Less Than Significant Impact.* As described in the impact criteria "b", the project would store large amounts of diesel fuel on site. However as discussed in impact criteria "b", with the listed safety features and precautions, the risk to the off-site public or environment through reasonably foreseeable upset and accident conditions involving the release of hazardous materials would have a less than significant impact.

**d. Be located on a site which is included on a list of hazardous materials sites compiled pursuant to Government Code Section 65962.5 and, as a result, would it create a significant hazard to the public or the environment?**

### *Construction*

*Less Than Significant Impact with Mitigation Incorporated.* According to a review of the Envirostor and GeoTracker databases, the project site does not have any known, open cases on the hazardous materials sites compiled pursuant to Government Code section 65962.5. The site was originally covered by agricultural orchards and the western portion of the project was undeveloped. In 1982, the project site had been redeveloped as a commercial property with only one building located on the site. Currently, the project site is leased by Mia Sole for operation as a solar panel manufacturing facility (CA3 2021b). TRC's limited subsurface investigation conducted during a Phase II ESA found heavy metals (cobalt and nickel) were detected in some soil samples at concentrations exceeding the toxicity-based screening levels, but below regional background concentrations. Arsenic concentrations exceeded the toxicity-based screening levels and regional background concentrations. Elevated concentration of lead and arsenic were detected at the greatest frequency and magnitude in the soil samples likely associated with the prior agricultural uses of the property. Soil vapor detections included fuel-related VOCs and chlorinated solvents that were below the most stringent screening criteria, except for chloroform. The source of the chloroform is unknown but is often found as a laboratory contaminant. However, the chloroform concentrations detected do not represent a significant adverse impact to the planned commercial land use.

Ground disturbing activities associated with the grading and construction activities of the project would have the potential to encounter impacted groundwater and/or soil. The contaminated soils could contain organochlorine pesticides, heavy metals, and VOC's. The applicant proposed measure **HAZ-1** would require a SMP to be created. The SMP would establish proper procedures to be taken when groundwater and contaminated soil is found and how to dispose of the contaminated soil properly. In addition, if contaminated soils are found in concentrations above thresholds, the project would halt construction and the soil would be treated in place or removed to an appropriate disposal facility. With

the implementation of **HAZ-1**, the construction of the project would create a less than significant impact to the public or the environment.

### *Operation*

*No Impact.* Operation and maintenance activities would not involve excavation activities and would therefore have no impact.

- e. For a project located within an airport land use plan or, where such a plan has not been adopted, within two miles of a public airport or public use airport, would the project result in a safety hazard or excessive noise for people residing or working in the project area?**

### *Construction*

*Less Than Significant Impact.* The project site is approximately 1.75 miles southeast of the Norman Y. Mineta San Jose International Airport. The FAA establishes a maximum structure height of 212 feet AMSL at the project site (SCCALUC 2016). Even when accounting for the 48.8-foot AMSL finished floor elevation of the project site, the CA3DC, at 108.4 feet AGL and therefore 157.2 feet AMSL, would not exceed the FAA's obstruction surface of 212 AMSL.

The project site is still subject to Title 14, Part 77.9 of the Code of Federal Regulations, Construction or Alteration Requiring Notice. With a maximum project height of 108.4 feet AGL, the project would exceed the FAA notification 100:1 surface threshold of 92.4 feet at the project site. On August 23, 2021, the project applicant submitted Form 7460-1, Notice of Proposed Construction or Alteration, to the FAA for review (CA3 2021g). Because the project's tallest structure would be far below the project site's FAR Part 77 (obstruction) surface of 212 feet AMSL, as identified in Figure 6 of the Comprehensive Land Use Plan for San Jose International Airport, staff anticipates the FAA issuing a Determination of No Hazard for CA3DC. Therefore, the project would not pose a safety hazard and would have a less than significant impact.

The project site does not fall within any Airport Safety zone, as identified in Figure 7 of the Comprehensive Land Use Plan for San Jose International Airport (SCCALUC 2016). Therefore, the project would not pose a safety hazard and would have a less than significant impact. Project construction would not result in excessive noise impacts for people residing or working in the project area, as described in a more detailed analysis in **Section 4.13 Noise**.

### *Operation*

*No Impact.* Operation and maintenance activities for the project site would be similar to those for a similarly sized industrial building and would not have an impact on people working or residing in the area. In addition, the thermal plume generated by the project would not pose a safety hazard to any aircraft near the Norman Y. Mineta San Jose International Airport., as described in a more detailed analysis in **Section 4.17 Transportation.**

### **f. Impair implementation of or physically interfere with an adopted emergency response plan or emergency evacuation plan?**

#### *Construction*

*No Impact.* A review of the Santa Clara County Operational Area Hazard Mitigation Plan for the project revealed no specific mapping or delineation of emergency evacuation or access routes. The plans identified that the area police, fire department, and other emergency services would implement their emergency response or evacuation plans according to their communications protocols and hazard mitigation programs. The project site is not identified on any emergency evacuation or access routes. In addition, the construction would not require any road closures since the work would all be done onsite. During project construction, there would be no impact to an adopted response plan or emergency evacuation plan.

#### *Operation*

*No Impact.* After construction, no lane closures would be needed, and no impact to a response plan or emergency evacuation plan would occur.

### **g. Expose people or structures, either directly or indirectly, to a significant risk of loss, injury or death involving wildland fires?**

#### *Construction and Operation*

*No Impact.* The project site is in Santa Clara County. It is within an un-zoned Fire Hazard Severity Zone, within an LRA, indicating that the project site has a less than moderate susceptibility to wildland fires. The project site is not adjacent to wildlands. The project site is currently developed with one one-story commercial building. The project area consists primarily of commercial and industrial land uses to the north and east and residential uses to the south and west. Although equipment and vehicles used during construction, as well as welding activities, have the potential to ignite dry vegetation, the project is within an urban area and is surrounded by commercial buildings that have very limited dry vegetation. In addition, the project is within an un-zoned fire hazard area. Therefore, there would be no impact from wildland fires resulting from construction activities related to the project.

### 4.9.3 Mitigation Measures

The following design measure (Proposed Design) is proposed to be incorporated as part of the project to mitigate potential impacts to less than significant levels. (CA3 2021b).

**HAZ-1:** The project will implement the following measures to reduce potentially significant soil and or groundwater impacts to construction workers to a less than significant level.

- Prior to the issuance of grading permits, shallow soil samples shall be taken in areas where soil disturbance is anticipated to determine if contaminated soils with concentrations above established construction/trench worker thresholds may be present due to historical agricultural use and from historical leaks and spills. The soil sampling plan must be reviewed and approved by the Santa Clara Fire Department Fire Prevention and Hazardous Materials Division prior to initiation of work. Once the soil sampling analysis is complete, a report of the findings will be provided to the Santa Clara Fire Department Fire Prevention and Hazardous Materials Division and other applicable City staff for review.
- Documentation of the results of the soil sampling shall be submitted to and reviewed by the City of Santa Clara prior to the issuance of a grading permit. Any soil with concentrations above applicable environmental screening levels or hazardous waste limits would be characterized, removed, and disposed of off-site at an appropriate landfill according to all state and federal requirements.
- A Site Management Plan (SMP) will be prepared to establish management practices for handling impacted groundwater and/or soil material that may be encountered during site development and soil-disturbing activities. Components of the SMP will include:
  - a detailed discussion of the site background.
  - a summary of the analytical results.
  - preparation of a Health and Safety Plan by an industrial hygienist.
  - protocols for conducting earthwork activities in areas where impacted soil and/or groundwater are present or suspected.
  - worker training requirements, health and safety measures and soil handling procedures shall be described.
  - protocols shall be prepared to characterize/profile soil suspected of being contaminated so that appropriate mitigation, disposal, or reuse alternatives, if necessary, can be implemented.
  - notification procedures if previously undiscovered significantly impacted soil or groundwater is encountered during construction.
  - notification procedures if previously unidentified hazardous materials, hazardous waste, underground storage tanks are encountered during construction.

- on-site soil reuse guidelines.
- sampling and laboratory analyses of excess soil requiring disposal at an appropriate off-site waste disposal facility.
- soil stockpiling protocols; and
- protocols to manage groundwater that may be encountered during trenching and/or subsurface excavation activities. Prior to issuance of grading permits, a copy of the SMP must be approved by the Santa Clara County Environmental Health Department, and the Santa Clara Fire Department Fire Prevention and Hazardous Materials Division. Prior to issuance of grading permits, a copy of the SMP must be approved by the Santa Clara County Environmental Health Department, and the Santa Clara Planning Division.

If contaminated soils are found in concentrations above risk-based thresholds pursuant to the terms of the SMP, remedial actions and/or mitigation measures will be taken to reduce concentrations of contaminants to levels deemed appropriate by the selected regulatory oversight agency for ongoing site uses. Any contaminated soils found in concentrations above thresholds to be determined in coordination with regulatory agencies shall be either 1) managed or treated in place, if deemed appropriate by the oversight agency or 2) removed and disposed of at an appropriate disposal facility according to California Hazardous Waste Regulations and applicable local, state, and federal laws.

#### **4.9.4 References**

- CEC 2021 – California Energy Commission (CEC). (TN 237380). CEC Data Requests, Set 1 for CA3 Backup Generating Facility, dated April 5, 2021. Available online at: <https://efiling.energy.ca.gov/GetDocument.aspx?tn=238130&DocumentContentId=71392>
- CalFire 2007 – California Department of Forestry and Fire Protection (CalFire). 2007 Santa Clara County – Very High Fire Hazard Severity Zones in State Responsibility Area. Available online at: <https://osfm.fire.ca.gov/divisions/wildfire-planning-engineering/wildland-hazards-building-codes/fire-hazard-severity-zones-maps/>
- DTSC 2018 – Department of Toxic Substances Control (DTSC). Envirostor Database. Available online at: <http://www.envirostor.dtsc.ca.gov/public/> Accessed on: August 3, 2021
- Santa Clara County 2017 – County of Santa Clara Emergency Management. October 15, 2017. Santa Clara County Operational Area Hazard Mitigation Plan Volumes 1&2

- SWRCB 2018 – State Water Resources Control Board (SWRCB). GeoTracker Database. Available online at: <http://geotracker.waterboards.ca.gov>. Accessed on: August 3, 2021
- CA3 2021a – Application for Small Power Plant Exemption: VDC CA3 Backup Generating Facility, Part I, dated April 2021. (TN 237380). Available online at: <https://efiling.energy.ca.gov/GetDocument.aspx?tn=237380&DocumentContentId=70567>
- CA3 2021b – Application for Small Power Plant Exemption: VDC CA3 Backup Generating Facility, Part II, dated April 2021. (TN 237423). Available online at: <https://efiling.energy.ca.gov/GetDocument.aspx?tn=237423&DocumentContentId=70609>
- CA3 2021c – Application for Small Power Plant Exemption: VDC CA3 Backup Generating Facility, Part III, dated April 2021. (TN 237381). Available online at: <https://efiling.energy.ca.gov/GetDocument.aspx?tn=237381&DocumentContentId=70569>
- CA3 2021d – Application for Small Power Plant Exemption: VDC CA3 Backup Generating Facility, Part IV, dated April 2021. (TN 237382). Available online at: <https://efiling.energy.ca.gov/GetDocument.aspx?tn=237382&DocumentContentId=70570>
- CA3 2021e – Application for Small Power Plant Exemption: VDC CA3 Backup Generating Facility, Part V, dated April 2021. (TN 237383). Available online at: <https://efiling.energy.ca.gov/GetDocument.aspx?tn=237383&DocumentContentId=70571>
- CA3 2021f – Response to CEC staff data request set 1 Part I, VDC CA3 Backup Generating Facility (21-SPPE-01), June 2021 (TN 238215). Available online at: <https://efiling.energacy.ca.gov/GetDocument.aspx?tn=238215&DocumentContentId=71489>
- CA3 2021g – Response to CEC staff data request set 3, VDC CA3 Backup Generating Facility (21-SPPE-01), June 2021 (TN 239485). Available online at: <https://efiling.energy.ca.gov/GetDocument.aspx?tn=239485&DocumentContentId=72949>

## 4.10 Hydrology and Water Quality

This section describes the environmental and regulatory setting and discusses impacts associated with the construction and operation of the project with respect to hydrology and water quality.

<b>HYDROLOGY AND WATER QUALITY</b>	<b>Potentially Significant Impact</b>	<b>Less than Significant with Mitigation Incorporated</b>	<b>Less than Significant Impact</b>	<b>No Impact</b>
Would the project:				
a. Violate water quality standards or waste discharge requirements or otherwise substantially degrade surface or ground water quality?	<input type="checkbox"/>	<input type="checkbox"/>	<input checked="" type="checkbox"/>	<input type="checkbox"/>
b. Substantially decrease groundwater supplies or interfere substantially with groundwater recharge such that the project may impede sustainable groundwater management of the basin?	<input type="checkbox"/>	<input type="checkbox"/>	<input checked="" type="checkbox"/>	<input type="checkbox"/>
c. Substantially alter the existing drainage pattern of the site or area, including through the alteration of the course of a stream or river, or through the addition of impervious surfaces in a manner which would:				
i. result in substantial erosion or siltation, on- or offsite;	<input type="checkbox"/>	<input type="checkbox"/>	<input checked="" type="checkbox"/>	<input type="checkbox"/>
ii. substantially increase the rate or amount of surface runoff in a manner which would result in flooding on- or offsite;	<input type="checkbox"/>	<input type="checkbox"/>	<input checked="" type="checkbox"/>	<input type="checkbox"/>
iii. create or contribute runoff water which would exceed the capacity of existing or planned storm water drainage systems or provide substantial additional sources of polluted runoff; or	<input type="checkbox"/>	<input type="checkbox"/>	<input checked="" type="checkbox"/>	<input type="checkbox"/>
iv. impede or redirect flood flows?	<input type="checkbox"/>	<input type="checkbox"/>	<input checked="" type="checkbox"/>	<input type="checkbox"/>
d. In flood hazard, tsunami, or seiche zones, risk release of pollutants due to project inundation?	<input type="checkbox"/>	<input type="checkbox"/>	<input checked="" type="checkbox"/>	<input type="checkbox"/>
e. Conflict with or obstruct implementation of a water quality control plan or sustainable groundwater management plan?	<input type="checkbox"/>	<input type="checkbox"/>	<input checked="" type="checkbox"/>	<input type="checkbox"/>

Environmental checklist established by CEQA Guidelines, Appendix G

### 4.10.1 Setting

#### Storm Drainage and Water Quality

The project would be constructed in the city of Santa Clara, within the Guadalupe watershed. The Guadalupe watershed drains to the San Francisco Bay, located a few miles northwest of the proposed project site. The site is located west of San Tomas Aquino Creek and the Guadalupe River. Storm water from the project site drains into the city of Santa Clara's storm water drain system along Walsh Avenue, which



discharges to Guadalupe River and ultimately to San Francisco Bay.

The water quality of San Tomas Aquino Creek and other creeks is influenced by pollutants contained in storm water runoff. Storm water runoff from urban areas typically contains pollutants such as sediment, metals, pesticides, herbicides, oil, grease, asbestos, lead, and animal wastes.

Since the site is currently developed with a single story 115,000-square-foot office building and associated paved parking and loading dock areas, the site is generally impervious. The proposed project would consist of construction of a four-story data center building with 469,482 square feet of floor space, a utility substation, a generator equipment yard, a parking lot and landscaping, and a recycled water pipeline. The site is approximately 6.7 acres in size.

### **Groundwater**

The Santa Clara Valley groundwater basin is divided into four interconnected subbasins that border the southern San Francisco Bay. The proposed project would be located in the Santa Clara Subbasin, which extends across the Santa Clara Valley in the region south of San Francisco Bay.

Fluctuations in rainfall, changing drainage patterns, and other hydrologic factors can influence groundwater levels. Based on the Seismic Hazard Zone Report 051 prepared by the Department of Conservation for the San Jose West 7.5-Minute Quadrangle, the historic shallowest observed depth to groundwater in the general site area was about 10 feet below ground surface (bgs) (CGS 2002).

The project site and surrounding areas have historically been used for industrial purposes. Though the site does not have any open contamination investigations shown on the Department of Toxic Substances Control's Envirostor website, site contamination is possible.

### **Flooding**

The average elevation of the existing project site is approximately 40-50 feet above the 1988 North American Vertical Datum (NAVD88) (USGS 2018). According to the Federal Emergency Management Agency's (FEMA) Flood Insurance Rate Map (FIRM) 06085C0226H, effective May 18, 2009, the project site is located within Zone X. Zone X is defined as areas of 0.2 percent annual chance of flood (or a 500-year flood), areas of one percent chance of annual flood (100-yr flood) with average depths of less than one foot, or with drainage areas less than one square mile, and areas protected by levees from one percent annual chance of flood.

The project site is also not within an area mapped as vulnerable to sea level rise in the National Oceanic and Atmospheric Administration's Digital Coast, Sea Level Rise Viewer (NOAA 2021).

## Regulatory Background

### *Federal*

#### **Clean Water Act and California's Porter-Cologne Water Quality Control Act.**

The State Water Resources Control Board (SWRCB) and its nine Regional Water Quality Control Boards (RWQCB) are responsible for the regulation and enforcement of the water quality protection requirements of the federal Clean Water Act (CWA) and the state's Porter-Cologne Water Quality Control Act (Porter-Cologne). The National Pollutant Discharge Elimination System (NPDES) is the permitting program that allows point source dischargers to comply with the CWA and Porter-Cologne laws. This regulatory framework protects the beneficial uses of the state's surface and groundwater resources for public benefit and environmental protection. Protection of water quality could be achieved by ensuring the proposed project complies with applicable NPDES permits from the SWRCB or the San Francisco Bay RWQCB.

Under Section 303(d) of the CWA, states are required to identify impaired surface water bodies and develop total maximum daily loads (TMDLs) for contaminants of concern. The TMDL is the quantity of pollutant that can be assimilated by a water body without violating water quality standards. Listing of a water body as impaired does not necessarily suggest that the water body cannot support the beneficial uses; rather, the intent is to identify the water body as requiring future development of a TMDL to maintain water quality and reduce the potential for future water quality degradation.

The San Francisco Bay RWQCB issued a Municipal Regional Storm Water NPDES Permit (Permit Number CAS612008) that requires the city of Santa Clara to implement a storm water quality protection program. This regional permit applies to 77 Bay Area municipalities, including the city of Santa Clara. Under the provisions of the Municipal NPDES permit, redevelopment projects that disturb more than 10,000 square feet are required to design and construct storm water treatment controls to treat post-construction storm water runoff. The permit requires the post-construction runoff from qualifying projects to be treated by using Low Impact Development (LID) treatment controls, such as biotreatment facilities. The Santa Clara Valley Urban Runoff Pollution Prevention Program (SCVURPPP) assists co-permittees, such as the city of Santa Clara, in the implementation of the provisions of the Municipal NPDES permit. In addition to water quality controls, the Municipal NPDES permit requires all new and redevelopment projects that create or replace one acre or more of impervious surface to manage development-related increases in peak runoff flow, volume, and duration, where such hydromodification is likely to cause increased erosion, silt pollutant generation, or other impacts to beneficial uses of local rivers, streams, and creeks. Projects may be deemed exempt from the permit requirements if they do not meet the size threshold, drain into tidally influenced areas or directly into the Bay, drain into hardened channels, or are infill projects in subwatersheds or catchment areas that are at least 65 percent impervious (per the city of Santa Clara Hydromodification Management Applicability Map). The project site is located in a catchment area with imperviousness greater than 65 percent; thus, the project site is not

subject to the SCVURPPP hydromodification requirements.

**Federal Emergency Management Agency Flood Insurance Program.** The magnitude of flood used nationwide as the standard for floodplain management is a flood having a probability of occurrence of one percent in any given year. This flood is also known as the 100-year flood, or base flood. The FIRM is the official map created and distributed by FEMA for the National Flood Insurance Program that shows areas subject to inundation by the base flood for participating communities. FIRMs contain flood risk information based on historic, meteorologic, hydrologic, and hydraulic data, as well as open-space conditions, flood control works, and development.

### *State*

**State Sustainable Groundwater Management Act.** The 2014 Sustainable Groundwater Management Act (SGMA) requires local public agencies and Groundwater Sustainability Agencies (GSAs) in high- and medium-priority basins to develop and implement Groundwater Sustainability Plans (GSPs) or Alternatives to GSPs. GSPs include detailed road maps for how groundwater basins will attain long term sustainability.

The Santa Clara Valley Water District (SCVWD) is the exclusive GSA for the Santa Clara Valley groundwater Subbasin, which contains the proposed project. SCVWD developed a groundwater management plan for the Santa Clara and Llagas Subbasins that is intended to be functionally equivalent to a GSP.

### *Local*

**City of Santa Clara Code, Prevention of Flood Damage.** Chapter 15.45 of the Santa Clara city code requires that buildings' lowest floor be constructed at least as high as the base flood elevation.

## **4.10.2 Environmental Impacts**

### **a. Would the project violate water quality standards or waste discharge requirements or otherwise substantially degrade surface or ground water quality?**

#### ***Construction and Operation***

*Less Than Significant Impact.* The proposed project would disturb about 6.7 acres of land and would be subject to construction-related storm water permit requirements of California's NPDES General Permit for Storm Water Discharges Associated with Construction and Land Disturbance Activities (Construction General Permit) administered by the SWRCB. Prior to any ground-disturbing construction activity, the applicant must comply with the Construction General Permit, which includes preparation of a Storm Water Pollution Prevention Plan (SWPPP). With implementation of the construction SWPPP, redevelopment of the site would not cause a substantial degradation in the

quality, or an increase in the rate or volume, of storm water runoff from the site during construction. In addition, the Municipal NPDES permit, as well as the SCVURPPP, requires that redevelopment not result in a substantial net increase in storm water flow exiting the project site during operation. As a result, runoff from the project site would not be expected to exceed the capacity of the local drainage system or to significantly contribute to the degradation of storm water runoff quality.

It is possible that up to 10,000 cubic yards of soil would be removed from the site during construction and it is therefore possible to encounter groundwater and make dewatering necessary. If dewatering is necessary, and the discharge is found to be contaminated, the project owner would likely be required to obtain coverage under the VOC and Fuel General Permit (San Francisco RWQCB General Order No. R2-2017-0048 NPDES Permit No. CAG912002). Discharge of uncontaminated water from the dewatering operation to waters of the US within the San Francisco RWQCB's jurisdiction is a permitted activity under the Construction General Permit.

Thus, the project would not be expected to violate water quality standards or waste discharge requirements during construction and operation, and impacts would be less than significant.

**b. Would the project substantially decrease groundwater supplies or interfere substantially with groundwater recharge such that the project may impede sustainable groundwater management of the basin?**

*Construction and Operation*

*Less Than Significant Impact.* Since the project would be in an area served with imported surface water from the San Francisco Public Utilities Commission (SFPUC), the water supply to the project would not likely be from a groundwater source. The city's Urban Water Management Plan (UWMP) for 2020 shows that the city has sufficient supply to meet the project's demand of 2 AFY of potable water in normal and single dry year scenarios. However, the UWMP shows that the city would have a deficit in a multiple dry year scenario that assumes supply from SFPUC would be interrupted. Under this scenario, the city's supply from SFPUC might be interrupted if certain conditions specified in the interruptible contract between the city and SFPUC are met (UWMP 2020). If supply from SFPUC is interrupted, the city would have to replace the demand using groundwater or water supplied by SCVWD.

According to the UWMP, the groundwater basin has been managed successfully to prevent overdraft conditions. In case of a water supply shortage, the city has adopted water conservation policies to reduce demand such that available supplies are sufficient to meet demand (UWMP 2020). As discussed in **Section 4.18, Utilities and Service Systems**, the project does not meet the definition of a "project" for the purposes of preparing a Water Supply Assessment (WSA) by the water supplier. The project is similar

to the Walsh Data Center (exempted by the Energy Commission in August 2020) in terms of total square footage but is expected to use less water. The city of Santa Clara determined that the Walsh Data Center project did not require a WSA, so a similar determination would be expected for the CA3 Data Center project (Walsh 2019b, Appendix E). The project's impact on groundwater supplies or recharge during construction and operation would therefore be less than significant.

**c. Would the project substantially alter the existing drainage pattern of the site or area, including through the alteration of the course of a stream or river, or through the addition of impervious surfaces in a manner which would:**

**i. Result in substantial erosion or siltation on- or off-site;**

*Construction, Operation, and Maintenance*

*Less Than Significant Impact.* The existing site is nearly completely covered with impervious surfaces and includes storm water collection and disposal facilities throughout the parcel. The proposed project would result in a reduction in impervious areas (by replacing some of the existing impervious areas with pervious ones for landscaping) and would also include a new storm water collection system that would incorporate source control and treatment best management practices (BMPs). These BMP's would reduce the overall runoff into the city's collection system, also reducing erosion and sedimentation impacts. This post-construction design would therefore not be expected to result in increased runoff (rate or volume) from the site. The storm water design is expected to comply with the BMP's well, by implementing measures to ensure the project would not result in a substantial net increase in storm water flow exiting the project site or alter local runoff drainage patterns during project construction. Therefore, impacts would be less than significant.

**ii. Substantially increase the rate or amount of surface runoff in a manner which would result in flooding on- or offsite;**

*Construction and Operation*

*Less Than Significant Impact.* Surface runoff would be controlled as described in section (c)(i) above. Therefore, impacts would be less than significant.

**iii. Create or contribute runoff water which would exceed the capacity of existing or planned storm water drainage systems or provide substantial additional sources of polluted runoff; or**

*Construction and Operation*

*Less Than Significant Impact.* The proposed project would result in a reduction in impervious areas and would also include a new storm water collection system that includes drainage swales to reduce the overall runoff into the city's collection system. The

discharge of polluted runoff would be expected to be similarly reduced. Therefore, impacts would be less than significant.

#### **iv. Impede or redirect flood flows?**

##### ***Construction and Operation***

*Less Than Significant Impact.* Though the site is located near the Guadalupe River and San Tomas Aquino Creek, these waterways do not pose a likely flood risk. According to FIRM 06085C0226H, effective May 18, 2009, the project site is located within Zone X. As described above, Zone X is expected to be protected from the 100-year flood.

The project site is not within an area mapped as vulnerable to sea level rise in the National Oceanic and Atmospheric Administration's Digital Coast, Sea Level Rise Viewer (NOAA 2021).

The proposed project also would not be expected to add significantly to the existing potential of the site to impede flood flows. The proposed project would have significant structures, like the existing site did, that would similarly impede or redirect flood flows. Therefore, no net change in obstruction is expected from the proposed project and the impacts would be less than significant.

#### **d. Would the project, in flood hazard, tsunami, or seiche zones, risk release of pollutants due to project inundation?**

##### ***Construction and Operation***

*Less Than Significant Impact.* The project site is located within FEMA flood Zone X and not subject to inundation by the 100-year flood. The project is therefore not expected to be a source of pollution from flooding.

The project site is not within an area mapped as vulnerable to sea level rise in the National Oceanic and Atmospheric Administration's Digital Coast, Sea Level Rise Viewer (NOAA 2021).

The project site is not located near a large body of water, the ocean, or steep slopes. Due to the location of the proposed project site, it would not be subject to inundation by seiche, tsunami, or mudflow (CEMA 2009).

The project site is within the inundation zones of two upstream reservoirs. Lexington Reservoir and James J. Lenihan Dam are located on Los Gatos Creek approximately 15 miles upstream. The Lenihan Dam Flood Inundation Map shows that dam failure would result in flooding at the project site.

In the unlikely event of a flood, release of on-site pollutants would be prevented by the SWPPP, Worker Environmental Training, a Spill Prevention, Control, and Countermeasure Plan, a Hazardous Materials Business Plan, and through an emergency spill response

program. All of these measures would work together to help keep potential pollutants properly contained. Therefore, the impacts would be less than significant.

**e. Would the project conflict with or obstruct implementation of a water quality control plan or sustainable groundwater management plan?**

*Construction and Operation*

*Less Than Significant Impact.* The Water Quality Control Plan for the San Francisco Bay Basin (Basin Plan) is the local water quality control plan. The project would comply with the Basin Plan by implementing the requirements of the Construction General Permit, as described in section (a) above, and through the preparation of a construction SWPPP. The project would not be expected to obstruct the implementation of the local water quality control plan and this impact would be less than significant.

SCVWD developed a groundwater management plan for the Santa Clara and Llagas Subbasins that is intended to be functionally equivalent to a GSP. The information contained in the SCVWD groundwater management plan is used to inform the city of Santa Clara's UWMP about groundwater supplies. Therefore, it is reasonable to rely on the UWMP to evaluate how a proposed project would impact the implementation of the sustainable groundwater management plan. The city's UWMP for 2020 shows that it has sufficient supply to meet the project's demand of 2 AFY of potable water in normal and single dry year scenarios. However, the UWMP also shows that the city would have a deficit in a multiple dry year scenario that assumes that supply from SFPUC would be interrupted. Under this scenario, the city's supply from SFPUC might be interrupted if certain conditions specified in the interruptible contract between the city and SFPUC are met (UWMP 2020). If supply from SFPUC is interrupted the city would have to replace the demand using groundwater or supply water from SCVWD.

According to the UWMP, the groundwater basin has been managed successfully to prevent overdraft conditions. In case of a water supply shortage, the city has adopted water conservation policies to reduce demand such that available supplies are sufficient to meet demand (UWMP 2020). The proposed project would therefore not be expected to impede the implementation of the SCVWD's groundwater management plan. This impact would be less than significant.

### **4.10.3 Mitigation Measures**

None.

### **4.10.4 References**

CEMA 2009 – California Emergency Management Agency (CEMA). Tsunami Inundation Map for Emergency Planning, Mountain View Quadrangle. Prepared by the California Emergency Management Agency. Published July 31, 2009. Accessed at: <https://www.conservation.ca.gov/cgs/Documents/Publications/Tsunami->

- Maps/Tsunami\_Inundation\_MountainView\_Quad\_SantaClara.pdf. Accessed June 11, 2021
- CGS 2002 – California Department of Conservation (CGS). Seismic Hazard Zone Report for the San Jose West 7.5-Minute Quadrangle, Santa Clara County, California. Seismic Hazard Zone Report 058. California Department of Conservation, 2001
- NOAA 2021 – National Oceanic and Atmospheric Administration (NOAA). Digital Coast, Sea Level Rise Viewer. Accessed at: <https://coast.noaa.gov/slr/#/layer/slr/0/-11581024.663779823/5095888.569004184/4/satellite/none/0.8/2050/interHigh/midAccretion>. Accessed on June 10, 2021
- Santa Clara 2020 – City of Santa Clara 2020 Urban Water Management Plan (UWMP). Prepared by the city of Santa Clara Water and Sewer Utilities. Adopted June 22, 2021. Available online at: <https://www.santaclaraca.gov/home/showpublisheddocument/74073/637606452907100000>. Accessed: August 2, 2021
- USGS 2018 – United States Geological Survey, San Jose West Quadrangle, 7.5-minute series, Published 2018. Accessed at: <https://viewer.nationalmap.gov>. Accessed June 10, 2021
- Walsh 2019b – Application for Small Power Plant Exemption: Walsh Data Center, Appendices A-E, dated June 28, 2019. (TN 228877-1). Available online at: <https://efiling.energy.ca.gov/Lists/DocketLog.aspx?docketnumber=19-SPPE-02>



## 4.11 Land Use and Planning

This section describes the environmental setting and regulatory background and discusses impacts associated with the construction and operation of the project specific to land use and planning.

<b>LAND USE AND PLANNING</b>	<b>Potentially Significant Impact</b>	<b>Less Than Significant with Mitigation Incorporated</b>	<b>Less Than Significant Impact</b>	<b>No Impact</b>
Would the project:				
a. Physically divide an established community?	<input type="checkbox"/>	<input type="checkbox"/>	<input type="checkbox"/>	<input checked="" type="checkbox"/>
b. Cause a significant environmental impact due to a conflict with any land use plan, policy, or regulation adopted for the purpose of avoiding or mitigating an environmental effect?	<input type="checkbox"/>	<input type="checkbox"/>	<input checked="" type="checkbox"/>	<input type="checkbox"/>

Environmental checklist established by CEQA Guidelines, Appendix G.

### 4.11.1 Environmental Setting

The project site is located within one of the city of Santa Clara's (city) primary employment centers that extends south of U.S. Highway 101 and north of the Caltrain corridor. Land use classifications within this employment center region primarily include Light/Heavy Industrial and Office/Research and Development uses (Santa Clara 2021a). The project would utilize a 6.69-acre site (APN 216-28-112) that is zoned Light Industrial (ML) and is currently developed with a 115,000-square-foot office and warehouse building. Land uses that surround the project site include the following (Santa Clara 2021a):

- North-northeast of project site: Vantage Santa Clara Data Center Campus CA1 at 2625 Walsh Avenue (ML zoning district);
- East-southeast of project site: existing ML uses (software development and telecommunications equipment supplier) at 2550 Walsh Avenue (ML zoning district);
- South-southwest of project site: Caltrain corridor along the project site's southern boundary, which separates the project site from Medium-Density Residential development located approximately 150 feet south of the project;
- West of project site: Silicon Valley Power's (SVP) Uranium Substation at 2747 Bowers Avenue (Public or Quasi-Public zoning district);
- Northwest of project site: KeyPoint Credit Union at 2805 Bowers Avenue (ML zoning district); and
- North-northwest of project site: existing Office/Research and Development uses at 2630 Walsh Avenue (ML zoning district).

The Norman Y. Mineta San Jose International Airport (San Jose International Airport) is located approximately 1.75 miles east of the project site. Per the Comprehensive Land Use Plan for the San Jose International Airport, the project site is outside of the Airport Influence Area (Santa Clara County 2016).

## **Regulatory Background**

### ***Federal***

No federal regulations relating to land use and planning apply to the project.

### ***State***

No state regulations relating to land use and planning apply to the project.

### ***Local***

**City of Santa Clara 2010-2035 General Plan.** The project would be in an area of the city between U.S. Highway 101 and the Caltrain corridor that has been designated in the City of Santa Clara 2010-2035 General Plan (general plan) as primarily industrial (Santa Clara 2010). The city's industrial land use designation is used to identify areas that serve as major employment centers for the city. Industrial land use designations are located away from sensitive receptors to prevent their exposure to hazardous materials commonly used in manufacturing and warehousing. Data centers are identified as a light industrial land use (Santa Clara 2010).

Section 5.3.5 of the general plan contains the following policies that pertain to industrial land uses and are applicable to the project:

- 5.3.5-P6 – Encourage innovative design of new office space to promote higher-intensity new development and on-site expansion of existing uses.
- 5.3.5-P12 – Promote development, such as manufacturing, auto services and data centers, in Light and Heavy Industrial classifications to compliment employment areas and retail uses.
- 5.3.5-P14 – Prohibit Data Centers from properties designated High Intensity Office/Research and Development except as support to the primary use on the property.

Section 5.9 of the general plan contains the following public facilities policy that is applicable to the proposed on-site switching station.

- 5.9.2-P9 – Prohibit new public and quasi-public facilities on land designated for Light or Heavy Industrial uses on the Land Use Diagram (general plan figure 5.2-1), excluding public utility facilities.

Floor area ratio (FAR) of a development is the total square footage of a building(s) on a lot divided by the total lot area. The general plan identifies an FAR of 0.6 for a light industrial land use. However, Section 5.5.1 of the general plan contains the following

discretionary use policy that provides flexibility in the density of specific land uses, such as a data center, provided that the permitted land use supports the General Plan's Major Strategies.

- 5.5.1-P9 – For Data Centers on Light or Heavy Industrial designated properties, allow a 20 percent increase in the maximum allowed non-residential square-footage, provided that sufficient onsite land area is available to meet the parking requirements for other uses allowed under those designations, and provided that the increased intensity is compatible with planned uses on neighboring properties and consistent with other applicable General Plan policies.

**City of Santa Clara Zoning Code.** The entire project site is within an ML zoning district, which “is intended to provide an optimum general industrial environment, and it is intended to accommodate industries operating substantially within an enclosed building” (city of Santa Clara 2021b).

**Permitted Uses:** Permitted uses within an ML zoning district include the following (City Code Section 18.48.030):

- Plants and facilities for the assembly, compounding, manufacture, packaging, processing, repairing, or treatment of equipment, materials, merchandise, or products.
- Incidental and accessory buildings, storage buildings, outdoor storage, warehouses, exposed mechanical appurtenances, and the like, that comprise less than 25% of the total lot area and are shielded from public view.

**Development Standards:** The following development standards are applicable to the ML zoning district:

- Building Height Limits – Maximum permitted height within an ML zoning district shall not exceed 70 feet (City Code Section 18.48.070). Height requirements shall also be subject to the following additional requirements, conditions, and exceptions (City Code Section 18.64.010):
  - (a) The height limitations do not apply to spires, belfries, cupolas, antennas, water tanks, ventilators, chimneys, or other mechanical appurtenances usually required to be placed above the roof level and not intended for human occupancy or to be used for any commercial or advertising purposes.
  - (b) The height limitations shall not apply to flagpoles, sculpture, antennas and radio towers; provided, that the same may be safely erected and maintained at such a height with respect to the surrounding conditions and circumstances.
- Maximum Building Coverage – The maximum building coverage within an ML zoning district is 75%, subject to required parking, landscaping, and setback (City Code Section 18.48.110).

Front yard – Each lot shall have a street side front yard of not less than 15 feet in depth (City Code Section 18.48.080).

Side yards – Side yards are required for every lot that is adjacent to a residentially zoned property or property designated as residential in the general plan. Each such side yard shall be not less than ten feet in width (City Code Section 18.48.090).

Rear yard – A rear yard is required for each portion of a lot that is adjacent at rear of lot to a residentially zoned property or property designated as residential in the general plan. Such rear yard shall be not less than ten feet in depth (City Code Section 18.48.100).

- **Outdoor Storage and Exposed Mechanical Equipment** – Outdoor storage and exposed mechanical equipment shall not exceed six feet in height within the first six feet immediately adjacent to the front or street side yard setback line or any interior side or rear lot line. Beyond this point, storage may extend to a maximum height of ten feet. Height of mechanical equipment and any accompanying screening shall be subject to Director of Community Development approval (City Code Section 18.48.140).

The city's Zoning Administrator has the authority to grant a minor modification to height, area, and yard regulations, provided that the minor modification does not exceed 25% of any zoning requirement (City Code Section 18.90.020). If a project were to exceed a 25% threshold of any zoning requirement, the project would require variance approval by the Planning Commission at a noticed public hearing (City Code Chapter 18.108).

**Comprehensive Land Use Plan, Norman Y. Mineta San Jose International Airport.** The Santa Clara County Airport Land Use Commission (ALUC) adopted the Comprehensive Land Use Plan (CLUP) for the San Jose International Airport in 2011; the ALUC approved minor amendments to the CLUP in 2016. The purpose of the CLUP is to safeguard the welfare of the inhabitants in the airport vicinity and ensure that new land uses do not affect airport operations. The project site is outside of the Airport Influence Area, which is a “composite of the areas surrounding the Airport that are affected by noise, height, and safety considerations” (Santa Clara County 2016). The CLUP policies regarding land use and planning do not apply to the project. Therefore, the Land Use and Planning analysis contains no further discussion of the CLUP for the San Jose International Airport.

## **4.11.2 Environmental Impacts**

### **a. Would the project physically divide an established community?**

#### ***Construction and Operation***

*No Impact.* The project would be constructed and operated on a single parcel of land that was previously developed for an industrial use. The project would demolish the existing on-site building and construct and operate a new industrial use on the same site. The parcel boundaries would remain the same. The project would not introduce a new barrier or otherwise restrict public access within the community. Neither project construction nor operation activities would physically divide an established community, and no impact would occur.

**b. Would the project cause a significant environmental impact due to a conflict with any land use plan, policy, or regulation adopted for the purpose of avoiding or mitigating an environmental effect?**

***Construction and Operation***

*Less Than Significant Impact.* As discussed in the subsections that follow, the construction and operation of the project would not conflict with applicable land use plans or policies such that significant environmental impacts would occur. Impacts would be less than significant.

**City of Santa Clara General Plan.** The project site has a general plan land use designation of ML, which “allows combinations of single and multiple users, warehouses, mini-storage, wholesale, bulk retail, gas stations, data centers, indoor auto-related uses and other uses that require large, warehouse-style buildings” (Santa Clara 2010). The proposed project is an allowable use in areas designated ML.

As described below, the project is also consistent with industrial land use policies applicable to the project:

- Policy 5.3.5-P6 – The project would increase the intensity (i.e., building mass and height) of the existing industrial land use onsite by replacing a single-story 115,000-square-foot building with a four-story 468,170-square-foot building to accommodate the proposed project. As this policy promotes higher intensity of new development and on-site expansion of existing uses, the project would be consistent with this policy.
- Policies 5.3.5-P12 and 5.3.5-P14 – The project would construct a data center within a light industrial land use designation and would, therefore, be consistent with these policies.
- Policy 5.9.2-P9 – The proposed project would include construction of a new, on-site switching station that would be owned and operated by SVP. As a public utility facility, the switching station would not conflict with the site’s ML land use designation.

Staff calculated the proposed project’s FAR to be 1.61,<sup>1</sup> which exceeds the general plan’s maximum FAR of 0.6 for an ML land use designation. Staff spoke with city of Santa Clara Associate Planner Debby Fernandez, who explained that the FAR exceedance would be allowed for a data center as it would be considered a very low employee trip generating use (CEC 2021j). Daily operations at the proposed data center would not conflict with ongoing operations at neighboring properties as the anticipated average number of persons per shift would be no more than 30 employees. To provide sufficient parking for data center operations, the proposed project site would include 30 parking spaces, while

---

<sup>1</sup> The proposed project’s building square footage is 468,170 square feet (sq. ft.). The lot area is 6.69 acres, or 291,416 sq. ft. The FAR of a development is the total building square footage divided by the total lot area.

an additional 96 parking places would be provided across Walsh Avenue on the applicant's existing CA1 campus (DayZenLLC 2021bb).

The proposed project is in an identified employment center area that is targeted for intensification of industrial, research, and development uses within the city (Santa Clara 2010). In addition, the proposed project site is in a ML zone. The properties surrounding the proposed project to the north, east, and west are similarly zoned ML, and are developed with compatible uses (i.e., CA1 data center, research and development facility, software development and telecommunications equipment supplier, and a credit union). The Caltrain corridor that is located along the proposed project's southern boundary is not directly accessible via the project site and would not be affected by an increase in the site's land use intensity. Because the proposed project is consistent with the general plan and zoning for the existing industrial site and surrounding area and is consistent with the city's intent for development within the area, the project's increase in intensity over existing conditions would not conflict with the operations of the similar existing industrial land uses on neighboring properties. Therefore, the impact would be less than significant.

### **City of Santa Clara Zoning Code.**

- Building height limits – The height of the proposed data center building would be 87.5 feet from the grade to the highest point of the parapet coping of the flat roof (DayZenLLC 2021z). While this height exceeds the maximum permitted height of 70 feet within an ML zoning district (City Code Section 18.48.070), the city's Zoning Administrator has the authority to grant a minor modification in the permitted height provided that the height does not exceed 25% of the zoning requirement, which would be 87.5 feet within an ML zone (City Code Section 18.90.020). Staff spoke with city of Santa Clara Associate Planner Debby Fernandez, who confirmed that the height requirements would not apply to the proposed mechanical equipment to be placed on the project's rooftop (CEC 2021j). Therefore, the proposed project's height of 87.5 feet would not exceed 25% of the zoning requirement. To obtain a minor modification, the applicant must submit an application to the Zoning Administrator accompanied by plans and elevations necessary to show the detail of the proposed modification to the satisfaction of the Zoning Administrator. The proposed project is currently under review by the city of Santa Clara's project clearance committee, and the applicant will submit any additional application forms, plans, and elevations required by the Zoning Administrator in order to grant a minor modification for the project. Upon issuance of the city's minor modification, the project would not conflict with the height restrictions within an ML zone.
- Maximum building coverage – To comply with the ML zone requirement for a 15-foot landscaped front yard setback, the applicant submitted a revised site plan for the proposed project on July 22, 2021 (DayZenLLC 2021b). City of Santa Clara Associate Planner Debby Fernandez confirmed to staff that the revised site plan would be consistent with the front yard setback requirement (CEC 2021s).
- Exposed Mechanical Equipment – The project's proposed substation would be partially surrounded by a 13-foot-high masonry wall, with the remainder of the substation

enclosed within an eight-foot-high chain link fence. The generator yard would be enclosed within a 25-foot-high perforated metal screen wall along its north, east, and west sides. Per the requirements of City Code Section 18.48.140, the height of mechanical equipment and any accompanying screening shall be subject to Director of Community Development approval. The Architectural Review process would ensure that screening of the generator yard and the substation would conform with ML zoning standards.

### 4.11.3 Mitigation Measures

None.

### 4.11.4 References

CEC 2021j – California Energy Commission (CEC). (TN 239135). Record of Conversation PCC Minutes dated August 2, 2021. Available online at: <https://efiling.energy.ca.gov/Lists/DocketLog.aspx?docketnumber=21-SPPE-01>

CEC 2021s – California Energy Commission (CEC). (TN 240141). Report of Conversation – Revised Site Plan Conformity to Setback Requirements, dated October 22, 2021. Available online at: <https://efiling.energy.ca.gov/Lists/DocketLog.aspx?docketnumber=21-SPPE-01>

Santa Clara 2021a – City of Santa Clara (Santa Clara). Interactive. Amended February 23, 2021. Accessed on: July 6, 2021. Available online at <https://www.santaclaraca.gov/our-city/departments-a-f/community-development/planning-division/zoning>

Santa Clara 2021b – City of Santa Clara (Santa Clara). Santa Clara City Code. Current through Ordinance 2029, passed February 23, 2021. Accessed on July 7, 2021. Available online at: <https://www.codepublishing.com/CA/SantaClara/#!/SantaClaraNT.html>

Santa Clara 2010 – City of Santa Clara (Santa Clara). *City of Santa Clara General Plan 2010-2035*. Adopted on November 16, 2010. Chapter 3, pg. 3-17; Chapter 5, pgs. 5-14, 5-39, 5-67; Table 8.3-1. Accessed on July 7, 2021. <https://www.santaclaraca.gov/our-city/departments-a-f/community-development/planning-division/general-plan>

DayZenLLC 2021a – DayZenLLC (DayZenLLC) – (TN 237423). VDC CA3BGF SPPE Application Part II, dated April 12, 2021. Available online at: <https://efiling.energy.ca.gov/Lists/DocketLog.aspx?docketnumber=21-SPPE-01>

DayZenLLC 2021b – DayZenLLC (DayZenLLC) – (TN 238970). VDC Initial Responses to CEC Data Request Set 2-CA3BGF, dated July 22, 2021. Available online at: <https://efiling.energy.ca.gov/Lists/DocketLog.aspx?docketnumber=21-SPPE-01>

DayZenLLC 2021z – DayZenLLC (DayZenLLC). (TN240157). CA3DC PPC Drawing Set Rev3 – Part II, dated October 28, 2021. Available online at: <https://efiling.energy.ca.gov/Lists/DocketLog.aspx?docketnumber=21-SPPE-01>

DayZenLLC 2021bb – DayZenLLC (DayZenLLC). (TN 240159). CA3DC Revised Project Description – PCC Revisions, dated October 28, 2021. Available online at: <https://efiling.energy.ca.gov/Lists/DocketLog.aspx?docketnumber=21-SPPE-01>

Santa Clara County 2016 – Norman Y. Mineta San Jose International Airport Comprehensive Land Use Plan for Santa Clara County. Figure 6 and Figure 8. Adopted by Santa Clara County Airport Land Use Commission, San Jose, CA, May 25, 2011; amended November 16, 2016. Accessed on July 6, 2021. Available online at: <https://plandev.sccgov.org/commissions-other-meetings/airport-land-use-commission>



## 4.12 Mineral Resources

This section describes the environmental and regulatory setting and discusses impacts associated with the construction and operation of the project with respect to mineral resources.

<b>MINERAL RESOURCES</b>	<b>Potentially Significant Impact</b>	<b>Less Than Significant with Mitigation Incorporated</b>	<b>Less Than Significant Impact</b>	<b>No Impact</b>
Would the project:				
a. Result in the loss of availability of a known mineral resource that would be of value to the region and the residents of the State?	<input type="checkbox"/>	<input type="checkbox"/>	<input type="checkbox"/>	<input checked="" type="checkbox"/>
b. Result in the loss of availability of a locally important mineral resource recovery site delineated on a local general plan, specific plan or other land use plan?	<input type="checkbox"/>	<input type="checkbox"/>	<input type="checkbox"/>	<input checked="" type="checkbox"/>

Environmental checklist established by CEQA Guidelines, Appendix G.

### 4.12.1 Setting

Information on mineral resources was compiled from published literature, maps, and review of aerial photographs. Impacts to mineral resources from project construction and operational activities were evaluated qualitatively based on the area occupied by the project, site conditions, expected construction practices, anticipated materials used, and the locations and duration of project construction and operational activities.

The project site, located in the City of Santa Clara within Santa Clara County (DayZenLLC 2021), is in an area identified as Mineral Resource Zone 1 (MRZ-1) for aggregate materials by the State of California (DOC 2015). MRZ-1 refers to an area where available geologic information indicates that no significant mineral deposits are present, or where it is judged that little likelihood for their presence exists (DOC 2015). The project site and surrounding area are not known to support significant mineral resources of any type. Other than the Communication Hill Area, located about 10 miles southeast of the project site, which contains mineral deposits that are of regional significance as a source of construction aggregate materials, the city of Santa Clara does not have mineral deposits as defined by to the California Surface Mining and Reclamation Act of 1975 (SMARA) (DOC 2016). The Division of Mine Reclamation's list of mines, referred to as the Assembly Bill (AB) 3098 List and regulated under SMARA, identifies four other facilities in Santa Clara County, the closest being the Lexington Quarry (mine ID: 91-43-0006), located about 7.7 miles southwest of the project site (DOC 2016).

### Regulatory Background

#### *Federal*

No federal regulations related to mineral resources apply to the project.

### ***State***

**Surface Mining and Reclamation Act.** SMARA requires that the State Geologist classify land into MRZ or Scientific Zones according to the known or inferred mineral potential of the land (Pub. Resources Code, §§ 2710-2796).

MRZs are defined as the following (DOC 2015):

- MRZ-1: Areas where adequate information indicates that no significant mineral deposits are present, or where it is judged that little likelihood for their presence exists.
- MRZ-2: Areas where adequate information indicates that significant deposits are present, or where it is judged that a high likelihood for their presence exists. The guidelines set forth two requirements to be used to determine if land should be classified MRZ-2:
  - The deposit must be composed of material that is suitable as a marketable commodity.
  - The deposit must meet threshold value. The projected value (gross selling price) of the deposit, based on the value of the first marketable product, must be at least \$5 million (1978 dollars).
- MRZ-3: Areas containing mineral deposits, but their significance cannot be evaluated from available data.
- MRZ-4: Areas where available information is inadequate for assignment to any other MRZ category.

Scientific Zones are defined as areas containing unique or rare occurrence of rocks, minerals, or fossils that are of outstanding scientific significance.

### ***Local***

No local regulations related to mineral resources apply to the project.

## **4.12.2 Environmental Impacts**

- a. Would the project result in the loss of availability of a known mineral resource that would be of value to the region and the residents of the State?**

### ***Construction and Operation***

*No Impact.* The project site is in a developed urban area and does not contain any known or designated mineral resources. Therefore, the project would not result in the loss of availability of a known mineral resource.

**b. Would the project result in the loss of availability of a locally important mineral resource recovery site delineated on a local general plan, specific plan, or other land use plan?**

***Construction and Operation***

*No Impact.* The project site is not delineated in the General Plan or other land use plan as a locally important mineral resource recovery site. Also, the project site is in an area and does not contain any known or designated mineral resources. Therefore, for these reasons the project would not result in the loss of availability of a locally important mineral resource recovery site.

**4.12.3 Mitigation Measures**

None.

**4.12.4 References**

DayZenLLC 2021a – DayZenLLC (DayZenLLC). (TN 237380). VDC CA3BGF SPPE Application Part I, dated April 5, 2021. Available online at: <https://efiling.energy.ca.gov/Lists/DocketLog.aspx?docketnumber=21-SPPE-01>

DOC 2015 – California Department of Conservation (DOC). Surface Mining and Reclamation Act (SMARA) Mineral Lands Classification (MLC) data portal. Mineral Land Classification: Aggregate Materials in the San Francisco-Monterey Bay Area: Classification of Aggregate Resource Areas: South San Francisco Bay Production-Consumption Region. Author: Melvin C. Stinson, Michael W. Manson and John J. Plappert (1987) Special Report 146. Accessed on: June 17, 2021. Available online at: <https://maps.conservation.ca.gov/cgs/informationwarehouse/index.html?map=mlc>

DOC 2016 – California Department of Conservation (DOC). AB 3098 List. This list is updated daily. Accessed on: June 17, 2021. Available online at: <https://www.conservation.ca.gov/dmr>

## 4.13 Noise

This section describes the environmental and regulatory setting and discusses impacts associated with the construction and operation of the project related to noise.

NOISE	Potentially Significant Impact	Less Than Significant with Mitigation Incorporated	Less Than Significant Impact	No Impact
Would the project result in:				
a. Generation of a substantial temporary or permanent increase in ambient noise levels in the vicinity of the project in excess of standards established in the local general plan or noise ordinance, or applicable standards of other agencies?	<input type="checkbox"/>	<input checked="" type="checkbox"/>	<input type="checkbox"/>	<input type="checkbox"/>
b. Generation of excessive groundborne vibration or groundborne noise levels?	<input type="checkbox"/>	<input type="checkbox"/>	<input checked="" type="checkbox"/>	<input type="checkbox"/>
c. For a project located within the vicinity of a private airstrip or an airport land use plan or, where such a plan has not been adopted, within two miles of a public airport or public use airport, would the project expose people residing or working in the project area to excessive noise levels?	<input type="checkbox"/>	<input type="checkbox"/>	<input checked="" type="checkbox"/>	<input type="checkbox"/>

Environmental checklist established by CEQA Guidelines, Appendix G.

### 4.13.1 Environmental Setting

The project site is zoned Light Industrial (ML) (DayZenLLC 2021e, Section 3.6). The area surrounding the project site consists of ML land uses to the north, east, and west. Approximately 150-200 feet to the south-southwest, the Caltrain corridor separates the project site from medium-density residential development. The nearest airport is Norman Y. Mineta San Jose International Airport approximately 1.75 miles east of the project site. The predominant long-term ambient noise sources are nearby and distant traffic, and by cooling and mechanical noise from various facilities. Additionally, noise events that interrupt the ambient noise are caused by trains and loud vehicles occasionally passing by (DayZenLLC 2021e, Section 4.13.2.3).

The applicant conducted noise surveys to characterize ambient noise in the areas surrounding the project site. One long-term, 24-hour survey was conducted from February 8 through February 9, 2021, at the southern boundary of the project site. This location represents the existing noise environment at the nearest residential receptor

directly across the CalTrain line (DayZenLLC 2021e, Section 4.13.2.3). The results of the survey provided average daytime and nighttime ambient noise levels at the residential receptors of approximately 59 and 53 dBA  $L_{eq}$ , respectively (DayZenLLC 2021d, Appendix F). The survey also provided the maximum noise level,  $L_{max}$ , of approximately 89 dBA at the residential receptor, primarily due to passing trains (DayZenLLC 2021d, Appendix F).

### ***Regulatory Background***

#### Thresholds of Significance

The California Environmental Quality Act (CEQA) Guidelines state that a project would normally be considered to have a significant impact if noise levels conflict with adopted environmental standards or plans, or if noise levels generated by the project would substantially increase existing noise levels at noise-sensitive receivers on a permanent or temporary basis. CEQA does not define what noise level increase would be substantial. Generally, an increase of 3 decibels on the A-weighted scale (dBA) is noticeable and an increase of 5 dBA is distinct. Other factors, such as the frequency of occurrence of the noise and time of day/night it occurs, are also commonly considered in determining if such an increase is clearly significant or not.

There are no adopted thresholds for an increase in dBA level to be considered a significant impact for construction activities. Noise due to construction activities are considered to be less than significant if the construction activity is temporary and the use of heavy equipment and noisy activities is limited to daytime hours. However, an increase of 10 dBA or more during the day can be perceived as noisy (triggering a community reaction) and warrant additional measures to address the noise levels. An increase of 10 dBA corresponds to a doubling of loudness or dBA level and is generally considered to be the starting point at which significant impacts may occur. It is very difficult to identify the exact level of noise resulting from construction because it fluctuates based on many factors over the course of a week, day, or even hour. It also depends on other factors, such as intervening structures, land topography and land cover. For example, intervening structures block or impede sound waves, and undulating topography and land roughness would play a role in attenuating the propagation of noise waves. Therefore, performance standards (i.e., a complaint and redress process) are ultimately used as a backstop measure to address any impacts that are perceived by the community.

In September 2013, the California Department of Transportation (Caltrans) released the Transportation and Construction Vibration Guidance Manual. This manual includes the Federal Transit Administration's (FTA) methods and findings. The Caltrans manual states that for construction activities that generate vibration, the threshold of human response begins at a peak particle velocity (ppv) of 0.16 inch per second (in/sec). This is characterized by Caltrans as a "distinctly perceptible" event with an incident range of transient to continuous (Caltrans 2013). A level of 0.20 in/sec has been found to be annoying to people in buildings and can pose a risk of architectural damage to buildings.

### *Local*

**City of Santa Clara 2010-2035 General Plan.** The City of Santa Clara 2010-2035 General Plan (General Plan) describes the levels of exterior noise considered compatible for various land uses to guide land use planning decisions. The Santa Clara City Code, discussed below, establishes more specific sound limits (Santa Clara 2019). The General Plan also includes several policies that aim to keep noise levels to within acceptable levels and avoid nuisance to residents. The following are General Plan policies applicable to the project:

*Policy 5.10.6-P1:* Review all land use and development proposals for consistency with the General Plan compatibility standards and acceptable noise exposure levels defined on Table 5.10-1 [of the General Plan].

*Policy 5.10.6-P3:* New development should include noise control techniques to reduce noise to acceptable levels, including site layout (setbacks, separation and shielding), building treatments (mechanical ventilation system, sound-rated windows, solid core doors and baffling) and structural measures (earthen berms and sound walls).

*Policy 5.10.6-P4:* Encourage the control of noise at the source through site design, building design, landscaping, hours of operation and other techniques.

*Policy 5.10.6-P5:* Require noise-generating uses near residential neighborhoods to include solid walls and heavy landscaping along common property lines, and to place compressors and mechanical equipment in sound-proof enclosures.

**City of Santa Clara Zoning Code (City Code).** Chapter 9.10 (noise ordinance) of the City Code applies to the regulation of noise and vibration for this project. Section 9.10.040 specifies the exterior noise limits that apply to land use zones within the city. The city's exterior noise limit is 75 dBA (anytime) for heavy industrial land use zones, 70 dBA (anytime) for ML land use zones, 65 dBA daytime and 60 dBA nighttime for commercial land use zones, and 55 dBA daytime and 50 dBA nighttime for residential land use zones. The city's noise limits for stationary noise sources are not applicable to emergency work, including the operation of emergency generators during an emergency (Section 9.10.070); however, the intermittent testing of emergency generators is subject to the local noise regulations previously discussed in the City Code (Section 9.10.040).

### **4.13.2 Environmental Impacts**

**a. Would the project result in generation of a substantial temporary or permanent increase in ambient noise levels in the vicinity of the project in excess of standards established in the local general plan or noise ordinance, or applicable standards of other agencies?**

## *Construction*

*Less Than Significant with Mitigation Incorporated.* The City Code exempts construction activities from the established noise limits when activities occur during the daytime hours of 7:00 a.m. to 6:00 p.m. Monday through Friday and between 9:00 a.m. to 6:00 p.m. on Saturday (Santa Clara 2021). Two phases of construction activities would occur for a total of 22 months. Phase one would last for about 15 months which includes site work (demo, site prep. grading), construction of the entire building shell and substation, placement of half the generators. Phase two would last 7 months which includes interior buildout of the structure and placement of the other half of the generators. Construction activities for the project would likely utilize equipment that could generate noise levels that exceed ambient noise, such as bulldozers and jackhammers. Construction noise can be significant for short periods of time at any particular location. The highest noise levels would often be generated during grading and excavation, while lower noise levels normally occur during building construction. Large pieces of earth-moving equipment, such as graders, scrapers, and bulldozers, generate noise levels up to 85 to 90 dBA at 50-feet. Typical hourly average construction-generated noise levels are 61 to 90 dBA, measured at 50-feet from the site during busy construction periods. The loudest construction activities (from concrete saw or hydra break ram) can elevate ambient noise levels at the nearest residences by up to 11 dBA. However, noise levels from construction activities would be limited to daytime hours, in compliance with the City Code as discussed below. Additionally, the elevated noise levels from construction activities would be lower than the noise levels from passing trains. Trains pass by four times per hour during peak commute (6 a.m. to 9 a.m. and 4 p.m. to 7 p.m.) and two times per hour during non-peak commute (CalTrain 2021). This can elevate noise levels at residences by up to 30 dBA, intermittently resulting in noise levels as high as 89 dBA  $L_{max}$  compared to the existing daytime ambient level of 59 dBA  $L_{eq}$ .

As discussed above, an increase of 10 dBA or more during the day can be perceived as noisy (triggering a community reaction) and warrant additional measures to address noise levels. An increase of 10 dBA corresponds to a doubling of loudness or dBA level and is the starting point for significant impacts. Again, the loudest construction activities can elevate the existing ambient noise levels at the nearest residences by up to 11 dBA—average of the loudest construction noise levels, causing noise levels up to 70 dBA compared to the existing daytime ambient level of 59 dBA  $L_{eq}$ . The noise levels from construction activities can be perceived as noisy; however, less noisy than passing trains. Moreover, construction noise would not be heard by the residents to the south of the construction site when trains are passing by (noise levels from passing trains elevates noise levels by 30 dBA).

Two noise sources that produce noise levels that differ by 9 dBA or less can combine to produce an even louder noise level. However, if noise levels differ by 10 or more dBA, they do not combine to produce a louder noise level.

Moreover, performance standards (i.e., a complaint and redress process) are ultimately used as a backstop measure to address any impacts that might be perceived by the community. Therefore, staff proposes **NOI-1**, requiring a complaint and redress process be implemented to ensure construction noise impacts would not be significant, as perceived by the community. With the implementation of **NOI-1**, the project's construction noise impact would be less than significant.

### *Operation*

*Less Than Significant Impact.* The proposed emergency backup generators (gensets) would provide backup power to the data center buildings in the event of an equipment failure or other conditions resulting in an interruption of the electricity delivered from Silicon Valley Power via Pacific Gas and Electric Company (PG&E) utility lines. The gensets would be enclosed in equipment yards located adjacent to the north side of the building. The General Plan along with the City Code (Section 9.10.040) establish mitigation and noise level performance standards to control noise within the city. The General Plan policy includes goals to minimize operational noise impacts from existing and new industrial and commercial development to protect sensitive land uses from noise intrusions. In accordance with the General Plan, the project's maximum sound level at nearby residential use properties must be 55 dBA during the hours of 7 a.m. to 10 p.m., and 70 dBA, anytime, at nearby ML use properties. However, the City Code does not apply to the operation of the gensets during an emergency, such as the interruption of electricity delivered via PG&E.

The applicant would use gensets that ensure sufficient exhaust silencing and other design measures if required, such that the project meets the City Code noise requirements. The project would include 44 gensets that would be located at the northern end of the project site, the opposite side of the data center building away from the nearby residents and would be housed in acoustically enhanced enclosures. Each genset would be tested only during daytime hours. An 8-foot-high by 200-foot-long wall along the northern property boundary would be installed to mitigate noise levels at adjacent properties. Heating, ventilation, and air conditioning (HVAC) equipment, including chiller plant modules and condensing units, would be located on the rooftop of the data center building, fitted with a "Superior" sound package, and solid barriers extending three feet above the top of the chiller fans. The substation would be surrounded by 15-foot-high walls (DayZenLLC 2021e, Section 4.13.3.1).

The applicant modeled sources of noise for the project using computer aided noise abatement (CadnaA) to assess the impact of its operational activities on nearby noise receptors. Noise modeling was performed for two scenarios: "normal" and "worst-case." Normal operation would primarily consist of the continuous operation of the HVAC equipment and other air-handling units.



The worst-case modeled scenario, under CadnaA, consists of the simultaneous operation of the project in normal mode along with 12 of the gensets closest to the nearest noise receptors. This scenario is only intended for modeling the worst-case noise impact on the adjacent properties and not the typical noise levels during testing and maintenance since the gensets would be tested one at a time. The noise generated during the worst-case scenario would be higher than that during testing and maintenance. The frequency of genset testing would be low (not to exceed 50 hours per engine per year) and testing would only occur during daytime hours (DayZenLLC 2021e, Section 4.6.3.1).

The CadnaA modeling results show that for the normal mode of operation, the noise level at the residential receptor would be anticipated to reach a maximum of 50 dBA  $L_{eq}$  (DayZenLLC 2021e, Table 4.13-9). This is below the daytime and nighttime ambient noise levels of 59 dBA and 53 dBA, respectively, at the nearby residential area. At the same location, the project's 50 dBA sound level is below the City Code daytime noise level limit of 55 dBA and does not exceed the City Code nighttime level of 50 dBA  $L_{eq}$ . The project's noise level at the nearby industrial receptor would not exceed 56 dBA  $L_{eq}$ . This is below the ambient level of 59 dBA  $L_{eq}$  at this location and below the City Code noise level limit of 70 dBA  $L_{eq}$  for ML uses (CA3 2021, Table 4.13-9).

The results of the CadnaA computer modeling also show that during the worst-case scenario, the modeled equivalent continuous sound level ( $L_{eq}$ ) at the residential receptors would reach a maximum of 50 dBA. This is the same as normal operation because the gensets are located on the opposite side of the data center building, away from these residences. A 50 dBA noise level is below the daytime and nighttime ambient noise levels of 59 and 53 dBA, respectively. Additionally, it is below the City Code daytime residential noise level limit of 55 dBA  $L_{eq}$  and does not exceed the City Code nighttime limit of 50 dBA  $L_{eq}$ . Note that this would be due to emergency operation and is, therefore, exempt from the City Code noise limits. The project's noise level at the nearby industrial receptor would not exceed 70 dBA, the City Code limit for ML uses (DayZenLLC 2021e, Table 4.13-10).

In the unlikely event that actual noise emissions are higher than modeling predictions and additional improvements are needed to reduce project noise to acceptable levels (city's allowable limit or existing ambient noise level, whichever is higher), practical and available noise-reducing measures may need to be considered. Examples of measures typically implemented at data centers are listed below.

- Low speed fans.
- Acoustical building panels, tiles, and baffles: These are typically installed inside buildings to reduce internal noise levels.
- Sound dampening server cabinets: These are also used to reduce noise levels inside buildings.

The project would generate 13.2 daily vehicle miles traveled (VMT) per worker for project operations. This is below the city's threshold for VMT and as the permitting agency, the city would ensure project consistency with the General Plan policies related to trip reduction, transit connectivity, and alternative modes of transportation. Thus, the noise impact of vehicle trips associated with the project would be less than significant. See **Section 4.17 Transportation** for more discussion.

The noise impact from project operation would be less than significant.

Noise impacts from project construction and operation would not be in excess of adopted environmental standards or plans.

## **b. Would the project result in generation of excessive groundborne vibration or groundborne noise levels?**

### *Construction*

*Less Than Significant Impact.* This analysis relies on the vibration thresholds identified by Caltrans to determine the significance of vibration impacts related to adverse human reaction. The threshold of human response begins at a peak particle velocity (PPV) of 0.16 in/sec. Caltrans characterizes this as a "distinctly perceptible" event (Caltrans 2013). A level of 0.20 in/sec has been found to be annoying to people in buildings and can pose a risk of architectural damage to buildings.

Pile driving would not be performed as a method of construction activity for the project, but there would be other construction activities that would generate groundbourne vibrations at the immediate vicinity of the work area.

Jackhammers can cause a groundborne vibration rate of 0.035 in/sec at 25 feet (less than the threshold of human response), and vibratory rollers can cause a groundborne vibration of 0.21 in/sec at 25 feet (Caltrans 2013). The nearest structure to the project construction area is an existing ML building located approximately 60 feet southeast of the project site. A vibratory roller would be used during project construction for paving activities (DayZen LLC 2021e, Section 4.13.3.2). At the nearest noise receptors, the ML building, 0.21 in/sec translates to approximately 0.056 in/sec,<sup>1</sup> less than the threshold of human response to nearby residents or employees. Construction equipment and activities would be similar to those used at similar projects and are not expected to result in rates greater than those noted above. Staff therefore concludes that vibration impacts from project construction would be less than significant.

---

<sup>1</sup> Calculated as:  $PPV_{@distance} = PPV_{ref. equipment} \times (ref. distance/distance)^{1.5} = 0.21 \times (25/60)^{1.5} = 0.056$  in/sec

## ***Operation***

*Less Than Significant Impact.* Sources of groundborne vibration associated with project operation would include the gensets and rooftop equipment. These pieces of equipment would be well-balanced, as they are designed to produce very low vibration levels throughout the life of a project. In most cases, even when there is an imbalance, they could contribute to ground vibration levels only in the vicinity of the equipment and would be dampened within a short distance. Furthermore, the gensets would be equipped with specifications that ensure sufficient exhaust silencing to reduce vibration. Therefore, vibration impacts due to project operation would be less than significant.

- c. For a project located within the vicinity of a private airstrip or an airport land use plan or, where such a plan has not been adopted, within two miles of a public airport or public use airport, would the project expose people residing or working in the project area to excessive noise levels?**

## ***Construction and Operation***

*Less than Significant Impact.* The nearest airport to the project site is the Norman Y. Mineta San Jose International Airport, located approximately 1.75 miles east of the project site. The project site is located outside the Airport Noise Zone (the 65 CNEL<sup>2</sup> contour, as set forth by state law in the Public Utilities Code, section 21601 et. seq), as defined in the Comprehensive Land Use Plan, adopted by the Santa Clara County Airport Land Use Commission, for the airport. The project site is not in the vicinity of a private airport, and it would not place sensitive land uses within the airport noise contour. Thus, the project would not combine with the airport to expose people to excessive noise levels.

### **4.13.3 Mitigation Measures**

**NOI-1:** The project shall implement the following measures to reduce temporary construction noise to less than significant levels.

- Construction is not permitted during the hours of 6 p.m. to 7 a.m. Monday through Friday, and between 6 p.m. to 9 a.m. on Saturday.
- Prior to the start of construction, identify a noise control disturbance coordinator. The disturbance coordinator shall be responsible for responding to any local complaints about construction noise. The disturbance coordinator shall determine the cause of any noise complaint received (e.g. starting too early, bad muffler, etc.) and shall

---

<sup>2</sup> CNEL is the average sound level over a 24-hour period, with a penalty of 5 dB added between 7 pm and 10 pm and a penalty of 10 dB added for the nighttime hours of 10 pm to 7 am. CNEL is frequently used in regulations of airport noise impact on the surrounding community.

ensure that reasonable measures warranted to correct the problem are implemented as soon as possible.

- Prior to the start of construction, establish a telephone number for the disturbance coordinator, and post it in a conspicuous location on the construction site.
- Prior to the start of construction, notify the residents within 800 feet from the center of the project to the south across the rail line and industrial buildings to the north, east, and west of the project site of the construction schedule, in writing, and provide a written schedule of “noisy” construction activities to the adjacent land uses.
- Include the telephone number for the disturbance coordinator construction site in the above notice regarding the construction schedule sent to residences south across the rail line and industrial buildings to the north, east, and west of the project site.
- The project owner shall orient construction equipment and locate construction staging areas within the project site away from the nearest residences to the south, to the extent feasible.
- Equip all construction-related internal combustion engine-driven equipment with the best available noise control equipment (including mufflers, intake silencers, ducts, engine enclosures, and acoustically attenuating shields or shrouds) and use best noise control practices to minimize noise levels from construction activities.

#### 4.13.4 References

Caltrans 2013 – California Department of Transportation (Caltrans). Technical Noise Supplement to the Caltrans Traffic Noise Analysis Protocol, A Guide for Measuring, Modeling, and Abating Highway Operation and Construction Noise Impacts, Division of Environmental Analysis, Environmental Engineering. September 2013. Report No. CT-HWANP-RT-13069.25.3. Accessed on: April 27, 2020. Available online at: <http://website.dot.ca.gov/env/noise/docs/tens-sep2013.pdf>

Caltrain 2021 – Caltrain. Weekday Service Schedule – Effective August 30, 2021. Accessed online: December 17, 2021. Available online at: [https://www.caltrain.com/schedules/weekdaytimetable/Weekday\\_Service\\_Changes\\_-\\_Effective\\_August\\_30\\_\\_2021.html](https://www.caltrain.com/schedules/weekdaytimetable/Weekday_Service_Changes_-_Effective_August_30__2021.html)

San Jose 2020 – City of San Jose (San Jose). *Envision San Jose 2040 General Plan*. Adopted November 1, 2011, amended December 18, 2018, and updated March 16, 2020. Available online at: <https://www.sanjoseca.gov/home/showdocument?id=22359>

DayZenLLC 2021d – DayZenLLC (DayZenLLC). (TN 237383). VDC CA3BGF SPPE Application Part V, dated April 5, 2021. Available online at: <https://efiling.energy.ca.gov/Lists/DocketLog.aspx?docketnumber=21-SPPE-01>

DayZenLLC 2021e – DayZenLLC (DayZenLLC). (TN 237423). VDC CA3BGF SPPE  
Application Part II, dated April 12, 2021. Available online at:  
<https://efiling.energy.ca.gov/Lists/DocketLog.aspx?docketnumber=21-SPPE-01>

## 4.14 Population and Housing

This section describes the environmental setting and regulatory background, and discusses impacts associated with the construction and operation of the project specific to population and housing.

POPULATION AND HOUSING	Potentially Significant Impact	Less Than Significant with Mitigation Incorporated	Less Than Significant Impact	No Impact
Would the project: a. Induce substantial unplanned population growth in an area, either directly (for example, by proposing new homes and businesses) or indirectly (for example, through extension of roads or other infrastructure)?	<input type="checkbox"/>	<input type="checkbox"/>	<input checked="" type="checkbox"/>	<input type="checkbox"/>
b. Displace substantial numbers of existing people or housing, necessitating the construction of replacement housing elsewhere?	<input type="checkbox"/>	<input type="checkbox"/>	<input type="checkbox"/>	<input checked="" type="checkbox"/>

Environmental checklist established by CEQA Guidelines, Appendix G.

### 4.14.1 Environmental Setting

The project is proposed in the city of Santa Clara in Santa Clara County. Nearby cities include San Jose, Campbell, Sunnyvale, and Mountain View. As discussed further below, staff considers the local workers<sup>1</sup> from the greater Bay Area are not likely to temporarily (during construction) or permanently (during operations) move closer to the project. Staff considers the city of Santa Clara and neighboring cities as the primary study area for population and housing-related impacts and the San Jose-Sunnyvale-Santa Clara Metropolitan Statistical Area (MSA), which covers San Benito and Santa Clara counties, as the setting for labor supply for the project.

#### Population Growth

**Table 4.14-1** shows the historical and projected populations for the cities within proximity of the project site, plus Santa Clara County as a whole. Population projections between 2020 and 2040 show growth ranging from 7.8 to 48.2 percent, or 0.4 to 2.4 percent on average per year in the cities within and around the project site.

<sup>1</sup> Workers with a greater commute would be considered non-local and would tend to seek lodging closer to the project site (temporarily during construction or permanently during operations).

**TABLE 4.14-1 HISTORICAL AND PROJECTED POPULATIONS**

Area	2010	2020	2030	2040	Projected Population Change 2020-2040 Percent (%)	Projected Population Change 2020-2040 Percent per Year (%)
Santa Clara	114,115	131,665	142,425	159,500	21.1	1.0
San Jose	958,585	1,028,210	1,189,660	1,377,145	33.9	1.7
Campbell	39,349	43,700	46,170	47,120	7.8	0.4
Sunnyvale	145,225	149,935	162,975	222,210	48.2	2.4
Mountain View	76,360	111,725	119,445	138,980	24.4	1.2
Santa Clara County	1,781,642	1,986,340	2,217,750	2,538,320	27.8	1.4

Sources: ABAG 2019

### Housing

**Table 4.14-2** presents housing supply data for the project area. Year 2020 housing estimates indicated 31,293 vacant housing units within Santa Clara County representing a vacancy rate of 4.6 percent (CA DOF 2021).

**TABLE 4.14-2 HOUSING SUPPLY ESTIMATES IN THE PROJECT AREA**

Housing Supply		2021 Total	2021 Vacant
Santa Clara	Number	51,041	2,756
	Percent	100	5.4
San Jose	Number	337,442	12,823
	Percent	100	3.8
Campbell	Number	18,195	1,383
	Percent	100	7.6
Sunnyvale	Number	60,761	2,977
	Percent	100	4.9
Mountain View	Number	37,820	2,610
	Percent	100	6.9
Santa Clara County	Number	680,298	31,294
	Percent	100	4.6

Source: CA DOF 2021

### Labor Supply

**Table 4.14-3** presents the California Employment Development Department 2018-2028 Occupational Employment Projections for the project's construction occupations in the MSA.

**TABLE 4.14-3 PROJECTED EMPLOYMENT GROWTH**

<b>San Jose-Sunnyvale-Santa Clara MSA</b>	<b>Year 2018</b>	<b>Year 2028</b>	<b>Percent Change</b>
Construction Trades Workers	38,350	41,380	7.9
Computer and Information Systems Managers	14,110	15,760	11.7

Source: CA EDD 2021

## Regulatory Background

No regulations related to population and housing apply to the project.

### 4.14.2 Environmental Impacts

- a. Induce substantial unplanned population growth in an area, either directly (for example, by proposing new homes and businesses) or indirectly (for example, through extension of roads or other infrastructure)?**

#### ***Construction***

*Less Than Significant Impact.* The project would not directly or indirectly induce substantial unplanned growth in the city of Santa Clara. The project does not propose new housing or land use designation changes and it would not facilitate growth through the extension of roads, water supply pipelines, or other growth-inducing infrastructure. While the project includes an emergency backup generating facility, the electricity produced would directly serve the data center if power interruptions occurred and would not be an extension of infrastructure serving customers or entities beyond the boundaries of the project parcel that would result in indirect population growth.

Construction of the first phase would last approximately 14 months. Construction of the second phase and third phase would each take approximately 11 months to complete. Phase I would include a construction workforce with a peak number of workers of approximately 150 per month and an average of approximately 100 per month (Vantage 2021 pg. 2-11). Phase II construction would begin as soon as commercially feasible, likely in late 2023, and take approximately 11 months to complete for commercial operation at the beginning of 2025. The Phase II construction workforce is estimated to have a peak number of workers of approximately 200 per month with an average of approximately 80 per month (Vantage 2021 pg. 2-11).

As shown in **Table 4.14.-3** above, there is a sufficient local construction workforce, with approximately 41,000 construction trades workers projected by 2028, in the project area MSA to accommodate the projected labor needs for construction of the project. The Phase I estimated peak construction workforce of 150 workers per month would account for .003 percent or less of the available projected Construction Trades Workers in the project area MSA. Similarly, the Phase II estimated peak workforce of 200 workers per month would account for .005 percent or less of the available projected Construction Trades Workers in the project area MSA. With a local construction workforce available to serve



the project, it is not expected workers would come from outside the area and no construction workers are expected to seek temporary lodging closer to the project site. Therefore, the project's construction workforce would not directly or indirectly induce substantial population growth in the project area. The impacts would be less than significant.

### ***Operation***

*Less Than Significant Impact.* The applicant anticipates the project would require a total of 19-21 permanent employees, with approximately 10-14 rental space tenant employees visiting the facility daily (Vantage 2021 pg. 4-135). As shown in **Table 4.14.-3**, there is a sufficient local workforce, with approximately 15,000 Computer and Information Systems Managers projected by 2028, in the project area's MSA to accommodate the projected permanent labor needs of the project. The permanent workforce of 21 workers would account for .001 percent or less of the available projected Computer and Information Systems Managers workforce in the project area's MSA. Furthermore, this permanent employment is well within the projected growth in this job sector, as shown in **Table 4.14-3**. Lastly, while the type of rental space tenant employees is not known, the small, anticipated number of employees (10-14 workers) is also not expected to induce substantial population.

If some workers were to relocate to the project area, housing data shows a vacancy rate of 5.4 percent in the city of Santa Clara and 3.8 percent in the nearby city of San Jose (refer to **Table 4.14-2**). Available housing counts in the project area indicate a sufficient supply of available housing units would be available for operations workers should they seek housing closer to the project and would not result in unplanned population growth. Therefore, the project's operations workforce would not directly or indirectly induce substantial population growth in the project area. The impact would be less than significant.

### **b. Displace substantial numbers of existing people or housing, necessitating the construction of replacement housing elsewhere?**

#### ***Construction and Operation***

*No Impact.* The 6.69-acre property is zoned Light Industrial (ML) and is currently developed with an approximately 115,000-square-foot, single-story office and warehouse building and associated paved surface parking and loading dock. While the existing office and warehouse buildings would be demolished, these structures do not contain any housing. As a result, no people or houses would be displaced and both construction and operation of the project would not require replacement housing to be constructed elsewhere. No impact would occur.

### **4.14.3 Mitigation Measures**

None.

#### 4.14.4 References

ABAG 2019 – Association of Bay Area Governments (ABAG). Projections 2040 by Jurisdiction. Data last updated May 1, 2019. Available online at: <https://data.bayareametro.gov/Demography/Projections-2040-by-Jurisdiction/grqz-amra>

CA DOF 2021 – California Department of Finance (CA DOF). E-5 Population and Housing Estimates for Cities, Counties and the State — January 1, 2021. Data last updated May 2021. Available online at: <http://dof.ca.gov/Forecasting/Demographics/Estimates/E-5/>

CA EDD 2021 – Employment Development Department, State of California (CA EDD). Labor Market Information Division, 2016-2026 Occupational Employment Projections, San Jose-Sunnyvale-Santa Clara Metropolitan Statistical Area, (San Benito and Santa Clara Counties), data last update May 7, 2021. Available online at: <https://data.edd.ca.gov/Employment-Projections/Long-Term-Occupational-Employment-Projections/4yzm-uyfq>

DayZenLLC 2021a-d – DayZenLLC (DayZenLLC). (TN 237380-383). VDC CA3BGF SPPE Application Part I, dated April 5, 2021. Available online at: <https://efiling.energy.ca.gov/Lists/DocketLog.aspx?docketnumber=21-SPPE-01>

## 4.15 Public Services

This section describes the environmental setting and regulatory background, and discusses impacts associated with the construction and operation of the project specific to public services. Water supply and treatment services are discussed in the Utilities and Service Systems section.

<b>PUBLIC SERVICES</b>	<b>Potentially Significant Impact</b>	<b>Less Than Significant with Mitigation Incorporated</b>	<b>Less Than Significant Impact</b>	<b>No Impact</b>
a. Would the project result in substantial adverse physical impacts associated with the provision of new or physically altered governmental facilities, need for new or physically altered governmental facilities, the construction of which could cause significant environmental impacts, in order to maintain acceptable service ratios, response times, or other performance objectives for any of the public services:	<input type="checkbox"/>	<input type="checkbox"/>	<input checked="" type="checkbox"/>	<input type="checkbox"/>
i. Fire protection?	<input type="checkbox"/>	<input type="checkbox"/>	<input checked="" type="checkbox"/>	<input type="checkbox"/>
ii. Police Protection?	<input type="checkbox"/>	<input type="checkbox"/>	<input checked="" type="checkbox"/>	<input type="checkbox"/>
iii. Schools?	<input type="checkbox"/>	<input type="checkbox"/>	<input checked="" type="checkbox"/>	<input type="checkbox"/>
iv. Parks?	<input type="checkbox"/>	<input type="checkbox"/>	<input checked="" type="checkbox"/>	<input type="checkbox"/>
v. Other public facilities?	<input type="checkbox"/>	<input type="checkbox"/>	<input checked="" type="checkbox"/>	<input type="checkbox"/>

Environmental checklist established by CEQA Guidelines, Appendix G.

### 4.15.1 Environmental Setting

The proposed project is in the city of Santa Clara (city) within Santa Clara County. Therefore, the study area for public services is the city. Fire protection and related paramedic services for the project site are provided by the Santa Clara Fire Department (SCFD). Police protection services are provided by the Santa Clara Police Department (SCPD). Parks and recreation facilities in the city are provided and maintained by the Santa Clara Department of Parks & Recreation. The project site is within the Santa Clara Unified School District (SCUSD) boundaries.

#### ***Fire Protection***

The SCFD has 10 stations consisting of eight engines, two trucks, two ambulances, one rescue/light unit, one hazardous materials unit, and one command vehicle (SCFD 2021). The closest fire station to the project site is Station 2, located at 1900 Walsh Avenue, which is approximately 0.8 mile east of the project site.

The SCFD responds to all emergencies within six minutes 90 percent of the time (SCFD 2021).

### ***Police Protection***

The SCPD consists of 239 full-time employees and a varying number of part-time or per diem employees, community volunteers, police reserves, and chaplains. Police headquarters are located at 601 El Camino Real, approximately 2.25 miles southeast of the project site (SCPD 2021).

The City of Santa Clara 2010-2035 General Plan (General Plan) identifies the goal of maintaining an average response time of three minutes for all areas of the city (Santa Clara 2010).

### ***Parks, Schools, and Libraries***

The nearest public parks to the project site are:

- Bracher Park, located at 2560 Alhambra Drive, directly west of the project site across from, and physically separated by, the Caltrain railroad right of way;
- Bowers Park, located at 2582 Cabrillo Avenue, approximately 0.8 mile south of the project site; and
- Warburton Park, located at 2250 Royal Drive, approximately 1.2 miles south of the project site.

The General Plan identifies a standard of maintaining 2.4 acres of parkland per 1,000 residents (Santa Clara 2010). The General Plan also identifies proposed parkland sites of at least 25 acres to maintain the city's ratio for parkland and serve the demand generated by future residential and employment center development.

The nearest public schools to the project site are:

- Bracher Elementary School, located at 2700 Chromite Drive, approximately 0.25 mile south of the project site;
- Adrian Wilcox High School, located at 3250 Monroe Street, approximately 0.6 mile west of the project site;
- Bowers Elementary School, located at 2755 Barkley Avenue, approximately 0.8 mile south of the project site; and
- Cabrillo Middle School, located at 2550 Cabrillo Avenue, approximately 0.8 mile south of the project site.

The nearest private school (within one mile) to the project site is the Cabrillo Montessori, located at 2495 Cabrillo Avenue.

According to the city's General Plan, SCUSD currently has four closed school sites (three of which are in the city of Santa Clara) that could be used to serve new development (Santa Clara 2010). Alternatively, SCUSD may choose to modify school catchment areas

or add modular classrooms to accommodate new students. SCUSD is also anticipating the construction of new school facilities in north San Jose as a result of an agreement with the city of San Jose and future housing developers.

The nearest library to the project site is the Northside Branch Library, located at 695 Moreland Way, approximately 2.25 miles northeast of the project site.

The General Plan states that new library facilities may be needed to accommodate future development, and the addition of approximately 33,000 residents, anticipated as a result of the implementation of the General Plan, but this need would be evaluated as part of the comprehensive planning process for new residential development (Santa Clara 2010). The General Plan also states that arts, cultural, and community facilities are sufficient to meet future demand particularly when the city can optimize the use of streets or other existing neighborhood amenities for community events.

## **Regulatory Background**

No specific regulations related to public services apply to the project. Prior to issuing land use and building permits, the city requires projects to be reviewed under a development review process, which includes an assessment of a project's consistency and compliance with the city's goals and objectives that are established in the General Plan and Santa Clara City Code, and in other applicable regulations and standards. As part of this process, the Project Clearance Committee (PCC) reviews project applications for completeness and compliance with city standards.

The SCFD, SCPD, and Santa Clara Department of Parks & Recreation are included in the PCC review to determine if project applications are complete and require conditions of approval. These conditions may include revisions to project plans to ensure that the site design incorporates safety and security measures as well as adequate emergency access. The SCFD, SCPD, and Santa Clara Department of Parks & Recreation provided comments and conditions for the proposed project related to fire services, police services, and park facilities at the PCC meetings held on June 22, 2021 (CEC 2021j) and November 2, 2021 (CEC 2021u). The project applicant is currently working to address these comments in an iterative process with the PCC and any conditions deemed necessary through that process will ultimately be folded into any permit issued by the city. Any changes to the project as a result of these conditions would only serve to reduce the project's potential for impacts and would not have the potential to result in a significant adverse impact.

### **4.15.2 Environmental Impacts**

- a. Would the project result in substantial adverse physical impacts associated with the provision of new or physically altered governmental facilities, need for new or physically altered governmental facilities, the construction of which could cause significant environmental impacts, in order to maintain acceptable**

**service ratios, response times, or other performance objectives for any of the public services:**

**i. Fire Protection?**

***Construction***

*Less Than Significant Impact.* The project would require a large temporary construction workforce. As stated in the application, Phase I of construction would occur over a 14-month period and would require an average of approximately 100 workers per month with a peak number of approximately 150 workers per month (DayZenLLC 2021a). Phase II of construction would occur over an 11-month period and would require an average of approximately 80 workers per month with a peak number of approximately 200 workers per month.

The city is a self-identified employment hub, with approximately 70 percent of employees commuting from residences outside of the city's jurisdiction (Santa Clara 2010). As discussed in section **4.14 Population and Housing**, the anticipated construction workforce for the project would likely be drawn from the San Jose-Sunnyvale-Santa Clara region.<sup>1</sup> Based on the proximity of the available workforce to the project, construction workers from neighboring cities and counties are not likely to temporarily relocate closer to the project site. Therefore, this workforce is unlikely to increase the need for residential area fire services. In addition, any changes to service ratios as a result of the project's construction phases would be temporary and would not require the need for new or physically altered fire protection facilities.

Project construction activities that could pose a risk for fire due to heated exhaust or sparks include the use of welding equipment, grinders, cranes, excavation equipment, vehicles, and bulldozers. AQ-1 requires the project to properly tune and maintain construction equipment in accordance with manufacturer's specifications. Additionally, the use of best practices ensures that construction equipment would be inspected regularly and operated by qualified personnel in compliance with operator manuals and standard safety procedures to minimize the risk of fire. However, the need for fire protection response may increase slightly in the unlikely event that a fire occurs during equipment operation.

Potential effects on the need for fire protection response as a result of the project's construction phases would be temporary and would cease at the end of project construction. In addition, the nearest fire station is relatively close to the project site (0.8 mile away), so that the existing six-minute response time goal mentioned earlier could still be achieved without the need for new or physically altered facilities. Therefore, impacts would be less than significant.

---

<sup>1</sup> Region in this instance is the Metropolitan Statistical Area. A Metropolitan Statistical Area is a geographical area with a population of 50,000 or more, plus adjacent territory that has a high degree of social and economic integration with the core as measured by commuting ties (EDD 2021).

## ***Operation***

*Less Than Significant Impact.* The existing project site includes a 115,000-square-foot, one-story office and warehouse building. While the proposed project includes a larger building (a 468,170-square-foot, four-story building), the operation of the computer servers would not require a substantial number of employees. The project is anticipated to require a total of 19 to 21 permanent employees, with approximately 10 to 14 tenant employees visiting the CA3DC daily (DayZenLLC 2021e). The CA3BGF would not have any dedicated employees. Because the project would require a relatively limited number of permanent employees (approximately 20 employees), any changes to service ratios resulting from project operation would not be substantial.

The project site is currently developed with an office and warehouse that is already served by the SCFD. Therefore, the proposed project would not introduce new residential or business uses that would attract a substantial number of new residents to the project area. Given the availability of an existing workforce throughout the greater Bay Area, the project's permanent employees are likely to currently reside within commuting distance of the project site and would not need to relocate closer to the project. If employees were to move closer to the project, this small increase in population would not create a notable increase in the need for fire protection services.

Project elements that could pose a risk for fire include the operation of the emergency backup generators because of the use of diesel fuel (a flammable liquid) as well as the electrical substation and electricity distribution lines that could overheat and potentially spark fires. Emergency backup generators would run for short periods (i.e., duration and frequency) for testing and maintenance purposes, and would not fully operate unless there is a disturbance or interruption in the utility's electricity supply. The limited operation of the emergency backup generators would minimize the potential fire risk from overheating and sparks and would also minimize the use and handling of the diesel fuel required to operate the emergency backup generators.

The storage and handling of diesel fuel would also be conducted in compliance with safety procedures to minimize the risk of fire. Although a substantial quantity of diesel fuel would be stored on-site, the storage of this fuel would be split among many separate tanks, a portion of which would be stored in the double-walled belly tank beneath each emergency backup generator. Deliveries of diesel fuel by tanker truck during project operation would be scheduled on an as-needed basis. An emergency pump shut-off would be available in case a pump hose breaks during fueling. Other safety features include a 15-foot-high wall that would be installed around much of the electrical substation perimeter to reduce safety and fire hazards. Routine inspections of the electrical substation and electricity distribution lines would be conducted so that any operational issues are addressed to minimize overheating and fire hazards.

To further minimize the need for fire protection response, the project would be designed and constructed in conformance with current building and fire codes. As part of the recent PCC review, the SCFD reviewed the project plans to ensure appropriate safety features

have been incorporated to reduce fire hazards, including the provision of adequate emergency access for firefighting equipment and vehicles (CEC 2021j). As of the November 2, 2021, PCC meeting, the applicant was working with the city regarding the SCFD's requirements, including an emergency vehicle access easement, and the location of on-site power lines. The SCFD will review the final site design and may require conditions of approval prior to the issuance of land use and building permits.

With the implementation of standard safety protocols required by SCFD, potential effects on the need for fire protection response would be substantially minimized. No new or physically altered fire protection facilities would be required for project operation. Therefore, impacts would be less than significant.

## **ii. Police Protection?**

### ***Construction***

*Less Than Significant Impact.* The proposed project's construction phases would not generate substantial population growth in the project area that would result in the need for additional police protection facilities for new residents. Based on the proximity of the available workforce to the project, construction workers from neighboring cities and counties are not likely to temporarily relocate closer to the project site. Therefore, they are unlikely to increase the need for residential area police services. In addition, any changes to service ratios as a result of project construction would be temporary and would not require the need for new or physically altered police protection facilities.

Project construction may result in a slight increase in the need for police response in the event law enforcement is needed at the site. The applicant has indicated that it (contractors) would provide fencing during the construction phase. As part of the recent PCC review, the SCPD reviewed the project plans and is requiring that the property be fenced off during demolition and construction as a safety barrier and deterrent of theft and other crime (CEC 2021j). SCPD is requesting that screening material on the fence allow visual access into the site for police patrol vehicles.

With the implementation of standard safety protocols as required by SCPD, potential effects on the need for police response would be substantially minimized. No new or physically altered police protection facilities would be required for project construction. Therefore, impacts would be less than significant.

### ***Operation***

*Less Than Significant Impact.* Because the project would require a relatively limited number of permanent employees (approximately 20), any changes to service ratios as a result of the project's operation would not be substantial. The project site is developed with a pre-existing office and warehouse that is already served by the SCPD. Therefore, the proposed project would not introduce new residential or business uses that would attract a substantial number of new residents to the project area.



Given the availability of an existing workforce throughout the greater Bay Area, the project's permanent employees are likely to currently reside within commuting distance of the project site and would not need to relocate closer to the project. If employees were to move closer to the project, this small increase in population would not create a notable increase in the need for police protection services.

To enhance site security and reduce the need for police response, the project would include pole-mounted lighting fixtures along the site perimeter as well as along the perimeter of the CA3BGF utility yard, and outdoor security lighting would be provided along the CA3DC building and driveway entrances. Access to the project site would not be available to the public and would be restricted to persons having business on-site. A security checkpoint for vehicles would be located at the eastern driveway.

As part of the recent PCC review, the SCPD reviewed the project plans and provided comments and conditions of approval related to incorporating safety and security measures into the site design (CEC 2021j). These comments and conditions include:

- Providing vegetation and structures that do not block views or create hiding spaces;
- Installing signage to discourage trespassing and unauthorized parking;
- Incorporating alarm systems, security cameras, and a coded entry system for police access; and
- Ensuring that radio signals do not interfere with police communication.

With the implementation of standard safety protocols as required by SCPD, potential effects on the need for police response would be substantially minimized. No new or physically altered police protection facilities would be required for project operation. Therefore, impacts would be less than significant.

### **iii. Schools?**

#### ***Construction and Operation***

*Less Than Significant Impact.* The project would be in the SCUSD. SCUSD Board Policy (BP 7211 Facilities: Developer Fees) allows the Board of Trustees, among other things, to establish, levy, and collect developer fees on residential, commercial, and industrial construction within the district for the purpose of funding the construction or reconstruction of school facilities consistent with Education Code section 17620 and Government Code section 65995 et seq. Government Code section 65995(h) expressly provides that "[t]he payment or satisfaction of a fee, charge, or other requirement levied or imposed pursuant to Section 17620 of the Education Code... are hereby deemed to be full and complete mitigation of the impacts of any legislative or adjudicative act, or both, involving, but not limited to, the planning, use, or development of real property, or any change in governmental organization... on the provision of adequate school facilities." The current school impact fee for the district is \$0.66 per square foot of covered, enclosed commercial/industrial space (SCUSD 2020). Based on the proposed size of the four-story, 468,170-square-foot data center building, an estimated \$308,992 would be assessed.

These fees would be collected at the time the applicant applies for building permits from the city of Santa Clara; therefore, impacts would be less than significant.

#### **iv. Parks?**

##### ***Construction***

*Less Than Significant Impact.* Based on the proximity of the available workforce to the project, construction workers from neighboring cities and counties are not likely to temporarily relocate closer to the project site. Therefore, the construction workers are very unlikely to increase levels of residential area park use. Temporary construction workers may visit park facilities before, during, or after a workday, but this would be a short-term use, if any, that would cease at the end of the project's construction. Although Bracher Park is located directly west of the project site, the project site has no direct access to the park. The entrance to Bracher Park is approximately one mile from the site. Furthermore, the presence of a Caltrain railroad right of way between the project site and the park makes increased park use by potential users from this project highly unlikely. No new or physically altered park facilities would be required for the project's construction. Therefore, impacts would be less than significant.

##### ***Operation***

*Less Than Significant Impact.* The proposed project would not generate substantial population growth in the project area that would result in the need for additional park facilities for new residents. The project is not a residential project, and, therefore, developed parkland and recreational amenities are not required under the city's Park and Recreational Land ordinance (CEC 2021j). Employees at the project site may visit parks in the area, but the limited number of employees (approximately 20 employees) would not substantially increase demand for park facilities or affect service ratios. No new or physically altered park facilities would be required for project operation. Therefore, impacts would be less than significant.

#### **v. Other Public Facilities?**

##### ***Construction***

*Less Than Significant Impact.* Based on the proximity of the available workforce to the project, construction workers from neighboring cities and counties are not likely to temporarily relocate closer to the project site. Those construction workers would most likely use the public facilities in the communities where they are permanent residents. Temporary construction workers may visit public facilities, such as public libraries, before, during, or after a workday, but this use would be temporary and would cease at the end of project construction. No new or physically altered public facilities or services would be required for project construction. Therefore, impacts would be less than significant.

## ***Operation***

*Less Than Significant Impact.* The proposed project would not generate substantial population growth in the project area that would result in the need for additional public facilities or services for new residents. Employees at the project site may visit local libraries or other public facilities, but the limited number of employees (approximately 20 employees) would not substantially increase demand for public facilities. No new or physically altered public facilities would be required for project operation. Therefore, impacts would be less than significant.

### **4.15.3 Mitigation Measures**

None.

### **4.15.4 References**

CEC 2021j – California Energy Commission (CEC). (TN 239135). Record of Conversation PCC Minutes dated August 2, 2021. Available online at: <https://efiling.energy.ca.gov/Lists/DocketLog.aspx?docketnumber=21-SPPE-01>

CEC 2021u – California Energy Commission (CEC). (TN 240967). Report of Conversation - City of Santa Clara, PCC Meeting Minutes, dated November 17, 2021. Available online at: <https://efiling.energy.ca.gov/Lists/DocketLog.aspx?docketnumber=21-SPPE-01>

Santa Clara 2010 – City of Santa Clara (Santa Clara). *City of Santa Clara General Plan 2010-2035*. Adopted on November 16, 2010. Chapter 5.9, Public Facilities and Services. Accessed on June 29, 2021. Available online at: <https://www.santaclaraca.gov/our-city/departments-a-f/community-development/planning-division/general-plan>

SCFD 2021 – City of Santa Clara Fire Department (SCFD). “Emergency Services.” Accessed on June 25, 2021. Available online at: <https://www.santaclaraca.gov/services/emergency-services>

SCPD 2021 – City of Santa Clara Police Department (SCPD). “Fact Sheet.” Accessed on June 25, 2021. Available online at: <https://www.santaclaraca.gov/our-city/departments-g-z/police-department/about-us/fact-sheet>

DayZenLLC 2021a – DayZenLLC (DayZenLLC). (TN 237380). VDC CA3BGF SPPE Application Part I, dated April 5, 2021. Available online at: <https://efiling.energy.ca.gov/Lists/DocketLog.aspx?docketnumber=21-SPPE-01>

DayZenLLC 2021e – DayZenLLC (DayZenLLC). (TN 237423). VDC CA3BGF SPPE Application Part II, dated April 12, 2021. Available online at: <https://efiling.energy.ca.gov/Lists/DocketLog.aspx?docketnumber=21-SPPE-01>

DayZenLLC 2021bb – DayZenLLC (DayZenLLC). (TN 240159). CA3DC Revised Project Description – PCC Revisions, dated October 28, 2021. Available online at: <https://efiling.energy.ca.gov/Lists/DocketLog.aspx?docketnumber=21-SPPE-01>

EDD 2021 – State of California Employment Development Department (EDD). LMI for San Jose-Sunnyvale-Santa Clara MSA, California. Accessed on June 29, 2021. Available online at: <https://www.labormarketinfo.edd.ca.gov/geography/msa/san-jose-sunnyvale-santa-clara.html>

SCUSD 2020 – Santa Clara Unified School District (SCUSD). Santa Clara Unified School District Developer Fee. Approved on March 12, 2020, and effective May 11, 2020. Accessed on: January 2021. Available online at: <https://www.santaclarausd.org/Page/53>.

## 4.16 Recreation

This section describes the environmental setting and regulatory background, and discusses impacts associated with the construction and operation of the project specific to recreation.

RECREATION	Potentially Significant Impact	Less Than Significant with Mitigation Incorporated	Less Than Significant Impact	No Impact
Would the project: a. Would the project increase the use of existing neighborhood and regional parks or other recreational facilities such that substantial physical deterioration of the facility would occur or be accelerated?	<input type="checkbox"/>	<input type="checkbox"/>	<input checked="" type="checkbox"/>	<input type="checkbox"/>
b. Does the project include recreational facilities or require the construction or expansion of recreational facilities, which might have an adverse physical effect on the environment?	<input type="checkbox"/>	<input type="checkbox"/>	<input type="checkbox"/>	<input checked="" type="checkbox"/>

Environmental checklist established by CEQA Guidelines, Appendix G.

### 4.16.1 Environmental Setting

The project would be in the city of Santa Clara (city) within Santa Clara County. The 6.69-acre project site is currently developed with an office and warehouse building and is zoned Light Industrial (ML). Adjacent uses are designated by the city as industrial and research and development uses (Santa Clara 2021).

The project would require a large, temporary construction workforce and a small, permanent operation workforce. Phase I of construction would occur over a 14-month period and would require an average of approximately 100 workers per month with a peak number of approximately 150 workers per month (Vantage 2021a). Phase II of construction would occur over an 11-month period and would require an average of approximately 80 workers per month with a peak number of approximately 200 workers per month. During operation, approximately 10 to 14 employees would be onsite daily, with a total permanent workforce of approximately 19 to 21 employees (Vantage 2021b).

#### Recreation Facilities

The city owns and maintains 497 acres of parks and recreation facilities, which include one community park, three mini parks, 24 neighborhood parks, three city-designated public open spaces, and 16 recreation facilities (i.e., sports fields, skate park, swimming pools/centers, senior center, and youth center) (Santa Clara 2010). The recreation site nearest to the project is Bracher Park, a 3.5-acre neighborhood park located approximately 170 feet southwest of the project site, albeit in another neighborhood. Bracher Park is physically separated from the project site by an existing Caltrain railroad right-of-way and is not directly accessible from the project site. The entrance to Bracher

Park is approximately one mile from the project site via the local street network. There are no parks or recreation facilities within one mile of the project site.

## Regulatory Background

### *Federal*

No federal regulations related to recreation apply to the project.

### *State*

No state regulations related to recreation apply to the project.

### *Local*

**City of Santa Clara General Plan.** The City of Santa Clara 2010-2035 General Plan (General Plan) describes goals and policies for the city to actively seek additional park and open space as residential and employment populations increase (Santa Clara 2010). The General Plan's implementation policies are designed to maintain a standard ratio of 2.4 acres of parkland per 1,000 residents. Staff identified the following applicable recreation policy:

- 5.9.1-P7 – Allow new parks in the general locations shown on the Land Use Diagram in all General Plan designations, except in areas designated for Light and Heavy Industrial uses.

## 4.16.2 Environmental Impacts

### **a. Would the project increase the use of existing neighborhood and regional parks or other recreational facilities such that substantial physical deterioration of the facility would occur or be accelerated?**

#### ***Construction***

*No Impact.* The city of Santa Clara is a self-identified employment hub, with approximately 70 percent of employees commuting from residences outside of the city's jurisdiction (Santa Clara 2010). As discussed in section **4.14 Population and Housing**, the anticipated construction workforce for the project would likely be drawn from the San Jose-Sunnyvale-Santa Clara region.<sup>1</sup> Based on the proximity of the available workforce to the project, construction workers from neighboring cities and counties are unlikely to temporarily relocate closer to the project site or utilize nearby parks or recreation facilities. In certain instances where construction workers do temporarily relocate for their employment, they by and large return to their community on the weekends and therefore recreate closer to home. Thus, the project would not increase the use of or accelerate

---

<sup>1</sup> Region in this instance is the Metropolitan Statistical Area. A Metropolitan Statistical Area is a geographical area with a population of 50,000 or more, plus adjacent territory that has a high degree of social and economic integration with the core as measured by commuting ties (EDD 2021).

the physical deterioration of a recreation site. The project would have no impact on parks and recreation facilities within the city.

### ***Operation***

*Less Than Significant Impact.* The project would employ a small number of permanent employees (i.e., approximately 20). Given the availability of an existing workforce throughout the greater Bay Area, it is likely that the project's permanent employees currently reside within commuting distance of the project site and would not need to relocate closer to the project. If employees were to move closer to the project, this small increase in population would not create a notable increase in the use of an existing park or recreation facility. Furthermore, the project would not contribute to a substantial physical deterioration of a park or recreation facility. Impacts to city parks and recreation facilities would be less than significant.

### **b. Does the project include recreational facilities or require the construction or expansion of recreational facilities, which might have an adverse physical effect on the environment?**

### ***Construction***

*No Impact.* Recreation facilities are not included as part of the project, and the project would not require the construction or expansion of a recreation facility. As described in the City's General Plan Policy 5.9.1-P7, new park facilities are not allowed in areas designated for Light Industrial uses, which would include the project site. Construction of the project would have no impacts to a recreation facility.

### ***Operation***

*No Impact.* The project's small operational workforce (i.e., approximately 20 employees) would not create a demand for recreational facilities that would require the construction of new facilities or the expansion of existing facilities. The operation of the project would have no impact on recreation facilities.

## **4.16.3 Mitigation Measures**

None.

## **4.16.4 References**

Santa Clara 2010 – City of Santa Clara (Santa Clara). *City of Santa Clara General Plan 2010-2035*. Adopted on November 16, 2010. Chapter 3, pg. 3-18; Chapter 5.9; Appendix 8, pgs. 8.8-3 to 8.8-5. Accessed on June 29, 2021. Available online at: <https://www.santaclaraca.gov/our-city/departments-a-f/community-development/planning-division/general-plan>

Santa Clara 2021 – City of Santa Clara (Santa Clara). Interactive. Amended February 23, 2021. Accessed on: June 29, 2021. Available online at: <https://www>.

[santaclaraca.gov/our-city/departments-a-f/community-development/planning-division/zoning](http://santaclaraca.gov/our-city/departments-a-f/community-development/planning-division/zoning)

EDD 2021 – State of California Employment Development Department (EDD). LMI for San Jose-Sunnyvale-Santa Clara MSA, California. Accessed on June 29, 2021. Available online at: <https://www.labormarketinfo.edd.ca.gov/geography/msa/san-jose-sunnyvale-santa-clara.html>

Vantage 2021a – Vantage Data Centers, LLC. (Vantage). Application for Small Power Plant Exemption: CA3 Backup Generating Facility Part I (TN 237423), April 2021. Available online at: <https://efiling.energy.ca.gov/Lists/DocketLog.aspx?docketnumber=21-SPPE-01>

Vantage 2021b – Vantage Data Centers, LLC. (Vantage). Application for Small Power Plant Exemption: CA3 Backup Generating Facility Part II (TN 237423), April 2021. Available online at: <https://efiling.energy.ca.gov/Lists/DocketLog.aspx?docketnumber=21-SPPE-01>



## 4.17 Transportation

This section describes the environmental setting and regulatory background and discusses impacts specific to transportation associated with the construction and operation of the project.

<b>TRANSPORTATION</b>	<b>Potentially Significant Impact</b>	<b>Less Than Significant with Mitigation Incorporated</b>	<b>Less Than Significant Impact</b>	<b>No Impact</b>
Would the project:				
a. Conflict with a program, plan, ordinance or policy addressing the circulation system, including transit, roadway, bicycle, and pedestrian facilities?	<input type="checkbox"/>	<input type="checkbox"/>	<input checked="" type="checkbox"/>	<input type="checkbox"/>
b. Conflict or be inconsistent with CEQA Guidelines section 15064.3, subdivision (b)?	<input type="checkbox"/>	<input type="checkbox"/>	<input checked="" type="checkbox"/>	<input type="checkbox"/>
c. Substantially increase hazards due to a geometric design feature (e.g., sharp curves or dangerous intersections) or incompatible uses (e.g., farm equipment)?	<input type="checkbox"/>	<input type="checkbox"/>	<input checked="" type="checkbox"/>	<input type="checkbox"/>
d. Result in inadequate emergency access?	<input type="checkbox"/>	<input type="checkbox"/>	<input checked="" type="checkbox"/>	<input type="checkbox"/>

Environmental checklist established by CEQA Guidelines, Appendix G.

### 4.17.1 Environmental Setting

The project site is at 2590 Walsh Avenue in Santa Clara, California. The site is currently developed with an approximately 115,000-square-foot single-story office and warehouse building and associated paved surface parking and loading dock. Numerous freeways, including U.S. Highway 101 (US-101) and Interstates 680, 280, and 880, provide regional access to the Santa Clara area. Local access to the project area is provided by both Bowers Avenue and San Tomas Expressway, which connect directly to US-101 approximately one mile north of the project site. Both of these local roadways connect to Walsh Avenue, which provides direct access to the project site.

Transportation infrastructure on Walsh Avenue between Bowers Avenue and San Tomas Expressway (where the project site is located) is limited to four travel lanes with a dedicated center turn lane and pedestrian sidewalks on both sides of the road. Because Walsh Avenue is a short connector road serving the various industrial and commercial uses that are located along this segment, there are no designated bicycle lanes (VTA 2021a) and minimal roadway shoulder exists.

Public transit service to the project area includes regional light rail (provided by Caltrain) and local light rail and local bus transport (provided by the Santa Clara Valley Transportation Agency [VTA]). The nearest transit hub to the project is the Caltrain Lawrence Station, located approximately 1.2 miles west of the project site on Lawrence

Expressway. Lawrence Station is part of the regional Caltrain commuter rail system and is one of 32 stations serving the San Francisco Peninsula. From Lawrence Station, the Caltrain regional light rail connects to the VTA local light rail system at the San Jose Diridon Station, which is in downtown San Jose approximately 6 miles southeast of the Lawrence Station. The San Jose Diridon Station is served by the VTA Green local rail line, Amtrak, and the ACE Train (VTA 2021b).

From the Lawrence Station, the Caltrain regional light rail connects to local bus transport at the Santa Clara Transit Center approximately 3.5 miles southeast. The Santa Clara Transit Center is served by VTA local Bus Route 21, which connects 1,250 feet to the south on Monroe Street (VTA 2021c). VTA Bus Route 21 stops at Monroe Street and San Tomas Creek, which is the closest bus stop to the project (VTA 2021c). From this stop, the project site is approximately 3,500 feet to the north. Direct public transit access is not available to the project site.

The closest airport to the project site is the Norman Y. Mineta San Jose International Airport (San Jose International Airport), with the nearest runway located 1.75 miles east of the project site.

## **Regulatory Background**

### *Federal*

**Code of Federal Regulations (14 CFR §77.5 et. seq).** Under federal law, 14 CFR § 77.9(a), notification is required to be sent to the Federal Aviation Administration (FAA) for any construction or alterations exceeding 200 feet above ground level (AGL) (CFR 2021a). If a project's height, including any temporary equipment (such as cranes used during construction) or any ancillary structures (such as transmission poles or roof spires), exceeds 200 feet AGL, the project applicant must submit a copy of FAA Form 7460-1, Notice of Proposed Construction or Alteration, to the FAA. The FAA then reviews the project to determine any potential hazards to navigable airspace.

Where a project is located within a horizontal distance of 20,000 feet from a public or military airport where at least one runway is more than 3,200 feet in length, 14 CFR § 77.9(b) also requires FAA notification of any construction or alteration of greater height than an imaginary surface extending outward and upward at a slope of 100 to 1 (CFR 2021a). Because San Jose International Airport has a runway exceeding this length and is located 1.75 miles (9,240 feet) east of the project site, 14 CFR § 77.9(b) requires notification be sent to the FAA for any temporary or permanent features that exceed 92.4 feet in height AGL.

### *State*

**California Department of Transportation.** Project construction activities that require the movement of oversized or excessive load vehicles on state roadways require a transportation permit issued by the California Department of Transportation under Vehicle Code, section 35780 (Caltrans).

### *Local*

**City of Santa Clara 2021-2035 General Plan.** The City of Santa Clara 2010-2035 General Plan (General Plan) includes policies for the purpose of avoiding or mitigating impacts resulting from planned development projects within the city. While a number of General Plan policies pertain to city efforts to enhance the overall multimodal transportation system, the following policies are specific to new development and are assumed applicable to the proposed project (Santa Clara 2010):

- **Policy 5.8.3-P8:** Require new development to include transit stop amenities, such as pedestrian pathways to stops, benches, traveler information and shelters.
- **Policy 5.8.3-P9:** Require new development to incorporate reduced onsite parking and provide enhanced amenities, such as pedestrian links, benches and lighting, in order to encourage transit use and increase access to transit services.
- **Policy 5.8.3-P10:** Require new development to participate in public/private partnerships to provide new transit options between Santa Clara residences and businesses.
- **Policy 5.8.4-P7:** Require new development to provide sidewalks, street trees and lighting on both sides of all streets in accordance with city standards, including new developments in employment areas.
- **Policy 5.8.5-P1:** Require new development and city employees to implement transportation demand management programs that can include site-design measures, including preferred carpool and vanpool parking, enhanced pedestrian access, bicycle storage and recreational facilities.
- **Policy 5.8.5-P2:** Require development to offer on-site services, such as ATMs, dry cleaning, exercise rooms, cafeterias, and concierge services, to reduce daytime trips.
- **Policy 5.8.5-P3:** Encourage all new development to provide on-site bicycle facilities and pedestrian circulation.
- **Policy 5.8.5-P4:** Encourage new development to participate in shuttle programs to access local transit services within the city, including buses, light rail, Bay Area Rapid Transit, Caltrain, Altamont Commuter Express Yellow Shuttle and Lawrence Caltrain Bowers/Walsh Shuttle services.

**City of Santa Clara, Transportation Analysis Policy.** The city of Santa Clara approved their Transportation Analysis Policy on June 23, 2020. This policy establishes requirements for evaluating transportation impacts under the California Environmental Quality Act (CEQA) using the Vehicle Miles Traveled (VMT) methodology. The policy includes VMT baselines, thresholds, as well as criteria for exempting certain types of land use projects from VMT analysis. The policy also formalizes Transportation Operational Analysis (TOA) requirements that occur outside of CEQA.

With respect to VMT analyses under CEQA, the Transportation Analysis Policy establishes the following requirements that are applicable to the proposed project (Santa Clara 2020):

- **Evaluating VMT.** To evaluate whether a project will have a significant impact under CEQA, the city policy states that projects that result in a change of use to an existing development (which is applicable to the proposed project) are presumed to have a less than significant impact per state guidance and will not require a VMT analysis should the following criterion, among other possible criteria, be met:
  - Small Projects (generating 110 daily trips or less)

Projects that are considered a change of use to an existing development but do not meet the above small project requirement, among others, are required to evaluate and disclose potential VMT environmental impacts with the established threshold criteria outlined in the city's Transportation Analysis Policy.

**Santa Clara County Airport Land Use Commission's Comprehensive Land Use Plan for San Jose International Airport.** San Jose International Airport is located 1.75 miles east of the project site. However, the project site is not within the airport's area of influence or within noise hazard areas identified in the Santa Clara County Comprehensive Land Use Plan (CLUP) (Santa Clara County 2016). Figure 6 of the CLUP identifies the Federal Aviation Regulations (FAR) Part 77 of Title 14 of the Code of Federal Regulations obstruction surfaces around the airport. An exceedance of these structure elevations could result in the obstruction of airspace and create hazards to aircraft entering or exiting the airport. The project site is located within the CLUP surface elevation threshold of 212 feet above mean sea level (MSL); meaning any structures at the project site exceeding 212 feet above MSL could pose a safety hazard (Santa Clara County 2016). The project site surface is 42 feet above sea level. Therefore, according to Figure 6 of the CLUP, any structure greater than 170 feet in height AGL may pose a safety hazard.

#### 4.17.2 Environmental Impacts

##### a. Conflict with a program, plan, ordinance or policy addressing the circulation system, including transit, roadway, bicycle and pedestrian facilities?

###### *Construction*

*Less Than Significant Impact.* Construction of the project would not significantly obstruct any transit, roadway, bicycle, or pedestrian facilities in the area. Construction activities would occur mostly onsite and not in the public right-of-way, with the exception of extending an existing recycled water line from the intersection of Walsh Avenue and Northwestern Parkway (approximately 500 feet east of the project site) to the site for secondary water needs. While this construction would require temporary lane blockages/closures on Walsh Avenue during daytime hours, it would not interfere with a designated bike lane or transit route, as none exist on the affected portion of Walsh

Avenue. Furthermore, Walsh Avenue has four travel lanes. Temporary construction associated with connecting the project site to the existing buried recycled water line is not anticipated to disrupt more than one travel lane at a time. This would ensure at least one travel lane remains open in each direction. Project construction would not otherwise temporarily or permanently alter any public roadways or intersections.

The city of Santa Clara, as the permitting agency, would ensure the project applicant obtains the proper encroachment permit to minimize disruption to Walsh Avenue during construction. Furthermore, the city of Santa Clara, as the permitting agency, would require the applicant to obtain any required permits from Caltrans for the movement of oversized or excessive load vehicles on state roadways prior to construction to reduce effects on the state transportation network. The permitting process ensures that all applicable requirements are complied with. Therefore, the construction of the project would not conflict with any program, plan, ordinance, or policy addressing the circulation system, including transit, roadway, bicycle, and pedestrian facilities, and would, therefore, have less than significant impacts.

### ***Operation***

*Less Than Significant Impact.* Operation of the project would occur fully onsite and would not obstruct pedestrian, bike, or transit facilities. As discussed, the segment of Walsh Avenue containing the project site does not contain any pedestrian, bicycle, or public transit facilities. Additionally, the project would not interfere with any future pedestrian, bike, or transit plans for the area. The city of Santa Clara, as the permitting agency, would determine any transportation demand management (TDM) activities or conditions of approval necessary for the project to be consistent with General Plan Policies 5.8.3-P8, 5.8.3-P9, 5.8.3-P10, 5.8.4-P6, 5.8.4-P7, 5.8.5-P1, 5.8.5-P2, 5.8.5-P3, and 5.8.5-P4 (discussed under the "Regulatory Background" heading of this section). These policies are intended to improve multimodal accessibility between land uses and to facilitate the use of non-vehicular travel. For these reasons, operation of the project would not conflict with any program, plan, ordinance, or policy addressing the circulation system, including transit, roadway, bicycle, and pedestrian facilities, and would, therefore, have less than significant impacts.

### **b. Conflict or be inconsistent with CEQA Guidelines section 15064.3, subdivision (b)?**

CEQA Guidelines section 15064.3, subdivision (b), states that VMT is the most appropriate measure of transportation impacts under CEQA. VMT refers to the amount and distance of automobile travel attributable to a project. Increased VMT exceeding an applicable threshold could constitute a significant impact. If existing models or methods are not available to estimate the VMT for a particular project being considered, a lead agency may analyze the project's VMT qualitatively, evaluating factors such as the availability of transit or proximity to other destinations.

## *Construction*

*Less Than Significant Impact.* For construction traffic, a qualitative analysis of VMT impacts (instead of a more detailed quantitative analysis) is often appropriate (see CEQA Guidelines section 15064.3, subdivision (b)(3)). Project construction would involve a temporary increase in vehicle trips resulting from workers commuting to the project site and the delivery and hauling of project materials.

Construction would occur in two separate phases. Phase I activities, involving the building shell, substation and switchyard, site work, and paving, are anticipated to begin in January 2022 and take approximately 14 months to complete. Phase I would include a construction workforce with a peak number of workers of approximately 150 per month and an average of approximately 100 per month. Phase II construction, involving the interior fit out and appointments, would begin as soon thereafter as feasible, likely in late 2023 and take approximately 11 months to complete for commercial operation at the beginning of 2025. The Phase II construction workforce is estimated to have a peak number of workers of approximately 200 per month with an average of approximately 80 per month.

Based on the construction details provided above, the average construction workforce is estimated to be 90 persons per day, with a peak estimated to be 175 for both phases. Similar to other recent data center projects, the daily trip rates for employees at a general light industrial facility were used to estimate construction worker trips. The Institute of Transportation Engineers (ITE) Trip Generation Manual, 10th Edition, has a trip generation rate for general light industrial land uses (land use code 110) of 3.05 daily one-way trips per employee (ITE 2021).

Project construction is estimated to generate an average of 275 (i.e., 3.05 daily one-way trips X 90 workers = 275) daily one-way worker commute trips. The peak construction interval is estimated to involve a maximum of 534 (i.e., 3.05 daily one-way trips X 175 workers = 534) daily one-way worker commute trips. Many of the construction worker trips would be expected to occur prior to the morning and evening peak traffic hours in the Santa Clara region, in accordance with typical construction schedules. Truck trips associated with the removal and delivery of equipment and materials would occur throughout the day and would be scheduled for off-peak regional traffic hours whenever possible. The preparation of the site would include grading the entire site. It is possible that up to 10,000 cubic yards of soil and undocumented fill would be removed from the site but can be part of a balanced cut and fill approach. However, based on experience at other sites, if all the material cannot be used on site, it is estimated that the undocumented fill could be transported from the site with a frequency average of about 25 trucks per day.

As assumed in **Section 4.14 Population and Housing**, it is expected that workers would be from the greater Bay Area and the San Jose-Sunnyvale-Santa Clara Metropolitan Statistical Area has a local workforce available to serve the project. While some construction truck trips may require slightly higher VMT to access the project site, such

trips would likely only be necessary to deliver specialized equipment and materials that may not be readily available locally. The construction contractor and project owner would likely look for opportunities to reduce the distance of material delivery and removal trips, as longer distances increase construction costs. Therefore, construction is not expected to result in unnecessary VMT.

Upon the completion of construction, all temporary worker commute trips and truck trips would cease. As such, project-related construction trips would not result in a substantial or sustained increase in VMT compared to Santa Clara County average VMT. Further, construction trips would not result in temporary emissions increases at levels that could obstruct the implementation of plans and policies related to the reduction of greenhouse gas emissions by reducing VMT. Refer to **Section 4.3 Air Quality** for information related to exhaust emissions during construction. For these reasons, project construction would not conflict or be inconsistent with CEQA Guidelines section 15064.3, subdivision (b).

**Operation**

*Less Than Significant Impact.* The data center would be operational 24-hours, 7-days a week. **Table 4.17-1** summarizes the anticipated headcount of personnel and visitors that would be on-site throughout a typical day.

<b>TABLE 4.17-1. ANTICIPATED AVERAGE DAILY HEADCOUNT</b>		
<b>Type</b>	<b>Daily Persons</b>	<b>Persons Per Shift</b>
Data Center Operations	14	2-9 <sup>1</sup>
Security	5	2-5 <sup>2</sup>
Janitor	2	1-2
Tenant Personnel	10-12	10-12
Visitors	2	2
<b>TOTAL</b>	<b>33-35</b>	<b>17-30</b>

1 Operational staff would work in three shifts: Day Shift (9 employees), Swing Shift (3 employees), and Graveyard Shift (2 employees)

2 There would be 2 security staff stationed at the building and 3 shift rovers that patrol the proposed project building and other nearby Vantage sites.

Source: Kimley Horn 2021

Operation trips would be generated by the 33-35 employees at the building throughout the day, with 17-30 employees in the building at the same time (Kimley Horn 2021). It should be noted that some personnel would be shared with other Vantage data center sites within the area and may park at the other sites. In addition, trips associated with rented office space workers would also occur.

The trip generation was determined based on average rates from the Institute of Transportation Engineers (ITE) Trip Generation Manual, 10th Edition. This manual provides trip rates based on land use. For the project, ITE Land Use 160: Data Center was used, which estimates 0.99 one-way trips would occur for every 1,000 square feet of data center land use. Based on a transportation operational analysis conducted for the proposed project, it is estimated that the project would generate a total of 467 daily worker one-way trips ([472,180 total square feet/1,000] x 0.99). Of these total 467 daily

one-way trips, the analysis shows 52 trips occurring in the morning peak hours (7:00–9:00 a.m.) and 42 trips occurring in the afternoon peak hours (4:00–6:00 p.m.) (Kimley Horn 2021).

The VTA in conjunction with Santa Clara County and the cities in the county developed the Santa Clara Countywide VMT Evaluation Tool. This tool allows local government staff, consultants, and new developments to measure VMT for land use projects within Santa Clara County. Based on this tool, the target VMT for the project is 15 percent below the county average, which results in project-related commute trips needing to be no more than 14.14 daily vehicle miles per worker (Kimley Horn 2021). This threshold and the following analysis was reviewed and approved by the city of Santa Clara (Kimley Horn 2021).

**Table 4.17-2** shows the VMT analysis conducted for the project. As shown, the project under a normal 5-day workweek schedule would exceed the VMT threshold. However, when the workweek schedule is shifted to a 4-40 (four days a week, 10-hour workdays), the project's VMT would reduce to below the threshold.

<b>VMT Threshold and Scenario</b>	<b>VMT Per Worker</b>	
Santa Clara County Average VMT	16.64	<i>Exceed 14.14 VMT Threshold?</i>
Project Threshold: 15% Below County Average	14.14	
Estimated Project VMT (5-Day Work Schedule)	15.53	<i>YES</i>
Estimated Project VMT (4-40 Work Schedule)	13.20	<i>NO</i>

Source: Kimley Horn 2021

To meet the target VMT for the project, the applicant has proposed an alternative work schedule for employees reflecting a 4-40 workweek (40 hours in 4 days) so that the project VMT would be below the city's threshold. This is a Transportation Demand Management (TDM) measure, which is the commitment to a 4-40 work schedule. Staff evaluated the measure in the context of impacts to VMT and concludes that the requirement defined in this TDM measure is sufficient. This TDM measure would reduce the project VMT to 13.20 per employee, causing the project VMT to fall below the city-approved threshold of 14.14. The city requires a TDM annual report, which would allow it to obtain confirmation that the 4-day, 40-hour work schedule has been complied with. Staff proposes **TRANS-1**, which would require the implementation of a TDM program that incorporates the 4-40 work schedule TMD measure.

Additionally, the city of Santa Clara, as the permitting agency for the project, would ensure project consistency with the General Plan policies related to trip reduction, transit connectivity, and alternative modes of transportation (as provided in Section 4.17.1, Local Regulatory Background). Therefore, with implementation of **TRANS-1**, the project would have a less-than-significant impact on VMT.



**c. Substantially increase hazards due to a geometric design feature (e.g., sharp curves or dangerous intersections) or incompatible uses (e.g., farm equipment)?**

*Construction*

*Less Than Significant Impact.* As discussed under question “a” above, project construction would include extending an existing recycled water line from the intersection of Walsh Avenue and Northwestern Parkway (approximately 500 feet east of the project site) to the site for secondary water needs. While this construction would require temporary lane blockages/closures on Walsh Avenue during daytime hours, Walsh Avenue has four travel lanes. The temporary construction associated with connecting the project site to the existing buried recycled water line is not anticipated to disrupt more than one travel lane at a time. This would ensure at least one travel lane remains open in each direction. Project construction would not otherwise temporarily or permanently alter any public roadways or intersections that could result in roadway hazards.

The city of Santa Clara, as the permitting agency, would ensure the project applicant obtains the proper encroachment permit to minimize disruption to Walsh Avenue during construction. As part of this permit, the city of Santa Clara may require the applicant to ensure temporary lane closures and traffic control measures occur according to standard guidelines outlined in the Manual on Uniform Traffic Control Devices, the Standard Specifications for Public Works Construction, and/or the California Joint Utility Traffic Control Manual. Lastly, the city of Santa Clara would require the applicant to obtain any required permits from Caltrans for the movement of oversized or excessive load vehicles on state roadways prior to construction to reduce effects on the state transportation network, as discussed under the “Regulatory Background” heading of this section. These actions would reduce any hazards from construction activities affecting roadways and from transporting materials to and from the site. Therefore, the impact to roadway hazards would be less than significant.

As discussed under the “Regulatory Background” heading of this section, under federal law, 14 CFR § 77.5 et. seq, the height threshold for FAA notification is 92 feet AGL at the project site. Project construction is expected to require a crane for placement of each chiller on the proposed structure roof. The top of the chillers is estimated to be nearly 110 feet AGL (DayZenLLC 2021e). Therefore, the crane boom would exceed 92 feet in height. This requires the project applicant to submit Form 7460-1, Notice of Proposed Construction or Alteration, to the FAA. It should be noted, the FAA generally grants a Determination of No Hazard for temporary construction equipment. The city of Santa Clara, as the permitting agency for the project, would ensure consistency with this federal regulation and compliance with any of the FAA’s conditions to reduce potential airspace hazards. For these reasons, project construction would not increase hazards from an incompatible use and impacts would be less than significant.

## *Operation*

### *Less Than Significant Impact.*

**Access.** The existing curb locations and geometric design of vehicle site access from Walsh Avenue would remain identical to their current locations. For vehicle access, vehicles would be able to enter the site from the two gated entrances located at the eastern driveway and the western driveway. However, security protocols would most likely require vehicles to enter through the security checkpoint located at the eastern driveway. Vehicles exiting the site may use either the western or eastern driveways. As these driveways would be identical to the existing vehicle ingress and egress points of the site, the operation of the project would not increase surface transportation hazards.

**Structure Height.** As discussed under the “Regulatory Background” heading of this section, under federal law, 14 CFR § 77.5 et. seq, the height threshold for FAA notification is 92 feet AGL at the project site. Furthermore, the Santa Clara County Airport Land Use Commission’s CLUP identifies that any structure greater than 170 feet AGL may pose a safety hazard at the site.

The highest point of the proposed project structure, the top of the penthouse roof, would be approximately 108 feet and 5 inches AGL (DayZenLLC 2021e). The proposed chillers would also be located on the roof of the building, with the top of the chillers being nearly 110 feet AGL (DayZenLLC 2021e). Based on these peak heights, the project would not exceed the Santa Clara County Airport Land Use Commission’s CLUP hazard height restriction. However, the project would exceed the FAA’s obstruction threshold of 92.4 feet AGL at the project site. As a result, the project applicant would be required to submit Form 7460-1, Notice of Proposed Construction or Alteration, to the FAA. The city of Santa Clara, as the permitting agency for the project, would ensure consistency with this regulation and compliance with any of the FAA’s conditions. For these reasons, project operation would not increase airspace hazards due to an incompatible structure and impacts would be less than significant.

**Thermal Plumes.** The project would involve 44 emergency backup diesel generators (generators) and 48 roof-mounted air chillers. The generators would be located at ground level, and the chillers would be located on the roof. Both the generators and the chillers would discharge vertical thermal plumes (i.e., high-velocity columns of hot air) during operation. Thermal plume velocities would be greatest at the discharge points, with plume velocities decreasing with altitude. Plume velocities would also be highest during certain weather conditions, such as cool temperatures and calm winds.

High velocity thermal plumes have the potential to affect aviation safety, and the FAA Aeronautical Information Manual identifies thermal plumes as potential flight hazards (FAA 2017). Though it should be noted that while the FAA regulates potential airspace safety impacts from the heights of physical structures, it does not regulate thermal plumes. Aircraft flying through thermal plumes may experience significant air disturbances, such as turbulence and vertical shear. The FAA manual advises that, when

able, a pilot should fly upwind of smokestacks and cooling towers to avoid encountering thermal plumes.

CEC staff uses a peak vertical plume velocity of 10.6 meters per second (m/s) (5.3 m/s average plume velocity) as a screening threshold for potential impacts to aviation. Based on a literature search, this velocity generally defines the point at which aircraft begin to experience severe turbulence. Two project features would produce thermal plumes: the generators and the chillers. Thermal plumes from these two features are discussed below.

- Emergency Backup Diesel Generators. Under worst-case weather conditions (calm winds), estimates show the project's generator plumes would maintain a peak vertical velocity of 10.6 m/s up to approximately 83 feet AGL (DayZenLLC 2021e). As the generators would be located at ground level next to the proposed building, this height is lower than the proposed building height of 110 feet AGL. Therefore, thermal plumes from the operation of the generators would not impact aviation safety.
- Chillers. Estimates show the project's chiller plumes would maintain a peak vertical velocity of 10.6 m/s up to approximately 131 feet AGL. As chillers would be located on the roof, which would be at 110 feet AGL (DayZenLLC 2021e), this means thermal plumes from the chillers at a speed of 10.6 m/s would only extend 21 feet above the proposed building roof. Federal law, 14 CFR § 91.119, states that unless necessary for takeoff or landing, the minimum safe altitudes for aircraft are 500 feet AGL for non-congested areas and 1,000 feet AGL for congested areas, such as the area around the project site (CFR 2020b). Therefore, aircraft would not be expected to be flying low enough (21 feet above the proposed building) to encounter potentially hazardous thermal plumes produced by the project's chillers. Therefore, the project would result in less than significant hazards to aircraft from thermal plumes.

#### **d. Result in inadequate emergency access?**

##### ***Construction***

Less Than Significant Impact. As discussed under Impact 4.17.a, project construction would include extending an existing recycled water line from the intersection of Walsh Avenue and Northwestern Parkway (approximately 500 feet east of the project site) to the site for secondary water needs. While this construction would require temporary lane blockages/closures on Walsh Avenue during daytime hours, Walsh Avenue has four travel lanes. The temporary construction associated with connecting the project site to the existing buried recycled water line is not anticipated to disrupt more than one travel lane at a time. This would ensure at least one travel lane remains open in each direction. Project construction would not otherwise temporarily or permanently alter any public roadways or intersections that could result in roadway hazards.

The city of Santa Clara, as the permitting agency, would ensure the project applicant obtains the proper encroachment permit to minimize disruption to Walsh Avenue during construction. As part of this permit, the city of Santa Clara may require the applicant to ensure temporary lane closures and traffic control measures occur according to standard

guidelines outlined in the Manual on Uniform Traffic Control Devices, the Standard Specifications for Public Works Construction, and/or the California Joint Utility Traffic Control Manual. This would ensure emergency vehicle travel on Walsh Avenue and access to adjacent buildings is not disrupted during the construction of the recycled water line extension. Therefore, the impact would be less than significant.

### ***Operation***

*Less Than Significant Impact.* The city of Santa Clara Fire Department reviewed the project and recommended several access and internal circulation changes to ensure proper turning radius and movement of emergency vehicles would occur. These changes included (DayZenLLC 2021f):

- Expanding the width and apron radius at the existing entrance on Walsh Avenue (west side),
- Creating a new entrance on Walsh Avenue at the east side to allow for the circular movement of vehicles through the project site; and
- Expanding the width of internal access roads and adjusting the location of the proposed substation to ensure the turning radius requested by the Fire Department was provided at all four corners of the proposed building.

With the incorporation of these changes into the project design, all requests by the city of Santa Clara Fire Department have been met to ensure proper access and movement of emergency service vehicles throughout the project site. Lastly, the city of Santa Clara, as the permitting agency, would ensure the project is consistent with building and zoning code requirements ensuring adequate emergency access. Therefore, the impact would be less than significant.

### **4.17.3 Mitigation Measures**

TRANS-1: The project shall implement a Transportation Demand Management (TDM) program sufficient to demonstrate that vehicle miles travelled (VMT) associated with the project would be reduced to 14.14 or less per employee. The TDM program shall include, but is not limited to, the following measure, which has been determined to be a feasible method for achieving the required VMT reduction:

- The operations workforce at the project shall work a 4-40 work schedule (40 hours in 4 days).

Prior to the issuance of an occupancy permit, the TDM program shall be submitted and approved by the Director of Community Development and shall be monitored annually to gauge its effectiveness in meeting the required VMT reduction. The TDM program shall establish an appropriate estimate of initial vehicle trips generated by the occupant of the proposed project and shall include the conducting of driveway traffic counts annually to measure peak-hour entering and exiting vehicle volumes. The volumes shall be compared to trip thresholds established in the TDM program to determine whether the required

reduction in vehicle trips is being met. The results of annual vehicle counts shall be reported in writing to the Director of Community Development.

If TDM program monitoring results show that the trip reduction targets are not being met, the TDM program shall be updated to identify replacement and/or additional feasible TDM measures to be implemented. The updated TDM program shall be subject to the same approvals and monitoring requirements listed above.

#### **4.17.4 References**

CFR 2021a – Code of Federal Regulations (CFR). Title 14, Section 77.9, Construction or Alteration Requiring Notice. Accessed on: July 8, 2021. Available online at: [https://gov.ecfr.io/cgi-bin/text-idx?SID=8a9408b6022186a8d9460c5fa676d1ff&mc=true&node=se14.2.77\\_19&rgn=div8](https://gov.ecfr.io/cgi-bin/text-idx?SID=8a9408b6022186a8d9460c5fa676d1ff&mc=true&node=se14.2.77_19&rgn=div8)

CFR 2021b - Code of Federal Regulations (CFR). Title 14, Section 91.119, Minimum Safe Altitudes: General. Accessed on: March 25, 2020. Available online at: [https://gov.ecfr.io/cgi-bin/text-idx?SID=1cdef684edba4fd0373ed7de0d3b1569&mc=true&node=se14.2.91\\_1119&rgn=div8](https://gov.ecfr.io/cgi-bin/text-idx?SID=1cdef684edba4fd0373ed7de0d3b1569&mc=true&node=se14.2.91_1119&rgn=div8)

DayZenLLC 2021e – DayZenLLC (DayZenLLC). (TN 237423). VDC CA3BGF SPPE Application Part II, dated April 12, 2021. Available online at: <https://efiling.energy.ca.gov/Lists/DocketLog.aspx?docketnumber=21-SPPE-01>

DayZenLLC 2021f – DayZenLLC (DayZenLLC). (TN 240158). CA3DC PCC Drawing Set REV3- Part 1, dated October 28, 2021. Available online at: <https://efiling.energy.ca.gov/Lists/DocketLog.aspx?docketnumber=21-SPPE-01>

FAA 2017 – Federal Aviation Administration (FAA). Aeronautical Information Manual, Chapter 7. Safety of Flight, Section 6: Potential Flight Hazards, Subsection 7-6-15: Avoid Flight in the Vicinity of Exhaust Plumes (Smoke Stacks and Cooling Towers), October 12, 2017. Accessed on: July 8, 2021. Available online at: [https://www.faa.gov/air\\_traffic/publications/atpubs/aim\\_html/index.html](https://www.faa.gov/air_traffic/publications/atpubs/aim_html/index.html)

Kimley Horn 2021 – VDC CA3BGF Supplemental Response to Data Request Set 1, DR 22 VMT (TN 239147), August 2, 2021. Available online at: <https://efiling.energy.ca.gov/Lists/DocketLog.aspx?docketnumber=21-SPPE-01>

ITE 2021 – The Institute of Transportation Engineers. Trip Generation Manual, Tenth Edition's trip generation rate. Available for purchase online at: <https://www.ite.org/technical-resources/topics/trip-and-parking-generation/trip-generation-10th-edition-formats/>

Santa Clara 2010 – City of Santa Clara. 2010-2035 General Plan, Chapter 5 Goals and Policies. Accessed on June 22, 2021. Available online at: <https://www.santaclaraca.gov/our-city/departments-a-f/community-development/planning-division/general-plan>

Santa Clara 2020 – City of Santa Clara. Resolution and Final Transportation Analysis Policy. Accessed on June 22, 2021. Available online at: <https://www.santaclaraca.gov/our-city/departments-g-z/public-works/engineering/traffic-engineering/transportation-analysis-policy-update>

Santa Clara County 2016 – Airport Land Use Commission. Comprehensive Land Use Plan for Norman Y. Mineta San Jose International Airport. Accessed on July 8, 2021. Available online at: <https://plandev.sccgov.org/commissions-other-meetings/airport-land-use-commission>

VTA 2021a – Santa Clara Valley Transportation Agency (VTA). Bikeway Map. Accessed on: July 9, 2021. Available online at: [https://www.vta.org/sites/default/files/images/2020-07/vta%20bike%20map\\_web-01.jpg](https://www.vta.org/sites/default/files/images/2020-07/vta%20bike%20map_web-01.jpg)

VTA 2021b – Santa Clara Valley Transportation Agency (VTA). VTA System Maps, Downtown San Jose Map and Main Map. Accessed on January 6, 2022. Available online at: <https://www.vta.org/go/maps>

VTA 2021c – Santa Clara Valley Transportation Agency (VTA). Bus Route 21 information. Accessed on July 9, 2021. Available online at: <https://newservice.vta.org/routes/21>

## 4.18 Utilities and Service Systems

This section describes the environmental and regulatory setting and discusses impacts associated with the construction and operation of the project including the data center and the backup generation facility on the Utilities and Service Systems in the project area.

UTILITIES AND SERVICE SYSTEMS  Would the project:	Potentially Significant Impact	Less than Significant With Mitigation Incorporated	Less than Significant Impact	No Impact
a. Require or result in the relocation or construction of new or expanded water, wastewater treatment or storm water drainage, electric power, natural gas, or telecommunications facilities, the construction or relocation of which could cause significant environmental effects?	<input type="checkbox"/>	<input type="checkbox"/>	<input checked="" type="checkbox"/>	<input type="checkbox"/>
b. Have sufficient water supplies available to serve the project and reasonably foreseeable future development during normal, dry and multiple dry years?	<input type="checkbox"/>	<input type="checkbox"/>	<input checked="" type="checkbox"/>	<input type="checkbox"/>
c. Result in a determination by the wastewater treatment provider which serves or may serve the project that it has adequate capacity to serve the project's projected demand in addition to the provider's existing commitments?	<input type="checkbox"/>	<input type="checkbox"/>	<input checked="" type="checkbox"/>	<input type="checkbox"/>
d. Generate solid waste in excess of State or local standards, or in excess of the capacity of local infrastructure, or otherwise impair the attainment of solid waste reduction goals?	<input type="checkbox"/>	<input type="checkbox"/>	<input checked="" type="checkbox"/>	<input type="checkbox"/>
e. Comply with federal, state, and local management and reduction statutes and regulations related to solid waste?	<input type="checkbox"/>	<input type="checkbox"/>	<input checked="" type="checkbox"/>	<input type="checkbox"/>

Environmental checklist established by CEQA Guidelines, Appendix G.

### 4.18.1 Environmental Setting

The proposed project would be constructed on a previously disturbed site that was fully developed and was originally used for commercial purposes. The project is estimated to use approximately 1.75 acre-feet (AF) during the two phases of construction expected to last about 24 months (CA3 Vantage 2021). The proposed project would have an operational demand of approximately 2.0 acre-feet per year (AFY) of potable water and approximately 0.8 AFY of recycled water for landscaping purposes. The project would generate approximately 144,000 gallons per day (gpd) of wastewater, which would be discharged to the San Jose-Santa Clara Regional Wastewater Facility (RWF) for treatment and disposal. The project would use up to 832,000 MWh of electricity per year (CA3 Vantage 2021). Electricity demand for the proposed project would be provided by Santa Clara County's Silicon Valley Power (SVP). A small amount of typical data center solid

waste would be generated by the project and would be disposed of at the Newby Island Landfill in San Jose.

### **Potable Water Supply**

The project would be supplied with potable water provided by the city of Santa Clara. The potable water system gets water from three sources: Santa Clara Valley Water District (SCVWD), the San Francisco Public Utilities Commission (SFPUC), and 26 groundwater wells operated by the city's Department of Water and Sewer Utilities. The project is in the northern part of the city, which is served with water from SFPUC. In 2020, about one-third of the city's potable water came from the imported treated water supplies (SCVWD and SFPUC) and groundwater made up approximately two-thirds of the city's potable water supply. The water system in the city consists of more than 335 miles of distribution mains, 26 groundwater wells, and seven storage tanks with a total capacity of approximately 28.8 million gallons, or approximately 88 AF. According to the city's 2020 Urban Water Management Plan (UWMP), which was approved and adopted by the Santa Clara City Council on June 22, 2021, the citywide demand for potable water in 2020 was 18,302 AF (Santa Clara 2016). One AF is the equivalent of approximately 326,000 gallons.

### **Recycled Water Supply**

Recycled water is supplied to the city of Santa Clara through the South Bay Water Recycling (SBWR) program. The SBWR obtains advanced tertiary treated water from the RWF, formerly known as the San Jose-Santa Clara Water Pollution Control Plant. In 2020, the RWF treated a total of 113,493 AF of wastewater, of which 12,571 AF was treated to state Title 22 recycled water standards, out of which the city of Santa Clara received 3,499 AF. The remaining treated wastewater was discharged to the San Francisco Bay (Santa Clara 2020). The recycled water purchased from the SBWR made up approximately 19 percent of the overall water use in the city. The city of Santa Clara uses recycled water for the non-potable needs of businesses, industries, parks, and schools located along pipeline routes. Water Code sections 13550 and 13551 include strong language prohibiting the use of potable water where recycled water can be used, such as cooling, if recycled water is available and economically feasible. The Santa Clara City Code also has similar requirements (Santa Clara 2020). A recycled water connection that can serve the proposed project is located at the intersection of Walsh Avenue and Northwestern Parkway, approximately 500 feet to the southeast of the project site. The project plans to extend the recycled water line as a secondary source of water (CA3 2021).

### **Wastewater Service**

The city of Santa Clara's Departments of Public Works and Water and Sewer Utilities are responsible for the wastewater collection system within the city. Wastewater is collected by sewer systems in Santa Clara and is conveyed by pipelines to the RWF. The RWF is jointly owned by the cities of San Jose and Santa Clara and is operated by the city of San



Jose's Department of Environmental Services. The RWF has a capacity to treat 167 million gallons per day (mgd) of wastewater and currently treats an average of 110 mgd, thus the RWF facility has 57 mgd, or 35 percent of available capacity. Approximately 13 percent of the RWF's effluent undergoes advanced tertiary treatment to meet state Title 22 recycled water standards, after which it flows to SBWR's adjacent pump station to be distributed to several customers in the city. The remaining effluent flows into San Francisco Bay. The RWF's current Waste Discharge Requirements (WDRs) were issued by the San Francisco Bay Regional Water Quality Control Board (RWQCB) in September 2014.

### **Storm Sewer Service**

The city of Santa Clara owns and maintains the municipal storm drainage system in the vicinity of the project site. The project site drains by a combination of surface flow and underground pipes towards the city's stormwater system located underneath Walsh Avenue (Walsh 2019), which discharges to Guadalupe River and ultimately the San Francisco Bay (Santa Clara 2016).

### **Solid Waste**

Solid waste and recycling collection for businesses at commercial and institutional properties in the city of Santa Clara is provided by Mission Trail Waste Systems through a contract with the city. All waste is sorted locally at the Newby Island Resource Recovery Park. After sorting, recyclable materials are captured for reuse, diverting them from landfill, and organic material is taken to a Zero Waste Energy Development facility, where it is put through an anaerobic digestion process, ultimately producing electricity and compost. Newby Island Landfill, located in San Jose, provides disposal capacity to nearby cities, including San Jose, Santa Clara, Cupertino, Los Altos, and Los Altos Hills. The Newby Island Landfill is permitted to accept a maximum of 3,260 tons of solid waste per day. In December 2016, the city of San Jose Planning Commission approved a vertical expansion of the Newby Island Landfill where the permitted height was increased from 150 feet to 245 feet. The approved increase in elevation resulted in an increase of approximately 15.12 million cubic yards in the landfill capacity and an estimated closure date of January 2041 (Mercury News 2016).

### **Electric Power, Natural Gas, and Telecommunications**

Electricity needed for project operation would be provided by SVP. Telecommunication services would be provided by one of several fiber optics providers in the project area, who provide their services using lines that run in city-owned conduits close to the project site. The services would be provided to the facility via established rights of way, as is the industry's common practice.

Natural gas for comfort heating would be supplied to the project by Pacific Gas and Electric (PG&E).

## Regulatory Background

### *Federal*

**Federal Clean Water Act (33 U.S.C. Sec. 1251 et seq.) and State Porter-Cologne Water Quality Control Act (Water Code, Sec. 13000 et seq.).** The State Water Resources Control Board (SWRCB) and its nine RWQCBs are responsible for the regulation and enforcement of the water quality protection requirements of the federal Clean Water Act (33 U.S.C. Sec. 1251 et seq.) (CWA) and the state Porter-Cologne Water Quality Control Act (Water Code, Sec. 13000 et seq.) (Porter-Cologne). The National Pollutant Discharge Elimination System (NPDES) is the permitting program that allows point source dischargers to comply with the CWA and Porter-Cologne laws. This regulatory framework protects the beneficial uses of the state's surface and groundwater resources for public benefit and environmental protection. The protection of water quality could be achieved by the proposed project by complying with applicable NPDES permits from the SWRCB or the San Francisco Bay RWQCB. The RWF complies with the CWA through its current NPDES WDRs, which were issued by the San Francisco Bay RWQCB September 2014.

Under Section 303(d) of the CWA, states are required to identify impaired surface water bodies and develop total maximum daily loads (TMDLs) for contaminants of concern. The TMDL is the quantity of pollutant that can be assimilated by a water body without violating water quality standards. The listing of a water body as impaired does not necessarily suggest that the water body cannot support the beneficial uses; rather, the intent is to identify the water body as requiring future development of a TMDL to maintain water quality and reduce the potential for future water quality degradation. Coyote Creek, east of the project site, is currently listed on the United States Environmental Protection Agency's Section 303(d) Listed Waters for California for diazinon and trash.

The San Francisco Bay RWQCB issued a Municipal Regional Stormwater NPDES Permit (Permit Number CAS612008) that requires the city of Santa Clara to implement a stormwater quality protection program. This regional permit applies to 77 Bay Area municipalities, including the city of Santa Clara. Under the provisions of the Municipal NPDES Permit, redevelopment projects that disturb more than 10,000 square feet are required to design and construct stormwater treatment controls to treat post-construction stormwater runoff. The permit requires the post-construction runoff from qualifying projects to be treated by using low impact development (LID) treatment controls, such as biotreatment facilities.

The Santa Clara Valley Urban Runoff Pollution Prevention Program (SCVURPPP) assists co-permittees, such as the city of Santa Clara, in the implementation of the provisions of the Municipal NPDES Permit. In addition to water quality controls, the Municipal NPDES Permit requires all new and redevelopment projects that create or replace one acre or more of impervious surface to manage development-related increases in peak runoff flow, volume, and duration, where such hydromodification is likely to cause increased erosion, silt pollutant generation, or other impacts to beneficial uses of local rivers, streams, and creeks. Projects may be deemed exempt from the Municipal NPDES Permit requirements

if they do not meet the size threshold, drain into tidally influenced areas or directly into San Francisco Bay (per the city of Santa Clara Hydromodification Management Map). The project site is in a catchment area with a hardened channel or drains to a tidal area; thus, the project site is not subject to the SCVURPPP hydromodification requirements.

### *State*

**Water Code, Sections 10910-10915.** Water Code sections 10910-10915 require water service providers to evaluate stresses to the water supply service system caused by proposed project developments. The code sections require public water systems to prepare water supply assessments (WSA) for certain defined development projects subject to the California Environmental Quality Act (CEQA).

Water Code, section 10912, defines a "Project" as meeting any of the following criteria:

- A proposed residential development of more than 500 dwelling units.
- A proposed shopping center or business establishment employing more than 1,000 persons or having more than 500,000 square feet of floor space.
- A proposed commercial office building employing more than 1,000 persons or having more than 250,000 square feet of floor space.
- A proposed hotel or motel, or both, having more than 500 rooms.
- A proposed industrial, manufacturing, or processing plant, or industrial park planned to house more than 1,000 persons, occupying more than 40 acres of land, or having more than 650,000 square feet of floor area.
- A mixed-use project that includes one or more of the projects specified in the prior bullet points.
- A project that would demand an amount of water equivalent to, or greater than, the amount of water required by a 500 dwelling unit project.

If a proposed project satisfies that definition of a "Project," then pursuant to Water Code, section 10910, a detailed WSA would be required to be prepared by the water supplier.

Further guidance for how to interpret these sections of the Water Code is provided in a Department of Water Resources document titled "Guidebook for Implementation of Senate Bill 610 and Senate Bill 221 of 2001" (Guidebook) (DWR 2003). A helpful interpretive section on page 3 of the Guidebook explains how to interpret the first bullet point above. It states that one dwelling unit typically consumes 0.3 to 0.5 AF of water per year (DWR 2003). Therefore, 500 dwelling units could be interpreted to mean 150 to 250 AFY of potable water.

The Guidebook also provides guidance about how to interpret other items in the list, but the one central theme is that WSAs are necessary for projects that increase the demand on the local system substantially. The Guidebook also emphasizes that WSAs are

necessary in areas with a poorly understood water supply, or in an area where the project would increase the demand substantially, or 10-percent (DWR 2003).

The project would be in a very well-studied service area with many service connections. Furthermore, the project is similar to the Walsh Data Center (exempted by the California Energy Commission in August 2020) in terms of total square footage but is expected to use less water. The city of Santa Clara determined that the Walsh Data Center project did not require a WSA (Walsh 2019b, Appendix E), so a similar determination would be expected for this CA3 (Vantage) Data Center project.

**California 2019 Energy Efficiency Standards for Residential and Nonresidential Buildings—Green Building Standards Code, California Code of Regulations, Title 24.** The California Green Buildings Standards Code (California Code of Regulations, Title 24, Part 11) applies to the planning, design, operation, construction, use, and occupancy of newly constructed buildings and requires the installation of energy- and water-efficient indoor infrastructure. The related waste management plan is required to allow for the diversion of 50 percent of the generated waste away from the landfill.

**Integrated Waste Management Act of 1989 (Public Resources Code, Section 40000 et seq.).** The Integrated Waste Management Act of 1989 (Public Resources Code, section 40000 et seq.) requires cities and counties to reduce by 50 percent the amount of solid waste disposed of in landfills by the year 2000. To comply with the Integrated Waste Management Act, counties adopt regulations and policies to fulfill the requirements of the Act.

### **Senate Bill 350 (Renewable Energy Targets)**

Senate Bill (SB) 350, the Clean Energy and Pollution Reduction Act of 2015, was enacted October 7, 2015, and took effect January 1, 2016. SB 350 (Chapter 547, Statutes of 2015) codified, among other things, the state goal of increasing the procurement of electricity from renewable sources from 33 percent by 2020 to 50 percent by 2030. SB 350 also required the establishment of annual targets for statewide energy efficiency savings and demand reduction starting November 1, 2017. These energy efficiency savings and demand reductions would be designed to achieve a cumulative doubling of statewide energy efficiency savings in electricity and natural gas use by January 1, 2030.

### *Local*

**City of Santa Clara 2010-2035 General Plan.** The City of Santa Clara 2010-2035 General Plan (General Plan) includes numerous policies related to utilities and service systems. With respect to waste, General Plan Policy 5.10.1-P8 aims to increase a reduction for solid waste tonnage to 80 percent by 2020, or as consistent with the Climate Action Plan (CAP), Plan 2014 (Santa Clara 2016). Measure 4.2 of the CAP was adopted by the General Plan to achieve the goal of an 80 percent reduction in solid waste generation.

**Santa Clara City Code.** According to Santa Clara City Code Section 8.25.285, applicants seeking building or demolition permits for projects greater than 5,000 square feet are required to recycle at least 50 percent of the solid waste generated by the project (Santa Clara 2014).

#### 4.18.3 Environmental Impacts

- a. **Would the project require or result in the relocation or construction of new or expanded water, wastewater treatment or storm water drainage, electric power, natural gas, or telecommunications facilities, the construction or relocation of which could cause significant environmental effects?**

##### *Construction and Operation*

*Less Than Significant Impact.* The project's wastewater flow during construction and operation would be treated by the RWF. Typical of other low wastewater producing industries, data centers produce low volumes of wastewater with no hazardous constituents. Treated wastewater is monitored by the San Francisco Bay RWQCB to ensure compliance with the facility's NPDES wastewater discharge permit. The RWF is permitted to treat the industrial and sanitary waste flows that would be generated by the project. Furthermore, as discussed below, the RWF has sufficient available capacity to accommodate the project's estimated wastewater flow. Therefore, the project would not cause the RWF to exceed its wastewater treatment requirements of the San Francisco Bay RWQCB for project construction and operation. The impact of the project on wastewater treatment capacity would be less than significant.

While the project would use a relatively small amount of electric energy during construction, it would use up to 832,000 MWh per year of electricity during operation (CA3 Vantage 2021). Electricity demand for the proposed project would be provided by SVP. In 2020, SVP sold approximately 3.5 million MWh to its customers, the vast majority of which was for non-residential (industrial and commercial) customers (CEC 2021). According to SVP's 2017 Integrated Resources Plan (IRP), electric demand in the SVP service area is projected to grow from 586 MW in 2017 to approximately 873 MW in 2038 (SVP 2021). The projected increase is attributed to a projected increase in population and an increase in demand for prospective commercial and industrial development, including data centers. To meet the projected increase in demand, SVP is continuously entering into agreements to procure electricity from renewable sources. Between currently owned supplies and guaranteed future deliveries, SVP has a total of approximately 1,121 MW, or approximately 9.8 million MWh per year of total energy supplies (SVP 2021). Thus, SVP has approximately 6.3 million MWh per year available to meet projected growth in demand. This is much more than the project's estimated annual energy demand of 832,000 MWh per year. SVP electrical resources

available are reliable. Project electricity demand during construction and operation would not be expected to affect existing users. The construction and operation of the project would not require new or expanded electric power utilities. Therefore, potential impacts would be less than significant.

Telecommunication services for the proposed project would be provided by providers that have been serving the existing business in the project area. Those providers have adequate available capacity to accommodate the project needs during construction and operation as evidenced by the fact that there is an abundance of telecommunication providers in the Santa Clara region, including Frontier, AT&T, T-Mobile, Verizon, and many others. The impact of the project on telecommunication services would be less than significant.

PG&E owns natural gas distribution facilities within the city of Santa Clara. CA3 would incrementally increase natural gas use, primarily for comfort heating purposes. Natural gas would be obtained from PG&E but would not require the construction of any additional offsite facilities.

**b. Would the project have sufficient water supplies available to serve the project and reasonably foreseeable future development during normal, dry, and multiple dry years?**

*Construction and Operation*

*Less Than Significant Impact.* The water system in the city is operated and maintained by the city's Department of Water and Sewer Utilities. This system is supplied with potable water from three sources: SCVWD, SFPUC, and 26 groundwater wells operated by the city's Department of Water and Sewer Utilities. The proposed project is in an area served primarily with surface water from SFPUC. In 2020, about one-third of the city's potable water came from the imported treated water supplies (SCVWD and SFPUC); the other two-thirds came from groundwater. The water system in the city consists of more than 335 miles of distribution mains, the 26 groundwater wells discussed above, and seven storage tanks with approximately 28.8 million gallons of capacity. According to the 2020 UWMP, the citywide demand for potable water in 2020 was 18,302 AF (Santa Clara 2020). The city also distributed 3,499 AFY of recycled water in 2020, which resulted in a savings of 19 percent of potable water for the city (UWMP 2020). The UWMP also concludes that the city is expected to meet projected future demands ranging from approximately 21,801 AFY in 2025 and gradually increasing to approximately 31,676 AFY in 2045. Those demands include recycled water demands projected to be approximately 4,570 AFY in 2025 and gradually increasing to approximately 9,488 AFY in 2045.

The project is estimated to use approximately 1.75 AF during the two phases of construction expected to last about 24 months (CA3 Vantage 2021). That is equivalent to 0.88 AFY, which is less than half the project's estimated annual demand of

approximately 2.8 AFY for operational needs, which, as discussed below, is less than the historic use of 3.2 AFY by the previous user at the project site. The impact of construction water demand would, therefore, be less than significant.

The proposed project would have an operational demand of approximately 2.0 AFY of potable water and approximately 0.8 AFY of recycled water for landscaping purposes. The city's UWMP for 2020 shows that the city has a sufficient supply to meet the project's demand in normal and single dry-year scenarios. However, the UWMP shows that the city could have a deficit in multiple dry-year scenarios if supply from SFPUC is interrupted. Under a multi-year drought scenario, the city's supply from SFPUC might be interrupted if certain conditions specified in the interruptible contract between the city and SFPUC are met (Santa Clara 2020). However, if supply from SFPUC is interrupted for any reason, the city has conservation plans and other measures in place to manage supply to meet demand. Examples of measures the city would implement to deal with water shortages include increasing groundwater pumping and encouraging customers to practice voluntarily, or, in severe shortage situations, imposing mandatory reductions of water supplies to reduce consumption (Santa Clara 2020).

The proposed project would be constructed on a previously disturbed site that was fully developed and was originally used for commercial purposes. Historic water use for the pre-existing and soon-to-be-demolished commercial activities were approximately 3.2 AFY of potable water supplied by the city. Thus, the proposed project would result in a slight net reduction in potable water use and a net beneficial impact on local water supplies.

**c. Would the project result in a determination by the wastewater treatment provider which serves or may serve the project that it has adequate capacity to serve the project's projected demand in addition to the provider's existing commitments?**

*Construction and Operation*

*Less Than Significant Impact.* The RWF treats an average of 110 mgd of wastewater, which is 57 mgd less than its 167 mgd treatment capacity. No information was provided by the applicant on the amount of wastewater that would be generated by the project. However, similar data center projects of comparable sizes generate less than a maximum of 100 gallons per minute, or 144,000 gallons per day, which is less than 0.1 percent of the available treatment capacity of the RWF. Implementation of the proposed project would not result in an increase in the RWF's need for wastewater treatment beyond its design capacity. Therefore, the impact on wastewater treatment facilities would be less than significant.

The majority of the project site is currently covered with impervious surfaces. The

project would reduce impervious areas at the site, which would result in more stormwater infiltration and, thus, a reduction in stormwater runoff. The proposed project would also include a stormwater collection system that includes stormwater bio-swales to reduce the overall runoff into the city's collection system and to control sedimentation impacts. In addition, the project would have to comply with the city's municipal stormwater permit, which would further reduce the likelihood of the project causing an increase in stormwater discharge from the site. Although the project would not be expected to result in increasing stormwater runoff from the project, the implementation of the new stormwater collection system described above would ensure that the project would comply with the city's municipal stormwater permit. The impact from the project on the stormwater system capacity would be less than significant.

**d. Would the project generate solid waste in excess of State or local standards, or in excess of the capacity of local infrastructure, or otherwise impair the attainment of solid waste reduction goals?**

*Construction and Operation*

*Less Than Significant Impact.* The demolition and construction activities for the project would result in minor amounts of solid wastes and a temporary increase in solid wastes. The project would divert construction and demolition waste during project construction to help the city reach its 80 percent waste diversion rate as required by Measure 4.2 of the CAP (CA3 Vantage 2021). Operations would result in the long-term generation of a small amount of solid waste. Based on solid waste generation rates for different uses published by the Department of Resources Recycling and Recovery (CalRecycle), the project would generate about 6,674 pounds, or 3.3 tons, per day of solid waste during operation (CA3 Vantage 2021). The solid waste would be disposed of at the Newby Island Landfill in San Jose. The Newby Island Landfill is permitted to accept a maximum of 3,260 tons of solid waste per day. In December 2016, the city of San Jose Planning Commission approved a vertical expansion of the Newby Island Landfill where the permitted height was increased from 150 feet to 245 feet. The approved increase in elevation resulted in an increase of approximately 15.12 million cubic yards in the landfill capacity and an estimated closure date of January 2041 (Mercury News 2016). The estimated rate of solid waste generation of 3.3 tons per day the constitutes a small fraction (0.1 percent) of the total daily capacity of 3,260 tons per day the landfill is capable of processing. Thus, the project would not significantly increase solid waste generation and could be accommodated by existing solid waste facilities. Therefore, the impact resulting from the construction and operation of the proposed project on landfill capacity would be less than significant.



**e. Would the project comply with federal, state, and local management and reduction statutes and regulations related to solid waste?**

*Construction and Operation*

*Less Than Significant Impact.* The Integrated Waste Management Act of 1989 requires local jurisdictions in California to reduce by 50 percent the amount of solid waste disposed of in landfills by the year 2000. During construction, the project would collect and haul construction debris off-site for recycling or disposal in local jurisdictions that comply with this state requirement and have programs in place to ensure that the disposal of solid waste meets these requirements. Through recycling efforts, such as sorting wastes at the disposal facilities and diverting some waste(s) for recycling, the project will help to achieve General Plan goals for waste reduction. The project would divert construction and demolition waste during project construction to help the city reach its 80 percent waste diversion rate as required by Measure 4.2 of the CAP. The project would not result in an adverse impact on solid waste collection and would comply with management and reduction regulations (CA3 Vantage 2021). Typically, data centers do not generate special or unique wastes. Likewise, this project would not generate any special or unique wastes to cause non-compliance with federal, state, and local statutes or solid waste management and reduction regulations. The management of hazardous waste and applicable federal regulations are discussed in **Section 5.9, Hazards and Hazardous Materials**.

During operation, the project would comply with federal, state, and local statutes and regulations related to solid waste and recycling requirements. Specifically, the project would handle its solid waste in compliance with city regulations and measures to achieve recycling goals. The project would recycle as much as possible of the solid waste generated and dispose only of permitted wastes to the waste handler. In the unlikely event the waste handler determines that the project is disposing of wastes that could be recycled, they would notify the project owner to alter its waste stream to facilitate compliance with the city requirements. There would be no change in compliance with federal, state, or local statutes and regulations related to solid waste management and reduction, and, therefore, no impact would occur.

#### **4.18.4 Mitigation Measures**

None

#### **4.18.5 References**

DayZenLLC 2021a-d – DayZenLLC (DayZenLLC). (TN 237380-383). VDC CA3BGF SPPE Application Part I, dated April 5, 2021. Available online at:  
<https://efiling.energy.ca.gov/Lists/DocketLog.aspx?docketnumber=21-SPPE-01>

DWR 2003 – Department of Water Resources (DWR). Guidebook for Implementation of Senate Bill 610 and Senate Bill 221 of 2001. California Department of Water

- Resources. October 8, 2003. Available online at:  
<https://documents.pub/reader/full/guidebook-for-implementation-of-senate-bill-610-and-for-implementation-of-senate>. Accessed on: August 2, 2021.
- Santa Clara 2012 – City of Santa Clara recycled water system map, July 2012 update. Available online at: <http://santaclaraca.gov/home/showdocument?id=14883>. Accessed on August 2, 2021.
- Santa Clara 2020 – City of Santa Clara 2020 Urban Water Management Plan (UWMP). Prepared by the city of Santa Clara Water and Sewer Utilities. Adopted June 22, 2021. Available online at:  
<https://www.santaclaraca.gov/home/showpublisheddocument/74073/637606452907100000>. Accessed: August 2, 2021
- Santa Clara 2014 – City of Santa Clara 2010-2035 General Plan. Approved by City Council November 16, 2010 and updated December 9, 2014. Available at:  
<http://santaclaraca.gov/government/departments/communitydevelopment/planning-division/general-plan> . Accessed: July 25, 2021.
- SVP 2021a – Silicon Valley Power (SVP). 2017 Integrated Resources Plan. Accessed on December 9, 2021. Available online at:  
<https://www.siliconvalleypower.com/home/showpublisheddocument/62481/637268684502400000>.
- SVP 2021b – The Silicon Valley Power (SVP). Resources Map. Accessed: December 9, 2021. Available at:  
<http://www.siliconvalleypower.com/home/showdocument?id=5763>
- Walsh 2019b – Application for Small Power Plant Exemption: Walsh Data Center, Appendices A-E, dated June 28, 2019. (TN 228877-1). Available online at:  
<https://efiling.energy.ca.gov/Lists/DocketLog.aspx?docketnumber=19-SPPE-02>.

## 4.19 Wildfire

This section describes the environmental and regulatory setting and discusses impacts associated with the construction and operation of the project with respect to wildfires.

<b>WILDFIRE</b>	<b>Potentially Significant Impact</b>	<b>Less Than Significant with Mitigation Incorporated</b>	<b>Less Than Significant Impact</b>	<b>No Impact</b>
If located in or near state responsibility areas or lands classified as very high fire hazard severity zones, would the project:				
a. Substantially impair an adopted emergency response plan or emergency evacuation plan?	<input type="checkbox"/>	<input type="checkbox"/>	<input type="checkbox"/>	<input checked="" type="checkbox"/>
b. Due to slope, prevailing winds, and other factors, exacerbate wildfire risks, and thereby expose project occupants to, pollutant concentrations from a wildfire or the uncontrolled spread of a wildfire?	<input type="checkbox"/>	<input type="checkbox"/>	<input type="checkbox"/>	<input checked="" type="checkbox"/>
c. Require the installation or maintenance of associated infrastructure (such as roads, fuel breaks, emergency water sources, power lines or other utilities) that may exacerbate fire risk or that may result in temporary or ongoing impacts to the environment?	<input type="checkbox"/>	<input type="checkbox"/>	<input type="checkbox"/>	<input checked="" type="checkbox"/>
d. Expose people or structures to significant risks, including downslope or downstream flooding or landslides, as a result of runoff, post-fire slope instability, or drainage changes?	<input type="checkbox"/>	<input type="checkbox"/>	<input type="checkbox"/>	<input checked="" type="checkbox"/>

Environmental criteria established by CEQA Guidelines, Appendix G.

### 4.19.1 Setting

#### Wildfire Hazards

The Department of Forestry and Fire Protection (Cal Fire) identifies and maps areas of significant fire hazards based on fuels, terrain, and other relevant factors. These maps categorize this information by Fire Hazard Severity Zones (FHSZ), grouped into unzoned, moderate, high, and very high zones. State Responsibility Areas (SRA) are locations where the state of California is responsible for wildfire protection and Local Responsibility Areas are locations where the responding agency is the county or city.

The California Public Utilities Commission (CPUC) categorizes fire threat areas as Tier 1, Tier 2, or Tier 3. Tier 1 (or CAL FIRE Zone 1) encompasses High Hazard Zones (HHZ) on the United States Forest Service (USFS-CAL FIRE) joint map of Tree Mortality HHZ. This tier represents areas where tree mortality directly coincides with critical infrastructure such as communities, roads, and utility lines, and are a direct threat to public safety. Tier 2 consists of areas where there is an elevated risk (including likelihood and potential impacts on people and property) from wildfires associated with overhead utility power lines or overhead utility power-line facilities also supporting communication facilities. Tier 3 consists of areas where there is an extreme risk (including likelihood and potential

impacts on people and property) from wildfires associated with overhead utility power lines or overhead utility power-line facilities also supporting communication facilities.

The project site is surrounded by urban and industrial development in the city of Santa Clara and is not located in or near an SRA or a very high FHSZ, or land classified as having a fire threat by the CPUC. The project site is also not within a state of California FHSZ (Cal Fire 2019) at the wildland and urban interface and is not in the vicinity of wildlands.

## **Regulatory Background**

### *Federal*

No federal regulations related to wildfires apply to the project.

### *State*

**Fire Hazard Severity Zones (Pub. Resources Code, §§ 4201-4204).** The purpose of this code section is to provide for the classification of lands within SRAs in accordance with the severity of fire hazard present and identify measures to be taken to retard the rate of spreading and to reduce the potential intensity of uncontrolled fires that threaten to destroy resources, life, or property.

**Fire Hazard Severity (Cal. Code Regs, tit. 14, § 1280).** FHSZs reflect the degree of severity of fire hazard.

**CPUC General Order 95: Rules for Overhead Electric Line Construction.** CPUC GO 95, Section 35, covers all aspects of design, construction, operation, and maintenance of overhead electrical lines and management of safety hazards. Its application would ensure adequate service and safety to persons engaged in the construction, maintenance, operation or use of overhead lines and to the public in general.

**CPUC General Order 166: Standards for Operation, Reliability, and Safety during Emergencies and Disasters.** CPUC GO 166 covers the standards which require all electric utilities to be prepared for emergencies and disasters in order to minimize damage and inconvenience to the public which may occur as a result of electric system failures, major outages, or hazards posed by damage to electric distribution facilities.

### *Local*

**Santa Clara County Operational Area Hazard Mitigation Plan.** The plan includes risk assessment that identifies the natural hazards and risks that can impact a community based on historical experience, estimate the potential frequency and magnitude of disasters, and assess potential losses to life and property. The plan also includes developed mitigation goals and objectives as part of a strategy for mitigating hazard-related losses.

## 4.19.2 Environmental Impacts

### **a. Would the project substantially impair an adopted emergency response plan or emergency evacuation plan?**

#### *Construction*

*No Impact.* During project construction, traffic levels would experience a minimal increase that is not expected to degrade traffic performance significantly. Emergency response access during construction would not be significantly impeded. The project would not involve the development of structures that could potentially impair implementation of or physically interfere with an adopted emergency response plan or emergency evacuation plan. No streets would be closed, rerouted, or substantially altered during construction.

Additionally, the project is not located in or near an SRA or a very high FHSZ, or land classified as having a fire threat by the CPUC.

#### *Operation*

*No Impact.* The project does not involve the addition of a large number of people to the local area who could increase emergency response demand during a potential evacuation. Thus, the project would not interfere with the coordination of the city's emergency operations plan at the emergency operations center or alternate emergency operations center, nor would the project interfere with any statewide emergency response, or evacuation routes or plans. Adequate emergency access to the project site and surrounding industrial area would be maintained.

Additionally, the project is not located in or near an SRA or a very high FHSZ, or land classified as having a fire threat by the CPUC.

### **b. Would the project due to slope, prevailing winds, and other factors, exacerbate wildfire risks, and thereby expose project occupants to, pollutant concentrations from a wildfire or the uncontrolled spread of a wildfire?**

#### *Construction and Operation*

*No Impact.* The topography of the project site is flat and the project area is highly developed with minimal open space areas, faces, or slopes. Therefore, project construction would not exacerbate wildfire risk or expose occupants to pollutant concentrations from a wildfire.

Additionally, the project is not located in or near an SRA or a very high FHSZ, or land classified as having a fire threat by the CPUC.

### **c. Would the project require the installation or maintenance of associated infrastructure (such as roads, fuel breaks, emergency**

**water sources, power lines or other utilities) that may exacerbate fire risk or that may result in temporary or ongoing impacts to the environment?**

### *Construction and Operation*

*No Impact.* The project would require the installation of an onsite distribution substation to provide 60kV service to the site. The switching station will ultimately be owned and operated by Silicon Valley Power as part of its 60kV loop system. The construction of the substation would not block access to any road or result in traffic congestion. Maintenance of this substation would not physically block any access roads or result in traffic congestion that could significantly compromise timely access to this facility or any other location. Any large trees that would be crossed by the electrical supply line would be trimmed or removed consistent with electric reliability requirements. Therefore, the constructed electrical supply line and other project infrastructure will not constitute a possible ignition source for local vegetation, nor will it block access to any road or result in traffic congestion.

Additionally, the project is not located in or near an SRA or a very high FHSZ, or land classified as having a fire threat by the CPUC.

**d. Would the project expose people or structures to significant risks, including downslope or downstream flooding or landslides, as a result of runoff, post-fire slope instability, or drainage changes?**

### *Construction*

*No Impact.* The project would not substantially alter local drainage patterns. Storm water discharge during construction would be managed according to the project's Storm Water Pollution Prevention Plan, and appropriately discharged to the city of Santa Clara's storm drain system. The project would therefore not be expected to contribute to a flooding hazard onsite or offsite. For further discussion of the potential flooding impacts that could result from the proposed project, please see the discussion in section **4.10 Hydrology and Water Quality**.

As discussed in this section, the topography of the project site and surrounding area is relatively flat and highly developed. Therefore, the project would not be exposed to post-fire slope instability or drainage changes.

Additionally, the project is not located in or near an SRA or a very high FHSZ, or land classified as having a fire threat by the CPUC, so the types of hazards listed as potentially occurring in a post-fire situation are not likely to occur.

### *Operation*

*No Impact.* Operation of the project would not alter the course of a drainage (stream or river) and would not substantially alter local drainage patterns. The proposed onsite storm

drainage system would be designed to meet the city's storm water drainage standards and sized adequately to convey water away from the site and to the city of Santa Clara's storm drain system. The project would therefore not contribute to a flooding hazard onsite or offsite.

As discussed in this section, the topography of the project site and surrounding area is relatively flat and highly developed. Therefore, the project would not be exposed to post-fire slope instability or drainage changes.

Additionally, the project is not located in or near an SRA or a very high FHSZ, or land classified as having a fire threat by the CPUC, so the types of hazards listed as potentially occurring in a post-fire situation are not likely to occur.

### **4.19.3 Mitigation Measures**

None

### **4.19.4 References**

CALFIRE 2019 – Santa Clara County FHSZ Map in Local Responsibility Area. Accessed on: June 15, 2021. Available online at:  
[https://osfm.fire.ca.gov/media/5935/san\\_jose.pdf](https://osfm.fire.ca.gov/media/5935/san_jose.pdf)

## 4.20 Mandatory Findings of Significance

This section describes impacts specific to mandatory findings of significance associated with the construction and operation of the project.

MANDATORY FINDINGS OF SIGNIFICANCE	Potentially Significant Impact	Less Than Significant with Mitigation Incorporated	Less Than Significant Impact	No Impact
a. Does the project have the potential to substantially degrade the quality of the environment, substantially reduce the habitat of a fish or wildlife species, cause a fish or wildlife population to drop below self-sustaining levels, threaten to eliminate a plant or animal community, substantially reduce the number or restrict the range of a rare or endangered plant or animal or eliminate important examples of the major periods of California history or prehistory?	<input type="checkbox"/>	<input checked="" type="checkbox"/>	<input type="checkbox"/>	<input type="checkbox"/>
b. Does the project have impacts that are individually limited, but cumulatively considerable? (“Cumulatively considerable” means that the incremental effects of an individual project are significant when viewed in connection with the effects of past projects, the effects of other current projects, and the effects of probable future projects)??	<input type="checkbox"/>	<input checked="" type="checkbox"/>	<input type="checkbox"/>	<input type="checkbox"/>
c. Does the project have environmental effects which will cause substantial adverse effects on human beings, either directly or indirectly?	<input type="checkbox"/>	<input checked="" type="checkbox"/>	<input type="checkbox"/>	<input type="checkbox"/>

Environmental checklist established by CEQA Guidelines, Appendix G.

**a. Does the project have the potential to substantially degrade the quality of the environment, substantially reduce the habitat of a fish or wildlife species, cause a fish or wildlife population to drop below self-sustaining levels, threaten to eliminate a plant or animal community, substantially reduce the number or restrict the range of a rare or endangered plant or animal or eliminate important examples of the major periods of California history or prehistory?**

*Less Than Significant with Mitigation Incorporated*

### Biology Resources

*Less Than Significant with Mitigation Incorporated.* With the implementation of staff recommended mitigation measures, the project would not substantially degrade the quality of the environment, substantially reduce the existing habitat of any fish or wildlife species, cause any fish or wildlife population to drop below self-sustaining levels, threaten



to eliminate any plant or animal community, or substantially reduce the number or restrict the range of an endangered, threatened, or rare plant or animal species.

The project site is in a highly developed area and surrounded by commercial and industrial buildings. Therefore, the potential to degrade environmental quality is minimal, as the project site and surrounding properties do not support natural vegetation that would allow for extensive wildlife foraging or occupancy. However, mature landscaping trees and shrubs provide nesting opportunities for protected migratory bird species. Existing structures and trees also provide roosting opportunities for protected bat species. The implementation of mitigation measures **BIO-1** and **BIO-2**, which would require avoidance and minimization measures for protected migratory bird species and protected bat species, would ensure that project impacts would be less than significant.

### **Cultural and Tribal Cultural Resources**

*Less Than Significant with Mitigation Incorporated.* Important examples of the major periods of California history or prehistory represented by historical, unique archaeological, or tribal cultural resources are not known to be present in the project area. Nevertheless, the extent of proposed ground disturbance has the potential to damage unknown, buried archaeological resources in the project area. As described in **Section 4.5 Cultural and Tribal Cultural Resources**, most archaeological resources aged about 5,000 years or older are buried beneath the ground surface. If these resources were to be exposed or destroyed, it would be a significant impact. The implementation of mitigation measures **CUL-1** and **CUL-2** included in **Section 4.5 Cultural and Tribal Cultural Resources** would reduce the impacts to buried cultural resources to a less-than-significant level. The proposed project, therefore, is unlikely to eliminate important examples of major periods of California history or prehistory. Therefore, the impact would be less than significant.

### **Geology and Soils**

*Less Than Significant with Mitigation Incorporated.* Paleontological resources that represent important examples of the major periods of California prehistory are known to be present in the project area. The extent of proposed ground disturbance has the potential to damage unknown, buried paleontological resources in the project footprint. As described in **Section 4.7 Geology and Soils**, paleontological resources may be buried beneath the ground surface in Pleistocene age sediments. Five (5) fossil sites have been found at or near the ground surface within several miles of the project site, particularly along stream beds (UCMP 2020). If significant paleontological resources were to be exposed or destroyed, it would be a significant impact. Adherence to the City of Santa Clara 2010-2035 General Plan (General Plan) (Santa Clara 2010) policies (5.6.3-P1, -P2, -P4, -P5) and implementation of proposed **GEO-1** included in **Section 4.7 Geology and Soils** would reduce the impacts to buried paleontological resources to a less-than-significant level. The proposed project, therefore, is unlikely to eliminate important examples of paleontological resources that are part of the prehistory of California, and, therefore, the impact would be less than significant.

**b. Does the project have impacts that are individually limited, but cumulatively considerable? (“Cumulatively considerable” means that the incremental effects of an individual project are significant when viewed in connection with the effects of past projects, the effects of other current projects, and the effects of probable future projects)?**

*Less Than Significant with Mitigation Incorporated.* The analysis of cumulative impacts can employ one of two methods to establish the effects of other past, current, and probable future projects. A lead agency may select a list of projects, including those outside the control of the agency, or, alternatively, a summary of projections. These projections may be from an adopted general plan or related planning document, or from a prior environmental document that has been adopted or certified, and these documents may describe or evaluate the regional or area-wide conditions contributing to the cumulative impact.

### **General Plan Projection**

This section evaluates cumulative impacts using the City of Santa Clara 2010-2035 General Plan Integrated Final Environmental Impact Report (General Plan EIR) since the project would be consistent with applicable land use plans and policies (Santa Clara 2011). The General Plan EIR identified that the build-out of the general plan would contribute to five significant and unavoidable cumulative impacts in the areas of climate change, noise, population and housing, traffic, and solid waste.

#### ***General Plan Significant Unavoidable Impacts***

The General Plan EIR identified the following significant unavoidable environmental impacts applicable to the proposed project:

- Climate Change – Contribution to greenhouse gas (GHG) emissions exceeding Santa Clara’s emissions reduction target for 2035;
- Noise – Increase in localized traffic noise level on roadway segments throughout Santa Clara;
- Population and Housing – Exacerbation of land use impacts arising from the jobs/housing imbalance;
- Traffic – Degradation of traffic operations on regional roadways and highways within Santa Clara of an unacceptable level of service; and
- Solid Waste – Contribution to solid waste generation beyond available capacity after 2024.

Although the project, in combination with future development in the city of Santa Clara, could conceivably have a significant cumulative impact to these environmental resources, the following discussion demonstrates how the project’s contribution to these impacts would be less than cumulatively considerable.

## Climate Change Impacts (Greenhouse Gas Emissions)

*Less Than Significant with Mitigation Incorporated.* The Bay Area Air Quality Management District (BAAQMD) 2017 California Environmental Quality Act (CEQA) Air Quality Guidelines do not identify a GHG emissions threshold for construction-related emissions. Instead, BAAQMD recommends that GHG emissions from construction be quantified and disclosed and the impacts be determined in relation to meeting California Global Warming Solution Act of 2006, Assembly Bill (AB) 32, GHG emissions reduction goals. BAAQMD further recommends the incorporation of Best Management Practices (BMPs) to reduce GHG emissions during construction, as feasible and applicable. The project's construction emissions would be in conformance with state and local GHG emissions reduction goals, so impacts would be less than significant and not cumulatively considerable.

For readiness testing and maintenance-related emissions, the BAAQMD 2017 CEQA Air Quality Guidelines state that for stationary-source projects, the threshold to determine the significance of an impact from GHG emissions is 10,000 metric tons per year of carbon dioxide equivalent (MTCO<sub>2</sub>e/yr). However, BAAQMD is in the process of preparing and presenting to the BAAQMD board for approval an update to the CEQA GHG threshold for stationary sources to 2,000 MTCO<sub>2</sub>e/yr or compliance with the California Air Resources Board's cap-and-trade program. As a stationary source, the project's emergency backup generators may be subject to the pending CEQA GHG threshold. The emergency backup generators would not have a cumulatively considerable contribution to GHGs if emissions are below the applicable BAAQMD CEQA GHG threshold.

Other project-related emissions from mobile sources, area sources, energy use, and water use would not be included for comparison to the stationary source threshold, based on guidance in BAAQMD's CEQA Guidelines. Instead, GHG impacts from all other project-related emissions sources would be considered to have a less-than-significant impact if the project is consistent with the city of Santa Clara Climate Action Plan (CAP), which is considered a qualified GHG reduction strategy, and applicable regulatory programs and policies adopted by the California Air Resources Board (CARB) or other California agencies. However, it should be noted that the current versions of the CAP and CARB's scoping plan, a statewide planning document for the reduction of GHG emissions across sectors, have focused on the near-term 2020 and 2030 GHG goals. They do not address the sharp cuts that will be needed to meet the state's 2045 goals and beyond. The city of Santa Clara is in the process of updating the CAP with a planned adoption date of April 2022 (Santa Clara 2021, CEC 2021x). The 2022 update to CARB's scoping plan is also currently under development to plan for the 2045 target set forth by the Governor's Executive Order B-55-18.

With the applicant's conservative estimate of 35 hours of readiness testing and maintenance per year per engine, the GHG emissions of the emergency backup generators of the project are expected to be less than the 10,000 MTCO<sub>2</sub>e/yr threshold but more than the 2,000 MTCO<sub>2</sub>e/yr threshold BAAQMD is currently considering. Therefore, staff proposes mitigation measure **GHG-1** to require the applicant to limit the GHG emissions of the emergency backup generators to the BAAQMD CEQA GHG threshold

applicable at the time of permitting. Staff also proposes mitigation measure **GHG-2** to require the applicant to use an increasing mix of renewable diesel and phase out the use of conventional petroleum diesel. Staff also proposes mitigation measure **GHG-3** to require the applicant to participate in Silicon Valley Power's Large Customer Renewable Energy (LCRE) program for 100 percent carbon-free electricity or purchase carbon offsets or similar instruments that accomplish the same goals of 100 percent carbon-free electricity. Additionally, the project would implement efficiency measures to meet California's green building standards, and additional voluntary efficiency and use reduction measures. As such, GHG emissions related to the project would not conflict with the city of Santa Clara CAP or other plans, policies, or regulations adopted for the purpose of reducing the emissions of GHGs. Therefore, the project's GHG emissions would not be cumulatively considerable.

## Noise Impacts

*Less Than Significant with Mitigation Incorporated.* The General Plan EIR anticipates significant noise impacts from the build-out of the General Plan. Temporary construction activities at the project site may significantly increase the existing ambient noise levels at the residential area immediately south of the project site (depending on the activity occurring and equipment being used at the time). However, with the implementation of the proposed mitigation measure **NOI-1**, noise impacts would be reduced during construction to less than significant. Likewise, with the implementation of **NOI-1**, the project's contribution to cumulative noise impacts during project construction would not be cumulatively considerable.

The project would contribute to vehicle trips during the construction period as construction workers commute and trucks deliver construction materials to the project site. These trips would be temporary in nature; therefore, they would not significantly add to regular traffic. Based on the facility's anticipated 13.2 daily vehicle miles traveled (VMT) per worker for operations, the facility would not substantially increase the traffic or associated traffic-related noise levels in the project area. Any noise impacts associated with construction and operation-related traffic would be less than significant and not cumulatively considerable.

## Population and Housing Impacts

*Less Than Significant Impact.* The General Plan EIR identified significant impacts from the build-out of the General Plan land use designations. The General Plan EIR concluded that the proposed land uses would create a regional jobs/housing imbalance, as workers who are unable to live near their employment would commute long distances from outlying areas. As described in **Section 4.14 Population and Housing**, the project would not displace any people or housing or necessitate construction of replacement housing elsewhere. The operation of the project is anticipated to require a total of 19-21 employees. The project's construction and operation workforce would not directly or indirectly induce a substantial population growth in the project area. Therefore, the

project's contribution to the jobs/housing imbalance would not be cumulatively considerable.

## Traffic Impacts

*Less Than Significant with Mitigation Incorporated.* The General Plan EIR anticipates significant traffic impacts from the build-out of the General Plan. As discussed in **Section 4.17 Transportation**, the implementation of **TRANS-1** would reduce the project-generated VMT to a level below the city's threshold and reduce the project impact to a less-than-significant level. With the implementation of **TRANS-1**, the project's contribution to cumulative transportation impacts during project construction and operation would not be cumulatively considerable.

## Solid Waste Impacts

*Less Than Significant Impact.* As stated in **Section 5.18 Utilities and Service Systems**, the city of Santa Clara has available landfill capacity at the Newby Island Landfill in the city of San Jose through 2041. The current landfill impacts are addressed within an ongoing Integrated Waste Management Plan of the city of Santa Clara to provide waste disposal services. The project would participate in the city's Construction & Demolition Debris Recycling Program by recycling or diverting at least 65 percent of materials generated for discards by the project to reduce the amount of demolition and construction waste going to the landfill. The operation of the project would generate minimal operational waste as data centers typically require very little equipment turnover. Additionally, the project does not include a residential component and would not generate any increases in the supply and demand of utility services and infrastructure. Therefore, the project's contribution to this cumulative impact would not be cumulatively considerable.

## Other Technical Areas

Although the city's General Plan EIR did not identify significant effects in the areas of air quality, cultural resources, and geology (paleontology), and did not include an analysis of impacts to tribal cultural resources as the General Plan EIR was adopted before the enactment of AB 52 requiring such analysis, the CEC staff concluded that the project's impacts in these areas are *less than significant with mitigation*. Thus, staff has considered whether the project would contribute to cumulatively considerable impacts in these areas. Staff has also included an analysis of potential cumulative impacts for the other technical areas where project impacts would be *less than significant*.

## Aesthetics

*Less Than Significant Impact.* The proposed project is located on relatively flat land in a highly developed urban area within the city of Santa Clara, specifically intended to accommodate a range of light industrial uses that may have smoke, odor, dust, noxious gases, vibrations, glare, heat, fire hazards, or industrial wastes emanating from the property. The area permits light industrial uses, such as general service, warehousing, storage, distribution, and manufacturing.

There are no scenic vistas as discussed in **Section 4.1 Aesthetics** in the area. Existing aboveground buildings, structures, earthworks, equipment, trees, and vegetation, et cetera block or limit public views of the project and new or foreseeable projects from scenic resources.

The project would not conflict with the applicable city zoning and other regulations governing scenic quality. Nor is it expected that any foreseeable projects proposed and approved within this urbanized area would have significant impacts.

The project and other similar projects typically include outdoor lighting for driveways, entrances, walkways, parking areas, and security purposes. The City Code requires that lighting be directed away from residential areas and public streets. The nearest and only residential area is south of the Caltrain corridor and Bracher Park (public park).

The project would not: have a substantial adverse effect on a scenic vista; substantially damage scenic resources; substantially degrade the existing visual character or quality of public views of the site and its surrounding; and would not create a new source of substantial light or glare which would adversely affect day or nighttime views in the area. Nor is it expected that any foreseeable projects proposed and approved in the vicinity would have significant impacts under this technical area.

The project's contribution to Aesthetics impacts in the area would not be cumulatively considerable.

## **Air Quality**

*Less Than Significant with Mitigation Incorporated.* The proposed project would be in Santa Clara County in the San Francisco Bay Area Air Basin (SFBAAB), under the jurisdiction of BAAQMD. The SFBAAB is designated as a nonattainment area for ozone and fine particulate matter having a diameter of less than or equal to 2.5 microns (PM<sub>2.5</sub>) under both California Ambient Air Quality Standards (CAAQS) and National Ambient Air Quality Standards (NAAQS). The SFBAAB is also designated as nonattainment for particulate matter having a diameter of less than or equal to 10 microns (PM<sub>10</sub>) under CAAQS but not NAAQS.

SFBAAB's nonattainment status is attributed to the region's development history. Past, present, and future development projects contribute to the region's adverse air quality impacts on a cumulative basis. In developing thresholds of significance for air pollutants, BAAQMD considers the emissions levels for which a project's individual emissions would be cumulatively considerable. If a project exceeds the identified significance thresholds, its emissions would be cumulatively considerable, resulting in significant adverse air quality impacts to the region's existing air quality conditions. CEQA would then require the implementation of all feasible mitigation measures.

The construction exhaust emissions of the project would be lower than the thresholds of significance from the BAAQMD CEQA Air Quality Guidelines. There is no numerical threshold for fugitive dust generated during construction in BAAQMD's jurisdictional

boundaries. The BAAQMD CEQA Guidelines recommend the control of fugitive dust through BMPs to conclude that impacts from fugitive dust emissions are less than significant. The mitigation measure **AQ-1** would reduce air quality impacts during project construction. This measure requires incorporation of BAAQMD's recommended construction BMPs to control fugitive dust. This measure also incorporates exhaust control measures to reduce emissions from construction equipment. With the implementation of **AQ-1**, PM10 and PM2.5 emissions during construction would be reduced to a level that would not result in a considerable increase of these pollutants. Therefore, the project's construction emissions would not be cumulatively considerable.

During readiness testing and maintenance, the oxides of nitrogen (NOx) emissions of the emergency backup generators are estimated to exceed the BAAQMD significance threshold of 10 tons per year. All other pollutants would have estimated emissions rates below BAAQMD significance thresholds. The NOx emissions from the emergency backup generator readiness testing and maintenance would be required to be fully offset through the BAAQMD permitting process. Therefore, the project's emissions during readiness testing and maintenance would not be cumulatively considerable.

The criteria pollutant air quality impact analysis found that the concentrations from construction and readiness testing and maintenance of the gensets would not cause any exceedance of ambient air quality standards. Therefore, the project's criteria air pollutant impacts from genset readiness testing and maintenance would be less than significant.

The health risk assessment (HRA) shows that the project's health risk impacts would not exceed BAAQMD significance thresholds during construction or emergency backup generator readiness testing and maintenance. The project would not expose sensitive receptors to substantial toxic air contaminant (TAC) concentrations during construction or emergency backup generator readiness testing and maintenance.

Due to the infrequent nature of emergency conditions and the record of highly reliable electric service available to the project (see **Appendix B**), the project's emergency operations would be unlikely to expose sensitive receptors to substantial concentrations of criteria air pollutants or TACs.

Therefore, the project's air quality impacts would not be cumulatively significant.

## **Biological Resources**

*Less Than Significant with Mitigation Incorporated.* The General Plan EIR found less than significant biological resources impacts in the event of a full build-out scenario. The project site and surrounding properties are highly developed with commercial and industrial buildings and associated paved parking. The potential to degrade environmental quality is minimal, as the project site and surrounding properties do not support natural vegetation that would allow for extensive wildlife foraging or occupancy. However, mature landscaping trees and shrubs and other features on and near the project site could provide nesting opportunities for birds protected under the Migratory Bird Treaty

Act and Fish and Game Code. Effects could include disruptions during the breeding season from construction and tree removal. In addition, mature landscaping trees as well as the existing building have the potential to provide roosting habitat for protected bat species in the roof cavities and other suitable crevices. Effects could include direct mortality during tree removal or building demolition. To ensure impact avoidance, **Section 5.4 Biological Resources** identifies the following mitigation measures: **BIO-1**, which requires nesting bird pre-construction surveys and implementation of appropriate nest buffers; **BIO-2**, which requires conducting bat clearance surveys prior to the demolition of the existing buildings or removal of trees and development of a Bat Mitigation and Monitoring Plan, which details exclusion methods, roost removal procedures, and compensatory mitigation methods for permanent impacts from roost removal; **BIO-3**, which provides detailed requirements for the replacement of trees removed as part of the project; and **BIO-4**, which requires the implementation of tree protection measures to avoid and minimize impacts to trees that remain on site. Biological resource impacts from the proposed project would be less than significant with the implementation of staff's proposed mitigation measures, and, therefore, would not be cumulatively considerable.

### **Cultural and Tribal Cultural Resources**

*Less Than Significant with Mitigation Incorporated.* The General Plan EIR does not specifically address impacts on tribal cultural resources. Historical resources and unique archaeological resources, as defined by CEQA, share several of the impact vulnerabilities that tribal cultural resources face, especially the effects of ground-disturbing activities. In addition, historical and unique archaeological resources can also qualify as tribal cultural resources. The policies and resulting suite of mitigation measures for cultural resources presented in the General Plan EIR would reduce the severity of some impacts on tribal cultural resources. No known historical resources, unique archaeological resources, or tribal cultural resources have been found on the project site, although ground disturbance associated with the proposed project could result in the exposure and destruction of buried, as-yet unknown archaeological resources that could qualify as historical resources, unique archaeological resources, or tribal cultural resources. The implementation of proposed mitigation measures **CUL-1** and **CUL-2** would prevent, minimize, or compensate for impacts on buried, historical, unique archaeological, or tribal cultural resources. Project impacts to cultural resources and tribal cultural resources, therefore, would not be cumulatively considerable.

### **Energy and Energy Resources**

*Less Than Significant Impact.* The total number of hours of operation for reliability purposes (i.e., readiness testing and maintenance) for the emergency backup generators would be limited to no more than 50 hours per generator annually and could be limited even further with implementation of GHG-1. At this rate, the total quantities of diesel fuel used for all the generators operating at full load would be approximately 10,047 barrels per year (bbl/yr). California has a diesel fuel supply of approximately 316,441,000 bbl/yr. The project's use of fuel constitutes a small fraction (less than 0.003 percent) of available



resources, and the supply is more than sufficient to meet necessary demand. For these reasons, the project's use of fuel is less than significant.

The project's consumption of energy resources during operation would not be inefficient or wasteful, as discussed in **Section 4.6 Energy and Energy Resources**. Project operation would have a less than significant impact on local or regional energy supplies and energy resources and, likewise, would not be cumulatively considerable.

## Geology and Soils

*Less Than Significant with Mitigation Incorporated.* The General Plan identifies several policies (5.6.3-P1, -P2, -P4, -P5) that specifically address impacts on paleontological resources (Santa Clara 2021). Paleontological resources can be impacted by the effects of ground-disturbing activities. Five fossil sites have been found at or near the ground surface within several miles of the project site, particularly along stream beds (UCMP 2020). The suite of mitigation measures for paleontological resources presented in the General Plan EIR would reduce the severity of some impacts on paleontological resources. No known paleontological resources have been found on the project site. Ground disturbance associated with the proposed project could result in the exposure and destruction of buried, as-yet unknown paleontological resources that could qualify as significant paleontological resources. The implementation of **GEO-1** would prevent, or minimize, impacts on buried paleontological resources. Project impacts to paleontological resources, therefore, would not be cumulatively considerable.

## Hazards and Hazardous Materials

*Less Than Significant with Mitigation Incorporated.* As discussed in **Section 4.9 Hazards and Hazardous Materials**, ground-disturbing activities associated with the grading and construction activities of the project would have the potential to encounter impacted groundwater and/or soil. The contaminated soils could contain organochlorine pesticides, heavy metals, and volatile organic compounds. The applicant's proposed measure **HAZ-1** would require a site mitigation plan (SMP) to be created. The SMP would establish proper procedures to be taken when groundwater and contaminated soil is found and how to dispose of the contaminated soil properly. In addition, if contaminated soils are found in concentrations above thresholds, the project would halt construction and the soil would be treated in place or removed to an appropriate disposal facility. With the implementation of **HAZ-1**, the construction of the project would create a less than significant impact to the public or the environment.

The proposed project would use hazardous materials in small quantities associated with construction. These hazardous materials would be stored in designated construction staging areas in compliance with local, state, and federal requirements. Any diesel fuel transported on site would also comply with the extensive regulatory framework that applies to the shipment of hazardous materials. In addition, the applicant would implement procedures and safety features and precautions that would reduce the risk of an accidental hazardous materials release. Therefore, the impact from the use, transport,

disposal, or accidental release of hazardous materials would not be cumulatively significant.

## Hydrology and Water Quality

*Less Than Significant Impact.* The project would be required to comply with the Municipal NPDES Permit and the Santa Clara Valley Urban Runoff Pollution Prevention Program. The NPDES permit and the urban runoff pollution prevention program work together to establish specific requirements to reduce storm water pollution from new and redevelopment projects, singularly and cumulatively. With the implementation as described in **Section 4.10 Hydrology and Water Quality**, these standards would protect the watershed receiving discharge from the project from a cumulatively considerable impact to the basin's hydrology. Similarly, these same plans and permits would be protective of water quality. These standards would be protective of the quality of both surface water and groundwater bodies receiving discharge from the project.

## Land Use and Planning

*Less Than Significant Impact.* The project site is designated Light Industrial (ML), which includes data centers as an allowable use. The height of the proposed data center would exceed the permitted height for the ML zoning district (City Code Section 18.48.070). The city's Zoning Administrator has the authority to grant a minor modification to height, area, and yard regulations, provided that the minor modification does not exceed 25 percent of any zoning requirement (City Code Section 18.90.020). The city's granting of a minor modification in ML zoning requirements for height would ensure the project would be consistent with local land use regulations and that there would be no cumulative impacts from conflicts with local land use regulations.

## Public Services

*Less Than Significant Impact.* As discussed in **Section 4.15 Public Services**, the construction and operation of the project would not result in substantial adverse physical environmental impacts associated with the provision of new or physically altered fire and police service facilities to maintain acceptable service ratios, response times, or other performance objectives. The project would be consistent with the planned growth in the General Plan. The Santa Clara Fire Department reviewed the project plans to ensure appropriate safety features have been incorporated to reduce fire hazards and will review the final site design prior to the issuance of land use and building permits. The Santa Clara Police Department reviewed the project plans and provided comments and conditions of approval for land use and building permits related to incorporating safety and security measures into the site design.

In accordance with Government Code Section 65996, the project would be required to the appropriate school impact fees to Santa Clara Unified School District. The operation of the project is anticipated to require a total of 19-21 employees. Given the availability of an existing workforce throughout the Bay Area, employees are likely to currently reside within commuting distance of the project site and would not need to relocate closer to

the project. Even if all the operation workforce would relocate closer to the project site, the additional population would be consistent with growth projections and service ratios in the General Plan and, thus, the project would not cause significant environmental impacts associated with the provision of new or physically altered park and other public facilities to maintain acceptable service ratios or other performance objectives. The project's impacts to public services would not be cumulatively considerable.

## Recreation

*Less Than Significant Impact.* As discussed in **Section 4.16 Recreation**, the project does not require or propose the construction or expansion of recreation facilities. The operation of the project would require a total of 19-21 employees. The project's operation workforce would be consistent with growth projects and service ratios in the General Plan and, thus, the project would not increase the use of existing parks or recreational facilities to the extent that substantial physical deterioration of the park or facility would result. The project's impacts to recreation would not be cumulatively considerable.

### c. Does the project have environmental effects which will cause substantial adverse effects on human beings, either directly or indirectly?

*Less Than Significant with Mitigation Incorporated.* The proposed project would not cause substantial adverse effects on human beings either directly or indirectly. The proposed project would result in less than significant temporary impacts to human health during construction, including changes to air quality, and exposure to geologic hazards, noise, and hazardous materials. As discussed in **Section 4.3 Air Quality**, with the implementation of **AQ-1** to control emissions during project construction and NOx emissions fully offset for engine testing and maintenance, the project would result in a less-than-significant impact related to human health. As discussed in **Section 4.7 Geology and Soils**, the implementation of seismic design guidelines in the current California Building Standards Code and project-specific recommendations in a final geotechnical engineering report, as required by **GEO-1**, would ensure the project would not expose people or property to significant impacts associated with geologic or seismic conditions onsite. The project would result in temporary noise impacts to humans during construction and intermittently during operation. As discussed in **Section 4.13 Noise**, with the implementation of **NOI-1**, the project's noise impacts during project construction and operation would be less than significant. As discussed in **Section 4.9 Hazards and Hazardous Materials**, with the implementation of **HAZ-1**, hazards and hazardous material impacts would be less than significant. As discussed in **Section 4.10 Hydrology and Water Quality**, water quality impacts would be less than significant. No additional impacts to human beings would occur during project operation.

## References

- CEC 2021x – California Energy Commission (CEC). (TN 241090). Report of Conversation – Climate Action Plan Update and Applicability between CEC and City of Santa Clara, dated December 28, 2021. Available online at:  
<https://efiling.energy.ca.gov/Lists/DocketLog.aspx?docketnumber=21-SPPE-01>
- Santa Clara 2010 – City of Santa Clara (Santa Clara). City of Santa Clara 2010–2035 General Plan. Adopted November 16, 2010. Available online at:  
<https://www.santaclaraca.gov/our-city/departments-a-f/community-development/planning-division/general-plan>.
- Santa Clara 2011 – City of Santa Clara (Santa Clara). 2010-2035 General Plan Integrated Final Environmental Impact Report. January 2011. Available online at:  
<http://santaclaraca.gov/home/showdocument?id=12900>.
- Santa Clara 2021 – City of Santa Clara (Santa Clara). Climate Action Plan Update. Accessed August 2021. Available online at: <https://www.santaclaraca.gov/our-city/departments-a-f/community-development/planning-division/general-plan/climate-action-plan>.
- UCMP 2020 – University of California Museum of Paleontology (UCMP) 2019. *UCMP database*. Accessed on: June 22, 2020. Available online at:  
<http://ucmpdb.berkeley.edu/>

## **4.21 Environmental Justice**

This section describes the environmental setting and regulatory background and discusses impacts specific to environmental justice associated with the construction and operation of the proposed project.

### **4.21.1 Environmental Setting and Regulatory Background**

The United States Environmental Protection Agency (U.S. EPA) defines environmental justice (EJ) as, “the fair treatment and meaningful involvement of all people regardless of race, color, national origin or income with respect to the development, implementation and enforcement of environmental laws, regulations and policies” (U.S. EPA 2015, pg. 4).

The “Environmental Justice in the Energy Commission Site Certification Process” subsection immediately below describes why EJ is part of the California Energy Commission’s (CEC’s) site certification process, the methodology used to identify an EJ population, and the consideration of data from the California Environmental Protection Agency’s (CalEPA) California Communities Environmental Health Screening Tool (CalEnviroScreen 4.0). Below that, the “Environmental Justice Project Screening” subsection presents the demographic data for those people living in a six-mile radius of the project site and a determination on the presence or absence of an EJ population. When an EJ population is identified, the analysis in 10 technical areas<sup>1</sup> and Mandatory Findings of Significance consider the project’s impacts on this population and whether any impacts would disproportionately affect the EJ population. Lastly, the “Project Outreach” subsection discusses the CEC’s outreach program specifically as it relates to the proposed project.

### **Environmental Justice in the CEC Site Certification Process**

President Clinton’s Executive Order 12898, “Federal Actions to Address Environmental Justice in Minority Populations and Low-Income Populations,” focuses federal attention on the environment and human health conditions of minority communities and calls on federal agencies to achieve environmental justice as part of their mission. The order requires the U.S. EPA and all other federal agencies (as well as state agencies receiving federal funds) to develop strategies to address this issue. The agencies are required to identify and address any disproportionately high and adverse human health or environmental effects of their programs, policies, and activities on minority and/or low-income populations.

---

<sup>1</sup> The 10 technical areas are Aesthetics, Air Quality, Cultural and Tribal Cultural Resources, Hazards and Hazardous Materials, Hydrology and Water Quality, Land Use and Planning, Noise, Population and Housing, Transportation, and Utilities and Service Systems. Cultural and Tribal Cultural Resources considers impacts to Native American populations.

The California Natural Resources Agency recognizes that EJ communities are commonly identified as those where residents are predominantly minorities or live below the poverty level; where residents have been excluded from the environmental policy setting or decision-making process; where they are subject to a disproportionate impact from one or more environmental hazards; and where residents experience disparate implementation of environmental regulations, requirements, practices, and activities in their communities. Environmental justice efforts attempt to address the inequities of environmental protection in these communities.

An EJ analysis is composed of all the following:

- Identification of areas potentially affected by various emissions or impacts from a proposed project;
- Providing notice in appropriate languages (when possible) of the proposed project and opportunities for participation in public meetings to EJ communities;
- A determination of whether there is a comparatively larger population of minority persons, or persons below the poverty level, living in an area potentially affected by the proposed project; and
- A determination of whether there may be a significant adverse impact on a population of minority persons or persons below the poverty level caused by the proposed project alone, or in combination with other existing and/or planned projects in the area.

California law defines EJ as “the fair treatment and meaningful involvement of people of all races, cultures, incomes, and national origins, with respect to the development, adoption, implementation, and enforcement of environmental laws, regulations, and policies” (Gov. Code, § 65040.12; see also Pub. Resources Code, §§ 71110-71118). All departments, boards, commissions, conservancies, and special programs of the California Natural Resources Agency must consider EJ in their decision-making process if their actions have an impact on the environment, environmental laws, or policies. Such actions that require EJ consideration may include:

- Adopting regulations;
- Enforcing environmental laws or regulations;
- Making discretionary decisions or taking actions that affect the environment;
- Providing funding for activities affecting the environment; and
- Interacting with the public on environmental issues.

### **Bay Area Air Quality Management District Community Health Programs**

The project site is located within the Bay Area Air Quality Management District (BAAQMD). BAAQMD has community health programs intended to reduce air pollution disparities in the San Francisco Bay Area.

The Community Air Risk Evaluation (CARE) program identified areas in the San Francisco Bay Area where air pollution disparities are most significant and where populations are most vulnerable to air pollution. Information from the CARE program has been used to design and focus effective mitigation measures in these areas (BAAQMD 2022). The project site is not located in a CARE community.

The Community Health Protection Program is BAAQMD's local implementation of the California Air Resources Board's (CARB) Community Air Protection Program, as enacted by Assembly Bill (AB) 617(C. Garcia, Chapter 136, Statutes of 2017). The statewide Community Air Protection Program requires CARB to develop a new community-focused program to reduce exposure more effectively to air pollution and preserve public health and to take measures to protect communities disproportionately impacted by air pollution. CARB is required to select the highest priority locations in the state for the deployment of community air monitoring systems and select locations around the state for the preparation of community emissions reduction programs. CARB has initially selected seven communities for a community emissions reduction program, and the project site is not located in an AB 617 community.

### **CalEnviroScreen - More Information About an EJ Population**

CalEnviroScreen is a science-based mapping tool used by CalEPA to identify disadvantaged communities<sup>2</sup> pursuant to Health and Safety Code section 39711 as enacted by Senate Bill (SB) 535 (De León, Stats. 2012 Ch. 830). As required by state law, disadvantaged communities are identified based on geographic, socioeconomic, public health, and environmental hazard criteria. CalEnviroScreen identifies impacted communities by taking into consideration pollution exposure and its effects, as well as health and socioeconomic status, at the census-tract level. (OEHHA 2021, pg. 8).

Using data from federal and state sources, the tool consists of four components in two broad groups. The Exposure and Environmental Effects components comprise a Pollution Burden Group, and the Sensitive Populations and Socioeconomic Factors components comprise a Population Characteristic Group. The four components are made up of environmental, health, and socioeconomic data from 21 indicators.

The CalEnviroScreen score presents a relative, rather than an absolute, evaluation of pollution burdens and vulnerabilities in California communities by providing a relative ranking of communities across the state (CalEPA, 2021 pg. 8). CalEnviroScreen scores are calculated by combining the individual indicator scores within each of the four components, then multiplying the Pollution Burden and Population Characteristics groups scores to produce a final score (Pollution Burden X Population Characteristics = CalEnviroScreen Score). (CalEPA 2017, pg. 3) Each group has a maximum score of 10, and, thus, the maximum CalEnviroScreen score is 100. Based on these scores, census

---

<sup>2</sup> The California Environmental Protection Agency, for the purposes of its Cap-and-Trade Program, has designated *disadvantaged communities* as census tracts having a CalEnviroScreen score at the top 25 percent (75<sup>th</sup> percentile) (CalEPA 2017).

tracts across California are ranked relative to one another (OEHHA 2021, pg. 13). Values for the various components are shown as percentiles, which indicate the percent of all census tracts with a lower score. A higher percentile indicates a higher potential relative burden. A percentile does not describe the magnitude of the difference between two tracts, but rather it simply tells the percentage of tracts with lower values for that indicator (CalEPA 2021, pg. 20).

**Table 4.21-1** lists the indicators that go into the Pollution Burden score and the Population Characteristics score to form the final CalEnviroScreen score. These indicators are used to measure factors that affect the potential for pollution impacts in communities.

<b>TABLE 4.21-1 COMPONENTS THAT FORM THE CALENVIROSCREEN 4.0 SCORE</b>	
<b>Pollution Burden</b>	
<b>Exposure Indicators</b>	<b>Environmental Effects Indicators</b>
Children's lead risk from housing	Cleanup sites
Diesel particulate matter (PM) emissions	Groundwater threats
Drinking water contaminants	Hazardous waste
Ozone concentrations	Impaired water bodies
PM 2.5 concentrations	Solid waste sites and facilities
Pesticide use	
Toxic releases from facilities	
Traffic density	
<b>Population Characteristics</b>	
<b>Sensitive Populations Indicators</b>	<b>Socioeconomic Factors Indicators</b>
Asthma emergency department visits	Educational attainment
Cardiovascular disease (emergency department visits for heart attacks)	Housing-burdened low-income households
Low birth weight infants	Linguistic isolation
	Poverty
	Unemployment

Notes: PM= particulate matter. PM 2.5= fine particulate matter 2.5 microns or less.

Source: OEHHA 2021

Part of staff's assessment of how, or if, the project would impact an EJ population includes a review of CalEnviroScreen data for the project area. There are three technical areas that could have project impacts that could combine with the indicators in CalEnviroScreen: Air Quality, Hydrology and Water Quality, and Utilities and Service Systems.

The CalEnviroScreen indicators relevant to each of the three technical areas are:

- For air quality, these indicators are asthma, cardiovascular disease, diesel particulate matter (PM) emissions, low birth weight infants, ozone concentrations, pesticide use, PM with diameters of 2.5 micrometers or smaller (PM2.5) concentrations, toxic releases from facilities, and traffic density.
- For hydrology and water quality, these indicators are drinking water contaminants, groundwater threats, and impaired water bodies.



- For utilities and service systems, these indicators are cleanup sites, hazardous waste, and solid waste sites and facilities.

When these technical areas have identified a potential project impact where an EJ population is present, CalEnviroScreen is used to better understand the characteristics of the areas where the impact would occur and ensure that disadvantaged communities in the vicinity of the proposed project have not been missed when screened by race/ethnicity and low income.

Note that CalEnviroScreen is not intended to:

- Substitute for a cumulative impact analysis under the California Environmental Quality Act (CEQA);
- Restrict the authority of government agencies in permit and land use decisions; or,
- Guide all public policy decisions.

### **Project Outreach**

As a part of the U.S. EPA's definition of EJ, meaningful involvement is an important part of the siting process. Meaningful involvement occurs when:

- Those whose environment and/or health would be potentially affected by the decision on the proposed activity have an appropriate opportunity to participate in the decision;
- The population's contribution can influence the decision;
- The concerns of all participants involved will be considered in the decision-making process; and,

The Office of the Public Advisor, Energy Equity and Tribal Affairs outreach consists of emails to state and local elected officials, environmental justice organizations, local chambers of commerce, schools, and school districts, interested public, labor unions and trade associations, community centers, daycare centers, park departments, and religious organizations within a six- and twelve-mile radius of the proposed project.

The CEC staff (staff) docketed and mailed to the project mail list, including EJ organizations and similar interest groups, a Notice of Receipt of the CA3 Backup Generating Facility SPPE on July 15, 2021. Based on current U.S. Census English fluency data for the population residing in the cities and communities within a six-mile radius of the project site, translation of project notices was deemed appropriate. U.S. Census data also showed that of those who report they "Speak English less than very well," the predominant languages spoken were Spanish, Chinese, and Vietnamese. In addition, CalEnviroScreen data for the two disadvantaged community census tracts within a six-mile radius of the project showed the linguistic isolation population characteristic with a percentile of 90 and above. The CalEnviroScreen data supports the U.S. Census language fluency data, showing that the population living in this immediate project area are linguistically isolated and translation is warranted. Public notices for the project were

published in local newspapers in English, Spanish, Chinese, and Vietnamese on July 30, 2020.

Staff conducted outreach and consultation with regional tribal governments as described in **Section 4.5 Cultural and Tribal Cultural Resources**.

As described in **Section 2 Introduction**, staff exceeded the noticing requirements under CEQA Guidelines section 15087 by mailing the Notice of Availability of the Draft EIR to all owners and occupants not just contiguous to the project site but also to property owners within 1,000 feet of the project site and 500 feet of project linears.

### **Environmental Justice Project Screening**

**Figure 4.21-1** shows 2020 census blocks in a six-mile radius of the project with a minority population greater than or equal to 50 percent (U.S. Census 2020). The population in these census blocks represents an EJ population based on race and ethnicity as defined in the U.S. EPA's *Guidance on Considering Environmental Justice During the Development of Regulatory Actions* (U.S. EPA 2015).

Based on California Department of Education data in **Table 4.21-2** and presented in **Figure 4.21-2**, staff concludes that the percentage of those living in the school districts of Campbell Union, Luther Burbank Elementary, San Jose Unified, and Santa Clara Unified (in a six-mile radius of the project site) that are enrolled in the free or reduced-price meal program is larger than the percentage of those in the reference geography (Santa Clara County) that are enrolled in these programs. Thus, the population in these school districts are considered an EJ population based on a low income as defined in *Guidance on Considering Environmental Justice During the Development of Regulatory Actions*.

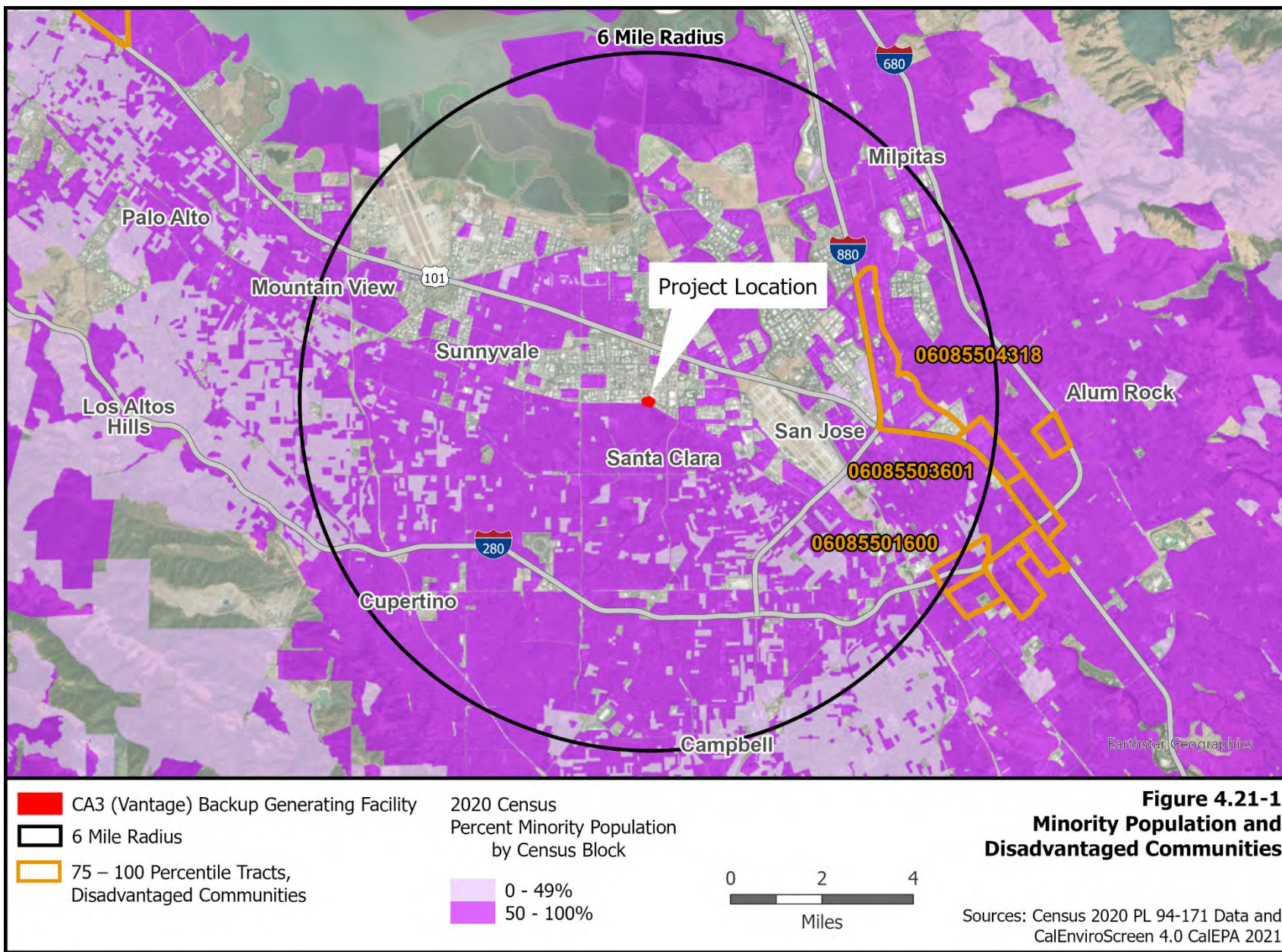



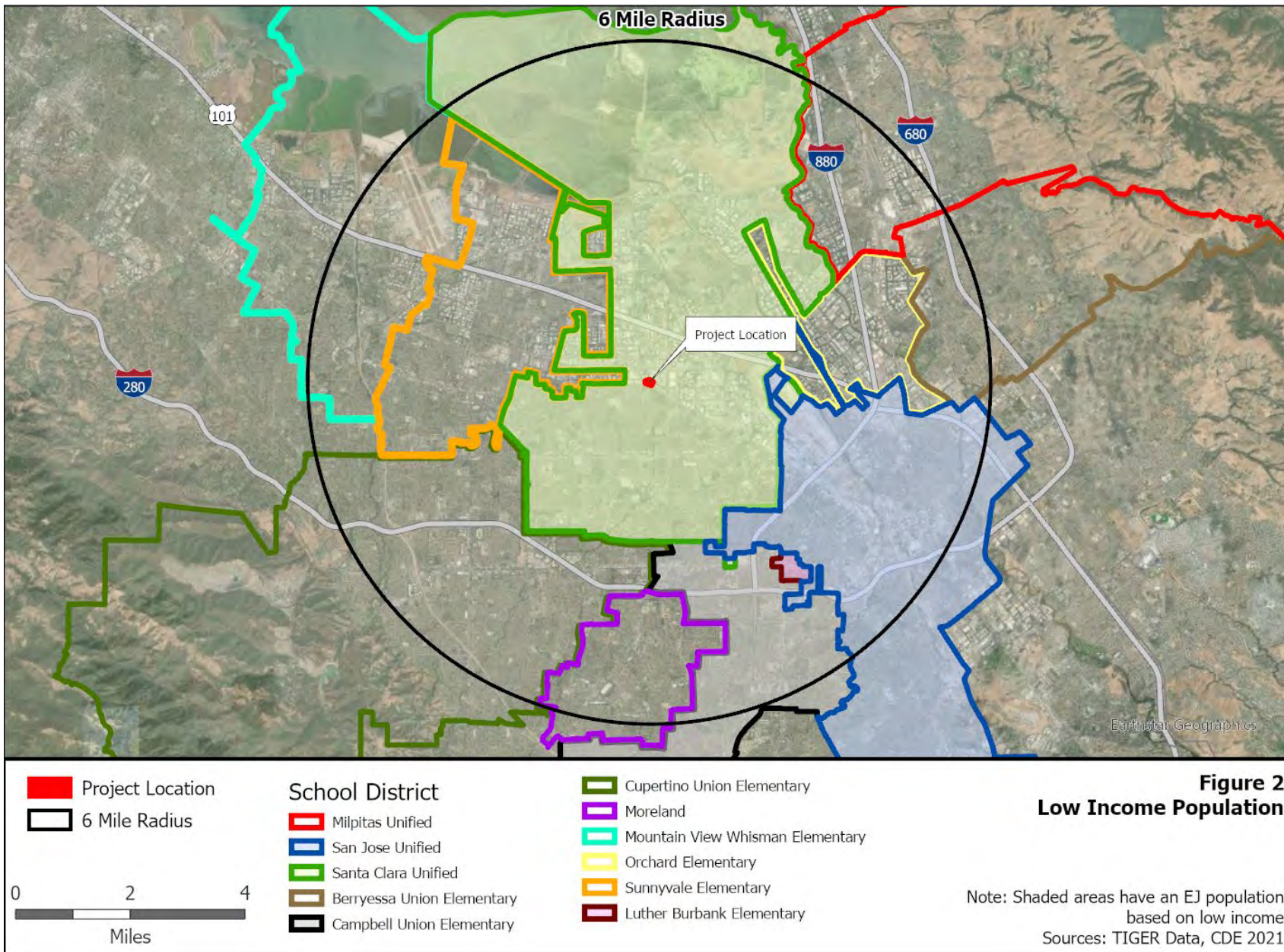

**TABLE 4.21-2 LOW INCOME DATA WITHIN THE PROJECT AREA**

School Districts in a Six-Mile Radius of the Project Site	Enrollment Used for Meals	Free or Reduced-Price Meals	
Berryessa Union Elementary	6,534	1,765	27.0%
<b>Campbell Union</b>	<b>6,622</b>	<b>2,721</b>	<b>41.1%</b>
Cupertino Union Elementary	15,663	885	5.7%
<b>Luther Burbank Elementary</b>	<b>475</b>	<b>397</b>	<b>83.6%</b>
Milpitas Unified	10,413	2,887	27.7%
Moreland	4,364	1,014	23.2%
Mountain View Whisman	4,753	1,315	27.7%
Orchard Elementary	815	219	26.9%
<b>San Jose Unified</b>	<b>28,710</b>	<b>10,622</b>	<b>37.0%</b>
<b>Santa Clara Unified</b>	<b>14,808</b>	<b>5,373</b>	<b>36.3%</b>
Sunnyvale Elementary	5,950	1,344	22.6%
Reference Geography			
Santa Clara County	253,625	82,218	32.4%

Note: **Bold** indicates school districts considered having an EJ population based on low income.  
Source: CDE 2021.

### CalEnviroScreen - Disadvantaged Communities

CalEnviroScreen 4.0 was used to gather additional information about the population potentially impacted by the proposed project. The CalEnviroScreen indicators (see **Figure 4.21-1**) are used to measure factors that affect the potential<sup>3</sup> for pollution impacts in communities. Staff used CalEnviroScreen to identify disadvantaged communities<sup>4</sup> in the vicinity of the proposed project and better understand the characteristics of the areas where impacts could occur. **Table 4.21-3** presents the CalEnviroScreen overall scores for the three disadvantaged communities within a six-mile radius of the project site. The location of each of these census tracts is shown on **Figure 4.21-1**.

**TABLE 4.21-3 CALENVIROSCREEN SCORES FOR DISADVANTAGED COMMUNITIES**

Census Tract No.	Total Population	CES 4.0 Percentile	Pollution Burden Percentile	Population Characteristics Percentile
06085504318	6,095	80.06	88.82	63.28
06085503601	3,383	85.36	84.12	76.94
06085501600	7,716	85.01	77.80	81.48

Note: Disadvantaged communities by census tract in the project's 6-mile radius. Source: CalEPA 2021

<sup>3</sup> It is important to note that CalEnviroScreen is not an expression of health risk and does not provide quantitative information on increases of impacts for specific sites or project. CalEnviroScreen uses the criteria of "proximity" to a hazardous waste site, a leaking underground tank, contaminated soil, an emission stack (industry, power plant, etc.) to determine that a population is "impacted". It does not address general principles of toxicology: dose/response and exposure pathways. For certain toxic chemicals to pose a risk to the public, offsite mitigation pathways must exist (through ingestion, inhalation, dermal contact, etc.) and contact to a certain amount, not just any amount, must exist.

<sup>4</sup> The California Environmental Protection Agency (CalEPA), for purposes of its Cap-and-Trade Program, has designated *disadvantaged communities* as census tracts having a CalEnviroScreen score at or above the 75th percentile (CalEPA 2017). As a comparative screen tool, it is not intended to be used as a health or ecological risk assessment for a specific area.

**Table 4.21-4** presents the CalEnviroScreen percentiles for the indicators that make up the pollution burden percentile. Where percentiles for CalEnviroScreen indicators are 90 and above, the percentile is shown in bold. These relatively higher percentiles could be seen as drivers for the census tract's identification as a disadvantaged community. There are no census tracts where the pollution burden percentile is 90 or above, and there are three census tracts where individual pollution burden indicators are in the 90 or above percentile. **Table 4.21-5** presents the CalEnviroScreen percentiles for the indicators that make up the population characteristics. There are no census tracts where the population characteristics burden percentile is 90 or above and three census tracts where individual population characteristic indicators are in the 90 or above percentile.

**TABLE 4.21-4 CALENVIROSCREEN INDICATOR PERCENTILES FOR POLLUTION BURDEN FOR DISADVANTAGED COMMUNITIES**

	Percentiles for Census Tracts		
	06085504318	06085503601	06085501600
Pollution Burden	88.82	84.12	77.80
Ozone	20.85	20.85	20.85
PM2.5	33.71	35.76	37.13
Diesel PM	<b>90.49</b>	<b>91.50</b>	<b>95.13</b>
Drinking Water	22.74	22.74	22.74
Lead	52.73	<b>93.48</b>	83.20
Pesticides	4.97	0.00	0.79
Toxic Release	39.48	33.02	32.10
Traffic	<b>94.31</b>	<b>91.00</b>	79.25
Cleanup Sites	<b>99.74</b>	81.02	50.56
Groundwater Threats	<b>96.73</b>	62.49	<b>91.57</b>
Hazardous Waste	<b>99.85</b>	<b>91.36</b>	65.18
Impaired Water Bodies	33.16	33.16	43.78
Solid Waste	<b>99.77</b>	84.74	77.96

Notes: Disadvantaged communities by census tract in the project's 6-mile radius. **Bold** indicates a percentile is 90 or above. Source: CalEPA 2021

**TABLE 4.21-5 CALENVIROSCREEN INDICATOR PERCENTILES FOR POPULATION CHARACTERISTICS FOR DISADVANTAGED COMMUNITIES**

	Percentiles for Census Tracts		
	06085504318	06085503601	06085501600
Population Characteristics	63.28	76.94	81.48
Asthma	36.05	73.54	72.98
Low Birth Weight	71.79	77.05	<b>91.34</b>
Cardiovascular Disease	28.12	53.39	39.71
Education	78.63	79.42	63.76
Linguistic Isolation	<b>95.72</b>	<b>95.03</b>	67.45
Poverty	59.52	78.45	80.28
Unemployment	78.97	21.11	64.51
Housing Burden	46.02	63.23	<b>94.47</b>

Notes: Disadvantaged communities by census tract in the project's 6-mile radius. **Bold** indicates a percentile is 90 or above. Source: CalEPA 2021

## 4.21.2 Environmental Impacts

The following technical areas discuss impacts to EJ populations: Aesthetics, Air Quality<sup>5</sup>, Cultural and Tribal Cultural Resources, Hazards and Hazardous Materials, Hydrology and Water Quality, Land Use and Planning, Noise, Population and Housing, Transportation, and Utilities and Service Systems.

Part of staff's assessment of how, or if, the project would impact an EJ population includes a review of CalEnviroScreen data for the project area. There are three technical areas that could have project impacts that could combine with the indicators in CalEnviroScreen: Air Quality, Hydrology and Water Quality, and Utilities and Service Systems. When these technical areas have identified a potential impact where an EJ population is present, CalEnviroScreen is used to better understand the characteristics of the areas where the impact would occur and ensure that disadvantaged communities in the vicinity of the proposed project have not been missed when screened by race/ethnicity and low income.

### Aesthetics

*Less Than Significant Impact.* A disproportionate impact pertaining to Aesthetics to an EJ population may occur if a project is in proximity to an EJ population and any of the following true:

- The project, if in an "urbanized area" as defined in Public Resources Code section 21071, conflicts with applicable zoning and other regulations governing scenic quality.
- The project, if in a non-urbanized area, substantially degrades the existing visual character or quality of the public view of the site and its surroundings.
- The project creates a new source of substantial light or glare that adversely affects day or nighttime views in the area.

As discussed in **Section 4.1 Aesthetics**, the project is in an urbanized area. The project conforms to the applicable city zoning and other regulations governing scenic quality.

Staff viewed aerial, surface, and street imagery, and topographic and other maps in addition to the EJ section EJ figures and concludes the nearest EJ population would have a restricted public view from Bracher Park. The project's capability of being seen in the landscape from the public park rates moderate to high. It would be plainly visible and could not be missed by the casual observer from views in the general direction of the project. However, it would not strongly attract visual attention or dominate views because of apparent size and due to the existence of aboveground landscape components (buildings, structures, earthworks, trees, etc.) including the movement of passenger cars along the Caltrain corridor. The proposed project landscaping would aid in obstructing the view.

---

<sup>5</sup> Public Health concern discussed under Air Quality.

The project design includes directional and shielded light fixtures to keep lighting onsite. The project design includes installing LED lighting throughout the project site. Project components would have no to low reflectivity offsite.

The project would have a less than significant effect on aesthetics and would not have a disproportionate effect to an EJ population.

### **Air Quality**

*Less Than Significant Impact.* **Table 4.21-4** and **Table 4.21-5** include indicators that relate to both air quality and public health. The indicators that are associated with criteria air pollutants, such as ozone, PM2.5, and nitrogen dioxide (NO<sub>2</sub>), are indicators related to air quality. Indicators that are associated with protecting public health are: Diesel PM, Pesticide Use, Toxic Release from Facilities, Traffic Density, Asthma, Low Birth Weight Infants, and Cardiovascular Disease. Each of these air quality and public health indicators are summarized under this Air Quality subsection.

Ambient air quality standards (AAQS) are established to protect the health of even the most sensitive individuals in our communities, which includes the EJ population, by defining the maximum amount of a pollutant that can be present in outdoor air without harm to the public's health. Both CARB and the U.S. EPA are authorized to set AAQS.

Staff identified the potential air quality impacts (i.e., ozone and PM2.5) that could affect the EJ population represented in **Figures 4.21-1** and **4.21-2**. Staff also examined individual contributions of indicators in CalEnviroScreen that are relevant to air quality (see **Table 4.21-4**).

Staff identified the potential public health impacts (i.e., cancer and non-cancer health effects) that could affect the EJ population represented in **Figures 4.21-1** and **4.21-2**. These potential public health risks were evaluated quantitatively based on the most sensitive population, which includes the EJ population, by conducting a health risk assessment (HRA). The results were presented by levels of risk. The potential construction and emergency backup generator (gensets) readiness testing and maintenance risks are associated with exposure to diesel PM.

In **Section 4.3 Air Quality**, staff concludes that, with the implementation of mitigation measure **AQ-1** and oxides of nitrogen (NO<sub>x</sub>) emissions fully offset through the permitting process with BAAQMD, the project would not have a significant impact on air quality or public health. Criteria air pollutants would not cause or contribute substantially to exceedances of health-based ambient standards and the project's toxic air emissions would not exceed health risk limits. Likewise, the project would not cause disproportionate air quality or public health impacts on sensitive populations, such as the EJ population represented in **Figures 4.21-1** and **4.21-2**.

The text below addresses each of the air quality and public health indicators included in **Tables 4.21-4** and **4.21-5**.



### *Ozone Impacts*

Ozone is known to cause numerous health effects, which can potentially affect EJ communities as follows:

- Lung irritation, inflammation and exacerbation of existing chronic conditions, even at low exposures (Alexis et al. 2010, Fann et al. 2012, Zanobetti and Schwartz 2011);
- Increased risk of asthma among children under two years of age, young males, and African American children (Lin et al. 2008, Burnett et al. 2001); and,
- Higher mortality, particularly in the elderly, women, and African Americans (Medina-Ramón and Schwartz 2008).

Even though ozone is not directly emitted from emission sources such as the gensets, precursor pollutants that create ozone, such as NO<sub>x</sub> and volatile organic compounds (VOCs), would be emitted. The NO<sub>x</sub> emissions of the gensets during readiness testing and maintenance would be required to be fully offset through the BAAQMD permitting process. See more detailed discussion in **Section 4.3 Air Quality**.

For CalEnviroScreen, the air monitoring data used in this indicator have been updated to reflect ozone measurements for the years 2017 to 2019. CalEnviroScreen 4.0 uses the mean of the daily maximum eight-hour ozone concentration (ppm) for the summer months (May-October), averaged over three years (2017-2019). According to CalEnviroScreen data, census tracts are ordered by ozone concentration values, and then are assigned a percentile based on the statewide distribution of values.

Results for ozone are included in **Table 4.21-4**. Ozone levels in the three census tracts within a six-mile radius of the project site are relatively low, with percentiles around 21. Another way to look at the data is that approximately 79 percent of all California census tracts have higher ozone levels than these census tracts near the project. For ozone, the census tracts within a six-mile radius of the proposed project's site are not exposed to high ozone concentrations compared to the rest of the state.

The project would not be expected to contribute significantly to regional air quality as it relates to ozone. The project would be required to comply with air quality emission rate significance thresholds for NO<sub>x</sub> and VOCs, which are precursor pollutants that create ozone during the construction and testing and maintenance phases. The project would use best management practices (BMPs) during construction, which would reduce NO<sub>x</sub> and VOCs. The project's impacts would not be expected to cause an exceedance of AAQS during readiness testing and maintenance. NO<sub>x</sub> emissions resulting from readiness testing and maintenance would be high enough to trigger offset requirements due to BAAQMD Regulation 2, Rule 2. Therefore, the NO<sub>x</sub> emissions would need to be fully offset to reduce net impacts to levels below the BAAQMD's CEQA threshold. VOC emissions would be below the BAAQMD's threshold of significance and the applicant would not be required to offset them. Therefore, the project would not contribute significantly to regional ozone concentrations, relative to baseline conditions.

Staff concludes that the project would not expose sensitive receptors to substantial ozone precursor concentrations. The project's ozone and ozone precursor air quality impacts would be less than significant for the local EJ community and the general population. Additionally, as NO<sub>x</sub> emissions of the gensets would be fully offset, the project would not result in a cumulatively considerable net increase of secondary pollutants, such as ozone, in the air basin.

### ***PM<sub>2.5</sub> Impacts***

PM is a complex mixture of aerosolized solid and liquid particles, including such substances as organic chemicals, dust, allergens, and metals. These particles can come from many sources, including cars and trucks, industrial processes, wood burning, or other activities involving combustion. The composition of PM depends on the local and regional sources, time of year, location, and weather.

PM<sub>2.5</sub> refers to particles that have a diameter less than or equal to 2.5 micrometers. PM<sub>2.5</sub> is known to cause numerous health effects, which can potentially affect EJ communities. Particles in this size range can have adverse effects on the heart and lungs, including lung irritation, exacerbation of existing respiratory disease, and cardiovascular effects.

For CalEnviroScreen, the indicator PM<sub>2.5</sub> is determined by the annual mean concentration of PM<sub>2.5</sub> (weighted average of measured monitor concentrations and satellite observations,  $\mu\text{g}/\text{m}^3$ ), averaged over three years (2015-2017). According to CalEnviroScreen data, census tracts are ordered by PM<sub>2.5</sub> concentration values, and then are assigned a percentile based on the statewide distribution of values and are shown in **Table 4.21-4**. While the three census tracts within the six-mile radius of the project site are similar, with percentiles being 33.71, 35.76, and 37.13 for census tracts 6085504318, 6085503601, and 6085501600, respectively, the highest percentile is from census tract 6085501600. Census tract 6085501600 was at the 37.13 percentile in the PM<sub>2.5</sub> category (see **Table 4.21-4**). This indicates that PM concentrations in this census tract are higher than 37.13 percent of tracts statewide. This means that these communities are exposed to below average PM<sub>2.5</sub> concentrations compared to the rest of the state.

The project would not be expected to contribute significantly to the regional air quality related to PM<sub>2.5</sub>. The project would not expose sensitive receptors to substantial pollutant concentrations of PM<sub>2.5</sub> during construction or the readiness testing and maintenance of the gensets. The project would use BMPs during construction, which would reduce PM emissions. The gensets would be equipped with diesel PM filters, which would reduce PM emissions from the engines. Therefore, the project would not contribute significantly to regional PM<sub>2.5</sub> concentrations, relative to baseline conditions.

The project's PM<sub>2.5</sub> air quality impacts would be less than significant for the local EJ community and the general population. Additionally, as NO<sub>x</sub> emissions of the gensets would be fully offset, the project would not result in cumulatively considerable net increase of secondary pollutants, such as PM, in the air basin.

### *NO<sub>2</sub> Impacts*

**Section 4.3 Air Quality** includes an additional assessment of other criteria air pollutant impacts, including NO<sub>2</sub> impacts. Staff's analysis indicates that the project would not cause adverse NO<sub>2</sub> impacts during construction or readiness testing and maintenance. The project's NO<sub>2</sub> air quality impacts would be less than significant for the local EJ community and the general population.

### *Diesel PM*

This indicator represents how much diesel PM is emitted into the air within and near the census tract. The data are from 2016 California Air Resources Board's emission data from on-road vehicles (trucks and buses) and off-road sources (ships and trains, for example). This is the most recent data available with which to make the necessary comparisons.

**Table 4.21-4** shows that among these three census tracts, all are higher than the 90th percentile. They are 95.13, 91.5, and 90.49 (in census tracts 06085501600, 06085503601, and 06085504318, respectively), meaning these three are higher than 95.13, 91.5 and 90.49 percent of the census tracts in California.

However, according to the results of the HRA conducted for this project in **Section 4.3 Air Quality**, impacts associated with diesel PM from the proposed project construction and readiness testing and maintenance activities (diesel-fueled equipment) would be less than significant and would not have a significant cumulative contribution to the diesel PM levels in the disadvantaged communities. Therefore, the project's diesel PM impacts would be less than significant for the local EJ community and the general population.

### *Pesticide Use*

Specific pesticides included in the Pesticide Use category were narrowed from the list of all registered pesticides in use in California to focus on a subset of 132 active pesticide ingredients that are filtered for hazard and volatility for the years 2017-2019 collected by the California Department of Pesticide Regulation. Only pesticides used on agricultural commodities are included in the indicator.

Census tract 06085504318 was at 4.97 percentile, census tract 06085501600 was at 0.79 percentile, and census tract 06085503601 was at zero percentile in the Pesticide Use category (see **Table 4.12-4**). This indicates that pesticide use in these census tracts are below the statewide average in terms of pesticide use. This indicates that these communities are not exposed to high pesticide concentrations as compared to the rest of the state. Therefore, the project's pesticide use would be less than significant for the local EJ community and the general population.

### *Toxic Releases from Facilities*

This indicator represents modeled toxicity-weighted concentrations of chemical releases to air from facility emissions and off-site incineration in and near the census tract. The U.S. EPA provides public information on the amount of chemicals released into the environment from many facilities. This indicator uses the modeled air concentration and toxicity of the chemical to determine the toxic release score. The data are from 2017-2019.

**Table 4.21-4** shows three census tracts are similar, with the percentiles being 39.48, 33.02, and 32.10 for census tracts 06085504318, 06085503601, and 06085501600, respectively. The highest percentile is from census tract 6085504318, indicating that toxic release from facilities threats in this census tract (6085504318) is higher than 39.48 percent of tracts statewide. This also indicates that these communities are lower than the state average for exposure to toxic releases.

According to the results of the HRA conducted for the project in **Section 4.3 Air Quality**, impacts associated with toxic releases from construction and readiness testing and maintenance activities (diesel-fueled equipment) would be less than significant. The project would not have a significant cumulative contribution to toxic releases. Therefore, the project's toxics emissions would be less than significant for the local EJ community and the general population.

### *Traffic Density*

This indicator represents the sum of traffic volumes adjusted by road segment length. It is calculated as the sum of traffic volumes adjusted by road segment length (vehicle-kilometers per hour) divided by total road length (kilometers) within 150 meters of the census tract. It is not a measure of level of service on roadways. The data are from 2017.

**Table 4.21-4** shows that among these three census tracts, two are higher than the 90th percentile. The highest percentiles are 94.31 and 91 (in census tracts 06085504318 and 06085503601, respectively), meaning these two are higher than 94.31 and 91 percent of the census tracts in California. The percentile of census tract 06085501600 is at the 79.25 percentile. Traffic impacts are related to the diesel PM emitted from diesel-fueled vehicles.

The proposed project would generate a small number of vehicle trips to the site. These trips include workers, material, and equipment deliveries. It is unlikely that the addition of vehicle trips from the project would result in a significant contribution to the traffic density on any roadway in the vicinity of the project site. However, according to the results of the HRA conducted for the project in **Section 4.3 Air Quality**, impacts associated with diesel PM from the proposed project construction and operation activities (diesel-fueled equipment) would be less than significant and would not have a significant cumulative contribution to the diesel PM-related traffic density in the disadvantaged communities. Therefore, the project's traffic volume impact would not have a significant cumulative contribution to the traffic density for the local EJ community and the general population.

### ***Asthma***

This indicator is a representation of an asthma rate. It measures the number of emergency department (ED) visits for asthma per 10,000 people over the years 2015 to 2017. The information was collected by the California Office of Statewide Health Planning and Development.

**Table 4.21-5** shows census tract 06085503601 was at the 73.54 percentile in the Asthma category. This indicates the number of emergency department visits for asthma per 10,000 people over the years 2015 to 2017 are higher than 73.54 percent of tracts statewide. Census tract 06085501600 was slightly lower, at the 72.98 percentile. This indicates that these two communities have above average numbers of emergency room visits due to asthma compared to the rest of the state. On the contrary, census tract 06085504318 was at the 36.05 percentile, lower than the state average for asthma ED visits.

According to the results of the HRA conducted for the project in **Section 4.3 Air Quality**, impacts associated with emissions from construction, and readiness testing and maintenance activities (diesel-fueled equipment) would be less than significant and would not have a significant cumulative contribution to asthma ED visits. Therefore, the project's emissions would not have a significant cumulative contribution to asthma ED visits for the local EJ community and the general population.

### ***Low Birth Weight Infants***

This indicator measures the percentage of babies born weighing less than 2500 grams (about 5.5 pounds) out of the total number of live births over the years 2009 to 2015. The information was collected by the California Department of Public Health.

Among these three census tracts, Census Tract 06085501600 has the highest potential relative burden. The low birth-weight percentile for this census tract is 91.34, meaning the percent low birth weight is higher than 91.34 percent of tracts statewide. Census tract 06085504318 and 06085503601 were slightly lower, at the 71.79 and 77.05 percentile, respectively. This indicates that these two communities are also higher than the state average of low birth-weight infants.

The HRA of the project in **Section 4.3 Air Quality** was based on a highly conservative health-protective methodology that accounts for impacts on the most sensitive individuals in a population. According to the results of the assessment, the risks at the maximally exposed sensitive receptors (i.e., the maximally exposed individual resident [MEIR], maximally exposed school receptor [MESR], maximally exposed daycare receptor [MEDR], and the maximally exposed recreational receptor [MERR]) would be below health-based thresholds. Therefore, the toxic emissions from the project would not cause significant health effects for the low birth-weight infants in these disadvantaged communities or have a significant cumulative contribution to these disadvantaged communities. The project's emissions would not have a significant cumulative

contribution to low birth-weight infant births for the local EJ community and the general population.

### ***Cardiovascular Disease***

This indicator represents the rate of heart attacks. It measures the number of ED visits for acute myocardial infarction (AMI) (or heart attack) per 10,000 people over the years 2015 to 2017.

**Table 4.21-4** shows three census tracts are with the percentiles being 28.12, 53.39, and 39.71 for census tracts 06085504318, 06085503601, and 06085501600, respectively. The highest percentile is from census tract 06085503601, indicating the number of emergency department visits for AMI per 10,000 people over the years 2015 to 2017 is higher than 53.39 percent of tracts statewide. This also indicates that this community is about the average number of emergency department visits for AMI compared to the rest of the state.

According to the results of the HRA conducted for the project in **Section 4.3 Air Quality**, impacts associated with emissions from construction and readiness testing and maintenance activities (diesel-fueled equipment) would be less than significant and would not have a significant cumulative contribution to cardiovascular disease. The project's emissions would not have a significant cumulative contribution to cardiovascular disease for the local EJ community and the general population.

### **Cultural and Tribal Cultural Resources**

*No Impact.* Staff did not identify any Native American EJ populations that either reside within six miles of the project or that rely on any subsistence resources that could be impacted by the proposed project.

### **Hazards and Hazardous Materials**

*Less Than Significant Impact.* An EJ population may experience disproportionate hazards and hazardous materials impacts if the storage and use of hazardous materials within or near EJ communities occur to a greater extent than within the community at large. A disproportionate impact upon the EJ population resulting from the planned storage and use of hazardous materials on the site is extremely low. Diesel fuel to run the gensets is the hazardous material that the project site would have in greatest quantity. The total quantity would be divided up and stored in many separate double-walled fuel tanks (one for each genset) with proper spill controls. Therefore, the likelihood of a spill of sufficient quantity to impact the surrounding community and EJ population would be very small, and, thus, the impact on the EJ community would be less than significant.

## Hydrology and Water Quality

*Less Than Significant Impact.* A disproportionate hydrologic or water quality impact on an EJ population could occur if the project would contribute to the impairment of drinking water, exacerbate groundwater contamination threats, or contribute pollutants to impaired water bodies.

Since the overall CalEnviroScreen score reflects the collective impacts of multiple pollutants and factors, staff examined the individual contributions to indicators as they relate to hydrology and water quality. The pollutants of concern in this analysis are those from construction and operational activities. The CalEnviroScreen scores for the disadvantaged community census tract in a six-mile radius of the project (see **Figure 4.21-1**) are presented in **Table 4.12-4** for each of the following environmental stressors that relate to hydrology and water quality: Drinking Water Contaminants, Groundwater Threat, and Impaired Water Bodies. The percentile for each disadvantaged census tract reflects its relative ranking among all of California's census tracts. A disproportionate hydrology or water quality impact on an EJ population could occur if a project introduces an additional pollutant burden to a disadvantaged community.

CalEnviroScreen assigns a score to each type of stressor. To assess the impact of a stressor on population within a census tract, the score is assigned a weighting factor that decreases with distance from the census tract. For stationary stressors related to hydrology or water quality, the weighting factor diminishes to zero for distances greater than 1,000 meters (0.6 mile). As **Figure 4.21-1** shows, there are no disadvantaged census tracts within 1,000 meters from the project. Therefore, impacts to Hydrology and Water Quality would not introduce an additional burden to an EJ population and would be less than significant.

## Land Use and Planning

*Less Than Significant Impact.* A disproportionate land use impact on an EJ population could occur if a project would physically divide the established community of an EJ population or if a project in proximity to an EJ population conflicts with applicable land use plans, policies, or regulations adopted for the purpose of avoiding or mitigating environmental impacts on a population. The primary purpose of planning is to protect the public health, safety, and welfare. Incompatible land uses may create health, safety, and welfare issues for the community.

Staff concludes the project would not divide an existing community as the project is proposed on a parcel of land that was previously developed for industrial use. The project would not introduce a new barrier or otherwise restrict public access within the community.

The project site is in the Light Industrial (ML) zoning district. The maximum permitted building height in the ML zoning district is 70 feet. The height of the proposed data center building would be 87.5 feet from the grade to the highest point of the parapet coping of the flat roof. The project would be eligible for a minor modification in ML zoning

requirements for height, and, with the city's approval of the minor modification, the project would conform to zoning. The project's floor area ratio (FAR) would exceed the maximum FAR for the zoning district. However, as is typical of data center projects, the project would have a low employment density relative to the size of its data center building. With its low employment density, the project would not cause the types of environmental impacts sometimes attributed to projects with high employment densities due to a commensurate increase in vehicle miles traveled. The project would not cause environmental impacts associated with the FAR exceedance, including no disproportionate impacts on an EJ population.

As discussed in section **4.11 Land Use and Planning**, the project would not conflict with land use plans or policies such that significant environmental impacts would occur. The overall impact would be less than significant, including potential disproportionate impacts on an EJ population.

### **Noise**

*Less Than Significant with Mitigation Incorporated.* EJ populations may experience disproportionate noise impacts if the siting of unmitigated industrial facilities occurs within or near EJ communities to a greater extent than within the community at large. The project site is within an area having an EJ population. The area surrounding the site is primarily industrial. The nearest sensitive receptors are residences approximately 200 feet south of the project site's property line, across from the Caltrain rail line.

Construction activities would increase existing noise levels at the adjacent industrial land uses and the nearby residences identified above, but they would be temporary and intermittent. Staff proposes mitigation measure **NOI-1**, requiring a complaint and redress process be implemented to ensure construction noise impacts would not be significant, as perceived by the community. With this, impacts would be reduced to less than significant. In addition, construction would occur during the daytime hours of 7:00 a.m. to 6:00 p.m. Monday through Friday, and between 9:00 a.m. to 6:00 p.m. on Saturday, in compliance with the city of Santa Clara City Code.

Therefore, potential noise effects related to construction would not result in a significant noise impact on the area's population, including the EJ population.

Sources of operational noise for the project would include the gensets, rooftop mechanical equipment, including HVAC and other equipment necessary for project operation. The City Code requires existing and new industrial development to reduce the effects of operational noise on adjacent properties through compliance with noise standards (Sections 9.10.040). Since the project is near a residential land use, noise reduction measures, such as mechanical equipment screening and enclosures, would be included (these measures have been incorporated in the operational noise modeling). Thus, the operation of the project would have a less than significant noise impact for all the of area's population, including the EJ population.



## Population and Housing

*Less Than Significant Impact.* Because the study area used in this analysis for impacts related to population influx and housing supply includes the cities of Santa Clara, Campbell, Mountain View, San Jose, and Sunnyvale, and the county of Santa Clara, staff considered the project's population and housing impacts on the EJ population living in these geographic areas.

The potential for population and housing impacts is predominantly driven by the temporary influx of non-local construction workers seeking lodging closer to the project site. There is a sufficient local construction workforce in the San Jose-Sunnyvale-Santa Clara Metropolitan Statistical Area (MSA) to accommodate the projected needs of the project, and, thus, workers would not likely seek temporary lodging closer to the project site. The local workforce in the MSA is sufficient to accommodate the permanent labor needs projected for the project, and, thus, operation workers would not likely seek housing closer to the project site. If some operations workers were to relocate closer to the project site, there would be sufficient housing in the project area.

A population and housing impact could disproportionately affect an EJ population if the project were to displace minority or low-income residents from where they live, causing them to find housing elsewhere. If this occurs, an EJ population may have a more difficult time finding replacement housing due to racial biases and possible financial constraints. As the project would not displace any residents or remove any housing, there would be no disproportionate impact to EJ populations from this project.

## Transportation

*Less Than Significant Impact.* Significant reductions in transportation options may significantly impact EJ populations. An impact to bus transit, pedestrian facilities, or bicycle facilities could cause disproportionate impacts to low-income communities, as low-income residents more often use these modes of transportation. However, as concluded in **Section 4.17 Transportation** all transportation impacts, including impacts to alternative transportation, would be less than significant, and, therefore, would cause less than significant impacts to EJ populations. Likewise, transportation impacts would not be disproportionate.

## Utilities and Service Systems

*Less Than Significant Impact.* Disproportionate impacts to an EJ population could occur if the project would contribute to or exacerbate the effects of cleanup sites, hazardous waste generators and facilities, and solid waste facilities.

Since the overall CalEnviroScreen score reflects the collective impacts of multiple pollutants and factors, staff examined the individual contributions to indicators as they relate to wastes addressed under utilities and service systems. The wastes of concern in this analysis are those from construction and operational activities. The handling and disposal of each type of waste depends on the hazardous ranking of its constituent

materials. Existing laws, ordinances, regulations, and standards ensure the desired handling and disposal of waste materials without potential public or environmental health impacts. The CalEnviroScreen scores for the disadvantaged community census tract in a six-mile radius of the project (see **Figure 4.21-1**) are presented in **Table 4.21-4** for each of the following environmental stressors that relate to waste management: cleanup sites, hazardous waste generators and facilities, and solid waste facilities. The percentile for each disadvantaged census tract reflects its relative ranking among all of California's census tracts. A disproportionate waste management impact on an EJ population could occur if project wastes impacted the disadvantaged community.

CalEnviroScreen assigns a score to each category of stressors. To assess the impact of a stressor on population within a census tract, the score is assigned a weighting factor that decreases with distance from the census tract. The weighting factor for stationary stressors more than 1,000 meters (0.6 mile) away from a census tract is zero. As **Figure 4.21-1** shows, there are no disadvantaged census tracts within 1,000 meters from the project. Therefore, no stressor under Utilities and Service Systems is close enough to create an additional burden to an EJ population and, therefore, the project impact on EJ communities would be less than significant.

### List of Preparers and Contributors

The following are a list of preparers and contributors to **Section 4.21 Environmental Justice**:

Ellen LeFevre	General Environmental Justice information, CalEnviroScreen information, Environmental Justice screening, public outreach, CalEnviroScreen project screening
Mark Hamblin	Aesthetics impact analysis
Wenjun Qian	Air Quality (public health) impact analysis
Melissa Mourkas, Gabriel Roark	Cultural and Tribal Cultural Resources impact analysis
Abdel-Karim Abulaban	Hazards and Hazardous Materials impact analysis
Abdel-Karim Abulaban	Hydrology and Water Quality impact analysis
Tatiana Inouye	Land Use and Planning impact analysis
Kenneth Salyphone	Noise impact analysis
Scott Debauche	Population and Housing impact analysis
Abdel-Karim Abulaban	Utilities and Service Systems impact analyses
Scott Debauche	Transportation impact analysis

### 4.21.3 Mitigation Measures

None.

### 4.21.4 References

- Alexis NE et al. 2010 – Alexis NE, Lay JC, Hazucha M, Harris B, Hernandez ML, Bromberg PA, et al. Low-level ozone exposure induces airways inflammation and modifies cell surface phenotypes in healthy humans. *Inhal Toxicol* 22(7):593-600. Available online at: <https://www.ncbi.nlm.nih.gov/pubmed/20384440>
- BAAQMD 2022 – Bay Area Air Quality Management District (BAAQMD). Community Health. Available online at: <https://www.baaqmd.gov/community-health>
- Burnett RT et al. 2001 – Burnett RT, Smith-Doiron M, Stieb D, Raizenne ME, Brook JR, et al. Association between Ozone and Hospitalization for Acute Respiratory Diseases in Children Less than 2 Years of Age. *American Journal of Epidemiology* 153(5):444-452. Available online at: <https://academic.oup.com/aje/article/153/5/444/149769>
- CalEPA 2017 – California Environmental Protection Agency (CalEPA). *Designation of Disadvantaged Communities Pursuant to Senate Bill 535 (De Leon)*, April 2017. Available online at: <https://calepa.ca.gov/wp-content/uploads/sites/6/2017/04/SB-535-Designation-Final.pdf>
- CalEPA 2021 – California Environmental Protection Agency (CalEPA). CalEnviroScreen 4.0 Microsoft Excel Spreadsheet data, last updated October 2021. Available online at: <https://oehha.ca.gov/calenviroscreen/report/calenviroscreen-40>
- CDE 2021 – California Department of Education (CDE). California Department of Education Educational Demographics Unit, Data Quest, Selected District Level Data - 4369674--Santa Clara Unified for the year 2020-21. Free or Reduced Price Meals. Available online at: <https://dq.cde.ca.gov/dataquest/cbeds2.asp?cYear=2020-21&FreeLunch=on&cChoice=CoProf2&TheCounty=43%2CSANTA%2525ECLARA&cLevel=County&cTopic=Profile&myTimeFrame=S&submit1=Submit>
- Fann N et al. 2012 – Fann N, Lamson AD, Anenberg SC, Wesson K, Risley D, Hubbell BJ, Estimating the National Public Health Burden Associated with Exposure to Ambient PM2.5 and Ozone. *Risk Analysis* 32(1):81- 95. Available online at: <https://www.ncbi.nlm.nih.gov/pubmed/21627672>
- Lin S et al. 2008 – Lin S, Liu X, Le, LH, Hwang, S, Chronic Exposure to Ambient Ozone and Asthma Hospital Admissions among Children. *Environ Health Perspect* 116(12):1725-1730. Available online at: <https://www.ncbi.nlm.nih.gov/pmc/articles/PMC2599770/>
- Medina-Ramón M, Schwartz J 2008 – Who is more vulnerable to die from ozone air pollution? *Epidemiology* 19(5):672-9. Available online at: <https://www.ncbi.nlm.nih.gov/pubmed/18480732>

- OEHHA 2014 – California Environmental Protection Agency's Office of Environmental Health Hazard and Assessment (OEHHA). CalEnviroScreen 2.0, October 2014. Available online at:  
<https://oehha.ca.gov/media/CES20FinalReportUpdateOct2014.pdf>
- OEHHA 2021 – California Environmental Protection Agency's Office of Environmental Health Hazard and Assessment (OEHHA). CalEnviroScreen 4.0, October 2021. Available online at:  
<https://oehha.ca.gov/media/downloads/calenviroscreen/report/calenviroscreen40reportf2021.pdf>
- U.S. Census 2020 – United States Census Bureau (U.S. Census). PL-Race, Hispanic or Latino, Age, and Housing Occupancy: 2020 – DEC Redistricting Data (Public Law 94-171) Summary File, Tables P1, P2, P3, P4, H1. Available online at:  
<https://www.census.gov/data.html>
- U.S. EPA 2015 – United States Environmental Protection Agency (U.S. EPA). Guidance on Considering Environmental Justice During the Development of Regulatory Actions, May 2015. Available online at:  
<https://www.epa.gov/environmentaljustice/guidance-considering-environmental-justice-during-development-action>
- Zanobetti A, Schwartz J 2011 – Ozone and survival in four cohorts with potentially predisposing diseases. *Am J Respir Crit Care Med* 184(7):836-41. Available online at: <https://www.ncbi.nlm.nih.gov/pubmed/21700916>

# **Section 5**

---

Alternatives

## 5 Alternatives

### 5.1 Introduction

This section evaluates a reasonable range of potentially feasible alternatives to the CA3 Data Center/Backup Generating Facility (CA3DC/CA3BGF). Both together are known as CA3 or the project. Alternatives considered but dismissed for full analysis due to reliability concerns include biodiesel fuel, fuel cells, and battery energy storage systems. Alternatives selected for more detailed analysis were limited to the “No Project/No Build Alternative,” as required by the California Environmental Quality Act (CEQA), and those that could feasibly attain most of the proposed project’s basic objectives while reducing or avoiding any of its significant effects. The alternatives selected for detailed analysis are:

- Alternative 1: No Project/No Build Alternative
- Alternative 2: Renewable Diesel Fuel
- Alternative 3: Natural Gas Internal Combustion Engines

### 5.2 CEQA Requirements

CEQA Guidelines (Cal. Code Regs., tit. 14, § 15000 et seq.) require that an EIR consider and discuss alternatives to the proposed project. Section 15126.6 of the CEQA Guidelines provides that the alternatives analysis must include all of the following:

- Describe a range of reasonable alternatives to the project, or to the location of the project, which would feasibly attain most of the basic objectives of the project;
- Evaluate the comparative merits of the alternatives;
- Focus on alternatives that would avoid or substantially lessen any significant effects of the project, even if these alternatives would impede to some degree attainment of the project objectives, or would be more costly; and
- Describe the rationale for selecting alternatives to be discussed and identify alternatives that were initially considered but then rejected from further evaluation.

CEQA requires that an EIR “consider a reasonable range of potentially feasible alternatives that will foster informed decision making and public participation” (Cal. Code Regs., tit. 14, § 15126.6, subd. (a)). Alternatives may be eliminated from detailed consideration by the lead agency if they fail to meet most of the basic project objectives, are infeasible, or could not avoid any significant environmental effects (Cal. Code Regs., tit. 14, § 15126.6, subd. (c)). In addressing the feasibility of alternatives, factors that may be taken into account are: site suitability; economic viability; availability of infrastructure; general plan consistency; other plans or regulatory limitations; jurisdictional boundaries; and whether the proponent can reasonably acquire, control, or otherwise have access to the alternative site (Cal. Code Regs., tit. 14, § 15126.6, subd. (f)(1)).

The range of potentially feasible alternatives selected for analysis is governed by a “rule of reason,” requiring the evaluation of only those alternatives “necessary to permit a reasoned choice” (Cal. Code Regs., tit. 14, § 15126.6, subd. (f)). Also, an EIR “need not consider an alternative whose effect cannot be reasonably ascertained and whose implementation is remote and speculative” (Cal. Code Regs., tit. 14, § 15126.6, subd. (f)(3)).

The lead agency is also required to evaluate the impacts of the “No Project” alternative. Analyzing a “No Project” alternative allows decision makers to compare the impacts of approving the proposed project with the impacts of not approving the proposed project (Cal. Code Regs., tit. 14, § 15126.6, subd. (e)(1)). “The ‘no project’ analysis shall discuss the existing conditions at the time the notice of preparation is published...as well as what would be reasonably expected to occur in the foreseeable future if the project were not approved, based on current plans and consistent with available infrastructure and community services. If the environmentally superior alternative is the ‘no project’ alternative, the EIR shall also identify an environmentally superior alternative among the other alternatives” (Cal. Code Regs., tit. 14, § 15126.6, subd. (e)(2)).

### 5.3 Project Objectives and Alternatives Screening

The ideal process to select alternatives to include in the analysis begins with the establishment of project objectives. Section 15124 of the CEQA Guidelines addresses the requirement for an EIR to contain a statement of objectives, as follows:

*A clearly written statement of objectives will help the lead agency develop a reasonable range of alternatives to evaluate in the EIR and will aid the decision makers in preparing findings or a statement of overriding considerations, if necessary. The statement of objectives should include the underlying purpose of the project and may discuss the project benefits.*

The applicant’s overall project goal is to develop a state-of-the-art data center providing greater than 99.999 percent reliability for its customers, with mission-critical space to support their servers, including space conditioning and a steady stream of high-quality power supply. The applicant’s project objectives are as follows:

- Develop a state-of-the-art data center large enough to meet projected growth;
- Develop the data center on land that has been zoned for data center use at a location acceptable to the City of Santa Clara;
- Develop a data center that can be constructed in two phases, which can be timed to match projected customer growth; and
- Incorporate the most reliable and flexible form of backup electric generating technology considering the following evaluation criteria:
  - Commercial Availability and Feasibility. The selected backup electric generation technology must currently be in use and proven as an accepted industry standard for technology sufficient to receive commercial guarantees in a form and amount

acceptable to financing entities. It must be operational within a reasonable timeframe where permits and approvals are required.

- Technical Feasibility. The selected backup electric generation technology must utilize systems that are compatible with one another.
- Reliability. The selected backup electric generation technology must be extremely reliable in the case of an emergency loss of electricity from the utility.
  - The CA3BGF must provide a higher reliability than 99.999 percent in order for the CA3DC to achieve an overall reliability of equal to or greater than 99.999 percent reliability.
  - The CA3BGF must provide reliability to the greatest extent feasible during natural disasters, including earthquakes.
  - The selected back-up electric generation technology must have a proven built-in resilience so if any of the back-up unit fails due to external or internal failure, the system will have redundancy to continue to operate without interruption.
  - The CA3DC must have on-site means to sustain power for 24 hours minimum in failure mode, inclusive of utility outage.

## 5.4 Reliability and Risk Factors

The most important data center criterion is reliability. Crucial services, such as 911, offices of emergency management, and utilities infrastructure, are increasingly using data centers for their operation. The selected backup electric generation technology must be extremely reliable in the case of an emergency loss of electricity from the utility. Data center customers demand the most reliable data storage service available, and data center insurers are willing to underwrite only proven technologies with an extremely low probability of operational failure. Any alternative backup generation technology would be measured against proven available technologies, such as the current technology proposed. Should the reliability of that technology not match that of the proposed technology, it would not be considered a viable alternative.

Risk factors that affect the reliable operation of backup generators include the following: failure to start; failure to run due to various technical issues; and failure to run due to a lack of fuel supply (NREL 2021). Any alternative technology must have proven operational hours, a reliable source of fuel supply, and redundancy capabilities. Sufficiently mitigating these risks would ensure that data center operation is not interrupted during a utility power failure.

## 5.5 Environmental Impacts of the Proposed Project

This EIR evaluates the potential environmental impacts of the proposed project. Project impacts would be less than significant with the following proposed mitigation measures:

- **Air Quality** – Proposed mitigation measure **AQ-1** would reduce air quality impacts during project construction. This measure requires the incorporation of the local air



district's best management practices to control fugitive dust. This measure also incorporates exhaust control measures to reduce emissions from construction equipment. During readiness testing and maintenance, the oxides of nitrogen (NOx [as an ozone precursor]) emissions of the standby generators would be fully offset through the permitting process with the Bay Area Air Quality Management District (BAAQMD). With the implementation of **AQ-1** during construction and NOx offsets for readiness testing and maintenance through the local air district's permitting requirements, the project would not cause a cumulatively considerable net increase of any criteria air pollutant and impacts would be reduced to less than significant with mitigation incorporated.

- **Biological Resources** – Proposed mitigation measure **BIO-1** would ensure that potential construction impacts to protected bird and raptor species would be less than significant. **BIO-1** includes requirements to conduct tree removal outside the nesting period if possible, to conduct nesting bird surveys prior to the initiation of any construction activities during the nesting period, and to establish buffers to avoid the disturbance of nesting birds if active nests are detected.

Proposed mitigation measure **BIO-2** would reduce construction impacts to protected bat species, if present at the site, to less than significant. **BIO-2** includes requirements to conduct bat clearance surveys prior to the demolition of buildings or removal of trees. It also requires the development of a Bat Mitigation and Monitoring Plan detailing exclusion methods, roost removal procedures, and compensatory mitigation methods for the permanent impacts of roost removal.

The implementation of mitigation measures **BIO-3** and **BIO-4** would reduce construction impacts on trees covered by city of Santa Clara General Plan policies 5.10.1-P4 and 5.3.1-P10 to less than significant. **BIO-3** requires the applicant to obtain the appropriate tree removal permits from the city of Santa Clara for the removal of all healthy mature trees and mitigate for tree removal as required by the city. **BIO-4** requires the applicant to implement tree protection measures for the trees that are to remain in place as required by the city of Santa Clara through its tree removal permits and Architectural Review.

- **Cultural and Tribal Cultural Resources** – Proposed mitigation measure **CUL-1** requires qualified professionals to survey the exposed ground surface for cultural resources once the demolition of existing structures is complete. It also requires test excavation to determine the presence or absence of buried cultural resources and procedures for avoidance measures and construction monitoring. This measure would reduce impacts to any discovered historical resources and unique archaeological resources to a less than significant level. In addition to mitigation measure **CUL-1**, mitigation measure **CUL-2** requires specific protocols to minimize or avoid impacts on inadvertently discovered human remains. Combined, mitigation measures **CUL-1** and **CUL-2** would reduce potential impacts to human remains to a less than significant level.

Although there are no known tribal cultural resources on or directly adjacent to the proposed site, ground disturbance associated with the proposed project could result in the exposure and/or destruction of buried, as-yet-unknown prehistoric archaeological resources that could qualify as tribal cultural resources. If these resources were to be exposed or destroyed, it would be a significant impact. The implementation of **CUL-1** and **CUL-2** would reduce potential impacts to buried, tribal cultural resources to a less-than-significant level.

- **Geology and Soils** – With the implementation of mitigation measure **GEO-1**, potential impacts to paleontological resources from trenching would be reduced to a less-than significant level. **GEO-1** includes protocols for worker training to identify potential fossil finds, notification of a qualified paleontologist to assess any finds, and if the resource is considered to be significant, development by the paleontologist of a plan for preservation and mitigation.
- **Greenhouse Gas Emissions** – This project would have a less than significant impact on greenhouse gas (GHG) emissions with the implementation of mitigation measures **GHG-1**, **GHG-2**, and **GHG-3**. **GHG-1** would require the applicant to limit the GHG emissions of the standby generators to the BAAQMD CEQA GHG threshold applicable at the time of permitting. **GHG-2** would require the applicant to use an increasing mix of renewable diesel and phase out the use of petroleum-based conventional diesel (conventional diesel). **GHG-3** would require the applicant to participate in Silicon Valley Power's (SVP) Large Customer Renewable Energy (LCRE) Program for 100 percent carbon-free electricity or purchase carbon offsets or similar instruments that accomplish the same goals of 100 percent carbon-free electricity. The implementation of **GHG-1**, **GHG-2**, and **GHG-3** would ensure the project complies with the BAAQMD CEQA GHG threshold, the city of Santa Clara Climate Action Plan, and other applicable regulatory programs and policies. Accordingly, staff concludes that with the implementation of **GHG-1**, **GHG-2**, and **GHG-3**, the project's GHG emissions would not have a significant direct or indirect impact on the environment. With the implementation of **GHG-1**, **GHG-2**, and **GHG-3**, impacts related to GHG emissions would be less than significant.
- **Hazards and Hazardous Materials** – With the implementation of **HAZ-1**, construction of the project would result in less than significant impacts to the public and the environment from hazards and hazardous materials. **HAZ-1** would require the preparation of a Site Management Plan (SMP), which would establish procedures for handling any contaminated groundwater or soil found during construction to minimize health risks. Records would be maintained for documenting compliance with the storage and handling of hazardous materials, and personnel would be required to follow health and safety procedures in the event of a release of hazardous materials.  
  
With the implementation of **HAZ-1**, construction of the project would create a less than significant impact to the public or the environment.
- **Noise** – The loudest construction activities could elevate the existing ambient noise levels at the nearest residences by up to 11 dBA and could be perceived as noisy, although they would be less noisy than passing trains. The implementation of **NOI-**

1, requiring a noise complaint and redress process, would ensure construction noise impacts as perceived by the community would be less than significant.

- **Transportation** – The operation of the project would generate vehicle miles travelled (VMT) that would exceed the city's thresholds. **TRANS-1** would require the implementation of a Transportation Demand Management (TDM) program requiring a 4-40 workweek (40 hours in 4 days) to reduce the project VMT to a level below the city's threshold. This would ensure that VMT generated by the project would be less than significant.

## 5.6 Alternatives Considered

Staff concluded that there would be no significant impacts from the project with the incorporation of mitigation. Nevertheless, staff considered several alternatives to the project for a more comprehensive analysis. The following discussion provides staff's analysis of these alternatives.

### 5.6.1 Alternatives Considered and Not Evaluated Further

This subsection discusses alternatives initially considered but ultimately not evaluated further due to infeasibility, failure to reduce any impacts, and/or failure to meet the project objectives. As a result, these alternatives were not evaluated from an environmental impact perspective or compared with the proposed CA3GBF project. The alternatives considered but not evaluated further include an alternative project site and biodiesel fuel, fuel cell, and battery energy storage alternatives.

#### 5.6.1.1 Alternative Project Site

Although the impacts of the proposed project would be less than significant with mitigation, staff evaluated whether an alternative site location should be identified as a potentially feasible alternative to avoid or reduce potentially significant impacts. However, the project's impacts are the type that would not be avoided or lessened by proposing the project at another location, as some of the impacts are an inherent part of the project (e.g., air quality, GHG, construction noise) or would be similar at another location in the Santa Clara region (e.g., cultural and tribal resources, geology and soils [including paleontology]). Also, the applicant has already acquired the project site, zoned for the proposed use and located in close proximity to existing operational data centers, and acquiring an alternative site might be costly and infeasible if a suitable site (with needed infrastructure and consistent zoning) is not available for sale or lease within a reasonable timeframe, resulting in the project not meeting its project objectives. Finally, no alternative locations where environmental impacts would likely be avoided or substantially reduced compared to the project have been identified by the city of Santa Clara, public agencies, or members of the public.

For these reasons, further consideration of an alternative project site is not necessary. Staff concludes that further exploration of properties beyond the project site is unlikely

to yield a different location for the project that could feasibly be developed as an alternative to the project that would reduce or avoid potentially significant impacts.

### **5.6.1.2 Biodiesel Fuel Alternative**

Biodiesel is a domestically produced renewable fuel. Like renewable diesel, biodiesel can be manufactured from a variety of biomasses, such as vegetable oils, animal fats, and grease. However, biodiesel is not the same as renewable diesel. Biodiesel has different fuel properties than renewable diesel and must meet the definition of American Society for Testing and Materials (ASTM) D6751. Also, it is produced through transesterification, which is a chemical process that converts fats and oils into fatty acid methyl esters (U.S. EIA 2021). Biodiesel is generally blended with conventional diesel at a 5 percent to 20 percent ratio (Green Fleet 2021). Its physical properties are similar to those of conventional diesel, proposed for use by the applicant, but it is a cleaner burning fuel than conventional diesel. Biodiesel is compatible as an alternative fuel for diesel-fired emergency backup generators (gensets).

#### ***Potential Feasibility Issues***

Biodiesel fuel currently suffers from technical problems, making it an unsuitable substitution for 100 percent petroleum-based, ultra-low sulfur diesel. Biodiesel fuel can be problematic for the genset's fuel system. It is harmful to rubber material, such as the hoses that transfer fuel, and the associated O-rings and seals that prevent fuel leaks. Additionally, this fuel suffers from stability issues when stored for long periods of time. Compared to conventional diesel, biodiesel is more hygroscopic (i.e., it attracts water) (Farm Energy 2021). Water can accumulate during transportation and storage. Moisture, if allowed to accumulate for a long time, will alter the fuel's chemical structure. Moreover, in cold weather conditions, the fuel thickens sooner than conventional diesel. Both conditions affect the function of the fuel filter, pump, and injectors in the fuel system of an engine. These issues would also increase the maintenance cycles and cost and can be a cause to void engine warranties. Additionally, biodiesel is expensive.

To date, the operating hours for biodiesel fuel use in data centers are minimal.

Finally, the production of biodiesel from plant material could have environmental impacts of its own; it is a water-intensive operation, as 2,500 liters of water would be needed to produce 1.0 liter of biodiesel fuel (UNESCO 2021).

Due to technical feasibility issues and potential additional environmental impacts, biodiesel fuel as an alternative was eliminated from further analysis.

### **5.6.1.3 Fuel Cell Alternatives**

Fuel cells convert chemical energy into electrical energy. There are several types of fuel cells, which vary according to the types of electrochemical reactions that take place in the cells, the types of catalysts required, the operating temperature range, the fuel requirements, and other factors affecting the applications suitable for the fuel cells.

The most promising types of fuel cells for powering data centers are solid oxide fuel cells (SOFCs) and polymer electrolyte membrane or proton exchange membrane (PEM) fuel cells (Microsoft 2021).

### **Solid Oxide Fuel Cells Alternative**

SOFCs are electrochemical devices that convert the chemical energy of a fuel and oxidant directly into electrical energy. They operate at high temperatures, as high as 2,100 degrees Fahrenheit. Operating at high temperatures enables the SOFCs to use a variety of fuels to produce hydrogen but also carbon oxides. SOFCs can use natural gas, biogas and gases made from coal as fuel (U.S. DOE 2020a), but more commonly use natural gas. SOFCs are resilient and not susceptible to carbon monoxide (CO) poisoning. CO is a product of the chemical reaction created by the fuel and steam molecules. CO poisoning affects the voltage output of other types of fuel cells, such as PEM fuel cells. Due to their resiliency against CO poisoning and because they operate at extremely high temperatures, SOFCs can reform fuel internally. This reduces the cost associated with adding a reformer to the system.

### ***Potential Feasibility Issues***

SOFCs are typically configured and more suitable to serve as a prime base load power. To date, eBay's data center in Utah is using 30 200-kilowatt (kW) SOFCs to provide continuous base load power to the IT load, 6 megawatts (MW), 24 hours/day, all year round, with the electric grid as their backup power supply. Additionally, some data centers (i.e., Apple and Equinix) have supplemented their base load power demand (IT and cooling systems) with SOFCs but rely on the electric grid to support other loads, while retaining traditional uninterruptible power supply (UPS) and generators for emergency power (Data Center 2021). However, SOFCs providing power for 100 percent base load demand (i.e., IT and cooling systems) are not yet industry standard for large-scale data centers.

Because it takes time to reach critical operating temperatures, SOFCs have slow startup times requiring up to 60 minutes (GenCell 2021). Data centers must have a constant electricity supply, with even a momentary outage risking the loss of data; they, thus, require fast startup for their backup power generators. SOFCs also have a slow response to electricity demand (GenCell 2021). This can pose a problem for data centers, as their IT and cooling load demands constantly fluctuate, in addition to changes in environmental conditions (ambient air temperature and humidity). The internal temperature of the data center buildings must remain steady for the IT servers' optimal performance. The rapid changes in electricity demand could outpace the SOFCs' ability to provide the needed services offered by the data center.

The durability of the fuel cells is also an important factor that cannot be ignored. The high operating temperatures place stringent durability requirements on fuel cell materials. Outfitting SOFCs with durable materials is costly.

SOFCs would utilize the underground natural gas pipeline system. At least one pipeline connection would be needed to supply the project with natural gas. A second, independent pipeline connection may be needed for redundancy. The project site could interconnect with two independent gas distribution lines.

A crucial hurdle facing potential big users of SOFCs, such as data centers, is the lack of a sufficient supply of components. According to the Clean Energy Institute there is currently a limited production of SOFC components to meet the needs of major users (ZDNet 2021).

### **PEM Fuel Cells Alternative**

A suitable fuel cell technology for backup energy generation is PEM fuel cell technology (U.S. DOE 2020a). PEM fuel cells are available for low-power applications that require intermittent backup power. They are typically used in small applications, such as mobile services or small stationary applications, such as backup generators for communication towers. Their power capacity ranges between 10 and 125 kW. However, the technology has expanded to data center applications with fuel cell capacity up to 1.0 MW delivered in the size of a 40-foot International Organization for Standardization (ISO) container (GenSureHP 2021). For a 100-MW system, the footprint required would be 32,000 square feet, or approximately 0.73 acre. PEM fuel cells operate at low temperatures and require fuels that are carbon-free and rich in hydrogen content, preferably pure hydrogen, for maximum voltage output and quick start-up times that a data center generator requires in a backup capacity. Hydrogen can either be piped in or made on-site from a methane source, such as natural gas, or from water through electrolysis. These options are discussed in more detail below. Unlike SOFCs, CO poisoning is an important issue for PEM fuel cells because they cannot tolerate great amounts of CO (Fuel Cell 2021).

### ***Potential Feasibility Issues***

On-site fuel storage, the current pipeline infrastructure, and on-site generation of hydrogen would challenge the project's ability to provide fuel to the fuel cell.

**On-site Fuel Storage.** The simplest way to store large volumes of hydrogen would be to compress it. Hydrogen can be compressed to 240 times the gas volumes at atmospheric pressure. The gauge pressure of hydrogen stored as a high-pressure gas is 3600 pounds per square inch (psig) (Hydrogen Properties 2021). Assuming a PEM fuel cell consumes 0.8 normal cubic meter (Nm<sup>3</sup>) of fuel per kilowatt-hour produced (Air Liquide 2021), the fuel consumption rate for a 1.0-MW fuel cell would be 800 normal cubic meters per hour. The proposed project would need fuel for up to 24 hours of fuel cell operation (the same as the backup duration for diesel). Therefore, the project site would need approximately 3,000 cubic feet of compressed hydrogen<sup>1</sup>, at 3600 psig, stored on-site per 1.0-MW fuel cell. Furthermore, the site would need approximately 300,000 cubic feet, or over 7 acre-feet of compressed hydrogen, for 100 MW of fuel cells

---

<sup>1</sup> Compressed hydrogen conversion: 800 cubic meter per hour x 24 hours x 1/240 compression ratio x 35.32 cubic feet per cubic meter = 2,826 cubic feet

(not including redundant fuel cells). The project would require a storage system that includes at least several pressure vessels to store such a large amount of compressed hydrogen. The storage space required for compressed hydrogen would not be feasible on the project site.

Alternatively, hydrogen could be stored in liquid form to reduce the storage footprint. Hydrogen can be liquified to 848 times less volume than gas at atmospheric conditions (Hydrogen Properties 2021). Liquefying hydrogen would reduce the volume and storage space. The project would need approximately 80,000 cubic feet, or 2 acre-feet, of liquid hydrogen gas (LHG) for 100 MW of fuel cells. Liquid hydrogen gas requires hydrogen to be cooled below its critical point of minus 400 degrees Fahrenheit. LHG would need to be stored and distributed in specialized equipment, including insulated storage tanks to keep the fuel in liquid state at atmospheric pressure, at a temperature of minus 423 degrees Fahrenheit. LHG would result in a smaller footprint than compressed hydrogen. However, problems exist with storing the liquid, such as boil-off losses due to heat leakage. For LHG to remain at a constant temperature and pressure, it must allow for natural evaporation known as boil-off gas (BOG). BOG is a loss of stored fuel that occurs when the ambient temperature heats the insulated tanks. LHG must release this gas to maintain its liquid state, and the release in gas occurs at a rate of approximately 1 percent per day (Hydrogen 2021a).

Safely managing compressed or liquefied hydrogen storage systems would require special expertise and equipment, which would add to the cost and complexity of the proposed project. The presence of such storage systems would also likely raise concerns of public safety and introduce new impacts not found in the proposed project.

Fuel storage equipment must comply with the standards specified by the National Fire Protection Association along with the Santa Clara City Code (City Code) to protect against hazardous material release, fire, and explosions during natural disasters and as the result of accidents. Additionally, permits for the storage of hazardous materials would be needed pursuant to the City Code.

**Pipeline Infrastructure.** For large applications, such as the proposed project, hydrogen would need to be supplied through multiple pipelines to mitigate on-site storage challenges and increase reliability. However, according to the U.S. Department of Energy (U.S. DOE 2020b), with approximately 1,600 miles of hydrogen pipeline currently operating in the United States, there are technical concerns related to pipeline transmission, including: the potential for hydrogen to embrittle the steel and welds used to fabricate the pipelines; the need to control hydrogen permeating and leaks; and the need for lower cost, more reliable, and more durable hydrogen compression technology.

**On-site Generation (Reforming and Electrolysis).** Alternatively, hydrogen for PEM fuel cells can be supplied using other methods, such as reforming and electrolysis.

## Reforming

Reforming is a process that uses existing fuels with hydrogen content to react with water, which produces hydrogen and carbon oxides as products.

Steam-methane reforming (SMR) is a type of reforming. It is a thermal process, combining steam with a methane source, such as natural gas, to produce hydrogen and carbon oxides. The project currently has access to two natural gas pipelines that could be used for SMR. Although SMR is typically used in SOFCs because of the resiliency of the SOFCs' interior components to high levels of CO, it is not suitable for PEM fuel cells. The CO can poison the PEM fuel cells' platinum on the electrode, which leads to lower voltage at a given electrical current density (Fuel Cell 2021). SMR could produce the desired hydrogen content for PEM fuel cells should further processing to remove undesired levels of CO be performed, or by using a larger PEM fuel cell where the same amount of CO would be spread over a larger electrode.

Methanol reforming, however, is the leading reforming technology candidate for PEM fuel cells because of its high efficiency and energy density (Fuel Cell 2021). Methanol is a liquid, like conventional diesel, and can be stored on-site. Methanol is reformed with water to produce hydrogen and carbon oxides.

Both SMR and methanol reforming consume energy during hydrogen production and produce carbon dioxide (CO<sub>2</sub>) that may be released into the atmosphere. Also, additional equipment for both types of reforming would increase project costs.

## Electrolysis

Electrolysis can also be used to produce the hydrogen needed for PEM fuel cells. It is a promising option for carbon-free hydrogen production, using electricity to cause the chemical reaction of splitting water into hydrogen and oxygen. The reaction takes place in a unit called an electrolyzer. Like fuel cells, electrolyzers consist of an anode and a cathode separated by an electrolyte. There are different types of electrolyzers mainly due to the different electrolyte materials, such as PEM, alkaline, and solid oxide, but their function is essentially the same—generating hydrogen (Hydrogen 2021b).

A 1.0-MW PEM electrolyzer, the size of a 40-foot ISO container<sup>2</sup>, can generate 18 kilograms (kg), or 200 Nm<sup>3</sup>, of hydrogen per hour. For every kg of hydrogen produced, 10 kg of water is needed. Additionally, the electrolyzer would need 49.9 kWh of energy to produce 1 kg of hydrogen (GenFuel 2021). For a 100-MW system, the footprint required would be 32,000 square feet, or approximately 0.73 acre.

During a grid outage, energy for the electrolyzer to generate hydrogen fuel may not be available, rendering the fuel cell inoperable and the data center without power. Therefore, hydrogen may need to be produced and stored on-site for future use during emergency

---

<sup>2</sup> An ISO container is a container which has been built in accordance with the International Organization for Standardization regulations.



generation. Again, fuel storage equipment must comply with standards specified by the National Fire Protection Association along with the City Code to protect against hazardous material release, fire, and explosions during natural disasters and as the result of accidents. Additionally, permits for the storage of hazardous materials would be needed pursuant to the City Code. Additional equipment required for hydrogen electrolyzers would increase project costs.

In conclusion, advances in fuel cell technology have led to increases in PEM fuel cell capacity and applications. However, the technology has not shown proven operating hours for large-scale backup energy solutions used in data centers. Furthermore, fuel cells would require a more robust hydrogen fuel supply infrastructure to meet the reliability requirements of large-scale data centers. At this time further testing is needed to verify the compatibility and reliability of these fuel cells. To ensure system compatibility, more test sites or small hybrid power systems should be considered in data centers.

**SOFC and PEM Fuel Cells Feasibility Conclusion.** In summary, fuel cells for large-scale backup generation are not fully proven; thus, their reliability is undetermined. Data center customers demand the most reliable data storage service available, as reflected in the applicant's project objectives, which include the development of a highly reliable data center. Furthermore, data center insurers are not willing to provide insurance coverage unless data centers use proven technologies with an extremely low probability of operational failure. Securing fuel for the cells and storing it is a challenge requiring specialized expertise and increased costs for installing and maintaining systems that are expected to be used only infrequently. Because of the limitations described above, fuel cell technology is not currently a viable alternative to the proposed project's use of diesel-powered backup generators.

#### 5.6.1.4 Battery Energy Storage Alternatives

##### Standalone Battery Energy Storage Alternative

Batteries store chemical energy and convert it to electrical energy. They are used to supply power for many applications. Batteries come in many different shapes and sizes, and different battery types can have different chemical properties. Lithium-ion batteries in huge battery banks provide standby or emergency power and almost instantaneous startup times and are therefore considered suitable for data centers.

Data centers currently use UPS systems consisting of batteries to ensure a smooth transition from the grid to the gensets while the gensets synchronize to the data centers' electrical busbars<sup>3</sup>. The UPS system proposed for the project is designed to provide up to five minutes of backup power at 100 percent load. UPS systems are proven and reliable to support genset start up, but they are currently limited in power supply duration.

---

<sup>3</sup> In electric power distribution, a busbar is a metallic strip or bar used to connect high voltage equipment at electrical switchyards, and low voltage equipment in battery banks.

A Battery Energy Storage System (BESS) would provide higher capacity and support longer outages for data center projects. A BESS can be designed to provide up to approximately 100 MWs of backup power and provides the quick start times that a data center requires.

A standalone BESS for a data center's load demands would require ample on-site storage space for long outage durations. To date, a 300-MW/1200 megawatt-hours (MWh) (supplying 300 MW continuously for 4 hours) BESS is the largest one successfully deployed (Power Magazine 2021). Until recently, the operational duration of battery systems has been in the range of four to six hours, not necessarily because battery systems do not have the potential to operate longer, but because a longer duration has not been demonstrated in large-scale data center applications requiring long-duration backup power. Staff is aware of a recent proposal, the Gilroy Backup Generating Facility (GBGF 2021), for two BESS facilities, each with a capacity of 50 MW and discharge capacity of 640 MWh for a total capacity of approximately 100 MW and a discharge duration of approximately 13 hours. The design of this proposal includes diesel-fired gensets to support the data center when the batteries are fully discharged and further backup generation is needed, prior to the electrical grid being restored.

### ***Potential Feasibility Issues***

The employment of a standalone BESS for the project would be the first application of this technology for a project of this magnitude for long durations. The project proposes storing fuel on-site for approximately 24 hours of backup generation. A 6-MWh battery storage container requires approximately 380 square feet of space. To supply approximately 100 MW of uninterruptable power in case of 24 hours of grid outage, the project would need a 2,400-MWh battery system, assuming a 100-percent charging and discharging scenario. This translates to approximately 3.5 acres of battery storage space alone, not including the data center buildings and miscellaneous equipment and structures. The storage space could double or triple for the project to meet its reliability and backup generation duration requirements. This footprint could be reduced by stacking the batteries on top of each other; however, the stacked height would be limited. The stacked containers would need to be constructed such that they could be readily accessible for maintenance and potential fire response, while mitigating seismic concerns. Alternatively, the batteries could be stored in buildings to reduce their footprint, but they would then be subject to stricter building code fire protection requirements. Reducing the footprint would increase the project cost.

Whether the batteries are single-stacked, double-stacked in containers, or stored in a building, the risk of fires, typically caused by thermal runaway, is apparent and currently trending in large-scale applications. Thermal runaway begins when the heat generated within a battery exceeds the amount of heat dissipated to its surroundings. If the cause of the excessive heat generated is not remedied (through heat transfer), the condition will worsen. The internal battery temperature will continue to rise, causing the battery current to rise, thereby creating a domino effect. The rise in temperature in a single

battery will begin to affect other batteries in its proximity, and the pattern will continue, thus the term “runaway” (Mitsubishi 2021).

There are extensive mitigations, codes and standards, and a comprehensive regulatory framework in place that apply to battery storage to ensure the risk is less than significant. However, even a less than significant risk, such as thermal runaway, could affect the overall reliability of the data center and the assurance that data would not be lost. Loss of data would be very significant for an operation whose topmost goal is protecting the data against loss and guaranteeing continuous and uninterrupted access to the data. Furthermore, if a single cell or cluster of the battery system fails, the entire project may be shut down for investigation. Once discharged, the batteries would require power to recharge; further design considerations would be needed to make this happen. Batteries have a lifetime of about 10 years. If the project’s lifespan is 20 years, the batteries would have to be replaced at least once, adding to the project cost. If the project were expected to continue beyond 20 years, which is conceivable, additional replacements may be necessary.

### **Tandem Battery Storage Alternative**

Staff considered a battery energy storage system in tandem (tandem BESS) with the proposed project’s diesel-fired gensets. A tandem solution proposal would not be the first of its kind for a data center application, as previously mentioned. Such an option would allow the batteries to act as primary backup power for short outage durations, while the project’s 44 diesel-fired gensets would provide backup power when outages are longer in duration and the batteries have been discharged.

For this project, the hypothetical tandem solution would include an approximately 100-MW-capacity BESS with a discharge capacity of 1370 MWh (approximately 100 MW with a discharge duration of approximately 13 hours) along with the 44 gensets. The battery system would supply backup power for a duration of approximately 13 hours and the 44 gensets would serve to back up the battery system once the batteries have been discharged until the electrical grid is restored. However, having a tandem solution would not reduce the number of gensets required for the project; again, the gensets would need to be sufficient to support data center load demands for longer outages if necessary. The battery system would require approximately 6,300 square feet of storage space.

### ***Potential Feasibility Issues***

The project site does not provide sufficient room for the proposed project and 6,300 square feet of battery storage for a tandem BESS. There is insufficient room around the building for an access road and battery storage.

Also, project cost would increase significantly with a 1370 MWh BESS configuration. Between 2015 and 2018, the average cost of utility-scale battery storage in the United States rapidly decreased from \$2,152 to \$625 per kWh. However, in 2019, the average cost of battery storage in California was \$1,522 per kWh (EIA 2021). In addition, the required reliability would still need to be ensured. The electrical and electronic interface

between the batteries and gensets would need to be tested to ensure operational reliability of at least 99.999 percent (DayZenLLC 2021a, Section 1.1).

As previously mentioned, once the batteries are discharged to the designed threshold, they would have to be recharged when grid service is restored. Since the proposed gensets would not be connected to the grid, to be able to recharge the batteries from the grid would require a redesign of the project's electrical connections. Alternatively, the batteries could be recharged using separate gensets designated for battery charging. This method is not preferable since it would require additional gensets on-site and fuel use, which would defeat the purpose of deploying batteries to reduce gensets and fuel consumption.

While there is currently a proposal for a tandem battery and diesel-fired gensets for a large-scale data center, each project is subject to different reliability requirements. What can work for one project may not work for another.

Additionally, although the 2022 update to the California energy code California Code of Regulations, (title 24, part 6, Building Energy Efficiency Standards, Nonresidential Photovoltaic and Battery Storage) requires battery storage systems when PV systems are required, this does not apply to data centers. The use of battery systems set forth in the California energy code update through its goals and primary functions is much different than that of large-scale data centers. Appendix JA12 of the updated code states that the primary function of the battery storage system is daily cycling for the purpose of load shifting, maximized solar self-utilization, and grid harmonization. The measure predicts that 100 MW of batteries will be installed in new nonresidential buildings in 2023 (Energy Code Update 2021, Section 3.2.2). Given this prediction, it is assumed that many small capacity batteries would be installed across many buildings with PV generation to reduce peak demand for a few hours.

The goal and primary function of battery systems for large-scale data centers with large capacity demand (99 MW) is not daily cycling, but to provide backup power during a grid electrical outage that may last many hours. The daily cycling of battery systems reduces the overall lifespan of the battery system, increases wear and tear, and may reduce battery system reliability. Also, the reliability requirements of small capacity batteries used for peak demand relief for limited duration is different than large capacity batteries used as a backup power solution in large-scale data centers. Should a battery system of a building used for peak demand relief fail for any reason, the grid would still provide power to support the building's load. In contrast, if a single cell in a backup battery system fails, the whole system would be rendered inoperable and the battery system would need to be taken offline and inspected. Again, for a data center, such as the proposed project, the only backup energy in the event of a grid outage would be from its backup power source. The reliability of the project's backup power source is of utmost importance to ensure customers' data is not lost.

### **5.6.1.5 Decision to Eliminate These Alternatives from Further Consideration**

The applicant's overall goal is to develop a state-of-the-art data center providing greater than 99.999 percent reliability for its customers, with mission-critical space to support their servers. One of the project objectives is to incorporate the most reliable and flexible form of backup electric generating technology considering commercial availability and feasibility, technical feasibility, and reliability. Biodiesel fuel, fuel cells, and battery storage alternatives were eliminated from further consideration as alternative technologies to the proposed project based on their infeasibility and/or lack of a sufficient level of proven reliability. Data center customers need the most reliable data storage service available, and data center insurers are willing to provide coverage only for proven technologies with an extremely low probability of operational failure.

## **5.7 Alternatives Selected for Analysis**

The following alternatives are evaluated in this EIR:

- Alternative 1: No Project/No Build Alternative
- Alternative 2: Renewable Diesel Fuel
- Alternative 3: Natural Gas Internal Combustion Engines

Other than the No Project/No Build Alternative, which is required for analysis for every project, project alternatives were developed that could feasibly avoid or reduce the proposed project's potentially significant impacts. A comparative analysis of the impacts of these alternatives is below, followed by an assessment of the extent to which each alternative could meet the basic project objectives and an assessment of each alternative's feasibility.

The comparative analysis that follows is centered on impacts to air quality, public health, and GHG emissions. **Table 5-1**, below, compares the proposed project's impacts in each of these topic areas to those of each alternative. Impacts in other topic areas are not discussed, as staff found essentially no differences in other topic areas between the impacts identified under the proposed project and the impacts associated with the alternatives evaluated below.

As discussed in more detail below, the first alternative (No Project/No Build) would not meet the project objectives. The second and third alternatives (Renewable Diesel Fuel and Natural Gas Internal Combustion Engines, respectively) would not achieve the level of reliability required to ensure an uninterrupted power supply. (See the subsection above, "5.4 Reliability and Risk Factors," for further discussion of reliability.) It is assumed that the project site location would remain the same under the following alternatives.

### **5.7.1 Alternative 1: No Project/No Build Alternative**

The project site is currently developed with a 115,000-square-foot office and warehouse building. Under the No Project/No Build Alternative, the development of the project site would not occur, and current conditions would continue at the site for an unknown period.

As discussed in **Section 4.11 Land Use and Planning** in this EIR, the project site has a general plan land use designation of Light Industrial (ML), which “allows combinations of single and multiple users, warehouses, mini-storage, wholesale, bulk retail, gas stations, data centers, indoor auto-related uses and other uses that require large, warehouse-style buildings” (Santa Clara 2010). The project site is also zoned Light Industrial (ML), which “is intended to provide an optimum general industrial environment, and...is intended to accommodate industries operating substantially within an enclosed building” (Santa Clara 2021b). The proposed project is an allowable use in the ML land use designation and ML zoning district.

The site could eventually be approved for a use or uses consistent with these land use designations should the project not move forward. Although a different project would likely be proposed at the site in the future, no development plan exists to allow a comparison with CA3, and it would be speculative to assume the characteristics of such an alternative.

The No Project/No Build Alternative would avoid the proposed project’s potentially significant impacts identified in this EIR (*no impact* compared to the proposed project). However, if the project is not constructed, the applicant’s primary goal to develop a state-of-the-art data center, along with the basic project objectives, would not be attained.

### **5.7.2 Alternative 2: Renewable Diesel Fuel**

Renewable diesel fuel is an alternative to conventional diesel fuel. It is not a fossil fuel and is made of nonpetroleum renewable resources (vegetable oil or other biomass feedstock such as wood, agricultural waste, garbage, etc.). Renewable diesel is produced through various thermochemical processes, such as hydrotreating, gasification, and pyrolysis (U.S. EIA 2021). It has the same chemical structure as conventional diesel and meets ASTM D975 specifications for conventional diesel in the United States (U.S. DOE 2020c). This makes renewable diesel a drop-in replacement for conventional diesel. Also, renewable diesel is a cleaner burning fuel alternative to conventional diesel that would be expected to meet the project objectives as a source of fuel for the gensets.

Under this alternative, the project would be developed the same as proposed, except it would use renewable diesel as the fuel source for the gensets. There would be no changes to the number, size, or placement of the gensets. The number of fuel deliveries would remain the same.

### **Air Quality and Public Health**

Previous testing on engines used in motor vehicles without selective catalytic reduction (SCR) or diesel particulate filter (DPF) exhaust after treatment systems show that renewable diesel would have lower criteria air pollutant emissions than conventional, ultra-low sulfur diesel (ULSD) proposed to be used for the project. However, as shown in **Appendix D**, more recent testing on new technology diesel engines (NTDE) with SCR and DPF shows no statistically significant differences in NO<sub>x</sub>, particulate matter (PM), and

total hydrocarbon emissions, but lower CO and CO<sub>2</sub> emissions using renewable diesel compared to CARB reference fuel.

However, the above conclusions are based on the limited testing done for much smaller engines than those proposed for the project. The above conclusions would need to be confirmed with testing under controlled conditions of the size of engines proposed for this facility, preferably using the same source test protocol used for engine certification.

Air quality and public health impacts using renewable diesel during project operations would likely be similar to those that would occur with the project. However, this conclusion would need to be confirmed by testing emissions under controlled conditions for the size of engines (equipped with DPFs and SCR) proposed for the project.

### ***Greenhouse Gas Emissions***

Compared to ULSD, renewable diesel would reduce CO<sub>2</sub> tailpipe emissions approximately 3 to 4 percent (**Appendix D**). However, renewable diesel is produced with a fuel cycle that has a far lower carbon intensity (CI) than ULSD. To have a more complete understanding of the impact of replacing ULSD with renewable diesel, it is necessary to examine the full fuel cycle of each fuel from origin to use. This is because GHGs have a global impact rather than a local impact.

Based on data from CARB's Low Carbon Fuel Standard (LCFS) program, staff computed the average amount of GHG reduction per million gallons of renewable diesel and used it as a factor to compute the fuel cycle emissions that would be avoided by switching from ULSD to renewable diesel. The results show that replacing the proposed ULSD with renewable diesel would reduce the project's readiness testing and maintenance GHG emissions from 3,387 metric tons of CO<sub>2</sub>e (MTCO<sub>2</sub>e) per year with ULSD by 2,280 MTCO<sub>2</sub>e per year, to annual emissions of 1,107 MTCO<sub>2</sub>e per year with renewable diesel.

Based on the limited information contained in **Appendix C**, using renewable diesel in place of ULSD would reduce the project's full fuel cycle GHG emissions associated with on-site fuel consumption during the operations period. However, renewable diesel still has some carbon associated with the fuel cycle because the CI values are not zero or negative. Therefore, additional measures would be needed before an alternative fueled by renewable diesel could be considered a carbon-free facility. The comparative impact is *likely less* under this alternative.

While the project would meet BAAQMD GHG thresholds for the readiness testing and maintenance of the diesel backup generators with the implementation of **GHG-1**, the GHG emissions could be reduced further by using renewable diesel in place of petroleum-based diesel. Because of California's ambitious GHG reduction goals, staff concludes it is imperative that all feasible methods of carbon reduction be employed to ensure the project's GHG emissions are less than significant. Staff proposes **GHG-2** to require the project owner to use an increasing mix of renewable diesel to the maximum extent feasible, and only use ULSD as a secondary fuel in the event of supply challenges or

disruption in obtaining renewable diesel. With **GHG-2**, the project's gensets would use renewable diesel to ensure that operation of the gensets would not hinder California's efforts to achieve the statewide 2030 or 2045 goals.

### *Potential Feasibility Issues and Attaining the Project Objectives*

Renewable diesel fuel is not new but would be considered new for large-scale stationary equipment, such as the proposed project's gensets. The fuel is currently used in heavy-duty mobile engines and trucks. The city of Oakland and other cities surrounding the San Francisco Bay Area are using renewable diesel in their transportation fleet (Green Fleet 2021). While renewable diesel has been used in such applications, at this time there is no significant data regarding its use in large stationary engines, such as those for the proposed project.

The majority of renewable diesel consumed in California is primarily sourced and produced from overseas. Single-sourced production challenges fuel supply reliability and cost. If the source could no longer produce the fuel or other production and distribution issues arise, not the least of which are supply-chain issues, the project could face a supply shortage. Single-sourced products are quite often expensive, and for renewable diesel, the current cost is approximately two times that of conventional diesel. Distributors could mitigate these challenges by having a large supply on hand. In addition, new fuel supplies could increase in the future as more suppliers are added, such as Exxon Mobil, Bakersfield Renewable Fuels, Marathon Petroleum, and others (Biodiesel 2021). These future suppliers have announced plans for operation as early as 2022. At this point, the availability of a second source does not seem timely for the project to identify it as a feasible 100 percent replacement of conventional diesel fuel from the start of operation. However, in the foreseeable future, if and when more suppliers come online and the supply is plentiful, the project should revisit the feasibility of renewable diesel as the primary source of fuel. Staff has proposed mitigation measure **GHG-2** to reflect the increasing availability of renewable diesel over time.

Currently, there are LCFS credits available for mobile sources to use renewable diesel, making this fuel more financially viable; however, those credits are not currently available for stationary sources. The extension of credits for non-mobile sources could result in an effective decrease to fuel cost for the project.

Data center customers demand the most reliable data storage service available, and data center insurers are willing to provide insurance coverage only for proven technologies with an extremely low probability of operational failure. Until a renewable diesel supply is more available and readily accessible and in the absence of a second source of renewable diesel, conventional diesel fuel is the most feasible backup fuel. This alternative could potentially attain the project objectives if a reliable fuel source could be obtained.



### 5.7.3 Alternative 3: Natural Gas Internal Combustion Engines

Natural gas internal combustion engines (ICEs) are fueled by natural gas, while the proposed engines for the project would use conventional diesel. Natural gas ICEs are available up to 18 MW each. Their physical dimensions range based on their MW capacity. For example, one of the natural gas ICEs from manufacturer Power Solution International (PSI) has a capacity of 445 kW and a nominal height of 12 feet. One of the natural gas ICEs manufactured by Innio has a capacity of 3 MW with a height for the genset assembly of 23 feet. As a point of reference, the height of the proposed genset assembly for the project is 27 feet. Under this alternative, the footprint of the natural gas ICEs may not be the same as for the proposed diesel gensets. The number of engines and associated equipment, height, fuel delivery, and on-site fuel storage would be different. It is assumed that the massing and locations of the data center buildings would be essentially the same as for the proposed project.

Data centers require a power generating solution with quick start times. The time it takes a natural gas ICE to begin carrying data center load from its power-off position (the moment the engine synchronizes to the bus bar) varies depending on the natural gas ICE's size and capacity. In the meantime, the UPS system can provide power to the data center. The startup time for the PSI natural gas ICEs and the Innio natural gas ICEs are fast enough that the proposed project's UPS system would not need to be redesigned.

The preferred, most feasible method to supply fuel for the natural gas ICEs would be by pipeline through Pacific Gas and Electric's underground natural gas transmission system. The two closest locations for independent natural gas pipeline connections are one adjacent to the project site on Walsh Avenue and one approximately 1.36 miles west of the project site on the Lawrence Expressway.<sup>4</sup> The project's primary pipeline would connect to the nearby gas line on Walsh Avenue. Another pipeline connecting to the gas line at Lawrence Avenue could also be installed to provide added reliability. It is assumed that new pipelines would be constructed along existing roadway rights-of-way and utility corridors. The natural gas pipeline trenches would be approximately 6 feet deep and 4 to 6 feet wide, with a minimum cover depth of 36 inches.

The installation of natural gas pipelines could cause temporary impacts during construction. Staff assumes that the implementation of the same mitigation and project design measures for the project would apply to pipeline construction impacts under this alternative (e.g., measures to reduce impacts on air quality, biological resources, water quality, noise, soil resources, transportation, and cultural and tribal cultural resources). This would reduce any potential impacts from gas pipeline construction to less than significant levels.

#### Air Quality and Public Health

Staff compared criteria air pollutant emissions and CO<sub>2</sub> emissions of natural gas ICEs against the proposed diesel-fired engines for CA3. The proposed 44 2.75-MW engines for

---

<sup>4</sup> Along Walsh Avenue to Lawrence Expressway.

the project would be equipped with SCR and DPFs to achieve compliance with Tier 4 emission standards. However, it takes time for the SCR to reach the activation temperature and become fully effective in controlling NOx emissions. Depending on load, the SCR would be expected to kick on within 15 minutes.

For the natural gas ICEs alternative, information is primarily based on the data provided for the San Jose Data Center (Jacobs 2021s) application. The natural gas ICEs for the San Jose Data Center would be equipped with a 3-way catalyst system to reduce emissions of NOx, CO, volatile organic compounds (VOC), and air toxics. The applicant for the San Jose Data Center also assumed 15 minutes of operation with uncontrolled emissions and 45 minutes of operation with controlled emissions to estimate hourly emissions (Jacobs 2021o).

Staff compared the emission factors in pounds per megawatt-hour (lbs/MWe-hr) for the proposed diesel-fired engines at CA3 and those for the natural gas ICEs proposed at the San Jose Data Center. Staff assumed the same 15-minute warm up period for the SCRs of the diesel engines and the 3-way catalyst system for the natural gas ICEs. As shown in **Table D-3 of Appendix C**, the emission factors in lbs/MWe-hr for the NOx emissions would reduce by more than 98 percent using natural gas ICEs compared to the proposed diesel-fired engines for CA3. The PM emissions would reduce by more than 83 percent using natural gas ICEs compared to the proposed diesel-fired engines. The VOC emissions would reduce by about 46 percent using natural gas ICEs compared to the proposed diesel-fired engines. There would be less reduction in CO and sulfur dioxide (SO<sub>2</sub>) emissions (about 11 percent reduction for CO and about 25 percent reduction for SO<sub>2</sub>). Staff is unable to find data comparing air toxics emissions of natural gas ICEs with those for diesel-fired engines; however, these are expected to be reduced due to the reductions reported for VOCs and PM.

In addition, staff does not assume additional operation of the natural gas ICEs to offset the cost difference between the technologies and acknowledges that the capital cost of natural gas ICEs may be more expensive. Staff acknowledges that the operational profile may be different for the natural gas ICEs, and annual emissions may be higher since they may operate more based on other project applications. However, staff is not able to predict the exact number of operation hours and the associated emissions for the natural gas ICEs in such a scenario since it is unknown how much grid support service would be provided. Therefore, staff only compares the emission factors in lbs/MWe-hour for the natural gas ICEs and those for the conventional diesel-fired engines for the proposed project, assuming a similar operating profile.

Air quality impacts using natural gas ICEs are expected to be *much less* than those that would occur with the proposed conventional diesel-fired engines for the project. Public health impacts from toxic air contaminants using natural gas ICEs are *likely less* than those that would occur with the proposed conventional diesel-fired engines for the project.

### ***Greenhouse Gas Emissions***

As shown in **Appendix C**, natural gas fueled ICEs would reduce GHG emissions by approximately 7 percent from conventional diesel-fired engines. When extending to the full fuel cycle, GHG emissions from natural gas ICEs fueled with pipeline natural gas produced from fossil feedstocks would be 20 percent lower than those from conventional diesel as indicated by the CI values. Moreover, natural gas feedstocks from some renewable feedstocks may have a much lower CI. The CI values of most renewable feedstocks are even negative, reflecting a net reduction in fuel cycle carbon emissions. The comparative impact is *likely less* under this alternative.

Fossil natural gas and some forms of renewable natural gas still have some carbon associated with the fuel cycle. These show up in the table for those fuels with a CI that is greater than zero. In these cases, additional measures could be needed before an alternative fueled by natural gas would be considered a carbon-free facility.

### ***Potential Feasibility Issues and Attaining the Project Objectives***

Natural gas ICEs are cleaner burning due to the type of fuel; however, the technology is not without feasibility issues. The project would employ 44 total backup gensets (including the four house gensets that serve administrative and emergency response functions). Depending upon the MW size of the natural gas ICE engine, more engines may or may not be needed.

There are two potential fuel supply methods: on-site storage and pipeline connection. On-site storage would require redesigning the project and would suffer from some feasibility issues. The project would need approximately 201 million gallons of natural gas storage to provide 24 hours of backup natural gas ICE operation, the same backup duration as the current proposal. Liquefied natural gas (LNG)<sup>5</sup> would minimize the storage space, but the needed storage volume would still be substantially larger than that of diesel fuel.<sup>6,7</sup>

LNG would need to be stored and distributed with specialized equipment and stored in insulated tanks to keep the fuel in a liquid state at minus 260 degrees Fahrenheit. For LNG to remain at a constant temperature and pressure, it must allow for natural evaporation known as BOG. BOG is essentially a loss of stored fuel that occurs when the ambient temperature heats the insulated tanks. LNG must release this gas to maintain its liquid state. To mitigate the loss of fuel and gas release into the atmosphere, BOG can

---

5 Natural Gas can be liquefied to 600 cubic meters times smaller than its volume in its gas state.

6 LNG calculated as: Approximate ICE Fuel Consumption 9,500 cubic feet per megawatt-hour x 118 MW (includes redundant engines) x 24 hours of backup duration = 26,904,000 cubic feet of natural gas = 201 million gallons

Conversion Cubic feet gas to liquid gallons: 26,904,000 cubic feet x 0.0283168 cubic meter gas x (1 cubic meter LNG / 600 cubic meter gas) x 264.172 liquid gallons = 335,426 gallons

7 Diesel volume for current proposal: Genset Fuel Consumption 191.8 gallons per hour x 44 gensets x 24 hours = 202,541 gallons

be reliquefied and put back into the LNG tank or used as fuel in certain marine applications, steam turbines, or in a gasification unit for creating alternative fuels. LNG would need to undergo a regasification process for the fuel to be used in natural gas ICEs. Both reliquefaction and regasification would result in additional processes, equipment, and footprint.

Fuel storage, reliquefaction, and regasification equipment must comply with standards specified by the National Fire Protection Association and the City Code to protect against hazardous material release, fire, and explosions during natural disasters and as the result of accidents. Additionally, permits for the storage of hazardous materials would be needed pursuant to the City Code.

The utility's underground pipeline transmission system would be the primary and preferred method of fuel supply, as discussed earlier. However, pipelines are susceptible to natural disasters (e.g., earthquakes) as well as accidents. This can potentially cut off fuel supply to the project during a grid outage. Access to the secondary pipeline 1.36 miles west of the project site on Lawrence Expressway would increase fuel supply reliability. The natural gas ICE alternative could potentially be feasible and attain the project objectives using the underground natural gas pipeline system.

## 5.8 Environmentally Superior Alternative

CEQA requires that if the environmentally superior alternative is the "no project" alternative, the EIR shall also identify an environmentally superior alternative among the other alternatives (Cal. Code Regs., tit. 14, § 15126.6, subd. (e)(2)). Alternative 1, the No Project/No Build Alternative, is the environmentally superior alternative because it would avoid the potentially significant impacts of the proposed project. However, Alternative 1 would not meet any of the project objectives.

Staff compared the other alternatives to the proposed project and determined that each has some advantages in terms of reducing impacts. Staff examined the potential for the alternatives to meet most of the project's basic objectives. Staff's conclusions for the alternatives are summarized below, including discussions of whether the alternatives could attain the project objectives.

### 5.8.1 Alternative 2: Renewable Diesel Fuel

Air quality and public health impacts using renewable diesel during project operations would likely be similar to those that would occur under the proposed project. However, the conclusion would need to be confirmed with testing under controlled conditions for the size of engines proposed for this facility with DPFs and SCR being operative.

The GHG impacts from this alternative would likely be less than those of the project due to the reduced GHG emissions during the entire fuel cycle.

Staff considers Alternative 2 to be *somewhat environmentally superior* to the proposed project, although further study and analysis would be needed to fully compare this

alternative to the proposed project. Changing the fuel source from conventional to renewable diesel would not require a project redesign or necessarily cause a schedule delay. Currently, however, the lack of LCFS fuel credits for non-mobile sources results in an effective increase to the cost of fuel for projects like CA3.

There are two options for the operation of a renewable diesel alternative. One option is to use renewable diesel as the primary source for the project, with conventional diesel as its backup fuel. The second option is to solely use renewable diesel. To only use renewable diesel, a second renewable fuel source should be available for reliability purposes. Future renewable diesel fuel suppliers have announced plans to provide additional fuel for California as early as 2022. If these plans are implemented and the supply becomes plentiful, the project owner should revisit the feasibility of fully replacing conventional diesel with renewable diesel.

If one of these options were fulfilled, this alternative could potentially attain the project objectives. Staff's proposed mitigation measure **GHG-2** implements a variation of this alternative by requiring the phase-in of renewable diesel fuel use over time as supply increases.

### **5.8.2 Alternative 3: Natural Gas Internal Combustion Engines**

The GHG impacts of this alternative would likely be less than those of the CA3BGF due to the reduced GHG emissions during the entire fuel cycle. Also, criteria air pollutant emissions and air quality impacts using natural gas ICEs are expected to be much less than those that would occur with the project's gensets. Staff is not able to find data comparing the air toxics emissions of natural gas ICEs with those for diesel engines, but these are expected to be reduced due to the reductions reported for VOCs and PM. Therefore, public health impacts using natural gas ICEs would likely be less than those that would occur with the project's diesel engines.

Staff considers Alternative 3 to be *environmentally superior* to the proposed project due to its deep reductions in criteria air pollutants. Redesigning the project with natural gas ICE technology could increase the number of engines on-site depending upon the MW sizing and physical dimensions. As discussed earlier, two gas pipeline connections are available and likely needed to match the fuel supply reliability of the proposed project. Permitting and construction of the new pipelines would take time to complete.

**Table 5-1** (below) summarizes the environmental effects for each alternative compared to the proposed project for the topics of air quality, public health, and GHG emissions. As discussed above, staff's comparative analyses for the other topics covered in this EIR show essentially no differences between the impacts identified under the proposed project and the alternatives selected for analysis.

**TABLE 5-1 SUMMARY COMPARISON OF IMPACTS OF THE PROPOSED PROJECT TO THE ALTERNATIVES**

<b>Environmental Topics and Impacts</b>	<b>Proposed Project</b>	<b>No Project/No Build</b>	<b>Renewable Diesel Fuel</b>	<b>Natural Gas ICEs</b>
Criteria air pollutants	LTS with Mitigation	No Impact	LTS with Mitigation (Likely Similar)	LTS with/without Mitigation (Much Less)
Toxic Air Contaminants (TACs)	LTS	No Impact	LTS (Likely Similar)	LTS (Likely Less)
GHG emissions	LTS with Mitigation	No Impact	LTS (Likely Less)	LTS with/without Mitigation (Likely Less)

Notes: Impact conclusions for the proposed project and the alternatives in **Table 5-1** are shown using these abbreviations:

No Impact = the proposed project or an alternative has no potential to affect the resource

LTS = less than significant impact, no mitigation required

LTS with Mitigation = mitigation measure(s) required to reduce a potentially significant impact to less than significant

The comparisons of impacts to the proposed project in **Table 5-1** are conveyed using these abbreviations (staff identified no impacts that would be greater than the proposed project):

- Much Less
- Less
- Likely Less (conclusion that is estimated and cannot be fully verified with available data)
- Likely Similar (conclusion that is estimated and cannot be fully verified with available data)

## 5.9 References

- Air Liquide 2021 – Air Liquide. Fuel Cell. Accessed October 20, 2021. Available online at: <https://energies.airliquide.com/resources-planet-hydrogen/fuel-cell>
- Biodiesel 2021 – Biodiesel Magazine (Biodiesel). Renewable Diesel's Rising Tide, January 2021. Accessed April 2021. Available online at: <http://www.biodieselmagazine.com/articles/2517318/renewable-diesels-rising-tide>
- Data Center 2021 – Data Center Knowledge (Data Center). eBay Goes Live With its Bloom Powered Data Center, September 2013. Accessed April 19, 2021. Available online at: <https://www.datacenterknowledge.com/archives/2013/09/26/eBay-goes-live-with-its-bloom-powered-data-center>
- DayZenLLC 2021a – DayZenLLC (DayZenLLC). (TN 237380). VDC CA3BGF SPPE Application Part I, dated April 5, 2021. Available online at: <https://efiling.energy.ca.gov/Lists/DocketLog.aspx?docketnumber=21-SPPE-01>
- EIA 2021 – U.S. Energy Information Administration (EIA). Today in Energy: Utility-scale battery storage costs decreased nearly 70% between 2015 and 2018, October 2020. Accessed on November 22, 2021. Available online at: <https://www.eia.gov/todayinenergy/detail.php?id=45596>
- Energy Code Update 2021 – California Energy Commission (CEC). Nonresidential PV and Battery Storage Measure Proposal (TN 23776), May 2021. Accessed November 2, 2021. Available online at: <https://efiling.energy.ca.gov/GetDocument.aspx?tn=237776&DocumentContentId=71014>
- Farm Energy 2021 – Farm Energy (Farm Energy). Biodiesel Fuel Quality, April 2019. Accessed March 31, 2021. Available online at: <https://farm-energy.extension.org/biodiesel-fuel-quality/>
- Fuel Cell 2021 – Fuel Cell Store (Fuel Cell). Processing Alternative Fuels for Fuel Cells, March 2019. Accessed April 19, 2021. Available online at: <https://www.fuelcellstore.com/blog-section/processing-alternative-fuels-for-fuel-cells>
- GBGF 2021 – Gilroy Backup Generating Facility (GBGF). GBGF Revised Project Description – Addition of BESS Facilities (TN 239193). California Energy Commission Docket Number 20-SPPE-03. Docketed on August 5, 2021. Available online at: <https://efiling.energy.ca.gov/Lists/DocketLog.aspx?docketnumber=20-SPPE-03>
- GenCell 2021 – GenCell (GenCell). Comparing Fuel Cell Technologies. Accessed April 19, 2021. Available online at: <https://www.gencellenergy.com/news/compairing-fuel-cell-technologies/>

- GenFuel 2021 – GENFUEL (Plug Power). The 1MW Electrolyzer. Accessed October 20, 2021. Available online at: [https://www.plugpower.com/wp-content/uploads/2020/10/2020\\_1MWELX\\_Spec051821\\_sm.pdf](https://www.plugpower.com/wp-content/uploads/2020/10/2020_1MWELX_Spec051821_sm.pdf)
- GenSureHP 2021 – GENSURE (Plug Power). GENSURE HP Fuel Cells. Accessed October 20, 2021. Available online at: [https://www.plugpower.com/wp-content/uploads/2020/08/GenSureHP\\_082021\\_R2.pdf](https://www.plugpower.com/wp-content/uploads/2020/08/GenSureHP_082021_R2.pdf)
- Green Fleet 2021 – Government Fleet (Green Fleet). What You Need to Know About Renewable Diesel, March 2016. Accessed March 29, 2021. Available online at: <https://www.government-fleet.com/156621/what-you-need-to-know-about-renewable-diesel>
- Hydrogen 2021a – Internet Archive. Hydrogen as an Alternative Fuel. Accessed October 19, 2021. Available online at: <https://web.archive.org/web/20080808053811/http://www.almc.army.mil/alog/issues/MayJun00/MS492.htm>
- Hydrogen 2021b – Office of Energy Efficiency & Renewable Energy (EERE). Hydrogen Production: Electrolysis. Accessed October 19, 2021. Available online at: <https://www.energy.gov/eere/fuelcells/hydrogen-production-electrolysis>
- Hydrogen Properties 2021 – Office of Energy Efficiency & Renewable Energy (EERE). Module 1: Hydrogen Properties. Accessed October 20, 2021. Available online at: [https://www1.eere.energy.gov/hydrogenandfuelcells/tech\\_validation/pdfs/fcm01r0.pdf](https://www1.eere.energy.gov/hydrogenandfuelcells/tech_validation/pdfs/fcm01r0.pdf)
- Jacobs 2021o – Jacobs (Jacobs). (TN 239409). SJC Data Center SPPE Application Supplemental Filing Volume 1, dated August 20, 2021. Available online at: <https://efiling.energy.ca.gov/Lists/DocketLog.aspx?docketnumber=19-SPPE-04>
- Jacobs 2021s – Jacobs (Jacobs). (TN 239413). SJC Data Center SPPE Application Supplemental Filing Appendix Air - Traffic, Part 1, dated August 20, 2021. Available online at: <https://efiling.energy.ca.gov/Lists/DocketLog.aspx?docketnumber=19-SPPE-04>
- Microsoft 2021 – Microsoft. Fuel Cells for Data Centers. By Li Zhao. February 2016. Accessed in March 2021. Available online at: <https://www.microsoft.com/en-us/research/wp-content/uploads/2016/02/FCDC-TechReport.pdf>
- Mitsubishi 2021 – Mitsubishi. What is Thermal Runaway. 2021. Accessed in December 2021. Available online at: <https://www.microsoft.com/en-us/research/wp-content/uploads/2016/02/FCDC-TechReport.pdf>



- NREL 2021 – National Renewable Energy Laboratory (NREL). A Comparison of Fuel Choice for Backup Generators, March 2019. Accessed January 2021. Available online at: <https://www.nrel.gov/docs/fy19osti/72509.pdf>
- Power Magazine 2021 – Power Magazine (Power Magazine). Vistra Energizes Massive 1.2-GWh Battery System at California Gas Plant. By Sonal Patel. January 14, 2021. Accessed in March 2021. Available online at: <https://www.powermag.com/vistra-energizes-massive-1-2-gwh-battery-system-at-california-gas-plant/>
- Santa Clara 2010 – City of Santa Clara (Santa Clara). *City of Santa Clara General Plan 2010-2035*. Adopted on November 16, 2010. Chapter 3, pg. 3-17; Chapter 5, pgs. 5-14, 5-39, 5-67; Table 8.3-1. Accessed on July 7, 2021. <https://www.santaclaraca.gov/our-city/departments-a-f/community-development/planning-division/general-plan>
- Santa Clara 2021b – City of Santa Clara (Santa Clara). Santa Clara City Code. Current through Ordinance 2029, passed February 23, 2021. Accessed on July 7, 2021. Available online at: <https://www.codepublishing.com/CA/SantaClara/>
- UNESCO 2021 – United Nations Educational, Scientific, and Cultural Organization (UNESCO). World Water Assessment Programme, 2017. Accessed March 2021. Available online at: <http://www.unesco.org/new/en/natural-sciences/environment/water/wwap/facts-and-figures/all-facts-wwdr3/fact-7-water-biofuel/>
- U.S. DOE 2020a – U.S. Department of Energy (U.S. DOE). U.S. DOE Office of Energy Efficiency and Renewable Energy. Types of Fuel Cells. Accessed October 2020. Available online at: <https://www.energy.gov/eere/fuelcells/types-fuel-cells>
- U.S. DOE 2020b – U.S. Department of Energy (U.S. DOE). U.S. DOE Office of Energy Efficiency and Renewable Energy. Hydrogen Pipelines. Accessed February 2021. Available online at: <https://www.energy.gov/eere/fuelcells/hydrogen-pipelines>
- U.S. DOE 2020c – U.S. Department of Energy (U.S. DOE). U.S. DOE Office of Energy Efficiency and Renewable Energy. Alternative Fuels Data Center. Accessed February 2021. Available online at: [https://afdc.energy.gov/fuels/emerging\\_hydrocarbon.html](https://afdc.energy.gov/fuels/emerging_hydrocarbon.html)
- U.S. EIA 2021 – U.S. Energy Information Administration (U.S. EIA). Biofuels Explained. Accessed April 2021. Available online at: <https://www.eia.gov/energyexplained/biofuels/>
- ZDNet 2021 – ZDNet (ZDNet). Data centers want to be a lot greener. One big problem is holding them back. Accessed April 2021. Available online at: <https://www.zdnet.com/article/data-centers-want-to-be-a-lot-greener-one-big-problem-is-holding-them-back/>



# **Section 6**

---

Authors and Reviewers

## **6 Authors and Reviewers**

### **Lead Agency—California Energy Commission**

#### *Technical Staff / Section Authors*

Laiping Ng (Appendix B, Project Description)  
Mark Hamblin (Aesthetics)  
Wenjun Qian (Air Quality, Greenhouse Gas Emissions, Appendix C)  
Andrea Koch (Alternatives)  
Ann Crisp (Biological Resources)  
Gabriel Roark, Melissa Mourkas (Cultural and Tribal Cultural Resources)  
Kenneth Salyphone (Energy/Energy Resources, Alternatives, Noise, MFOS, Appendix A, Appendix B)  
Garry Maurath (Geology/Soils and Minerals)  
Karim Abulaban (Hazards/Hazardous Materials)  
Karim Abulaban (Wildfire, Utilities/Service Systems)  
Karim Abulaban, Ryan Casebeer (Hydrology/Water Resources)  
Ellen LeFevre (Population/Housing, Environmental Justice, Mandatory Findings of Significance)  
Scott Debauche (Transportation)  
Negar Vahidi, Tatiana Inouye, Eileen Allen (Agriculture/Forestry, Land Use, Recreation, Public Services)  
Brewster Birdsall (Air Quality, Greenhouse Gas Emissions, and Appendix C)

#### *Supervision and Management*

Joseph Hughes, Air Quality Unit Supervisor  
Steven Kerr, Community Resources and CEQA Unit Supervisor  
Gabriel Roark, Cultural Unit Lead  
Shahab Koshmashrab, Engineering Unit Supervisor  
Brett Fooks, Engineering Unit Supervisor  
Geoff Lesh, Engineering Office Manager  
Mark Hesters, Energy Reliability Unit Supervisor, Energy Assessments Division  
Eric Knight, Environmental Office Manager and Acting Biology Unit Supervisor  
Shawn Pittard, Deputy Director—Siting, Transmission and Environmental Protection Division

#### *Project Management/Legal*

Eric Veerkamp, Project Manager  
Lisa DeCarlo, Jennifer Baldwin, Staff Counsel

# **Appendix A:**

---

Project's Jurisdictional and Generating  
Capacity Analysis

## Appendix A: Project's Jurisdictional and Generating Capacity Analysis

The CA3 Backup Generating Facility and Data Center (CA3 or project) proposed by Vantage Data Services would include 44 diesel-fueled standby emergency backup generators (gensets) that would provide emergency backup power supply for the project only during interruptions of electric service delivered by Silicon Valley Power, via Pacific Gas and Electric transmission lines. The gensets would be electrically isolated from the PG&E electrical transmission system with no means to deliver electricity offsite of VDC (the distribution line would only allow power to flow in one direction—from PG&E electrical transmission line to CA3).

There are other Vantage-owned data centers in the city of Santa Clara, the closest one of which, is located across the street from CA3 project site. There would be no common facilities between any of these data centers and CA3. Therefore, CA3 is considered an independent data center for the purpose of jurisdictional determination. While staff recognizes that employees of CA3 may use parking facilities located at another Vantage-owned data center, this alone is insufficient to consider the data centers part of the same project.

Each genset would have a nameplate output capacity of 2.75 megawatts (MW) and continuous steady-state output capacity of 2.2 MW. The maximum total facility load requirements would not exceed 96 MW. This includes the critical information technology (IT) load of the servers and server bays, the cooling load of the IT servers and bays, and the facility's ancillary electrical and telecommunications equipment operating loads to support the data customers and campus.

The California Energy Commission (CEC) is responsible for reviewing, and ultimately approving or denying, all applications for thermal electric power plants that are 50 MW and greater being proposed for construction in California. (Pub. Resources Code, § 25500.) The CEC has a regulatory process, referred to as the Small Power Plant Exemption (SPPE) process, that allows applicants with projects between 50 and 100 MW to obtain an exemption from the CEC's jurisdiction and from obtaining a CEC certificate and instead proceed with local approval if the CEC finds that the proposed project would not create a substantial adverse impact on the environment or energy resources. (Pub. Resources Code, § 25541.)

CEC staff (staff) calculated a net deliverable or useable electricity capacity of more than 50 MW and less than 100 MW from CA3 gensets, qualifying it for a SPPE under the capacity criterion. The following provides a summary of the factors supporting this conclusion, with a more detailed discussion of these factors following after:

1. The diesel-fueled reciprocating engine gensets use a thermal energy source.

2. The gensets and the associated project equipment that they would support would all be located on a common property under common ownership sharing common utilities, and the 44 gensets should be aggregated and considered as one thermal power generating facility with a generation capacity of greater than 50 MW.
3. While CA3 has an apparent installed generation capacity greater than 100 MW (44 gensets, each with 2.75 MW peak capacity), the “extra” MW installed are redundant. In no case would the maximum facility-wide load demand exceed 96 MW due to physical constraints built into the project.
4. Jurisdictional analyses are based on the net MWs that can be delivered for “use” (i.e., to a data center facility or the electricity grid), not the gross or nameplate rating. Unlike a traditional power plant supplying electricity to the grid, for a data center, the maximum load being served is determinative and not the combined net capacity of the installed gensets. Here, the maximum facility wide CA3 load requirement would be 96 MW.
5. The gensets would be exclusively connected to the CA3 buildings and would not be capable of delivering electricity to any off-site user or to the electrical transmission grid. The proposed redundancies built into the design of the facility are to ensure performance reliability, not to generate and supply the CA3 facility with more than 96 MW of electricity.
6. The restriction on the facility's load demand is hardwired through various control systems. It would be physically impossible for the gensets to generate more electricity than the buildings require. Excess electricity would damage components or at a minimum, isolate the project loads from the gensets.

To make a jurisdictional recommendation, staff assessed the generating capacity of the project, using the following:

1. *CA3 is a thermal power plant under the statutory definition.*

The Warren-Alquist State Energy Resources Conservation and Development Act (Public Resources Code, section 25000 et. seq) defines a thermal power plant “as any stationary or floating electrical generating facility using any source of thermal energy, with a generating capacity of 50 megawatts or more, and any facilities appurtenant thereto.” (Pub. Resources Code, § 25120.) CA3’s generation yard would be made up of gensets that use petroleum-based diesel engines to convert the thermal energy in the diesel fuel<sup>1</sup> into electricity via a rotating generator, and, thus, each genset is an electrical generating device that uses a source of thermal energy. The facility proposes to use 44 such gensets to service CA3.

---

<sup>1</sup> Diesel fuel is composed of a mixture of hydrocarbons, containing chemical energy. When ignited, this chemical energy is converted to thermal energy.

CA3's 44 gensets, and the associated data center that they would support, would all be located on a common property under common ownership sharing common utilities. The gensets would operate to provide backup electricity to the project when its connection to the grid is lost. The gensets system includes a 5-to-make-4 design configuration, meaning that for every four gensets that would support load in the event of a utility failure, there is one redundant genset. The 44 gensets would never operate simultaneously at 100 percent capacity. However, any genset can function either as a back-up to the grid or a back-up to the grid back-up gensets, so there is not a functional difference in the type of engine or generator between each genset. All the gensets at the project would share a common trigger for operation during an emergency: the transfer switch isolating CA3 from the grid. Thus, because the project is stationary, under common ownership sharing common utilities, uses a fuel source to generate thermal energy, and has a generating capacity of 96 MW, the project meets the statutory definition of a thermal power plant.

*2. California Code of Regulations, Title 20, section 2003 requires the generating capacity to be the net generating capacity.*

For CA3, the data center would be installed during the initial construction of the project by the project owner, but there is no specific timeline proposed for when data center would need the full capacity of gensets; the exact timing of individual leases that fill server bay space is subject to the market decisions of disparate customers. Therefore, it may be years before the data center is at full load. Nevertheless, for purposes of this analysis, staff assumes full load will eventually be reached.

California Code of Regulations, Title 20, section 2003 specifies how the CEC calculates "generating capacity" for jurisdictional determinations, including the 50 MW threshold for the definition of a thermal power plant under Public Resources Code, section 25120. However, section 2003, which uses nameplate capacity in addition to consideration of other factors, only addresses steam and combustion turbines, not diesel-fueled gensets as used in the VDC, and is, therefore, not controlling here. There are also other reasons to conclude that simply focusing on nameplate capacity here is not appropriate.

For a typical power plant, outside the factors identified in California Code of Regulations, Title 20, section 2003, there is almost no limit on what might be generated and provided to the grid, so the approach outlined in that provision identifies the potential maximum generating capacity and is reasonable for those facilities. This is not the case with data centers, where producing electricity more than what the data center requires would be economically wasteful and likely result in damage to the facility.

In traditional turbine-based power plants, parasitic loads (fans, pumps, and heaters) are external to the turbine. Thus, the generating capacity is the total net MWs at the switchyard bus; that is, gross MWs less parasitic loads. If the grid "demands" more, the power plant cannot deliver more electricity unless it burns fuel at a higher rate or reduces parasitic loads. Even then, equipment would have to have the physical capacity to burn more fuel and convert thermal energy into rotational energy, and then operate the generator at a higher output. The calculations assume normal conditions, where



generation would be under average operating conditions, and assumes the onsite loads (often called parasitic loads) are also average (e.g., a filter backwash pumping load would not be included if that operation only occurs monthly or annually). Typically, at a traditional power plant, no redundant generating equipment is installed.<sup>2</sup> Generating capacity at a traditional power plant is determined based on the net capacity of all generators proposed to be installed and connected to the grid because there is almost no limitation on the amount of MWs the grid can “take” from the facility.

Typically, emergency backup generating facilities serving data centers are not physically able to send excess electricity to the grid, and all electricity generated must be absorbed by the data center itself. Data centers are designed with precise loads, assuming full build-out, and providing electricity more than these loads is not only economically wasteful (burning fuel for no benefit or reason) but can result in damage to the sensitive components located inside these data centers as well as to the heating, ventilation, air conditioning (HVAC) unit and other systems serving the buildings. Therefore, for purposes of evaluating the capacity of emergency backup generating facilities serving data centers, it is reasonable for staff to consider building loads to be the controlling factor in determining generating capacity.

*3. Data centers are analyzed differently than conventional power plant facilities for several reasons.*

To determine the net generating capacity of a collection of gensets<sup>3</sup> for data centers, the approach is slightly different but consistent with that used on a traditional power plant. The differences are: 1) the end user is the building and data servers, not the grid, and 2) extra gensets or generating capacity are installed to provide electricity not only for building and data server loads but to provide redundancy that achieves a statistical reliability that can be marketed to data customers.

Staff’s approach is consistent with widely practiced standards. For example, ASHRAE’s (American Society of Heating, Refrigerating and Air-Conditioning Engineers) Energy Standards for Data Centers do not use the nameplate or gross capacity but the net generating capacity of data centers, or the actual cooling and IT server loads.<sup>4</sup> These ASHRAE standards are performance-based as opposed to prescriptive standards,

---

2 At modern power plants, some equipment design includes 50 to 100 percent redundancy. The redundant equipment is generally limited to certain critical components like transformers, which are often custom items with long lead times for fabrication, or boiler water feed pumps, which are intended to protect the steam boiler components from damage from too much heat if circulating water flow is interrupted.

3 Backup generators, by definition, generally have the following characteristics: reliable starts, fast starting to full load, cheap to maintain as they sit idle most of the time, use cheap and stable fuel as the fuel sits unused most of the time, and use high-density fuels to limit storage volumes onsite so the project can operate if “islanded.”

4 American National Standards Institute (ANSI)/ASHRAE Standard 90.4-2016, [www.ashrae.org](http://www.ashrae.org).

advocating the determination of load requirements be based on project-specific operational characteristics.

Staff's approach to calculating generating capacity has also been devised based on the International Organization for Standardization (ISO), which sets standards for different industries including the energy industry. The ISO standards are widely accepted by, and used throughout, the energy industry. Consistent with staff's method, the ISO specifies that generating capacity should be the net capacity at average annual ambient conditions.<sup>5</sup>

In the case of CA3, the load served acts as a limit to the generation levels from the gensets. This factor is not present in a capacity generation determination for a typical power plant feeding to the grid because the grid does not act in the same way the "CA3 grid" does. If the breakers between the CA3 data center building and the gensets were to trip due to excess generation, the data center would be isolated from the gensets, with the servers and building cooling forced to shut down. This subverts the intention of using the gensets to maintain reliable and high-quality electricity. Excess electricity would damage components or, at a minimum, isolate the load from the gensets. If the building cooling load were to increase (e.g., the day gets warmer), the gensets would open the engine fuel throttle to increase generation output and match demand but would still not exceed the combined 96 MW IT and building demand.

#### *4. CA3's capacity will not exceed 96 MW.*

The exact number of gensets that could operate in an emergency depends on actual cooling and IT server loads and the reliability and performance of the gensets. In no case would the combined output of gensets exceed the prescribed maximum load of 96 MW. As explained above, it would be physically impossible for the gensets to generate more electricity than the buildings require. For purposes of testing and maintenance, only one genset would operate at any given time.

The maximum demand of 96 MW would be fixed by the specification and installation of electrical buses and panels, switchyard, and breakers that would have an upper electrical capacity limit. The cooling equipment's maximum demand would also be fixed by the specification and installation of equipment that have an upper physical limit of cooling capacity and would include some redundant cooling equipment. Such redundant equipment could only be operated if a primary component fails and could not be operated in addition to the primary components because that would damage the CA3 data center. The CA3 data center would be served from the grid or from the gensets with electricity that matches and does not exceed demand for the operations of the data server bays and buildings.

---

5 ISO 3046-1 Reciprocating Internal Combustion Engines – Performance, [www.iso.org/standards](http://www.iso.org/standards).

The heat rejected by the IT servers must be removed from each server bay or else the server equipment and data would be damaged. Any attempt to add more servers to a bay would result in direct, immediate, and dire consequences because the building and equipment would have been designed for an upper critical IT load. It is important to note that the maximum combined facility load of 96 MW is based on 100 percent critical IT load with maximum cooling on the hottest day. In actuality, the critical IT load and related cooling load would typically be less than this worst-case scenario.

In recent years, the power and energy industries have advanced in terms of software development and hardwired digital control to permanently limit generation capacity. The generation by CA3 would be regulated by each building and each bay in that building. Software would be used to operate the gensets in a manner that meets the bay and building demand. If the demand decreases (i.e., less mechanical load for cooling, etc.), the gensets sets would automatically adjust the loading and corresponding electrical output. If a genset or the software were to malfunction and attempt to generate more electricity than the building demand, individual electrical gensets controllers would shut down. CA3 would employ physical electronic devices and software technology that limit and monitor the facility's electrical load.

For the maximum generating capacity to increase, the project would have to be redesigned to physically fit more servers in a server bay or add more bays. The project owner would have to address the unplanned increase in electricity demand for normal operations because the existing electrical equipment would not be sized for the higher electricity throughput. Additionally, the project owner would have to install additional cooling equipment units to address the increased heat rejected by the server bays and buildings, and install additional redundant cooling equipment, additional uninterruptible power supply (UPS) battery units, and additional gensets to maintain the level of backup and reliability to match the new higher levels of load. This is an unlikely outcome because such changes are not trivial and would result in a cascade of design and physical changes to the facility.

When CA3 is at full load, its worst-case day combined IT and building load<sup>6</sup> would not exceed 96 MW. The project proposes gensets that total more than 96 MW for purposes of redundancy. The combined generating capacity of the installed operational gensets is autonomously determined by the electrical equipment in the CA3 server bays and building equipment in use at the time of an emergency. CA3 has been designed with one generation yard, configured as 16 data center suites or lineups. The lineups would be paired together in such a configuration that each pair would consist of five gensets, one of which would be redundant. The emergency operation of each of the data center lineups is fully automated. Once CA3 loses connection to the local grid, the transfer switch isolates CA3 from the local electrical transmission grid, and all the gensets assigned to a server

---

<sup>6</sup> Based on the hottest, most humid day of the year and with all IT servers in use at their full usage rate

bay set initiate startup. As the gensets start, synchronize, and take up load associated with their server bays and building equipment, the UPS system would provide full-load power for up to five minutes<sup>7</sup> to smoothly transition the CA3 customers' data servers from the grid to the gensets (DayZenLLC 2021e, Section 2.2.4.3). If a genset or two fail to start or synchronize, the remaining genset in the 5-to-make-4 server bay or the other gensets in other server bay sets ramp up to higher output levels. The output of the genset assigned to a server bay set match (meet but cannot exceed) the CA3 data customers' IT demand in the respective server bay and the server bay's HVAC demand. The combined output of the server bay set is autonomously determined by the electrical equipment in the CA3 server bays and building equipment.

Combined output would be limited by sizing the electricity handling equipment to throttle transfer capacity to no more than 96 MW, which would prevent damage to IT servers and building equipment. Therefore, it would be physically impossible for the gensets to generate more electricity than what the data center would use, or more than 96 MW.

---

<sup>7</sup> The gensets are expected to be on and synchronized within a minute or so, but the UPS can supply up to 5 minutes of power at 100 percent full-load UPS to ensure a complete transition from the grid to the gensets.

# **Appendix B:**

---

Silicon Valley Power's Transmission System  
and Related Pacific Gas and Electric  
Company's Transmission System

## **Appendix B: Silicon Valley Power's Transmission System and Related Pacific Gas and Electric Company's Transmission System**

This appendix includes a discussion of the Silicon Valley Power's (SVP) and Pacific Gas and Electric Company's (PG&E) electrical system reliability (including supporting information) and emergency operations.

### ***Electrical System Reliability***

Apart from readiness testing and maintenance, the emergency backup generators (gensets) are designed to operate only when the electric system is unable to provide power to the Vantage Data Services CA3 Data Center (CA3DC). To understand the potential for the gensets to operate during emergencies, one needs to know the conditions under which the electric system is unable to provide power to CA3DC. There are essentially four conditions that might result in the operation of the gensets:

- A fault occurs (power supply interruption) or planned maintenance is required on the equipment interconnecting CA3DC to the SVP 60 kV loop system, and CA3DC's electricity needs cannot be met.
- An outage or fault occurs on the utility transmission system, and PG&E is unable to deliver power to SVP system which provides electricity to CA3DC.
- A Public Safety Power Shutoff (PSPS) impacts the utility transmission system, and CA3DC is not able to receive power from SVP.
- An energy shortage crisis similar to the one in late Summer 2020 where the utility for transmission (e.g. PG&E) is unable to supply electricity to SVP or CA3DC's operators voluntarily disconnect from the utility and rely on gensets to provide the needed electricity.

The SVP 60 kilovolt (kV) loop systems are designed to provide reliable electric service to customers. The looped interconnection allows SVP to provide continuous electricity to customers even under contingency conditions, when one part of the electric network is not functioning. The interconnections for data centers, like CA3DC, on the SVP 60 kV system are designed with redundant equipment throughout such that there is no single point of failure. It takes at least two contingencies before customers on the 60 kV system lose power and, in the case of data centers, would instead rely on gensets. According to SVP, double outages on the 60 kV loop systems are extremely rare, and the data supports this.

SVP provided a list of the outages on its 60 kV system over the last 12 years. There were 41 outages, only six of which resulted in customers being without power. This means that in 35 of these outages the redundant design of the system prevented customers from being without power; data centers would not be isolated from the grid

and would not have relied on their gensets.

Only four outages from January 1, 2009, to June 16, 2021, affected data centers in the SVP service territory. One approximately 7.5-hour outage on May 28, 2016, which was the result of two contingencies (a balloon and a breaker failure), affected two data centers. Another 12-minute outage on December 2, 2016, affected four data centers. Two different outages on August 16, 2020 (both outages due to multiple lightning strikes), with one approximately 2.5 hours and the other one approximately 10.5 hours, affected data centers at various locations on the associated loops.

SVP's root-cause analysis of every outage resulted in changes in maintenance procedures to ensure that breakers are reset before power is restored to a portion of the system that was down for maintenance. Outages would be extremely rare, and the consequences or effects on the fleet of data centers almost negligible.

Wildfire policies could impact SVP's ability to supply power to customers if curtailments on the PG&E system interrupt SVP's access to its remote electricity supplies. A PSPS essentially de-energizes power lines to prevent the lines from causing or being damaged by wildfires. The PSPSs to date have been generally limited to high-fire risk zones and only implemented under special conditions. While the SVP service territory and the SVP's primary PG&E bulk transmission line interconnection points are not in high-risk zones, a line de-energization in one of PG&E's high risk fire zones to reduce the risk of lines causing a wildfire could reduce the SVP electricity transmission access and supply through PG&E lines.

The future impact of PSPSs on the PG&E system are not currently known. To date, two broadly implemented PSPSs in PG&E service territory last fall had no impact on SVP and its customers. As the utilities and regulators try to balance the costs and benefits of PSPSs by finetuning and targeting the implementation, the mostly likely outcome is that future PSPSs will have even fewer potential effects on SVP service territory. SVP has the ability to produce about 200 megawatts (MW) through generators located locally and can adapt to planned outages on the PG&E system just as it has reacted or recovered from unplanned outages in the past to maintain reliable and high-quality electricity supplies to its service territory customers.

Energy shortages, like those that occurred on two occasions in 2020, could prevent a utility from supplying CA3DC's electricity needs and CA3DC would then rely on gensets. Recently, the California Public Utilities Commission (CPUC) adopted a new five-year pilot program (D.21-03-056), in effect through 2025, that orders PG&E, Southern California Edison, and San Diego Gas & Electric to administer the Emergency Load Reduction Program (ELRP). Data centers could voluntarily participate in ELRP and, in the event of an energy shortage emergency, these utilities would disconnect from the grid and use their on-site gensets to supply electricity. The ELRP provides a mechanism for utilities to measure the load reduction and provide financial compensation to the participants. The ELRP does not affect the likelihood of emergency events. The last time an emergency

event occurred, like those in 2020, was 2001. Energy emergencies continue to be rare events. In addition, in the text below, California Energy Commission (CEC) staff (staff) discussed that CA3DC would not be online in time to be part of the first phase of the ELRP, and it is less likely that these types of measures will be necessary beyond the immediate future. Lastly, it is unclear whether the U.S. EPA would consider participation in such a program to be an emergency use and, thus, allowed under federal permit restrictions. For these reasons staff does not consider the existence of the ELRP to have any effect on the likelihood of the CA3 Backup Generators operating outside of testing and maintenance.

Still, staff expects the CA3DC gensets to be required to supply data center loads only rarely. The gensets would not be used when maintenance is performed on the transmission line or substation connecting CA3DC to the SVP grid. The SVP looped systems, designed with redundant equipment, ensure that line outages and other system faults only rarely result in a customer losing connection to grid power and over 10 years of data supports this. PSPSs have not directly impacted SVP customers, and, as staff expects the effects of PSPSs to decrease over time, staff does not think this would be an issue for CA3DC going forward. Finally, emergency events affecting electric supply are rare.

### *Emergency Operations*

#### *Historical Power Outage Frequency*

This section provides information on the likelihood of an interruption of SVP's electrical supply that would trigger the emergency operation of the gensets at the Vantage Data Services CA3 Backup Generating Facility (CA3BGF). More than 12 years of historical data of past outages of data centers in the SVP service territory is available. Staff has used it to estimate the frequency and duration of reasonably foreseeable, future electrical outages that could trigger emergency operations. Emergency operations would be unplanned and infrequent.

Reliability statistics for all electric customers served by SVP appears within the 2018 Integrated Resource Plan (IRP), and to expand on this information, staff explored specifically how data centers in SVP's territory have been historically affected by outages.

From the 2018 IRP: "SVP's electric system experiences approximately 0.5 to 1.5 hours of outage time per customer per year. This compares favorably with other utilities in California with reliability factors ranging from 1.0 to 2.5 hours outage per customer per year" (SVP 2018a). The 2018 IRP for SVP reports the Average Service Availability Index (ASAI), defined as the customer-minutes-available divided by the total customer-minutes, expressed as a percentage, and the ASAI has been 99.979% or higher in each recent year, with an average of 99.989 over the past seven years. The SAIFI (interruptions per customer) shows that one or fewer outages have occurred, on average, for all customer types annually (SVP 2018a). This data for all customers is summarized in **Table B-1**.



**TABLE B-1 SVP RELIABILITY STATISTICS FOR ALL CUSTOMER TYPES**

Year	ASAI (%)	SAIDI (minutes)	SAIFI (interruptions per customer)	Total Outages (number)
2012	99.994	29.34	0.48	67
2013	99.991	47.33	0.49	69
2014	99.989	56.6	0.48	80
2015	99.986	73.96	0.59	123
2016	99.993	36.29	0.5	123
2017	99.979	109.08	1.03	195
2018	99.992	42.61	0.41	132

**Notes:**

ASAI (%): Average Service Availability Index - (customer minutes available / total customer minutes, as a %).

SAIDI (minutes): System Average Interruption Duration Index - (average minutes interrupted per customer for all customer).

SAIFI (number): System Average Interruption Frequency Index - (number of interruptions per customer for all customers).

**Source:** SVP 2018a.

The proposed CA3DC would be a large customer of SVP that would receive better-than-average reliability compared to all SVP customers by including a dedicated onsite substation that would be directly served by SVP's looped 60 kV system. Staff reviewed the frequency and duration of known data center customers' outages, as provided by SVP (DayZenLLC 2021I), to discern how redundant features allow SVP's system to provide greater reliability to data centers when compared with average SVP customers.

That data indicates that the likelihood of an outage on SVP's looped 60 kV system that forces the emergency operation of a data center's gensets would be "extremely rare" (DayZenLLC 2021I). Project-specific design factors include the site-specific substation that would connect CA3DC to the SVP looped 60 kV system, a limited number of commercial customers on the looped 60 kV system, redundant transformers to supply CA3DC, and CA3DC's proposed uninterruptible power supply (UPS) battery system to carry critical loads during short-term electric service disruptions or transients.

As mentioned above, there were 41 outages on the SVP 60 kV system over the last 12 years (January 1, 2009, to June 16, 2021), only six of which resulted in customers being without power. Of these outages, only four of them affected data centers in the SVP service territory. These customers are all served by a distribution system that includes "looped" lines that can provide alternate flow paths for power flow to data centers. Thus, in general, it takes more than one 60-kV system path failure to cause a power outage at data center.

One approximately 7.5-hour outage on May 28, 2016, which was the result of two contingencies (a balloon and a breaker failure), affected two data centers. Another 12-minute outage on December 2, 2016, affected four data centers. Two different outages

on August 16, 2020 (both outages due to multiple lightning strikes), with one approximately 2.5 hours and the other one approximately 10.5 hours, affected data centers at various locations on the associated loops.

### ***BAAQMD's Review of Data Center Diesel Genset Engine Operations***

Scoping comments from the Bay Area Air Quality Management District (BAAQMD) provided a review of data centers that initiated the operation of diesel genset engines for "non-testing/non-maintenance" purposes to inform staff's consideration of scenarios of emergency backup power generation operations beyond routine testing and maintenance (BAAQMD 2021b). BAAQMD's review covers a recent 13-month period (September 1, 2019, to September 30, 2020) that spans different types of emergency situations across California.

There are 66 data centers under the jurisdiction of BAAQMD with staff at BAAQMD gathering information from 45 of those data center facilities. The attachment to BAAQMD's scoping comments listed 20 facilities that reported some level of "non-testing/non-maintenance" diesel genset engine use in the 13-month period (CEC 2021).

The scope of BAAQMD's review can be summarized as follows:

- a. Period covered: 13 months (9,504 hours)
- b. Facilities (data centers) under BAAQMD jurisdiction: 66 data centers
- c. Facilities from which information was collected: 45 data centers
- d. Facilities responding with some "non-testing/non-maintenance" use: 20 data centers
- e. Permitted genset engines at the 20 facilities responding: 288 engines
- f. Installed generating capacity of genset engines at the 20 facilities responding: 686.5 MW
- g. Information was not provided for the 25 facilities that did not report any non-testing/non-maintenance use or the other 21 facilities under BAAQMD's jurisdiction that were not surveyed in this data gathering effort.

BAAQMD normally issues permits for diesel genset engines, and the permit requires each owner or operator to maintain records of the number of operating hours for each "emergency" and the nature of the emergency. The types of events within BAAQMD's review period include a Governor-proclaimed state of emergency, other outages, power quality events, and human errors. The data shows that 75 percent of all genset engine-hours occurred either during the August 2020 Governor-proclaimed state of emergency or the subsequent heat event in September 2020. Staff does not consider this a typical year, and the data is probably not representative or indicative of future years.

For the 20 data centers listed in BAAQMD's review, the total permitted and installed generating capacity of these facilities equals 686.5 MW, across 288 individual genset

engines. The total amount of “non-testing/non-maintenance” runtime of all these 288 genset engines amounted to approximately 1,877 engine-hours of operation.

**Table B-2** summarizes the runtimes found by BAAQMD’s review for each of the 20 data centers. BAAQMD’s review identified one data center facility that ran diesel gensets for approximately 400 hours for non-testing/non-maintenance purposes during this time. **Table B-2** shows that this facility has over 40 individual genset engines permitted at the site for an average runtime of about 10 hours per engine. The different data centers within BAAQMD’s review showed that nine of the 20 facilities responding had fewer than 50 hours of operating one or more diesel genset engines for non-testing/non-maintenance purposes.

**TABLE B-2 BAAQMD’S REVIEW OF NON-TESTING/ NON-MAINTENANCE OPERATION (ENGINE-HOURS)**

Data Center	# of Permitted Genset Engines	# of Genset Engines with Non-Testing/ Non-Maintenance Operations	Sum of Non-Testing/ Non-Maintenance Operations (Engine-Hours)	Average Hours of Operations per Genset Engine Used
1	10	10	83	8.3
2	5	5	77	15.3
3	6	6	108	18.0
4	44	44	22	0.5
5	3	2	11	5.5
6	6	6	219	36.5
7	24	24	202	8.4
8	26	24	10	0.4
9	5	5	26	5.2
10	41	40	401	10.0
11	14	11	75	6.8
12	11	11	275	25.0
13	5	5	85	17.0
14	22	8	28	3.4
15	8	7	98	14.0
16	17	4	10	2.4
17	2	2	4	2.0
18	8	6	18	3.0
19	6	6	24	4.0
20	25	17	103	6.0
<b>Total</b>	<b>288</b>	<b>243</b>	<b>1,877</b>	<b>Max. 36.5</b>

Sources: BAAQMD 2021b, Energy Commission staff analysis of data from BAAQMD

From the runtimes of all the genset engines at all facilities in BAAQMD’s review, **Table B-2** estimates that the average genset engine ran no more than 36.5 hours over the 13-month period. Staff also found that no single engine within BAAQMD’s review ran for more than 50 hours overall for “non-testing/non-maintenance” purposes.

Staff used the data in BAAQMD’s review (BAAQMD 2021b) and a clarifying email of BAAQMD results (CEC 2021) to estimate the power production during “non-testing/non-

maintenance” diesel genset engine use and found that approximately 1,575 MWh was generated during this 13-month (9,504 hour) period. The power generated by these genset engines presumably displaced grid service for the on-site data center facility electrical demand. Based on the installed generating capacity of 686.5 MW partially operating within the 13-month record, the genset engines in BAAQMD’s review that did operate would have an extremely low capacity-factor of 0.024 percent [0.024 percent = 1,575 MWh / (686.5 MW \* 9,504 hours)]. This capacity factor is only considering the facilities that had genset engines that ran during this 13-month period. Twenty-five of the 45 facilities reporting had zero hours of engine runtime.

**Consideration of Extreme Events.** California experienced different types of emergency situations within the 13-month period (September 1, 2019, to September 30, 2020) of BAAQMD’s review. This period included the expansion of PG&E’s PSPS program, severe wildfires, several California Independent System Operator (CAISO) declared emergencies, and winter storms. From August 14, to 19, 2020, California experienced excessive heat. On August 16, 2020, Governor Newsom proclaimed a state of emergency<sup>1</sup> because of the extreme heat wave in California and surrounding western states. This was a one in 30-year weather event that resulted in the first system-wide power outages California had seen in 20 years. In addition to the extreme heat wave in mid-August, high temperatures and high electricity demand occurred over the 2020 Labor Day weekend, especially on Sunday, September 6, and Monday, September 7, 2020 (CAISO 2021). Thus, the data set provided is not necessarily representative of an average 13-month period from which one could extrapolate average genset facility use into the future.

**Table B-3** summarizes how these extreme events influenced the runtimes found by BAAQMD’s review for each of the 20 data centers.

**Table B-3** shows that most “non-testing/non-maintenance” diesel genset engine use identified by BAAQMD’s review (over 1,400 engine-hours out of 1,877 engine-hours) occurred either during the August 2020 Governor-proclaimed state of emergency or the subsequent heat event in September. Excluding these extreme events results in 473.7 engine-hours of “non-testing/non-maintenance” diesel genset engine use during other dates, or fewer than two hours per engine for all 288 engines in the review. Out of the 20 data centers that ran genset engines for “non-testing/non-maintenance” purposes, the 473.7 engine-hours of runtime outside of extreme events was spread across 10 data centers out of the 45 data centers covered by BAAQMD’s review.

Similarly, staff estimates that over 50 percent of the overall power produced by the genset engines in BAAQMD’s review (at least 843 MWh of 1,575 MWh) occurred during the Governor-proclaimed state of emergency, and another 25 percent of the power

---

<sup>1</sup> <https://www.gov.ca.gov/wp-content/uploads/2020/08/8.16.20-Extreme-Heat-Event-proclamation-text.pdf>.

produced was attributable to unknown days in the period. Staff's analysis of actual power produced during each day of the 13-month record appears in **Table B-4**.

**TABLE B-3 EXTREME EVENTS: NON-TESTING/NON-MAINTENANCE OPERATION (ENGINE-HOURS)**

Data Center	Operations During August 2020 State of Emergency (Engine-Hours)	Operations During September 2020 Heat Event (Engine-Hours)	Other Dates of Operations (Engine-Hours)	Sum of Non- Testing/ Non-Maintenance Operations (Engine-Hours)
1	82.7			83
2			76.6	77
3	107.8			108
4	21.6			22
5	11.0			11
6	218.8			219
7	88.2	81.2	32.5	202
8			10.3	10
9	26.0			26
10	259.7		141.1	401
11	75.0			75
12	275.3			275
13			85.0	85
14	19.9		7.6	28
15			98.0	98
16			9.6	10
17			4.0	4
18	9.0		9.0	18
19	24.0			24
20	88.4	14.3		103
<b>Total</b>	<b>1,307.4</b>	<b>95.5</b>	<b>473.7</b>	<b>1,877</b>

Sources: BAAQMD 2021b, Energy Commission staff analysis of data from BAAQMD

Across all events, including the extreme event days within the period, **Table B-4** shows that the average genset engine loading in BAAQMD's review was below 40 percent. However, the data does not establish a typical type of operation that could be reasonably expected to occur during any emergency or any typical operational characteristics that could be used in representative air quality modeling. For example, some genset engines in the data set ran at no load or with very low loads; one genset engine ran at no load for 41.7 hours while the highest genset engine load in the data set was 70 percent load. The range of genset engine loads and the fact that most genset engines operated at low loads demonstrates the difficulty in predicting the level of facility electrical demands that would need to be served by the genset engines during

an emergency. This also demonstrates the difficulty in making an informed prediction of the genset engines' emission rates, which vary depending on load, in the event of an emergency.

**TABLE B-4 EXTREME EVENTS: NON-TESTING/NON-MAINTENANCE OPERATION (ENGINE LOADS)**

<b>Date of Event Start</b>	<b>Extreme Heat Wave Event?</b>	<b>Non-Testing/Non-Maintenance Operations - @ actual load (MWh - per day)</b>	<b>Average Genset Engine Loading on Event Day</b>
Unknown		418.0	45.3%
11/26/2019		1.1	13.8%
11/27/2019		5.5	17.7%
2/15/2020		0.7	7.0%
7/31/2020		2.9	17.3%
8/14/2020		39.0	48.0%
8/16/2020		25.6	38.4%
8/17/2020	Aug 2020 Emergency	843.1	34.5%
8/18/2020	Aug 2020 Emergency	112.0	31.2%
8/19/2020	Aug 2020 Emergency	14.4	40.0%
8/25/2020		5.4	30.0%
9/6/2020	Sept 2020 Event	90.0	48.6%
9/7/2020	Sept 2020 Event	16.8	39.2%
<b>Total</b>		<b>1,574.7</b>	<b>Average 31.6%</b>

Sources: BAAQMD 2021b, Energy Commission staff analysis of data from BAAQMD

**Frequency of Diesel Genset Engine Emergency Use, Discussion:** The BAAQMD scoping comment illustrates that genset engines were used at data centers for “non-testing/non-maintenance” purposes that could occur more frequently than utility service power outages. In staff’s review of prior data center cases that were proposed within the SVP territory, staff found that the likelihood of an outage on SVP’s looped 60 kV system that forces the emergency operation of a data center’s gensets would be “extremely rare” and a low-probability event. For the prior cases in SVP territory, staff estimated a 1.6 percent probability of any given data center facility experiencing a power outage in a period of a year based on 10 years of data between 2009 and 2019 (e.g. CEC 2020a, CEC 2020b).

In BAAQMD’s review, including the extreme events, 1,877 engine-hours of diesel genset engine use occurred at 20 data centers for “non-testing/non-maintenance” purposes (less than half of the 45 facilities included in the review, and less than a third of such facilities under BAAQMD’s jurisdiction). These runtimes occurred due to power outages, in response to the heat storm, and also for other unspecified situations categorized by the genset engine operators as “emergencies.” BAAQMD’s review covered 288 individual diesel genset engines that operated over a 13-month record. Data was not provided concerning the number of genset engines at the 25 facilities that did not operate under

these circumstances. Because the genset engines were collectively available for over 2.74 million engine-hours during the 13-month period (288 engines \* 9,504 hours), and they were used for emergency operations for 1,877 engine-hours, at those facilities where operation occurred, the genset engines entered emergency operations during 0.07 percent of their available time (1,877 / 2.74 million). This confirms that emergency use of the genset engines would be very infrequent. It is important to note that this calculation only takes into consideration those genset engines that BAAQMD found to run during this time period; a more comprehensive review would also include the availability of the 25 facilities that had zero hours of genset engine run time and also conceivably the 21 facilities that were not surveyed at all. If these facilities without genset engine runs were included, the estimated probability that any given genset engine would be likely to run would be lower.

**Duration of Diesel Genset Engine Emergency Use, Discussion:** The BAAQMD scoping comment shows genset engines were used for “non-testing/non-maintenance” purposes, mostly due to extreme events within the 13-month record. The average runtime for each event in BAAQMD’s review was approximately 5.0 hours. This shows that the duration of diesel genset engine use for “non-testing/non-maintenance” purposes, without excluding the extreme events, could involve longer runtimes than for typical utility service power outages. However, again this calculation does not factor in the larger proportion of facilities that did not run at all. In staff’s review of prior data center cases, staff found an average of 2.6 hours per outage, based on only two transmission line outages occurred in 10 years (between 2009 and 2019) affecting data centers served by SVP’s 60-KV lines (e.g. CEC 2020a, CEC 2020b).

BAAQMD’s review of diesel genset engine use considers a wider variety of reasons for running the genset engines than solely an electric power service outage. The listed reasons include: state of emergency load shedding, human error event, utility-inflicted disturbance, lightning strikes to transmission line, utility outage, power outage, system-wide power quality event, equipment failure, power bump, power supplier request, power blips, UPS/board repair, utility sag event, mandatory load transfer, and substation transformer power equipment failure. Many of these explanations are simply subcategories under the general category of grid reliability analyzed for prior cases. Others like a human error event, equipment failure, and UPS/board repair appear to be exceedingly rare occurrences unlikely to significantly add to the calculation of when emergency operations might occur. Lastly, the category of emergency load shedding/power supplier request/mandatory load transfer all appear related to the heat storm and Governor-proclaimed state of emergency described above and, given the state’s efforts to address reliability in response to such events, are unlikely to re-occur with any frequency. The provision of these categories and sub-categories helps to explain why BAAQMD shows more instances of genset engines running than staff found in prior cases and longer durations of runtimes during emergency situations. Although emergency operations could be triggered for a range of situations, including extreme events like those of August and September 2020, this information confirms that

regardless of the triggering event, emergency operations of genset engines would be expected to be infrequent and of short duration.

**Summary of Staff's Analysis of "Non-testing/Non-maintenance" Genset Engine Use:** BAAQMD's review of "non-testing/non-maintenance" genset engine operations expands our understanding of "when, why, and for how long" diesel genset engine use might occur. BAAQMD's 13-month period of review included a Governor-proclaimed state of emergency, other outages, power quality events, and human errors. Accordingly, BAAQMD's review confirms that genset engine use may occur for reasons other than grid outages, though the period is not representative of a typical year due to the rare heat storm events. Many genset engines were used for "non-testing/non-maintenance" purposes in the period reviewed by BAAQMD, but the overall number of hours of operation for the less than half of the facilities in the review that did run was 0.07 percent of the available time. Genset engine loading levels recorded during these times of use were low (average below 40 percent), and the capacity factor of these genset engines was extremely low (0.024 percent). The BAAQMD review confirms that these types of events remain infrequent, irregular, and unlikely, and the resulting emissions are not easily predictable or quantifiable. The BAAQMD review does not show that these facilities operate significantly more than staff previously analyzed in the grid reliability context in prior cases.

***CPUC Decision, D.21-03-056, Directing PG&E, Southern California Edison, and San Diego Gas & Electric To Take Actions To Prepare For Potential Extreme Weather In The Summers Of 2021 And 2022***

On March 25, 2021, CPUC adopted decision D.21-03-056, which directed the utilities to take specific actions to decrease peak and net peak demand and increase peak and net peak supply to avert the potential need for rotating outages that are similar to the events that occurred in summer 2020 in the summers of 2021 and 2022. On December 2, 2021, CPUC adopted decision D.21-12-015, which is Phase 2 of the proceeding, and focuses on increasing electric supply and reducing demand for 2022 and 2023 (CPUC 2021b).

Addressed in the decisions are the following scoped issues:

1. Flex Alert program authorization and design
2. Modifications to and expansion of Critical Peak Pricing (CPP) Program
3. The development of an Emergency Load Reduction Program (ELRP)
4. Modifications to existing demand response (DR) programs
5. Expedited Integrated Resource Plan (IRP) procurement
6. Modifications to the planning reserve margin (PRM)
7. Parameters for supply side capacity procurement
8. Expanded electric vehicle participation



This menu of options attempts to ensure grid reliability. One of the options, ELRP, allows PG&E, Southern California Edison, San Diego Gas & Electric, and CAISO to access additional load reduction during times of high grid stress and emergencies involving inadequate market resources, with the goal of avoiding rotating outages while minimizing costs to ratepayers.

The CPUC decisions would allow data centers to choose to participate in a program whereby they could be asked to shed load if an extreme heat event similar to the August 2020 event occurs in the summer of 2022 or 2023. The initial duration of the ELRP pilot program will be five years, 2021-2025, with years 2023-2025 subject to review and revision in the Demand Response Applications proceeding that is expected to be initiated May 2022.<sup>2</sup> However, the CPUC decision lays out many options for emergency load reduction to ensure grid reliability that could be utilized before resorting to gensets. The decision explains that the ELRP design aspects that are subject to review and revision as part of the pilot program include minimizing the use of diesel gensets where there are safe, cost-effective, and feasible alternatives (CPUC 2021a, Section 5.2, page 19).

However, it is not expected that CA3DC would be operational until after the summer of 2023, based on these factors: 1) estimated construction schedule of 15 months for the first phase of the project; 2) estimated completion of CEC exemption proceeding in May or June of 2022; 3) additional time needed for the city and BAAQMD to permit the project. Thus, CA3 would not be online in time to be part of the first phase of ELRP. The next two summers are likely to be the most critical in terms of extra measures needed to ensure grid reliability. It is less likely that these types of measures will be necessary beyond the immediate future, as longer-term strategies for grid resilience, such as battery facilities to supplement intermittent renewable generation, come online.

Additionally, it is unclear whether the U.S. EPA would consider participation in such a program to be an emergency use and, thus, allowed under federal permit restrictions. For these reasons staff does not consider the existence of the ELRP to have any effect on the likelihood of the CA3 Backup Generators operating outside of testing and maintenance.

Furthermore, based on the capacity factors and run times for data centers that operated during the 2020 heat events, even if it were necessary to call on data centers to shed load again, it is expected that these facilities would be called on very infrequently and would have very low capacity-factors and run times in any potential future events.

---

<sup>2</sup> CPUC Decision 21-12-015 Attachments 1-3. Available Online at:  
<https://docs.cpuc.ca.gov/PublishedDocs/Published/G000/M428/K821/428821668.PDF>

### *Electrical Reliability Supporting Information*

Staff provided a series of questions to SVP to understand when, why, and for how long gensets would need to operate for any purpose, including PSPSs, other than readiness testing or maintenance at CA3DC in the SVP service area.

This supporting information includes the following:

- A. VDC Supplemental Responses to Data Requests 15-20 – CA3BGF on June 22, 2021 to staff's questions (including a table listing SVP system outages between January 1, 2009 to June 16, 2021)
- B. VDC Responses to CEC Data Request Set 3 – CA3BGF on August 26, 2021
- C. Report of Conversation: CA3 Backup Generating Facility docketed on September 21, 2021
- D. A schematic diagram of the SVP 230 kV, 115 kV and 60 kV transmission system, SVP System Map, and
- E. A list of the customers connected to each of the five 60 kV loops in the SVP system.

**A. VDC Supplemental Responses to Data Requests 15-20 on June 22, 2021**

15. Please explain whether the Uranium Substation or the Walsh Substation could provide 100 percent power to the CD3DC in the event one of the substations is unable to.

**RESPONSE TO DATA REQUEST 15**

SVP provided the following response.

Walsh and Uranium Substations are General Distribution Stations for customers connected at 12kV and with loads less than 13.5 MW's. In the event a customer load will exceed 13.5 megavolt ampere (MVA) for a single parcel, as we expect for CAD3DC, then they will be required to build a dedicated substation.

VDC adds that it has proposed the necessary substation improvements and expansion for a dedicated Switchyard in its Application for SPPE to accommodate electricity delivery above 13.5 MVA. The improvements are designed to accommodate full electricity demand of the CA3DC after full buildout.

16. SVP has divided its 60 kV system into "loops" each with its own name; please clarify which loop the CA3DC on-site substation would be interconnected to.

**RESPONSE TO DATA REQUEST 16**

17. CA3DC will be on the Central Loop. Please explain whether the additional load associated with CA3DC would cause overloads on the SVP transmission system that would require upgrades to the existing system.

**RESPONSE TO DATA REQUEST 17**

SVP provided the following response.

From SVP's initial investigations, the additional load associated with CA3DC will be loadramp restricted until projects to reconfigure the Center Loop and Northwest loop and certain PG&E projects being developed to increase the transmission capacity to the SVP system are completed. To fully understand the impacts of this facility, SVP is conducting a System Impact Study funded by CA3DC and that information will be presented to CA3DC. The System Impact Study is underway. Once the System Impact

Study and the SVP and PG&E projects are completed, CA3DC will be allowed to ramp based upon the approved load ramp schedule. Please see attached letter to Vantage from SVP dated 9/24/2020 for additional details related to when load will be able to be served to this facility.

VDC adds that it is proceeding in constructing and operating the CA3DC in phases as described in its SPPE Application pursuant to the 9/24/2020 letter (attached). The SPPE Application has been prepared to accommodate the future load growth and electricity availability but presents the “whole of the action” as required by CEQA for full planned buildout of the CA3DC facility.

18. Please provide for the 60 kV loop on the SVP system that would serve the CA3DC:
  - a. A physical description
  - b. The interconnection points to SVP service
  - c. The breakers and isolation devices and use protocols
  - d. A list of other connected loads and type of customers
  - e. A written description of the redundant features that allow the system to provide continuous service during maintenance and fault conditions

#### **RESPONSE TO DATA REQUEST 18**

The following response was provided by SVP.

- a. The loop serving CA3DC is an overhead transmission line comprised of mainly wooden transmission poles, bundled 954 AAC Conductor, serving the Central Clara Area.
- b. Interconnection with the SVP system would be in the 60KV Junction Feeder that serves the customer’s transformer.
- c. SVP utilizes a breaker and half bus design primarily to isolate any faults within each breakers zone of protection, isolating a fault to the specific location and preventing an extended outage to adjacent transformers within the substation or to an adjacent substation.
- d. Center Loop serves a mix of General Distribution substations and customer dedicated 60kV Junctions for a total of six substations.

- e. Loop services are designed to have two sources of power so that in the event of an unplanned outage, the faulted zone is isolated from the remainder of the loop system, isolating the unplanned outage to the affected zone. In the same manner, a planned outage used to perform maintenance on a section of the transmission line can be performed without having to drop load, by planning the isolation locations around the piece of equipment to be maintained.
19. Please describe any outages or service interruptions on the 60 kV systems that would serve the CA3DC:
- a. How many 60 kV lines serve data centers in SVP, and how many data centers are on each?
  - b. What is the frequency of these outages and how would they require the use of backup generators?
  - c. How long were outages and what were their causes?
  - d. Are there breakers on the 60 kV line or disconnect switch(es) and did they isolate the faults?
  - e. What was the response to the outage(s) by the existing data centers (i.e., initiated operation of some or all back up generation equipment, data offshoring, data center planned shutdown, etc.)?

**RESPONSE TO DATA REQUEST 19**

The following responses were provided by SVP.

- a. SVP currently has five 60 kV loops plus an internal 60 kV loop at the Scott Receiving Station (SRS) and the Kifer Receiving Station (KRS). The number of Data Centers (DC) on each Loop:
  - i. North East Loop—4 DC
  - ii. North West Loop—5 DC
  - iii. East Loop—8 DC
  - iv. Center Loop--18 DC
  - v. South Loop—5 DC
  - vi. SRS Internal Loop – 2 DC
  - vii. KRS Internal Loop – 4 DC
- b&c. There were four outages between January 1st, 2009 and June 16, 2021 where SVP lost both 60kV feeds into a substation that affected a data center where back-up generators were required to operate. Over this

period, this equates to a system reliability of 99.98%.

The outages occurred on May 28th, 2016 (7 hours 23 minutes), December 2nd, 2016 (12 minutes) and two different outages on August 16th, 2020 (one 2 hours 21 minutes and second 10 hours 22 minutes). This is a total outage time affecting data centers of 20 hours and 18 minutes. Only the data centers at various locations on the associated loops were affected, not all data centers.

Since 2009, 60kV outage data is presented in the below table (over 12 years, 5 months of data). The items highlighted in yellow indicate that there was some kind of fault occurred. The items highlighted in blue is when we had a customer out of power as a result. The non-highlighted items are where an outage was taken to correct an observed situation.

- e. d. Each loop has breaker/switches and they operated as expected.  
SVP does not have knowledge of how each data center reacts to an SVP-caused outage. SVP only know the times we restored service.

20. Please provide the following regarding PSPS events:

- a. Would historical PSPS events have resulted in the emergency operations of the backup generators at the proposed CA3DC?
- b. Have there been changes to the SVP and PG&E system around the CA3DC that would affect the likelihood that future PSPS events would result in the operation of emergency generators at the proposed CA3DC?

### **RESPONSE TO DATA REQUEST 20**

SVP provided the following responses.

- a. To date, SVP has not had any historical PSPS events. As such there has been no impact to SVP or SVP customers by a PG&E initiated PSPS event in other areas.
- b. SVP has not been notified of any changes related to PG&E's transmission system that would change the likelihood of future PSPS events.

DATE	LINE (S)	CAUSE	DURATION	CUSTOMERS OUT OF POWER
01/29/21	HOM-BRO	Tree Trimming	1 Hour 38 Min	0
12/29/20	ZEN-URA	Tree Trimming	1 Hour 25 Min	0
09/26/20	HOM-BRO	Tree Trimming	2 Hours 55 Min	0
09/22/20	NAJ-PLM	Tree Trimming	1 Hour 36 Min	0
08/16/20	KRS 60KV BUS AND LAF SUB	Multiple Lightning Strikes	2 Hours 21 min	1273
08/16/20	WAL-FIB, WAL-URA	Multiple Lightning Strikes	10 Hours 22 min	5438
10/24/19	MIS CB62 (NRS-MIS)	Hot Spot Repair	29 Min	0
10/11/19	WAL-FIB	Balloons close to line	6 Min	0
09/17/16	KRS-PLM	Rotten Pole Replacement	10 Hours 5 Min	0
08/14/19	SRS CB982-(SRS-CEN)	Faulty JMUX Card	4 Min	0
03/30/19	URA-WAL	Bird @ UW43	1 Hour 46Min	0
11/22/18	HOM-SER	Pole Fire HS9 (forceout)	1 Hour 27Min	0
07/5/18	SER-HOM	Force out to remove balloons	9 Min	0
05/5/18	SER-HOM	Force out to remove balloons	11 Min	0
09/1/17	AGN-NAJ	Force out to cut trees	1 hour 5 min	0
08/8/17	URA-ZEN	Force out to remove balloons	20 Min	0
05/25/17	SRS-FRV	Tripped during SCADA commissioning	1 Min	0
05/8/17	NWN-ZEN	Force out to remove bird	50 Min	0
04/29/17	SRS-HOM	Force out to remove balloons	2 hours 22 min	0
03/20/17	JUL-CEN	Third Party got into 60kV	9 hours 55 min	0
01/22/17	SER-BRO	Tree in wires	3 hours 31 min	0
01/22/17	NAJ-PLM	A phase contact guy wire when winds pick up	1 hour 47 min	0
01/19/17	KRS-PLM	Palm frond between phases	41 min	0
01/18/17	NAJ-PLM	A phase contact guy wire when winds pick up	1 Hour 44 min	0
12/02/16	RAY T1 & T2	Dropped both transformers during restoration switching due to relay not reset	12 minutes	257
09/06/16	SRS-CEN	Bird Contact	40 Min	0
06/30/16	WAL-FIB	Bird nest contact	12 hours and 4 min	0
05/28/16	SRS-FRV- NWN-ZEN	Balloons in line and breaker fail	7 hours 23 min	28
02/17/16	SRS-FRV	Palm tree with fire	7 hours	0
11/18/15	SER-BRO	Arcing wires forced	2 hours 59 min	0
11/16/15	SER-BRO	Rotten Pole- forced	22 hours 32 min	0
11/09/15	JUL CB32	Possible lightning	53 min	0
10/29/15	SER-BRO	Roller arcing-forced	3 hours 33 min	0

DATE	LINE (S)	CAUSE	DURATION	CUSTOMERS OUT OF POWER
08/12/15	BRO-DCJ, BRO T1	Squirrel on CB100	3 hours 55 min	2155
06/24/15	CCA CB22	Bad JMUX card	3 hours 23 min	0
05/30/15	SER-BRO	No cause found	3 hours 12 min	0
03/31/15	BRO-DCJ 12KV BUS 1& 2	Squirrel across 12kv bus tie	3 hours 26 min	2927
01/28/15	Mission CB12	Shorted control cable	6 hours 29 min	0
04/24/14	DCJ CB42	Tripped during relay work. BF wired as TT	1 Hour 30 Min	0
10/14/13	URA_WAL	Sheared Hydrant hit 60kV above	2 hours 26 min	0
12/06/12	Jul CB 32	Tripped due to cabinet vibration	2 min	0





September 24, 2020

Vantage Data Centers  
Sam Huckaby, Vice President – Construction  
2820 Northwestern Parkway  
Santa Clara, CA 95051

Subject: New Data Center at 2590 Walsh

Dear Mr. Huckaby,

The City of Santa Clara's Electric Department, Silicon Valley Power, is the electric utility for the City of Santa Clara. Electric service to the subject project will be provided in accordance with the Rules and Regulations for the utility as approved by the Santa Clara City Council. Silicon Valley Power has reviewed the power needs and commitments at all Vantage sites within the City per the property list below:

- 2820 Northwestern
- 2897 Northwestern
- 737 Mathew
- 2590 Walsh (new proposed project not yet approved – request for 90 MVA)

Based on Vantage's existing and future power needs, Silicon Valley Power should be able to provide the following total power combined for all the sites:

- Up to 126.5 MVA from the current date to the end of Second Quarter of 2022
- Up to 192.5 MVA at Third Quarter of 2022 upon completion of the South Loop Project.
  - If there are delays on the South Loop Project, it will affect the timeline to increase from 126.5 to 192.5.
  - 737 Mathew is limited to 33 MW until the South Loop Project is completed.
- Silicon Valley Power is starting the process for additional transmission capacity to the City. The conceptual timeline for completion is Fourth Quarter of 2025. Upon completion of additional transmission, Vantage can increase from 192.5 MVA to 273 MVA.
- If Vantage has a need to exceed 192.5 MVA prior to these timeframes, the City would be interested in partnering on a battery storage project or other generation facility to serve those needs.

The specific details of this service and SVP system modifications required to provide this capacity for 2590 Walsh will be worked out in a Substation Service Agreement at a future date. The City is also in the process of reviewing and updating its load development fee, which will be applicable for any new project (or above 192.5 MVA). It is also important to note that all appropriate fees will need to be paid, and this letter does not supersede any requirements or

881 Martin Avenue • Santa Clara, CA 95050 • 408-615-6600 • Fax 408-249-0217  
[www.siliconvalleypower.com](http://www.siliconvalleypower.com)

agreements for the already approved sites at 2820 Northwestern, 2897 Northwestern, and 737 Mathew.

Questions can be directed to Wendy Stone at (408) 615-5648.

Thank you,

A handwritten signature in blue ink, appearing to read 'MP', with a stylized flourish at the end.

Manuel Pineda  
Chief Electric Utility Officer  
City of Santa Clara – Silicon Valley Power

cc: Michael Stoner

**B. VDC Responses to CEC Data Request Set 3 – CA3BGF on August 26, 2021**

5. Please provide the System Impact Study.

**RESPONSE TO DATA REQUEST 5**

The background provided is generally correct, but Vantage provides additional clarification. As described in the SPPE Application, the CA3DC will be constructed but leased to clients over time in accordance with the then present demand for data center space and services. Additionally, as with every data center project or any other project that would require electricity, Vantage's future clients cannot occupy portions of the CA3DC without Vantage's ability to provide the electricity necessary for the client's demand. This is unlike a power plant which upon reaching commercial operation would have the ability to transmit all of its electricity to the grid, the CA3DC will ramp up its electrical demand over time. That demand curve is unknown, but Vantage believes that ultimately the entire CA3DC can be successfully leased and occupied by clients.

As described by SVP at evidentiary hearing in prior proceedings, it works closely with all of its large electricity users, especially data centers, to forecast increasing electrical demand on an annual basis. If SVP simply did not have the ability to serve Vantage's predicted demand, Vantage could and would not increase its electrical demand until SVP could provide the electricity. Therefore, Staff's reliance on a System Impact Study for use in its CEQA analysis is misplaced. There can be no environmental impact associated with SVP's inability to provide electricity to meet Vantage's desired electrical demand.

Therefore, the background's assertion that "the build out of the data center would be restricted until the impacts on the SVP are understood" is only partially accurate. A better statement would be that Vantage simply could not use more electricity than SVP can provide. Therefore, as with other projects approved by the Commission, the System Impact Study is not needed for the Commission to be able to complete its analysis.

Unlike a System Impact Study for a power plant, the SVP System Impact Study will study the ability to serve the CA3DC over the long term in addition to serving other existing and new users. In other words, the System Impact Study is not solely studying the impacts to the system from the CA3DC alone.

Vantage has already included the known upgrades to the SVP system necessary for it to receive electricity at the CA3DC site. They include the new substation and switching station and the overhead wires and poles necessary to interconnect to the Uranium Substation. Any other upgrades would not be specifically attributable to the CA3 alone and therefore, would not be required for Staff's CEQA

analysis.

For example, as shown in Attachment PD DR-5, SVP acknowledges that it requires outside the system upgrades to be performed by PG&E to increase electricity imports into its system. These network upgrades are not solely the result of the CA3DC, but instead are the result of all the increased electrical demand forecasted by SVP. These outside the system upgrades are part of the Transmission Planning Process. Such upgrade projects have not yet been defined but would be subject to CEQA at the time they are proposed by PG&E.

Similarly, as part of SVP's network upgrade evaluation, if it is determined that additional network upgrades would be necessary to serve future load, such network upgrades would be processed within the City of Santa Clara and compliance with CEQA would be conducted by the City at the time the network upgrade is proposed. This is how the upgrades to the SVP "loops" was performed. While new users benefit from the loop upgrades, no individual project was the sole cause for the loop upgrades.

Staff should not treat these potential future upgrades as "part of the whole of the action" with the CA3DC because they are not caused by CA3DC, are not necessary for the project to be built, and are part of the routine SVP planning processes to serve future load.

Vantage believes that the letter provided by SVP in Attachment PD DR-5 is sufficient for it to fulfill its obligations under CEQA and to determine that the CA3DC will not cause environmental impacts associated with SVP's supply of electricity.

6. Please identify any system upgrades that would be required to fully support the CA3DC.

**RESPONSE TO DATA REQUEST 6**

See Response to Data Request 5.

**C. Report of Conversation: CA3 Backup Generating Facility docketed on September 21, 2021**

1. Generally, what is the System Impact Study?

- a. What is the purpose of the study?

**RESPONSE TO Question a.**

The System Impact Study evaluates the SVP transmission system for impacts based on the projected load from the specific project.

- b. Does the study look at overall SVP system needs or is it specific to the Vantage Data Centers?

**RESPONSE TO Question b.**

The System Impact Study evaluates the overall SVP system and where we think issues will occur within SVP and potentially with the interconnection points we have with the CAISO controlled electric grid.

- c. When will the study be completed?

**RESPONSE TO Question c.**

Anticipated completion 12/2021, but can be as late as Q2 of 2023. Depends on the CAISO TPP 2021/2022 Reliability report findings, and approved mitigation work by PG&E.

- d. When completed, will the study identify specific SVP transmission/distribution system upgrades that are directly assigned to the CA3 Data Center at 2590 Walsh Ave?

**RESPONSE TO Question d.**

Yes, for SVP's system. The present CAISO TPP 2021/2022 reliability model does not account for CA3, however it does account for load growth of the Applicants two other data centers in SVP's territory that may be used to grow load at CA3 instead. The mitigations approved by the CAISO will provide a schedule when capacity may be available for CA3 to connect to the system. In addition SVP may decide to add CA3 to the new TPP 2022/2023 forecast presently being developed. The reliability model for this TPP 2022/2023 year will not be ready until August 2022. SVP expects that the TPP 2022/2023 reliability report and approved mitigation plans will provide a ramp up schedule for CA3.

2. The project owner's statement indicates that there are both SVP projects and PG&E projects that are "being developed" and until these projects are completed

the CA3 Data Center will be limited in the amount of load it can connect to the SVP system.

- a. What are the PG&E projects that are “being developed”?

**RESPONSE TO Question a.**

PG&E projects for CA3 have not yet been identified since this project was not included in the 2021/2022 Transmission Planning Process (TPP). If this project (CA3) is elected to be included in the SVP Load Forecast for TPP 2022/2023, and the CEC adopts SVP’s load forecast. Then CA3 load will be included for the CAISO to consider in their approved TPP 2022/2023 projects.

- i. Are there specific line upgrades that have been identified?

**RESPONSE TO Question i.**

It is anticipated that the TPP 2021/2022 Approved projects will provide for a significant increase in Load Service Capacity to the SVP system beyond its projected load growth. However, we will be monitoring any PG&E construction schedules provided by PG&E and provide the estimates to the customer on when capacity may be available for their load ramp.

- ii. When are they expected to be completed?

**RESPONSE TO Question ii.**

Unknown

- iii. Are these upgrades directly attributable to the CA3 Data Center or are they more generally being developed for SVP loads as a whole? What is the expected date of operation for any identified upgrades?

**RESPONSE TO Question iii.**

Unknown

- b. What are the SVP projects that are “being developed”?

- i. Are there specific line upgrades that have been identified?

**RESPONSE TO Question i.**

Yes

- ii. When are they expected to be completed?

**RESPONSE TO Question ii.**

To be determined

- iii. Are these upgrades directly attributable to the CA3 Data Center or are they more generally being developed for SVP loads as a whole? What is the expected date of operation for any identified upgrades?

**RESPONSE TO Question iii.**

Directly and as a whole to SVP's system. Upgrades will occur over the next 3-6 years.

3. If possible, we would appreciate a general description of what is happening on the SVP system as a whole with load growth due to data centers and other end users and how that relates to the need for upgrades on the PG&E system into SVP and upgrades within the SVP system.

**RESPONSE TO Question 3.**

Over the past several years, a number of data centers in Santa Clara have received a Small Power Plant Exemption (SPPE) from the CEC. The approved projects currently under construction in Santa Clara represents a significant increase in load. This information was presented to the CEC in the fall of 2020 for an update to the CAISO 2021/2022 Transmission Planning Process (TPP). The CEC and CAISO evaluated SVP's data and ultimately recommended SVP's load growth be included in the Base Case for the 2021/2022 TPP process. During the CAISO Governors Board meeting in the Spring of 2021, SVP's growth was adopted the Base Case TPP plan approved by the Governor's Board.

SVP's peak load has been near 600 MW. At approximately 780 MW, SVP experiences N-1 issues with SVP's ability to support a higher load. SVP's adopted load growth for the 1 in 10 scenario is an increase to 1,130 MW by 2031. PG&E is currently studying what projects are required to meet this load growth and will be providing its mitigation plans to the CAISO in September 2021. The CA3 data center is not included in this load growth. As the CA3 projects become real (once CEQA is finalized and the project earns entitlements), SVP will add it to our projections per the CEC guidance we have received. SVP will be updating the projections to the CEC on a yearly basis.

PG&E is currently studying the effects of this load growth and SVP has shared with PG&E potential projects being investigating. Identified projects will be presented Fall of 2021 and voted on by the CAISO Governors Board in the Spring of 2022. Timing of these projects is

currently unknown.

In regard to the Vantage projects, they approached SVP with utilizing unused capacity they currently have entitlements for in Santa Clara for a new data center, CA3. The letter you attached limits their ability to go above certain limits based on projects currently in progress and futures once yet to be identified. The first project is completion of the South Loop Project. This is a project that has been in developments for nearly 10 years, includes reconductoring and splitting of existing loops. This project has gone through CEQA, engineering, easement acquisition and is currently being bid. Construction should begin by the end of the year and be completed by end of 2<sup>nd</sup> quarter 2022. This will enable the McLaren data center to increase their load. The next level of projects required to go beyond the established numbers are in PG&E system. The McLaren data center, plus other approved data centers were included in the load forecast provided to the CEC and ultimately adopted by the CAISO Governors Board. These projects are currently being studied through the 2021/2022 TPP process.

SVP cannot provide an estimate when Vantage's portfolio will be able to go beyond the values included in the referenced letter. Specifically, the 192.5 MW value. There are options for additional storage facilities to accommodate above the 192.5 MW values. The SVP system limitations are during peak temperature days for up to 4 hours per day which may occur 20 to 30 times annually. Vantage has not approached SVP related the storage options.



**D. Schematic diagram of the SVP 230 kV, 115 kV and 60 kV transmission system, and SVP System Map**

PLOTTED 5/10/2015 10:58 AM BY LAURICE  
 FILE LOCATION: H:\CLIENTS\WINDCROSS\WINDCROSS\LAURICE.DWG

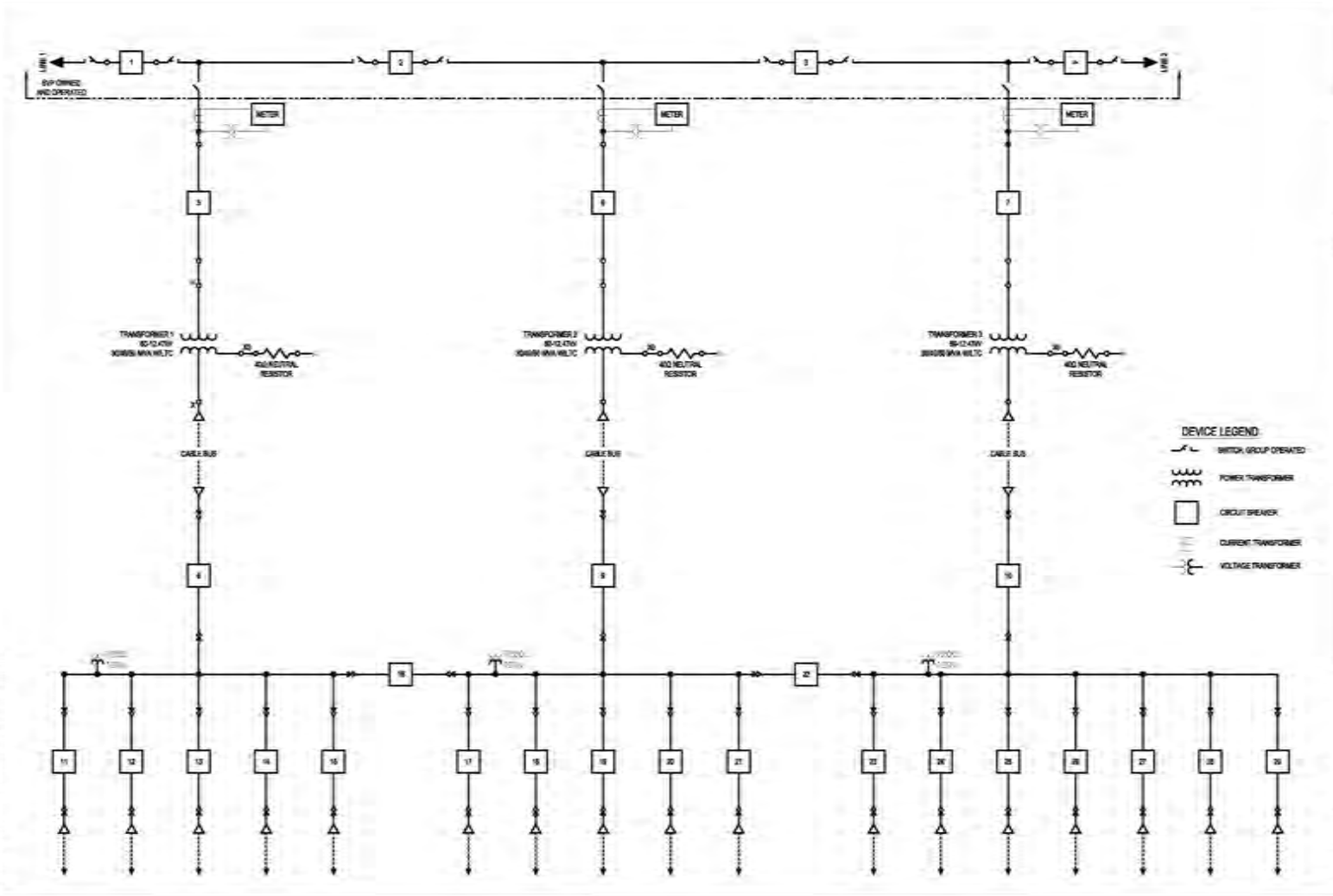

**DEVICE LEGEND**

- SWITCH GROUP OPERATED
- POWER TRANSFORMER
- CIRCUIT BREAKER
- CURRENT TRANSFORMER
- VOLTAGE TRANSFORMER

ENGINEER: LAURICE  
 PROJECT: WINDCROSS  
 SINGLE LINE DIAGRAM  
 5/10/2015

**patterson & dewar**  
 ENGINEERS  
 400 GUYTON WAY, SUITE 200, ALBANY, NY 12206  
 (518) 534-1100

CABLE:

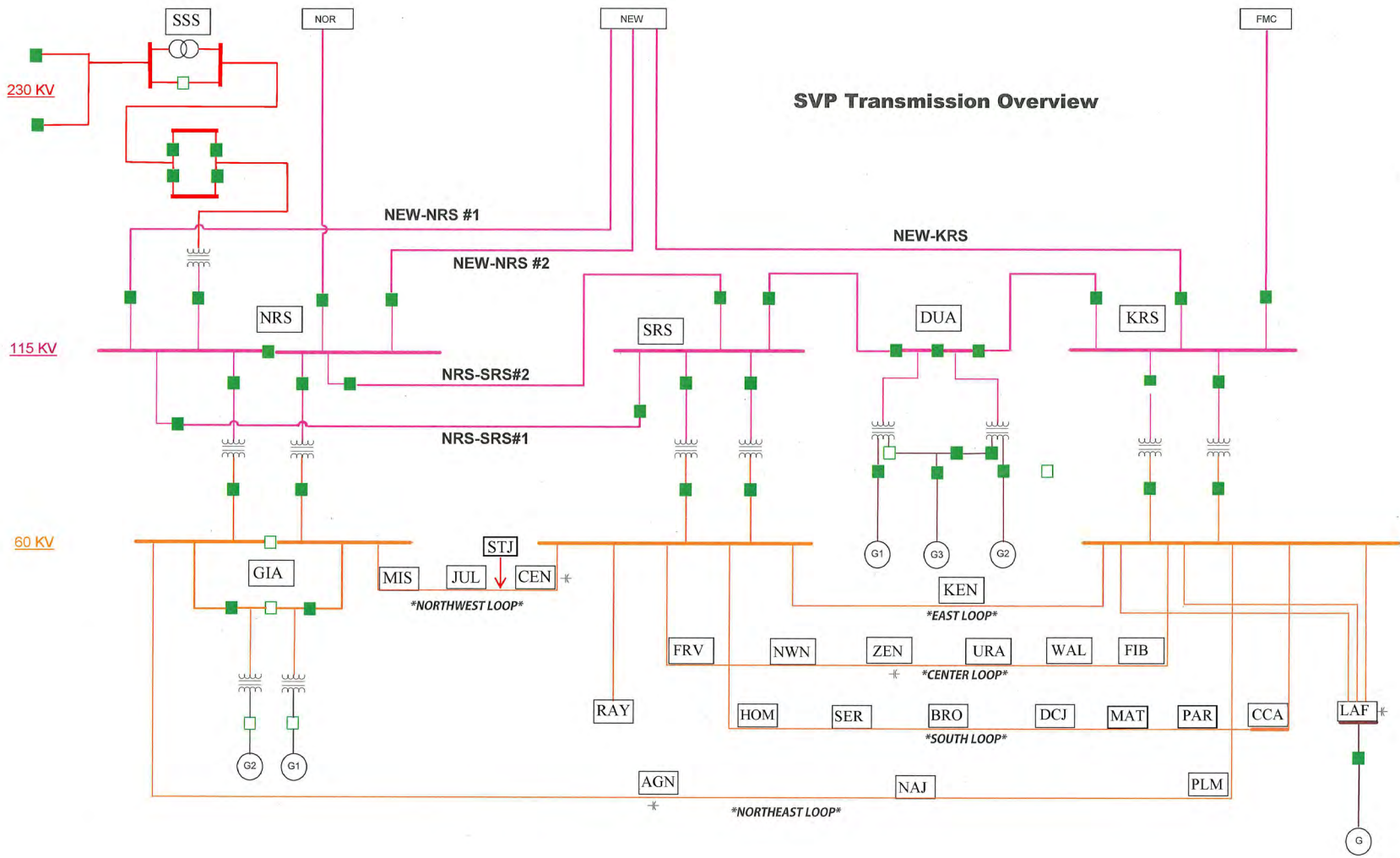

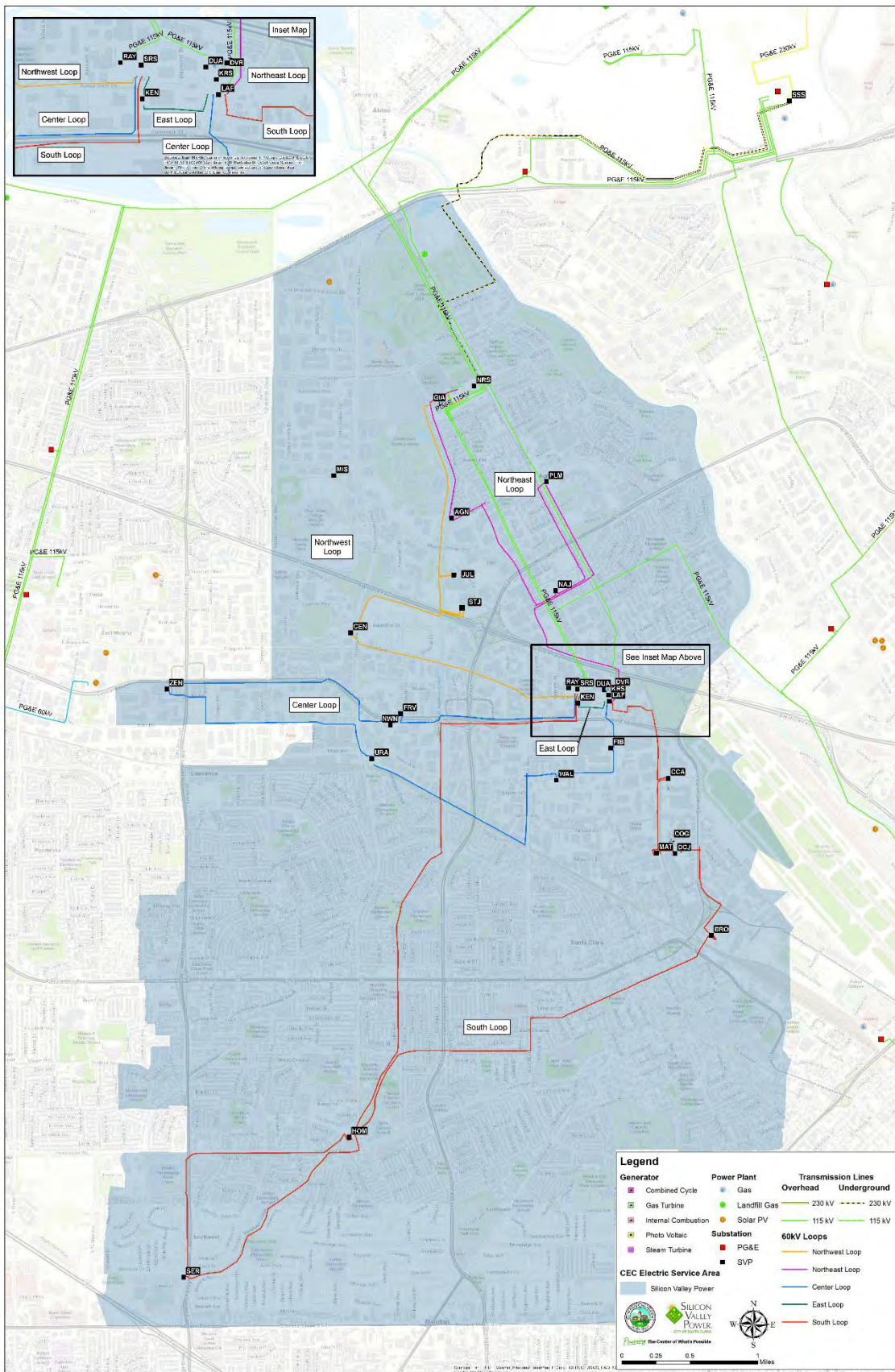

**E. A list of the customers connected to each of the five 60 kV loops in the SVP system.**

**SVP Loop Customers and Loading Peak - Substation:**

Substation	Loop	Customer/Industry	Substation	Loop	Customer/Industry
Fairview	Center	Mfg1	Central	Northwest	Medical2
Fairview	Center	Datacenter1	Central	Northwest	Real Estate2
Fairview	Center	Datacenter2	Central	Northwest	Real Estate3
Fairview	Center	Datacenter3	Central	Northwest	Real Estate4
Fairview	Center	Datacenter4	Central	Northwest	Datacenter24
FIB	Center	Mfg2	Central	Northwest	Datacenter25
Lafayette	Center	Mfg3	Central	Northwest	R&D2
Lafayette	Center	Datacenter5	Central	Northwest	Real Estate5
Lafayette	Center	Mfg4	Central	Northwest	Real Estate6
Lafayette	Center	Mfg5	Central	Northwest	Healthcare equipment
Lafayette	Center	Datacenter6	Central	Northwest	Education13
Lafayette	Center	Mfg6	Central	Northwest	Semiconductor/R&D
NWN	Center	Datacenter7	JUL	Northwest	Datacenter26
Uranium	Center	Datacenter8	Mission	Northwest	Property Management7
Uranium	Center	R&D1	Mission	Northwest	Computer hardware/software 2
Uranium	Center	Property Management1	Mission	Northwest	Real Estate7
Uranium	Center	Datacenter9	Mission	Northwest	Datacenter27
Uranium	Center	Datacenter10	Mission	Northwest	Software1
Uranium	Center	Datacenter11	Mission	Northwest	Computer hardware/software 3
Uranium	Center	Property Management2	Mission	Northwest	Cyber Security 2
Uranium	Center	Education1	Mission	Northwest	Conventions 2
Uranium	Center	Education2	Mission	Northwest	Hotel3
Uranium	Center	Education3	Mission	Northwest	Medical3
Uranium	Center	Education4	Mission	Northwest	Cyber Security 3
Uranium	Center	Semiconductor/ Telecommunications	Mission	Northwest	Education14
Uranium	Center	Gaming/AI/ Semiconductors1	Mission	Northwest	Datacenter28
Uranium	Center	R&D/Mfg	Mission	Northwest	R&D3
Uranium	Center	Mfg7	Mission	Northwest	Semiconductor6
Walsh	Center	Semiconductor1	Mission	Northwest	Storage1
Walsh	Center	Gaming/AI/ Semiconductors2	Mission	Northwest	Entertainment3
Walsh	Center	Mfg8	Mission	Northwest	Property Management8
Walsh	Center	Gaming/AI/ Semiconductors3	Mission	Northwest	Medical4
Walsh	Center	Datacenter12	Mission	Northwest	Telecommunications2
Walsh	Center	Education5	Mission	Northwest	NFL5
Walsh	Center	Government1	Raymond	Northwest	Datacenter29
Walsh	Center	Government2	Raymond	Northwest	Datacenter30
Walsh	Center	Semiconductor2	Raymond	Northwest	Datacenter31
Walsh	Center	Semiconductor/R&D/Mfg	Raymond	Northwest	Datacenter32
Walsh	Center	Mfg9	Raymond	Northwest	Telecommunications3
Walsh	Center	Telecommunications1	Raymond	Northwest	Datacenter33
Walsh	Center	Datacenter13	Raymond	Northwest	Gaming/AI/Semiconductors5
Walsh	Center	Education6	Raymond	Northwest	Datacenter34

Walsh	Center	Datacenter14	Brokaw	South	Government3
Zeno	Center	Education7	Brokaw	South	Education15
Zeno	Center	Education8	Brokaw	South	Education16
Zeno	Center	Semiconductor3	Brokaw	South	Education17



Substation	Loop	Customer/Industry	Substation	Loop	Customer/Industry
Zeno	Center	Datacenter15	Brokaw	South	Real Estate8
Zeno	Center	Bio Tech 1	Brokaw	South	Design1
Zeno	Center	Semiconductor/ Telecommunications	Brokaw	South	Security 2
Zeno	Center	Semiconductor/R&D/Mfg	Brokaw	South	Education18
Agnew	Northeast	Security1	Brokaw	South	Education19
Agnew	Northeast	Property Management3	CCA	South	Mfg12
Agnew	Northeast	Property Management4	DCJ	South	Datacenter35
Agnew	Northeast	Entertainment1	Homestead	South	Education20
Agnew	Northeast	NFL1	Homestead	South	Education21
Agnew	Northeast	Property Management5	Homestead	South	Education22
Agnew	Northeast	Entertainment2	Homestead	South	Education23
Agnew	Northeast	Hotel1	Homestead	South	Education24
Agnew	Northeast	Datacenter18	Homestead	South	Education25
Agnew	Northeast	Medical1	Homestead	South	Education26
Agnew	Northeast	Mfg10	Homestead	South	Healthcare1
Agnew	Northeast	Datacenter19	Homestead	South	Telecommunications4
Agnew	Northeast	Datacenter20	Homestead	South	Education27
Agnew	Northeast	Datacenter21	Homestead	South	Education28
Agnew	Northeast	Datacenter22	MAT	South	Datacenter36
Agnew	Northeast	Cyber Security 1	PRK	South	Datacenter37
Agnew	Northeast	Hotel2	Serra	South	Medical device
Agnew	Northeast	Property Management6	Serra	South	Education29
NAJ	Northeast	Mfg11	Serra	South	Education30
Palm	Northeast	Datacenter/software/ cloud computing	Serra	South	Healthcare2
Palm	Northeast	NFL2	Serra	South	Healthcare3
Palm	Northeast	NFL3	Serra	South	Healthcare4
Palm	Northeast	NFL4	Serra	South	Healthcare5
Palm	Northeast	Education9	Kenneth	East	Datacenter16
Palm	Northeast	Education10	Kenneth	East	Datacenter17
Palm	Northeast	Conventions 1	Kenneth	East	Gaming/AI/Semiconductors4
Palm	Northeast	Education11			
Palm	Northeast	Semiconductor4			
Palm	Northeast	Datacenter23			
Palm	Northeast	Education12			
Palm	Northeast	Real Estate1			
Palm	Northeast	Network hardware1			
Palm	Northeast	Semiconductor5			
Palm	Northeast	Computer hardware/software 1			

**SVP Loop Customers and Loading Peak - Loop:**

<b>Center 141MW</b>	<b>East Loop 15MW</b>	<b>Northeast Loop 28MW</b>	<b>Northwest Loop 112MW</b>	<b>South Loop 65MW</b>
Mfg1	Datacenter16	Security1	Medical2	Government3
Datacenter1	Datacenter17	Property Management3	Real Estate2	Education15
Datacenter2	Gaming/AI/Semiconductors4	Property Management4	Real Estate3	Education16
Datacenter3		Entertainment1	Real Estate4	Education17
Datacenter4		NFL1	Datacenter24	Real Estate8
Mfg2		Property Management5	Datacenter25	Design1
Mfg3		Entertainment2	R&D2	Security 2
Datacenter5		Hotel1	Real Estate5	Education18
Mfg4		Datacenter18	Real Estate6	Education19
Mfg5		Medical1	Healthcare equipment	Mfg12
Datacenter6		Mfg10	Education13	Datacenter35
Mfg6		Datacenter19	Semiconductor/R&D	Education20
Datacenter7		Datacenter20	Datacenter26	Education21
Datacenter8		Datacenter21	Property Management7	Education22
R&D1		Datacenter22	Computer hardware/software 2	Education23
Property Management1		Cyber Security 1	Real Estate7	Education24
Datacenter9		Hotel2	Datacenter27	Education25
Datacenter10		Property Management6	Software1	Education26
Datacenter11		Mfg11	Computer hardware/software 3	Healthcare1
Property Management2		Datacenter/software/cloud computing	Cyber Security 2	Telecommunications4
Education1		NFL2	Conventions 2	Education27
Education2		NFL3	Hotel3	Education28
Education3		NFL4	Medical3	Datacenter36
Education4		Education9	Cyber Security 3	Datacenter37
Semiconductor/Telecommunications		Education10	Education14	Medical device
Gaming/AI/Semiconductors1		Conventions 1	Datacenter28	Education29
R&D/Mfg		Education11	R&D3	Education30
Mfg7		Semiconductor4	Semiconductor6	Healthcare2
Semiconductor1		Datacenter23	Storage1	Healthcare3
Gaming/AI/Semiconductors2		Education12	Entertainment3	Healthcare4
Mfg8		Real Estate1	Property Management8	Healthcare5
Gaming/AI/Semiconductors3		Network hardware1	Medical4	
Datacenter12		Semiconductor5	Telecommunications2	
Education5		Computer hardware/software 1	NFL5	



<b>Center 141MW</b>	<b>East Loop 15MW</b>	<b>Northeast Loop 28MW</b>	<b>Northwest Loop 112MW</b>	<b>South Loop 65MW</b>
Government1			Datacenter29	
Government2			Datacenter30	
Semiconductor2			Datacenter31	
Semiconductor/R&D/Mfg			Datacenter32	
Mfg9			Telecommunications3	
Telecommunications1			Datacenter33	
Datacenter13			Gaming/AI/Semiconductors5	
Education6			Datacenter34	
Datacenter14				
Education7				
Education8				
Semiconductor3				
Datacenter15				
Bio Tech 1				
Semiconductor/Telecommunications				
Semiconductor/R&D/Mfg				

## References

- BAAQMD 2021b – Bay Area Air Quality Management District Comments (BAAQMD). (TN 239805). Letter for CA3 Data Center NOP, dated September 21, 2021. Available online at: <https://efiling.energy.ca.gov/Lists/DocketLog.aspx?docketnumber=21-SPPE-01>
- CAISO 2021 – California Independent System Operator (CAISO). Final Root Cause Analysis Mid-August 2020 Extreme Heat Wave, dated January 13, 2021. Accessed November 2021. Available online at: <http://www.caiso.com/Documents/Final-Root-Cause-Analysis-Mid-August-2020-Extreme-Heat-Wave.pdf>
- CEC 2020a – California Energy Commission (CEC). Walsh Data Center Initial Study and Proposed Mitigated Negative Declaration (TN 232078), February 2020. Available online at: <https://efiling.energy.ca.gov/Lists/DocketLog.aspx?docketnumber=19-SPPE-02>
- CEC 2020b – California Energy Commission (CEC). Mission College Data Center Initial Study and Proposed Mitigated Negative Declaration (TN 232798), April 2020. Available online at: <https://efiling.energy.ca.gov/Lists/DocketLog.aspx?docketnumber=19-SPPE-05>
- CEC 2021 – California Energy Commission (CEC). Record of Conversation with J. Zielkiewicz, BAAQMD Staff Regarding Emergency Operations: Great Oaks South Backup Generating Facility (TN 237631), May 2021. Available online at: <https://efiling.energy.ca.gov/Lists/DocketLog.aspx?docketnumber=20-SPPE-01>
- CPUC 2021a – California Public Utilities Commission (CPUC). Decision Directing Pacific Gas and Electric Company, Southern California Edison Company, and San Diego Gas & Electric Company To Take Actions To Prepare For Potential Extreme Weather In The Summers Of 2021 and 2022. Decision 21-03-056 March 25, 2021. Available online at: <https://docs.cpuc.ca.gov/publisheddocs/published/g000/m373/k745/373745051.pdf>
- CPUC 2021b – California Public Utilities Commission (CPUC). Phase 2 Decision Directing Pacific Gas and Electric Company, Southern California Edison Company, and San Diego Gas & Electric Company To Take Actions To Prepare For Potential Extreme Weather In The Summers Of 2022 and 2023. Decision 21-12-015, December 2, 2021. Available online at: <https://docs.cpuc.ca.gov/PublishedDocs/Published/G000/M428/K821/428821475.PDF>
- DayZenLLC 2021I – DayZenLLC (DayZenLLC). (TN 238416). VDC Supplemental Responses to Data Requests 15-20 CA3BGF, dated June 22, 2021. Available online at: <https://efiling.energy.ca.gov/Lists/DocketLog.aspx?docketnumber=21-SPPE-01>

SVP 2018a – Silicon Valley Power (SVP). Final 2018 Integrated Resource Plan for Silicon Valley Power. Adopted by the Santa Clara City Council, November 27, 2018. Available online at: <http://www.siliconvalleypower.com/svp-and-community/about-svp/integrated-resource-plan>.

# **Appendix C:**

---

Renewable Diesel and Natural Gas  
Supplemental Information

# Appendix C: Renewable Diesel and Natural Gas Supplemental Information

## Renewable Diesel

### Introduction

Staff has researched the difference in cost, the production, supply, and emissions of renewable diesel in place of conventional, petroleum diesel for the emergency backup generators proposed for this project. Renewable diesel fuel supply is increasing year-by-year and limited emissions data indicate that greenhouse gas (GHG) emissions would be reduced if the ultra-low sulfur diesel (ULSD) fuel proposed for this facility is replaced with renewable diesel.

On July 31, 2013, the State Air Resources Board (CARB) and the State Water Resources Control Board issued a joint statement declaring that renewable diesel is fully equivalent to conventional low-sulfur diesel for sale in California.<sup>1</sup> Renewable diesel and CARB diesel (called ULSD below) both meet the same definition of “hydrocarbon oil” and American Society of Testing and Materials (ASTM) specification ASTM D975-12a. The joint statement states that renewable diesel is considered by these agencies to be a “drop in” fuel and fully equivalent to one another. A table attached to this joint statement shows that renewable diesel has much lower sulfur content than CARB diesel, a higher cetane number (for improved auto-ignition), and a much lower total aromatic content.

### Cost Difference Between Renewable Diesel and ULSD

As explained more fully below, renewable diesel is manufactured at industrial facilities, such as refineries, using high pressures and temperatures to convert feedstocks to the final product. Currently, the most likely source of renewable diesel that could substitute for ULSD is the Neste facility located in Singapore.

There is very little data available comparing the unsubsidized cost of renewable diesel to ULSD. A representative of Western States Oil Company<sup>2</sup>, which is a distributor of Neste renewable diesel, indicated that federal and state subsidies that are only available for transportation uses “pretty much covers the differential cost,” which he estimated to be around \$2.50 to \$3.00 per gallon. In addition, transportation fuels are subject to approximately \$0.66 per gallon in road taxes, and for a stationary source to avoid these taxes, the fuel supplier must dye the fuel red to distinguish it as a non-taxed use. Staff at the US Environmental Protection Agency (U.S. EPA) confirmed that federal tax credits are only available for transportation fuel uses at this time and that it would take an act

---

<sup>1</sup> Letter from Air Resources Board, signed by Ricard Corey, Executive Officer of CARB and Tom Howard, Executive Director of SWRCB, dated July 31, 2013. Link:

<https://ww2.arb.ca.gov/resources/documents/renewable-diesel-joint-statement>

<sup>2</sup> Email exchanges of information occurred by phone and email on June 22 and June 24, 2020, between Gerry Bemis of CEC staff and Bob Brown of Western State Oil (TN 233855).

of congress to extend them to stationary source use.<sup>3</sup> In addition, CARB staff confirmed that credits issued under the state's Low Carbon Fuel Standard (LCFS) regulation (California Code of Regulations, Title 17, sec. 95480 et. seq) are only available for transportation uses.<sup>4</sup>

CARB initially approved the LCFS regulation in 2009 with the operative date beginning on January 1, 2011. CARB approved some amendments to the LCFS in December 2011, which became operative on January 1, 2013. In September 2015, CARB approved the re-adoption of the LCFS, which became operative on January 1, 2016, to address procedural deficiencies in the way the original regulation was adopted.

Due to the complexity of the LCFS program, CARB staff have indicated that it was more likely CARB would establish a parallel program for stationary uses rather than to expand the existing LCFS Program.

The applicant estimated the worst-case annual amount of petroleum diesel fuel needed for readiness testing and maintenance activities to be approximately 421,740 gallons per year of ULSD, assuming each generator is tested at full load for a maximum of 50 hours per year<sup>5</sup>. However, the applicant is proposing an annual limit of 35 hours of readiness testing and maintenance per year per generator. Therefore, the annual amount of petroleum diesel fuel needed would be prorated to 295,218 gallons. If the cost of renewable diesel is \$3.00 per gallon more than ULSD, this equates to an annual increase in fuel cost of about \$886,000 per year.<sup>6</sup> For comparison purposes, the cost of providing electricity to the CA3 data center (project) is estimated to be about \$87 million dollars per year.<sup>7</sup>

## Production of Renewable Diesel

Almost all renewable diesel fuel currently used in California is produced in Singapore by Neste, using a patented vegetable oil refining process<sup>8</sup>. Chemically, the production

---

3 Information exchanges occurred by email between Gerry Bemis of CEC staff and Paul Michiele, Fuel Center Director, Office of Transportation and Air Quality, US EPA. These emails were dated July 6 and 7, 2020 (TN 234353 in the Great Oaks South Data Center proceeding).

4 Information exchange occurred by email between Gerry Bemis of CEC staff and Rachel Connors of ARB staff on July 17, 2020 (TN 235915 in the Great Oaks South Data Center proceeding).

5 VDC CA3BGF SPPE Application Part II (TN 237423), dated April 12, 2021. Available online at: <https://efiling.energy.ca.gov/GetDocument.aspx?tn=237423&DocumentContentId=70609>

6 Computed from 295,218 gallons/yr. x \$3.00/gallon = ~\$886,000/yr.

7 Computed assuming a maximum data center occupancy and cooling load equal to 96 MW and 8,760 hours per year, or 840,960,000 kWh/yr. x \$0.173 per kWh (PG&E's E-20P rate) x 0.60 (assumed occupancy rate) = ~\$87 million per year. This is likely an overstatement of annual electricity procurement costs because the cooling portion of the electricity demand is based on the hottest day of the year.

8 Vegetable oil refining is a process to transform vegetable oil into biofuel by hydrocracking or hydrogenation. Hydrocracking breaks big molecules into smaller ones using hydrogen while hydrogenation adds hydrogen to molecules. Diesel fuel produced from these sources is known as *green diesel* or *renewable diesel*.

process entails direct catalytic hydrodeoxygenation<sup>9</sup> of plant oils, which are triglycerides<sup>10</sup>, into the corresponding alkanes<sup>11</sup> and propane<sup>12</sup>. The glycerol chain of the triglyceride is hydrogenated to propane.

Thus, renewable diesel is made in an industrial facility that can accommodate the high temperatures and pressures needed to manufacture it.

## **Adequacy of Renewable Diesel Supply**

Currently, renewable diesel is used mostly in mobile source applications in California. This use is supported by both the federal and state credits discussed above that are only available to transportation uses of renewable diesel. As explained above, these credits currently are high enough to cover the increased price of renewable diesel over ULSD for those uses that qualify for these credits.

Renewable diesel produced by Neste and ULSD are both available from a terminal located near the proposed project. The distributor is Western States Oil Company, located at 1790 South 10th Street, San Jose. A representative of this company indicated that they could easily supply one million gallons of renewable diesel per year. It is located approximately 7.5 miles southeast of the project's proposed location, and the drive time is typically less than 20 minutes.

CARB began reporting the consumption of renewable diesel in 2011. Annual sales volumes have grown from approximately 1.8 million gallons sold in 2011 to 618 million gallons sold in 2019. The annual consumption of ULSD for the project for readiness testing and maintenance is estimated to be about 295,218 gallons. If this were replaced with renewable diesel, this level of demand would be about 0.05 percent of renewable diesel consumption in 2019. Thus, if the project used renewable diesel in place of ULSD, there would be little change in the annual consumption of renewable diesel in California and the current supply should be adequate. See **Figure D-1** for annual sales of renewable diesel in California from 2011 to 2019.

---

9 Hydrodeoxygenation (HDO) is a hydrogenolysis process for removing oxygen from oxygen containing compounds.

10 A triglyceride is an ester derived from glycerol and three fatty acids. Triglycerides are the main constituents of body fat in humans and other vertebrates, as well as vegetable fat.

11 An alkane consists of hydrogen and carbon atoms arranged in a structure in which all the carbon-carbon bonds are single.

12 Propane is a three-carbon alkane with the molecular formula C<sub>3</sub>H<sub>8</sub>. It is a by-product of natural gas process and petroleum refining and is commonly used as a fuel.

**FIGURE D-1 CALIFORNIA'S ANNUAL SALES OF RENEWABLE DIESEL (MILLIONS OF GALLONS)**

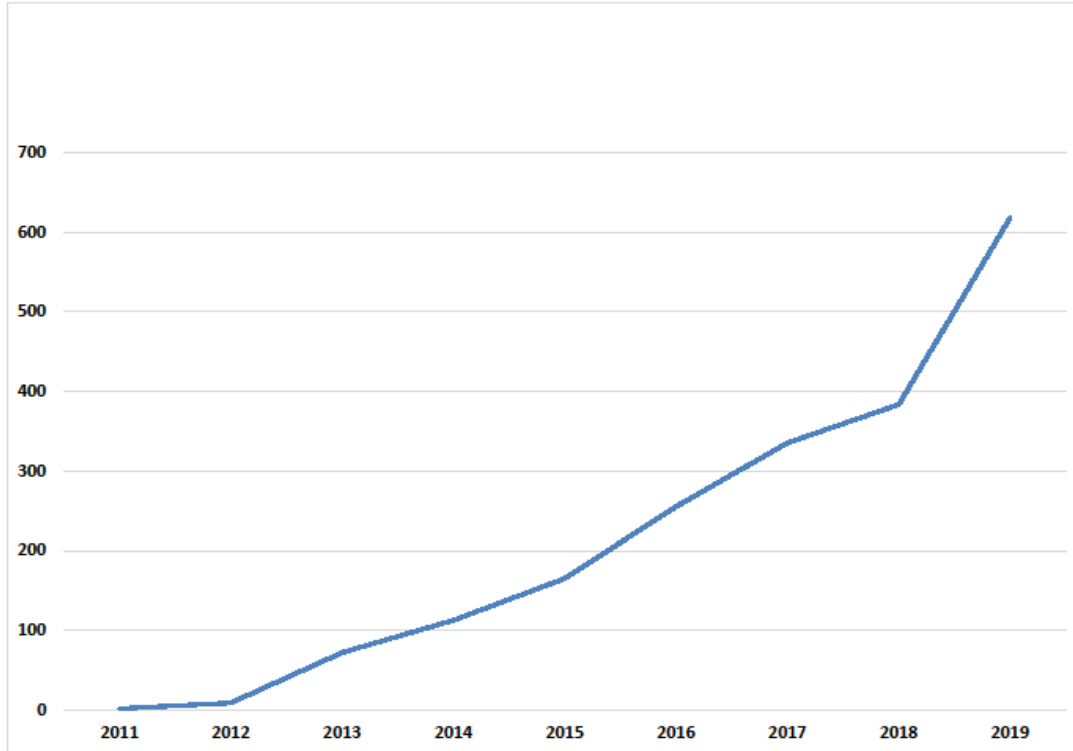

### **Renewable Diesel Emissions Compared to ULSD**

Previous limited test results for motor vehicle engines show renewable diesel would have lower criteria air pollutants emissions, GHG emissions (over the full fuel-cycle), and toxics substance emissions than conventional ULSD. However, the previously tested engines did not have selective catalytic reduction (SCR) or diesel particulate filter (DPF) exhaust aftertreatment systems. CARB's most recent testing on new technology diesel engines (NTDE) with SCR and DPF shows no statistically significant differences in oxides of nitrogen (NOx), particulate matter (PM), and total hydrocarbon emissions, but lower carbon monoxide (CO) and carbon dioxide (CO<sub>2</sub>) emissions using renewable diesel compared to CARB reference fuel. This should be confirmed with testing under controlled conditions in the size of engine proposed for this facility and using the same source test protocol used for engine certification.

#### ***Criteria Air Pollutant, Carbon Dioxide, and Fuel Use Test Results***

CARB has conducted testing to evaluate emissions from the use of renewable diesel/biodiesel in one on-road and one off-road NTDE with SCR and DPF exhaust after treatment systems, and one off-road non-NTDE (legacy engine) without DPF and SCR.<sup>13</sup>

<sup>13</sup> Low Emission Diesel (LED) Study: Biodiesel and Renewable Diesel Emissions in Legacy and New Technology Diesel Engines, Final Report – November 2021. Available Online at: <https://ww2.arb.ca.gov/resources/documents/low-emission-diesel-led-study-biodiesel-and-renewable-diesel-emissions-legacy>. Accessed December 2021.



The emissions and performance effects of three renewable diesel/biodiesel blends – 100 percent renewable diesel (R100), 65 percent renewable diesel/35 percent biodiesel (R65/B35), and 50 percent renewable diesel/50 percent biodiesel (R50/B50) – were tested in each engine against a petroleum-based CARB reference fuel (CARB reference fuel).

**Table D-1** summarizes the test results comparing R100 and CARB reference fuel from CARB's report.

For the off-road legacy engine (115 horsepower [hp] 2009 John Deere 4045HF285, without DPF and SCR), test results are consistent with previous observations. R100 showed statistically significant NO<sub>x</sub> reduction of 5.4 percent using the Non-Road Transient Cycle (NRTC) for testing and 4.9 percent using the five-mode D2 ISO 8718 steady state cycle (D2 cycle) for testing compared to CARB reference diesel. Emissions of PM decrease by 38 percent using the NRTC and 27 percent using the D2 cycle. Total Hydrocarbon (THC) emissions showed significant decreases (45 percent using the NRTC and 35 percent using the D2 cycle) using R100 compared to CARB reference diesel. Emissions of CO showed statistically significant decreases (22 percent using the NRTC and 14 percent using the D2 cycle) using R100 compared to CARB reference diesel. Emissions of CO<sub>2</sub> showed statistically significant reductions (4.1 percent using the NRTC and 4.6 percent using the D2 cycle) using R100 compared to CARB reference diesel. Brake Specific Fuel Consumption (BSFC), measured in gallons/bhp-hr, showed statistically significant increases of 3.5 percent for R100 using the NRTC. For the D2 cycle, there was no statistically significant change in BSFC for R100. Total particle number ([TPN] greater than 3 nm in diameter) and solid particle number ([SPN] greater than 23 nm in diameter) emissions show reductions for R100, except for the TPN tested in the D2 cycle that also showed a relatively large measurement variability.

For the on-road NTDE (450 hp 2019 Cummins C-15, with DPF and SCR), no statistically significant NO<sub>x</sub> emissions differences were found between the CARB reference fuel and R100. Emissions of PM of the on-road NTDE are low and near background levels. PM emissions observed for the CARB reference fuel and R100 did not show statistically significant differences. Emissions of THC were near or below background values. With the Federal Test Procedure (FTP), R100 showed no statistically significant difference in THC emissions relative to the CARB reference fuel. With the steady state Ramped Modal Cycles (RMC), THC emissions levels were below the background levels for all tests, and hence there were no measurable THC emissions. Emissions of CO from the FTP testing showed no statistically significant changes, but the RMC testing showed a slight reduction of 5 percent with R100. Emissions of CO<sub>2</sub> showed statistically significant decreases (3.2 percent using the FTP and 2.9 percent using the RMC) using R100 compared to CARB reference diesel. BSFC showed statistically significant increases (4.8 percent using the FTP and 5.1 percent using the RMC) using R100 compared to CARB reference diesel. Emissions of TPN show reductions (16 percent using the FTP and 14 percent using the RMC) for R100. Emissions of SPN also show reductions (22 percent using the FTP and 19 percent using the RMC) for R100.

**TABLE D-1 COMPARISON OF TEST RESULTS FOR R100 AND CARB REFERENCE FUEL**

	Percent Difference Comparing R100 and CARB Reference Fuel		
	Off-Road Legacy Engine	On-Road New Technology Diesel Engine (NTDE)	Off-Road NTDE
<b>NO<sub>x</sub></b>	-5.4 (NRTC), -4.9 (D2 cycle)	No Statistically Significant Difference	No Statistically Significant Difference
<b>PM</b>	-38 (NRTC), -27 (D2 cycle)	No Statistically Significant Difference	No Statistically Significant Difference
<b>Total Hydrocarbon (THC)</b>	-45 (NRTC), -35 (D2 cycle)	No Statistically Significant Difference	No Statistically Significant Difference
<b>CO</b>	-22 (NRTC), -14 (D2 cycle)	No Statistically Significant Difference (FTP), -5 (RMC)	-44 (NRTC), Below Background Levels (C1 cycle)
<b>CO<sub>2</sub></b>	-4.1 (NRTC), -4.6 (D2 cycle)	-3.2 (FTP), -2.9 (RMC)	-3.8 (NRTC), -3.0 (C1 cycle)
<b>Brake Specific Fuel Consumption (BSFC)</b>	+3.5 (NRTC), No Statistically Significant Difference (D2 cycle)	+4.8 (FTP), +5.1 (RMC)	+4.1 (NRTC), +5.0 (C1 cycle)
<b>Total Particle Number (TPN) Emissions</b>	-16 (NRTC), No Statistically Significant Difference (D2 cycle)	-16 (FTP), -14 (RMC)	Not Tested
<b>Solid Particle Number (SPN) Emissions</b>	-19 (NRTC), -21 (D2 cycle)	-22 (FTP), -19 (RMC)	Not Tested

Source: See footnote 13.

For the off-road NTDE (225 hp 2018 Caterpillar C7.1 ACERT, with DPF and SCR), NO<sub>x</sub> emissions showed no statistically significant differences between the CARB reference fuel and R100. Emissions of PM were more than a factor of 30 below the Tier 4 PM standard of 0.015 g/bhp-hr in that size category. No statistically significant differences in PM emissions were seen between different fuels. Emissions of THC were below the background levels for both the NRTC and eight-mode C1 ISO 8718 steady state cycle (C1) cycles and for all fuels. Therefore, there were no statistically significant differences in THC emissions relative to the CARB reference fuel. Emissions of CO from the NRTC testing for R100 were 44 percent lower than those for the CARB reference fuel. With the C1 cycle testing, CO emissions were near or below background levels for all tests. Emissions of CO<sub>2</sub> showed statistically significant reductions (3.8 percent using the NRTC and 3.0 percent using the C1 cycle) using R100 compared to CARB reference diesel. BSFC showed statistically significant increases (4.1 percent using the NRTC and 5.0 percent using the C1 cycle) using R100 compared to CARB reference diesel. Emissions of TPN and SPN were not tested for the off-road NTDE.

In summary, test results for the off-road legacy engine are consistent with previous observations, which showed that renewable diesel is expected to reduce criteria air pollutant and tailpipe CO<sub>2</sub> emissions from levels expected for ULSD. However, for the on-road NTDE and off-road NTDE engines, which were equipped with DPF and SCR, no statistically significant differences were found in the NO<sub>x</sub>, PM, and THC emissions using renewable diesel and CARB reference diesel. Emissions of CO for the on-road NTDE and off-road NTDE engines showed reduction using the renewable diesel for some testing cycles. Emissions of CO<sub>2</sub> for the on-road NTDE and off-road NTDE engines also showed reduction using the renewable diesel. Fuel consumption (shown as BSFC) is increased for the renewable diesel for all three engines tested, which is likely due to its slightly lower energy density per gallon, around 4 to 10 percent lower than ULSD. TEmissions of TPN and SPN are generally reduced using renewable diesel for the off-road legacy engine and the on-road NTDE.

The Caterpillar 3516E engines proposed by the applicant to be used at the project for the backup generators are rated at a nominal 2.75 megawatt (MW) (4,043 hp), much larger than the engines tested in the report cited above. The Caterpillar 3516E engines proposed for the project would be equipped with SCR and DPF to achieve compliance with Tier 4 emission standards. Test results for the new technology diesel engines would be more comparable to the proposed engines than the legacy engine. Ideally, tests should be performed on the proposed engine using renewable diesel compared with ULSD to have a better understanding of the amount of reduction in emissions expected using renewable diesel in place of ULSD. However, based upon testing to date, criteria air pollutant emissions should be significantly reduced when replacing ULSD with renewable diesel.

**Toxics Emissions Test Results.** Toxics emissions were tested previously on a 475 hp 2000 Caterpillar C-15 engine in the Freightliner chassis tested on a heavy-duty vehicle dynamometer.<sup>14</sup> The previous test data show good potential for reducing toxics substance emissions by substituting renewable diesel for ULSD. However, the results obtained for increased acetone emissions may need further study and analysis. In addition, the tested engine did not have SCR and DPF, and, therefore, it may not be comparable to the proposed engines.

Toxics emissions were not tested for CARB's most recent report. Based on the test results for total hydrocarbon emissions and PM emissions for the NTDE (shown in **Table D-1**), staff expects no statistically significant difference in toxics emissions using renewable diesel compared to ULSD.

---

<sup>14</sup> CARB Assessment of the Emissions from the Use of Biodiesel as a Motor Vehicle Fuel in California—Biodiesel Characterization and NO<sub>x</sub> Mitigation Study (October 2011); Appendix G.

## Fuel-cycle Greenhouse Gas Emissions Comparison

As shown in **Table D-1** above, renewable diesel used in place of ULSD can reduce CO<sub>2</sub> tailpipe emissions approximately 3 to 4 percent. However, renewable diesel is produced with a fuel-cycle that is a far lower carbon intensity (CI) than ULSD. To have a more complete understanding of the impact of replacing ULSD with renewable diesel, it is necessary to examine the full fuel-cycle of each fuel from origin to use. This is because GHGs have a global impact rather than a local impact.

To compute full fuel-cycle GHG emissions, a model called GREET<sup>15</sup> is commonly used to evaluate full fuel-cycle GHG emissions for transportation. Although staff has not computed fuel-cycle emissions using GREET, we can estimate the relative change in GHG emissions using CI values from the LCFS program. Although the use of renewable diesel does not qualify for obtaining credits from LCFS as explained above, CI values obtained from that program<sup>16</sup> can be used to estimate the expected GHG emissions reductions associated with switching from ULSD to renewable diesel in this project. CARB staff use a version of GREET called CA-GREET to compute CI values for the LCFS program.<sup>17</sup>

The data shown below in **Table D-2** are CARB-estimated values for Neste reformulated diesel supplied from various feedstocks with the renewable diesel produced at the Neste refinery located in Singapore. These CI values include the feedstock and transport to California via oceangoing tanker. They apparently do not include the consumption of the fuel. Combining the CI of the fuel-cycle with the reduced tailpipe emissions from **Table D-1** provides an approximate estimate of the full fuel-cycle benefit of replacing ULSD with renewable diesel. For comparison purposes, the CI for ULSD/CARB diesel has a value of 100.45.

---

15 Greenhouse gases, Regulated Emissions, and Energy use in Transportation. Available from Argonne National Labs. From the Arbonne web site: Analysis of transportation systems on a life-cycle basis permits us to better understand the breadth and magnitude of impacts produced when vehicle systems are operated on different fuels or energy options like electricity or hydrogen. Such detailed analysis also provides the granularity needed to investigate policy implications, set R&D goals, and perform follow-on impact and policy assessments. US Department Energy's Office of Energy Efficiency and Renewable Energy, Systems Assessment Group in Argonne's Energy Systems Division has been developing the GREET model to provide a common, transparent platform for lifecycle analysis (LCA) of alternative combinations of vehicle and fuel technologies. Vehicle technologies include conventional internal combustion engines, hybrid electric systems, battery electric vehicles, and fuel cell electric vehicles. Fuel/energy options include petroleum fuels, natural gas-based fuels, biofuels, hydrogen, and electricity. LCAs conducted with the GREET platform permit consideration of a host of different fuel production, and vehicle material and production pathways, as well as alternative vehicle utilization assumptions. GREET includes all transportation modes – on-road vehicles, aircraft, marine vessels, and rail (to be added in a new GREET release). The Systems Assessment Group has conducted various LCAs of vehicle/fuel systems for DOE and other agencies. There are more than 20,000 registered GREET users.

16 <https://ww2.arb.ca.gov/resources/documents/lcfs-pathway-certified-carbon-intensities>

17 <https://ww2.arb.ca.gov/resources/documents/lcfs-pathway-certified-carbon-intensities>.

**TABLE D-2 CARBON INTENSITY VALUES COMPUTED FROM CA-GREET MODEL**

<b>Feedstock</b>	<b>Carbon intensity (CI)</b>	<b>Percent Reduction of Renewable Diesel From ULSD (%)</b>
Asian-sourced used cooking oil	16.89	-83
Globally averaged used cooking oil	25.61	-75
Southeast Asian fish oil	33.08	-67
North American tallow	34.19	-66
New Zealand tallow	34.81	-65
Australian tallow	36.83	-63
Midwest corn oil	37.39	-63
Globally averaged tallow	39.06	-61
ULSD/CARB Diesel	100.45	0

Thus, the 61 to 83 percent reduction in CI values from **Table D-2** should be combined with results in **Table D-1** above. However, it can be seen that using renewable diesel in place of ULSD would greatly reduce the project’s full fuel-cycle GHG emissions associated with operating diesel-fueled equipment during the construction period and onsite fuel consumption during the operations period. However, renewable diesel still has some carbon associated with the fuel-cycle, as evidenced by the CI values in **Table D-2** not being zero, so additional measures would be needed before the project could be considered a carbon-free facility.

## **Natural Gas Internal Combustion Engines**

### **Introduction**

Staff has researched the difference in cost, supply, and emissions of using natural-gas-fueled internal combustion engines (ICEs) in place of conventional petroleum diesel for the emergency backup generators proposed for this project. Currently, there is limited information available on the fuel supply reliability of natural gas delivered to the site by pipeline versus the reliability of delivering liquid petroleum diesel by tanker truck to the site. However, most backup generators currently in place use diesel. A nationwide survey in 2016 revealed that 85 percent of the emergency backup generation was served by diesel, while 10 percent was served by natural gas and the remainder by propane.<sup>18</sup>

### **Cost Difference Between Natural Gas and Petroleum Diesel Emergency Backup Generators**

The reliability of a system is an important consideration when selecting an emergency backup generator. But cost is important as well. Many factors contribute to the life-cycle costs of a backup system, such as equipment, maintenance, and fuel costs.

---

<sup>18</sup> National Renewable Energy Laboratory report. A Comparison of Fuel Choices for Backup Generators; <https://www.nrel.gov/docs/fy19osti/72509.pdf>.

Both, natural gas ICEs and diesel engines are reciprocating engines. They are available in sizes up to 18 MW. The fast start-up capability of reciprocating engines allows for the timely resumption of the system following a maintenance procedure. In peaking or emergency power applications, reciprocating engines can quickly supply electricity on demand. The annual energy cost (\$/MMBtu) for natural gas fuel is lower than conventional diesel. But diesel generators generally have a lower component cost than ICEs. It is notable that improvements in ICEs and recently promulgated air quality regulations have reduced some of the cost advantages of diesel systems.<sup>19</sup>

The size of the engines can impact operating cost. If switching from one generating technology to another requires more engines to deliver the same total MW capacity, the repair and maintenance frequency and testing requirements could increase, which may result in an increase in associated costs.

## **Space Needs**

Diesel-fueled emergency backup generators are typically built on a rack over their fuel supply tank, requiring space between each generator and a staircase and service deck at the elevation of the diesel engine. Based on air quality modeling files, staff estimated the footprint of the 44 engines proposed at the project site as approximately 0.48 acres for 121 MW (peak power) or approximately 252 MW per acre.

Enchanted Rock, a vendor for natural gas ICEs, provided a drawing showing how they would arrange their engines at a typical site. The result was an approximate capacity of 78 MW per acre.

## **Natural Gas ICE Emissions Compared to Petroleum Diesel**

### *Criteria Air Pollutant and Carbon Dioxide Emissions Comparison*

Staff compared criteria air pollutant emissions and carbon dioxide emissions of natural gas ICEs against the proposed diesel-fired engines for the project. The proposed 44, 2.75-MW engines would be equipped with SCR and DPF to achieve compliance with Tier 4 emission standards. However, it takes time for the SCR to reach the activation temperature and become fully effective in controlling NOx emissions. Depending on load, the SCR would be expected to kick on within 15 minutes.

Information for the natural gas ICEs is primarily based on the data provided for the Small Power Plant Exemption application for the San Jose Data Center (Jacobs 2021s). The natural gas ICEs for the San Jose Data Center would be equipped with a 3-way catalyst system to reduce emissions of NOx, CO, volatile organic compounds (VOC), and air toxics. The applicant for the San Jose Data Center also assumed 15 minutes of operation with uncontrolled emissions and 45 minutes of operation with controlled emissions to estimate hourly emissions (Jacobs 2021o).

**Table D-3** compares the emission factors in pounds per megawatt-hour (lbs/MWe-hr) for the proposed diesel engines at the project and those for the natural gas ICEs proposed at the San Jose Data Center. Staff assumed the same 15-minute warm up period for the SCRs of the diesel engines and the 3-way catalyst system for the natural gas ICEs.

	<b>Units</b>	<b>Proposed Petroleum Diesel Engine</b>	<b>Natural Gas ICE</b>	<b>Difference</b>	<b>Percent Difference (%)</b>
NOx	Lbs/MWe-hr	4.89	0.09	-4.81	-98.2
PM	Lbs/MWe-hr	0.06	0.01	-0.05	-83.1
VOC	Lbs/MWe-hr	0.19	0.10	-0.09	-45.9
CO	Lbs/MWe-hr	1.89	1.68	-0.21	-11.3
SO <sub>2</sub>	Lbs/MWe-hr	0.01	0.009	-0.003	-25.4
CO <sub>2</sub>	Lbs/MWe-hr	1,556	1,440	-116	-7.4

Sources: DayZenLLC 2021b, Jacobs 2021s, and Energy Commission staff analysis

### *Toxics Emissions*

Staff is not able to find data comparing toxics emissions of natural gas ICEs with those for diesel engines. However, these are expected to be reduced due to the reductions reported above for VOCs and PM.

### **Fuel-cycle Greenhouse Gas Emissions Comparison**

As mentioned above, to compute full fuel-cycle GHG emissions, the GREET model is commonly used to evaluate full fuel-cycle GHG emissions for transportation. Although staff has not computed fuel-cycle emissions using GREET, we can estimate the relative change in GHG emissions using carbon intensity (CI) values from the LCFS program. GREET results should be combined with stack emissions shown above to get an understanding of the relative GHG emissions associated with both natural gas ICEs and petroleum diesel ICEs.

CI values indicate that natural gas ICEs fueled with pipeline natural gas produced from fossil feedstocks have a CI about 20 percent lower than petroleum diesel, as shown in the first three rows of **Table D-4**, compared to petroleum diesel, which is shown at the bottom of the table.

Natural gas feedstocks from renewable feedstocks have a CI that is much lower, with most of the renewable feedstocks associated with a net reduction in fuel-cycle carbon emissions. In other words, these feedstock options act as a way of capturing GHG emissions that would otherwise escape. Negative values in **Table D-4** below reflect this outcome. Converting these feedstocks into a fuel would provide substantial societal benefits since the feedstock would otherwise be contributing directly to global warming.

A recent study done for the State Water Resources Control Board by Carollo Engineers<sup>19</sup> and published in June 2019 illustrates how food wastes can be converted to renewable natural gas and achieve significant GHG emissions reductions. Through the co-digestion of food waste diverted from landfills and processed in anaerobic digesters, municipal wastewater treatment plants have the potential produce, capture, and make beneficial use of biogas, which is a renewable source of methane.

The Carollo report stated that landfills accounted for approximately 8,560,000 metric tons of carbon dioxide equivalent (MT CO<sub>2</sub>e) emissions as methane in 2016, or about 22 percent of statewide methane emissions. They estimated that by the year 2030, approximately 3.4 million short wet tons of food waste could be diverted from landfills to municipal wastewater treatment plants for co-digestion and processing into renewable natural gas for beneficial use. This would reduce methane emissions from landfills and reduce GHG emissions from this sector by up to approximately 2.4 MMTCO<sub>2</sub>e.

<b>Feedstock</b>	<b>Carbon intensity (CI)</b>	<b>Percent Reduction of Natural Gas ICEs From Petroleum Diesel (%)</b>
PG&E Gas	80.59	-19.7
Average Pipeline Gas	79.21	-21.1
SoCal Gas	78.21	-22.1
Landfill Gas	-5.28 to 62.30	-105 to -38
Food Wastes	-22.93	-122
Dairy Manure	-377.83 to -192.49	-476 to -292
Renewable Natural Gas	-630.72 to -151.41	-728 to -251
ULSD/CARB Diesel	100.45	0

While using pipeline natural gas in place of ULSD would reduce fuel-cycle GHG emissions approximately 20 percent, a 2018 report funded by the Public Utilities Commission (CPUC) evaluated issues with injecting fuels other than natural gas into natural gas pipelines. The report was titled: *Biomethane in California Common Carrier Pipelines: Assessing Heating Value and Maximum Siloxane Specifications -- An Independent Review of Scientific and Technical Information*.<sup>20</sup> Assembly Bill 1900 (Chapter 602, Statutes of 2012), which became operative beginning in 2013, required, among other things, that the CPUC review and upgrade as appropriate specifications for adding biogas to the state's existing natural gas pipeline system.

In 2006, the CPUC adopted Decision 06-09-039, which increased the specified minimum allowable biomethane heating value (HV) from 970 British Thermal Units per standard cubic foot of gas (BTU/scf) to 990 BTU/scf.

19 WRCB, Co-Digestion Capacity In California; Co-Digestion Capacity Analysis Prepared for the California State Water Resources Control Board under Agreement #17-014-240; [https://www.waterboards.ca.gov/water\\_issues/programs/climate/docs/co\\_digestion/final\\_co\\_digestion\\_capacity\\_in\\_california\\_report\\_only.pdf](https://www.waterboards.ca.gov/water_issues/programs/climate/docs/co_digestion/final_co_digestion_capacity_in_california_report_only.pdf); June 2019.

20 See: <https://ccst.us/wp-content/uploads/2018biomethane.pdf>



In 2014 the CPUC adopted Decision 14-01-034, which included additional gas quality specification requirements that biogas would need to meet before it could be added to natural gas pipelines, including a maximum siloxane content of 0.1 mg siloxane per cubic meter of gas (Si/m<sup>3</sup>). This level was set to protect against equipment damage and catalyst poisoning.

The 2018 CPUC report recommends that CPUC conduct further work to determine the acceptability of allowing an HV as low as 970 BTU/scf, which is the value that was allowed before the 2006 CPUC decision to increase the HV to 990 BTU/scf.

The 2018 CPUC report stated that siloxanes are not expected to be present in dairy waste, agriculture waste, or forestry residues. It concluded that some sources are very unlikely to have siloxanes (e.g., dairies or agricultural waste) and that these sources could be held to a reduced and simplified verification regime.

Further work may be needed to integrate renewable natural gas into the existing natural gas pipeline system in a cost-effective manner.

Contracting to obtain rights for renewable gas would lead to greater GHG benefits. This can be accomplished simply by displacement if the issues identified above can be resolved, assuming that the location of the use of the renewable natural gas is different from the source of the renewable natural gas unless they are close enough together to use a dedicated pipeline.

As shown in **Table D-2**, *fossil* natural gas and some forms of renewable natural gas still has some carbon associated with the fuel cycle. These show up in the table for those fuels with a CI that is greater than zero. In these cases, additional measures could be needed before the project would be considered a carbon-free facility.

## References

- DayZenLLC 2021b – DayZenLLC (DayZenLLC). (TN 237381). VDC CA3BGF SPPE Application Part III, dated April 5, 2021. Available online at: <https://efiling.energy.ca.gov/Lists/DocketLog.aspx?docketnumber=21-SPPE-01>
- Jacobs 2021o – Jacobs (Jacobs). (TN 239409). SJC Data Center SPPE Application Supplemental Filing Volume 1, dated August 20, 2021. Available online at: <https://efiling.energy.ca.gov/Lists/DocketLog.aspx?docketnumber=19-SPPE-04>
- Jacobs 2021s – Jacobs (Jacobs). (TN 239413). SJC Data Center SPPE Application Supplemental Filing Appendix Air - Traffic, Part 1, dated August 20, 2021. Available online at: <https://efiling.energy.ca.gov/Lists/DocketLog.aspx?docketnumber=19-SPPE-04>

# **Appendix D:**

---

Mailing List

## Appendix D: Mailing List

The following is the mailing list for the San Jose Data Center project.

The following is a list of the State agencies that received State Clearinghouse notices and documents:

- California Air Resources Board (ARB)
- California Department of Conservation (DOC)
- California Department of Fish and Wildlife, Marin Region 7 (CDFW)
- California Department of Parks and Recreation
- California Department of Transportation, District 4 (DOT)
- California Department of Water Resources (DWR)
- California Energy Commission
- California Governor's Office of Emergency Services (OES)
- California Highway Patrol (CHP)
- California Natural Resources Agency
- California Public Utilities Commission (CPUC)
- California Regional Water Quality Control Board, San Francisco Bay Region 2 (RWQCB)
- California State Lands Commission (SLC)
- Department of Toxic Substances Control, Office of Historic Preservation
- San Francisco Bay Conservation and Development Commission (BCDC)
- State Water Resources Control Board, Division of Drinking Water
- State Water Resources Control Board, Division of Water Quality
- California Native American Heritage Commission (NAHC)
- California Department of Fish and Wildlife, Bay Delta Region 3 (CDFW)

**Table E-1** presents the list of occupants and property owners contiguous to the project site.

**Table E-2** presents the list of property owners within 1,000 feet of the project site and 500 feet of the project linears.

**Table E-3** presents the list of agencies, including responsible and trustee agencies and libraries.

**Table E-4** presents the list of interested parties including environmental justice and community-based organizations.

**TABLE E-1 OWNERS AND OCCUPANTS OF PROPERTY CONTIGUOUS TO PROJECT SITE**

<b>Name</b>	<b>Address</b>	<b>City</b>	<b>State</b>	<b>Zip</b>
CITY OF SANTA CLARA	1500 WARBURTON AVE.	SANTA CLARA	CA	95050
PENINSULA CORRIDOR JOINT POWERS, BOARD	1250 SAN CARLOS AVE	SAN CARLOS	CA	94070
WALSH INVESTMENT PROPERTIES LLC	2630 WALSH AVE	SANTA CLARA	CA	95051
JJ & W-WALSH LLC	2490 CHARLESTON RD	MOUNTAIN VIEW	CA	94043

**TABLE E-2 PROPERTY OWNERS WITHIN 1,000 FEET OF PROJECT SITE AND 500 FEET OF LINEARS**

<b>Name</b>	<b>Address</b>	<b>City</b>	<b>State</b>	<b>ZIP</b>
SANTA CLARA UNIFIED SCHOOL DISTRICT	1889 LAWRENCE ROAD	SANTA CLARA	CA	95051
ACHK ASSOCIATES LLC	2775 NORTHWESTERN PKWY	SANTA CLARA	CA	95051
	465 CALIFORNIA ST	SAN FRANCISCO	CA	94104
PEAK REALTY INVESTMENT LLC	2625 WALSH AVE	SANTA CLARA	CA	95051
KEYPOINT CREDIT UNION	2805 BOWERS AVE	SANTA CLARA	CA	95051
IPX WALSH BOWERS INVESTORS LP	225 W SANTA CLARA ST 12TH FL	SAN JOSE	CA	95113
SCPO LLC	5674 SONOMA DR	PLEASANTON	CA	94566
JST COMMERCIAL PROP LLC	2050 SEABROOK CT	REDWOOD CITY	CA	94065
LBA RV-COMPANY I LLC	PO BOX 847	CARLSBAD	CA	92018
SPTC ESMT MURRA N, U	1500 SANSOME ST	SAN FRANCISCO	CA	94111
MEAD VENTURES INC	10920 PRIETA CT,	SAN JOSE	CA	95127
SILVER HORSE EQUITIES LLC	265 SUNSET DR	WESTLAKE VILLAGE	CA	91361
PROLOGIS EXCHANGE 2800 MEAD AVENUE LLC	1800 WAZEE ST	DENVER	CO	80202
BODO, JOSEPH; BODO, VALERIE	2695 WALSH AVE	SANTA CLARA	CA	95051
STEPHENS & STEPHENS	2590 WALSH AVE	SANTA CLARA	CA	95051
DIGITAL REALTY TRUST LP	16600 WOODRUFF AVE	BELLFLOWER	CA	90706
NVIDIA CORP	2788 SAN TOMAS EXPY	SANTA CLARA	CA	95051
CHUNYUAN PHOTONICS LLC	2701 NORTHWESTERN PKWY	SANTA CLARA	CA	95051
CHUNYUAN PHOTONICS LLC	2710 NORTHWESTERN DR	SANTA CLARA	CA	95051
VANTAGE DATA CENTERS 4 LLC; VANTAGE DATA CENTERS 3 LLC	2820 NORTHWESTERN PKWY	SANTA CLARA	CA	95051
VANTAGE DATA CENTERS 3 LLC	2880 NORTHWESTERN PKWY	SANTA CLARA	CA	95051

**TABLE E-3 AGENCIES AND LIBRARIES**

<b>FIRST NAME</b>	<b>LAST NAME</b>	<b>TITLE</b>	<b>AGENCY</b>	<b>ADDRESS</b>	<b>CITY</b>	<b>STATE</b>	<b>ZIP</b>
ARIANA	HUSAIN	PERMIT ENGINEER	BAY AREA AIR QUALITY MANAGEMENT DISTRICT	375 BEALE STREET, SUITE 600	SAN FRANCISCO	CA	94105
DR. STACY	SHERMAN	ACTING REGIONAL MANAGER	CA. DEPT. OF FISH AND WILDLIFE, BAY DELTA REGION (REGION 3)	2825 CORDELIA ROAD SUITE 100	FAIRFIELD	CA	94534
GERRY	HAAS	CONSERVATION PLANNER	SANTA CLARA VALLEY HABITAT AGENCY	535 ALKIRE AVENUE	MORGAN HILL	CA	95037
SIMON	BAKER	DIRECTOR, ENERGY DIVISION	CALIFORNIA PUBLIC UTILITIES COMMISSION	505 VAN NESS AVENUE	SAN FRANCISCO	CA	94102
RYAN	OLAH	DIVISION CHIEF	US FISH & WILDLIFE SERVICE, SACRAMENTO FISH & WILDLIFE OFFICE, COAST BAY DIVISION	2800 COTTAGE WAY RM W-2605	SACRAMENTO	CA	95825
KERRI	KISKO	ENVIRONMENTAL SCIENTIST	CALIFORNIA DEPARTMENT OF CONSERVATION	801 K STREET, MS 14-15	SACRAMENTO	CA	95814
LAURA	MIRANDA	COMMISSIONER	NATIVE AMERICAN HERITAGE COMMISSION	1550 HARBOR BLVD, SUITE 100	WEST SACRAMENTO	CA	95691
SYLVIA	FUNG	SUPERVISING TRANSPORTATION ENGINEER	IGR, CALTRANS, DISTRICT 4	P.O. BOX 23660	OAKLAND	CA	94623-0660
KEITH	LICHTEN		SAN FRANCISCO BAY RWQCB, REGION 2	1515 CLAY SUITE 1400	OAKLAND	CA	94612
LORI	KOCH	ACTING CHIEF BERKELEY/HQ	DEPT. OF TOXIC SUBSTANCES CONTROL	700 HEINZ AVENUE SUITE 200	BERKELEY	CA	94710-2721
			SAN FRANCISCO BAY CONSERVATION & DEVELOPMENT COMMISSION	375 BEALE STREET, SUITE 510	SAN FRANCISCO	CA	94105
BINAYA	SHRESTHA	SUBJECT MATTER EXPERT, PG&E	CALIFORNIA INDEPENDENT SYSTEM OPERATOR	250 OUTCROPPING WAY	FOLSOM	CA	95630
WADE	CROWFOOT	SECRETARY	NATURAL RESOURCES AGENCY	1416 NINTH STREET, SUITE 1311	SACRAMENTO	CA	95814
PHILLIP	CRADER	ASST. DEPUTY DIRECTOR	STATE WATER RESOURCES CONTROL BOARD, WATER QUALITY DIVISION	P.O. BOX 100	SACRAMENTO	CA	95812-0100

**TABLE E-3 AGENCIES AND LIBRARIES**

<b>FIRST NAME</b>	<b>LAST NAME</b>	<b>TITLE</b>	<b>AGENCY</b>	<b>ADDRESS</b>	<b>CITY</b>	<b>STATE</b>	<b>ZIP</b>
ALYSON	AQUINO	SOIL CONVERSATIONIST	NATURAL RESOURCES CONSERVATION SERVICES	3585 GREENVILLE ROAD SUITE 2	LIVERMORE	CA	94550-6707
KARLA	NEMETH	DIRECTOR	DEPARTMENT OF WATER RESOURCES	P.O. BOX 942836	SACRAMENTO	CA	94236-0001
			COUNTY OF SANTA CLARA, OFFICE OF THE CLERK RECORDER	70 WEST HEDDING STREET	SAN JOSE	CA	95110
DENNIS	JANG	SUPERVISING AIR QUALITY ENGINEER	BAQMD, ENGINEERING DIVISION	375 BEALE STREET, SUITE 600	SAN FRANCISCO	CA	94105
PAMELA	LEONG	DIRECTOR, OFFICER	BAQMD, ENGINEERING DIVISION	375 BEALE STREET, SUITE 600	SAN FRANCISCO	CA	94105
REBECCA	FANCHER		CALIFORNIA AIR RESOURCES BOARD	1001 I ST	SACRAMENTO	CA	95814
COURTNEY	GRAHAM	MANAGER	CALIFORNIA AIR RESOURCES BOARD, ENFORCEMENT DIVISION	1001 I ST	SACRAMENTO	CA	95814
GLORIA	SCIARA	DEVELOPMENT REVIEW OFFICER	CITY OF SANTA CLARA PLANNING DIVISION	1500 WARBURTON AVENUE	SANTA CLARA	CA	95050
ROY	MOLSEED	SENIOR ENVIRONMENTAL PLANNER	SANTA CLARA VALLEY TRANSPORTATION AUTHORITY	3331 NORTH FIRST STREET	SAN JOSE	CA	95134-1927
ARUNA	BODDUNA	ASSOCIATE TRANSPORTATION PLANNER	COUNTY OF SANTA CLARA ROADS AND AIRPORT DEPARTMENT	101 SKYPORT DRIVE	SAN JOSE	CA	95110
MARK	CONNOLLY	PLANNER	SANTA CLARA COUNTY AIRPORT LAND USE COMMISSION	70 WEST HEDDING STREET; EAST WING, 7TH FLOOR	SAN JOSE	CA	95110
GWEN	GOODMAN	KEY CUSTOMER SERVICE REPRESENTATIVE	SILICON VALLEY POWER	1500 WARBURTON AVENUE	SANTA CLARA	CA	95050
KATHRIN	TURNER	ASSISTANT ENGINEER II	SANTA CLARA VALLEY WATER DISTRICT-- COMMUNITY PROJECTS REVIEW UNIT	5750 ALMADEN EXPRESSWAY	SAN JOSE	CA	95118

**TABLE E-3 AGENCIES AND LIBRARIES**

<b>FIRST NAME</b>	<b>LAST NAME</b>	<b>TITLE</b>	<b>AGENCY</b>	<b>ADDRESS</b>	<b>CITY</b>	<b>STATE</b>	<b>ZIP</b>
		STAFF LIAISON	HISTORICAL AND LANDMARKS COMMISSION	1500 WARBURTON AVENUE	SANTA CLARA	CA	95050
FREDERICK	CHUN	ASSOCIATE FIRE MARSHAL/HAZARDOUS MATERIALS MANAGER	CITY OF SANTA CLARA--FIRE PREVENTION/HAZARDOUS MATERIALS	1675 LINCOLN STREET	SANTA CLARA	CA	95050-4653
			SANTA CLARA FIRE STATION #2	1900 WALSH AVE	SANTA CLARA	CA	95050
RUBEN	TORRES	FIRE CHIEF	SANTA CLARA FIRE DEPARTMENT, FIRE STATION NO. 1 /FIRE ADMINISTRATION	777 BENTON STREET	SANTA CLARA	CA	95050
KEVIN	KEATING	ELECTRIC DIVISION MANAGER	SILICON VALLEY POWER (CITY OF SANTA CLARA)	1500 WARBURTON AVENUE	SANTA CLARA	CA	95050
KATHERINE	KENNEDY	AIRPORT PLANNER	FEDERAL AVIATION ADMINISTRATION (FAA)	1000 MARINA BOULEVARD, SUITE 220	BRISBANE	CA	94005
DREW	NIEMEYER	ADMINISTRATIVE OFFICES, AIRPORT DEPARTMENT	NORMAN Y. MINETA SAN JOSÉ INTERNATIONAL AIRPORT	1701 AIRPORT BOULEVARD, SUITE B-1130	SAN JOSE	CA	95110-1206
		ENVIRONMENTAL REVIEW, PLANNING DIVISION	DEPARTMENT OF PLANNING, BUILDING, AND CODE ENFORCEMENT	200 E. SANTA CLARA STREET	SAN JOSE	CA	95113
CARY	GREENE	AIRPORT PLANNER	CITY OF SAN JOSE AIRPORT DEPARTMENT	1701 AIRPORT BOULEVARD, SUITE B-1130	SAN JOSE	CA	95510
			SAN FRANCISCO BAY-DELTA FISH AND WILDLIFE	650 CAPITOL MALL, SUITE 8-300	SACRAMENTO	CA	95814
Nicole	WAUGH		CEC - ENERGY LIBRARY	1516 9TH ST, MS 10	SACRAMENTO	CA	95814-5504
			FRESNO COUNTY FREE LIBRARY	2420 MARIPOSA ST	FRESNO	CA	93721-2204
			HUMBOLDT COUNTY MAIN LIBRARY	1313 3RD STREET	EUREKA	CA	95501-0553

**TABLE E-3 AGENCIES AND LIBRARIES**

FIRST NAME	LAST NAME	TITLE	AGENCY	ADDRESS	CITY	STATE	ZIP
		SERIALS DIVISION	LOS ANGELES PUBLIC LIBRARY	630 W 5TH ST	LOS ANGELES	CA	90071-2002
		SCIENCE & INDUSTRY DIV	SAN DIEGO PUBLIC LIBRARY	330 PARK BLVD	SAN DIEGO	CA	92101-6478
		GOVERNMENT INFORMATION CENTER	SAN FRANCISCO PUBLIC LIBRARY	100 LARKIN ST	SAN FRANCISCO	CA	94102-4733
		GOV PUBS	STANLEY MOSK LIBRARY & COURTS BLDG	914 CAPITOL MALL, 3RD Floor	SACRAMENTO	CA	95814-5512
		Librarian	Northside Branch Library	695 Moreland	Santa Clara	CA	95054-5134

**TABLE E-4 INTERESTED PARTIES INCLUDING ENVIRONMENTAL JUSTICE AND COMMUNITY-BASED ORGANIZATIONS**

First Name	Last Name	Organization	Address	City	State	Zip
Carol	Zabin	Center for Labor Research and Education (Labor Center)	2521 Channing Way #5555	Berkeley	CA	94704
		Californians for Pesticide Reform (CPR)	2029 University Ave., Suite 200	Berkeley	CA	94704
Amy D.	Kyle	UC Berkeley, School of Public Health	140 Warren Hall	Berkeley	CA	94720
		Rising Sun Center For Opportunity	111 36th Street	Oakland	CA	94608
Brooks	Andrew	Association for Energy Affordability West	5900 Hollis Street, Suite R2	Emeryville	CA	94608
		San Mateo County Union Community Alliance (SMCUCA)	1153 Chess Dr.	Foster City	CA	94404
		Communities for a Better Environment	6325 Pacific Blvd. Ste 300	Huntington Park	CA	90255
LeVonne	Stone	Fort Ord Environmental Justice Network, Inc.	PO Box 361	Marina	CA	93933
		Asian Pacific Environmental Network	426 17th St #500	Oakland	CA	94612
Stephanie	Chen	Greenlining Institute	360 14th Street, 2nd Floor	Oakland	CA	94612



**TABLE E-4 INTERESTED PARTIES INCLUDING ENVIRONMENTAL JUSTICE AND COMMUNITY-BASED ORGANIZATIONS**

<b>First Name</b>	<b>Last Name</b>	<b>Organization</b>	<b>Address</b>	<b>City</b>	<b>State</b>	<b>Zip</b>
		Local Initiatives Support Corporation (LISC) Bay Area	1970 Broadway Suite 1100	Oakland	CA	94612
		GRID Alternatives	1171 Ocean Avenue, Suite 200	Oakland	CA	94608
Strela	Cervas	California Environmental Justice Alliance	1904 Franklin Street, Ste. 250	Oakland	CA	94612
Mia	Kitahara	StopWaste	1537 Webster St.	Oakland	CA	94612
		Center for Biological Diversity (CBD)	1212 Broadway, St. #800	Oakland	CA	94612
		The People's Senate	1999 Harrison Street, Suite 650	Oakland	CA	94612
		Center on Race, Poverty and Environment (CRPE)	1999 Harrison Street, Suite 650	Oakland	CA	94612
		The East Oakland Collective	PO Box 5382	Oakland	CA	94605
Bob	Allen	Urban Habitat Program	2000 Franklin Street	Oakland	CA	94612
		Union of Concerned Scientists	500 12th Street, Suite 340	Oakland	CA	94607
		People United for a Better Oakland (PUEBLO)	1728 Franklin Street	Oakland	CA	94612
Susannah	Churchill	Vote Solar	360 22nd Street, Suite 730	Oakland	CA	94612
Bradley	Angel	GreenAction	315 Sutter Street, 2nd Fl	San Francisco	CA	94108
		Literacy for Environmental Justice	P.O. Box 170039	San Francisco	CA	94117-0039
		Bluegreen Alliance	369 Pine Street, Suite 700	San Francisco	CA	94104
Maria	Stamas	Natural Resources Defense Council (NRDC)	111 Sutter Street, 21st Floor	San Francisco	CA	94104
Eddie	Ahn	Brightline Defense	1028A Howard Street	San Francisco	CA	94103
Jennifer	Berg	Association of Bay Area Governments (ABAG)	375 Beale Street, suite 700	San Francisco	CA	94105-2066
Ivan	Jimenez	Brightline Defense	1028A Howard Street	San Francisco	CA	94103
Erica	McConnell	Shute, Mihaly & Weinberger LLP	396 Hayes St.	San Francisco	CA	94102

**TABLE E-4 INTERESTED PARTIES INCLUDING ENVIRONMENTAL JUSTICE AND COMMUNITY-BASED ORGANIZATIONS**

<b>First Name</b>	<b>Last Name</b>	<b>Organization</b>	<b>Address</b>	<b>City</b>	<b>State</b>	<b>Zip</b>
Antonio	Diaz	People Organizing to Demand Environmental and Economic Rights (PODER)	474 Valencia Street, #125	San Francisco	CA	94103
		Environmental Law and Justice Clinic	536 Mission Street	San Francisco	CA	94105
		Bayview Hunters Point Community Advocates (Karen Pierce)	186 Maddux Avenue	San Francisco	CA	94124
		Silicon Valley Toxics Coalition	PO Box 27669	San Francisco	CA	94127
		Santa Clara Valley Audubon Society (SCVAS)--McClellan Ranch Preserve	22221 McClellan Road	Cupertino	CA	95014
		Loma Prieta Sierra Club Chapter Office	39821 East Bayshore Road, Suite 204	Palo Alto	CA	94303