

Appendix R. Traffic Impact Analysis



RIVERSIDE
COUNTY
TRANSPORTATION
COMMISSION

Riverside-Downtown STATION IMPROVEMENTS

Riverside-Downtown Station Improvements Project Traffic Impact Analysis



November 2020

TABLE OF CONTENTS

1.0	Introduction	1-1
1.1.	Project Description.....	1-1
1.2.	Project Objectives.....	1-3
1.3.	Alternatives Considered.....	1-3
1.3.1.	No Project Alternative.....	1-3
1.3.2.	Build Alternative	1-3
1.3.3.	Common Features of Build Alternative	1-5
1.3.4.	Design Options.....	1-6
1.4.	Study Area	1-15
2.0	Analysis Methodology	2-1
2.1.	Level of Service Definitions.....	2-1
2.2.	Level of Service Thresholds.....	2-3
3.0	Area Conditions	3-1
3.1.	Existing Geometrics.....	3-1
4.0	Traffic Analysis Without Project Volumes	4-1
4.1.	Existing Traffic Analysis.....	4-1
4.2.	Opening Year (2025) Analysis.....	4-1
4.3.	Opening Year (2025) With Cumulative Projects Analysis	4-1
4.4.	Build-Out (2045) Analysis	4-9
5.0	Project Traffic	5-1
5.1.	Project Trip Generation.....	5-1
5.2.	Project Trip Distribution and Assignment.....	5-1
6.0	Traffic Analysis With Project Volumes	6-1
6.1.	Existing Year With Project.....	6-1
6.2.	Opening Year (2025) With Projects Traffic.....	6-1
6.3.	Opening Year (2025) With Cumulative Projects and Project Conditions	6-1
6.4.	Build-Out Year (2045) With Projects Traffic.....	6-1
7.0	Intersection Levels of Service	7-1
7.1.	Existing Levels of Service	7-1

7.2.	Existing with Project Conditions Levels of Service	7-1
7.3.	Opening Year (2025) Without Project Conditions Levels of Service.....	7-4
7.4.	Opening Year (2025) With Project Conditions Levels of Service	7-4
7.5.	Opening Year (2025) With Cumulative Projects Levels of Service.....	7-4
7.6.	Opening Year (2025) With Cumulative Projects and Project Conditions Levels of Service	7-4
7.7.	Build-Out (2045) Without Project Conditions Levels of Service.....	7-5
7.8.	Build-Out (2045) With Project Conditions Levels of Service	7-5
8.0	Mitigation Analysis.....	8-1
8.1.	Existing Conditions.....	8-1
8.2.	Opening Year Conditions.....	8-1
8.3.	Build-Out Conditions.....	8-1
9.0	Summary and Conclusions.....	9-1
9.1.	Existing Conditions.....	9-1
9.2.	Opening Year Conditions.....	9-1
9.3.	Build-Out Conditions.....	9-1
9.3.1.	Build-Out Conditions – Howard Extension Analysis.....	9-2
10.0	References.....	10-1

LIST OF FIGURES

Figure 1-1.	Regional and Project Location Map.....	1-2
Figure 1-2.	Build Alternative.....	1-4
Figure 1-3.	Build Alternative with Pedestrian Overpass Access Design Option 1.....	1-5
Figure 1-4.	Build Alternative with Parking Design Option 1A.....	1-9
Figure 1-5.	Build Alternative with Parking Design Option 1B.....	1-10
Figure 1-6.	Build Alternative with Parking Design Option 2A.....	1-11
Figure 1-7.	Build Alternative with Parking Design Option 2B.....	1-12
Figure 1-8.	Build Alternative with Parking Design Option 3A.....	1-13
Figure 1-9.	Build Alternative with Parking Design Option 3B.....	1-14
Figure 1-10.	Study Intersections	1-16
Figure 3-1.	Study Area.....	3-2

Figure 4-1. Existing Traffic Volumes (2020).....	4-2
Figure 4-2. Opening Year Traffic Volumes (2025).....	4-3
Figure 4-3. Cumulative Project Locations.....	4-4
Figure 4-4. Cumulative Projects Trip Assignment.....	4-7
Figure 4-5. Opening Year Traffic Volumes (2025) With Cumulative Projects.....	4-8
Figure 4-6. Build-Out Traffic Volumes (2045).....	4-10
Figure 5-1. Project Trip Distribution Percentages.....	5-5
Figure 5-2. Project Trip Assignment.....	5-6
Figure 6-1. Existing Traffic Volumes (2020) With Project Conditions.....	6-2
Figure 6-2. Opening Year Traffic Volumes (2025) With Project Conditions.....	6-3
Figure 6-3. Opening Year Traffic Volumes (2025) With Cumulative and Project Conditions....	6-4
Figure 6-4. Build-Out Traffic Volumes (2045) With Project Conditions.....	6-5

LIST OF TABLES

Table 1-1. Summary of Proposed Build Alternative Improvements.....	1-4
Table 1-2. Summary of Proposed Build Alternative with Design Options.....	1-7
Table 2-1. Intersection Level of Service Definitions.....	2-1
Table 2-2. Level of Service Criteria for Unsignalized and Signalized Intersections.....	2-2
Table 2-3. Peak-Hour Delay Significant Impact Threshold.....	2-3
Table 4-1. Cumulative Projects Trip Generation.....	4-5
Table 5-1. Project Trip Generation.....	5-2
Table 5-2. Prism Aerospace Trip Generation.....	5-3
Table 5-3. Net Project Trip Generation.....	5-4
Table 7-1. Existing LOS.....	7-2
Table 7-2. Opening Year (2025) LOS.....	7-6
Table 7-3. Opening Year (2025) Cumulative Conditions LOS.....	7-7
Table 7-4. Build-Out (2045) LOS0F.....	7-8



Riverside-Downtown STATION IMPROVEMENTS

LIST OF APPENDICES

- Appendix A. Scoping Agreement
- Appendix B. Counts
- Appendix C. Los Outputs
- Appendix D. Signal Warrant Analysis
- Appendix E. Appendix Howard Extension

ACRONYMS AND ABBREVIATIONS

Acronym	Definition
ADA	Americans with Disabilities Act
AREMA	American Railway Engineering and Maintenance-of-Way Association
BNSF	Burlington Northern Santa Fe
CEQA	California Environmental Quality Act
IEOC	Empire Orange County
CPUC	California Public Utilities Commission
FRA	Federal Rail Administration
HCM	Highway Capacity Manual
ITE	Institute of Transportation Engineers
LOS	level of service
OPR	Office of Planning and Research
PHF	peak hour factor
RCTC	Riverside County Transportation Commission
RTA	Riverside Transit Authority
RTP	Regional Transportation Plan
SCAG	Southern California Association of Governments
SB-	Senate Bill 743
SCRRA	Southern California Regional Rail Authority
SR 91	State Route 91
TIA	Traffic Impact Analysis
USDOT	United States Department of Transportation
VMT	Vehicle Miles Traveled

1.0 Introduction

This Traffic Impact Analysis (TIA) details the potential traffic and circulation impacts and subsequent mitigation measures associated with the Riverside-Downtown Station Improvements Project.

This TIA was prepared in accordance with the requirements outlined in the City of Riverside *Public Works Department Traffic Impact Analysis Preparation Guide* (November 2017) under the California Environmental Quality Act (CEQA).

The proposed project includes new construction of an approximately 550-stall parking lot. Figure 1-1 shows the regional and project location. The proposed project also includes new platforms, pedestrian bridge expansion, additional tracks and structures, and an expected increase in transit ridership. All of these elements have the effect of attracting more traffic, and therefore a traffic analysis is required to evaluate impacts of the proposed parking lot extension.

City of Riverside Public Works reviewed the prerequisite scoping agreement included in Appendix A. The scoping agreement details the scope of work for this TIA, including study area, trip distribution, trip generation, intersection analysis, and analysis scenarios. This TIA analyzes traffic circulation in the study area surrounding the project under the following eight scenarios:

1. Existing Conditions (2020)
2. Existing Conditions (2020) With Project Conditions
3. Opening Year (2025) Without Project Conditions
4. Opening Year (2025) With Project Conditions
5. Opening Year (2025) With Cumulative Projects
6. Opening Year (2025) With Cumulative Projects and Project Conditions
7. Build-Out (2045) Without Project Conditions
8. Build-Out (2045) With Project Conditions

Traffic conditions were examined for weekday a.m. and p.m. peak-hour conditions. The a.m. peak hour is defined as the 1 hour of highest traffic volumes occurring between 7:00 and 9:00 a.m. The p.m. peak hour is the 1 hour of highest traffic volumes occurring between 4:00 and 6:00 p.m.

1.1. Project Description

The Riverside County Transportation Commission (RCTC) and Metrolink propose to improve the Riverside-Downtown Station Mile Post (MP) 9.9 to MP 10.2 on the Burlington Northern Santa Fe (BNSF) San Bernardino Subdivision located just east of State Route (SR) 91 and a short distance from the SR 60 in the City and County of Riverside, California. Proposed improvements include construction of an additional passenger loading platform, the extension of the existing pedestrian overcrossing and additional elevator and associated tracks which would allow for two trains to service the station off the BNSF mainline. The proposed track would be required to connect and integrate into the existing station layover tracks on the east side to improve train meet times without impacting BNSF operations. The project would also provide additional parking and improved vehicular traffic circulation on the east side of the station (see Figure 1-1, Regional and Project Location Map).



Figure 1-1. Regional and Project Location Map¹

¹ Full-page versions of all figures in this report are included at the end of the report.

The proposed project includes new construction of an adjacent approximately 550-stall parking lot (560-stalls were assumed in the TIA to cover all options being considered), and expansion of the existing pedestrian bridge. The proposed project site is located West of Howard Avenue between 9th and 14th Streets. The project is consistent with the City of Riverside General Plan 2025 (2019) concerning zoning designation and land use - Park-and-Ride Lot with Bus or Light Rail Service. The project will replace the existing commercial warehouse 'Prism Aerospace under a current land use – Manufacturing (Land Use 140) as defined in the Trip Generation Manual 10th Edition (Institute of Transportation Engineers, 2019). The project opening year is anticipated to be 2025.

1.2. Project Objectives

The purpose of the proposed project is to expand capacity, improve operations and efficiency, connectivity, and the passenger experience at the Riverside-Downtown Station. The basic project objectives supporting the purpose of the project are listed below:

- Expand platform capacity to meet passenger train storage needs;
- Allow for train meets off the BNSF mainline and minimize impacts to BNSF operations;
- Improve train connectivity and passenger accessibility while minimizing impacts on improvement projects near the station that are already designed or in construction;
- Facilitate more efficient passenger flow and reduce dwell times;
- Enhance safety and access for station users; and
- Accommodate projected future demand.

1.3. Alternatives Considered

1.3.1. No Project Alternative

Under the No Project Alternative, implementation of improvements at the Riverside-Downtown Station would not be constructed and the current configuration of the Riverside-Downtown Station would remain the same. Although there would be no project-related impacts to environmental resources, the No Project Alternative would not meet the Project Objectives or improve operations to accommodate the 91/Perris Valley (91/PV) Line and the Inland Empire Orange County (IEOC) Lines. Train capacity and storage would be limited to the existing platforms. The No Project Alternative does provide insight on future conditions with no improvements and serves as a baseline for comparison with the Build Alternative.

1.3.2. Build Alternative

RCTC and Metrolink propose improvements to the following elements of the Station: 1) Station Platform and Tracks; 2) Pedestrian Access; and 3) Parking, Circulation and Streetscape. The proposed improvements include building an additional passenger loading platform and tracks to the east side of existing station to improve Metrolink service and extending the existing pedestrian overpass to access the new proposed platform (see Figure 1-2, Build Alternative).

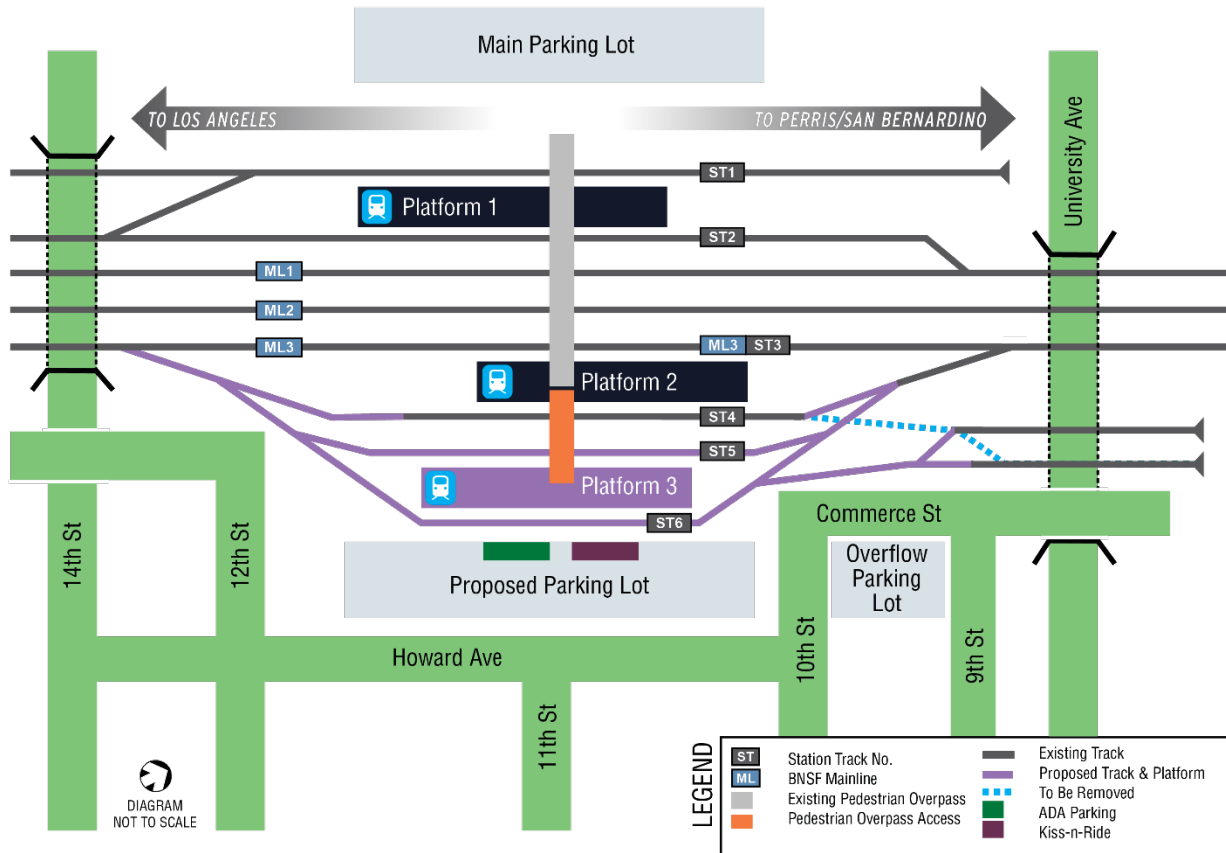

Figure 1-2. Build Alternative

The proposed track would also connect into the existing station layover tracks on the north end of the station as well as provide additional parking and improve traffic flow on the east side of the station. A summary of the proposed Build Alternative improvements is presented in Table 1-1.

Table 1-1. Summary of Proposed Build Alternative Improvements

Element	Description
Station Platform and Track Improvements	<ul style="list-style-type: none"> • Add new center platform (platform 3) • Add new tracks (station tracks 5 and 6) • Modification of railroad signal system
Pedestrian Access Improvements	<ul style="list-style-type: none"> • Extend pedestrian access to new platform 3 • Emergency egress would be provided at three locations
Parking, Circulation and Streetscape Improvements	<ul style="list-style-type: none"> • Relocate ADA parking • Modify Bus Drop-off Area • Add sidewalks and trees • Add up to 560 additional parking spaces

The proposed improvements would enhance Metrolink train connections without affecting BNSF services. The improvements would be designed in accordance with the most recent applicable codes, Southern California Regional Rail Authority (SCRRA), BNSF, Americans with Disabilities Act (ADA), American Railway Engineering and Maintenance-of-Way Association (AREMA), Federal Rail Administration (FRA), and California Public Utilities Commission (CPUC), standards and guidelines.

1.3.3. Common Features of Build Alternative

Station Platform and Track Improvements

The Build Alternative, includes the following station platform and track improvements as part of the proposed project (see Figure 1-3, Build Alternative with Pedestrian Overpass Access Design Option 1):

- Add a new center platform (Platform 3) that is approximately 680 feet in length and 30 feet in width with direct access from the new parking area to the east and access from the west using the at-grade crossings from Platform 2
- Add new tracks (Station Tracks 5 and 6) and other track improvements
- Modification of the railroad signal system

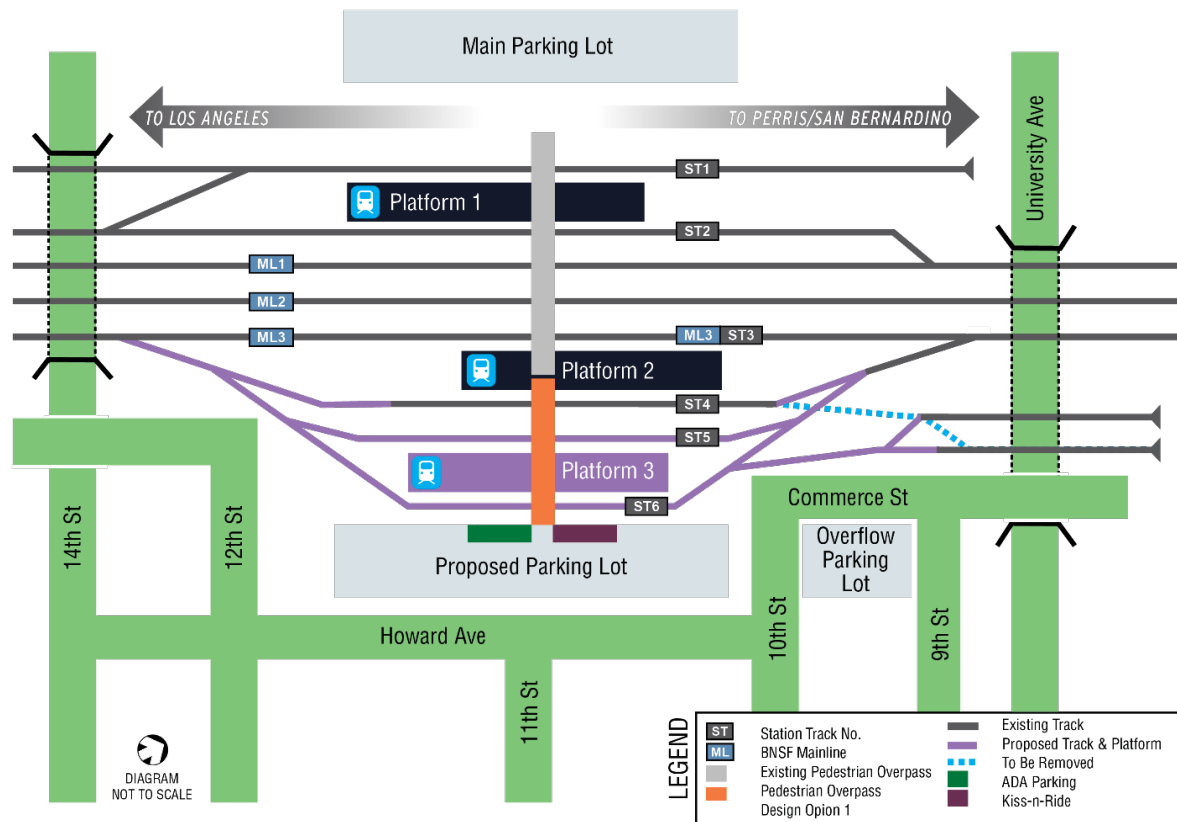

Figure 1-3. Build Alternative with Pedestrian Overpass Access Design Option 1

Platform 3 would be located between Station Tracks 5 and 6. Platform 3 would be able to service seven 85-foot passenger cars. The centerline to centerline spacing of the parallel tracks at the platform would be approximately 40 feet. Demolition of existing structures and other ancillary improvements would be required to facilitate construction of the station platform and track improvements.

Pedestrian Access Improvements

- The Build Alternative includes the following pedestrian access improvements as part of the proposed project:
 - Extend the existing pedestrian overpass access (see Figure 1-3, Build Alternative with Pedestrian Overpass Access Design Option 1).
 - Add pedestrian at-grade access from the proposed surface parking lot on the east side of proposed station improvements to Platforms 2 and 3 through an extension of the existing pedestrian at-grade crossing on the north end of the platforms and a new pedestrian at-grade rail crossing on the south end of the platforms. The pedestrian at-grade crossings would include safety enhancements such as proper channelization, automated gates and flashers.
- Emergency egress would be provided at three locations from Platform 3:
 - North end pedestrian at-grade crossing (existing at-grade crossing to be extended);
 - Pedestrian Access; and
 - South end pedestrian at-grade crossing (new).

Parking, Circulation and Streetscape

The Build Alternative includes the following parking, circulation and streetscape improvements as part of the proposed project:

- Relocate ADA parking;
- Modify the bus drop-off area;
- Add sidewalks and trees; and
- Add up to 560 additional parking spaces (proposed surface parking lot) with access to the east side of the station via at-grade pedestrian crossings.

1.3.4. Design Options

As part of the Build Alternative, there is a design option related to a longer extension of the pedestrian overpass from the new proposed platform to the new surface parking lot. Another design option is associated with the new surface parking lot and combining this new parking lot with the existing overflow parking lot on the east side of the station. This parking option includes traffic circulation improvements along Howard Avenue, 9th Street, 10th Street, and Commerce Street. The plans shown (throughout this report) for all options are conceptual in nature. The actual traffic circulation plan within the parking lot (in all options) is not fully developed at this stage of analysis. RCTC will continue to coordinate with the City of Riverside to incorporate elements from the City's Complete Streets Ordinance to the greatest extent feasible.

A summary of the proposed design options is presented in Table 1-2.

Table 1-2. Summary of Proposed Build Alternative with Design Options

Build + Design Option	Description
<i>Pedestrian Overpass Access Improvements</i>	
Pedestrian Overpass Access Design Option 1	Extend pedestrian overpass access to the new platform 3 and to the new surface parking lot
<i>Parking, Circulation and Streetscape Improvements</i>	
Parking Design Option 1A	New surface parking lot east of station. <i>Requires acquisition and demolition of existing structures and other ancillary structures and residential parcels on the corner of 12th Street and Howard Avenue to facilitate construction of the proposed improvements</i>
Parking Design Option 1B	<i>Same as Parking Design Option 1A but avoids relocation impacts to residential parcels on the corner of 12th Street and Howard Avenue</i>
Parking Design Option 2A	New surface parking lot east of station combined with existing overflow parking lot with the extension of Howard Avenue through to 9 th Street. <i>Requires acquisition and demolition of existing structures and other ancillary structures and residential parcels on the corner of 12th Street and Howard and requires acquisition of additional parcels directly east of the existing overflow parking lot</i>
Parking Design Option 2B	<i>Same as Parking Design Option 2A but avoids relocation impacts to residential parcels on corner of 12th Street and Howard Avenue</i>
Parking Design Option 3A	<i>Same as Parking Design Option 1A/2A but avoids impacts to additional parcels east of the existing overflow parking lot by routing Howard Avenue around the parcels.</i>
Parking Design Option 3B	<i>Same as Parking Design Option 1B/2B but avoids relocation impacts to additional parcels east of the existing overflow parking lot.</i>

Pedestrian Overpass Access Improvements

Access from the existing station area would be provided by the proposed extension of the pedestrian overpass (see Figure 1-3, Build Alternative with Pedestrian Overpass Access Design Option 1). The Build Alternative with Pedestrian Overpass Access Design Option 1 includes a longer extension of the pedestrian overpass to Platform 3 and new surface parking lot (two spans, two towers/elevators). The new pedestrian overpass elevator tower would be located 14 feet clear of both Track 5 and Track 6 on Platform 3. Access from the proposed surface parking

lot would be provided by two 10-foot wide at-grade pedestrian crossings at the north and south end of Platform 3.

Parking, Circulation and Streetscape Improvements

All parking design options would require the acquisition of parcels directly east of the station and demolition of existing structures and other ancillary structures to facilitate construction of the proposed Build Alternative improvements:

- Parking Design Option 1A would require the acquisition of residential parcels on the corner of 12th Street and Howard Avenue. Parking Option 1B would avoid the residential properties.
- Parking Design Option 2A and 2B would have similar ROW impacts as Options 1A and 1B but would require acquisition of additional parcels directly east of the existing overflow lot.
- Parking Design Option 3A and 3B would have similar ROW impacts as Options 2A and 2B but would avoid parcel acquisitions directly east of the overflow parking lot.
- Parking Design Option 1A/1B adds a new surface parking lot and maintains separation from the existing overflow parking lot on the eastside of station (Figure 1-4, Build Alternative with Parking Design Option 1A and Figure 1-5, Build Alternative with Parking Design Option 1B).

Parking Design Option 1A – Add new surface parking lot and maintain separation from existing overflow parking lot on the east side of the station. Acquisition and demolition of residential parcels on the corner of 12th Street and Howard Avenue would be required (see Figure 1-4, Build Alternative with Parking Design Option 1A).

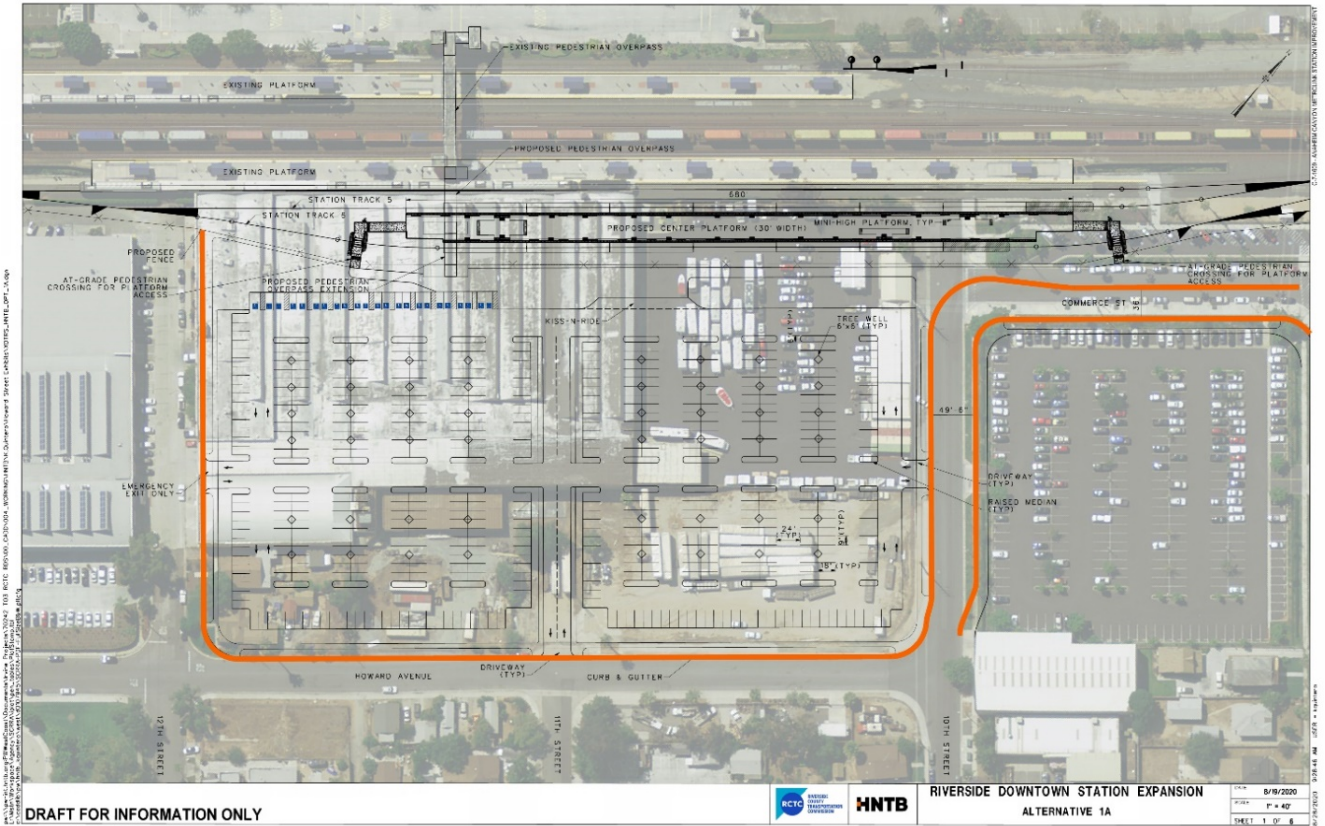

Figure 1-4. Build Alternative with Parking Design Option 1A

Parking Design Option 1B – Add proposed surface parking lot and maintain separation from existing overflow parking lot on the east side of the station and avoid impacts to residential parcels at the corner of 12th Street and Howard Avenue (see Figure 1-5, Build Alternative with Parking Design Option 1B).

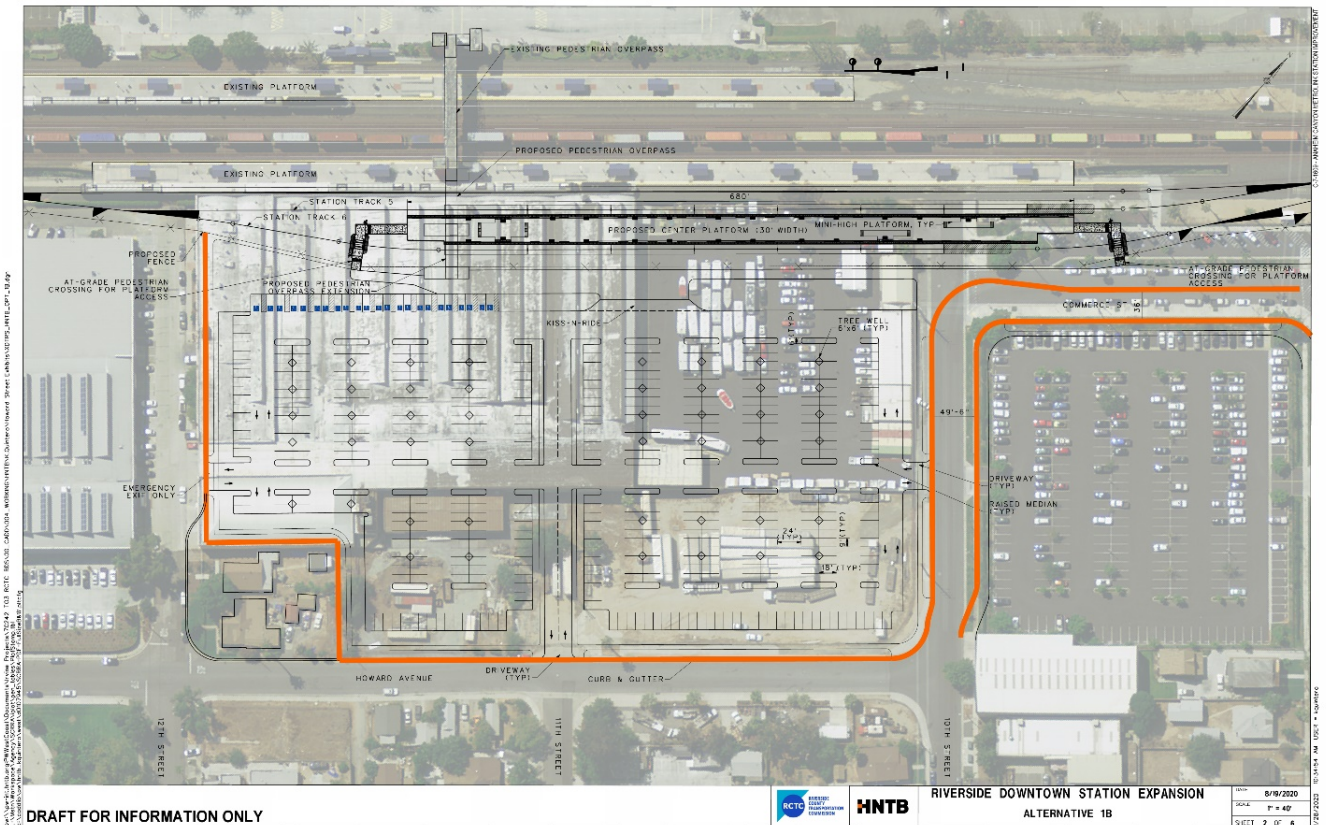

Figure 1-5. Build Alternative with Parking Design Option 1B

This traffic impact analysis will primarily focus on Option 1A/Option 1B (these two options are similar from a trip generation and traffic analysis perspective and are covered in the main section of the report).

- Parking Design Options 2A/2B proposes a new surface parking lot directly east of the station combined with the existing overflow parking lot (see Figure 1-6, Build Alternative with Parking Design Option 2A and Figure 1-7, Build Alternative with Parking Design Option 2B).
 - Parking Design Option 2A – Combine proposed surface parking lot with existing overflow parking lot on the east side of the station which would require acquisition and demolition of residential parcels on the corner of 12th Street and Howard Avenue. This option would also include extending Howard Avenue through to 9th Street and would require additional acquisition of parcels directly east of the existing overflow parking lot as well as partial street vacations for 10th Street and Commerce Street (see Figure 1-6, Build Alternative with Parking Design Option 2A).

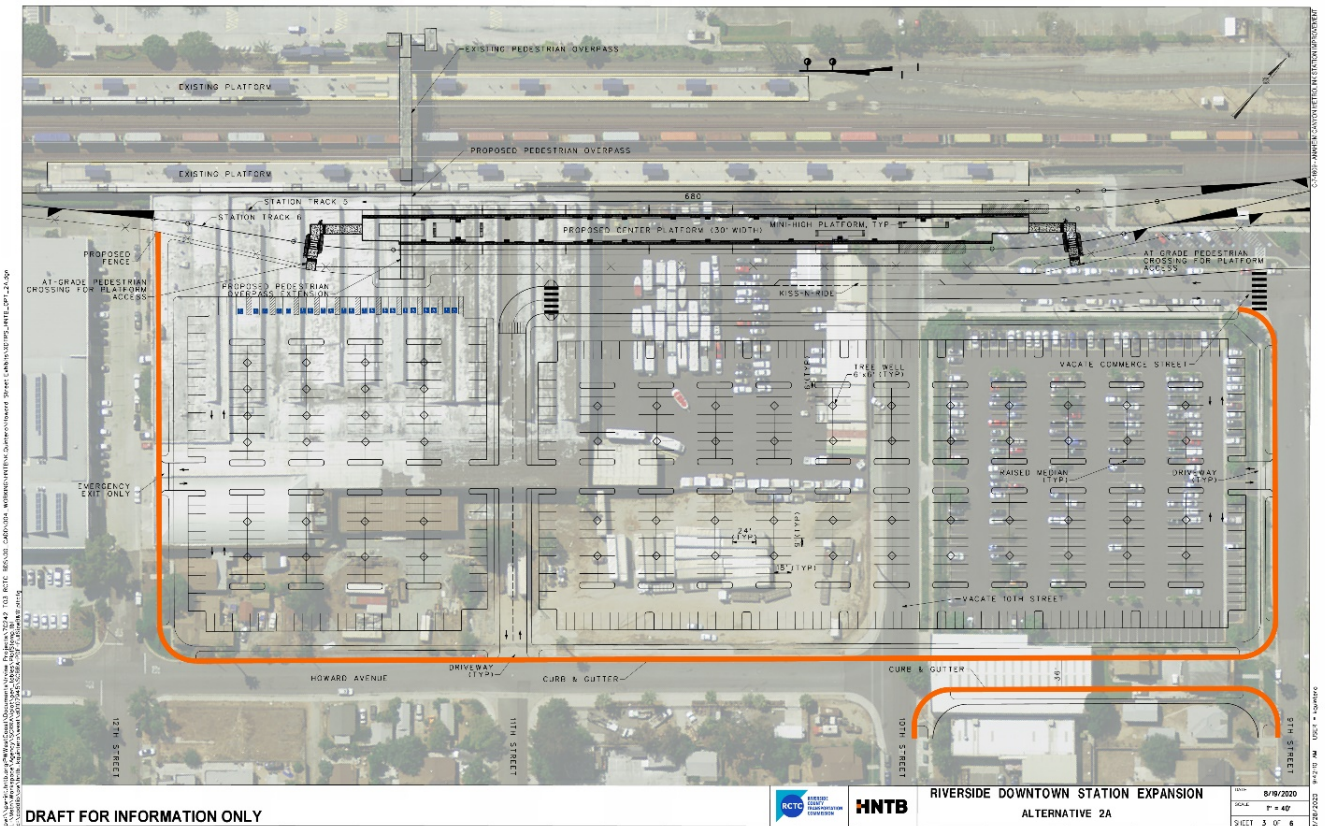

Figure 1-6. Build Alternative with Parking Design Option 2A

- Parking Design Option 2B – Combine proposed surface parking lot with existing overflow parking lot on the east side of the station and avoid impacts to residential parcels at the corner of 12th Street and Howard Avenue. This option would also include extending Howard Avenue through to 9th Street and would require additional acquisition of parcels directly east of the existing overflow parking lot as well as partial street vacations for 10th Street and Commerce Street (see Figure 1-7, Build Alternative with Parking Design Option 2B).

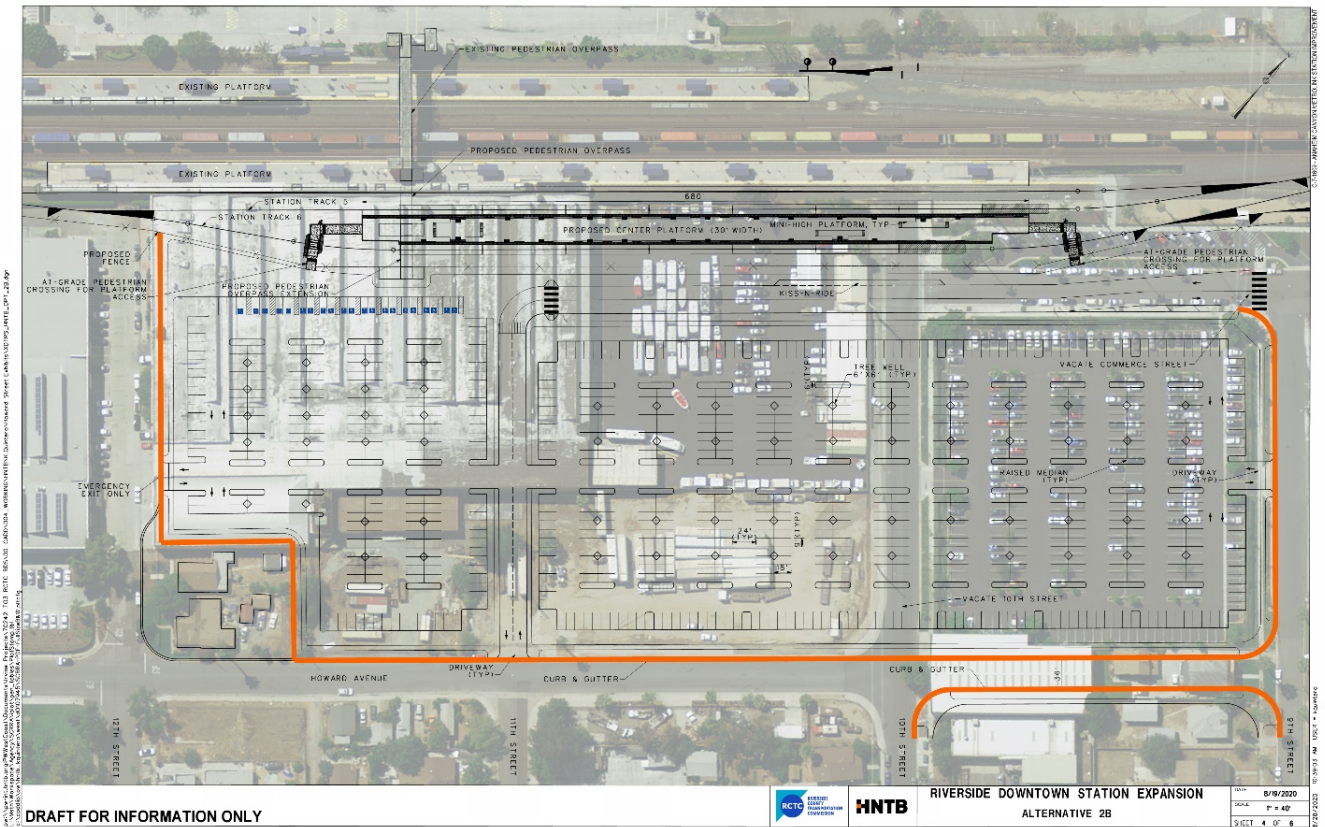

Figure 1-7. Build Alternative with Parking Design Option 2B

- Parking Design Options 3A and 3B propose a new surface parking lot directly east of the station combined with the existing overflow parking lot and extension of Howard Street through to 9th Street (see Figure 1-8, Build Alternative with Parking Design Option 3A and Figure 1-9, Build Alternative with Parking Design Option 3B).
 - Parking Design Option 3A – Combine proposed surface parking lot with existing overflow parking lot on the east side of the station which would require and demolition of residential parcels on the corner of 12th Street and Howard Avenue. This option would also include extending Howard Avenue through to 9th Street as well as partial street vacations for 10th Street and Commerce Street while avoiding additional acquisition of parcels directly east of the existing overflow parking lot (see Figure 1-8, Build Alternative with Parking Design Option 3A).

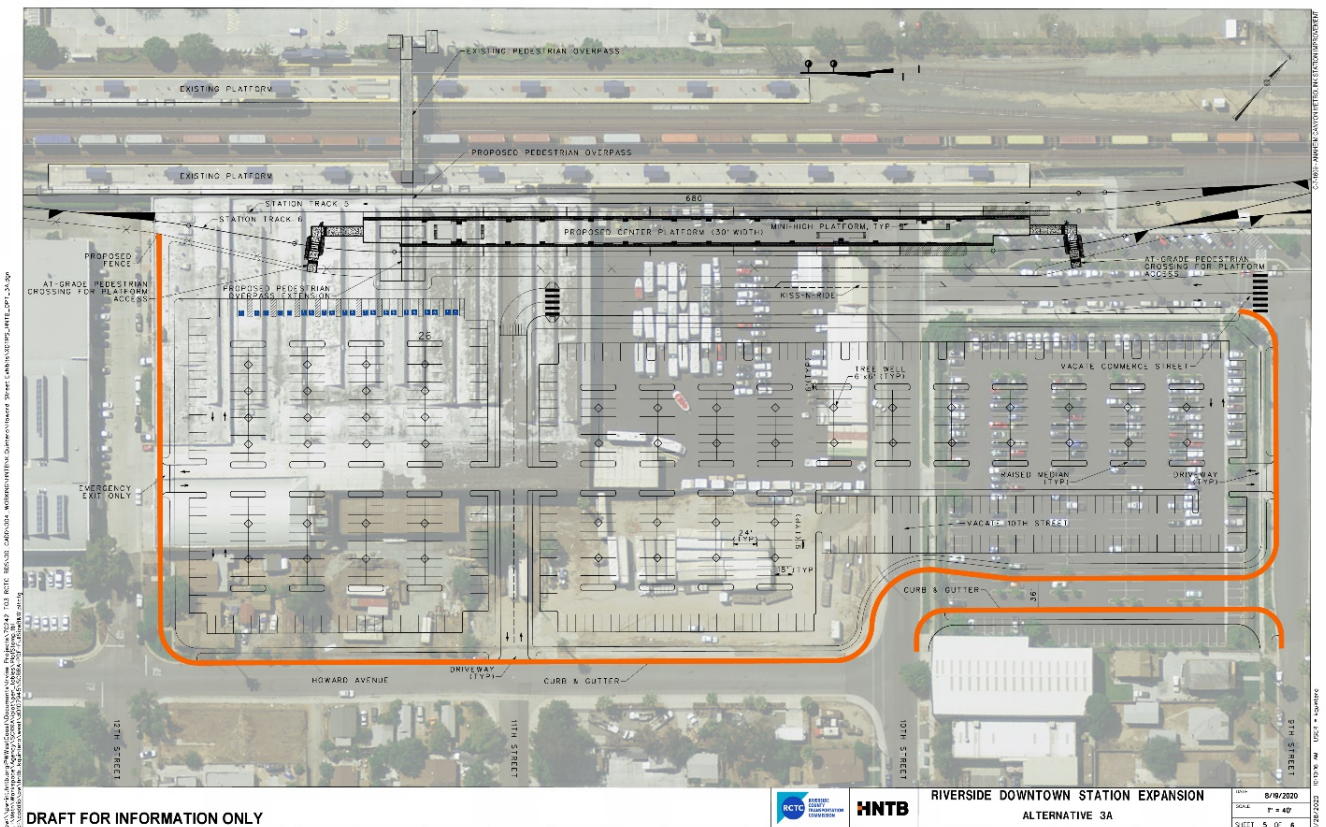

Figure 1-8. Build Alternative with Parking Design Option 3A

- Parking Design Option 3B - Combine proposed surface parking lot with existing overflow parking lot on the east side of the station and avoid impacts to residential parcels at the corner of 12th Street and Howard Avenue. This option would also include extending Howard Avenue through to 9th Street as well as partial street vacations for 10th Street and Commerce Street while avoiding additional acquisition of parcels directly east of the existing overflow parking lot (see Figure 1-9, Build Alternative with Parking Design Option 3B).

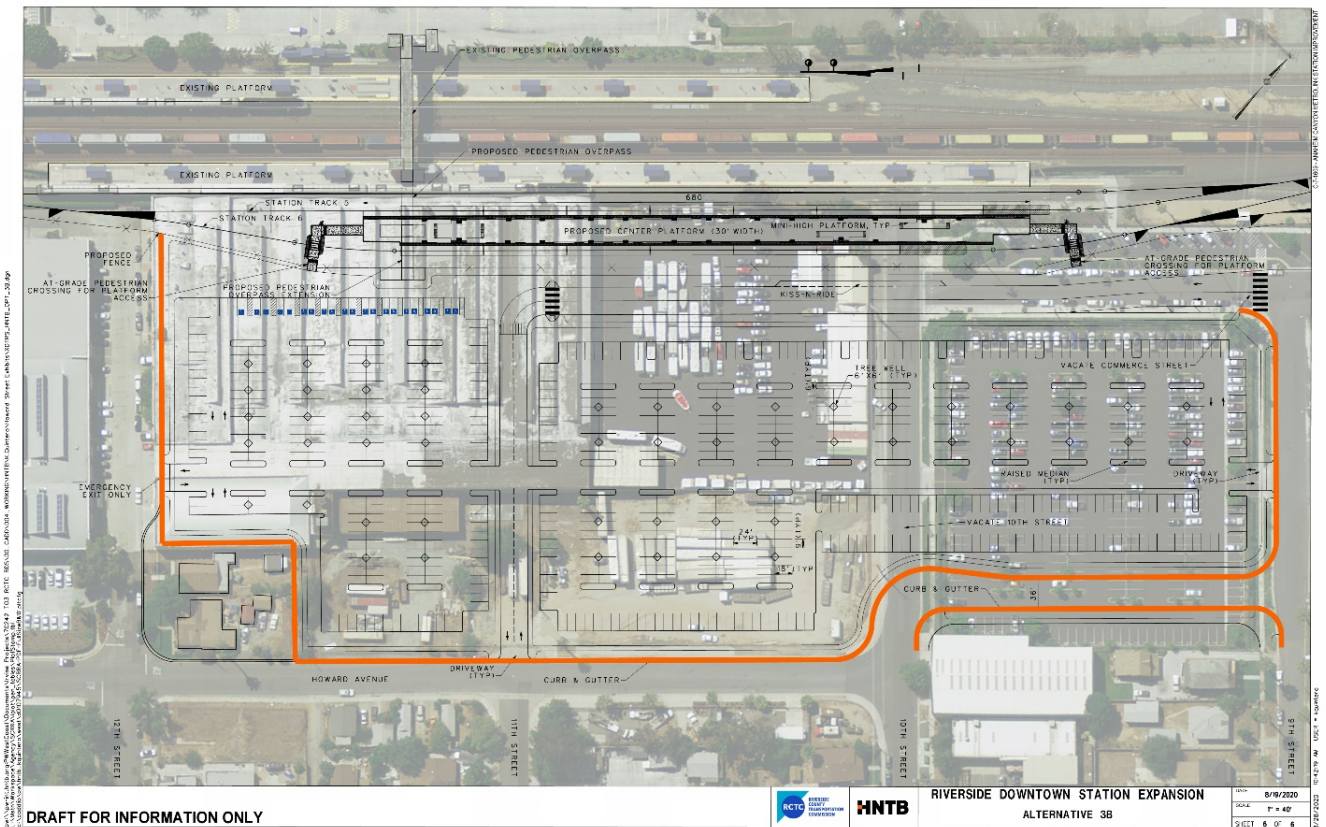

Figure 1-9. Build Alternative with Parking Design Option 3B

In the main section of this report, Option 1A/Option 1B will be analyzed. A separate traffic analysis was also conducted for Option 2A/Option 2B/Option A/Option 3B – all of these options involve extending Howard Avenue through to 9th Street. The details of the Howard Extension are included in Appendix E (Howard Extension Analysis).

1.4. Study Area

Study area intersections were identified in accordance with the City of Riverside TIA guidelines (November 2017) and include any intersection of “Collector” or higher classification that will create an additional 50 or more peak-hour trips. Based on this definition and coordination with the City of Riverside, the following 12 intersections were selected for traffic analysis:

1. SR 91 Westbound Off-Ramp and Mission Inn Avenue
2. Mulberry Street/SR 91 Eastbound On-Ramp and Mission Inn Avenue
3. Vine Street and Mission Inn Avenue
4. Commerce Street and Mission Inn Avenue
5. Park Avenue and University Avenue
6. Commerce Street and 9th Street
7. Howard Avenue and 10th Street
8. Howard Avenue and 12th Street
9. Howard Avenue and 14th Street
10. SR 91 Eastbound On/Off-Ramp and 14th Street
11. State Route 91 (SR 91) Westbound Off-Ramp/Mulberry Street and 14th Street
12. Lime Street/Olivewood Avenue and 14th Street

Figure 1-10 displays the locations of the study area intersections

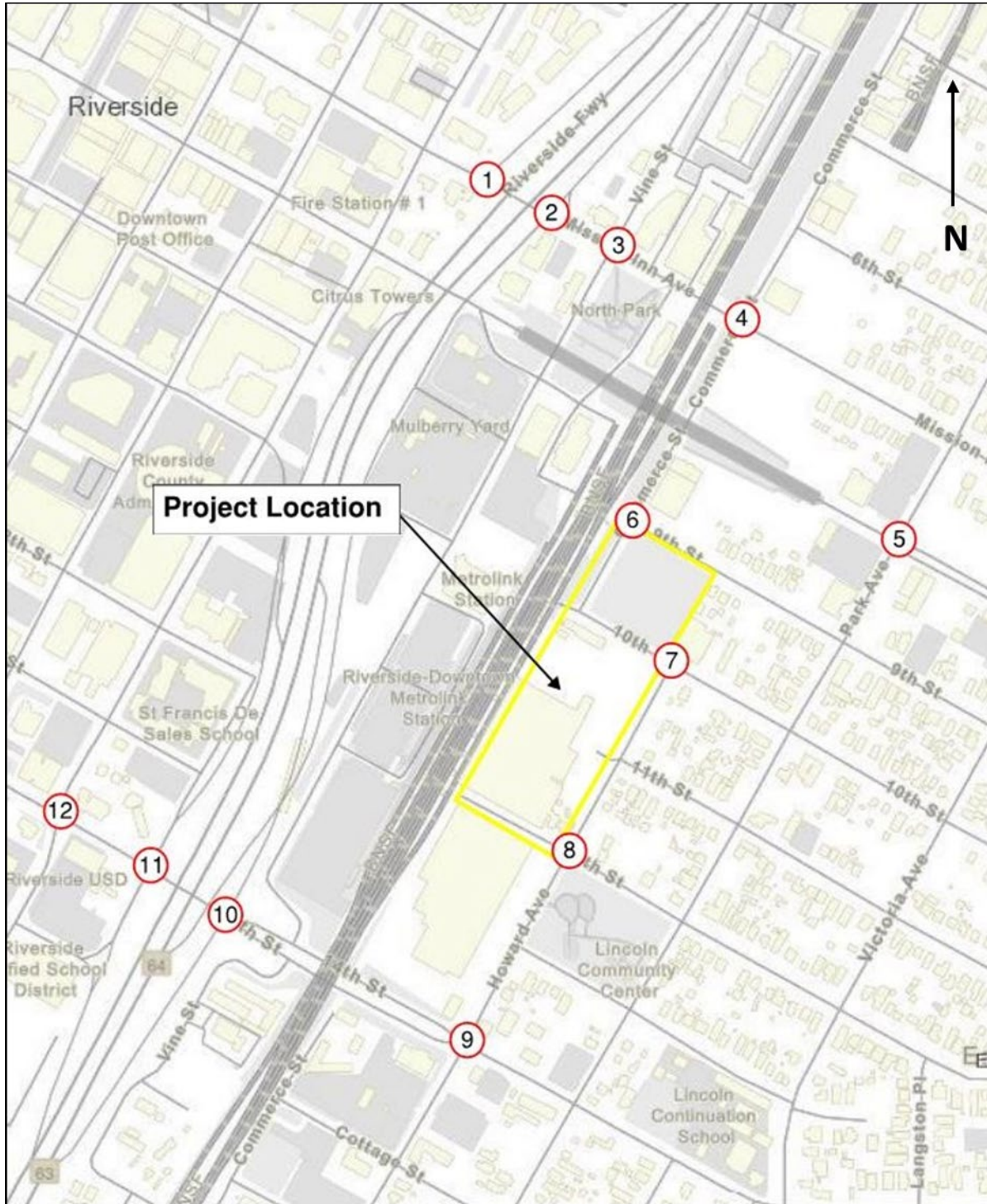

Figure 1-10. Study Intersections

2.0 Analysis Methodology

Conventional approaches include the guidelines provided in the City of Riverside traffic study guidelines (December 2017), and the impact analysis is generally focused on vehicle level of service (LOS). Senate Bill 743 (SB 743) changes this focus for all CEQA projects from measuring traffic impacts of driving to vehicle miles traveled (VMT).

The Governor’s Office of Planning and Research (OPR) of the State of California has issued a technical advisory that includes recommendations on evaluating VMT impacts of projects. It provides the following guidance regarding transit and active transportation projects:

“Transit and active transportation projects generally reduce VMT and therefore are presumed to cause a less-than-significant impact on transportation. This presumption may apply to all passenger rail projects, bus and bus rapid transit projects, and bicycle and pedestrian infrastructure Projects. Streamlining transit and active transportation projects aligns with each of the three statutory goals contained in SB 743 by reducing GHG emissions, increasing multimodal transportation networks, and facilitating mixed use development.”

Since the Project is a passenger rail project, based on above guidance, VMT-related impacts are therefore presumed to be less-than-significant. For this study, it is assumed that CEQA traffic studies will still require LOS analysis following the procedures provided in the City of Riverside traffic study guidelines.

2.1. Level of Service Definitions

LOS is defined in the Highway Capacity Manual 6th Edition (HCM) in terms of average control delay per vehicle and is designated by a letter grade A – F (National Academy of Sciences, 2016). LOS A represents an intersection where no approach phase is fully utilized by traffic. LOS E represents an intersection that is at capacity. LOS F represents an intersection that has exceeded capacity and has significant congestion and delay. A full description of LOS can be found in the HCM and in **Table 2-1** of this TIA report.

Table 2-1. Intersection Level of Service Definitions

LOS	Description
A	This service level represents a no-approach phase and is fully utilized by traffic. No vehicle waits longer than one red indication. Typically, the approach appears quite open, turns are made easily, and nearly all drivers find freedom of operation.
B	This service level represents stable operation, where an occasional approach phase is fully utilized and a substantial number are approaching full use. Many drivers begin to feel restricted within platoons of vehicles.
C	This service level still represents stable operating conditions. Occasionally drivers may have to wait through more than one red signal indication, and backups may develop behind turning vehicles. Most drivers feel somewhat restricted, but not objectionably so.

Table 2-1. Intersection Level of Service Definitions

LOS	Description
D	This service level encompasses a zone of increasing restriction approaching instability at the intersection. Delays to approaching vehicles may be substantial during short peaks within the peak period; however, enough cycles with a lower demand occur and permit periodic clearance of developing queues, thus excessive backups are prevented.
E	This service level allows represents the most vehicles that any particular intersection approach can accommodate. Capacity occurs at the upper end of this service level, and full utilization of every signal cycle is seldom attained no matter how great the demand.
F	This service level describes forced flow operations at low speeds, where volumes exceed capacity. These conditions usually result from queues of vehicles backing up from a restriction downstream. Speeds are reduced substantially, and stoppages may occur for short or long periods of time due to the congestion. In the extreme case, both speed and volume can drop to zero.

Factors affecting delay include cycle length and phasing. A signalized intersection with LOS A has an average delay less than or equal to 10 seconds per vehicle. A signalized intersection with LOS F has an average delay greater than 80 seconds per vehicle. **Table 2-2** provides a description of each LOS intersection letter designation and corresponding delay.

Table 2-2. Level of Service Criteria for Unsignalized and Signalized Intersections

Level of Service	Unsignalized Intersection Average Delay per Vehicle (sec)	Signalized Intersection Average Delay per Vehicle (sec)
A	< 10	< 10
B	> 10 and < 15	> 10 and < 20
C	> 15 and < 25	> 20 and < 35
D	> 25 and < 35	> 35 and < 55
E	> 35 and < 50	> 55 and < 80
F	> 50	> 80

< = less than

> = greater than

sec = second

All study area intersections used the HCM analysis methodologies in conjunction with Synchro 10 traffic analysis software to determine intersection levels of service. The results and reports of the Synchro 10 LOS calculations are attached in Appendix C.

2.2. Level of Service Thresholds

All study intersections are analyzed under the jurisdiction of the City of Riverside. The City of Riverside uses LOS D as the maximum acceptable threshold for the study intersections with roadways classified as “Collector.” All other street intersections are to maintain a LOS C.

The City of Riverside TIA guidelines outline the impact criteria used to determine a significant circulation impact for study intersections under the jurisdiction of the City of Riverside. The guidelines state that for projects contained in the General Plan 2025 (2019), a significant impact is defined when project generated trips cause the peak-hour LOS to change from above to below the acceptable threshold. For projects inconsistent with the General Plan, significant impact can also be identified when peak-hour delay increases in pre-defined increments defined in **Table 2-3**. The project is consistent with the General Plan (2025) and thus Table 2-3 does not apply.

Table 2-3. Peak-Hour Delay Significant Impact Threshold

Level of Service	Increase of Delay
A/B	By 10.0 seconds
C	By 8.0 seconds
D	By 5.0 seconds
E	By 2.0 seconds
F	By 1.0 seconds

Source: Highway Capacity Manual (6th Edition)

3.0 Area Conditions

3.1. Existing Geometrics

Figure 3-1 displays the existing study intersection geometrics and traffic control. The red symbols on the figure indicate that a specific approach is stop controlled at the corresponding intersections. Per the City of Riverside's General Plan 2025 (Master Plan of Roadways map section), the following roadways are classified as major arterials and are located within the project and TIA study area:

- **14th Avenue:** 14th Avenue is designated as a 4-lane, 100- to 110-foot arterial. There is no assigned Bicycle lane on the roadway.
- **Mission Inn Avenue:** Mission Inn Avenue is designated as a 4-lane, 100- to 110-foot arterial and scenic boulevard requiring special landscaping.
- **Lime Street/Olivewood Avenue:** Lime Street is designated as a 4-lane, 88-foot arterial. There is no assigned Bicycle lane on the roadway.

The City of Riverside General Plan 2025 (Transit Facilities in the Transportation/ Traffic Section) locates the transit routes and stations within the City of Riverside. The project study area coincides with many of the Riverside Transit Authority (RTA) bus routes, including routes: 10, 12, 13, 14, 16, 41, and 208. The project involves expansion to the existing downtown station and thus also lies within the Riverside Metrolink and SR 91/Orange County/Inland Empire Rail Corridors.

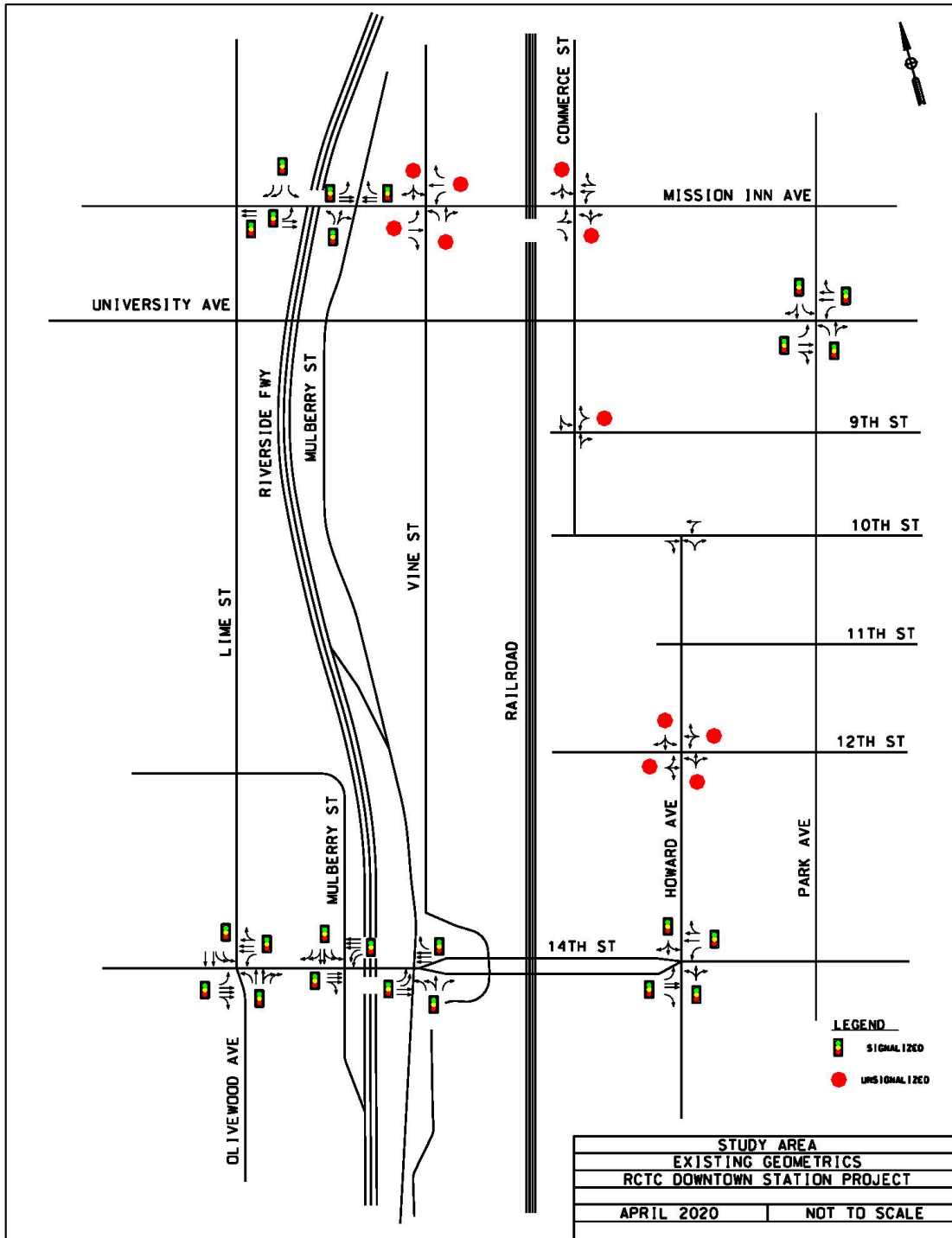

Figure 3-1. Study Area

4.0 Traffic Analysis Without Project Volumes

4.1. Existing Traffic Analysis

Existing traffic volumes are based on traffic counts conducted at the 12 previously discussed study intersections. The City of Riverside collected a.m. and p.m. peak-hour counts for two intersections in the study area in April 2019. Counts Unlimited collected a.m. and p.m. peak-hour counts for 10 intersections in the study area in February 2020. Detailed count sheets are attached in Appendix B.

Figure 4-1 displays the existing balanced peak hour traffic volumes at the study intersections. Traffic volumes were balanced for each scenario to account for driveways within the study area.

4.2. Opening Year (2025) Analysis

Opening Year (2025) Without Project Conditions Traffic Volumes were developed by applying a 2 percent compounded growth rate to the existing conditions traffic volumes. This growth rate is in accordance with the project Scoping Agreement.

Figure 4-2 displays the balanced peak hour intersection traffic volumes for the Opening Year (2025) Without Project Conditions scenario.

4.3. Opening Year (2025) With Cumulative Projects Analysis

The City of Riverside provided information regarding cumulative projects in the vicinity of the proposed project location. Figure 4-3 shows the locations of the projects in the study area that have the potential to generate a significant number of trips that coincide with project trip generation.

Trip generation resulting from these cumulative projects was developed using rates from the Institute of Transportation Engineers (ITE) Trip Generation Manual, 10th Edition (2017).

Table 4-1 displays the list of cumulative projects and their corresponding land uses, as well as a.m. peak hour, p.m. peak hour, and daily trips generated.

Cumulative project trips were assigned based on their location relative to access to the SR 91 freeway and local surrounding land uses. Figure 4-4 illustrates the a.m. and p.m. peak hour cumulative project trip assignment at the study area intersections².

The trips calculated from the trip generation of cumulative projects were added to the Opening Year (2025) Traffic Volumes to analyze the Opening Year (2025) With Cumulative Projects scenario. Figure 4-5 displays the balanced peak hour intersection traffic volumes for the Opening Year (2025) With Cumulative Projects scenario.

² All traffic volume figures attached at the end of the report in 11 by 17 format.

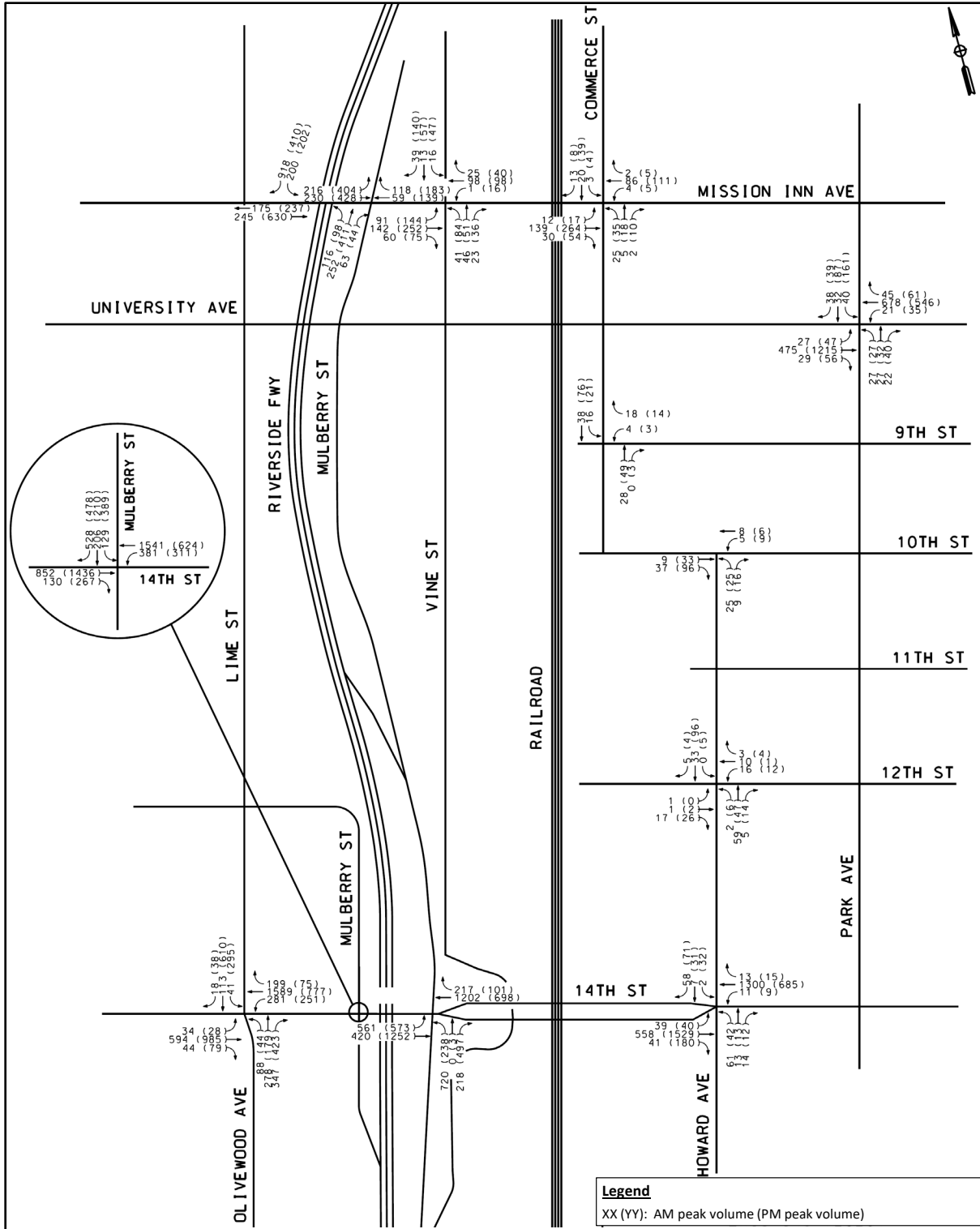

Figure 4-1. Existing Traffic Volumes (2020)

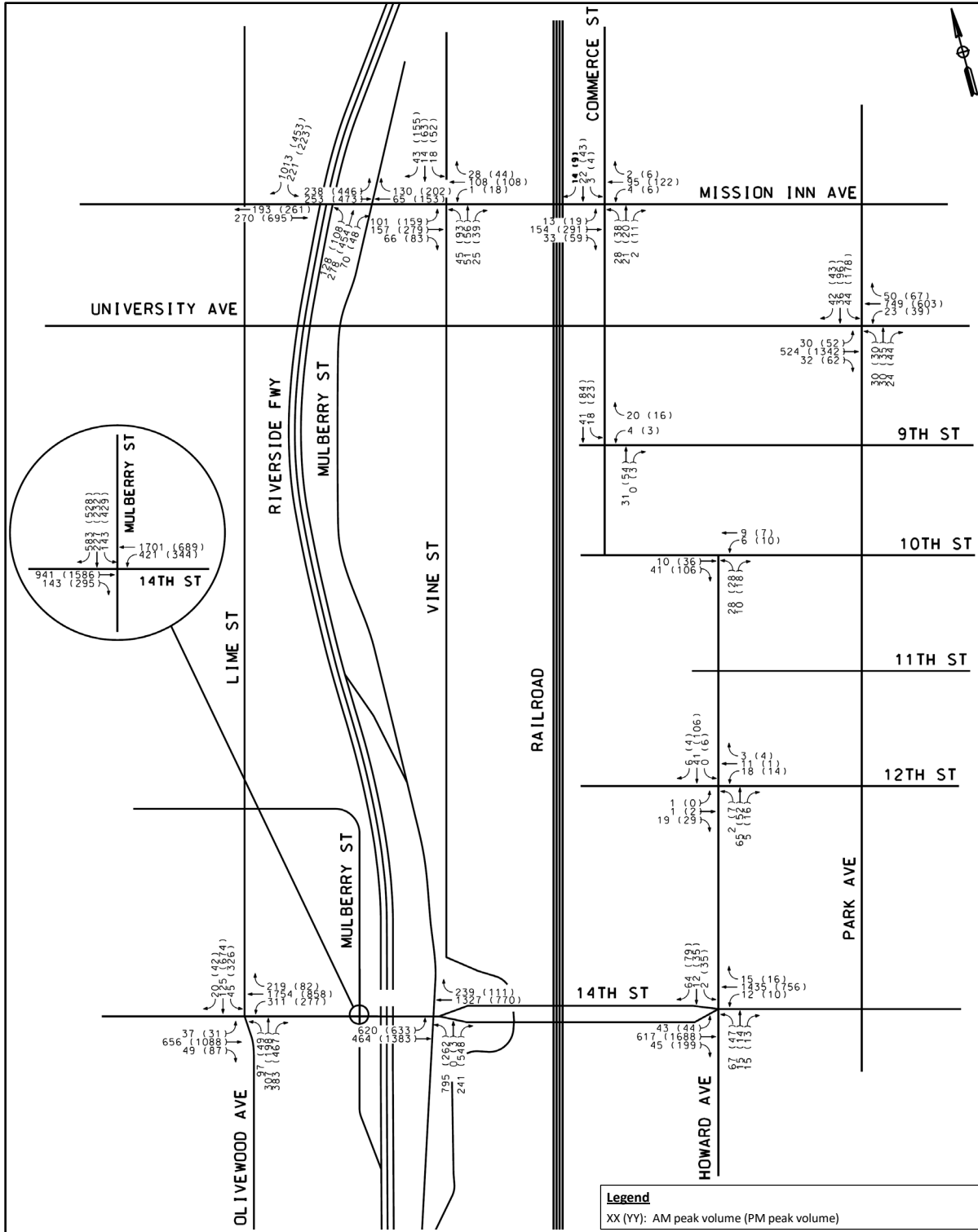

Figure 4-2. Opening Year Traffic Volumes (2025)

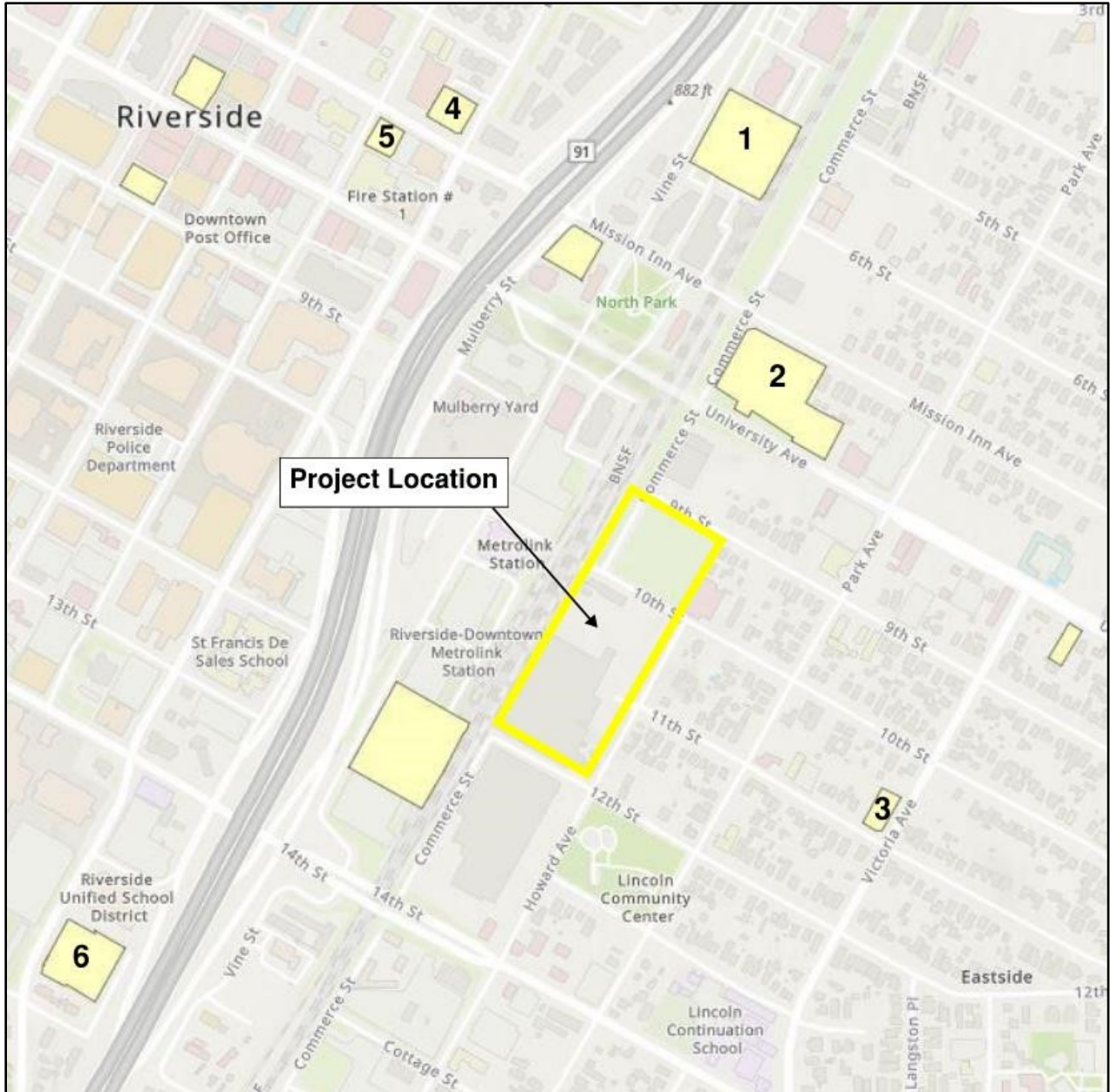

Figure 4-3. Cumulative Project Locations

Table 4-1. Cumulative Projects Trip Generation

Project Number	Land Use (ITE Trip Generation Manual Land Use Code)	Quantity	Units	AM Peak Hour			PM Peak Hour		
				In	Out	Total	In	Out	Total
1	Junior/Community College (540) 252 Students 22.45 5.26 27.72 15.52 12.19 27.72 CUP for new Vocational/Technical School 3550 Vine Street	252	Students	22.45	5.26	27.72	15.52	12.19	27.72
2	Mid-Rise Multifamily Housing (221) Mission Lofts Apartment Complex 3050 Mission Inn Avenue	212	Dwelling	19.84	56.47	76.32	56.9	36.38	93.28
3	Multifamily Low-Rise (220) Affordable Housing Development 2719 11 th Street	8	Dwelling	0.85	2.83	3.68	2.82	1.66	4.48
4	Mid-Rise Residential with 1st-Floor Commercial (231) CUP Mixed-Use Project 3393 Mission Inn Avenue	72	Dwelling	6.05	15.56	21.6	18.14	7.76	25.92
5	Hotel (310) 194,500 SF, 8-story Hotel 3466 Mission Inn Avenue	225	Rooms	62.39	43.36	105.8	68.5	66.15	135

Table 4-1. Cumulative Projects Trip Generation

Project Number	Land Use (ITE Trip Generation Manual Land Use Code)	Quantity	Units	AM Peak Hour			PM Peak Hour		
				In	Out	Total	In	Out	Total
6	Medical-Dental Office Building (720) Medical Office Building 4508 Olivewood Avenue	27,000	SF	58.55	16.51	75.06	26.16	67.26	93.42

CUP = Conditional Use Permit

SF = square feet

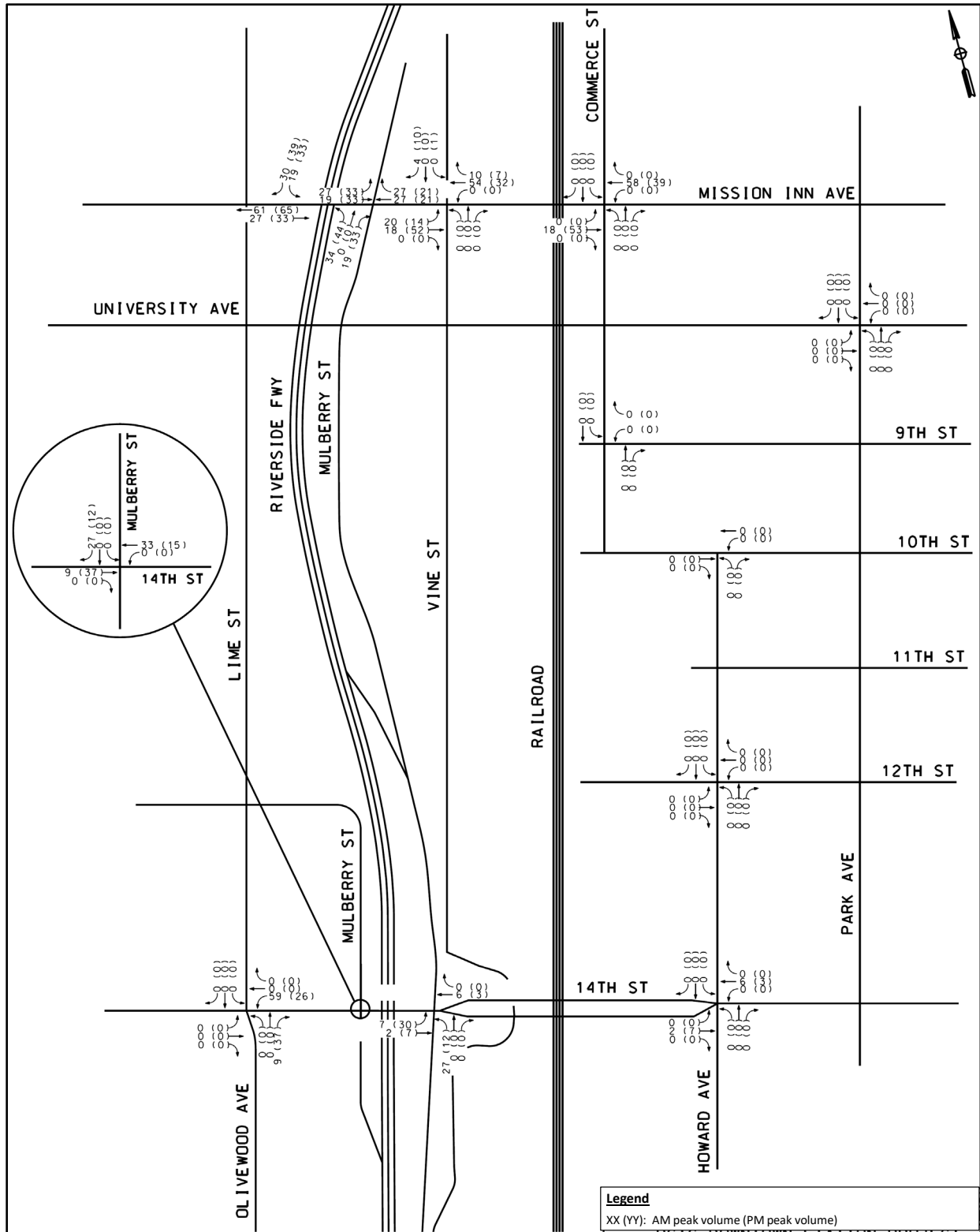

Figure 4-4. Cumulative Projects Trip Assignment

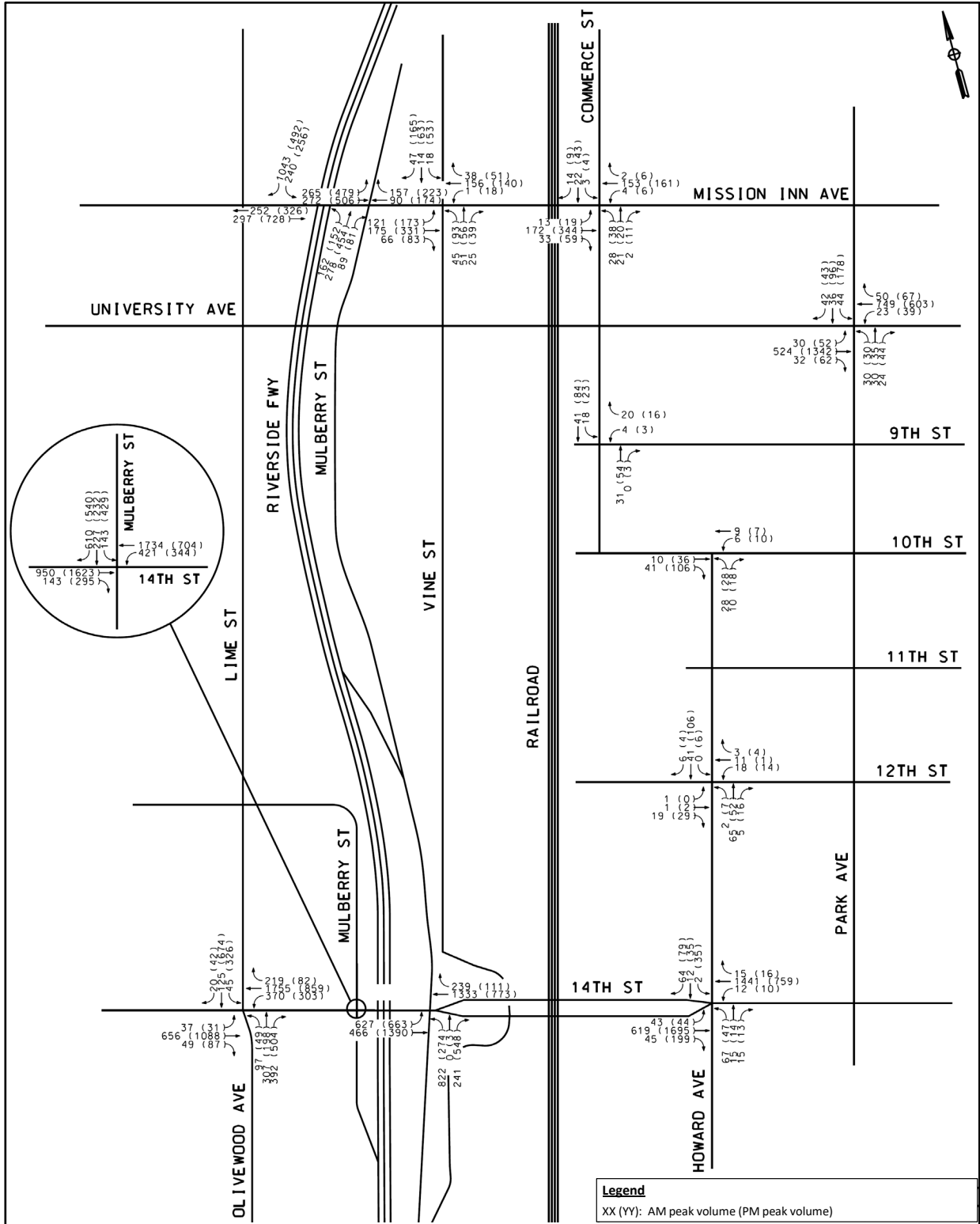

Figure 4-5. Opening Year Traffic Volumes (2025) With Cumulative Projects

4.4. Build-Out (2045) Analysis

Data from the Southern California Association of Governments (SCAG) Regional Travel Demand Model (2016) was used to develop traffic volumes for Build-Out (2045) scenarios. The SCAG model is consistent with the City of Riverside 2016 Regional Transportation Plan (RTP, Riverside County, 2019).

The methodology used for the future year 2045 forecasts is consistent with National Cooperative Highway Research Program (NCHRP) and local forecasting methodologies. The growth from base year model to future year models were used to calculate growth by roadway segment and the model derived growth was applied to the existing without project conditions traffic volumes at all the study area intersections.

Figure 4-6 shows the balanced peak hour intersection traffic volumes for the Build-Out (2045) Without Project Conditions scenario.

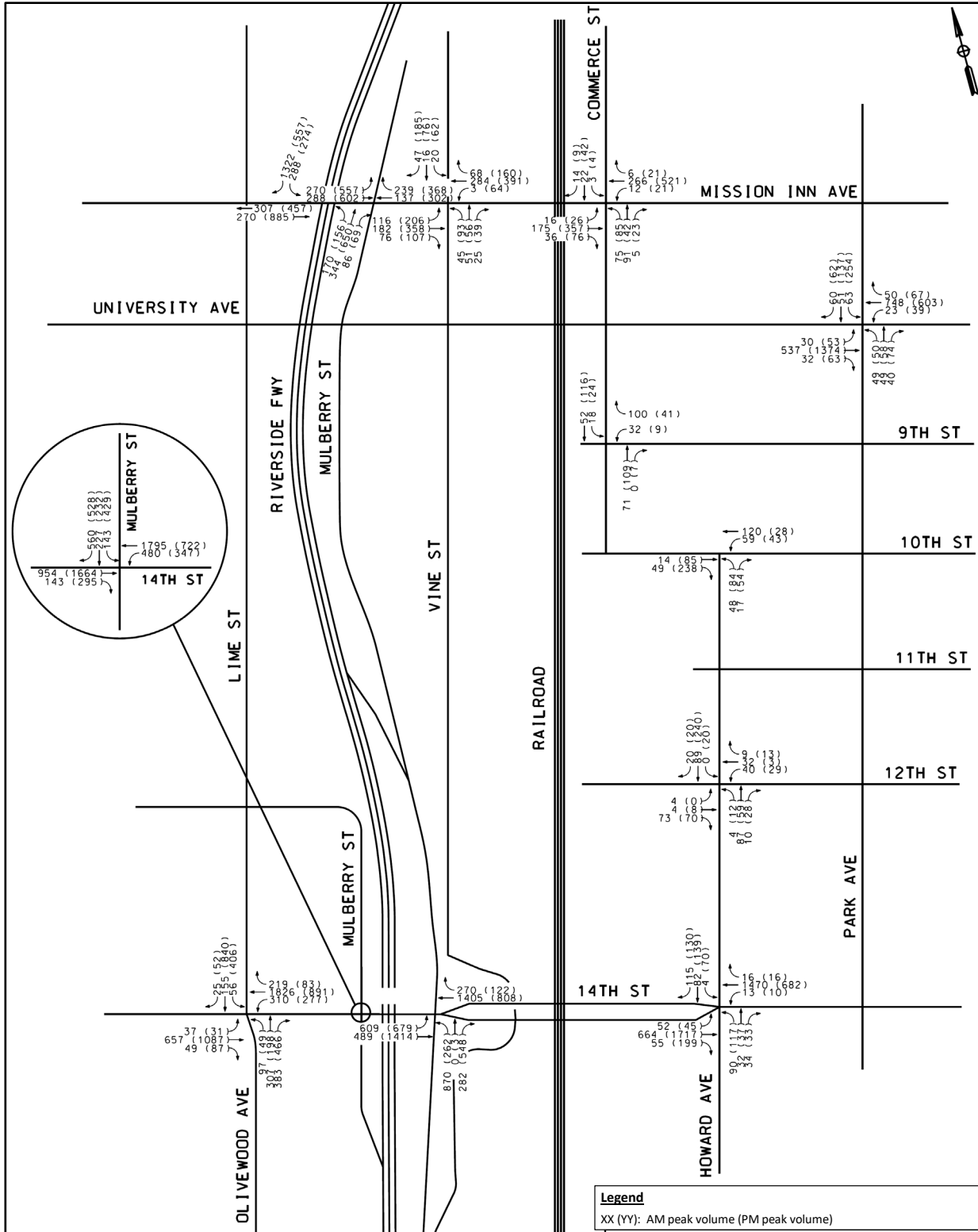

Figure 4-6. Build-Out Traffic Volumes (2045)

5.0 Project Traffic

5.1. Project Trip Generation

The trip generation for the proposed RCTC Riverside-Downtown Station Improvements Project was calculated using the 560 proposed parking stalls with rates from the ITE Trip Generation, 10th Edition Land Use 090 – Park-and-Ride Lot with Bus or Light Rail Service (2017). Table 5-1 shows that the proposed project will create 475 additional daily trips with 235 trips during the a.m. peak hour and 240 trips during the p.m. peak hour.

The proposed project site requires relocation of Prism Aerospace, an existing manufacturing warehouse. Trip generation was calculated for Prism Aerospace in order to determine the number of daily trips to subtract from the Riverside-Downtown Station Improvements Project trip generation as a result of the project. Trip generation for Prism Aerospace was determined using the area (in SF) of the facility with rates from the ITE Trip Generation, 10th Edition Land Use 140 – “Manufacturing” (Year). Table 5-2 shows that the existing facility creates approximately 191 additional daily trips with 92 trips during the a.m. peak hour and 99 trips during the p.m. peak hour.

Prism Aerospace trip generation was subtracted from project trip generation to determine net project trips. Table 5-3 displays the net project trip generation.

5.2. Project Trip Distribution and Assignment

Trip distribution of project trips was developed based on the project location in relation to access to the SR 91 freeway and commercial rail user access.

Figure 5-1 displays the incoming and outgoing trip distribution for the project. Project trip distribution was approved as part of the scoping agreement.

The project trip assignment was determined based on the project trip distribution in coordination with the results from the project trip generation. Prism Aerospace trip distribution was assumed similar to the project trip distribution. Figure 5-2 displays the trip assignment for each intersection as a result of the project. The assumption made for the project trip assignment is that the northbound right project traffic on Ninth Street is negligible (shown as zero in Figure 5-2), since the major movement is northbound through toward the SR-91 interchange further north.

Table 5-1. Project Trip Generation

RCTC Riverside-Downtown Station Improvements Project			
Land Use: Park-and-Ride Lot with Bus or Light Rail Service (090) Units: 560 Parking Stalls			
AM	Weekday, Peak Hour of Adjacent Street Traffic, 1 Hour between 7:00 and 9:00 a.m.		
	Average Rate: 42	79% Entering	21% Exiting
	Vehicle Trip Ends vs. Parking Spaces		
	In	185.8	Trips
	Out	49.4	Trips
	Total	235.2	Trips
PM	Weekday, Peak Hour of Adjacent Street Traffic, 1 Hour between 4:00 and 6:00 p.m.		
	Average Rate: .43	25% Entering	75% Exiting
	Vehicle Trip Ends vs. Parking Spaces		
	In	60.2	Trips
	Out	180.6	Trips
	Total	240.8	Trips

% = percent

vs. = versus

Table 5-2. Prism Aerospace Trip Generation

Prism Aerospace			
Land Use: Manufacturing (140)			Units: 148,000 SF
AM	Weekday, Peak Hour of Adjacent Street Traffic, 1 Hour between 7:00 and 9:00 a.m.		
	Average Rate: 62	77% Entering	23% Exiting
	Vehicle Trip Ends vs. SF (per 1,000)		
	In	70.65	Trips
	Out	21.1	Trips
	Total	91.76	Trips
PM	Weekday, Peak Hour of Adjacent Street Traffic, 1 Hour between 4 and 6 p.m.		
	Average Rate: 67	31% Entering	69% Exiting
	Vehicle Trip Ends vs. SF (per 1,000)		
	In	30.73	Trips
	Out	68.42	Trips
	Total	99.2	Trips

RCTC Riverside-Downtown Station Improvements Project will replace Prism Aerospace manufacturing. Thus, the calculated trips generated by Prism Aerospace in this table are subtracted from the vehicle trips generated by the RCTC Riverside-Downtown Station Improvements Project.

Table 5-3. Net Project Trip Generation

Net Trip Generation	
AM:	Weekday, Peak Hour of Adjacent Street Traffic, 1 Hour between 7:00 and 9:00 a.m.
	In $175.8 - 70.65 = 115.2$ Trips
	Out $49.4 - 21.1 = 28.3$ Trips
	Total $235.2 - 91.76 = 143.4$ Trips
PM:	Weekday, Peak Hour of Adjacent Street Traffic, 1 Hour between 4:00 and 6:00 p.m.
	In $60.2 - 30.73 = 29.5$ Trips
	Out $180.6 - 68.42 = 112.2$ Trips
	Total $240.8 - 99.2 = 141.6$ Trips

Note: It should be noted that the same net project trip generation was used for all options analyzed.

For the Howard Extension plan (that applies to Options 2A, 2B, 3A and 3B), all project and background traffic was re-routed to use the Howard extension (details of the Howard Extension plan analysis all shown in Appendix E). For the Howard Extension analysis, a small portion of the traffic (10%) entering the project was assumed to enter the one-way Kiss and Ride driveway with the remaining traffic entering the main parking lot driveway on 9th Avenue.

The plans developed so far for all options are conceptual in nature. The actual traffic circulation plan within the parking lot (in all options) is not fully developed at this stage of analysis. An assumption was made that the Kiss and Ride would be one-way with traffic exiting via the main entrance/exit on 10th or 9th Ave. Additionally, all the project related (and re-routed) volumes are very low, and will not impact traffic operations at the intersections in the immediate vicinity of the parking lot. All re-routed traffic was re-routed through multiple intersections with these assumptions, resulting in a conservative traffic analysis. Based on this analysis, it was estimated that the turning movement volumes at all major intersections beyond the immediate vicinity of the project were unchanged in this Howard Extension analysis scenario.

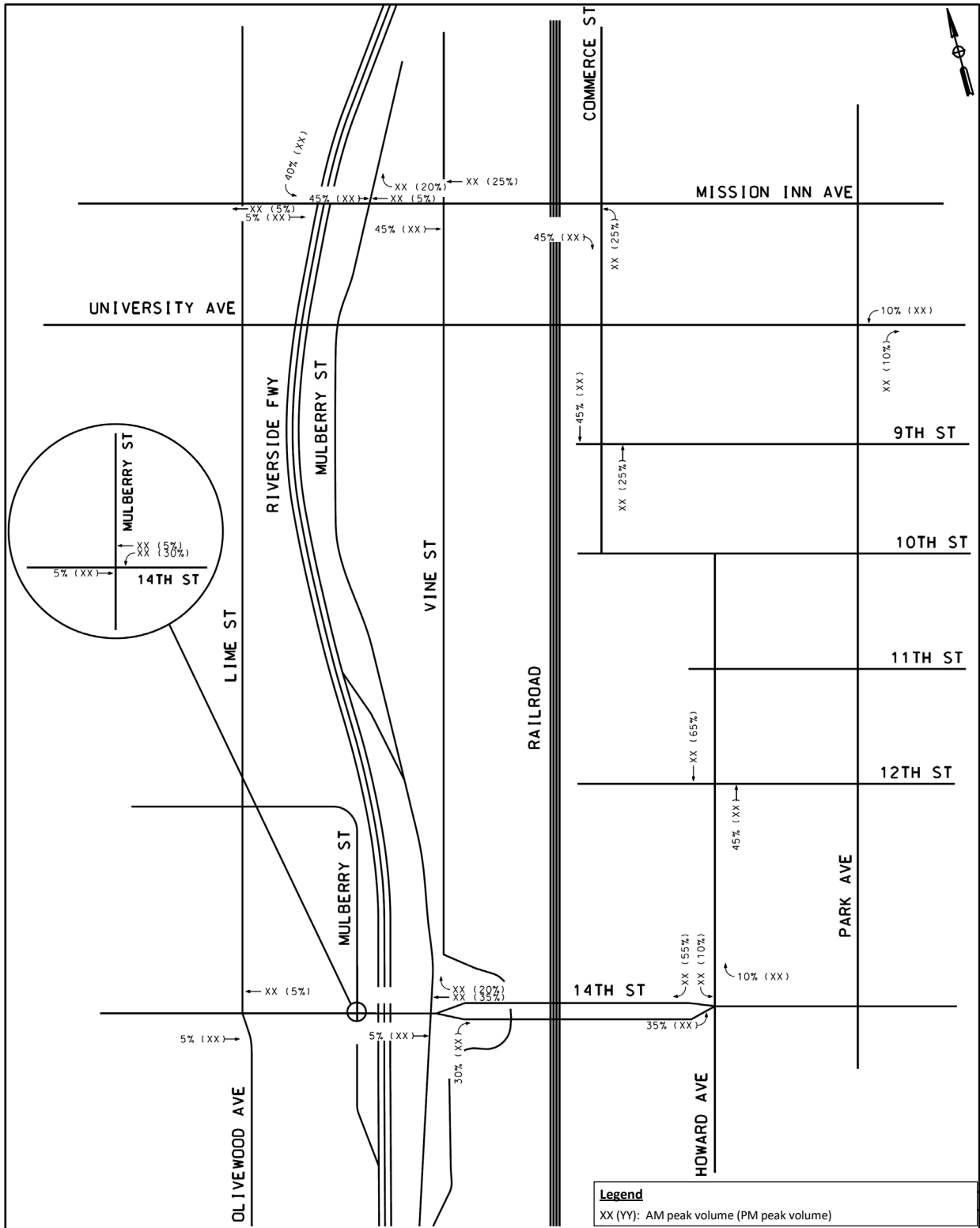

Figure 5-1. Project Trip Distribution Percentages

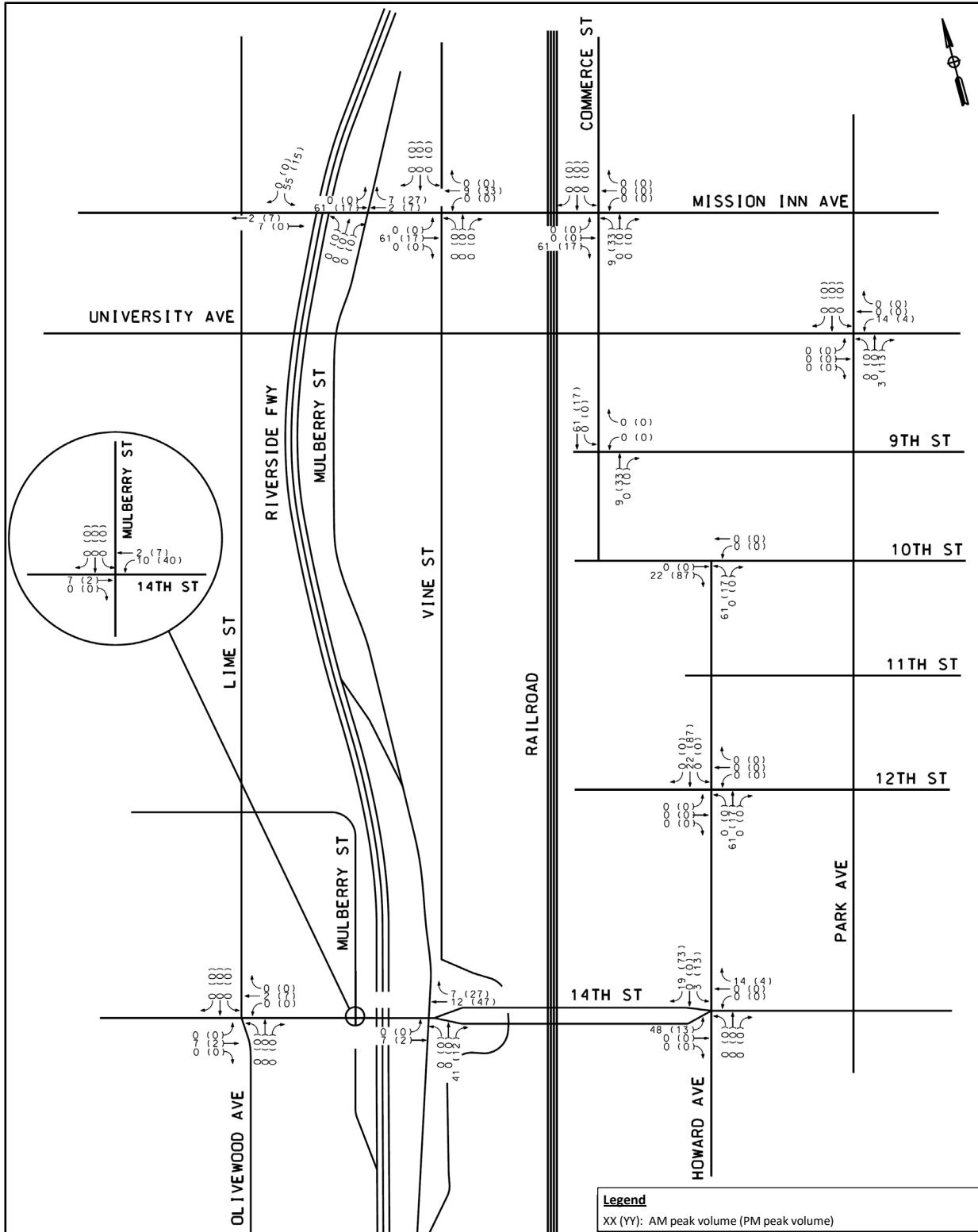

Figure 5-2. Project Trip Assignment

6.0 Traffic Analysis With Project Volumes

Traffic from the project trip generation was added to the Existing, Opening Year (2025) and Build-Out (2045) Without Project Conditions scenarios to develop the corresponding With Project Conditions scenarios for each turning movement for all applicable intersections.

6.1. Existing Year With Project

Figure 6-1 displays the balanced peak hour intersection traffic volumes for the Existing With Project Conditions scenario.

6.2. Opening Year (2025) With Projects Traffic

Figure 6-2 displays the balanced peak hour intersection traffic volumes for the Opening Year (2025) With Project Conditions scenario.

6.3. Opening Year (2025) With Cumulative Projects and Project Conditions

The trips calculated from the trip generation of cumulative projects were added to the Opening Year (2025) With Project Conditions scenario traffic volumes to analyze the Opening Year (2025) With Cumulative Projects and Project Conditions scenario.

Figure 6-3 displays the balanced peak hour intersection traffic volumes for the Opening Year (2025) With Cumulative Projects and Project Conditions scenario.

6.4. Build-Out Year (2045) With Projects Traffic

Figure 6-4 displays the balanced peak hour intersection traffic volumes for the Build-Out (2045) With Project Conditions scenario.

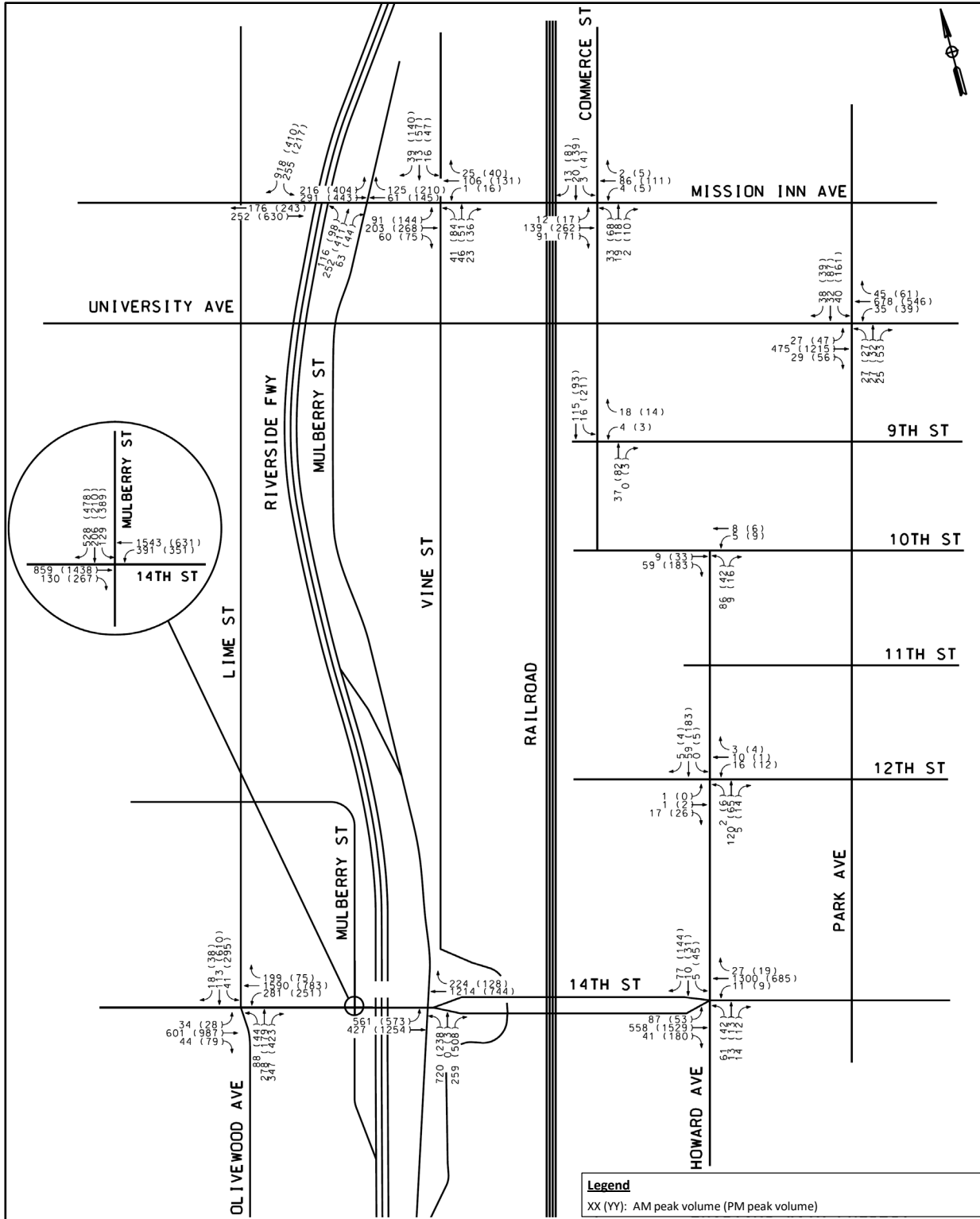

Figure 6-1. Existing Traffic Volumes (2020) With Project Conditions

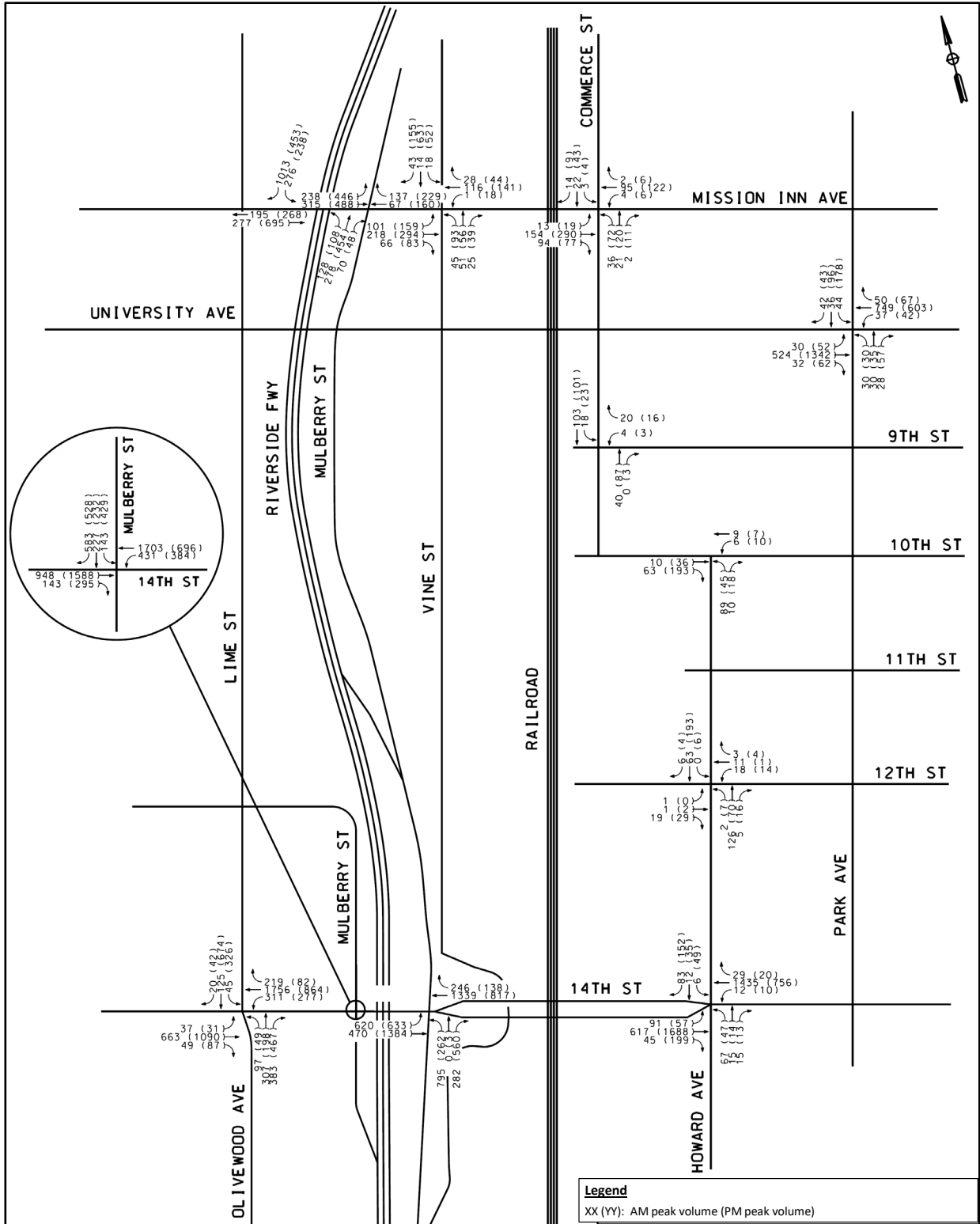

Figure 6-2. Opening Year Traffic Volumes (2025) With Project Conditions

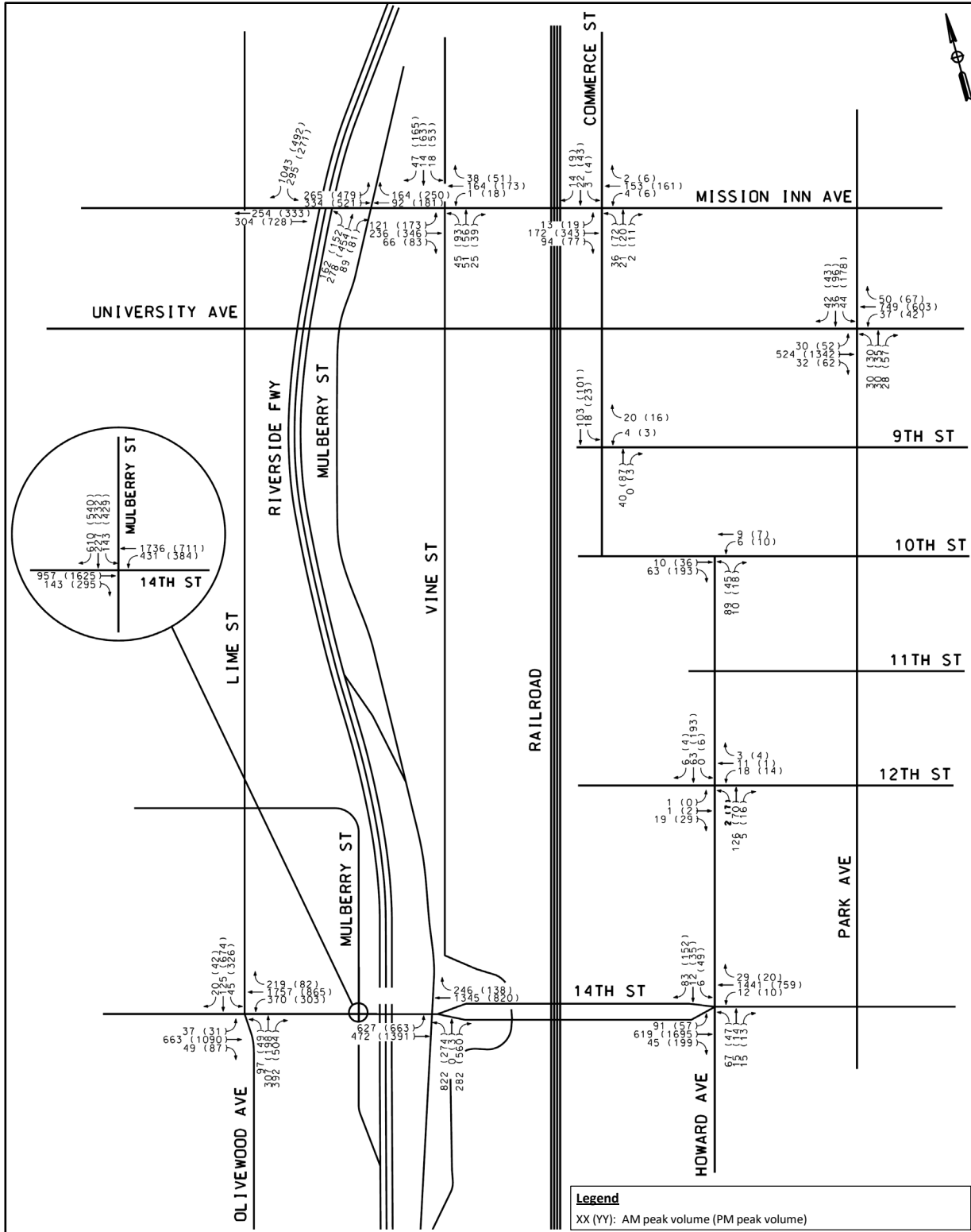

Figure 6-3. Opening Year Traffic Volumes (2025) With Cumulative and Project Conditions

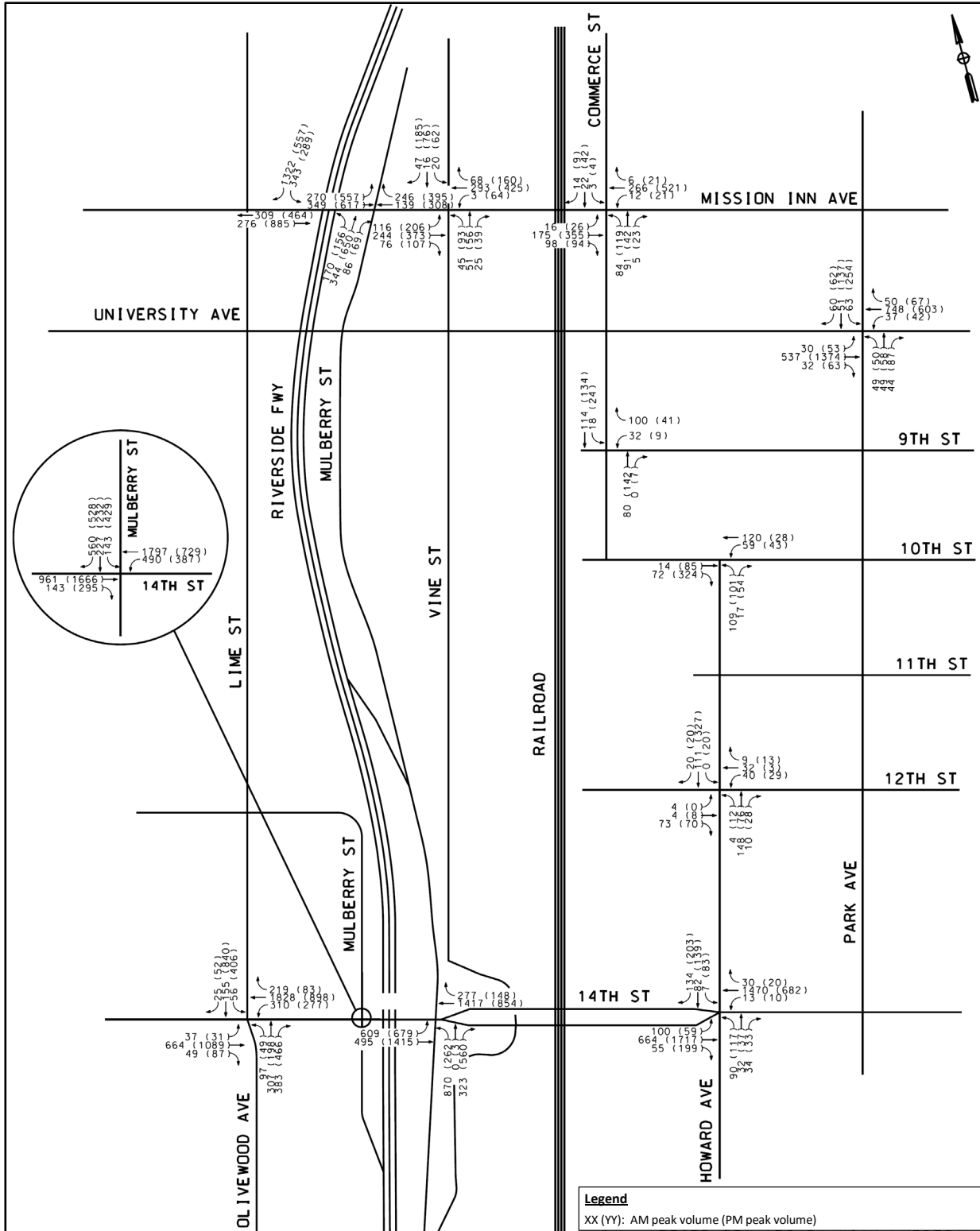

Figure 6-4. Build-Out Traffic Volumes (2045) With Project Conditions

7.0 Intersection Levels of Service

7.1. Existing Levels of Service

Table 7-1 displays the intersection LOS analysis for existing conditions following the level of service criteria defined by City of Riverside TIA guidelines. The table confirms that nearly all study intersections (except University Avenue/ Park Avenue in PM, which has an LOS of D) are currently above the minimum LOS threshold for each intersection.

7.2. Existing with Project Conditions Levels of Service

Table 7-1 displays the intersection LOS analysis for existing with project conditions following the level of service criteria defined by City of Riverside TIA guidelines. The table confirms that all study intersections are currently at or above the existing LOS or the minimum LOS threshold.

Table 7-1. Existing LOS

Intersection		Control	Without Project				With Project			
			AM Peak Hour		PM Peak Hour		AM Peak Hour		PM Peak Hour	
			Delay (sec)	LOS	Delay (sec)	LOS	Delay (sec)	LOS	Delay (sec)	LOS
1	SR 91 Off-Ramp and Mission Inn Avenue	Signalized	15.3	B	16.9	B	15.2	B	16.9	B
2	Mulberry Street and Mission Inn Avenue	Signalized	20.7	C	25.3	C	19.6	B	25.2	C
3	Vine Street and Mission Inn Avenue	AWSC	10	A	17.6	C	10.6	B	19.4	C
4	Commerce Street and Mission Inn Avenue	TWSC	11.4	B	15.6	C	12.2	B	17.9	C
5	University Avenue and Park Avenue	Signalized	28.6	C	42.8	D	29.4	C	43.5	D
6	Commerce Street and 9 th Street	TWSC	9	A	9.3	A	9.3	A	9.6	A
7	Howard Avenue and 10 th Street	TWSC	9	A	9.6	A	9.6	A	10.3	B
8	Howard Avenue and 12 th Street	AWSC	7.5	A	7.9	A	8	A	8.9	A
9	Howard Avenue and 14 th Street	Signalized	20.4	C	20.5	C	24.9	C	25.8	C
10	SR 91 On/Off-Ramps and 14 th Street	Signalized	32.6	C	34.4	C	32.9	C	35.2	D



Riverside-Downtown STATION IMPROVEMENTS

Intersection		Control	Without Project				With Project			
			AM Peak Hour		PM Peak Hour		AM Peak Hour		PM Peak Hour	
			Delay (sec)	LOS	Delay (sec)	LOS	Delay (sec)	LOS	Delay (sec)	LOS
11	Mulberry Street and 14 th Street	Signalized	25.6	C	35.6	D	25.4	C	40.7	D
12	Lime Street and 14 th Street	Signalized	24.6	C	49.9	D	24.7	C	49.9	D

AWSC = All Way Stop-Controlled

TWSC = Two Way Stop-Controlled

7.3. Opening Year (2025) Without Project Conditions Levels of Service

Table 7-2 displays the intersection LOS analysis for Opening Year (2025) Without Project Conditions following the level of service criteria defined by City of Riverside TIA guidelines (2017). The table shows the following intersection is expected to operate below the LOS threshold: Lime Street/14th Street (p.m. peak hour) with the anticipated growth.

All other study intersections are forecast to operate at or above the existing LOS or the minimum LOS threshold.

7.4. Opening Year (2025) With Project Conditions Levels of Service

Table 7-2 displays the intersection LOS analysis for Opening Year (2025) Without Project Conditions following the level of service criteria defined by City of Riverside TIA guidelines. The table shows the following intersection is expected to operate below the LOS threshold: Lime Street/14th Street (p.m. peak hour).

All other study intersections are forecast to operate at or above the existing LOS or the minimum LOS threshold.

7.5. Opening Year (2025) With Cumulative Projects Levels of Service

Table 7-3 displays the intersection LOS analysis for Opening Year (2025) Without Project Conditions following the level of service criteria defined by City of Riverside TIA guidelines. The table shows the following intersection is forecasted to operate below the LOS threshold: Lime Street/14th Street (p.m. peak hour).

All other study intersections are forecast to operate at or above the existing LOS or the minimum LOS threshold.

7.6. Opening Year (2025) With Cumulative Projects and Project Conditions Levels of Service

Table 7-3 displays the intersection LOS analysis for Opening Year (2025) Without Project Conditions following the level of service criteria defined by City of Riverside TIA guidelines. The table shows the following intersections are forecasted to operate below the LOS threshold: Lime Street/Olivewood Avenue and 14th Street (p.m. peak hour) and Vine Street and Mission Inn Avenue (p.m. peak hour).

All other study intersections are forecasted to operate at or above the existing LOS or the minimum LOS threshold.

7.7. Build-Out (2045) Without Project Conditions Levels of Service

Table 7-4 displays the intersection LOS analysis for Build-Out (2045) Without Project Conditions following the level of service criteria defined by City of Riverside TIA guidelines. The table shows the following intersections are forecasted to operate below the LOS threshold during the pm peak hour: Mulberry Street and Mission Inn Avenue, Vine Street and Mission Inn Avenue, and Commerce Street and Mission Inn Avenue.

All other study intersections are forecasted to operate at or above the existing LOS or the minimum LOS threshold.

7.8. Build-Out (2045) With Project Conditions Levels of Service

Table 7-4 displays the intersection LOS analysis for Build-Out (2045) With Project Conditions following the level of service criteria defined by City of Riverside TIA guidelines. The table shows the following intersections are forecasted to operate below the LOS threshold during the pm peak hour: Mulberry Street and Mission Inn Avenue, Vine Street and Mission Inn Avenue, and Commerce Street and Mission Inn Avenue. Delays for some intersections are lower for Build-Out (2045) compared to Opening Year (2025) because a 0.95 peak hour factor (PHF) was used for Build-Out (2045). For Opening Year 2025, the PHF for each intersection was consistent with the existing PHF for that intersection.

All other study intersections are forecasted to operate at or above the existing LOS or the minimum LOS threshold.

Table 7-2. Opening Year (2025) LOS

Intersection		Control	Without Project				With Project			
			AM Peak Hour		PM Peak Hour		AM Peak Hour		PM Peak Hour	
			Delay (sec)	LOS	Delay (sec)	LOS	Delay (sec)	LOS	Delay (sec)	LOS
1	SR 91 Off-Ramp and Mission Inn Avenue	Signalized	15.8	B	17.4	B	15.7	B	17.4	B
2	Mulberry Street and Mission Inn Avenue	Signalized	21.1	C	27.9	C	20.0	C	29.3	C
3	Vine Street and Mission Inn Avenue	AWSC	10.4	B	22.4	C	11.1	B	25	C
4	Commerce Street and Mission Inn Avenue	TWSC	12.5	B	17.5	C	12.7	B	20.9	C
5	University Avenue and Park Avenue	Signalized	29.0	C	53.0	D	29.5	C	53.1	D
6	Commerce Street and 9 th Street	TWSC	9	A	9.4	A	9.3	A	9.7	A
7	Howard Avenue and 10 th Street	TWSC	9.1	A	9.8	A	9.7	A	10.4	B
8	Howard Avenue and 12 th Street	AWSC	7.6	A	8.1	A	8.1	A	9.1	A
9	Howard Avenue and 14 th Street	Signalized	22.3	C	21.5	C	26.6	C	28.2	C
10	SR 91 On/Off-Ramps and 14 th Street	Signalized	35.3	D	40.3	D	35.7	D	41.9	D
11	Mulberry Street and 14 th Street	Signalized	28.8	C	45.3	D	28.9	C	47.3	D
12	Lime Street and 14 th Street	Signalized	27.7	C	56.0	^a E	27.8	C	56.0	^a E

^a **Bold** indicates LOS of E or F

Table 7-3. Opening Year (2025) Cumulative Conditions LOS

Intersection		Control	With Cumulative Projects				With Cumulative Projects and Project			
			AM Peak Hour		PM Peak Hour		AM Peak Hour		PM Peak Hour	
			Delay (sec)	LOS	Delay (sec)	LOS	Delay (sec)	LOS	Delay (sec)	LOS
1	SR 91 Off-Ramp and Mission Inn Avenue	Signalized	16.3	B	17.3	B	16.2	B	17.4	B
2	Mulberry Street and Mission Inn Avenue	Signalized	22.5	C	35.2	D	21.4	C	36.0	D
3	Vine Street and Mission Inn Avenue	AWSC	11.3	B	31.5	D	12.1	B	38.5	E
4	Commerce Street and Mission Inn Avenue	TWSC	13.5	B	20.7	C	13.8	B	26.2	D
5	University Avenue and Park Avenue	Signalized	29.0	C	53.0	D	29.5	C	53.1	D
6	Commerce Street and 9 th Street	TWSC	9	A	9.4	A	9.3	A	9.7	A
7	Howard Avenue and 10 th Street	TWSC	9.1	A	9.8	A	9.7	A	10.4	B
8	Howard Avenue and 12 th Street	AWSC	7.6	A	8.1	A	8.1	A	9.1	A
9	Howard Avenue and 14 th Street	Signalized	22.3	C	21.6	C	26.4	C	28.4	C
10	SR 91 On/Off-Ramps and 14 th Street	Signalized	36.3	D	41.1	D	36.3	D	42.5	D
11	Mulberry Street and 14 th Street	Signalized	28.6	C	42.4	D	28.7	C	45.0	D
12	Lime Street and 14 th Street	Signalized	29.2	C	61.0	^a E	28.5	C	60.7	^a E

^a **Bold** indicates LOS of E or F

Table 7-4. Build-Out (2045) LOS³

Intersection		Control	Without Project				With Project			
			AM Peak Hour		PM Peak Hour		AM Peak Hour		PM Peak Hour	
			Delay (sec)	LOS	Delay (sec)	LOS	Delay (sec)	LOS	Delay (sec)	LOS
1	SR 91 Off-Ramp and Mission Inn Avenue	Signalized	16.7	B	17.7	B	16.6	B	17.7	B
2	Mulberry Street and Mission Inn Avenue	Signalized	22.3	C	50.7	D	21.4	C	53.6	D
3	Vine Street and Mission Inn Avenue	AWSC	11.4	B	50.6	^aF	12.2	B	56.8	^aF
4	Commerce Street and Mission Inn Avenue	TWSC	17.1	C	39.9	^aE	17.5	C	55.8	^aF
5	University Avenue and Park Avenue	Signalized	29.6	C	51.0	D	30.1	C	46.6	D
6	Commerce Street and 9 th Street	TWSC	9.5	A	9.4	A	9.7	A	9.6	A
7	Howard Avenue and 10 th Street	TWSC	10.4	B	11.5	B	11.4	B	12.4	B
8	Howard Avenue and 12 th Street	AWSC	7.9	A	9	A	8.4	A	10.1	B
9	Howard Avenue and 14 th Street	Signalized	26.2	C	39.7	D	29.4	C	34.8	C
10	SR 91 On/Off-Ramps and 14 th Street	Signalized	35.4	D	36.1	D	35.8	D	36.2	D
11	Mulberry Street and 14 th Street	Signalized	26.8	C	37.8	D	27.0	C	38.5	D
12	Lime Street and 14 th Street	Signalized	23.6	C	49.0	D	23.7	C	49.8	D

^a **Bold** indicates LOS of E or F

³ Delays for some intersections are lower for Build-Out (2045) compared to Opening Year (2025) because a 0.95 peak hour factor (PHF) was used for Build-Out (2045). For Opening Year 2025, the PHF for each intersection was consistent with the existing PHF for that intersection.

8.0 Mitigation Analysis

8.1. Existing Conditions

Based on the LOS analysis conducted for this TIA, it was determined that mitigation measures are not necessary in the existing conditions with and without project scenarios.

8.2. Opening Year Conditions

Based on the LOS analysis conducted for this TIA, it was determined that the following intersections are forecasted to operate at an unsatisfactory LOS by the Opening Year (2025): Lime Street/Olivewood Avenue and 14th Street and Vine Street and Mission Inn Avenue.

Lime Street/Olivewood Avenue and 14th Street is a signalized intersection forecasted to operate at LOS E (below the City of Riverside threshold) for the p.m. peak-hour period for the Opening Year Without Project, Opening Year With Project, Opening Year With Cumulative Projects, and Opening Year With Cumulative Projects and Project Conditions. Section 7 of this TIA shows that the delay and LOS for this intersection does not change between the “without” and “with” project scenarios. Thus, the project does not cause a significant impact to the intersection.

Vine Street and Mission Inn Avenue is an all way stop-controlled intersection that is forecasted to operate at a LOS E below the City of Riverside threshold for the p.m. peak-hour period in the Opening Year with Cumulative Projects and Project Conditions scenario. Signal warrant analysis on the intersection determined that signals are not warranted for this scenario.

8.3. Build-Out Conditions

Based on the LOS analysis conducted for this TIA, it was determined that the following intersections are forecasted to operate at an unsatisfactory LOS by the year 2045: Commerce Street and Mission Inn Avenue, and Vine Street and Mission Inn Avenue. However, it should be noted that the project does not cause a significant impact at either intersection (LOS/delay are the same for “without project” and “with project” conditions) and hence mitigation is not required.

Commerce Street and Mission Inn Avenue is a two way stop-controlled intersection that is forecasted to operate at an unsatisfactory LOS below the City of Riverside threshold for the p.m. peak-hour period some time in the future for Without and With project conditions.⁴ Vine Street and Mission Inn Avenue is an all way stop-controlled intersection that is forecasted to operate at an unsatisfactory LOS below the City of Riverside threshold for the p.m. peak-hour period in the Build-out Conditions Without and With project conditions⁵.

⁴ While the project does not cause significant impacts, the intersection LOS is expected to degrade, and improvements such as a traffic signal could be considered to improve the intersection. A signal warrant analysis has been completed to improve the intersection (see Appendix D), and it was determined that the intersection met peak hour warrant criteria for signals in both without project and with project conditions.

⁵ The intersection LOS is expected to degrade, and a traffic signal could be considered to improve the intersection. A signal warrant analysis has been completed and it was determined that the intersection met peak hour warrant criteria for signals in both without project and with project conditions (Appendix D).



Riverside-Downtown STATION IMPROVEMENTS

Under the Build-Out condition, the LOS was estimated for intersections related to the Howard extension. Based on the LOS analysis, none of the intersections near the Howard extension are expected to operate at an unsatisfactory LOS. Detailed analysis is available in Appendix E.

9.0 Summary and Conclusions

The proposed project includes the expansion of the existing commuter transit platform, new construction of an adjacent 560 stall parking lot, and the expansion of the existing pedestrian bridge. The project is forecasted to generate an additional 475 daily trips. Provided herein is a summary of intersection LOS for the various scenarios analyzed, which include Existing Conditions, Opening Year Conditions, and “Build-out Conditions.

9.1. Existing Conditions

All study intersections With and Without Project Conditions currently operate at a satisfactory LOS above the threshold defined by City of Riverside.

9.2. Opening Year Conditions

The intersection of Lime Street/Olivewood Avenue and 14th Street is forecasted to operate at an unsatisfactory LOS below the threshold defined by City of Riverside during the p.m. peak hour for the Without Project Conditions, With Project Conditions, With Cumulative Projects, and With both Cumulative Projects and Project Conditions scenarios. As discussed in Section 8 of this TIA, Mitigation Analysis, the project is not forecasted to cause a significant impact on this intersection and therefore no mitigation is required.

In addition, the intersection of Vine Street and Mission Inn Avenue is forecasted to operate at an unsatisfactory LOS below the threshold defined by City of Riverside during the p.m. peak hour for the with cumulative projects and project conditions scenario. A signal warrant analysis was conducted at this intersection, and the warrant was not met at this intersection for this scenario. Additionally, a sensitivity test was performed to evaluate if the LOS improves with a dedicated right turn lane added in for the southbound right movement. This test indicated that (while this is not directly a project related impact) adding in a southbound right turn lane at Vine Street and Mission Inn Avenue will improve the LOS.

All other study intersections and scenarios are forecasted to operate at a satisfactory LOS above the threshold, as defined by City of Riverside.

9.3. Build-Out Conditions

During the p.m. peak-hour period, the following intersections are forecasted to operate at an unsatisfactory LOS below the threshold, as defined by City of Riverside for the With and Without Project Conditions: Vine Street and Mission Inn Avenue, and Commerce Street and Mission Inn Avenue. As discussed in Section 8 of this TIA, Mitigation Analysis, the project is not forecasted to cause a significant impact on this intersection and therefore no mitigation is required.

All other study intersections are forecasted to operate at a satisfactory LOS above the threshold, as defined by City of Riverside.

In addition to the intersection analysis developed for the original site plan, analysis was conducted for the Howard Extension plan. This analysis (shown in Appendix E) shows similar LOS results for all major intersections (and acceptable LOS for driveways in the immediate vicinity of the project site).

9.3.1. Build-Out Conditions – Howard Extension Analysis

In addition to the intersection analysis developed for the original site plan, analysis was conducted for the Howard Extension plan (Options 2A/2B/3A/3B). The results of this analysis show that the volumes on Howard Avenue and 10th Street are relatively low, and there are no traffic impacts resulting from the project or the Howard Avenue extension. It should be noted that any changes anticipated related to the Howard Extension options can be expected to be localized to Howard Avenue and 10th Street. The details of this analysis are shown in Appendix E.

10.0 References

- City of Riverside. 2017. *Traffic Impact Analysis Preparation Guide, December 2017.*
- Riverside County. 2019. *Riverside County Long Range Transportation Study. December 2019.*
- City of Riverside, General Plan 2025, 2007, Amended in 2018.*
- Institute of Transportation Engineers (ITE). 2017. *Trip Generation Manual, 10th Edition. September 2019.*
- Southern California Association of Governments (SCAG). 2016. *2016-2040 Regional Transportation Plan/ Sustainable Communities Strategy (2016 RTP/SCS or Plan). 2016.*
- Southern California Association of Governments (SCAG). 2016. *SCAG Regional Travel Demand Model and 2012 Model Validation, received in March 2020.*
- National Academy of Sciences. 2016. *Highway Capacity Manual 6th Edition. 2016.*



Riverside-Downtown STATION IMPROVEMENTS

Appendix A. Scoping Agreement



SCOPING AGREEMENT FOR TRAFFIC IMPACT STUDY

This letter acknowledges the City of Riverside Public Works Traffic Engineering Division requirements for traffic impact analysis of the following project. The analysis must follow the City Traffic Impact Analysis Preparation Guide dated January 2016.

Case No. _____
 Related Cases - _____
 SP No. _____
 EIR No. _____
 GPA No. _____
 CZ No. _____
 Project Name: RCTC Riverside Downtown Station Track and Platform Expansion
 Project Location: 4066 Vine St, Riverside, CA 92507
 Project Description: Expansion of existing commuter transit platform, new construction of adjacent 560 stall parking lot, and expansion of existing pedestrian bridge.

	<u>Consultant</u>	<u>Developer</u>
Name:	<u>HNTB</u>	<u>RCTC</u>
Address:	<u>3633 Inland Empire Blvd, Suite 750</u> <u>Ontario, CA 91764</u>	<u>4080 Lemon St, 3rd Floor</u> <u>Riverside, CA 92501</u>
Telephone:	<u>(909) 727-5600</u>	<u>951-787-7141</u>

A. Trip Generation Source: ITE Trip Generation Manual, most recent edition

Existing Land Use:	<u>(I) Industrial (090) Park-and-Ride Lot with Bus or Light Rail Service</u>	Proposed Land Use:	<u>(I) Industrial (090) Park-and-Ride Lot with Bus or Light Rail Service</u>
Existing Zoning	<u>(I) Industrial</u>	Proposed Zoning	<u>(I) Industrial</u>
Total Daily Trips	<u>476</u>		

	In	Out	Total
AM Trips	<u>186</u>	<u>49</u>	<u>235</u>
PM Trips	<u>60</u>	<u>181</u>	<u>241</u>

Internal Trip Yes No (_____ 0% Trip Discount)
 Allowance
 Pass-By Trip Allowance Yes No (_____ 0 % Trip Discount)
 (Attach additional sheet if this is a multi-use site with a breakdown of trips generated)

B. Trip Geographic Distribution: N 10% S 20% E 40% W 30%
 (See attached exhibit for detailed assignment)

C. Background Traffic

Project Completion Year: 2025 Annual Ambient Growth Rate: 2%
 Other area projects to be included: N/A

Please contact Planning Division or use the most recently provided data

Model/Forecast methodology if required: SCAG

D. Build-out Studies: Does this project require a Build-out Study per TIA Guidelines Section 7.2? Yes No

E. Study Intersections: (NOTE: Subject to revision after other projects, trip generation and distribution are determined, or comments from other agencies.)

- | | |
|---|---|
| 1. <u>Lime St. & 14th St</u> | 7. <u>Commerce St & 9th St</u> |
| 2. <u>Mulberry St & 14th St</u> | 8. <u>Commerce St & Mission Inn Ave</u> |
| 3. <u>SR 91 On/Off-Ramps & 14th St</u> | 9. <u>Vine St & Mission Inn Ave</u> |
| 4. <u>Howard Ave. & 14th St</u> | 10. <u>Mulberry St & Mission Inn Ave</u> |
| 5. <u>Howard Ave & 12th St</u> | 11. <u>SR 91 Off-Ramp & Mission Inn Ave</u> |
| 6. <u>Howard Ave & 10th St</u> | 12. <u>University Ave & Park Ave</u> |

F. Study Roadway Segments:

- | | |
|------------------------------|------------------------------|
| 1. <u>Mission Inn Ave</u> | 5. <u>University Ave</u> |
| 2. <u>14th St</u> | 6. <u>Commerce St</u> |
| 3. <u>Howard Ave</u> | 7. <u>10th St</u> |
| 4. <u>Park Ave</u> | 8. _____ |

G. Other Jurisdictional Impact:

Is this project within any other Agency's Sphere of Influence or one-mile radius of boundaries? Yes No

If so, name of Jurisdiction: California Department of Transportation

H. Site Plan (please attach a legible 11'X17' copy)

I. Specific issues to be addressed in the Study (in addition to the standard analysis described in the Guideline) (To be filled out by Public Works Traffic Department)

Recommended by:

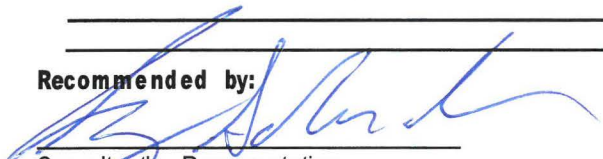

Consultant's Representative
CRAIG SCHNEIDER

2/7/2020
Date

Scoping Agreement Submitted on _____

Date

Scoping Agreement Resubmitted on _____

Date

Approved Scoping Agreement:

City of Riverside
Traffic Engineering Division

Date

cc: Planning Division



Riverside-Downtown STATION IMPROVEMENTS

Appendix B. Counts

City of Riverside
 N/S: 14th Street
 E/W: Lime Street
 Weather: Clear

File Name : 01_RIV_14th_Lime AM
 Site Code : 17920060
 Start Date : 1/28/2020
 Page No : 1

Groups Printed- Total Volume

Start Time	14th Street Southbound				Lime Street Westbound				14th Street Northbound				Lime Street Eastbound				Int. Total
	Left	Thru	Right	App. Total	Left	Thru	Right	App. Total	Left	Thru	Right	App. Total	Left	Thru	Right	App. Total	
07:00 AM	7	139	7	153	6	20	3	29	61	396	60	517	18	60	100	178	877
07:15 AM	12	101	11	124	17	28	9	54	72	353	53	478	28	57	89	174	830
07:30 AM	10	178	12	200	11	34	2	47	77	390	40	507	23	90	96	209	963
07:45 AM	5	183	14	202	8	31	4	43	71	421	45	537	19	71	61	151	933
Total	34	601	44	679	42	113	18	173	281	1560	198	2039	88	278	346	712	3603
08:00 AM	8	121	8	137	3	19	3	25	57	407	53	517	13	55	69	137	816
08:15 AM	8	99	15	122	6	18	5	29	43	365	43	451	16	58	101	175	777
08:30 AM	10	125	13	148	10	15	2	27	52	405	35	492	12	52	78	142	809
08:45 AM	8	128	6	142	14	24	7	45	45	355	34	434	13	30	72	115	736
Total	34	473	42	549	33	76	17	126	197	1532	165	1894	54	195	320	569	3138
Grand Total	68	1074	86	1228	75	189	35	299	478	3092	363	3933	142	473	666	1281	6741
Apprch %	5.5	87.5	7		25.1	63.2	11.7		12.2	78.6	9.2		11.1	36.9	52		
Total %	1	15.9	1.3	18.2	1.1	2.8	0.5	4.4	7.1	45.9	5.4	58.3	2.1	7	9.9	19	

Start Time	14th Street Southbound				Lime Street Westbound				14th Street Northbound				Lime Street Eastbound				Int. Total
	Left	Thru	Right	App. Total	Left	Thru	Right	App. Total	Left	Thru	Right	App. Total	Left	Thru	Right	App. Total	
Peak Hour Analysis From 07:00 AM to 08:45 AM - Peak 1 of 1																	
Peak Hour for Entire Intersection Begins at 07:00 AM																	
07:00 AM	7	139	7	153	6	20	3	29	61	396	60	517	18	60	100	178	877
07:15 AM	12	101	11	124	17	28	9	54	72	353	53	478	28	57	89	174	830
07:30 AM	10	178	12	200	11	34	2	47	77	390	40	507	23	90	96	209	963
07:45 AM	5	183	14	202	8	31	4	43	71	421	45	537	19	71	61	151	933
Total Volume	34	601	44	679	42	113	18	173	281	1560	198	2039	88	278	346	712	3603
% App. Total	5	88.5	6.5		24.3	65.3	10.4		13.8	76.5	9.7		12.4	39	48.6		
PHF	.708	.821	.786	.840	.618	.831	.500	.801	.912	.926	.825	.949	.786	.772	.865	.852	.935

City of Riverside
 N/S: 14th Street
 E/W: Lime Street
 Weather: Clear

File Name : 01_RIV_14th_Lime AM
 Site Code : 17920060
 Start Date : 1/28/2020
 Page No : 2

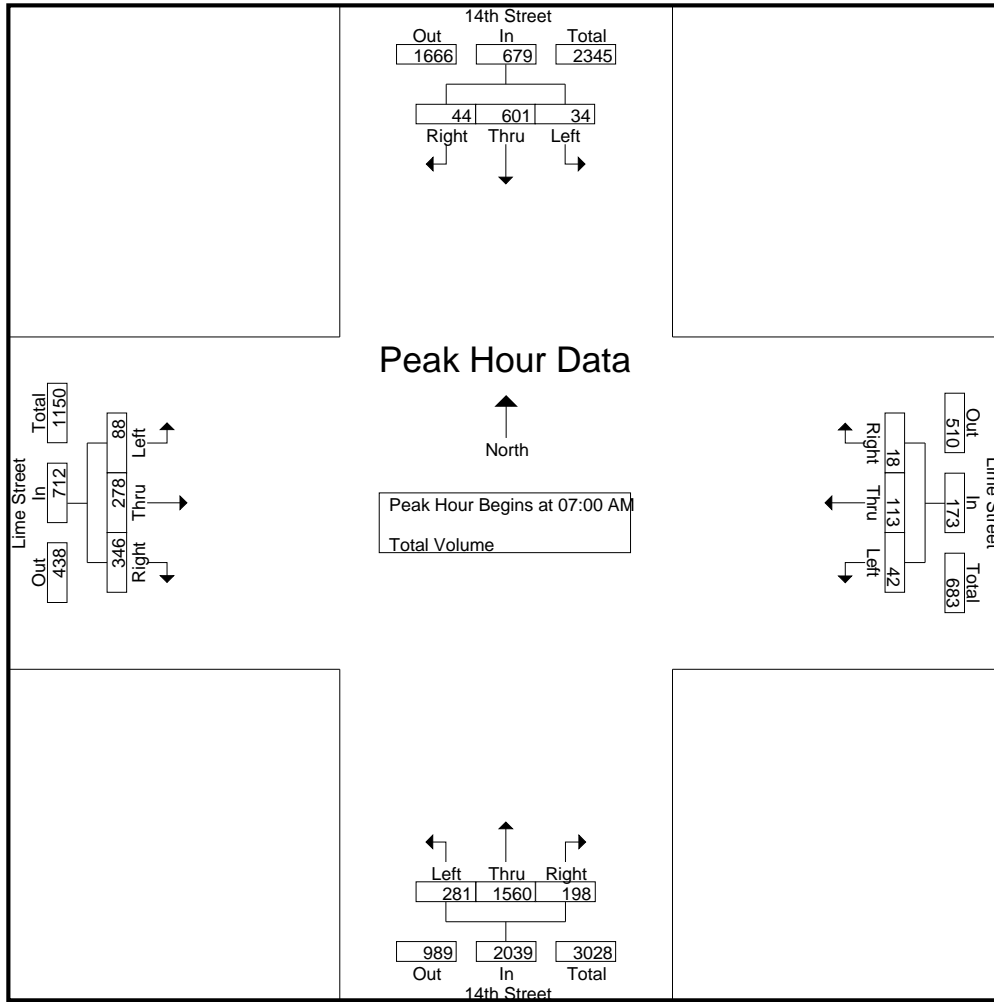

Peak Hour Analysis From 07:00 AM to 08:45 AM - Peak 1 of 1
 Peak Hour for Each Approach Begins at:

	07:00 AM				07:00 AM				07:00 AM				07:00 AM			
+0 mins.	7	139	7	153	6	20	3	29	61	396	60	517	18	60	100	178
+15 mins.	12	101	11	124	17	28	9	54	72	353	53	478	28	57	89	174
+30 mins.	10	178	12	200	11	34	2	47	77	390	40	507	23	90	96	209
+45 mins.	5	183	14	202	8	31	4	43	71	421	45	537	19	71	61	151
Total Volume	34	601	44	679	42	113	18	173	281	1560	198	2039	88	278	346	712
% App. Total	5	88.5	6.5		24.3	65.3	10.4		13.8	76.5	9.7		12.4	39	48.6	
PHF	.708	.821	.786	.840	.618	.831	.500	.801	.912	.926	.825	.949	.786	.772	.865	.852

City of Riverside
 N/S: 14th Street
 E/W: Lime Street
 Weather: Clear

File Name : 01_RIV_14th_Lime PM
 Site Code : 17920060
 Start Date : 1/28/2020
 Page No : 1

Groups Printed- Total Volume

Start Time	14th Street Southbound				Lime Street Westbound				14th Street Northbound				Lime Street Eastbound				Int. Total
	Left	Thru	Right	App. Total	Left	Thru	Right	App. Total	Left	Thru	Right	App. Total	Left	Thru	Right	App. Total	
04:00 PM	4	255	18	277	62	67	9	138	61	170	13	244	12	36	100	148	807
04:15 PM	8	248	23	279	58	93	8	159	56	168	24	248	10	51	97	158	844
04:30 PM	6	296	16	318	78	99	11	188	46	167	19	232	20	50	103	173	911
04:45 PM	13	208	17	238	63	118	7	188	66	200	22	288	8	49	120	177	891
Total	31	1007	74	1112	261	377	35	673	229	705	78	1012	50	186	420	656	3453
05:00 PM	4	262	25	291	75	169	10	254	57	201	21	279	12	37	89	138	962
05:15 PM	5	248	21	274	85	224	10	319	71	206	12	289	4	43	110	157	1039
05:30 PM	4	255	12	271	73	108	9	190	53	218	22	293	12	38	79	129	883
05:45 PM	8	181	17	206	45	87	10	142	76	241	16	333	12	60	70	142	823
Total	21	946	75	1042	278	588	39	905	257	866	71	1194	40	178	348	566	3707
Grand Total	52	1953	149	2154	539	965	74	1578	486	1571	149	2206	90	364	768	1222	7160
Apprch %	2.4	90.7	6.9		34.2	61.2	4.7		22	71.2	6.8		7.4	29.8	62.8		
Total %	0.7	27.3	2.1	30.1	7.5	13.5	1	22	6.8	21.9	2.1	30.8	1.3	5.1	10.7	17.1	

Start Time	14th Street Southbound				Lime Street Westbound				14th Street Northbound				Lime Street Eastbound				Int. Total
	Left	Thru	Right	App. Total	Left	Thru	Right	App. Total	Left	Thru	Right	App. Total	Left	Thru	Right	App. Total	
Peak Hour Analysis From 04:00 PM to 05:45 PM - Peak 1 of 1																	
Peak Hour for Entire Intersection Begins at 04:30 PM																	
04:30 PM	6	296	16	318	78	99	11	188	46	167	19	232	20	50	103	173	911
04:45 PM	13	208	17	238	63	118	7	188	66	200	22	288	8	49	120	177	891
05:00 PM	4	262	25	291	75	169	10	254	57	201	21	279	12	37	89	138	962
05:15 PM	5	248	21	274	85	224	10	319	71	206	12	289	4	43	110	157	1039
Total Volume	28	1014	79	1121	301	610	38	949	240	774	74	1088	44	179	422	645	3803
% App. Total	2.5	90.5	7		31.7	64.3	4		22.1	71.1	6.8		6.8	27.8	65.4		
PHF	.538	.856	.790	.881	.885	.681	.864	.744	.845	.939	.841	.941	.550	.895	.879	.911	.915

City of Riverside
 N/S: 14th Street
 E/W: Lime Street
 Weather: Clear

File Name : 01_RIV_14th_Lime PM
 Site Code : 17920060
 Start Date : 1/28/2020
 Page No : 2

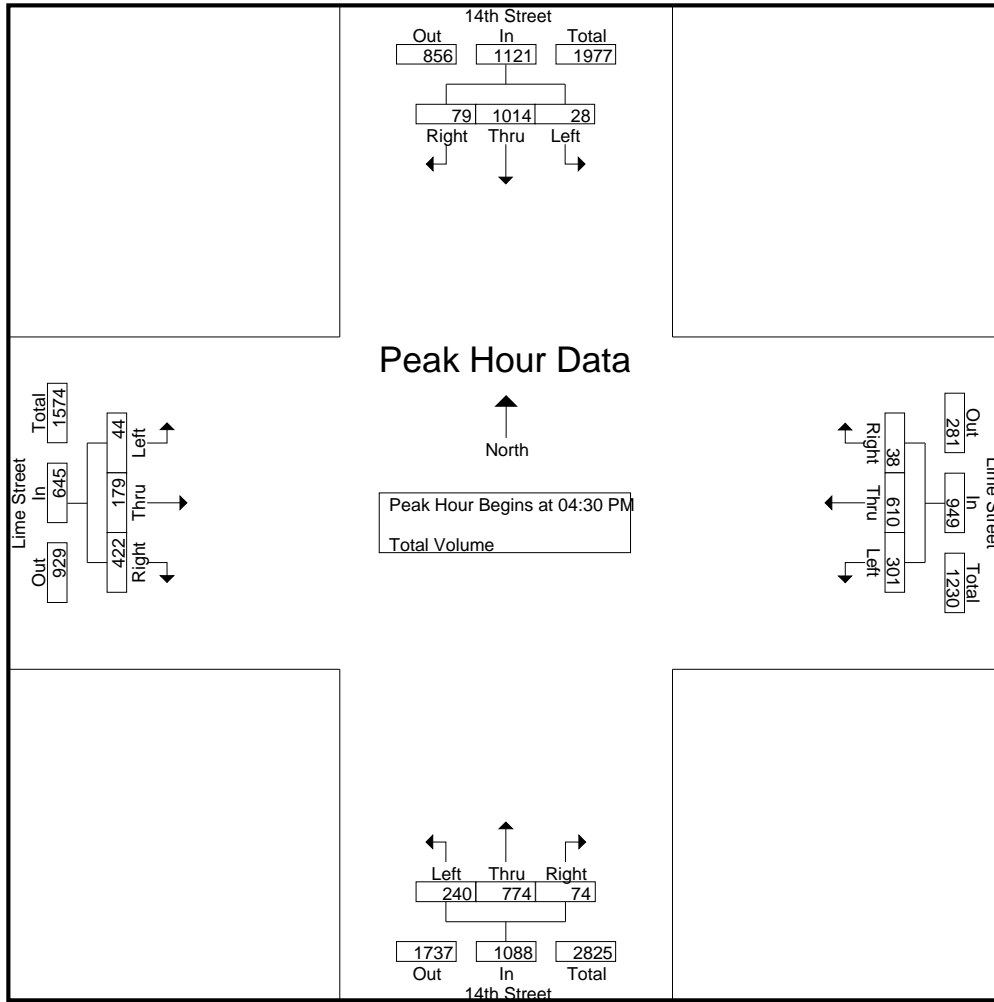

Peak Hour Analysis From 04:00 PM to 05:45 PM - Peak 1 of 1
 Peak Hour for Each Approach Begins at:

	04:15 PM				04:45 PM				05:00 PM				04:00 PM			
+0 mins.	8	248	23	279	63	118	7	188	57	201	21	279	12	36	100	148
+15 mins.	6	296	16	318	75	169	10	254	71	206	12	289	10	51	97	158
+30 mins.	13	208	17	238	85	224	10	319	53	218	22	293	20	50	103	173
+45 mins.	4	262	25	291	73	108	9	190	76	241	16	333	8	49	120	177
Total Volume	31	1014	81	1126	296	619	36	951	257	866	71	1194	50	186	420	656
% App. Total	2.8	90.1	7.2		31.1	65.1	3.8		21.5	72.5	5.9		7.6	28.4	64	
PHF	.596	.856	.810	.885	.871	.691	.900	.745	.845	.898	.807	.896	.625	.912	.875	.927

City of Riverside
 N/S: 14th Street
 E/W: Mulberry Street
 Weather: Clear

File Name : 02_RIV_14th_Mulberry AM
 Site Code : 17920060
 Start Date : 1/28/2020
 Page No : 1

Groups Printed- Total Volume

Start Time	14th Street Southbound				Mulberry Street Westbound				14th Street Northbound				Mulberry Street Eastbound				Int. Total
	Left	Thru	Right	App. Total	Left	Thru	Right	App. Total	Left	Thru	Right	App. Total	Left	Thru	Right	App. Total	
07:00 AM	0	196	22	218	28	38	148	214	71	352	0	423	0	0	0	0	855
07:15 AM	0	204	20	224	38	61	138	237	77	365	0	442	0	0	0	0	903
07:30 AM	0	227	31	258	20	59	143	222	129	348	0	477	0	0	0	0	957
07:45 AM	0	225	52	277	38	49	135	222	94	423	0	517	0	0	0	0	1016
Total	0	852	125	977	124	207	564	895	371	1488	0	1859	0	0	0	0	3731
08:00 AM	0	176	27	203	34	37	116	187	77	398	0	475	0	0	0	0	865
08:15 AM	0	177	30	207	31	45	139	215	74	339	0	413	0	0	0	0	835
08:30 AM	0	168	29	197	23	30	142	195	71	332	0	403	0	0	0	0	795
08:45 AM	0	170	50	220	31	21	146	198	50	312	0	362	0	0	0	0	780
Total	0	691	136	827	119	133	543	795	272	1381	0	1653	0	0	0	0	3275
Grand Total	0	1543	261	1804	243	340	1107	1690	643	2869	0	3512	0	0	0	0	7006
Apprch %	0	85.5	14.5		14.4	20.1	65.5		18.3	81.7	0		0	0	0		
Total %	0	22	3.7	25.7	3.5	4.9	15.8	24.1	9.2	41	0	50.1	0	0	0	0	

Start Time	14th Street Southbound				Mulberry Street Westbound				14th Street Northbound				Mulberry Street Eastbound				Int. Total
	Left	Thru	Right	App. Total	Left	Thru	Right	App. Total	Left	Thru	Right	App. Total	Left	Thru	Right	App. Total	
Peak Hour Analysis From 07:00 AM to 08:45 AM - Peak 1 of 1																	
Peak Hour for Entire Intersection Begins at 07:15 AM																	
07:15 AM	0	204	20	224	38	61	138	237	77	365	0	442	0	0	0	0	903
07:30 AM	0	227	31	258	20	59	143	222	129	348	0	477	0	0	0	0	957
07:45 AM	0	225	52	277	38	49	135	222	94	423	0	517	0	0	0	0	1016
08:00 AM	0	176	27	203	34	37	116	187	77	398	0	475	0	0	0	0	865
Total Volume	0	832	130	962	130	206	532	868	377	1534	0	1911	0	0	0	0	3741
% App. Total	0	86.5	13.5		15	23.7	61.3		19.7	80.3	0		0	0	0		
PHF	.000	.916	.625	.868	.855	.844	.930	.916	.731	.907	.000	.924	.000	.000	.000	.000	.921

City of Riverside
 N/S: 14th Street
 E/W: Mulberry Street
 Weather: Clear

File Name : 02_RIV_14th_Mulberry AM
 Site Code : 17920060
 Start Date : 1/28/2020
 Page No : 2

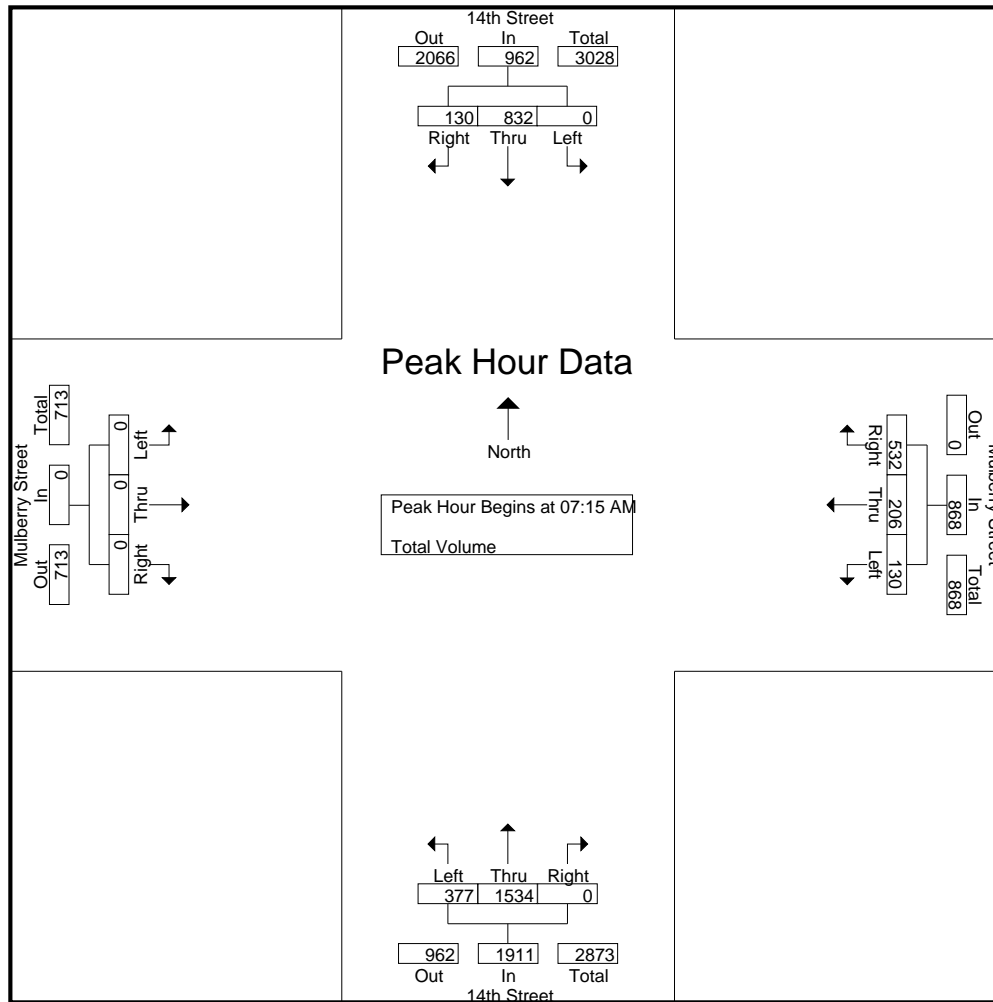

Peak Hour Analysis From 07:00 AM to 08:45 AM - Peak 1 of 1
 Peak Hour for Each Approach Begins at:

	07:00 AM				07:00 AM				07:15 AM				07:00 AM			
+0 mins.	0	196	22	218	28	38	148	214	77	365	0	442	0	0	0	0
+15 mins.	0	204	20	224	38	61	138	237	129	348	0	477	0	0	0	0
+30 mins.	0	227	31	258	20	59	143	222	94	423	0	517	0	0	0	0
+45 mins.	0	225	52	277	38	49	135	222	77	398	0	475	0	0	0	0
Total Volume	0	852	125	977	124	207	564	895	377	1534	0	1911	0	0	0	0
% App. Total	0	87.2	12.8		13.9	23.1	63		19.7	80.3	0		0	0	0	
PHF	.000	.938	.601	.882	.816	.848	.953	.944	.731	.907	.000	.924	.000	.000	.000	.000

City of Riverside
 N/S: 14th Street
 E/W: Mulberry Street
 Weather: Clear

File Name : 02_RIV_14th_Mulberry PM
 Site Code : 17920060
 Start Date : 1/28/2020
 Page No : 1

Groups Printed- Total Volume

Start Time	14th Street Southbound				Mulberry Street Westbound				14th Street Northbound				Mulberry Street Eastbound				Int. Total
	Left	Thru	Right	App. Total	Left	Thru	Right	App. Total	Left	Thru	Right	App. Total	Left	Thru	Right	App. Total	
04:00 PM	0	326	72	398	79	42	103	224	70	158	0	228	0	0	0	0	850
04:15 PM	0	327	69	396	93	27	106	226	67	154	0	221	0	0	0	0	843
04:30 PM	0	375	79	454	107	44	110	261	73	123	0	196	0	0	0	0	911
04:45 PM	0	329	57	386	100	48	131	279	57	158	0	215	0	0	0	0	880
Total	0	1357	277	1634	379	161	450	990	267	593	0	860	0	0	0	0	3484
05:00 PM	0	357	63	420	111	54	125	290	88	162	0	250	0	0	0	0	960
05:15 PM	0	371	68	439	72	64	114	250	86	183	0	269	0	0	0	0	958
05:30 PM	0	340	44	384	96	51	128	275	49	169	0	218	0	0	0	0	877
05:45 PM	0	248	49	297	78	37	118	233	67	202	0	269	0	0	0	0	799
Total	0	1316	224	1540	357	206	485	1048	290	716	0	1006	0	0	0	0	3594
Grand Total	0	2673	501	3174	736	367	935	2038	557	1309	0	1866	0	0	0	0	7078
Apprch %	0	84.2	15.8		36.1	18	45.9		29.8	70.2	0		0	0	0		
Total %	0	37.8	7.1	44.8	10.4	5.2	13.2	28.8	7.9	18.5	0	26.4	0	0	0	0	

Start Time	14th Street Southbound				Mulberry Street Westbound				14th Street Northbound				Mulberry Street Eastbound				Int. Total
	Left	Thru	Right	App. Total	Left	Thru	Right	App. Total	Left	Thru	Right	App. Total	Left	Thru	Right	App. Total	
Peak Hour Analysis From 04:00 PM to 05:45 PM - Peak 1 of 1																	
Peak Hour for Entire Intersection Begins at 04:30 PM																	
04:30 PM	0	375	79	454	107	44	110	261	73	123	0	196	0	0	0	0	911
04:45 PM	0	329	57	386	100	48	131	279	57	158	0	215	0	0	0	0	880
05:00 PM	0	357	63	420	111	54	125	290	88	162	0	250	0	0	0	0	960
05:15 PM	0	371	68	439	72	64	114	250	86	183	0	269	0	0	0	0	958
Total Volume	0	1432	267	1699	390	210	480	1080	304	626	0	930	0	0	0	0	3709
% App. Total	0	84.3	15.7		36.1	19.4	44.4		32.7	67.3	0		0	0	0		
PHF	.000	.955	.845	.936	.878	.820	.916	.931	.864	.855	.000	.864	.000	.000	.000	.000	.966

City of Riverside
 N/S: 14th Street
 E/W: Mulberry Street
 Weather: Clear

File Name : 02_RIV_14th_Mulberry PM
 Site Code : 17920060
 Start Date : 1/28/2020
 Page No : 2

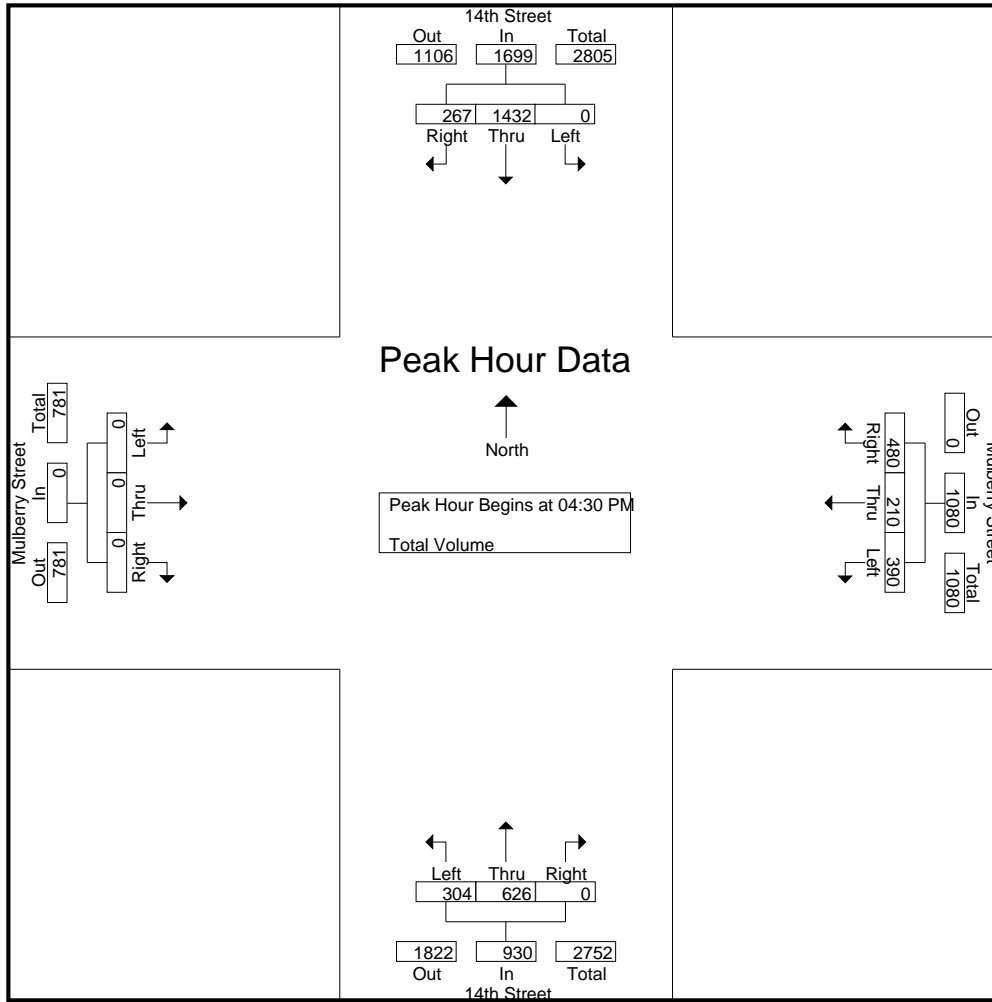

Peak Hour Analysis From 04:00 PM to 05:45 PM - Peak 1 of 1
 Peak Hour for Each Approach Begins at:

	04:30 PM				04:45 PM				05:00 PM				04:00 PM			
+0 mins.	0	375	79	454	100	48	131	279	88	162	0	250	0	0	0	0
+15 mins.	0	329	57	386	111	54	125	290	86	183	0	269	0	0	0	0
+30 mins.	0	357	63	420	72	64	114	250	49	169	0	218	0	0	0	0
+45 mins.	0	371	68	439	96	51	128	275	67	202	0	269	0	0	0	0
Total Volume	0	1432	267	1699	379	217	498	1094	290	716	0	1006	0	0	0	0
% App. Total	0	84.3	15.7		34.6	19.8	45.5		28.8	71.2	0		0	0	0	
PHF	.000	.955	.845	.936	.854	.848	.950	.943	.824	.886	.000	.935	.000	.000	.000	.000

City of Riverside
 N/S: 14th Street
 E/W: SR-91 Eastbound Ramps
 Weather: Clear

File Name : 03_RIV_14th_91E AM
 Site Code : 17920060
 Start Date : 1/28/2020
 Page No : 1

Groups Printed- Passenger Vehicles - Large 2 Axle Vehicles - 3 Axle Vehicles - 4+ Axle Trucks

Start Time	14th Street Southbound				SR-91 Eastbound On Ramp Westbound				14th Street Northbound				SR-91 Eastbound Off Ramp Eastbound				Int. Total
	Left	Thru	Right	App. Total	Left	Thru	Right	App. Total	Left	Thru	Right	App. Total	Left	Thru	Right	App. Total	
07:00 AM	139	77	0	216	0	0	0	0	0	261	54	315	157	0	25	182	713
07:15 AM	149	105	0	254	0	0	0	0	0	263	64	327	179	0	43	222	803
07:30 AM	137	107	0	244	0	0	0	0	0	312	31	343	160	0	65	225	812
07:45 AM	158	117	0	275	0	0	0	0	0	314	63	377	212	0	58	270	922
Total	583	406	0	989	0	0	0	0	0	1150	212	1362	708	0	191	899	3250
08:00 AM	117	91	0	208	0	0	0	0	0	292	58	350	189	0	53	242	800
08:15 AM	138	75	0	213	0	0	0	0	0	239	44	283	180	1	37	218	714
08:30 AM	105	77	0	182	0	0	0	0	0	240	40	280	174	0	40	214	676
08:45 AM	122	93	0	215	0	0	0	0	0	188	32	220	177	0	53	230	665
Total	482	336	0	818	0	0	0	0	0	959	174	1133	720	1	183	904	2855
Grand Total	1065	742	0	1807	0	0	0	0	0	2109	386	2495	1428	1	374	1803	6105
Apprch %	58.9	41.1	0		0	0	0		0	84.5	15.5		79.2	0.1	20.7		
Total %	17.4	12.2	0	29.6	0	0	0		0	34.5	6.3	40.9	23.4	0	6.1	29.5	
Passenger Vehicles	1049	728	0	1777	0	0	0	0	0	2069	372	2441	1415	1	370	1786	6004
% Passenger Vehicles	98.5	98.1	0	98.3	0	0	0	0	0	98.1	96.4	97.8	99.1	100	98.9	99.1	98.3
Large 2 Axle Vehicles	13	12	0	25	0	0	0	0	0	37	10	47	6	0	2	8	80
% Large 2 Axle Vehicles	1.2	1.6	0	1.4	0	0	0	0	0	1.8	2.6	1.9	0.4	0	0.5	0.4	1.3
3 Axle Vehicles	1	1	0	2	0	0	0	0	0	1	2	3	7	0	2	9	14
% 3 Axle Vehicles	0.1	0.1	0	0.1	0	0	0	0	0	0	0.5	0.1	0.5	0	0.5	0.5	0.2
4+ Axle Trucks	2	1	0	3	0	0	0	0	0	2	2	4	0	0	0	0	7
% 4+ Axle Trucks	0.2	0.1	0	0.2	0	0	0	0	0	0.1	0.5	0.2	0	0	0	0	0.1

Start Time	14th Street Southbound				SR-91 Eastbound On Ramp Westbound				14th Street Northbound				SR-91 Eastbound Off Ramp Eastbound				Int. Total
	Left	Thru	Right	App. Total	Left	Thru	Right	App. Total	Left	Thru	Right	App. Total	Left	Thru	Right	App. Total	
Peak Hour Analysis From 07:00 AM to 08:45 AM - Peak 1 of 1																	
Peak Hour for Entire Intersection Begins at 07:15 AM																	
07:15 AM	149	105	0	254	0	0	0	0	0	263	64	327	179	0	43	222	803
07:30 AM	137	107	0	244	0	0	0	0	0	312	31	343	160	0	65	225	812
07:45 AM	158	117	0	275	0	0	0	0	0	314	63	377	212	0	58	270	922
08:00 AM	117	91	0	208	0	0	0	0	0	292	58	350	189	0	53	242	800
Total Volume	561	420	0	981	0	0	0	0	0	1181	216	1397	740	0	219	959	3337
% App. Total	57.2	42.8	0		0	0	0		0	84.5	15.5		77.2	0	22.8		
PHF	.888	.897	.000	.892	.000	.000	.000	.000	.000	.940	.844	.926	.873	.000	.842	.888	.905

City of Riverside
 N/S: 14th Street
 E/W: SR-91 Eastbound Ramps
 Weather: Clear

File Name : 03_RIV_14th_91E AM
 Site Code : 17920060
 Start Date : 1/28/2020
 Page No : 2

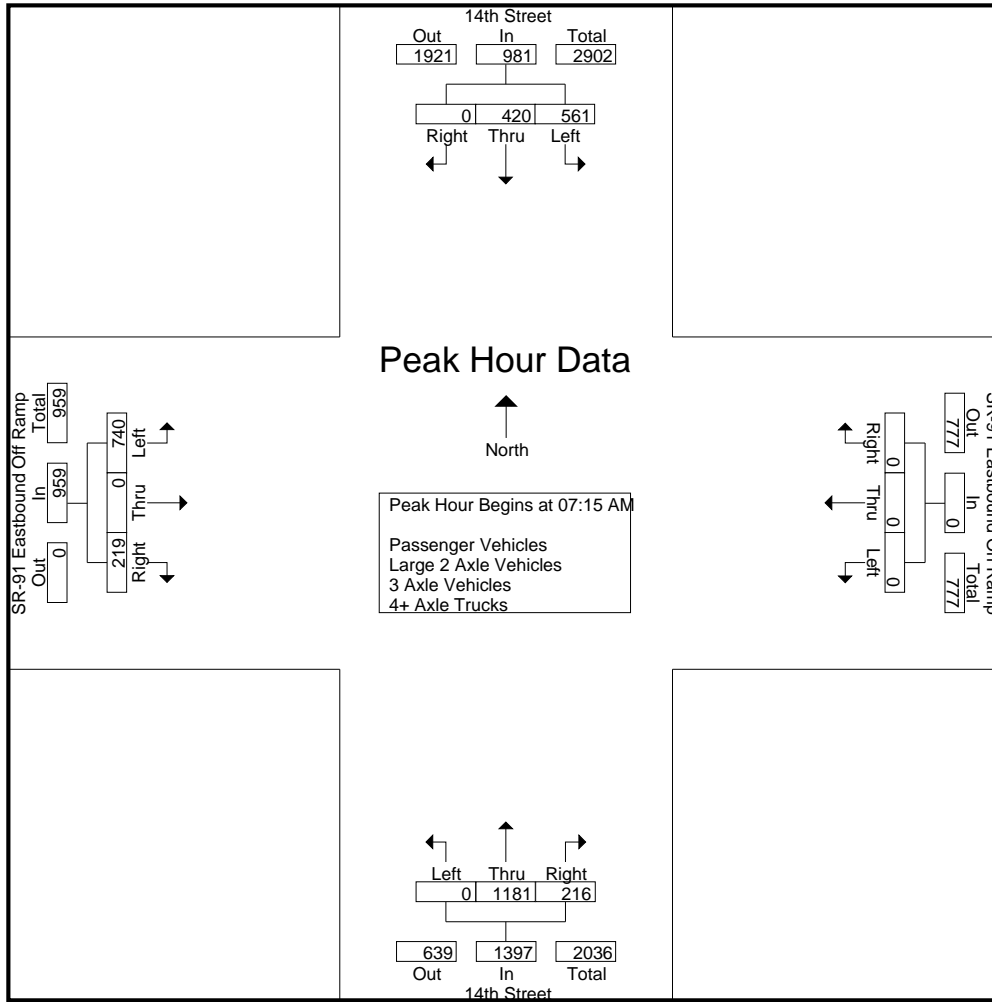

Peak Hour Analysis From 07:00 AM to 08:45 AM - Peak 1 of 1
 Peak Hour for Each Approach Begins at:

	07:00 AM				07:15 AM				07:15 AM							
+0 mins.	139	77	0	216	0	0	0	0	0	263	64	327	179	0	43	222
+15 mins.	149	105	0	254	0	0	0	0	0	312	31	343	160	0	65	225
+30 mins.	137	107	0	244	0	0	0	0	0	314	63	377	212	0	58	270
+45 mins.	158	117	0	275	0	0	0	0	0	292	58	350	189	0	53	242
Total Volume	583	406	0	989	0	0	0	0	0	1181	216	1397	740	0	219	959
% App. Total	58.9	41.1	0		0	0	0	0	0	84.5	15.5		77.2	0	22.8	
PHF	.922	.868	.000	.899	.000	.000	.000	.000	.000	.940	.844	.926	.873	.000	.842	.888

City of Riverside
 N/S: 14th Street
 E/W: SR-91 Eastbound Ramps
 Weather: Clear

File Name : 03_RIV_14th_91E AM
 Site Code : 17920060
 Start Date : 1/28/2020
 Page No : 1

Groups Printed- Passenger Vehicles

Start Time	14th Street Southbound				SR-91 Eastbound On Ramp Westbound				14th Street Northbound				SR-91 Eastbound Off Ramp Eastbound				Int. Total
	Left	Thru	Right	App. Total	Left	Thru	Right	App. Total	Left	Thru	Right	App. Total	Left	Thru	Right	App. Total	
07:00 AM	138	77	0	215	0	0	0	0	0	255	53	308	156	0	25	181	704
07:15 AM	147	103	0	250	0	0	0	0	0	260	62	322	178	0	43	221	793
07:30 AM	136	104	0	240	0	0	0	0	0	308	29	337	160	0	63	223	800
07:45 AM	157	116	0	273	0	0	0	0	0	307	62	369	212	0	58	270	912
Total	578	400	0	978	0	0	0	0	0	1130	206	1336	706	0	189	895	3209
08:00 AM	116	87	0	203	0	0	0	0	0	283	54	337	188	0	53	241	781
08:15 AM	134	73	0	207	0	0	0	0	0	234	42	276	180	1	36	217	700
08:30 AM	101	77	0	178	0	0	0	0	0	236	40	276	165	0	40	205	659
08:45 AM	120	91	0	211	0	0	0	0	0	186	30	216	176	0	52	228	655
Total	471	328	0	799	0	0	0	0	0	939	166	1105	709	1	181	891	2795
Grand Total	1049	728	0	1777	0	0	0	0	0	2069	372	2441	1415	1	370	1786	6004
Apprch %	59	41	0		0	0	0		0	84.8	15.2		79.2	0.1	20.7		
Total %	17.5	12.1	0	29.6	0	0	0	0	0	34.5	6.2	40.7	23.6	0	6.2	29.7	

Start Time	14th Street Southbound				SR-91 Eastbound On Ramp Westbound				14th Street Northbound				SR-91 Eastbound Off Ramp Eastbound				Int. Total
	Left	Thru	Right	App. Total	Left	Thru	Right	App. Total	Left	Thru	Right	App. Total	Left	Thru	Right	App. Total	
Peak Hour Analysis From 07:15 AM to 08:00 AM - Peak 1 of 1																	
Peak Hour for Entire Intersection Begins at 07:15 AM																	
07:15 AM	147	103	0	250	0	0	0	0	0	260	62	322	178	0	43	221	793
07:30 AM	136	104	0	240	0	0	0	0	0	308	29	337	160	0	63	223	800
07:45 AM	157	116	0	273	0	0	0	0	0	307	62	369	212	0	58	270	912
08:00 AM	116	87	0	203	0	0	0	0	0	283	54	337	188	0	53	241	781
Total Volume	556	410	0	966	0	0	0	0	0	1158	207	1365	738	0	217	955	3286
% App. Total	57.6	42.4	0		0	0	0		0	84.8	15.2		77.3	0	22.7		
PHF	.885	.884	.000	.885	.000	.000	.000	.000	.000	.940	.835	.925	.870	.000	.861	.884	.901

City of Riverside
 N/S: 14th Street
 E/W: SR-91 Eastbound Ramps
 Weather: Clear

File Name : 03_RIV_14th_91E AM
 Site Code : 17920060
 Start Date : 1/28/2020
 Page No : 2

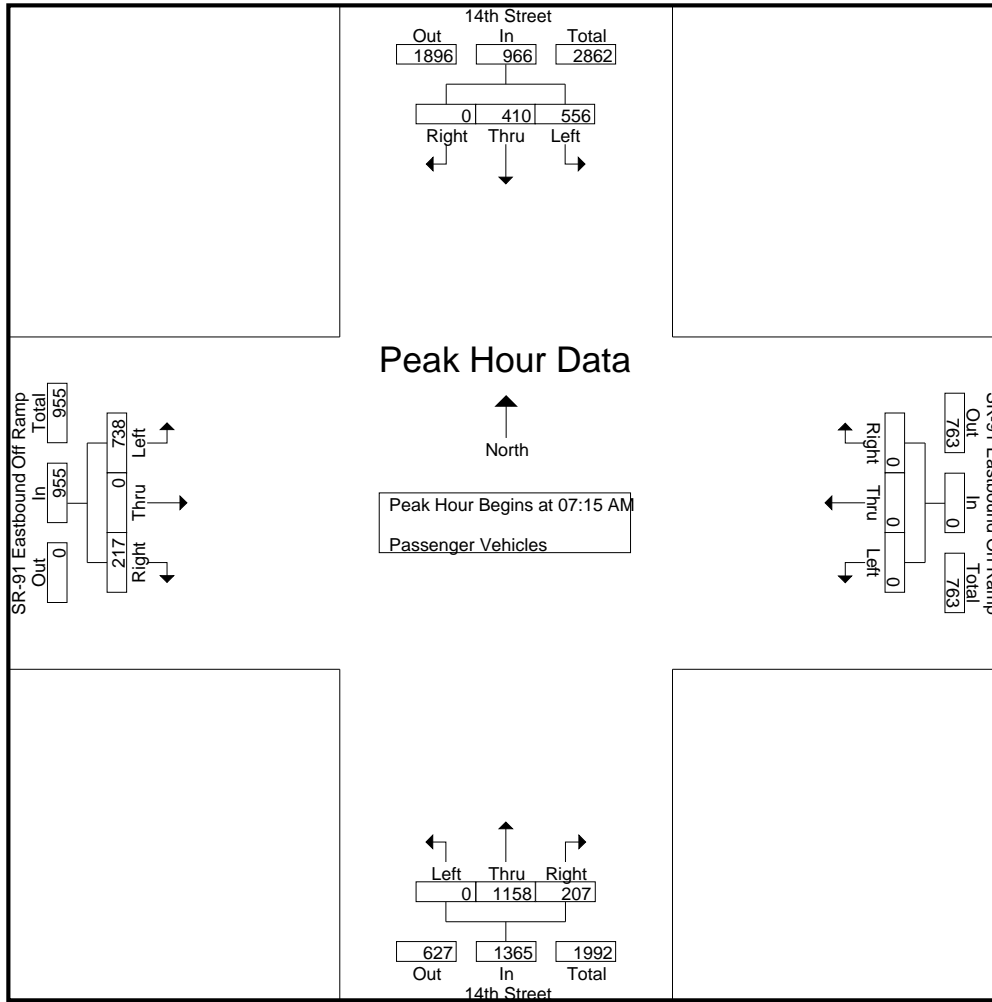

Peak Hour Analysis From 07:15 AM to 08:00 AM - Peak 1 of 1
 Peak Hour for Each Approach Begins at:

	07:15 AM				07:15 AM				07:15 AM				07:15 AM			
+0 mins.	147	103	0	250	0	0	0	0	0	260	62	322	178	0	43	221
+15 mins.	136	104	0	240	0	0	0	0	0	308	29	337	160	0	63	223
+30 mins.	157	116	0	273	0	0	0	0	0	307	62	369	212	0	58	270
+45 mins.	116	87	0	203	0	0	0	0	0	283	54	337	188	0	53	241
Total Volume	556	410	0	966	0	0	0	0	0	1158	207	1365	738	0	217	955
% App. Total	57.6	42.4	0		0	0	0	0	0	84.8	15.2		77.3	0	22.7	
PHF	.885	.884	.000	.885	.000	.000	.000	.000	.000	.940	.835	.925	.870	.000	.861	.884

City of Riverside
 N/S: 14th Street
 E/W: SR-91 Eastbound Ramps
 Weather: Clear

File Name : 03_RIV_14th_91E AM
 Site Code : 17920060
 Start Date : 1/28/2020
 Page No : 1

Groups Printed- Large 2 Axle Vehicles

Start Time	14th Street Southbound				SR-91 Eastbound On Ramp Westbound				14th Street Northbound				SR-91 Eastbound Off Ramp Eastbound				Int. Total
	Left	Thru	Right	App. Total	Left	Thru	Right	App. Total	Left	Thru	Right	App. Total	Left	Thru	Right	App. Total	
07:00 AM	1	0	0	1	0	0	0	0	0	6	1	7	1	0	0	1	9
07:15 AM	2	2	0	4	0	0	0	0	0	3	1	4	1	0	0	1	9
07:30 AM	1	2	0	3	0	0	0	0	0	4	1	5	0	0	1	1	9
07:45 AM	1	0	0	1	0	0	0	0	0	6	1	7	0	0	0	0	8
Total	5	4	0	9	0	0	0	0	0	19	4	23	2	0	1	3	35
08:00 AM	1	4	0	5	0	0	0	0	0	7	3	10	0	0	0	0	15
08:15 AM	3	2	0	5	0	0	0	0	0	5	1	6	0	0	0	0	11
08:30 AM	3	0	0	3	0	0	0	0	0	4	0	4	3	0	0	3	10
08:45 AM	1	2	0	3	0	0	0	0	0	2	2	4	1	0	1	2	9
Total	8	8	0	16	0	0	0	0	0	18	6	24	4	0	1	5	45
Grand Total	13	12	0	25	0	0	0	0	0	37	10	47	6	0	2	8	80
Apprch %	52	48	0		0	0	0		0	78.7	21.3		75	0	25		
Total %	16.2	15	0	31.2	0	0	0	0	0	46.2	12.5	58.8	7.5	0	2.5	10	

Start Time	14th Street Southbound				SR-91 Eastbound On Ramp Westbound				14th Street Northbound				SR-91 Eastbound Off Ramp Eastbound				Int. Total
	Left	Thru	Right	App. Total	Left	Thru	Right	App. Total	Left	Thru	Right	App. Total	Left	Thru	Right	App. Total	
Peak Hour Analysis From 07:15 AM to 08:00 AM - Peak 1 of 1																	
Peak Hour for Entire Intersection Begins at 07:15 AM																	
07:15 AM	2	2	0	4	0	0	0	0	0	3	1	4	1	0	0	1	9
07:30 AM	1	2	0	3	0	0	0	0	0	4	1	5	0	0	1	1	9
07:45 AM	1	0	0	1	0	0	0	0	0	6	1	7	0	0	0	0	8
08:00 AM	1	4	0	5	0	0	0	0	0	7	3	10	0	0	0	0	15
Total Volume	5	8	0	13	0	0	0	0	0	20	6	26	1	0	1	2	41
% App. Total	38.5	61.5	0		0	0	0		0	76.9	23.1		50	0	50		
PHF	.625	.500	.000	.650	.000	.000	.000	.000	.000	.714	.500	.650	.250	.000	.250	.500	.683

City of Riverside
 N/S: 14th Street
 E/W: SR-91 Eastbound Ramps
 Weather: Clear

File Name : 03_RIV_14th_91E AM
 Site Code : 17920060
 Start Date : 1/28/2020
 Page No : 2

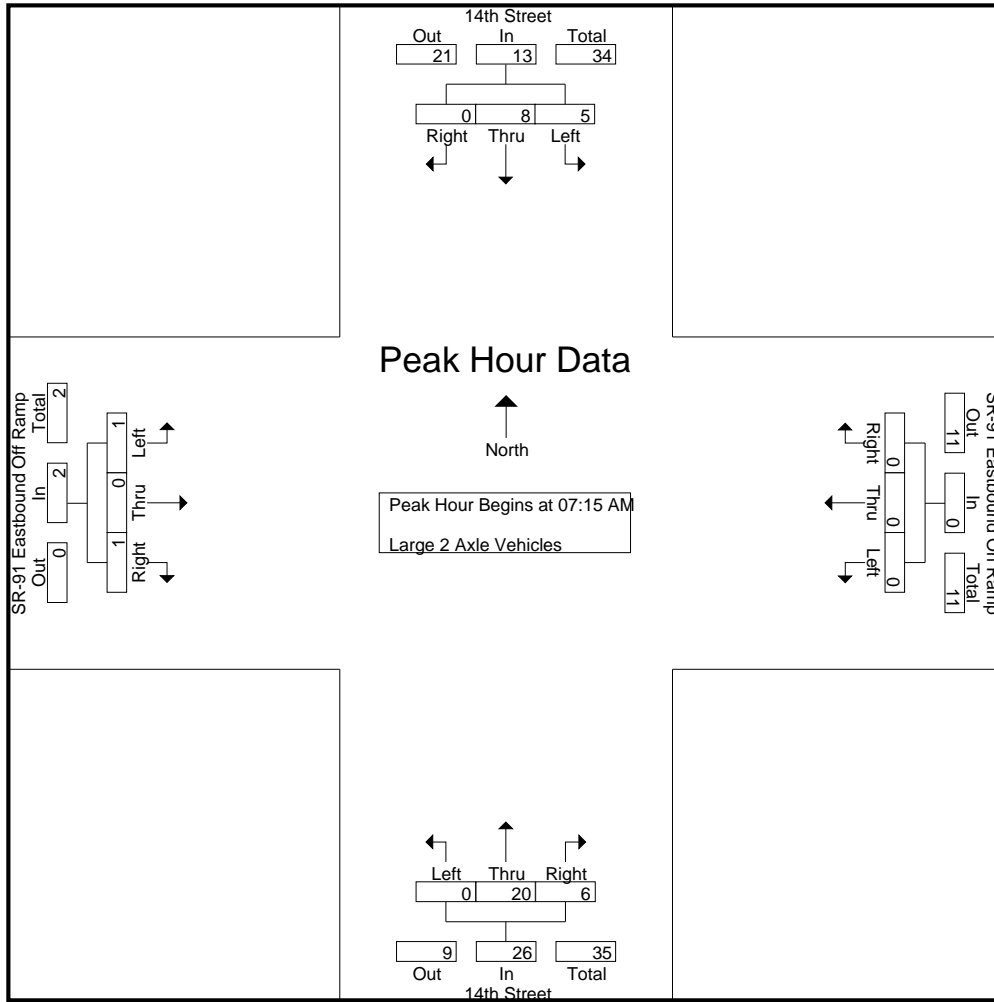

Peak Hour Analysis From 07:15 AM to 08:00 AM - Peak 1 of 1
 Peak Hour for Each Approach Begins at:

	07:15 AM				07:15 AM				07:15 AM				07:15 AM			
+0 mins.	2	2	0	4	0	0	0	0	0	3	1	4	1	0	0	1
+15 mins.	1	2	0	3	0	0	0	0	0	4	1	5	0	0	0	1
+30 mins.	1	0	0	1	0	0	0	0	0	6	1	7	0	0	0	0
+45 mins.	1	4	0	5	0	0	0	0	0	7	3	10	0	0	0	0
Total Volume	5	8	0	13	0	0	0	0	0	20	6	26	1	0	1	2
% App. Total	38.5	61.5	0		0	0	0	0	0	76.9	23.1		50	0	50	
PHF	.625	.500	.000	.650	.000	.000	.000	.000	.000	.714	.500	.650	.250	.000	.250	.500

City of Riverside
 N/S: 14th Street
 E/W: SR-91 Eastbound Ramps
 Weather: Clear

File Name : 03_RIV_14th_91E AM
 Site Code : 17920060
 Start Date : 1/28/2020
 Page No : 1

Groups Printed- 3 Axle Vehicles

Start Time	14th Street Southbound				SR-91 Eastbound On Ramp Westbound				14th Street Northbound				SR-91 Eastbound Off Ramp Eastbound				Int. Total
	Left	Thru	Right	App. Total	Left	Thru	Right	App. Total	Left	Thru	Right	App. Total	Left	Thru	Right	App. Total	
07:00 AM	0	0	0	0	0	0	0	0	0	0	0	0	0	0	0	0	0
07:15 AM	0	0	0	0	0	0	0	0	0	0	1	1	0	0	0	0	1
07:30 AM	0	1	0	1	0	0	0	0	0	0	1	1	0	0	1	1	3
07:45 AM	0	0	0	0	0	0	0	0	0	0	0	0	0	0	0	0	0
Total	0	1	0	1	0	0	0	0	0	0	2	2	0	0	1	1	4
08:00 AM	0	0	0	0	0	0	0	0	0	1	0	1	1	0	0	1	2
08:15 AM	1	0	0	1	0	0	0	0	0	0	0	0	0	0	1	1	2
08:30 AM	0	0	0	0	0	0	0	0	0	0	0	0	6	0	0	6	6
08:45 AM	0	0	0	0	0	0	0	0	0	0	0	0	0	0	0	0	0
Total	1	0	0	1	0	0	0	0	0	1	0	1	7	0	1	8	10
Grand Total	1	1	0	2	0	0	0	0	0	1	2	3	7	0	2	9	14
Apprch %	50	50	0		0	0	0		0	33.3	66.7		77.8	0	22.2		
Total %	7.1	7.1	0	14.3	0	0	0	0	0	7.1	14.3	21.4	50	0	14.3	64.3	

Start Time	14th Street Southbound				SR-91 Eastbound On Ramp Westbound				14th Street Northbound				SR-91 Eastbound Off Ramp Eastbound				Int. Total
	Left	Thru	Right	App. Total	Left	Thru	Right	App. Total	Left	Thru	Right	App. Total	Left	Thru	Right	App. Total	
Peak Hour Analysis From 07:15 AM to 08:00 AM - Peak 1 of 1																	
Peak Hour for Entire Intersection Begins at 07:15 AM																	
07:15 AM	0	0	0	0	0	0	0	0	0	0	1	1	0	0	0	0	1
07:30 AM	0	1	0	1	0	0	0	0	0	0	1	1	0	0	1	1	3
07:45 AM	0	0	0	0	0	0	0	0	0	0	0	0	0	0	0	0	0
08:00 AM	0	0	0	0	0	0	0	0	0	1	0	1	1	0	0	1	2
Total Volume	0	1	0	1	0	0	0	0	0	1	2	3	1	0	1	2	6
% App. Total	0	100	0		0	0	0		0	33.3	66.7		50	0	50		
PHF	.000	.250	.000	.250	.000	.000	.000	.000	.000	.250	.500	.750	.250	.000	.250	.500	.500

City of Riverside
 N/S: 14th Street
 E/W: SR-91 Eastbound Ramps
 Weather: Clear

File Name : 03_RIV_14th_91E AM
 Site Code : 17920060
 Start Date : 1/28/2020
 Page No : 2

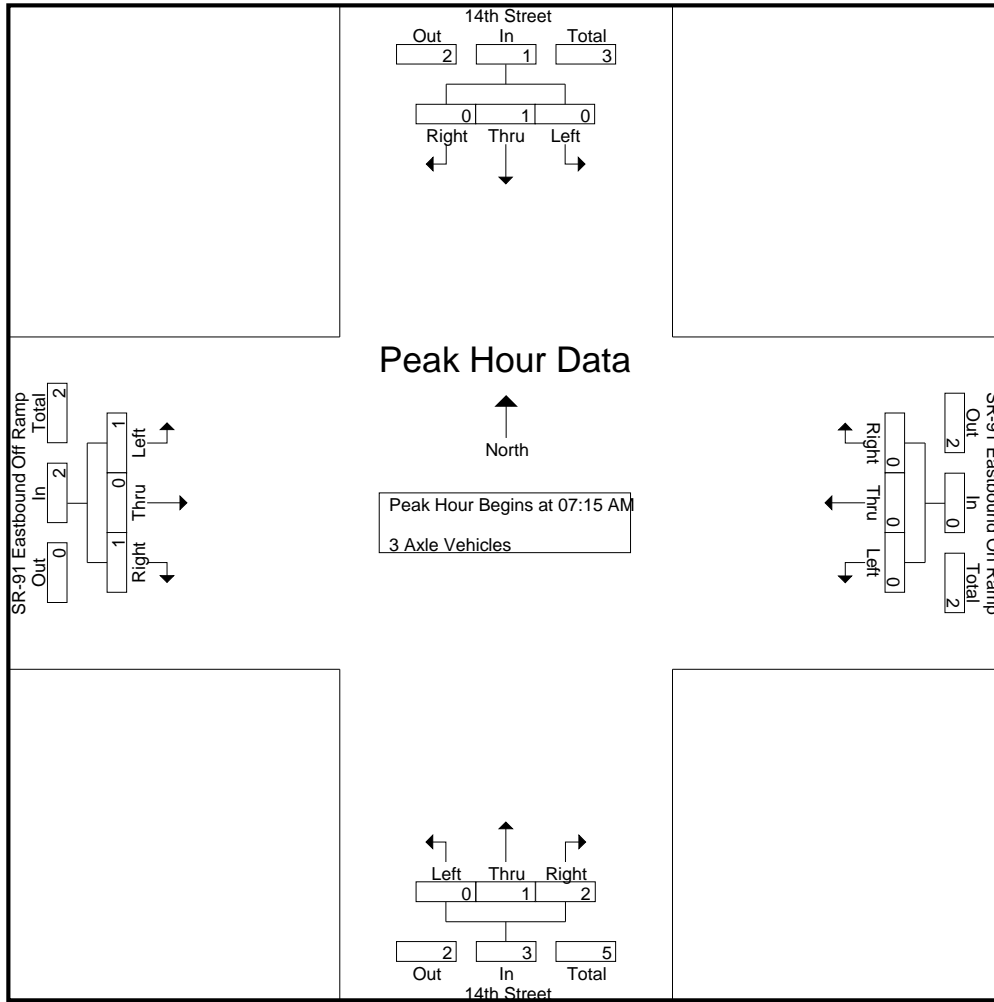

Peak Hour Analysis From 07:15 AM to 08:00 AM - Peak 1 of 1
 Peak Hour for Each Approach Begins at:

	07:15 AM				07:15 AM				07:15 AM				07:15 AM			
+0 mins.	0	0	0	0	0	0	0	0	0	0	1	1	0	0	0	0
+15 mins.	0	1	0	1	0	0	0	0	0	0	1	1	0	0	1	1
+30 mins.	0	0	0	0	0	0	0	0	0	0	0	0	0	0	0	0
+45 mins.	0	0	0	0	0	0	0	0	0	1	0	1	1	0	0	1
Total Volume	0	1	0	1	0	0	0	0	0	1	2	3	1	0	1	2
% App. Total	0	100	0	0	0	0	0	0	0	33.3	66.7	50	50	0	50	50
PHF	.000	.250	.000	.250	.000	.000	.000	.000	.000	.250	.500	.750	.250	.000	.250	.500

City of Riverside
 N/S: 14th Street
 E/W: SR-91 Eastbound Ramps
 Weather: Clear

File Name : 03_RIV_14th_91E AM
 Site Code : 17920060
 Start Date : 1/28/2020
 Page No : 1

Groups Printed- 4+ Axle Trucks

Start Time	14th Street Southbound				SR-91 Eastbound On Ramp Westbound				14th Street Northbound				SR-91 Eastbound Off Ramp Eastbound				Int. Total
	Left	Thru	Right	App. Total	Left	Thru	Right	App. Total	Left	Thru	Right	App. Total	Left	Thru	Right	App. Total	
07:00 AM	0	0	0	0	0	0	0	0	0	0	0	0	0	0	0	0	0
07:15 AM	0	0	0	0	0	0	0	0	0	0	0	0	0	0	0	0	0
07:30 AM	0	0	0	0	0	0	0	0	0	0	0	0	0	0	0	0	0
07:45 AM	0	1	0	1	0	0	0	0	0	1	0	1	0	0	0	0	2
Total	0	1	0	1	0	0	0	0	0	1	0	1	0	0	0	0	2
08:00 AM	0	0	0	0	0	0	0	0	0	1	1	2	0	0	0	0	2
08:15 AM	0	0	0	0	0	0	0	0	0	0	1	1	0	0	0	0	1
08:30 AM	1	0	0	1	0	0	0	0	0	0	0	0	0	0	0	0	1
08:45 AM	1	0	0	1	0	0	0	0	0	0	0	0	0	0	0	0	1
Total	2	0	0	2	0	0	0	0	0	1	2	3	0	0	0	0	5
Grand Total	2	1	0	3	0	0	0	0	0	2	2	4	0	0	0	0	7
Apprch %	66.7	33.3	0		0	0	0		0	50	50		0	0	0		
Total %	28.6	14.3	0	42.9	0	0	0	0	0	28.6	28.6	57.1	0	0	0	0	

Start Time	14th Street Southbound				SR-91 Eastbound On Ramp Westbound				14th Street Northbound				SR-91 Eastbound Off Ramp Eastbound				Int. Total
	Left	Thru	Right	App. Total	Left	Thru	Right	App. Total	Left	Thru	Right	App. Total	Left	Thru	Right	App. Total	
Peak Hour Analysis From 07:15 AM to 08:00 AM - Peak 1 of 1																	
Peak Hour for Entire Intersection Begins at 07:15 AM																	
07:15 AM	0	0	0	0	0	0	0	0	0	0	0	0	0	0	0	0	0
07:30 AM	0	0	0	0	0	0	0	0	0	0	0	0	0	0	0	0	0
07:45 AM	0	1	0	1	0	0	0	0	0	1	0	1	0	0	0	0	2
08:00 AM	0	0	0	0	0	0	0	0	0	1	1	2	0	0	0	0	2
Total Volume	0	1	0	1	0	0	0	0	0	2	1	3	0	0	0	0	4
% App. Total	0	100	0		0	0	0		0	66.7	33.3		0	0	0		
PHF	.000	.250	.000	.250	.000	.000	.000	.000	.000	.500	.250	.375	.000	.000	.000	.000	.500

City of Riverside
 N/S: 14th Street
 E/W: SR-91 Eastbound Ramps
 Weather: Clear

File Name : 03_RIV_14th_91E AM
 Site Code : 17920060
 Start Date : 1/28/2020
 Page No : 2

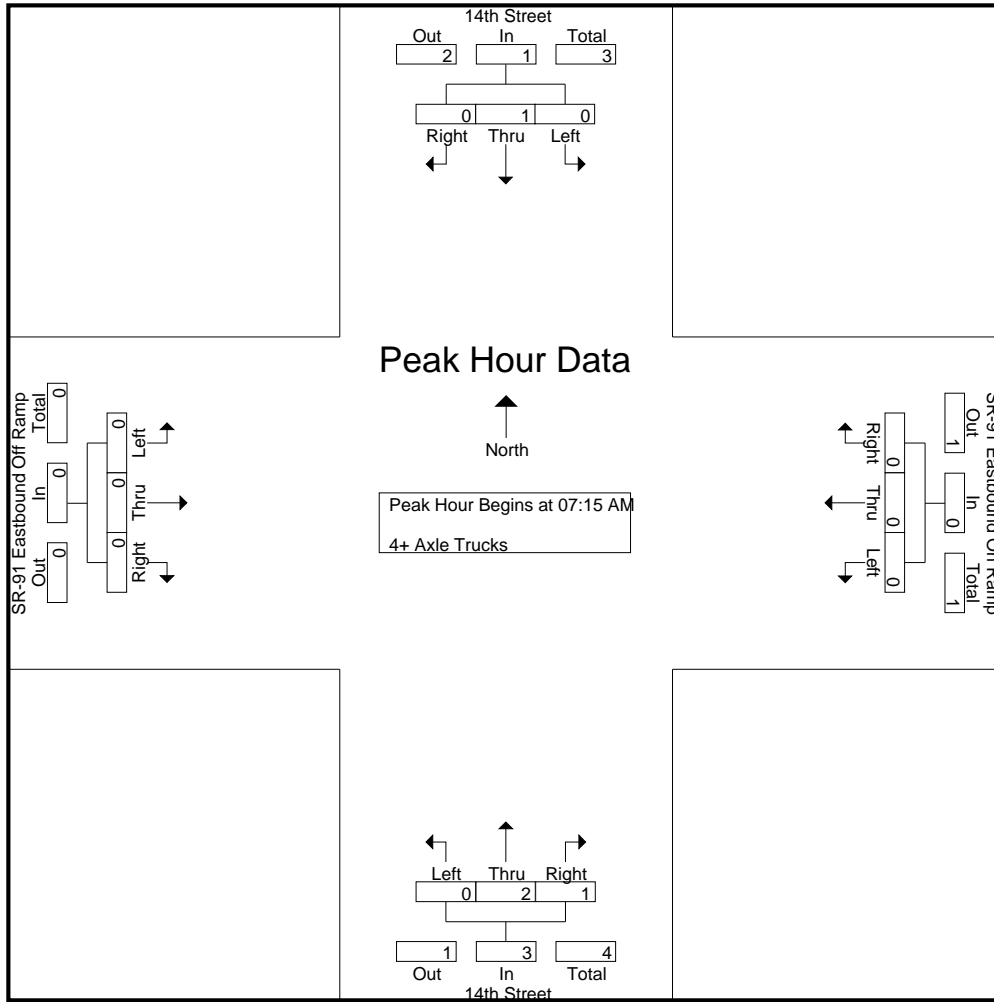

Peak Hour Analysis From 07:15 AM to 08:00 AM - Peak 1 of 1
 Peak Hour for Each Approach Begins at:

	07:15 AM				07:15 AM				07:15 AM				07:15 AM			
+0 mins.	0	0	0	0	0	0	0	0	0	0	0	0	0	0	0	0
+15 mins.	0	0	0	0	0	0	0	0	0	0	0	0	0	0	0	0
+30 mins.	0	1	0	1	0	0	0	0	0	1	0	1	0	0	0	0
+45 mins.	0	0	0	0	0	0	0	0	0	1	1	2	0	0	0	0
Total Volume	0	1	0	1	0	0	0	0	0	2	1	3	0	0	0	0
% App. Total	0	100	0	0	0	0	0	0	0	66.7	33.3		0	0	0	0
PHF	.000	.250	.000	.250	.000	.000	.000	.000	.000	.500	.250	.375	.000	.000	.000	.000

City of Riverside
 N/S: 14th Street
 E/W: SR-91 Eastbound Ramps
 Weather: Clear

File Name : 03_RIV_14th_91E PM
 Site Code : 17920060
 Start Date : 1/28/2020
 Page No : 1

Groups Printed- Passenger Vehicles - Large 2 Axle Vehicles - 3 Axle Vehicles - 4+ Axle Trucks

Start Time	14th Street Southbound				SR-91 Eastbound On Ramp Westbound				14th Street Northbound				SR-91 Eastbound Off Ramp Eastbound				Int. Total
	Left	Thru	Right	App. Total	Left	Thru	Right	App. Total	Left	Thru	Right	App. Total	Left	Thru	Right	App. Total	
04:00 PM	118	283	0	401	0	0	0	0	0	158	16	174	69	0	134	203	778
04:15 PM	125	292	0	417	0	0	0	0	0	135	17	152	78	0	154	232	801
04:30 PM	147	329	0	476	0	0	0	0	0	155	19	174	48	1	114	163	813
04:45 PM	125	303	0	428	0	0	0	0	0	149	21	170	69	1	129	199	797
Total	515	1207	0	1722	0	0	0	0	0	597	73	670	264	2	531	797	3189
05:00 PM	140	332	0	472	0	0	0	0	0	220	26	246	43	0	116	159	877
05:15 PM	161	293	0	454	0	0	0	0	0	178	35	213	76	1	138	215	882
05:30 PM	138	302	0	440	0	0	0	0	0	161	17	178	66	0	113	179	797
05:45 PM	104	227	0	331	0	0	0	0	0	159	15	174	104	0	123	227	732
Total	543	1154	0	1697	0	0	0	0	0	718	93	811	289	1	490	780	3288
Grand Total	1058	2361	0	3419	0	0	0	0	0	1315	166	1481	553	3	1021	1577	6477
Apprch %	30.9	69.1	0		0	0	0		0	88.8	11.2		35.1	0.2	64.7		
Total %	16.3	36.5	0	52.8	0	0	0	0	0	20.3	2.6	22.9	8.5	0	15.8	24.3	
Passenger Vehicles	1049	2348	0	3397	0	0	0	0	0	1300	152	1452	548	3	1015	1566	6415
% Passenger Vehicles	99.1	99.4	0	99.4	0	0	0	0	0	98.9	91.6	98	99.1	100	99.4	99.3	99
Large 2 Axle Vehicles	8	10	0	18	0	0	0	0	0	13	9	22	3	0	3	6	46
% Large 2 Axle Vehicles	0.8	0.4	0	0.5	0	0	0	0	0	1	5.4	1.5	0.5	0	0.3	0.4	0.7
3 Axle Vehicles	0	3	0	3	0	0	0	0	0	1	1	2	0	0	0	0	5
% 3 Axle Vehicles	0	0.1	0	0.1	0	0	0	0	0	0.1	0.6	0.1	0	0	0	0	0.1
4+ Axle Trucks	1	0	0	1	0	0	0	0	0	1	4	5	2	0	3	5	11
% 4+ Axle Trucks	0.1	0	0	0	0	0	0	0	0	0.1	2.4	0.3	0.4	0	0.3	0.3	0.2

Start Time	14th Street Southbound				SR-91 Eastbound On Ramp Westbound				14th Street Northbound				SR-91 Eastbound Off Ramp Eastbound				Int. Total
	Left	Thru	Right	App. Total	Left	Thru	Right	App. Total	Left	Thru	Right	App. Total	Left	Thru	Right	App. Total	
Peak Hour Analysis From 04:00 PM to 05:45 PM - Peak 1 of 1																	
Peak Hour for Entire Intersection Begins at 04:30 PM																	
04:30 PM	147	329	0	476	0	0	0	0	0	155	19	174	48	1	114	163	813
04:45 PM	125	303	0	428	0	0	0	0	0	149	21	170	69	1	129	199	797
05:00 PM	140	332	0	472	0	0	0	0	0	220	26	246	43	0	116	159	877
05:15 PM	161	293	0	454	0	0	0	0	0	178	35	213	76	1	138	215	882
Total Volume	573	1257	0	1830	0	0	0	0	0	702	101	803	236	3	497	736	3369
% App. Total	31.3	68.7	0		0	0	0		0	87.4	12.6		32.1	0.4	67.5		
PHF	.890	.947	.000	.961	.000	.000	.000	.000	.000	.798	.721	.816	.776	.750	.900	.856	.955

City of Riverside
 N/S: 14th Street
 E/W: SR-91 Eastbound Ramps
 Weather: Clear

File Name : 03_RIV_14th_91E PM
 Site Code : 17920060
 Start Date : 1/28/2020
 Page No : 2

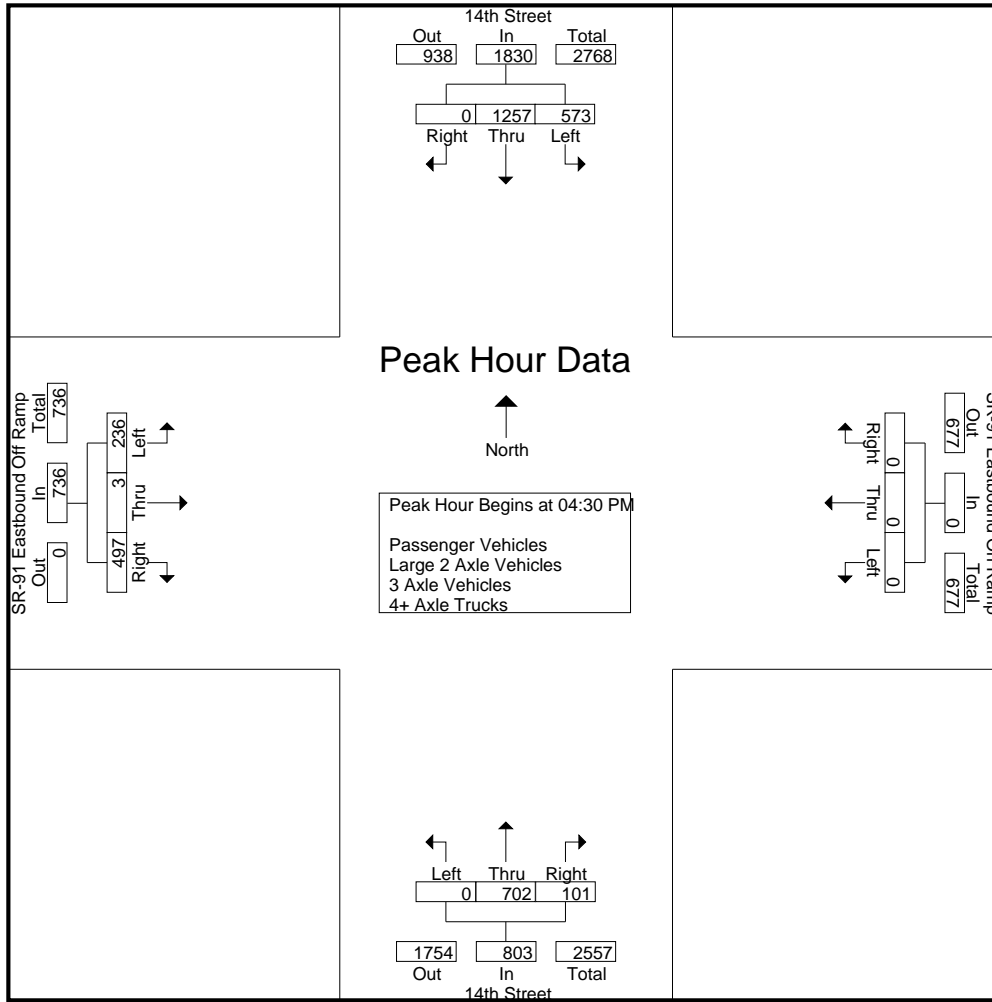

Peak Hour Analysis From 04:00 PM to 05:45 PM - Peak 1 of 1
 Peak Hour for Each Approach Begins at:

	04:30 PM				04:00 PM				05:00 PM				04:00 PM			
+0 mins.	147	329	0	476	0	0	0	0	0	220	26	246	69	0	134	203
+15 mins.	125	303	0	428	0	0	0	0	0	178	35	213	78	0	154	232
+30 mins.	140	332	0	472	0	0	0	0	0	161	17	178	48	1	114	163
+45 mins.	161	293	0	454	0	0	0	0	0	159	15	174	69	1	129	199
Total Volume	573	1257	0	1830	0	0	0	0	0	718	93	811	264	2	531	797
% App. Total	31.3	68.7	0		0	0	0	0	0	88.5	11.5		33.1	0.3	66.6	
PHF	.890	.947	.000	.961	.000	.000	.000	.000	.000	.816	.664	.824	.846	.500	.862	.859

City of Riverside
 N/S: 14th Street
 E/W: SR-91 Eastbound Ramps
 Weather: Clear

File Name : 03_RIV_14th_91E PM
 Site Code : 17920060
 Start Date : 1/28/2020
 Page No : 1

Groups Printed- Passenger Vehicles

Start Time	14th Street Southbound				SR-91 Eastbound On Ramp Westbound				14th Street Northbound				SR-91 Eastbound Off Ramp Eastbound				Int. Total
	Left	Thru	Right	App. Total	Left	Thru	Right	App. Total	Left	Thru	Right	App. Total	Left	Thru	Right	App. Total	
04:00 PM	117	281	0	398	0	0	0	0	0	157	16	173	67	0	134	201	772
04:15 PM	122	290	0	412	0	0	0	0	0	135	14	149	78	0	153	231	792
04:30 PM	146	329	0	475	0	0	0	0	0	151	17	168	47	1	114	162	805
04:45 PM	125	302	0	427	0	0	0	0	0	145	19	164	68	1	129	198	789
Total	510	1202	0	1712	0	0	0	0	0	588	66	654	260	2	530	792	3158
05:00 PM	139	330	0	469	0	0	0	0	0	218	23	241	43	0	114	157	867
05:15 PM	160	291	0	451	0	0	0	0	0	177	34	211	76	1	136	213	875
05:30 PM	137	301	0	438	0	0	0	0	0	159	16	175	65	0	113	178	791
05:45 PM	103	224	0	327	0	0	0	0	0	158	13	171	104	0	122	226	724
Total	539	1146	0	1685	0	0	0	0	0	712	86	798	288	1	485	774	3257
Grand Total	1049	2348	0	3397	0	0	0	0	0	1300	152	1452	548	3	1015	1566	6415
Apprch %	30.9	69.1	0		0	0	0		0	89.5	10.5		35	0.2	64.8		
Total %	16.4	36.6	0	53	0	0	0	0	0	20.3	2.4	22.6	8.5	0	15.8	24.4	

Start Time	14th Street Southbound				SR-91 Eastbound On Ramp Westbound				14th Street Northbound				SR-91 Eastbound Off Ramp Eastbound				Int. Total
	Left	Thru	Right	App. Total	Left	Thru	Right	App. Total	Left	Thru	Right	App. Total	Left	Thru	Right	App. Total	
Peak Hour Analysis From 04:30 PM to 05:15 PM - Peak 1 of 1																	
Peak Hour for Entire Intersection Begins at 04:30 PM																	
04:30 PM	146	329	0	475	0	0	0	0	0	151	17	168	47	1	114	162	805
04:45 PM	125	302	0	427	0	0	0	0	0	145	19	164	68	1	129	198	789
05:00 PM	139	330	0	469	0	0	0	0	0	218	23	241	43	0	114	157	867
05:15 PM	160	291	0	451	0	0	0	0	0	177	34	211	76	1	136	213	875
Total Volume	570	1252	0	1822	0	0	0	0	0	691	93	784	234	3	493	730	3336
% App. Total	31.3	68.7	0		0	0	0		0	88.1	11.9		32.1	0.4	67.5		
PHF	.891	.948	.000	.959	.000	.000	.000	.000	.000	.792	.684	.813	.770	.750	.906	.857	.953

City of Riverside
 N/S: 14th Street
 E/W: SR-91 Eastbound Ramps
 Weather: Clear

File Name : 03_RIV_14th_91E PM
 Site Code : 17920060
 Start Date : 1/28/2020
 Page No : 2

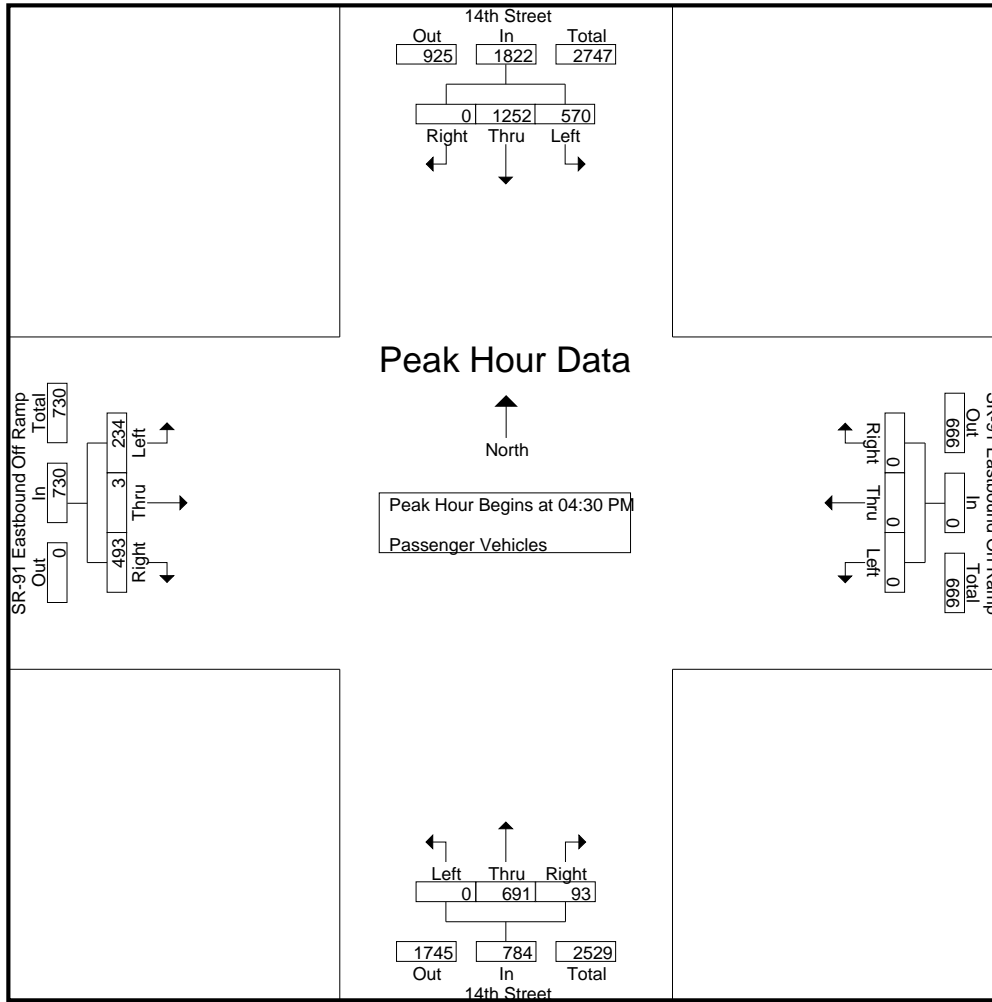

Peak Hour Analysis From 04:30 PM to 05:15 PM - Peak 1 of 1
 Peak Hour for Each Approach Begins at:

	04:30 PM				04:30 PM				04:30 PM				04:30 PM			
+0 mins.	146	329	0	475	0	0	0	0	0	151	17	168	47	1	114	162
+15 mins.	125	302	0	427	0	0	0	0	0	145	19	164	68	1	129	198
+30 mins.	139	330	0	469	0	0	0	0	0	218	23	241	43	0	114	157
+45 mins.	160	291	0	451	0	0	0	0	0	177	34	211	76	1	136	213
Total Volume	570	1252	0	1822	0	0	0	0	0	691	93	784	234	3	493	730
% App. Total	31.3	68.7	0		0	0	0	0	0	88.1	11.9		32.1	0.4	67.5	
PHF	.891	.948	.000	.959	.000	.000	.000	.000	.000	.792	.684	.813	.770	.750	.906	.857

City of Riverside
 N/S: 14th Street
 E/W: SR-91 Eastbound Ramps
 Weather: Clear

File Name : 03_RIV_14th_91E PM
 Site Code : 17920060
 Start Date : 1/28/2020
 Page No : 1

Groups Printed- Large 2 Axle Vehicles

Start Time	14th Street Southbound				SR-91 Eastbound On Ramp Westbound				14th Street Northbound				SR-91 Eastbound Off Ramp Eastbound				Int. Total	
	Left	Thru	Right	App. Total	Left	Thru	Right	App. Total	Left	Thru	Right	App. Total	Left	Thru	Right	App. Total		
04:00 PM	1	2	0	3	0	0	0	0	0	1	0	1	1	0	0	0	1	5
04:15 PM	3	1	0	4	0	0	0	0	0	0	1	1	0	0	1	1	1	6
04:30 PM	1	0	0	1	0	0	0	0	0	4	1	5	1	0	0	1	1	7
04:45 PM	0	1	0	1	0	0	0	0	0	2	1	3	0	0	0	0	0	4
Total	5	4	0	9	0	0	0	0	0	7	3	10	2	0	1	3		22
05:00 PM	1	2	0	3	0	0	0	0	0	2	3	5	0	0	0	0	0	8
05:15 PM	1	0	0	1	0	0	0	0	0	1	0	1	0	0	1	1	1	3
05:30 PM	0	1	0	1	0	0	0	0	0	2	1	3	1	0	0	1	1	5
05:45 PM	1	3	0	4	0	0	0	0	0	1	2	3	0	0	1	1	1	8
Total	3	6	0	9	0	0	0	0	0	6	6	12	1	0	2	3		24
Grand Total	8	10	0	18	0	0	0	0	0	13	9	22	3	0	3	6		46
Apprch %	44.4	55.6	0		0	0	0		0	59.1	40.9		50	0	50			
Total %	17.4	21.7	0	39.1	0	0	0	0	0	28.3	19.6	47.8	6.5	0	6.5	13		

Start Time	14th Street Southbound				SR-91 Eastbound On Ramp Westbound				14th Street Northbound				SR-91 Eastbound Off Ramp Eastbound				Int. Total	
	Left	Thru	Right	App. Total	Left	Thru	Right	App. Total	Left	Thru	Right	App. Total	Left	Thru	Right	App. Total		
Peak Hour Analysis From 04:30 PM to 05:15 PM - Peak 1 of 1																		
Peak Hour for Entire Intersection Begins at 04:30 PM																		
04:30 PM	1	0	0	1	0	0	0	0	0	4	1	5	1	0	0	1		7
04:45 PM	0	1	0	1	0	0	0	0	0	2	1	3	0	0	0	0		4
05:00 PM	1	2	0	3	0	0	0	0	0	2	3	5	0	0	0	0		8
05:15 PM	1	0	0	1	0	0	0	0	0	1	0	1	0	0	1	1		3
Total Volume	3	3	0	6	0	0	0	0	0	9	5	14	1	0	1	2		22
% App. Total	50	50	0		0	0	0		0	64.3	35.7		50	0	50			
PHF	.750	.375	.000	.500	.000	.000	.000	.000	.000	.563	.417	.700	.250	.000	.250	.500		.688

City of Riverside
 N/S: 14th Street
 E/W: SR-91 Eastbound Ramps
 Weather: Clear

File Name : 03_RIV_14th_91E PM
 Site Code : 17920060
 Start Date : 1/28/2020
 Page No : 2

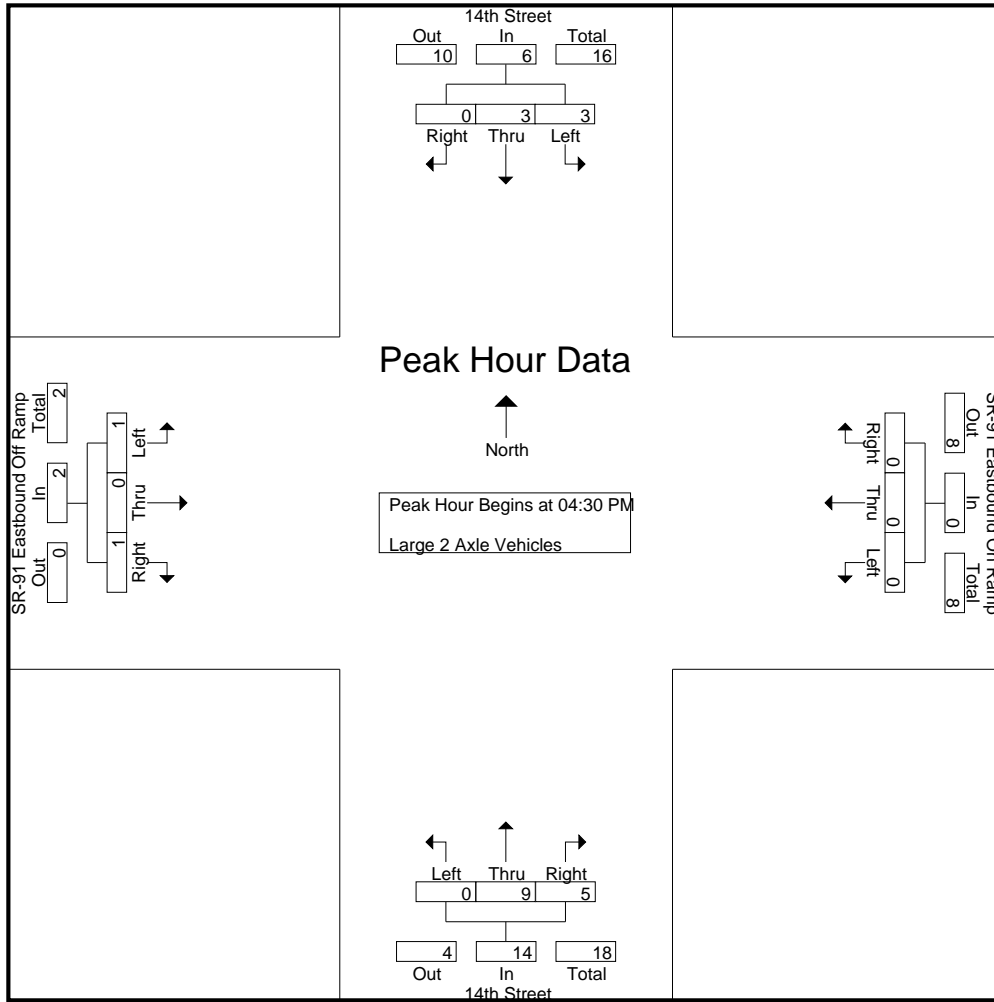

Peak Hour Analysis From 04:30 PM to 05:15 PM - Peak 1 of 1
 Peak Hour for Each Approach Begins at:

	04:30 PM				04:30 PM				04:30 PM				04:30 PM			
+0 mins.	1	0	0	1	0	0	0	0	0	4	1	5	1	0	0	1
+15 mins.	0	1	0	1	0	0	0	0	0	2	1	3	0	0	0	0
+30 mins.	1	2	0	3	0	0	0	0	0	2	3	5	0	0	0	0
+45 mins.	1	0	0	1	0	0	0	0	0	1	0	1	0	0	1	1
Total Volume	3	3	0	6	0	0	0	0	0	9	5	14	1	0	1	2
% App. Total	50	50	0		0	0	0		0	64.3	35.7		50	0	50	
PHF	.750	.375	.000	.500	.000	.000	.000	.000	.000	.563	.417	.700	.250	.000	.250	.500

City of Riverside
 N/S: 14th Street
 E/W: SR-91 Eastbound Ramps
 Weather: Clear

File Name : 03_RIV_14th_91E PM
 Site Code : 17920060
 Start Date : 1/28/2020
 Page No : 2

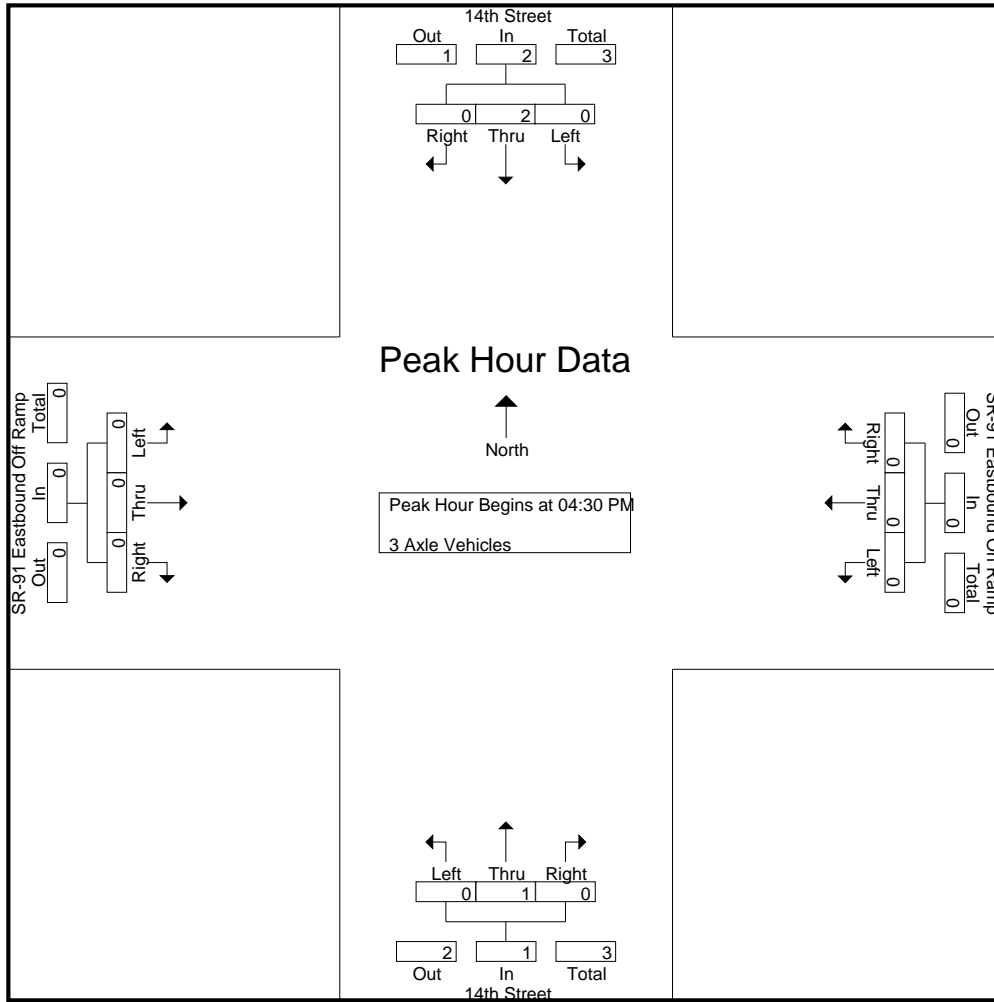

Peak Hour Analysis From 04:30 PM to 05:15 PM - Peak 1 of 1
 Peak Hour for Each Approach Begins at:

	04:30 PM				04:30 PM				04:30 PM				04:30 PM			
+0 mins.	0	0	0	0	0	0	0	0	0	0	0	0	0	0	0	0
+15 mins.	0	0	0	0	0	0	0	0	0	1	0	1	0	0	0	0
+30 mins.	0	0	0	0	0	0	0	0	0	0	0	0	0	0	0	0
+45 mins.	0	2	0	2	0	0	0	0	0	0	0	0	0	0	0	0
Total Volume	0	2	0	2	0	0	0	0	0	1	0	1	0	0	0	0
% App. Total	0	100	0	0	0	0	0	0	0	100	0	0	0	0	0	0
PHF	.000	.250	.000	.250	.000	.000	.000	.000	.000	.250	.000	.250	.000	.000	.000	.000

City of Riverside
 N/S: 14th Street
 E/W: SR-91 Eastbound Ramps
 Weather: Clear

File Name : 03_RIV_14th_91E PM
 Site Code : 17920060
 Start Date : 1/28/2020
 Page No : 1

Groups Printed- 4+ Axle Trucks

Start Time	14th Street Southbound				SR-91 Eastbound On Ramp Westbound				14th Street Northbound				SR-91 Eastbound Off Ramp Eastbound				Int. Total
	Left	Thru	Right	App. Total	Left	Thru	Right	App. Total	Left	Thru	Right	App. Total	Left	Thru	Right	App. Total	
04:00 PM	0	0	0	0	0	0	0	0	0	0	0	0	1	0	0	1	1
04:15 PM	0	0	0	0	0	0	0	0	0	0	1	1	0	0	0	0	1
04:30 PM	0	0	0	0	0	0	0	0	0	0	1	1	0	0	0	0	1
04:45 PM	0	0	0	0	0	0	0	0	0	1	1	2	1	0	0	1	3
Total	0	0	0	0	0	0	0	0	0	1	3	4	2	0	0	2	6
05:00 PM	0	0	0	0	0	0	0	0	0	0	0	0	0	0	2	2	2
05:15 PM	0	0	0	0	0	0	0	0	0	0	1	1	0	0	1	1	2
05:30 PM	1	0	0	1	0	0	0	0	0	0	0	0	0	0	0	0	1
05:45 PM	0	0	0	0	0	0	0	0	0	0	0	0	0	0	0	0	0
Total	1	0	0	1	0	0	0	0	0	0	1	1	0	0	3	3	5
Grand Total	1	0	0	1	0	0	0	0	0	1	4	5	2	0	3	5	11
Apprch %	100	0	0		0	0	0		0	20	80		40	0	60		
Total %	9.1	0	0	9.1	0	0	0	0	0	9.1	36.4	45.5	18.2	0	27.3	45.5	

Start Time	14th Street Southbound				SR-91 Eastbound On Ramp Westbound				14th Street Northbound				SR-91 Eastbound Off Ramp Eastbound				Int. Total
	Left	Thru	Right	App. Total	Left	Thru	Right	App. Total	Left	Thru	Right	App. Total	Left	Thru	Right	App. Total	
Peak Hour Analysis From 04:30 PM to 05:15 PM - Peak 1 of 1																	
Peak Hour for Entire Intersection Begins at 04:30 PM																	
04:30 PM	0	0	0	0	0	0	0	0	0	0	1	1	0	0	0	0	1
04:45 PM	0	0	0	0	0	0	0	0	0	1	1	2	1	0	0	1	3
05:00 PM	0	0	0	0	0	0	0	0	0	0	0	0	0	0	2	2	2
05:15 PM	0	0	0	0	0	0	0	0	0	0	1	1	0	0	1	1	2
Total Volume	0	0	0	0	0	0	0	0	0	1	3	4	1	0	3	4	8
% App. Total	0	0	0		0	0	0		0	25	75		25	0	75		
PHF	.000	.000	.000	.000	.000	.000	.000	.000	.000	.250	.750	.500	.250	.000	.375	.500	.667

City of Riverside
 N/S: 14th Street
 E/W: SR-91 Eastbound Ramps
 Weather: Clear

File Name : 03_RIV_14th_91E PM
 Site Code : 17920060
 Start Date : 1/28/2020
 Page No : 2

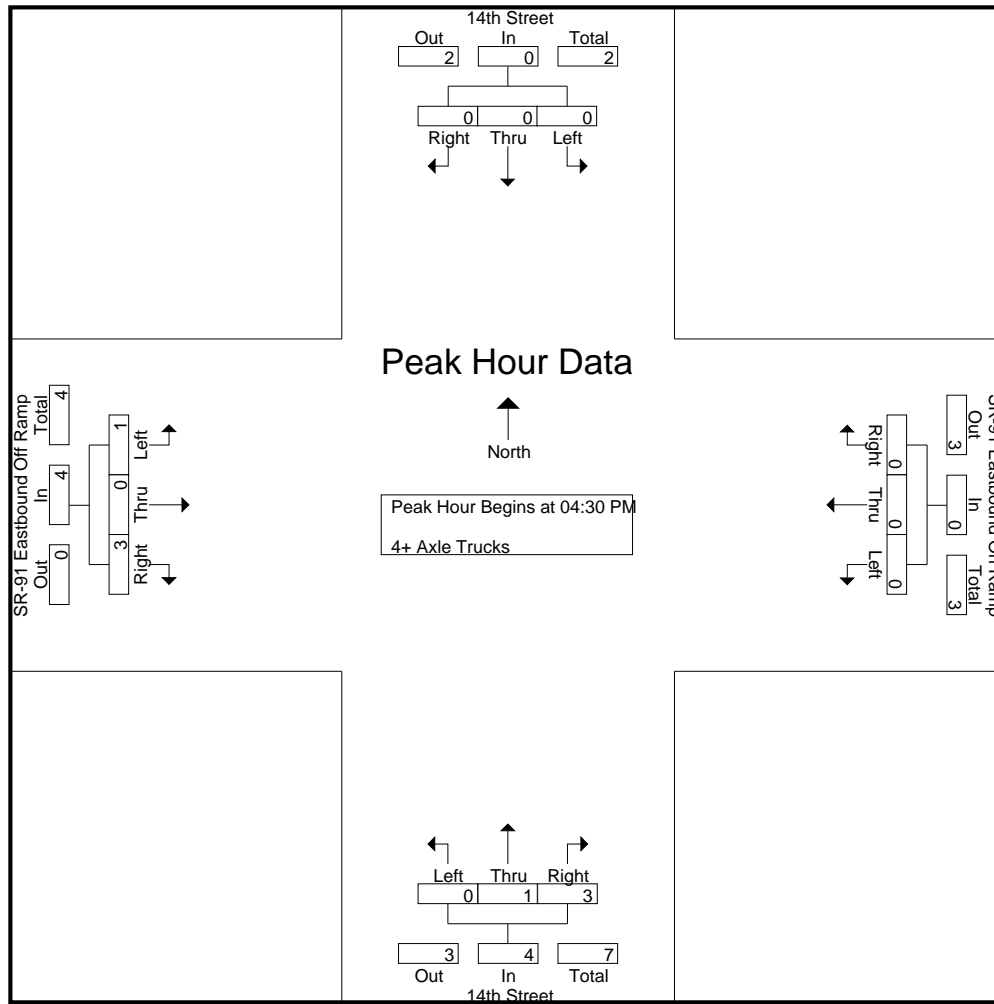

Peak Hour Analysis From 04:30 PM to 05:15 PM - Peak 1 of 1
 Peak Hour for Each Approach Begins at:

	04:30 PM				04:30 PM				04:30 PM				04:30 PM			
+0 mins.	0	0	0	0	0	0	0	0	0	0	1	1	0	0	0	0
+15 mins.	0	0	0	0	0	0	0	0	0	1	1	2	1	0	0	1
+30 mins.	0	0	0	0	0	0	0	0	0	0	0	0	0	0	2	2
+45 mins.	0	0	0	0	0	0	0	0	0	0	1	1	0	0	1	1
Total Volume	0	0	0	0	0	0	0	0	0	1	3	4	1	0	3	4
% App. Total	0	0	0	0	0	0	0	0	0	25	75	75	25	0	75	75
PHF	.000	.000	.000	.000	.000	.000	.000	.000	.000	.250	.750	.500	.250	.000	.375	.500

City of Riverside
 N/S: 14th Street
 E/W: Howard Avenue
 Weather: Clear

File Name : 04_RIV_14th_Howard AM
 Site Code : 17920060
 Start Date : 1/28/2020
 Page No : 1

Groups Printed- Total Volume

Start Time	14th Street Southbound				Howard Avenue Westbound				14th Street Northbound				Howard Avenue Eastbound				Int. Total
	Left	Thru	Right	App. Total	Left	Thru	Right	App. Total	Left	Thru	Right	App. Total	Left	Thru	Right	App. Total	
07:00 AM	7	68	11	86	1	2	10	13	1	278	6	285	11	1	5	17	401
07:15 AM	11	121	8	140	0	0	21	21	2	340	4	346	17	4	4	25	532
07:30 AM	14	154	10	178	1	4	16	21	1	305	5	311	10	2	3	15	525
07:45 AM	7	157	8	172	0	1	15	16	3	375	2	380	21	5	2	28	596
Total	39	500	37	576	2	7	62	71	7	1298	17	1322	59	12	14	85	2054
08:00 AM	7	128	14	149	1	2	11	14	5	301	3	309	13	3	6	22	494
08:15 AM	8	88	9	105	2	6	14	22	2	276	3	281	9	1	1	11	419
08:30 AM	2	115	6	123	0	2	6	8	4	262	5	271	10	0	1	11	413
08:45 AM	3	124	4	131	1	0	6	7	1	194	8	203	8	1	3	12	353
Total	20	455	33	508	4	10	37	51	12	1033	19	1064	40	5	11	56	1679
Grand Total	59	955	70	1084	6	17	99	122	19	2331	36	2386	99	17	25	141	3733
Apprch %	5.4	88.1	6.5		4.9	13.9	81.1		0.8	97.7	1.5		70.2	12.1	17.7		
Total %	1.6	25.6	1.9	29	0.2	0.5	2.7	3.3	0.5	62.4	1	63.9	2.7	0.5	0.7	3.8	

Start Time	14th Street Southbound				Howard Avenue Westbound				14th Street Northbound				Howard Avenue Eastbound				Int. Total
	Left	Thru	Right	App. Total	Left	Thru	Right	App. Total	Left	Thru	Right	App. Total	Left	Thru	Right	App. Total	
Peak Hour Analysis From 07:00 AM to 08:45 AM - Peak 1 of 1																	
Peak Hour for Entire Intersection Begins at 07:15 AM																	
07:15 AM	11	121	8	140	0	0	21	21	2	340	4	346	17	4	4	25	532
07:30 AM	14	154	10	178	1	4	16	21	1	305	5	311	10	2	3	15	525
07:45 AM	7	157	8	172	0	1	15	16	3	375	2	380	21	5	2	28	596
08:00 AM	7	128	14	149	1	2	11	14	5	301	3	309	13	3	6	22	494
Total Volume	39	560	40	639	2	7	63	72	11	1321	14	1346	61	14	15	90	2147
% App. Total	6.1	87.6	6.3		2.8	9.7	87.5		0.8	98.1	1		67.8	15.6	16.7		
PHF	.696	.892	.714	.897	.500	.438	.750	.857	.550	.881	.700	.886	.726	.700	.625	.804	.901

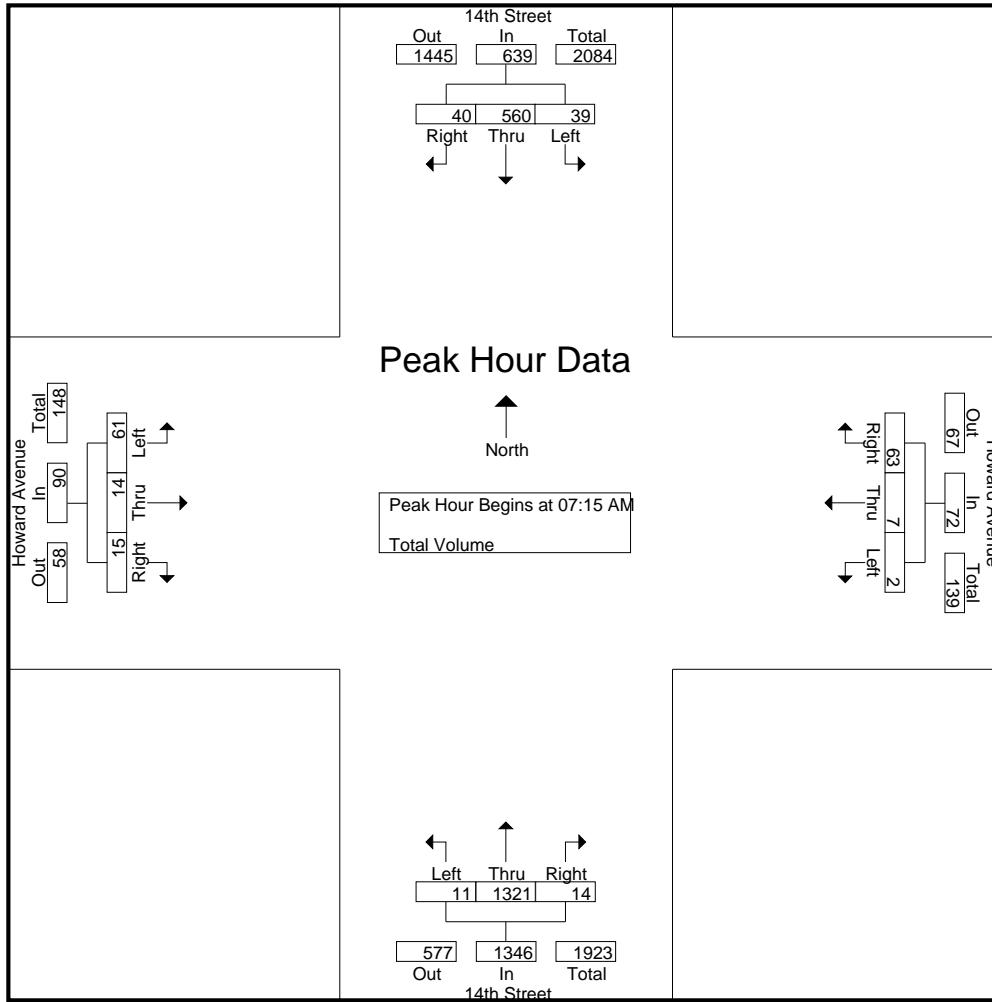

Peak Hour Analysis From 07:00 AM to 08:45 AM - Peak 1 of 1
 Peak Hour for Each Approach Begins at:

	07:15 AM				07:30 AM				07:45 AM				07:15 AM			
+0 mins.	11	121	8	140	1	4	16	21	2	340	4	346	17	4	4	25
+15 mins.	14	154	10	178	0	1	15	16	1	305	5	311	10	2	3	15
+30 mins.	7	157	8	172	1	2	11	14	3	375	2	380	21	5	2	28
+45 mins.	7	128	14	149	2	6	14	22	5	301	3	309	13	3	6	22
Total Volume	39	560	40	639	4	13	56	73	11	1321	14	1346	61	14	15	90
% App. Total	6.1	87.6	6.3		5.5	17.8	76.7		0.8	98.1	1		67.8	15.6	16.7	
PHF	.696	.892	.714	.897	.500	.542	.875	.830	.550	.881	.700	.886	.726	.700	.625	.804

City of Riverside
 N/S: 14th Street
 E/W: Howard Avenue
 Weather: Clear

File Name : 04_RIV_14th_Howard PM
 Site Code : 17920060
 Start Date : 1/28/2020
 Page No : 1

Groups Printed- Total Volume

Start Time	14th Street Southbound				Howard Avenue Westbound				14th Street Northbound				Howard Avenue Eastbound				Int. Total
	Left	Thru	Right	App. Total	Left	Thru	Right	App. Total	Left	Thru	Right	App. Total	Left	Thru	Right	App. Total	
04:00 PM	6	371	25	402	7	8	12	27	3	170	1	174	12	6	3	21	624
04:15 PM	10	420	29	459	3	2	8	13	3	131	3	137	13	2	0	15	624
04:30 PM	5	397	32	434	10	10	33	53	4	129	7	140	12	2	5	19	646
04:45 PM	10	383	44	437	5	4	13	22	1	147	4	152	13	1	2	16	627
Total	31	1571	130	1732	25	24	66	115	11	577	15	603	50	11	10	71	2521
05:00 PM	11	362	59	432	12	8	18	38	1	187	2	190	5	5	3	13	673
05:15 PM	14	387	45	446	6	10	17	33	3	156	2	161	12	5	2	19	659
05:30 PM	9	356	52	417	6	5	14	25	2	165	0	167	11	4	5	20	629
05:45 PM	6	340	21	367	3	3	11	17	6	146	1	153	10	3	3	16	553
Total	40	1445	177	1662	27	26	60	113	12	654	5	671	38	17	13	68	2514
Grand Total	71	3016	307	3394	52	50	126	228	23	1231	20	1274	88	28	23	139	5035
Apprch %	2.1	88.9	9		22.8	21.9	55.3		1.8	96.6	1.6		63.3	20.1	16.5		
Total %	1.4	59.9	6.1	67.4	1	1	2.5	4.5	0.5	24.4	0.4	25.3	1.7	0.6	0.5	2.8	

Start Time	14th Street Southbound				Howard Avenue Westbound				14th Street Northbound				Howard Avenue Eastbound				Int. Total
	Left	Thru	Right	App. Total	Left	Thru	Right	App. Total	Left	Thru	Right	App. Total	Left	Thru	Right	App. Total	
Peak Hour Analysis From 04:00 PM to 05:45 PM - Peak 1 of 1																	
Peak Hour for Entire Intersection Begins at 04:30 PM																	
04:30 PM	5	397	32	434	10	10	33	53	4	129	7	140	12	2	5	19	646
04:45 PM	10	383	44	437	5	4	13	22	1	147	4	152	13	1	2	16	627
05:00 PM	11	362	59	432	12	8	18	38	1	187	2	190	5	5	3	13	673
05:15 PM	14	387	45	446	6	10	17	33	3	156	2	161	12	5	2	19	659
Total Volume	40	1529	180	1749	33	32	81	146	9	619	15	643	42	13	12	67	2605
% App. Total	2.3	87.4	10.3		22.6	21.9	55.5		1.4	96.3	2.3		62.7	19.4	17.9		
PHF	.714	.963	.763	.980	.688	.800	.614	.689	.563	.828	.536	.846	.808	.650	.600	.882	.968

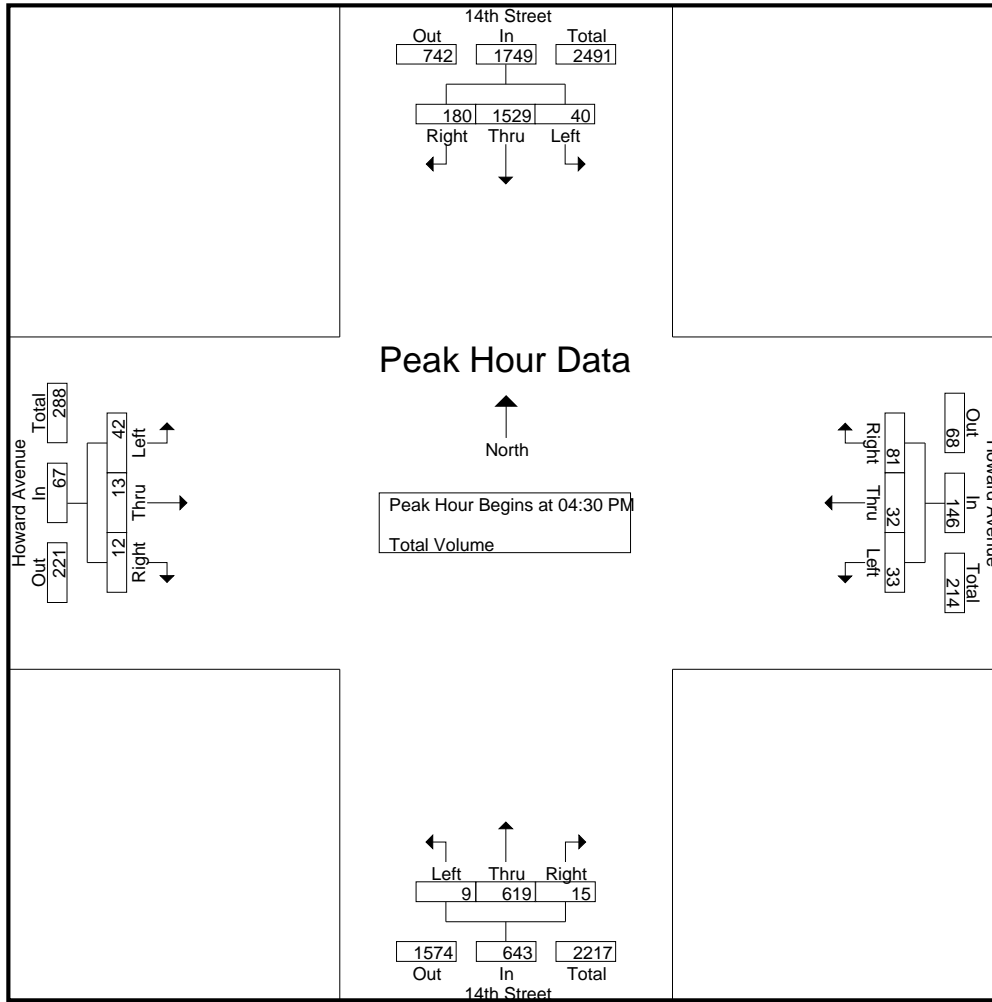

Peak Hour Analysis From 04:00 PM to 05:45 PM - Peak 1 of 1
 Peak Hour for Each Approach Begins at:

	04:15 PM				04:30 PM				05:00 PM				04:00 PM			
+0 mins.	10	420	29	459	10	10	33	53	1	187	2	190	12	6	3	21
+15 mins.	5	397	32	434	5	4	13	22	3	156	2	161	13	2	0	15
+30 mins.	10	383	44	437	12	8	18	38	2	165	0	167	12	2	5	19
+45 mins.	11	362	59	432	6	10	17	33	6	146	1	153	13	1	2	16
Total Volume	36	1562	164	1762	33	32	81	146	12	654	5	671	50	11	10	71
% App. Total	2	88.6	9.3		22.6	21.9	55.5		1.8	97.5	0.7		70.4	15.5	14.1	
PHF	.818	.930	.695	.960	.688	.800	.614	.689	.500	.874	.625	.883	.962	.458	.500	.845

City of Riverside
 N/S: Tenth Street
 E/W: Howard Avenue
 Weather: Clear

File Name : 05_RIV_Tenth_Howard AM
 Site Code : 17920060
 Start Date : 1/28/2020
 Page No : 1

Groups Printed- Total Volume

Start Time	Tenth Street Southbound			Tenth Street Northbound			Howard Avenue Eastbound			Int. Total
	Thru	Right	App. Total	Left	Thru	App. Total	Left	Right	App. Total	
07:00 AM	1	4	5	2	3	5	7	2	9	19
07:15 AM	2	6	8	1	1	2	9	1	10	20
07:30 AM	1	9	10	2	1	3	7	2	9	22
07:45 AM	1	11	12	0	3	3	3	0	3	18
Total	5	30	35	5	8	13	26	5	31	79
08:00 AM	6	7	13	1	4	5	6	4	10	28
08:15 AM	1	10	11	2	0	2	9	3	12	25
08:30 AM	1	3	4	1	1	2	2	1	3	9
08:45 AM	1	4	5	0	1	1	4	0	4	10
Total	9	24	33	4	6	10	21	8	29	72
Grand Total	14	54	68	9	14	23	47	13	60	151
Apprch %	20.6	79.4		39.1	60.9		78.3	21.7		
Total %	9.3	35.8	45	6	9.3	15.2	31.1	8.6	39.7	

Start Time	Tenth Street Southbound			Tenth Street Northbound			Howard Avenue Eastbound			Int. Total
	Thru	Right	App. Total	Left	Thru	App. Total	Left	Right	App. Total	
07:30 AM	1	9	10	2	1	3	7	2	9	22
07:45 AM	1	11	12	0	3	3	3	0	3	18
08:00 AM	6	7	13	1	4	5	6	4	10	28
08:15 AM	1	10	11	2	0	2	9	3	12	25
Total Volume	9	37	46	5	8	13	25	9	34	93
% App. Total	19.6	80.4		38.5	61.5		73.5	26.5		
PHF	.375	.841	.885	.625	.500	.650	.694	.563	.708	.830

Peak Hour Analysis From 07:00 AM to 08:45 AM - Peak 1 of 1

Peak Hour for Entire Intersection Begins at 07:30 AM

City of Riverside
 N/S: Tenth Street
 E/W: Howard Avenue
 Weather: Clear

File Name : 05_RIV_Tenth_Howard AM
 Site Code : 17920060
 Start Date : 1/28/2020
 Page No : 2

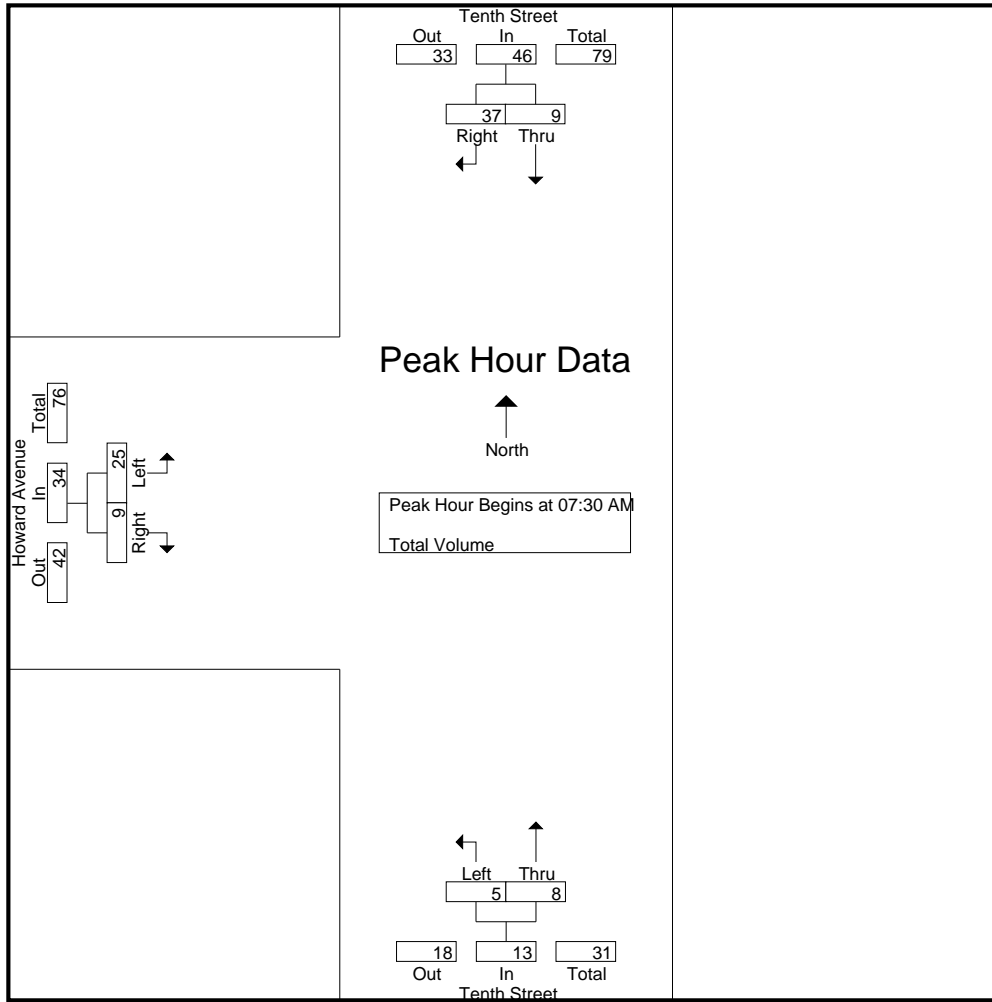

Peak Hour Analysis From 07:00 AM to 08:45 AM - Peak 1 of 1
 Peak Hour for Each Approach Begins at:

	07:30 AM			07:00 AM			07:30 AM		
+0 mins.	1	9	10	2	3	5	7	2	9
+15 mins.	1	11	12	1	1	2	3	0	3
+30 mins.	6	7	13	2	1	3	6	4	10
+45 mins.	1	10	11	0	3	3	9	3	12
Total Volume	9	37	46	5	8	13	25	9	34
% App. Total	19.6	80.4		38.5	61.5		73.5	26.5	
PHF	.375	.841	.885	.625	.667	.650	.694	.563	.708

City of Riverside
 N/S: Tenth Street
 E/W: Howard Avenue
 Weather: Clear

File Name : 05_RIV_Tenth_Howard PM
 Site Code : 17920060
 Start Date : 1/28/2020
 Page No : 1

Groups Printed- Total Volume

Start Time	Tenth Street Southbound			Tenth Street Northbound			Howard Avenue Eastbound			Int. Total
	Thru	Right	App. Total	Left	Thru	App. Total	Left	Right	App. Total	
04:00 PM	4	11	15	2	1	3	10	1	11	29
04:15 PM	6	5	11	3	1	4	2	3	5	20
04:30 PM	9	31	40	2	1	3	5	7	12	55
04:45 PM	2	21	23	1	1	2	7	3	10	35
Total	21	68	89	8	4	12	24	14	38	139
05:00 PM	7	13	20	4	3	7	8	4	12	39
05:15 PM	15	29	44	2	1	3	5	2	7	54
05:30 PM	6	7	13	2	1	3	3	5	8	24
05:45 PM	4	10	14	1	3	4	3	0	3	21
Total	32	59	91	9	8	17	19	11	30	138
Grand Total	53	127	180	17	12	29	43	25	68	277
Apprch %	29.4	70.6		58.6	41.4		63.2	36.8		
Total %	19.1	45.8	65	6.1	4.3	10.5	15.5	9	24.5	

Start Time	Tenth Street Southbound			Tenth Street Northbound			Howard Avenue Eastbound			Int. Total
	Thru	Right	App. Total	Left	Thru	App. Total	Left	Right	App. Total	
04:30 PM	9	31	40	2	1	3	5	7	12	55
04:45 PM	2	21	23	1	1	2	7	3	10	35
05:00 PM	7	13	20	4	3	7	8	4	12	39
05:15 PM	15	29	44	2	1	3	5	2	7	54
Total Volume	33	94	127	9	6	15	25	16	41	183
% App. Total	26	74		60	40		61	39		
PHF	.550	.758	.722	.563	.500	.536	.781	.571	.854	.832

Peak Hour Analysis From 04:00 PM to 05:45 PM - Peak 1 of 1

Peak Hour for Entire Intersection Begins at 04:30 PM

City of Riverside
 N/S: Tenth Street
 E/W: Howard Avenue
 Weather: Clear

File Name : 05_RIV_Tenth_Howard PM
 Site Code : 17920060
 Start Date : 1/28/2020
 Page No : 2

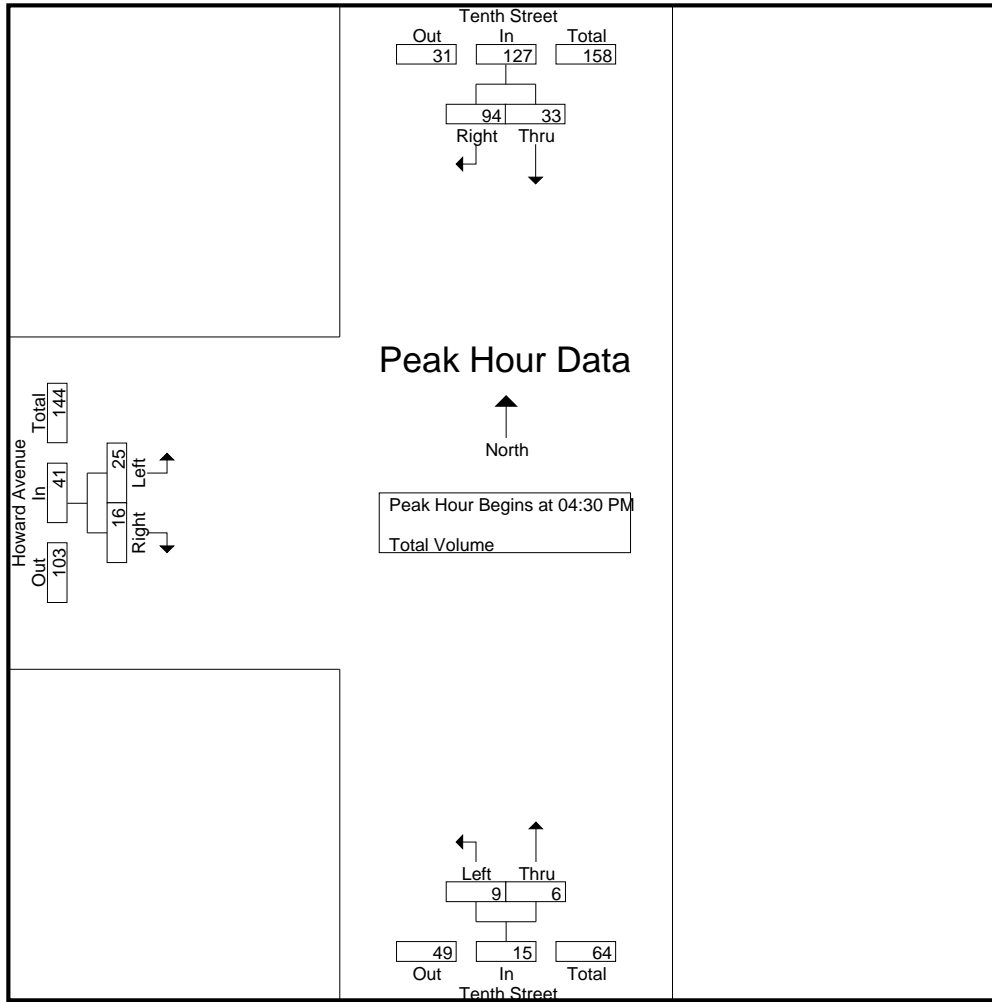

Peak Hour Analysis From 04:00 PM to 05:45 PM - Peak 1 of 1
 Peak Hour for Each Approach Begins at:

	04:30 PM			05:00 PM			04:30 PM		
+0 mins.	9	31	40	4	3	7	5	7	12
+15 mins.	2	21	23	2	1	3	7	3	10
+30 mins.	7	13	20	2	1	3	8	4	12
+45 mins.	15	29	44	1	3	4	5	2	7
Total Volume	33	94	127	9	8	17	25	16	41
% App. Total	26	74		52.9	47.1		61	39	
PHF	.550	.758	.722	.563	.667	.607	.781	.571	.854

City of Riverside
 N/S: 9th Street
 E/W: Commerce Street
 Weather: Clear

File Name : 06_RIV_9th_Commerce AM
 Site Code : 17920060
 Start Date : 1/28/2020
 Page No : 1

Groups Printed- Total Volume

Start Time	Handicapped Parking Entrance Southbound				Commerce Street Westbound				9th Street Northbound				Commerce Street Eastbound				Int. Total
	Left	Thru	Right	App. Total	Left	Thru	Right	App. Total	Left	Thru	Right	App. Total	Left	Thru	Right	App. Total	
07:00 AM	0	0	0	0	7	5	4	16	0	0	8	8	0	9	0	9	33
07:15 AM	0	0	0	0	6	7	2	15	1	0	2	3	0	8	0	8	26
07:30 AM	0	0	0	0	0	9	0	9	2	0	3	5	0	6	0	6	20
07:45 AM	0	0	0	0	3	11	0	14	1	0	5	6	0	5	0	5	25
Total	0	0	0	0	16	32	6	54	4	0	18	22	0	28	0	28	104
08:00 AM	0	0	0	0	4	13	0	17	0	0	5	5	0	11	0	11	33
08:15 AM	0	0	0	0	0	9	0	9	1	0	6	7	0	5	2	7	23
08:30 AM	0	0	0	0	0	4	0	4	0	0	0	0	0	3	1	4	8
08:45 AM	0	0	0	0	0	3	0	3	2	0	2	4	0	3	0	3	10
Total	0	0	0	0	4	29	0	33	3	0	13	16	0	22	3	25	74
Grand Total	0	0	0	0	20	61	6	87	7	0	31	38	0	50	3	53	178
Apprch %	0	0	0		23	70.1	6.9		18.4	0	81.6		0	94.3	5.7		
Total %	0	0	0		11.2	34.3	3.4	48.9	3.9	0	17.4	21.3	0	28.1	1.7	29.8	

Start Time	Handicapped Parking Entrance Southbound				Commerce Street Westbound				9th Street Northbound				Commerce Street Eastbound				Int. Total
	Left	Thru	Right	App. Total	Left	Thru	Right	App. Total	Left	Thru	Right	App. Total	Left	Thru	Right	App. Total	
Peak Hour Analysis From 07:00 AM to 08:45 AM - Peak 1 of 1																	
Peak Hour for Entire Intersection Begins at 07:00 AM																	
07:00 AM	0	0	0	0	7	5	4	16	0	0	8	8	0	9	0	9	33
07:15 AM	0	0	0	0	6	7	2	15	1	0	2	3	0	8	0	8	26
07:30 AM	0	0	0	0	0	9	0	9	2	0	3	5	0	6	0	6	20
07:45 AM	0	0	0	0	3	11	0	14	1	0	5	6	0	5	0	5	25
Total Volume	0	0	0	0	16	32	6	54	4	0	18	22	0	28	0	28	104
% App. Total	0	0	0		29.6	59.3	11.1		18.2	0	81.8		0	100	0		
PHF	.000	.000	.000	.000	.571	.727	.375	.844	.500	.000	.563	.688	.000	.778	.000	.778	.788

City of Riverside
 N/S: 9th Street
 E/W: Commerce Street
 Weather: Clear

File Name : 06_RIV_9th_Commerce AM
 Site Code : 17920060
 Start Date : 1/28/2020
 Page No : 2

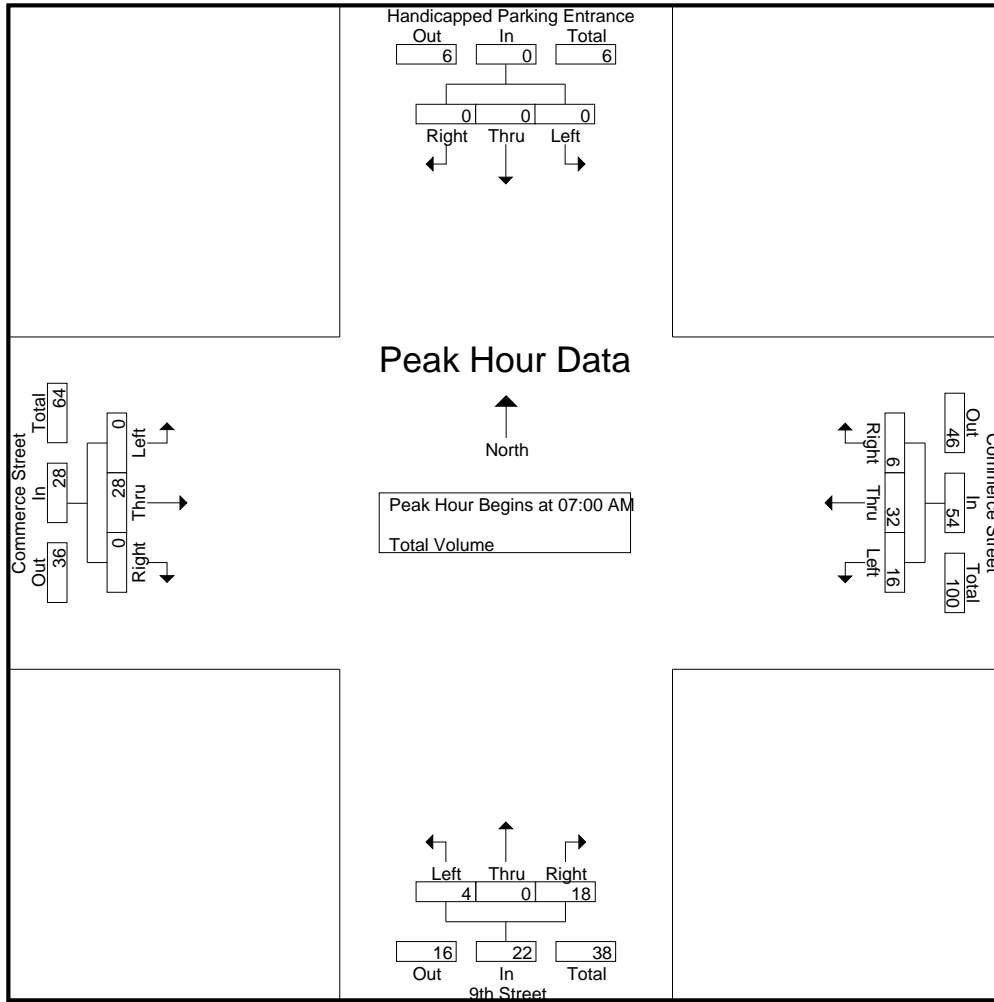

Peak Hour Analysis From 07:00 AM to 08:45 AM - Peak 1 of 1
 Peak Hour for Each Approach Begins at:

	07:00 AM				07:15 AM				07:30 AM				07:45 AM			
+0 mins.	0	0	0	0	6	7	2	15	2	0	3	5	0	8	0	8
+15 mins.	0	0	0	0	0	9	0	9	1	0	5	6	0	6	0	6
+30 mins.	0	0	0	0	3	11	0	14	0	0	5	5	0	5	0	5
+45 mins.	0	0	0	0	4	13	0	17	1	0	6	7	0	11	0	11
Total Volume	0	0	0	0	13	40	2	55	4	0	19	23	0	30	0	30
% App. Total	0	0	0	0	23.6	72.7	3.6	100	17.4	0	82.6	100	0	100	0	100
PHF	.000	.000	.000	.000	.542	.769	.250	.809	.500	.000	.792	.821	.000	.682	.000	.682

City of Riverside
 N/S: 9th Street
 E/W: Commerce Street
 Weather: Clear

File Name : 06_RIV_9th_Commerce PM
 Site Code : 17920060
 Start Date : 1/28/2020
 Page No : 1

Groups Printed- Total Volume

Start Time	Handicapped Parking Entrance Southbound				Commerce Street Westbound				9th Street Northbound				Commerce Street Eastbound				Int. Total
	Left	Thru	Right	App. Total	Left	Thru	Right	App. Total	Left	Thru	Right	App. Total	Left	Thru	Right	App. Total	
04:00 PM	0	0	0	0	7	13	0	20	1	0	0	1	0	12	0	12	33
04:15 PM	0	0	0	0	1	9	0	10	0	0	3	3	0	1	2	3	16
04:30 PM	0	0	0	0	3	21	1	25	1	0	0	1	0	17	0	17	43
04:45 PM	0	0	0	0	2	12	0	14	0	0	2	2	1	10	2	13	29
Total	0	0	0	0	13	55	1	69	2	0	5	7	1	40	4	45	121
05:00 PM	0	0	0	0	6	11	0	17	1	0	3	4	1	12	1	14	35
05:15 PM	0	0	0	0	10	18	0	28	1	0	9	10	1	9	0	10	48
05:30 PM	0	0	0	0	8	10	0	18	0	0	2	2	0	6	0	6	26
05:45 PM	0	0	0	0	5	14	1	20	2	1	4	7	0	7	0	7	34
Total	0	0	0	0	29	53	1	83	4	1	18	23	2	34	1	37	143
Grand Total	0	0	0	0	42	108	2	152	6	1	23	30	3	74	5	82	264
Apprch %	0	0	0		27.6	71.1	1.3		20	3.3	76.7		3.7	90.2	6.1		
Total %	0	0	0		15.9	40.9	0.8	57.6	2.3	0.4	8.7	11.4	1.1	28	1.9	31.1	

Start Time	Handicapped Parking Entrance Southbound				Commerce Street Westbound				9th Street Northbound				Commerce Street Eastbound				Int. Total
	Left	Thru	Right	App. Total	Left	Thru	Right	App. Total	Left	Thru	Right	App. Total	Left	Thru	Right	App. Total	
04:30 PM	0	0	0	0	3	21	1	25	1	0	0	1	0	17	0	17	43
04:45 PM	0	0	0	0	2	12	0	14	0	0	2	2	1	10	2	13	29
05:00 PM	0	0	0	0	6	11	0	17	1	0	3	4	1	12	1	14	35
05:15 PM	0	0	0	0	10	18	0	28	1	0	9	10	1	9	0	10	48
Total Volume	0	0	0	0	21	62	1	84	3	0	14	17	3	48	3	54	155
% App. Total	0	0	0		25	73.8	1.2		17.6	0	82.4		5.6	88.9	5.6		
PHF	.000	.000	.000	.000	.525	.738	.250	.750	.750	.000	.389	.425	.750	.706	.375	.794	.807

Peak Hour Analysis From 04:00 PM to 05:45 PM - Peak 1 of 1
 Peak Hour for Entire Intersection Begins at 04:30 PM

City of Riverside
 N/S: 9th Street
 E/W: Commerce Street
 Weather: Clear

File Name : 06_RIV_9th_Commerce PM
 Site Code : 17920060
 Start Date : 1/28/2020
 Page No : 2

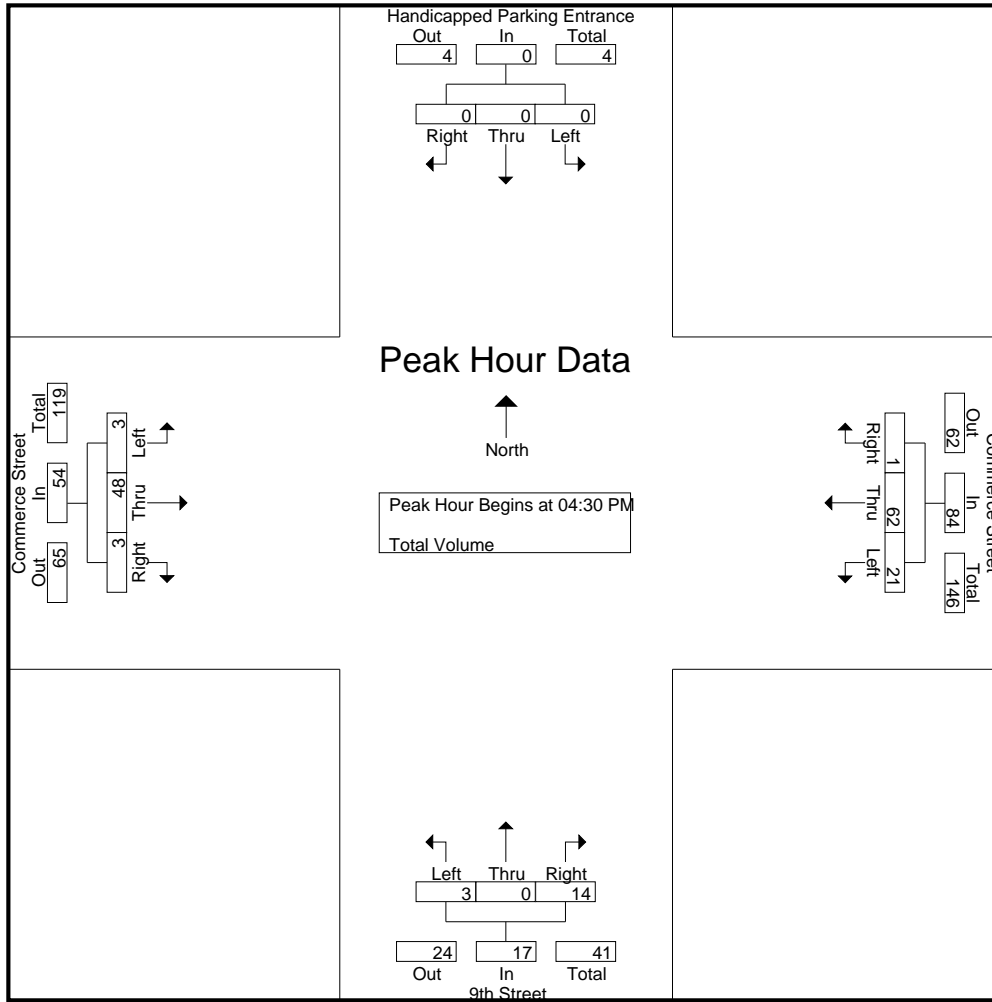

Peak Hour Analysis From 04:00 PM to 05:45 PM - Peak 1 of 1
 Peak Hour for Each Approach Begins at:

	04:00 PM				04:30 PM				05:00 PM				04:30 PM			
+0 mins.	0	0	0	0	3	21	1	25	1	0	3	4	0	17	0	17
+15 mins.	0	0	0	0	2	12	0	14	1	0	9	10	1	10	2	13
+30 mins.	0	0	0	0	6	11	0	17	0	0	2	2	1	12	1	14
+45 mins.	0	0	0	0	10	18	0	28	2	1	4	7	1	9	0	10
Total Volume	0	0	0	0	21	62	1	84	4	1	18	23	3	48	3	54
% App. Total	0	0	0	0	25	73.8	1.2	.750	17.4	4.3	78.3	.575	5.6	88.9	5.6	.794
PHF	.000	.000	.000	.000	.525	.738	.250	.750	.500	.250	.500	.575	.750	.706	.375	.794

City of Riverside
 N/S: University Avenue
 E/W: Park Avenue
 Weather: Clear

File Name : 07_RIV_University_Park AM
 Site Code : 17920060
 Start Date : 1/28/2020
 Page No : 1

Groups Printed- Total Volume

Start Time	University Avenue Southbound				Park Avenue Westbound				University Avenue Northbound				Park Avenue Eastbound				Int. Total
	Left	Thru	Right	App. Total	Left	Thru	Right	App. Total	Left	Thru	Right	App. Total	Left	Thru	Right	App. Total	
07:00 AM	7	77	4	88	9	4	9	22	5	154	12	171	4	5	4	13	294
07:15 AM	4	106	5	115	9	6	7	22	6	158	9	173	4	5	5	14	324
07:30 AM	11	145	6	162	7	6	16	29	2	171	8	181	7	5	7	19	391
07:45 AM	7	141	9	157	10	10	7	27	6	182	11	199	8	12	5	25	408
Total	29	469	24	522	35	26	39	100	19	665	40	724	23	27	21	71	1417
08:00 AM	7	83	7	97	14	10	8	32	7	167	17	191	8	5	5	18	338
08:15 AM	5	123	5	133	8	7	5	20	7	127	17	151	7	6	5	18	322
08:30 AM	13	95	3	111	5	7	7	19	8	134	11	153	3	6	5	14	297
08:45 AM	5	107	6	118	14	7	4	25	2	140	10	152	10	6	9	25	320
Total	30	408	21	459	41	31	24	96	24	568	55	647	28	23	24	75	1277
Grand Total	59	877	45	981	76	57	63	196	43	1233	95	1371	51	50	45	146	2694
Apprch %	6	89.4	4.6		38.8	29.1	32.1		3.1	89.9	6.9		34.9	34.2	30.8		
Total %	2.2	32.6	1.7	36.4	2.8	2.1	2.3	7.3	1.6	45.8	3.5	50.9	1.9	1.9	1.7	5.4	

Start Time	University Avenue Southbound				Park Avenue Westbound				University Avenue Northbound				Park Avenue Eastbound				Int. Total
	Left	Thru	Right	App. Total	Left	Thru	Right	App. Total	Left	Thru	Right	App. Total	Left	Thru	Right	App. Total	
Peak Hour Analysis From 07:00 AM to 08:45 AM - Peak 1 of 1																	
Peak Hour for Entire Intersection Begins at 07:15 AM																	
07:15 AM	4	106	5	115	9	6	7	22	6	158	9	173	4	5	5	14	324
07:30 AM	11	145	6	162	7	6	16	29	2	171	8	181	7	5	7	19	391
07:45 AM	7	141	9	157	10	10	7	27	6	182	11	199	8	12	5	25	408
08:00 AM	7	83	7	97	14	10	8	32	7	167	17	191	8	5	5	18	338
Total Volume	29	475	27	531	40	32	38	110	21	678	45	744	27	27	22	76	1461
% App. Total	5.5	89.5	5.1		36.4	29.1	34.5		2.8	91.1	6		35.5	35.5	28.9		
PHF	.659	.819	.750	.819	.714	.800	.594	.859	.750	.931	.662	.935	.844	.563	.786	.760	.895

City of Riverside
 N/S: University Avenue
 E/W: Park Avenue
 Weather: Clear

File Name : 07_RIV_University_Park AM
 Site Code : 17920060
 Start Date : 1/28/2020
 Page No : 2

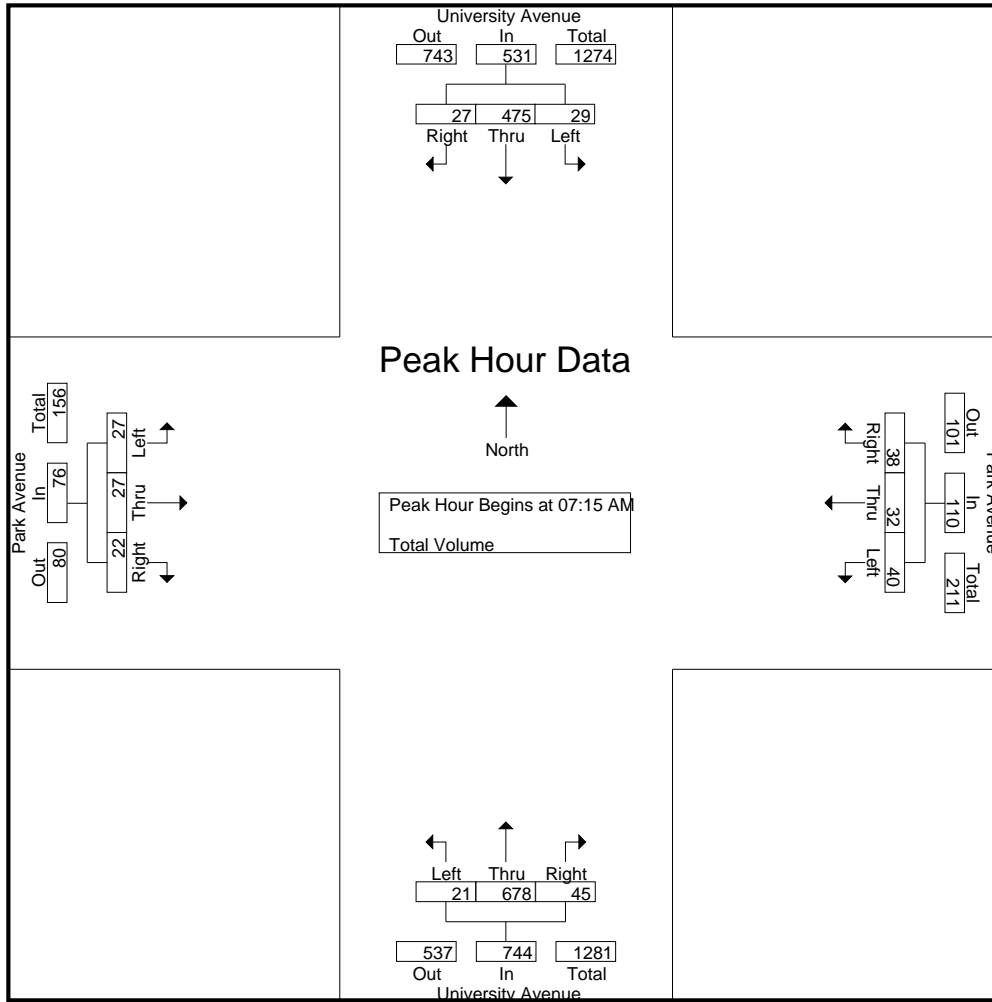

Peak Hour Analysis From 07:00 AM to 08:45 AM - Peak 1 of 1

Peak Hour for Each Approach Begins at:

	07:30 AM				07:15 AM				07:15 AM				07:30 AM			
+0 mins.	11	145	6	162	9	6	7	22	6	158	9	173	7	5	7	19
+15 mins.	7	141	9	157	7	6	16	29	2	171	8	181	8	12	5	25
+30 mins.	7	83	7	97	10	10	7	27	6	182	11	199	8	5	5	18
+45 mins.	5	123	5	133	14	10	8	32	7	167	17	191	7	6	5	18
Total Volume	30	492	27	549	40	32	38	110	21	678	45	744	30	28	22	80
% App. Total	5.5	89.6	4.9		36.4	29.1	34.5		2.8	91.1	6		37.5	35	27.5	
PHF	.682	.848	.750	.847	.714	.800	.594	.859	.750	.931	.662	.935	.938	.583	.786	.800

City of Riverside
 N/S: University Avenue
 E/W: Park Avenue
 Weather: Clear

File Name : 07_RIV_University_Park PM
 Site Code : 17920060
 Start Date : 1/28/2020
 Page No : 1

Groups Printed- Total Volume

Start Time	University Avenue Southbound				Park Avenue Westbound				University Avenue Northbound				Park Avenue Eastbound				Int. Total
	Left	Thru	Right	App. Total	Left	Thru	Right	App. Total	Left	Thru	Right	App. Total	Left	Thru	Right	App. Total	
04:00 PM	7	245	8	260	28	18	4	50	7	143	8	158	4	11	9	24	492
04:15 PM	10	272	12	294	17	15	11	43	6	132	16	154	10	6	11	27	518
04:30 PM	13	290	7	310	45	18	9	72	5	137	16	158	3	4	9	16	556
04:45 PM	8	326	15	349	37	19	12	68	5	128	19	152	5	7	11	23	592
Total	38	1133	42	1213	127	70	36	233	23	540	59	622	22	28	40	90	2158
05:00 PM	11	289	18	318	42	30	8	80	11	160	18	189	10	11	10	31	618
05:15 PM	15	310	16	341	37	20	10	67	14	121	8	143	9	10	10	29	580
05:30 PM	7	270	17	294	27	15	6	48	14	145	11	170	5	7	17	29	541
05:45 PM	12	238	6	256	39	10	6	55	11	138	13	162	7	9	11	27	500
Total	45	1107	57	1209	145	75	30	250	50	564	50	664	31	37	48	116	2239
Grand Total	83	2240	99	2422	272	145	66	483	73	1104	109	1286	53	65	88	206	4397
Apprch %	3.4	92.5	4.1		56.3	30	13.7		5.7	85.8	8.5		25.7	31.6	42.7		
Total %	1.9	50.9	2.3	55.1	6.2	3.3	1.5	11	1.7	25.1	2.5	29.2	1.2	1.5	2	4.7	

Start Time	University Avenue Southbound				Park Avenue Westbound				University Avenue Northbound				Park Avenue Eastbound				Int. Total
	Left	Thru	Right	App. Total	Left	Thru	Right	App. Total	Left	Thru	Right	App. Total	Left	Thru	Right	App. Total	
Peak Hour Analysis From 04:00 PM to 05:45 PM - Peak 1 of 1																	
Peak Hour for Entire Intersection Begins at 04:30 PM																	
04:30 PM	13	290	7	310	45	18	9	72	5	137	16	158	3	4	9	16	556
04:45 PM	8	326	15	349	37	19	12	68	5	128	19	152	5	7	11	23	592
05:00 PM	11	289	18	318	42	30	8	80	11	160	18	189	10	11	10	31	618
05:15 PM	15	310	16	341	37	20	10	67	14	121	8	143	9	10	10	29	580
Total Volume	47	1215	56	1318	161	87	39	287	35	546	61	642	27	32	40	99	2346
% App. Total	3.6	92.2	4.2		56.1	30.3	13.6		5.5	85	9.5		27.3	32.3	40.4		
PHF	.783	.932	.778	.944	.894	.725	.813	.897	.625	.853	.803	.849	.675	.727	.909	.798	.949

City of Riverside
 N/S: University Avenue
 E/W: Park Avenue
 Weather: Clear

File Name : 07_RIV_University_Park PM
 Site Code : 17920060
 Start Date : 1/28/2020
 Page No : 2

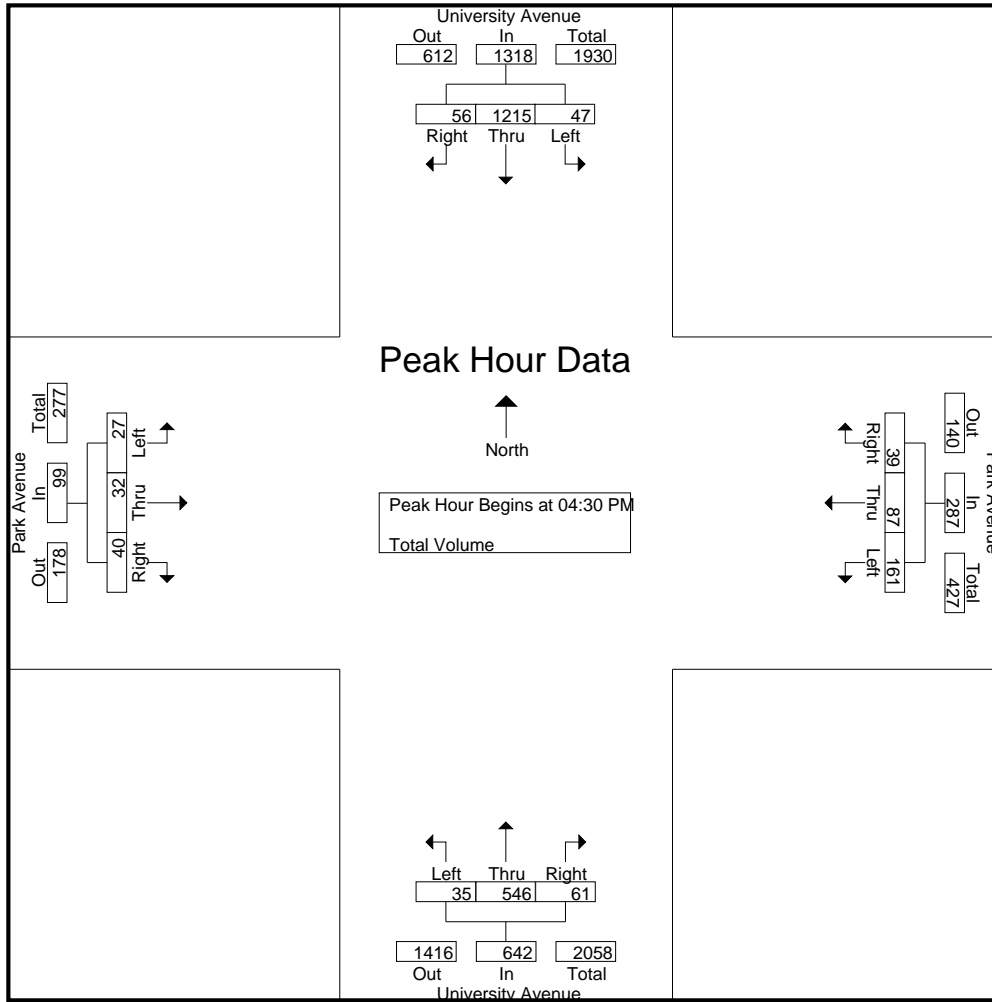

Peak Hour Analysis From 04:00 PM to 05:45 PM - Peak 1 of 1
 Peak Hour for Each Approach Begins at:

	04:30 PM				04:30 PM				05:00 PM				05:00 PM			
+0 mins.	13	290	7	310	45	18	9	72	11	160	18	189	10	11	10	31
+15 mins.	8	326	15	349	37	19	12	68	14	121	8	143	9	10	10	29
+30 mins.	11	289	18	318	42	30	8	80	14	145	11	170	5	7	17	29
+45 mins.	15	310	16	341	37	20	10	67	11	138	13	162	7	9	11	27
Total Volume	47	1215	56	1318	161	87	39	287	50	564	50	664	31	37	48	116
% App. Total	3.6	92.2	4.2		56.1	30.3	13.6		7.5	84.9	7.5		26.7	31.9	41.4	
PHF	.783	.932	.778	.944	.894	.725	.813	.897	.893	.881	.694	.878	.775	.841	.706	.935

City of Riverside
 N/S: Mission Inn Avenue
 E/W: SR-91 Westbound Off Ramp
 Weather: Clear

File Name : 08_RIV_Mission Inn_91W Off AM
 Site Code : 17920060
 Start Date : 1/28/2020
 Page No : 1

Groups Printed- Passenger Vehicles - Large 2 Axle Vehicles - 3 Axle Vehicles - 4+ Axle Trucks

Start Time	Mission Inn Avenue Southbound			SR-91 Westbound Off Ramp Westbound			Mission Inn Avenue Northbound			Int. Total
	Left	Thru	App. Total	Left	Right	App. Total	Thru	Right	App. Total	
07:00 AM	0	54	54	36	218	254	48	0	48	356
07:15 AM	0	67	67	41	242	283	46	0	46	396
07:30 AM	0	68	68	53	221	274	35	0	35	377
07:45 AM	0	65	65	54	245	299	49	0	49	413
Total	0	254	254	184	926	1110	178	0	178	1542
08:00 AM	0	58	58	54	210	264	45	0	45	367
08:15 AM	0	48	48	36	204	240	49	0	49	337
08:30 AM	0	51	51	27	163	190	53	0	53	294
08:45 AM	0	51	51	37	171	208	34	0	34	293
Total	0	208	208	154	748	902	181	0	181	1291
Grand Total	0	462	462	338	1674	2012	359	0	359	2833
Apprch %	0	100		16.8	83.2		100	0		
Total %	0	16.3	16.3	11.9	59.1	71	12.7	0	12.7	
Passenger Vehicles	0	441	441	318	1650	1968	335	0	335	2744
% Passenger Vehicles	0	95.5	95.5	94.1	98.6	97.8	93.3	0	93.3	96.9
Large 2 Axle Vehicles	0	21	21	17	18	35	24	0	24	80
% Large 2 Axle Vehicles	0	4.5	4.5	5	1.1	1.7	6.7	0	6.7	2.8
3 Axle Vehicles	0	0	0	2	3	5	0	0	0	5
% 3 Axle Vehicles	0	0	0	0.6	0.2	0.2	0	0	0	0.2
4+ Axle Trucks	0	0	0	1	3	4	0	0	0	4
% 4+ Axle Trucks	0	0	0	0.3	0.2	0.2	0	0	0	0.1

Start Time	Mission Inn Avenue Southbound			SR-91 Westbound Off Ramp Westbound			Mission Inn Avenue Northbound			Int. Total
	Left	Thru	App. Total	Left	Right	App. Total	Thru	Right	App. Total	
07:15 AM	0	67	67	41	242	283	46	0	46	396
07:30 AM	0	68	68	53	221	274	35	0	35	377
07:45 AM	0	65	65	54	245	299	49	0	49	413
08:00 AM	0	58	58	54	210	264	45	0	45	367
Total Volume	0	258	258	202	918	1120	175	0	175	1553
% App. Total	0	100		18	82		100	0		
PHF	.000	.949	.949	.935	.937	.936	.893	.000	.893	.940

Peak Hour Analysis From 07:00 AM to 08:45 AM - Peak 1 of 1
 Peak Hour for Entire Intersection Begins at 07:15 AM

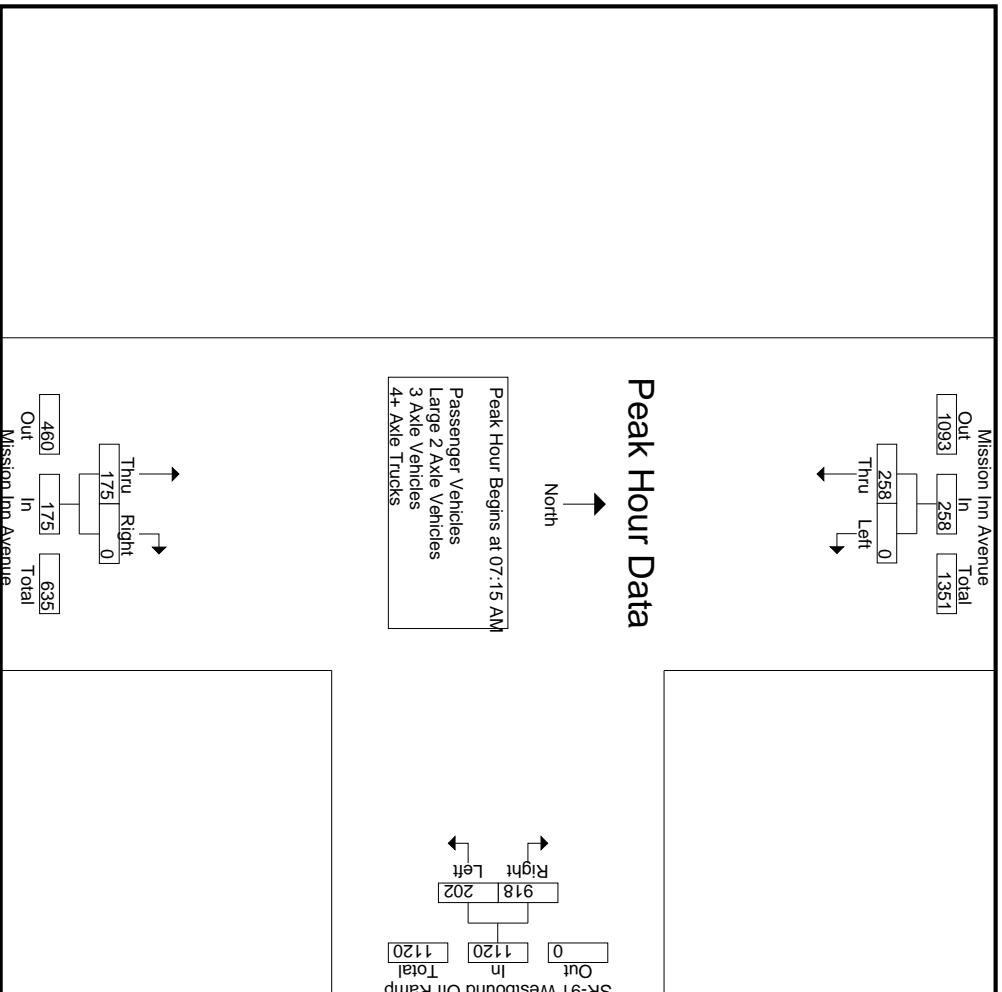

Peak Hour Analysis From 07:00 AM to 08:45 AM - Peak 1 of 1
 Peak Hour for Each Approach Begins at:

	07:15 AM	07:15 AM	07:45 AM	
+0 mins.	0	67	67	0
+15 mins.	0	68	68	0
+30 mins.	0	65	65	0
+45 mins.	0	58	58	0
Total Volume	0	258	258	0
% App. Total	0	100	18	0
PHF	.000	.949	.949	.000

City of Riverside
 N/S: Mission Inn Avenue
 E/W: SR-91 Westbound Off Ramp
 Weather: Clear

File Name : 08_RIV_Mission Inn_91W Off AM
 Site Code : 17920060
 Start Date : 1/28/2020
 Page No : 1

Groups Printed- Passenger Vehicles

Start Time	Mission Inn Avenue Southbound			SR-91 Westbound Off Ramp Westbound			Mission Inn Avenue Northbound			Int. Total
	Left	Thru	App. Total	Left	Right	App. Total	Thru	Right	App. Total	
07:00 AM	0	52	52	35	211	246	44	0	44	342
07:15 AM	0	65	65	40	240	280	45	0	45	390
07:30 AM	0	67	67	48	219	267	32	0	32	366
07:45 AM	0	63	63	50	243	293	49	0	49	405
Total	0	247	247	173	913	1086	170	0	170	1503
08:00 AM	0	54	54	50	207	257	40	0	40	351
08:15 AM	0	48	48	35	201	236	46	0	46	330
08:30 AM	0	46	46	26	160	186	48	0	48	280
08:45 AM	0	46	46	34	169	203	31	0	31	280
Total	0	194	194	145	737	882	165	0	165	1241
Grand Total	0	441	441	318	1650	1968	335	0	335	2744
Apprch %	0	100		16.2	83.8		100	0		
Total %	0	16.1	16.1	11.6	60.1	71.7	12.2	0	12.2	

Start Time	Mission Inn Avenue Southbound			SR-91 Westbound Off Ramp Westbound			Mission Inn Avenue Northbound			Int. Total
	Left	Thru	App. Total	Left	Right	App. Total	Thru	Right	App. Total	
07:15 AM	0	65	65	40	240	280	45	0	45	390
07:30 AM	0	67	67	48	219	267	32	0	32	366
07:45 AM	0	63	63	50	243	293	49	0	49	405
08:00 AM	0	54	54	50	207	257	40	0	40	351
Total Volume	0	249	249	188	909	1097	166	0	166	1512
% App. Total	0	100		17.1	82.9		100	0		
PHF	.000	.929	.929	.940	.935	.936	.847	.000	.847	.933

Peak Hour Analysis From 07:15 AM to 08:00 AM - Peak 1 of 1

Peak Hour for Entire Intersection Begins at 07:15 AM

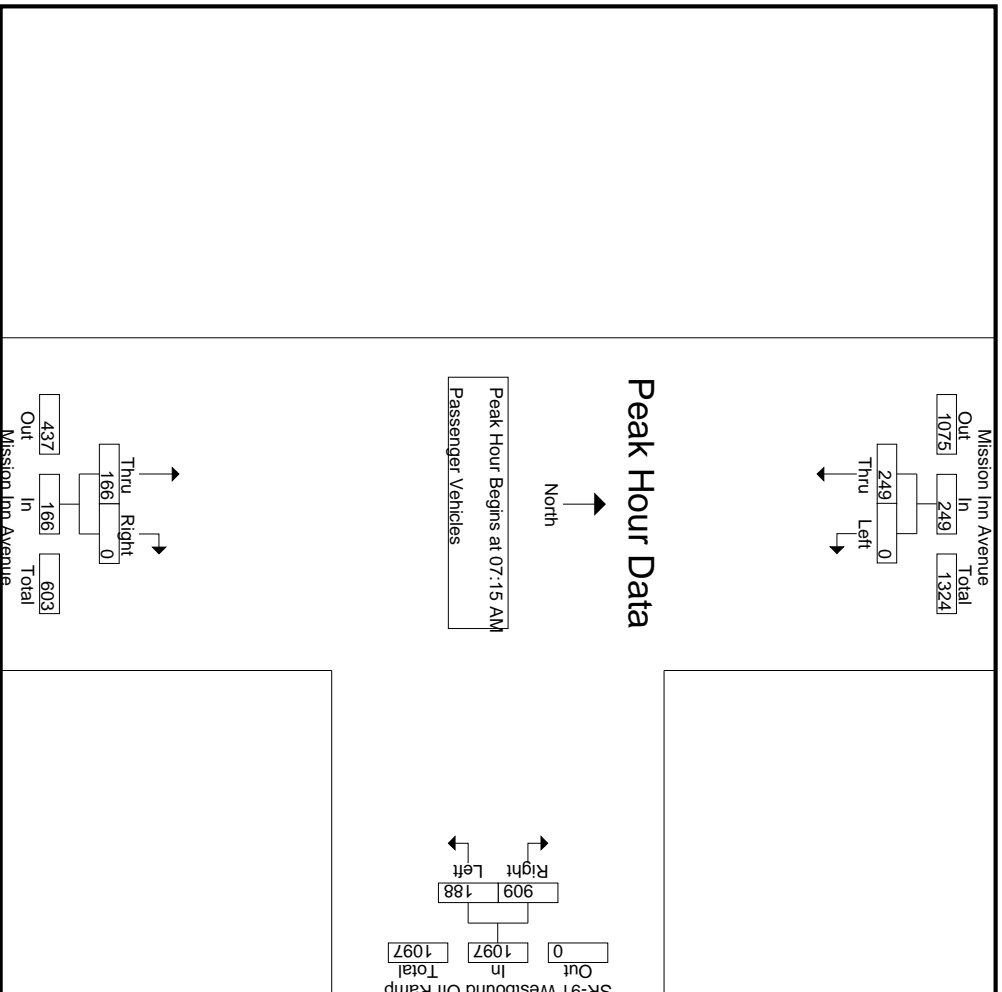

Peak Hour Analysis From 07:15 AM to 08:00 AM - Peak 1 of 1
 Peak Hour for Each Approach Begins at:

	07:15 AM	07:15 AM	07:15 AM	07:15 AM
+0 mins.	0	65	65	0
+15 mins.	0	67	67	0
+30 mins.	0	63	63	0
+45 mins.	0	54	54	0
Total Volume	0	249	249	0
% App. Total	0	100	17.1	0
PHF	.000	.929	.935	.000

City of Riverside
 N/S: Mission Inn Avenue
 E/W: SR-91 Westbound Off Ramp
 Weather: Clear

File Name : 08_RIV_Mission Inn_91W Off AM
 Site Code : 17920060
 Start Date : 1/28/2020
 Page No : 1

Groups Printed- Large 2 Axle Vehicles

Start Time	Mission Inn Avenue Southbound			SR-91 Westbound Off Ramp Westbound			Mission Inn Avenue Northbound			Int. Total
	Left	Thru	App. Total	Left	Right	App. Total	Thru	Right	App. Total	
07:00 AM	0	2	2	1	5	6	4	0	4	12
07:15 AM	0	2	2	1	1	2	1	0	1	5
07:30 AM	0	1	1	3	1	4	3	0	3	8
07:45 AM	0	2	2	4	2	6	0	0	0	8
Total	0	7	7	9	9	18	8	0	8	33
08:00 AM	0	4	4	4	2	6	5	0	5	15
08:15 AM	0	0	0	0	3	3	3	0	3	6
08:30 AM	0	5	5	1	3	4	5	0	5	14
08:45 AM	0	5	5	3	1	4	3	0	3	12
Total	0	14	14	8	9	17	16	0	16	47
Grand Total	0	21	21	17	18	35	24	0	24	80
Apprch %	0	100		48.6	51.4		100	0		
Total %	0	26.2	26.2	21.2	22.5	43.8	30	0	30	

Start Time	Mission Inn Avenue Southbound			SR-91 Westbound Off Ramp Westbound			Mission Inn Avenue Northbound			Int. Total
	Left	Thru	App. Total	Left	Right	App. Total	Thru	Right	App. Total	
07:15 AM	0	2	2	1	1	2	1	0	1	5
07:30 AM	0	1	1	3	1	4	3	0	3	8
07:45 AM	0	2	2	4	2	6	0	0	0	8
08:00 AM	0	4	4	4	2	6	5	0	5	15
Total Volume	0	9	9	12	6	18	9	0	9	36
% App. Total	0	100		66.7	33.3		100	0		
PHF	.000	.563	.563	.750	.750	.750	.450	.000	.450	.600

Peak Hour Analysis From 07:15 AM to 08:00 AM - Peak 1 of 1

Peak Hour for Entire Intersection Begins at 07:15 AM

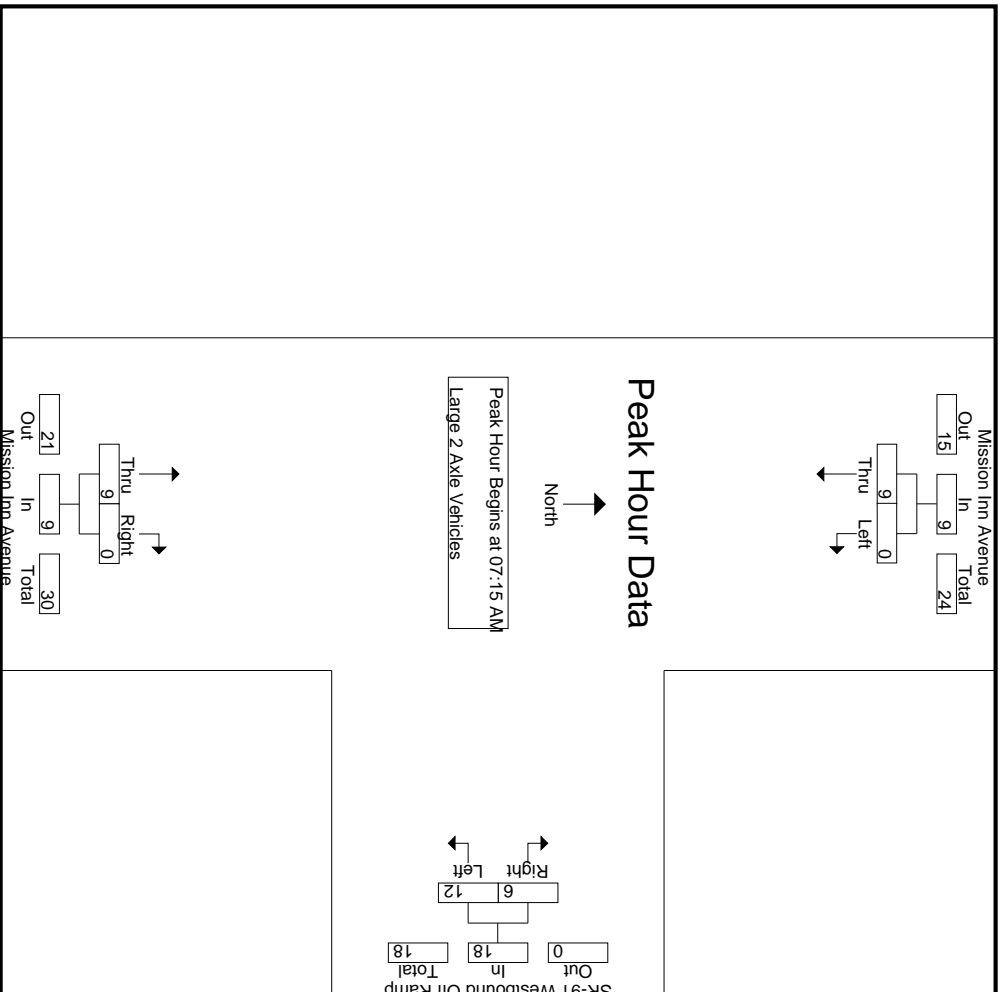

Peak Hour Analysis From 07:15 AM to 08:00 AM - Peak 1 of 1

Peak Hour for Each Approach Begins at:

	07:15 AM	07:15 AM	07:15 AM	07:15 AM
+0 mins.	0	2	2	0
+15 mins.	0	1	1	0
+30 mins.	0	2	2	0
+45 mins.	0	4	4	5
Total Volume	0	9	9	9
% App. Total	0	100	66.7	100
PHF	.000	.563	.563	.450

City of Riverside
 N/S: Mission Inn Avenue
 E/W: SR-91 Westbound Off Ramp
 Weather: Clear

File Name : 08_RIV_Mission Inn_91W Off AM
 Site Code : 17920060
 Start Date : 1/28/2020
 Page No : 1

Groups Printed- 3 Axle Vehicles

Start Time	Mission Inn Avenue Southbound			SR-91 Westbound Off Ramp Westbound			Mission Inn Avenue Northbound			Int. Total
	Left	Thru	App. Total	Left	Right	App. Total	Thru	Right	App. Total	
07:00 AM	0	0	0	0	1	1	0	0	0	1
07:15 AM	0	0	0	0	1	1	0	0	0	1
07:30 AM	0	0	0	2	1	3	0	0	0	3
07:45 AM	0	0	0	0	0	0	0	0	0	0
Total	0	0	0	2	3	5	0	0	0	5
08:00 AM	0	0	0	0	0	0	0	0	0	0
08:15 AM	0	0	0	0	0	0	0	0	0	0
08:30 AM	0	0	0	0	0	0	0	0	0	0
08:45 AM	0	0	0	0	0	0	0	0	0	0
Total	0	0	0	0	0	0	0	0	0	0
Grand Total	0	0	0	2	3	5	0	0	0	5
Apprch %	0	0		40	60		0	0		
Total %	0	0		40	60	100	0	0		

Start Time	Mission Inn Avenue Southbound			SR-91 Westbound Off Ramp Westbound			Mission Inn Avenue Northbound			Int. Total
	Left	Thru	App. Total	Left	Right	App. Total	Thru	Right	App. Total	
07:15 AM	0	0	0	0	1	1	0	0	0	1
07:30 AM	0	0	0	2	1	3	0	0	0	3
07:45 AM	0	0	0	0	0	0	0	0	0	0
08:00 AM	0	0	0	0	0	0	0	0	0	0
Total Volume	0	0	0	2	2	4	0	0	0	4
% App. Total	0	0		50	50		0	0		
PHF	.000	.000	.000	.250	.500	.333	.000	.000	.000	.333

Peak Hour Analysis From 07:15 AM to 08:00 AM - Peak 1 of 1

Peak Hour for Entire Intersection Begins at 07:15 AM

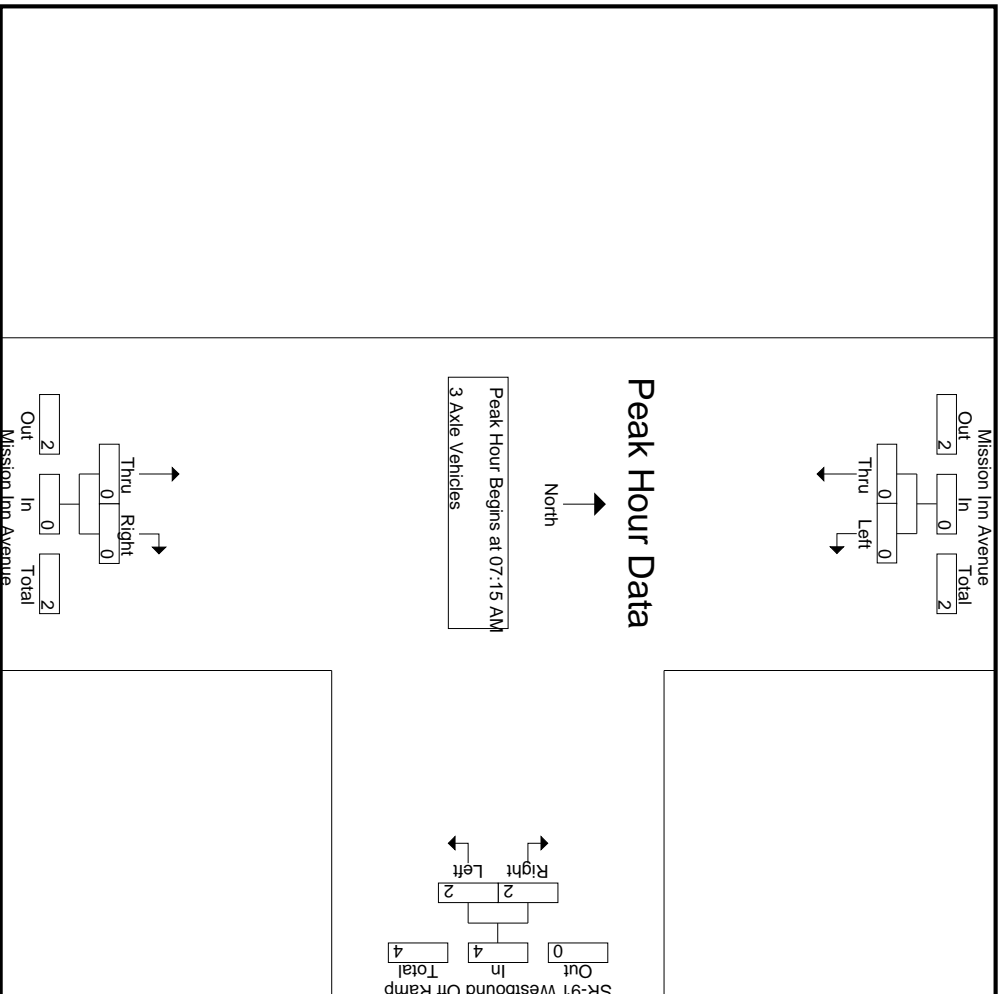

Peak Hour Analysis From 07:15 AM to 08:00 AM - Peak 1 of 1
 Peak Hour for Each Approach Begins at:

	07:15 AM	07:15 AM	07:15 AM	07:15 AM	07:15 AM
+0 mins.	0	0	0	0	0
+15 mins.	0	0	0	0	0
+30 mins.	0	2	1	3	0
+45 mins.	0	0	0	0	0
Total Volume	0	2	2	4	0
% App. Total	0	50	50	0	0
PHF	.000	.250	.500	.333	.000

City of Riverside
 N/S: Mission Inn Avenue
 E/W: SR-91 Westbound Off Ramp
 Weather: Clear

File Name : 08_RIV_Mission Inn_91W Off AM
 Site Code : 17920060
 Start Date : 1/28/2020
 Page No : 1

Groups Printed- 4+ Axle Trucks

Start Time	Mission Inn Avenue Southbound			SR-91 Westbound Off Ramp Westbound			Mission Inn Avenue Northbound			Int. Total
	Left	Thru	App. Total	Left	Right	App. Total	Thru	Right	App. Total	
07:00 AM	0	0	0	0	1	1	0	0	0	1
07:15 AM	0	0	0	0	0	0	0	0	0	0
07:30 AM	0	0	0	0	0	0	0	0	0	0
07:45 AM	0	0	0	0	0	0	0	0	0	0
Total	0	0	0	0	1	1	0	0	0	1
08:00 AM	0	0	0	0	1	1	0	0	0	1
08:15 AM	0	0	0	1	0	1	0	0	0	1
08:30 AM	0	0	0	0	0	0	0	0	0	0
08:45 AM	0	0	0	0	1	1	0	0	0	1
Total	0	0	0	1	2	3	0	0	0	3
Grand Total	0	0	0	1	3	4	0	0	0	4
Apprch %	0	0		25	75		0	0		
Total %	0	0		25	75	100	0	0		

Start Time	Mission Inn Avenue Southbound			SR-91 Westbound Off Ramp Westbound			Mission Inn Avenue Northbound			Int. Total
	Left	Thru	App. Total	Left	Right	App. Total	Thru	Right	App. Total	
07:15 AM	0	0	0	0	0	0	0	0	0	0
07:30 AM	0	0	0	0	0	0	0	0	0	0
07:45 AM	0	0	0	0	0	0	0	0	0	0
08:00 AM	0	0	0	0	1	1	0	0	0	1
Total Volume	0	0	0	0	1	1	0	0	0	1
% App. Total	0	0		0	100		0	0		
PHF	.000	.000	.000	.000	.250	.250	.000	.000	.000	.250

Peak Hour Analysis From 07:15 AM to 08:00 AM - Peak 1 of 1

Peak Hour for Entire Intersection Begins at 07:15 AM

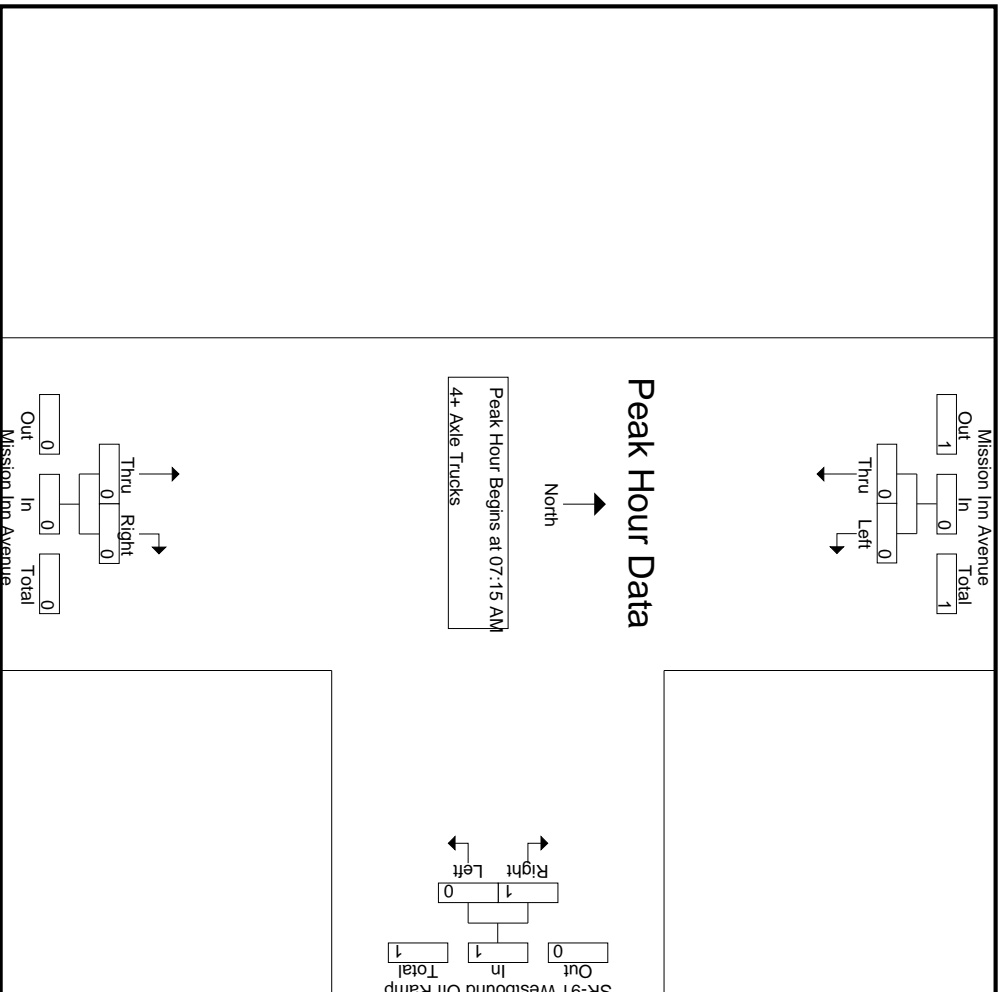

Peak Hour Analysis From 07:15 AM to 08:00 AM - Peak 1 of 1

Peak Hour for Each Approach Begins at:

	07:15 AM	07:15 AM	07:15 AM
+0 mins.	0	0	0
+15 mins.	0	0	0
+30 mins.	0	0	0
+45 mins.	0	0	1
Total Volume	0	0	1
% App. Total	0	0	100
PHF	.000	.000	.250

City of Riverside
 N/S: Mission Inn Avenue
 E/W: SR-91 Westbound Off Ramp
 Weather: Clear

File Name : 08_RIV_Mission Inn_91W Off PM
 Site Code : 17920060
 Start Date : 1/28/2020
 Page No : 1

Groups Printed- Passenger Vehicles - Large 2 Axle Vehicles - 3 Axle Vehicles - 4+ Axle Trucks

Start Time	Mission Inn Avenue Southbound			SR-91 Westbound Off Ramp Westbound			Mission Inn Avenue Northbound			Int. Total
	Left	Thru	App. Total	Left	Right	App. Total	Thru	Right	App. Total	
04:00 PM	0	125	125	58	87	145	50	0	50	320
04:15 PM	0	106	106	55	88	143	54	0	54	303
04:30 PM	0	144	144	59	97	156	55	0	55	355
04:45 PM	0	146	146	47	96	143	65	0	65	354
Total	0	521	521	219	368	587	224	0	224	1332
05:00 PM	0	167	167	39	94	133	60	0	60	360
05:15 PM	0	181	181	57	123	180	59	0	59	420
05:30 PM	0	118	118	44	114	158	43	0	43	319
05:45 PM	0	100	100	53	111	164	47	0	47	311
Total	0	566	566	193	442	635	209	0	209	1410
Grand Total	0	1087	1087	412	810	1222	433	0	433	2742
Apprch %	0	100		33.7	66.3		100	0		
Total %	0	39.6	39.6	15	29.5	44.6	15.8	0	15.8	
Passenger Vehicles	0	1072	1072	406	804	1210	431	0	431	2713
% Passenger Vehicles	0	98.6	98.6	98.5	99.3	99	99.5	0	99.5	98.9
Large 2 Axle Vehicles	0	13	13	3	6	9	2	0	2	24
% Large 2 Axle Vehicles	0	1.2	1.2	0.7	0.7	0.7	0.5	0	0.5	0.9
3 Axle Vehicles	0	1	1	1	0	1	0	0	0	2
% 3 Axle Vehicles	0	0.1	0.1	0.2	0	0.1	0	0	0	0.1
4+ Axle Trucks	0	1	1	2	0	2	0	0	0	3
% 4+ Axle Trucks	0	0.1	0.1	0.5	0	0.2	0	0	0	0.1

Start Time	Mission Inn Avenue Southbound			SR-91 Westbound Off Ramp Westbound			Mission Inn Avenue Northbound			Int. Total
	Left	Thru	App. Total	Left	Right	App. Total	Thru	Right	App. Total	
04:30 PM	0	144	144	59	97	156	55	0	55	355
04:45 PM	0	146	146	47	96	143	65	0	65	354
05:00 PM	0	167	167	39	94	133	60	0	60	360
05:15 PM	0	181	181	57	123	180	59	0	59	420
Total Volume	0	638	638	202	410	612	239	0	239	1489
% App. Total	0	100		33	67		100	0		
PHF	.000	.881	.881	.856	.833	.850	.919	.000	.919	.886

Peak Hour Analysis From 04:00 PM to 05:45 PM - Peak 1 of 1
 Peak Hour for Entire Intersection Begins at 04:30 PM

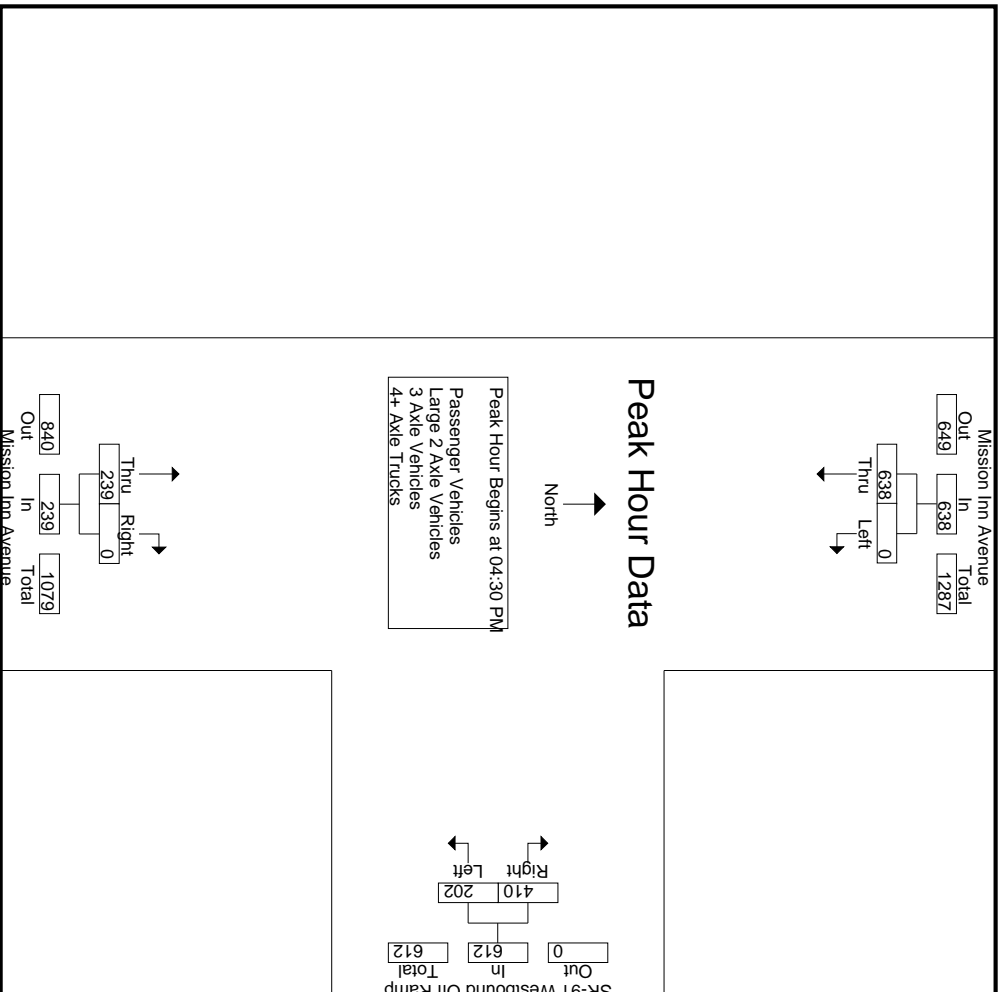

Peak Hour Analysis From 04:00 PM to 05:45 PM - Peak 1 of 1
 Peak Hour for Each Approach Begins at:

	04:30 PM	05:00 PM	04:30 PM
+0 mins.	0	39	0
+15 mins.	144	57	65
+30 mins.	146	44	60
+45 mins.	167	53	59
Total Volume	0	193	0
% App. Total	0	30.4	0
PHF	.000	.846	.000
	.881	.898	.882
			.919

City of Riverside
 N/S: Mission Inn Avenue
 E/W: SR-91 Westbound Off Ramp
 Weather: Clear

File Name : 08_RIV_Mission Inn_91W Off PM
 Site Code : 17920060
 Start Date : 1/28/2020
 Page No : 1

Groups Printed- Passenger Vehicles

Start Time	Mission Inn Avenue Southbound			SR-91 Westbound Off Ramp Westbound			Mission Inn Avenue Northbound			Int. Total
	Left	Thru	App. Total	Left	Right	App. Total	Thru	Right	App. Total	
04:00 PM	0	124	124	58	87	145	50	0	50	319
04:15 PM	0	105	105	54	88	142	53	0	53	300
04:30 PM	0	143	143	59	97	156	54	0	54	353
04:45 PM	0	140	140	47	94	141	65	0	65	346
Total	0	512	512	218	366	584	222	0	222	1318
05:00 PM	0	167	167	37	93	130	60	0	60	357
05:15 PM	0	179	179	56	123	179	59	0	59	417
05:30 PM	0	115	115	43	112	155	43	0	43	313
05:45 PM	0	99	99	52	110	162	47	0	47	308
Total	0	560	560	188	438	626	209	0	209	1395
Grand Total	0	1072	1072	406	804	1210	431	0	431	2713
Apprch %	0	100		33.6	66.4		100	0		
Total %	0	39.5	39.5	15	29.6	44.6	15.9	0	15.9	

Start Time	Mission Inn Avenue Southbound			SR-91 Westbound Off Ramp Westbound			Mission Inn Avenue Northbound			Int. Total
	Left	Thru	App. Total	Left	Right	App. Total	Thru	Right	App. Total	
04:30 PM	0	143	143	59	97	156	54	0	54	353
04:45 PM	0	140	140	47	94	141	65	0	65	346
05:00 PM	0	167	167	37	93	130	60	0	60	357
05:15 PM	0	179	179	56	123	179	59	0	59	417
Total Volume	0	629	629	199	407	606	238	0	238	1473
% App. Total	0	100		32.8	67.2		100	0		
PHF	.000	.878	.878	.843	.827	.846	.915	.000	.915	.883

Peak Hour Analysis From 04:30 PM to 05:15 PM - Peak 1 of 1

Peak Hour for Entire Intersection Begins at 04:30 PM

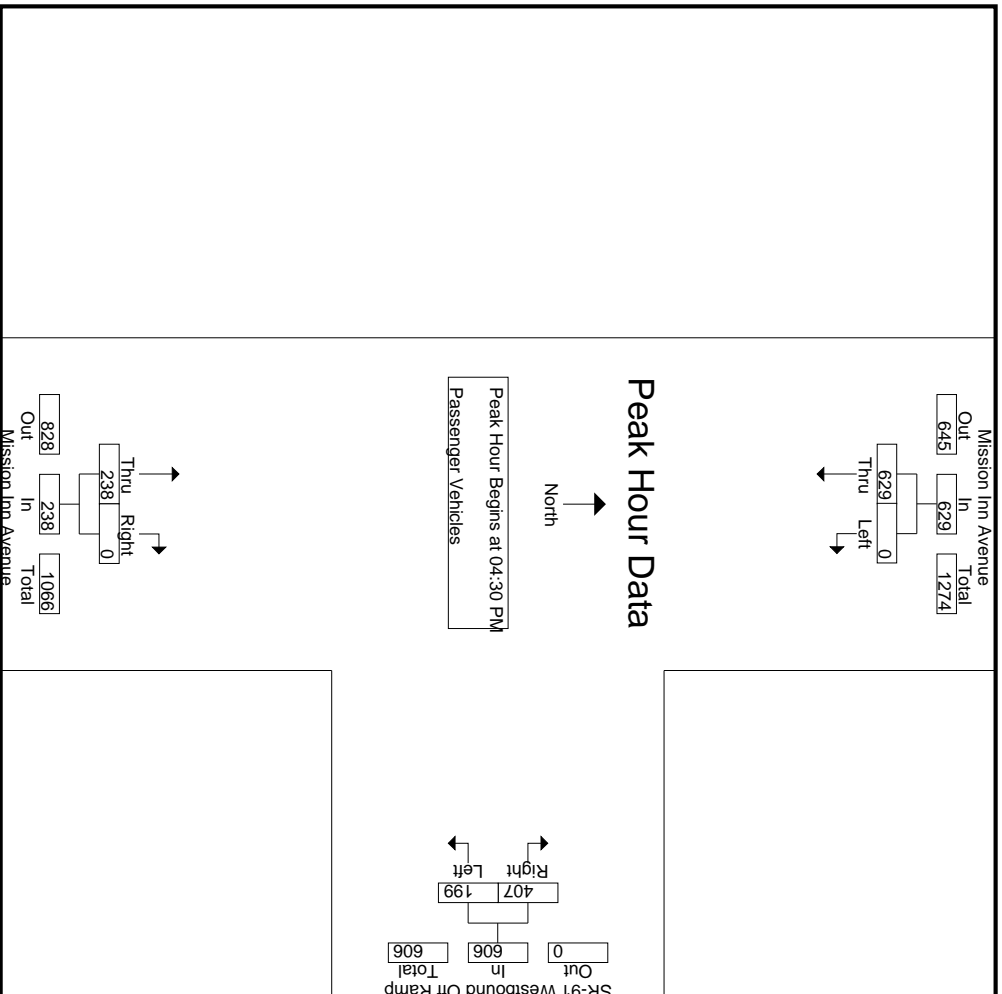

Peak Hour Analysis From 04:30 PM to 05:15 PM - Peak 1 of 1

Peak Hour for Each Approach Begins at:

	04:30 PM	04:30 PM	04:30 PM	04:30 PM
+0 mins.	0	143	143	0
+15 mins.	0	140	140	0
+30 mins.	0	167	167	0
+45 mins.	0	179	179	0
Total Volume	0	629	629	0
% App. Total	0	100	32.8	100
PHF	.000	.878	.878	.915

City of Riverside
 N/S: Mission Inn Avenue
 E/W: SR-91 Westbound Off Ramp
 Weather: Clear

File Name : 08_RIV_Mission Inn_91W Off PM
 Site Code : 17920060
 Start Date : 1/28/2020
 Page No : 1

Groups Printed- Large 2 Axle Vehicles

Start Time	Mission Inn Avenue Southbound			SR-91 Westbound Off Ramp Westbound			Mission Inn Avenue Northbound			Int. Total
	Left	Thru	App. Total	Left	Right	App. Total	Thru	Right	App. Total	
04:00 PM	0	1	1	0	0	0	0	0	0	1
04:15 PM	0	1	1	1	0	1	1	0	1	3
04:30 PM	0	1	1	0	0	0	1	0	1	2
04:45 PM	0	5	5	0	2	2	0	0	0	7
Total	0	8	8	1	2	3	2	0	2	13
05:00 PM	0	0	0	1	1	2	0	0	0	2
05:15 PM	0	1	1	1	0	1	0	0	0	2
05:30 PM	0	3	3	0	2	2	0	0	0	5
05:45 PM	0	1	1	0	1	1	0	0	0	2
Total	0	5	5	2	4	6	0	0	0	11
Grand Total	0	13	13	3	6	9	2	0	2	24
Apprch %	0	100		33.3	66.7		100	0		
Total %	0	54.2	54.2	12.5	25	37.5	8.3	0	8.3	

Start Time	Mission Inn Avenue Southbound			SR-91 Westbound Off Ramp Westbound			Mission Inn Avenue Northbound			Int. Total
	Left	Thru	App. Total	Left	Right	App. Total	Thru	Right	App. Total	
04:30 PM	0	1	1	0	0	0	1	0	1	2
04:45 PM	0	5	5	0	2	2	0	0	0	7
05:00 PM	0	0	0	1	1	2	0	0	0	2
05:15 PM	0	1	1	1	0	1	0	0	0	2
Total Volume	0	7	7	2	3	5	1	0	1	13
% App. Total	0	100		40	60		100	0		
PHF	.000	.350	.350	.500	.375	.625	.250	.000	.250	.464

Peak Hour Analysis From 04:30 PM to 05:15 PM - Peak 1 of 1

Peak Hour for Entire Intersection Begins at 04:30 PM

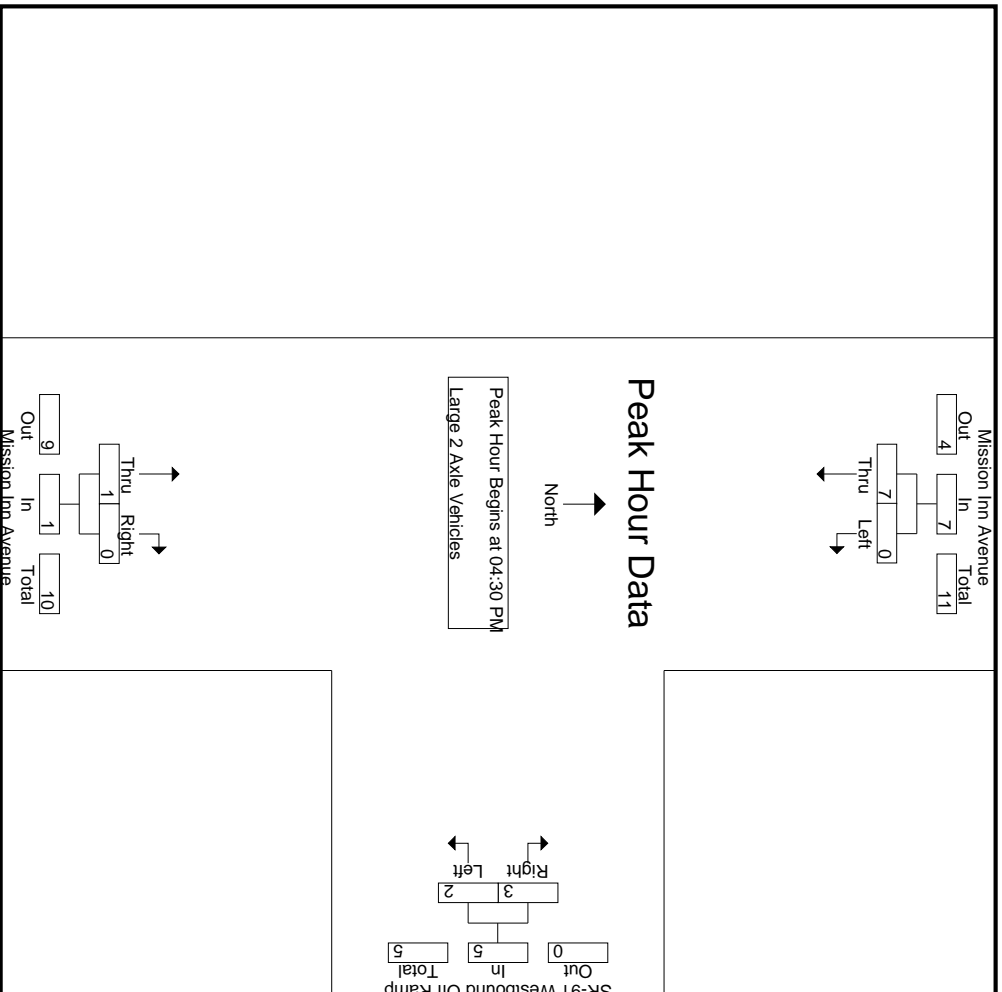

Peak Hour Analysis From 04:30 PM to 05:15 PM - Peak 1 of 1
 Peak Hour for Each Approach Begins at:

	04:30 PM	04:30 PM	04:30 PM
+0 mins.	0	1	1
+15 mins.	0	5	5
+30 mins.	0	0	0
+45 mins.	0	1	1
Total Volume	0	7	7
% App. Total	0	100	40
PHF	.000	.350	.625
			.250

City of Riverside
 N/S: Mission Inn Avenue
 E/W: SR-91 Westbound Off Ramp
 Weather: Clear

File Name : 08_RIV_Mission Inn_91W Off PM
 Site Code : 17920060
 Start Date : 1/28/2020
 Page No : 1

Groups Printed- 3 Axle Vehicles

Start Time	Mission Inn Avenue Southbound			SR-91 Westbound Off Ramp Westbound			Mission Inn Avenue Northbound			Int. Total
	Left	Thru	App. Total	Left	Right	App. Total	Thru	Right	App. Total	
04:00 PM	0	0	0	0	0	0	0	0	0	0
04:15 PM	0	0	0	0	0	0	0	0	0	0
04:30 PM	0	0	0	0	0	0	0	0	0	0
04:45 PM	0	0	0	0	0	0	0	0	0	0
Total	0	0	0	0	0	0	0	0	0	0
05:00 PM	0	0	0	1	0	1	0	0	0	1
05:15 PM	0	1	1	0	0	0	0	0	0	1
05:30 PM	0	0	0	0	0	0	0	0	0	0
05:45 PM	0	0	0	0	0	0	0	0	0	0
Total	0	1	1	1	0	1	0	0	0	2
Grand Total	0	1	1	1	0	1	0	0	0	2
Apprch %	0	100		100	0		0	0		
Total %	0	50	50	50	0	50	0	0	0	

Start Time	Mission Inn Avenue Southbound			SR-91 Westbound Off Ramp Westbound			Mission Inn Avenue Northbound			Int. Total
	Left	Thru	App. Total	Left	Right	App. Total	Thru	Right	App. Total	
04:30 PM	0	0	0	0	0	0	0	0	0	0
04:45 PM	0	0	0	0	0	0	0	0	0	0
05:00 PM	0	0	0	1	0	1	0	0	0	1
05:15 PM	0	1	1	0	0	0	0	0	0	1
Total Volume	0	1	1	1	0	1	0	0	0	2
% App. Total	0	100		100	0		0	0		
PHF	.000	.250	.250	.250	.000	.250	.000	.000	.000	.500

Peak Hour Analysis From 04:30 PM to 05:15 PM - Peak 1 of 1
 Peak Hour for Entire Intersection Begins at 04:30 PM

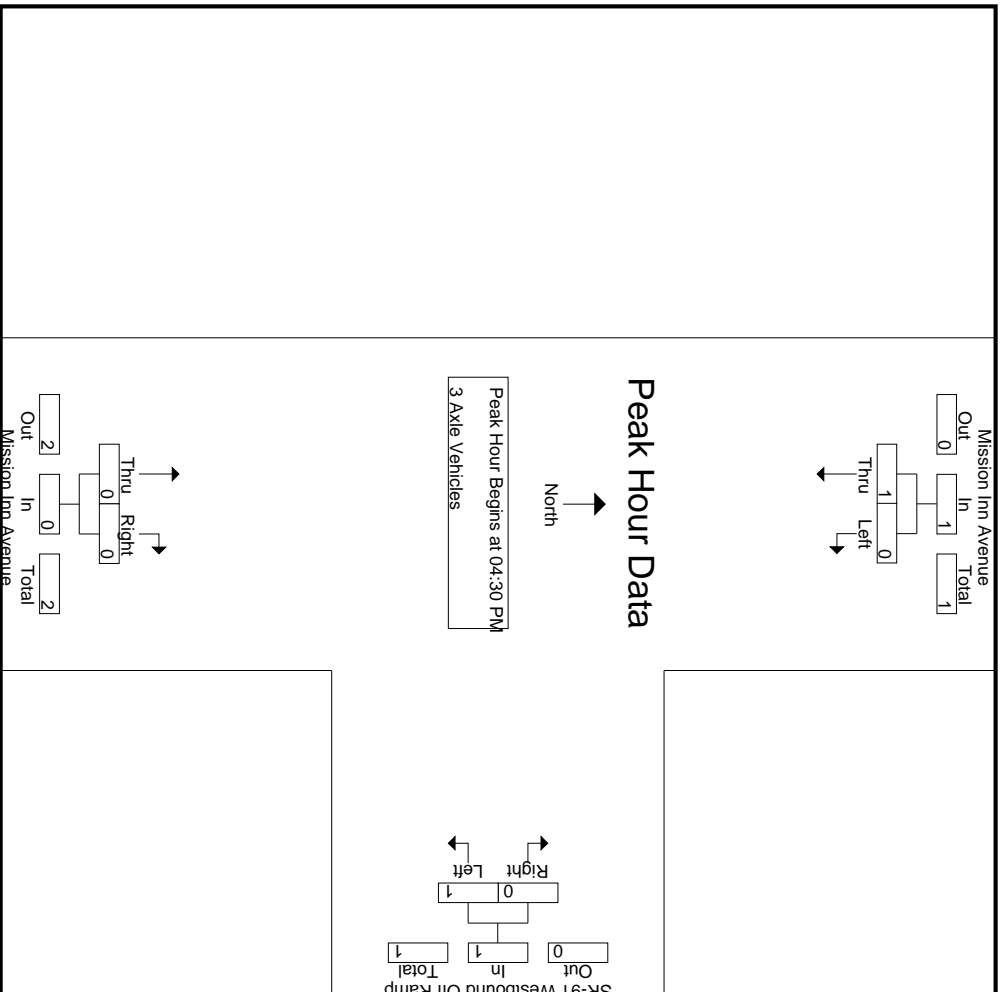

Peak Hour Analysis From 04:30 PM to 05:15 PM - Peak 1 of 1
 Peak Hour for Each Approach Begins at:

	04:30 PM	04:30 PM	04:30 PM	04:30 PM
+0 mins.	0	0	0	0
+15 mins.	0	0	0	0
+30 mins.	0	0	1	0
+45 mins.	0	1	0	0
Total Volume	0	1	0	0
% App. Total	0	100	0	0
PHF	.000	.250	.250	.000

City of Riverside
 N/S: Mission Inn Avenue
 E/W: SR-91 Westbound Off Ramp
 Weather: Clear

File Name : 08_RIV_Mission Inn_91W Off PM
 Site Code : 17920060
 Start Date : 1/28/2020
 Page No : 1

Groups Printed- 4+ Axle Trucks

Start Time	Mission Inn Avenue Southbound			SR-91 Westbound Off Ramp Westbound			Mission Inn Avenue Northbound			Int. Total
	Left	Thru	App. Total	Left	Right	App. Total	Thru	Right	App. Total	
04:00 PM	0	0	0	0	0	0	0	0	0	0
04:15 PM	0	0	0	0	0	0	0	0	0	0
04:30 PM	0	0	0	0	0	0	0	0	0	0
04:45 PM	0	1	1	0	0	0	0	0	0	1
Total	0	1	1	0	0	0	0	0	0	1
05:00 PM	0	0	0	0	0	0	0	0	0	0
05:15 PM	0	0	0	0	0	0	0	0	0	0
05:30 PM	0	0	0	1	0	1	0	0	0	1
05:45 PM	0	0	0	1	0	1	0	0	0	1
Total	0	0	0	2	0	2	0	0	0	2
Grand Total	0	1	1	2	0	2	0	0	0	3
Apprch %	0	100		100	0		0	0		
Total %	0	33.3	33.3	66.7	0	66.7	0	0	0	

Start Time	Mission Inn Avenue Southbound			SR-91 Westbound Off Ramp Westbound			Mission Inn Avenue Northbound			Int. Total
	Left	Thru	App. Total	Left	Right	App. Total	Thru	Right	App. Total	
04:30 PM	0	0	0	0	0	0	0	0	0	0
04:45 PM	0	1	1	0	0	0	0	0	0	1
05:00 PM	0	0	0	0	0	0	0	0	0	0
05:15 PM	0	0	0	0	0	0	0	0	0	0
Total Volume	0	1	1	0	0	0	0	0	0	1
% App. Total	0	100		0	0		0	0		
PHF	.000	.250	.250	.000	.000	.000	.000	.000	.000	.250

Peak Hour Analysis From 04:30 PM to 05:15 PM - Peak 1 of 1
 Peak Hour for Entire Intersection Begins at 04:30 PM

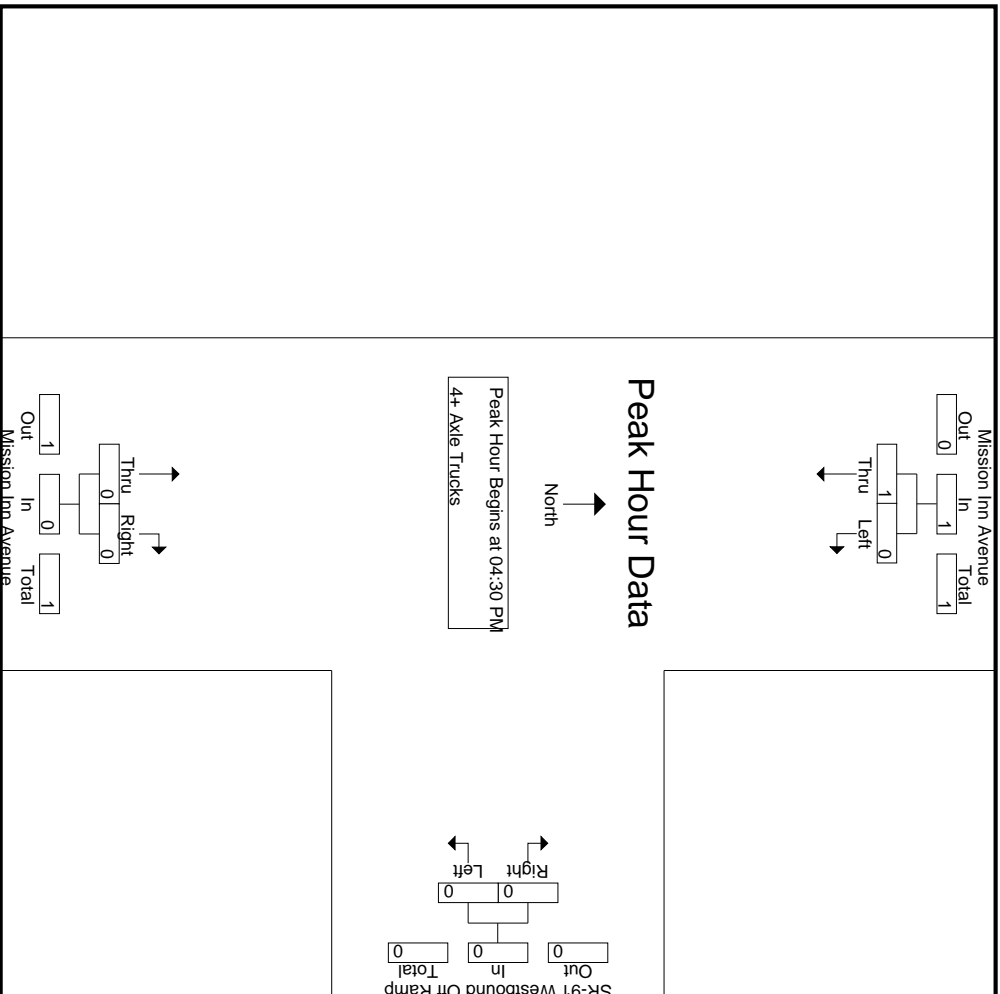

Peak Hour Analysis From 04:30 PM to 05:15 PM - Peak 1 of 1
 Peak Hour for Each Approach Begins at:

	04:30 PM	04:30 PM	04:30 PM	04:30 PM	04:30 PM
+0 mins.	0	0	0	0	0
+15 mins.	0	1	0	1	0
+30 mins.	0	0	0	0	0
+45 mins.	0	0	0	0	0
Total Volume	0	1	0	1	0
% App. Total	0	100	0	0	0
PHF	.000	.250	.250	.000	.000

City of Riverside
 N/S: Mission Inn Avenue
 E/W: Mulberry Street
 Weather: Clear

File Name : 09_RIV_Mission Inn_Mulberry AM
 Site Code : 17920060
 Start Date : 1/28/2020
 Page No : 1

Groups Printed- Total Volume

Start Time	Mission Inn Avenue Southbound				Mulberry Street Westbound				Mission Inn Avenue Northbound				Mulberry Street Eastbound				Int. Total
	Left	Thru	Right	App. Total	Left	Thru	Right	App. Total	Left	Thru	Right	App. Total	Left	Thru	Right	App. Total	
07:00 AM	49	46	0	95	0	0	0	0	0	15	22	37	31	55	12	98	230
07:15 AM	53	50	0	103	0	0	0	0	0	9	24	33	37	60	12	109	245
07:30 AM	58	59	0	117	0	0	0	0	0	18	10	28	18	77	14	109	254
07:45 AM	47	67	0	114	0	0	0	0	0	15	17	32	34	60	19	113	259
Total	207	222	0	429	0	0	0	0	0	57	73	130	120	252	57	429	988
08:00 AM	54	54	0	108	0	0	0	0	0	17	27	44	26	55	20	101	253
08:15 AM	38	43	0	81	0	0	0	0	0	20	23	43	32	46	11	89	213
08:30 AM	47	33	0	80	0	0	0	0	0	28	12	40	21	42	18	81	201
08:45 AM	34	52	0	86	0	0	0	0	0	20	11	31	15	49	7	71	188
Total	173	182	0	355	0	0	0	0	0	85	73	158	94	192	56	342	855
Grand Total	380	404	0	784	0	0	0	0	0	142	146	288	214	444	113	771	1843
Apprch %	48.5	51.5	0		0	0	0		0	49.3	50.7		27.8	57.6	14.7		
Total %	20.6	21.9	0	42.5	0	0	0	0	0	7.7	7.9	15.6	11.6	24.1	6.1	41.8	

Start Time	Mission Inn Avenue Southbound				Mulberry Street Westbound				Mission Inn Avenue Northbound				Mulberry Street Eastbound				Int. Total
	Left	Thru	Right	App. Total	Left	Thru	Right	App. Total	Left	Thru	Right	App. Total	Left	Thru	Right	App. Total	
Peak Hour Analysis From 07:00 AM to 08:45 AM - Peak 1 of 1																	
Peak Hour for Entire Intersection Begins at 07:15 AM																	
07:15 AM	53	50	0	103	0	0	0	0	0	9	24	33	37	60	12	109	245
07:30 AM	58	59	0	117	0	0	0	0	0	18	10	28	18	77	14	109	254
07:45 AM	47	67	0	114	0	0	0	0	0	15	17	32	34	60	19	113	259
08:00 AM	54	54	0	108	0	0	0	0	0	17	27	44	26	55	20	101	253
Total Volume	212	230	0	442	0	0	0	0	0	59	78	137	115	252	65	432	1011
% App. Total	48	52	0		0	0	0		0	43.1	56.9		26.6	58.3	15		
PHF	.914	.858	.000	.944	.000	.000	.000	.000	.000	.819	.722	.778	.777	.818	.813	.956	.976

City of Riverside
 N/S: Mission Inn Avenue
 E/W: Mulberry Street
 Weather: Clear

File Name : 09_RIV_Mission Inn_Mulberry AM
 Site Code : 17920060
 Start Date : 1/28/2020
 Page No : 2

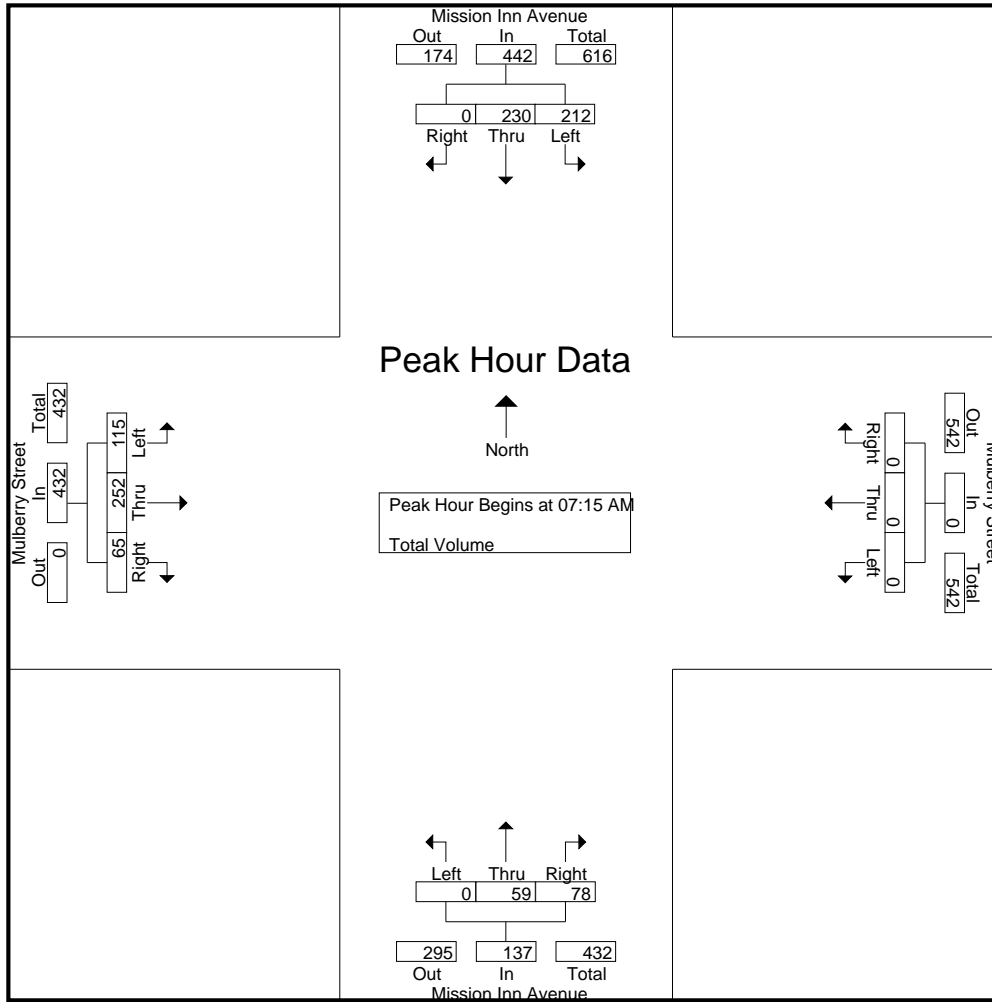

Peak Hour Analysis From 07:00 AM to 08:45 AM - Peak 1 of 1
 Peak Hour for Each Approach Begins at:

	07:15 AM				07:00 AM				07:45 AM				07:15 AM			
+0 mins.	53	50	0	103	0	0	0	0	0	15	17	32	37	60	12	109
+15 mins.	58	59	0	117	0	0	0	0	0	17	27	44	18	77	14	109
+30 mins.	47	67	0	114	0	0	0	0	0	20	23	43	34	60	19	113
+45 mins.	54	54	0	108	0	0	0	0	0	28	12	40	26	55	20	101
Total Volume	212	230	0	442	0	0	0	0	0	80	79	159	115	252	65	432
% App. Total	48	52	0		0	0	0		0	50.3	49.7		26.6	58.3	15	
PHF	.914	.858	.000	.944	.000	.000	.000	.000	.000	.714	.731	.903	.777	.818	.813	.956

City of Riverside
 N/S: Mission Inn Avenue
 E/W: Mulberry Street
 Weather: Clear

File Name : 09_RIV_Mission Inn_Mulberry PM
 Site Code : 17920060
 Start Date : 1/28/2020
 Page No : 1

Groups Printed- Total Volume

Start Time	Mission Inn Avenue Southbound				Mulberry Street Westbound				Mission Inn Avenue Northbound				Mulberry Street Eastbound				Int. Total
	Left	Thru	Right	App. Total	Left	Thru	Right	App. Total	Left	Thru	Right	App. Total	Left	Thru	Right	App. Total	
04:00 PM	96	90	0	186	0	0	0	0	0	30	39	69	20	78	9	107	362
04:15 PM	60	94	0	154	0	0	0	0	0	33	24	57	23	75	18	116	327
04:30 PM	89	116	0	205	0	0	0	0	0	33	41	74	22	97	10	129	408
04:45 PM	92	102	0	194	0	0	0	0	0	37	64	101	29	92	12	133	428
Total	337	402	0	739	0	0	0	0	0	133	168	301	94	342	49	485	1525
05:00 PM	120	100	0	220	0	0	0	0	0	37	75	112	22	132	14	168	500
05:15 PM	95	122	0	217	0	0	0	0	0	33	45	78	25	90	8	123	418
05:30 PM	64	100	0	164	0	0	0	0	0	28	23	51	20	80	11	111	326
05:45 PM	62	88	0	150	0	0	0	0	0	28	32	60	22	71	25	118	328
Total	341	410	0	751	0	0	0	0	0	126	175	301	89	373	58	520	1572
Grand Total	678	812	0	1490	0	0	0	0	0	259	343	602	183	715	107	1005	3097
Apprch %	45.5	54.5	0		0	0	0		0	43	57		18.2	71.1	10.6		
Total %	21.9	26.2	0	48.1	0	0	0	0	0	8.4	11.1	19.4	5.9	23.1	3.5	32.5	

Start Time	Mission Inn Avenue Southbound				Mulberry Street Westbound				Mission Inn Avenue Northbound				Mulberry Street Eastbound				Int. Total
	Left	Thru	Right	App. Total	Left	Thru	Right	App. Total	Left	Thru	Right	App. Total	Left	Thru	Right	App. Total	
Peak Hour Analysis From 04:00 PM to 05:45 PM - Peak 1 of 1																	
Peak Hour for Entire Intersection Begins at 04:30 PM																	
04:30 PM	89	116	0	205	0	0	0	0	0	33	41	74	22	97	10	129	408
04:45 PM	92	102	0	194	0	0	0	0	0	37	64	101	29	92	12	133	428
05:00 PM	120	100	0	220	0	0	0	0	0	37	75	112	22	132	14	168	500
05:15 PM	95	122	0	217	0	0	0	0	0	33	45	78	25	90	8	123	418
Total Volume	396	440	0	836	0	0	0	0	0	140	225	365	98	411	44	553	1754
% App. Total	47.4	52.6	0		0	0	0		0	38.4	61.6		17.7	74.3	8		
PHF	.825	.902	.000	.950	.000	.000	.000	.000	.000	.946	.750	.815	.845	.778	.786	.823	.877

City of Riverside
 N/S: Mission Inn Avenue
 E/W: Mulberry Street
 Weather: Clear

File Name : 09_RIV_Mission Inn_Mulberry PM
 Site Code : 17920060
 Start Date : 1/28/2020
 Page No : 2

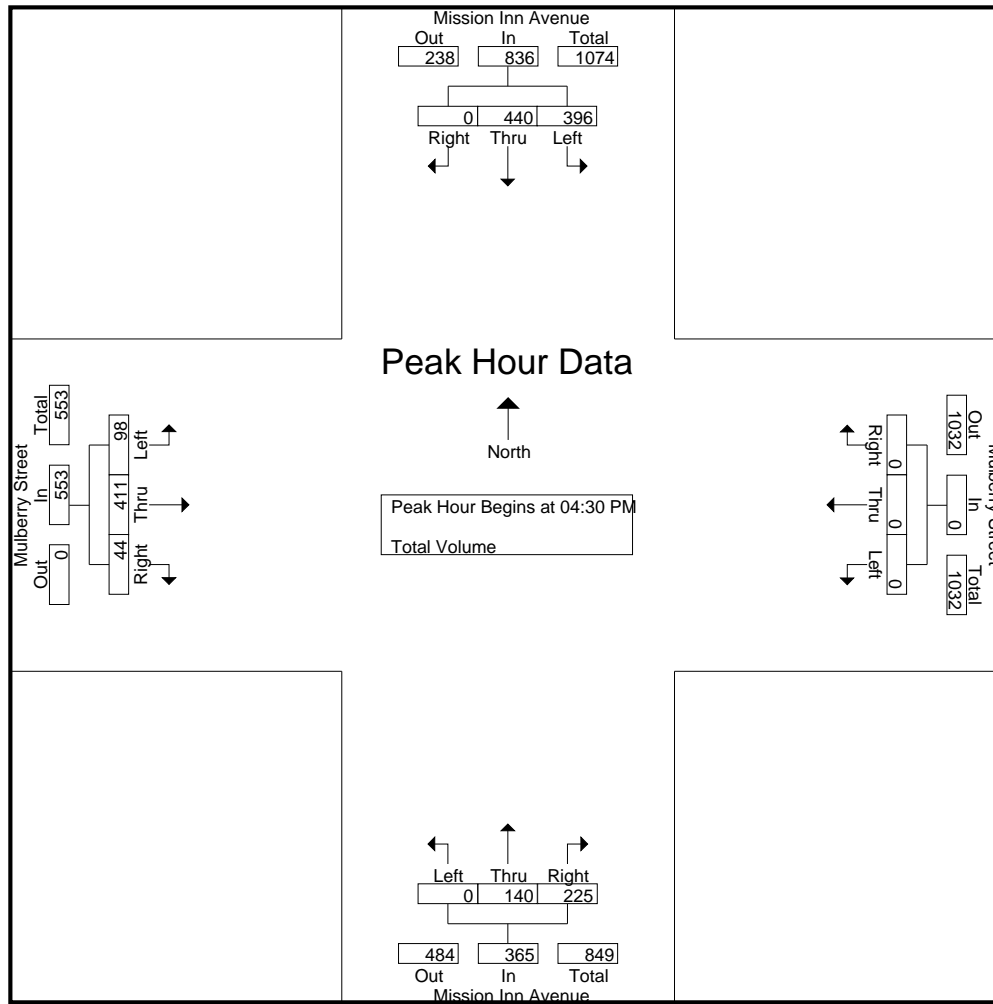

Peak Hour Analysis From 04:00 PM to 05:45 PM - Peak 1 of 1
 Peak Hour for Each Approach Begins at:

	04:30 PM				04:00 PM				04:30 PM				04:30 PM			
+0 mins.	89	116	0	205	0	0	0	0	0	33	41	74	22	97	10	129
+15 mins.	92	102	0	194	0	0	0	0	0	37	64	101	29	92	12	133
+30 mins.	120	100	0	220	0	0	0	0	0	37	75	112	22	132	14	168
+45 mins.	95	122	0	217	0	0	0	0	0	33	45	78	25	90	8	123
Total Volume	396	440	0	836	0	0	0	0	0	140	225	365	98	411	44	553
% App. Total	47.4	52.6	0		0	0	0		0	38.4	61.6		17.7	74.3	8	
PHF	.825	.902	.000	.950	.000	.000	.000	.000	.000	.946	.750	.815	.845	.778	.786	.823

National Data & Surveying Services

Intersection Turning Movement Count

Location: Commerce St & Mission Inn Ave
 City: Riverside
 Control: 2-Way Stop (NB/SB)

Project ID: 19-06052-004
 Date: 4/30/2019

Total

NS/EW Streets:	Commerce St				Commerce St				Mission Inn Ave				Mission Inn Ave				TOTAL
	NORTHBOUND				SOUTHBOUND				EASTBOUND				WESTBOUND				
AM	0	1	0	0	0	1	0	0	0	1	1	0	0	2	0	0	TOTAL
	NL	NT	NR	NU	SL	ST	SR	SU	EL	ET	ER	EU	WL	WT	WR	WU	
7:00 AM	6	0	0	0	2	3	5	0	4	16	11	0	1	18	0	0	66
7:15 AM	8	0	1	0	0	6	4	0	3	22	7	1	2	24	0	0	78
7:30 AM	9	3	0	0	0	3	5	0	4	17	4	0	1	22	1	0	69
7:45 AM	4	1	1	0	3	5	2	0	4	30	10	0	1	23	0	0	84
8:00 AM	4	1	0	0	0	6	2	0	1	21	9	0	0	22	1	0	67
8:15 AM	6	0	0	0	0	3	2	0	1	17	3	0	1	19	0	0	52
8:30 AM	3	1	2	0	2	1	3	0	3	11	1	1	0	15	1	1	45
8:45 AM	10	2	1	0	1	2	1	0	2	19	2	0	1	13	0	0	54
TOTAL VOLUMES:	NL	NT	NR	NU	SL	ST	SR	SU	EL	ET	ER	EU	WL	WT	WR	WU	TOTAL
	50	8	5	0	8	29	24	0	22	153	47	2	7	156	3	1	515
APPROACH %'s:	79.37%	12.70%	7.94%	0.00%	13.11%	47.54%	39.34%	0.00%	9.82%	68.30%	20.98%	0.89%	4.19%	93.41%	1.80%	0.60%	
PEAK HR:	07:15 AM - 08:15 AM																TOTAL
PEAK HR VOL:	25	5	2	0	3	20	13	0	12	90	30	1	4	91	2	0	298
PEAK HR FACTOR:	0.694	0.417	0.500	0.000	0.250	0.833	0.650	0.000	0.750	0.750	0.750	0.250	0.500	0.948	0.500	0.000	0.887
	0.667				0.900				0.756				0.933				
PM	0	1	0	0	0	1	0	0	0	1	1	0	0	2	0	0	TOTAL
	NL	NT	NR	NU	SL	ST	SR	SU	EL	ET	ER	EU	WL	WT	WR	WU	
4:00 PM	4	5	1	0	0	8	2	0	6	63	8	0	1	17	2	0	117
4:15 PM	5	4	0	0	4	8	4	0	1	57	14	0	0	11	1	0	109
4:30 PM	10	1	0	0	2	6	5	0	3	63	10	0	1	26	0	0	127
4:45 PM	9	2	2	0	1	12	2	0	4	68	16	1	0	20	2	1	140
5:00 PM	10	2	1	0	0	8	1	0	6	66	17	0	1	27	0	0	139
5:15 PM	6	1	3	0	2	10	3	0	4	62	9	0	4	25	2	0	131
5:30 PM	8	13	4	0	1	9	2	0	3	62	12	0	0	16	1	0	131
5:45 PM	8	3	1	0	3	8	3	0	3	73	23	0	0	12	2	0	139
TOTAL VOLUMES:	NL	NT	NR	NU	SL	ST	SR	SU	EL	ET	ER	EU	WL	WT	WR	WU	TOTAL
	60	31	12	0	13	69	22	0	30	514	109	1	7	154	10	1	1033
APPROACH %'s:	58.25%	30.10%	11.65%	0.00%	12.50%	66.35%	21.15%	0.00%	4.59%	78.59%	16.67%	0.15%	4.07%	89.53%	5.81%	0.58%	
PEAK HR:	04:45 PM - 05:45 PM																TOTAL
PEAK HR VOL:	33	18	10	0	4	39	8	0	17	258	54	1	5	88	5	1	541
PEAK HR FACTOR:	0.825	0.346	0.625	0.000	0.500	0.813	0.667	0.000	0.708	0.949	0.794	0.250	0.313	0.815	0.625	0.250	0.966
	0.610				0.850				0.927				0.798				

National Data & Surveying Services

Intersection Turning Movement Count

Location: Commerce St & Mission Inn Ave
City: Riverside
Control: 2-Way Stop (NB/SB)

Project ID: 19-06052-004
Date: 4/30/2019

Cars

NS/EW Streets:	Commerce St				Commerce St				Mission Inn Ave				Mission Inn Ave				
AM	NORTHBOUND				SOUTHBOUND				EASTBOUND				WESTBOUND				TOTAL
	NL	NT	NR	NU	SL	ST	SR	SU	EL	ET	ER	EU	WL	WT	WR	WU	
7:00 AM	6	0	0	0	2	3	4	0	3	15	10	0	1	18	0	0	62
7:15 AM	7	0	1	0	0	6	4	0	3	22	6	1	2	24	0	0	76
7:30 AM	9	3	0	0	0	3	5	0	3	17	4	0	1	21	1	0	67
7:45 AM	3	1	1	0	3	5	2	0	4	29	10	0	1	22	0	0	81
8:00 AM	4	1	0	0	0	6	2	0	1	20	9	0	0	22	1	0	66
8:15 AM	6	0	0	0	0	3	2	0	1	17	3	0	1	15	0	0	48
8:30 AM	3	1	2	0	2	1	3	0	3	11	1	1	0	14	1	1	44
8:45 AM	10	2	1	0	1	2	1	0	2	19	2	0	1	12	0	0	53
TOTAL VOLUMES :	NL	NT	NR	NU	SL	ST	SR	SU	EL	ET	ER	EU	WL	WT	WR	WU	TOTAL
	48	8	5	0	8	29	23	0	20	150	45	2	7	148	3	1	497
APPROACH %'s :	78.69%	13.11%	8.20%	0.00%	13.33%	48.33%	38.33%	0.00%	9.22%	69.12%	20.74%	0.92%	4.40%	93.08%	1.89%	0.63%	
PEAK HR :	07:15 AM - 08:15 AM																TOTAL
PEAK HR VOL :	23	5	2	0	3	20	13	0	11	88	29	1	4	89	2	0	290
PEAK HR FACTOR :	0.64	0.417	0.500	0.000	0.250	0.833	0.650	0.000	0.688	0.759	0.725	0.250	0.500	0.927	0.500	0.000	0.895
	0.625				0.900				0.750				0.913				
PM	NORTHBOUND				SOUTHBOUND				EASTBOUND				WESTBOUND				TOTAL
	NL	NT	NR	NU	SL	ST	SR	SU	EL	ET	ER	EU	WL	WT	WR	WU	
4:00 PM	4	5	1	0	0	8	2	0	6	63	8	0	1	17	2	0	117
4:15 PM	5	3	0	0	4	8	3	0	1	55	14	0	0	11	1	0	105
4:30 PM	10	1	0	0	2	6	5	0	3	63	10	0	1	26	0	0	127
4:45 PM	9	2	2	0	1	10	2	0	4	68	16	1	0	20	2	1	138
5:00 PM	10	2	1	0	0	8	1	0	6	66	17	0	1	26	0	0	138
5:15 PM	4	1	3	0	2	10	3	0	4	60	9	0	4	25	2	0	127
5:30 PM	8	13	4	0	1	9	2	0	3	62	12	0	0	16	1	0	131
5:45 PM	7	3	1	0	3	7	3	0	3	73	23	0	0	12	2	0	137
TOTAL VOLUMES :	NL	NT	NR	NU	SL	ST	SR	SU	EL	ET	ER	EU	WL	WT	WR	WU	TOTAL
	57	30	12	0	13	66	21	0	30	510	109	1	7	153	10	1	1020
APPROACH %'s :	57.58%	30.30%	12.12%	0.00%	13.00%	66.00%	21.00%	0.00%	4.62%	78.46%	16.77%	0.15%	4.09%	89.47%	5.85%	0.58%	
PEAK HR :	04:45 PM - 05:45 PM																TOTAL
PEAK HR VOL :	31	18	10	0	4	37	8	0	17	256	54	1	5	87	5	1	534
PEAK HR FACTOR :	0.78	0.346	0.625	0.000	0.500	0.925	0.667	0.000	0.708	0.941	0.794	0.250	0.313	0.837	0.625	0.250	0.967
	0.590				0.817				0.921				0.790				

National Data & Surveying Services

Intersection Turning Movement Count

Location: Commerce St & Mission Inn Ave
City: Riverside
Control: 2-Way Stop (NB/SB)

Project ID: 19-06052-004
Date: 4/30/2019

MT

NS/EW Streets:	Commerce St				Commerce St				Mission Inn Ave				Mission Inn Ave				
AM	NORTHBOUND				SOUTHBOUND				EASTBOUND				WESTBOUND				
	NL	NT	NR	NU	SL	ST	SR	SU	EL	ET	ER	EU	WL	WT	WR	WU	TOTAL
7:00 AM	0	0	0	0	0	0	0	0	0	1	0	0	0	0	0	0	1
7:15 AM	1	0	0	0	0	0	0	0	0	0	1	0	0	0	0	0	2
7:30 AM	0	0	0	0	0	0	0	0	0	0	0	0	0	0	0	0	0
7:45 AM	1	0	0	0	0	0	0	0	0	1	0	0	0	0	0	0	2
8:00 AM	0	0	0	0	0	0	0	0	0	0	0	0	0	0	0	0	0
8:15 AM	0	0	0	0	0	0	0	0	0	0	0	0	0	3	0	0	3
8:30 AM	0	0	0	0	0	0	0	0	0	0	0	0	0	1	0	0	1
8:45 AM	0	0	0	0	0	0	0	0	0	0	0	0	0	1	0	0	1
TOTAL VOLUMES :	NL	NT	NR	NU	SL	ST	SR	SU	EL	ET	ER	EU	WL	WT	WR	WU	TOTAL
APPROACH %'s :	2	0	0	0	0	0	0	0	0	2	1	0	0	5	0	0	10
	100.00%	0.00%	0.00%	0.00%					0.00%	66.67%	33.33%	0.00%	0.00%	100.00%	0.00%	0.00%	
PEAK HR :	07:15 AM - 08:15 AM																TOTAL
PEAK HR VOL :	2	0	0	0	0	0	0	0	0	1	1	0	0	0	0	0	4
PEAK HR FACTOR :	0.500	0.000	0.000	0.000	0.000	0.000	0.000	0.000	0.000	0.250	0.250	0.000	0.000	0.000	0.000	0.000	0.500
	0.500								0.500								
PM	NORTHBOUND				SOUTHBOUND				EASTBOUND				WESTBOUND				
	NL	NT	NR	NU	SL	ST	SR	SU	EL	ET	ER	EU	WL	WT	WR	WU	TOTAL
4:00 PM	0	0	0	0	0	0	0	0	0	0	0	0	0	0	0	0	0
4:15 PM	0	0	0	0	0	0	0	0	0	2	0	0	0	0	0	0	2
4:30 PM	0	0	0	0	0	0	0	0	0	0	0	0	0	0	0	0	0
4:45 PM	0	0	0	0	0	1	0	0	0	0	0	0	0	0	0	0	1
5:00 PM	0	0	0	0	0	0	0	0	0	0	0	0	0	1	0	0	1
5:15 PM	1	0	0	0	0	0	0	0	0	1	0	0	0	0	0	0	2
5:30 PM	0	0	0	0	0	0	0	0	0	0	0	0	0	0	0	0	0
5:45 PM	1	0	0	0	0	1	0	0	0	0	0	0	0	0	0	0	2
TOTAL VOLUMES :	NL	NT	NR	NU	SL	ST	SR	SU	EL	ET	ER	EU	WL	WT	WR	WU	TOTAL
APPROACH %'s :	2	0	0	0	0	2	0	0	0	3	0	0	0	1	0	0	8
	100.00%	0.00%	0.00%	0.00%	0.00%	100.00%	0.00%	0.00%	0.00%	100.00%	0.00%	0.00%	0.00%	100.00%	0.00%	0.00%	
PEAK HR :	04:45 PM - 05:45 PM																TOTAL
PEAK HR VOL :	1	0	0	0	0	1	0	0	0	1	0	0	0	1	0	0	4
PEAK HR FACTOR :	0.25	0.000	0.000	0.000	0.000	0.250	0.000	0.000	0.000	0.250	0.000	0.000	0.000	0.250	0.000	0.000	0.500
	0.250				0.250				0.250				0.250				

National Data & Surveying Services

Intersection Turning Movement Count

Location: Commerce St & Mission Inn Ave
 City: Riverside
 Control: 2-Way Stop (NB/SB)

Project ID: 19-06052-004
 Date: 4/30/2019

HT

NS/EW Streets:	Commerce St				Commerce St				Mission Inn Ave				Mission Inn Ave					
AM	NORTHBOUND				SOUTHBOUND				EASTBOUND				WESTBOUND				TOTAL	
	NL	NT	NR	NU	SL	ST	SR	SU	EL	ET	ER	EU	WL	WT	WR	WU		
7:00 AM	0	0	0	0	0	0	1	0	0	1	0	0	0	0	0	0	0	3
7:15 AM	0	0	0	0	0	0	0	0	0	0	0	0	0	0	0	0	0	0
7:30 AM	0	0	0	0	0	0	0	0	0	1	0	0	0	0	1	0	0	2
7:45 AM	0	0	0	0	0	0	0	0	0	0	0	0	0	0	1	0	0	1
8:00 AM	0	0	0	0	0	0	0	0	0	0	1	0	0	0	0	0	0	1
8:15 AM	0	0	0	0	0	0	0	0	0	0	0	0	0	0	1	0	0	1
8:30 AM	0	0	0	0	0	0	0	0	0	0	0	0	0	0	0	0	0	0
8:45 AM	0	0	0	0	0	0	0	0	0	0	0	0	0	0	0	0	0	0
TOTAL VOLUMES :	NL	NT	NR	NU	SL	ST	SR	SU	EL	ET	ER	EU	WL	WT	WR	WU	TOTAL	
APPROACH %s :	0	0	0	0	0	0	1	0	2	1	1	0	0	3	0	0	8	
PEAK HR :	07:15 AM - 08:15 AM																TOTAL	
PEAK HR VOL :	0	0	0	0	0	0	0	0	1	1	0	0	0	2	0	0	4	
PEAK HR FACTOR :	0.000	0.000	0.000	0.000	0.000	0.000	0.000	0.000	0.250	0.250	0.000	0.000	0.000	0.500	0.000	0.000	0.500	
									0.500									
PM	NORTHBOUND				SOUTHBOUND				EASTBOUND				WESTBOUND				TOTAL	
	NL	NT	NR	NU	SL	ST	SR	SU	EL	ET	ER	EU	WL	WT	WR	WU		
4:00 PM	0	0	0	0	0	0	0	0	0	0	0	0	0	0	0	0	0	0
4:15 PM	0	1	0	0	0	0	1	0	0	0	0	0	0	0	0	0	0	2
4:30 PM	0	0	0	0	0	0	0	0	0	0	0	0	0	0	0	0	0	0
4:45 PM	0	0	0	0	0	1	0	0	0	0	0	0	0	0	0	0	0	1
5:00 PM	0	0	0	0	0	0	0	0	0	0	0	0	0	0	0	0	0	0
5:15 PM	1	0	0	0	0	0	0	0	0	1	0	0	0	0	0	0	0	2
5:30 PM	0	0	0	0	0	0	0	0	0	0	0	0	0	0	0	0	0	0
5:45 PM	0	0	0	0	0	0	0	0	0	0	0	0	0	0	0	0	0	0
TOTAL VOLUMES :	NL	NT	NR	NU	SL	ST	SR	SU	EL	ET	ER	EU	WL	WT	WR	WU	TOTAL	
APPROACH %s :	1	1	0	0	0	1	1	0	0	1	0	0	0	0	0	0	5	
PEAK HR :	04:45 PM - 05:45 PM																TOTAL	
PEAK HR VOL :	1	0	0	0	0	1	0	0	0	1	0	0	0	0	0	0	3	
PEAK HR FACTOR :	0.25	0.000	0.000	0.000	0.000	0.250	0.000	0.000	0.000	0.250	0.000	0.000	0.000	0.000	0.000	0.000	0.375	
									0.250									

Commerce St & Mission Inn Ave

Peak Hour Turning Movement Count

ID: 19-06052-004
City: Riverside

Day: Tuesday
Date: 04/30/2019

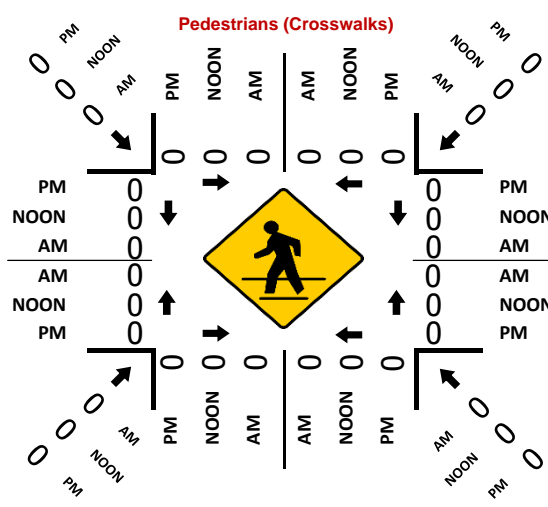
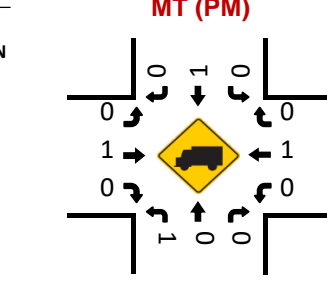
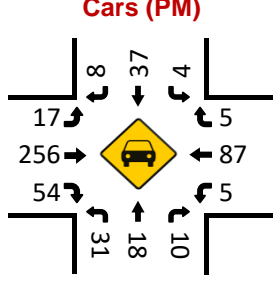
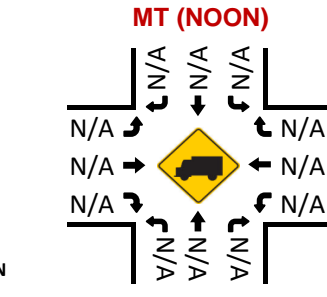
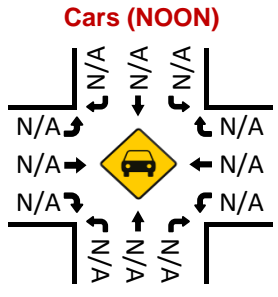
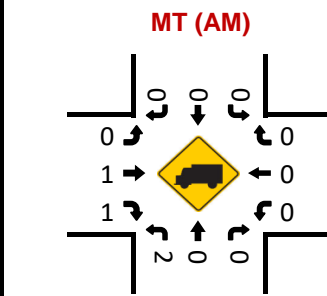
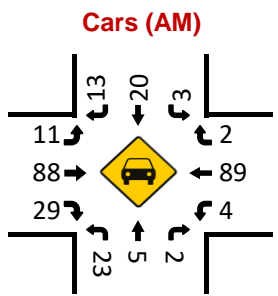
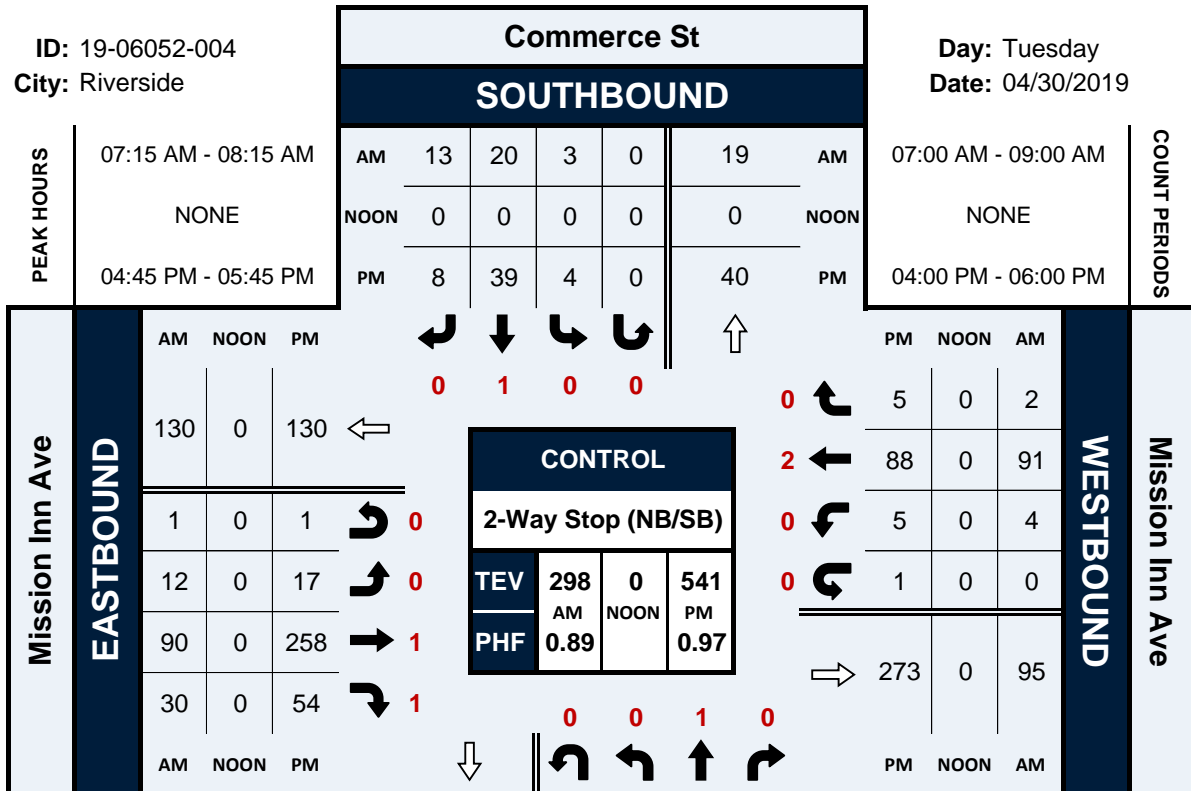

City of Riverside
 N/S: 12th Street
 E/W: Howard Avenue
 Weather: Clear

File Name : RIV_12th_Howard AM
 Site Code : 99915000
 Start Date : 2/12/2020
 Page No : 1

Groups Printed- Total Volume

Start Time	12th Street Southbound				Howard Avenue Westbound				12th Street Northbound				Howard Avenue Eastbound				Int. Total
	Left	Thru	Right	App. Total	Left	Thru	Right	App. Total	Left	Thru	Right	App. Total	Left	Thru	Right	App. Total	
07:00 AM	0	0	5	5	0	6	1	7	4	2	1	7	2	11	1	14	33
07:15 AM	0	1	4	5	0	5	1	6	4	4	2	10	5	9	1	15	36
07:30 AM	1	0	5	6	0	7	3	10	5	2	0	7	3	5	0	8	31
07:45 AM	0	0	3	3	0	15	0	15	3	2	0	5	11	6	3	20	43
Total	1	1	17	19	0	33	5	38	16	10	3	29	21	31	5	57	143
08:00 AM	0	1	4	5	0	7	2	9	3	3	2	8	4	4	0	8	30
08:15 AM	1	2	2	5	0	10	1	11	7	2	1	10	4	4	0	8	34
08:30 AM	1	1	2	4	0	9	2	11	7	1	1	9	5	7	0	12	36
08:45 AM	2	0	1	3	0	7	1	8	3	4	0	7	3	1	0	4	22
Total	4	4	9	17	0	33	6	39	20	10	4	34	16	16	0	32	122
Grand Total	5	5	26	36	0	66	11	77	36	20	7	63	37	47	5	89	265
Apprch %	13.9	13.9	72.2		0	85.7	14.3		57.1	31.7	11.1		41.6	52.8	5.6		
Total %	1.9	1.9	9.8	13.6	0	24.9	4.2	29.1	13.6	7.5	2.6	23.8	14	17.7	1.9	33.6	

Start Time	12th Street Southbound				Howard Avenue Westbound				12th Street Northbound				Howard Avenue Eastbound				Int. Total
	Left	Thru	Right	App. Total	Left	Thru	Right	App. Total	Left	Thru	Right	App. Total	Left	Thru	Right	App. Total	
Peak Hour Analysis From 07:00 AM to 08:45 AM - Peak 1 of 1																	
Peak Hour for Entire Intersection Begins at 07:00 AM																	
07:00 AM	0	0	5	5	0	6	1	7	4	2	1	7	2	11	1	14	33
07:15 AM	0	1	4	5	0	5	1	6	4	4	2	10	5	9	1	15	36
07:30 AM	1	0	5	6	0	7	3	10	5	2	0	7	3	5	0	8	31
07:45 AM	0	0	3	3	0	15	0	15	3	2	0	5	11	6	3	20	43
Total Volume	1	1	17	19	0	33	5	38	16	10	3	29	21	31	5	57	143
% App. Total	5.3	5.3	89.5		0	86.8	13.2		55.2	34.5	10.3		36.8	54.4	8.8		
PHF	.250	.250	.850	.792	.000	.550	.417	.633	.800	.625	.375	.725	.477	.705	.417	.713	.831

City of Riverside
 N/S: 12th Street
 E/W: Howard Avenue
 Weather: Clear

File Name : RIV_12th_Howard AM
 Site Code : 99915000
 Start Date : 2/12/2020
 Page No : 2

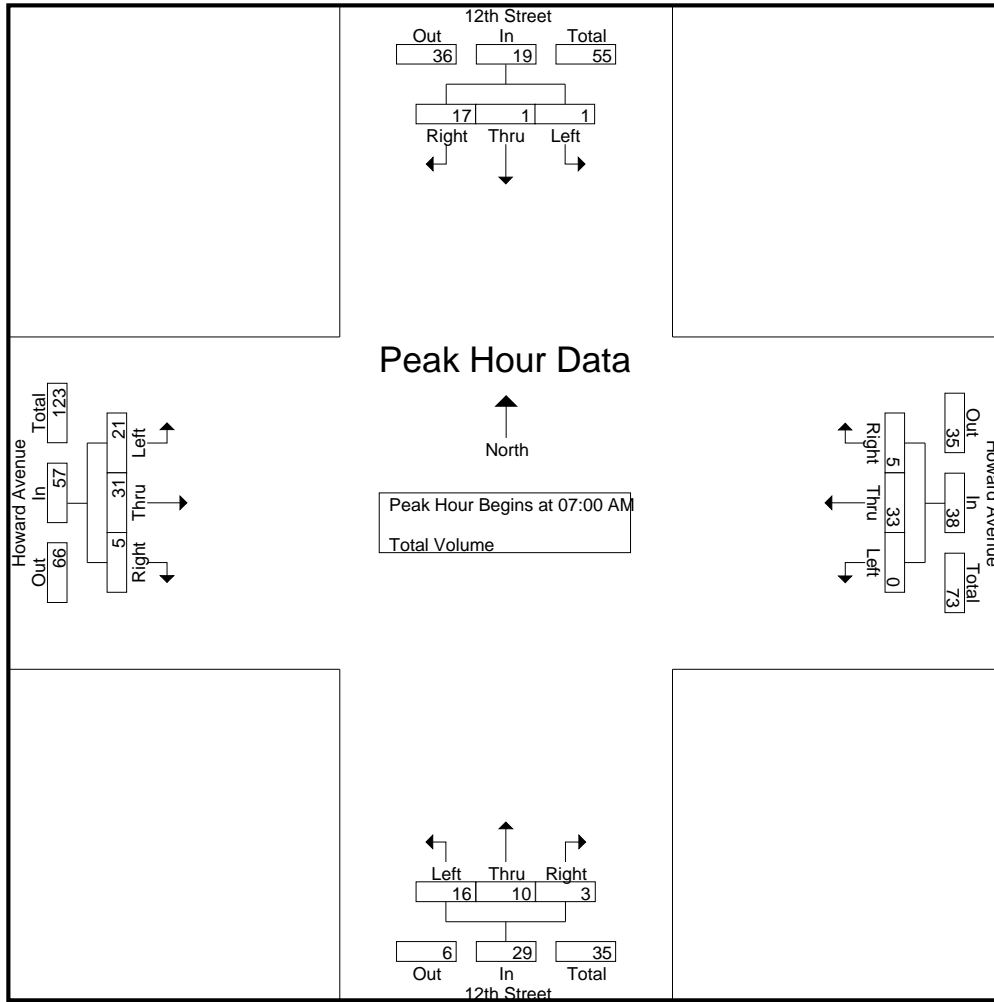

Peak Hour Analysis From 07:00 AM to 08:45 AM - Peak 1 of 1
 Peak Hour for Each Approach Begins at:

	07:00 AM				07:45 AM				08:00 AM				07:00 AM			
+0 mins.	0	0	5	5	0	15	0	15	3	3	2	8	2	11	1	14
+15 mins.	0	1	4	5	0	7	2	9	7	2	1	10	5	9	1	15
+30 mins.	1	0	5	6	0	10	1	11	7	1	1	9	3	5	0	8
+45 mins.	0	0	3	3	0	9	2	11	3	4	0	7	11	6	3	20
Total Volume	1	1	17	19	0	41	5	46	20	10	4	34	21	31	5	57
% App. Total	5.3	5.3	89.5		0	89.1	10.9		58.8	29.4	11.8		36.8	54.4	8.8	
PHF	.250	.250	.850	.792	.000	.683	.625	.767	.714	.625	.500	.850	.477	.705	.417	.713

City of Riverside
 N/S: 12th Street
 E/W: Howard Avenue
 Weather: Clear

File Name : RIV_12th_Howard PM
 Site Code : 99915000
 Start Date : 2/12/2020
 Page No : 1

Groups Printed- Total Volume

Start Time	12th Street Southbound				Howard Avenue Westbound				12th Street Northbound				Howard Avenue Eastbound				Int. Total
	Left	Thru	Right	App. Total	Left	Thru	Right	App. Total	Left	Thru	Right	App. Total	Left	Thru	Right	App. Total	
04:00 PM	2	1	3	6	0	11	0	11	2	0	1	3	1	10	3	14	34
04:15 PM	1	0	2	3	0	7	0	7	2	1	3	6	2	4	0	6	22
04:30 PM	0	1	13	14	0	32	2	34	7	0	1	8	1	8	5	14	70
04:45 PM	0	1	6	7	2	16	0	18	1	0	1	2	2	4	4	10	37
Total	3	3	24	30	2	66	2	70	12	1	6	19	6	26	12	44	163
05:00 PM	0	0	3	3	1	17	0	18	2	0	1	3	1	9	3	13	37
05:15 PM	0	0	4	4	2	29	2	33	2	1	1	4	2	8	2	12	53
05:30 PM	0	2	3	5	1	9	4	14	0	0	2	2	0	8	2	10	31
05:45 PM	1	0	2	3	2	9	2	13	2	0	0	2	2	3	0	5	23
Total	1	2	12	15	6	64	8	78	6	1	4	11	5	28	7	40	144
Grand Total	4	5	36	45	8	130	10	148	18	2	10	30	11	54	19	84	307
Apprch %	8.9	11.1	80		5.4	87.8	6.8		60	6.7	33.3		13.1	64.3	22.6		
Total %	1.3	1.6	11.7	14.7	2.6	42.3	3.3	48.2	5.9	0.7	3.3	9.8	3.6	17.6	6.2	27.4	

Start Time	12th Street Southbound				Howard Avenue Westbound				12th Street Northbound				Howard Avenue Eastbound				Int. Total
	Left	Thru	Right	App. Total	Left	Thru	Right	App. Total	Left	Thru	Right	App. Total	Left	Thru	Right	App. Total	
Peak Hour Analysis From 04:00 PM to 05:45 PM - Peak 1 of 1																	
Peak Hour for Entire Intersection Begins at 04:30 PM																	
04:30 PM	0	1	13	14	0	32	2	34	7	0	1	8	1	8	5	14	70
04:45 PM	0	1	6	7	2	16	0	18	1	0	1	2	2	4	4	10	37
05:00 PM	0	0	3	3	1	17	0	18	2	0	1	3	1	9	3	13	37
05:15 PM	0	0	4	4	2	29	2	33	2	1	1	4	2	8	2	12	53
Total Volume	0	2	26	28	5	94	4	103	12	1	4	17	6	29	14	49	197
% App. Total	0	7.1	92.9		4.9	91.3	3.9		70.6	5.9	23.5		12.2	59.2	28.6		
PHF	.000	.500	.500	.500	.625	.734	.500	.757	.429	.250	1.00	.531	.750	.806	.700	.875	.704

City of Riverside
 N/S: 12th Street
 E/W: Howard Avenue
 Weather: Clear

File Name : RIV_12th_Howard PM
 Site Code : 99915000
 Start Date : 2/12/2020
 Page No : 2

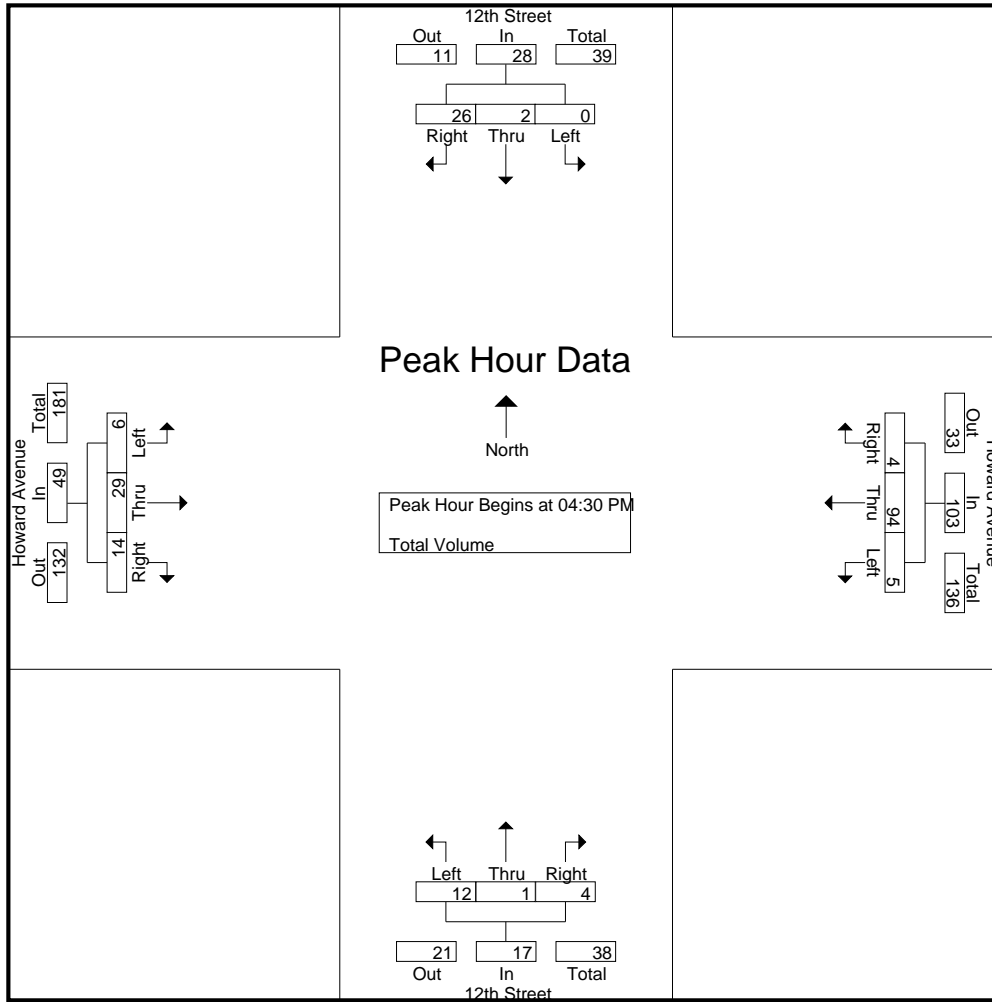

Peak Hour Analysis From 04:00 PM to 05:45 PM - Peak 1 of 1
 Peak Hour for Each Approach Begins at:

	04:00 PM				04:30 PM				04:00 PM				04:30 PM			
+0 mins.	2	1	3	6	0	32	2	34	2	0	1	3	1	8	5	14
+15 mins.	1	0	2	3	2	16	0	18	2	1	3	6	2	4	4	10
+30 mins.	0	1	13	14	1	17	0	18	7	0	1	8	1	9	3	13
+45 mins.	0	1	6	7	2	29	2	33	1	0	1	2	2	8	2	12
Total Volume	3	3	24	30	5	94	4	103	12	1	6	19	6	29	14	49
% App. Total	10	10	80		4.9	91.3	3.9		63.2	5.3	31.6		12.2	59.2	28.6	
PHF	.375	.750	.462	.536	.625	.734	.500	.757	.429	.250	.500	.594	.750	.806	.700	.875

National Data & Surveying Services

Intersection Turning Movement Count

Location: Vine St & Mission Inn Ave
 City: Riverside
 Control: 4-Way Stop

Project ID: 19-06052-003
 Date: 4/30/2019

Total

NS/EW Streets:	Vine St				Vine St				Mission Inn Ave				Mission Inn Ave				TOTAL
	NORTHBOUND				SOUTHBOUND				EASTBOUND				WESTBOUND				
AM	1 NL	1 NT	0 NR	0 NU	0 SL	1 ST	0 SR	0 SU	1 EL	1 ET	1 ER	0 EU	1 WL	2 WT	0 WR	0 WU	
7:00 AM	7	7	2	0	2	3	13	0	19	32	13	1	1	18	8	0	126
7:15 AM	15	10	6	0	6	3	10	0	11	33	13	2	1	23	5	0	138
7:30 AM	7	11	3	0	3	4	10	0	23	35	13	0	0	33	6	0	148
7:45 AM	8	12	10	0	3	4	10	0	29	40	22	0	0	20	7	0	165
8:00 AM	12	13	4	0	5	2	9	0	24	32	11	0	0	21	7	0	140
8:15 AM	5	10	2	0	3	2	12	0	26	18	6	0	0	20	5	0	109
8:30 AM	4	15	1	0	2	9	8	0	28	12	9	0	1	17	3	0	109
8:45 AM	9	12	0	0	2	5	9	0	17	24	8	0	2	12	8	0	108
TOTAL VOLUMES:	NL 67	NT 90	NR 28	NU 0	SL 26	ST 32	SR 81	SU 0	EL 177	ET 226	ER 95	EU 3	WL 5	WT 164	WR 49	WU 0	TOTAL 1043
APPROACH %'s:	36.22%	48.65%	15.14%	0.00%	18.71%	23.02%	58.27%	0.00%	35.33%	45.11%	18.96%	0.60%	2.29%	75.23%	22.48%	0.00%	
PEAK HR:	07:15 AM - 08:15 AM																TOTAL
PEAK HR VOL:	42	46	23	0	17	13	39	0	87	140	59	2	1	97	25	0	591
PEAK HR FACTOR:	0.700	0.885	0.575	0.000	0.708	0.813	0.975	0.000	0.750	0.875	0.670	0.250	0.250	0.735	0.893	0.000	0.895
	0.895				0.908				0.791				0.788				
PM	1 NL	1 NT	0 NR	0 NU	0 SL	1 ST	0 SR	0 SU	1 EL	1 ET	1 ER	0 EU	1 WL	2 WT	0 WR	0 WU	
4:00 PM	22	18	3	0	7	8	28	0	26	64	6	0	2	16	4	0	204
4:15 PM	6	15	7	0	12	10	31	1	27	58	9	0	2	14	6	0	198
4:30 PM	7	15	4	0	7	11	18	0	36	61	3	1	2	22	16	0	203
4:45 PM	37	19	11	0	14	12	33	0	29	58	9	0	2	20	11	0	255
5:00 PM	24	12	14	0	14	17	36	0	40	59	13	0	6	37	8	0	280
5:15 PM	8	9	3	0	7	12	31	0	28	57	27	0	5	23	13	0	223
5:30 PM	15	11	8	0	12	16	32	0	40	66	20	0	3	17	10	0	250
5:45 PM	19	16	15	0	24	16	24	0	27	53	22	1	1	20	8	0	246
TOTAL VOLUMES:	NL 138	NT 115	NR 65	NU 0	SL 97	ST 102	SR 233	SU 1	EL 253	ET 476	ER 109	EU 2	WL 23	WT 169	WR 76	WU 0	TOTAL 1859
APPROACH %'s:	43.40%	36.16%	20.44%	0.00%	22.40%	23.56%	53.81%	0.23%	30.12%	56.67%	12.98%	0.24%	8.58%	63.06%	28.36%	0.00%	
PEAK HR:	04:45 PM - 05:45 PM																TOTAL
PEAK HR VOL:	84	51	36	0	47	57	132	0	137	240	69	0	16	97	42	0	1008
PEAK HR FACTOR:	0.568	0.671	0.643	0.000	0.839	0.838	0.917	0.000	0.856	0.909	0.639	0.000	0.667	0.655	0.808	0.000	0.900
	0.638				0.881				0.885				0.760				

National Data & Surveying Services

Intersection Turning Movement Count

Location: Vine St & Mission Inn Ave
City: Riverside
Control: 4-Way Stop

Project ID: 19-06052-003
Date: 4/30/2019

Cars

NS/EW Streets:	Vine St				Vine St				Mission Inn Ave				Mission Inn Ave				TOTAL
	NORTHBOUND				SOUTHBOUND				EASTBOUND				WESTBOUND				
AM	1 NL	1 NT	0 NR	0 NU	0 SL	1 ST	0 SR	0 SU	1 EL	1 ET	1 ER	0 EU	1 WL	2 WT	0 WR	0 WU	TOTAL
7:00 AM	7	7	2	0	2	2	12	0	19	29	10	1	1	17	8	0	
7:15 AM	14	10	6	0	6	2	9	0	10	32	11	2	1	22	5	0	130
7:30 AM	7	10	3	0	3	3	9	0	21	34	11	0	0	32	6	0	139
7:45 AM	6	12	10	0	3	4	9	0	29	39	20	0	0	18	7	0	157
8:00 AM	10	13	4	0	5	2	8	0	22	31	9	0	0	21	7	0	132
8:15 AM	5	10	2	0	3	2	12	0	25	18	6	0	0	18	3	0	104
8:30 AM	4	15	1	0	2	8	8	0	25	12	8	0	1	15	3	0	102
8:45 AM	9	11	0	0	2	5	9	0	16	23	7	0	2	12	8	0	104
TOTAL VOLUMES :	NL	NT	NR	NU	SL	ST	SR	SU	EL	ET	ER	EU	WL	WT	WR	WU	TOTAL
APPROACH %'s :	62	88	28	0	26	28	76	0	167	218	82	3	5	155	47	0	985
PEAK HR :	07:15 AM - 08:15 AM																TOTAL
PEAK HR VOL :	37	45	23	0	17	11	35	0	82	136	51	2	1	93	25	0	558
PEAK HR FACTOR :	0.66	0.865	0.575	0.000	0.708	0.688	0.972	0.000	0.707	0.872	0.638	0.250	0.250	0.727	0.893	0.000	0.889
	0.875				0.926				0.770				0.783				
PM	1 NL	1 NT	0 NR	0 NU	0 SL	1 ST	0 SR	0 SU	1 EL	1 ET	1 ER	0 EU	1 WL	2 WT	0 WR	0 WU	TOTAL
4:00 PM	22	16	3	0	7	6	28	0	26	63	5	0	2	15	4	0	
4:15 PM	5	14	7	0	12	10	31	1	27	57	8	0	2	13	6	0	193
4:30 PM	6	15	4	0	7	11	18	0	34	61	2	1	2	22	16	0	199
4:45 PM	37	19	11	0	14	12	32	0	28	58	8	0	2	20	11	0	252
5:00 PM	24	12	14	0	14	17	36	0	40	58	12	0	6	36	8	0	277
5:15 PM	8	9	3	0	7	12	31	0	27	56	27	0	5	22	12	0	219
5:30 PM	15	11	8	0	12	16	32	0	40	66	15	0	3	17	10	0	245
5:45 PM	19	16	15	0	24	16	24	0	27	53	19	1	1	19	8	0	242
TOTAL VOLUMES :	NL	NT	NR	NU	SL	ST	SR	SU	EL	ET	ER	EU	WL	WT	WR	WU	TOTAL
APPROACH %'s :	136	112	65	0	97	100	232	1	249	472	96	2	23	164	75	0	1824
PEAK HR :	04:45 PM - 05:45 PM																TOTAL
PEAK HR VOL :	84	51	36	0	47	57	131	0	135	238	62	0	16	95	41	0	993
PEAK HR FACTOR :	0.57	0.671	0.643	0.000	0.839	0.838	0.910	0.000	0.844	0.902	0.574	0.000	0.667	0.660	0.854	0.000	0.896
	0.638				0.877				0.899				0.760				

National Data & Surveying Services

Intersection Turning Movement Count

Location: Vine St & Mission Inn Ave
 City: Riverside
 Control: 4-Way Stop

Project ID: 19-06052-003
 Date: 4/30/2019

MT

NS/EW Streets:	Vine St				Vine St				Mission Inn Ave				Mission Inn Ave				
AM	NORTHBOUND				SOUTHBOUND				EASTBOUND				WESTBOUND				TOTAL
	NL	NT	NR	NU	SL	ST	SR	SU	EL	ET	ER	EU	WL	WT	WR	WU	
7:00 AM	0	0	0	0	0	0	1	0	0	1	0	0	0	0	0	0	2
7:15 AM	0	0	0	0	0	0	1	0	1	1	0	0	0	1	0	0	4
7:30 AM	0	0	0	0	0	0	0	0	1	0	0	0	0	0	0	0	1
7:45 AM	0	0	0	0	0	0	1	0	0	1	0	0	0	1	0	0	3
8:00 AM	0	0	0	0	0	0	1	0	1	0	0	0	0	0	0	0	2
8:15 AM	0	0	0	0	0	0	0	0	0	0	0	0	0	2	1	0	3
8:30 AM	0	0	0	0	0	0	0	0	2	0	0	0	0	2	0	0	4
8:45 AM	0	0	0	0	0	0	0	0	0	1	0	0	0	0	0	0	1
TOTAL VOLUMES :	NL	NT	NR	NU	SL	ST	SR	SU	EL	ET	ER	EU	WL	WT	WR	WU	TOTAL
APPROACH %'s :	0	0	0	0	0	0	4	0	5	4	0	0	0	6	1	0	20
PEAK HR :	07:15 AM - 08:15 AM				0.00%	0.00%	100.00%	0.00%	55.56%	44.44%	0.00%	0.00%	0.00%	85.71%	14.29%	0.00%	TOTAL
PEAK HR VOL :	0	0	0	0	0	0	3	0	3	2	0	0	0	2	0	0	10
PEAK HR FACTOR :	0.000	0.000	0.000	0.000	0.000	0.000	0.750	0.000	0.750	0.500	0.000	0.000	0.000	0.500	0.000	0.000	0.625
							0.750				0.625				0.500		
PM	NORTHBOUND				SOUTHBOUND				EASTBOUND				WESTBOUND				TOTAL
	NL	NT	NR	NU	SL	ST	SR	SU	EL	ET	ER	EU	WL	WT	WR	WU	
4:00 PM	0	0	0	0	0	1	0	0	0	1	1	0	0	1	0	0	4
4:15 PM	0	1	0	0	0	0	0	0	0	1	0	0	0	0	0	0	2
4:30 PM	0	0	0	0	0	0	0	0	1	0	0	0	0	0	0	0	1
4:45 PM	0	0	0	0	0	0	1	0	1	0	0	0	0	0	0	0	2
5:00 PM	0	0	0	0	0	0	0	0	0	1	0	0	0	1	0	0	2
5:15 PM	0	0	0	0	0	0	0	0	1	0	0	0	0	0	1	0	2
5:30 PM	0	0	0	0	0	0	0	0	0	0	0	0	0	0	0	0	0
5:45 PM	0	0	0	0	0	0	0	0	0	0	0	0	0	1	0	0	1
TOTAL VOLUMES :	NL	NT	NR	NU	SL	ST	SR	SU	EL	ET	ER	EU	WL	WT	WR	WU	TOTAL
APPROACH %'s :	0	1	0	0	0	1	1	0	3	3	1	0	0	3	1	0	14
PEAK HR :	04:45 PM - 05:45 PM				0.00%	100.00%	0.00%	0.00%	42.86%	42.86%	14.29%	0.00%	0.00%	75.00%	25.00%	0.00%	TOTAL
PEAK HR VOL :	0	0	0	0	0	0	1	0	2	1	0	0	0	1	1	0	6
PEAK HR FACTOR :	0.00	0.000	0.000	0.000	0.000	0.000	0.250	0.000	0.500	0.250	0.000	0.000	0.000	0.250	0.250	0.000	0.750
							0.250				0.750				0.500		

National Data & Surveying Services

Intersection Turning Movement Count

Location: Vine St & Mission Inn Ave
 City: Riverside
 Control: 4-Way Stop

Project ID: 19-06052-003
 Date: 4/30/2019

HT

NS/EW Streets:	Vine St				Vine St				Mission Inn Ave				Mission Inn Ave				TOTAL
	NORTHBOUND				SOUTHBOUND				EASTBOUND				WESTBOUND				
AM	1 NL	1 NT	0 NR	0 NU	0 SL	1 ST	0 SR	0 SU	1 EL	1 ET	1 ER	0 EU	1 WL	2 WT	0 WR	0 WU	
7:00 AM	0	0	0	0	0	1	0	0	0	2	3	0	0	1	0	0	7
7:15 AM	1	0	0	0	0	1	0	0	0	0	2	0	0	0	0	0	4
7:30 AM	0	1	0	0	0	1	1	0	1	1	2	0	0	1	0	0	8
7:45 AM	2	0	0	0	0	0	0	0	0	0	2	0	0	1	0	0	5
8:00 AM	2	0	0	0	0	0	0	0	1	1	2	0	0	0	0	0	6
8:15 AM	0	0	0	0	0	0	0	0	1	0	0	0	0	0	1	0	2
8:30 AM	0	0	0	0	0	1	0	0	1	0	1	0	0	0	0	0	3
8:45 AM	0	1	0	0	0	0	0	0	1	0	1	0	0	0	0	0	3
TOTAL VOLUMES :	NL	NT	NR	NU	SL	ST	SR	SU	EL	ET	ER	EU	WL	WT	WR	WU	TOTAL
APPROACH %'s :	5	2	0	0	0	4	1	0	5	4	13	0	0	3	1	0	38
PEAK HR :	71.43%	28.57%	0.00%	0.00%	0.00%	80.00%	20.00%	0.00%	22.73%	18.18%	59.09%	0.00%	0.00%	75.00%	25.00%	0.00%	
PEAK HR VOL :	5	1	0	0	0	2	1	0	2	2	8	0	0	2	0	0	23
PEAK HR FACTOR :	0.625	0.250	0.000	0.000	0.000	0.500	0.250	0.000	0.500	0.500	1.000	0.000	0.000	0.500	0.000	0.000	0.719
	0.750				0.375				0.750				0.500				
PM	1 NL	1 NT	0 NR	0 NU	0 SL	1 ST	0 SR	0 SU	1 EL	1 ET	1 ER	0 EU	1 WL	2 WT	0 WR	0 WU	
4:00 PM	0	2	0	0	0	1	0	0	0	0	0	0	0	0	0	0	3
4:15 PM	1	0	0	0	0	0	0	0	0	0	1	0	0	1	0	0	3
4:30 PM	1	0	0	0	0	0	0	0	1	0	1	0	0	0	0	0	3
4:45 PM	0	0	0	0	0	0	0	0	0	0	1	0	0	0	0	0	1
5:00 PM	0	0	0	0	0	0	0	0	0	0	1	0	0	0	0	0	1
5:15 PM	0	0	0	0	0	0	0	0	0	1	0	0	0	1	0	0	2
5:30 PM	0	0	0	0	0	0	0	0	0	0	5	0	0	0	0	0	5
5:45 PM	0	0	0	0	0	0	0	0	0	0	3	0	0	0	0	0	3
TOTAL VOLUMES :	NL	NT	NR	NU	SL	ST	SR	SU	EL	ET	ER	EU	WL	WT	WR	WU	TOTAL
APPROACH %'s :	2	2	0	0	0	1	0	0	1	1	12	0	0	2	0	0	21
PEAK HR :	50.00%	50.00%	0.00%	0.00%	0.00%	100.00%	0.00%	0.00%	7.14%	7.14%	85.71%	0.00%	0.00%	100.00%	0.00%	0.00%	
PEAK HR VOL :	0	0	0	0	0	0	0	0	0	1	7	0	0	1	0	0	9
PEAK HR FACTOR :	0.00	0.000	0.000	0.000	0.000	0.000	0.000	0.000	0.000	0.250	0.350	0.000	0.000	0.250	0.000	0.000	0.450
	0.000				0.000				0.400				0.250				

Vine St & Mission Inn Ave

Peak Hour Turning Movement Count

ID: 19-06052-003
City: Riverside

Day: Tuesday
Date: 04/30/2019

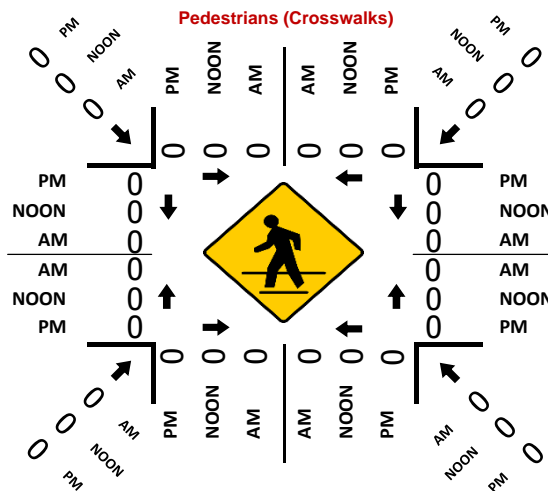
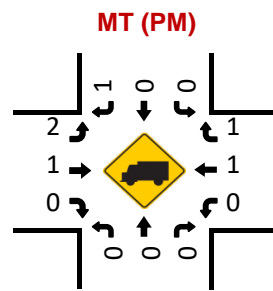
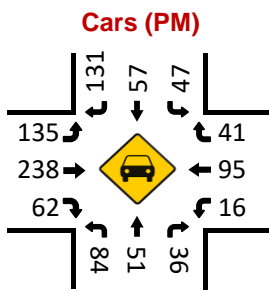
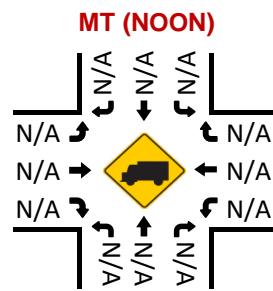
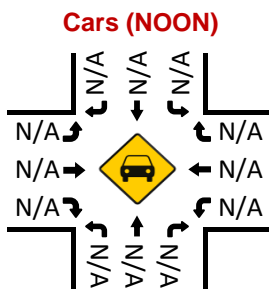
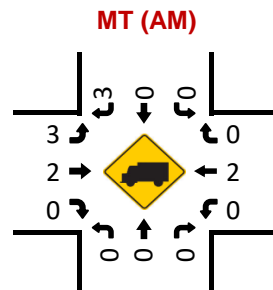
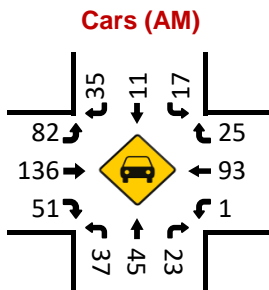
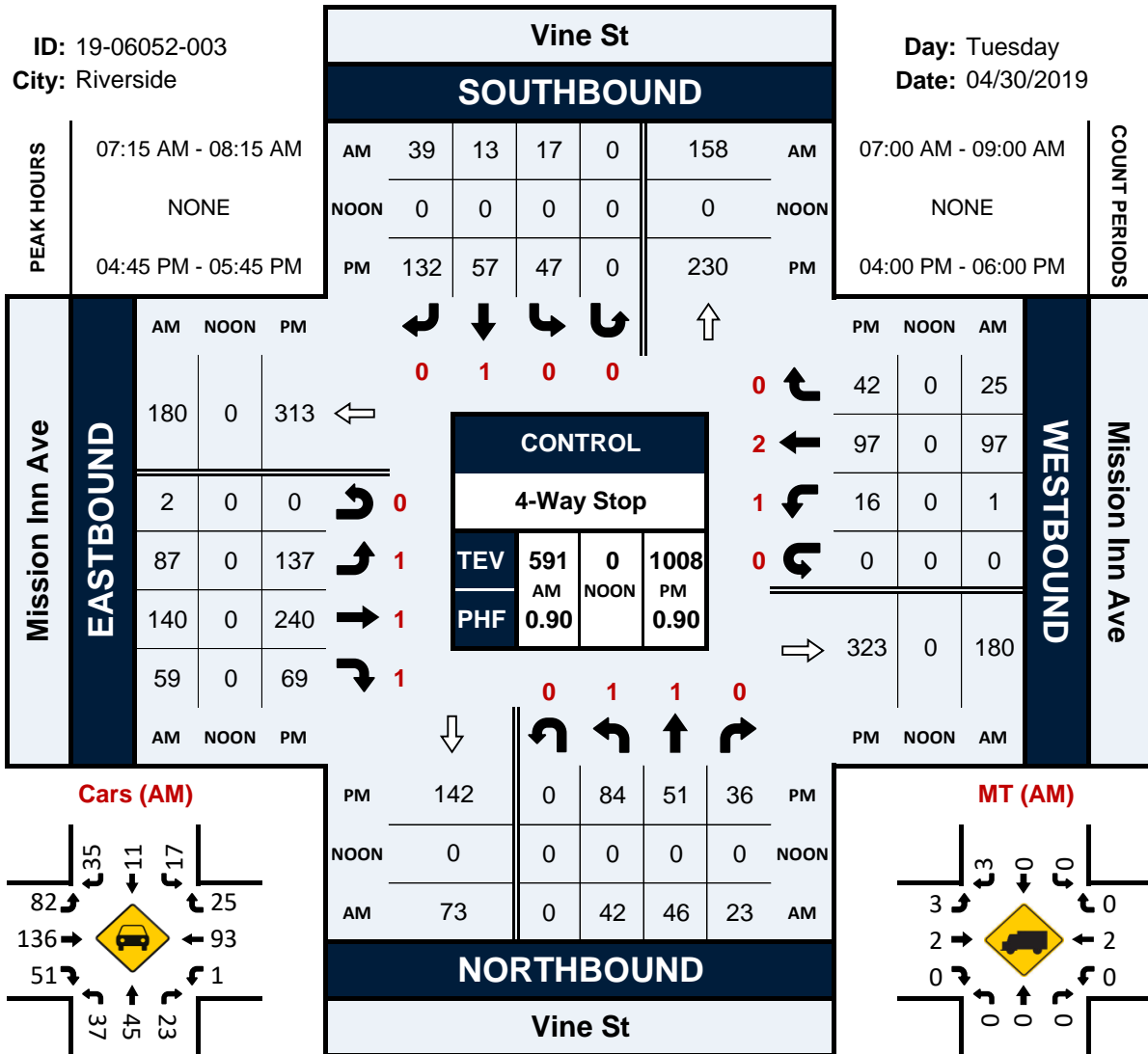



Riverside-Downtown STATION IMPROVEMENTS

Appendix C. LOS Outputs

Existing AM

HCM 6th Signalized Intersection Summary

2: Mission Inn Ave & SR 91 Off-Ramp

05/04/2020

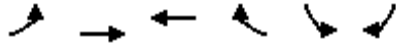

Movement	EBL	EBT	WBT	WBR	SBL	SBR
Lane Configurations		↑↑	↑↑		↙	↘
Traffic Volume (veh/h)	0	245	175	0	200	918
Future Volume (veh/h)	0	245	175	0	200	918
Initial Q (Qb), veh	0	0	0	0	0	0
Ped-Bike Adj(A_pbT)	1.00			1.00	1.00	1.00
Parking Bus, Adj	1.00	1.00	1.00	1.00	1.00	1.00
Work Zone On Approach		No	No		No	
Adj Sat Flow, veh/h/ln	0	1870	1870	0	1870	1870
Adj Flow Rate, veh/h	0	258	188	0	213	977
Peak Hour Factor	0.25	0.95	0.93	0.25	0.94	0.94
Percent Heavy Veh, %	0	2	2	0	2	2
Cap, veh/h	0	953	953	0	1158	1813
Arrive On Green	0.00	0.27	0.54	0.00	0.65	0.65
Sat Flow, veh/h	0	3741	3741	0	1781	2790
Grp Volume(v), veh/h	0	258	188	0	213	977
Grp Sat Flow(s),veh/h/ln	0	1777	1777	0	1781	1395
Q Serve(g_s), s	0.0	6.3	3.0	0.0	5.2	20.8
Cycle Q Clear(g_c), s	0.0	6.3	3.0	0.0	5.2	20.8
Prop In Lane	0.00			0.00	1.00	1.00
Lane Grp Cap(c), veh/h	0	953	953	0	1158	1813
V/C Ratio(X)	0.00	0.27	0.20	0.00	0.18	0.54
Avail Cap(c_a), veh/h	0	953	953	0	1158	1813
HCM Platoon Ratio	1.00	1.00	2.00	1.00	1.00	1.00
Upstream Filter(I)	0.00	1.00	1.00	0.00	1.00	1.00
Uniform Delay (d), s/veh	0.0	31.8	19.4	0.0	7.7	10.4
Incr Delay (d2), s/veh	0.0	0.7	0.5	0.0	0.4	1.2
Initial Q Delay(d3),s/veh	0.0	0.0	0.0	0.0	0.0	0.0
%ile BackOfQ(50%),veh/ln	0.0	2.8	1.3	0.0	2.0	6.2
Unsig. Movement Delay, s/veh						
LnGrp Delay(d),s/veh	0.0	32.5	19.8	0.0	8.0	11.5
LnGrp LOS	A	C	B	A	A	B
Approach Vol, veh/h		258	188		1190	
Approach Delay, s/veh		32.5	19.8		10.9	
Approach LOS		C	B		B	
Timer - Assigned Phs				4	6	8
Phs Duration (G+Y+Rc), s				34.0	76.0	34.0
Change Period (Y+Rc), s				4.5	4.5	4.5
Max Green Setting (Gmax), s				29.5	71.5	29.5
Max Q Clear Time (g_c+I1), s				8.3	22.8	5.0
Green Ext Time (p_c), s				1.6	5.9	1.1
Intersection Summary						
HCM 6th Ctrl Delay			15.3			
HCM 6th LOS			B			

HCM 6th Signalized Intersection Summary

3: Mulberry St/SR 91 On-Ramp & Mission Inn Ave

05/04/2020



Movement	EBL	EBT	EBR	WBL	WBT	WBR	NBL	NBT	NBR	SBL	SBT	SBR
Lane Configurations	↘	↑↑			↑↑		↘	↘				
Traffic Volume (veh/h)	216	230	0	0	59	118	116	252	63	0	0	0
Future Volume (veh/h)	216	230	0	0	59	118	116	252	63	0	0	0
Initial Q (Qb), veh	0	0	0	0	0	0	0	0	0			
Ped-Bike Adj(A_pbT)	1.00		1.00	1.00		1.00	1.00		1.00			
Parking Bus, Adj	1.00	1.00	1.00	1.00	1.00	1.00	1.00	1.00	1.00			
Work Zone On Approach		No			No			No				
Adj Sat Flow, veh/h/ln	1870	1870	0	0	1870	1870	1870	1870	1870			
Adj Flow Rate, veh/h	237	267	0	0	83	0	149	307	78			
Peak Hour Factor	0.91	0.86	0.25	0.25	0.71	0.73	0.78	0.82	0.81			
Percent Heavy Veh, %	2	2	0	0	2	2	2	2	2			
Cap, veh/h	494	1890	0	0	759		688	556	141			
Arrive On Green	0.55	1.00	0.00	0.00	0.21	0.00	0.39	0.39	0.39			
Sat Flow, veh/h	1781	3647	0	0	3741	0	1781	1439	366			
Grp Volume(v), veh/h	237	267	0	0	83	0	149	0	385			
Grp Sat Flow(s),veh/h/ln	1781	1777	0	0	1777	0	1781	0	1805			
Q Serve(g_s), s	8.9	0.0	0.0	0.0	2.1	0.0	6.2	0.0	18.3			
Cycle Q Clear(g_c), s	8.9	0.0	0.0	0.0	2.1	0.0	6.2	0.0	18.3			
Prop In Lane	1.00		0.00	0.00		0.00	1.00		0.20			
Lane Grp Cap(c), veh/h	494	1890	0	0	759		688	0	697			
V/C Ratio(X)	0.48	0.14	0.00	0.00	0.11		0.22	0.00	0.55			
Avail Cap(c_a), veh/h	494	1890	0	0	759		688	0	697			
HCM Platoon Ratio	2.00	2.00	1.00	1.00	1.00	1.00	1.00	1.00	1.00			
Upstream Filter(I)	1.00	1.00	0.00	0.00	1.00	0.00	1.00	0.00	1.00			
Uniform Delay (d), s/veh	19.7	0.0	0.0	0.0	34.8	0.0	22.6	0.0	26.3			
Incr Delay (d2), s/veh	3.3	0.2	0.0	0.0	0.3	0.0	0.7	0.0	3.1			
Initial Q Delay(d3),s/veh	0.0	0.0	0.0	0.0	0.0	0.0	0.0	0.0	0.0			
%ile BackOfQ(50%),veh/ln	3.5	0.0	0.0	0.0	0.9	0.0	2.7	0.0	8.4			
Unsig. Movement Delay, s/veh												
LnGrp Delay(d),s/veh	23.0	0.2	0.0	0.0	35.1	0.0	23.3	0.0	29.5			
LnGrp LOS	C	A	A	A	D		C	A	C			
Approach Vol, veh/h		504			83	A		534				
Approach Delay, s/veh		10.9			35.1			27.7				
Approach LOS		B			D			C				
Timer - Assigned Phs		2		4			7	8				
Phs Duration (G+Y+Rc), s		47.0		63.0			35.0	28.0				
Change Period (Y+Rc), s		4.5		4.5			4.5	4.5				
Max Green Setting (Gmax), s		42.5		58.5			30.5	23.5				
Max Q Clear Time (g_c+I1), s		20.3		2.0			10.9	4.1				
Green Ext Time (p_c), s		2.9		1.9			0.6	0.4				

Intersection Summary

HCM 6th Ctrl Delay	20.7
HCM 6th LOS	C

Notes

Unsignalized Delay for [WBR] is excluded from calculations of the approach delay and intersection delay.

HCM 6th Signalized Intersection Summary

4: Howard Ave & 14th St

05/04/2020



Movement	EBL	EBT	EBR	WBL	WBT	WBR	NBL	NBT	NBR	SBL	SBT	SBR
Lane Configurations												
Traffic Volume (veh/h)	39	558	41	11	1300	13	61	13	14	2	7	58
Future Volume (veh/h)	39	558	41	11	1300	13	61	13	14	2	7	58
Initial Q (Qb), veh	0	0	0	0	0	0	0	0	0	0	0	0
Ped-Bike Adj(A_pbT)	1.00		1.00	1.00		1.00	1.00		1.00	1.00		1.00
Parking Bus, Adj	1.00	1.00	1.00	1.00	1.00	1.00	1.00	1.00	1.00	1.00	1.00	1.00
Work Zone On Approach		No			No			No			No	
Adj Sat Flow, veh/h/ln	1870	1870	1870	1870	1870	1870	1870	1870	1870	1870	1870	1870
Adj Flow Rate, veh/h	56	627	58	20	1477	19	84	19	23	4	13	66
Peak Hour Factor	0.70	0.89	0.71	0.55	0.88	0.70	0.73	0.70	0.62	0.50	0.54	0.88
Percent Heavy Veh, %	2	2	2	2	2	2	2	2	2	2	2	2
Cap, veh/h	157	2171	968	97	2074	27	256	59	58	39	66	274
Arrive On Green	0.09	0.61	0.61	0.05	0.58	0.58	0.21	0.21	0.21	0.21	0.21	0.21
Sat Flow, veh/h	1781	3554	1585	1781	3593	46	950	278	274	23	311	1295
Grp Volume(v), veh/h	56	627	58	20	730	766	126	0	0	83	0	0
Grp Sat Flow(s),veh/h/ln	1781	1777	1585	1781	1777	1862	1503	0	0	1629	0	0
Q Serve(g_s), s	3.3	9.2	1.6	1.2	32.4	32.5	2.4	0.0	0.0	0.0	0.0	0.0
Cycle Q Clear(g_c), s	3.3	9.2	1.6	1.2	32.4	32.5	7.0	0.0	0.0	4.6	0.0	0.0
Prop In Lane	1.00		1.00	1.00		0.02	0.67		0.18	0.05		0.80
Lane Grp Cap(c), veh/h	157	2171	968	97	1026	1075	373	0	0	379	0	0
V/C Ratio(X)	0.36	0.29	0.06	0.21	0.71	0.71	0.34	0.00	0.00	0.22	0.00	0.00
Avail Cap(c_a), veh/h	157	2171	968	97	1026	1075	373	0	0	379	0	0
HCM Platoon Ratio	1.00	1.00	1.00	1.00	1.00	1.00	1.00	1.00	1.00	1.00	1.00	1.00
Upstream Filter(I)	1.00	1.00	1.00	1.00	1.00	1.00	1.00	0.00	0.00	1.00	0.00	0.00
Uniform Delay (d), s/veh	47.2	10.1	8.6	49.7	16.7	16.7	36.8	0.0	0.0	36.0	0.0	0.0
Incr Delay (d2), s/veh	6.2	0.3	0.1	4.7	4.2	4.0	2.4	0.0	0.0	1.3	0.0	0.0
Initial Q Delay(d3),s/veh	0.0	0.0	0.0	0.0	0.0	0.0	0.0	0.0	0.0	0.0	0.0	0.0
%ile BackOfQ(50%),veh/ln	1.7	3.5	0.6	0.7	13.6	14.2	3.1	0.0	0.0	2.0	0.0	0.0
Unsig. Movement Delay, s/veh												
LnGrp Delay(d),s/veh	53.4	10.4	8.8	54.5	20.9	20.7	39.2	0.0	0.0	37.3	0.0	0.0
LnGrp LOS	D	B	A	D	C	C	D	A	A	D	A	A
Approach Vol, veh/h		741			1516			126			83	
Approach Delay, s/veh		13.6			21.2			39.2			37.3	
Approach LOS		B			C			D			D	
Timer - Assigned Phs		2	3	4		6	7	8				
Phs Duration (G+Y+Rc), s		27.8	10.5	71.7		27.8	14.2	68.0				
Change Period (Y+Rc), s		4.5	4.5	4.5		4.5	4.5	4.5				
Max Green Setting (Gmax), s		23.3	6.0	67.2		23.3	9.7	63.5				
Max Q Clear Time (g_c+I1), s		9.0	3.2	11.2		6.6	5.3	34.5				
Green Ext Time (p_c), s		0.5	0.0	5.3		0.3	0.0	13.5				
Intersection Summary												
HCM 6th Ctrl Delay											20.4	
HCM 6th LOS											C	

HCM 6th AWSC
5: Vine St & Mission Inn Ave

05/04/2020

Intersection

Intersection Delay, s/veh 10
Intersection LOS A

Movement	EBL	EBT	EBR	WBL	WBT	WBR	NBL	NBT	NBR	SBL	SBT	SBR
Lane Configurations	↙	↑	↗	↙	↑↑		↙	↗			↕	
Traffic Vol, veh/h	91	142	60	1	98	25	41	46	23	16	13	39
Future Vol, veh/h	91	142	60	1	98	25	41	46	23	16	13	39
Peak Hour Factor	0.75	0.88	0.67	0.25	0.73	0.89	0.70	0.89	0.57	0.71	0.81	0.97
Heavy Vehicles, %	2	2	2	2	2	2	2	2	2	2	2	2
Mvmt Flow	121	161	90	4	134	28	59	52	40	23	16	40
Number of Lanes	1	1	1	1	2	0	1	1	0	0	1	0

Approach	EB	WB	NB	SB
Opposing Approach	WB	EB	SB	NB
Opposing Lanes	3	3	1	2
Conflicting Approach Left	SB	NB	EB	WB
Conflicting Lanes Left	1	2	3	3
Conflicting Approach Right	NB	SB	WB	EB
Conflicting Lanes Right	2	1	3	3
HCM Control Delay	10.1	9.7	10	9.8
HCM LOS	B	A	A	A

Lane	NBLn1	NBLn2	EBLn1	EBLn2	EBLn3	WBLn1	WBLn2	WBLn3	SBLn1
Vol Left, %	100%	0%	100%	0%	0%	100%	0%	0%	24%
Vol Thru, %	0%	67%	0%	100%	0%	0%	100%	57%	19%
Vol Right, %	0%	33%	0%	0%	100%	0%	0%	43%	57%
Sign Control	Stop	Stop	Stop	Stop	Stop	Stop	Stop	Stop	Stop
Traffic Vol by Lane	41	69	91	142	60	1	65	58	68
LT Vol	41	0	91	0	0	1	0	0	16
Through Vol	0	46	0	142	0	0	65	33	13
RT Vol	0	23	0	0	60	0	0	25	39
Lane Flow Rate	59	92	121	161	90	4	89	73	79
Geometry Grp	8	8	8	8	8	8	8	8	8
Degree of Util (X)	0.11	0.154	0.211	0.258	0.125	0.007	0.153	0.118	0.134
Departure Headway (Hd)	6.741	6.007	6.25	5.745	5.039	6.657	6.152	5.845	6.133
Convergence, Y/N	Yes	Yes	Yes	Yes	Yes	Yes	Yes	Yes	Yes
Cap	532	597	575	626	712	538	583	613	585
Service Time	4.474	3.74	3.978	3.473	2.766	4.394	3.889	3.582	3.871
HCM Lane V/C Ratio	0.111	0.154	0.21	0.257	0.126	0.007	0.153	0.119	0.135
HCM Control Delay	10.3	9.8	10.6	10.5	8.5	9.4	10	9.4	9.8
HCM Lane LOS	B	A	B	B	A	A	A	A	A
HCM 95th-tile Q	0.4	0.5	0.8	1	0.4	0	0.5	0.4	0.5

HCM 6th TWSC
6: Commerce St & Mission Inn Ave

05/04/2020

Intersection												
Int Delay, s/veh	3.1											
Movement	EBL	EBT	EBR	WBL	WBT	WBR	NBL	NBT	NBR	SBL	SBT	SBR
Lane Configurations		↔	↔		↔	↔		↔			↔	
Traffic Vol, veh/h	12	139	30	4	86	2	25	5	2	3	20	13
Future Vol, veh/h	12	139	30	4	86	2	25	5	2	3	20	13
Conflicting Peds, #/hr	0	0	0	0	0	0	0	0	0	0	0	0
Sign Control	Free	Free	Free	Free	Free	Free	Stop	Stop	Stop	Stop	Stop	Stop
RT Channelized	-	-	None	-	-	None	-	-	None	-	-	None
Storage Length	-	-	0	-	-	-	-	-	-	-	-	-
Veh in Median Storage, #	-	0	-	-	0	-	-	0	-	-	0	-
Grade, %	-	0	-	-	0	-	-	0	-	-	0	-
Peak Hour Factor	75	75	75	50	95	50	69	42	50	25	83	65
Heavy Vehicles, %	2	2	2	2	2	2	2	2	2	2	2	2
Mvmt Flow	16	185	40	8	91	4	36	12	4	12	24	20

Major/Minor	Major1			Major2			Minor1			Minor2		
Conflicting Flow All	95	0	0	225	0	0	291	328	185	354	366	48
Stage 1	-	-	-	-	-	-	217	217	-	109	109	-
Stage 2	-	-	-	-	-	-	74	111	-	245	257	-
Critical Hdwy	4.13	-	-	4.13	-	-	7.33	6.53	6.23	7.33	6.53	6.93
Critical Hdwy Stg 1	-	-	-	-	-	-	6.13	5.53	-	6.53	5.53	-
Critical Hdwy Stg 2	-	-	-	-	-	-	6.53	5.53	-	6.13	5.53	-
Follow-up Hdwy	2.219	-	-	2.219	-	-	3.519	4.019	3.319	3.519	4.019	3.319
Pot Cap-1 Maneuver	1498	-	-	1342	-	-	650	590	857	589	562	1011
Stage 1	-	-	-	-	-	-	785	723	-	885	805	-
Stage 2	-	-	-	-	-	-	927	803	-	758	694	-
Platoon blocked, %	-	-	-	-	-	-	-	-	-	-	-	-
Mov Cap-1 Maneuver	1498	-	-	1342	-	-	608	579	857	569	552	1011
Mov Cap-2 Maneuver	-	-	-	-	-	-	608	579	-	569	552	-
Stage 1	-	-	-	-	-	-	776	714	-	874	800	-
Stage 2	-	-	-	-	-	-	876	798	-	733	686	-

Approach	EB			WB			NB			SB		
HCM Control Delay, s	0.5			0.6			11.4			10.9		
HCM LOS							B			B		

Minor Lane/Major Mvmt	NBLn1	EBL	EBT	EBR	WBL	WBT	WBR	SBLn1
Capacity (veh/h)	615	1498	-	-	1342	-	-	664
HCM Lane V/C Ratio	0.085	0.011	-	-	0.006	-	-	0.084
HCM Control Delay (s)	11.4	7.4	0	-	7.7	0	-	10.9
HCM Lane LOS	B	A	A	-	A	A	-	B
HCM 95th %tile Q(veh)	0.3	0	-	-	0	-	-	0.3

HCM 6th TWSC
7: Commerce St & 9th St

05/04/2020

Intersection						
Int Delay, s/veh	4					
Movement	WBL	WBR	NBT	NBR	SBL	SBT
Lane Configurations						
Traffic Vol, veh/h	4	18	28	0	16	38
Future Vol, veh/h	4	18	28	0	16	38
Conflicting Peds, #/hr	0	0	0	0	0	0
Sign Control	Stop	Stop	Free	Free	Free	Free
RT Channelized	-	None	-	None	-	None
Storage Length	0	-	-	-	-	-
Veh in Median Storage, #	0	-	0	-	-	0
Grade, %	0	-	0	-	-	0
Peak Hour Factor	50	79	77	25	25	68
Heavy Vehicles, %	2	2	2	2	2	2
Mvmt Flow	8	23	36	0	64	56

Major/Minor	Minor1	Major1	Major2			
Conflicting Flow All	220	36	0	0	36	0
Stage 1	36	-	-	-	-	-
Stage 2	184	-	-	-	-	-
Critical Hdwy	6.42	6.22	-	-	4.12	-
Critical Hdwy Stg 1	5.42	-	-	-	-	-
Critical Hdwy Stg 2	5.42	-	-	-	-	-
Follow-up Hdwy	3.518	3.318	-	-	2.218	-
Pot Cap-1 Maneuver	768	1037	-	-	1575	-
Stage 1	986	-	-	-	-	-
Stage 2	848	-	-	-	-	-
Platoon blocked, %			-	-		-
Mov Cap-1 Maneuver	736	1037	-	-	1575	-
Mov Cap-2 Maneuver	736	-	-	-	-	-
Stage 1	945	-	-	-	-	-
Stage 2	848	-	-	-	-	-

Approach	WB	NB	SB
HCM Control Delay, s	9	0	3.9
HCM LOS	A		

Minor Lane/Major Mvmt	NBT	NBRWBLn1	SBL	SBT
Capacity (veh/h)	-	-	937	1575
HCM Lane V/C Ratio	-	-	0.033	0.041
HCM Control Delay (s)	-	-	9	7.4
HCM Lane LOS	-	-	A	A
HCM 95th %tile Q(veh)	-	-	0.1	0.1

HCM 6th TWSC
8: Howard Ave & Tenth St

05/04/2020

Intersection						
Int Delay, s/veh	3.8					
Movement	EBT	EBR	WBL	WBT	NBL	NBR
Lane Configurations						
Traffic Vol, veh/h	9	37	5	8	25	9
Future Vol, veh/h	9	37	5	8	25	9
Conflicting Peds, #/hr	0	0	0	0	0	0
Sign Control	Free	Free	Free	Free	Stop	Stop
RT Channelized	-	None	-	None	-	None
Storage Length	-	-	-	-	0	-
Veh in Median Storage, #	0	-	-	0	0	-
Grade, %	0	-	-	0	0	-
Peak Hour Factor	38	84	62	67	69	56
Heavy Vehicles, %	2	2	2	2	2	2
Mvmt Flow	24	44	8	12	36	16

Major/Minor	Major1	Major2	Minor1	Minor2	Minor3
Conflicting Flow All	0	0	68	0	74
Stage 1	-	-	-	-	46
Stage 2	-	-	-	-	28
Critical Hdwy	-	-	4.12	-	6.42
Critical Hdwy Stg 1	-	-	-	-	5.42
Critical Hdwy Stg 2	-	-	-	-	5.42
Follow-up Hdwy	-	-	2.218	-	3.518
Pot Cap-1 Maneuver	-	-	1533	-	930
Stage 1	-	-	-	-	976
Stage 2	-	-	-	-	995
Platoon blocked, %	-	-	-	-	-
Mov Cap-1 Maneuver	-	-	1533	-	925
Mov Cap-2 Maneuver	-	-	-	-	925
Stage 1	-	-	-	-	971
Stage 2	-	-	-	-	995

Approach	EB	WB	NB
HCM Control Delay, s	0	3	9
HCM LOS			A

Minor Lane/Major Mvmt	NBLn1	EBT	EBR	WBL	WBT
Capacity (veh/h)	953	-	-	1533	-
HCM Lane V/C Ratio	0.055	-	-	0.005	-
HCM Control Delay (s)	9	-	-	7.4	0
HCM Lane LOS	A	-	-	A	A
HCM 95th %tile Q(veh)	0.2	-	-	0	-

HCM 6th Signalized Intersection Summary
 9: SR 91 Off-Ramp/SR 91 On-Ramp & 14th St

05/04/2020



Movement	EBL	EBT	EBR	WBL	WBT	WBR	NBL	NBT	NBR	SBL	SBT	SBR
Lane Configurations	↔↔	↑↑			↑↑↑	↔	↔	↔	↔			
Traffic Volume (veh/h)	561	420	0	0	1202	217	720	0	218	0	0	0
Future Volume (veh/h)	561	420	0	0	1202	217	720	0	218	0	0	0
Initial Q (Qb), veh	0	0	0	0	0	0	0	0	0			
Ped-Bike Adj(A_pbT)	1.00		1.00	1.00		1.00	1.00		1.00			
Parking Bus, Adj	1.00	1.00	1.00	1.00	1.00	1.00	1.00	1.00	1.00			
Work Zone On Approach		No			No			No				
Adj Sat Flow, veh/h/ln	1870	1870	0	0	1870	1870	1870	1870	1870			
Adj Flow Rate, veh/h	610	483	0	0	1279	258	828	0	260			
Peak Hour Factor	0.92	0.87	0.25	0.25	0.94	0.84	0.87	0.25	0.84			
Percent Heavy Veh, %	2	2	0	0	2	2	2	2	2			
Cap, veh/h	778	2079	0	0	1608	499	1158	0	515			
Arrive On Green	0.22	0.58	0.00	0.00	0.31	0.31	0.32	0.00	0.32			
Sat Flow, veh/h	3456	3647	0	0	5274	1585	3563	0	1585			
Grp Volume(v), veh/h	610	483	0	0	1279	258	828	0	260			
Grp Sat Flow(s),veh/h/ln	1728	1777	0	0	1702	1585	1781	0	1585			
Q Serve(g_s), s	16.6	6.5	0.0	0.0	22.9	13.3	20.4	0.0	13.2			
Cycle Q Clear(g_c), s	16.6	6.5	0.0	0.0	22.9	13.3	20.4	0.0	13.2			
Prop In Lane	1.00		0.00	0.00		1.00	1.00		1.00			
Lane Grp Cap(c), veh/h	778	2079	0	0	1608	499	1158	0	515			
V/C Ratio(X)	0.78	0.23	0.00	0.00	0.80	0.52	0.72	0.00	0.50			
Avail Cap(c_a), veh/h	778	2079	0	0	1608	499	1158	0	515			
HCM Platoon Ratio	1.00	1.00	1.00	1.00	1.00	1.00	1.00	1.00	1.00			
Upstream Filter(I)	1.00	1.00	0.00	0.00	1.00	1.00	1.00	0.00	1.00			
Uniform Delay (d), s/veh	36.5	10.0	0.0	0.0	31.3	28.0	29.7	0.0	27.3			
Incr Delay (d2), s/veh	7.8	0.3	0.0	0.0	4.2	3.8	3.8	0.0	3.5			
Initial Q Delay(d3),s/veh	0.0	0.0	0.0	0.0	0.0	0.0	0.0	0.0	0.0			
%ile BackOfQ(50%),veh/ln	7.7	2.5	0.0	0.0	9.8	5.5	9.2	0.0	5.4			
Unsig. Movement Delay, s/veh												
LnGrp Delay(d),s/veh	44.3	10.2	0.0	0.0	35.5	31.8	33.5	0.0	30.8			
LnGrp LOS	D	B	A	A	D	C	C	A	C			
Approach Vol, veh/h		1093			1537			1088				
Approach Delay, s/veh		29.2			34.8			32.8				
Approach LOS		C			C			C				
Timer - Assigned Phs		2		4			7	8				
Phs Duration (G+Y+Rc), s		37.0		63.0			27.0	36.0				
Change Period (Y+Rc), s		4.5		4.5			4.5	4.5				
Max Green Setting (Gmax), s		32.5		58.5			22.5	31.5				
Max Q Clear Time (g_c+I1), s		22.4		8.5			18.6	24.9				
Green Ext Time (p_c), s		3.3		3.7			1.0	4.7				

Intersection Summary

HCM 6th Ctrl Delay	32.6
HCM 6th LOS	C

Notes

User approved volume balancing among the lanes for turning movement.

HCM 6th Signalized Intersection Summary

11: Park Ave & University Ave

05/04/2020



Movement	EBL	EBT	EBR	WBL	WBT	WBR	NBL	NBT	NBR	SBL	SBT	SBR
Lane Configurations												
Traffic Volume (veh/h)	27	475	29	21	678	45	27	27	22	40	32	38
Future Volume (veh/h)	27	475	29	21	678	45	27	27	22	40	32	38
Initial Q (Qb), veh	0	0	0	0	0	0	0	0	0	0	0	0
Ped-Bike Adj(A_pbT)	1.00		1.00	1.00		1.00	1.00		1.00	1.00		1.00
Parking Bus, Adj	1.00	1.00	1.00	1.00	1.00	1.00	1.00	1.00	1.00	1.00	1.00	1.00
Work Zone On Approach		No			No			No			No	
Adj Sat Flow, veh/h/ln	1870	1870	1870	1870	1870	1870	1870	1870	1870	1870	1870	1870
Adj Flow Rate, veh/h	40	559	39	28	729	68	29	47	28	56	40	64
Peak Hour Factor	0.68	0.85	0.75	0.75	0.93	0.66	0.94	0.58	0.79	0.71	0.80	0.59
Percent Heavy Veh, %	2	2	2	2	2	2	2	2	2	2	2	2
Cap, veh/h	154	1425	99	138	1359	127	138	245	146	202	168	268
Arrive On Green	0.09	0.42	0.42	0.08	0.41	0.41	0.08	0.22	0.22	0.11	0.26	0.26
Sat Flow, veh/h	1781	3370	235	1781	3286	306	1781	1098	654	1781	648	1036
Grp Volume(v), veh/h	40	294	304	28	394	403	29	0	75	56	0	104
Grp Sat Flow(s),veh/h/ln	1781	1777	1828	1781	1777	1815	1781	0	1753	1781	0	1684
Q Serve(g_s), s	2.3	12.6	12.7	1.6	18.4	18.4	1.7	0.0	3.8	3.2	0.0	5.4
Cycle Q Clear(g_c), s	2.3	12.6	12.7	1.6	18.4	18.4	1.7	0.0	3.8	3.2	0.0	5.4
Prop In Lane	1.00		0.13	1.00		0.17	1.00		0.37	1.00		0.62
Lane Grp Cap(c), veh/h	154	751	773	138	735	751	138	0	390	202	0	436
V/C Ratio(X)	0.26	0.39	0.39	0.20	0.54	0.54	0.21	0.00	0.19	0.28	0.00	0.24
Avail Cap(c_a), veh/h	154	751	773	138	735	751	138	0	390	202	0	436
HCM Platoon Ratio	1.00	1.00	1.00	1.00	1.00	1.00	1.00	1.00	1.00	1.00	1.00	1.00
Upstream Filter(I)	1.00	1.00	1.00	1.00	1.00	1.00	1.00	0.00	1.00	1.00	0.00	1.00
Uniform Delay (d), s/veh	47.0	22.0	22.0	47.6	24.3	24.3	47.6	0.0	34.7	44.6	0.0	32.2
Incr Delay (d2), s/veh	4.1	1.5	1.5	3.3	2.8	2.7	3.5	0.0	1.1	3.4	0.0	1.3
Initial Q Delay(d3),s/veh	0.0	0.0	0.0	0.0	0.0	0.0	0.0	0.0	0.0	0.0	0.0	0.0
%ile BackOfQ(50%),veh/ln	1.2	5.5	5.7	0.8	8.2	8.4	0.9	0.0	1.8	1.6	0.0	2.3
Unsig. Movement Delay, s/veh												
LnGrp Delay(d),s/veh	51.0	23.5	23.5	50.9	27.1	27.0	51.1	0.0	35.8	48.0	0.0	33.5
LnGrp LOS	D	C	C	D	C	C	D	A	D	D	A	C
Approach Vol, veh/h		638			825			104			160	
Approach Delay, s/veh		25.2			27.9			40.1			38.5	
Approach LOS		C			C			D			D	
Timer - Assigned Phs	1	2	3	4	5	6	7	8				
Phs Duration (G+Y+Rc), s	7.0	29.0	13.0	51.0	13.0	33.0	14.0	50.0				
Change Period (Y+Rc), s	4.5	4.5	4.5	4.5	4.5	4.5	4.5	4.5				
Max Green Setting (Gmax), s	12.5	24.5	8.5	46.5	8.5	28.5	9.5	45.5				
Max Q Clear Time (g_c+1/2), s	11.2	5.8	3.6	14.7	3.7	7.4	4.3	20.4				
Green Ext Time (p_c), s	0.0	0.3	0.0	4.0	0.0	0.5	0.0	5.4				
Intersection Summary												
HCM 6th Ctrl Delay												28.6
HCM 6th LOS												C

HCM 6th AWSC
12: Howard Ave & 12th St

05/04/2020

Intersection

Intersection Delay, s/veh 7.5

Intersection LOS A

Movement	EBL	EBT	EBR	WBL	WBT	WBR	NBL	NBT	NBR	SBL	SBT	SBR
Lane Configurations		↔		↔				↔			↔	
Traffic Vol, veh/h	1	1	17	16	10	3	2	59	5	0	33	5
Future Vol, veh/h	1	1	17	16	10	3	2	59	5	0	33	5
Peak Hour Factor	0.25	0.25	0.85	0.71	0.62	0.50	0.48	0.70	0.42	0.25	0.68	0.62
Heavy Vehicles, %	2	2	2	2	2	2	2	2	2	2	2	2
Mvmt Flow	4	4	20	23	16	6	4	84	12	0	49	8
Number of Lanes	0	1	0	0	1	0	0	1	0	0	1	0

Approach	EB	WB	NB	SB
Opposing Approach	WB	EB	SB	NB
Opposing Lanes	1	1	1	1
Conflicting Approach Left SB	NB	EB	WB	WB
Conflicting Lanes Left	1	1	1	1
Conflicting Approach Right NB	SB	WB	WB	EB
Conflicting Lanes Right	1	1	1	1
HCM Control Delay	6.9	7.6	7.6	7.4
HCM LOS	A	A	A	A

Lane	NBLn1	EBLn1	WBLn1	SBLn1
Vol Left, %	3%	5%	55%	0%
Vol Thru, %	89%	5%	34%	87%
Vol Right, %	8%	89%	10%	13%
Sign Control	Stop	Stop	Stop	Stop
Traffic Vol by Lane	66	19	29	38
LT Vol	2	1	16	0
Through Vol	59	1	10	33
RT Vol	5	17	3	5
Lane Flow Rate	100	28	45	57
Geometry Grp	1	1	1	1
Degree of Util (X)	0.113	0.029	0.053	0.064
Departure Headway (Hd)	4.064	3.712	4.274	4.058
Convergence, Y/N	Yes	Yes	Yes	Yes
Cap	877	949	828	876
Service Time	2.11	1.796	2.351	2.113
HCM Lane V/C Ratio	0.114	0.03	0.054	0.065
HCM Control Delay	7.6	6.9	7.6	7.4
HCM Lane LOS	A	A	A	A
HCM 95th-tile Q	0.4	0.1	0.2	0.2

HCM 6th Signalized Intersection Summary

13: Olivewood Ave/Lime St & 14th St

05/04/2020



Movement	EBL	EBT	EBR	WBL	WBT	WBR	NBL	NBT	NBR	SBL	SBT	SBR
Lane Configurations	↔ ↑↑↑			↔ ↑↑↑			↔ ↑↑		↔ ↑↑		↔ ↑↑	
Traffic Volume (veh/h)	34	594	44	281	1589	199	88	278	347	41	113	18
Future Volume (veh/h)	34	594	44	281	1589	199	88	278	347	41	113	18
Initial Q (Qb), veh	0	0	0	0	0	0	0	0	0	0	0	0
Ped-Bike Adj(A_pbT)	1.00		1.00	1.00		1.00	1.00		1.00	1.00		1.00
Parking Bus, Adj	1.00	1.00	1.00	1.00	1.00	1.00	1.00	1.00	1.00	1.00	1.00	1.00
Work Zone On Approach	No			No			No		No		No	
Adj Sat Flow, veh/h/ln	1870	1870	1870	1870	1870	1870	1870	1870	1870	1870	1870	1870
Adj Flow Rate, veh/h	48	724	56	309	1709	243	111	329	424	66	136	36
Peak Hour Factor	0.71	0.82	0.79	0.91	0.93	0.82	0.79	0.77	0.86	0.62	0.83	0.50
Percent Heavy Veh, %	2	2	2	2	2	2	2	2	2	2	2	2
Cap, veh/h	118	1297	100	491	2157	305	219	454	769	173	476	122
Arrive On Green	0.07	0.27	0.27	0.55	0.95	0.95	0.12	0.24	0.24	0.05	0.17	0.17
Sat Flow, veh/h	1781	4835	372	1781	4520	639	1781	1870	3170	3456	2799	719
Grp Volume(v), veh/h	48	508	272	309	1285	667	111	329	424	66	85	87
Grp Sat Flow(s),veh/h/ln	1781	1702	1803	1781	1702	1755	1781	1870	1585	1728	1777	1741
Q Serve(g_s), s	2.8	14.1	14.3	13.1	7.7	7.9	6.4	17.8	12.9	2.0	4.6	4.8
Cycle Q Clear(g_c), s	2.8	14.1	14.3	13.1	7.7	7.9	6.4	17.8	12.9	2.0	4.6	4.8
Prop In Lane	1.00		0.21	1.00		0.36	1.00		1.00	1.00		0.41
Lane Grp Cap(c), veh/h	118	913	484	491	1625	838	219	454	769	173	302	296
V/C Ratio(X)	0.41	0.56	0.56	0.63	0.79	0.80	0.51	0.72	0.55	0.38	0.28	0.29
Avail Cap(c_a), veh/h	118	913	484	491	1625	838	219	454	769	173	302	296
HCM Platoon Ratio	1.00	1.00	1.00	2.00	2.00	2.00	1.00	1.00	1.00	1.00	1.00	1.00
Upstream Filter(I)	1.00	1.00	1.00	1.00	1.00	1.00	1.00	1.00	1.00	1.00	1.00	1.00
Uniform Delay (d), s/veh	49.3	34.6	34.7	20.8	1.5	1.5	45.1	38.3	36.4	50.6	39.8	39.9
Incr Delay (d2), s/veh	10.0	2.4	4.7	6.0	4.0	7.7	8.2	9.7	2.8	6.3	2.3	2.5
Initial Q Delay(d3),s/veh	0.0	0.0	0.0	0.0	0.0	0.0	0.0	0.0	0.0	0.0	0.0	0.0
%ile BackOfQ(50%),veh/ln	1.6	6.1	6.8	4.9	1.7	2.6	3.3	9.3	5.3	1.0	2.2	2.3
Unsig. Movement Delay, s/veh												
LnGrp Delay(d),s/veh	59.3	37.1	39.3	26.9	5.5	9.2	53.3	48.0	39.2	56.9	42.1	42.4
LnGrp LOS	E	D	D	C	A	A	D	D	D	E	D	D
Approach Vol, veh/h	828			2261			864		238			
Approach Delay, s/veh	39.1			9.5			44.4		46.3			
Approach LOS	D			A			D		D			
Timer - Assigned Phs	1	2	3	4	5	6	7	8				
Phs Duration (G+Y+Rc), s	30.0	31.2	34.8	34.0	18.0	23.2	11.8	57.0				
Change Period (Y+Rc), s	4.5	4.5	4.5	4.5	4.5	4.5	4.5	4.5				
Max Green Setting (Gmax), s	5.5	26.7	30.3	29.5	13.5	18.7	7.3	52.5				
Max Q Clear Time (g_c+1), s	19.8	19.8	15.1	16.3	8.4	6.8	4.8	9.9				
Green Ext Time (p_c), s	0.0	2.2	0.8	4.2	0.1	0.6	0.0	22.9				

Intersection Summary

HCM 6th Ctrl Delay	24.6
HCM 6th LOS	C

Notes

User approved volume balancing among the lanes for turning movement.

**Existing AM with Project
Conditions**

HCM 6th Signalized Intersection Summary

14: Mulberry St/SR 91 Off-Ramp & 14th St

05/04/2020



Movement	EBL	EBT	EBR	WBL	WBT	WBR	NBL	NBT	NBR	SBL	SBT	SBR
Lane Configurations		↑↑↑		↔↔	↑↑↑					↔	↔↔	↔
Traffic Volume (veh/h)	0	852	130	381	1541	0	0	0	0	129	206	528
Future Volume (veh/h)	0	852	130	381	1541	0	0	0	0	129	206	528
Initial Q (Qb), veh	0	0	0	0	0	0				0	0	0
Ped-Bike Adj(A_pbT)	1.00		1.00	1.00		1.00				1.00		1.00
Parking Bus, Adj	1.00	1.00	1.00	1.00	1.00	1.00				1.00	1.00	1.00
Work Zone On Approach		No			No						No	
Adj Sat Flow, veh/h/ln	0	1870	1870	1870	1870	0				1870	1870	1870
Adj Flow Rate, veh/h	0	906	217	522	1693	0				105	261	592
Peak Hour Factor	0.25	0.94	0.60	0.73	0.91	0.25				0.82	0.85	0.95
Percent Heavy Veh, %	0	2	2	2	2	0				2	2	2
Cap, veh/h	0	1366	326	833	3133	0				542	570	965
Arrive On Green	0.00	0.44	0.44	0.24	0.61	0.00				0.30	0.30	0.30
Sat Flow, veh/h	0	4284	982	3456	5274	0				1781	1870	3170
Grp Volume(v), veh/h	0	749	374	522	1693	0				105	261	592
Grp Sat Flow(s),veh/h/ln	0	1702	1694	1728	1702	0				1781	1870	1585
Q Serve(g_s), s	0.0	19.1	19.2	14.9	21.1	0.0				4.8	12.4	17.6
Cycle Q Clear(g_c), s	0.0	19.1	19.2	14.9	21.1	0.0				4.8	12.4	17.6
Prop In Lane	0.00		0.58	1.00		0.00				1.00		1.00
Lane Grp Cap(c), veh/h	0	1130	562	833	3133	0				542	570	965
V/C Ratio(X)	0.00	0.66	0.67	0.63	0.54	0.00				0.19	0.46	0.61
Avail Cap(c_a), veh/h	0	1130	562	833	3133	0				542	570	965
HCM Platoon Ratio	1.00	1.33	1.33	1.00	1.00	1.00				1.00	1.00	1.00
Upstream Filter(I)	0.00	1.00	1.00	1.00	1.00	0.00				1.00	1.00	1.00
Uniform Delay (d), s/veh	0.0	25.9	25.9	37.3	12.3	0.0				28.3	30.9	32.7
Incr Delay (d2), s/veh	0.0	3.1	6.1	3.6	0.7	0.0				0.8	2.6	2.9
Initial Q Delay(d3),s/veh	0.0	0.0	0.0	0.0	0.0	0.0				0.0	0.0	0.0
%ile BackOfQ(50%),veh/ln	0.0	7.5	8.0	6.7	7.7	0.0				2.2	6.0	7.1
Unsig. Movement Delay, s/veh												
LnGrp Delay(d),s/veh	0.0	28.9	32.0	40.9	13.0	0.0				29.1	33.6	35.6
LnGrp LOS	A	C	C	D	B	A				C	C	D
Approach Vol, veh/h		1123			2215						958	
Approach Delay, s/veh		30.0			19.5						34.3	
Approach LOS		C			B						C	
Timer - Assigned Phs			3	4		6		8				
Phs Duration (G+Y+Rc), s			31.0	41.0		38.0		72.0				
Change Period (Y+Rc), s			4.5	4.5		4.5		4.5				
Max Green Setting (Gmax), s			26.5	36.5		33.5		67.5				
Max Q Clear Time (g_c+I1), s			16.9	21.2		19.6		23.1				
Green Ext Time (p_c), s			1.4	6.8		3.9		19.7				
Intersection Summary												
HCM 6th Ctrl Delay			25.6									
HCM 6th LOS			C									
Notes												
User approved volume balancing among the lanes for turning movement.												

HCM 6th Signalized Intersection Summary

2: Mission Inn Ave & SR 91 Off-Ramp

05/04/2020

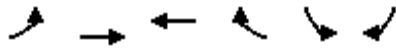

Movement	EBL	EBT	WBT	WBR	SBL	SBR
Lane Configurations		↑↑	↑↑		↵	↵↵
Traffic Volume (veh/h)	0	252	176	0	255	918
Future Volume (veh/h)	0	252	176	0	255	918
Initial Q (Qb), veh	0	0	0	0	0	0
Ped-Bike Adj(A_pbT)	1.00			1.00	1.00	1.00
Parking Bus, Adj	1.00	1.00	1.00	1.00	1.00	1.00
Work Zone On Approach		No	No		No	
Adj Sat Flow, veh/h/ln	0	1870	1870	0	1870	1870
Adj Flow Rate, veh/h	0	265	189	0	271	977
Peak Hour Factor	0.25	0.95	0.93	0.25	0.94	0.94
Percent Heavy Veh, %	0	2	2	0	2	2
Cap, veh/h	0	953	953	0	1158	1813
Arrive On Green	0.00	0.27	0.54	0.00	0.65	0.65
Sat Flow, veh/h	0	3741	3741	0	1781	2790
Grp Volume(v), veh/h	0	265	189	0	271	977
Grp Sat Flow(s),veh/h/ln	0	1777	1777	0	1781	1395
Q Serve(g_s), s	0.0	6.5	3.0	0.0	6.9	20.8
Cycle Q Clear(g_c), s	0.0	6.5	3.0	0.0	6.9	20.8
Prop In Lane	0.00			0.00	1.00	1.00
Lane Grp Cap(c), veh/h	0	953	953	0	1158	1813
V/C Ratio(X)	0.00	0.28	0.20	0.00	0.23	0.54
Avail Cap(c_a), veh/h	0	953	953	0	1158	1813
HCM Platoon Ratio	1.00	1.00	2.00	1.00	1.00	1.00
Upstream Filter(I)	0.00	1.00	1.00	0.00	1.00	1.00
Uniform Delay (d), s/veh	0.0	31.8	19.4	0.0	7.9	10.4
Incr Delay (d2), s/veh	0.0	0.7	0.5	0.0	0.5	1.2
Initial Q Delay(d3),s/veh	0.0	0.0	0.0	0.0	0.0	0.0
%ile BackOfQ(50%),veh/ln	0.0	2.9	1.3	0.0	2.6	6.2
Unsig. Movement Delay, s/veh						
LnGrp Delay(d),s/veh	0.0	32.6	19.8	0.0	8.4	11.5
LnGrp LOS	A	C	B	A	A	B
Approach Vol, veh/h		265	189		1248	
Approach Delay, s/veh		32.6	19.8		10.8	
Approach LOS		C	B		B	
Timer - Assigned Phs				4	6	8
Phs Duration (G+Y+Rc), s				34.0	76.0	34.0
Change Period (Y+Rc), s				4.5	4.5	4.5
Max Green Setting (Gmax), s				29.5	71.5	29.5
Max Q Clear Time (g_c+I1), s				8.5	22.8	5.0
Green Ext Time (p_c), s				1.6	6.2	1.1
Intersection Summary						
HCM 6th Ctrl Delay			15.2			
HCM 6th LOS			B			

HCM 6th Signalized Intersection Summary

3: Mulberry St/SR 91 On-Ramp & Mission Inn Ave

05/04/2020



Movement	EBL	EBT	EBR	WBL	WBT	WBR	NBL	NBT	NBR	SBL	SBT	SBR
Lane Configurations	↖	↑↑			↑↑		↖	↗				
Traffic Volume (veh/h)	216	291	0	0	61	125	116	252	63	0	0	0
Future Volume (veh/h)	216	291	0	0	61	125	116	252	63	0	0	0
Initial Q (Qb), veh	0	0	0	0	0	0	0	0	0			
Ped-Bike Adj(A_pbT)	1.00		1.00	1.00		1.00	1.00		1.00			
Parking Bus, Adj	1.00	1.00	1.00	1.00	1.00	1.00	1.00	1.00	1.00			
Work Zone On Approach		No			No			No				
Adj Sat Flow, veh/h/ln	1870	1870	0	0	1870	1870	1870	1870	1870			
Adj Flow Rate, veh/h	237	338	0	0	86	0	149	307	78			
Peak Hour Factor	0.91	0.86	0.25	0.25	0.71	0.73	0.78	0.82	0.81			
Percent Heavy Veh, %	2	2	0	0	2	2	2	2	2			
Cap, veh/h	494	1890	0	0	759		688	556	141			
Arrive On Green	0.55	1.00	0.00	0.00	0.21	0.00	0.39	0.39	0.39			
Sat Flow, veh/h	1781	3647	0	0	3741	0	1781	1439	366			
Grp Volume(v), veh/h	237	338	0	0	86	0	149	0	385			
Grp Sat Flow(s),veh/h/ln	1781	1777	0	0	1777	0	1781	0	1805			
Q Serve(g_s), s	8.9	0.0	0.0	0.0	2.1	0.0	6.2	0.0	18.3			
Cycle Q Clear(g_c), s	8.9	0.0	0.0	0.0	2.1	0.0	6.2	0.0	18.3			
Prop In Lane	1.00		0.00	0.00		0.00	1.00		0.20			
Lane Grp Cap(c), veh/h	494	1890	0	0	759		688	0	697			
V/C Ratio(X)	0.48	0.18	0.00	0.00	0.11		0.22	0.00	0.55			
Avail Cap(c_a), veh/h	494	1890	0	0	759		688	0	697			
HCM Platoon Ratio	2.00	2.00	1.00	1.00	1.00	1.00	1.00	1.00	1.00			
Upstream Filter(I)	1.00	1.00	0.00	0.00	1.00	0.00	1.00	0.00	1.00			
Uniform Delay (d), s/veh	19.7	0.0	0.0	0.0	34.9	0.0	22.6	0.0	26.3			
Incr Delay (d2), s/veh	3.3	0.2	0.0	0.0	0.3	0.0	0.7	0.0	3.1			
Initial Q Delay(d3),s/veh	0.0	0.0	0.0	0.0	0.0	0.0	0.0	0.0	0.0			
%ile BackOfQ(50%),veh/ln	3.5	0.1	0.0	0.0	1.0	0.0	2.7	0.0	8.4			
Unsig. Movement Delay, s/veh												
LnGrp Delay(d),s/veh	23.0	0.2	0.0	0.0	35.2	0.0	23.3	0.0	29.5			
LnGrp LOS	C	A	A	A	D		C	A	C			
Approach Vol, veh/h		575			86	A		534				
Approach Delay, s/veh		9.6			35.2			27.7				
Approach LOS		A			D			C				
Timer - Assigned Phs		2		4			7	8				
Phs Duration (G+Y+Rc), s		47.0		63.0			35.0	28.0				
Change Period (Y+Rc), s		4.5		4.5			4.5	4.5				
Max Green Setting (Gmax), s		42.5		58.5			30.5	23.5				
Max Q Clear Time (g_c+I1), s		20.3		2.0			10.9	4.1				
Green Ext Time (p_c), s		2.9		2.5			0.6	0.4				

Intersection Summary

HCM 6th Ctrl Delay	19.6
HCM 6th LOS	B

Notes

Unsignalized Delay for [WBR] is excluded from calculations of the approach delay and intersection delay.

HCM 6th Signalized Intersection Summary

4: Howard Ave & 14th St

05/04/2020



Movement	EBL	EBT	EBR	WBL	WBT	WBR	NBL	NBT	NBR	SBL	SBT	SBR
Lane Configurations												
Traffic Volume (veh/h)	87	558	41	11	1300	27	61	13	14	5	10	77
Future Volume (veh/h)	87	558	41	11	1300	27	61	13	14	5	10	77
Initial Q (Qb), veh	0	0	0	0	0	0	0	0	0	0	0	0
Ped-Bike Adj(A_pbT)	1.00		1.00	1.00		1.00	1.00		1.00	1.00		1.00
Parking Bus, Adj	1.00	1.00	1.00	1.00	1.00	1.00	1.00	1.00	1.00	1.00	1.00	1.00
Work Zone On Approach	No			No			No			No		
Adj Sat Flow, veh/h/ln	1870	1870	1870	1870	1870	1870	1870	1870	1870	1870	1870	1870
Adj Flow Rate, veh/h	124	627	58	20	1477	39	84	19	23	10	19	88
Peak Hour Factor	0.70	0.89	0.71	0.55	0.88	0.70	0.73	0.70	0.62	0.50	0.54	0.88
Percent Heavy Veh, %	2	2	2	2	2	2	2	2	2	2	2	2
Cap, veh/h	254	2219	990	92	1888	50	233	54	52	47	69	246
Arrive On Green	0.14	0.62	0.62	0.05	0.53	0.53	0.20	0.20	0.20	0.20	0.20	0.20
Sat Flow, veh/h	1781	3554	1585	1781	3537	93	886	267	258	58	345	1225
Grp Volume(v), veh/h	124	627	58	20	741	775	126	0	0	117	0	0
Grp Sat Flow(s),veh/h/ln	1781	1777	1585	1781	1777	1854	1411	0	0	1628	0	0
Q Serve(g_s), s	7.1	8.8	1.6	1.2	36.7	36.9	1.8	0.0	0.0	0.0	0.0	0.0
Cycle Q Clear(g_c), s	7.1	8.8	1.6	1.2	36.7	36.9	8.5	0.0	0.0	6.7	0.0	0.0
Prop In Lane	1.00		1.00	1.00		0.05	0.67		0.18	0.09		0.75
Lane Grp Cap(c), veh/h	254	2219	990	92	948	989	338	0	0	363	0	0
V/C Ratio(X)	0.49	0.28	0.06	0.22	0.78	0.78	0.37	0.00	0.00	0.32	0.00	0.00
Avail Cap(c_a), veh/h	254	2219	990	92	948	989	338	0	0	363	0	0
HCM Platoon Ratio	1.00	1.00	1.00	1.00	1.00	1.00	1.00	1.00	1.00	1.00	1.00	1.00
Upstream Filter(I)	1.00	1.00	1.00	1.00	1.00	1.00	1.00	0.00	0.00	1.00	0.00	0.00
Uniform Delay (d), s/veh	43.4	9.4	8.0	50.0	20.5	20.6	38.4	0.0	0.0	37.8	0.0	0.0
Incr Delay (d2), s/veh	6.6	0.3	0.1	5.3	6.4	6.2	3.1	0.0	0.0	2.3	0.0	0.0
Initial Q Delay(d3),s/veh	0.0	0.0	0.0	0.0	0.0	0.0	0.0	0.0	0.0	0.0	0.0	0.0
%ile BackOfQ(50%),veh/ln	3.6	3.4	0.5	0.7	16.1	16.8	3.3	0.0	0.0	2.9	0.0	0.0
Unsig. Movement Delay, s/veh												
LnGrp Delay(d),s/veh	50.0	9.7	8.2	55.3	26.9	26.8	41.5	0.0	0.0	40.2	0.0	0.0
LnGrp LOS	D	A	A	E	C	C	D	A	A	D	A	A
Approach Vol, veh/h	809			1536			126			117		
Approach Delay, s/veh	15.8			27.2			41.5			40.2		
Approach LOS	B			C			D			D		
Timer - Assigned Phs	2		3		4		6		7		8	
Phs Duration (G+Y+Rc), s	26.6		10.2		73.2		26.6		20.2		63.2	
Change Period (Y+Rc), s	4.5		4.5		4.5		4.5		4.5		4.5	
Max Green Setting (Gmax), s	22.1		5.7		68.7		22.1		15.7		58.7	
Max Q Clear Time (g_c+I1), s	10.5		3.2		10.8		8.7		9.1		38.9	
Green Ext Time (p_c), s	0.5		0.0		5.3		0.5		0.1		11.2	
Intersection Summary												
HCM 6th Ctrl Delay				24.9								
HCM 6th LOS				C								

Intersection

Intersection Delay, s/veh 10.6

Intersection LOS B

Movement	EBL	EBT	EBR	WBL	WBT	WBR	NBL	NBT	NBR	SBL	SBT	SBR
Lane Configurations	↙	↑	↗	↙	↑↑		↙	↗			↕	
Traffic Vol, veh/h	91	203	60	1	106	25	41	46	23	16	13	39
Future Vol, veh/h	91	203	60	1	106	25	41	46	23	16	13	39
Peak Hour Factor	0.75	0.88	0.67	0.25	0.73	0.89	0.70	0.89	0.57	0.71	0.81	0.97
Heavy Vehicles, %	2	2	2	2	2	2	2	2	2	2	2	2
Mvmt Flow	121	231	90	4	145	28	59	52	40	23	16	40
Number of Lanes	1	1	1	1	2	0	1	1	0	0	1	0

Approach	EB	WB	NB	SB
Opposing Approach	WB	EB	SB	NB
Opposing Lanes	3	3	1	2
Conflicting Approach Left SB		NB	EB	WB
Conflicting Lanes Left	1	2	3	3
Conflicting Approach Right NB		SB	WB	EB
Conflicting Lanes Right	2	1	3	3
HCM Control Delay	11	10.1	10.4	10.1
HCM LOS	B	B	B	B

Lane	NBLn1	NBLn2	EBLn1	EBLn2	EBLn3	WBLn1	WBLn2	WBLn3	SBLn1
Vol Left, %	100%	0%	100%	0%	0%	100%	0%	0%	24%
Vol Thru, %	0%	67%	0%	100%	0%	0%	100%	59%	19%
Vol Right, %	0%	33%	0%	0%	100%	0%	0%	41%	57%
Sign Control	Stop	Stop	Stop	Stop	Stop	Stop	Stop	Stop	Stop
Traffic Vol by Lane	41	69	91	203	60	1	71	60	68
LT Vol	41	0	91	0	0	1	0	0	16
Through Vol	0	46	0	203	0	0	71	35	13
RT Vol	0	23	0	0	60	0	0	25	39
Lane Flow Rate	59	92	121	231	90	4	97	76	79
Geometry Grp	8	8	8	8	8	8	8	8	8
Degree of Util (X)	0.113	0.159	0.213	0.372	0.127	0.008	0.17	0.128	0.139
Departure Headway (Hd)	6.966	6.231	6.312	5.807	5.1	6.832	6.326	6.033	6.363
Convergence, Y/N	Yes	Yes	Yes	Yes	Yes	Yes	Yes	Yes	Yes
Cap	515	575	569	621	703	524	567	594	563
Service Time	4.708	3.974	4.044	3.538	2.831	4.573	4.067	3.773	4.108
HCM Lane V/C Ratio	0.115	0.16	0.213	0.372	0.128	0.008	0.171	0.128	0.14
HCM Control Delay	10.6	10.2	10.8	12	8.6	9.6	10.4	9.7	10.1
HCM Lane LOS	B	B	B	B	A	A	B	A	B
HCM 95th-tile Q	0.4	0.6	0.8	1.7	0.4	0	0.6	0.4	0.5

HCM 6th TWSC
6: Commerce St & Mission Inn Ave

05/04/2020

Intersection												
Int Delay, s/veh	3.5											
Movement	EBL	EBT	EBR	WBL	WBT	WBR	NBL	NBT	NBR	SBL	SBT	SBR
Lane Configurations		↔	↔		↔			↔			↔	
Traffic Vol, veh/h	12	139	91	4	86	2	33	19	2	3	20	13
Future Vol, veh/h	12	139	91	4	86	2	33	19	2	3	20	13
Conflicting Peds, #/hr	0	0	0	0	0	0	0	0	0	0	0	0
Sign Control	Free	Free	Free	Free	Free	Free	Stop	Stop	Stop	Stop	Stop	Stop
RT Channelized	-	-	None	-	-	None	-	-	None	-	-	None
Storage Length	-	-	0	-	-	-	-	-	-	-	-	-
Veh in Median Storage, #	-	0	-	-	0	-	-	0	-	-	0	-
Grade, %	-	0	-	-	0	-	-	0	-	-	0	-
Peak Hour Factor	75	75	75	50	95	50	69	42	50	25	83	65
Heavy Vehicles, %	2	2	2	2	2	2	2	2	2	2	2	2
Mvmt Flow	16	185	121	8	91	4	48	45	4	12	24	20

Major/Minor	Major1			Major2			Minor1			Minor2		
Conflicting Flow All	95	0	0	306	0	0	291	328	185	411	447	48
Stage 1	-	-	-	-	-	-	217	217	-	109	109	-
Stage 2	-	-	-	-	-	-	74	111	-	302	338	-
Critical Hdwy	4.13	-	-	4.13	-	-	7.33	6.53	6.23	7.33	6.53	6.93
Critical Hdwy Stg 1	-	-	-	-	-	-	6.13	5.53	-	6.53	5.53	-
Critical Hdwy Stg 2	-	-	-	-	-	-	6.53	5.53	-	6.13	5.53	-
Follow-up Hdwy	2.219	-	-	2.219	-	-	3.519	4.019	3.319	3.519	4.019	3.319
Pot Cap-1 Maneuver	1498	-	-	1253	-	-	650	590	857	538	506	1011
Stage 1	-	-	-	-	-	-	785	723	-	885	805	-
Stage 2	-	-	-	-	-	-	927	803	-	706	640	-
Platoon blocked, %	-	-	-	-	-	-	-	-	-	-	-	-
Mov Cap-1 Maneuver	1498	-	-	1253	-	-	605	578	857	496	496	1011
Mov Cap-2 Maneuver	-	-	-	-	-	-	605	578	-	496	496	-
Stage 1	-	-	-	-	-	-	775	714	-	873	799	-
Stage 2	-	-	-	-	-	-	875	797	-	650	632	-

Approach	EB			WB			NB			SB		
HCM Control Delay, s	0.4			0.6			12.2			11.5		
HCM LOS							B			B		

Minor Lane/Major Mvmt	NBLn1	EBL	EBT	EBR	WBL	WBT	WBR	SBLn1
Capacity (veh/h)	599	1498	-	-	1253	-	-	606
HCM Lane V/C Ratio	0.162	0.011	-	-	0.006	-	-	0.093
HCM Control Delay (s)	12.2	7.4	0	-	7.9	0	-	11.5
HCM Lane LOS	B	A	A	-	A	A	-	B
HCM 95th %tile Q(veh)	0.6	0	-	-	0	-	-	0.3

HCM 6th TWSC
7: Commerce St & 9th St

05/04/2020

Intersection						
Int Delay, s/veh	2.4					
Movement	WBL	WBR	NBT	NBR	SBL	SBT
Lane Configurations	W		T			T
Traffic Vol, veh/h	4	18	37	0	16	115
Future Vol, veh/h	4	18	37	0	16	115
Conflicting Peds, #/hr	0	0	0	0	0	0
Sign Control	Stop	Stop	Free	Free	Free	Free
RT Channelized	-	None	-	None	-	None
Storage Length	0	-	-	-	-	-
Veh in Median Storage, #	0	-	0	-	-	0
Grade, %	0	-	0	-	-	0
Peak Hour Factor	50	79	77	25	25	68
Heavy Vehicles, %	2	2	2	2	2	2
Mvmt Flow	8	23	48	0	64	169

Major/Minor	Minor1	Major1	Major2			
Conflicting Flow All	345	48	0	0	48	0
Stage 1	48	-	-	-	-	-
Stage 2	297	-	-	-	-	-
Critical Hdwy	6.42	6.22	-	-	4.12	-
Critical Hdwy Stg 1	5.42	-	-	-	-	-
Critical Hdwy Stg 2	5.42	-	-	-	-	-
Follow-up Hdwy	3.518	3.318	-	-	2.218	-
Pot Cap-1 Maneuver	652	1021	-	-	1559	-
Stage 1	974	-	-	-	-	-
Stage 2	754	-	-	-	-	-
Platoon blocked, %			-	-		-
Mov Cap-1 Maneuver	623	1021	-	-	1559	-
Mov Cap-2 Maneuver	623	-	-	-	-	-
Stage 1	930	-	-	-	-	-
Stage 2	754	-	-	-	-	-

Approach	WB	NB	SB
HCM Control Delay, s	9.3	0	2
HCM LOS	A		

Minor Lane/Major Mvmt	NBT	NBRWBLn1	SBL	SBT
Capacity (veh/h)	-	-	876	1559
HCM Lane V/C Ratio	-	-	0.035	0.041
HCM Control Delay (s)	-	-	9.3	7.4
HCM Lane LOS	-	-	A	A
HCM 95th %tile Q(veh)	-	-	0.1	0.1

Intersection						
Int Delay, s/veh	5.5					
Movement	EBT	EBR	WBL	WBT	NBL	NBR
Lane Configurations						
Traffic Vol, veh/h	9	59	5	8	86	9
Future Vol, veh/h	9	59	5	8	86	9
Conflicting Peds, #/hr	0	0	0	0	0	0
Sign Control	Free	Free	Free	Free	Stop	Stop
RT Channelized	-	None	-	None	-	None
Storage Length	-	-	-	-	0	-
Veh in Median Storage, #	0	-	-	0	0	-
Grade, %	0	-	-	0	0	-
Peak Hour Factor	38	84	62	67	69	56
Heavy Vehicles, %	2	2	2	2	2	2
Mvmt Flow	24	70	8	12	125	16

Major/Minor	Major1	Major2	Minor1	Minor2	Minor3
Conflicting Flow All	0	0	94	0	87
Stage 1	-	-	-	-	59
Stage 2	-	-	-	-	28
Critical Hdwy	-	-	4.12	-	6.42
Critical Hdwy Stg 1	-	-	-	-	5.42
Critical Hdwy Stg 2	-	-	-	-	5.42
Follow-up Hdwy	-	-	2.218	-	3.518
Pot Cap-1 Maneuver	-	-	1500	-	914
Stage 1	-	-	-	-	964
Stage 2	-	-	-	-	995
Platoon blocked, %	-	-	-	-	-
Mov Cap-1 Maneuver	-	-	1500	-	909
Mov Cap-2 Maneuver	-	-	-	-	909
Stage 1	-	-	-	-	959
Stage 2	-	-	-	-	995

Approach	EB	WB	NB
HCM Control Delay, s	0	3	9.6
HCM LOS			A

Minor Lane/Major Mvmt	NBLn1	EBT	EBR	WBL	WBT
Capacity (veh/h)	919	-	-	1500	-
HCM Lane V/C Ratio	0.153	-	-	0.005	-
HCM Control Delay (s)	9.6	-	-	7.4	0
HCM Lane LOS	A	-	-	A	A
HCM 95th %tile Q(veh)	0.5	-	-	0	-

HCM 6th Signalized Intersection Summary
 9: SR 91 Off-Ramp/SR 91 On-Ramp & 14th St

05/04/2020



Movement	EBL	EBT	EBR	WBL	WBT	WBR	NBL	NBT	NBR	SBL	SBT	SBR
Lane Configurations	↖↗	↑↑			↑↑↑	↖	↖	↖	↖			
Traffic Volume (veh/h)	561	427	0	0	1214	224	720	0	259	0	0	0
Future Volume (veh/h)	561	427	0	0	1214	224	720	0	259	0	0	0
Initial Q (Qb), veh	0	0	0	0	0	0	0	0	0			
Ped-Bike Adj(A_pbT)	1.00		1.00	1.00		1.00	1.00		1.00			
Parking Bus, Adj	1.00	1.00	1.00	1.00	1.00	1.00	1.00	1.00	1.00			
Work Zone On Approach		No			No			No				
Adj Sat Flow, veh/h/ln	1870	1870	0	0	1870	1870	1870	1870	1870			
Adj Flow Rate, veh/h	610	491	0	0	1291	267	828	0	308			
Peak Hour Factor	0.92	0.87	0.25	0.25	0.94	0.84	0.87	0.25	0.84			
Percent Heavy Veh, %	2	2	0	0	2	2	2	2	2			
Cap, veh/h	778	2079	0	0	1608	499	1158	0	515			
Arrive On Green	0.22	0.58	0.00	0.00	0.31	0.31	0.32	0.00	0.32			
Sat Flow, veh/h	3456	3647	0	0	5274	1585	3563	0	1585			
Grp Volume(v), veh/h	610	491	0	0	1291	267	828	0	308			
Grp Sat Flow(s),veh/h/ln	1728	1777	0	0	1702	1585	1781	0	1585			
Q Serve(g_s), s	16.6	6.7	0.0	0.0	23.2	13.9	20.4	0.0	16.3			
Cycle Q Clear(g_c), s	16.6	6.7	0.0	0.0	23.2	13.9	20.4	0.0	16.3			
Prop In Lane	1.00		0.00	0.00		1.00	1.00		1.00			
Lane Grp Cap(c), veh/h	778	2079	0	0	1608	499	1158	0	515			
V/C Ratio(X)	0.78	0.24	0.00	0.00	0.80	0.53	0.72	0.00	0.60			
Avail Cap(c_a), veh/h	778	2079	0	0	1608	499	1158	0	515			
HCM Platoon Ratio	1.00	1.00	1.00	1.00	1.00	1.00	1.00	1.00	1.00			
Upstream Filter(I)	1.00	1.00	0.00	0.00	1.00	1.00	1.00	0.00	1.00			
Uniform Delay (d), s/veh	36.5	10.0	0.0	0.0	31.4	28.2	29.7	0.0	28.3			
Incr Delay (d2), s/veh	7.8	0.3	0.0	0.0	4.3	4.1	3.8	0.0	5.1			
Initial Q Delay(d3),s/veh	0.0	0.0	0.0	0.0	0.0	0.0	0.0	0.0	0.0			
%ile BackOfQ(50%),veh/ln	7.7	2.5	0.0	0.0	9.9	5.7	9.2	0.0	6.8			
Unsig. Movement Delay, s/veh												
LnGrp Delay(d),s/veh	44.3	10.3	0.0	0.0	35.7	32.3	33.5	0.0	33.3			
LnGrp LOS	D	B	A	A	D	C	C	A	C			
Approach Vol, veh/h		1101			1558			1136				
Approach Delay, s/veh		29.1			35.1			33.4				
Approach LOS		C			D			C				
Timer - Assigned Phs		2		4			7	8				
Phs Duration (G+Y+Rc), s		37.0		63.0			27.0	36.0				
Change Period (Y+Rc), s		4.5		4.5			4.5	4.5				
Max Green Setting (Gmax), s		32.5		58.5			22.5	31.5				
Max Q Clear Time (g_c+I1), s		22.4		8.7			18.6	25.2				
Green Ext Time (p_c), s		3.4		3.8			1.0	4.5				

Intersection Summary

HCM 6th Ctrl Delay	32.9
HCM 6th LOS	C

Notes

User approved volume balancing among the lanes for turning movement.

HCM 6th Signalized Intersection Summary

11: Park Ave & University Ave

05/04/2020



Movement	EBL	EBT	EBR	WBL	WBT	WBR	NBL	NBT	NBR	SBL	SBT	SBR
Lane Configurations	↖	↗		↖	↗		↖	↗		↖	↗	
Traffic Volume (veh/h)	27	475	29	35	678	45	27	27	25	40	32	38
Future Volume (veh/h)	27	475	29	35	678	45	27	27	25	40	32	38
Initial Q (Qb), veh	0	0	0	0	0	0	0	0	0	0	0	0
Ped-Bike Adj(A_pbT)	1.00		1.00	1.00		1.00	1.00		1.00	1.00		1.00
Parking Bus, Adj	1.00	1.00	1.00	1.00	1.00	1.00	1.00	1.00	1.00	1.00	1.00	1.00
Work Zone On Approach		No		No		No		No		No		No
Adj Sat Flow, veh/h/ln	1870	1870	1870	1870	1870	1870	1870	1870	1870	1870	1870	1870
Adj Flow Rate, veh/h	40	559	39	47	729	68	29	47	32	56	40	64
Peak Hour Factor	0.68	0.85	0.75	0.75	0.93	0.66	0.94	0.58	0.79	0.71	0.80	0.59
Percent Heavy Veh, %	2	2	2	2	2	2	2	2	2	2	2	2
Cap, veh/h	154	1363	95	170	1359	127	138	231	157	202	168	268
Arrive On Green	0.09	0.40	0.40	0.10	0.41	0.41	0.08	0.22	0.22	0.11	0.26	0.26
Sat Flow, veh/h	1781	3370	235	1781	3286	306	1781	1037	706	1781	648	1036
Grp Volume(v), veh/h	40	294	304	47	394	403	29	0	79	56	0	104
Grp Sat Flow(s),veh/h/ln	1781	1777	1828	1781	1777	1815	1781	0	1743	1781	0	1684
Q Serve(g_s), s	2.3	13.0	13.1	2.7	18.4	18.4	1.7	0.0	4.1	3.2	0.0	5.4
Cycle Q Clear(g_c), s	2.3	13.0	13.1	2.7	18.4	18.4	1.7	0.0	4.1	3.2	0.0	5.4
Prop In Lane	1.00		0.13	1.00		0.17	1.00		0.41	1.00		0.62
Lane Grp Cap(c), veh/h	154	719	740	170	735	751	138	0	388	202	0	436
V/C Ratio(X)	0.26	0.41	0.41	0.28	0.54	0.54	0.21	0.00	0.20	0.28	0.00	0.24
Avail Cap(c_a), veh/h	154	719	740	170	735	751	138	0	388	202	0	436
HCM Platoon Ratio	1.00	1.00	1.00	1.00	1.00	1.00	1.00	1.00	1.00	1.00	1.00	1.00
Upstream Filter(I)	1.00	1.00	1.00	1.00	1.00	1.00	1.00	0.00	1.00	1.00	0.00	1.00
Uniform Delay (d), s/veh	47.0	23.4	23.4	46.2	24.3	24.3	47.6	0.0	34.8	44.6	0.0	32.2
Incr Delay (d2), s/veh	4.1	1.7	1.7	4.0	2.8	2.7	3.5	0.0	1.2	3.4	0.0	1.3
Initial Q Delay(d3),s/veh	0.0	0.0	0.0	0.0	0.0	0.0	0.0	0.0	0.0	0.0	0.0	0.0
%ile BackOfQ(50%),veh/ln	1.2	5.7	5.9	1.4	8.2	8.4	0.9	0.0	1.9	1.6	0.0	2.3
Unsig. Movement Delay, s/veh												
LnGrp Delay(d),s/veh	51.0	25.1	25.1	50.2	27.1	27.0	51.1	0.0	36.0	48.0	0.0	33.5
LnGrp LOS	D	C	C	D	C	C	D	A	D	D	A	C
Approach Vol, veh/h		638			844			108			160	
Approach Delay, s/veh		26.7			28.4			40.0			38.5	
Approach LOS		C			C			D			D	
Timer - Assigned Phs	1	2	3	4	5	6	7	8				
Phs Duration (G+Y+Rc), s	17.0	29.0	15.0	49.0	13.0	33.0	14.0	50.0				
Change Period (Y+Rc), s	4.5	4.5	4.5	4.5	4.5	4.5	4.5	4.5				
Max Green Setting (Gmax), s	12.5	24.5	10.5	44.5	8.5	28.5	9.5	45.5				
Max Q Clear Time (g_c+1), s	11.2	6.1	4.7	15.1	3.7	7.4	4.3	20.4				
Green Ext Time (p_c), s	0.0	0.3	0.0	4.0	0.0	0.5	0.0	5.4				
Intersection Summary												
HCM 6th Ctrl Delay												29.4
HCM 6th LOS												C

HCM 6th AWSC
12: Howard Ave & 12th St

05/04/2020

Intersection

Intersection Delay, s/veh 8

Intersection LOS A

Movement	EBL	EBT	EBR	WBL	WBT	WBR	NBL	NBT	NBR	SBL	SBT	SBR
Lane Configurations		↔		↔		↔		↔			↔	
Traffic Vol, veh/h	1	1	17	16	10	3	2	120	5	0	59	5
Future Vol, veh/h	1	1	17	16	10	3	2	120	5	0	59	5
Peak Hour Factor	0.25	0.25	0.85	0.71	0.62	0.50	0.48	0.70	0.42	0.25	0.68	0.62
Heavy Vehicles, %	2	2	2	2	2	2	2	2	2	2	2	2
Mvmt Flow	4	4	20	23	16	6	4	171	12	0	87	8
Number of Lanes	0	1	0	0	1	0	0	1	0	0	1	0

Approach	EB	WB	NB	SB
Opposing Approach	WB	EB	SB	NB
Opposing Lanes	1	1	1	1
Conflicting Approach Left SB	NB	EB	WB	WB
Conflicting Lanes Left	1	1	1	1
Conflicting Approach RightNB	SB	WB	WB	EB
Conflicting Lanes Right	1	1	1	1
HCM Control Delay	7.2	7.9	8.3	7.8
HCM LOS	A	A	A	A

Lane	NBLn1	EBLn1	WBLn1	SBLn1
Vol Left, %	2%	5%	55%	0%
Vol Thru, %	94%	5%	34%	92%
Vol Right, %	4%	89%	10%	8%
Sign Control	Stop	Stop	Stop	Stop
Traffic Vol by Lane	127	19	29	64
LT Vol	2	1	16	0
Through Vol	120	1	10	59
RT Vol	5	17	3	5
Lane Flow Rate	188	28	45	95
Geometry Grp	1	1	1	1
Degree of Util (X)	0.214	0.032	0.057	0.11
Departure Headway (Hd)	4.113	4.079	4.632	4.158
Convergence, Y/N	Yes	Yes	Yes	Yes
Cap	864	883	778	849
Service Time	2.183	2.08	2.633	2.247
HCM Lane V/C Ratio	0.218	0.032	0.058	0.112
HCM Control Delay	8.3	7.2	7.9	7.8
HCM Lane LOS	A	A	A	A
HCM 95th-tile Q	0.8	0.1	0.2	0.4

HCM 6th Signalized Intersection Summary

13: Olivewood Ave/Lime St & 14th St

05/04/2020



Movement	EBL	EBT	EBR	WBL	WBT	WBR	NBL	NBT	NBR	SBL	SBT	SBR
Lane Configurations	↙ ↑↑↑			↙ ↑↑↑			↙ ↑↑		↙ ↘		↑↑	
Traffic Volume (veh/h)	34	601	44	281	1590	199	88	278	347	41	113	18
Future Volume (veh/h)	34	601	44	281	1590	199	88	278	347	41	113	18
Initial Q (Qb), veh	0	0	0	0	0	0	0	0	0	0	0	0
Ped-Bike Adj(A_pbT)	1.00		1.00	1.00		1.00	1.00		1.00	1.00		1.00
Parking Bus, Adj	1.00	1.00	1.00	1.00	1.00	1.00	1.00	1.00	1.00	1.00	1.00	1.00
Work Zone On Approach	No			No			No		No			
Adj Sat Flow, veh/h/ln	1870	1870	1870	1870	1870	1870	1870	1870	1870	1870	1870	1870
Adj Flow Rate, veh/h	48	733	56	309	1710	243	111	329	424	66	136	36
Peak Hour Factor	0.71	0.82	0.79	0.91	0.93	0.82	0.79	0.77	0.86	0.62	0.83	0.50
Percent Heavy Veh, %	2	2	2	2	2	2	2	2	2	2	2	2
Cap, veh/h	118	1298	99	491	2157	305	219	454	769	173	476	122
Arrive On Green	0.07	0.27	0.27	0.55	0.95	0.95	0.12	0.24	0.24	0.05	0.17	0.17
Sat Flow, veh/h	1781	4840	368	1781	4520	639	1781	1870	3170	3456	2799	719
Grp Volume(v), veh/h	48	514	275	309	1285	668	111	329	424	66	85	87
Grp Sat Flow(s),veh/h/ln	1781	1702	1804	1781	1702	1755	1781	1870	1585	1728	1777	1741
Q Serve(g_s), s	2.8	14.3	14.5	13.1	7.7	7.9	6.4	17.8	12.9	2.0	4.6	4.8
Cycle Q Clear(g_c), s	2.8	14.3	14.5	13.1	7.7	7.9	6.4	17.8	12.9	2.0	4.6	4.8
Prop In Lane	1.00		0.20	1.00		0.36	1.00		1.00	1.00		0.41
Lane Grp Cap(c), veh/h	118	913	484	491	1625	838	219	454	769	173	302	296
V/C Ratio(X)	0.41	0.56	0.57	0.63	0.79	0.80	0.51	0.72	0.55	0.38	0.28	0.29
Avail Cap(c_a), veh/h	118	913	484	491	1625	838	219	454	769	173	302	296
HCM Platoon Ratio	1.00	1.00	1.00	2.00	2.00	2.00	1.00	1.00	1.00	1.00	1.00	1.00
Upstream Filter(l)	1.00	1.00	1.00	1.00	1.00	1.00	1.00	1.00	1.00	1.00	1.00	1.00
Uniform Delay (d), s/veh	49.3	34.7	34.7	20.8	1.5	1.5	45.1	38.3	36.4	50.6	39.8	39.9
Incr Delay (d2), s/veh	10.0	2.5	4.8	6.0	4.0	7.8	8.2	9.7	2.8	6.3	2.3	2.5
Initial Q Delay(d3),s/veh	0.0	0.0	0.0	0.0	0.0	0.0	0.0	0.0	0.0	0.0	0.0	0.0
%ile BackOfQ(50%),veh/ln	1.6	6.2	6.9	4.9	1.7	2.6	3.3	9.3	5.3	1.0	2.2	2.3
Unsig. Movement Delay, s/veh												
LnGrp Delay(d),s/veh	59.3	37.2	39.5	26.9	5.5	9.3	53.3	48.0	39.2	56.9	42.1	42.4
LnGrp LOS	E	D	D	C	A	A	D	D	D	E	D	D
Approach Vol, veh/h	837			2262			864		238			
Approach Delay, s/veh	39.2			9.5			44.4		46.3			
Approach LOS	D			A			D		D			
Timer - Assigned Phs	1	2	3	4	5	6	7	8				
Phs Duration (G+Y+Rc), s	30.0	31.2	34.8	34.0	18.0	23.2	11.8	57.0				
Change Period (Y+Rc), s	4.5	4.5	4.5	4.5	4.5	4.5	4.5	4.5				
Max Green Setting (Gmax), s	5.5	26.7	30.3	29.5	13.5	18.7	7.3	52.5				
Max Q Clear Time (g_c+1), s	19.8	19.8	15.1	16.5	8.4	6.8	4.8	9.9				
Green Ext Time (p_c), s	0.0	2.2	0.8	4.3	0.1	0.6	0.0	22.9				

Intersection Summary

HCM 6th Ctrl Delay	24.7
HCM 6th LOS	C

Notes

User approved volume balancing among the lanes for turning movement.

Existing PM

HCM 6th Signalized Intersection Summary

14: Mulberry St/SR 91 Off-Ramp & 14th St

05/04/2020



Movement	EBL	EBT	EBR	WBL	WBT	WBR	NBL	NBT	NBR	SBL	SBT	SBR
Lane Configurations	↑↑↑			↔↔↔			↑↑↑			↔↔↔		
Traffic Volume (veh/h)	0	859	130	391	1543	0	0	0	0	129	206	528
Future Volume (veh/h)	0	859	130	391	1543	0	0	0	0	129	206	528
Initial Q (Qb), veh	0	0	0	0	0	0				0	0	0
Ped-Bike Adj(A_pbT)	1.00		1.00	1.00		1.00				1.00		1.00
Parking Bus, Adj	1.00	1.00	1.00	1.00	1.00	1.00				1.00	1.00	1.00
Work Zone On Approach	No			No						No		
Adj Sat Flow, veh/h/ln	0	1870	1870	1870	1870	0				1870	1870	1870
Adj Flow Rate, veh/h	0	914	217	536	1696	0				105	261	592
Peak Hour Factor	0.25	0.94	0.60	0.73	0.91	0.25				0.82	0.85	0.95
Percent Heavy Veh, %	0	2	2	2	2	0				2	2	2
Cap, veh/h	0	1406	332	833	3180	0				526	553	937
Arrive On Green	0.00	0.45	0.45	0.24	0.62	0.00				0.30	0.30	0.30
Sat Flow, veh/h	0	4292	975	3456	5274	0				1781	1870	3170
Grp Volume(v), veh/h	0	754	377	536	1696	0				105	261	592
Grp Sat Flow(s),veh/h/ln	0	1702	1695	1728	1702	0				1781	1870	1585
Q Serve(g_s), s	0.0	18.9	19.0	15.3	20.6	0.0				4.9	12.6	17.8
Cycle Q Clear(g_c), s	0.0	18.9	19.0	15.3	20.6	0.0				4.9	12.6	17.8
Prop In Lane	0.00		0.58	1.00		0.00				1.00		1.00
Lane Grp Cap(c), veh/h	0	1160	578	833	3180	0				526	553	937
V/C Ratio(X)	0.00	0.65	0.65	0.64	0.53	0.00				0.20	0.47	0.63
Avail Cap(c_a), veh/h	0	1160	578	833	3180	0				526	553	937
HCM Platoon Ratio	1.00	1.33	1.33	1.00	1.00	1.00				1.00	1.00	1.00
Upstream Filter(I)	0.00	1.00	1.00	1.00	1.00	0.00				1.00	1.00	1.00
Uniform Delay (d), s/veh	0.0	25.0	25.0	37.5	11.7	0.0				29.0	31.7	33.6
Incr Delay (d2), s/veh	0.0	2.8	5.7	3.8	0.6	0.0				0.9	2.9	3.2
Initial Q Delay(d3),s/veh	0.0	0.0	0.0	0.0	0.0	0.0				0.0	0.0	0.0
%ile BackOfQ(50%),veh/ln	0.0	7.3	7.8	6.9	7.5	0.0				2.2	6.1	7.2
Unsig. Movement Delay, s/veh												
LnGrp Delay(d),s/veh	0.0	27.8	30.7	41.3	12.4	0.0				29.9	34.6	36.8
LnGrp LOS	A	C	C	D	B	A				C	C	D
Approach Vol, veh/h	1131			2232						958		
Approach Delay, s/veh	28.8			19.3						35.4		
Approach LOS	C			B						D		
Timer - Assigned Phs	3			4			6			8		
Phs Duration (G+Y+Rc), s	31.0			42.0			37.0			73.0		
Change Period (Y+Rc), s	4.5			4.5			4.5			4.5		
Max Green Setting (Gmax), s	26.5			37.5			32.5			68.5		
Max Q Clear Time (g_c+I1), s	17.3			21.0			19.8			22.6		
Green Ext Time (p_c), s	1.4			7.2			3.7			20.0		
Intersection Summary												
HCM 6th Ctrl Delay	25.4											
HCM 6th LOS	C											
Notes												
User approved volume balancing among the lanes for turning movement.												

HCM 6th Signalized Intersection Summary

2: Mission Inn Ave & SR 91 Off-Ramp

05/04/2020

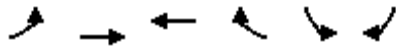

Movement	EBL	EBT	WBT	WBR	SBL	SBR
Lane Configurations		↑↑	↑↑		↵	↵↵
Traffic Volume (veh/h)	0	630	237	0	202	410
Future Volume (veh/h)	0	630	237	0	202	410
Initial Q (Qb), veh	0	0	0	0	0	0
Ped-Bike Adj(A_pbT)	1.00			1.00	1.00	1.00
Parking Bus, Adj	1.00	1.00	1.00	1.00	1.00	1.00
Work Zone On Approach		No	No		No	
Adj Sat Flow, veh/h/ln	0	1870	1870	0	1870	1870
Adj Flow Rate, veh/h	0	663	255	0	215	436
Peak Hour Factor	0.25	0.95	0.93	0.25	0.94	0.94
Percent Heavy Veh, %	0	2	2	0	2	2
Cap, veh/h	0	1825	1825	0	721	1129
Arrive On Green	0.00	0.51	1.00	0.00	0.40	0.40
Sat Flow, veh/h	0	3741	3741	0	1781	2790
Grp Volume(v), veh/h	0	663	255	0	215	436
Grp Sat Flow(s),veh/h/ln	0	1777	1777	0	1781	1395
Q Serve(g_s), s	0.0	12.3	0.0	0.0	9.0	12.1
Cycle Q Clear(g_c), s	0.0	12.3	0.0	0.0	9.0	12.1
Prop In Lane	0.00			0.00	1.00	1.00
Lane Grp Cap(c), veh/h	0	1825	1825	0	721	1129
V/C Ratio(X)	0.00	0.36	0.14	0.00	0.30	0.39
Avail Cap(c_a), veh/h	0	1825	1825	0	721	1129
HCM Platoon Ratio	1.00	1.00	2.00	1.00	1.00	1.00
Upstream Filter(I)	0.00	1.00	1.00	0.00	1.00	1.00
Uniform Delay (d), s/veh	0.0	16.0	0.0	0.0	22.2	23.1
Incr Delay (d2), s/veh	0.0	0.6	0.2	0.0	1.1	1.0
Initial Q Delay(d3),s/veh	0.0	0.0	0.0	0.0	0.0	0.0
%ile BackOfQ(50%),veh/ln	0.0	5.0	0.0	0.0	4.0	4.1
Unsig. Movement Delay, s/veh						
LnGrp Delay(d),s/veh	0.0	16.6	0.2	0.0	23.2	24.1
LnGrp LOS	A	B	A	A	C	C
Approach Vol, veh/h		663	255		651	
Approach Delay, s/veh		16.6	0.2		23.8	
Approach LOS		B	A		C	
Timer - Assigned Phs				4	6	8
Phs Duration (G+Y+Rc), s				61.0	49.0	61.0
Change Period (Y+Rc), s				4.5	4.5	4.5
Max Green Setting (Gmax), s				56.5	44.5	56.5
Max Q Clear Time (g_c+I1), s				14.3	14.1	2.0
Green Ext Time (p_c), s				5.3	2.5	1.8
Intersection Summary						
HCM 6th Ctrl Delay		16.9				
HCM 6th LOS		B				

HCM 6th Signalized Intersection Summary

3: Mulberry St/SR 91 On-Ramp & Mission Inn Ave

05/04/2020



Movement	EBL	EBT	EBR	WBL	WBT	WBR	NBL	NBT	NBR	SBL	SBT	SBR
Lane Configurations												
Traffic Volume (veh/h)	404	428	0	0	139	183	98	411	44	0	0	0
Future Volume (veh/h)	404	428	0	0	139	183	98	411	44	0	0	0
Initial Q (Qb), veh	0	0	0	0	0	0	0	0	0			
Ped-Bike Adj(A_pbT)	1.00		1.00	1.00		1.00	1.00		1.00			
Parking Bus, Adj	1.00	1.00	1.00	1.00	1.00	1.00	1.00	1.00	1.00			
Work Zone On Approach		No			No			No				
Adj Sat Flow, veh/h/ln	1870	1870	0	0	1870	1870	1870	1870	1870			
Adj Flow Rate, veh/h	444	498	0	0	196	0	126	501	54			
Peak Hour Factor	0.91	0.86	0.25	0.25	0.71	0.73	0.78	0.82	0.81			
Percent Heavy Veh, %	2	2	0	0	2	2	2	2	2			
Cap, veh/h	575	1955	0	0	662		656	611	66			
Arrive On Green	0.65	1.00	0.00	0.00	0.19	0.00	0.37	0.37	0.37			
Sat Flow, veh/h	1781	3647	0	0	3741	0	1781	1659	179			
Grp Volume(v), veh/h	444	498	0	0	196	0	126	0	555			
Grp Sat Flow(s),veh/h/ln	1781	1777	0	0	1777	0	1781	0	1838			
Q Serve(g_s), s	19.4	0.0	0.0	0.0	5.2	0.0	5.3	0.0	30.1			
Cycle Q Clear(g_c), s	19.4	0.0	0.0	0.0	5.2	0.0	5.3	0.0	30.1			
Prop In Lane	1.00		0.00	0.00		0.00	1.00		0.10			
Lane Grp Cap(c), veh/h	575	1955	0	0	662		656	0	677			
V/C Ratio(X)	0.77	0.25	0.00	0.00	0.30		0.19	0.00	0.82			
Avail Cap(c_a), veh/h	575	1955	0	0	662		656	0	677			
HCM Platoon Ratio	2.00	2.00	1.00	1.00	1.00	1.00	1.00	1.00	1.00			
Upstream Filter(I)	1.00	1.00	0.00	0.00	1.00	0.00	1.00	0.00	1.00			
Uniform Delay (d), s/veh	16.6	0.0	0.0	0.0	38.5	0.0	23.6	0.0	31.5			
Incr Delay (d2), s/veh	9.7	0.3	0.0	0.0	1.1	0.0	0.7	0.0	10.7			
Initial Q Delay(d3),s/veh	0.0	0.0	0.0	0.0	0.0	0.0	0.0	0.0	0.0			
%ile BackOfQ(50%),veh/ln	6.3	0.1	0.0	0.0	2.4	0.0	2.3	0.0	15.1			
Unsig. Movement Delay, s/veh												
LnGrp Delay(d),s/veh	26.3	0.3	0.0	0.0	39.7	0.0	24.3	0.0	42.2			
LnGrp LOS	C	A	A	A	D		C	A	D			
Approach Vol, veh/h		942			196	A		681				
Approach Delay, s/veh		12.6			39.7			38.8				
Approach LOS		B			D			D				
Timer - Assigned Phs		2		4			7	8				
Phs Duration (G+Y+Rc), s		45.0		65.0			40.0	25.0				
Change Period (Y+Rc), s		4.5		4.5			4.5	4.5				
Max Green Setting (Gmax), s		40.5		60.5			35.5	20.5				
Max Q Clear Time (g_c+I1), s		32.1		2.0			21.4	7.2				
Green Ext Time (p_c), s		2.6		3.8			1.2	0.9				

Intersection Summary

HCM 6th Ctrl Delay	25.3
HCM 6th LOS	C

Notes

Unsignalized Delay for [WBR] is excluded from calculations of the approach delay and intersection delay.

HCM 6th Signalized Intersection Summary

4: Howard Ave & 14th St

05/04/2020



Movement	EBL	EBT	EBR	WBL	WBT	WBR	NBL	NBT	NBR	SBL	SBT	SBR
Lane Configurations												
Traffic Volume (veh/h)	40	1529	180	9	685	15	42	13	12	32	31	71
Future Volume (veh/h)	40	1529	180	9	685	15	42	13	12	32	31	71
Initial Q (Qb), veh	0	0	0	0	0	0	0	0	0	0	0	0
Ped-Bike Adj(A_pbT)	1.00		1.00	1.00		1.00	1.00		1.00	1.00		1.00
Parking Bus, Adj	1.00	1.00	1.00	1.00	1.00	1.00	1.00	1.00	1.00	1.00	1.00	1.00
Work Zone On Approach		No			No			No			No	
Adj Sat Flow, veh/h/ln	1870	1870	1870	1870	1870	1870	1870	1870	1870	1870	1870	1870
Adj Flow Rate, veh/h	57	1718	254	16	778	21	58	19	19	64	57	81
Peak Hour Factor	0.70	0.89	0.71	0.55	0.88	0.70	0.73	0.70	0.62	0.50	0.54	0.88
Percent Heavy Veh, %	2	2	2	2	2	2	2	2	2	2	2	2
Cap, veh/h	147	2148	958	83	2008	54	219	72	59	139	126	148
Arrive On Green	0.08	0.60	0.60	0.05	0.57	0.57	0.23	0.23	0.23	0.23	0.23	0.23
Sat Flow, veh/h	1781	3554	1585	1781	3535	95	736	317	260	423	556	655
Grp Volume(v), veh/h	57	1718	254	16	391	408	96	0	0	202	0	0
Grp Sat Flow(s),veh/h/ln	1781	1777	1585	1781	1777	1853	1313	0	0	1633	0	0
Q Serve(g_s), s	3.3	40.7	8.3	1.0	13.4	13.4	0.0	0.0	0.0	4.4	0.0	0.0
Cycle Q Clear(g_c), s	3.3	40.7	8.3	1.0	13.4	13.4	7.0	0.0	0.0	11.5	0.0	0.0
Prop In Lane	1.00		1.00	1.00		0.05	0.60		0.20	0.32		0.40
Lane Grp Cap(c), veh/h	147	2148	958	83	1010	1053	350	0	0	413	0	0
V/C Ratio(X)	0.39	0.80	0.27	0.19	0.39	0.39	0.27	0.00	0.00	0.49	0.00	0.00
Avail Cap(c_a), veh/h	147	2148	958	83	1010	1053	350	0	0	413	0	0
HCM Platoon Ratio	1.00	1.00	1.00	1.00	1.00	1.00	1.00	1.00	1.00	1.00	1.00	1.00
Upstream Filter(I)	1.00	1.00	1.00	1.00	1.00	1.00	1.00	0.00	0.00	1.00	0.00	0.00
Uniform Delay (d), s/veh	47.8	16.7	10.2	50.5	13.1	13.2	35.4	0.0	0.0	37.2	0.0	0.0
Incr Delay (d2), s/veh	7.5	3.2	0.7	5.2	1.1	1.1	1.9	0.0	0.0	4.1	0.0	0.0
Initial Q Delay(d3),s/veh	0.0	0.0	0.0	0.0	0.0	0.0	0.0	0.0	0.0	0.0	0.0	0.0
%ile BackOfQ(50%),veh/ln	8	16.2	3.0	0.5	5.5	5.7	2.3	0.0	0.0	5.2	0.0	0.0
Unsig. Movement Delay, s/veh												
LnGrp Delay(d),s/veh	55.3	19.9	10.9	55.6	14.3	14.2	37.3	0.0	0.0	41.3	0.0	0.0
LnGrp LOS	E	B	B	E	B	B	D	A	A	D	A	A
Approach Vol, veh/h		2029			815			96			202	
Approach Delay, s/veh		19.8			15.1			37.3			41.3	
Approach LOS		B			B			D			D	
Timer - Assigned Phs		2	3	4		6	7	8				
Phs Duration (G+Y+Rc), s		29.4	9.6	71.0		29.4	13.6	67.0				
Change Period (Y+Rc), s		4.5	4.5	4.5		4.5	4.5	4.5				
Max Green Setting (Gmax), s		24.9	5.1	66.5		24.9	9.1	62.5				
Max Q Clear Time (g_c+I1), s		9.0	3.0	42.7		13.5	5.3	15.4				
Green Ext Time (p_c), s		0.4	0.0	16.1		0.8	0.0	6.0				
Intersection Summary												
HCM 6th Ctrl Delay											20.5	
HCM 6th LOS											C	

Intersection

Intersection Delay, s/veh 17.6

Intersection LOS C

Movement	EBL	EBT	EBR	WBL	WBT	WBR	NBL	NBT	NBR	SBL	SBT	SBR
Lane Configurations												
Traffic Vol, veh/h	144	252	75	16	98	40	84	51	36	47	57	140
Future Vol, veh/h	144	252	75	16	98	40	84	51	36	47	57	140
Peak Hour Factor	0.75	0.88	0.67	0.25	0.73	0.89	0.70	0.89	0.57	0.71	0.81	0.97
Heavy Vehicles, %	2	2	2	2	2	2	2	2	2	2	2	2
Mvmt Flow	192	286	112	64	134	45	120	57	63	66	70	144
Number of Lanes	1	1	1	1	2	0	1	1	0	0	1	0

Approach	EB	WB	NB	SB
Opposing Approach	WB	EB	SB	NB
Opposing Lanes	3	3	1	2
Conflicting Approach Left SB		NB	EB	WB
Conflicting Lanes Left	1	2	3	3
Conflicting Approach Right NB		SB	WB	EB
Conflicting Lanes Right	2	1	3	3
HCM Control Delay	18.2	13.4	14.7	22.3
HCM LOS	C	B	B	C

Lane	NBLn1	NBLn2	EBLn1	EBLn2	EBLn3	WBLn1	WBLn2	WBLn3	SBLn1
Vol Left, %	100%	0%	100%	0%	0%	100%	0%	0%	19%
Vol Thru, %	0%	59%	0%	100%	0%	0%	100%	45%	23%
Vol Right, %	0%	41%	0%	0%	100%	0%	0%	55%	57%
Sign Control	Stop	Stop	Stop	Stop	Stop	Stop	Stop	Stop	Stop
Traffic Vol by Lane	84	87	144	252	75	16	65	73	244
LT Vol	84	0	144	0	0	16	0	0	47
Through Vol	0	51	0	252	0	0	65	33	57
RT Vol	0	36	0	0	75	0	0	40	140
Lane Flow Rate	120	120	192	286	112	64	89	90	281
Geometry Grp	8	8	8	8	8	8	8	8	8
Degree of Util (X)	0.3	0.274	0.434	0.606	0.215	0.162	0.213	0.204	0.611
Departure Headway (Hd)	8.987	8.182	8.243	7.727	7.005	9.089	8.57	8.17	7.938
Convergence, Y/N	Yes	Yes	Yes	Yes	Yes	Yes	Yes	Yes	Yes
Cap	402	442	440	470	516	396	421	441	458
Service Time	6.687	5.882	5.943	5.427	4.705	6.803	6.284	5.884	5.638
HCM Lane V/C Ratio	0.299	0.271	0.436	0.609	0.217	0.162	0.211	0.204	0.614
HCM Control Delay	15.5	13.9	17.1	21.6	11.6	13.6	13.6	13	22.3
HCM Lane LOS	C	B	C	C	B	B	B	B	C
HCM 95th-tile Q	1.2	1.1	2.2	3.9	0.8	0.6	0.8	0.8	4

HCM 6th TWSC
6: Commerce St & Mission Inn Ave

05/04/2020

Intersection												
Int Delay, s/veh	4.1											
Movement	EBL	EBT	EBR	WBL	WBT	WBR	NBL	NBT	NBR	SBL	SBT	SBR
Lane Configurations		↕	↕		↕↕			↕			↕	
Traffic Vol, veh/h	17	264	54	5	111	5	35	18	10	4	39	8
Future Vol, veh/h	17	264	54	5	111	5	35	18	10	4	39	8
Conflicting Peds, #/hr	0	0	0	0	0	0	0	0	0	0	0	0
Sign Control	Free	Free	Free	Free	Free	Free	Stop	Stop	Stop	Stop	Stop	Stop
RT Channelized	-	-	None	-	-	None	-	-	None	-	-	None
Storage Length	-	-	0	-	-	-	-	-	-	-	-	-
Veh in Median Storage, #	-	0	-	-	0	-	-	0	-	-	0	-
Grade, %	-	0	-	-	0	-	-	0	-	-	0	-
Peak Hour Factor	75	75	75	50	95	50	69	42	50	25	83	65
Heavy Vehicles, %	2	2	2	2	2	2	2	2	2	2	2	2
Mvmt Flow	23	352	72	10	117	10	51	43	20	16	47	12

Major/Minor	Major1			Major2			Minor1			Minor2		
Conflicting Flow All	127	0	0	424	0	0	500	545	352	608	612	64
Stage 1	-	-	-	-	-	-	398	398	-	142	142	-
Stage 2	-	-	-	-	-	-	102	147	-	466	470	-
Critical Hdwy	4.13	-	-	4.13	-	-	7.33	6.53	6.23	7.33	6.53	6.93
Critical Hdwy Stg 1	-	-	-	-	-	-	6.13	5.53	-	6.53	5.53	-
Critical Hdwy Stg 2	-	-	-	-	-	-	6.53	5.53	-	6.13	5.53	-
Follow-up Hdwy	2.219	-	-	2.219	-	-	3.519	4.019	3.319	3.519	4.019	3.319
Pot Cap-1 Maneuver	1458	-	-	1133	-	-	467	445	691	393	407	988
Stage 1	-	-	-	-	-	-	627	602	-	847	779	-
Stage 2	-	-	-	-	-	-	893	775	-	576	559	-
Platoon blocked, %	-	-	-	-	-	-	-	-	-	-	-	-
Mov Cap-1 Maneuver	1458	-	-	1133	-	-	410	431	691	344	394	988
Mov Cap-2 Maneuver	-	-	-	-	-	-	410	431	-	344	394	-
Stage 1	-	-	-	-	-	-	614	589	-	829	771	-
Stage 2	-	-	-	-	-	-	820	767	-	508	547	-

Approach	EB			WB			NB			SB		
HCM Control Delay, s	0.4			0.6			15.6			15.4		
HCM LOS							C			C		

Minor Lane/Major Mvmt	NBLn1	EBL	EBT	EBR	WBL	WBT	WBR	SBLn1
Capacity (veh/h)	451	1458	-	-	1133	-	-	422
HCM Lane V/C Ratio	0.252	0.016	-	-	0.009	-	-	0.178
HCM Control Delay (s)	15.6	7.5	0	-	8.2	0	-	15.4
HCM Lane LOS	C	A	A	-	A	A	-	C
HCM 95th %tile Q(veh)	1	0	-	-	0	-	-	0.6

HCM 6th TWSC
7: Commerce St & 9th St

05/04/2020

Intersection						
Int Delay, s/veh	2.9					
Movement	WBL	WBR	NBT	NBR	SBL	SBT
Lane Configurations	W		T			T
Traffic Vol, veh/h	3	14	49	3	21	76
Future Vol, veh/h	3	14	49	3	21	76
Conflicting Peds, #/hr	0	0	0	0	0	0
Sign Control	Stop	Stop	Free	Free	Free	Free
RT Channelized	-	None	-	None	-	None
Storage Length	0	-	-	-	-	-
Veh in Median Storage, #	0	-	0	-	-	0
Grade, %	0	-	0	-	-	0
Peak Hour Factor	50	79	77	25	25	68
Heavy Vehicles, %	2	2	2	2	2	2
Mvmt Flow	6	18	64	12	84	112

Major/Minor	Minor1	Major1	Major2			
Conflicting Flow All	350	70	0	0	76	0
Stage 1	70	-	-	-	-	-
Stage 2	280	-	-	-	-	-
Critical Hdwy	6.42	6.22	-	-	4.12	-
Critical Hdwy Stg 1	5.42	-	-	-	-	-
Critical Hdwy Stg 2	5.42	-	-	-	-	-
Follow-up Hdwy	3.518	3.318	-	-	2.218	-
Pot Cap-1 Maneuver	647	993	-	-	1523	-
Stage 1	953	-	-	-	-	-
Stage 2	767	-	-	-	-	-
Platoon blocked, %			-	-		
Mov Cap-1 Maneuver	609	993	-	-	1523	-
Mov Cap-2 Maneuver	609	-	-	-	-	-
Stage 1	897	-	-	-	-	-
Stage 2	767	-	-	-	-	-

Approach	WB	NB	SB
HCM Control Delay, s	9.3	0	3.2
HCM LOS	A		

Minor Lane/Major Mvmt	NBT	NBRWBLn1	SBL	SBT
Capacity (veh/h)	-	-	856	1523
HCM Lane V/C Ratio	-	-	0.028	0.055
HCM Control Delay (s)	-	-	9.3	7.5
HCM Lane LOS	-	-	A	A
HCM 95th %tile Q(veh)	-	-	0.1	0.2

HCM 6th TWSC
8: Howard Ave & Tenth St

05/04/2020

Intersection						
Int Delay, s/veh	2.5					
Movement	EBT	EBR	WBL	WBT	NBL	NBR
Lane Configurations						
Traffic Vol, veh/h	33	96	9	6	25	16
Future Vol, veh/h	33	96	9	6	25	16
Conflicting Peds, #/hr	0	0	0	0	0	0
Sign Control	Free	Free	Free	Free	Stop	Stop
RT Channelized	-	None	-	None	-	None
Storage Length	-	-	-	-	0	-
Veh in Median Storage, #	0	-	-	0	0	-
Grade, %	0	-	-	0	0	-
Peak Hour Factor	38	84	62	67	69	56
Heavy Vehicles, %	2	2	2	2	2	2
Mvmt Flow	87	114	15	9	36	29

Major/Minor	Major1	Major2	Minor1		
Conflicting Flow All	0	0	201	0	183
Stage 1	-	-	-	-	144
Stage 2	-	-	-	-	39
Critical Hdwy	-	-	4.12	-	6.42
Critical Hdwy Stg 1	-	-	-	-	5.42
Critical Hdwy Stg 2	-	-	-	-	5.42
Follow-up Hdwy	-	-	2.218	-	3.518
Pot Cap-1 Maneuver	-	-	1371	-	806
Stage 1	-	-	-	-	883
Stage 2	-	-	-	-	983
Platoon blocked, %	-	-	-	-	-
Mov Cap-1 Maneuver	-	-	1371	-	797
Mov Cap-2 Maneuver	-	-	-	-	797
Stage 1	-	-	-	-	873
Stage 2	-	-	-	-	983

Approach	EB	WB	NB
HCM Control Delay, s	0	4.7	9.6
HCM LOS			A

Minor Lane/Major Mvmt	NBLn1	EBT	EBR	WBL	WBT
Capacity (veh/h)	841	-	-	1371	-
HCM Lane V/C Ratio	0.077	-	-	0.011	-
HCM Control Delay (s)	9.6	-	-	7.7	0
HCM Lane LOS	A	-	-	A	A
HCM 95th %tile Q(veh)	0.2	-	-	0	-

HCM 6th Signalized Intersection Summary
 9: SR 91 Off-Ramp/SR 91 On-Ramp & 14th St

05/04/2020



Movement	EBL	EBT	EBR	WBL	WBT	WBR	NBL	NBT	NBR	SBL	SBT	SBR
Lane Configurations	↗↘	↑↑			↑↑↑	↗	↘	↖	↗			
Traffic Volume (veh/h)	573	1252	0	0	698	101	238	3	497	0	0	0
Future Volume (veh/h)	573	1252	0	0	698	101	238	3	497	0	0	0
Initial Q (Qb), veh	0	0	0	0	0	0	0	0	0			
Ped-Bike Adj(A_pbT)	1.00		1.00	1.00		1.00	1.00		1.00			
Parking Bus, Adj	1.00	1.00	1.00	1.00	1.00	1.00	1.00	1.00	1.00			
Work Zone On Approach		No			No			No				
Adj Sat Flow, veh/h/ln	1870	1870	0	0	1870	1870	1870	1870	1870			
Adj Flow Rate, veh/h	623	1439	0	0	743	120	283	0	592			
Peak Hour Factor	0.92	0.87	0.25	0.25	0.94	0.84	0.87	0.25	0.84			
Percent Heavy Veh, %	2	2	0	0	2	2	2	2	2			
Cap, veh/h	778	1724	0	0	1098	341	1514	0	674			
Arrive On Green	0.22	0.49	0.00	0.00	0.22	0.22	0.43	0.00	0.43			
Sat Flow, veh/h	3456	3647	0	0	5274	1585	3563	0	1585			
Grp Volume(v), veh/h	623	1439	0	0	743	120	283	0	592			
Grp Sat Flow(s),veh/h/ln	1728	1777	0	0	1702	1585	1781	0	1585			
Q Serve(g_s), s	17.0	35.0	0.0	0.0	13.4	6.4	5.0	0.0	34.3			
Cycle Q Clear(g_c), s	17.0	35.0	0.0	0.0	13.4	6.4	5.0	0.0	34.3			
Prop In Lane	1.00		0.00	0.00		1.00	1.00		1.00			
Lane Grp Cap(c), veh/h	778	1724	0	0	1098	341	1514	0	674			
V/C Ratio(X)	0.80	0.83	0.00	0.00	0.68	0.35	0.19	0.00	0.88			
Avail Cap(c_a), veh/h	778	1724	0	0	1098	341	1514	0	674			
HCM Platoon Ratio	1.00	1.00	1.00	1.00	1.00	1.00	1.00	1.00	1.00			
Upstream Filter(I)	1.00	1.00	0.00	0.00	1.00	1.00	1.00	0.00	1.00			
Uniform Delay (d), s/veh	36.6	22.3	0.0	0.0	36.1	33.3	18.0	0.0	26.4			
Incr Delay (d2), s/veh	8.5	5.0	0.0	0.0	3.4	2.8	0.3	0.0	15.2			
Initial Q Delay(d3),s/veh	0.0	0.0	0.0	0.0	0.0	0.0	0.0	0.0	0.0			
%ile BackOfQ(50%),veh/ln	8.0	15.0	0.0	0.0	5.8	2.7	2.1	0.0	15.2			
Unsig. Movement Delay, s/veh												
LnGrp Delay(d),s/veh	45.2	27.2	0.0	0.0	39.4	36.2	18.2	0.0	41.5			
LnGrp LOS	D	C	A	A	D	D	B	A	D			
Approach Vol, veh/h		2062			863			875				
Approach Delay, s/veh		32.7			39.0			34.0				
Approach LOS		C			D			C				
Timer - Assigned Phs		2		4			7	8				
Phs Duration (G+Y+Rc), s		47.0		53.0			27.0	26.0				
Change Period (Y+Rc), s		4.5		4.5			4.5	4.5				
Max Green Setting (Gmax), s		42.5		48.5			22.5	21.5				
Max Q Clear Time (g_c+I1), s		36.3		37.0			19.0	15.4				
Green Ext Time (p_c), s		2.0		7.6			0.9	2.8				
Intersection Summary												
HCM 6th Ctrl Delay				34.4								
HCM 6th LOS				C								
Notes												
User approved volume balancing among the lanes for turning movement.												

HCM 6th Signalized Intersection Summary

11: Park Ave & University Ave

05/04/2020



Movement	EBL	EBT	EBR	WBL	WBT	WBR	NBL	NBT	NBR	SBL	SBT	SBR
Lane Configurations	↖	↗		↖	↗		↖	↗		↖	↗	
Traffic Volume (veh/h)	47	1215	56	35	546	61	27	32	40	161	87	39
Future Volume (veh/h)	47	1215	56	35	546	61	27	32	40	161	87	39
Initial Q (Qb), veh	0	0	0	0	0	0	0	0	0	0	0	0
Ped-Bike Adj(A_pbT)	1.00		1.00	1.00		1.00	1.00		1.00	1.00		1.00
Parking Bus, Adj	1.00	1.00	1.00	1.00	1.00	1.00	1.00	1.00	1.00	1.00	1.00	1.00
Work Zone On Approach		No		No		No		No		No		No
Adj Sat Flow, veh/h/ln	1870	1870	1870	1870	1870	1870	1870	1870	1870	1870	1870	1870
Adj Flow Rate, veh/h	69	1429	75	47	587	92	29	55	51	227	109	66
Peak Hour Factor	0.68	0.85	0.75	0.75	0.93	0.66	0.94	0.58	0.79	0.71	0.80	0.59
Percent Heavy Veh, %	2	2	2	2	2	2	2	2	2	2	2	2
Cap, veh/h	160	1546	81	86	1257	197	99	160	148	283	308	187
Arrive On Green	0.09	0.45	0.45	0.05	0.41	0.41	0.06	0.18	0.18	0.16	0.28	0.28
Sat Flow, veh/h	1781	3435	180	1781	3079	481	1781	893	828	1781	1091	661
Grp Volume(v), veh/h	69	737	767	47	338	341	29	0	106	227	0	175
Grp Sat Flow(s),veh/h/ln	1781	1777	1838	1781	1777	1784	1781	0	1721	1781	0	1751
Q Serve(g_s), s	4.0	42.9	43.3	2.8	15.3	15.4	1.7	0.0	5.9	13.5	0.0	8.8
Cycle Q Clear(g_c), s	4.0	42.9	43.3	2.8	15.3	15.4	1.7	0.0	5.9	13.5	0.0	8.8
Prop In Lane	1.00		0.10	1.00		0.27	1.00		0.48	1.00		0.38
Lane Grp Cap(c), veh/h	160	800	827	86	725	728	99	0	308	283	0	495
V/C Ratio(X)	0.43	0.92	0.93	0.55	0.47	0.47	0.29	0.00	0.34	0.80	0.00	0.35
Avail Cap(c_a), veh/h	160	800	827	86	725	728	99	0	308	283	0	495
HCM Platoon Ratio	1.00	1.00	1.00	1.00	1.00	1.00	1.00	1.00	1.00	1.00	1.00	1.00
Upstream Filter(I)	1.00	1.00	1.00	1.00	1.00	1.00	1.00	0.00	1.00	1.00	0.00	1.00
Uniform Delay (d), s/veh	47.4	28.4	28.5	51.2	23.8	23.8	49.9	0.0	39.5	44.6	0.0	31.4
Incr Delay (d2), s/veh	8.2	17.7	17.9	22.8	2.1	2.2	7.4	0.0	3.0	20.8	0.0	2.0
Initial Q Delay(d3),s/veh	0.0	0.0	0.0	0.0	0.0	0.0	0.0	0.0	0.0	0.0	0.0	0.0
%ile BackOfQ(50%),veh/ln	2.2	21.5	22.4	1.8	6.8	6.8	1.0	0.0	2.8	7.6	0.0	4.0
Unsig. Movement Delay, s/veh												
LnGrp Delay(d),s/veh	55.6	46.2	46.4	74.0	25.9	26.0	57.3	0.0	42.5	65.3	0.0	33.4
LnGrp LOS	E	D	D	E	C	C	E	A	D	E	A	C
Approach Vol, veh/h		1573			726			135			402	
Approach Delay, s/veh		46.7			29.1			45.7			51.4	
Approach LOS		D			C			D			D	
Timer - Assigned Phs	1	2	3	4	5	6	7	8				
Phs Duration (G+Y+Rc), s	22.0	24.2	9.8	54.0	10.6	35.6	14.4	49.4				
Change Period (Y+Rc), s	4.5	4.5	4.5	4.5	4.5	4.5	4.5	4.5				
Max Green Setting (Gmax), s	19.7	19.7	5.3	49.5	6.1	31.1	9.9	44.9				
Max Q Clear Time (g_c+Tr), s	7.9	7.9	4.8	45.3	3.7	10.8	6.0	17.4				
Green Ext Time (p_c), s	0.1	0.4	0.0	3.2	0.0	0.9	0.0	4.6				

Intersection Summary

HCM 6th Ctrl Delay	42.8
HCM 6th LOS	D

HCM 6th AWSC
12: Howard Ave & 12th St

05/04/2020

Intersection

Intersection Delay, s/veh 7.9

Intersection LOS A

Movement	EBL	EBT	EBR	WBL	WBT	WBR	NBL	NBT	NBR	SBL	SBT	SBR
Lane Configurations		↔		↔		↔		↔			↔	
Traffic Vol, veh/h	0	2	26	12	1	4	6	47	14	5	96	4
Future Vol, veh/h	0	2	26	12	1	4	6	47	14	5	96	4
Peak Hour Factor	0.25	0.25	0.85	0.71	0.62	0.50	0.48	0.70	0.42	0.25	0.68	0.62
Heavy Vehicles, %	2	2	2	2	2	2	2	2	2	2	2	2
Mvmt Flow	0	8	31	17	2	8	13	67	33	20	141	6
Number of Lanes	0	1	0	0	1	0	0	1	0	0	1	0

Approach	EB	WB	WB	NB	SB
Opposing Approach	WB	EB	EB	SB	NB
Opposing Lanes	1	1	1	1	1
Conflicting Approach Left	SB	NB	NB	EB	WB
Conflicting Lanes Left	1	1	1	1	1
Conflicting Approach Right	NB	SB	WB	WB	EB
Conflicting Lanes Right	1	1	1	1	1
HCM Control Delay	7.2	7.7	7.7	7.8	8.2
HCM LOS	A	A	A	A	A

Lane	NBLn1	EBLn1	WBLn1	SBLn1
Vol Left, %	9%	0%	71%	5%
Vol Thru, %	70%	7%	6%	91%
Vol Right, %	21%	93%	24%	4%
Sign Control	Stop	Stop	Stop	Stop
Traffic Vol by Lane	67	28	17	105
LT Vol	6	0	12	5
Through Vol	47	2	1	96
RT Vol	14	26	4	4
Lane Flow Rate	113	39	27	168
Geometry Grp	1	1	1	1
Degree of Util (X)	0.128	0.043	0.034	0.192
Departure Headway (Hd)	4.067	4.017	4.586	4.12
Convergence, Y/N	Yes	Yes	Yes	Yes
Cap	871	896	785	863
Service Time	2.143	2.018	2.587	2.182
HCM Lane V/C Ratio	0.13	0.044	0.034	0.195
HCM Control Delay	7.8	7.2	7.7	8.2
HCM Lane LOS	A	A	A	A
HCM 95th-tile Q	0.4	0.1	0.1	0.7

HCM 6th Signalized Intersection Summary

13: Olivewood Ave/Lime St & 14th St

05/04/2020



Movement	EBL	EBT	EBR	WBL	WBT	WBR	NBL	NBT	NBR	SBL	SBT	SBR
Lane Configurations	↙ ↑↑ ↘			↙ ↑↑ ↘			↙ ↑↑		↙ ↘		↑↑ ↘	
Traffic Volume (veh/h)	28	985	79	251	777	75	44	179	423	295	610	38
Future Volume (veh/h)	28	985	79	251	777	75	44	179	423	295	610	38
Initial Q (Qb), veh	0	0	0	0	0	0	0	0	0	0	0	0
Ped-Bike Adj(A_pbT)	1.00		1.00	1.00		1.00	1.00		1.00	1.00		1.00
Parking Bus, Adj	1.00	1.00	1.00	1.00	1.00	1.00	1.00	1.00	1.00	1.00	1.00	1.00
Work Zone On Approach	No			No			No		No			
Adj Sat Flow, veh/h/ln	1870	1870	1870	1870	1870	1870	1870	1870	1870	1870	1870	1870
Adj Flow Rate, veh/h	39	1201	100	276	835	91	56	232	492	476	735	76
Peak Hour Factor	0.71	0.82	0.79	0.91	0.93	0.82	0.79	0.77	0.86	0.62	0.83	0.50
Percent Heavy Veh, %	2	2	2	2	2	2	2	2	2	2	2	2
Cap, veh/h	108	1375	114	358	1994	216	102	328	556	600	949	98
Arrive On Green	0.06	0.29	0.29	0.07	0.14	0.14	0.06	0.18	0.18	0.17	0.29	0.29
Sat Flow, veh/h	1781	4803	400	1781	4676	507	1781	1870	3170	3456	3251	336
Grp Volume(v), veh/h	39	851	450	276	607	319	56	232	492	476	402	409
Grp Sat Flow(s),veh/h/ln	1781	1702	1798	1781	1702	1779	1781	1870	1585	1728	1777	1810
Q Serve(g_s), s	2.3	26.2	26.2	16.8	17.9	18.0	3.4	12.8	16.7	14.5	22.7	22.8
Cycle Q Clear(g_c), s	2.3	26.2	26.2	16.8	17.9	18.0	3.4	12.8	16.7	14.5	22.7	22.8
Prop In Lane	1.00		0.22	1.00		0.29	1.00		1.00	1.00		0.19
Lane Grp Cap(c), veh/h	108	975	515	358	1451	759	102	328	556	600	519	528
V/C Ratio(X)	0.36	0.87	0.87	0.77	0.42	0.42	0.55	0.71	0.88	0.79	0.77	0.78
Avail Cap(c_a), veh/h	108	975	515	358	1451	759	102	328	556	600	519	528
HCM Platoon Ratio	1.00	1.00	1.00	0.33	0.33	0.33	1.00	1.00	1.00	1.00	1.00	1.00
Upstream Filter(I)	1.00	1.00	1.00	1.00	1.00	1.00	1.00	1.00	1.00	1.00	1.00	1.00
Uniform Delay (d), s/veh	49.6	37.3	37.4	48.9	34.8	34.9	50.5	42.7	44.3	43.6	35.6	35.6
Incr Delay (d2), s/veh	9.0	10.7	18.3	14.8	0.9	1.7	19.6	12.1	18.3	10.4	10.8	10.6
Initial Q Delay(d3),s/veh	0.0	0.0	0.0	0.0	0.0	0.0	0.0	0.0	0.0	0.0	0.0	0.0
%ile BackOfQ(50%),veh/ln	1.3	12.2	14.0	9.5	8.3	8.9	2.1	7.0	7.9	7.0	11.3	11.5
Unsig. Movement Delay, s/veh												
LnGrp Delay(d),s/veh	58.6	48.1	55.6	63.7	35.7	36.6	70.0	54.8	62.6	53.9	46.4	46.3
LnGrp LOS	E	D	E	E	D	D	E	D	E	D	D	D
Approach Vol, veh/h	1340			1202			780		1287			
Approach Delay, s/veh	50.9			42.4			60.8		49.1			
Approach LOS	D			D			E		D			
Timer - Assigned Phs	1	2	3	4	5	6	7	8				
Phs Duration (G+Y+Rc), s	23.6	23.8	26.6	36.0	10.8	36.6	11.2	51.4				
Change Period (Y+Rc), s	4.5	4.5	4.5	4.5	4.5	4.5	4.5	4.5				
Max Green Setting (Gmax), s	19.3	19.3	22.1	31.5	6.3	32.1	6.7	46.9				
Max Q Clear Time (g_c+M0), s	18.7	18.7	18.8	28.2	5.4	24.8	4.3	20.0				
Green Ext Time (p_c), s	0.5	0.3	0.3	2.4	0.0	3.0	0.0	6.9				

Intersection Summary

HCM 6th Ctrl Delay	49.9
HCM 6th LOS	D

Notes

User approved volume balancing among the lanes for turning movement.

HCM 6th Signalized Intersection Summary

14: Mulberry St/SR 91 Off-Ramp & 14th St

05/04/2020



Movement	EBL	EBT	EBR	WBL	WBT	WBR	NBL	NBT	NBR	SBL	SBT	SBR
Lane Configurations	↑↑↑			↔↔↑↑↑						↔↔↑↑		
Traffic Volume (veh/h)	0	1436	267	311	624	0	0	0	0	389	210	478
Future Volume (veh/h)	0	1436	267	311	624	0	0	0	0	389	210	478
Initial Q (Qb), veh	0	0	0	0	0	0				0	0	0
Ped-Bike Adj(A_pbT)	1.00		1.00	1.00		1.00				1.00		1.00
Parking Bus, Adj	1.00	1.00	1.00	1.00	1.00	1.00				1.00	1.00	1.00
Work Zone On Approach	No			No						No		
Adj Sat Flow, veh/h/ln	0	1870	1870	1870	1870	0				1870	1870	1870
Adj Flow Rate, veh/h	0	1528	445	426	686	0				316	720	335
Peak Hour Factor	0.25	0.94	0.60	0.73	0.91	0.25				0.82	0.85	0.95
Percent Heavy Veh, %	0	2	2	2	2	0				2	2	2
Cap, veh/h	0	1808	520	550	3365	0				462	969	411
Arrive On Green	0.00	0.46	0.46	0.16	0.66	0.00				0.26	0.26	0.26
Sat Flow, veh/h	0	4106	1133	3456	5274	0				1781	3741	1585
Grp Volume(v), veh/h	0	1319	654	426	686	0				316	720	335
Grp Sat Flow(s),veh/h/ln	0	1702	1666	1728	1702	0				1781	1870	1585
Q Serve(g_s), s	0.0	37.6	38.5	13.0	5.8	0.0				17.6	19.4	21.8
Cycle Q Clear(g_c), s	0.0	37.6	38.5	13.0	5.8	0.0				17.6	19.4	21.8
Prop In Lane	0.00		0.68	1.00		0.00				1.00		1.00
Lane Grp Cap(c), veh/h	0	1563	765	550	3365	0				462	969	411
V/C Ratio(X)	0.00	0.84	0.86	0.77	0.20	0.00				0.68	0.74	0.82
Avail Cap(c_a), veh/h	0	1563	765	550	3365	0				462	969	411
HCM Platoon Ratio	1.00	1.00	1.00	1.00	1.00	1.00				1.00	1.00	1.00
Upstream Filter(I)	0.00	1.00	1.00	1.00	1.00	0.00				1.00	1.00	1.00
Uniform Delay (d), s/veh	0.0	26.3	26.5	44.4	7.4	0.0				36.7	37.4	38.3
Incr Delay (d2), s/veh	0.0	5.8	11.8	10.2	0.1	0.0				8.0	5.1	16.2
Initial Q Delay(d3),s/veh	0.0	0.0	0.0	0.0	0.0	0.0				0.0	0.0	0.0
%ile BackOfQ(50%),veh/ln	0.0	15.9	17.2	6.3	2.0	0.0				8.6	9.5	10.2
Unsig. Movement Delay, s/veh												
LnGrp Delay(d),s/veh	0.0	32.0	38.3	54.6	7.5	0.0				44.7	42.5	54.5
LnGrp LOS	A	C	D	D	A	A				D	D	D
Approach Vol, veh/h	1973			1112						1371		
Approach Delay, s/veh	34.1			25.6						46.0		
Approach LOS	C			C						D		
Timer - Assigned Phs	3			4			6			8		
Phs Duration (G+Y+Rc), s	22.0			55.0			33.0			77.0		
Change Period (Y+Rc), s	4.5			4.5			4.5			4.5		
Max Green Setting (Gmax), s	17.5			50.5			28.5			72.5		
Max Q Clear Time (g_c+I1), s	15.0			40.5			23.8			7.8		
Green Ext Time (p_c), s	0.4			8.2			2.9			5.7		
Intersection Summary												
HCM 6th Ctrl Delay	35.6											
HCM 6th LOS	D											
Notes												
User approved volume balancing among the lanes for turning movement.												

Existing PM with Project Conditions

HCM 6th Signalized Intersection Summary

2: Mission Inn Ave & SR 91 Off-Ramp

05/04/2020

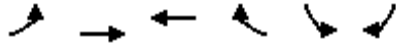

Movement	EBL	EBT	WBT	WBR	SBL	SBR
Lane Configurations		↑↑	↑↑		↘	↘
Traffic Volume (veh/h)	0	630	243	0	217	410
Future Volume (veh/h)	0	630	243	0	217	410
Initial Q (Qb), veh	0	0	0	0	0	0
Ped-Bike Adj(A_pbT)	1.00			1.00	1.00	1.00
Parking Bus, Adj	1.00	1.00	1.00	1.00	1.00	1.00
Work Zone On Approach		No	No		No	
Adj Sat Flow, veh/h/ln	0	1870	1870	0	1870	1870
Adj Flow Rate, veh/h	0	663	261	0	231	436
Peak Hour Factor	0.25	0.95	0.93	0.25	0.94	0.94
Percent Heavy Veh, %	0	2	2	0	2	2
Cap, veh/h	0	1793	1793	0	737	1154
Arrive On Green	0.00	0.50	1.00	0.00	0.41	0.41
Sat Flow, veh/h	0	3741	3741	0	1781	2790
Grp Volume(v), veh/h	0	663	261	0	231	436
Grp Sat Flow(s),veh/h/ln	0	1777	1777	0	1781	1395
Q Serve(g_s), s	0.0	12.5	0.0	0.0	9.6	11.9
Cycle Q Clear(g_c), s	0.0	12.5	0.0	0.0	9.6	11.9
Prop In Lane	0.00			0.00	1.00	1.00
Lane Grp Cap(c), veh/h	0	1793	1793	0	737	1154
V/C Ratio(X)	0.00	0.37	0.15	0.00	0.31	0.38
Avail Cap(c_a), veh/h	0	1793	1793	0	737	1154
HCM Platoon Ratio	1.00	1.00	2.00	1.00	1.00	1.00
Upstream Filter(I)	0.00	1.00	1.00	0.00	1.00	1.00
Uniform Delay (d), s/veh	0.0	16.6	0.0	0.0	21.7	22.4
Incr Delay (d2), s/veh	0.0	0.6	0.2	0.0	1.1	0.9
Initial Q Delay(d3),s/veh	0.0	0.0	0.0	0.0	0.0	0.0
%ile BackOfQ(50%),veh/ln	0.0	5.1	0.0	0.0	4.2	4.0
Unsig. Movement Delay, s/veh						
LnGrp Delay(d),s/veh	0.0	17.2	0.2	0.0	22.8	23.4
LnGrp LOS	A	B	A	A	C	C
Approach Vol, veh/h		663	261		667	
Approach Delay, s/veh		17.2	0.2		23.2	
Approach LOS		B	A		C	
Timer - Assigned Phs				4	6	8
Phs Duration (G+Y+Rc), s				60.0	50.0	60.0
Change Period (Y+Rc), s				4.5	4.5	4.5
Max Green Setting (Gmax), s				55.5	45.5	55.5
Max Q Clear Time (g_c+I1), s				14.5	13.9	2.0
Green Ext Time (p_c), s				5.3	2.6	1.9
Intersection Summary						
HCM 6th Ctrl Delay		16.9				
HCM 6th LOS		B				

HCM 6th Signalized Intersection Summary

3: Mulberry St/SR 91 On-Ramp & Mission Inn Ave

05/04/2020



Movement	EBL	EBT	EBR	WBL	WBT	WBR	NBL	NBT	NBR	SBL	SBT	SBR
Lane Configurations	↖	↑↑			↑↑		↖	↗				
Traffic Volume (veh/h)	404	443	0	0	145	210	98	411	44	0	0	0
Future Volume (veh/h)	404	443	0	0	145	210	98	411	44	0	0	0
Initial Q (Qb), veh	0	0	0	0	0	0	0	0	0			
Ped-Bike Adj(A_pbT)	1.00		1.00	1.00		1.00	1.00		1.00			
Parking Bus, Adj	1.00	1.00	1.00	1.00	1.00	1.00	1.00	1.00	1.00			
Work Zone On Approach		No			No			No				
Adj Sat Flow, veh/h/ln	1870	1870	0	0	1870	1870	1870	1870	1870			
Adj Flow Rate, veh/h	444	515	0	0	204	0	126	501	54			
Peak Hour Factor	0.91	0.86	0.25	0.25	0.71	0.73	0.78	0.82	0.81			
Percent Heavy Veh, %	2	2	0	0	2	2	2	2	2			
Cap, veh/h	575	1955	0	0	662		656	611	66			
Arrive On Green	0.65	1.00	0.00	0.00	0.19	0.00	0.37	0.37	0.37			
Sat Flow, veh/h	1781	3647	0	0	3741	0	1781	1659	179			
Grp Volume(v), veh/h	444	515	0	0	204	0	126	0	555			
Grp Sat Flow(s),veh/h/ln	1781	1777	0	0	1777	0	1781	0	1838			
Q Serve(g_s), s	19.4	0.0	0.0	0.0	5.5	0.0	5.3	0.0	30.1			
Cycle Q Clear(g_c), s	19.4	0.0	0.0	0.0	5.5	0.0	5.3	0.0	30.1			
Prop In Lane	1.00		0.00	0.00		0.00	1.00		0.10			
Lane Grp Cap(c), veh/h	575	1955	0	0	662		656	0	677			
V/C Ratio(X)	0.77	0.26	0.00	0.00	0.31		0.19	0.00	0.82			
Avail Cap(c_a), veh/h	575	1955	0	0	662		656	0	677			
HCM Platoon Ratio	2.00	2.00	1.00	1.00	1.00	1.00	1.00	1.00	1.00			
Upstream Filter(I)	1.00	1.00	0.00	0.00	1.00	0.00	1.00	0.00	1.00			
Uniform Delay (d), s/veh	16.6	0.0	0.0	0.0	38.6	0.0	23.6	0.0	31.5			
Incr Delay (d2), s/veh	9.7	0.3	0.0	0.0	1.2	0.0	0.7	0.0	10.7			
Initial Q Delay(d3),s/veh	0.0	0.0	0.0	0.0	0.0	0.0	0.0	0.0	0.0			
%ile BackOfQ(50%),veh/ln	6.3	0.1	0.0	0.0	2.5	0.0	2.3	0.0	15.1			
Unsig. Movement Delay, s/veh												
LnGrp Delay(d),s/veh	26.3	0.3	0.0	0.0	39.8	0.0	24.3	0.0	42.2			
LnGrp LOS	C	A	A	A	D		C	A	D			
Approach Vol, veh/h		959			204	A		681				
Approach Delay, s/veh		12.4			39.8			38.8				
Approach LOS		B			D			D				
Timer - Assigned Phs		2		4			7	8				
Phs Duration (G+Y+Rc), s		45.0		65.0			40.0	25.0				
Change Period (Y+Rc), s		4.5		4.5			4.5	4.5				
Max Green Setting (Gmax), s		40.5		60.5			35.5	20.5				
Max Q Clear Time (g_c+I1), s		32.1		2.0			21.4	7.5				
Green Ext Time (p_c), s		2.6		4.0			1.2	0.9				

Intersection Summary

HCM 6th Ctrl Delay	25.2
HCM 6th LOS	C

Notes

Unsignalized Delay for [WBR] is excluded from calculations of the approach delay and intersection delay.

HCM 6th Signalized Intersection Summary

4: Howard Ave & 14th St

05/04/2020



Movement	EBL	EBT	EBR	WBL	WBT	WBR	NBL	NBT	NBR	SBL	SBT	SBR
Lane Configurations												
Traffic Volume (veh/h)	53	1529	180	9	685	19	42	13	12	45	31	144
Future Volume (veh/h)	53	1529	180	9	685	19	42	13	12	45	31	144
Initial Q (Qb), veh	0	0	0	0	0	0	0	0	0	0	0	0
Ped-Bike Adj(A_pbT)	1.00		1.00	1.00		1.00	1.00		1.00	1.00		1.00
Parking Bus, Adj	1.00	1.00	1.00	1.00	1.00	1.00	1.00	1.00	1.00	1.00	1.00	1.00
Work Zone On Approach		No			No			No			No	
Adj Sat Flow, veh/h/ln	1870	1870	1870	1870	1870	1870	1870	1870	1870	1870	1870	1870
Adj Flow Rate, veh/h	76	1718	254	16	778	27	58	19	19	90	57	164
Peak Hour Factor	0.70	0.89	0.71	0.55	0.88	0.70	0.73	0.70	0.62	0.50	0.54	0.88
Percent Heavy Veh, %	2	2	2	2	2	2	2	2	2	2	2	2
Cap, veh/h	167	1987	886	81	1790	62	221	73	60	152	98	232
Arrive On Green	0.09	0.56	0.56	0.05	0.51	0.51	0.27	0.27	0.27	0.27	0.27	0.27
Sat Flow, veh/h	1781	3554	1585	1781	3504	122	619	266	218	403	360	851
Grp Volume(v), veh/h	76	1718	254	16	394	411	96	0	0	311	0	0
Grp Sat Flow(s),veh/h/ln	1781	1777	1585	1781	1777	1848	1103	0	0	1614	0	0
Q Serve(g_s), s	4.4	45.4	9.3	1.0	15.4	15.4	0.0	0.0	0.0	10.5	0.0	0.0
Cycle Q Clear(g_c), s	4.4	45.4	9.3	1.0	15.4	15.4	8.1	0.0	0.0	18.6	0.0	0.0
Prop In Lane	1.00		1.00	1.00		0.07	0.60		0.20	0.29		0.53
Lane Grp Cap(c), veh/h	167	1987	886	81	908	944	353	0	0	482	0	0
V/C Ratio(X)	0.46	0.86	0.29	0.20	0.43	0.43	0.27	0.00	0.00	0.64	0.00	0.00
Avail Cap(c_a), veh/h	167	1987	886	81	908	944	353	0	0	482	0	0
HCM Platoon Ratio	1.00	1.00	1.00	1.00	1.00	1.00	1.00	1.00	1.00	1.00	1.00	1.00
Upstream Filter(I)	1.00	1.00	1.00	1.00	1.00	1.00	1.00	0.00	0.00	1.00	0.00	0.00
Uniform Delay (d), s/veh	47.2	20.7	12.7	50.6	16.9	16.9	31.6	0.0	0.0	35.6	0.0	0.0
Incr Delay (d2), s/veh	8.7	5.3	0.8	5.4	1.5	1.5	1.9	0.0	0.0	6.5	0.0	0.0
Initial Q Delay(d3),s/veh	0.0	0.0	0.0	0.0	0.0	0.0	0.0	0.0	0.0	0.0	0.0	0.0
%ile BackOfQ(50%),veh/ln	2.4	19.1	3.4	0.5	6.5	6.7	2.2	0.0	0.0	8.3	0.0	0.0
Unsig. Movement Delay, s/veh												
LnGrp Delay(d),s/veh	55.9	26.0	13.5	56.0	18.4	18.4	33.5	0.0	0.0	42.1	0.0	0.0
LnGrp LOS	E	C	B	E	B	B	C	A	A	D	A	A
Approach Vol, veh/h		2048			821			96			311	
Approach Delay, s/veh		25.6			19.1			33.5			42.1	
Approach LOS		C			B			C			D	
Timer - Assigned Phs		2	3	4		6	7	8				
Phs Duration (G+Y+Rc), s		34.5	9.5	66.0		34.5	14.8	60.7				
Change Period (Y+Rc), s		4.5	4.5	4.5		4.5	4.5	4.5				
Max Green Setting (Gmax), s		30.0	5.0	61.5		30.0	10.3	56.2				
Max Q Clear Time (g_c+I1), s		10.1	3.0	47.4		20.6	6.4	17.4				
Green Ext Time (p_c), s		0.5	0.0	10.8		1.3	0.0	5.9				
Intersection Summary												
HCM 6th Ctrl Delay											25.8	
HCM 6th LOS											C	

Intersection

Intersection Delay, s/veh 19.4
Intersection LOS C

Movement	EBL	EBT	EBR	WBL	WBT	WBR	NBL	NBT	NBR	SBL	SBT	SBR
Lane Configurations	↙	↑	↗	↙	↑↑		↙	↗			↕	
Traffic Vol, veh/h	144	268	75	16	131	40	84	51	36	47	57	140
Future Vol, veh/h	144	268	75	16	131	40	84	51	36	47	57	140
Peak Hour Factor	0.75	0.88	0.67	0.25	0.73	0.89	0.70	0.89	0.57	0.71	0.81	0.97
Heavy Vehicles, %	2	2	2	2	2	2	2	2	2	2	2	2
Mvmt Flow	192	305	112	64	179	45	120	57	63	66	70	144
Number of Lanes	1	1	1	1	2	0	1	1	0	0	1	0

Approach	EB	WB	NB	SB
Opposing Approach	WB	EB	SB	NB
Opposing Lanes	3	3	1	2
Conflicting Approach Left SB		NB	EB	WB
Conflicting Lanes Left	1	2	3	3
Conflicting Approach Right NB		SB	WB	EB
Conflicting Lanes Right	2	1	3	3
HCM Control Delay	20.9	14.4	15.4	24.6
HCM LOS	C	B	C	C

Lane	NBLn1	NBLn2	EBLn1	EBLn2	EBLn3	WBLn1	WBLn2	WBLn3	SBLn1
Vol Left, %	100%	0%	100%	0%	0%	100%	0%	0%	19%
Vol Thru, %	0%	59%	0%	100%	0%	0%	100%	52%	23%
Vol Right, %	0%	41%	0%	0%	100%	0%	0%	48%	57%
Sign Control	Stop	Stop	Stop	Stop	Stop	Stop	Stop	Stop	Stop
Traffic Vol by Lane	84	87	144	268	75	16	87	84	244
LT Vol	84	0	144	0	0	16	0	0	47
Through Vol	0	51	0	268	0	0	87	44	57
RT Vol	0	36	0	0	75	0	0	40	140
Lane Flow Rate	120	120	192	305	112	64	120	105	281
Geometry Grp	8	8	8	8	8	8	8	8	8
Degree of Util (X)	0.31	0.284	0.454	0.676	0.226	0.165	0.291	0.244	0.641
Departure Headway (Hd)	9.308	8.5	8.508	7.991	7.267	9.262	8.742	8.394	8.216
Convergence, Y/N	Yes	Yes	Yes	Yes	Yes	Yes	Yes	Yes	Yes
Cap	386	423	426	454	497	387	410	427	438
Service Time	7.066	6.258	6.208	5.691	4.967	7.021	6.5	6.152	5.969
HCM Lane V/C Ratio	0.311	0.284	0.451	0.672	0.225	0.165	0.293	0.246	0.642
HCM Control Delay	16.2	14.6	18.1	25.8	12.1	13.9	15.1	13.9	24.6
HCM Lane LOS	C	B	C	D	B	B	C	B	C
HCM 95th-tile Q	1.3	1.2	2.3	4.9	0.9	0.6	1.2	0.9	4.4

HCM 6th TWSC
6: Commerce St & Mission Inn Ave

05/04/2020

Intersection												
Int Delay, s/veh	5.2											
Movement	EBL	EBT	EBR	WBL	WBT	WBR	NBL	NBT	NBR	SBL	SBT	SBR
Lane Configurations		↕	↗		↕↗			↕↗			↕↗	
Traffic Vol, veh/h	17	262	71	5	111	5	68	18	10	4	39	8
Future Vol, veh/h	17	262	71	5	111	5	68	18	10	4	39	8
Conflicting Peds, #/hr	0	0	0	0	0	0	0	0	0	0	0	0
Sign Control	Free	Free	Free	Free	Free	Free	Stop	Stop	Stop	Stop	Stop	Stop
RT Channelized	-	-	None	-	-	None	-	-	None	-	-	None
Storage Length	-	-	0	-	-	-	-	-	-	-	-	-
Veh in Median Storage, #	-	0	-	-	0	-	-	0	-	-	0	-
Grade, %	-	0	-	-	0	-	-	0	-	-	0	-
Peak Hour Factor	75	75	75	50	95	50	69	42	50	25	83	65
Heavy Vehicles, %	2	2	2	2	2	2	2	2	2	2	2	2
Mvmt Flow	23	349	95	10	117	10	99	43	20	16	47	12

Major/Minor	Major1			Major2			Minor1			Minor2		
Conflicting Flow All	127	0	0	444	0	0	497	542	349	616	632	64
Stage 1	-	-	-	-	-	-	395	395	-	142	142	-
Stage 2	-	-	-	-	-	-	102	147	-	474	490	-
Critical Hdwy	4.13	-	-	4.13	-	-	7.33	6.53	6.23	7.33	6.53	6.93
Critical Hdwy Stg 1	-	-	-	-	-	-	6.13	5.53	-	6.53	5.53	-
Critical Hdwy Stg 2	-	-	-	-	-	-	6.53	5.53	-	6.13	5.53	-
Follow-up Hdwy	2.219	-	-	2.219	-	-	3.519	4.019	3.319	3.519	4.019	3.319
Pot Cap-1 Maneuver	1458	-	-	1114	-	-	469	447	693	388	397	988
Stage 1	-	-	-	-	-	-	629	604	-	847	779	-
Stage 2	-	-	-	-	-	-	893	775	-	570	548	-
Platoon blocked, %	-	-	-	-	-	-	-	-	-	-	-	-
Mov Cap-1 Maneuver	1458	-	-	1114	-	-	410	433	693	340	385	988
Mov Cap-2 Maneuver	-	-	-	-	-	-	410	433	-	340	385	-
Stage 1	-	-	-	-	-	-	616	591	-	829	771	-
Stage 2	-	-	-	-	-	-	820	767	-	503	536	-

Approach	EB			WB			NB			SB		
HCM Control Delay, s	0.4			0.6			17.9			15.6		
HCM LOS							C			C		

Minor Lane/Major Mvmt	NBLn1	EBL	EBT	EBR	WBL	WBT	WBR	SBLn1
Capacity (veh/h)	438	1458	-	-	1114	-	-	415
HCM Lane V/C Ratio	0.369	0.016	-	-	0.009	-	-	0.181
HCM Control Delay (s)	17.9	7.5	0	-	8.3	0	-	15.6
HCM Lane LOS	C	A	A	-	A	A	-	C
HCM 95th %tile Q(veh)	1.7	0	-	-	0	-	-	0.7

HCM 6th TWSC
7: Commerce St & 9th St

05/04/2020

Intersection						
Int Delay, s/veh	2.4					
Movement	WBL	WBR	NBT	NBR	SBL	SBT
Lane Configurations						
Traffic Vol, veh/h	3	14	82	3	21	93
Future Vol, veh/h	3	14	82	3	21	93
Conflicting Peds, #/hr	0	0	0	0	0	0
Sign Control	Stop	Stop	Free	Free	Free	Free
RT Channelized	-	None	-	None	-	None
Storage Length	0	-	-	-	-	-
Veh in Median Storage, #	0	-	0	-	-	0
Grade, %	0	-	0	-	-	0
Peak Hour Factor	50	79	77	25	25	68
Heavy Vehicles, %	2	2	2	2	2	2
Mvmt Flow	6	18	106	12	84	137

Major/Minor	Minor1	Major1	Major2			
Conflicting Flow All	417	112	0	0	118	0
Stage 1	112	-	-	-	-	-
Stage 2	305	-	-	-	-	-
Critical Hdwy	6.42	6.22	-	-	4.12	-
Critical Hdwy Stg 1	5.42	-	-	-	-	-
Critical Hdwy Stg 2	5.42	-	-	-	-	-
Follow-up Hdwy	3.518	3.318	-	-	2.218	-
Pot Cap-1 Maneuver	592	941	-	-	1470	-
Stage 1	913	-	-	-	-	-
Stage 2	748	-	-	-	-	-
Platoon blocked, %			-	-		-
Mov Cap-1 Maneuver	555	941	-	-	1470	-
Mov Cap-2 Maneuver	555	-	-	-	-	-
Stage 1	856	-	-	-	-	-
Stage 2	748	-	-	-	-	-

Approach	WB	NB	SB
HCM Control Delay, s	9.6	0	2.9
HCM LOS	A		

Minor Lane/Major Mvmt	NBT	NBRWBLn1	SBL	SBT
Capacity (veh/h)	-	-	800	1470
HCM Lane V/C Ratio	-	-	0.03	0.057
HCM Control Delay (s)	-	-	9.6	7.6
HCM Lane LOS	-	-	A	A
HCM 95th %tile Q(veh)	-	-	0.1	0.2

Intersection						
Int Delay, s/veh	2.5					
Movement	EBT	EBR	WBL	WBT	NBL	NBR
Lane Configurations						
Traffic Vol, veh/h	33	183	9	6	42	16
Future Vol, veh/h	33	183	9	6	42	16
Conflicting Peds, #/hr	0	0	0	0	0	0
Sign Control	Free	Free	Free	Free	Stop	Stop
RT Channelized	-	None	-	None	-	None
Storage Length	-	-	-	-	0	-
Veh in Median Storage, #	0	-	-	0	0	-
Grade, %	0	-	-	0	0	-
Peak Hour Factor	38	84	62	67	69	56
Heavy Vehicles, %	2	2	2	2	2	2
Mvmt Flow	87	218	15	9	61	29

Major/Minor	Major1	Major2	Minor1	Minor2	Minor3
Conflicting Flow All	0	0	305	0	235
Stage 1	-	-	-	-	196
Stage 2	-	-	-	-	39
Critical Hdwy	-	-	4.12	-	6.42
Critical Hdwy Stg 1	-	-	-	-	5.42
Critical Hdwy Stg 2	-	-	-	-	5.42
Follow-up Hdwy	-	-	2.218	-	3.518
Pot Cap-1 Maneuver	-	-	1256	-	753
Stage 1	-	-	-	-	837
Stage 2	-	-	-	-	983
Platoon blocked, %	-	-	-	-	-
Mov Cap-1 Maneuver	-	-	1256	-	744
Mov Cap-2 Maneuver	-	-	-	-	744
Stage 1	-	-	-	-	827
Stage 2	-	-	-	-	983

Approach	EB	WB	NB
HCM Control Delay, s	0	4.9	10.3
HCM LOS			B

Minor Lane/Major Mvmt	NBLn1	EBT	EBR	WBL	WBT
Capacity (veh/h)	774	-	-	1256	-
HCM Lane V/C Ratio	0.116	-	-	0.012	-
HCM Control Delay (s)	10.3	-	-	7.9	0
HCM Lane LOS	B	-	-	A	A
HCM 95th %tile Q(veh)	0.4	-	-	0	-

HCM 6th Signalized Intersection Summary
 9: SR 91 Off-Ramp/SR 91 On-Ramp & 14th St

05/04/2020



Movement	EBL	EBT	EBR	WBL	WBT	WBR	NBL	NBT	NBR	SBL	SBT	SBR
Lane Configurations	↗↘	↑↑			↑↑↑	↗	↘	↖	↗			
Traffic Volume (veh/h)	573	1254	0	0	744	128	238	3	508	0	0	0
Future Volume (veh/h)	573	1254	0	0	744	128	238	3	508	0	0	0
Initial Q (Qb), veh	0	0	0	0	0	0	0	0	0			
Ped-Bike Adj(A_pbT)	1.00		1.00	1.00		1.00	1.00		1.00			
Parking Bus, Adj	1.00	1.00	1.00	1.00	1.00	1.00	1.00	1.00	1.00			
Work Zone On Approach		No			No			No				
Adj Sat Flow, veh/h/ln	1870	1870	0	0	1870	1870	1870	1870	1870			
Adj Flow Rate, veh/h	623	1441	0	0	791	152	283	0	605			
Peak Hour Factor	0.92	0.87	0.25	0.25	0.94	0.84	0.87	0.25	0.84			
Percent Heavy Veh, %	2	2	0	0	2	2	2	2	2			
Cap, veh/h	778	1724	0	0	1098	341	1514	0	674			
Arrive On Green	0.22	0.49	0.00	0.00	0.22	0.22	0.43	0.00	0.43			
Sat Flow, veh/h	3456	3647	0	0	5274	1585	3563	0	1585			
Grp Volume(v), veh/h	623	1441	0	0	791	152	283	0	605			
Grp Sat Flow(s),veh/h/ln	1728	1777	0	0	1702	1585	1781	0	1585			
Q Serve(g_s), s	17.0	35.1	0.0	0.0	14.4	8.3	5.0	0.0	35.5			
Cycle Q Clear(g_c), s	17.0	35.1	0.0	0.0	14.4	8.3	5.0	0.0	35.5			
Prop In Lane	1.00		0.00	0.00		1.00	1.00		1.00			
Lane Grp Cap(c), veh/h	778	1724	0	0	1098	341	1514	0	674			
V/C Ratio(X)	0.80	0.84	0.00	0.00	0.72	0.45	0.19	0.00	0.90			
Avail Cap(c_a), veh/h	778	1724	0	0	1098	341	1514	0	674			
HCM Platoon Ratio	1.00	1.00	1.00	1.00	1.00	1.00	1.00	1.00	1.00			
Upstream Filter(I)	1.00	1.00	0.00	0.00	1.00	1.00	1.00	0.00	1.00			
Uniform Delay (d), s/veh	36.6	22.3	0.0	0.0	36.5	34.1	18.0	0.0	26.7			
Incr Delay (d2), s/veh	8.5	5.0	0.0	0.0	4.1	4.2	0.3	0.0	17.1			
Initial Q Delay(d3),s/veh	0.0	0.0	0.0	0.0	0.0	0.0	0.0	0.0	0.0			
%ile BackOfQ(50%),veh/ln	8.0	15.0	0.0	0.0	6.3	3.6	2.1	0.0	16.0			
Unsig. Movement Delay, s/veh												
LnGrp Delay(d),s/veh	45.2	27.3	0.0	0.0	40.6	38.3	18.2	0.0	43.9			
LnGrp LOS	D	C	A	A	D	D	B	A	D			
Approach Vol, veh/h		2064			943			888				
Approach Delay, s/veh		32.7			40.2			35.7				
Approach LOS		C			D			D				
Timer - Assigned Phs		2		4			7	8				
Phs Duration (G+Y+Rc), s		47.0		53.0			27.0	26.0				
Change Period (Y+Rc), s		4.5		4.5			4.5	4.5				
Max Green Setting (Gmax), s		42.5		48.5			22.5	21.5				
Max Q Clear Time (g_c+I1), s		37.5		37.1			19.0	16.4				
Green Ext Time (p_c), s		1.7		7.5			0.9	2.6				
Intersection Summary												
HCM 6th Ctrl Delay				35.2								
HCM 6th LOS				D								
Notes												
User approved volume balancing among the lanes for turning movement.												

HCM 6th Signalized Intersection Summary

11: Park Ave & University Ave

05/04/2020



Movement	EBL	EBT	EBR	WBL	WBT	WBR	NBL	NBT	NBR	SBL	SBT	SBR
Lane Configurations	↖	↗		↖	↗		↖	↗		↖	↗	
Traffic Volume (veh/h)	47	1215	56	39	546	61	27	32	53	161	87	39
Future Volume (veh/h)	47	1215	56	39	546	61	27	32	53	161	87	39
Initial Q (Qb), veh	0	0	0	0	0	0	0	0	0	0	0	0
Ped-Bike Adj(A_pbT)	1.00		1.00	1.00		1.00	1.00		1.00	1.00		1.00
Parking Bus, Adj	1.00	1.00	1.00	1.00	1.00	1.00	1.00	1.00	1.00	1.00	1.00	1.00
Work Zone On Approach		No		No		No		No		No		No
Adj Sat Flow, veh/h/ln	1870	1870	1870	1870	1870	1870	1870	1870	1870	1870	1870	1870
Adj Flow Rate, veh/h	69	1429	75	52	587	92	29	55	67	227	109	66
Peak Hour Factor	0.68	0.85	0.75	0.75	0.93	0.66	0.94	0.58	0.79	0.71	0.80	0.59
Percent Heavy Veh, %	2	2	2	2	2	2	2	2	2	2	2	2
Cap, veh/h	160	1546	81	89	1262	197	99	143	174	267	306	186
Arrive On Green	0.09	0.45	0.45	0.05	0.41	0.41	0.06	0.19	0.19	0.15	0.28	0.28
Sat Flow, veh/h	1781	3435	180	1781	3079	481	1781	767	935	1781	1091	661
Grp Volume(v), veh/h	69	737	767	52	338	341	29	0	122	227	0	175
Grp Sat Flow(s),veh/h/ln	1781	1777	1838	1781	1777	1784	1781	0	1702	1781	0	1751
Q Serve(g_s), s	4.0	42.9	43.3	3.1	15.3	15.3	1.7	0.0	6.9	13.7	0.0	8.8
Cycle Q Clear(g_c), s	4.0	42.9	43.3	3.1	15.3	15.3	1.7	0.0	6.9	13.7	0.0	8.8
Prop In Lane	1.00		0.10	1.00		0.27	1.00		0.55	1.00		0.38
Lane Grp Cap(c), veh/h	160	800	827	89	729	731	99	0	317	267	0	492
V/C Ratio(X)	0.43	0.92	0.93	0.58	0.46	0.47	0.29	0.00	0.38	0.85	0.00	0.36
Avail Cap(c_a), veh/h	160	800	827	89	729	731	99	0	317	267	0	492
HCM Platoon Ratio	1.00	1.00	1.00	1.00	1.00	1.00	1.00	1.00	1.00	1.00	1.00	1.00
Upstream Filter(I)	1.00	1.00	1.00	1.00	1.00	1.00	1.00	0.00	1.00	1.00	0.00	1.00
Uniform Delay (d), s/veh	47.4	28.4	28.5	51.1	23.6	23.7	49.9	0.0	39.2	45.5	0.0	31.6
Incr Delay (d2), s/veh	8.2	17.7	17.9	25.0	2.1	2.1	7.4	0.0	3.5	27.2	0.0	2.0
Initial Q Delay(d3),s/veh	0.0	0.0	0.0	0.0	0.0	0.0	0.0	0.0	0.0	0.0	0.0	0.0
%ile BackOfQ(50%),veh/ln	2.2	21.5	22.4	2.0	6.8	6.8	1.0	0.0	3.2	8.0	0.0	4.0
Unsig. Movement Delay, s/veh												
LnGrp Delay(d),s/veh	55.6	46.2	46.4	76.1	25.8	25.8	57.3	0.0	42.7	72.7	0.0	33.6
LnGrp LOS	E	D	D	E	C	C	E	A	D	E	A	C
Approach Vol, veh/h		1573			731			151			402	
Approach Delay, s/veh		46.7			29.4			45.5			55.7	
Approach LOS		D			C			D			E	
Timer - Assigned Phs	1	2	3	4	5	6	7	8				
Phs Duration (G+Y+Rc), s	21.0	25.0	10.0	54.0	10.6	35.4	14.4	49.6				
Change Period (Y+Rc), s	4.5	4.5	4.5	4.5	4.5	4.5	4.5	4.5				
Max Green Setting (Gmax), s	10.5	20.5	5.5	49.5	6.1	30.9	9.9	45.1				
Max Q Clear Time (g_c+Tr), s	10.5	8.9	5.1	45.3	3.7	10.8	6.0	17.3				
Green Ext Time (p_c), s	0.1	0.4	0.0	3.2	0.0	0.9	0.0	4.6				
Intersection Summary												
HCM 6th Ctrl Delay												43.5
HCM 6th LOS												D

HCM 6th AWSC
12: Howard Ave & 12th St

05/04/2020

Intersection

Intersection Delay, s/veh 8.9

Intersection LOS A

Movement	EBL	EBT	EBR	WBL	WBT	WBR	NBL	NBT	NBR	SBL	SBT	SBR
Lane Configurations		↔			↔			↔			↔	
Traffic Vol, veh/h	0	2	26	12	1	4	6	65	14	5	183	4
Future Vol, veh/h	0	2	26	12	1	4	6	65	14	5	183	4
Peak Hour Factor	0.25	0.25	0.85	0.71	0.62	0.50	0.48	0.70	0.42	0.25	0.68	0.62
Heavy Vehicles, %	2	2	2	2	2	2	2	2	2	2	2	2
Mvmt Flow	0	8	31	17	2	8	13	93	33	20	269	6
Number of Lanes	0	1	0	0	1	0	0	1	0	0	1	0

Approach	EB	WB	WB	NB	SB
Opposing Approach	WB	EB	SB	SB	NB
Opposing Lanes	1	1	1	1	1
Conflicting Approach Left	SB	NB	EB	EB	WB
Conflicting Lanes Left	1	1	1	1	1
Conflicting Approach Right	NB	SB	WB	WB	EB
Conflicting Lanes Right	1	1	1	1	1
HCM Control Delay	7.6	8.1	8.2	8.2	9.4
HCM LOS	A	A	A	A	A

Lane	NBLn1	EBLn1	WBLn1	SBLn1
Vol Left, %	7%	0%	71%	3%
Vol Thru, %	76%	7%	6%	95%
Vol Right, %	16%	93%	24%	2%
Sign Control	Stop	Stop	Stop	Stop
Traffic Vol by Lane	85	28	17	192
LT Vol	6	0	12	5
Through Vol	65	2	1	183
RT Vol	14	26	4	4
Lane Flow Rate	139	39	27	296
Geometry Grp	1	1	1	1
Degree of Util (X)	0.166	0.047	0.036	0.34
Departure Headway (Hd)	4.298	4.355	4.927	4.145
Convergence, Y/N	Yes	Yes	Yes	Yes
Cap	838	825	729	854
Service Time	2.306	2.365	2.939	2.233
HCM Lane V/C Ratio	0.166	0.047	0.037	0.347
HCM Control Delay	8.2	7.6	8.1	9.4
HCM Lane LOS	A	A	A	A
HCM 95th-tile Q	0.6	0.1	0.1	1.5

HCM 6th Signalized Intersection Summary

13: Olivewood Ave/Lime St & 14th St

05/04/2020



Movement	EBL	EBT	EBR	WBL	WBT	WBR	NBL	NBT	NBR	SBL	SBT	SBR
Lane Configurations	↵ ↑↑↑			↵ ↑↑↑			↵ ↑↑	↑↑	↵	↵↵	↑↑	
Traffic Volume (veh/h)	28	987	79	251	783	75	44	179	423	295	610	38
Future Volume (veh/h)	28	987	79	251	783	75	44	179	423	295	610	38
Initial Q (Qb), veh	0	0	0	0	0	0	0	0	0	0	0	0
Ped-Bike Adj(A_pbT)	1.00		1.00	1.00		1.00	1.00		1.00	1.00		1.00
Parking Bus, Adj	1.00	1.00	1.00	1.00	1.00	1.00	1.00	1.00	1.00	1.00	1.00	1.00
Work Zone On Approach	No			No			No			No		
Adj Sat Flow, veh/h/ln	1870	1870	1870	1870	1870	1870	1870	1870	1870	1870	1870	1870
Adj Flow Rate, veh/h	39	1204	100	276	842	91	56	232	492	476	735	76
Peak Hour Factor	0.71	0.82	0.79	0.91	0.93	0.82	0.79	0.77	0.86	0.62	0.83	0.50
Percent Heavy Veh, %	2	2	2	2	2	2	2	2	2	2	2	2
Cap, veh/h	108	1376	114	358	1996	215	102	328	556	600	949	98
Arrive On Green	0.06	0.29	0.29	0.07	0.14	0.14	0.06	0.18	0.18	0.17	0.29	0.29
Sat Flow, veh/h	1781	4804	399	1781	4680	504	1781	1870	3170	3456	3251	336
Grp Volume(v), veh/h	39	853	451	276	611	322	56	232	492	476	402	409
Grp Sat Flow(s),veh/h/ln	1781	1702	1799	1781	1702	1780	1781	1870	1585	1728	1777	1810
Q Serve(g_s), s	2.3	26.3	26.3	16.8	18.0	18.2	3.4	12.8	16.7	14.5	22.7	22.8
Cycle Q Clear(g_c), s	2.3	26.3	26.3	16.8	18.0	18.2	3.4	12.8	16.7	14.5	22.7	22.8
Prop In Lane	1.00		0.22	1.00		0.28	1.00		1.00	1.00		0.19
Lane Grp Cap(c), veh/h	108	975	515	358	1451	759	102	328	556	600	519	528
V/C Ratio(X)	0.36	0.88	0.88	0.77	0.42	0.42	0.55	0.71	0.88	0.79	0.77	0.78
Avail Cap(c_a), veh/h	108	975	515	358	1451	759	102	328	556	600	519	528
HCM Platoon Ratio	1.00	1.00	1.00	0.33	0.33	0.33	1.00	1.00	1.00	1.00	1.00	1.00
Upstream Filter(I)	1.00	1.00	1.00	1.00	1.00	1.00	1.00	1.00	1.00	1.00	1.00	1.00
Uniform Delay (d), s/veh	49.6	37.4	37.4	48.9	34.9	34.9	50.5	42.7	44.3	43.6	35.6	35.6
Incr Delay (d2), s/veh	9.0	10.8	18.5	14.8	0.9	1.7	19.6	12.1	18.3	10.4	10.8	10.6
Initial Q Delay(d3),s/veh	0.0	0.0	0.0	0.0	0.0	0.0	0.0	0.0	0.0	0.0	0.0	0.0
%ile BackOfQ(50%),veh/ln	1.3	12.2	14.0	9.5	8.4	9.0	2.1	7.0	7.9	7.0	11.3	11.5
Unsig. Movement Delay, s/veh												
LnGrp Delay(d),s/veh	58.6	48.2	55.9	63.7	35.8	36.7	70.0	54.8	62.6	53.9	46.4	46.3
LnGrp LOS	E	D	E	E	D	D	E	D	E	D	D	D
Approach Vol, veh/h	1343		1209		780		1287					
Approach Delay, s/veh	51.1		42.4		60.8		49.1					
Approach LOS	D		D		E		D					
Timer - Assigned Phs	1	2	3	4	5	6	7	8				
Phs Duration (G+Y+Rc), s	23.6	23.8	26.6	36.0	10.8	36.6	11.2	51.4				
Change Period (Y+Rc), s	4.5	4.5	4.5	4.5	4.5	4.5	4.5	4.5				
Max Green Setting (Gmax), s	19.3	19.3	22.1	31.5	6.3	32.1	6.7	46.9				
Max Q Clear Time (g_c+10), s	18.7	18.7	18.8	28.3	5.4	24.8	4.3	20.2				
Green Ext Time (p_c), s	0.5	0.3	0.3	2.3	0.0	3.0	0.0	7.0				

Intersection Summary

HCM 6th Ctrl Delay	49.9
HCM 6th LOS	D

Notes

User approved volume balancing among the lanes for turning movement.

HCM 6th Signalized Intersection Summary

14: Mulberry St/SR 91 Off-Ramp & 14th St

05/04/2020



Movement	EBL	EBT	EBR	WBL	WBT	WBR	NBL	NBT	NBR	SBL	SBT	SBR
Lane Configurations		↑↑↑		↔↔	↑↑↑					↔	↑↑	↔
Traffic Volume (veh/h)	0	1438	267	351	631	0	0	0	0	389	210	478
Future Volume (veh/h)	0	1438	267	351	631	0	0	0	0	389	210	478
Initial Q (Qb), veh	0	0	0	0	0	0				0	0	0
Ped-Bike Adj(A_pbT)	1.00		1.00	1.00		1.00				1.00		1.00
Parking Bus, Adj	1.00	1.00	1.00	1.00	1.00	1.00				1.00	1.00	1.00
Work Zone On Approach		No			No						No	
Adj Sat Flow, veh/h/ln	0	1870	1870	1870	1870	0				1870	1870	1870
Adj Flow Rate, veh/h	0	1530	445	481	693	0				316	720	335
Peak Hour Factor	0.25	0.94	0.60	0.73	0.91	0.25				0.82	0.85	0.95
Percent Heavy Veh, %	0	2	2	2	2	0				2	2	2
Cap, veh/h	0	1765	507	613	3403	0				449	942	399
Arrive On Green	0.00	0.30	0.30	0.18	0.67	0.00				0.25	0.25	0.25
Sat Flow, veh/h	0	4107	1132	3456	5274	0				1781	3741	1585
Grp Volume(v), veh/h	0	1320	655	481	693	0				316	720	335
Grp Sat Flow(s),veh/h/ln	0	1702	1667	1728	1702	0				1781	1870	1585
Q Serve(g_s), s	0.0	40.3	41.1	14.6	5.8	0.0				17.7	19.6	22.1
Cycle Q Clear(g_c), s	0.0	40.3	41.1	14.6	5.8	0.0				17.7	19.6	22.1
Prop In Lane	0.00		0.68	1.00		0.00				1.00		1.00
Lane Grp Cap(c), veh/h	0	1526	747	613	3403	0				449	942	399
V/C Ratio(X)	0.00	0.87	0.88	0.79	0.20	0.00				0.70	0.76	0.84
Avail Cap(c_a), veh/h	0	1526	747	613	3403	0				449	942	399
HCM Platoon Ratio	1.00	0.67	0.67	1.00	1.00	1.00				1.00	1.00	1.00
Upstream Filter(I)	0.00	1.00	1.00	1.00	1.00	0.00				1.00	1.00	1.00
Uniform Delay (d), s/veh	0.0	35.3	35.6	43.2	7.1	0.0				37.4	38.1	39.0
Incr Delay (d2), s/veh	0.0	6.8	13.8	9.8	0.1	0.0				9.0	5.9	18.7
Initial Q Delay(d3),s/veh	0.0	0.0	0.0	0.0	0.0	0.0				0.0	0.0	0.0
%ile BackOfQ(50%),veh/ln	0.0	18.8	20.1	7.0	2.0	0.0				8.8	9.7	10.6
Unsig. Movement Delay, s/veh												
LnGrp Delay(d),s/veh	0.0	42.1	49.4	53.0	7.2	0.0				46.4	44.0	57.7
LnGrp LOS		A	D	D	D	A	A			D	D	E
Approach Vol, veh/h		1975			1174			1371				
Approach Delay, s/veh		44.5			26.0			47.9				
Approach LOS		D			C			D				
Timer - Assigned Phs			3	4		6		8				
Phs Duration (G+Y+Rc), s			24.0	53.8		32.2		77.8				
Change Period (Y+Rc), s			4.5	4.5		4.5		4.5				
Max Green Setting (Gmax), s			19.5	49.3		27.7		73.3				
Max Q Clear Time (g_c+I1), s			16.6	43.1		24.1		7.8				
Green Ext Time (p_c), s			0.6	5.3		2.3		5.8				
Intersection Summary												
HCM 6th Ctrl Delay		40.7										
HCM 6th LOS		D										
Notes												
User approved volume balancing among the lanes for turning movement.												

Build-Out AM

HCM 6th Signalized Intersection Summary

2: Mission Inn Ave & SR 91 Off-Ramp

05/04/2020

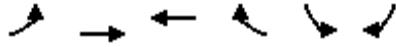

Movement	EBL	EBT	WBT	WBR	SBL	SBR
Lane Configurations		↑↑	↑↑		↵	↵↵
Traffic Volume (veh/h)	0	270	307	0	288	1322
Future Volume (veh/h)	0	270	307	0	288	1322
Initial Q (Qb), veh	0	0	0	0	0	0
Ped-Bike Adj(A_pbT)	1.00			1.00	1.00	1.00
Parking Bus, Adj	1.00	1.00	1.00	1.00	1.00	1.00
Work Zone On Approach		No	No		No	
Adj Sat Flow, veh/h/ln	0	1870	1870	0	1870	1870
Adj Flow Rate, veh/h	0	284	323	0	303	1392
Peak Hour Factor	0.95	0.95	0.95	0.95	0.95	0.95
Percent Heavy Veh, %	0	2	2	0	2	2
Cap, veh/h	0	759	759	0	1255	1965
Arrive On Green	0.00	0.21	0.43	0.00	0.70	0.70
Sat Flow, veh/h	0	3741	3741	0	1781	2790
Grp Volume(v), veh/h	0	284	323	0	303	1392
Grp Sat Flow(s),veh/h/ln	0	1777	1777	0	1781	1395
Q Serve(g_s), s	0.0	7.5	7.0	0.0	6.7	32.4
Cycle Q Clear(g_c), s	0.0	7.5	7.0	0.0	6.7	32.4
Prop In Lane	0.00			0.00	1.00	1.00
Lane Grp Cap(c), veh/h	0	759	759	0	1255	1965
V/C Ratio(X)	0.00	0.37	0.43	0.00	0.24	0.71
Avail Cap(c_a), veh/h	0	759	759	0	1255	1965
HCM Platoon Ratio	1.00	1.00	2.00	1.00	1.00	1.00
Upstream Filter(I)	0.00	1.00	1.00	0.00	1.00	1.00
Uniform Delay (d), s/veh	0.0	37.0	26.8	0.0	5.8	9.6
Incr Delay (d2), s/veh	0.0	1.4	1.7	0.0	0.5	2.2
Initial Q Delay(d3),s/veh	0.0	0.0	0.0	0.0	0.0	0.0
%ile BackOfQ(50%),veh/ln	0.0	3.4	2.8	0.0	2.4	9.1
Unsig. Movement Delay, s/veh						
LnGrp Delay(d),s/veh	0.0	38.4	28.5	0.0	6.2	11.8
LnGrp LOS	A	D	C	A	A	B
Approach Vol, veh/h		284	323		1695	
Approach Delay, s/veh		38.4	28.5		10.8	
Approach LOS		D	C		B	
Timer - Assigned Phs				4	6	8
Phs Duration (G+Y+Rc), s				28.0	82.0	28.0
Change Period (Y+Rc), s				4.5	4.5	4.5
Max Green Setting (Gmax), s				23.5	77.5	23.5
Max Q Clear Time (g_c+I1), s				9.5	34.4	9.0
Green Ext Time (p_c), s				1.5	10.2	1.7
Intersection Summary						
HCM 6th Ctrl Delay			16.7			
HCM 6th LOS			B			

HCM 6th Signalized Intersection Summary

3: Mulberry St/SR 91 On-Ramp & Mission Inn Ave

05/04/2020



Movement	EBL	EBT	EBR	WBL	WBT	WBR	NBL	NBT	NBR	SBL	SBT	SBR
Lane Configurations												
Traffic Volume (veh/h)	270	288	0	0	137	239	170	344	86	0	0	0
Future Volume (veh/h)	270	288	0	0	137	239	170	344	86	0	0	0
Initial Q (Qb), veh	0	0	0	0	0	0	0	0	0			
Ped-Bike Adj(A_pbT)	1.00		1.00	1.00		1.00	1.00		1.00			
Parking Bus, Adj	1.00	1.00	1.00	1.00	1.00	1.00	1.00	1.00	1.00			
Work Zone On Approach	No			No			No					
Adj Sat Flow, veh/h/ln	1870	1870	0	0	1870	1870	1870	1870	1870			
Adj Flow Rate, veh/h	284	303	0	0	144	0	179	362	91			
Peak Hour Factor	0.95	0.95	0.95	0.95	0.95	0.95	0.95	0.95	0.95			
Percent Heavy Veh, %	2	2	0	0	2	2	2	2	2			
Cap, veh/h	510	1858	0	0	695		704	570	143			
Arrive On Green	0.57	1.00	0.00	0.00	0.20	0.00	0.40	0.40	0.40			
Sat Flow, veh/h	1781	3647	0	0	3741	0	1781	1442	363			
Grp Volume(v), veh/h	284	303	0	0	144	0	179	0	453			
Grp Sat Flow(s),veh/h/ln	1781	1777	0	0	1777	0	1781	0	1805			
Q Serve(g_s), s	11.0	0.0	0.0	0.0	3.7	0.0	7.4	0.0	22.3			
Cycle Q Clear(g_c), s	11.0	0.0	0.0	0.0	3.7	0.0	7.4	0.0	22.3			
Prop In Lane	1.00		0.00	0.00		0.00	1.00		0.20			
Lane Grp Cap(c), veh/h	510	1858	0	0	695		704	0	714			
V/C Ratio(X)	0.56	0.16	0.00	0.00	0.21		0.25	0.00	0.63			
Avail Cap(c_a), veh/h	510	1858	0	0	695		704	0	714			
HCM Platoon Ratio	2.00	2.00	1.00	1.00	1.00	1.00	1.00	1.00	1.00			
Upstream Filter(I)	1.00	1.00	0.00	0.00	1.00	0.00	1.00	0.00	1.00			
Uniform Delay (d), s/veh	19.1	0.0	0.0	0.0	37.1	0.0	22.3	0.0	26.8			
Incr Delay (d2), s/veh	4.3	0.2	0.0	0.0	0.7	0.0	0.9	0.0	4.3			
Initial Q Delay(d3),s/veh	0.0	0.0	0.0	0.0	0.0	0.0	0.0	0.0	0.0			
%ile BackOfQ(50%),veh/ln	4.2	0.0	0.0	0.0	1.7	0.0	3.3	0.0	10.3			
Unsig. Movement Delay, s/veh												
LnGrp Delay(d),s/veh	23.5	0.2	0.0	0.0	37.8	0.0	23.2	0.0	31.1			
LnGrp LOS	C	A	A	A	D		C	A	C			
Approach Vol, veh/h	587			144			632					
Approach Delay, s/veh	11.4			37.8			28.9					
Approach LOS	B			D			C					
Timer - Assigned Phs	2		4		7		8					
Phs Duration (G+Y+Rc), s	48.0		62.0		36.0		26.0					
Change Period (Y+Rc), s	4.5		4.5		4.5		4.5					
Max Green Setting (Gmax), s	43.5		57.5		31.5		21.5					
Max Q Clear Time (g_c+I1), s	24.3		2.0		13.0		5.7					
Green Ext Time (p_c), s	3.4		2.2		0.8		0.7					

Intersection Summary

HCM 6th Ctrl Delay	22.3
HCM 6th LOS	C

Notes

Unsignalized Delay for [WBR] is excluded from calculations of the approach delay and intersection delay.

HCM 6th Signalized Intersection Summary

4: Howard Ave & 14th St

05/04/2020



Movement	EBL	EBT	EBR	WBL	WBT	WBR	NBL	NBT	NBR	SBL	SBT	SBR
Lane Configurations												
Traffic Volume (veh/h)	52	664	55	13	1470	16	90	32	34	4	82	115
Future Volume (veh/h)	52	664	55	13	1470	16	90	32	34	4	82	115
Initial Q (Qb), veh	0	0	0	0	0	0	0	0	0	0	0	0
Ped-Bike Adj(A_pbT)	1.00		1.00	1.00		1.00	1.00		1.00	1.00		1.00
Parking Bus, Adj	1.00	1.00	1.00	1.00	1.00	1.00	1.00	1.00	1.00	1.00	1.00	1.00
Work Zone On Approach		No			No			No			No	
Adj Sat Flow, veh/h/ln	1870	1870	1870	1870	1870	1870	1870	1870	1870	1870	1870	1870
Adj Flow Rate, veh/h	55	699	58	14	1547	17	95	34	36	4	86	121
Peak Hour Factor	0.95	0.95	0.95	0.95	0.95	0.95	0.95	0.95	0.95	0.95	0.95	0.95
Percent Heavy Veh, %	2	2	2	2	2	2	2	2	2	2	2	2
Cap, veh/h	138	1993	889	86	1915	21	229	82	72	36	191	260
Arrive On Green	0.08	0.56	0.56	0.05	0.53	0.53	0.27	0.27	0.27	0.27	0.27	0.27
Sat Flow, veh/h	1781	3554	1585	1781	3601	40	660	307	270	9	713	970
Grp Volume(v), veh/h	55	699	58	14	763	801	165	0	0	211	0	0
Grp Sat Flow(s),veh/h/ln	1781	1777	1585	1781	1777	1863	1237	0	0	1692	0	0
Q Serve(g_s), s	3.2	11.8	1.8	0.8	38.7	38.8	2.7	0.0	0.0	0.0	0.0	0.0
Cycle Q Clear(g_c), s	3.2	11.8	1.8	0.8	38.7	38.8	14.1	0.0	0.0	11.4	0.0	0.0
Prop In Lane	1.00		1.00	1.00		0.02	0.58		0.22	0.02		0.57
Lane Grp Cap(c), veh/h	138	1993	889	86	945	991	383	0	0	487	0	0
V/C Ratio(X)	0.40	0.35	0.07	0.16	0.81	0.81	0.43	0.00	0.00	0.43	0.00	0.00
Avail Cap(c_a), veh/h	138	1993	889	86	945	991	383	0	0	487	0	0
HCM Platoon Ratio	1.00	1.00	1.00	1.00	1.00	1.00	1.00	1.00	1.00	1.00	1.00	1.00
Upstream Filter(I)	1.00	1.00	1.00	1.00	1.00	1.00	1.00	0.00	0.00	1.00	0.00	0.00
Uniform Delay (d), s/veh	48.3	13.2	11.0	50.2	21.1	21.1	34.5	0.0	0.0	33.6	0.0	0.0
Incr Delay (d2), s/veh	8.4	0.5	0.1	4.0	7.4	7.1	3.5	0.0	0.0	2.8	0.0	0.0
Initial Q Delay(d3),s/veh	0.0	0.0	0.0	0.0	0.0	0.0	0.0	0.0	0.0	0.0	0.0	0.0
%ile BackOfQ(50%),veh/ln	1.8	4.7	0.7	0.5	17.2	18.0	4.2	0.0	0.0	5.1	0.0	0.0
Unsig. Movement Delay, s/veh												
LnGrp Delay(d),s/veh	56.8	13.7	11.1	54.3	28.5	28.2	38.0	0.0	0.0	36.4	0.0	0.0
LnGrp LOS	E	B	B	D	C	C	D	A	A	D	A	A
Approach Vol, veh/h		812			1578			165			211	
Approach Delay, s/veh		16.4			28.6			38.0			36.4	
Approach LOS		B			C			D			D	
Timer - Assigned Phs		2	3	4		6	7	8				
Phs Duration (G+Y+Rc), s		34.0	9.8	66.2		34.0	13.0	63.0				
Change Period (Y+Rc), s		4.5	4.5	4.5		4.5	4.5	4.5				
Max Green Setting (Gmax), s		29.5	5.3	61.7		29.5	8.5	58.5				
Max Q Clear Time (g_c+I1), s		16.1	2.8	13.8		13.4	5.2	40.8				
Green Ext Time (p_c), s		0.7	0.0	6.0		1.1	0.0	10.7				
Intersection Summary												
HCM 6th Ctrl Delay											26.2	
HCM 6th LOS											C	

HCM 6th AWSC
5: Vine St & Mission Inn Ave

05/04/2020

Intersection

Intersection Delay, s/veh 11.4

Intersection LOS B

Movement	EBL	EBT	EBR	WBL	WBT	WBR	NBL	NBT	NBR	SBL	SBT	SBR
Lane Configurations	↙	↑	↗	↙	↑↑		↙	↗			↕	
Traffic Vol, veh/h	116	182	76	3	284	68	45	51	25	20	16	47
Future Vol, veh/h	116	182	76	3	284	68	45	51	25	20	16	47
Peak Hour Factor	0.95	0.95	0.95	0.95	0.95	0.95	0.95	0.95	0.95	0.95	0.95	0.95
Heavy Vehicles, %	2	2	2	2	2	2	2	2	2	2	2	2
Mvmt Flow	122	192	80	3	299	72	47	54	26	21	17	49
Number of Lanes	1	1	1	1	2	0	1	1	0	0	1	0

Approach	EB	WB	NB	SB
Opposing Approach	WB	EB	SB	NB
Opposing Lanes	3	3	1	2
Conflicting Approach Left SB		NB	EB	WB
Conflicting Lanes Left	1	2	3	3
Conflicting Approach Right NB		SB	WB	EB
Conflicting Lanes Right	2	1	3	3
HCM Control Delay	11.3	11.8	10.8	10.9
HCM LOS	B	B	B	B

Lane	NBLn1	NBLn2	EBLn1	EBLn2	EBLn3	WBLn1	WBLn2	WBLn3	SBLn1
Vol Left, %	100%	0%	100%	0%	0%	100%	0%	0%	24%
Vol Thru, %	0%	67%	0%	100%	0%	0%	100%	58%	19%
Vol Right, %	0%	33%	0%	0%	100%	0%	0%	42%	57%
Sign Control	Stop	Stop	Stop	Stop	Stop	Stop	Stop	Stop	Stop
Traffic Vol by Lane	45	76	116	182	76	3	189	163	83
LT Vol	45	0	116	0	0	3	0	0	20
Through Vol	0	51	0	182	0	0	189	95	16
RT Vol	0	25	0	0	76	0	0	68	47
Lane Flow Rate	47	80	122	192	80	3	199	171	87
Geometry Grp	8	8	8	8	8	8	8	8	8
Degree of Util (X)	0.098	0.15	0.229	0.332	0.123	0.006	0.348	0.285	0.164
Departure Headway (Hd)	7.462	6.728	6.745	6.239	5.531	6.787	6.281	5.985	6.778
Convergence, Y/N	Yes	Yes	Yes	Yes	Yes	Yes	Yes	Yes	Yes
Cap	479	531	531	575	646	526	572	599	527
Service Time	5.23	4.496	4.5	3.994	3.285	4.542	4.036	3.74	4.55
HCM Lane V/C Ratio	0.098	0.151	0.23	0.334	0.124	0.006	0.348	0.285	0.165
HCM Control Delay	11	10.7	11.5	12.1	9.1	9.6	12.4	11.1	10.9
HCM Lane LOS	B	B	B	B	A	A	B	B	B
HCM 95th-tile Q	0.3	0.5	0.9	1.4	0.4	0	1.5	1.2	0.6

HCM 6th TWSC
6: Commerce St & Mission Inn Ave

05/04/2020

Intersection												
Int Delay, s/veh	5.1											
Movement	EBL	EBT	EBR	WBL	WBT	WBR	NBL	NBT	NBR	SBL	SBT	SBR
Lane Configurations		↔	↔		↔↔			↔			↔	
Traffic Vol, veh/h	16	175	36	12	266	6	75	91	5	3	22	14
Future Vol, veh/h	16	175	36	12	266	6	75	91	5	3	22	14
Conflicting Peds, #/hr	0	0	0	0	0	0	0	0	0	0	0	0
Sign Control	Free	Free	Free	Free	Free	Free	Stop	Stop	Stop	Stop	Stop	Stop
RT Channelized	-	-	None	-	-	None	-	-	None	-	-	None
Storage Length	-	-	0	-	-	-	-	-	-	-	-	-
Veh in Median Storage, #	-	0	-	-	0	-	-	0	-	-	0	-
Grade, %	-	0	-	-	0	-	-	0	-	-	0	-
Peak Hour Factor	95	95	95	95	95	95	95	95	95	95	95	95
Heavy Vehicles, %	2	2	2	2	2	2	2	2	2	2	2	2
Mvmt Flow	17	184	38	13	280	6	79	96	5	3	23	15

Major/Minor	Major1			Major2			Minor1			Minor2		
Conflicting Flow All	286	0	0	222	0	0	396	530	184	597	565	143
Stage 1	-	-	-	-	-	-	218	218	-	309	309	-
Stage 2	-	-	-	-	-	-	178	312	-	288	256	-
Critical Hdwy	4.13	-	-	4.13	-	-	7.33	6.53	6.23	7.33	6.53	6.93
Critical Hdwy Stg 1	-	-	-	-	-	-	6.13	5.53	-	6.53	5.53	-
Critical Hdwy Stg 2	-	-	-	-	-	-	6.53	5.53	-	6.13	5.53	-
Follow-up Hdwy	2.219	-	-	2.219	-	-	3.519	4.019	3.319	3.519	4.019	3.319
Pot Cap-1 Maneuver	1275	-	-	1346	-	-	551	454	858	400	433	879
Stage 1	-	-	-	-	-	-	784	722	-	677	659	-
Stage 2	-	-	-	-	-	-	807	657	-	719	695	-
Platoon blocked, %	-	-	-	-	-	-	-	-	-	-	-	-
Mov Cap-1 Maneuver	1275	-	-	1346	-	-	509	442	858	325	422	879
Mov Cap-2 Maneuver	-	-	-	-	-	-	509	442	-	325	422	-
Stage 1	-	-	-	-	-	-	772	711	-	667	652	-
Stage 2	-	-	-	-	-	-	757	650	-	609	685	-

Approach	EB			WB			NB			SB		
HCM Control Delay, s	0.6			0.3			17.1			12.8		
HCM LOS							C			B		

Minor Lane/Major Mvmt	NBLn1	EBL	EBT	EBR	WBL	WBT	WBR	SBLn1
Capacity (veh/h)	476	1275	-	-	1346	-	-	505
HCM Lane V/C Ratio	0.378	0.013	-	-	0.009	-	-	0.081
HCM Control Delay (s)	17.1	7.9	0	-	7.7	0	-	12.8
HCM Lane LOS	C	A	A	-	A	A	-	B
HCM 95th %tile Q(veh)	1.7	0	-	-	0	-	-	0.3

HCM 6th TWSC
7: Commerce St & 9th St

05/04/2020

Intersection						
Int Delay, s/veh	5.1					
Movement	WBL	WBR	NBT	NBR	SBL	SBT
Lane Configurations						
Traffic Vol, veh/h	32	100	71	0	18	52
Future Vol, veh/h	32	100	71	0	18	52
Conflicting Peds, #/hr	0	0	0	0	0	0
Sign Control	Stop	Stop	Free	Free	Free	Free
RT Channelized	-	None	-	None	-	None
Storage Length	0	-	-	-	-	-
Veh in Median Storage, #	0	-	0	-	-	0
Grade, %	0	-	0	-	-	0
Peak Hour Factor	95	95	95	95	95	95
Heavy Vehicles, %	2	2	2	2	2	2
Mvmt Flow	34	105	75	0	19	55

Major/Minor	Minor1	Major1	Major2			
Conflicting Flow All	168	75	0	0	75	0
Stage 1	75	-	-	-	-	-
Stage 2	93	-	-	-	-	-
Critical Hdwy	6.42	6.22	-	-	4.12	-
Critical Hdwy Stg 1	5.42	-	-	-	-	-
Critical Hdwy Stg 2	5.42	-	-	-	-	-
Follow-up Hdwy	3.518	3.318	-	-	2.218	-
Pot Cap-1 Maneuver	822	986	-	-	1524	-
Stage 1	948	-	-	-	-	-
Stage 2	931	-	-	-	-	-
Platoon blocked, %			-	-		
Mov Cap-1 Maneuver	811	986	-	-	1524	-
Mov Cap-2 Maneuver	811	-	-	-	-	-
Stage 1	936	-	-	-	-	-
Stage 2	931	-	-	-	-	-

Approach	WB	NB	SB
HCM Control Delay, s	9.5	0	1.9
HCM LOS	A		

Minor Lane/Major Mvmt	NBT	NBRWBLn1	SBL	SBT
Capacity (veh/h)	-	-	937	1524
HCM Lane V/C Ratio	-	-	0.148	0.012
HCM Control Delay (s)	-	-	9.5	7.4
HCM Lane LOS	-	-	A	A
HCM 95th %tile Q(veh)	-	-	0.5	0

Intersection

Int Delay, s/veh 3.7

Movement EBT EBR WBL WBT NBL NBR

Lane Configurations						
Traffic Vol, veh/h	14	49	59	120	48	17
Future Vol, veh/h	14	49	59	120	48	17
Conflicting Peds, #/hr	0	0	0	0	0	0
Sign Control	Free	Free	Free	Free	Stop	Stop
RT Channelized	-	None	-	None	-	None
Storage Length	-	-	-	-	0	-
Veh in Median Storage, #	0	-	-	0	0	-
Grade, %	0	-	-	0	0	-
Peak Hour Factor	95	95	95	95	95	95
Heavy Vehicles, %	2	2	2	2	2	2
Mvmt Flow	15	52	62	126	51	18

Major/Minor Major1 Major2 Minor1

Conflicting Flow All	0	0	67	0	291	41
Stage 1	-	-	-	-	41	-
Stage 2	-	-	-	-	250	-
Critical Hdwy	-	-	4.12	-	6.42	6.22
Critical Hdwy Stg 1	-	-	-	-	5.42	-
Critical Hdwy Stg 2	-	-	-	-	5.42	-
Follow-up Hdwy	-	-	2.218	-	3.518	3.318
Pot Cap-1 Maneuver	-	-	1535	-	700	1030
Stage 1	-	-	-	-	981	-
Stage 2	-	-	-	-	792	-
Platoon blocked, %	-	-	-	-	-	-
Mov Cap-1 Maneuver	-	-	1535	-	670	1030
Mov Cap-2 Maneuver	-	-	-	-	670	-
Stage 1	-	-	-	-	939	-
Stage 2	-	-	-	-	792	-

Approach EB WB NB

HCM Control Delay, s	0	2.5	10.4
HCM LOS			B

Minor Lane/Major Mvmt NBLn1 EBT EBR WBL WBT

Capacity (veh/h)	737	-	-	1535	-
HCM Lane V/C Ratio	0.093	-	-	0.04	-
HCM Control Delay (s)	10.4	-	-	7.4	0
HCM Lane LOS	B	-	-	A	A
HCM 95th %tile Q(veh)	0.3	-	-	0.1	-

HCM 6th Signalized Intersection Summary
 9: SR 91 Off-Ramp/SR 91 On-Ramp & 14th St

05/04/2020



Movement	EBL	EBT	EBR	WBL	WBT	WBR	NBL	NBT	NBR	SBL	SBT	SBR
Lane Configurations	↗↘	↕			↕↕↕	↗	↘	↕	↗			
Traffic Volume (veh/h)	609	489	0	0	1405	270	870	0	282	0	0	0
Future Volume (veh/h)	609	489	0	0	1405	270	870	0	282	0	0	0
Initial Q (Qb), veh	0	0	0	0	0	0	0	0	0			
Ped-Bike Adj(A_pbT)	1.00		1.00	1.00		1.00	1.00		1.00			
Parking Bus, Adj	1.00	1.00	1.00	1.00	1.00	1.00	1.00	1.00	1.00			
Work Zone On Approach		No			No			No				
Adj Sat Flow, veh/h/ln	1870	1870	0	0	1870	1870	1870	1870	1870			
Adj Flow Rate, veh/h	641	515	0	0	1479	284	916	0	297			
Peak Hour Factor	0.95	0.95	0.95	0.95	0.95	0.95	0.95	0.95	0.95			
Percent Heavy Veh, %	2	2	0	0	2	2	2	2	2			
Cap, veh/h	743	2114	0	0	1711	531	1122	0	499			
Arrive On Green	0.22	0.60	0.00	0.00	0.34	0.34	0.31	0.00	0.31			
Sat Flow, veh/h	3456	3647	0	0	5274	1585	3563	0	1585			
Grp Volume(v), veh/h	641	515	0	0	1479	284	916	0	297			
Grp Sat Flow(s),veh/h/ln	1728	1777	0	0	1702	1585	1781	0	1585			
Q Serve(g_s), s	17.9	6.9	0.0	0.0	27.1	14.5	23.7	0.0	15.8			
Cycle Q Clear(g_c), s	17.9	6.9	0.0	0.0	27.1	14.5	23.7	0.0	15.8			
Prop In Lane	1.00		0.00	0.00		1.00	1.00		1.00			
Lane Grp Cap(c), veh/h	743	2114	0	0	1711	531	1122	0	499			
V/C Ratio(X)	0.86	0.24	0.00	0.00	0.86	0.53	0.82	0.00	0.59			
Avail Cap(c_a), veh/h	743	2114	0	0	1711	531	1122	0	499			
HCM Platoon Ratio	1.00	1.00	1.00	1.00	1.00	1.00	1.00	1.00	1.00			
Upstream Filter(I)	1.00	1.00	0.00	0.00	1.00	1.00	1.00	0.00	1.00			
Uniform Delay (d), s/veh	37.8	9.6	0.0	0.0	31.1	26.9	31.6	0.0	28.9			
Incr Delay (d2), s/veh	12.6	0.3	0.0	0.0	6.1	3.8	6.6	0.0	5.1			
Initial Q Delay(d3),s/veh	0.0	0.0	0.0	0.0	0.0	0.0	0.0	0.0	0.0			
%ile BackOfQ(50%),veh/ln	8.7	2.6	0.0	0.0	11.8	6.0	11.0	0.0	6.6			
Unsig. Movement Delay, s/veh												
LnGrp Delay(d),s/veh	50.5	9.9	0.0	0.0	37.2	30.8	38.2	0.0	34.0			
LnGrp LOS	D	A	A	A	D	C	D	A	C			
Approach Vol, veh/h		1156			1763			1213				
Approach Delay, s/veh		32.4			36.2			37.2				
Approach LOS		C			D			D				
Timer - Assigned Phs		2		4			7	8				
Phs Duration (G+Y+Rc), s		36.0		64.0			26.0	38.0				
Change Period (Y+Rc), s		4.5		4.5			4.5	4.5				
Max Green Setting (Gmax), s		31.5		59.5			21.5	33.5				
Max Q Clear Time (g_c+I1), s		25.7		8.9			19.9	29.1				
Green Ext Time (p_c), s		2.6		4.0			0.5	3.5				

Intersection Summary

HCM 6th Ctrl Delay	35.4
HCM 6th LOS	D

Notes

User approved volume balancing among the lanes for turning movement.

HCM 6th Signalized Intersection Summary

11: Park Ave & University Ave

05/04/2020



Movement	EBL	EBT	EBR	WBL	WBT	WBR	NBL	NBT	NBR	SBL	SBT	SBR
Lane Configurations												
Traffic Volume (veh/h)	30	537	32	23	748	50	49	49	40	63	51	60
Future Volume (veh/h)	30	537	32	23	748	50	49	49	40	63	51	60
Initial Q (Qb), veh	0	0	0	0	0	0	0	0	0	0	0	0
Ped-Bike Adj(A_pbT)	1.00		1.00	1.00		1.00	1.00		1.00	1.00		1.00
Parking Bus, Adj	1.00	1.00	1.00	1.00	1.00	1.00	1.00	1.00	1.00	1.00	1.00	1.00
Work Zone On Approach		No		No		No		No		No		No
Adj Sat Flow, veh/h/ln	1870	1870	1870	1870	1870	1870	1870	1870	1870	1870	1870	1870
Adj Flow Rate, veh/h	32	565	34	24	787	53	52	52	42	66	54	63
Peak Hour Factor	0.95	0.95	0.95	0.95	0.95	0.95	0.95	0.95	0.95	0.95	0.95	0.95
Percent Heavy Veh, %	2	2	2	2	2	2	2	2	2	2	2	2
Cap, veh/h	138	1409	85	138	1398	94	202	213	172	219	182	213
Arrive On Green	0.08	0.41	0.41	0.08	0.41	0.41	0.11	0.22	0.22	0.12	0.23	0.23
Sat Flow, veh/h	1781	3406	205	1781	3379	227	1781	958	773	1781	787	918
Grp Volume(v), veh/h	32	294	305	24	414	426	52	0	94	66	0	117
Grp Sat Flow(s),veh/h/ln	1781	1777	1834	1781	1777	1829	1781	0	1731	1781	0	1705
Q Serve(g_s), s	1.9	12.8	12.9	1.4	19.6	19.6	2.9	0.0	4.9	3.7	0.0	6.2
Cycle Q Clear(g_c), s	1.9	12.8	12.9	1.4	19.6	19.6	2.9	0.0	4.9	3.7	0.0	6.2
Prop In Lane	1.00		0.11	1.00		0.12	1.00		0.45	1.00		0.54
Lane Grp Cap(c), veh/h	138	735	758	138	735	757	202	0	386	219	0	395
V/C Ratio(X)	0.23	0.40	0.40	0.17	0.56	0.56	0.26	0.00	0.24	0.30	0.00	0.30
Avail Cap(c_a), veh/h	138	735	758	138	735	757	202	0	386	219	0	395
HCM Platoon Ratio	1.00	1.00	1.00	1.00	1.00	1.00	1.00	1.00	1.00	1.00	1.00	1.00
Upstream Filter(I)	1.00	1.00	1.00	1.00	1.00	1.00	1.00	0.00	1.00	1.00	0.00	1.00
Uniform Delay (d), s/veh	47.7	22.7	22.7	47.5	24.7	24.7	44.5	0.0	35.1	44.0	0.0	34.8
Incr Delay (d2), s/veh	3.9	1.6	1.6	2.7	3.1	3.0	3.0	0.0	1.5	3.5	0.0	1.9
Initial Q Delay(d3),s/veh	0.0	0.0	0.0	0.0	0.0	0.0	0.0	0.0	0.0	0.0	0.0	0.0
%ile BackOfQ(50%),veh/ln	0	5.6	5.8	0.7	8.7	9.0	1.5	0.0	2.2	1.9	0.0	2.8
Unsig. Movement Delay, s/veh												
LnGrp Delay(d),s/veh	51.6	24.3	24.3	50.2	27.8	27.7	47.6	0.0	36.6	47.5	0.0	36.8
LnGrp LOS	D	C	C	D	C	C	D	A	D	D	A	D
Approach Vol, veh/h		631			864			146			183	
Approach Delay, s/veh		25.7			28.3			40.5			40.6	
Approach LOS		C			C			D			D	
Timer - Assigned Phs	1	2	3	4	5	6	7	8				
Phs Duration (G+Y+Rc), s	18.0	29.0	13.0	50.0	17.0	30.0	13.0	50.0				
Change Period (Y+Rc), s	4.5	4.5	4.5	4.5	4.5	4.5	4.5	4.5				
Max Green Setting (Gmax), s	13.5	24.5	8.5	45.5	12.5	25.5	8.5	45.5				
Max Q Clear Time (g_c+I), s	11.5	6.9	3.4	14.9	4.9	8.2	3.9	21.6				
Green Ext Time (p_c), s	0.1	0.4	0.0	4.0	0.0	0.5	0.0	5.7				
Intersection Summary												
HCM 6th Ctrl Delay												29.6
HCM 6th LOS												C

HCM 6th AWSC
12: Howard Ave & 12th St

05/04/2020

Intersection

Intersection Delay, s/veh 7.9

Intersection LOS A

Movement	EBL	EBT	EBR	WBL	WBT	WBR	NBL	NBT	NBR	SBL	SBT	SBR
Lane Configurations		↔		↔		↔		↔			↔	
Traffic Vol, veh/h	4	4	73	40	32	9	4	87	10	0	89	20
Future Vol, veh/h	4	4	73	40	32	9	4	87	10	0	89	20
Peak Hour Factor	0.95	0.95	0.95	0.95	0.95	0.95	0.95	0.95	0.95	0.95	0.95	0.95
Heavy Vehicles, %	2	2	2	2	2	2	2	2	2	2	2	2
Mvmt Flow	4	4	77	42	34	9	4	92	11	0	94	21
Number of Lanes	0	1	0	0	1	0	0	1	0	0	1	0

Approach	EB	WB	NB	SB
Opposing Approach	WB	EB	SB	NB
Opposing Lanes	1	1	1	1
Conflicting Approach Left SB	NB	EB	WB	WB
Conflicting Lanes Left	1	1	1	1
Conflicting Approach RightNB	SB	WB	WB	EB
Conflicting Lanes Right	1	1	1	1
HCM Control Delay	7.4	8.1	8.1	8
HCM LOS	A	A	A	A

Lane	NBLn1	EBLn1	WBLn1	SBLn1
Vol Left, %	4%	5%	49%	0%
Vol Thru, %	86%	5%	40%	82%
Vol Right, %	10%	90%	11%	18%
Sign Control	Stop	Stop	Stop	Stop
Traffic Vol by Lane	101	81	81	109
LT Vol	4	4	40	0
Through Vol	87	4	32	89
RT Vol	10	73	9	20
Lane Flow Rate	106	85	85	115
Geometry Grp	1	1	1	1
Degree of Util (X)	0.129	0.095	0.108	0.138
Departure Headway (Hd)	4.384	3.999	4.552	4.318
Convergence, Y/N	Yes	Yes	Yes	Yes
Cap	820	898	790	832
Service Time	2.402	2.016	2.569	2.334
HCM Lane V/C Ratio	0.129	0.095	0.108	0.138
HCM Control Delay	8.1	7.4	8.1	8
HCM Lane LOS	A	A	A	A
HCM 95th-tile Q	0.4	0.3	0.4	0.5

HCM 6th Signalized Intersection Summary

13: Olivewood Ave/Lime St & 14th St

05/04/2020



Movement	EBL	EBT	EBR	WBL	WBT	WBR	NBL	NBT	NBR	SBL	SBT	SBR
Lane Configurations	↙ ↑↑ ↘			↙ ↑↑ ↘			↙ ↑↑		↙ ↘		↙ ↑↑	
Traffic Volume (veh/h)	37	657	49	310	1826	219	97	307	383	56	155	25
Future Volume (veh/h)	37	657	49	310	1826	219	97	307	383	56	155	25
Initial Q (Qb), veh	0	0	0	0	0	0	0	0	0	0	0	0
Ped-Bike Adj(A_pbT)	1.00		1.00	1.00		1.00	1.00		1.00	1.00		1.00
Parking Bus, Adj	1.00	1.00	1.00	1.00	1.00	1.00	1.00	1.00	1.00	1.00	1.00	1.00
Work Zone On Approach	No			No			No		No			
Adj Sat Flow, veh/h/ln	1870	1870	1870	1870	1870	1870	1870	1870	1870	1870	1870	1870
Adj Flow Rate, veh/h	39	692	52	326	1922	231	102	322	403	59	163	26
Peak Hour Factor	0.95	0.95	0.95	0.95	0.95	0.95	0.95	0.95	0.95	0.95	0.95	0.95
Percent Heavy Veh, %	2	2	2	2	2	2	2	2	2	2	2	2
Cap, veh/h	89	1234	92	518	2291	273	186	454	769	167	574	90
Arrive On Green	0.05	0.25	0.25	0.58	0.99	0.99	0.10	0.24	0.24	0.05	0.19	0.19
Sat Flow, veh/h	1781	4847	362	1781	4624	551	1781	1870	3170	3456	3078	482
Grp Volume(v), veh/h	39	485	259	326	1410	743	102	322	403	59	93	96
Grp Sat Flow(s),veh/h/ln	1781	1702	1805	1781	1702	1771	1781	1870	1585	1728	1777	1784
Q Serve(g_s), s	2.3	13.6	13.8	13.3	2.4	2.6	6.0	17.3	12.1	1.8	4.9	5.1
Cycle Q Clear(g_c), s	2.3	13.6	13.8	13.3	2.4	2.6	6.0	17.3	12.1	1.8	4.9	5.1
Prop In Lane	1.00		0.20	1.00		0.31	1.00		1.00	1.00		0.27
Lane Grp Cap(c), veh/h	89	866	460	518	1687	878	186	454	769	167	331	332
V/C Ratio(X)	0.44	0.56	0.56	0.63	0.84	0.85	0.55	0.71	0.52	0.35	0.28	0.29
Avail Cap(c_a), veh/h	89	866	460	518	1687	878	186	454	769	167	331	332
HCM Platoon Ratio	1.00	1.00	1.00	2.00	2.00	2.00	1.00	1.00	1.00	1.00	1.00	1.00
Upstream Filter(I)	1.00	1.00	1.00	1.00	1.00	1.00	1.00	1.00	1.00	1.00	1.00	1.00
Uniform Delay (d), s/veh	50.7	35.6	35.7	19.1	0.3	0.3	46.8	38.1	36.1	50.7	38.4	38.5
Incr Delay (d2), s/veh	14.9	2.6	4.9	5.7	5.1	9.9	11.1	9.0	2.5	5.8	2.1	2.2
Initial Q Delay(d3),s/veh	0.0	0.0	0.0	0.0	0.0	0.0	0.0	0.0	0.0	0.0	0.0	0.0
%ile BackOfQ(50%),veh/ln	1.4	5.9	6.7	4.9	1.4	2.6	3.2	9.0	4.9	0.9	2.3	2.4
Unsig. Movement Delay, s/veh												
LnGrp Delay(d),s/veh	65.6	38.2	40.6	24.8	5.4	10.1	57.9	47.1	38.7	56.5	40.5	40.7
LnGrp LOS	E	D	D	C	A	B	E	D	D	E	D	D
Approach Vol, veh/h	783			2479			827		248			
Approach Delay, s/veh	40.4			9.3			44.3		44.4			
Approach LOS	D			A			D		D			
Timer - Assigned Phs	1	2	3	4	5	6	7	8				
Phs Duration (G+Y+Rc), s	9.8	31.2	36.5	32.5	16.0	25.0	10.0	59.0				
Change Period (Y+Rc), s	4.5	4.5	4.5	4.5	4.5	4.5	4.5	4.5				
Max Green Setting (Gmax), s	3	26.7	32.0	28.0	11.5	20.5	5.5	54.5				
Max Q Clear Time (g_c+1), s	3	19.3	15.3	15.8	8.0	7.1	4.3	4.6				
Green Ext Time (p_c), s	0.0	2.2	0.9	3.9	0.1	0.8	0.0	28.8				

Intersection Summary

HCM 6th Ctrl Delay	23.6
HCM 6th LOS	C

Notes

User approved volume balancing among the lanes for turning movement.

HCM 6th Signalized Intersection Summary

14: Mulberry St/SR 91 Off-Ramp & 14th St

05/04/2020



Movement	EBL	EBT	EBR	WBL	WBT	WBR	NBL	NBT	NBR	SBL	SBT	SBR
Lane Configurations		↑↑↑		↗↘	↑↑↑					↙	↔	↗
Traffic Volume (veh/h)	0	954	143	480	1795	0	0	0	0	143	227	560
Future Volume (veh/h)	0	954	143	480	1795	0	0	0	0	143	227	560
Initial Q (Qb), veh	0	0	0	0	0	0				0	0	0
Ped-Bike Adj(A_pbT)	1.00		1.00	1.00		1.00				1.00		1.00
Parking Bus, Adj	1.00	1.00	1.00	1.00	1.00	1.00				1.00	1.00	1.00
Work Zone On Approach		No			No						No	
Adj Sat Flow, veh/h/ln	0	1870	1870	1870	1870	0				1870	1870	1870
Adj Flow Rate, veh/h	0	1004	151	505	1889	0				101	263	620
Peak Hour Factor	0.95	0.95	0.95	0.95	0.95	0.95				0.95	0.95	0.95
Percent Heavy Veh, %	0	2	2	2	2	0				2	2	2
Cap, veh/h	0	1528	229	801	3133	0				542	570	965
Arrive On Green	0.00	0.34	0.34	0.23	0.61	0.00				0.30	0.30	0.30
Sat Flow, veh/h	0	4649	672	3456	5274	0				1781	1870	3170
Grp Volume(v), veh/h	0	762	393	505	1889	0				101	263	620
Grp Sat Flow(s),veh/h/ln	0	1702	1749	1728	1702	0				1781	1870	1585
Q Serve(g_s), s	0.0	20.9	21.0	14.5	25.0	0.0				4.6	12.5	18.6
Cycle Q Clear(g_c), s	0.0	20.9	21.0	14.5	25.0	0.0				4.6	12.5	18.6
Prop In Lane	0.00		0.38	1.00		0.00				1.00		1.00
Lane Grp Cap(c), veh/h	0	1160	596	801	3133	0				542	570	965
V/C Ratio(X)	0.00	0.66	0.66	0.63	0.60	0.00				0.19	0.46	0.64
Avail Cap(c_a), veh/h	0	1160	596	801	3133	0				542	570	965
HCM Platoon Ratio	1.00	1.00	1.00	1.00	1.00	1.00				1.00	1.00	1.00
Upstream Filter(I)	0.00	1.00	1.00	1.00	1.00	0.00				1.00	1.00	1.00
Uniform Delay (d), s/veh	0.0	30.8	30.8	38.0	13.0	0.0				28.2	31.0	33.1
Incr Delay (d2), s/veh	0.0	2.9	5.6	3.7	0.9	0.0				0.8	2.7	3.3
Initial Q Delay(d3),s/veh	0.0	0.0	0.0	0.0	0.0	0.0				0.0	0.0	0.0
%ile BackOfQ(50%),veh/ln	0.0	8.9	9.7	6.5	9.2	0.0				2.1	6.0	7.5
Unsig. Movement Delay, s/veh												
LnGrp Delay(d),s/veh	0.0	33.7	36.4	41.8	13.9	0.0				29.0	33.6	36.3
LnGrp LOS	A	C	D	D	B	A				C	C	D
Approach Vol, veh/h		1155			2394						984	
Approach Delay, s/veh		34.6			19.8						34.9	
Approach LOS		C			B						C	
Timer - Assigned Phs			3	4		6		8				
Phs Duration (G+Y+Rc), s			30.0	42.0		38.0		72.0				
Change Period (Y+Rc), s			4.5	4.5		4.5		4.5				
Max Green Setting (Gmax), s			25.5	37.5		33.5		67.5				
Max Q Clear Time (g_c+1), s			16.5	23.0		20.6		27.0				
Green Ext Time (p_c), s			1.3	6.8		3.9		22.2				
Intersection Summary												
HCM 6th Ctrl Delay			26.8									
HCM 6th LOS			C									
Notes												
User approved volume balancing among the lanes for turning movement.												

Build-Out AM with Project Conditions

HCM 6th Signalized Intersection Summary

2: Mission Inn Ave & SR 91 Off-Ramp

05/04/2020

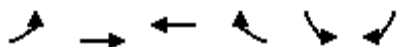

Movement	EBL	EBT	WBT	WBR	SBL	SBR
Lane Configurations		↑↑	↑↑		↘	↘
Traffic Volume (veh/h)	0	276	309	0	343	1322
Future Volume (veh/h)	0	276	309	0	343	1322
Initial Q (Qb), veh	0	0	0	0	0	0
Ped-Bike Adj(A_pbT)	1.00			1.00	1.00	1.00
Parking Bus, Adj	1.00	1.00	1.00	1.00	1.00	1.00
Work Zone On Approach		No	No		No	
Adj Sat Flow, veh/h/ln	0	1870	1870	0	1870	1870
Adj Flow Rate, veh/h	0	291	325	0	361	1392
Peak Hour Factor	0.95	0.95	0.95	0.95	0.95	0.95
Percent Heavy Veh, %	0	2	2	0	2	2
Cap, veh/h	0	759	759	0	1255	1965
Arrive On Green	0.00	0.21	0.43	0.00	0.70	0.70
Sat Flow, veh/h	0	3741	3741	0	1781	2790
Grp Volume(v), veh/h	0	291	325	0	361	1392
Grp Sat Flow(s),veh/h/ln	0	1777	1777	0	1781	1395
Q Serve(g_s), s	0.0	7.7	7.1	0.0	8.3	32.4
Cycle Q Clear(g_c), s	0.0	7.7	7.1	0.0	8.3	32.4
Prop In Lane	0.00			0.00	1.00	1.00
Lane Grp Cap(c), veh/h	0	759	759	0	1255	1965
V/C Ratio(X)	0.00	0.38	0.43	0.00	0.29	0.71
Avail Cap(c_a), veh/h	0	759	759	0	1255	1965
HCM Platoon Ratio	1.00	1.00	2.00	1.00	1.00	1.00
Upstream Filter(I)	0.00	1.00	1.00	0.00	1.00	1.00
Uniform Delay (d), s/veh	0.0	37.0	26.8	0.0	6.0	9.6
Incr Delay (d2), s/veh	0.0	1.5	1.8	0.0	0.6	2.2
Initial Q Delay(d3),s/veh	0.0	0.0	0.0	0.0	0.0	0.0
%ile BackOfQ(50%),veh/ln	0.0	3.5	2.9	0.0	3.0	9.1
Unsig. Movement Delay, s/veh						
LnGrp Delay(d),s/veh	0.0	38.5	28.6	0.0	6.6	11.8
LnGrp LOS	A	D	C	A	A	B
Approach Vol, veh/h		291	325		1753	
Approach Delay, s/veh		38.5	28.6		10.7	
Approach LOS		D	C		B	
Timer - Assigned Phs				4	6	8
Phs Duration (G+Y+Rc), s				28.0	82.0	28.0
Change Period (Y+Rc), s				4.5	4.5	4.5
Max Green Setting (Gmax), s				23.5	77.5	23.5
Max Q Clear Time (g_c+I1), s				9.7	34.4	9.1
Green Ext Time (p_c), s				1.5	10.6	1.7
Intersection Summary						
HCM 6th Ctrl Delay		16.6				
HCM 6th LOS		B				

HCM 6th Signalized Intersection Summary

3: Mulberry St/SR 91 On-Ramp & Mission Inn Ave

05/04/2020



Movement	EBL	EBT	EBR	WBL	WBT	WBR	NBL	NBT	NBR	SBL	SBT	SBR
Lane Configurations	↖	↗			↖	↗	↖	↗				
Traffic Volume (veh/h)	270	349	0	0	139	246	170	344	86	0	0	0
Future Volume (veh/h)	270	349	0	0	139	246	170	344	86	0	0	0
Initial Q (Qb), veh	0	0	0	0	0	0	0	0	0			
Ped-Bike Adj(A_pbT)	1.00		1.00	1.00		1.00	1.00		1.00			
Parking Bus, Adj	1.00	1.00	1.00	1.00	1.00	1.00	1.00	1.00	1.00			
Work Zone On Approach		No			No			No				
Adj Sat Flow, veh/h/ln	1870	1870	0	0	1870	1870	1870	1870	1870			
Adj Flow Rate, veh/h	284	367	0	0	146	0	179	362	91			
Peak Hour Factor	0.95	0.95	0.95	0.95	0.95	0.95	0.95	0.95	0.95			
Percent Heavy Veh, %	2	2	0	0	2	2	2	2	2			
Cap, veh/h	510	1858	0	0	695		704	570	143			
Arrive On Green	0.57	1.00	0.00	0.00	0.20	0.00	0.40	0.40	0.40			
Sat Flow, veh/h	1781	3647	0	0	3741	0	1781	1442	363			
Grp Volume(v), veh/h	284	367	0	0	146	0	179	0	453			
Grp Sat Flow(s),veh/h/ln	1781	1777	0	0	1777	0	1781	0	1805			
Q Serve(g_s), s	11.0	0.0	0.0	0.0	3.8	0.0	7.4	0.0	22.3			
Cycle Q Clear(g_c), s	11.0	0.0	0.0	0.0	3.8	0.0	7.4	0.0	22.3			
Prop In Lane	1.00		0.00	0.00		0.00	1.00		0.20			
Lane Grp Cap(c), veh/h	510	1858	0	0	695		704	0	714			
V/C Ratio(X)	0.56	0.20	0.00	0.00	0.21		0.25	0.00	0.63			
Avail Cap(c_a), veh/h	510	1858	0	0	695		704	0	714			
HCM Platoon Ratio	2.00	2.00	1.00	1.00	1.00	1.00	1.00	1.00	1.00			
Upstream Filter(I)	1.00	1.00	0.00	0.00	1.00	0.00	1.00	0.00	1.00			
Uniform Delay (d), s/veh	19.1	0.0	0.0	0.0	37.1	0.0	22.3	0.0	26.8			
Incr Delay (d2), s/veh	4.3	0.2	0.0	0.0	0.7	0.0	0.9	0.0	4.3			
Initial Q Delay(d3),s/veh	0.0	0.0	0.0	0.0	0.0	0.0	0.0	0.0	0.0			
%ile BackOfQ(50%),veh/ln	4.2	0.1	0.0	0.0	1.7	0.0	3.3	0.0	10.3			
Unsig. Movement Delay, s/veh												
LnGrp Delay(d),s/veh	23.5	0.2	0.0	0.0	37.8	0.0	23.2	0.0	31.1			
LnGrp LOS	C	A	A	A	D		C	A	C			
Approach Vol, veh/h		651			146	A		632				
Approach Delay, s/veh		10.4			37.8			28.9				
Approach LOS		B			D			C				
Timer - Assigned Phs		2		4			7	8				
Phs Duration (G+Y+Rc), s		48.0		62.0			36.0	26.0				
Change Period (Y+Rc), s		4.5		4.5			4.5	4.5				
Max Green Setting (Gmax), s		43.5		57.5			31.5	21.5				
Max Q Clear Time (g_c+I1), s		24.3		2.0			13.0	5.8				
Green Ext Time (p_c), s		3.4		2.7			0.8	0.7				

Intersection Summary

HCM 6th Ctrl Delay	21.4
HCM 6th LOS	C

Notes

Unsignalized Delay for [WBR] is excluded from calculations of the approach delay and intersection delay.

HCM 6th Signalized Intersection Summary

4: Howard Ave & 14th St

05/04/2020



Movement	EBL	EBT	EBR	WBL	WBT	WBR	NBL	NBT	NBR	SBL	SBT	SBR
Lane Configurations												
Traffic Volume (veh/h)	100	664	55	13	1470	30	90	32	34	7	82	134
Future Volume (veh/h)	100	664	55	13	1470	30	90	32	34	7	82	134
Initial Q (Qb), veh	0	0	0	0	0	0	0	0	0	0	0	0
Ped-Bike Adj(A_pbT)	1.00		1.00	1.00		1.00	1.00		1.00	1.00		1.00
Parking Bus, Adj	1.00	1.00	1.00	1.00	1.00	1.00	1.00	1.00	1.00	1.00	1.00	1.00
Work Zone On Approach		No			No			No			No	
Adj Sat Flow, veh/h/ln	1870	1870	1870	1870	1870	1870	1870	1870	1870	1870	1870	1870
Adj Flow Rate, veh/h	105	699	58	14	1547	32	95	34	36	7	86	141
Peak Hour Factor	0.95	0.95	0.95	0.95	0.95	0.95	0.95	0.95	0.95	0.95	0.95	0.95
Percent Heavy Veh, %	2	2	2	2	2	2	2	2	2	2	2	2
Cap, veh/h	170	2000	892	83	1829	38	219	79	69	38	175	272
Arrive On Green	0.10	0.56	0.56	0.05	0.51	0.51	0.27	0.27	0.27	0.27	0.27	0.27
Sat Flow, veh/h	1781	3554	1585	1781	3560	74	623	293	256	17	651	1013
Grp Volume(v), veh/h	105	699	58	14	771	808	165	0	0	234	0	0
Grp Sat Flow(s),veh/h/ln	1781	1777	1585	1781	1777	1857	1171	0	0	1681	0	0
Q Serve(g_s), s	6.2	11.8	1.8	0.8	41.0	41.2	2.6	0.0	0.0	0.0	0.0	0.0
Cycle Q Clear(g_c), s	6.2	11.8	1.8	0.8	41.0	41.2	15.5	0.0	0.0	13.0	0.0	0.0
Prop In Lane	1.00		1.00	1.00		0.04	0.58		0.22	0.03		0.60
Lane Grp Cap(c), veh/h	170	2000	892	83	913	954	366	0	0	485	0	0
V/C Ratio(X)	0.62	0.35	0.07	0.17	0.84	0.85	0.45	0.00	0.00	0.48	0.00	0.00
Avail Cap(c_a), veh/h	170	2000	892	83	913	954	366	0	0	485	0	0
HCM Platoon Ratio	1.00	1.00	1.00	1.00	1.00	1.00	1.00	1.00	1.00	1.00	1.00	1.00
Upstream Filter(I)	1.00	1.00	1.00	1.00	1.00	1.00	1.00	0.00	0.00	1.00	0.00	0.00
Uniform Delay (d), s/veh	47.8	13.1	10.9	50.4	23.0	23.0	35.0	0.0	0.0	34.2	0.0	0.0
Incr Delay (d2), s/veh	15.7	0.5	0.1	4.4	9.5	9.2	4.0	0.0	0.0	3.4	0.0	0.0
Initial Q Delay(d3),s/veh	0.0	0.0	0.0	0.0	0.0	0.0	0.0	0.0	0.0	0.0	0.0	0.0
%ile BackOfQ(50%),veh/ln	3.5	4.7	0.7	0.5	18.7	19.5	4.3	0.0	0.0	5.7	0.0	0.0
Unsig. Movement Delay, s/veh												
LnGrp Delay(d),s/veh	63.5	13.6	11.1	54.8	32.4	32.2	39.0	0.0	0.0	37.6	0.0	0.0
LnGrp LOS	E	B	B	D	C	C	D	A	A	D	A	A
Approach Vol, veh/h		862			1593			165			234	
Approach Delay, s/veh		19.5			32.5			39.0			37.6	
Approach LOS		B			C			D			D	
Timer - Assigned Phs		2	3	4		6	7	8				
Phs Duration (G+Y+Rc), s		34.0	9.6	66.4		34.0	15.0	61.0				
Change Period (Y+Rc), s		4.5	4.5	4.5		4.5	4.5	4.5				
Max Green Setting (Gmax), s		29.5	5.1	61.9		29.5	10.5	56.5				
Max Q Clear Time (g_c+I1), s		17.5	2.8	13.8		15.0	8.2	43.2				
Green Ext Time (p_c), s		0.7	0.0	6.0		1.2	0.0	8.9				
Intersection Summary												
HCM 6th Ctrl Delay											29.4	
HCM 6th LOS											C	

Intersection

Intersection Delay, s/veh	12.2
Intersection LOS	B

Movement	EBL	EBT	EBR	WBL	WBT	WBR	NBL	NBT	NBR	SBL	SBT	SBR
Lane Configurations	↙	↑	↗	↙	↑↑		↙	↗			↕	
Traffic Vol, veh/h	116	244	76	3	293	68	45	51	25	20	16	47
Future Vol, veh/h	116	244	76	3	293	68	45	51	25	20	16	47
Peak Hour Factor	0.95	0.95	0.95	0.95	0.95	0.95	0.95	0.95	0.95	0.95	0.95	0.95
Heavy Vehicles, %	2	2	2	2	2	2	2	2	2	2	2	2
Mvmt Flow	122	257	80	3	308	72	47	54	26	21	17	49
Number of Lanes	1	1	1	1	2	0	1	1	0	0	1	0

Approach	EB	WB	NB	SB
Opposing Approach	WB	EB	SB	NB
Opposing Lanes	3	3	1	2
Conflicting Approach Left	SB	NB	EB	WB
Conflicting Lanes Left	1	2	3	3
Conflicting Approach Right	NB	SB	WB	EB
Conflicting Lanes Right	2	1	3	3
HCM Control Delay	12.6	12.3	11.1	11.2
HCM LOS	B	B	B	B

Lane	NBLn1	NBLn2	EBLn1	EBLn2	EBLn3	WBLn1	WBLn2	WBLn3	SBLn1
Vol Left, %	100%	0%	100%	0%	0%	100%	0%	0%	24%
Vol Thru, %	0%	67%	0%	100%	0%	0%	100%	59%	19%
Vol Right, %	0%	33%	0%	0%	100%	0%	0%	41%	57%
Sign Control	Stop	Stop	Stop	Stop	Stop	Stop	Stop	Stop	Stop
Traffic Vol by Lane	45	76	116	244	76	3	195	166	83
LT Vol	45	0	116	0	0	3	0	0	20
Through Vol	0	51	0	244	0	0	195	98	16
RT Vol	0	25	0	0	76	0	0	68	47
Lane Flow Rate	47	80	122	257	80	3	206	174	87
Geometry Grp	8	8	8	8	8	8	8	8	8
Degree of Util (X)	0.101	0.154	0.231	0.45	0.124	0.006	0.368	0.298	0.17
Departure Headway (Hd)	7.685	6.95	6.808	6.302	5.593	6.958	6.451	6.16	7.001
Convergence, Y/N	Yes	Yes	Yes	Yes	Yes	Yes	Yes	Yes	Yes
Cap	464	513	526	570	638	513	555	581	509
Service Time	5.467	4.732	4.569	4.063	3.354	4.724	4.218	3.926	4.783
HCM Lane V/C Ratio	0.101	0.156	0.232	0.451	0.125	0.006	0.371	0.299	0.171
HCM Control Delay	11.3	11	11.6	14.2	9.2	9.8	13	11.5	11.2
HCM Lane LOS	B	B	B	B	A	A	B	B	B
HCM 95th-tile Q	0.3	0.5	0.9	2.3	0.4	0	1.7	1.2	0.6

HCM 6th TWSC
6: Commerce St & Mission Inn Ave

05/04/2020

Intersection												
Int Delay, s/veh	4.9											
Movement	EBL	EBT	EBR	WBL	WBT	WBR	NBL	NBT	NBR	SBL	SBT	SBR
Lane Configurations		↕	↗		↕↗			↕↗			↕↗	
Traffic Vol, veh/h	16	175	98	12	266	6	84	91	5	3	22	14
Future Vol, veh/h	16	175	98	12	266	6	84	91	5	3	22	14
Conflicting Peds, #/hr	0	0	0	0	0	0	0	0	0	0	0	0
Sign Control	Free	Free	Free	Free	Free	Free	Stop	Stop	Stop	Stop	Stop	Stop
RT Channelized	-	-	None	-	-	None	-	-	None	-	-	None
Storage Length	-	-	0	-	-	-	-	-	-	-	-	-
Veh in Median Storage, #	-	0	-	-	0	-	-	0	-	-	0	-
Grade, %	-	0	-	-	0	-	-	0	-	-	0	-
Peak Hour Factor	95	95	95	95	95	95	95	95	95	95	95	95
Heavy Vehicles, %	2	2	2	2	2	2	2	2	2	2	2	2
Mvmt Flow	17	184	103	13	280	6	88	96	5	3	23	15

Major/Minor	Major1			Major2			Minor1			Minor2		
Conflicting Flow All	286	0	0	287	0	0	396	530	184	629	630	143
Stage 1	-	-	-	-	-	-	218	218	-	309	309	-
Stage 2	-	-	-	-	-	-	178	312	-	320	321	-
Critical Hdwy	4.13	-	-	4.13	-	-	7.33	6.53	6.23	7.33	6.53	6.93
Critical Hdwy Stg 1	-	-	-	-	-	-	6.13	5.53	-	6.53	5.53	-
Critical Hdwy Stg 2	-	-	-	-	-	-	6.53	5.53	-	6.13	5.53	-
Follow-up Hdwy	2.219	-	-	2.219	-	-	3.519	4.019	3.319	3.519	4.019	3.319
Pot Cap-1 Maneuver	1275	-	-	1274	-	-	551	454	858	381	398	879
Stage 1	-	-	-	-	-	-	784	722	-	677	659	-
Stage 2	-	-	-	-	-	-	807	657	-	691	651	-
Platoon blocked, %	-	-	-	-	-	-	-	-	-	-	-	-
Mov Cap-1 Maneuver	1275	-	-	1274	-	-	506	441	858	309	387	879
Mov Cap-2 Maneuver	-	-	-	-	-	-	506	441	-	309	387	-
Stage 1	-	-	-	-	-	-	771	710	-	666	651	-
Stage 2	-	-	-	-	-	-	756	649	-	585	641	-

Approach	EB			WB			NB			SB		
HCM Control Delay, s	0.4			0.3			17.5			13.3		
HCM LOS							C			B		

Minor Lane/Major Mvmt	NBLn1	EBL	EBT	EBR	WBL	WBT	WBR	SBLn1
Capacity (veh/h)	476	1275	-	-	1274	-	-	473
HCM Lane V/C Ratio	0.398	0.013	-	-	0.01	-	-	0.087
HCM Control Delay (s)	17.5	7.9	0	-	7.9	0	-	13.3
HCM Lane LOS	C	A	A	-	A	A	-	B
HCM 95th %tile Q(veh)	1.9	0	-	-	0	-	-	0.3

Intersection						
Int Delay, s/veh	4.1					
Movement	WBL	WBR	NBT	NBR	SBL	SBT
Lane Configurations						
Traffic Vol, veh/h	32	100	80	0	18	114
Future Vol, veh/h	32	100	80	0	18	114
Conflicting Peds, #/hr	0	0	0	0	0	0
Sign Control	Stop	Stop	Free	Free	Free	Free
RT Channelized	-	None	-	None	-	None
Storage Length	0	-	-	-	-	-
Veh in Median Storage, #	0	-	0	-	-	0
Grade, %	0	-	0	-	-	0
Peak Hour Factor	95	95	95	95	95	95
Heavy Vehicles, %	2	2	2	2	2	2
Mvmt Flow	34	105	84	0	19	120

Major/Minor	Minor1	Major1	Major2		
Conflicting Flow All	242	84	0	0	84
Stage 1	84	-	-	-	-
Stage 2	158	-	-	-	-
Critical Hdwy	6.42	6.22	-	-	4.12
Critical Hdwy Stg 1	5.42	-	-	-	-
Critical Hdwy Stg 2	5.42	-	-	-	-
Follow-up Hdwy	3.518	3.318	-	-	2.218
Pot Cap-1 Maneuver	746	975	-	-	1513
Stage 1	939	-	-	-	-
Stage 2	871	-	-	-	-
Platoon blocked, %			-	-	-
Mov Cap-1 Maneuver	736	975	-	-	1513
Mov Cap-2 Maneuver	736	-	-	-	-
Stage 1	927	-	-	-	-
Stage 2	871	-	-	-	-

Approach	WB	NB	SB
HCM Control Delay, s	9.7	0	1
HCM LOS	A		

Minor Lane/Major Mvmt	NBT	NBRWBLn1	SBL	SBT
Capacity (veh/h)	-	-	904	1513
HCM Lane V/C Ratio	-	-	0.154	0.013
HCM Control Delay (s)	-	-	9.7	7.4
HCM Lane LOS	-	-	A	A
HCM 95th %tile Q(veh)	-	-	0.5	0

HCM 6th TWSC
8: Howard Ave & Tenth St

05/04/2020

Intersection						
Int Delay, s/veh	4.8					
Movement	EBT	EBR	WBL	WBT	NBL	NBR
Lane Configurations						
Traffic Vol, veh/h	14	72	59	120	109	17
Future Vol, veh/h	14	72	59	120	109	17
Conflicting Peds, #/hr	0	0	0	0	0	0
Sign Control	Free	Free	Free	Free	Stop	Stop
RT Channelized	-	None	-	None	-	None
Storage Length	-	-	-	-	0	-
Veh in Median Storage, #	0	-	-	0	0	-
Grade, %	0	-	-	0	0	-
Peak Hour Factor	95	95	95	95	95	95
Heavy Vehicles, %	2	2	2	2	2	2
Mvmt Flow	15	76	62	126	115	18

Major/Minor	Major1	Major2	Minor1	Minor2	Minor3
Conflicting Flow All	0	0	91	0	303
Stage 1	-	-	-	-	53
Stage 2	-	-	-	-	250
Critical Hdwy	-	-	4.12	-	6.42
Critical Hdwy Stg 1	-	-	-	-	5.42
Critical Hdwy Stg 2	-	-	-	-	5.42
Follow-up Hdwy	-	-	2.218	-	3.518
Pot Cap-1 Maneuver	-	-	1504	-	689
Stage 1	-	-	-	-	970
Stage 2	-	-	-	-	792
Platoon blocked, %	-	-	-	-	-
Mov Cap-1 Maneuver	-	-	1504	-	659
Mov Cap-2 Maneuver	-	-	-	-	659
Stage 1	-	-	-	-	927
Stage 2	-	-	-	-	792

Approach	EB	WB	NB
HCM Control Delay, s	0	2.5	11.4
HCM LOS			B

Minor Lane/Major Mvmt	NBLn1	EBT	EBR	WBL	WBT
Capacity (veh/h)	692	-	-	1504	-
HCM Lane V/C Ratio	0.192	-	-	0.041	-
HCM Control Delay (s)	11.4	-	-	7.5	0
HCM Lane LOS	B	-	-	A	A
HCM 95th %tile Q(veh)	0.7	-	-	0.1	-

HCM 6th Signalized Intersection Summary
 9: SR 91 Off-Ramp/SR 91 On-Ramp & 14th St

05/04/2020



Movement	EBL	EBT	EBR	WBL	WBT	WBR	NBL	NBT	NBR	SBL	SBT	SBR
Lane Configurations	↔↔	↑↑			↑↑↑	↔	↔	↔	↔			
Traffic Volume (veh/h)	609	495	0	0	1417	277	870	0	323	0	0	0
Future Volume (veh/h)	609	495	0	0	1417	277	870	0	323	0	0	0
Initial Q (Qb), veh	0	0	0	0	0	0	0	0	0			
Ped-Bike Adj(A_pbT)	1.00		1.00	1.00		1.00	1.00		1.00			
Parking Bus, Adj	1.00	1.00	1.00	1.00	1.00	1.00	1.00	1.00	1.00			
Work Zone On Approach		No			No			No				
Adj Sat Flow, veh/h/ln	1870	1870	0	0	1870	1870	1870	1870	1870			
Adj Flow Rate, veh/h	641	521	0	0	1492	292	916	0	340			
Peak Hour Factor	0.95	0.95	0.95	0.95	0.95	0.95	0.95	0.95	0.95			
Percent Heavy Veh, %	2	2	0	0	2	2	2	2	2			
Cap, veh/h	743	2114	0	0	1711	531	1122	0	499			
Arrive On Green	0.22	0.60	0.00	0.00	0.34	0.34	0.31	0.00	0.31			
Sat Flow, veh/h	3456	3647	0	0	5274	1585	3563	0	1585			
Grp Volume(v), veh/h	641	521	0	0	1492	292	916	0	340			
Grp Sat Flow(s),veh/h/ln	1728	1777	0	0	1702	1585	1781	0	1585			
Q Serve(g_s), s	17.9	7.0	0.0	0.0	27.5	15.0	23.7	0.0	18.7			
Cycle Q Clear(g_c), s	17.9	7.0	0.0	0.0	27.5	15.0	23.7	0.0	18.7			
Prop In Lane	1.00		0.00	0.00		1.00	1.00		1.00			
Lane Grp Cap(c), veh/h	743	2114	0	0	1711	531	1122	0	499			
V/C Ratio(X)	0.86	0.25	0.00	0.00	0.87	0.55	0.82	0.00	0.68			
Avail Cap(c_a), veh/h	743	2114	0	0	1711	531	1122	0	499			
HCM Platoon Ratio	1.00	1.00	1.00	1.00	1.00	1.00	1.00	1.00	1.00			
Upstream Filter(I)	1.00	1.00	0.00	0.00	1.00	1.00	1.00	0.00	1.00			
Uniform Delay (d), s/veh	37.8	9.6	0.0	0.0	31.2	27.1	31.6	0.0	29.9			
Incr Delay (d2), s/veh	12.6	0.3	0.0	0.0	6.5	4.1	6.6	0.0	7.3			
Initial Q Delay(d3),s/veh	0.0	0.0	0.0	0.0	0.0	0.0	0.0	0.0	0.0			
%ile BackOfQ(50%),veh/ln	8.7	2.6	0.0	0.0	12.0	6.2	11.0	0.0	8.0			
Unsig. Movement Delay, s/veh												
LnGrp Delay(d),s/veh	50.5	9.9	0.0	0.0	37.7	31.2	38.2	0.0	37.2			
LnGrp LOS	D	A	A	A	D	C	D	A	D			
Approach Vol, veh/h		1162			1784			1256				
Approach Delay, s/veh		32.3			36.6			37.9				
Approach LOS		C			D			D				
Timer - Assigned Phs		2		4			7	8				
Phs Duration (G+Y+Rc), s		36.0		64.0			26.0	38.0				
Change Period (Y+Rc), s		4.5		4.5			4.5	4.5				
Max Green Setting (Gmax), s		31.5		59.5			21.5	33.5				
Max Q Clear Time (g_c+I1), s		25.7		9.0			19.9	29.5				
Green Ext Time (p_c), s		2.7		4.0			0.5	3.3				

Intersection Summary

HCM 6th Ctrl Delay	35.8
HCM 6th LOS	D

Notes

User approved volume balancing among the lanes for turning movement.

HCM 6th Signalized Intersection Summary

11: Park Ave & University Ave

05/04/2020



Movement	EBL	EBT	EBR	WBL	WBT	WBR	NBL	NBT	NBR	SBL	SBT	SBR
Lane Configurations												
Traffic Volume (veh/h)	30	537	32	37	748	50	49	49	44	63	51	60
Future Volume (veh/h)	30	537	32	37	748	50	49	49	44	63	51	60
Initial Q (Qb), veh	0	0	0	0	0	0	0	0	0	0	0	0
Ped-Bike Adj(A_pbT)	1.00		1.00	1.00		1.00	1.00		1.00	1.00		1.00
Parking Bus, Adj	1.00	1.00	1.00	1.00	1.00	1.00	1.00	1.00	1.00	1.00	1.00	1.00
Work Zone On Approach		No		No		No		No		No		No
Adj Sat Flow, veh/h/ln	1870	1870	1870	1870	1870	1870	1870	1870	1870	1870	1870	1870
Adj Flow Rate, veh/h	32	565	34	39	787	53	52	52	46	66	54	63
Peak Hour Factor	0.95	0.95	0.95	0.95	0.95	0.95	0.95	0.95	0.95	0.95	0.95	0.95
Percent Heavy Veh, %	2	2	2	2	2	2	2	2	2	2	2	2
Cap, veh/h	138	1378	83	154	1398	94	202	204	180	219	182	213
Arrive On Green	0.08	0.40	0.40	0.09	0.41	0.41	0.11	0.22	0.22	0.12	0.23	0.23
Sat Flow, veh/h	1781	3406	205	1781	3379	227	1781	915	810	1781	787	918
Grp Volume(v), veh/h	32	294	305	39	414	426	52	0	98	66	0	117
Grp Sat Flow(s),veh/h/ln	1781	1777	1834	1781	1777	1829	1781	0	1725	1781	0	1705
Q Serve(g_s), s	1.9	13.0	13.1	2.2	19.6	19.6	2.9	0.0	5.2	3.7	0.0	6.2
Cycle Q Clear(g_c), s	1.9	13.0	13.1	2.2	19.6	19.6	2.9	0.0	5.2	3.7	0.0	6.2
Prop In Lane	1.00		0.11	1.00		0.12	1.00		0.47	1.00		0.54
Lane Grp Cap(c), veh/h	138	719	742	154	735	757	202	0	384	219	0	395
V/C Ratio(X)	0.23	0.41	0.41	0.25	0.56	0.56	0.26	0.00	0.26	0.30	0.00	0.30
Avail Cap(c_a), veh/h	138	719	742	154	735	757	202	0	384	219	0	395
HCM Platoon Ratio	1.00	1.00	1.00	1.00	1.00	1.00	1.00	1.00	1.00	1.00	1.00	1.00
Upstream Filter(I)	1.00	1.00	1.00	1.00	1.00	1.00	1.00	0.00	1.00	1.00	0.00	1.00
Uniform Delay (d), s/veh	47.7	23.4	23.4	46.9	24.7	24.7	44.5	0.0	35.2	44.0	0.0	34.8
Incr Delay (d2), s/veh	3.9	1.7	1.7	3.9	3.1	3.0	3.0	0.0	1.6	3.5	0.0	1.9
Initial Q Delay(d3),s/veh	0.0	0.0	0.0	0.0	0.0	0.0	0.0	0.0	0.0	0.0	0.0	0.0
%ile BackOfQ(50%),veh/ln	0	5.7	5.9	1.2	8.7	9.0	1.5	0.0	2.3	1.9	0.0	2.8
Unsig. Movement Delay, s/veh												
LnGrp Delay(d),s/veh	51.6	25.1	25.1	50.9	27.8	27.7	47.6	0.0	36.8	47.5	0.0	36.8
LnGrp LOS	D	C	C	D	C	C	D	A	D	D	A	D
Approach Vol, veh/h		631			879			150				183
Approach Delay, s/veh		26.4			28.7			40.5				40.6
Approach LOS		C			C			D				D
Timer - Assigned Phs	1	2	3	4	5	6	7	8				
Phs Duration (G+Y+Rc), s	18.0	29.0	14.0	49.0	17.0	30.0	13.0	50.0				
Change Period (Y+Rc), s	4.5	4.5	4.5	4.5	4.5	4.5	4.5	4.5				
Max Green Setting (Gmax), s	13.5	24.5	9.5	44.5	12.5	25.5	8.5	45.5				
Max Q Clear Time (g_c+1/3), s	11.5	7.2	4.2	15.1	4.9	8.2	3.9	21.6				
Green Ext Time (p_c), s	0.1	0.4	0.0	4.0	0.0	0.5	0.0	5.7				
Intersection Summary												
HCM 6th Ctrl Delay												30.1
HCM 6th LOS												C

HCM 6th AWSC
12: Howard Ave & 12th St

05/04/2020

Intersection

Intersection Delay, s/veh 8.4

Intersection LOS A

Movement	EBL	EBT	EBR	WBL	WBT	WBR	NBL	NBT	NBR	SBL	SBT	SBR
Lane Configurations		↔		↔		↔		↔			↔	
Traffic Vol, veh/h	4	4	73	40	32	9	4	148	10	0	111	20
Future Vol, veh/h	4	4	73	40	32	9	4	148	10	0	111	20
Peak Hour Factor	0.95	0.95	0.95	0.95	0.95	0.95	0.95	0.95	0.95	0.95	0.95	0.95
Heavy Vehicles, %	2	2	2	2	2	2	2	2	2	2	2	2
Mvmt Flow	4	4	77	42	34	9	4	156	11	0	117	21
Number of Lanes	0	1	0	0	1	0	0	1	0	0	1	0

Approach	EB	WB	NB	SB
Opposing Approach	WB	EB	SB	NB
Opposing Lanes	1	1	1	1
Conflicting Approach Left SB	NB	EB	WB	WB
Conflicting Lanes Left	1	1	1	1
Conflicting Approach RightNB	SB	WB	WB	EB
Conflicting Lanes Right	1	1	1	1
HCM Control Delay	7.7	8.4	8.7	8.4
HCM LOS	A	A	A	A

Lane	NBLn1	EBLn1	WBLn1	SBLn1
Vol Left, %	2%	5%	49%	0%
Vol Thru, %	91%	5%	40%	85%
Vol Right, %	6%	90%	11%	15%
Sign Control	Stop	Stop	Stop	Stop
Traffic Vol by Lane	162	81	81	131
LT Vol	4	4	40	0
Through Vol	148	4	32	111
RT Vol	10	73	9	20
Lane Flow Rate	171	85	85	138
Geometry Grp	1	1	1	1
Degree of Util (X)	0.211	0.1	0.113	0.169
Departure Headway (Hd)	4.445	4.208	4.762	4.423
Convergence, Y/N	Yes	Yes	Yes	Yes
Cap	808	851	753	811
Service Time	2.47	2.236	2.79	2.449
HCM Lane V/C Ratio	0.212	0.1	0.113	0.17
HCM Control Delay	8.7	7.7	8.4	8.4
HCM Lane LOS	A	A	A	A
HCM 95th-tile Q	0.8	0.3	0.4	0.6

HCM 6th Signalized Intersection Summary

13: Olivewood Ave/Lime St & 14th St

05/04/2020



Movement	EBL	EBT	EBR	WBL	WBT	WBR	NBL	NBT	NBR	SBL	SBT	SBR
Lane Configurations	↙ ↑↑↑ ↘			↙ ↑↑↑ ↘			↙ ↑↑ ↘		↙ ↘		↑↑ ↘	
Traffic Volume (veh/h)	37	664	49	310	1828	219	97	307	383	56	155	25
Future Volume (veh/h)	37	664	49	310	1828	219	97	307	383	56	155	25
Initial Q (Qb), veh	0	0	0	0	0	0	0	0	0	0	0	0
Ped-Bike Adj(A_pbT)	1.00		1.00	1.00		1.00	1.00		1.00	1.00		1.00
Parking Bus, Adj	1.00	1.00	1.00	1.00	1.00	1.00	1.00	1.00	1.00	1.00	1.00	1.00
Work Zone On Approach	No			No			No		No			
Adj Sat Flow, veh/h/ln	1870	1870	1870	1870	1870	1870	1870	1870	1870	1870	1870	1870
Adj Flow Rate, veh/h	39	699	52	326	1924	231	102	322	403	59	163	26
Peak Hour Factor	0.95	0.95	0.95	0.95	0.95	0.95	0.95	0.95	0.95	0.95	0.95	0.95
Percent Heavy Veh, %	2	2	2	2	2	2	2	2	2	2	2	2
Cap, veh/h	89	1235	91	518	2291	273	186	454	769	167	574	90
Arrive On Green	0.05	0.25	0.25	0.58	0.99	0.99	0.10	0.24	0.24	0.05	0.19	0.19
Sat Flow, veh/h	1781	4851	359	1781	4625	550	1781	1870	3170	3456	3078	482
Grp Volume(v), veh/h	39	489	262	326	1412	743	102	322	403	59	93	96
Grp Sat Flow(s),veh/h/ln	1781	1702	1806	1781	1702	1771	1781	1870	1585	1728	1777	1784
Q Serve(g_s), s	2.3	13.8	13.9	13.3	2.4	2.6	6.0	17.3	12.1	1.8	4.9	5.1
Cycle Q Clear(g_c), s	2.3	13.8	13.9	13.3	2.4	2.6	6.0	17.3	12.1	1.8	4.9	5.1
Prop In Lane	1.00		0.20	1.00		0.31	1.00		1.00	1.00		0.27
Lane Grp Cap(c), veh/h	89	866	460	518	1687	878	186	454	769	167	331	332
V/C Ratio(X)	0.44	0.56	0.57	0.63	0.84	0.85	0.55	0.71	0.52	0.35	0.28	0.29
Avail Cap(c_a), veh/h	89	866	460	518	1687	878	186	454	769	167	331	332
HCM Platoon Ratio	1.00	1.00	1.00	2.00	2.00	2.00	1.00	1.00	1.00	1.00	1.00	1.00
Upstream Filter(I)	1.00	1.00	1.00	1.00	1.00	1.00	1.00	1.00	1.00	1.00	1.00	1.00
Uniform Delay (d), s/veh	50.7	35.7	35.7	19.1	0.3	0.3	46.8	38.1	36.1	50.7	38.4	38.5
Incr Delay (d2), s/veh	14.9	2.7	5.0	5.7	5.1	9.9	11.1	9.0	2.5	5.8	2.1	2.2
Initial Q Delay(d3),s/veh	0.0	0.0	0.0	0.0	0.0	0.0	0.0	0.0	0.0	0.0	0.0	0.0
%ile BackOfQ(50%),veh/ln	4	6.0	6.7	4.9	1.4	2.6	3.2	9.0	4.9	0.9	2.3	2.4
Unsig. Movement Delay, s/veh												
LnGrp Delay(d),s/veh	65.6	38.4	40.8	24.8	5.4	10.2	57.9	47.1	38.7	56.5	40.5	40.7
LnGrp LOS	E	D	D	C	A	B	E	D	D	E	D	D
Approach Vol, veh/h	790			2481				827		248		
Approach Delay, s/veh	40.5			9.4				44.3		44.4		
Approach LOS	D			A				D		D		
Timer - Assigned Phs	1	2	3	4	5	6	7	8				
Phs Duration (G+Y+Rc), s	9.8	31.2	36.5	32.5	16.0	25.0	10.0	59.0				
Change Period (Y+Rc), s	4.5	4.5	4.5	4.5	4.5	4.5	4.5	4.5				
Max Green Setting (Gmax), s	3	26.7	32.0	28.0	11.5	20.5	5.5	54.5				
Max Q Clear Time (g_c+1), s	3	19.3	15.3	15.9	8.0	7.1	4.3	4.6				
Green Ext Time (p_c), s	0.0	2.2	0.9	3.9	0.1	0.8	0.0	28.9				

Intersection Summary

HCM 6th Ctrl Delay	23.7
HCM 6th LOS	C

Notes

User approved volume balancing among the lanes for turning movement.

HCM 6th Signalized Intersection Summary

14: Mulberry St/SR 91 Off-Ramp & 14th St

05/04/2020



Movement	EBL	EBT	EBR	WBL	WBT	WBR	NBL	NBT	NBR	SBL	SBT	SBR
Lane Configurations		↑↑↑		↔↔	↑↑↑					↔	↑↑	↔
Traffic Volume (veh/h)	0	961	143	490	1797	0	0	0	0	143	227	560
Future Volume (veh/h)	0	961	143	490	1797	0	0	0	0	143	227	560
Initial Q (Qb), veh	0	0	0	0	0	0				0	0	0
Ped-Bike Adj(A_pbT)	1.00		1.00	1.00		1.00				1.00		1.00
Parking Bus, Adj	1.00	1.00	1.00	1.00	1.00	1.00				1.00	1.00	1.00
Work Zone On Approach		No			No						No	
Adj Sat Flow, veh/h/ln	0	1870	1870	1870	1870	0				1870	1870	1870
Adj Flow Rate, veh/h	0	1012	151	516	1892	0				101	263	620
Peak Hour Factor	0.95	0.95	0.95	0.95	0.95	0.95				0.95	0.95	0.95
Percent Heavy Veh, %	0	2	2	2	2	0				2	2	2
Cap, veh/h	0	1529	228	801	3133	0				542	570	965
Arrive On Green	0.00	0.34	0.34	0.23	0.61	0.00				0.30	0.30	0.30
Sat Flow, veh/h	0	4654	668	3456	5274	0				1781	1870	3170
Grp Volume(v), veh/h	0	767	396	516	1892	0				101	263	620
Grp Sat Flow(s),veh/h/ln	0	1702	1750	1728	1702	0				1781	1870	1585
Q Serve(g_s), s	0.0	21.1	21.2	14.8	25.0	0.0				4.6	12.5	18.6
Cycle Q Clear(g_c), s	0.0	21.1	21.2	14.8	25.0	0.0				4.6	12.5	18.6
Prop In Lane	0.00		0.38	1.00		0.00				1.00		1.00
Lane Grp Cap(c), veh/h	0	1160	597	801	3133	0				542	570	965
V/C Ratio(X)	0.00	0.66	0.66	0.64	0.60	0.00				0.19	0.46	0.64
Avail Cap(c_a), veh/h	0	1160	597	801	3133	0				542	570	965
HCM Platoon Ratio	1.00	1.00	1.00	1.00	1.00	1.00				1.00	1.00	1.00
Upstream Filter(I)	0.00	1.00	1.00	1.00	1.00	0.00				1.00	1.00	1.00
Uniform Delay (d), s/veh	0.0	30.8	30.9	38.2	13.0	0.0				28.2	31.0	33.1
Incr Delay (d2), s/veh	0.0	3.0	5.7	4.0	0.9	0.0				0.8	2.7	3.3
Initial Q Delay(d3),s/veh	0.0	0.0	0.0	0.0	0.0	0.0				0.0	0.0	0.0
%ile BackOfQ(50%),veh/ln	0.0	9.0	9.8	6.7	9.2	0.0				2.1	6.0	7.5
Unsig. Movement Delay, s/veh												
LnGrp Delay(d),s/veh	0.0	33.8	36.6	42.1	13.9	0.0				29.0	33.6	36.3
LnGrp LOS		A	C	D	D	B	A			C	C	D
Approach Vol, veh/h		1163			2408					984		
Approach Delay, s/veh		34.8			20.0					34.9		
Approach LOS		C			B					C		
Timer - Assigned Phs			3	4		6		8				
Phs Duration (G+Y+Rc), s			30.0	42.0		38.0		72.0				
Change Period (Y+Rc), s			4.5	4.5		4.5		4.5				
Max Green Setting (Gmax), s			25.5	37.5		33.5		67.5				
Max Q Clear Time (g_c+1), s			16.8	23.2		20.6		27.0				
Green Ext Time (p_c), s			1.3	6.8		3.9		22.2				
Intersection Summary												
HCM 6th Ctrl Delay											27.0	
HCM 6th LOS											C	
Notes												
User approved volume balancing among the lanes for turning movement.												

Build-Out PM

HCM 6th Signalized Intersection Summary

2: Mission Inn Ave & SR 91 Off-Ramp

05/04/2020

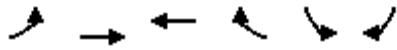

Movement	EBL	EBT	WBT	WBR	SBL	SBR
Lane Configurations		↑↑	↑↑		↘	↘
Traffic Volume (veh/h)	0	885	457	0	274	557
Future Volume (veh/h)	0	885	457	0	274	557
Initial Q (Qb), veh	0	0	0	0	0	0
Ped-Bike Adj(A_pbT)	1.00			1.00	1.00	1.00
Parking Bus, Adj	1.00	1.00	1.00	1.00	1.00	1.00
Work Zone On Approach		No	No		No	
Adj Sat Flow, veh/h/ln	0	1870	1870	0	1870	1870
Adj Flow Rate, veh/h	0	932	481	0	288	586
Peak Hour Factor	0.95	0.95	0.95	0.95	0.95	0.95
Percent Heavy Veh, %	0	2	2	0	2	2
Cap, veh/h	0	1890	1890	0	688	1078
Arrive On Green	0.00	0.53	1.00	0.00	0.39	0.39
Sat Flow, veh/h	0	3741	3741	0	1781	2790
Grp Volume(v), veh/h	0	932	481	0	288	586
Grp Sat Flow(s),veh/h/ln	0	1777	1777	0	1781	1395
Q Serve(g_s), s	0.0	18.3	0.0	0.0	13.0	17.9
Cycle Q Clear(g_c), s	0.0	18.3	0.0	0.0	13.0	17.9
Prop In Lane	0.00			0.00	1.00	1.00
Lane Grp Cap(c), veh/h	0	1890	1890	0	688	1078
V/C Ratio(X)	0.00	0.49	0.25	0.00	0.42	0.54
Avail Cap(c_a), veh/h	0	1890	1890	0	688	1078
HCM Platoon Ratio	1.00	1.00	2.00	1.00	1.00	1.00
Upstream Filter(I)	0.00	1.00	1.00	0.00	1.00	1.00
Uniform Delay (d), s/veh	0.0	16.3	0.0	0.0	24.7	26.2
Incr Delay (d2), s/veh	0.0	0.9	0.3	0.0	1.9	2.0
Initial Q Delay(d3),s/veh	0.0	0.0	0.0	0.0	0.0	0.0
%ile BackOfQ(50%),veh/ln	0.0	7.5	0.1	0.0	5.8	6.2
Unsig. Movement Delay, s/veh						
LnGrp Delay(d),s/veh	0.0	17.3	0.3	0.0	26.6	28.2
LnGrp LOS	A	B	A	A	C	C
Approach Vol, veh/h		932	481		874	
Approach Delay, s/veh		17.3	0.3		27.7	
Approach LOS		B	A		C	
Timer - Assigned Phs				4	6	8
Phs Duration (G+Y+Rc), s				63.0	47.0	63.0
Change Period (Y+Rc), s				4.5	4.5	4.5
Max Green Setting (Gmax), s				58.5	42.5	58.5
Max Q Clear Time (g_c+I1), s				20.3	19.9	2.0
Green Ext Time (p_c), s				8.2	3.5	3.7
Intersection Summary						
HCM 6th Ctrl Delay			17.7			
HCM 6th LOS			B			

HCM 6th Signalized Intersection Summary

3: Mulberry St/SR 91 On-Ramp & Mission Inn Ave

05/13/2020



Movement	EBL	EBT	EBR	WBL	WBT	WBR	NBL	NBT	NBR	SBL	SBT	SBR
Lane Configurations	↗	↗↗			↖↖		↗	↖				
Traffic Volume (veh/h)	557	602	0	0	302	368	156	650	69	0	0	0
Future Volume (veh/h)	557	602	0	0	302	368	156	650	69	0	0	0
Initial Q (Qb), veh	0	0	0	0	0	0	0	0	0			
Ped-Bike Adj(A_pbT)	1.00		1.00	1.00		1.00	1.00		1.00			
Parking Bus, Adj	1.00	1.00	1.00	1.00	1.00	1.00	1.00	1.00	1.00			
Work Zone On Approach		No			No			No				
Adj Sat Flow, veh/h/ln	1870	1870	0	0	1870	1870	1870	1870	1870			
Adj Flow Rate, veh/h	586	634	0	0	318	0	164	684	73			
Peak Hour Factor	0.95	0.95	0.95	0.95	0.95	0.95	0.95	0.95	0.95			
Percent Heavy Veh, %	2	2	0	0	2	2	2	2	2			
Cap, veh/h	562	1890	0	0	624		688	642	68			
Arrive On Green	0.63	1.00	0.00	0.00	0.18	0.00	0.39	0.39	0.39			
Sat Flow, veh/h	1781	3647	0	0	3741	0	1781	1661	177			
Grp Volume(v), veh/h	586	634	0	0	318	0	164	0	757			
Grp Sat Flow(s),veh/h/ln	1781	1777	0	0	1777	0	1781	0	1838			
Q Serve(g_s), s	34.7	0.0	0.0	0.0	8.9	0.0	6.8	0.0	42.5			
Cycle Q Clear(g_c), s	34.7	0.0	0.0	0.0	8.9	0.0	6.8	0.0	42.5			
Prop In Lane	1.00		0.00	0.00		0.00	1.00		0.10			
Lane Grp Cap(c), veh/h	562	1890	0	0	624		688	0	710			
V/C Ratio(X)	1.04	0.34	0.00	0.00	0.51		0.24	0.00	1.07			
Avail Cap(c_a), veh/h	562	1890	0	0	624		688	0	710			
HCM Platoon Ratio	2.00	2.00	1.00	1.00	1.00	1.00	1.00	1.00	1.00			
Upstream Filter(I)	1.00	1.00	0.00	0.00	1.00	0.00	1.00	0.00	1.00			
Uniform Delay (d), s/veh	20.3	0.0	0.0	0.0	41.1	0.0	22.8	0.0	33.8			
Incr Delay (d2), s/veh	49.6	0.5	0.0	0.0	3.0	0.0	0.8	0.0	52.7			
Initial Q Delay(d3),s/veh	0.0	0.0	0.0	0.0	0.0	0.0	0.0	0.0	0.0			
%ile BackOfQ(50%),veh/ln	16.1	0.1	0.0	0.0	4.1	0.0	3.0	0.0	28.7			
Unsig. Movement Delay, s/veh												
LnGrp Delay(d),s/veh	69.9	0.5	0.0	0.0	44.0	0.0	23.6	0.0	86.4			
LnGrp LOS	F	A	A	A	D		C	A	F			
Approach Vol, veh/h		1220			318	A		921				
Approach Delay, s/veh		33.8			44.0			75.2				
Approach LOS		C			D			E				
Timer - Assigned Phs		2		4			7	8				
Phs Duration (G+Y+Rc), s		47.0		63.0			39.2	23.8				
Change Period (Y+Rc), s		4.5		4.5			4.5	4.5				
Max Green Setting (Gmax), s		42.5		58.5			34.7	19.3				
Max Q Clear Time (g_c+I1), s		44.5		2.0			36.7	10.9				
Green Ext Time (p_c), s		0.0		5.1			0.0	1.2				

Intersection Summary

HCM 6th Ctrl Delay	50.7
HCM 6th LOS	D

Notes

Unsignalized Delay for [WBR] is excluded from calculations of the approach delay and intersection delay.

HCM 6th Signalized Intersection Summary

4: Howard Ave & 14th St

05/04/2020



Movement	EBL	EBT	EBR	WBL	WBT	WBR	NBL	NBT	NBR	SBL	SBT	SBR
Lane Configurations												
Traffic Volume (veh/h)	45	1717	199	10	682	16	117	37	33	70	139	130
Future Volume (veh/h)	45	1717	199	10	682	16	117	37	33	70	139	130
Initial Q (Qb), veh	0	0	0	0	0	0	0	0	0	0	0	0
Ped-Bike Adj(A_pbT)	1.00		1.00	1.00		1.00	1.00		1.00	1.00		1.00
Parking Bus, Adj	1.00	1.00	1.00	1.00	1.00	1.00	1.00	1.00	1.00	1.00	1.00	1.00
Work Zone On Approach	No			No			No			No		
Adj Sat Flow, veh/h/ln	1870	1870	1870	1870	1870	1870	1870	1870	1870	1870	1870	1870
Adj Flow Rate, veh/h	47	1807	209	11	718	17	123	39	35	74	146	137
Peak Hour Factor	0.95	0.95	0.95	0.95	0.95	0.95	0.95	0.95	0.95	0.95	0.95	0.95
Percent Heavy Veh, %	2	2	2	2	2	2	2	2	2	2	2	2
Cap, veh/h	154	1793	800	81	1645	39	250	79	60	131	245	209
Arrive On Green	0.09	0.50	0.50	0.05	0.46	0.46	0.33	0.33	0.33	0.33	0.33	0.33
Sat Flow, veh/h	1781	3554	1585	1781	3548	84	601	240	182	279	747	639
Grp Volume(v), veh/h	47	1807	209	11	359	376	197	0	0	357	0	0
Grp Sat Flow(s),veh/h/ln	1781	1777	1585	1781	1777	1855	1023	0	0	1665	0	0
Q Serve(g_s), s	2.7	55.5	8.3	0.7	15.0	15.0	2.1	0.0	0.0	0.0	0.0	0.0
Cycle Q Clear(g_c), s	2.7	55.5	8.3	0.7	15.0	15.0	21.9	0.0	0.0	19.7	0.0	0.0
Prop In Lane	1.00		1.00	1.00		0.05	0.62		0.18	0.21		0.38
Lane Grp Cap(c), veh/h	154	1793	800	81	824	860	388	0	0	585	0	0
V/C Ratio(X)	0.31	1.01	0.26	0.14	0.44	0.44	0.51	0.00	0.00	0.61	0.00	0.00
Avail Cap(c_a), veh/h	154	1793	800	81	824	860	388	0	0	585	0	0
HCM Platoon Ratio	1.00	1.00	1.00	1.00	1.00	1.00	1.00	1.00	1.00	1.00	1.00	1.00
Upstream Filter(I)	1.00	1.00	1.00	1.00	1.00	1.00	1.00	0.00	0.00	1.00	0.00	0.00
Uniform Delay (d), s/veh	47.2	27.3	15.6	50.4	19.8	19.8	32.1	0.0	0.0	31.4	0.0	0.0
Incr Delay (d2), s/veh	5.1	23.2	0.8	3.5	1.7	1.6	4.7	0.0	0.0	4.7	0.0	0.0
Initial Q Delay(d3),s/veh	0.0	0.0	0.0	0.0	0.0	0.0	0.0	0.0	0.0	0.0	0.0	0.0
%ile BackOfQ(50%),veh/ln	4	27.9	3.1	0.4	6.5	6.7	5.1	0.0	0.0	8.7	0.0	0.0
Unsig. Movement Delay, s/veh												
LnGrp Delay(d),s/veh	52.2	50.4	16.3	53.9	21.5	21.4	36.8	0.0	0.0	36.1	0.0	0.0
LnGrp LOS	D	F	B	D	C	C	D	A	A	D	A	A
Approach Vol, veh/h	2063			746			197			357		
Approach Delay, s/veh	47.0			22.0			36.8			36.1		
Approach LOS	D			C			D			D		
Timer - Assigned Phs	2		3		4		6		7		8	
Phs Duration (G+Y+Rc), s	40.5		9.5		60.0		40.5		14.0		55.5	
Change Period (Y+Rc), s	4.5		4.5		4.5		4.5		4.5		4.5	
Max Green Setting (Gmax), s	36.0		5.0		55.5		36.0		9.5		51.0	
Max Q Clear Time (g_c+I1), s	23.9		2.7		57.5		21.7		4.7		17.0	
Green Ext Time (p_c), s	0.9		0.0		0.0		1.9		0.0		5.2	
Intersection Summary												
HCM 6th Ctrl Delay				39.7								
HCM 6th LOS				D								

Intersection

Intersection Delay, s/veh 50.6

Intersection LOS F

Movement	EBL	EBT	EBR	WBL	WBT	WBR	NBL	NBT	NBR	SBL	SBT	SBR
Lane Configurations	↙	↑	↗	↙	↑↑		↙	↗			↕	
Traffic Vol, veh/h	206	358	107	64	391	160	93	56	39	62	76	185
Future Vol, veh/h	206	358	107	64	391	160	93	56	39	62	76	185
Peak Hour Factor	0.95	0.95	0.95	0.95	0.95	0.95	0.95	0.95	0.95	0.95	0.95	0.95
Heavy Vehicles, %	2	2	2	2	2	2	2	2	2	2	2	2
Mvmt Flow	217	377	113	67	412	168	98	59	41	65	80	195
Number of Lanes	1	1	1	1	2	0	1	1	0	0	1	0

Approach	EB	WB	NB	SB
Opposing Approach	WB	EB	SB	NB
Opposing Lanes	3	3	1	2
Conflicting Approach Left SB		NB	EB	WB
Conflicting Lanes Left	1	2	3	3
Conflicting Approach Right NB		SB	WB	EB
Conflicting Lanes Right	2	1	3	3
HCM Control Delay	59.8	38.4	19.8	72.5
HCM LOS	F	E	C	F

Lane	NBLn1	NBLn2	EBLn1	EBLn2	EBLn3	WBLn1	WBLn2	WBLn3	SBLn1
Vol Left, %	100%	0%	100%	0%	0%	100%	0%	0%	19%
Vol Thru, %	0%	59%	0%	100%	0%	0%	100%	45%	24%
Vol Right, %	0%	41%	0%	0%	100%	0%	0%	55%	57%
Sign Control	Stop	Stop	Stop	Stop	Stop	Stop	Stop	Stop	Stop
Traffic Vol by Lane	93	95	206	358	107	64	261	290	323
LT Vol	93	0	206	0	0	64	0	0	62
Through Vol	0	56	0	358	0	0	261	130	76
RT Vol	0	39	0	0	107	0	0	160	185
Lane Flow Rate	98	100	217	377	113	67	274	306	340
Geometry Grp	8	8	8	8	8	8	8	8	8
Degree of Util (X)	0.323	0.308	0.63	1.039	0.288	0.194	0.757	0.81	0.963
Departure Headway (Hd)	12.214	11.386	10.456	9.929	9.192	10.731	10.203	9.796	10.415
Convergence, Y/N	Yes	Yes	Yes	Yes	Yes	Yes	Yes	Yes	Yes
Cap	297	318	345	366	391	336	357	373	350
Service Time	9.914	9.086	8.227	7.7	6.962	8.431	7.903	7.496	8.115
HCM Lane V/C Ratio	0.33	0.314	0.629	1.03	0.289	0.199	0.768	0.82	0.971
HCM Control Delay	20.6	19.1	29.6	90.4	15.7	16	38.6	43.2	72.5
HCM Lane LOS	C	C	D	F	C	C	E	E	F
HCM 95th-tile Q	1.4	1.3	4.1	12.8	1.2	0.7	6	7.1	10.4

HCM 6th TWSC
6: Commerce St & Mission Inn Ave

05/04/2020

Intersection												
Int Delay, s/veh	6.5											
Movement	EBL	EBT	EBR	WBL	WBT	WBR	NBL	NBT	NBR	SBL	SBT	SBR
Lane Configurations		↕	↗		↕↗			↕			↕	
Traffic Vol, veh/h	26	357	76	21	521	21	85	42	23	4	42	9
Future Vol, veh/h	26	357	76	21	521	21	85	42	23	4	42	9
Conflicting Peds, #/hr	0	0	0	0	0	0	0	0	0	0	0	0
Sign Control	Free	Free	Free	Free	Free	Free	Stop	Stop	Stop	Stop	Stop	Stop
RT Channelized	-	-	None	-	-	None	-	-	None	-	-	None
Storage Length	-	-	0	-	-	-	-	-	-	-	-	-
Veh in Median Storage, #	-	0	-	-	0	-	-	0	-	-	0	-
Grade, %	-	0	-	-	0	-	-	0	-	-	0	-
Peak Hour Factor	95	95	95	95	95	95	95	95	95	95	95	95
Heavy Vehicles, %	2	2	2	2	2	2	2	2	2	2	2	2
Mvmt Flow	27	376	80	22	548	22	89	44	24	4	44	9

Major/Minor	Major1			Major2			Minor1			Minor2		
Conflicting Flow All	570	0	0	456	0	0	770	1044	376	1107	1113	285
Stage 1	-	-	-	-	-	-	430	430	-	603	603	-
Stage 2	-	-	-	-	-	-	340	614	-	504	510	-
Critical Hdwy	4.13	-	-	4.13	-	-	7.33	6.53	6.23	7.33	6.53	6.93
Critical Hdwy Stg 1	-	-	-	-	-	-	6.13	5.53	-	6.53	5.53	-
Critical Hdwy Stg 2	-	-	-	-	-	-	6.53	5.53	-	6.13	5.53	-
Follow-up Hdwy	2.219	-	-	2.219	-	-	3.519	4.019	3.319	3.519	4.019	3.319
Pot Cap-1 Maneuver	1000	-	-	1103	-	-	304	228	670	176	208	713
Stage 1	-	-	-	-	-	-	603	583	-	454	487	-
Stage 2	-	-	-	-	-	-	649	482	-	549	537	-
Platoon blocked, %	-	-	-	-	-	-	-	-	-	-	-	-
Mov Cap-1 Maneuver	1000	-	-	1103	-	-	236	213	670	136	194	713
Mov Cap-2 Maneuver	-	-	-	-	-	-	236	213	-	136	194	-
Stage 1	-	-	-	-	-	-	581	561	-	437	473	-
Stage 2	-	-	-	-	-	-	564	468	-	469	517	-

Approach	EB			WB			NB			SB		
HCM Control Delay, s	0.5			0.4			39.9			28.1		
HCM LOS							E			D		

Minor Lane/Major Mvmt	NBLn1	EBL	EBT	EBR	WBL	WBT	WBR	SBLn1
Capacity (veh/h)	254	1000	-	-	1103	-	-	213
HCM Lane V/C Ratio	0.622	0.027	-	-	0.02	-	-	0.272
HCM Control Delay (s)	39.9	8.7	0	-	8.3	0.1	-	28.1
HCM Lane LOS	E	A	A	-	A	A	-	D
HCM 95th %tile Q(veh)	3.8	0.1	-	-	0.1	-	-	1.1

HCM 6th TWSC
7: Commerce St & 9th St

05/04/2020

Intersection						
Int Delay, s/veh	2.1					
Movement	WBL	WBR	NBT	NBR	SBL	SBT
Lane Configurations	W	W	T			T
Traffic Vol, veh/h	9	41	109	7	24	116
Future Vol, veh/h	9	41	109	7	24	116
Conflicting Peds, #/hr	0	0	0	0	0	0
Sign Control	Stop	Stop	Free	Free	Free	Free
RT Channelized	-	None	-	None	-	None
Storage Length	0	-	-	-	-	-
Veh in Median Storage, #	0	-	0	-	-	0
Grade, %	0	-	0	-	-	0
Peak Hour Factor	95	95	95	95	95	95
Heavy Vehicles, %	2	2	2	2	2	2
Mvmt Flow	9	43	115	7	25	122

Major/Minor	Minor1	Major1	Major2			
Conflicting Flow All	291	119	0	0	122	0
Stage 1	119	-	-	-	-	-
Stage 2	172	-	-	-	-	-
Critical Hdwy	6.42	6.22	-	-	4.12	-
Critical Hdwy Stg 1	5.42	-	-	-	-	-
Critical Hdwy Stg 2	5.42	-	-	-	-	-
Follow-up Hdwy	3.518	3.318	-	-	2.218	-
Pot Cap-1 Maneuver	700	933	-	-	1465	-
Stage 1	906	-	-	-	-	-
Stage 2	858	-	-	-	-	-
Platoon blocked, %			-	-		-
Mov Cap-1 Maneuver	687	933	-	-	1465	-
Mov Cap-2 Maneuver	687	-	-	-	-	-
Stage 1	890	-	-	-	-	-
Stage 2	858	-	-	-	-	-

Approach	WB	NB	SB
HCM Control Delay, s	9.4	0	1.3
HCM LOS	A		

Minor Lane/Major Mvmt	NBT	NBRWBLn1	SBL	SBT
Capacity (veh/h)	-	-	877	1465
HCM Lane V/C Ratio	-	-	0.06	0.017
HCM Control Delay (s)	-	-	9.4	7.5
HCM Lane LOS	-	-	A	A
HCM 95th %tile Q(veh)	-	-	0.2	0.1

HCM 6th TWSC
8: Howard Ave & Tenth St

05/04/2020

Intersection						
Int Delay, s/veh	3.6					
Movement	EBT	EBR	WBL	WBT	NBL	NBR
Lane Configurations	T			T		T
Traffic Vol, veh/h	85	238	43	28	84	54
Future Vol, veh/h	85	238	43	28	84	54
Conflicting Peds, #/hr	0	0	0	0	0	0
Sign Control	Free	Free	Free	Free	Stop	Stop
RT Channelized	-	None	-	None	-	None
Storage Length	-	-	-	-	0	-
Veh in Median Storage, #	0	-	-	0	0	-
Grade, %	0	-	-	0	0	-
Peak Hour Factor	95	95	95	95	95	95
Heavy Vehicles, %	2	2	2	2	2	2
Mvmt Flow	89	251	45	29	88	57

Major/Minor	Major1	Major2	Minor1			
Conflicting Flow All	0	0	340	0	334	215
Stage 1	-	-	-	-	215	-
Stage 2	-	-	-	-	119	-
Critical Hdwy	-	-	4.12	-	6.42	6.22
Critical Hdwy Stg 1	-	-	-	-	5.42	-
Critical Hdwy Stg 2	-	-	-	-	5.42	-
Follow-up Hdwy	-	-	2.218	-	3.518	3.318
Pot Cap-1 Maneuver	-	-	1219	-	661	825
Stage 1	-	-	-	-	821	-
Stage 2	-	-	-	-	906	-
Platoon blocked, %	-	-	-	-	-	-
Mov Cap-1 Maneuver	-	-	1219	-	636	825
Mov Cap-2 Maneuver	-	-	-	-	636	-
Stage 1	-	-	-	-	790	-
Stage 2	-	-	-	-	906	-

Approach	EB	WB	NB
HCM Control Delay, s	0	4.9	11.5
HCM LOS			B

Minor Lane/Major Mvmt	NBLn1	EBT	EBR	WBL	WBT
Capacity (veh/h)	699	-	-	1219	-
HCM Lane V/C Ratio	0.208	-	-	0.037	-
HCM Control Delay (s)	11.5	-	-	8.1	0
HCM Lane LOS	B	-	-	A	A
HCM 95th %tile Q(veh)	0.8	-	-	0.1	-

HCM 6th Signalized Intersection Summary
 9: SR 91 Off-Ramp/SR 91 On-Ramp & 14th St

05/04/2020



Movement	EBL	EBT	EBR	WBL	WBT	WBR	NBL	NBT	NBR	SBL	SBT	SBR
Lane Configurations	↗↘	↕			↕↕↕	↗	↘	↕	↗			
Traffic Volume (veh/h)	679	1414	0	0	808	122	262	3	548	0	0	0
Future Volume (veh/h)	679	1414	0	0	808	122	262	3	548	0	0	0
Initial Q (Qb), veh	0	0	0	0	0	0	0	0	0			
Ped-Bike Adj(A_pbT)	1.00		1.00	1.00		1.00	1.00		1.00			
Parking Bus, Adj	1.00	1.00	1.00	1.00	1.00	1.00	1.00	1.00	1.00			
Work Zone On Approach		No			No			No				
Adj Sat Flow, veh/h/ln	1870	1870	0	0	1870	1870	1870	1870	1870			
Adj Flow Rate, veh/h	715	1488	0	0	851	128	278	0	577			
Peak Hour Factor	0.95	0.95	0.95	0.95	0.95	0.95	0.95	0.95	0.95			
Percent Heavy Veh, %	2	2	0	0	2	2	2	2	2			
Cap, veh/h	795	1795	0	0	1174	365	1443	0	642			
Arrive On Green	0.23	0.50	0.00	0.00	0.23	0.23	0.41	0.00	0.41			
Sat Flow, veh/h	3456	3647	0	0	5274	1585	3563	0	1585			
Grp Volume(v), veh/h	715	1488	0	0	851	128	278	0	577			
Grp Sat Flow(s),veh/h/ln	1728	1777	0	0	1702	1585	1781	0	1585			
Q Serve(g_s), s	20.1	35.7	0.0	0.0	15.4	6.8	5.0	0.0	34.1			
Cycle Q Clear(g_c), s	20.1	35.7	0.0	0.0	15.4	6.8	5.0	0.0	34.1			
Prop In Lane	1.00		0.00	0.00		1.00	1.00		1.00			
Lane Grp Cap(c), veh/h	795	1795	0	0	1174	365	1443	0	642			
V/C Ratio(X)	0.90	0.83	0.00	0.00	0.72	0.35	0.19	0.00	0.90			
Avail Cap(c_a), veh/h	795	1795	0	0	1174	365	1443	0	642			
HCM Platoon Ratio	1.00	1.00	1.00	1.00	1.00	1.00	1.00	1.00	1.00			
Upstream Filter(I)	1.00	1.00	0.00	0.00	1.00	1.00	1.00	0.00	1.00			
Uniform Delay (d), s/veh	37.4	21.1	0.0	0.0	35.6	32.2	19.2	0.0	27.8			
Incr Delay (d2), s/veh	15.2	4.6	0.0	0.0	3.9	2.6	0.3	0.0	17.9			
Initial Q Delay(d3),s/veh	0.0	0.0	0.0	0.0	0.0	0.0	0.0	0.0	0.0			
%ile BackOfQ(50%),veh/ln	10.0	15.0	0.0	0.0	6.7	2.8	2.1	0.0	15.6			
Unsig. Movement Delay, s/veh												
LnGrp Delay(d),s/veh	52.6	25.7	0.0	0.0	39.5	34.9	19.5	0.0	45.7			
LnGrp LOS	D	C	A	A	D	C	B	A	D			
Approach Vol, veh/h		2203			979			855				
Approach Delay, s/veh		34.4			38.9			37.2				
Approach LOS		C			D			D				
Timer - Assigned Phs		2		4			7	8				
Phs Duration (G+Y+Rc), s		45.0		55.0			27.5	27.5				
Change Period (Y+Rc), s		4.5		4.5			4.5	4.5				
Max Green Setting (Gmax), s		40.5		50.5			23.0	23.0				
Max Q Clear Time (g_c+I1), s		36.1		37.7			22.1	17.4				
Green Ext Time (p_c), s		1.5		8.5			0.3	2.9				
Intersection Summary												
HCM 6th Ctrl Delay				36.1								
HCM 6th LOS				D								
Notes												
User approved volume balancing among the lanes for turning movement.												

HCM 6th Signalized Intersection Summary

11: Park Ave & University Ave

05/04/2020



Movement	EBL	EBT	EBR	WBL	WBT	WBR	NBL	NBT	NBR	SBL	SBT	SBR
Lane Configurations	↖	↖↗		↖	↖↗		↖	↖		↖	↖	
Traffic Volume (veh/h)	53	1374	63	39	603	67	50	58	74	254	137	62
Future Volume (veh/h)	53	1374	63	39	603	67	50	58	74	254	137	62
Initial Q (Qb), veh	0	0	0	0	0	0	0	0	0	0	0	0
Ped-Bike Adj(A_pbT)	1.00		1.00	1.00		1.00	1.00		1.00	1.00		1.00
Parking Bus, Adj	1.00	1.00	1.00	1.00	1.00	1.00	1.00	1.00	1.00	1.00	1.00	1.00
Work Zone On Approach		No			No			No			No	
Adj Sat Flow, veh/h/ln	1870	1870	1870	1870	1870	1870	1870	1870	1870	1870	1870	1870
Adj Flow Rate, veh/h	56	1446	66	41	635	71	53	61	78	267	144	65
Peak Hour Factor	0.95	0.95	0.95	0.95	0.95	0.95	0.95	0.95	0.95	0.95	0.95	0.95
Percent Heavy Veh, %	2	2	2	2	2	2	2	2	2	2	2	2
Cap, veh/h	168	1463	67	81	1204	134	143	136	173	332	352	159
Arrive On Green	0.09	0.42	0.42	0.05	0.37	0.37	0.08	0.18	0.18	0.19	0.29	0.29
Sat Flow, veh/h	1781	3461	158	1781	3223	360	1781	746	953	1781	1220	551
Grp Volume(v), veh/h	56	741	771	41	350	356	53	0	139	267	0	209
Grp Sat Flow(s),veh/h/ln	1781	1777	1842	1781	1777	1806	1781	0	1699	1781	0	1771
Q Serve(g_s), s	3.2	45.4	45.8	2.5	16.9	16.9	3.1	0.0	8.0	15.8	0.0	10.5
Cycle Q Clear(g_c), s	3.2	45.4	45.8	2.5	16.9	16.9	3.1	0.0	8.0	15.8	0.0	10.5
Prop In Lane	1.00		0.09	1.00		0.20	1.00		0.56	1.00		0.31
Lane Grp Cap(c), veh/h	168	751	779	81	664	675	143	0	309	332	0	510
V/C Ratio(X)	0.33	0.99	0.99	0.51	0.53	0.53	0.37	0.00	0.45	0.80	0.00	0.41
Avail Cap(c_a), veh/h	168	751	779	81	664	675	143	0	309	332	0	510
HCM Platoon Ratio	1.00	1.00	1.00	1.00	1.00	1.00	1.00	1.00	1.00	1.00	1.00	1.00
Upstream Filter(I)	1.00	1.00	1.00	1.00	1.00	1.00	1.00	0.00	1.00	1.00	0.00	1.00
Uniform Delay (d), s/veh	46.6	31.4	31.5	51.3	26.9	26.9	48.0	0.0	40.1	42.8	0.0	31.6
Incr Delay (d2), s/veh	5.2	29.6	30.1	20.8	3.0	2.9	7.3	0.0	4.7	18.4	0.0	2.4
Initial Q Delay(d3),s/veh	0.0	0.0	0.0	0.0	0.0	0.0	0.0	0.0	0.0	0.0	0.0	0.0
%ile BackOfQ(50%),veh/ln	1.7	24.9	26.1	1.6	7.6	7.8	1.7	0.0	3.7	8.6	0.0	4.8
Unsig. Movement Delay, s/veh												
LnGrp Delay(d),s/veh	51.8	61.0	61.6	72.1	29.8	29.8	55.3	0.0	44.8	61.3	0.0	34.0
LnGrp LOS	D	E	E	E	C	C	E	A	D	E	A	C
Approach Vol, veh/h		1568			747			192				476
Approach Delay, s/veh		61.0			32.2			47.7				49.3
Approach LOS		E			C			D				D
Timer - Assigned Phs	1	2	3	4	5	6	7	8				
Phs Duration (G+Y+Rc), s	25.0	24.5	9.5	51.0	13.3	36.2	14.9	45.6				
Change Period (Y+Rc), s	4.5	4.5	4.5	4.5	4.5	4.5	4.5	4.5				
Max Green Setting (Gmax), s	20.5	20.0	5.0	46.5	8.8	31.7	10.4	41.1				
Max Q Clear Time (g_c+1/3), s	17.8	10.0	4.5	47.8	5.1	12.5	5.2	18.9				
Green Ext Time (p_c), s	0.2	0.5	0.0	0.0	0.0	1.1	0.0	4.5				

Intersection Summary

HCM 6th Ctrl Delay	51.0
HCM 6th LOS	D

HCM 6th AWSC
12: Howard Ave & 12th St

05/04/2020

Intersection

Intersection Delay, s/veh 9
Intersection LOS A

Movement	EBL	EBT	EBR	WBL	WBT	WBR	NBL	NBT	NBR	SBL	SBT	SBR
Lane Configurations		↔		↔		↔		↔			↔	
Traffic Vol, veh/h	0	8	70	29	3	13	12	59	28	20	240	20
Future Vol, veh/h	0	8	70	29	3	13	12	59	28	20	240	20
Peak Hour Factor	0.95	0.95	0.95	0.95	0.95	0.95	0.95	0.95	0.95	0.95	0.95	0.95
Heavy Vehicles, %	2	2	2	2	2	2	2	2	2	2	2	2
Mvmt Flow	0	8	74	31	3	14	13	62	29	21	253	21
Number of Lanes	0	1	0	0	1	0	0	1	0	0	1	0

Approach	EB	WB	WB	NB	SB
Opposing Approach	WB	EB		SB	NB
Opposing Lanes	1	1		1	1
Conflicting Approach Left	SB	NB		EB	WB
Conflicting Lanes Left	1	1		1	1
Conflicting Approach Right	NB	SB		WB	EB
Conflicting Lanes Right	1	1		1	1
HCM Control Delay	7.8	8.2		8.1	9.7
HCM LOS	A	A		A	A

Lane	NBLn1	EBLn1	WBLn1	SBLn1
Vol Left, %	12%	0%	64%	7%
Vol Thru, %	60%	10%	7%	86%
Vol Right, %	28%	90%	29%	7%
Sign Control	Stop	Stop	Stop	Stop
Traffic Vol by Lane	99	78	45	280
LT Vol	12	0	29	20
Through Vol	59	8	3	240
RT Vol	28	70	13	20
Lane Flow Rate	104	82	47	295
Geometry Grp	1	1	1	1
Degree of Util (X)	0.127	0.099	0.064	0.353
Departure Headway (Hd)	4.4	4.345	4.879	4.317
Convergence, Y/N	Yes	Yes	Yes	Yes
Cap	815	825	734	834
Service Time	2.424	2.37	2.907	2.336
HCM Lane V/C Ratio	0.128	0.099	0.064	0.354
HCM Control Delay	8.1	7.8	8.2	9.7
HCM Lane LOS	A	A	A	A
HCM 95th-tile Q	0.4	0.3	0.2	1.6

HCM 6th Signalized Intersection Summary

13: Olivewood Ave/Lime St & 14th St

05/04/2020



Movement	EBL	EBT	EBR	WBL	WBT	WBR	NBL	NBT	NBR	SBL	SBT	SBR
Lane Configurations	↖ ↑↑↑			↖ ↑↑↑			↖ ↑↑	↑↑	↗	↖↖	↑↑	
Traffic Volume (veh/h)	31	1087	87	277	891	83	49	198	466	406	840	52
Future Volume (veh/h)	31	1087	87	277	891	83	49	198	466	406	840	52
Initial Q (Qb), veh	0	0	0	0	0	0	0	0	0	0	0	0
Ped-Bike Adj(A_pbT)	1.00		1.00	1.00		1.00	1.00		1.00	1.00		1.00
Parking Bus, Adj	1.00	1.00	1.00	1.00	1.00	1.00	1.00	1.00	1.00	1.00	1.00	1.00
Work Zone On Approach	No			No			No			No		
Adj Sat Flow, veh/h/ln	1870	1870	1870	1870	1870	1870	1870	1870	1870	1870	1870	1870
Adj Flow Rate, veh/h	33	1144	92	292	938	87	52	208	491	427	884	55
Peak Hour Factor	0.95	0.95	0.95	0.95	0.95	0.95	0.95	0.95	0.95	0.95	0.95	0.95
Percent Heavy Veh, %	2	2	2	2	2	2	2	2	2	2	2	2
Cap, veh/h	113	1336	107	316	1859	172	86	349	591	675	1134	71
Arrive On Green	0.06	0.28	0.28	0.06	0.13	0.13	0.05	0.19	0.19	0.20	0.33	0.33
Sat Flow, veh/h	1781	4818	387	1781	4755	440	1781	1870	3170	3456	3398	211
Grp Volume(v), veh/h	33	808	428	292	671	354	52	208	491	427	462	477
Grp Sat Flow(s),veh/h/ln	1781	1702	1801	1781	1702	1791	1781	1870	1585	1728	1777	1832
Q Serve(g_s), s	1.9	24.7	24.8	17.9	20.2	20.3	3.1	11.2	16.4	12.5	25.8	25.8
Cycle Q Clear(g_c), s	1.9	24.7	24.8	17.9	20.2	20.3	3.1	11.2	16.4	12.5	25.8	25.8
Prop In Lane	1.00		0.22	1.00		0.25	1.00		1.00	1.00		0.12
Lane Grp Cap(c), veh/h	113	944	499	316	1331	700	86	349	591	675	593	611
V/C Ratio(X)	0.29	0.86	0.86	0.92	0.50	0.51	0.61	0.60	0.83	0.63	0.78	0.78
Avail Cap(c_a), veh/h	113	944	499	316	1331	700	86	349	591	675	593	611
HCM Platoon Ratio	1.00	1.00	1.00	0.33	0.33	0.33	1.00	1.00	1.00	1.00	1.00	1.00
Upstream Filter(I)	1.00	1.00	1.00	1.00	1.00	1.00	1.00	1.00	1.00	1.00	1.00	1.00
Uniform Delay (d), s/veh	49.1	37.7	37.7	51.1	38.0	38.0	51.3	41.0	43.1	40.6	33.0	33.0
Incr Delay (d2), s/veh	6.4	9.9	17.1	34.6	1.4	2.6	27.9	7.3	12.8	4.5	9.8	9.5
Initial Q Delay(d3),s/veh	0.0	0.0	0.0	0.0	0.0	0.0	0.0	0.0	0.0	0.0	0.0	0.0
%ile BackOfQ(50%),veh/ln	1.1	11.5	13.1	11.6	9.5	10.2	2.1	5.8	7.4	5.7	12.5	12.9
Unsig. Movement Delay, s/veh												
LnGrp Delay(d),s/veh	55.5	47.5	54.8	85.7	39.3	40.6	79.2	48.3	55.9	45.1	42.8	42.5
LnGrp LOS	E	D	D	F	D	D	E	D	E	D	D	D
Approach Vol, veh/h	1269		1317		751		1366					
Approach Delay, s/veh	50.2		50.0		55.4		43.4					
Approach LOS	D		D		E		D					
Timer - Assigned Phs	1	2	3	4	5	6	7	8				
Phs Duration (G+Y+Rc), s	36.0	25.0	24.0	35.0	9.8	41.2	11.5	47.5				
Change Period (Y+Rc), s	4.5	4.5	4.5	4.5	4.5	4.5	4.5	4.5				
Max Green Setting (Gmax), s	21.5	20.5	19.5	30.5	5.3	36.7	7.0	43.0				
Max Q Clear Time (g_c+M), s	14.5	18.4	19.9	26.8	5.1	27.8	3.9	22.3				
Green Ext Time (p_c), s	0.9	0.8	0.0	2.5	0.0	4.0	0.0	7.1				

Intersection Summary

HCM 6th Ctrl Delay	49.0
HCM 6th LOS	D

Notes

User approved volume balancing among the lanes for turning movement.

HCM 6th Signalized Intersection Summary

14: Mulberry St/SR 91 Off-Ramp & 14th St

05/04/2020



Movement	EBL	EBT	EBR	WBL	WBT	WBR	NBL	NBT	NBR	SBL	SBT	SBR
Lane Configurations		↑↑↑		↔↔	↑↑↑					↔	↑↑	↔
Traffic Volume (veh/h)	0	1664	295	347	722	0	0	0	0	429	232	528
Future Volume (veh/h)	0	1664	295	347	722	0	0	0	0	429	232	528
Initial Q (Qb), veh	0	0	0	0	0	0				0	0	0
Ped-Bike Adj(A_pbT)	1.00		1.00	1.00		1.00				1.00		1.00
Parking Bus, Adj	1.00	1.00	1.00	1.00	1.00	1.00				1.00	1.00	1.00
Work Zone On Approach		No			No						No	
Adj Sat Flow, veh/h/ln	0	1870	1870	1870	1870	0				1870	1870	1870
Adj Flow Rate, veh/h	0	1752	311	365	760	0				301	350	626
Peak Hour Factor	0.95	0.95	0.95	0.95	0.95	0.95				0.95	0.95	0.95
Percent Heavy Veh, %	0	2	2	2	2	0				2	2	2
Cap, veh/h	0	2109	371	531	3458	0				429	451	764
Arrive On Green	0.00	0.32	0.32	0.15	0.68	0.00				0.24	0.24	0.24
Sat Flow, veh/h	0	4537	768	3456	5274	0				1781	1870	3170
Grp Volume(v), veh/h	0	1361	702	365	760	0				301	350	626
Grp Sat Flow(s),veh/h/ln	0	1702	1732	1728	1702	0				1781	1870	1585
Q Serve(g_s), s	0.0	40.7	41.4	11.0	6.2	0.0				17.0	19.2	20.5
Cycle Q Clear(g_c), s	0.0	40.7	41.4	11.0	6.2	0.0				17.0	19.2	20.5
Prop In Lane	0.00		0.44	1.00		0.00				1.00		1.00
Lane Grp Cap(c), veh/h	0	1643	836	531	3458	0				429	451	764
V/C Ratio(X)	0.00	0.83	0.84	0.69	0.22	0.00				0.70	0.78	0.82
Avail Cap(c_a), veh/h	0	1643	836	531	3458	0				429	451	764
HCM Platoon Ratio	1.00	0.67	0.67	1.00	1.00	1.00				1.00	1.00	1.00
Upstream Filter(I)	0.00	1.00	1.00	1.00	1.00	0.00				1.00	1.00	1.00
Uniform Delay (d), s/veh	0.0	33.0	33.2	44.1	6.7	0.0				38.1	39.0	39.5
Incr Delay (d2), s/veh	0.0	5.0	9.9	7.1	0.1	0.0				9.2	12.4	9.6
Initial Q Delay(d3),s/veh	0.0	0.0	0.0	0.0	0.0	0.0				0.0	0.0	0.0
%ile BackOfQ(50%),veh/ln	0.0	18.6	20.3	5.2	2.1	0.0				8.4	10.3	8.9
Unsig. Movement Delay, s/veh												
LnGrp Delay(d),s/veh	0.0	38.0	43.1	51.2	6.9	0.0				47.4	51.4	49.1
LnGrp LOS	A	D	D	D	A	A				D	D	D
Approach Vol, veh/h		2063			1125						1277	
Approach Delay, s/veh		39.7			21.2						49.3	
Approach LOS		D			C						D	
Timer - Assigned Phs			3	4		6		8				
Phs Duration (G+Y+Rc), s			21.4	57.6		31.0		79.0				
Change Period (Y+Rc), s			4.5	4.5		4.5		4.5				
Max Green Setting (Gmax), s			16.9	53.1		26.5		74.5				
Max Q Clear Time (g_c+I1), s			13.0	43.4		22.5		8.2				
Green Ext Time (p_c), s			0.5	8.1		2.2		6.5				
Intersection Summary												
HCM 6th Ctrl Delay			37.8									
HCM 6th LOS			D									
Notes												
User approved volume balancing among the lanes for turning movement.												

Build-Out PM with Project Conditions

HCM 6th Signalized Intersection Summary

1: Lime St & Mission Inn Ave

05/04/2020



Movement	EBL	EBT	EBR	WBL	WBT	WBR	NBL	NBT	NBR	SBL	SBT	SBR
Lane Configurations	↖	↗		↖	↗	↗	↖	↗	↗	↖	↗	
Traffic Volume (veh/h)	0	0	0	0	0	0	0	0	0	0	0	0
Future Volume (veh/h)	0	0	0	0	0	0	0	0	0	0	0	0
Initial Q (Qb), veh	0	0	0	0	0	0	0	0	0	0	0	0
Ped-Bike Adj(A_pbT)	1.00		1.00	1.00		1.00	1.00		1.00	1.00		1.00
Parking Bus, Adj	1.00	1.00	1.00	1.00	1.00	1.00	1.00	1.00	1.00	1.00	1.00	1.00
Work Zone On Approach		No			No			No			No	
Adj Sat Flow, veh/h/ln	1870	1870	1870	1870	1870	1870	1870	1870	1870	1870	1870	1870
Adj Flow Rate, veh/h	0	0	0	0	0	0	0	0	0	0	0	0
Peak Hour Factor	0.92	0.92	0.92	0.92	0.92	0.92	0.92	0.92	0.92	0.92	0.92	0.92
Percent Heavy Veh, %	2	2	2	2	2	2	2	2	2	2	2	2
Cap, veh/h	160	1421	0	160	748	634	160	748	634	160	1421	0
Arrive On Green	0.00	0.00	0.00	0.00	0.00	0.00	0.00	0.00	0.00	0.00	0.00	0.00
Sat Flow, veh/h	1781	3647	0	1781	1870	1585	1781	1870	1585	1781	3647	0
Grp Volume(v), veh/h	0	0	0	0	0	0	0	0	0	0	0	0
Grp Sat Flow(s),veh/h/ln	1781	1777	0	1781	1870	1585	1781	1870	1585	1781	1777	0
Q Serve(g_s), s	0.0	0.0	0.0	0.0	0.0	0.0	0.0	0.0	0.0	0.0	0.0	0.0
Cycle Q Clear(g_c), s	0.0	0.0	0.0	0.0	0.0	0.0	0.0	0.0	0.0	0.0	0.0	0.0
Prop In Lane	1.00		0.00	1.00		1.00	1.00		1.00	1.00		0.00
Lane Grp Cap(c), veh/h	160	1421	0	160	748	634	160	748	634	160	1421	0
V/C Ratio(X)	0.00	0.00	0.00	0.00	0.00	0.00	0.00	0.00	0.00	0.00	0.00	0.00
Avail Cap(c_a), veh/h	160	1421	0	160	748	634	160	748	634	160	1421	0
HCM Platoon Ratio	1.00	1.00	1.00	1.00	1.00	1.00	1.00	1.00	1.00	1.00	1.00	1.00
Upstream Filter(I)	0.00	0.00	0.00	0.00	0.00	0.00	0.00	0.00	0.00	0.00	0.00	0.00
Uniform Delay (d), s/veh	0.0	0.0	0.0	0.0	0.0	0.0	0.0	0.0	0.0	0.0	0.0	0.0
Incr Delay (d2), s/veh	0.0	0.0	0.0	0.0	0.0	0.0	0.0	0.0	0.0	0.0	0.0	0.0
Initial Q Delay(d3),s/veh	0.0	0.0	0.0	0.0	0.0	0.0	0.0	0.0	0.0	0.0	0.0	0.0
%ile BackOfQ(50%),veh/ln	0.0	0.0	0.0	0.0	0.0	0.0	0.0	0.0	0.0	0.0	0.0	0.0
Unsig. Movement Delay, s/veh												
LnGrp Delay(d),s/veh	0.0	0.0	0.0	0.0	0.0	0.0	0.0	0.0	0.0	0.0	0.0	0.0
LnGrp LOS	A	A	A	A	A	A	A	A	A	A	A	A
Approach Vol, veh/h		0			0			0			0	
Approach Delay, s/veh		0.0			0.0			0.0			0.0	
Approach LOS												
Timer - Assigned Phs		2		4		6		8				
Phs Duration (G+Y+Rc), s		22.5		22.5		22.5		22.5				
Change Period (Y+Rc), s		4.5		4.5		4.5		4.5				
Max Green Setting (Gmax), s		18.0		18.0		18.0		18.0				
Max Q Clear Time (g_c+I1), s		0.0		0.0		0.0		0.0				
Green Ext Time (p_c), s		0.0		0.0		0.0		0.0				
Intersection Summary												
HCM 6th Ctrl Delay				0.0								
HCM 6th LOS				A								

HCM 6th Signalized Intersection Summary

2: Mission Inn Ave & SR 91 Off-Ramp

05/04/2020

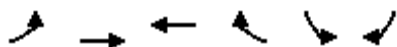

Movement	EBL	EBT	WBT	WBR	SBL	SBR
Lane Configurations		↑↑	↑↑		↘	↘
Traffic Volume (veh/h)	0	885	464	0	289	557
Future Volume (veh/h)	0	885	464	0	289	557
Initial Q (Qb), veh	0	0	0	0	0	0
Ped-Bike Adj(A_pbT)	1.00			1.00	1.00	1.00
Parking Bus, Adj	1.00	1.00	1.00	1.00	1.00	1.00
Work Zone On Approach		No	No		No	
Adj Sat Flow, veh/h/ln	0	1870	1870	0	1870	1870
Adj Flow Rate, veh/h	0	932	488	0	304	586
Peak Hour Factor	0.95	0.95	0.95	0.95	0.95	0.95
Percent Heavy Veh, %	0	2	2	0	2	2
Cap, veh/h	0	1858	1858	0	704	1103
Arrive On Green	0.00	0.52	1.00	0.00	0.40	0.40
Sat Flow, veh/h	0	3741	3741	0	1781	2790
Grp Volume(v), veh/h	0	932	488	0	304	586
Grp Sat Flow(s),veh/h/ln	0	1777	1777	0	1781	1395
Q Serve(g_s), s	0.0	18.7	0.0	0.0	13.7	17.7
Cycle Q Clear(g_c), s	0.0	18.7	0.0	0.0	13.7	17.7
Prop In Lane	0.00			0.00	1.00	1.00
Lane Grp Cap(c), veh/h	0	1858	1858	0	704	1103
V/C Ratio(X)	0.00	0.50	0.26	0.00	0.43	0.53
Avail Cap(c_a), veh/h	0	1858	1858	0	704	1103
HCM Platoon Ratio	1.00	1.00	2.00	1.00	1.00	1.00
Upstream Filter(I)	0.00	1.00	1.00	0.00	1.00	1.00
Uniform Delay (d), s/veh	0.0	17.0	0.0	0.0	24.2	25.4
Incr Delay (d2), s/veh	0.0	1.0	0.3	0.0	1.9	1.8
Initial Q Delay(d3),s/veh	0.0	0.0	0.0	0.0	0.0	0.0
%ile BackOfQ(50%),veh/ln	0.0	7.6	0.1	0.0	6.1	6.1
Unsig. Movement Delay, s/veh						
LnGrp Delay(d),s/veh	0.0	18.0	0.3	0.0	26.2	27.3
LnGrp LOS	A	B	A	A	C	C
Approach Vol, veh/h		932	488		890	
Approach Delay, s/veh		18.0	0.3		26.9	
Approach LOS		B	A		C	
Timer - Assigned Phs				4	6	8
Phs Duration (G+Y+Rc), s				62.0	48.0	62.0
Change Period (Y+Rc), s				4.5	4.5	4.5
Max Green Setting (Gmax), s				57.5	43.5	57.5
Max Q Clear Time (g_c+I1), s				20.7	19.7	2.0
Green Ext Time (p_c), s				8.1	3.5	3.7
Intersection Summary						
HCM 6th Ctrl Delay			17.7			
HCM 6th LOS			B			

HCM 6th Signalized Intersection Summary

3: Mulberry St/SR 91 On-Ramp & Mission Inn Ave

05/13/2020



Movement	EBL	EBT	EBR	WBL	WBT	WBR	NBL	NBT	NBR	SBL	SBT	SBR
Lane Configurations	↖	↗↗			↖↖		↖	↗				
Traffic Volume (veh/h)	557	617	0	0	308	395	156	650	69	0	0	0
Future Volume (veh/h)	557	617	0	0	308	395	156	650	69	0	0	0
Initial Q (Qb), veh	0	0	0	0	0	0	0	0	0			
Ped-Bike Adj(A_pbT)	1.00		1.00	1.00		1.00	1.00		1.00			
Parking Bus, Adj	1.00	1.00	1.00	1.00	1.00	1.00	1.00	1.00	1.00			
Work Zone On Approach		No			No			No				
Adj Sat Flow, veh/h/ln	1870	1870	0	0	1870	1870	1870	1870	1870			
Adj Flow Rate, veh/h	586	649	0	0	324	0	164	684	73			
Peak Hour Factor	0.95	0.95	0.95	0.95	0.95	0.95	0.95	0.95	0.95			
Percent Heavy Veh, %	2	2	0	0	2	2	2	2	2			
Cap, veh/h	559	1922	0	0	662		672	627	67			
Arrive On Green	0.63	1.00	0.00	0.00	0.19	0.00	0.38	0.38	0.38			
Sat Flow, veh/h	1781	3647	0	0	3741	0	1781	1661	177			
Grp Volume(v), veh/h	586	649	0	0	324	0	164	0	757			
Grp Sat Flow(s),veh/h/ln	1781	1777	0	0	1777	0	1781	0	1838			
Q Serve(g_s), s	34.5	0.0	0.0	0.0	9.0	0.0	6.9	0.0	41.5			
Cycle Q Clear(g_c), s	34.5	0.0	0.0	0.0	9.0	0.0	6.9	0.0	41.5			
Prop In Lane	1.00		0.00	0.00		0.00	1.00		0.10			
Lane Grp Cap(c), veh/h	559	1922	0	0	662		672	0	694			
V/C Ratio(X)	1.05	0.34	0.00	0.00	0.49		0.24	0.00	1.09			
Avail Cap(c_a), veh/h	559	1922	0	0	662		672	0	694			
HCM Platoon Ratio	2.00	2.00	1.00	1.00	1.00	1.00	1.00	1.00	1.00			
Upstream Filter(I)	1.00	1.00	0.00	0.00	1.00	0.00	1.00	0.00	1.00			
Uniform Delay (d), s/veh	20.5	0.0	0.0	0.0	40.1	0.0	23.5	0.0	34.3			
Incr Delay (d2), s/veh	51.5	0.5	0.0	0.0	2.6	0.0	0.9	0.0	61.8			
Initial Q Delay(d3),s/veh	0.0	0.0	0.0	0.0	0.0	0.0	0.0	0.0	0.0			
%ile BackOfQ(50%),veh/ln	16.4	0.1	0.0	0.0	4.2	0.0	3.1	0.0	29.9			
Unsig. Movement Delay, s/veh												
LnGrp Delay(d),s/veh	72.0	0.5	0.0	0.0	42.6	0.0	24.4	0.0	96.0			
LnGrp LOS	F	A	A	A	D		C	A	F			
Approach Vol, veh/h		1235			324	A		921				
Approach Delay, s/veh		34.4			42.6			83.3				
Approach LOS		C			D			F				
Timer - Assigned Phs		2		4			7	8				
Phs Duration (G+Y+Rc), s		46.0		64.0			39.0	25.0				
Change Period (Y+Rc), s		4.5		4.5			4.5	4.5				
Max Green Setting (Gmax), s		41.5		59.5			34.5	20.5				
Max Q Clear Time (g_c+I1), s		43.5		2.0			36.5	11.0				
Green Ext Time (p_c), s		0.0		5.3			0.0	1.4				

Intersection Summary

HCM 6th Ctrl Delay	53.6
HCM 6th LOS	D

Notes

User approved pedestrian interval to be less than phase max green.
 Unsignalized Delay for [WBR] is excluded from calculations of the approach delay and intersection delay.

HCM 6th Signalized Intersection Summary

4: Howard Ave & 14th St

05/04/2020



Movement	EBL	EBT	EBR	WBL	WBT	WBR	NBL	NBT	NBR	SBL	SBT	SBR
Lane Configurations												
Traffic Volume (veh/h)	59	1717	199	10	682	20	117	37	33	83	139	203
Future Volume (veh/h)	59	1717	199	10	682	20	117	37	33	83	139	203
Initial Q (Qb), veh	0	0	0	0	0	0	0	0	0	0	0	0
Ped-Bike Adj(A_pbT)	1.00		1.00	1.00		1.00	1.00		1.00	1.00		1.00
Parking Bus, Adj	1.00	1.00	1.00	1.00	1.00	1.00	1.00	1.00	1.00	1.00	1.00	1.00
Work Zone On Approach		No			No			No			No	
Adj Sat Flow, veh/h/ln	1870	1870	1870	1870	1870	1870	1870	1870	1870	1870	1870	1870
Adj Flow Rate, veh/h	62	1807	209	11	718	21	123	39	35	87	146	214
Peak Hour Factor	0.95	0.95	0.95	0.95	0.95	0.95	0.95	0.95	0.95	0.95	0.95	0.95
Percent Heavy Veh, %	2	2	2	2	2	2	2	2	2	2	2	2
Cap, veh/h	152	1890	843	81	1734	51	185	58	41	122	178	240
Arrive On Green	0.09	0.53	0.53	0.05	0.49	0.49	0.30	0.30	0.30	0.30	0.30	0.30
Sat Flow, veh/h	1781	3554	1585	1781	3526	103	439	193	137	278	595	801
Grp Volume(v), veh/h	62	1807	209	11	362	377	197	0	0	447	0	0
Grp Sat Flow(s),veh/h/ln	1781	1777	1585	1781	1777	1852	768	0	0	1674	0	0
Q Serve(g_s), s	3.6	53.3	7.8	0.7	14.3	14.3	1.5	0.0	0.0	0.0	0.0	0.0
Cycle Q Clear(g_c), s	3.6	53.3	7.8	0.7	14.3	14.3	29.3	0.0	0.0	27.8	0.0	0.0
Prop In Lane	1.00		1.00	1.00		0.06	0.62		0.18	0.19		0.48
Lane Grp Cap(c), veh/h	152	1890	843	81	874	911	284	0	0	541	0	0
V/C Ratio(X)	0.41	0.96	0.25	0.14	0.41	0.41	0.69	0.00	0.00	0.83	0.00	0.00
Avail Cap(c_a), veh/h	152	1890	843	81	874	911	284	0	0	541	0	0
HCM Platoon Ratio	1.00	1.00	1.00	1.00	1.00	1.00	1.00	1.00	1.00	1.00	1.00	1.00
Upstream Filter(I)	1.00	1.00	1.00	1.00	1.00	1.00	1.00	0.00	0.00	1.00	0.00	0.00
Uniform Delay (d), s/veh	47.7	24.5	13.9	50.4	17.8	17.8	36.8	0.0	0.0	36.6	0.0	0.0
Incr Delay (d2), s/veh	7.9	12.7	0.7	3.5	1.4	1.4	13.2	0.0	0.0	13.5	0.0	0.0
Initial Q Delay(d3),s/veh	0.0	0.0	0.0	0.0	0.0	0.0	0.0	0.0	0.0	0.0	0.0	0.0
%ile BackOfQ(50%),veh/ln	9	24.3	2.9	0.4	6.1	6.3	6.1	0.0	0.0	13.3	0.0	0.0
Unsig. Movement Delay, s/veh												
LnGrp Delay(d),s/veh	55.6	37.2	14.6	53.9	19.3	19.2	50.0	0.0	0.0	50.1	0.0	0.0
LnGrp LOS	E	D	B	D	B	B	D	A	A	D	A	A
Approach Vol, veh/h		2078			750			197			447	
Approach Delay, s/veh		35.5			19.8			50.0			50.1	
Approach LOS		D			B			D			D	
Timer - Assigned Phs		2	3	4		6	7	8				
Phs Duration (G+Y+Rc), s		37.5	9.5	63.0		37.5	13.9	58.6				
Change Period (Y+Rc), s		4.5	4.5	4.5		4.5	4.5	4.5				
Max Green Setting (Gmax), s		33.0	5.0	58.5		33.0	9.4	54.1				
Max Q Clear Time (g_c+I1), s		31.3	2.7	55.3		29.8	5.6	16.3				
Green Ext Time (p_c), s		0.2	0.0	2.9		0.9	0.0	5.3				
Intersection Summary												
HCM 6th Ctrl Delay											34.8	
HCM 6th LOS											C	

Intersection

Intersection Delay, s/veh 56.8

Intersection LOS F

Movement	EBL	EBT	EBR	WBL	WBT	WBR	NBL	NBT	NBR	SBL	SBT	SBR
Lane Configurations												
Traffic Vol, veh/h	206	373	107	64	425	160	93	56	39	62	76	185
Future Vol, veh/h	206	373	107	64	425	160	93	56	39	62	76	185
Peak Hour Factor	0.95	0.95	0.95	0.95	0.95	0.95	0.95	0.95	0.95	0.95	0.95	0.95
Heavy Vehicles, %	2	2	2	2	2	2	2	2	2	2	2	2
Mvmt Flow	217	393	113	67	447	168	98	59	41	65	80	195
Number of Lanes	1	1	1	1	2	0	1	1	0	0	1	0

Approach	EB	WB	NB	SB
Opposing Approach	WB	EB	SB	NB
Opposing Lanes	3	3	1	2
Conflicting Approach Left SB		NB	EB	WB
Conflicting Lanes Left	1	2	3	3
Conflicting Approach Right NB		SB	WB	EB
Conflicting Lanes Right	2	1	3	3
HCM Control Delay	70.1	44	20.2	75.7
HCM LOS	F	E	C	F

Lane	NBLn1	NBLn2	EBLn1	EBLn2	EBLn3	WBLn1	WBLn2	WBLn3	SBLn1
Vol Left, %	100%	0%	100%	0%	0%	100%	0%	0%	19%
Vol Thru, %	0%	59%	0%	100%	0%	0%	100%	47%	24%
Vol Right, %	0%	41%	0%	0%	100%	0%	0%	53%	57%
Sign Control	Stop	Stop	Stop	Stop	Stop	Stop	Stop	Stop	Stop
Traffic Vol by Lane	93	95	206	373	107	64	283	302	323
LT Vol	93	0	206	0	0	64	0	0	62
Through Vol	0	56	0	373	0	0	283	142	76
RT Vol	0	39	0	0	107	0	0	160	185
Lane Flow Rate	98	100	217	393	113	67	298	318	340
Geometry Grp	8	8	8	8	8	8	8	8	8
Degree of Util (X)	0.325	0.31	0.636	1.094	0.291	0.195	0.821	0.841	0.973
Departure Headway (Hd)	12.418	11.589	10.558	10.031	9.293	10.827	10.299	9.906	10.615
Convergence, Y/N	Yes	Yes	Yes	Yes	Yes	Yes	Yes	Yes	Yes
Cap	292	312	340	361	385	333	355	368	343
Service Time	10.118	9.289	8.348	7.82	7.081	8.527	7.999	7.606	8.315
HCM Lane V/C Ratio	0.336	0.321	0.638	1.089	0.294	0.201	0.839	0.864	0.991
HCM Control Delay	21	19.4	30.2	107.7	15.9	16.1	46.4	47.7	75.7
HCM Lane LOS	C	C	D	F	C	C	E	E	F
HCM 95th-tile Q	1.4	1.3	4.1	14.3	1.2	0.7	7.2	7.7	10.6

HCM 6th TWSC
6: Commerce St & Mission Inn Ave

05/04/2020

Intersection												
Int Delay, s/veh	9.6											
Movement	EBL	EBT	EBR	WBL	WBT	WBR	NBL	NBT	NBR	SBL	SBT	SBR
Lane Configurations		↕	↗		↕↗			↕			↕	
Traffic Vol, veh/h	26	355	94	21	521	21	119	42	23	4	42	9
Future Vol, veh/h	26	355	94	21	521	21	119	42	23	4	42	9
Conflicting Peds, #/hr	0	0	0	0	0	0	0	0	0	0	0	0
Sign Control	Free	Free	Free	Free	Free	Free	Stop	Stop	Stop	Stop	Stop	Stop
RT Channelized	-	-	None	-	-	None	-	-	None	-	-	None
Storage Length	-	-	0	-	-	-	-	-	-	-	-	-
Veh in Median Storage, #	-	0	-	-	0	-	-	0	-	-	0	-
Grade, %	-	0	-	-	0	-	-	0	-	-	0	-
Peak Hour Factor	95	95	95	95	95	95	95	95	95	95	95	95
Heavy Vehicles, %	2	2	2	2	2	2	2	2	2	2	2	2
Mvmt Flow	27	374	99	22	548	22	125	44	24	4	44	9

Major/Minor	Major1			Major2			Minor1			Minor2		
Conflicting Flow All	570	0	0	473	0	0	768	1042	374	1115	1130	285
Stage 1	-	-	-	-	-	-	428	428	-	603	603	-
Stage 2	-	-	-	-	-	-	340	614	-	512	527	-
Critical Hdwy	4.13	-	-	4.13	-	-	7.33	6.53	6.23	7.33	6.53	6.93
Critical Hdwy Stg 1	-	-	-	-	-	-	6.13	5.53	-	6.53	5.53	-
Critical Hdwy Stg 2	-	-	-	-	-	-	6.53	5.53	-	6.13	5.53	-
Follow-up Hdwy	2.219	-	-	2.219	-	-	3.519	4.019	3.319	3.519	4.019	3.319
Pot Cap-1 Maneuver	1000	-	-	1087	-	-	305	229	671	174	203	713
Stage 1	-	-	-	-	-	-	604	584	-	454	487	-
Stage 2	-	-	-	-	-	-	649	482	-	544	527	-
Platoon blocked, %	-	-	-	-	-	-	-	-	-	-	-	-
Mov Cap-1 Maneuver	1000	-	-	1087	-	-	235	214	671	134	190	713
Mov Cap-2 Maneuver	-	-	-	-	-	-	235	214	-	134	190	-
Stage 1	-	-	-	-	-	-	582	562	-	437	472	-
Stage 2	-	-	-	-	-	-	563	468	-	465	508	-

Approach	EB			WB			NB			SB		
HCM Control Delay, s	0.5			0.4			55.8			28.7		
HCM LOS							F			D		

Minor Lane/Major Mvmt	NBLn1	EBL	EBT	EBR	WBL	WBT	WBR	SBLn1
Capacity (veh/h)	250	1000	-	-	1087	-	-	209
HCM Lane V/C Ratio	0.775	0.027	-	-	0.02	-	-	0.277
HCM Control Delay (s)	55.8	8.7	0	-	8.4	0.1	-	28.7
HCM Lane LOS	F	A	A	-	A	A	-	D
HCM 95th %tile Q(veh)	5.7	0.1	-	-	0.1	-	-	1.1

Intersection						
Int Delay, s/veh	1.9					
Movement	WBL	WBR	NBT	NBR	SBL	SBT
Lane Configurations	W		T			T
Traffic Vol, veh/h	9	41	142	7	24	134
Future Vol, veh/h	9	41	142	7	24	134
Conflicting Peds, #/hr	0	0	0	0	0	0
Sign Control	Stop	Stop	Free	Free	Free	Free
RT Channelized	-	None	-	None	-	None
Storage Length	0	-	-	-	-	-
Veh in Median Storage, #	0	-	0	-	-	0
Grade, %	0	-	0	-	-	0
Peak Hour Factor	95	95	95	95	95	95
Heavy Vehicles, %	2	2	2	2	2	2
Mvmt Flow	9	43	149	7	25	141

Major/Minor	Minor1	Major1	Major2			
Conflicting Flow All	344	153	0	0	156	0
Stage 1	153	-	-	-	-	-
Stage 2	191	-	-	-	-	-
Critical Hdwy	6.42	6.22	-	-	4.12	-
Critical Hdwy Stg 1	5.42	-	-	-	-	-
Critical Hdwy Stg 2	5.42	-	-	-	-	-
Follow-up Hdwy	3.518	3.318	-	-	2.218	-
Pot Cap-1 Maneuver	652	893	-	-	1424	-
Stage 1	875	-	-	-	-	-
Stage 2	841	-	-	-	-	-
Platoon blocked, %			-	-	-	-
Mov Cap-1 Maneuver	640	893	-	-	1424	-
Mov Cap-2 Maneuver	640	-	-	-	-	-
Stage 1	858	-	-	-	-	-
Stage 2	841	-	-	-	-	-

Approach	WB	NB	SB
HCM Control Delay, s	9.6	0	1.2
HCM LOS	A		

Minor Lane/Major Mvmt	NBT	NBRWBLn1	SBL	SBT
Capacity (veh/h)	-	-	834	1424
HCM Lane V/C Ratio	-	-	0.063	0.018
HCM Control Delay (s)	-	-	9.6	7.6
HCM Lane LOS	-	-	A	A
HCM 95th %tile Q(veh)	-	-	0.2	0.1

HCM 6th TWSC
8: Howard Ave & Tenth St

05/04/2020

Intersection						
Int Delay, s/veh	3.6					
Movement	EBT	EBR	WBL	WBT	NBL	NBR
Lane Configurations	T			T		T
Traffic Vol, veh/h	85	324	43	28	101	54
Future Vol, veh/h	85	324	43	28	101	54
Conflicting Peds, #/hr	0	0	0	0	0	0
Sign Control	Free	Free	Free	Free	Stop	Stop
RT Channelized	-	None	-	None	-	None
Storage Length	-	-	-	-	0	-
Veh in Median Storage, #	0	-	-	0	0	-
Grade, %	0	-	-	0	0	-
Peak Hour Factor	95	95	95	95	95	95
Heavy Vehicles, %	2	2	2	2	2	2
Mvmt Flow	89	341	45	29	106	57

Major/Minor	Major1	Major2	Minor1	Minor2	Minor3
Conflicting Flow All	0	0	430	0	379
Stage 1	-	-	-	-	260
Stage 2	-	-	-	-	119
Critical Hdwy	-	-	4.12	-	6.42
Critical Hdwy Stg 1	-	-	-	-	5.42
Critical Hdwy Stg 2	-	-	-	-	5.42
Follow-up Hdwy	-	-	2.218	-	3.518
Pot Cap-1 Maneuver	-	-	1129	-	623
Stage 1	-	-	-	-	783
Stage 2	-	-	-	-	906
Platoon blocked, %	-	-	-	-	-
Mov Cap-1 Maneuver	-	-	1129	-	597
Mov Cap-2 Maneuver	-	-	-	-	597
Stage 1	-	-	-	-	751
Stage 2	-	-	-	-	906

Approach	EB	WB	NB
HCM Control Delay, s	0	5	12.4
HCM LOS	B		

Minor Lane/Major Mvmt	NBLn1	EBT	EBR	WBL	WBT
Capacity (veh/h)	650	-	-	1129	-
HCM Lane V/C Ratio	0.251	-	-	0.04	-
HCM Control Delay (s)	12.4	-	-	8.3	0
HCM Lane LOS	B	-	-	A	A
HCM 95th %tile Q(veh)	1	-	-	0.1	-

HCM 6th Signalized Intersection Summary
 9: SR 91 Off-Ramp/SR 91 On-Ramp & 14th St

05/04/2020



Movement	EBL	EBT	EBR	WBL	WBT	WBR	NBL	NBT	NBR	SBL	SBT	SBR
Lane Configurations	↔↔	↑↑			↑↑↑	↔	↔	↔	↔			
Traffic Volume (veh/h)	679	1415	0	0	854	148	262	3	560	0	0	0
Future Volume (veh/h)	679	1415	0	0	854	148	262	3	560	0	0	0
Initial Q (Qb), veh	0	0	0	0	0	0	0	0	0			
Ped-Bike Adj(A_pbT)	1.00		1.00	1.00		1.00	1.00		1.00			
Parking Bus, Adj	1.00	1.00	1.00	1.00	1.00	1.00	1.00	1.00	1.00			
Work Zone On Approach		No			No			No				
Adj Sat Flow, veh/h/ln	1870	1870	0	0	1870	1870	1870	1870	1870			
Adj Flow Rate, veh/h	715	1489	0	0	899	156	278	0	589			
Peak Hour Factor	0.95	0.95	0.95	0.95	0.95	0.95	0.95	0.95	0.95			
Percent Heavy Veh, %	2	2	0	0	2	2	2	2	2			
Cap, veh/h	847	1830	0	0	1149	357	1407	0	626			
Arrive On Green	0.25	0.51	0.00	0.00	0.22	0.22	0.40	0.00	0.40			
Sat Flow, veh/h	3456	3647	0	0	5274	1585	3563	0	1585			
Grp Volume(v), veh/h	715	1489	0	0	899	156	278	0	589			
Grp Sat Flow(s),veh/h/ln	1728	1777	0	0	1702	1585	1781	0	1585			
Q Serve(g_s), s	19.7	35.0	0.0	0.0	16.6	8.5	5.1	0.0	35.8			
Cycle Q Clear(g_c), s	19.7	35.0	0.0	0.0	16.6	8.5	5.1	0.0	35.8			
Prop In Lane	1.00		0.00	0.00		1.00	1.00		1.00			
Lane Grp Cap(c), veh/h	847	1830	0	0	1149	357	1407	0	626			
V/C Ratio(X)	0.84	0.81	0.00	0.00	0.78	0.44	0.20	0.00	0.94			
Avail Cap(c_a), veh/h	847	1830	0	0	1149	357	1407	0	626			
HCM Platoon Ratio	1.00	1.00	1.00	1.00	1.00	1.00	1.00	1.00	1.00			
Upstream Filter(I)	1.00	1.00	0.00	0.00	1.00	1.00	1.00	0.00	1.00			
Uniform Delay (d), s/veh	35.9	20.2	0.0	0.0	36.4	33.3	19.9	0.0	29.1			
Incr Delay (d2), s/veh	10.1	4.1	0.0	0.0	5.3	3.9	0.3	0.0	24.0			
Initial Q Delay(d3),s/veh	0.0	0.0	0.0	0.0	0.0	0.0	0.0	0.0	0.0			
%ile BackOfQ(50%),veh/ln	9.3	14.6	0.0	0.0	7.3	3.6	2.2	0.0	17.2			
Unsig. Movement Delay, s/veh												
LnGrp Delay(d),s/veh	46.0	24.3	0.0	0.0	41.8	37.2	20.2	0.0	53.1			
LnGrp LOS	D	C	A	A	D	D	C	A	D			
Approach Vol, veh/h		2204			1055			867				
Approach Delay, s/veh		31.4			41.1			42.6				
Approach LOS		C			D			D				
Timer - Assigned Phs		2		4			7	8				
Phs Duration (G+Y+Rc), s		44.0		56.0			29.0	27.0				
Change Period (Y+Rc), s		4.5		4.5			4.5	4.5				
Max Green Setting (Gmax), s		39.5		51.5			24.5	22.5				
Max Q Clear Time (g_c+I1), s		37.8		37.0			21.7	18.6				
Green Ext Time (p_c), s		0.7		9.3			0.9	2.3				

Intersection Summary

HCM 6th Ctrl Delay	36.2
HCM 6th LOS	D

Notes

User approved volume balancing among the lanes for turning movement.

HCM 6th Signalized Intersection Summary

11: Park Ave & University Ave

05/04/2020



Movement	EBL	EBT	EBR	WBL	WBT	WBR	NBL	NBT	NBR	SBL	SBT	SBR
Lane Configurations												
Traffic Volume (veh/h)	53	1374	63	42	603	67	50	58	87	254	137	62
Future Volume (veh/h)	53	1374	63	42	603	67	50	58	87	254	137	62
Initial Q (Qb), veh	0	0	0	0	0	0	0	0	0	0	0	0
Ped-Bike Adj(A_pbT)	1.00		1.00	1.00		1.00	1.00		1.00	1.00		1.00
Parking Bus, Adj	1.00	1.00	1.00	1.00	1.00	1.00	1.00	1.00	1.00	1.00	1.00	1.00
Work Zone On Approach		No			No			No			No	
Adj Sat Flow, veh/h/ln	1870	1870	1870	1870	1870	1870	1870	1870	1870	1870	1870	1870
Adj Flow Rate, veh/h	56	1446	66	44	635	71	53	61	92	267	144	65
Peak Hour Factor	0.95	0.95	0.95	0.95	0.95	0.95	0.95	0.95	0.95	0.95	0.95	0.95
Percent Heavy Veh, %	2	2	2	2	2	2	2	2	2	2	2	2
Cap, veh/h	147	1526	69	83	1304	146	144	122	184	300	327	148
Arrive On Green	0.08	0.44	0.44	0.05	0.40	0.40	0.08	0.18	0.18	0.17	0.27	0.27
Sat Flow, veh/h	1781	3461	158	1781	3223	360	1781	673	1015	1781	1220	551
Grp Volume(v), veh/h	56	741	771	44	350	356	53	0	153	267	0	209
Grp Sat Flow(s),veh/h/ln	1781	1777	1842	1781	1777	1806	1781	0	1688	1781	0	1771
Q Serve(g_s), s	3.3	44.0	44.3	2.7	16.1	16.1	3.1	0.0	9.0	16.1	0.0	10.8
Cycle Q Clear(g_c), s	3.3	44.0	44.3	2.7	16.1	16.1	3.1	0.0	9.0	16.1	0.0	10.8
Prop In Lane	1.00		0.09	1.00		0.20	1.00		0.60	1.00		0.31
Lane Grp Cap(c), veh/h	147	783	812	83	719	730	144	0	305	300	0	475
V/C Ratio(X)	0.38	0.95	0.95	0.53	0.49	0.49	0.37	0.00	0.50	0.89	0.00	0.44
Avail Cap(c_a), veh/h	147	783	812	83	719	730	144	0	305	300	0	475
HCM Platoon Ratio	1.00	1.00	1.00	1.00	1.00	1.00	1.00	1.00	1.00	1.00	1.00	1.00
Upstream Filter(I)	1.00	1.00	1.00	1.00	1.00	1.00	1.00	0.00	1.00	1.00	0.00	1.00
Uniform Delay (d), s/veh	47.8	29.5	29.6	51.3	24.3	24.3	47.9	0.0	40.6	44.8	0.0	33.4
Incr Delay (d2), s/veh	7.3	21.3	21.5	22.5	2.3	2.3	7.1	0.0	5.8	30.4	0.0	2.9
Initial Q Delay(d3),s/veh	0.0	0.0	0.0	0.0	0.0	0.0	0.0	0.0	0.0	0.0	0.0	0.0
%ile BackOfQ(50%),veh/ln	1.8	22.7	23.7	1.7	7.1	7.3	1.7	0.0	4.2	9.6	0.0	5.0
Unsig. Movement Delay, s/veh												
LnGrp Delay(d),s/veh	55.1	50.8	51.1	73.7	26.6	26.6	55.0	0.0	46.4	75.1	0.0	36.3
LnGrp LOS	E	D	D	E	C	C	D	A	D	E	A	D
Approach Vol, veh/h		1568			750			206				476
Approach Delay, s/veh		51.1			29.4			48.6				58.1
Approach LOS		D			C			D				E
Timer - Assigned Phs	1	2	3	4	5	6	7	8				
Phs Duration (G+Y+Rc), s	23.0	24.4	9.6	53.0	13.4	34.0	13.6	49.0				
Change Period (Y+Rc), s	4.5	4.5	4.5	4.5	4.5	4.5	4.5	4.5				
Max Green Setting (Gmax), s	10.5	19.9	5.1	48.5	8.9	29.5	9.1	44.5				
Max Q Clear Time (g_c+10), s	11.0	11.0	4.7	46.3	5.1	12.8	5.3	18.1				
Green Ext Time (p_c), s	0.0	0.5	0.0	1.8	0.0	1.0	0.0	4.8				
Intersection Summary												
HCM 6th Ctrl Delay												46.6
HCM 6th LOS												D

HCM 6th AWSC
12: Howard Ave & 12th St

05/04/2020

Intersection

Intersection Delay, s/veh10:1

Intersection LOS B

Movement	EBL	EBT	EBR	WBL	WBT	WBR	NBL	NBT	NBR	SBL	SBT	SBR
Lane Configurations		↔			↔			↔			↔	
Traffic Vol, veh/h	0	8	70	29	3	13	12	76	28	20	327	20
Future Vol, veh/h	0	8	70	29	3	13	12	76	28	20	327	20
Peak Hour Factor	0.95	0.95	0.95	0.95	0.95	0.95	0.95	0.95	0.95	0.95	0.95	0.95
Heavy Vehicles, %	2	2	2	2	2	2	2	2	2	2	2	2
Mvmt Flow	0	8	74	31	3	14	13	80	29	21	344	21
Number of Lanes	0	1	0	0	1	0	0	1	0	0	1	0

Approach	EB	WB	SB
Opposing Approach	WB	EB	SB
Opposing Lanes	1	1	1
Conflicting Approach Left	SB	NB	EB
Conflicting Lanes Left	1	1	1
Conflicting Approach Right	NB	SB	WB
Conflicting Lanes Right	1	1	1
HCM Control Delay	8.2	8.6	8.4
HCM LOS	A	A	B

Lane NBLn1 EBLn1WBLn1 SBLn1

Vol Left, %	10%	0%	64%	5%
Vol Thru, %	66%	10%	7%	89%
Vol Right, %	24%	90%	29%	5%
Sign Control	Stop	Stop	Stop	Stop
Traffic Vol by Lane	116	78	45	367
LT Vol	12	0	29	20
Through Vol	76	8	3	327
RT Vol	28	70	13	20
Lane Flow Rate	122	82	47	386
Geometry Grp	1	1	1	1
Degree of Util (X)	0.154	0.105	0.068	0.468
Departure Headway (Hd)	4.535	4.596	5.135	4.359
Convergence, Y/N	Yes	Yes	Yes	Yes
Cap	789	778	695	827
Service Time	2.571	2.639	3.182	2.387
HCM Lane V/C Ratio	0.155	0.105	0.068	0.467
HCM Control Delay	8.4	8.2	8.6	11.2
HCM Lane LOS	A	A	A	B
HCM 95th-tile Q	0.5	0.4	0.2	2.5

HCM 6th Signalized Intersection Summary

13: Olivewood Ave/Lime St & 14th St

05/04/2020



Movement	EBL	EBT	EBR	WBL	WBT	WBR	NBL	NBT	NBR	SBL	SBT	SBR
Lane Configurations	↖ ↑↑↑			↖ ↑↑↑			↖ ↑↑	↑↑	↖	↖↖	↑↑	
Traffic Volume (veh/h)	31	1089	87	277	898	83	49	198	466	406	840	52
Future Volume (veh/h)	31	1089	87	277	898	83	49	198	466	406	840	52
Initial Q (Qb), veh	0	0	0	0	0	0	0	0	0	0	0	0
Ped-Bike Adj(A_pbT)	1.00		1.00	1.00		1.00	1.00		1.00	1.00		1.00
Parking Bus, Adj	1.00	1.00	1.00	1.00	1.00	1.00	1.00	1.00	1.00	1.00	1.00	1.00
Work Zone On Approach	No			No			No			No		
Adj Sat Flow, veh/h/ln	1870	1870	1870	1870	1870	1870	1870	1870	1870	1870	1870	1870
Adj Flow Rate, veh/h	33	1146	92	292	945	87	52	208	491	427	884	55
Peak Hour Factor	0.95	0.95	0.95	0.95	0.95	0.95	0.95	0.95	0.95	0.95	0.95	0.95
Percent Heavy Veh, %	2	2	2	2	2	2	2	2	2	2	2	2
Cap, veh/h	102	1248	100	348	1891	174	89	420	712	543	1127	70
Arrive On Green	0.06	0.26	0.26	0.06	0.13	0.13	0.05	0.22	0.22	0.16	0.33	0.33
Sat Flow, veh/h	1781	4818	387	1781	4759	437	1781	1870	3170	3456	3398	211
Grp Volume(v), veh/h	33	809	429	292	675	357	52	208	491	427	462	477
Grp Sat Flow(s),veh/h/ln	1781	1702	1801	1781	1702	1792	1781	1870	1585	1728	1777	1832
Q Serve(g_s), s	2.0	25.4	25.5	17.8	20.3	20.4	3.1	10.7	15.6	13.1	25.8	25.8
Cycle Q Clear(g_c), s	2.0	25.4	25.5	17.8	20.3	20.4	3.1	10.7	15.6	13.1	25.8	25.8
Prop In Lane	1.00		0.21	1.00		0.24	1.00		1.00	1.00		0.12
Lane Grp Cap(c), veh/h	102	882	467	348	1352	712	89	420	712	543	590	608
V/C Ratio(X)	0.32	0.92	0.92	0.84	0.50	0.50	0.58	0.50	0.69	0.79	0.78	0.78
Avail Cap(c_a), veh/h	102	882	467	348	1352	712	89	420	712	543	590	608
HCM Platoon Ratio	1.00	1.00	1.00	0.33	0.33	0.33	1.00	1.00	1.00	1.00	1.00	1.00
Upstream Filter(I)	1.00	1.00	1.00	1.00	1.00	1.00	1.00	1.00	1.00	1.00	1.00	1.00
Uniform Delay (d), s/veh	49.8	39.6	39.6	49.7	37.6	37.7	51.1	37.2	39.1	44.6	33.2	33.2
Incr Delay (d2), s/veh	8.2	15.9	25.6	20.9	1.3	2.5	25.0	4.1	5.4	10.9	10.0	9.8
Initial Q Delay(d3),s/veh	0.0	0.0	0.0	0.0	0.0	0.0	0.0	0.0	0.0	0.0	0.0	0.0
%ile BackOfQ(50%),veh/ln	1.1	12.4	14.4	10.5	9.5	10.3	2.0	5.3	6.6	6.4	12.6	12.9
Unsig. Movement Delay, s/veh												
LnGrp Delay(d),s/veh	58.0	55.5	65.2	70.6	38.9	40.2	76.1	41.3	44.5	55.5	43.2	43.0
LnGrp LOS	E	E	E	E	D	D	E	D	D	E	D	D
Approach Vol, veh/h	1271		1324		751		1366					
Approach Delay, s/veh	58.9		46.3		45.8		47.0					
Approach LOS	E		D		D		D					
Timer - Assigned Phs	1	2	3	4	5	6	7	8				
Phs Duration (G+Y+Rc), s	31.8	29.2	26.0	33.0	10.0	41.0	10.8	48.2				
Change Period (Y+Rc), s	4.5	4.5	4.5	4.5	4.5	4.5	4.5	4.5				
Max Green Setting (Gmax), s	31.8	24.7	21.5	28.5	5.5	36.5	6.3	43.7				
Max Q Clear Time (g_c+M), s	17.6	17.6	19.8	27.5	5.1	27.8	4.0	22.4				
Green Ext Time (p_c), s	0.4	2.0	0.2	0.8	0.0	3.9	0.0	7.3				

Intersection Summary

HCM 6th Ctrl Delay	49.8
HCM 6th LOS	D

Notes

User approved volume balancing among the lanes for turning movement.

HCM 6th Signalized Intersection Summary

14: Mulberry St/SR 91 Off-Ramp & 14th St

05/04/2020



Movement	EBL	EBT	EBR	WBL	WBT	WBR	NBL	NBT	NBR	SBL	SBT	SBR
Lane Configurations		↑↑↑		↗↘	↑↑↑					↗	↔	↘
Traffic Volume (veh/h)	0	1666	295	387	729	0	0	0	0	429	232	528
Future Volume (veh/h)	0	1666	295	387	729	0	0	0	0	429	232	528
Initial Q (Qb), veh	0	0	0	0	0	0				0	0	0
Ped-Bike Adj(A_pbT)	1.00		1.00	1.00		1.00				1.00		1.00
Parking Bus, Adj	1.00	1.00	1.00	1.00	1.00	1.00				1.00	1.00	1.00
Work Zone On Approach		No		No						No		
Adj Sat Flow, veh/h/ln	0	1870	1870	1870	1870	0				1870	1870	1870
Adj Flow Rate, veh/h	0	1754	311	407	767	0				301	350	626
Peak Hour Factor	0.95	0.95	0.95	0.95	0.95	0.95				0.95	0.95	0.95
Percent Heavy Veh, %	0	2	2	2	2	0				2	2	2
Cap, veh/h	0	2038	358	525	3365	0				462	485	821
Arrive On Green	0.00	0.31	0.31	0.15	0.66	0.00				0.26	0.26	0.26
Sat Flow, veh/h	0	4538	767	3456	5274	0				1781	1870	3170
Grp Volume(v), veh/h	0	1363	702	407	767	0				301	350	626
Grp Sat Flow(s),veh/h/ln	0	1702	1732	1728	1702	0				1781	1870	1585
Q Serve(g_s), s	0.0	41.4	42.1	12.5	6.6	0.0				16.6	18.8	20.1
Cycle Q Clear(g_c), s	0.0	41.4	42.1	12.5	6.6	0.0				16.6	18.8	20.1
Prop In Lane	0.00		0.44	1.00		0.00				1.00		1.00
Lane Grp Cap(c), veh/h	0	1588	808	525	3365	0				462	485	821
V/C Ratio(X)	0.00	0.86	0.87	0.78	0.23	0.00				0.65	0.72	0.76
Avail Cap(c_a), veh/h	0	1588	808	525	3365	0				462	485	821
HCM Platoon Ratio	1.00	0.67	0.67	1.00	1.00	1.00				1.00	1.00	1.00
Upstream Filter(I)	0.00	1.00	1.00	1.00	1.00	0.00				1.00	1.00	1.00
Uniform Delay (d), s/veh	0.0	34.4	34.7	44.8	7.5	0.0				36.3	37.1	37.6
Incr Delay (d2), s/veh	0.0	6.3	12.3	10.7	0.2	0.0				7.0	9.0	6.6
Initial Q Delay(d3),s/veh	0.0	0.0	0.0	0.0	0.0	0.0				0.0	0.0	0.0
%ile BackOfQ(50%),veh/ln	0.0	19.1	21.1	6.1	2.3	0.0				8.0	9.7	8.4
Unsig. Movement Delay, s/veh												
LnGrp Delay(d),s/veh	0.0	40.7	46.9	55.6	7.7	0.0				43.3	46.2	44.2
LnGrp LOS	A	D	D	E	A	A				D	D	D
Approach Vol, veh/h		2065			1174						1277	
Approach Delay, s/veh		42.8			24.3						44.5	
Approach LOS		D			C						D	
Timer - Assigned Phs			3	4		6		8				
Phs Duration (G+Y+Rc), s			21.2	55.8		33.0		77.0				
Change Period (Y+Rc), s			4.5	4.5		4.5		4.5				
Max Green Setting (Gmax), s			16.7	51.3		28.5		72.5				
Max Q Clear Time (g_c+I1), s			14.5	44.1		22.1		8.6				
Green Ext Time (p_c), s			0.4	6.2		3.2		6.5				
Intersection Summary												
HCM 6th Ctrl Delay			38.5									
HCM 6th LOS			D									
Notes												
User approved volume balancing among the lanes for turning movement.												

Opening Year AM

HCM 6th Signalized Intersection Summary

2: Mission Inn Ave & SR 91 Off-Ramp

05/04/2020

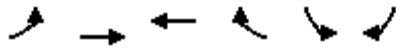

Movement	EBL	EBT	WBT	WBR	SBL	SBR
Lane Configurations		↑↑	↑↑		↘	↘↘
Traffic Volume (veh/h)	0	270	193	0	221	1013
Future Volume (veh/h)	0	270	193	0	221	1013
Initial Q (Qb), veh	0	0	0	0	0	0
Ped-Bike Adj(A_pbT)	1.00			1.00	1.00	1.00
Parking Bus, Adj	1.00	1.00	1.00	1.00	1.00	1.00
Work Zone On Approach		No	No		No	
Adj Sat Flow, veh/h/ln	0	1870	1870	0	1870	1870
Adj Flow Rate, veh/h	0	284	208	0	235	1078
Peak Hour Factor	0.25	0.95	0.93	0.25	0.94	0.94
Percent Heavy Veh, %	0	2	2	0	2	2
Cap, veh/h	0	921	921	0	1174	1839
Arrive On Green	0.00	0.26	0.52	0.00	0.66	0.66
Sat Flow, veh/h	0	3741	3741	0	1781	2790
Grp Volume(v), veh/h	0	284	208	0	235	1078
Grp Sat Flow(s),veh/h/ln	0	1777	1777	0	1781	1395
Q Serve(g_s), s	0.0	7.1	3.5	0.0	5.7	23.6
Cycle Q Clear(g_c), s	0.0	7.1	3.5	0.0	5.7	23.6
Prop In Lane	0.00			0.00	1.00	1.00
Lane Grp Cap(c), veh/h	0	921	921	0	1174	1839
V/C Ratio(X)	0.00	0.31	0.23	0.00	0.20	0.59
Avail Cap(c_a), veh/h	0	921	921	0	1174	1839
HCM Platoon Ratio	1.00	1.00	2.00	1.00	1.00	1.00
Upstream Filter(l)	0.00	1.00	1.00	0.00	1.00	1.00
Uniform Delay (d), s/veh	0.0	32.8	20.5	0.0	7.4	10.4
Incr Delay (d2), s/veh	0.0	0.9	0.6	0.0	0.4	1.4
Initial Q Delay(d3),s/veh	0.0	0.0	0.0	0.0	0.0	0.0
%ile BackOfQ(50%),veh/ln	0.0	3.2	1.5	0.0	2.2	7.0
Unsig. Movement Delay, s/veh						
LnGrp Delay(d),s/veh	0.0	33.7	21.1	0.0	7.7	11.8
LnGrp LOS	A	C	C	A	A	B
Approach Vol, veh/h		284	208		1313	
Approach Delay, s/veh		33.7	21.1		11.1	
Approach LOS		C	C		B	
Timer - Assigned Phs				4	6	8
Phs Duration (G+Y+Rc), s				33.0	77.0	33.0
Change Period (Y+Rc), s				4.5	4.5	4.5
Max Green Setting (Gmax), s				28.5	72.5	28.5
Max Q Clear Time (g_c+I1), s				9.1	25.6	5.5
Green Ext Time (p_c), s				1.7	6.8	1.2
Intersection Summary						
HCM 6th Ctrl Delay			15.8			
HCM 6th LOS			B			

HCM 6th Signalized Intersection Summary

3: Mulberry St/SR 91 On-Ramp & Mission Inn Ave

05/04/2020



Movement	EBL	EBT	EBR	WBL	WBT	WBR	NBL	NBT	NBR	SBL	SBT	SBR
Lane Configurations	↖	↗			↖	↗	↖	↗				
Traffic Volume (veh/h)	238	253	0	0	65	130	128	278	70	0	0	0
Future Volume (veh/h)	238	253	0	0	65	130	128	278	70	0	0	0
Initial Q (Qb), veh	0	0	0	0	0	0	0	0	0			
Ped-Bike Adj(A_pbT)	1.00		1.00	1.00		1.00	1.00		1.00			
Parking Bus, Adj	1.00	1.00	1.00	1.00	1.00	1.00	1.00	1.00	1.00			
Work Zone On Approach		No			No			No				
Adj Sat Flow, veh/h/ln	1870	1870	0	0	1870	1870	1870	1870	1870			
Adj Flow Rate, veh/h	262	294	0	0	92	0	164	339	86			
Peak Hour Factor	0.91	0.86	0.25	0.25	0.71	0.73	0.78	0.82	0.81			
Percent Heavy Veh, %	2	2	0	0	2	2	2	2	2			
Cap, veh/h	494	1858	0	0	727		704	569	144			
Arrive On Green	0.55	1.00	0.00	0.00	0.20	0.00	0.40	0.40	0.40			
Sat Flow, veh/h	1781	3647	0	0	3741	0	1781	1439	365			
Grp Volume(v), veh/h	262	294	0	0	92	0	164	0	425			
Grp Sat Flow(s),veh/h/ln	1781	1777	0	0	1777	0	1781	0	1805			
Q Serve(g_s), s	10.2	0.0	0.0	0.0	2.3	0.0	6.7	0.0	20.5			
Cycle Q Clear(g_c), s	10.2	0.0	0.0	0.0	2.3	0.0	6.7	0.0	20.5			
Prop In Lane	1.00		0.00	0.00		0.00	1.00		0.20			
Lane Grp Cap(c), veh/h	494	1858	0	0	727		704	0	714			
V/C Ratio(X)	0.53	0.16	0.00	0.00	0.13		0.23	0.00	0.60			
Avail Cap(c_a), veh/h	494	1858	0	0	727		704	0	714			
HCM Platoon Ratio	2.00	2.00	1.00	1.00	1.00	1.00	1.00	1.00	1.00			
Upstream Filter(I)	1.00	1.00	0.00	0.00	1.00	0.00	1.00	0.00	1.00			
Uniform Delay (d), s/veh	20.0	0.0	0.0	0.0	35.7	0.0	22.1	0.0	26.3			
Incr Delay (d2), s/veh	4.0	0.2	0.0	0.0	0.4	0.0	0.8	0.0	3.6			
Initial Q Delay(d3),s/veh	0.0	0.0	0.0	0.0	0.0	0.0	0.0	0.0	0.0			
%ile BackOfQ(50%),veh/ln	0.0	0.0	0.0	0.0	1.0	0.0	3.0	0.0	9.4			
Unsig. Movement Delay, s/veh												
LnGrp Delay(d),s/veh	24.0	0.2	0.0	0.0	36.1	0.0	22.9	0.0	29.9			
LnGrp LOS	C	A	A	A	D		C	A	C			
Approach Vol, veh/h		556			92	A		589				
Approach Delay, s/veh		11.4			36.1			28.0				
Approach LOS		B			D			C				
Timer - Assigned Phs		2		4			7	8				
Phs Duration (G+Y+Rc), s		48.0		62.0			35.0	27.0				
Change Period (Y+Rc), s		4.5		4.5			4.5	4.5				
Max Green Setting (Gmax), s		43.5		57.5			30.5	22.5				
Max Q Clear Time (g_c+I1), s		22.5		2.0			12.2	4.3				
Green Ext Time (p_c), s		3.2		2.1			0.7	0.4				

Intersection Summary

HCM 6th Ctrl Delay	21.1
HCM 6th LOS	C

Notes

Unsignalized Delay for [WBR] is excluded from calculations of the approach delay and intersection delay.

HCM 6th Signalized Intersection Summary

4: Howard Ave & 14th St

05/04/2020



Movement	EBL	EBT	EBR	WBL	WBT	WBR	NBL	NBT	NBR	SBL	SBT	SBR
Lane Configurations												
Traffic Volume (veh/h)	43	617	45	12	1435	15	67	15	15	2	12	64
Future Volume (veh/h)	43	617	45	12	1435	15	67	15	15	2	12	64
Initial Q (Qb), veh	0	0	0	0	0	0	0	0	0	0	0	0
Ped-Bike Adj(A_pbT)	1.00		1.00	1.00		1.00	1.00		1.00	1.00		1.00
Parking Bus, Adj	1.00	1.00	1.00	1.00	1.00	1.00	1.00	1.00	1.00	1.00	1.00	1.00
Work Zone On Approach		No			No			No			No	
Adj Sat Flow, veh/h/ln	1870	1870	1870	1870	1870	1870	1870	1870	1870	1870	1870	1870
Adj Flow Rate, veh/h	61	693	63	22	1631	21	92	21	24	4	22	73
Peak Hour Factor	0.70	0.89	0.71	0.55	0.88	0.70	0.73	0.70	0.62	0.50	0.54	0.88
Percent Heavy Veh, %	2	2	2	2	2	2	2	2	2	2	2	2
Cap, veh/h	157	2181	973	96	2080	27	250	58	54	38	87	255
Arrive On Green	0.09	0.61	0.61	0.05	0.58	0.58	0.21	0.21	0.21	0.21	0.21	0.21
Sat Flow, veh/h	1781	3554	1585	1781	3593	46	931	276	256	19	413	1213
Grp Volume(v), veh/h	61	693	63	22	806	846	137	0	0	99	0	0
Grp Sat Flow(s),veh/h/ln	1781	1777	1585	1781	1777	1862	1464	0	0	1645	0	0
Q Serve(g_s), s	3.6	10.3	1.8	1.3	38.4	38.6	2.8	0.0	0.0	0.0	0.0	0.0
Cycle Q Clear(g_c), s	3.6	10.3	1.8	1.3	38.4	38.6	8.4	0.0	0.0	5.5	0.0	0.0
Prop In Lane	1.00		1.00	1.00		0.02	0.67		0.18	0.04		0.74
Lane Grp Cap(c), veh/h	157	2181	973	96	1029	1078	362	0	0	379	0	0
V/C Ratio(X)	0.39	0.32	0.06	0.23	0.78	0.78	0.38	0.00	0.00	0.26	0.00	0.00
Avail Cap(c_a), veh/h	157	2181	973	96	1029	1078	362	0	0	379	0	0
HCM Platoon Ratio	1.00	1.00	1.00	1.00	1.00	1.00	1.00	1.00	1.00	1.00	1.00	1.00
Upstream Filter(I)	1.00	1.00	1.00	1.00	1.00	1.00	1.00	0.00	0.00	1.00	0.00	0.00
Uniform Delay (d), s/veh	47.3	10.2	8.6	49.9	17.8	17.9	37.5	0.0	0.0	36.5	0.0	0.0
Incr Delay (d2), s/veh	7.1	0.4	0.1	5.5	6.0	5.7	3.0	0.0	0.0	1.7	0.0	0.0
Initial Q Delay(d3),s/veh	0.0	0.0	0.0	0.0	0.0	0.0	0.0	0.0	0.0	0.0	0.0	0.0
%ile BackOfQ(50%),veh/ln	1.9	3.9	0.6	0.7	16.4	17.2	3.5	0.0	0.0	2.4	0.0	0.0
Unsig. Movement Delay, s/veh												
LnGrp Delay(d),s/veh	54.4	10.6	8.7	55.4	23.8	23.6	40.5	0.0	0.0	38.2	0.0	0.0
LnGrp LOS	D	B	A	E	C	C	D	A	A	D	A	A
Approach Vol, veh/h		817			1674			137			99	
Approach Delay, s/veh		13.7			24.1			40.5			38.2	
Approach LOS		B			C			D			D	
Timer - Assigned Phs		2	3	4		6	7	8				
Phs Duration (G+Y+Rc), s		27.6	10.4	72.0		27.6	14.2	68.2				
Change Period (Y+Rc), s		4.5	4.5	4.5		4.5	4.5	4.5				
Max Green Setting (Gmax), s		23.1	5.9	67.5		23.1	9.7	63.7				
Max Q Clear Time (g_c+I1), s		10.4	3.3	12.3		7.5	5.6	40.6				
Green Ext Time (p_c), s		0.5	0.0	6.0		0.4	0.0	13.7				
Intersection Summary												
HCM 6th Ctrl Delay											22.3	
HCM 6th LOS											C	

HCM 6th AWSC
5: Vine St & Mission Inn Ave

05/04/2020

Intersection

Intersection Delay, s/veh 10.4

Intersection LOS B

Movement	EBL	EBT	EBR	WBL	WBT	WBR	NBL	NBT	NBR	SBL	SBT	SBR
Lane Configurations	↙	↑	↗	↙	↑↑		↙	↗			↕	
Traffic Vol, veh/h	101	157	66	1	108	28	45	51	25	18	14	43
Future Vol, veh/h	101	157	66	1	108	28	45	51	25	18	14	43
Peak Hour Factor	0.75	0.88	0.67	0.25	0.73	0.89	0.70	0.89	0.57	0.71	0.81	0.97
Heavy Vehicles, %	2	2	2	2	2	2	2	2	2	2	2	2
Mvmt Flow	135	178	99	4	148	31	64	57	44	25	17	44
Number of Lanes	1	1	1	1	2	0	1	1	0	0	1	0

Approach	EB	WB	NB	SB
Opposing Approach	WB	EB	SB	NB
Opposing Lanes	3	3	1	2
Conflicting Approach Left	SB	NB	EB	WB
Conflicting Lanes Left	1	2	3	3
Conflicting Approach Right	NB	SB	WB	EB
Conflicting Lanes Right	2	1	3	3
HCM Control Delay	10.6	10.1	10.5	10.3
HCM LOS	B	B	B	B

Lane	NBLn1	NBLn2	EBLn1	EBLn2	EBLn3	WBLn1	WBLn2	WBLn3	SBLn1
Vol Left, %	100%	0%	100%	0%	0%	100%	0%	0%	24%
Vol Thru, %	0%	67%	0%	100%	0%	0%	100%	56%	19%
Vol Right, %	0%	33%	0%	0%	100%	0%	0%	44%	57%
Sign Control	Stop	Stop	Stop	Stop	Stop	Stop	Stop	Stop	Stop
Traffic Vol by Lane	45	76	101	157	66	1	72	64	75
LT Vol	45	0	101	0	0	1	0	0	18
Through Vol	0	51	0	157	0	0	72	36	14
RT Vol	0	25	0	0	66	0	0	28	43
Lane Flow Rate	64	101	135	178	99	4	99	81	87
Geometry Grp	8	8	8	8	8	8	8	8	8
Degree of Util (X)	0.124	0.175	0.24	0.292	0.142	0.008	0.174	0.136	0.154
Departure Headway (Hd)	6.941	6.21	6.405	5.899	5.192	6.859	6.353	6.043	6.355
Convergence, Y/N	Yes	Yes	Yes	Yes	Yes	Yes	Yes	Yes	Yes
Cap	516	577	560	608	690	521	564	592	564
Service Time	4.69	3.959	4.145	3.639	2.931	4.607	4.1	3.79	4.107
HCM Lane V/C Ratio	0.124	0.175	0.241	0.293	0.143	0.008	0.176	0.137	0.154
HCM Control Delay	10.7	10.3	11.2	11.1	8.8	9.7	10.4	9.7	10.3
HCM Lane LOS	B	B	B	B	A	A	B	A	B
HCM 95th-tile Q	0.4	0.6	0.9	1.2	0.5	0	0.6	0.5	0.5

HCM 6th TWSC
6: Commerce St & Mission Inn Ave

05/04/2020

Intersection												
Int Delay, s/veh	3.9											
Movement	EBL	EBT	EBR	WBL	WBT	WBR	NBL	NBT	NBR	SBL	SBT	SBR
Lane Configurations		↔	↔		↔			↔			↔	
Traffic Vol, veh/h	13	154	33	4	95	2	28	21	2	3	22	14
Future Vol, veh/h	13	154	33	4	95	2	28	21	2	3	22	14
Conflicting Peds, #/hr	0	0	0	0	0	0	0	0	0	0	0	0
Sign Control	Free	Free	Free	Free	Free	Free	Stop	Stop	Stop	Stop	Stop	Stop
RT Channelized	-	-	None	-	-	None	-	-	None	-	-	None
Storage Length	-	-	0	-	-	-	-	-	-	-	-	-
Veh in Median Storage, #	-	0	-	-	0	-	-	0	-	-	0	-
Grade, %	-	0	-	-	0	-	-	0	-	-	0	-
Peak Hour Factor	75	75	75	50	95	50	69	42	50	25	83	65
Heavy Vehicles, %	2	2	2	2	2	2	2	2	2	2	2	2
Mvmt Flow	17	205	44	8	100	4	41	50	4	12	27	22

Major/Minor	Major1			Major2			Minor1			Minor2		
Conflicting Flow All	104	0	0	249	0	0	319	359	205	406	401	52
Stage 1	-	-	-	-	-	-	239	239	-	118	118	-
Stage 2	-	-	-	-	-	-	80	120	-	288	283	-
Critical Hdwy	4.13	-	-	4.13	-	-	7.33	6.53	6.23	7.33	6.53	6.93
Critical Hdwy Stg 1	-	-	-	-	-	-	6.13	5.53	-	6.53	5.53	-
Critical Hdwy Stg 2	-	-	-	-	-	-	6.53	5.53	-	6.13	5.53	-
Follow-up Hdwy	2.219	-	-	2.219	-	-	3.519	4.019	3.319	3.519	4.019	3.319
Pot Cap-1 Maneuver	1487	-	-	1315	-	-	622	567	835	542	537	1005
Stage 1	-	-	-	-	-	-	764	707	-	874	798	-
Stage 2	-	-	-	-	-	-	920	796	-	719	676	-
Platoon blocked, %	-	-	-	-	-	-	-	-	-	-	-	-
Mov Cap-1 Maneuver	1487	-	-	1315	-	-	577	556	835	495	527	1005
Mov Cap-2 Maneuver	-	-	-	-	-	-	577	556	-	495	527	-
Stage 1	-	-	-	-	-	-	754	698	-	863	793	-
Stage 2	-	-	-	-	-	-	865	791	-	656	667	-

Approach	EB			WB			NB			SB		
HCM Control Delay, s	0.5			0.6			12.5			11.4		
HCM LOS							B			B		

Minor Lane/Major Mvmt	NBLn1	EBL	EBT	EBR	WBL	WBT	WBR	SBLn1
Capacity (veh/h)	573	1487	-	-	1315	-	-	626
HCM Lane V/C Ratio	0.165	0.012	-	-	0.006	-	-	0.096
HCM Control Delay (s)	12.5	7.5	0	-	7.8	0	-	11.4
HCM Lane LOS	B	A	A	-	A	A	-	B
HCM 95th %tile Q(veh)	0.6	0	-	-	0	-	-	0.3

HCM 6th TWSC
7: Commerce St & 9th St

05/04/2020

Intersection						
Int Delay, s/veh	4					
Movement	WBL	WBR	NBT	NBR	SBL	SBT
Lane Configurations						
Traffic Vol, veh/h	4	20	31	0	18	41
Future Vol, veh/h	4	20	31	0	18	41
Conflicting Peds, #/hr	0	0	0	0	0	0
Sign Control	Stop	Stop	Free	Free	Free	Free
RT Channelized	-	None	-	None	-	None
Storage Length	0	-	-	-	-	-
Veh in Median Storage, #	0	-	0	-	-	0
Grade, %	0	-	0	-	-	0
Peak Hour Factor	50	79	77	25	25	68
Heavy Vehicles, %	2	2	2	2	2	2
Mvmt Flow	8	25	40	0	72	60

Major/Minor	Minor1	Major1	Major2			
Conflicting Flow All	244	40	0	0	40	0
Stage 1	40	-	-	-	-	-
Stage 2	204	-	-	-	-	-
Critical Hdwy	6.42	6.22	-	-	4.12	-
Critical Hdwy Stg 1	5.42	-	-	-	-	-
Critical Hdwy Stg 2	5.42	-	-	-	-	-
Follow-up Hdwy	3.518	3.318	-	-	2.218	-
Pot Cap-1 Maneuver	744	1031	-	-	1570	-
Stage 1	982	-	-	-	-	-
Stage 2	830	-	-	-	-	-
Platoon blocked, %			-	-		
Mov Cap-1 Maneuver	709	1031	-	-	1570	-
Mov Cap-2 Maneuver	709	-	-	-	-	-
Stage 1	936	-	-	-	-	-
Stage 2	830	-	-	-	-	-

Approach	WB	NB	SB
HCM Control Delay, s	9	0	4
HCM LOS	A		

Minor Lane/Major Mvmt	NBT	NBRWBLn1	SBL	SBT
Capacity (veh/h)	-	-	930	1570
HCM Lane V/C Ratio	-	-	0.036	0.046
HCM Control Delay (s)	-	-	9	7.4
HCM Lane LOS	-	-	A	A
HCM 95th %tile Q(veh)	-	-	0.1	0.1

HCM 6th TWSC
8: Howard Ave & Tenth St

05/04/2020

Intersection						
Int Delay, s/veh	3.9					
Movement	EBT	EBR	WBL	WBT	NBL	NBR
Lane Configurations						
Traffic Vol, veh/h	10	41	6	9	28	10
Future Vol, veh/h	10	41	6	9	28	10
Conflicting Peds, #/hr	0	0	0	0	0	0
Sign Control	Free	Free	Free	Free	Stop	Stop
RT Channelized	-	None	-	None	-	None
Storage Length	-	-	-	-	0	-
Veh in Median Storage, #	0	-	-	0	0	-
Grade, %	0	-	-	0	0	-
Peak Hour Factor	38	84	62	67	69	56
Heavy Vehicles, %	2	2	2	2	2	2
Mvmt Flow	26	49	10	13	41	18

Major/Minor	Major1	Major2	Minor1	Minor2	Minor3
Conflicting Flow All	0	0	75	0	84
Stage 1	-	-	-	-	51
Stage 2	-	-	-	-	33
Critical Hdwy	-	-	4.12	-	6.42
Critical Hdwy Stg 1	-	-	-	-	5.42
Critical Hdwy Stg 2	-	-	-	-	5.42
Follow-up Hdwy	-	-	2.218	-	3.518
Pot Cap-1 Maneuver	-	-	1524	-	918
Stage 1	-	-	-	-	971
Stage 2	-	-	-	-	989
Platoon blocked, %	-	-	-	-	-
Mov Cap-1 Maneuver	-	-	1524	-	912
Mov Cap-2 Maneuver	-	-	-	-	912
Stage 1	-	-	-	-	964
Stage 2	-	-	-	-	989

Approach	EB	WB	NB
HCM Control Delay, s	0	3.1	9.1
HCM LOS			A

Minor Lane/Major Mvmt	NBLn1	EBT	EBR	WBL	WBT
Capacity (veh/h)	942	-	-	1524	-
HCM Lane V/C Ratio	0.062	-	-	0.006	-
HCM Control Delay (s)	9.1	-	-	7.4	0
HCM Lane LOS	A	-	-	A	A
HCM 95th %tile Q(veh)	0.2	-	-	0	-

HCM 6th Signalized Intersection Summary
 9: SR 91 Off-Ramp/SR 91 On-Ramp & 14th St

05/04/2020



Movement	EBL	EBT	EBR	WBL	WBT	WBR	NBL	NBT	NBR	SBL	SBT	SBR
Lane Configurations	↗↘	↑↑			↑↑↑	↗	↘	↖	↗			
Traffic Volume (veh/h)	620	464	0	0	1327	239	795	0	241	0	0	0
Future Volume (veh/h)	620	464	0	0	1327	239	795	0	241	0	0	0
Initial Q (Qb), veh	0	0	0	0	0	0	0	0	0			
Ped-Bike Adj(A_pbT)	1.00		1.00	1.00		1.00	1.00		1.00			
Parking Bus, Adj	1.00	1.00	1.00	1.00	1.00	1.00	1.00	1.00	1.00			
Work Zone On Approach		No			No			No				
Adj Sat Flow, veh/h/ln	1870	1870	0	0	1870	1870	1870	1870	1870			
Adj Flow Rate, veh/h	674	533	0	0	1412	285	914	0	287			
Peak Hour Factor	0.92	0.87	0.25	0.25	0.94	0.84	0.87	0.25	0.84			
Percent Heavy Veh, %	2	2	0	0	2	2	2	2	2			
Cap, veh/h	778	2114	0	0	1659	515	1122	0	499			
Arrive On Green	0.22	0.60	0.00	0.00	0.32	0.32	0.31	0.00	0.31			
Sat Flow, veh/h	3456	3647	0	0	5274	1585	3563	0	1585			
Grp Volume(v), veh/h	674	533	0	0	1412	285	914	0	287			
Grp Sat Flow(s),veh/h/ln	1728	1777	0	0	1702	1585	1781	0	1585			
Q Serve(g_s), s	18.8	7.1	0.0	0.0	25.8	14.8	23.6	0.0	15.1			
Cycle Q Clear(g_c), s	18.8	7.1	0.0	0.0	25.8	14.8	23.6	0.0	15.1			
Prop In Lane	1.00		0.00	0.00		1.00	1.00		1.00			
Lane Grp Cap(c), veh/h	778	2114	0	0	1659	515	1122	0	499			
V/C Ratio(X)	0.87	0.25	0.00	0.00	0.85	0.55	0.81	0.00	0.57			
Avail Cap(c_a), veh/h	778	2114	0	0	1659	515	1122	0	499			
HCM Platoon Ratio	1.00	1.00	1.00	1.00	1.00	1.00	1.00	1.00	1.00			
Upstream Filter(I)	1.00	1.00	0.00	0.00	1.00	1.00	1.00	0.00	1.00			
Uniform Delay (d), s/veh	37.3	9.6	0.0	0.0	31.5	27.8	31.6	0.0	28.6			
Incr Delay (d2), s/veh	12.5	0.3	0.0	0.0	5.7	4.2	6.5	0.0	4.8			
Initial Q Delay(d3),s/veh	0.0	0.0	0.0	0.0	0.0	0.0	0.0	0.0	0.0			
%ile BackOfQ(50%),veh/ln	9.1	2.7	0.0	0.0	11.2	6.1	10.9	0.0	6.3			
Unsig. Movement Delay, s/veh												
LnGrp Delay(d),s/veh	49.8	9.9	0.0	0.0	37.2	32.0	38.1	0.0	33.4			
LnGrp LOS	D	A	A	A	D	C	D	A	C			
Approach Vol, veh/h		1207			1697			1201				
Approach Delay, s/veh		32.2			36.3			37.0				
Approach LOS		C			D			D				
Timer - Assigned Phs		2		4			7	8				
Phs Duration (G+Y+Rc), s		36.0		64.0			27.0	37.0				
Change Period (Y+Rc), s		4.5		4.5			4.5	4.5				
Max Green Setting (Gmax), s		31.5		59.5			22.5	32.5				
Max Q Clear Time (g_c+I1), s		25.6		9.1			20.8	27.8				
Green Ext Time (p_c), s		2.6		4.1			0.5	3.7				

Intersection Summary

HCM 6th Ctrl Delay	35.3
HCM 6th LOS	D

Notes

User approved volume balancing among the lanes for turning movement.

HCM 6th Signalized Intersection Summary

11: Park Ave & University Ave

05/04/2020



Movement	EBL	EBT	EBR	WBL	WBT	WBR	NBL	NBT	NBR	SBL	SBT	SBR
Lane Configurations												
Traffic Volume (veh/h)	30	524	32	23	749	50	30	30	24	44	36	42
Future Volume (veh/h)	30	524	32	23	749	50	30	30	24	44	36	42
Initial Q (Qb), veh	0	0	0	0	0	0	0	0	0	0	0	0
Ped-Bike Adj(A_pbT)	1.00		1.00	1.00		1.00	1.00		1.00	1.00		1.00
Parking Bus, Adj	1.00	1.00	1.00	1.00	1.00	1.00	1.00	1.00	1.00	1.00	1.00	1.00
Work Zone On Approach		No			No			No			No	
Adj Sat Flow, veh/h/ln	1870	1870	1870	1870	1870	1870	1870	1870	1870	1870	1870	1870
Adj Flow Rate, veh/h	44	616	43	31	805	76	32	52	30	62	45	71
Peak Hour Factor	0.68	0.85	0.75	0.75	0.93	0.66	0.94	0.58	0.79	0.71	0.80	0.59
Percent Heavy Veh, %	2	2	2	2	2	2	2	2	2	2	2	2
Cap, veh/h	154	1455	101	138	1387	131	138	238	137	202	163	258
Arrive On Green	0.09	0.43	0.43	0.08	0.42	0.42	0.08	0.21	0.21	0.11	0.25	0.25
Sat Flow, veh/h	1781	3370	235	1781	3282	310	1781	1113	642	1781	654	1031
Grp Volume(v), veh/h	44	324	335	31	436	445	32	0	82	62	0	116
Grp Sat Flow(s),veh/h/ln	1781	1777	1828	1781	1777	1815	1781	0	1755	1781	0	1685
Q Serve(g_s), s	2.5	14.0	14.0	1.8	20.6	20.6	1.9	0.0	4.2	3.5	0.0	6.1
Cycle Q Clear(g_c), s	2.5	14.0	14.0	1.8	20.6	20.6	1.9	0.0	4.2	3.5	0.0	6.1
Prop In Lane	1.00		0.13	1.00		0.17	1.00		0.37	1.00		0.61
Lane Grp Cap(c), veh/h	154	767	789	138	751	767	138	0	375	202	0	421
V/C Ratio(X)	0.29	0.42	0.42	0.23	0.58	0.58	0.23	0.00	0.22	0.31	0.00	0.28
Avail Cap(c_a), veh/h	154	767	789	138	751	767	138	0	375	202	0	421
HCM Platoon Ratio	1.00	1.00	1.00	1.00	1.00	1.00	1.00	1.00	1.00	1.00	1.00	1.00
Upstream Filter(I)	1.00	1.00	1.00	1.00	1.00	1.00	1.00	0.00	1.00	1.00	0.00	1.00
Uniform Delay (d), s/veh	47.1	21.7	21.7	47.7	24.3	24.3	47.7	0.0	35.7	44.8	0.0	33.2
Incr Delay (d2), s/veh	4.6	1.7	1.7	3.8	3.3	3.2	3.9	0.0	1.3	3.9	0.0	1.6
Initial Q Delay(d3),s/veh	0.0	0.0	0.0	0.0	0.0	0.0	0.0	0.0	0.0	0.0	0.0	0.0
%ile BackOfQ(50%),veh/ln	1.3	6.1	6.3	0.9	9.2	9.4	1.0	0.0	2.0	1.8	0.0	2.7
Unsig. Movement Delay, s/veh												
LnGrp Delay(d),s/veh	51.7	23.4	23.4	51.4	27.5	27.5	51.6	0.0	37.0	48.6	0.0	34.8
LnGrp LOS	D	C	C	D	C	C	D	A	D	D	A	C
Approach Vol, veh/h		703			912			114				178
Approach Delay, s/veh		25.2			28.3			41.1				39.7
Approach LOS		C			C			D				D
Timer - Assigned Phs	1	2	3	4	5	6	7	8				
Phs Duration (G+Y+Rc), s	17.0	28.0	13.0	52.0	13.0	32.0	14.0	51.0				
Change Period (Y+Rc), s	4.5	4.5	4.5	4.5	4.5	4.5	4.5	4.5				
Max Green Setting (Gmax), s	12.5	23.5	8.5	47.5	8.5	27.5	9.5	46.5				
Max Q Clear Time (g_c+1), s	11.5	6.2	3.8	16.0	3.9	8.1	4.5	22.6				
Green Ext Time (p_c), s	0.1	0.3	0.0	4.5	0.0	0.5	0.0	6.1				
Intersection Summary												
HCM 6th Ctrl Delay												29.0
HCM 6th LOS												C

HCM 6th AWSC
12: Howard Ave & 12th St

05/04/2020

Intersection

Intersection Delay, s/veh 7.6

Intersection LOS A

Movement	EBL	EBT	EBR	WBL	WBT	WBR	NBL	NBT	NBR	SBL	SBT	SBR
Lane Configurations		↔		↔		↔		↔			↔	
Traffic Vol, veh/h	1	1	19	18	11	3	2	65	5	0	41	6
Future Vol, veh/h	1	1	19	18	11	3	2	65	5	0	41	6
Peak Hour Factor	0.25	0.25	0.85	0.71	0.62	0.50	0.48	0.70	0.42	0.25	0.68	0.62
Heavy Vehicles, %	2	2	2	2	2	2	2	2	2	2	2	2
Mvmt Flow	4	4	22	25	18	6	4	93	12	0	60	10
Number of Lanes	0	1	0	0	1	0	0	1	0	0	1	0

Approach	EB	WB	WB	NB	NB	SB	SB
Opposing Approach	WB	EB	EB	SB	SB	NB	NB
Opposing Lanes	1	1	1	1	1	1	1
Conflicting Approach Left SB	SB	NB	NB	EB	EB	WB	WB
Conflicting Lanes Left	1	1	1	1	1	1	1
Conflicting Approach RightNB	NB	SB	SB	WB	WB	EB	EB
Conflicting Lanes Right	1	1	1	1	1	1	1
HCM Control Delay	7	7.7	7.7	7.7	7.7	7.5	7.5
HCM LOS	A	A	A	A	A	A	A

Lane	NBLn1	EBLn1	WBLn1	SBLn1	NBLn1
Vol Left, %	3%	5%	56%	0%	
Vol Thru, %	90%	5%	34%	87%	
Vol Right, %	7%	90%	9%	13%	
Sign Control	Stop	Stop	Stop	Stop	
Traffic Vol by Lane	72	21	32	47	
LT Vol	2	1	18	0	
Through Vol	65	1	11	41	
RT Vol	5	19	3	6	
Lane Flow Rate	109	30	49	70	
Geometry Grp	1	1	1	1	
Degree of Util (X)	0.124	0.032	0.059	0.079	
Departure Headway (Hd)	4.09	3.747	4.322	4.08	
Convergence, Y/N	Yes	Yes	Yes	Yes	
Cap	870	937	817	870	
Service Time	2.144	1.845	2.411	2.143	
HCM Lane V/C Ratio	0.125	0.032	0.06	0.08	
HCM Control Delay	7.7	7	7.7	7.5	
HCM Lane LOS	A	A	A	A	
HCM 95th-tile Q	0.4	0.1	0.2	0.3	

HCM 6th Signalized Intersection Summary

13: Olivewood Ave/Lime St & 14th St

05/04/2020



Movement	EBL	EBT	EBR	WBL	WBT	WBR	NBL	NBT	NBR	SBL	SBT	SBR
Lane Configurations	↔ ↑↑↑			↔ ↑↑↑			↔ ↑↑		↔ ↑↑		↔ ↑↑	
Traffic Volume (veh/h)	37	656	49	311	1754	219	97	307	383	45	125	20
Future Volume (veh/h)	37	656	49	311	1754	219	97	307	383	45	125	20
Initial Q (Qb), veh	0	0	0	0	0	0	0	0	0	0	0	0
Ped-Bike Adj(A_pbT)	1.00		1.00	1.00		1.00	1.00		1.00	1.00		1.00
Parking Bus, Adj	1.00	1.00	1.00	1.00	1.00	1.00	1.00	1.00	1.00	1.00	1.00	1.00
Work Zone On Approach	No			No			No		No		No	
Adj Sat Flow, veh/h/ln	1870	1870	1870	1870	1870	1870	1870	1870	1870	1870	1870	1870
Adj Flow Rate, veh/h	52	800	62	342	1886	267	123	363	469	73	151	40
Peak Hour Factor	0.71	0.82	0.79	0.91	0.93	0.82	0.79	0.77	0.86	0.62	0.83	0.50
Percent Heavy Veh, %	2	2	2	2	2	2	2	2	2	2	2	2
Cap, veh/h	105	1147	89	533	2160	303	202	474	804	160	521	134
Arrive On Green	0.06	0.24	0.24	0.60	0.95	0.95	0.11	0.25	0.25	0.05	0.19	0.19
Sat Flow, veh/h	1781	4834	373	1781	4526	634	1781	1870	3170	3456	2798	720
Grp Volume(v), veh/h	52	562	300	342	1414	739	123	363	469	73	94	97
Grp Sat Flow(s),veh/h/ln	1781	1702	1803	1781	1702	1756	1781	1870	1585	1728	1777	1741
Q Serve(g_s), s	3.1	16.6	16.7	13.8	12.2	13.3	7.2	19.8	14.3	2.3	5.0	5.3
Cycle Q Clear(g_c), s	3.1	16.6	16.7	13.8	12.2	13.3	7.2	19.8	14.3	2.3	5.0	5.3
Prop In Lane	1.00		0.21	1.00		0.36	1.00		1.00	1.00		0.41
Lane Grp Cap(c), veh/h	105	808	428	533	1625	838	202	474	804	160	331	324
V/C Ratio(X)	0.49	0.70	0.70	0.64	0.87	0.88	0.61	0.77	0.58	0.46	0.28	0.30
Avail Cap(c_a), veh/h	105	808	428	533	1625	838	202	474	804	160	331	324
HCM Platoon Ratio	1.00	1.00	1.00	2.00	2.00	2.00	1.00	1.00	1.00	1.00	1.00	1.00
Upstream Filter(I)	1.00	1.00	1.00	1.00	1.00	1.00	1.00	1.00	1.00	1.00	1.00	1.00
Uniform Delay (d), s/veh	50.2	38.3	38.4	18.3	1.6	1.6	46.4	38.0	36.0	51.1	38.5	38.6
Incr Delay (d2), s/veh	15.6	4.9	9.2	5.8	6.7	12.9	12.8	11.2	3.1	9.1	2.1	2.3
Initial Q Delay(d3),s/veh	0.0	0.0	0.0	0.0	0.0	0.0	0.0	0.0	0.0	0.0	0.0	0.0
%ile BackOfQ(50%),veh/ln	1.8	7.4	8.4	4.9	2.3	3.9	3.9	10.4	5.8	1.2	2.4	2.5
Unsig. Movement Delay, s/veh												
LnGrp Delay(d),s/veh	65.8	43.3	47.6	24.1	8.2	14.5	59.3	49.2	39.0	60.2	40.6	40.9
LnGrp LOS	E	D	D	C	A	B	E	D	D	E	D	D
Approach Vol, veh/h	914			2495			955		264			
Approach Delay, s/veh	46.0			12.3			45.5		46.1			
Approach LOS	D			B			D		D			
Timer - Assigned Phs	1	2	3	4	5	6	7	8				
Phs Duration (G+Y+Rc), s	9.6	32.4	37.4	30.6	17.0	25.0	11.0	57.0				
Change Period (Y+Rc), s	4.5	4.5	4.5	4.5	4.5	4.5	4.5	4.5				
Max Green Setting (Gmax), s	1	27.9	32.9	26.1	12.5	20.5	6.5	52.5				
Max Q Clear Time (g_c+1), s	1	21.8	15.8	18.7	9.2	7.3	5.1	15.3				
Green Ext Time (p_c), s	0.0	2.3	1.0	3.2	0.1	0.8	0.0	24.2				

Intersection Summary

HCM 6th Ctrl Delay	27.7
HCM 6th LOS	C

Notes

User approved volume balancing among the lanes for turning movement.

HCM 6th Signalized Intersection Summary

14: Mulberry St/SR 91 Off-Ramp & 14th St

05/04/2020



Movement	EBL	EBT	EBR	WBL	WBT	WBR	NBL	NBT	NBR	SBL	SBT	SBR
Lane Configurations		↑↑↑		↗↘	↑↑↑					↗	↔	↘
Traffic Volume (veh/h)	0	941	143	421	1701	0	0	0	0	143	227	583
Future Volume (veh/h)	0	941	143	421	1701	0	0	0	0	143	227	583
Initial Q (Qb), veh	0	0	0	0	0	0				0	0	0
Ped-Bike Adj(A_pbT)	1.00		1.00	1.00		1.00				1.00		1.00
Parking Bus, Adj	1.00	1.00	1.00	1.00	1.00	1.00				1.00	1.00	1.00
Work Zone On Approach		No			No						No	
Adj Sat Flow, veh/h/ln	0	1870	1870	1870	1870	0				1870	1870	1870
Adj Flow Rate, veh/h	0	1001	238	577	1869	0				116	288	654
Peak Hour Factor	0.25	0.94	0.60	0.73	0.91	0.25				0.82	0.85	0.95
Percent Heavy Veh, %	0	2	2	2	2	0				2	2	2
Cap, veh/h	0	1330	316	851	3115	0				549	576	977
Arrive On Green	0.00	0.32	0.32	0.25	0.61	0.00				0.31	0.31	0.31
Sat Flow, veh/h	0	4289	978	3456	5274	0				1781	1870	3170
Grp Volume(v), veh/h	0	827	412	577	1869	0				116	288	654
Grp Sat Flow(s),veh/h/ln	0	1702	1694	1728	1702	0				1781	1870	1585
Q Serve(g_s), s	0.0	23.9	24.0	16.6	24.8	0.0				5.3	13.9	19.8
Cycle Q Clear(g_c), s	0.0	23.9	24.0	16.6	24.8	0.0				5.3	13.9	19.8
Prop In Lane	0.00		0.58	1.00		0.00				1.00		1.00
Lane Grp Cap(c), veh/h	0	1099	547	851	3115	0				549	576	977
V/C Ratio(X)	0.00	0.75	0.75	0.68	0.60	0.00				0.21	0.50	0.67
Avail Cap(c_a), veh/h	0	1099	547	851	3115	0				549	576	977
HCM Platoon Ratio	1.00	1.00	1.00	1.00	1.00	1.00				1.00	1.00	1.00
Upstream Filter(I)	0.00	1.00	1.00	1.00	1.00	0.00				1.00	1.00	1.00
Uniform Delay (d), s/veh	0.0	33.3	33.3	37.5	13.2	0.0				28.2	31.1	33.2
Incr Delay (d2), s/veh	0.0	4.8	9.3	4.3	0.9	0.0				0.9	3.1	3.6
Initial Q Delay(d3),s/veh	0.0	0.0	0.0	0.0	0.0	0.0				0.0	0.0	0.0
%ile BackOfQ(50%),veh/ln	0.0	10.4	11.1	7.5	9.1	0.0				2.4	6.7	8.0
Unsig. Movement Delay, s/veh												
LnGrp Delay(d),s/veh	0.0	38.1	42.7	41.8	14.1	0.0				29.0	34.2	36.8
LnGrp LOS		A	D	D	D	B	A			C	C	D
Approach Vol, veh/h		1239		2446						1058		
Approach Delay, s/veh		39.6		20.6						35.2		
Approach LOS		D		C						D		
Timer - Assigned Phs			3	4		6		8				
Phs Duration (G+Y+Rc), s			31.6	40.0		38.4		71.6				
Change Period (Y+Rc), s			4.5	4.5		4.5		4.5				
Max Green Setting (Gmax), s			27.1	35.5		33.9		67.1				
Max Q Clear Time (g_c+I1), s			18.6	26.0		21.8		26.8				
Green Ext Time (p_c), s			1.5	5.5		4.1		21.8				
Intersection Summary												
HCM 6th Ctrl Delay		28.8										
HCM 6th LOS		C										
Notes												
User approved volume balancing among the lanes for turning movement.												

Opening Year AM with Cumulative Projects

HCM 6th Signalized Intersection Summary

2: Mission Inn Ave & SR 91 Off-Ramp

05/04/2020

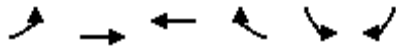

Movement	EBL	EBT	WBT	WBR	SBL	SBR
Lane Configurations		↑↑	↑↑		↵	↵↵
Traffic Volume (veh/h)	0	297	252	0	240	1043
Future Volume (veh/h)	0	297	252	0	240	1043
Initial Q (Qb), veh	0	0	0	0	0	0
Ped-Bike Adj(A_pbT)	1.00			1.00	1.00	1.00
Parking Bus, Adj	1.00	1.00	1.00	1.00	1.00	1.00
Work Zone On Approach		No	No		No	
Adj Sat Flow, veh/h/ln	0	1870	1870	0	1870	1870
Adj Flow Rate, veh/h	0	313	271	0	255	1110
Peak Hour Factor	0.25	0.95	0.93	0.25	0.94	0.94
Percent Heavy Veh, %	0	2	2	0	2	2
Cap, veh/h	0	888	888	0	1190	1864
Arrive On Green	0.00	0.25	0.50	0.00	0.67	0.67
Sat Flow, veh/h	0	3741	3741	0	1781	2790
Grp Volume(v), veh/h	0	313	271	0	255	1110
Grp Sat Flow(s),veh/h/ln	0	1777	1777	0	1781	1395
Q Serve(g_s), s	0.0	8.0	4.9	0.0	6.1	24.1
Cycle Q Clear(g_c), s	0.0	8.0	4.9	0.0	6.1	24.1
Prop In Lane	0.00			0.00	1.00	1.00
Lane Grp Cap(c), veh/h	0	888	888	0	1190	1864
V/C Ratio(X)	0.00	0.35	0.31	0.00	0.21	0.60
Avail Cap(c_a), veh/h	0	888	888	0	1190	1864
HCM Platoon Ratio	1.00	1.00	2.00	1.00	1.00	1.00
Upstream Filter(I)	0.00	1.00	1.00	0.00	1.00	1.00
Uniform Delay (d), s/veh	0.0	33.9	21.9	0.0	7.1	10.1
Incr Delay (d2), s/veh	0.0	1.1	0.9	0.0	0.4	1.4
Initial Q Delay(d3),s/veh	0.0	0.0	0.0	0.0	0.0	0.0
%ile BackOfQ(50%),veh/ln	0.0	3.6	2.0	0.0	2.3	7.0
Unsig. Movement Delay, s/veh						
LnGrp Delay(d),s/veh	0.0	35.0	22.7	0.0	7.5	11.5
LnGrp LOS	A	D	C	A	A	B
Approach Vol, veh/h		313	271		1365	
Approach Delay, s/veh		35.0	22.7		10.7	
Approach LOS		D	C		B	
Timer - Assigned Phs				4	6	8
Phs Duration (G+Y+Rc), s				32.0	78.0	32.0
Change Period (Y+Rc), s				4.5	4.5	4.5
Max Green Setting (Gmax), s				27.5	73.5	27.5
Max Q Clear Time (g_c+I1), s				10.0	26.1	6.9
Green Ext Time (p_c), s				1.8	7.2	1.6
Intersection Summary						
HCM 6th Ctrl Delay		16.3				
HCM 6th LOS		B				

HCM 6th Signalized Intersection Summary

3: Mulberry St/SR 91 On-Ramp & Mission Inn Ave

05/04/2020



Movement	EBL	EBT	EBR	WBL	WBT	WBR	NBL	NBT	NBR	SBL	SBT	SBR
Lane Configurations	↖	↑↑			↑↑		↖	↗				
Traffic Volume (veh/h)	265	272	0	0	90	157	162	278	89	0	0	0
Future Volume (veh/h)	265	272	0	0	90	157	162	278	89	0	0	0
Initial Q (Qb), veh	0	0	0	0	0	0	0	0	0			
Ped-Bike Adj(A_pbT)	1.00		1.00	1.00		1.00	1.00		1.00			
Parking Bus, Adj	1.00	1.00	1.00	1.00	1.00	1.00	1.00	1.00	1.00			
Work Zone On Approach		No			No			No				
Adj Sat Flow, veh/h/ln	1870	1870	0	0	1870	1870	1870	1870	1870			
Adj Flow Rate, veh/h	291	316	0	0	127	0	208	339	110			
Peak Hour Factor	0.91	0.86	0.25	0.25	0.71	0.73	0.78	0.82	0.81			
Percent Heavy Veh, %	2	2	0	0	2	2	2	2	2			
Cap, veh/h	510	1890	0	0	727		688	523	170			
Arrive On Green	0.57	1.00	0.00	0.00	0.20	0.00	0.39	0.39	0.39			
Sat Flow, veh/h	1781	3647	0	0	3741	0	1781	1353	439			
Grp Volume(v), veh/h	291	316	0	0	127	0	208	0	449			
Grp Sat Flow(s),veh/h/ln	1781	1777	0	0	1777	0	1781	0	1791			
Q Serve(g_s), s	11.4	0.0	0.0	0.0	3.2	0.0	8.9	0.0	22.6			
Cycle Q Clear(g_c), s	11.4	0.0	0.0	0.0	3.2	0.0	8.9	0.0	22.6			
Prop In Lane	1.00		0.00	0.00		0.00	1.00		0.24			
Lane Grp Cap(c), veh/h	510	1890	0	0	727		688	0	692			
V/C Ratio(X)	0.57	0.17	0.00	0.00	0.17		0.30	0.00	0.65			
Avail Cap(c_a), veh/h	510	1890	0	0	727		688	0	692			
HCM Platoon Ratio	2.00	2.00	1.00	1.00	1.00	1.00	1.00	1.00	1.00			
Upstream Filter(I)	1.00	1.00	0.00	0.00	1.00	0.00	1.00	0.00	1.00			
Uniform Delay (d), s/veh	19.2	0.0	0.0	0.0	36.1	0.0	23.4	0.0	27.6			
Incr Delay (d2), s/veh	4.6	0.2	0.0	0.0	0.5	0.0	1.1	0.0	4.7			
Initial Q Delay(d3),s/veh	0.0	0.0	0.0	0.0	0.0	0.0	0.0	0.0	0.0			
%ile BackOfQ(50%),veh/ln	4.3	0.1	0.0	0.0	1.5	0.0	3.9	0.0	10.4			
Unsig. Movement Delay, s/veh												
LnGrp Delay(d),s/veh	23.8	0.2	0.0	0.0	36.6	0.0	24.6	0.0	32.3			
LnGrp LOS	C	A	A	A	D		C	A	C			
Approach Vol, veh/h		607			127	A		657				
Approach Delay, s/veh		11.5			36.6			29.9				
Approach LOS		B			D			C				
Timer - Assigned Phs		2		4			7	8				
Phs Duration (G+Y+Rc), s		47.0		63.0			36.0	27.0				
Change Period (Y+Rc), s		4.5		4.5			4.5	4.5				
Max Green Setting (Gmax), s		42.5		58.5			31.5	22.5				
Max Q Clear Time (g_c+I1), s		24.6		2.0			13.4	5.2				
Green Ext Time (p_c), s		3.4		2.3			0.8	0.6				

Intersection Summary

HCM 6th Ctrl Delay	22.5
HCM 6th LOS	C

Notes

Unsignalized Delay for [WBR] is excluded from calculations of the approach delay and intersection delay.

HCM 6th Signalized Intersection Summary

4: Howard Ave & 14th St

05/04/2020



Movement	EBL	EBT	EBR	WBL	WBT	WBR	NBL	NBT	NBR	SBL	SBT	SBR
Lane Configurations												
Traffic Volume (veh/h)	43	619	45	12	1441	15	67	15	15	2	12	64
Future Volume (veh/h)	43	619	45	12	1441	15	67	15	15	2	12	64
Initial Q (Qb), veh	0	0	0	0	0	0	0	0	0	0	0	0
Ped-Bike Adj(A_pbT)	1.00		1.00	1.00		1.00	1.00		1.00	1.00		1.00
Parking Bus, Adj	1.00	1.00	1.00	1.00	1.00	1.00	1.00	1.00	1.00	1.00	1.00	1.00
Work Zone On Approach		No			No			No			No	
Adj Sat Flow, veh/h/ln	1870	1870	1870	1870	1870	1870	1870	1870	1870	1870	1870	1870
Adj Flow Rate, veh/h	61	696	63	22	1638	21	92	21	24	4	22	73
Peak Hour Factor	0.70	0.89	0.71	0.55	0.88	0.70	0.73	0.70	0.62	0.50	0.54	0.88
Percent Heavy Veh, %	2	2	2	2	2	2	2	2	2	2	2	2
Cap, veh/h	157	2187	976	96	2087	27	248	58	53	38	86	252
Arrive On Green	0.09	0.62	0.62	0.05	0.58	0.58	0.21	0.21	0.21	0.21	0.21	0.21
Sat Flow, veh/h	1781	3554	1585	1781	3593	46	931	276	256	19	413	1213
Grp Volume(v), veh/h	61	696	63	22	809	850	137	0	0	99	0	0
Grp Sat Flow(s),veh/h/ln	1781	1777	1585	1781	1777	1862	1464	0	0	1645	0	0
Q Serve(g_s), s	3.6	10.3	1.8	1.3	38.5	38.7	2.9	0.0	0.0	0.0	0.0	0.0
Cycle Q Clear(g_c), s	3.6	10.3	1.8	1.3	38.5	38.7	8.4	0.0	0.0	5.6	0.0	0.0
Prop In Lane	1.00		1.00	1.00		0.02	0.67		0.18	0.04		0.74
Lane Grp Cap(c), veh/h	157	2187	976	96	1032	1082	359	0	0	376	0	0
V/C Ratio(X)	0.39	0.32	0.06	0.23	0.78	0.79	0.38	0.00	0.00	0.26	0.00	0.00
Avail Cap(c_a), veh/h	157	2187	976	96	1032	1082	359	0	0	376	0	0
HCM Platoon Ratio	1.00	1.00	1.00	1.00	1.00	1.00	1.00	1.00	1.00	1.00	1.00	1.00
Upstream Filter(I)	1.00	1.00	1.00	1.00	1.00	1.00	1.00	0.00	0.00	1.00	0.00	0.00
Uniform Delay (d), s/veh	47.3	10.1	8.5	49.9	17.7	17.8	37.7	0.0	0.0	36.7	0.0	0.0
Incr Delay (d2), s/veh	7.1	0.4	0.1	5.5	6.0	5.8	3.1	0.0	0.0	1.7	0.0	0.0
Initial Q Delay(d3),s/veh	0.0	0.0	0.0	0.0	0.0	0.0	0.0	0.0	0.0	0.0	0.0	0.0
%ile BackOfQ(50%),veh/ln	1.9	4.0	0.6	0.7	16.4	17.2	3.5	0.0	0.0	2.4	0.0	0.0
Unsig. Movement Delay, s/veh												
LnGrp Delay(d),s/veh	54.4	10.5	8.6	55.4	23.7	23.5	40.7	0.0	0.0	38.4	0.0	0.0
LnGrp LOS	D	B	A	E	C	C	D	A	A	D	A	A
Approach Vol, veh/h		820			1681			137			99	
Approach Delay, s/veh		13.6			24.0			40.7			38.4	
Approach LOS		B			C			D			D	
Timer - Assigned Phs		2	3	4		6	7	8				
Phs Duration (G+Y+Rc), s		27.4	10.4	72.2		27.4	14.2	68.4				
Change Period (Y+Rc), s		4.5	4.5	4.5		4.5	4.5	4.5				
Max Green Setting (Gmax), s		22.9	5.9	67.7		22.9	9.7	63.9				
Max Q Clear Time (g_c+I1), s		10.4	3.3	12.3		7.6	5.6	40.7				
Green Ext Time (p_c), s		0.5	0.0	6.0		0.4	0.0	13.8				
Intersection Summary												
HCM 6th Ctrl Delay											22.3	
HCM 6th LOS											C	

Intersection

Intersection Delay, s/veh 11.3

Intersection LOS B

Movement	EBL	EBT	EBR	WBL	WBT	WBR	NBL	NBT	NBR	SBL	SBT	SBR
Lane Configurations	↙	↑	↗	↙	↑↑		↙	↗			↕	
Traffic Vol, veh/h	121	175	66	1	156	38	45	51	25	18	14	47
Future Vol, veh/h	121	175	66	1	156	38	45	51	25	18	14	47
Peak Hour Factor	0.75	0.88	0.67	0.25	0.73	0.89	0.70	0.89	0.57	0.71	0.81	0.97
Heavy Vehicles, %	2	2	2	2	2	2	2	2	2	2	2	2
Mvmt Flow	161	199	99	4	214	43	64	57	44	25	17	48
Number of Lanes	1	1	1	1	2	0	1	1	0	0	1	0

Approach	EB	WB	NB	SB
Opposing Approach	WB	EB	SB	NB
Opposing Lanes	3	3	1	2
Conflicting Approach Left SB		NB	EB	WB
Conflicting Lanes Left	1	2	3	3
Conflicting Approach Right NB		SB	WB	EB
Conflicting Lanes Right	2	1	3	3
HCM Control Delay	11.5	11.1	11	10.9
HCM LOS	B	B	B	B

Lane	NBLn1	NBLn2	EBLn1	EBLn2	EBLn3	WBLn1	WBLn2	WBLn3	SBLn1
Vol Left, %	100%	0%	100%	0%	0%	100%	0%	0%	23%
Vol Thru, %	0%	67%	0%	100%	0%	0%	100%	58%	18%
Vol Right, %	0%	33%	0%	0%	100%	0%	0%	42%	59%
Sign Control	Stop	Stop	Stop	Stop	Stop	Stop	Stop	Stop	Stop
Traffic Vol by Lane	45	76	121	175	66	1	104	90	79
LT Vol	45	0	121	0	0	1	0	0	18
Through Vol	0	51	0	175	0	0	104	52	14
RT Vol	0	25	0	0	66	0	0	38	47
Lane Flow Rate	64	101	161	199	99	4	142	114	91
Geometry Grp	8	8	8	8	8	8	8	8	8
Degree of Util (X)	0.131	0.186	0.299	0.34	0.149	0.008	0.259	0.198	0.17
Departure Headway (Hd)	7.349	6.616	6.664	6.157	5.448	7.053	6.546	6.246	6.735
Convergence, Y/N	Yes	Yes	Yes	Yes	Yes	Yes	Yes	Yes	Yes
Cap	487	540	539	583	656	506	547	572	530
Service Time	5.116	4.383	4.418	3.912	3.203	4.816	4.309	4.009	4.507
HCM Lane V/C Ratio	0.131	0.187	0.299	0.341	0.151	0.008	0.26	0.199	0.172
HCM Control Delay	11.2	10.9	12.3	12.1	9.2	9.9	11.6	10.6	10.9
HCM Lane LOS	B	B	B	B	A	A	B	B	B
HCM 95th-tile Q	0.4	0.7	1.2	1.5	0.5	0	1	0.7	0.6

HCM 6th TWSC
6: Commerce St & Mission Inn Ave

05/04/2020

Intersection												
Int Delay, s/veh	3.6											
Movement	EBL	EBT	EBR	WBL	WBT	WBR	NBL	NBT	NBR	SBL	SBT	SBR
Lane Configurations		↕	↗		↕↗			↕↗			↕↗	
Traffic Vol, veh/h	13	172	33	4	153	2	28	21	2	3	22	14
Future Vol, veh/h	13	172	33	4	153	2	28	21	2	3	22	14
Conflicting Peds, #/hr	0	0	0	0	0	0	0	0	0	0	0	0
Sign Control	Free	Free	Free	Free	Free	Free	Stop	Stop	Stop	Stop	Stop	Stop
RT Channelized	-	-	None	-	-	None	-	-	None	-	-	None
Storage Length	-	-	0	-	-	-	-	-	-	-	-	-
Veh in Median Storage, #	-	0	-	-	0	-	-	0	-	-	0	-
Grade, %	-	0	-	-	0	-	-	0	-	-	0	-
Peak Hour Factor	75	75	75	50	95	50	69	42	50	25	83	65
Heavy Vehicles, %	2	2	2	2	2	2	2	2	2	2	2	2
Mvmt Flow	17	229	44	8	161	4	41	50	4	12	27	22

Major/Minor	Major1			Major2			Minor1			Minor2		
Conflicting Flow All	165	0	0	273	0	0	373	444	229	491	486	83
Stage 1	-	-	-	-	-	-	263	263	-	179	179	-
Stage 2	-	-	-	-	-	-	110	181	-	312	307	-
Critical Hdwy	4.13	-	-	4.13	-	-	7.33	6.53	6.23	7.33	6.53	6.93
Critical Hdwy Stg 1	-	-	-	-	-	-	6.13	5.53	-	6.53	5.53	-
Critical Hdwy Stg 2	-	-	-	-	-	-	6.53	5.53	-	6.13	5.53	-
Follow-up Hdwy	2.219	-	-	2.219	-	-	3.519	4.019	3.319	3.519	4.019	3.319
Pot Cap-1 Maneuver	1412	-	-	1289	-	-	571	508	810	474	481	960
Stage 1	-	-	-	-	-	-	741	690	-	806	751	-
Stage 2	-	-	-	-	-	-	884	749	-	698	660	-
Platoon blocked, %	-	-	-	-	-	-	-	-	-	-	-	-
Mov Cap-1 Maneuver	1412	-	-	1289	-	-	526	497	810	428	471	960
Mov Cap-2 Maneuver	-	-	-	-	-	-	526	497	-	428	471	-
Stage 1	-	-	-	-	-	-	731	680	-	795	746	-
Stage 2	-	-	-	-	-	-	828	744	-	634	651	-

Approach	EB			WB			NB			SB		
HCM Control Delay, s	0.5			0.4			13.5			12.2		
HCM LOS							B			B		

Minor Lane/Major Mvmt	NBLn1	EBL	EBT	EBR	WBL	WBT	WBR	SBLn1
Capacity (veh/h)	518	1412	-	-	1289	-	-	562
HCM Lane V/C Ratio	0.183	0.012	-	-	0.006	-	-	0.107
HCM Control Delay (s)	13.5	7.6	0	-	7.8	0	-	12.2
HCM Lane LOS	B	A	A	-	A	A	-	B
HCM 95th %tile Q(veh)	0.7	0	-	-	0	-	-	0.4

HCM 6th TWSC
7: Commerce St & 9th St

05/04/2020

Intersection						
Int Delay, s/veh	4					
Movement	WBL	WBR	NBT	NBR	SBL	SBT
Lane Configurations	W	R	T	R	L	T
Traffic Vol, veh/h	4	20	31	0	18	41
Future Vol, veh/h	4	20	31	0	18	41
Conflicting Peds, #/hr	0	0	0	0	0	0
Sign Control	Stop	Stop	Free	Free	Free	Free
RT Channelized	-	None	-	None	-	None
Storage Length	0	-	-	-	-	-
Veh in Median Storage, #	0	-	0	-	-	0
Grade, %	0	-	0	-	-	0
Peak Hour Factor	50	79	77	25	25	68
Heavy Vehicles, %	2	2	2	2	2	2
Mvmt Flow	8	25	40	0	72	60

Major/Minor	Minor1	Major1	Major2			
Conflicting Flow All	244	40	0	0	40	0
Stage 1	40	-	-	-	-	-
Stage 2	204	-	-	-	-	-
Critical Hdwy	6.42	6.22	-	-	4.12	-
Critical Hdwy Stg 1	5.42	-	-	-	-	-
Critical Hdwy Stg 2	5.42	-	-	-	-	-
Follow-up Hdwy	3.518	3.318	-	-	2.218	-
Pot Cap-1 Maneuver	744	1031	-	-	1570	-
Stage 1	982	-	-	-	-	-
Stage 2	830	-	-	-	-	-
Platoon blocked, %			-	-		
Mov Cap-1 Maneuver	709	1031	-	-	1570	-
Mov Cap-2 Maneuver	709	-	-	-	-	-
Stage 1	936	-	-	-	-	-
Stage 2	830	-	-	-	-	-

Approach	WB	NB	SB
HCM Control Delay, s	9	0	4
HCM LOS	A		

Minor Lane/Major Mvmt	NBT	NBRWBLn1	SBL	SBT
Capacity (veh/h)	-	-	930	1570
HCM Lane V/C Ratio	-	-	0.036	0.046
HCM Control Delay (s)	-	-	9	7.4
HCM Lane LOS	-	-	A	A
HCM 95th %tile Q(veh)	-	-	0.1	0.1

Intersection						
Int Delay, s/veh	3.9					
Movement	EBT	EBR	WBL	WBT	NBL	NBR
Lane Configurations						
Traffic Vol, veh/h	10	41	6	9	28	10
Future Vol, veh/h	10	41	6	9	28	10
Conflicting Peds, #/hr	0	0	0	0	0	0
Sign Control	Free	Free	Free	Free	Stop	Stop
RT Channelized	-	None	-	None	-	None
Storage Length	-	-	-	-	0	-
Veh in Median Storage, #	0	-	-	0	0	-
Grade, %	0	-	-	0	0	-
Peak Hour Factor	38	84	62	67	69	56
Heavy Vehicles, %	2	2	2	2	2	2
Mvmt Flow	26	49	10	13	41	18

Major/Minor	Major1	Major2	Minor1	Minor2	Minor3
Conflicting Flow All	0	0	75	0	84
Stage 1	-	-	-	-	51
Stage 2	-	-	-	-	33
Critical Hdwy	-	-	4.12	-	6.42
Critical Hdwy Stg 1	-	-	-	-	5.42
Critical Hdwy Stg 2	-	-	-	-	5.42
Follow-up Hdwy	-	-	2.218	-	3.518
Pot Cap-1 Maneuver	-	-	1524	-	918
Stage 1	-	-	-	-	971
Stage 2	-	-	-	-	989
Platoon blocked, %	-	-	-	-	-
Mov Cap-1 Maneuver	-	-	1524	-	912
Mov Cap-2 Maneuver	-	-	-	-	912
Stage 1	-	-	-	-	964
Stage 2	-	-	-	-	989

Approach	EB	WB	NB
HCM Control Delay, s	0	3.1	9.1
HCM LOS			A

Minor Lane/Major Mvmt	NBLn1	EBT	EBR	WBL	WBT
Capacity (veh/h)	942	-	-	1524	-
HCM Lane V/C Ratio	0.062	-	-	0.006	-
HCM Control Delay (s)	9.1	-	-	7.4	0
HCM Lane LOS	A	-	-	A	A
HCM 95th %tile Q(veh)	0.2	-	-	0	-

HCM 6th Signalized Intersection Summary
 9: SR 91 Off-Ramp/SR 91 On-Ramp & 14th St

05/04/2020



Movement	EBL	EBT	EBR	WBL	WBT	WBR	NBL	NBT	NBR	SBL	SBT	SBR
Lane Configurations	↔↔	↑↑			↑↑↑	↔	↔	↔	↔			
Traffic Volume (veh/h)	627	466	0	0	1333	239	822	0	241	0	0	0
Future Volume (veh/h)	627	466	0	0	1333	239	822	0	241	0	0	0
Initial Q (Qb), veh	0	0	0	0	0	0	0	0	0			
Ped-Bike Adj(A_pbT)	1.00		1.00	1.00		1.00	1.00		1.00			
Parking Bus, Adj	1.00	1.00	1.00	1.00	1.00	1.00	1.00	1.00	1.00			
Work Zone On Approach		No			No			No				
Adj Sat Flow, veh/h/ln	1870	1870	0	0	1870	1870	1870	1870	1870			
Adj Flow Rate, veh/h	682	536	0	0	1418	285	945	0	287			
Peak Hour Factor	0.92	0.87	0.25	0.25	0.94	0.84	0.87	0.25	0.84			
Percent Heavy Veh, %	2	2	0	0	2	2	2	2	2			
Cap, veh/h	778	2079	0	0	1608	499	1158	0	515			
Arrive On Green	0.22	0.58	0.00	0.00	0.31	0.31	0.32	0.00	0.32			
Sat Flow, veh/h	3456	3647	0	0	5274	1585	3563	0	1585			
Grp Volume(v), veh/h	682	536	0	0	1418	285	945	0	287			
Grp Sat Flow(s),veh/h/ln	1728	1777	0	0	1702	1585	1781	0	1585			
Q Serve(g_s), s	19.1	7.4	0.0	0.0	26.3	15.0	24.4	0.0	14.9			
Cycle Q Clear(g_c), s	19.1	7.4	0.0	0.0	26.3	15.0	24.4	0.0	14.9			
Prop In Lane	1.00		0.00	0.00		1.00	1.00		1.00			
Lane Grp Cap(c), veh/h	778	2079	0	0	1608	499	1158	0	515			
V/C Ratio(X)	0.88	0.26	0.00	0.00	0.88	0.57	0.82	0.00	0.56			
Avail Cap(c_a), veh/h	778	2079	0	0	1608	499	1158	0	515			
HCM Platoon Ratio	1.00	1.00	1.00	1.00	1.00	1.00	1.00	1.00	1.00			
Upstream Filter(I)	1.00	1.00	0.00	0.00	1.00	1.00	1.00	0.00	1.00			
Uniform Delay (d), s/veh	37.4	10.1	0.0	0.0	32.5	28.6	31.0	0.0	27.8			
Incr Delay (d2), s/veh	13.3	0.3	0.0	0.0	7.3	4.7	6.4	0.0	4.3			
Initial Q Delay(d3),s/veh	0.0	0.0	0.0	0.0	0.0	0.0	0.0	0.0	0.0			
%ile BackOfQ(50%),veh/ln	9.3	2.8	0.0	0.0	11.6	6.3	11.2	0.0	6.2			
Unsig. Movement Delay, s/veh												
LnGrp Delay(d),s/veh	50.7	10.4	0.0	0.0	39.8	33.3	37.4	0.0	32.1			
LnGrp LOS	D	B	A	A	D	C	D	A	C			
Approach Vol, veh/h		1218			1703			1232				
Approach Delay, s/veh		33.0			38.7			36.2				
Approach LOS		C			D			D				
Timer - Assigned Phs		2		4			7	8				
Phs Duration (G+Y+Rc), s		37.0		63.0			27.0	36.0				
Change Period (Y+Rc), s		4.5		4.5			4.5	4.5				
Max Green Setting (Gmax), s		32.5		58.5			22.5	31.5				
Max Q Clear Time (g_c+I1), s		26.4		9.4			21.1	28.3				
Green Ext Time (p_c), s		2.7		4.2			0.5	2.6				

Intersection Summary

HCM 6th Ctrl Delay	36.3
HCM 6th LOS	D

Notes

User approved volume balancing among the lanes for turning movement.

HCM 6th Signalized Intersection Summary
 11: Park Ave & University Ave

05/04/2020



Movement	EBL	EBT	EBR	WBL	WBT	WBR	NBL	NBT	NBR	SBL	SBT	SBR
Lane Configurations	↖	↗		↖	↗		↖	↗		↖	↗	
Traffic Volume (veh/h)	30	524	32	23	749	50	30	30	24	44	36	42
Future Volume (veh/h)	30	524	32	23	749	50	30	30	24	44	36	42
Initial Q (Qb), veh	0	0	0	0	0	0	0	0	0	0	0	0
Ped-Bike Adj(A_pbT)	1.00		1.00	1.00		1.00	1.00		1.00	1.00		1.00
Parking Bus, Adj	1.00	1.00	1.00	1.00	1.00	1.00	1.00	1.00	1.00	1.00	1.00	1.00
Work Zone On Approach		No		No		No		No		No		No
Adj Sat Flow, veh/h/ln	1870	1870	1870	1870	1870	1870	1870	1870	1870	1870	1870	1870
Adj Flow Rate, veh/h	44	616	43	31	805	76	32	52	30	62	45	71
Peak Hour Factor	0.68	0.85	0.75	0.75	0.93	0.66	0.94	0.58	0.79	0.71	0.80	0.59
Percent Heavy Veh, %	2	2	2	2	2	2	2	2	2	2	2	2
Cap, veh/h	154	1455	101	138	1387	131	138	238	137	202	163	258
Arrive On Green	0.09	0.43	0.43	0.08	0.42	0.42	0.08	0.21	0.21	0.11	0.25	0.25
Sat Flow, veh/h	1781	3370	235	1781	3282	310	1781	1113	642	1781	654	1031
Grp Volume(v), veh/h	44	324	335	31	436	445	32	0	82	62	0	116
Grp Sat Flow(s),veh/h/ln	1781	1777	1828	1781	1777	1815	1781	0	1755	1781	0	1685
Q Serve(g_s), s	2.5	14.0	14.0	1.8	20.6	20.6	1.9	0.0	4.2	3.5	0.0	6.1
Cycle Q Clear(g_c), s	2.5	14.0	14.0	1.8	20.6	20.6	1.9	0.0	4.2	3.5	0.0	6.1
Prop In Lane	1.00		0.13	1.00		0.17	1.00		0.37	1.00		0.61
Lane Grp Cap(c), veh/h	154	767	789	138	751	767	138	0	375	202	0	421
V/C Ratio(X)	0.29	0.42	0.42	0.23	0.58	0.58	0.23	0.00	0.22	0.31	0.00	0.28
Avail Cap(c_a), veh/h	154	767	789	138	751	767	138	0	375	202	0	421
HCM Platoon Ratio	1.00	1.00	1.00	1.00	1.00	1.00	1.00	1.00	1.00	1.00	1.00	1.00
Upstream Filter(I)	1.00	1.00	1.00	1.00	1.00	1.00	1.00	0.00	1.00	1.00	0.00	1.00
Uniform Delay (d), s/veh	47.1	21.7	21.7	47.7	24.3	24.3	47.7	0.0	35.7	44.8	0.0	33.2
Incr Delay (d2), s/veh	4.6	1.7	1.7	3.8	3.3	3.2	3.9	0.0	1.3	3.9	0.0	1.6
Initial Q Delay(d3),s/veh	0.0	0.0	0.0	0.0	0.0	0.0	0.0	0.0	0.0	0.0	0.0	0.0
%ile BackOfQ(50%),veh/ln	1.3	6.1	6.3	0.9	9.2	9.4	1.0	0.0	2.0	1.8	0.0	2.7
Unsig. Movement Delay, s/veh												
LnGrp Delay(d),s/veh	51.7	23.4	23.4	51.4	27.5	27.5	51.6	0.0	37.0	48.6	0.0	34.8
LnGrp LOS	D	C	C	D	C	C	D	A	D	D	A	C
Approach Vol, veh/h		703		912		114		178				
Approach Delay, s/veh		25.2		28.3		41.1		39.7				
Approach LOS		C		C		D		D				
Timer - Assigned Phs	1	2	3	4	5	6	7	8				
Phs Duration (G+Y+Rc), s	7.0	28.0	13.0	52.0	13.0	32.0	14.0	51.0				
Change Period (Y+Rc), s	4.5	4.5	4.5	4.5	4.5	4.5	4.5	4.5				
Max Green Setting (Gmax), s	12.5	23.5	8.5	47.5	8.5	27.5	9.5	46.5				
Max Q Clear Time (g_c+1), s	11.5	6.2	3.8	16.0	3.9	8.1	4.5	22.6				
Green Ext Time (p_c), s	0.1	0.3	0.0	4.5	0.0	0.5	0.0	6.1				
Intersection Summary												
HCM 6th Ctrl Delay				29.0								
HCM 6th LOS				C								

HCM 6th AWSC
12: Howard Ave & 12th St

05/04/2020

Intersection

Intersection Delay, s/veh 7.6

Intersection LOS A

Movement	EBL	EBT	EBR	WBL	WBT	WBR	NBL	NBT	NBR	SBL	SBT	SBR
Lane Configurations		↔		↔		↔		↔			↔	
Traffic Vol, veh/h	1	1	19	18	11	3	2	65	5	0	41	6
Future Vol, veh/h	1	1	19	18	11	3	2	65	5	0	41	6
Peak Hour Factor	0.25	0.25	0.85	0.71	0.62	0.50	0.48	0.70	0.42	0.25	0.68	0.62
Heavy Vehicles, %	2	2	2	2	2	2	2	2	2	2	2	2
Mvmt Flow	4	4	22	25	18	6	4	93	12	0	60	10
Number of Lanes	0	1	0	0	1	0	0	1	0	0	1	0

Approach	EB	WB	NB	SB
Opposing Approach	WB	EB	SB	NB
Opposing Lanes	1	1	1	1
Conflicting Approach Left SB	NB	EB	WB	WB
Conflicting Lanes Left	1	1	1	1
Conflicting Approach RightNB	SB	WB	WB	EB
Conflicting Lanes Right	1	1	1	1
HCM Control Delay	7	7.7	7.7	7.5
HCM LOS	A	A	A	A

Lane	NBLn1	EBLn1	WBLn1	SBLn1
Vol Left, %	3%	5%	56%	0%
Vol Thru, %	90%	5%	34%	87%
Vol Right, %	7%	90%	9%	13%
Sign Control	Stop	Stop	Stop	Stop
Traffic Vol by Lane	72	21	32	47
LT Vol	2	1	18	0
Through Vol	65	1	11	41
RT Vol	5	19	3	6
Lane Flow Rate	109	30	49	70
Geometry Grp	1	1	1	1
Degree of Util (X)	0.124	0.032	0.059	0.079
Departure Headway (Hd)	4.09	3.747	4.322	4.08
Convergence, Y/N	Yes	Yes	Yes	Yes
Cap	870	937	817	870
Service Time	2.144	1.845	2.411	2.143
HCM Lane V/C Ratio	0.125	0.032	0.06	0.08
HCM Control Delay	7.7	7	7.7	7.5
HCM Lane LOS	A	A	A	A
HCM 95th-tile Q	0.4	0.1	0.2	0.3

HCM 6th Signalized Intersection Summary

13: Olivewood Ave/Lime St & 14th St

05/04/2020



Movement	EBL	EBT	EBR	WBL	WBT	WBR	NBL	NBT	NBR	SBL	SBT	SBR
Lane Configurations	↖ ↑↑↑			↖ ↑↑↑			↖ ↑↑		↖ ↑↑		↖ ↑↑	
Traffic Volume (veh/h)	37	656	49	370	1755	219	97	307	392	45	125	20
Future Volume (veh/h)	37	656	49	370	1755	219	97	307	392	45	125	20
Initial Q (Qb), veh	0	0	0	0	0	0	0	0	0	0	0	0
Ped-Bike Adj(A_pbT)	1.00		1.00	1.00		1.00	1.00		1.00	1.00		1.00
Parking Bus, Adj	1.00	1.00	1.00	1.00	1.00	1.00	1.00	1.00	1.00	1.00	1.00	1.00
Work Zone On Approach	No			No			No		No		No	
Adj Sat Flow, veh/h/ln	1870	1870	1870	1870	1870	1870	1870	1870	1870	1870	1870	1870
Adj Flow Rate, veh/h	52	800	62	407	1887	267	123	370	475	73	151	40
Peak Hour Factor	0.71	0.82	0.79	0.91	0.93	0.82	0.79	0.77	0.86	0.62	0.83	0.50
Percent Heavy Veh, %	2	2	2	2	2	2	2	2	2	2	2	2
Cap, veh/h	105	1182	91	520	2160	303	202	474	804	160	521	134
Arrive On Green	0.06	0.24	0.24	0.58	0.95	0.95	0.11	0.25	0.25	0.05	0.19	0.19
Sat Flow, veh/h	1781	4834	373	1781	4527	634	1781	1870	3170	3456	2798	720
Grp Volume(v), veh/h	52	562	300	407	1414	740	123	370	475	73	94	97
Grp Sat Flow(s),veh/h/ln	1781	1702	1803	1781	1702	1756	1781	1870	1585	1728	1777	1741
Q Serve(g_s), s	3.1	16.4	16.6	19.3	12.3	13.4	7.2	20.2	14.5	2.3	5.0	5.3
Cycle Q Clear(g_c), s	3.1	16.4	16.6	19.3	12.3	13.4	7.2	20.2	14.5	2.3	5.0	5.3
Prop In Lane	1.00		0.21	1.00		0.36	1.00		1.00	1.00		0.41
Lane Grp Cap(c), veh/h	105	832	441	520	1625	838	202	474	804	160	331	324
V/C Ratio(X)	0.49	0.68	0.68	0.78	0.87	0.88	0.61	0.78	0.59	0.46	0.28	0.30
Avail Cap(c_a), veh/h	105	832	441	520	1625	838	202	474	804	160	331	324
HCM Platoon Ratio	1.00	1.00	1.00	2.00	2.00	2.00	1.00	1.00	1.00	1.00	1.00	1.00
Upstream Filter(I)	1.00	1.00	1.00	1.00	1.00	1.00	1.00	1.00	1.00	1.00	1.00	1.00
Uniform Delay (d), s/veh	50.2	37.6	37.6	20.2	1.6	1.6	46.4	38.2	36.0	51.1	38.5	38.6
Incr Delay (d2), s/veh	15.6	4.4	8.2	11.2	6.7	13.0	12.8	12.0	3.2	9.1	2.1	2.3
Initial Q Delay(d3),s/veh	0.0	0.0	0.0	0.0	0.0	0.0	0.0	0.0	0.0	0.0	0.0	0.0
%ile BackOfQ(50%),veh/ln	1.8	7.3	8.3	6.8	2.3	3.9	3.9	10.8	5.9	1.2	2.4	2.5
Unsig. Movement Delay, s/veh												
LnGrp Delay(d),s/veh	65.8	42.0	45.8	31.4	8.3	14.6	59.3	50.2	39.2	60.2	40.6	40.9
LnGrp LOS	E	D	D	C	A	B	E	D	D	E	D	D
Approach Vol, veh/h	914			2561			968		264			
Approach Delay, s/veh	44.6			13.8			46.0		46.1			
Approach LOS	D			B			D		D			
Timer - Assigned Phs	1	2	3	4	5	6	7	8				
Phs Duration (G+Y+Rc), s	9.6	32.4	36.6	31.4	17.0	25.0	11.0	57.0				
Change Period (Y+Rc), s	4.5	4.5	4.5	4.5	4.5	4.5	4.5	4.5				
Max Green Setting (Gmax), s	27.9	32.1	26.9	12.5	20.5	6.5	52.5					
Max Q Clear Time (g_c+1), s	22.2	21.3	18.6	9.2	7.3	5.1	15.4					
Green Ext Time (p_c), s	0.0	2.2	1.0	3.5	0.1	0.8	0.0	24.2				

Intersection Summary

HCM 6th Ctrl Delay	28.2
HCM 6th LOS	C

Notes

User approved volume balancing among the lanes for turning movement.

HCM 6th Signalized Intersection Summary

14: Mulberry St/SR 91 Off-Ramp & 14th St

05/04/2020



Movement	EBL	EBT	EBR	WBL	WBT	WBR	NBL	NBT	NBR	SBL	SBT	SBR
Lane Configurations		↑↑↑		↔↔	↑↑↑					↔	↔↔	↔
Traffic Volume (veh/h)	0	950	143	421	1734	0	0	0	0	143	227	610
Future Volume (veh/h)	0	950	143	421	1734	0	0	0	0	143	227	610
Initial Q (Qb), veh	0	0	0	0	0	0				0	0	0
Ped-Bike Adj(A_pbT)	1.00		1.00	1.00		1.00				1.00		1.00
Parking Bus, Adj	1.00	1.00	1.00	1.00	1.00	1.00				1.00	1.00	1.00
Work Zone On Approach		No			No						No	
Adj Sat Flow, veh/h/ln	0	1870	1870	1870	1870	0				1870	1870	1870
Adj Flow Rate, veh/h	0	1011	238	577	1905	0				116	293	679
Peak Hour Factor	0.25	0.94	0.60	0.73	0.91	0.25				0.82	0.85	0.95
Percent Heavy Veh, %	0	2	2	2	2	0				2	2	2
Cap, veh/h	0	1408	331	801	3133	0				542	570	965
Arrive On Green	0.00	0.34	0.34	0.23	0.61	0.00				0.30	0.30	0.30
Sat Flow, veh/h	0	4298	971	3456	5274	0				1781	1870	3170
Grp Volume(v), veh/h	0	833	416	577	1905	0				116	293	679
Grp Sat Flow(s),veh/h/ln	0	1702	1696	1728	1702	0				1781	1870	1585
Q Serve(g_s), s	0.0	23.5	23.6	16.9	25.3	0.0				5.3	14.2	20.9
Cycle Q Clear(g_c), s	0.0	23.5	23.6	16.9	25.3	0.0				5.3	14.2	20.9
Prop In Lane	0.00		0.57	1.00		0.00				1.00		1.00
Lane Grp Cap(c), veh/h	0	1160	578	801	3133	0				542	570	965
V/C Ratio(X)	0.00	0.72	0.72	0.72	0.61	0.00				0.21	0.51	0.70
Avail Cap(c_a), veh/h	0	1160	578	801	3133	0				542	570	965
HCM Platoon Ratio	1.00	1.00	1.00	1.00	1.00	1.00				1.00	1.00	1.00
Upstream Filter(I)	0.00	1.00	1.00	1.00	1.00	0.00				1.00	1.00	1.00
Uniform Delay (d), s/veh	0.0	31.6	31.7	39.0	13.1	0.0				28.5	31.5	33.9
Incr Delay (d2), s/veh	0.0	3.8	7.5	5.5	0.9	0.0				0.9	3.3	4.3
Initial Q Delay(d3),s/veh	0.0	0.0	0.0	0.0	0.0	0.0				0.0	0.0	0.0
%ile BackOfQ(50%),veh/ln	0.0	10.1	10.7	7.7	9.3	0.0				2.4	6.9	8.5
Unsig. Movement Delay, s/veh												
LnGrp Delay(d),s/veh	0.0	35.5	39.2	44.5	14.0	0.0				29.4	34.8	38.1
LnGrp LOS	A	D	D	D	B	A				C	C	D
Approach Vol, veh/h		1249			2482						1088	
Approach Delay, s/veh		36.7			21.1						36.3	
Approach LOS		D			C						D	
Timer - Assigned Phs			3	4		6		8				
Phs Duration (G+Y+Rc), s			30.0	42.0		38.0		72.0				
Change Period (Y+Rc), s			4.5	4.5		4.5		4.5				
Max Green Setting (Gmax), s			25.5	37.5		33.5		67.5				
Max Q Clear Time (g_c+I1), s			18.9	25.6		22.9		27.3				
Green Ext Time (p_c), s			1.3	6.5		3.9		22.4				
Intersection Summary												
HCM 6th Ctrl Delay			28.6									
HCM 6th LOS			C									
Notes												
User approved volume balancing among the lanes for turning movement.												

Opening Year AM with Project Conditions

HCM 6th Signalized Intersection Summary

2: Mission Inn Ave & SR 91 Off-Ramp

05/04/2020

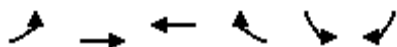

Movement	EBL	EBT	WBT	WBR	SBL	SBR
Lane Configurations		↑↑	↑↑		↘	↘
Traffic Volume (veh/h)	0	277	195	0	276	1013
Future Volume (veh/h)	0	277	195	0	276	1013
Initial Q (Qb), veh	0	0	0	0	0	0
Ped-Bike Adj(A_pbT)	1.00			1.00	1.00	1.00
Parking Bus, Adj	1.00	1.00	1.00	1.00	1.00	1.00
Work Zone On Approach		No	No		No	
Adj Sat Flow, veh/h/ln	0	1870	1870	0	1870	1870
Adj Flow Rate, veh/h	0	292	210	0	294	1078
Peak Hour Factor	0.25	0.95	0.93	0.25	0.94	0.94
Percent Heavy Veh, %	0	2	2	0	2	2
Cap, veh/h	0	921	921	0	1174	1839
Arrive On Green	0.00	0.26	0.52	0.00	0.66	0.66
Sat Flow, veh/h	0	3741	3741	0	1781	2790
Grp Volume(v), veh/h	0	292	210	0	294	1078
Grp Sat Flow(s),veh/h/ln	0	1777	1777	0	1781	1395
Q Serve(g_s), s	0.0	7.3	3.6	0.0	7.4	23.6
Cycle Q Clear(g_c), s	0.0	7.3	3.6	0.0	7.4	23.6
Prop In Lane	0.00			0.00	1.00	1.00
Lane Grp Cap(c), veh/h	0	921	921	0	1174	1839
V/C Ratio(X)	0.00	0.32	0.23	0.00	0.25	0.59
Avail Cap(c_a), veh/h	0	921	921	0	1174	1839
HCM Platoon Ratio	1.00	1.00	2.00	1.00	1.00	1.00
Upstream Filter(I)	0.00	1.00	1.00	0.00	1.00	1.00
Uniform Delay (d), s/veh	0.0	32.9	20.5	0.0	7.7	10.4
Incr Delay (d2), s/veh	0.0	0.9	0.6	0.0	0.5	1.4
Initial Q Delay(d3),s/veh	0.0	0.0	0.0	0.0	0.0	0.0
%ile BackOfQ(50%),veh/ln	0.0	3.3	1.5	0.0	2.8	7.0
Unsig. Movement Delay, s/veh						
LnGrp Delay(d),s/veh	0.0	33.8	21.1	0.0	8.2	11.8
LnGrp LOS	A	C	C	A	A	B
Approach Vol, veh/h		292	210		1372	
Approach Delay, s/veh		33.8	21.1		11.0	
Approach LOS		C	C		B	
Timer - Assigned Phs				4	6	8
Phs Duration (G+Y+Rc), s				33.0	77.0	33.0
Change Period (Y+Rc), s				4.5	4.5	4.5
Max Green Setting (Gmax), s				28.5	72.5	28.5
Max Q Clear Time (g_c+I1), s				9.3	25.6	5.6
Green Ext Time (p_c), s				1.7	7.1	1.3
Intersection Summary						
HCM 6th Ctrl Delay			15.7			
HCM 6th LOS			B			

HCM 6th Signalized Intersection Summary

3: Mulberry St/SR 91 On-Ramp & Mission Inn Ave

05/04/2020



Movement	EBL	EBT	EBR	WBL	WBT	WBR	NBL	NBT	NBR	SBL	SBT	SBR
Lane Configurations	↖	↑↑			↑↑		↖	↗				
Traffic Volume (veh/h)	238	315	0	0	67	137	128	278	70	0	0	0
Future Volume (veh/h)	238	315	0	0	67	137	128	278	70	0	0	0
Initial Q (Qb), veh	0	0	0	0	0	0	0	0	0			
Ped-Bike Adj(A_pbT)	1.00		1.00	1.00		1.00	1.00		1.00			
Parking Bus, Adj	1.00	1.00	1.00	1.00	1.00	1.00	1.00	1.00	1.00			
Work Zone On Approach		No			No			No				
Adj Sat Flow, veh/h/ln	1870	1870	0	0	1870	1870	1870	1870	1870			
Adj Flow Rate, veh/h	262	366	0	0	94	0	164	339	86			
Peak Hour Factor	0.91	0.86	0.25	0.25	0.71	0.73	0.78	0.82	0.81			
Percent Heavy Veh, %	2	2	0	0	2	2	2	2	2			
Cap, veh/h	494	1858	0	0	727		704	569	144			
Arrive On Green	0.55	1.00	0.00	0.00	0.20	0.00	0.40	0.40	0.40			
Sat Flow, veh/h	1781	3647	0	0	3741	0	1781	1439	365			
Grp Volume(v), veh/h	262	366	0	0	94	0	164	0	425			
Grp Sat Flow(s),veh/h/ln	1781	1777	0	0	1777	0	1781	0	1805			
Q Serve(g_s), s	10.2	0.0	0.0	0.0	2.4	0.0	6.7	0.0	20.5			
Cycle Q Clear(g_c), s	10.2	0.0	0.0	0.0	2.4	0.0	6.7	0.0	20.5			
Prop In Lane	1.00		0.00	0.00		0.00	1.00		0.20			
Lane Grp Cap(c), veh/h	494	1858	0	0	727		704	0	714			
V/C Ratio(X)	0.53	0.20	0.00	0.00	0.13		0.23	0.00	0.60			
Avail Cap(c_a), veh/h	494	1858	0	0	727		704	0	714			
HCM Platoon Ratio	2.00	2.00	1.00	1.00	1.00	1.00	1.00	1.00	1.00			
Upstream Filter(I)	1.00	1.00	0.00	0.00	1.00	0.00	1.00	0.00	1.00			
Uniform Delay (d), s/veh	20.0	0.0	0.0	0.0	35.7	0.0	22.1	0.0	26.3			
Incr Delay (d2), s/veh	4.0	0.2	0.0	0.0	0.4	0.0	0.8	0.0	3.6			
Initial Q Delay(d3),s/veh	0.0	0.0	0.0	0.0	0.0	0.0	0.0	0.0	0.0			
%ile BackOfQ(50%),veh/ln	0.0	0.1	0.0	0.0	1.1	0.0	3.0	0.0	9.4			
Unsig. Movement Delay, s/veh												
LnGrp Delay(d),s/veh	24.0	0.2	0.0	0.0	36.1	0.0	22.9	0.0	29.9			
LnGrp LOS	C	A	A	A	D		C	A	C			
Approach Vol, veh/h		628			94	A		589				
Approach Delay, s/veh		10.2			36.1			28.0				
Approach LOS		B			D			C				
Timer - Assigned Phs		2		4			7	8				
Phs Duration (G+Y+Rc), s		48.0		62.0			35.0	27.0				
Change Period (Y+Rc), s		4.5		4.5			4.5	4.5				
Max Green Setting (Gmax), s		43.5		57.5			30.5	22.5				
Max Q Clear Time (g_c+I1), s		22.5		2.0			12.2	4.4				
Green Ext Time (p_c), s		3.2		2.7			0.7	0.4				

Intersection Summary

HCM 6th Ctrl Delay	20.0
HCM 6th LOS	C

Notes

Unsignalized Delay for [WBR] is excluded from calculations of the approach delay and intersection delay.

HCM 6th Signalized Intersection Summary

4: Howard Ave & 14th St

05/04/2020



Movement	EBL	EBT	EBR	WBL	WBT	WBR	NBL	NBT	NBR	SBL	SBT	SBR
Lane Configurations												
Traffic Volume (veh/h)	91	617	45	12	1435	29	67	15	15	6	12	83
Future Volume (veh/h)	91	617	45	12	1435	29	67	15	15	6	12	83
Initial Q (Qb), veh	0	0	0	0	0	0	0	0	0	0	0	0
Ped-Bike Adj(A_pbT)	1.00		1.00	1.00		1.00	1.00		1.00	1.00		1.00
Parking Bus, Adj	1.00	1.00	1.00	1.00	1.00	1.00	1.00	1.00	1.00	1.00	1.00	1.00
Work Zone On Approach	No			No			No			No		
Adj Sat Flow, veh/h/ln	1870	1870	1870	1870	1870	1870	1870	1870	1870	1870	1870	1870
Adj Flow Rate, veh/h	130	693	63	22	1631	41	92	21	24	12	22	94
Peak Hour Factor	0.70	0.89	0.71	0.55	0.88	0.70	0.73	0.70	0.62	0.50	0.54	0.88
Percent Heavy Veh, %	2	2	2	2	2	2	2	2	2	2	2	2
Cap, veh/h	219	2207	984	92	1948	49	233	54	49	50	75	245
Arrive On Green	0.12	0.62	0.62	0.05	0.55	0.55	0.20	0.20	0.20	0.20	0.20	0.20
Sat Flow, veh/h	1781	3554	1585	1781	3542	89	871	264	241	69	364	1197
Grp Volume(v), veh/h	130	693	63	22	816	856	137	0	0	128	0	0
Grp Sat Flow(s),veh/h/ln	1781	1777	1585	1781	1777	1854	1375	0	0	1629	0	0
Q Serve(g_s), s	7.6	10.1	1.7	1.3	42.1	42.4	2.5	0.0	0.0	0.0	0.0	0.0
Cycle Q Clear(g_c), s	7.6	10.1	1.7	1.3	42.1	42.4	9.8	0.0	0.0	7.3	0.0	0.0
Prop In Lane	1.00		1.00	1.00		0.05	0.67		0.18	0.09		0.73
Lane Grp Cap(c), veh/h	219	2207	984	92	977	1020	336	0	0	369	0	0
V/C Ratio(X)	0.59	0.31	0.06	0.24	0.84	0.84	0.41	0.00	0.00	0.35	0.00	0.00
Avail Cap(c_a), veh/h	219	2207	984	92	977	1020	336	0	0	369	0	0
HCM Platoon Ratio	1.00	1.00	1.00	1.00	1.00	1.00	1.00	1.00	1.00	1.00	1.00	1.00
Upstream Filter(I)	1.00	1.00	1.00	1.00	1.00	1.00	1.00	0.00	0.00	1.00	0.00	0.00
Uniform Delay (d), s/veh	45.7	9.8	8.2	50.1	20.6	20.7	38.6	0.0	0.0	37.7	0.0	0.0
Incr Delay (d2), s/veh	11.4	0.4	0.1	6.0	8.4	8.3	3.6	0.0	0.0	2.6	0.0	0.0
Initial Q Delay(d3),s/veh	0.0	0.0	0.0	0.0	0.0	0.0	0.0	0.0	0.0	0.0	0.0	0.0
%ile BackOfQ(50%),veh/ln	0.0	3.8	0.6	0.7	18.7	19.6	3.6	0.0	0.0	3.2	0.0	0.0
Unsig. Movement Delay, s/veh												
LnGrp Delay(d),s/veh	57.0	10.2	8.4	56.1	29.0	28.9	42.3	0.0	0.0	40.3	0.0	0.0
LnGrp LOS	E	B	A	E	C	C	D	A	A	D	A	A
Approach Vol, veh/h	886			1694			137			128		
Approach Delay, s/veh	16.9			29.3			42.3			40.3		
Approach LOS	B			C			D			D		
Timer - Assigned Phs	2		3		4		6		7		8	
Phs Duration (G+Y+Rc), s	27.0		10.2		72.8		27.0		18.0		65.0	
Change Period (Y+Rc), s	4.5		4.5		4.5		4.5		4.5		4.5	
Max Green Setting (Gmax), s	22.5		5.7		68.3		22.5		13.5		60.5	
Max Q Clear Time (g_c+I1), s	11.8		3.3		12.1		9.3		9.6		44.4	
Green Ext Time (p_c), s	0.5		0.0		6.0		0.5		0.1		10.8	
Intersection Summary												
HCM 6th Ctrl Delay				26.6								
HCM 6th LOS				C								

HCM 6th AWSC
5: Vine St & Mission Inn Ave

05/04/2020

Intersection

Intersection Delay, s/veh11.1

Intersection LOS B

Movement	EBL	EBT	EBR	WBL	WBT	WBR	NBL	NBT	NBR	SBL	SBT	SBR
Lane Configurations	↙	↑	↗	↙	↑↑		↙	↗			↕	
Traffic Vol, veh/h	101	218	66	1	116	28	45	51	25	18	14	43
Future Vol, veh/h	101	218	66	1	116	28	45	51	25	18	14	43
Peak Hour Factor	0.75	0.88	0.67	0.25	0.73	0.89	0.70	0.89	0.57	0.71	0.81	0.97
Heavy Vehicles, %	2	2	2	2	2	2	2	2	2	2	2	2
Mvmt Flow	135	248	99	4	159	31	64	57	44	25	17	44
Number of Lanes	1	1	1	1	2	0	1	1	0	0	1	0

Approach	EB	WB	NB	SB
Opposing Approach	WB	EB	SB	NB
Opposing Lanes	3	3	1	2
Conflicting Approach Left SB		NB	EB	WB
Conflicting Lanes Left	1	2	3	3
Conflicting Approach Right NB		SB	WB	EB
Conflicting Lanes Right	2	1	3	3
HCM Control Delay	11.6	10.5	10.8	10.6
HCM LOS	B	B	B	B

Lane	NBLn1	NBLn2	EBLn1	EBLn2	EBLn3	WBLn1	WBLn2	WBLn3	SBLn1
Vol Left, %	100%	0%	100%	0%	0%	100%	0%	0%	24%
Vol Thru, %	0%	67%	0%	100%	0%	0%	100%	58%	19%
Vol Right, %	0%	33%	0%	0%	100%	0%	0%	42%	57%
Sign Control	Stop	Stop	Stop	Stop	Stop	Stop	Stop	Stop	Stop
Traffic Vol by Lane	45	76	101	218	66	1	77	67	75
LT Vol	45	0	101	0	0	1	0	0	18
Through Vol	0	51	0	218	0	0	77	39	14
RT Vol	0	25	0	0	66	0	0	28	43
Lane Flow Rate	64	101	135	248	99	4	106	84	87
Geometry Grp	8	8	8	8	8	8	8	8	8
Degree of Util (X)	0.128	0.181	0.242	0.411	0.144	0.008	0.192	0.146	0.159
Departure Headway (Hd)	7.172	6.441	6.472	5.967	5.259	7.039	6.532	6.234	6.59
Convergence, Y/N	Yes	Yes	Yes	Yes	Yes	Yes	Yes	Yes	Yes
Cap	499	555	555	602	681	508	548	574	543
Service Time	4.926	4.194	4.215	3.709	3	4.793	4.286	3.987	4.348
HCM Lane V/C Ratio	0.128	0.182	0.243	0.412	0.145	0.008	0.193	0.146	0.16
HCM Control Delay	11	10.6	11.3	12.8	8.9	9.9	10.8	10.1	10.6
HCM Lane LOS	B	B	B	B	A	A	B	B	B
HCM 95th-tile Q	0.4	0.7	0.9	2	0.5	0	0.7	0.5	0.6

HCM 6th TWSC
6: Commerce St & Mission Inn Ave

05/04/2020

Intersection												
Int Delay, s/veh	3.6											
Movement	EBL	EBT	EBR	WBL	WBT	WBR	NBL	NBT	NBR	SBL	SBT	SBR
Lane Configurations		↔	↔		↔			↔			↔	
Traffic Vol, veh/h	13	154	94	4	95	2	36	21	2	3	22	14
Future Vol, veh/h	13	154	94	4	95	2	36	21	2	3	22	14
Conflicting Peds, #/hr	0	0	0	0	0	0	0	0	0	0	0	0
Sign Control	Free	Free	Free	Free	Free	Free	Stop	Stop	Stop	Stop	Stop	Stop
RT Channelized	-	-	None	-	-	None	-	-	None	-	-	None
Storage Length	-	-	0	-	-	-	-	-	-	-	-	-
Veh in Median Storage, #	-	0	-	-	0	-	-	0	-	-	0	-
Grade, %	-	0	-	-	0	-	-	0	-	-	0	-
Peak Hour Factor	75	75	75	50	95	50	69	42	50	25	83	65
Heavy Vehicles, %	2	2	2	2	2	2	2	2	2	2	2	2
Mvmt Flow	17	205	125	8	100	4	52	50	4	12	27	22

Major/Minor	Major1			Major2			Minor1			Minor2		
Conflicting Flow All	104	0	0	330	0	0	319	359	205	447	482	52
Stage 1	-	-	-	-	-	-	239	239	-	118	118	-
Stage 2	-	-	-	-	-	-	80	120	-	329	364	-
Critical Hdwy	4.13	-	-	4.13	-	-	7.33	6.53	6.23	7.33	6.53	6.93
Critical Hdwy Stg 1	-	-	-	-	-	-	6.13	5.53	-	6.53	5.53	-
Critical Hdwy Stg 2	-	-	-	-	-	-	6.53	5.53	-	6.13	5.53	-
Follow-up Hdwy	2.219	-	-	2.219	-	-	3.519	4.019	3.319	3.519	4.019	3.319
Pot Cap-1 Maneuver	1487	-	-	1228	-	-	622	567	835	508	483	1005
Stage 1	-	-	-	-	-	-	764	707	-	874	798	-
Stage 2	-	-	-	-	-	-	920	796	-	683	623	-
Platoon blocked, %	-	-	-	-	-	-	-	-	-	-	-	-
Mov Cap-1 Maneuver	1487	-	-	1228	-	-	573	555	835	463	473	1005
Mov Cap-2 Maneuver	-	-	-	-	-	-	573	555	-	463	473	-
Stage 1	-	-	-	-	-	-	753	697	-	862	792	-
Stage 2	-	-	-	-	-	-	864	790	-	622	614	-

Approach	EB			WB			NB			SB		
HCM Control Delay, s	0.4			0.6			12.7			11.9		
HCM LOS							B			B		

Minor Lane/Major Mvmt	NBLn1	EBL	EBT	EBR	WBL	WBT	WBR	SBLn1
Capacity (veh/h)	571	1487	-	-	1228	-	-	581
HCM Lane V/C Ratio	0.186	0.012	-	-	0.007	-	-	0.103
HCM Control Delay (s)	12.7	7.5	0	-	8	0	-	11.9
HCM Lane LOS	B	A	A	-	A	A	-	B
HCM 95th %tile Q(veh)	0.7	0	-	-	0	-	-	0.3

Intersection						
Int Delay, s/veh	2.7					
Movement	WBL	WBR	NBT	NBR	SBL	SBT
Lane Configurations	W	R	T	R	L	T
Traffic Vol, veh/h	4	20	40	0	18	103
Future Vol, veh/h	4	20	40	0	18	103
Conflicting Peds, #/hr	0	0	0	0	0	0
Sign Control	Stop	Stop	Free	Free	Free	Free
RT Channelized	-	None	-	None	-	None
Storage Length	0	-	-	-	-	-
Veh in Median Storage, #	0	-	0	-	-	0
Grade, %	0	-	0	-	-	0
Peak Hour Factor	50	79	77	25	25	68
Heavy Vehicles, %	2	2	2	2	2	2
Mvmt Flow	8	25	52	0	72	151

Major/Minor	Minor1	Major1	Major2			
Conflicting Flow All	347	52	0	0	52	0
Stage 1	52	-	-	-	-	-
Stage 2	295	-	-	-	-	-
Critical Hdwy	6.42	6.22	-	-	4.12	-
Critical Hdwy Stg 1	5.42	-	-	-	-	-
Critical Hdwy Stg 2	5.42	-	-	-	-	-
Follow-up Hdwy	3.518	3.318	-	-	2.218	-
Pot Cap-1 Maneuver	650	1016	-	-	1554	-
Stage 1	970	-	-	-	-	-
Stage 2	755	-	-	-	-	-
Platoon blocked, %			-	-		
Mov Cap-1 Maneuver	617	1016	-	-	1554	-
Mov Cap-2 Maneuver	617	-	-	-	-	-
Stage 1	921	-	-	-	-	-
Stage 2	755	-	-	-	-	-

Approach	WB	NB	SB
HCM Control Delay, s	9.3	0	2.4
HCM LOS	A		

Minor Lane/Major Mvmt	NBT	NBRWBLn1	SBL	SBT
Capacity (veh/h)	-	-	879	1554
HCM Lane V/C Ratio	-	-	0.038	0.046
HCM Control Delay (s)	-	-	9.3	7.4
HCM Lane LOS	-	-	A	A
HCM 95th %tile Q(veh)	-	-	0.1	0.1

Intersection						
Int Delay, s/veh	5.5					
Movement	EBT	EBR	WBL	WBT	NBL	NBR
Lane Configurations						
Traffic Vol, veh/h	10	63	6	9	89	10
Future Vol, veh/h	10	63	6	9	89	10
Conflicting Peds, #/hr	0	0	0	0	0	0
Sign Control	Free	Free	Free	Free	Stop	Stop
RT Channelized	-	None	-	None	-	None
Storage Length	-	-	-	-	0	-
Veh in Median Storage, #	0	-	-	0	0	-
Grade, %	0	-	-	0	0	-
Peak Hour Factor	38	84	62	67	69	56
Heavy Vehicles, %	2	2	2	2	2	2
Mvmt Flow	26	75	10	13	129	18

Major/Minor	Major1	Major2	Minor1	Minor2	Minor3
Conflicting Flow All	0	0	101	0	97
Stage 1	-	-	-	-	64
Stage 2	-	-	-	-	33
Critical Hdwy	-	-	4.12	-	6.42
Critical Hdwy Stg 1	-	-	-	-	5.42
Critical Hdwy Stg 2	-	-	-	-	5.42
Follow-up Hdwy	-	-	2.218	-	3.518
Pot Cap-1 Maneuver	-	-	1491	-	902
Stage 1	-	-	-	-	959
Stage 2	-	-	-	-	989
Platoon blocked, %	-	-	-	-	-
Mov Cap-1 Maneuver	-	-	1491	-	896
Mov Cap-2 Maneuver	-	-	-	-	896
Stage 1	-	-	-	-	952
Stage 2	-	-	-	-	989

Approach	EB	WB	NB
HCM Control Delay, s	0	3.1	9.7
HCM LOS			A

Minor Lane/Major Mvmt	NBLn1	EBT	EBR	WBL	WBT
Capacity (veh/h)	907	-	-	1491	-
HCM Lane V/C Ratio	0.162	-	-	0.006	-
HCM Control Delay (s)	9.7	-	-	7.4	0
HCM Lane LOS	A	-	-	A	A
HCM 95th %tile Q(veh)	0.6	-	-	0	-

HCM 6th Signalized Intersection Summary
 9: SR 91 Off-Ramp/SR 91 On-Ramp & 14th St

05/04/2020



Movement	EBL	EBT	EBR	WBL	WBT	WBR	NBL	NBT	NBR	SBL	SBT	SBR
Lane Configurations	↖↗	↑↑			↑↑↑	↖	↖	↖	↖			
Traffic Volume (veh/h)	620	470	0	0	1339	246	795	0	282	0	0	0
Future Volume (veh/h)	620	470	0	0	1339	246	795	0	282	0	0	0
Initial Q (Qb), veh	0	0	0	0	0	0	0	0	0			
Ped-Bike Adj(A_pbT)	1.00		1.00	1.00		1.00	1.00		1.00			
Parking Bus, Adj	1.00	1.00	1.00	1.00	1.00	1.00	1.00	1.00	1.00			
Work Zone On Approach		No			No			No				
Adj Sat Flow, veh/h/ln	1870	1870	0	0	1870	1870	1870	1870	1870			
Adj Flow Rate, veh/h	674	540	0	0	1424	293	914	0	336			
Peak Hour Factor	0.92	0.87	0.25	0.25	0.94	0.84	0.87	0.25	0.84			
Percent Heavy Veh, %	2	2	0	0	2	2	2	2	2			
Cap, veh/h	778	2114	0	0	1659	515	1122	0	499			
Arrive On Green	0.22	0.60	0.00	0.00	0.32	0.32	0.31	0.00	0.31			
Sat Flow, veh/h	3456	3647	0	0	5274	1585	3563	0	1585			
Grp Volume(v), veh/h	674	540	0	0	1424	293	914	0	336			
Grp Sat Flow(s),veh/h/ln	1728	1777	0	0	1702	1585	1781	0	1585			
Q Serve(g_s), s	18.8	7.3	0.0	0.0	26.1	15.3	23.6	0.0	18.4			
Cycle Q Clear(g_c), s	18.8	7.3	0.0	0.0	26.1	15.3	23.6	0.0	18.4			
Prop In Lane	1.00		0.00	0.00		1.00	1.00		1.00			
Lane Grp Cap(c), veh/h	778	2114	0	0	1659	515	1122	0	499			
V/C Ratio(X)	0.87	0.26	0.00	0.00	0.86	0.57	0.81	0.00	0.67			
Avail Cap(c_a), veh/h	778	2114	0	0	1659	515	1122	0	499			
HCM Platoon Ratio	1.00	1.00	1.00	1.00	1.00	1.00	1.00	1.00	1.00			
Upstream Filter(I)	1.00	1.00	0.00	0.00	1.00	1.00	1.00	0.00	1.00			
Uniform Delay (d), s/veh	37.3	9.7	0.0	0.0	31.6	27.9	31.6	0.0	29.8			
Incr Delay (d2), s/veh	12.5	0.3	0.0	0.0	6.0	4.5	6.5	0.0	7.1			
Initial Q Delay(d3),s/veh	0.0	0.0	0.0	0.0	0.0	0.0	0.0	0.0	0.0			
%ile BackOfQ(50%),veh/ln	9.1	2.7	0.0	0.0	11.4	6.3	10.9	0.0	7.9			
Unsig. Movement Delay, s/veh												
LnGrp Delay(d),s/veh	49.8	10.0	0.0	0.0	37.6	32.5	38.1	0.0	36.9			
LnGrp LOS	D	A	A	A	D	C	D	A	D			
Approach Vol, veh/h		1214			1717			1250				
Approach Delay, s/veh		32.1			36.7			37.8				
Approach LOS		C			D			D				
Timer - Assigned Phs		2		4			7	8				
Phs Duration (G+Y+Rc), s		36.0		64.0			27.0	37.0				
Change Period (Y+Rc), s		4.5		4.5			4.5	4.5				
Max Green Setting (Gmax), s		31.5		59.5			22.5	32.5				
Max Q Clear Time (g_c+I1), s		25.6		9.3			20.8	28.1				
Green Ext Time (p_c), s		2.7		4.2			0.5	3.5				

Intersection Summary

HCM 6th Ctrl Delay	35.7
HCM 6th LOS	D

Notes

User approved volume balancing among the lanes for turning movement.

HCM 6th Signalized Intersection Summary

11: Park Ave & University Ave

05/04/2020



Movement	EBL	EBT	EBR	WBL	WBT	WBR	NBL	NBT	NBR	SBL	SBT	SBR
Lane Configurations	↖	↗		↖	↗		↖	↗		↖	↗	
Traffic Volume (veh/h)	30	524	32	37	749	50	30	30	28	44	36	42
Future Volume (veh/h)	30	524	32	37	749	50	30	30	28	44	36	42
Initial Q (Qb), veh	0	0	0	0	0	0	0	0	0	0	0	0
Ped-Bike Adj(A_pbT)	1.00		1.00	1.00		1.00	1.00		1.00	1.00		1.00
Parking Bus, Adj	1.00	1.00	1.00	1.00	1.00	1.00	1.00	1.00	1.00	1.00	1.00	1.00
Work Zone On Approach		No			No			No			No	
Adj Sat Flow, veh/h/ln	1870	1870	1870	1870	1870	1870	1870	1870	1870	1870	1870	1870
Adj Flow Rate, veh/h	44	616	43	49	805	76	32	52	35	62	45	71
Peak Hour Factor	0.68	0.85	0.75	0.75	0.93	0.66	0.94	0.58	0.79	0.71	0.80	0.59
Percent Heavy Veh, %	2	2	2	2	2	2	2	2	2	2	2	2
Cap, veh/h	154	1425	99	154	1387	131	138	223	150	202	163	258
Arrive On Green	0.09	0.42	0.42	0.09	0.42	0.42	0.08	0.21	0.21	0.11	0.25	0.25
Sat Flow, veh/h	1781	3370	235	1781	3282	310	1781	1042	702	1781	654	1031
Grp Volume(v), veh/h	44	324	335	49	436	445	32	0	87	62	0	116
Grp Sat Flow(s),veh/h/ln	1781	1777	1828	1781	1777	1815	1781	0	1744	1781	0	1685
Q Serve(g_s), s	2.5	14.2	14.2	2.8	20.6	20.6	1.9	0.0	4.5	3.5	0.0	6.1
Cycle Q Clear(g_c), s	2.5	14.2	14.2	2.8	20.6	20.6	1.9	0.0	4.5	3.5	0.0	6.1
Prop In Lane	1.00		0.13	1.00		0.17	1.00		0.40	1.00		0.61
Lane Grp Cap(c), veh/h	154	751	773	154	751	767	138	0	373	202	0	421
V/C Ratio(X)	0.29	0.43	0.43	0.32	0.58	0.58	0.23	0.00	0.23	0.31	0.00	0.28
Avail Cap(c_a), veh/h	154	751	773	154	751	767	138	0	373	202	0	421
HCM Platoon Ratio	1.00	1.00	1.00	1.00	1.00	1.00	1.00	1.00	1.00	1.00	1.00	1.00
Upstream Filter(I)	1.00	1.00	1.00	1.00	1.00	1.00	1.00	0.00	1.00	1.00	0.00	1.00
Uniform Delay (d), s/veh	47.1	22.4	22.4	47.2	24.3	24.3	47.7	0.0	35.8	44.8	0.0	33.2
Incr Delay (d2), s/veh	4.6	1.8	1.8	5.4	3.3	3.2	3.9	0.0	1.5	3.9	0.0	1.6
Initial Q Delay(d3),s/veh	0.0	0.0	0.0	0.0	0.0	0.0	0.0	0.0	0.0	0.0	0.0	0.0
%ile BackOfQ(50%),veh/ln	1.3	6.2	6.4	1.5	9.2	9.4	1.0	0.0	2.1	1.8	0.0	2.7
Unsig. Movement Delay, s/veh												
LnGrp Delay(d),s/veh	51.7	24.2	24.2	52.6	27.5	27.5	51.6	0.0	37.3	48.6	0.0	34.8
LnGrp LOS	D	C	C	D	C	C	D	A	D	D	A	C
Approach Vol, veh/h		703			930			119				178
Approach Delay, s/veh		25.9			28.8			41.1				39.7
Approach LOS		C			C			D				D
Timer - Assigned Phs	1	2	3	4	5	6	7	8				
Phs Duration (G+Y+Rc), s	7.0	28.0	14.0	51.0	13.0	32.0	14.0	51.0				
Change Period (Y+Rc), s	4.5	4.5	4.5	4.5	4.5	4.5	4.5	4.5				
Max Green Setting (Gmax), s	12.5	23.5	9.5	46.5	8.5	27.5	9.5	46.5				
Max Q Clear Time (g_c+1), s	11.5	6.5	4.8	16.2	3.9	8.1	4.5	22.6				
Green Ext Time (p_c), s	0.1	0.3	0.0	4.5	0.0	0.5	0.0	6.1				
Intersection Summary												
HCM 6th Ctrl Delay												29.5
HCM 6th LOS												C

HCM 6th AWSC
12: Howard Ave & 12th St

05/04/2020

Intersection

Intersection Delay, s/veh 8.1

Intersection LOS A

Movement	EBL	EBT	EBR	WBL	WBT	WBR	NBL	NBT	NBR	SBL	SBT	SBR
Lane Configurations		↔		↔		↔		↔			↔	
Traffic Vol, veh/h	1	1	19	18	11	3	2	126	5	0	63	6
Future Vol, veh/h	1	1	19	18	11	3	2	126	5	0	63	6
Peak Hour Factor	0.25	0.25	0.85	0.71	0.62	0.50	0.48	0.70	0.42	0.25	0.68	0.62
Heavy Vehicles, %	2	2	2	2	2	2	2	2	2	2	2	2
Mvmt Flow	4	4	22	25	18	6	4	180	12	0	93	10
Number of Lanes	0	1	0	0	1	0	0	1	0	0	1	0

Approach	EB	WB	NB	SB
Opposing Approach	WB	EB	SB	NB
Opposing Lanes	1	1	1	1
Conflicting Approach Left SB	NB	EB	WB	WB
Conflicting Lanes Left	1	1	1	1
Conflicting Approach RightNB	SB	WB	WB	EB
Conflicting Lanes Right	1	1	1	1
HCM Control Delay	7.3	8	8.4	7.9
HCM LOS	A	A	A	A

Lane	NBLn1	EBLn1	WBLn1	SBLn1
Vol Left, %	2%	5%	56%	0%
Vol Thru, %	95%	5%	34%	91%
Vol Right, %	4%	90%	9%	9%
Sign Control	Stop	Stop	Stop	Stop
Traffic Vol by Lane	133	21	32	69
LT Vol	2	1	18	0
Through Vol	126	1	11	63
RT Vol	5	19	3	6
Lane Flow Rate	196	30	49	102
Geometry Grp	1	1	1	1
Degree of Util (X)	0.225	0.035	0.064	0.121
Departure Headway (Hd)	4.131	4.116	4.68	4.272
Convergence, Y/N	Yes	Yes	Yes	Yes
Cap	857	874	769	844
Service Time	2.213	2.121	2.685	2.272
HCM Lane V/C Ratio	0.229	0.034	0.064	0.121
HCM Control Delay	8.4	7.3	8	7.9
HCM Lane LOS	A	A	A	A
HCM 95th-tile Q	0.9	0.1	0.2	0.4

HCM 6th Signalized Intersection Summary

13: Olivewood Ave/Lime St & 14th St

05/04/2020



Movement	EBL	EBT	EBR	WBL	WBT	WBR	NBL	NBT	NBR	SBL	SBT	SBR
Lane Configurations	↙ ↑↑↑			↙ ↑↑↑			↙ ↑↑		↙ ↑↑		↑↑	
Traffic Volume (veh/h)	37	663	49	311	1756	219	97	307	383	45	125	20
Future Volume (veh/h)	37	663	49	311	1756	219	97	307	383	45	125	20
Initial Q (Qb), veh	0	0	0	0	0	0	0	0	0	0	0	0
Ped-Bike Adj(A_pbT)	1.00		1.00	1.00		1.00	1.00		1.00	1.00		1.00
Parking Bus, Adj	1.00	1.00	1.00	1.00	1.00	1.00	1.00	1.00	1.00	1.00	1.00	1.00
Work Zone On Approach	No			No			No		No		No	
Adj Sat Flow, veh/h/ln	1870	1870	1870	1870	1870	1870	1870	1870	1870	1870	1870	1870
Adj Flow Rate, veh/h	52	809	62	342	1888	267	123	363	469	73	151	40
Peak Hour Factor	0.71	0.82	0.79	0.91	0.93	0.82	0.79	0.77	0.86	0.62	0.83	0.50
Percent Heavy Veh, %	2	2	2	2	2	2	2	2	2	2	2	2
Cap, veh/h	105	1148	88	533	2161	302	202	474	804	160	521	134
Arrive On Green	0.06	0.24	0.24	0.60	0.95	0.95	0.11	0.25	0.25	0.05	0.19	0.19
Sat Flow, veh/h	1781	4839	369	1781	4527	634	1781	1870	3170	3456	2798	720
Grp Volume(v), veh/h	52	568	303	342	1415	740	123	363	469	73	94	97
Grp Sat Flow(s),veh/h/ln	1781	1702	1804	1781	1702	1756	1781	1870	1585	1728	1777	1741
Q Serve(g_s), s	3.1	16.8	16.9	13.8	12.3	13.4	7.2	19.8	14.3	2.3	5.0	5.3
Cycle Q Clear(g_c), s	3.1	16.8	16.9	13.8	12.3	13.4	7.2	19.8	14.3	2.3	5.0	5.3
Prop In Lane	1.00		0.20	1.00		0.36	1.00		1.00	1.00		0.41
Lane Grp Cap(c), veh/h	105	808	428	533	1625	838	202	474	804	160	331	324
V/C Ratio(X)	0.49	0.70	0.71	0.64	0.87	0.88	0.61	0.77	0.58	0.46	0.28	0.30
Avail Cap(c_a), veh/h	105	808	428	533	1625	838	202	474	804	160	331	324
HCM Platoon Ratio	1.00	1.00	1.00	2.00	2.00	2.00	1.00	1.00	1.00	1.00	1.00	1.00
Upstream Filter(l)	1.00	1.00	1.00	1.00	1.00	1.00	1.00	1.00	1.00	1.00	1.00	1.00
Uniform Delay (d), s/veh	50.2	38.4	38.5	18.3	1.6	1.6	46.4	38.0	36.0	51.1	38.5	38.6
Incr Delay (d2), s/veh	15.6	5.1	9.5	5.8	6.7	13.0	12.8	11.2	3.1	9.1	2.1	2.3
Initial Q Delay(d3),s/veh	0.0	0.0	0.0	0.0	0.0	0.0	0.0	0.0	0.0	0.0	0.0	0.0
%ile BackOfQ(50%),veh/ln	1.8	7.5	8.6	4.9	2.3	3.9	3.9	10.4	5.8	1.2	2.4	2.5
Unsig. Movement Delay, s/veh												
LnGrp Delay(d),s/veh	65.8	43.5	47.9	24.1	8.3	14.6	59.3	49.2	39.0	60.2	40.6	40.9
LnGrp LOS	E	D	D	C	A	B	E	D	D	E	D	D
Approach Vol, veh/h	923			2497			955		264			
Approach Delay, s/veh	46.2			12.3			45.5		46.1			
Approach LOS	D			B			D		D			
Timer - Assigned Phs	1	2	3	4	5	6	7	8				
Phs Duration (G+Y+Rc), s	9.6	32.4	37.4	30.6	17.0	25.0	11.0	57.0				
Change Period (Y+Rc), s	4.5	4.5	4.5	4.5	4.5	4.5	4.5	4.5				
Max Green Setting (Gmax), s	1	27.9	32.9	26.1	12.5	20.5	6.5	52.5				
Max Q Clear Time (g_c+1), s	1	21.8	15.8	18.9	9.2	7.3	5.1	15.4				
Green Ext Time (p_c), s	0.0	2.3	1.0	3.2	0.1	0.8	0.0	24.2				

Intersection Summary

HCM 6th Ctrl Delay	27.8
HCM 6th LOS	C

Notes

User approved volume balancing among the lanes for turning movement.

HCM 6th Signalized Intersection Summary

14: Mulberry St/SR 91 Off-Ramp & 14th St

05/04/2020



Movement	EBL	EBT	EBR	WBL	WBT	WBR	NBL	NBT	NBR	SBL	SBT	SBR
Lane Configurations		↑↑↑		↔↔	↑↑↑					↔	↑↑	↔
Traffic Volume (veh/h)	0	948	143	431	1703	0	0	0	0	143	227	583
Future Volume (veh/h)	0	948	143	431	1703	0	0	0	0	143	227	583
Initial Q (Qb), veh	0	0	0	0	0	0				0	0	0
Ped-Bike Adj(A_pbT)	1.00		1.00	1.00		1.00				1.00		1.00
Parking Bus, Adj	1.00	1.00	1.00	1.00	1.00	1.00				1.00	1.00	1.00
Work Zone On Approach		No			No						No	
Adj Sat Flow, veh/h/ln	0	1870	1870	1870	1870	0				1870	1870	1870
Adj Flow Rate, veh/h	0	1009	238	590	1871	0				116	288	654
Peak Hour Factor	0.25	0.94	0.60	0.73	0.91	0.25				0.82	0.85	0.95
Percent Heavy Veh, %	0	2	2	2	2	0				2	2	2
Cap, veh/h	0	1332	314	864	3133	0				542	570	965
Arrive On Green	0.00	0.32	0.32	0.25	0.61	0.00				0.30	0.30	0.30
Sat Flow, veh/h	0	4296	972	3456	5274	0				1781	1870	3170
Grp Volume(v), veh/h	0	832	415	590	1871	0				116	288	654
Grp Sat Flow(s),veh/h/ln	0	1702	1695	1728	1702	0				1781	1870	1585
Q Serve(g_s), s	0.0	24.1	24.2	17.0	24.6	0.0				5.3	13.9	19.9
Cycle Q Clear(g_c), s	0.0	24.1	24.2	17.0	24.6	0.0				5.3	13.9	19.9
Prop In Lane	0.00		0.57	1.00		0.00				1.00		1.00
Lane Grp Cap(c), veh/h	0	1099	547	864	3133	0				542	570	965
V/C Ratio(X)	0.00	0.76	0.76	0.68	0.60	0.00				0.21	0.51	0.68
Avail Cap(c_a), veh/h	0	1099	547	864	3133	0				542	570	965
HCM Platoon Ratio	1.00	1.00	1.00	1.00	1.00	1.00				1.00	1.00	1.00
Upstream Filter(I)	0.00	1.00	1.00	1.00	1.00	0.00				1.00	1.00	1.00
Uniform Delay (d), s/veh	0.0	33.4	33.4	37.3	13.0	0.0				28.5	31.4	33.5
Incr Delay (d2), s/veh	0.0	4.9	9.5	4.4	0.8	0.0				0.9	3.2	3.8
Initial Q Delay(d3),s/veh	0.0	0.0	0.0	0.0	0.0	0.0				0.0	0.0	0.0
%ile BackOfQ(50%),veh/ln	0.0	10.5	11.2	7.6	9.0	0.0				2.4	6.8	8.1
Unsig. Movement Delay, s/veh												
LnGrp Delay(d),s/veh	0.0	38.3	42.9	41.7	13.8	0.0				29.4	34.6	37.3
LnGrp LOS	A	D	D	D	B	A				C	C	D
Approach Vol, veh/h		1247			2461						1058	
Approach Delay, s/veh		39.8			20.5						35.7	
Approach LOS		D			C						D	
Timer - Assigned Phs			3	4		6		8				
Phs Duration (G+Y+Rc), s			32.0	40.0		38.0		72.0				
Change Period (Y+Rc), s			4.5	4.5		4.5		4.5				
Max Green Setting (Gmax), s			27.5	35.5		33.5		67.5				
Max Q Clear Time (g_c+I1), s			19.0	26.2		21.9		26.6				
Green Ext Time (p_c), s			1.5	5.5		4.0		22.0				
Intersection Summary												
HCM 6th Ctrl Delay			28.9									
HCM 6th LOS			C									
Notes												
User approved volume balancing among the lanes for turning movement.												

**Opening Year AM with
Cumulative Projects and
Project Conditions**

HCM 6th Signalized Intersection Summary

2: Mission Inn Ave & SR 91 Off-Ramp

05/04/2020

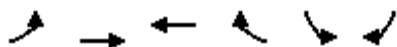

Movement	EBL	EBT	WBT	WBR	SBL	SBR
Lane Configurations		↑↑	↑↑		↵	↵↵
Traffic Volume (veh/h)	0	304	254	0	295	1043
Future Volume (veh/h)	0	304	254	0	295	1043
Initial Q (Qb), veh	0	0	0	0	0	0
Ped-Bike Adj(A_pbT)	1.00			1.00	1.00	1.00
Parking Bus, Adj	1.00	1.00	1.00	1.00	1.00	1.00
Work Zone On Approach		No	No		No	
Adj Sat Flow, veh/h/ln	0	1870	1870	0	1870	1870
Adj Flow Rate, veh/h	0	320	273	0	314	1110
Peak Hour Factor	0.25	0.95	0.93	0.25	0.94	0.94
Percent Heavy Veh, %	0	2	2	0	2	2
Cap, veh/h	0	888	888	0	1190	1864
Arrive On Green	0.00	0.25	0.50	0.00	0.67	0.67
Sat Flow, veh/h	0	3741	3741	0	1781	2790
Grp Volume(v), veh/h	0	320	273	0	314	1110
Grp Sat Flow(s),veh/h/ln	0	1777	1777	0	1781	1395
Q Serve(g_s), s	0.0	8.2	5.0	0.0	7.8	24.1
Cycle Q Clear(g_c), s	0.0	8.2	5.0	0.0	7.8	24.1
Prop In Lane	0.00			0.00	1.00	1.00
Lane Grp Cap(c), veh/h	0	888	888	0	1190	1864
V/C Ratio(X)	0.00	0.36	0.31	0.00	0.26	0.60
Avail Cap(c_a), veh/h	0	888	888	0	1190	1864
HCM Platoon Ratio	1.00	1.00	2.00	1.00	1.00	1.00
Upstream Filter(I)	0.00	1.00	1.00	0.00	1.00	1.00
Uniform Delay (d), s/veh	0.0	34.0	21.9	0.0	7.4	10.1
Incr Delay (d2), s/veh	0.0	1.1	0.9	0.0	0.5	1.4
Initial Q Delay(d3),s/veh	0.0	0.0	0.0	0.0	0.0	0.0
%ile BackOfQ(50%),veh/ln	0.0	3.7	2.0	0.0	2.9	7.0
Unsig. Movement Delay, s/veh						
LnGrp Delay(d),s/veh	0.0	35.1	22.8	0.0	7.9	11.5
LnGrp LOS	A	D	C	A	A	B
Approach Vol, veh/h		320	273		1424	
Approach Delay, s/veh		35.1	22.8		10.7	
Approach LOS		D	C		B	
Timer - Assigned Phs				4	6	8
Phs Duration (G+Y+Rc), s				32.0	78.0	32.0
Change Period (Y+Rc), s				4.5	4.5	4.5
Max Green Setting (Gmax), s				27.5	73.5	27.5
Max Q Clear Time (g_c+I1), s				10.2	26.1	7.0
Green Ext Time (p_c), s				1.9	7.5	1.6
Intersection Summary						
HCM 6th Ctrl Delay			16.2			
HCM 6th LOS			B			

HCM 6th Signalized Intersection Summary

3: Mulberry St/SR 91 On-Ramp & Mission Inn Ave

05/04/2020



Movement	EBL	EBT	EBR	WBL	WBT	WBR	NBL	NBT	NBR	SBL	SBT	SBR
Lane Configurations	↖	↗			↖	↗	↖	↗				
Traffic Volume (veh/h)	265	334	0	0	92	164	162	278	89	0	0	0
Future Volume (veh/h)	265	334	0	0	92	164	162	278	89	0	0	0
Initial Q (Qb), veh	0	0	0	0	0	0	0	0	0			
Ped-Bike Adj(A_pbT)	1.00		1.00	1.00		1.00	1.00		1.00			
Parking Bus, Adj	1.00	1.00	1.00	1.00	1.00	1.00	1.00	1.00	1.00			
Work Zone On Approach		No			No			No				
Adj Sat Flow, veh/h/ln	1870	1870	0	0	1870	1870	1870	1870	1870			
Adj Flow Rate, veh/h	291	388	0	0	130	0	208	339	110			
Peak Hour Factor	0.91	0.86	0.25	0.25	0.71	0.73	0.78	0.82	0.81			
Percent Heavy Veh, %	2	2	0	0	2	2	2	2	2			
Cap, veh/h	510	1890	0	0	727		688	523	170			
Arrive On Green	0.57	1.00	0.00	0.00	0.20	0.00	0.39	0.39	0.39			
Sat Flow, veh/h	1781	3647	0	0	3741	0	1781	1353	439			
Grp Volume(v), veh/h	291	388	0	0	130	0	208	0	449			
Grp Sat Flow(s),veh/h/ln	1781	1777	0	0	1777	0	1781	0	1791			
Q Serve(g_s), s	11.4	0.0	0.0	0.0	3.3	0.0	8.9	0.0	22.6			
Cycle Q Clear(g_c), s	11.4	0.0	0.0	0.0	3.3	0.0	8.9	0.0	22.6			
Prop In Lane	1.00		0.00	0.00		0.00	1.00		0.24			
Lane Grp Cap(c), veh/h	510	1890	0	0	727		688	0	692			
V/C Ratio(X)	0.57	0.21	0.00	0.00	0.18		0.30	0.00	0.65			
Avail Cap(c_a), veh/h	510	1890	0	0	727		688	0	692			
HCM Platoon Ratio	2.00	2.00	1.00	1.00	1.00	1.00	1.00	1.00	1.00			
Upstream Filter(I)	1.00	1.00	0.00	0.00	1.00	0.00	1.00	0.00	1.00			
Uniform Delay (d), s/veh	19.2	0.0	0.0	0.0	36.1	0.0	23.4	0.0	27.6			
Incr Delay (d2), s/veh	4.6	0.2	0.0	0.0	0.5	0.0	1.1	0.0	4.7			
Initial Q Delay(d3),s/veh	0.0	0.0	0.0	0.0	0.0	0.0	0.0	0.0	0.0			
%ile BackOfQ(50%),veh/ln	4.3	0.1	0.0	0.0	1.5	0.0	3.9	0.0	10.4			
Unsig. Movement Delay, s/veh												
LnGrp Delay(d),s/veh	23.8	0.2	0.0	0.0	36.7	0.0	24.6	0.0	32.3			
LnGrp LOS	C	A	A	A	D		C	A	C			
Approach Vol, veh/h		679			130	A		657				
Approach Delay, s/veh		10.3			36.7			29.9				
Approach LOS		B			D			C				
Timer - Assigned Phs		2		4			7	8				
Phs Duration (G+Y+Rc), s		47.0		63.0			36.0	27.0				
Change Period (Y+Rc), s		4.5		4.5			4.5	4.5				
Max Green Setting (Gmax), s		42.5		58.5			31.5	22.5				
Max Q Clear Time (g_c+I1), s		24.6		2.0			13.4	5.3				
Green Ext Time (p_c), s		3.4		2.9			0.8	0.6				

Intersection Summary

HCM 6th Ctrl Delay	21.4
HCM 6th LOS	C

Notes

Unsignalized Delay for [WBR] is excluded from calculations of the approach delay and intersection delay.

HCM 6th Signalized Intersection Summary

4: Howard Ave & 14th St

05/04/2020



Movement	EBL	EBT	EBR	WBL	WBT	WBR	NBL	NBT	NBR	SBL	SBT	SBR
Lane Configurations												
Traffic Volume (veh/h)	91	619	45	12	1441	29	67	15	15	6	12	83
Future Volume (veh/h)	91	619	45	12	1441	29	67	15	15	6	12	83
Initial Q (Qb), veh	0	0	0	0	0	0	0	0	0	0	0	0
Ped-Bike Adj(A_pbT)	1.00		1.00	1.00		1.00	1.00		1.00	1.00		1.00
Parking Bus, Adj	1.00	1.00	1.00	1.00	1.00	1.00	1.00	1.00	1.00	1.00	1.00	1.00
Work Zone On Approach		No			No			No			No	
Adj Sat Flow, veh/h/ln	1870	1870	1870	1870	1870	1870	1870	1870	1870	1870	1870	1870
Adj Flow Rate, veh/h	130	696	63	22	1638	41	92	21	24	12	22	94
Peak Hour Factor	0.70	0.89	0.71	0.55	0.88	0.70	0.73	0.70	0.62	0.50	0.54	0.88
Percent Heavy Veh, %	2	2	2	2	2	2	2	2	2	2	2	2
Cap, veh/h	219	2207	984	92	1949	49	233	54	49	50	75	245
Arrive On Green	0.12	0.62	0.62	0.05	0.55	0.55	0.20	0.20	0.20	0.20	0.20	0.20
Sat Flow, veh/h	1781	3554	1585	1781	3543	88	871	264	241	69	364	1197
Grp Volume(v), veh/h	130	696	63	22	820	859	137	0	0	128	0	0
Grp Sat Flow(s),veh/h/ln	1781	1777	1585	1781	1777	1854	1375	0	0	1629	0	0
Q Serve(g_s), s	7.6	10.2	1.7	1.3	42.4	42.7	2.5	0.0	0.0	0.0	0.0	0.0
Cycle Q Clear(g_c), s	7.6	10.2	1.7	1.3	42.4	42.7	9.8	0.0	0.0	7.3	0.0	0.0
Prop In Lane	1.00		1.00	1.00		0.05	0.67		0.18	0.09		0.73
Lane Grp Cap(c), veh/h	219	2207	984	92	977	1020	336	0	0	369	0	0
V/C Ratio(X)	0.59	0.32	0.06	0.24	0.84	0.84	0.41	0.00	0.00	0.35	0.00	0.00
Avail Cap(c_a), veh/h	219	2207	984	92	977	1020	336	0	0	369	0	0
HCM Platoon Ratio	1.00	1.00	1.00	1.00	1.00	1.00	1.00	1.00	1.00	1.00	1.00	1.00
Upstream Filter(I)	1.00	1.00	1.00	1.00	1.00	1.00	1.00	0.00	0.00	1.00	0.00	0.00
Uniform Delay (d), s/veh	45.7	9.8	8.2	50.1	20.7	20.8	38.6	0.0	0.0	37.7	0.0	0.0
Incr Delay (d2), s/veh	11.4	0.4	0.1	6.0	8.6	8.4	3.6	0.0	0.0	2.6	0.0	0.0
Initial Q Delay(d3),s/veh	0.0	0.0	0.0	0.0	0.0	0.0	0.0	0.0	0.0	0.0	0.0	0.0
%ile BackOfQ(50%),veh/ln	0.0	3.9	0.6	0.7	18.8	19.8	3.6	0.0	0.0	3.2	0.0	0.0
Unsig. Movement Delay, s/veh												
LnGrp Delay(d),s/veh	57.0	10.2	8.4	56.1	29.2	29.2	42.3	0.0	0.0	40.3	0.0	0.0
LnGrp LOS	E	B	A	E	C	C	D	A	A	D	A	A
Approach Vol, veh/h		889			1701			137			128	
Approach Delay, s/veh		16.9			29.6			42.3			40.3	
Approach LOS		B			C			D			D	
Timer - Assigned Phs		2	3	4		6	7	8				
Phs Duration (G+Y+Rc), s		27.0	10.2	72.8		27.0	18.0	65.0				
Change Period (Y+Rc), s		4.5	4.5	4.5		4.5	4.5	4.5				
Max Green Setting (Gmax), s		22.5	5.7	68.3		22.5	13.5	60.5				
Max Q Clear Time (g_c+I1), s		11.8	3.3	12.2		9.3	9.6	44.7				
Green Ext Time (p_c), s		0.5	0.0	6.0		0.5	0.1	10.7				
Intersection Summary												
HCM 6th Ctrl Delay											26.7	
HCM 6th LOS											C	

Intersection

Intersection Delay, s/veh 12.1

Intersection LOS B

Movement	EBL	EBT	EBR	WBL	WBT	WBR	NBL	NBT	NBR	SBL	SBT	SBR
Lane Configurations	↙	↑	↗	↙	↑↑		↙	↗			↕	
Traffic Vol, veh/h	121	236	66	1	164	38	45	51	25	18	14	47
Future Vol, veh/h	121	236	66	1	164	38	45	51	25	18	14	47
Peak Hour Factor	0.75	0.88	0.67	0.25	0.73	0.89	0.70	0.89	0.57	0.71	0.81	0.97
Heavy Vehicles, %	2	2	2	2	2	2	2	2	2	2	2	2
Mvmt Flow	161	268	99	4	225	43	64	57	44	25	17	48
Number of Lanes	1	1	1	1	2	0	1	1	0	0	1	0

Approach	EB	WB	NB	SB
Opposing Approach	WB	EB	SB	NB
Opposing Lanes	3	3	1	2
Conflicting Approach Left SB		NB	EB	WB
Conflicting Lanes Left	1	2	3	3
Conflicting Approach Right NB		SB	WB	EB
Conflicting Lanes Right	2	1	3	3
HCM Control Delay	12.8	11.6	11.4	11.3
HCM LOS	B	B	B	B

Lane	NBLn1	NBLn2	EBLn1	EBLn2	EBLn3	WBLn1	WBLn2	WBLn3	SBLn1
Vol Left, %	100%	0%	100%	0%	0%	100%	0%	0%	23%
Vol Thru, %	0%	67%	0%	100%	0%	0%	100%	59%	18%
Vol Right, %	0%	33%	0%	0%	100%	0%	0%	41%	59%
Sign Control	Stop	Stop	Stop	Stop	Stop	Stop	Stop	Stop	Stop
Traffic Vol by Lane	45	76	121	236	66	1	109	93	79
LT Vol	45	0	121	0	0	1	0	0	18
Through Vol	0	51	0	236	0	0	109	55	14
RT Vol	0	25	0	0	66	0	0	38	47
Lane Flow Rate	64	101	161	268	99	4	150	118	91
Geometry Grp	8	8	8	8	8	8	8	8	8
Degree of Util (X)	0.135	0.192	0.302	0.464	0.151	0.008	0.28	0.21	0.176
Departure Headway (Hd)	7.575	6.842	6.735	6.228	5.519	7.232	6.725	6.433	6.966
Convergence, Y/N	Yes	Yes	Yes	Yes	Yes	Yes	Yes	Yes	Yes
Cap	471	521	532	577	647	493	532	555	512
Service Time	5.358	4.624	4.496	3.989	3.279	5.007	4.499	4.207	4.752
HCM Lane V/C Ratio	0.136	0.194	0.303	0.464	0.153	0.008	0.282	0.213	0.178
HCM Control Delay	11.5	11.3	12.4	14.3	9.3	10.1	12.1	10.9	11.3
HCM Lane LOS	B	B	B	B	A	B	B	B	B
HCM 95th-tile Q	0.5	0.7	1.3	2.4	0.5	0	1.1	0.8	0.6

HCM 6th TWSC
6: Commerce St & Mission Inn Ave

05/04/2020

Intersection												
Int Delay, s/veh	3.4											
Movement	EBL	EBT	EBR	WBL	WBT	WBR	NBL	NBT	NBR	SBL	SBT	SBR
Lane Configurations		↕	↗		↕			↕			↕	
Traffic Vol, veh/h	13	172	94	4	153	2	36	21	2	3	22	14
Future Vol, veh/h	13	172	94	4	153	2	36	21	2	3	22	14
Conflicting Peds, #/hr	0	0	0	0	0	0	0	0	0	0	0	0
Sign Control	Free	Free	Free	Free	Free	Free	Stop	Stop	Stop	Stop	Stop	Stop
RT Channelized	-	-	None	-	-	None	-	-	None	-	-	None
Storage Length	-	-	0	-	-	-	-	-	-	-	-	-
Veh in Median Storage, #	-	0	-	-	0	-	-	0	-	-	0	-
Grade, %	-	0	-	-	0	-	-	0	-	-	0	-
Peak Hour Factor	75	75	75	50	95	50	69	42	50	25	83	65
Heavy Vehicles, %	2	2	2	2	2	2	2	2	2	2	2	2
Mvmt Flow	17	229	125	8	161	4	52	50	4	12	27	22

Major/Minor	Major1			Major2			Minor1			Minor2		
Conflicting Flow All	165	0	0	354	0	0	373	444	229	532	567	83
Stage 1	-	-	-	-	-	-	263	263	-	179	179	-
Stage 2	-	-	-	-	-	-	110	181	-	353	388	-
Critical Hdwy	4.13	-	-	4.13	-	-	7.33	6.53	6.23	7.33	6.53	6.93
Critical Hdwy Stg 1	-	-	-	-	-	-	6.13	5.53	-	6.53	5.53	-
Critical Hdwy Stg 2	-	-	-	-	-	-	6.53	5.53	-	6.13	5.53	-
Follow-up Hdwy	2.219	-	-	2.219	-	-	3.519	4.019	3.319	3.519	4.019	3.319
Pot Cap-1 Maneuver	1412	-	-	1203	-	-	571	508	810	444	432	960
Stage 1	-	-	-	-	-	-	741	690	-	806	751	-
Stage 2	-	-	-	-	-	-	884	749	-	663	608	-
Platoon blocked, %	-	-	-	-	-	-	-	-	-	-	-	-
Mov Cap-1 Maneuver	1412	-	-	1203	-	-	522	497	810	401	422	960
Mov Cap-2 Maneuver	-	-	-	-	-	-	522	497	-	401	422	-
Stage 1	-	-	-	-	-	-	730	680	-	794	746	-
Stage 2	-	-	-	-	-	-	828	744	-	602	599	-

Approach	EB			WB			NB			SB		
HCM Control Delay, s	0.4			0.4			13.8			12.8		
HCM LOS							B			B		

Minor Lane/Major Mvmt	NBLn1	EBL	EBT	EBR	WBL	WBT	WBR	SBLn1
Capacity (veh/h)	517	1412	-	-	1203	-	-	521
HCM Lane V/C Ratio	0.205	0.012	-	-	0.007	-	-	0.115
HCM Control Delay (s)	13.8	7.6	0	-	8	0	-	12.8
HCM Lane LOS	B	A	A	-	A	A	-	B
HCM 95th %tile Q(veh)	0.8	0	-	-	0	-	-	0.4

Intersection						
Int Delay, s/veh	2.7					
Movement	WBL	WBR	NBT	NBR	SBL	SBT
Lane Configurations	W	R	T	R	L	T
Traffic Vol, veh/h	4	20	40	0	18	103
Future Vol, veh/h	4	20	40	0	18	103
Conflicting Peds, #/hr	0	0	0	0	0	0
Sign Control	Stop	Stop	Free	Free	Free	Free
RT Channelized	-	None	-	None	-	None
Storage Length	0	-	-	-	-	-
Veh in Median Storage, #	0	-	0	-	-	0
Grade, %	0	-	0	-	-	0
Peak Hour Factor	50	79	77	25	25	68
Heavy Vehicles, %	2	2	2	2	2	2
Mvmt Flow	8	25	52	0	72	151

Major/Minor	Minor1	Major1	Major2			
Conflicting Flow All	347	52	0	0	52	0
Stage 1	52	-	-	-	-	-
Stage 2	295	-	-	-	-	-
Critical Hdwy	6.42	6.22	-	-	4.12	-
Critical Hdwy Stg 1	5.42	-	-	-	-	-
Critical Hdwy Stg 2	5.42	-	-	-	-	-
Follow-up Hdwy	3.518	3.318	-	-	2.218	-
Pot Cap-1 Maneuver	650	1016	-	-	1554	-
Stage 1	970	-	-	-	-	-
Stage 2	755	-	-	-	-	-
Platoon blocked, %			-	-		
Mov Cap-1 Maneuver	617	1016	-	-	1554	-
Mov Cap-2 Maneuver	617	-	-	-	-	-
Stage 1	921	-	-	-	-	-
Stage 2	755	-	-	-	-	-

Approach	WB	NB	SB
HCM Control Delay, s	9.3	0	2.4
HCM LOS	A		

Minor Lane/Major Mvmt	NBT	NBRWBLn1	SBL	SBT
Capacity (veh/h)	-	-	879	1554
HCM Lane V/C Ratio	-	-	0.038	0.046
HCM Control Delay (s)	-	-	9.3	7.4
HCM Lane LOS	-	-	A	A
HCM 95th %tile Q(veh)	-	-	0.1	0.1

Intersection						
Int Delay, s/veh	5.5					
Movement	EBT	EBR	WBL	WBT	NBL	NBR
Lane Configurations						
Traffic Vol, veh/h	10	63	6	9	89	10
Future Vol, veh/h	10	63	6	9	89	10
Conflicting Peds, #/hr	0	0	0	0	0	0
Sign Control	Free	Free	Free	Free	Stop	Stop
RT Channelized	-	None	-	None	-	None
Storage Length	-	-	-	-	0	-
Veh in Median Storage, #	0	-	-	0	0	-
Grade, %	0	-	-	0	0	-
Peak Hour Factor	38	84	62	67	69	56
Heavy Vehicles, %	2	2	2	2	2	2
Mvmt Flow	26	75	10	13	129	18

Major/Minor	Major1	Major2	Minor1	Minor2	Minor3
Conflicting Flow All	0	0	101	0	97
Stage 1	-	-	-	-	64
Stage 2	-	-	-	-	33
Critical Hdwy	-	-	4.12	-	6.42
Critical Hdwy Stg 1	-	-	-	-	5.42
Critical Hdwy Stg 2	-	-	-	-	5.42
Follow-up Hdwy	-	-	2.218	-	3.518
Pot Cap-1 Maneuver	-	-	1491	-	902
Stage 1	-	-	-	-	959
Stage 2	-	-	-	-	989
Platoon blocked, %	-	-	-	-	-
Mov Cap-1 Maneuver	-	-	1491	-	896
Mov Cap-2 Maneuver	-	-	-	-	896
Stage 1	-	-	-	-	952
Stage 2	-	-	-	-	989

Approach	EB	WB	NB
HCM Control Delay, s	0	3.1	9.7
HCM LOS			A

Minor Lane/Major Mvmt	NBLn1	EBT	EBR	WBL	WBT
Capacity (veh/h)	907	-	-	1491	-
HCM Lane V/C Ratio	0.162	-	-	0.006	-
HCM Control Delay (s)	9.7	-	-	7.4	0
HCM Lane LOS	A	-	-	A	A
HCM 95th %tile Q(veh)	0.6	-	-	0	-

HCM 6th Signalized Intersection Summary
 9: SR 91 Off-Ramp/SR 91 On-Ramp & 14th St

05/04/2020



Movement	EBL	EBT	EBR	WBL	WBT	WBR	NBL	NBT	NBR	SBL	SBT	SBR
Lane Configurations	↖↗	↑↑			↑↑↑	↖	↖	↖	↖			
Traffic Volume (veh/h)	627	472	0	0	1345	246	822	0	282	0	0	0
Future Volume (veh/h)	627	472	0	0	1345	246	822	0	282	0	0	0
Initial Q (Qb), veh	0	0	0	0	0	0	0	0	0			
Ped-Bike Adj(A_pbT)	1.00		1.00	1.00		1.00	1.00		1.00			
Parking Bus, Adj	1.00	1.00	1.00	1.00	1.00	1.00	1.00	1.00	1.00			
Work Zone On Approach		No			No			No				
Adj Sat Flow, veh/h/ln	1870	1870	0	0	1870	1870	1870	1870	1870			
Adj Flow Rate, veh/h	682	543	0	0	1431	293	945	0	336			
Peak Hour Factor	0.92	0.87	0.25	0.25	0.94	0.84	0.87	0.25	0.84			
Percent Heavy Veh, %	2	2	0	0	2	2	2	2	2			
Cap, veh/h	778	2114	0	0	1659	515	1122	0	499			
Arrive On Green	0.22	0.60	0.00	0.00	0.32	0.32	0.31	0.00	0.31			
Sat Flow, veh/h	3456	3647	0	0	5274	1585	3563	0	1585			
Grp Volume(v), veh/h	682	543	0	0	1431	293	945	0	336			
Grp Sat Flow(s),veh/h/ln	1728	1777	0	0	1702	1585	1781	0	1585			
Q Serve(g_s), s	19.1	7.3	0.0	0.0	26.3	15.3	24.7	0.0	18.4			
Cycle Q Clear(g_c), s	19.1	7.3	0.0	0.0	26.3	15.3	24.7	0.0	18.4			
Prop In Lane	1.00		0.00	0.00		1.00	1.00		1.00			
Lane Grp Cap(c), veh/h	778	2114	0	0	1659	515	1122	0	499			
V/C Ratio(X)	0.88	0.26	0.00	0.00	0.86	0.57	0.84	0.00	0.67			
Avail Cap(c_a), veh/h	778	2114	0	0	1659	515	1122	0	499			
HCM Platoon Ratio	1.00	1.00	1.00	1.00	1.00	1.00	1.00	1.00	1.00			
Upstream Filter(I)	1.00	1.00	0.00	0.00	1.00	1.00	1.00	0.00	1.00			
Uniform Delay (d), s/veh	37.4	9.7	0.0	0.0	31.7	27.9	31.9	0.0	29.8			
Incr Delay (d2), s/veh	13.3	0.3	0.0	0.0	6.2	4.5	7.7	0.0	7.1			
Initial Q Delay(d3),s/veh	0.0	0.0	0.0	0.0	0.0	0.0	0.0	0.0	0.0			
%ile BackOfQ(50%),veh/ln	9.3	2.8	0.0	0.0	11.5	6.3	11.6	0.0	7.9			
Unsig. Movement Delay, s/veh												
LnGrp Delay(d),s/veh	50.7	10.0	0.0	0.0	37.8	32.5	39.6	0.0	36.9			
LnGrp LOS	D	A	A	A	D	C	D	A	D			
Approach Vol, veh/h		1225			1724			1281				
Approach Delay, s/veh		32.7			36.9			38.9				
Approach LOS		C			D			D				
Timer - Assigned Phs		2		4			7	8				
Phs Duration (G+Y+Rc), s		36.0		64.0			27.0	37.0				
Change Period (Y+Rc), s		4.5		4.5			4.5	4.5				
Max Green Setting (Gmax), s		31.5		59.5			22.5	32.5				
Max Q Clear Time (g_c+I1), s		26.7		9.3			21.1	28.3				
Green Ext Time (p_c), s		2.4		4.2			0.5	3.4				

Intersection Summary

HCM 6th Ctrl Delay	36.3
HCM 6th LOS	D

Notes

User approved volume balancing among the lanes for turning movement.

HCM 6th Signalized Intersection Summary

11: Park Ave & University Ave

05/04/2020



Movement	EBL	EBT	EBR	WBL	WBT	WBR	NBL	NBT	NBR	SBL	SBT	SBR
Lane Configurations												
Traffic Volume (veh/h)	30	524	32	37	749	50	30	30	28	44	36	42
Future Volume (veh/h)	30	524	32	37	749	50	30	30	28	44	36	42
Initial Q (Qb), veh	0	0	0	0	0	0	0	0	0	0	0	0
Ped-Bike Adj(A_pbT)	1.00		1.00	1.00		1.00	1.00		1.00	1.00		1.00
Parking Bus, Adj	1.00	1.00	1.00	1.00	1.00	1.00	1.00	1.00	1.00	1.00	1.00	1.00
Work Zone On Approach		No			No			No			No	
Adj Sat Flow, veh/h/ln	1870	1870	1870	1870	1870	1870	1870	1870	1870	1870	1870	1870
Adj Flow Rate, veh/h	44	616	43	49	805	76	32	52	35	62	45	71
Peak Hour Factor	0.68	0.85	0.75	0.75	0.93	0.66	0.94	0.58	0.79	0.71	0.80	0.59
Percent Heavy Veh, %	2	2	2	2	2	2	2	2	2	2	2	2
Cap, veh/h	154	1425	99	154	1387	131	138	223	150	202	163	258
Arrive On Green	0.09	0.42	0.42	0.09	0.42	0.42	0.08	0.21	0.21	0.11	0.25	0.25
Sat Flow, veh/h	1781	3370	235	1781	3282	310	1781	1042	702	1781	654	1031
Grp Volume(v), veh/h	44	324	335	49	436	445	32	0	87	62	0	116
Grp Sat Flow(s),veh/h/ln	1781	1777	1828	1781	1777	1815	1781	0	1744	1781	0	1685
Q Serve(g_s), s	2.5	14.2	14.2	2.8	20.6	20.6	1.9	0.0	4.5	3.5	0.0	6.1
Cycle Q Clear(g_c), s	2.5	14.2	14.2	2.8	20.6	20.6	1.9	0.0	4.5	3.5	0.0	6.1
Prop In Lane	1.00		0.13	1.00		0.17	1.00		0.40	1.00		0.61
Lane Grp Cap(c), veh/h	154	751	773	154	751	767	138	0	373	202	0	421
V/C Ratio(X)	0.29	0.43	0.43	0.32	0.58	0.58	0.23	0.00	0.23	0.31	0.00	0.28
Avail Cap(c_a), veh/h	154	751	773	154	751	767	138	0	373	202	0	421
HCM Platoon Ratio	1.00	1.00	1.00	1.00	1.00	1.00	1.00	1.00	1.00	1.00	1.00	1.00
Upstream Filter(I)	1.00	1.00	1.00	1.00	1.00	1.00	1.00	0.00	1.00	1.00	0.00	1.00
Uniform Delay (d), s/veh	47.1	22.4	22.4	47.2	24.3	24.3	47.7	0.0	35.8	44.8	0.0	33.2
Incr Delay (d2), s/veh	4.6	1.8	1.8	5.4	3.3	3.2	3.9	0.0	1.5	3.9	0.0	1.6
Initial Q Delay(d3),s/veh	0.0	0.0	0.0	0.0	0.0	0.0	0.0	0.0	0.0	0.0	0.0	0.0
%ile BackOfQ(50%),veh/ln	1.3	6.2	6.4	1.5	9.2	9.4	1.0	0.0	2.1	1.8	0.0	2.7
Unsig. Movement Delay, s/veh												
LnGrp Delay(d),s/veh	51.7	24.2	24.2	52.6	27.5	27.5	51.6	0.0	37.3	48.6	0.0	34.8
LnGrp LOS	D	C	C	D	C	C	D	A	D	D	A	C
Approach Vol, veh/h		703			930			119				178
Approach Delay, s/veh		25.9			28.8			41.1				39.7
Approach LOS		C			C			D				D
Timer - Assigned Phs	1	2	3	4	5	6	7	8				
Phs Duration (G+Y+Rc), s	7.0	28.0	14.0	51.0	13.0	32.0	14.0	51.0				
Change Period (Y+Rc), s	4.5	4.5	4.5	4.5	4.5	4.5	4.5	4.5				
Max Green Setting (Gmax), s	12.5	23.5	9.5	46.5	8.5	27.5	9.5	46.5				
Max Q Clear Time (g_c+1), s	17.5	6.5	4.8	16.2	3.9	8.1	4.5	22.6				
Green Ext Time (p_c), s	0.1	0.3	0.0	4.5	0.0	0.5	0.0	6.1				
Intersection Summary												
HCM 6th Ctrl Delay												29.5
HCM 6th LOS												C

HCM 6th AWSC
12: Howard Ave & 12th St

05/04/2020

Intersection

Intersection Delay, s/veh 8.1

Intersection LOS A

Movement	EBL	EBT	EBR	WBL	WBT	WBR	NBL	NBT	NBR	SBL	SBT	SBR
Lane Configurations		↔		↔		↔		↔			↔	
Traffic Vol, veh/h	1	1	19	18	11	3	2	126	5	0	63	6
Future Vol, veh/h	1	1	19	18	11	3	2	126	5	0	63	6
Peak Hour Factor	0.25	0.25	0.85	0.71	0.62	0.50	0.48	0.70	0.42	0.25	0.68	0.62
Heavy Vehicles, %	2	2	2	2	2	2	2	2	2	2	2	2
Mvmt Flow	4	4	22	25	18	6	4	180	12	0	93	10
Number of Lanes	0	1	0	0	1	0	0	1	0	0	1	0

Approach	EB	WB	NB	SB
Opposing Approach	WB	EB	SB	NB
Opposing Lanes	1	1	1	1
Conflicting Approach Left SB	NB	EB	WB	WB
Conflicting Lanes Left	1	1	1	1
Conflicting Approach RightNB	SB	WB	WB	EB
Conflicting Lanes Right	1	1	1	1
HCM Control Delay	7.3	8	8.4	7.9
HCM LOS	A	A	A	A

Lane	NBLn1	EBLn1	WBLn1	SBLn1
Vol Left, %	2%	5%	56%	0%
Vol Thru, %	95%	5%	34%	91%
Vol Right, %	4%	90%	9%	9%
Sign Control	Stop	Stop	Stop	Stop
Traffic Vol by Lane	133	21	32	69
LT Vol	2	1	18	0
Through Vol	126	1	11	63
RT Vol	5	19	3	6
Lane Flow Rate	196	30	49	102
Geometry Grp	1	1	1	1
Degree of Util (X)	0.225	0.035	0.064	0.121
Departure Headway (Hd)	4.131	4.116	4.68	4.272
Convergence, Y/N	Yes	Yes	Yes	Yes
Cap	857	874	769	844
Service Time	2.213	2.121	2.685	2.272
HCM Lane V/C Ratio	0.229	0.034	0.064	0.121
HCM Control Delay	8.4	7.3	8	7.9
HCM Lane LOS	A	A	A	A
HCM 95th-tile Q	0.9	0.1	0.2	0.4

HCM 6th Signalized Intersection Summary

13: Olivewood Ave/Lime St & 14th St

05/04/2020



Movement	EBL	EBT	EBR	WBL	WBT	WBR	NBL	NBT	NBR	SBL	SBT	SBR	
Lane Configurations	↙ ↑↑↑			↙ ↑↑↑			↙ ↑↑		↙ ↑↑		↑↑		
Traffic Volume (veh/h)	37	663	49	370	1757	219	97	307	392	45	125	20	
Future Volume (veh/h)	37	663	49	370	1757	219	97	307	392	45	125	20	
Initial Q (Qb), veh	0	0	0	0	0	0	0	0	0	0	0	0	
Ped-Bike Adj(A_pbT)	1.00		1.00	1.00		1.00	1.00		1.00	1.00		1.00	
Parking Bus, Adj	1.00	1.00	1.00	1.00	1.00	1.00	1.00	1.00	1.00	1.00	1.00	1.00	
Work Zone On Approach	No			No			No		No		No		
Adj Sat Flow, veh/h/ln	1870	1870	1870	1870	1870	1870	1870	1870	1870	1870	1870	1870	
Adj Flow Rate, veh/h	52	809	62	407	1889	267	123	370	475	73	151	40	
Peak Hour Factor	0.71	0.82	0.79	0.91	0.93	0.82	0.79	0.77	0.86	0.62	0.83	0.50	
Percent Heavy Veh, %	2	2	2	2	2	2	2	2	2	2	2	2	
Cap, veh/h	105	1122	86	542	2161	302	202	474	804	160	521	134	
Arrive On Green	0.06	0.23	0.23	0.61	0.95	0.95	0.11	0.25	0.25	0.05	0.19	0.19	
Sat Flow, veh/h	1781	4839	369	1781	4527	633	1781	1870	3170	3456	2798	720	
Grp Volume(v), veh/h	52	568	303	407	1415	741	123	370	475	73	94	97	
Grp Sat Flow(s),veh/h/ln	1781	1702	1804	1781	1702	1756	1781	1870	1585	1728	1777	1741	
Q Serve(g_s), s	3.1	16.9	17.0	18.1	12.3	13.5	7.2	20.2	14.5	2.3	5.0	5.3	
Cycle Q Clear(g_c), s	3.1	16.9	17.0	18.1	12.3	13.5	7.2	20.2	14.5	2.3	5.0	5.3	
Prop In Lane	1.00		0.20	1.00		0.36	1.00		1.00	1.00		0.41	
Lane Grp Cap(c), veh/h	105	789	418	542	1625	838	202	474	804	160	331	324	
V/C Ratio(X)	0.49	0.72	0.72	0.75	0.87	0.88	0.61	0.78	0.59	0.46	0.28	0.30	
Avail Cap(c_a), veh/h	105	789	418	542	1625	838	202	474	804	160	331	324	
HCM Platoon Ratio	1.00	1.00	1.00	2.00	2.00	2.00	1.00	1.00	1.00	1.00	1.00	1.00	
Upstream Filter(I)	1.00	1.00	1.00	1.00	1.00	1.00	1.00	1.00	1.00	1.00	1.00	1.00	
Uniform Delay (d), s/veh	50.2	39.0	39.0	18.5	1.6	1.6	46.4	38.2	36.0	51.1	38.5	38.6	
Incr Delay (d2), s/veh	15.6	5.6	10.4	9.2	6.7	13.0	12.8	12.0	3.2	9.1	2.1	2.3	
Initial Q Delay(d3),s/veh	0.0	0.0	0.0	0.0	0.0	0.0	0.0	0.0	0.0	0.0	0.0	0.0	
%ile BackOfQ(50%),veh/ln	1.8	7.6	8.7	6.2	2.3	3.9	3.9	10.8	5.9	1.2	2.4	2.5	
Unsig. Movement Delay, s/veh													
LnGrp Delay(d),s/veh	65.8	44.6	49.4	27.7	8.3	14.7	59.3	50.2	39.2	60.2	40.6	40.9	
LnGrp LOS	E	D	D	C	A	B	E	D	D	E	D	D	
Approach Vol, veh/h	923			2563			968		264				
Approach Delay, s/veh	47.4			13.2			46.0		46.1				
Approach LOS	D			B			D		D				
Timer - Assigned Phs	1	2	3	4	5	6	7	8					
Phs Duration (G+Y+Rc), s	9.6	32.4	38.0	30.0	17.0	25.0	11.0	57.0					
Change Period (Y+Rc), s	4.5	4.5	4.5	4.5	4.5	4.5	4.5	4.5					
Max Green Setting (Gmax), s	27.9	33.5	25.5	12.5	20.5	6.5	52.5						
Max Q Clear Time (g_c+1), s	22.2	20.1	19.0	9.2	7.3	5.1	15.5						
Green Ext Time (p_c), s	0.0	2.2	1.1	3.0	0.1	0.8	0.0	24.2					

Intersection Summary

HCM 6th Ctrl Delay	28.5
HCM 6th LOS	C

Notes

User approved volume balancing among the lanes for turning movement.

HCM 6th Signalized Intersection Summary

14: Mulberry St/SR 91 Off-Ramp & 14th St

05/04/2020



Movement	EBL	EBT	EBR	WBL	WBT	WBR	NBL	NBT	NBR	SBL	SBT	SBR
Lane Configurations		↑↑↑		↔↔	↑↑↑					↔	↔↔	↔
Traffic Volume (veh/h)	0	957	143	431	1736	0	0	0	0	143	227	610
Future Volume (veh/h)	0	957	143	431	1736	0	0	0	0	143	227	610
Initial Q (Qb), veh	0	0	0	0	0	0				0	0	0
Ped-Bike Adj(A_pbT)	1.00		1.00	1.00		1.00				1.00		1.00
Parking Bus, Adj	1.00	1.00	1.00	1.00	1.00	1.00				1.00	1.00	1.00
Work Zone On Approach		No			No						No	
Adj Sat Flow, veh/h/ln	0	1870	1870	1870	1870	0				1870	1870	1870
Adj Flow Rate, veh/h	0	1018	238	590	1908	0				116	293	679
Peak Hour Factor	0.25	0.94	0.60	0.73	0.91	0.25				0.82	0.85	0.95
Percent Heavy Veh, %	0	2	2	2	2	0				2	2	2
Cap, veh/h	0	1410	329	801	3133	0				542	570	965
Arrive On Green	0.00	0.34	0.34	0.23	0.61	0.00				0.30	0.30	0.30
Sat Flow, veh/h	0	4304	965	3456	5274	0				1781	1870	3170
Grp Volume(v), veh/h	0	838	418	590	1908	0				116	293	679
Grp Sat Flow(s),veh/h/ln	0	1702	1697	1728	1702	0				1781	1870	1585
Q Serve(g_s), s	0.0	23.7	23.7	17.4	25.4	0.0				5.3	14.2	20.9
Cycle Q Clear(g_c), s	0.0	23.7	23.7	17.4	25.4	0.0				5.3	14.2	20.9
Prop In Lane	0.00		0.57	1.00		0.00				1.00		1.00
Lane Grp Cap(c), veh/h	0	1160	578	801	3133	0				542	570	965
V/C Ratio(X)	0.00	0.72	0.72	0.74	0.61	0.00				0.21	0.51	0.70
Avail Cap(c_a), veh/h	0	1160	578	801	3133	0				542	570	965
HCM Platoon Ratio	1.00	1.00	1.00	1.00	1.00	1.00				1.00	1.00	1.00
Upstream Filter(I)	0.00	1.00	1.00	1.00	1.00	0.00				1.00	1.00	1.00
Uniform Delay (d), s/veh	0.0	31.7	31.7	39.1	13.1	0.0				28.5	31.5	33.9
Incr Delay (d2), s/veh	0.0	3.9	7.7	6.0	0.9	0.0				0.9	3.3	4.3
Initial Q Delay(d3),s/veh	0.0	0.0	0.0	0.0	0.0	0.0				0.0	0.0	0.0
%ile BackOfQ(50%),veh/ln	0.0	10.2	10.8	8.0	9.3	0.0				2.4	6.9	8.5
Unsig. Movement Delay, s/veh												
LnGrp Delay(d),s/veh	0.0	35.6	39.4	45.1	14.0	0.0				29.4	34.8	38.1
LnGrp LOS	A	D	D	D	B	A				C	C	D
Approach Vol, veh/h		1256			2498						1088	
Approach Delay, s/veh		36.9			21.3						36.3	
Approach LOS		D			C						D	
Timer - Assigned Phs			3	4		6		8				
Phs Duration (G+Y+Rc), s			30.0	42.0		38.0		72.0				
Change Period (Y+Rc), s			4.5	4.5		4.5		4.5				
Max Green Setting (Gmax), s			25.5	37.5		33.5		67.5				
Max Q Clear Time (g_c+1), s			19.4	25.7		22.9		27.4				
Green Ext Time (p_c), s			1.3	6.5		3.9		22.4				
Intersection Summary												
HCM 6th Ctrl Delay			28.7									
HCM 6th LOS			C									
Notes												
User approved volume balancing among the lanes for turning movement.												

Opening Year PM

HCM 6th Signalized Intersection Summary

2: Mission Inn Ave & SR 91 Off-Ramp

05/04/2020

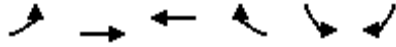

Movement	EBL	EBT	WBT	WBR	SBL	SBR
Lane Configurations		↑↑	↑↑		↵	↵↵
Traffic Volume (veh/h)	0	695	261	0	223	453
Future Volume (veh/h)	0	695	261	0	223	453
Initial Q (Qb), veh	0	0	0	0	0	0
Ped-Bike Adj(A_pbT)	1.00			1.00	1.00	1.00
Parking Bus, Adj	1.00	1.00	1.00	1.00	1.00	1.00
Work Zone On Approach		No	No		No	
Adj Sat Flow, veh/h/ln	0	1870	1870	0	1870	1870
Adj Flow Rate, veh/h	0	732	281	0	237	482
Peak Hour Factor	0.25	0.95	0.93	0.25	0.94	0.94
Percent Heavy Veh, %	0	2	2	0	2	2
Cap, veh/h	0	1858	1858	0	704	1103
Arrive On Green	0.00	0.52	1.00	0.00	0.40	0.40
Sat Flow, veh/h	0	3741	3741	0	1781	2790
Grp Volume(v), veh/h	0	732	281	0	237	482
Grp Sat Flow(s),veh/h/ln	0	1777	1777	0	1781	1395
Q Serve(g_s), s	0.0	13.6	0.0	0.0	10.2	13.9
Cycle Q Clear(g_c), s	0.0	13.6	0.0	0.0	10.2	13.9
Prop In Lane	0.00			0.00	1.00	1.00
Lane Grp Cap(c), veh/h	0	1858	1858	0	704	1103
V/C Ratio(X)	0.00	0.39	0.15	0.00	0.34	0.44
Avail Cap(c_a), veh/h	0	1858	1858	0	704	1103
HCM Platoon Ratio	1.00	1.00	2.00	1.00	1.00	1.00
Upstream Filter(I)	0.00	1.00	1.00	0.00	1.00	1.00
Uniform Delay (d), s/veh	0.0	15.8	0.0	0.0	23.2	24.3
Incr Delay (d2), s/veh	0.0	0.6	0.2	0.0	1.3	1.3
Initial Q Delay(d3),s/veh	0.0	0.0	0.0	0.0	0.0	0.0
%ile BackOfQ(50%),veh/ln	0.0	5.6	0.0	0.0	4.5	4.7
Unsig. Movement Delay, s/veh						
LnGrp Delay(d),s/veh	0.0	16.4	0.2	0.0	24.5	25.6
LnGrp LOS	A	B	A	A	C	C
Approach Vol, veh/h		732	281		719	
Approach Delay, s/veh		16.4	0.2		25.2	
Approach LOS		B	A		C	
Timer - Assigned Phs				4	6	8
Phs Duration (G+Y+Rc), s				62.0	48.0	62.0
Change Period (Y+Rc), s				4.5	4.5	4.5
Max Green Setting (Gmax), s				57.5	43.5	57.5
Max Q Clear Time (g_c+I1), s				15.6	15.9	2.0
Green Ext Time (p_c), s				6.0	2.8	2.0
Intersection Summary						
HCM 6th Ctrl Delay			17.4			
HCM 6th LOS			B			

HCM 6th Signalized Intersection Summary

3: Mulberry St/SR 91 On-Ramp & Mission Inn Ave

05/04/2020



Movement	EBL	EBT	EBR	WBL	WBT	WBR	NBL	NBT	NBR	SBL	SBT	SBR
Lane Configurations	↖	↗			↖	↗	↖	↗				
Traffic Volume (veh/h)	446	473	0	0	153	202	108	454	48	0	0	0
Future Volume (veh/h)	446	473	0	0	153	202	108	454	48	0	0	0
Initial Q (Qb), veh	0	0	0	0	0	0	0	0	0			
Ped-Bike Adj(A_pbT)	1.00		1.00	1.00		1.00	1.00		1.00			
Parking Bus, Adj	1.00	1.00	1.00	1.00	1.00	1.00	1.00	1.00	1.00			
Work Zone On Approach		No			No			No				
Adj Sat Flow, veh/h/ln	1870	1870	0	0	1870	1870	1870	1870	1870			
Adj Flow Rate, veh/h	490	550	0	0	215	0	138	554	59			
Peak Hour Factor	0.91	0.86	0.25	0.25	0.71	0.73	0.78	0.82	0.81			
Percent Heavy Veh, %	2	2	0	0	2	2	2	2	2			
Cap, veh/h	588	1922	0	0	604		672	627	67			
Arrive On Green	0.66	1.00	0.00	0.00	0.17	0.00	0.38	0.38	0.38			
Sat Flow, veh/h	1781	3647	0	0	3741	0	1781	1662	177			
Grp Volume(v), veh/h	490	550	0	0	215	0	138	0	613			
Grp Sat Flow(s),veh/h/ln	1781	1777	0	0	1777	0	1781	0	1839			
Q Serve(g_s), s	22.9	0.0	0.0	0.0	5.9	0.0	5.8	0.0	34.3			
Cycle Q Clear(g_c), s	22.9	0.0	0.0	0.0	5.9	0.0	5.8	0.0	34.3			
Prop In Lane	1.00		0.00	0.00		0.00	1.00		0.10			
Lane Grp Cap(c), veh/h	588	1922	0	0	604		672	0	694			
V/C Ratio(X)	0.83	0.29	0.00	0.00	0.36		0.21	0.00	0.88			
Avail Cap(c_a), veh/h	588	1922	0	0	604		672	0	694			
HCM Platoon Ratio	2.00	2.00	1.00	1.00	1.00	1.00	1.00	1.00	1.00			
Upstream Filter(I)	1.00	1.00	0.00	0.00	1.00	0.00	1.00	0.00	1.00			
Uniform Delay (d), s/veh	16.4	0.0	0.0	0.0	40.3	0.0	23.1	0.0	32.0			
Incr Delay (d2), s/veh	13.1	0.4	0.0	0.0	1.6	0.0	0.7	0.0	15.3			
Initial Q Delay(d3),s/veh	0.0	0.0	0.0	0.0	0.0	0.0	0.0	0.0	0.0			
%ile BackOfQ(50%),veh/ln	7.2	0.1	0.0	0.0	2.7	0.0	2.5	0.0	17.8			
Unsig. Movement Delay, s/veh												
LnGrp Delay(d),s/veh	29.5	0.4	0.0	0.0	42.0	0.0	23.8	0.0	47.3			
LnGrp LOS	C	A	A	A	D		C	A	D			
Approach Vol, veh/h		1040			215	A		751				
Approach Delay, s/veh		14.1			42.0			43.0				
Approach LOS		B			D			D				
Timer - Assigned Phs		2		4			7	8				
Phs Duration (G+Y+Rc), s		46.0		64.0			40.8	23.2				
Change Period (Y+Rc), s		4.5		4.5			4.5	4.5				
Max Green Setting (Gmax), s		41.5		59.5			36.3	18.7				
Max Q Clear Time (g_c+I1), s		36.3		2.0			24.9	7.9				
Green Ext Time (p_c), s		2.1		4.3			1.3	0.9				

Intersection Summary

HCM 6th Ctrl Delay	27.9
HCM 6th LOS	C

Notes

Unsignalized Delay for [WBR] is excluded from calculations of the approach delay and intersection delay.

HCM 6th Signalized Intersection Summary

4: Howard Ave & 14th St

05/04/2020



Movement	EBL	EBT	EBR	WBL	WBT	WBR	NBL	NBT	NBR	SBL	SBT	SBR
Lane Configurations												
Traffic Volume (veh/h)	44	1688	199	10	756	16	47	14	13	35	35	79
Future Volume (veh/h)	44	1688	199	10	756	16	47	14	13	35	35	79
Initial Q (Qb), veh	0	0	0	0	0	0	0	0	0	0	0	0
Ped-Bike Adj(A_pbT)	1.00		1.00	1.00		1.00	1.00		1.00	1.00		1.00
Parking Bus, Adj	1.00	1.00	1.00	1.00	1.00	1.00	1.00	1.00	1.00	1.00	1.00	1.00
Work Zone On Approach		No			No			No			No	
Adj Sat Flow, veh/h/ln	1870	1870	1870	1870	1870	1870	1870	1870	1870	1870	1870	1870
Adj Flow Rate, veh/h	63	1897	280	18	859	23	64	20	21	70	65	90
Peak Hour Factor	0.70	0.89	0.71	0.55	0.88	0.70	0.73	0.70	0.62	0.50	0.54	0.88
Percent Heavy Veh, %	2	2	2	2	2	2	2	2	2	2	2	2
Cap, veh/h	154	2213	987	83	2060	55	196	62	51	131	117	137
Arrive On Green	0.09	0.62	0.62	0.05	0.58	0.58	0.21	0.21	0.21	0.21	0.21	0.21
Sat Flow, veh/h	1781	3554	1585	1781	3536	95	688	296	246	423	563	658
Grp Volume(v), veh/h	63	1897	280	18	432	450	105	0	0	225	0	0
Grp Sat Flow(s),veh/h/ln	1781	1777	1585	1781	1777	1853	1229	0	0	1644	0	0
Q Serve(g_s), s	3.7	47.5	8.9	1.1	14.7	14.7	0.0	0.0	0.0	4.7	0.0	0.0
Cycle Q Clear(g_c), s	3.7	47.5	8.9	1.1	14.7	14.7	8.7	0.0	0.0	13.3	0.0	0.0
Prop In Lane	1.00		1.00	1.00		0.05	0.61		0.20	0.31		0.40
Lane Grp Cap(c), veh/h	154	2213	987	83	1035	1080	309	0	0	385	0	0
V/C Ratio(X)	0.41	0.86	0.28	0.22	0.42	0.42	0.34	0.00	0.00	0.58	0.00	0.00
Avail Cap(c_a), veh/h	154	2213	987	83	1035	1080	309	0	0	385	0	0
HCM Platoon Ratio	1.00	1.00	1.00	1.00	1.00	1.00	1.00	1.00	1.00	1.00	1.00	1.00
Upstream Filter(I)	1.00	1.00	1.00	1.00	1.00	1.00	1.00	0.00	0.00	1.00	0.00	0.00
Uniform Delay (d), s/veh	47.6	16.8	9.5	50.5	12.6	12.7	37.6	0.0	0.0	39.6	0.0	0.0
Incr Delay (d2), s/veh	7.9	4.6	0.7	6.0	1.2	1.2	3.0	0.0	0.0	6.3	0.0	0.0
Initial Q Delay(d3),s/veh	0.0	0.0	0.0	0.0	0.0	0.0	0.0	0.0	0.0	0.0	0.0	0.0
%ile BackOfQ(50%),veh/ln	2.0	19.0	3.1	0.6	6.0	6.2	2.7	0.0	0.0	6.2	0.0	0.0
Unsig. Movement Delay, s/veh												
LnGrp Delay(d),s/veh	55.5	21.4	10.2	56.5	13.9	13.8	40.6	0.0	0.0	46.0	0.0	0.0
LnGrp LOS	E	C	B	E	B	B	D	A	A	D	A	A
Approach Vol, veh/h		2240			900			105			225	
Approach Delay, s/veh		20.9			14.7			40.6			46.0	
Approach LOS		C			B			D			D	
Timer - Assigned Phs		2	3	4		6	7	8				
Phs Duration (G+Y+Rc), s		27.4	9.6	73.0		27.4	14.0	68.6				
Change Period (Y+Rc), s		4.5	4.5	4.5		4.5	4.5	4.5				
Max Green Setting (Gmax), s		22.9	5.1	68.5		22.9	9.5	64.1				
Max Q Clear Time (g_c+I1), s		10.7	3.1	49.5		15.3	5.7	16.7				
Green Ext Time (p_c), s		0.4	0.0	14.9		0.7	0.0	6.8				
Intersection Summary												
HCM 6th Ctrl Delay											21.5	
HCM 6th LOS											C	

Intersection

Intersection Delay, s/veh	22.4
Intersection LOS	C

Movement	EBL	EBT	EBR	WBL	WBT	WBR	NBL	NBT	NBR	SBL	SBT	SBR
Lane Configurations	↙	↑	↗	↙	↑↑		↙	↗			↕	
Traffic Vol, veh/h	159	279	83	18	108	44	93	56	39	52	63	155
Future Vol, veh/h	159	279	83	18	108	44	93	56	39	52	63	155
Peak Hour Factor	0.75	0.88	0.67	0.25	0.73	0.89	0.70	0.89	0.57	0.71	0.81	0.97
Heavy Vehicles, %	2	2	2	2	2	2	2	2	2	2	2	2
Mvmt Flow	212	317	124	72	148	49	133	63	68	73	78	160
Number of Lanes	1	1	1	1	2	0	1	1	0	0	1	0

Approach	EB	WB	NB	SB
Opposing Approach	WB	EB	SB	NB
Opposing Lanes	3	3	1	2
Conflicting Approach Left	SB	NB	EB	WB
Conflicting Lanes Left	1	2	3	3
Conflicting Approach Right	NB	SB	WB	EB
Conflicting Lanes Right	2	1	3	3
HCM Control Delay	23.7	14.8	16.7	31.2
HCM LOS	C	B	C	D

Lane	NBLn1	NBLn2	EBLn1	EBLn2	EBLn3	WBLn1	WBLn2	WBLn3	SBLn1
Vol Left, %	100%	0%	100%	0%	0%	100%	0%	0%	19%
Vol Thru, %	0%	59%	0%	100%	0%	0%	100%	45%	23%
Vol Right, %	0%	41%	0%	0%	100%	0%	0%	55%	57%
Sign Control	Stop	Stop	Stop	Stop	Stop	Stop	Stop	Stop	Stop
Traffic Vol by Lane	93	95	159	279	83	18	72	80	270
LT Vol	93	0	159	0	0	18	0	0	52
Through Vol	0	56	0	279	0	0	72	36	63
RT Vol	0	39	0	0	83	0	0	44	155
Lane Flow Rate	133	131	212	317	124	72	99	99	311
Geometry Grp	8	8	8	8	8	8	8	8	8
Degree of Util (X)	0.355	0.322	0.516	0.726	0.259	0.195	0.253	0.242	0.732
Departure Headway (Hd)	9.622	8.814	8.761	8.242	7.516	9.756	9.233	8.831	8.478
Convergence, Y/N	Yes	Yes	Yes	Yes	Yes	Yes	Yes	Yes	Yes
Cap	373	407	411	438	477	368	389	406	426
Service Time	7.386	6.578	6.517	5.998	5.271	7.523	7	6.597	6.235
HCM Lane V/C Ratio	0.357	0.322	0.516	0.724	0.26	0.196	0.254	0.244	0.73
HCM Control Delay	17.6	15.7	20.5	30	12.9	14.9	15.1	14.4	31.2
HCM Lane LOS	C	C	C	D	B	B	C	B	D
HCM 95th-tile Q	1.6	1.4	2.9	5.7	1	0.7	1	0.9	5.8

HCM 6th TWSC
6: Commerce St & Mission Inn Ave

05/04/2020

Intersection												
Int Delay, s/veh	4.5											
Movement	EBL	EBT	EBR	WBL	WBT	WBR	NBL	NBT	NBR	SBL	SBT	SBR
Lane Configurations		↔	↔		↔			↔			↔	
Traffic Vol, veh/h	19	291	59	6	122	6	38	20	11	4	43	9
Future Vol, veh/h	19	291	59	6	122	6	38	20	11	4	43	9
Conflicting Peds, #/hr	0	0	0	0	0	0	0	0	0	0	0	0
Sign Control	Free	Free	Free	Free	Free	Free	Stop	Stop	Stop	Stop	Stop	Stop
RT Channelized	-	-	None	-	-	None	-	-	None	-	-	None
Storage Length	-	-	0	-	-	-	-	-	-	-	-	-
Veh in Median Storage, #	-	0	-	-	0	-	-	0	-	-	0	-
Grade, %	-	0	-	-	0	-	-	0	-	-	0	-
Peak Hour Factor	75	75	75	50	95	50	69	42	50	25	83	65
Heavy Vehicles, %	2	2	2	2	2	2	2	2	2	2	2	2
Mvmt Flow	25	388	79	12	128	12	55	48	22	16	52	14

Major/Minor	Major1			Major2			Minor1			Minor2		
Conflicting Flow All	140	0	0	467	0	0	552	602	388	671	675	70
Stage 1	-	-	-	-	-	-	438	438	-	158	158	-
Stage 2	-	-	-	-	-	-	114	164	-	513	517	-
Critical Hdwy	4.13	-	-	4.13	-	-	7.33	6.53	6.23	7.33	6.53	6.93
Critical Hdwy Stg 1	-	-	-	-	-	-	6.13	5.53	-	6.53	5.53	-
Critical Hdwy Stg 2	-	-	-	-	-	-	6.53	5.53	-	6.13	5.53	-
Follow-up Hdwy	2.219	-	-	2.219	-	-	3.519	4.019	3.319	3.519	4.019	3.319
Pot Cap-1 Maneuver	1442	-	-	1093	-	-	430	413	659	356	375	979
Stage 1	-	-	-	-	-	-	597	578	-	829	767	-
Stage 2	-	-	-	-	-	-	879	762	-	543	533	-
Platoon blocked, %	-	-	-	-	-	-	-	-	-	-	-	-
Mov Cap-1 Maneuver	1442	-	-	1093	-	-	367	398	659	304	362	979
Mov Cap-2 Maneuver	-	-	-	-	-	-	367	398	-	304	362	-
Stage 1	-	-	-	-	-	-	583	564	-	809	758	-
Stage 2	-	-	-	-	-	-	798	753	-	469	520	-

Approach	EB			WB			NB			SB		
HCM Control Delay, s	0.4			0.7			17.5			16.7		
HCM LOS							C			C		

Minor Lane/Major Mvmt	NBLn1	EBL	EBT	EBR	WBL	WBT	WBR	SBLn1
Capacity (veh/h)	411	1442	-	-	1093	-	-	389
HCM Lane V/C Ratio	0.303	0.018	-	-	0.011	-	-	0.21
HCM Control Delay (s)	17.5	7.5	0	-	8.3	0	-	16.7
HCM Lane LOS	C	A	A	-	A	A	-	C
HCM 95th %tile Q(veh)	1.3	0.1	-	-	0	-	-	0.8

HCM 6th TWSC
7: Commerce St & 9th St

05/04/2020

Intersection						
Int Delay, s/veh	2.9					
Movement	WBL	WBR	NBT	NBR	SBL	SBT
Lane Configurations	W		T			T
Traffic Vol, veh/h	3	16	54	3	23	84
Future Vol, veh/h	3	16	54	3	23	84
Conflicting Peds, #/hr	0	0	0	0	0	0
Sign Control	Stop	Stop	Free	Free	Free	Free
RT Channelized	-	None	-	None	-	None
Storage Length	0	-	-	-	-	-
Veh in Median Storage, #	0	-	0	-	-	0
Grade, %	0	-	0	-	-	0
Peak Hour Factor	50	79	77	25	25	68
Heavy Vehicles, %	2	2	2	2	2	2
Mvmt Flow	6	20	70	12	92	124

Major/Minor	Minor1	Major1	Major2		
Conflicting Flow All	384	76	0	0	82
Stage 1	76	-	-	-	-
Stage 2	308	-	-	-	-
Critical Hdwy	6.42	6.22	-	-	4.12
Critical Hdwy Stg 1	5.42	-	-	-	-
Critical Hdwy Stg 2	5.42	-	-	-	-
Follow-up Hdwy	3.518	3.318	-	-	2.218
Pot Cap-1 Maneuver	619	985	-	-	1515
Stage 1	947	-	-	-	-
Stage 2	745	-	-	-	-
Platoon blocked, %			-	-	-
Mov Cap-1 Maneuver	579	985	-	-	1515
Mov Cap-2 Maneuver	579	-	-	-	-
Stage 1	885	-	-	-	-
Stage 2	745	-	-	-	-

Approach	WB	NB	SB
HCM Control Delay, s	9.4	0	3.2
HCM LOS	A		

Minor Lane/Major Mvmt	NBT	NBRWBLn1	SBL	SBT
Capacity (veh/h)	-	-	849	1515
HCM Lane V/C Ratio	-	-	0.031	0.061
HCM Control Delay (s)	-	-	9.4	7.5
HCM Lane LOS	-	-	A	A
HCM 95th %tile Q(veh)	-	-	0.1	0.2

HCM 6th TWSC
8: Howard Ave & Tenth St

05/04/2020

Intersection						
Int Delay, s/veh	2.6					
Movement	EBT	EBR	WBL	WBT	NBL	NBR
Lane Configurations						
Traffic Vol, veh/h	36	106	10	7	28	18
Future Vol, veh/h	36	106	10	7	28	18
Conflicting Peds, #/hr	0	0	0	0	0	0
Sign Control	Free	Free	Free	Free	Stop	Stop
RT Channelized	-	None	-	None	-	None
Storage Length	-	-	-	-	0	-
Veh in Median Storage, #	0	-	-	0	0	-
Grade, %	0	-	-	0	0	-
Peak Hour Factor	38	84	62	67	69	56
Heavy Vehicles, %	2	2	2	2	2	2
Mvmt Flow	95	126	16	10	41	32

Major/Minor	Major1	Major2	Minor1		
Conflicting Flow All	0	0	221	0	200 158
Stage 1	-	-	-	-	158 -
Stage 2	-	-	-	-	42 -
Critical Hdwy	-	-	4.12	-	6.42 6.22
Critical Hdwy Stg 1	-	-	-	-	5.42 -
Critical Hdwy Stg 2	-	-	-	-	5.42 -
Follow-up Hdwy	-	-	2.218	-	3.518 3.318
Pot Cap-1 Maneuver	-	-	1348	-	789 887
Stage 1	-	-	-	-	871 -
Stage 2	-	-	-	-	980 -
Platoon blocked, %	-	-	-	-	-
Mov Cap-1 Maneuver	-	-	1348	-	780 887
Mov Cap-2 Maneuver	-	-	-	-	780 -
Stage 1	-	-	-	-	861 -
Stage 2	-	-	-	-	980 -

Approach	EB	WB	NB
HCM Control Delay, s	0	4.7	9.8
HCM LOS			A

Minor Lane/Major Mvmt	NBLn1	EBT	EBR	WBL	WBT
Capacity (veh/h)	824	-	-	1348	-
HCM Lane V/C Ratio	0.088	-	-	0.012	-
HCM Control Delay (s)	9.8	-	-	7.7	0
HCM Lane LOS	A	-	-	A	A
HCM 95th %tile Q(veh)	0.3	-	-	0	-

HCM 6th Signalized Intersection Summary
 9: SR 91 Off-Ramp/SR 91 On-Ramp & 14th St

05/04/2020



Movement	EBL	EBT	EBR	WBL	WBT	WBR	NBL	NBT	NBR	SBL	SBT	SBR
Lane Configurations	↗↘	↗↗			↗↗↗	↗	↘	↗	↗			
Traffic Volume (veh/h)	633	1383	0	0	770	111	262	3	548	0	0	0
Future Volume (veh/h)	633	1383	0	0	770	111	262	3	548	0	0	0
Initial Q (Qb), veh	0	0	0	0	0	0	0	0	0			
Ped-Bike Adj(A_pbT)	1.00		1.00	1.00		1.00	1.00		1.00			
Parking Bus, Adj	1.00	1.00	1.00	1.00	1.00	1.00	1.00	1.00	1.00			
Work Zone On Approach		No			No			No				
Adj Sat Flow, veh/h/ln	1870	1870	0	0	1870	1870	1870	1870	1870			
Adj Flow Rate, veh/h	688	1590	0	0	819	132	310	0	652			
Peak Hour Factor	0.92	0.87	0.25	0.25	0.94	0.84	0.87	0.25	0.84			
Percent Heavy Veh, %	2	2	0	0	2	2	2	2	2			
Cap, veh/h	771	1759	0	0	1159	360	1478	0	658			
Arrive On Green	0.22	0.50	0.00	0.00	0.23	0.23	0.41	0.00	0.41			
Sat Flow, veh/h	3456	3647	0	0	5274	1585	3563	0	1585			
Grp Volume(v), veh/h	688	1590	0	0	819	132	310	0	652			
Grp Sat Flow(s),veh/h/ln	1728	1777	0	0	1702	1585	1781	0	1585			
Q Serve(g_s), s	19.3	40.9	0.0	0.0	14.8	7.0	5.6	0.0	40.9			
Cycle Q Clear(g_c), s	19.3	40.9	0.0	0.0	14.8	7.0	5.6	0.0	40.9			
Prop In Lane	1.00		0.00	0.00		1.00	1.00		1.00			
Lane Grp Cap(c), veh/h	771	1759	0	0	1159	360	1478	0	658			
V/C Ratio(X)	0.89	0.90	0.00	0.00	0.71	0.37	0.21	0.00	0.99			
Avail Cap(c_a), veh/h	771	1759	0	0	1159	360	1478	0	658			
HCM Platoon Ratio	1.00	1.00	1.00	1.00	1.00	1.00	1.00	1.00	1.00			
Upstream Filter(I)	1.00	1.00	0.00	0.00	1.00	1.00	1.00	0.00	1.00			
Uniform Delay (d), s/veh	37.7	23.1	0.0	0.0	35.6	32.6	18.7	0.0	29.1			
Incr Delay (d2), s/veh	14.9	8.1	0.0	0.0	3.6	2.9	0.3	0.0	33.0			
Initial Q Delay(d3),s/veh	0.0	0.0	0.0	0.0	0.0	0.0	0.0	0.0	0.0			
%ile BackOfQ(50%),veh/ln	9.6	18.0	0.0	0.0	6.4	3.0	2.3	0.0	20.8			
Unsig. Movement Delay, s/veh												
LnGrp Delay(d),s/veh	52.6	31.2	0.0	0.0	39.2	35.5	19.1	0.0	62.1			
LnGrp LOS	D	C	A	A	D	D	B	A	E			
Approach Vol, veh/h		2278			951			962				
Approach Delay, s/veh		37.6			38.7			48.2				
Approach LOS		D			D			D				
Timer - Assigned Phs		2		4			7	8				
Phs Duration (G+Y+Rc), s		46.0		54.0			26.8	27.2				
Change Period (Y+Rc), s		4.5		4.5			4.5	4.5				
Max Green Setting (Gmax), s		41.5		49.5			22.3	22.7				
Max Q Clear Time (g_c+I1), s		42.9		42.9			21.3	16.8				
Green Ext Time (p_c), s		0.0		5.2			0.3	3.0				

Intersection Summary

HCM 6th Ctrl Delay	40.3
HCM 6th LOS	D

Notes

User approved volume balancing among the lanes for turning movement.

HCM 6th Signalized Intersection Summary

11: Park Ave & University Ave

05/04/2020



Movement	EBL	EBT	EBR	WBL	WBT	WBR	NBL	NBT	NBR	SBL	SBT	SBR
Lane Configurations	↖	↗		↖	↗		↖	↗		↖	↗	
Traffic Volume (veh/h)	52	1342	62	39	603	67	30	35	44	178	96	43
Future Volume (veh/h)	52	1342	62	39	603	67	30	35	44	178	96	43
Initial Q (Qb), veh	0	0	0	0	0	0	0	0	0	0	0	0
Ped-Bike Adj(A_pbT)	1.00		1.00	1.00		1.00	1.00		1.00	1.00		1.00
Parking Bus, Adj	1.00	1.00	1.00	1.00	1.00	1.00	1.00	1.00	1.00	1.00	1.00	1.00
Work Zone On Approach		No		No		No		No		No		No
Adj Sat Flow, veh/h/ln	1870	1870	1870	1870	1870	1870	1870	1870	1870	1870	1870	1870
Adj Flow Rate, veh/h	76	1579	83	52	648	102	32	60	56	251	120	73
Peak Hour Factor	0.68	0.85	0.75	0.75	0.93	0.66	0.94	0.58	0.79	0.71	0.80	0.59
Percent Heavy Veh, %	2	2	2	2	2	2	2	2	2	2	2	2
Cap, veh/h	167	1577	83	86	1273	200	102	159	149	267	296	180
Arrive On Green	0.09	0.46	0.46	0.05	0.41	0.41	0.06	0.18	0.18	0.15	0.27	0.27
Sat Flow, veh/h	1781	3435	180	1781	3077	484	1781	890	831	1781	1089	662
Grp Volume(v), veh/h	76	813	849	52	374	376	32	0	116	251	0	193
Grp Sat Flow(s),veh/h/ln	1781	1777	1838	1781	1777	1783	1781	0	1721	1781	0	1751
Q Serve(g_s), s	4.4	50.2	50.5	3.1	17.2	17.2	1.9	0.0	6.5	15.3	0.0	9.9
Cycle Q Clear(g_c), s	4.4	50.2	50.5	3.1	17.2	17.2	1.9	0.0	6.5	15.3	0.0	9.9
Prop In Lane	1.00		0.10	1.00		0.27	1.00		0.48	1.00		0.38
Lane Grp Cap(c), veh/h	167	816	844	86	735	738	102	0	308	267	0	476
V/C Ratio(X)	0.46	1.00	1.01	0.61	0.51	0.51	0.31	0.00	0.38	0.94	0.00	0.41
Avail Cap(c_a), veh/h	167	816	844	86	735	738	102	0	308	267	0	476
HCM Platoon Ratio	1.00	1.00	1.00	1.00	1.00	1.00	1.00	1.00	1.00	1.00	1.00	1.00
Upstream Filter(I)	1.00	1.00	1.00	1.00	1.00	1.00	1.00	0.00	1.00	1.00	0.00	1.00
Uniform Delay (d), s/veh	47.2	29.7	29.8	51.3	23.9	24.0	49.8	0.0	39.7	46.3	0.0	32.8
Incr Delay (d2), s/veh	8.7	30.8	32.4	27.9	2.5	2.5	7.9	0.0	3.5	41.4	0.0	2.6
Initial Q Delay(d3),s/veh	0.0	0.0	0.0	0.0	0.0	0.0	0.0	0.0	0.0	0.0	0.0	0.0
%ile BackOfQ(50%),veh/ln	2.4	27.4	28.9	2.1	7.6	7.7	1.1	0.0	3.1	9.8	0.0	4.5
Unsig. Movement Delay, s/veh												
LnGrp Delay(d),s/veh	55.9	60.5	62.1	79.2	26.5	26.5	57.6	0.0	43.2	87.7	0.0	35.3
LnGrp LOS	E	E	F	E	C	C	E	A	D	F	A	D
Approach Vol, veh/h		1738			802			148			444	
Approach Delay, s/veh		61.1			29.9			46.3			64.9	
Approach LOS		E			C			D			E	
Timer - Assigned Phs	1	2	3	4	5	6	7	8				
Phs Duration (G+Y+Rc), s	31.0	24.2	9.8	55.0	10.8	34.4	14.8	50.0				
Change Period (Y+Rc), s	4.5	4.5	4.5	4.5	4.5	4.5	4.5	4.5				
Max Green Setting (Gmax), s	10.5	19.7	5.3	50.5	6.3	29.9	10.3	45.5				
Max Q Clear Time (g_c+M), s	11.3	8.5	5.1	52.5	3.9	11.9	6.4	19.2				
Green Ext Time (p_c), s	0.0	0.4	0.0	0.0	0.0	1.0	0.0	5.1				

Intersection Summary

HCM 6th Ctrl Delay	53.0
HCM 6th LOS	D

HCM 6th AWSC
12: Howard Ave & 12th St

05/04/2020

Intersection

Intersection Delay, s/veh 8.1

Intersection LOS A

Movement	EBL	EBT	EBR	WBL	WBT	WBR	NBL	NBT	NBR	SBL	SBT	SBR
Lane Configurations		↔		↔		↔		↔			↔	
Traffic Vol, veh/h	0	2	29	14	1	4	7	52	16	6	106	4
Future Vol, veh/h	0	2	29	14	1	4	7	52	16	6	106	4
Peak Hour Factor	0.25	0.25	0.85	0.71	0.62	0.50	0.48	0.70	0.42	0.25	0.68	0.62
Heavy Vehicles, %	2	2	2	2	2	2	2	2	2	2	2	2
Mvmt Flow	0	8	34	20	2	8	15	74	38	24	156	6
Number of Lanes	0	1	0	0	1	0	0	1	0	0	1	0

Approach	EB	WB	WB	NB	SB
Opposing Approach	WB	EB	SB	SB	NB
Opposing Lanes	1	1	1	1	1
Conflicting Approach Left	SB	NB	EB	EB	WB
Conflicting Lanes Left	1	1	1	1	1
Conflicting Approach Right	NB	SB	WB	WB	EB
Conflicting Lanes Right	1	1	1	1	1
HCM Control Delay	7.3	7.9	7.9	7.9	8.4
HCM LOS	A	A	A	A	A

Lane	NBLn1	EBLn1	WBLn1	SBLn1
Vol Left, %	9%	0%	74%	5%
Vol Thru, %	69%	6%	5%	91%
Vol Right, %	21%	94%	21%	3%
Sign Control	Stop	Stop	Stop	Stop
Traffic Vol by Lane	75	31	19	116
LT Vol	7	0	14	6
Through Vol	52	2	1	106
RT Vol	16	29	4	4
Lane Flow Rate	127	42	29	186
Geometry Grp	1	1	1	1
Degree of Util (X)	0.144	0.048	0.038	0.214
Departure Headway (Hd)	4.09	4.087	4.683	4.144
Convergence, Y/N	Yes	Yes	Yes	Yes
Cap	863	881	769	857
Service Time	2.178	2.088	2.685	2.217
HCM Lane V/C Ratio	0.147	0.048	0.038	0.217
HCM Control Delay	7.9	7.3	7.9	8.4
HCM Lane LOS	A	A	A	A
HCM 95th-tile Q	0.5	0.2	0.1	0.8

HCM 6th Signalized Intersection Summary

13: Olivewood Ave/Lime St & 14th St

05/04/2020



Movement	EBL	EBT	EBR	WBL	WBT	WBR	NBL	NBT	NBR	SBL	SBT	SBR
Lane Configurations	↖ ↑↑ ↗			↖ ↑↑ ↗			↖ ↑	↑ ↗	↖ ↗	↖ ↗	↑ ↗	
Traffic Volume (veh/h)	31	1088	87	277	858	82	49	198	467	326	674	42
Future Volume (veh/h)	31	1088	87	277	858	82	49	198	467	326	674	42
Initial Q (Qb), veh	0	0	0	0	0	0	0	0	0	0	0	0
Ped-Bike Adj(A_pbT)	1.00		1.00	1.00		1.00	1.00		1.00	1.00		1.00
Parking Bus, Adj	1.00	1.00	1.00	1.00	1.00	1.00	1.00	1.00	1.00	1.00	1.00	1.00
Work Zone On Approach	No			No			No			No		
Adj Sat Flow, veh/h/ln	1870	1870	1870	1870	1870	1870	1870	1870	1870	1870	1870	1870
Adj Flow Rate, veh/h	44	1327	110	304	923	100	62	257	543	526	812	84
Peak Hour Factor	0.71	0.82	0.79	0.91	0.93	0.82	0.79	0.77	0.86	0.62	0.83	0.50
Percent Heavy Veh, %	2	2	2	2	2	2	2	2	2	2	2	2
Cap, veh/h	113	1376	114	335	1922	208	89	362	614	581	1014	105
Arrive On Green	0.06	0.29	0.29	0.06	0.14	0.14	0.05	0.19	0.19	0.17	0.31	0.31
Sat Flow, veh/h	1781	4804	398	1781	4678	505	1781	1870	3170	3456	3250	336
Grp Volume(v), veh/h	44	940	497	304	671	352	62	257	543	526	444	452
Grp Sat Flow(s),veh/h/ln	1781	1702	1799	1781	1702	1779	1781	1870	1585	1728	1777	1810
Q Serve(g_s), s	2.6	30.0	30.0	18.7	20.0	20.1	3.8	14.1	18.3	16.4	25.2	25.2
Cycle Q Clear(g_c), s	2.6	30.0	30.0	18.7	20.0	20.1	3.8	14.1	18.3	16.4	25.2	25.2
Prop In Lane	1.00		0.22	1.00		0.28	1.00		1.00	1.00		0.19
Lane Grp Cap(c), veh/h	113	975	515	335	1399	731	89	362	614	581	554	564
V/C Ratio(X)	0.39	0.96	0.96	0.91	0.48	0.48	0.70	0.71	0.88	0.91	0.80	0.80
Avail Cap(c_a), veh/h	113	975	515	335	1399	731	89	362	614	581	554	564
HCM Platoon Ratio	1.00	1.00	1.00	0.33	0.33	0.33	1.00	1.00	1.00	1.00	1.00	1.00
Upstream Filter(I)	1.00	1.00	1.00	1.00	1.00	1.00	1.00	1.00	1.00	1.00	1.00	1.00
Uniform Delay (d), s/veh	49.4	38.7	38.7	50.6	36.7	36.7	51.4	41.5	43.2	44.9	34.7	34.7
Incr Delay (d2), s/veh	9.7	21.4	31.8	30.3	1.2	2.3	36.5	11.2	16.9	20.1	11.6	11.4
Initial Q Delay(d3),s/veh	0.0	0.0	0.0	0.0	0.0	0.0	0.0	0.0	0.0	0.0	0.0	0.0
%ile BackOfQ(50%),veh/ln	1.5	15.2	17.5	11.7	9.4	10.1	2.6	7.6	8.6	8.6	12.5	12.7
Unsig. Movement Delay, s/veh												
LnGrp Delay(d),s/veh	59.2	60.1	70.5	81.0	37.8	39.0	88.0	52.6	60.1	65.0	46.3	46.1
LnGrp LOS	E	E	E	F	D	D	F	D	E	E	D	D
Approach Vol, veh/h	1481			1327			862			1422		
Approach Delay, s/veh	63.6			48.0			59.9			53.2		
Approach LOS	E			D			E			D		
Timer - Assigned Phs	1	2	3	4	5	6	7	8				
Phs Duration (G+Y+Rc), s	23.0	25.8	25.2	36.0	10.0	38.8	11.5	49.7				
Change Period (Y+Rc), s	4.5	4.5	4.5	4.5	4.5	4.5	4.5	4.5				
Max Green Setting (Gmax), s	10.5	21.3	20.7	31.5	5.5	34.3	7.0	45.2				
Max Q Clear Time (g_c+10), s	10.5	20.3	20.7	32.0	5.8	27.2	4.6	22.1				
Green Ext Time (p_c), s	0.0	0.4	0.0	0.0	0.0	3.2	0.0	7.4				

Intersection Summary

HCM 6th Ctrl Delay	56.0
HCM 6th LOS	E

Notes

User approved volume balancing among the lanes for turning movement.

HCM 6th Signalized Intersection Summary

14: Mulberry St/SR 91 Off-Ramp & 14th St

05/04/2020



Movement	EBL	EBT	EBR	WBL	WBT	WBR	NBL	NBT	NBR	SBL	SBT	SBR
Lane Configurations		↑↑↑		↔↔	↑↑↑					↔	↑↑	↔
Traffic Volume (veh/h)	0	1586	295	344	689	0	0	0	0	429	232	528
Future Volume (veh/h)	0	1586	295	344	689	0	0	0	0	429	232	528
Initial Q (Qb), veh	0	0	0	0	0	0				0	0	0
Ped-Bike Adj(A_pbT)	1.00		1.00	1.00		1.00				1.00		1.00
Parking Bus, Adj	1.00	1.00	1.00	1.00	1.00	1.00				1.00	1.00	1.00
Work Zone On Approach		No			No						No	
Adj Sat Flow, veh/h/ln	0	1870	1870	1870	1870	0				1870	1870	1870
Adj Flow Rate, veh/h	0	1687	492	471	757	0				349	795	371
Peak Hour Factor	0.25	0.94	0.60	0.73	0.91	0.25				0.82	0.85	0.95
Percent Heavy Veh, %	0	2	2	2	2	0				2	2	2
Cap, veh/h	0	1848	527	550	3412	0				445	935	396
Arrive On Green	0.00	0.31	0.31	0.16	0.67	0.00				0.25	0.25	0.25
Sat Flow, veh/h	0	4115	1125	3456	5274	0				1781	3741	1585
Grp Volume(v), veh/h	0	1450	729	471	757	0				349	795	371
Grp Sat Flow(s),veh/h/ln	0	1702	1668	1728	1702	0				1781	1870	1585
Q Serve(g_s), s	0.0	45.0	46.7	14.6	6.4	0.0				20.1	22.3	25.2
Cycle Q Clear(g_c), s	0.0	45.0	46.7	14.6	6.4	0.0				20.1	22.3	25.2
Prop In Lane	0.00		0.67	1.00		0.00				1.00		1.00
Lane Grp Cap(c), veh/h	0	1594	781	550	3412	0				445	935	396
V/C Ratio(X)	0.00	0.91	0.93	0.86	0.22	0.00				0.78	0.85	0.94
Avail Cap(c_a), veh/h	0	1594	781	550	3412	0				445	935	396
HCM Platoon Ratio	1.00	0.67	0.67	1.00	1.00	1.00				1.00	1.00	1.00
Upstream Filter(I)	0.00	1.00	1.00	1.00	1.00	0.00				1.00	1.00	1.00
Uniform Delay (d), s/veh	0.0	35.5	36.1	45.0	7.1	0.0				38.5	39.3	40.4
Incr Delay (d2), s/veh	0.0	9.3	19.7	15.7	0.2	0.0				12.9	9.6	31.7
Initial Q Delay(d3),s/veh	0.0	0.0	0.0	0.0	0.0	0.0				0.0	0.0	0.0
%ile BackOfQ(50%),veh/ln	0.0	21.3	23.9	7.4	2.2	0.0				10.3	11.3	13.2
Unsig. Movement Delay, s/veh												
LnGrp Delay(d),s/veh	0.0	44.8	55.8	60.8	7.3	0.0				51.4	48.8	72.1
LnGrp LOS	A	D	E	E	A	A				D	D	E
Approach Vol, veh/h		2179			1228						1515	
Approach Delay, s/veh		48.4			27.8						55.1	
Approach LOS		D			C						E	
Timer - Assigned Phs			3	4		6		8				
Phs Duration (G+Y+Rc), s			22.0	56.0		32.0		78.0				
Change Period (Y+Rc), s			4.5	4.5		4.5		4.5				
Max Green Setting (Gmax), s			17.5	51.5		27.5		73.5				
Max Q Clear Time (g_c+I1), s			16.6	48.7		27.2		8.4				
Green Ext Time (p_c), s			0.2	2.6		0.2		6.4				
Intersection Summary												
HCM 6th Ctrl Delay			45.3									
HCM 6th LOS			D									
Notes												
User approved volume balancing among the lanes for turning movement.												

Opening Year PM with Cumulative Projects

HCM 6th Signalized Intersection Summary

2: Mission Inn Ave & SR 91 Off-Ramp

05/04/2020

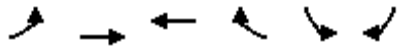

Movement	EBL	EBT	WBT	WBR	SBL	SBR
Lane Configurations		↑↑	↑↑		↘	↘
Traffic Volume (veh/h)	0	728	326	0	256	492
Future Volume (veh/h)	0	728	326	0	256	492
Initial Q (Qb), veh	0	0	0	0	0	0
Ped-Bike Adj(A_pbT)	1.00			1.00	1.00	1.00
Parking Bus, Adj	1.00	1.00	1.00	1.00	1.00	1.00
Work Zone On Approach		No	No		No	
Adj Sat Flow, veh/h/ln	0	1870	1870	0	1870	1870
Adj Flow Rate, veh/h	0	766	351	0	272	523
Peak Hour Factor	0.25	0.95	0.93	0.25	0.94	0.94
Percent Heavy Veh, %	0	2	2	0	2	2
Cap, veh/h	0	1793	1793	0	737	1154
Arrive On Green	0.00	0.50	1.00	0.00	0.41	0.41
Sat Flow, veh/h	0	3741	3741	0	1781	2790
Grp Volume(v), veh/h	0	766	351	0	272	523
Grp Sat Flow(s),veh/h/ln	0	1777	1777	0	1781	1395
Q Serve(g_s), s	0.0	15.0	0.0	0.0	11.6	14.9
Cycle Q Clear(g_c), s	0.0	15.0	0.0	0.0	11.6	14.9
Prop In Lane	0.00			0.00	1.00	1.00
Lane Grp Cap(c), veh/h	0	1793	1793	0	737	1154
V/C Ratio(X)	0.00	0.43	0.20	0.00	0.37	0.45
Avail Cap(c_a), veh/h	0	1793	1793	0	737	1154
HCM Platoon Ratio	1.00	1.00	2.00	1.00	1.00	1.00
Upstream Filter(I)	0.00	1.00	1.00	0.00	1.00	1.00
Uniform Delay (d), s/veh	0.0	17.2	0.0	0.0	22.3	23.3
Incr Delay (d2), s/veh	0.0	0.7	0.2	0.0	1.4	1.3
Initial Q Delay(d3),s/veh	0.0	0.0	0.0	0.0	0.0	0.0
%ile BackOfQ(50%),veh/ln	0.0	6.2	0.1	0.0	5.1	5.0
Unsig. Movement Delay, s/veh						
LnGrp Delay(d),s/veh	0.0	18.0	0.2	0.0	23.7	24.6
LnGrp LOS	A	B	A	A	C	C
Approach Vol, veh/h		766	351		795	
Approach Delay, s/veh		18.0	0.2		24.3	
Approach LOS		B	A		C	
Timer - Assigned Phs				4	6	8
Phs Duration (G+Y+Rc), s				60.0	50.0	60.0
Change Period (Y+Rc), s				4.5	4.5	4.5
Max Green Setting (Gmax), s				55.5	45.5	55.5
Max Q Clear Time (g_c+I1), s				17.0	16.9	2.0
Green Ext Time (p_c), s				6.3	3.2	2.6
Intersection Summary						
HCM 6th Ctrl Delay			17.3			
HCM 6th LOS			B			

HCM 6th Signalized Intersection Summary

3: Mulberry St/SR 91 On-Ramp & Mission Inn Ave

05/04/2020



Movement	EBL	EBT	EBR	WBL	WBT	WBR	NBL	NBT	NBR	SBL	SBT	SBR
Lane Configurations												
Traffic Volume (veh/h)	479	506	0	0	174	223	152	454	81	0	0	0
Future Volume (veh/h)	479	506	0	0	174	223	152	454	81	0	0	0
Initial Q (Qb), veh	0	0	0	0	0	0	0	0	0			
Ped-Bike Adj(A_pbT)	1.00		1.00	1.00		1.00	1.00		1.00			
Parking Bus, Adj	1.00	1.00	1.00	1.00	1.00	1.00	1.00	1.00	1.00			
Work Zone On Approach	No			No			No					
Adj Sat Flow, veh/h/ln	1870	1870	0	0	1870	1870	1870	1870	1870			
Adj Flow Rate, veh/h	526	588	0	0	245	0	195	554	100			
Peak Hour Factor	0.91	0.86	0.25	0.25	0.71	0.73	0.78	0.82	0.81			
Percent Heavy Veh, %	2	2	0	0	2	2	2	2	2			
Cap, veh/h	575	1955	0	0	662		656	568	102			
Arrive On Green	0.65	1.00	0.00	0.00	0.19	0.00	0.37	0.37	0.37			
Sat Flow, veh/h	1781	3647	0	0	3741	0	1781	1542	278			
Grp Volume(v), veh/h	526	588	0	0	245	0	195	0	654			
Grp Sat Flow(s),veh/h/ln	1781	1777	0	0	1777	0	1781	0	1820			
Q Serve(g_s), s	28.1	0.0	0.0	0.0	6.6	0.0	8.5	0.0	39.0			
Cycle Q Clear(g_c), s	28.1	0.0	0.0	0.0	6.6	0.0	8.5	0.0	39.0			
Prop In Lane	1.00		0.00	0.00		0.00	1.00		0.15			
Lane Grp Cap(c), veh/h	575	1955	0	0	662		656	0	670			
V/C Ratio(X)	0.91	0.30	0.00	0.00	0.37		0.30	0.00	0.98			
Avail Cap(c_a), veh/h	575	1955	0	0	662		656	0	670			
HCM Platoon Ratio	2.00	2.00	1.00	1.00	1.00	1.00	1.00	1.00	1.00			
Upstream Filter(I)	1.00	1.00	0.00	0.00	1.00	0.00	1.00	0.00	1.00			
Uniform Delay (d), s/veh	18.2	0.0	0.0	0.0	39.1	0.0	24.7	0.0	34.3			
Incr Delay (d2), s/veh	21.6	0.4	0.0	0.0	1.6	0.0	1.2	0.0	29.3			
Initial Q Delay(d3),s/veh	0.0	0.0	0.0	0.0	0.0	0.0	0.0	0.0	0.0			
%ile BackOfQ(50%),veh/ln	9.9	0.1	0.0	0.0	3.0	0.0	3.8	0.0	22.2			
Unsig. Movement Delay, s/veh												
LnGrp Delay(d),s/veh	39.7	0.4	0.0	0.0	40.7	0.0	25.8	0.0	63.6			
LnGrp LOS	D	A	A	A	D		C	A	E			
Approach Vol, veh/h	1114			245			849					
Approach Delay, s/veh	19.0			40.7			54.9					
Approach LOS	B			D			D					
Timer - Assigned Phs	2		4		7		8					
Phs Duration (G+Y+Rc), s	45.0		65.0		40.0		25.0					
Change Period (Y+Rc), s	4.5		4.5		4.5		4.5					
Max Green Setting (Gmax), s	40.5		60.5		35.5		20.5					
Max Q Clear Time (g_c+I1), s	41.0		2.0		30.1		8.6					
Green Ext Time (p_c), s	0.0		4.7		0.9		1.1					
Intersection Summary												
HCM 6th Ctrl Delay	35.2											
HCM 6th LOS	D											
Notes												
Unsignalized Delay for [WBR] is excluded from calculations of the approach delay and intersection delay.												

HCM 6th Signalized Intersection Summary

4: Howard Ave & 14th St

05/04/2020



Movement	EBL	EBT	EBR	WBL	WBT	WBR	NBL	NBT	NBR	SBL	SBT	SBR
Lane Configurations												
Traffic Volume (veh/h)	44	1695	199	10	759	16	47	14	13	35	35	79
Future Volume (veh/h)	44	1695	199	10	759	16	47	14	13	35	35	79
Initial Q (Qb), veh	0	0	0	0	0	0	0	0	0	0	0	0
Ped-Bike Adj(A_pbT)	1.00		1.00	1.00		1.00	1.00		1.00	1.00		1.00
Parking Bus, Adj	1.00	1.00	1.00	1.00	1.00	1.00	1.00	1.00	1.00	1.00	1.00	1.00
Work Zone On Approach		No			No			No			No	
Adj Sat Flow, veh/h/ln	1870	1870	1870	1870	1870	1870	1870	1870	1870	1870	1870	1870
Adj Flow Rate, veh/h	63	1904	280	18	862	23	64	20	21	70	65	90
Peak Hour Factor	0.70	0.89	0.71	0.55	0.88	0.70	0.73	0.70	0.62	0.50	0.54	0.88
Percent Heavy Veh, %	2	2	2	2	2	2	2	2	2	2	2	2
Cap, veh/h	154	2213	987	83	2060	55	196	62	51	131	117	137
Arrive On Green	0.09	0.62	0.62	0.05	0.58	0.58	0.21	0.21	0.21	0.21	0.21	0.21
Sat Flow, veh/h	1781	3554	1585	1781	3536	94	688	296	246	423	563	658
Grp Volume(v), veh/h	63	1904	280	18	433	452	105	0	0	225	0	0
Grp Sat Flow(s),veh/h/ln	1781	1777	1585	1781	1777	1853	1229	0	0	1644	0	0
Q Serve(g_s), s	3.7	47.9	8.9	1.1	14.8	14.8	0.0	0.0	0.0	4.7	0.0	0.0
Cycle Q Clear(g_c), s	3.7	47.9	8.9	1.1	14.8	14.8	8.7	0.0	0.0	13.3	0.0	0.0
Prop In Lane	1.00		1.00	1.00		0.05	0.61		0.20	0.31		0.40
Lane Grp Cap(c), veh/h	154	2213	987	83	1035	1080	309	0	0	385	0	0
V/C Ratio(X)	0.41	0.86	0.28	0.22	0.42	0.42	0.34	0.00	0.00	0.58	0.00	0.00
Avail Cap(c_a), veh/h	154	2213	987	83	1035	1080	309	0	0	385	0	0
HCM Platoon Ratio	1.00	1.00	1.00	1.00	1.00	1.00	1.00	1.00	1.00	1.00	1.00	1.00
Upstream Filter(I)	1.00	1.00	1.00	1.00	1.00	1.00	1.00	0.00	0.00	1.00	0.00	0.00
Uniform Delay (d), s/veh	47.6	16.9	9.5	50.5	12.7	12.7	37.6	0.0	0.0	39.6	0.0	0.0
Incr Delay (d2), s/veh	7.9	4.7	0.7	6.0	1.2	1.2	3.0	0.0	0.0	6.3	0.0	0.0
Initial Q Delay(d3),s/veh	0.0	0.0	0.0	0.0	0.0	0.0	0.0	0.0	0.0	0.0	0.0	0.0
%ile BackOfQ(50%),veh/ln	2.0	19.1	3.1	0.6	6.0	6.2	2.7	0.0	0.0	6.2	0.0	0.0
Unsig. Movement Delay, s/veh												
LnGrp Delay(d),s/veh	55.5	21.5	10.2	56.5	13.9	13.9	40.6	0.0	0.0	46.0	0.0	0.0
LnGrp LOS	E	C	B	E	B	B	D	A	A	D	A	A
Approach Vol, veh/h		2247			903			105			225	
Approach Delay, s/veh		21.1			14.7			40.6			46.0	
Approach LOS		C			B			D			D	
Timer - Assigned Phs		2	3	4		6	7	8				
Phs Duration (G+Y+Rc), s		27.4	9.6	73.0		27.4	14.0	68.6				
Change Period (Y+Rc), s		4.5	4.5	4.5		4.5	4.5	4.5				
Max Green Setting (Gmax), s		22.9	5.1	68.5		22.9	9.5	64.1				
Max Q Clear Time (g_c+I1), s		10.7	3.1	49.9		15.3	5.7	16.8				
Green Ext Time (p_c), s		0.4	0.0	14.7		0.7	0.0	6.9				
Intersection Summary												
HCM 6th Ctrl Delay											21.6	
HCM 6th LOS											C	

Intersection

Intersection Delay, s/veh	31.5
Intersection LOS	D

Movement	EBL	EBT	EBR	WBL	WBT	WBR	NBL	NBT	NBR	SBL	SBT	SBR
Lane Configurations	↙	↑	↗	↙	↑↑		↙	↗			↕	
Traffic Vol, veh/h	173	331	83	18	140	51	93	56	39	53	63	165
Future Vol, veh/h	173	331	83	18	140	51	93	56	39	53	63	165
Peak Hour Factor	0.75	0.88	0.67	0.25	0.73	0.89	0.70	0.89	0.57	0.71	0.81	0.97
Heavy Vehicles, %	2	2	2	2	2	2	2	2	2	2	2	2
Mvmt Flow	231	376	124	72	192	57	133	63	68	75	78	170
Number of Lanes	1	1	1	1	2	0	1	1	0	0	1	0

Approach	EB	WB	NB	SB
Opposing Approach	WB	EB	SB	NB
Opposing Lanes	3	3	1	2
Conflicting Approach Left	SB	NB	EB	WB
Conflicting Lanes Left	1	2	3	3
Conflicting Approach Right	NB	SB	WB	EB
Conflicting Lanes Right	2	1	3	3
HCM Control Delay	38.3	16.8	18.5	41.6
HCM LOS	E	C	C	E

Lane	NBLn1	NBLn2	EBLn1	EBLn2	EBLn3	WBLn1	WBLn2	WBLn3	SBLn1
Vol Left, %	100%	0%	100%	0%	0%	100%	0%	0%	19%
Vol Thru, %	0%	59%	0%	100%	0%	0%	100%	48%	22%
Vol Right, %	0%	41%	0%	0%	100%	0%	0%	52%	59%
Sign Control	Stop	Stop	Stop	Stop	Stop	Stop	Stop	Stop	Stop
Traffic Vol by Lane	93	95	173	331	83	18	93	98	281
LT Vol	93	0	173	0	0	18	0	0	53
Through Vol	0	56	0	331	0	0	93	47	63
RT Vol	0	39	0	0	83	0	0	51	165
Lane Flow Rate	133	131	231	376	124	72	128	121	323
Geometry Grp	8	8	8	8	8	8	8	8	8
Degree of Util (X)	0.382	0.348	0.592	0.911	0.275	0.206	0.347	0.316	0.815
Departure Headway (Hd)	10.362	9.548	9.245	8.723	7.993	10.304	9.779	9.395	9.092
Convergence, Y/N	Yes	Yes	Yes	Yes	Yes	Yes	Yes	Yes	Yes
Cap	347	376	390	414	448	347	367	382	397
Service Time	8.156	7.341	7.024	6.501	5.771	8.098	7.572	7.187	6.872
HCM Lane V/C Ratio	0.383	0.348	0.592	0.908	0.277	0.207	0.349	0.317	0.814
HCM Control Delay	19.5	17.4	24.7	54.8	13.8	15.8	17.7	16.5	41.6
HCM Lane LOS	C	C	C	F	B	C	C	C	E
HCM 95th-tile Q	1.7	1.5	3.7	9.8	1.1	0.8	1.5	1.3	7.3

HCM 6th TWSC
6: Commerce St & Mission Inn Ave

05/04/2020

Intersection												
Int Delay, s/veh	4.6											
Movement	EBL	EBT	EBR	WBL	WBT	WBR	NBL	NBT	NBR	SBL	SBT	SBR
Lane Configurations		↔	↔		↔			↔			↔	
Traffic Vol, veh/h	19	344	59	6	161	6	38	20	11	4	43	9
Future Vol, veh/h	19	344	59	6	161	6	38	20	11	4	43	9
Conflicting Peds, #/hr	0	0	0	0	0	0	0	0	0	0	0	0
Sign Control	Free	Free	Free	Free	Free	Free	Stop	Stop	Stop	Stop	Stop	Stop
RT Channelized	-	-	None	-	-	None	-	-	None	-	-	None
Storage Length	-	-	0	-	-	-	-	-	-	-	-	-
Veh in Median Storage, #	-	0	-	-	0	-	-	0	-	-	0	-
Grade, %	-	0	-	-	0	-	-	0	-	-	0	-
Peak Hour Factor	75	75	75	50	95	50	69	42	50	25	83	65
Heavy Vehicles, %	2	2	2	2	2	2	2	2	2	2	2	2
Mvmt Flow	25	459	79	12	169	12	55	48	22	16	52	14

Major/Minor	Major1			Major2			Minor1			Minor2		
Conflicting Flow All	181	0	0	538	0	0	644	714	459	783	787	91
Stage 1	-	-	-	-	-	-	509	509	-	199	199	-
Stage 2	-	-	-	-	-	-	135	205	-	584	588	-
Critical Hdwy	4.13	-	-	4.13	-	-	7.33	6.53	6.23	7.33	6.53	6.93
Critical Hdwy Stg 1	-	-	-	-	-	-	6.13	5.53	-	6.53	5.53	-
Critical Hdwy Stg 2	-	-	-	-	-	-	6.53	5.53	-	6.13	5.53	-
Follow-up Hdwy	2.219	-	-	2.219	-	-	3.519	4.019	3.319	3.519	4.019	3.319
Pot Cap-1 Maneuver	1393	-	-	1028	-	-	372	356	601	297	323	949
Stage 1	-	-	-	-	-	-	546	537	-	785	736	-
Stage 2	-	-	-	-	-	-	855	731	-	497	495	-
Platoon blocked, %	-	-	-	-	-	-	-	-	-	-	-	-
Mov Cap-1 Maneuver	1393	-	-	1028	-	-	310	342	601	248	310	949
Mov Cap-2 Maneuver	-	-	-	-	-	-	310	342	-	248	310	-
Stage 1	-	-	-	-	-	-	532	523	-	765	726	-
Stage 2	-	-	-	-	-	-	772	721	-	424	482	-

Approach	EB			WB			NB			SB		
HCM Control Delay, s	0.3			0.5			20.7			19.3		
HCM LOS							C			C		

Minor Lane/Major Mvmt	NBLn1	EBL	EBT	EBR	WBL	WBT	WBR	SBLn1
Capacity (veh/h)	353	1393	-	-	1028	-	-	332
HCM Lane V/C Ratio	0.353	0.018	-	-	0.012	-	-	0.246
HCM Control Delay (s)	20.7	7.6	0	-	8.5	0	-	19.3
HCM Lane LOS	C	A	A	-	A	A	-	C
HCM 95th %tile Q(veh)	1.6	0.1	-	-	0	-	-	0.9

Intersection						
Int Delay, s/veh	2.9					
Movement	WBL	WBR	NBT	NBR	SBL	SBT
Lane Configurations	W		T			T
Traffic Vol, veh/h	3	16	54	3	23	84
Future Vol, veh/h	3	16	54	3	23	84
Conflicting Peds, #/hr	0	0	0	0	0	0
Sign Control	Stop	Stop	Free	Free	Free	Free
RT Channelized	-	None	-	None	-	None
Storage Length	0	-	-	-	-	-
Veh in Median Storage, #	0	-	0	-	-	0
Grade, %	0	-	0	-	-	0
Peak Hour Factor	50	79	77	25	25	68
Heavy Vehicles, %	2	2	2	2	2	2
Mvmt Flow	6	20	70	12	92	124

Major/Minor	Minor1	Major1	Major2		
Conflicting Flow All	384	76	0	0	82
Stage 1	76	-	-	-	-
Stage 2	308	-	-	-	-
Critical Hdwy	6.42	6.22	-	-	4.12
Critical Hdwy Stg 1	5.42	-	-	-	-
Critical Hdwy Stg 2	5.42	-	-	-	-
Follow-up Hdwy	3.518	3.318	-	-	2.218
Pot Cap-1 Maneuver	619	985	-	-	1515
Stage 1	947	-	-	-	-
Stage 2	745	-	-	-	-
Platoon blocked, %			-	-	-
Mov Cap-1 Maneuver	579	985	-	-	1515
Mov Cap-2 Maneuver	579	-	-	-	-
Stage 1	885	-	-	-	-
Stage 2	745	-	-	-	-

Approach	WB	NB	SB
HCM Control Delay, s	9.4	0	3.2
HCM LOS	A		

Minor Lane/Major Mvmt	NBT	NBRWBLn1	SBL	SBT
Capacity (veh/h)	-	-	849	1515
HCM Lane V/C Ratio	-	-	0.031	0.061
HCM Control Delay (s)	-	-	9.4	7.5
HCM Lane LOS	-	-	A	A
HCM 95th %tile Q(veh)	-	-	0.1	0.2

HCM 6th TWSC
8: Howard Ave & Tenth St

05/04/2020

Intersection						
Int Delay, s/veh	2.6					
Movement	EBT	EBR	WBL	WBT	NBL	NBR
Lane Configurations						
Traffic Vol, veh/h	36	106	10	7	28	18
Future Vol, veh/h	36	106	10	7	28	18
Conflicting Peds, #/hr	0	0	0	0	0	0
Sign Control	Free	Free	Free	Free	Stop	Stop
RT Channelized	-	None	-	None	-	None
Storage Length	-	-	-	-	0	-
Veh in Median Storage, #	0	-	-	0	0	-
Grade, %	0	-	-	0	0	-
Peak Hour Factor	38	84	62	67	69	56
Heavy Vehicles, %	2	2	2	2	2	2
Mvmt Flow	95	126	16	10	41	32

Major/Minor	Major1	Major2	Minor1	Minor2	Minor3
Conflicting Flow All	0	0	221	0	200
Stage 1	-	-	-	-	158
Stage 2	-	-	-	-	42
Critical Hdwy	-	-	4.12	-	6.42
Critical Hdwy Stg 1	-	-	-	-	5.42
Critical Hdwy Stg 2	-	-	-	-	5.42
Follow-up Hdwy	-	-	2.218	-	3.518
Pot Cap-1 Maneuver	-	-	1348	-	789
Stage 1	-	-	-	-	871
Stage 2	-	-	-	-	980
Platoon blocked, %	-	-	-	-	-
Mov Cap-1 Maneuver	-	-	1348	-	780
Mov Cap-2 Maneuver	-	-	-	-	780
Stage 1	-	-	-	-	861
Stage 2	-	-	-	-	980

Approach	EB	WB	NB
HCM Control Delay, s	0	4.7	9.8
HCM LOS			A

Minor Lane/Major Mvmt	NBLn1	EBT	EBR	WBL	WBT
Capacity (veh/h)	824	-	-	1348	-
HCM Lane V/C Ratio	0.088	-	-	0.012	-
HCM Control Delay (s)	9.8	-	-	7.7	0
HCM Lane LOS	A	-	-	A	A
HCM 95th %tile Q(veh)	0.3	-	-	0	-

HCM 6th Signalized Intersection Summary
 9: SR 91 Off-Ramp/SR 91 On-Ramp & 14th St

05/04/2020



Movement	EBL	EBT	EBR	WBL	WBT	WBR	NBL	NBT	NBR	SBL	SBT	SBR
Lane Configurations	↗↘	↗↗			↗↗↗	↗	↘	↗	↗			
Traffic Volume (veh/h)	663	1390	0	0	773	111	274	3	548	0	0	0
Future Volume (veh/h)	663	1390	0	0	773	111	274	3	548	0	0	0
Initial Q (Qb), veh	0	0	0	0	0	0	0	0	0			
Ped-Bike Adj(A_pbT)	1.00		1.00	1.00		1.00	1.00		1.00			
Parking Bus, Adj	1.00	1.00	1.00	1.00	1.00	1.00	1.00	1.00	1.00			
Work Zone On Approach		No			No			No				
Adj Sat Flow, veh/h/ln	1870	1870	0	0	1870	1870	1870	1870	1870			
Adj Flow Rate, veh/h	721	1598	0	0	822	132	324	0	652			
Peak Hour Factor	0.92	0.87	0.25	0.25	0.94	0.84	0.87	0.25	0.84			
Percent Heavy Veh, %	2	2	0	0	2	2	2	2	2			
Cap, veh/h	784	1759	0	0	1139	353	1478	0	658			
Arrive On Green	0.23	0.50	0.00	0.00	0.22	0.22	0.41	0.00	0.41			
Sat Flow, veh/h	3456	3647	0	0	5274	1585	3563	0	1585			
Grp Volume(v), veh/h	721	1598	0	0	822	132	324	0	652			
Grp Sat Flow(s),veh/h/ln	1728	1777	0	0	1702	1585	1781	0	1585			
Q Serve(g_s), s	20.4	41.3	0.0	0.0	14.9	7.1	5.9	0.0	40.9			
Cycle Q Clear(g_c), s	20.4	41.3	0.0	0.0	14.9	7.1	5.9	0.0	40.9			
Prop In Lane	1.00		0.00	0.00		1.00	1.00		1.00			
Lane Grp Cap(c), veh/h	784	1759	0	0	1139	353	1478	0	658			
V/C Ratio(X)	0.92	0.91	0.00	0.00	0.72	0.37	0.22	0.00	0.99			
Avail Cap(c_a), veh/h	784	1759	0	0	1139	353	1478	0	658			
HCM Platoon Ratio	1.00	1.00	1.00	1.00	1.00	1.00	1.00	1.00	1.00			
Upstream Filter(I)	1.00	1.00	0.00	0.00	1.00	1.00	1.00	0.00	1.00			
Uniform Delay (d), s/veh	37.8	23.2	0.0	0.0	36.0	32.9	18.8	0.0	29.1			
Incr Delay (d2), s/veh	17.6	8.4	0.0	0.0	4.0	3.0	0.3	0.0	33.0			
Initial Q Delay(d3),s/veh	0.0	0.0	0.0	0.0	0.0	0.0	0.0	0.0	0.0			
%ile BackOfQ(50%),veh/ln	10.4	18.2	0.0	0.0	6.5	3.0	2.5	0.0	20.8			
Unsig. Movement Delay, s/veh												
LnGrp Delay(d),s/veh	55.3	31.6	0.0	0.0	40.0	35.9	19.2	0.0	62.1			
LnGrp LOS	E	C	A	A	D	D	B	A	E			
Approach Vol, veh/h		2319			954			976				
Approach Delay, s/veh		39.0			39.4			47.8				
Approach LOS		D			D			D				
Timer - Assigned Phs		2		4			7	8				
Phs Duration (G+Y+Rc), s		46.0		54.0			27.2	26.8				
Change Period (Y+Rc), s		4.5		4.5			4.5	4.5				
Max Green Setting (Gmax), s		41.5		49.5			22.7	22.3				
Max Q Clear Time (g_c+I1), s		42.9		43.3			22.4	16.9				
Green Ext Time (p_c), s		0.0		4.9			0.1	2.8				

Intersection Summary

HCM 6th Ctrl Delay	41.1
HCM 6th LOS	D

Notes

User approved volume balancing among the lanes for turning movement.

HCM 6th Signalized Intersection Summary

11: Park Ave & University Ave

05/04/2020



Movement	EBL	EBT	EBR	WBL	WBT	WBR	NBL	NBT	NBR	SBL	SBT	SBR
Lane Configurations												
Traffic Volume (veh/h)	52	1342	62	39	603	67	30	35	44	178	96	43
Future Volume (veh/h)	52	1342	62	39	603	67	30	35	44	178	96	43
Initial Q (Qb), veh	0	0	0	0	0	0	0	0	0	0	0	0
Ped-Bike Adj(A_pbT)	1.00		1.00	1.00		1.00	1.00		1.00	1.00		1.00
Parking Bus, Adj	1.00	1.00	1.00	1.00	1.00	1.00	1.00	1.00	1.00	1.00	1.00	1.00
Work Zone On Approach		No			No			No			No	
Adj Sat Flow, veh/h/ln	1870	1870	1870	1870	1870	1870	1870	1870	1870	1870	1870	1870
Adj Flow Rate, veh/h	76	1579	83	52	648	102	32	60	56	251	120	73
Peak Hour Factor	0.68	0.85	0.75	0.75	0.93	0.66	0.94	0.58	0.79	0.71	0.80	0.59
Percent Heavy Veh, %	2	2	2	2	2	2	2	2	2	2	2	2
Cap, veh/h	167	1577	83	86	1273	200	102	159	149	267	296	180
Arrive On Green	0.09	0.46	0.46	0.05	0.41	0.41	0.06	0.18	0.18	0.15	0.27	0.27
Sat Flow, veh/h	1781	3435	180	1781	3077	484	1781	890	831	1781	1089	662
Grp Volume(v), veh/h	76	813	849	52	374	376	32	0	116	251	0	193
Grp Sat Flow(s),veh/h/ln	1781	1777	1838	1781	1777	1783	1781	0	1721	1781	0	1751
Q Serve(g_s), s	4.4	50.2	50.5	3.1	17.2	17.2	1.9	0.0	6.5	15.3	0.0	9.9
Cycle Q Clear(g_c), s	4.4	50.2	50.5	3.1	17.2	17.2	1.9	0.0	6.5	15.3	0.0	9.9
Prop In Lane	1.00		0.10	1.00		0.27	1.00		0.48	1.00		0.38
Lane Grp Cap(c), veh/h	167	816	844	86	735	738	102	0	308	267	0	476
V/C Ratio(X)	0.46	1.00	1.01	0.61	0.51	0.51	0.31	0.00	0.38	0.94	0.00	0.41
Avail Cap(c_a), veh/h	167	816	844	86	735	738	102	0	308	267	0	476
HCM Platoon Ratio	1.00	1.00	1.00	1.00	1.00	1.00	1.00	1.00	1.00	1.00	1.00	1.00
Upstream Filter(I)	1.00	1.00	1.00	1.00	1.00	1.00	1.00	0.00	1.00	1.00	0.00	1.00
Uniform Delay (d), s/veh	47.2	29.7	29.8	51.3	23.9	24.0	49.8	0.0	39.7	46.3	0.0	32.8
Incr Delay (d2), s/veh	8.7	30.8	32.4	27.9	2.5	2.5	7.9	0.0	3.5	41.4	0.0	2.6
Initial Q Delay(d3),s/veh	0.0	0.0	0.0	0.0	0.0	0.0	0.0	0.0	0.0	0.0	0.0	0.0
%ile BackOfQ(50%),veh/ln	2.4	27.4	28.9	2.1	7.6	7.7	1.1	0.0	3.1	9.8	0.0	4.5
Unsig. Movement Delay, s/veh												
LnGrp Delay(d),s/veh	55.9	60.5	62.1	79.2	26.5	26.5	57.6	0.0	43.2	87.7	0.0	35.3
LnGrp LOS	E	E	F	E	C	C	E	A	D	F	A	D
Approach Vol, veh/h		1738			802			148			444	
Approach Delay, s/veh		61.1			29.9			46.3			64.9	
Approach LOS		E			C			D			E	
Timer - Assigned Phs	1	2	3	4	5	6	7	8				
Phs Duration (G+Y+Rc), s	31.0	24.2	9.8	55.0	10.8	34.4	14.8	50.0				
Change Period (Y+Rc), s	4.5	4.5	4.5	4.5	4.5	4.5	4.5	4.5				
Max Green Setting (Gmax), s	10.5	19.7	5.3	50.5	6.3	29.9	10.3	45.5				
Max Q Clear Time (g_c+M), s	11.3	8.5	5.1	52.5	3.9	11.9	6.4	19.2				
Green Ext Time (p_c), s	0.0	0.4	0.0	0.0	0.0	1.0	0.0	5.1				
Intersection Summary												
HCM 6th Ctrl Delay												53.0
HCM 6th LOS												D

HCM 6th AWSC
12: Howard Ave & 12th St

05/04/2020

Intersection

Intersection Delay, s/veh 8.1

Intersection LOS A

Movement	EBL	EBT	EBR	WBL	WBT	WBR	NBL	NBT	NBR	SBL	SBT	SBR
Lane Configurations		↔		↔		↔		↔			↔	
Traffic Vol, veh/h	0	2	29	14	1	4	7	52	16	6	106	4
Future Vol, veh/h	0	2	29	14	1	4	7	52	16	6	106	4
Peak Hour Factor	0.25	0.25	0.85	0.71	0.62	0.50	0.48	0.70	0.42	0.25	0.68	0.62
Heavy Vehicles, %	2	2	2	2	2	2	2	2	2	2	2	2
Mvmt Flow	0	8	34	20	2	8	15	74	38	24	156	6
Number of Lanes	0	1	0	0	1	0	0	1	0	0	1	0

Approach	EB	WB	WB	NB	SB
Opposing Approach	WB	EB	SB	SB	NB
Opposing Lanes	1	1	1	1	1
Conflicting Approach Left	SB	NB	EB	EB	WB
Conflicting Lanes Left	1	1	1	1	1
Conflicting Approach Right	NB	SB	WB	WB	EB
Conflicting Lanes Right	1	1	1	1	1
HCM Control Delay	7.3	7.9	7.9	7.9	8.4
HCM LOS	A	A	A	A	A

Lane	NBLn1	EBLn1	WBLn1	SBLn1
Vol Left, %	9%	0%	74%	5%
Vol Thru, %	69%	6%	5%	91%
Vol Right, %	21%	94%	21%	3%
Sign Control	Stop	Stop	Stop	Stop
Traffic Vol by Lane	75	31	19	116
LT Vol	7	0	14	6
Through Vol	52	2	1	106
RT Vol	16	29	4	4
Lane Flow Rate	127	42	29	186
Geometry Grp	1	1	1	1
Degree of Util (X)	0.144	0.048	0.038	0.214
Departure Headway (Hd)	4.09	4.087	4.683	4.144
Convergence, Y/N	Yes	Yes	Yes	Yes
Cap	863	881	769	857
Service Time	2.178	2.088	2.685	2.217
HCM Lane V/C Ratio	0.147	0.048	0.038	0.217
HCM Control Delay	7.9	7.3	7.9	8.4
HCM Lane LOS	A	A	A	A
HCM 95th-tile Q	0.5	0.2	0.1	0.8

HCM 6th Signalized Intersection Summary

13: Olivewood Ave/Lime St & 14th St

05/04/2020



Movement	EBL	EBT	EBR	WBL	WBT	WBR	NBL	NBT	NBR	SBL	SBT	SBR
Lane Configurations	↖ ↑↑ ↗			↖ ↑↑ ↗			↖ ↑↑	↖ ↑↑	↖ ↑↑	↖ ↗	↖ ↗	↖ ↗
Traffic Volume (veh/h)	31	1088	87	303	859	82	49	198	504	326	674	42
Future Volume (veh/h)	31	1088	87	303	859	82	49	198	504	326	674	42
Initial Q (Qb), veh	0	0	0	0	0	0	0	0	0	0	0	0
Ped-Bike Adj(A_pbT)	1.00		1.00	1.00		1.00	1.00		1.00	1.00		1.00
Parking Bus, Adj	1.00	1.00	1.00	1.00	1.00	1.00	1.00	1.00	1.00	1.00	1.00	1.00
Work Zone On Approach	No			No			No			No		
Adj Sat Flow, veh/h/ln	1870	1870	1870	1870	1870	1870	1870	1870	1870	1870	1870	1870
Adj Flow Rate, veh/h	44	1327	110	333	924	100	62	257	586	526	812	84
Peak Hour Factor	0.71	0.82	0.79	0.91	0.93	0.82	0.79	0.77	0.86	0.62	0.83	0.50
Percent Heavy Veh, %	2	2	2	2	2	2	2	2	2	2	2	2
Cap, veh/h	113	1376	114	364	1999	216	86	332	562	581	966	100
Arrive On Green	0.06	0.29	0.29	0.07	0.14	0.14	0.05	0.18	0.18	0.17	0.30	0.30
Sat Flow, veh/h	1781	4804	398	1781	4679	505	1781	1870	3170	3456	3250	336
Grp Volume(v), veh/h	44	940	497	333	671	353	62	257	586	526	444	452
Grp Sat Flow(s),veh/h/ln	1781	1702	1799	1781	1702	1780	1781	1870	1585	1728	1777	1810
Q Serve(g_s), s	2.6	30.0	30.0	20.4	19.9	20.0	3.8	14.4	19.5	16.4	25.7	25.7
Cycle Q Clear(g_c), s	2.6	30.0	30.0	20.4	19.9	20.0	3.8	14.4	19.5	16.4	25.7	25.7
Prop In Lane	1.00		0.22	1.00		0.28	1.00		1.00	1.00		0.19
Lane Grp Cap(c), veh/h	113	975	515	364	1454	760	86	332	562	581	528	538
V/C Ratio(X)	0.39	0.96	0.96	0.91	0.46	0.46	0.72	0.78	1.04	0.91	0.84	0.84
Avail Cap(c_a), veh/h	113	975	515	364	1454	760	86	332	562	581	528	538
HCM Platoon Ratio	1.00	1.00	1.00	0.33	0.33	0.33	1.00	1.00	1.00	1.00	1.00	1.00
Upstream Filter(I)	1.00	1.00	1.00	1.00	1.00	1.00	1.00	1.00	1.00	1.00	1.00	1.00
Uniform Delay (d), s/veh	49.4	38.7	38.7	50.3	35.6	35.7	51.6	43.2	45.3	44.9	36.2	36.2
Incr Delay (d2), s/veh	9.7	21.4	31.8	29.7	1.1	2.0	41.1	16.1	49.6	20.1	14.9	14.6
Initial Q Delay(d3),s/veh	0.0	0.0	0.0	0.0	0.0	0.0	0.0	0.0	0.0	0.0	0.0	0.0
%ile BackOfQ(50%),veh/ln	1.5	15.2	17.5	12.8	9.3	10.0	2.7	8.1	11.5	8.6	13.2	13.4
Unsig. Movement Delay, s/veh												
LnGrp Delay(d),s/veh	59.2	60.1	70.5	80.0	36.7	37.7	92.7	59.3	94.8	65.0	51.1	50.8
LnGrp LOS	E	E	E	F	D	D	F	E	F	E	D	D
Approach Vol, veh/h	1481			1357			905			1422		
Approach Delay, s/veh	63.6			47.6			84.6			56.1		
Approach LOS	E			D			F			E		
Timer - Assigned Phs	1	2	3	4	5	6	7	8				
Phs Duration (G+Y+Rc), s	23.0	24.0	27.0	36.0	9.8	37.2	11.5	51.5				
Change Period (Y+Rc), s	4.5	4.5	4.5	4.5	4.5	4.5	4.5	4.5				
Max Green Setting (Gmax), s	19.5	19.5	22.5	31.5	5.3	32.7	7.0	47.0				
Max Q Clear Time (g_c+10), s	19.4	21.5	22.4	32.0	5.8	27.7	4.6	22.0				
Green Ext Time (p_c), s	0.0	0.0	0.0	0.0	0.0	2.4	0.0	7.6				

Intersection Summary

HCM 6th Ctrl Delay	61.0
HCM 6th LOS	E

Notes

User approved volume balancing among the lanes for turning movement.

HCM 6th Signalized Intersection Summary

14: Mulberry St/SR 91 Off-Ramp & 14th St

05/04/2020



Movement	EBL	EBT	EBR	WBL	WBT	WBR	NBL	NBT	NBR	SBL	SBT	SBR
Lane Configurations		↑↑↑		↔↔	↑↑↑					↔	↑↑	↔
Traffic Volume (veh/h)	0	1623	295	344	704	0	0	0	0	429	232	540
Future Volume (veh/h)	0	1623	295	344	704	0	0	0	0	429	232	540
Initial Q (Qb), veh	0	0	0	0	0	0				0	0	0
Ped-Bike Adj(A_pbT)	1.00		1.00	1.00		1.00				1.00		1.00
Parking Bus, Adj	1.00	1.00	1.00	1.00	1.00	1.00				1.00	1.00	1.00
Work Zone On Approach		No			No						No	
Adj Sat Flow, veh/h/ln	0	1870	1870	1870	1870	0				1870	1870	1870
Adj Flow Rate, veh/h	0	1727	492	471	774	0				349	801	379
Peak Hour Factor	0.25	0.94	0.60	0.73	0.91	0.25				0.82	0.85	0.95
Percent Heavy Veh, %	0	2	2	2	2	0				2	2	2
Cap, veh/h	0	1885	524	528	3412	0				445	935	396
Arrive On Green	0.00	0.47	0.47	0.15	0.67	0.00				0.25	0.25	0.25
Sat Flow, veh/h	0	4140	1104	3456	5274	0				1781	3741	1585
Grp Volume(v), veh/h	0	1474	745	471	774	0				349	801	379
Grp Sat Flow(s),veh/h/ln	0	1702	1672	1728	1702	0				1781	1870	1585
Q Serve(g_s), s	0.0	44.1	46.5	14.7	6.5	0.0				20.1	22.5	25.9
Cycle Q Clear(g_c), s	0.0	44.1	46.5	14.7	6.5	0.0				20.1	22.5	25.9
Prop In Lane	0.00		0.66	1.00		0.00				1.00		1.00
Lane Grp Cap(c), veh/h	0	1615	793	528	3412	0				445	935	396
V/C Ratio(X)	0.00	0.91	0.94	0.89	0.23	0.00				0.78	0.86	0.96
Avail Cap(c_a), veh/h	0	1615	793	528	3412	0				445	935	396
HCM Platoon Ratio	1.00	1.00	1.00	1.00	1.00	1.00				1.00	1.00	1.00
Upstream Filter(I)	0.00	1.00	1.00	1.00	1.00	0.00				1.00	1.00	1.00
Uniform Delay (d), s/veh	0.0	26.8	27.4	45.7	7.1	0.0				38.5	39.4	40.7
Incr Delay (d2), s/veh	0.0	9.4	20.2	20.0	0.2	0.0				12.9	10.0	35.5
Initial Q Delay(d3),s/veh	0.0	0.0	0.0	0.0	0.0	0.0				0.0	0.0	0.0
%ile BackOfQ(50%),veh/ln	0.0	19.2	22.2	7.7	2.2	0.0				10.3	11.5	13.9
Unsig. Movement Delay, s/veh												
LnGrp Delay(d),s/veh	0.0	36.2	47.6	65.7	7.3	0.0				51.4	49.3	76.1
LnGrp LOS	A	D	D	E	A	A				D	D	E
Approach Vol, veh/h		2219			1245						1529	
Approach Delay, s/veh		40.0			29.4						56.4	
Approach LOS		D			C						E	
Timer - Assigned Phs			3	4		6		8				
Phs Duration (G+Y+Rc), s			21.3	56.7		32.0		78.0				
Change Period (Y+Rc), s			4.5	4.5		4.5		4.5				
Max Green Setting (Gmax), s			16.8	52.2		27.5		73.5				
Max Q Clear Time (g_c+I1), s			16.7	48.5		27.9		8.5				
Green Ext Time (p_c), s			0.0	3.4		0.0		6.6				
Intersection Summary												
HCM 6th Ctrl Delay			42.4									
HCM 6th LOS			D									
Notes												
User approved volume balancing among the lanes for turning movement.												

Opening Year PM with Project Conditions

HCM 6th Signalized Intersection Summary

2: Mission Inn Ave & SR 91 Off-Ramp

05/04/2020

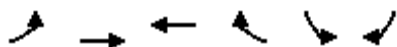

Movement	EBL	EBT	WBT	WBR	SBL	SBR
Lane Configurations		↑↑	↑↑		↘	↘
Traffic Volume (veh/h)	0	695	268	0	238	453
Future Volume (veh/h)	0	695	268	0	238	453
Initial Q (Qb), veh	0	0	0	0	0	0
Ped-Bike Adj(A_pbT)	1.00			1.00	1.00	1.00
Parking Bus, Adj	1.00	1.00	1.00	1.00	1.00	1.00
Work Zone On Approach		No	No		No	
Adj Sat Flow, veh/h/ln	0	1870	1870	0	1870	1870
Adj Flow Rate, veh/h	0	732	288	0	253	482
Peak Hour Factor	0.25	0.95	0.93	0.25	0.94	0.94
Percent Heavy Veh, %	0	2	2	0	2	2
Cap, veh/h	0	1793	1793	0	737	1154
Arrive On Green	0.00	0.50	1.00	0.00	0.41	0.41
Sat Flow, veh/h	0	3741	3741	0	1781	2790
Grp Volume(v), veh/h	0	732	288	0	253	482
Grp Sat Flow(s),veh/h/ln	0	1777	1777	0	1781	1395
Q Serve(g_s), s	0.0	14.1	0.0	0.0	10.7	13.5
Cycle Q Clear(g_c), s	0.0	14.1	0.0	0.0	10.7	13.5
Prop In Lane	0.00			0.00	1.00	1.00
Lane Grp Cap(c), veh/h	0	1793	1793	0	737	1154
V/C Ratio(X)	0.00	0.41	0.16	0.00	0.34	0.42
Avail Cap(c_a), veh/h	0	1793	1793	0	737	1154
HCM Platoon Ratio	1.00	1.00	2.00	1.00	1.00	1.00
Upstream Filter(I)	0.00	1.00	1.00	0.00	1.00	1.00
Uniform Delay (d), s/veh	0.0	17.0	0.0	0.0	22.0	22.9
Incr Delay (d2), s/veh	0.0	0.7	0.2	0.0	1.3	1.1
Initial Q Delay(d3),s/veh	0.0	0.0	0.0	0.0	0.0	0.0
%ile BackOfQ(50%),veh/ln	0.0	5.8	0.0	0.0	4.7	4.6
Unsig. Movement Delay, s/veh						
LnGrp Delay(d),s/veh	0.0	17.7	0.2	0.0	23.3	24.0
LnGrp LOS	A	B	A	A	C	C
Approach Vol, veh/h		732	288		735	
Approach Delay, s/veh		17.7	0.2		23.7	
Approach LOS		B	A		C	
Timer - Assigned Phs				4	6	8
Phs Duration (G+Y+Rc), s				60.0	50.0	60.0
Change Period (Y+Rc), s				4.5	4.5	4.5
Max Green Setting (Gmax), s				55.5	45.5	55.5
Max Q Clear Time (g_c+I1), s				16.1	15.5	2.0
Green Ext Time (p_c), s				6.0	2.9	2.1
Intersection Summary						
HCM 6th Ctrl Delay			17.4			
HCM 6th LOS			B			

HCM 6th Signalized Intersection Summary

3: Mulberry St/SR 91 On-Ramp & Mission Inn Ave

05/04/2020



Movement	EBL	EBT	EBR	WBL	WBT	WBR	NBL	NBT	NBR	SBL	SBT	SBR
Lane Configurations	↖	↑↑			↑↑		↖	↗				
Traffic Volume (veh/h)	446	488	0	0	160	229	108	454	48	0	0	0
Future Volume (veh/h)	446	488	0	0	160	229	108	454	48	0	0	0
Initial Q (Qb), veh	0	0	0	0	0	0	0	0	0			
Ped-Bike Adj(A_pbT)	1.00		1.00	1.00		1.00	1.00		1.00			
Parking Bus, Adj	1.00	1.00	1.00	1.00	1.00	1.00	1.00	1.00	1.00			
Work Zone On Approach		No			No			No				
Adj Sat Flow, veh/h/ln	1870	1870	0	0	1870	1870	1870	1870	1870			
Adj Flow Rate, veh/h	490	567	0	0	225	0	138	554	59			
Peak Hour Factor	0.91	0.86	0.25	0.25	0.71	0.73	0.78	0.82	0.81			
Percent Heavy Veh, %	2	2	0	0	2	2	2	2	2			
Cap, veh/h	575	1955	0	0	662		656	612	65			
Arrive On Green	0.65	1.00	0.00	0.00	0.19	0.00	0.37	0.37	0.37			
Sat Flow, veh/h	1781	3647	0	0	3741	0	1781	1662	177			
Grp Volume(v), veh/h	490	567	0	0	225	0	138	0	613			
Grp Sat Flow(s),veh/h/ln	1781	1777	0	0	1777	0	1781	0	1839			
Q Serve(g_s), s	23.8	0.0	0.0	0.0	6.0	0.0	5.8	0.0	34.8			
Cycle Q Clear(g_c), s	23.8	0.0	0.0	0.0	6.0	0.0	5.8	0.0	34.8			
Prop In Lane	1.00		0.00	0.00		0.00	1.00		0.10			
Lane Grp Cap(c), veh/h	575	1955	0	0	662		656	0	677			
V/C Ratio(X)	0.85	0.29	0.00	0.00	0.34		0.21	0.00	0.91			
Avail Cap(c_a), veh/h	575	1955	0	0	662		656	0	677			
HCM Platoon Ratio	2.00	2.00	1.00	1.00	1.00	1.00	1.00	1.00	1.00			
Upstream Filter(I)	1.00	1.00	0.00	0.00	1.00	0.00	1.00	0.00	1.00			
Uniform Delay (d), s/veh	17.4	0.0	0.0	0.0	38.9	0.0	23.8	0.0	32.9			
Incr Delay (d2), s/veh	14.8	0.4	0.0	0.0	1.4	0.0	0.7	0.0	17.9			
Initial Q Delay(d3),s/veh	0.0	0.0	0.0	0.0	0.0	0.0	0.0	0.0	0.0			
%ile BackOfQ(50%),veh/ln	7.9	0.1	0.0	0.0	2.8	0.0	2.6	0.0	18.5			
Unsig. Movement Delay, s/veh												
LnGrp Delay(d),s/veh	32.2	0.4	0.0	0.0	40.3	0.0	24.5	0.0	50.9			
LnGrp LOS	C	A	A	A	D		C	A	D			
Approach Vol, veh/h		1057			225	A		751				
Approach Delay, s/veh		15.1			40.3			46.0				
Approach LOS		B			D			D				
Timer - Assigned Phs		2		4			7	8				
Phs Duration (G+Y+Rc), s		45.0		65.0			40.0	25.0				
Change Period (Y+Rc), s		4.5		4.5			4.5	4.5				
Max Green Setting (Gmax), s		40.5		60.5			35.5	20.5				
Max Q Clear Time (g_c+I1), s		36.8		2.0			25.8	8.0				
Green Ext Time (p_c), s		1.6		4.5			1.2	1.0				

Intersection Summary

HCM 6th Ctrl Delay	29.3
HCM 6th LOS	C

Notes

Unsignalized Delay for [WBR] is excluded from calculations of the approach delay and intersection delay.

HCM 6th Signalized Intersection Summary

4: Howard Ave & 14th St

05/04/2020



Movement	EBL	EBT	EBR	WBL	WBT	WBR	NBL	NBT	NBR	SBL	SBT	SBR
Lane Configurations												
Traffic Volume (veh/h)	57	1688	199	10	756	20	47	14	13	49	35	152
Future Volume (veh/h)	57	1688	199	10	756	20	47	14	13	49	35	152
Initial Q (Qb), veh	0	0	0	0	0	0	0	0	0	0	0	0
Ped-Bike Adj(A_pbT)	1.00		1.00	1.00		1.00	1.00		1.00	1.00		1.00
Parking Bus, Adj	1.00	1.00	1.00	1.00	1.00	1.00	1.00	1.00	1.00	1.00	1.00	1.00
Work Zone On Approach		No			No			No			No	
Adj Sat Flow, veh/h/ln	1870	1870	1870	1870	1870	1870	1870	1870	1870	1870	1870	1870
Adj Flow Rate, veh/h	81	1897	280	18	859	29	64	20	21	98	65	173
Peak Hour Factor	0.70	0.89	0.71	0.55	0.88	0.70	0.73	0.70	0.62	0.50	0.54	0.88
Percent Heavy Veh, %	2	2	2	2	2	2	2	2	2	2	2	2
Cap, veh/h	172	2051	915	81	1846	62	196	62	51	148	93	211
Arrive On Green	0.10	0.58	0.58	0.05	0.53	0.53	0.25	0.25	0.25	0.25	0.25	0.25
Sat Flow, veh/h	1781	3554	1585	1781	3507	118	565	243	202	415	365	828
Grp Volume(v), veh/h	81	1897	280	18	435	453	105	0	0	336	0	0
Grp Sat Flow(s),veh/h/ln	1781	1777	1585	1781	1777	1849	1009	0	0	1607	0	0
Q Serve(g_s), s	4.7	53.2	10.0	1.1	16.9	16.9	0.0	0.0	0.0	11.6	0.0	0.0
Cycle Q Clear(g_c), s	4.7	53.2	10.0	1.1	16.9	16.9	9.8	0.0	0.0	21.4	0.0	0.0
Prop In Lane	1.00		1.00	1.00		0.06	0.61		0.20	0.29		0.51
Lane Grp Cap(c), veh/h	172	2051	915	81	935	973	310	0	0	451	0	0
V/C Ratio(X)	0.47	0.92	0.31	0.22	0.47	0.47	0.34	0.00	0.00	0.74	0.00	0.00
Avail Cap(c_a), veh/h	172	2051	915	81	935	973	310	0	0	451	0	0
HCM Platoon Ratio	1.00	1.00	1.00	1.00	1.00	1.00	1.00	1.00	1.00	1.00	1.00	1.00
Upstream Filter(I)	1.00	1.00	1.00	1.00	1.00	1.00	1.00	0.00	0.00	1.00	0.00	0.00
Uniform Delay (d), s/veh	47.1	21.1	11.9	50.6	16.3	16.3	33.8	0.0	0.0	38.3	0.0	0.0
Incr Delay (d2), s/veh	9.0	8.6	0.9	6.2	1.7	1.6	3.0	0.0	0.0	10.6	0.0	0.0
Initial Q Delay(d3),s/veh	0.0	0.0	0.0	0.0	0.0	0.0	0.0	0.0	0.0	0.0	0.0	0.0
%ile BackOfQ(50%),veh/ln	2.5	22.8	3.6	0.6	7.1	7.4	2.6	0.0	0.0	9.7	0.0	0.0
Unsig. Movement Delay, s/veh												
LnGrp Delay(d),s/veh	56.1	29.7	12.8	56.9	18.0	17.9	36.7	0.0	0.0	49.0	0.0	0.0
LnGrp LOS	E	C	B	E	B	B	D	A	A	D	A	A
Approach Vol, veh/h		2258			906			105			336	
Approach Delay, s/veh		28.5			18.7			36.7			49.0	
Approach LOS		C			B			D			D	
Timer - Assigned Phs		2	3	4		6	7	8				
Phs Duration (G+Y+Rc), s		32.5	9.5	68.0		32.5	15.1	62.4				
Change Period (Y+Rc), s		4.5	4.5	4.5		4.5	4.5	4.5				
Max Green Setting (Gmax), s		28.0	5.0	63.5		28.0	10.6	57.9				
Max Q Clear Time (g_c+I1), s		11.8	3.1	55.2		23.4	6.7	18.9				
Green Ext Time (p_c), s		0.5	0.0	7.2		0.8	0.0	6.8				
Intersection Summary												
HCM 6th Ctrl Delay											28.2	
HCM 6th LOS											C	

Intersection

Intersection Delay, s/veh 25
Intersection LOS C

Movement	EBL	EBT	EBR	WBL	WBT	WBR	NBL	NBT	NBR	SBL	SBT	SBR
Lane Configurations	↙	↑	↗	↙	↑↑		↙	↗			↕	
Traffic Vol, veh/h	159	294	83	18	141	44	93	56	39	52	63	155
Future Vol, veh/h	159	294	83	18	141	44	93	56	39	52	63	155
Peak Hour Factor	0.75	0.88	0.67	0.25	0.73	0.89	0.70	0.89	0.57	0.71	0.81	0.97
Heavy Vehicles, %	2	2	2	2	2	2	2	2	2	2	2	2
Mvmt Flow	212	334	124	72	193	49	133	63	68	73	78	160
Number of Lanes	1	1	1	1	2	0	1	1	0	0	1	0

Approach	EB	WB	NB	SB
Opposing Approach	WB	EB	SB	NB
Opposing Lanes	3	3	1	2
Conflicting Approach Left	SB	NB	EB	WB
Conflicting Lanes Left	1	2	3	3
Conflicting Approach Right	NB	SB	WB	EB
Conflicting Lanes Right	2	1	3	3
HCM Control Delay	27.6	16	17.5	34.7
HCM LOS	D	C	C	D

Lane	NBLn1	NBLn2	EBLn1	EBLn2	EBLn3	WBLn1	WBLn2	WBLn3	SBLn1
Vol Left, %	100%	0%	100%	0%	0%	100%	0%	0%	19%
Vol Thru, %	0%	59%	0%	100%	0%	0%	100%	52%	23%
Vol Right, %	0%	41%	0%	0%	100%	0%	0%	48%	57%
Sign Control	Stop	Stop	Stop	Stop	Stop	Stop	Stop	Stop	Stop
Traffic Vol by Lane	93	95	159	294	83	18	94	91	270
LT Vol	93	0	159	0	0	18	0	0	52
Through Vol	0	56	0	294	0	0	94	47	63
RT Vol	0	39	0	0	83	0	0	44	155
Lane Flow Rate	133	131	212	334	124	72	129	114	311
Geometry Grp	8	8	8	8	8	8	8	8	8
Degree of Util (X)	0.368	0.335	0.532	0.79	0.268	0.199	0.337	0.287	0.76
Departure Headway (Hd)	9.981	9.17	9.034	8.513	7.785	9.948	9.424	9.07	8.799
Convergence, Y/N	Yes	Yes	Yes	Yes	Yes	Yes	Yes	Yes	Yes
Cap	360	391	399	424	461	360	381	395	410
Service Time	7.762	6.95	6.802	6.282	5.553	7.729	7.205	6.85	6.571
HCM Lane V/C Ratio	0.369	0.335	0.531	0.788	0.269	0.2	0.339	0.289	0.759
HCM Control Delay	18.5	16.5	21.7	36.7	13.4	15.2	17	15.5	34.7
HCM Lane LOS	C	C	C	E	B	C	C	C	D
HCM 95th-tile Q	1.7	1.4	3	6.9	1.1	0.7	1.5	1.2	6.3

HCM 6th TWSC
6: Commerce St & Mission Inn Ave

05/04/2020

Intersection												
Int Delay, s/veh	5.8											
Movement	EBL	EBT	EBR	WBL	WBT	WBR	NBL	NBT	NBR	SBL	SBT	SBR
Lane Configurations		↔	↔		↔			↔			↔	
Traffic Vol, veh/h	19	290	77	6	122	6	72	20	11	4	43	9
Future Vol, veh/h	19	290	77	6	122	6	72	20	11	4	43	9
Conflicting Peds, #/hr	0	0	0	0	0	0	0	0	0	0	0	0
Sign Control	Free	Free	Free	Free	Free	Free	Stop	Stop	Stop	Stop	Stop	Stop
RT Channelized	-	-	None	-	-	None	-	-	None	-	-	None
Storage Length	-	-	0	-	-	-	-	-	-	-	-	-
Veh in Median Storage, #	-	0	-	-	0	-	-	0	-	-	0	-
Grade, %	-	0	-	-	0	-	-	0	-	-	0	-
Peak Hour Factor	75	75	75	50	95	50	69	42	50	25	83	65
Heavy Vehicles, %	2	2	2	2	2	2	2	2	2	2	2	2
Mvmt Flow	25	387	103	12	128	12	104	48	22	16	52	14

Major/Minor	Major1			Major2			Minor1			Minor2		
Conflicting Flow All	140	0	0	490	0	0	551	601	387	682	698	70
Stage 1	-	-	-	-	-	-	437	437	-	158	158	-
Stage 2	-	-	-	-	-	-	114	164	-	524	540	-
Critical Hdwy	4.13	-	-	4.13	-	-	7.33	6.53	6.23	7.33	6.53	6.93
Critical Hdwy Stg 1	-	-	-	-	-	-	6.13	5.53	-	6.53	5.53	-
Critical Hdwy Stg 2	-	-	-	-	-	-	6.53	5.53	-	6.13	5.53	-
Follow-up Hdwy	2.219	-	-	2.219	-	-	3.519	4.019	3.319	3.519	4.019	3.319
Pot Cap-1 Maneuver	1442	-	-	1071	-	-	431	413	660	350	364	979
Stage 1	-	-	-	-	-	-	597	578	-	829	767	-
Stage 2	-	-	-	-	-	-	879	762	-	536	520	-
Platoon blocked, %	-	-	-	-	-	-	-	-	-	-	-	-
Mov Cap-1 Maneuver	1442	-	-	1071	-	-	367	398	660	299	351	979
Mov Cap-2 Maneuver	-	-	-	-	-	-	367	398	-	299	351	-
Stage 1	-	-	-	-	-	-	583	564	-	809	758	-
Stage 2	-	-	-	-	-	-	798	753	-	463	508	-

Approach	EB			WB			NB			SB		
HCM Control Delay, s	0.4			0.7			20.9			17.1		
HCM LOS							C			C		

Minor Lane/Major Mvmt	NBLn1	EBL	EBT	EBR	WBL	WBT	WBR	SBLn1
Capacity (veh/h)	398	1442	-	-	1071	-	-	379
HCM Lane V/C Ratio	0.437	0.018	-	-	0.011	-	-	0.215
HCM Control Delay (s)	20.9	7.5	0	-	8.4	0	-	17.1
HCM Lane LOS	C	A	A	-	A	A	-	C
HCM 95th %tile Q(veh)	2.2	0.1	-	-	0	-	-	0.8

HCM 6th TWSC
7: Commerce St & 9th St

05/04/2020

Intersection						
Int Delay, s/veh	2.4					
Movement	WBL	WBR	NBT	NBR	SBL	SBT
Lane Configurations						
Traffic Vol, veh/h	3	16	87	3	23	101
Future Vol, veh/h	3	16	87	3	23	101
Conflicting Peds, #/hr	0	0	0	0	0	0
Sign Control	Stop	Stop	Free	Free	Free	Free
RT Channelized	-	None	-	None	-	None
Storage Length	0	-	-	-	-	-
Veh in Median Storage, #	0	-	0	-	-	0
Grade, %	0	-	0	-	-	0
Peak Hour Factor	50	79	77	25	25	68
Heavy Vehicles, %	2	2	2	2	2	2
Mvmt Flow	6	20	113	12	92	149

Major/Minor	Minor1	Major1	Major2			
Conflicting Flow All	452	119	0	0	125	0
Stage 1	119	-	-	-	-	-
Stage 2	333	-	-	-	-	-
Critical Hdwy	6.42	6.22	-	-	4.12	-
Critical Hdwy Stg 1	5.42	-	-	-	-	-
Critical Hdwy Stg 2	5.42	-	-	-	-	-
Follow-up Hdwy	3.518	3.318	-	-	2.218	-
Pot Cap-1 Maneuver	565	933	-	-	1462	-
Stage 1	906	-	-	-	-	-
Stage 2	726	-	-	-	-	-
Platoon blocked, %			-	-		-
Mov Cap-1 Maneuver	526	933	-	-	1462	-
Mov Cap-2 Maneuver	526	-	-	-	-	-
Stage 1	843	-	-	-	-	-
Stage 2	726	-	-	-	-	-

Approach	WB	NB	SB
HCM Control Delay, s	9.7	0	2.9
HCM LOS	A		

Minor Lane/Major Mvmt	NBT	NBRWBLn1	SBL	SBT
Capacity (veh/h)	-	-	793	1462
HCM Lane V/C Ratio	-	-	0.033	0.063
HCM Control Delay (s)	-	-	9.7	7.6
HCM Lane LOS	-	-	A	A
HCM 95th %tile Q(veh)	-	-	0.1	0.2

HCM 6th TWSC
8: Howard Ave & Tenth St

05/04/2020

Intersection						
Int Delay, s/veh	2.5					
Movement	EBT	EBR	WBL	WBT	NBL	NBR
Lane Configurations						
Traffic Vol, veh/h	36	193	10	7	45	18
Future Vol, veh/h	36	193	10	7	45	18
Conflicting Peds, #/hr	0	0	0	0	0	0
Sign Control	Free	Free	Free	Free	Stop	Stop
RT Channelized	-	None	-	None	-	None
Storage Length	-	-	-	-	0	-
Veh in Median Storage, #	0	-	-	0	0	-
Grade, %	0	-	-	0	0	-
Peak Hour Factor	38	84	62	67	69	56
Heavy Vehicles, %	2	2	2	2	2	2
Mvmt Flow	95	230	16	10	65	32

Major/Minor	Major1	Major2	Minor1			
Conflicting Flow All	0	0	325	0	252	210
Stage 1	-	-	-	-	210	-
Stage 2	-	-	-	-	42	-
Critical Hdwy	-	-	4.12	-	6.42	6.22
Critical Hdwy Stg 1	-	-	-	-	5.42	-
Critical Hdwy Stg 2	-	-	-	-	5.42	-
Follow-up Hdwy	-	-	2.218	-	3.518	3.318
Pot Cap-1 Maneuver	-	-	1235	-	737	830
Stage 1	-	-	-	-	825	-
Stage 2	-	-	-	-	980	-
Platoon blocked, %	-	-	-	-	-	-
Mov Cap-1 Maneuver	-	-	1235	-	727	830
Mov Cap-2 Maneuver	-	-	-	-	727	-
Stage 1	-	-	-	-	814	-
Stage 2	-	-	-	-	980	-

Approach	EB	WB	NB
HCM Control Delay, s	0	4.8	10.4
HCM LOS			B

Minor Lane/Major Mvmt	NBLn1	EBT	EBR	WBL	WBT
Capacity (veh/h)	758	-	-	1235	-
HCM Lane V/C Ratio	0.128	-	-	0.013	-
HCM Control Delay (s)	10.4	-	-	8	0
HCM Lane LOS	B	-	-	A	A
HCM 95th %tile Q(veh)	0.4	-	-	0	-

HCM 6th Signalized Intersection Summary
 9: SR 91 Off-Ramp/SR 91 On-Ramp & 14th St

05/04/2020



Movement	EBL	EBT	EBR	WBL	WBT	WBR	NBL	NBT	NBR	SBL	SBT	SBR
Lane Configurations	↗↘	↑↑			↑↑↑	↗	↘	↑	↗			
Traffic Volume (veh/h)	633	1384	0	0	817	138	262	3	560	0	0	0
Future Volume (veh/h)	633	1384	0	0	817	138	262	3	560	0	0	0
Initial Q (Qb), veh	0	0	0	0	0	0	0	0	0			
Ped-Bike Adj(A_pbT)	1.00		1.00	1.00		1.00	1.00		1.00			
Parking Bus, Adj	1.00	1.00	1.00	1.00	1.00	1.00	1.00	1.00	1.00			
Work Zone On Approach		No			No			No				
Adj Sat Flow, veh/h/ln	1870	1870	0	0	1870	1870	1870	1870	1870			
Adj Flow Rate, veh/h	688	1591	0	0	869	164	310	0	667			
Peak Hour Factor	0.92	0.87	0.25	0.25	0.94	0.84	0.87	0.25	0.84			
Percent Heavy Veh, %	2	2	0	0	2	2	2	2	2			
Cap, veh/h	750	1759	0	0	1190	369	1478	0	658			
Arrive On Green	0.22	0.50	0.00	0.00	0.23	0.23	0.41	0.00	0.41			
Sat Flow, veh/h	3456	3647	0	0	5274	1585	3563	0	1585			
Grp Volume(v), veh/h	688	1591	0	0	869	164	310	0	667			
Grp Sat Flow(s),veh/h/ln	1728	1777	0	0	1702	1585	1781	0	1585			
Q Serve(g_s), s	19.5	40.9	0.0	0.0	15.7	8.9	5.6	0.0	41.5			
Cycle Q Clear(g_c), s	19.5	40.9	0.0	0.0	15.7	8.9	5.6	0.0	41.5			
Prop In Lane	1.00		0.00	0.00		1.00	1.00		1.00			
Lane Grp Cap(c), veh/h	750	1759	0	0	1190	369	1478	0	658			
V/C Ratio(X)	0.92	0.90	0.00	0.00	0.73	0.44	0.21	0.00	1.01			
Avail Cap(c_a), veh/h	750	1759	0	0	1190	369	1478	0	658			
HCM Platoon Ratio	1.00	1.00	1.00	1.00	1.00	1.00	1.00	1.00	1.00			
Upstream Filter(I)	1.00	1.00	0.00	0.00	1.00	1.00	1.00	0.00	1.00			
Uniform Delay (d), s/veh	38.3	23.1	0.0	0.0	35.4	32.8	18.7	0.0	29.2			
Incr Delay (d2), s/veh	18.0	8.1	0.0	0.0	4.0	3.8	0.3	0.0	38.6			
Initial Q Delay(d3),s/veh	0.0	0.0	0.0	0.0	0.0	0.0	0.0	0.0	0.0			
%ile BackOfQ(50%),veh/ln	10.0	18.0	0.0	0.0	6.9	3.8	2.3	0.0	22.1			
Unsig. Movement Delay, s/veh												
LnGrp Delay(d),s/veh	56.3	31.2	0.0	0.0	39.4	36.6	19.1	0.0	67.9			
LnGrp LOS	E	C	A	A	D	D	B	A	F			
Approach Vol, veh/h		2279			1033			977				
Approach Delay, s/veh		38.8			39.0			52.4				
Approach LOS		D			D			D				
Timer - Assigned Phs		2		4			7	8				
Phs Duration (G+Y+Rc), s		46.0		54.0			26.2	27.8				
Change Period (Y+Rc), s		4.5		4.5			4.5	4.5				
Max Green Setting (Gmax), s		41.5		49.5			21.7	23.3				
Max Q Clear Time (g_c+I1), s		43.5		42.9			21.5	17.7				
Green Ext Time (p_c), s		0.0		5.1			0.1	3.0				
Intersection Summary												
HCM 6th Ctrl Delay				41.9								
HCM 6th LOS				D								
Notes												
User approved volume balancing among the lanes for turning movement.												

HCM 6th Signalized Intersection Summary

11: Park Ave & University Ave

05/04/2020



Movement	EBL	EBT	EBR	WBL	WBT	WBR	NBL	NBT	NBR	SBL	SBT	SBR
Lane Configurations	↖	↗		↖	↗		↖	↗		↖	↗	
Traffic Volume (veh/h)	52	1342	62	42	603	67	30	35	57	178	96	43
Future Volume (veh/h)	52	1342	62	42	603	67	30	35	57	178	96	43
Initial Q (Qb), veh	0	0	0	0	0	0	0	0	0	0	0	0
Ped-Bike Adj(A_pbT)	1.00		1.00	1.00		1.00	1.00		1.00	1.00		1.00
Parking Bus, Adj	1.00	1.00	1.00	1.00	1.00	1.00	1.00	1.00	1.00	1.00	1.00	1.00
Work Zone On Approach		No			No			No			No	
Adj Sat Flow, veh/h/ln	1870	1870	1870	1870	1870	1870	1870	1870	1870	1870	1870	1870
Adj Flow Rate, veh/h	76	1579	83	56	648	102	32	60	72	251	120	73
Peak Hour Factor	0.68	0.85	0.75	0.75	0.93	0.66	0.94	0.58	0.79	0.71	0.80	0.59
Percent Heavy Veh, %	2	2	2	2	2	2	2	2	2	2	2	2
Cap, veh/h	167	1577	83	86	1273	200	102	139	166	267	296	180
Arrive On Green	0.09	0.46	0.46	0.05	0.41	0.41	0.06	0.18	0.18	0.15	0.27	0.27
Sat Flow, veh/h	1781	3435	180	1781	3077	484	1781	774	929	1781	1089	662
Grp Volume(v), veh/h	76	813	849	56	374	376	32	0	132	251	0	193
Grp Sat Flow(s),veh/h/ln	1781	1777	1838	1781	1777	1783	1781	0	1703	1781	0	1751
Q Serve(g_s), s	4.4	50.2	50.5	3.4	17.2	17.2	1.9	0.0	7.6	15.3	0.0	9.9
Cycle Q Clear(g_c), s	4.4	50.2	50.5	3.4	17.2	17.2	1.9	0.0	7.6	15.3	0.0	9.9
Prop In Lane	1.00		0.10	1.00		0.27	1.00		0.55	1.00		0.38
Lane Grp Cap(c), veh/h	167	816	844	86	735	738	102	0	305	267	0	476
V/C Ratio(X)	0.46	1.00	1.01	0.65	0.51	0.51	0.31	0.00	0.43	0.94	0.00	0.41
Avail Cap(c_a), veh/h	167	816	844	86	735	738	102	0	305	267	0	476
HCM Platoon Ratio	1.00	1.00	1.00	1.00	1.00	1.00	1.00	1.00	1.00	1.00	1.00	1.00
Upstream Filter(I)	1.00	1.00	1.00	1.00	1.00	1.00	1.00	0.00	1.00	1.00	0.00	1.00
Uniform Delay (d), s/veh	47.2	29.7	29.8	51.4	23.9	24.0	49.8	0.0	40.2	46.3	0.0	32.8
Incr Delay (d2), s/veh	8.7	30.8	32.4	32.6	2.5	2.5	7.9	0.0	4.4	41.4	0.0	2.6
Initial Q Delay(d3),s/veh	0.0	0.0	0.0	0.0	0.0	0.0	0.0	0.0	0.0	0.0	0.0	0.0
%ile BackOfQ(50%),veh/ln	2.4	27.4	28.9	2.3	7.6	7.7	1.1	0.0	3.6	9.8	0.0	4.5
Unsig. Movement Delay, s/veh												
LnGrp Delay(d),s/veh	55.9	60.5	62.1	84.0	26.5	26.5	57.6	0.0	44.6	87.7	0.0	35.3
LnGrp LOS	E	E	F	F	C	C	E	A	D	F	A	D
Approach Vol, veh/h		1738			806			164			444	
Approach Delay, s/veh		61.1			30.5			47.1			64.9	
Approach LOS		E			C			D			E	
Timer - Assigned Phs	1	2	3	4	5	6	7	8				
Phs Duration (G+Y+Rc), s	31.0	24.2	9.8	55.0	10.8	34.4	14.8	50.0				
Change Period (Y+Rc), s	4.5	4.5	4.5	4.5	4.5	4.5	4.5	4.5				
Max Green Setting (Gmax), s	10.5	19.7	5.3	50.5	6.3	29.9	10.3	45.5				
Max Q Clear Time (g_c+M), s	11.3	9.6	5.4	52.5	3.9	11.9	6.4	19.2				
Green Ext Time (p_c), s	0.0	0.4	0.0	0.0	0.0	1.0	0.0	5.1				
Intersection Summary												
HCM 6th Ctrl Delay					53.1							
HCM 6th LOS					D							

HCM 6th AWSC
12: Howard Ave & 12th St

05/04/2020

Intersection

Intersection Delay, s/veh 9.1

Intersection LOS A

Movement	EBL	EBT	EBR	WBL	WBT	WBR	NBL	NBT	NBR	SBL	SBT	SBR
Lane Configurations		↔		↔		↔		↔			↔	
Traffic Vol, veh/h	0	2	29	14	1	4	7	70	16	6	193	4
Future Vol, veh/h	0	2	29	14	1	4	7	70	16	6	193	4
Peak Hour Factor	0.25	0.25	0.85	0.71	0.62	0.50	0.48	0.70	0.42	0.25	0.68	0.62
Heavy Vehicles, %	2	2	2	2	2	2	2	2	2	2	2	2
Mvmt Flow	0	8	34	20	2	8	15	100	38	24	284	6
Number of Lanes	0	1	0	0	1	0	0	1	0	0	1	0

Approach	EB	WB	WB	NB	SB
Opposing Approach	WB	EB	SB	SB	NB
Opposing Lanes	1	1	1	1	1
Conflicting Approach Left	SB	NB	EB	EB	WB
Conflicting Lanes Left	1	1	1	1	1
Conflicting Approach Right	NB	SB	WB	WB	EB
Conflicting Lanes Right	1	1	1	1	1
HCM Control Delay	7.7	8.3	8.3	8.3	9.8
HCM LOS	A	A	A	A	A

Lane	NBLn1	EBLn1	WBLn1	SBLn1
Vol Left, %	8%	0%	74%	3%
Vol Thru, %	75%	6%	5%	95%
Vol Right, %	17%	94%	21%	2%
Sign Control	Stop	Stop	Stop	Stop
Traffic Vol by Lane	93	31	19	203
LT Vol	7	0	14	6
Through Vol	70	2	1	193
RT Vol	16	29	4	4
Lane Flow Rate	153	42	29	314
Geometry Grp	1	1	1	1
Degree of Util (X)	0.184	0.052	0.041	0.373
Departure Headway (Hd)	4.334	4.431	5.03	4.27
Convergence, Y/N	Yes	Yes	Yes	Yes
Cap	829	808	712	849
Service Time	2.353	2.459	3.059	2.27
HCM Lane V/C Ratio	0.185	0.052	0.041	0.37
HCM Control Delay	8.3	7.7	8.3	9.8
HCM Lane LOS	A	A	A	A
HCM 95th-tile Q	0.7	0.2	0.1	1.7

HCM 6th Signalized Intersection Summary

13: Olivewood Ave/Lime St & 14th St

05/04/2020



Movement	EBL	EBT	EBR	WBL	WBT	WBR	NBL	NBT	NBR	SBL	SBT	SBR
Lane Configurations	↖ ↑↑ ↗			↖ ↑↑ ↗			↖ ↑↑	↖ ↑↑	↖ ↑↑	↖ ↗	↖ ↗	↖ ↗
Traffic Volume (veh/h)	31	1090	87	277	864	82	49	198	467	326	674	42
Future Volume (veh/h)	31	1090	87	277	864	82	49	198	467	326	674	42
Initial Q (Qb), veh	0	0	0	0	0	0	0	0	0	0	0	0
Ped-Bike Adj(A_pbT)	1.00		1.00	1.00		1.00	1.00		1.00	1.00		1.00
Parking Bus, Adj	1.00	1.00	1.00	1.00	1.00	1.00	1.00	1.00	1.00	1.00	1.00	1.00
Work Zone On Approach	No			No			No			No		
Adj Sat Flow, veh/h/ln	1870	1870	1870	1870	1870	1870	1870	1870	1870	1870	1870	1870
Adj Flow Rate, veh/h	44	1329	110	304	929	100	62	257	543	526	812	84
Peak Hour Factor	0.71	0.82	0.79	0.91	0.93	0.82	0.79	0.77	0.86	0.62	0.83	0.50
Percent Heavy Veh, %	2	2	2	2	2	2	2	2	2	2	2	2
Cap, veh/h	113	1380	114	335	1928	207	89	360	611	581	1011	105
Arrive On Green	0.06	0.29	0.29	0.06	0.14	0.14	0.05	0.19	0.19	0.17	0.31	0.31
Sat Flow, veh/h	1781	4805	398	1781	4682	502	1781	1870	3170	3456	3250	336
Grp Volume(v), veh/h	44	941	498	304	675	354	62	257	543	526	444	452
Grp Sat Flow(s),veh/h/ln	1781	1702	1799	1781	1702	1780	1781	1870	1585	1728	1777	1810
Q Serve(g_s), s	2.6	30.0	30.0	18.7	20.2	20.2	3.8	14.1	18.4	16.4	25.2	25.2
Cycle Q Clear(g_c), s	2.6	30.0	30.0	18.7	20.2	20.2	3.8	14.1	18.4	16.4	25.2	25.2
Prop In Lane	1.00		0.22	1.00		0.28	1.00		1.00	1.00		0.19
Lane Grp Cap(c), veh/h	113	978	517	335	1402	733	89	360	611	581	552	563
V/C Ratio(X)	0.39	0.96	0.96	0.91	0.48	0.48	0.70	0.71	0.89	0.91	0.80	0.80
Avail Cap(c_a), veh/h	113	978	517	335	1402	733	89	360	611	581	552	563
HCM Platoon Ratio	1.00	1.00	1.00	0.33	0.33	0.33	1.00	1.00	1.00	1.00	1.00	1.00
Upstream Filter(l)	1.00	1.00	1.00	1.00	1.00	1.00	1.00	1.00	1.00	1.00	1.00	1.00
Uniform Delay (d), s/veh	49.4	38.6	38.6	50.6	36.7	36.7	51.4	41.6	43.3	44.9	34.8	34.8
Incr Delay (d2), s/veh	9.7	21.1	31.4	30.3	1.2	2.3	36.5	11.4	17.5	20.1	11.8	11.6
Initial Q Delay(d3),s/veh	0.0	0.0	0.0	0.0	0.0	0.0	0.0	0.0	0.0	0.0	0.0	0.0
%ile BackOfQ(50%),veh/ln	1.5	15.1	17.5	11.7	9.4	10.1	2.6	7.6	8.6	8.6	12.5	12.7
Unsig. Movement Delay, s/veh												
LnGrp Delay(d),s/veh	59.2	59.7	70.0	81.0	37.8	39.0	88.0	52.9	60.7	65.0	46.6	46.4
LnGrp LOS	E	E	E	F	D	D	F	D	E	E	D	D
Approach Vol, veh/h	1483			1333			862			1422		
Approach Delay, s/veh	63.1			48.0			60.4			53.3		
Approach LOS	E			D			E			D		
Timer - Assigned Phs	1	2	3	4	5	6	7	8				
Phs Duration (G+Y+Rc), s	33.0	25.7	25.2	36.1	10.0	38.7	11.5	49.8				
Change Period (Y+Rc), s	4.5	4.5	4.5	4.5	4.5	4.5	4.5	4.5				
Max Green Setting (Gmax), s	10.5	21.2	20.7	31.6	5.5	34.2	7.0	45.3				
Max Q Clear Time (g_c+10), s	10.5	20.4	20.7	32.0	5.8	27.2	4.6	22.2				
Green Ext Time (p_c), s	0.0	0.4	0.0	0.0	0.0	3.2	0.0	7.5				

Intersection Summary

HCM 6th Ctrl Delay	56.0
HCM 6th LOS	E

Notes

User approved volume balancing among the lanes for turning movement.

HCM 6th Signalized Intersection Summary

14: Mulberry St/SR 91 Off-Ramp & 14th St

05/04/2020



Movement	EBL	EBT	EBR	WBL	WBT	WBR	NBL	NBT	NBR	SBL	SBT	SBR
Lane Configurations	↑↑↑			↔↔	↑↑↑					↔	↑↑	↔
Traffic Volume (veh/h)	0	1588	295	384	696	0	0	0	0	429	232	528
Future Volume (veh/h)	0	1588	295	384	696	0	0	0	0	429	232	528
Initial Q (Qb), veh	0	0	0	0	0	0				0	0	0
Ped-Bike Adj(A_pbT)	1.00		1.00	1.00		1.00				1.00		1.00
Parking Bus, Adj	1.00	1.00	1.00	1.00	1.00	1.00				1.00	1.00	1.00
Work Zone On Approach		No			No						No	
Adj Sat Flow, veh/h/ln	0	1870	1870	1870	1870	0				1870	1870	1870
Adj Flow Rate, veh/h	0	1689	492	526	765	0				349	795	371
Peak Hour Factor	0.25	0.94	0.60	0.73	0.91	0.25				0.82	0.85	0.95
Percent Heavy Veh, %	0	2	2	2	2	0				2	2	2
Cap, veh/h	0	1848	526	581	3458	0				429	901	382
Arrive On Green	0.00	0.31	0.31	0.17	0.68	0.00				0.24	0.24	0.24
Sat Flow, veh/h	0	4117	1124	3456	5274	0				1781	3741	1585
Grp Volume(v), veh/h	0	1451	730	526	765	0				349	795	371
Grp Sat Flow(s),veh/h/ln	0	1702	1668	1728	1702	0				1781	1870	1585
Q Serve(g_s), s	0.0	45.0	46.8	16.4	6.3	0.0				20.3	22.5	25.5
Cycle Q Clear(g_c), s	0.0	45.0	46.8	16.4	6.3	0.0				20.3	22.5	25.5
Prop In Lane	0.00		0.67	1.00		0.00				1.00		1.00
Lane Grp Cap(c), veh/h	0	1594	781	581	3458	0				429	901	382
V/C Ratio(X)	0.00	0.91	0.94	0.91	0.22	0.00				0.81	0.88	0.97
Avail Cap(c_a), veh/h	0	1594	781	581	3458	0				429	901	382
HCM Platoon Ratio	1.00	0.67	0.67	1.00	1.00	1.00				1.00	1.00	1.00
Upstream Filter(I)	0.00	1.00	1.00	1.00	1.00	0.00				1.00	1.00	1.00
Uniform Delay (d), s/veh	0.0	35.5	36.1	44.9	6.7	0.0				39.4	40.2	41.4
Incr Delay (d2), s/veh	0.0	9.3	19.8	20.1	0.1	0.0				15.4	12.2	39.5
Initial Q Delay(d3),s/veh	0.0	0.0	0.0	0.0	0.0	0.0				0.0	0.0	0.0
%ile BackOfQ(50%),veh/ln	0.0	21.4	24.0	8.6	2.1	0.0				10.7	11.8	14.0
Unsig. Movement Delay, s/veh												
LnGrp Delay(d),s/veh	0.0	44.8	55.9	65.0	6.9	0.0				54.8	52.4	80.8
LnGrp LOS	A	D	E	E	A	A				D	D	F
Approach Vol, veh/h		2181			1291					1515		
Approach Delay, s/veh		48.5			30.6					59.9		
Approach LOS		D			C					E		
Timer - Assigned Phs			3	4		6		8				
Phs Duration (G+Y+Rc), s			23.0	56.0		31.0		79.0				
Change Period (Y+Rc), s			4.5	4.5		4.5		4.5				
Max Green Setting (Gmax), s			18.5	51.5		26.5		74.5				
Max Q Clear Time (g_c+I1), s			18.4	48.8		27.5		8.3				
Green Ext Time (p_c), s			0.0	2.5		0.0		6.5				
Intersection Summary												
HCM 6th Ctrl Delay		47.3										
HCM 6th LOS		D										
Notes												
User approved volume balancing among the lanes for turning movement.												

**Opening Year PM with
Cumulative Projects and Project
Conditions**

HCM 6th Signalized Intersection Summary

2: Mission Inn Ave & SR 91 Off-Ramp

05/04/2020

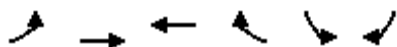

Movement	EBL	EBT	WBT	WBR	SBL	SBR
Lane Configurations		↑↑	↑↑		↵	↵↵
Traffic Volume (veh/h)	0	728	333	0	271	492
Future Volume (veh/h)	0	728	333	0	271	492
Initial Q (Qb), veh	0	0	0	0	0	0
Ped-Bike Adj(A_pbT)	1.00			1.00	1.00	1.00
Parking Bus, Adj	1.00	1.00	1.00	1.00	1.00	1.00
Work Zone On Approach		No	No		No	
Adj Sat Flow, veh/h/ln	0	1870	1870	0	1870	1870
Adj Flow Rate, veh/h	0	766	358	0	288	523
Peak Hour Factor	0.25	0.95	0.93	0.25	0.94	0.94
Percent Heavy Veh, %	0	2	2	0	2	2
Cap, veh/h	0	1761	1761	0	753	1179
Arrive On Green	0.00	0.50	0.99	0.00	0.42	0.42
Sat Flow, veh/h	0	3741	3741	0	1781	2790
Grp Volume(v), veh/h	0	766	358	0	288	523
Grp Sat Flow(s),veh/h/ln	0	1777	1777	0	1781	1395
Q Serve(g_s), s	0.0	15.3	0.1	0.0	12.2	14.7
Cycle Q Clear(g_c), s	0.0	15.3	0.1	0.0	12.2	14.7
Prop In Lane	0.00			0.00	1.00	1.00
Lane Grp Cap(c), veh/h	0	1761	1761	0	753	1179
V/C Ratio(X)	0.00	0.44	0.20	0.00	0.38	0.44
Avail Cap(c_a), veh/h	0	1761	1761	0	753	1179
HCM Platoon Ratio	1.00	1.00	2.00	1.00	1.00	1.00
Upstream Filter(I)	0.00	1.00	1.00	0.00	1.00	1.00
Uniform Delay (d), s/veh	0.0	17.8	0.3	0.0	21.9	22.6
Incr Delay (d2), s/veh	0.0	0.8	0.3	0.0	1.5	1.2
Initial Q Delay(d3),s/veh	0.0	0.0	0.0	0.0	0.0	0.0
%ile BackOfQ(50%),veh/ln	0.0	6.3	0.1	0.0	5.4	4.9
Unsig. Movement Delay, s/veh						
LnGrp Delay(d),s/veh	0.0	18.6	0.5	0.0	23.3	23.8
LnGrp LOS	A	B	A	A	C	C
Approach Vol, veh/h		766	358		811	
Approach Delay, s/veh		18.6	0.5		23.6	
Approach LOS		B	A		C	
Timer - Assigned Phs				4	6	8
Phs Duration (G+Y+Rc), s				59.0	51.0	59.0
Change Period (Y+Rc), s				4.5	4.5	4.5
Max Green Setting (Gmax), s				54.5	46.5	54.5
Max Q Clear Time (g_c+I1), s				17.3	16.7	2.1
Green Ext Time (p_c), s				6.3	3.3	2.6
Intersection Summary						
HCM 6th Ctrl Delay			17.4			
HCM 6th LOS			B			

HCM 6th Signalized Intersection Summary

3: Mulberry St/SR 91 On-Ramp & Mission Inn Ave

05/04/2020



Movement	EBL	EBT	EBR	WBL	WBT	WBR	NBL	NBT	NBR	SBL	SBT	SBR
Lane Configurations												
Traffic Volume (veh/h)	479	521	0	0	181	250	152	454	81	0	0	0
Future Volume (veh/h)	479	521	0	0	181	250	152	454	81	0	0	0
Initial Q (Qb), veh	0	0	0	0	0	0	0	0	0			
Ped-Bike Adj(A_pbT)	1.00		1.00	1.00		1.00	1.00		1.00			
Parking Bus, Adj	1.00	1.00	1.00	1.00	1.00	1.00	1.00	1.00	1.00			
Work Zone On Approach		No			No			No				
Adj Sat Flow, veh/h/ln	1870	1870	0	0	1870	1870	1870	1870	1870			
Adj Flow Rate, veh/h	526	606	0	0	255	0	195	554	100			
Peak Hour Factor	0.91	0.86	0.25	0.25	0.71	0.73	0.78	0.82	0.81			
Percent Heavy Veh, %	2	2	0	0	2	2	2	2	2			
Cap, veh/h	562	1955	0	0	688		656	568	102			
Arrive On Green	0.63	1.00	0.00	0.00	0.19	0.00	0.37	0.37	0.37			
Sat Flow, veh/h	1781	3647	0	0	3741	0	1781	1542	278			
Grp Volume(v), veh/h	526	606	0	0	255	0	195	0	654			
Grp Sat Flow(s),veh/h/ln	1781	1777	0	0	1777	0	1781	0	1820			
Q Serve(g_s), s	29.3	0.0	0.0	0.0	6.9	0.0	8.5	0.0	39.0			
Cycle Q Clear(g_c), s	29.3	0.0	0.0	0.0	6.9	0.0	8.5	0.0	39.0			
Prop In Lane	1.00		0.00	0.00		0.00	1.00		0.15			
Lane Grp Cap(c), veh/h	562	1955	0	0	688		656	0	670			
V/C Ratio(X)	0.94	0.31	0.00	0.00	0.37		0.30	0.00	0.98			
Avail Cap(c_a), veh/h	562	1955	0	0	688		656	0	670			
HCM Platoon Ratio	2.00	2.00	1.00	1.00	1.00	1.00	1.00	1.00	1.00			
Upstream Filter(I)	1.00	1.00	0.00	0.00	1.00	0.00	1.00	0.00	1.00			
Uniform Delay (d), s/veh	19.3	0.0	0.0	0.0	38.5	0.0	24.7	0.0	34.3			
Incr Delay (d2), s/veh	25.1	0.4	0.0	0.0	1.5	0.0	1.2	0.0	29.3			
Initial Q Delay(d3),s/veh	0.0	0.0	0.0	0.0	0.0	0.0	0.0	0.0	0.0			
%ile BackOfQ(50%),veh/ln	11.0	0.1	0.0	0.0	3.1	0.0	3.8	0.0	22.2			
Unsig. Movement Delay, s/veh												
LnGrp Delay(d),s/veh	44.4	0.4	0.0	0.0	40.1	0.0	25.8	0.0	63.6			
LnGrp LOS	D	A	A	A	D		C	A	E			
Approach Vol, veh/h		1132			255	A		849				
Approach Delay, s/veh		20.8			40.1			54.9				
Approach LOS		C			D			D				
Timer - Assigned Phs		2		4			7	8				
Phs Duration (G+Y+Rc), s		45.0		65.0			39.2	25.8				
Change Period (Y+Rc), s		4.5		4.5			4.5	4.5				
Max Green Setting (Gmax), s		40.5		60.5			34.7	21.3				
Max Q Clear Time (g_c+I1), s		41.0		2.0			31.3	8.9				
Green Ext Time (p_c), s		0.0		4.9			0.7	1.2				

Intersection Summary

HCM 6th Ctrl Delay	36.0
HCM 6th LOS	D

Notes

Unsignalized Delay for [WBR] is excluded from calculations of the approach delay and intersection delay.

HCM 6th Signalized Intersection Summary

4: Howard Ave & 14th St

05/04/2020



Movement	EBL	EBT	EBR	WBL	WBT	WBR	NBL	NBT	NBR	SBL	SBT	SBR
Lane Configurations												
Traffic Volume (veh/h)	57	1695	199	10	759	20	47	14	13	49	35	152
Future Volume (veh/h)	57	1695	199	10	759	20	47	14	13	49	35	152
Initial Q (Qb), veh	0	0	0	0	0	0	0	0	0	0	0	0
Ped-Bike Adj(A_pbT)	1.00		1.00	1.00		1.00	1.00		1.00	1.00		1.00
Parking Bus, Adj	1.00	1.00	1.00	1.00	1.00	1.00	1.00	1.00	1.00	1.00	1.00	1.00
Work Zone On Approach		No			No			No			No	
Adj Sat Flow, veh/h/ln	1870	1870	1870	1870	1870	1870	1870	1870	1870	1870	1870	1870
Adj Flow Rate, veh/h	81	1904	280	18	862	29	64	20	21	98	65	173
Peak Hour Factor	0.70	0.89	0.71	0.55	0.88	0.70	0.73	0.70	0.62	0.50	0.54	0.88
Percent Heavy Veh, %	2	2	2	2	2	2	2	2	2	2	2	2
Cap, veh/h	172	2051	915	81	1846	62	196	62	51	148	93	211
Arrive On Green	0.10	0.58	0.58	0.05	0.53	0.53	0.25	0.25	0.25	0.25	0.25	0.25
Sat Flow, veh/h	1781	3554	1585	1781	3508	118	565	243	202	415	365	828
Grp Volume(v), veh/h	81	1904	280	18	437	454	105	0	0	336	0	0
Grp Sat Flow(s),veh/h/ln	1781	1777	1585	1781	1777	1849	1009	0	0	1607	0	0
Q Serve(g_s), s	4.7	53.7	10.0	1.1	17.0	17.0	0.0	0.0	0.0	11.6	0.0	0.0
Cycle Q Clear(g_c), s	4.7	53.7	10.0	1.1	17.0	17.0	9.8	0.0	0.0	21.4	0.0	0.0
Prop In Lane	1.00		1.00	1.00		0.06	0.61		0.20	0.29		0.51
Lane Grp Cap(c), veh/h	172	2051	915	81	935	973	310	0	0	451	0	0
V/C Ratio(X)	0.47	0.93	0.31	0.22	0.47	0.47	0.34	0.00	0.00	0.74	0.00	0.00
Avail Cap(c_a), veh/h	172	2051	915	81	935	973	310	0	0	451	0	0
HCM Platoon Ratio	1.00	1.00	1.00	1.00	1.00	1.00	1.00	1.00	1.00	1.00	1.00	1.00
Upstream Filter(I)	1.00	1.00	1.00	1.00	1.00	1.00	1.00	0.00	0.00	1.00	0.00	0.00
Uniform Delay (d), s/veh	47.1	21.2	11.9	50.6	16.4	16.4	33.8	0.0	0.0	38.3	0.0	0.0
Incr Delay (d2), s/veh	9.0	8.9	0.9	6.2	1.7	1.6	3.0	0.0	0.0	10.6	0.0	0.0
Initial Q Delay(d3),s/veh	0.0	0.0	0.0	0.0	0.0	0.0	0.0	0.0	0.0	0.0	0.0	0.0
%ile BackOfQ(50%),veh/ln	2.5	23.1	3.6	0.6	7.1	7.4	2.6	0.0	0.0	9.7	0.0	0.0
Unsig. Movement Delay, s/veh												
LnGrp Delay(d),s/veh	56.1	30.1	12.8	56.9	18.0	18.0	36.7	0.0	0.0	49.0	0.0	0.0
LnGrp LOS	E	C	B	E	B	B	D	A	A	D	A	A
Approach Vol, veh/h		2265			909			105			336	
Approach Delay, s/veh		28.9			18.8			36.7			49.0	
Approach LOS		C			B			D			D	
Timer - Assigned Phs		2	3	4		6	7	8				
Phs Duration (G+Y+Rc), s		32.5	9.5	68.0		32.5	15.1	62.4				
Change Period (Y+Rc), s		4.5	4.5	4.5		4.5	4.5	4.5				
Max Green Setting (Gmax), s		28.0	5.0	63.5		28.0	10.6	57.9				
Max Q Clear Time (g_c+I1), s		11.8	3.1	55.7		23.4	6.7	19.0				
Green Ext Time (p_c), s		0.5	0.0	6.9		0.8	0.0	6.8				
Intersection Summary												
HCM 6th Ctrl Delay											28.4	
HCM 6th LOS											C	

Intersection

Intersection Delay, s/veh	38.5
Intersection LOS	E

Movement	EBL	EBT	EBR	WBL	WBT	WBR	NBL	NBT	NBR	SBL	SBT	SBR
Lane Configurations	↙	↑	↗	↙	↑↑		↙	↗			↕	
Traffic Vol, veh/h	173	346	83	18	173	51	93	56	39	53	63	165
Future Vol, veh/h	173	346	83	18	173	51	93	56	39	53	63	165
Peak Hour Factor	0.75	0.88	0.67	0.25	0.73	0.89	0.70	0.89	0.57	0.71	0.81	0.97
Heavy Vehicles, %	2	2	2	2	2	2	2	2	2	2	2	2
Mvmt Flow	231	393	124	72	237	57	133	63	68	75	78	170
Number of Lanes	1	1	1	1	2	0	1	1	0	0	1	0

Approach	EB	WB	NB	SB
Opposing Approach	WB	EB	SB	NB
Opposing Lanes	3	3	1	2
Conflicting Approach Left	SB	NB	EB	WB
Conflicting Lanes Left	1	2	3	3
Conflicting Approach Right	NB	SB	WB	EB
Conflicting Lanes Right	2	1	3	3
HCM Control Delay	50.6	18.8	19.6	48.5
HCM LOS	F	C	C	E

Lane	NBLn1	NBLn2	EBLn1	EBLn2	EBLn3	WBLn1	WBLn2	WBLn3	SBLn1
Vol Left, %	100%	0%	100%	0%	0%	100%	0%	0%	19%
Vol Thru, %	0%	59%	0%	100%	0%	0%	100%	53%	22%
Vol Right, %	0%	41%	0%	0%	100%	0%	0%	47%	59%
Sign Control	Stop	Stop	Stop	Stop	Stop	Stop	Stop	Stop	Stop
Traffic Vol by Lane	93	95	173	346	83	18	115	109	281
LT Vol	93	0	173	0	0	18	0	0	53
Through Vol	0	56	0	346	0	0	115	58	63
RT Vol	0	39	0	0	83	0	0	51	165
Lane Flow Rate	133	131	231	393	124	72	158	136	323
Geometry Grp	8	8	8	8	8	8	8	8	8
Degree of Util (X)	0.401	0.366	0.62	0.999	0.29	0.212	0.443	0.369	0.854
Departure Headway (Hd)	10.859	10.041	9.674	9.15	8.417	10.62	10.093	9.746	9.534
Convergence, Y/N	Yes	Yes	Yes	Yes	Yes	Yes	Yes	Yes	Yes
Cap	332	359	376	401	430	338	357	369	381
Service Time	8.624	7.806	7.374	6.85	6.117	8.384	7.856	7.51	7.293
HCM Lane V/C Ratio	0.401	0.365	0.614	0.98	0.288	0.213	0.443	0.369	0.848
HCM Control Delay	20.7	18.5	26.9	75.8	14.5	16.2	20.7	18.1	48.5
HCM Lane LOS	C	C	D	F	B	C	C	C	E
HCM 95th-tile Q	1.9	1.6	4	12.1	1.2	0.8	2.2	1.7	8.1

HCM 6th TWSC
6: Commerce St & Mission Inn Ave

05/04/2020

Intersection												
Int Delay, s/veh	6.2											
Movement	EBL	EBT	EBR	WBL	WBT	WBR	NBL	NBT	NBR	SBL	SBT	SBR
Lane Configurations		↕	↕		↕↔			↕↔			↕↔	
Traffic Vol, veh/h	19	343	77	6	161	6	72	20	11	4	43	9
Future Vol, veh/h	19	343	77	6	161	6	72	20	11	4	43	9
Conflicting Peds, #/hr	0	0	0	0	0	0	0	0	0	0	0	0
Sign Control	Free	Free	Free	Free	Free	Free	Stop	Stop	Stop	Stop	Stop	Stop
RT Channelized	-	-	None	-	-	None	-	-	None	-	-	None
Storage Length	-	-	0	-	-	-	-	-	-	-	-	-
Veh in Median Storage, #	-	0	-	-	0	-	-	0	-	-	0	-
Grade, %	-	0	-	-	0	-	-	0	-	-	0	-
Peak Hour Factor	75	75	75	50	95	50	69	42	50	25	83	65
Heavy Vehicles, %	2	2	2	2	2	2	2	2	2	2	2	2
Mvmt Flow	25	457	103	12	169	12	104	48	22	16	52	14

Major/Minor	Major1			Major2			Minor1			Minor2		
Conflicting Flow All	181	0	0	560	0	0	642	712	457	793	809	91
Stage 1	-	-	-	-	-	-	507	507	-	199	199	-
Stage 2	-	-	-	-	-	-	135	205	-	594	610	-
Critical Hdwy	4.13	-	-	4.13	-	-	7.33	6.53	6.23	7.33	6.53	6.93
Critical Hdwy Stg 1	-	-	-	-	-	-	6.13	5.53	-	6.53	5.53	-
Critical Hdwy Stg 2	-	-	-	-	-	-	6.53	5.53	-	6.13	5.53	-
Follow-up Hdwy	2.219	-	-	2.219	-	-	3.519	4.019	3.319	3.519	4.019	3.319
Pot Cap-1 Maneuver	1393	-	-	1009	-	-	373	357	603	293	314	949
Stage 1	-	-	-	-	-	-	547	538	-	785	736	-
Stage 2	-	-	-	-	-	-	855	731	-	490	484	-
Platoon blocked, %	-	-	-	-	-	-	-	-	-	-	-	-
Mov Cap-1 Maneuver	1393	-	-	1009	-	-	310	343	603	245	302	949
Mov Cap-2 Maneuver	-	-	-	-	-	-	310	343	-	245	302	-
Stage 1	-	-	-	-	-	-	533	524	-	765	726	-
Stage 2	-	-	-	-	-	-	772	721	-	418	471	-

Approach	EB			WB			NB			SB		
HCM Control Delay, s	0.3			0.5			26.2			19.8		
HCM LOS							D			C		

Minor Lane/Major Mvmt	NBLn1	EBL	EBT	EBR	WBL	WBT	WBR	SBLn1
Capacity (veh/h)	340	1393	-	-	1009	-	-	325
HCM Lane V/C Ratio	0.512	0.018	-	-	0.012	-	-	0.251
HCM Control Delay (s)	26.2	7.6	0	-	8.6	0	-	19.8
HCM Lane LOS	D	A	A	-	A	A	-	C
HCM 95th %tile Q(veh)	2.8	0.1	-	-	0	-	-	1

HCM 6th TWSC
7: Commerce St & 9th St

05/04/2020

Intersection						
Int Delay, s/veh	2.4					
Movement	WBL	WBR	NBT	NBR	SBL	SBT
Lane Configurations						
Traffic Vol, veh/h	3	16	87	3	23	101
Future Vol, veh/h	3	16	87	3	23	101
Conflicting Peds, #/hr	0	0	0	0	0	0
Sign Control	Stop	Stop	Free	Free	Free	Free
RT Channelized	-	None	-	None	-	None
Storage Length	0	-	-	-	-	-
Veh in Median Storage, #	0	-	0	-	-	0
Grade, %	0	-	0	-	-	0
Peak Hour Factor	50	79	77	25	25	68
Heavy Vehicles, %	2	2	2	2	2	2
Mvmt Flow	6	20	113	12	92	149

Major/Minor	Minor1	Major1	Major2			
Conflicting Flow All	452	119	0	0	125	0
Stage 1	119	-	-	-	-	-
Stage 2	333	-	-	-	-	-
Critical Hdwy	6.42	6.22	-	-	4.12	-
Critical Hdwy Stg 1	5.42	-	-	-	-	-
Critical Hdwy Stg 2	5.42	-	-	-	-	-
Follow-up Hdwy	3.518	3.318	-	-	2.218	-
Pot Cap-1 Maneuver	565	933	-	-	1462	-
Stage 1	906	-	-	-	-	-
Stage 2	726	-	-	-	-	-
Platoon blocked, %			-	-		-
Mov Cap-1 Maneuver	526	933	-	-	1462	-
Mov Cap-2 Maneuver	526	-	-	-	-	-
Stage 1	843	-	-	-	-	-
Stage 2	726	-	-	-	-	-

Approach	WB	NB	SB
HCM Control Delay, s	9.7	0	2.9
HCM LOS	A		

Minor Lane/Major Mvmt	NBT	NBRWBLn1	SBL	SBT
Capacity (veh/h)	-	-	793	1462
HCM Lane V/C Ratio	-	-	0.033	0.063
HCM Control Delay (s)	-	-	9.7	7.6
HCM Lane LOS	-	-	A	A
HCM 95th %tile Q(veh)	-	-	0.1	0.2

Intersection						
Int Delay, s/veh	2.5					
Movement	EBT	EBR	WBL	WBT	NBL	NBR
Lane Configurations						
Traffic Vol, veh/h	36	193	10	7	45	18
Future Vol, veh/h	36	193	10	7	45	18
Conflicting Peds, #/hr	0	0	0	0	0	0
Sign Control	Free	Free	Free	Free	Stop	Stop
RT Channelized	-	None	-	None	-	None
Storage Length	-	-	-	-	0	-
Veh in Median Storage, #	0	-	-	0	0	-
Grade, %	0	-	-	0	0	-
Peak Hour Factor	38	84	62	67	69	56
Heavy Vehicles, %	2	2	2	2	2	2
Mvmt Flow	95	230	16	10	65	32

Major/Minor	Major1	Major2	Minor1			
Conflicting Flow All	0	0	325	0	252	210
Stage 1	-	-	-	-	210	-
Stage 2	-	-	-	-	42	-
Critical Hdwy	-	-	4.12	-	6.42	6.22
Critical Hdwy Stg 1	-	-	-	-	5.42	-
Critical Hdwy Stg 2	-	-	-	-	5.42	-
Follow-up Hdwy	-	-	2.218	-	3.518	3.318
Pot Cap-1 Maneuver	-	-	1235	-	737	830
Stage 1	-	-	-	-	825	-
Stage 2	-	-	-	-	980	-
Platoon blocked, %	-	-	-	-	-	-
Mov Cap-1 Maneuver	-	-	1235	-	727	830
Mov Cap-2 Maneuver	-	-	-	-	727	-
Stage 1	-	-	-	-	814	-
Stage 2	-	-	-	-	980	-

Approach	EB	WB	NB
HCM Control Delay, s	0	4.8	10.4
HCM LOS			B

Minor Lane/Major Mvmt	NBLn1	EBT	EBR	WBL	WBT
Capacity (veh/h)	758	-	-	1235	-
HCM Lane V/C Ratio	0.128	-	-	0.013	-
HCM Control Delay (s)	10.4	-	-	8	0
HCM Lane LOS	B	-	-	A	A
HCM 95th %tile Q(veh)	0.4	-	-	0	-

HCM 6th Signalized Intersection Summary
 9: SR 91 Off-Ramp/SR 91 On-Ramp & 14th St

05/04/2020



Movement	EBL	EBT	EBR	WBL	WBT	WBR	NBL	NBT	NBR	SBL	SBT	SBR
Lane Configurations	↗↘	↑↑			↑↑↑	↗	↘	↖	↗			
Traffic Volume (veh/h)	663	1391	0	0	820	138	274	3	560	0	0	0
Future Volume (veh/h)	663	1391	0	0	820	138	274	3	560	0	0	0
Initial Q (Qb), veh	0	0	0	0	0	0	0	0	0			
Ped-Bike Adj(A_pbT)	1.00		1.00	1.00		1.00	1.00		1.00			
Parking Bus, Adj	1.00	1.00	1.00	1.00	1.00	1.00	1.00	1.00	1.00			
Work Zone On Approach		No			No			No				
Adj Sat Flow, veh/h/ln	1870	1870	0	0	1870	1870	1870	1870	1870			
Adj Flow Rate, veh/h	721	1599	0	0	872	164	324	0	667			
Peak Hour Factor	0.92	0.87	0.25	0.25	0.94	0.84	0.87	0.25	0.84			
Percent Heavy Veh, %	2	2	0	0	2	2	2	2	2			
Cap, veh/h	778	1759	0	0	1149	357	1478	0	658			
Arrive On Green	0.22	0.50	0.00	0.00	0.22	0.22	0.41	0.00	0.41			
Sat Flow, veh/h	3456	3647	0	0	5274	1585	3563	0	1585			
Grp Volume(v), veh/h	721	1599	0	0	872	164	324	0	667			
Grp Sat Flow(s),veh/h/ln	1728	1777	0	0	1702	1585	1781	0	1585			
Q Serve(g_s), s	20.4	41.3	0.0	0.0	16.0	8.9	5.9	0.0	41.5			
Cycle Q Clear(g_c), s	20.4	41.3	0.0	0.0	16.0	8.9	5.9	0.0	41.5			
Prop In Lane	1.00		0.00	0.00		1.00	1.00		1.00			
Lane Grp Cap(c), veh/h	778	1759	0	0	1149	357	1478	0	658			
V/C Ratio(X)	0.93	0.91	0.00	0.00	0.76	0.46	0.22	0.00	1.01			
Avail Cap(c_a), veh/h	778	1759	0	0	1149	357	1478	0	658			
HCM Platoon Ratio	1.00	1.00	1.00	1.00	1.00	1.00	1.00	1.00	1.00			
Upstream Filter(I)	1.00	1.00	0.00	0.00	1.00	1.00	1.00	0.00	1.00			
Uniform Delay (d), s/veh	37.9	23.2	0.0	0.0	36.2	33.5	18.8	0.0	29.2			
Incr Delay (d2), s/veh	18.8	8.5	0.0	0.0	4.7	4.2	0.3	0.0	38.6			
Initial Q Delay(d3),s/veh	0.0	0.0	0.0	0.0	0.0	0.0	0.0	0.0	0.0			
%ile BackOfQ(50%),veh/ln	10.5	18.3	0.0	0.0	7.0	3.8	2.5	0.0	22.1			
Unsig. Movement Delay, s/veh												
LnGrp Delay(d),s/veh	56.7	31.7	0.0	0.0	40.9	37.7	19.2	0.0	67.9			
LnGrp LOS	E	C	A	A	D	D	B	A	F			
Approach Vol, veh/h		2320			1036			991				
Approach Delay, s/veh		39.4			40.4			51.9				
Approach LOS		D			D			D				
Timer - Assigned Phs		2		4			7	8				
Phs Duration (G+Y+Rc), s		46.0		54.0			27.0	27.0				
Change Period (Y+Rc), s		4.5		4.5			4.5	4.5				
Max Green Setting (Gmax), s		41.5		49.5			22.5	22.5				
Max Q Clear Time (g_c+I1), s		43.5		43.3			22.4	18.0				
Green Ext Time (p_c), s		0.0		4.9			0.0	2.5				

Intersection Summary

HCM 6th Ctrl Delay	42.5
HCM 6th LOS	D

Notes

User approved volume balancing among the lanes for turning movement.

HCM 6th Signalized Intersection Summary

11: Park Ave & University Ave

05/04/2020



Movement	EBL	EBT	EBR	WBL	WBT	WBR	NBL	NBT	NBR	SBL	SBT	SBR
Lane Configurations	↖	↗		↖	↗		↖	↗		↖	↗	
Traffic Volume (veh/h)	52	1342	62	42	603	67	30	35	57	178	96	43
Future Volume (veh/h)	52	1342	62	42	603	67	30	35	57	178	96	43
Initial Q (Qb), veh	0	0	0	0	0	0	0	0	0	0	0	0
Ped-Bike Adj(A_pbT)	1.00		1.00	1.00		1.00	1.00		1.00	1.00		1.00
Parking Bus, Adj	1.00	1.00	1.00	1.00	1.00	1.00	1.00	1.00	1.00	1.00	1.00	1.00
Work Zone On Approach		No		No		No		No		No		No
Adj Sat Flow, veh/h/ln	1870	1870	1870	1870	1870	1870	1870	1870	1870	1870	1870	1870
Adj Flow Rate, veh/h	76	1579	83	56	648	102	32	60	72	251	120	73
Peak Hour Factor	0.68	0.85	0.75	0.75	0.93	0.66	0.94	0.58	0.79	0.71	0.80	0.59
Percent Heavy Veh, %	2	2	2	2	2	2	2	2	2	2	2	2
Cap, veh/h	167	1577	83	86	1273	200	102	139	166	267	296	180
Arrive On Green	0.09	0.46	0.46	0.05	0.41	0.41	0.06	0.18	0.18	0.15	0.27	0.27
Sat Flow, veh/h	1781	3435	180	1781	3077	484	1781	774	929	1781	1089	662
Grp Volume(v), veh/h	76	813	849	56	374	376	32	0	132	251	0	193
Grp Sat Flow(s),veh/h/ln	1781	1777	1838	1781	1777	1783	1781	0	1703	1781	0	1751
Q Serve(g_s), s	4.4	50.2	50.5	3.4	17.2	17.2	1.9	0.0	7.6	15.3	0.0	9.9
Cycle Q Clear(g_c), s	4.4	50.2	50.5	3.4	17.2	17.2	1.9	0.0	7.6	15.3	0.0	9.9
Prop In Lane	1.00		0.10	1.00		0.27	1.00		0.55	1.00		0.38
Lane Grp Cap(c), veh/h	167	816	844	86	735	738	102	0	305	267	0	476
V/C Ratio(X)	0.46	1.00	1.01	0.65	0.51	0.51	0.31	0.00	0.43	0.94	0.00	0.41
Avail Cap(c_a), veh/h	167	816	844	86	735	738	102	0	305	267	0	476
HCM Platoon Ratio	1.00	1.00	1.00	1.00	1.00	1.00	1.00	1.00	1.00	1.00	1.00	1.00
Upstream Filter(I)	1.00	1.00	1.00	1.00	1.00	1.00	1.00	0.00	1.00	1.00	0.00	1.00
Uniform Delay (d), s/veh	47.2	29.7	29.8	51.4	23.9	24.0	49.8	0.0	40.2	46.3	0.0	32.8
Incr Delay (d2), s/veh	8.7	30.8	32.4	32.6	2.5	2.5	7.9	0.0	4.4	41.4	0.0	2.6
Initial Q Delay(d3),s/veh	0.0	0.0	0.0	0.0	0.0	0.0	0.0	0.0	0.0	0.0	0.0	0.0
%ile BackOfQ(50%),veh/ln	2.4	27.4	28.9	2.3	7.6	7.7	1.1	0.0	3.6	9.8	0.0	4.5
Unsig. Movement Delay, s/veh												
LnGrp Delay(d),s/veh	55.9	60.5	62.1	84.0	26.5	26.5	57.6	0.0	44.6	87.7	0.0	35.3
LnGrp LOS	E	E	F	F	C	C	E	A	D	F	A	D
Approach Vol, veh/h		1738			806			164			444	
Approach Delay, s/veh		61.1			30.5			47.1			64.9	
Approach LOS		E			C			D			E	
Timer - Assigned Phs	1	2	3	4	5	6	7	8				
Phs Duration (G+Y+Rc), s	31.0	24.2	9.8	55.0	10.8	34.4	14.8	50.0				
Change Period (Y+Rc), s	4.5	4.5	4.5	4.5	4.5	4.5	4.5	4.5				
Max Green Setting (Gmax), s	10.5	19.7	5.3	50.5	6.3	29.9	10.3	45.5				
Max Q Clear Time (g_c+M), s	10.5	9.6	5.4	52.5	3.9	11.9	6.4	19.2				
Green Ext Time (p_c), s	0.0	0.4	0.0	0.0	0.0	1.0	0.0	5.1				
Intersection Summary												
HCM 6th Ctrl Delay												53.1
HCM 6th LOS												D

HCM 6th AWSC
12: Howard Ave & 12th St

05/04/2020

Intersection

Intersection Delay, s/veh 9.1

Intersection LOS A

Movement	EBL	EBT	EBR	WBL	WBT	WBR	NBL	NBT	NBR	SBL	SBT	SBR
Lane Configurations		↔			↔			↔			↔	
Traffic Vol, veh/h	0	2	29	14	1	4	7	70	16	6	193	4
Future Vol, veh/h	0	2	29	14	1	4	7	70	16	6	193	4
Peak Hour Factor	0.25	0.25	0.85	0.71	0.62	0.50	0.48	0.70	0.42	0.25	0.68	0.62
Heavy Vehicles, %	2	2	2	2	2	2	2	2	2	2	2	2
Mvmt Flow	0	8	34	20	2	8	15	100	38	24	284	6
Number of Lanes	0	1	0	0	1	0	0	1	0	0	1	0

Approach	EB	WB	WB	NB	SB
Opposing Approach	WB	EB	SB	SB	NB
Opposing Lanes	1	1	1	1	1
Conflicting Approach Left	SB	NB	EB	EB	WB
Conflicting Lanes Left	1	1	1	1	1
Conflicting Approach Right	NB	SB	WB	WB	EB
Conflicting Lanes Right	1	1	1	1	1
HCM Control Delay	7.7	8.3	8.3	8.3	9.8
HCM LOS	A	A	A	A	A

Lane	NBLn1	EBLn1	WBLn1	SBLn1
Vol Left, %	8%	0%	74%	3%
Vol Thru, %	75%	6%	5%	95%
Vol Right, %	17%	94%	21%	2%
Sign Control	Stop	Stop	Stop	Stop
Traffic Vol by Lane	93	31	19	203
LT Vol	7	0	14	6
Through Vol	70	2	1	193
RT Vol	16	29	4	4
Lane Flow Rate	153	42	29	314
Geometry Grp	1	1	1	1
Degree of Util (X)	0.184	0.052	0.041	0.373
Departure Headway (Hd)	4.334	4.431	5.03	4.27
Convergence, Y/N	Yes	Yes	Yes	Yes
Cap	829	808	712	849
Service Time	2.353	2.459	3.059	2.27
HCM Lane V/C Ratio	0.185	0.052	0.041	0.37
HCM Control Delay	8.3	7.7	8.3	9.8
HCM Lane LOS	A	A	A	A
HCM 95th-tile Q	0.7	0.2	0.1	1.7

HCM 6th Signalized Intersection Summary

13: Olivewood Ave/Lime St & 14th St

05/04/2020



Movement	EBL	EBT	EBR	WBL	WBT	WBR	NBL	NBT	NBR	SBL	SBT	SBR
Lane Configurations	↖ ↑↑↑			↖ ↑↑↑			↖ ↑↑	↖ ↑↑		↖ ↗	↑↑	↖
Traffic Volume (veh/h)	31	1090	87	303	865	82	49	198	504	326	674	42
Future Volume (veh/h)	31	1090	87	303	865	82	49	198	504	326	674	42
Initial Q (Qb), veh	0	0	0	0	0	0	0	0	0	0	0	0
Ped-Bike Adj(A_pbT)	1.00		1.00	1.00		1.00	1.00		1.00	1.00		1.00
Parking Bus, Adj	1.00	1.00	1.00	1.00	1.00	1.00	1.00	1.00	1.00	1.00	1.00	1.00
Work Zone On Approach	No			No			No			No		
Adj Sat Flow, veh/h/ln	1870	1870	1870	1870	1870	1870	1870	1870	1870	1870	1870	1870
Adj Flow Rate, veh/h	44	1329	110	333	930	100	62	257	586	526	812	84
Peak Hour Factor	0.71	0.82	0.79	0.91	0.93	0.82	0.79	0.77	0.86	0.62	0.83	0.50
Percent Heavy Veh, %	2	2	2	2	2	2	2	2	2	2	2	2
Cap, veh/h	113	1380	114	364	2005	215	86	335	568	572	963	100
Arrive On Green	0.06	0.29	0.29	0.07	0.14	0.14	0.05	0.18	0.18	0.17	0.30	0.30
Sat Flow, veh/h	1781	4805	398	1781	4682	502	1781	1870	3170	3456	3250	336
Grp Volume(v), veh/h	44	941	498	333	675	355	62	257	586	526	444	452
Grp Sat Flow(s),veh/h/ln	1781	1702	1799	1781	1702	1780	1781	1870	1585	1728	1777	1810
Q Serve(g_s), s	2.6	30.0	30.0	20.4	20.1	20.1	3.8	14.4	19.7	16.5	25.8	25.8
Cycle Q Clear(g_c), s	2.6	30.0	30.0	20.4	20.1	20.1	3.8	14.4	19.7	16.5	25.8	25.8
Prop In Lane	1.00		0.22	1.00		0.28	1.00		1.00	1.00		0.19
Lane Grp Cap(c), veh/h	113	978	517	364	1458	762	86	335	568	572	527	536
V/C Ratio(X)	0.39	0.96	0.96	0.91	0.46	0.47	0.72	0.77	1.03	0.92	0.84	0.84
Avail Cap(c_a), veh/h	113	978	517	364	1458	762	86	335	568	572	527	536
HCM Platoon Ratio	1.00	1.00	1.00	0.33	0.33	0.33	1.00	1.00	1.00	1.00	1.00	1.00
Upstream Filter(I)	1.00	1.00	1.00	1.00	1.00	1.00	1.00	1.00	1.00	1.00	1.00	1.00
Uniform Delay (d), s/veh	49.4	38.6	38.6	50.3	35.6	35.7	51.6	43.0	45.2	45.2	36.3	36.3
Incr Delay (d2), s/veh	9.7	21.1	31.4	29.7	1.1	2.0	41.1	15.4	46.3	22.3	15.1	14.9
Initial Q Delay(d3),s/veh	0.0	0.0	0.0	0.0	0.0	0.0	0.0	0.0	0.0	0.0	0.0	0.0
%ile BackOfQ(50%),veh/ln	1.5	15.1	17.5	12.8	9.4	10.0	2.7	8.0	11.3	8.8	13.2	13.4
Unsig. Movement Delay, s/veh												
LnGrp Delay(d),s/veh	59.2	59.7	70.0	80.0	36.7	37.7	92.7	58.4	91.4	67.5	51.4	51.2
LnGrp LOS	E	E	E	F	D	D	F	E	F	E	D	D
Approach Vol, veh/h	1483		1363		905		1422					
Approach Delay, s/veh	63.1		47.5		82.1		57.3					
Approach LOS	E		D		F		E					
Timer - Assigned Phs	1	2	3	4	5	6	7	8				
Phs Duration (G+Y+Rc), s	22.7	24.2	27.0	36.1	9.8	37.1	11.5	51.6				
Change Period (Y+Rc), s	4.5	4.5	4.5	4.5	4.5	4.5	4.5	4.5				
Max Green Setting (Gmax), s	19.7	19.7	22.5	31.6	5.3	32.6	7.0	47.1				
Max Q Clear Time (g_c+10), s	19.5	21.7	22.4	32.0	5.8	27.8	4.6	22.1				
Green Ext Time (p_c), s	0.0	0.0	0.0	0.0	0.0	2.4	0.0	7.7				

Intersection Summary

HCM 6th Ctrl Delay	60.7
HCM 6th LOS	E

Notes

User approved volume balancing among the lanes for turning movement.

HCM 6th Signalized Intersection Summary

14: Mulberry St/SR 91 Off-Ramp & 14th St

05/04/2020



Movement	EBL	EBT	EBR	WBL	WBT	WBR	NBL	NBT	NBR	SBL	SBT	SBR
Lane Configurations		↑↑↑		↔↔	↑↑↑					↔	↑↑↑	↔
Traffic Volume (veh/h)	0	1625	295	384	711	0	0	0	0	429	232	540
Future Volume (veh/h)	0	1625	295	384	711	0	0	0	0	429	232	540
Initial Q (Qb), veh	0	0	0	0	0	0				0	0	0
Ped-Bike Adj(A_pbT)	1.00		1.00	1.00		1.00				1.00		1.00
Parking Bus, Adj	1.00	1.00	1.00	1.00	1.00	1.00				1.00	1.00	1.00
Work Zone On Approach		No			No						No	
Adj Sat Flow, veh/h/ln	0	1870	1870	1870	1870	0				1870	1870	1870
Adj Flow Rate, veh/h	0	1729	492	526	781	0				349	801	379
Peak Hour Factor	0.25	0.94	0.60	0.73	0.91	0.25				0.82	0.85	0.95
Percent Heavy Veh, %	0	2	2	2	2	0				2	2	2
Cap, veh/h	0	1860	516	581	3458	0				429	901	382
Arrive On Green	0.00	0.47	0.47	0.17	0.68	0.00				0.24	0.24	0.24
Sat Flow, veh/h	0	4142	1103	3456	5274	0				1781	3741	1585
Grp Volume(v), veh/h	0	1475	746	526	781	0				349	801	379
Grp Sat Flow(s),veh/h/ln	0	1702	1672	1728	1702	0				1781	1870	1585
Q Serve(g_s), s	0.0	44.7	47.1	16.4	6.4	0.0				20.3	22.8	26.2
Cycle Q Clear(g_c), s	0.0	44.7	47.1	16.4	6.4	0.0				20.3	22.8	26.2
Prop In Lane	0.00		0.66	1.00		0.00				1.00		1.00
Lane Grp Cap(c), veh/h	0	1594	783	581	3458	0				429	901	382
V/C Ratio(X)	0.00	0.93	0.95	0.91	0.23	0.00				0.81	0.89	0.99
Avail Cap(c_a), veh/h	0	1594	783	581	3458	0				429	901	382
HCM Platoon Ratio	1.00	1.00	1.00	1.00	1.00	1.00				1.00	1.00	1.00
Upstream Filter(I)	0.00	1.00	1.00	1.00	1.00	0.00				1.00	1.00	1.00
Uniform Delay (d), s/veh	0.0	27.4	28.1	44.9	6.8	0.0				39.4	40.3	41.7
Incr Delay (d2), s/veh	0.0	10.6	22.6	20.1	0.2	0.0				15.4	12.7	44.2
Initial Q Delay(d3),s/veh	0.0	0.0	0.0	0.0	0.0	0.0				0.0	0.0	0.0
%ile BackOfQ(50%),veh/ln	0.0	19.7	22.9	8.6	2.2	0.0				10.7	11.9	14.8
Unsig. Movement Delay, s/veh												
LnGrp Delay(d),s/veh	0.0	38.1	50.7	65.0	6.9	0.0				54.8	53.1	85.9
LnGrp LOS		A	D	D	E	A				D	D	F
Approach Vol, veh/h		2221			1307						1529	
Approach Delay, s/veh		42.3			30.3						61.6	
Approach LOS		D			C						E	
Timer - Assigned Phs			3	4		6		8				
Phs Duration (G+Y+Rc), s			23.0	56.0		31.0		79.0				
Change Period (Y+Rc), s			4.5	4.5		4.5		4.5				
Max Green Setting (Gmax), s			18.5	51.5		26.5		74.5				
Max Q Clear Time (g_c+I1), s			18.4	49.1		28.2		8.4				
Green Ext Time (p_c), s			0.0	2.2		0.0		6.7				
Intersection Summary												
HCM 6th Ctrl Delay			45.0									
HCM 6th LOS			D									
Notes												
User approved volume balancing among the lanes for turning movement.												



Riverside-Downtown STATION IMPROVEMENTS

Appendix D. Signal Warrant Analysis



Riverside-Downtown
STATION IMPROVEMENTS

Signal Warrant Analysis

Signal Warrant Analysis: Commerce St & Mission Inn Ave

**Figure 4C-10. Warrant 9, Intersection Near a Grade Crossing
(Two or More Approach Lanes at the Track Crossing)**

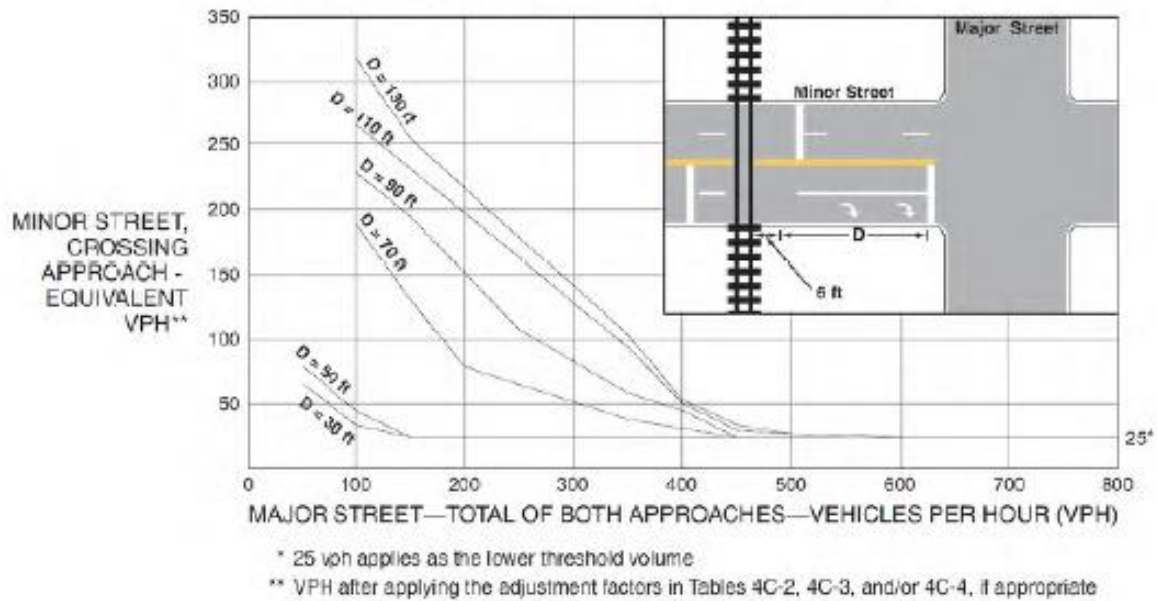

D = 95 feet

Major Street Total of Both Approaches (VPH) = 239

Minor Street Crossing Approach VPH (before applying VPH adjustment factors that increase Equivalent VPH) = EB: 475 & WB: 563

Signal Warrant Analysis: Vine & Mission Inn Ave (Opening Year 2025)

Figure 4C-3. Warrant 3, Peak Hour

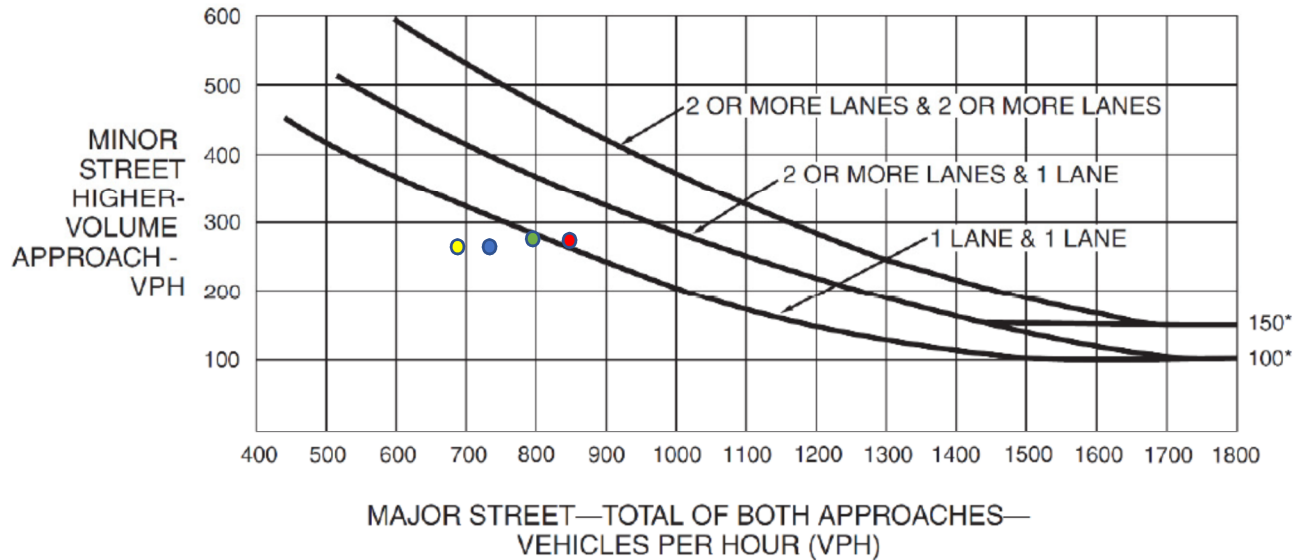

*Note: 150 vph applies as the lower threshold volume for a minor-street approach with two or more lanes and 100 vph applies as the lower threshold volume for a minor-street approach with one lane.

Opening Year 2025 (Without Project) conditions for PM peak hour:

Major Street—Total both approaches = 691 vph; Minor Street—Higher volume approach = 270 vph

Since the plotted point (yellow dot) on the peak hour warrant exhibit lies below the (2 OR MORE LANES & 1 LANE) curve, a signal is not warranted at Vine and Mission Inn Ave in 2025 for this scenario.

Opening Year 2025 with cumulative project conditions for PM peak hour:

Major Street—Total both approaches = 796 vph; Minor Street—Higher volume approach = 281 vph

Since the plotted point (green dot) on the peak hour warrant exhibit lies below the (2 OR MORE LANES & 1 LANE) curve, a signal is not warranted at Vine and Mission Inn Ave in 2025 for this scenario.

Opening Year 2025 with project conditions for PM peak hour:

Major Street – Total of both approaches = 739 vph; Minor Street – Higher volume approach = 270 vph

Since the plotted point (blue dot) on the peak hour warrant exhibit lies below the (2 OR MORE LANES & 1 LANE) curve, a signal is not warranted at Vine and Mission Inn Ave in 2025 for this scenario.

Opening Year 2025 with cumulative and project conditions for PM peak hour:

Major Street – Total of both approaches = 844 vph; Minor Street – Higher volume approach = 281 vph

Since the plotted point (red dot) on the peak hour warrant exhibit lies below the (2 OR MORE LANES & 1 LANE) curve, a signal is not warranted at Vine and Mission Inn Ave in 2025 for this scenario.

Signal Warrant Analysis: Vine & Mission Inn Ave (2045)

Figure 4C-3. Warrant 3, Peak Hour

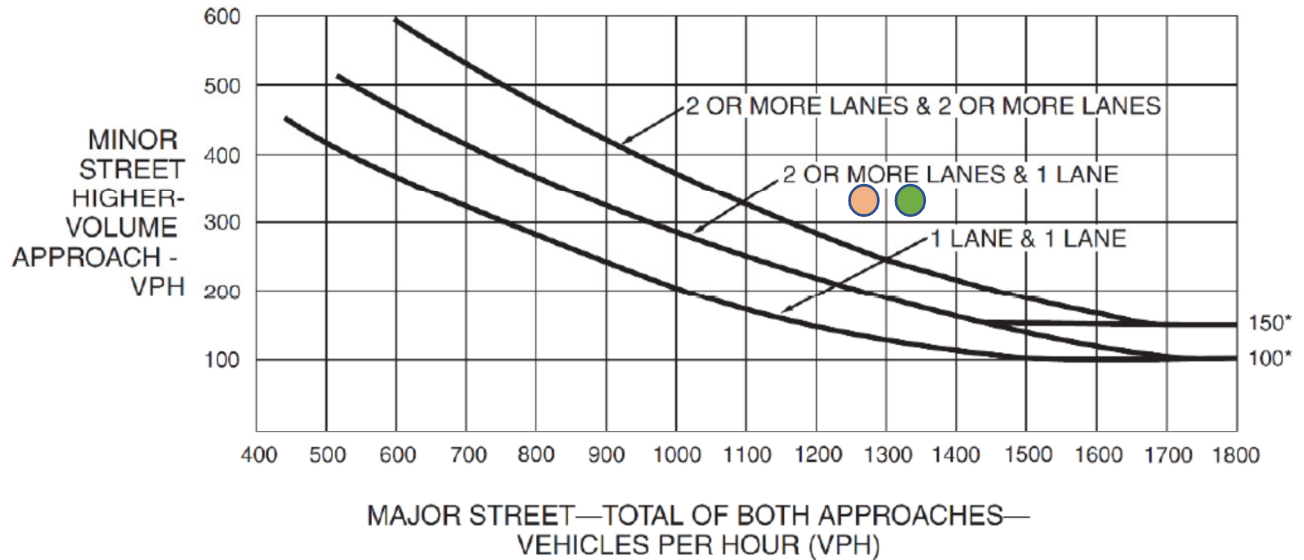

*Note: 150 vph applies as the lower threshold volume for a minor-street approach with two or more lanes and 100 vph applies as the lower threshold volume for a minor-street approach with one lane.

Build-Out 2045 (without project) conditions for PM peak hour:

Major Street – Total of both approaches vph = 1,286 vph

Minor Street – Higher volume approach – vph = 323 vph

Since the plotted point (orange dot) on the peak hour warrant exhibit lies above the (2 OR MORE LANES & 1 LANE) curve, a signal is warranted at Vine and Mission Inn Ave.

Build-Out 2045 with project conditions for PM peak hour:

Major Street – Total of both approaches vph = 1,335 vph

Minor Street – Higher volume approach – vph = 323 vph

Since the plotted point (green dot) on the peak hour warrant exhibit lies above the (2 OR MORE LANES & 1 LANE) curve, a signal is warranted at Vine and Mission Inn Ave.



Riverside-Downtown STATION IMPROVEMENTS

Appendix E. Appendix Howard Extension

Howard Extension

This section of the report analyzes the traffic operations for Option 2A, Option 2B, Option 3A, Option 3B, which involve extending Howard Avenue from 10th to 9th Street. This option was chosen for traffic analysis because it represents the option with the highest trip generation from the park and ride. In this option, a portion of 10th Street is vacated from Howard Avenue to Commerce Street and the proposed station parking lot is combined with the existing parking located between 9th Street and 10th Street. The conceptual site plan for the proposed project is illustrated in the Site Plan (Figure E-1 shows details of Option 2A as an example of the Howard Extension) shown in Appendix E. The proposed project site is located West of Howard Avenue between 10th Street and 12th Street. The project will replace the existing commercial warehouse 'Prism Aerospace' under a current land use Manufacturing (140). This site plan also creates a kiss and ride directly in front of the proposed station platform, with a one-way entrance directly off Commerce Street. Vehicles are assumed to enter the facility via the one-way entrance off Commerce Street, drop off passengers and exit the project site via the main entrance on 9th Street.

Howard Extension Traffic Volumes

Traffic volumes were adjusted based on the proposed Howard Extension and the portion of 10th street being vacated in accordance to the site plan. For the proposed Howard extension, traffic volumes and turning movements were developed by rerouting vehicles to use the Howard extension. The only turning movements that are expected to be affected due to the Howard extension are the intersections that are in close proximity to the park and ride lot – namely, 9th Street, Howard Street and Commerce Street. The forecasted turning movement volumes for Option 2A/Option 2B/Option 3A/Option 3B at these localized intersections (as shown in the turning movement volumes in Figure E-2 and Figure E-3 in Appendix E, for two build conditions for Opening Year and Future Build-Out for the Howard Extension). At all other intersections, traffic is assumed to remain the same as the Option 1A/Option 1B (analyzed in the main report).

Turning movement volumes were estimated at major intersections for two conditions:

- Opening Year With Cumulative and Project conditions
- Build-Out (2045) With Project conditions.

These two conditions represent the worst-case (highest volume) scenarios for opening year and build-out years, respectively. The balanced peak hour intersection traffic volumes for the Opening Year with Cumulative Projects and Project Conditions and the Build-Out (2045) With Project Conditions are illustrated later in Appendix E. Since the volumes for all other conditions (including the Existing with Project Conditions and Opening Year with Project Conditions) are lower than the two conditions listed above.

Howard Extension Intersection LOS Results

The intersection LOS results are illustrated in a LOS table later in Appendix E. The LOS results for the intersections affected by the Howard Extension indicate that:

- All the major intersections shown in the Table E-1 are expected to have acceptable LOS.

- Additionally, the proposed driveways to the project and other intersections (including those at Howard extension/9th Street, Howard/10th, Commerce/Kiss and Ride entrance, 9th/Project Parking lot entrance/exit) were analyzed and are expected to have acceptable LOS.

Conclusion

The results of this analysis show that the volumes on Howard Avenue and 10th Street are relatively low, and there are no traffic impacts resulting from the project or the Howard Avenue extension. It should be noted that any changes anticipated related to the Howard Extension options can be expected to be localized to Howard Avenue and 10th Street.

This analysis shown in Table E-1 shows similar LOS results for all major intersections (and acceptable LOS for driveways in the immediate vicinity of the project site) for even the worst-case with project conditions for both Opening Year and Build-Out (2045).

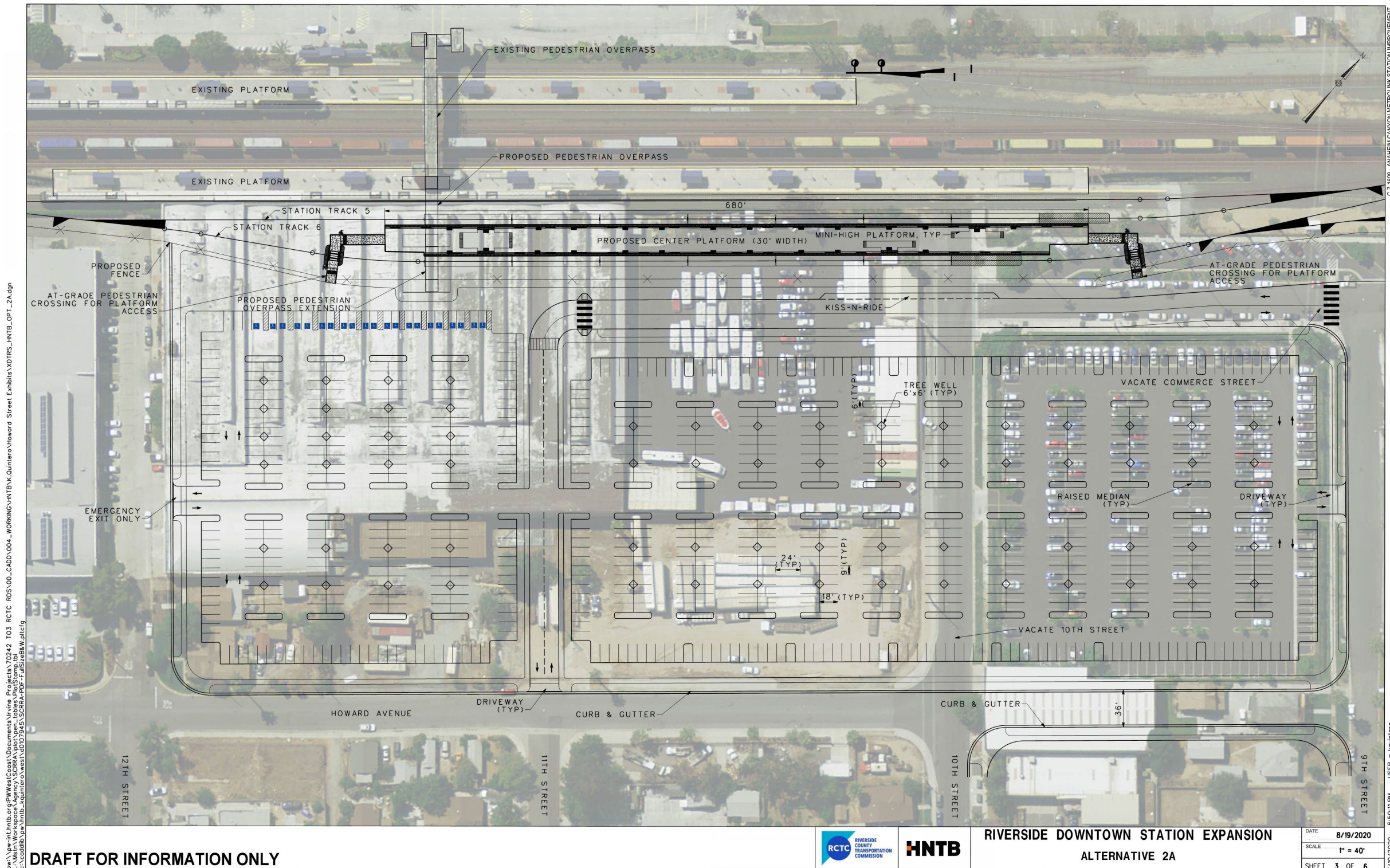

DRAFT FOR INFORMATION ONLY



**RIVERSIDE DOWNTOWN STATION EXPANSION
ALTERNATIVE 2A**

DATE	8/19/2020
SCALE	1" = 40'
SHEET	3 OF 6

Figure E-1. Howard Extension Site Plan

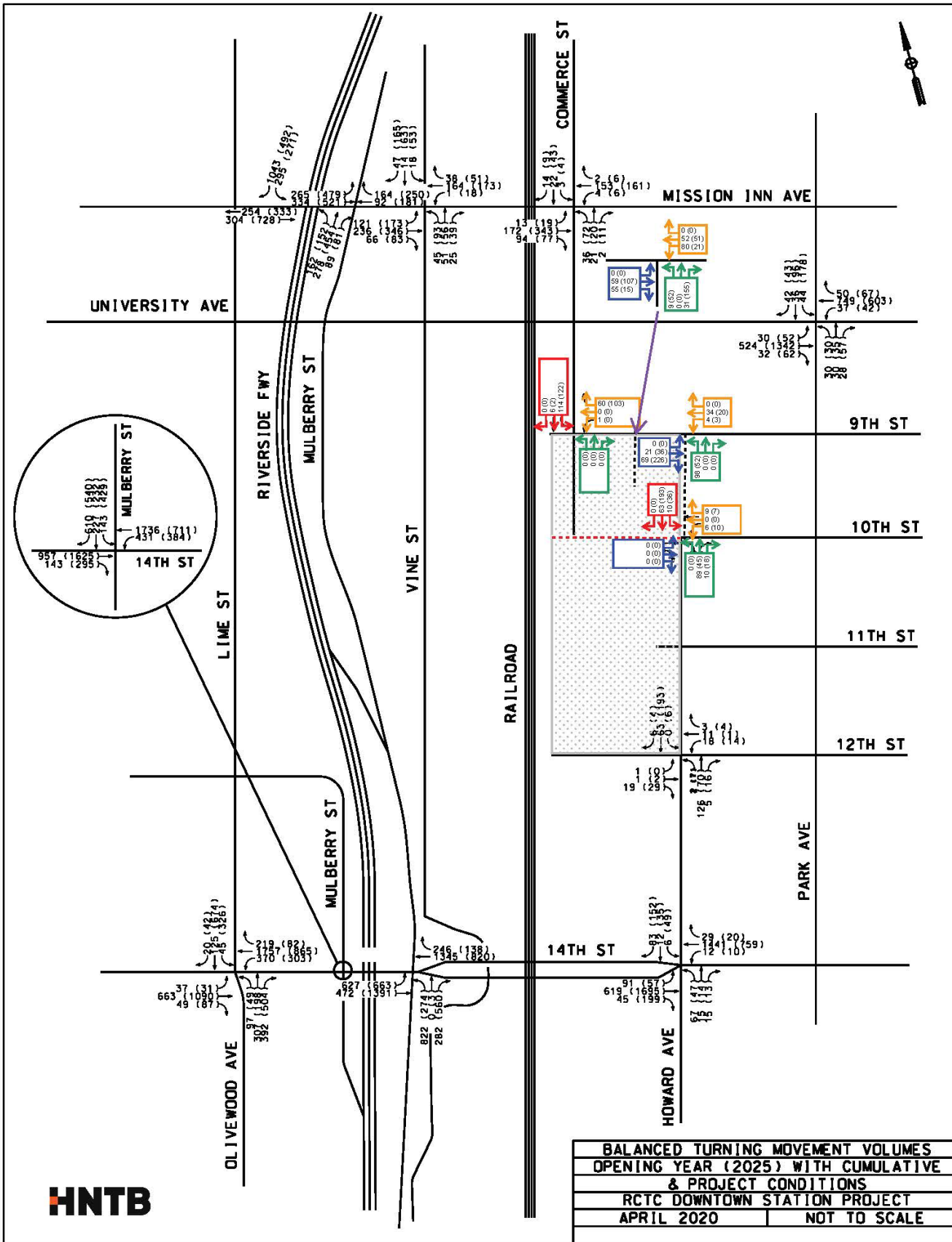

Opening Year Traffic Volumes (2025) with Cumulative and Project Conditions - Howard Extension

RCTC Downtown Station Metrolink Expansion Project
Traffic Impact Analysis

Figure E-2. Howard Extension Opening Year Traffic Volumes for Cumulative Projects and With Project Condition

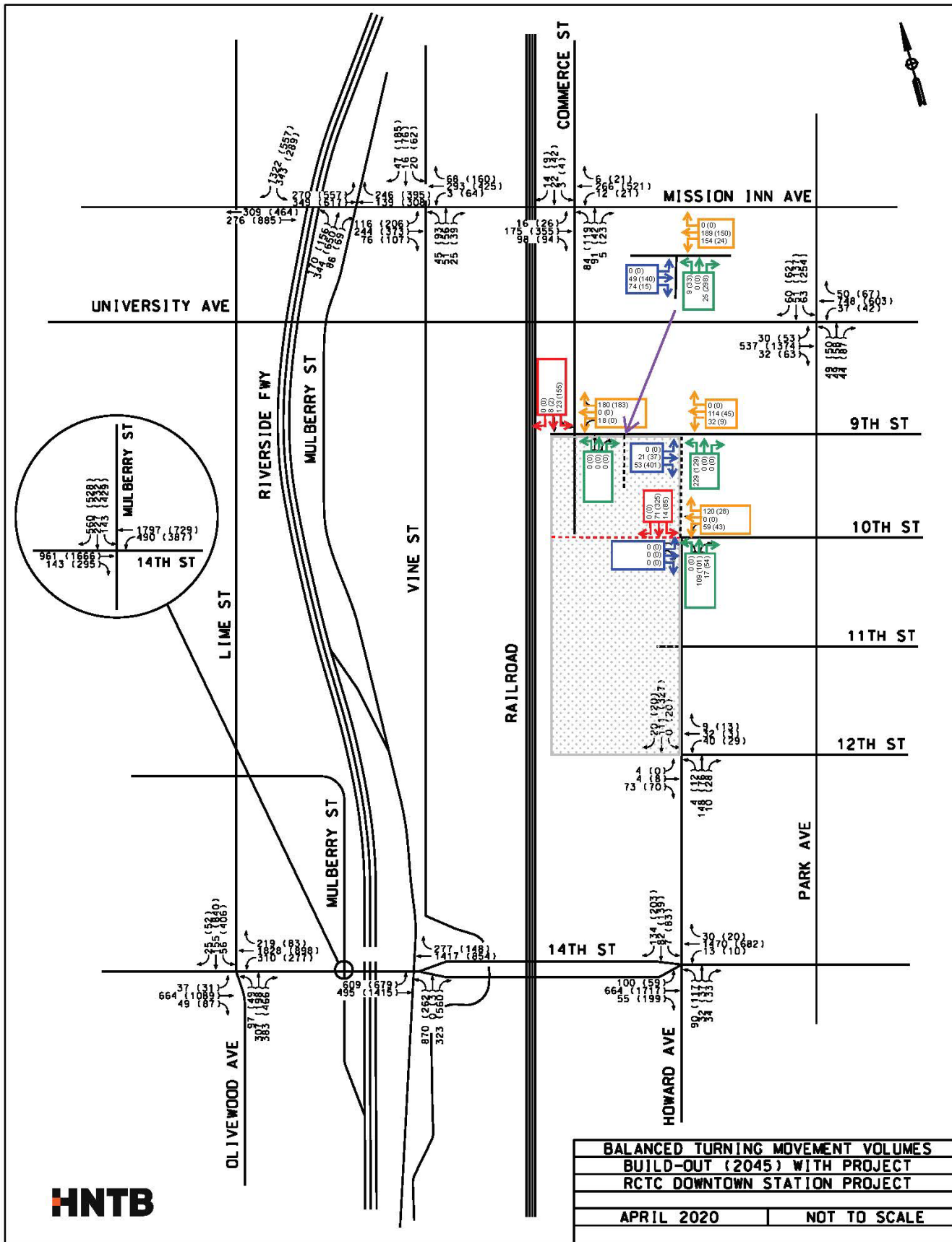

Build-Out Traffic Volumes (2045) with Project Conditions - Howard Extension

RCTC Downtown Station Metrolink Expansion Project
Traffic Impact Analysis

Figure E-3. Howard Extension Future Year Traffic Volumes for With Project Condition

Table E-1. LOS for Howard Extension Analysis Opening Year with Cumulative Projects and With Project and Future Year With Project Conditions⁶

Intersection	Control	Opening Year Cumulative Projects and With Project Conditions ⁷				Build-Out (2045) With Project Conditions ⁸				
		AM Peak Hour		PM Peak Hour		AM Peak Hour		PM Peak Hour		
		Delay (sec)	LOS	Delay (sec)	LOS	Delay (sec)	LOS	Delay (sec)	LOS	
1	Commerce Street and Mission Inn Avenue	TWSC	13.8	B	26.2	D	17.5	C	55.8	F
2	University Avenue and Park Avenue	Signalized	29.5	C	53.1	D	30.1	C	46.6	D
3	Commerce Street and 9 th Street	Stop on Commerce	9.6	A	9.9	A	12.6	B	11.9	B
4	Howard Avenue and 10 th Street	Stop on 10 th Street	9.3	A	10.2	B	10.4	B	13.5	B
5	Howard Avenue and 12 th Street	AWSC	8.1	A	9.1	A	8.4	A	10.1	B
6	Howard Avenue and 14 th Street	Signalized	26.7	C	28.4	C	29.4	C	34.8	C

Note: In addition to the major intersections shown in the table, the proposed driveways and other intersections (including those at Howard extension/9th Street, Howard/10th, Commerce/Kiss and Ride entrance, 9th / Project Parking lot entrance/exit) were analyzed and had acceptable LOS.

All other intersections have the same LOS and delays as the original site plan analyzed. It should be noted that while the Commerce Street and Mission Inn Avenue intersection operates at LOS of F, the LOS and delays are no worse than Option 1A/1B analysis.

⁶ Volumes and LOS analyses tables for the Howard Extension analysis are shown for the “with project” conditions with the highest traffic volumes for Opening Year and Future Year. Other “with project” conditions are expected to have lower traffic and better LOS than these worst-case (highest volume) conditions.

⁷ Volumes and LOS analyses for the Howard Extension analysis for Opening Year “with project” conditions represent the highest traffic volumes for the Opening Year.

⁸ Volumes and LOS analyses for the Howard Extension analysis for Future Year “with project” conditions represent the highest traffic volumes for Future Year.



Riverside-Downtown STATION IMPROVEMENTS

HCM RESULTS FOR HOWARD EXTENSION ANALYSIS

**OPENING YEAR WITH CUMULATIVE PROJECTS AND WITH
PROJECT CONDITIONS**

HCM 6th Signalized Intersection Summary

4: Howard Ave & 14th St

07/13/2020



Movement	EBL	EBT	EBR	WBL	WBT	WBR	NBL	NBT	NBR	SBL	SBT	SBR
Lane Configurations												
Traffic Volume (veh/h)	91	619	45	12	1441	29	67	15	15	6	12	83
Future Volume (veh/h)	91	619	45	12	1441	29	67	15	15	6	12	83
Initial Q (Qb), veh	0	0	0	0	0	0	0	0	0	0	0	0
Ped-Bike Adj(A_pbT)	1.00		1.00	1.00		1.00	1.00		1.00	1.00		1.00
Parking Bus, Adj	1.00	1.00	1.00	1.00	1.00	1.00	1.00	1.00	1.00	1.00	1.00	1.00
Work Zone On Approach		No			No			No			No	
Adj Sat Flow, veh/h/ln	1870	1870	1870	1870	1870	1870	1870	1870	1870	1870	1870	1870
Adj Flow Rate, veh/h	130	696	63	22	1638	41	92	21	24	12	22	94
Peak Hour Factor	0.70	0.89	0.71	0.55	0.88	0.70	0.73	0.70	0.62	0.50	0.54	0.88
Percent Heavy Veh, %	2	2	2	2	2	2	2	2	2	2	2	2
Cap, veh/h	219	2207	984	92	1949	49	233	54	49	50	75	245
Arrive On Green	0.12	0.62	0.62	0.05	0.55	0.55	0.20	0.20	0.20	0.20	0.20	0.20
Sat Flow, veh/h	1781	3554	1585	1781	3543	88	871	264	241	69	364	1197
Grp Volume(v), veh/h	130	696	63	22	820	859	137	0	0	128	0	0
Grp Sat Flow(s),veh/h/ln	1781	1777	1585	1781	1777	1854	1375	0	0	1629	0	0
Q Serve(g_s), s	7.6	10.2	1.7	1.3	42.4	42.7	2.5	0.0	0.0	0.0	0.0	0.0
Cycle Q Clear(g_c), s	7.6	10.2	1.7	1.3	42.4	42.7	9.8	0.0	0.0	7.3	0.0	0.0
Prop In Lane	1.00		1.00	1.00		0.05	0.67		0.18	0.09		0.73
Lane Grp Cap(c), veh/h	219	2207	984	92	977	1020	336	0	0	369	0	0
V/C Ratio(X)	0.59	0.32	0.06	0.24	0.84	0.84	0.41	0.00	0.00	0.35	0.00	0.00
Avail Cap(c_a), veh/h	219	2207	984	92	977	1020	336	0	0	369	0	0
HCM Platoon Ratio	1.00	1.00	1.00	1.00	1.00	1.00	1.00	1.00	1.00	1.00	1.00	1.00
Upstream Filter(I)	1.00	1.00	1.00	1.00	1.00	1.00	1.00	0.00	0.00	1.00	0.00	0.00
Uniform Delay (d), s/veh	45.7	9.8	8.2	50.1	20.7	20.8	38.6	0.0	0.0	37.7	0.0	0.0
Incr Delay (d2), s/veh	11.4	0.4	0.1	6.0	8.6	8.4	3.6	0.0	0.0	2.6	0.0	0.0
Initial Q Delay(d3),s/veh	0.0	0.0	0.0	0.0	0.0	0.0	0.0	0.0	0.0	0.0	0.0	0.0
%ile BackOfQ(50%),veh/ln	4.0	3.9	0.6	0.7	18.8	19.8	3.6	0.0	0.0	3.2	0.0	0.0
Unsig. Movement Delay, s/veh												
LnGrp Delay(d),s/veh	57.0	10.2	8.4	56.1	29.2	29.2	42.3	0.0	0.0	40.3	0.0	0.0
LnGrp LOS	E	B	A	E	C	C	D	A	A	D	A	A
Approach Vol, veh/h		889			1701			137			128	
Approach Delay, s/veh		16.9			29.6			42.3			40.3	
Approach LOS		B			C			D			D	
Timer - Assigned Phs		2	3	4		6	7	8				
Phs Duration (G+Y+Rc), s		27.0	10.2	72.8		27.0	18.0	65.0				
Change Period (Y+Rc), s		4.5	4.5	4.5		4.5	4.5	4.5				
Max Green Setting (Gmax), s		22.5	5.7	68.3		22.5	13.5	60.5				
Max Q Clear Time (g_c+I1), s		11.8	3.3	12.2		9.3	9.6	44.7				
Green Ext Time (p_c), s		0.5	0.0	6.0		0.5	0.1	10.7				
Intersection Summary												
HCM 6th Ctrl Delay											26.7	
HCM 6th LOS											C	

HCM 6th TWSC
6: Commerce St & Mission Inn Ave

07/13/2020

Intersection												
Int Delay, s/veh	3.4											
Movement	EBL	EBT	EBR	WBL	WBT	WBR	NBL	NBT	NBR	SBL	SBT	SBR
Lane Configurations		↕	↗		↕			↕			↕	
Traffic Vol, veh/h	13	172	94	4	153	2	36	21	2	3	22	14
Future Vol, veh/h	13	172	94	4	153	2	36	21	2	3	22	14
Conflicting Peds, #/hr	0	0	0	0	0	0	0	0	0	0	0	0
Sign Control	Free	Free	Free	Free	Free	Free	Stop	Stop	Stop	Stop	Stop	Stop
RT Channelized	-	-	None	-	-	None	-	-	None	-	-	None
Storage Length	-	-	0	-	-	-	-	-	-	-	-	-
Veh in Median Storage, #	-	0	-	-	0	-	-	0	-	-	0	-
Grade, %	-	0	-	-	0	-	-	0	-	-	0	-
Peak Hour Factor	75	75	75	50	95	50	69	42	50	25	83	65
Heavy Vehicles, %	2	2	2	2	2	2	2	2	2	2	2	2
Mvmt Flow	17	229	125	8	161	4	52	50	4	12	27	22

Major/Minor	Major1			Major2			Minor1			Minor2		
Conflicting Flow All	165	0	0	354	0	0	373	444	229	532	567	83
Stage 1	-	-	-	-	-	-	263	263	-	179	179	-
Stage 2	-	-	-	-	-	-	110	181	-	353	388	-
Critical Hdwy	4.13	-	-	4.13	-	-	7.33	6.53	6.23	7.33	6.53	6.93
Critical Hdwy Stg 1	-	-	-	-	-	-	6.13	5.53	-	6.53	5.53	-
Critical Hdwy Stg 2	-	-	-	-	-	-	6.53	5.53	-	6.13	5.53	-
Follow-up Hdwy	2.219	-	-	2.219	-	-	3.519	4.019	3.319	3.519	4.019	3.319
Pot Cap-1 Maneuver	1412	-	-	1203	-	-	571	508	810	444	432	960
Stage 1	-	-	-	-	-	-	741	690	-	806	751	-
Stage 2	-	-	-	-	-	-	884	749	-	663	608	-
Platoon blocked, %	-	-	-	-	-	-	-	-	-	-	-	-
Mov Cap-1 Maneuver	1412	-	-	1203	-	-	522	497	810	401	422	960
Mov Cap-2 Maneuver	-	-	-	-	-	-	522	497	-	401	422	-
Stage 1	-	-	-	-	-	-	730	680	-	794	746	-
Stage 2	-	-	-	-	-	-	828	744	-	602	599	-

Approach	EB			WB			NB			SB		
HCM Control Delay, s	0.4			0.4			13.8			12.8		
HCM LOS							B			B		

Minor Lane/Major Mvmt	NBLn1	EBL	EBT	EBR	WBL	WBT	WBR	SBLn1
Capacity (veh/h)	517	1412	-	-	1203	-	-	521
HCM Lane V/C Ratio	0.205	0.012	-	-	0.007	-	-	0.115
HCM Control Delay (s)	13.8	7.6	0	-	8	0	-	12.8
HCM Lane LOS	B	A	A	-	A	A	-	B
HCM 95th %tile Q(veh)	0.8	0	-	-	0	-	-	0.4

HCM 6th TWSC
8: Howard Ave & Tenth St

07/13/2020

Intersection						
Int Delay, s/veh	1.2					
Movement	WBL	WBR	NBT	NBR	SBL	SBT
Lane Configurations	W	R	T	R	L	T
Traffic Vol, veh/h	6	9	89	10	10	63
Future Vol, veh/h	6	9	89	10	10	63
Conflicting Peds, #/hr	0	0	0	0	0	0
Sign Control	Stop	Stop	Free	Free	Free	Free
RT Channelized	-	None	-	None	-	None
Storage Length	0	-	-	-	-	-
Veh in Median Storage, #	0	-	0	-	-	0
Grade, %	0	-	0	-	-	0
Peak Hour Factor	62	92	92	56	92	92
Heavy Vehicles, %	2	2	2	2	2	2
Mvmt Flow	10	10	97	18	11	68

Major/Minor	Minor1	Major1	Major2			
Conflicting Flow All	196	106	0	0	115	0
Stage 1	106	-	-	-	-	-
Stage 2	90	-	-	-	-	-
Critical Hdwy	6.42	6.22	-	-	4.12	-
Critical Hdwy Stg 1	5.42	-	-	-	-	-
Critical Hdwy Stg 2	5.42	-	-	-	-	-
Follow-up Hdwy	3.518	3.318	-	-	2.218	-
Pot Cap-1 Maneuver	793	948	-	-	1474	-
Stage 1	918	-	-	-	-	-
Stage 2	934	-	-	-	-	-
Platoon blocked, %			-	-		
Mov Cap-1 Maneuver	787	948	-	-	1474	-
Mov Cap-2 Maneuver	787	-	-	-	-	-
Stage 1	911	-	-	-	-	-
Stage 2	934	-	-	-	-	-

Approach	WB	NB	SB
HCM Control Delay, s	9.3	0	1
HCM LOS	A		

Minor Lane/Major Mvmt	NBT	NBRWBLn1	SBL	SBT
Capacity (veh/h)	-	-	860	1474
HCM Lane V/C Ratio	-	-	0.023	0.007
HCM Control Delay (s)	-	-	9.3	7.5
HCM Lane LOS	-	-	A	A
HCM 95th %tile Q(veh)	-	-	0.1	0

HCM 6th AWSC
12: Howard Ave & 12th St

07/13/2020

Intersection

Intersection Delay, s/veh 8.1

Intersection LOS A

Movement	EBL	EBT	EBR	WBL	WBT	WBR	NBL	NBT	NBR	SBL	SBT	SBR
Lane Configurations		↕		↕				↕			↕	
Traffic Vol, veh/h	1	1	19	18	11	3	2	126	5	0	63	6
Future Vol, veh/h	1	1	19	18	11	3	2	126	5	0	63	6
Peak Hour Factor	0.25	0.25	0.85	0.71	0.62	0.50	0.48	0.70	0.42	0.25	0.68	0.62
Heavy Vehicles, %	2	2	2	2	2	2	2	2	2	2	2	2
Mvmt Flow	4	4	22	25	18	6	4	180	12	0	93	10
Number of Lanes	0	1	0	0	1	0	0	1	0	0	1	0

Approach	EB	WB	NB	SB
Opposing Approach	WB	EB	SB	NB
Opposing Lanes	1	1	1	1
Conflicting Approach Left SB		NB	EB	WB
Conflicting Lanes Left	1	1	1	1
Conflicting Approach RightNB		SB	WB	EB
Conflicting Lanes Right	1	1	1	1
HCM Control Delay	7.3	8	8.4	7.9
HCM LOS	A	A	A	A

Lane	NBLn1	EBLn1	WBLn1	SBLn1
Vol Left, %	2%	5%	56%	0%
Vol Thru, %	95%	5%	34%	91%
Vol Right, %	4%	90%	9%	9%
Sign Control	Stop	Stop	Stop	Stop
Traffic Vol by Lane	133	21	32	69
LT Vol	2	1	18	0
Through Vol	126	1	11	63
RT Vol	5	19	3	6
Lane Flow Rate	196	30	49	102
Geometry Grp	1	1	1	1
Degree of Util (X)	0.225	0.035	0.064	0.121
Departure Headway (Hd)	4.131	4.116	4.68	4.272
Convergence, Y/N	Yes	Yes	Yes	Yes
Cap	857	874	769	844
Service Time	2.213	2.121	2.685	2.272
HCM Lane V/C Ratio	0.229	0.034	0.064	0.121
HCM Control Delay	8.4	7.3	8	7.9
HCM Lane LOS	A	A	A	A
HCM 95th-tile Q	0.9	0.1	0.2	0.4

Intersection						
Int Delay, s/veh	4.3					
Movement	EBT	EBR	WBL	WBT	NBL	NBR
Lane Configurations						
Traffic Vol, veh/h	21	69	4	34	98	0
Future Vol, veh/h	21	69	4	34	98	0
Conflicting Peds, #/hr	0	0	0	0	0	0
Sign Control	Free	Free	Free	Free	Stop	Stop
RT Channelized	-	None	-	None	-	None
Storage Length	-	-	-	-	0	-
Veh in Median Storage, #	0	-	-	0	0	-
Grade, %	0	-	-	0	0	-
Peak Hour Factor	92	92	92	92	92	92
Heavy Vehicles, %	2	2	2	2	2	2
Mvmt Flow	23	75	4	37	107	0

Major/Minor	Major1	Major2	Minor1	Minor2	Minor3
Conflicting Flow All	0	0	98	0	106
Stage 1	-	-	-	-	61
Stage 2	-	-	-	-	45
Critical Hdwy	-	-	4.12	-	6.42
Critical Hdwy Stg 1	-	-	-	-	5.42
Critical Hdwy Stg 2	-	-	-	-	5.42
Follow-up Hdwy	-	-	2.218	-	3.518
Pot Cap-1 Maneuver	-	-	1495	-	892
Stage 1	-	-	-	-	962
Stage 2	-	-	-	-	977
Platoon blocked, %	-	-	-	-	-
Mov Cap-1 Maneuver	-	-	1495	-	889
Mov Cap-2 Maneuver	-	-	-	-	889
Stage 1	-	-	-	-	959
Stage 2	-	-	-	-	977

Approach	EB	WB	NB
HCM Control Delay, s	0	0.8	9.6
HCM LOS			A

Minor Lane/Major Mvmt	NBLn1	EBT	EBR	WBL	WBT
Capacity (veh/h)	889	-	-	1495	-
HCM Lane V/C Ratio	0.12	-	-	0.003	-
HCM Control Delay (s)	9.6	-	-	7.4	0
HCM Lane LOS	A	-	-	A	A
HCM 95th %tile Q(veh)	0.4	-	-	0	-

HCM 6th Signalized Intersection Summary

4: Howard Ave & 14th St

07/13/2020



Movement	EBL	EBT	EBR	WBL	WBT	WBR	NBL	NBT	NBR	SBL	SBT	SBR
Lane Configurations												
Traffic Volume (veh/h)	57	1695	199	10	759	20	47	14	13	49	35	152
Future Volume (veh/h)	57	1695	199	10	759	20	47	14	13	49	35	152
Initial Q (Qb), veh	0	0	0	0	0	0	0	0	0	0	0	0
Ped-Bike Adj(A_pbT)	1.00		1.00	1.00		1.00	1.00		1.00	1.00		1.00
Parking Bus, Adj	1.00	1.00	1.00	1.00	1.00	1.00	1.00	1.00	1.00	1.00	1.00	1.00
Work Zone On Approach		No			No			No			No	
Adj Sat Flow, veh/h/ln	1870	1870	1870	1870	1870	1870	1870	1870	1870	1870	1870	1870
Adj Flow Rate, veh/h	81	1904	280	18	862	29	64	20	21	98	65	173
Peak Hour Factor	0.70	0.89	0.71	0.55	0.88	0.70	0.73	0.70	0.62	0.50	0.54	0.88
Percent Heavy Veh, %	2	2	2	2	2	2	2	2	2	2	2	2
Cap, veh/h	172	2051	915	81	1846	62	196	62	51	148	93	211
Arrive On Green	0.10	0.58	0.58	0.05	0.53	0.53	0.25	0.25	0.25	0.25	0.25	0.25
Sat Flow, veh/h	1781	3554	1585	1781	3508	118	565	243	202	415	365	828
Grp Volume(v), veh/h	81	1904	280	18	437	454	105	0	0	336	0	0
Grp Sat Flow(s),veh/h/ln	1781	1777	1585	1781	1777	1849	1009	0	0	1607	0	0
Q Serve(g_s), s	4.7	53.7	10.0	1.1	17.0	17.0	0.0	0.0	0.0	11.6	0.0	0.0
Cycle Q Clear(g_c), s	4.7	53.7	10.0	1.1	17.0	17.0	9.8	0.0	0.0	21.4	0.0	0.0
Prop In Lane	1.00		1.00	1.00		0.06	0.61		0.20	0.29		0.51
Lane Grp Cap(c), veh/h	172	2051	915	81	935	973	310	0	0	451	0	0
V/C Ratio(X)	0.47	0.93	0.31	0.22	0.47	0.47	0.34	0.00	0.00	0.74	0.00	0.00
Avail Cap(c_a), veh/h	172	2051	915	81	935	973	310	0	0	451	0	0
HCM Platoon Ratio	1.00	1.00	1.00	1.00	1.00	1.00	1.00	1.00	1.00	1.00	1.00	1.00
Upstream Filter(I)	1.00	1.00	1.00	1.00	1.00	1.00	1.00	0.00	0.00	1.00	0.00	0.00
Uniform Delay (d), s/veh	47.1	21.2	11.9	50.6	16.4	16.4	33.8	0.0	0.0	38.3	0.0	0.0
Incr Delay (d2), s/veh	9.0	8.9	0.9	6.2	1.7	1.6	3.0	0.0	0.0	10.6	0.0	0.0
Initial Q Delay(d3),s/veh	0.0	0.0	0.0	0.0	0.0	0.0	0.0	0.0	0.0	0.0	0.0	0.0
%ile BackOfQ(50%),veh/ln	2.5	23.1	3.6	0.6	7.1	7.4	2.6	0.0	0.0	9.7	0.0	0.0
Unsig. Movement Delay, s/veh												
LnGrp Delay(d),s/veh	56.1	30.1	12.8	56.9	18.0	18.0	36.7	0.0	0.0	49.0	0.0	0.0
LnGrp LOS	E	C	B	E	B	B	D	A	A	D	A	A
Approach Vol, veh/h		2265			909			105			336	
Approach Delay, s/veh		28.9			18.8			36.7			49.0	
Approach LOS		C			B			D			D	
Timer - Assigned Phs		2	3	4		6	7	8				
Phs Duration (G+Y+Rc), s		32.5	9.5	68.0		32.5	15.1	62.4				
Change Period (Y+Rc), s		4.5	4.5	4.5		4.5	4.5	4.5				
Max Green Setting (Gmax), s		28.0	5.0	63.5		28.0	10.6	57.9				
Max Q Clear Time (g_c+I1), s		11.8	3.1	55.7		23.4	6.7	19.0				
Green Ext Time (p_c), s		0.5	0.0	6.9		0.8	0.0	6.8				
Intersection Summary												
HCM 6th Ctrl Delay											28.4	
HCM 6th LOS											C	

HCM 6th TWSC
6: Commerce St & Mission Inn Ave

07/13/2020

Intersection												
Int Delay, s/veh	6.2											
Movement	EBL	EBT	EBR	WBL	WBT	WBR	NBL	NBT	NBR	SBL	SBT	SBR
Lane Configurations		↕	↗		↕↗			↕↗			↕↗	
Traffic Vol, veh/h	19	343	77	6	161	6	72	20	11	4	43	9
Future Vol, veh/h	19	343	77	6	161	6	72	20	11	4	43	9
Conflicting Peds, #/hr	0	0	0	0	0	0	0	0	0	0	0	0
Sign Control	Free	Free	Free	Free	Free	Free	Stop	Stop	Stop	Stop	Stop	Stop
RT Channelized	-	-	None	-	-	None	-	-	None	-	-	None
Storage Length	-	-	0	-	-	-	-	-	-	-	-	-
Veh in Median Storage, #	-	0	-	-	0	-	-	0	-	-	0	-
Grade, %	-	0	-	-	0	-	-	0	-	-	0	-
Peak Hour Factor	75	75	75	50	95	50	69	42	50	25	83	65
Heavy Vehicles, %	2	2	2	2	2	2	2	2	2	2	2	2
Mvmt Flow	25	457	103	12	169	12	104	48	22	16	52	14

Major/Minor	Major1			Major2			Minor1			Minor2		
Conflicting Flow All	181	0	0	560	0	0	642	712	457	793	809	91
Stage 1	-	-	-	-	-	-	507	507	-	199	199	-
Stage 2	-	-	-	-	-	-	135	205	-	594	610	-
Critical Hdwy	4.13	-	-	4.13	-	-	7.33	6.53	6.23	7.33	6.53	6.93
Critical Hdwy Stg 1	-	-	-	-	-	-	6.13	5.53	-	6.53	5.53	-
Critical Hdwy Stg 2	-	-	-	-	-	-	6.53	5.53	-	6.13	5.53	-
Follow-up Hdwy	2.219	-	-	2.219	-	-	3.519	4.019	3.319	3.519	4.019	3.319
Pot Cap-1 Maneuver	1393	-	-	1009	-	-	373	357	603	293	314	949
Stage 1	-	-	-	-	-	-	547	538	-	785	736	-
Stage 2	-	-	-	-	-	-	855	731	-	490	484	-
Platoon blocked, %	-	-	-	-	-	-	-	-	-	-	-	-
Mov Cap-1 Maneuver	1393	-	-	1009	-	-	310	343	603	245	302	949
Mov Cap-2 Maneuver	-	-	-	-	-	-	310	343	-	245	302	-
Stage 1	-	-	-	-	-	-	533	524	-	765	726	-
Stage 2	-	-	-	-	-	-	772	721	-	418	471	-

Approach	EB			WB			NB			SB		
HCM Control Delay, s	0.3			0.5			26.2			19.8		
HCM LOS							D			C		

Minor Lane/Major Mvmt	NBLn1	EBL	EBT	EBR	WBL	WBT	WBR	SBLn1
Capacity (veh/h)	340	1393	-	-	1009	-	-	325
HCM Lane V/C Ratio	0.512	0.018	-	-	0.012	-	-	0.251
HCM Control Delay (s)	26.2	7.6	0	-	8.6	0	-	19.8
HCM Lane LOS	D	A	A	-	A	A	-	C
HCM 95th %tile Q(veh)	2.8	0.1	-	-	0	-	-	1

Intersection						
Int Delay, s/veh	1.5					
Movement	WBL	WBR	NBT	NBR	SBL	SBT
Lane Configurations	W		T			T
Traffic Vol, veh/h	10	7	45	18	36	193
Future Vol, veh/h	10	7	45	18	36	193
Conflicting Peds, #/hr	0	0	0	0	0	0
Sign Control	Stop	Stop	Free	Free	Free	Free
RT Channelized	-	None	-	None	-	None
Storage Length	0	-	-	-	-	-
Veh in Median Storage, #	0	-	0	-	-	0
Grade, %	0	-	0	-	-	0
Peak Hour Factor	62	92	92	56	92	92
Heavy Vehicles, %	2	2	2	2	2	2
Mvmt Flow	16	8	49	32	39	210

Major/Minor	Minor1	Major1	Major2		
Conflicting Flow All	353	65	0	0	81
Stage 1	65	-	-	-	-
Stage 2	288	-	-	-	-
Critical Hdwy	6.42	6.22	-	-	4.12
Critical Hdwy Stg 1	5.42	-	-	-	-
Critical Hdwy Stg 2	5.42	-	-	-	-
Follow-up Hdwy	3.518	3.318	-	-	2.218
Pot Cap-1 Maneuver	645	999	-	-	1517
Stage 1	958	-	-	-	-
Stage 2	761	-	-	-	-
Platoon blocked, %					
Mov Cap-1 Maneuver	626	999	-	-	1517
Mov Cap-2 Maneuver	626	-	-	-	-
Stage 1	930	-	-	-	-
Stage 2	761	-	-	-	-

Approach	WB	NB	SB
HCM Control Delay, s	10.2	0	1.2
HCM LOS	B		

Minor Lane/Major Mvmt	NBT	NBRWBLn1	SBL	SBT
Capacity (veh/h)	-	-	711	1517
HCM Lane V/C Ratio	-	-	0.033	0.026
HCM Control Delay (s)	-	-	10.2	7.4
HCM Lane LOS	-	-	B	A
HCM 95th %tile Q(veh)	-	-	0.1	0.1

HCM 6th Signalized Intersection Summary

11: Park Ave & University Ave

07/13/2020



Movement	EBL	EBT	EBR	WBL	WBT	WBR	NBL	NBT	NBR	SBL	SBT	SBR
Lane Configurations												
Traffic Volume (veh/h)	52	1342	62	42	603	67	30	35	57	178	96	43
Future Volume (veh/h)	52	1342	62	42	603	67	30	35	57	178	96	43
Initial Q (Qb), veh	0	0	0	0	0	0	0	0	0	0	0	0
Ped-Bike Adj(A_pbT)	1.00		1.00	1.00		1.00	1.00		1.00	1.00		1.00
Parking Bus, Adj	1.00	1.00	1.00	1.00	1.00	1.00	1.00	1.00	1.00	1.00	1.00	1.00
Work Zone On Approach		No			No			No			No	
Adj Sat Flow, veh/h/ln	1870	1870	1870	1870	1870	1870	1870	1870	1870	1870	1870	1870
Adj Flow Rate, veh/h	76	1579	83	56	648	102	32	60	72	251	120	73
Peak Hour Factor	0.68	0.85	0.75	0.75	0.93	0.66	0.94	0.58	0.79	0.71	0.80	0.59
Percent Heavy Veh, %	2	2	2	2	2	2	2	2	2	2	2	2
Cap, veh/h	167	1577	83	86	1273	200	102	139	166	267	296	180
Arrive On Green	0.09	0.46	0.46	0.05	0.41	0.41	0.06	0.18	0.18	0.15	0.27	0.27
Sat Flow, veh/h	1781	3435	180	1781	3077	484	1781	774	929	1781	1089	662
Grp Volume(v), veh/h	76	813	849	56	374	376	32	0	132	251	0	193
Grp Sat Flow(s),veh/h/ln	1781	1777	1838	1781	1777	1783	1781	0	1703	1781	0	1751
Q Serve(g_s), s	4.4	50.2	50.5	3.4	17.2	17.2	1.9	0.0	7.6	15.3	0.0	9.9
Cycle Q Clear(g_c), s	4.4	50.2	50.5	3.4	17.2	17.2	1.9	0.0	7.6	15.3	0.0	9.9
Prop In Lane	1.00		0.10	1.00		0.27	1.00		0.55	1.00		0.38
Lane Grp Cap(c), veh/h	167	816	844	86	735	738	102	0	305	267	0	476
V/C Ratio(X)	0.46	1.00	1.01	0.65	0.51	0.51	0.31	0.00	0.43	0.94	0.00	0.41
Avail Cap(c_a), veh/h	167	816	844	86	735	738	102	0	305	267	0	476
HCM Platoon Ratio	1.00	1.00	1.00	1.00	1.00	1.00	1.00	1.00	1.00	1.00	1.00	1.00
Upstream Filter(I)	1.00	1.00	1.00	1.00	1.00	1.00	1.00	0.00	1.00	1.00	0.00	1.00
Uniform Delay (d), s/veh	47.2	29.7	29.8	51.4	23.9	24.0	49.8	0.0	40.2	46.3	0.0	32.8
Incr Delay (d2), s/veh	8.7	30.8	32.4	32.6	2.5	2.5	7.9	0.0	4.4	41.4	0.0	2.6
Initial Q Delay(d3),s/veh	0.0	0.0	0.0	0.0	0.0	0.0	0.0	0.0	0.0	0.0	0.0	0.0
%ile BackOfQ(50%),veh/ln	2.4	27.4	28.9	2.3	7.6	7.7	1.1	0.0	3.6	9.8	0.0	4.5
Unsig. Movement Delay, s/veh												
LnGrp Delay(d),s/veh	55.9	60.5	62.1	84.0	26.5	26.5	57.6	0.0	44.6	87.7	0.0	35.3
LnGrp LOS	E	E	F	F	C	C	E	A	D	F	A	D
Approach Vol, veh/h		1738			806			164			444	
Approach Delay, s/veh		61.1			30.5			47.1			64.9	
Approach LOS		E			C			D			E	
Timer - Assigned Phs	1	2	3	4	5	6	7	8				
Phs Duration (G+Y+Rc), s	1.0	24.2	9.8	55.0	10.8	34.4	14.8	50.0				
Change Period (Y+Rc), s	4.5	4.5	4.5	4.5	4.5	4.5	4.5	4.5				
Max Green Setting (Gmax), s	6.5	19.7	5.3	50.5	6.3	29.9	10.3	45.5				
Max Q Clear Time (g_c+I1), s	11.3	9.6	5.4	52.5	3.9	11.9	6.4	19.2				
Green Ext Time (p_c), s	0.0	0.4	0.0	0.0	0.0	1.0	0.0	5.1				
Intersection Summary												
HCM 6th Ctrl Delay					53.1							
HCM 6th LOS					D							

HCM 6th AWSC
12: Howard Ave & 12th St

07/13/2020

Intersection

Intersection Delay, s/veh 9:1

Intersection LOS A

Movement	EBL	EBT	EBR	WBL	WBT	WBR	NBL	NBT	NBR	SBL	SBT	SBR
Lane Configurations		↔		↔		↔		↔			↔	
Traffic Vol, veh/h	0	2	29	14	1	4	7	70	16	6	193	4
Future Vol, veh/h	0	2	29	14	1	4	7	70	16	6	193	4
Peak Hour Factor	0.25	0.25	0.85	0.71	0.62	0.50	0.48	0.70	0.42	0.25	0.68	0.62
Heavy Vehicles, %	2	2	2	2	2	2	2	2	2	2	2	2
Mvmt Flow	0	8	34	20	2	8	15	100	38	24	284	6
Number of Lanes	0	1	0	0	1	0	0	1	0	0	1	0

Approach	EB	WB	SB
Opposing Approach	WB	EB	SB
Opposing Lanes	1	1	1
Conflicting Approach Left	SB	NB	EB
Conflicting Lanes Left	1	1	1
Conflicting Approach Right	NB	SB	WB
Conflicting Lanes Right	1	1	1
HCM Control Delay	7.7	8.3	8.3
HCM LOS	A	A	A

Lane	NBLn1	EBLn1	WBLn1	SBLn1
Vol Left, %	8%	0%	74%	3%
Vol Thru, %	75%	6%	5%	95%
Vol Right, %	17%	94%	21%	2%
Sign Control	Stop	Stop	Stop	Stop
Traffic Vol by Lane	93	31	19	203
LT Vol	7	0	14	6
Through Vol	70	2	1	193
RT Vol	16	29	4	4
Lane Flow Rate	153	42	29	314
Geometry Grp	1	1	1	1
Degree of Util (X)	0.184	0.052	0.041	0.373
Departure Headway (Hd)	4.334	4.431	5.03	4.27
Convergence, Y/N	Yes	Yes	Yes	Yes
Cap	829	808	712	849
Service Time	2.353	2.459	3.059	2.27
HCM Lane V/C Ratio	0.185	0.052	0.041	0.37
HCM Control Delay	8.3	7.7	8.3	9.8
HCM Lane LOS	A	A	A	A
HCM 95th-tile Q	0.7	0.2	0.1	1.7

Intersection						
Int Delay, s/veh	1.6					
Movement	EBT	EBR	WBL	WBT	NBL	NBR
Lane Configurations	↔			↔	↔	
Traffic Vol, veh/h	36	226	3	20	52	0
Future Vol, veh/h	36	226	3	20	52	0
Conflicting Peds, #/hr	0	0	0	0	0	0
Sign Control	Free	Free	Free	Free	Stop	Stop
RT Channelized	-	None	-	None	-	None
Storage Length	-	-	-	-	0	-
Veh in Median Storage, #	0	-	-	0	0	-
Grade, %	0	-	-	0	0	-
Peak Hour Factor	92	92	92	92	92	92
Heavy Vehicles, %	2	2	2	2	2	2
Mvmt Flow	39	246	3	22	57	0

Major/Minor	Major1	Major2	Minor1	Minor2	Minor3
Conflicting Flow All	0	0	285	0	190
Stage 1	-	-	-	-	162
Stage 2	-	-	-	-	28
Critical Hdwy	-	-	4.12	-	6.42
Critical Hdwy Stg 1	-	-	-	-	5.42
Critical Hdwy Stg 2	-	-	-	-	5.42
Follow-up Hdwy	-	-	2.218	-	3.518
Pot Cap-1 Maneuver	-	-	1277	-	799
Stage 1	-	-	-	-	867
Stage 2	-	-	-	-	995
Platoon blocked, %	-	-	-	-	-
Mov Cap-1 Maneuver	-	-	1277	-	797
Mov Cap-2 Maneuver	-	-	-	-	797
Stage 1	-	-	-	-	865
Stage 2	-	-	-	-	995

Approach	EB	WB	NB
HCM Control Delay, s	0	1	9.9
HCM LOS			A

Minor Lane/Major Mvmt	NBLn1	EBT	EBR	WBL	WBT
Capacity (veh/h)	797	-	-	1277	-
HCM Lane V/C Ratio	0.071	-	-	0.003	-
HCM Control Delay (s)	9.9	-	-	7.8	0
HCM Lane LOS	A	-	-	A	A
HCM 95th %tile Q(veh)	0.2	-	-	0	-



Riverside-Downtown **STATION IMPROVEMENTS**

FUTURE YEAR WITH PROJECT CONDITIONS

HCM 6th Signalized Intersection Summary

4: Howard Ave & 14th St

07/13/2020



Movement	EBL	EBT	EBR	WBL	WBT	WBR	NBL	NBT	NBR	SBL	SBT	SBR
Lane Configurations												
Traffic Volume (veh/h)	100	664	55	13	1470	30	90	32	34	7	82	134
Future Volume (veh/h)	100	664	55	13	1470	30	90	32	34	7	82	134
Initial Q (Qb), veh	0	0	0	0	0	0	0	0	0	0	0	0
Ped-Bike Adj(A_pbT)	1.00		1.00	1.00		1.00	1.00		1.00	1.00		1.00
Parking Bus, Adj	1.00	1.00	1.00	1.00	1.00	1.00	1.00	1.00	1.00	1.00	1.00	1.00
Work Zone On Approach		No			No			No			No	
Adj Sat Flow, veh/h/ln	1870	1870	1870	1870	1870	1870	1870	1870	1870	1870	1870	1870
Adj Flow Rate, veh/h	105	699	58	14	1547	32	95	34	36	7	86	141
Peak Hour Factor	0.95	0.95	0.95	0.95	0.95	0.95	0.95	0.95	0.95	0.95	0.95	0.95
Percent Heavy Veh, %	2	2	2	2	2	2	2	2	2	2	2	2
Cap, veh/h	170	2000	892	83	1829	38	219	79	69	38	175	272
Arrive On Green	0.10	0.56	0.56	0.05	0.51	0.51	0.27	0.27	0.27	0.27	0.27	0.27
Sat Flow, veh/h	1781	3554	1585	1781	3560	74	623	293	256	17	651	1013
Grp Volume(v), veh/h	105	699	58	14	771	808	165	0	0	234	0	0
Grp Sat Flow(s),veh/h/ln	1781	1777	1585	1781	1777	1857	1171	0	0	1681	0	0
Q Serve(g_s), s	6.2	11.8	1.8	0.8	41.0	41.2	2.6	0.0	0.0	0.0	0.0	0.0
Cycle Q Clear(g_c), s	6.2	11.8	1.8	0.8	41.0	41.2	15.5	0.0	0.0	13.0	0.0	0.0
Prop In Lane	1.00		1.00	1.00		0.04	0.58		0.22	0.03		0.60
Lane Grp Cap(c), veh/h	170	2000	892	83	913	954	366	0	0	485	0	0
V/C Ratio(X)	0.62	0.35	0.07	0.17	0.84	0.85	0.45	0.00	0.00	0.48	0.00	0.00
Avail Cap(c_a), veh/h	170	2000	892	83	913	954	366	0	0	485	0	0
HCM Platoon Ratio	1.00	1.00	1.00	1.00	1.00	1.00	1.00	1.00	1.00	1.00	1.00	1.00
Upstream Filter(I)	1.00	1.00	1.00	1.00	1.00	1.00	1.00	0.00	0.00	1.00	0.00	0.00
Uniform Delay (d), s/veh	47.8	13.1	10.9	50.4	23.0	23.0	35.0	0.0	0.0	34.2	0.0	0.0
Incr Delay (d2), s/veh	15.7	0.5	0.1	4.4	9.5	9.2	4.0	0.0	0.0	3.4	0.0	0.0
Initial Q Delay(d3),s/veh	0.0	0.0	0.0	0.0	0.0	0.0	0.0	0.0	0.0	0.0	0.0	0.0
%ile BackOfQ(50%),veh/ln	3.5	4.7	0.7	0.5	18.7	19.5	4.3	0.0	0.0	5.7	0.0	0.0
Unsig. Movement Delay, s/veh												
LnGrp Delay(d),s/veh	63.5	13.6	11.1	54.8	32.4	32.2	39.0	0.0	0.0	37.6	0.0	0.0
LnGrp LOS	E	B	B	D	C	C	D	A	A	D	A	A
Approach Vol, veh/h		862			1593			165			234	
Approach Delay, s/veh		19.5			32.5			39.0			37.6	
Approach LOS		B			C			D			D	
Timer - Assigned Phs		2	3	4		6	7	8				
Phs Duration (G+Y+Rc), s		34.0	9.6	66.4		34.0	15.0	61.0				
Change Period (Y+Rc), s		4.5	4.5	4.5		4.5	4.5	4.5				
Max Green Setting (Gmax), s		29.5	5.1	61.9		29.5	10.5	56.5				
Max Q Clear Time (g_c+I1), s		17.5	2.8	13.8		15.0	8.2	43.2				
Green Ext Time (p_c), s		0.7	0.0	6.0		1.2	0.0	8.9				
Intersection Summary												
HCM 6th Ctrl Delay											29.4	
HCM 6th LOS											C	

HCM 6th TWSC
6: Commerce St & Mission Inn Ave

07/13/2020

Intersection												
Int Delay, s/veh	4.9											
Movement	EBL	EBT	EBR	WBL	WBT	WBR	NBL	NBT	NBR	SBL	SBT	SBR
Lane Configurations		↕	↗		↕			↕			↕	
Traffic Vol, veh/h	16	175	98	12	266	6	84	91	5	3	22	14
Future Vol, veh/h	16	175	98	12	266	6	84	91	5	3	22	14
Conflicting Peds, #/hr	0	0	0	0	0	0	0	0	0	0	0	0
Sign Control	Free	Free	Free	Free	Free	Free	Stop	Stop	Stop	Stop	Stop	Stop
RT Channelized	-	-	None	-	-	None	-	-	None	-	-	None
Storage Length	-	-	0	-	-	-	-	-	-	-	-	-
Veh in Median Storage, #	-	0	-	-	0	-	-	0	-	-	0	-
Grade, %	-	0	-	-	0	-	-	0	-	-	0	-
Peak Hour Factor	95	95	95	95	95	95	95	95	95	95	95	95
Heavy Vehicles, %	2	2	2	2	2	2	2	2	2	2	2	2
Mvmt Flow	17	184	103	13	280	6	88	96	5	3	23	15

Major/Minor	Major1			Major2			Minor1			Minor2		
Conflicting Flow All	286	0	0	287	0	0	396	530	184	629	630	143
Stage 1	-	-	-	-	-	-	218	218	-	309	309	-
Stage 2	-	-	-	-	-	-	178	312	-	320	321	-
Critical Hdwy	4.13	-	-	4.13	-	-	7.33	6.53	6.23	7.33	6.53	6.93
Critical Hdwy Stg 1	-	-	-	-	-	-	6.13	5.53	-	6.53	5.53	-
Critical Hdwy Stg 2	-	-	-	-	-	-	6.53	5.53	-	6.13	5.53	-
Follow-up Hdwy	2.219	-	-	2.219	-	-	3.519	4.019	3.319	3.519	4.019	3.319
Pot Cap-1 Maneuver	1275	-	-	1274	-	-	551	454	858	381	398	879
Stage 1	-	-	-	-	-	-	784	722	-	677	659	-
Stage 2	-	-	-	-	-	-	807	657	-	691	651	-
Platoon blocked, %	-	-	-	-	-	-	-	-	-	-	-	-
Mov Cap-1 Maneuver	1275	-	-	1274	-	-	506	441	858	309	387	879
Mov Cap-2 Maneuver	-	-	-	-	-	-	506	441	-	309	387	-
Stage 1	-	-	-	-	-	-	771	710	-	666	651	-
Stage 2	-	-	-	-	-	-	756	649	-	585	641	-

Approach	EB			WB			NB			SB		
HCM Control Delay, s	0.4			0.3			17.5			13.3		
HCM LOS							C			B		

Minor Lane/Major Mvmt	NBLn1	EBL	EBT	EBR	WBL	WBT	WBR	SBLn1
Capacity (veh/h)	476	1275	-	-	1274	-	-	473
HCM Lane V/C Ratio	0.398	0.013	-	-	0.01	-	-	0.087
HCM Control Delay (s)	17.5	7.9	0	-	7.9	0	-	13.3
HCM Lane LOS	C	A	A	-	A	A	-	B
HCM 95th %tile Q(veh)	1.9	0	-	-	0	-	-	0.3

HCM 6th TWSC
8: Howard Ave & Tenth St

07/13/2020

Intersection						
Int Delay, s/veh	5					
Movement	WBL	WBR	NBT	NBR	SBL	SBT
Lane Configurations						
Traffic Vol, veh/h	59	120	109	17	14	71
Future Vol, veh/h	59	120	109	17	14	71
Conflicting Peds, #/hr	0	0	0	0	0	0
Sign Control	Stop	Stop	Free	Free	Free	Free
RT Channelized	-	None	-	None	-	None
Storage Length	0	-	-	-	-	-
Veh in Median Storage, #	0	-	0	-	-	0
Grade, %	0	-	0	-	-	0
Peak Hour Factor	95	92	92	95	92	92
Heavy Vehicles, %	2	2	2	2	2	2
Mvmt Flow	62	130	118	18	15	77

Major/Minor	Minor1	Major1	Major2		
Conflicting Flow All	234	127	0	0	136
Stage 1	127	-	-	-	-
Stage 2	107	-	-	-	-
Critical Hdwy	6.42	6.22	-	-	4.12
Critical Hdwy Stg 1	5.42	-	-	-	-
Critical Hdwy Stg 2	5.42	-	-	-	-
Follow-up Hdwy	3.518	3.318	-	-	2.218
Pot Cap-1 Maneuver	754	923	-	-	1448
Stage 1	899	-	-	-	-
Stage 2	917	-	-	-	-
Platoon blocked, %			-	-	-
Mov Cap-1 Maneuver	746	923	-	-	1448
Mov Cap-2 Maneuver	746	-	-	-	-
Stage 1	889	-	-	-	-
Stage 2	917	-	-	-	-

Approach	WB	NB	SB
HCM Control Delay, s	10.4	0	1.2
HCM LOS	B		

Minor Lane/Major Mvmt	NBT	NBRWBLn1	SBL	SBT
Capacity (veh/h)	-	-	857	1448
HCM Lane V/C Ratio	-	-	0.225	0.011
HCM Control Delay (s)	-	-	10.4	7.5
HCM Lane LOS	-	-	B	A
HCM 95th %tile Q(veh)	-	-	0.9	0

HCM 6th Signalized Intersection Summary
 11: Park Ave & University Ave

07/13/2020



Movement	EBL	EBT	EBR	WBL	WBT	WBR	NBL	NBT	NBR	SBL	SBT	SBR
Lane Configurations	↖	↗		↖	↗		↖	↗		↖	↗	
Traffic Volume (veh/h)	30	537	32	37	748	50	49	49	44	63	51	60
Future Volume (veh/h)	30	537	32	37	748	50	49	49	44	63	51	60
Initial Q (Qb), veh	0	0	0	0	0	0	0	0	0	0	0	0
Ped-Bike Adj(A_pbT)	1.00		1.00	1.00		1.00	1.00		1.00	1.00		1.00
Parking Bus, Adj	1.00	1.00	1.00	1.00	1.00	1.00	1.00	1.00	1.00	1.00	1.00	1.00
Work Zone On Approach		No		No		No		No		No		No
Adj Sat Flow, veh/h/ln	1870	1870	1870	1870	1870	1870	1870	1870	1870	1870	1870	1870
Adj Flow Rate, veh/h	32	565	34	39	787	53	52	52	46	66	54	63
Peak Hour Factor	0.95	0.95	0.95	0.95	0.95	0.95	0.95	0.95	0.95	0.95	0.95	0.95
Percent Heavy Veh, %	2	2	2	2	2	2	2	2	2	2	2	2
Cap, veh/h	138	1378	83	154	1398	94	202	204	180	219	182	213
Arrive On Green	0.08	0.40	0.40	0.09	0.41	0.41	0.11	0.22	0.22	0.12	0.23	0.23
Sat Flow, veh/h	1781	3406	205	1781	3379	227	1781	915	810	1781	787	918
Grp Volume(v), veh/h	32	294	305	39	414	426	52	0	98	66	0	117
Grp Sat Flow(s),veh/h/ln	1781	1777	1834	1781	1777	1829	1781	0	1725	1781	0	1705
Q Serve(g_s), s	1.9	13.0	13.1	2.2	19.6	19.6	2.9	0.0	5.2	3.7	0.0	6.2
Cycle Q Clear(g_c), s	1.9	13.0	13.1	2.2	19.6	19.6	2.9	0.0	5.2	3.7	0.0	6.2
Prop In Lane	1.00		0.11	1.00		0.12	1.00		0.47	1.00		0.54
Lane Grp Cap(c), veh/h	138	719	742	154	735	757	202	0	384	219	0	395
V/C Ratio(X)	0.23	0.41	0.41	0.25	0.56	0.56	0.26	0.00	0.26	0.30	0.00	0.30
Avail Cap(c_a), veh/h	138	719	742	154	735	757	202	0	384	219	0	395
HCM Platoon Ratio	1.00	1.00	1.00	1.00	1.00	1.00	1.00	1.00	1.00	1.00	1.00	1.00
Upstream Filter(I)	1.00	1.00	1.00	1.00	1.00	1.00	1.00	0.00	1.00	1.00	0.00	1.00
Uniform Delay (d), s/veh	47.7	23.4	23.4	46.9	24.7	24.7	44.5	0.0	35.2	44.0	0.0	34.8
Incr Delay (d2), s/veh	3.9	1.7	1.7	3.9	3.1	3.0	3.0	0.0	1.6	3.5	0.0	1.9
Initial Q Delay(d3),s/veh	0.0	0.0	0.0	0.0	0.0	0.0	0.0	0.0	0.0	0.0	0.0	0.0
%ile BackOfQ(50%),veh/ln	1.0	5.7	5.9	1.2	8.7	9.0	1.5	0.0	2.3	1.9	0.0	2.8
Unsig. Movement Delay, s/veh												
LnGrp Delay(d),s/veh	51.6	25.1	25.1	50.9	27.8	27.7	47.6	0.0	36.8	47.5	0.0	36.8
LnGrp LOS	D	C	C	D	C	C	D	A	D	D	A	D
Approach Vol, veh/h		631			879			150			183	
Approach Delay, s/veh		26.4			28.7			40.5			40.6	
Approach LOS		C			C			D			D	
Timer - Assigned Phs	1	2	3	4	5	6	7	8				
Phs Duration (G+Y+Rc), s	8.0	29.0	14.0	49.0	17.0	30.0	13.0	50.0				
Change Period (Y+Rc), s	4.5	4.5	4.5	4.5	4.5	4.5	4.5	4.5				
Max Green Setting (Gmax), s	15.5	24.5	9.5	44.5	12.5	25.5	8.5	45.5				
Max Q Clear Time (g_c+15), s	15.5	7.2	4.2	15.1	4.9	8.2	3.9	21.6				
Green Ext Time (p_c), s	0.1	0.4	0.0	4.0	0.0	0.5	0.0	5.7				
Intersection Summary												
HCM 6th Ctrl Delay												30.1
HCM 6th LOS												C

HCM 6th AWSC
12: Howard Ave & 12th St

07/13/2020

Intersection

Intersection Delay, s/veh 8.4

Intersection LOS A

Movement	EBL	EBT	EBR	WBL	WBT	WBR	NBL	NBT	NBR	SBL	SBT	SBR
Lane Configurations		↔		↔		↔		↔			↔	
Traffic Vol, veh/h	4	4	73	40	32	9	4	148	10	0	111	20
Future Vol, veh/h	4	4	73	40	32	9	4	148	10	0	111	20
Peak Hour Factor	0.95	0.95	0.95	0.95	0.95	0.95	0.95	0.95	0.95	0.95	0.95	0.95
Heavy Vehicles, %	2	2	2	2	2	2	2	2	2	2	2	2
Mvmt Flow	4	4	77	42	34	9	4	156	11	0	117	21
Number of Lanes	0	1	0	0	1	0	0	1	0	0	1	0

Approach	EB	WB	NB	SB
Opposing Approach	WB	EB	SB	NB
Opposing Lanes	1	1	1	1
Conflicting Approach Left SB		NB	EB	WB
Conflicting Lanes Left	1	1	1	1
Conflicting Approach RightNB		SB	WB	EB
Conflicting Lanes Right	1	1	1	1
HCM Control Delay	7.7	8.4	8.7	8.4
HCM LOS	A	A	A	A

Lane	NBLn1	EBLn1	WBLn1	SBLn1
Vol Left, %	2%	5%	49%	0%
Vol Thru, %	91%	5%	40%	85%
Vol Right, %	6%	90%	11%	15%
Sign Control	Stop	Stop	Stop	Stop
Traffic Vol by Lane	162	81	81	131
LT Vol	4	4	40	0
Through Vol	148	4	32	111
RT Vol	10	73	9	20
Lane Flow Rate	171	85	85	138
Geometry Grp	1	1	1	1
Degree of Util (X)	0.211	0.1	0.113	0.169
Departure Headway (Hd)	4.445	4.208	4.762	4.423
Convergence, Y/N	Yes	Yes	Yes	Yes
Cap	808	851	753	811
Service Time	2.47	2.236	2.79	2.449
HCM Lane V/C Ratio	0.212	0.1	0.113	0.17
HCM Control Delay	8.7	7.7	8.4	8.4
HCM Lane LOS	A	A	A	A
HCM 95th-tile Q	0.8	0.3	0.4	0.6

Intersection						
Int Delay, s/veh	6.9					
Movement	EBT	EBR	WBL	WBT	NBL	NBR
Lane Configurations						
Traffic Vol, veh/h	21	53	32	114	229	0
Future Vol, veh/h	21	53	32	114	229	0
Conflicting Peds, #/hr	0	0	0	0	0	0
Sign Control	Free	Free	Free	Free	Stop	Stop
RT Channelized	-	None	-	None	-	None
Storage Length	-	-	-	-	0	-
Veh in Median Storage, #	0	-	-	0	0	-
Grade, %	0	-	-	0	0	-
Peak Hour Factor	92	92	92	92	92	92
Heavy Vehicles, %	2	2	2	2	2	2
Mvmt Flow	23	58	35	124	249	0

Major/Minor	Major1	Major2	Minor1	Minor2	Minor3
Conflicting Flow All	0	0	81	0	246
Stage 1	-	-	-	-	52
Stage 2	-	-	-	-	194
Critical Hdwy	-	-	4.12	-	6.42
Critical Hdwy Stg 1	-	-	-	-	5.42
Critical Hdwy Stg 2	-	-	-	-	5.42
Follow-up Hdwy	-	-	2.218	-	3.518
Pot Cap-1 Maneuver	-	-	1517	-	742
Stage 1	-	-	-	-	970
Stage 2	-	-	-	-	839
Platoon blocked, %	-	-	-	-	-
Mov Cap-1 Maneuver	-	-	1517	-	723
Mov Cap-2 Maneuver	-	-	-	-	723
Stage 1	-	-	-	-	946
Stage 2	-	-	-	-	839

Approach	EB	WB	NB
HCM Control Delay, s	0	1.6	12.6
HCM LOS			B

Minor Lane/Major Mvmt	NBLn1	EBT	EBR	WBL	WBT
Capacity (veh/h)	723	-	-	1517	-
HCM Lane V/C Ratio	0.344	-	-	0.023	-
HCM Control Delay (s)	12.6	-	-	7.4	0
HCM Lane LOS	B	-	-	A	A
HCM 95th %tile Q(veh)	1.5	-	-	0.1	-

HCM 6th Signalized Intersection Summary
 4: Howard Ave & 14th St

07/13/2020



Movement	EBL	EBT	EBR	WBL	WBT	WBR	NBL	NBT	NBR	SBL	SBT	SBR
Lane Configurations												
Traffic Volume (veh/h)	59	1717	199	10	682	20	117	37	33	83	139	203
Future Volume (veh/h)	59	1717	199	10	682	20	117	37	33	83	139	203
Initial Q (Qb), veh	0	0	0	0	0	0	0	0	0	0	0	0
Ped-Bike Adj(A_pbT)	1.00		1.00	1.00		1.00	1.00		1.00	1.00		1.00
Parking Bus, Adj	1.00	1.00	1.00	1.00	1.00	1.00	1.00	1.00	1.00	1.00	1.00	1.00
Work Zone On Approach		No			No			No			No	
Adj Sat Flow, veh/h/ln	1870	1870	1870	1870	1870	1870	1870	1870	1870	1870	1870	1870
Adj Flow Rate, veh/h	62	1807	209	11	718	21	123	39	35	87	146	214
Peak Hour Factor	0.95	0.95	0.95	0.95	0.95	0.95	0.95	0.95	0.95	0.95	0.95	0.95
Percent Heavy Veh, %	2	2	2	2	2	2	2	2	2	2	2	2
Cap, veh/h	152	1890	843	81	1734	51	185	58	41	122	178	240
Arrive On Green	0.09	0.53	0.53	0.05	0.49	0.49	0.30	0.30	0.30	0.30	0.30	0.30
Sat Flow, veh/h	1781	3554	1585	1781	3526	103	439	193	137	278	595	801
Grp Volume(v), veh/h	62	1807	209	11	362	377	197	0	0	447	0	0
Grp Sat Flow(s),veh/h/ln	1781	1777	1585	1781	1777	1852	768	0	0	1674	0	0
Q Serve(g_s), s	3.6	53.3	7.8	0.7	14.3	14.3	1.5	0.0	0.0	0.0	0.0	0.0
Cycle Q Clear(g_c), s	3.6	53.3	7.8	0.7	14.3	14.3	29.3	0.0	0.0	27.8	0.0	0.0
Prop In Lane	1.00		1.00	1.00		0.06	0.62		0.18	0.19		0.48
Lane Grp Cap(c), veh/h	152	1890	843	81	874	911	284	0	0	541	0	0
V/C Ratio(X)	0.41	0.96	0.25	0.14	0.41	0.41	0.69	0.00	0.00	0.83	0.00	0.00
Avail Cap(c_a), veh/h	152	1890	843	81	874	911	284	0	0	541	0	0
HCM Platoon Ratio	1.00	1.00	1.00	1.00	1.00	1.00	1.00	1.00	1.00	1.00	1.00	1.00
Upstream Filter(I)	1.00	1.00	1.00	1.00	1.00	1.00	1.00	0.00	0.00	1.00	0.00	0.00
Uniform Delay (d), s/veh	47.7	24.5	13.9	50.4	17.8	17.8	36.8	0.0	0.0	36.6	0.0	0.0
Incr Delay (d2), s/veh	7.9	12.7	0.7	3.5	1.4	1.4	13.2	0.0	0.0	13.5	0.0	0.0
Initial Q Delay(d3),s/veh	0.0	0.0	0.0	0.0	0.0	0.0	0.0	0.0	0.0	0.0	0.0	0.0
%ile BackOfQ(50%),veh/ln	1.9	24.3	2.9	0.4	6.1	6.3	6.1	0.0	0.0	13.3	0.0	0.0
Unsig. Movement Delay, s/veh												
LnGrp Delay(d),s/veh	55.6	37.2	14.6	53.9	19.3	19.2	50.0	0.0	0.0	50.1	0.0	0.0
LnGrp LOS	E	D	B	D	B	B	D	A	A	D	A	A
Approach Vol, veh/h		2078			750			197			447	
Approach Delay, s/veh		35.5			19.8			50.0			50.1	
Approach LOS		D			B			D			D	
Timer - Assigned Phs		2	3	4		6	7	8				
Phs Duration (G+Y+Rc), s		37.5	9.5	63.0		37.5	13.9	58.6				
Change Period (Y+Rc), s		4.5	4.5	4.5		4.5	4.5	4.5				
Max Green Setting (Gmax), s		33.0	5.0	58.5		33.0	9.4	54.1				
Max Q Clear Time (g_c+I1), s		31.3	2.7	55.3		29.8	5.6	16.3				
Green Ext Time (p_c), s		0.2	0.0	2.9		0.9	0.0	5.3				
Intersection Summary												
HCM 6th Ctrl Delay											34.8	
HCM 6th LOS											C	

HCM 6th TWSC
6: Commerce St & Mission Inn Ave

07/13/2020

Intersection												
Int Delay, s/veh	9.6											
Movement	EBL	EBT	EBR	WBL	WBT	WBR	NBL	NBT	NBR	SBL	SBT	SBR
Lane Configurations		↕	↗		↕↗			↕↗			↕↗	
Traffic Vol, veh/h	26	355	94	21	521	21	119	42	23	4	42	9
Future Vol, veh/h	26	355	94	21	521	21	119	42	23	4	42	9
Conflicting Peds, #/hr	0	0	0	0	0	0	0	0	0	0	0	0
Sign Control	Free	Free	Free	Free	Free	Free	Stop	Stop	Stop	Stop	Stop	Stop
RT Channelized	-	-	None	-	-	None	-	-	None	-	-	None
Storage Length	-	-	0	-	-	-	-	-	-	-	-	-
Veh in Median Storage, #	-	0	-	-	0	-	-	0	-	-	0	-
Grade, %	-	0	-	-	0	-	-	0	-	-	0	-
Peak Hour Factor	95	95	95	95	95	95	95	95	95	95	95	95
Heavy Vehicles, %	2	2	2	2	2	2	2	2	2	2	2	2
Mvmt Flow	27	374	99	22	548	22	125	44	24	4	44	9

Major/Minor	Major1			Major2			Minor1			Minor2		
Conflicting Flow All	570	0	0	473	0	0	768	1042	374	1115	1130	285
Stage 1	-	-	-	-	-	-	428	428	-	603	603	-
Stage 2	-	-	-	-	-	-	340	614	-	512	527	-
Critical Hdwy	4.13	-	-	4.13	-	-	7.33	6.53	6.23	7.33	6.53	6.93
Critical Hdwy Stg 1	-	-	-	-	-	-	6.13	5.53	-	6.53	5.53	-
Critical Hdwy Stg 2	-	-	-	-	-	-	6.53	5.53	-	6.13	5.53	-
Follow-up Hdwy	2.219	-	-	2.219	-	-	3.519	4.019	3.319	3.519	4.019	3.319
Pot Cap-1 Maneuver	1000	-	-	1087	-	-	305	229	671	174	203	713
Stage 1	-	-	-	-	-	-	604	584	-	454	487	-
Stage 2	-	-	-	-	-	-	649	482	-	544	527	-
Platoon blocked, %	-	-	-	-	-	-	-	-	-	-	-	-
Mov Cap-1 Maneuver	1000	-	-	1087	-	-	235	214	671	134	190	713
Mov Cap-2 Maneuver	-	-	-	-	-	-	235	214	-	134	190	-
Stage 1	-	-	-	-	-	-	582	562	-	437	472	-
Stage 2	-	-	-	-	-	-	563	468	-	465	508	-

Approach	EB			WB			NB			SB		
HCM Control Delay, s	0.5			0.4			55.8			28.7		
HCM LOS							F			D		

Minor Lane/Major Mvmt	NBLn1	EBL	EBT	EBR	WBL	WBT	WBR	SBLn1
Capacity (veh/h)	250	1000	-	-	1087	-	-	209
HCM Lane V/C Ratio	0.775	0.027	-	-	0.02	-	-	0.277
HCM Control Delay (s)	55.8	8.7	0	-	8.4	0.1	-	28.7
HCM Lane LOS	F	A	A	-	A	A	-	D
HCM 95th %tile Q(veh)	5.7	0.1	-	-	0.1	-	-	1.1

HCM 6th TWSC
8: Howard Ave & Tenth St

07/13/2020

Intersection						
Int Delay, s/veh	2.5					
Movement	WBL	WBR	NBT	NBR	SBL	SBT
Lane Configurations	W	R	T	R	L	T
Traffic Vol, veh/h	43	28	101	54	85	325
Future Vol, veh/h	43	28	101	54	85	325
Conflicting Peds, #/hr	0	0	0	0	0	0
Sign Control	Stop	Stop	Free	Free	Free	Free
RT Channelized	-	None	-	None	-	None
Storage Length	0	-	-	-	-	-
Veh in Median Storage, #	0	-	0	-	-	0
Grade, %	0	-	0	-	-	0
Peak Hour Factor	95	92	92	95	92	92
Heavy Vehicles, %	2	2	2	2	2	2
Mvmt Flow	45	30	110	57	92	353

Major/Minor	Minor1	Major1	Major2		
Conflicting Flow All	676	139	0	0	167
Stage 1	139	-	-	-	-
Stage 2	537	-	-	-	-
Critical Hdwy	6.42	6.22	-	-	4.12
Critical Hdwy Stg 1	5.42	-	-	-	-
Critical Hdwy Stg 2	5.42	-	-	-	-
Follow-up Hdwy	3.518	3.318	-	-	2.218
Pot Cap-1 Maneuver	419	909	-	-	1411
Stage 1	888	-	-	-	-
Stage 2	586	-	-	-	-
Platoon blocked, %			-	-	-
Mov Cap-1 Maneuver	385	909	-	-	1411
Mov Cap-2 Maneuver	385	-	-	-	-
Stage 1	816	-	-	-	-
Stage 2	586	-	-	-	-

Approach	WB	NB	SB
HCM Control Delay, s	13.5	0	1.6
HCM LOS	B		

Minor Lane/Major Mvmt	NBT	NBRWBLn1	SBL	SBT
Capacity (veh/h)	-	-	501	1411
HCM Lane V/C Ratio	-	-	0.151	0.065
HCM Control Delay (s)	-	-	13.5	7.7
HCM Lane LOS	-	-	B	A
HCM 95th %tile Q(veh)	-	-	0.5	0.2

HCM 6th Signalized Intersection Summary
 11: Park Ave & University Ave

07/13/2020



Movement	EBL	EBT	EBR	WBL	WBT	WBR	NBL	NBT	NBR	SBL	SBT	SBR
Lane Configurations												
Traffic Volume (veh/h)	53	1374	63	42	603	67	50	58	87	254	137	62
Future Volume (veh/h)	53	1374	63	42	603	67	50	58	87	254	137	62
Initial Q (Qb), veh	0	0	0	0	0	0	0	0	0	0	0	0
Ped-Bike Adj(A_pbT)	1.00		1.00	1.00		1.00	1.00		1.00	1.00		1.00
Parking Bus, Adj	1.00	1.00	1.00	1.00	1.00	1.00	1.00	1.00	1.00	1.00	1.00	1.00
Work Zone On Approach		No		No		No		No		No		No
Adj Sat Flow, veh/h/ln	1870	1870	1870	1870	1870	1870	1870	1870	1870	1870	1870	1870
Adj Flow Rate, veh/h	56	1446	66	44	635	71	53	61	92	267	144	65
Peak Hour Factor	0.95	0.95	0.95	0.95	0.95	0.95	0.95	0.95	0.95	0.95	0.95	0.95
Percent Heavy Veh, %	2	2	2	2	2	2	2	2	2	2	2	2
Cap, veh/h	147	1526	69	83	1304	146	144	122	184	300	327	148
Arrive On Green	0.08	0.44	0.44	0.05	0.40	0.40	0.08	0.18	0.18	0.17	0.27	0.27
Sat Flow, veh/h	1781	3461	158	1781	3223	360	1781	673	1015	1781	1220	551
Grp Volume(v), veh/h	56	741	771	44	350	356	53	0	153	267	0	209
Grp Sat Flow(s),veh/h/ln	1781	1777	1842	1781	1777	1806	1781	0	1688	1781	0	1771
Q Serve(g_s), s	3.3	44.0	44.3	2.7	16.1	16.1	3.1	0.0	9.0	16.1	0.0	10.8
Cycle Q Clear(g_c), s	3.3	44.0	44.3	2.7	16.1	16.1	3.1	0.0	9.0	16.1	0.0	10.8
Prop In Lane	1.00		0.09	1.00		0.20	1.00		0.60	1.00		0.31
Lane Grp Cap(c), veh/h	147	783	812	83	719	730	144	0	305	300	0	475
V/C Ratio(X)	0.38	0.95	0.95	0.53	0.49	0.49	0.37	0.00	0.50	0.89	0.00	0.44
Avail Cap(c_a), veh/h	147	783	812	83	719	730	144	0	305	300	0	475
HCM Platoon Ratio	1.00	1.00	1.00	1.00	1.00	1.00	1.00	1.00	1.00	1.00	1.00	1.00
Upstream Filter(I)	1.00	1.00	1.00	1.00	1.00	1.00	1.00	0.00	1.00	1.00	0.00	1.00
Uniform Delay (d), s/veh	47.8	29.5	29.6	51.3	24.3	24.3	47.9	0.0	40.6	44.8	0.0	33.4
Incr Delay (d2), s/veh	7.3	21.3	21.5	22.5	2.3	2.3	7.1	0.0	5.8	30.4	0.0	2.9
Initial Q Delay(d3),s/veh	0.0	0.0	0.0	0.0	0.0	0.0	0.0	0.0	0.0	0.0	0.0	0.0
%ile BackOfQ(50%),veh/ln	1.8	22.7	23.7	1.7	7.1	7.3	1.7	0.0	4.2	9.6	0.0	5.0
Unsig. Movement Delay, s/veh												
LnGrp Delay(d),s/veh	55.1	50.8	51.1	73.7	26.6	26.6	55.0	0.0	46.4	75.1	0.0	36.3
LnGrp LOS	E	D	D	E	C	C	D	A	D	E	A	D
Approach Vol, veh/h		1568			750			206			476	
Approach Delay, s/veh		51.1			29.4			48.6			58.1	
Approach LOS		D			C			D			E	
Timer - Assigned Phs	1	2	3	4	5	6	7	8				
Phs Duration (G+Y+Rc), s	30.0	24.4	9.6	53.0	13.4	34.0	13.6	49.0				
Change Period (Y+Rc), s	4.5	4.5	4.5	4.5	4.5	4.5	4.5	4.5				
Max Green Setting (Gmax), s	30.5	19.9	5.1	48.5	8.9	29.5	9.1	44.5				
Max Q Clear Time (g_c+11g), s	11.0	11.0	4.7	46.3	5.1	12.8	5.3	18.1				
Green Ext Time (p_c), s	0.0	0.5	0.0	1.8	0.0	1.0	0.0	4.8				
Intersection Summary												
HCM 6th Ctrl Delay			46.6									
HCM 6th LOS			D									

HCM 6th AWSC
12: Howard Ave & 12th St

07/13/2020

Intersection

Intersection Delay, s/veh 10.1

Intersection LOS B

Movement	EBL	EBT	EBR	WBL	WBT	WBR	NBL	NBT	NBR	SBL	SBT	SBR
Lane Configurations		↔			↔			↔			↔	
Traffic Vol, veh/h	0	8	70	29	3	13	12	76	28	20	327	20
Future Vol, veh/h	0	8	70	29	3	13	12	76	28	20	327	20
Peak Hour Factor	0.95	0.95	0.95	0.95	0.95	0.95	0.95	0.95	0.95	0.95	0.95	0.95
Heavy Vehicles, %	2	2	2	2	2	2	2	2	2	2	2	2
Mvmt Flow	0	8	74	31	3	14	13	80	29	21	344	21
Number of Lanes	0	1	0	0	1	0	0	1	0	0	1	0

Approach	EB	WB	SB
Opposing Approach	WB	EB	SB
Opposing Lanes	1	1	1
Conflicting Approach Left	SB	NB	EB
Conflicting Lanes Left	1	1	1
Conflicting Approach Right	NB	SB	WB
Conflicting Lanes Right	1	1	1
HCM Control Delay	8.2	8.6	8.4
HCM LOS	A	A	B

Lane NBLn1 EBLn1WBLn1 SBLn1

Vol Left, %	10%	0%	64%	5%
Vol Thru, %	66%	10%	7%	89%
Vol Right, %	24%	90%	29%	5%
Sign Control	Stop	Stop	Stop	Stop
Traffic Vol by Lane	116	78	45	367
LT Vol	12	0	29	20
Through Vol	76	8	3	327
RT Vol	28	70	13	20
Lane Flow Rate	122	82	47	386
Geometry Grp	1	1	1	1
Degree of Util (X)	0.154	0.105	0.068	0.468
Departure Headway (Hd)	4.535	4.596	5.135	4.359
Convergence, Y/N	Yes	Yes	Yes	Yes
Cap	789	778	695	827
Service Time	2.571	2.639	3.182	2.387
HCM Lane V/C Ratio	0.155	0.105	0.068	0.467
HCM Control Delay	8.4	8.2	8.6	11.2
HCM Lane LOS	A	A	A	B
HCM 95th-tile Q	0.5	0.4	0.2	2.5

Intersection						
Int Delay, s/veh	2.6					
Movement	EBT	EBR	WBL	WBT	NBL	NBR
Lane Configurations						
Traffic Vol, veh/h	37	401	9	45	129	0
Future Vol, veh/h	37	401	9	45	129	0
Conflicting Peds, #/hr	0	0	0	0	0	0
Sign Control	Free	Free	Free	Free	Stop	Stop
RT Channelized	-	None	-	None	-	None
Storage Length	-	-	-	-	0	-
Veh in Median Storage, #	0	-	-	0	0	-
Grade, %	0	-	-	0	0	-
Peak Hour Factor	92	92	92	92	92	92
Heavy Vehicles, %	2	2	2	2	2	2
Mvmt Flow	40	436	10	49	140	0

Major/Minor	Major1	Major2	Minor1	Minor2	Minor3
Conflicting Flow All	0	0	476	0	327
Stage 1	-	-	-	-	258
Stage 2	-	-	-	-	69
Critical Hdwy	-	-	4.12	-	6.42
Critical Hdwy Stg 1	-	-	-	-	5.42
Critical Hdwy Stg 2	-	-	-	-	5.42
Follow-up Hdwy	-	-	2.218	-	3.518
Pot Cap-1 Maneuver	-	-	1086	-	667
Stage 1	-	-	-	-	785
Stage 2	-	-	-	-	954
Platoon blocked, %	-	-	-	-	-
Mov Cap-1 Maneuver	-	-	1086	-	661
Mov Cap-2 Maneuver	-	-	-	-	661
Stage 1	-	-	-	-	778
Stage 2	-	-	-	-	954

Approach	EB	WB	NB
HCM Control Delay, s	0	1.4	11.9
HCM LOS			B

Minor Lane/Major Mvmt	NBLn1	EBT	EBR	WBL	WBT
Capacity (veh/h)	661	-	-	1086	-
HCM Lane V/C Ratio	0.212	-	-	0.009	-
HCM Control Delay (s)	11.9	-	-	8.3	0
HCM Lane LOS	B	-	-	A	A
HCM 95th %tile Q(veh)	0.8	-	-	0	-