

FINAL Rancho Cuvee Transportation Impact Study

Prepared for:

CRP/WP Alta Cuvee Venture, LLC

Updated January 20, 2022

OC20-0752

FEHR  PEERS

Table of Contents

1.	EXECUTIVE SUMMARY	4
	Findings	4
2.	INTRODUCTION.....	6
	Project Description.....	6
	Study area.....	6
	Analysis Scenario	8
3.	ANALYSIS METHODOLOGY	9
	Level of Service Criteria	9
	Intersection Analysis.....	9
	VMT Criteria	10
	Future Forecasting.....	13
	San Bernardino Transportation Analysis Model (SBTAM).....	13
	Existing Year (2020) Conditions	13
	Opening Year (2023) Conditions.....	14
	Cumulative Year (2040) Conditions.....	14
4.	EXISTING YEAR (2020) CONDITIONS.....	15
	Existing Roadway Facilities.....	15
	Regional Roads.....	15
	Local Access Road	15
	Bicycle Facilities	15
	Class I Bikeways (Bike Paths).....	15
	Class II Bikeways (Bike Lanes)	16
	Class III Bikeways (Bike Routes)	17
	Class IV Bikeways (Cycle Tracks).....	17
	Pedestrian Facilities.....	18
	Transit Facilities	20
	Metrolink.....	20
	Bus Transit.....	20
	Traffic Volumes and Configurations.....	21

	Intersection Operations.....	21
5.	PROJECT TRAFFIC VOLUMES.....	23
	Project Trip Generation.....	23
	Project Trip Distribution.....	23
	Project Trip Assignment.....	24
6.	OPENING YEAR (2023) CONDITIONS	27
	Traffic Volumes.....	27
	Planned Roadway Network Improvements.....	27
	Intersection Operations.....	27
7.	CUMULATIVE YEAR (2040) PLUS PROJECT CONDITIONS.....	31
	Traffic Volumes.....	31
	Planned Roadway Improvements.....	31
	Intersection Operations.....	31
8.	IMPROVMENTS AND RECOMMENDATIONS	35
	Opening Year Plus Project Intersection Improvements.....	35
	Recommended Intersection Improvements	35
	Cumulative Year (2040) Plus Project Intersection Improvements	36
	Recommended Intersection improvements	36
	Intersection LOS Comparison.....	37
9.	ACTIVE TRANSPORTATION AND PUBLIC TRANSIT ANALYSIS	39
10.	VEHICLE MILES TRAVELED (VMT) ANALYSIS.....	40

List of Figures

Figure 2-1	Project Site Plan.....	7
Figure 4-1	Bicycle Facilities.....	19
Figure 4-2	Existing Year (2020) Conditions Peak Hour Traffic Volumes and Lane Configurations.....	22
Figure 5-1	Project Trip Distribution.....	25
Figure 5-2	Project Trip Assignment.....	26



Figure 6-1 Opening Year (2023) Conditions Peak Hour Traffic Volumes and Lane Configurations 29

Figure 6-2 Opening Year (2023) Plus Project Conditions Peak Hour Traffic Volumes and Lane Configurations 30

Figure 7-1 Cumulative Year (2040) Conditions Peak Hour Traffic Volumes and Lane Configurations 33

Figure 7-2 Cumulative Year (2040) Plus Project Conditions Peak Hour Traffic Volumes and Lane Configurations 34

Figure 8-1 Proposed Geometric Changes to Etiwanda Avenue and Foothill Boulevard 38

List of Tables

Table 1-1 Summary Matrix 5

Table 3-1 Intersection LOS Criteria 11

Table 4-1 Existing Conditions Intersection LOS 21

Table 5-1 Project Trip Generation Estimates 23

Table 6-1 Opening Year (2023) Conditions Intersection LOS 27

Table 7-1 Cumulative Year (2040) Conditions Intersection LOS 31

Table 8-1 Opening Year (2023) Comparison Of No Project, Plus Project, And Improved Scenarios 36

Table 8-2 Cumulative Year (2040) Comparison Of No Project, Plus Project, And Improved Scenarios 37

Appendices

- Appendix A: Traffic Counts
- Appendix B: Approved Development Projects
- Appendix C: Level of Service Calculation

1. EXECUTIVE SUMMARY

Fehr & Peers has completed the transportation impact assessment for the Rancho Cuvee development (Project) in Rancho Cucamonga, California. This Transportation Impact Analysis (TIA) was developed based on coordination with the City of Rancho Cucamonga and the recently updated *City of Rancho Cucamonga Traffic Impact Analysis Guidelines*. The project site is located at the intersection of Etiwanda Avenue and Foothill Boulevard. The Project consists of 260 multi-family residential units with 200 surface and 327 garage parking spaces within a lot area of 5.2 acres, and driveway access will be provided to the site from Etiwanda Avenue and Foothill Boulevard.

As part of the TIA, and consistent with San Bernardino Congestion Management Plan (CMP) requirements, the following scenarios were analyzed:

- Existing (2020) No Project Counts: Existing traffic volumes and lane geometries were used to evaluate existing conditions. This represents 2020 conditions in a non-COVID environment.
- Baseline (opening year) No Project Conditions: This consisted of traffic volumes during the opening year of the Project (2023) without the proposed Project generated volumes. The opening year volumes were developed with an interpolation of the cumulative forecasts.
- Baseline with Project Forecasts: This consisted of traffic volumes during the opening year of the Project (2023) without the proposed Project generated volumes. The opening year volumes were developed with an interpolation of the cumulative forecasts.
- Cumulative Year (2040) No Project Forecasts: Fehr & Peers used the cumulative forecasts developed for the study area using the travel demand model (SBTAM) and including cumulative projects and funded improvements in the study area
- Cumulative Year (2040) With Project Forecasts: Traffic generated by the Project was added to the Cumulative Year No Project traffic volumes.

FINDINGS

The project was found to be screened from VMT and presumed to have a less-than-significant transportation impact. No significant impacts have been determined for pedestrian, bicycle, and transit modes.

The proposed project adds delay to one study intersection that is operating at an unacceptable LOS as identified in **Table 1-1**. Intersection improvements have been recommended to provide an acceptable LOS.

**TABLE 1-1
SUMMARY MATRIX**

Intersection	Scenario(s)	Improvements
4. Etiwanda Avenue & Foothill Boulevard	2023 (AM)	<p>Modify northbound approach of the intersection from one left-turn lane, one through lane and one right-turn pocket to two left-turn lanes, two through lanes, and one right-turn pocket</p> <p>Restripe the eastbound approach from two left-turn lanes, two through lanes, and one right-turn lane to two left-turn lanes, three through lanes, and one right-turn lane</p> <p>Modify southbound approach of the intersection from one left-turn lane, one through lane, and one shared through right lane, to one left-turn lane, two through lanes, and one right-right turn pocket</p> <p>Optimization of coordinated splits</p>
4. Etiwanda Avenue & Foothill Boulevard	2040 (AM & PM)	<p>Modify northbound approach of the intersection from one left-turn lane, one through lane and one right-turn pocket to two left-turn lanes, two through lanes, and one right-turn pocket</p> <p>Restripe the eastbound approach from two left-turn lanes, two through lanes, and one right-turn lane to two left-turn lanes, three through lanes, and one right-turn lane</p> <p>Modify the westbound approach of the intersection from two left-turn lanes, two through lanes, and one right-turn lane to two left-turn lanes, three through lanes, and one right-turn lane</p> <p>Optimization of coordinated splits</p>

Source: Fehr & Peers, 2020

2. INTRODUCTION

Fehr & Peers is assisting with the transportation impact assessment for the Rancho Cuvee development in Rancho Cucamonga, California. This report summarizes the methodology, findings, and conclusions of the analyses; including identification of recommended improvements for deficient intersections. This chapter outlines the geographic scope of the transportation impact analysis, including the study area.

This assessment is consistent with the requirements as outlined in the City's recently adopted transportation impact study guidelines dated June 2020.

PROJECT DESCRIPTION

The project site is located at the intersection of Etiwanda Avenue and Foothill Boulevard. The Project consists of 260 multi-family residential units with 200 surface and 327 garage parking spaces within a lot area of 5.2 acres. Access will be provided to the site from Etiwanda Avenue and Foothill Boulevard.

Figure 2-1 shows the Project Site Plan.

STUDY AREA

The study area and analyzed intersections were determined based on preliminary trip generation, trip distribution, trip assignment estimates developed for the project, our knowledge of the study area, and input from staff at the City of Rancho Cucamonga. The study area is consistent with the San Bernardino County CMP study area guidelines and includes, within a five-mile radius, all freeway links that the project is anticipated to add 100 or more peak-hour project trips to and arterial roadways that the project is anticipated to add 50 or more peak-hour project trips to.

1. Foothill Boulevard & Southbound I-15 Ramps
2. Foothill Boulevard & Northbound I-15 Ramps
3. Foothill Boulevard & Scared Heart Place
4. Foothill Boulevard & Etiwanda Avenue



Site Plan - Ground Level



A1

JANUARY 11, 2022

PREPARED FOR
WOOD PARTNERS
 11849 W. Olympic Boulevard
 Suite 204
 Los Angeles, CA 90064

Rancho Cuvee
 12939 FOOTHILL BLVD. RANCHO CUCAMONGA, CA 91739

40001
 VAN TILBURG, BANNARD & SODERBERG, AIA
 ARCHITECTURE • PLANNING • DESIGN



Figure 2-1
 Project Site Plan

ANALYSIS SCENARIO

To identify potential project effects on the transportation system, Fehr & Peers analyzed the following five scenarios:

- Existing (2020) No Project Counts: Existing traffic volumes and lane geometries were used to evaluate existing conditions. This represents 2020 conditions in a non-COVID environment.
- Baseline (opening year) No Project Conditions: This consisted of traffic volumes during the opening year of the Project (2023) without the proposed Project generated volumes. The opening year volumes were developed with an interpolation of the cumulative forecasts.
- Baseline With Project Forecasts: This consisted of traffic volumes during the opening year of the Project (2023) without the proposed Project generated volumes. The opening year volumes were developed with an interpolation of the cumulative forecasts.
- Cumulative Year (2040) No Project Forecasts: Fehr & Peers used the cumulative forecasts developed for the study area using the travel demand model (SBTAM) and including cumulative projects and funded improvements in the study area
- Cumulative Year (2040) With Project Forecasts: Traffic generated by the Project was added to the Cumulative Year No Project traffic volumes.

The LOS analysis was performed during typical weekday AM and PM peak hour conditions as the Project is anticipated to generate the most traffic during these times and these peak hours are consistent with the greatest levels of congestion seen in the study area. Weekends and weekday non-peak hours were not analyzed as there are lower levels of congestion and the Project is anticipated to generate fewer trips. Therefore, the peak hour analysis will capture any transportation related impacts as these time periods experience the most severe congestion. For each scenario, the study intersections were analyzed in both the AM and PM peak hours.

3. ANALYSIS METHODOLOGY

This chapter discusses the analysis methodology and assumptions as approved by the City of Rancho Cucamonga.

LEVEL OF SERVICE CRITERIA

INTERSECTION ANALYSIS

Intersection operating conditions in the study area were evaluated using the Highway Capacity Manual (HCM) 6th Edition Transportation Research Board (TRB) methodology, which is considered the state-of-the-practice methodology for evaluating intersection operations and is consistent with the City of Rancho Cucamonga requirements, Caltrans requirements, and the County of San Bernardino requirements.

The HCM 6th Edition Methodology estimates a quantitative delay at intersections. After the quantitative delay estimates are complete, the methodology assigns a qualitative letter grade that represents the operations of the intersection. These grades range from level of service (LOS) A (minimal delay) to LOS F (excessive congestion). LOS E represents at-capacity operations. Descriptions of the LOS letter grades for signalized and unsignalized intersections are provided in Table 3-1. Please see Table 3-1 for intersection LOS criteria.

Trafficware Synchro 10 software package was used to facilitate the HCM 6th Edition calculations. The analysis assumes parameters from the San Bernardino County Congestion Management Program (CMP), as directed by the City of Rancho Cucamonga staff. The delay, calculated in seconds, was compared to the LOS thresholds outlined in the HCM 6th Edition. For signalized and all-way stop-controlled intersections, intersection level of service is determined based on average delay per the standard HCM 6th Edition methodology. For side-street stop-controlled intersections, intersection level of service is determined based on worst-case approach delay.

The following factors were applied in the intersection analysis:

- Peak Hour Factor (PHF) was based on traffic counts collected in the field for all Existing Conditions analysis
- PHF for all future analysis was set to 0.95
- Heavy vehicle percentage was to set to 2% for all analysis scenarios
- For the Existing conditions analysis, current signal timing plans were referenced
- For the Opening Year and Future conditions analysis, the uncoordinated signals were assumed to be coordinated and the signal timing cycle lengths were optimized under the Opening Year and

Cumulative No Project conditions. The same signal timing is assumed in Opening Year No Project and Plus Project conditions. The same signal timing is assumed in Cumulative Year No Project and Plus Project conditions.

- For Existing Scenarios and Opening Year, saturated flow rates were set to:
 - Exclusive thru: 1,800 vehicles per hour green per lane (vphgpl)
 - Exclusive left: 1,700 vphgpl
 - Exclusive right: 1,800 vphgpl
 - Exclusive double left: 1,600 vphgpl
- For Cumulative Scenarios, saturated flow rates were set to:
 - Exclusive thru: 1,900 vphgpl
 - Exclusive left: 1,800 vphgpl
 - Exclusive right: 1,900 vphgpl
 - Exclusive double right: 1,800 vphgpl
 - Exclusive double left: 1,700 vphgpl

Please note that Fehr & Peers measured existing saturation flow rates in the study area that ranged from 1,800 to 2,000 vphgpl at the study intersections; given our observations, we utilized the CMP rates as part of this effort to provide a consistent yet conservative assessment.

Based on the recently updated *City of Rancho Cucamonga Traffic Impact Analysis Guidelines*, intersections operating at LOS D or better would be considered acceptable, and intersections operating at LOS E or F would be considered deficient. Any intersection operating at an unacceptable LOS is required to identify intersection improvements to address LOS.

VMT CRITERIA

The recently adopted *City of Rancho Cucamonga Transportation Impact Analysis Guidelines* specifies that VMT should be assessed on all projects. In order to determine what level of VMT analysis is required, the project should be evaluated to determine if it meets any of the three screening criteria outlined in the guidelines. These criteria are:

- **Transit Priority Area (TPA) Screening** – projects located within one-half mile of a major transit stop or an existing stop along a high-quality transit corridor¹.

¹ Pub. Resources Code, § 21064.3 - 'Major transit stop' means a site containing an existing rail transit station, a ferry terminal served by either a bus or rail transit service, or the intersection of two or more major bus routes with a frequency of service interval of 15 minutes or less during the morning and afternoon peak commute periods.

**TABLE 3-1
INTERSECTION LOS CRITERIA**

Level of Service	Description	Signalized Delay (Seconds)
A	Operations with very low delay occurring with favorable progression and/or short cycle length.	< 10.0
B	Operations with low delay occurring with good progression and/or short cycle lengths.	> 10.0 to 20.0
C	Operations with average delays resulting from fair progression and/or longer cycle lengths. Individual cycle failures begin to appear.	> 20.0 to 35.0
D	Operations with longer delays due to a combination of unfavorable progression, long cycle lengths, or high V/C ratios. Many vehicles stop and individual cycle failures are noticeable.	> 35.0 to 55.0
E	Operations with high delay values indicating poor progression, long cycle lengths, and high V/C ratios. Individual cycle failures are frequent occurrences.	> 55.0 to 80.0
F	Operation with delays unacceptable to most drivers occurring due to over saturation, poor progression, or very long cycle lengths.	> 80.0

Source: Highway Capacity Manual (Transportation Research Board, 2017).

Projects located within a TPA may be presumed to have a less than significant impact absent substantial evidence to the contrary. This presumption may **NOT** be appropriate if the project:

- Has a Floor Area Ratio (FAR) of less than 0.75;
- Includes more parking for use by residents, customers, or employees of the project than required by the City (if the City requires the project to supply parking);
- Is inconsistent with the applicable Sustainable Communities Strategy (as determined by the lead agency, with input from the Metropolitan Planning Organization); or
- Replaces affordable residential units with a smaller number of moderate- or high-income residential units.

Pub. Resources Code, § 21155 - For purposes of this section, a 'high-quality transit corridor' means a corridor with fixed route bus service with service intervals no longer than 15 minutes during peak commute hours.

- **Low VMT Area Screening** – projects located within individual traffic analysis zones (TAZ) where total daily Origin/Destination VMT per service population is lower than the City average total daily Origin/Destination VMT per service population.²

Projects located within a Low VMT zone may be presumed to have a less than significant impact if they are consistent with the existing land use within that traffic analysis zone (TAZ) and use professional judgement to determine that there is nothing unique about the project that would otherwise be mis-represented utilizing the data from the travel demand model.

- **Project Type Screening** – projects that are identified as local-serving per the City's TIA Guidelines, and projects generated fewer than 250 daily trips.

Projects which are not eligible for any of the screening criteria are required to complete a VMT analysis and forecasting through the SBTAM model to determine if they have a significant VMT impact. This analysis is to include 'project generated VMT' and 'project effect on VMT' estimates.

A project would result in a significant project-generated VMT impact if either of the following conditions:

1. The baseline project-generated VMT per service population exceeds the City of Rancho Cucamonga baseline VMT per service population, or
2. The cumulative project-generated VMT per service population exceeds the City of Rancho Cucamonga baseline VMT per service population.

The project's effect on VMT would be considered significant if it resulted in either of the following conditions:

1. The cumulative link-level boundary VMT per service population within City of Rancho Cucamonga increases under the plus project condition compared to the no project condition).³

² TAZs are geographic polygons similar to Census block groups used to represent areas of homogenous travel behavior. Service population is population plus employment. Used with VMT, it provides a normalized standard unit for comparison purposes while accounting for the population and/or employment in a given area.

³ Please note, that for most projects establishing a boundary of the City limits should be sufficient. However, for larger projects or projects located near the City limit, a larger boundary should be applied to ensure that the true project effect is not truncated. Typically, doubling the average trip length to/from the site could establish an appropriate boundary if the City limit is not appropriate.

FUTURE FORECASTING

SAN BERNARDINO TRANSPORTATION ANALYSIS MODEL (SBTAM)

The San Bernardino Transportation Analysis Model (SBTAM) was utilized to develop forecasts in the study area. SBTAM is a San Bernardino County model that began as the Southern California Association of Governments (SCAG) regional travel demand model (which is utilized for the SCAG Regional Transportation Plan [RTP] and forecasts traffic volumes on roadway segments for the entire six-county SCAG region). The SCAG model was refined to provide additional detail for San Bernardino County and was calibrated for use in San Bernardino County by ensuring that the model is able to replicate existing traffic volumes on county roadways after refinement. SBTAM is considered the most appropriate tool for testing changes in land use and roadway network in San Bernardino County. When SBTAM was developed, extensive model documentation was prepared which outlined the model.

For use in this project, SBTAM was updated to be consistent with the 2016 SCAG Regional Transportation Plan (RTP) and Sustainable Communities Strategy (SCS) with updated 2018 base year and 2040 future year land use assumptions. The future year roadway network updated to assume all funded 2016 SCAG RTP/SCS projects.

The Base Year and Future Year models are able to produce link and intersection turning movement volumes. National Cooperative Highway Research Program (NCHRP) Report 255 prescribes a variety of methods for developing intersection turning movement volume forecasts from travel demand model outputs. For typical applications, the Base Year and Future Year model outputs are compared to one another and are used in conjunction with existing traffic counts to develop future traffic forecasts. In this study, the absolute difference between the Base Year and Future Year model outputs were utilized to interpolate the 2040 volume forecasts. This method is known as the difference method, and is a state of the practice approach consistent with NCHRP Report 255.

EXISTING YEAR (2020) CONDITIONS

Existing Year (2020) traffic forecasts were developed using a three-step process:

- First, The City of Rancho Cucamonga provided traffic movement counts for all study intersections from the recently completed Traffic Signal Coordination for the Freeway and Arterial Signal Synchronization City of Rancho Cucamonga Existing Conditions Report Study (2019). Most counts in the study are from February of 2019, while counts at Foothill Boulevard & Etiwanda Avenue are from November of 2017.

- Second, Fehr & Peers applied a 2% per year growth factor to these counts to represent 2020 conditions in a non-COVID environment.
- Third, Fehr & Peers made small adjustments to the volumes to balance the traffic between the I-15 ramps.

OPENING YEAR (2023) CONDITIONS

Opening Year (2023) forecasts were developed using a three-step process:

- First, linear interpolation was applied between the Existing (2020) traffic volumes and the Future Year (2040) traffic forecasts to produce Opening Year (2023) No Project forecasts.
- Second, trip generation and distribution estimates were developed for the Project.
- Lastly, project trips were manually assigned to the study roadway network based on the trip generation and distribution pattern described above. Opening Year (2023) Plus Project forecasts were developed by applying the project only trip assignment on top of the Opening Year (2023) No Project forecasts.

CUMULATIVE YEAR (2040) CONDITIONS

Cumulative Year (2040) forecasts were developed using a four-step process:

- First, the 2040 SCAG land use dataset was reviewed to ensure that all pending and approved development projects within the City of Rancho Cucamonga were included in the 2040 forecasts, if they were not already assumed in the land use growth assumptions. These pending and approved development projects are included in **Appendix B**.
- Second, the local roadway network was reviewed for consistency with the Rancho Cucamonga General Plan.
- Third, the future year model was run and the difference method was applied to the existing counts based on the proportional growth between the base year model and future year model, accounting for 20 years of growth from 2020 to 2040. To provide a conservative analysis, if the model predicted negative growth (representing a decrease in trips along a roadway segment either due to revised land use estimates or an increase in parallel infrastructure capacity), existing counts were used (e.g. no negative growth was applied).
- Finally, Cumulative Year (2040) Plus Project forecasts were developed by applying the project only trip assignment on top of the Cumulative Year (2040) forecasts.

4. EXISTING YEAR (2020) CONDITIONS

This chapter evaluates the Existing Year (2020) Conditions in the project study area including the roadway, transit, and pedestrian networks in order to document the baseline conditions against which the project will be assessed.

EXISTING ROADWAY FACILITIES

REGIONAL ROADS

- Interstate 15 Freeway (I-15): I-15 is the main north-south facility through San Bernardino County. It extends the entire length of San Bernardino County, from its southern border with Riverside County to the California-Nevada State Line. I-15 is a twelve-lane divided freeway near the project.

LOCAL ACCESS ROAD

- Foothill Boulevard: Foothill Boulevard is classified as a six lane, east-west road near Vineyard Avenue, narrows to four-lane road near Hellman Avenue, and increases to a six-lane road near Haven Avenue. Foothill Boulevard is designated as a Principal Travel Corridor by the City of Rancho Cucamonga General Plan, which provides service to between 30,000 and 40,000 vehicles per day.
- Etiwanda Avenue: Etiwanda Avenue is a four-lane, north-south road that provides users with access to the Project site. Etiwanda Avenue is designated as a Tertiary Travel Corridor and provides service to between 10,000 to 15,000 vehicles per day.
- Sacred Heart Avenue: Sacred Heart Avenue provides north-south access near the project. It provides local access to the shopping center, Sacred Heart Church, and Sacred Heart School along Foothill Boulevard near the project site.

BICYCLE FACILITIES

Bicycle facilities in the City of Rancho Cucamonga are classified as follows:

CLASS I BIKEWAYS (BIKE PATHS)

Class I bicycle facilities are bicycle trails or paths that are off-street and separated from automobiles. They are a minimum of eight feet in width for two-way travel and include bike lane signage and designated street crossings where needed. A Class I Bike Path may parallel a roadway (within the parkway) or may be a

completely separate right-of-way that meanders through a neighborhood or along a flood control channel or utility right-of-way.



CLASS I - Multi-Use Path

Provides a completely separated right-of-way for exclusive use of bicycles and pedestrians with crossflow minimized.



MUTCD R44A (CA)

CLASS II BIKEWAYS (BIKE LANES)

Class II bicycle facilities are striped lanes that provide bike travel and can be either located next to a curb or parking lane. If located next to a curb, a minimum width of five feet is recommended. However, a bike lane adjacent to a parking lane can be four feet in width. Bike lanes are exclusively for the use of bicycles and include bike lane signage, special lane lines, and pavement markings.

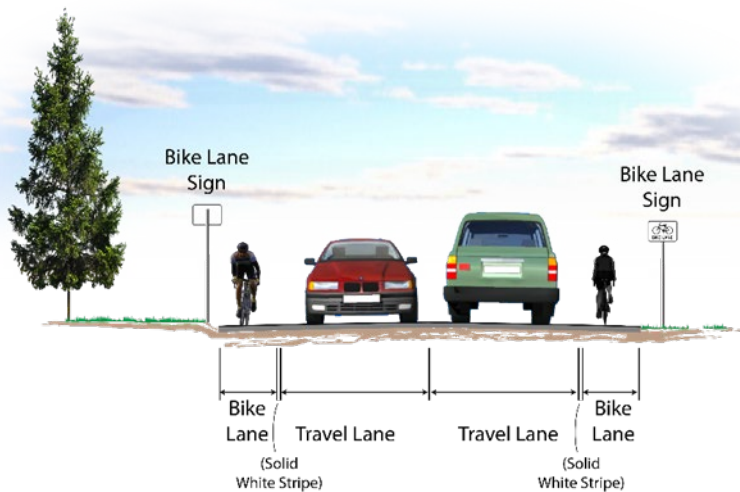

CLASS II - Bike Lane

Provides a striped lane for one-way bike travel on a street or highway.



MUTCD R81 (CA)

CLASS III BIKEWAYS (BIKE ROUTES)

Class III Bikeways are streets providing for shared use by motor vehicles and bicyclists. While bicyclists have no exclusive use or priority, signage both by the side of the street and stenciled on the roadway surface alerts motorists to bicyclists sharing the roadway space and denotes that the street is an official bike route.

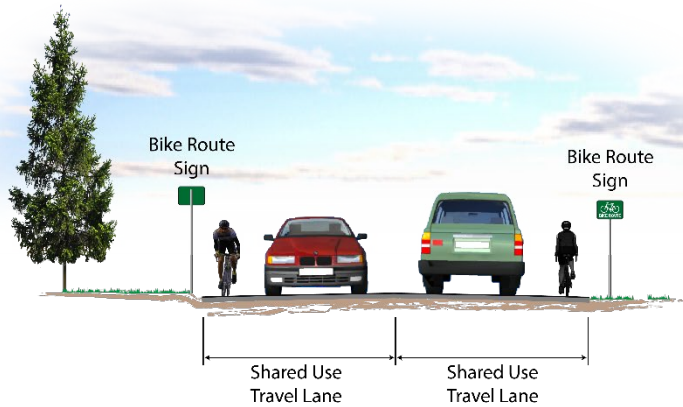

CLASS III - Bike Route

Provides a shared use with pedestrians or motor vehicle traffic, typically on lower volume roadways.



MUTCD D11-1

CLASS IV BIKEWAYS (CYCLE TRACKS)

Class IV bicycle facilities, sometimes called cycle tracks or separated bikeways, provide a right-of-way designated exclusively for bicycle travel adjacent to a roadway and are protected from vehicular traffic via separations (e.g. grade separation, flexible posts, inflexible physical barriers, on-street parking). California Assembly Bill 1193 (AB 1193) legalized and established design standards for Class IV bikeways in 2015.

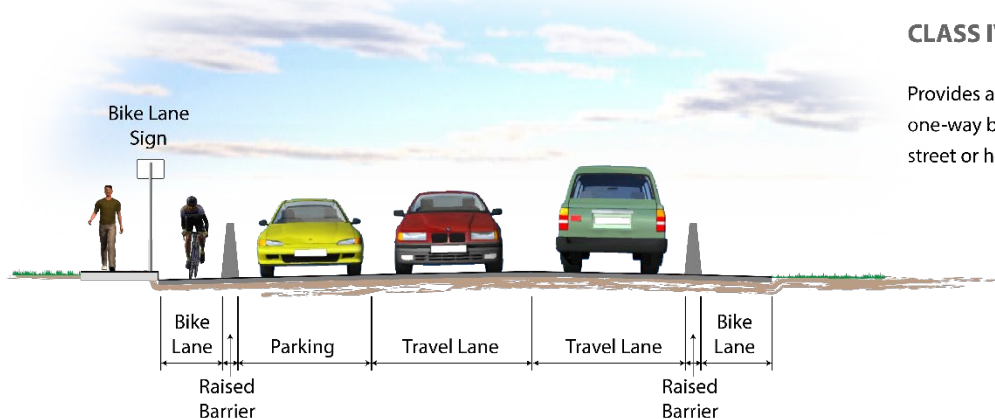

CLASS IV - Separated Bikeway (Cycle Track)

Provides a protected lane for one-way bike travel on a street or highway.

Foothill Boulevard and Etiwanda Avenue are both designated as streets with Class II facilities in the City's General Plan. However, neither currently have a bike facility within the project vicinity. This is typical of a number of streets in Rancho Cucamonga, as most major streets in Rancho Cucamonga provide Class II or Class III facilities along the street running as far north as Wilson Avenue, with some gaps and planned facilities that will provide a more connect bike network throughout the City.

The current bicycle network, including planned facilities in the area, are presented on **Figure 4-1**.

PEDESTRIAN FACILITIES

The City of Rancho Cucamonga provides pedestrian facilities as a means to reduce auto travel and as healthy exercise (Rancho Cucamonga General Plan, 2010). According to the City's 2010 General Plan, supporting walking as way to travel is ensured by providing the following pedestrian facilities:

- Adequate or wide sidewalks
- Street furniture and seating
- Unobstructed travel path (e.g. utility boxes placed out of travel path)
- Enhanced lighting
- Shade
- Wider crossings and bulbouts

The major streets that provide access to the project Foothill Boulevard and Etiwanda Avenue, both have well connected and maintained sidewalk networks along the frontage of developed parcels on both corridors. These facilities currently provide access for pedestrians to the Project from bus stops nearby, as well as several grocery stores near the Project. The project site frontage is currently undeveloped and does not provide a continue sidewalk connection with the existing sidewalks on Etiwanda Avenue or Foothill Drive. Striped crosswalks are provided on all four approaches of the intersection of Etiwanda Avenue and Foothill Boulevard, and on the westbound, southbound, and northbound approaches of the intersection of Sacred Heart Avenue and Foothill Boulevard.

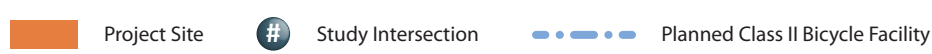
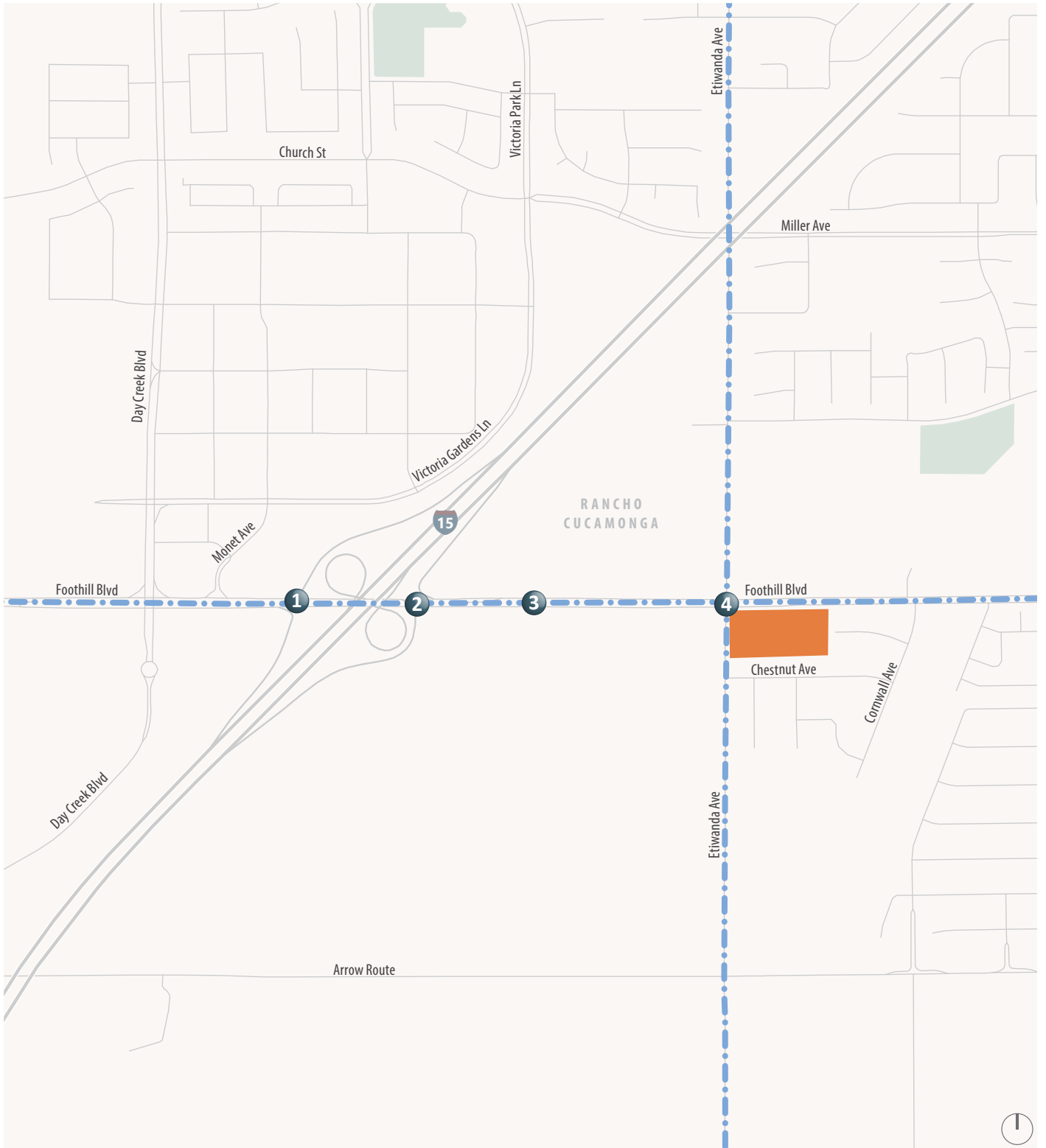

Source: City of Rancho Cucamonga General Plan.



Figure 4-1

Existing and Planned Bicycle Facilities

TRANSIT FACILITIES

The following transit facilities are provided in the City of Rancho Cucamonga:

METROLINK

Commuter train service in the City of Rancho Cucamonga is provided by Metrolink, which operates six commuter rail lines throughout Southern California. The Rancho Cucamonga Metrolink Station is located approximately three miles from the project site, west of Milliken Avenue, where passenger trains run daily from downtown Los Angeles to downtown San Bernardino. Rancho Cucamonga is served by the San Bernardino Line, which links San Bernardino to Union Station in downtown Los Angeles. The Metrolink railroad runs east-west through the southern section of the city, with grade separations at Milliken and Haven Avenues. This same rail line is occasionally used by freight trains when the Union Pacific Railroad line (running east-west south of the I-10 freeway) is closed or restricted for limited periods. Local freight train traffic in the city includes switches on various spur lines serving the industrial areas at the southern section of the city.

BUS TRANSIT

Omnitrans Transit Agency provides local transit service throughout San Bernardino County, including the City of Rancho Cucamonga. Bus transit services are available in the city through fixed-route and demand-response services. Bus routes that run through the city connect to the neighboring cities of Fontana, Upland, Ontario, Montclair, and Chino. The routes serve major destinations in the region, including Chaffey College, the Rancho Cucamonga Metrolink Station, the Fontana Metrolink Station, the Ontario Mills Mall, the LA/Ontario Airport, the Ontario Civic Center, the Pomona TransCenter, the Montclair TransCenter, the Chino Civic Center and Transit Center, and the Rancho Cucamonga Civic Center. Within Rancho Cucamonga, bus routes run on major roadways, including Haven Avenue, Day Creek Boulevard, Milliken Avenue Line Road, Foothill Boulevard, and segments of Banyan Street and Victoria Park Lane.

The transit route that operates within the study area is Route 66 on Foothill Boulevard. This route runs from the Montclair Transit Center and Fontana Metrolink Station, with stops along Foothill Boulevard in Montclair, Fontana, and Rancho Cucamonga. The route operates Monday through Friday and on weekends. Typical headways are less than 15-minutes during weekday commute hours. As of October 2020, due to the COVID-19 pandemic, schedules have been temporarily modified to have longer headways. However, this change to the transit service is considered temporary.

TRAFFIC VOLUMES AND CONFIGURATIONS

Existing (2020) peak hour traffic volumes for the study intersections are shown on **Figure 4-3**. Existing traffic counts are provided in **Appendix A**.

As part of the field inventory, Fehr & Peers also collected the following information:

- Lane configurations
- Signal phasing
- Land uses in the study area
- Existing pedestrian and bicycle facilities
- On-street parking conditions

INTERSECTION OPERATIONS

Existing traffic volumes, lane configurations, and signal timings were used to evaluate operations at the study intersections for existing AM and PM peak hour conditions. The results are summarized in **Table 4-1**, showing vehicular LOS at the study intersections. The Existing LOS report is provided in **Appendix C**.

As shown **Table 4-1**, the intersection of Etiwanda Avenue and Foothill Boulevard currently operates at a deficient LOS during the AM peak hour.

TABLE 4-1
EXISTING CONDITIONS INTERSECTION LOS

Intersection	Traffic Control	Peak Hour	Delay (sec/veh) ¹	LOS ^{2,3}
1. Southbound I-15 Ramps & Foothill Boulevard	Signalized	AM	21.3	C
		PM	20.7	C
2. Northbound I-15 Ramps & Foothill Boulevard	Signalized	AM	28.3	C
		PM	23.4	C
3. Scared Heart Place & Foothill Boulevard	Signalized	AM	25.7	C
		PM	22.0	C
4. Etiwanda Avenue & Foothill Boulevard	Signalized	AM	57.1	E
		PM	48.1	D

Notes:

1. Whole intersection weighted average stopped delay expressed in seconds per vehicle.
2. LOS calculations performed using the Highway Capacity Manual (HCM) 6th Edition method.
3. Unacceptable seconds of delay per vehicle and LOS highlighted in **bold**.

Source: Fehr & Peers, 2020

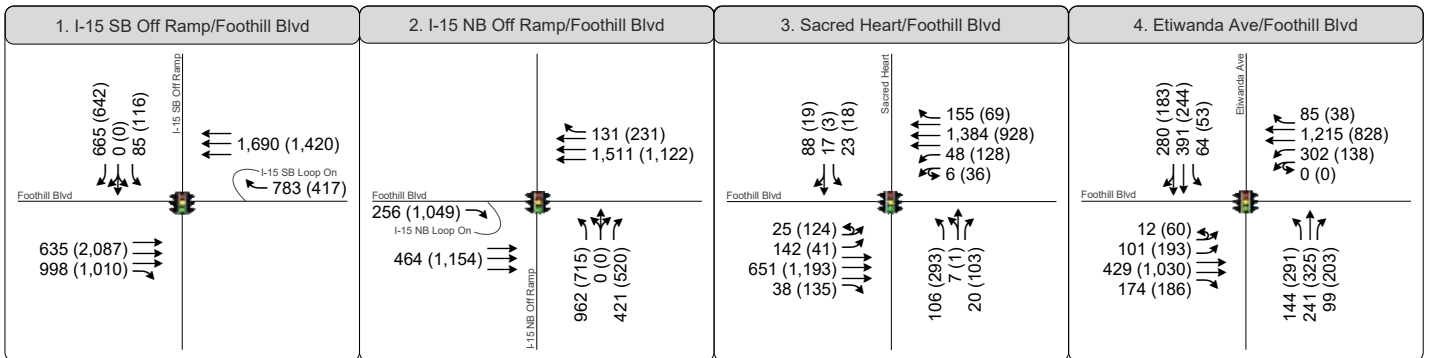
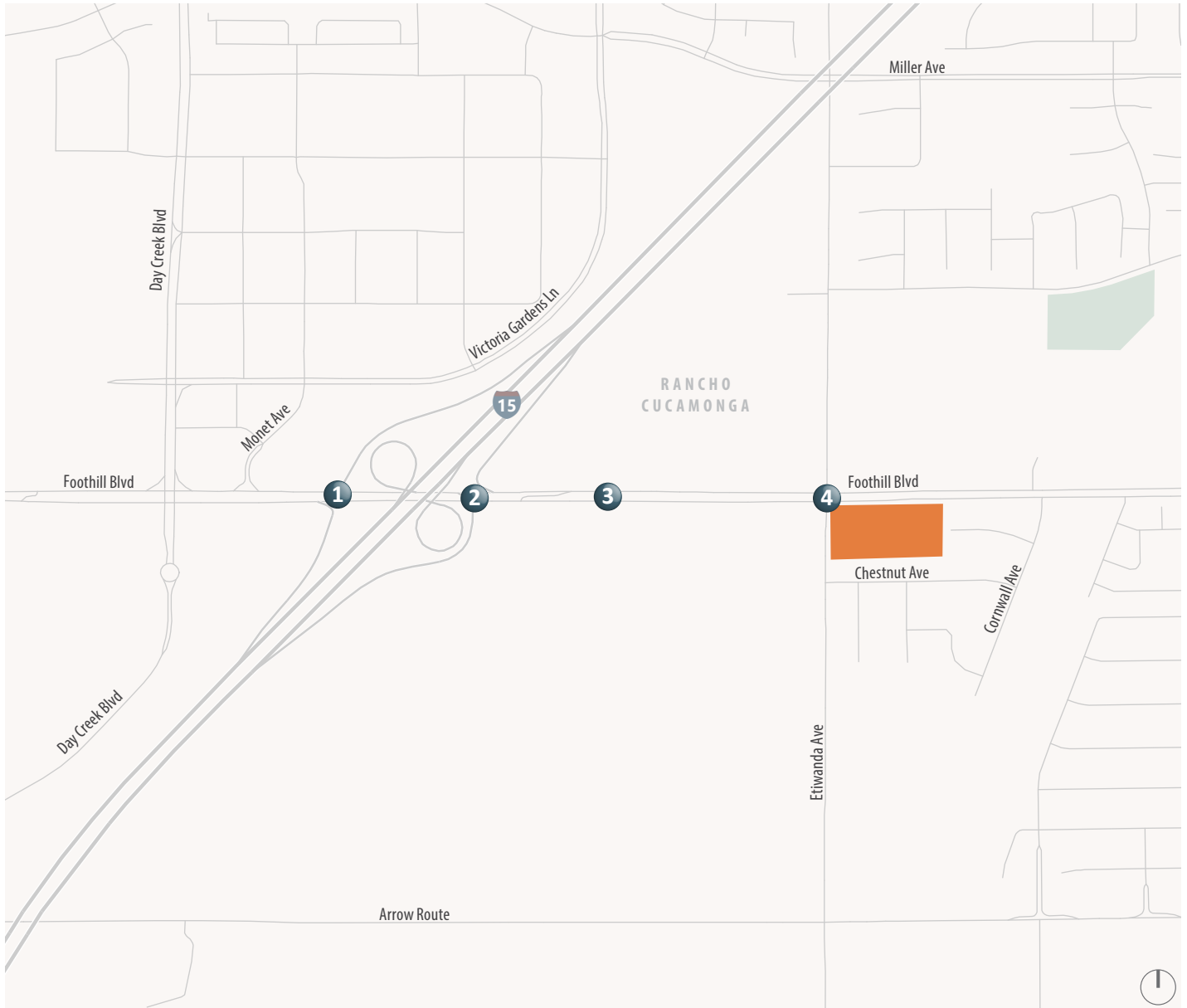

XX (YY) AM (PM) Peak Hour Traffic Volumes Signalized Intersection

Project Site Study Intersection



Figure 4-2
Existing Year (2020) Conditions
Peak Hour Traffic Volumes and Lane Configurations

5. PROJECT TRAFFIC VOLUMES

PROJECT TRIP GENERATION

Fehr & Peers used the *Trip Generation Manual, 10th Edition* (Institute of Transportation Engineers [ITE], 2017) to obtain the trip rates for calculating the approximate number of trips that the Project would generate

Table 5-1 summarizes the anticipated daily, AM, and PM peak hour of adjacent street traffic trips generated by the proposed project.

**TABLE 5-1
PROJECT TRIP GENERATION ESTIMATES**

Use	Size	Estimated Trip Generation [a], [b]						
		Daily	AM Peak Hour			PM Peak Hour		
			In	Out	Total	In	Out	Total
Multi-Family Housing (Mid Rise) ^[c]	260 Dwelling Units	1,420	24	70	94	69	45	114

Notes:

[a] Source: *Trip Generation Manual, 10th Edition (Institute of Transportation Engineers, 2017)*.

[b] Average trip rates for ITE Code 221: Daily = 5.44; AM Peak Hour = 0.36 (26% Entering, 74% Exiting), PM Peak Hour = 0.41 (60% Entering, 40% Exiting)

[c] ITE defines "mid-rise" multi-family housing as buildings or developments that are 3 to 10 stories high. The project proposes four stories of multi-family units.

PROJECT TRIP DISTRIBUTION

Fehr & Peers estimated that trips entering and exiting the Project would be distributed along the following routes:

- 30% to/from I-15 southbound
- 10% to/from I-15 northbound
- 10% on Foothill Boulevard to/from the west
- 10% on Foothill Boulevard to/from the east
- 10% on Etiwanda Avenue to/from the north
- 30% on Etiwanda Avenue to/from the south

The project trip distribution is shown on **Figure 5-1**.



PROJECT TRIP ASSIGNMENT

Based on the trip generation and trip distribution estimates developed and described above, project trips were assigned to the study area roadway network. The assignment of “project only” trips for the development is shown on **Figure 5-2** for the Opening Year Plus Project Scenario and the Cumulative Plus Project Scenario.

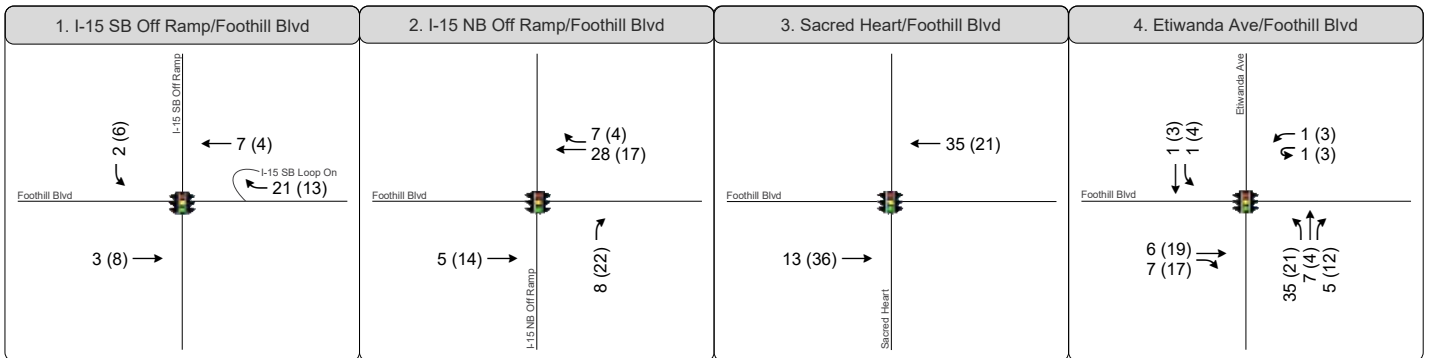
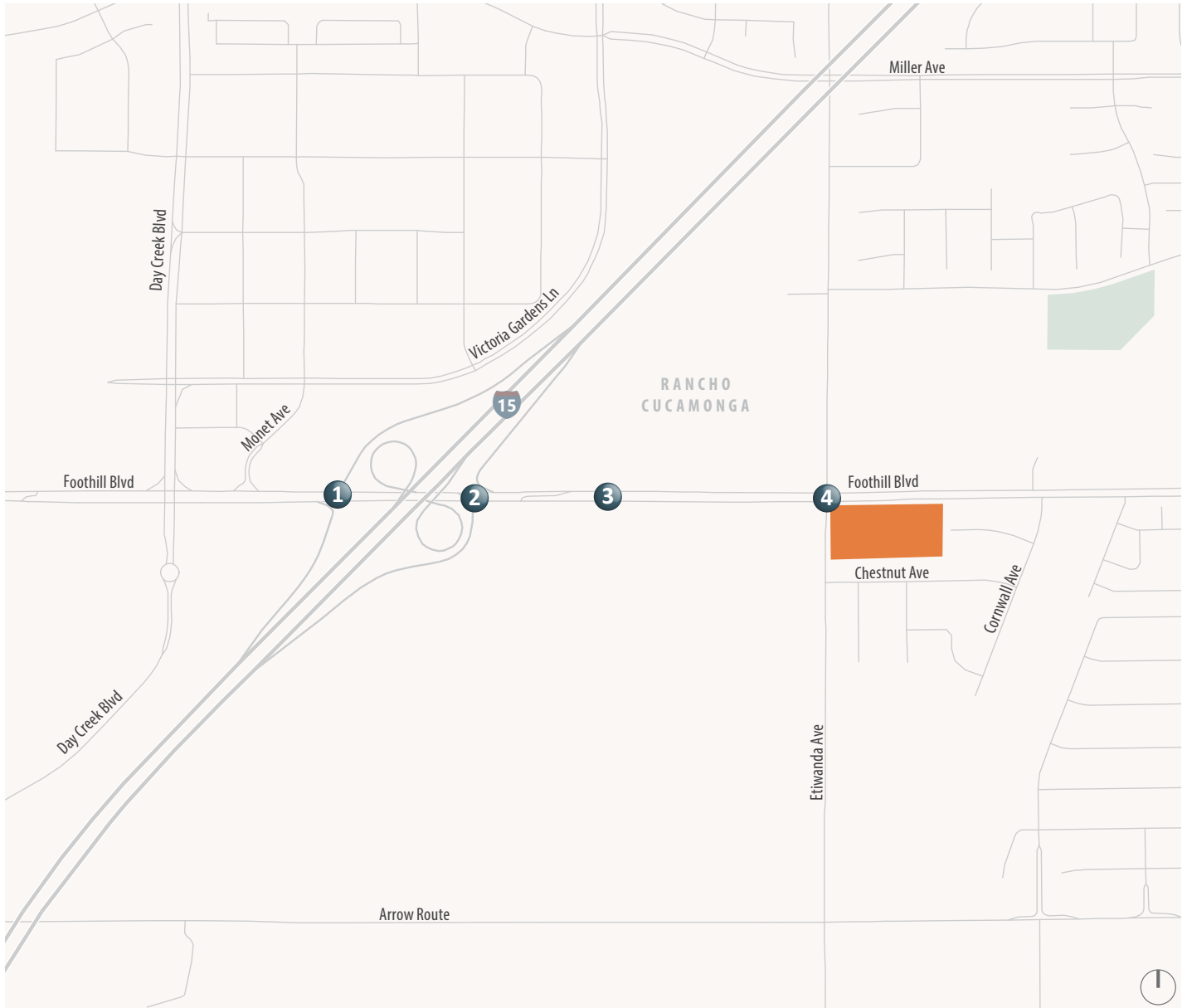

XX (YY) AM (PM) Peak Hour Traffic Volumes Signalized Intersection

Project Site Study Intersection



Figure 5-2

Project Trip Assignment



Figure 5-1



Project Trip Distribution

6. OPENING YEAR (2023) CONDITIONS

This chapter evaluates the Opening Year (2023) Conditions as outlined in Chapter 3. This scenario analyzes the conditions that are expected to be present during the Opening Year 2023.

TRAFFIC VOLUMES

As described in Chapter 3, the traffic volumes for this scenario consists of existing counts plus the addition of growth derived from SBTAM. The Opening Year (2023) Conditions traffic forecasts are shown on **Figure 6-1**. The Opening Year (2023) Plus Project Conditions traffic forecasts are shown on **Figure 6-2**.

PLANNED ROADWAY NETWORK IMPROVEMENTS

This scenario assumes a completion of the planned signal coordination along Foothill Boulevard. As a result, the intersections of Foothill Boulevard/Sacred Heart Avenue and Foothill Boulevard/Etiwanda Avenue were presumed to be coordinated in the Opening Year.

INTERSECTION OPERATIONS

The intersection LOS results are summarized in **Table 6-1** for Opening Year (2023) Conditions. The LOS report is provided in **Appendix C**.

TABLE 6-1
OPENING YEAR (2023) CONDITIONS INTERSECTION LOS

Intersection	Traffic Control	Peak Hour	No Project		Plus Project	
			Delay (sec/veh) ¹	LOS ^{2,3}	Delay (sec/veh) ¹	LOS ^{2,3}
1. Southbound I-15 Ramps & Foothill Boulevard	Signalized	AM	19.4	B	18.8	B
		PM	19.3	B	19.4	B
2. Northbound I-15 Ramps & Foothill Boulevard	Signalized	AM	28.8	C	27.3	C
		PM	23.1	C	22.4	C
3. Sacred Heart Place & Foothill Boulevard	Signalized	AM	31.0	C	38.4	D
		PM	24.7	C	25.4	C
4. Etiwanda Avenue & Foothill Boulevard	Signalized	AM	64.4	E	68.8	E
		PM	49.6	D	52.4	D

Notes:

1. Whole intersection weighted average stopped delay expressed in seconds per vehicle.
2. LOS calculations performed using the Highway Capacity Manual (HCM) 6th Edition method.
3. Unacceptable seconds of delay per vehicle and LOS highlighted in **bold**.

Source: Fehr & Peers, 2020

As shown in **Table 6-1**, the following study intersections are forecast to operate at a deficient LOS for Opening Year (2023) Conditions:

- (4) Etiwanda Avenue & Foothill Boulevard – AM Peak Hour (LOS E)

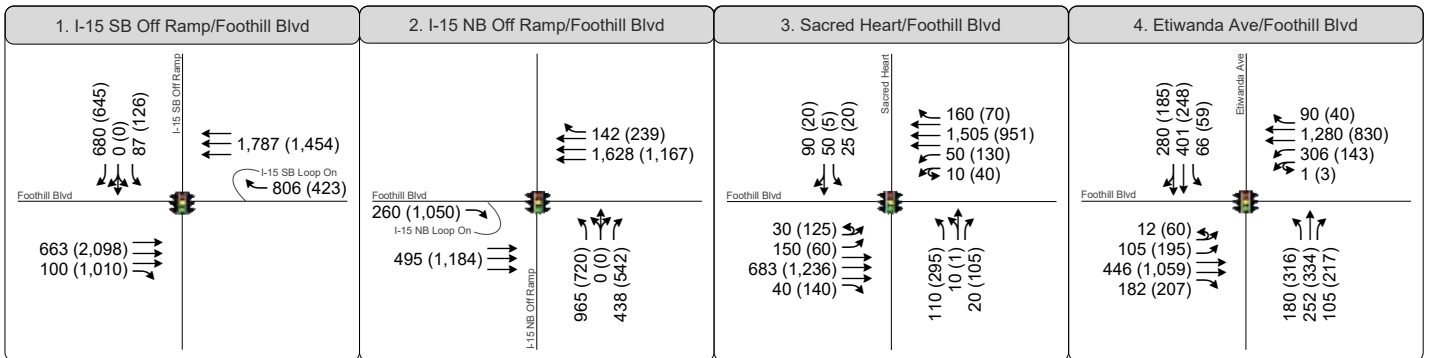
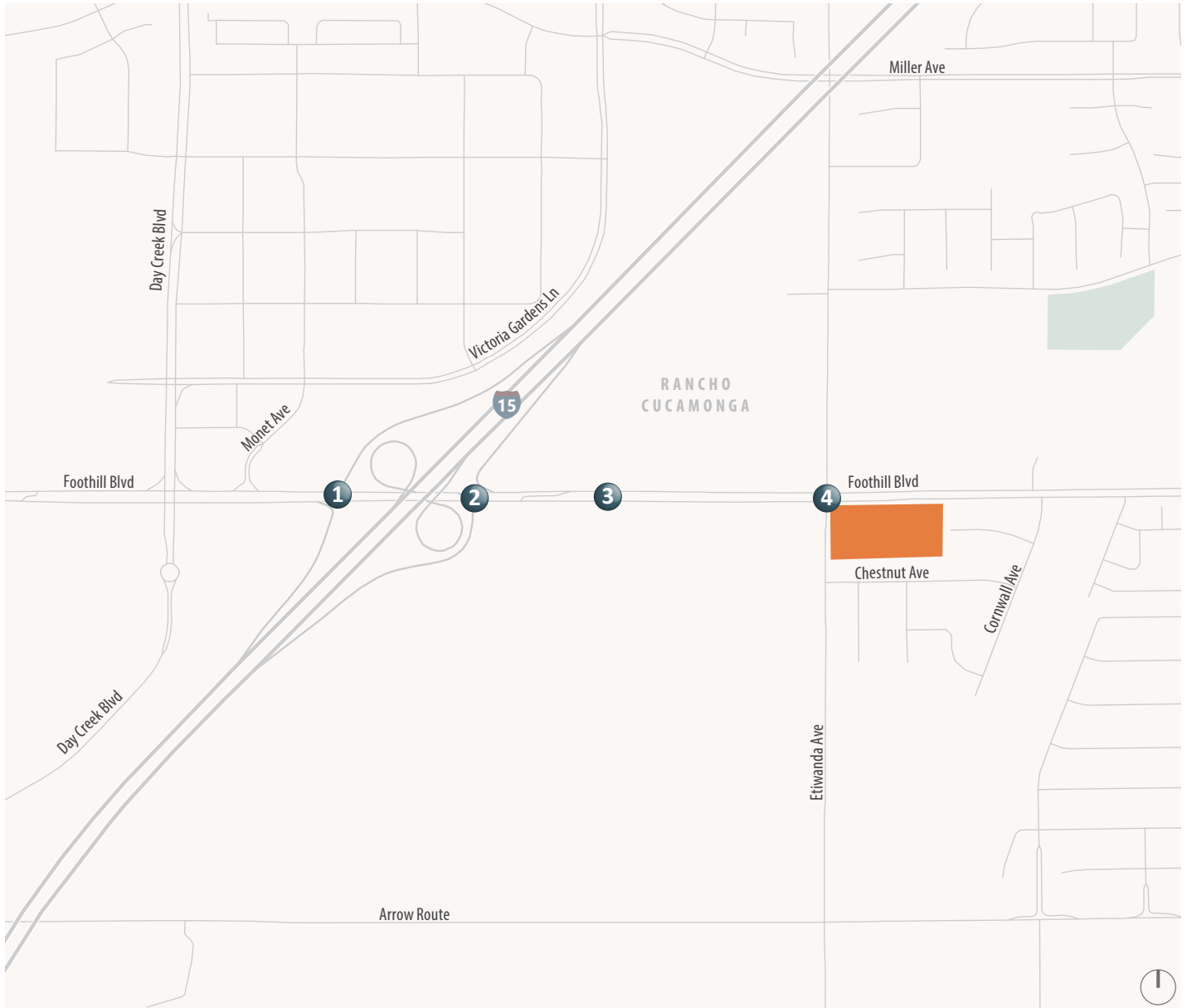

XX (YY) AM (PM) Peak Hour Traffic Volumes Signalized Intersection

Project Site Study Intersection



Figure 6-2
Opening Year (2023) Plus Project Conditions
Peak Hour Traffic Volumes and Lane Configurations

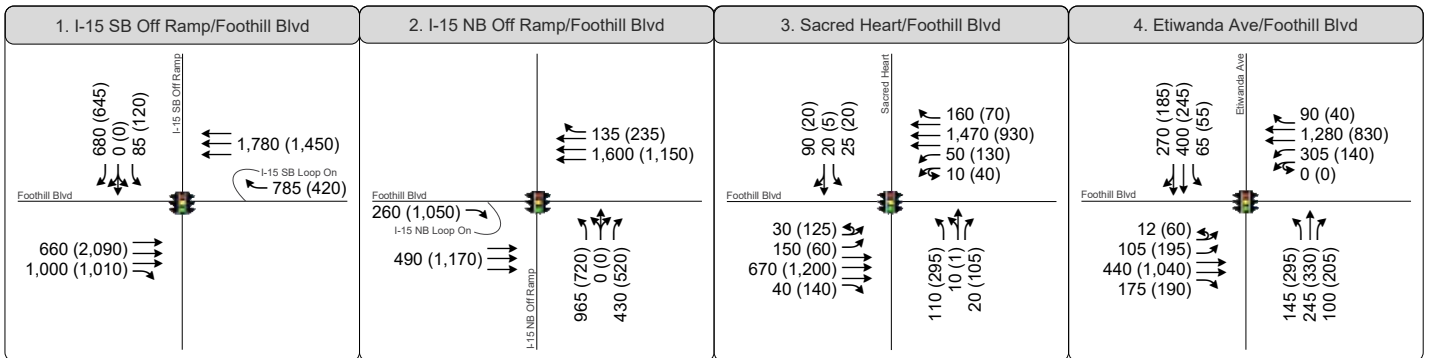
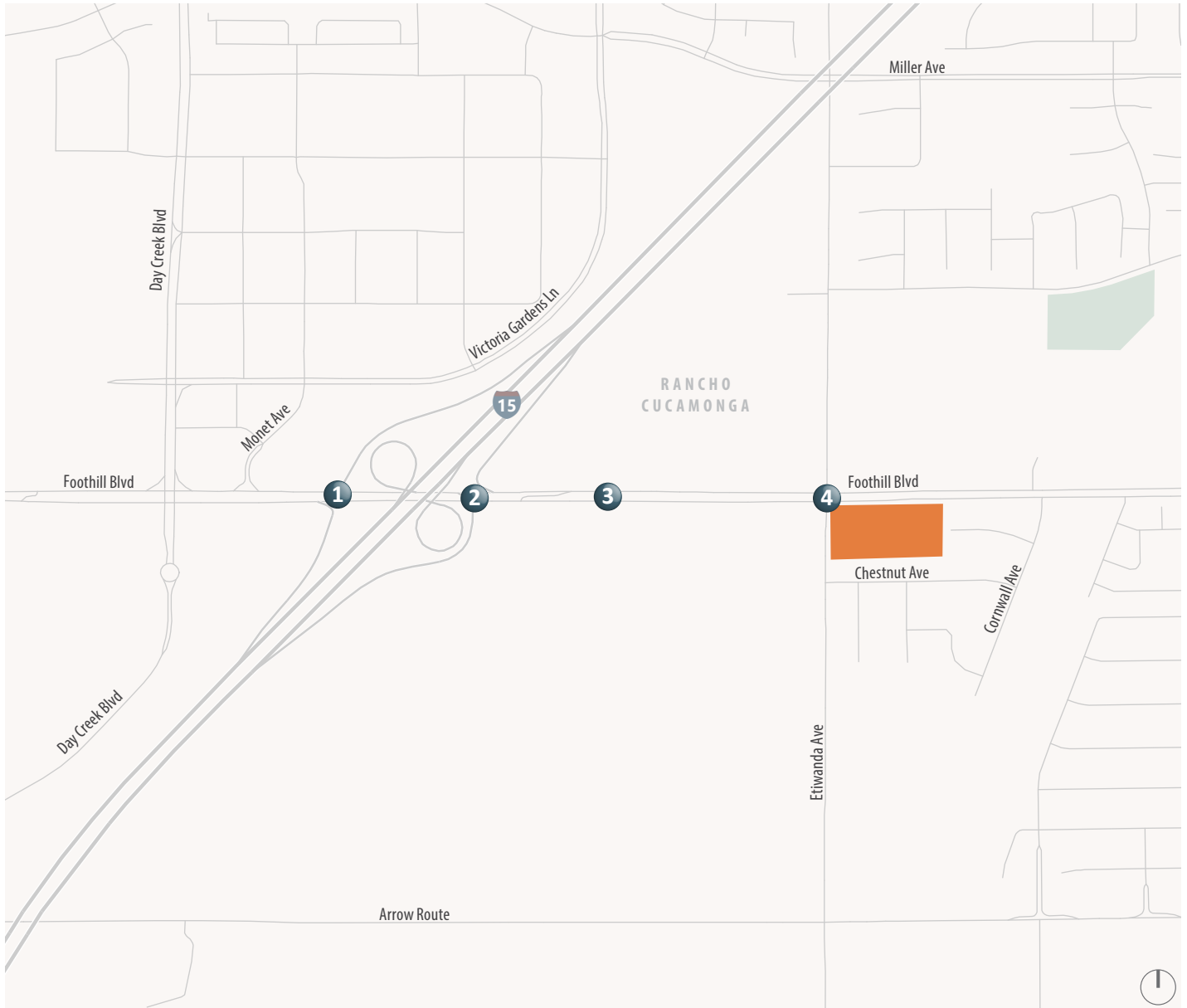

XX (YY) AM (PM) Peak Hour Traffic Volumes Signalized Intersection

Project Site Study Intersection



Figure 6-1

Opening Year (2023) Conditions Peak Hour Traffic Volumes and Lane Configurations

7. CUMULATIVE YEAR (2040) PLUS PROJECT CONDITIONS

This chapter evaluates the Cumulative Year (2040) Plus Project Conditions as outlined in Chapter 3. This scenario analyzes the conditions that are expected to be present during the Cumulative Year 2040.

TRAFFIC VOLUMES

As described in Chapter 3, the traffic volumes for this scenario consists of existing counts plus the addition of growth derived from SBTAM. The Cumulative Year (2040) Conditions traffic forecasts are shown on **Figure 7-1**.

PLANNED ROADWAY IMPROVEMENTS

This scenario assumes a completion of the planned signal coordination along Foothill Boulevard. As a result, the intersections of Foothill Boulevard/Sacred Heart Avenue and Foothill Boulevard/Etiwanda Avenue were presumed to be coordinated in the Cumulative Year.

INTERSECTION OPERATIONS

The intersection LOS results are summarized in **Table 7-1** for Cumulative Year (2040) Plus Project Conditions. The LOS report is provided in **Appendix C**.

**TABLE 7-1
CUMULATIVE YEAR (2040) CONDITIONS INTERSECTION LOS**

Intersection	Traffic Control	Peak Hour	No Project		Plus Project	
			Delay (sec/veh) ¹	LOS ^{2,3}	Delay (sec/veh) ¹	LOS ^{2,3}
1. Southbound I-15 Ramps & Foothill Boulevard	Signalized	AM	23.0	C	24.1	C
		PM	19.9	B	20.7	C
2. Northbound I-15 Ramps & Foothill Boulevard	Signalized	AM	31.5	C	32.2	C
		PM	23.5	C	23.9	C
3. Sacred Heart Place & Foothill Boulevard	Signalized	AM	32.3	C	32.5	C
		PM	32.2	C	38.6	D
4. Etiwanda Avenue & Foothill Boulevard	Signalized	AM	128.3	F	129.9	F
		PM	51.1	D	55.5	E

Notes:

1. Whole intersection weighted average stopped delay expressed in seconds per vehicle.
2. LOS calculations performed using the Highway Capacity Manual (HCM) 6th Edition method.
3. Unacceptable seconds of delay per vehicle and LOS highlighted in **bold**.

Source: Fehr & Peers, 2020

As shown in **Table 7-1**, the following study intersections are forecast to operate at a deficient LOS during one or both of the peak hours for Cumulative Year (2040) Conditions:

- Etiwanda Avenue & Foothill Boulevard

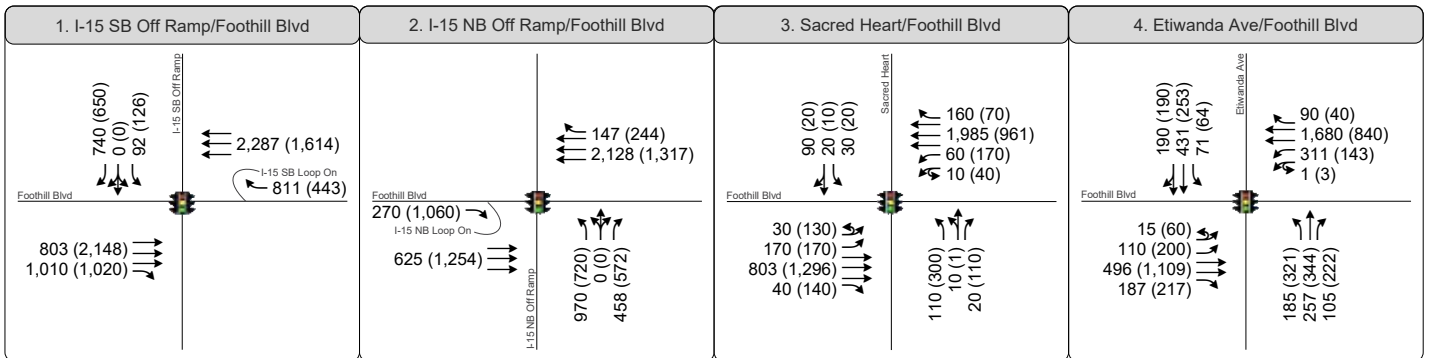
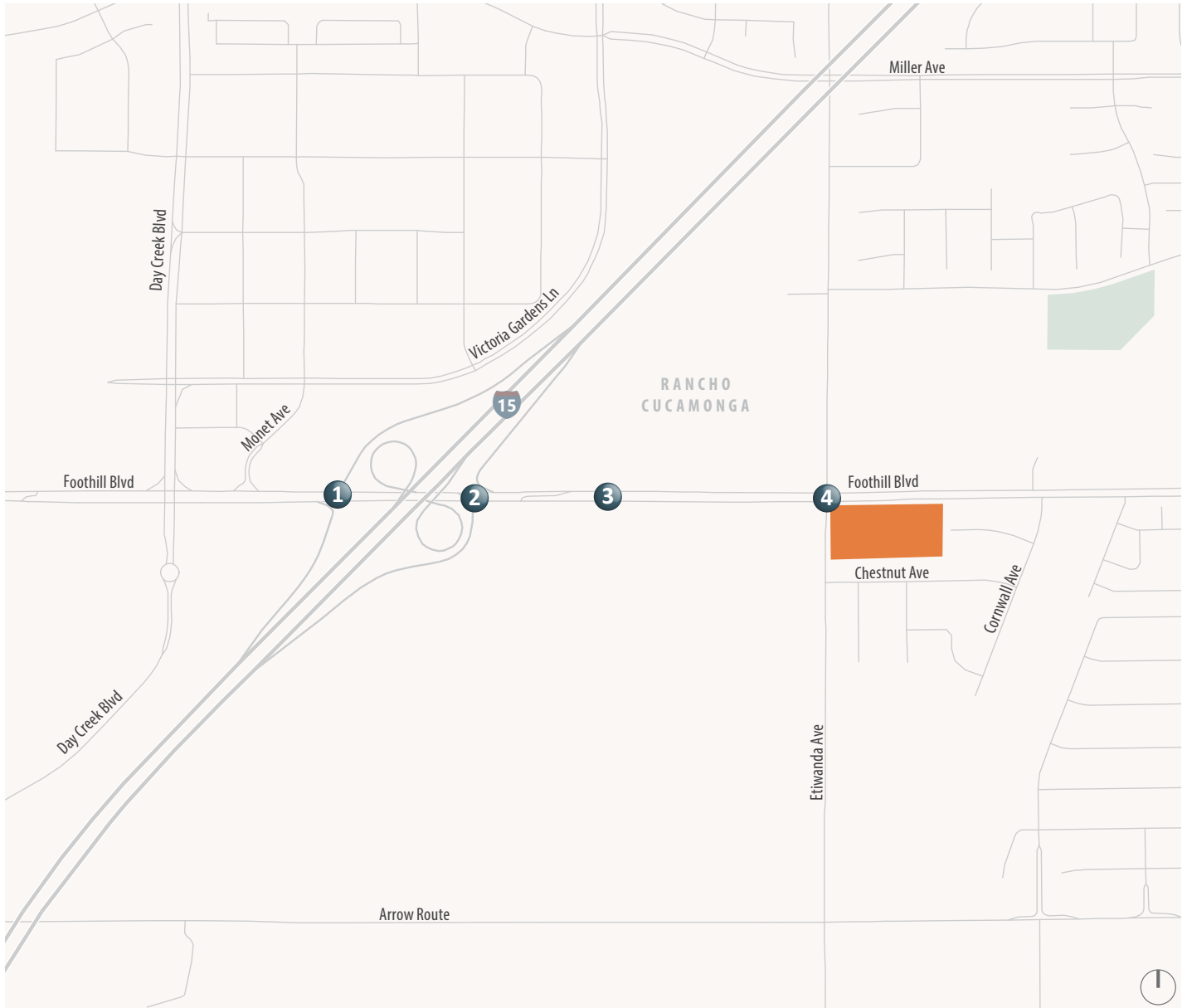

XX (YY) AM (PM) Peak Hour Traffic Volumes Signalized Intersection

Project Site Study Intersection



Figure 7-2
 Cumulative Year (2040) Plus Project Conditions
 Peak Hour Traffic Volumes and Lane Configurations

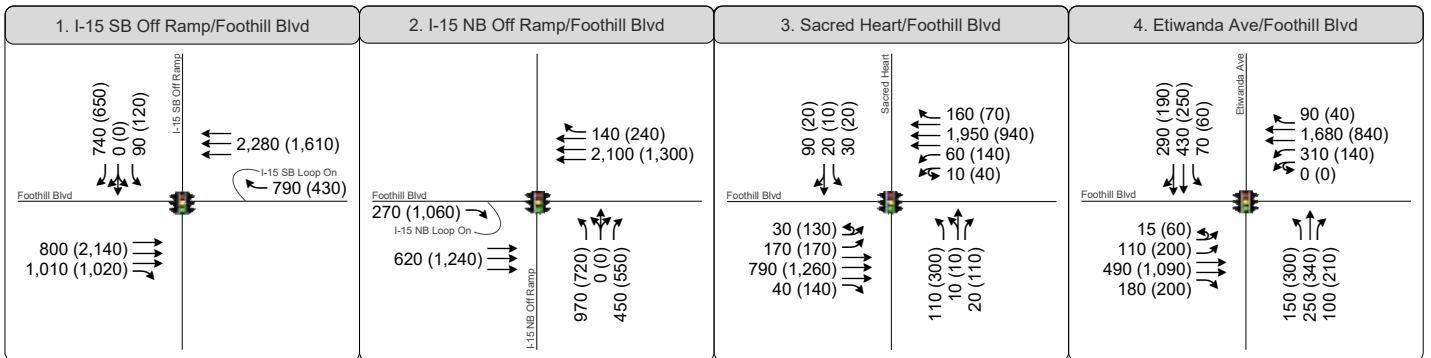
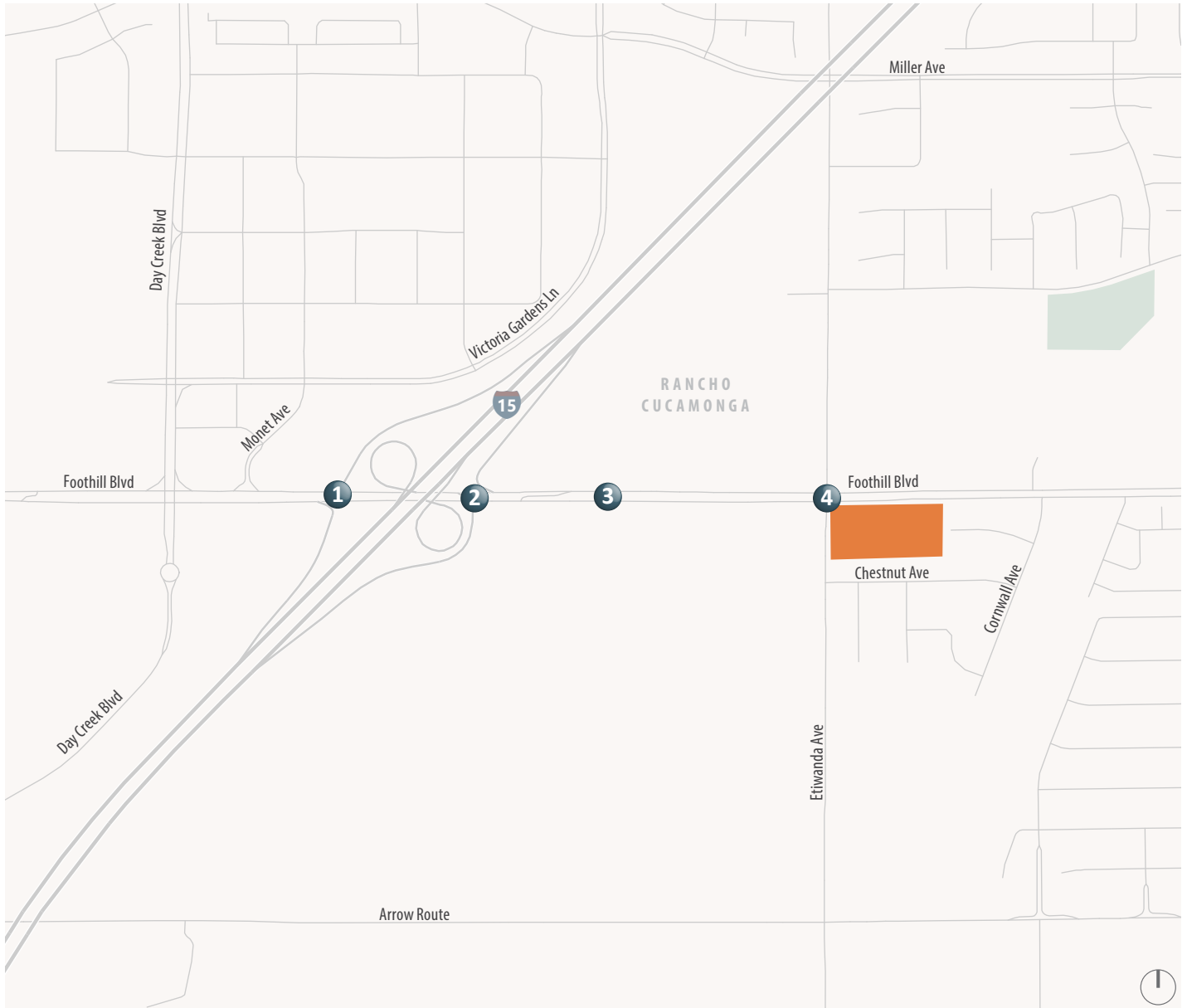

XX (YY) AM (PM) Peak Hour Traffic Volumes Signalized Intersection

Project Site Study Intersection



Figure 7-1

Cumulative Year (2040) Conditions Peak Hour Traffic Volumes and Lane Configurations

8. IMPROVEMENTS AND RECOMMENDATIONS

OPENING YEAR PLUS PROJECT INTERSECTION IMPROVEMENTS

Improvement measures were developed for significantly impacted locations to minimize the impact of the project on the study area. LOS calculation worksheets for mitigated locations are provided in **Appendix C**.

RECOMMENDED INTERSECTION IMPROVEMENTS

As shown in **Table 5-4**, the following study intersections are forecast to result in unacceptable intersection operations based on the City's LOS standards for Opening Year Plus Project Conditions:

- 4) Etiwanda Avenue & Foothill Boulevard – AM Peak Hour (LOS E)

In order for this intersection to operate acceptably with the addition of the project traffic, the following modifications will be needed:

- Modify northbound approach of the intersection from one left-turn lane, one through lane and one right-turn lane to two left-turn lanes, two through lanes, and one right-turn lane. The additional right-of-way required is accommodated by the proposed site plan along the project frontage.
- Restripe the eastbound approach from two-left turn lanes, two through lanes, and one right-turn lane to two-left turn lanes, three through lanes, and one right-turn lane. This requires no additional right-of-way, as approximately 12 feet of roadway capacity is striped adjacent to the curb on this approach.
- Optimization of coordinated splits

These improvements would result in the intersection operating with less delay than the no project condition, but the intersection would still operate at an unacceptable LOS E.

In order for this intersection to operate at an acceptable LOS D with the addition of the project traffic, the following modifications will be needed:

- Modifications described above
- Modify southbound approach of the intersection from one left-turn lane, one through lane, and one shared right-turn through right lane, to one left-turn lane, two through lanes, and one right-right turn lane. The proposed geometric changes are shown in Figure 8-1.
- Optimization of coordinated splits

The above modifications can fit within the existing right-of-way on Foothill Boulevard and will require signing and striping modifications.

INTERSECTION LOS COMPARISON

Table 7-1 below compares the delay and LOS for the Opening Year (2023), Opening Year (2023) Plus Project, and Opening Year (2023) Plus Project with the identified Improvements noted above. For all locations, the identified measures improve the intersection operations to either an acceptable LOS or pre-project conditions.

**TABLE 8-1
OPENING YEAR (2023) COMPARISON OF NO PROJECT, PLUS PROJECT, AND IMPROVED SCENARIOS**

Intersection	Peak Hour	Opening Year (2023) Conditions		Opening Year Plus Project Conditions		Opening Year Plus Improvements Conditions	
		Delay	LOS	Delay	LOS	Delay	LOS
4. Etiwanda Avenue & Foothill Boulevard	AM	64.4	E	68.8	E	45.1	D
	PM	49.6	D	52.4	D	37.5	D

Source: Fehr & Peers 2020

CUMULATIVE YEAR (2040) PLUS PROJECT INTERSECTION IMPROVEMENTS

RECOMMENDED INTERSECTION IMPROVEMENTS

As also shown in **Table 7-4**, the following study intersections are forecast to result in unacceptable intersection operations based on the City's LOS standards for Cumulative Year (2040) Plus Project Conditions:

- 4) Etiwanda Avenue & Foothill Boulevard – AM Peak Hour (LOS F), PM Peak Hour (LOS E)

Since the deficiency identified is cumulative in nature, the project would be responsible for a fair share contribution toward the improvements. In order for this intersection to operate better than no project conditions with the addition of the project traffic, the following modifications will be needed:

- Modify northbound approach of the intersection from one left-turn lane, one through lane and one right-turn lane to two left-turn lanes, two through lanes, and one right-turn lane. The additional right-of-way required is accommodated by the proposed site plan along the project frontage.
- Restripe the eastbound approach from two-left turn lanes, two through lanes, and one right-turn lane to two-left turn lanes, three through lanes, and one right-turn lane. This requires no additional

right-of-way, as approximately 12 feet of roadway capacity is striped adjacent to the curb on this approach.

- Optimization of coordinated splits.

These improvements would result in the intersection operating with less delay than the no project condition, but the intersection would still operate at an unacceptable LOS F.

In order for this intersection to operate at an acceptable LOS D with the addition of the project traffic, the following modifications will be needed:

- Modifications described above
- Modify the westbound approach of the intersection from two left-turn lanes, two through, and one right-turn lane to two left-turn lanes, three through lanes and one right-turn lane. The proposed geometric changes are shown in Figure 8-1.
- Optimization of coordinated splits

With these recommended improvements, operations are forecast to operate at an acceptable LOS during the AM and PM peak hours.

The project would be responsible a fair-share contribution of 2% for the improvements described above based on the *City of Rancho Cucamonga TIA Guidelines*.

INTERSECTION LOS COMPARISON

Table 7-2 below compares the delay and LOS for the Cumulative Year (2040), Cumulative Year (2040) Plus Project, and Cumulative Year (2040) Plus Project with Improvements scenarios. The identified measures improve the intersection operations to acceptable operations.

**TABLE 8-2
CUMULATIVE YEAR (2040) COMPARISON OF NO PROJECT, PLUS PROJECT, AND IMPROVED SCENARIOS**

Intersection	Peak Hour	Cumulative Year (2040)		Cumulative Year (2040) Plus Project		Cumulative Year (2040) Plus Project with Improvements	
		Delay	LOS ^{2,3}	Delay	LOS ^{2,3}	Delay	LOS ^{2,3}
4. Etiwanda Avenue & Foothill Boulevard	AM	128.3	F	129.9	F	47.0	D
	PM	51.1	D	55.5	E	39.3	D

Source: Fehr & Peers, 2020

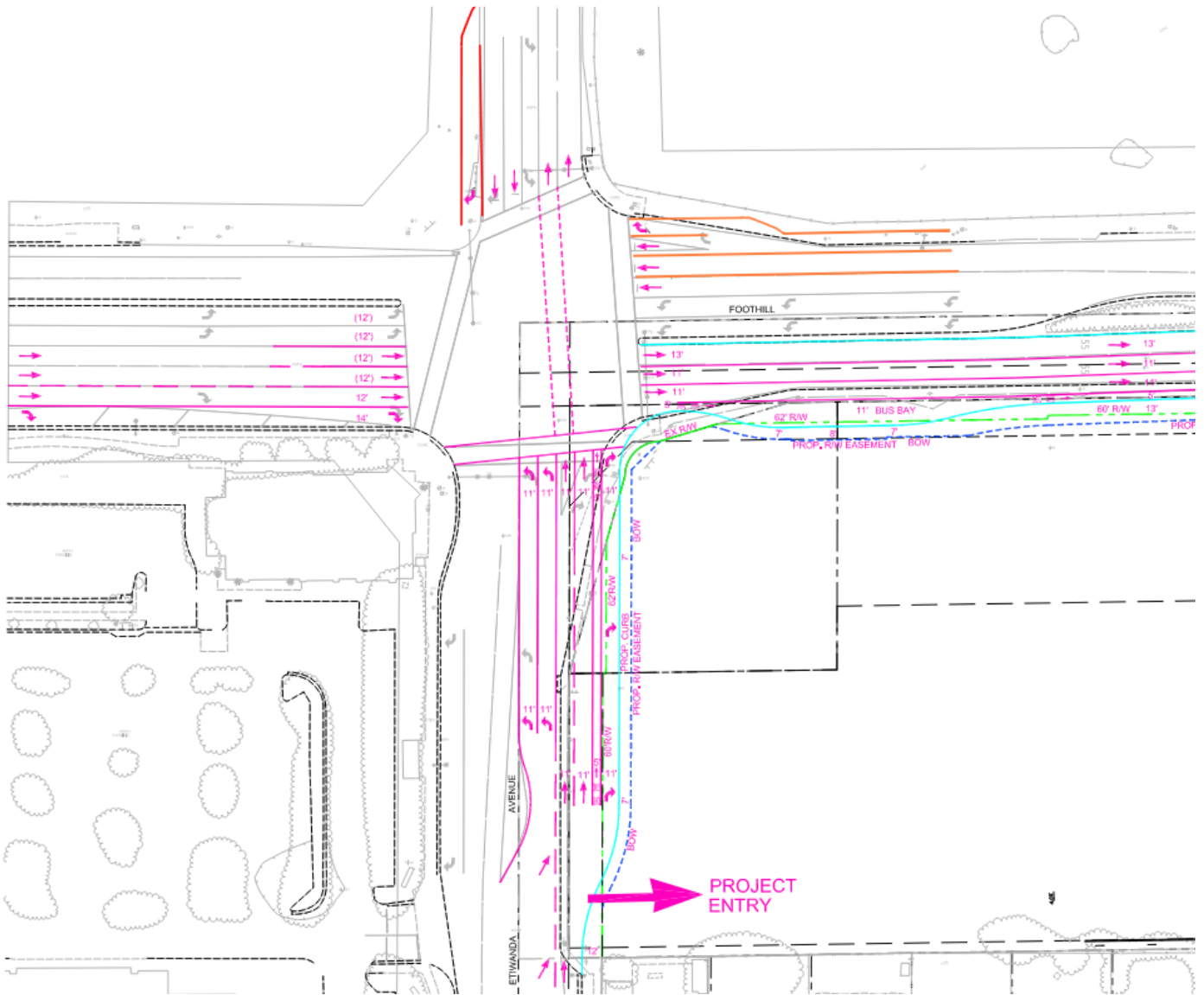

- Proposed Geometric Changes which provide better operations than No Project Conditions
- Proposed Geometric Changes which provide acceptable operations in the Opening Year
- Proposed Geometric Change which provide acceptable operations in the Cumulative Year



Figure 8-1

Proposed Geometric Changes to Etiwanda Avenue and Foothill Boulevard

9. ACTIVE TRANSPORTATION AND PUBLIC TRANSIT ANALYSIS

Per the recently adopted *City of Rancho Cucamonga Transportation Impact Analysis Guidelines* a significant impact occurs if the project conflicts with adopted policies, plans, or programs regarding public transit, bicycle, or pedestrian facilities, or otherwise decreases the performance or safety of such facilities.

As noted in Chapter 3, Foothill Boulevard and Etiwanda Avenue are both designated as streets with Class II facilities, however neither currently have a bike facility within the project vicinity. Similarly, sidewalk is not present on Etiwanda Avenue and Foothill Boulevard along the project frontage. As shown in the project site plan, the projects frontage on Etiwanda Avenue and Foothill Boulevard will be designed to accommodate bicycle lanes and sidewalks. The bicycle lanes on Etiwanda Avenue and Foothill Boulevard along the project frontage will each be 5 feet wide and will striped as a Class II bike facility without a buffer. The proposed width between Etiwanda Avenue and the property line is 7 feet, and on Foothill Boulevard the proposed width between the curb and property line varies from 7 feet to 13 feet wide. This would provide sufficient width for sidewalk on the project frontage.

The project will not conflict with existing facilities and will construct frontage improvements consistent with planned facilities and the City's design standards.

Omnitrans Route 66 runs along Foothill Boulevard, with bus stops on both sides of Foothill Boulevard within 1,000 feet of the project site. The project is not expected to conflict with the existing bus stops or bus route. The project proposes to construct an 11' wide and 62' long bus bay on Foothill Boulevard on the project frontage, to accommodate Route 66 and other potential future bus service. The proposed width between the curb and the property line is 8 feet long the length of the bus bay.

The proposed project is not expected to conflict with adopted policies, plans, or programs regarding public transit, bicycle, or pedestrian facilities, or otherwise decreases the performance or safety of such facilities, and therefore is considered to have a less-than-significant impact of active transportation and public transit.

10. VEHICLE MILES TRAVELED (VMT) ANALYSIS

Per the recently adopted *City of Rancho Cucamonga Transportation Impact Analysis Guidelines*, projects can be presumed to have a less-than-significant impact on VMT if the project is located within a Transit Priority Area (TPA). The project site is located within 0.5 miles of a stop on the Omnitrans Route 66 alignment which provides 15-minute headways along Foothill Boulevard during commute periods. Due to the 15-minute headways, Foothill Boulevard is classified as a high-quality transit corridor, and the Project is located within a TPA. A screenshot from the SBCTA VMT screening tool is provided below for additional reference, with the project site outlined in red.

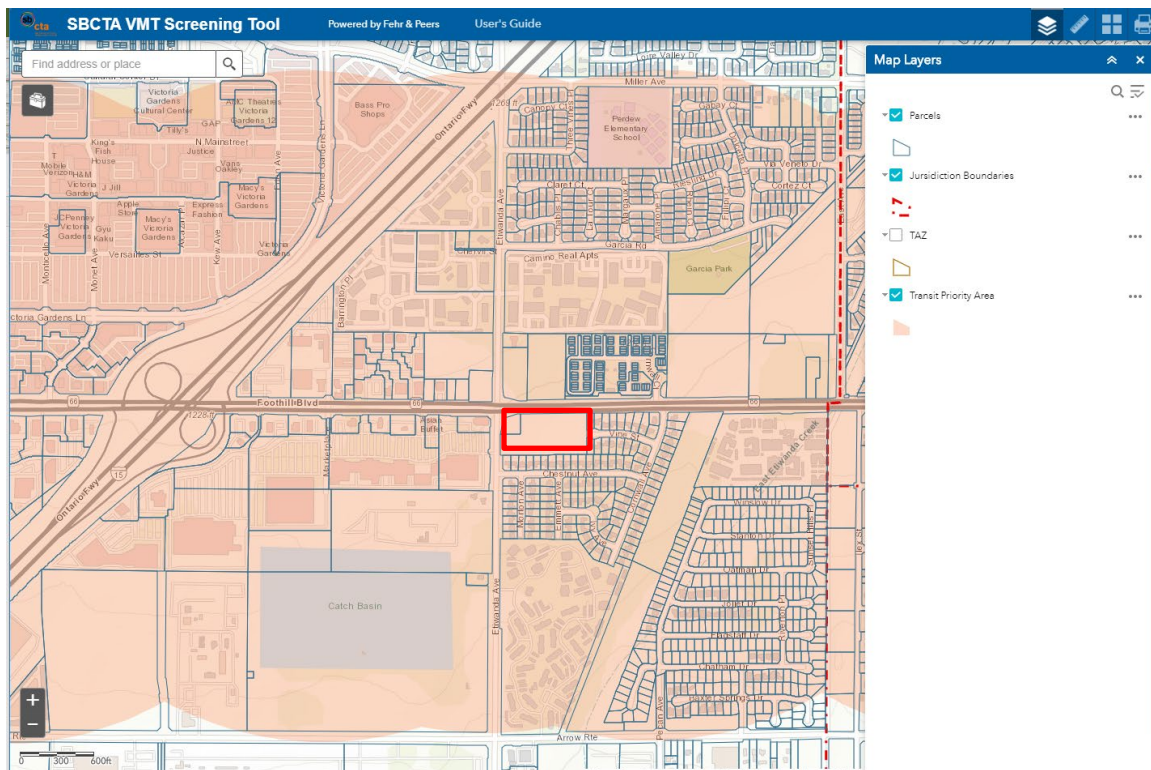

Projects can be presumed less-than-significant and screened from further VMT analysis when it meets the requirements outlined in the City's guidelines for TPA screening. The project's ability to be screened from VMT assessment is summarized below in Table 10-1.

**TABLE 10-1
VMT TRANSIT PRIORITY AREA SCREENING CRITERIA**

Criteria	Rancho Cuvee Eligibility
Project is located within a half mile of high-quality transit	Project is within a half mile of Omnitrans Route 66 alignment which provides 15-minute headways along Foothill Boulevard during commute periods
Project has a minimum FAR of 0.75	Project has a FAR of greater than 1.0. FAR was calculated by the following formula: (Total usable square footage of the proposed building/Total land area of project parcels). The project site is 5.2 acres and proposes a building with 228,000 square feet (or 5.23 acres) of rentable area. This results in a FAR of just over 1.0.
Project shall not supply more parking than is required by the City code	Project proposes to park the site at City code requirements.
Project is consistent with the RTP/SCS land use assumptions	The land use growth assumed in the RTP/SCS includes an increase in multi-family housing units in the project location greater than the number of multi-family housing units proposed, which indicates the project is consistent with the RTP/SCS.
Project does not replace affordable housing with market-rate housing units	There are no existing affordable housing units on the Project site which would be replaced

Source: Fehr & Peers, 2020

This project meets all of requirements of screening under a TPA and can be presumed to have a less-than-significant transportation impact. No further VMT analysis will be performed as part of this assessment.



APPENDIX A: TRAFFIC COUNTS



INTERSECTION TURNING MOVEMENT COUNTS

PREPARED BY: AimTD LLC. tel: 714 253 7888 cs@aimtd.com

DATE: Tue, Feb 26, 19	LOCATION: NORTH & SOUTH: EAST & WEST:	Rancho Cucamonga I-15 SB Ramps Foothill	PROJECT #: SC2042	LOCATION #: 20	CONTROL: SIGNAL
---------------------------------	--	---	-----------------------------	--------------------------	---------------------------

NOTES:	AM	▲ N E ▶
	PM	
	MD	
	OTHER	



LANES:	NORTHBOUND I-15 SB Ramps			SOUTHBOUND I-15 SB Ramps			EASTBOUND Foothill			WESTBOUND Foothill			TOTAL
	NL X	NT X	NR X	SL 1.5	ST X	SR 1.5	EL X	ET 3	ER 1	WL X	WT 3	WR 1	

U-TURNS				
NB	SB	EB	WB	TTL

AM	7:00 AM	0	0	0	13	0	111	0	93	254	0	329	197	997	0	0	0	0	0
	7:15 AM	0	0	0	14	0	146	0	119	260	0	406	190	1,135	0	0	0	0	0
	7:30 AM	0	0	0	18	0	164	0	156	258	0	433	204	1,233	0	0	0	0	0
	7:45 AM	0	0	0	26	0	183	0	163	234	0	429	173	1,208	0	0	0	0	0
	8:00 AM	0	0	0	21	0	159	0	157	226	0	389	201	1,153	0	0	0	0	0
	8:15 AM	0	0	0	17	0	156	0	149	222	0	392	195	1,131	0	0	0	0	0
	8:30 AM	0	0	0	27	0	178	0	123	209	0	334	151	1,022	0	0	0	0	0
	8:45 AM	0	0	0	24	0	186	0	135	191	0	340	134	1,010	0	0	0	0	0
	VOLUMES	0	0	0	160	0	1,283	0	1,095	1,854	0	3,052	1,445	8,889	0	0	0	0	0
	APPROACH %	0%	0%	0%	11%	0%	89%	0%	37%	63%	0%	68%	32%						
APP/DEPART	0	/	1,445	1,443	/	1,854	2,949	/	1,255	4,497	/	4,335	0						
BEGIN PEAK HR	7:15 AM																		
VOLUMES	0	0	0	79	0	652	0	595	978	0	1,657	768	4,729						
APPROACH %	0%	0%	0%	11%	0%	89%	0%	38%	62%	0%	68%	32%							
PEAK HR FACTOR	0.000			0.874			0.950			0.952			0.959						
APP/DEPART	0	/	768	731	/	978	1,573	/	674	2,425	/	2,309	0						
MIDDAY	12:00 PM	0	0	0	34	0	126	0	285	229	0	368	129	1,171	0	0	0	0	0
	12:15 PM	0	0	0	32	0	143	0	272	266	0	402	114	1,229	0	0	0	0	0
	12:30 PM	0	0	0	30	0	132	0	316	235	0	388	101	1,202	0	0	0	0	0
	12:45 PM	0	0	0	35	0	139	0	310	243	0	408	118	1,253	0	0	0	0	0
	1:00 PM	0	0	0	28	0	117	0	339	264	0	347	106	1,201	0	0	0	0	0
	1:15 PM	0	0	0	28	0	129	0	279	252	0	346	110	1,144	0	0	0	0	0
	1:30 PM	0	0	0	29	0	141	0	318	259	0	311	114	1,172	0	0	0	0	0
	1:45 PM	0	0	0	26	0	120	0	301	234	0	305	108	1,094	0	0	0	0	0
	VOLUMES	0	0	0	242	0	1,047	0	2,420	1,982	0	2,875	900	9,466	0	0	0	0	0
	APPROACH %	0%	0%	0%	19%	0%	81%	0%	55%	45%	0%	76%	24%						
APP/DEPART	0	/	900	1,289	/	1,982	4,402	/	2,662	3,775	/	3,922	0						
BEGIN PEAK HR	12:15 PM																		
VOLUMES	0	0	0	125	0	531	0	1,237	1,008	0	1,545	439	4,885						
APPROACH %	0%	0%	0%	19%	0%	81%	0%	55%	45%	0%	78%	22%							
PEAK HR FACTOR	0.000			0.937			0.931			0.943			0.975						
APP/DEPART	0	/	439	656	/	1,008	2,245	/	1,362	1,984	/	2,076	0						
PM	5:00 PM	0	0	0	36	0	166	0	549	258	0	313	99	1,421	0	0	0	0	0
	5:15 PM	0	0	0	35	0	143	0	515	231	0	333	109	1,366	0	0	0	0	0
	5:30 PM	0	0	0	24	0	155	0	533	268	0	371	81	1,432	0	0	0	0	0
	5:45 PM	0	0	0	19	0	165	0	449	233	0	333	107	1,306	0	0	0	0	0
	6:00 PM	0	0	0	28	0	143	0	484	240	0	366	105	1,366	0	0	0	0	0
	6:15 PM	0	0	0	30	0	133	0	499	249	0	335	100	1,346	0	0	0	0	0
	6:30 PM	0	0	0	30	0	104	0	468	240	0	339	95	1,276	0	0	0	0	0
	6:45 PM	0	0	0	28	0	119	0	384	231	0	324	110	1,196	0	0	0	0	0
	VOLUMES	0	0	0	230	0	1,128	0	3,881	1,950	0	2,714	806	10,709	0	0	0	0	0
	APPROACH %	0%	0%	0%	17%	0%	83%	0%	67%	33%	0%	77%	23%						
APP/DEPART	0	/	806	1,358	/	1,950	5,831	/	4,111	3,520	/	3,842	0						
BEGIN PEAK HR	5:00 PM																		
VOLUMES	0	0	0	114	0	629	0	2,046	990	0	1,350	396	5,525						
APPROACH %	0%	0%	0%	15%	0%	85%	0%	67%	33%	0%	77%	23%							
PEAK HR FACTOR	0.000			0.920			0.941			0.966			0.965						
APP/DEPART	0	/	396	743	/	990	3,036	/	2,160	1,746	/	1,979	0						

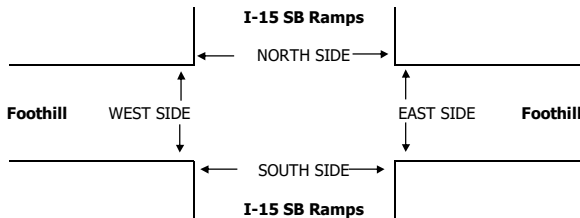

	AM	MIDDAY	PM	PEDESTRIAN + BIKE CROSSINGS				
				N SIDE	S SIDE	E SIDE	W SIDE	TOTAL

	AM	MIDDAY	PM	PEDESTRIAN CROSSINGS				
				N SIDE	S SIDE	E SIDE	W SIDE	TOTAL

	AM	MIDDAY	PM	BICYCLE CROSSINGS				
				NS	SS	ES	WS	TOTAL

	AM	MIDDAY	PM	PEDESTRIAN + BIKE CROSSINGS				
				N SIDE	S SIDE	E SIDE	W SIDE	TOTAL

AimTD LLC
TURNING MOVEMENT COUNTS

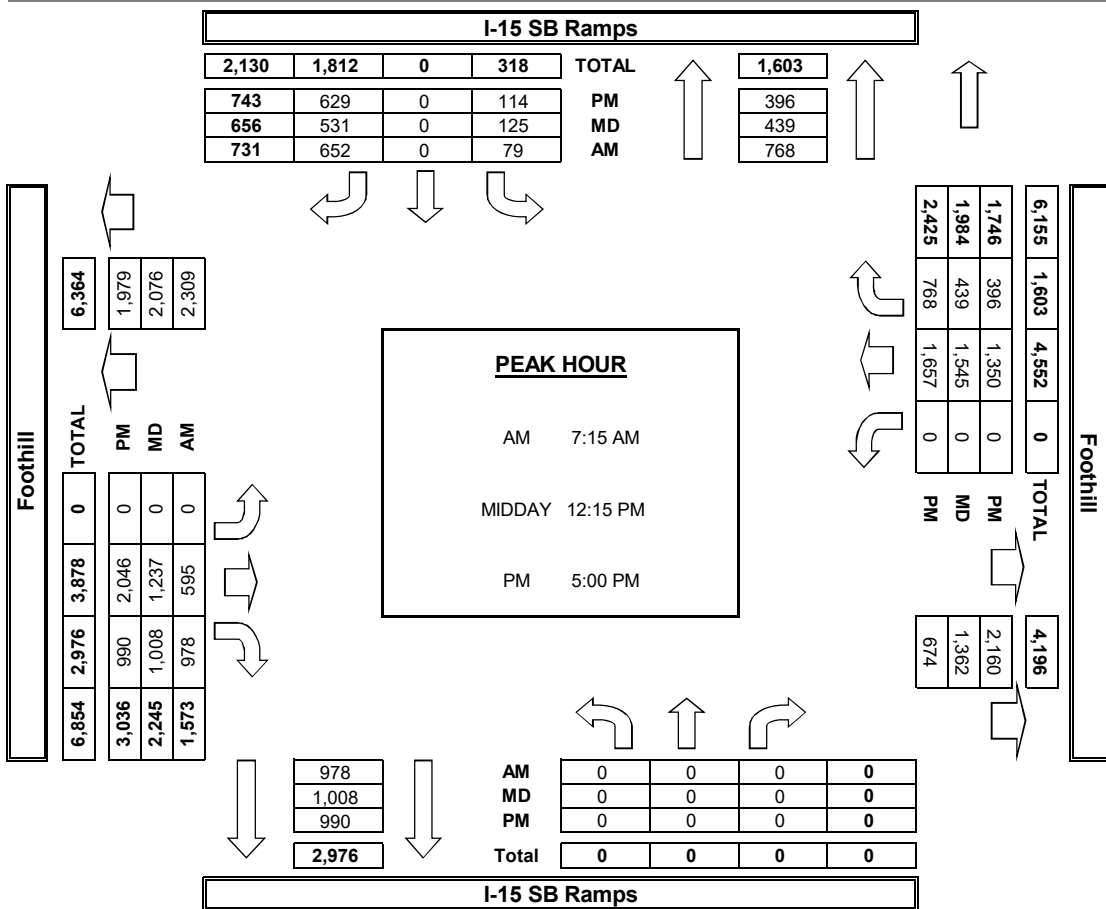
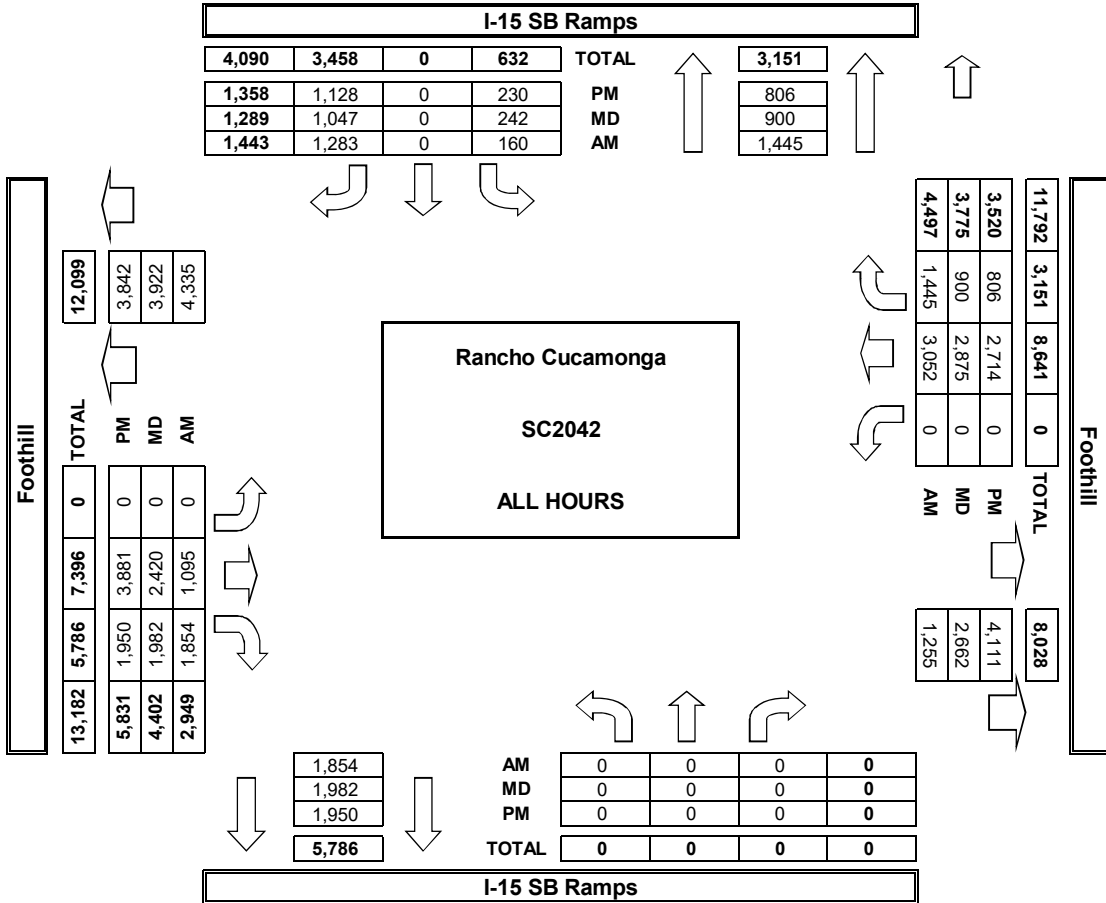

INTERSECTION TURNING MOVEMENT COUNTS

PREPARED BY: AimTD LLC. tel: 714 253 7888 cs@aimtd.com

DATE: Tue, Feb 26, 19
LOCATION: NORTH & SOUTH: Rancho Cucamonga, I-15 NB Ramps; EAST & WEST: Foothill
PROJECT #: SC2042; LOCATION #: 21; CONTROL: SIGNAL

NOTES:
AM PM MD OTHER OTHER
N W E S



Main traffic volume table with columns for Northbound, Southbound, Eastbound, Westbound, and U-Turns. Rows include time intervals (7:00 AM to 7:15 PM), VOLUMES, APPROACH %, APP/DEPART, and BEGIN PEAK HR for AM, MIDDAY, and PM periods.

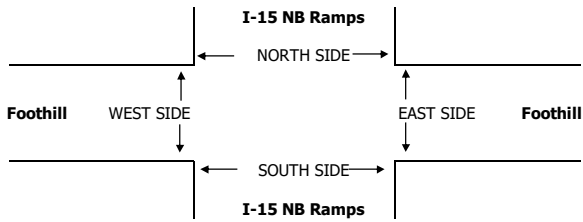

Time period labels: AM, MIDDAY, PM

PEDESTRIAN + BIKE CROSSINGS table with columns N SIDE, S SIDE, E SIDE, W SIDE, TOTAL

PEDESTRIAN CROSSINGS table with columns N SIDE, S SIDE, E SIDE, W SIDE, TOTAL

BICYCLE CROSSINGS table with columns NS, SS, ES, WS, TOTAL

AimTD LLC
TURNING MOVEMENT COUNTS

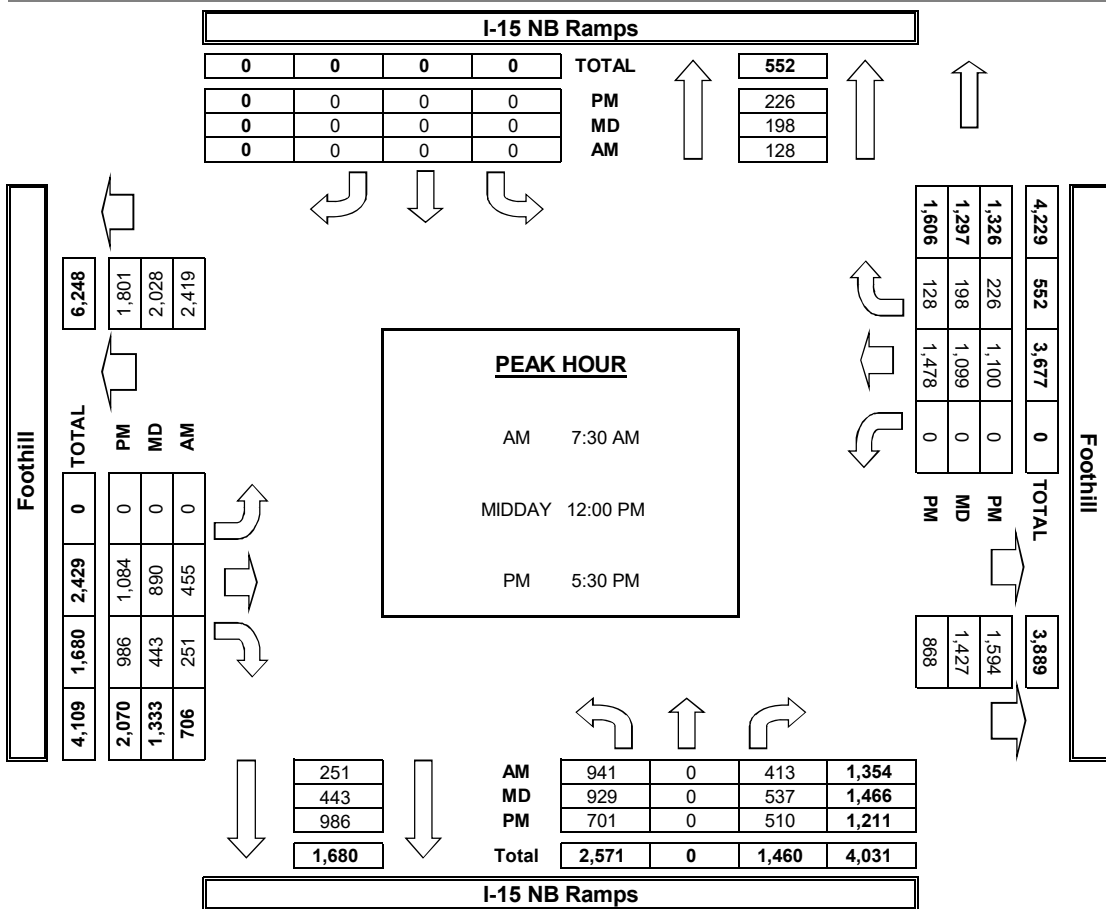
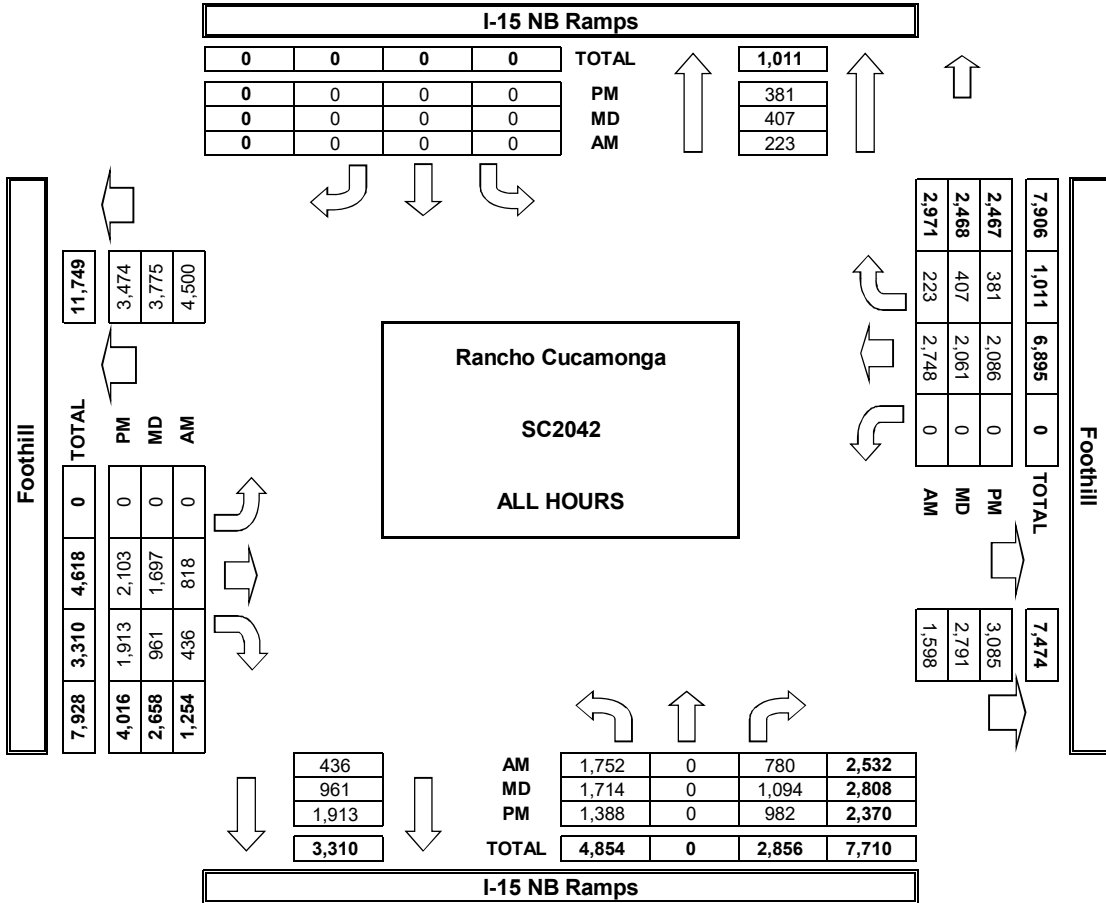

AimTD LLC
TURNING MOVEMENT COUNTS

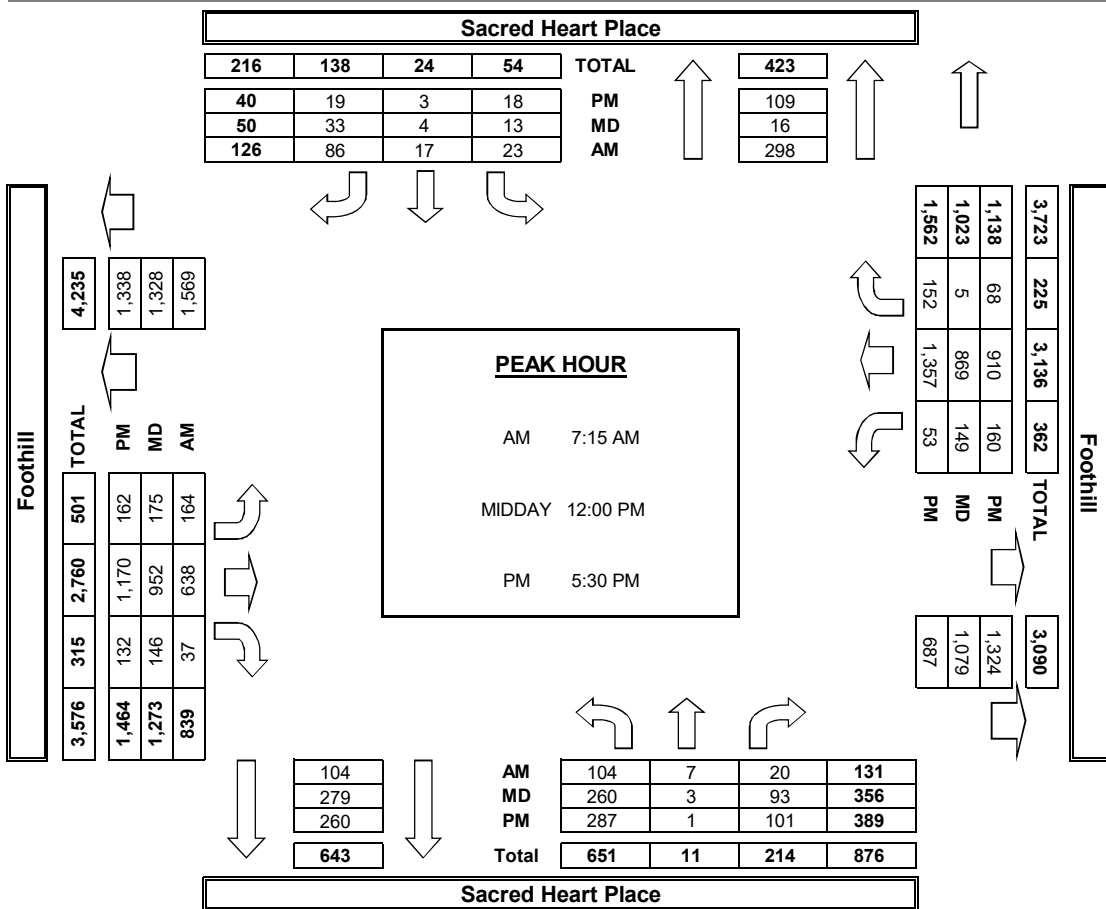
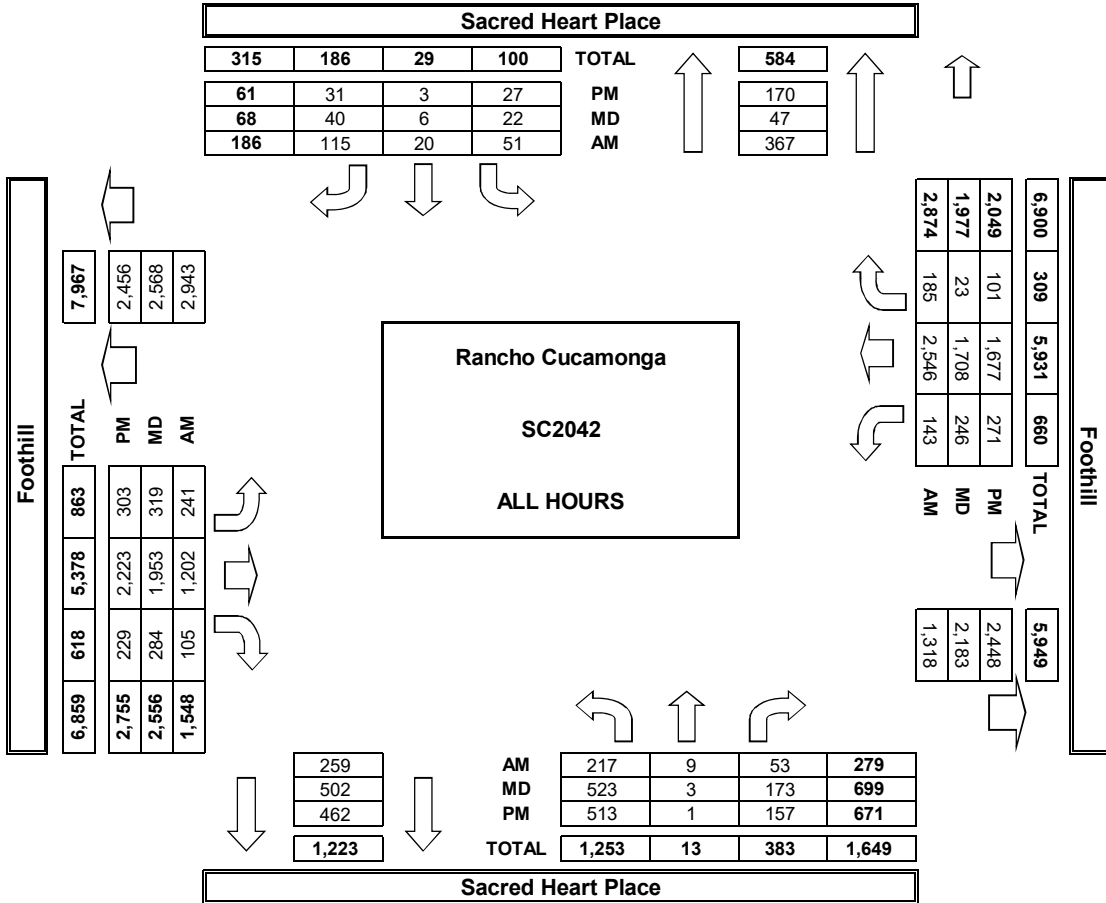

National Data & Surveying Services

Intersection Turning Movement Count

Location: Etiwanda Ave & Foothill Blvd (SR-66)
 City: Rancho Cucamonga
 Control: Signalized

Project ID: 17-06167-030
 Date: 11/2/2017

Total

NS/EW Streets:	Etiwanda Ave				Etiwanda Ave				Foothill Blvd (SR-66)				Foothill Blvd (SR-66)				TOTAL
	NORTHBOUND				SOUTHBOUND				EASTBOUND				WESTBOUND				
AM	1 NL	0.5 NT	0.5 NR	0 NU	1 SL	2 ST	0 SR	0 SU	2 EL	2 ET	1 ER	0 EU	2 WL	2 WT	1 WR	0 WU	TOTAL
7:00 AM	40	45	18	0	14	85	53	0	17	86	33	1	49	245	20	0	706
7:15 AM	32	58	22	0	19	71	68	0	22	74	30	3	63	267	20	0	749
7:30 AM	30	52	23	0	12	85	57	0	19	106	52	1	78	330	22	0	867
7:45 AM	45	66	22	0	17	106	67	0	25	109	36	1	79	308	18	0	899
8:00 AM	29	51	26	0	12	106	72	0	29	115	46	6	65	240	20	0	817
8:15 AM	33	26	27	0	13	73	46	0	29	86	32	3	62	207	11	0	648
8:30 AM	35	30	15	0	7	55	43	0	12	142	28	4	34	189	10	0	604
8:45 AM	39	26	20	0	4	39	36	0	16	104	31	3	28	183	6	0	535
TOTAL VOLUMES :	NL	NT	NR	NU	SL	ST	SR	SU	EL	ET	ER	EU	WL	WT	WR	WU	TOTAL
APPROACH %'s :	283	354	173	0	98	620	442	0	169	822	288	22	458	1969	127	0	5825
	34.94%	43.70%	21.36%	0.00%	8.45%	53.45%	38.10%	0.00%	12.99%	63.18%	22.14%	1.69%	17.93%	77.09%	4.97%	0.00%	
PEAK HR :	07:15 AM - 08:15 AM																TOTAL
PEAK HR VOL :	136	227	93	0	60	368	264	0	95	404	164	11	285	1145	80	0	3332
PEAK HR FACTOR :	0.756	0.860	0.894	0.000	0.789	0.868	0.917	0.000	0.819	0.878	0.788	0.458	0.902	0.867	0.909	0.000	0.927
	0.857				0.911				0.860				0.878				
NOON	1 NL	0.5 NT	0.5 NR	0 NU	1 SL	2 ST	0 SR	0 SU	2 EL	2 ET	1 ER	0 EU	2 WL	2 WT	1 WR	0 WU	TOTAL
11:00 AM	42	37	21	0	5	36	38	0	28	127	27	9	14	166	6	0	556
11:15 AM	38	43	15	0	9	43	42	0	31	150	43	14	20	161	10	0	619
11:30 AM	54	20	16	0	9	41	46	0	15	137	59	11	24	183	13	1	629
11:45 AM	56	36	20	0	14	37	46	0	42	169	45	14	19	181	9	0	688
12:00 PM	55	40	28	0	13	50	33	0	46	156	68	8	31	182	10	0	720
12:15 PM	50	29	23	0	8	30	30	0	38	199	45	8	22	165	13	0	660
12:30 PM	44	27	22	0	9	42	37	0	28	191	56	10	25	170	13	1	675
12:45 PM	47	37	30	0	7	36	34	0	40	157	52	13	29	166	11	0	659
TOTAL VOLUMES :	NL	NT	NR	NU	SL	ST	SR	SU	EL	ET	ER	EU	WL	WT	WR	WU	TOTAL
APPROACH %'s :	386	269	175	0	74	315	306	0	268	1286	395	87	184	1374	85	2	5206
	46.51%	32.41%	21.08%	0.00%	10.65%	45.32%	44.03%	0.00%	13.16%	63.16%	19.40%	4.27%	11.19%	83.53%	5.17%	0.12%	
PEAK HR :	11:45 AM - 12:45 PM																TOTAL
PEAK HR VOL :	205	132	93	0	44	159	146	0	154	715	214	40	97	698	45	1	2743
PEAK HR FACTOR :	0.915	0.825	0.830	0.000	0.786	0.795	0.793	0.000	0.837	0.898	0.787	0.714	0.782	0.959	0.865	0.250	0.952
	0.874				0.899				0.968				0.943				
PM	1 NL	0.5 NT	0.5 NR	0 NU	1 SL	2 ST	0 SR	0 SU	2 EL	2 ET	1 ER	0 EU	2 WL	2 WT	1 WR	0 WU	TOTAL
4:00 PM	77	68	59	0	18	63	31	0	45	217	55	12	37	185	12	0	879
4:15 PM	71	72	54	0	16	57	35	0	31	229	45	20	28	191	7	0	856
4:30 PM	63	74	49	0	6	57	43	0	48	263	37	13	36	198	7	0	894
4:45 PM	83	88	53	0	11	59	45	0	40	222	45	16	34	184	9	0	889
5:00 PM	57	72	35	0	17	57	49	0	63	257	48	8	32	207	13	0	915
5:15 PM	67	95	57	0	22	36	45	0	39	219	38	2	27	195	9	1	852
5:30 PM	59	89	48	0	15	39	34	1	51	252	40	9	44	191	10	0	882
5:45 PM	58	106	50	0	12	47	40	0	58	235	40	14	23	172	19	0	874
TOTAL VOLUMES :	NL	NT	NR	NU	SL	ST	SR	SU	EL	ET	ER	EU	WL	WT	WR	WU	TOTAL
APPROACH %'s :	535	664	405	0	117	415	322	1	375	1894	348	94	261	1523	86	1	7041
	33.35%	41.40%	25.25%	0.00%	13.68%	48.54%	37.66%	0.12%	13.83%	69.86%	12.84%	3.47%	13.95%	81.40%	4.60%	0.05%	
PEAK HR :	04:15 PM - 05:15 PM																TOTAL
PEAK HR VOL :	274	306	191	0	50	230	172	0	182	971	175	57	130	780	36	0	3554
PEAK HR FACTOR :	0.825	0.869	0.884	0.000	0.735	0.975	0.878	0.000	0.722	0.923	0.911	0.713	0.903	0.942	0.692	0.000	0.971
	0.860				0.919				0.921				0.938				

National Data & Surveying Services

Intersection Turning Movement Count

Location: Etiwanda Ave & Foothill Blvd (SR-66)
City: Rancho Cucamonga
Control: Signalized

Project ID: 17-06167-030
Date: 11/2/2017

Bikes

NS/EW Streets:	Etiwanda Ave				Etiwanda Ave				Foothill Blvd (SR-66)				Foothill Blvd (SR-66)				
AM	NORTHBOUND				SOUTHBOUND				EASTBOUND				WESTBOUND				TOTAL
	1 NL	0.5 NT	0.5 NR	0 NU	1 SL	2 ST	0 SR	0 SU	2 EL	2 ET	1 ER	0 EU	2 WL	2 WT	1 WR	0 WU	
7:00 AM	0	1	0	0	1	0	0	0	0	0	0	0	0	0	0	0	2
7:15 AM	0	3	0	0	0	0	0	0	0	1	0	0	0	0	0	0	4
7:30 AM	0	0	0	0	0	0	0	0	0	0	0	0	0	0	0	0	0
7:45 AM	0	0	0	0	0	0	0	0	0	0	0	0	0	0	0	0	0
8:00 AM	0	0	0	0	0	0	0	0	0	0	0	0	0	0	0	0	0
8:15 AM	0	0	0	0	0	0	0	0	0	0	0	0	0	0	0	0	0
8:30 AM	0	0	0	0	0	0	0	0	0	0	0	0	0	1	0	0	1
8:45 AM	0	0	0	0	0	0	0	0	0	0	0	0	0	0	0	0	0
TOTAL VOLUMES :	NL	NT	NR	NU	SL	ST	SR	SU	EL	ET	ER	EU	WL	WT	WR	WU	TOTAL
APPROACH %'s :	0	4	0	0	1	0	0	0	0	1	0	0	1	0	1	0	7
	0.00%	100.00%	0.00%	0.00%	100.00%	0.00%	0.00%	0.00%	0.00%	100.00%	0.00%	0.00%	0.00%	100.00%	0.00%	0.00%	
PEAK HR :	07:15 AM - 08:15 AM																TOTAL
PEAK HR VOL :	0	3	0	0	0	0	0	0	0	1	0	0	0	0	0	0	4
PEAK HR FACTOR :	0.000	0.250	0.000	0.000	0.000	0.000	0.000	0.000	0.000	0.250	0.000	0.000	0.000	0.000	0.000	0.000	0.250
	0.250								0.250								
NOON	NORTHBOUND				SOUTHBOUND				EASTBOUND				WESTBOUND				TOTAL
	1 NL	0.5 NT	0.5 NR	0 NU	1 SL	2 ST	0 SR	0 SU	2 EL	2 ET	1 ER	0 EU	2 WL	2 WT	1 WR	0 WU	
11:00 AM	0	0	0	0	0	0	1	0	0	0	0	0	0	0	0	0	1
11:15 AM	0	0	0	0	0	1	0	0	0	0	0	0	0	0	0	0	1
11:30 AM	0	1	0	0	0	0	0	0	0	0	0	0	1	0	0	0	2
11:45 AM	0	0	0	0	0	0	0	0	0	0	0	0	0	0	0	0	0
12:00 PM	0	0	0	0	0	0	0	0	0	0	0	0	0	0	0	0	0
12:15 PM	0	0	0	0	0	0	0	0	0	1	0	0	0	1	1	0	3
12:30 PM	0	0	0	0	1	0	0	0	0	1	0	0	0	0	0	0	2
12:45 PM	0	0	0	0	0	0	0	0	1	0	0	0	0	0	0	0	1
TOTAL VOLUMES :	NL	NT	NR	NU	SL	ST	SR	SU	EL	ET	ER	EU	WL	WT	WR	WU	TOTAL
APPROACH %'s :	0	1	0	0	1	1	1	0	1	2	0	0	1	1	1	0	10
	0.00%	100.00%	0.00%	0.00%	33.33%	33.33%	33.33%	0.00%	33.33%	66.67%	0.00%	0.00%	33.33%	33.33%	33.33%	0.00%	
PEAK HR :	11:45 AM - 12:45 PM																TOTAL
PEAK HR VOL :	0	0	0	0	1	0	0	0	0	2	0	0	0	1	1	0	5
PEAK HR FACTOR :	0.00	0.000	0.000	0.000	0.250	0.000	0.000	0.000	0.000	0.500	0.000	0.000	0.000	0.250	0.250	0.000	0.417
	0.250								0.500								
PM	NORTHBOUND				SOUTHBOUND				EASTBOUND				WESTBOUND				TOTAL
	1 NL	0.5 NT	0.5 NR	0 NU	1 SL	2 ST	0 SR	0 SU	2 EL	2 ET	1 ER	0 EU	2 WL	2 WT	1 WR	0 WU	
4:00 PM	0	0	0	0	0	1	1	0	0	0	0	0	0	0	0	0	2
4:15 PM	0	1	0	0	0	0	0	0	0	0	0	0	0	0	0	0	1
4:30 PM	0	1	0	0	0	1	0	0	0	0	0	0	0	0	0	0	2
4:45 PM	0	0	0	0	0	1	0	0	0	0	0	0	0	0	0	0	1
5:00 PM	0	1	0	0	0	0	1	0	1	0	0	0	0	0	1	0	4
5:15 PM	0	0	0	0	0	0	0	0	0	0	0	0	0	0	0	0	0
5:30 PM	0	0	0	0	1	0	0	0	0	0	0	0	0	0	0	0	1
5:45 PM	0	0	0	0	0	0	0	0	0	0	0	0	0	4	0	0	4
TOTAL VOLUMES :	NL	NT	NR	NU	SL	ST	SR	SU	EL	ET	ER	EU	WL	WT	WR	WU	TOTAL
APPROACH %'s :	0	3	0	0	1	3	2	0	1	0	0	0	0	4	1	0	15
	0.00%	100.00%	0.00%	0.00%	16.67%	50.00%	33.33%	0.00%	100.00%	0.00%	0.00%	0.00%	0.00%	80.00%	20.00%	0.00%	
PEAK HR :	04:15 PM - 05:15 PM																TOTAL
PEAK HR VOL :	0	3	0	0	0	2	1	0	1	0	0	0	0	0	1	0	8
PEAK HR FACTOR :	0.00	0.750	0.000	0.000	0.000	0.500	0.250	0.000	0.250	0.000	0.000	0.000	0.000	0.000	0.250	0.000	0.500
	0.750				0.750				0.250				0.250				

National Data & Surveying Services

Intersection Turning Movement Count

Location: Etiwanda Ave & Foothill Blvd (SR-66)
City: Rancho Cucamonga

Project ID: 17-06167-030
Date: 11/2/2017

Pedestrians (Crosswalks)

NS/EW Streets:	Etiwanda Ave		Etiwanda Ave		Foothill Blvd (SR-66)		Foothill Blvd (SR-66)		
AM	NORTH LEG		SOUTH LEG		EAST LEG		WEST LEG		TOTAL
	EB	WB	EB	WB	NB	SB	NB	SB	
7:00 AM	0	0	0	0	0	0	0	0	0
7:15 AM	0	0	0	2	2	0	0	1	5
7:30 AM	0	0	0	0	0	0	0	0	0
7:45 AM	0	0	1	2	0	1	0	1	5
8:00 AM	0	0	2	0	0	0	0	0	2
8:15 AM	0	0	1	2	0	0	0	0	3
8:30 AM	0	0	1	0	0	0	0	1	2
8:45 AM	0	0	1	0	0	0	2	0	3
TOTAL VOLUMES :	0	0	6	6	2	1	2	3	20
APPROACH %'s :			50.00%	50.00%	66.67%	33.33%	40.00%	60.00%	
PEAK HR :	07:15 AM - 08:15 AM								TOTAL
PEAK HR VOL :	0	0	3	4	2	1	0	2	12
PEAK HR FACTOR :			0.375	0.500	0.250	0.250		0.500	0.600
			0.583		0.375		0.500		

NOON	NORTH LEG		SOUTH LEG		EAST LEG		WEST LEG		TOTAL
	EB	WB	EB	WB	NB	SB	NB	SB	
11:00 AM	0	0	0	0	0	0	0	0	0
11:15 AM	1	0	0	0	0	0	0	0	1
11:30 AM	0	0	1	0	0	0	0	0	1
11:45 AM	0	0	1	0	0	0	0	1	2
12:00 PM	0	0	0	0	0	0	0	0	0
12:15 PM	1	0	0	0	0	0	1	0	2
12:30 PM	0	0	0	1	0	0	0	1	2
12:45 PM	0	0	0	0	0	0	1	0	1
TOTAL VOLUMES :	2	0	2	1	0	0	2	2	9
APPROACH %'s :	100.00%	0.00%	66.67%	33.33%			50.00%	50.00%	
PEAK HR :	11:45 AM - 12:45 PM								TOTAL
PEAK HR VOL :	1	0	1	1	0	0	1	2	6
PEAK HR FACTOR :	0.250		0.250	0.250			0.250	0.500	0.750
	0.250		0.500		0.750		0.750		

PM	NORTH LEG		SOUTH LEG		EAST LEG		WEST LEG		TOTAL
	EB	WB	EB	WB	NB	SB	NB	SB	
4:00 PM	0	0	0	0	0	0	0	0	0
4:15 PM	0	0	0	0	0	0	0	0	0
4:30 PM	0	0	0	0	0	0	0	0	0
4:45 PM	0	1	0	0	0	0	1	0	2
5:00 PM	0	0	0	0	0	1	0	0	1
5:15 PM	0	0	0	0	0	0	0	0	0
5:30 PM	0	0	0	0	0	0	2	1	3
5:45 PM	0	0	0	0	0	0	2	1	3
TOTAL VOLUMES :	0	1	0	0	0	1	5	2	9
APPROACH %'s :	0.00%	100.00%			0.00%	100.00%	71.43%	28.57%	
PEAK HR :	04:15 PM - 05:15 PM								TOTAL
PEAK HR VOL :	0	1	0	0	0	1	1	0	3
PEAK HR FACTOR :		0.250				0.250	0.250	0.250	0.375
	0.250				0.250		0.250		

Etiwanda Ave & Foothill Blvd (SR-66)

Peak Hour Turning Movement Count

ID: 17-06167-030
City: Rancho Cucamonga

Day: Thursday
Date: 11/02/2017

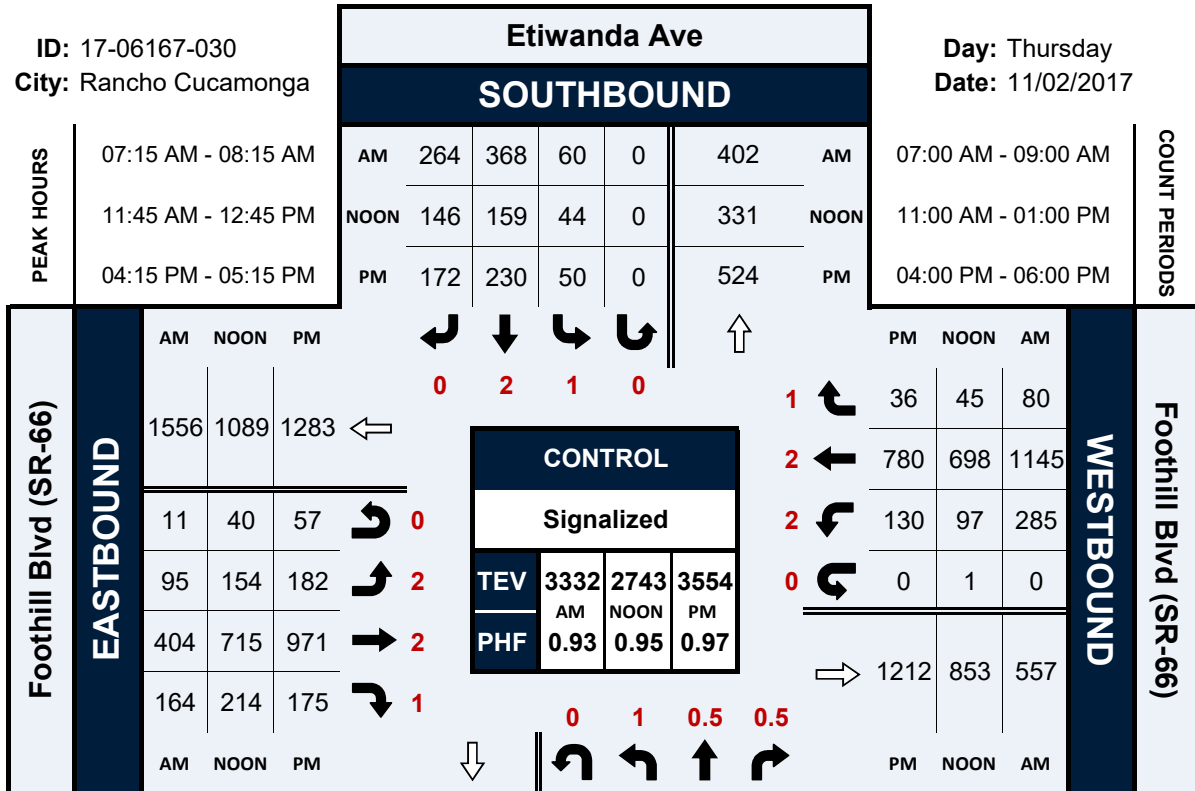

Total Vehicles (AM)

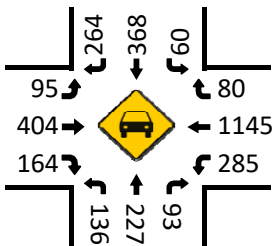

Bikes (AM)

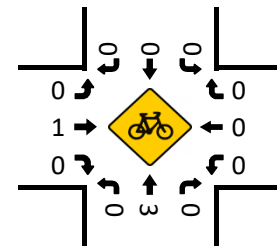

Total Vehicles (Noon)

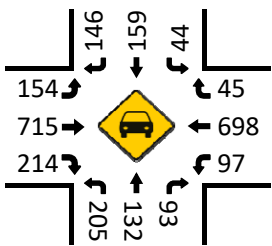

Bikes (NOON)

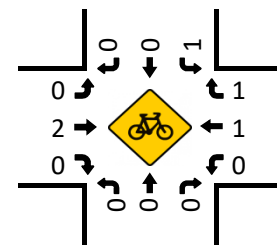

Total Vehicles (PM)

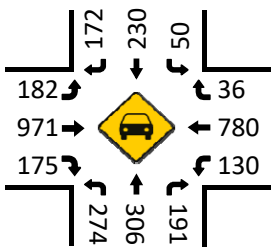

Bikes (PM)

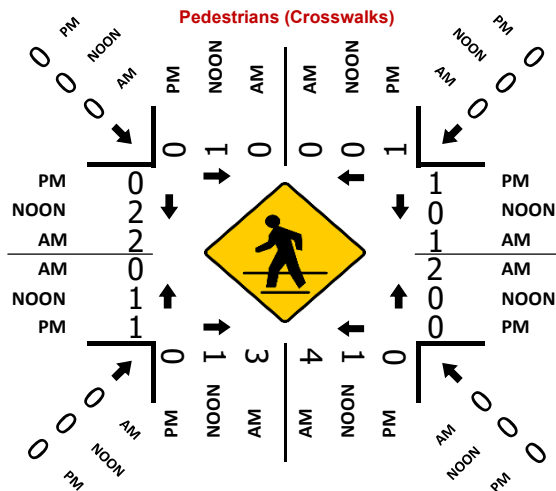
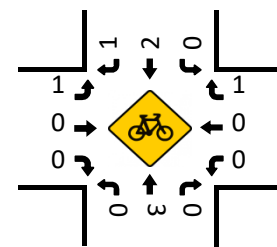



APPENDIX B: APPROVED DEVELOPMENT PROJECTS



Appendix B: Approved and Pending Developments

Project Name	Project Location	Description	Status
Starbucks	Foothill and Vineyard SWC	Replacing three existing commercial building with three new commercial buildings, one to include a drive-thru lane.	Entitlements
Panattoni 9th and Vineyard	SWC 9th Street and Vineyard Avenue	1,037,467 square-foot industrial warehouse (3 buildings)	Entitlements
Phelan	9th and Vineyard	3 Industrial Buildings, 235,534 s.f.	Building Plan Check
Sycamore Heights	North side of Foothill Boulevard, between Red Hill Country Club Drive and the Pacific Electric Trail Right-of-Way	175 Attached Condominium Units	Entitled, but not submitted for building plan check
Red Hill Gas Station	NEC Red Hill and Foothill	Expand Existing Gas Station	Building Plan Check
Hellman 6-Home Subdivision	6929 Hellman Ave.	10 Single-Family Residences	Entitlements
Carden Arbor View School	19th and Beryl	18,000 square foot K-8 school	Under Construction
Carwash	Arrow west of Archibald	New Carwash	Entitlements
7-11/Laredo Taco Gas Station	Archibald/9th St	6,600 square foot building including a 7-11 convenience store and Laredo's Tacos Restaurant plus gas station	Entitlements
BOB 2.0	8794 Lion St.	15,000 square foot warehouse building at the City's Public Works Yard	Entitlements
Bolnado's 20K Building	8th and Vineyard	25,399 square foot industrial building.	Building Plan Check
Cadence Senior Assisted	10459 Church St	97 Assisted Senior Apartments	Under Construction
REF Industrial Building Expansion	7915 Center Ave.	7,782 square foot expansion to an existing 16,000 square foot industrial building	Building Plan Check
Arte (Formerly the Vitner)	NEC fo Foothill Blvd and Hermosa Ave	182-Unit Mixed-Use Apartments	Completed 2019
Ken's Sushi Restaurant	10006 Foothill Blvd.	Demolish existing Ken's sushi Restaurant and construct a new 3,111 square-foot replacement	Entitlements
Scheu	9668 7th St	124K and 74K Buildings	Building Plan Check
6th and Center Industrial	NEC 6th St and Center Ave	87,554 square-foot industrial/warehouse development consisting of three buildings	Under Construction
7th and Center Industrial	9063 Center Ave.	110,743 square foot industrial/warehouse building	Building Plan Check
Watt	SWC of Foothill and Haven Avenue	302 Unit Mixed Use Development	Entitlements
Haven and Arrow	SWC of Haven Ave. and Arrow Rte.	200,175 square-foot commercial/office complex consisting of a 6-story office building with restaurant, a 3-story office building with restaurant, three 1-story office and restaurant buildings, and a 2-level parking structure	Entitlements
Haven and 26th	SWC of Haven Avenue and 26th Street	207 Multi-Family Units and 14,3000 square feet of commercial on 5.21-acres.	On Hold
Empire Lakes Specific Plan	Resort Development - North of 6th Street	Amendment to the current specific plan to address circulation changes, planning areas for the north portion of the Resort	Entitlements
Van Daele	The Resort*	296 Multi-Family Development	Under Construction
New Home	The Resort*	135 Multi-Family Development	Under Construction
Tempo at the Resort	The Resort*	80 Single-Family Condominiums	Under Construction
Homecoming at the Resort	The Resort*	867 Apartments	Building Plan Check
The Bungalows at Terra Vista	SWC of Haven and Church	214 Multi-Family Units	Under Construction
Premier Swim Academy	7827 Haven Ave.	9,695 square foot swim school	Under Construction
8281 Utica Office	8281 Utica	12,000 square foot office building	Entitlements
Milliken and Jersey Industrial	NWC of Jersey Blvd. and Milliken Ave.	143,014 square-foot industrial warehouse	Entitlements
Foothill and Mayten Industrial	South of Footill at Mayten Ave APN: 022901249	171,322 square foot industrial/warehouse development consisting of six buildings	Under Construction
23,380 sf. Commercial	9125 Hyssop Drive	23,380 square foot commercial warehouse building	Building Plan Check
Two industrial warehouse buildings	12434 4th Street	Two buildings totaling 2.2M square feet; project involves GPA, ZMA.	Entitlements
Day Creek Villas	Terminus of Firehouse Ct., West of Day Creek Blvd. APN: 1089-031-36	140 Affordable Senior Apartments	Under Construction
St. Mary's Montessori	6880 N Victoria Windrows Loop	9,970 square foot expansion to existing daycare center and after-school facility.	Under Construction
Kiddie Academy	Southwest corner of Atwood Street and Victoria Park Lane	10,763 square foot child care facility with outdoor play areas	Under Construction
Air Liquide	12550 Arrow Route	New industrial building 16,000 sf, with 3,000 sf office space for air liquide production/manufacturing	Entitlements

Hickory and Arrow Industrial	SWC of Hickory and Arrow	34,161 square foot industrial/warehouse building	Building Plan Check
104,269 Industrial Building	East Side of Peacan South of Arrow	104,269 SF Industrial Building	Building Plan Check
Two industrial warehouse buildings	N/o Napa St e/o Etiwanda	Two buildings totaling 651,000 square feet; project involves GPA, ZMA, Prezone, Annexation	Entitlements
Cityscape	Northwest Corner of Foothill and Etiwanda	160 Unit Mixed Use Project	Entitlements
Pacific Reserve	North Side of Foothill West of Cornwall Court	71 Unit Multi-Family Development	Entitlements
Westbury	West Side of East Avenue North of Foothill	133 Unit Mixed Use Project	Entitlements
Day Creek Villages	SWC of Daycreek Blvd. and Baseline Rd.	392 residential units, 71 room hotel, and 21,627 square feet of commercial space	Under construction
East Avenue Villa	6737 East Ave.	12 Single-Family residences	Entitlements
N/A	North of the 210 Fwy, east of East Ave at the Easterly extension of Wilshire Dr. and Copley Dr. APN: 0226-102-30	10 Single-Family Residences	Entitlements
Manning Homes 17	East Side of East Avenue and South of Banyan	17 Single -Family Residences	















APPENDIX C: LEVEL OF SERVICE CALCULATION SHEETS



HCM 6th Signalized Intersection Summary
 1: Foothill Blvd & I-15 SB Off Ramp

Rancho Cuvee
 Existing AM

												
Movement	EBL	EBT	EBR	WBL	WBT	WBR	NBL	NBT	NBR	SBL	SBT	SBR
Lane Configurations		↑↑↑	↗		↑↑↑					↖	↔	↗
Traffic Volume (veh/h)	0	635	998	0	1690	0	0	0	0	85	0	665
Future Volume (veh/h)	0	635	998	0	1690	0	0	0	0	85	0	665
Initial Q (Qb), veh	0	0	0	0	0	0				0	0	0
Ped-Bike Adj(A_pbT)	1.00		1.00	1.00		1.00				1.00		1.00
Parking Bus, Adj	1.00	1.00	1.00	1.00	1.00	1.00				1.00	1.00	1.00
Work Zone On Approach		No			No						No	
Adj Sat Flow, veh/h/ln	0	1772	1772	0	1772	0				1575	1772	1772
Adj Flow Rate, veh/h	0	661	0	0	1760	0				59	0	725
Peak Hour Factor	0.96	0.96	0.92	0.92	0.96	0.96				0.96	0.92	0.96
Percent Heavy Veh, %	0	2	2	0	2	0				2	2	2
Cap, veh/h	0	2992		0	2992	0				388	0	776
Arrive On Green	0.00	0.62	0.00	0.00	0.62	0.00				0.26	0.00	0.26
Sat Flow, veh/h	0	4997	1502	0	5156	0				1500	0	3003
Grp Volume(v), veh/h	0	661	0	0	1760	0				59	0	725
Grp Sat Flow(s),veh/h/ln	0	1612	1502	0	1612	0				1500	0	1502
Q Serve(g_s), s	0.0	6.0	0.0	0.0	21.8	0.0				3.0	0.0	23.6
Cycle Q Clear(g_c), s	0.0	6.0	0.0	0.0	21.8	0.0				3.0	0.0	23.6
Prop In Lane	0.00		1.00	0.00		0.00				1.00		1.00
Lane Grp Cap(c), veh/h	0	2992		0	2992	0				388	0	776
V/C Ratio(X)	0.00	0.22		0.00	0.59	0.00				0.15	0.00	0.93
Avail Cap(c_a), veh/h	0	2992		0	2992	0				393	0	787
HCM Platoon Ratio	1.00	1.00	1.00	1.00	1.00	1.00				1.00	1.00	1.00
Upstream Filter(I)	0.00	1.00	0.00	0.00	1.00	0.00				1.00	0.00	1.00
Uniform Delay (d), s/veh	0.0	8.4	0.0	0.0	11.4	0.0				28.6	0.0	36.2
Incr Delay (d2), s/veh	0.0	0.2	0.0	0.0	0.9	0.0				0.2	0.0	17.9
Initial Q Delay(d3),s/veh	0.0	0.0	0.0	0.0	0.0	0.0				0.0	0.0	0.0
%ile BackOfQ(50%),veh/ln	0.0	1.8	0.0	0.0	6.5	0.0				1.1	0.0	10.5
Unsig. Movement Delay, s/veh												
LnGrp Delay(d),s/veh	0.0	8.6	0.0	0.0	12.3	0.0				28.8	0.0	54.1
LnGrp LOS	A	A		A	B	A				C	A	D
Approach Vol, veh/h		661	A		1760						784	
Approach Delay, s/veh		8.6			12.3						52.2	
Approach LOS		A			B						D	
Timer - Assigned Phs		2		4		6						
Phs Duration (G+Y+Rc), s		68.3		31.7		68.3						
Change Period (Y+Rc), s		6.5		5.8		6.5						
Max Green Setting (Gmax), s		61.5		26.2		61.5						
Max Q Clear Time (g_c+I1), s		8.0		25.6		23.8						
Green Ext Time (p_c), s		3.6		0.3		13.2						
Intersection Summary												
HCM 6th Ctrl Delay				21.3								
HCM 6th LOS				C								
Notes												
User approved volume balancing among the lanes for turning movement.												
Unsignalized Delay for [EBR] is excluded from calculations of the approach delay and intersection delay.												

HCM 6th Signalized Intersection Summary
2: I-15 NB Off Ramp & Foothill Blvd

Rancho Cuvee
Existing AM



Movement	EBL	EBT	EBR	WBL	WBT	WBR	NBL	NBT	NBR	SBL	SBT	SBR
Lane Configurations		↑↑↑			↑↑↑	↗	↘	↕	↗			
Traffic Volume (veh/h)	0	464	0	0	1511	131	962	0	421	0	0	0
Future Volume (veh/h)	0	464	0	0	1511	131	962	0	421	0	0	0
Initial Q (Qb), veh	0	0	0	0	0	0	0	0	0			
Ped-Bike Adj(A_pbT)	1.00		1.00	1.00		1.00	1.00		0.99			
Parking Bus, Adj	1.00	1.00	1.00	1.00	1.00	1.00	1.00	1.00	1.00			
Work Zone On Approach		No			No			No				
Adj Sat Flow, veh/h/ln	0	1772	0	0	1772	1772	1575	1772	1772			
Adj Flow Rate, veh/h	0	483	0	0	1574	0	1139	0	293			
Peak Hour Factor	0.92	0.96	0.96	0.96	0.96	0.92	0.96	0.92	0.96			
Percent Heavy Veh, %	0	2	0	0	2	2	2	2	2			
Cap, veh/h	0	2320	0	0	2320		1192	0	589			
Arrive On Green	0.00	0.48	0.00	0.00	0.48	0.00	0.40	0.00	0.40			
Sat Flow, veh/h	0	5156	0	0	4997	1502	3000	0	1482			
Grp Volume(v), veh/h	0	483	0	0	1574	0	1139	0	293			
Grp Sat Flow(s),veh/h/ln	0	1612	0	0	1612	1502	1500	0	1482			
Q Serve(g_s), s	0.0	5.8	0.0	0.0	25.1	0.0	36.9	0.0	14.9			
Cycle Q Clear(g_c), s	0.0	5.8	0.0	0.0	25.1	0.0	36.9	0.0	14.9			
Prop In Lane	0.00		0.00	0.00		1.00	1.00		1.00			
Lane Grp Cap(c), veh/h	0	2320	0	0	2320		1192	0	589			
V/C Ratio(X)	0.00	0.21	0.00	0.00	0.68		0.96	0.00	0.50			
Avail Cap(c_a), veh/h	0	2320	0	0	2320		1206	0	596			
HCM Platoon Ratio	1.00	1.00	1.00	1.00	1.00	1.00	1.00	1.00	1.00			
Upstream Filter(I)	0.00	1.00	0.00	0.00	0.47	0.00	1.00	0.00	1.00			
Uniform Delay (d), s/veh	0.0	15.0	0.0	0.0	20.1	0.0	29.3	0.0	22.6			
Incr Delay (d2), s/veh	0.0	0.2	0.0	0.0	0.8	0.0	16.3	0.0	0.7			
Initial Q Delay(d3),s/veh	0.0	0.0	0.0	0.0	0.0	0.0	0.0	0.0	0.0			
%ile BackOfQ(50%),veh/ln	0.0	2.0	0.0	0.0	9.2	0.0	15.4	0.0	5.2			
Unsig. Movement Delay, s/veh												
LnGrp Delay(d),s/veh	0.0	15.2	0.0	0.0	20.8	0.0	45.6	0.0	23.3			
LnGrp LOS	A	B	A	A	C		D	A	C			
Approach Vol, veh/h		483			1574	A		1432				
Approach Delay, s/veh		15.2			20.8			41.0				
Approach LOS		B			C			D				
Timer - Assigned Phs		2				6		8				
Phs Duration (G+Y+Rc), s		54.5				54.5		45.5				
Change Period (Y+Rc), s		6.5				6.5		5.8				
Max Green Setting (Gmax), s		47.5				47.5		40.2				
Max Q Clear Time (g_c+I1), s		7.8				27.1		38.9				
Green Ext Time (p_c), s		2.5				10.4		0.9				

Intersection Summary

HCM 6th Ctrl Delay	28.3
HCM 6th LOS	C

Notes

- User approved volume balancing among the lanes for turning movement.
- User approved changes to right turn type.
- Unsignalized Delay for [WBR] is excluded from calculations of the approach delay and intersection delay.

HCM 6th Signalized Intersection Summary
 3: Sacred Heart & Foothill Blvd

Rancho Cuvee
 Existing AM

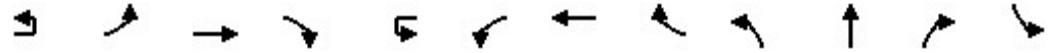

Movement	EBU	EBL	EBT	EBR	WBU	WBL	WBT	WBR	NBL	NBT	NBR	SBL
Lane Configurations		↘ ↙	↑ ↑ ↑	↗		↘ ↙	↑ ↑ ↑	↗	↘	↙	↗	↘
Traffic Volume (veh/h)	25	142	651	38	6	48	1384	155	106	7	20	23
Future Volume (veh/h)	25	142	651	38	6	48	1384	155	106	7	20	23
Initial Q (Qb), veh		0	0	0		0	0	0	0	0	0	0
Ped-Bike Adj(A_pbT)		1.00		1.00		1.00		1.00	1.00		1.00	1.00
Parking Bus, Adj		1.00	1.00	1.00		1.00	1.00	1.00	1.00	1.00	1.00	1.00
Work Zone On Approach			No				No			No		
Adj Sat Flow, veh/h/ln		1575	1772	1772		1575	1772	1772	1673	1772	1772	1673
Adj Flow Rate, veh/h		148	678	20		50	1442	110	115	0	2	24
Peak Hour Factor		0.96	0.96	0.96		0.96	0.96	0.96	0.96	0.96	0.96	0.96
Percent Heavy Veh, %		2	2	2		2	2	2	2	2	2	2
Cap, veh/h		401	1961	749		262	1729	631	299	0	140	101
Arrive On Green		0.14	0.41	0.41		0.09	0.36	0.36	0.09	0.00	0.09	0.06
Sat Flow, veh/h		2910	4837	1499		2910	4837	1499	3188	0	1497	1594
Grp Volume(v), veh/h		148	678	20		50	1442	110	115	0	2	24
Grp Sat Flow(s),veh/h/ln		1455	1612	1499		1455	1612	1499	1594	0	1497	1594
Q Serve(g_s), s		3.9	8.2	0.6		1.3	23.0	3.9	2.9	0.0	0.1	1.2
Cycle Q Clear(g_c), s		3.9	8.2	0.6		1.3	23.0	3.9	2.9	0.0	0.1	1.2
Prop In Lane		1.00		1.00		1.00		1.00	1.00		1.00	1.00
Lane Grp Cap(c), veh/h		401	1961	749		262	1729	631	299	0	140	101
V/C Ratio(X)		0.37	0.35	0.03		0.19	0.83	0.17	0.38	0.00	0.01	0.24
Avail Cap(c_a), veh/h		414	1961	749		380	1876	677	1626	0	763	151
HCM Platoon Ratio		1.00	1.00	1.00		1.00	1.00	1.00	1.00	1.00	1.00	1.00
Upstream Filter(l)		1.00	1.00	1.00		1.00	1.00	1.00	1.00	0.00	1.00	1.00
Uniform Delay (d), s/veh		33.0	17.3	10.7		35.5	24.8	15.3	35.9	0.0	34.7	37.6
Incr Delay (d2), s/veh		0.6	0.5	0.1		0.3	3.2	0.1	0.8	0.0	0.0	1.2
Initial Q Delay(d3),s/veh		0.0	0.0	0.0		0.0	0.0	0.0	0.0	0.0	0.0	0.0
%ile BackOfQ(50%),veh/ln		1.3	2.7	0.2		0.5	8.2	1.4	1.1	0.0	0.0	0.5
Unsig. Movement Delay, s/veh												
LnGrp Delay(d),s/veh		33.6	17.8	10.8		35.9	28.0	15.4	36.7	0.0	34.7	38.7
LnGrp LOS		C	B	B		D	C	B	D	A	C	D
Approach Vol, veh/h			846				1602			117		
Approach Delay, s/veh			20.4				27.4			36.7		
Approach LOS			C				C			D		
Timer - Assigned Phs	1	2		4	5	6		8				
Phs Duration (G+Y+Rc), s	11.6	41.5		16.9	15.6	37.4		14.3				
Change Period (Y+Rc), s	4.0	* 7.3		9.0	4.0	* 7.3		9.0				
Max Green Setting (Gmax), s	11.0	* 34		43.0	12.0	* 33		8.0				
Max Q Clear Time (g_c+I1), s	3.3	10.2		4.9	5.9	25.0		3.2				
Green Ext Time (p_c), s	0.0	4.3		0.4	0.2	5.1		0.0				

Intersection Summary

HCM 6th Ctrl Delay	25.7
HCM 6th LOS	C

Notes

- User approved volume balancing among the lanes for turning movement.
- User approved ignoring U-Turning movement.
- * HCM 6th computational engine requires equal clearance times for the phases crossing the barrier.

HCM 6th Signalized Intersection Summary
 3: Sacred Heart & Foothill Blvd

Rancho Cuvee
 Existing AM



Movement	SBT	SBR
Lane Configurations	↓	↘
Traffic Volume (veh/h)	17	88
Future Volume (veh/h)	17	88
Initial Q (Qb), veh	0	0
Ped-Bike Adj(A_pbT)		1.00
Parking Bus, Adj	1.00	1.00
Work Zone On Approach	No	
Adj Sat Flow, veh/h/ln	1772	1772
Adj Flow Rate, veh/h	18	5
Peak Hour Factor	0.96	0.96
Percent Heavy Veh, %	2	2
Cap, veh/h	84	23
Arrive On Green	0.06	0.06
Sat Flow, veh/h	1333	370
Grp Volume(v), veh/h	0	23
Grp Sat Flow(s),veh/h/ln	0	1704
Q Serve(g_s), s	0.0	1.1
Cycle Q Clear(g_c), s	0.0	1.1
Prop In Lane		0.22
Lane Grp Cap(c), veh/h	0	108
V/C Ratio(X)	0.00	0.21
Avail Cap(c_a), veh/h	0	162
HCM Platoon Ratio	1.00	1.00
Upstream Filter(l)	0.00	1.00
Uniform Delay (d), s/veh	0.0	37.5
Incr Delay (d2), s/veh	0.0	1.0
Initial Q Delay(d3),s/veh	0.0	0.0
%ile BackOfQ(50%),veh/ln	0.0	0.5
Unsig. Movement Delay, s/veh		
LnGrp Delay(d),s/veh	0.0	38.5
LnGrp LOS	A	D
Approach Vol, veh/h	47	
Approach Delay, s/veh	38.6	
Approach LOS	D	
Timer - Assigned Phs		

HCM 6th Signalized Intersection Summary
4: Etiwanda Ave & Foothill Blvd

Rancho Cuvee
Existing AM

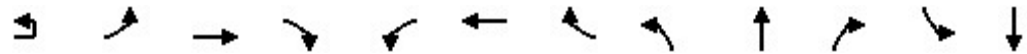

Movement	EBU	EBL	EBT	EBR	WBL	WBT	WBR	NBL	NBT	NBR	SBL	SBT
Lane Configurations		↔	↕	↔	↔	↕	↕	↔	↔	↕	↔	↕
Traffic Volume (veh/h)	12	101	429	174	302	1215	85	144	241	99	64	391
Future Volume (veh/h)	12	101	429	174	302	1215	85	144	241	99	64	391
Initial Q (Qb), veh		0	0	0	0	0	0	0	0	0	0	0
Ped-Bike Adj(A_pbT)		1.00		0.98	1.00		0.99	1.00		0.98	1.00	
Parking Bus, Adj		1.00	1.00	1.00	1.00	1.00	1.00	1.00	1.00	1.00	1.00	1.00
Work Zone On Approach			No			No			No			No
Adj Sat Flow, veh/h/ln		1575	1772	1772	1575	1772	1772	1673	1772	1772	1673	1772
Adj Flow Rate, veh/h		109	461	128	325	1306	32	155	259	22	69	420
Peak Hour Factor		0.93	0.93	0.93	0.93	0.93	0.93	0.93	0.93	0.93	0.93	0.93
Percent Heavy Veh, %		2	2	2	2	2	2	2	2	2	2	2
Cap, veh/h		295	1260	715	374	1352	600	173	404	336	153	478
Arrive On Green		0.10	0.37	0.37	0.13	0.40	0.40	0.11	0.23	0.23	0.10	0.22
Sat Flow, veh/h		2910	3367	1474	2910	3367	1494	1594	1772	1473	1594	2214
Grp Volume(v), veh/h		109	461	128	325	1306	32	155	259	22	69	318
Grp Sat Flow(s),veh/h/ln		1455	1683	1474	1455	1683	1494	1594	1772	1473	1594	1683
Q Serve(g_s), s		4.7	13.5	6.7	14.9	51.5	1.8	13.0	17.9	1.6	5.6	24.8
Cycle Q Clear(g_c), s		4.7	13.5	6.7	14.9	51.5	1.8	13.0	17.9	1.6	5.6	24.8
Prop In Lane		1.00		1.00	1.00		1.00	1.00		1.00	1.00	
Lane Grp Cap(c), veh/h		295	1260	715	374	1352	600	173	404	336	153	363
V/C Ratio(X)		0.37	0.37	0.18	0.87	0.97	0.05	0.90	0.64	0.07	0.45	0.88
Avail Cap(c_a), veh/h		300	1260	715	493	1352	600	173	457	380	153	413
HCM Platoon Ratio		1.00	1.00	1.00	1.00	1.00	1.00	1.00	1.00	1.00	1.00	1.00
Upstream Filter(I)		1.00	1.00	1.00	1.00	1.00	1.00	1.00	1.00	1.00	1.00	1.00
Uniform Delay (d), s/veh		56.9	30.8	19.9	58.0	39.7	24.9	59.8	47.3	41.0	58.0	51.5
Incr Delay (d2), s/veh		0.8	0.8	0.5	12.3	17.7	0.2	40.9	2.5	0.1	2.1	17.2
Initial Q Delay(d3),s/veh		0.0	0.0	0.0	0.0	0.0	0.0	0.0	0.0	0.0	0.0	0.0
%ile BackOfQ(50%),veh/ln		1.7	5.4	2.3	6.0	23.4	0.6	7.1	8.0	0.6	2.3	11.9
Unsig. Movement Delay, s/veh												
LnGrp Delay(d),s/veh		57.7	31.6	20.4	70.3	57.4	25.0	100.7	49.9	41.1	60.1	68.7
LnGrp LOS		E	C	C	E	E	C	F	D	D	E	E
Approach Vol, veh/h			698			1663			436			690
Approach Delay, s/veh			33.6			59.3			67.5			69.1
Approach LOS			C			E			E			E
Timer - Assigned Phs	1	2	3	4	5	6	7	8				
Phs Duration (G+Y+Rc), s	21.4	58.7	18.2	37.4	17.8	62.4	16.5	39.1				
Change Period (Y+Rc), s	4.0	* 7.9	3.5	* 8.1	4.0	* 7.9	3.5	* 8.1				
Max Green Setting (Gmax), s	23.0	* 46	14.7	* 33	14.0	* 55	13.0	* 35				
Max Q Clear Time (g_c+I1), s	16.9	15.5	15.0	27.3	6.7	53.5	7.6	19.9				
Green Ext Time (p_c), s	0.6	3.2	0.0	1.8	0.1	0.8	0.0	1.2				

Intersection Summary

HCM 6th Ctrl Delay	57.1
HCM 6th LOS	E

Notes

User approved ignoring U-Turning movement.

* HCM 6th computational engine requires equal clearance times for the phases crossing the barrier.

HCM 6th Signalized Intersection Summary
 4: Etiwanda Ave & Foothill Blvd

Rancho Cuvee
 Existing AM

Movement	SBR
Lane Configurations	
Traffic Volume (veh/h)	280
Future Volume (veh/h)	280
Initial Q (Qb), veh	0
Ped-Bike Adj(A_pbT)	1.00
Parking Bus, Adj	1.00
Work Zone On Approach	
Adj Sat Flow, veh/h/ln	1772
Adj Flow Rate, veh/h	201
Peak Hour Factor	0.93
Percent Heavy Veh, %	2
Cap, veh/h	226
Arrive On Green	0.22
Sat Flow, veh/h	1048
Grp Volume(v), veh/h	303
Grp Sat Flow(s),veh/h/ln	1578
Q Serve(g_s), s	25.3
Cycle Q Clear(g_c), s	25.3
Prop In Lane	0.66
Lane Grp Cap(c), veh/h	340
V/C Ratio(X)	0.89
Avail Cap(c_a), veh/h	387
HCM Platoon Ratio	1.00
Upstream Filter(l)	1.00
Uniform Delay (d), s/veh	51.7
Incr Delay (d2), s/veh	19.9
Initial Q Delay(d3),s/veh	0.0
%ile BackOfQ(50%),veh/ln	11.6
Unsig. Movement Delay, s/veh	
LnGrp Delay(d),s/veh	71.6
LnGrp LOS	E
Approach Vol, veh/h	
Approach Delay, s/veh	
Approach LOS	
Timer - Assigned Phs	

HCM 6th Signalized Intersection Summary
 1: Foothill Blvd & I-15 SB Off Ramp

Rancho Cuvee
 Existing PM



Movement	EBL	EBT	EBR	WBL	WBT	WBR	NBL	NBT	NBR	SBL	SBT	SBR
Lane Configurations		↑↑↑	↗		↑↑↑					↘	↕	↗
Traffic Volume (veh/h)	0	2087	1010	0	1420	0	0	0	0	116	0	642
Future Volume (veh/h)	0	2087	1010	0	1420	0	0	0	0	116	0	642
Initial Q (Qb), veh	0	0	0	0	0	0				0	0	0
Ped-Bike Adj(A_pbT)	1.00		1.00	1.00		1.00				1.00		1.00
Parking Bus, Adj	1.00	1.00	1.00	1.00	1.00	1.00				1.00	1.00	1.00
Work Zone On Approach		No			No						No	
Adj Sat Flow, veh/h/ln	0	1772	1772	0	1772	0				1575	1772	1772
Adj Flow Rate, veh/h	0	2174	0	0	1479	0				81	0	712
Peak Hour Factor	0.96	0.96	0.92	0.92	0.96	0.96				0.96	0.92	0.96
Percent Heavy Veh, %	0	2	2	0	2	0				2	2	2
Cap, veh/h	0	3059		0	3059	0				384	0	768
Arrive On Green	0.00	0.63	0.00	0.00	0.63	0.00				0.26	0.00	0.26
Sat Flow, veh/h	0	4997	1502	0	5156	0				1500	0	3003
Grp Volume(v), veh/h	0	2174	0	0	1479	0				81	0	712
Grp Sat Flow(s),veh/h/ln	0	1612	1502	0	1612	0				1500	0	1502
Q Serve(g_s), s	0.0	33.0	0.0	0.0	17.8	0.0				4.7	0.0	25.4
Cycle Q Clear(g_c), s	0.0	33.0	0.0	0.0	17.8	0.0				4.7	0.0	25.4
Prop In Lane	0.00		1.00	0.00		0.00				1.00		1.00
Lane Grp Cap(c), veh/h	0	3059		0	3059	0				384	0	768
V/C Ratio(X)	0.00	0.71		0.00	0.48	0.00				0.21	0.00	0.93
Avail Cap(c_a), veh/h	0	3059		0	3059	0				398	0	797
HCM Platoon Ratio	1.00	1.00	1.00	1.00	1.00	1.00				1.00	1.00	1.00
Upstream Filter(I)	0.00	1.00	0.00	0.00	1.00	0.00				1.00	0.00	1.00
Uniform Delay (d), s/veh	0.0	13.5	0.0	0.0	10.7	0.0				32.2	0.0	39.9
Incr Delay (d2), s/veh	0.0	1.4	0.0	0.0	0.5	0.0				0.3	0.0	16.5
Initial Q Delay(d3),s/veh	0.0	0.0	0.0	0.0	0.0	0.0				0.0	0.0	0.0
%ile BackOfQ(50%),veh/ln	0.0	10.2	0.0	0.0	5.5	0.0				1.7	0.0	11.1
Unsig. Movement Delay, s/veh												
LnGrp Delay(d),s/veh	0.0	14.9	0.0	0.0	11.3	0.0				32.5	0.0	56.4
LnGrp LOS	A	B		A	B	A				C	A	E
Approach Vol, veh/h		2174	A		1479						793	
Approach Delay, s/veh		14.9			11.3						53.9	
Approach LOS		B			B						D	
Timer - Assigned Phs		2		4		6						
Phs Duration (G+Y+Rc), s		76.1		33.9		76.1						
Change Period (Y+Rc), s		6.5		5.8		6.5						
Max Green Setting (Gmax), s		68.5		29.2		68.5						
Max Q Clear Time (g_c+I1), s		35.0		27.4		19.8						
Green Ext Time (p_c), s		17.6		0.7		10.5						

Intersection Summary

HCM 6th Ctrl Delay	20.7
HCM 6th LOS	C

Notes

User approved volume balancing among the lanes for turning movement.
 Unsignalized Delay for [EBR] is excluded from calculations of the approach delay and intersection delay.

HCM 6th Signalized Intersection Summary
 2: I-15 NB Off Ramp & Foothill Blvd

Rancho Cuvee
 Existing PM



Movement	EBL	EBT	EBR	WBL	WBT	WBR	NBL	NBT	NBR	SBL	SBT	SBR
Lane Configurations		↑↑↑			↑↑↑	↑	↑	↔	↑			
Traffic Volume (veh/h)	0	1154	0	0	1122	231	715	0	520	0	0	0
Future Volume (veh/h)	0	1154	0	0	1122	231	715	0	520	0	0	0
Initial Q (Qb), veh	0	0	0	0	0	0	0	0	0			
Ped-Bike Adj(A_pbT)	1.00		1.00	1.00		1.00	1.00		0.98			
Parking Bus, Adj	1.00	1.00	1.00	1.00	1.00	1.00	1.00	1.00	1.00			
Work Zone On Approach		No			No			No				
Adj Sat Flow, veh/h/ln	0	1772	0	0	1772	1772	1575	1772	1772			
Adj Flow Rate, veh/h	0	1202	0	0	1169	0	914	0	361			
Peak Hour Factor	0.92	0.96	0.96	0.96	0.96	0.92	0.96	0.92	0.96			
Percent Heavy Veh, %	0	2	0	0	2	2	2	2	2			
Cap, veh/h	0	2610	0	0	2610		1046	0	516			
Arrive On Green	0.00	0.54	0.00	0.00	0.54	0.00	0.35	0.00	0.35			
Sat Flow, veh/h	0	5156	0	0	4997	1502	3000	0	1479			
Grp Volume(v), veh/h	0	1202	0	0	1169	0	914	0	361			
Grp Sat Flow(s),veh/h/ln	0	1612	0	0	1612	1502	1500	0	1479			
Q Serve(g_s), s	0.0	16.7	0.0	0.0	16.1	0.0	31.4	0.0	23.1			
Cycle Q Clear(g_c), s	0.0	16.7	0.0	0.0	16.1	0.0	31.4	0.0	23.1			
Prop In Lane	0.00		0.00	0.00		1.00	1.00		1.00			
Lane Grp Cap(c), veh/h	0	2610	0	0	2610		1046	0	516			
V/C Ratio(X)	0.00	0.46	0.00	0.00	0.45		0.87	0.00	0.70			
Avail Cap(c_a), veh/h	0	2610	0	0	2610		1369	0	675			
HCM Platoon Ratio	1.00	1.00	1.00	1.00	1.00	1.00	1.00	1.00	1.00			
Upstream Filter(I)	0.00	1.00	0.00	0.00	0.79	0.00	1.00	0.00	1.00			
Uniform Delay (d), s/veh	0.0	15.5	0.0	0.0	15.4	0.0	33.6	0.0	30.9			
Incr Delay (d2), s/veh	0.0	0.6	0.0	0.0	0.4	0.0	5.2	0.0	2.2			
Initial Q Delay(d3),s/veh	0.0	0.0	0.0	0.0	0.0	0.0	0.0	0.0	0.0			
%ile BackOfQ(50%),veh/ln	0.0	5.6	0.0	0.0	5.9	0.0	11.9	0.0	8.4			
Unsig. Movement Delay, s/veh												
LnGrp Delay(d),s/veh	0.0	16.1	0.0	0.0	15.8	0.0	38.8	0.0	33.0			
LnGrp LOS	A	B	A	A	B		D	A	C			
Approach Vol, veh/h		1202			1169	A		1275				
Approach Delay, s/veh		16.1			15.8			37.2				
Approach LOS		B			B			D				
Timer - Assigned Phs		2				6		8				
Phs Duration (G+Y+Rc), s		65.8				65.8		44.2				
Change Period (Y+Rc), s		6.5				6.5		5.8				
Max Green Setting (Gmax), s		47.5				47.5		50.2				
Max Q Clear Time (g_c+I1), s		18.7				18.1		33.4				
Green Ext Time (p_c), s		7.1				8.3		4.9				

Intersection Summary

HCM 6th Ctrl Delay	23.4
HCM 6th LOS	C

Notes

- User approved volume balancing among the lanes for turning movement.
- User approved changes to right turn type.
- Unsignalized Delay for [WBR] is excluded from calculations of the approach delay and intersection delay.

HCM 6th Signalized Intersection Summary
 3: Sacred Heart & Foothill Blvd

Rancho Cuvee
 Existing PM



Movement	EBU	EBL	EBT	EBR	WBU	WBL	WBT	WBR	NBL	NBT	NBR	SBL
Lane Configurations		↘ ↙	↑ ↑ ↑	↗		↘ ↙	↑ ↑ ↑	↗	↖	↑	↗	↖
Traffic Volume (veh/h)	124	41	1193	135	36	128	928	69	293	1	103	18
Future Volume (veh/h)	124	41	1193	135	36	128	928	69	293	1	103	18
Initial Q (Qb), veh		0	0	0		0	0	0	0	0	0	0
Ped-Bike Adj(A_pbT)		1.00		1.00		1.00		0.98	1.00		0.99	1.00
Parking Bus, Adj		1.00	1.00	1.00		1.00	1.00	1.00	1.00	1.00	1.00	1.00
Work Zone On Approach			No				No			No		
Adj Sat Flow, veh/h/ln		1575	1772	1772		1575	1772	1772	1673	1772	1772	1673
Adj Flow Rate, veh/h		43	1243	75		133	967	26	306	0	17	19
Peak Hour Factor		0.96	0.96	0.96		0.96	0.96	0.96	0.96	0.96	0.96	0.96
Percent Heavy Veh, %		2	2	2		2	2	2	2	2	2	2
Cap, veh/h		112	1922	812		195	2060	666	460	0	215	39
Arrive On Green		0.04	0.40	0.40		0.07	0.43	0.43	0.14	0.00	0.14	0.02
Sat Flow, veh/h		2910	4837	1497		2910	4837	1478	3188	0	1492	1594
Grp Volume(v), veh/h		43	1243	75		133	967	26	306	0	17	19
Grp Sat Flow(s),veh/h/ln		1455	1612	1497		1455	1612	1478	1594	0	1492	1594
Q Serve(g_s), s		1.2	16.6	1.9		3.6	11.4	0.8	7.3	0.0	0.8	0.9
Cycle Q Clear(g_c), s		1.2	16.6	1.9		3.6	11.4	0.8	7.3	0.0	0.8	0.9
Prop In Lane		1.00		1.00		1.00		1.00	1.00		1.00	1.00
Lane Grp Cap(c), veh/h		112	1922	812		195	2060	666	460	0	215	39
V/C Ratio(X)		0.38	0.65	0.09		0.68	0.47	0.04	0.66	0.00	0.08	0.49
Avail Cap(c_a), veh/h		365	1922	812		292	2060	666	1718	0	804	360
HCM Platoon Ratio		1.00	1.00	1.00		1.00	1.00	1.00	1.00	1.00	1.00	1.00
Upstream Filter(l)		1.00	1.00	1.00		1.00	1.00	1.00	1.00	0.00	1.00	1.00
Uniform Delay (d), s/veh		37.4	19.5	8.8		36.4	16.4	12.3	32.3	0.0	29.5	38.5
Incr Delay (d2), s/veh		2.1	1.7	0.2		4.2	0.2	0.0	1.7	0.0	0.2	9.4
Initial Q Delay(d3),s/veh		0.0	0.0	0.0		0.0	0.0	0.0	0.0	0.0	0.0	0.0
%ile BackOfQ(50%),veh/ln		0.4	5.6	0.8		1.3	3.6	0.2	2.9	0.0	0.3	0.5
Unsig. Movement Delay, s/veh												
LnGrp Delay(d),s/veh		39.6	21.2	9.1		40.6	16.6	12.3	34.0	0.0	29.7	47.9
LnGrp LOS		D	C	A		D	B	B	C	A	C	D
Approach Vol, veh/h			1361				1126			323		
Approach Delay, s/veh			21.1				19.3			33.7		
Approach LOS			C				B			C		
Timer - Assigned Phs	1	2		4	5	6		8				
Phs Duration (G+Y+Rc), s	9.3	39.0		20.5	7.1	41.3		10.9				
Change Period (Y+Rc), s	4.0	* 7.3		9.0	4.0	* 7.3		9.0				
Max Green Setting (Gmax), s	8.0	* 32		43.0	10.0	* 30		18.0				
Max Q Clear Time (g_c+I1), s	5.6	18.6		9.3	3.2	13.4		2.9				
Green Ext Time (p_c), s	0.1	6.5		1.2	0.0	5.6		0.0				

Intersection Summary

HCM 6th Ctrl Delay	22.0
HCM 6th LOS	C

Notes

- User approved volume balancing among the lanes for turning movement.
- User approved ignoring U-Turning movement.
- * HCM 6th computational engine requires equal clearance times for the phases crossing the barrier.

HCM 6th Signalized Intersection Summary
 3: Sacred Heart & Foothill Blvd

Rancho Cuvee
 Existing PM



Movement	SBT	SBR
Lane Configurations	PT	
Traffic Volume (veh/h)	3	19
Future Volume (veh/h)	3	19
Initial Q (Qb), veh	0	0
Ped-Bike Adj(A_pbT)		1.00
Parking Bus, Adj	1.00	1.00
Work Zone On Approach	No	
Adj Sat Flow, veh/h/ln	1772	1772
Adj Flow Rate, veh/h	3	0
Peak Hour Factor	0.96	0.96
Percent Heavy Veh, %	2	2
Cap, veh/h	43	0
Arrive On Green	0.02	0.00
Sat Flow, veh/h	1772	0
Grp Volume(v), veh/h	3	0
Grp Sat Flow(s),veh/h/ln	1772	0
Q Serve(g_s), s	0.1	0.0
Cycle Q Clear(g_c), s	0.1	0.0
Prop In Lane		0.00
Lane Grp Cap(c), veh/h	43	0
V/C Ratio(X)	0.07	0.00
Avail Cap(c_a), veh/h	400	0
HCM Platoon Ratio	1.00	1.00
Upstream Filter(l)	1.00	0.00
Uniform Delay (d), s/veh	38.1	0.0
Incr Delay (d2), s/veh	0.7	0.0
Initial Q Delay(d3),s/veh	0.0	0.0
%ile BackOfQ(50%),veh/ln	0.1	0.0
Unsig. Movement Delay, s/veh		
LnGrp Delay(d),s/veh	38.7	0.0
LnGrp LOS	D	A
Approach Vol, veh/h	22	
Approach Delay, s/veh	46.6	
Approach LOS	D	
Timer - Assigned Phs		

HCM 6th Signalized Intersection Summary
4: Etiwanda Ave & Foothill Blvd

Rancho Cuvee
Existing PM

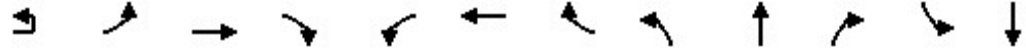

Movement	EBU	EBL	EBT	EBR	WBL	WBT	WBR	NBL	NBT	NBR	SBL	SBT
Lane Configurations		↔↗	↕↗	↗	↔↗	↕↗	↗	↗	↕	↗	↗	↕↗
Traffic Volume (veh/h)	60	193	1030	186	138	828	38	291	325	203	53	244
Future Volume (veh/h)	60	193	1030	186	138	828	38	291	325	203	53	244
Initial Q (Qb), veh		0	0	0	0	0	0	0	0	0	0	0
Ped-Bike Adj(A_pbT)		1.00		0.99	1.00		1.00	1.00		0.99	1.00	
Parking Bus, Adj		1.00	1.00	1.00	1.00	1.00	1.00	1.00	1.00	1.00	1.00	1.00
Work Zone On Approach			No			No			No			No
Adj Sat Flow, veh/h/ln		1575	1772	1772	1575	1772	1772	1673	1772	1772	1673	1772
Adj Flow Rate, veh/h		208	1108	200	148	890	41	313	349	218	57	262
Peak Hour Factor		0.93	0.93	0.93	0.93	0.93	0.93	0.93	0.93	0.93	0.93	0.93
Percent Heavy Veh, %		2	2	2	2	2	2	2	2	2	2	2
Cap, veh/h		255	1214	850	171	1117	498	335	587	490	83	321
Arrive On Green		0.09	0.36	0.36	0.06	0.33	0.33	0.21	0.33	0.33	0.05	0.17
Sat Flow, veh/h		2910	3367	1481	2910	3367	1500	1594	1772	1479	1594	1850
Grp Volume(v), veh/h		208	1108	200	148	890	41	313	349	218	57	237
Grp Sat Flow(s),veh/h/ln		1455	1683	1481	1455	1683	1500	1594	1772	1479	1594	1683
Q Serve(g_s), s		8.4	37.4	8.0	6.0	28.6	2.2	23.0	19.6	13.8	4.2	16.2
Cycle Q Clear(g_c), s		8.4	37.4	8.0	6.0	28.6	2.2	23.0	19.6	13.8	4.2	16.2
Prop In Lane		1.00		1.00	1.00		1.00	1.00		1.00	1.00	
Lane Grp Cap(c), veh/h		255	1214	850	171	1117	498	335	587	490	83	292
V/C Ratio(X)		0.82	0.91	0.24	0.87	0.80	0.08	0.93	0.59	0.44	0.68	0.81
Avail Cap(c_a), veh/h		317	1214	850	171	1117	498	341	587	490	241	438
HCM Platoon Ratio		1.00	1.00	1.00	1.00	1.00	1.00	1.00	1.00	1.00	1.00	1.00
Upstream Filter(I)		1.00	1.00	1.00	1.00	1.00	1.00	1.00	1.00	1.00	1.00	1.00
Uniform Delay (d), s/veh		53.4	36.3	12.7	55.6	36.2	27.4	46.3	33.2	31.3	55.5	47.4
Incr Delay (d2), s/veh		10.2	11.9	0.7	33.1	5.9	0.3	31.6	1.1	0.2	3.7	4.1
Initial Q Delay(d3),s/veh		0.0	0.0	0.0	0.0	0.0	0.0	0.0	0.0	0.0	0.0	0.0
%ile BackOfQ(50%),veh/ln		3.3	16.4	2.6	2.9	12.0	0.8	11.7	8.3	4.8	1.7	6.9
Unsig. Movement Delay, s/veh												
LnGrp Delay(d),s/veh		63.6	48.2	13.3	88.8	42.1	27.7	77.8	34.3	31.5	59.2	51.5
LnGrp LOS		E	D	B	F	D	C	E	C	C	E	D
Approach Vol, veh/h			1516			1079			880			516
Approach Delay, s/veh			45.7			48.0			49.1			53.8
Approach LOS			D			D			D			D
Timer - Assigned Phs	1	2	3	4	5	6	7	8				
Phs Duration (G+Y+Rc), s	11.0	50.9	28.5	28.8	14.5	47.4	9.7	47.6				
Change Period (Y+Rc), s	4.0	* 7.9	3.5	* 8.1	4.0	* 7.9	3.5	* 8.1				
Max Green Setting (Gmax), s	7.0	* 43	25.5	* 31	13.0	* 37	18.0	* 39				
Max Q Clear Time (g_c+I1), s	8.0	39.4	25.0	19.0	10.4	30.6	6.2	21.6				
Green Ext Time (p_c), s	0.0	1.6	0.0	1.3	0.1	1.7	0.0	1.4				

Intersection Summary

HCM 6th Ctrl Delay	48.1
HCM 6th LOS	D

Notes

User approved ignoring U-Turning movement.

* HCM 6th computational engine requires equal clearance times for the phases crossing the barrier.

HCM 6th Signalized Intersection Summary
 4: Etiwanda Ave & Foothill Blvd

Rancho Cuvee
 Existing PM

Movement	SBR
Lane Configurations	
Traffic Volume (veh/h)	183
Future Volume (veh/h)	183
Initial Q (Qb), veh	0
Ped-Bike Adj(A_pbT)	0.98
Parking Bus, Adj	1.00
Work Zone On Approach	
Adj Sat Flow, veh/h/ln	1772
Adj Flow Rate, veh/h	197
Peak Hour Factor	0.93
Percent Heavy Veh, %	2
Cap, veh/h	232
Arrive On Green	0.17
Sat Flow, veh/h	1338
Grp Volume(v), veh/h	222
Grp Sat Flow(s),veh/h/ln	1505
Q Serve(g_s), s	17.0
Cycle Q Clear(g_c), s	17.0
Prop In Lane	0.89
Lane Grp Cap(c), veh/h	261
V/C Ratio(X)	0.85
Avail Cap(c_a), veh/h	391
HCM Platoon Ratio	1.00
Upstream Filter(l)	1.00
Uniform Delay (d), s/veh	47.8
Incr Delay (d2), s/veh	7.1
Initial Q Delay(d3),s/veh	0.0
%ile BackOfQ(50%),veh/ln	6.7
Unsig. Movement Delay, s/veh	
LnGrp Delay(d),s/veh	54.9
LnGrp LOS	D
Approach Vol, veh/h	
Approach Delay, s/veh	
Approach LOS	
Timer - Assigned Phs	

HCM 6th Signalized Intersection Summary
 1: Foothill Blvd & I-15 SB Off Ramp

Rancho Cuvee
 Opening Year AM



Movement	EBL	EBT	EBR	WBL	WBT	WBR	NBL	NBT	NBR	SBL	SBT	SBR
Lane Configurations		↑↑↑	↗		↑↑↑					↘	↕	↗
Traffic Volume (veh/h)	0	660	1000	0	1780	0	0	0	0	85	0	680
Future Volume (veh/h)	0	660	1000	0	1780	0	0	0	0	85	0	680
Initial Q (Qb), veh	0	0	0	0	0	0				0	0	0
Ped-Bike Adj(A_pbT)	1.00		1.00	1.00		1.00				1.00		1.00
Parking Bus, Adj	1.00	1.00	1.00	1.00	1.00	1.00				1.00	1.00	1.00
Work Zone On Approach		No			No						No	
Adj Sat Flow, veh/h/ln	0	1772	1772	0	1772	0				1575	1772	1772
Adj Flow Rate, veh/h	0	688	0	0	1854	0				59	0	740
Peak Hour Factor	0.96	0.96	0.92	0.92	0.96	0.96				0.96	0.92	0.96
Percent Heavy Veh, %	0	2	2	0	2	0				2	2	2
Cap, veh/h	0	2871		0	2871	0				425	0	851
Arrive On Green	0.00	0.59	0.00	0.00	0.59	0.00				0.28	0.00	0.28
Sat Flow, veh/h	0	4997	1502	0	5156	0				1500	0	3003
Grp Volume(v), veh/h	0	688	0	0	1854	0				59	0	740
Grp Sat Flow(s),veh/h/ln	0	1612	1502	0	1612	0				1500	0	1502
Q Serve(g_s), s	0.0	6.7	0.0	0.0	25.3	0.0				2.9	0.0	23.4
Cycle Q Clear(g_c), s	0.0	6.7	0.0	0.0	25.3	0.0				2.9	0.0	23.4
Prop In Lane	0.00		1.00	0.00		0.00				1.00		1.00
Lane Grp Cap(c), veh/h	0	2871		0	2871	0				425	0	851
V/C Ratio(X)	0.00	0.24		0.00	0.65	0.00				0.14	0.00	0.87
Avail Cap(c_a), veh/h	0	2871		0	2871	0				567	0	1135
HCM Platoon Ratio	1.00	1.00	1.00	1.00	1.00	1.00				1.00	1.00	1.00
Upstream Filter(I)	0.00	1.00	0.00	0.00	1.00	0.00				1.00	0.00	1.00
Uniform Delay (d), s/veh	0.0	9.6	0.0	0.0	13.4	0.0				26.7	0.0	34.1
Incr Delay (d2), s/veh	0.0	0.2	0.0	0.0	1.1	0.0				0.1	0.0	5.8
Initial Q Delay(d3),s/veh	0.0	0.0	0.0	0.0	0.0	0.0				0.0	0.0	0.0
%ile BackOfQ(50%),veh/ln	0.0	2.1	0.0	0.0	7.8	0.0				1.1	0.0	9.2
Unsig. Movement Delay, s/veh												
LnGrp Delay(d),s/veh	0.0	9.8	0.0	0.0	14.5	0.0				26.9	0.0	39.9
LnGrp LOS	A	A		A	B	A				C	A	D
Approach Vol, veh/h		688	A		1854						799	
Approach Delay, s/veh		9.8			14.5						38.9	
Approach LOS		A			B						D	
Timer - Assigned Phs		2		4		6						
Phs Duration (G+Y+Rc), s		65.9		34.1		65.9						
Change Period (Y+Rc), s		6.5		5.8		6.5						
Max Green Setting (Gmax), s		49.9		37.8		49.9						
Max Q Clear Time (g_c+I1), s		8.7		25.4		27.3						
Green Ext Time (p_c), s		3.7		2.9		11.5						

Intersection Summary

HCM 6th Ctrl Delay	19.4
HCM 6th LOS	B

Notes

User approved volume balancing among the lanes for turning movement.
 Unsignalized Delay for [EBR] is excluded from calculations of the approach delay and intersection delay.

HCM 6th Signalized Intersection Summary
2: I-15 NB Off Ramp & Foothill Blvd

Rancho Cuvee
Opening Year AM



Movement	EBL	EBT	EBR	WBL	WBT	WBR	NBL	NBT	NBR	SBL	SBT	SBR
Lane Configurations		↑↑↑			↑↑↑	↗	↘	↕	↗			
Traffic Volume (veh/h)	0	490	0	0	1600	135	965	0	430	0	0	0
Future Volume (veh/h)	0	490	0	0	1600	135	965	0	430	0	0	0
Initial Q (Qb), veh	0	0	0	0	0	0	0	0	0			
Ped-Bike Adj(A_pbT)	1.00		1.00	1.00		1.00	1.00		0.99			
Parking Bus, Adj	1.00	1.00	1.00	1.00	1.00	1.00	1.00	1.00	1.00			
Work Zone On Approach		No			No			No				
Adj Sat Flow, veh/h/ln	0	1772	0	0	1772	1772	1575	1772	1772			
Adj Flow Rate, veh/h	0	510	0	0	1667	0	1144	0	299			
Peak Hour Factor	0.92	0.96	0.96	0.96	0.96	0.92	0.96	0.92	0.96			
Percent Heavy Veh, %	0	2	0	0	2	2	2	2	2			
Cap, veh/h	0	2316	0	0	2316		1195	0	590			
Arrive On Green	0.00	0.48	0.00	0.00	0.48	0.00	0.40	0.00	0.40			
Sat Flow, veh/h	0	5156	0	0	4997	1502	3000	0	1482			
Grp Volume(v), veh/h	0	510	0	0	1667	0	1144	0	299			
Grp Sat Flow(s),veh/h/ln	0	1612	0	0	1612	1502	1500	0	1482			
Q Serve(g_s), s	0.0	6.1	0.0	0.0	27.4	0.0	37.1	0.0	15.2			
Cycle Q Clear(g_c), s	0.0	6.1	0.0	0.0	27.4	0.0	37.1	0.0	15.2			
Prop In Lane	0.00		0.00	0.00		1.00	1.00		1.00			
Lane Grp Cap(c), veh/h	0	2316	0	0	2316		1195	0	590			
V/C Ratio(X)	0.00	0.22	0.00	0.00	0.72		0.96	0.00	0.51			
Avail Cap(c_a), veh/h	0	2316	0	0	2316		1206	0	596			
HCM Platoon Ratio	1.00	1.00	1.00	1.00	1.00	1.00	1.00	1.00	1.00			
Upstream Filter(I)	0.00	1.00	0.00	0.00	0.75	0.00	1.00	0.00	1.00			
Uniform Delay (d), s/veh	0.0	15.2	0.0	0.0	20.7	0.0	29.3	0.0	22.7			
Incr Delay (d2), s/veh	0.0	0.2	0.0	0.0	1.5	0.0	16.7	0.0	0.7			
Initial Q Delay(d3),s/veh	0.0	0.0	0.0	0.0	0.0	0.0	0.0	0.0	0.0			
%ile BackOfQ(50%),veh/ln	0.0	2.1	0.0	0.0	10.1	0.0	15.5	0.0	5.3			
Unsig. Movement Delay, s/veh												
LnGrp Delay(d),s/veh	0.0	15.4	0.0	0.0	22.2	0.0	45.9	0.0	23.4			
LnGrp LOS	A	B	A	A	C		D	A	C			
Approach Vol, veh/h		510			1667	A		1443				
Approach Delay, s/veh		15.4			22.2			41.3				
Approach LOS		B			C			D				
Timer - Assigned Phs		2				6		8				
Phs Duration (G+Y+Rc), s		54.4				54.4		45.6				
Change Period (Y+Rc), s		6.5				6.5		5.8				
Max Green Setting (Gmax), s		47.5				47.5		40.2				
Max Q Clear Time (g_c+I1), s		8.1				29.4		39.1				
Green Ext Time (p_c), s		2.6				10.3		0.7				

Intersection Summary

HCM 6th Ctrl Delay	28.8
HCM 6th LOS	C

Notes

- User approved volume balancing among the lanes for turning movement.
- User approved changes to right turn type.
- Unsignalized Delay for [WBR] is excluded from calculations of the approach delay and intersection delay.

HCM 6th Signalized Intersection Summary
 3: Sacred Heart & Foothill Blvd

Rancho Cuvee
 Opening Year AM



Movement	EBU	EBL	EBT	EBR	WBU	WBL	WBT	WBR	NBL	NBT	NBR	SBL
Lane Configurations		↔↔	↑↑↑	↗		↔↔	↑↑↑	↗	↖	↑	↗	↖
Traffic Volume (veh/h)	30	150	670	40	10	50	1470	160	110	10	20	25
Future Volume (veh/h)	30	150	670	40	10	50	1470	160	110	10	20	25
Initial Q (Qb), veh		0	0	0		0	0	0	0	0	0	0
Ped-Bike Adj(A_pbT)		1.00		1.00		1.00		1.00	1.00		1.00	1.00
Parking Bus, Adj		1.00	1.00	1.00		1.00	1.00	1.00	1.00	1.00	1.00	1.00
Work Zone On Approach			No			No			No			
Adj Sat Flow, veh/h/ln		1575	1772	1772		1575	1772	1772	1673	1772	1772	1673
Adj Flow Rate, veh/h		156	698	26		52	1531	126	122	0	1	26
Peak Hour Factor		0.96	0.96	0.96		0.96	0.96	0.96	0.96	0.96	0.96	0.96
Percent Heavy Veh, %		2	2	2		2	2	2	2	2	2	2
Cap, veh/h		268	2785	962		209	2686	925	210	0	98	98
Arrive On Green		0.09	0.58	0.58		0.07	0.56	0.56	0.07	0.00	0.07	0.06
Sat Flow, veh/h		2910	4837	1500		2910	4837	1500	3188	0	1495	1594
Grp Volume(v), veh/h		156	698	26		52	1531	126	122	0	1	26
Grp Sat Flow(s),veh/h/ln		1455	1612	1500		1455	1612	1500	1594	0	1495	1594
Q Serve(g_s), s		6.7	9.3	0.8		2.2	26.8	4.6	4.8	0.0	0.1	2.0
Cycle Q Clear(g_c), s		6.7	9.3	0.8		2.2	26.8	4.6	4.8	0.0	0.1	2.0
Prop In Lane		1.00		1.00		1.00		1.00	1.00		1.00	1.00
Lane Grp Cap(c), veh/h		268	2785	962		209	2686	925	210	0	98	98
V/C Ratio(X)		0.58	0.25	0.03		0.25	0.57	0.14	0.58	0.00	0.01	0.27
Avail Cap(c_a), veh/h		269	2785	962		246	2686	925	1054	0	494	98
HCM Platoon Ratio		1.00	1.00	1.00		1.00	1.00	1.00	1.00	1.00	1.00	1.00
Upstream Filter(l)		0.94	0.94	0.94		1.00	1.00	1.00	1.00	0.00	1.00	1.00
Uniform Delay (d), s/veh		56.6	13.7	8.5		57.0	18.8	10.4	59.0	0.0	56.8	58.2
Incr Delay (d2), s/veh		3.0	0.2	0.0		0.6	0.9	0.3	2.6	0.0	0.0	1.4
Initial Q Delay(d3),s/veh		0.0	0.0	0.0		0.0	0.0	0.0	0.0	0.0	0.0	0.0
%ile BackOfQ(50%),veh/ln		2.5	3.2	0.3		0.8	9.4	1.8	2.0	0.0	0.0	0.9
Unsig. Movement Delay, s/veh												
LnGrp Delay(d),s/veh		59.6	13.9	8.6		57.7	19.7	10.7	61.5	0.0	56.8	59.6
LnGrp LOS		E	B	A		E	B	B	E	A	E	E
Approach Vol, veh/h			880				1709			123		
Approach Delay, s/veh			21.8				20.2			61.5		
Approach LOS			C				C			E		
Timer - Assigned Phs	1	2		4	5	6		8				
Phs Duration (G+Y+Rc), s	13.3	82.1		17.5	16.0	79.5		17.0				
Change Period (Y+Rc), s	4.0	* 7.3		9.0	4.0	* 7.3		9.0				
Max Green Setting (Gmax), s	11.0	* 39		43.0	12.0	* 38		8.0				
Max Q Clear Time (g_c+I1), s	4.2	11.3		6.8	8.7	28.8		10.0				
Green Ext Time (p_c), s	0.0	4.6		0.4	0.1	6.1		0.0				

Intersection Summary

HCM 6th Ctrl Delay	31.0
HCM 6th LOS	C

Notes

- User approved volume balancing among the lanes for turning movement.
- User approved ignoring U-Turning movement.
- * HCM 6th computational engine requires equal clearance times for the phases crossing the barrier.

HCM 6th Signalized Intersection Summary
 3: Sacred Heart & Foothill Blvd

Rancho Cuvee
 Opening Year AM



Movement	SBT	SBR
Lane Configurations	↓	↙
Traffic Volume (veh/h)	20	90
Future Volume (veh/h)	20	90
Initial Q (Qb), veh	0	0
Ped-Bike Adj(A_pbT)		1.00
Parking Bus, Adj	1.00	1.00
Work Zone On Approach	No	
Adj Sat Flow, veh/h/ln	1772	1772
Adj Flow Rate, veh/h	21	94
Peak Hour Factor	0.96	0.96
Percent Heavy Veh, %	2	2
Cap, veh/h	17	77
Arrive On Green	0.06	0.06
Sat Flow, veh/h	281	1257
Grp Volume(v), veh/h	0	115
Grp Sat Flow(s),veh/h/ln	0	1538
Q Serve(g_s), s	0.0	8.0
Cycle Q Clear(g_c), s	0.0	8.0
Prop In Lane		0.82
Lane Grp Cap(c), veh/h	0	95
V/C Ratio(X)	0.00	1.21
Avail Cap(c_a), veh/h	0	95
HCM Platoon Ratio	1.00	1.00
Upstream Filter(l)	0.00	1.00
Uniform Delay (d), s/veh	0.0	61.0
Incr Delay (d2), s/veh	0.0	161.2
Initial Q Delay(d3),s/veh	0.0	0.0
%ile BackOfQ(50%),veh/ln	0.0	7.4
Unsig. Movement Delay, s/veh		
LnGrp Delay(d),s/veh	0.0	222.2
LnGrp LOS	A	F
Approach Vol, veh/h	141	
Approach Delay, s/veh	192.2	
Approach LOS	F	
Timer - Assigned Phs		

HCM 6th Signalized Intersection Summary
4: Etiwanda Ave & Foothill Blvd

Rancho Cuvee
Opening Year AM

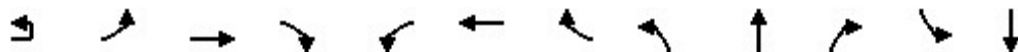

Movement	EBU	EBL	EBT	EBR	WBL	WBT	WBR	NBL	NBT	NBR	SBL	SBT
Lane Configurations		↘ ↙	↕	↗	↘ ↙	↕	↗	↘ ↙	↕	↗	↘ ↙	↕
Traffic Volume (veh/h)	12	105	440	175	305	1280	90	145	245	100	65	400
Future Volume (veh/h)	12	105	440	175	305	1280	90	145	245	100	65	400
Initial Q (Qb), veh		0	0	0	0	0	0	0	0	0	0	0
Ped-Bike Adj(A_pbT)		1.00		0.98	1.00		0.99	1.00		0.98	1.00	
Parking Bus, Adj		1.00	1.00	1.00	1.00	1.00	1.00	1.00	1.00	1.00	1.00	1.00
Work Zone On Approach			No		No			No				No
Adj Sat Flow, veh/h/ln		1575	1772	1772	1575	1772	1772	1673	1772	1772	1673	1772
Adj Flow Rate, veh/h		113	473	121	328	1376	31	156	263	23	70	430
Peak Hour Factor		0.93	0.93	0.93	0.93	0.93	0.93	0.93	0.93	0.93	0.93	0.93
Percent Heavy Veh, %		2	2	2	2	2	2	2	2	2	2	2
Cap, veh/h		308	1227	697	377	1307	580	169	399	332	159	498
Arrive On Green		0.11	0.36	0.36	0.13	0.39	0.39	0.11	0.23	0.23	0.10	0.22
Sat Flow, veh/h		2910	3367	1474	2910	3367	1494	1594	1772	1473	1594	2276
Grp Volume(v), veh/h		113	473	121	328	1376	31	156	263	23	70	317
Grp Sat Flow(s),veh/h/ln		1455	1683	1474	1455	1683	1494	1594	1772	1473	1594	1683
Q Serve(g_s), s		4.7	13.5	6.2	14.4	50.5	1.7	12.6	17.6	1.6	5.4	23.5
Cycle Q Clear(g_c), s		4.7	13.5	6.2	14.4	50.5	1.7	12.6	17.6	1.6	5.4	23.5
Prop In Lane		1.00		1.00	1.00		1.00	1.00		1.00	1.00	
Lane Grp Cap(c), veh/h		308	1227	697	377	1307	580	169	399	332	159	369
V/C Ratio(X)		0.37	0.39	0.17	0.87	1.05	0.05	0.92	0.66	0.07	0.44	0.86
Avail Cap(c_a), veh/h		313	1227	697	470	1307	580	169	477	397	159	443
HCM Platoon Ratio		1.00	1.00	1.00	1.00	1.00	1.00	1.00	1.00	1.00	1.00	1.00
Upstream Filter(I)		1.00	1.00	1.00	1.00	1.00	1.00	1.00	1.00	1.00	1.00	1.00
Uniform Delay (d), s/veh		54.1	30.5	19.8	55.5	39.8	24.8	57.6	45.8	39.6	55.1	48.8
Incr Delay (d2), s/veh		0.7	0.9	0.5	13.6	40.1	0.2	47.1	2.5	0.1	1.9	13.6
Initial Q Delay(d3),s/veh		0.0	0.0	0.0	0.0	0.0	0.0	0.0	0.0	0.0	0.0	0.0
%ile BackOfQ(50%),veh/ln		1.7	5.4	2.2	5.8	26.8	0.6	7.2	7.8	0.6	2.2	11.0
Unsig. Movement Delay, s/veh												
LnGrp Delay(d),s/veh		54.8	31.5	20.4	69.1	79.9	25.0	104.7	48.4	39.7	57.0	62.5
LnGrp LOS		D	C	C	E	F	C	F	D	D	E	E
Approach Vol, veh/h			707			1735			442			690
Approach Delay, s/veh			33.3			76.8			67.8			62.9
Approach LOS			C			E			E			E
Timer - Assigned Phs	1	2	3	4	5	6	7	8				
Phs Duration (G+Y+Rc), s	20.8	55.3	17.3	36.6	17.8	58.4	16.5	37.4				
Change Period (Y+Rc), s	4.0	* 7.9	3.5	* 8.1	4.0	* 7.9	3.5	* 8.1				
Max Green Setting (Gmax), s	21.0	* 38	13.8	* 34	14.0	* 45	13.0	* 35				
Max Q Clear Time (g_c+I1), s	16.4	15.5	14.6	25.9	6.7	52.5	7.4	19.6				
Green Ext Time (p_c), s	0.5	3.1	0.0	2.2	0.2	0.0	0.1	1.2				

Intersection Summary

HCM 6th Ctrl Delay	64.4
HCM 6th LOS	E

Notes

User approved ignoring U-Turning movement.

* HCM 6th computational engine requires equal clearance times for the phases crossing the barrier.

HCM 6th Signalized Intersection Summary
 4: Etiwanda Ave & Foothill Blvd

Rancho Cuvee
 Opening Year AM

Movement	SBR
Lane Configurations	
Traffic Volume (veh/h)	270
Future Volume (veh/h)	270
Initial Q (Qb), veh	0
Ped-Bike Adj(A_pbT)	1.00
Parking Bus, Adj	1.00
Work Zone On Approach	
Adj Sat Flow, veh/h/ln	1772
Adj Flow Rate, veh/h	190
Peak Hour Factor	0.93
Percent Heavy Veh, %	2
Cap, veh/h	218
Arrive On Green	0.22
Sat Flow, veh/h	995
Grp Volume(v), veh/h	303
Grp Sat Flow(s),veh/h/ln	1588
Q Serve(g_s), s	23.9
Cycle Q Clear(g_c), s	23.9
Prop In Lane	0.63
Lane Grp Cap(c), veh/h	348
V/C Ratio(X)	0.87
Avail Cap(c_a), veh/h	418
HCM Platoon Ratio	1.00
Upstream Filter(l)	1.00
Uniform Delay (d), s/veh	49.0
Incr Delay (d2), s/veh	15.7
Initial Q Delay(d3),s/veh	0.0
%ile BackOfQ(50%),veh/ln	10.7
Unsig. Movement Delay, s/veh	
LnGrp Delay(d),s/veh	64.7
LnGrp LOS	E
Approach Vol, veh/h	
Approach Delay, s/veh	
Approach LOS	
Timer - Assigned Phs	

HCM 6th Signalized Intersection Summary
 1: Foothill Blvd & I-15 SB Off Ramp

Rancho Cuvee
 Opening Year PM



Movement	EBL	EBT	EBR	WBL	WBT	WBR	NBL	NBT	NBR	SBL	SBT	SBR
Lane Configurations		↑↑↑	↗		↑↑↑					↘	↕	↗
Traffic Volume (veh/h)	0	2090	1010	0	1450	0	0	0	0	120	0	645
Future Volume (veh/h)	0	2090	1010	0	1450	0	0	0	0	120	0	645
Initial Q (Qb), veh	0	0	0	0	0	0				0	0	0
Ped-Bike Adj(A_pbT)	1.00		1.00	1.00		1.00				1.00		1.00
Parking Bus, Adj	1.00	1.00	1.00	1.00	1.00	1.00				1.00	1.00	1.00
Work Zone On Approach		No			No						No	
Adj Sat Flow, veh/h/ln	0	1772	1772	0	1772	0				1575	1772	1772
Adj Flow Rate, veh/h	0	2177	0	0	1510	0				83	0	691
Peak Hour Factor	0.96	0.96	0.92	0.92	0.96	0.96				0.96	0.92	0.96
Percent Heavy Veh, %	0	2	2	0	2	0				2	2	2
Cap, veh/h	0	3027		0	3027	0				394	0	788
Arrive On Green	0.00	0.63	0.00	0.00	0.63	0.00				0.26	0.00	0.26
Sat Flow, veh/h	0	4997	1502	0	5156	0				1500	0	3003
Grp Volume(v), veh/h	0	2177	0	0	1510	0				83	0	691
Grp Sat Flow(s),veh/h/ln	0	1612	1502	0	1612	0				1500	0	1502
Q Serve(g_s), s	0.0	33.7	0.0	0.0	18.7	0.0				4.8	0.0	24.2
Cycle Q Clear(g_c), s	0.0	33.7	0.0	0.0	18.7	0.0				4.8	0.0	24.2
Prop In Lane	0.00		1.00	0.00		0.00				1.00		1.00
Lane Grp Cap(c), veh/h	0	3027		0	3027	0				394	0	788
V/C Ratio(X)	0.00	0.72		0.00	0.50	0.00				0.21	0.00	0.88
Avail Cap(c_a), veh/h	0	3027		0	3027	0				507	0	1016
HCM Platoon Ratio	1.00	1.00	1.00	1.00	1.00	1.00				1.00	1.00	1.00
Upstream Filter(I)	0.00	1.00	0.00	0.00	1.00	0.00				1.00	0.00	1.00
Uniform Delay (d), s/veh	0.0	14.0	0.0	0.0	11.2	0.0				31.7	0.0	38.9
Incr Delay (d2), s/veh	0.0	1.5	0.0	0.0	0.6	0.0				0.3	0.0	7.2
Initial Q Delay(d3),s/veh	0.0	0.0	0.0	0.0	0.0	0.0				0.0	0.0	0.0
%ile BackOfQ(50%),veh/ln	0.0	10.5	0.0	0.0	5.8	0.0				1.8	0.0	9.7
Unsig. Movement Delay, s/veh												
LnGrp Delay(d),s/veh	0.0	15.5	0.0	0.0	11.8	0.0				31.9	0.0	46.0
LnGrp LOS	A	B		A	B	A				C	A	D
Approach Vol, veh/h		2177	A		1510						774	
Approach Delay, s/veh		15.5			11.8						44.5	
Approach LOS		B			B						D	
Timer - Assigned Phs		2		4		6						
Phs Duration (G+Y+Rc), s		75.3		34.7		75.3						
Change Period (Y+Rc), s		6.5		5.8		6.5						
Max Green Setting (Gmax), s		60.5		37.2		60.5						
Max Q Clear Time (g_c+I1), s		35.7		26.2		20.7						
Green Ext Time (p_c), s		14.9		2.6		10.5						

Intersection Summary

HCM 6th Ctrl Delay	19.3
HCM 6th LOS	B

Notes

User approved volume balancing among the lanes for turning movement.
 Unsignalized Delay for [EBR] is excluded from calculations of the approach delay and intersection delay.

HCM 6th Signalized Intersection Summary

2: I-15 NB Off Ramp & Foothill Blvd

Rancho Cuvee
Opening Year PM



Movement	EBL	EBT	EBR	WBL	WBT	WBR	NBL	NBT	NBR	SBL	SBT	SBR
Lane Configurations		↑↑↑			↑↑↑	↗	↘	↕	↗			
Traffic Volume (veh/h)	0	1170	0	0	1150	235	720	0	520	0	0	0
Future Volume (veh/h)	0	1170	0	0	1150	235	720	0	520	0	0	0
Initial Q (Qb), veh	0	0	0	0	0	0	0	0	0			
Ped-Bike Adj(A_pbT)	1.00		1.00	1.00		1.00	1.00		0.98			
Parking Bus, Adj	1.00	1.00	1.00	1.00	1.00	1.00	1.00	1.00	1.00			
Work Zone On Approach		No			No			No				
Adj Sat Flow, veh/h/ln	0	1772	0	0	1772	1772	1575	1772	1772			
Adj Flow Rate, veh/h	0	1219	0	0	1198	0	919	0	361			
Peak Hour Factor	0.92	0.96	0.96	0.96	0.96	0.92	0.96	0.92	0.96			
Percent Heavy Veh, %	0	2	0	0	2	2	2	2	2			
Cap, veh/h	0	2588	0	0	2588		1059	0	522			
Arrive On Green	0.00	0.54	0.00	0.00	0.54	0.00	0.35	0.00	0.35			
Sat Flow, veh/h	0	5156	0	0	4997	1502	3000	0	1479			
Grp Volume(v), veh/h	0	1219	0	0	1198	0	919	0	361			
Grp Sat Flow(s),veh/h/ln	0	1612	0	0	1612	1502	1500	0	1479			
Q Serve(g_s), s	0.0	17.2	0.0	0.0	16.8	0.0	31.4	0.0	23.0			
Cycle Q Clear(g_c), s	0.0	17.2	0.0	0.0	16.8	0.0	31.4	0.0	23.0			
Prop In Lane	0.00		0.00	0.00		1.00	1.00		1.00			
Lane Grp Cap(c), veh/h	0	2588	0	0	2588		1059	0	522			
V/C Ratio(X)	0.00	0.47	0.00	0.00	0.46		0.87	0.00	0.69			
Avail Cap(c_a), veh/h	0	2588	0	0	2588		1533	0	756			
HCM Platoon Ratio	1.00	1.00	1.00	1.00	1.00	1.00	1.00	1.00	1.00			
Upstream Filter(I)	0.00	1.00	0.00	0.00	0.88	0.00	1.00	0.00	1.00			
Uniform Delay (d), s/veh	0.0	15.9	0.0	0.0	15.8	0.0	33.2	0.0	30.4			
Incr Delay (d2), s/veh	0.0	0.6	0.0	0.0	0.5	0.0	3.9	0.0	1.6			
Initial Q Delay(d3),s/veh	0.0	0.0	0.0	0.0	0.0	0.0	0.0	0.0	0.0			
%ile BackOfQ(50%),veh/ln	0.0	5.8	0.0	0.0	6.1	0.0	11.8	0.0	8.3			
Unsig. Movement Delay, s/veh												
LnGrp Delay(d),s/veh	0.0	16.5	0.0	0.0	16.3	0.0	37.1	0.0	32.1			
LnGrp LOS	A	B	A	A	B		D	A	C			
Approach Vol, veh/h		1219			1198	A		1280				
Approach Delay, s/veh		16.5			16.3			35.7				
Approach LOS		B			B			D				
Timer - Assigned Phs		2			6			8				
Phs Duration (G+Y+Rc), s		65.4			65.4			44.6				
Change Period (Y+Rc), s		6.5			6.5			5.8				
Max Green Setting (Gmax), s		41.5			41.5			56.2				
Max Q Clear Time (g_c+I1), s		19.2			18.8			33.4				
Green Ext Time (p_c), s		6.7			7.9			5.4				

Intersection Summary

HCM 6th Ctrl Delay	23.1
HCM 6th LOS	C

Notes

- User approved volume balancing among the lanes for turning movement.
- User approved changes to right turn type.
- Unsignalized Delay for [WBR] is excluded from calculations of the approach delay and intersection delay.

HCM 6th Signalized Intersection Summary
 3: Sacred Heart & Foothill Blvd

Rancho Cuvee
 Opening Year PM

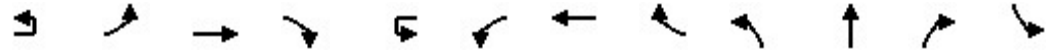

Movement	EBU	EBL	EBT	EBR	WBU	WBL	WBT	WBR	NBL	NBT	NBR	SBL
Lane Configurations		↘ ↙	↑ ↑ ↑	↗		↘ ↙	↑ ↑ ↑	↗	↘ ↙	↑	↗	↘ ↙
Traffic Volume (veh/h)	125	60	1200	140	40	130	930	70	295	1	105	20
Future Volume (veh/h)	125	60	1200	140	40	130	930	70	295	1	105	20
Initial Q (Qb), veh		0	0	0		0	0	0	0	0	0	0
Ped-Bike Adj(A_pbT)		1.00		1.00		1.00		0.99	1.00		0.99	1.00
Parking Bus, Adj		1.00	1.00	1.00		1.00	1.00	1.00	1.00	1.00	1.00	1.00
Work Zone On Approach			No				No			No		
Adj Sat Flow, veh/h/ln		1575	1772	1772		1575	1772	1772	1673	1772	1772	1673
Adj Flow Rate, veh/h		62	1250	89		135	969	33	308	0	15	21
Peak Hour Factor		0.96	0.96	0.96		0.96	0.96	0.96	0.96	0.96	0.96	0.96
Percent Heavy Veh, %		2	2	2		2	2	2	2	2	2	2
Cap, veh/h		100	2716	1035		176	2843	905	411	0	192	37
Arrive On Green		0.03	0.56	0.56		0.06	0.59	0.59	0.13	0.00	0.13	0.02
Sat Flow, veh/h		2910	4837	1498		2910	4837	1479	3188	0	1491	1594
Grp Volume(v), veh/h		62	1250	89		135	969	33	308	0	15	21
Grp Sat Flow(s),veh/h/ln		1455	1612	1498		1455	1612	1479	1594	0	1491	1594
Q Serve(g_s), s		2.7	19.9	2.5		5.9	13.4	1.2	12.1	0.0	1.2	1.7
Cycle Q Clear(g_c), s		2.7	19.9	2.5		5.9	13.4	1.2	12.1	0.0	1.2	1.7
Prop In Lane		1.00		1.00		1.00		1.00	1.00		1.00	1.00
Lane Grp Cap(c), veh/h		100	2716	1035		176	2843	905	411	0	192	37
V/C Ratio(X)		0.62	0.46	0.09		0.77	0.34	0.04	0.75	0.00	0.08	0.56
Avail Cap(c_a), veh/h		224	2716	1035		179	2843	905	1054	0	493	221
HCM Platoon Ratio		1.00	1.00	1.00		1.00	1.00	1.00	1.00	1.00	1.00	1.00
Upstream Filter(l)		0.80	0.80	0.80		1.00	1.00	1.00	1.00	0.00	1.00	1.00
Uniform Delay (d), s/veh		61.9	16.9	6.6		60.1	13.8	10.0	54.6	0.0	49.8	62.8
Incr Delay (d2), s/veh		4.9	0.5	0.1		17.5	0.3	0.1	2.8	0.0	0.2	12.6
Initial Q Delay(d3),s/veh		0.0	0.0	0.0		0.0	0.0	0.0	0.0	0.0	0.0	0.0
%ile BackOfQ(50%),veh/ln		1.1	6.9	1.2		2.6	4.6	0.4	5.1	0.0	0.4	0.8
Unsig. Movement Delay, s/veh												
LnGrp Delay(d),s/veh		66.9	17.3	6.7		77.7	14.1	10.1	57.3	0.0	50.0	75.4
LnGrp LOS		E	B	A		E	B	B	E	A	D	E
Approach Vol, veh/h			1401				1137			323		
Approach Delay, s/veh			18.8				21.6			57.0		
Approach LOS			B				C			E		
Timer - Assigned Phs	1	2		4	5	6		8				
Phs Duration (G+Y+Rc), s	11.9	80.3		25.8	8.5	83.7		12.0				
Change Period (Y+Rc), s	4.0	* 7.3		9.0	4.0	* 7.3		9.0				
Max Green Setting (Gmax), s	8.0	* 32		43.0	10.0	* 30		18.0				
Max Q Clear Time (g_c+l1), s	7.9	21.9		14.1	4.7	15.4		3.7				
Green Ext Time (p_c), s	0.0	5.5		1.2	0.0	5.3		0.0				

Intersection Summary

HCM 6th Ctrl Delay	24.7
HCM 6th LOS	C

Notes

- User approved volume balancing among the lanes for turning movement.
- User approved ignoring U-Turning movement.
- * HCM 6th computational engine requires equal clearance times for the phases crossing the barrier.

HCM 6th Signalized Intersection Summary
 3: Sacred Heart & Foothill Blvd

Rancho Cuvee
 Opening Year PM



Movement	SBT	SBR
Lane Configurations	↓	↘
Traffic Volume (veh/h)	5	20
Future Volume (veh/h)	5	20
Initial Q (Qb), veh	0	0
Ped-Bike Adj(A_pbT)		1.00
Parking Bus, Adj	1.00	1.00
Work Zone On Approach	No	
Adj Sat Flow, veh/h/ln	1772	1772
Adj Flow Rate, veh/h	5	0
Peak Hour Factor	0.96	0.96
Percent Heavy Veh, %	2	2
Cap, veh/h	41	0
Arrive On Green	0.02	0.00
Sat Flow, veh/h	1772	0
Grp Volume(v), veh/h	5	0
Grp Sat Flow(s),veh/h/ln	1772	0
Q Serve(g_s), s	0.4	0.0
Cycle Q Clear(g_c), s	0.4	0.0
Prop In Lane		0.00
Lane Grp Cap(c), veh/h	41	0
V/C Ratio(X)	0.12	0.00
Avail Cap(c_a), veh/h	245	0
HCM Platoon Ratio	1.00	1.00
Upstream Filter(l)	1.00	0.00
Uniform Delay (d), s/veh	62.2	0.0
Incr Delay (d2), s/veh	1.3	0.0
Initial Q Delay(d3),s/veh	0.0	0.0
%ile BackOfQ(50%),veh/ln	0.2	0.0
Unsig. Movement Delay, s/veh		
LnGrp Delay(d),s/veh	63.4	0.0
LnGrp LOS	E	A
Approach Vol, veh/h	26	
Approach Delay, s/veh	73.1	
Approach LOS	E	
Timer - Assigned Phs		

HCM 6th Signalized Intersection Summary
4: Etiwanda Ave & Foothill Blvd

Rancho Cuvee
Opening Year PM

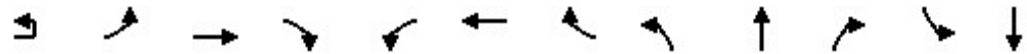

Movement	EBU	EBL	EBT	EBR	WBL	WBT	WBR	NBL	NBT	NBR	SBL	SBT
Lane Configurations		↔	↕	↗	↔	↕	↗	↔	↕	↗	↔	↕
Traffic Volume (veh/h)	60	195	1040	190	140	830	40	295	330	205	55	245
Future Volume (veh/h)	60	195	1040	190	140	830	40	295	330	205	55	245
Initial Q (Qb), veh		0	0	0	0	0	0	0	0	0	0	0
Ped-Bike Adj(A_pbT)		1.00		0.99	1.00		1.00	1.00		0.98	1.00	
Parking Bus, Adj		1.00	1.00	1.00	1.00	1.00	1.00	1.00	1.00	1.00	1.00	1.00
Work Zone On Approach			No			No			No			No
Adj Sat Flow, veh/h/ln		1575	1772	1772	1575	1772	1772	1673	1772	1772	1673	1772
Adj Flow Rate, veh/h		210	1118	109	151	892	12	317	355	116	59	263
Peak Hour Factor		0.93	0.93	0.93	0.93	0.93	0.93	0.93	0.93	0.93	0.93	0.93
Percent Heavy Veh, %		2	2	2	2	2	2	2	2	2	2	2
Cap, veh/h		253	1452	936	157	1341	598	315	500	417	83	328
Arrive On Green		0.09	0.43	0.43	0.05	0.40	0.40	0.20	0.28	0.28	0.05	0.14
Sat Flow, veh/h		2910	3367	1482	2910	3367	1500	1594	1772	1478	1594	2407
Grp Volume(v), veh/h		210	1118	109	151	892	12	317	355	116	59	182
Grp Sat Flow(s),veh/h/ln		1455	1683	1482	1455	1683	1500	1594	1772	1478	1594	1683
Q Serve(g_s), s		9.2	36.8	3.8	6.7	28.2	0.6	25.7	23.4	7.9	4.7	13.6
Cycle Q Clear(g_c), s		9.2	36.8	3.8	6.7	28.2	0.6	25.7	23.4	7.9	4.7	13.6
Prop In Lane		1.00		1.00	1.00		1.00	1.00		1.00	1.00	
Lane Grp Cap(c), veh/h		253	1452	936	157	1341	598	315	500	417	83	230
V/C Ratio(X)		0.83	0.77	0.12	0.96	0.67	0.02	1.01	0.71	0.28	0.71	0.79
Avail Cap(c_a), veh/h		291	1452	936	157	1341	598	315	527	440	221	401
HCM Platoon Ratio		1.00	1.00	1.00	1.00	1.00	1.00	1.00	1.00	1.00	1.00	1.00
Upstream Filter(I)		1.00	1.00	1.00	1.00	1.00	1.00	1.00	1.00	1.00	1.00	1.00
Uniform Delay (d), s/veh		58.4	31.5	9.7	61.4	32.0	23.7	52.2	41.9	36.4	60.7	54.3
Incr Delay (d2), s/veh		14.3	4.0	0.3	60.5	2.6	0.1	52.2	3.4	0.1	4.1	2.3
Initial Q Delay(d3),s/veh		0.0	0.0	0.0	0.0	0.0	0.0	0.0	0.0	0.0	0.0	0.0
%ile BackOfQ(50%),veh/ln		3.8	14.8	1.2	3.7	11.4	0.2	14.5	10.4	2.8	2.0	5.8
Unsig. Movement Delay, s/veh												
LnGrp Delay(d),s/veh		72.8	35.5	9.9	121.9	34.6	23.8	104.4	45.3	36.5	64.8	56.7
LnGrp LOS		E	D	A	F	C	C	F	D	D	E	E
Approach Vol, veh/h			1437			1055			788			420
Approach Delay, s/veh			39.0			47.0			67.8			58.2
Approach LOS			D			D			E			E
Timer - Assigned Phs	1	2	3	4	5	6	7	8				
Phs Duration (G+Y+Rc), s	11.0	64.0	29.2	25.8	15.3	59.7	10.3	44.8				
Change Period (Y+Rc), s	4.0	* 7.9	3.5	* 8.1	4.0	* 7.9	3.5	* 8.1				
Max Green Setting (Gmax), s	7.0	* 43	25.7	* 31	13.0	* 37	18.0	* 39				
Max Q Clear Time (g_c+I1), s	8.7	38.8	27.7	16.2	11.2	30.2	6.7	25.4				
Green Ext Time (p_c), s	0.0	1.7	0.0	1.0	0.1	1.7	0.0	1.2				

Intersection Summary

HCM 6th Ctrl Delay	49.6
HCM 6th LOS	D

Notes

User approved ignoring U-Turning movement.

* HCM 6th computational engine requires equal clearance times for the phases crossing the barrier.

HCM 6th Signalized Intersection Summary
 4: Etiwanda Ave & Foothill Blvd

Rancho Cuvee
 Opening Year PM

Movement	SBR
Lane Configurations	
Traffic Volume (veh/h)	185
Future Volume (veh/h)	185
Initial Q (Qb), veh	0
Ped-Bike Adj(A_pbT)	0.98
Parking Bus, Adj	1.00
Work Zone On Approach	
Adj Sat Flow, veh/h/ln	1772
Adj Flow Rate, veh/h	98
Peak Hour Factor	0.93
Percent Heavy Veh, %	2
Cap, veh/h	119
Arrive On Green	0.14
Sat Flow, veh/h	873
Grp Volume(v), veh/h	179
Grp Sat Flow(s),veh/h/ln	1597
Q Serve(g_s), s	14.2
Cycle Q Clear(g_c), s	14.2
Prop In Lane	0.55
Lane Grp Cap(c), veh/h	218
V/C Ratio(X)	0.82
Avail Cap(c_a), veh/h	381
HCM Platoon Ratio	1.00
Upstream Filter(l)	1.00
Uniform Delay (d), s/veh	54.6
Incr Delay (d2), s/veh	3.0
Initial Q Delay(d3),s/veh	0.0
%ile BackOfQ(50%),veh/ln	5.8
Unsig. Movement Delay, s/veh	
LnGrp Delay(d),s/veh	57.6
LnGrp LOS	E
Approach Vol, veh/h	
Approach Delay, s/veh	
Approach LOS	
Timer - Assigned Phs	

HCM 6th Signalized Intersection Summary
 1: Foothill Blvd & I-15 SB Off Ramp

Rancho Cuvee
 Opening Year Plus Project AM



Movement	EBL	EBT	EBR	WBL	WBT	WBR	NBL	NBT	NBR	SBL	SBT	SBR
Lane Configurations		↑↑↑	↗		↑↑↑					↘	↕	↗
Traffic Volume (veh/h)	0	663	100	0	1787	0	0	0	0	87	0	680
Future Volume (veh/h)	0	663	100	0	1787	0	0	0	0	87	0	680
Initial Q (Qb), veh	0	0	0	0	0	0				0	0	0
Ped-Bike Adj(A_pbT)	1.00		1.00	1.00		1.00				1.00		1.00
Parking Bus, Adj	1.00	1.00	1.00	1.00	1.00	1.00				1.00	1.00	1.00
Work Zone On Approach		No			No						No	
Adj Sat Flow, veh/h/ln	0	1772	1772	0	1772	0				1575	1772	1772
Adj Flow Rate, veh/h	0	691	0	0	1861	0				61	0	713
Peak Hour Factor	0.96	0.96	0.92	0.92	0.96	0.96				0.96	0.92	0.96
Percent Heavy Veh, %	0	2	2	0	2	0				2	2	2
Cap, veh/h	0	2914		0	2914	0				412	0	825
Arrive On Green	0.00	0.60	0.00	0.00	0.60	0.00				0.27	0.00	0.27
Sat Flow, veh/h	0	4997	1502	0	5156	0				1500	0	3003
Grp Volume(v), veh/h	0	691	0	0	1861	0				61	0	713
Grp Sat Flow(s),veh/h/ln	0	1612	1502	0	1612	0				1500	0	1502
Q Serve(g_s), s	0.0	6.6	0.0	0.0	24.9	0.0				3.1	0.0	22.6
Cycle Q Clear(g_c), s	0.0	6.6	0.0	0.0	24.9	0.0				3.1	0.0	22.6
Prop In Lane	0.00		1.00	0.00		0.00				1.00		1.00
Lane Grp Cap(c), veh/h	0	2914		0	2914	0				412	0	825
V/C Ratio(X)	0.00	0.24		0.00	0.64	0.00				0.15	0.00	0.86
Avail Cap(c_a), veh/h	0	2914		0	2914	0				567	0	1135
HCM Platoon Ratio	1.00	1.00	1.00	1.00	1.00	1.00				1.00	1.00	1.00
Upstream Filter(l)	0.00	1.00	0.00	0.00	1.00	0.00				1.00	0.00	1.00
Uniform Delay (d), s/veh	0.0	9.2	0.0	0.0	12.8	0.0				27.4	0.0	34.5
Incr Delay (d2), s/veh	0.0	0.2	0.0	0.0	1.1	0.0				0.2	0.0	5.3
Initial Q Delay(d3),s/veh	0.0	0.0	0.0	0.0	0.0	0.0				0.0	0.0	0.0
%ile BackOfQ(50%),veh/ln	0.0	2.0	0.0	0.0	7.6	0.0				1.1	0.0	8.8
Unsig. Movement Delay, s/veh												
LnGrp Delay(d),s/veh	0.0	9.4	0.0	0.0	13.9	0.0				27.6	0.0	39.8
LnGrp LOS	A	A		A	B	A				C	A	D
Approach Vol, veh/h		691	A		1861						774	
Approach Delay, s/veh		9.4			13.9						38.9	
Approach LOS		A			B						D	
Timer - Assigned Phs		2		4		6						
Phs Duration (G+Y+Rc), s		66.7		33.3		66.7						
Change Period (Y+Rc), s		6.5		5.8		6.5						
Max Green Setting (Gmax), s		49.9		37.8		49.9						
Max Q Clear Time (g_c+I1), s		8.6		24.6		26.9						
Green Ext Time (p_c), s		3.7		2.9		11.7						

Intersection Summary

HCM 6th Ctrl Delay	18.8
HCM 6th LOS	B

Notes

User approved volume balancing among the lanes for turning movement.
 Unsignalized Delay for [EBR] is excluded from calculations of the approach delay and intersection delay.

HCM 6th Signalized Intersection Summary
 2: I-15 NB Off Ramp & Foothill Blvd

Rancho Cuvee
 Opening Year Plus Project AM



Movement	EBL	EBT	EBR	WBL	WBT	WBR	NBL	NBT	NBR	SBL	SBT	SBR
Lane Configurations		↑↑↑			↑↑↑	↗	↘	↕	↗			
Traffic Volume (veh/h)	0	495	0	0	1628	142	965	0	438	0	0	0
Future Volume (veh/h)	0	495	0	0	1628	142	965	0	438	0	0	0
Initial Q (Qb), veh	0	0	0	0	0	0	0	0	0			
Ped-Bike Adj(A_pbT)	1.00		1.00	1.00		1.00	1.00		0.99			
Parking Bus, Adj	1.00	1.00	1.00	1.00	1.00	1.00	1.00	1.00	1.00			
Work Zone On Approach		No			No			No				
Adj Sat Flow, veh/h/ln	0	1772	0	0	1772	1772	1575	1772	1772			
Adj Flow Rate, veh/h	0	516	0	0	1696	0	1095	0	193			
Peak Hour Factor	0.92	0.96	0.96	0.96	0.96	0.92	0.96	0.92	0.96			
Percent Heavy Veh, %	0	2	0	0	2	2	2	2	2			
Cap, veh/h	0	2363	0	0	2363		1165	0	575			
Arrive On Green	0.00	0.49	0.00	0.00	0.49	0.00	0.39	0.00	0.39			
Sat Flow, veh/h	0	5156	0	0	4997	1502	3000	0	1482			
Grp Volume(v), veh/h	0	516	0	0	1696	0	1095	0	193			
Grp Sat Flow(s),veh/h/ln	0	1612	0	0	1612	1502	1500	0	1482			
Q Serve(g_s), s	0.0	6.1	0.0	0.0	27.6	0.0	35.2	0.0	9.2			
Cycle Q Clear(g_c), s	0.0	6.1	0.0	0.0	27.6	0.0	35.2	0.0	9.2			
Prop In Lane	0.00		0.00	0.00		1.00	1.00		1.00			
Lane Grp Cap(c), veh/h	0	2363	0	0	2363		1165	0	575			
V/C Ratio(X)	0.00	0.22	0.00	0.00	0.72		0.94	0.00	0.34			
Avail Cap(c_a), veh/h	0	2363	0	0	2363		1206	0	596			
HCM Platoon Ratio	1.00	1.00	1.00	1.00	1.00	1.00	1.00	1.00	1.00			
Upstream Filter(I)	0.00	1.00	0.00	0.00	0.67	0.00	1.00	0.00	1.00			
Uniform Delay (d), s/veh	0.0	14.6	0.0	0.0	20.1	0.0	29.5	0.0	21.5			
Incr Delay (d2), s/veh	0.0	0.2	0.0	0.0	1.3	0.0	13.7	0.0	0.3			
Initial Q Delay(d3),s/veh	0.0	0.0	0.0	0.0	0.0	0.0	0.0	0.0	0.0			
%ile BackOfQ(50%),veh/ln	0.0	2.0	0.0	0.0	10.1	0.0	14.4	0.0	3.2			
Unsig. Movement Delay, s/veh												
LnGrp Delay(d),s/veh	0.0	14.9	0.0	0.0	21.4	0.0	43.1	0.0	21.8			
LnGrp LOS	A	B	A	A	C		D	A	C			
Approach Vol, veh/h		516			1696	A		1288				
Approach Delay, s/veh		14.9			21.4			40.0				
Approach LOS		B			C			D				
Timer - Assigned Phs		2				6		8				
Phs Duration (G+Y+Rc), s		55.4				55.4		44.6				
Change Period (Y+Rc), s		6.5				6.5		5.8				
Max Green Setting (Gmax), s		47.5				47.5		40.2				
Max Q Clear Time (g_c+I1), s		8.1				29.6		37.2				
Green Ext Time (p_c), s		2.7				10.4		1.7				

Intersection Summary

HCM 6th Ctrl Delay	27.3
HCM 6th LOS	C

Notes

- User approved volume balancing among the lanes for turning movement.
- User approved changes to right turn type.
- Unsignalized Delay for [WBR] is excluded from calculations of the approach delay and intersection delay.

HCM 6th Signalized Intersection Summary
 3: Sacred Heart & Foothill Blvd

Rancho Cuvee
 Opening Year Plus Project AM

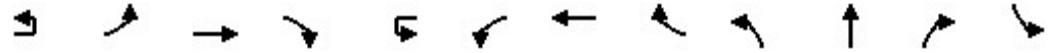

Movement	EBU	EBL	EBT	EBR	WBU	WBL	WBT	WBR	NBL	NBT	NBR	SBL
Lane Configurations		↘ ↙	↑ ↑ ↑	↗		↘ ↙	↑ ↑ ↑	↗	↘	↙	↗	↘
Traffic Volume (veh/h)	30	150	683	40	10	50	1505	160	110	10	20	25
Future Volume (veh/h)	30	150	683	40	10	50	1505	160	110	10	20	25
Initial Q (Qb), veh		0	0	0		0	0	0	0	0	0	0
Ped-Bike Adj(A_pbT)		1.00		1.00		1.00		1.00	1.00		1.00	1.00
Parking Bus, Adj		1.00	1.00	1.00		1.00	1.00	1.00	1.00	1.00	1.00	1.00
Work Zone On Approach			No			No			No			
Adj Sat Flow, veh/h/ln		1575	1772	1772		1575	1772	1772	1673	1772	1772	1673
Adj Flow Rate, veh/h		156	711	24		52	1568	127	122	0	1	26
Peak Hour Factor		0.96	0.96	0.96		0.96	0.96	0.96	0.96	0.96	0.96	0.96
Percent Heavy Veh, %		2	2	2		2	2	2	2	2	2	2
Cap, veh/h		268	2785	962		209	2686	925	210	0	98	98
Arrive On Green		0.09	0.58	0.58		0.07	0.56	0.56	0.07	0.00	0.07	0.06
Sat Flow, veh/h		2910	4837	1500		2910	4837	1500	3188	0	1495	1594
Grp Volume(v), veh/h		156	711	24		52	1568	127	122	0	1	26
Grp Sat Flow(s),veh/h/ln		1455	1612	1500		1455	1612	1500	1594	0	1495	1594
Q Serve(g_s), s		6.7	9.5	0.8		2.2	27.7	4.6	4.8	0.0	0.1	2.0
Cycle Q Clear(g_c), s		6.7	9.5	0.8		2.2	27.7	4.6	4.8	0.0	0.1	2.0
Prop In Lane		1.00		1.00		1.00		1.00	1.00		1.00	1.00
Lane Grp Cap(c), veh/h		268	2785	962		209	2686	925	210	0	98	98
V/C Ratio(X)		0.58	0.26	0.02		0.25	0.58	0.14	0.58	0.00	0.01	0.27
Avail Cap(c_a), veh/h		269	2785	962		246	2686	925	1054	0	494	98
HCM Platoon Ratio		1.00	1.00	1.00		1.00	1.00	1.00	1.00	1.00	1.00	1.00
Upstream Filter(l)		0.93	0.93	0.93		1.00	1.00	1.00	1.00	0.00	1.00	1.00
Uniform Delay (d), s/veh		56.6	13.7	8.5		57.0	19.0	10.4	59.0	0.0	56.8	58.2
Incr Delay (d2), s/veh		2.9	0.2	0.0		0.6	0.9	0.3	2.6	0.0	0.0	1.4
Initial Q Delay(d3),s/veh		0.0	0.0	0.0		0.0	0.0	0.0	0.0	0.0	0.0	0.0
%ile BackOfQ(50%),veh/ln		2.5	3.3	0.3		0.8	9.7	1.8	2.0	0.0	0.0	0.9
Unsig. Movement Delay, s/veh												
LnGrp Delay(d),s/veh		59.6	13.9	8.5		57.7	19.9	10.7	61.5	0.0	56.8	59.6
LnGrp LOS		E	B	A		E	B	B	E	A	E	E
Approach Vol, veh/h			891				1747			123		
Approach Delay, s/veh			21.8				20.4			61.5		
Approach LOS			C				C			E		
Timer - Assigned Phs	1	2		4	5	6		8				
Phs Duration (G+Y+Rc), s	13.3	82.1		17.5	16.0	79.5		17.0				
Change Period (Y+Rc), s	4.0	* 7.3		9.0	4.0	* 7.3		9.0				
Max Green Setting (Gmax), s	11.0	* 39		43.0	12.0	* 38		8.0				
Max Q Clear Time (g_c+l1), s	4.2	11.5		6.8	8.7	29.7		10.0				
Green Ext Time (p_c), s	0.0	4.7		0.4	0.1	5.6		0.0				

Intersection Summary

HCM 6th Ctrl Delay	38.4
HCM 6th LOS	D

Notes

- User approved volume balancing among the lanes for turning movement.
- User approved ignoring U-Turning movement.
- * HCM 6th computational engine requires equal clearance times for the phases crossing the barrier.

HCM 6th Signalized Intersection Summary
 3: Sacred Heart & Foothill Blvd

Rancho Cuvee
 Opening Year Plus Project AM



Movement	SBT	SBR
Lane Configurations	↑	
Traffic Volume (veh/h)	50	90
Future Volume (veh/h)	50	90
Initial Q (Qb), veh	0	0
Ped-Bike Adj(A_pbT)		1.00
Parking Bus, Adj	1.00	1.00
Work Zone On Approach	No	
Adj Sat Flow, veh/h/ln	1772	1772
Adj Flow Rate, veh/h	52	94
Peak Hour Factor	0.96	0.96
Percent Heavy Veh, %	2	2
Cap, veh/h	35	63
Arrive On Green	0.06	0.06
Sat Flow, veh/h	564	1019
Grp Volume(v), veh/h	0	146
Grp Sat Flow(s),veh/h/ln	0	1583
Q Serve(g_s), s	0.0	8.0
Cycle Q Clear(g_c), s	0.0	8.0
Prop In Lane		0.64
Lane Grp Cap(c), veh/h	0	97
V/C Ratio(X)	0.00	1.50
Avail Cap(c_a), veh/h	0	97
HCM Platoon Ratio	1.00	1.00
Upstream Filter(l)	0.00	1.00
Uniform Delay (d), s/veh	0.0	61.0
Incr Delay (d2), s/veh	0.0	270.7
Initial Q Delay(d3),s/veh	0.0	0.0
%ile BackOfQ(50%),veh/ln	0.0	10.6
Unsig. Movement Delay, s/veh		
LnGrp Delay(d),s/veh	0.0	331.7
LnGrp LOS	A	F
Approach Vol, veh/h	172	
Approach Delay, s/veh	290.5	
Approach LOS	F	
Timer - Assigned Phs		

HCM 6th Signalized Intersection Summary
4: Etiwanda Ave & Foothill Blvd

Rancho Cuvee
Opening Year Plus Project AM



Movement	EBU	EBL	EBT	EBR	WBU	WBL	WBT	WBR	NBL	NBT	NBR	SBL
Lane Configurations		↔↗	↕↗	↗		↔↗	↕↗	↗	↗	↕	↗	↗
Traffic Volume (veh/h)	12	105	446	182	1	306	1280	90	180	252	105	66
Future Volume (veh/h)	12	105	446	182	1	306	1280	90	180	252	105	66
Initial Q (Qb), veh		0	0	0		0	0	0	0	0	0	0
Ped-Bike Adj(A_pbT)		1.00		0.98		1.00		0.99	1.00		0.98	1.00
Parking Bus, Adj		1.00	1.00	1.00		1.00	1.00	1.00	1.00	1.00	1.00	1.00
Work Zone On Approach			No				No			No		
Adj Sat Flow, veh/h/ln		1575	1772	1772		1575	1772	1772	1673	1772	1772	1673
Adj Flow Rate, veh/h		113	480	124		329	1376	30	194	271	24	71
Peak Hour Factor		0.93	0.93	0.93		0.93	0.93	0.93	0.93	0.93	0.93	0.93
Percent Heavy Veh, %		2	2	2		2	2	2	2	2	2	2
Cap, veh/h		308	1222	695		378	1303	578	169	401	333	159
Arrive On Green		0.11	0.36	0.36		0.13	0.39	0.39	0.11	0.23	0.23	0.10
Sat Flow, veh/h		2910	3367	1474		2910	3367	1493	1594	1772	1473	1594
Grp Volume(v), veh/h		113	480	124		329	1376	30	194	271	24	71
Grp Sat Flow(s),veh/h/ln		1455	1683	1474		1455	1683	1493	1594	1772	1473	1594
Q Serve(g_s), s		4.7	13.8	6.3		14.4	50.3	1.6	13.8	18.2	1.7	5.5
Cycle Q Clear(g_c), s		4.7	13.8	6.3		14.4	50.3	1.6	13.8	18.2	1.7	5.5
Prop In Lane		1.00		1.00		1.00		1.00	1.00		1.00	1.00
Lane Grp Cap(c), veh/h		308	1222	695		378	1303	578	169	401	333	159
V/C Ratio(X)		0.37	0.39	0.18		0.87	1.06	0.05	1.15	0.68	0.07	0.45
Avail Cap(c_a), veh/h		313	1222	695		470	1303	578	169	477	397	159
HCM Platoon Ratio		1.00	1.00	1.00		1.00	1.00	1.00	1.00	1.00	1.00	1.00
Upstream Filter(l)		1.00	1.00	1.00		1.00	1.00	1.00	1.00	1.00	1.00	1.00
Uniform Delay (d), s/veh		54.1	30.8	20.0		55.5	39.8	24.9	58.1	45.9	39.6	55.1
Incr Delay (d2), s/veh		0.7	0.9	0.6		13.7	41.1	0.2	114.1	3.0	0.1	1.9
Initial Q Delay(d3),s/veh		0.0	0.0	0.0		0.0	0.0	0.0	0.0	0.0	0.0	0.0
%ile BackOfQ(50%),veh/ln		1.7	5.5	2.2		5.8	27.0	0.6	10.8	8.1	0.6	2.2
Unsig. Movement Delay, s/veh												
LnGrp Delay(d),s/veh		54.8	31.7	20.6		69.2	80.9	25.1	172.2	48.9	39.6	57.0
LnGrp LOS		D	C	C		E	F	C	F	D	D	E
Approach Vol, veh/h			717				1735			489		
Approach Delay, s/veh			33.4				77.7			97.4		
Approach LOS			C				E			F		
Timer - Assigned Phs	1	2	3	4	5	6	7	8				
Phs Duration (G+Y+Rc), s	20.9	55.1	17.3	36.7	17.8	58.2	16.5	37.5				
Change Period (Y+Rc), s	4.0	* 7.9	3.5	* 8.1	4.0	* 7.9	3.5	* 8.1				
Max Green Setting (Gmax), s	21.0	* 38	13.8	* 34	14.0	* 45	13.0	* 35				
Max Q Clear Time (g_c+I1), s	16.4	15.8	15.8	26.1	6.7	52.3	7.5	20.2				
Green Ext Time (p_c), s	0.5	3.1	0.0	2.2	0.2	0.0	0.1	1.2				

Intersection Summary

HCM 6th Ctrl Delay	68.8
HCM 6th LOS	E

Notes

User approved ignoring U-Turning movement.

* HCM 6th computational engine requires equal clearance times for the phases crossing the barrier.

HCM 6th Signalized Intersection Summary
 4: Etiwanda Ave & Foothill Blvd

Rancho Cuvee
 Opening Year Plus Project AM



Movement	SBT	SBR
Lane Configurations	↑↑	
Traffic Volume (veh/h)	401	280
Future Volume (veh/h)	401	280
Initial Q (Qb), veh	0	0
Ped-Bike Adj(A_pbT)		1.00
Parking Bus, Adj	1.00	1.00
Work Zone On Approach	No	
Adj Sat Flow, veh/h/ln	1772	1772
Adj Flow Rate, veh/h	431	193
Peak Hour Factor	0.93	0.93
Percent Heavy Veh, %	2	2
Cap, veh/h	499	221
Arrive On Green	0.22	0.22
Sat Flow, veh/h	2265	1004
Grp Volume(v), veh/h	319	305
Grp Sat Flow(s),veh/h/ln	1683	1586
Q Serve(g_s), s	23.7	24.1
Cycle Q Clear(g_c), s	23.7	24.1
Prop In Lane		0.63
Lane Grp Cap(c), veh/h	371	349
V/C Ratio(X)	0.86	0.87
Avail Cap(c_a), veh/h	443	417
HCM Platoon Ratio	1.00	1.00
Upstream Filter(l)	1.00	1.00
Uniform Delay (d), s/veh	48.8	48.9
Incr Delay (d2), s/veh	13.9	16.0
Initial Q Delay(d3),s/veh	0.0	0.0
%ile BackOfQ(50%),veh/ln	11.1	10.8
Unsig. Movement Delay, s/veh		
LnGrp Delay(d),s/veh	62.7	64.9
LnGrp LOS	E	E
Approach Vol, veh/h	695	
Approach Delay, s/veh	63.1	
Approach LOS	E	
Timer - Assigned Phs		

HCM 6th Signalized Intersection Summary
 1: Foothill Blvd & I-15 SB Off Ramp

Rancho Cuvee
 Opening Year Plus Project PM



Movement	EBL	EBT	EBR	WBL	WBT	WBR	NBL	NBT	NBR	SBL	SBT	SBR
Lane Configurations		↑↑↑	↗		↑↑↑					↘	↕	↗
Traffic Volume (veh/h)	0	2098	1010	0	1454	0	0	0	0	126	0	645
Future Volume (veh/h)	0	2098	1010	0	1454	0	0	0	0	126	0	645
Initial Q (Qb), veh	0	0	0	0	0	0				0	0	0
Ped-Bike Adj(A_pbT)	1.00		1.00	1.00		1.00				1.00		1.00
Parking Bus, Adj	1.00	1.00	1.00	1.00	1.00	1.00				1.00	1.00	1.00
Work Zone On Approach		No			No						No	
Adj Sat Flow, veh/h/ln	0	1772	1772	0	1772	0				1575	1772	1772
Adj Flow Rate, veh/h	0	2185	0	0	1515	0				87	0	693
Peak Hour Factor	0.96	0.96	0.92	0.92	0.96	0.96				0.96	0.92	0.96
Percent Heavy Veh, %	0	2	2	0	2	0				2	2	2
Cap, veh/h	0	3024		0	3024	0				395	0	790
Arrive On Green	0.00	0.63	0.00	0.00	0.63	0.00				0.26	0.00	0.26
Sat Flow, veh/h	0	4997	1502	0	5156	0				1500	0	3003
Grp Volume(v), veh/h	0	2185	0	0	1515	0				87	0	693
Grp Sat Flow(s),veh/h/ln	0	1612	1502	0	1612	0				1500	0	1502
Q Serve(g_s), s	0.0	34.0	0.0	0.0	18.8	0.0				5.0	0.0	24.3
Cycle Q Clear(g_c), s	0.0	34.0	0.0	0.0	18.8	0.0				5.0	0.0	24.3
Prop In Lane	0.00		1.00	0.00		0.00				1.00		1.00
Lane Grp Cap(c), veh/h	0	3024		0	3024	0				395	0	790
V/C Ratio(X)	0.00	0.72		0.00	0.50	0.00				0.22	0.00	0.88
Avail Cap(c_a), veh/h	0	3024		0	3024	0				507	0	1016
HCM Platoon Ratio	1.00	1.00	1.00	1.00	1.00	1.00				1.00	1.00	1.00
Upstream Filter(I)	0.00	1.00	0.00	0.00	1.00	0.00				1.00	0.00	1.00
Uniform Delay (d), s/veh	0.0	14.1	0.0	0.0	11.3	0.0				31.7	0.0	38.8
Incr Delay (d2), s/veh	0.0	1.5	0.0	0.0	0.6	0.0				0.3	0.0	7.2
Initial Q Delay(d3),s/veh	0.0	0.0	0.0	0.0	0.0	0.0				0.0	0.0	0.0
%ile BackOfQ(50%),veh/ln	0.0	10.6	0.0	0.0	5.8	0.0				1.9	0.0	9.7
Unsig. Movement Delay, s/veh												
LnGrp Delay(d),s/veh	0.0	15.6	0.0	0.0	11.9	0.0				32.0	0.0	46.0
LnGrp LOS	A	B		A	B	A				C	A	D
Approach Vol, veh/h		2185	A		1515						780	
Approach Delay, s/veh		15.6			11.9						44.5	
Approach LOS		B			B						D	
Timer - Assigned Phs		2		4		6						
Phs Duration (G+Y+Rc), s		75.3		34.7		75.3						
Change Period (Y+Rc), s		6.5		5.8		6.5						
Max Green Setting (Gmax), s		60.5		37.2		60.5						
Max Q Clear Time (g_c+I1), s		36.0		26.3		20.8						
Green Ext Time (p_c), s		14.9		2.6		10.5						

Intersection Summary

HCM 6th Ctrl Delay	19.4
HCM 6th LOS	B

Notes

- User approved volume balancing among the lanes for turning movement.
- Unsignalized Delay for [EBR] is excluded from calculations of the approach delay and intersection delay.

HCM 6th Signalized Intersection Summary

2: I-15 NB Off Ramp & Foothill Blvd

Rancho Cuvee
Opening Year Plus Project PM



Movement	EBL	EBT	EBR	WBL	WBT	WBR	NBL	NBT	NBR	SBL	SBT	SBR
Lane Configurations		↑↑↑			↑↑↑	↑	↑	↔	↑			
Traffic Volume (veh/h)	0	1184	0	0	1167	239	720	0	542	0	0	0
Future Volume (veh/h)	0	1184	0	0	1167	239	720	0	542	0	0	0
Initial Q (Qb), veh	0	0	0	0	0	0	0	0	0			
Ped-Bike Adj(A_pbT)	1.00		1.00	1.00		1.00	1.00		0.98			
Parking Bus, Adj	1.00	1.00	1.00	1.00	1.00	1.00	1.00	1.00	1.00			
Work Zone On Approach		No			No			No				
Adj Sat Flow, veh/h/ln	0	1772	0	0	1772	1772	1575	1772	1772			
Adj Flow Rate, veh/h	0	1233	0	0	1216	0	892	0	305			
Peak Hour Factor	0.92	0.96	0.96	0.96	0.96	0.92	0.96	0.92	0.96			
Percent Heavy Veh, %	0	2	0	0	2	2	2	2	2			
Cap, veh/h	0	2639	0	0	2639		1028	0	507			
Arrive On Green	0.00	0.55	0.00	0.00	0.55	0.00	0.34	0.00	0.34			
Sat Flow, veh/h	0	5156	0	0	4997	1502	3000	0	1479			
Grp Volume(v), veh/h	0	1233	0	0	1216	0	892	0	305			
Grp Sat Flow(s),veh/h/ln	0	1612	0	0	1612	1502	1500	0	1479			
Q Serve(g_s), s	0.0	17.1	0.0	0.0	16.8	0.0	30.6	0.0	18.8			
Cycle Q Clear(g_c), s	0.0	17.1	0.0	0.0	16.8	0.0	30.6	0.0	18.8			
Prop In Lane	0.00		0.00	0.00		1.00	1.00		1.00			
Lane Grp Cap(c), veh/h	0	2639	0	0	2639		1028	0	507			
V/C Ratio(X)	0.00	0.47	0.00	0.00	0.46		0.87	0.00	0.60			
Avail Cap(c_a), veh/h	0	2639	0	0	2639		1533	0	756			
HCM Platoon Ratio	1.00	1.00	1.00	1.00	1.00	1.00	1.00	1.00	1.00			
Upstream Filter(l)	0.00	1.00	0.00	0.00	0.88	0.00	1.00	0.00	1.00			
Uniform Delay (d), s/veh	0.0	15.2	0.0	0.0	15.2	0.0	33.8	0.0	29.9			
Incr Delay (d2), s/veh	0.0	0.6	0.0	0.0	0.5	0.0	3.7	0.0	1.2			
Initial Q Delay(d3),s/veh	0.0	0.0	0.0	0.0	0.0	0.0	0.0	0.0	0.0			
%ile BackOfQ(50%),veh/ln	0.0	5.7	0.0	0.0	6.1	0.0	11.5	0.0	6.8			
Unsig. Movement Delay, s/veh												
LnGrp Delay(d),s/veh	0.0	15.8	0.0	0.0	15.7	0.0	37.6	0.0	31.1			
LnGrp LOS	A	B	A	A	B		D	A	C			
Approach Vol, veh/h		1233			1216	A		1197				
Approach Delay, s/veh		15.8			15.7			35.9				
Approach LOS		B			B			D				
Timer - Assigned Phs		2				6		8				
Phs Duration (G+Y+Rc), s		66.5				66.5		43.5				
Change Period (Y+Rc), s		6.5				6.5		5.8				
Max Green Setting (Gmax), s		41.5				41.5		56.2				
Max Q Clear Time (g_c+I1), s		19.1				18.8		32.6				
Green Ext Time (p_c), s		6.8				8.0		5.0				

Intersection Summary

HCM 6th Ctrl Delay	22.4
HCM 6th LOS	C

Notes

- User approved volume balancing among the lanes for turning movement.
- User approved changes to right turn type.
- Unsignalized Delay for [WBR] is excluded from calculations of the approach delay and intersection delay.

HCM 6th Signalized Intersection Summary
 3: Sacred Heart & Foothill Blvd

Rancho Cuvee
 Opening Year Plus Project PM

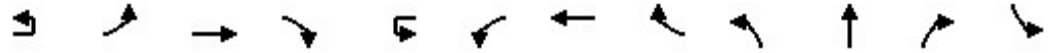

Movement	EBU	EBL	EBT	EBR	WBU	WBL	WBT	WBR	NBL	NBT	NBR	SBL
Lane Configurations		↔↗	↑↑↑	↗		↔↗	↑↑↑	↗	↗	↖	↗	↖
Traffic Volume (veh/h)	125	60	1236	140	40	130	951	70	295	1	105	20
Future Volume (veh/h)	125	60	1236	140	40	130	951	70	295	1	105	20
Initial Q (Qb), veh		0	0	0		0	0	0	0	0	0	0
Ped-Bike Adj(A_pbT)		1.00		1.00		1.00		0.99	1.00		0.99	1.00
Parking Bus, Adj		1.00	1.00	1.00		1.00	1.00	1.00	1.00	1.00	1.00	1.00
Work Zone On Approach			No				No			No		
Adj Sat Flow, veh/h/ln		1575	1772	1772		1575	1772	1772	1673	1772	1772	1673
Adj Flow Rate, veh/h		62	1288	91		135	991	33	308	0	15	21
Peak Hour Factor		0.96	0.96	0.96		0.96	0.96	0.96	0.96	0.96	0.96	0.96
Percent Heavy Veh, %		2	2	2		2	2	2	2	2	2	2
Cap, veh/h		100	2678	1023		176	2805	905	411	0	192	50
Arrive On Green		0.03	0.55	0.55		0.06	0.58	0.58	0.13	0.00	0.13	0.03
Sat Flow, veh/h		2910	4837	1498		2910	4837	1479	3188	0	1491	1594
Grp Volume(v), veh/h		62	1288	91		135	991	33	308	0	15	21
Grp Sat Flow(s),veh/h/ln		1455	1612	1498		1455	1612	1479	1594	0	1491	1594
Q Serve(g_s), s		2.7	21.1	2.7		5.9	14.1	1.2	12.1	0.0	1.2	1.7
Cycle Q Clear(g_c), s		2.7	21.1	2.7		5.9	14.1	1.2	12.1	0.0	1.2	1.7
Prop In Lane		1.00		1.00		1.00		1.00	1.00		1.00	1.00
Lane Grp Cap(c), veh/h		100	2678	1023		176	2805	905	411	0	192	50
V/C Ratio(X)		0.62	0.48	0.09		0.77	0.35	0.04	0.75	0.00	0.08	0.42
Avail Cap(c_a), veh/h		224	2678	1023		179	2805	905	1054	0	493	221
HCM Platoon Ratio		1.00	1.00	1.00		1.00	1.00	1.00	1.00	1.00	1.00	1.00
Upstream Filter(l)		0.79	0.79	0.79		1.00	1.00	1.00	1.00	0.00	1.00	1.00
Uniform Delay (d), s/veh		61.9	17.7	7.0		60.1	14.4	10.0	54.6	0.0	49.8	61.8
Incr Delay (d2), s/veh		4.9	0.5	0.1		17.5	0.4	0.1	2.8	0.0	0.2	5.5
Initial Q Delay(d3),s/veh		0.0	0.0	0.0		0.0	0.0	0.0	0.0	0.0	0.0	0.0
%ile BackOfQ(50%),veh/ln		1.1	7.3	1.2		2.6	4.8	0.4	5.1	0.0	0.4	0.8
Unsig. Movement Delay, s/veh												
LnGrp Delay(d),s/veh		66.8	18.2	7.1		77.7	14.8	10.1	57.3	0.0	50.0	67.3
LnGrp LOS		E	B	A		E	B	B	E	A	D	E
Approach Vol, veh/h			1441				1159			323		
Approach Delay, s/veh			19.5				22.0			57.0		
Approach LOS			B				C			E		
Timer - Assigned Phs	1	2		4	5	6		8				
Phs Duration (G+Y+Rc), s	11.9	79.3		25.8	8.5	82.7		13.1				
Change Period (Y+Rc), s	4.0	* 7.3		9.0	4.0	* 7.3		9.0				
Max Green Setting (Gmax), s	8.0	* 32		43.0	10.0	* 30		18.0				
Max Q Clear Time (g_c+I1), s	7.9	23.1		14.1	4.7	16.1		4.2				
Green Ext Time (p_c), s	0.0	5.1		1.2	0.0	5.2		0.1				

Intersection Summary

HCM 6th Ctrl Delay	25.4
HCM 6th LOS	C

Notes

- User approved volume balancing among the lanes for turning movement.
- User approved ignoring U-Turning movement.
- * HCM 6th computational engine requires equal clearance times for the phases crossing the barrier.

HCM 6th Signalized Intersection Summary
 3: Sacred Heart & Foothill Blvd

Rancho Cuvee
 Opening Year Plus Project PM



Movement	SBT	SBR
Lane Configurations	↑	
Traffic Volume (veh/h)	5	20
Future Volume (veh/h)	5	20
Initial Q (Qb), veh	0	0
Ped-Bike Adj(A_pbT)		0.98
Parking Bus, Adj	1.00	1.00
Work Zone On Approach	No	
Adj Sat Flow, veh/h/ln	1772	1772
Adj Flow Rate, veh/h	5	21
Peak Hour Factor	0.96	0.96
Percent Heavy Veh, %	2	2
Cap, veh/h	9	38
Arrive On Green	0.03	0.03
Sat Flow, veh/h	292	1225
Grp Volume(v), veh/h	0	26
Grp Sat Flow(s),veh/h/ln	0	1517
Q Serve(g_s), s	0.0	2.2
Cycle Q Clear(g_c), s	0.0	2.2
Prop In Lane		0.81
Lane Grp Cap(c), veh/h	0	48
V/C Ratio(X)	0.00	0.55
Avail Cap(c_a), veh/h	0	210
HCM Platoon Ratio	1.00	1.00
Upstream Filter(l)	0.00	1.00
Uniform Delay (d), s/veh	0.0	62.0
Incr Delay (d2), s/veh	0.0	9.4
Initial Q Delay(d3),s/veh	0.0	0.0
%ile BackOfQ(50%),veh/ln	0.0	1.0
Unsig. Movement Delay, s/veh		
LnGrp Delay(d),s/veh	0.0	71.4
LnGrp LOS	A	E
Approach Vol, veh/h	47	
Approach Delay, s/veh	69.6	
Approach LOS	E	
Timer - Assigned Phs		

HCM 6th Signalized Intersection Summary
4: Etiwanda Ave & Foothill Blvd

Rancho Cuvee
Opening Year Plus Project PM



Movement	EBU	EBL	EBT	EBR	WBU	WBL	WBT	WBR	NBL	NBT	NBR	SBL
Lane Configurations		↔↔	↕↕	↗		↔↔	↕↕	↗	↗	↕	↗	↗
Traffic Volume (veh/h)	60	195	1059	207	3	143	830	40	316	334	217	59
Future Volume (veh/h)	60	195	1059	207	3	143	830	40	316	334	217	59
Initial Q (Qb), veh		0	0	0		0	0	0	0	0	0	0
Ped-Bike Adj(A_pbT)		1.00		0.99		1.00		1.00	1.00		0.98	1.00
Parking Bus, Adj		1.00	1.00	1.00		1.00	1.00	1.00	1.00	1.00	1.00	1.00
Work Zone On Approach			No			No			No			
Adj Sat Flow, veh/h/ln		1575	1772	1772		1575	1772	1772	1673	1772	1772	1673
Adj Flow Rate, veh/h		210	1139	115		154	892	12	340	359	129	63
Peak Hour Factor		0.93	0.93	0.93		0.93	0.93	0.93	0.93	0.93	0.93	0.93
Percent Heavy Veh, %		2	2	2		2	2	2	2	2	2	2
Cap, veh/h		253	1441	931		157	1330	593	315	501	418	87
Arrive On Green		0.09	0.43	0.43		0.05	0.39	0.39	0.20	0.28	0.28	0.05
Sat Flow, veh/h		2910	3367	1482		2910	3367	1500	1594	1772	1479	1594
Grp Volume(v), veh/h		210	1139	115		154	892	12	340	359	129	63
Grp Sat Flow(s),veh/h/ln		1455	1683	1482		1455	1683	1500	1594	1772	1479	1594
Q Serve(g_s), s		9.2	38.0	4.1		6.9	28.4	0.6	25.7	23.7	8.9	5.1
Cycle Q Clear(g_c), s		9.2	38.0	4.1		6.9	28.4	0.6	25.7	23.7	8.9	5.1
Prop In Lane		1.00		1.00		1.00		1.00	1.00		1.00	1.00
Lane Grp Cap(c), veh/h		253	1441	931		157	1330	593	315	501	418	87
V/C Ratio(X)		0.83	0.79	0.12		0.98	0.67	0.02	1.08	0.72	0.31	0.72
Avail Cap(c_a), veh/h		291	1441	931		157	1330	593	315	527	440	221
HCM Platoon Ratio		1.00	1.00	1.00		1.00	1.00	1.00	1.00	1.00	1.00	1.00
Upstream Filter(l)		1.00	1.00	1.00		1.00	1.00	1.00	1.00	1.00	1.00	1.00
Uniform Delay (d), s/veh		58.4	32.1	9.9		61.4	32.4	24.0	52.2	41.9	36.6	60.5
Incr Delay (d2), s/veh		14.3	4.5	0.3		66.4	2.7	0.1	73.4	3.6	0.2	4.2
Initial Q Delay(d3),s/veh		0.0	0.0	0.0		0.0	0.0	0.0	0.0	0.0	0.0	0.0
%ile BackOfQ(50%),veh/ln		3.8	15.4	1.3		3.9	11.5	0.2	16.4	10.6	3.2	2.1
Unsig. Movement Delay, s/veh												
LnGrp Delay(d),s/veh		72.8	36.6	10.1		127.8	35.1	24.0	125.5	45.6	36.8	64.7
LnGrp LOS		E	D	B		F	D	C	F	D	D	E
Approach Vol, veh/h			1464				1058			828		
Approach Delay, s/veh			39.7				48.5			77.0		
Approach LOS			D				D			E		
Timer - Assigned Phs	1	2	3	4	5	6	7	8				
Phs Duration (G+Y+Rc), s	11.0	63.5	29.2	26.3	15.3	59.2	10.6	44.9				
Change Period (Y+Rc), s	4.0	* 7.9	3.5	* 8.1	4.0	* 7.9	3.5	* 8.1				
Max Green Setting (Gmax), s	7.0	* 43	25.7	* 31	13.0	* 37	18.0	* 39				
Max Q Clear Time (g_c+I1), s	8.9	40.0	27.7	16.6	11.2	30.4	7.1	25.7				
Green Ext Time (p_c), s	0.0	1.3	0.0	1.1	0.1	1.7	0.0	1.2				

Intersection Summary

HCM 6th Ctrl Delay	52.4
HCM 6th LOS	D

Notes

User approved ignoring U-Turning movement.
* HCM 6th computational engine requires equal clearance times for the phases crossing the barrier.

HCM 6th Signalized Intersection Summary
 4: Etiwanda Ave & Foothill Blvd

Rancho Cuvee
 Opening Year Plus Project PM



Movement	SBT	SBR
Lane Configurations	↑↑	
Traffic Volume (veh/h)	248	185
Future Volume (veh/h)	248	185
Initial Q (Qb), veh	0	0
Ped-Bike Adj(A_pbT)		0.98
Parking Bus, Adj	1.00	1.00
Work Zone On Approach	No	
Adj Sat Flow, veh/h/ln	1772	1772
Adj Flow Rate, veh/h	267	104
Peak Hour Factor	0.93	0.93
Percent Heavy Veh, %	2	2
Cap, veh/h	332	126
Arrive On Green	0.14	0.14
Sat Flow, veh/h	2375	900
Grp Volume(v), veh/h	187	184
Grp Sat Flow(s),veh/h/ln	1683	1591
Q Serve(g_s), s	14.0	14.6
Cycle Q Clear(g_c), s	14.0	14.6
Prop In Lane		0.57
Lane Grp Cap(c), veh/h	235	222
V/C Ratio(X)	0.80	0.83
Avail Cap(c_a), veh/h	401	379
HCM Platoon Ratio	1.00	1.00
Upstream Filter(l)	1.00	1.00
Uniform Delay (d), s/veh	54.1	54.4
Incr Delay (d2), s/veh	2.3	3.0
Initial Q Delay(d3),s/veh	0.0	0.0
%ile BackOfQ(50%),veh/ln	5.9	5.9
Unsig. Movement Delay, s/veh		
LnGrp Delay(d),s/veh	56.5	57.4
LnGrp LOS	E	E
Approach Vol, veh/h	434	
Approach Delay, s/veh	58.1	
Approach LOS	E	
Timer - Assigned Phs		

HCM 6th Signalized Intersection Summary
4: Etiwanda Ave & Foothill Blvd

Rancho Cuvee
Opening Year Plus Project AM with Improvements



Movement	EBU	EBL	EBT	EBR	WBU	WBL	WBT	WBR	NBL	NBT	NBR	SBL
Lane Configurations		↔↔	↑↑↑	↗		↔↔	↑↑	↗	↔↔	↑↑	↗	↘
Traffic Volume (veh/h)	12	105	446	182	1	306	1280	90	180	252	105	66
Future Volume (veh/h)	12	105	446	182	1	306	1280	90	180	252	105	66
Initial Q (Qb), veh		0	0	0		0	0	0	0	0	0	0
Ped-Bike Adj(A_pbT)		1.00		0.98		1.00		1.00	1.00		0.98	1.00
Parking Bus, Adj		1.00	1.00	1.00		1.00	1.00	1.00	1.00	1.00	1.00	1.00
Work Zone On Approach			No			No			No			
Adj Sat Flow, veh/h/ln		1575	1772	1772		1575	1772	1772	1673	1772	1772	1673
Adj Flow Rate, veh/h		113	480	124		329	1376	30	194	271	24	71
Peak Hour Factor		0.93	0.93	0.93		0.93	0.93	0.93	0.93	0.93	0.93	0.93
Percent Heavy Veh, %		2	2	2		2	2	2	2	2	2	2
Cap, veh/h		308	2026	768		388	1502	667	309	563	246	159
Arrive On Green		0.11	0.42	0.42		0.13	0.45	0.45	0.10	0.17	0.17	0.10
Sat Flow, veh/h		2910	4837	1475		2910	3367	1495	3092	3367	1470	1594
Grp Volume(v), veh/h		113	480	124		329	1376	30	194	271	24	71
Grp Sat Flow(s),veh/h/ln		1455	1612	1475		1455	1683	1495	1546	1683	1470	1594
Q Serve(g_s), s		4.7	8.3	5.7		14.4	49.8	1.5	7.8	9.5	1.8	5.5
Cycle Q Clear(g_c), s		4.7	8.3	5.7		14.4	49.8	1.5	7.8	9.5	1.8	5.5
Prop In Lane		1.00		1.00		1.00		1.00	1.00		1.00	1.00
Lane Grp Cap(c), veh/h		308	2026	768		388	1502	667	309	563	246	159
V/C Ratio(X)		0.37	0.24	0.16		0.85	0.92	0.04	0.63	0.48	0.10	0.45
Avail Cap(c_a), veh/h		313	2026	768		739	1502	667	309	906	396	159
HCM Platoon Ratio		1.00	1.00	1.00		1.00	1.00	1.00	1.00	1.00	1.00	1.00
Upstream Filter(l)		1.00	1.00	1.00		1.00	1.00	1.00	1.00	1.00	1.00	1.00
Uniform Delay (d), s/veh		54.1	24.4	16.4		55.0	33.7	20.3	56.2	49.0	45.8	55.1
Incr Delay (d2), s/veh		0.7	0.3	0.5		5.2	10.3	0.1	4.0	0.6	0.2	1.9
Initial Q Delay(d3),s/veh		0.0	0.0	0.0		0.0	0.0	0.0	0.0	0.0	0.0	0.0
%ile BackOfQ(50%),veh/ln		1.7	3.1	2.0		5.4	21.0	0.5	3.2	4.0	0.7	2.2
Unsig. Movement Delay, s/veh												
LnGrp Delay(d),s/veh		54.8	24.7	16.9		60.2	44.0	20.5	60.2	49.7	46.0	57.0
LnGrp LOS		D	C	B		E	D	C	E	D	D	E
Approach Vol, veh/h			717				1735			489		
Approach Delay, s/veh			28.1				46.6			53.7		
Approach LOS			C				D			D		
Timer - Assigned Phs	1	2	3	4	5	6	7	8				
Phs Duration (G+Y+Rc), s	21.3	62.3	16.5	29.8	17.8	65.9	16.5	29.8				
Change Period (Y+Rc), s	4.0	* 7.9	3.5	* 8.1	4.0	* 7.9	3.5	* 8.1				
Max Green Setting (Gmax), s	33.0	* 26	13.0	* 35	14.0	* 45	13.0	* 35				
Max Q Clear Time (g_c+I1), s	16.4	10.3	9.8	17.9	6.7	51.8	7.5	11.5				
Green Ext Time (p_c), s	1.0	2.9	0.2	2.7	0.2	0.0	0.1	1.6				

Intersection Summary

HCM 6th Ctrl Delay	45.1
HCM 6th LOS	D

Notes

User approved ignoring U-Turning movement.

* HCM 6th computational engine requires equal clearance times for the phases crossing the barrier.

HCM 6th Signalized Intersection Summary
 4: Etiwanda Ave & Foothill Blvd

Rancho Cuvee
 Opening Year Plus Project AM with Improvements



Movement	SBT	SBR
Lane Configurations	↑↑	↑
Traffic Volume (veh/h)	401	280
Future Volume (veh/h)	401	280
Initial Q (Qb), veh	0	0
Ped-Bike Adj(A_pbT)		0.99
Parking Bus, Adj	1.00	1.00
Work Zone On Approach	No	
Adj Sat Flow, veh/h/ln	1772	1772
Adj Flow Rate, veh/h	431	133
Peak Hour Factor	0.93	0.93
Percent Heavy Veh, %	2	2
Cap, veh/h	563	250
Arrive On Green	0.17	0.17
Sat Flow, veh/h	3367	1494
Grp Volume(v), veh/h	431	133
Grp Sat Flow(s),veh/h/ln	1683	1494
Q Serve(g_s), s	15.9	10.6
Cycle Q Clear(g_c), s	15.9	10.6
Prop In Lane		1.00
Lane Grp Cap(c), veh/h	563	250
V/C Ratio(X)	0.77	0.53
Avail Cap(c_a), veh/h	906	402
HCM Platoon Ratio	1.00	1.00
Upstream Filter(l)	1.00	1.00
Uniform Delay (d), s/veh	51.7	49.5
Incr Delay (d2), s/veh	2.2	1.8
Initial Q Delay(d3),s/veh	0.0	0.0
%ile BackOfQ(50%),veh/ln	6.7	4.0
Unsig. Movement Delay, s/veh		
LnGrp Delay(d),s/veh	53.9	51.3
LnGrp LOS	D	D
Approach Vol, veh/h	635	
Approach Delay, s/veh	53.7	
Approach LOS	D	
Timer - Assigned Phs		

HCM 6th Signalized Intersection Summary
 4: Etiwanda Ave & Foothill Blvd

Rancho Cuvee
 Opening Year Plus Project PM with Improvements

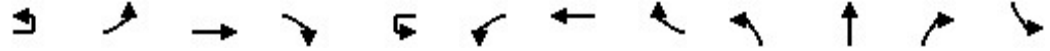

Movement	EBU	EBL	EBT	EBR	WBU	WBL	WBT	WBR	NBL	NBT	NBR	SBL
Lane Configurations		↔↔	↑↑↑	↗		↔↔	↑↑	↗	↔↔	↑↑	↗	↘
Traffic Volume (veh/h)	60	195	1059	207	3	143	830	40	316	334	217	59
Future Volume (veh/h)	60	195	1059	207	3	143	830	40	316	334	217	59
Initial Q (Qb), veh		0	0	0		0	0	0	0	0	0	0
Ped-Bike Adj(A_pbT)		1.00		0.99		1.00		1.00	1.00		0.98	1.00
Parking Bus, Adj		1.00	1.00	1.00		1.00	1.00	1.00	1.00	1.00	1.00	1.00
Work Zone On Approach			No				No			No		
Adj Sat Flow, veh/h/ln		1575	1772	1772		1575	1772	1772	1673	1772	1772	1673
Adj Flow Rate, veh/h		210	1139	115		154	892	12	340	359	129	63
Peak Hour Factor		0.93	0.93	0.93		0.93	0.93	0.93	0.93	0.93	0.93	0.93
Percent Heavy Veh, %		2	2	2		2	2	2	2	2	2	2
Cap, veh/h		253	2510	958		200	1686	751	390	596	261	87
Arrive On Green		0.09	0.52	0.52		0.07	0.50	0.50	0.13	0.18	0.18	0.05
Sat Flow, veh/h		2910	4837	1482		2910	3367	1501	3092	3367	1475	1594
Grp Volume(v), veh/h		210	1139	115		154	892	12	340	359	129	63
Grp Sat Flow(s),veh/h/ln		1455	1612	1482		1455	1683	1501	1546	1683	1475	1594
Q Serve(g_s), s		9.2	19.3	3.9		6.8	23.4	0.5	14.0	12.8	10.2	5.1
Cycle Q Clear(g_c), s		9.2	19.3	3.9		6.8	23.4	0.5	14.0	12.8	10.2	5.1
Prop In Lane		1.00		1.00		1.00		1.00	1.00		1.00	1.00
Lane Grp Cap(c), veh/h		253	2510	958		200	1686	751	390	596	261	87
V/C Ratio(X)		0.83	0.45	0.12		0.77	0.53	0.02	0.87	0.60	0.49	0.72
Avail Cap(c_a), veh/h		291	2510	958		582	1686	751	521	906	397	221
HCM Platoon Ratio		1.00	1.00	1.00		1.00	1.00	1.00	1.00	1.00	1.00	1.00
Upstream Filter(l)		1.00	1.00	1.00		1.00	1.00	1.00	1.00	1.00	1.00	1.00
Uniform Delay (d), s/veh		58.4	19.7	8.9		59.5	22.0	16.3	55.8	49.3	48.2	60.5
Incr Delay (d2), s/veh		14.3	0.6	0.3		2.4	1.2	0.0	9.8	0.4	0.5	4.2
Initial Q Delay(d3),s/veh		0.0	0.0	0.0		0.0	0.0	0.0	0.0	0.0	0.0	0.0
%ile BackOfQ(50%),veh/ln		3.8	6.9	1.2		2.5	8.9	0.2	5.9	5.3	3.7	2.1
Unsig. Movement Delay, s/veh												
LnGrp Delay(d),s/veh		72.8	20.3	9.1		61.9	23.2	16.4	65.6	49.6	48.8	64.7
LnGrp LOS		E	C	A		E	C	B	E	D	D	E
Approach Vol, veh/h			1464				1058			828		
Approach Delay, s/veh			26.9				28.8			56.0		
Approach LOS			C				C			E		
Timer - Assigned Phs	1	2	3	4	5	6	7	8				
Phs Duration (G+Y+Rc), s	12.9	75.3	19.9	21.8	15.3	73.0	10.6	31.1				
Change Period (Y+Rc), s	4.0	* 7.9	3.5	* 8.1	4.0	* 7.9	3.5	* 8.1				
Max Green Setting (Gmax), s	26.0	* 28	21.9	* 31	13.0	* 41	18.0	* 35				
Max Q Clear Time (g_c+I1), s	8.8	21.3	16.0	12.0	11.2	25.4	7.1	14.8				
Green Ext Time (p_c), s	0.2	2.3	0.3	1.1	0.1	2.5	0.0	1.5				

Intersection Summary												
HCM 6th Ctrl Delay			37.5									
HCM 6th LOS			D									

Notes
 User approved ignoring U-Turning movement.
 * HCM 6th computational engine requires equal clearance times for the phases crossing the barrier.

HCM 6th Signalized Intersection Summary
 4: Etiwanda Ave & Foothill Blvd

Rancho Cuvee
 Opening Year Plus Project PM with Improvements



Movement	SBT	SBR
Lane Configurations	↑↑	↑
Traffic Volume (veh/h)	248	185
Future Volume (veh/h)	248	185
Initial Q (Qb), veh	0	0
Ped-Bike Adj(A_pbT)		0.98
Parking Bus, Adj	1.00	1.00
Work Zone On Approach	No	
Adj Sat Flow, veh/h/ln	1772	1772
Adj Flow Rate, veh/h	267	104
Peak Hour Factor	0.93	0.93
Percent Heavy Veh, %	2	2
Cap, veh/h	356	156
Arrive On Green	0.11	0.11
Sat Flow, veh/h	3367	1473
Grp Volume(v), veh/h	267	104
Grp Sat Flow(s),veh/h/ln	1683	1473
Q Serve(g_s), s	10.0	8.8
Cycle Q Clear(g_c), s	10.0	8.8
Prop In Lane		1.00
Lane Grp Cap(c), veh/h	356	156
V/C Ratio(X)	0.75	0.67
Avail Cap(c_a), veh/h	805	352
HCM Platoon Ratio	1.00	1.00
Upstream Filter(l)	1.00	1.00
Uniform Delay (d), s/veh	56.5	55.9
Incr Delay (d2), s/veh	1.2	1.8
Initial Q Delay(d3),s/veh	0.0	0.0
%ile BackOfQ(50%),veh/ln	4.2	3.3
Unsig. Movement Delay, s/veh		
LnGrp Delay(d),s/veh	57.7	57.8
LnGrp LOS	E	E
Approach Vol, veh/h	434	
Approach Delay, s/veh	58.7	
Approach LOS	E	
Timer - Assigned Phs		

HCM 6th Signalized Intersection Summary
 1: Foothill Blvd & I-15 SB Off Ramp

Rancho Cuvee
 Future Year AM



Movement	EBL	EBT	EBR	WBL	WBT	WBR	NBL	NBT	NBR	SBL	SBT	SBR
Lane Configurations		↑↑↑	↗		↑↑↑					↘	↕	↗
Traffic Volume (veh/h)	0	800	1010	0	2280	0	0	0	0	90	0	740
Future Volume (veh/h)	0	800	1010	0	2280	0	0	0	0	90	0	740
Initial Q (Qb), veh	0	0	0	0	0	0				0	0	0
Ped-Bike Adj(A_pbT)	1.00		1.00	1.00		1.00				1.00		1.00
Parking Bus, Adj	1.00	1.00	1.00	1.00	1.00	1.00				1.00	1.00	1.00
Work Zone On Approach		No			No						No	
Adj Sat Flow, veh/h/ln	0	1772	1772	0	1772	0				1575	1772	1772
Adj Flow Rate, veh/h	0	842	0	0	2400	0				63	0	785
Peak Hour Factor	0.95	0.95	0.95	0.95	0.95	0.95				0.95	0.95	0.95
Percent Heavy Veh, %	0	2	2	0	2	0				2	2	2
Cap, veh/h	0	2840		0	2840	0				435	0	871
Arrive On Green	0.00	0.59	0.00	0.00	0.59	0.00				0.29	0.00	0.29
Sat Flow, veh/h	0	4997	1502	0	5156	0				1500	0	3003
Grp Volume(v), veh/h	0	842	0	0	2400	0				63	0	785
Grp Sat Flow(s),veh/h/ln	0	1612	1502	0	1612	0				1500	0	1502
Q Serve(g_s), s	0.0	8.7	0.0	0.0	40.7	0.0				3.1	0.0	25.1
Cycle Q Clear(g_c), s	0.0	8.7	0.0	0.0	40.7	0.0				3.1	0.0	25.1
Prop In Lane	0.00		1.00	0.00		0.00				1.00		1.00
Lane Grp Cap(c), veh/h	0	2840		0	2840	0				435	0	871
V/C Ratio(X)	0.00	0.30		0.00	0.85	0.00				0.14	0.00	0.90
Avail Cap(c_a), veh/h	0	2840		0	2840	0				486	0	973
HCM Platoon Ratio	1.00	1.00	1.00	1.00	1.00	1.00				1.00	1.00	1.00
Upstream Filter(I)	0.00	1.00	0.00	0.00	1.00	0.00				1.00	0.00	1.00
Uniform Delay (d), s/veh	0.0	10.3	0.0	0.0	16.9	0.0				26.3	0.0	34.1
Incr Delay (d2), s/veh	0.0	0.3	0.0	0.0	3.3	0.0				0.2	0.0	10.6
Initial Q Delay(d3),s/veh	0.0	0.0	0.0	0.0	0.0	0.0				0.0	0.0	0.0
%ile BackOfQ(50%),veh/ln	0.0	2.7	0.0	0.0	13.1	0.0				1.1	0.0	10.4
Unsig. Movement Delay, s/veh												
LnGrp Delay(d),s/veh	0.0	10.6	0.0	0.0	20.2	0.0				26.5	0.0	44.8
LnGrp LOS	A	B		A	C	A				C	A	D
Approach Vol, veh/h		842	A		2400						848	
Approach Delay, s/veh		10.6			20.2						43.4	
Approach LOS		B			C						D	
Timer - Assigned Phs		2		4		6						
Phs Duration (G+Y+Rc), s		65.2		34.8		65.2						
Change Period (Y+Rc), s		6.5		5.8		6.5						
Max Green Setting (Gmax), s		55.3		32.4		55.3						
Max Q Clear Time (g_c+I1), s		10.7		27.1		42.7						
Green Ext Time (p_c), s		4.7		1.9		10.0						

Intersection Summary

HCM 6th Ctrl Delay	23.0
HCM 6th LOS	C

Notes

User approved volume balancing among the lanes for turning movement.
 Unsignalized Delay for [EBR] is excluded from calculations of the approach delay and intersection delay.

HCM 6th Signalized Intersection Summary
 2: I-15 NB Off Ramp & Foothill Blvd

Rancho Cuvee
 Future Year AM



Movement	EBL	EBT	EBR	WBL	WBT	WBR	NBL	NBT	NBR	SBL	SBT	SBR
Lane Configurations		↑↑↑			↑↑↑	↑	↑	↔	↑			
Traffic Volume (veh/h)	0	620	0	0	2100	140	970	0	450	0	0	0
Future Volume (veh/h)	0	620	0	0	2100	140	970	0	450	0	0	0
Initial Q (Qb), veh	0	0	0	0	0	0	0	0	0			
Ped-Bike Adj(A_pbT)	1.00		1.00	1.00		1.00	1.00		0.99			
Parking Bus, Adj	1.00	1.00	1.00	1.00	1.00	1.00	1.00	1.00	1.00			
Work Zone On Approach		No			No			No				
Adj Sat Flow, veh/h/ln	0	1772	0	0	1772	1772	1575	1772	1772			
Adj Flow Rate, veh/h	0	653	0	0	2211	0	1133	0	240			
Peak Hour Factor	0.95	0.95	0.95	0.95	0.95	0.95	0.95	0.95	0.95			
Percent Heavy Veh, %	0	2	0	0	2	2	2	2	2			
Cap, veh/h	0	2326	0	0	2326		1189	0	587			
Arrive On Green	0.00	0.48	0.00	0.00	0.48	0.00	0.40	0.00	0.40			
Sat Flow, veh/h	0	5156	0	0	4997	1502	3000	0	1482			
Grp Volume(v), veh/h	0	653	0	0	2211	0	1133	0	240			
Grp Sat Flow(s),veh/h/ln	0	1612	0	0	1612	1502	1500	0	1482			
Q Serve(g_s), s	0.0	8.1	0.0	0.0	43.7	0.0	36.6	0.0	11.7			
Cycle Q Clear(g_c), s	0.0	8.1	0.0	0.0	43.7	0.0	36.6	0.0	11.7			
Prop In Lane	0.00		0.00	0.00		1.00	1.00		1.00			
Lane Grp Cap(c), veh/h	0	2326	0	0	2326		1189	0	587			
V/C Ratio(X)	0.00	0.28	0.00	0.00	0.95		0.95	0.00	0.41			
Avail Cap(c_a), veh/h	0	2326	0	0	2326		1206	0	596			
HCM Platoon Ratio	1.00	1.00	1.00	1.00	1.00	1.00	1.00	1.00	1.00			
Upstream Filter(I)	0.00	1.00	0.00	0.00	0.44	0.00	1.00	0.00	1.00			
Uniform Delay (d), s/veh	0.0	15.6	0.0	0.0	24.8	0.0	29.3	0.0	21.8			
Incr Delay (d2), s/veh	0.0	0.3	0.0	0.0	5.3	0.0	15.9	0.0	0.5			
Initial Q Delay(d3),s/veh	0.0	0.0	0.0	0.0	0.0	0.0	0.0	0.0	0.0			
%ile BackOfQ(50%),veh/ln	0.0	2.7	0.0	0.0	16.8	0.0	15.3	0.0	4.0			
Unsig. Movement Delay, s/veh												
LnGrp Delay(d),s/veh	0.0	15.9	0.0	0.0	30.1	0.0	45.2	0.0	22.2			
LnGrp LOS	A	B	A	A	C		D	A	C			
Approach Vol, veh/h		653			2211	A		1373				
Approach Delay, s/veh		15.9			30.1			41.2				
Approach LOS		B			C			D				
Timer - Assigned Phs		2				6		8				
Phs Duration (G+Y+Rc), s		54.6				54.6		45.4				
Change Period (Y+Rc), s		6.5				6.5		5.8				
Max Green Setting (Gmax), s		47.5				47.5		40.2				
Max Q Clear Time (g_c+I1), s		10.1				45.7		38.6				
Green Ext Time (p_c), s		3.5				1.6		1.0				

Intersection Summary

HCM 6th Ctrl Delay	31.5
HCM 6th LOS	C

Notes

- User approved volume balancing among the lanes for turning movement.
- User approved changes to right turn type.
- Unsignalized Delay for [WBR] is excluded from calculations of the approach delay and intersection delay.

HCM 6th Signalized Intersection Summary
 3: Sacred Heart & Foothill Blvd

Rancho Cuvee
 Future Year AM

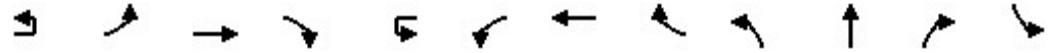

Movement	EBU	EBL	EBT	EBR	WBU	WBL	WBT	WBR	NBL	NBT	NBR	SBL
Lane Configurations		↘ ↙	↑ ↑ ↑	↗		↘ ↙	↑ ↑ ↑	↗	↖	↑	↗	↘
Traffic Volume (veh/h)	30	170	790	40	10	60	1950	160	110	10	20	30
Future Volume (veh/h)	30	170	790	40	10	60	1950	160	110	10	20	30
Initial Q (Qb), veh		0	0	0		0	0	0	0	0	0	0
Ped-Bike Adj(A_pbT)		1.00		1.00		1.00		1.00	1.00		1.00	1.00
Parking Bus, Adj		1.00	1.00	1.00		1.00	1.00	1.00	1.00	1.00	1.00	1.00
Work Zone On Approach			No			No			No			
Adj Sat Flow, veh/h/ln		1575	1772	1772		1575	1772	1772	1673	1772	1772	1673
Adj Flow Rate, veh/h		179	832	26		63	2053	128	124	0	1	32
Peak Hour Factor		0.95	0.95	0.95		0.95	0.95	0.95	0.95	0.95	0.95	0.95
Percent Heavy Veh, %		2	2	2		2	2	2	2	2	2	2
Cap, veh/h		268	2764	956		221	2685	925	210	0	98	98
Arrive On Green		0.09	0.57	0.57		0.08	0.56	0.56	0.07	0.00	0.07	0.06
Sat Flow, veh/h		2910	4837	1500		2910	4837	1500	3188	0	1495	1594
Grp Volume(v), veh/h		179	832	26		63	2053	128	124	0	1	32
Grp Sat Flow(s),veh/h/ln		1455	1612	1500		1455	1612	1500	1594	0	1495	1594
Q Serve(g_s), s		7.7	11.6	0.8		2.7	42.6	4.6	4.9	0.0	0.1	2.5
Cycle Q Clear(g_c), s		7.7	11.6	0.8		2.7	42.6	4.6	4.9	0.0	0.1	2.5
Prop In Lane		1.00		1.00		1.00		1.00	1.00		1.00	1.00
Lane Grp Cap(c), veh/h		268	2764	956		221	2685	925	210	0	98	98
V/C Ratio(X)		0.67	0.30	0.03		0.29	0.76	0.14	0.59	0.00	0.01	0.33
Avail Cap(c_a), veh/h		269	2764	956		246	2685	925	1054	0	494	98
HCM Platoon Ratio		1.00	1.00	1.00		1.00	1.00	1.00	1.00	1.00	1.00	1.00
Upstream Filter(l)		0.91	0.91	0.91		1.00	1.00	1.00	1.00	0.00	1.00	1.00
Uniform Delay (d), s/veh		57.1	14.4	8.7		56.7	22.3	10.4	59.0	0.0	56.8	58.4
Incr Delay (d2), s/veh		5.6	0.3	0.0		0.7	2.1	0.3	2.6	0.0	0.0	1.9
Initial Q Delay(d3),s/veh		0.0	0.0	0.0		0.0	0.0	0.0	0.0	0.0	0.0	0.0
%ile BackOfQ(50%),veh/ln		3.0	4.0	0.3		1.0	15.1	1.8	2.1	0.0	0.0	1.1
Unsig. Movement Delay, s/veh												
LnGrp Delay(d),s/veh		62.7	14.7	8.8		57.4	24.5	10.8	61.7	0.0	56.8	60.3
LnGrp LOS		E	B	A		E	C	B	E	A	E	E
Approach Vol, veh/h			1037				2244			125		
Approach Delay, s/veh			22.8				24.6			61.6		
Approach LOS			C				C			E		
Timer - Assigned Phs	1	2		4	5	6		8				
Phs Duration (G+Y+Rc), s	13.9	81.6		17.6	16.0	79.5		17.0				
Change Period (Y+Rc), s	4.0	* 7.3		9.0	4.0	* 7.3		9.0				
Max Green Setting (Gmax), s	11.0	* 39		43.0	12.0	* 38		8.0				
Max Q Clear Time (g_c+I1), s	4.7	13.6		6.9	9.7	44.6		10.0				
Green Ext Time (p_c), s	0.1	5.5		0.4	0.1	0.0		0.0				

Intersection Summary

HCM 6th Ctrl Delay	32.3
HCM 6th LOS	C

Notes

- User approved volume balancing among the lanes for turning movement.
- User approved ignoring U-Turning movement.
- * HCM 6th computational engine requires equal clearance times for the phases crossing the barrier.

HCM 6th Signalized Intersection Summary
 3: Sacred Heart & Foothill Blvd

Rancho Cuvee
 Future Year AM



Movement	SBT	SBR
Lane Configurations	↓	↙
Traffic Volume (veh/h)	20	90
Future Volume (veh/h)	20	90
Initial Q (Qb), veh	0	0
Ped-Bike Adj(A_pbT)		1.00
Parking Bus, Adj	1.00	1.00
Work Zone On Approach	No	
Adj Sat Flow, veh/h/ln	1772	1772
Adj Flow Rate, veh/h	21	95
Peak Hour Factor	0.95	0.95
Percent Heavy Veh, %	2	2
Cap, veh/h	17	78
Arrive On Green	0.06	0.06
Sat Flow, veh/h	278	1260
Grp Volume(v), veh/h	0	116
Grp Sat Flow(s),veh/h/ln	0	1538
Q Serve(g_s), s	0.0	8.0
Cycle Q Clear(g_c), s	0.0	8.0
Prop In Lane		0.82
Lane Grp Cap(c), veh/h	0	95
V/C Ratio(X)	0.00	1.23
Avail Cap(c_a), veh/h	0	95
HCM Platoon Ratio	1.00	1.00
Upstream Filter(l)	0.00	1.00
Uniform Delay (d), s/veh	0.0	61.0
Incr Delay (d2), s/veh	0.0	165.1
Initial Q Delay(d3),s/veh	0.0	0.0
%ile BackOfQ(50%),veh/ln	0.0	7.5
Unsig. Movement Delay, s/veh		
LnGrp Delay(d),s/veh	0.0	226.1
LnGrp LOS	A	F
Approach Vol, veh/h	148	
Approach Delay, s/veh	190.3	
Approach LOS	F	
Timer - Assigned Phs		

HCM 6th Signalized Intersection Summary
4: Etiwanda Ave & Foothill Blvd

Rancho Cuvee
Future Year AM

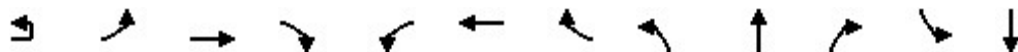

Movement	EBU	EBL	EBT	EBR	WBL	WBT	WBR	NBL	NBT	NBR	SBL	SBT
Lane Configurations		↘ ↙	↑↑	↗	↘ ↙	↑↑	↗	↘ ↙	↑	↗	↘ ↙	↑↑
Traffic Volume (veh/h)	15	110	490	180	310	1680	90	150	250	100	70	430
Future Volume (veh/h)	15	110	490	180	310	1680	90	150	250	100	70	430
Initial Q (Qb), veh		0	0	0	0	0	0	0	0	0	0	0
Ped-Bike Adj(A_pbT)		1.00		0.98	1.00		0.99	1.00		0.98	1.00	
Parking Bus, Adj		1.00	1.00	1.00	1.00	1.00	1.00	1.00	1.00	1.00	1.00	1.00
Work Zone On Approach			No		No			No				No
Adj Sat Flow, veh/h/ln		1575	1772	1772	1575	1772	1772	1673	1772	1772	1673	1772
Adj Flow Rate, veh/h		116	516	122	326	1768	31	158	263	25	74	453
Peak Hour Factor		0.95	0.95	0.95	0.95	0.95	0.95	0.95	0.95	0.95	0.95	0.95
Percent Heavy Veh, %		2	2	2	2	2	2	2	2	2	2	2
Cap, veh/h		309	1189	682	377	1267	562	172	419	349	159	514
Arrive On Green		0.11	0.35	0.35	0.13	0.38	0.38	0.11	0.24	0.24	0.10	0.23
Sat Flow, veh/h		2910	3367	1474	2910	3367	1493	1594	1772	1474	1594	2244
Grp Volume(v), veh/h		116	516	122	326	1768	31	158	263	25	74	339
Grp Sat Flow(s),veh/h/ln		1455	1683	1474	1455	1683	1493	1594	1772	1474	1594	1683
Q Serve(g_s), s		4.8	15.2	6.3	14.3	48.9	1.7	12.8	17.3	1.7	5.7	25.3
Cycle Q Clear(g_c), s		4.8	15.2	6.3	14.3	48.9	1.7	12.8	17.3	1.7	5.7	25.3
Prop In Lane		1.00		1.00	1.00		1.00	1.00		1.00	1.00	
Lane Grp Cap(c), veh/h		309	1189	682	377	1267	562	172	419	349	159	385
V/C Ratio(X)		0.38	0.43	0.18	0.87	1.39	0.06	0.92	0.63	0.07	0.46	0.88
Avail Cap(c_a), veh/h		313	1189	682	492	1267	562	172	477	397	159	440
HCM Platoon Ratio		1.00	1.00	1.00	1.00	1.00	1.00	1.00	1.00	1.00	1.00	1.00
Upstream Filter(I)		1.00	1.00	1.00	1.00	1.00	1.00	1.00	1.00	1.00	1.00	1.00
Uniform Delay (d), s/veh		54.1	32.1	20.6	55.5	40.5	25.8	57.4	44.5	38.5	55.2	48.4
Incr Delay (d2), s/veh		0.8	1.2	0.6	12.1	182.6	0.2	46.3	2.1	0.1	2.1	16.6
Initial Q Delay(d3),s/veh		0.0	0.0	0.0	0.0	0.0	0.0	0.0	0.0	0.0	0.0	0.0
%ile BackOfQ(50%),veh/ln		1.8	6.2	2.2	5.7	51.2	0.6	7.2	7.7	0.6	2.3	12.1
Unsig. Movement Delay, s/veh												
LnGrp Delay(d),s/veh		54.9	33.3	21.2	67.5	223.1	26.0	103.8	46.6	38.6	57.3	65.0
LnGrp LOS		D	C	C	E	F	C	F	D	D	E	E
Approach Vol, veh/h			754			2125			446			735
Approach Delay, s/veh			34.6			196.4			66.4			65.2
Approach LOS			C			F			E			E
Timer - Assigned Phs	1	2	3	4	5	6	7	8				
Phs Duration (G+Y+Rc), s	20.8	53.8	17.5	37.9	17.8	56.8	16.5	38.9				
Change Period (Y+Rc), s	4.0	* 7.9	3.5	* 8.1	4.0	* 7.9	3.5	* 8.1				
Max Green Setting (Gmax), s	22.0	* 37	14.0	* 34	14.0	* 45	13.0	* 35				
Max Q Clear Time (g_c+I1), s	16.3	17.2	14.8	27.6	6.8	50.9	7.7	19.3				
Green Ext Time (p_c), s	0.5	3.3	0.0	2.0	0.2	0.0	0.1	1.2				

Intersection Summary

HCM 6th Ctrl Delay	128.3
HCM 6th LOS	F

Notes

User approved ignoring U-Turning movement.

* HCM 6th computational engine requires equal clearance times for the phases crossing the barrier.

HCM 6th Signalized Intersection Summary
 4: Etiwanda Ave & Foothill Blvd

Rancho Cuvee
 Future Year AM

Movement	SBR
Lane Configurations	
Traffic Volume (veh/h)	290
Future Volume (veh/h)	290
Initial Q (Qb), veh	0
Ped-Bike Adj(A_pbT)	1.00
Parking Bus, Adj	1.00
Work Zone On Approach	
Adj Sat Flow, veh/h/ln	1772
Adj Flow Rate, veh/h	208
Peak Hour Factor	0.95
Percent Heavy Veh, %	2
Cap, veh/h	234
Arrive On Green	0.23
Sat Flow, veh/h	1022
Grp Volume(v), veh/h	322
Grp Sat Flow(s),veh/h/ln	1583
Q Serve(g_s), s	25.6
Cycle Q Clear(g_c), s	25.6
Prop In Lane	0.65
Lane Grp Cap(c), veh/h	363
V/C Ratio(X)	0.89
Avail Cap(c_a), veh/h	414
HCM Platoon Ratio	1.00
Upstream Filter(l)	1.00
Uniform Delay (d), s/veh	48.5
Incr Delay (d2), s/veh	18.8
Initial Q Delay(d3),s/veh	0.0
%ile BackOfQ(50%),veh/ln	11.7
Unsig. Movement Delay, s/veh	
LnGrp Delay(d),s/veh	67.3
LnGrp LOS	E
Approach Vol, veh/h	
Approach Delay, s/veh	
Approach LOS	
Timer - Assigned Phs	

HCM 6th Signalized Intersection Summary
 1: Foothill Blvd & I-15 SB Off Ramp

Rancho Cuvee
 Future Year PM



Movement	EBL	EBT	EBR	WBL	WBT	WBR	NBL	NBT	NBR	SBL	SBT	SBR
Lane Configurations		↑↑↑	↗		↑↑↑					↘	↕	↗
Traffic Volume (veh/h)	0	2140	1020	0	1610	0	0	0	0	120	0	650
Future Volume (veh/h)	0	2140	1020	0	1610	0	0	0	0	120	0	650
Initial Q (Qb), veh	0	0	0	0	0	0				0	0	0
Ped-Bike Adj(A_pbT)	1.00		1.00	1.00		1.00				1.00		1.00
Parking Bus, Adj	1.00	1.00	1.00	1.00	1.00	1.00				1.00	1.00	1.00
Work Zone On Approach		No			No						No	
Adj Sat Flow, veh/h/ln	0	1772	1772	0	1772	0				1575	1772	1772
Adj Flow Rate, veh/h	0	2253	0	0	1695	0				84	0	703
Peak Hour Factor	0.95	0.95	0.95	0.95	0.95	0.95				0.95	0.95	0.95
Percent Heavy Veh, %	0	2	2	0	2	0				2	2	2
Cap, veh/h	0	3013		0	3013	0				398	0	797
Arrive On Green	0.00	0.62	0.00	0.00	0.62	0.00				0.27	0.00	0.27
Sat Flow, veh/h	0	4997	1502	0	5156	0				1500	0	3003
Grp Volume(v), veh/h	0	2253	0	0	1695	0				84	0	703
Grp Sat Flow(s),veh/h/ln	0	1612	1502	0	1612	0				1500	0	1502
Q Serve(g_s), s	0.0	36.2	0.0	0.0	22.4	0.0				4.8	0.0	24.7
Cycle Q Clear(g_c), s	0.0	36.2	0.0	0.0	22.4	0.0				4.8	0.0	24.7
Prop In Lane	0.00		1.00	0.00		0.00				1.00		1.00
Lane Grp Cap(c), veh/h	0	3013		0	3013	0				398	0	797
V/C Ratio(X)	0.00	0.75		0.00	0.56	0.00				0.21	0.00	0.88
Avail Cap(c_a), veh/h	0	3013		0	3013	0				494	0	988
HCM Platoon Ratio	1.00	1.00	1.00	1.00	1.00	1.00				1.00	1.00	1.00
Upstream Filter(I)	0.00	1.00	0.00	0.00	1.00	0.00				1.00	0.00	1.00
Uniform Delay (d), s/veh	0.0	14.6	0.0	0.0	12.0	0.0				31.5	0.0	38.8
Incr Delay (d2), s/veh	0.0	1.7	0.0	0.0	0.8	0.0				0.3	0.0	8.1
Initial Q Delay(d3),s/veh	0.0	0.0	0.0	0.0	0.0	0.0				0.0	0.0	0.0
%ile BackOfQ(50%),veh/ln	0.0	11.4	0.0	0.0	6.9	0.0				1.8	0.0	10.0
Unsig. Movement Delay, s/veh												
LnGrp Delay(d),s/veh	0.0	16.4	0.0	0.0	12.8	0.0				31.7	0.0	46.8
LnGrp LOS	A	B		A	B	A				C	A	D
Approach Vol, veh/h		2253	A		1695						787	
Approach Delay, s/veh		16.4			12.8						45.2	
Approach LOS		B			B						D	
Timer - Assigned Phs		2		4		6						
Phs Duration (G+Y+Rc), s		75.0		35.0		75.0						
Change Period (Y+Rc), s		6.5		5.8		6.5						
Max Green Setting (Gmax), s		61.5		36.2		61.5						
Max Q Clear Time (g_c+I1), s		38.2		26.7		24.4						
Green Ext Time (p_c), s		14.9		2.5		12.4						

Intersection Summary

HCM 6th Ctrl Delay	19.9
HCM 6th LOS	B

Notes

- User approved volume balancing among the lanes for turning movement.
- Unsignalized Delay for [EBR] is excluded from calculations of the approach delay and intersection delay.

HCM 6th Signalized Intersection Summary
2: I-15 NB Off Ramp & Foothill Blvd

Rancho Cuvee
Future Year PM



Movement	EBL	EBT	EBR	WBL	WBT	WBR	NBL	NBT	NBR	SBL	SBT	SBR
Lane Configurations		↑↑↑			↑↑↑	↑	↑	↑	↑			
Traffic Volume (veh/h)	0	1240	0	0	1300	240	720	0	550	0	0	0
Future Volume (veh/h)	0	1240	0	0	1300	240	720	0	550	0	0	0
Initial Q (Qb), veh	0	0	0	0	0	0	0	0	0			
Ped-Bike Adj(A_pbT)	1.00		1.00	1.00		1.00	1.00		0.98			
Parking Bus, Adj	1.00	1.00	1.00	1.00	1.00	1.00	1.00	1.00	1.00			
Work Zone On Approach		No			No			No				
Adj Sat Flow, veh/h/ln	0	1772	0	0	1772	1772	1575	1772	1772			
Adj Flow Rate, veh/h	0	1292	0	0	1354	0	928	0	382			
Peak Hour Factor	0.92	0.96	0.96	0.96	0.96	0.92	0.96	0.92	0.96			
Percent Heavy Veh, %	0	2	0	0	2	2	2	2	2			
Cap, veh/h	0	2575	0	0	2575		1068	0	526			
Arrive On Green	0.00	0.53	0.00	0.00	0.53	0.00	0.36	0.00	0.36			
Sat Flow, veh/h	0	5156	0	0	4997	1502	3000	0	1479			
Grp Volume(v), veh/h	0	1292	0	0	1354	0	928	0	382			
Grp Sat Flow(s),veh/h/ln	0	1612	0	0	1612	1502	1500	0	1479			
Q Serve(g_s), s	0.0	18.7	0.0	0.0	20.0	0.0	31.7	0.0	24.7			
Cycle Q Clear(g_c), s	0.0	18.7	0.0	0.0	20.0	0.0	31.7	0.0	24.7			
Prop In Lane	0.00		0.00	0.00		1.00	1.00		1.00			
Lane Grp Cap(c), veh/h	0	2575	0	0	2575		1068	0	526			
V/C Ratio(X)	0.00	0.50	0.00	0.00	0.53		0.87	0.00	0.73			
Avail Cap(c_a), veh/h	0	2575	0	0	2575		1478	0	729			
HCM Platoon Ratio	1.00	1.00	1.00	1.00	1.00	1.00	1.00	1.00	1.00			
Upstream Filter(I)	0.00	1.00	0.00	0.00	0.82	0.00	1.00	0.00	1.00			
Uniform Delay (d), s/veh	0.0	16.4	0.0	0.0	16.7	0.0	33.0	0.0	30.8			
Incr Delay (d2), s/veh	0.0	0.7	0.0	0.0	0.6	0.0	4.3	0.0	2.3			
Initial Q Delay(d3),s/veh	0.0	0.0	0.0	0.0	0.0	0.0	0.0	0.0	0.0			
%ile BackOfQ(50%),veh/ln	0.0	6.3	0.0	0.0	7.3	0.0	11.9	0.0	9.0			
Unsig. Movement Delay, s/veh												
LnGrp Delay(d),s/veh	0.0	17.1	0.0	0.0	17.3	0.0	37.4	0.0	33.0			
LnGrp LOS	A	B	A	A	B		D	A	C			
Approach Vol, veh/h		1292			1354	A		1310				
Approach Delay, s/veh		17.1			17.3			36.1				
Approach LOS		B			B			D				
Timer - Assigned Phs		2				6		8				
Phs Duration (G+Y+Rc), s		65.1				65.1		44.9				
Change Period (Y+Rc), s		6.5				6.5		5.8				
Max Green Setting (Gmax), s		43.5				43.5		54.2				
Max Q Clear Time (g_c+I1), s		20.7				22.0		33.7				
Green Ext Time (p_c), s		7.3				8.9		5.4				

Intersection Summary

HCM 6th Ctrl Delay	23.5
HCM 6th LOS	C

Notes

- User approved volume balancing among the lanes for turning movement.
- User approved changes to right turn type.
- Unsignalized Delay for [WBR] is excluded from calculations of the approach delay and intersection delay.

HCM 6th Signalized Intersection Summary
 3: Sacred Heart & Foothill Blvd

Rancho Cuvee
 Future Year PM



Movement	EBU	EBL	EBT	EBR	WBU	WBL	WBT	WBR	NBL	NBT	NBR	SBL
Lane Configurations		↔↔	↑↑↑	↔		↔↔	↑↑↑	↔	↔	↑	↔	↔
Traffic Volume (veh/h)	130	170	1260	140	40	140	940	70	300	10	110	20
Future Volume (veh/h)	130	170	1260	140	40	140	940	70	300	10	110	20
Initial Q (Qb), veh		0	0	0		0	0	0	0	0	0	0
Ped-Bike Adj(A_pbT)		1.00		1.00		1.00		0.98	1.00		0.99	1.00
Parking Bus, Adj		1.00	1.00	1.00		1.00	1.00	1.00	1.00	1.00	1.00	1.00
Work Zone On Approach			No				No			No		
Adj Sat Flow, veh/h/ln		1575	1772	1772		1575	1772	1772	1673	1772	1772	1673
Adj Flow Rate, veh/h		177	1312	86		146	979	28	319	0	17	21
Peak Hour Factor		0.96	0.96	0.96		0.96	0.96	0.96	0.96	0.96	0.96	0.96
Percent Heavy Veh, %		2	2	2		2	2	2	2	2	2	2
Cap, veh/h		222	2725	1043		134	2580	838	422	0	198	52
Arrive On Green		0.08	0.56	0.56		0.05	0.53	0.53	0.13	0.00	0.13	0.03
Sat Flow, veh/h		2910	4837	1498		2910	4837	1479	3188	0	1491	1594
Grp Volume(v), veh/h		177	1312	86		146	979	28	319	0	17	21
Grp Sat Flow(s),veh/h/ln		1455	1612	1498		1455	1612	1479	1594	0	1491	1594
Q Serve(g_s), s		7.8	21.1	2.4		6.0	15.4	1.1	12.5	0.0	1.3	1.7
Cycle Q Clear(g_c), s		7.8	21.1	2.4		6.0	15.4	1.1	12.5	0.0	1.3	1.7
Prop In Lane		1.00		1.00		1.00		1.00	1.00		1.00	1.00
Lane Grp Cap(c), veh/h		222	2725	1043		134	2580	838	422	0	198	52
V/C Ratio(X)		0.80	0.48	0.08		1.09	0.38	0.03	0.76	0.00	0.09	0.40
Avail Cap(c_a), veh/h		291	2725	1043		134	2580	838	1054	0	493	221
HCM Platoon Ratio		1.00	1.00	1.00		1.00	1.00	1.00	1.00	1.00	1.00	1.00
Upstream Filter(l)		0.77	0.77	0.77		1.00	1.00	1.00	1.00	0.00	1.00	1.00
Uniform Delay (d), s/veh		59.1	17.0	6.4		62.0	17.8	12.5	54.4	0.0	49.5	61.6
Incr Delay (d2), s/veh		8.7	0.5	0.1		102.9	0.4	0.1	2.8	0.0	0.2	5.0
Initial Q Delay(d3),s/veh		0.0	0.0	0.0		0.0	0.0	0.0	0.0	0.0	0.0	0.0
%ile BackOfQ(50%),veh/ln		3.1	7.3	1.1		4.1	5.4	0.4	5.2	0.0	0.5	0.8
Unsig. Movement Delay, s/veh												
LnGrp Delay(d),s/veh		67.7	17.5	6.5		164.9	18.2	12.6	57.1	0.0	49.7	66.6
LnGrp LOS		E	B	A		F	B	B	E	A	D	E
Approach Vol, veh/h			1575				1153			336		
Approach Delay, s/veh			22.5				36.6			56.7		
Approach LOS			C				D			E		
Timer - Assigned Phs	1	2		4	5	6		8				
Phs Duration (G+Y+Rc), s	10.0	80.5		26.2	13.9	76.6		13.2				
Change Period (Y+Rc), s	4.0	* 7.3		9.0	4.0	* 7.3		9.0				
Max Green Setting (Gmax), s	6.0	* 34		43.0	13.0	* 27		18.0				
Max Q Clear Time (g_c+I1), s	8.0	23.1		14.5	9.8	17.4		4.6				
Green Ext Time (p_c), s	0.0	6.0		1.2	0.2	4.1		0.1				

Intersection Summary

HCM 6th Ctrl Delay	32.2
HCM 6th LOS	C

Notes

- User approved volume balancing among the lanes for turning movement.
- User approved ignoring U-Turning movement.
- * HCM 6th computational engine requires equal clearance times for the phases crossing the barrier.

HCM 6th Signalized Intersection Summary
 3: Sacred Heart & Foothill Blvd

Rancho Cuvee
 Future Year PM



Movement	SBT	SBR
Lane Configurations	↓	↙
Traffic Volume (veh/h)	10	20
Future Volume (veh/h)	10	20
Initial Q (Qb), veh	0	0
Ped-Bike Adj(A_pbT)		0.98
Parking Bus, Adj	1.00	1.00
Work Zone On Approach	No	
Adj Sat Flow, veh/h/ln	1772	1772
Adj Flow Rate, veh/h	10	21
Peak Hour Factor	0.96	0.96
Percent Heavy Veh, %	2	2
Cap, veh/h	16	34
Arrive On Green	0.03	0.03
Sat Flow, veh/h	501	1052
Grp Volume(v), veh/h	0	31
Grp Sat Flow(s),veh/h/ln	0	1553
Q Serve(g_s), s	0.0	2.6
Cycle Q Clear(g_c), s	0.0	2.6
Prop In Lane		0.68
Lane Grp Cap(c), veh/h	0	51
V/C Ratio(X)	0.00	0.61
Avail Cap(c_a), veh/h	0	215
HCM Platoon Ratio	1.00	1.00
Upstream Filter(l)	0.00	1.00
Uniform Delay (d), s/veh	0.0	62.1
Incr Delay (d2), s/veh	0.0	11.4
Initial Q Delay(d3),s/veh	0.0	0.0
%ile BackOfQ(50%),veh/ln	0.0	1.2
Unsig. Movement Delay, s/veh		
LnGrp Delay(d),s/veh	0.0	73.5
LnGrp LOS	A	E
Approach Vol, veh/h	52	
Approach Delay, s/veh	70.7	
Approach LOS	E	
Timer - Assigned Phs		

HCM 6th Signalized Intersection Summary
4: Etiwanda Ave & Foothill Blvd

Rancho Cuvee
Future Year PM

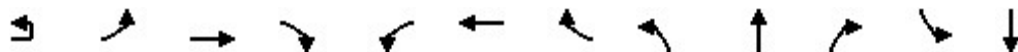

Movement	EBU	EBL	EBT	EBR	WBL	WBT	WBR	NBL	NBT	NBR	SBL	SBT
Lane Configurations		↔	↕	↗	↔	↕	↗	↔	↕	↗	↔	↕
Traffic Volume (veh/h)	60	200	1090	200	140	840	40	300	340	210	60	250
Future Volume (veh/h)	60	200	1090	200	140	840	40	300	340	210	60	250
Initial Q (Qb), veh		0	0	0	0	0	0	0	0	0	0	0
Ped-Bike Adj(A_pbT)		1.00		0.99	1.00		1.00	1.00		0.98	1.00	
Parking Bus, Adj		1.00	1.00	1.00	1.00	1.00	1.00	1.00	1.00	1.00	1.00	1.00
Work Zone On Approach			No			No			No			No
Adj Sat Flow, veh/h/ln		1575	1772	1772	1575	1772	1772	1673	1772	1772	1673	1772
Adj Flow Rate, veh/h		215	1172	118	151	903	12	323	366	122	65	269
Peak Hour Factor		0.93	0.93	0.93	0.93	0.93	0.93	0.93	0.93	0.93	0.93	0.93
Percent Heavy Veh, %		2	2	2	2	2	2	2	2	2	2	2
Cap, veh/h		258	1442	929	157	1325	591	313	498	416	89	334
Arrive On Green		0.09	0.43	0.43	0.05	0.39	0.39	0.20	0.28	0.28	0.06	0.14
Sat Flow, veh/h		2910	3367	1482	2910	3367	1500	1594	1772	1478	1594	2366
Grp Volume(v), veh/h		215	1172	118	151	903	12	323	366	122	65	189
Grp Sat Flow(s),veh/h/ln		1455	1683	1482	1455	1683	1500	1594	1772	1478	1594	1683
Q Serve(g_s), s		9.5	39.7	4.2	6.7	28.9	0.6	25.5	24.3	8.4	5.2	14.1
Cycle Q Clear(g_c), s		9.5	39.7	4.2	6.7	28.9	0.6	25.5	24.3	8.4	5.2	14.1
Prop In Lane		1.00		1.00	1.00		1.00	1.00		1.00	1.00	
Lane Grp Cap(c), veh/h		258	1442	929	157	1325	591	313	498	416	89	237
V/C Ratio(X)		0.83	0.81	0.13	0.96	0.68	0.02	1.03	0.73	0.29	0.73	0.80
Avail Cap(c_a), veh/h		291	1442	929	157	1325	591	313	525	438	221	401
HCM Platoon Ratio		1.00	1.00	1.00	1.00	1.00	1.00	1.00	1.00	1.00	1.00	1.00
Upstream Filter(I)		1.00	1.00	1.00	1.00	1.00	1.00	1.00	1.00	1.00	1.00	1.00
Uniform Delay (d), s/veh		58.3	32.6	10.0	61.4	32.7	24.1	52.3	42.3	36.6	60.4	54.0
Incr Delay (d2), s/veh		15.2	5.1	0.3	60.5	2.8	0.1	59.7	4.3	0.1	4.3	2.3
Initial Q Delay(d3),s/veh		0.0	0.0	0.0	0.0	0.0	0.0	0.0	0.0	0.0	0.0	0.0
%ile BackOfQ(50%),veh/ln		3.9	16.2	1.4	3.7	11.7	0.2	15.1	10.9	3.0	2.2	6.0
Unsig. Movement Delay, s/veh												
LnGrp Delay(d),s/veh		73.5	37.7	10.2	121.9	35.5	24.2	112.0	46.6	36.7	64.7	56.4
LnGrp LOS		E	D	B	F	D	C	F	D	D	E	E
Approach Vol, veh/h			1505			1066			811			440
Approach Delay, s/veh			40.7			47.6			71.2			58.0
Approach LOS			D			D			E			E
Timer - Assigned Phs	1	2	3	4	5	6	7	8				
Phs Duration (G+Y+Rc), s	11.0	63.6	29.0	26.4	15.5	59.1	10.8	44.7				
Change Period (Y+Rc), s	4.0	* 7.9	3.5	* 8.1	4.0	* 7.9	3.5	* 8.1				
Max Green Setting (Gmax), s	7.0	* 43	25.5	* 31	13.0	* 37	18.0	* 39				
Max Q Clear Time (g_c+I1), s	8.7	41.7	27.5	16.8	11.5	30.9	7.2	26.3				
Green Ext Time (p_c), s	0.0	0.7	0.0	1.1	0.1	1.7	0.0	1.2				

Intersection Summary

HCM 6th Ctrl Delay	51.1
HCM 6th LOS	D

Notes

User approved ignoring U-Turning movement.

* HCM 6th computational engine requires equal clearance times for the phases crossing the barrier.

HCM 6th Signalized Intersection Summary
 4: Etiwanda Ave & Foothill Blvd

Rancho Cuvee
 Future Year PM

Movement	SBR
Lane Configurations	
Traffic Volume (veh/h)	190
Future Volume (veh/h)	190
Initial Q (Qb), veh	0
Ped-Bike Adj(A_pbT)	0.98
Parking Bus, Adj	1.00
Work Zone On Approach	
Adj Sat Flow, veh/h/ln	1772
Adj Flow Rate, veh/h	106
Peak Hour Factor	0.93
Percent Heavy Veh, %	2
Cap, veh/h	128
Arrive On Green	0.14
Sat Flow, veh/h	907
Grp Volume(v), veh/h	186
Grp Sat Flow(s),veh/h/ln	1590
Q Serve(g_s), s	14.8
Cycle Q Clear(g_c), s	14.8
Prop In Lane	0.57
Lane Grp Cap(c), veh/h	224
V/C Ratio(X)	0.83
Avail Cap(c_a), veh/h	379
HCM Platoon Ratio	1.00
Upstream Filter(l)	1.00
Uniform Delay (d), s/veh	54.3
Incr Delay (d2), s/veh	3.0
Initial Q Delay(d3),s/veh	0.0
%ile BackOfQ(50%),veh/ln	6.0
Unsig. Movement Delay, s/veh	
LnGrp Delay(d),s/veh	57.3
LnGrp LOS	E
Approach Vol, veh/h	
Approach Delay, s/veh	
Approach LOS	
Timer - Assigned Phs	

HCM 6th Signalized Intersection Summary
 1: Foothill Blvd & I-15 SB Off Ramp

Rancho Cuvee
 Future Year Plus Project AM



Movement	EBL	EBT	EBR	WBL	WBT	WBR	NBL	NBT	NBR	SBL	SBT	SBR
Lane Configurations		↑↑↑	↗		↑↑↑					↘	↕	↗
Traffic Volume (veh/h)	0	803	1010	0	2287	0	0	0	0	92	0	740
Future Volume (veh/h)	0	803	1010	0	2287	0	0	0	0	92	0	740
Initial Q (Qb), veh	0	0	0	0	0	0				0	0	0
Ped-Bike Adj(A_pbT)	1.00		1.00	1.00		1.00				1.00		1.00
Parking Bus, Adj	1.00	1.00	1.00	1.00	1.00	1.00				1.00	1.00	1.00
Work Zone On Approach		No			No						No	
Adj Sat Flow, veh/h/ln	0	1772	1772	0	1772	0				1575	1772	1772
Adj Flow Rate, veh/h	0	845	0	0	2407	0				65	0	814
Peak Hour Factor	0.95	0.95	0.95	0.95	0.95	0.95				0.95	0.95	0.95
Percent Heavy Veh, %	0	2	2	0	2	0				2	2	2
Cap, veh/h	0	2802		0	2802	0				447	0	894
Arrive On Green	0.00	0.58	0.00	0.00	0.58	0.00				0.30	0.00	0.30
Sat Flow, veh/h	0	4997	1502	0	5156	0				1500	0	3003
Grp Volume(v), veh/h	0	845	0	0	2407	0				65	0	814
Grp Sat Flow(s),veh/h/ln	0	1612	1502	0	1612	0				1500	0	1502
Q Serve(g_s), s	0.0	8.9	0.0	0.0	41.7	0.0				3.2	0.0	26.1
Cycle Q Clear(g_c), s	0.0	8.9	0.0	0.0	41.7	0.0				3.2	0.0	26.1
Prop In Lane	0.00		1.00	0.00		0.00				1.00		1.00
Lane Grp Cap(c), veh/h	0	2802		0	2802	0				447	0	894
V/C Ratio(X)	0.00	0.30		0.00	0.86	0.00				0.15	0.00	0.91
Avail Cap(c_a), veh/h	0	2802		0	2802	0				486	0	973
HCM Platoon Ratio	1.00	1.00	1.00	1.00	1.00	1.00				1.00	1.00	1.00
Upstream Filter(l)	0.00	1.00	0.00	0.00	1.00	0.00				1.00	0.00	1.00
Uniform Delay (d), s/veh	0.0	10.7	0.0	0.0	17.6	0.0				25.8	0.0	33.8
Incr Delay (d2), s/veh	0.0	0.3	0.0	0.0	3.7	0.0				0.1	0.0	11.8
Initial Q Delay(d3),s/veh	0.0	0.0	0.0	0.0	0.0	0.0				0.0	0.0	0.0
%ile BackOfQ(50%),veh/ln	0.0	2.8	0.0	0.0	13.6	0.0				1.2	0.0	10.9
Unsig. Movement Delay, s/veh												
LnGrp Delay(d),s/veh	0.0	11.0	0.0	0.0	21.3	0.0				25.9	0.0	45.6
LnGrp LOS	A	B		A	C	A				C	A	D
Approach Vol, veh/h		845	A		2407						879	
Approach Delay, s/veh		11.0			21.3						44.1	
Approach LOS		B			C						D	
Timer - Assigned Phs		2		4		6						
Phs Duration (G+Y+Rc), s		64.4		35.6		64.4						
Change Period (Y+Rc), s		6.5		5.8		6.5						
Max Green Setting (Gmax), s		55.3		32.4		55.3						
Max Q Clear Time (g_c+I1), s		10.9		28.1		43.7						
Green Ext Time (p_c), s		4.8		1.7		9.3						

Intersection Summary

HCM 6th Ctrl Delay	24.1
HCM 6th LOS	C

Notes

User approved volume balancing among the lanes for turning movement.
 Unsignalized Delay for [EBR] is excluded from calculations of the approach delay and intersection delay.

HCM 6th Signalized Intersection Summary

2: I-15 NB Off Ramp & Foothill Blvd

Rancho Cuvee
Future Year Plus Project AM



Movement	EBL	EBT	EBR	WBL	WBT	WBR	NBL	NBT	NBR	SBL	SBT	SBR
Lane Configurations		↑↑↑			↑↑↑	↗	↘	↕	↗			
Traffic Volume (veh/h)	0	625	0	0	2128	147	970	0	458	0	0	0
Future Volume (veh/h)	0	625	0	0	2128	147	970	0	458	0	0	0
Initial Q (Qb), veh	0	0	0	0	0	0	0	0	0			
Ped-Bike Adj(A_pbT)	1.00		1.00	1.00		1.00	1.00		0.99			
Parking Bus, Adj	1.00	1.00	1.00	1.00	1.00	1.00	1.00	1.00	1.00			
Work Zone On Approach		No			No			No				
Adj Sat Flow, veh/h/ln	0	1772	0	0	1772	1772	1575	1772	1772			
Adj Flow Rate, veh/h	0	658	0	0	2240	0	1136	0	247			
Peak Hour Factor	0.95	0.95	0.95	0.95	0.95	0.95	0.95	0.95	0.95			
Percent Heavy Veh, %	0	2	0	0	2	2	2	2	2			
Cap, veh/h	0	2323	0	0	2323		1190	0	588			
Arrive On Green	0.00	0.48	0.00	0.00	0.48	0.00	0.40	0.00	0.40			
Sat Flow, veh/h	0	5156	0	0	4997	1502	3000	0	1482			
Grp Volume(v), veh/h	0	658	0	0	2240	0	1136	0	247			
Grp Sat Flow(s),veh/h/ln	0	1612	0	0	1612	1502	1500	0	1482			
Q Serve(g_s), s	0.0	8.2	0.0	0.0	44.8	0.0	36.8	0.0	12.1			
Cycle Q Clear(g_c), s	0.0	8.2	0.0	0.0	44.8	0.0	36.8	0.0	12.1			
Prop In Lane	0.00		0.00	0.00		1.00	1.00		1.00			
Lane Grp Cap(c), veh/h	0	2323	0	0	2323		1190	0	588			
V/C Ratio(X)	0.00	0.28	0.00	0.00	0.96		0.95	0.00	0.42			
Avail Cap(c_a), veh/h	0	2323	0	0	2323		1206	0	596			
HCM Platoon Ratio	1.00	1.00	1.00	1.00	1.00	1.00	1.00	1.00	1.00			
Upstream Filter(l)	0.00	1.00	0.00	0.00	0.41	0.00	1.00	0.00	1.00			
Uniform Delay (d), s/veh	0.0	15.6	0.0	0.0	25.2	0.0	29.3	0.0	21.8			
Incr Delay (d2), s/veh	0.0	0.3	0.0	0.0	6.2	0.0	16.1	0.0	0.5			
Initial Q Delay(d3),s/veh	0.0	0.0	0.0	0.0	0.0	0.0	0.0	0.0	0.0			
%ile BackOfQ(50%),veh/ln	0.0	2.8	0.0	0.0	17.4	0.0	15.4	0.0	4.2			
Unsig. Movement Delay, s/veh												
LnGrp Delay(d),s/veh	0.0	15.9	0.0	0.0	31.3	0.0	45.4	0.0	22.3			
LnGrp LOS	A	B	A	A	C		D	A	C			
Approach Vol, veh/h		658			2240	A		1383				
Approach Delay, s/veh		15.9			31.3			41.3				
Approach LOS		B			C			D				
Timer - Assigned Phs		2				6		8				
Phs Duration (G+Y+Rc), s		54.5				54.5		45.5				
Change Period (Y+Rc), s		6.5				6.5		5.8				
Max Green Setting (Gmax), s		47.5				47.5		40.2				
Max Q Clear Time (g_c+I1), s		10.2				46.8		38.8				
Green Ext Time (p_c), s		3.5				0.6		0.9				

Intersection Summary

HCM 6th Ctrl Delay	32.2
HCM 6th LOS	C

Notes

User approved volume balancing among the lanes for turning movement.

User approved changes to right turn type.

Unsignalized Delay for [WBR] is excluded from calculations of the approach delay and intersection delay.

HCM 6th Signalized Intersection Summary
 3: Sacred Heart & Foothill Blvd

Rancho Cuvee
 Future Year Plus Project AM



Movement	EBU	EBL	EBT	EBR	WBU	WBL	WBT	WBR	NBL	NBT	NBR	SBL
Lane Configurations		↘ ↙	↑ ↑ ↑	↗		↘ ↙	↑ ↑ ↑	↗	↘ ↙	↑	↗	↘ ↙
Traffic Volume (veh/h)	30	170	803	40	10	60	1985	160	110	10	20	30
Future Volume (veh/h)	30	170	803	40	10	60	1985	160	110	10	20	30
Initial Q (Qb), veh		0	0	0		0	0	0	0	0	0	0
Ped-Bike Adj(A_pbT)		1.00		1.00		1.00		1.00	1.00		1.00	1.00
Parking Bus, Adj		1.00	1.00	1.00		1.00	1.00	1.00	1.00	1.00	1.00	1.00
Work Zone On Approach			No			No			No			
Adj Sat Flow, veh/h/ln		1575	1772	1772		1575	1772	1772	1673	1772	1772	1673
Adj Flow Rate, veh/h		179	845	21		63	2089	117	124	0	2	32
Peak Hour Factor		0.95	0.95	0.95		0.95	0.95	0.95	0.95	0.95	0.95	0.95
Percent Heavy Veh, %		2	2	2		2	2	2	2	2	2	2
Cap, veh/h		268	2764	956		221	2685	925	210	0	98	98
Arrive On Green		0.09	0.57	0.57		0.08	0.56	0.56	0.07	0.00	0.07	0.06
Sat Flow, veh/h		2910	4837	1500		2910	4837	1500	3188	0	1495	1594
Grp Volume(v), veh/h		179	845	21		63	2089	117	124	0	2	32
Grp Sat Flow(s),veh/h/ln		1455	1612	1500		1455	1612	1500	1594	0	1495	1594
Q Serve(g_s), s		7.7	11.8	0.7		2.7	44.0	4.2	4.9	0.0	0.2	2.5
Cycle Q Clear(g_c), s		7.7	11.8	0.7		2.7	44.0	4.2	4.9	0.0	0.2	2.5
Prop In Lane		1.00		1.00		1.00		1.00	1.00		1.00	1.00
Lane Grp Cap(c), veh/h		268	2764	956		221	2685	925	210	0	98	98
V/C Ratio(X)		0.67	0.31	0.02		0.29	0.78	0.13	0.59	0.00	0.02	0.33
Avail Cap(c_a), veh/h		269	2764	956		246	2685	925	1054	0	494	98
HCM Platoon Ratio		1.00	1.00	1.00		1.00	1.00	1.00	1.00	1.00	1.00	1.00
Upstream Filter(l)		0.90	0.90	0.90		1.00	1.00	1.00	1.00	0.00	1.00	1.00
Uniform Delay (d), s/veh		57.1	14.5	8.7		56.7	22.6	10.4	59.0	0.0	56.8	58.4
Incr Delay (d2), s/veh		5.6	0.3	0.0		0.7	2.3	0.3	2.6	0.0	0.1	1.9
Initial Q Delay(d3),s/veh		0.0	0.0	0.0		0.0	0.0	0.0	0.0	0.0	0.0	0.0
%ile BackOfQ(50%),veh/ln		3.0	4.1	0.3		1.0	15.6	1.6	2.1	0.0	0.1	1.1
Unsig. Movement Delay, s/veh												
LnGrp Delay(d),s/veh		62.7	14.7	8.7		57.4	24.9	10.6	61.7	0.0	56.9	60.3
LnGrp LOS		E	B	A		E	C	B	E	A	E	E
Approach Vol, veh/h			1045				2269			126		
Approach Delay, s/veh			22.8				25.1			61.6		
Approach LOS			C				C			E		
Timer - Assigned Phs	1	2		4	5	6		8				
Phs Duration (G+Y+Rc), s	13.9	81.6		17.6	16.0	79.5		17.0				
Change Period (Y+Rc), s	4.0	* 7.3		9.0	4.0	* 7.3		9.0				
Max Green Setting (Gmax), s	11.0	* 39		43.0	12.0	* 38		8.0				
Max Q Clear Time (g_c+I1), s	4.7	13.8		6.9	9.7	46.0		10.0				
Green Ext Time (p_c), s	0.1	5.6		0.4	0.1	0.0		0.0				

Intersection Summary

HCM 6th Ctrl Delay	32.5
HCM 6th LOS	C

Notes

- User approved volume balancing among the lanes for turning movement.
- User approved ignoring U-Turning movement.
- * HCM 6th computational engine requires equal clearance times for the phases crossing the barrier.

HCM 6th Signalized Intersection Summary
 3: Sacred Heart & Foothill Blvd

Rancho Cuvee
 Future Year Plus Project AM



Movement	SBT	SBR
Lane Configurations	↓	↙
Traffic Volume (veh/h)	20	90
Future Volume (veh/h)	20	90
Initial Q (Qb), veh	0	0
Ped-Bike Adj(A_pbT)		1.00
Parking Bus, Adj	1.00	1.00
Work Zone On Approach	No	
Adj Sat Flow, veh/h/ln	1772	1772
Adj Flow Rate, veh/h	21	95
Peak Hour Factor	0.95	0.95
Percent Heavy Veh, %	2	2
Cap, veh/h	17	78
Arrive On Green	0.06	0.06
Sat Flow, veh/h	278	1260
Grp Volume(v), veh/h	0	116
Grp Sat Flow(s),veh/h/ln	0	1538
Q Serve(g_s), s	0.0	8.0
Cycle Q Clear(g_c), s	0.0	8.0
Prop In Lane		0.82
Lane Grp Cap(c), veh/h	0	95
V/C Ratio(X)	0.00	1.23
Avail Cap(c_a), veh/h	0	95
HCM Platoon Ratio	1.00	1.00
Upstream Filter(l)	0.00	1.00
Uniform Delay (d), s/veh	0.0	61.0
Incr Delay (d2), s/veh	0.0	165.1
Initial Q Delay(d3),s/veh	0.0	0.0
%ile BackOfQ(50%),veh/ln	0.0	7.5
Unsig. Movement Delay, s/veh		
LnGrp Delay(d),s/veh	0.0	226.1
LnGrp LOS	A	F
Approach Vol, veh/h	148	
Approach Delay, s/veh	190.3	
Approach LOS	F	
Timer - Assigned Phs		

HCM 6th Signalized Intersection Summary
4: Etiwanda Ave & Foothill Blvd

Rancho Cuvee
Future Year Plus Project AM

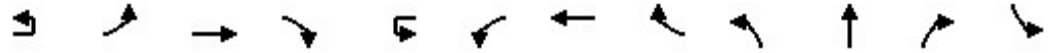

Movement	EBU	EBL	EBT	EBR	WBU	WBL	WBT	WBR	NBL	NBT	NBR	SBL
Lane Configurations		↔↔	↕↕	↗		↔↔	↕↕	↗	↗	↕	↗	↗
Traffic Volume (veh/h)	15	110	496	187	1	311	1680	90	185	257	105	71
Future Volume (veh/h)	15	110	496	187	1	311	1680	90	185	257	105	71
Initial Q (Qb), veh		0	0	0		0	0	0	0	0	0	0
Ped-Bike Adj(A_pbT)		1.00		0.98		1.00		0.99	1.00		0.98	1.00
Parking Bus, Adj		1.00	1.00	1.00		1.00	1.00	1.00	1.00	1.00	1.00	1.00
Work Zone On Approach			No				No			No		
Adj Sat Flow, veh/h/ln		1575	1772	1772		1575	1772	1772	1673	1772	1772	1673
Adj Flow Rate, veh/h		116	522	124		327	1768	31	195	271	25	75
Peak Hour Factor		0.95	0.95	0.95		0.95	0.95	0.95	0.95	0.95	0.95	0.95
Percent Heavy Veh, %		2	2	2		2	2	2	2	2	2	2
Cap, veh/h		333	1194	698		384	1252	555	186	370	307	173
Arrive On Green		0.11	0.35	0.35		0.13	0.37	0.37	0.12	0.21	0.21	0.11
Sat Flow, veh/h		2910	3367	1474		2910	3367	1493	1594	1772	1472	1594
Grp Volume(v), veh/h		116	522	124		327	1768	31	195	271	25	75
Grp Sat Flow(s),veh/h/ln		1455	1683	1474		1455	1683	1493	1594	1772	1472	1594
Q Serve(g_s), s		4.4	14.2	5.8		13.2	44.5	1.6	14.0	17.1	1.6	5.3
Cycle Q Clear(g_c), s		4.4	14.2	5.8		13.2	44.5	1.6	14.0	17.1	1.6	5.3
Prop In Lane		1.00		1.00		1.00		1.00	1.00		1.00	1.00
Lane Grp Cap(c), veh/h		333	1194	698		384	1252	555	186	370	307	173
V/C Ratio(X)		0.35	0.44	0.18		0.85	1.41	0.06	1.05	0.73	0.08	0.43
Avail Cap(c_a), veh/h		340	1194	698		535	1252	555	186	518	431	173
HCM Platoon Ratio		1.00	1.00	1.00		1.00	1.00	1.00	1.00	1.00	1.00	1.00
Upstream Filter(l)		1.00	1.00	1.00		1.00	1.00	1.00	1.00	1.00	1.00	1.00
Uniform Delay (d), s/veh		48.9	29.5	18.2		50.8	37.6	24.1	52.8	44.2	38.1	49.9
Incr Delay (d2), s/veh		0.6	1.2	0.6		9.3	190.3	0.2	78.5	3.3	0.1	1.7
Initial Q Delay(d3),s/veh		0.0	0.0	0.0		0.0	0.0	0.0	0.0	0.0	0.0	0.0
%ile BackOfQ(50%),veh/ln		1.6	5.6	2.0		5.1	50.1	0.6	9.5	7.6	0.6	2.1
Unsig. Movement Delay, s/veh												
LnGrp Delay(d),s/veh		49.5	30.7	18.8		60.1	227.9	24.3	131.3	47.5	38.2	51.6
LnGrp LOS		D	C	B		E	F	C	F	D	D	D
Approach Vol, veh/h			762				2126			491		
Approach Delay, s/veh			31.6				199.1			80.3		
Approach LOS			C				F			F		
Timer - Assigned Phs	1	2	3	4	5	6	7	8				
Phs Duration (G+Y+Rc), s	19.8	50.3	17.5	32.1	17.7	52.4	16.5	33.1				
Change Period (Y+Rc), s	4.0	* 7.9	3.5	* 8.1	4.0	* 7.9	3.5	* 8.1				
Max Green Setting (Gmax), s	22.0	* 37	14.0	* 34	14.0	* 45	13.0	* 35				
Max Q Clear Time (g_c+I1), s	15.2	16.2	16.0	20.8	6.4	46.5	7.3	19.1				
Green Ext Time (p_c), s	0.6	3.4	0.0	2.5	0.2	0.0	0.1	1.3				

Intersection Summary

HCM 6th Ctrl Delay	129.9
HCM 6th LOS	F

Notes

- User approved ignoring U-Turning movement.
- * HCM 6th computational engine requires equal clearance times for the phases crossing the barrier.

HCM 6th Signalized Intersection Summary
 4: Etiwanda Ave & Foothill Blvd

Rancho Cuvee
 Future Year Plus Project AM



Movement	SBT	SBR
Lane Configurations	↑↑	
Traffic Volume (veh/h)	431	190
Future Volume (veh/h)	431	190
Initial Q (Qb), veh	0	0
Ped-Bike Adj(A_pbT)		1.00
Parking Bus, Adj	1.00	1.00
Work Zone On Approach	No	
Adj Sat Flow, veh/h/ln	1772	1772
Adj Flow Rate, veh/h	454	92
Peak Hour Factor	0.95	0.95
Percent Heavy Veh, %	2	2
Cap, veh/h	559	112
Arrive On Green	0.20	0.20
Sat Flow, veh/h	2790	561
Grp Volume(v), veh/h	273	273
Grp Sat Flow(s),veh/h/ln	1683	1668
Q Serve(g_s), s	18.5	18.8
Cycle Q Clear(g_c), s	18.5	18.8
Prop In Lane		0.34
Lane Grp Cap(c), veh/h	337	334
V/C Ratio(X)	0.81	0.82
Avail Cap(c_a), veh/h	478	474
HCM Platoon Ratio	1.00	1.00
Upstream Filter(l)	1.00	1.00
Uniform Delay (d), s/veh	45.7	45.8
Incr Delay (d2), s/veh	6.8	7.5
Initial Q Delay(d3),s/veh	0.0	0.0
%ile BackOfQ(50%),veh/ln	8.1	8.2
Unsig. Movement Delay, s/veh		
LnGrp Delay(d),s/veh	52.5	53.2
LnGrp LOS	D	D
Approach Vol, veh/h	621	
Approach Delay, s/veh	52.7	
Approach LOS	D	
Timer - Assigned Phs		

HCM 6th Signalized Intersection Summary
 1: Foothill Blvd & I-15 SB Off Ramp

Rancho Cuvee
 Future Year Plus Project PM



Movement	EBL	EBT	EBR	WBL	WBT	WBR	NBL	NBT	NBR	SBL	SBT	SBR
Lane Configurations		↑↑↑	↗		↑↑↑					↘	↕	↗
Traffic Volume (veh/h)	0	2148	1020	0	1614	0	0	0	0	126	0	650
Future Volume (veh/h)	0	2148	1020	0	1614	0	0	0	0	126	0	650
Initial Q (Qb), veh	0	0	0	0	0	0				0	0	0
Ped-Bike Adj(A_pbT)	1.00		1.00	1.00		1.00				1.00		1.00
Parking Bus, Adj	1.00	1.00	1.00	1.00	1.00	1.00				1.00	1.00	1.00
Work Zone On Approach		No			No						No	
Adj Sat Flow, veh/h/ln	0	1772	1772	0	1772	0				1575	1772	1772
Adj Flow Rate, veh/h	0	2261	0	0	1699	0				89	0	732
Peak Hour Factor	0.95	0.95	0.95	0.95	0.95	0.95				0.95	0.95	0.95
Percent Heavy Veh, %	0	2	2	0	2	0				2	2	2
Cap, veh/h	0	2970		0	2970	0				411	0	824
Arrive On Green	0.00	0.61	0.00	0.00	0.61	0.00				0.27	0.00	0.27
Sat Flow, veh/h	0	4997	1502	0	5156	0				1500	0	3003
Grp Volume(v), veh/h	0	2261	0	0	1699	0				89	0	732
Grp Sat Flow(s),veh/h/ln	0	1612	1502	0	1612	0				1500	0	1502
Q Serve(g_s), s	0.0	37.3	0.0	0.0	23.0	0.0				5.0	0.0	25.7
Cycle Q Clear(g_c), s	0.0	37.3	0.0	0.0	23.0	0.0				5.0	0.0	25.7
Prop In Lane	0.00		1.00	0.00		0.00				1.00		1.00
Lane Grp Cap(c), veh/h	0	2970		0	2970	0				411	0	824
V/C Ratio(X)	0.00	0.76		0.00	0.57	0.00				0.22	0.00	0.89
Avail Cap(c_a), veh/h	0	2970		0	2970	0				494	0	988
HCM Platoon Ratio	1.00	1.00	1.00	1.00	1.00	1.00				1.00	1.00	1.00
Upstream Filter(I)	0.00	1.00	0.00	0.00	1.00	0.00				1.00	0.00	1.00
Uniform Delay (d), s/veh	0.0	15.4	0.0	0.0	12.6	0.0				30.8	0.0	38.3
Incr Delay (d2), s/veh	0.0	1.9	0.0	0.0	0.8	0.0				0.3	0.0	8.8
Initial Q Delay(d3),s/veh	0.0	0.0	0.0	0.0	0.0	0.0				0.0	0.0	0.0
%ile BackOfQ(50%),veh/ln	0.0	11.8	0.0	0.0	7.2	0.0				1.9	0.0	10.5
Unsig. Movement Delay, s/veh												
LnGrp Delay(d),s/veh	0.0	17.3	0.0	0.0	13.4	0.0				31.1	0.0	47.1
LnGrp LOS	A	B		A	B	A				C	A	D
Approach Vol, veh/h		2261	A		1699						821	
Approach Delay, s/veh		17.3			13.4						45.4	
Approach LOS		B			B						D	
Timer - Assigned Phs		2		4		6						
Phs Duration (G+Y+Rc), s		74.0		36.0		74.0						
Change Period (Y+Rc), s		6.5		5.8		6.5						
Max Green Setting (Gmax), s		61.5		36.2		61.5						
Max Q Clear Time (g_c+I1), s		39.3		27.7		25.0						
Green Ext Time (p_c), s		14.5		2.4		12.4						

Intersection Summary

HCM 6th Ctrl Delay	20.7
HCM 6th LOS	C

Notes

- User approved volume balancing among the lanes for turning movement.
- Unsignalized Delay for [EBR] is excluded from calculations of the approach delay and intersection delay.

HCM 6th Signalized Intersection Summary

2: I-15 NB Off Ramp & Foothill Blvd

Rancho Cuvee
Future Year Plus Project PM



Movement	EBL	EBT	EBR	WBL	WBT	WBR	NBL	NBT	NBR	SBL	SBT	SBR
Lane Configurations		↑↑↑			↑↑↑	↗	↘	↕	↗			
Traffic Volume (veh/h)	0	1254	0	0	1317	244	720	0	572	0	0	0
Future Volume (veh/h)	0	1254	0	0	1317	244	720	0	572	0	0	0
Initial Q (Qb), veh	0	0	0	0	0	0	0	0	0			
Ped-Bike Adj(A_pbT)	1.00		1.00	1.00		1.00	1.00		0.98			
Parking Bus, Adj	1.00	1.00	1.00	1.00	1.00	1.00	1.00	1.00	1.00			
Work Zone On Approach		No			No			No				
Adj Sat Flow, veh/h/ln	0	1772	0	0	1772	1772	1575	1772	1772			
Adj Flow Rate, veh/h	0	1320	0	0	1386	0	945	0	401			
Peak Hour Factor	0.95	0.95	0.95	0.95	0.95	0.95	0.95	0.95	0.95			
Percent Heavy Veh, %	0	2	0	0	2	2	2	2	2			
Cap, veh/h	0	2546	0	0	2546		1086	0	535			
Arrive On Green	0.00	0.53	0.00	0.00	0.53	0.00	0.36	0.00	0.36			
Sat Flow, veh/h	0	5156	0	0	4997	1502	3000	0	1479			
Grp Volume(v), veh/h	0	1320	0	0	1386	0	945	0	401			
Grp Sat Flow(s),veh/h/ln	0	1612	0	0	1612	1502	1500	0	1479			
Q Serve(g_s), s	0.0	19.6	0.0	0.0	20.9	0.0	32.3	0.0	26.1			
Cycle Q Clear(g_c), s	0.0	19.6	0.0	0.0	20.9	0.0	32.3	0.0	26.1			
Prop In Lane	0.00		0.00	0.00		1.00	1.00		1.00			
Lane Grp Cap(c), veh/h	0	2546	0	0	2546		1086	0	535			
V/C Ratio(X)	0.00	0.52	0.00	0.00	0.54		0.87	0.00	0.75			
Avail Cap(c_a), veh/h	0	2546	0	0	2546		1478	0	729			
HCM Platoon Ratio	1.00	1.00	1.00	1.00	1.00	1.00	1.00	1.00	1.00			
Upstream Filter(I)	0.00	1.00	0.00	0.00	0.82	0.00	1.00	0.00	1.00			
Uniform Delay (d), s/veh	0.0	17.0	0.0	0.0	17.3	0.0	32.7	0.0	30.7			
Incr Delay (d2), s/veh	0.0	0.8	0.0	0.0	0.7	0.0	4.5	0.0	2.9			
Initial Q Delay(d3),s/veh	0.0	0.0	0.0	0.0	0.0	0.0	0.0	0.0	0.0			
%ile BackOfQ(50%),veh/ln	0.0	6.7	0.0	0.0	7.7	0.0	12.1	0.0	9.6			
Unsig. Movement Delay, s/veh												
LnGrp Delay(d),s/veh	0.0	17.7	0.0	0.0	18.0	0.0	37.2	0.0	33.6			
LnGrp LOS	A	B	A	A	B		D	A	C			
Approach Vol, veh/h		1320			1386	A		1346				
Approach Delay, s/veh		17.7			18.0			36.1				
Approach LOS		B			B			D				
Timer - Assigned Phs		2				6		8				
Phs Duration (G+Y+Rc), s		64.4				64.4		45.6				
Change Period (Y+Rc), s		6.5				6.5		5.8				
Max Green Setting (Gmax), s		43.5				43.5		54.2				
Max Q Clear Time (g_c+I1), s		21.6				22.9		34.3				
Green Ext Time (p_c), s		7.4				9.0		5.5				

Intersection Summary

HCM 6th Ctrl Delay	23.9
HCM 6th LOS	C

Notes

User approved volume balancing among the lanes for turning movement.

User approved changes to right turn type.

Unsignalized Delay for [WBR] is excluded from calculations of the approach delay and intersection delay.

HCM 6th Signalized Intersection Summary
 3: Sacred Heart & Foothill Blvd

Rancho Cuvee
 Future Year Plus Project PM

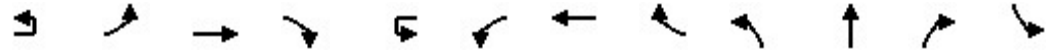

Movement	EBU	EBL	EBT	EBR	WBU	WBL	WBT	WBR	NBL	NBT	NBR	SBL
Lane Configurations		RT	LT	LT		RT	LT	LT	RT	LT	LT	RT
Traffic Volume (veh/h)	130	170	1296	140	40	170	961	70	300	1	110	20
Future Volume (veh/h)	130	170	1296	140	40	170	961	70	300	1	110	20
Initial Q (Qb), veh		0	0	0		0	0	0	0	0	0	0
Ped-Bike Adj(A_pbT)		1.00		1.00		1.00		0.98	1.00		0.99	1.00
Parking Bus, Adj		1.00	1.00	1.00		1.00	1.00	1.00	1.00	1.00	1.00	1.00
Work Zone On Approach			No				No			No		
Adj Sat Flow, veh/h/ln		1575	1772	1772		1575	1772	1772	1673	1772	1772	1673
Adj Flow Rate, veh/h		179	1364	85		179	1012	29	317	0	16	21
Peak Hour Factor		0.95	0.95	0.95		0.95	0.95	0.95	0.95	0.95	0.95	0.95
Percent Heavy Veh, %		2	2	2		2	2	2	2	2	2	2
Cap, veh/h		223	2739	1046		133	2589	841	420	0	196	52
Arrive On Green		0.08	0.57	0.57		0.05	0.54	0.54	0.13	0.00	0.13	0.03
Sat Flow, veh/h		2910	4837	1498		2910	4837	1479	3188	0	1491	1594
Grp Volume(v), veh/h		179	1364	85		179	1012	29	317	0	16	21
Grp Sat Flow(s),veh/h/ln		1455	1612	1498		1455	1612	1479	1594	0	1491	1594
Q Serve(g_s), s		7.9	22.3	2.4		6.0	16.1	1.1	12.6	0.0	1.2	1.7
Cycle Q Clear(g_c), s		7.9	22.3	2.4		6.0	16.1	1.1	12.6	0.0	1.2	1.7
Prop In Lane		1.00		1.00		1.00		1.00	1.00		1.00	1.00
Lane Grp Cap(c), veh/h		223	2739	1046		133	2589	841	420	0	196	52
V/C Ratio(X)		0.80	0.50	0.08		1.34	0.39	0.03	0.76	0.00	0.08	0.40
Avail Cap(c_a), veh/h		289	2739	1046		133	2589	841	1046	0	490	219
HCM Platoon Ratio		1.00	1.00	1.00		1.00	1.00	1.00	1.00	1.00	1.00	1.00
Upstream Filter(l)		0.75	0.75	0.75		1.00	1.00	1.00	1.00	0.00	1.00	1.00
Uniform Delay (d), s/veh		59.5	17.2	6.3		62.5	17.9	12.5	54.8	0.0	49.9	62.1
Incr Delay (d2), s/veh		8.9	0.5	0.1		196.0	0.4	0.1	2.8	0.0	0.2	5.0
Initial Q Delay(d3),s/veh		0.0	0.0	0.0		0.0	0.0	0.0	0.0	0.0	0.0	0.0
%ile BackOfQ(50%),veh/ln		3.1	7.7	1.1		5.8	5.7	0.4	5.3	0.0	0.5	0.8
Unsig. Movement Delay, s/veh												
LnGrp Delay(d),s/veh		68.4	17.7	6.5		258.5	18.3	12.6	57.6	0.0	50.1	67.1
LnGrp LOS		E	B	A		F	B	B	E	A	D	E
Approach Vol, veh/h			1628				1220			333		
Approach Delay, s/veh			22.6				53.4			57.3		
Approach LOS			C				D			E		
Timer - Assigned Phs	1	2		4	5	6		8				
Phs Duration (G+Y+Rc), s	10.0	81.5		26.2	14.1	77.4		13.3				
Change Period (Y+Rc), s	4.0	* 7.3		9.0	4.0	* 7.3		9.0				
Max Green Setting (Gmax), s	6.0	* 35		43.0	13.0	* 27		18.0				
Max Q Clear Time (g_c+I1), s	8.0	24.3		14.6	9.9	18.1		4.7				
Green Ext Time (p_c), s	0.0	6.1		1.2	0.1	4.0		0.1				

Intersection Summary

HCM 6th Ctrl Delay	38.6
HCM 6th LOS	D

Notes

- User approved volume balancing among the lanes for turning movement.
- User approved ignoring U-Turning movement.
- * HCM 6th computational engine requires equal clearance times for the phases crossing the barrier.

HCM 6th Signalized Intersection Summary
 3: Sacred Heart & Foothill Blvd

Rancho Cuvee
 Future Year Plus Project PM



Movement	SBT	SBR
Lane Configurations	↓	↙
Traffic Volume (veh/h)	10	20
Future Volume (veh/h)	10	20
Initial Q (Qb), veh	0	0
Ped-Bike Adj(A_pbT)		0.98
Parking Bus, Adj	1.00	1.00
Work Zone On Approach	No	
Adj Sat Flow, veh/h/ln	1772	1772
Adj Flow Rate, veh/h	11	21
Peak Hour Factor	0.95	0.95
Percent Heavy Veh, %	2	2
Cap, veh/h	17	33
Arrive On Green	0.03	0.03
Sat Flow, veh/h	536	1023
Grp Volume(v), veh/h	0	32
Grp Sat Flow(s),veh/h/ln	0	1559
Q Serve(g_s), s	0.0	2.7
Cycle Q Clear(g_c), s	0.0	2.7
Prop In Lane		0.66
Lane Grp Cap(c), veh/h	0	51
V/C Ratio(X)	0.00	0.63
Avail Cap(c_a), veh/h	0	214
HCM Platoon Ratio	1.00	1.00
Upstream Filter(l)	0.00	1.00
Uniform Delay (d), s/veh	0.0	62.6
Incr Delay (d2), s/veh	0.0	12.1
Initial Q Delay(d3),s/veh	0.0	0.0
%ile BackOfQ(50%),veh/ln	0.0	1.2
Unsig. Movement Delay, s/veh		
LnGrp Delay(d),s/veh	0.0	74.7
LnGrp LOS	A	E
Approach Vol, veh/h	53	
Approach Delay, s/veh	71.7	
Approach LOS	E	
Timer - Assigned Phs		

HCM 6th Signalized Intersection Summary
4: Etiwanda Ave & Foothill Blvd

Rancho Cuvee
Future Year Plus Project PM



Movement	EBU	EBL	EBT	EBR	WBU	WBL	WBT	WBR	NBL	NBT	NBR	SBL
Lane Configurations		↔↔	↕↕	↗		↔↔	↕↕	↗	↗	↕	↗	↗
Traffic Volume (veh/h)	60	200	1109	217	3	143	840	40	321	344	222	64
Future Volume (veh/h)	60	200	1109	217	3	143	840	40	321	344	222	64
Initial Q (Qb), veh		0	0	0		0	0	0	0	0	0	0
Ped-Bike Adj(A_pbT)		1.00		0.99		1.00		1.00	1.00		0.98	1.00
Parking Bus, Adj		1.00	1.00	1.00		1.00	1.00	1.00	1.00	1.00	1.00	1.00
Work Zone On Approach			No				No			No		
Adj Sat Flow, veh/h/ln		1575	1772	1772		1575	1772	1772	1673	1772	1772	1673
Adj Flow Rate, veh/h		211	1167	123		151	884	13	338	362	132	67
Peak Hour Factor		0.95	0.95	0.95		0.95	0.95	0.95	0.95	0.95	0.95	0.95
Percent Heavy Veh, %		2	2	2		2	2	2	2	2	2	2
Cap, veh/h		254	1335	882		157	1223	545	313	552	461	91
Arrive On Green		0.09	0.40	0.40		0.05	0.36	0.36	0.20	0.31	0.31	0.06
Sat Flow, veh/h		2910	3367	1482		2910	3367	1500	1594	1772	1479	1594
Grp Volume(v), veh/h		211	1167	123		151	884	13	338	362	132	67
Grp Sat Flow(s),veh/h/ln		1455	1683	1482		1455	1683	1500	1594	1772	1479	1594
Q Serve(g_s), s		9.3	41.6	4.8		6.7	29.5	0.7	25.5	23.0	8.8	5.4
Cycle Q Clear(g_c), s		9.3	41.6	4.8		6.7	29.5	0.7	25.5	23.0	8.8	5.4
Prop In Lane		1.00		1.00		1.00		1.00	1.00		1.00	1.00
Lane Grp Cap(c), veh/h		254	1335	882		157	1223	545	313	552	461	91
V/C Ratio(X)		0.83	0.87	0.14		0.96	0.72	0.02	1.08	0.66	0.29	0.74
Avail Cap(c_a), veh/h		291	1335	882		157	1223	545	313	552	461	221
HCM Platoon Ratio		1.00	1.00	1.00		1.00	1.00	1.00	1.00	1.00	1.00	1.00
Upstream Filter(l)		1.00	1.00	1.00		1.00	1.00	1.00	1.00	1.00	1.00	1.00
Uniform Delay (d), s/veh		58.4	36.2	11.8		61.4	35.7	26.6	52.3	38.7	33.8	60.3
Incr Delay (d2), s/veh		14.5	8.2	0.3		60.5	3.7	0.1	74.2	2.2	0.1	4.3
Initial Q Delay(d3),s/veh		0.0	0.0	0.0		0.0	0.0	0.0	0.0	0.0	0.0	0.0
%ile BackOfQ(50%),veh/ln		3.8	17.6	1.6		3.7	12.1	0.3	16.3	10.0	3.1	2.2
Unsig. Movement Delay, s/veh												
LnGrp Delay(d),s/veh		72.9	44.4	12.1		121.9	39.5	26.7	126.5	40.9	33.9	64.6
LnGrp LOS		E	D	B		F	D	C	F	D	C	E
Approach Vol, veh/h			1501				1048			832		
Approach Delay, s/veh			45.8				51.2			74.6		
Approach LOS			D				D			E		
Timer - Assigned Phs	1	2	3	4	5	6	7	8				
Phs Duration (G+Y+Rc), s	11.0	59.5	29.0	30.5	15.3	55.1	10.9	48.6				
Change Period (Y+Rc), s	4.0	* 7.9	3.5	* 8.1	4.0	* 7.9	3.5	* 8.1				
Max Green Setting (Gmax), s	7.0	* 43	25.5	* 31	13.0	* 37	18.0	* 39				
Max Q Clear Time (g_c+I1), s	8.7	43.6	27.5	20.9	11.3	31.5	7.4	25.0				
Green Ext Time (p_c), s	0.0	0.0	0.0	1.2	0.1	1.5	0.0	1.2				

Intersection Summary

HCM 6th Ctrl Delay	55.5
HCM 6th LOS	E

Notes

- User approved ignoring U-Turning movement.
- * HCM 6th computational engine requires equal clearance times for the phases crossing the barrier.

HCM 6th Signalized Intersection Summary
 4: Etiwanda Ave & Foothill Blvd

Rancho Cuvee
 Future Year Plus Project PM



Movement	SBT	SBR
Lane Configurations	↑↑	
Traffic Volume (veh/h)	253	190
Future Volume (veh/h)	253	190
Initial Q (Qb), veh	0	0
Ped-Bike Adj(A_pbT)		0.98
Parking Bus, Adj	1.00	1.00
Work Zone On Approach	No	
Adj Sat Flow, veh/h/ln	1772	1772
Adj Flow Rate, veh/h	266	200
Peak Hour Factor	0.95	0.95
Percent Heavy Veh, %	2	2
Cap, veh/h	319	231
Arrive On Green	0.17	0.17
Sat Flow, veh/h	1849	1339
Grp Volume(v), veh/h	241	225
Grp Sat Flow(s),veh/h/ln	1683	1505
Q Serve(g_s), s	18.0	18.9
Cycle Q Clear(g_c), s	18.0	18.9
Prop In Lane		0.89
Lane Grp Cap(c), veh/h	291	260
V/C Ratio(X)	0.83	0.87
Avail Cap(c_a), veh/h	401	359
HCM Platoon Ratio	1.00	1.00
Upstream Filter(l)	1.00	1.00
Uniform Delay (d), s/veh	51.9	52.3
Incr Delay (d2), s/veh	7.3	11.7
Initial Q Delay(d3),s/veh	0.0	0.0
%ile BackOfQ(50%),veh/ln	8.0	7.8
Unsig. Movement Delay, s/veh		
LnGrp Delay(d),s/veh	59.3	64.0
LnGrp LOS	E	E
Approach Vol, veh/h	533	
Approach Delay, s/veh	61.9	
Approach LOS	E	
Timer - Assigned Phs		

HCM 6th Signalized Intersection Summary

4: Etiwanda Ave & Foothill Blvd

Rancho Cuvee
Future Year Plus Project AM with Improvements



Movement	EBU	EBL	EBT	EBR	WBU	WBL	WBT	WBR	NBL	NBT	NBR	SBL
Lane Configurations		↔↔	↑↑↑	↔		↔↔	↑↑↑	↔	↔↔	↑↑	↔	↔
Traffic Volume (veh/h)	15	110	496	187	1	311	1680	90	185	257	105	71
Future Volume (veh/h)	15	110	496	187	1	311	1680	90	185	257	105	71
Initial Q (Qb), veh		0	0	0		0	0	0	0	0	0	0
Ped-Bike Adj(A_pbT)		1.00		0.98		1.00		0.99	1.00		0.98	1.00
Parking Bus, Adj		1.00	1.00	1.00		1.00	1.00	1.00	1.00	1.00	1.00	1.00
Work Zone On Approach			No				No			No		
Adj Sat Flow, veh/h/ln		1575	1772	1772		1575	1772	1772	1673	1772	1772	1673
Adj Flow Rate, veh/h		116	522	124		327	1768	31	195	271	25	75
Peak Hour Factor		0.95	0.95	0.95		0.95	0.95	0.95	0.95	0.95	0.95	0.95
Percent Heavy Veh, %		2	2	2		2	2	2	2	2	2	2
Cap, veh/h		336	1723	690		392	1816	560	339	678	296	175
Arrive On Green		0.12	0.36	0.36		0.13	0.38	0.38	0.11	0.20	0.20	0.11
Sat Flow, veh/h		2910	4837	1474		2910	4837	1493	3092	3367	1472	1594
Grp Volume(v), veh/h		116	522	124		327	1768	31	195	271	25	75
Grp Sat Flow(s),veh/h/ln		1455	1612	1474		1455	1612	1493	1546	1683	1472	1594
Q Serve(g_s), s		4.4	9.2	5.8		13.0	42.7	1.6	7.1	8.3	1.6	5.2
Cycle Q Clear(g_c), s		4.4	9.2	5.8		13.0	42.7	1.6	7.1	8.3	1.6	5.2
Prop In Lane		1.00		1.00		1.00		1.00	1.00		1.00	1.00
Lane Grp Cap(c), veh/h		336	1723	690		392	1816	560	339	678	296	175
V/C Ratio(X)		0.35	0.30	0.18		0.83	0.97	0.06	0.58	0.40	0.08	0.43
Avail Cap(c_a), veh/h		344	1723	690		810	1816	560	339	994	435	175
HCM Platoon Ratio		1.00	1.00	1.00		1.00	1.00	1.00	1.00	1.00	1.00	1.00
Upstream Filter(l)		1.00	1.00	1.00		1.00	1.00	1.00	1.00	1.00	1.00	1.00
Uniform Delay (d), s/veh		48.3	27.6	18.5		50.0	36.5	23.6	50.2	41.1	38.5	49.3
Incr Delay (d2), s/veh		0.6	0.5	0.6		4.7	15.8	0.2	2.4	0.4	0.1	1.7
Initial Q Delay(d3),s/veh		0.0	0.0	0.0		0.0	0.0	0.0	0.0	0.0	0.0	0.0
%ile BackOfQ(50%),veh/ln		1.6	3.5	2.0		4.8	18.2	0.6	2.8	3.4	0.6	2.1
Unsig. Movement Delay, s/veh												
LnGrp Delay(d),s/veh		48.9	28.0	19.0		54.7	52.2	23.8	52.5	41.5	38.6	51.0
LnGrp LOS		D	C	B		D	D	C	D	D	D	D
Approach Vol, veh/h			762				2126			491		
Approach Delay, s/veh			29.7				52.2			45.7		
Approach LOS			C				D			D		
Timer - Assigned Phs	1	2	3	4	5	6	7	8				
Phs Duration (G+Y+Rc), s	20.0	50.1	16.5	32.0	17.7	52.4	16.5	32.0				
Change Period (Y+Rc), s	4.0	* 7.9	3.5	* 8.1	4.0	* 7.9	3.5	* 8.1				
Max Green Setting (Gmax), s	33.0	* 26	13.0	* 35	14.0	* 45	13.0	* 35				
Max Q Clear Time (g_c+I1), s	15.0	11.2	9.1	20.6	6.4	44.7	7.2	10.3				
Green Ext Time (p_c), s	1.0	3.0	0.2	2.6	0.2	0.0	0.1	1.6				

Intersection Summary

HCM 6th Ctrl Delay	47.0
HCM 6th LOS	D

Notes

User approved ignoring U-Turning movement.

* HCM 6th computational engine requires equal clearance times for the phases crossing the barrier.

HCM 6th Signalized Intersection Summary
 4: Etiwanda Ave & Foothill Blvd

Rancho Cuvee
 Future Year Plus Project AM with Improvements



Movement	SBT	SBR
Lane Configurations	↑↑	
Traffic Volume (veh/h)	431	190
Future Volume (veh/h)	431	190
Initial Q (Qb), veh	0	0
Ped-Bike Adj(A_pbT)		1.00
Parking Bus, Adj	1.00	1.00
Work Zone On Approach	No	
Adj Sat Flow, veh/h/ln	1772	1772
Adj Flow Rate, veh/h	454	92
Peak Hour Factor	0.95	0.95
Percent Heavy Veh, %	2	2
Cap, veh/h	562	113
Arrive On Green	0.20	0.20
Sat Flow, veh/h	2790	561
Grp Volume(v), veh/h	273	273
Grp Sat Flow(s),veh/h/ln	1683	1668
Q Serve(g_s), s	18.3	18.6
Cycle Q Clear(g_c), s	18.3	18.6
Prop In Lane		0.34
Lane Grp Cap(c), veh/h	339	336
V/C Ratio(X)	0.80	0.81
Avail Cap(c_a), veh/h	497	492
HCM Platoon Ratio	1.00	1.00
Upstream Filter(l)	1.00	1.00
Uniform Delay (d), s/veh	45.1	45.2
Incr Delay (d2), s/veh	6.0	6.6
Initial Q Delay(d3),s/veh	0.0	0.0
%ile BackOfQ(50%),veh/ln	8.0	8.0
Unsig. Movement Delay, s/veh		
LnGrp Delay(d),s/veh	51.1	51.8
LnGrp LOS	D	D
Approach Vol, veh/h	621	
Approach Delay, s/veh	51.4	
Approach LOS	D	
Timer - Assigned Phs		

HCM 6th Signalized Intersection Summary

4: Etiwanda Ave & Foothill Blvd

Rancho Cuvee
Future Year Plus Project PM with Improvements



Movement	EBU	EBL	EBT	EBR	WBU	WBL	WBT	WBR	NBL	NBT	NBR	SBL
Lane Configurations		↔↔	↑↑↑	↔		↔↔	↑↑↑	↔	↔↔	↑↑	↔	↔
Traffic Volume (veh/h)	60	200	1109	217	3	143	840	40	321	344	222	64
Future Volume (veh/h)	60	200	1109	217	3	143	840	40	321	344	222	64
Initial Q (Qb), veh		0	0	0		0	0	0	0	0	0	0
Ped-Bike Adj(A_pbT)		1.00		0.99		1.00		1.00	1.00		0.98	1.00
Parking Bus, Adj		1.00	1.00	1.00		1.00	1.00	1.00	1.00	1.00	1.00	1.00
Work Zone On Approach			No				No			No		
Adj Sat Flow, veh/h/ln		1575	1772	1772		1575	1772	1772	1673	1772	1772	1673
Adj Flow Rate, veh/h		211	1167	123		151	884	13	338	362	132	67
Peak Hour Factor		0.95	0.95	0.95		0.95	0.95	0.95	0.95	0.95	0.95	0.95
Percent Heavy Veh, %		2	2	2		2	2	2	2	2	2	2
Cap, veh/h		257	2194	860		197	2094	650	388	811	356	91
Arrive On Green		0.09	0.45	0.45		0.07	0.43	0.43	0.13	0.24	0.24	0.06
Sat Flow, veh/h		2910	4837	1482		2910	4837	1501	3092	3367	1478	1594
Grp Volume(v), veh/h		211	1167	123		151	884	13	338	362	132	67
Grp Sat Flow(s),veh/h/ln		1455	1612	1482		1455	1612	1501	1546	1683	1478	1594
Q Serve(g_s), s		9.3	22.6	5.0		6.6	16.5	0.6	14.0	11.9	9.7	5.4
Cycle Q Clear(g_c), s		9.3	22.6	5.0		6.6	16.5	0.6	14.0	11.9	9.7	5.4
Prop In Lane		1.00		1.00		1.00		1.00	1.00		1.00	1.00
Lane Grp Cap(c), veh/h		257	2194	860		197	2094	650	388	811	356	91
V/C Ratio(X)		0.82	0.53	0.14		0.77	0.42	0.02	0.87	0.45	0.37	0.74
Avail Cap(c_a), veh/h		425	2194	860		560	2094	650	521	906	398	221
HCM Platoon Ratio		1.00	1.00	1.00		1.00	1.00	1.00	1.00	1.00	1.00	1.00
Upstream Filter(l)		1.00	1.00	1.00		1.00	1.00	1.00	1.00	1.00	1.00	1.00
Uniform Delay (d), s/veh		58.3	25.6	12.6		59.6	25.6	21.1	55.8	42.0	41.1	60.3
Incr Delay (d2), s/veh		2.5	0.9	0.3		2.4	0.6	0.1	9.6	0.1	0.2	4.3
Initial Q Delay(d3),s/veh		0.0	0.0	0.0		0.0	0.0	0.0	0.0	0.0	0.0	0.0
%ile BackOfQ(50%),veh/ln		3.4	8.4	1.6		2.4	6.1	0.2	5.8	4.8	3.5	2.2
Unsig. Movement Delay, s/veh												
LnGrp Delay(d),s/veh		60.8	26.5	12.9		62.0	26.2	21.1	65.4	42.1	41.4	64.6
LnGrp LOS		E	C	B		E	C	C	E	D	D	E
Approach Vol, veh/h			1501			1048			832			
Approach Delay, s/veh			30.2			31.3			51.5			
Approach LOS			C			C			D			
Timer - Assigned Phs	1	2	3	4	5	6	7	8				
Phs Duration (G+Y+Rc), s	12.8	66.9	19.8	30.5	15.5	64.2	10.9	39.4				
Change Period (Y+Rc), s	4.0	* 7.9	3.5	* 8.1	4.0	* 7.9	3.5	* 8.1				
Max Green Setting (Gmax), s	25.0	* 29	21.9	* 31	19.0	* 35	18.0	* 35				
Max Q Clear Time (g_c+I1), s	8.6	24.6	16.0	20.9	11.3	18.5	7.4	13.9				
Green Ext Time (p_c), s	0.2	1.7	0.3	1.2	0.2	2.6	0.0	1.5				

Intersection Summary

HCM 6th Ctrl Delay	39.3
HCM 6th LOS	D

Notes

User approved ignoring U-Turning movement.

* HCM 6th computational engine requires equal clearance times for the phases crossing the barrier.

HCM 6th Signalized Intersection Summary
 4: Etiwanda Ave & Foothill Blvd

Rancho Cuvee
 Future Year Plus Project PM with Improvements



Movement	SBT	SBR
Lane Configurations	↑↑	
Traffic Volume (veh/h)	253	190
Future Volume (veh/h)	253	190
Initial Q (Qb), veh	0	0
Ped-Bike Adj(A_pbT)		0.98
Parking Bus, Adj	1.00	1.00
Work Zone On Approach	No	
Adj Sat Flow, veh/h/ln	1772	1772
Adj Flow Rate, veh/h	266	200
Peak Hour Factor	0.95	0.95
Percent Heavy Veh, %	2	2
Cap, veh/h	319	231
Arrive On Green	0.17	0.17
Sat Flow, veh/h	1849	1339
Grp Volume(v), veh/h	241	225
Grp Sat Flow(s),veh/h/ln	1683	1505
Q Serve(g_s), s	18.0	18.9
Cycle Q Clear(g_c), s	18.0	18.9
Prop In Lane		0.89
Lane Grp Cap(c), veh/h	291	260
V/C Ratio(X)	0.83	0.87
Avail Cap(c_a), veh/h	403	360
HCM Platoon Ratio	1.00	1.00
Upstream Filter(l)	1.00	1.00
Uniform Delay (d), s/veh	51.9	52.3
Incr Delay (d2), s/veh	7.2	11.6
Initial Q Delay(d3),s/veh	0.0	0.0
%ile BackOfQ(50%),veh/ln	8.0	7.8
Unsig. Movement Delay, s/veh		
LnGrp Delay(d),s/veh	59.2	63.9
LnGrp LOS	E	E
Approach Vol, veh/h	533	
Approach Delay, s/veh	61.8	
Approach LOS	E	
Timer - Assigned Phs		